



United States  
Department  
of Agriculture

Office of the  
Chief Economist

Office of Energy Policy  
and New Uses

April 2011

2011

# Renewable Power Opportunities for Rural Communities





## **Renewable Power Opportunities for Rural Communities**

**Authors: Samuel V. Brown, David G. Nderitu, Paul V. Preckel (P.I.), Douglas J. Gotham (Co-P.I.), Benjamin W. Allen**

### **Abstract**

Renewable resources for the generation of electricity (e.g., wind, solar, geothermal, etc.) are typically most abundant and practical for development in rural areas. This creates an opportunity for rural electric utilities that are at a geographical advantage for investing in these projects. This report is intended to serve as a summary and guide to assist rural utilities that may be considering investing in a renewable electricity generation project and for policymakers who may be considering how to encourage such investments.

Rural utilities are motivated to provide power at least cost to their customers, and thus renewable generation projects must be competitive on economic grounds. Ample, unexploited renewable generation resources are available with some resource types more available in some regions than in others. One of the challenges to expanding renewable generation in rural areas is that many of the areas with rich resources do not have the transmission capacity needed to get the additional power to demand centers.

Due to their typical incorporation as member-customer-owned not-for-profit entities, rural electric utilities are focused on supplying electricity to their local customers in areas where demand growth prospects are often limited. Other aspects of the business models of alternative types of rural utilities, especially the tax system and electric power sector policies, have an impact on their ability to successfully invest in renewable power generation enterprises. An important aspect of policy is related to the ability of rural utilities to finance the development of renewable electricity generation projects. Various loan and grant programs at the federal, state, and local levels are targeted specifically to different types of rural utilities and in some cases specifically targeted to investments in renewable generation capacity.

The answers to a number of questions detailed in this report regarding a rural utility's opportunities for investing in renewable electricity generation capacity can serve as a basis for prescreening these investments. Beyond the prescreening phase, a full-blown engineering and economic analysis of any investment that passes the prescreening tests will of course be required. While it may be tempting to perform regional analyses to identify promising opportunities for investments, a survey of successful projects indicates that often unique local factors provide an added advantage to the selected technology.

In sum, there is clearly substantial latitude for expansion of renewable electricity generation in the United States. The location and the extent of that expansion will depend on many factors including shifting economic conditions, technological improvements, and government policies. As policymakers consider the alternatives, they will need to take into account the broad impacts of investments in

renewable electricity generation, including impacts on the transmission system, the economy (local, national, and international), and national security.

## Reviewers

This report was reviewed by Joseph S. Badin, Director, Northern Regional Division, USDA/Rural Development/Rural Utilities Service/Electric Programs; Carol Whitman, Senior Legislative Principal, Environmental Policy, National Rural Electric Cooperative Association; Marcy Halsema, Administrative Assistant, Purdue University; Nancy Alexander, freelance copy editor; Robert Gibbs and Tim Wojan of USDA's Economic Research Service. Their helpful comments and assistance are gratefully acknowledged.

## Preface

This study identifies and discusses a wide array of renewable power opportunities available in rural America. Other relevant topics bearing on the potential viability of renewable power projects, such as transmission access for renewable electrical power, system regulation, transmission expansion paths for renewable energy including modernization and a smart grid, future electricity demand, electric utility business models, and developing/financing strategies of renewable energy, are addressed. In addition, a large number of renewable electric power developments in rural America are highlighted. The principal audience for this study is expected to be local and state governments, rural leaders, rural-based utilities (cooperatives, municipals, and investor owned) and their leadership, and rural residents whose interests are focused on renewable power, distributed generation, and rural economic development.

The study was prepared under the direction of the Office of Energy Policy and New Uses (OEPNU) of the USDA Office of the Chief Economist. The study was produced under a cooperative agreement with the State Utility Forecasting Group at Purdue University, West Lafayette, Indiana. Principal authors of the study were Samuel V. Brown, David G. Nderitu, Paul V. Preckel (Principal Investigator), Douglas J. Gotham (Co-Principal Investigator), and Benjamin W. Allen.

Marvin Duncan, a Senior Economist in OEPNU, managed the cooperative agreement under which this study was prepared and is the primary USDA contact for the study. He can be reached at 202-401-0532 or by e-mail at [mduncan@oce.usda.gov](mailto:mduncan@oce.usda.gov).

The preface was written by Harry Baumes, Acting Director, Office of Energy Policy and New Uses.

The cover image was obtained from the National Renewable Energy Laboratory Photographic Information Exchange (NREL PIX)

## Table of Contents

Abstract .....	i
Reviewers .....	ii
Preface.....	ii
List of Figures.....	vi
List of Tables.....	ix
List Acronyms and Abbreviations.....	x
Executive Summary .....	1
Introduction.....	3
Renewable Resource Availability .....	5
Wind Power.....	5
Advantages.....	5
Issues .....	6
Applications.....	7
Regional Availability .....	8
Biopower .....	13
Advantages.....	14
Issues .....	14
Applications.....	14
Solar Power .....	30
Advantages.....	32
Issues .....	32
Applications.....	32
Regional Availability .....	35
Hydropower .....	41
Advantages.....	42
Issues .....	42
Applications.....	43
Regional Availability .....	43
Geothermal Power .....	50
Advantages.....	50
Issues .....	51

Applications.....	51
Regional Availability .....	54
Summary of Regional Resource Availability.....	59
Transmission Access & Adequacy for Renewables .....	61
Overview of the Electrical Power System .....	61
Generation.....	62
Transmission.....	62
Distribution.....	64
Regulation of the Electrical Power System .....	65
State-Level Regulation.....	65
National-Level Regulation .....	65
Transmission Congestion .....	68
Transmission Access.....	71
Transmission and Bulk Power Reliability .....	74
Variability and Uncertainty .....	75
Demand Outstripping Supply .....	75
Reactive Power.....	76
New Grid Technologies .....	76
Transmission Expansion Paths for Renewable Energy.....	76
Approaches to Transmission Expansion.....	76
Transmission Expansion Challenges.....	77
Transmission Modernization and the Smart Grid.....	79
Energy Efficiency .....	80
Demand Response and Load Management .....	80
Distributed Generation .....	81
Energy Storage .....	82
Future Electricity Demand.....	86
Regional Demand Forecasts.....	86
Summary of Future Regional Demand .....	101
Rural Development Potential.....	101
Rural Population Growth.....	101
Rural Employment Opportunities .....	103

Renewable Energy and Rural Development.....	106
Electric Utility Business Models .....	109
Investor-Owned Utilities .....	109
Federally Owned Utilities .....	109
Publicly Owned Utilities .....	110
Rural Electric Cooperatives .....	111
Non-Utility Generators.....	114
Electric Utility Comparisons .....	114
Developing and Financing Renewable Energy .....	117
Development and Financing Challenges .....	117
Development Paths .....	119
Financing Options.....	121
Internal Funding .....	121
Federal Funding.....	121
State and Local Funding .....	130
Private Credit.....	132
Other Funding Sources.....	133
Renewable Investment Prescreening Questions .....	142
Why invest in renewable power?.....	142
Which renewables are the best investment under the circumstances?.....	142
What are the financing options?.....	144
Is there sufficient demand?.....	145
Are there unique features of the project that provide a competitive advantage? .....	146
Information Resources.....	149

## List of Figures

Figure 1. Modern wind turbine. Source: NREL Photographic Information eXchange (PIX).....	5
Figure 2. Small, grid-connected wind turbine. Source: NREL PIX.....	7
Figure 3. U.S. wind resource map, 2008. Source: Wind Powering America. ....	9
Figure 4. State wind power activities, March 2010. Source: Wind Powering America.....	10
Figure 5. U.S. installed wind power capacity by state, 2010. Source: Wind Powering America.....	11
Figure 6. Projected regional wind power generation capacity, 2005-2030. Data: EIA (April 2008). ....	12
Figure 7. Concrete digester on a hog farm. Source: NREL PIX. ....	16
Figure 8. U.S. Biomass resource map, 2005. Source: NREL/TP-560-39181.....	19
Figure 9. U.S. Biomass resource map normalized by area, 2005. Source: NREL/TP-560-39181.....	20
Figure 10. U.S. Biomass resource map, normalized by county population, 2005. Source: NREL/TP-560-39181. ....	21
Figure 11. U.S. resource map, crop residues, 2005. Source: NREL/TP-560-39181. ....	24
Figure 12. U.S. resource map, potential switchgrass production on CRP lands, 2005. Source: NREL/TP-560-39181. ....	25
Figure 13. U.S. resource map, potential willow or hybrid poplar production on CRP lands, 2005. Source: NREL/TP-560-39181. ....	26
Figure 14. U.S. resource map, methane emissions from manure, 2005. Source: NREL/TP-560-39181. ....	27
Figure 15. Landfill gas projects and candidate landfills by state, 2008. Source: LMOP.....	28
Figure 16. Projected regional biomass power generation capacity, 2005-2030. Data: EIA (April 2008)....	30
Figure 17. Modern photovoltaic (PV) array. Source: NREL PIX. ....	31
Figure 18. Solar-powered horse corral. Source: NREL PIX. ....	33
Figure 19. Solar-powered water pumping station. Source: NREL PIX.....	33
Figure 20. Solar Two power tower concentrating solar power facility. Source: NREL PIX.....	34
Figure 21. Parabolic trough solar power facility. Source: NREL PIX. ....	34
Figure 22. U.S. solar resource availability, non-tracking photovoltaic, 2004. Source: NREL GIS.....	36
Figure 23. U.S. solar resource availability, tracking photovoltaic or concentrating solar power, 2004. Source: NREL GIS.....	37
Figure 24. Southwestern U.S. concentrating solar power resource availability, excluding land with slopes >1%, 2007. Source: NREL. ....	38
Figure 25. Southwestern U.S. concentrating solar power resource availability, excluding land with slopes >3%, 2007. Source: NREL. ....	39
Figure 26. Projected regional PV solar power generation capacity, 2005-2030. Data: EIA (April 2008). ....	40
Figure 27. Projected regional concentrating solar power generation capacity, 2005-2030. Data: EIA (April 2008).....	41
Figure 28. Number of feasible hydropower projects, 2006. Data: DOE/DOE-ID-11263.....	44
Figure 29. Feasible hydropower project potential annual mean power, 2006. Data: DOE/DOE-ID-11263.....	44
Figure 30. U.S. existing hydroelectric plants and feasible potential hydropower projects, 2006. Source: DOE/DOE-ID-11263. ....	46
Figure 31. Total gross hydropower resource potential by state, 2006. Source: DOE/DOE-ID-11263. ....	47



Figure 32. Total gross hydropower resource potential by state, normalized by population, 2006. Source: DOE/DOE-ID-11263. ....	48
Figure 33. Geothermal-heated greenhouse. Source: NREL PIX. ....	52
Figure 34. Dry steam geothermal power plant. Source: NREL PIX. ....	52
Figure 35. Dual flash geothermal power plant. Source: NREL PIX. ....	53
Figure 36. Single flash geothermal power plant. Source: NREL PIX. ....	53
Figure 37. U.S. geothermal resource map, 2005. Source: INL Geothermal Program. ....	55
Figure 38. U.S. heatflow map, 2004. Source: Southern Methodist University (SMU) Geothermal Lab. ....	56
Figure 39. Alaska heatflow map, 2004. Source: SMU Geothermal Lab. ....	57
Figure 40. Regional geothermal power generation capacity, 2005-2030. Data: EIA (April 2008). ....	59
Figure 41. Basic structure of the electrical power system. Source: U.S.-Canada Power System Outage Task Force (2004). ....	62
Figure 42. United States' interconnections. Source: EIA (2003). ....	63
Figure 43. Map of ISOs and RTOs. Source: FERC (August 2009). ....	66
Figure 44. NERC Regions. Source: NERC (August 2007). ....	67
Figure 45. Critical congestion area in the Eastern Interconnection. Source: DOE NETCS (April 2009). ....	68
Figure 46. One critical congestion area and three congestion areas of concern in the Western Interconnection. Source: DOE NETCS (April 2009). ....	69
Figure 47. Mid-Atlantic Area National Corridor map. Source: DOE (October 2007). ....	70
Figure 48. Southwest Area National Corridor map. Source: DOE (October 2007). ....	71
Figure 49. U.S. Electric Grid. Source: NPR (2010). ....	72
Figure 50. U.S. Conditional constraint areas. Source: DOE NETCS (April 2009). ....	74
Figure 51. Map of regions used for electricity demand forecasts. Source: EIA Annual Energy Outlook (2009). ....	86
Figure 52. East Central Area Reliability Coordination Agreement projected electricity demand, 2007-2035. Data: EIA (December 2009). ....	87
Figure 53. Electric Reliability Council of Texas projected electricity demand, 2007-2035. Data: EIA (December 2009). ....	88
Figure 54. Mid-Atlantic Area Council projected electricity demand, 2007-2035. Data: EIA (December 2009). ....	89
Figure 55. Mid-America Interconnected Network projected electricity demand, 2007-2035. Data: EIA (December 2009). ....	90
Figure 56. Mid-Continent Area Power Pool projected electricity demand, 2007-2035. Data: EIA (December 2009). ....	91
Figure 57. Northeast Power Coordinating Council/New York projected electricity demand, 2007-2035. Data: EIA (December 2009). ....	92
Figure 58. Northeast Power Coordinating Council/New England projected electricity demand, 2007-2035. Data: EIA (December 2009). ....	93
Figure 59. Florida Reliability Coordinating Council projected electricity demand, 2007-2035. Data: EIA (December 2009). ....	94
Figure 60. Southeastern Electric Reliability Council projected electricity demand, 2007-2035. Data: EIA (December 2009). ....	95

Figure 61. Southwest Power Pool projected electricity demand, 2007-2035. Data: EIA (December 2009).....	96
Figure 62. Western Electricity Coordinating Council/Northwest Power Pool Area projected electricity demand, 2007-2035. Data: EIA (December 2009).....	97
Figure 63. Western Electricity Coordinating Council/Rocky Mountain Power Area and Arizona-New Mexico-Southern Nevada Power Area projected electricity demand, 2007-2035. Data: EIA (December 2009). ....	98
Figure 64. Western Electricity Coordinating Council/California projected electricity demand, 2007-2035. Data: EIA (December 2009). ....	99
Figure 65. U.S. total projected electricity demand, 2007-2035. Data: EIA (December 2009). ....	100
Figure 66. Rural population change, 1990-2000. Source: USDA ERS. ....	102
Figure 67. Farm earnings in rural counties, 1969 and 1999. Source: USDA Economic Research Service.....	104
Figure 68. Urban and rural employment, 2005. Source: USDA Economic Research Service.....	105
Figure 69. Rural employment growth rates by region, 1976-1990 and 1990-2005. Source: USDA Economic Research Service.....	105
Figure 70. Unemployment rates by county, June 2009-May 2010 averages. Source: U.S. Department of Labor, Bureau of Labor Statistics. ....	106
Figure 71. Map of NRCO member cooperatives. ....	113
Figure 72. Retail electricity customers by business model. Data: NRECA (February 2008).....	115
Figure 73. Miles of transmission line by business model. Data: NRECA (February 2008). ....	115
Figure 74. Miles of distribution line by business model. Data: NRECA (February 2008). ....	115
Figure 75. Generation by business model. Data: NRECA (February 2008). ....	115
Figure 76. Utility customer base by business model. Data: NRECA (February 2008). ....	116
Figure 77. Utility customers per mile by business model. Data: NRECA (February 2008).....	116
Figure 78. U.S. Net Metering Customers, 2003-2007. Data: EIA (April 2009).....	134
Figure 79. Map of state net metering policies. Source: Interstate Renewable Energy Council (August 2009). ....	135
Figure 80. Map of state net metering policies for wind power. Source: NREL (May 2009).....	135
Figure 81. U.S. green pricing customers, 2003-2007. Data: EIA (April 2009).....	137
Figure 82. Map of states with green pricing programs. Source: NREL (Sept 2008). ....	138
Figure 83. Map of states with green marketing programs. Source: NREL (Sept 2008).....	139
Figure 84. Map of Renewable Energy Certificate tracking systems. Source: EPA.....	140

## List of Tables

Table 1. Total installed biopower capacity by state, 2007 (MW). Data: EIA, Form EIA-860, "Annual Electric Generator Report." .....	22
Table 2. Biomass resource availability by state, 2005 (1000 tons). Data: NREL/TP-560-39181. ....	23
Table 3. Total installed solar power capacity by state, 2007 (MW). Data: EIA, Form EIA-860, "Annual Electric Generator Report." .....	39
Table 4. U.S. hydropower potential, 2006. Data: DOE/DOE-ID-11263. ....	43
Table 5. Potential hydropower increase by state, 2006. Data: DOE/DOE-ID-11263. ....	49
Table 6. Communities with collocated geothermal resources. Data: GHC. ....	58
Table 7. High voltage transmission by owner and region. Source: CRS (April 2009). ....	64
Table 8. Energy storage technologies Source: ESA. ....	84
Table 9. East Central Area Reliability Coordination Agreement projected electricity demand, 2007-2035 (billion kWh). Data: EIA (December 2009). ....	87
Table 10. Electric Reliability Council of Texas projected electricity demand, 2007-2035 (billion kWh). Data: EIA (December 2009). ....	88
Table 11. Mid-Atlantic Area Council projected electricity demand, 2007-2035 (billion kWh). Data: EIA (December 2009). ....	89
Table 12. Mid-America Interconnected Network projected electricity demand, 2007-2035 (billion kWh). Data: EIA (December 2009). ....	90
Table 13. Mid Continent Area Power Pool projected electricity demand, 2007-2035 (billion kWh). Data: EIA (December 2009). ....	91
Table 14. Northeast Power Coordinating Council/New York projected electricity demand, 2007-2035 (billion kWh). Data: EIA (December 2009). ....	92
Table 15. Northeast Power Coordinating Council/New England projected electricity demand, 2007-2035 (billion kWh). Data: EIA (December 2009). ....	93
Table 16. Florida Reliability Coordinating Council projected electricity demand, 2007-2035 (billion kWh). Data: EIA (December 2009). ....	94
Table 17. Southeastern Electric Reliability Council projected electricity demand, 2007-2035 (billion kWh). Data: EIA (December 2009). ....	95
Table 18. Southwest Power Pool projected electricity demand, 2007-2035 (billion kWh). Data: EIA (December 2009). ....	96
Table 19. Western Electricity Coordinating Council/Northwest Power Pool Area projected electricity demand, 2007-2035 (billion kWh). Data: EIA (December 2009). ....	97
Table 20. Western Electricity Coordinating Council/Rocky Mountain Power Area and Arizona-New Mexico-Southern Nevada Power Area projected electricity demand, 2007-2035 (billion kWh). Data: EIA (December 2009). ....	98
Table 21. Western Electricity Coordinating Council/California projected electricity demand, 2007-2035 (billion kWh). Data: EIA (December 2009). ....	99
Table 22. U.S. total projected electricity demand, 2007-2035 (billion kWh). Data: EIA (December 2009). ....	100

## Acronyms and Abbreviations

AC	Alternating Current
APX NARR	APX Corporation North American Renewables Registry
AEPCO	Arizona Electric Power Cooperative
AECI	Associated Electric Cooperative, Inc.
ASCC	Alaska Systems Coordinating Council
BED	Burlington Electric Department
BPI	Buckeye Power Incorporated
CAES	Compressed Air Energy Storage
CEC	Cloverland Electric Cooperative
CESA	Clean Energy States Alliance
CFC	National Rural Utilities Cooperative Finance Corporation
CHP	Combined Heat and Power (Cogeneration)
CIP	Conservation Improvement Program, Minnesota
CLMS	Coordinated Load Management System, Pennsylvania Rural Electric Association
CREB	Clean Renewable Energy Bond
CRP	Conservation Reserve Program
CSP	Concentrating Solar Power
DC	Direct Current
DEC	Delaware Electric Cooperative
DOE	U. S. Department of Energy
DSMES	Distributed superconducting Magnetic Energy Storage
ECAR	East Central Area Reliability Coordination Agreement
EERE	Office of Energy Efficiency and Renewable Energy, U.S. Department of Energy

EIA	Energy Information Administration
EKPC	East Kentucky Power Cooperative
ERCOT	Electric Reliability Council of Texas
ERO	Electric Reliability Organization
ERS	USDA Economic Research Service
ETNNA	Environmental Tracking Network of North America
FACTS	Flexible AC Transmission System
FCS	Farm Credit System
FERC	Federal Energy Regulatory Commission
FRCC	Florida Reliability Coordinating Council
G&T	Generation and Transmission Cooperative
GAP	Gap Analysis Program - A method of identifying whether potential hydroelectric development sites are part of the habitat for an endangered species
GHC	Geo-Heat Center, Oregon Institute of Technology
GPN	NREL Green Power Network
GRE	Great River Energy
INL	Idaho National Laboratory
IOU	Investor-Owned Utility
ISO	Independent System Operator
IREC	Illinois Rural Electric Cooperative
ITC	Business Energy Investment Tax Credit
JEDI	Jobs and Economic Development Impact
kV	Kilovolt
kW	Kilowatt
kWa	Average Kilowatt

kWh	Kilowatt-hour
LFGE	Landfill Gas Energy
LMOP	U.S. Environmental Protection Agency Landfill Methane Outreach Program
LVE	Lower Valley Energy
OEPNU	USDA Office of Energy Policy and New Uses
MAAC	Mid-Atlantic Area Council
MACRS	Modified Accelerated Cost-Recovery System
MAIN	Mid-America Interconnected Network
MAPP	Mid Continent Area Power Pool
mmscfd	Million Standard Cubic Feet per Day
MMTCE	Million Metric Tons of Carbon Equivalent
mmtons	Million Metric Tons
MRES	Missouri River Energy Services
M-RETS	Midwest Renewable Energy Tracking System
MRO	Midwest Reliability Organization
MSW	Municipal Solid Waste
MW	Megawatt
MWa	Average Megawatt
NE	Northeast Power Coordinating Council New England
NEPOOL	New England Power Pool
NEPOOLGIS	New England Power Pool Geographical Information System
NERC	North American Electric Reliability Corporation
NETCS	National Electric Transmission Congestion Study
NETL	National Energy Technology Laboratory

NIETC	National Interest Electric Transmission Corridor
NPCC	Northeast Power Coordinating Council
NRCO	National Renewables Cooperative Organization
NRECA	National Rural Electric Cooperative Association
NREL	National Renewable Energy Laboratory
NREL PIX	Photographic Information Exchange, National Renewable Energy Laboratory
NWCPUD	Northern Wasco County People's Utility District
NWP	Northwest Power Pool Area
NYSERDA	New York State Energy Research and Development Authority
ODEC	Old Dominion Electric Cooperative
OPALCO	Orcas Power & Light Cooperative
OPPD	Omaha Public Power District
PJM	PJM Interconnection LLC, a Regional Transmission Organization
PJM GATS	PJM Generation Attribute Tracking System
PMA	USDOE Power Marketing Agency
POU	Publicly Owned Utility
PPA	Power Purchase Agreement
PREA	Pennsylvania Rural Electric Association
PRPA	Platte River Power Authority
PSB	Polysulfide bromide battery
PTC	Renewable Electricity Production Tax Credit
PV	Photovoltaic
QECB	Qualified Energy Conservation Bond
RA	Rocky Mountain Power Area, Arizona, New Mexico, and Southern Nevada Power

REA	U.S. Rural Electrification Administration
REAP	Renewable Energy Assistance Program
REC	Renewable Energy Certificate
RECC	Rural Electric Convenience Cooperative
REPI	Renewable Energy Production Incentive
RFC	ReliabilityFirst Corporation
RUS	USDA Rural Utilities Service
SERC	Southeastern Electric Reliability Council
SIPC	Southern Illinois Power Cooperative
SMES	Superconducting Magnetic Energy Storage
SMECO	Southern Maryland Electric Cooperative
SMEPA	South Mississippi Electric Power Association
SMU	Southern Methodist University
SPP	Southwest Power Pool
STATCOMS	Static Compensators
SVC	Static Reactive Volt-Ampere (VAR) Compensators
TRC	Tradable Renewable Certificates
TRE	Texas Regional Entity
TVA	Tennessee Valley Authority
USDA	United States Department of Agriculture
VAR	Reactive Volt-Amperes
VPPSA	Vermont Public Power Supply Authority
VRB	Vanadium Redox Battery
WAPA	Western Area Power Administration



WECC	Western Electricity Coordinating Council
WLP	Waverly Light and Power
WPA	The National Renewable Energy Laboratory Wind Powering America program
WPPI	Wisconsin Public Power, Inc.
WPU	Worthington Public Utilities
WREGIS	Western Renewable Energy Generation Information System
WVPA	Wabash Valley Power Association



## Executive Summary

Renewable resources for the generation of electricity (e.g., wind, solar, geothermal, etc.) are typically most abundant and practical for development in rural areas. This creates an opportunity for rural electric utilities, which are at a geographical advantage for investing in these projects. This report is a summary and guide to assist rural utilities that may be considering investing in a renewable electricity generation project and policymakers who may be considering how to encourage such investments. The following points summarize the highlights of the issues addressed in this report.

- Rural utilities are motivated to provide power at least cost to their customers; renewable generation projects must be economically competitive after including all government incentives and tax impacts.
- Ample, unexploited renewable generation resources are available, with some resource types more available in some regions than in others. The Great Plains states are particularly well endowed with both wind and biomass resources, and the Southwestern and Western states are generally well endowed with solar and geothermal resources. With the exception of biomass potential in Maine, the Northeastern and Southeastern states have relatively less renewable generation resources. All coastal states have potential for off-shore wind; however, significant technical and acceptance barriers to developing these resources remain.
- One of the challenges to expanding renewable generation in rural areas is that many of the areas with rich resources do not have the transmission capacity needed to get the additional power to demand centers. This capacity limitation is exacerbated by the intermittent nature of some renewable generation sources such as wind and solar power. While a number of plans are currently under consideration for expanding the capacity of the transmission system, there are several issues. Foremost among these is how to allocate the substantial cost of new transmission capacity.
- Due to their typical incorporation as member-customer owned, not-for-profit entities, rural electric utilities are focused on supplying electricity to their local customers. While there are localized exceptions, the prospects for demand growth in these areas appear to be limited. The reasons for this include increasing consolidation in the farming sector and the continuing erosion of the manufacturing sector. Although there are exceptions driven by local economic activities, areas that appear likely to see demand growth are either adjacent to urban areas or offer recreational or retirement amenities.
- Other aspects of the business models of alternative types of rural utilities impact their ability to successfully invest in renewable power generation enterprises. These are due to differences in how they are treated by the tax system and by policies that are targeted to the electric power sector. For example, a cooperative that primarily serves its member-owners may enjoy tax-exempt status. This makes policies with incentives based on tax benefits relatively ineffective in influencing the investment behavior of cooperatives. The benefits of these policies in some

cases can be recaptured through the creation of partnerships or wholly owned subsidiary companies that have different business models.

- An important aspect of policy is related to the ability of rural utilities to finance the development of renewable electricity generation projects. Various loan and grant programs at the federal, state, and local levels are targeted specifically to different types of rural utilities and, in some cases, specifically targeted to investments in renewable generation capacity. The nature of these programs may restrict the types of investments that can benefit, and in designing new policies, careful consideration must be given to the provisions of existing policies that may offset the benefits of the new policy.
- The answers to a number of questions regarding a rural utility's opportunities for investing in renewable electricity generation capacity can serve as a basis for prescreening these investments. Beyond the prescreening phase, a full-blown engineering and economic analysis of any investment that passes the prescreening tests will of course be required. While it may be tempting to perform regional analyses to identify promising opportunities for investments, a survey of successful projects indicates that unique local factors often provide an added advantage to the selected technology.

In sum, there is clearly substantial latitude for expansion of renewable electricity generation in the United States. The location and the extent of that expansion will depend on many factors, including shifting economic conditions, technological improvements, and government policies. As policymakers consider the alternatives, they will need to take into account the broad impacts of investments in renewable electricity generation, including impacts on the transmission system, the economy (local, national, and international), and national security.

## Introduction

This document is an information resource for rural electric utilities and policymakers interested in expanding their communities' renewable energy generation capacity. Many renewable energy resources are located near rural communities, making these communities well-positioned to generate and use renewable electric power. This presents a unique opportunity for rural electricity providers to adopt renewable energy technologies, as they face the challenges of rising energy costs and increasing demand as well as state and federal renewable energy mandates. While many rural communities have already adopted such technologies, adoption has varied widely at both state and regional levels. Power from renewable resources continues to represent only a small fraction of most rural electricity providers' energy portfolios.

The economics of renewable energy systems depend on several factors. While resource availability is essential, projected demand, the provider's business model, federal and state investment incentives, and current and planned transmission infrastructure also play important roles.

This document is organized into six main sections that address the issues a utility should consider before investing in renewable electricity generation. To illustrate the concepts under discussion, each section includes relevant examples of existing renewable electricity generation projects. These examples are highlighted in blue boxes located throughout the main body of the text.

The first section describes the regional availability of five renewable resources—wind, biomass, solar, hydro, and geothermal. An overview of the processes used to convert each resource into electricity is provided. The advantages and issues associated with each resource are also described. Following these descriptions, examples of small- and large-scale renewable power applications for each resource are provided. Lastly, the regional availability of the resource in question is analyzed, and currently installed generation capacity is compared to projected capacity. This section closes with a cross-resource summary of regional availability.

The second section describes transmission issues that affect renewable energy systems. An overview of the electrical power system is provided, and the regulatory structure of that system is briefly discussed. Transmission congestion, access, and reliability are then treated, as is the impact of renewable energy on these issues. This section closes with a description of different approaches to transmission expansion and modernization currently under consideration by policymakers, regulators, and utilities.

The third section details current and future electricity demand. After treating demand projections for different regions of the United States, a summary of future regional demand is provided. Opportunities for demand growth in rural areas are then treated, particularly those related to new renewable energy projects.

The fourth section details the types of businesses that own and operate rural electricity generation facilities. The business models treated in this section are investor-owned utilities, federally owned utilities, municipal and other publicly owned utilities, and rural electric cooperatives. A brief description is provided for each business model, including how each raises capital for new investments and

distributes earnings. Non-utility businesses are also mentioned, as a significant number of facilities generating renewable power are not owned by electric utilities.

The fifth section describes alternative development paths and financing options for renewable energy projects. The unique challenges facing renewable energy projects are described, as are the different development paths that such projects can take, including common types of partnerships. The types of renewable energy financing options are then described, including federal, state, and local funding as well as private credit and other funding sources.

The sixth section provides a list of questions that should be considered as a rural utility considers whether to invest in a renewable generation project. These questions are presented in roughly the order they would be logically addressed during a prescreening process. Of course these questions do not constitute a sufficient screening process, which generally requires a full-blown engineering and economic analysis. However they may be useful in quickly sorting among projects that are clearly unreasonable or potentially viable. Following this list of questions is a qualitative summary of the results of a survey of rural utilities that have invested in renewable electricity generation projects. This summary highlights the factors that appear to have contributed to the success of these projects.

As of this writing, many rural communities are not utilizing nearby renewable energy resources. This document should assist any entities and individuals interested in taking advantage of those resources.

## Renewable Resource Availability

This section describes the availability of renewable energy resources within the United States. The resources addressed are wind, biomass, solar, hydro, and geothermal. Most regions of the United States are endowed with renewable resources. Due to significant variations in climate and geography, however, some regions are better suited to certain types of renewable energy than others. It is important to keep this in mind when considering potential renewable power generation projects.

Each subsection focuses on a particular renewable resource and begins with a brief introduction to the technology used for converting the energy source to electricity. The advantages and disadvantages of that resource are described, as well as the types of applications for which it is well-suited. The regional availability of the resource is summarized, and finally, currently installed generation capacity that uses the resource is compared to projected capacity, indicating the potential for expansion.

### Wind Power

Electricity from wind is generated by using turbines to convert the wind's kinetic energy into electrical energy. Wind turbines typically have two or three airfoils, which spin due to the aerodynamic lift that is created as wind passes over them. These airfoils are attached to a shaft that drives a generator, which in turn creates electricity. Most turbines are mounted at least 30 meters (m) above the ground to take advantage of wind resources that are faster and less turbulent than those closer to the ground. A picture of a modern wind turbine can be seen in Figure 1.



Figure 1. Modern wind turbine. Source: NREL Photographic Information eXchange (PIX).

A typical modern wind turbine has three airfoils that are 70-80 m in diameter mounted atop a tower 60-80 meters tall. Such a turbine can generate roughly 1.6 megawatts (MW) of electrical power. Although turbines with larger airfoils, higher towers, and greater generation capacity may be developed in the future, it is doubtful the airfoil diameter of land-based wind turbines will exceed 100 m, which corresponds to a power output of 3-6 MW. This is because the transportation costs of such large components present a significant economic barrier to widespread adoption.

### Advantages

The use of wind power has numerous advantages. It does not degrade air or water quality, and it does not produce any carbon dioxide (CO<sub>2</sub>) emissions. Unlike many other forms of power generation, it does

not require the extraction, transportation, storage, or combustion of fuels. Wind power also uses less water than power generated from fossil fuels.

Another advantage of wind power is that it is modular. Utility-scale wind power applications are made up of many modules—turbines—and consequently may be scaled up or down as needed. This means that increases in demand over time may be met by simply adding more modules. The scalability of wind power makes it suitable for powering a single farm, an entire community, or even larger applications.

Wind power presents several advantages specific to rural communities as well. Agricultural areas often have open land that is particularly well-suited to wind power generation. In many cases, landowners can significantly increase their income per acre by hosting a wind plant, and rural communities in resource-rich areas can use wind power as a new source of tax revenue. Further, wind turbines have a small physical footprint, so their installation does not exclude other land uses. Crops may be planted and livestock grazed right up to the base of a turbine.

Another significant advantage of wind power is that it is a well-established and mature technology. This sets it apart from some other renewable power technologies, which are in earlier stages of research and development. The maturity of wind power makes wind one of the most cost-competitive renewable power resources. Although estimates of wind power generation costs vary according to numerous factors, including turbine efficiency and resource quality, costs of 4-6 cents per kilowatt-hour (kWh) are often used as a guideline. (Note that this figure includes the federal production tax credit of 2.2¢/kWh and does not include potentially high transmission costs.) Future developments could further lower prices by as much as 50 percent.

## Issues

Wind power is not without disadvantages. The installation of a wind plant is often met with siting and environmental concerns. Property owners may be concerned that the obstruction of views caused by turbines might lower property values. Some individuals and institutions also may be concerned with the impact of turbines on birds and grassland species.

The variability and intermittency of wind power constitutes another disadvantage. Wind power depends on the speed at which the wind blows. Although varying airfoil pitch can compensate somewhat for variations in wind speed, wind power is unavailable when wind speed is either too low or too high, making wind an uncertain source of electricity. The United States Department of Energy (DOE) states in its *20% Wind Energy by 2030* report, however, that the cost impact of such variation and uncertainty may be as low as 10 percent or less of the value of the wind energy generated.

Complementing wind power with other power technologies may be an effective way of addressing the variability and intermittency of wind resources. Such solutions often combine wind turbines with a form of energy storage, which can be used when wind resources are unavailable. An example is wind/hydro combinations, in which wind turbines are used with pumped storage. More information on pumped storage can be found in the *Hydropower* section of this report. Another strategy is to complement the wind-generating units with one or more appropriately sized natural-gas-fired generators that can be brought online as needed.



## Applications

Wind power has both small- and utility-scale applications. Small-scale applications typically feature turbines that produce 100 kW or less of power. Clusters of these turbines may be connected to the grid for distributed generation. Alternatively, they may be used by homeowners, ranchers, and farmers to lower electricity bills or to compensate for power fluctuations that can occur at the end of weak transmission lines. The latter, smaller scale domestic applications typically feature turbines with a capacity of 1-3 kW.

Applications for stand-alone turbines that produce 50 kW or less include pumping water for irrigation as well as powering communications equipment and even homes. Such off-grid applications may allow rural communities to forego expensive utility power line extensions to remote areas. In the future, there may be more opportunities for connecting such small, distributed turbines to the grid.

Figure 2 shows one application for a small, grid-connected wind turbine. This 10 kW turbine provides supplemental power for a farmer, and any excess power it generates is sent back to the grid.



Figure 2. Small, grid-connected wind turbine. Source: NREL PIX.

Utility-scale wind power applications can produce anywhere from less than 1 MW to hundreds of MWs of power. These applications feature many turbines that have been grouped together to form a wind plant, or “wind farm.” The wind turbines used in such a setting may generate as little as 50 kW, or as much as 2 MW, per turbine.

### Wolverine Power Supply Cooperative

Wolverine Power Supply Cooperative is a generation and transmission cooperative based in Cadillac, Michigan. It has six member distribution cooperatives that serve more than 220,000 residences and businesses in rural portions of Michigan's Lower Peninsula.

Wolverine solicited proposals for wind power in 2006 and, as a result, entered into a partnership with John Deere to develop the Harvest Wind Farm. This facility came online in 2008, and Wolverine has agreed to purchase its entire output for the first 20 years of its operation. It has a nameplate capacity of 52.8 MW and was the state's first utility-scale wind power project. Wolverine is currently looking into further wind development near Rogers City.

## Minnkota Power Cooperative

Minnkota Power Cooperative is a generation and transmission cooperative that provides electrical power to 11 member cooperatives in eastern North Dakota and northwestern Minnesota. It also serves as an operating agent for the Northern Municipal Power Agency (NMPA), which serves 12 municipal utilities.

Minnkota has entered into partnerships with NextEra Energy Resources and Otter Tail Power Company, through which it purchases wind power from two different wind farms. The first wind farm, Langdon Wind Energy Center, is located south of Langdon, ND. It generates 199.5 MW of power, features 133 turbines, and is jointly owned by NextEra Energy Resources and Otter Tail Power Company. Minnkota has agreed to purchase 139.5 MW from NextEra for the first 25 years of the facility's operation. The second wind farm, Ashtabula Wind Energy Center, is located northeast of Valley City, ND. It generates 366 MW of power, features 244 turbines, and is jointly owned by NextEra Energy Resources and Otter Tail Power Company. Minnkota has agreed to purchase 217.5 MW from NextEra for the first 25 years of the facility's operation.

Minnkota Power Cooperative has invested in renewable energy largely to meet the renewable energy mandates legislated by Minnesota and North Dakota. Minnesota's renewable portfolio standard requires a 25-percent renewable power supply by 2025, and North Dakota's renewable energy goal requires a 10-percent renewable power supply by 2015. As of November 2010, Minnkota was estimating that over 30 percent of its 2010 energy would be from wind.

Minnkota also operates two 900 kW wind turbines, one located on a ridge six miles east of Valley City, ND, and one located on a ridge three miles east of Petersburg, ND. Both came online in 2002. The power from the former is sold to cooperative and NMPA customers through Minnkota's Infinity Wind Energy Program. The power from the latter is likewise sold through the Infinity Wind Energy Program as well as to Grand Forks Air Force Base. Customers participating in the Infinity Wind Energy Program pay an additional 30 cents per 100 kWh block of wind power.

## Regional Availability

A map depicting wind resource availability within the United States can be seen in Figure 3. The Great Plains and upper Midwestern United States are rich in wind resources, and this makes them particularly suitable for utility-scale wind power applications. These areas are also well-suited for wind power development due to their large open spaces. Wind resources are also quite good in coastal areas, especially the east and west coasts and the Great Lakes. However, siting and environmental concerns may be an issue in these areas. State-level wind resource maps are available from the *Resources & Tools* section of the Wind Powering America website (<http://www.windpoweringamerica.gov>).

Wind resource maps should be used only to determine if further exploration into wind power opportunities is worthwhile. Detailed, professional measurements should be taken before determining that there is adequate wind resource for a planned wind turbine or wind plant. For more detailed information on the deployment of new wind power facilities, visit the Federal Wind Siting Information Center, available on the U.S. DOE *Energy Efficiency and Renewable Energy* (EERE) program's website (<http://www.eere.energy.gov/windandhydro/federalwindsiting/>).

A map depicting state activities that relate to wind power can be seen in Figure 4. Of the activities depicted in Figure 4, anemometer loan programs and the establishment of wind working groups are of particular interest to rural communities interested in investing in wind power.

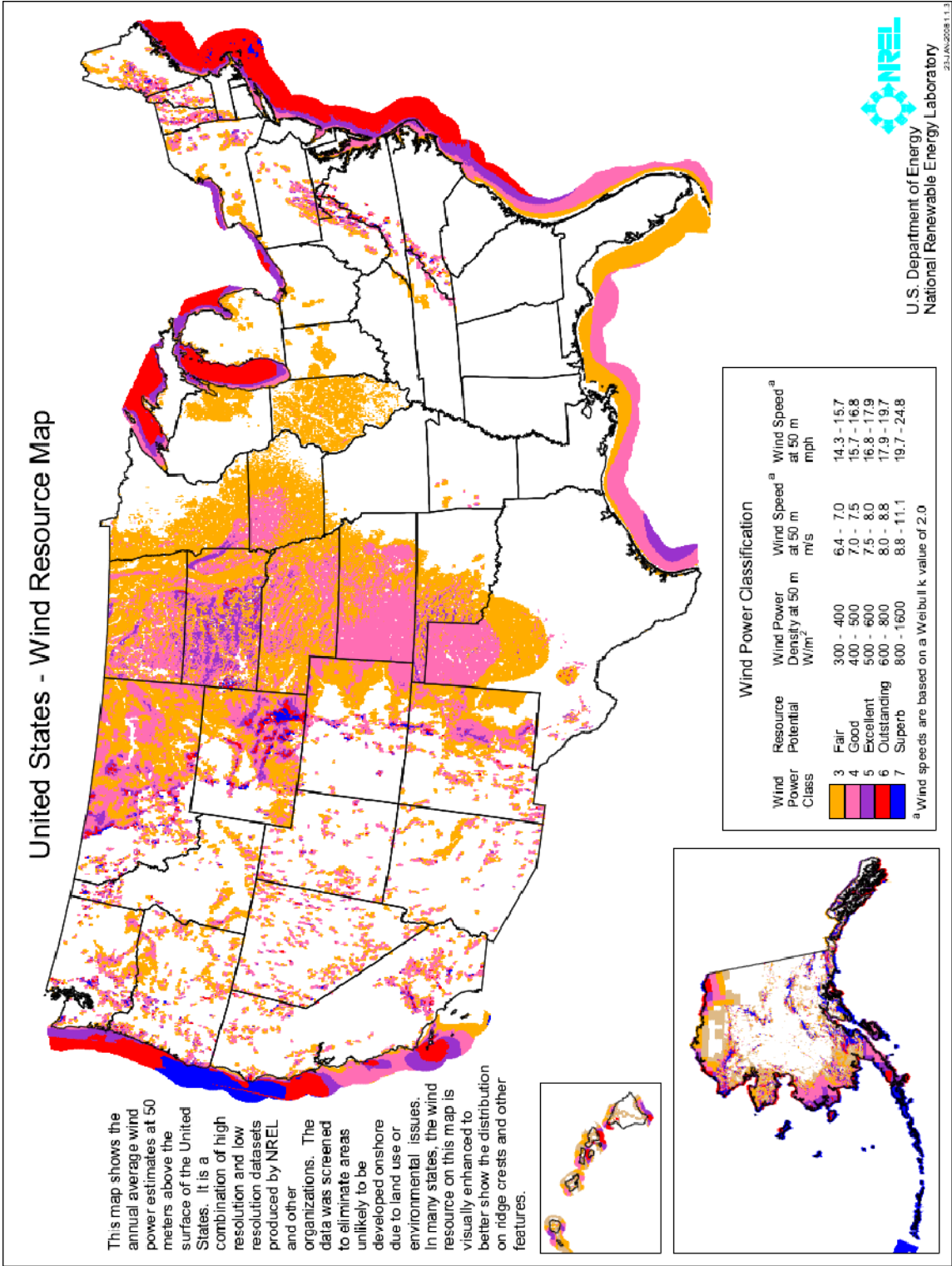

Figure 3. U.S. wind resource map, 2008. Source: Wind Powering America.

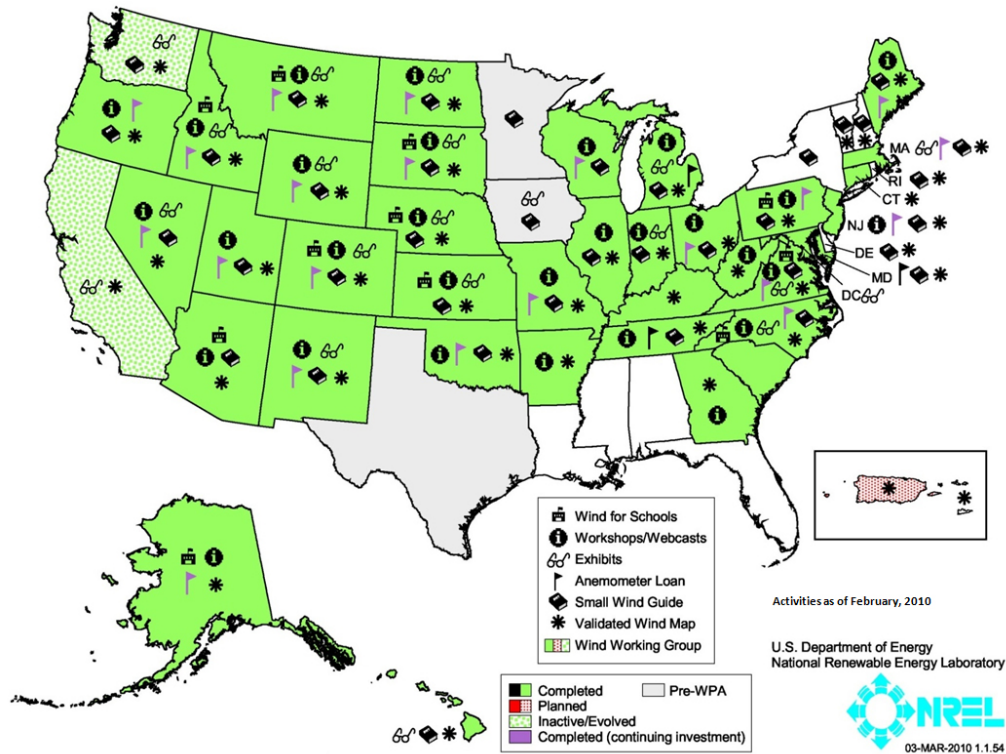

Figure 4. State wind power activities, March 2010. Source: Wind Powering America.

Wind working groups bring together industry stakeholders, consumers, and government representatives to promote the development of wind energy in a particular state. More details regarding state-level wind activities, including wind working group contact information, can be found in the *Program Areas* section of the Wind Powering America website.

Figure 5 shows the distribution by state of 36,698 wind capacity installed in the U.S. as of September 2010. The September 2010 map was the latest update available from the NREL Wind Powering America website at the time of writing of this report.

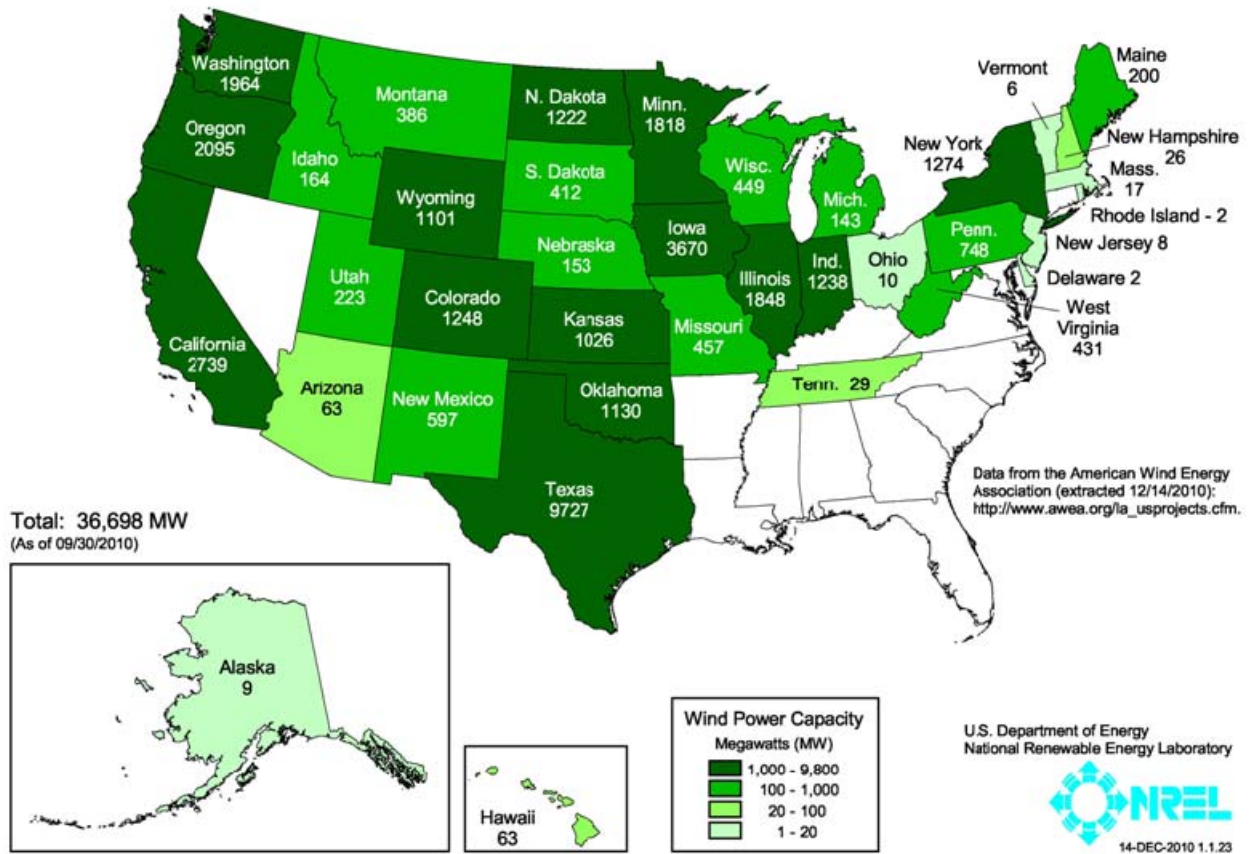

Figure 5. U.S. installed wind power capacity by state, 2010. Source: Wind Powering America.

As can be seen in Figure 5, the Great Plains states—which Figure 3 shows have the richest wind resources—are not leading the nation in installed wind power capacity. The five states with the most installed capacity are Texas, California, Iowa, Minnesota, and Washington, none of which are in the Great Plains<sup>1</sup>. This indicates that the Great Plains are significantly underutilizing their wind resources relative to their potential.

Projections of regional wind power generation capacity for the electric power sector can be seen in Figure 6. The regions in Figure 6 are adapted from the 2004 North American Electric Reliability Council (NERC) regions and sub-regions, in compliance with the Annual Energy Outlook (AEO) published by the Energy Information Administration (EIA). For a map of these regions, refer to Figure 51 in the section of this report entitled *Forecasts of Future Electricity Demand*.

<sup>1</sup> Great Plains states with richest wind resources are Colorado, North Dakota, South Dakota, Iowa, Kansas, Minnesota, Montana, New Mexico, Oklahoma, Texas, and Wyoming.

## Regional Wind Power Generation Capacity, 2005-2030

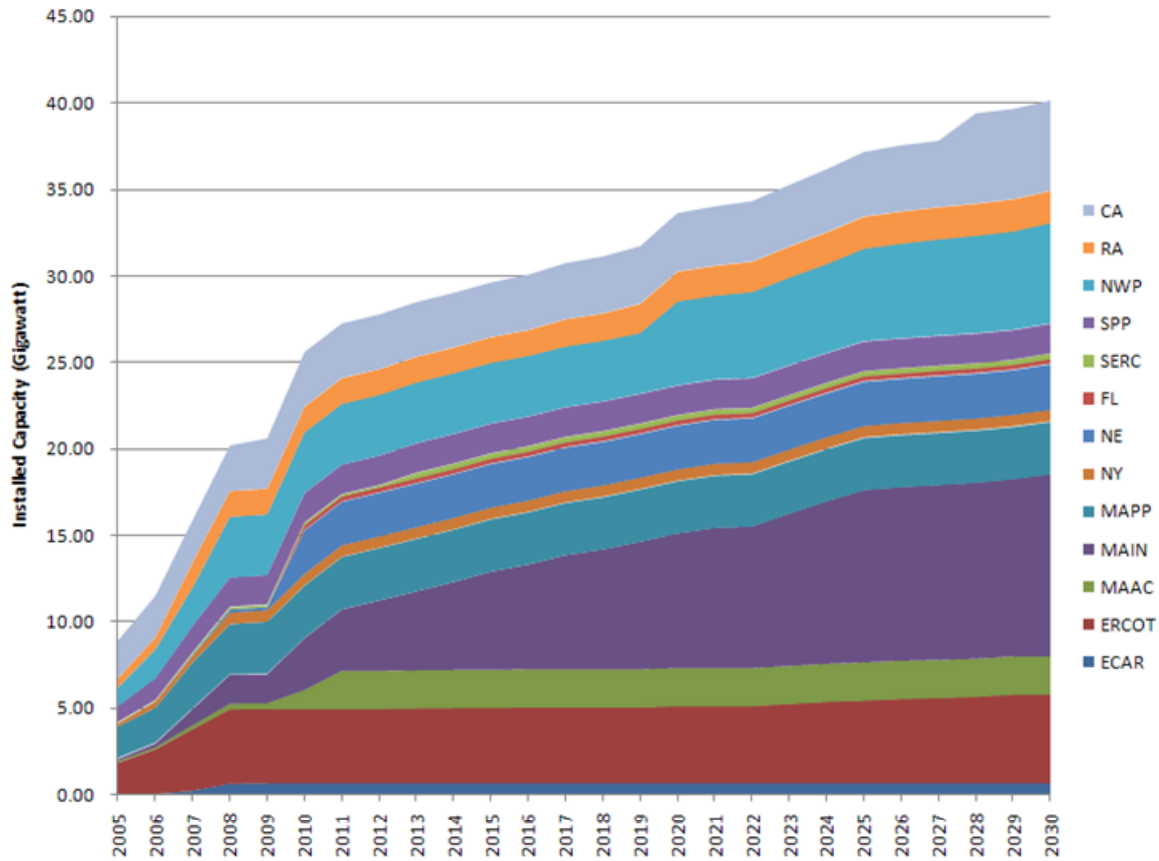

CA - Western Electric Coordinating Council/California  
 RA - Western Electric Coordinating Council/  
 Rocky Mountain Power Area and Arizona-New  
 Mexico-Southern Nevada Power Area  
 NWP - Western Electric Coordinating Council/  
 Northwest Power Pool  
 SPP - Southwest Power Pool  
 SERC - Southeastern Electric Reliability Council

FL - Florida Reliability Coordinating Council  
 NE - Northeast Power Coordinating Council/New England  
 NY - Northeast Power Coordinating Council/New York  
 MAPP - Mid-Continent Area Power Pool  
 MAIN - Mid-America Interconnected Network  
 MAAC - Mid-Atlantic Area Council  
 ERCOT - Electric Reliability Council of Texas  
 ECAR - East Central Area Coordination Agreement

**Figure 6.** Projected regional wind power generation capacity, 2005-2030. Data: EIA (April 2008).

The projections of Figure 6 confirm that states in the Great Plains and the Midwest have a significant amount of wind power generating capacity yet to be realized. Most other regions have unrealized potential as well, although the growth possibilities in the Southeastern states are small. This is consistent with the wind resource map, Figure 3.

## Basin Electric Power Cooperative

Basin Electric Power Cooperative is a generation and transmission cooperative based in Bismarck, ND. It serves 136 member cooperatives in Colorado, Iowa, Minnesota, Montana, Nebraska, New Mexico, North Dakota, South Dakota, and Wyoming. These cooperatives collectively provide electricity to roughly 2.8 million consumers over 540,000 square miles. Basin Electric is both constructing renewable generation and purchasing renewable power.

The board of directors of Basin Electric decided in 2008 to create two for-profit subsidiaries to develop wind projects in North Dakota and South Dakota— Prairie Winds ND 1, Inc., and Prairie Winds SD 1, Inc., respectively.

The Prairie Winds ND 1 subsidiary developed the Prairie Winds 1 project, a 115.5 MW wind farm south of Minot, ND. It features 77 turbines, cost approximately \$240 million, and came online in late 2009. This project provides power to Basin Electric customers through an interconnection with the Western Area Power Administration's transmission system.

Prairie Winds ND 1 also owns Minot Wind 2, a 4.5 MW wind farm also located south of Minot, ND. This facility features three turbines, cost approximately \$11 million, and came online in December 2009.

The Prairie Winds SD 1 subsidiary is currently in the planning and permitting stages for a 151.5 MW wind farm located near Crow Lake, SD. This facility will feature 101 turbines and will cost approximately \$350 million. It is expected to come online in early 2011. Basin Electric is working with the USDA Rural Utility Service for the financing of SD 1.

Basin Electric Power Cooperative is developing renewable energy largely to ensure that it will be able to meet any future renewable energy regulations, legislated either by the federal government or by any of the nine states in which it does business. After examining demand growth and renewable energy policies, Basin Electric determined that investing in its own renewable generation facilities was a least-cost option for satisfying any such regulations.

Basin Electric has also entered into six wind power purchasing agreements with NextEra Energy Resources. In the most recent of these, Basin Electric agreed to purchase 100 MW of power from a new wind farm being constructed near Baldwin, ND. NextEra will build, own, and operate the facility, which will feature 68 turbines and is expected to come online by the end of 2010. When this project is finished, Basin Electric's renewable energy sources will have a nameplate capacity in excess of 20 percent of its members' peak demand.

In 2005, Basin Electric's membership passed a resolution setting a goal that 10 percent of the co-op members' electricity demand be provided from green or renewable forms of energy. "Basin Electric has been working hard to meet that directive ever since, and today, the cooperative is emerging as a national leader in developing renewable energy in the region," said Ron Harper, chief executive officer and general manager. "By the end of 2010, Basin Electric is on track to have green or renewable generation with an installed capacity equal to more than 20 percent of current member load." In 2010, Basin Electric received the DOE's Wind Powering America achievement award for outstanding leadership with wind power and significant contribution to the wind power industry.

## Biopower

Biopower is the process of converting the energy stored in biomass into electrical energy. "Biomass" refers to any organic matter derived from plants or animals. Many different types of biomass feedstocks are suitable for biopower applications, including dedicated energy crops, various crop and wood wastes, and crop, forest, and mill residues. Many biomass depositories such as landfills, manure management systems, and wastewater treatment plants produce methane emissions that can also be used to generate electricity.

Biopower feedstocks vary greatly in energy content, conversion efficiency, and cost. Sources of biomass also vary; municipalities, manufacturers, farmers and ranchers all produce potential biomass feedstocks in differing quantities and with varying schedules. This means that the economic feasibility of a new biopower installation depends significantly on the feedstock under consideration, its source and availability, and the technology used to convert it into electrical power.

### **Advantages**

A significant advantage of biopower is that, in many cases, biomass can be converted to electrical power using processes similar to those used with fossil fuels. Pre-existing infrastructure can often be employed. Biopower is also well-established; it is currently second only to hydropower for renewable electricity generation.

Biopower has several other advantages as well. Biomass efficiently stores energy until it is needed, so biomass resources do not suffer from the same intermittency and/or seasonality as do wind and solar resources. Biopower technologies are also highly scalable. They can provide enough power for a single farm, a rural community, or even a small city. Another significant advantage of biopower generation is that it reduces the amount of methane gas released into the atmosphere by burning biomass before it decomposes or by using the methane directly.

### **Issues**

An important issue with biomass relates to its availability in terms of volume and timing. To achieve high-capacity factors, the biomass feedstock for a biopower generator must be available in adequate quantities over time. Biomass is in many cases less energy dense than fossil fuels, so transportation cost can be a limiting factor in determining the volume of feedstock that can be economically supplied to the biopower project. In addition, some biomass feedstocks originate from seasonal crops and thus are available only part of the year, requiring storage to maintain year-round production. Some feedstocks and generation technologies raise concerns about environmental impacts to air and water resources as well as ash disposal associated with direct combustion. Some of the newer biopower technologies, such as gasification, remain too costly for widespread adoption.

### **Applications**

Electricity can be generated from biomass either directly, by combusting the biomass itself, or indirectly, by combusting gasses emitted from decaying biomass. There are three main technologies for converting biomass into electrical power by combusting the biomass itself: direct firing, co-firing, and gasification.

In direct-firing plants, the biomass is burned in a boiler, which produces steam that turns a turbine, which drives a generator that produces electricity. Similar to fossil fuel power plants, most existing biopower plants use direct firing. Direct-fired biopower plants typically operate with an efficiency of 20-24 percent, while a typical coal-burning power plant has an efficiency of 33-35 percent. Technologies exist that can provide direct fired biopower plants with efficiencies in excess of 40 percent, but they are not cost effective for smaller plants. Agricultural, industrial, and forestry residues are commonly used for direct firing.



Co-firing plants simply replace some amount of the coal in their boilers with biomass. Co-firing is the cheapest way to generate electric power from biomass in the short run, because it uses existing power plants and requires very little modification to existing infrastructure. After they have been “tuned” to accept biomass, co-firing plants can achieve efficiencies of 33-37 percent. So with investment in the necessary equipment, there may be little to no energy loss when biomass is added to a conventional boiler.

Gasification power plants heat biomass to an extremely high temperature, at which point it breaks down into a flammable gas, which is then burned to generate electricity. Since the gas resulting from this process can be cleaned before it is burned, a greater variety of feedstocks can be used in gasification plants. Gasification plants may also use both heated gas *and* steam to turn their turbines, achieving efficiencies as high as 60 percent. This type of process is referred to as “combined cycle” power generation. Many biomass gasification technologies are still in the research and development stages.

### Vermont Public Power Supply Authority

Vermont Public Power Supply Authority (VPPSA) is a private authority of the state of Vermont. It purchases and sells wholesale power within Vermont, as well as wholesale and retail power outside of the state. It also issues tax-free debt on behalf of Vermont municipal utilities and electric cooperatives.

Vermont Public Power Supply Authority owns a 19-percent stake in McNeil Station, a 50 MW biomass gasification generator that uses wood chips as its primary feedstock. These chips come from whole-tree chipping operations and sawmills. McNeil Station is operated by Burlington Electric Department (BED), the utility that also constructed it. VPPSA has sold all of the McNeil project's output to eight municipal utilities in the villages of Enosburg Falls, Ludlow, Lyndonville, Morrisville, Northfield, and Swanton Village, and the towns of Hardwick and Stowe. Each of these utilities is a member of VPPSA and receives power under an identical contract.

The wood used by McNeil Station is delivered 75 percent by rail and the rest by truck. An existing rail facility is adjacent to the facility. Under the wood procurement plan authorized by McNeil's joint owners, BED contracts with wood suppliers for approximately 420,000 tons of biomass per year. Contracts are typically renewed at four- to six-month intervals.

McNeil Station functions as an intermediate load unit, since it has relatively high costs. It has an overall availability of approximately 91 percent, but it is only dispatched about 53 percent of the time. As the cost of oil and natural gas increase, so does station operation.

The emissions from decaying biomass can also be used to generate electricity. Decaying biomass produces methane, which can be used to drive a combustion turbine or an internal combustion engine to generate electricity. Landfills are a common resource for this type of power generation. Wells are drilled into a landfill to route the methane from decaying biomass to a central location, where it is then burned.

## East Kentucky Power Cooperative

East Kentucky Power Cooperative (EKPC) is a generation and transmission cooperative based in Winchester, KY. Its 16 member distribution cooperatives serve about 518,000 residences and businesses across 87 counties. EKPC was the first electric utility in Kentucky to bring landfill gas power online. It has received six awards totaling \$20,985,551 for its landfill gas development.

East Kentucky Power Cooperative owns and operates six landfill gas power plants. The first three of these plants came online in fall 2003 and are located near Grayson, London, and Walton, KY. The fourth facility came online in 2006 and is located near the Pearl Hollow landfill in Hardin County. The fifth facility came online in 2007 and is located in Pendleton County. The sixth facility became operational in spring 2009 and is located at the Mason County/Maysville landfill. Combined, these facilities generate roughly 16.8 MW of power.

EKPC has also partnered with the University of Kentucky's College of Agriculture and with farmers in northeastern Kentucky to explore opportunities for using switchgrass in EKPC's power plants.

A closely related alternative to the use of landfill gas is a process referred to as anaerobic digestion. In anaerobic digesters, waste from feedlots or sewage treatment facilities is fed to bacteria that decompose it in an oxygen-free environment. This decomposition produces gases that can then be combusted to produce electricity. A concrete anaerobic digester on a hog farm can be seen in Figure 7.



Figure 7. Concrete digester on a hog farm. Source: NREL PIX.

Despite the unique advantages of anaerobic digestion—its production of high-quality fertilizer as a byproduct, odor control, and contribution to water-quality protection—it does not yet occur on a large scale. Most waste energy is currently derived from municipal solid waste (MSW), manufacturing waste, and landfill gas.

## Dairyland Power Cooperative

Dairyland Power Cooperative is a generation and transmission cooperative based in La Crosse, WI. It provides wholesale power to 25 member cooperatives and 16 municipal utilities in Illinois, Iowa, Minnesota, and Wisconsin. Dairyland engages in numerous renewable energy and energy efficiency activities. Its goal is to get 10 percent of its total power from renewable sources by 2015. Its projected 2011 renewable energy mix is 41 percent biomass, 22 percent landfill gas, 5 percent anaerobic digesters, 22 percent wind, and 10 percent hydro.

Dairyland has gas purchase agreements with three dairy farms in its service territory, in which farmer-owned digesters deliver biogas to Dairyland-owned generators located on the farms. The operation and maintenance of the combined digester and generator plant is contracted to Microgy to keep the digesters from being a burden to the farmers. The first of the three biogas-fired plants is located on Five Star Dairy Farm near Elk Mound, WI, and came online in June 2005. The second is located on Wild Rose Dairy near La Forge, WI, and came online in August 2005. The third is located on Norswiss Farms near Rice Lake, WI, and came online in 2006. Each of these facilities has a capacity between 775 kW and 840 kW. Dairyland also buys the output of several additional digesters, including one on Bach Farms near Dorchester, WI. It plans to eventually get as much as 25 MW of power from anaerobic digesters.

Dairyland has invested in landfill gas generation as well. It owns the Veolia ES Seven Mile Creek landfill gas generation facility at the Seven Mile Creek landfill near Eau Claire, WI. This facility first came online in 2004 and was subsequently expanded in 2008. It now has a nameplate capacity of 2 MW. Dairyland also purchases the output of landfill generators at Timberline Trail landfill, located in Bruce, WI, and Central Disposal Landfill, located in Lake Mills, IA. These generation facilities are owned by Waste Management, Inc. The former facility has a capacity of 5.6 MW, and the latter has a capacity of 4.8 MW. Both have been online since 2006.

Dairyland also has a voluntary green pricing program through which its customers can purchase 100 kWh blocks of renewable energy at a premium of \$1.50 per block. This energy is sourced from wind, hydro, and biomass. Revenue from this program has enabled Dairyland to purchase the entire output of a new biomass power plant in Cassville, WI, owned by a subsidiary of DTE Energy Services.

## Regional Availability

A map depicting biomass resource availability within the United States can be seen in Figure 8. For more information on the methods with which these data were determined, refer to NREL/TP-560-39181, *A Geographic Perspective on the Current Biomass Resource Availability in the United States*, by A. Milbrandt.

The same data as those depicted in Figure 8, normalized by county area, can be seen in Figure 9. This gives a rough indication of the amount of biomass available per square kilometer in each county.

The same data as those depicted in Figure 8, normalized by county population, can be seen in Figure 10. This gives a rough indication of the amount of biomass available per person in each county.

### Buckeye Power, Inc.

Buckeye Power, Inc. (BPI) is a generation and transmission cooperative based in Columbus, OH. It has 24 member distribution cooperatives in Ohio and one in Michigan. These co-ops collectively serve more than 380,000 residences and businesses in 77 of Ohio's 88 counties. BPI has recently added power from two anaerobic digesters to its energy portfolio.

The first of these digesters, located at Bridgewater Dairy in Columbus, came online in August 2008. It was the first anaerobic digester to generate electricity in the state. It features an underground digester designed by GHD, Inc., that processes manure from roughly 3,900 cows. The nameplate capacity of this facility is 1.2 MW, and BPI purchases its entire output, including the renewable energy credits. The USDA Rural Development program awarded Bridgewater Dairy a \$500,000 grant for the digester, under the 2002 Farm Bill's Renewable Energy Systems and Energy Efficiency Improvements Program (Section 9006).

The second digester is located at Wenning Poultry in Mercer County, OH, and came online in October 2008. It also features an underground digester designed by GHD, Inc. This digester processes the roughly 25 tons of waste produced daily by about 750,000 hens. Its nameplate capacity is 1.8 MW, and BPI purchases the entire output, including the renewable energy credits. It features three 600 kW generators and is designed to use 30 percent to 60 percent of the waste heat it generates. The remaining waste heat can be used by the farm. As with the Bridgewater Dairy facility, the USDA Rural Development program awarded Wenning Poultry a \$500,000 grant for its digester. Notably, a nearby 3-phase circuit made it easy for Midwest Electric, a member of BPI, to connect the Wenning Poultry project to the grid. Wenning Poultry expects seven years to elapse before it sees a positive return on its investment.

# Biomass Resources Available in the United States

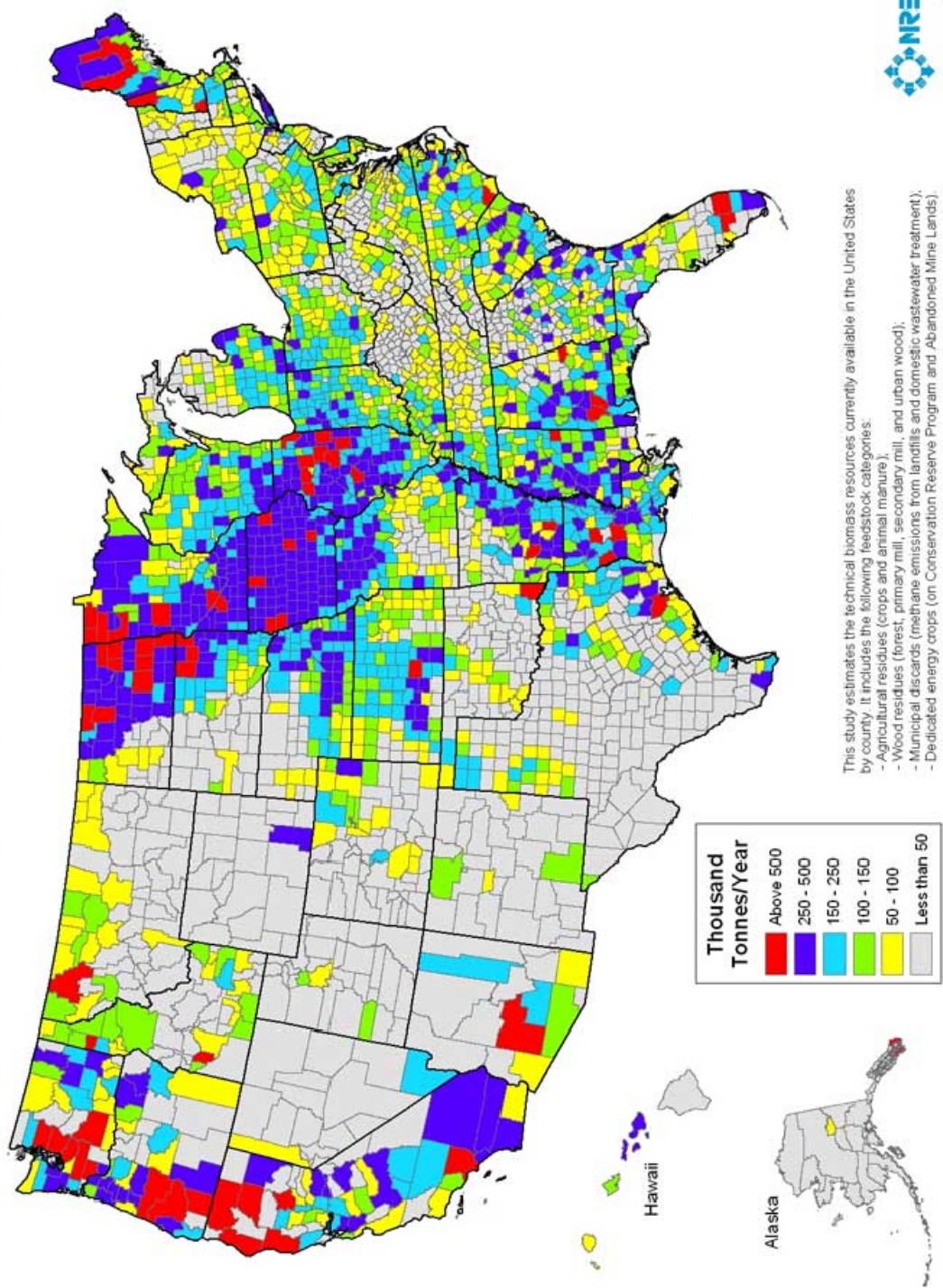

This study estimates the technical biomass resources currently available in the United States by county. It includes the following feedstock categories:

- Agricultural residues (crops and animal manure);
- Wood residues (forest, primary mill, secondary mill, and urban wood);
- Municipal discards (methane emissions from landfills and domestic wastewater treatment);
- Dedicated energy crops (on Conservation Reserve Program and Abandoned Mine Lands).

Figure 8. U.S. Biomass resource map, 2005. Source: NREL/TP-560-39181.

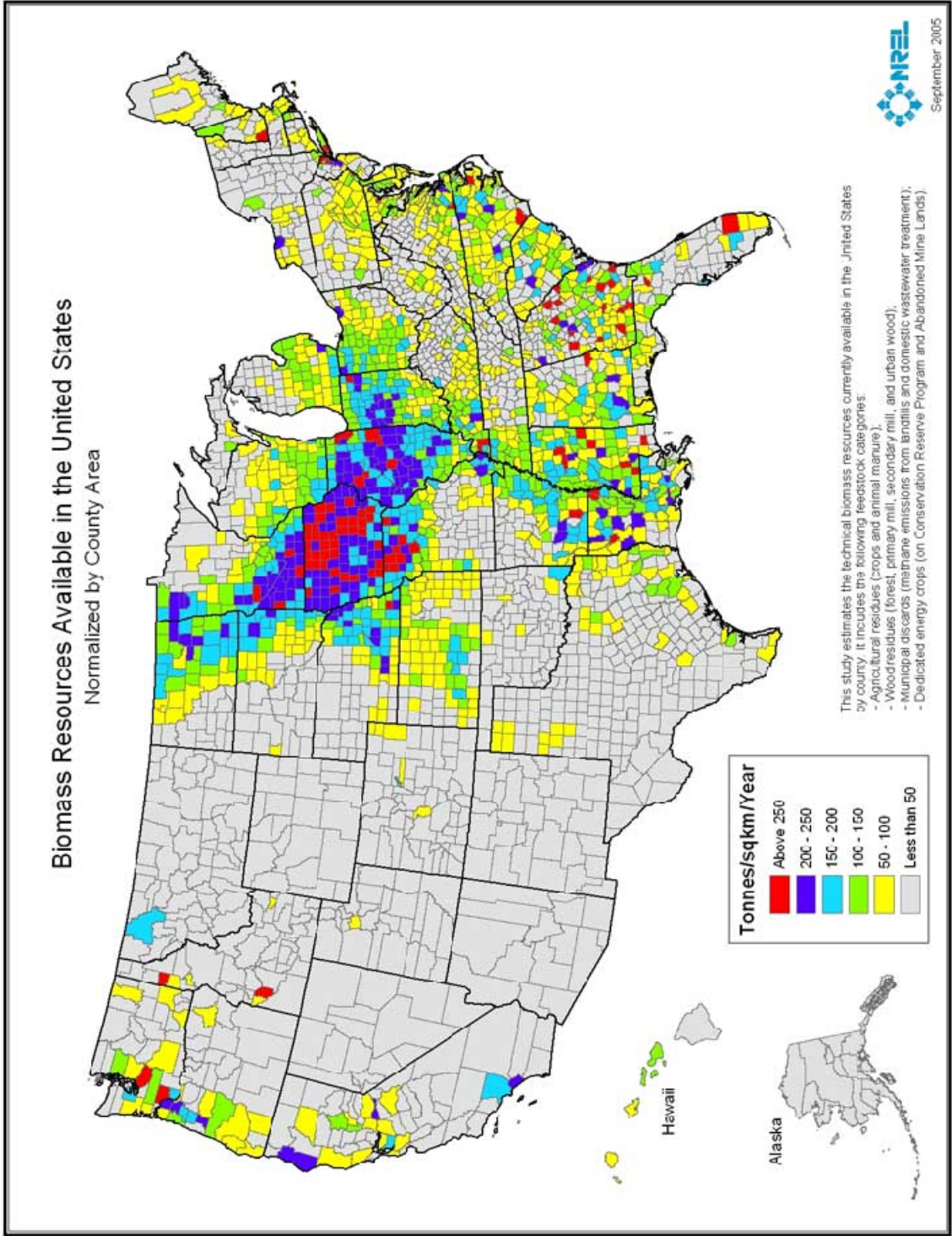

Figure 9. U.S. Biomass resource map normalized by area, 2005. Source: NREL/TP-560-39181.

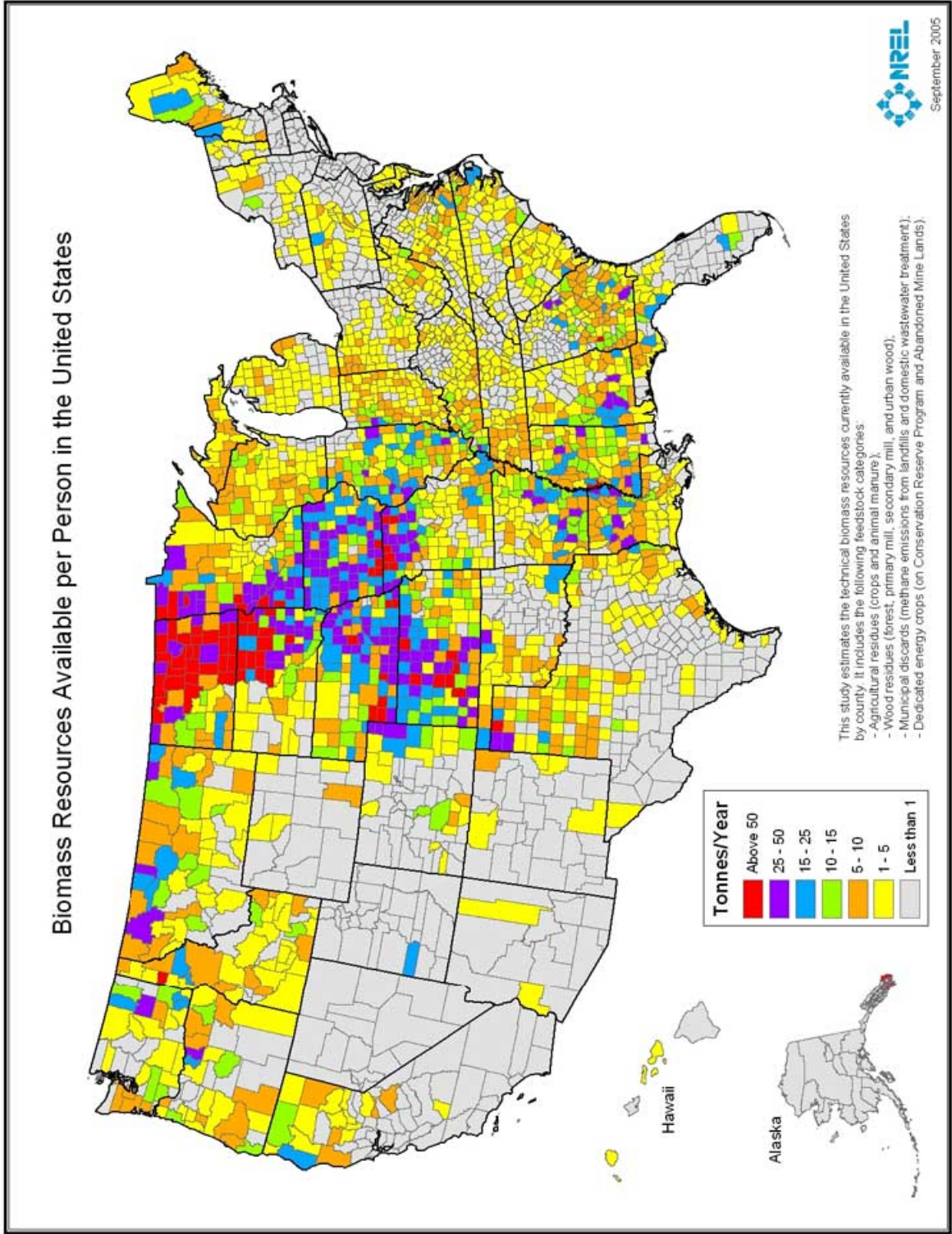

Figure 10. U.S. Biomass resource map, normalized by county population, 2005. Source: NREL/TP-560-39181.

**Table 1. Total installed biopower capacity by state, 2007 (MW). Data: EIA, Form EIA-860, "Annual Electric Generator Report."**

State	Landfill Gas / MSW / Biogenic <sup>a</sup> (Waste)	Other Biomass <sup>b</sup> (Residues/Waste)	Wood and Derived Fuels <sup>c</sup>
Alabama	-	-	-
Alaska	-	-	-
Arizona	4	-	3
Arkansas	5	6	292
California	278	145	584
Colorado	-	10	-
Connecticut	170	-	-
Delaware	7	-	-
District of Columbia	-	-	-
Florida	463	193	343
Georgia	5	44	450
Hawaii	60	49	-
Idaho	-	-	75
Illinois	118	15	-
Indiana	40	-	-
Iowa	11	3	-
Kansas	-	-	-
Kentucky	15	-	43
Louisiana	-	15	318
Maine	53	36	620
Maryland	126	-	2
Massachusetts	264	9	26
Michigan	152	-	210
Minnesota	129	55	162
Mississippi	-	-	229
Missouri	3	-	-
Montana	-	-	17
Nebraska	6	4	-
Nevada	-	-	-
New Hampshire	31	-	141
New Jersey	181	20	-
New Mexico	-	6	-
New York	325	-	37
North Carolina	14	-	324
North Dakota	-	10	-
Ohio	4	-	64
Oklahoma	16	-	63
Oregon	17	3	195
Pennsylvania	359	-	108
Rhode Island	24	-	-
South Carolina	29	-	220
South Dakota	-	-	-
Tennessee	5	2	145
Texas	55	16	130
Utah	4	-	-
Vermont	-	-	76
Virginia	170	-	409
Washington	35	-	345
West Virginia	-	-	-
Wisconsin	62	1	220
Wyoming	-	-	-
<b>Total</b>	<b>3,238</b>	<b>643</b>	<b>6,432</b>

<sup>a</sup> Total capacity whose primary energy source is landfill gas or MSW.

<sup>b</sup> Agriculture byproducts/crops, sludge waste and other biomass solids, liquids and gases.

<sup>c</sup> Black liquor, and wood/woodwaste solids and liquids.

PV=Photovoltaic.

MSW=Municipal Solid Waste.

\* =Less than 500 kilowatts.

Note: Dash indicates the state has no data to report for that energy source. Totals may not equal sum of components due to independent rounding.

As shown in Figure 8 through Figure 10, the Great Plains and upper Midwest are rich in biomass resources, and this makes them particularly well-suited for biopower applications. However, as can be seen in Table 1, much of this potential is not realized. The 10 states with the most installed biopower capacity are California, Florida, Maine, Virginia, Georgia, Pennsylvania, Washington, Michigan, New York, and Minnesota. Only two of these states are in the relatively biomass-rich Great Plains and upper Midwest.

Biomass resource availability by state can be seen in Table 2. These data indicate that the Great Plains and upper Midwestern states are particularly rich in crop residues, switchgrass on Conservation Reserve Program (CRP) Lands, and methane from manure management. A map depicting the availability of crop residues can be seen in Figure 11. Maps depicting potential switchgrass production on CRP lands, and potential willow or hybrid poplar (trees that can be grown as dedicated energy crops) production on CRP lands, can be seen in Figure 12 and Figure 13, respectively. A map depicting the availability of methane from manure management can be seen in Figure 14.

Note that methane emissions from manure management are not as concentrated in the Great Plains and upper Midwest as are crop residues and potential dedicated energy crop production. This indicates that methane from manure may be a more viable source of biopower for communities outside of these regions.

A map depicting landfill gas projects and candidate landfills for each state, provided by the Landfill Methane Outreach Program (LMOP), can be seen in **Error! Reference source not found..**



Table 2. Biomass resource availability by state, 2005 (1000 tonnes). Data: NREL/TP-560-39181.

State	Crop Residues	Switchgrass on CRP Lands	Forest Residues	Methane from Landfills	Methane from Manure Management	Primary Mill	Secondary Mill	Urban Wood	Methane From Domestic Wastewater	Total Biomass
Alabama	391	2,660	2,555	236	94	5,857	57	483	7	12,340
Alaska	0	0	738	11	0	231	2	65	1	1,049
Arizona	351	0	59	151	14	109	41	526	8	1,258
Arkansas	4,796	951	2,874	38	145	3,623	32	314	4	12,777
California	1,659	0	1,303	1,359	142	4,772	247	3,901	56	13,437
Colorado	1,550	0	70	273	28	181	41	451	7	2,601
Connecticut	0	1	78	66	0	75	24	376	6	625
Delaware	245	22	51	58	0.5	14	8	85	1	482
District of Columbia	0	0	0	0	0	0	0	56	1	57
Florida	3,263	460	1,778	457	19	1,901	130	1,678	26	9,711
Georgia	997	1,646	3,556	201	139	7,231	97	924	14	14,804
Hawaii	396	0	0	58	3	0	10	133	2	603
Idaho	1,788	0	873	7	31	4,400	20	129	2	7,250
Illinois	19,593	5,290	664	974	76	233	96	1,337	21	28,284
Indiana	8,976	1,609	863	526	77	574	71	715	10	13,421
Iowa	23,590	10,249	359	137	142	130	29	320	5	34,961
Kansas	7,614	6,274	134	139	22	29	19	332	4	14,568
Kentucky	1,722	1,822	2,055	250	34	1,433	52	454	7	7,830
Louisiana	4,335	1,072	3,384	166	6	3,577	33	474	7	13,054
Maine	0	0	2,890	27	0.2	421	15	133	2	3,489
Maryland	584	271	263	204	6	138	33	624	9	2,131
Massachusetts	0	0	89	206	0.1	113	52	687	10	1,157
Michigan	3,586	1,451	1,275	446	30	1,314	86	1,196	16	9,399
Minnesota	14,231	7,851	2,242	148	71	985	59	496	8	26,090
Mississippi	2,191	4,883	3,825	93	72	4,548	33	307	5	15,956
Missouri	6,007	8,473	1,840	273	120	1,036	69	613	9	18,439
Montana	1,560	0	704	21	4	1,937	13	106	1	4,347
Nebraska	10,931	3,344	72	48	102	57	13	189	3	14,759
Nevada	4	0	5	76	0.4	0	17	232	3	338
New Hampshire	0	0	986	40	0	925	18	126	2	2,097
New Jersey	91	11	29	497	0.3	17	58	894	14	1,612
New Mexico	168	0	71	31	60	165	9	191	3	697
New York	507	264	1,111	885	10	1,063	119	2,041	31	6,031
North Carolina	1,494	577	2,995	427	370	3,900	115	833	13	10,726
North Dakota	6,602	10,476	27	5	4	0.4	7	67	1	17,190
Ohio	5,001	1,587	796	647	41	786	124	1,272	19	10,272
Oklahoma	1,641	407	655	153	47	633	23	377	6	3,943
Oregon	567	0	1,041	125	17	6,454	86	382	6	8,676
Pennsylvania	810	672	1,679	642	23	1,358	127	1,238	20	6,569
Rhode Island	0	0	8	28	0	21	6	109	2	174
South Carolina	331	1,061	1,733	181	30	2,468	38	467	7	6,315
South Dakota	5,140	4,807	125	10	36	142	7	75	1	10,342
Tennessee	1,501	1,375	1,319	274	20	1,557	75	614	9	6,745
Texas	6,089	569	2,060	845	58	2,085	148	2,307	34	14,195
Utah	88	0	30	76	10	102	18	228	4	557
Vermont	0	4	496	21	3	103	9	65	1	701
Virginia	502	297	2,403	275	23	2,147	62	813	12	6,535
Washington	1,746	0	1,034	240	39	5,597	85	675	10	9,426
West Virginia	32	9	1,347	47	1	807	15	184	3	2,445
Wisconsin	4,419	3,126	2,011	273	19	1,621	69	548	9	12,096
Wyoming	106	0	58	8	2	255	4	59	1	492
<b>U.S. Total</b>	<b>157,194</b>	<b>83,572</b>	<b>56,612</b>	<b>12,380</b>	<b>2,189</b>	<b>77,125</b>	<b>2,615</b>	<b>30,902</b>	<b>465</b>	<b>423,054</b>

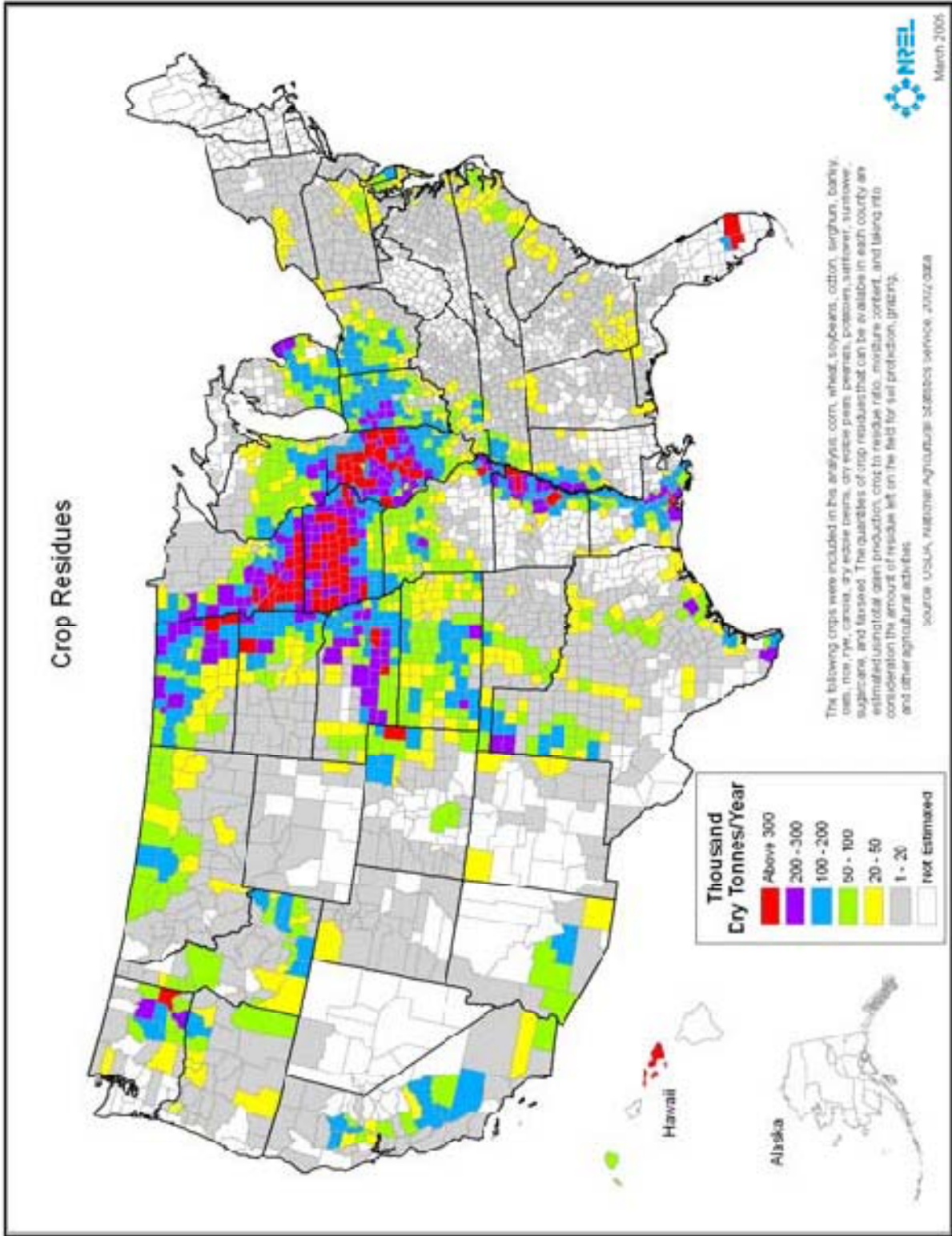

Figure 11. U.S. resource map, crop residues, 2005. Source: NREL/TP-560-39181.

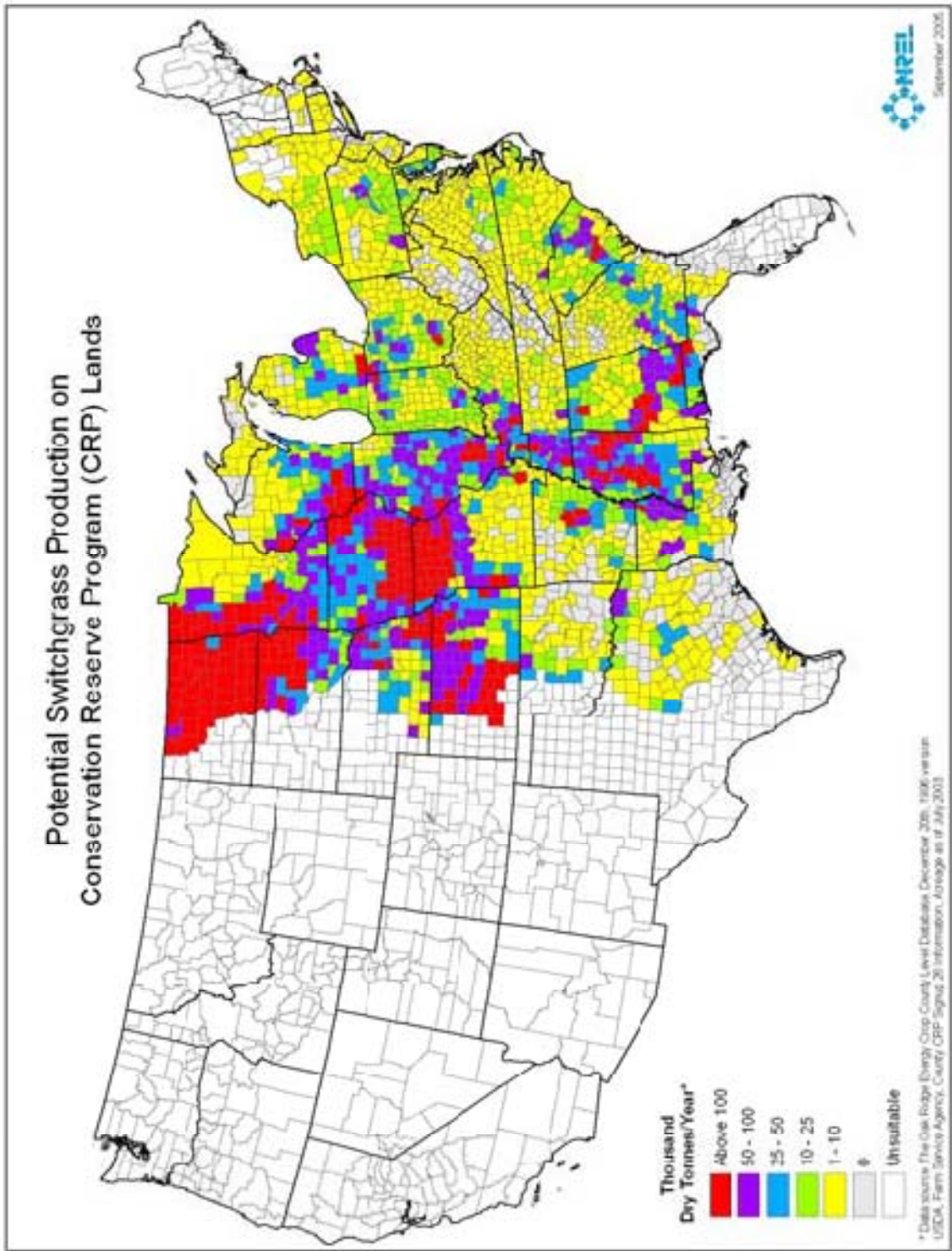

Figure 12. U.S. resource map, potential switchgrass production on CRP lands, 2005. Source: NREL/TP-560-39181.

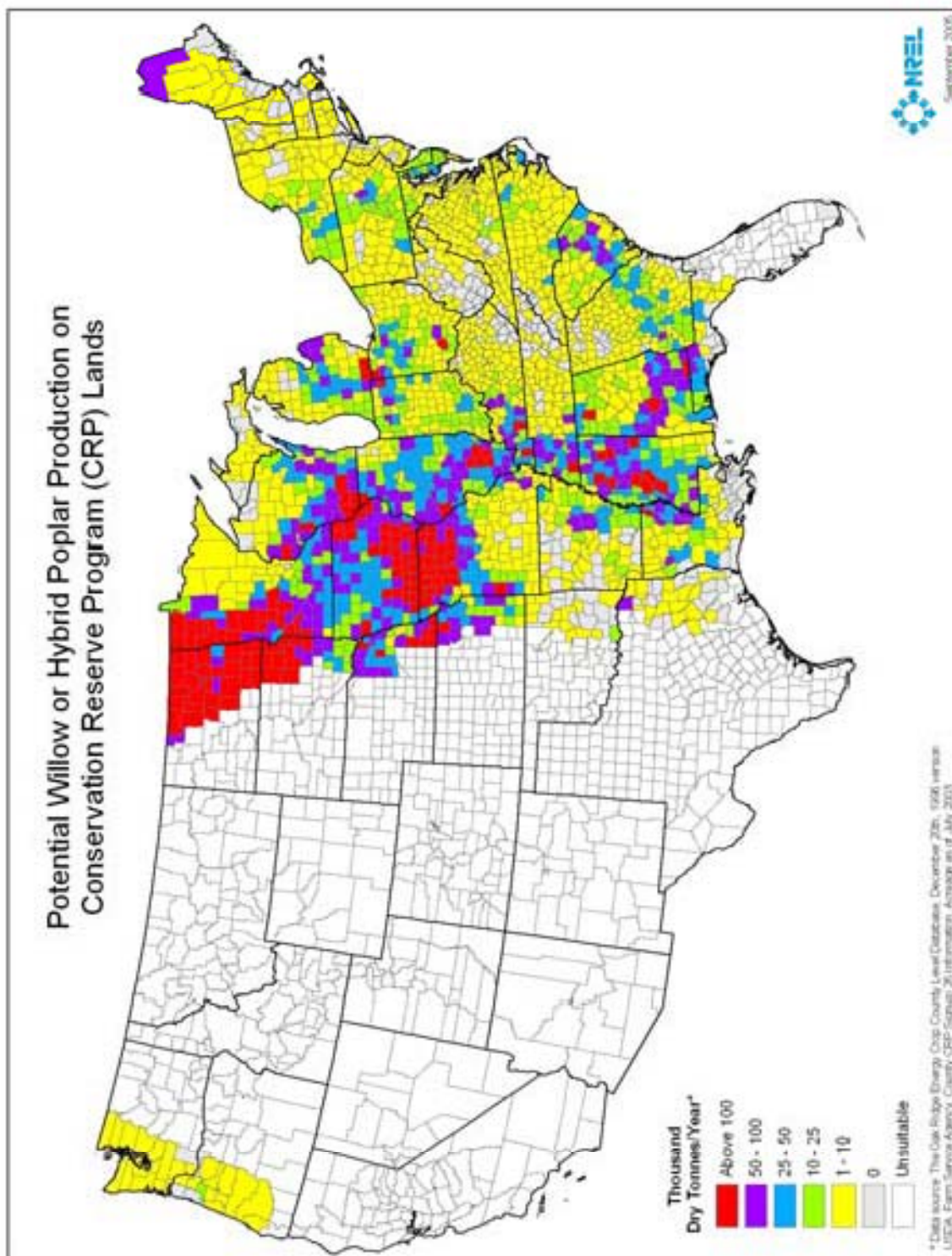

Figure 13. U.S. resource map, potential willow or hybrid poplar production on CRP lands, 2005. Source: NREL/TP-560-39181.

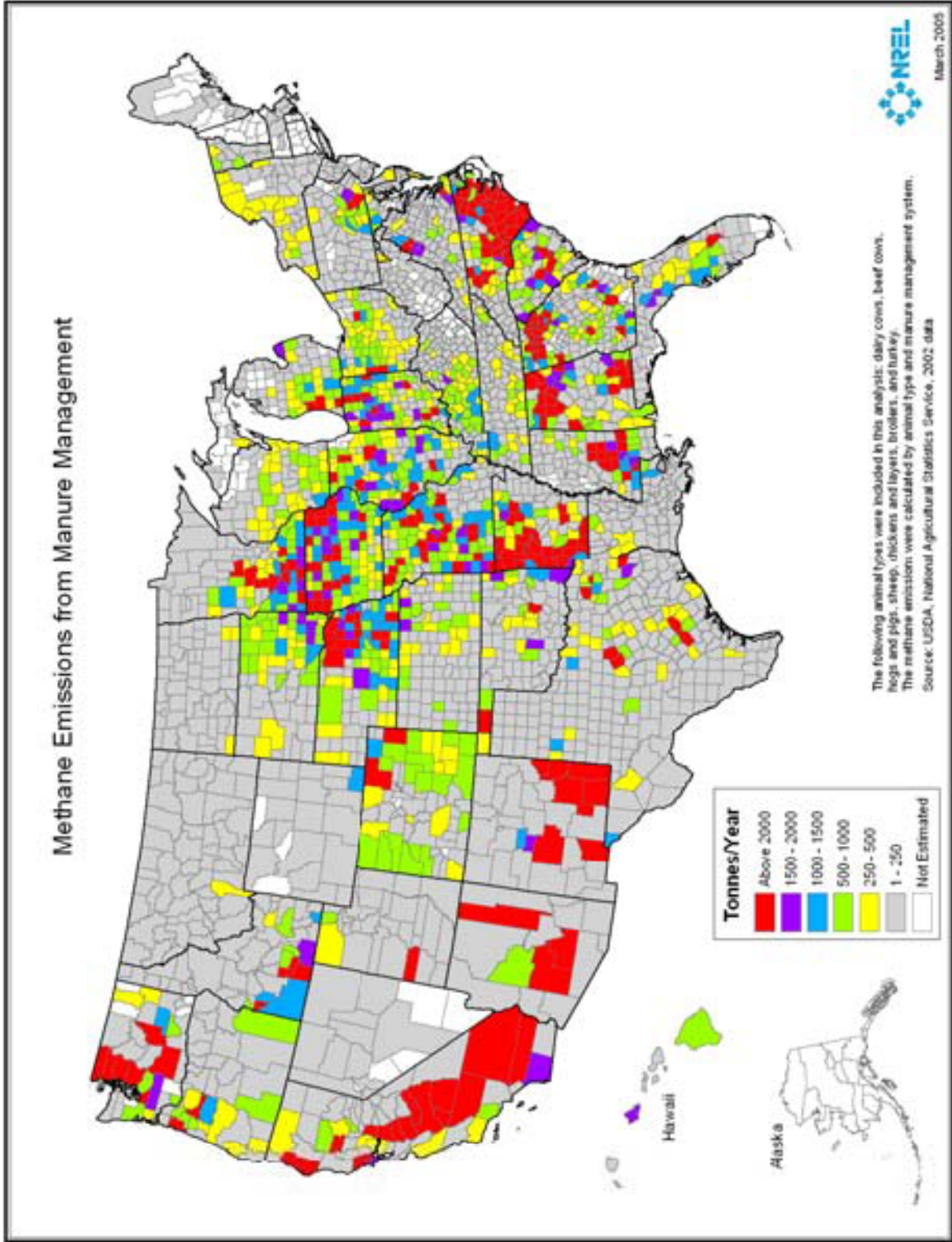
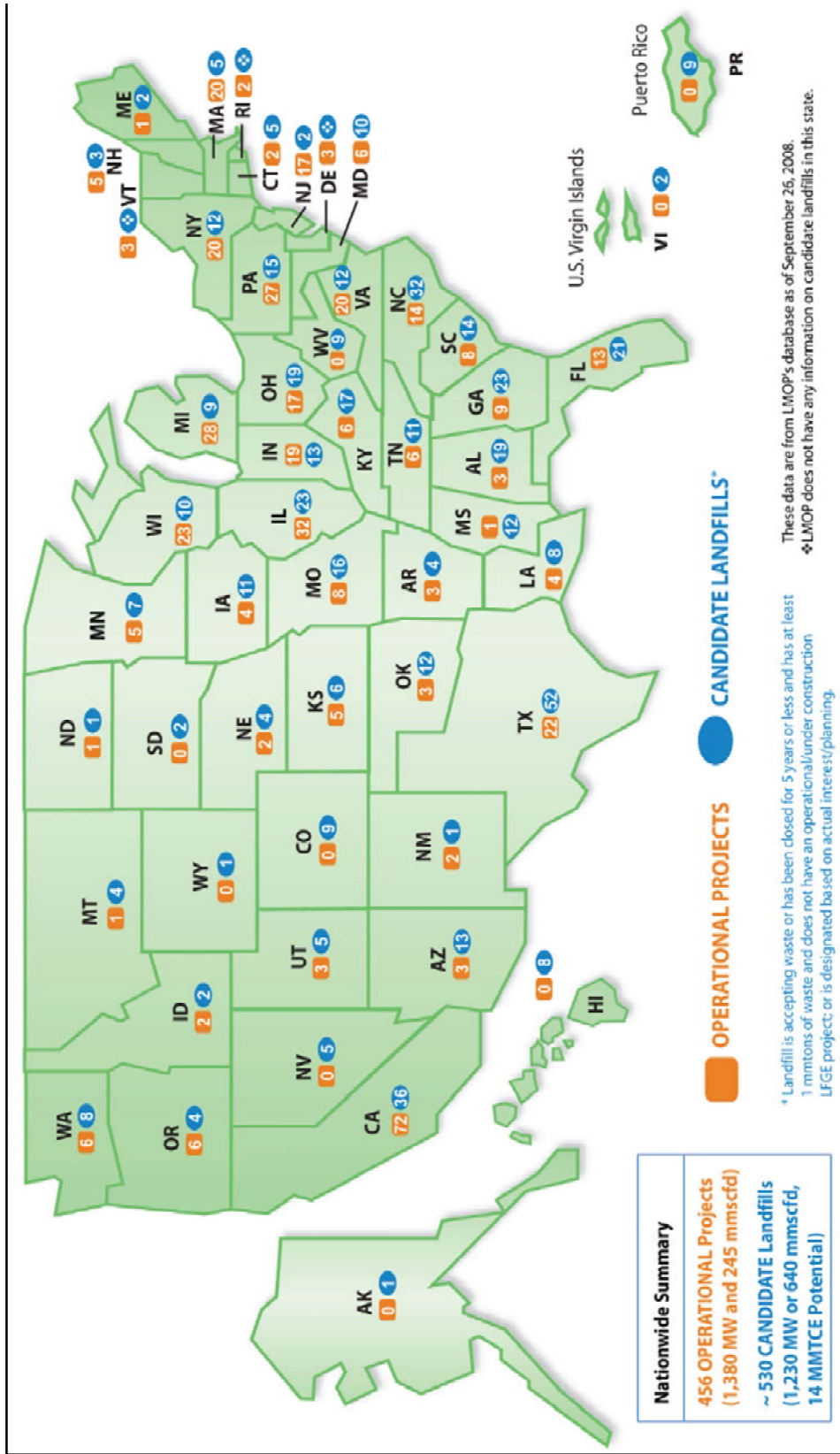

Figure 14. U.S. resource map, methane emissions from manure, 2005. Source: NREL/TP-560-39181.



mmscfd - Million standard cubic feet per day  
 MMTCE - million metric tons of carbon equivalent  
 LMOP - Environmental Protection Agency Landfill Methane Outreach Program

mmtons – million metric tons  
 LFGE – landfill gas energy

Figure 15. Landfill gas projects and candidate landfills by state, 2008. Source: LMOP.

More detailed information on biomass resources can be found in NREL Report No. TP-560-39181, *Geographic Perspective on the Current Biomass Resource Availability in the United States*. Further information is also available from state and regional biomass contacts, whose contact information can be found in the *State & Regional Resources* section of the EERE Biomass Program website (<http://www.eere.energy.gov/biomass/>).

Projections of regional biomass generation capacity can be seen in Figure 16. These data do not include Municipal Solid Waste (MSW).

Figure 16 shows that current projections have the Eastern United States dominating future biopower generation capacity. The Mid-Atlantic Area Council is projected to expand its biopower capacity by 21.4 percent over the period shown, while there is little growth in the remaining regions. This indicates that, unless incentives are re-structured and/or transmission infrastructure is expanded, much of the potential biomass power generation capacity in the Great Plains, upper Midwest, and rural communities with methane emissions from manure will not be realized.

## Regional Biomass Power Generation Capacity, 2005-2030

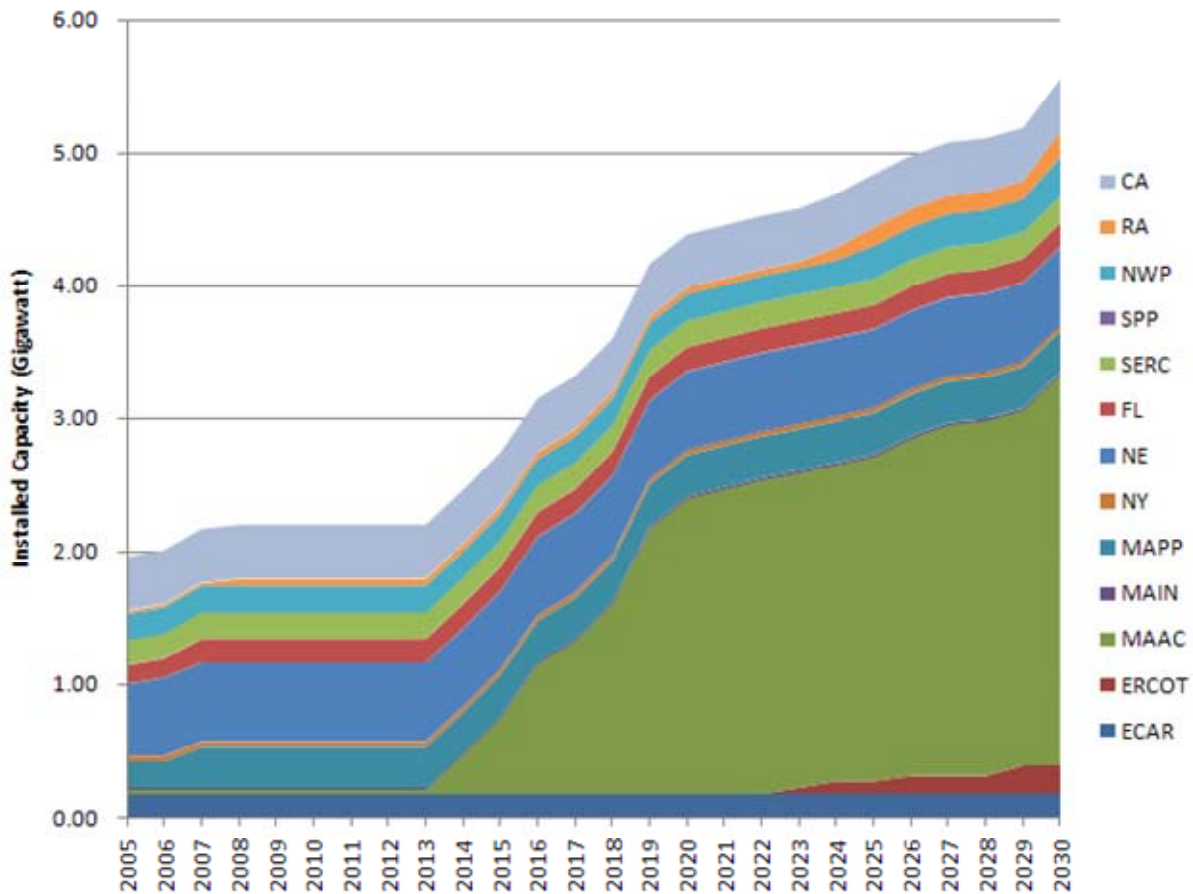

CA - Western Electric Coordinating Council/California  
 RA - Western Electric Coordinating Council/  
 Rocky Mountain Power Area and Arizona-New  
 Mexico-Southern Nevada Power Area  
 NWP - Western Electric Coordinating Council/  
 Northwest Power Pool  
 SPP - Southwest Power Pool  
 SERC - Southeastern Electric Reliability Council

FL - Florida Reliability Coordinating Council  
 NE - Northeast Power Coordinating Council/New England  
 NY - Northeast Power Coordinating Council/New York  
 MAPP - Mid-Continent Area Power Pool  
 MAIN - Mid-America Interconnected Network  
 MAAC - Mid-Atlantic Area Council  
 ERCOT - Electric Reliability Council of Texas  
 ECAR - East Central Area Coordination Agreement

Figure 16. Projected regional biomass power generation capacity, 2005-2030. Data: EIA (April 2008).

## Solar Power

Solar power is generated by turning energy in the sun's light into electrical energy. Many technologies take advantage of solar energy, including Photovoltaic (PV) power systems and Concentrating Solar Power (CSP) systems, as well as passive solar heating, solar hot water, and solar process heating and cooling. The two main technologies used for solar electric power generation are PV and CSP.



PV arrays use semiconductor devices called solar cells to convert sunlight to electricity. These solar cells are typically grouped into modules that hold about 40 cells, and about 10 of these modules are then combined to form the PV array, which is usually several meters to a side. PV arrays can be mounted at a fixed angle facing south, or on a tracking device that follows the motion of the sun across the sky. A household can be powered using 10-20 PV arrays, while utility-scale PV power generation requires hundreds of connected arrays. Most areas in the United States have enough sunlight for cost effective, small-scale, non-grid connected PV, but not all areas have sufficient sunlight for utility-scale PV power generation. A modern PV array can be seen in Figure 17.



Figure 17. Modern photovoltaic (PV) array. Source: NREL PIX.

CSP systems focus the sun's light to produce high-temperature thermal energy, which is then converted into electricity. There are three main types of CSP systems: parabolic trough, dish-engine, and power tower.

In a parabolic trough system, long, U-shaped mirrors concentrate the sun's light onto a pipe that runs parallel to the bottom of the U. Oil flowing through this pipe is heated to extremely high temperatures and then is used to produce steam, which turns a turbine that drives a generator. The largest single-trough system in existence currently produces 80 MW of electricity, but future troughs may produce as much as 250 MW. Multiple troughs are often combined in a single facility.

In a dish-engine system, a dish is used to concentrate the sun's light. This concentrated light produces heat, which is transferred to a liquid that expands against a piston or turbine to produce mechanical power. This mechanical power can then be used to drive a generator or to perform other tasks. Dish-engine systems produce less power than other types of CSP systems, typically generating 3 to 25 kW of electricity.

In a power tower system, a large field of mirrors concentrates the sun's light at the top of a tower. This concentrated light heats molten salt that flows through a receiver at the top of the tower, and the molten salt is then used to produce steam. This steam turns a turbine that drives a generator, producing electricity. Power tower systems can produce up to 200 MW of electricity.

## Advantages

There are several advantages to the use of solar power. It does not degrade air or water quality and does not produce any CO<sub>2</sub> emissions. Unlike many other forms of power generation, it does not require the extraction, transportation, storage, or combustion of fuels. Some solar power systems have no moving parts, reducing maintenance costs. Also, while CSP technologies are still in relatively early stages of development, PV is a well-established technology.

A significant advantage of CSP technologies is that these systems are readily scalable. They can be sized to generate several kilowatts of power for a single community or hundreds of megawatts for a grid-connected application. A further advantage specific to power tower systems is that molten salt retains heat well, so it can be stored for days before being used to produce electricity. This can help to mitigate the variable availability of solar resources by allowing the power tower system to provide power on cloudy days or even after the sun has set.

## Issues

High capital cost is a major, though not insurmountable, issue for solar power. Another significant issue is that resource availability depends on the time of day and the weather. This leads to daily and seasonal fluctuations in solar power generation. Technologies that track the movement of the sun and efficiently store energy, such as power tower systems, can help to mitigate this variability. Furthermore, solar resource availability is often positively correlated with demand; more sunlight is available during the summer months, when peak electricity demand is often highest, which also helps mitigate the issue of intermittency.

One issue with PV technologies is that their efficiency is low compared to those of traditional fossil fuel or nuclear power plants. Commercial PV cells typically exhibit efficiencies of roughly 15 percent. Also, very large surface areas are required for utility-scale PV power generation. Although the Great Plains and upper Midwest feature many large open spaces that could be repurposed for PV power generation, this would preclude any other use of that land. (This is in contrast to wind power, which minimally disrupts other land uses.) Utility-scale PV power generation therefore may be more feasible in the relatively arid Southwest. This aridness, however, can pose a challenge to solar power technologies that require water to produce steam and for cooling.

## Applications

There are many small, stand-alone applications for solar power, most of which use PV technologies, though some may rely on small dish-engine systems. Businesses can use PV for heating and cooling, various industrial processes, and water heating. Homes can use PV for heating and cooling as well as water heating, and may even produce enough electricity with PV to operate off of the grid. Businesses and homes may be able to use PV to reduce electricity bills by selling excess electricity back to utilities. Such grid-connected solar systems have become a larger market than off-grid applications. Technologies are also being developed that will allow PV cells to be built directly into roofs, windows, and other structural elements of a building.

An example of a small, stand-alone application of solar power can be seen in Figure 18, which shows a horse corral powered by PV arrays on its roof.



**Figure 18. Solar-powered horse corral. Source: NREL PIX.**

Communities and individuals can find many applications for small-scale PV in addition to those associated with buildings. PV can be used to power water pumps and communication equipment in remote areas. It is also well-suited for small electronics applications in which using PV is cheaper and cleaner than extending existing power lines. For example, a solar-powered water pumping station can be seen in Figure 19.



**Figure 19. Solar-powered water pumping station. Source: NREL PIX.**

Though very few utility-scale PV power generation facilities have been installed as of this writing, PV does have utility-scale potential. To supply bulk power for the grid, PV arrays would have to be installed in large fields for power output of a few MW or more.

## Tri-State Generation and Transmission Association

Tri-State Generation and Transmission Association is a generation and transmission cooperative based in Westminster, CO. It has 44 member cooperatives in Colorado, Nebraska, New Mexico, and Wyoming, covering a 250,000-square-mile service territory. It is a leading investor in utility-scale solar power.

Tri-State recently entered into a partnership with First Solar, Inc. to develop the Cimarron I Solar Project in northeastern New Mexico. The project includes a solar power plant that uses 500,000 2-foot by 4-foot photovoltaic panels to generate 30 MW of power. It will be one of the largest PV power plants worldwide and is expected to come online in December 2010.

First Solar is a private company based in Tempe, AZ. It will be in charge of engineering, procurement, and construction (EPC) and responsible for maintaining the Cimarron I facility. Tri-State has agreed to purchase the output of Cimarron I for the first 25 years of its operation.

Unlike PV systems, CSP systems were designed specifically for utility-scale applications. Over the last 15 years, several prototype CSP systems have been tested around the world. Nine parabolic trough plants with total capacity of 354 MW have been operating in California since the 1980s. Arizona, Colorado, Nevada, and Spain all have experimental dish-engine systems in operation. The U.S. government currently sponsors Solar Two, a prototype 10 MW power tower plant with three hours of energy storage. A picture of Solar Two can be seen in Figure 20.



Figure 20. Solar Two power tower concentrating solar power facility. Source: NREL PIX.



Figure 21. Parabolic trough solar power facility. Source: NREL PIX.

The world's largest solar power facility can be seen in Figure 21. This parabolic trough CSP facility is located near Kramer Junction, CA, and consists of five Solar Electric Generating Stations (SEGS) that have a combined generation capacity of 150 MW. The parabolic troughs have more than 1 million square meters of surface area, and the facility itself covers more than 1,000 acres.

### Arizona Electric Power Cooperative

Arizona Electric Power Cooperative (AEPCO) is a generation and transmission cooperative based in Benson, Arizona. It has joined the Southwest Energy Service Provider's Consortium for Solar Development, a group of southwestern energy providers that plan to build a 250 MW Concentrating Solar Power (CSP) power plant, either in Arizona or Nevada. The plant will be owned by a third party, and each member will enter into a long-term power purchase agreement with that entity.

AEPCO has encouraged its customers to invest in distributed solar generation. As a part of its SunWatts program, many photovoltaic arrays have been installed throughout its service territory.

### Regional Availability

A map depicting solar resource availability within the United States for non-tracking PV applications can be seen in Figure 22. This map displays total solar resource availability averaged over one year, on a grid whose cells are approximately 40 km by 40 km in size. The values displayed represent the resource available to a photovoltaic panel oriented due south, at an angle from horizontal equal to the latitude of the panel's location.

A map depicting solar resource availability within the United States for tracking PV or CSP applications can be seen in Figure 23. This map also displays total solar resource availability averaged over one year, on a grid whose cells are approximately 40 km by 40 km in size. The values displayed in Figure 23, however, represent the resource available to PV panels or concentrating systems that track the movement of the sun across the sky.

Figure 22 and Figure 23 show that the best solar resources are located in the Southwestern United States. More detailed maps of Southwestern solar resources can be seen in Figure 24 and Figure 25. These maps identify areas most economically suitable for deploying large-scale CSP power plants by filtering data similar to that of Figure 23 by solar resource availability and land availability.

# PV Solar Radiation (Flat Plate, Facing South, Latitude Tilt)

Annual

Model estimates of monthly average daily total radiation using inputs derived from satellite and/or surface observations of cloud cover, aerosol optical depth, precipitable water vapor, albedo, atmospheric pressure and ozone resampled to a 40km resolution. See [http://www.nrel.gov/gisfil\\_solar\\_pv.html](http://www.nrel.gov/gisfil_solar_pv.html) documentation for more details.

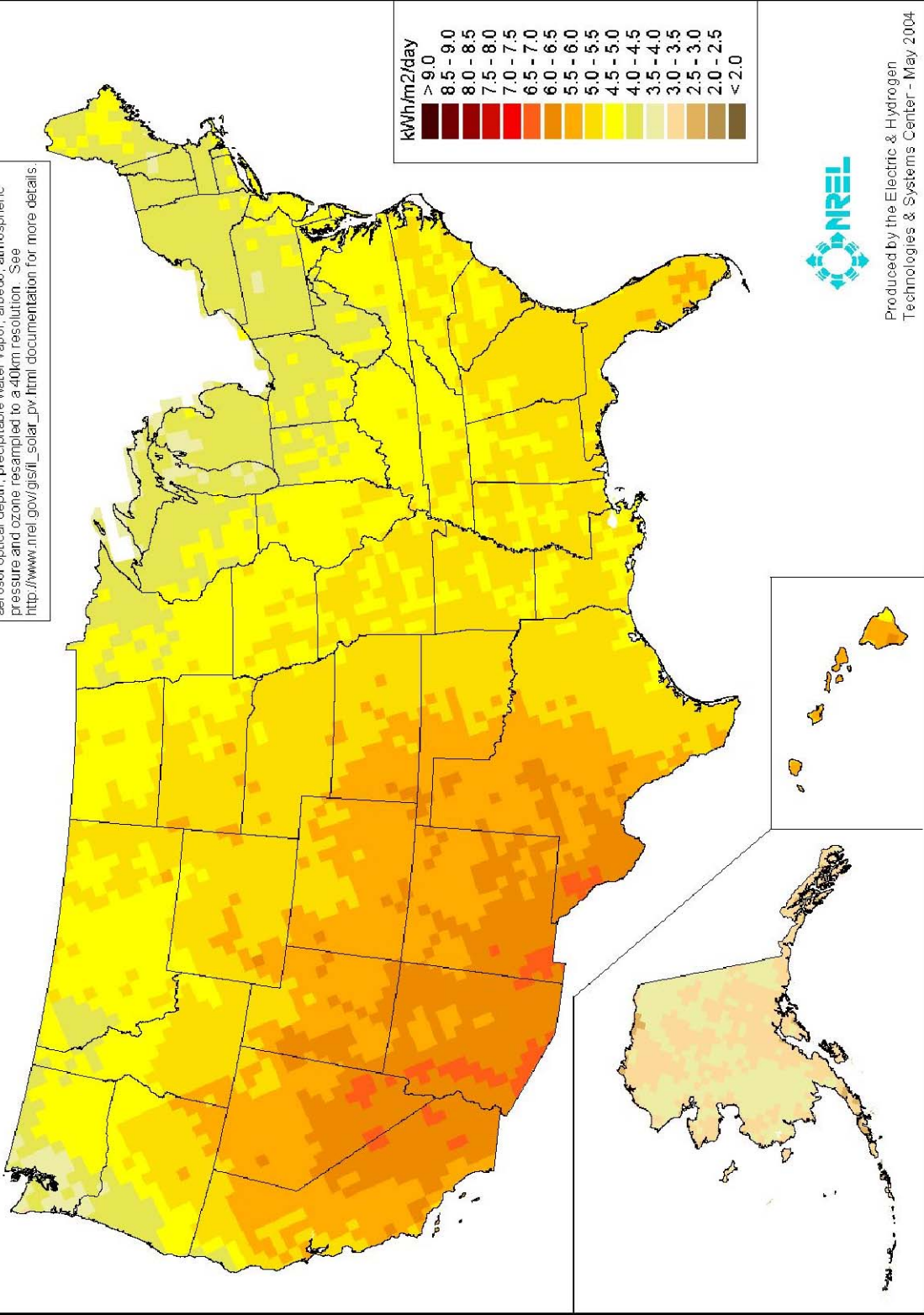

Produced by the Electric & Hydrogen  
Technologies & Systems Center - May 2004

Figure 22. U.S. solar resource availability, non-tracking photovoltaic, 2004 (40-km resolution). Source: NREL GIS.

# Direct Normal Solar Radiation (Two-Axis Tracking Concentrator)

# Annual

Model estimates of monthly average daily total radiation using inputs derived from satellite and/or surface observations of cloud cover, aerosol optical depth, precipitable water vapor, albedo, atmospheric pressure and ozone resampled to a 40km resolution. See [http://www.nrel.gov/gis/til\\_csp.html](http://www.nrel.gov/gis/til_csp.html) documentation for more details.

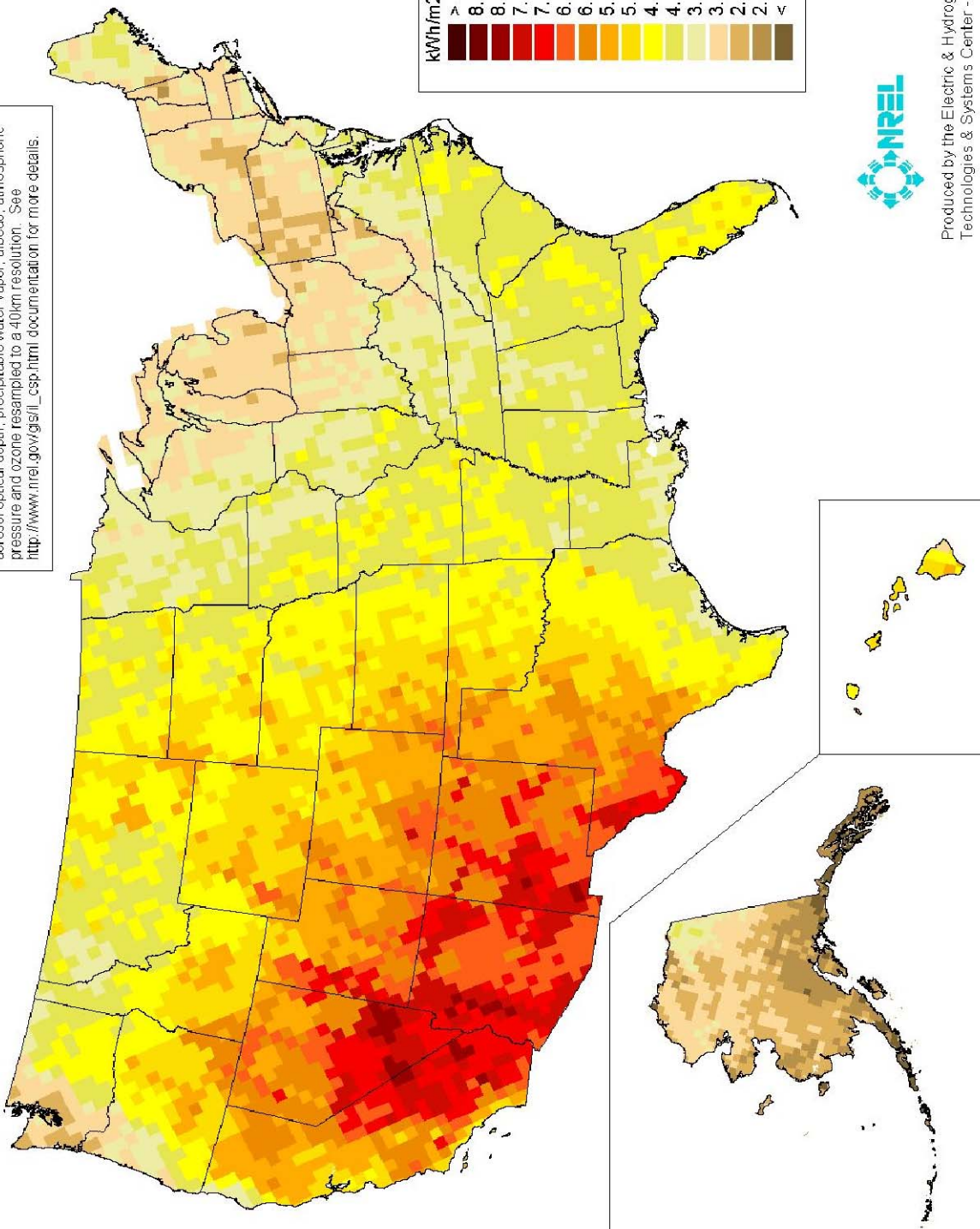

Produced by the Electric & Hydrogen  
Technologies & Systems Center - May 2004

Figure 23. U.S. solar resource availability, tracking photovoltaic or concentrating solar power, 2004 (40-km resolution). Source: NREL GIS.

Figure 24 excludes land with a slope that exceeds 1 percent. Figure 25 excludes land with a slope that exceeds 3 percent. This is because CSP facilities must be built on flat ground. Note that increasing the maximum allowable slope to 3 percent significantly increases the total surface area that is economically suitable for deploying large-scale CSP power plants.

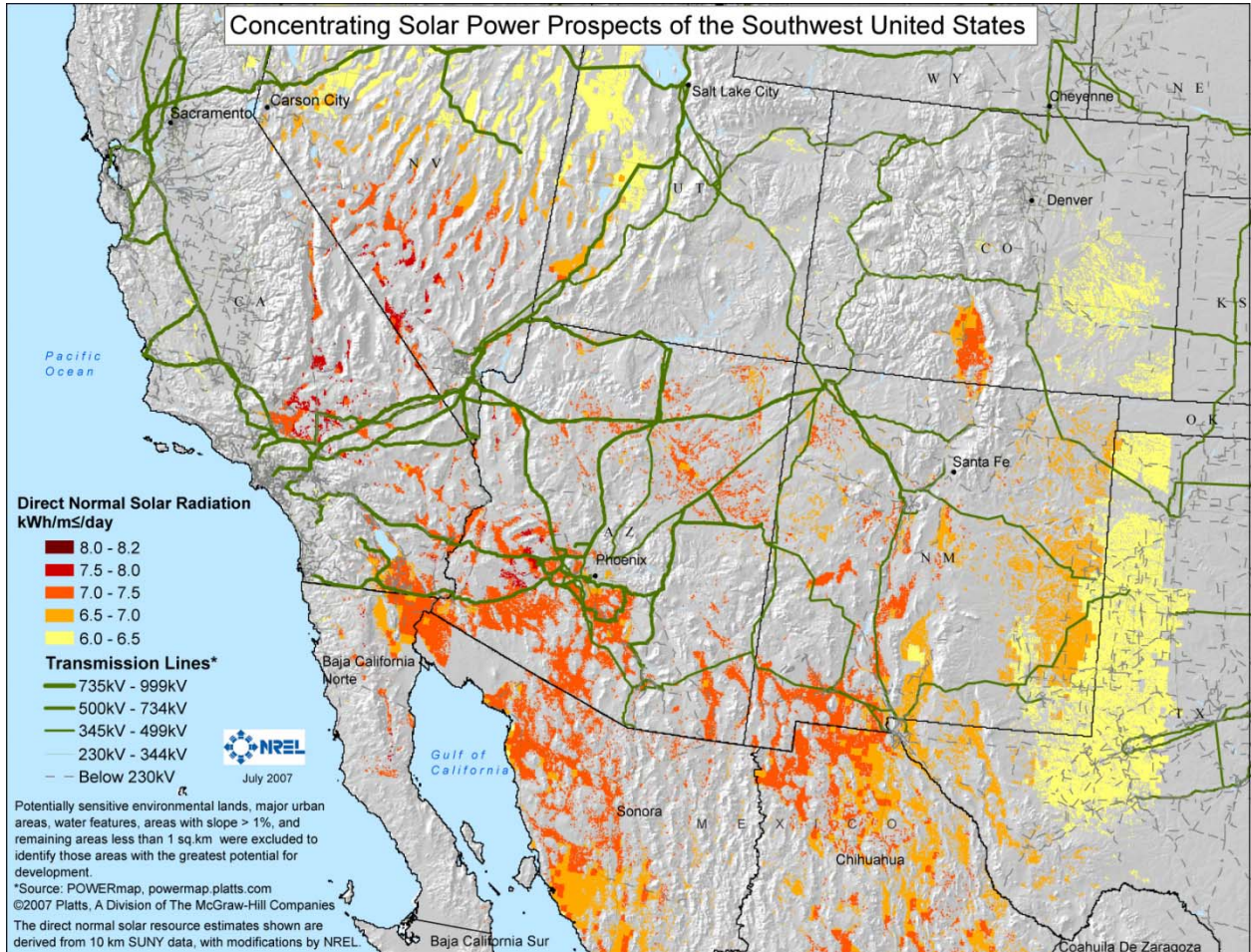

Figure 24. Southwestern U.S. concentrating solar power resource availability, excluding land with slopes >1%, 2007. Source: NREL.



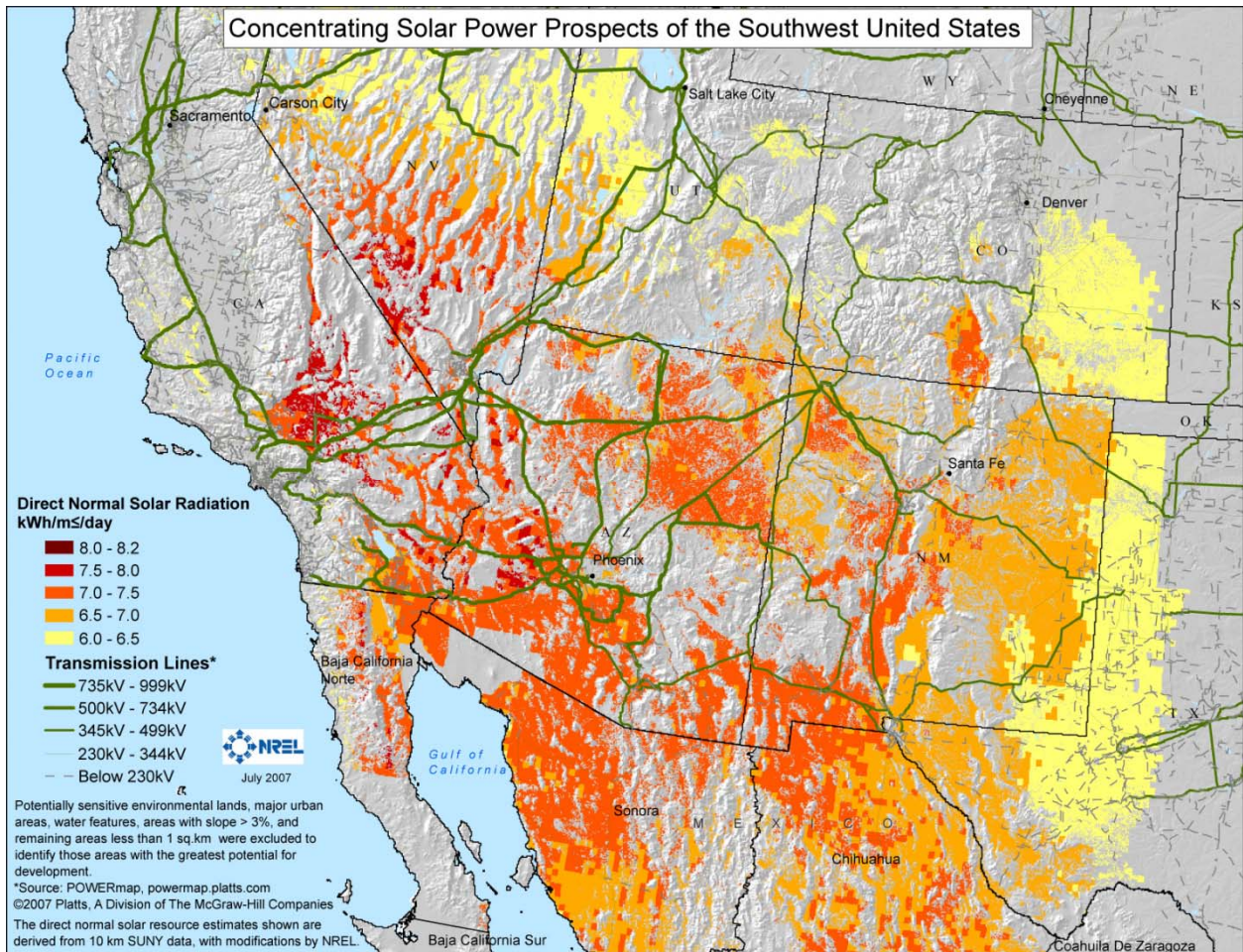

Figure 25. Southwestern U.S. concentrating solar power resource availability, excluding land with slopes >3%, 2007. Source: NREL.

Table 3. Total installed solar power capacity by state, 2007 (MW). Data: EIA, Form EIA-860, "Annual Electric Generator Report."

State	Capacity
Arizona	9
California	403
Colorado	8
Nevada	78
<b>Total</b>	<b>498</b>

Note: Totals may not equal sum of components due to independent rounding. Data for 2007 is preliminary.

State-level CSP solar resource maps similar to those in Figure 24 and Figure 25 are available for Arizona, California, Colorado, New Mexico, Nevada, Texas, and Utah, from the *Data & Resources* section of the NREL Concentrating Solar Power Research website (<http://www.nrel.gov/csp/>).

Currently installed solar power capacity by state can be seen in Table 3; only states that had data to report are shown. Table 3 indicates that much of the potential solar power generation capacity in the Southwest has not been realized.

Projections of regional PV solar power generation capacity for the electric power sector can be seen in Figure 26.

### Regional Photovoltaic Power Generation Capacity, 2005-2030

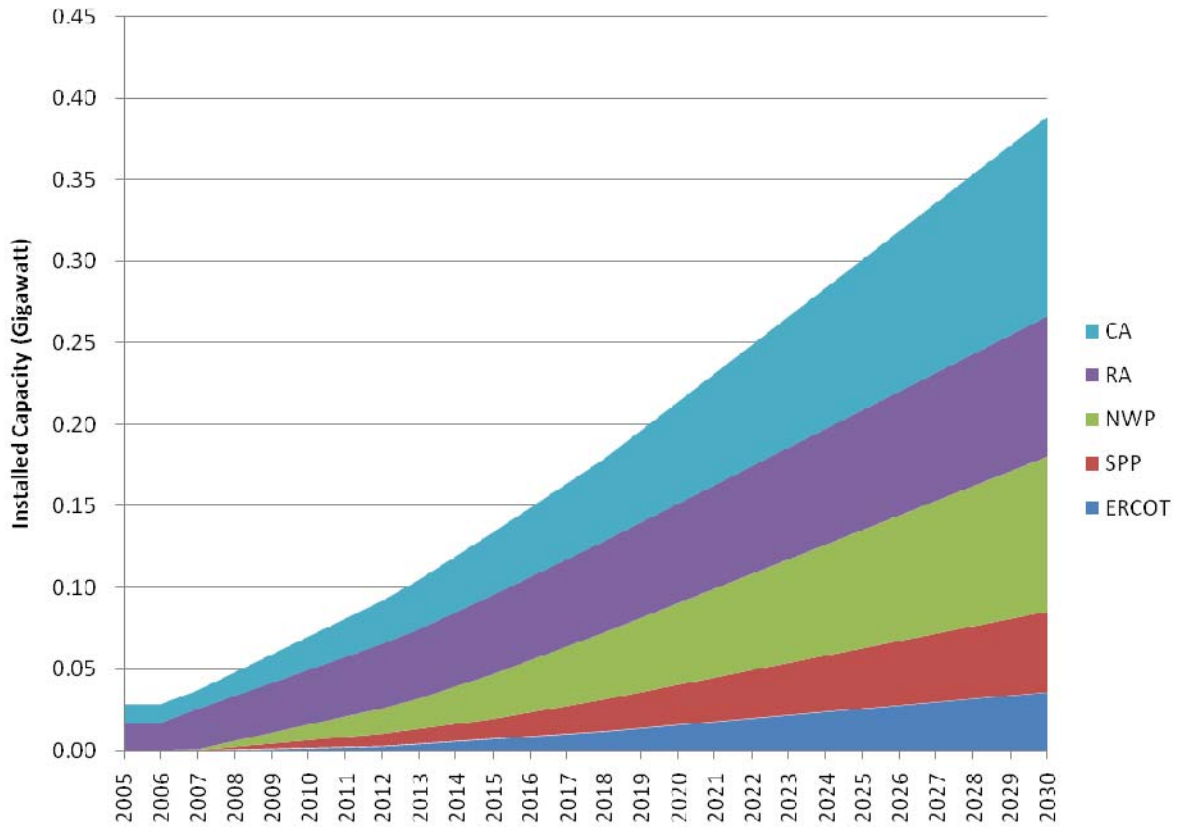

CA - Western Electric Coordinating Council/California  
 RA - Western Electric Coordinating Council/Rocky Mountain Power area and Arizona-New Mexico-Southern Nevada Power Area  
 NWP - Western Electric Coordinating Council/Northwest Power Pool  
 SPP - Southwest Power Pool  
 ERCOT - Electric Reliability Council of Texas

Figure 26. Projected regional PV solar power generation capacity, 2005-2030. Data: EIA (April 2008).

Projections of regional CSP solar power generation capacity for the electric power sector can be seen in Figure 27.

## Regional Concentrating Solar Power Generation Capacity, 2005-2030

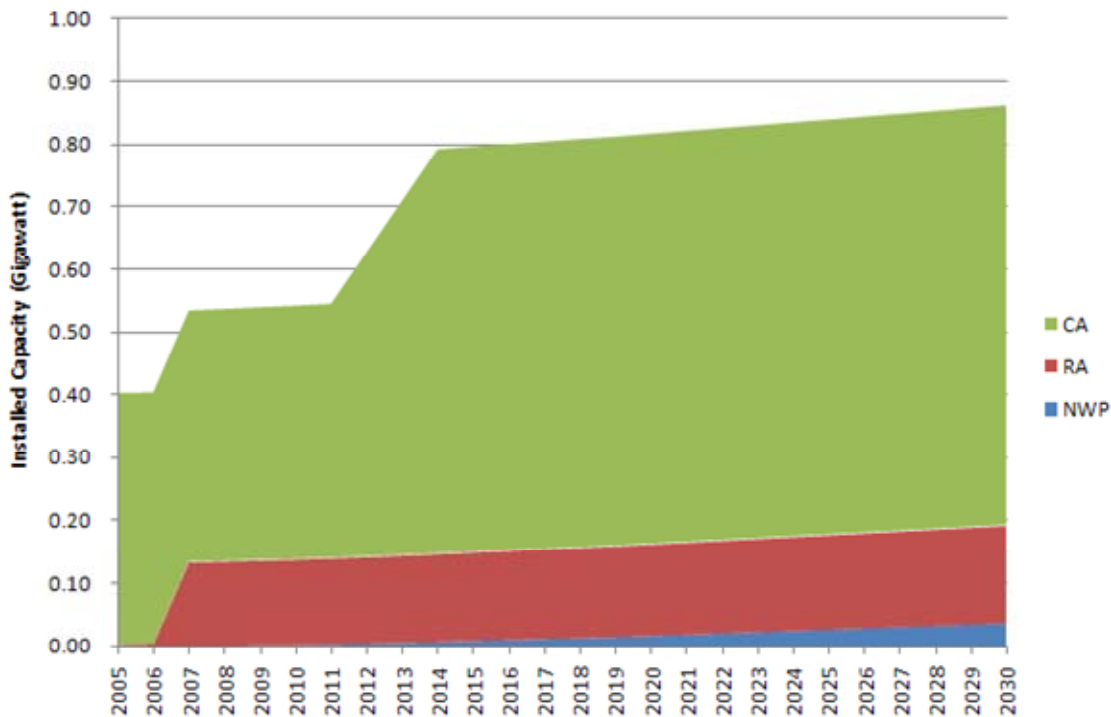

CA - Western Electric Coordinating Council/California  
 RA - Western Electric Coordinating Council/Rocky Mountain Power area and Arizona-New Mexico-Southern Nevada Power Area  
 NWP - Western Electric Coordinating Council/Northwest Power Pool

Figure 27. Projected regional concentrating solar power generation capacity, 2005-2030. Data: EIA (April 2008).

Figure 26 and Figure 27 show that the Southwest is projected to dominate the solar power sector. This is consistent with the solar resource maps in Figure 22, Figure 23, Figure 24, and Figure 25. However, the total projected capacities for both PV and CSP are relatively small.

### Hydropower

Hydropower converts the kinetic energy stored in water by the hydrologic cycle into electricity, by routing water through turbines as it flows downstream. The turbines turn generators, which produce electricity. There are three main types of hydropower systems: impoundment, diversion, and pumped storage.

Impoundment plants, which store water in a reservoir, are the most common type of hydropower plant. Water is released from the plant’s reservoir and flows through a turbine, which turns a generator to produce electricity. The rate at which water is released can be adjusted to meet demand or to maintain a consistent reservoir level.

While many hydropower plants use impoundment, hydropower can also be generated by diverting a portion of a river through a canal or penstock. The diverted water flows through a turbine, which turns a generator to produce electricity. These systems are called diversion systems. Diversion systems sometimes require a dam; however, a diversion dam is often smaller and less disruptive than an impoundment dam.

Pumped storage systems combine another power generation technology, often wind power, with hydropower. During periods of low electrical demand, a pumped storage facility stores energy by pumping water from a lower reservoir to a higher one. Then, during periods of high electrical demand, the water is released back to the lower reservoir, through a turbine that is used to generate electricity.

Although 192 large hydroelectric plants provide most of the hydroelectric power generated in the United States, 92 percent of domestic hydro-electric plants are small or very small, with an average generating capacity of less than 20 MW.

### Advantages

Hydropower has several advantages. It does not degrade air or water quality and does not produce any CO<sub>2</sub> emissions. Water, the fuel for hydropower, is not depleted or used up in the process of generating electricity. Given sufficient available water, hydropower can be dispatched as needed, since the rate at which water flows through a plant's turbines can be regulated to meet varying demand.

Like wind power, the most significant advantage of hydropower is that it is a well-established and mature technology. It already accounts for roughly 75 percent of the electricity generated from renewable resources in the United States. In contrast to wind power, however, there is not much unrealized hydropower capacity for large hydro systems.

### Issues

Hydropower is not without disadvantages. The installation of a hydropower plant is often met with siting and environmental concerns. Property owners may be concerned that its installation could lower property values. Hydropower might damage or destroy riverside habitats; it may create low dissolved oxygen levels in the water, and impoundments can prevent fish from migrating upstream. Riverside habitats can be somewhat protected by maintaining minimum water flows downstream, however, and low dissolved oxygen levels can be mitigated by aeration techniques. The disruption of fish migration can be offset by using fish ladders or by trucking fish upstream.

#### Northern Wasco County People's Utility District

Northern Wasco County People's Utility District (NWCPUD) is a member-owned, not-for-profit utility based in The Dalles, Oregon. NWCPUD owns and operates two hydropower facilities.

The first facility is located at The Dalles Dam. It uses the attraction water for the dam's north fish ladder to generate 5 MW of power and first came online in 1991. To prevent fish from entering the hydroelectric turbine, the water that enters the dam's forebay passes through a screen.

The second facility is located at the McNary Dam. It similarly uses the attraction water for the dam's fish ladder, and generates 10 MW of power that NWCPUD splits equally with its partner, Klickitat County PUD. This facility came online in 1997 and is used by NWCPUD for baseload power.

Most of the negative impacts of hydropower are significantly reduced when using diversion rather than impoundment, but turbines in diversion plants nevertheless can kill fish. This can be mitigated by using racks or screens, or even underwater lights and sounds, to prevent fish from entering turbines. Maintaining a minimum spill flow past turbines can also help prevent fish deaths.

### Applications

The U.S. Department of Energy (DOE) divides hydropower applications into three power classes: large hydropower, small hydropower, and microhydro. Large hydropower facilities have a generation capacity greater than 30 MW and typically use impoundment. The DOE has determined that there are no more feasible, unrealized large hydro opportunities in the United States. Small hydropower facilities have a generation capacity between 100 kW and 30 MW and can produce enough electricity for a small town. They typically use penstocks rather than dams but can still use pre-existing technologies in many cases. In contrast to large hydro, the DOE has identified many feasible, unrealized small hydro opportunities in the United States. Microhydro facilities have a generation capacity less than 100 kW and can produce enough electricity for a home, small business, farm, or ranch. The DOE has identified many resources suitable for microhydro applications, but many would require technology that has not yet been developed.

### Lower Valley Energy

Lower Valley Energy (LVE) is a generation and transmission cooperative based in Afton, WY. It recently entered into a unique partnership with the town of Jackson, WY, through which it provides Jackson with power from its Strawberry Hydroelectric Project. This project features a hydroelectric power plant certified by the Low Impact Hydropower Institute in Portland, Maine. The plant annually generates between 9 million and 10 million kWh, and the town of Jackson uses 8.5 million to 9 million kWh per year. Thus Jackson can source all of its power from the Strawberry Hydroelectric Project.

LVE also is working to restore a hydro project in its home town of Afton that was abandoned about 40 years ago.

LVE was awarded a \$9.46 million Clean Renewable Energy Bond (CREB) for developing the Strawberry Hydroelectric Project. In 2007, it received a \$5.73 million CREB for its hydro project in Afton.

### Regional Availability

The DOE recently conducted a detailed assessment of potential hydropower opportunities in the United States. A brief summary of the results can be seen in Table 4.

Table 4. U.S. hydropower potential, 2006. Data: DOE/DOE-ID-11263.

Annual Mean Power (MWa)	Total	Developed	Federally Excluded	GAP Excluded	Available	Feasible	Potential
TOTAL POWER	297,436	24,084	84,682	13,163	175,507	98,700	29,438
TOTAL HIGH POWER	237,193	23,786	73,591	10,097	129,719	75,853	18,450
Large Hydro	77,187	19,380	17,600	2,307	37,900	21,691	0
Small Hydro	160,006	4,406	55,991	7,790	91,819	54,161	18,450
TOTAL LOW POWER	60,243	298	11,091	3,066	45,788	22,848	10,988
Conventional Turbine	45,208	241	9,517	2,426	33,024	17,729	6,297
Unconventional Systems	3,986	37	520	187	3,243	2,355	1,640
Microhydro	11,049	20	1,054	453	9,522	2,763	3,052

Gap Analysis Program (GAP) is a method to identify sites which are part of a habitat for an endangered species

These estimates of hydropower potential are expressed as *annual mean power*. This designates the average number of megawatt-hours available from the resource in question over the course of a year and is measured in average megawatts (MWa). This is *not* the same as hydropower capacity. These numbers are most useful for making comparisons between power classes and between regions to determine which ones are best suited for future hydro development. Actual hydropower capacity varies significantly between sites and depends on the specifics of the planned facility. In the United States, the average ratio of annual mean power to hydropower capacity is roughly one-half.

The first column in Table 4 indicates the power class, while the second column indicates the total hydropower potential for that class. The third column indicates the number of average megawatts that correspond to already existing hydropower facilities. The fourth and fifth columns indicate the number of MWa excluded due to resources being located in areas either excluded by the federal government or deemed physically inaccessible by the practitioners of the DOE hydropower assessment, respectively. Subtracting the values in columns 3, 4, and 5 from those in column 2 provides the values in column 6, which are the numbers of MWa available for future development. Of the available MWa, those that could feasibly be realized are shown in column 7. Column 8, the rightmost column, contains the annual mean power that may potentially be developed; these final values exclude those feasible MWa shown in column 7 that correspond to resources that the practitioners of the DOE assessment deemed ineligible for development.

Of most interest for the purposes of this document are the values in column 8 of Table 4—the annual mean power that may potentially be developed for each power class. The number of feasible small and low power hydropower projects in the United States can be seen in Figure 28 (there are no feasible high power projects, since the potential annual mean power of this power class is zero), while the amount of annual mean power each of these power classes may contribute can be seen in Figure 29. Note that the data in Figure 29 are taken from column 8 of Table 4.

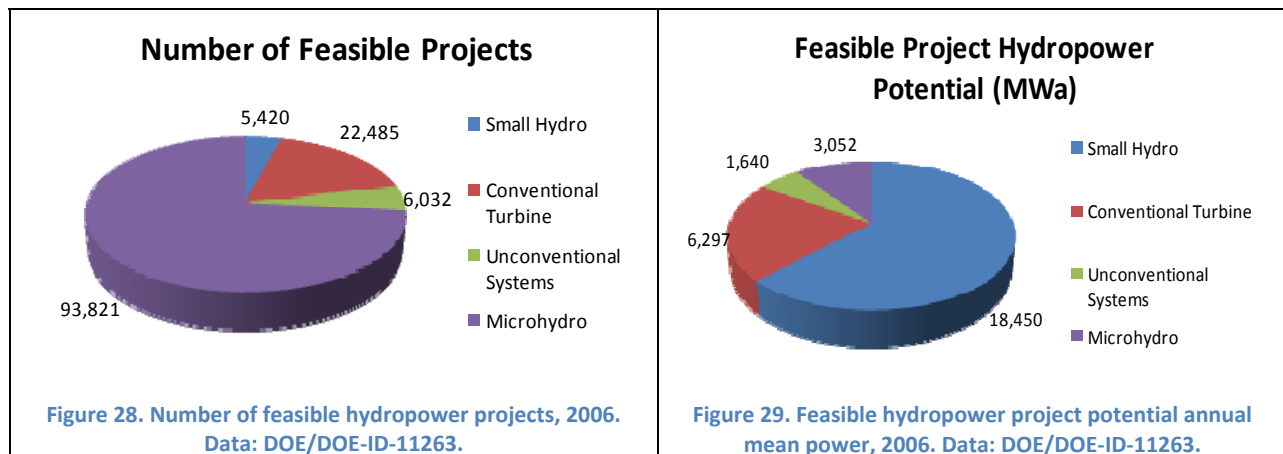

Figure 28 and Figure 29 show that while small hydro accounts for only a small number of feasible hydropower projects, it accounts for more than half of the power generation potential. Furthermore, the 5,420 feasible small hydro projects represent realistic development possibilities, while the low power projects mostly depend on unproven or yet-to-be developed technologies. While relatively small

in number, the feasible small hydro projects represent nearly 20,000 MWa of unrealized hydropower potential. If developed, they could increase annual U.S. hydropower generation by more than 50 percent.

A map of existing hydroelectric plants and feasible potential hydropower projects in the United States can be seen in Figure 30. Existing hydroelectric plants are denoted by yellow dots, while all other dots correspond to feasible potential projects.

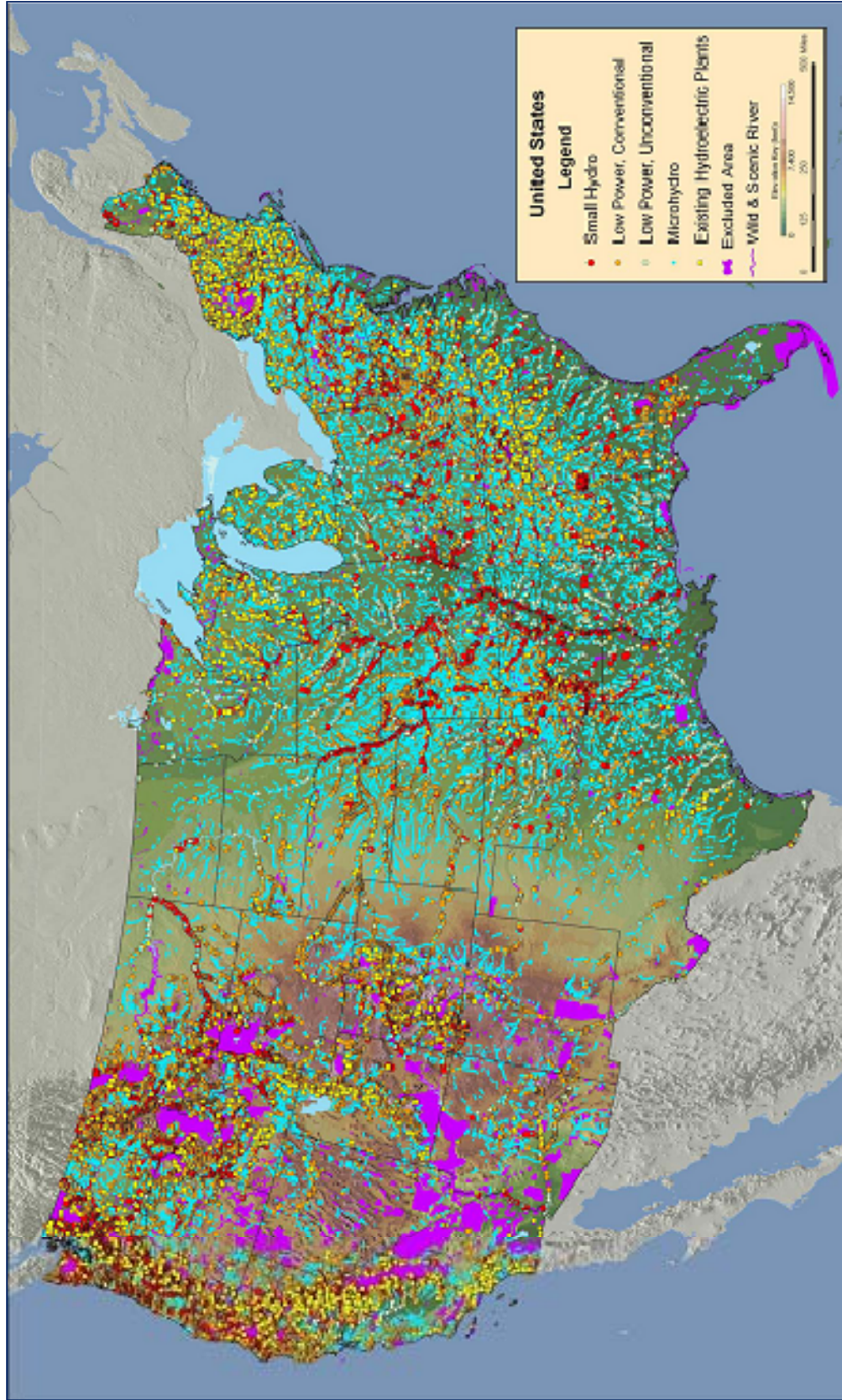

Figure 30. U.S. existing hydroelectric plants and feasible potential hydropower projects, 2006. Source: DOE/DOE-ID-11263.



Figure 30 shows that many resources are suitable for small hydro applications in the Eastern and Northwestern states as well as in the Midwest. The total gross power potential of hydro resources in the 50 states, divided into feasible, other available, excluded, and developed power categories can be seen in Figure 31. Excluding Alaska, the five states with the largest gross hydropower potential are California, Idaho, Montana, Oregon, and Washington. Alaska has far more gross hydropower potential than any other state, at nearly 90,000 MWa, but only a small fraction of this amount is feasible for development.

The same data as those depicted in Figure 31, normalized by state population, can be seen in Figure 32. This gives a rough indicator of the amount of gross potential hydropower that is available per person in each state or, in other words, the gross potential hydropower density of each state. Washington, Oregon, Idaho, Hawaii and California have the top five largest gross potential hydropower densities.

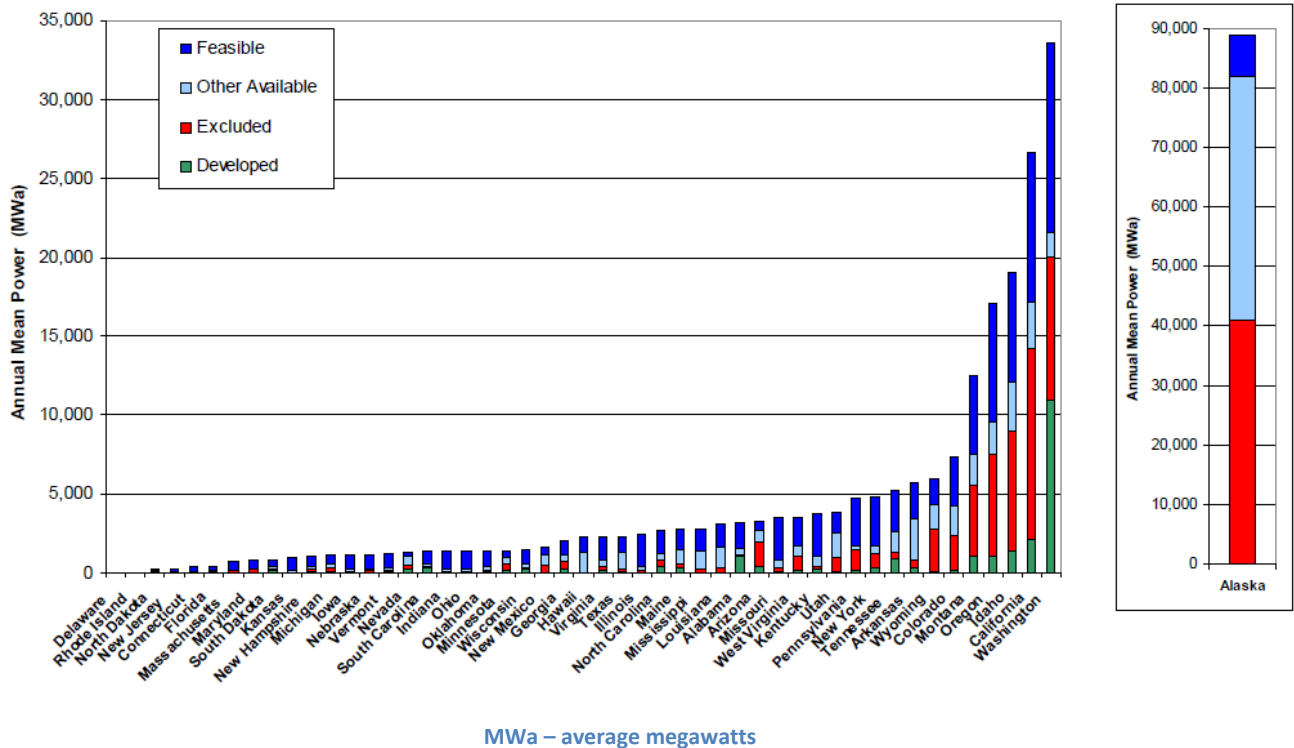
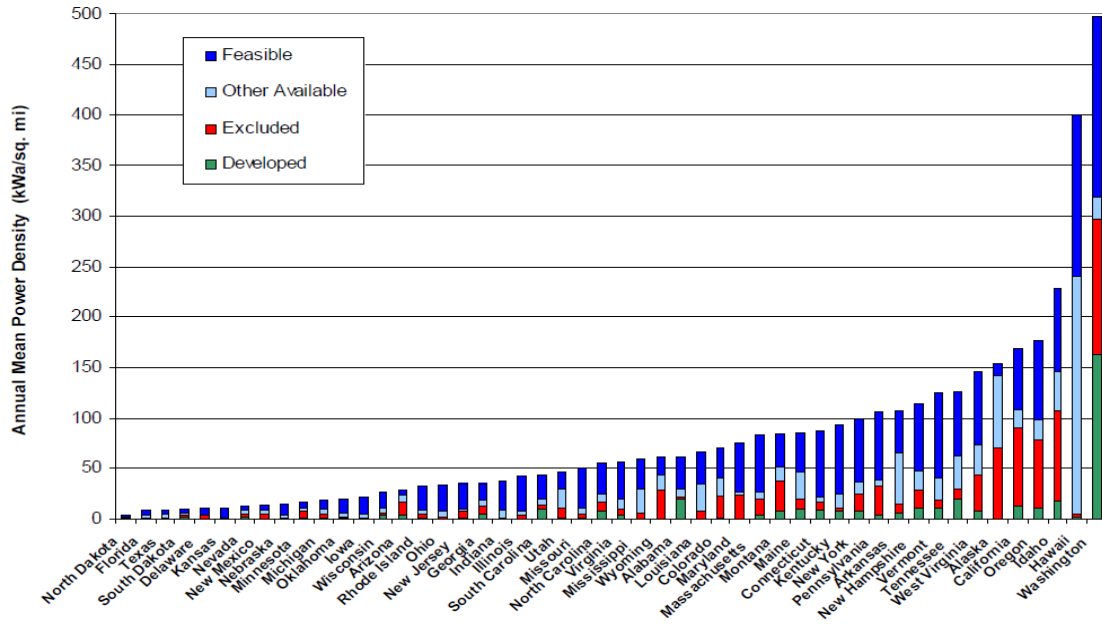

Figure 31. Total gross hydropower resource potential by state, 2006. Source: DOE/DOE-ID-11263.



kWa/sq. mi – average kilowatts per square mile

Figure 32. Total gross hydropower resource potential by state, normalized by population, 2006. Source: DOE/DOE-ID-11263.

Table 5. Potential hydropower increase by state, 2006. Data: DOE/DOE-ID-11263.

State Name	Developed Hydro-power (MWa)	Feasible Potential Hydropower (MWa)	Potential Hydropower Increase	State Name	Developed Hydro-power (MWa)	Feasible Potential Hydropower (MWa)	Potential Hydropower Increase
Alabama	1113	462	41%	Montana	1192	1,669	140%
Alaska	171	2,694	2103%	Nebraska	152	354	233%
Arizona	928	150	16%	Nevada	263	95	36%
Arkansas	405	590	146%	New Hampshire	187	174	93%
California	4699	3,425	73%	New Jersey	6	63	1057%
Colorado	246	891	362%	New Mexico	30	156	519%
Connecticut	55	105	191%	New York	2861	757	26%
Delaware	0	6	∞	North Carolina	610	348	57%
Florida	32	79	245%	North Dakota	270	40	15%
Georgia	429	230	54%	Ohio	63	319	506%
Hawaii	20	280	1400%	Oklahoma	239	345	144%
Idaho	1288	2,122	165%	Oregon	3271	2,072	63%
Illinois	27	568	2103%	Pennsylvania	284	953	336%
Indiana	67	305	455%	Rhode Island	4	7	163%
Iowa	95	329	347%	South Carolina	428	211	49%
Kansas	1	295	29451%	South Dakota	622	119	19%
Kentucky	383	518	135%	Tennessee	1082	655	61%
Louisiana	89	306	343%	Texas	189	328	174%
Maine	432	432	100%	Utah	135	401	297%
Maryland	203	91	45%	Vermont	128	217	170%
Massachusetts	126	136	108%	Virginia	147	418	284%
Michigan	209	133	64%	Washington	11470	3,106	27%
Minnesota	128	140	109%	West Virginia	140	484	346%
Mississippi	0	298	∞	Wisconsin	264	259	98%
Missouri	129	798	618%	Wyoming	117	507	433%

MWa – average megawatts

A comparison of the hydropower potential of feasible projects with the total annual mean power of installed hydroelectric plants in each of the 50 states is displayed in

Table 5. These data are a good indicator of how much unrealized hydropower potential each state has.

The EIA does not currently report numbers for unconventional hydropower generation, which includes small and low power hydro, so hydropower generation capacity projections will not be included in this publication.

For more detailed information, the DOE assessment of potential hydropower opportunities in the United States can be found in the *Resource Assessment* section of the Idaho National Laboratories website (<http://hydropower.id.doe.gov/>). The national assessment is titled *Feasibility Assessment of the Water Energy Resources of the United States for New Low Power and Small Hydro Classes of Hydroelectric Plants*. Individual state resource assessment reports are also available for 49 states. (Due to scarce resources, no report was generated for Delaware.)

#### PNGC Power

PNGC Power is a generation and transmission cooperative based in Portland, OR. It serves 16 member distribution cooperatives in Idaho, Montana, Nevada, Oregon, Utah, Washington, and Wyoming. PNGC is participating in efforts to commercialize wave energy by contributing to wave energy efforts in Reedsport, OR. Research conducted by Oregon State University and the Electric Power Research Institute indicates that this location has particularly rich wave energy resources.

In 2007, PNGC entered into a partnership with Ocean Power Technologies (OPT). PNGC agreed to commit \$500,000 to the Reedsport OPT Wave Energy Park and to offer expertise in grid requirements and onshore power. This project will come online in 2010, featuring a nameplate capacity of 2 MW with possible expansion eventually to as much as 50 MW.

### Geothermal Power

Geothermal power is generated by converting the thermal energy from the Earth's core into electrical energy. This thermal energy is stored in geothermal reservoirs, which are systems of fractured and permeable rocks that trap hot water or steam below the surface of the Earth. The rocks hold most of the energy, although it is the hot water or steam that allows it to be transferred to the surface of the Earth. Many reservoirs are located deep underground and must be accessed by drilling. Some reservoirs—particularly those in Hawaii, Alaska, and the Western United States—are relatively close to the Earth's surface and are much easier to access.

It is also relevant to note that the ground near the Earth's surface maintains a relatively constant temperature of 10 to 16 °C, and this geothermal energy can be used for heating and cooling applications. It is not sufficient, however, to support geothermal power. So it is important to differentiate between electricity-generating geothermal applications and other, more direct, uses of geothermal energy, such as geothermal process heating and cooling.

#### Advantages

Geothermal power has several advantages. It does not produce any CO<sub>2</sub> emissions and does not require the transportation, storage, or combustion of fuels. The heat generated by the Earth's core, which is the fuel for geothermal power, is virtually inexhaustible. Geothermal power is also reliable. While coal

power plants have an average system availability of 75 percent, geothermal facilities have an average system availability of 95 percent. Geothermal power also is not intermittent, unlike wind and solar.

### Issues

A significant issue for geothermal power is that while the heat from the earth is inexhaustible, the hot water or steam in a particular geothermal reservoir is not. Reservoirs must be managed carefully to ensure the longevity and reliability of any geothermal facility, and no geothermal reservoir can be used indefinitely. The underground water that is required for geothermal power plants is not nearly as ubiquitous as geothermal energy itself.

The design of geothermal power plants is also very site specific. Each geothermal site has a unique set of characteristics and operating conditions that must be accommodated. The chemical composition of the heated liquids in reservoirs can vary substantially between sites, as can temperatures and pressure levels. In some cases, costly surface disposal of sludge or salt is required.

Another issue with geothermal technologies is that their efficiencies are low compared to those of traditional fossil fuel or nuclear power plants. This is mainly due to the relatively low temperature ranges over which geothermal plants operate, typically between 50 and 250 °C. At such low differences in temperature, technologies that convert heat to electricity are naturally less efficient. Even small efficiency gains can have significant impact on the economic feasibility of a geothermal project. This makes it even more important to tailor the design of geothermal power plants to site-specific conditions.

### Applications

Geothermal power has both small- and utility-scale applications. There are many potential applications for small-scale geothermal power plants in rural communities. Such plants would typically have operating capacities under 5 MW and would use technologies similar to those seen in larger geothermal plants. These technologies will be explained in more detail later in this section.

More direct uses of geothermal energy also may occur on a relatively small scale. Reservoirs with temperatures of roughly 20 to 150 °C may be used in a variety of direct-use applications, including heating homes and businesses, greenhouses, and fish farms. Individuals, small businesses, and municipalities throughout the Western United States use geothermal energy for district heating systems, which distribute hot water or steam to multiple buildings, or for space heating.

For example, a geothermal powered greenhouse in Hooper, CO, can be seen in Figure 33.



Figure 33. Geothermal-heated greenhouse. Source: NREL PIX.

Organic hydroponic tomatoes are grown in this greenhouse, which uses the energy from low-temperature geothermal wells to both heat and water the produce.

A typical utility-scale geothermal power plant produces roughly 50 MW of power and uses one of three types of geothermal power conversion technologies: dry steam, flash, or binary cycle. The type of technology used depends on the state and temperature of the fluid in the geothermal reservoir.

Dry steam plants route steam directly from a geothermal reservoir to turn turbines, which drive generators that produce electricity. These are the oldest type of geothermal power plant and require reservoir water temperatures in excess of 182 °C. They are also a very clean source of power, emitting only excess steam and small amounts of other gases.

A picture of The Geysers, the largest complex of geothermal power plants in the world, can be seen in Figure 34. This California facility uses dry steam technology to convert geothermal energy into electrical energy and has been online since the early 1960s. It has a net generating capacity of about 725 MW.



Figure 34. Dry steam geothermal power plant. Source: NREL PIX.

Flash technologies route high-pressure hot water from a geothermal reservoir into a low-pressure tank, where it vaporizes, or “flashes,” and the resulting steam is used to turn a turbine. The turbine drives a

generator that produces electricity. Any water that remains after the first flash can be flashed again in a second tank, resulting in even more efficient generation. Similar to dry steam plants, flash plants require reservoir water temperatures in excess of 182 °C.

A picture of the Heber Geothermal Power Station, a power plant that uses dual flash technology, can be seen in Figure 35. It is located in Imperial County, CA.



**Figure 35. Dual flash geothermal power plant. Source: NREL PIX.**

The Heber Geothermal Power Station has been online since the mid-1980s and has a generating capacity of about 47 MW.

The first geothermal power plant to be built outside of California, the Blundell geothermal power plant, can be seen in Figure 36. This plant also uses flash technology to generate electricity and has been online since 1984. The Blundell plant, located in Roosevelt Hot Springs, UT, has a generating capacity of about 26 MW.



**Figure 36. Single flash geothermal power plant. Source: NREL PIX.**

Binary cycle technologies route moderately hot water from a geothermal reservoir by a second fluid that has a significantly lower boiling point; the secondary fluid flashes to steam and is then used to turn a turbine that drives a generator to produce electricity. With this type of technology, water or steam from the reservoir never comes in contact with the turbine(s). Because the geothermal fluids never escape the Earth's surface, binary cycle plants have effectively zero emissions.

Binary cycle plants can be used with reservoir water temperatures below 200 °C, making them suitable for sites with only moderate temperatures. Since most geothermal areas feature temperatures in this range, this technology is of particular interest for future development.

### Navopache Electric Cooperative

Navopache Electric Cooperative (NEC) is a transmission and distribution cooperative based in Pinetop-Lakeside, AZ. It serves roughly 35,000 customers over a 10,000-square-mile area.

Largely in response to Arizona's renewable portfolio standard, Navopache Electric Cooperative decided to revive 25-year-old plans to build a geothermal power plant within its service territory. The plant is currently being developed and is expected to come online in 2012. It will use Enhanced Geothermal System (EGS) technology, which involves improving the permeability of an existing reservoir and injecting water into it. The completed project will generate 5 MW of power. Development of this project was facilitated by a 69 kV transmission line that already traverses the property where the plant will be located.

### Regional Availability

A map depicting geothermal resource availability within the United States can be seen in Figure 37. This map uses the estimated temperature 6 km below the Earth's surface as an indicator of availability. Maps using depths of 3, 4, 5, 6, and 10 km can be found in the *Maps* section of the Idaho National Laboratory (INL) Geothermal Program website (<http://geothermal.inl.gov>).

As shown in Figure 37, the Western United States is rich in geothermal resources, which makes it particularly suitable for utility-scale geothermal power applications.

A map depicting heatflow information for the United States can be seen in Figure 38. Heatflow is another way of measuring geothermal resource availability and is determined by multiplying the well temperature gradient by thermal conductivity. The data shown in Figure 38 align well with those of Figure 37.



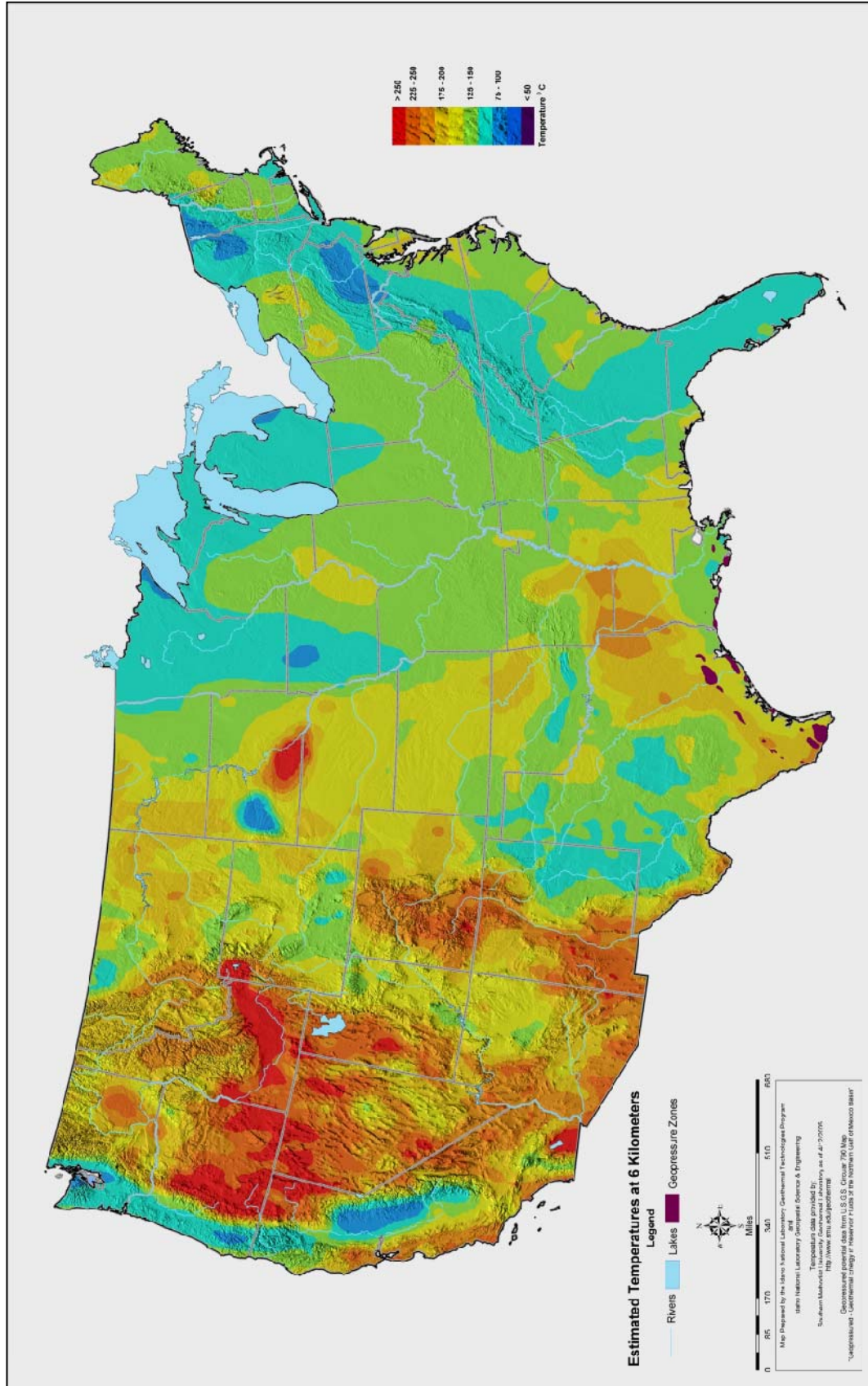

Figure 37. U.S. geothermal resource map, 2005. Source: INL Geothermal Program.

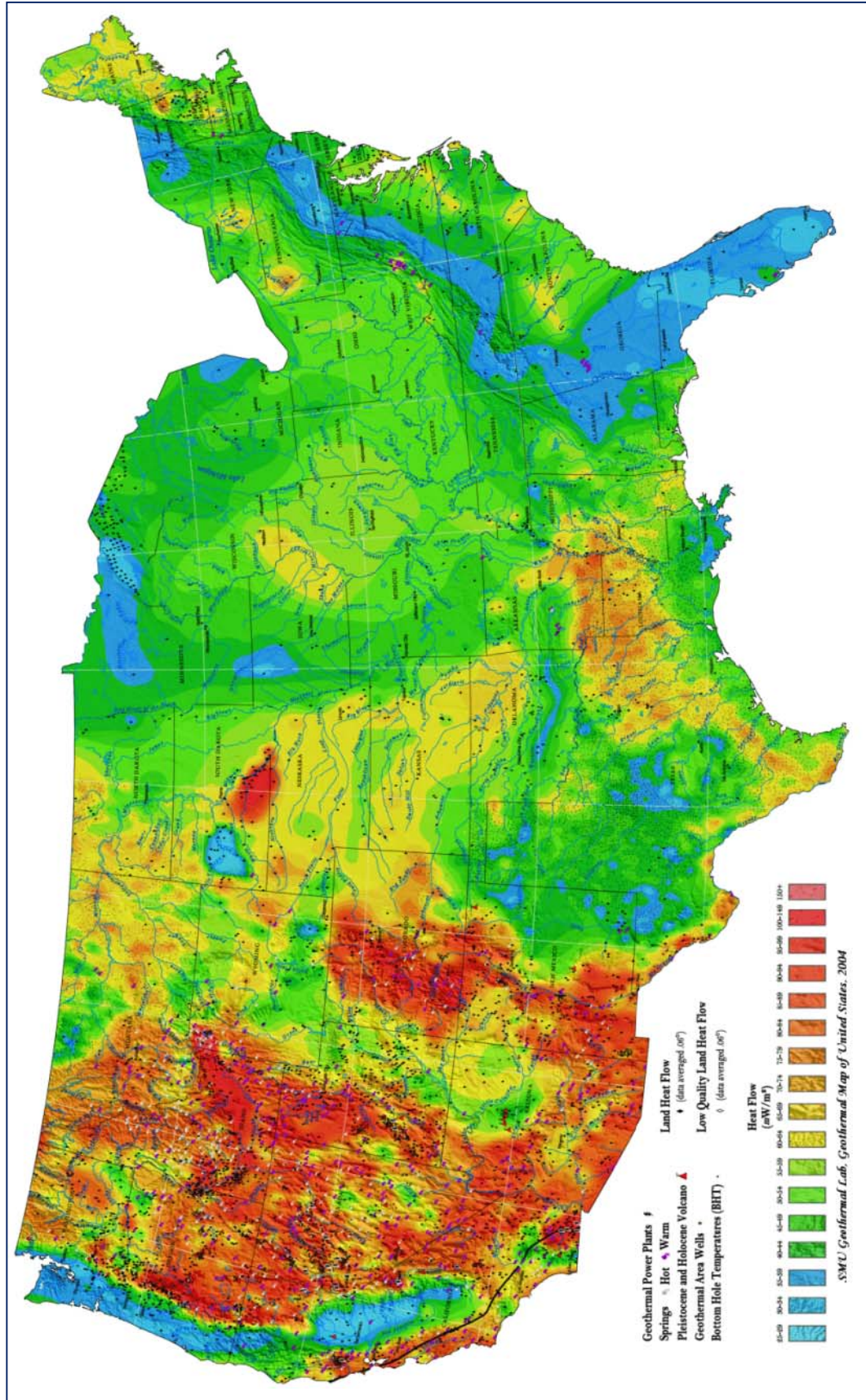

Figure 38. U.S. heatflow map, 2004. Source: Southern Methodist University (SMU) Geothermal Lab.

A heatflow map for Alaska, which is also rich in geothermal resources, can be seen in Figure 39.

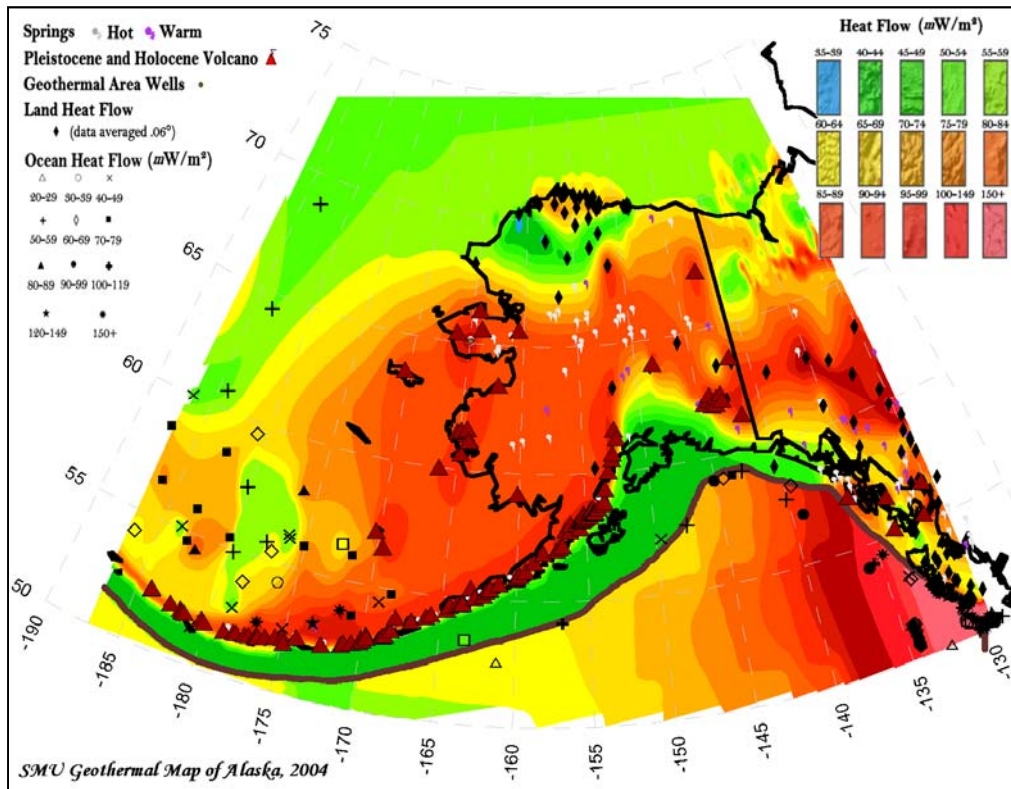

Figure 39. Alaska heatflow map, 2004. Source: SMU Geothermal Lab.

Detailed state-level geothermal resource maps for the Western United States are available from the INL Geothermal Program website. These maps contain data on specific geothermal wells and springs as well as heatflow data. The Southern Methodist University Geothermal Laboratory website also contains several heatflow maps for the entire United States, Alaska, and the Western states only (<http://smu.edu/geothermal/>).

A study conducted by the Geo-Heat Center (GHC) at Oregon Institute of Technology recently identified 271 cities and communities in the Western United States that could potentially use geothermal energy for district heating and other applications. A summary of these data can be seen in Table 6. Detailed information about these communities and the resources available to them can be found on the GHC website (<http://geoheat.oit.edu>). The GHC also has an interactive map of the United States that shows where current geothermal power plants and direct use projects are located.

Another useful resource is the DOE EERE Geothermal Technologies Program website (<http://www.eere.energy.gov/geothermal/>). Contact information for the Utility Geothermal Working Group (UGWG), a group of utilities and other associations whose purpose is to promote the development of geothermal power in the Western United States, can also be found on this website.

Table 6. Communities with collocated geothermal resources. Data: GHC.

State	Number of Communities	State	Number of Communities
Arizona	14	Utah	23
California	70	Washington	6
Colorado	15	Alaska	17
Idaho	51	Nebraska	9
Montana	18	North Dakota	1
Nevada	30	South Dakota	58
New Mexico	12	Texas	43
Oregon	32	Wyoming	5

Projections of regional geothermal power generation capacity for the electric power sector can be seen in Figure 40. These projections confirm that the Western United States is best suited for geothermal power generation, with California making the most significant contribution to future geothermal power capacity. This is consistent with the geothermal resource map in Figure 37. No regions outside the West are projected to contribute to future geothermal power capacity, although some of these areas may use geothermal energy in smaller, direct-use applications.

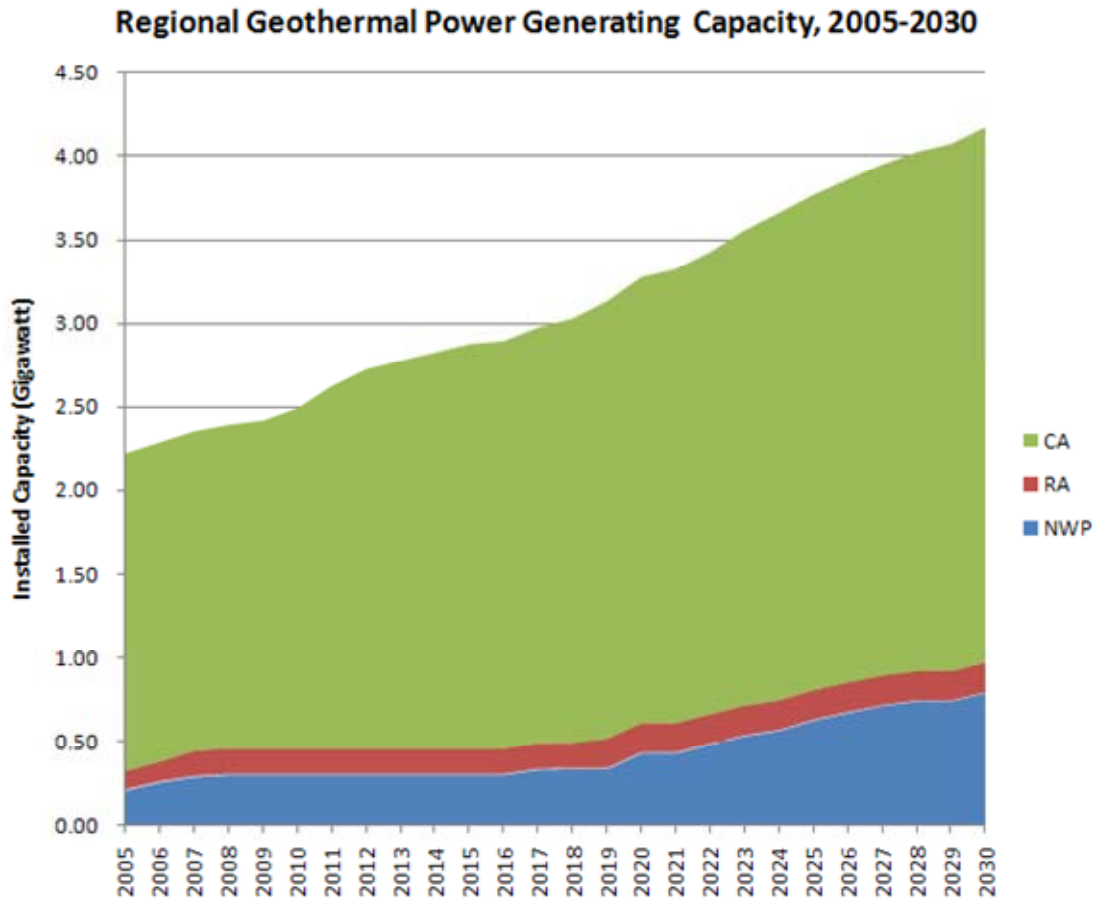

CA - Western Electric Coordinating Council/California  
 RA - Western Electric Coordinating Council/Rocky Mountain Power area and Arizona-New Mexico-Southern Nevada Power Area  
 NWP - Western Electric Coordinating Council/Northwest Power Pool

Figure 40. Regional geothermal power generation capacity, 2005-2030. Data: EIA (April 2008).

### Summary of Regional Resource Availability

Below is a cross-resource summary of regional availability. Note that most regions have *some* wind and solar resources, but not all regions have an amount sufficient for utility-scale generation.

**Alaska.** Alaska is endowed with rich wind and hydro resources. The wind resources are mostly concentrated in coastal areas. There are also some geothermal resources available in selected areas.

**Northeast.** The Northeast is endowed with some biomass resources, including forest and secondary mill residues and methane emissions from landfills. There are also some urban wood residues and methane emissions from domestic wastewater treatment facilities available in the Mid-Atlantic states. There are some offshore wind resources as well, but siting issues may hinder their development. Lastly, there are some undeveloped small hydro resources.

**Southeast.** The Southeast is endowed with fair biomass resources, including forest residues, primary and secondary mill residues, and methane emissions from manure management and landfills. There are also some fair solar resources and minimal undeveloped small hydro resources.

**Midwest.** The Midwest is endowed with the richest biomass resources in the United States. These include crop residues, methane emissions from manure management, and forest and primary mill residues. The residues are concentrated in the upper Midwest. There are fair wind resources as well in northern Indiana, Illinois, and parts of Ohio and Michigan. There are also some undeveloped small hydro resources.

**Great Plains.** The Great Plains are endowed with the best land-based wind resources in the United States. Their development may be hindered by a lack of transmission access, however. Biomass resources available in the Great Plains include crop residues and methane emissions from manure management. The methane resources are mostly concentrated in South Dakota and Nebraska.

**West.** The West is endowed with the best solar and geothermal resources in the nation. There are also some offshore wind resources on the west coast, but siting issues may hinder their development. There are some biomass resources available in the Southwest, including mill and urban wood residues, and methane emissions from landfills, manure management, and domestic wastewater treatment facilities.

**Northwest.** The Northwest is endowed with the best undeveloped small hydro resources in the United States. There are also some geothermal and offshore wind resources, but development of the latter may be hindered by siting issues. Biomass resources available in the Northwest include forest, mill, and urban wood residues and some methane emissions, particularly those from landfills and manure management.

## **Transmission Access & Adequacy for Renewables**

Demand for electricity, which has grown steadily in the United States for several decades, is projected to continue growing through the first half of the 21st century. The Energy Information Administration (EIA) of the U.S. Department of Energy (DOE) projects that, by 2030, domestic electricity demand will grow by 30 percent over 2006 levels. Furthermore, growth in peak electricity demand has consistently outstripped growth in transmission capacity. This demand growth is driven by a number of different factors, including larger houses, more and larger appliances, and population growth. According to the DOE's Office of Electricity Delivery and Energy Reliability, growth in peak demand has exceeded transmission growth by nearly 25 percent every year since 1982.

This has created a situation in which the strain placed on the United States' transmission infrastructure, much of which dates from the first half of the 20th century, largely exceeds its planned use. Lagging investment in new transmission lines is due to many different factors. Prominent among these are myriad regulatory and financial obstacles, which will be treated in more detail below. The manner in which the transmission system was originally developed has also proved an obstacle to expansion. Technological developments that allow more efficient use of the infrastructure already in place have also reduced the need for building new transmission lines, and will continue to play an important role in meeting electricity demand in the future.

Nevertheless, investment in the transmission system has been increasing in recent years. According to the Congressional Research Service (CRS), in 2007 such investment by investor-owned utilities (IOUs) reached a 30-year high of \$6.5 billion in constant 2000 U.S. dollars. Note that between 1977 and 1997, transmission system investment declined to a 1998 low of \$2.1 billion in constant 2000 U.S. dollars.

The recent increase in transmission investments by IOUs notwithstanding, even greater transmission investment will be required to meet projected electricity demand. Much more transmission infrastructure will also be required to reliably integrate variable and/or location-constrained resources into the electricity supply—such as wind, solar, and many other renewable resources.

## **Overview of the Electrical Power System**

The electrical power system consists of interconnected components that convert nonelectrical energy into electrical form, transmit that electricity across long distances, and then convert it into a specific format appropriate for end use. The components of the electrical power system can be divided into three main categories: generation, transmission, and distribution. Transformers are located between generation and transmission components as well as between transmission and distribution components. The basic structure of the electrical power system is displayed in Figure 41.

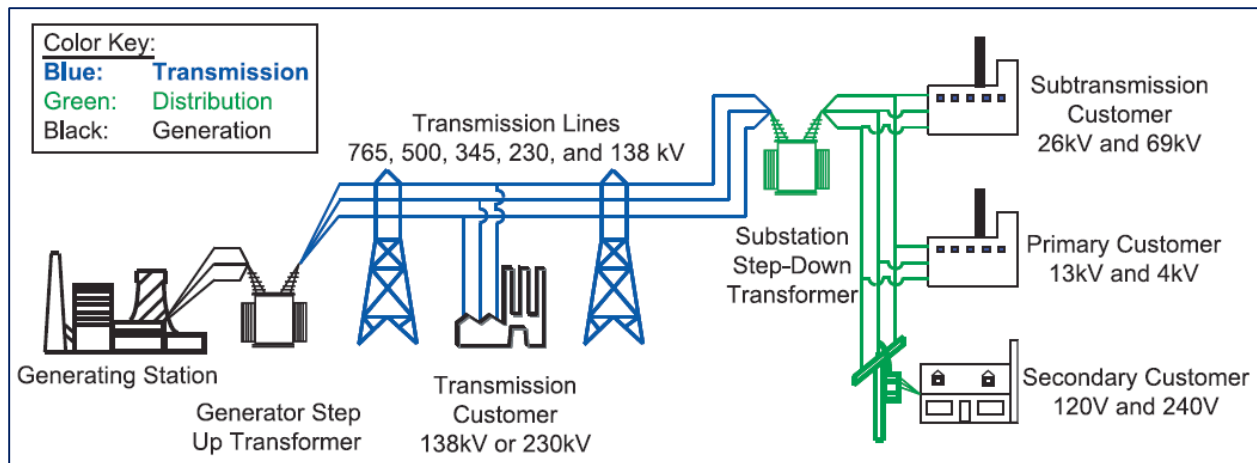

Figure 41. Basic structure of the electrical power system. Source: U.S.-Canada Power System Outage Task Force (2004).

Note that subtransmission lines are lower capacity transmission lines that cover shorter distances and have a greater number of terminations; they are often simply older transmission lines.

## Generation

The generation components of the electrical power system include all entities that supply electrical power to that system. These include investor-, federally, and publicly owned utilities, as well as cooperatives and various non-utility power sources such as paper mills and other industrial entities. They generate electrical power from either combustible fuels like coal, natural gas, and biomass, or from non-combustible energy sources like wind, solar, and hydro. Generators range in size from a capacity of hundreds of kilowatts to larger than a gigawatt.

## Transmission

The transmission components of the electrical power system carry bulk power from the generation entities' facilities to concentrated areas of customers, often referred to as demand centers. Step-up transformers connect generation facilities to transmission; they transform the high-current, low-voltage electricity coming from the generators into low-current, high-voltage electricity, so it is easier to transmit long distances.

Most transmission lines are Alternating Current (AC), which is easier to step up and down than Direct Current (DC). A small number of lines are DC, which transmits power very efficiently but requires complex and expensive conversion technology to connect with AC lines. The voltages of transmission lines range from as little as 115 kV to as much as 765 kV. Most policy decisions currently affecting transmission infrastructure concern "high" and "extra-high" voltage transmission, whose line voltages are 230 kV or greater.

It is important to understand that once electricity is supplied to the grid, it will flow across any available path to reach its customers. It is very difficult, if not impossible, to designate any specific path across which it must flow. For this reason, buying and selling electricity requires coordination and monitoring across the entire transmission system.



The transmission system was not originally planned at a national level, like the interstate highway system, for example. It was built by individual generators to meet local needs. Over time, generators patched together these individual transmission systems to increase reliability as they entered into joint ownership of generation facilities or simply to mutually increase sales. This process was not systematic.

Eventually, the transmission system evolved into three main sections, often called “interconnections” or simply “grids.” These are as follows: the Eastern Interconnection, the Western Interconnection, and the Electricity Reliability Council of Texas. Note that some interconnections reach into Canada or Mexico.

The United States’ power system interconnections can be seen in Figure 42.

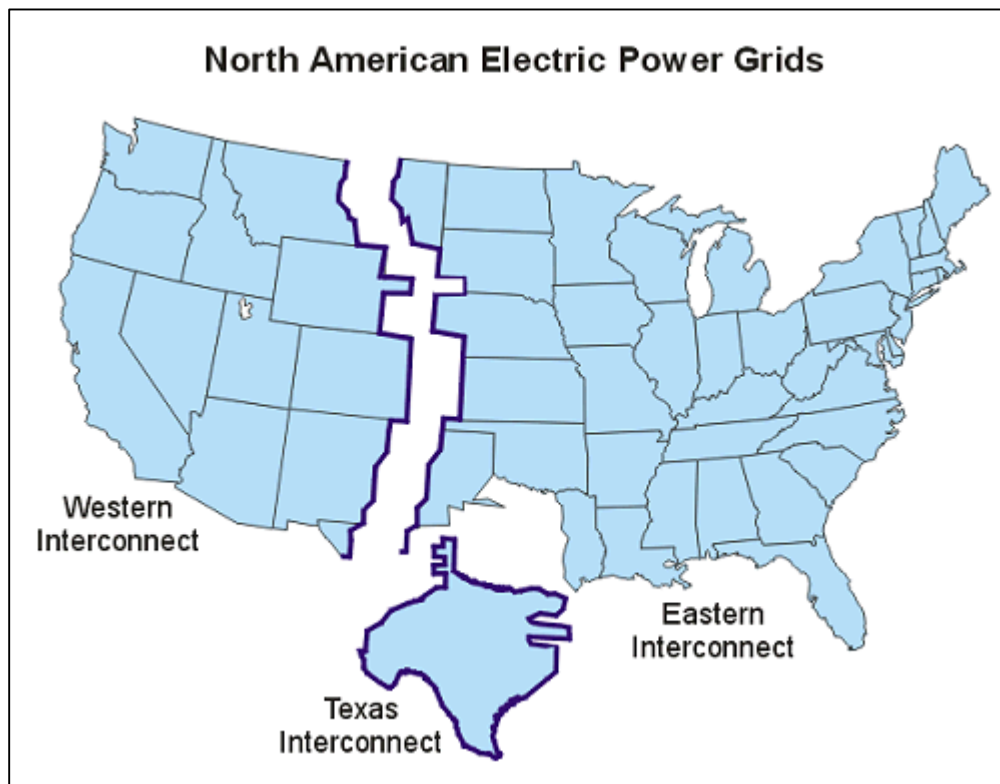

Figure 42. United States’ interconnections. Source: EIA (2003).

Within each interconnection, generators must all be synchronized to 60 cycles per second (Hz). Because the three interconnections of Figure 42 are not synchronized, it is not possible to transmit AC power between them. There are a mere eight low-capacity, DC links or “ties” between them.

Although all generators are allowed access to the grid, its transmission lines are owned by hundreds of private and public entities. The ownership of high voltage transmission lines by region can be seen in Table 7.

Table 7. High voltage transmission by owner and region. Source: CRS (April 2009).

Data in Miles [and Regional %] for the 48 Contiguous States for Transmission Lines of 230 kV and Higher

Owner Type	Northeast /Midwest	Southeast	Southwest	Upper Plains	West	U.S. Total
Federal	21 [0%]	2,768 [7%]	0 [0%]	2,541 [17%]	18,214 [27%]	23,544 [14%]
Other Public Power	964 [3%]	2,079 [5%]	731 [5%]	1,798 [12%]	5,525 [8%]	11,098 [7%]
Cooperative	0 [0%]	2,993 [8%]	387 [2%]	2,908 [20%]	4,496 [7%]	10,784 [6%]
Subtotal – All Public Power and Cooperatives	986 [3%]	7,840 [20%]	1,118 [7%]	7,247 [49%]	28,235 [42%]	45,426 [27%]
Independent Transmission Companies	4,640 [15%]	0 [0%]	351 [2%]	1,045 [7%]	0 [0%]	6,036 [4%]
Investor Owned Utilities	24,968 [81%]	31,412 [79%]	12,408 [80%]	5,402 [36%]	37,034 [56%]	111,223 [66%]
N/A	260 [1%]	264 [1%]	1,686 [11%]	1,148 [8%]	1,250 [2%]	4,609 [3%]
Total	30,853 [100%]	39,516 [100%]	15,563 [100%]	14,843 [100%]	66,519 [100%]	167,294 [100%]

**Source:** Data downloaded from Platts POWERmap, information on entity ownership type provided by the Energy Information Administration, and CRS estimates.

**Notes:** The Northeast/Midwest region is the combination of the RFC and NPCC NERC regions; the Southeast is the combination of SERC and FRCC; the Southwest is the combination of ERCOT and SPP; the Upper Plains is the MRO region; and the West is the WECC region. For a NERC regional map, see **Figure 3**. N/A signifies that ownership information is not available. Other Public Power includes municipal and state systems. kV = kilovolt. Detail may not add to totals due to independent rounding.

CRS – Congressional Research Service  
 NPCC – Northeast Power Coordinating Council  
 FRCC – Florida Reliability Council  
 SPP – Southwestern Power Pool  
 WECC – Western Electric Coordinating Council  
 RFC – Reliability First Corporation

SERC – Southeastern Reliability Council (SERC) Reliability Corporation  
 ERCOT – Electric Reliability Council of Texas  
 MRO – Midwest Reliability Organization  
 NERC – North American Electric Reliability Corporation

As shown in Table 7, transmission ownership varies significantly across regions. IOUs own the majority of lines in the Northeast/Midwest and South. However, their ownership is significantly reduced in the Upper Plains and the West, where public power entities and cooperatives own a much larger share than they do in the other regions.

The transmission system will often be referred to as simply the “grid.”

### Distribution

The distribution components of the electrical power system deliver power to the industrial, commercial, and residential customers in demand centers. Substations, or step-down transformers, connect transmission lines to distribution lines. These substations transform the low-current, high-voltage

electricity coming from the transmission lines into high-current, low-voltage electricity that can be easily distributed.

## **Regulation of the Electrical Power System**

The electrical power system is regulated at the regional, state, and federal levels. The state and federal levels are of particular interest for transmission issues, which are the focus of the following section of this document. Policies regarding siting permission fall largely under state regulation, while policies affecting transmission access and reliability fall largely under federal regulation.

### **State-Level Regulation**

State-level regulation of the electric power sector is typically handled by a Public Utility Commission (PUC). The authority of PUCs most often extends only to IOU operations. They usually do not regulate publicly owned utilities, such as those owned by state governments and municipalities, which typically make their own decisions regarding new generating capacity and new transmission lines.

PUCs regulate retail electricity rates, monitor the operations of utilities, and—of most interest here—issue siting permits for new transmission lines. Generally, permission to install transmission lines must first come from states, not from the federal government. This generalization excludes federal lands and is subject to some notable exceptions that are treated in more detail in the following subsection.

### **National-Level Regulation**

National-level regulation of the electric power sector is administered by the Federal Energy Regulatory Commission (FERC), an independent agency of the U.S. Department of Energy (DOE). It is the responsibility of FERC to approve transmission line projects after they have received state siting permission, as well as to regulate wholesale electricity rates and transmission rates.

FERC generally does not regulate publically owned utilities, such as federal power authorities, municipal utilities and electric cooperatives. However, if these entities wish to buy or sell wholesale electricity or to use transmission facilities under FERC's jurisdiction, they must then follow federal regulations.

Encouraging competition in the electricity transmission sector is an important aspect of FERC's regulatory responsibilities. In 1996, FERC mandated "open access" to the U.S. transmission system, which requires transmission owners to allow any generator or power buyer to access available transmission capacity at cost-based or market-based fees. Open access prevents transmission owners from using their sole ownership of transmission lines to drive up costs.

As suggested by FERC when it established open access, Independent System Operators (ISOs) soon were created to ensure non-discriminatory access to transmission. Each ISO is a not-for-profit corporation regulated by FERC. FERC later encouraged the creation of voluntary Regional Transmission Organizations (RTOs), which are responsible for administering the transmission system on a regional basis throughout North America. Each RTO takes over the operation of the transmission system in a particular state or region, although the components of this system remain under the ownership of individual utilities. The responsibilities of RTOs include ensuring open access as well as coordinating transmission planning and organizing funding for new transmission lines.

A map of current ISOs and RTOs can be seen in Figure 43.

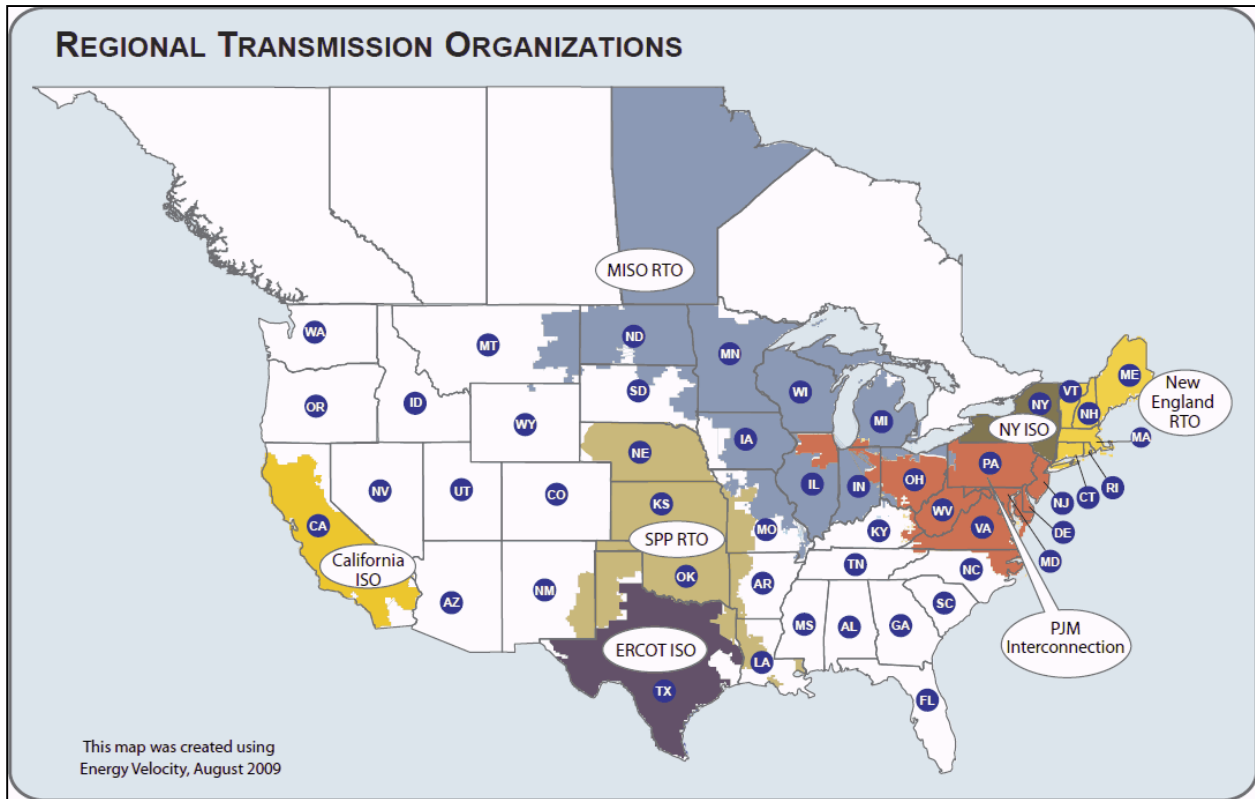

Figure 43. Map of ISOs and RTOs. Source: FERC (August 2009).

An important development in FERC’s regulatory responsibilities came with the Energy Policy Act of 2005, which gave FERC “backstop” siting authority for new transmission lines. Under this act, the DOE is required to conduct a transmission congestion study every three years, which it can use to designate any number of National Interest Electric Transmission Corridors (NIETCs). These NIETCs are designated as “any geographic area experiencing electric energy transmission capacity constraints or congestion that adversely affects customers.” Once the DOE has designated a NIETC, special rules apply to proposed transmission projects within it. If a state fails to act on an application for any such project within a year of its submission, or if a state rejects such an application, FERC can bypass the state and approve that application. This is backstop siting authority.

This new backstop authority has not gone unquestioned, however. In February 2009, the 4th Circuit Court of Appeals ruled that FERC had overstepped its authority. This issue has not been resolved, however, as FERC has asked for reconsideration of this decision.

Another major aspect of federal regulation of the electrical power system is ensuring the reliability of that system. The EIA defines reliability as “adequacy of supply and security of operations.” The electrical power system has long been operated with the intention to provide customers with the power they demand with a high level of reliability.

FERC has the authority to conduct oversight of all electrical power entities in the 48 contiguous states to ensure reliable operation of the bulk power system, which includes transmission. Before the Energy Policy Act of 2005, however, reliability was largely taken care of by voluntary self-regulation of the electrical power industry. This was done through an industry association called the North American Electric Reliability Council (NERC). Since it was a voluntary organization, NERC did not initially have the authority to enforce its reliability standards.

After the Northeastern blackouts of 2003, FERC was ordered by the Energy Policy Act of 2005 to designate an official Electric Reliability Organization (ERO). In 2006, FERC designated NERC as this ERO, after it had been reorganized as the North American Electric Reliability Corporation. Now FERC must approve all regulation and enforcement actions by NERC. The NERC has delegated some of its regulatory responsibilities to its eight regions. These regions are displayed in Figure 44.

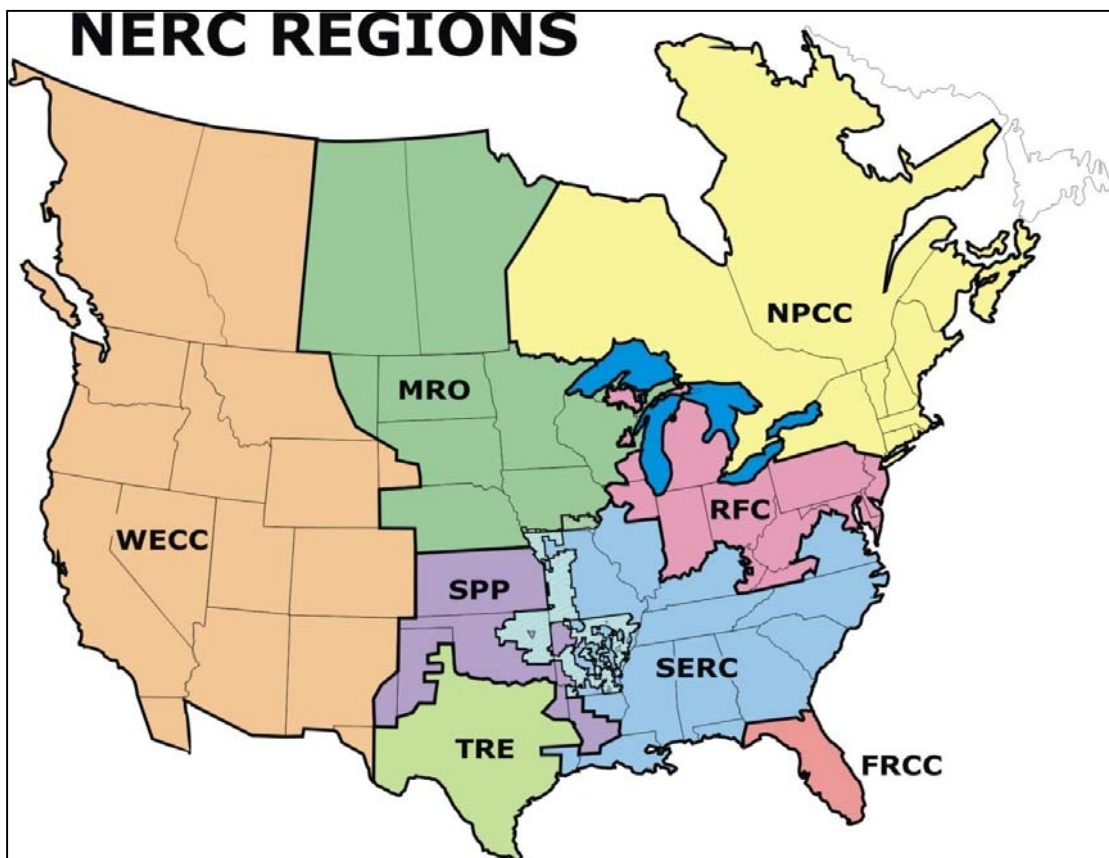

Figure 44. NERC Regions. Source: NERC (August 2007).

The abbreviations in Figure 44 are as follows: FRCC – Florida Reliability Coordinating Council; MRO – Midwest Reliability Organization; NPCC – Northeast Power Coordinating Council; RFC – ReliabilityFirst Corporation; SERC – SERC Reliability Corporation; SPP – Southwest Power Pool; TRE – Texas Regional Entity; and WECC – Western Electricity Coordinating Council. ASCC – the Alaska Systems Coordinating Council, is an affiliate member of the North American Electric Reliability Corporation (NERC).

## Transmission Congestion

Transmission congestion occurs whenever electricity flowing across a transmission line is restricted. This might happen due to physical constraints, such as the maximum capacity of the line. It also might happen due to operational constraints, such as limits placed on electricity flows to ensure system reliability and security. Transmission congestion often leads to higher electricity prices, and it can cause interruptions in service. In areas of chronic congestion, it may prevent new generation facilities from being built, since congested lines reduce the market access of any potential generators.

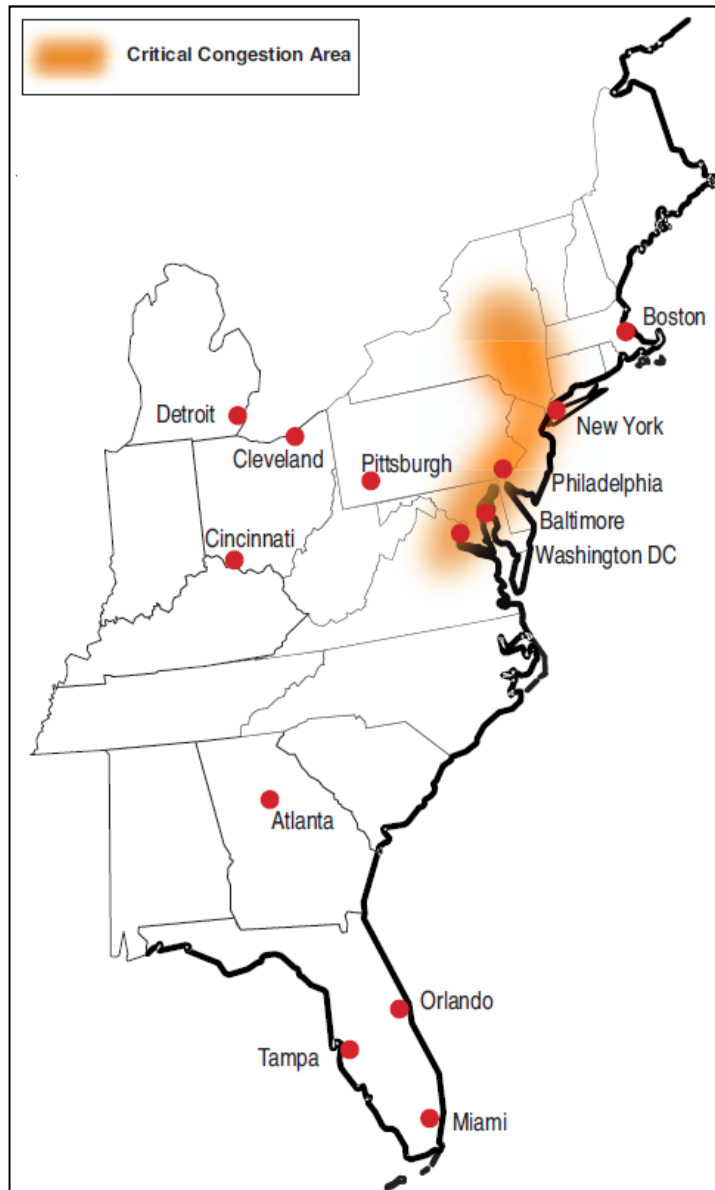

Figure 45. Critical congestion area in the Eastern Interconnection. Source: DOE NETCS (April 2009).

The DOE National Electric Transmission Congestion Study (NETCS) measures transmission congestion across the United States every three years. As of this writing, the most recent NETCS report was published in April 2009. This study and the 2006 NETCS study are the main data sources for the remainder of this subsection.

The NETCS measures transmission congestion in three ways: in terms of magnitude—such as the number of hours per year a line operates at its maximum safe level; in terms of cost—such as any increases in price caused by a line operating at its maximum safe level; and in terms of shortfalls in reliability. The NETCS also identifies three classes of areas experiencing transmission congestion, which are as follows in order of greatest to least severity: critical congestion areas, congestion areas of concern, and conditional congestion areas.

Critical congestion areas are those in which the current or projected effects of transmission congestion are severe, so it is imperative they be remedied as soon as possible. These areas are mostly large, densely populated, and economically active demand centers that experience

repeated adverse effects from congestion. Congestion areas of concern are those in which there are large or emerging congestion problems, but for which more research is required to determine both the

magnitude of these problems and the appropriate response to them. Conditional congestion areas are those that currently exhibit some congestion and would be adversely affected by a large increase in generation that is not paired with a concurrent increase in transmission capacity.

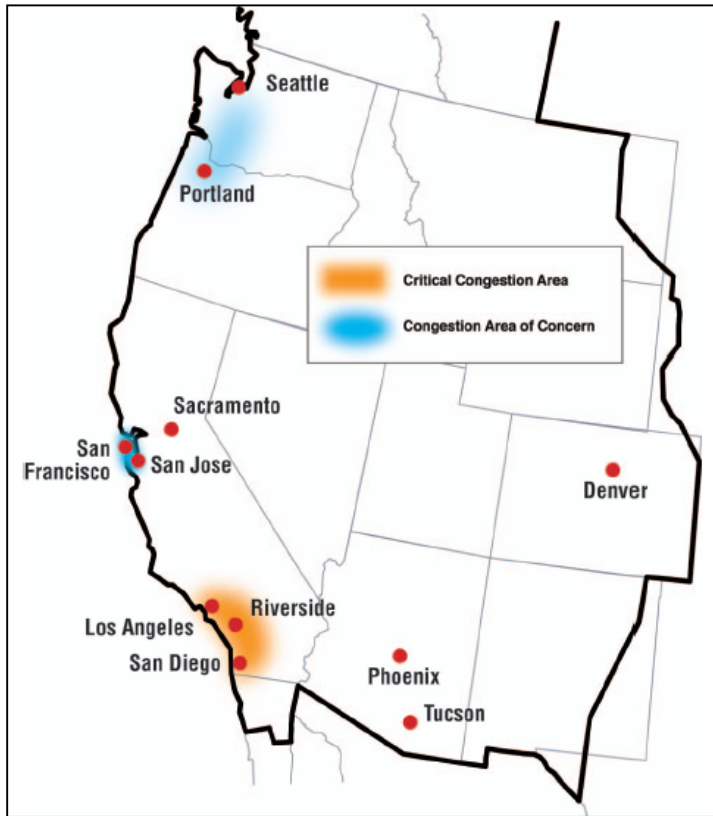

Figure 46. One critical congestion area and three congestion areas of concern in the Western Interconnection. Source: DOE NETCS (April 2009).

Each of the congestion areas identified in the report face a unique set of technical and policy challenges as well as a unique set of potential solutions to their problems. Sometimes building new transmission lines is a suitable solution, but sometimes this simply shifts the congestion from one location to another. At other times, the expected cost of alleviating the congestion may exceed that of the congestion itself, in which case it may be most economical to refrain from implementing a solution. Sometimes alternatives to new transmission lines—energy-efficiency initiatives, demand response or load management programs, distributed generation, or energy storage technologies—are viable solutions to congestion. The DOE has committed to working with FERC, various regional authorities, states, companies, and other

stakeholders to address the problems outlined in the NETCS.

Figure 45 illustrates a critical congestion area. Designated by the orange-shaded area, the critical congestion area extends southward along the Atlantic coast from metropolitan New York to northern Virginia.

Figure 46 illustrates one critical congestion area and two congestion areas of concern in the Western Interconnection. The critical congestion area is designated by the orange-shaded region in southern California. The congestion areas of concern include the San Francisco Bay area as well as Portland/Seattle. The development of wind resources to the east of Portland and Seattle is exacerbating the transmission congestion in that area.

Two areas identified as congestion areas of concern in the 2006 NETCS were alleviated to the extent that they were removed from the 2009 NETCS. The first was New England, which used a combination of new transmission lines and demand-side management to significantly reduce any reliability issues while

meeting its load requirements. The second was the greater Phoenix and Tucson region, which since 2006 has benefited from numerous new transmission projects.

Recall that the congestion areas identified by the 2009 NETCS, and shown in Figure 45 and Figure 46 above, are not themselves National Interest Electric Transmission Corridors (NIETCs). Based on the data from the 2006 NETCS, the U.S. Secretary of Energy designated two NIETCs in October 2007: the Mid-Atlantic Area National Corridor and the Southwest Area National Corridor. This designation will remain in effect until October 2019. As of this writing, the Secretary of Energy has not taken further action on the 2009 NETCS study.

A map of the Mid-Atlantic Area National Corridor can be seen in Figure 47. This corridor includes counties in New York, Ohio, Pennsylvania, Virginia, and West Virginia, as well as all of New Jersey, Delaware, and Washington, DC. It is designated by the black-and-white dotted area in Figure 47.

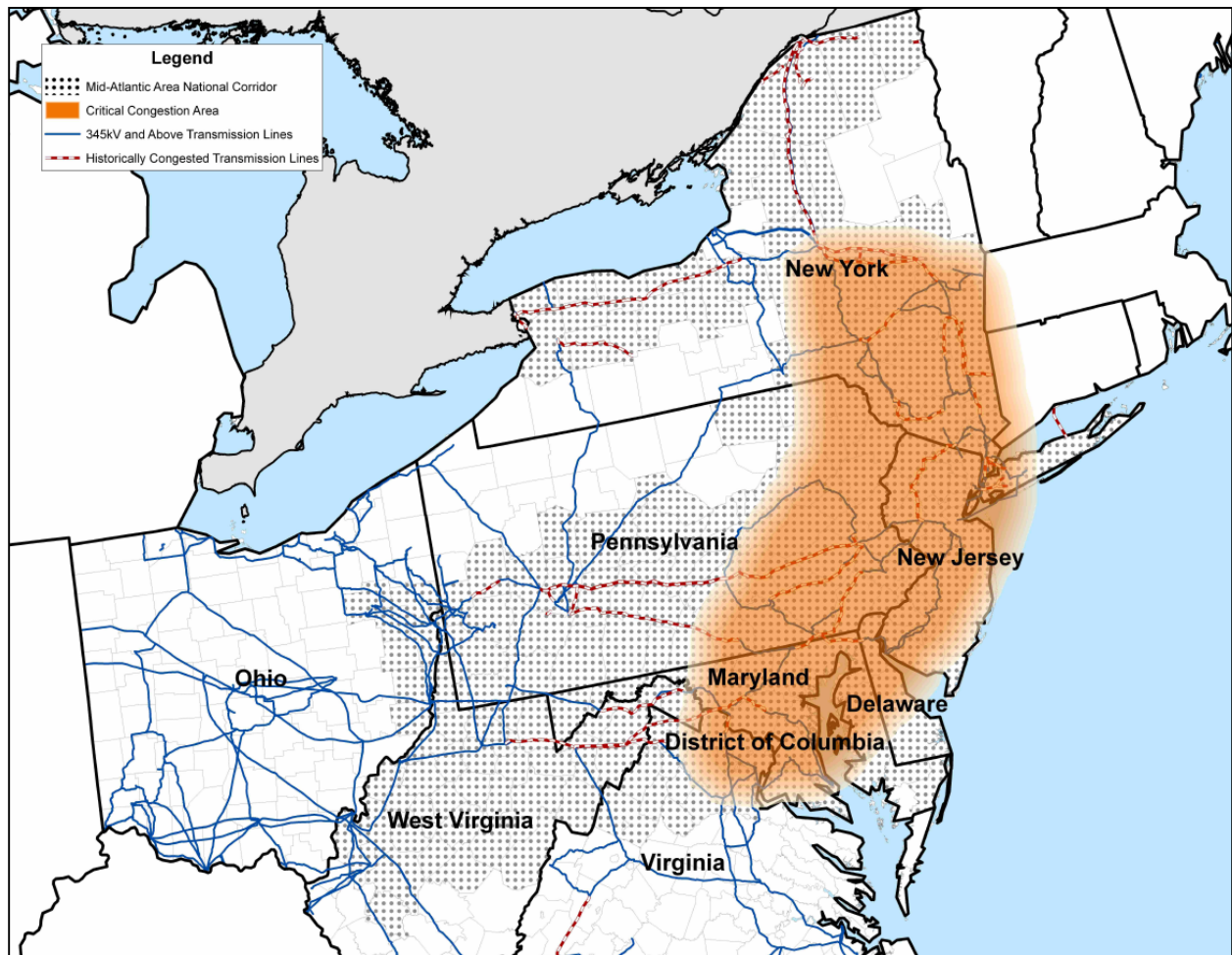

Figure 47. Mid-Atlantic Area National Corridor map. Source: DOE (October 2007).

A map of the Southwest Area National Corridor can be seen in Figure 48. This corridor includes certain counties in Arizona and California. It is also designated by a black-and-white dotted area.



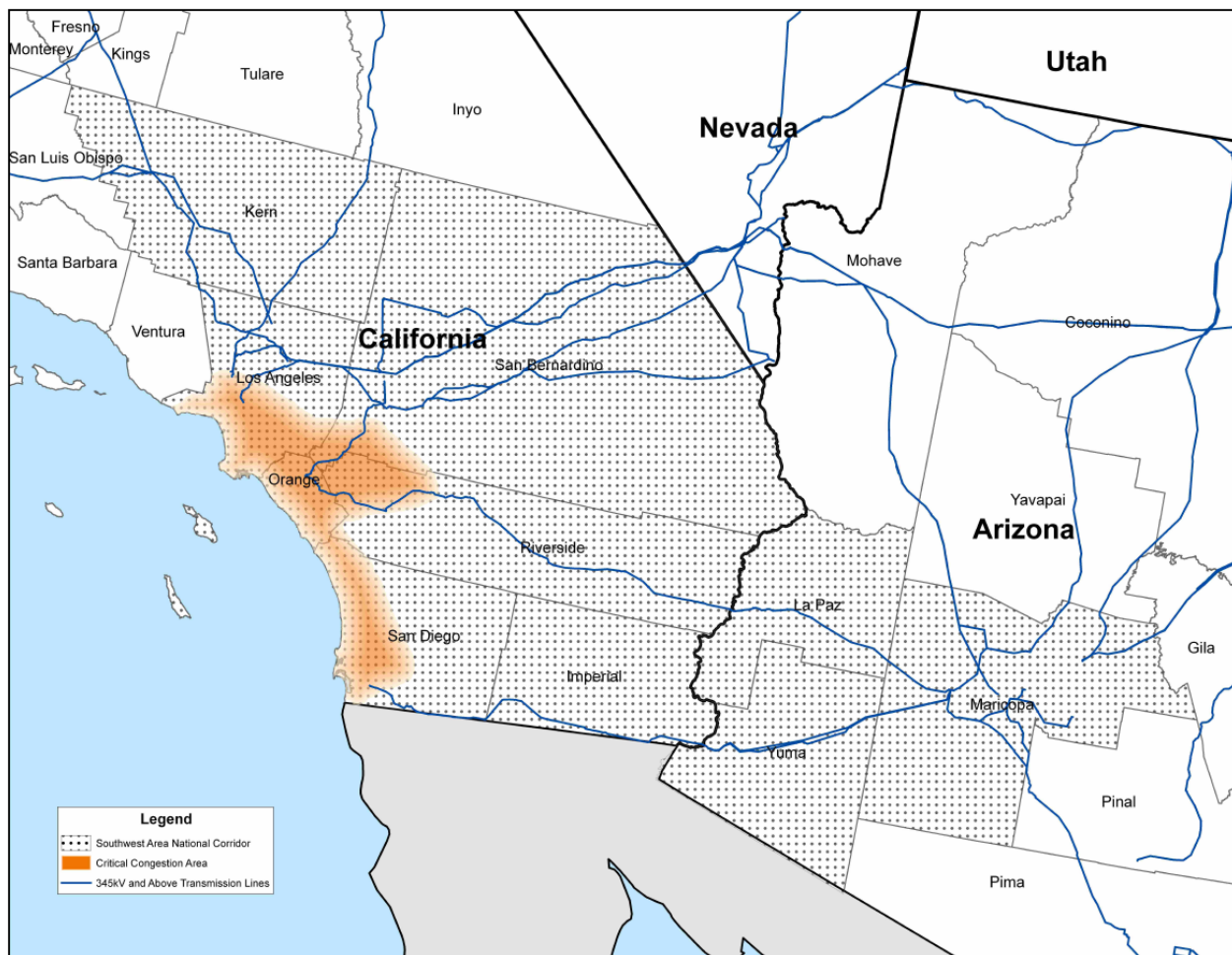

Figure 48. Southwest Area National Corridor map. Source: DOE (October 2007).

Note that the National Interest Electric Transmission Corridors shown in Figure 47 and Figure 48 extend beyond the boundaries of the critical congestion areas designated by the DOE in its NETCS. This was done to include all areas adversely affected by congestion, including those “downstream” from transmission lines in the critical congestion areas; and areas with underutilized generation capacity or significant potential for renewable generation development—factors that may contribute to greater transmission congestion in the future.

### Transmission Access

Unlike traditional fuels such as coal, petroleum, or natural gas, most renewable energy resources cannot be transported from one location to another. Wind, solar, hydro, and geothermal resources all require collocated generation facilities. Even biomass can be economically transported only modest distances due to its low energy density. This may be a significant barrier to investment in renewable energy, since many of these resources are located in remote areas that do not have nearby transmission lines with excess capacity.

The dearth of high-power transmission lines in regions that are rich in renewable resources can be inferred in part from visual inspection of Figure 49, which displays a map of the United States' existing transmission infrastructure. With the exception of two DC lines that span parts of North Dakota and Minnesota, the wind-rich Great Plains only have 345–499 kV transmission lines, and existing lines in that region are sparse. Broadly speaking, few high-power transmission lines exist that are capable of transporting power from the middle of the country—where many renewable resources are located—to demand centers near the coasts. In the Upper Plains in particular, cooperatives own roughly half of the existing transmission infrastructure, and because of their incentive to primarily serve members, have little economic interest in building lines that will primarily serve customers in other regions.

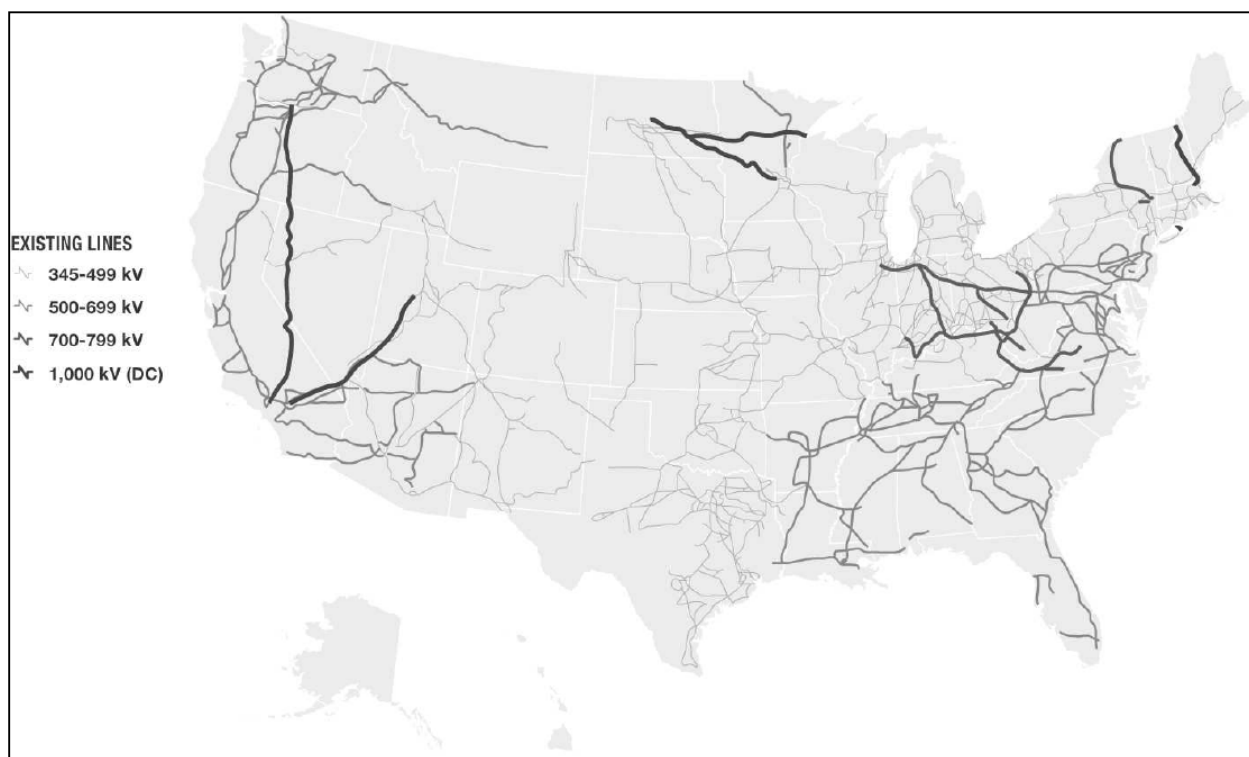

Figure 49. U.S. Electric Grid. Source: NPR (2010).

Although physical access to transmission lines is much less of an issue in the Eastern and Western United States than it is in the middle of the country, congestion in these regions may limit access to transmission capacity. There are many transmission lines in the Northeast, but this region suffers from relatively severe transmission congestion. In the Southeast, a history of vertically integrated IOUs may be making it more difficult to implement open access to the transmission lines in that region. The transmission system of the Western United States, unlike that of the Eastern United States, was built to transport power across long distances and from remote locations to densely populated demand centers. For this reason, transmission access for location-constrained renewables may be less of an issue in this region than it is in the East. However, the Southwest suffers from relatively severe transmission congestion, and this may bar investments in solar and geothermal power in the near future by limiting access to transmission capacity.

In some cases, access to transmission can be the deciding factor in determining the feasibility of a proposed renewable generation project. The 2009 NETCS discussed in the preceding section also identified areas in which further development of renewable resources is being blocked by inadequate access to transmission capacity. These areas can be seen in Figure 50. The Type I areas are those in which renewable resources could be cost effectively developed using existing technologies, but are not being developed due to transmission constraints. The Type II areas are those in which there are rich renewable resources, but mature technologies for developing those resources do not yet exist. Once such technologies are developed, the primary constraint to resource development in those areas will likely be the adequacy of the transmission infrastructure.

### Waverly Light and Power

Waverly Light and Power (WLP) is a publicly owned utility that serves the residences and businesses of Waverly, IA. WLP became the first utility in Iowa to own and operate its own wind power when, in 1993, it installed an 80 kW turbine. It later installed two 750 kW turbines at the Storm Lake wind facility and an additional 800 kW turbine in the town of Waverly. This latter turbine was constructed in an area with less-than-ideal wind resources, because it was more economical to connect it to existing lines than to build a new transmission line.

The price of the electricity coming from these wind turbines is competitive with other energy sources but varies according to the availability of the Renewable Energy Production Incentive (REPI). As an additional source of revenue, Waverly Light and Power sells the renewable energy credits generated by its turbines.

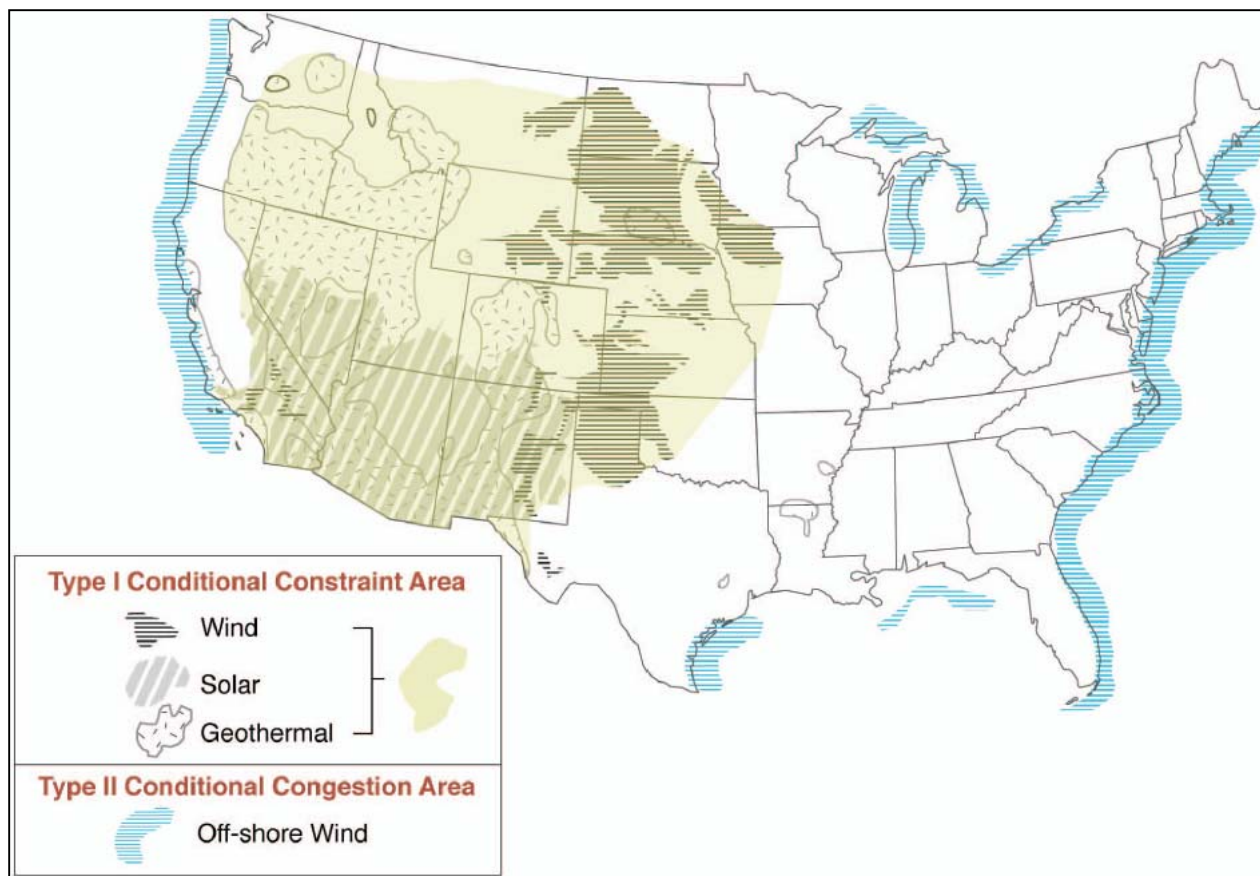

Figure 50. U.S. Conditional constraint areas. Source: DOE NETCS (April 2009).

Figure 50 shows large areas in which inadequate transmission infrastructure is a barrier to the development of wind, solar, and geothermal resources in the United States.

### Transmission and Bulk Power Reliability

As previously stated, the EIA defines reliability as “adequacy of supply and security of operations.” Similarly, according to NERC, there are two main aspects of transmission system reliability: sufficient capacity to continuously meet customer needs and sufficient resiliency to withstand major failures, such as the loss of a crucial transmission line.

The relationship between renewable energy and transmission reliability is complicated. Integrating more renewable energy and distributed generation into the electrical power system may have a positive impact on system-wide reliability, as it diversifies that system’s energy portfolio. However, the variability of intermittent renewable power sources may pose significant reliability challenges—especially as the number of these sources that are connected to the grid increases in the coming years.

## Variability and Uncertainty

Some sources of renewable power are more variable than others. This variability is often measured by a generation facility's on-peak capacity factor, or the percentage of time that the facility operates at its maximum capacity. The on-peak capacity factor of wind power facilities is fairly low at an average 24 percent, while that of solar power is a mere 14 percent. Geothermal and biomass fare better, for example, with average on-peak capacity factors of 74 percent and 28 percent, respectively.

The variability of wind power, in particular, will become a pressing issue if wind power remains the focus of North American renewable energy development. Its prevalence will create reliability challenges on two fronts: it may place a strain on transmission capacity during periods of peak wind generation, and it may reduce the availability of generation capacity during periods of peak demand, since peak wind generation does not necessarily track peak demand.

According to NERC's Integration of Variable Generation Task Force, the bulk power system must become more flexible in order to accommodate wind variability. New transmission infrastructure must also be able to manage both the variability and intermittency of wind resources.

## Demand Outstripping Supply

In the United States, the demand for renewable energy currently exceeds the supply. This is largely due to states enacting Renewable Portfolio Standards (RPSs)—policies that mandate electricity providers obtain a minimum amount of their power from renewable resources by a certain date. As of this writing, 29 states and Washington, DC, have RPSs in place, with mandates as high as 40 percent and transition periods that range from five years to more than 20.

### Platte River Power Authority

Platte River Power Authority (PRPA) is a joint action agency based in Fort Collins, CO. It was formed by four municipal utilities in Estes Park, Fort Collins, Longmont, and Loveland. PRPA owns and operates the Medicine Bow Wind Project in Medicine Bow, WY, which generates roughly 6 MW of wind power. Most of the power generated at that site is sold through PRPA's member utilities' green pricing programs, and some of it is sold to the Tri-State generation and transmission Cooperative.

In the early 1990s, the Platte River Power Authority conducted surveys to determine customers' willingness to pay for renewable energy. Following a positive response from its customers, it decided in 1996 to take an ownership stake in a wind power project planned for the nearby Foot Creek Rim area. This project met with financial difficulties before construction could begin, however, so PRPA withdrew.

After its negative experience with the Foot Creek Rim project, PRPA decided to purchase green power, rather than own its own facilities. After soliciting bids from various suppliers, PRPA agreed to purchase the output of a planned wind power project near the town of Medicine Bow. Its developer encountered financial difficulties as well, though, so PRPA decided to assume sole ownership of all of the project's assets in 1998. At the time, this consisted of two wind turbines generating about 1 MW of power. Most of this power was sold to Fort Collins.

In 1999, PRPA installed five additional turbines at the Medicine Bow wind farm to meet demand for green power from its member utilities as well as from Tri-State generation and transmission Cooperative and the Municipal Energy Agency of Nebraska. Demand from its member utilities for green power continued to increase, so it installed two more turbines in 2000.

PRPA planned to add more turbines to the Medicine Bow facility in subsequent years, but was prevented from doing so by transmission constraints. Due to the variability of wind power, integrating additional turbines into PRPA's service area would entail significant regulatory costs. In 2005, it leased land to Clipper Wind Power to develop a 2.5 MW prototype turbine. The output of this turbine is purchased by PRPA.

According to NERC, the demand for renewable resources may outstrip the available supply by as much as 30 percent in 2010. If wind power remains the focus of North American renewable energy development, this will place a strain on the procurement of wind turbines in the United States. As of this writing, only two U.S. wind turbine manufacturers account for more than 75 percent of the market. As the demand for wind power increases, shortages of wind turbines and delays in turbine delivery could significantly impact the reliability of the bulk power system.

### **Reactive Power**

Reactive power, garnered from the magnetic fields created by traditional generation technologies, is often used to provide dynamic voltage support to the electrical power delivered to the grid. The reactive power derived from renewable resources, particularly wind and solar, in some cases can be provided neither dynamically nor in continuously variable amounts. For this reason, as more renewable power is added to the grid, reactive power may not be as readily available and voltage stability may be negatively impacted.

To address this problem, some renewable power facilities are installing systems that provide dynamic reactive power support and regulate grid voltages. Examples of this kind of technology are static compensators (STATCOMS), static VAR compensators (SVC), and Flexible AC Transmission System (FACTS) devices. These dynamic reactive power systems allow reactive power-deficient renewable power facilities to better meet grid interconnection standards. Such technologies have not yet been deployed on a large scale, however.

### **New Grid Technologies**

Connecting a large number of non-traditional resources to the grid, such as distributed generation and “Smart Grid” technologies, may pose additional reliability challenges. While many of these new technologies are not without precedent and are currently part of the grid on a small scale, their increased use may strain a bulk power system designed largely around different technologies.

For more information on distributed generation and “Smart Grid” technologies, refer to the section of this document entitled *Transmission Modernization and the Smart Grid*.

### **Transmission Expansion Paths for Renewable Energy**

The two main goals for transmission expansion are: relieving congestion and improving the reliability of the bulk power system, as discussed above, and reaching areas where renewable resources are located, which are often remote. While these two goals do not conflict, emphasizing one over the other will likely lead to different transmission expansion paths. Expansion to relieve congestion and improve reliability will typically focus on urban areas, while expansion to reach renewables will more likely focus on rural areas and may do little to relieve congestion and improve reliability. While transmission expansion for renewable energy is primarily addressed here, transmission expansion policy will have to balance these dual goals, taking into account resource constraints.

### **Approaches to Transmission Expansion**

There is currently a great diversity of transmission expansion plans and proposals, from utilities, regional authorities, and state and national government entities, among others. These prioritize different aspects

of the transmission expansion process, and vary in both scope and level of detail. Many of the current plans and proposals take a local or regional perspective, rather than a national one, as would be required to develop a fully integrated plan that responds to society's long-term needs. Policy debates regarding transmission are, however, beginning to place greater emphasis on national-level transmission planning as well as on renewables.

In national policy debates, two main approaches are being discussed for transmission planning to expand access to renewable electricity generation. The first of these is a "transmission superhighway" approach. This would involve a transcontinental overlay of ultra-high voltage transmission lines, much like an electrical equivalent of the interstate highway system. Such a transmission superhighway would allow flows of electricity generated from renewable energy to reach customers across the entire country, not just those collocated with renewable resources. A study that provides an example of this type of planning is the 2008 DOE report *20% Wind Energy by 2030*. Plans of this type are still in conceptual stages.

The second main approach to transmission planning for expanding access to renewable electricity generation is that of regionally connecting demand centers to "renewable energy zones." This approach deploys regional or interconnection-wide plans that have identified areas of abundant renewable resources located within the region. The main benefit of this approach is that it reduces the amount of coordination needed across regions and interconnections. A study that provides an example of this type of planning is the Joint Coordinated System Plan (JCSP) 2008 report.

Policymakers are also debating whether a top-down or bottom-up approach should be used when designating national transmission planning authority. Some advocate for centralized authorities, at either the national or the interconnection-wide level. Others advocate for smaller, regional authorities. Yet others think the authority should include a mix of national, interconnection-wide, and regional authorities.

A recent development of special importance to transmission planning is a Funding Opportunity Announcement (FOA) issued by the DOE in June 2009. Through this FOA, the DOE made available to the three interconnections serving the 48 contiguous states funding to both analyze transmission requirements under a broad range of possible future scenarios, and to develop long-term plans for interconnection-wide transmission expansion.

### **Transmission Expansion Challenges**

A number of challenges must be overcome if expansion of the United States' transmission infrastructure is to be successful. These challenges involve permitting issues as well as issues associated with financing and cost allocation. Another important factor influencing transmission expansion is the extent to which renewable power is considered in transmission expansion plans and proposals.

### **Permitting Transmission Lines**

Interstate transmission lines require siting permits from all of the states in which they are located. This can be a major hurdle. For example, according to FERC, only 14 interstate high-voltage transmission lines were built between 2000 and mid-2007, covering a mere 668 miles. Multi-state permitting can

pose significant challenges to developing new long distance transmission lines, required by many transmission expansion plans and proposals for expanding access to renewable electricity generation.

A number of proposals currently address this issue. Some focus on streamlining and making more transparent the state-level permitting process. Others focus on creating a federal-level permitting process, or at least giving FERC or another federal entity an increased role in permitting. Recall that FERC's backstop siting authority, which gives it the ability to override state transmission siting decisions, recently has been called into question.

### *Transmission Expansion Financing and Cost Allocation*

No matter what path it follows, transmission expansion will be costly. The DOE report *20% Wind Energy by 2030* estimates that transmission expansion costs for its scenario will reach \$60 billion by 2030. The Joint Coordinated System Plan (JCSP) 2008 report estimates that bringing wind power from the Great Plains to the East Coast may cost anywhere from \$49 billion to \$80 billion. Another study, *Transforming America's Power Industry: The Investment Challenge 2010-2030*, estimates that costs for all transmission expansion purposes would total roughly \$300 billion.

Open access to the transmission system has complicated funding new transmission projects. While the wholesale electricity market responded positively to open access reforms, a commonly accepted framework for enabling and encouraging investment in new transmission infrastructure under open access is yet to emerge. Some current construction incentives for new transmission lines were made available through the Energy Policy Act of 2005, although this has had little impact on the number of new transmission projects.

A transmission funding issue that is particularly prominent for renewable power projects is the "early funding" problem. This problem is as follows: Renewable power plant developers cannot secure sufficient funding because the transmission infrastructure necessary to deliver their power to demand centers does not yet exist; and, conversely, transmission projects designed to connect renewable resource-abundant areas to demand centers cannot secure sufficient funding because the generation facilities that would exploit those resources are not yet in place. Although state and regional authorities, as well as FERC, have been designing mechanisms to solve this problem, a standard or commonly used approach is not yet in place.

Cost allocation for new transmission projects has become a pressing issue in the wake of open access reforms. While traditional mechanisms for distributing expansion costs among various transmission stakeholders are clearly no longer appropriate, new mechanisms for cost allocation have been neither fully designed nor widely implemented. A particularly contentious issue is the allocation of costs for new interstate transmission lines—lines that will be crucial for integrating more renewable energy into the U.S. electrical power system. In such cases, it is difficult to decide which stakeholders will pay for how much of the proposed project, especially since potential benefits may likely accrue to individuals largely outside of the states in which most of the new lines will be located.

The Electricity Advisory Committee of the DOE recently concluded, "cost allocation is the single largest impediment to any transmission development." It also noted that cost allocation issues can often impact



siting decisions, so it is important that these two aspects of the transmission planning process be addressed in tandem. In the absence of a clear cost allocation mechanism, arguments about costs may become proxies for siting disagreements, or even for other seemingly unrelated disputes.

In the final analysis, it is unlikely that large-scale transmission expansion will occur in the absence of a clear regulatory structure governing the cost allocation of new transmission projects. Reports such as *A National Perspective on Allocating the Costs of New Transmission Investment: Practice and Principles* argue for broadly inclusive regional and sub-regional transmission planning. *A National Perspective...* also suggests similarly inclusive cost allocation that operates according to a “beneficiaries pay” principle.

Broad cost allocation is often justified by the consideration that, in a synchronized grid, all ratepayers benefit to some extent from new transmission lines. Also, when new transmission infrastructure is built to accommodate new renewable power sources, the environmental benefits similarly accrue to all ratepayers. Interconnection-wide cost sharing streamlines project approvals by replacing complicated rate hearings with a simple cost allocation mechanism and by minimizing the financial impact of a new project on any one group of stakeholders.

Broad cost allocation is not without its critics, however. Regional or sub-regional cost allocation may become unfair when the use of the electrical power system changes and flows across the grid are significantly altered. It can also be argued that cost discipline will decline when costs are spread too broadly. Making the financing of new transmission lines disproportionately attractive will create a disincentive for investments in other solutions, such as demand response measures or new local renewable power sources.

As with transmission permitting and financing, there are many diverse proposals for ways to address transmission cost allocation issues. Nevertheless, a standard or commonly used approach is not yet in place.

### **Transmission Modernization and the Smart Grid**

Additional transmission lines are not the only available option for addressing transmission congestion and reliability challenges. Pre-existing transmission assets can be improved or upgraded. Generally, efforts to update the transmission system without laying down new transmission lines fall under the “Smart Grid” heading. The National Energy Technology Laboratory (NETL) has identified the following aspects of the Smart Grid:

1. Self-healing from power disturbance events
2. Enabling active participation by consumers in demand response
3. Operating resiliently against physical and cyber attack
4. Providing power quality for 21st century needs
5. Accommodating all generation and storage options
6. Enabling new products, services, and markets
7. Optimizing asset utilization and operating efficiently

This section will focus on four elements of the Smart Grid that are directly related to connecting more renewable power sources to the grid: energy efficiency improvements; demand response and load management technologies; distributed generation systems; and energy storage options.

### **Energy Efficiency**

New grid information technologies can lead to more efficient use of current grid capacity. Any technology that improves the efficiency of preexisting transmission infrastructure makes more capacity available for new renewable power sources to connect to the grid. For this reason, there is a close relationship between energy efficiency and the integration of more renewable resources into the electrical power system.

#### **Minnesota**

The Minnesota state legislature has implemented a program that requires electric and natural gas utilities to achieve a savings of 1.5 percent in energy sales per year, with a minimum of 1 percent achieved through energy efficiency measures. Through the state's Conservation Improvement Program (CIP), utilities have access to grants, rebates, energy audits, and educational programs designed to assist them in their energy efficiency initiatives. Additionally, Minnesota's Public Utilities Commission can require publicly owned utilities to invest in energy efficiency improvements, and it can stipulate the terms through which these utilities must offer such improvements to their customers.

#### **Prairie Power, Inc.**

Prairie Power, Inc., is a generation and transmission cooperative based in Jacksonville, IL. It has 10 member distribution cooperatives and serves more than 83,100 customers.

To encourage its customers to engage in energy efficiency activities, Prairie Power and its 10 member Touchstone Energy Cooperatives developed "The Energy Efficiency Wall." The "Wall" is a display that illustrates many different devices and techniques that can be used to conserve energy in the home. It features geothermal heating devices, energy-efficient lights and appliances, insulation and ventilation techniques, and DVDs and brochures with more information. It is shown at a variety of cooperative customer/member events, including annual meetings, trade shows, and county fairs.

### **Demand Response and Load Management**

Demand response programs help to lower peak demand by transmitting real-time pricing information to electricity consumers. Because prices are notably higher at times of especially high demand, consumers who have access to real-time price information may respond by reducing their consumption during peak hours. Load management programs operate according to a similar principle, except they involve utilities physically reducing the electricity supplied to air-conditioning units and other large appliances during peak hours. Some load management programs also involve agreements with industrial customers to switch to on-site generation during periods of high demand.

## Pennsylvania Rural Electric Association

The Pennsylvania Rural Electric Association (PREA) is a nonprofit service organization located in Harrisburg, PA. It serves 14 cooperatives in Pennsylvania and New Jersey, and is governed by a board of directors that has one director from each cooperative. Its member cooperatives provide electricity to more than 225,000 customers, which represent roughly 600,000 consumers. Its 13 member cooperatives from Pennsylvania own roughly 12.5 percent of the distribution lines in that state, covering nearly one-third of its land area.

In December 1986, PREA launched the Coordinated Load Management System (CLMS). This demand-side management system controls electric water heaters and other special equipment during times of high demand. The homes and businesses of more than 47,000 consumers currently participate. CLMS is able to reduce demand by about 50 MW, which is equal to roughly 8 percent of the participating cooperatives' peak load.

PREA also recently launched the Renewable Energy Assistance Program (REAP). Through this program, cooperative members can receive assistance for installing a small renewable generation system at their home or farm (for instance, a wind turbine or an anaerobic digester). REAP provides grants to offset interconnection costs and to ensure that cooperative members do not subsidize other members' systems. Qualifying systems must be no larger than 500 kW. Any excess power generated by such a system is purchased by Allegheny Electric Cooperative, at its avoided cost.

Members participating in the REAP program have the option of assigning their renewable energy credits to Allegheny Electric Cooperative, in which case revenue from the sale of those renewable energy credits contributes to future REAP grants.

While such programs result in some overall reduction in electricity consumption, they mostly induce customers to shift consumption from peak hours to other times of the day. This has a smoothing effect on demand. For example, the Congressional Research Service reports that in Florida and the northeastern NERC regions, demand response programs allowed approximately 6 percent and 4 percent of peak demand, respectively, to be met by reduced consumption rather than by increased power output.

Demand response and load management programs may also allow demand to better respond to increased variability in supply occasioned by a greater number of renewable power sources connected to the grid. In general, these programs have the potential to significantly reduce the electrical power system's reliance on traditional generation facilities, if they are introduced on a large enough scale.

## Distributed Generation

Distributed generation refers to any local generation that is controlled by an electrical power customer. Examples include a wind turbine or solar panel on a residential customer's roof, or even a large industrial facility with onsite power generation. A distributed generation site will sometimes consume power from the grid; at other times, when its total generation exceeds its own consumption requirements, it will reverse the normal flow of electricity to its location and provide power back to the grid.

Because the existing grid was not designed to accommodate distributed generation, Smart Grid technologies could facilitate the integration of distributed generation into the electrical power system

on a large scale. In the future, having a large number of smaller generation facilities connected to the grid may increase system reliability by reducing the probability of widespread generation failure. Including more generation at the point of consumption also will reduce transmission losses and free up transmission capacity for new renewable power sources to connect to the grid. These effects will reduce the need for new transmission lines and will also place downward pressure on consumer delivery costs.

Another benefit of distributed generation is that distributed generation facilities that use variable resources and are located across a wide geographic area smooth the effects of local changes in resource availability. This characteristic of distributed generation may be particularly important for wind power. Other ways of managing wind power variability include combining wind facilities with energy storage or with a complementary power source such as a quick-start generator.

### Delaware Electric Cooperative

Delaware Electric Cooperative (DEC) is a distribution cooperative that serves more than 75,000 members in Kent and Sussex County, DE. In addition to offering a green power option to its members, DEC administers an independent renewable energy fund.

Through this fund, DEC members can apply for grants to offset the cost of new, small-scale, distributed renewable energy projects such as wind turbines, geothermal heaters, or photovoltaic solar panels. Grants are also available for energy efficiency and demand-side management projects. In the first year of the fund, DEC received applications for more than 20 geothermal heat pumps and two solar energy projects.

### Orcas Power & Light Cooperative

Orcas Power & Light Cooperative (OPALCO) is a cooperative that provides electric power to San Juan County, WA. San Juan County encompasses an archipelago of 20 islands off the coast of Washington State. Roughly 85 percent of the power OPALCO distributes to its members is hydropower purchased from Bonneville Power Administration (BPA) and delivered to the islands by submarine transmission lines. The remaining power comes from coal-fired plants, member-owned renewable energy systems, and wind power purchased through OPALCO's green pricing program.

OPALCO helps its members/customers connect small renewable energy projects to the grid, including solar, wind, and microhydro generators, as well as electric cars. Projects must meet OPALCO's interconnection standards and must have a capacity of 200 kW or less. Members who choose to install such systems can opt either for Net Metering or for an agreement through which they are paid for any power they generate in excess of their own demand.

OPALCO also administers an incentive program for members that choose to install small renewable energy systems. Generally, it provides members with \$1.50 per watt of capacity, up to a maximum of \$4,500 per member. In 2010, the fund had \$25,000 at its disposal.

## Energy Storage

Energy storage can be used for a number of different applications, including improving power quality, managing peak loads, supporting renewables, and deferring transmission upgrades. Since energy

storage enables one to decouple power generation and consumption, it is particularly useful for renewable power sources that are variable and/or intermittent, such as wind or solar.

Intermittent renewable power sources like wind turbines are often paired with second type of generation, such as natural gas turbines. This second type of generation is used to provide backup power during lapses in renewable generation. High-power storage technologies could be used to smooth the power output of such pairings by providing power during transitions between generators.

The electrical power supplied by intermittent and variable renewable power sources does not always line up with demand. High-volume energy storage technologies can mitigate this mismatch between supply and demand by storing power from renewable sources whenever it is generated and dispatching it during periods of high demand. Such technologies can also be used to generally smooth the output of variable renewable power sources, so they require less grid capacity and can dispatch power more reliably. In these ways, energy storage may improve the cost-effectiveness of renewable generation.

By improving power quality and reducing peak demand, energy storage technologies enable more efficient use of existing transmission infrastructure. Additionally, they provide system operators greater flexibility when incorporating new power sources on the grid. Such improved efficiency and flexibility make more transmission capacity available for new renewable power sources. By decoupling generation and consumption, storage technologies also allow renewable generators to better avoid transmission congestion charges, further improving their cost-effectiveness.

Another use of high-energy storage technologies is to defer upgrades to transmission (or distribution) infrastructure. In such cases, an energy storage device is typically installed near the site where upgrades are needed. The device can reduce the loading on the existing infrastructure during times when the infrastructure is heavily loaded, thereby temporarily fulfilling needs that may ultimately be met by future transmission (or distribution) upgrades.

Table 8. Energy storage technologies Source: ESA.

Storage Technologies	Main Advantages (relative)	Disadvantages (Relative)	Power Application	Energy Application
Pumped Storage	High Capacity, Low Cost	Special Site Requirement		●
CAES	High Capacity, Low Cost	Special Site Requirement, Need Gas Fuel		●
Flow Batteries: PSB VRB ZnBr	High Capacity, Independent Power and Energy Ratings	Low Energy Density	◐	●
Metal-Air	Very High Energy Density	Electric Charging is Difficult		●
NaS	High Power & Energy Densities, High Efficiency	Production Cost, Safety Concerns (addressed in design)	●	●
Li-ion	High Power & Energy Densities, High Efficiency	High Production Cost, Requires Special Charging Circuit	●	○
Ni-Cd	High Power & Energy Densities, Efficiency		●	◐
Other Advanced Batteries	High Power & Energy Densities, High Efficiency	High Production Cost	●	○
Lead-Acid	Low Capital Cost	Limited Cycle Life when Deeply Discharged	●	○
Flywheels	High Power	Low Energy density	●	○
SMES, DSMES	High Power	Low Energy Density, High Production Cost	●	
E.C. Capacitors	Long Cycle Life, High Efficiency	Low Energy Density	●	◐

CAES - Compressed air energy storage

DSMES - Distributed superconducting magnetic energy storage

E.C. capacitors - Electrochemical capacitors

Li-ion - lithium-ion battery

NaS - Sodium-sulfur battery

Ni-Cd - Nickel-cadmium battery

PSB - Polysulfide bromide battery

SMES - superconducting magnetic energy storage

VRB - Vanadium redox battery

ZnBr - Zinc-bromine battery

Most energy storage technologies are suitable for either high-power or high-energy applications, but not both. The types of application for which existing energy storage technologies are best suited can be seen in Table 8. A fully shaded circle indicates that a technology is fully capable and reasonable for a given application; a half-shaded circle indicates that a technology is reasonable, but not ideal, for a given application; and an unshaded circle indicates that a technology is not practical or economical for a given application.

In Table 8, CAES refers to a specialized gas turbine system that uses compressed air to store energy during off-peak hours. A polysulfide bromide battery (PSB) is a fuel-cell-based energy storage technology. Vanadium redox (VRB), zinc-bromine (ZnBr), sodium-sulfur (NaS), lithium-ion (Li-ion) and nickel-cadmium (Ni-Cd) batteries are several kinds of advanced battery systems. Superconducting

Magnetic Energy Storage (SMES) and Distributed SMES (DSMES) systems use the magnetic field in a cryogenically frozen superconductor to store energy.

High-power applications include those that improve power quality and that provide power during transitions between generators. High-energy applications manage energy over longer periods of time, such as peak load management, intermittent renewables support, and transmission upgrade deferral.

When selecting an energy storage technology, a number of factors must be considered. These include size and weight, capital costs, lifetime efficiency, and per-cycle cost. For applications that include frequent charge and discharge, such as many of those that support renewables, per-cycle cost is often a good measure of application cost. This cost should be calculated in a manner that includes operations and management costs as well as replacement, disposal, and other ownership costs. These figures are not always known for newer technologies.

More information on energy storage technologies is available from the Electricity Storage Association (<http://www.electricitystorage.org/>).

## Future Electricity Demand

This section contains regional and national electricity demand projections. All data for the regional demand forecasts are from the EIA Annual Energy Outlook 2010 reference case (<http://www.eia.doe.gov/oiaf/aeo/>). Additional data on population and employment are from the USDA Economic Research Service (ERS), the U.S. Census Bureau, and the U.S. Bureau of Labor Statistics.

### Regional Demand Forecasts

A map of the 13 regions used below for regional demand forecasts is displayed in Figure 51. These regions are adapted from the 2004 North American Electric Reliability Council (NERC) regions and sub-regions.

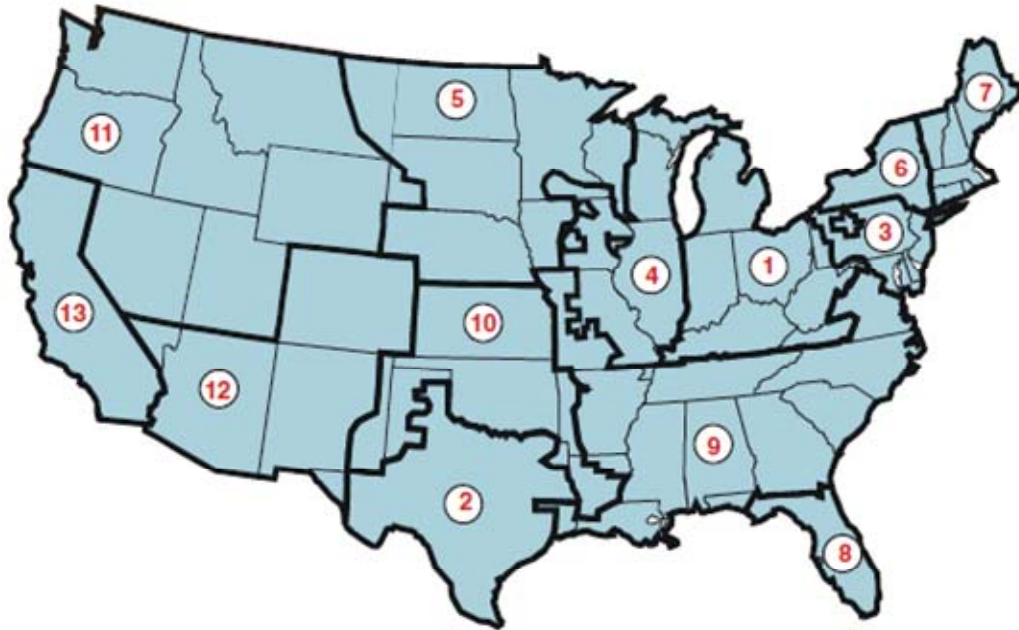

- |  |  |
|--|--|
| 1. East Central Area Reliability Coordination Agreement (ECAR) | 8. Florida Reliability Coordinating Council (FL)                             |
| 2. Electric Reliability Council of Texas (ERCOT)               | 9. Southeastern Electric Reliability Council (SERC)                          |
| 3. Mid-Atlantic Area Council (MAAC)                            | 10. Southwest Power Pool (SPP)   |
| 4. Mid-American Interconnected Network (MAIN)                  | 11. Northwest Power Pool (NWP)   |
| 5. Mid-Continent Area Power Pool (MAPP)                        | 12. Rocky Mountain Power Area, Arizona, New Mexico, and Southern Nevada (RA) |
| 6. New York (NY)   | 13. California (CA)  |
| 7. New England (NE)  |  |

Figure 51. Map of regions used for electricity demand forecasts. Source: EIA Annual Energy Outlook (2009).



## East Central Area Reliability Coordination Agreement

A regional demand forecast for the East Central Area Reliability Coordination Agreement can be seen in Figure 52.

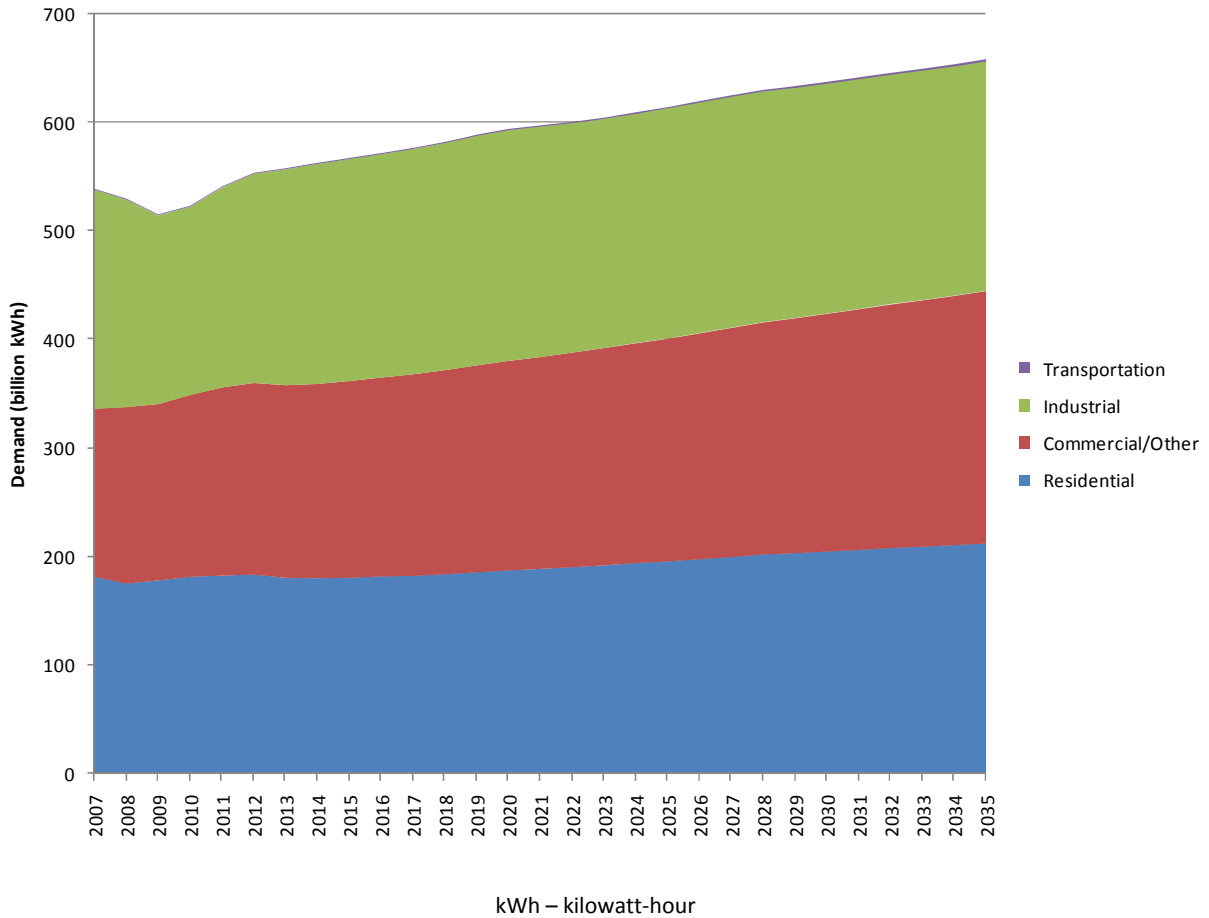

Figure 52. East Central Area Reliability Coordination Agreement projected electricity demand, 2007-2035. Data: EIA (December 2009).\*

\*The transportation band in Figure 52 is quite thin. The data are in Table 9.

Table 9. East Central Area Reliability Coordination Agreement projected electricity demand, 2007-2035 (billion kWh). Data: EIA (December 2009).

Sector	2007	2008	2009	2010	2011	2012	2013	2014	2015	2016	2017	2018	2019	2020	2021
Residential	180.95	174.72	177.50	180.91	181.99	183.00	179.87	179.57	180.09	181.18	181.82	183.25	185.12	186.86	188.12
Commercial/Other	155.42	163.08	163.17	168.12	173.90	177.00	178.12	179.68	181.76	183.91	186.16	188.58	191.15	193.53	195.91
Industrial	201.31	190.76	173.17	173.00	183.69	192.51	198.64	202.20	204.13	205.51	207.12	209.07	211.11	212.22	211.98
Transportation	0.85	0.86	0.87	0.87	0.88	0.90	0.92	0.94	0.97	1.00	1.03	1.06	1.10	1.14	1.18
<b>Total Sales</b>	<b>538.53</b>	<b>529.42</b>	<b>514.70</b>	<b>522.89</b>	<b>540.45</b>	<b>553.41</b>	<b>557.55</b>	<b>562.39</b>	<b>566.95</b>	<b>571.61</b>	<b>576.12</b>	<b>581.96</b>	<b>588.47</b>	<b>593.75</b>	<b>597.19</b>

	2022	2023	2024	2025	2026	2027	2028	2029	2030	2031	2032	2033	2034	2035	2007-2035
Residential	189.74	191.42	193.59	195.09	197.25	199.30	201.59	202.64	204.12	205.59	207.50	208.51	209.98	211.56	0.71%
Commercial/Other	198.31	200.73	203.11	205.85	208.74	211.62	214.47	217.15	219.75	222.41	225.08	227.85	230.52	233.31	1.34%
Industrial	211.23	210.79	211.10	211.81	212.31	212.52	212.38	212.03	211.84	211.69	211.35	211.32	211.20	211.42	0.38%
Transportation	1.22	1.28	1.33	1.38	1.44	1.51	1.57	1.64	1.71	1.78	1.85	1.92	1.99	2.06	3.27%
<b>Total</b>	<b>600.50</b>	<b>604.23</b>	<b>609.13</b>	<b>614.14</b>	<b>619.74</b>	<b>624.95</b>	<b>630.02</b>	<b>633.46</b>	<b>637.42</b>	<b>641.47</b>	<b>645.78</b>	<b>649.60</b>	<b>653.69</b>	<b>658.35</b>	<b>0.81%</b>

## Electric Reliability Council of Texas

A regional demand forecast for the Electric Reliability Council of Texas can be seen in Figure 53.

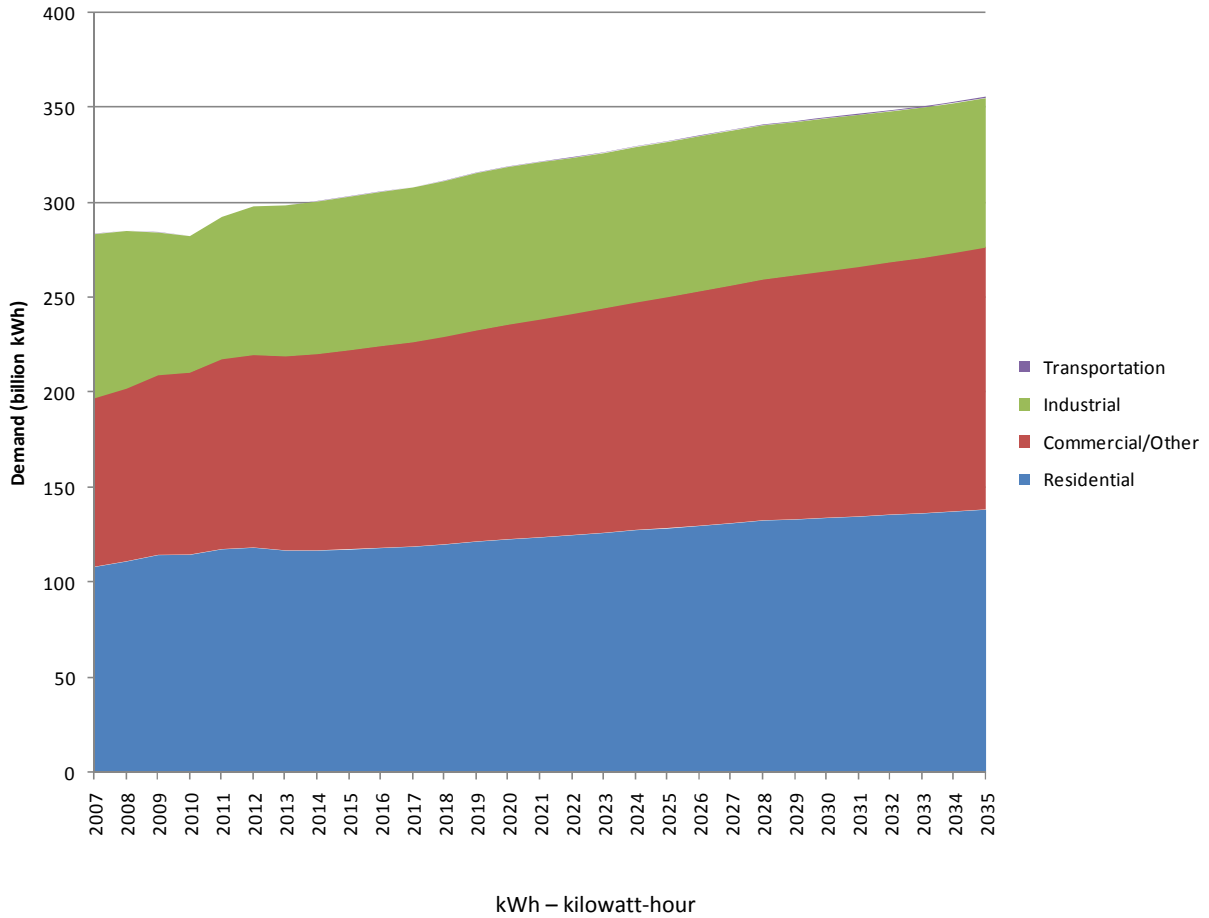

Figure 53. Electric Reliability Council of Texas projected electricity demand, 2007-2035. Data: EIA (December 2009).\*

\*The transportation band in Figure 53 is quite thin. The data are in Table 10.

Table 10. Electric Reliability Council of Texas projected electricity demand, 2007-2035 (billion kWh). Data: EIA (December 2009).

Sector	2007	2008	2009	2010	2011	2012	2013	2014	2015	2016	2017	2018	2019	2020	2021
Residential	108.12	111.07	114.45	114.50	117.39	118.23	116.75	116.83	117.34	118.11	118.76	119.98	121.40	122.72	123.71
Commercial/Other	89.12	91.20	94.94	96.16	100.40	101.65	102.47	103.59	105.08	106.48	107.91	109.63	111.51	113.23	115.00
Industrial	86.43	83.01	75.08	71.90	74.90	78.36	79.55	80.39	80.94	81.25	81.48	82.05	82.90	83.10	82.85
Transportation	0.07	0.07	0.08	0.08	0.08	0.08	0.08	0.09	0.10	0.11	0.12	0.13	0.14	0.16	0.17
<b>Total Sales</b>	<b>283.74</b>	<b>285.35</b>	<b>284.55</b>	<b>282.64</b>	<b>292.77</b>	<b>298.33</b>	<b>298.85</b>	<b>300.90</b>	<b>303.45</b>	<b>305.95</b>	<b>308.27</b>	<b>311.78</b>	<b>315.95</b>	<b>319.20</b>	<b>321.73</b>

	2022	2023	2024	2025	2026	2027	2028	2029	2030	2031	2032	2033	2034	2035	2007-2035
	124.88	126.07	127.47	128.46	129.78	131.07	132.51	133.15	133.95	134.66	135.67	136.26	137.27	138.33	0.82%
	116.70	118.46	120.14	121.90	123.67	125.43	127.15	128.71	130.18	131.63	133.09	134.69	136.44	138.29	1.55%
	82.19	81.82	81.93	81.88	81.75	81.62	81.23	80.71	80.56	80.05	79.54	79.21	78.90	78.60	-0.20%
	0.19	0.22	0.24	0.27	0.29	0.33	0.36	0.39	0.43	0.46	0.50	0.54	0.58	0.62	8.30%
	<b>323.96</b>	<b>326.57</b>	<b>329.77</b>	<b>332.50</b>	<b>335.50</b>	<b>338.45</b>	<b>341.24</b>	<b>342.96</b>	<b>345.11</b>	<b>346.81</b>	<b>348.80</b>	<b>350.70</b>	<b>353.19</b>	<b>355.84</b>	<b>0.82%</b>

## Mid-Atlantic Area Council

A regional demand forecast for the Mid-Atlantic Area Council can be seen in Figure 54.

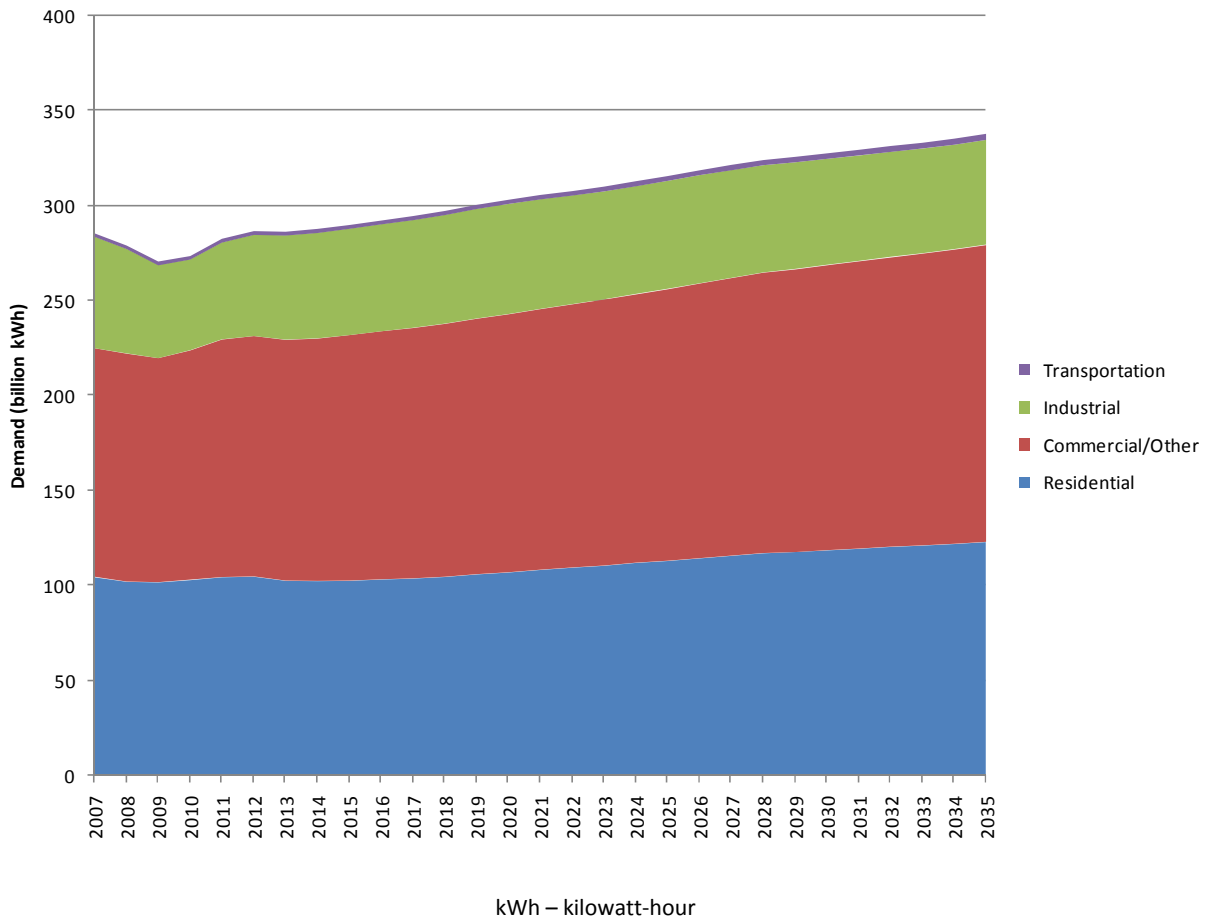

Figure 54. Mid-Atlantic Area Council projected electricity demand, 2007-2035. Data: EIA (December 2009). \*

\*The transportation band in Figure 54 is quite thin. The data are in Table 11.

Table 11. Mid-Atlantic Area Council projected electricity demand, 2007-2035 (billion kWh). Data: EIA (December 2009).

Sector	2007	2008	2009	2010	2011	2012	2013	2014	2015	2016	2017	2018	2019	2020	2021
Residential	104.49	102.03	101.63	102.97	104.42	104.78	102.57	102.31	102.60	103.23	103.72	104.64	105.85	106.93	108.34
Commercial/Other	120.64	120.34	118.35	121.05	125.34	126.74	127.01	127.96	129.43	130.84	132.10	133.39	134.87	136.21	137.51
Industrial	58.57	55.03	48.94	47.78	50.95	53.18	54.82	55.56	55.90	56.14	56.58	57.07	57.58	57.79	57.50
Transportation	1.90	1.90	1.95	1.94	1.95	1.98	1.99	2.03	2.07	2.12	2.16	2.20	2.25	2.31	2.36
<b>Total Sales</b>	<b>285.61</b>	<b>279.30</b>	<b>270.87</b>	<b>273.74</b>	<b>282.67</b>	<b>286.68</b>	<b>286.40</b>	<b>287.86</b>	<b>290.01</b>	<b>292.33</b>	<b>294.56</b>	<b>297.31</b>	<b>300.55</b>	<b>303.24</b>	<b>305.70</b>

	2022	2023	2024	2025	2026	2027	2028	2029	2030	2031	2032	2033	2034	2035	2007-2035
Residential	109.43	110.54	112.00	113.04	114.39	115.67	117.05	117.65	118.53	119.37	120.48	121.08	122.01	122.99	0.69%
Commercial/Other	138.86	140.21	141.61	143.24	144.86	146.44	147.91	149.12	150.35	151.53	152.70	153.96	155.24	156.61	0.98%
Industrial	57.05	56.74	56.67	56.75	56.72	56.54	56.26	55.91	55.66	55.33	55.01	54.86	54.78	54.87	-0.01%
Transportation	2.41	2.48	2.53	2.59	2.65	2.71	2.77	2.84	2.91	2.97	3.04	3.10	3.17	3.23	1.98%
<b>Total Sales</b>	<b>307.75</b>	<b>309.97</b>	<b>312.80</b>	<b>315.62</b>	<b>318.62</b>	<b>321.35</b>	<b>323.98</b>	<b>325.53</b>	<b>327.45</b>	<b>329.21</b>	<b>331.23</b>	<b>333.01</b>	<b>335.20</b>	<b>337.70</b>	<b>0.71%</b>

## Mid-America Interconnected Network

A regional demand forecast for the Mid-America Interconnected Network can be seen in Figure 55.

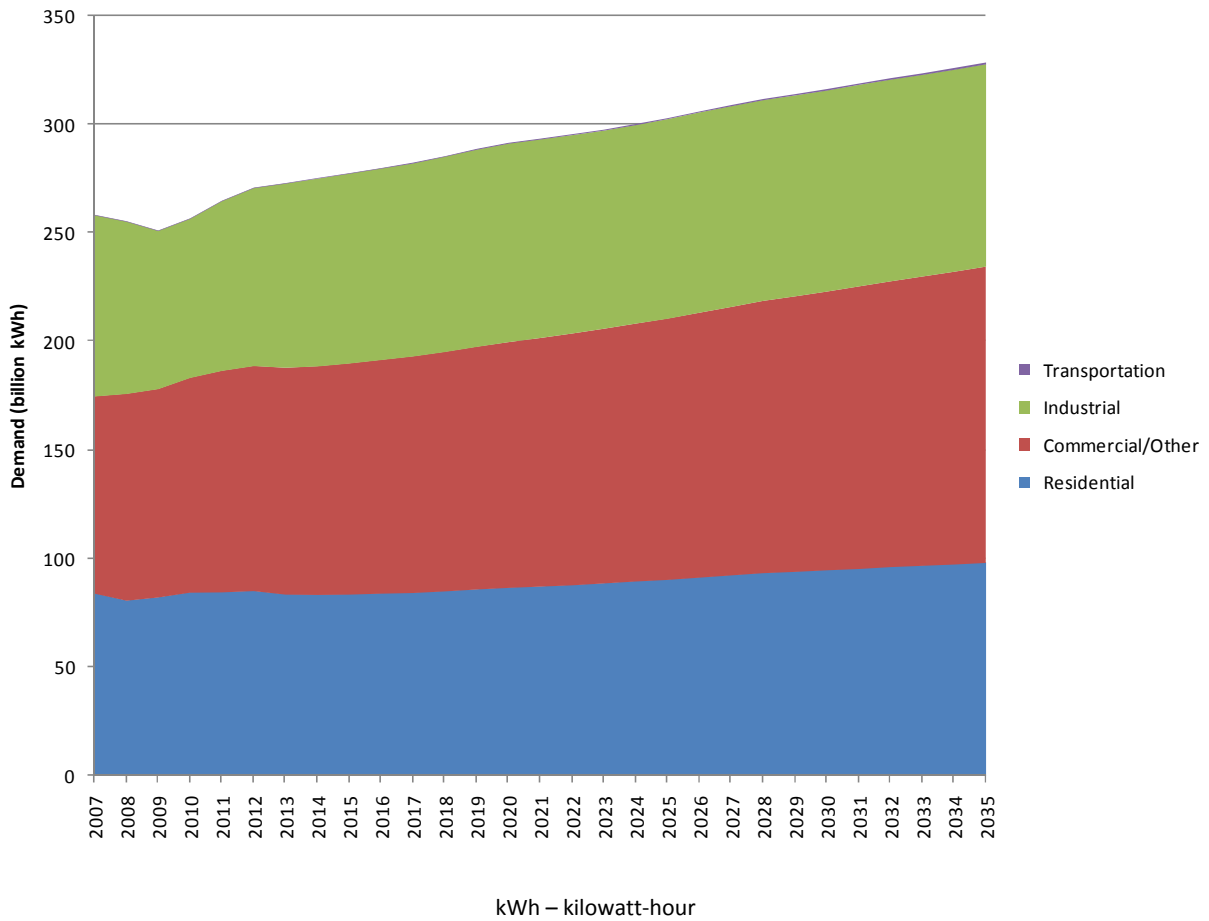

Figure 55. Mid-America Interconnected Network projected electricity demand, 2007-2035. Data: EIA (December 2009). \*

\*The transportation band in Figure 55 is quite thin. The data are in Table 12.

Table 12. Mid-America Interconnected Network projected electricity demand, 2007-2035 (billion kWh). Data: EIA (December 2009).

Sector	2007	2008	2009	2010	2011	2012	2013	2014	2015	2016	2017	2018	2019	2020	2021
Residential	83.82	80.45	81.91	84.16	84.41	84.87	83.36	83.16	83.33	83.80	84.08	84.75	85.60	86.40	86.93
Commercial/Other	90.85	95.40	96.20	99.16	102.15	103.86	104.53	105.40	106.53	107.74	109.04	110.46	111.94	113.30	114.68
Industrial	83.36	79.29	72.73	73.18	77.99	81.87	84.68	86.36	87.30	88.03	88.80	89.72	90.69	91.28	91.35
Transportation	0.26	0.27	0.26	0.26	0.26	0.27	0.28	0.29	0.30	0.31	0.33	0.34	0.35	0.37	0.38
<b>Total Sales</b>	<b>258.29</b>	<b>255.41</b>	<b>251.10</b>	<b>256.76</b>	<b>264.81</b>	<b>270.87</b>	<b>272.86</b>	<b>275.21</b>	<b>277.47</b>	<b>279.88</b>	<b>282.25</b>	<b>285.27</b>	<b>288.58</b>	<b>291.35</b>	<b>293.34</b>

	2022	2023	2024	2025	2026	2027	2028	2029	2030	2031	2032	2033	2034	2035	2007-2035
Residential	87.65	88.41	89.43	90.13	91.17	92.14	93.23	93.75	94.46	95.17	96.06	96.54	97.23	97.95	0.73%
Commercial/Other	116.04	117.43	118.79	120.38	122.06	123.75	125.42	127.00	128.53	130.09	131.64	133.27	134.83	136.43	1.33%
Industrial	91.22	91.11	91.34	91.76	92.08	92.30	92.38	92.39	92.41	92.70	92.68	92.78	92.91	93.08	0.60%
Transportation	0.40	0.43	0.45	0.47	0.50	0.53	0.56	0.59	0.62	0.65	0.68	0.71	0.74	0.77	4.00%
<b>Total</b>	<b>295.31</b>	<b>297.38</b>	<b>300.01</b>	<b>302.74</b>	<b>305.81</b>	<b>308.71</b>	<b>311.58</b>	<b>313.73</b>	<b>316.02</b>	<b>318.61</b>	<b>321.06</b>	<b>323.30</b>	<b>325.72</b>	<b>328.24</b>	<b>0.93%</b>

## Mid-Continent Area Power Pool

A regional demand forecast for the Mid-Continent Area Power Pool can be seen in Figure 56.

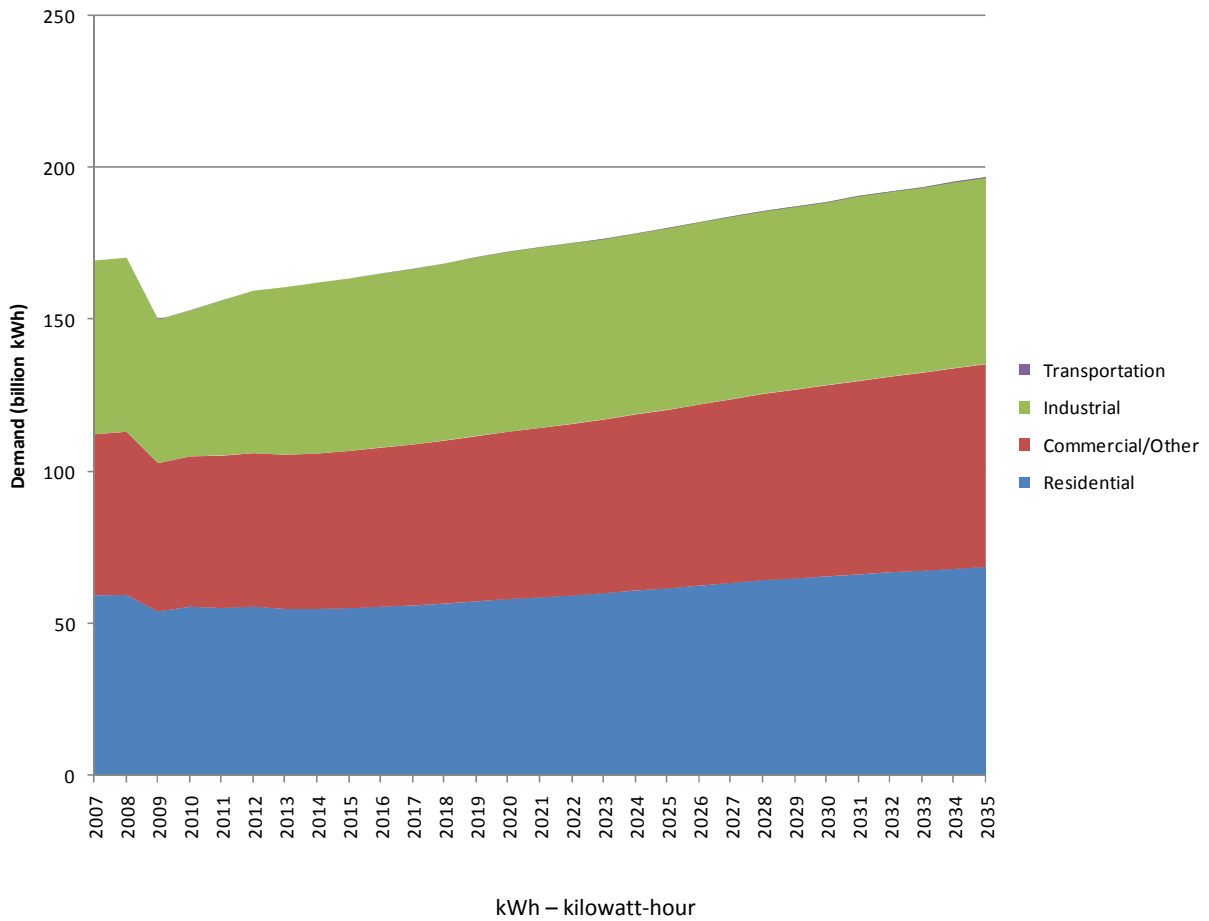

Figure 56. Mid-Continent Area Power Pool projected electricity demand, 2007-2035. Data: EIA (December 2009). \*

\*The transportation band in Figure 56 is quite thin. The data are in Table 13.

Table 13. Mid-Continent Area Power Pool projected electricity demand, 2007-2035 (billion kWh). Data: EIA (December 2009).

Sector	2007	2008	2009	2010	2011	2012	2013	2014	2015	2016	2017	2018	2019	2020	2021
Residential	59.49	59.56	54.12	55.68	55.31	55.73	54.93	54.96	55.22	55.73	56.11	56.73	57.48	58.23	58.78
Commercial/Other	52.94	53.74	48.86	49.56	50.15	50.55	50.83	51.22	51.75	52.36	52.99	53.68	54.39	55.06	55.75
Industrial	56.98	57.07	47.05	47.75	50.81	53.19	54.91	55.94	56.53	57.03	57.50	58.06	58.67	59.04	59.22
Transportation	0.05	0.05	0.05	0.05	0.05	0.05	0.05	0.06	0.06	0.07	0.07	0.08	0.08	0.09	0.10
<b>Total Sales</b>	<b>169.46</b>	<b>170.42</b>	<b>150.07</b>	<b>153.04</b>	<b>156.32</b>	<b>159.52</b>	<b>160.72</b>	<b>162.17</b>	<b>163.56</b>	<b>165.18</b>	<b>166.68</b>	<b>168.54</b>	<b>170.61</b>	<b>172.42</b>	<b>173.85</b>
	2022	2023	2024	2025	2026	2027	2028	2029	2030	2031	2032	2033	2034	2035	2007-
	59.44	60.15	61.07	61.76	62.65	63.51	64.45	65.01	65.69	66.30	67.03	67.51	68.19	68.82	0.54%
	56.44	57.17	57.92	58.74	59.58	60.43	61.26	62.07	62.86	63.62	64.35	65.16	65.97	66.74	0.81%
	59.26	59.15	59.30	59.56	59.78	59.90	59.96	60.06	60.01	60.69	60.64	60.75	61.08	61.19	0.26%
	0.11	0.12	0.13	0.14	0.16	0.17	0.19	0.20	0.22	0.23	0.25	0.27	0.28	0.30	6.53%
	<b>175.25</b>	<b>176.59</b>	<b>178.42</b>	<b>180.21</b>	<b>182.16</b>	<b>184.00</b>	<b>185.86</b>	<b>187.34</b>	<b>188.77</b>	<b>190.85</b>	<b>192.28</b>	<b>193.69</b>	<b>195.53</b>	<b>197.04</b>	<b>0.54%</b>

## Northeast Power Coordinating Council/New York

A regional demand forecast for the Northeast Power Coordinating Council/New York can be seen in Figure 57.

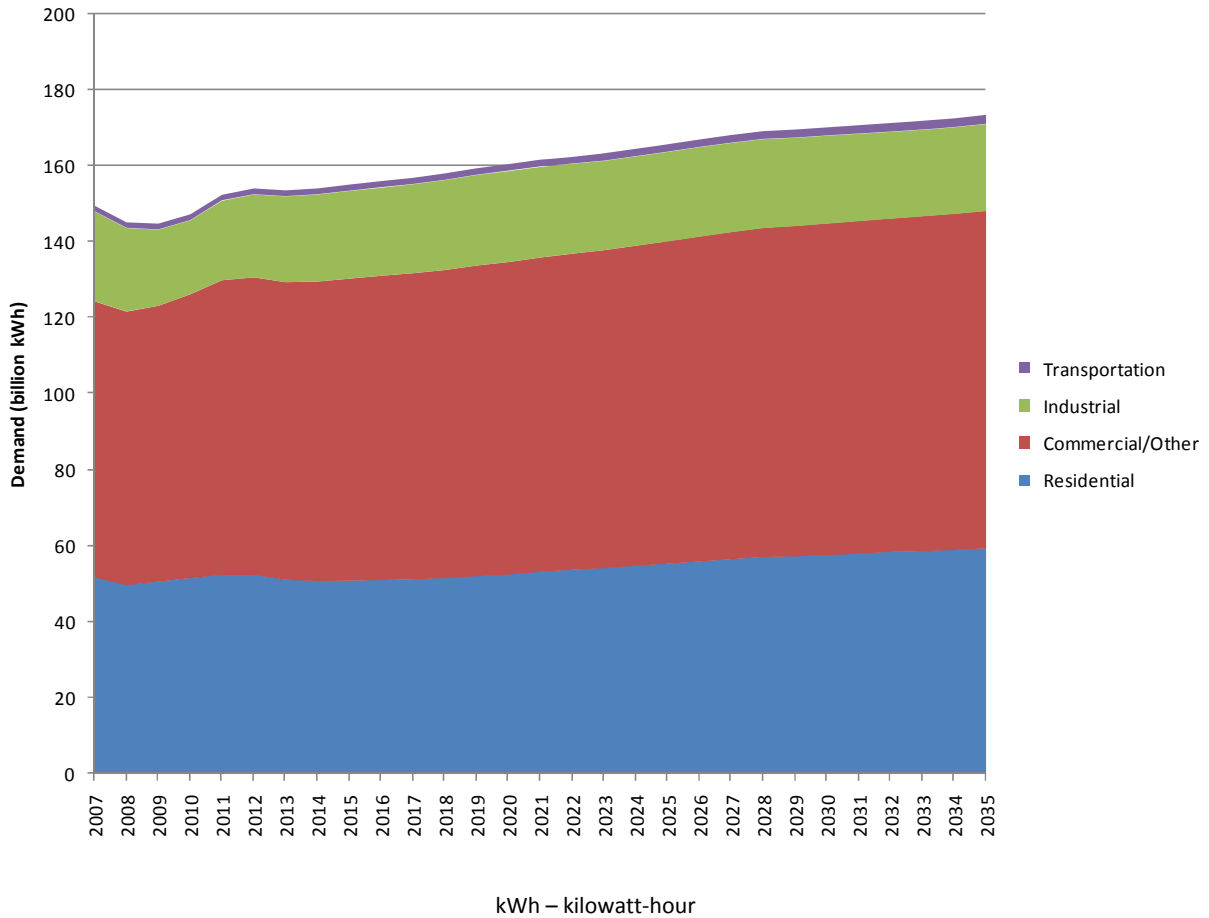

Figure 57. Northeast Power Coordinating Council/New York projected electricity demand, 2007-2035. Data: EIA (December 2009).\*

\*The transportation band in Figure 52 is quite thin. The data are in Table 14.

Table 14. Northeast Power Coordinating Council/New York projected electricity demand, 2007-2035 (billion kWh). Data: EIA (December 2009).

Sector	2007	2008	2009	2010	2011	2012	2013	2014	2015	2016	2017	2018	2019	2020	2021
Residential	51.71	49.72	50.58	51.51	52.38	52.41	51.09	50.81	50.83	51.01	51.16	51.53	52.04	52.48	53.22
Commercial/Other	72.54	71.87	72.46	74.56	77.44	78.12	78.19	78.63	79.37	79.99	80.49	81.00	81.60	82.11	82.58
Industrial	23.72	21.95	20.10	19.53	20.97	21.92	22.67	23.00	23.15	23.27	23.48	23.71	23.95	24.06	23.94
Transportation	1.44	1.42	1.49	1.48	1.49	1.51	1.52	1.55	1.58	1.61	1.65	1.68	1.71	1.75	1.79
<b>Total Sales</b>	<b>149.42</b>	<b>144.96</b>	<b>144.63</b>	<b>147.09</b>	<b>152.29</b>	<b>153.97</b>	<b>153.47</b>	<b>153.98</b>	<b>154.93</b>	<b>155.88</b>	<b>156.77</b>	<b>157.92</b>	<b>159.31</b>	<b>160.41</b>	<b>161.54</b>

	2022	2023	2024	2025	2026	2027	2028	2029	2030	2031	2032	2033	2034	2035	2007-2035
Residential	53.69	54.16	54.82	55.29	55.90	56.46	57.05	57.25	57.60	57.92	58.39	58.59	58.95	59.34	0.66%
Commercial/Other	83.08	83.55	84.07	84.74	85.39	86.00	86.51	86.82	87.14	87.43	87.69	88.01	88.33	88.72	0.78%
Industrial	23.76	23.63	23.61	23.66	23.66	23.59	23.47	23.33	23.23	23.10	22.97	22.92	22.90	22.98	0.17%
Transportation	1.83	1.87	1.91	1.95	1.99	2.03	2.07	2.12	2.16	2.20	2.25	2.29	2.33	2.37	1.92%
<b>Total Sales</b>	<b>162.36</b>	<b>163.22</b>	<b>164.41</b>	<b>165.64</b>	<b>166.94</b>	<b>168.08</b>	<b>169.11</b>	<b>169.52</b>	<b>170.13</b>	<b>170.65</b>	<b>171.30</b>	<b>171.81</b>	<b>172.51</b>	<b>173.40</b>	<b>0.67%</b>

## Northeast Power Coordinating Council/New England

A regional demand forecast for the Northeast Power Coordinating Council/New England can be seen in Figure 58.

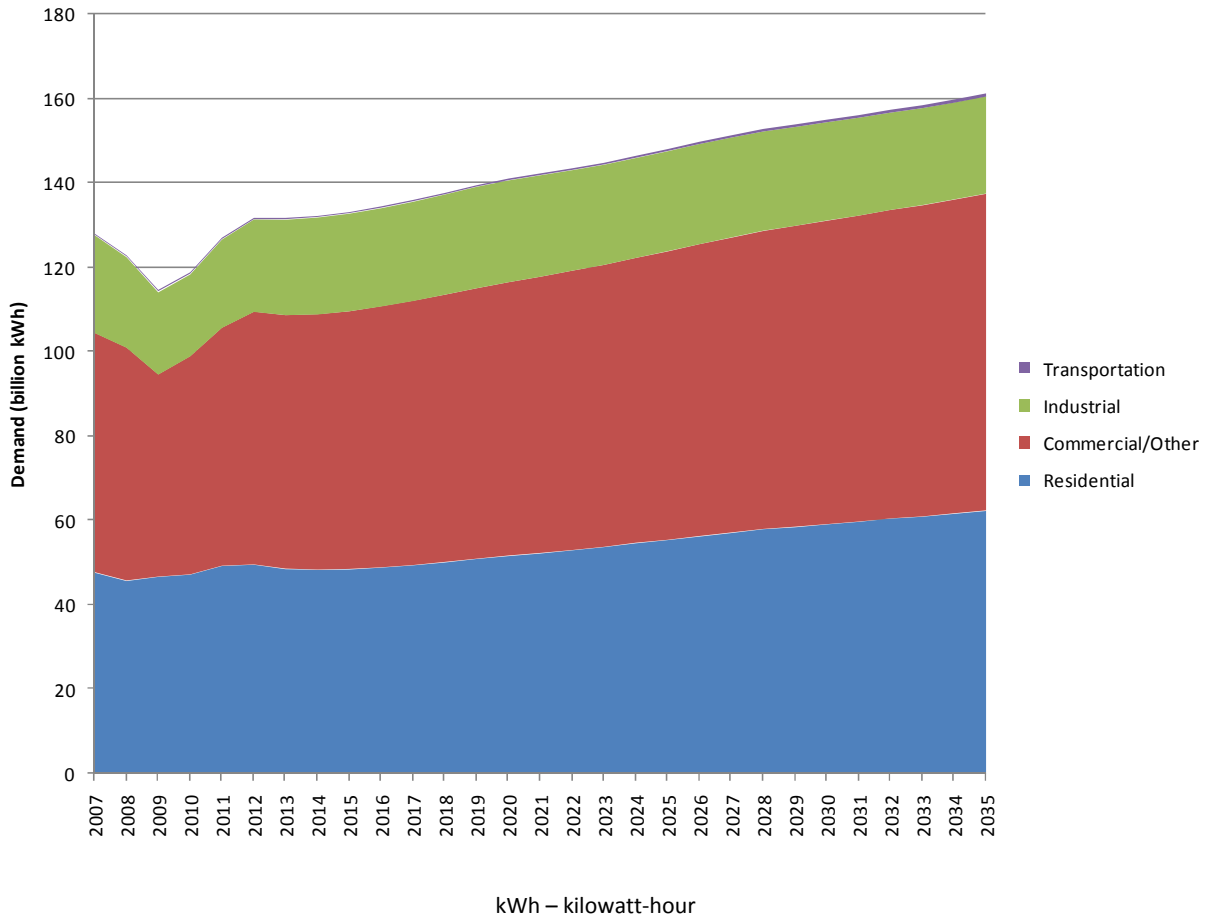

Figure 58. Northeast Power Coordinating Council/New England projected electricity demand, 2007-2035. Data: EIA (December 2009).\*

\*The transportation band in Figure 58 is quite thin. The data are in Table 15.

Table 15. Northeast Power Coordinating Council/New England projected electricity demand, 2007-2035 (billion kWh). Data: EIA (December 2009).

Sector	2007	2008	2009	2010	2011	2012	2013	2014	2015	2016	2017	2018	2019	2020	2021
Residential	47.71	45.74	46.68	47.20	49.26	49.54	48.52	48.34	48.45	48.88	49.41	50.13	50.91	51.65	52.25
Commercial/Other	56.84	55.32	47.97	51.78	56.50	59.99	60.25	60.61	61.22	61.96	62.71	63.46	64.20	64.90	65.62
Industrial	23.11	21.42	19.51	19.42	20.85	21.83	22.58	22.91	23.08	23.25	23.45	23.70	23.98	24.10	24.00
Transportation	0.24	0.21	0.28	0.27	0.27	0.27	0.26	0.27	0.29	0.30	0.32	0.33	0.35	0.37	0.39
<b>Total Sales</b>	<b>127.89</b>	<b>122.70</b>	<b>114.46</b>	<b>118.66</b>	<b>126.88</b>	<b>131.64</b>	<b>131.61</b>	<b>132.13</b>	<b>133.04</b>	<b>134.39</b>	<b>135.88</b>	<b>137.62</b>	<b>139.45</b>	<b>141.02</b>	<b>142.26</b>

	2022	2023	2024	2025	2026	2027	2028	2029	2030	2031	2032	2033	2034	2035	2007-2035
Residential	52.97	53.72	54.69	55.41	56.29	57.11	57.97	58.48	59.11	59.72	60.49	60.98	61.66	62.37	1.15%
Commercial/Other	66.29	66.94	67.64	68.46	69.29	70.05	70.77	71.44	72.05	72.62	73.20	73.83	74.52	75.19	1.14%
Industrial	23.81	23.67	23.65	23.70	23.69	23.62	23.51	23.35	23.26	23.12	22.99	22.94	22.92	23.00	0.26%
Transportation	0.41	0.44	0.47	0.49	0.52	0.55	0.57	0.60	0.63	0.66	0.69	0.72	0.75	0.77	4.89%
<b>Total Sales</b>	<b>143.49</b>	<b>144.78</b>	<b>146.44</b>	<b>148.06</b>	<b>149.79</b>	<b>151.32</b>	<b>152.83</b>	<b>153.87</b>	<b>155.05</b>	<b>156.12</b>	<b>157.38</b>	<b>158.47</b>	<b>159.85</b>	<b>161.32</b>	<b>1.02%</b>

## Florida Reliability Coordinating Council

A regional demand forecast for the Florida Reliability Coordinating Council can be seen in Figure 59.

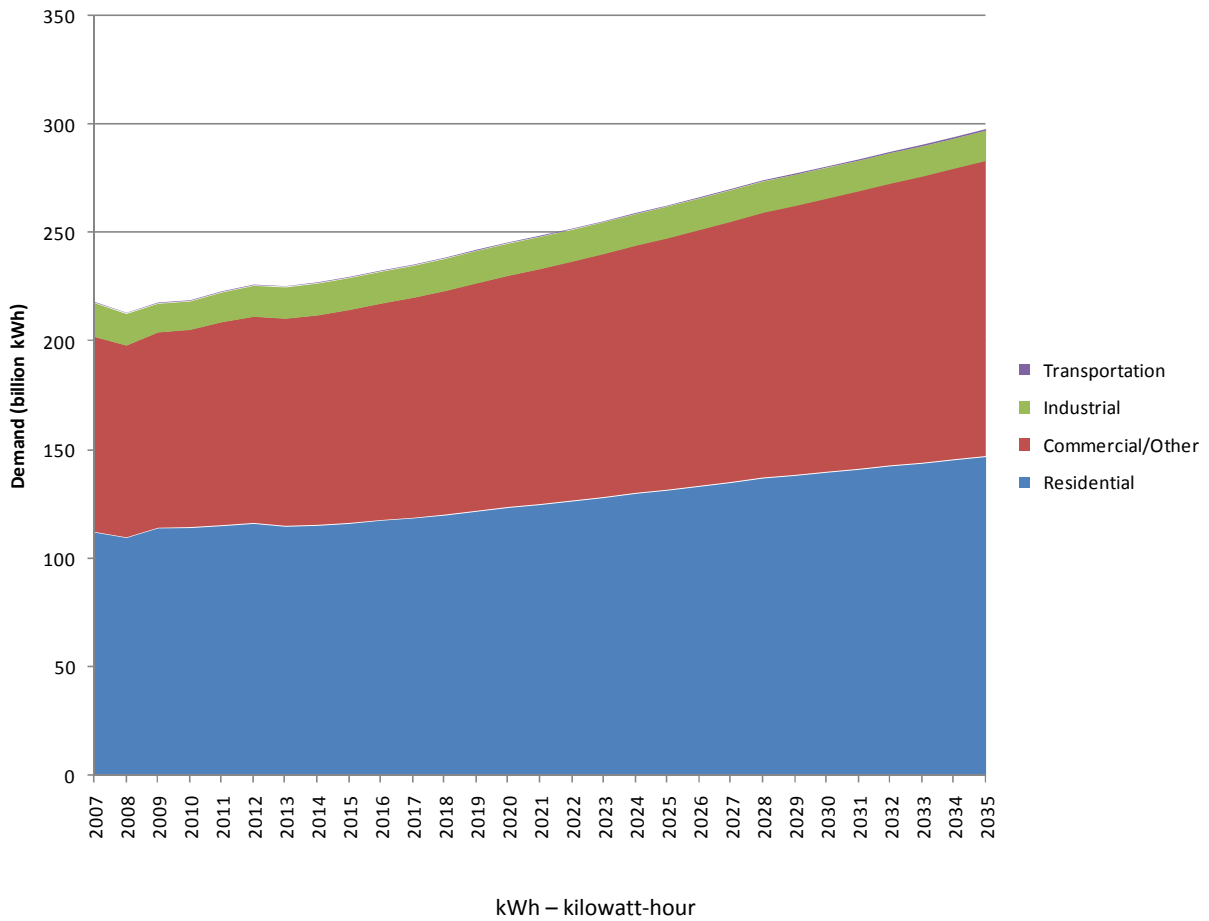

Figure 59. Florida Reliability Coordinating Council projected electricity demand, 2007-2035. Data: EIA (December 2009). \*

\*The transportation band in Figure 59 is quite thin. The data are in Table 16.

Table 16. Florida Reliability Coordinating Council projected electricity demand, 2007-2035 (billion kWh). Data: EIA (December 2009).

Sector	2007	2008	2009	2010	2011	2012	2013	2014	2015	2016	2017	2018	2019	2020	2021
Residential	112.11	109.64	114.03	114.23	115.16	116.24	114.84	115.30	116.23	117.59	118.62	120.06	121.85	123.57	124.90
Commercial/Other	89.96	88.40	90.02	90.98	93.65	95.13	95.59	96.64	98.16	99.81	101.41	103.07	104.93	106.69	108.46
Industrial	15.56	14.64	13.31	13.19	13.75	14.29	14.58	14.73	14.80	14.82	14.87	14.94	15.01	15.02	14.94
Transportation	0.23	0.24	0.24	0.24	0.25	0.25	0.26	0.27	0.27	0.28	0.29	0.30	0.31	0.33	0.34
<b>Total Sales</b>	<b>217.87</b>	<b>212.91</b>	<b>217.60</b>	<b>218.64</b>	<b>222.81</b>	<b>225.91</b>	<b>225.27</b>	<b>226.94</b>	<b>229.46</b>	<b>232.50</b>	<b>235.19</b>	<b>238.38</b>	<b>242.10</b>	<b>245.61</b>	<b>248.64</b>

	2022	2023	2024	2025	2026	2027	2028	2029	2030	2031	2032	2033	2034	2035	2007-2035
Residential	126.53	128.17	130.09	131.54	133.35	135.14	137.14	138.33	139.76	141.13	142.81	143.95	145.50	147.06	1.09%
Commercial/Other	110.27	112.16	114.05	116.08	118.13	120.18	122.24	124.22	126.19	128.14	130.11	132.17	134.26	136.38	1.62%
Industrial	14.81	14.73	14.70	14.68	14.65	14.60	14.52	14.43	14.34	14.25	14.16	14.09	14.04	13.99	-0.17%
Transportation	0.36	0.38	0.40	0.42	0.45	0.48	0.50	0.53	0.57	0.60	0.63	0.67	0.70	0.73	4.29%
<b>Total Sales</b>	<b>251.98</b>	<b>255.44</b>	<b>259.24</b>	<b>262.72</b>	<b>266.58</b>	<b>270.40</b>	<b>274.40</b>	<b>277.51</b>	<b>280.86</b>	<b>284.12</b>	<b>287.71</b>	<b>290.88</b>	<b>294.49</b>	<b>298.16</b>	<b>1.26%</b>



## Southeastern Electric Reliability Council

A regional demand forecast for the Southeastern Electric Reliability Council can be seen in Figure 60.

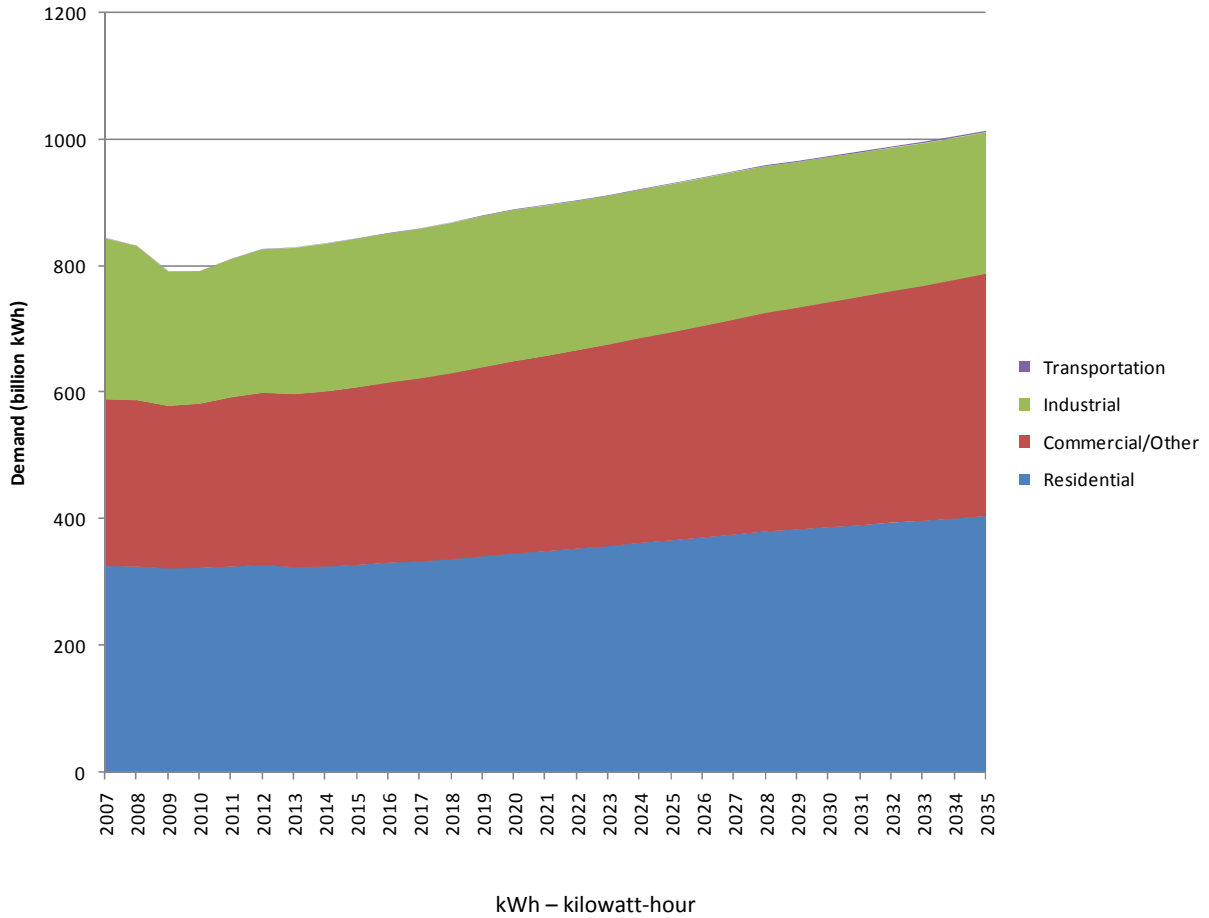

Figure 60. Southeastern Electric Reliability Council projected electricity demand, 2007-2035. Data: EIA (December 2009). \*

\*The transportation band in Figure 60 is quite thin. The data are in Table 17.

Table 17. Southeastern Electric Reliability Council projected electricity demand, 2007-2035 (billion kWh). Data: EIA (December 2009).

Sector	2007	2008	2009	2010	2011	2012	2013	2014	2015	2016	2017	2018	2019	2020	2021
Residential	327.08	326.02	323.23	323.90	325.97	328.77	325.02	326.10	328.45	331.87	334.24	337.84	342.38	346.84	350.17
Commercial/Other	262.53	262.20	256.04	259.07	267.09	271.24	272.90	275.91	280.06	284.46	288.73	293.26	298.28	303.05	307.89
Industrial	254.89	243.90	212.63	209.27	218.22	227.09	231.47	233.87	235.10	235.62	236.37	237.61	239.06	239.32	238.18
Transportation	0.54	0.56	0.54	0.55	0.56	0.57	0.59	0.61	0.64	0.66	0.69	0.72	0.76	0.80	0.84
<b>Total Sales</b>	<b>845.04</b>	<b>832.67</b>	<b>792.44</b>	<b>792.79</b>	<b>811.83</b>	<b>827.67</b>	<b>829.98</b>	<b>836.50</b>	<b>844.26</b>	<b>852.61</b>	<b>860.03</b>	<b>869.42</b>	<b>880.48</b>	<b>890.02</b>	<b>897.08</b>

	2022	2023	2024	2025	2026	2027	2028	2029	2030	2031	2032	2033	2034	2035	2007-2035
	354.29	358.49	363.48	367.14	371.77	376.36	381.47	384.31	387.81	391.12	395.31	397.98	401.75	405.61	0.81%
	312.83	317.95	323.05	328.46	333.93	339.44	344.93	350.19	355.39	360.54	365.76	371.22	376.77	382.43	1.41%
	236.22	234.98	234.63	234.44	234.01	233.26	232.08	230.61	229.52	228.14	226.62	225.67	224.79	224.05	-0.31%
	0.90	0.98	1.04	1.11	1.19	1.28	1.37	1.46	1.57	1.67	1.77	1.88	1.99	2.09	5.03%
	<b>904.23</b>	<b>912.41</b>	<b>922.20</b>	<b>931.15</b>	<b>940.91</b>	<b>950.34</b>	<b>959.85</b>	<b>966.57</b>	<b>974.28</b>	<b>981.47</b>	<b>989.46</b>	<b>996.75</b>	<b>1005.30</b>	<b>1014.18</b>	<b>0.73%</b>

## Southwest Power Pool

A regional demand forecast for the Southwest Power Pool can be seen in Figure 61.

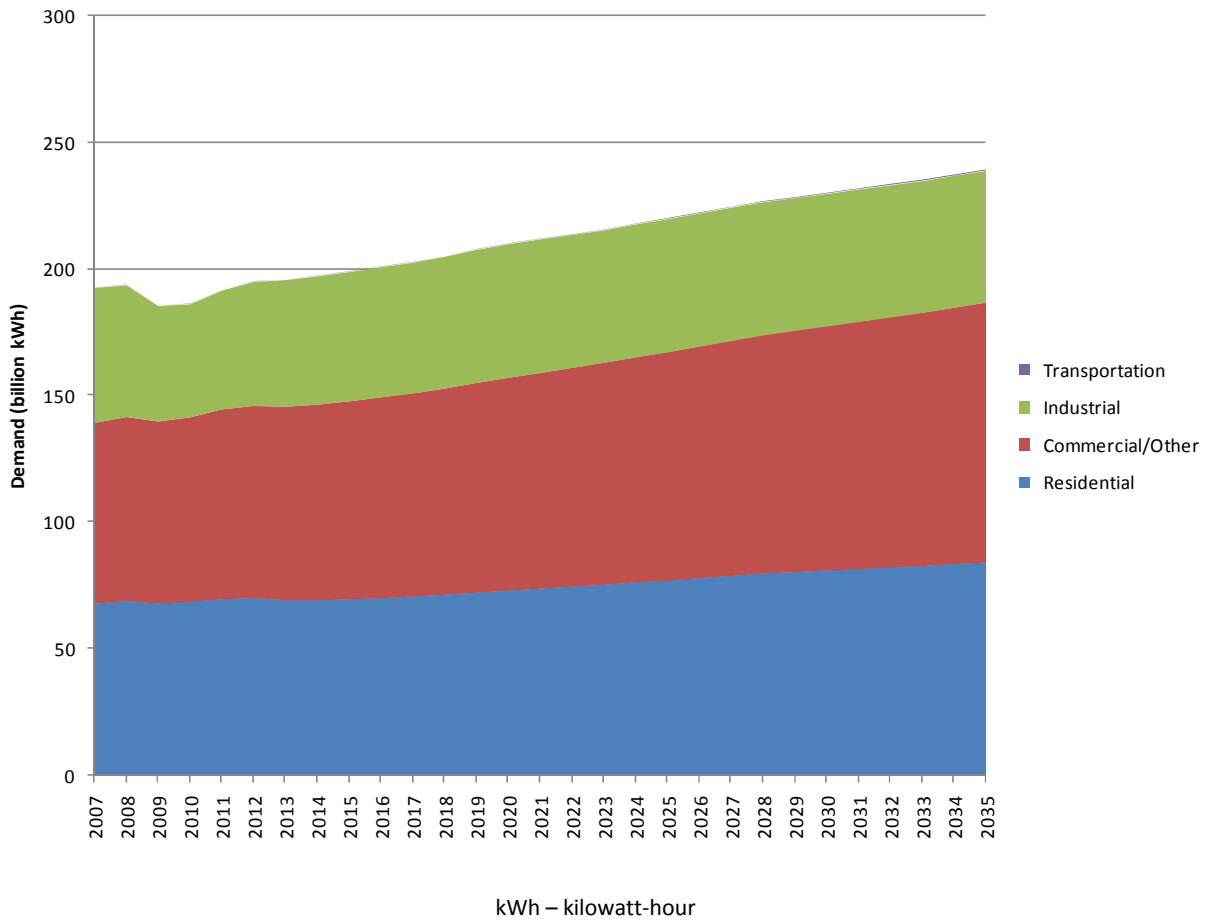

Figure 61. Southwest Power Pool projected electricity demand, 2007-2035. Data: EIA (December 2009). \*

\*The transportation band in Figure 61 is quite thin. The data are in Table 18.

Table 18. Southwest Power Pool projected electricity demand, 2007-2035 (billion kWh). Data: EIA (December 2009).

Sector	2007	2008	2009	2010	2011	2012	2013	2014	2015	2016	2017	2018	2019	2020	2021	
Residential	67.90	69.03	67.99	68.73	69.65	70.17	69.25	69.32	69.64	70.19	70.63	71.40	72.30	73.16	73.80	
Commercial/Other	71.35	72.54	71.79	72.74	74.98	75.79	76.34	77.11	78.12	79.15	80.21	81.42	82.72	83.92	85.15	
Industrial	53.49	52.12	45.75	44.76	46.96	49.11	50.17	50.84	51.25	51.55	51.81	52.22	52.75	52.96	52.92	
Transportation	0.05	0.05	0.05	0.05	0.05	0.05	0.05	0.06	0.06	0.07	0.07	0.08	0.09	0.10	0.11	
<b>Total Sales</b>	<b>192.80</b>	<b>193.73</b>	<b>185.57</b>	<b>186.28</b>	<b>191.65</b>	<b>195.12</b>	<b>195.81</b>	<b>197.32</b>	<b>199.08</b>	<b>200.96</b>	<b>202.72</b>	<b>205.12</b>	<b>207.85</b>	<b>210.13</b>	<b>211.99</b>	
																<b>2007-</b>
	<b>2022</b>	<b>2023</b>	<b>2024</b>	<b>2025</b>	<b>2026</b>	<b>2027</b>	<b>2028</b>	<b>2029</b>	<b>2030</b>	<b>2031</b>	<b>2032</b>	<b>2033</b>	<b>2034</b>	<b>2035</b>		<b>2035</b>
	74.57	75.36	76.34	77.05	77.97	78.87	79.87	80.39	81.02	81.59	82.32	82.79	83.50	84.21		0.74%
	86.36	87.61	88.85	90.16	91.49	92.80	94.10	95.31	96.47	97.60	98.72	99.95	101.25	102.56		1.29%
	52.69	52.52	52.62	52.71	52.75	52.74	52.63	52.48	52.41	52.49	52.31	52.25	52.29	52.27		0.01%
	0.12	0.14	0.15	0.17	0.19	0.20	0.22	0.25	0.27	0.29	0.31	0.34	0.36	0.38		8.05%
	<b>213.73</b>	<b>215.63</b>	<b>217.96</b>	<b>220.09</b>	<b>222.39</b>	<b>224.63</b>	<b>226.82</b>	<b>228.43</b>	<b>230.17</b>	<b>231.98</b>	<b>233.67</b>	<b>235.32</b>	<b>237.40</b>	<b>239.42</b>		<b>0.79%</b>

## Western Electricity Coordinating Council/Northwest Power Pool Area

A regional demand forecast for the Western Electricity Coordinating Council/Northwest Power Pool Area can be seen in Figure 62.

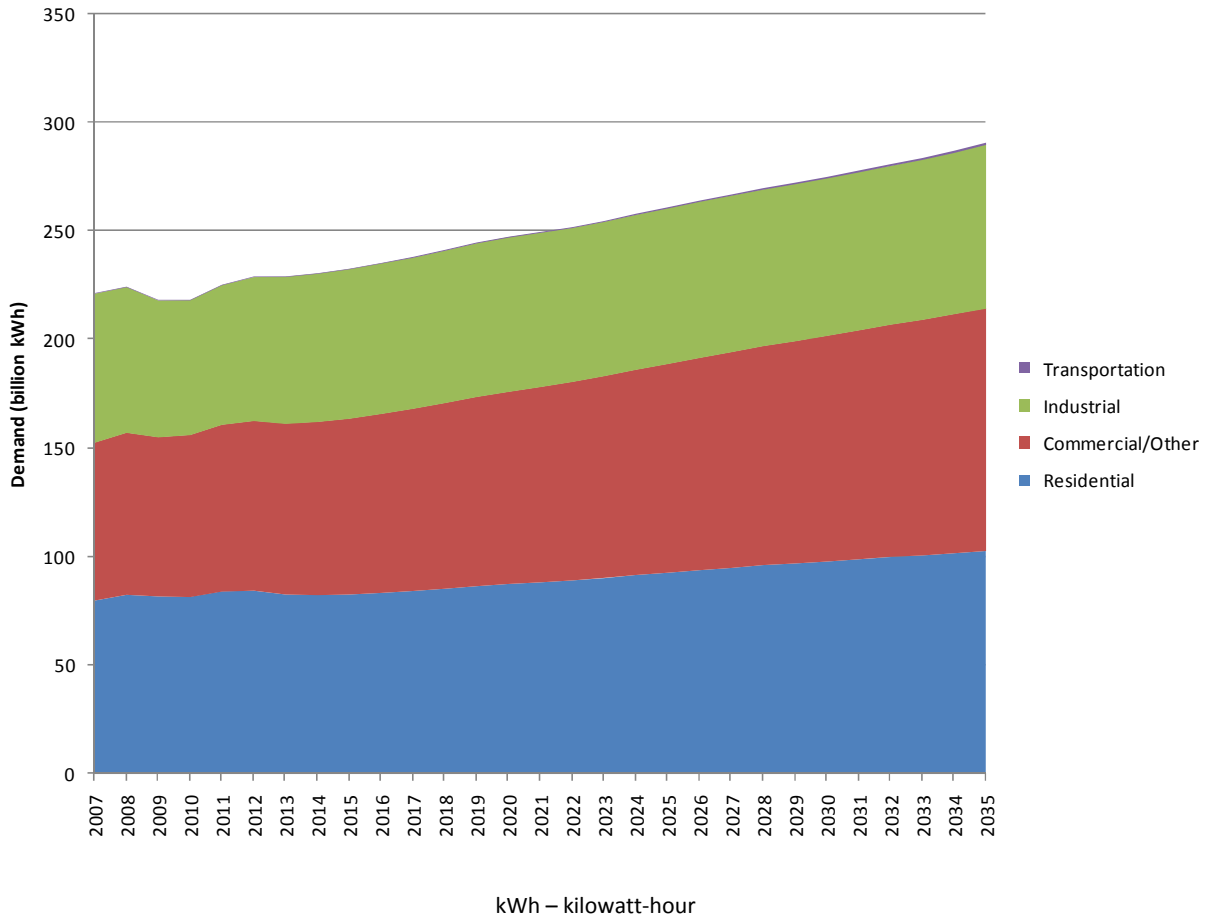

Figure 62. Western Electricity Coordinating Council/Northwest Power Pool Area projected electricity demand, 2007-2035. Data: EIA (December 2009).\*

\*The transportation band in Figure 62 is quite thin. The data are in Table 19.

Table 19. Western Electricity Coordinating Council/Northwest Power Pool Area projected electricity demand, 2007-2035 (billion kWh). Data: EIA (December 2009).

Sector	2007	2008	2009	2010	2011	2012	2013	2014	2015	2016	2017	2018	2019	2020	2021
Residential	79.88	82.46	81.81	81.55	84.06	84.38	82.60	82.43	82.70	83.45	84.22	85.30	86.51	87.45	88.20
Commercial/Other	72.71	74.70	73.23	74.56	76.81	78.22	78.73	79.65	80.94	82.41	83.93	85.48	87.05	88.51	89.96
Industrial	68.64	67.10	63.10	62.14	64.25	66.32	67.66	68.35	68.84	69.28	69.73	70.28	70.89	71.25	71.23
Transportation	0.28	0.29	0.29	0.29	0.30	0.30	0.31	0.32	0.33	0.35	0.36	0.38	0.39	0.41	0.44
<b>Total Sales</b>	<b>221.50</b>	<b>224.55</b>	<b>218.43</b>	<b>218.53</b>	<b>225.42</b>	<b>229.23</b>	<b>229.30</b>	<b>230.75</b>	<b>232.81</b>	<b>235.50</b>	<b>238.24</b>	<b>241.44</b>	<b>244.84</b>	<b>247.61</b>	<b>249.83</b>

	2022	2023	2024	2025	2026	2027	2028	2029	2030	2031	2032	2033	2034	2035	2007-2035
Residential	89.19	90.24	91.66	92.66	93.84	94.93	96.19	96.93	97.88	98.82	99.96	100.66	101.65	102.67	0.82%
Commercial/Other	91.42	92.90	94.50	96.16	97.74	99.27	100.80	102.36	103.89	105.40	106.90	108.46	110.05	111.66	1.50%
Industrial	71.00	71.16	71.46	71.82	72.12	72.23	72.36	72.53	72.73	73.05	73.39	73.92	74.58	75.64	0.44%
Transportation	0.46	0.50	0.53	0.56	0.60	0.64	0.68	0.73	0.78	0.82	0.87	0.92	0.97	1.02	4.83%
<b>Total Sales</b>	<b>252.06</b>	<b>254.80</b>	<b>258.15</b>	<b>261.20</b>	<b>264.30</b>	<b>267.07</b>	<b>270.02</b>	<b>272.55</b>	<b>275.28</b>	<b>278.10</b>	<b>281.12</b>	<b>283.97</b>	<b>287.26</b>	<b>290.99</b>	<b>0.96%</b>

## Western Electricity Coordinating Council/Rocky Mountain Power Area and Arizona-New Mexico-Southern Nevada Power Area

A regional demand forecast for the Western Electricity Coordinating Council/Rocky Mountain Power Area and Arizona-New Mexico-Southern Nevada Power Area can be seen in Figure 63.

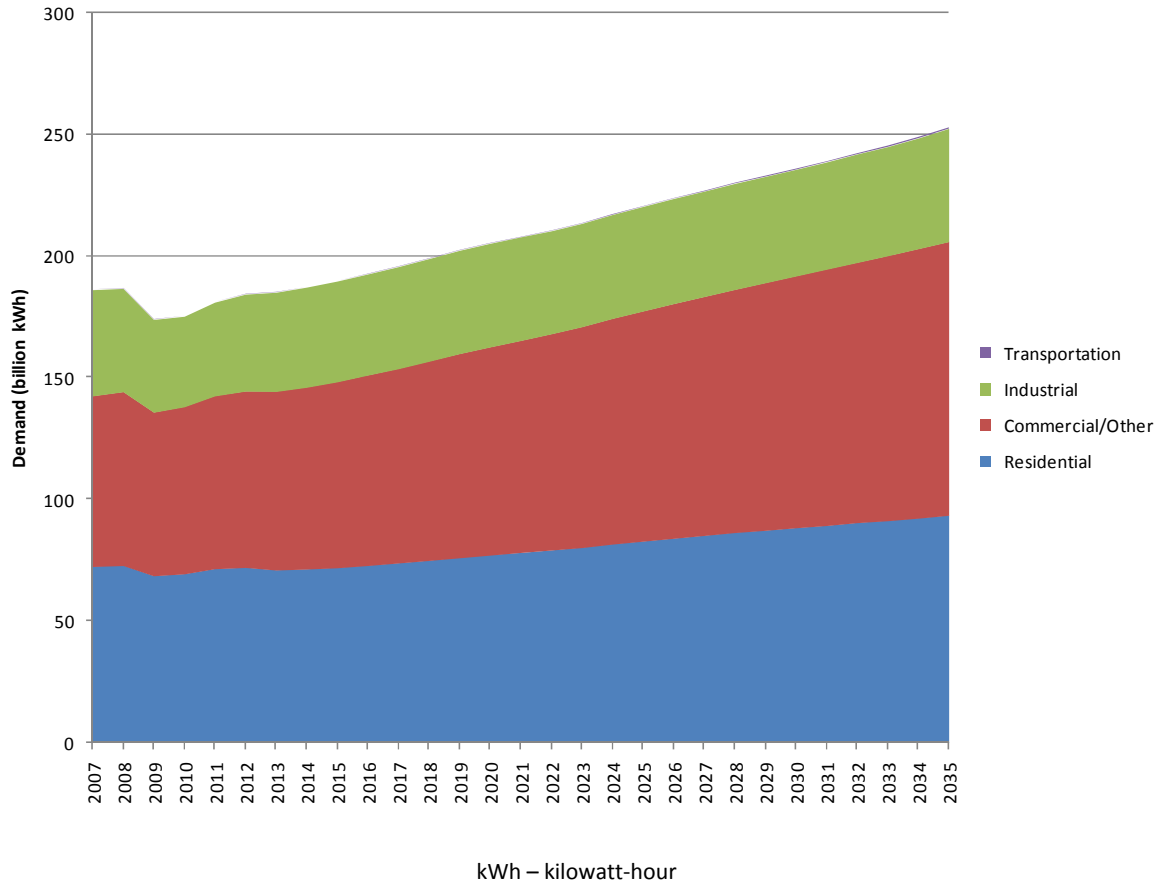

Figure 63. Western Electricity Coordinating Council/Rocky Mountain Power Area and Arizona-New Mexico-Southern Nevada Power Area projected electricity demand, 2007-2035. Data: EIA (December 2009).\*

\*The transportation band in Figure 63 is quite thin. The data are in Table 20.

Table 20. Western Electricity Coordinating Council/Rocky Mountain Power Area and Arizona-New Mexico-Southern Nevada Power Area projected electricity demand, 2007-2035 (billion kWh). Data: EIA (December 2009).

Sector	2007	2008	2009	2010	2011	2012	2013	2014	2015	2016	2017	2018	2019	2020	2021
Residential	72.37	72.75	68.47	69.28	71.36	71.86	70.88	71.21	71.82	72.75	73.65	74.79	76.03	77.07	77.93
Commercial/Other	70.08	71.43	67.30	68.76	71.14	72.56	73.49	74.84	76.47	78.24	80.05	81.90	83.75	85.48	87.22
Industrial	43.63	42.37	38.04	37.12	38.45	39.74	40.60	40.98	41.21	41.47	41.75	42.07	42.38	42.52	42.44
Transportation	0.06	0.06	0.06	0.06	0.06	0.06	0.07	0.07	0.08	0.09	0.09	0.10	0.11	0.12	0.14
<b>Total Sales</b>	<b>186.14</b>	<b>186.61</b>	<b>173.87</b>	<b>175.23</b>	<b>181.01</b>	<b>184.23</b>	<b>185.04</b>	<b>187.10</b>	<b>189.58</b>	<b>192.55</b>	<b>195.54</b>	<b>198.87</b>	<b>202.28</b>	<b>205.20</b>	<b>207.74</b>

	2022	2023	2024	2025	2026	2027	2028	2029	2030	2031	2032	2033	2034	2035	2007-2035
Residential	78.97	80.09	81.54	82.65	83.86	84.99	86.26	87.11	88.13	89.11	90.28	91.12	92.19	93.29	0.93%
Commercial/Other	88.96	90.73	92.63	94.58	96.41	98.16	99.94	101.74	103.51	105.24	106.96	108.74	110.57	112.40	1.69%
Industrial	42.26	42.40	42.64	42.93	43.14	43.25	43.39	43.58	43.71	44.05	44.42	44.83	45.44	46.42	0.34%
Transportation	0.15	0.17	0.19	0.21	0.24	0.26	0.29	0.31	0.34	0.37	0.40	0.44	0.47	0.50	8.04%
<b>Total Sales</b>	<b>210.34</b>	<b>213.39</b>	<b>217.00</b>	<b>220.37</b>	<b>223.64</b>	<b>226.66</b>	<b>229.87</b>	<b>232.75</b>	<b>235.69</b>	<b>238.77</b>	<b>242.05</b>	<b>245.13</b>	<b>248.67</b>	<b>252.61</b>	<b>1.13%</b>

## Western Electricity Coordinating Council/California

A regional demand forecast for the Western Electricity Coordinating Council/California can be seen in Figure 64.

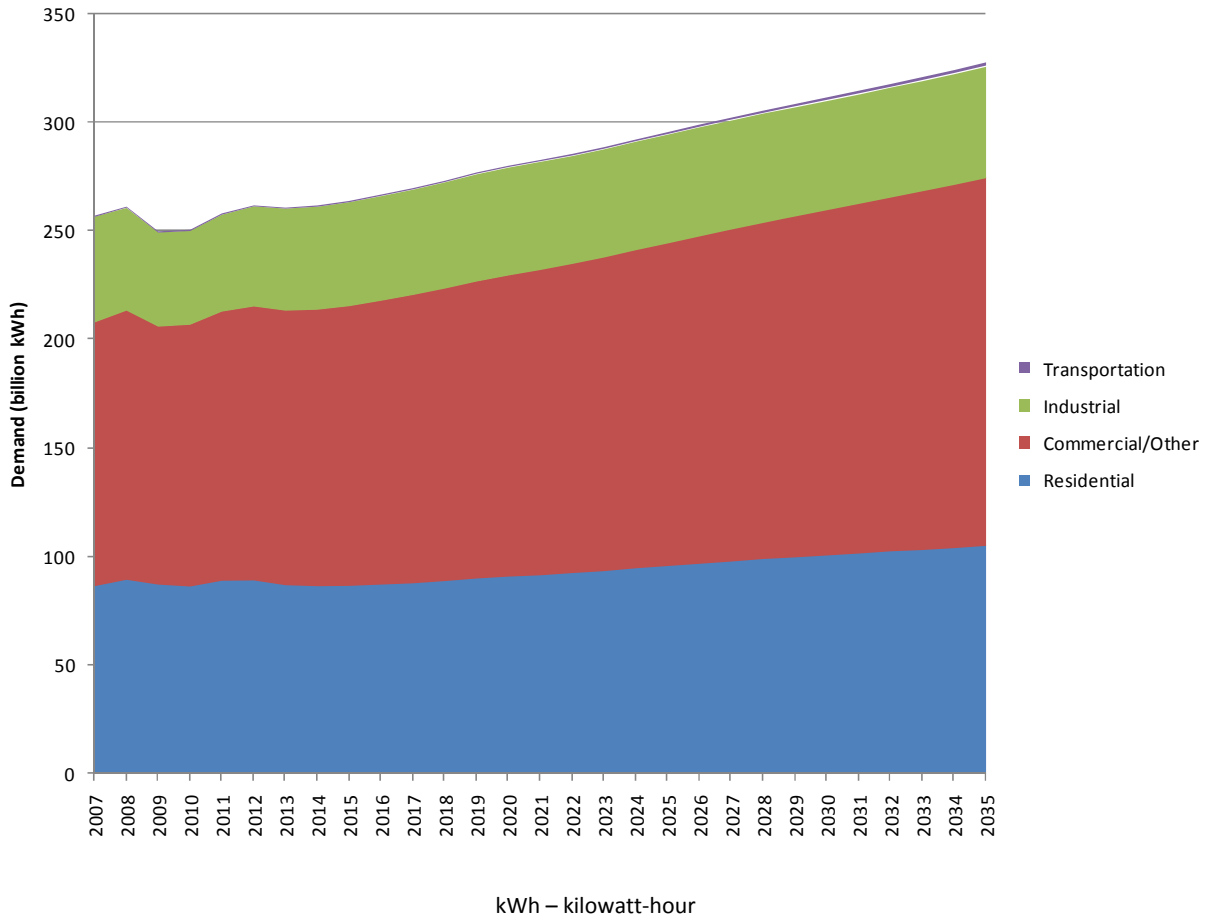

Figure 64. Western Electricity Coordinating Council/California projected electricity demand, 2007-2035. Data: EIA (December 2009).

\*The transportation band in Figure 64 is quite thin. The data are in Table 21.

Table 21. Western Electricity Coordinating Council/California projected electricity demand, 2007-2035 (billion kWh). Data: EIA (December 2009).

Sector	2007	2008	2009	2010	2011	2012	2013	2014	2015	2016	2017	2018	2019	2020	2021
Residential	86.52	89.51	87.25	86.38	89.04	89.26	87.06	86.61	86.66	87.29	87.95	88.96	90.10	90.96	91.63
Commercial/Other	121.54	124.06	118.82	120.68	124.00	126.11	126.41	127.33	128.90	130.79	132.75	134.77	136.82	138.73	140.63
Industrial	48.82	47.41	43.65	43.38	44.82	46.22	47.09	47.62	48.04	48.35	48.65	49.04	49.54	49.87	49.94
Transportation	0.48	0.49	0.49	0.49	0.50	0.51	0.52	0.53	0.55	0.57	0.59	0.61	0.63	0.66	0.69
<b>Total Sales</b>	<b>257.36</b>	<b>261.47</b>	<b>250.21</b>	<b>250.93</b>	<b>258.36</b>	<b>262.10</b>	<b>261.08</b>	<b>262.09</b>	<b>264.14</b>	<b>267.00</b>	<b>269.94</b>	<b>273.38</b>	<b>277.10</b>	<b>280.22</b>	<b>282.88</b>

	2022	2023	2024	2025	2026	2027	2028	2029	2030	2031	2032	2033	2034	2035	2007-2035
Residential	92.54	93.53	94.88	95.79	96.90	97.94	99.15	99.80	100.68	101.56	102.64	103.24	104.15	105.08	0.60%
Commercial/Other	142.51	144.45	146.53	148.74	150.85	152.91	154.96	157.06	159.12	161.15	163.17	165.28	167.44	169.63	1.17%
Industrial	49.84	49.89	50.01	50.16	50.33	50.36	50.36	50.36	50.48	50.53	50.55	50.79	50.97	51.26	0.29%
Transportation	0.72	0.77	0.81	0.85	0.90	0.96	1.01	1.07	1.13	1.19	1.26	1.32	1.39	1.45	4.09%
<b>Total Sales</b>	<b>285.62</b>	<b>288.64</b>	<b>292.23</b>	<b>295.54</b>	<b>298.99</b>	<b>302.17</b>	<b>305.48</b>	<b>308.29</b>	<b>311.41</b>	<b>314.43</b>	<b>317.61</b>	<b>320.63</b>	<b>323.94</b>	<b>327.42</b>	<b>0.84%</b>

## Entire United States

A regional demand forecast for the entire United States can be seen in Figure 65.

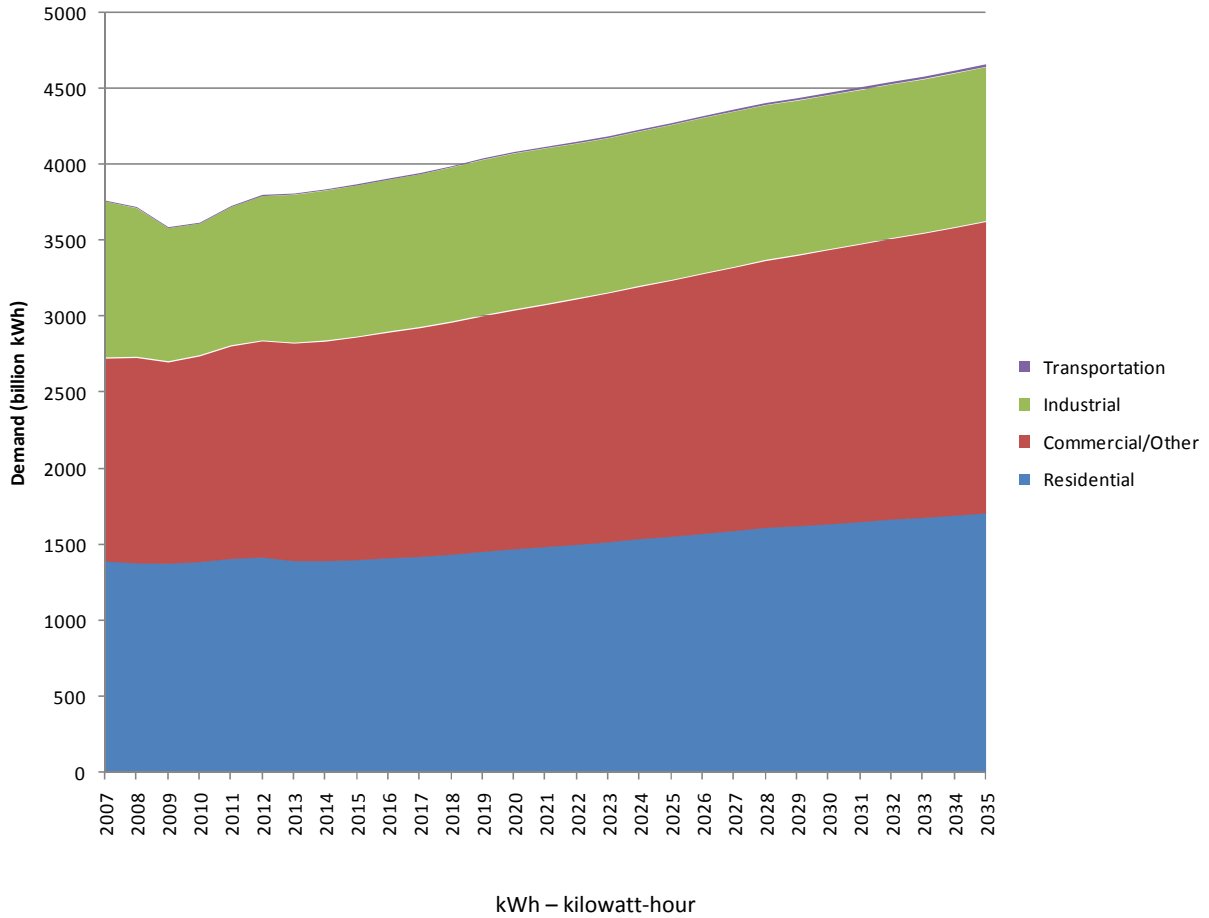

Figure 65. U.S. total projected electricity demand, 2007-2035. Data: EIA (December 2009). \*

\*The transportation band in Figure 65 is quite thin. The data are in Table 22.

Table 22. U.S. total projected electricity demand, 2007-2035 (billion kWh). Data: EIA (December 2009).

Sector	2007	2008	2009	2010	2011	2012	2013	2014	2015	2016	2017	2018	2019	2020	2021
Residential	1392.24	1379.31	1376.42	1387.71	1407.30	1416.16	1393.52	1393.69	1400.13	1411.88	1421.22	1436.28	1454.58	1471.40	1485.12
Commercial/Other	1336.32	1352.45	1326.57	1354.74	1401.33	1424.87	1432.79	1446.55	1465.87	1486.34	1506.80	1528.56	1551.79	1573.43	1595.18
Industrial	1027.83	982.15	878.87	868.18	912.58	951.80	975.68	989.08	996.66	1002.03	1008.11	1016.07	1025.13	1029.18	1027.17
Transportation	6.49	6.56	6.69	6.66	6.74	6.86	6.96	7.13	7.36	7.57	7.81	8.06	8.34	8.65	8.98
<b>Total Sales</b>	<b>3762.88</b>	<b>3720.47</b>	<b>3588.54</b>	<b>3617.29</b>	<b>3727.94</b>	<b>3799.70</b>	<b>3808.95</b>	<b>3836.46</b>	<b>3870.02</b>	<b>3907.82</b>	<b>3943.93</b>	<b>3988.97</b>	<b>4039.84</b>	<b>4082.66</b>	<b>4116.46</b>
	2022	2023	2024	2025	2026	2027	2028	2029	2030	2031	2032	2033	2034	2035	2007-2035
	1501.10	1517.64	1538.43	1553.47	1572.66	1591.12	1611.65	1622.58	1636.58	1649.98	1666.93	1677.25	1692.15	1707.45	0.79%
	1617.00	1639.37	1662.07	1686.83	1711.61	1736.06	1760.17	1783.05	1805.39	1827.51	1849.61	1872.94	1896.69	1920.97	1.31%
	1021.98	1019.25	1020.33	1022.53	1023.68	1023.23	1021.21	1018.41	1016.82	1015.91	1013.35	1013.07	1013.54	1015.58	0.12%
	9.34	9.84	10.24	10.69	11.18	11.71	12.25	12.82	13.43	14.01	14.60	15.23	15.82	16.42	3.45%
	<b>4149.43</b>	<b>4186.09</b>	<b>4231.06</b>	<b>4273.52</b>	<b>4319.14</b>	<b>4362.12</b>	<b>4405.28</b>	<b>4436.86</b>	<b>4472.22</b>	<b>4507.41</b>	<b>4544.49</b>	<b>4578.49</b>	<b>4618.20</b>	<b>4660.41</b>	<b>0.84%</b>

As can be seen in Table 22, the strongest demand growth is in the commercial/other sector, with an increase of nearly 600 billion kWh from 2007 to 2035, followed by the residential sector with a growth of over 300 billion kWh over the same period. The share of the residential sector in total demand remains roughly constant at 37 percent during this period. The commercial/other share increases from about 36 percent to 41 percent, and the share of the industrial sector declines from 27 percent to 22 percent. In percentage terms, the strongest growth comes from the transportation sector, but due to an extremely small initial base, the 3.45 percent annual growth for 2007-2035 still results in a total share of demand that is only about one-third of 1 percent.

### **Summary of Future Regional Demand**

Over the period 2007-2035, the highest rates of demand growth are expected to come from Florida (8) and Rocky Mountain Power Area (12), which exhibit projected annual growth rates of 1.26 percent and 1.13 percent, respectively. Strong demand growth rates are also expected from the Western United States (11, 13), Texas (2), and parts of the Midwest (4). These regions combined account for roughly half of the total projected increase in national electricity demand.

### **Rural Development Potential**

Rural development and electricity demand are closely related phenomena. As rural communities experience economic growth, they will also be expected to experience growth in demand for electricity. Economic growth, in turn, is closely related to growth in rural population and in rural employment opportunities. Renewable energy projects can benefit rural communities both by creating new employment opportunities, thereby stimulating economic activity, and by meeting the electricity demand created by rural economic growth in general.

### **Rural Population Growth**

Rural America experienced an increase in in-migration during the 1990s, after a period of slower population growth in the 1980s. This increase was due to a number of factors, including high immigration rates, high birth rates, and expansion of urban areas, which caused many commuters to take up residence in rural areas adjacent to or near urban centers. Another important factor that contributed to the growth in rural population during the 1990s was an influx of retirement-age baby boomers into rural areas. This general trend is expected to continue, with the rural population of 55- to 75-year-olds increasing through 2020.

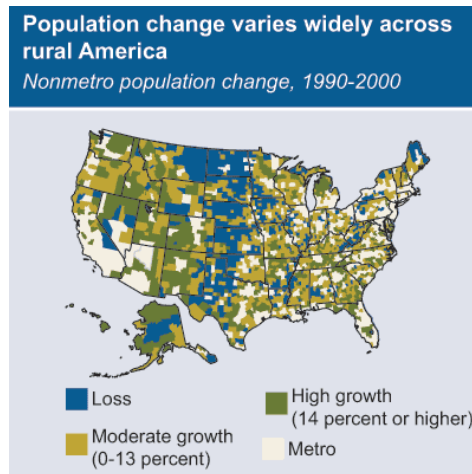

**Figure 66. Rural population change, 1990-2000. Source: USDA ERS.**

This growth in rural population was not uniform across the United States, and some areas saw significantly higher population growth than others. These differences can be seen in Figure 66, which was prepared by the USDA Economic Research Service (ERS) in 2003.

The surge in rural population growth during the 1990s was not to last, however. With the exception of a brief mid-decade increase, migration to rural areas decreased throughout the first decade of the 2000s. Since the beginning of the decade, urban populations have grown twice as fast as rural ones. This is generally because urban areas receive more international immigrants and have a higher rate of natural increase. County-level data on population change for the years 2000-2009, analogous to that of Figure 66, can be found on the ERS website (<http://www.ers.usda.gov/Data/Population/>). As in the 1990s, growth in rural population varied across the United States throughout the first decade of the 2000s. Some counties did experience growth.

The recent decrease in net migration to rural areas has been somewhat offset by a rise in natural increase. This rise is largely due to the children of the baby boom generation entering childbearing age. This phenomenon is referred to as the “baby boom echo,” and will soon be exhausted—at which point the rate of natural increase will likely fall once again. Note also that the rate of natural increase in urban areas remains twice as high as that of rural areas.

Despite declining rural population growth, between 2004 and 2006 104,000 more people moved from urban to rural areas than vice versa. This was a significant increase over previous years and was largely driven by baby boomer retirees. After July 2006, this figure dropped to 34,000 people, a result of the foreclosures that began in late 2006 and the economic recession that began in late 2007.

In general, patterns in rural population growth appear to be associated with certain county characteristics. Counties with retirement and recreation facilities tend to exhibit significant growth. Counties that contain or are located nearby urban centers tend to exhibit above-average growth. In contrast, population loss is generally exhibited by counties that are located far from urban centers, or whose economies are mostly dependent on agriculture.



### **Rural Employment Opportunities**

The rural economy of the United States has historically been built on three pillars: natural amenities, natural resources, and low-cost land and labor for manufacturing. However, these three pillars have provided less support to domestic rural economies in recent years. While natural amenities remain critical to some rural economies, characteristics that are conducive to farming—such as abundant rain and good quality farmland—do not provide the kinds of amenities that attract economic activity related to recreation and retirement. In addition, domestic employment in agriculture and mining has declined for several decades. Thus many rural economies that have continued to rely on such traditional natural resource-based industries have experienced population loss and reduced or even negative economic growth. Finally, a great deal of manufacturing has moved overseas since the 1980s and, since the 1990s, domestic manufacturing has largely shifted to sectors that require a highly educated workforce. Thus the number of rural manufacturing jobs continues to decline.

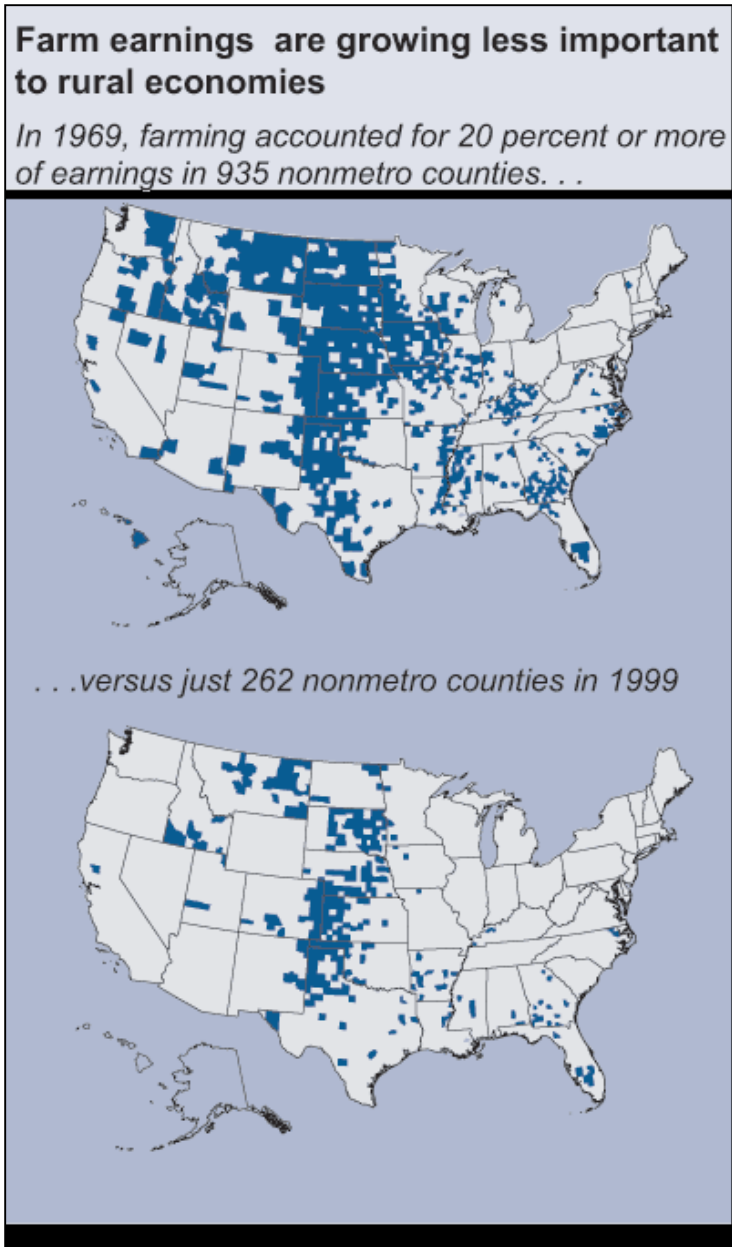

Figure 67. Farm earnings in rural counties, 1969 and 1999. Source: USDA Economic Research Service.

In response to these trends, many rural economies have diversified. This has been most striking in the shift away from agriculture. In 1969, 935 rural counties relied on farming for 20 percent or more of their total earnings; in 1999, this number had fallen to 292. This shift can be seen in Figure 67. Currently, seven out of eight rural counties are dominated by non-farm employment.

As a result of rural economies' shift away from farming, farm households depend more and more on the local economy for their welfare. Many jobs have shifted to the service sector, including retail trade, health care, education, and other subsectors. Other common sources of new rural employment are activities related to recreation and retirement. A comparison of urban and rural (metro and non-metro) employment can be seen in Figure 68.

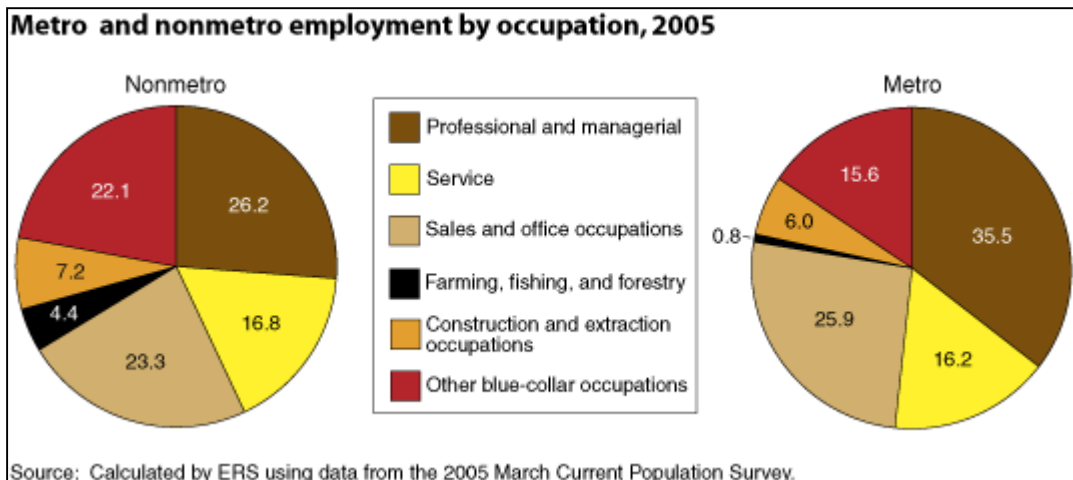

Figure 68. Urban and rural employment, 2005. Source: USDA Economic Research Service.

Sustained by diversification, rural employment exhibited growth throughout the 1980s, 1990s, and early 2000s. This can be seen in Figure 69. Employment growth rates from 1976 to 1990 ranged from 2.1 percent in the West and 1.6 percent in the Northeast, to 1.2 percent in the South and 0.7 percent in the Midwest. From 1990 to 2005, employment growth remained strong in the Western United States at 1.9 percent, while the growth rate of the Northeast dropped to 0.8 percent, and those of the South and the Midwest remained relatively stable at 1.0 percent and 0.9 percent, respectively.

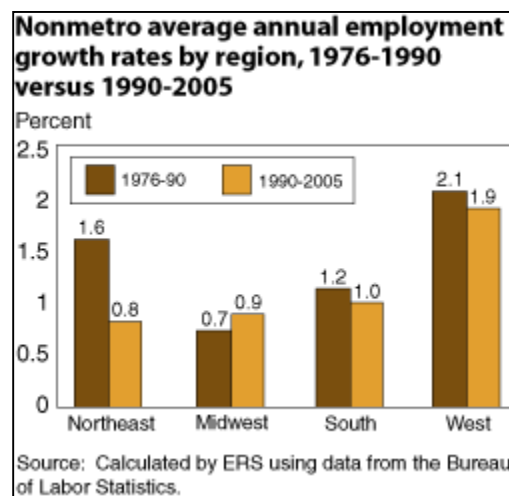
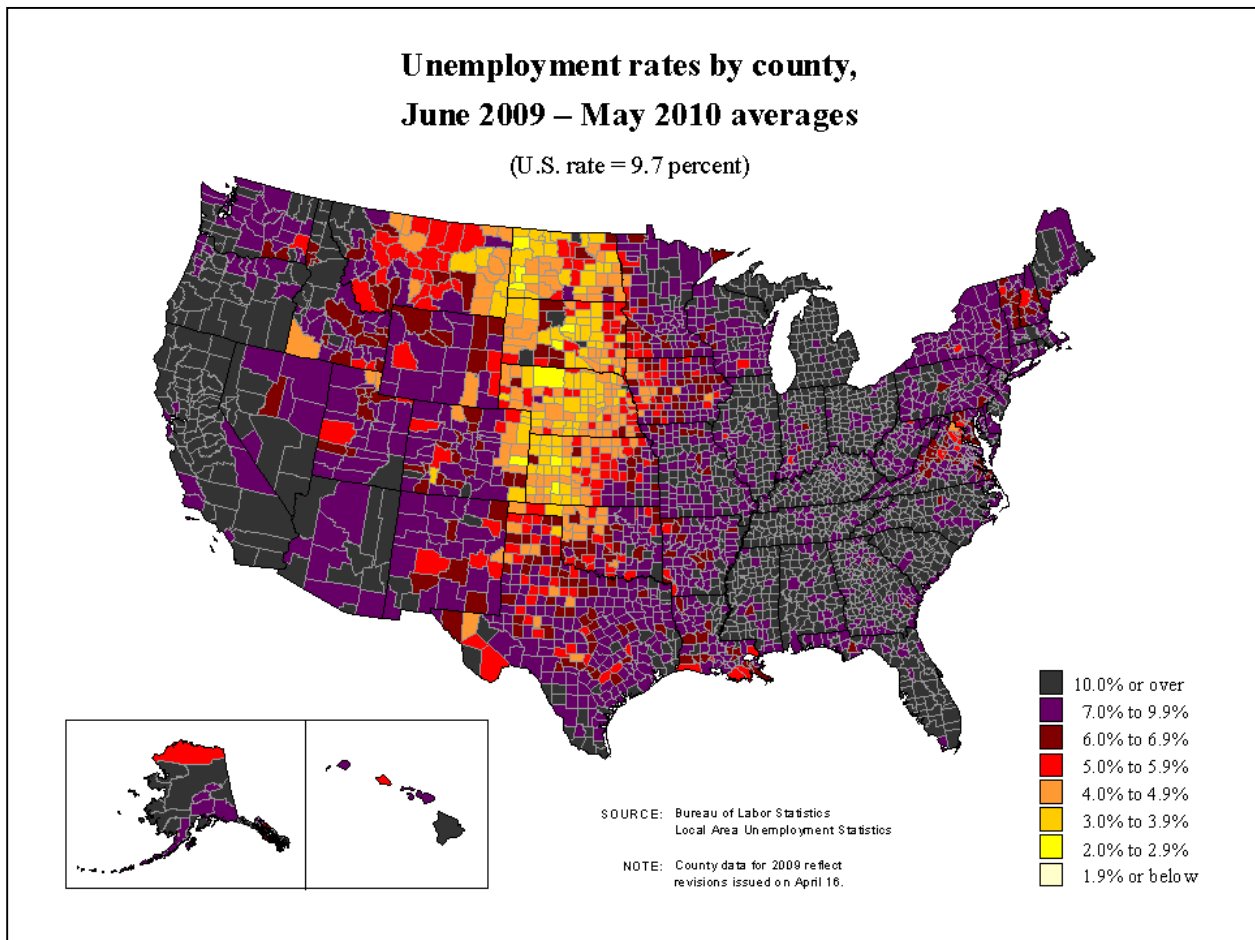

Figure 69. Rural employment growth rates by region, 1976-1990 and 1990-2005. Source: USDA Economic Research Service.

After this period of sustained growth, rural employment began to fall in the fourth quarter of 2006, anticipating the economic downturn that began in late 2007. Employment losses accelerated through the second half of 2008 as the recession worsened and continued into 2009. The number of jobs lost was greatest in rural manufacturing and construction, followed by transportation and utilities. Regionally speaking, rural employment declines were greatest in the Southeast, in industrial Midwestern areas, and in several Western states, including California.

As of mid-2009, the largest increases in the rural unemployment rate since 2008 had occurred in the Southeast, in the Great Lakes region of the Midwest, and in the Pacific Northwest. The latest 12-month averages of unemployment rates by county can be seen in Figure 70. Note that this figure includes both urban and rural counties.

As can be seen in Figure 70, the Southeast, the Great Lakes region of the Midwest, and parts of the Western United States are experiencing the highest rates of unemployment. Many counties in these regions exhibit an unemployment rate greater than or equal to 10 percent. The Great Plains states have fared better, with many counties exhibiting unemployment rates of 4 percent or less.



**Figure 70. Unemployment rates by county, June 2009–May 2010 averages. Source: U.S. Department of Labor, Bureau of Labor Statistics.**

Future growth in rural employment will most likely come from off-farm activities and from farm-related industries, not from traditional agriculture or manufacturing. That the current recession has exacerbated employment losses in manufacturing only reinforces this notion.

### **Renewable Energy and Rural Development**

Renewable energy projects provide rural communities with an opportunity to fortify the second and third pillars referred to in the previous section—jobs related to natural resources and manufacturing.

Renewable energy projects also provide further economic diversification, which is needed if rural economies are to remain vital well into the 21st century.

As has been described earlier in this document, many rural communities have rich renewable resource endowments. Many also feature resources that can be put to use in renewable energy projects, such as farmland that can be devoted to dedicated energy crops. In this way, natural resources and agricultural activities can continue to provide an important source of income in rural communities.

As renewable energy becomes more prominent, rural communities also have opportunities to capitalize on the manufacture of components for renewable energy generation, such as wind turbines. Furthermore, since renewable energy projects require new infrastructure to be built, they can create new construction jobs as well as jobs associated with the operation and maintenance of new generation and transmission facilities. These opportunities are particularly important, given that manufacturing and construction are two of the sectors hit hardest by the current recession.

The economic impact of a new renewable energy project on a rural community can be significant, with benefits that extend into agriculture, manufacturing, construction, and other sectors. Such a project can also increase land values and tax revenues. A review of studies on the economic impacts of wind energy investments can be found in the NREL report *Analysis: Economic Impacts of Wind Applications in Rural Communities*. Wind Powering America (WPA) has developed a Jobs and Economic Development Impact (JEDI) model for predicting the economic impact of renewable energy projects, including wind, concentrating solar power, and biopower projects. More information on the JEDI model and related issues can be found on the WPA website (<http://www.windpoweringamerica.gov/economics.asp>).

Generally, wind power projects tend to have the greatest direct impact on small rural economies that are not already significantly diversified, while the greatest indirect impacts are experienced by communities with larger economies. Whether construction uses local labor or not depends largely on the skill level of the local labor force. Policy may also play a role in determining the economic impact of renewable energy projects. The NREL report mentioned above indicates that some local governments have provided developers with incentives to hire local labor.

Rural population tends to track employment opportunities, so new renewable energy jobs in rural areas will likely be accompanied by rural population growth. This can lead to a virtuous cycle, in which increasing populations demand more electricity and thereby create a demand for further renewable energy investments, which create more jobs and induce further population growth, and so on. Insofar as farm households are now more dependent on their local economies, this can also lead to a significant increase in farm household welfare.

To ensure that all stakeholders benefit from a new renewable energy investment, it is important to involve as much of the community in the planning process as possible. As rural economies diversify and become more interconnected, it is also important to look for renewable energy opportunities that involve more than one community or cross regional boundaries. Communication will be crucial if rural America is to benefit as much as possible from investing in renewable energy now and in the future.

## Wisconsin Biogas Digestion Project

Largely through the efforts of the Wisconsin Biogas Digestion Project, Wisconsin leads the United States in its number of farm-based anaerobic digesters. This project not only provides financial support for digester installations but also provides education and technical assistance and facilitates communication among stakeholders.

The Wisconsin Biogas Digestion Project is run by Focus on Energy, an organization administered by the Wisconsin Energy Conservation Corporation. Focus on Energy was formed as part of a law that requires Wisconsin investor-owned electric and gas utilities to support renewable energy projects throughout the state.

Focus on Energy worked with state utilities to make it easier to connect generators fired by gas from biodigesters to the grid and arranged for higher rates for electricity generated from biogas. It organizes a yearly biogas conference, engages in educational forums, and participates in monthly meetings of the Wisconsin Biogas Development Group. This group includes utilities, government organizations, universities, private firms, and the press. Focus on Energy also worked with farmers and others to secure 32 grants from the 2002 Farm Bill's Renewable Energy Systems and Energy Efficiency Improvements Program (Section 9006), and it monitors biogas system performance using a US Environmental Protection Agency protocol. The 2002 Farm Bill Section 9006 program is now covered under Section 9007 of the 2008 Farm Bill and is currently known as the Rural Energy for America Program.

The efforts of Focus on Energy have contributed to 11 completed biodigester projects, and 13 more are under construction. The completed projects have a capacity of nearly 5 MW, and the additional projects under construction will roughly double that capacity.

The popularity of Focus on Energy's Biogas Digestion Project has led to a five-fold increase in its budget over three years. Its operating budget in 2009 was \$2.3 million, roughly 90 percent of which was dedicated to incentives.

Focus on Energy has supplied information to other states, and Indiana and Vermont have already started using technologies developed as a part of the Wisconsin Biogas Digestion Project.

The Wisconsin Biogas Digestion Project is a good example of combining financial incentives with initiatives that involve entire communities. The extension of this program beyond finance and into direct community involvement contributed greatly to its success, by making renewable energy more popular among individuals and groups that would not have traditionally supported it.

## Electric Utility Business Models

An electric utility is any entity that provides its customers with electrical power, either by generating it directly or by engaging in power purchasing agreements. They include investor-, federally, and publicly owned utilities as well as rural electric cooperatives. Each type of utility has a unique history and business model and a unique set of financial instruments available to it. Most utilities are subject to regulation at the local, state, and federal levels.

### Investor-Owned Utilities

The business structure of an investor-owned utility (IOU) is designed to maximize the value of the company for its stockholders—those individuals and/or entities that have invested in it. As corporations, IOUs are all state chartered, and they operate in all 50 states except for Nebraska, which is served exclusively by municipals and other public power entities. The majority of IOUs are involved in all three aspects of the electrical power system: generation, transmission, and distribution. They serve 73 percent of utility customers and own 77 percent and 48 percent of transmission and distribution lines, respectively. They provide roughly 47 percent of total domestic electricity generated.

IOUs are managed by a board of directors and officers who are elected by stockholders. These directors and officers control policy and business decisions for the utility. Unlike co-op board members, owners of IOUs are under no obligation to use their corporation's goods or services. Votes are allotted to stockholders in proportion to shares of voting stock they own, so some stockholders wield significantly more impact on the outcome of board member elections than others.

IOUs typically raise capital either by selling shares of stock to investors or by issuing corporate bonds. The corporation alone is liable for any debts it incurs, while its stockholders are liable only for the amount they have invested in the corporation. This limited liability is a significant advantage of the corporate business model, as it reduces the risk faced by individuals when they invest in a corporation.

The earnings of an IOU are allotted to stockholders as dividends, based on the number of shares of stock that each stockholder owns, or they may be retained for reinvestment in the corporation. The magnitude of profit distributions and the time at which they occur are both determined by the board of directors. Note that an IOU's earnings are taxed twice—both corporate income *and* dividends are taxed.

### Federally Owned Utilities

Federally owned utilities are nonprofit government entities designed to market and transmit power generated from government-owned hydroelectric facilities and to provide other related services. Some have already invested in renewable generation in addition to hydroelectric capacity, including wind, solar, and methane gas facilities. There are currently five federally owned utilities. Four are operated as Power Marketing Agencies (PMAs) within the U.S. Department of Energy while a fifth, the Tennessee Valley Authority (TVA), operates as a separate, stand-alone federal entity. The four Power Marketing Agencies are the Bonneville Power Administration, the Southeastern Power Administration, the Southwestern Power Administration, and the Western Area Power Administration. The federal PMAs give preference in the sale of power to public entities and electric cooperatives. The five federal entities

own 11 percent and 3 percent of transmission and distribution lines, respectively, and provide roughly 7 percent of total domestic electricity generated.

The four federal PMAs were created under the federal power marketing program, which began in the early 1900s. Power being produced at federal hydropower projects was exceeding the needs of those projects, so excess power was sold to repay the government debt that financed them. Once this debt was repaid, the PMAs continued to offer power at cost. The TVA, on the other hand, was established in 1933 with a much broader mandate to help lift the Tennessee Valley region out of the Great Depression.

As federal agencies, the TVA and the four PMAs are owned and controlled by the U.S. government. Each is managed by a board of directors that is responsible for policy and business decisions.

Federal PMAs raise capital through annual congressional appropriations, or from customer-advanced funding or other alternative financing sources. They raise debt capital by borrowing from the U.S. Treasury. Any such debt is paid back in full, plus interest. Since 2000, the TVA legal mandate has been modified to allow it to access financial markets by issuing bonds.

All five federal electricity marketing entities are not-for-profit entities and, as federal agencies, do not pay taxes, which means they sell power at rates that cover the costs of electricity marketing and transmission and no more. Any excess earnings go toward paying down government debt or investing in new facilities or equipment.

## Publicly Owned Utilities

Publicly owned utilities (POUs) are nonprofit electric systems owned and operated by the people they serve, through either a state or local government. They include municipal utilities, public power districts, state power authorities, and other state and local government entities that generate and/or purchase electrical power. They are designed to provide electrical power to their community members, and sometimes other nearby consumers, at cost. There are currently 2,010 POUs. Most of them only distribute power, although some large ones also generate and transmit electricity. They serve roughly 14 percent of utility customers, and own 6 percent and 7 percent of transmission and distribution lines, respectively. They provide roughly 9 percent of total domestic electricity generated.

The first POUs were formed in the early 1880s, and by 1888, 68 were in existence. After rapid growth followed by a decline throughout the 1920s, the number of POUs has remained relatively constant since the 1930s. In the last 10 years, 24 new POUs have been created and 12 have been sold. Most of these sales were to nearby rural electric cooperatives.

Publicly owned utilities are effectively owned by their consumers and governed locally by elected or appointed citizen boards. These boards may be a local city governing body, such as a city council, or an independent body.

Publicly owned utilities typically raise capital through municipal treasuries or by issuing revenue bonds secured by proceeds from electricity sales. The relevant governing body, either state or local, is liable for any debts that a POU incurs.



As previously stated, POU's operate at cost, which means that they charge rates to cover their costs and no more. Any excess earnings are used to lower rates, returned to consumers through community contributions, or invested in new facilities or equipment. As government entities, POU's do not have to pay income tax.

## Rural Electric Cooperatives

Rural electric cooperatives are state chartered as not-for-profit corporations, owned by the customers they serve. They meet demand for electricity in rural areas with low concentrations of consumers—areas that IOU's have historically avoided for economic reasons. The cooperative business structure is designed to operate for the sole benefit of its members, who are both its owners and its customers.

There are two types of rural electric cooperatives—distribution co-ops, and generation and transmission (G&T) co-ops. Distribution co-ops simply purchase electrical power and distribute it to their members, who are typically local individuals and businesses. As their name implies, G&T co-ops generate electrical power and transmit it to their members, who are typically regional distribution co-ops. (A G&T cooperative is a co-op of co-ops.)

Rural electric cooperatives serve 12 percent of all utility customers. They own 6 percent and 42 percent of transmission and distribution lines, respectively. They provide roughly 5 percent of total domestic electricity generated.

Rural electric cooperatives first came into existence under the auspices of the U.S. Rural Electrification Administration (REA), established by an executive order signed by President Franklin D. Roosevelt in 1935. One year later, the Rural Electrification Act enabled the REA to provide direct loans and loan guarantees to rural communities so they could fund their own electric cooperatives. Mostly due to the creation of such co-ops, more than 90 percent of U.S. farms had electric service by 1953. Today, roughly 99 percent of U.S. farms have electric service.

The REA became the Rural Utilities Service (RUS), part of the U.S. Department of Agriculture (USDA), in 1994. RUS supports the USDA's Rural Development mission area and its role to increase economic opportunities and enhance the quality of life in rural communities across the nation. RUS programs include the Electric Programs, Telecommunications and Broadband Programs, and Water and Environmental Programs. Through the RUS Electric Programs, the federal government is currently the majority note holder for roughly 700 borrowers in 46 states.

The RUS Electric Programs continue to provide financial assistance to rural communities for improving, constructing, or acquiring electricity generation, transmission, or distribution facilities, including renewable energy facilities. For this reason, these programs will figure prominently in the section of this report on renewable energy development and financing. USDA also provides financial assistance for energy projects through its Business Programs and Community Development Programs within the Rural Development mission area.

As previously stated, cooperatives are owned by their members. Each co-op is managed by a board of directors elected by its members. This board of directors selects a manager. The board of directors

controls policy and business decisions, while the manager is responsible for general business operations. Each member of a co-op gets one vote, regardless of that member's equity stake in the cooperative, and only members can approve major changes in policy or business structure. Unlike IOUs, all or most rural electric cooperative board members must be members, and hence customers, of the cooperative.

The equity capital of cooperatives typically belongs to co-op members, rather than to outside investors. This equity capital may be financed through retained earnings, by contributions through member fees, or by the sale of stock to members. Co-ops also often raise equity capital internally by withholding a portion of net income from members, according to the amount of income generated by each member. Members are liable only for the amount they have invested in a co-op.

Because cooperatives pass earnings on to members based on patronage, they cannot attract equity from outside sources in the same way that IOUs can. For this reason, they face a unique set of financing challenges. Given the constraints on equity capital inherent in the cooperative business model, debt capital is the most common way co-ops raise capital for new investments. For investments that are especially high cost or that involve renewable resources, grants are sometimes available as well.

Federal Clean Renewable Energy Bonds (CREBs) currently provide rural electric cooperatives with the lowest cost source of debt capital, followed by loans from the USDA RUS Programs, then loans from supplemental banks such as CoBank, the National Rural Utilities Cooperative Finance Corporation, and so on. These financial instruments are described in more detail in the section of this report that treats renewable energy development and financing.

Since distribution co-ops are small, they are usually not rated by the major investment rating agencies and therefore have no direct access to private capital markets. However, this is not the case with most G&T co-ops, which are able to more readily access regular commercial capital markets and lending institutions. In general, G&T co-ops are more flexible than distribution co-ops when it comes to investing, as G&T co-ops typically use the "all requirements" contracts they have with their member distribution co-ops to access capital markets.

The earnings or losses of a rural electric cooperative, called margins, are allotted to members according to how much each member has used the co-op's services—*not* according to members' equity stakes. Margins can be distributed as cash or retained as equity stakes; usually a combination is used. Most co-ops do not pay any dividends on capital, although some pay a modest return in accordance with state and federal statutes.

Rural electric cooperatives operate as not-for-profit corporations, and the test for not-for-profit status is done over several years. Based on this, a co-op's earnings can be higher or lower than break-even in individual years without that co-op forfeiting its not-for-profit status. Another restriction on rural electric cooperatives' earnings is that no more than 15 percent of gross income can come from non-members, or the co-op will become a taxable entity. Some G&T co-ops opt to exceed this 15-percent limit and become taxable when it makes economic sense. Note that the earnings of co-ops whose gross income from non-members falls below this limit are taxed only once, as members' income. In aggregate, non-member sales account for roughly 17 percent of G&T power sales.

In addition to the previously mentioned USDA RUS Electric Programs, two organizations important to rural electric cooperatives are the National Rural Electric Cooperative Association (NRECA) and the National Renewables Cooperative Organization (NRCO).

The National Rural Electric Cooperative Association, formed in 1942, is the national service organization for rural electric cooperatives and their members. It performs lobbying for electric co-ops and provides legal representation, education and consulting, and other services. It also provides insurance, employee benefits, and financial services to its member co-ops. It currently has 47 members, one from each state that has electric distribution cooperatives.

The National Renewables Cooperative Organization is a not-for-profit organization formed by rural electric cooperatives to facilitate and promote the development of renewable energy systems among its members, with the assistance of NRECA. A map of NRCO members can be seen in Figure 71.

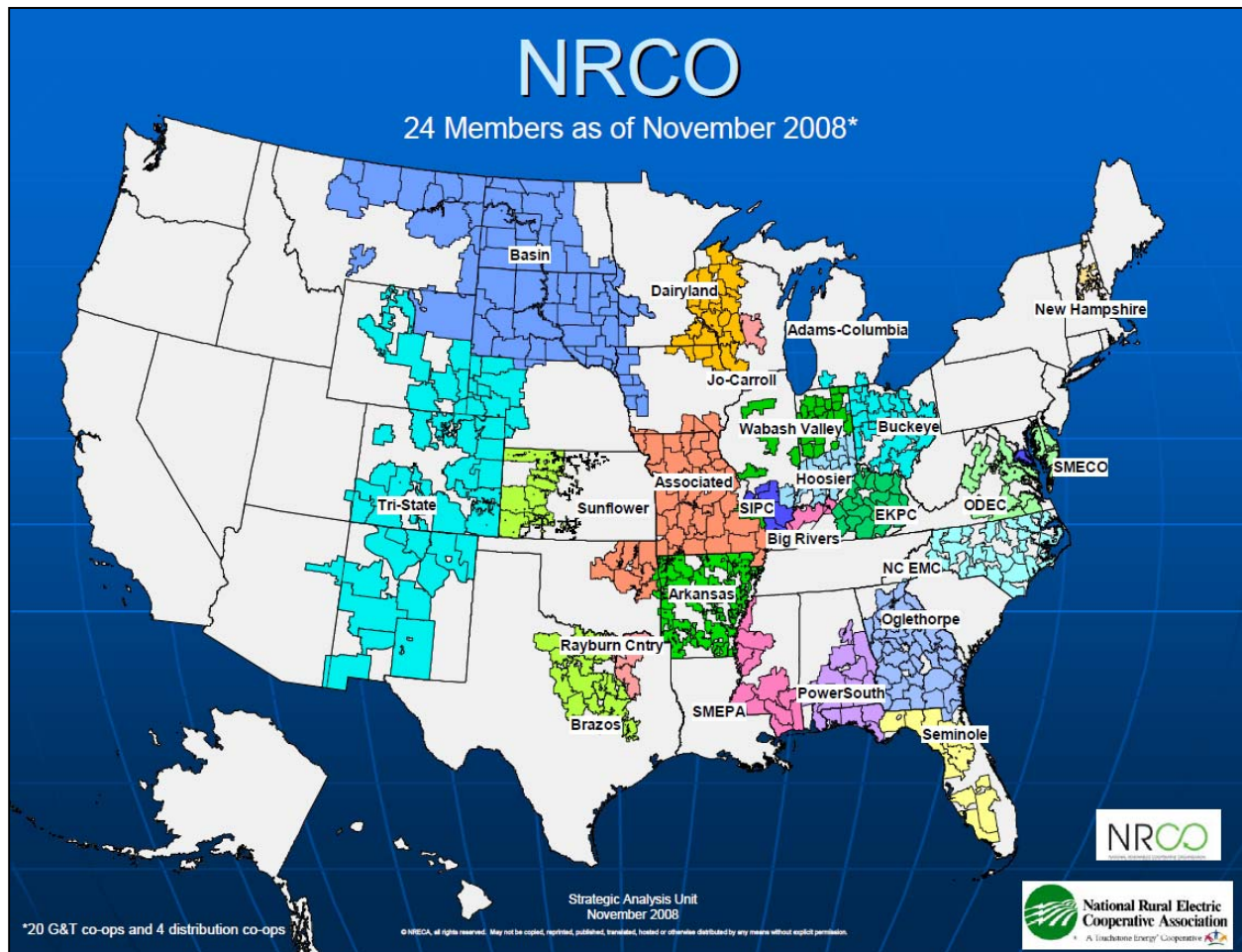

EKPC - East Kentucky Power Cooperative  
 ODEC - Old Dominion Electric Cooperative  
 SMECO - Southern Maryland Electric Cooperative

SIPC - Southern Illinois Power Cooperative  
 SMEPA - South Mississippi Electric Power Association

Figure 71. Map of NRCO member cooperatives.

As of May 2008, NRCO had 24 members—20 G&T co-ops and four distribution co-ops.

### **Non-Utility Generators**

A significant portion of the electricity generated in the United States comes from non-utility generators, so they bear mentioning here. These non-utility generators are corporations, firms, households, or any other type of entity that owns generating capacity but has neither a franchised service area nor an obligation to serve retail customers. This includes independent power producers that supply electricity to utilities, as well as commercial and industrial entities that generate power for themselves and/or buy and sell electricity on wholesale markets. An example of this type of generator is a paper mill that burns sawdust onsite to generate electricity primarily to serve in-house demand. Non-utility generators provide roughly 32 percent of total domestic electricity generated, including 9 percent of renewable generation.

### **Electric Utility Comparisons**

Graphs comparing the five different types of business models detailed above can be seen in Figures 72-75.

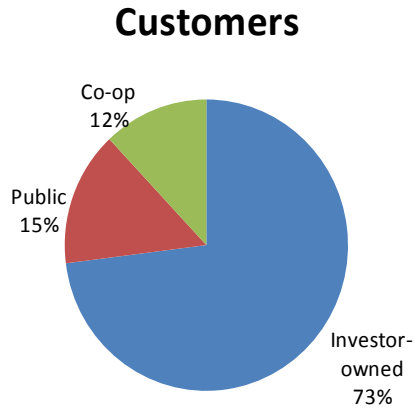

Figure 72. Retail electricity customers by business model. Data: NRECA (February 2008).

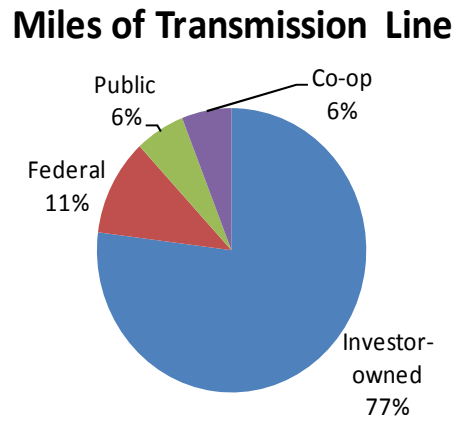

Figure 73. Miles of transmission line by business model. Data: NRECA (February 2008).

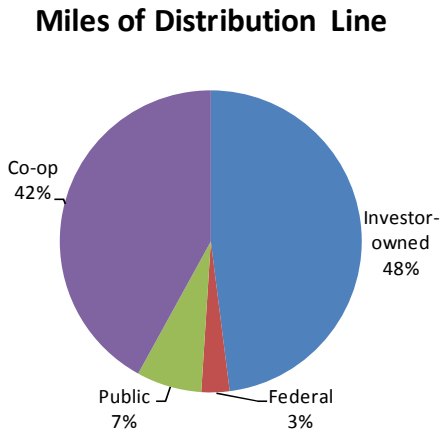

Figure 74. Miles of distribution line by business model. Data: NRECA (February 2008).

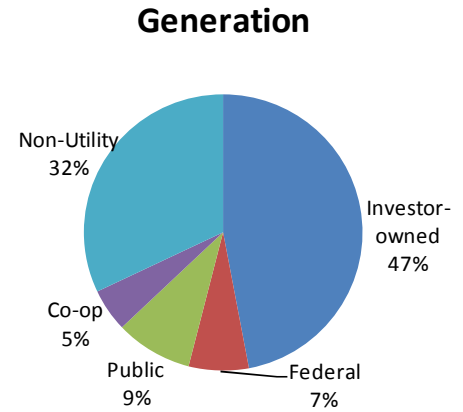

Figure 75. Generation by business model. Data: NRECA (February 2008).

Graphs comparing the customer base of each business model can be seen in Figure 76 and Figure 77.

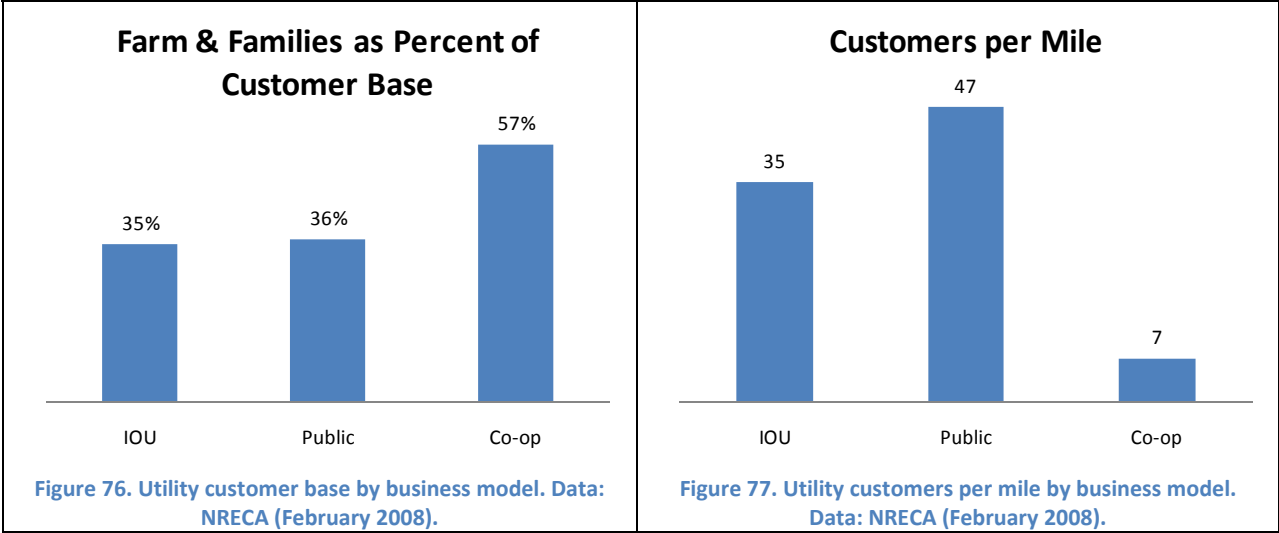

Figure 74 and Figure 75 show that electric co-ops own nearly half of the United States’ distribution lines, even though they generate only a small fraction of its electrical power. This is a result of their service to mostly sparsely populated rural areas, a characteristic further evidenced by Figure 76 and Figure 77. These figures confirm that electric co-ops serve mostly farms and families and have the fewest customers per mile.

## Developing and Financing Renewable Energy

There has been significant growth in both the size and the profitability of the renewable energy sector in recent years. This constitutes an important economic development opportunity for rural communities in the United States. However, the growth in the renewable energy sector has also attracted a large number of investors from outside of rural communities, whether domestic or international, public or private. For rural communities in the United States to maximally benefit from investment in renewable energy, the largest possible share of profits from such investments should be re-circulated within those communities. To this end, rural policymakers should evaluate the costs and benefits of facilitating the participation of cooperatives, farmers, and other rural entities in the renewable energy sector.

## Development and Financing Challenges

As renewable energy resources are abundant in many rural areas, so are renewable energy investment opportunities. However, a number of challenges face rural entities that are interested in such opportunities. These challenges can be grouped into four main categories: high equity investment requirements, complex development paths, renewable energy investment risks, and access to transmission infrastructure.

The equity investments required for new renewable energy infrastructure are often substantial, especially for utility-scale renewable power facilities. Sufficient equity is sometimes difficult to raise solely from co-op members, farmers, and other rural investors. This difficulty is compounded by the risk-aversion of potential rural investors, especially farmers. Also, the low population density of many rural areas may lead to investment situations in which there are too few rural investors to fully exploit the economies of scale for generation technology. These challenges have been overcome in some cases by entering into partnerships that bring in outside equity capital. Such partnerships will be treated in more detail in the next section of this report.

Many renewable energy investments follow a complex and often unfamiliar development path. There is a substantial learning curve for rural entities and investors not familiar with renewable energy infrastructure development. It can also be difficult to determine which government grants and loans are available for which entities and which technologies, and under what conditions. As of this writing, there are relatively few experienced professionals and facilitating organizations available to assist with planning—although this is changing, with the creation of organizations such as NRCO, the Clean Energy States Alliance (CESA), and others, and the increasing involvement of organizations such as USDA's RUS and NRECA with renewable technologies.

A number of risks are associated with renewable energy investments. Such investments often have high up-front costs to pay for project planning and siting, equipment, and construction. There is also often a dearth of risk mitigation, or risk sharing, mechanisms available during the early development stages. Since some renewable energy technologies are not yet well-established, there are also risks associated with investing in these technologies, because future changes in technology can significantly impact the profitability of an investment. There are also unique risks associated with renewable energy technologies that rely on weather, such as wind power and solar power, because their profitability is subject to future variations in weather patterns. Renewable energy investments can also suffer from a

lack of reliable information about the long-term availability of the feedstock on which they depend. Lastly, all of these risks are confounded by renewable energy policies that lack consistency and clarity, thereby increasing the economic ambiguity of investments in renewable energy.

### Worthington Public Utilities

Worthington Public Utilities (WPU) is a municipal utility that serves the city of Worthington, MN. Worthington has roughly 11,000 residents and is located in an area with rich wind resources. Before investing in wind power, WPU purchased 70 percent of its power from Missouri River Energy Services (MRES) and 30 percent of its power from the federal Western Area Power Administration (WAPA).

In 2000, Windustry proposed that WPU invest directly in wind power. Windustry is a nonprofit organization that provides rural communities across America with information and technical assistance on wind power. The Worthington Utility Board accepted this proposal and formed a task force to assess the feasibility of doing a municipal wind power project.

The task force included representatives from all the project's major stakeholders, including WPU, the Worthington Utility Board, MRES, the city, and the local community. It also included a "citizens' task force" of students, well-known community members, and a representative from the local meatpacking plant. Those who might be antagonistic to the project were invited to join the task force as well.

The task force met several times over six months, discussed the project with consultants, and regularly communicated with the local community. At the end of this process, it decided to install two wind turbines. It also decided to include the wind generation assets in WPU's rate base, rather than paying for it through a green pricing program.

After these decisions, WPU met with two setbacks. First, the state passed a new law requiring all utilities doing business in Minnesota to offer green pricing programs. Second, the Water and Light Commission determined that the state could not commit the required funds to the wind project because they had already been committed to a new diesel generator.

To meet these challenges, WPU forged a partnership with MRES. Through this partnership, MRES agreed to build two wind turbines, and WPU agreed to build a dedicated feeder line from those turbines to Worthington. The wind power would go directly to the city and would be paid for by a voluntary green-pricing program. WPU would build its own turbines at a later date.

At that point, Wisconsin Public Power, Inc., (WPPI) indicated that it would also like to partner with WPU and MRES on the Worthington wind power project. As a result of the additional WPPI partnership, the project capacity increased to six turbines.

As shown by the evolution of the Worthington wind power project, developing renewable energy can be a challenge. Planning that includes stakeholders and community members can increase the probability of success, as can innovative partnerships among local and regional firms. The provision of accurate information and technical support also plays an important role.

Potential renewable energy investments are also often constrained by access to transmission infrastructure. Many rural communities and renewable resources are located a significant distance from major load centers and transmission lines. This distance makes it difficult to get the renewable energy to market and can preclude investment. More information on transmission access and adequacy for renewables can be found in the section of this report dedicated to that topic. As of this writing, it



remains a significant challenge to large-scale investment in renewable energy in many areas of the United States.

## Development Paths

Two main development paths are available to rural entities that intend to invest in renewable energy: They can build renewable generation infrastructure themselves, or they can buy renewable power from another entity. Often this decision depends upon what type of partnership, if any, the entity enters into when making the investment.

Rural electric cooperatives and municipals often partner with other cooperatives or municipalities, or with other public or private entities, when investing in new renewable energy facilities. Such partnerships exhibit many advantages, notably the sharing of equity investment requirements and investment risks. If a rural electric cooperative decides to build and own renewable generation facilities itself, it may partner with another entity, such as an IOU, that agrees to purchase power from it once the facilities are in operation. Or, as is more often the case, a cooperative can partner with an IOU that plans to build and own a new renewable energy facility and agree to purchase power from that facility once it is in operation. Similar options are available to many rural municipals. If a rural electric cooperative or municipal does not enter into any partnerships, it naturally becomes the sole owner and operator of whatever infrastructure it develops.

The decision whether to build or buy, which is closely related to the decision to enter into a partnership or not, is influenced by many factors. The cost of maintenance and operation of any new facility is always a major consideration. The mix of available financing options and incentives

### Associated Electric Cooperative, Inc.

Associated Electric Cooperative, Inc. (AECI) is a generation and transmission cooperative based in Springfield, MO. It has six regional and 52 local member cooperatives in Missouri, Oklahoma, and Iowa. Partnership has played an important role in AECI's renewable energy investments.

Associated Electric Cooperative, Inc. entered into a partnership with Wind Capital Group and John Deere Wind Energy to develop the first utility-scale wind farms in Missouri. In 2006 AECI agreed to purchase all the power from three 50 MW wind generation facilities for 20 years. The first facility, Bluegrass Ridge Wind Farm, came online in 2007, and the second and third facilities, Cow Branch and Conception, came online in 2008.

In 2009, AECI agreed to purchase all the power from a fourth facility, Lost Creek Wind Farm, which is scheduled to come online in 2010. This facility will generate 150 MW of power.

Securing a long-term power purchase agreement for the output of these facilities, as well as access to the transmission infrastructure owned by AECI, made these

### Omaha Public Power District

Omaha Public Power District (OPPD) is a publicly owned utility based in Omaha, NE. It serves more than 340,000 customers in 13 southeast Nebraska counties. Partnership has played an important role in OPPD's renewable energy investments.

Omaha Public Power District entered into a partnership with Waste Management, Inc., to generate power from the methane gas produced at the local Douglas County Landfill. OPPD owns a methane gas power plant at that landfill, which Waste Management, Inc., operates. This facility currently has a capacity of 6.1 MW, all of which is supplied to OPPD.

Waste Management, Inc., operates similar facilities across the United States, and partnerships of this type are common.

also heavily influences the decision to build or buy, and depends on the type of partnership, if any, that is chosen. This mix varies most significantly between not-for-profit and private entities. For example, a rural electric cooperative and an IOU entering into a partnership must weigh the relative benefits of the Renewable Energy Production Incentive (REPI) versus the federal Production Tax Credit (PTC), tax-free versus taxed operation, low-cost public financing versus private financing, the availability of accelerated asset depreciation, and so on, before deciding who will own the planned facility. Ultimately, the decision to build or buy is made strictly on economic grounds.

If a rural municipality, G&T co-op, or other entity decides to build and own a new renewable power facility itself, it must raise all the capital necessary for that facility. As previously noted, this can be difficult due to the high equity capital requirements and up-front costs associated with most renewable power generation technologies. Nevertheless, the choice to own and operate a new renewable power facility is sometimes the most economically beneficial. This is often the case in partnerships where an entity with greater access to capital partners with a rural electric cooperative or municipal utility that agrees to purchase power from the planned facility.

If a rural entity decides to invest in renewable energy without owning the required renewable power generation facilities itself, it buys the renewable power from another entity. This may take the form of a partnership like those previously mentioned, and ultimately amounts to some type of power purchasing agreement. Such agreements are most beneficial when investment or operation costs are too high, when experience with the involved technologies is limited, or when siting is difficult. For not-for-profit entities, the uncertain future of the REPI provides an incentive to buy renewable power from private entities rather than building their own renewable generation facilities.

### Wabash Valley Power Association

Wabash Valley Power Association (WVPA) is a generation and transmission cooperative based in Indianapolis, IN. It has 28 member cooperatives in Indiana, Illinois, Michigan, Missouri, and Ohio. WVPA has both built renewable generation facilities and entered into power purchase agreements (PPAs) with other renewable generators.

Starting with an initial investment in a landfill gas generation facility in 2002, WVPA now owns and operates 11 landfill gas generators. These generators combined supply roughly 35 MW of power. Clean Renewable Energy Bonds (CREBs) were an important funding source for the construction of these facilities.

WVPA also has two PPAs through which it purchases wind power—with AgriWind LLC, an Illinois-based wind energy developer, and with Story County Wind Energy Center, based in Iowa. These PPAs combined supply roughly 30 MW of power.

From these power sources, WVPA has created a Renewable Energy Certificate (REC) product called *WVPA Wind and Landfill Gas RECs*. These RECs can be purchased by members of its member cooperatives through the EnviroWatts program. In March 2009, WVPA's REC product was certified by Green-e Energy, a national certification program for renewable energy. It was the first utility in Indiana to earn this certification.

Indiana's "Hoosier Homegrown Energy Plan" requires state government facilities to purchase 10 percent of their power from renewable generators in Indiana. WVPA supplies the RECs that satisfy this requirement.

In addition to renewable generation, WVPA is also involved in demand-side management. It has worked with its member cooperatives since 2002 to provide their members with incentives to reduce electricity consumption during peak hours. Many of its member cooperatives' commercial and industrial customers have also agreed to switch to auxiliary power sources when notified. Additionally, through a voluntary demand-side management program called COOL, residential customers can agree to allow WVPA to control the compressors in their air conditioners.

## Financing Options

A great number of financing options are available to rural entities interested in investing in renewable energy. Most can be grouped into four main categories: internal funding, federal funding, state and local funding, and private credit.

### Internal Funding

A rural municipality, G&T co-op, or other entity may finance a renewable power project internally—in other words, without recourse to any external source of funds—using whatever means most appropriate to its business model. These means are treated in more detail in the preceding *Electric Utility Business Models* section of this report. Financing utility-scale renewable power projects internally will likely be difficult for most rural electric cooperatives due to their not-for-profit status and the equity capital constraints of their members.

Regardless of business structure, the economic viability of most renewable power projects still depends on the financial support of national, state, and local policies. These policies, and attendant sources of funding, are treated in more detail below.

### Federal Funding

This section addresses loans, loan guarantees, grants, production subsidies, and tax credits made available by the federal government for renewable energy investments. These sources of federal funding are most relevant to utility-scale renewable power generation facilities. For a full list of federal incentives, and for more detail, refer to the *Federal Incentives/Policies for Renewables & Efficiency* section of the Database of State Incentives for Renewable Energy (DSIRE) at

<http://www.dsireusa.org/>. Most of the data in this section were taken from DSIRE. Also visit the USDA's Rural Utilities Service page at [http://www.rurdev.usda.gov/UEP\\_HomePage.html](http://www.rurdev.usda.gov/UEP_HomePage.html).

### Fox Islands Electric Cooperative

Due to high electricity prices, two Maine island communities, North Haven and Vinalhaven, began to investigate the potential of wind energy to provide their energy needs through their electric cooperative.

In 2005, Fox Islands Electric Cooperative obtained a loan from the USDA Rural Utilities Service (RUS) to install a reliable underwater cable that connected the Island's electrical system to the Mainland. This marine cable was the sole source of electricity for the cooperative and its 1,900 customers, and the cost of the electricity purchased through the cable was rather high. In 2008, its cost of per kWh sold was 12.4 cents. In an effort to reduce this cost by at least a third, Fox Islands Electric formed Fox Islands Wind, LLC, a for-profit entity, to construct, own, and operate three General Electric wind turbines and related interconnection facilities with a total capacity of 4.5 MW.

In May 2009, Fox Islands Wind LLC received a \$9.5 million loan from RUS, enough to cover 66 percent of the project cost. RUS provided an additional \$500,000 grant under the High Energy Cost Grant Program to cover grounding costs encountered during construction. The rest of the project cost was covered through equity investments. Because of the for-profit nature of the wholly owned Fox Island Wind LLC, equity investors in the project could take advantage of allowable Treasury grants for renewable projects in lieu of tax credits. The project was completed in November and became the largest community wind project on the East Coast.

## *Federal Loan & Grant Programs*

The following describes loans, loan guarantees, and grants made available by the federal government.

- **U.S. Department of Agriculture, Rural Utilities Service (RUS) Electric Loan Program**

The RUS is the primary and largest source of funding for rural electric utilities. RUS's predecessor, the Rural Electrification Administration, was established under the authority of the Rural Electrification Act of 1936 for the express purpose of financing the extension of electric service to the nation's rural areas at a time when for-profit electric utilities did not find doing so cost effective. Since then, the program has grown to become the largest federal government loan program in the electric sector, with a \$40 billion loan and loan guarantee portfolio. In 2009 the program issued \$6.6 billion in loans and loan guarantees. Projects applying for funding are screened for technical feasibility and economic feasibility, and to ensure they meet RUS requirements and are able to repay the loan.

Loans offered by the program fall into four major categories: hardship, municipal rate, Treasury rate, and guaranteed loans. The guaranteed loans are provided through the Federal Financing Bank. Those eligible for RUS electric loans include the following entities that supply rural and agricultural communities:

- Cooperatives
- Municipalities
- People's Utility Districts
- Corporations, states, territories, and subdivisions and their agencies
- Nonprofit, limited-dividend or mutual associations

*Program webpage:*

*[http://www.rurdev.usda.gov/UEP\\_HomePage.html](http://www.rurdev.usda.gov/UEP_HomePage.html)*

*Contacts for renewable energy projects:*

Georg Shultz  
Director, Electric Staff Division  
[Georg.shultz@wdc.usda.gov](mailto:Georg.shultz@wdc.usda.gov)

Joseph Badin  
Director, Northern Regional Division  
[joe.badin@wdc.usda.gov](mailto:joe.badin@wdc.usda.gov)

Doris Nolte  
Director, Southern Regional Division  
[Divdoris.nolte@wdc.usda.gov](mailto:Divdoris.nolte@wdc.usda.gov)

### **Greensburg, Kansas**

The town of Greensburg, KS, experienced a tornado in 2007 that destroyed 90 percent of the structures in the city. Reconstruction of the town has focused on sustainable solutions. In March 2010, John Deere Renewable Energy completed a wind farm with 12.5 MW of capacity obtained from 10 turbines. The community will use only a quarter of the power generated and will sell the rest to the Kansas Power Pool. The bulk of the project was financed by a \$17.4 million loan through the USDA Rural Utilities Service Electric Loan Program.

- **USDA RUS High Energy Cost Grant Program**

This program, started in 2000, offers grants for improvement of electric infrastructure for rural communities that have energy costs 275 percent above the national average. Eligible entities include individuals, nonprofits, commercial entities, state and local governments, and tribal governments.

*Contact:*

Karen Larsen

U.S. Department of Agriculture

Rural Development, Electric Programs

1400 Independence Ave, SW Stop 1560,  
Room 5165-South, Washington, DC 20250-1560

Phone: (202) 720-9545

E-Mail: [energy.grants@wdc.usda.gov](mailto:energy.grants@wdc.usda.gov)

#### Biomass Funding in Georgia

Multitrade Rabun Gap LLC received \$20.7 million in loans from the USDA Rural Utilities Service Electric Loan Program to upgrade a wood-fired boiler used to produce electricity for a textile manufacturer. This loan will be used to construct and operate a 17 MW wood-fueled biomass facility.

Fitzgerald Renewable Energy LLC received a \$139 million loan guarantee to build a 55 MW biomass-fueled generating facility. The source of the biomass will mostly be wood waste from within 50 miles of the site.

- **Clean Renewable Energy Bonds (CREBs)**

These bonds were established under the federal Energy Policy Act of 2005 as a means of financing public sector renewable energy projects. They can be issued by co-ops and other public entities such as municipal utilities, as well as state, local, and tribal governments. The qualifying technologies for CREBs are largely the same as for the federal Production Tax Credit—wind, solar thermal electric (i.e., concentrating solar power), solar photovoltaic, hydroelectric, geothermal electric, biomass, municipal solid waste, landfill gas, and anaerobic digestion.

These bonds are ideally issued with a 0-percent interest rate. The borrower pays back only the principal, and the bondholder gets a tax credit equivalent to the forgone interest payments. The tax credit rate is set daily by the U.S. Treasury Department.

Participation in the CREB program is limited by the amount of funds allocated for it by Congress. As of February 2009, the total CREB allocation was \$2.4 billion under the Energy Improvement and Extension Act of 2008 and the American Recovery and Reinvestment Act of 2009. Equal shares of one-third of these funds are reserved for public power providers, government entities, and electric cooperatives. Participants must apply for allocations through the Internal Revenue Service (IRS). Current CREB allocations do not expire, but bonds approved under recent IRS solicitations must be issued within three years of approval.

*Contact:*

Public Information - IRS  
U.S. Internal Revenue Service  
1111 Constitution Avenue, NW  
Washington, DC 20224  
Phone: (800) 829-1040  
Website: <http://www.irs.gov>

- **Qualified Energy Conservation Bonds (QECBs)**

These bonds were established under the Energy Improvement and Extension Act of 2008. They may be issued only by state, local, and tribal governments. The qualifying technologies for QECBs are largely the same as for CREBs—wind, solar thermal electric (i.e., concentrating solar power), solar photovoltaic, hydroelectric, geothermal electric, biomass, municipal solid waste, landfill gas, and anaerobic digestion. The definition of qualifying technologies for QECBs is broad and includes energy-efficiency technologies as well as the renewable energy technologies mentioned above.

These bonds are ideally issued with a 0-percent interest rate. The borrower pays back only the principal, and the bondholder gets a tax credit equivalent to the forgone interest payments. The tax credit rate is set daily by the U.S. Treasury Department. Unlike traditional tax-exempt bonds, however, the tax credits issued through this program are treated as taxable income for the bondholder.

Participation in the QECB program is limited by the amount of funds allocated for it by Congress. As of February 2009, the total QECB allocation was \$3.2 billion, under the Energy Improvement and Extension Act of 2008 and the American

### Great River Energy

Great River Energy (GRE) is a generation and transmission cooperative that is based in Maple Grove, MN. It has 28 member cooperatives, and it owns power lines that cover roughly 60 percent of Minnesota and extend into North Dakota and Wisconsin. GRE has used several CREBs to finance its renewable energy investments.

In 2007, Great River Energy received a Clean Renewable Energy Bond (CREB) award of \$3.8 million for wind development. In 2008, it received an additional \$2.4 million CREB award for solar/wind, as well as a \$30 million CREB award for biomass development.

GRE currently purchases the output of six different wind projects in Minnesota, for a total of 318 MW of renewable power. First is the 100 MW Trimont Area Wind Farm, which has 67 turbines. To develop this facility, 43 landowners in Jackson and Martin counties partnered with GRE and PPM Energy (now Iberdrola Renewables). Second is the 100 MW Prairie Star Wind Farm in Mower County, with 61 turbines. This project was developed by Horizon Wind Energy. Third is the 100 MW Elm Creek Wind Farm, located near the Trimont Area Wind Farm and also developed by Iberdrola Renewables. GRE purchases power from three smaller wind projects as well, in Chandler, Dodge Center, and Jackson County, MN.

GRE also purchases the output of several biopower facilities: Elk River Station, a power plant that uses mixed municipal waste to generate roughly 40 MW of power; a landfill gas facility in Elk River, MN, that generates an additional 3.2 MW of power; and anaerobic digesters at five Minnesota dairies, totaling about 5 MW of power.

GRE also purchases hydro power from Manitoba Hydropower and the federal Western Area Power Administration (WAPA).

Members of GRE may participate in a green pricing program called Wellspring Renewable Energy, through which they can purchase additional wind power for a monthly fee. More than 6,000 cooperative members participate.

Recovery and Reinvestment Act of 2009. Unlike CREBs, QECBs are not subject to a U.S. Treasury Department application and approval process. Rather, they are allocated to the states according to each state's percentage of the total U.S. population. States then allocate the funds among "large local governments." The local governments can then allocate the funds to various projects or return them to the state government.

*Contact:*

Public Information - IRS  
U.S. Internal Revenue Service  
1111 Constitution Avenue, NW  
Washington, DC 20224  
Phone: (800) 829-1040  
Website: <http://www.irs.gov>

- **U.S. Department of Energy Loan Guarantee Program**

This loan guarantee program was established under Title XVII of the Energy Policy Act of 2005. It is available to any non-federal entity, including cooperatives and municipalities, as well as private entities. It is intended for projects with total costs of more than \$25 million, which "avoid, reduce or sequester air pollutants or anthropogenic emissions of greenhouse gases; and employ new or significantly improved technologies as compared to commercial technologies in service in the United States at the time the guarantee is issued." Technologies that qualify for this program include many types of renewable energy technologies as well as advanced transmission and distribution technologies.

The DOE Loan Guarantee Program was created as an incentive for early adopters of large, *commercializable* technologies. It is intended for stand-alone projects, manufacturing projects, and other large-scale projects that integrate a number of different renewable energy, energy efficiency, and transmission and distribution technologies. As such, it is not available to projects that are small-scale, experimental, or have an otherwise research-based character.

Participation in the DOE Loan Guarantee Program is limited by the amount of funds allocated for it by Congress. As of July 2009, Congress authorized the program to offer more than \$10 billion in loan guarantees.

*Contact:*

Public Information - DOE  
U.S. Department of Energy  
1000 Independence Avenue, SW  
Washington, DC 20585-0121  
Phone: (202) 586-8336  
E-Mail: [LGProgram@hq.doe.gov](mailto:LGProgram@hq.doe.gov)  
Website: <http://www.lgprogram.energy.gov>

- **Rural Energy for America Program (REAP) Loan Guarantees**

This loan guarantee program was established under the Food, Conservation, and Energy Act of 2008. (It used to be called the Renewable Energy Systems and Energy Efficiency Improvements Program.) REAP includes both loan guarantees and grants and is available to agricultural producers and rural small businesses. Loan guarantees under REAP may not exceed \$25 million, and the combined grant and loan guarantee amount may not exceed 75 percent of a project's total cost. It is intended for projects that introduce energy-efficiency improvements or renewable energy systems, such as biodigesters; locally owned wind turbines; solar panels; cost-cutting ventilation and cooling systems; and so on. Qualifying technologies include wind, solar, biomass, and geothermal, as well as hydrogen derived from biomass or water using wind, solar, or geothermal energy sources.

Participation in the REAP loan guarantee program is limited by the amount of funds allocated for it by Congress. Congress allocated \$55 million for REAP for fiscal year 2009, \$60 million for 2010, and \$70 million each for 2011 and 2012. REAP is administered by the USDA, which is responsible for implementing the program.

*Contact:*

Public Information - RBS  
U.S. Department of Agriculture  
Rural Business - Cooperative Service  
USDA/RBS, Room 5045-S, Mail Stop 3201  
1400 Independence Avenue, SW  
Washington, DC 20250-3201  
Phone: (202) 690-4730  
Fax: (202) 690-4737  
E-Mail: [webmaster@rurdev.usda.gov](mailto:webmaster@rurdev.usda.gov)  
Website: <http://www.rurdev.usda.gov/rbs>

- **U.S. Department of the Treasury Renewable Energy Grants**

This grant program was established under the American Recovery and Reinvestment Act of 2009, as an alternative to the Business Energy Investment Tax Credit (ITC). It is available to tax-paying entities only. Federal, state, and local government entities; nonprofits; and co-ops are not eligible; neither are partners or pass-through entities associated with government entities, non-profits, or co-ops. Eligible projects must either enter into service in 2009 or 2010 or enter into construction in those years and enter into service before the credit termination date. Credit termination dates vary according to what technologies are involved in the project. Qualifying technologies include wind, solar heating and lighting, solar thermal electric (i.e., concentrating solar power), solar photovoltaic, biomass, landfill gas, municipal solid waste, geothermal electric, geothermal heat pumps, combined heat and power (CHP)/cogeneration, hydroelectric, and small and micro hydropower.



Grant amounts vary from 10 percent to 30 percent of the property value of eligible projects, according to what technologies are involved. As of this writing, there is an online application process, and applications are currently being accepted. All applications must be submitted by October 1, 2011.

It is important to note that eligible taxpaying entities can receive a grant from the U.S. Treasury Department *instead of* receiving the Production Tax Credit (PTC) or the Investment Tax Credit (ITC). Such a taxpaying entity *cannot* receive *both*—if they receive the PTC or the ITC, they cannot also receive a grant.

*Contact:*

Grant Information  
U.S. Department of Treasury  
1500 Pennsylvania Avenue, NW  
Washington, DC 20220  
Phone: (202) 622-2000  
Fax: (202) 622-6415  
E-Mail: 1603Questions@do.treas.gov  
Website: <http://www.treasury.gov>

- **Rural Energy for America Program (REAP) Grants**

These grants are administered under the same program as the previously detailed REAP loan guarantees. As with the loan guarantees, REAP grants are available to agricultural producers and rural small businesses. Grants under REAP may not exceed 25 percent of a project's cost and, as previously stated, the combined grant and loan guarantee amount may not exceed 75 percent of the total cost. Qualifying technologies are the same as those for REAP loan guarantees: wind, solar, biomass, and geothermal, as well as hydrogen derived from biomass or water using wind, solar, or geothermal energy sources.

Competitive grants may also be given to qualifying entities to assist agricultural producers and rural small businesses with energy audits and other energy-efficiency measures, and with renewable energy development. Four percent of total REAP funds are allocated for these competitive grants.

*Contact:*

Public Information - RBS  
U.S. Department of Agriculture  
Rural Business - Cooperative Service  
USDA/RBS, Room 5045-S, Mail Stop 3201  
1400 Independence Avenue, SW  
Washington, DC 20250-3201  
Phone: (202) 690-4730  
Fax: (202) 690-4737

E-Mail: [webmaster@rurdev.usda.gov](mailto:webmaster@rurdev.usda.gov)

Website: <http://www.rurdev.usda.gov/rbs>

### ***Tax Credits & Depreciation***

The following describes tax credits and special depreciation schedules made available by the federal government.

- **Business Energy Investment Tax Credit (ITC)**

This tax credit was originally established under United States Code Title 26 section 48 (26 USC § 48), which provided a 10-percent credit to businesses that invested in or purchased solar or geothermal property. It was expanded under the Energy Policy Act of 2005 and again under the Energy Improvement and Extension Act of 2008, which extended eligibility for the credits to utilities. It was further expanded under the American Recovery and Reinvestment Act of 2009. As of this writing, commercial and industrial entities, as well as utilities, are eligible for the ITC. Qualifying technologies include wind, solar heating and lighting, solar thermal electric (i.e., concentrating solar power), solar photovoltaic, biomass, geothermal electric, geothermal heat pumps, direct use geothermal, combined heat and power (CHP)/cogeneration, and micro hydropower.

Credits are available to eligible systems that enter into service on or before December 31, 2016. Credit amounts range from 10 percent to 30 percent of expenditures, depending on the technology involved.

*Contact:*

Public Information - IRS

U.S. Internal Revenue Service

1111 Constitution Avenue, NW

Washington, DC 20224

Phone: (800) 829-1040

Website: <http://www.irs.gov>

- **Renewable Energy Electricity Production Tax Credit (PTC)**

This tax credit was originally established under the Energy Policy Act of 1992 and has been updated and extended many times, most recently in February 2009. Like the ITC, the PTC is available to commercial and industrial entities, as well as utilities. Qualifying technologies include wind, biomass, landfill gas, municipal solid waste, geothermal electric, biodigesters, hydroelectric, and small and micro hydropower. The credit is either 1.5 or 0.75 cents per kWh in 1993 dollars, depending on the technology involved. As of this writing, that amounts to 2.2 cents per kWh for wind, geothermal, or “closed-loop” biomass, and 1.1 cents per kWh for other qualifying technologies.

The duration of the PTC is 10 years after the date that the eligible systems enter into service. The amount of the credit is reduced for systems that receive other federal tax credits, subsidies, grants, and so on.

*Contact:*

Public Information - IRS  
U.S. Internal Revenue Service  
1111 Constitution Avenue, NW  
Washington, DC 20224  
Phone: (800) 829-1040  
Website: <http://www.irs.gov>

- **Modified Accelerated Cost-Recovery System (MACRS) & Bonus Depreciation**

The Modified Accelerated Cost-Recovery System (MACRS) was originally established in 1989 under 26 USC § 168. It is available to commercial and industrial entities and is intended to enable businesses to recover the cost of investments in certain renewable energy properties through depreciation deductions. Qualifying technologies include wind, solar heating and lighting, solar thermal electric (i.e., concentrating solar power), solar photovoltaic, biomass, biodigesters, landfill gas, municipal solid waste, geothermal electric, geothermal heat pumps, direct use geothermal, CHP/cogeneration, and micro hydropower. Most property is defined as having a five-year lifetime, while some biomass properties have a seven-year lifetime. The properties eligible for this depreciation program are the same as those that are eligible for the ITC.

A 50-percent bonus depreciation provision was included in the federal Economic Stimulus Act of 2008, enacted in February 2008. This bonus depreciation is available to renewable energy systems acquired and placed into service in 2008. It simply allows an additional 50 percent depreciation for the eligible property's first year in service. The American Recovery and Reinvestment Act of 2009 extended it in February 2009, retroactively including the entire 2009 tax year. As of this writing, the bonus depreciation provision has not been renewed for 2010.

*Contact:*

Public Information - IRS  
U.S. Internal Revenue Service  
1111 Constitution Avenue, NW  
Washington, DC 20224  
Phone: (800) 829-1040  
Website: <http://www.irs.gov>

### *Production Incentives*

The following describes direct production subsidies made available by the federal government.

- **Renewable Energy Production Incentive (REPI)**

This production subsidy was originally established under the Energy Policy Act of 1992 to provide incentive payments for electricity generated and sold by new qualifying renewable energy facilities—notably those of nonprofit and not-for-profit entities. It is available to local and state governments, tribal governments, municipal utilities, rural electric cooperatives, and

native corporations. Qualifying technologies include wind, solar thermal electric, solar photovoltaic, biomass (excluding municipal solid waste), geothermal (with some restrictions), landfill gas, and methane from livestock manure management. Eligible entities receive annual payments of 1.5 cents per kWh in 1993 dollars adjusted for inflation for the first 10 years of their operation. This amounted to 2.1 cents per kWh in 2010.

The availability of the REPI is subject to annual congressional appropriations. Although appropriations have been authorized through fiscal year 2026, this does not ensure that sufficient funds will be allocated for all qualifying entities in a given year. If appropriations are insufficient, 60 percent of funds will be paid to systems that use wind, solar, ocean, geothermal, or “closed-loop” biomass technologies, and 40 percent will be paid to the remaining qualified systems. Since REPI is subject to the annual budget appropriation process, it has tended to be underfunded and therefore not as effective as the production tax credit as a funding vehicle.

*Contact:*

Christine Carter  
U.S. Department of Energy  
1617 Cole Blvd.  
Golden, CO 80401-3393  
E-Mail: [christine.carter@go.doe.gov](mailto:christine.carter@go.doe.gov)  
Website: <http://www.energy.gov>

*or*

Information Specialist - REPI  
U.S. Department of Energy  
Washington, DC  
E-Mail: [repi@ee.doe.gov](mailto:repi@ee.doe.gov)  
Website: <http://www.energy.gov>

### **State and Local Funding**

Many programs maintained by state and local governments facilitate the financing of renewable energy investments. For a full list of state and local renewable energy incentives and policies, and for more detail on specific states, refer to the Database of State Incentives for Renewable Energy (DSIRE) at <http://www.dsireusa.org/>. The Clean Energy States Alliance (CESA) also provides information on state government activities in renewable energy at <http://www.cleanenergystates.org/>.

Common forms of state financial support for utility-scale renewable energy include loans, grants, and production subsidies. While diverse in implementation, these policy instruments are largely analogous to those described in the immediately preceding section on federal funding. Other state policies include directly investing in new renewable energy projects and providing loans and rebates for small, customer-owned, renewable generation systems. Some states have also provided price insurance for new renewable energy projects.

An important consideration when designing a state renewable energy program is whether state financial incentives for renewable energy reduce the value of already available federal funding. State incentives will more effectively encourage new renewable investments if they complement, rather than replace or offset, federal incentives. This is of particular concern with the federal Renewable Energy Electricity Production Tax Credit (PTC).

#### Mississippi Renewable Energy Loan Program

The state of Mississippi offers low-interest loans for a variety of different types of renewable energy projects. These loans offer an interest rate 3 percentage points below prime. To qualify, firms must demonstrate that the project will reduce energy costs. Loans are funded through a surcharge on oil, and range from \$15,000 to \$300,000.

### *Loans*

Cooperatives and other kinds of utilities are sometimes unable to secure private loans for renewable energy projects. This may be due to high interest rates, difficult loan application procedures, the riskiness of renewable investments, or lenders' lack of knowledge regarding renewables. In such instances, states can step in to directly provide loans.

States can also provide additional incentives for investing in renewable energy by ensuring that their renewable energy loans have lower interest rates, longer repayment periods, and streamlined application procedures. States have also frequently offered unsecured loans, or loans without collateral requirements, and forgivable loans, or loans that do not require repayment if the investment fails. Unsecured and forgivable loans significantly reduce the risk faced by investors in renewable energy projects.

In addition to direct loan programs, other types of state renewable energy loan programs include matching loan programs and interest rate buy-down programs. In a matching loan program, the state provides a certain share of a privately secured loan, often at a lower interest rate and/or with more flexible repayment terms. In an interest rate buy-down program, the state agrees to subsidize the interest payments of a privately secured loan.

This is often done by providing the lender with an up-front payment equal to the present value of the forgone interest payments.

### *Grants*

Renewable energy investments often face high up-front capital costs, and grants can be an effective way for states to offset these costs. Competitive grants in particular have become a popular policy instrument. By awarding grants within a competitive framework, states can allocate funds on a basis other than first-come, first-served. This allows states to be more selective and specific with regard to which and

#### New York State Energy Research and Development Authority

In New York, a system benefits charge raises roughly \$175 million annually to support renewable energy and energy efficiency. These funds are administered by the New York State Energy Research and Development Authority (NYSERDA). NYSERDA recently issued an open solicitation for grants to support the development of renewable energy and energy efficiency-related manufacturing in the state of New York. Grants are capped at a maximum of \$1.5 million per firm. NYSERDA also offers an interest rate buy-down program for renewable energy loans made by private lenders.

what types of projects they support. Common frameworks include awarding grants to the most promising projects and performing a reverse auction to provide funds to the least expensive projects.

Although grants are among the simplest renewable energy incentives to implement, they are not always appropriate for utility-scale projects. States with limited budgets have difficulty providing funds that would significantly offset the up-front costs of such projects. Additionally, grants tend to provide weak performance incentives—although competitive grant programs allow funding to be more closely coupled to expected project performance. Lastly, grants may reduce the value of the PTC. For this last reason, many wind developers avoid grants.

#### **Energy Trust of Oregon**

The Energy Trust of Oregon offers grants to offset the costs of both emerging and well-established renewable energy technologies. It also offers grants to offset up to 50 percent of the cost of feasibility studies. In return for such support, the Energy Trust retains the project's Renewable Energy Certificates (RECs).

#### **Massachusetts Renewable Energy Trust**

The Massachusetts Renewable Energy Trust features a wide variety of grant solicitations. These include a Community Wind Collaborative, which offsets the costs of feasibility assessments, siting, and turbine construction.

### ***Production Subsidies***

States have also used production subsidies to provide an incentive for renewable energy investments. This type of incentive is awarded on a \$/kWh basis, and usually expires after a specified time period. While production subsidies are typically awarded in real time, they may also be paid in a lump sum up front and then earned over time. Advantages of this type of subsidy are that it tightly couples payments to project performance and generally does not negatively impact the PTC.

### ***Direct Investments***

States have also been known to invest directly in new renewable energy projects. This can take the form of an equity stake, although this is risky for the state government. Alternatively, states can agree to purchase a proposed renewable generator's power output and/or RECs, thus providing investors with a guaranteed market for their power.

### ***Private Credit***

In addition to the public sources of funding detailed above, a great many private sources of funding are available to rural entities interested in investing in renewable energy, or in new transmission or distribution infrastructure. These sources are generally not renewable-specific, unlike the sources detailed above.

Rural electric cooperatives generally seek funding from USDA RUS before financing a project through one of the following entities.

### ***Farm Credit System and CoBank***

The Farm Credit System (FCS), created in 1916, is the largest and oldest financial cooperative in the United States. It provides financial services to more than 500,000 farmers, rural residents, and cooperative borrowers. Roughly 25 percent of all money loaned to U.S. agriculture comes from the FCS.

Within the FCS, the entity most relevant to rural power providers is CoBank, which was chartered specifically to provide financial services to rural cooperatives. Founded in 1916, CoBank is a \$63 billion cooperative that provides loans, leases, and specialized products and services, as well as online banking and cash management. It operates in 12 locations throughout the United States, including a national office in Denver, CO, and also has an international office in Singapore. It serves agribusinesses and rural power, water, and communications providers in all 50 states.

As a member of the Farm Credit System, CoBank funds loans with proceeds from the sale of Farm Credit debt securities, which attract favorable terms and enable the bank to offer loans at competitive interest rates. One reason Farm Credit securities receive favorable terms in the capital markets is that they carry an implicit guarantee from the federal government due to the System's status as a government-sponsored enterprise.

### ***National Rural Utilities Cooperative Finance Corporation (CFC)***

The National Rural Utilities Cooperative Finance Corporation (CFC) was founded in 1969 as an independent source of funding to supplement the USDA RUS credit programs. The CFC remains a major private-market lender for rural electric cooperatives. As of May 2008, it had 1,538 members, including 898 utilities; of these utilities, 829 are distribution systems and 69 are G&T systems. CFC serves roughly 1,050 cooperatives and affiliated organizations across the United States, which represent more than 37 million customers.

The CFC raises funds from its members' equity and investments as well as by selling various financial instruments in private financial markets. With its large size and history, CFC is able to maintain a high credit rating and deliver financial products to its members at a reasonable cost. It is CoBank's main competitor.

### ***Commercial Lenders***

Rural entities may also seek funding through any number of commercial lenders. In the case of rural electric cooperatives, such lenders are typically used only for insurance and general operational costs.

### ***Other Funding Sources***

This subsection describes several additional instruments that can be used to increase the profitability of renewable investments. In this way, these instruments often play an important role in the development and financing of new renewable energy projects.

### ***Net Metering***

Net metering is an arrangement that permits utility customers to sell any electricity that they generate in excess of their own requirements back to the grid to offset their own consumption. It is enabled by electricity meters that measure the difference between the amount of electricity a facility generates and the amount it consumes. At the end of a billing period, such a meter displays either the customer's net energy received or the net energy delivered to the grid, rather than the customer's total consumption during that period.

The main benefit of net metering is that it can make small-scale generation more economical. It is particularly advantageous for utility customers who generate power that is intermittent or variable. For such customers, net metering effectively allows them to use the grid to “bank” power—in other words, produce electricity at one time and use it at another, later, time. This makes net metering well-suited for renewable resources that exhibit variability or intermittency, such as wind and solar.

Most net-metering programs are available only to small, customer-owned generating facilities. Some are further restricted to renewable sources only. The rules for their implementation vary from state to state, and pricing varies according to individual circumstances.

### Cloverland Electric Cooperative

Cloverland Electric Cooperative (CEC) is a distribution cooperative based in Dafer, MI. CEC receives roughly 40 percent of its power from hydroelectric facilities located on the St. Mary’s River. It also offers its members the option to purchase additional renewable power through a green pricing program.

In October 2008, Michigan passed the Clean, Renewable, and Efficient Energy Act (PA295). This law includes a provision for a net metering program, which encourages cooperative members to install their own small renewable energy generators. It also requires all gas and electric utilities with customers in Michigan to implement customer-supported energy-efficiency programs. To finance these programs, a mandatory Energy Optimization (EO) surcharge on all energy bills was implemented in July 2009.

Although few customers are currently engaged in net metering programs, participation is growing quickly. For example, in 2007 the number of net metering customers increased by 45 percent to 48,820. The number of U.S. net metering customers from 2003 to 2007 can be seen in Figure 78.

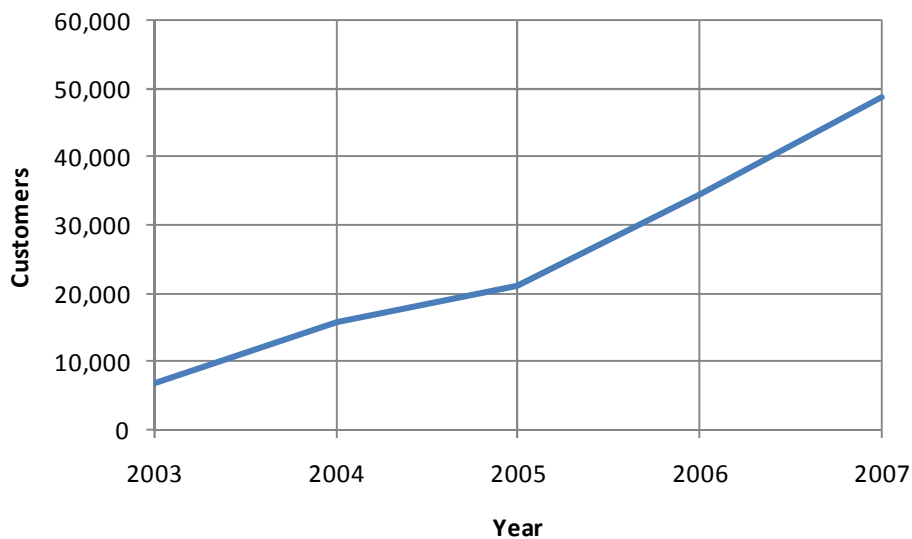

Figure 78. U.S. Net Metering Customers, 2003-2007. Data: EIA (April 2009).

A map showing states with net metering policies can be seen in Figure 79.



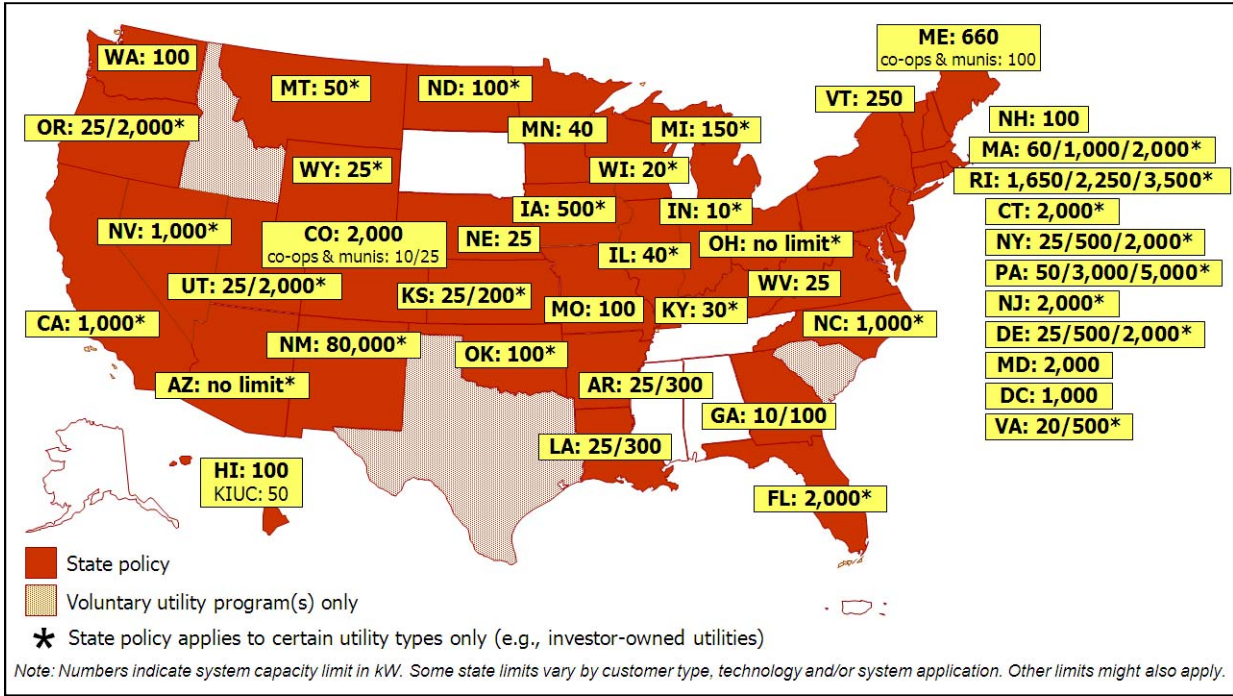

Figure 79. Map of state net metering policies. Source: Interstate Renewable Energy Council (August 2009).

As of this writing, 42 states and Washington, DC, have adopted net metering policies.

A map showing states with net metering policies specifically for wind power can be seen in Figure 80.

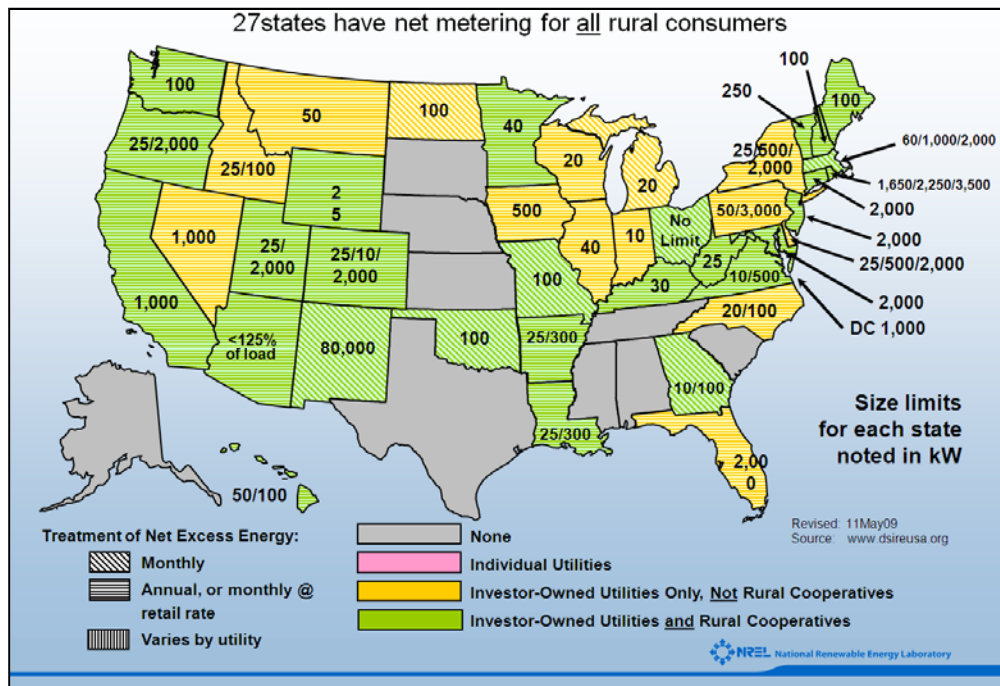

Figure 80. Map of state net metering policies for wind power. Source: NREL (May 2009).

California is currently the largest source of net metering participants, accounting for 72 percent of the national total in 2007. California and New Jersey have seen large increases in net metering participation due to policies that have encouraged the adoption of solar technologies in conjunction with net metering, through incentives such as rebates. In 2007, California saw an increase of 8,779 net metering participants, while New Jersey saw an increase of 1,233.

In designing net metering programs, it is important to set limits on the amount of energy that can be supplied by customers to a level the transmission and distribution infrastructure can support. In addition, customer generation and supply to the grid has implications for system protection and maintenance procedures. Thus it may require utilities to implement new training programs and procedures for maintenance staff.

#### NC GreenPower

NC GreenPower is a nonprofit organization created by the North Carolina Utilities Commission and administered by Advanced Energy, a nonprofit corporation located in Raleigh, NC. It is the first statewide green power program in the United States. As of 2008, NC GreenPower also offered carbon offsets.

Eighteen North Carolina cooperatives offer their members a green pricing option through NC GreenPower. Members have an option of buying either small or large blocks of renewable power. The small-volume product includes power from solar, wind, and biomass facilities that came online after 2001. The large-volume product features a slightly different mix of resources, and includes power from facilities that came online prior to 2001 to support demand for existing renewable power supplies.

#### *Green Pricing & Green Marketing Programs*

Green pricing programs allow customers to voluntarily pay a premium for electricity generated from renewable resources. This premium is used to defray the extra costs incurred by using a renewable technology that otherwise would not be economically efficient. Such programs can work because some customers are willing to pay a premium for “green” power.

The initial goal of green pricing was to provide a customer-driven means of financing relatively expensive renewable energy projects. Some companies are now using it to differentiate their products in competitive power markets.

#### GreenPower EMC

GreenPower EMC is the first green power program in Georgia. It was conceived in 2001 and has been in operation since 2003. It currently has 38 electric cooperatives as members and provides green power to 1.6 million households across roughly 73 percent of the state’s land area.

Since 2001, GreenPower EMC has brought online two landfill gas facilities and a low-impact hydro plant. It also purchases roughly 20 MW of electricity from Plant Carl, Georgia’s first biomass power plant that uses chicken litter as a feedstock. Plant Carl is owned and operated by Earth Resources, Inc.

### State Green Power Purchasing

More than 20 states have required state government facilities to source a certain percentage of their electricity from renewable sources. New Mexico, for example, has required all state government agencies to purchase 100 percent of their power from renewable sources by 2011. Maine has set a goal that its government agencies should buy at least 50 percent of their power from renewable sources, and plans to offset the cost of achieving this goal through energy conservation improvements in government facilities.

The renewable energy rider programs instituted by some rural electric cooperatives provide an example of green pricing. In these programs, a G&T co-op purchases green energy, and its member distribution co-ops offer it to their customers at a premium. Customers' willingness to pay for renewable power is important when assessing the economic feasibility of such programs.

The number of customers participating in green pricing programs from 2003 to 2007 can be seen in Figure 81.

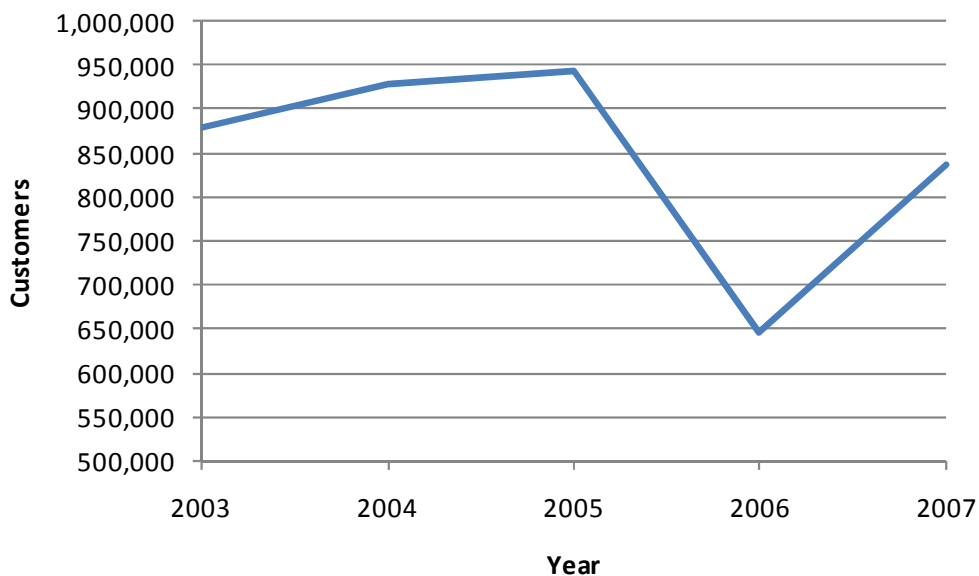

Figure 81. U.S. green pricing customers, 2003-2007. Data: EIA (April 2009).

### Austin Energy

Publicly owned utility Austin Energy implemented a green power program with a unique set of incentives for businesses that opt into the program. Businesses could lock in the rates for their renewable power purchases for several years, hedging against future increases in energy prices. Austin Energy then created a green power purchasing recognition program that regularly advertises businesses' green power purchases in a local newspaper. Because this recognition comes from a third party, customers of local businesses value it more highly than ads placed by those businesses themselves. This public relations advantage is valued highly by participating businesses.

As of 2008, more than 750 utilities offered a green pricing option. This number includes IOUs, rural electric cooperatives, and municipals. A map showing states with green pricing programs can be seen in Figure 82.

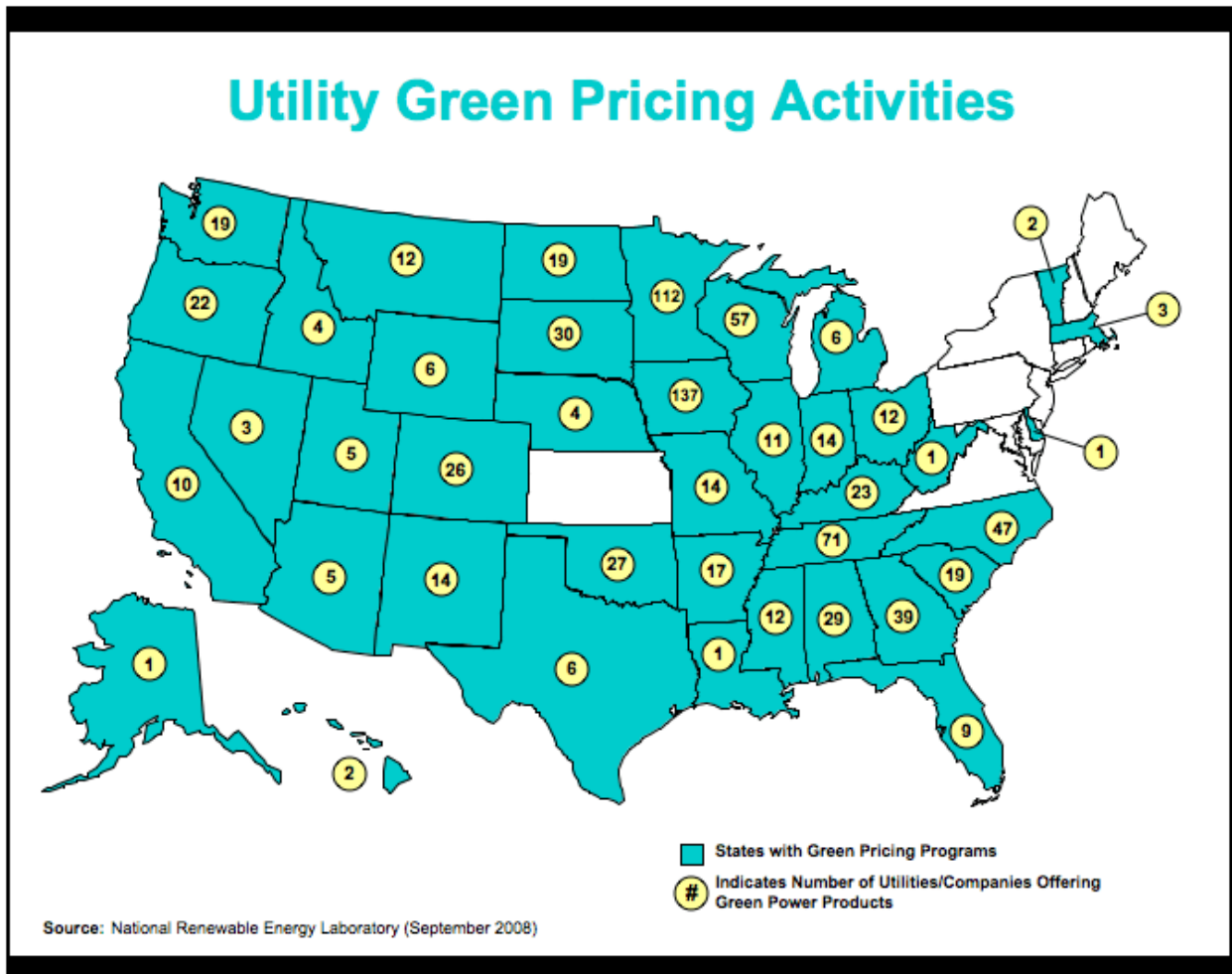

Figure 82. Map of states with green pricing programs. Source: NREL (Sept 2008).

Green marketing is a related, but more general concept. It refers to the sale of “green” power, or power generated specifically from renewable sources, in competitive markets. As of December 2007, competitive marketers offered green power in California, Illinois, Maryland, New Jersey, New York, Pennsylvania, Texas, Virginia, several New England states, and Washington, DC.

A map showing states with green marketing programs can be seen in Figure 83.

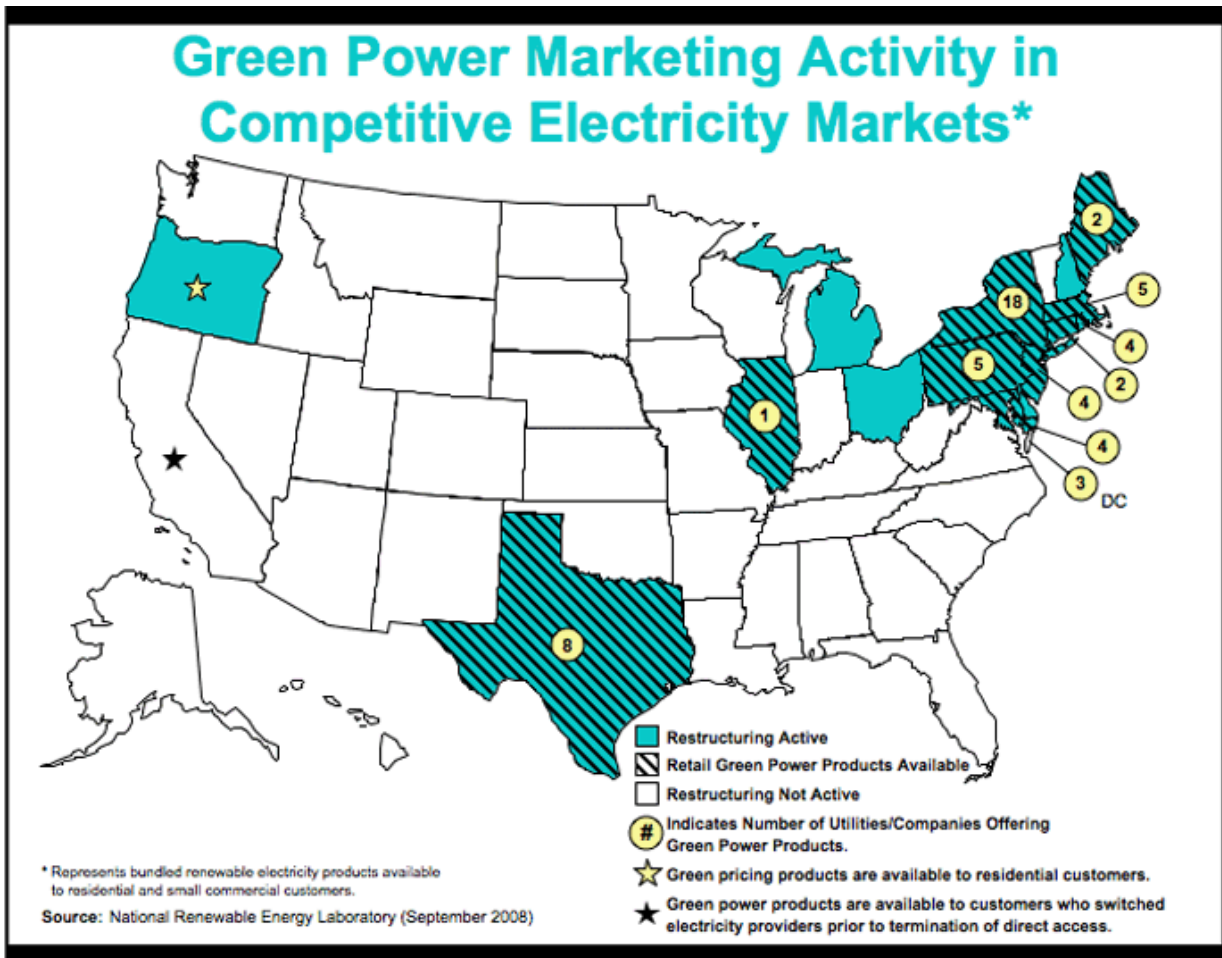

Figure 83. Map of states with green marketing programs. Source: NREL (Sept 2008).

For more information on green pricing and green marketing programs, refer to the NREL Green Power Network (GPN) website: <http://apps3.eere.energy.gov/greenpower/>. The GPN gathers information and links related to green pricing programs, green power marketers and their programs, and policies that impact green power offerings. It also maintains a library of related papers, articles, and reports.

### **Renewable Energy Certificates**

Renewable Energy Certificates (RECs), also known as “green tags” or Tradable Renewable Certificates (TRCs), are a way to separate the renewable energy “attributes” of electricity generation from the physical power itself. A REC represents the attributes, and it can be sold separately from the physical power.

### **Rural Electric Convenience Cooperative**

Rural Electric Convenience Cooperative (RECC) is a distribution cooperative based in Auburn, IL. RECC recently invested in a 0.9 MW wind turbine that provides renewable power exclusively to its members through one of its substations. To finance construction of the wind turbine, RECC used a Clean Renewable Energy Bond (CREB) award of \$1.5 million as well as USDA grants and state grants.

Rural Electric Convenience Cooperative is located in central Illinois, which does not have the rich wind resources available elsewhere in that state. However, it was able to take advantage of its local geography, which features a 60-foot pile of coal tailings that covers roughly 14 acres. This elevated land allows for access to higher wind speeds than the surrounding area.

Each generated kWh of renewable power corresponds to a single REC. Utility customers can purchase RECs whether their utility offers green power products or not. By purchasing RECs on wholesale markets and bundling them with their own physical electricity, utilities can sell green power products even if they do not themselves generate power from renewable resources. Purchasing RECs may also be a convenient way for utilities to comply with Renewable Portfolio Standards (RPSs). A significant portion of total REC purchases comes from business and other nonresidential entities.

A REC is retired once it has been matched with an identical quantity of physical electricity that has been consumed. The “shelf life” of RECs, or the amount of time a REC may be used toward RPS requirements, varies among states, from several months to several years. In general, longer shelf lives are better for renewables, because they help smooth seasonal fluctuations in supply due to changing resource availability. Some states also allow generators to “bank” RECs to use for future RPS compliance.

Whether through limits on shelf life or banking, it may be advantageous to place time limits on the use of RECs. If this is not done, an oversupply of pre-existing RECs may reduce demand for new renewable production.

Renewable Energy Certificates can be verified to prevent fraud and double-counting in one of two ways: through contracts between buyers and sellers, or through an independent REC tracking system. Tracking systems—electronic databases used to track REC ownership—are more transparent when tracking RECs from their source to their final destination. A map of REC tracking systems can be seen in Figure 84.

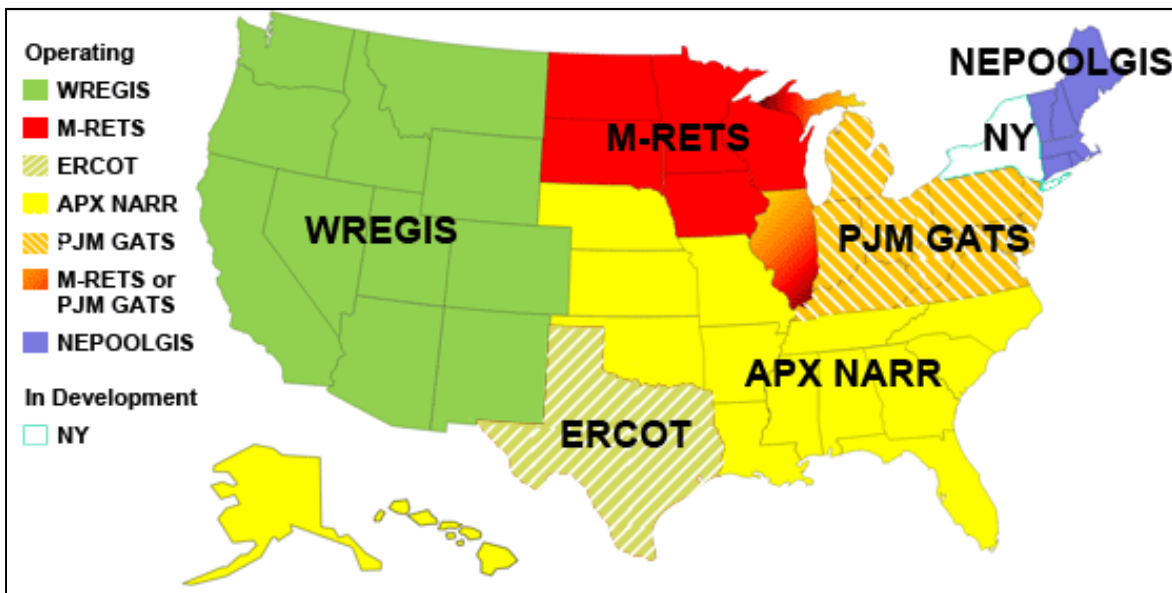

APX NARR – APX Corporation North American Renewables Registry  
 ERCOT - Electric Reliability Council of Texas  
 PJM GATS - PJM Generation Attribute Tracking System

NEPOOLGIS - New England Power Pool Geographical Information System  
 M-RETS - Midwest Renewable Energy Tracking System  
 WREGIS - Western Renewable Energy Generation Information System

Figure 84. Map of Renewable Energy Certificate tracking systems. Source: EPA.

## Illinois Rural Electric Cooperative

Illinois Rural Electric Cooperative (IREC) is a distribution cooperative based in Winchester, IL, which serves more than 10,000 consumers in 10 west-central Illinois counties. IREC has used renewable energy grants and several other types of renewable energy funding from both federal and state sources.

Illinois Rural Electric Cooperative became the first cooperative in Illinois to use wind power when it completed a 1.65 MW wind turbine project in 2005. The total cost of this project was \$1.878 million, plus an additional \$300,000 for upgrades to the co-op's distribution system so it could accommodate the turbine. IREC did not consider this \$300,000 part of the project cost, since it was for a general upgrade to its system. Nevertheless, given the project's overall cost, it would not have been possible to build the turbine without significant external funding.

The first grant that IREC received was a \$438,000 grant from the 2002 Farm Bill's Renewable Energy Systems and Energy Efficiency Improvements Program (Section 9006), administered through the Illinois Department of Agriculture. IREC received a second grant for \$250,000 from the State of Illinois, administered through the Illinois Department of Commerce and Economic Opportunity. The Illinois Clean Energy Community Foundation provided an additional \$250,000 in return for the first 10 years of RECs generated by the turbine.

Additional funding was secured through the USDA Rural Utilities Service, which provided term debt financing at the municipal capital rate in the amount of \$1.3 million. This covered the \$300,000 of distribution system upgrades.

With the two grants, the REC sales, and the RUS loan, the project generates power at a price slightly below the co-op's wholesale power contract rate.

The wind resource in Pike County, where the turbine is located, could support up to 100 turbines of a similar size. Installing them would result in a \$5 million to \$7 million increase in the local tax base. The turbine manufacturer estimates that it would also create \$1.5 million in maintenance work income, which would result in an additional \$5.25 million in economic activity in the county. Benefits to the county would in turn benefit co-op members in other counties, since the co-op shares costs among all members. The IREC wind turbine thus demonstrated the feasibility of wind power installations in an area where further development of wind resources could have significant community development impacts.

For more information on REC tracking systems, refer to the Environmental Tracking Network of North America (ETNNA), a voluntary organization of certificate tracking systems, registries, regulators, and other market participants. Its website is at <http://www.etnna.org/>.

## Renewable Investment Prescreening Questions

The following provides a list of questions to ask when analyzing possible renewable energy investments. They may be helpful at the stage of prescreening investment opportunities. They may also be helpful to policymakers considering the design of programs for influencing the development of renewable power.

### Why invest in renewable power?

Before deciding to invest in renewable power, it is important to consider the motivation behind this decision. What goal is achieved by investing in renewable power? Clearly articulated motivation makes it easier to obtain support from project stakeholders and to define project goals and priorities.

There are different reasons for investing in renewable power, depending on the situation. Here are some possible motivations:

**Reduced cost to customers.** Since many rural communities are located near rich renewable energy resources, developing those resources may be the most cost effective means of adding new generation capacity to these communities' electricity supply.

**Satisfaction of renewable energy mandates.** Many states and municipalities have enacted renewable energy mandates or targets. In some situations, it may be most cost effective for rural utilities to invest in their own renewable generation capacity to satisfy such mandates. In other situations, it may be more cost effective to satisfy mandates or targets through renewable power purchase agreements or purchase of renewable energy certificates.

**Satisfaction of customer demand.** Utility customers may express interest in having a portion of their electricity supply come from renewable sources. In such instances, customers are often willing to pay a premium for renewable power. If their willingness to pay is sufficient, it can entirely offset the cost disadvantage of some types of renewable power.

**Community development.** When assessing the costs and benefits of a potential renewable power project from a policy perspective, it may be important to consider the broad impacts of the project on the local economy; that is, a renewable power project may be a vehicle for community economic development. Renewable power projects may benefit rural communities in ways that extend well beyond supplying low-cost electricity, such as direct and indirect job creation, attracting outside investment to the community, and raising land values and tax revenues. For more information on community development, refer to the section of this document entitled *Rural Development Potentials*.

**Promoting company values.** Investing in renewable energy can be an opportunity to promote company and/or community values, like energy independence or sustainability. As such, it can offer a valuable public relations opportunity.

### Which renewables are the best investment under the circumstances?

Many different factors determine which renewable resource is the most appropriate investment. Depending on the situation, one or more of the following considerations may play an important role in that determination:



**Resource characteristics.** It is important to consider in detail the characteristics of the available renewable resources before selecting an investment. How much of the resource under consideration is available in your local community and the surrounding area? How efficiently can it be converted into electrical power? How expensive is it relative to the other available resources? How tightly coupled is the resource's availability to electricity demand in the target service area? If the resource exhibits variable availability, can it be paired with another resource that exhibits complementary availability? (For example, wind and solar have been found to be somewhat complementary due to negative correlation in their availability in some areas.)

**Infrastructure Support.** It is also important to consider whether your local infrastructure can accommodate the resource under consideration. If the resource is not collocated with the planned generation facility, is the required transportation infrastructure (roads, rail, and so on) in place, and does it have sufficient capacity? Does the local transmission infrastructure have sufficient capacity and adaptability to accommodate electricity generated from the resource? If energy storage capacity is needed, is it in place? If water is needed for the energy conversion technology, is it readily available? If waste disposal is needed, is the required infrastructure in place? If any of the preceding criteria are not met, would construction of the required infrastructure be physically possible and economically feasible?

**Technological Support.** Some renewable energy technologies are more well-established than others. Resources with proven technologies may be more attractive investments than those whose required technologies are still in their early or experimental stages. Technology complexity, reliability, and availability may be important determinants in the cost of operations and maintenance, and by extension, the cost-effectiveness of investing in a given renewable energy resource.

**Policy Support.** Depending on federal, state, and local policies—and how those policies interact with each other—some renewable resources may have greater policy support in your area than others. In other words, the mix of available incentives may shift the advantage from one resource to another. This may end up determining which renewable resource is the most attractive investment.

**Institutional Support.** It is also important to consider which institutions are in place to provide support for the resource under consideration. Are there resource working groups that can provide tools and expertise? Are there other national or state-level organizations that can facilitate knowledge transfers between different entities involved in developing a common renewable resource? Are other institutions in your region engaged in renewable energy activities related to the project(s) you are considering, such as research or planning? Have other firms in your area invested in a particular resource, thereby creating some momentum for its further development? Are there community groups that can aid in disseminating project information and generating interest among community members and local stakeholders?

**Investment risk.** Some renewable energy resources are more risky to develop than others. These risks may be due to uncertainties about the technology, the availability of the renewable resource, prospects for sales, and the continuation of existing policies. The level of risk may have a strong influence on determining which renewable resource is most cost effective to invest in.

For more information on the different types of renewable resources, refer to the section of this document entitled *Renewable Resource Availability*. For more information on issues regarding transmission infrastructure, refer to the section entitled *Transmission Access and Adequacy for Renewables*.

## What are the financing options?

Many different types of financial instruments, both public and private, are available for funding a renewable energy investment. Putting together a portfolio of these instruments is a critical aspect of any project planning process, and care should be taken to ensure that instruments do not offset one another.

Partnerships can also play an important role in funding a renewable energy investment. However, different types of financial instruments are available to different types of firms, and it is important to keep this in mind when deciding how to structure a partnership. The way that equity capital is allocated within a partnership can have a significant impact on the amount and type of external funding that is available. Alternative tax exposures of the members of a partnership also merit special attention.

Financing options can be divided into the following categories:

**Internal funding.** For small renewable energy investments, a firm can simply use its own capital stock to finance a project. This is not feasible for larger investments, however, especially since most renewable energy projects have high up-front capital costs.

**Federal funding.** There are many different federal policy instruments designed to provide financial support for renewable energy investments. These include grants, loans, and production subsidies. Clean Renewable Energy Bonds (CREBs) are a popular instrument for not-for-profit and public utilities' renewable energy investments. On the other hand, the Production Tax Credit (PTC) is a popular instrument for investor-owned utilities' renewable energy investments. The Renewable Energy Production Incentive (REPI) is a similar instrument available to not-for-profit and public utilities, but it is a less reliable source of funding than the PTC. Sometimes it is advantageous to sell production credits in advance to a third party to offset up-front project costs.

**State and local funding.** Many state and local governments also provide financial support for renewable energy investments through grants, loans, and production subsidies. Some states have set up independent renewable energy funds to finance such incentives. It is important to ensure that these incentives do not offset federal incentives.

### Private credit.

Once internal, federal, and state and local funding sources have been exhausted, a firm can meet remaining project costs by accessing private capital markets. Two important sources available for cooperatives to access the private capital markets are the National Rural Utilities Cooperative Finance Corporation (CFC) and CoBank. As explained in the Financing Options section, CFC is an independent,

private cooperative that serves as a private lender to electric cooperatives. CFC raises funds through its members' equity and investments and by selling financial instruments in the markets.

CoBank, on the other hand, is a member of the Farm Credit System (FCS), which is a federal government-sponsored enterprise. The FCS raises funds from capital markets by the sale of Farm Credit System Securities. These securities attract very favorable terms in the markets, thereby enabling CoBank to offer loans at competitive interest rates. One of the reasons for favorable treatment of Farm Credit System Securities in capital markets is the implicit federal government guarantee associated with the System being a government-sponsored enterprise.

**Partnerships.** If funding a proposed renewable energy investment on your own proves unfeasible, entering into a partnership may provide a solution. Partnerships can take on several different forms, including joint ownership of a new generation facility, a Power Purchase Agreement (PPA), or an agreement to purchase the renewable attributes of a project. Firms with access to different types of financial instruments also have the option of structuring their partnership to take advantage of an optimal mix of these instruments. For more information on the different types of firms that generate electricity, refer to the section of this document entitled *Electric Utility Business Models*.

The preceding is not an exhaustive list of funding options. For more information on financing renewable energy investments, including additional funding options, refer to the section of this document entitled *Developing and Financing Renewable Energy*.

### **Is there sufficient demand?**

It is important to consider whether there will be sufficient demand for the new renewable generation capacity. This demand can come from a number of different sources:

**Existing customers.** Demand for new renewable energy can come from existing customers, who may indicate a willingness to pay a premium for electricity generated from renewable sources, as in the case of green pricing programs. Or the cost of new renewable energy can simply be included in customers' rates, and this energy can be used to meet general demand.

**New Customers.** Demand for new renewable energy can also come from an influx of new customers. This can happen as a result of population growth, a new large commercial or industrial customer in the service area, or through a third party's agreement to purchase the output of a new renewable generation facility. Insofar as renewable energy investments contribute to community development, these investments can also contribute to the demand they end up fulfilling.

**Renewable energy mandates.** Renewable energy mandates are the surest way of securing demand, since they create a guaranteed market for new renewable energy. The most common form of renewable energy mandate is a state Renewable Portfolio Standard (RPS). Governments also create demand by requiring their own facilities to use a certain amount of renewable power.

For more information on sources of electricity demand, refer to the section of this document entitled *Future Electricity Demand*.

## Are there unique features of the project that provide a competitive advantage?

The background work for this document included a survey of rural electric utilities that have invested in renewable electricity generation. The survey was designed to identify factors that influenced the rural utilities' successful investment in a renewable electricity generation project. At the time of writing, 15 utilities, covering the spectrum from distribution cooperatives to generation and transmission (G&T) cooperatives to public power districts, responded to the survey.

A major underlying issue brought up in almost all the responses was the sensitivity of these utilities to their rates; that is, the cost of electricity delivered to their member-customers. This makes the cost of a renewable electricity generation project absorbed by the utilities one of the main considerations in the decision to invest. To the degree that factors such as abundance of resource, financial incentives, existing infrastructure, etc. affect the cost of energy delivered, those factors will influence to the same degree the decision to invest in the project.

There were also non-financial factors encountered. Rural utilities in some states are subject to renewable electricity portfolio standards and net metering rules. In these cases, the utilities would look for the least-cost renewable resource to meet the mandate. Even in states where utilities were not subject to renewable portfolio standards, the need to hedge against the possibility of a renewable mandate in the future was cited as part of the motivation to invest in renewable electricity generation. In regions of the country having limited access to renewable resources, the desire to lock in the supply of this scarce resource in preparation for such a future was given as motivation for investment in renewable generation projects that were not yet financially attractive. There were also instances where the absence of other energy resources combined with inadequate transmission infrastructure made a renewable resource the least-cost alternative.

Listed below are the project characteristics that combined to make the various renewable electricity generation projects successful for the utilities that responded to the survey.

**Projects able to compete on economic terms without a renewable mandate and without financial incentives beyond the federal production tax credit.** For some of the larger cooperatives and public power districts in the Great Plains states, the abundance of the wind resource, size of the utility, and production tax credit combine to make wind competitive with other traditional generation resources. The size of the utility is a factor in two ways—demand and financing. On the demand side, the utility may be large enough to absorb the output of a wind project of the size necessary to take full advantage of the economies of scale associated with erecting and maintaining wind farms. On the financing side, the utility may be large enough to have a tax liability sufficient to fully take advantage of the production tax credit. The utilities in these cases access the production tax credit by establishing fully owned, for-profit corporations to operate these wind farms.

Included in this category of economically competitive projects were several landfill-gas generation projects. Unlike wind farms, landfill-based generators tend to be on a much smaller scale, typically with a nameplate capacity of less than 10 MW.

**Power purchase agreements as a proxy to equity ownership.** Several rural utilities opted to invest in renewable projects (mostly wind farms) by guaranteeing a market for the output through long-term power purchase agreements. In these instances, the wind farms were developed by private developers, and most of the output was contracted to the utility. The utilities viewed this as a proxy to actual equity ownership. It provided a way to access the federal production tax credit and exploit the economies of scale in project development without having to set up a for-profit corporation. In some cases, the utility built and owned wind generating capacity up to its maximum production tax-absorbing ability and then switched to power purchase agreements for any further development. Participation in wind farm development through long-term power purchase agreements appears to provide an attractive arrangement for both the rural utility and the private wind farm developer. The electric utility gets the renewable electricity it desires without having to develop in-house expertise in wind farm development and management, while the private developer gets the benefit of a guaranteed long-term market for a portion of the wind farm's output and the freedom to trade the balance in the wholesale spot market.

**Projects established through state grants to attract investments to rural communities.** A couple of distribution cooperatives responding to the survey have wind projects supported heavily by state, federal, and private foundation grants. As a one of their objectives, these projects showcase the abundance of a renewable resource with the hope of attracting private developers to a resource-rich area of the state. With as much as half the cost of the project funded by grants, the cost to the cooperatives is well within their acceptable cost of electricity delivered to their members. Such projects may be beneficial in that the increased economic activity in such an area can more than compensate for the tax dollars invested in the long term. Examples of the sources of such grants include the U.S. Department of Energy (DOE), the USDA Rural Development Program, the home-state's economic development office, or a community energy foundation.

**Projects supported by several federal agencies to meet the need for an experimentation station for renewable generation technology.** A distribution cooperative in Alaska has substantial funding from several federal and state agencies because the cooperative's wind installations serve as a test station for wind technology suited for the harsh arctic weather. Diesel-fired generation is the predominant technology for these stand-alone Alaskan cooperatives. Reduction of diesel use and its associated costs are a major benefit for the cooperative. Diesel-related costs include transportation and storage; therefore wind energy adds to the co-op's system reliability by having a locally available resource that is not subject to transportation, storage, or other such availability constraints. Other areas that have unique climate or physical attributes may qualify the project for this type of funding. Sponsoring federal agencies included the U.S. DOE, the National Renewable Energy Laboratory, and the U.S. Environmental Protection Agency.

**Projects supported by voluntary green pricing programs.** Several renewable generation projects were encountered in which a generation and transmission cooperative was aggregating the demand from voluntary green pricing programs from their member cooperatives to support the extra cost associated with the project. These projects tended to be small in scale.

**Projects established to lock in access to a scarce renewable resource.** Several biomass projects (woody biomass and landfill gas) were undertaken due to concern that an outside entity would lock in the limited biomass supply available. This was biomass occurring in areas of the country that are not endowed with wind and other readily accessible renewable resources. The utilities were concerned that if a renewable portfolio standard were to be enacted in the future, they would be hard-pressed to find access to this renewable resource. So the utilities opted to invest in the projects, even though they were not yet economically competitive.

**Projects undertaken to meet a state renewable mandate.** A number of the distribution cooperatives responding to the survey had customer-side distributed renewable resource generation under a net metering arrangement. In most cases, this was a result of a state mandate, and in one case, it was a voluntary program by the cooperative and by extension the member-owners.

**Projects made feasible by severe transmission constraint.** In one case, the renewable resource (wind) was the only feasible generating resource available because of the combination of a lack of other energy resources and community opposition to fossil fuel-based generation. The location of this utility is such that it is connected by single transmission line to its main supplying utility, and its choices for improving reliability in the system were extremely limited.

**Projects made attractive by collocation of abundant resource and a large load.** A case was encountered in which the collocation of large industrial loads and an abundant wind resource in the distribution cooperative's territory combined to greatly enhance the economic attractiveness for wind farms located next to the industrial loads. The industrial loads were beneficial in two ways: providing the high load-factor demand to absorb the output from the wind farms, and having the transmission infrastructure in place. The wind farms were laid out to connect directly to the sub-stations built to provide electricity to the industrial customers, greatly reducing the transmission-related cost. This was combined with 100 percent CREBS financing to make the projects by this distribution cooperative produce a favorable revenue stream. Another important ingredient was the favorable terms the distribution cooperative was able establish with its supplier G&T cooperative. This contract includes agreement by the G&T cooperative to absorb the electricity from the wind farms if demand from the industrial load disappeared in the future.

**Project's compatibility with contractual agreements.** The unique circumstances of a situation may also weigh against a project's success. In particular, the economic viability of an investment in generation by a distribution cooperative is greatly affected by the contractual arrangement between that distribution cooperative and its supplier G&T cooperative. In several cases, distribution cooperatives indicated that their contract with their supplier did not allow for them to own any generation. In one case, the installation of wind project by a distribution cooperative had greatly strained their contractual relationship with their host G&T.

## Information Resources

### General

1. National Renewables Cooperative Organization (NRCO)  
<http://www.renewable.coop/>
2. U.S. Department of Energy (DOE)  
<http://www.energy.gov/>
3. U.S. Energy Information Administration (EIA)  
<http://www.eia.doe.gov/>
4. U.S. DOE National Energy Technology Laboratory  
[www.netl.doe.gov/](http://www.netl.doe.gov/)
5. National Renewable Energy Laboratory (NREL)  
<http://www.nrel.gov/>
6. Lawrence Berkeley National Laboratory  
<http://www.lbl.gov/>
7. Lawrence Berkeley National Laboratory Environmental Energy Technologies Division (EETD)  
<http://www.eetd.lbl.gov/>
8. Oak Ridge National Laboratory  
<http://www.ornl.gov/>
9. Idaho National Laboratory  
<http://www.inl.gov/>
10. Pacific Northwest National Laboratory (PNNL)  
<http://www.sandia.gov/>
11. Sandia National Laboratories (SNL)  
<http://www.sandia.gov/>
12. The Electric Power Research Institute (EPRI)  
<http://www.epri.com/>
13. United States Department of Agriculture (USDA)  
<http://www.usda.gov/>
14. USDA Rural Utilities Service (RUS)  
<http://www.usda.gov/rus/>
15. USDA Economic Research Service (ERS)  
<http://www.ers.usda.gov/>
16. National Rural Electric Cooperative Association (NRECA) White Paper on Renewable Energy  
<http://www.scribd.com/doc/27088301/NRECA-White-Paper-on-Renewable-Energy>
17. Information Bridge: DOE Scientific and Technical Information  
<http://www.osti.gov/bridge/>
18. NREL Power Technologies Energy Data Book  
[http://www.nrel.gov/analysis/power\\_databook/](http://www.nrel.gov/analysis/power_databook/)
19. NREL Geographic Information System (GIS)  
<http://www.nrel.gov/gis/>
20. NREL Renewable Resource Data Center

- <http://www.nrel.gov/rredc/>
21. NREL United States Atlas of Renewable Resources  
[http://mapserve2.nrel.gov/website/Resource\\_Atlas/viewer.htm](http://mapserve2.nrel.gov/website/Resource_Atlas/viewer.htm)
  22. U.S. DOE Office of Energy Efficiency and Renewable Energy (EERE)  
<http://www.eere.energy.gov/>
  23. U.S. DOE EERE State Energy Alternatives Website  
<http://apps1.eere.energy.gov/states/alternatives/>
  24. U.S. Environmental Protection Agency (EPA)  
<http://www.epa.gov/>
  25. U.S. EPA NEEDS 2006 Database  
<http://www.epa.gov/airmarkt/progsregs/epa-ipm/index.html#needs>
  26. U.S. DOE Power Marketing Administrations  
<http://www.energy.gov/organization/powermarketingadmin.htm>
  27. Co-ops 101- An Introduction to Cooperatives  
[www.rurdev.usda.gov/rbs/pub/cir55/cir55rpt.htm](http://www.rurdev.usda.gov/rbs/pub/cir55/cir55rpt.htm)
  28. Cooperative Research Network (CRN)  
<http://www.cooperative.com/>
  29. American Public Power Association (APPA)  
<http://www.appanet.org/>
  30. Environmental Law and Policy Center (ELPC)  
<http://www.elpc.org/>
  31. Climate VISION — Voluntary Innovative Sector Initiatives: Opportunities Now  
<http://www.climatevision.gov/>
  32. The Center for Resource Solutions (CRS)  
<http://www.resource-solutions.org>
  33. State Energy Office Contacts, U.S. DOE EERE State Energy Program Information Resources  
[http://apps1.eere.energy.gov/state\\_energy\\_program/seo\\_contacts.cfm](http://apps1.eere.energy.gov/state_energy_program/seo_contacts.cfm)
  34. National Governors Association  
<http://www.nga.org/>

## **Wind**

1. NREL Wind Research Laboratory  
<http://www.nrel.gov/wind/>
2. U.S. DOE EERE Wind and Hydro Program  
<http://www1.eere.energy.gov/windandhydro/>
3. Wind Powering America  
<http://www.windpoweringamerica.gov/>
4. State Wind Working Group Resource Handbook  
[http://www.windpoweringamerica.gov/filter\\_detail.asp?itemid=655](http://www.windpoweringamerica.gov/filter_detail.asp?itemid=655)
5. American Wind Energy Association (AWEA)  
<http://www.awea.org/>
6. The National Wind Coordinating Collaborative (NWCC)



<http://www.nationalwind.org/>

7. Wind on the Wires  
<http://www.windonthewires.org/>
8. Windustry  
<http://www.windustry.org/>

### **Biomass**

1. NREL Biomass Research Laboratory  
<http://www.nrel.gov/biomass/>
2. U.S. DOE EERE Biomass Program  
<http://www.eere.energy.gov/biomass/>
3. U.S. DOE EERE Biomass Energy Data Book  
<https://cta.ornl.gov/bedb/index.shtml>
4. *Geographic Perspective on the Current Biomass Resource Availability in the United States*  
<http://www.nrel.gov/docs/fy06osti/39181.pdf>
5. U.S. DOE/USDA Joint Feedstock Portfolio Review  
<http://feedstockreview.ornl.gov/>
6. U.S. EPA Landfill Methane Outreach Program (LMOP)  
<http://www.epa.gov/lmop/>
7. U.S. EPA AgSTAR Program  
<http://www.epa.gov/agstar/>
8. Biomass Contacts, U.S. DOE EERE Biomass Program Information Resources  
[http://www1.eere.energy.gov/biomass/state\\_contacts.html](http://www1.eere.energy.gov/biomass/state_contacts.html)

### **Solar**

1. Sandia National Laboratories Solar Power Program  
<http://www.sandia.gov/solar/>
2. NREL Solar Research Laboratory  
<http://www.nrel.gov/solar/>
3. U.S. DOE EERE Solar Program  
<http://www1.eere.energy.gov/solar/>
4. Solar Electric Power Association  
<http://www.solarelectricpower.org/>

### **Geothermal**

1. Idaho National Laboratory (INL) Geothermal Program  
<http://geothermal.inel.gov/>
2. Geo-Heat Center  
<http://geoheat.oit.edu/index.htm>
3. NREL Geothermal Technologies Program  
<http://www.nrel.gov/geothermal/>
4. U.S. DOE EERE Geothermal Program  
<http://www1.eere.energy.gov/geothermal/>

5. Southern Methodist University (SMU) Geothermal Laboratory  
<http://smu.edu/geothermal/>

## **Hydro**

1. Feasibility Assessment of the Water Energy Resources of the United States for New Low Power and Small Hydro Classes of Hydroelectric Plants  
<http://hydropower.id.doe.gov/resourceassessment/>
2. U.S. DOE EERE Wind and Hydro Program  
<http://www1.eere.energy.gov/windandhydro/>

## **Electricity Demand**

1. U.S. EIA Renewable Energy Consumption and Electricity Preliminary Statistics  
[http://www.eia.doe.gov/cneaf/alternate/page/renew\\_energy\\_consump/rea\\_prereport.html](http://www.eia.doe.gov/cneaf/alternate/page/renew_energy_consump/rea_prereport.html)
2. U.S. EIA Annual Energy Review  
<http://www.eia.doe.gov/aer/>
3. U.S. EIA Annual Energy Outlook  
<http://www.eia.doe.gov/oiaf/aeo/>
4. U.S. EIA Renewable Energy Annual  
[http://www.eia.doe.gov/cneaf/solar.renewables/page/rea\\_data/rea\\_sum.html](http://www.eia.doe.gov/cneaf/solar.renewables/page/rea_data/rea_sum.html)
5. U.S. EIA Renewable & Alternative Fuels  
<http://www.eia.doe.gov/fuelrenewable.html>
6. U.S. Bureau of Labor Statistics  
<http://www.bls.gov/>
7. USDA Rural Electric Power Generation and Capacity Expansion Report  
<http://www.rurdev.usda.gov/rd/farbill/08/GenInfo/ElectricPowerGenerationReport.pdf>
8. Renewable Portfolio Standards in the States: Balancing Goals and Implementation Strategies  
<http://www.nrel.gov/docs/fy08osti/41409.pdf>
9. State Clean Energy Practices: Renewable Portfolio Standards  
<http://www.nrel.gov/docs/fy08osti/43512.pdf>
10. USDA ERS Rural Development  
<http://www.ers.usda.gov/Briefing/RuralDevelopment/>
11. UDSA ERS County-Level Population Data  
<http://www.ers.usda.gov/Data/Population/>
12. Baby Boom Migration and Its Impact on Rural America  
[http://www.ers.usda.gov/Publications/ERR79/ERR79\\_ReportSummary.pdf](http://www.ers.usda.gov/Publications/ERR79/ERR79_ReportSummary.pdf)
13. Rural America: Opportunities and Challenges  
<http://www.ers.usda.gov/Amberwaves/Feb03/features/ruralamerica.htm>
14. Wind Powering America (WPA) Wind Economic Development  
<http://www.windpoweringamerica.gov/economics.asp>

## **Transmission**

1. U.S. DOE Office of Electricity Delivery and Energy Reliability  
<http://www.oe.energy.gov/>

2. U.S. EIA Electricity Transmission Fact Sheet  
[http://www.eia.doe.gov/cneaf/electricity/page/fact\\_sheets/transmission.html](http://www.eia.doe.gov/cneaf/electricity/page/fact_sheets/transmission.html)
3. Working Group for Investment in Reliable and Economic Electric Systems  
<http://www.wiresgroup.com/>
4. The Cost of Transmission for Wind Energy: A Review of Transmission Planning Studies  
<http://eetd.lbl.gov/EA/EMP>
5. Challenges of Electric Power Industry Restructuring for Fuel Suppliers  
[http://www.eia.doe.gov/cneaf/electricity/chg\\_str\\_fuel/execsumm.html](http://www.eia.doe.gov/cneaf/electricity/chg_str_fuel/execsumm.html)
6. Electric Power Transmission: Background and Policy Issues  
<http://opencrs.com/document/R40511/>
7. National Interest Electric Transmission Corridors and Congestion Study  
<http://nietc.anl.gov/>
8. North American Electric Reliability Corporation (NERC)  
<http://www.nerc.com/>
9. NERC Reliability Assessments  
<http://www.nerc.com/page.php?cid=4|61>
10. NERC Integration of Variable Generation Task Force (IVGTF)  
<http://www.nerc.com/filez/ivgtf.html>
11. Federal Energy Regulatory Commission (FERC)  
<http://www.ferc.gov/>
12. Florida Reliability Coordinating Council (FRCC)  
<http://www.frcc.com/>
13. Midwest Reliability Organization (MRO)  
<http://www.midwestreliability.org/>
14. Northeast Power Coordinating Council (NPCC)  
<http://www.npcc.org/>
15. ReliabilityFirst Corporation (RFC)  
<http://www.rfirst.org/>
16. SERC Reliability Corporation (SERC)  
<http://www.serc1.org/>
17. Southwest Power Pool (SPP)  
<http://www.spp.org/>
18. Texas Regional Entity (TRE)  
<http://www.texasre.org/>
19. Western Electricity Coordinating Council (WECC)  
<http://www.wecc.biz/>
20. Alaska Systems Coordinating Council (ASCC)  
<http://www.alaskapower.org/>
21. National Transmission Grid Study  
<http://www.ferc.gov/industries/electric/gen-info/transmission-grid.pdf>
22. U.S. DOE EERE 20% Wind Energy by 2030 Report  
<http://www.20percentwind.org/>

23. Joint Coordinated System Planning (JCSP)  
[www.jcspstudy.org/](http://www.jcspstudy.org/)
24. Keeping the Lights On in a New World  
[http://www.oe.energy.gov/adequacy\\_report\\_01-09-09.pdf](http://www.oe.energy.gov/adequacy_report_01-09-09.pdf)
25. A National Perspective On Allocating the Costs of New Transmission Investment: Practice and Principles  
[http://www.wiresgroup.com/images/Blue\\_Ribbon\\_Panel\\_-\\_Final\\_Report.pdf](http://www.wiresgroup.com/images/Blue_Ribbon_Panel_-_Final_Report.pdf)
26. U.S. DOE Office of Electricity Delivery and Energy Reliability, Smart Grid  
<http://www.oe.energy.gov/smartgrid.htm>
27. The Smart Grid: An Introduction  
[http://www.oe.energy.gov/DOE\\_SG\\_Book\\_Single\\_Pages.pdf](http://www.oe.energy.gov/DOE_SG_Book_Single_Pages.pdf)
28. "Grid 2030" — A National Vision for Electricity's Second 100 Years  
[http://www.climatevision.gov/sectors/electricpower/pdfs/electric\\_vision.pdf](http://www.climatevision.gov/sectors/electricpower/pdfs/electric_vision.pdf)
29. Wind Power and Grid Reliability  
[http://uaelp.pennnet.com/display\\_article/321231/34/ARTCL/none/none/1/Wind-Power-and-Grid-Reliability/](http://uaelp.pennnet.com/display_article/321231/34/ARTCL/none/none/1/Wind-Power-and-Grid-Reliability/)
30. U.S. Transmission Capacity: A Review of Transmission Plans  
The Electricity Journal, Volume 17, Issue 7, August-September 2004, Pages 65-79  
Eric Hirst
31. Transforming America's Power Industry: The Investment Challenge 2010–2030  
[http://www.eei.org/ourissues/finance/Documents/Transforming\\_Americas\\_Power\\_Industry.pdf](http://www.eei.org/ourissues/finance/Documents/Transforming_Americas_Power_Industry.pdf)
32. Transmission Super Highways: Assessing the Potential Benefits of Extra-High-Voltage Transmission Overlays in the Midwest  
[http://www.brattle.com/\\_documents/UploadLibrary/Upload746.pdf](http://www.brattle.com/_documents/UploadLibrary/Upload746.pdf)
33. Final Report on the August 14, 2003, Blackout in the United States and Canada: Causes and Recommendations  
<https://reports.energy.gov/B-F-Web-Part1.pdf>
34. Electricity Storage Association (ESA)  
<http://www.electricitystorage.org/>
35. Handbook of Energy Storage for Transmission or Distribution Applications  
[http://my.epri.com/portal/server.pt?Abstract\\_id=00000000001007189](http://my.epri.com/portal/server.pt?Abstract_id=00000000001007189)

### **Renewable Energy Financing**

1. The Database of State Incentives for Renewable Energy (DSIRE)  
<http://www.dsireusa.org/>
2. U.S. Department of the Treasury (DOT)  
<http://www.treasury.gov>
3. National Rural Utilities Cooperative Finance Corporation (CFC)  
<http://www.nrucfc.org/>
4. CoBank  
<http://www.cobank.com/>
5. Clean and Secure State Energy Actions – 2008

[www.nga.org/Files/pdf/0807ENERGYACTIONS.PDF](http://www.nga.org/Files/pdf/0807ENERGYACTIONS.PDF)

6. Models for Funneling Local Investment Capital into Biofuel Production  
[http://www.rurdev.usda.gov/rbs/coops/Special%20Studies%20Investment%20Models\\_Informa.pdf](http://www.rurdev.usda.gov/rbs/coops/Special%20Studies%20Investment%20Models_Informa.pdf)
7. USDA Farm Bill Electric Programs  
[http://www.usda.gov/rus/electric/fs/UEP-2008\\_Farm\\_Bill\\_Electric\\_Programs.pdf](http://www.usda.gov/rus/electric/fs/UEP-2008_Farm_Bill_Electric_Programs.pdf)
8. U.S. DOE EERE Geothermal Risk Mitigation Strategies Report  
[http://www1.eere.energy.gov/geothermal/pdfs/geothermal\\_risk\\_mitigation.pdf](http://www1.eere.energy.gov/geothermal/pdfs/geothermal_risk_mitigation.pdf)
9. Global Trends in Sustainable Energy Investment 2007: Analysis of Trends and Issues in the Financing of Renewable Energy and Energy Efficiency in OECD and Developing Countries  
[http://www.unep.org/civil\\_society/GCSF/3\\_SEFI\\_Investment\\_Report\\_2007.pdf](http://www.unep.org/civil_society/GCSF/3_SEFI_Investment_Report_2007.pdf)
10. Renewable Energy Financing: The Role of Policy and Economics  
<http://www.nrel.gov/docs/fy08osti/42918.pdf>
11. Bloomberg New Energy Finance  
<http://www.bnef.com/>
12. U.S. EIA Green Pricing and Net Metering Programs  
[http://www.eia.doe.gov/cneaf/solar.renewables/page/greenprice/green\\_pricing.html](http://www.eia.doe.gov/cneaf/solar.renewables/page/greenprice/green_pricing.html)
13. U.S. DOE EERE Green Power Network  
<http://apps3.eere.energy.gov/greenpower/>
14. U.S. EPA Green Power Partnership  
<http://www.epa.gov/grnpower/>
15. Green Power Marketing in the United States: A Status Report  
[www.nrel.gov/docs/fy09osti/44094.pdf](http://www.nrel.gov/docs/fy09osti/44094.pdf)
16. Environmental Tracking Network of North America (ETNNA)  
<http://www.etnna.org/>
17. Green-e  
<http://www.green-e.org/>
18. Clean Energy States Alliance  
<http://www.cleanenergystates.org/>
19. Public Renewables Partnership  
<http://www.repartners.org/>

The U.S. Department of Agriculture (USDA) prohibits discrimination in all of its programs and activities on the basis of race, color, national origin, age, disability, and where applicable, sex, marital status, familial status, parental status, religion, sexual orientation, political beliefs, genetic information, reprisal, or because all or part of an individual's income is derived from any public assistance program. (Not all prohibited bases apply to all programs.) Persons with disabilities who require alternative means for communication of program information (Braille, large print, audiotape, etc.) should contact USDA's TARGET Center at (202) 720-2600 (voice and TDD). To file a complaint of discrimination, write to USDA, Assistant Secretary for Civil Rights, Office of the Assistant Secretary for Civil Rights, 1400 Independence Avenue, S.W., Stop 9410, Washington, DC 20250-9410, or call toll-free at (866) 632-9992 (English) or (800) 877-8339 (TDD) or (866) 377-8642 (English Federal-relay) or (800) 845-6136 (Spanish Federal-relay). USDA is an equal opportunity provider and employer.