

# United States of America

United States Patent and Trademark Office

## LE MORE

**Reg. No. 4,123,333**

PURE DESIGN, INC. (CALIFORNIA CORPORATION)

**Registered Apr. 10, 2012**

400 W. 30TH ST.  
LOS ANGELES, CA 90007

**Int. Cl.: 25**

FOR: CLOTHING, NAMELY, SHIRTS, PANTS, SKIRTS AND JACKETS, IN CLASS 25 (U.S. CLS. 22 AND 39).

**TRADEMARK**

FIRST USE 3-13-2003; IN COMMERCE 3-13-2003.

**PRINCIPAL REGISTER**

SER. NO. 76-499,919, FILED 3-21-2003.

BARBARA GAYNOR, EXAMINING ATTORNEY



*David J. Kybas*

Director of the United States Patent and Trademark Office

# United States of America

United States Patent and Trademark Office

## PERFECT WHITE DRESS

**Reg. No. 4,123,334**

**Registered Apr. 10, 2012**

**Int. Cl.: 3**

**TRADEMARK**

**PRINCIPAL REGISTER**

BARE ESSENTUALS BEAUTY, INC. (DELAWARE CORPORATION)  
71 STEVENSON STREET  
22ND FLOOR  
SAN FRANCISCO, CA 94105

FOR: LOTIONS FOR THE SKIN, BODY LOTIONS, CREAMS AND GELS FOR THE BODY,  
BATH LOTIONS; COLOGNES AND TOILET WATERS, IN CLASS 3 (U.S. CLS. 1, 4, 6, 50, 51  
AND 52).

FIRST USE 11-0-2004; IN COMMERCE 12-0-2004.

THE MARK CONSISTS OF STANDARD CHARACTERS WITHOUT CLAIM TO ANY PAR-  
TICULAR FONT, STYLE, SIZE, OR COLOR.

SER. NO. 76-646,564, FILED 9-12-2005.

DANNEAN HETZEL, EXAMINING ATTORNEY



*David J. Kybas*

Director of the United States Patent and Trademark Office

# United States of America

United States Patent and Trademark Office

## THE CITY BEAUTIFUL

**Reg. No. 4,123,335**

**Registered Apr. 10, 2012**

**Int. Cl.: 35**

**SERVICE MARK**

**PRINCIPAL REGISTER**

CITY OF CORAL GABLES (FLORIDA MUNICIPAL CORPORATION)  
405 BILTMORE WAY  
CORAL GABLES, FL 33134

FOR: PROMOTING THE BUSINESS, COMMUNITY, CULTURAL AND HISTORICAL ATTRACTIONS, ECONOMIC DEVELOPMENT, RESIDENTIAL AND COMMERCIAL GROWTH, TOURISM, AND THE CIVIC INTERESTS, AND MUNICIPAL AND GOVERNMENT SERVICES OF THE CITY OF CORAL GABLES, FLORIDA; PROVIDING INFORMATION ON ECONOMIC DEVELOPMENT, BUSINESS SERVICES, AND EMPLOYMENT OPPORTUNITIES IN THE CITY OF CORAL GABLES, FLORIDA, IN CLASS 35 (U.S. CLS. 100, 101 AND 102).

FIRST USE 0-0-1933; IN COMMERCE 0-0-1933.

THE MARK CONSISTS OF STANDARD CHARACTERS WITHOUT CLAIM TO ANY PARTICULAR FONT, STYLE, SIZE, OR COLOR.

SER. NO. 76-664,598, FILED 8-14-2006.

KAREN SEVERSON, EXAMINING ATTORNEY



*David J. Kyros*

Director of the United States Patent and Trademark Office

# United States of America

United States Patent and Trademark Office



**Reg. No. 4,123,336**

**Registered Apr. 10, 2012**

**Int. Cls.: 35 and 42**

**SERVICE MARK**

**PRINCIPAL REGISTER**

GMMB, INC. (D.C. CORPORATION)  
1010 WISCONSIN AVENUE, N.W.  
SUITE 800  
WASHINGTON, DC 20007

FOR: CONSULTING SERVICES IN THE FIELDS OF ADVERTISING, PUBLIC RELATIONS, AND POLITICS AND CONSULTATION SERVICES REGARDING DEVELOPMENT OF MARKETING CAMPAIGNS, POLITICAL CAMPAIGN AND PUBLIC AWARENESS CAMPAIGNS THROUGH PUBLIC COMMUNICATION MEANS, IN CLASS 35 (U.S. CLS. 100, 101 AND 102).

FIRST USE 10-19-2009; IN COMMERCE 10-19-2009.

FOR: CONSULTING SERVICES IN THE FIELD OF WEB SITE DESIGN AND DEVELOPMENT OF WEBSITES, IN CLASS 42 (U.S. CLS. 100 AND 101).

FIRST USE 10-19-2009; IN COMMERCE 10-19-2009.

OWNER OF U.S. REG. NO. 2,808,589.

THE COLOR(S) GREY, AND ORANGE IS/ARE CLAIMED AS A FEATURE OF THE MARK.

THE MARK CONSISTS OF A PLUS SIGN IN GREY, FOLLOWED BY THE LETTERS "GMMB" IN ORANGE, WITH THE WORDS "CAUSE THE EFFECT" IN GREY UNDERNEATH.

SER. NO. 76-700,551, FILED 11-25-2009.

CARYN GLASSER, EXAMINING ATTORNEY



*David J. Kyjars*

Director of the United States Patent and Trademark Office

# United States of America

United States Patent and Trademark Office

## SECURE SLIDE

**Reg. No. 4,123,337**

FRIEDMAN, HAROLD S. (UNITED STATES INDIVIDUAL)  
53-15 37TH AVENUE  
WOODSIDE, NY 11377

**Registered Apr. 10, 2012**

**Int. Cl.: 7**

FOR: METAL ELEVATOR DOORS AND PARTS THEREOF, IN CLASS 7 (U.S. CLS. 13, 19, 21, 23, 31, 34 AND 35).

**TRADEMARK**

FIRST USE 6-30-1997; IN COMMERCE 6-30-1997.

**PRINCIPAL REGISTER**

THE MARK CONSISTS OF STANDARD CHARACTERS WITHOUT CLAIM TO ANY PARTICULAR FONT, STYLE, SIZE, OR COLOR.

OWNER OF U.S. REG. NOS. 2,392,586 AND 2,772,866.

NO CLAIM IS MADE TO THE EXCLUSIVE RIGHT TO USE "SLIDE", APART FROM THE MARK AS SHOWN.

SER. NO. 76-704,116, FILED 8-16-2010.

ALYSSA STEEL, EXAMINING ATTORNEY



*David J. Kyffers*

Director of the United States Patent and Trademark Office

# United States of America

United States Patent and Trademark Office

统一

**Reg. No. 4,123,338**

**Registered Apr. 10, 2012**

**Int. Cls.: 29, 30, 31 and  
32**

**TRADEMARK**

**PRINCIPAL REGISTER**

UNI-PRESIDENT ENTERPRISES CORP. (TAIWAN CORPORATION)  
301 CHUNG CHENG RD., YAN HAMG  
YEONG KANG SHIH  
TAINAN HSIEN, TAIWAN

FOR: ANIMAL MILK, FLAVORED MILK, LACTIC ACID BACTERIA DRINKS, YOGHURT DRINKS, RICE MILK FOR USE AS A MILK SUBSTITUTE, SOY MILK, SOY MILK WITH HONEY, CREAM, POWDERED MILK, CHEESE, TOFU PUDDINGS, TOFU PUDDING MIXES, GINGER SAUCES NAMELY, GINGER JAM; EDIBLE OILS, EDIBLE FAT, NAMELY, ANIMAL AND VEGETABLE OILS FOR COOKING, SESAME OILS, SALAD OILS, OLIVE OILS, SUNFLOWER OILS, JELLY, TEA JELLY, COFFEE JELLY, AIVU JELLY, MEATS AND THEIR PRODUCTS, NAMELY, MEAT, FRIED SHREDDED MEAT, POULTRY MEAT, FRIED CHICKEN NUGGET, CRAB MEAT, BEEF AND PORK JERKY, DRIED MEAT FLOSS, SAUSAGES, HAMS, HOT DOG MEATS, NON-LIVE AQUATIC PRODUCTS, NAMELY, ABALONE, SCALLOP, FRIED SHRIMP, FISH PASTE PRODUCTS, NAMELY, FISH PASTE, KAMABOKO FISH CAKE; DRIED FISH FLOSS, FISH BALLS, FISH PRODUCTS, NAMELY, FISH FLUFF; INSTANT PREPARED MEAT PACK MEALS, INSTANT FROZEN PREPARED SEAFOOD PACK MEALS, MEAT SOUP, FISH SOUP, DRIED FRUITS AND VEGETABLES, FROZEN FRUITS AND VEGETABLES, DRIED EDIBLE SEAWEED, DEHYDRATED FRUITS AND VEGETABLES, GLAZED FRUITS AND VEGETABLES, PICKLES, INSTANT PREPARED VEGETABLE PACKS FOR USE IN PREPARED MEALS, VEGETABLE SOUPS, RED BEAN SOUPS, GREEN BEAN SOUPS, PEANUT SOUPS, EGGS, MEAT EXTRACTS, CHICKEN EXTRACTS, MARMALADE, TOFU, DRIED BEAN CURD, ARTIFICIAL MEATS, NAMELY, ARTIFICIAL MEATS MADE FROM TOFU, INSTANT PREPARED ARTIFICIAL MEAT PACKS COMPRISING ARTIFICIAL MEATS MADE FROM TOFU; SOUP STOCK FOR VEGETARIANS MADE FROM VEGETABLES; PROTEIN POWDER ADDITIVE TO FOODS, IN CLASS 29 (U.S. CL. 46).

FOR: TEA, TEA POWDER, TEA BAGS; DRINKS MADE OF TEA, COFFEE, COCOA, CHOCOLATE POWDER, NON-DAIRY BASED DRINKS MADE OF COFFEE, COCOA AND CHOCOLATE, COFFEE AND COFFEE-BASED DRINKS, ICE CUBES, ICE CREAM, FROZEN CONFECTIONS, ICE CREAM BARS, SALT, SOY SAUCE, SEASONING SAUCES FOR COOKING, VINEGAR, SEASONINGS, SPICES, SUGAR, PROPOLIS FOR FOOD PURPOSES, CONFECTIONERIES, NAMELY, CANDIES, COOKIES, CEREAL BASED SNACK FOOD CHIPS, TOAST, CAKES, BREAD, HAMBURGER SANDWICHES, SANDWICHES, PUDDINGS, TARTS, STEAMED BUNS, STEAMED STUFFED BUNS, FISH DUMPLINGS, EGG DUMPLINGS, SHRIMP DUMPLINGS, SQUID DUMPLINGS, PORK DUMPLINGS, RICE, PROCESSED



*David J. Kybas*

Director of the United States Patent and Trademark Office

**Reg. No. 4,123,338** WHEAT, FLOUR, GRAIN FLOUR, MIXED CEREALS IN POWDER FORM; GREEN BEAN STARCH PEARLS, NAMELY, BALL MADE OF FOOD STARCH; SAGO, GLUTINOUS POWDER, CONGEE, NAMELY, PORRIDGE, COOKED RICE, INSTANT NOODLES, INSTANT RICE NOODLES, INSTANT BEAN VERMICELLI, NOODLES, DUMPLINGS, WONTONS, DOUGH, YEAST, SWEET FERMENTED GLUTINOUS RICE, MEAT TENDERIZERS FOR HOUSEHOLD PURPOSES, GRAVIES; MILK TEA; MILK TEA MIX; MILK TEA MIX BAGS, HERB TEA, MIXED HERB DRINKS, PLANT FLORAL TEA, HERB TEA BAGS, HEALTH VINEGAR, IN CLASS 30 (U.S. CL. 46).

FOR: FRESH FRUITS AND VEGETABLES, LIVE ANIMALS, LIVE AQUATIC PRODUCTS, NAMELY, LIVE FISH FOR FOOD AND NON-FOOD PURPOSES AND LIVE AQUATIC ANIMALS; EGGS FOR HATCHING, ANIMAL FEEDS, LIVING PLANTS AND FLOWERS; SEEDS IN THE NATURE OF FLOWER SEEDS, GRASS SEEDS, RYE SEEDS, BIRD SEEDS, FRUIT SEEDS, VEGETABLE SEEDS, HERB SEEDS FOR PLANTING, UNPROCESSED EDIBLE SEEDS; SILKWORMS, SILKWORM EGGS, UNPROCESSED TIMBER, ANIMAL LITTER, BETEL NUTS AND BETEL FRUITS FOR CHEWING, RED LIME PASTE FOR USE WITH BETEL NUTS AND BETEL FRUITS FOR CHEWING, UNPROCESSED GRAINS, IN CLASS 31 (U.S. CLS. 1 AND 46).

FOR: BEER, AERATED WATER, FRUIT JUICE, NON-ALCOHOL DRINKS CONTAINING FRUIT JUICE, MIXED FRUIT JUICE, FRUIT JUICE MIX, VEGETABLE JUICE, FRUIT AND VEGETABLE JUICE, COLA, WHITE GOURD SOFT DRINKS, ALMOND SOFT DRINKS, CHRYSANTHEMUM SOFT DRINKS; ASPARAGUS JUICE, SPORTS DRINKS, MINERAL WATER, PACKED DRINKING WATER, DRINKS CONTAINING VINEGAR, NAMELY, SOFT DRINKS CONTAINING VINEGAR; FRUIT-BASED SOFT DRINKS FLAVORED WITH TEA; NON-ALCOHOL DRINKS, NAMELY, CARBONATED AND NON-CARBONATED SOFT DRINKS, SYRUP PREPARATIONS FOR MAKING NON-ALCOHOLIC BEVERAGES, NAMELY, SOFT DRINKS; STEWED BIRD'S NEST WITH ROCK SUGAR, NAMELY, SOFT DRINKS CONTAINING EDIBLE BIRD'S NEST, FIBER DRINKS, NAMELY, FRUIT AND VEGETABLE FIBER SOFT DRINKS; DRINKS RICH IN GRAIN FIBER AND PROTEIN, NAMELY, SOFT DRINKS CONTAINING GRAIN FIBER AND PROTEIN; DRINKS CONTAINING KONJAC AND OTHER SUBSTANCES NAMELY, SOFT DRINKS CONTAINING FRUIT JELLY, KONJAC'S AND DEVIL'S TONGUE, IN CLASS 32 (U.S. CLS. 45, 46 AND 48).

OWNER OF TAIWAN REG. NO. 01198787, DATED 3-1-2006, EXPIRES 2-29-2016.

THE NON-LATIN CHARACTERS IN THE MARK TRANSLITERATE TO "TONG I" WHICH MEANS "UNIFICATION."

OWNER OF TAIWAN REG. NO. 01198767, DATED 3-1-2006, EXPIRES 2-29-2016.

OWNER OF TAIWAN REG. NO. 01198693, DATED 3-1-2006, EXPIRES 2-29-2016.

OWNER OF TAIWAN REG. NO. 01198634, DATED 3-1-2006, EXPIRES 2-29-2016.

OWNER OF U.S. REG. NO. 2,864,032.

THE MARK CONSISTS OF THE DISTINCTIVE DESIGN OF ASIAN CHARACTERS.

SER. NO. 76-704,417, FILED 9-8-2010.

DAVID HOFFMAN, EXAMINING ATTORNEY

# United States of America

United States Patent and Trademark Office

## VERUS INVESTMENT ADVISORY GROUP

**Reg. No. 4,123,339**

**Registered Apr. 10, 2012**

**Int. Cl.: 36**

**SERVICE MARK**

**PRINCIPAL REGISTER**

VERUS INVESTMENT ADVISORY GROUP INC (WISCONSIN CORPORATION)  
5765 WEST GRAND MARKET DRIVE  
APPLETON, WI 54913

FOR: ADVISORY SERVICES RELATING TO INVESTMENTS, NAMELY, INVESTMENT MANAGEMENT AND PERSONAL PLANNING FOR INDIVIDUAL PERSONAL INVESTMENTS AND SMALL BUSINESS QUALIFIED AND NONQUALIFIED INVESTMENTS, THE FOREGOING SERVICES BEING LIMITED TO INDIVIDUAL INVESTORS AND SMALL BUSINESSES AND NOT OFFERED TO GOVERNMENTAL ENTITIES, IN CLASS 36 (U.S. CLS. 100, 101 AND 102).

FIRST USE 4-1-2009; IN COMMERCE 4-1-2009.

THE MARK CONSISTS OF STANDARD CHARACTERS WITHOUT CLAIM TO ANY PARTICULAR FONT, STYLE, SIZE, OR COLOR.

NO CLAIM IS MADE TO THE EXCLUSIVE RIGHT TO USE "INVESTMENT ADVISORY GROU", APART FROM THE MARK AS SHOWN.

SER. NO. 76-705,837, FILED 12-29-2010.

CHARLOTTE CORWIN, EXAMINING ATTORNEY



*David J. Kybas*

Director of the United States Patent and Trademark Office



# United States of America

United States Patent and Trademark Office

## JOINT SERVICE OPEN HOUSE ANDREWS AIR SHOW

**Reg. No. 4,123,340**

**Registered Apr. 10, 2012**

**Int. Cls.: 16 and 41**

**TRADEMARK**

**SERVICE MARK**

**PRINCIPAL REGISTER**

UNITED STATES AIR FORCE (UNITED STATES FEDERAL AGENCY)  
BUILDING 11, ROOM E14  
2240 B STREET  
WRIGHT-PATTERSON AFB, OH 45433

FOR: PRINTED MATTER, NAMELY, EVENT PROGRAMS, MAPS, AND POSTERS, IN CLASS 16 (U.S. CLS. 2, 5, 22, 23, 29, 37, 38 AND 50).

FIRST USE 3-11-2010; IN COMMERCE 3-11-2010.

FOR: EDUCATION AND ENTERTAINMENT SERVICES, NAMELY, PROVIDING SKYDIVING AND AERIAL DEMONSTRATIONS, STATIC DISPLAYS AND EXHIBITS OF MILITARY EQUIPMENT, IN CLASS 41 (U.S. CLS. 100, 101 AND 107).

FIRST USE 3-11-2010; IN COMMERCE 3-11-2010.

THE MARK CONSISTS OF STANDARD CHARACTERS WITHOUT CLAIM TO ANY PARTICULAR FONT, STYLE, SIZE, OR COLOR.

NO CLAIM IS MADE TO THE EXCLUSIVE RIGHT TO USE "JOINT SERVICE OPEN HOUSE" OR "AIR SHOW", APART FROM THE MARK AS SHOWN.

SER. NO. 76-705,963, FILED 1-10-2011.

KRISTIN CARLSON, EXAMINING ATTORNEY



*David J. Kybas*

Director of the United States Patent and Trademark Office

# United States of America

United States Patent and Trademark Office

## WE ARE LIVE

**Reg. No. 4,123,341**

**Registered Apr. 10, 2012**

**Int. Cls.: 35 and 41**

**SERVICE MARK**

**PRINCIPAL REGISTER**

BUFFER ENTERPRISES, INC. (CALIFORNIA CORPORATION)  
C/O MARK E. KALMANSOHN, ESQ.  
KALMANSOHN & ANDERSEN, LLP, 24TH FLOOR,  
LOS ANGELES, CA 90067

FOR: ADVERTISING AND PROMOTING THE GOODS AND PRODUCTS AND SERVICES OF OTHERS AT OR IN CONNECTION WITH SPORTING, ENTERTAINMENT, MEDIA AND CULTURAL EVENTS OR SERVICES RENDERED BY OR IN: POSTERS, PRINTS AND OTHER ARTWORK, SCRIPT AND ON-SCREEN LETTERING, LIVE AND PRE-RECORDED ANNOUNCEMENTS TRANSMITTED VIA RADIO, TELEVISION, MOTION PICTURE FILMS, MOTION PICTURE TRAILERS, THE GLOBAL COMPUTER NETWORK, VIDEOTAPES COMPUTER SOFTWARE AND OTHER ELECTRONIC DISKS, NAMELY, LASER, CD-ROMS AND DVDS, AT OR IN CONNECTION WITH SPORTING, ENTERTAINMENT, MEDIA AND CULTURAL EVENTS OR SERVICES, IN CLASS 35 (U.S. CLS. 100, 101 AND 102).

FIRST USE 1-1-1999; IN COMMERCE 1-1-1999.

FOR: ENTERTAINMENT IN THE NATURE OF A LIVE PERFORMANCES BY AN ANNOUNCER PERFORMED AT SPORTING, ENTERTAINMENT, MEDIA AND CULTURAL EVENTS; AND ENTERTAINMENT IN THE NATURE OF PRE-RECORDED ANNOUNCEMENTS BROADCAST AT SPORTING, ENTERTAINMENT, MEDIA AND CULTURAL EVENTS VIA TELEPHONE, RADIO, AUDIO AND VIDEO MEDIA, THE GLOBAL COMPUTER NETWORK, TELEVISION, MOTION PICTURE TRAILERS, VIDEOTAPES, CD'S, THE GLOBAL COMPUTER NETWORK, VIDEOTAPES COMPUTER SOFTWARE AND OTHER ELECTRONIC DISKS, NAMELY, LASER, CDROMS AND DVDS, IN CLASS 41 (U.S. CLS. 100, 101 AND 107).

FIRST USE 1-1-1999; IN COMMERCE 1-1-1999.

THE MARK CONSISTS OF STANDARD CHARACTERS WITHOUT CLAIM TO ANY PARTICULAR FONT, STYLE, SIZE, OR COLOR.

SER. NO. 76-706,269, FILED 2-4-2011.

RONALD AIKENS, EXAMINING ATTORNEY



*David J. Kyffers*

Director of the United States Patent and Trademark Office

# United States of America

United States Patent and Trademark Office

## ARE YOU READY?

**Reg. No. 4,123,342**

**Registered Apr. 10, 2012**

**Int. Cls.: 35 and 41**

**SERVICE MARK**

**PRINCIPAL REGISTER**

READY TO RUMBLE, LLC (CALIFORNIA CORPORATION)  
C/O MARK E. KALMANSOHN, ESQ.  
KALMANSOHN & ANDERSEN, LLP, 24TH FLOOR,  
LOS ANGELES, CA 90067

FOR: ADVERTISING AND PROMOTING THE GOODS AND PRODUCTS AND SERVICES OF OTHERS AT OR IN CONNECTION WITH SPORTING, ENTERTAINMENT, MEDIA AND CULTURAL EVENTS OR SERVICES, RENDERED BY OR IN: POSTERS, PRINTS AND OTHER ARTWORK, SCRIPT AND ON-SCREEN LETTERING, LIVE AND PRE-RECORDED ANNOUNCEMENTS TRANSMITTED VIA RADIO, TELEVISION, MOTION PICTURE FILMS, MOTION PICTURE TRAILERS, THE GLOBAL COMPUTER NETWORK, VIDEOTAPES COMPUTER SOFTWARE AND OTHER ELECTRONIC DISKS, NAMELY, LASER, CD-ROMS AND DVDS, AT OR IN CONNECTION WITH SPORTING, ENTERTAINMENT, MEDIA AND CULTURAL EVENTS OR SERVICES, IN CLASS 35 (U.S. CLS. 100, 101 AND 102).

FIRST USE 1-1-1993; IN COMMERCE 1-1-1993.

FOR: ENTERTAINMENT IN THE NATURE OF A LIVE PERFORMANCES BY AN ANNOUNCER PERFORMED AT SPORTING, ENTERTAINMENT, MEDIA AND CULTURAL EVENTS; AND ENTERTAINMENT IN THE NATURE OF PRE-RECORDED ANNOUNCEMENTS BROADCAST AT SPORTING, ENTERTAINMENT, MEDIA AND CULTURAL EVENTS VIA TELEPHONE, RADIO, AUDIO AND VIDEO MEDIA, THE GLOBAL COMPUTER NETWORK, TELEVISION, MOTION PICTURE TRAILERS, VIDEOTAPES, CD'S, THE GLOBAL COMPUTER NETWORK, VIDEOTAPES COMPUTER SOFTWARE AND OTHER ELECTRONIC DISKS, NAMELY, LASER, CDROMS AND DVDS, AT OR IN CONNECTION WITH SPORTING, ENTERTAINMENT, MEDIA AND CULTURAL EVENTS OR SERVICES, IN CLASS 41 (U.S. CLS. 100, 101 AND 107).

FIRST USE 1-1-1993; IN COMMERCE 1-1-1993.

THE MARK CONSISTS OF STANDARD CHARACTERS WITHOUT CLAIM TO ANY PARTICULAR FONT, STYLE, SIZE, OR COLOR.

SER. NO. 76-706,276, FILED 2-4-2011.

RONALD AIKENS, EXAMINING ATTORNEY



*David J. Kyffers*

Director of the United States Patent and Trademark Office

# United States of America

United States Patent and Trademark Office



**Reg. No. 4,123,343**

**Registered Apr. 10, 2012**

**Int. Cls.: 13 and 18**

**TRADEMARK**

**PRINCIPAL REGISTER**

GALLAGHER, RICHARD N (UNITED STATES INDIVIDUAL)  
2019 WEST QUAIL AVENUE  
PHOENIX, AZ 85027

FOR: FIREARM ACCESSORIES, NAMELY, HOLSTERS, GUN BELTS, AMMUNITION POUCHES, SLINGS, CARTRIDGE CARRIERS AND GUN CASES, IN CLASS 13 (U.S. CLS. 2 AND 9).

FIRST USE 1-18-2011; IN COMMERCE 1-18-2011.

FOR: PURSES, BRIEFCASES, ALL-PURPOSE GEAR BAGS, DUFFEL BAGS, GARMENT BAGS FOR TRAVEL, CARRYING CASES, AND KEY CASES, IN CLASS 18 (U.S. CLS. 1, 2, 3, 22 AND 41).

FIRST USE 1-18-2011; IN COMMERCE 1-18-2011.

OWNER OF U.S. REG. NOS. 1,999,105 AND 2,086,912.

THE MARK CONSISTS OF A STYLIZED LETTER "X" IN A SQUARE CARRIER LOCATED NEXT TO THE TERM "GALCO".

SER. NO. 76-706,336, FILED 2-8-2011.

MARK RADEMACHER, EXAMINING ATTORNEY



*David J. Kyffers*

Director of the United States Patent and Trademark Office

# United States of America

United States Patent and Trademark Office

# Network

**INTERNATIONAL**

**Reg. No. 4,123,344**

**Registered Apr. 10, 2012**

**Int. Cl.: 35**

**SERVICE MARK**

**PRINCIPAL REGISTER**

NETWORK INTERNATIONAL, INC. (DELAWARE CORPORATION)  
3555 TIMMONS LANE, SUITE 1200  
HOUSTON, TX 77027

FOR: AUCTIONING INDUSTRIAL ASSETS OF OTHERS; ONLINE AUCTIONING SERVICES; PRIVATE RETAIL STORE SERVICES IN THE FIELD OF INDUSTRIAL ASSETS OF OTHERS; ONLINE RETAIL STORE SERVICES FEATURING INDUSTRIAL ASSETS OF OTHERS; BUSINESS APPRAISALS FOR SURPLUS OF OLD AND NEW PETROLEUM, CONSTRUCTION, AGRICULTURE, MINING, TRANSPORTATION, AND POWER INDUSTRY EQUIPMENT; INVENTORY VERIFICATION OF EQUIPMENT; EQUIPMENT DESCRIPTION ANALYSIS, NAMELY, ANALYSIS OF CUSTOMER EQUIPMENT DESCRIPTIONS AND ASSIST WITH REFINEMENT OF THE DESCRIPTIONS, IN CLASS 35 (U.S. CLS. 100, 101 AND 102).

FIRST USE 9-1-2006, THE MARK WAS USED AT LEAST AS EARLY AS FEBRUARY 2005 IN A PRIOR SIMILAR DESIGN VERSION OF THIS MARK.; IN COMMERCE 9-1-2006.

OWNER OF U.S. REG. NOS. 2,787,153 AND 3,529,561.

NO CLAIM IS MADE TO THE EXCLUSIVE RIGHT TO USE "INTERNATIONAL", APART FROM THE MARK AS SHOWN.

SER. NO. 76-706,392, FILED 2-14-2011.

HEATHER BIDDULPH, EXAMINING ATTORNEY



*David J. Kybas*

Director of the United States Patent and Trademark Office

# United States of America

United States Patent and Trademark Office

## BEST OF FARMS

**Reg. No. 4,123,345**

**Registered Apr. 10, 2012**

**Int. Cl.: 29**

**TRADEMARK**

**PRINCIPAL REGISTER**

BEST OF FARMS, LLC (NEW JERSEY LIMITED LIABILITY COMPANY)  
12-17 RIVER ROAD  
FAIRLAWN, NJ 07410

FOR: CHEESE, FETA CHEESE, FARMER CHEESE, STRING CHEESE, SOUR CREAM, YOGURT, YOGURT DRINK, BAKED STYLE MILK, BUTTER, AND YOGURT BUTTER, IN CLASS 29 (U.S. CL. 46).

FIRST USE 4-0-2010; IN COMMERCE 4-0-2010.

THE MARK CONSISTS OF STANDARD CHARACTERS WITHOUT CLAIM TO ANY PARTICULAR FONT, STYLE, SIZE, OR COLOR.

SER. NO. 76-706,548, FILED 2-24-2011.

KATHERINE E. HALMEN, EXAMINING ATTORNEY



*David J. Kybas*

Director of the United States Patent and Trademark Office

# United States of America

United States Patent and Trademark Office



**Reg. No. 4,123,346**

**Registered Apr. 10, 2012**

**Int. Cl.: 12**

**TRADEMARK**

**PRINCIPAL REGISTER**

FEDERATED AUTO PARTS DISTRIBUTORS, INC. (VIRGINIA CORPORATION)  
542 GREENVILLE AVENUE  
STAUNTON, VA 24401

FOR: DISC BRAKE PADS FOR VEHICLES, IN CLASS 12 (U.S. CLS. 19, 21, 23, 31, 35 AND 44).

FIRST USE 2-17-2011; IN COMMERCE 2-17-2011.

NO CLAIM IS MADE TO THE EXCLUSIVE RIGHT TO USE "ENGINEERED VEHICLE SPECIFIC", APART FROM THE MARK AS SHOWN.

THE MARK CONSISTS OF THE STYLIZED LETTERS "EVS" ABOVE "ENGINEERED VEHICLE SPECIFIC" ON A BORDERED SIGN OVER A BORDERED OCTAGON THAT IS SHADED AND CONTAINS THE REPEATED WORDING "FRICTION".

SER. NO. 76-706,625, FILED 3-1-2011.

JASON TURNER, EXAMINING ATTORNEY



*David J. Kyffers*

Director of the United States Patent and Trademark Office

# United States of America

United States Patent and Trademark Office



**Reg. No. 4,123,347**

**Registered Apr. 10, 2012**

**Int. Cl.: 41**

**SERVICE MARK**

**PRINCIPAL REGISTER**

TRI-STATE LOTTO COMMISSION (VERMONT INTERSTATE AGENCY OF NEW HAMPSHIRE, VERMONT AND MAINE)  
1311 U.S. ROUTE 302  
BERLIN-SUITE 100  
BARRE, VT 05641

FOR: LOTTERY GAME SERVICES, IN CLASS 41 (U.S. CLS. 100, 101 AND 107).

FIRST USE 5-30-2011; IN COMMERCE 5-30-2011.

OWNER OF U.S. REG. NOS. 2,783,685 AND 3,558,027.

NO CLAIM IS MADE TO THE EXCLUSIVE RIGHT TO USE "TRI-STATE", "WEEKLY GRAND", "MAINE" AND "\$", APART FROM THE MARK AS SHOWN.

THE MARK CONSISTS OF "TRI-STATE" ON THE TOP LEFT SIDE OF THE MARK ABOVE A "\$" SIGN WHICH IS TO THE LEFT OF "EXTRA", WITH ALL THREE BEING ABOVE "WEEKLY GRAND" AND THEN "MAINE". ALL OF THE WORDING IS CONTAINED WITHIN A STYLIZED DESIGN OUTLINING SUCH WORDING AND "\$" SIGN.

SER. NO. 76-706,896, FILED 3-21-2011.

KARANENDRA S. CHHINA, EXAMINING ATTORNEY



*David J. Kyjars*

Director of the United States Patent and Trademark Office



# United States of America

United States Patent and Trademark Office

## BEHAVIOR ANALYST CERTIFICATION BOARD

**Reg. No. 4,123,348**

**Registered Apr. 10, 2012**

**Int. Cl.: 42**

**SERVICE MARK**

**PRINCIPAL REGISTER**

BEHAVIOR ANALYST CERTIFICATION BOARD, INC. (FLORIDA CORPORATION)  
2888 REMINGTON GREEN LANE, SUITE C  
TALLAHASSEE, FL 32308

FOR: ESTABLISHING AND UPDATING EDUCATIONAL, CERTIFICATION, AND RECERTIFICATION STANDARDS FOR BEHAVIOR ANALYSIS PRACTITIONERS; AND ADMINISTRATION OF CERTIFICATION AND RECERTIFICATION PROGRAMS FOR BEHAVIOR ANALYSIS PRACTITIONERS, IN CLASS 42 (U.S. CLS. 100 AND 101).

FIRST USE 5-0-1998; IN COMMERCE 5-0-1998.

THE MARK CONSISTS OF STANDARD CHARACTERS WITHOUT CLAIM TO ANY PARTICULAR FONT, STYLE, SIZE, OR COLOR.

OWNER OF U.S. REG. NO. 2,530,882.

NO CLAIM IS MADE TO THE EXCLUSIVE RIGHT TO USE "CERTIFICATION BOARD", APART FROM THE MARK AS SHOWN.

SEC. 2(F).

SER. NO. 76-707,098, FILED 4-4-2011.

SUE LAWRENCE, EXAMINING ATTORNEY



*David J. Kyffers*

Director of the United States Patent and Trademark Office

# United States of America

United States Patent and Trademark Office

## U-MAD

**Reg. No. 4,123,349**

BARRIER SYSTEMS, INC. (CALIFORNIA CORPORATION)  
3333 VACA VALLEY PARKWAY, SUITE 800  
VACAVILLE, CA 95688

**Registered Apr. 10, 2012**

**Int. Cl.: 12**

FOR: VEHICLE MOUNTED AUTOMOTIVE IMPACT ATTENUATION DEVICES, NAMELY, CRASH CUSHIONS, IN CLASS 12 (U.S. CLS. 19, 21, 23, 31, 35 AND 44).

**TRADEMARK**

FIRST USE 3-18-2011; IN COMMERCE 3-18-2011.

**PRINCIPAL REGISTER**

THE MARK CONSISTS OF STANDARD CHARACTERS WITHOUT CLAIM TO ANY PARTICULAR FONT, STYLE, SIZE, OR COLOR.

SER. NO. 76-707,361, FILED 4-25-2011.

JASON TURNER, EXAMINING ATTORNEY



*David J. Kybas*

Director of the United States Patent and Trademark Office

# United States of America

United States Patent and Trademark Office

## DURACRAFT CABINETRY

**Reg. No. 4,123,350**

CUNNINGHAM, JIMMY B., SR. (UNITED STATES INDIVIDUAL)  
1045 W. BROAD STREET  
SMITHVILLE, TN 371662502

**Registered Apr. 10, 2012**

**Int. Cl.: 20**

FOR: KITCHEN CABINETS, IN CLASS 20 (U.S. CLS. 2, 13, 22, 25, 32 AND 50).

**TRADEMARK**

FIRST USE 8-20-1999; IN COMMERCE 8-20-1999.

**PRINCIPAL REGISTER**

THE MARK CONSISTS OF STANDARD CHARACTERS WITHOUT CLAIM TO ANY PARTICULAR FONT, STYLE, SIZE, OR COLOR.

NO CLAIM IS MADE TO THE EXCLUSIVE RIGHT TO USE "CABINETRY", APART FROM THE MARK AS SHOWN.

SER. NO. 76-707,403, FILED 4-26-2011.

EVELYN BRADLEY, EXAMINING ATTORNEY



*David J. Kyffers*

Director of the United States Patent and Trademark Office

# United States of America

United States Patent and Trademark Office

# MODIFY

**Reg. No. 4,123,351**

TREND THEORY INC (CALIFORNIA CORPORATION)  
6244 OTIS AVE  
BELL, CA 90201

**Registered Apr. 10, 2012**

**Int. Cl.: 25**

FOR: MEN'S, LADIES AND CHILDREN'S CLOTHING, NAMELY, SHIRTS, BOTTOMS, TOPS, JACKETS, VESTS, TROUSERS, PANTS, SKIRTS, BLOUSES, SWEATERS, POLO SHIRTS, KNIT SHIRTS, T-SHIRTS, JEANS, SHOES, BELTS, HATS, NECKWEAR, IN CLASS 25 (U.S. CLS. 22 AND 39).

**TRADEMARK**

**PRINCIPAL REGISTER**

FIRST USE 4-1-2010; IN COMMERCE 4-1-2010.

THE MARK CONSISTS OF STANDARD CHARACTERS WITHOUT CLAIM TO ANY PARTICULAR FONT, STYLE, SIZE, OR COLOR.

SER. NO. 76-707,794, FILED 5-31-2011.

KATHERINE E. HALMEN, EXAMINING ATTORNEY



*David J. Kyros*

Director of the United States Patent and Trademark Office

# United States of America

United States Patent and Trademark Office

M O D I F Y

**Reg. No. 4,123,352**

**Registered Apr. 10, 2012**

**Int. Cl.: 25**

**TRADEMARK**

**PRINCIPAL REGISTER**

TREND THEORY INC (CALIFORNIA CORPORATION)  
6244 OTIS AVE  
BELL, CA 90201

FOR: MEN'S, LADIES AND CHILDREN'S CLOTHING, NAMELY, SHIRTS, BOTTOMS, TOPS, JACKETS, VESTS, TROUSERS, PANTS, SKIRTS, BLOUSES, SWEATERS, POLO SHIRTS, KNIT SHIRTS, T-SHIRTS, JEANS, SHOES, BELTS, HATS, NECKWEAR, IN CLASS 25 (U.S. CLS. 22 AND 39).

FIRST USE 4-1-2010; IN COMMERCE 4-1-2010.

THE MARK CONSISTS OF THE WORD "MODIFY" WITH THE "F" APPEARING BACKWARDS.

SER. NO. 76-707,795, FILED 5-31-2011.

KATHERINE E. HALMEN, EXAMINING ATTORNEY



*David J. Kyffers*

Director of the United States Patent and Trademark Office

# United States of America

United States Patent and Trademark Office

## LSOUND MUSIC

**Reg. No. 4,123,353**

**Registered Apr. 10, 2012**

**Int. Cl.: 9**

**TRADEMARK**

**PRINCIPAL REGISTER**

LSOUND MUSIC, L.L.C. (GEORGIA LIMITED LIABILITY COMPANY)  
P. O. BOX 1910  
ATLANTA, GA 30301

FOR: SOUND RECORDINGS, MUSICAL RECORDINGS, VIDEO RECORDINGS AND COMPACT DISC RECORDINGS FEATURING A VARIETY OF MUSIC RECORDS, PRE-RECORDED VIDEO TAPES AND PRE-RECORDED VIDEO CASSETTES ALL FEATURING MOTION PICTURES AND TELEVISION PROGRAMS, CD-ROM PROGRAMS FEATURING MOTION PICTURES AND TELEVISION PROGRAMS; MUSICAL SOUND RECORDINGS; PHOTOGRAPHIC CAMERAS; RADIOS; SUN-GLASSES; DECORATIVE MAGNETS; COMPUTER GAME PROGRAMS; COMPUTER GAME CARTRIDGES; COMPUTER GAME CASSETTES; VIDEO GAME CARTRIDGES; AND VIDEO GAME CASSETTES, IN CLASS 9 (U.S. CLS. 21, 23, 26, 36 AND 38).

FIRST USE 5-1-2011; IN COMMERCE 5-1-2011.

THE MARK CONSISTS OF STANDARD CHARACTERS WITHOUT CLAIM TO ANY PARTICULAR FONT, STYLE, SIZE, OR COLOR.

NO CLAIM IS MADE TO THE EXCLUSIVE RIGHT TO USE "MUSIC", APART FROM THE MARK AS SHOWN.

SER. NO. 76-707,938, FILED 6-10-2011.

ESTHER BELENKER, EXAMINING ATTORNEY



*David J. Kyffers*

Director of the United States Patent and Trademark Office

# United States of America

United States Patent and Trademark Office



**Reg. No. 4,123,354**

BUOY BEACH, LLC (NEW JERSEY LIMITED LIABILITY COMPANY)  
399 CONGRESS STREET  
NEW MILFORD, NJ 07646

**Registered Apr. 10, 2012**

**Int. Cl.: 18**

FOR: BAGS WITH SHOULDER STRAP(S) WHICH SERVE AS A BEACH BAG AND, WHEN FILLED WITH SAND OR OTHER HEAVY MATERIAL, WORK WITH ANY BEACH UMBRELLA, TENT OR CANOPY TO KEEP IT STABLE IN THE WIND, IN CLASS 18 (U.S. CLS. 1, 2, 3, 22 AND 41).

**TRADEMARK**

**PRINCIPAL REGISTER**

FIRST USE 8-25-2010; IN COMMERCE 8-25-2010.

NO CLAIM IS MADE TO THE EXCLUSIVE RIGHT TO USE "SHADE", APART FROM THE MARK AS SHOWN.

THE MARK CONSISTS OF THE WORDS "SHADE ANCHOR" IN STYLIZED FONT, WITH A STYLIZED REPRESENTATION OF A BEACH UMBRELLA SEPARATING THE TWO WORDS, WITH A LINE CONNECTING THE UMBRELLA TO A STYLIZED REPRESENTATION OF AN ANCHOR, WHICH ANCHOR IS SUPERIMPOSED OVER THE "A" IN "ANCHOR".

SER. NO. 76-707,939, FILED 6-10-2011.

ESTHER BELENKER, EXAMINING ATTORNEY



*David J. Kyros*

Director of the United States Patent and Trademark Office

# United States of America

United States Patent and Trademark Office

# AMDRY

**Reg. No. 4,123,355**

**Registered Apr. 10, 2012**

**Int. Cls.: 1 and 6**

**TRADEMARK**

**PRINCIPAL REGISTER**

SULZER METCO MANAGEMENT AG (SWITZERLAND CORPORATION)  
ZUERCHERSTRASSE 12  
CH-8400 WINTERTHUR, SWITZERLAND

FOR: METAL OXIDE AND METAL CARBIDE POWDERS FOR USE IN THERMAL SPRAY PROCESSES, APPLIED AS SURFACE LAYERS, IN CLASS 1 (U.S. CLS. 1, 5, 6, 10, 26 AND 46).

FIRST USE 6-28-1967; IN COMMERCE 6-28-1967.

FOR: METAL AND METAL ALLOY POWDERS, PASTES, TAPES AND PREFORMS FOR USE IN THERMAL SPRAY PROCESSES, APPLIED AS SURFACE LAYERS, AND FOR USE IN BRAZING, IN CLASS 6 (U.S. CLS. 2, 12, 13, 14, 23, 25 AND 50).

FIRST USE 6-28-1967; IN COMMERCE 6-28-1967.

THE MARK CONSISTS OF STANDARD CHARACTERS WITHOUT CLAIM TO ANY PARTICULAR FONT, STYLE, SIZE, OR COLOR.

OWNER OF U.S. REG. NO. 1,152,886.

SER. NO. 76-707,976, FILED 6-14-2011.

ZHALEH DELANEY, EXAMINING ATTORNEY



*David J. Kybas*

Director of the United States Patent and Trademark Office



# United States of America

United States Patent and Trademark Office

## NIPPLE HUGGERS

**Reg. No. 4,123,356**

**Registered Apr. 10, 2012**

**Int. Cl.: 14**

**TRADEMARK**

**PRINCIPAL REGISTER**

CROFT, CLAUDIA A. (UNITED STATES INDIVIDUAL)  
7433 PELICAN DRIVE  
TAMPA, FL 336359674

FOR: JEWELRY, NAMELY, WIRE JEWELRY FOR ADORNING THE BREAST NIPPLES OF A WEARER AND NIPPLE JEWELRY WHICH INCLUDES A FLEXIBLE LOOP WHICH ENCIRCLES A WEARER'S NIPPLE, IN CLASS 14 (U.S. CLS. 2, 27, 28 AND 50).

FIRST USE 11-1-2008; IN COMMERCE 11-1-2008.

THE MARK CONSISTS OF STANDARD CHARACTERS WITHOUT CLAIM TO ANY PARTICULAR FONT, STYLE, SIZE, OR COLOR.

NO CLAIM IS MADE TO THE EXCLUSIVE RIGHT TO USE "NIPPLE", APART FROM THE MARK AS SHOWN.

SER. NO. 76-707,998, FILED 6-15-2011.

APRIL ROACH, EXAMINING ATTORNEY



*David J. Kybas*

Director of the United States Patent and Trademark Office

# United States of America

United States Patent and Trademark Office

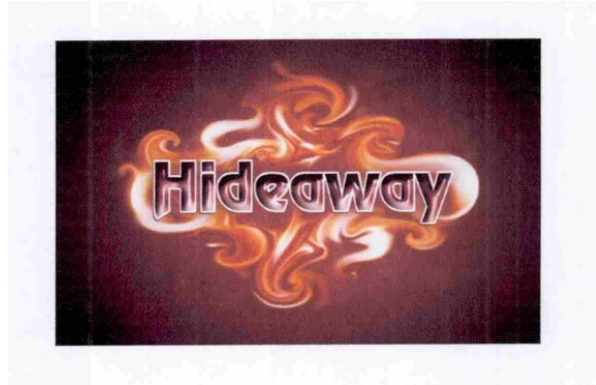

**Reg. No. 4,123,357**

**Registered Apr. 10, 2012**

**Int. Cl.: 35**

**SERVICE MARK**

**PRINCIPAL REGISTER**

HIDEAWAY (MINNESOTA LIMITED LIABILITY COMPANY)  
314 BUCHANAN ST. NE  
MINNEAPOLIS, MN 55413

FOR: RETAIL STORE SERVICES IN THE FIELD OF SMOKERS' ARTICLES AND SMOKERS' ACCESSORIES, IN CLASS 35 (U.S. CLS. 100, 101 AND 102).

FIRST USE 4-1-2011; IN COMMERCE 4-20-2011.

THE MARK CONSISTS OF THE WORDING "HIDEAWAY" IN STYLIZED LETTERING. A WHITE OUTLINE APPEARS IN THE WORD "HIDEAWAY". A GRADIENT APPEARS IN THE WORDING "HIDEAWAY" STARTING BLACK AT THE TOP, FADING MAROON AT THE MIDDLE AND GRAY AT THE BOTTOM. WHITE HIGHLIGHTS APPEAR INSIDE THE WORDING "HIDEAWAY". THE WORDING "HIDEAWAY" APPEARS SUPERIMPOSED OVER A RED, ORANGE, MAROON, WHITE AND CREAM DRAMATIC FIRE FLAME. A BLACK BACKGROUND APPEARS FADING MAROON TOWARDS THE MIDDLE.

THE COLOR(S) BLACK, WHITE, RED, MAROON, ORANGE, CREAM AND GRAY IS/ARE CLAIMED AS A FEATURE OF THE MARK.

SER. NO. 76-708,238, FILED 7-5-2011.

JENNIFER WILLISTON, EXAMINING ATTORNEY



*David J. Kybas*

Director of the United States Patent and Trademark Office

United States of America  
United States Patent and Trademark Office

# PACSHHealth

**Reg. No. 4,123,358**

**Registered Apr. 10, 2012**

**Int. Cl.: 9**

**TRADEMARK**

**PRINCIPAL REGISTER**

PACSHEALTH, LLC (ARIZONA LIMITED LIABILITY COMPANY)  
5893 EAST NIGHT GLOW CIRCLE  
SCOTTSDALE, AZ 85262

FOR: COMPUTER SOFTWARE FOR USE IN MANAGING, AUDITING, AND MONITORING  
MEDICAL IMAGING TECHNOLOGY SYSTEMS, IN CLASS 9 (U.S. CLS. 21, 23, 26, 36 AND  
38).

FIRST USE 4-1-2005; IN COMMERCE 11-1-2005.

THE MARK CONSISTS OF STANDARD CHARACTERS WITHOUT CLAIM TO ANY PAR-  
TICULAR FONT, STYLE, SIZE, OR COLOR.

OWNER OF U.S. REG. NO. 3,337,496.

SEC. 2(F).

SER. NO. 76-708,402, FILED 7-19-2011.

JAMES GRIFFIN, EXAMINING ATTORNEY



*David J. Kyffers*

Director of the United States Patent and Trademark Office

# United States of America

United States Patent and Trademark Office

## LocateYourLove.com

**Reg. No. 4,123,359**

HARVEY, STEVE (UNITED STATES INDIVIDUAL)  
4355 COBB PARKWAY, STE. J320  
ATLANTA, GA 30339 AND

**Registered Apr. 10, 2012**

**Int. Cl.: 45**

MCDONALD, RUSHION (UNITED STATES INDIVIDUAL)  
4355 COBB PARKWAY, STE. J320  
ATLANTA, GA 30339 AND

**SERVICE MARK**

**PRINCIPAL REGISTER**

ANDERSON, RICKY (UNITED STATES INDIVIDUAL)  
7322 S. W. FRWY., STE. 2010  
HOUSTON, TX 77074

FOR: INTERNET-BASED DATING AND SOCIAL INTRODUCTION SERVICES, NAMELY, A RELATIONSHIP MATCH MAKING WEBSITE IN WHICH SINGLE MEMBERS INTERESTED IN SERIOUS RELATIONSHIPS, CASUAL DATING OR FRIENDSHIPS WITH OTHER SINGLE MEMBERS SELECT FROM ONLINE PROFILES TO LOCATE AN IDEAL MATE BY THEIR OWN SEARCH OR WITH THE ASSISTANCE OF THE ONLINE SEARCH ENGINE TO FIND THEIR TOP MATCHES, IN CLASS 45 (U.S. CLS. 100 AND 101).

FIRST USE 11-19-2009; IN COMMERCE 11-19-2009.

THE MARK CONSISTS OF STANDARD CHARACTERS WITHOUT CLAIM TO ANY PARTICULAR FONT, STYLE, SIZE, OR COLOR.

OWNER OF U.S. REG. NO. 3,875,238.

SER. NO. 76-708,412, FILED 7-19-2011.

DAVID HOFFMAN, EXAMINING ATTORNEY



*David J. Kyfos*

Director of the United States Patent and Trademark Office

# United States of America

United States Patent and Trademark Office

# BRILLIANCE

**Reg. No. 4,123,360**

**Registered Apr. 10, 2012**

**Int. Cls.: 2, 17 and 19**

**TRADEMARK**

**PRINCIPAL REGISTER**

BOMAT HOLDING CO., INC. (HAWAII CORPORATION)  
91-400 KOMOHANA STREET  
KAPOLEI, HI 95707

FOR: GROUT STAIN, IN CLASS 2 (U.S. CLS. 6, 11 AND 16).

FIRST USE 5-1-2009; IN COMMERCE 5-1-2009.

FOR: CAULKING, GROUT SEALANT , IN CLASS 17 (U.S. CLS. 1, 5, 12, 13, 35 AND 50).

FIRST USE 5-1-2009; IN COMMERCE 5-1-2009.

FOR: SANDED GROUT, NON-SANDED GROUT, PAVER GROUT, IN CLASS 19 (U.S. CLS. 1, 12, 33 AND 50).

FIRST USE 5-1-2009; IN COMMERCE 5-1-2009.

THE MARK CONSISTS OF STANDARD CHARACTERS WITHOUT CLAIM TO ANY PARTICULAR FONT, STYLE, SIZE, OR COLOR.

SER. NO. 76-708,455, FILED 7-21-2011.

KAREN K. BUSH, EXAMINING ATTORNEY



*David J. Kyffers*

Director of the United States Patent and Trademark Office

# United States of America

United States Patent and Trademark Office

## BEHRINGER SECURITIES

**Reg. No. 4,123,361**

**Registered Apr. 10, 2012**

**Int. Cl.: 36**

**SERVICE MARK**

**PRINCIPAL REGISTER**

BEHRINGER HARVARD HOLDINGS, LLC (DELAWARE LIMITED LIABILITY COMPANY)  
15601 DALLAS PARKWAY, SUITE 600  
ADDISON, TX 75001

FOR: SECURITY BROKERAGE SERVICES; INVESTMENT ADVICE AND CONSULTATIONS;  
PENSION FUND ADVICE; FINANCIAL INVESTMENT IN THE FIELDS OF SECURITIES,  
REAL ESTATE FUNDS AND REAL ESTATE; REAL ESTATE FUND BROKERAGE; REAL  
ESTATE INVESTMENT MANAGEMENT; FINANCIAL EVALUATION OF REAL ESTATE;  
AND REAL ESTATE SYNDICATION, IN CLASS 36 (U.S. CLS. 100, 101 AND 102).

FIRST USE 2-0-2003; IN COMMERCE 2-0-2003.

THE MARK CONSISTS OF STANDARD CHARACTERS WITHOUT CLAIM TO ANY PAR-  
TICULAR FONT, STYLE, SIZE, OR COLOR.

OWNER OF U.S. REG. NOS. 2,947,624 AND 2,982,374.

NO CLAIM IS MADE TO THE EXCLUSIVE RIGHT TO USE "SECURITIES" , APART FROM  
THE MARK AS SHOWN.

SEC. 2(F).

SER. NO. 76-708,530, FILED 7-28-2011.

WILLIAM BRECKENFELD, EXAMINING ATTORNEY



*David J. Kybas*

Director of the United States Patent and Trademark Office

# United States of America

United States Patent and Trademark Office

## LIVE BEAUTIFULLY

**Reg. No. 4,123,362**

ALLAN KNIGHT & ASSOCIATES, INC. (TEXAS CORPORATION)  
150 TURTLE CREEK BLVD., SUITE 101  
DALLAS, TX 75234

**Registered Apr. 10, 2012**

**Int. Cl.: 35**

FOR: WHOLESALE AND ON-LINE RETAIL STORE SERVICES, FEATURING FURNITURE AND DECORATIVE HOME ACCESSORIES, IN CLASS 35 (U.S. CLS. 100, 101 AND 102).

**SERVICE MARK**

FIRST USE 5-1-2011; IN COMMERCE 5-1-2011.

**PRINCIPAL REGISTER**

THE MARK CONSISTS OF STANDARD CHARACTERS WITHOUT CLAIM TO ANY PARTICULAR FONT, STYLE, SIZE, OR COLOR.

SER. NO. 76-708,546, FILED 8-1-2011.

RENEE MCCRAY, EXAMINING ATTORNEY



*David J. Kybas*

Director of the United States Patent and Trademark Office

# United States of America

United States Patent and Trademark Office

# ALLAN KNIGHT

**Reg. No. 4,123,363**

**Registered Apr. 10, 2012**

**Int. Cl.: 35**

**SERVICE MARK**

**PRINCIPAL REGISTER**

ALLAN KNIGHT & ASSOCIATES, INC. (TEXAS CORPORATION)  
150 TURTLE CREEK BLVD., SUITE 101  
DALLAS, TX 75234

FOR: WHOLESALE AND ON-LINE RETAIL STORE SERVICES, FEATURING FURNITURE AND DECORATIVE HOME ACCESSORIES, IN CLASS 35 (U.S. CLS. 100, 101 AND 102).

FIRST USE 11-1-1999; IN COMMERCE 11-1-1999.

THE MARK CONSISTS OF STANDARD CHARACTERS WITHOUT CLAIM TO ANY PARTICULAR FONT, STYLE, SIZE, OR COLOR.

THE NAME "ALLAN KNIGHT" IDENTIFIES A LIVING INDIVIDUAL WHOSE CONSENT IS OF RECORD.

SER. NO. 76-708,547, FILED 8-1-2011.

RENEE MCCRAY, EXAMINING ATTORNEY



*David J. Kybas*

Director of the United States Patent and Trademark Office



# United States of America

United States Patent and Trademark Office

# Kera10

**Reg. No. 4,123,364**

GARCOA, INC. (OHIO CORPORATION)  
26135 MUREAU ROAD, SUITE #100  
CALABASAS, CA 91302

**Registered Apr. 10, 2012**

**Int. Cl.: 3**

FOR: HAIR AND SKIN CARE PRODUCTS, NAMELY, SHAMPOO, CONDITIONER, HAIR SPRAY, HAIR GEL, HAIR CREAM, HAIR STYLING PREPARATIONS, HAND AND BODY MOISTURIZER, BATH AND SHOWER GELEE, WITH ALL THE FOREGOING CONTAINING KERATIN, IN CLASS 3 (U.S. CLS. 1, 4, 6, 50, 51 AND 52).

**TRADEMARK**

**PRINCIPAL REGISTER**

FIRST USE 7-29-2011; IN COMMERCE 7-29-2011.

THE MARK CONSISTS OF STANDARD CHARACTERS WITHOUT CLAIM TO ANY PARTICULAR FONT, STYLE, SIZE, OR COLOR.

SER. NO. 76-708,580, FILED 8-1-2011.

LINDA POWELL, EXAMINING ATTORNEY



*David J. Kyffers*

Director of the United States Patent and Trademark Office

# United States of America

United States Patent and Trademark Office



*Emerald Star Cleaning, LLC*

*!We Make 'Em Sparkle!*

**Reg. No. 4,123,365**

WASHINGTON, D.C. LLC. (D.C. LIMITED LIABILITY COMPANY)

**Registered Apr. 10, 2012**

1613 4TH ST NW  
WASHINGTON, DC 200011907

**Int. Cl.: 37**

FOR: JANITORIAL SERVICES, IN CLASS 37 (U.S. CLS. 100, 103 AND 106).

**SERVICE MARK**

FIRST USE 5-8-2007; IN COMMERCE 5-8-2007.

**PRINCIPAL REGISTER**

NO CLAIM IS MADE TO THE EXCLUSIVE RIGHT TO USE "CLEANING, LLC", APART FROM THE MARK AS SHOWN.

THE MARK CONSISTS OF STAR TO THE LEFT OF THE WORDING "EMERALD STAR CLEANING, LLC" WHICH IS ON TOP OF THE WORDING "!WE MAKE 'EM SPARKLE!" AND WHICH IS DIVIDE A BY A LINE.

SER. NO. 76-708,685, FILED 8-10-2011.

RAUL CORDOVA, EXAMINING ATTORNEY



*David J. Kyffers*

Director of the United States Patent and Trademark Office

# United States of America

United States Patent and Trademark Office

## BUS GONE WILD

**Reg. No. 4,123,366**

ANDERSON, KENNETH (UNITED STATES INDIVIDUAL)  
4289 E. WYNDEMERE CIRCLE  
SCHNECKSVILLE, PA 18078

**Registered Apr. 10, 2012**

**Int. Cl.: 39**

FOR: TRANSPORTATION SERVICES, NAMELY, THE CARRIAGE OF PASSENGERS BY MULTI-PASSENGER VEHICLES FROM A PICK-UP LOCATION TO A DESTINATION INCLUDING A RETURN TO THE PICK-UP LOCATION, IN CLASS 39 (U.S. CLS. 100 AND 105).

**SERVICE MARK**

**PRINCIPAL REGISTER**

FIRST USE 5-10-2011; IN COMMERCE 5-10-2011.

THE MARK CONSISTS OF STANDARD CHARACTERS WITHOUT CLAIM TO ANY PARTICULAR FONT, STYLE, SIZE, OR COLOR.

NO CLAIM IS MADE TO THE EXCLUSIVE RIGHT TO USE "BUS", APART FROM THE MARK AS SHOWN.

SER. NO. 76-708,717, FILED 8-12-2011.

KELLY CHOE, EXAMINING ATTORNEY



*David J. Kyffers*

Director of the United States Patent and Trademark Office

# United States of America

United States Patent and Trademark Office



## PolyQuest

**Reg. No. 4,123,367**

**Registered Apr. 10, 2012**

**Int. Cl.: 1**

**TRADEMARK**

**PRINCIPAL REGISTER**

POLYQUEST, INC. (NORTH CAROLINA CORPORATION)  
1985 EASTWOOD ROAD  
SUITE 206  
WILMINGTON, NC 28403

FOR: POLYETHYLENE TEREPHTHALATE (PET) RESINS, IN CLASS 1 (U.S. CLS. 1, 5, 6, 10, 26 AND 46).

FIRST USE 5-25-2000; IN COMMERCE 5-25-2000.

THE MARK CONSISTS OF A STYLIZED "Q" IN A DIAMOND DESIGN AND THE WORDING "POLYQUEST".

SER. NO. 76-708,772, FILED 8-17-2011.

PAUL E. FAHRENKOPF, EXAMINING ATTORNEY



*David J. Kybas*

Director of the United States Patent and Trademark Office

# United States of America

United States Patent and Trademark Office

## WOBBLER

**Reg. No. 4,123,368**

**Registered Apr. 10, 2012**

**Int. Cl.: 11**

**TRADEMARK**

**PRINCIPAL REGISTER**

SENNINGER IRRIGATION INC. (FLORIDA CORPORATION)  
16220 E. HIGHWAY 50  
CLERMONT, FL 34711

FOR: IRRIGATION SPRINKLER HEADS, IN CLASS 11 (U.S. CLS. 13, 21, 23, 31 AND 34).

FIRST USE 10-22-1979; IN COMMERCE 10-22-1979.

THE MARK CONSISTS OF STANDARD CHARACTERS WITHOUT CLAIM TO ANY PARTICULAR FONT, STYLE, SIZE, OR COLOR.

OWNER OF U.S. REG. NO. 1,167,150.

SER. NO. 76-709,056, FILED 9-13-2011.

JULIE GUTTADAURO, EXAMINING ATTORNEY



*David J. Kyffers*

Director of the United States Patent and Trademark Office

# United States of America

United States Patent and Trademark Office

# Plantmedics

**Reg. No. 4,123,369**

**Registered Apr. 10, 2012**

**Int. Cl.: 3**

**TRADEMARK**

**PRINCIPAL REGISTER**

GARCOA, INC. (OHIO CORPORATION)  
26135 MUREAU ROAD, SUITE #100  
CALABASAS, CA 91302

FOR: HAIR AND SKIN CARE PRODUCTS, NAMELY, SHAMPOO, CONDITIONER, HAIR SPRAY, HAIR GEL, HAIR CREAM, HAIR STYLING PREPARATIONS, EXFOLIATING CREAMS, SKIN CLEANSER, FACIAL SCRUB, NON-MEDICATED SKIN ASTRINGENT FOR COSMETIC PURPOSES, SKIN MOISTURIZER AND NIGHT CREAM, HAND AND BODY MOISTURIZER, BATH AND SHOWER GELEE, BATH OIL, ANTI-WRINKLE CREAM, MOISTURIZING CREAM, NON-MEDICATED LIP CARE PREPARATIONS, IN CLASS 3 (U.S. CLS. 1, 4, 6, 50, 51 AND 52).

FIRST USE 9-12-2011; IN COMMERCE 9-12-2011.

THE MARK CONSISTS OF STANDARD CHARACTERS WITHOUT CLAIM TO ANY PARTICULAR FONT, STYLE, SIZE, OR COLOR.

SER. NO. 76-709,252, FILED 9-29-2011.

LINDA POWELL, EXAMINING ATTORNEY



*David J. Kyros*

Director of the United States Patent and Trademark Office

# United States of America

United States Patent and Trademark Office

## just hatched

**Reg. No. 4,123,370**

**Registered Apr. 10, 2012**

**Int. Cl.: 16**

**TRADEMARK**

**PRINCIPAL REGISTER**

GARCOA, INC. (OHIO CORPORATION)  
26135 MUREAU ROAD, SUITE #100  
CALABASAS, CA 91302

FOR: DISPOSABLE DIAPERS, IN CLASS 16 (U.S. CLS. 2, 5, 22, 23, 29, 37, 38 AND 50).

FIRST USE 9-30-2011; IN COMMERCE 9-30-2011.

THE MARK CONSISTS OF STANDARD CHARACTERS WITHOUT CLAIM TO ANY PARTICULAR FONT, STYLE, SIZE, OR COLOR.

OWNER OF U.S. REG. NO. 4,040,047.

SER. NO. 76-709,355, FILED 10-7-2011.

LINDA POWELL, EXAMINING ATTORNEY



*David J. Kyffers*

Director of the United States Patent and Trademark Office

# United States of America

United States Patent and Trademark Office

# KOOZA

**Reg. No. 4,123,371**

**Registered Apr. 10, 2012**

**Int. Cls.: 9, 16, 18, 25, 28  
and 41**

**TRADEMARK**

**SERVICE MARK**

**PRINCIPAL REGISTER**

CIRQUE DU SOLEIL HOLDING USA, INC. (DELAWARE CORPORATION)  
16, AVENUE PASTEUR  
GRAND DUCHY OF LUXEMBOURG, LUXEMBOURG L2310

FOR: PRE-RECORDED MEDIA FOR THE STORAGE AND REPRODUCTION OF SOUND AND VIDEO, FEATURING MUSIC AND THEATRICAL OR DRAMATIC PERFORMANCES, NAMELY, AUDIOCASSETTES, VIDEOCASSETTES, AUDIO DISCS, VIDEO DISCS, COMPACT DISCS, DIGITAL VERSATILE DISKS, DIGITAL VIDEO DISCS, INTERACTIVE COMPACT DISCS, DISKETTES, RECORDS, AUDIO TAPES, VIDEOTAPES; MOTION PICTURE FILMS FEATURING MUSICAL, THEATRICAL AND DRAMATIC PERFORMANCES; CASES FOR HOLDING AUDIOTAPE AND VIDEOTAPE CASSETTES AND DISCS; SUNGLASSES AND SUNGLASSES CASES; DECORATIVE MAGNETS; ENTERTAINMENT SOFTWARE, NAMELY, MULTIMEDIA INTERACTIVE COMPUTER GAME SOFTWARE; EDUCATIONAL SOFTWARE, NAMELY, MULTIMEDIA INTERACTIVE COMPUTER GAME SOFTWARE; MULTIMEDIA SOFTWARE RECORDED ON CD-ROM AND OTHER READ-ONLY FORMATS FEATURING EDUCATION IN THE FIELDS OF MUSIC, DRAMA AND VARIETY ACTS; MAGNETICALLY-ENCODED DEBIT CARDS FOR USE IN PUBLIC TELEPHONES; PROTECTIVE BICYCLE HELMETS; BINOCULARS; MUSICAL SOUND AND VIDEO RECORDINGS, DOWNLOADABLE MUSICAL SOUND AND VIDEO RECORDINGS; MOUSE PADS, IN CLASS 9 (U.S. CLS. 21, 23, 26, 36 AND 38).

FOR: PAPER GOODS, NAMELY, MAGAZINES, BROCHURES, SOUVENIR PROGRAMMES, PHOTOS, BOOKS AND COMMEMORATIVE BOOKS REGARDING CIRCUSES AND THE ARTS; POSTERS; LITHOGRAPHS; CALENDARS; DIARIES; MEMO PADS; DECALCOMANIAS; DECORATIVE TATTOOS; PAPER FLAGS; COLOURING BOOKS; PAINTING AND COLOURING SETS FOR CHILDREN; COMIC BOOKS; SCRAP BOOKS; ADDRESS BOOKS; BOOKMARKS; LETTER OPENERS; PHOTO ALBUMS; APPOINTMENT BOOKS; LOOSE-LEAFS BINDERS; GIFT WRAPPING PAPER; PAPER AND PLASTIC BAGS FOR SHOPPING, PACKAGING, MICROWAVE COOKING; GROCERY BAGS; LUNCH BAGS; MERCHANDISE BAGS; FABRIC GIFT BAGS; STATIONERY; PENS; PENCILS DESK SETS, PEN AND PENCIL SETS; RUBBER BANDS; NOT-MAGNETICALLY-ENCODED DEBIT CARDS FOR USE IN PUBLIC TELEPHONES; PRINTED PUBLICATIONS RELATED TO MUSIC, NAMELY, CATALOGUES, MAGAZINES AND BOOKS RELATED TO MUSIC; BOOK ENDS; PENCIL CASES; GLASS PAPERWEIGHTS; GREETING CARDS; POST CARDS; NOTE CARDS; PICTURES, IN CLASS 16 (U.S. CLS. 2, 5, 22, 23, 29, 37, 38 AND 50).

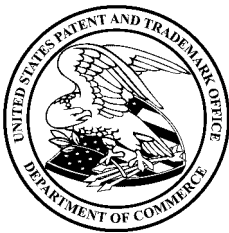

*David J. Kyjars*

Director of the United States Patent and Trademark Office



**Reg. No. 4,123,371** FOR: BAGS AND CASES, NAMELY, TOTE BAGS, SPORTS BAGS, TRAVEL BAGS, LUGGAGE, SUITCASES, GARMENT BAGS FOR TRAVEL, TRUNKS, ATTACHE CASES, CLUTCH BAGS, HAND BAGS, PURSES, KNAPSACKS, FANNY PACKS, GYM BAGS, KEY CASES, COIN PURSES; WALLETS; COMBINATION WALLETS FOR CARRYING KEYS AND COINS; ID HOLDERS; COSMETIC BAGS SOLD EMPTY; BEEPER BAGS; UMBRELLAS, IN CLASS 18 (U.S. CLS. 1, 2, 3, 22 AND 41).

FOR: CLOTHING, WEARING APPAREL AND ACCESSORIES, NAMELY, SHIRTS, SWEATSHIRTS, T-SHIRTS, JERSEYS, SWEATERS, TANK TOPS, PANTS, SWEAT PANTS, SHORTS, BOXER SHORTS, BATHROBES, NIGHT SHIRTS, PAJAMAS, COATS, JACKETS, WIND-RESISTANT JACKETS, VESTS, DRESSES, SKIRTS, BLOUSES, ROMPERS, SWIM-SUITS, ANKLE GARTERS, GARTER BELTS, THONGS, THONG UNDERWEAR, STOCKINGS; RAINWEAR; TIES, ASCOTS, BELTS, SCARVES; FOOTWEAR; HEADGEAR, NAMELY, HATS, CAPS AND BEANIES; APRONS; MASQUERADE COSTUMES, IN CLASS 25 (U.S. CLS. 22 AND 39).

FOR: GAMES, TOYS AND PLAYTHINGS, NAMELY, JUGGLING BALLS, JUGGLING PLATES, JUGGLING PINS, DIABOLOS, FLOWER STICKS, JUGGLING STICKS, JUGGLING SCARVES, SKIPPING ROPES, PUZZLES, VIEWERS FOR 3-D PLASTIC TRANSPARENCIES, MUSICAL RAINSTICKS, PLAYING CARDS, SPIN TOY, TOY MOBILES, RETURN TOPS, DOLLS AND ACCESSORIES THEREFOR, MECHANICAL ACTION TOYS, GOLF BALLS, SOAP BUBBLES, KITES, BALLS, NAMELY, PLAYING BALLS AND RUBBER ACTION BOUNCING BALLS; CHRISTMAS TREE DECORATIONS; FACE MASKS, COSTUME MASKS; THEATRICAL MASKS FOR DECORATIVE PURPOSES; PUPPETS AND MARIONETTE PUPPETS; CLOWN NOSES; COLLECTIBLE DOLLS, IN CLASS 28 (U.S. CLS. 22, 23, 38 AND 50).

FOR: ENTERTAINMENT SERVICES, NAMELY, PRODUCTION OF MUSICAL AUDIO AND VIDEO RECORDINGS; MUSICAL CONCERT TOUR; CONCEPTION, CREATION, PRODUCTION AND PRESENTATION OF THEATRICAL PERFORMANCES FEATURING ARTISTIC ACROBATIC ACTS, COMICAL ACTS, CHOREOGRAPHY AND/OR DANCE, SET TO MUSIC AND/OR SONG; CONCEPTION, CREATION, PRODUCTION AND PRESENTATION OF AUDIO-VISUAL WORKS, NAMELY, TELEVISION AND RADIO PROGRAMS, MOTION PICTURE FILMS; ENTERTAINMENT CONCEPTION, CREATION, AND PRODUCTION IN THE FIELD OF MUSIC, DRAMA AND VARIETY ACTS IN THE FORM OF MULTIMEDIA RECORDED ON CD-ROM, A VIDEO, VIDEOTAPE; ENTERTAINMENT SERVICES, NAMELY, LIVE, TELEVISED, BROADCAST, RECORDED, AND MOVIE APPEARANCES BY PROFESSIONAL PERFORMERS; PRESENTATION OF LIVE SHOW PERFORMANCES, IN CLASS 41 (U.S. CLS. 100, 101 AND 107).

THE MARK CONSISTS OF STANDARD CHARACTERS WITHOUT CLAIM TO ANY PARTICULAR FONT, STYLE, SIZE, OR COLOR.

PRIORITY CLAIMED UNDER SEC. 44(D) ON CANADA APPLICATION NO. 1325042, FILED 11-21-2006, REG. NO. TMA783,230, DATED 11-23-2010, EXPIRES 11-23-2025.

SER. NO. 77-049,893, FILED 11-22-2006.

JENNY PARK, EXAMINING ATTORNEY

# United States of America

United States Patent and Trademark Office

## Crystal Clear Bags

**Reg. No. 4,123,372**

**Registered Apr. 10, 2012**

**Int. Cl.: 17**

**TRADEMARK**

**PRINCIPAL REGISTER**

CLEAR IMAGE INC. (CALIFORNIA CORPORATION), DBA IMPACT IMAGES  
#100  
4949 WINDPLAY DRIVE  
EL DORADO HILLS, CA 95762

FOR: POLYPROPYLENE FILMS FOR COMMERCIAL AND INDUSTRIAL PACKING USE;  
AND POLYPROPYLENE FILMS FOR USE IN THE MANUFACTURE OF ENVELOPES , IN  
CLASS 17 (U.S. CLS. 1, 5, 12, 13, 35 AND 50).

FIRST USE 1-1-1985; IN COMMERCE 1-1-1985.

THE MARK CONSISTS OF STANDARD CHARACTERS WITHOUT CLAIM TO ANY PAR-  
TICULAR FONT, STYLE, SIZE, OR COLOR.

NO CLAIM IS MADE TO THE EXCLUSIVE RIGHT TO USE "BAGS", APART FROM THE  
MARK AS SHOWN.

SEC. 2(F).

SER. NO. 77-073,942, FILED 12-31-2006.

MARTHA FROMM, EXAMINING ATTORNEY



*David J. Kyros*

Director of the United States Patent and Trademark Office

# United States of America

United States Patent and Trademark Office



**Reg. No. 4,123,373**

**Registered Apr. 10, 2012**

**Int. Cls.: 9, 35 and 42**

**TRADEMARK**

**SERVICE MARK**

**PRINCIPAL REGISTER**

RUGGEDCOM INC. (CANADA CORPORATION)  
30 WHITMORE ROAD  
WOODBIDGE, CANADA L4L7Z4

FOR: COMPUTER HARDWARE; COMPUTER SOFTWARE FOR DETECTING AND RECOVERING FROM A FAULT IN A NETWORK; COMMUNICATION ROUTERS, SWITCHES, GATEWAYS, COMPUTERS AND MODEMS; FIBER OPTIC CABLES, CONNECTORS AND FILTERS; FIBER OPTICAL NETWORKS COMPRISED OF HUBS, SWITCHES AND FIBER-TO-ELECTRICAL MEDIA CONVERTERS, COMMUNICATION HUBS, COMMUNICATION ROUTERS AND SWITCHES HAVING MIXED FIBER OPTICAL AND ELECTRICAL MEDIA PORTS; COMPUTER NETWORK HUBS, SWITCHES AND ROUTER SHAVING FIBER OPTICAL PORTS; COMPUTER HUBS, ROUTERS AND SWITCHES HAVING MIXED FIBER OPTICAL AND ELECTRICAL MEDIA PORT; FIBER OPTICAL ETHERNET NETWORKS COMPRISED OF HUBS, SWITCHES, FIBER-TO-ELECTRICAL MEDIA CONVERTERS, SERIAL TO ETHERNET SERVERS, COMMUNICATION HUBS, COMMUNICATION ROUTERS, COMPUTER HUBS, COMPUTER NETWORK ROUTERS, SWITCHES AND SERIAL TO ETHERNET SERVERS HAVING MIXED FIBER OPTIC TO ELECTRICAL MEDIA PORTS; COMPUTER NETWORK HUBS, SWITCHES AND ROUTERS HAVING OPTICAL PORTS; COMPUTER HUBS, ROUTERS, SWITCHES, SERIAL TO ETHERNET SERVERS AND SERIAL DEVICE SERVERS HAVING MIXED FIBER OPTIC AND COPPER PORTS; VIDEO ENCODERS; FIBER OPTIC TO CABLE CONVERTERS; FIBER OPTICAL TO ELECTRICAL MEDIA CONVERTERS; SERIAL TO ETHERNET GATEWAYS; SERIAL DEVICE SERVERS, IN CLASS 9 (U.S. CLS. 21, 23, 26, 36 AND 38).

FOR: ON-LINE RETAIL STORE SERVICES FEATURING FIBER OPTICAL NETWORKS, COMPUTER HARDWARE, COMPUTER SOFTWARE AND COMMUNICATIONS EQUIPMENT; COMPUTERIZED ON-LINE RETAIL STORE SERVICES FEATURING FIBER OPTICAL NETWORKS, COMPUTER HARDWARE, COMPUTER SOFTWARE AND COMMUNICATIONS EQUIPMENT, IN CLASS 35 (U.S. CLS. 100, 101 AND 102).

FOR: TECHNICAL SUPPORT, NAMELY, MONITORING OF NETWORK SYSTEMS; COMPUTER NETWORK DIAGNOSTIC SERVICES; COMPUTER NETWORK DESIGN FOR OTHERS; COMPUTER NETWORK CONSULTING SERVICES, IN CLASS 42 (U.S. CLS. 100 AND 101).

PRIORITY CLAIMED UNDER SEC. 44(D) ON CANADA APPLICATION NO. 1313123, FILED 8-16-2006, REG. NO. TMA775824, DATED 8-31-2010, EXPIRES 8-31-2026.



*David J. Kyffers*

Director of the United States Patent and Trademark Office

**Reg. No. 4,123,373** SER. NO. 77-108,183, FILED 2-15-2007.

MICHAEL WEBSTER, EXAMINING ATTORNEY

# United States of America

United States Patent and Trademark Office

# GENERSYS

**Reg. No. 4,123,374**

GENERSYS PLC (UNITED KINGDOM CORPORATION)  
37 QUEEN ANNE STREET

**Registered Apr. 10, 2012**

LONDON, UNITED KINGDOM W1G9JB

**Int. Cls.: 9, 11, 16 and 37**

FOR: DVDS, CASSETTES, CDS, VIDEOS, DOWNLOADABLE MP3 FILES AND DOWNLOADABLE MP3 RECORDINGS AND COMPUTER SOFTWARE FEATURING INFORMATION IN THE FIELD OF SOLAR ENERGY; COMPUTER SOFTWARE IN THE FIELD OF SOLAR ENERGY, IN CLASS 9 (U.S. CLS. 21, 23, 26, 36 AND 38).

**TRADEMARK**

**SERVICE MARK**

FOR: SOLAR COLLECTORS; SOLAR HEAT COLLECTION PANELS; SOLAR THERMAL INSTALLATIONS, NAMELY, SOLAR THERMAL MODULES; SOLAR COLLECTORS FOR HEATING; SOLAR COLLECTORS FOR AIR CONDITIONING; SOLAR PANELS FOR HEATING; SOLAR PANELS FOR AIR CONDITIONING; PARTS AND FITTINGS FOR ALL OF THE AFORESAID GOODS, IN CLASS 11 (U.S. CLS. 13, 21, 23, 31 AND 34).

**PRINCIPAL REGISTER**

FOR: PRINTED MATTER, NAMELY, BOOKS, MAGAZINES, BROCHURES, JOURNALS, ALL RELATING TO THE FIELD OF SOLAR ENERGY, IN CLASS 16 (U.S. CLS. 2, 5, 22, 23, 29, 37, 38 AND 50).

FOR: ADVISORY AND CONSULTANCY SERVICES IN THE FIELD OF INSTALLATION AND MAINTENANCE OF SOLAR ENERGY-POWERED HEATING AND AIR-CONDITIONING INSTALLATIONS, IN CLASS 37 (U.S. CLS. 100, 103 AND 106).

THE MARK CONSISTS OF STANDARD CHARACTERS WITHOUT CLAIM TO ANY PARTICULAR FONT, STYLE, SIZE, OR COLOR.



OWNER OF ERPN CMNTY TM OFC REG. NO. 002352508, DATED 7-5-2005, RENEWED AS REG. NO. 002352508, DATED 7-31-2011, EXPIRES 8-24-2021.

OWNER OF ERPN CMNTY TM OFC REG. NO. 005671334, DATED 7-30-2010, EXPIRES 1-26-2017.

SER. NO. 77-115,753, FILED 2-26-2007.

*David J. Kypos*

CAROLYN CATALDO, EXAMINING ATTORNEY

# United States of America

United States Patent and Trademark Office

# SAKURA

**Reg. No. 4,123,375**

**Registered Apr. 10, 2012**

**Int. Cl.: 16**

**TRADEMARK**

**PRINCIPAL REGISTER**

SAKURA COLOR PRODUCTS CORPORATION (JAPAN CORPORATION)  
10-17, NAKAMICHI 1-CHOME, HIGASHINARI-KU  
OSAKA-SHI, OSAKA-FU, JAPAN 537-0025

FOR: ERASER REFILLS FOR BATTERY POWERED ERASERS; AND ERASERS, IN CLASS  
16 (U.S. CLS. 2, 5, 22, 23, 29, 37, 38 AND 50).

FIRST USE 0-0-1986; IN COMMERCE 0-0-1986.

THE MARK CONSISTS OF STANDARD CHARACTERS WITHOUT CLAIM TO ANY PAR-  
TICULAR FONT, STYLE, SIZE, OR COLOR.

OWNER OF U.S. REG. NOS. 942,195, 1,805,680, AND 1,826,047.

THE FOREIGN WORDING IN THE MARK TRANSLATES INTO ENGLISH AS CHERRY OR  
CHERRY BLOSSOM.

SER. NO. 77-132,560, FILED 3-15-2007.

LESLIE RICHARDS, EXAMINING ATTORNEY



*David J. Kypos*

Director of the United States Patent and Trademark Office

# United States of America

United States Patent and Trademark Office

## SOUL OF '68

**Reg. No. 4,123,376**

**Registered Apr. 10, 2012**

**Int. Cl.: 28**

**TRADEMARK**

**PRINCIPAL REGISTER**

MATTEL, INC. (DELAWARE CORPORATION)  
333 CONTINENTAL BLVD.  
M1-1518  
EL SEGUNDO, CA 90245

FOR: TOYS, GAMES AND PLAYTHINGS, NAMELY, TOY VEHICLES AND ACCESSORIES THEREFOR, IN CLASS 28 (U.S. CLS. 22, 23, 38 AND 50).

FIRST USE 1-3-2008; IN COMMERCE 1-3-2008.

THE MARK CONSISTS OF STANDARD CHARACTERS WITHOUT CLAIM TO ANY PARTICULAR FONT, STYLE, SIZE, OR COLOR.

SER. NO. 77-291,579, FILED 9-28-2007.

LINDA MICKLEBURGH, EXAMINING ATTORNEY



*David J. Kyffers*

Director of the United States Patent and Trademark Office

# United States of America

## United States Patent and Trademark Office



**Reg. No. 4,123,377**

**Registered Apr. 10, 2012**

**Int. Cls.: 1, 6, 14, 35, 37,  
40 and 42**

**TRADEMARK**

**SERVICE MARK**

**PRINCIPAL REGISTER**

COMPANHIA VALE DO RIO DOCE (BRAZIL CORPORATION)  
AVENIDA GRAÇA ARANHA, 26 - BAIRRO CASTEL  
RIO DE JANEIRO - RJ, BRAZIL

FOR: ALKALINE METALS, NAMELY, POTASSIUM, CESIUM, SODIUM AND LITHIUM AND ITS OXIDES; EARTHY ALKALINE METALS, NAMELY, BERYLLIUM, MAGNESIUM, CALCIUM, BARIUM, STRONTIUM AND RADIUM; ROUGH OR SEMIWORKED METALS AND THEIR ALLOYS, NAMELY, RARE EARTH, URANIUM, ANTIMONY, BARIUM, GALLIUM, LITHIUM, RADIUM, SELENIUM, YTTRIUM, RARE EARTH METALS; OXIDIZED ALUM, BAUXITE, IN CLASS 1 (U.S. CLS. 1, 5, 6, 10, 26 AND 46).

FOR: ALUMINUM ALLOYS AND INGOTS; ORES, NAMELY, TIN ORE, FERROTITANIUM ORE, TITANIUM ORE, NIOBIUM ORE, NICKEL ORE, NICKEL-SILVER ORE, MOLYBDENUM ORE, COBALT ORE, ZINC ORE, COPPER ORE, MAGNESIUM ORE, MANGANESE ORE, ALUMINUM ORE; NONFERROUS METAL INGOTS OF ALUMINUM, COPPER, TITANIUM, ZINC, NICKEL, COBALT, AND TUNGSTEN; COMMON METALS AND THEIR ALLOYS UNWROUGHT FOR FURTHER MANUFACTURE, NAMELY, FERROTITANIUM, NIOBIUM, NICKEL-SILVER, MOLYBDENUM, MAGNESIUM, MANGANESE; SEMIWORKED ARTICLES OF UNREFINED NICKEL, MOLYBDENUM, COBALT, ZINC, ZINC ALLOYS, COPPER ALLOYS, MAGNESIUM, MANGANESE, ALUMINUM, AND ALUMINUM ALLOYS; ALUMINUM ALLOYS, NAMELY, ALUMINUM OXIDE; IRON ORES; UNWROUGHT IRONS AND STEELS, COPPER ALLOYS AND INGOTS, NICKEL INGOTS, ALUMINUM INGOTS, LEAD INGOTS, ZINC INGOTS, TIN INGOTS, TITANIUM ALLOY INGOTS, NIOBIUM INGOTS; INGOTS OF WHITE METALS, NAMELY, TIN, LEAD, COPPER, ZINC, ALUMINUM AND NICKEL, IN CLASS 6 (U.S. CLS. 2, 12, 13, 14, 23, 25 AND 50).

FOR: GOLD; PRECIOUS METAL ALLOYS; DIAMONDS; PRECIOUS STONES, NAMELY, SPINEL; IRIDIUM AND ITS ALLOYS; INGOTS OF PRECIOUS METAL; OLIVINE; OSMIUM AND ITS ALLOYS; PALLADIUM AND ITS ALLOYS; PLATINUM; RHODIUM AND ITS ALLOYS; RUTHENIUM AND ITS ALLOYS, IN CLASS 14 (U.S. CLS. 2, 27, 28 AND 50).

FOR: IMPORT AND EXPORT OF RAW MATERIALS AND PRODUCTS, NAMELY, ALKALINE METALS, NAMELY, POTASSIUM, CESIUM, SODIUM AND LITHIUM AND ITS OXIDES, EARTHY ALKALINE METALS, NAMELY, BERYLLIUM, MAGNESIUM, CALCIUM, BARIUM, STRONTIUM AND RADIUM, ROUGH OR SEMIWORKED METALS AND THEIR ALLOYS, NAMELY, RARE EARTH, URANIUM, ANTIMONY, BARIUM, GALLIUM, LITHIUM, RADIUM, SELENIUM, YTTRIUM, RARE EARTH METALS, OXIDIZED ALUM,



*David J. Kybas*

Director of the United States Patent and Trademark Office



**Reg. No. 4,123,377** BAUXITE, ALUMINUM ALLOYS AND INGOTS, ORES, NAMELY, TIN ORE, FERROTITANIUM ORE, TITANIUM ORE, NIOBIUM ORE, NICKEL ORE, NICKEL-SILVER ORE, MOLYBDENUM ORE, COBALT ORE, ZINC ORE, COPPER ORE, MAGNESIUM ORE, MANGANESE ORE, ALUMINUM ORE, NONFERROUS METAL INGOTS OF ALUMINUM, COPPER, TITANIUM, ZINC, NICKEL, COBALT, AND TUNGSTEN, COMMON METALS AND THEIR ALLOYS UNWROUGHT FOR FURTHER MANUFACTURE, NAMELY, FERROTITANIUM, NIOBIUM, NICKEL-SILVER, MOLYBDENUM, MAGNESIUM, MANGANESE, SEMI-WORKED ARTICLES OF UNREFINED NICKEL, MOLYBDENUM, COBALT, ZINC, ZINC ALLOYS, COPPER ALLOYS, MAGNESIUM, MANGANESE, ALUMINUM, AND ALUMINUM ALLOYS, ALUMINUM ALLOYS, NAMELY, ALUMINUM OXIDE, IRON ORES, UNWROUGHT IRONS AND STEELS, COPPER ALLOYS AND INGOTS, NICKEL INGOTS, ALUMINUM INGOTS, LEAD INGOTS, ZINC INGOTS, TIN INGOTS, TITANIUM ALLOY INGOTS, NIOBIUM INGOTS, INGOTS OF WHITE METALS, NAMELY, TIN, LEAD, COPPER, ZINC, ALUMINUM AND NICKEL, GOLD, PRECIOUS METAL ALLOYS, DIAMONDS, PRECIOUS STONES, NAMELY, SPINEL, IRIDIUM AND ITS ALLOYS, INGOTS OF PRECIOUS METAL, OLIVINE, OSMIUM AND ITS ALLOYS, PALLADIUM AND ITS ALLOYS, PLATINUM, RHODIUM AND ITS ALLOYS, RUTHENIUM AND ITS ALLOYS, IN CLASS 35 (U.S. CLS. 100, 101 AND 102).

FOR: MINING EXTRACTION, IN CLASS 37 (U.S. CLS. 100, 103 AND 106).

FOR: TREATMENT OF METAL, IN CLASS 40 (U.S. CLS. 100, 103 AND 106).

FOR: CHEMICAL RESEARCH AND ANALYSIS; GEOLOGICAL RESEARCH, IN CLASS 42 (U.S. CLS. 100 AND 101).

OWNER OF BRAZIL REG. NO. 829448721, DATED 5-25-2010, EXPIRES 5-25-2020.

THE MARK CONSISTS OF A STYLIZED LETTER "V".

SER. NO. 77-342,076, FILED 12-2-2007.

EDWARD FENNESSY, EXAMINING ATTORNEY

# United States of America

United States Patent and Trademark Office

## CASCH COPENHAGEN

**Reg. No. 4,123,378**

SCHLAMOVITZ, CARSTEN (UNITED STATES INDIVIDUAL)  
1801 CENTURY PARK EAST, SUITE 1201  
LOS ANGELES, CA 90067

**Registered Apr. 10, 2012**

**Int. Cl.: 25**

FOR: MEN'S, WOMEN'S AND CHILDREN'S CLOTHING, NAMELY, SHIRTS, BLOUSES, PANTS, DRESSES, TOPS, SHORTS, VESTS, T-SHIRTS, JUMPERS, SWEATERS, OVERALLS, BRAS, ROMPERS, JACKETS, SWEATSHIRTS, AND TANK-TOPS; HEADWEAR, NAMELY, CAPS; FOOTWEAR, IN CLASS 25 (U.S. CLS. 22 AND 39).

**TRADEMARK**

**PRINCIPAL REGISTER**

FIRST USE 1-31-1987; IN COMMERCE 1-31-1987.

THE MARK CONSISTS OF STANDARD CHARACTERS WITHOUT CLAIM TO ANY PARTICULAR FONT, STYLE, SIZE, OR COLOR.

NO CLAIM IS MADE TO THE EXCLUSIVE RIGHT TO USE "COPENHAGEN", APART FROM THE MARK AS SHOWN.

SER. NO. 77-350,615, FILED 12-12-2007.

JOHN GARTNER, EXAMINING ATTORNEY



*David J. Kyffers*

Director of the United States Patent and Trademark Office

# United States of America

United States Patent and Trademark Office

## RE-ANIMATOR

**Reg. No. 4,123,379**

RE-ANIMATOR PRODUCTIONS, INC. (CALIFORNIA CORPORATION)  
1626 NORTH WILCOX AVENUE, #244  
LOS ANGELES, CA 90028

**Registered Apr. 10, 2012**

**Int. Cl.: 25**

FOR: SHORT-SLEEVED OR LONG-SLEEVED T-SHIRTS, IN CLASS 25 (U.S. CLS. 22 AND 39).

**TRADEMARK**

FIRST USE 7-0-2005; IN COMMERCE 7-0-2005.

**PRINCIPAL REGISTER**

THE MARK CONSISTS OF STANDARD CHARACTERS WITHOUT CLAIM TO ANY PARTICULAR FONT, STYLE, SIZE, OR COLOR.

SER. NO. 77-356,821, FILED 12-20-2007.

BRIAN NEVILLE, EXAMINING ATTORNEY



*David J. Kybas*

Director of the United States Patent and Trademark Office

# United States of America

United States Patent and Trademark Office



**Reg. No. 4,123,380**

**Registered Apr. 10, 2012**

**Int. Cl.: 5**

**TRADEMARK**

**PRINCIPAL REGISTER**

HOKKO CHEMICAL INDUSTRY CO., LTD. (JAPAN CORPORATION)  
4-20, NIHONBASHI HONGOKU-CHU 4-CHOME  
CHUO-KU, TOKYO, JAPAN

FOR: ANTIBIOTICS, ALL PURPOSE DISINFECTANTS, INSECTICIDES, AND HERBICIDES  
FOR AGRICULTURAL AND DOMESTIC USE, IN CLASS 5 (U.S. CLS. 6, 18, 44, 46, 51 AND  
52).

FIRST USE 8-21-1979; IN COMMERCE 5-4-2009.

OWNER OF JAPAN REG. NO. 3086917, DATED 10-31-1995, EXPIRES 10-31-2015.

OWNER OF U.S. REG. NOS. 1,273,248 AND 1,607,887.

NO CLAIM IS MADE TO THE EXCLUSIVE RIGHT TO USE "CHEMICAL INDUSTRY CO.,  
LTD.", APART FROM THE MARK AS SHOWN.

THE MARK CONSISTS OF THE WORDING "HOKKO CHEMICAL INDUSTRY CO., LTD."  
PRECEDED BY A DESIGN OF A SEED LEAF.

SER. NO. 77-474,420, FILED 5-14-2008.

ERNEST SHOSHO, EXAMINING ATTORNEY



*David J. Kyffers*

Director of the United States Patent and Trademark Office

# United States of America

United States Patent and Trademark Office

# Singlefriends

**Reg. No. 4,123,381**

JUNGLE WILD MEDIA, INC. (PENNSYLVANIA CORPORATION)  
113 LINCOLN DR.  
SARVER, PA 16055

**Registered Apr. 10, 2012**

**Int. Cl.: 45**

FOR: DATING AND ONLINE SOCIAL NETWORKING SERVICES PROVIDED VIA A GLOBAL COMPUTER NETWORK, IN CLASS 45 (U.S. CLS. 100 AND 101).

**SERVICE MARK**

FIRST USE 2-2-2008; IN COMMERCE 2-2-2008.

**PRINCIPAL REGISTER**

THE MARK CONSISTS OF STANDARD CHARACTERS WITHOUT CLAIM TO ANY PARTICULAR FONT, STYLE, SIZE, OR COLOR.

SER. NO. 77-480,401, FILED 5-21-2008.

BARNEY CHARLON, EXAMINING ATTORNEY



*David J. Kyros*

Director of the United States Patent and Trademark Office

# United States of America

United States Patent and Trademark Office

# VYCLEVRA

**Reg. No. 4,123,382**

ASTRAZENECA AB (SWEDEN AKTIEBOLAG (AB))  
SE-151 85

**Registered Apr. 10, 2012**

SÖDERTÄLJE, SWEDEN

**Int. Cl.: 5**

FOR: PHARMACEUTICAL PREPARATIONS FOR THE TREATMENT OF CENTRAL NERVOUS SYSTEM AND PERIPHERAL NERVOUS SYSTEM DISEASES AND DISORDERS, IN CLASS 5 (U.S. CLS. 6, 18, 44, 46, 51 AND 52).

**TRADEMARK**

THE MARK CONSISTS OF STANDARD CHARACTERS WITHOUT CLAIM TO ANY PARTICULAR FONT, STYLE, SIZE, OR COLOR.

**PRINCIPAL REGISTER**

PRIORITY CLAIMED UNDER SEC. 44(D) ON ERPN CMNTY TM OFC APPLICATION NO. 6581301, FILED 12-20-2007, REG. NO. 006581301, DATED 11-24-2008, EXPIRES 12-20-2017.

SER. NO. 77-499,577, FILED 6-16-2008.

MARK RADEMACHER, EXAMINING ATTORNEY



*David J. Kyjars*

Director of the United States Patent and Trademark Office

# United States of America

United States Patent and Trademark Office

## LUMINOUS AQUA

**Reg. No. 4,123,383**

AMOREPACIFIC CORPORATION (REPUBLIC OF KOREA CORPORATION)  
181, 2-KA, HANGANG-RO, YONGSAN-KU  
SEOUL, REPUBLIC OF KOREA 140-777

**Registered Apr. 10, 2012**

**Int. Cl.: 3**

FOR: SKIN CREAMS NOT FOR MEDICAL PURPOSES; COSMETIC CREAMS FOR SKIN CARE; CREAMY FOUNDATION; SKIN MILK LOTIONS FOR COSMETIC PURPOSES; LIQUID FOUNDATION FOR COSMETIC PURPOSES, IN CLASS 3 (U.S. CLS. 1, 4, 6, 50, 51 AND 52).

**TRADEMARK**

THE MARK CONSISTS OF STANDARD CHARACTERS WITHOUT CLAIM TO ANY PARTICULAR FONT, STYLE, SIZE, OR COLOR.

**PRINCIPAL REGISTER**

OWNER OF CANADA REG. NO. TMA779713, DATED 10-13-2010, EXPIRES 10-13-2025.

SER. NO. 77-503,537, FILED 6-19-2008.

KAPIL BHANOT, EXAMINING ATTORNEY



*David J. Kybas*

Director of the United States Patent and Trademark Office

# United States of America

United States Patent and Trademark Office



THE BRAND EXPERIENCE

**Reg. No. 4,123,384**

**Registered Apr. 10, 2012**

**Int. Cl.: 35**

**SERVICE MARK**

**PRINCIPAL REGISTER**

BRAND EXPERIENCE, LLC, THE (DELAWARE LIMITED LIABILITY COMPANY)  
3909 OAK STREET  
CINCINNATI, OH 45227

FOR: ADVERTISING AGENCY SPECIALIZING IN THE DESIGN AND EXECUTION OF WORD OF MOUTH, VIRAL, BUZZ AND EXPERIENTIAL MARKETING PROGRAMS; ORGANIZING AND CONDUCTING CORPORATE MARKETING MEETINGS FOR OTHERS; PROMOTING THE GOODS AND SERVICES OF OTHERS THROUGH CONFERENCES, EXHIBITIONS, MEETINGS, MOBILE MARKETING EVENTS, TRAVELING EXHIBITS, TOURS AND STREET TEAMS, FOR COMMERCIAL OR ADVERTISING PURPOSES, IN CLASS 35 (U.S. CLS. 100, 101 AND 102).

FIRST USE 1-1-2008; IN COMMERCE 1-1-2008.

NO CLAIM IS MADE TO THE EXCLUSIVE RIGHT TO USE "BRAND EXPERIENCE", APART FROM THE MARK AS SHOWN.

THE COLOR(S) PURPLE, WHITE, BLACK AND GRAY IS/ARE CLAIMED AS A FEATURE OF THE MARK.

THE MARK CONSISTS OF THE STYLIZED LETTERS "B" AND "E" IN THE WHITE COLOR INSIDE A PURPLE CIRCLE; TO THE RIGHT OF THAT IS THE WORDING "THE BRAND EXPERIENCE" IN BLOCK LETTERING IN THE COLOR BLACK AND UNDERLINED BY A GRAY LINE.

SER. NO. 77-531,122, FILED 7-24-2008.

LINDA E. BLOHM, EXAMINING ATTORNEY



*David J. Kyjars*

Director of the United States Patent and Trademark Office



# United States of America

United States Patent and Trademark Office



**Reg. No. 4,123,385**

CANNERY CASINO RESORTS, LLC (NEVADA LIMITED LIABILITY COMPANY)  
9107 WEST RUSSELL ROAD  
LAS VEGAS, NV 89148

**Registered Apr. 10, 2012**

**Int. Cl.: 43**

FOR: CAFES; DELICATESSENS; PREPARATION OF FOOD AND BEVERAGES; RESTAURANT AND CATERING SERVICES, IN CLASS 43 (U.S. CLS. 100 AND 101).

**SERVICE MARK**

FIRST USE 8-28-2008; IN COMMERCE 8-28-2008.

**PRINCIPAL REGISTER**

NO CLAIM IS MADE TO THE EXCLUSIVE RIGHT TO USE "24 HOUR RESTAURANT", APART FROM THE MARK AS SHOWN.

THE MARK CONSISTS OF THE TEXT "SNAPS" SUPERIMPOSED OVER A SCALENE TRIANGLE. POSITIONED UNDER THE LETTERS "A", "P" AND "S" IS A RECTANGLE WITH THE TEXT "24 HOUR RESTAURANT" CENTERED INSIDE. DIRECTLY TO THE RIGHT OF AND FLUSH TO THE TRIANGLE IS AN EIGHT POINT STAR.

SER. NO. 77-536,462, FILED 7-31-2008.

Laurie Kaufman, Examining Attorney



*David J. Kyffers*

Director of the United States Patent and Trademark Office

# United States of America

United States Patent and Trademark Office

# iDRI

**Reg. No. 4,123,386**

**Registered Apr. 10, 2012**

**Int. Cl.: 9**

**TRADEMARK**

**PRINCIPAL REGISTER**

TENOVA GOODFELLOW INC. (CANADA CORPORATION)  
7070 MISSISSAUGA ROAD, SUITE 170  
MISSISSAUGA, CANADA L5N7G2

FOR: ELECTRIC CONTROL SYSTEMS FOR MACHINES, NAMELY, CONTROL SYSTEMS FOR INDUSTRIAL FURNACES; FURNACE SENSORS AND PROBES, NAMELY, TEMPERATURE SENSORS, PRESSURE SENSORS, OPTICAL SENSORS, NAMELY, LIGHT LEVEL SENSORS, LIGHT INTENSITY SENSORS, LIGHT FREQUENCY SENSORS, OPTICAL FREQUENCY METROLOGY SENSORS; GAS SENSORS AND PROBES, NAMELY, COMBUSTION GAS ANALYZERS, OFF-GAS ANALYZERS, RESIDUAL GAS ANALYZERS, OFF-GAS DETECTORS; COMPUTER SOFTWARE FOR CONTROLLING INDUSTRIAL EQUIPMENT IN FURNACES, IN CLASS 9 (U.S. CLS. 21, 23, 26, 36 AND 38).

THE MARK CONSISTS OF STANDARD CHARACTERS WITHOUT CLAIM TO ANY PARTICULAR FONT, STYLE, SIZE, OR COLOR.

PRIORITY CLAIMED UNDER SEC. 44(D) ON CANADA APPLICATION NO. 1402703, FILED 7-9-2008, REG. NO. TMA812054, DATED 11-18-2011, EXPIRES 11-18-2026.

SER. NO. 77-537,520, FILED 8-1-2008.

MATTHEW KLINE, EXAMINING ATTORNEY



*David J. Kypas*

Director of the United States Patent and Trademark Office

# United States of America

United States Patent and Trademark Office

## MAKE IT COUNT

**Reg. No. 4,123,387**

FARRIS LONG (UNITED STATES INDIVIDUAL)  
P.O. BOX 16394

**Registered Apr. 10, 2012**

JACKSONVILLE, FL 32245

**Int. Cls.: 16, 21 and 25**

FOR: BLANK WRITING JOURNALS; BUMPER STICKERS; CALENDARS; DAY PLANNERS,  
IN CLASS 16 (U.S. CLS. 2, 5, 22, 23, 29, 37, 38 AND 50).

**TRADEMARK**

FIRST USE 3-18-2007; IN COMMERCE 3-18-2007.

**PRINCIPAL REGISTER**

FOR: CUPS, IN CLASS 21 (U.S. CLS. 2, 13, 23, 29, 30, 33, 40 AND 50).

FIRST USE 3-18-2007; IN COMMERCE 3-18-2007.

FOR: HATS; PANTS; SHIRTS; WRIST BANDS, IN CLASS 25 (U.S. CLS. 22 AND 39).

FIRST USE 3-18-2007; IN COMMERCE 3-18-2007.

THE MARK CONSISTS OF STANDARD CHARACTERS WITHOUT CLAIM TO ANY PAR-  
TICULAR FONT, STYLE, SIZE, OR COLOR.

SER. NO. 77-543,287, FILED 8-10-2008.

CHARLOTTE CORWIN, EXAMINING ATTORNEY



*David J. Kybas*

Director of the United States Patent and Trademark Office

# United States of America

United States Patent and Trademark Office

## \$TAKE YOUR CLAIM

**Reg. No. 4,123,388**

**Registered Apr. 10, 2012**

**Int. Cl.: 9**

**TRADEMARK**

**PRINCIPAL REGISTER**

SPIELO INTERNATIONAL CANADA ULC (CANADA CORPORATION)  
328 URQUHART AVENUE  
MONCTON, NEW BRUNSWICK, CANADA E1H 2R6

FOR: COMPUTER GAME SOFTWARE FOR GAMING MACHINES, NAMELY, SLOT MACHINES AND VIDEO LOTTERY TERMINALS; GAMING MACHINES, NAMELY, SLOT MACHINES AND VIDEO LOTTERY TERMINALS, IN CLASS 9 (U.S. CLS. 21, 23, 26, 36 AND 38).

THE MARK CONSISTS OF STANDARD CHARACTERS WITHOUT CLAIM TO ANY PARTICULAR FONT, STYLE, SIZE, OR COLOR.

PRIORITY CLAIMED UNDER SEC. 44(D) ON CANADA APPLICATION NO. 1407707, FILED 8-8-2008, REG. NO. TMA801955, DATED 7-12-2011, EXPIRES 7-12-2026.

SER. NO. 77-563,433, FILED 9-5-2008.

COLLEEN KEARNEY, EXAMINING ATTORNEY



*David J. Kyros*

Director of the United States Patent and Trademark Office

# United States of America

United States Patent and Trademark Office

# COREUPT.com

**Reg. No. 4,123,389**

**Registered Apr. 10, 2012**

**Int. Cl.: 28**

**TRADEMARK**

**PRINCIPAL REGISTER**

CHICHERIT & LUTZ INVESTISSEMENTS (FRANCE SOCIÉTÉ PAR ACTIONS SIMPLIFIÉE (SAS))  
N 1 LE PONTET  
TIGNES, FRANCE 73320

FOR: SURFBOARDS, SNOW AND WATER SKIS, SNOW BOARDS, SKI AND SURF BINDINGS, SKI STICKS, ICE SKATES, SNOW SLEDS FOR RECREATIONAL USE, BOB SLEIGHS, SNOW SHOES, SKI COVERS AND SURFBOARDS, ELBOW GUARDS, KNEE GUARDS, SHIN GUARDS, WRIST GUARDS, ALL FOR ATHLETIC USE; SPORTS ARTICLES, NAMELY, SKATE BOARDS; BODY PROTECTION ARTICLES, NAMELY, CHEST GUARDS, SHOULDER PADS, BACK GUARDS ALL FOR ATHLETIC USE; FACE MASKS FOR PRACTICING SPORTS, NAMELY, FOR SKIING AND SNOWBOARDING, IN CLASS 28 (U.S. CLS. 22, 23, 38 AND 50).

THE MARK CONSISTS OF STANDARD CHARACTERS WITHOUT CLAIM TO ANY PARTICULAR FONT, STYLE, SIZE, OR COLOR.

PRIORITY CLAIMED UNDER SEC. 44(D) ON FRANCE APPLICATION NO. 083565588, FILED 3-28-2008, REG. NO. 083565588, DATED 3-28-2008, EXPIRES 3-27-2018.

SER. NO. 77-580,898, FILED 9-29-2008.

ELLEN PERKINS, EXAMINING ATTORNEY



*David J. Kyffers*

Director of the United States Patent and Trademark Office

# United States of America

United States Patent and Trademark Office

# SleepEase

**Reg. No. 4,123,390**

EIGHT AND COMPANY, LLC (NEW JERSEY LIMITED LIABILITY COMPANY)  
P.O. BOX 6558

**Registered Apr. 10, 2012**

FAIR HAVEN, NJ 07704

**Int. Cl.: 5**

FOR: HOMEOPATHIC PREPARATIONS IN THE NATURE OF AN ORAL SPRAY FOR THE TREATMENT OF INSOMNIA AND SYMPTOMS OF INSOMNIA SUCH AS WAKEFULNESS, RESTLESSNESS, CAFFEINE SENSITIVITY, EMOTIONAL STRESS AND ANXIETY, IN CLASS 5 (U.S. CLS. 6, 18, 44, 46, 51 AND 52).

**TRADEMARK**

**PRINCIPAL REGISTER**

FIRST USE 12-31-2001; IN COMMERCE 12-31-2001.

THE MARK CONSISTS OF STANDARD CHARACTERS WITHOUT CLAIM TO ANY PARTICULAR FONT, STYLE, SIZE, OR COLOR.

SER. NO. 77-587,309, FILED 10-7-2008.

JENNIFER WILLISTON, EXAMINING ATTORNEY



*David J. Kybas*

Director of the United States Patent and Trademark Office

# United States of America

United States Patent and Trademark Office

# GET STOKED

**Reg. No. 4,123,391**

**Registered Apr. 10, 2012**

**Int. Cls.: 39 and 41**

**SERVICE MARK**

**PRINCIPAL REGISTER**

CAMP OF CHAMPIONS INC. (CANADA CORPORATION)  
8629 DRIFTER WAY  
WHISTLER, CANADA V0N1B8

FOR: TRAVEL GUIDE AND TOUR GUIDE SERVICES, IN CLASS 39 (U.S. CLS. 100 AND 105).

FOR: OPERATION OF AN OUTDOOR RECREATIONAL SPORT CAMP; INSTRUCTION IN THE FIELD OF SNOWBOARDING, SKIING, MOUNTAIN BIKING, BMX BIKING, SURFING, KITE SURFING, WIND SURFING AND SKATEBOARDING, IN CLASS 41 (U.S. CLS. 100, 101 AND 107).

THE MARK CONSISTS OF STANDARD CHARACTERS WITHOUT CLAIM TO ANY PARTICULAR FONT, STYLE, SIZE, OR COLOR.

PRIORITY CLAIMED UNDER SEC. 44(D) ON CANADA APPLICATION NO. 1,418,378, FILED 11-14-2008, REG. NO. TMA812,210, DATED 11-21-2011, EXPIRES 11-21-2026.

SER. NO. 77-625,057, FILED 12-2-2008.

JESSICA A. POWERS, EXAMINING ATTORNEY



*David J. Kyros*

Director of the United States Patent and Trademark Office

# United States of America

United States Patent and Trademark Office

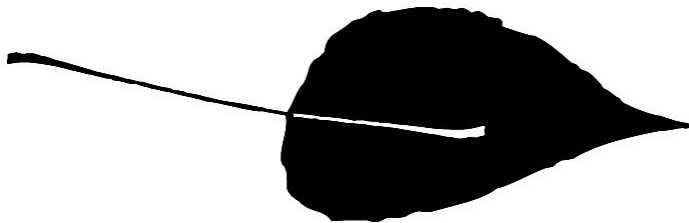

destinationearth

**Reg. No. 4,123,392**

**Registered Apr. 10, 2012**

**Int. Cl.: 35**

**SERVICE MARK**

**PRINCIPAL REGISTER**

DESTINATION HOTELS AND RESORTS, INC. (CALIFORNIA CORPORATION)  
11777 SAN VICENTE BLVD., SUITE 900  
LOS ANGELES, CA 90049

FOR: ADVERTISING AND PROMOTING ECO-FRIENDLY HOTELS AND RESORTS; ADVERTISING AND PROMOTING HOTEL AND RESORT ENVIRONMENTAL INITIATIVES WHICH DECREASE ENERGY AND WATER USAGE, REDUCE WASTE, AND INCREASE RECYCLING; PROVIDING CONSUMER INFORMATION ON THE NEED FOR ECO-FRIENDLY AND ENVIRONMENTALLY SUSTAINABLE PRACTICES IN THE FIELD OF HOTEL AND RESORT OPERATIONS; ENERGY USAGE MANAGEMENT, IN CLASS 35 (U.S. CLS. 100, 101 AND 102).

FIRST USE 1-1-2008; IN COMMERCE 1-1-2008.

THE MARK CONSISTS OF A LEAF DESIGN WITH THE WORDS "DESTINATIONEARTH" BELOW THE LEAF DESIGN.

SER. NO. 77-631,733, FILED 12-12-2008.

INGA ERVIN, EXAMINING ATTORNEY



*David J. Kyffers*

Director of the United States Patent and Trademark Office



# United States of America

United States Patent and Trademark Office

## FISH ' EM ALL

**Reg. No. 4,123,393**

**Registered Apr. 10, 2012**

**Int. Cl.: 9**

**TRADEMARK**

**PRINCIPAL REGISTER**

ABYLIGHT, S.L. (SPAIN CORPORATION)  
AV. MERIDIANA 308 ENT 2 K55  
BARCELONA, SPAIN 08027

FOR: COMPUTER GAME CARTRIDGES; COMPUTER GAME CASSETTES; COMPUTER GAME DISCS; AND COMPUTER GAME PROGRAMS, IN CLASS 9 (U.S. CLS. 21, 23, 26, 36 AND 38).

THE MARK CONSISTS OF STANDARD CHARACTERS WITHOUT CLAIM TO ANY PARTICULAR FONT, STYLE, SIZE, OR COLOR.

PRIORITY CLAIMED UNDER SEC. 44(D) ON ERPN CMNTY TM OFC APPLICATION NO. 7528987, FILED 1-16-2009, REG. NO. 007528987, DATED 8-20-2009, EXPIRES 1-16-2019.

SER. NO. 77-652,332, FILED 1-20-2009.

REGINA DRUMMOND, EXAMINING ATTORNEY



*David J. Kybas*

Director of the United States Patent and Trademark Office

# United States of America

United States Patent and Trademark Office

# CHIA +

**Reg. No. 4,123,394**

**Registered Apr. 10, 2012**

**Int. Cl.: 5**

**TRADEMARK**

**PRINCIPAL REGISTER**

WALTER, JEFF (UNITED STATES INDIVIDUAL)  
SUITE A-3  
1300 SEAWAY DRIVE  
FORT PIERCE, FL 34949

FOR: DIETARY DRINK MIX FOR USE AS A MEAL REPLACEMENT; DIETARY SUPPLEMENTAL DRINKS; MEAL REPLACEMENT AND DIETARY SUPPLEMENT DRINK MIXES; MEAL REPLACEMENT BARS; MEAL REPLACEMENT POWDERS; MEAL REPLACEMENT SHAKES; MEAL REPLACEMENT SNACKS; NUTRITIONAL DRINK MIX FOR USE AS A MEAL REPLACEMENT; NUTRITIONAL ENERGY BARS FOR USE AS A MEAL SUBSTITUTE; NUTRITIONAL SHAKES FOR USE AS A MEAL SUBSTITUTE; POWDERED NUTRITIONAL SUPPLEMENT DRINK MIX THAT ALL USE EITHER PLANT SEEDS OR PLANT SEED OIL IN THEM, ALL OF THE AFORESAID GOODS FEATURING CHIA AS AN INGREDIENT, IN CLASS 5 (U.S. CLS. 6, 18, 44, 46, 51 AND 52).

FIRST USE 2-29-2008; IN COMMERCE 2-29-2008.

THE MARK CONSISTS OF STANDARD CHARACTERS WITHOUT CLAIM TO ANY PARTICULAR FONT, STYLE, SIZE, OR COLOR.

NO CLAIM IS MADE TO THE EXCLUSIVE RIGHT TO USE "CHIA", APART FROM THE MARK AS SHOWN.

SER. NO. 77-660,252, FILED 1-30-2009.

MARTHA FROMM, EXAMINING ATTORNEY



*David J. Kyros*

Director of the United States Patent and Trademark Office

# United States of America

United States Patent and Trademark Office

# ALCOLOCK

**Reg. No. 4,123,395**

**Registered Apr. 10, 2012**

**Int. Cls.: 9 and 10**

**TRADEMARK**

**PRINCIPAL REGISTER**

ALCOHOL COUNTERMEASURE SYSTEMS (INTERNATIONAL) INC. (CANADA CORPORATION)  
60 INTERNATIONAL BOULEVARD  
TORONTO, ONTARIO, CANADA M9W 6J2

FOR: BREATH ALCOHOL IGNITION INTERLOCK DEVICES FOR DISABLING A VEHICLE IN RESPONSE TO A DETECTION OF ALCOHOL IN THE BLOOD OF ITS PURPORTED OPERATOR, NAMELY, ELECTRONIC BREATH-ACTIVATED IGNITION LOCKS; VEHICLE IMMOBILIZERS IN THE NATURE OF ELECTRONIC AUTOMOTIVE IGNITION LOCKS INCORPORATING BREATH ALCOHOL TESTERS THAT ENGAGE IN RESPONSE TO A MEASUREMENT OF ALCOHOL IN EXCESS OF A SAFETY THRESHOLD IN THE BLOOD OF ITS PURPORTED OPERATOR, IN CLASS 9 (U.S. CLS. 21, 23, 26, 36 AND 38).

FIRST USE 0-0-2004; IN COMMERCE 0-0-2004.

FOR: ALCOHOL BREATH TESTING UNITS, IN CLASS 10 (U.S. CLS. 26, 39 AND 44).

FIRST USE 0-0-2004; IN COMMERCE 0-0-2004.

THE MARK CONSISTS OF STANDARD CHARACTERS WITHOUT CLAIM TO ANY PARTICULAR FONT, STYLE, SIZE, OR COLOR.

OWNER OF CANADA REG. NO. TMA781331, DATED 11-2-2010, EXPIRES 11-2-2025.

SER. NO. 77-662,323, FILED 2-3-2009.

KATHERINE CHANG, EXAMINING ATTORNEY



*David J. Kybas*

Director of the United States Patent and Trademark Office

# United States of America

United States Patent and Trademark Office

# LYSANDA

**Reg. No. 4,123,396**

**Registered Apr. 10, 2012**

**Int. Cls.: 9 and 42**

**TRADEMARK**

**SERVICE MARK**

**PRINCIPAL REGISTER**

LYSANDA LIMITED (UNITED KINGDOM COMPANY)  
BRAXTED PARK ESTATE  
SUITE 3 - THE COURTYARD  
WITHAM, ESSEX, UNITED KINGDOM CM83GA

FOR: EQUIPMENT FOR ENGINE MANAGEMENT, CONTROL AND DIAGNOSIS, NAMELY, ENGINE MANAGEMENT, CONTROL AND DIAGNOSTIC SOFTWARE; DEVICES COMPRISED OF SENSORS AND COMPUTER SOFTWARE FOR MEASURING, CONTROLLING AND DISPLAYING FUEL CONSUMPTION OR DISPLAYING THE PRODUCTS OF COMBUSTION, ALL FOR LAND VEHICLES, IN CLASS 9 (U.S. CLS. 21, 23, 26, 36 AND 38).

FOR: SERVICES AND SOFTWARE ENGINEERING FOR EVALUATING, ESTIMATING, MEASURING AND RESEARCH INTO FUEL CONSUMPTION AND THE ANALYSIS, PREDICTION, AND MEASUREMENT OF COMBUSTION PRODUCTS FOR VEHICLE ENGINES; CONSULTING AND TECHNICAL SERVICES RELATING TO FUEL CONSUMPTION, COMBUSTION, AND EXHAUST GASES; DESIGN AND DEVELOPMENT OF COMPUTER PROGRAMS AND SOFTWARE RELATING TO COMBUSTION, EXHAUST GAS ANALYSIS AND PREDICTION AND FUEL ECONOMY FOR VEHICLE ENGINES AND RELATED ENGINE MANAGEMENT EQUIPMENT, IN CLASS 42 (U.S. CLS. 100 AND 101).

THE MARK CONSISTS OF STANDARD CHARACTERS WITHOUT CLAIM TO ANY PARTICULAR FONT, STYLE, SIZE, OR COLOR.

OWNER OF ERPN CMNTY TM OFC REG. NO. 005595228, DATED 4-17-2008, EXPIRES 1-3-2017.

SER. NO. 77-664,014, FILED 2-5-2009.

KELLEY WELLS, EXAMINING ATTORNEY



*David J. Kyffers*

Director of the United States Patent and Trademark Office

# United States of America

United States Patent and Trademark Office

## Fielder'sChoice

**Reg. No. 4,123,397**

EASTBAY, INC. (WISCONSIN CORPORATION)

**Registered Apr. 10, 2012**

111 S. FIRST AVENUE  
WAUSAU, WI 54402

**Int. Cl.: 35**

FOR: CATALOG ORDERING SERVICE FEATURING SPORTING GOODS, NAMELY, BASEBALL APPAREL, FOOTWEAR, BATS AND EQUIPMENT; ELECTRONIC CATALOG SERVICES FEATURING SPORTING GOODS, NAMELY, BASEBALL APPAREL, FOOTWEAR, BATS AND EQUIPMENT; MAIL ORDER CATALOG SERVICES FEATURING SPORTING GOODS, NAMELY, BASEBALL APPAREL, FOOTWEAR, BATS AND EQUIPMENT; ON-LINE ORDERING SERVICES FEATURING SPORTING GOODS, NAMELY, BASEBALL APPAREL, FOOTWEAR, BATS AND EQUIPMENT, IN CLASS 35 (U.S. CLS. 100, 101 AND 102).

**SERVICE MARK**

**PRINCIPAL REGISTER**

FIRST USE 1-1-1997; IN COMMERCE 1-1-1997.

THE MARK CONSISTS OF STANDARD CHARACTERS WITHOUT CLAIM TO ANY PARTICULAR FONT, STYLE, SIZE, OR COLOR.

SER. NO. 77-665,178, FILED 2-6-2009.

BRIAN NEVILLE, EXAMINING ATTORNEY



*David J. Kypos*

Director of the United States Patent and Trademark Office

# United States of America

United States Patent and Trademark Office



sea change  
S W I M W E A R

**Reg. No. 4,123,398**

**Registered Apr. 10, 2012**

**Int. Cl.: 35**

**SERVICE MARK**

**PRINCIPAL REGISTER**

MANUFACTURE DE LINGERIE CHÂTEAU INC./CHÂTEAU LINGERIE MFG INC. (CANADA CORPORATION)  
215 ST-ZOTIQUE WEST  
MONTREAL, CANADA H2V1A2

FOR: EXPORT AND IMPORT AGENCY FEATURING ARTICLES OF CLOTHING, BEACHWEAR AND SWIMWEAR; WHOLESALE DISTRIBUTORSHIP IN THE FIELD OF CLOTHING, BEACHWEAR AND SWIMWEAR, IN CLASS 35 (U.S. CLS. 100, 101 AND 102).

FIRST USE 7-31-2008; IN COMMERCE 12-31-2008.

NO CLAIM IS MADE TO THE EXCLUSIVE RIGHT TO USE "SWIMWEAR", APART FROM THE MARK AS SHOWN.

THE MARK CONSISTS OF A STYLIZED "S" IN A CIRCLE AND THE TERMS "SEA CHANGE SWIMWEAR".

SER. NO. 77-669,819, FILED 2-13-2009.

JOHN KELLY, EXAMINING ATTORNEY

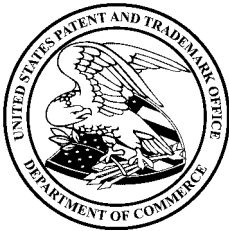

*David J. Kyffers*

Director of the United States Patent and Trademark Office

# United States of America

United States Patent and Trademark Office

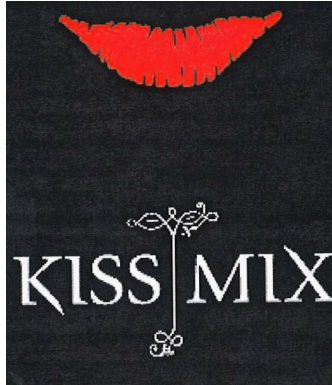

**Reg. No. 4,123,399**

**Registered Apr. 10, 2012**

**Int. Cl.: 33**

**TRADEMARK**

**PRINCIPAL REGISTER**

CHARVET NIGERIA LIMITED (NIGERIA LIMITED LIABILITY CORPORATION)  
OSHODI-APAPA EXPRESSWAY  
PLOT 7 BLOCK H, OSHODI INDUSTRIAL ESTATE  
LAGOS, NIGERIA

FOR: ALCOHOLIC BEVERAGES EXCEPT BEERS; ALCOHOLIC BEVERAGES, NAMELY, ALCOHOLIC DRINKS MIXED WITH FRUIT JUICES AND TONIC WATER, IN CLASS 33 (U.S. CLS. 47 AND 49).

OWNER OF NIGERIA REG. NO. 89864, DATED 6-15-2007, EXPIRES 6-15-2014.

THE COLOR(S) BLACK, RED AND WHITE IS/ARE CLAIMED AS A FEATURE OF THE MARK.

NO CLAIM IS MADE TO THE EXCLUSIVE RIGHT TO USE "MIX", APART FROM THE MARK AS SHOWN.

THE MARK CONSISTS OF A BLACK RECTANGLE WITH THE WORDS "KISS MIX" WRITTEN IN WHITE, STYLIZED LETTERING WITH A FANCIFUL DESIGN BETWEEN "KISS" AND "MIX", AND RED LIPS AT THE TOP OF THE RECTANGLE ABOVE THE WORDING.

SER. NO. 77-691,220, FILED 3-14-2009.

THOMAS MANOR, EXAMINING ATTORNEY



*David J. Kyffers*

Director of the United States Patent and Trademark Office

# United States of America

United States Patent and Trademark Office

## Doodle Wear

**Reg. No. 4,123,400**

**Registered Apr. 10, 2012**

**Int. Cl.: 25**

**TRADEMARK**

**PRINCIPAL REGISTER**

GAYLA R KILBRIDE (UNITED STATES INDIVIDUAL), DBA DOODLE WEAR  
2926 2ND AVE N., APT A  
ST. PETERSBURG, FL 33713

FOR: CLOTHING, NAMELY, HATS, SHOES, SOCKS, SWEATSHIRTS, PANTS, JACKETS, BLOUSES, SKIRTS, GLOVES, INFANT WEAR, NIGHTWEAR, BEACHWEAR, TENNIS WEAR, NECK TIES, CLOTH BIBS, T-SHIRTS, SWEAT PANTS, SWEATERS, POLO SHIRTS DYED IN A SPECIFIC MANNER OF COLORFUL DYE SPLOTCHES IN THE FASHION OF CLOUDS AND PACKAGED ALONG WITH A WRITING INSTRUMENT, NAMELY, A FELT TIP MARKER FOR A PERSON TO USE TO DRAW IN THE DETAILS OF THE IMAGES THEY FIND IN THE COLORFUL DYE SPLOTCHES AND MARKETED TO ARTS AND CRAFT STORES OR THE CRAFT DEPARTMENT IN RETAIL STORES, IN CLASS 25 (U.S. CLS. 22 AND 39).

FIRST USE 6-28-2007; IN COMMERCE 6-1-2008.

THE MARK CONSISTS OF STANDARD CHARACTERS WITHOUT CLAIM TO ANY PARTICULAR FONT, STYLE, SIZE, OR COLOR.

NO CLAIM IS MADE TO THE EXCLUSIVE RIGHT TO USE "WEAR", APART FROM THE MARK AS SHOWN.

SER. NO. 77-693,279, FILED 3-17-2009.

DAVID ELTON, EXAMINING ATTORNEY



*David J. Kyffers*

Director of the United States Patent and Trademark Office



# United States of America

United States Patent and Trademark Office



American Optometric Association  
**VISION USA**  
Volunteers In Service In Our Nation

**Reg. No. 4,123,401**

**Registered Apr. 10, 2012**

**Int. Cls.: 35 and 44**

**SERVICE MARK**

**PRINCIPAL REGISTER**

THE AMERICAN OPTOMETRIC ASSOCIATION (OHIO NON-PROFIT CORPORATION),  
DBA AMERICAN OPTOMETRIC ASSOCIATION  
243 NORTH LINDBERGH BOULEVARD  
ST. LOUIS, MO 63141

FOR: ASSOCIATION SERVICES, NAMELY, PROMOTING THE INTERESTS OF VOLUNTEERS IN THE VISION CARE FIELD BY PROVIDING COORDINATION OF PUBLIC RELATIONS EFFORTS, DEVELOPING MEMBERSHIP, MARKETING PROGRAMS, AND MARKETING MATERIALS, AND ENCOURAGING SUPPORT FOR VOLUNTEERS GIVING OF THEIR TIME TO PROMOTE VISION CARE, IN CLASS 35 (U.S. CLS. 100, 101 AND 102).

FIRST USE 12-31-1998; IN COMMERCE 12-31-1998.

FOR: PROVIDING FREE EYE EXAMINATIONS TO LOW INCOME FAMILIES, IN CLASS 44 (U.S. CLS. 100 AND 101).

FIRST USE 12-31-1998; IN COMMERCE 12-31-1998.

OWNER OF U.S. REG. NOS. 1,165,018, 1,165,923, AND 2,513,076.

NO CLAIM IS MADE TO THE EXCLUSIVE RIGHT TO USE "ASSOCIATION" AND "VISION USA VOLUNTEERS IN SERVICE TO OUR NATION", APART FROM THE MARK AS SHOWN.

THE MARK CONSISTS OF A STYLIZED DRAWING OF A HUMAN EYE AND THE WORDING "AMERICAN OPTOMETRIC ASSOCIATION VISION USA VOLUNTEERS IN SERVICE IN OUR NATION".

SEC. 2(F) AS TO "AMERICAN OPTOMETRIC ASSOCIATION".

SER. NO. 77-708,962, FILED 4-7-2009.

JENNY PARK, EXAMINING ATTORNEY



*David J. Kyffers*

Director of the United States Patent and Trademark Office

# United States of America

United States Patent and Trademark Office

## DIGGER VISION

**Reg. No. 4,123,402**

TWENTIETH CENTURY FOX FILM CORPORATION (DELAWARE CORPORATION)  
10201 WEST PICO BOULEVARD  
LOS ANGELES, CA 90035

**Registered Apr. 10, 2012**

**Int. Cl.: 38**

FOR: TELEVISION BROADCASTING OF SPORTING EVENTS FEATURING AN ANIMATED CHARACTER, IN CLASS 38 (U.S. CLS. 100, 101 AND 104).

**SERVICE MARK**

FIRST USE 4-18-2009; IN COMMERCE 4-18-2009.

**PRINCIPAL REGISTER**

THE MARK CONSISTS OF STANDARD CHARACTERS WITHOUT CLAIM TO ANY PARTICULAR FONT, STYLE, SIZE, OR COLOR.

SER. NO. 77-718,934, FILED 4-21-2009.

MARY I. SPARROW, EXAMINING ATTORNEY



*David J. Kybas*

Director of the United States Patent and Trademark Office

# United States of America

United States Patent and Trademark Office

# IMPACT

**Reg. No. 4,123,403**

**Registered Apr. 10, 2012**

**Int. Cls.: 9 and 42**

**TRADEMARK**

**SERVICE MARK**

**PRINCIPAL REGISTER**

IMPACT TECHNOLOGIES GROUP, INC. (NORTH CAROLINA CORPORATION)  
SUITE 350  
10735 DAVID TAYLOR DRIVE  
CHARLOTTE, NC 28262

FOR: COMPUTER SOFTWARE FOR USE BY FINANCIAL AND INSURANCE ADVISORS AND THEIR CLIENTS, NAMELY, SOFTWARE FOR CALCULATING FINANCIAL NEEDS ANALYSES, AS WELL AS THE EFFECT OF ASSETS, INCOME, AND INVESTMENTS ON THOSE NEEDS FOR USE IN THE FIELDS OF FINANCIAL PLANNING, ESTATE PLANNING, INSURANCE PLANNING, RETIREMENT PLANNING, BUSINESS PLANNING, FINANCIAL NEEDS ANALYSIS AND BUSINESS WORKSITE MARKETING, IN CLASS 9 (U.S. CLS. 21, 23, 26, 36 AND 38).

FIRST USE 1-11-1998; IN COMMERCE 1-11-1998.

FOR: PROVIDING TEMPORARY USE OF NON-DOWNLOADABLE COMPUTER SOFTWARE FOR USE BY FINANCIAL AND INSURANCE ADVISORS AND THEIR CLIENTS, NAMELY, SOFTWARE FOR CALCULATING FINANCIAL NEEDS ANALYSES, AS WELL AS THE EFFECT OF ASSETS, INCOME, AND INVESTMENTS ON THOSE NEEDS FOR USE IN THE FIELDS OF FINANCIAL PLANNING, ESTATE PLANNING, INSURANCE PLANNING, RETIREMENT PLANNING, BUSINESS PLANNING, FINANCIAL NEEDS ANALYSIS AND BUSINESS WORKSITE MARKETING, IN CLASS 42 (U.S. CLS. 100 AND 101).

FIRST USE 1-11-1998; IN COMMERCE 1-11-1998.

THE MARK CONSISTS OF STANDARD CHARACTERS WITHOUT CLAIM TO ANY PARTICULAR FONT, STYLE, SIZE, OR COLOR.

OWNER OF U.S. REG. NOS. 1,861,263, 1,861,636, AND 2,708,464.

SER. NO. 77-719,468, FILED 4-22-2009.

JIM RINGLE, EXAMINING ATTORNEY



*David J. Kyffers*

Director of the United States Patent and Trademark Office

# United States of America

United States Patent and Trademark Office



**Reg. No. 4,123,404**

**Registered Apr. 10, 2012**

**Int. Cls.: 35 and 41**

THE ORGANIZING COMMITTEE FOR THE EXPO 2012 YEOSU KOREA (REPUBLIC OF KOREA NON-PROFIT ORGANIZATION)  
4F., HYUNDAI BUILDING  
140-2, KYE-DONG, JONGNO-GU  
SEOUL, REPUBLIC OF KOREA

**SERVICE MARK**

**PRINCIPAL REGISTER**

FOR: ADVERTISING OF PUBLISHED TEXTS; ADVERTISEMENT PLANNING; LAYOUT SERVICES FOR ADVERTISING PURPOSES; PROVIDING ADVERTISING SPACE ON BILLBOARDS; ADVERTISING BY WIRELESS COMMUNICATION; ORGANIZATION OF TRADE FAIRS FOR COMMERCIAL OR ADVERTISING PURPOSES; ORGANIZATION OF EXHIBITIONS FOR COMMERCIAL OR ADVERTISING PURPOSES; ADVERTISING IN NEWSPAPERS; ADVERTISING VIA ELECTRONIC MEDIA AND THE INTERNET; TELEVISION ADVERTISING; BUSINESS MANAGEMENT OF EXHIBITION HOSTING, IN CLASS 35 (U.S. CLS. 100, 101 AND 102).

FOR: STAGE DIRECTION; PERFORMANCES BY A LIVE MUSICAL BAND; ORGANIZATION OF FAIRS FOR CULTURE, ART OR ENTERTAINMENT PURPOSES; PUBLICATION OF TEXTS AND JOURNALS; ORGANIZATION OF EXHIBITIONS FOR CULTURAL OR EDUCATIONAL PURPOSES; ARRANGING AND CONDUCTING OF SEMINARS IN THE FIELD OF STAGE DIRECTION; ART EXHIBITIONS; ARRANGING AND CONDUCTING OF TRAINING WORKSHOPS IN THE FIELD OF STAGE DIRECTION; ORGANIZATION OF ENTERTAINMENT EXHIBITIONS; ORGANIZATION AND ARRANGEMENT OF CULTURAL EVENTS FOR OTHERS, IN CLASS 41 (U.S. CLS. 100, 101 AND 107).

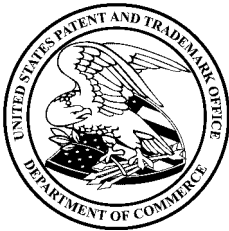

PRIORITY CLAIMED UNDER SEC. 44(D) ON REPUBLIC OF KOREA APPLICATION NO. 2009-0005285, FILED 3-16-2009, REG. NO. 0200681, DATED 9-2-2010, EXPIRES 9-2-2020.

THE COLOR(S) RED, ORANGE, LIGHT BLUE, DARK BLUE, GREEN, PINK, WHITE, AND BLACK IS/ARE CLAIMED AS A FEATURE OF THE MARK.

THE NON-LATIN CHARACTERS IN THE MARK TRANSLITERATE TO "YEONIYASUNI" AND THIS MEANS "YEONI AND SUNI" IN ENGLISH.

*David J. Kypos*

PRIORITY CLAIMED UNDER SEC. 44(D) ON REPUBLIC OF KOREA APPLICATION NO. 2009-0004747, FILED 3-9-2009, REG. NO. 0198117, DATED 6-18-2010, EXPIRES 6-18-2020.

**Reg. No. 4,123,404** THE MARK CONSISTS OF TWO CARTOON CHARACTERS WITH KOREAN CHARACTERS BENEATH (THE TRANSLITERATION OF WHICH IS "YEONIYASUNI", WHICH CAN BE TRANSLATED TO MEAN "YEONI" AND "SUNI"). ONE CHARACTER HAS A LIGHT BLUE AND DARK BLUE BODY WITH A WHITE FACE, PINK CHEEKS, BLACK AND WHITE EYES, A RED MOUTH, PINK TONGUE, AND A LIGHT BLUE AND GREEN STRIPED TAIL. THE OTHER CHARACTER HAS A RED AND ORANGE BODY WITH A WHITE FACE, PINK CHEEKS, BLACK AND WHITE EYES, A RED MOUTH, PINK TONGUE, AND TWO ORANGE AND GREEN STRIPED TAILS. THE KOREAN CHARACTER FOR "YEONI" IS LIGHT AND DARK BLUE. THE KOREAN CHARACTER FOR "AND" IS BLACK. THE KOREAN CHARACTER FOR "SUNI" IS RED AND ORANGE. THERE IS A SMALL ORANGE FISH TO THE RIGHT OF THE KOREAN CHARACTER FOR "SUNI".

SER. NO. 77-730,976, FILED 5-6-2009.

JENNIFER VASQUEZ, EXAMINING ATTORNEY

# United States of America

United States Patent and Trademark Office



**Reg. No. 4,123,405**

**Registered Apr. 10, 2012**

**Int. Cl.: 5**

**TRADEMARK**

**PRINCIPAL REGISTER**

VALEANT PHARMACEUTICALS INTERNATIONAL (DELAWARE CORPORATION)  
LEGAL DEPT.  
1 ENTERPRISE  
ALISO VIEJO, CA 92656

FOR: HOUSE MARK FOR PHARMACEUTICAL PREPARATIONS FOR USE IN DERMATOLOGY, NEUROLOGY, ONCOLOGY, PAIN RELIEF AND PSYCHIATRIC DISORDERS , IN CLASS 5 (U.S. CLS. 6, 18, 44, 46, 51 AND 52).

FIRST USE 9-0-2004; IN COMMERCE 9-0-2004.

OWNER OF U.S. REG. NOS. 3,437,512, 3,446,413 AND OTHERS.

THE MARK CONSISTS OF TWO RECTANGLES FORMING A "V" AND THE TERM "VALEANT".

SER. NO. 77-753,614, FILED 6-5-2009.

CAROL SPILS, EXAMINING ATTORNEY



*David J. Kyros*

Director of the United States Patent and Trademark Office

# United States of America

United States Patent and Trademark Office

# Eco Trust

**Reg. No. 4,123,406**

LG ELECTRONICS INC. (REPUBLIC OF KOREA CORPORATION)  
20, YOIDO-DONG, YONGDUNGPO-GU  
SEOUL, REPUBLIC OF KOREA

**Registered Apr. 10, 2012**

**Int. Cls.: 7, 9, 10, 11 and 35**

FOR: ELECTRIC CLOTHES WASHING MACHINES FOR INDUSTRIAL PURPOSES; ELECTRIC CLOTHES WASHING MACHINES FOR HOUSEHOLD USE; AUTOMATIC DISHWASHERS; STEAM VACUUM CLEANERS; ROBOT VACUUM CLEANERS; ROBOT VACUUM CLEANERS, NAMELY, VACUUM CLEANERS FEATURING ARTIFICIAL INTELLIGENCE; PORTABLE VACUUM CLEANERS; PORTABLE VACUUM CLEANERS FOR AUTOMOBILE; STICK-TYPE VACUUM IN CLEANERS; INDUSTRIAL VACUUM CLEANERS, IN CLASS 7 (U.S. CLS. 13, 19, 21, 23, 31, 34 AND 35).

**TRADEMARK**

**SERVICE MARK**

**PRINCIPAL REGISTER**

FOR: TELEPHONE SETS; WIRELESS TELEPHONE SETS; PORTABLE COMMUNICATIONS APPARATUS, NAMELY, TELEPHONE HANDSETS, WALKIE-TALKIES, SATELLITE TELEPHONES AND PERSONAL DIGITAL ASSISTANTS; MOBILE PHONES; MP3 PLAYERS; TELEVISION RECEIVERS; UNIVERSAL SERIAL BUS HARDWARE DRIVES; DIGITAL MEDIA BROADCASTING (DMB) PLAYERS, NAMELY, DIGITAL AUDIO PLAYERS; HEADSETS FOR MOBILE PHONES; PORTABLE BATTERY CHARGERS; COMPUTER MONITORS; LAPTOP COMPUTERS; COMPUTERS; DIGITAL VERSATILE DISC PLAYERS; PORTABLE HARD DISK DRIVES; APPARATUS FOR RECORDING, TRANSMISSION OR REPRODUCTION OF SOUND OR IMAGES FOR USE IN TELECOMMUNICATION; APPARATUS FOR RECORDING, TRANSMISSION OR REPRODUCTION OF SOUND OR IMAGES; COMPUTER APPLICATION SOFTWARE FOR MOBILE PHONE; DIGITAL VERSATILE DISC PLAYERS FOR HOME THEATERS; AUDIO SPEAKERS FOR HOME THEATERS; AUDIO-VIDEO RECEIVERS FOR HOME THEATERS; PROJECTORS FOR HOME THEATERS, NAMELY, VIDEO AND MOVIE PROJECTORS; INTEGRATED CIRCUITS, IN CLASS 9 (U.S. CLS. 21, 23, 26, 36 AND 38).

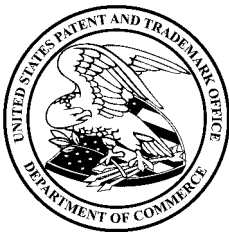

FOR: ELECTRIC MASSAGE APPARATUS FOR HOUSEHOLD USE, IN CLASS 10 (U.S. CLS. 26, 39 AND 44).

FOR: ELECTRIC REFRIGERATORS; REFRIGERATORS FOR KIMCHI; ELECTRIC COOKING OVENS, NAMELY, LIGHT WAVE OVENS; APPLIANCES FOR DOMESTIC USE, NAMELY, TEMPERATURE CONTROLLED ELECTRIC WINE CELLARS; ELECTRIC COOKING OVENS; ELECTRIC FREEZERS; ELECTRIC CLOTHES DRYERS; GAS RANGES; MICROWAVE OVENS; GAS COOK TOPS; ELECTRIC RANGES FOR HOUSEHOLD USE; AIR PURIFIERS;

*David J. Kyjars*

Director of the United States Patent and Trademark Office

**Reg. No. 4,123,406** AIR CONDITIONERS; HOT AIR SPACE HEATING APPARATUS; HUMIDIFIERS; ELECTRIC DEHUMIDIFIER FOR HOUSEHOLD USE, IN CLASS 11 (U.S. CLS. 13, 21, 23, 31 AND 34).

FOR: ADVERTISING SERVICES, NAMELY, ADVERTISEMENT PLANNING; ADVERTISING AGENCIES; DEMONSTRATION OF PRODUCTS; MARKET OPINION POLLING; PUBLICITY AND SALES PROMOTION SERVICES; EMPLOYMENT AGENCIES; AUCTIONEERING; COMMERCIAL INFORMATION AGENCIES; PROCURING OF CONTRACTS FOR THE PURCHASE AND SALE OF PORTABLE COMMUNICATIONS APPARATUS; ON-LINE AUCTIONEERING SERVICES VIA COMPUTER NETWORKS; ON-LINE EMPLOYMENT AGENCIES VIA GLOBAL COMPUTER NETWORKS; PROVISION OF CONSUMER PRODUCT INFORMATION VIA GLOBAL COMPUTER NETWORK; PROVISION OF BUSINESS ADVICE AND COMMERCIAL INFORMATION VIA THE INTERNET; INTERNET ADVERTISING SERVICES, NAMELY, ARRANGEMENT AND DISSEMINATION OF ADVERTISING MATERIAL ON COMPUTER NETWORKS AND GLOBAL COMMUNICATION NETWORKS; PROVISION OF INFORMATION AND ADVICE TO CONSUMERS REGARDING THE SELECTION OF PRODUCTS AND ITEMS TO BE PURCHASED VIA GLOBAL COMPUTER NETWORK; BUSINESS MANAGEMENT; ADVERTISING SERVICES BY MEANS OF MOBILE TELEPHONES; ADVERTISING VIA ELECTRONIC MEDIA AND THE INTERNET; SALES PROMOTION FOR OTHERS VIA A COMPUTER NETWORK; PROVISION OF BUSINESS ADVICE AND COMMERCIAL INFORMATION VIA A COMPUTER NETWORK; PROVISION OF ADVERTISING INFORMATION VIA GLOBAL COMPUTER NETWORK, NAMELY, PROVIDING INFORMATION ABOUT PRODUCTS VIA TELECOMMUNICATION NETWORKS FOR ADVERTISING AND SALES PURPOSES; RENTAL OF OFFICE MACHINERY AND EQUIPMENT; BUSINESS INTERMEDIARY SERVICES IN THE FIELD OF SELLING PRODUCTS, NAMELY, INFORMATION COMMUNICATION MACHINES AND APPARATUS, COMPUTERS, OFFICE MACHINES AND EQUIPMENT, ELECTRIC TOOLS AND EQUIPMENT FOR HOUSEHOLD PURPOSES, APPARATUS FOR FOOD AND DRINK PROCESSING, PNEUMATIC OR HYDRAULIC MACHINES AND INSTRUMENTS, CHEMICAL APPARATUS AND MACHINES, TELECOMMUNICATION MACHINES AND IMPLEMENTS, ELECTRONIC MACHINES, APPARATUS AND THEIR PARTS, ELECTRIC HEATING APPARATUS AND EQUIPMENT FOR HOUSEHOLD PURPOSES, HEATING APPARATUS, REFRIGERATING MACHINES AND APPARATUS, HEATERS, DISH DISINFECTING APPARATUS; PROCURING CONTRACTS FOR THE PURCHASE AND SALE OF GOODS, NAMELY, INFORMATION COMMUNICATION MACHINES AND APPARATUS, COMPUTERS, OFFICE MACHINES AND EQUIPMENT, ELECTRIC TOOLS AND EQUIPMENT FOR HOUSEHOLD PURPOSES, APPARATUS FOR FOOD AND DRINK PROCESSING, PNEUMATIC OR HYDRAULIC MACHINES AND INSTRUMENTS, CHEMICAL APPARATUS AND MACHINES, TELECOMMUNICATION MACHINES AND IMPLEMENTS, ELECTRONIC MACHINES, APPARATUS AND THEIR PARTS, ELECTRIC HEATING APPARATUS AND EQUIPMENT FOR HOUSEHOLD PURPOSES, HEATING APPARATUS, REFRIGERATING MACHINES AND APPARATUS, HEATERS, DISH DISINFECTING APPARATUS, IN CLASS 35 (U.S. CLS. 100, 101 AND 102).

THE MARK CONSISTS OF STANDARD CHARACTERS WITHOUT CLAIM TO ANY PARTICULAR FONT, STYLE, SIZE, OR COLOR.

OWNER OF REPUBLIC OF KOREA REG. NO. 0032696, DATED 10-20-2010, EXPIRES 10-20-2020.

SER. NO. 77-756,145, FILED 6-10-2009.

HELENE LIWINSKI, EXAMINING ATTORNEY



# United States of America

United States Patent and Trademark Office



**Reg. No. 4,123,407**

**Registered Apr. 10, 2012**

**Int. Cl.: 11**

**TRADEMARK**

**PRINCIPAL REGISTER**

CULLIGAN INTERNATIONAL COMPANY (ILLINOIS CORPORATION)  
SUITE 1100  
9399 HIGGINS ROAD  
ROSEMONT, IL 60018

FOR: INDUSTRIAL-WATER PURIFYING APPARATUS; WATER PURIFYING UNITS, FOR POTABLE WATER FOR INDUSTRIAL APPLICATIONS, IN CLASS 11 (U.S. CLS. 13, 21, 23, 31 AND 34).

FIRST USE 1-1-2009; IN COMMERCE 1-1-2009.

OWNER OF U.S. REG. NOS. 683,671, 1,588,702 AND OTHERS.

THE COLOR(S) BLUE AND BLACK IS/ARE CLAIMED AS A FEATURE OF THE MARK.

THE MARK CONSISTS OF THE FOLLOWING: THE WORDING "CULLIGAN MATRIX SOLUTIONS" WITH THE TERMS "CULLIGAN" AND "SOLUTIONS" IN BLACK AND THE TERM "MATRIX" IN BLUE. A WATER DROP DESIGN IN BLUE APPEARS ABOVE AND BELOW THE LETTER "I" IN "MATRIX".

SER. NO. 77-760,932, FILED 6-16-2009.

WILLIAM P. SHANAHAN, EXAMINING ATTORNEY



*David J. Kyffers*

Director of the United States Patent and Trademark Office

# United States of America

United States Patent and Trademark Office

## CONDUCTOR SEARCHLIGHT

**Reg. No. 4,123,408**

**Registered Apr. 10, 2012**

**Int. Cl.: 42**

**SERVICE MARK**

**PRINCIPAL REGISTER**

CONDUCTOR, INC. (DELAWARE CORPORATION)  
230 PARK AVE S, 12TH FLOOR  
NEW YORK, NY 10003

FOR: SEARCH ENGINE OPTIMIZATION AND INTELLIGENCE SERVICES FOR SEARCH ENGINE OPTIMIZATION PROFESSIONALS, NAMELY, RESEARCHING, TRACKING, ANALYZING, MONITORING AND OPTIMIZING SEARCH ENGINE RESULTS AND WEBSITE VISIBILITY TO IMPROVE INCLUSION AND PROMINENCE IN INTERNET SEARCH ENGINE RESULTS; PROVIDING ON-LINE SEARCH ENGINE INTELLIGENCE SOFTWARE, NAMELY, NON-DOWNLOADABLE SOFTWARE USED FOR TRACKING, ANALYZING, MONITORING, AND OPTIMIZING SEARCH ENGINE RESULTS AND WEBSITE VISIBILITY TO IMPROVE INCLUSION AND PROMINENCE IN INTERNET SEARCH ENGINE RESULTS, IN CLASS 42 (U.S. CLS. 100 AND 101).

FIRST USE 12-0-2009; IN COMMERCE 12-0-2009.

THE MARK CONSISTS OF STANDARD CHARACTERS WITHOUT CLAIM TO ANY PARTICULAR FONT, STYLE, SIZE, OR COLOR.

SER. NO. 77-763,887, FILED 6-19-2009.

JANET LEE, EXAMINING ATTORNEY



*David J. Kybas*

Director of the United States Patent and Trademark Office

# United States of America

United States Patent and Trademark Office

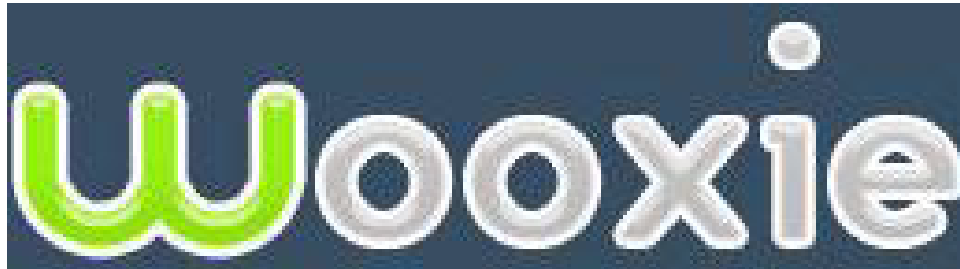

**Reg. No. 4,123,409**

JEFF KNIZE (UNITED STATES INDIVIDUAL), DBA WOOXIE  
16511 TUSCARORA COURT  
LOCKPORT, IL 60441

**Registered Apr. 10, 2012**

**Int. Cl.: 42**

FOR: COMPUTER SERVICES, NAMELY, CREATING AN ON-LINE COMMUNITY FOR REGISTERED USERS TO PARTICIPATE IN DISCUSSIONS, GET FEEDBACK FROM THEIR PEERS, FORM VIRTUAL COMMUNITIES, AND ENGAGE IN SOCIAL NETWORKING, IN CLASS 42 (U.S. CLS. 100 AND 101).

**SERVICE MARK**

**PRINCIPAL REGISTER**

FIRST USE 5-27-2009; IN COMMERCE 5-27-2009.

THE MARK CONSISTS OF THE WORD "WOOXIE". THE "W" IS GREEN AND THE LETTERS "OOXIE" ARE GREY. THE LETTERS ARE OUTLINED IN WHITE AND THE BACKGROUND IS BLUE.

THE COLOR(S) GREEN, GREY, WHITE, AND BLUE IS/ARE CLAIMED AS A FEATURE OF THE MARK.

SER. NO. 77-769,837, FILED 6-29-2009.

SHAUNIA CARLYLE, EXAMINING ATTORNEY



*David J. Kyffers*

Director of the United States Patent and Trademark Office

# United States of America

United States Patent and Trademark Office

## Freedom Federation

**Reg. No. 4,123,410**

LIBERTY COUNSEL, INC. (FLORIDA CORPORATION)  
PO BOX 540774  
ORLANDO, FL 32854

**Registered Apr. 10, 2012**

**Int. Cl.: 35**

FOR: ASSOCIATION SERVICES, NAMELY, PROMOTING THE INTERESTS OF FAITH-BASED ORGANIZATIONS DEDICATED TO PRESERVING FREEDOM AND PROMOTING JUSTICE, IN CLASS 35 (U.S. CLS. 100, 101 AND 102).

**SERVICE MARK**

FIRST USE 5-15-2009; IN COMMERCE 5-29-2009.

**PRINCIPAL REGISTER**

THE MARK CONSISTS OF STANDARD CHARACTERS WITHOUT CLAIM TO ANY PARTICULAR FONT, STYLE, SIZE, OR COLOR.

NO CLAIM IS MADE TO THE EXCLUSIVE RIGHT TO USE "FEDERATION", APART FROM THE MARK AS SHOWN.

SEC. 2(F).

SER. NO. 77-770,335, FILED 6-29-2009.

DAWN HAN, EXAMINING ATTORNEY



*David J. Kyros*

Director of the United States Patent and Trademark Office

# United States of America

United States Patent and Trademark Office



**Reg. No. 4,123,411**

**Registered Apr. 10, 2012**

**Int. Cl.: 16**

**TRADEMARK**

**PRINCIPAL REGISTER**

LUDOVICO TECHNIQUE, LLC (CALIFORNIA CORPORATION)  
817 N. LAS PALMAS AVENUE, #1  
LOS ANGELES, CA 90038 AND

RAAB, BENJAMIN (UNITED STATES INDIVIDUAL)  
4232 RHODES AVENUE  
STUDIO CITY, CA 91604 AND

HUGHES, DERIC A. (UNITED STATES INDIVIDUAL)  
4630 WORTSER AVENUE  
SHERMAN OAKS, CA 91423

FOR: ANNOUNCEMENT CARDS; BLANK CARDS; BOOK MARKERS; COLORING BOOKS; COMIC BOOKS; COMIC STRIPS; COMIC STRIPS APPEARING IN MAGAZINES, NEWSPAPERS, AND OTHER PERIODICALS; COMICS; GREETINGS CARDS AND POSTCARDS; INVITATION CARDS; MOUNTED POSTERS; NOTE CARDS; POSTERS; POSTERS MADE OF PAPER; TRADING CARD DISCS OF PAPER OR CARDBOARD; TRADING CARDS, IN CLASS 16 (U.S. CLS. 2, 5, 22, 23, 29, 37, 38 AND 50).

FIRST USE 7-22-2004; IN COMMERCE 7-22-2004.

THE MARK CONSISTS OF THE WORDS "LIVING IN INFAMY" IN A DESIGN FORMAT WHERE THE WORDS "LIVING IN" ARE IN STYLIZED FORMAT AND "INFAMY" IS IN BLOCK FORMAT.

SER. NO. 77-775,139, FILED 7-6-2009.

EUGENIA MARTIN, EXAMINING ATTORNEY



*David J. Kyffers*

Director of the United States Patent and Trademark Office

# United States of America

United States Patent and Trademark Office



**Reg. No. 4,123,412**

**Registered Apr. 10, 2012**

**Int. Cl.: 37**

**SERVICE MARK**

**PRINCIPAL REGISTER**

GREENER CAR CARE LLC (OKLAHOMA LIMITED LIABILITY COMPANY)  
2633 W. 65TH STREET  
TULSA, OK 74132

FOR: AUTOMOBILE CLEANING AND CAR WASHING, IN CLASS 37 (U.S. CLS. 100, 103 AND 106).

FIRST USE 3-1-2009; IN COMMERCE 3-1-2009.

NO CLAIM IS MADE TO THE EXCLUSIVE RIGHT TO USE "CAR WASH", APART FROM THE MARK AS SHOWN.

THE COLOR(S) BLUE, GREEN, AND GRAY IS/ARE CLAIMED AS A FEATURE OF THE MARK.

THE MARK CONSISTS OF A GEOMETRIC IMAGE CONSISTING OF 6 TEAR DROP SHAPES ARRANGED IN A CIRCULAR PATTERN WITH FIVE TEAR DROPS APPEARING IN GREEN AND THE TEAR DROP ON THE LOWER RIGHT APPEARING IN BLUE WITH THE PHRASE "GREENKLEAN" APPEARING AS ONE JOINED PHRASE BELOW AND TO THE RIGHT OF THE GEOMETRIC IMAGE, WITH THE WORD "GREEN" APPEARING IN GREEN LOWER CASE LETTERING AND THE WORD "KLEAN" APPEARING IN BLUE UPPER CASE LETTERING. THE PHRASE "CAR WASH" APPEARS AS TWO SEPARATE WORDS IN UPPER CASE GRAY LETTERING AND IS DIRECTLY BELOW THE "KLEAN" PORTION OF THE MARK.

SER. NO. 77-775,418, FILED 7-7-2009.

ERIN FALK, EXAMINING ATTORNEY



*David J. Kybas*

Director of the United States Patent and Trademark Office

# United States of America

United States Patent and Trademark Office

# FIREBRITE

**Reg. No. 4,123,413**

**Registered Apr. 10, 2012**

**Int. Cl.: 6**

**TRADEMARK**

**PRINCIPAL REGISTER**

STEEL FABRICATORS INTERNATIONAL, L.L.C. (OKLAHOMA LIMITED LIABILITY COMPANY)  
POST OFFICE BOX 270366  
OKLAHOMA CITY, OK 73137

FOR: FIREPLACE REFLECTORS, NAMELY, A METAL REFLECTIVE SHEET TO BE INSERTED IN FIREPLACES TO REFLECT LIGHT AND HEAT, IN CLASS 6 (U.S. CLS. 2, 12, 13, 14, 23, 25 AND 50).

FIRST USE 9-0-1996; IN COMMERCE 9-0-1996.

THE MARK CONSISTS OF STANDARD CHARACTERS WITHOUT CLAIM TO ANY PARTICULAR FONT, STYLE, SIZE, OR COLOR.

SER. NO. 77-781,421, FILED 7-15-2009.

JOHN GARTNER, EXAMINING ATTORNEY



*David J. Kybas*

Director of the United States Patent and Trademark Office

# United States of America

United States Patent and Trademark Office



**Reg. No. 4,123,414**

**Registered Apr. 10, 2012**

**Int. Cl.: 9**

**TRADEMARK**

**PRINCIPAL REGISTER**

PREMIER PARTNERS DISTRIBUTING INC. (FLORIDA CORPORATION), DBA PREMIER PRODUCTS WORLDWIDE  
7040 W PALMETTO PARK ROAD, SUITE 610  
BOCA RATON, FL 33433

FOR: SOLAR-POWERED BATTERY CHARGERS FOR USE WITH PORTABLE HAND-HELD ELECTRONIC DEVICES , IN CLASS 9 (U.S. CLS. 21, 23, 26, 36 AND 38).

FIRST USE 1-1-2008; IN COMMERCE 5-1-2008.

THE MARK CONSISTS OF THE WORD "JUICEBAR" WITH A RED BACKGROUND, GREEN LETTERS AND THE DOT IN "I" WHITE.

THE COLOR(S) GREEN, RED, WHITE IS/ARE CLAIMED AS A FEATURE OF THE MARK.

SER. NO. 77-789,083, FILED 7-24-2009.

PATRICIA EVANKO, EXAMINING ATTORNEY



*David J. Kybas*

Director of the United States Patent and Trademark Office



# United States of America

United States Patent and Trademark Office



**Reg. No. 4,123,415**

**Registered Apr. 10, 2012**

**Int. Cl.: 9**

**TRADEMARK**

**PRINCIPAL REGISTER**

NINTENDO OF AMERICA INC. (WASHINGTON CORPORATION)  
4600 150TH AVENUE NE  
REDMOND, WA 98052

FOR: COMPACT DISCS AND OPTICAL DISCS FEATURING ENTERTAINMENT, EDUCATIONAL AND INFORMATIONAL CONTENT, NAMELY, PUZZLES, GAMES, MUSIC; COMPUTER GAME DISCS; COMPUTER GAME MACHINES, NAMELY, COMPUTER GAME CONSOLES FOR USE WITH AN EXTERNAL DISPLAY SCREEN OR MONITOR; COMPUTER GAME PERIPHERALS AND ACCESSORIES, NAMELY, JOYSTICKS AND CONTROLLERS; COMPUTER GAME PROGRAMS; COMPUTER GAME SOFTWARE; DOWNLOADABLE MULTIMEDIA FILES, NAMELY, GAMES; INTERACTIVE ELECTRONIC VIDEO GAME EQUIPMENT, NAMELY, VIDEO GAME INTERACTIVE REMOTE CONTROL UNITS; INTERACTIVE ELECTRONIC VIDEO GAME MACHINES; INTERACTIVE ELECTRONIC GAME SOFTWARE; INTERACTIVE VIDEO GAME PROGRAMS; INTERACTIVE VIDEO GAME SOFTWARE; VIDEO GAME DISCS; VIDEO GAME MACHINES, NAMELY, VIDEO GAME CONSOLES FOR USE WITH AN EXTERNAL DISPLAY SCREEN OR MONITOR; VIDEO GAME EQUIPMENT, NAMELY, CONTROLLERS AND JOYSTICKS, WIRELESS CONTROL SYSTEMS FOR CONTROLLING AND OPERATING VIDEO GAME SYSTEMS, POWER SUPPLIES, CONNECTORS FOR INTERCONNECTING THE COMPONENTS OF VIDEO GAME SYSTEMS, STANDS AND SUPPORTS FOR VIDEO GAME SYSTEMS; VIDEO GAME PROGRAMS; VIDEO GAME SOFTWARE, IN CLASS 9 (U.S. CLS. 21, 23, 26, 36 AND 38).

FIRST USE 11-19-2006; IN COMMERCE 11-19-2006.

NO CLAIM IS MADE TO THE EXCLUSIVE RIGHT TO USE "SPORTS," "GAME INCLUDED!," "JEU INCLUS!" AND "JUEGO INCLUIDO!," APART FROM THE MARK AS SHOWN.

THE MARK CONSISTS OF A DARKER BACKGROUND IN THE OUTLINE SHAPE OF A SHIELD, ALONG THE TOP OF WHICH ARE STYLIZED FIGURES FROM THE LEFT SIDE OF THE MARK TO RIGHT OF THE MARK OF A BASEBALL BAT HITTING A BASEBALL, A BOWLING BALL HITTING A BOWLING PIN, A BOXING GLOVE, A GOLF CLUB HITTING A GOLF BALL AND A TENNIS RACQUET HITTING A TENNIS BALL. UNDERNEATH THESE IMAGES ARE THE WORDS "WII SPORTS" ON A WHITE SUB-FIELD WITHIN THE LARGER SHIELD DESIGN. UNDERNEATH THIS ARE THE WORDS "GAME INCLUDED!," "JEU INCLUS!" AND "JUEGO INCLUIDO!". AT THE BOTTOM OF THE MARK, IN A WHITE SUB-FIELD WITHIN THE LARGER SHIELD BACKGROUND, IS THE DESIGNATION "NINTENDO" ENCOMPASSED WITHIN AN OVAL BORDER.



*David J. Kybas*

Director of the United States Patent and Trademark Office

**Reg. No. 4,123,415** THE ENGLISH TRANSLATION OF "JEU INCLUS!" AND "JUEGO INCLUIDO!" IN THE MARK IS "GAME INCLUDED".

SER. NO. 77-794,207, FILED 7-31-2009.

SUSAN STIGLITZ, EXAMINING ATTORNEY

# United States of America

United States Patent and Trademark Office

## SYMS TAILORED & TUX

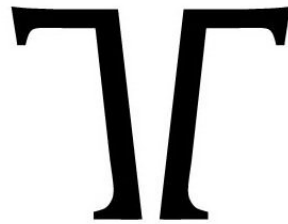

**Reg. No. 4,123,416**

FILENE'S BASEMENT, LLC (DELAWARE LIMITED LIABILITY COMPANY)  
ONE SYMS WAY  
SEACAUCUS, NJ 07094

**Registered Apr. 10, 2012**

**Int. Cl.: 35**

FOR: RETAIL STORE SERVICES FEATURING CLOTHING, IN CLASS 35 (U.S. CLS. 100, 101 AND 102).

**SERVICE MARK**

FIRST USE 5-15-2009; IN COMMERCE 5-15-2009.

**PRINCIPAL REGISTER**

OWNER OF U.S. REG. NOS. 1,047,869, 3,380,818 AND OTHERS.

NO CLAIM IS MADE TO THE EXCLUSIVE RIGHT TO USE "TAILORED & TUX", APART FROM THE MARK AS SHOWN.

THE MARK CONSISTS OF THE WORDS "SYMS TAILORED & TUX" ABOVE A GRAPHIC REPRESENTATION OF THE LETTER "T".

SER. NO. 77-806,802, FILED 8-18-2009.

SUE LAWRENCE, EXAMINING ATTORNEY

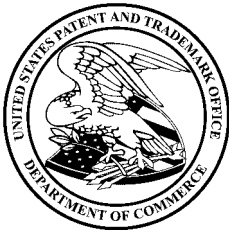

*David J. Kybas*

Director of the United States Patent and Trademark Office

# United States of America

United States Patent and Trademark Office

## INKJET FLEX

**Reg. No. 4,123,417**

**Registered Apr. 10, 2012**

**Int. Cls.: 9 and 40**

**TRADEMARK**

**SERVICE MARK**

**PRINCIPAL REGISTER**

CONDUCTIVE INKJET TECHNOLOGY LIMITED (UNITED KINGDOM LIMITED COMPANY  
(LTD.))  
SPRINGSTONE HOUSE, 27 DEWSBURY ROAD  
OSSETT, UNITED KINGDOM WF59WS

FOR: ELECTRONIC APPARATUS AND COMPONENTS, NAMELY, COMPUTER HARDWARE, ELECTRONIC CIRCUITS, COMPUTER CHIPS, MICROPROCESSORS, TRANSISTORS, DIODES, LIGHT EMITTING DIODES, AND PHOTOVOLTAIC CELLS; ELECTRONIC CIRCUIT BOARDS; PRINTED CIRCUIT BOARDS; PRINTED CIRCUITS; APPARATUS FOR DESIGN, IMPLEMENTATION AND TESTING OF ELECTRONIC COMPONENTS AND CIRCUIT BOARDS; PRINTED ELECTRONIC COMPONENTS, NAMELY, RESISTORS, CONDUCTORS, CAPACITORS, TRANSISTORS, THIN FILM TRANSISTORS, ORGANIC FIELD EFFECT RESISTORS, ORGANIC LIGHT EMITTING DIODES, AND ORGANIC PHOTOVOLTAIC CELLS; ANTENNAS; PARTS AND FITTINGS FOR THE AFORESAID GOODS, IN CLASS 9 (U.S. CLS. 21, 23, 26, 36 AND 38).

FOR: CUSTOM MANUFACTURE OF ELECTRICAL AND ELECTRONIC APPARATUS, INSTRUMENTS, COMPONENTS, CIRCUITS AND CIRCUIT BOARDS, IN CLASS 40 (U.S. CLS. 100, 103 AND 106).

THE MARK CONSISTS OF STANDARD CHARACTERS WITHOUT CLAIM TO ANY PARTICULAR FONT, STYLE, SIZE, OR COLOR.

OWNER OF ERPN CMNTY TM OFC REG. NO. 009833112, DATED 10-11-2011, EXPIRES 3-23-2021.

NO CLAIM IS MADE TO THE EXCLUSIVE RIGHT TO USE "INKJET" , APART FROM THE MARK AS SHOWN.

SER. NO. 77-814,870, FILED 8-28-2009.

TOBY BULLOFF, EXAMINING ATTORNEY



*David J. Kyffers*

Director of the United States Patent and Trademark Office

# United States of America

United States Patent and Trademark Office

# AIRTEX

**Reg. No. 4,123,418**

**Registered Apr. 10, 2012**

**Int. Cl.: 12**

**TRADEMARK**

**PRINCIPAL REGISTER**

THE YOKOHAMA RUBBER COMPANY LIMITED (JAPAN CORPORATION)  
36-11, SHIMBASHI 5-CHOME  
MINATO-KU, TOKYO, JAPAN 105-8685

FOR: AUTOMOBILE TIRES, EXCLUDING AIR SPRINGS FOR VEHICLE SUSPENSION AND FOR CUSHIONING DRIVER'S SEATS AND CABS, IN CLASS 12 (U.S. CLS. 19, 21, 23, 31, 35 AND 44).

THE MARK CONSISTS OF STANDARD CHARACTERS WITHOUT CLAIM TO ANY PARTICULAR FONT, STYLE, SIZE, OR COLOR.

OWNER OF JAPAN REG. NO. 5301881, DATED 2-12-2010, EXPIRES 2-12-2020.

SER. NO. 77-826,245, FILED 9-14-2009.

BARBARA BROWN, EXAMINING ATTORNEY



*David J. Kyros*

Director of the United States Patent and Trademark Office

# United States of America

United States Patent and Trademark Office

# green tango

**Reg. No. 4,123,419**

**Registered Apr. 10, 2012**

**Int. Cl.: 9**

**TRADEMARK**

**PRINCIPAL REGISTER**

CYPRESS VENTURE GROUP, LLC. (WASHINGTON LIMITED LIABILITY COMPANY)  
SUITE 4100  
800 FIFTH AVENUE  
SEATTLE, WA 98104

FOR: COMPUTER APPLICATION SOFTWARE FOR MOBILE PHONES, IN CLASS 9 (U.S. CLS. 21, 23, 26, 36 AND 38).

FIRST USE 5-10-2009; IN COMMERCE 9-10-2009.

THE MARK CONSISTS OF STANDARD CHARACTERS WITHOUT CLAIM TO ANY PARTICULAR FONT, STYLE, SIZE, OR COLOR.

SER. NO. 77-827,327, FILED 9-16-2009.

WILLIAM BRECKENFELD, EXAMINING ATTORNEY



*David J. Kyffers*

Director of the United States Patent and Trademark Office

# United States of America

United States Patent and Trademark Office

**CopperLan**



**Reg. No. 4,123,420**

**Registered Apr. 10, 2012**

**Int. Cl.: 9**

**TRADEMARK**

**PRINCIPAL REGISTER**

KLAVIS TECHNOLOGIES (BELGIUM CORPORATION)  
9A BD DE FRANCE  
BRAINE-L'ALLEUD, BELGIUM 1420

FOR: COMPUTER SOFTWARE FOR MANIPULATING DIGITAL AUDIO INFORMATION FOR USE IN AUDIO MEDIA APPLICATIONS; MUSIC-COMPOSITION SOFTWARE; MUSICAL INSTRUMENT ADAPTORS; MUSICAL INSTRUMENT CONNECTORS, IN CLASS 9 (U.S. CLS. 21, 23, 26, 36 AND 38).

OWNER OF BELGIUM REG. NO. 0713673, DATED 2-28-2001, RENEWED AS REG. NO. 0713673, DATED 10-19-2010, EXPIRES 2-28-2021.

THE MARK CONSISTS OF THE MARK CONSIST OF 3 SAME CIRCLES PLACED IN A TRIANGULAR FORM, THOSE CIRCLES ARE LINKED BY TWO BARS.

SER. NO. 77-828,465, FILED 9-17-2009.

LESLIE RICHARDS, EXAMINING ATTORNEY



*David J. Kybas*

Director of the United States Patent and Trademark Office

# United States of America

United States Patent and Trademark Office

## Net Tool Optimizer

**Reg. No. 4,123,421**

**Registered Apr. 10, 2012**

**Int. Cl.: 9**

**TRADEMARK**

**PRINCIPAL REGISTER**

ANUE SYSTEMS, INC. (DELAWARE CORPORATION)  
8310 N. CAPITAL OF TEXAS HWY BLDG 2-300  
AUSTIN, TX 78731

FOR: COMPUTER HARDWARE AND SOFTWARE FOR SETTING UP AND CONFIGURING WIDE AREA NETWORKS; COMPUTER NETWORKING HARDWARE; COMPUTER SOFTWARE AND HARDWARE THAT ACCEPTS BI-DIRECTIONAL NETWORK TRAFFIC, AND THEN AGGREGATES, FILTERS, AND ROUTES TO NETWORK MONITORING TOOLS USING AN ADVANCED GRAPHICAL USER INTERFACE, PROVIDING INCREASED VISIBILITY AND PERFORMANCE FOR MONITORING TOOLS, IN CLASS 9 (U.S. CLS. 21, 23, 26, 36 AND 38).

FIRST USE 4-28-2009; IN COMMERCE 4-28-2009.

THE MARK CONSISTS OF STANDARD CHARACTERS WITHOUT CLAIM TO ANY PARTICULAR FONT, STYLE, SIZE, OR COLOR.

NO CLAIM IS MADE TO THE EXCLUSIVE RIGHT TO USE "TOOL OPTIMIZER" , APART FROM THE MARK AS SHOWN.

SEC. 2(F).

SER. NO. 77-829,046, FILED 9-17-2009.

KARANENDRA S. CHHINA, EXAMINING ATTORNEY



*David J. Kybas*

Director of the United States Patent and Trademark Office



# United States of America

United States Patent and Trademark Office

## NAUGHTY BEAR

**Reg. No. 4,123,422**

**Registered Apr. 10, 2012**

**Int. Cl.: 28**

**TRADEMARK**

**PRINCIPAL REGISTER**

BEHAVIOUR INTERACTIVE INC. (CANADA CORPORATION)  
416, BOULEVARD DE MAISONNEUVE, BUREAU  
600  
MONTREAL, QC H3A 1L2, CANADA

FOR: BOARD GAMES AND TOYS, NAMELY, MECHANICAL ACTION TOYS, TOY ACTION FIGURES AND ACCESSORIES THEREOF, IN CLASS 28 (U.S. CLS. 22, 23, 38 AND 50).

THE MARK CONSISTS OF STANDARD CHARACTERS WITHOUT CLAIM TO ANY PARTICULAR FONT, STYLE, SIZE, OR COLOR.

PRIORITY CLAIMED UNDER SEC. 44(D) ON CANADA APPLICATION NO. 1451802, FILED 9-15-2009, REG. NO. TMA797,065, DATED 5-10-2011, EXPIRES 5-10-2026.

NO CLAIM IS MADE TO THE EXCLUSIVE RIGHT TO USE "BEAR", APART FROM THE MARK AS SHOWN.

SER. NO. 77-832,163, FILED 9-22-2009.

KRISTIN DAHLING, EXAMINING ATTORNEY



*David J. Kyffers*

Director of the United States Patent and Trademark Office

# United States of America

United States Patent and Trademark Office

## ASSOCIATION OF HOME APPLIANCE MANUFACTURERS

**Reg. No. 4,123,423**

**Registered Apr. 10, 2012**

**Int. Cls.: 35, 37, 41, 42  
and 45**

**SERVICE MARK**

**PRINCIPAL REGISTER**

ASSOCIATION OF HOME APPLIANCE MANUFACTURERS (ILLINOIS CORPORATION)  
SUITE 402  
1111 19TH STREET, N.W.  
WASHINGTON, DC 20036

FOR: ASSOCIATION SERVICES, NAMELY, PROMOTING THE INTERESTS OF THE HOME APPLIANCE INDUSTRY IN THE FIELD OF HOME APPLIANCES; PROVIDING A WEB SITE FEATURING CONSUMER PRODUCT INFORMATION ABOUT HOME APPLIANCES; PROVIDING A WEB SITE FEATURING STATISTICAL INFORMATION USED FOR BUSINESS PURPOSES IN THE FIELD OF HOME APPLIANCES; PROVIDING A WEB SITE FEATURING COMMERCIAL AND TRADE INFORMATION ABOUT BUSINESSES, GOVERNMENT AGENCIES, ASSOCIATIONS, AND TRADE AND BUSINESS MAGAZINES IN THE FIELD OF HOME APPLIANCES VIA HYPERLINK TEXTS TO OTHER WEB SITES, IN CLASS 35 (U.S. CLS. 100, 101 AND 102).

FIRST USE 0-0-1967; IN COMMERCE 0-0-1967.

FOR: PROVIDING A WEB SITE IN THE FIELD OF MAINTAINING HOME APPLIANCES FOR CONSUMERS, IN CLASS 37 (U.S. CLS. 100, 103 AND 106).

FIRST USE 0-0-1996; IN COMMERCE 0-0-1996.

FOR: EDUCATIONAL SERVICES, NAMELY, ORGANIZING EVENTS AND PROVIDING SEMINARS, WORKSHOPS AND CONFERENCES IN THE FIELD OF HOME APPLIANCES; ONLINE JOURNALS, NAMELY, BLOGS IN THE FIELD OF HOME APPLIANCES; PROVIDING ON-LINE NEWSLETTERS IN THE FIELDS OF HOME APPLIANCES, ONLINE MARKET RESEARCH STUDIES, ONLINE MARKET DATA ON TRENDS IN THE HOME APPLIANCE INDUSTRY, INFORMATION ON ENERGY CONSERVATION AND RECYCLING IN THE HOME APPLIANCE INDUSTRY; PROVIDING A WEBSITE FEATURING CURRENT EVENT NEWS IN THE FIELD OF HOME APPLIANCES FOR MANUFACTURERS AND CONSUMERS, IN CLASS 41 (U.S. CLS. 100, 101 AND 107).

FIRST USE 0-0-1967; IN COMMERCE 0-0-1967.

FOR: PROVIDING A WEBSITE FEATURING INFORMATION ON THE TESTING, ANALYSIS AND EVALUATION OF HOME APPLIANCE PRODUCTS FOR VERIFICATION PURPOSES; PROVIDING A WEBSITE FEATURING CONSUMER PRODUCT SAFETY INFORMATION



*David J. Kyffers*

Director of the United States Patent and Trademark Office

**Reg. No. 4,123,423** IN THE FIELD OF HOME APPLIANCES FOR MANUFACTURERS AND CONSUMERS; PROVIDING A WEBSITE FEATURING INFORMATION ON SCIENTIFIC RESEARCH REGARDING PERFORMANCE AND ENGINEERING OF HOME APPLIANCES FOR MANUFACTURERS AND CONSUMERS, IN CLASS 42 (U.S. CLS. 100 AND 101).

FIRST USE 0-0-1996; IN COMMERCE 0-0-1996.

FOR: PROVIDING A WEBSITE FEATURING INFORMATION ON REGULATORY COMPLIANCE AND TECHNICAL PERFORMANCE STANDARDS FOR HOME APPLIANCES; AND PROVIDING A WEBSITE FEATURING INFORMATION ON CONSUMER PRODUCT SAFETY INFORMATION IN THE FIELD OF HOME APPLIANCES FOR CONSUMERS, IN CLASS 45 (U.S. CLS. 100 AND 101).

FIRST USE 0-0-1996; IN COMMERCE 0-0-1996.

THE MARK CONSISTS OF STANDARD CHARACTERS WITHOUT CLAIM TO ANY PARTICULAR FONT, STYLE, SIZE, OR COLOR.

OWNER OF U.S. REG. NOS. 2,088,840 AND 3,267,022.

NO CLAIM IS MADE TO THE EXCLUSIVE RIGHT TO USE "ASSOCIATION", APART FROM THE MARK AS SHOWN.

SEC. 2(F).

SER. NO. 77-851,362, FILED 10-19-2009.

VERNA BETH RIRIE, EXAMINING ATTORNEY

# United States of America

United States Patent and Trademark Office



**Reg. No. 4,123,424**

**Registered Apr. 10, 2012**

**Int. Cls.: 35, 37, 41, 42  
and 45**

**SERVICE MARK**

**PRINCIPAL REGISTER**

ASSOCIATION OF HOME APPLIANCE MANUFACTURERS (ILLINOIS CORPORATION)  
SUITE 402  
1111 19TH STREET, N.W.  
WASHINGTON, DC 20036

FOR: ASSOCIATION SERVICES, NAMELY, PROMOTING THE INTERESTS OF THE HOME APPLIANCE INDUSTRY IN THE FIELD OF HOME APPLIANCES; PROVIDING A WEB SITE FEATURING CONSUMER PRODUCT INFORMATION ABOUT HOME APPLIANCES; PROVIDING A WEB SITE FEATURING STATISTICAL INFORMATION USED FOR BUSINESS PURPOSES IN THE FIELD OF HOME APPLIANCES; PROVIDING A WEB SITE FEATURING COMMERCIAL AND TRADE INFORMATION ABOUT BUSINESSES, GOVERNMENT AGENCIES, ASSOCIATIONS, AND TRADE AND BUSINESS MAGAZINES IN THE FIELD OF HOME APPLIANCES VIA HYPERLINK TEXTS TO OTHER WEB SITES, IN CLASS 35 (U.S. CLS. 100, 101 AND 102).

FIRST USE 9-30-2008; IN COMMERCE 9-30-2008.

FOR: PROVIDING A WEB SITE IN THE FIELD OF MAINTAINING HOME APPLIANCES FOR CONSUMERS, IN CLASS 37 (U.S. CLS. 100, 103 AND 106).

FIRST USE 0-0-1996; IN COMMERCE 0-0-1996.

FOR: EDUCATIONAL SERVICES, NAMELY, ORGANIZING EVENTS AND PROVIDING SEMINARS, WORKSHOPS AND CONFERENCES IN THE FIELD OF HOME APPLIANCES; ONLINE JOURNALS, NAMELY, BLOGS IN THE FIELD OF HOME APPLIANCES; PROVIDING ON-LINE NEWSLETTERS IN THE FIELDS OF HOME APPLIANCES, ONLINE MARKET RESEARCH STUDIES, ONLINE MARKET DATA ON TRENDS IN THE HOME APPLIANCE INDUSTRY, INFORMATION ON ENERGY CONSERVATION AND RECYCLING IN THE HOME APPLIANCE INDUSTRY; PROVIDING A WEBSITE FEATURING CURRENT EVENT NEWS IN THE FIELD OF HOME APPLIANCES FOR MANUFACTURERS AND CONSUMERS, IN CLASS 41 (U.S. CLS. 100, 101 AND 107).

FIRST USE 9-30-2008; IN COMMERCE 9-30-2008.

FOR: PROVIDING A WEBSITE FEATURING INFORMATION ON THE TESTING, ANALYSIS AND EVALUATION OF HOME APPLIANCE PRODUCTS FOR VERIFICATION PURPOSES; PROVIDING A WEBSITE FEATURING INFORMATION ON SCIENTIFIC RESEARCH RE-



*David J. Kyffers*

Director of the United States Patent and Trademark Office

**Reg. No. 4,123,424** GARDING PERFORMANCE AND ENGINEERING OF HOME APPLIANCES FOR MANUFACTURERS AND CONSUMERS, IN CLASS 42 (U.S. CLS. 100 AND 101).

FIRST USE 9-30-2008; IN COMMERCE 9-30-2008.

FOR: PROVIDING A WEBSITE FEATURING INFORMATION ON REGULATORY COMPLIANCE AND TECHNICAL PERFORMANCE STANDARDS FOR HOME APPLIANCES; AND PROVIDING A WEBSITE FEATURING INFORMATION ON CONSUMER PRODUCT SAFETY IN THE FIELD OF HOME APPLIANCES FOR MANUFACTURERS AND CONSUMERS, IN CLASS 45 (U.S. CLS. 100 AND 101).

FIRST USE 0-0-1996; IN COMMERCE 0-0-1996.

OWNER OF U.S. REG. NOS. 2,088,840 AND 3,267,022.

NO CLAIM IS MADE TO THE EXCLUSIVE RIGHT TO USE "ASSOCIATION", APART FROM THE MARK AS SHOWN.

THE MARK CONSISTS OF THE LETTERS "AHAM" AND WORDS "ASSOCIATION OF HOME APPLIANCE MANUFACTURERS" DIVIDED BY THE DRAWING OF A SHINING STAR.

SEC. 2(F) AS TO "ASSOCIATION OF HOME APPLIANCE MANUFACTURERS".

SER. NO. 77-851,379, FILED 10-19-2009.

VERNA BETH RIRIE, EXAMINING ATTORNEY

# United States of America

United States Patent and Trademark Office

# FINE LIFE

**Reg. No. 4,123,425**

GENERATION MARKETING GROUP INC (NEW YORK CORPORATION)  
101 MOONACHIE AVE  
MOONACHIE, NJ 07074

**Registered Apr. 10, 2012**

**Int. Cl.: 21**

FOR: KITCHEN UTENSILS, NAMELY, MUG HOLDER, IN CLASS 21 (U.S. CLS. 2, 13, 23, 29, 30, 33, 40 AND 50).

**TRADEMARK**

FIRST USE 2-2-2009; IN COMMERCE 2-2-2009.

**PRINCIPAL REGISTER**

THE MARK CONSISTS OF STANDARD CHARACTERS WITHOUT CLAIM TO ANY PARTICULAR FONT, STYLE, SIZE, OR COLOR.

SER. NO. 77-852,073, FILED 10-19-2009.

WILLIAM VERHOSEK, EXAMINING ATTORNEY



*David J. Kyffers*

Director of the United States Patent and Trademark Office

# United States of America

United States Patent and Trademark Office



**Reg. No. 4,123,426**

**Registered Apr. 10, 2012**

**Int. Cl.: 9**

**TRADEMARK**

**PRINCIPAL REGISTER**

LG ELECTRONICS INC. (REPUBLIC OF KOREA CORPORATION)  
20, YOIDO-DONG, YONGDUNGPO-GU  
SEOUL, REPUBLIC OF KOREA

FOR: TELEPHONE SETS; WIRELESS TELEPHONE SETS; PORTABLE COMMUNICATIONS APPARATUS, NAMELY, HANDSETS, WALKIE-TALKIES, SATELLITE TELEPHONES AND PERSONAL DIGITAL ASSISTANTS; MOBILE PHONES; MPEG AUDIO LAYER-3 PLAYERS; TELEVISION RECEIVERS; TELEVISION REMOTE CONTROLS; UNIVERSAL SERIAL BUS DRIVES; DIGITAL MEDIA BROADCASTING RECEIVERS; HEADSETS FOR MOBILE PHONES; PORTABLE CHARGERS FOR BATTERIES; ELECTRONIC ALBUMS, NAMELY, ELECTRONIC PHOTO ALBUMS FOR DISPLAYING DIGITAL PICTURES; DIGITAL PICTURE FRAMES FOR DISPLAYING DIGITAL PICTURES, VIDEO CLIPS AND MUSIC; MONITORS FOR COMPUTERS; LAPTOP COMPUTERS; COMPUTERS; DIGITAL VERSATILE DISC PLAYER; PORTABLE HARD DISK DRIVES; APPARATUS FOR RECORDING, TRANSMISSION OR REPRODUCTION OF SOUND OR IMAGES FOR USE IN TELECOMMUNICATION; APPARATUS FOR RECORDING, TRANSMISSION OR REPRODUCTION OF SOUND OR IMAGES; COMPUTER SOFTWARE FOR MOBILE PHONES, NAMELY, MOBILE PHONE OPERATING SYSTEM PROGRAMS, SOFTWARE FOR SENDING AND RECEIVING INFORMATION, SOFTWARE FOR PROVIDING WEB-BASED ACCESS TO APPLICATIONS, AND SOFTWARE FOR ALLOWING THE WEB-BASED PURCHASE OF PRODUCTS AND SERVICES; DIGITAL VERSATILE DISC PLAYERS FOR HOME THEATERS; AUDIO SPEAKERS FOR HOME THEATERS; AUDIO-VIDEO RECEIVERS FOR HOME THEATERS; MULTIMEDIA PROJECTORS FOR HOME THEATERS; INTEGRATED CIRCUITS; AUDIO RECEIVERS; ELECTRONICS TOLL COLLECTION SYSTEMS COMPRISED OF ON BOARD TRANSPONDER UNITS, ENCODED ELECTRONIC CHIP CARD AND ELECTRONIC PAYMENT TERMINAL; ELECTRONIC TERMINALS FOR ELECTRONIC TRANSACTIONS EQUIPPED IN VEHICLE; CLOSED-CIRCUIT TELEVISION CAMERAS; NETWORK MONITORING CAMERAS; ELECTRONIC DISPLAYS, NAMELY, DIGITAL SIGNAGE, IN CLASS 9 (U.S. CLS. 21, 23, 26, 36 AND 38).



OWNER OF EUROPEAN UNION REG. NO. 008643975, DATED 5-3-2010, EXPIRES 10-27-2019.

*David J. Kyjars*

THE COLOR(S) RED, BLACK, GREY AND WHITE IS/ARE CLAIMED AS A FEATURE OF THE MARK.

**Reg. No. 4,123,426** NO CLAIM IS MADE TO THE EXCLUSIVE RIGHT TO USE "SIGN" OR "DIGITAL SIGNAGE SOLUTION", APART FROM THE MARK AS SHOWN.

THE MARK CONSISTS OF FOUR SQUARES LAID OUT IN A SQUARE PATTERN. THE TOP LEFT AND BOTTOM RIGHT SQUARES ARE WHITE AND OUTLINED IN RED AND GREY. THE TOP RIGHT AND BOTTOM LEFT SQUARES ARE RED AND OUTLINED IN GREY. TO THE RIGHT OF THE SQUARE DESIGN IS THE WORDING "SUPER SIGN" IN BLACK. BELOW THAT WORDING IS THE WORDING "DIGITAL SIGNAGE SOLUTION" IN GREY.

SER. NO. 77-858,662, FILED 10-27-2009.

KATHERINE CHANG, EXAMINING ATTORNEY



# United States of America

United States Patent and Trademark Office

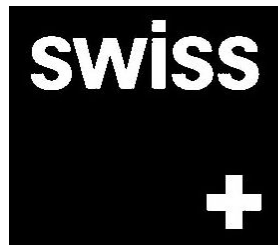

# Swiss WorldCargo

**Reg. No. 4,123,427**

**Registered Apr. 10, 2012**

**Int. Cls.: 35, 38, 39 and 45**

**SERVICE MARK**

**PRINCIPAL REGISTER**

SWISS INTERNATIONAL AIR LINES AG (SWITZERLAND CORPORATION)  
MALZGASSE 15  
BASEL, SWITZERLAND 4052

FOR: BUSINESS ORGANIZATION CONSULTANCY; OFFICE FUNCTIONS; DRAWING UP CUSTOMS DOCUMENTS AND TRANSPORT DOCUMENTS NECESSARY FOR THE SHIPMENT OF GOODS; CUSTOMS CLEARANCE SERVICES FOR THIRD PARTIES, IN CLASS 35 (U.S. CLS. 100, 101 AND 102).

FOR: COMPUTER-AIDED MESSAGE COLLECTION AND TRANSMISSION; PROVIDING ELECTRONIC TELECOMMUNICATIONS SERVICES IN SUPPORT OF THE STORAGE AND TRANSPORT OF GOODS, NAMELY, PROVIDING ELECTRONIC TELECOMMUNICATIONS CONNECTIONS, IN CLASS 38 (U.S. CLS. 100, 101 AND 104).

FOR: TRANSPORT OF GOODS BY WATER, BY LAND, SEA AND AIR; EMERGENCY TRANSPORT SERVICES; TRANSPORT OF VALUABLES; STORAGE OF GOODS; PACKAGING ARTICLES FOR TRANSPORTATION; RENTAL OF WAREHOUSES; TRANSPORTATION RESERVATION SERVICES; TRANSPORT INFORMATION; SERVICES OF ROAD FREIGHT BROKER; TRANSPORT LOGISTICS, NAMELY, ARRANGING THE TRANSPORTATION OF GOODS FOR OTHERS AND PLANNING AND SCHEDULING SHIPMENTS FOR USERS OF TRANSPORTATION SERVICES; CONSULTING IN THE TRANSPORT LOGISTICS FIELD, IN CLASS 39 (U.S. CLS. 100 AND 105).

FOR: SECURITY SERVICES FOR THE PROTECTION OF PROPERTY AND INDIVIDUALS, NAMELY, SECURITY GUARD SERVICES; SECURITY CONSULTANCY, NAMELY, AIR TRANSPORT SECURITY CONSULTANCY, BAGGAGE INSPECTION; BAGGAGE INSPECTION SERVICES FOR SECURITY PURPOSES, IN CLASS 45 (U.S. CLS. 100 AND 101).

OWNER OF SWITZERLAND REG. NO. 571090, DATED 5-2-2008, EXPIRES 2-2-2018.

NO CLAIM IS MADE TO THE EXCLUSIVE RIGHT TO USE "SWISS" AND "SWISS WORLD CARGO" WITH RESPECT TO INTERNATIONAL CLASSES 35, 38, AND 45; AND "WORLD CARGO" WITH RESPECT TO INTERNATIONAL CLASS 39, APART FROM THE MARK AS SHOWN.



*David J. Kybas*

Director of the United States Patent and Trademark Office

**Reg. No. 4,123,427** THE MARK CONSISTS OF THE WORD "SWISS" SHOWN IN A SQUARE CENTERED AT THE TOP, WITH A CROSS IN THE SQUARE AT THE BOTTOM RIGHT, ALL TO THE LEFT OF THE WORDS "SWISS WORLD CARGO".

SEC. 2(F) AS TO "SWISS" WITH RESPECT TO INTERNATIONAL CLASS 39..

SER. NO. 77-860,350, FILED 10-29-2009.

SUNG IN, EXAMINING ATTORNEY

# United States of America

United States Patent and Trademark Office

## 궁중 (宮中) 비누 HERBAL SOAP

**Reg. No. 4,123,428**

**Registered Apr. 10, 2012**

**Int. Cl.: 3**

**TRADEMARK**

**PRINCIPAL REGISTER**

AMOREPACIFIC CORPORATION (REPUBLIC OF KOREA CORPORATION)  
181 2-GA, HANGANG-RO, YONGSAN-GU,  
SEOUL, REPUBLIC OF KOREA 140-777

FOR: BODY MILK; COSMETIC SOAPS; COSMETICS; MEDICATED SOAPS; TOILET SOAPS,  
IN CLASS 3 (U.S. CLS. 1, 4, 6, 50, 51 AND 52).

PRIORITY CLAIMED UNDER SEC. 44(D) ON REPUBLIC OF KOREA APPLICATION NO.  
402009003850, FILED 8-12-2009, REG. NO. 400837926000, DATED 10-1-2010, EXPIRES 10-  
1-2020.

THE NON-LATIN CHARACTERS IN THE MARK TRANSLITERATE TO KOONG-CHOONG  
(KOONG-CHOONG) BEE-NOO AND THIS MEANS ROYAL COURT (ROYAL COURT) SOAP  
IN ENGLISH.

NO CLAIM IS MADE TO THE EXCLUSIVE RIGHT TO USE "HERBAL SOAP" AND THE  
NON-LATIN CHARACTERS THAT TRANSLITERATE TO "SOAP", APART FROM THE  
MARK AS SHOWN.

THE MARK CONSISTS OF TWO-SYLLABLE KOREAN LETTERS FOLLOWED BY TWO-  
SYLLABLE CHINESE LETTERS IN PARENTHESIS AND TWO SYLLABLE KOREAN LET-  
TERS IN FIRST LINE, AND "HERBAL SOAP" IN SECOND LINE.

SER. NO. 77-861,544, FILED 10-30-2009.

TEJBIR SINGH, EXAMINING ATTORNEY



*David J. Kypos*

Director of the United States Patent and Trademark Office

# United States of America

United States Patent and Trademark Office

상백 (常白) 크림  
**SNOWISE UV PROTECT CREAM**

**Reg. No. 4,123,429**

**Registered Apr. 10, 2012**

**Int. Cl.: 3**

**TRADEMARK**

**PRINCIPAL REGISTER**

AMOREPACIFIC CORPORATION (REPUBLIC OF KOREA CORPORATION)  
181 2-GA, HANGANG-RO, YONGSAN-GU,  
SEOUL, REPUBLIC OF KOREA 140-777

FOR: COSMETIC CREAMS FOR SKIN CARE; COSMETICS; FACIAL CREAMS; LOTIONS FOR COSMETIC PURPOSES; NON-MEDICATED SKIN CREAMS; SUN-BLOCK LOTIONS; SUNSCREEN CREAMS, IN CLASS 3 (U.S. CLS. 1, 4, 6, 50, 51 AND 52).

PRIORITY CLAIMED UNDER SEC. 44(D) ON REPUBLIC OF KOREA APPLICATION NO. 40200938507, FILED 8-12-2009, REG. NO. 40-0835800-0, DATED 9-9-2010, EXPIRES 9-9-2020.

THE NON-LATIN CHARACTERS IN THE MARK TRANSLITERATE TO SAHNG-BACK (SAHANG-BACK) KUH-RIM AND THIS MEANS CONSTANT WHITE ( CONSTANT WHITE ) CREAM IN ENGLISH.

NO CLAIM IS MADE TO THE EXCLUSIVE RIGHT TO USE "UV PROTECT CREAM" AND THE NON-LATIN CHARACTERS THAT TRANSLITERATE TO WHITE CREAM, APART FROM THE MARK AS SHOWN.

THE MARK CONSISTS OF TWO-SYLLABLE KOREAN LETTERS FOLLOWED BY TWO-SYLLABLE CHINESE LETTERS IN PARENTHESIS AND TWO SYLLABLE KOREAN LETTERS IN FIRST LINE, AND "SNOWISE UV PROTECT CREAM" IN SECOND LINE.

SER. NO. 77-861,602, FILED 10-30-2009.

TEJBIR SINGH, EXAMINING ATTORNEY



*David J. Kyros*

Director of the United States Patent and Trademark Office

# United States of America

United States Patent and Trademark Office

INSPIRE THE WORLD CREATE  
THE FUTURE

**Reg. No. 4,123,430**

SAMSUNG ELECTRONICS CO., LTD. (REPUBLIC OF KOREA CORPORATION)  
416, MAETAN-DONG, YEONGTONG-GU

**Registered Apr. 10, 2012**

SUWON-SI, GYEONGGI-DO, REPUBLIC OF KOREA

**Int. Cls.: 7, 9, 11, 35 and  
38**

FOR: ELECTRIC WASHING MACHINES FOR HOUSEHOLD PURPOSES; VACUUM CLEANERS; ELECTRIC MIXERS FOR HOUSEHOLD PURPOSES; ELECTRIC FOOD BLENDERS FOR HOUSEHOLD PURPOSES; VACUUM CLEANER BAGS; DISH WASHING MACHINES; ROBOTIC VACUUM CLEANERS, IN CLASS 7 (U.S. CLS. 13, 19, 21, 23, 31, 34 AND 35).

**TRADEMARK**

**SERVICE MARK**

**PRINCIPAL REGISTER**

FOR: SEMICONDUCTORS; UNIVERSAL SERIAL BUS (USB) HARDWARE; SMART PHONES; MOBILE PHONES; MOBILE PHONE BATTERY CHARGERS; SET-TOP BOXES; NOTEBOOK COMPUTERS; COMPUTERS; PRINTERS FOR COMPUTERS; MONITORS FOR COMPUTERS; PERSONAL DIGITAL ASSISTANTS (PDAS); TELEVISIONS; CASH REGISTERS; BATTERIES FOR USE WITH MOBILE PHONES; TELEPHONES; DIGITAL VERSATILE DISC (DVD) PLAYERS; MP3 PLAYERS; PORTABLE MEDIA PLAYERS (PMP); CAMCORDERS; VIDEO CAMERAS; CAMERAS; HOME THEATER SYSTEMS COMPRISING TELEVISION RECEIVERS, AUDIO AMPLIFIERS AND AUDIO SPEAKERS; ELECTRONIC PUBLICATIONS, NAMELY, ELECTRONIC BOOKS IN THE FIELDS OF CULTURE, LIFESTYLE, FASHION, CURRENT EVENT NEWS, MUSIC, SPORTS, ENTERTAINMENT, COMICS, GAMES AND ELECTRONICS, RECORDED ON COMPUTER MEDIA; EARPHONES; HEADSETS FOR USE WITH MOBILE PHONES; SATELLITE RECEIVERS; TELEVISION SETS; SATELLITE NAVIGATION SYSTEM, NAMELY, A GLOBAL POSITIONING SYSTEM (GPS); CASES FOR MOBILE PHONES; DIGITAL MEDIA RECEIVERS; ELECTRONIC POCKET TRANSLATORS; ELECTRONIC GAME SOFTWARE FOR MOBILE PHONES; OPTICAL CABLES; COMPUTER NETWORK HUBS, SWITCHES AND ROUTERS; HARD DISC DRIVES; BATTERIES AND BATTERY CHARGERS; COMPUTER PERIPHERAL DEVICES, IN CLASS 9 (U.S. CLS. 21, 23, 26, 36 AND 38).



*David J. Kappas*

FOR: WATER PURIFIERS FOR HOUSEHOLD PURPOSES; ICE-COOLING REFRIGERATORS FOR HOUSEHOLD PURPOSES; GAS RANGES; AIR CONDITIONERS; MICROWAVE OVENS; ELECTRIC FANS; REFRIGERATORS; HUMIDIFIERS; AIR PURIFIERS FOR HOUSEHOLD PURPOSES; REFRIGERATING MACHINES; ELECTRIC RADIATORS; AIR PURIFYING APPARATUS; ELECTRIC AIR DEODORIZERS, IN CLASS 11 (U.S. CLS. 13, 21, 23, 31 AND 34).

**Reg. No. 4,123,430** FOR: ADVERTISEMENT PLANNING, NAMELY, PREPARING AND PLACING ADVERTISEMENTS FOR OTHERS; ON-LINE ADVERTISING ON A COMPUTER NETWORK; TV ADVERTISING; SYSTEMIZATION OF INFORMATION INTO COMPUTER DATABASES; WHOLESALE AND RETAIL STORE SERVICES IN THE FIELD OF ELECTRONICS AND ELECTRIC HOUSEHOLD APPLIANCES; COMPUTERIZED ON-LINE RETAIL STORE SERVICES IN THE FIELD OF ELECTRONICS AND ELECTRIC HOUSEHOLD APPLIANCES, IN CLASS 35 (U.S. CLS. 100, 101 AND 102).

FOR: COMMUNICATION BY MOBILE TELEPHONE; WIRELESS COMMUNICATION AND TELECOMMUNICATION SERVICES, NAMELY, TRANSMISSION OF VOICE, DATA, GRAPHICS, IMAGES, AUDIO AND VIDEO BY MEANS OF TELECOMMUNICATIONS NETWORKS, WIRELESS COMMUNICATION NETWORKS, AND THE INTERNET; PROVIDING MULTIPLE-USER ACCESS TO A GLOBAL COMPUTER NETWORK; SATELLITE COMMUNICATION SERVICES; INTERNET BROADCASTING SERVICES; TELEVISION BROADCASTING SERVICES, IN CLASS 38 (U.S. CLS. 100, 101 AND 104).

THE MARK CONSISTS OF STANDARD CHARACTERS WITHOUT CLAIM TO ANY PARTICULAR FONT, STYLE, SIZE, OR COLOR.

PRIORITY CLAIMED UNDER SEC. 44(D) ON REPUBLIC OF KOREA APPLICATION NO. 20090003993, FILED 11-2-2009, REG. NO. 0035351, DATED 7-6-2011, EXPIRES 7-6-2021.

SER. NO. 77-864,761, FILED 11-4-2009.

FRED CARL, EXAMINING ATTORNEY

# United States of America

United States Patent and Trademark Office

## ASTON MARTIN CYGNET

**Reg. No. 4,123,431**

**Registered Apr. 10, 2012**

**Int. Cls.: 3, 6, 7, 8, 9, 11,  
12, 14, 16, 18, 20, 21, 24,  
25, 26, 27, 28, 29, 30, 32,  
33, 34, 35, 36, 37, 39, 41  
and 43**

**TRADEMARK**

**SERVICE MARK**

**PRINCIPAL REGISTER**

ASTON MARTIN LAGONDA LIMITED (UNITED KINGDOM CORPORATION)  
GAYDON  
BANBURY ROAD  
WARWICK, UNITED KINGDOM CV350DB

FOR: BLEACHING PREPARATIONS FOR LAUNDRY USE; CLEANING, POLISHING, SCOURING AND ABRASIVE PREPARATIONS; SOAPS, NAMELY, BAR SOAP, BODY CREAM SOAP, COSMETIC SOAP, HAND SOAP; PERFUMES; PERFUMERY, ESSENTIAL OILS, COSMETICS, HAIR LOTION; DENTIFRICES; COSMETICS; BEAUTY PRODUCTS, NAMELY, BEAUTY CREAMS, BEAUTY GELS, BEAUTY MASKS, BEAUTY SERUMS, FACIAL BEAUTY MASKS; AFTERSHAVE; ASTRINGENTS FOR COSMETIC PURPOSES; PREPARATIONS FOR THE BATH AND SHOWER, NAMELY, SHOWER GEL AND BATH GEL; COSMETIC PREPARATIONS FOR THE HAIR; HAIR SHAMPOOS AND CONDITIONERS; HAIR LOTIONS; NON-MEDICATED TOILETRIES; BODY LOTIONS; SKIN CLEANSERS, FACIAL CLEANSERS; SKIN MOISTURIZERS; MOISTURIZING BEAUTY CREAM, MOISTURIZING SKIN CREAM; ESSENTIAL OILS; MASSAGE OILS; EYE GELS; NON-MEDICATED EYE BALMS; MAKE-UP REMOVER; SKIN TONERS; FACIAL MASKS AND FACIAL SCRUBS; SKIN MASKS, HAIR MASKS; FACIAL MUD MASKS; NON-MEDICATED SKIN CARE PREPARATIONS, NAMELY, BODY WRAPS; DEPILATORY PREPARATIONS; FRAGRANCED BATH PEBBLES; INCENSE STICKS; SCENTED OILS FOR BURNING; POTPOURRI; BODY SPRAYS; BODY SPRITZ; HAND AND BODY SALT SCRUB; ANTI-PERSPIRANTS; PERSONAL DEODORANTS; NON-MEDICATED FOOT SOAKS; NON-MEDICATED FOOT LOTIONS; FOOT SCRUBS; NON-MEDICATED FOOT POWDER; FOOT SPRITZ; PUMICE STONES FOR PERSONAL USE; PREPARATIONS FOR NAIL CARE; NON-MEDICATED CLOTHS OR TISSUES IMPREGNATED WITH SKIN CLEANSER FOR USE ON THE SKIN, IN CLASS 3 (U.S. CLS. 1, 4, 6, 50, 51 AND 52).



*David J. Kypos*

Director of the United States Patent and Trademark Office

FOR: COMMON METALS AND THEIR ALLOYS; METAL BUILDING MATERIALS, NAMELY, SOFFITS, FASCIA, REINFORCEMENT MATERIALS FOR BUILDING, TRANSPORTABLE BUILDINGS OF METAL; MATERIALS OF METAL FOR RAILWAY TRACKS; NON-ELECTRIC CABLES AND WIRES OF COMMON METAL; SMALL ITEMS OF METAL HARDWARE, NAMELY, METAL GATE LATCHES, METAL BRACKETS FOR BATH ACCESSORIES AND DECORATIVE HOOKS, PULLEYS, SPRINGS, NUTS, WASHERS, CARABINERS OF METAL, KARABINERS OF METAL, THIMBLES; PIPES AND TUBES OF METAL; METAL SAFES; ORES, NAMELY, CHROME IRON ORES, COBALT ORES, COPPER ORES, IRON ORES, LEAD ORES, MANGANESE ORES, MOLYBDENUM ORES, NICKEL ORES, TIN ORES, TUNGSTEN ORES, ZINC ORES, GOLD ORES, SILVER ORES; NAME BADGES OF METAL;

**Reg. No. 4,123,431** KEY RINGS MADE OF METAL; BOXES OF COMMON METAL; PINS MADE OF METAL, NAMELY, COTTER PINS; METAL BALL LOCK PINS; NON-ELECTRIC CABLES OF METAL AND SNOWBOARD LOCKS OF METAL FOR SECURING A SNOWBOARD , IN CLASS 6 (U.S. CLS. 2, 12, 13, 14, 23, 25 AND 50).

FOR: MACHINE TOOLS, NAMELY, BROACHES, CHASERS, GEAR CUTTERS, GRINDING TOOLS FOR GRINDING MACHINES, LATHES, THREAD MILLING CUTTERS, TAPS, MILLING CUTTERS; MACHINE COUPLING AND TRANSMISSION COMPONENTS EXCEPT FOR LAND VEHICLES; ENGINES AND MOTORS OTHER THAN FOR LAND VEHICLES; ENGINE EXHAUST SYSTEMS COMPRISED OF PIPES, COLLECTOR AND MUFFLER; MOTOR STARTERS; POWER TOOLS, NAMELY, IMPACT WRENCHES, RATCHET WRENCHES, DRILLS, GRINDERS, ORBITAL SANDERS, DRILL HAMMERS, CHIPPER, SHREDDERS, LAWN AND GARDEN EDGERS, COLLETS, TILE SAWS, ROUTERS, CIRCULAR SAWS, BURRS, COUNTERSINKS, END MILLS, REAMERS, THREAD MILLS, DRILL PRESSES, BUFFERS; MACHINES OR APPARATUS FOR MAKING, MIXING, OR DISPENSING BEVERAGES, NAMELY, AERATED BEVERAGE MAKING MACHINES, IN CLASS 7 (U.S. CLS. 13, 19, 21, 23, 31, 34 AND 35).

FOR: CUTLERY, NAMELY, KNIVES, FORKS, SPOONS, SCALERS, RAZORS; CUTTERS, NAMELY, CAKE CUTTERS, CALLUS CUTTERS, CUTTERS FOR WINE BOTTLE FOIL, ELECTRIC HAIR CUTTERS, FISHING LINE CUTTERS, FRENCH FRY CUTTERS, GLASS CUTTERS, PIZZA CUTTERS, WIRE CUTTERS; OPENERS, NAMELY, MANUALLY OPERATED CONTAINER OPENER FOR HOUSEHOLD OR DOMESTIC USE; KNIVES; SHARPENING APPARATUS, NAMELY, KNIFE SHARPENERS, IN CLASS 8 (U.S. CLS. 23, 28 AND 44).

FOR: SCIENTIFIC INSTRUMENTS, NAMELY, CHROMATOGRAPHY COLUMNS FOR USE IN PURIFICATION IN THE LABORATORY; SCIENTIFIC APPARATUS AND INSTRUMENTS FOR MEASURING DNA/RNA AND PROTEIN; FLUORESCENCE DETECTOR FOR CRIME SCENE INVESTIGATIONS; ELECTRONIC ANALYZERS FOR TESTING CONSUMER PRODUCTS FOR THE PRESENCE OF CONTAMINANTS; ELECTRONIC ANALYZERS FOR MEASURING, TESTING AND DETECTING CONTAMINANTS AND ENVIRONMENTAL POLLUTANTS; OPTICAL INSTRUMENTS, NAMELY, OPTICAL TRANSMITTERS, OPTICAL RECEIVERS, OPTICAL DATA LINKS, OPTICAL TRANSCEIVERS, CABLE TELEVISION TRANSMITTERS, DIGITAL TRANSMITTERS, COMMUNICATION LINK TESTERS FOR COMMUNICATION LINKS; ASTRONOMETRIC MEASURING MACHINES AND INSTRUMENTS, AUTOMOTIVE WATER TEMPERATURE GAUGES, AUTOMOTIVE AIR FUEL/RATIO GAUGES, AUTOMOTIVE BOOST GAUGES, AUTOMOTIVE VACUUM GAUGES AND EXHAUST GAS TEMPERATURE GAUGES, TOOL MEASURING INSTRUMENTS, SCREW-THREAD MEASURING MACHINES AND INSTRUMENTS, RADIATION MEASURING INSTRUMENTS, RESISTANCE MEASURING INSTRUMENTS, INSTRUMENTS FOR MEASURING MILK QUALITY PARAMETERS, INSTRUMENTS FOR MEASURING LENGTH; SIGNALING INSTRUMENTS, NAMELY, ELECTRONIC SIGNALING MECHANISM, NAMELY, A TRAIN CONTROL SYSTEM USED IN THE RAILWAY INDUSTRY FOR DETECTING AND CONTROLLING TRAINS, GROUND FAULTS, BROKEN RAILS, POWER FAILURES, TRACK SWITCHES AND LIGHTS; LIFE-SAVING INSTRUMENTS, NAMELY, RAFTS; EDUCATIONAL APPARATUS, NAMELY, A TRANSPARENT TANK USED AS A TEACHING AID FOR THE CHEMICAL PROCESS OF MAKING ALTERNATIVE FUELS; BLANK MAGNETIC DATA CARRIERS; PRERECORDED MAGNETIC DATA CARRIERS FEATURING INFORMATION IN THE AUTOMOTIVE FIELD; BLANK RECORDING DISCS; PRERECORDED COMPACT DISCS FEATURING INFORMATION IN THE AUTOMOTIVE FIELD; AUTOMATIC VENDING MACHINES AND MECHANISMS FOR COIN OPERATED APPARATUS; AUTOMATIC VENDING MACHINES FOR DISPENSING DRINKS; CASH REGISTERS; CALCULATING MACHINES, DATA PROCESSING EQUIPMENT AND COMPUTERS; FIRE-EXTINGUISHING APPARATUS; IGNITION BATTERIES; PETROL FUEL GAUGES, NAVIGATION APPARATUS FOR VEHICLES IN THE NATURE OF ON-BOARD COMPUTERS; COMPUTER GAME SOFTWARE; EYEWEAR; SPECTACLES; SUNGLASSES; CONTACT LENSES; PROTECTIVE EYE PIECES; SAFETY HELMETS; PHOTOGRAPHIC



**Reg. No. 4,123,431** APPARATUS, NAMELY, CASES FOR PHOTOGRAPHIC APPARATUS, DRYING APPARATUS FOR PHOTOGRAPHIC PRINTS, STANDS FOR PHOTOGRAPHIC APPARATUS; DIVING APPARATUS, NAMELY, AIR TANK DOLLY FOR SCUBA DIVING, AIR TANKS FOR SCUBA DIVING, BUOYANCY COMPENSATOR JACKET FOR USE IN SCUBA DIVING, DIVING GOGGLES, DIVING GLOVES, DIVING HELMETS, DIVING SUITS, FACE MASKS FOR DIVING, REGULATORS FOR USE IN SCUBA DIVING, WEIGHT BELTS FOR SCUBA DIVING; CD PLAYER; REMOTE CONTROLS FOR RADIOS, TELEVISIONS, STEREOS; CAMERAS; CAMERAS FOR CHILDREN; COMPUTER HARDWARE; COMPUTER FIRMWARE FOR USE IN DATABASE MANAGEMENT IN THE AUTOMOTIVE FIELD, USE AS A SPREADSHEET IN THE AUTOMOTIVE FIELD, WORD PROCESSING IN THE AUTOMOTIVE FIELD; COMPUTER SOFTWARE FOR USE IN DATABASE MANAGEMENT IN THE AUTOMOTIVE FIELD; COMPACT DISCS FEATURING INFORMATION IN THE AUTOMOTIVE FIELD; DIGITAL MUSIC DOWNLOADABLE FROM THE INTERNET; TELECOMMUNICATIONS APPARATUS, NAMELY, AUTOMATIC SWITCHING APPARATUS, CHANGE-OVER SWITCHES, ELECTRIC CAPACITORS, ELECTRIC RESISTORS, ELECTRICAL TRANSFORMERS, TELECOMMUNICATION LINE INTEGRITY TESTING APPARATUS, FUSES, INDICATOR LIGHTS, MICROPHONES, PICKUP FOR TELECOMMUNICATION APPARATUS; COMPUTER GAMES CONSOLES FOR USE WITH TELEVISION RECEIVERS; COMPUTER GAME EQUIPMENT, NAMELY, JOY STICKS ADAPTED FOR USE WITH TELEVISION RECEIVERS; MOUSE PADS; TELEPHONES; MOBILE TELEPHONES; COVERS FOR MOBILE TELEPHONE RECEIVERS NOT MADE OF PAPER; MOBILE TELEPHONE CASES; MOBILE PHONE ACCESSORIES, NAMELY, CASES FOR MOBILE PHONES, DEVICES FOR HANDS-FREE USE OF MOBILE PHONES, DOWNLOADABLE GRAPHICS FOR MOBILE PHONES, DOWNLOADABLE RING TONES FOR MOBILE PHONES, HEADSETS FOR MOBILE PHONES, KEYBOARDS FOR MOBILE PHONES, MOBILE PHONE STRAPS; CLOTHING, HEADGEAR AND SHOES FOR PROTECTION AGAINST ACCIDENT, IRRADIATION OR FIRE; ELECTRICAL CONDUCTORS; ELECTRIC TRANSFORMERS; ELECTRIC CIGARETTE LIGHTERS FOR USE IN AUTOMOBILES; SIGNALING LANTERNS AND VEHICLE BREAKDOWN WARNING TRIANGLES; TELEPHONE AERIAL INSTALLATION COMPONENTS, NAMELY, OPTICAL FIBRES, TELEPHONE RECEIVERS, SWITCHBOARDS, TELEPHONE AND TELEGRAPH WIRES, VIDEO TELEPHONES; INTERCOMS; BRAKE CONTROLLERS; SPEEDOMETERS; GAUGES, NAMELY, ULTRASONIC GAUGES, TIRE TREAD DEPTH GAUGES, TIRE PRESSURE GAUGES, PRESSURE GAUGES, MICROMETER GAUGES, RAIN GAUGES, LEVEL GAUGES, LENGTH MEASURING GAUGES, DIGITAL FORCE GAUGES, DIGITAL TORQUE GAUGES AND MANUAL AND MOTORIZED TEST STANDS USED THEREWITH SOLD AS A UNIT WITH THE GAUGES, CROSS BEAM DEPTH GAUGES, WATER TEMPERATURE GAUGES, AIR FUEL/RATIO GAUGES, BOOST GAUGES, VACUUM GAUGES AND EXHAUST GAS TEMPERATURE GAUGES; WARNING AND INFORMATION APPARATUS AND INSTRUMENTS, NAMELY, ELECTRIC WARNING LIGHT SYSTEMS; ELECTRONIC HYDRAULIC CONTROL APPARATUS, NAMELY, PRESSURE TRANSDUCERS AND TRANSMITTERS THAT CONVERT HYDRAULIC OR PNEUMATIC PRESSURE INTO ANALOG ELECTRICAL SIGNALS FOR MONITORING AND CONTROLLING HYDRAULIC OR PNEUMATIC SYSTEMS; ELECTRONIC DAMPER CONTROL DEVICE FOR USE WITH MOTOR LAND VEHICLES OR VEHICLES FOR LOCOMOTION BY AIR OR WATER; ELECTRONIC CRUISE CONTROLS FOR USE WITH MOTOR LAND VEHICLES OR VEHICLES FOR LOCOMOTION BY AIR OR WATER; ANTI THEFT WARNING APPARATUS FOR MOTOR CARS; DISTANCE MEASURING APPARATUS; COMPUTERS FOR USE IN VEHICLES OR APPARATUS FOR LOCOMOTION BY AIR OR WATER; RADIOS; BLANK AUDIO CASSETTES; PRERECORDED AUDIO CASSETTES INFORMATION IN THE AUTOMOTIVE FIELD; LOUDSPEAKERS; AERIALS; RADIOS INCORPORATING CLOCKS; BLANK VIDEO AND AUDIO CASSETTES; PRERECORDED VIDEO AND AUDIO CASSETTES FEATURING INFORMATION IN THE AUTOMOTIVE FIELD; CALCULATORS; ELECTRICAL FUSES FOR MOTOR LAND VEHICLES OR APPARATUS FOR LOCOMOTION BY AIR OR WATER; OPTICAL EQUIPMENT AND INSTRUMENTS, NAMELY, EQUIPMENT DESIGNED FOR DRILLING OPTICAL LENSES FOR EYEGLASSES, EQUIPMENT DESIGNED FOR CUTTING DRILLING, MARKING, ENGRAVING AND SHAPING OPTICAL LENSES FOR EYEGLASSES, EQUIPMENT DESIGNED FOR ENGRAVING AND TINTING OPTICAL LENSES FOR EYEGLASSES;

**Reg. No. 4,123,431** PHOTOGRAPHIC EQUIPMENT, NAMELY, COLLAPSIBLE LIGHT DIRECTORS AND DIFFUSERS FOR USE WITH PHOTOGRAPHIC LIGHTING EQUIPMENT FOR PROFESSIONAL AND HIGH-END PHOTOGRAPHY; STILL CAMERAS, VIDEO CAMERAS, CAMERA LENSES; POUCHES AND CASES FOR CAMERAS; UMBRELLAS FOR PHOTOGRAPHIC USE; PORTABLE PHOTOGRAPHIC DARKROOMS; DARKROOM EQUIPMENT, NAMELY, DARKROOM LAMPS; PHOTOGRAPHIC DARKROOM TENTS; PHOTOGRAPHIC PROJECTORS; PROJECTION SCREENS; PHOTOGRAPHIC LIGHT EXPOSURE METERS; CAMERA FILTERS; PHOTOGRAPHIC SLIDE FRAMES AND SLIDE FILM MOUNTS; REELS FOR CINEMATOGRAPHIC FILM; APPARATUS FOR CUTTING AND/OR SPLICING FILM, MAGNETIC TAPES OR VIDEO TAPES, NAMELY, SLIDE CUTTERS; BLANK CASSETTES CONTAINING MAGNETIC OR VIDEO TAPES; AUDIO CASSETTE CASES; MICROPHONES, HEADPHONES; BATTERIES; BATTERY CHARGERS; ELECTRONIC TIMERS; THERMOMETERS; FITTED BAGS AND CASES ALL FOR PHOTOGRAPHIC APPARATUS; EXPOSED PHOTOGRAPHIC FILMS AND PHOTOGRAPHIC SLIDES PREPARED FOR EXHIBITION, PHOTOGRAPHIC TRANSPARENCIES; HOLOGRAM APPARATUS; UTENSILS FOR PHOTOGRAPHIC PURPOSES, NAMELY, MONOPODS AND TRIPODS; COLLAPSIBLE DIFFUSERS FOR USE WITH PHOTOGRAPHIC LIGHTING EQUIPMENT FOR PROFESSIONAL AND HIGH-END PHOTOGRAPHY; PORTABLE PHOTOGRAPHY EQUIPMENT, NAMELY, REFLECTORS; KEYBOARDS; COMPUTER MONITORS; MICE FOR COMPUTERS; PRINTERS; COMPUTER DISC DRIVES; BLANK MAGNETIC DISCS; MODEMS; FACSIMILE MACHINES; PHOTOCOPIERS; BINOCULARS; BIRDGLASSES, NAMELY, SUNGLASSES DESIGNED FOR BIRD WATCHING; TELESCOPIC GUN SIGHTS; SHOOTING SCOPES; NAMELY, GUN SCOPES; FLASHLIGHTS FOR USE IN PHOTOGRAPHY; COMPASSES; ENCODED MAGNETIC CARDS FOR PROCESSING FINANCIAL TRANSACTIONS; ELECTRONIC MACHINES FOR READING CREDIT CARDS AND RECORDING FINANCIAL TRANSACTIONS; SPORTS GLASSES AND GOGGLES FOR SHOOTING, SKIING AND OTHER SPORTS; INTERACTIVE GAME PROGRAMS; DIGITAL AUDIO PLAYERS; AUDIO RECORDERS; COMBINATION VIDEO PLAYERS AND RECORDERS; MUSICAL SOUND RECORDINGS; MUSICAL VIDEO RECORDINGS; DOWNLOADABLE ELECTRONIC PUBLICATIONS IN THE FIELD OF AUTOMOBILES; AUTOMATIC STEERING SYSTEMS COMPRISING ELECTRONIC CONTROLS FOR AUTOMATIC STEERING OF LAND, AIR, RAIL, AND WATER VEHICLES; INTERACTIVE SOUND RECORDINGS FEATURING VEHICLE SOUNDS; INTERACTIVE VISUAL RECORDINGS FEATURING MUSIC AND ANIMATION; INTERACTIVE COMPUTER SOFTWARE FOR USE AS A SPREADSHEET, WORD PROCESSING IN THE FIELD OF VEHICLES; DOWNLOADABLE ELECTRONIC PUBLICATIONS IN THE FIELD OF VEHICLES; COMPACT DISCS FEATURING INFORMATION IN THE FIELD OF VEHICLES; SUPER AUDIO COMPACT DISCS FEATURING INFORMATION IN THE FIELD OF AUTOMOBILES; DVDS FEATURING INFORMATION IN THE FIELD OF AUTOMOBILES; MULTIMEDIA SOFTWARE RECORDED ON CD-ROM FEATURING INFORMATION IN THE FIELD OF AUTOMOBILES; VIRTUAL REALITY SYSTEMS COMPRISING OF VIDEO GAME MACHINES AND VIDEO GAME CARTRIDGES FOR USE WITH TELEVISION SETS AND COMPUTERS; MP3 PLAYERS; MP4 PLAYERS; PERSONAL DIGITAL ASSISTANTS; DIGITAL MUSIC PROVIDED FROM MP3 INTERNET WEBSITES; ELECTRONIC GAME PROGRAMS; CD ROM GAMES, NAMELY, COMPUTER GAME PROGRAMS; DOWNLOADABLE RING TONES FOR MOBILE PHONES; SPORTS HEADGEAR, NAMELY, PROTECTIVE HELMETS; NAVIGATION APPARATUS IN THE NAME OF ON BOARD COMPUTERS FOR LAND, RAIL, WATER AND AIR VEHICLES; BAGS FOR CAMERAS AND PHOTOGRAPHIC EQUIPMENT; CASES FOR TRIPODS; PROTECTIVE CLOTHING, IN CLASS 9 (U.S. CLS. 21, 23, 26, 36 AND 38).

FOR: LIGHTING APPARATUS FOR VEHICLES, LIGHTING APPARATUS FOR THEATRES AND CLUBS, LIGHTING APPARATUS FOR SPORTS ARENAS; HEATING APPARATUS FOR DEFROSTING WINDOWS OF VEHICLES, APPARATUS FOR COOKING, NAMELY, COOKTOPS; AIR CONDITIONING APPARATUS; ELECTRIC KETTLES; GAS COOKERS; ELECTRIC SLOW COOKERS; ELECTRICAL APPARATUS FOR HEATING LIQUID, NAMELY, ELECTRIC KETTLES; WATER PURIFICATION AND FILTRATION APPARATUS; WATER PURIFICATION INSTALLATIONS; ELECTRIC COFFEE MAKERS; ELECTRIC ESPRESSO COFFEE MACHINES; ELECTRIC COFFEE PERCOLATORS; AND ELECTRIC COFFEE FILTER

**Reg. No. 4,123,431** MACHINES; BEVERAGES COOLING APPARATUS; VEHICLE LIGHTS AND VEHICLE AIR CONDITIONING UNITS; SIGNALING LANTERNS; FLASHLIGHTS, IN CLASS 11 (U.S. CLS. 13, 21, 23, 31 AND 34).

FOR: LAND VEHICLES; WATER VEHICLES, NAMELY, SMALL POWERBOATS, PERSONAL JET BOATS, WATER SCOOTERS, SURF SKIS, WATER-JET PROPULSION DRIVEN BOATS; AIR VEHICLES, NAMELY, AIRPLANES, AEROPLANES; ENGINES FOR LAND VEHICLES; SHIPS; BOATS; YACHTS; REMOTE CONTROL LAND VEHICLES OTHER THAN TOYS; REMOTE CONTROL RAIL VEHICLES OTHER THAN TOYS, NAMELY, PASSENGER CARRIAGES AND TRAINS; REMOTE CONTROL WATER VEHICLES OTHER THAN TOYS, NAMELY, SMALL POWERBOATS, PERSONAL JET BOATS, WATER SCOOTERS, SURF SKIS, WATER-JET PROPULSION DRIVEN BOATS; REMOTE CONTROL AIR VEHICLES OTHER THAN TOYS, NAMELY, AIRPLANES AND AEROPLANES; TOWING APPARATUS, NAMELY, METAL LOCKING DEVICE FOR TRAILER HITCH COUPLERS, IN CLASS 12 (U.S. CLS. 19, 21, 23, 31, 35 AND 44).

FOR: PRECIOUS METAL AND THEIR ALLOYS; JEWELRY; PRECIOUS STONES; HOROLOGICAL AND CHRONOMETRIC INSTRUMENTS AND PARTS THEREFOR; MODEL FIGURES MADE OF PRECIOUS METAL, NAMELY, MODEL VEHICLES MADE OF PRECIOUS METAL; ORNAMENTAL PINS; TIE-PINS; WATCHES; CLOCKS; ORNAMENTAL LAPEL PINS; QUARTZ MOVEMENTS BEING PARTS OF WATCHES, IN CLASS 14 (U.S. CLS. 2, 27, 28 AND 50).

FOR: PRINTED MATTER, NAMELY, TEACHING MATERIALS IN THE FIELD OF AUTOMOBILES, BOATS, YACHTS, AIRCRAFT AND ARCHITECTURE; PRINTED INFORMATION CARDS IN THE FIELD OF AUTOMOBILES, BOATS, YACHTS, AIRCRAFT AND ARCHITECTURE, PRINTED ANSWER SHEETS IN THE FIELD OF AUTOMOBILES, BOATS, YACHTS, AIRCRAFT AND ARCHITECTURE, PRINTED POST CARDS, PRINTED EDUCATIONAL MATERIALS IN THE FIELD OF AUTOMOBILES, BOATS, YACHTS, AIRCRAFT AND ARCHITECTURE, PRINTED CORRESPONDENCE COURSE MATERIALS IN THE FIELD OF AUTOMOBILES, BOATS, YACHTS, AIRCRAFT AND ARCHITECTURE, PRINTED INFORMATIONAL FOLDERS IN THE FIELD OF AUTOMOBILES, BOATS, YACHTS, AIRCRAFT AND ARCHITECTURE, POSTERS, PRINTED MAIL RESPONSE CARDS IN THE FIELD OF AUTOMOBILES, BOATS, YACHTS, AIRCRAFT AND ARCHITECTURE, PRINTED PRESS RELEASES IN THE FIELD OF AUTOMOBILES, BOATS, YACHTS, AIRCRAFT AND ARCHITECTURE, VINYL STATIC CLING SHEETS, NEWSPAPERS, NEWSLETTERS IN THE FIELD OF AUTOMOBILES, BOATS, YACHTS, AIRCRAFT AND ARCHITECTURE, BROCHURES IN THE FIELD OF AUTOMOBILES, BOATS, YACHTS, AIRCRAFT AND ARCHITECTURE, PAMPHLETS IN THE FIELD OF AUTOMOBILES, BOATS, YACHTS, AIRCRAFT AND ARCHITECTURE; ALBUM, NAMELY, STAMP ALBUMS AND PHOTO ALBUMS IN THE AUTOMOTIVE FIELD; BOOKS IN THE FIELD OF AUTOMOBILES; BOOK BINDING MATERIAL; PHOTOGRAPHS; STATIONERY; ADHESIVES FOR STATIONERY OR HOUSEHOLD PURPOSES; ARTISTS' MATERIALS, NAMELY, BRUSHES, PASTELS, PENCILS, PENS, CANVAS PANELS, MOLDS FOR MODELING CLAYS; PAINT BRUSHES; TYPEWRITERS AND OFFICE REQUISITES OTHER THAN FURNITURE, NAMELY, ADHESIVE TAPE DISPENSERS, PAPERWEIGHTS, CORRECTING FLUID FOR TYPE, ELECTRONIC PAPER HOLE PUNCHES, ENVELOPE SEALING MACHINES, PAPER EMBOSSERS, PAPER FOLDING MACHINES, RUBBER BANDS, STAPLERS; PRINTED INSTRUCTIONAL, EDUCATIONAL, AND TEACHING MATERIALS IN THE FIELD OF AUTOMOBILES; PLASTIC MATERIALS, NAMELY, BAGS AND BUBBLE PACKS FOR PACKAGING; PRINTERS' TYPE; PRINTING BLOCKS; WRITING INSTRUMENTS, PENS, PENCILS; PRINTS; PAPER TISSUES; TISSUES OF PAPER FOR CLEANING LENSES; PLASTIC TRANSPARENCIES; ALBUMS FOR PHOTOGRAPHS; FOLDERS; DOCUMENT FILES; BINDERS; BOOK COVERS; PHOTOGRAPH STANDS; PHOTOGRAPH MOUNTS; COMPOSING FRAMES, NAMELY, OFFICE TYPE COMPOSING MACHINES; APPARATUS FOR MOUNTING PHOTOGRAPHS, NAMELY, PHOTOGRAPH MOUNTS; PAPER SHREDDERS; TYPEWRITERS; RIBBONS FOR TYPEWRITERS; COMPUTER PRINTER RIBBONS; TYPEWRITER RIBBON SPOOLS; WRITING INSTRUMENTS; MARKERS; PAPER CUTTERS; PUNCHES; GLUE FOR STATIONERY OR

**Reg. No. 4,123,431** HOUSEHOLD USE; ADHESIVE LABELS; MODEL VEHICLES MADE OF PAPER/PAPER-MACHE FOR DECORATIVE PURPOSES AND NOT FOR USE AS TOYS; DRAWING PINS, NAMELY, PUSH PINS, THUMB TACKS; DOCUMENT POUCHES, NAMELY, DOCUMENT PORTFOLIOS; TOWELS OF PAPER/CELLULOSE; BOOKLETS IN THE FIELD OF AUTOMOBILES, BOATS, YACHTS, AIRCRAFT AND ARCHITECTURE; BOOK ENDS; BOOKMARKS; BOOK JACKETS IN THE NATURE OF BOOK COVERS OF PAPER, PLASTIC, OR CLOTH, IN CLASS 16 (U.S. CLS. 2, 5, 22, 23, 29, 37, 38 AND 50).

FOR: LEATHER AND IMITATIONS OF LEATHER; ANIMAL SKINS AND HIDES; BAGS, NAMELY, ALL PURPOSE CARRYING BAGS; TRAVELING TRUNKS AND TRAVELING BAGS; SPORTS BAGS; HUNTING BAGS AND PACKS; LUGGAGE; HANDBAGS; LEATHER CASES; BRIEFCASES; WALLETS; WALLETS INCLUDING CARD HOLDERS; RUCKSACKS; UMBRELLAS; PARASOLS; WALKING STICKS; WHIPS, HARNESS AND SADDLERY; REINS; BRIDLES; MARTINGALE; HORSE BREAST PLATE; STIRRUPS; BRIEFCASE-TYPE PORTFOLIO, IN CLASS 18 (U.S. CLS. 1, 2, 3, 22 AND 41).

FOR: FURNITURE; MIRRORS; PICTURE FRAMES; MODEL VEHICLES MADE OF WOOD, CORK, REED, CANE, WICKER, HORN BONE, IVORY, WHALEBONE, SHELL, AMBER, MOTHER-OF-PEARL, MEERSCHAUM, OR PLASTIC FOR DECORATIVE PURPOSES AND NOT FOR USE AS TOYS; BADGES MADE OF WOOD, CORK, REED, CANE, WICKER, HORN, BONE, IVORY, WHALEBONE, SHELL, AMBER, MOTHER-OF-PEARL, MEERSCHAUM OR PLASTIC; NON-METAL COTTER PINS; PHOTOGRAPH FRAMES, IN CLASS 20 (U.S. CLS. 2, 13, 22, 25, 32 AND 50).

FOR: HOUSEHOLD UTENSILS, NAMELY, GRATES, SIEVES, SPATULAS, STRAINERS, TURNERS, POT AND PAN SCRAPERS, ROLLING PINS, WHISKS, SKIMMERS; KITCHEN UTENSILS, NAMELY, KITCHEN TONGS, SPLATTER SCREENS, POURING AND STRAINING SPOUTS, NON-METAL FLEXIBLE LID DESIGNED FOR DRAINING OR PRESSING LIQUIDS FROM A FOOD CAN; SMALL DOMESTIC UTENSILS AND CONTAINERS, NAMELY, CUPS AND SAUCERS, BEAKERS IN THE NATURE OF WIDE-MOUTHED DRINKING CUPS FOR HOUSEHOLD USE, MUGS, PLATES, AND TRAYS; BOTTLE OPENERS; NON-ELECTRIC KETTLES; PILL BOXES FOR PERSONAL USE; COMBS; SPONGES FOR HOUSEHOLD PURPOSES; MATERIAL FOR BRUSH MAKING; ARTICLES FOR CLEANING PURPOSES, NAMELY, CLEANING SPONGES, CLEANING RAGS, CLEANING MITTS FOR FABRIC, CLEANING COMBS, CLEANING SWABS FOR COMMERCIAL USES; UNWORKED OR SEMI-WORKED GLASS, NOT FOR BUILDING; BEVERAGE GLASSWARE; DESKTOP STATUARY MADE OF MADE OF PORCELAIN, FIGURINES MADE OF PORCELAIN, HOLIDAY ORNAMENTS OF PORCELAIN, PLAQUES OF PORCELAIN, PORCELAIN CAKE DECORATIONS, PORCELAIN DOORKNOBS, PORCELAIN EGGS, PORCELAIN MUGS, SCULPTURES OF PORCELAIN; DESKTOP STATUARY MADE OF MADE OF EARTHENWARE, FIGURINES MADE OF EARTHENWARE, HOLIDAY ORNAMENTS OF EARTHENWARE, PLAQUES OF EARTHENWARE, EARTHENWARE CAKE DECORATIONS, EARTHENWARE DOORKNOBS, EARTHENWARE EGGS, EARTHENWARE MUGS, SCULPTURES OF EARTHENWARE; VEHICLE CLEANING MATERIALS, NAMELY, ACID-PROOF WASH BRUSHES USED FOR THE APPLICATION OF ACID TO VEHICLES FOR CLEANING PURPOSES; MODEL VEHICLES MADE OF PORCELAIN/TERRA COTTA/EARTHENWARE/GLASS FOR DECORATIVE PURPOSES NOT FOR USE AS TOYS; FIGURINES OF GLASS, NAMELY, BADGES MADE OF GLASS; GLOVES USE FOR HOUSEHOLD PURPOSES, NAMELY, DUSTING GLOVES, POLISHING GLOVES, AND GARDENING GLOVES; NON-ELECTRIC DOMESTIC APPLIANCES, NAMELY, NON-ELECTRIC KETTLES; TEA INFUSERS; EXFOLIATING MITTS, IN CLASS 21 (U.S. CLS. 2, 13, 23, 29, 30, 33, 40 AND 50).

FOR: TEXTILE FABRICS, NAMELY, COVERED RUBBER YARN FABRICS; TEXTILE WALL HANGINGS; BED COVERS AND TEXTILE TABLE CLOTHS; TOWELS; LINEN; ADHESIVE FABRICS FOR APPLICATION BY HEAT; HOME FURNISHING FABRICS; CURTAINS; FLANNEL; WASHING MITTS; DISH CLOTH, FACE CLOTH, CLOTHS FOR WASHING THE

**Reg. No. 4,123,431** BODY; CLOTH NAPKINS FOR REMOVING MAKE-UP; PICNIC BLANKETS, IN CLASS 24 (U.S. CLS. 42 AND 50).

FOR: CLOTHING, FOOTWEAR, AND HEADGEAR, NAMELY, WARM-UP SUITS, BLOUSES, SLACKS, CAPS, HOSIERY, SCARVES, TIES, GLOVES, SWEATERS, JACKETS, PARKAS, CLOTH BIBS, COVERALLS, PANTS, SHOES, GOLF SHOES, BOOTS, SHIRTS, VESTS, COATS, AND SPECIAL-PURPOSE CLOTHING IN THE NATURE OF RAINWEAR; SPORTS CLOTHING FOR SNOWBOARDING, NAMELY, SKI JACKETS AND SKI PANTS; EAR MUFFS; GOLF HATS; VISORS; WET SUITS FOR SURFACE WATERSPORTS; WET SUITS FOR USE WHILE WATER SKIING, WINDSURFING OR WAKEBOARDING; SWIMSUITS; WETSUITS; SILK SQUARES, NAMELY, KERCHIEFS; SAUNA SUITS, NAMELY, SWEAT SUITS WORN DURING EXERCISE TO RAISE ONE'S BODY TEMPERATURE, IN CLASS 25 (U.S. CLS. 22 AND 39).

FOR: LACES AND EMBROIDERY, RIBBONS AND BRAID; BUTTONS, HOOKS AND EYES, SEWING PINS AND SEWING NEEDLES; ORNAMENTAL NOVELTY BADGES; ARTIFICIAL FLOWERS; DECORATIVE PINS FOR WEAR, NAMELY, HAIR PINS AND HAT PINS; BADGES FOR WEAR, NAMELY, ORNAMENTAL NOVELTY BADGES; KNITTING NEEDLES, IN CLASS 26 (U.S. CLS. 37, 39, 40, 42 AND 50).

FOR: CARPETS, RUGS, MATS AND MATTING, LINOLEUM FOR COVERING EXISTING FLOORS; NON-TEXTILE WALL HANGINGS; CARPETS FOR LAND, RAIL, WATER AND AIR VEHICLES, IN CLASS 27 (U.S. CLS. 19, 20, 37, 42 AND 50).

FOR: GAMES AND PLAYTHINGS, NAMELY, STUFFED TOY ANIMALS; GYMNASTIC AND SPORTING ARTICLES, NAMELY, ATHLETIC WRIST AND JOINT SUPPORTS, ADHESIVE UNDER-EYE GLARE REDUCTION STRIPS, UNDER-EYE GREASE FOR REDUCING GLARE, A LIFE-SIZE INFLATABLE DUMMY WITH WATER-FILLED BASE, FOR USE AS A TARGET PRACTICE FOR KICKBOXING WORKOUTS, ADHESIVE TAPE FOR HOCKEY STICK AND UNIFORM SUPPORT, PORTABLE PITCHING MOUNDS, TOY GAME BALLS, RINGS, CONES, SPEED LADDERS, COACHING STICKS, TRAINING ARCHES, ANKLE BANDS, RESISTANCE CHUTES, HURDLES, SPRING BOARDS; ARTIFICIAL CHRISTMAS TREES; CHRISTMAS TREE DECORATIONS; TOYS, NAMELY, BATH TOYS, BATTERY OPERATED ACTION TOYS, BENDABLE TOYS, CASES FOR TOY VEHICLES, CHILDREN'S MULTIPLE ACTIVITY TOYS, CHILDREN'S TOY BICYCLES OTHER THAN FOR TRANSPORT, COLLECTABLE TOY FIGURES, CONSTRUCTION TOYS, DISC TOSS TOYS, ELECTRONIC TOY VEHICLES, FANTASY CHARACTER TOYS, LEVER ACTION TOYS, MECHANICAL ACTION TOYS, MINIATURE TOY HELMETS, MODELED PLASTIC TOY FIGURINES, MOLDED TOY FIGURES, PLASTIC CHARACTER TOYS, POP UP TOYS, PULL TOYS, PUNCHING TOYS, PUSH TOYS, RADIO CONTROLLED TOY VEHICLES, REMOTE CONTROLLED TOYS, NAMELY, CARS, RACE CARS, AIRPLANES, BOATS, SCALE MODEL KITS, TOY BUILDING BLOCKS, TOY CARS, TOY CONSTRUCTION BLOCKS, TOY MODEL KIT CARS, TOY MODEL TRAIN SETS, TOY ROCKETS, TOY SCOOTERS, TOY SLING PLANES, TOY SNOW GLOBES, TOY TRAINS, TOY LAND VEHICLES; TOY WATER VEHICLES; TOY AIR VEHICLES; TOY MODEL CARS; SKI BAGS; ELECTRONIC GAMES OTHER THAN THOSE ADAPTED FOR USE WITH TELEVISION RECEIVERS ONLY; REMOTE CONTROLLED TOY VEHICLES; SPORTS EQUIPMENT, NAMELY, SKIPPING ROPES, GYMNASIUM BALLS, MEDICINE BALLS, SWISS BALLS; POWER BALLS IN THE NATURE OF EXERCISE BALLS; PERSONAL EXERCISE MATS; HAND GRIPS FOR GOLF CLUBS; PUSH UP BARS; PUSH UP GRIPS, SIT UP BARS, CHINNING BARS, CURL BARS, EXERCISE THIGH TONERS, ABDOMINAL BOARDS, AEROBIC STEPS, EXERCISE SLIMMING BELTS; BOXING GLOVES; PUNCHING MITTS FOR USE IN BOXING; ELBOW PADS FOR USE IN BOXING, CHEST PADS FOR USE IN BOXING, KNEE PADS FOR USE IN BOXING; PUNCHING BAGS; MOUTH GUARDS FOR ATHLETIC USE; EXERCISE WEIGHTS; DUMBBELLS; GRIP PLATES, NAMELY, EXERCISE WEIGHT PLATES; EXERCISE BARS; WEIGHTLIFTING BENCHES; SPOTTER CATCHERS, NAMELY, BARBELL STANDS; WEIGHT LIFTING GLOVES; WEIGHT LIFTING BELTS; WEIGHT LIFTING STRAPS; MULTIGYMS, NAMELY, MANUALLY OPERATED EXERCISE EQUIPMENT; AEROBIC

**Reg. No. 4,123,431** STRETCH BANDS USED FOR PILATES; YOGA MATS; CARDIOVASCULAR APPARATUS, NAMELY, EXERCISE MACHINES; TRAMPOLINES; TRAMPETTES, NAMELY, MINIATURE TRAMPOLINES; EXERCISE BENCHES; EXERCISE ROWING MACHINES; STATIONARY EXERCISE BICYCLES; CROSS TRAINER EXERCISE MACHINES; PLASTIC TOY HOOPS; EXERCISE TREADMILLS; GOLF EQUIPMENT, NAMELY, GOLF CLUBS, GOLF BALLS, GOLF BAGS, AND GOLF TEES; HEAD COVERS FOR GOLF CLUBS; GOLF GLOVES; FISHING EQUIPMENT, NAMELY, FISHING LURE RETRIEVER; FISHING RODS; FISHING REELS; FISHING LINES; FISHING FLIES; FISHING STREAMERS, NAMELY, FLIES FOR USE IN FISHING; HAND-HELD FISHING NETS; FISHING TACKLE, NAMELY, CLEVICES; FISHING LURES, NAMELY, SPOONS; FISHING TACKLE; SKIS; SNOWBOARDS; SURFBOARDS; WAKEBOARDS; SKI BOBS; TOBOGGANS AND SKI POLES; SKI BINDINGS; SNOWBOARD BINDINGS; WAKEBOARD BINDINGS; SNOWBOARD PARTS, FITTINGS, AND ACCESSORIES, NAMELY, SNOWBOARD TOE BINDINGS, SNOWBOARD BINDING PLATES, SNOWBOARD BINDING BASES, SNOWBOARD BINDING DISKS, SNOWBOARD MOUNTING HARDWARE, SNOWBOARD TOE SUPPORT EXTENSIONS, SNOWBOARD BUCKLES, SNOWBOARD CUFFS, SNOWBOARD BRAKES, SNOWBOARD BRAKE PLATES, SNOWBOARD BRAKE PLATE INTERFACES, SNOWBOARD DEGREE INDICATORS, SNOWBOARD CLEANERS, SNOWBOARD LACE PROTECTORS, SNOWBOARD CANTS, SNOWBOARD LEASHES, SNOWBOARD STRAPS, SNOWBOARD TRACTION PADS, SNOWBOARD MATS, SNOWBOARD WAX, SNOWBOARD RAGS, SNOWBOARD LOCKS, SNOWBOARD SCREWS, SNOWBOARD WASHERS, SNOWBOARD RACKS, STORAGE RACKS FOR SNOWBOARDS; WAKEBOARD FINNS; WAKEBOARD AND WATER SKI HANDLES AND ROPES; CARRYING FRAMES FOR SNOWBOARDS; BAGS FOR SNOWBOARDS; COVERS AND CONTAINERS FOR SKIS, SNOWBOARDS, WAKEBOARDS, SURFBOARDS, SKI BOBS, TOBOGGANS AND SKI POLES; SKI WAX; ELBOW, WRIST, KNEE AND ANKLE GUARDS FOR ATHLETIC USE; ARCHERY EQUIPMENT, NAMELY, ARCHERY BOWS, ARCHERY ARROWS, ARCHERY BOW CASES, ARCHERY BOW RACKS, ARCHERY QUIVERS, ARCHERY BOW SLINGS; POLO MALLETS; HAND HELD UNITS FOR PLAYING ELECTRONIC GAMES OTHER THAN THOSE ADAPTED FOR USE WITH AN EXTERNAL DISPLAY SCREEN OR MONITOR; TOY MODEL VEHICLES MADE OF COMMON METAL; TOYS CAMERAS; SPORTSMAN'S FISHING BAGS, IN CLASS 28 (U.S. CLS. 22, 23, 38 AND 50).

FOR: SEAFOOD; PRESERVED, DRIED AND COOKED FRUITS AND VEGETABLES; JELLIES, JAMS, APPLESAUCE, EGGS, MILK, AND MILK PRODUCTS EXCLUDING ICE CREAM, ICE MILK AND FROZEN YOGURTS; EDIBLE OILS AND FATS; SOUPS; PREPARED AND PACKAGED MEALS CONSISTING PRIMARILY OF VEGETABLES, IN CLASS 29 (U.S. CL. 46).

FOR: COFFEE; TEA; COCOA; DRINKING CHOCOLATE, NAMELY, HOT CHOCOLATE; SUGAR; RICE; TAPIOCA; SAGO; ARTIFICIAL COFFEE; FLOUR; PREPARATIONS MADE FROM CEREALS, NAMELY, BREAKFAST CEREALS; CONFECTIONERY MADE OF SUGAR; CHOCOLATE; ICE CREAM; ICES; HONEY AND TREACLE; YEAST, BAKING POWDER, SALT, MUSTARD; VINEGAR, SAUCES; PROCESSED HERBS; SPICES; SANDWICHES; PIZZAS; PIES; PASTA, IN CLASS 30 (U.S. CL. 46).

FOR: BEERS; MINERAL AND AERATED WATERS; NON-ALCOHOLIC BEVERAGES, NAMELY, CARBONATED BEVERAGES; FRUIT DRINKS AND FRUIT JUICES; SYRUPS FOR MAKING BEVERAGES; DE-ALCOHOLISED DRINKS, NAMELY, NON-ALCOHOLIC BEER; NON-ALCOHOLIC BEERS; NON-ALCOHOLIC WINES, IN CLASS 32 (U.S. CLS. 45, 46 AND 48).

FOR: ALCOHOLIC BEVERAGES EXCEPT BEER; WINE; SPIRITS AND LIQUEURS; ALCOHOLIC BEVERAGES OF FRUIT; PREPARED ALCOHOLIC COCKTAILS, IN CLASS 33 (U.S. CLS. 47 AND 49).

**Reg. No. 4,123,431** FOR: TOBACCO; CIGARETTES; CIGARS; SMOKERS' ARTICLES, NAMELY, FILTER TUBES; SMOKING PIPES; CIGARETTE CASES AND PIPE CASES NOT OF PRECIOUS METAL; CIGAR LIGHTERS; MATCHES; ASHTRAYS , IN CLASS 34 (U.S. CLS. 2, 8, 9 AND 17).

FOR: ADVERTISING, MARKETING, AND PUBLICITY SERVICES; BUSINESS MANAGEMENT; BUSINESS ADMINISTRATIONS; PROVIDING OFFICE FUNCTIONS; RETAIL STORE SERVICES FEATURING LAND, WATER AND AIR VEHICLES, APPARATUS FOR LOCOMOTION BY LAND, AIR OR WATER, ENGINES, BOATS, YACHTS, MACHINES FOR HOUSEHOLD USE, HAND TOOLS, OPTICAL GOODS, CAMERAS, DOMESTIC ELECTRICAL AND ELECTRONIC EQUIPMENT INCLUDING WHITE GOODS, JEWELRY, CLOCKS, WATCHES, STATIONERY, PUBLICATIONS, LEATHER GOODS, LUGGAGE, FURNITURE, HOUSEHOLD CONTAINERS AND UTENSILS, FURNISHINGS, TEXTILES, CLOTHING, FOOTWEAR, HEADWEAR, HABERDASHERY, TOYS AND GAMES, SPORTS EQUIPMENT, SPORTING GOODS, HOUSEHOLD LINENS, ARTIFICIAL PLANTS AND TREES, GLASSWARE, PORCELAIN AND EARTHENWARE, GARDENING PRODUCTS AND EQUIPMENT, POWER AND HAND TOOLS, AUTOMOTIVE GOODS AND GASOLINE, HOUSEHOLD AND OUTDOOR FURNITURE, OFFICE FURNITURE AND EQUIPMENT, COMPUTERS AND COMPUTER PERIPHERALS, COMPUTER SOFTWARE AND HARDWARE, SMALL AND MAJOR APPLIANCES, COMPACT DISCS AND DVDS, CONSUMER ELECTRONICS, BATTERIES, LUGGAGE, JEWELRY, WATCHES, CLOCKS, ENTERTAINMENT TICKETS, HOLIDAY ORNAMENTS AND DECORATIONS, AND PARTS AND FITTINGS FOR THE AFORESAID GOODS; THE BRINGING TOGETHER, FOR THE BENEFIT OF OTHERS, OF A VARIETY OF SERVICES RELATING TO BUSINESS, FINANCE, REAL ESTATE, INSURANCE, TELECOMMUNICATIONS, TRAVEL, TICKETING AND RESERVATION, ENABLING CUSTOMERS TO CONVENIENTLY PURCHASE THOSE SERVICES FROM AN INTERNET WEB SITE PARTICULARLY SPECIALIZING IN THE MARKETING OF THE SALE OF GOODS AND SERVICES OF OTHERS; BUSINESS CONSULTATION SERVICES IN THE FIELD OF AUTOMOBILES, BOATS, YACHTS, AIRCRAFT AND ARCHITECTURE; PROVIDING INFORMATION IN THE FIELD OF AUTOMOBILES, BOATS, YACHTS, AIRCRAFT AND ARCHITECTURE; MANAGEMENT OF PERFORMING ARTISTS, IN CLASS 35 (U.S. CLS. 100, 101 AND 102).

FOR: FINANCIAL SERVICES, NAMELY, AUTOMOTIVE FINANCING, BOAT FINANCING, YACHT FINANCING, AIRCRAFT FINANCING, INSURANCE SERVICES, NAMELY, ASSISTING OTHERS WITH COLLECTING INSURANCE PREMIUMS, ASSISTING OTHERS WITH ADJUSTING INSURANCE PREMIUMS, IN THE NATURE OF LOSS CONTROL MANAGEMENT FOR OTHERS, UNDERWRITING EXTENDED WARRANTY CONTRACTS IN THE FIELD OF AUTOMOBILES, WRITING PROPERTY AND CASUALTY INSURANCE, UNDERWRITING, ISSUING AND ADMINISTRATION OF LIFE INSURANCE, UNDERWRITING SERVICES FOR ALL TYPES OF INSURANCE; MONETARY AFFAIRS, NAMELY, MONETARY EXCHANGE, MONETARY EXCHANGE OPERATIONS, MONITORING MONETARY CHARITABLE MONETARY GIVING THROUGH FINANCIAL AND ESTATE PLANNING, REAL ESTATE AFFAIRS, NAMELY, APPRAISAL AND EVALUATION OF REAL ESTATE, ASSESSMENT AND MANAGEMENT OF REAL ESTATE, COMMERCIAL AND RESIDENTIAL REAL ESTATE AGENCY SERVICES, LEASE OF REAL ESTATE, LEASING OF REAL ESTATE, PROVIDING REAL ESTATE LISTING VIA THE INTERNET, REAL ESTATE ACQUISITION SERVICES, REAL ESTATE AGENCIES, REAL ESTATE CONSULTATION, REAL ESTATE ESCROW SERVICES, REAL ESTATE MANAGEMENT SERVICES, REAL ESTATE MULTIPLE LISTING SERVICES, REAL ESTATE PROCUREMENT FOR OTHERS; BANK CARD SERVICES, NAMELY, DEBIT CARD SERVICES; CASH CARD SERVICES; CREDIT AND DEBIT CARD SERVICES; FINANCIAL GUARANTEES; LEASING OF LAND; ELECTRONIC CREDIT CARD TRANSACTIONS; ELECTRONIC DEBIT TRANSACTIONS; BROKERAGE FOR HIRE-PURCHASE; HIRE PURCHASE FINANCING; PROVISION OF FUNDS FOR HIRE PURCHASE; LEASE PURCHASE FINANCING; LEASE-PURCHASE FINANCING AND PURCHASE AGREEMENT FINANCING FOR LAND, RAIL, WATER AND AIR VEHICLES AND PARTS AND FITTINGS FOR SUCH GOODS; PROVIDING FINANCING FOR THE RENTAL OF LAND, RAIL, WATER AND AIR VEHICLES AND PARTS AND FITTINGS FOR SUCH GOODS; PROVIDING FINANCING FOR THE MAINTENANCE OF LAND,

**Reg. No. 4,123,431** RAIL, WATER AND AIR VEHICLES AND PARTS AND FITTINGS FOR SUCH GOODS; PROVIDING FINANCING FOR THE EMERGENCY REPAIR AND MAINTENANCE OF LAND, RAIL, WATER AND AIR VEHICLES, IN CLASS 36 (U.S. CLS. 100, 101 AND 102).

FOR: BUILDING CONSTRUCTION AND REPAIR; INSTALLATION OF MOTOR VEHICLES; CONSTRUCTION, REPAIR AND MAINTENANCE OF LAND, WATER AND AIR VEHICLES, ENGINES AND PARTS AND FITTINGS FOR SUCH GOODS, IN CLASS 37 (U.S. CLS. 100, 103 AND 106).

FOR: AIR, BOAT, RAIL TRANSPORT; PACKAGING ARTICLES FOR TRANSPORTATION; STORAGE OF GOODS; COORDINATING TRAVEL ARRANGEMENTS FOR INDIVIDUALS AND FOR GROUPS; TRAVEL AGENCY SERVICES, NAMELY, MAKING RESERVATIONS AND BOOKINGS FOR TRANSPORTATION; SHIPPING AND DELIVERY SERVICES, NAMELY, PICKUP TRANSPORTATION, AND DELIVERY OF PACKAGES AND LETTERS BY VARIOUS MODES OF TRANSPORTATION; RENTAL OF VEHICLES FOR LOCOMOTION BY LAND, AIR OR WATER; TAXI TRANSPORT SERVICES; TRANSPORTATION INFORMATION, IN CLASS 39 (U.S. CLS. 100 AND 105).

FOR: EDUCATIONAL SERVICES, NAMELY, CONDUCTING CLASSES, SEMINARS, CONFERENCES, WORKSHOPS IN THE FIELD OF AUTOMOBILES, BOATS, YACHTS, AIRCRAFT AND ARCHITECTURE; TRAINING SERVICES IN THE FIELD OF AUTOMOBILES, BOATS, YACHTS, AIRCRAFT AND ARCHITECTURE; ENTERTAINMENT SERVICES, NAMELY, PRODUCTION AND DISTRIBUTION OF ONGOING TELEVISION PROGRAMS IN THE FIELD OF FAMILY MANAGEMENT AND RELATIONSHIPS, PROVIDING MOTIVATIONAL AND EDUCATIONAL SPEAKERS, ON-LINE COMPETITIONS IN THE FIELD OF ENTERTAINMENT, EDUCATION, CULTURE, SPORTS, AND OTHER NON-BUSINESS AND NON-COMMERCIAL FIELDS, CONDUCTING CONTESTS, CONDUCTING PARTIES, CONDUCTING FAIRS, WINE AND FOOD TASTINGS, TELEVISED AND MOVIE APPEARANCES BY A PROFESSIONAL ENTERTAINER, LIVE MUSICAL PERFORMANCES, COMEDY SHOWS, MULTIMEDIA PRODUCTION SERVICES, BICYCLE RACING AND EXHIBITIONS; ORGANIZING COMMUNITY SPORTING AND CULTURAL EVENTS ACTIVITIES; HEALTH CLUB SERVICES, NAMELY, PROVIDING INSTRUCTION AND EQUIPMENT IN THE FIELD OF PHYSICAL EXERCISE; ENTERTAINMENT IN THE NATURE OF COMPETITIONS AND GAMES IN THE FIELD OF ATHLETICS AND SPELLING; ELECTRONIC PUBLISHING SERVICES, NAMELY, PUBLICATION OF TEXT AND GRAPHIC WORKS OF OTHERS ON CD, DVD AND ON-LINE FEATURING AUTOMOBILE CLUBS AND EXHIBITIONS; PROVIDING LEISURE CENTERS, NAMELY, PROVIDING FACILITIES FOR RECREATION ACTIVITIES; PROVIDING FITNESS AND EXERCISE FACILITIES; PROVIDING GYMNASIUM FACILITIES; PRODUCTION OF SOUND AND MUSIC VIDEO RECORDINGS; MUSIC PUBLISHING SERVICES; RECORDING STUDIO SERVICES; PROVIDING ON-LINE INFORMATION IN THE FIELD OF MUSIC, ENTERTAINMENT, AND COMPUTER GAMES; PRODUCTION AND DISTRIBUTION OF TELEVISION SHOWS, RADIO PROGRAMS, MOTION PICTURES, ANIMATED MOVIES, AUDIO RECORDINGS, AND VIDEO DISCS AND TAPES; RENTAL OF CINEMA FILMS, MOTION PICTURE FILMS, AND SOUND RECORDINGS; PRODUCTION OF LIVE ENTERTAINMENT FEATURES, NAMELY, LIVE PERFORMANCES BY A BAND; PRODUCTION AND PRESENTATION OF QUIZ SHOWS, EXHIBITIONS FOR CULTURAL OR EDUCATIONAL PURPOSES, SPORTING EVENTS, NAMELY, TRIATHLONS, SWIMMING MEETS, SOCCER COMPETITIONS; LIVE SHOW PERFORMANCES, LIVE SHOWS PERFORMANCES, LIVE MUSICAL ROAD SHOWS, LIVE STAGE PERFORMANCES IN THE NATURE OF PLAYS, LIVE THEATRICAL PRODUCTIONS, LIVE MUSICAL CONCERTS, LIVE PERFORMANCES BY MUSICAL BANDS, AUDIENCE PARTICIPATION EVENTS IN THE NATURE OF CONTESTS; PROVIDING ON-LINE ELECTRONIC GAMES; INFORMATION RELATING TO VEHICLES, PROVIDED ON-LINE FROM A COMPUTER DATABASE OR THE INTERNET OR FROM WIRELESS CABLE OR SATELLITE, IN CLASS 41 (U.S. CLS. 100, 101 AND 107).

FOR: PROVIDING OF FOOD AND DRINK; MAKING RESERVATIONS AND BOOKING FOR TEMPORARY LODGING; PROVIDING TEMPORARY ACCOMMODATION; HOTEL SER-



**Reg. No. 4,123,431** VICES; RESTAURANT SERVICES; CAFÉ SERVICES, IN CLASS 43 (U.S. CLS. 100 AND 101).

THE MARK CONSISTS OF STANDARD CHARACTERS WITHOUT CLAIM TO ANY PARTICULAR FONT, STYLE, SIZE, OR COLOR.

PRIORITY CLAIMED UNDER SEC. 44(D) ON ERPN CMNTY TM OFC APPLICATION NO. 8391336, FILED 6-26-2009, REG. NO. 9498304, DATED 11-26-2010, EXPIRES 6-26-2019.

OWNER OF U.S. REG. NOS. 840,338, 1,903,400 AND OTHERS.

SER. NO. 77-879,494, FILED 11-24-2009.

CIMMERIAN COLEMAN, EXAMINING ATTORNEY

# United States of America

United States Patent and Trademark Office



**Reg. No. 4,123,432**

**Registered Apr. 10, 2012**

**Int. Cl.: 30**

**TRADEMARK**

**PRINCIPAL REGISTER**

COMPAÑIA NACIONAL DE CHOCOLATES, S.A. (COLOMBIA CORPORATION)  
CARRERA 43 A NO. 1 A SUR  
143 MEDELLÍN, COLOMBIA

FOR: CHOCOLATES; CHOCOLATE BARS; MILK CHOCOLATE; SEMI-BITTER CHOCOLATE; BITTER CHOCOLATE; CHOCOLATE COVERED COCOA NIBS; CHOCOLATES WITH FILLING; COFFEE GRAINS COVERED WITH CHOCOLATE, IN CLASS 30 (U.S. CL. 46).

FIRST USE 7-1-2007; IN COMMERCE 7-1-2007.

THE MARK CONSISTS OF A SQUARE INSIDE OF WHICH APPEARS AN OVAL INSIDE OF WHICH APPEARS A FARMER HOLDING COCA FRUITS. BELOW THE OVAL AND STILL INSIDE THE SQUARE APPEAR THE WORDS "COMMITTED TO FARMERS". THE COLOR BROWN APPEARS IN THE SQUARE, THE FARMER AND IN THE COCOA FRUITS. THE COLOR BEIGE APPEARS IN THE INSIDE OF THE OVAL, WHICH SERVES AS BACKGROUND TO THE DRAWING OF THE FARMER, AND IN THE WORDING "COMMITTED TO FARMERS".

THE COLOR(S) BEIGE, AND BROWN IS/ARE CLAIMED AS A FEATURE OF THE MARK.

SER. NO. 77-880,857, FILED 11-25-2009.

WILLIAM P. SHANAHAN, EXAMINING ATTORNEY



*David J. Kybas*

Director of the United States Patent and Trademark Office

# United States of America

United States Patent and Trademark Office



**Day&Zimmermann**

**Reg. No. 4,123,433**

**Registered Apr. 10, 2012**

**Int. Cls.: 35, 37, 39, 40,  
41, 42 and 45**

**SERVICE MARK**

**PRINCIPAL REGISTER**

DAY & ZIMMERMANN, INC. (MARYLAND CORPORATION)  
1500 SPRING GARDEN STREET  
PHILADELPHIA, PA 19130

FOR: MANAGEMENT SERVICES FOR OTHERS, NAMELY, SUPERVISING ENGINEERING, ADMINISTRATIVE AND PLANT OPERATING PERSONNEL, CONDUCTING MARKETING STUDIES AND EXECUTIVE SEARCHING; MUNITIONS MANAGEMENT FOR OTHERS, NAMELY, RECEIVING MUNITIONS BY LAND, SEA AND AIR TRANSPORT FOR BUSINESS PURPOSES AND MUNITIONS INVENTORY CONTROL; OPERATION OF A BUSINESS FOR OTHERS, NAMELY, OPERATION OF PLANTS AND FACILITIES FOR OTHERS; STAFFING SERVICES, NAMELY, PERSONNEL MANAGEMENT CONSULTATION AND PERSONNEL PLACEMENT AND RECRUITMENT; CONSTRUCTION MANAGEMENT, NAMELY, SCHEDULING AND ESTIMATING BUILDING CONSTRUCTION FOR OTHERS; PROCURING MANAGEMENT INFORMATION SYSTEMS FOR OTHERS; AND LOGISTICS MANAGEMENT CONSULTING SERVICES IN THE FIELD OF MILITARY BASE AND GOVERNMENT FACILITIES OPERATIONS, NAMELY, HOUSEKEEPING, SECURITY AND MUNITIONS, IN CLASS 35 (U.S. CLS. 100, 101 AND 102).

FIRST USE 0-0-1911; IN COMMERCE 0-0-1911.

FOR: CONSTRUCTION MANAGEMENT, NAMELY, COST CONTROL AND PROJECT SUPERVISION; MAINTENANCE OF BUILDINGS, PLANTS AND FACILITIES OF OTHERS; CONSTRUCTION PROGRAM MANAGEMENT; CONSTRUCTION PROJECT MANAGEMENT; CONSTRUCTION PLANNING; BUILDING CONSTRUCTION AND REPAIR; PLANT CONSTRUCTION, NAMELY, HYDRO-ELECTRIC FACTORY CONSTRUCTION, POWER PLANT CONSTRUCTION, INDUSTRIAL PLANT CONSTRUCTION; BUILDING MAINTENANCE OF PHYSICAL PLANTS IN THE FIELD OF MILITARY BASE AND GOVERNMENT FACILITIES OPERATIONS; REAL ESTATE SITE SELECTION FOR OTHERS; AND DEMILITARIZATION OF MUNITIONS FOR OTHERS, NAMELY, DISMANTLING OF MUNITIONS FOR OTHERS, IN CLASS 37 (U.S. CLS. 100, 103 AND 106).

FIRST USE 0-0-1911; IN COMMERCE 0-0-1911.

FOR: MUNITIONS MANAGEMENT FOR OTHERS, NAMELY, STORING AND SHIPPING, IN CLASS 39 (U.S. CLS. 100 AND 105).

FIRST USE 12-31-1988; IN COMMERCE 12-31-1988.



*David J. Kyffers*

Director of the United States Patent and Trademark Office

**Reg. No. 4,123,433** FOR: MANUFACTURE OF MUNITIONS TO THE ORDER AND SPECIFICATION OF OTHERS, IN CLASS 40 (U.S. CLS. 100, 103 AND 106).

FIRST USE 12-31-1988; IN COMMERCE 12-31-1988.

FOR: LOGISTICS TRAINING IN THE FIELD OF MILITARY BASE AND GOVERNMENT FACILITIES OPERATION, NAMELY, PROVIDING CLASSES, TRAINING FEATURING SIMULATIONS AND HANDS-ON TRAINING ON THE SUBJECTS OF HOUSEKEEPING, SECURITY, PHYSICAL PLANT MAINTENANCE, CONSTRUCTION SITE OPERATIONS, AND MUNITIONS, IN CLASS 41 (U.S. CLS. 100, 101 AND 107).

FIRST USE 0-0-1989; IN COMMERCE 0-0-1989.

FOR: ENGINEERING AND ARCHITECTURAL DESIGN SERVICES; DESIGN ENGINEERING, NAMELY, DESIGNING PLANT FACILITIES AND MANUFACTURING PROCESSES FOR OTHERS; COMPUTERIZED DRAFTING, AND LAND USE PLANNING SERVICES, NAMELY, LAND USE ANALYSIS, IN CLASS 42 (U.S. CLS. 100 AND 101).

FIRST USE 0-0-1911; IN COMMERCE 0-0-1911.

FOR: SECURITY SERVICES, NAMELY, SECURITY GUARD SERVICES AND MONITORING OF SECURITY SYSTEMS, IN CLASS 45 (U.S. CLS. 100 AND 101).

FIRST USE 12-31-1988; IN COMMERCE 12-31-1988.

THE MARK CONSISTS OF THE TERM "DAY&ZIMMERMANN" BELOW A BROKEN HEXAGON.

SER. NO. 77-881,993, FILED 11-30-2009.

LAURA HAMMEL, EXAMINING ATTORNEY

# United States of America

United States Patent and Trademark Office

## DAY & ZIMMERMANN

**Reg. No. 4,123,434**

**Registered Apr. 10, 2012**

**Int. Cls.: 35, 37, 39, 40,  
41, 42 and 45**

**SERVICE MARK**

**PRINCIPAL REGISTER**

DAY & ZIMMERMANN, INC. (MARYLAND CORPORATION)  
1500 SPRING GARDEN STREET  
PHILADELPHIA, PA 19130

FOR: MANAGEMENT SERVICES FOR OTHERS, NAMELY, SUPERVISING ENGINEERING, ADMINISTRATIVE AND PLANT OPERATING PERSONNEL, CONDUCTING MARKETING STUDIES AND EXECUTIVE SEARCHING; MUNITIONS MANAGEMENT FOR OTHERS, NAMELY, RECEIVING MUNITIONS BY LAND, SEA AND AIR TRANSPORT FOR BUSINESS PURPOSES AND MUNITIONS INVENTORY CONTROL; OPERATION OF A BUSINESS FOR OTHERS, NAMELY, OPERATION OF PLANTS AND FACILITIES FOR OTHERS; STAFFING SERVICES, NAMELY, PERSONNEL MANAGEMENT CONSULTATION AND PERSONNEL PLACEMENT AND RECRUITMENT; CONSTRUCTION MANAGEMENT, NAMELY, SCHEDULING AND ESTIMATING BUILDING CONSTRUCTION FOR OTHERS; PROCURING MANAGEMENT INFORMATION SYSTEMS FOR OTHERS; AND LOGISTICS MANAGEMENT CONSULTING SERVICES IN THE FIELD OF MILITARY BASE AND GOVERNMENT FACILITIES OPERATIONS, NAMELY, HOUSEKEEPING, SECURITY AND MUNITIONS, IN CLASS 35 (U.S. CLS. 100, 101 AND 102).

FIRST USE 0-0-1911; IN COMMERCE 0-0-1911.

FOR: CONSTRUCTION MANAGEMENT, NAMELY, COST CONTROL AND PROJECT SUPERVISION; MAINTENANCE OF BUILDINGS, PLANTS AND FACILITIES OF OTHERS; CONSTRUCTION PROGRAM MANAGEMENT; CONSTRUCTION PROJECT MANAGEMENT; CONSTRUCTION PLANNING; BUILDING CONSTRUCTION AND REPAIR; PLANT CONSTRUCTION, NAMELY, HYDRO-ELECTRIC FACTORY CONSTRUCTION, POWER PLANT CONSTRUCTION, INDUSTRIAL PLANT CONSTRUCTION; BUILDING MAINTENANCE OF PHYSICAL PLANTS IN THE FIELD OF MILITARY BASE AND GOVERNMENT FACILITIES OPERATIONS; REAL ESTATE SITE SELECTION FOR OTHERS; AND DEMILITARIZATION OF MUNITIONS FOR OTHERS, NAMELY, DISMANTLING OF MUNITIONS FOR OTHERS, IN CLASS 37 (U.S. CLS. 100, 103 AND 106).

FIRST USE 0-0-1911; IN COMMERCE 0-0-1911.

FOR: MUNITIONS MANAGEMENT FOR OTHERS, NAMELY, STORING AND SHIPPING, IN CLASS 39 (U.S. CLS. 100 AND 105).

FIRST USE 12-31-1988; IN COMMERCE 12-31-1988.



*David J. Kyffers*

Director of the United States Patent and Trademark Office

**Reg. No. 4,123,434** FOR: MANUFACTURE OF MUNITIONS TO THE ORDER AND SPECIFICATION OF OTHERS, IN CLASS 40 (U.S. CLS. 100, 103 AND 106).

FIRST USE 12-31-1988; IN COMMERCE 12-31-1988.

FOR: LOGISTICS TRAINING IN THE FIELD OF MILITARY BASE AND GOVERNMENT FACILITIES OPERATION, NAMELY, PROVIDING CLASSES, TRAINING FEATURING SIMULATIONS AND HANDS-ON TRAINING ON THE SUBJECTS OF HOUSEKEEPING, SECURITY, PHYSICAL PLANT MAINTENANCE, CONSTRUCTION SITE OPERATIONS, AND MUNITIONS, IN CLASS 41 (U.S. CLS. 100, 101 AND 107).

FIRST USE 0-0-1989; IN COMMERCE 0-0-1989.

FOR: ENGINEERING AND ARCHITECTURAL DESIGN SERVICES; DESIGN ENGINEERING, NAMELY, DESIGNING PLANT FACILITIES AND MANUFACTURING PROCESSES FOR OTHERS; COMPUTERIZED DRAFTING, AND LAND USE PLANNING SERVICES, NAMELY, LAND USE ANALYSIS, IN CLASS 42 (U.S. CLS. 100 AND 101).

FIRST USE 0-0-1989; IN COMMERCE 0-0-1989.

FOR: SECURITY SERVICES, NAMELY, SECURITY GUARD SERVICES AND MONITORING OF SECURITY SYSTEMS, IN CLASS 45 (U.S. CLS. 100 AND 101).

FIRST USE 12-31-1988; IN COMMERCE 12-31-1988.

THE MARK CONSISTS OF STANDARD CHARACTERS WITHOUT CLAIM TO ANY PARTICULAR FONT, STYLE, SIZE, OR COLOR.

SER. NO. 77-882,008, FILED 11-30-2009.

LAURA HAMMEL, EXAMINING ATTORNEY

# United States of America

United States Patent and Trademark Office

## CERTIFIED INVESTMENT MANAGEMENT ANALYST

**Reg. No. 4,123,435**

**Registered Apr. 10, 2012**

**CERTIFICATION MARK**

**PRINCIPAL REGISTER**

INVESTMENT MANAGEMENT CONSULTANTS ASSOCIATION (COLORADO CORPORATION)  
SUITE 500  
5619 DTC PARKWAY  
GREENWOOD VILLAGE, CO 80111

FOR: INVESTMENT CONSULTING SERVICES, IN CLASS B (U.S. CL. B).

FIRST USE 9-0-1988; IN COMMERCE 9-0-1988.

THE MARK CONSISTS OF STANDARD CHARACTERS WITHOUT CLAIM TO ANY PARTICULAR FONT, STYLE, SIZE, OR COLOR.

OWNER OF U.S. REG. NO. 1,595,736.

NO CLAIM IS MADE TO THE EXCLUSIVE RIGHT TO USE "INVESTMENT MANAGEMENT ANALYST", APART FROM THE MARK AS SHOWN.

THE CERTIFICATION MARK, AS USED BY AUTHORIZED PERSONS, CERTIFIES MEETING A SPECIFIC LEVEL OF EDUCATION, PROFESSIONAL COMPETENCE AND EXPERIENCE AND SUCCESSFUL COMPLETION OF AN EXAMINATION ADMINISTERED BY THE CERTIFIER.

SEC. 2(F).

SER. NO. 77-883,090, FILED 12-1-2009.

DOMINICK J. SALEMI, EXAMINING ATTORNEY



*David J. Kybas*

Director of the United States Patent and Trademark Office

# United States of America

United States Patent and Trademark Office

# GEN-X

**Reg. No. 4,123,436**

HIGHLAND PARK ELECTRIC, INC. (ILLINOIS CORPORATION)  
3250 SKOKIE VALLEY ROAD  
HIGHLAND PARK, IL 60035

**Registered Apr. 10, 2012**

**Int. Cl.: 37**

FOR: INSTALLATION, MAINTENANCE AND REPAIR OF POWER GENERATION EQUIPMENT, IN CLASS 37 (U.S. CLS. 100, 103 AND 106).

**SERVICE MARK**

FIRST USE 1-5-1999; IN COMMERCE 6-14-1999.

**PRINCIPAL REGISTER**

THE MARK CONSISTS OF STANDARD CHARACTERS WITHOUT CLAIM TO ANY PARTICULAR FONT, STYLE, SIZE, OR COLOR.

SER. NO. 77-883,300, FILED 12-1-2009.

KATHERINE CHANG, EXAMINING ATTORNEY



*David J. Kybas*

Director of the United States Patent and Trademark Office



# United States of America

United States Patent and Trademark Office



**Reg. No. 4,123,437**

HIGHLAND PARK ELECTRIC, INC. (ILLINOIS CORPORATION)  
3250 SKOKIE VALLEY ROAD  
HIGHLAND PARK, IL 60035

**Registered Apr. 10, 2012**

**Int. Cl.: 37**

FOR: INSTALLATION, MAINTENANCE AND REPAIR OF POWER GENERATION EQUIPMENT, IN CLASS 37 (U.S. CLS. 100, 103 AND 106).

**SERVICE MARK**

FIRST USE 1-5-1999; IN COMMERCE 6-14-1999.

**PRINCIPAL REGISTER**

THE MARK CONSISTS OF THE WORDING "GENX" SURROUNDED BY A PARTIAL ELIPTICAL DESIGN, WHICH INCLUDES A SMALL CIRCLE ABOVE THE LETTER "G" AND INCORPORATES AND COMPRISES THE UPPER LEFT TO THE LOWER RIGHT PORTION OF THE LETTER "X".

SER. NO. 77-883,420, FILED 12-1-2009.

KATHERINE CHANG, EXAMINING ATTORNEY



*David J. Kybas*

Director of the United States Patent and Trademark Office

# United States of America

United States Patent and Trademark Office

# Enzymes 4U

**Reg. No. 4,123,438**

**Registered Apr. 10, 2012**

**Int. Cl.: 5**

**TRADEMARK**

**PRINCIPAL REGISTER**

ENZYMES 4 U, INC (CALIFORNIA CORPORATION)  
2015 ROCKWOOD DRIVE  
SACRAMENTO, CA 95864

FOR: ODOR NEUTRALIZING PREPARATIONS FOR USE ON TEXTILE MATERIALS, FLOORING, FURNITURE, CARPETS, UPHOLSTERY, HARD SURFACES, WALLS, FLOORS, BEDS, CRAWL SPACES, CEILINGS, ATTICS, STORAGE FACILITIES, WAREHOUSES, BARNs, EQUINE FACILITIES, LIVESTOCK FACILITIES, LABORATORIES, VEHICLES, AIRPLANES, TRAINS, SUBWAYS, BUSES, WATER CRAFT, HOMES, OFFICES, SCHOOLS, SITES, POOLS, SHOWERS, LAUNDRY, CLOTHING, HANDICAP EQUIPMENT, HUMAN REMAINS, DISASTER CLEAN-UP, CHEMICAL DEPOTS, WATER FILTRATION, ELECTRICAL DEVICES, AIR FILTRATION EQUIPMENT, SOIL, HOSPITALS, NURSING HOMES, HEALTHCARE FACILITIES, BUILDINGS, RESTAURANTS, BARS AND TAVERNS, KITCHENS, REFRIGERATORS, PORTABLE TOILETS, RESTROOMS, BATHROOMS, INDUSTRIAL PLANTS, SLAUGHTER HOUSES, MEAT AND POULTRY PACKING PLANTS, FEED LOTS, REFINERIES, ANIMAL KENNELS, MEDICAL AND VETERINARY OFFICES, ANIMAL CARE FACILITIES, POOL HALLS, BOWLING ALLEYS, DESIGNATED SMOKING AREAS, AIRPORTS, COMMERCIAL BUILDINGS, LOCKER ROOMS, HEALTH CLUBS, GARBAGE CANS AND WASTE DISPOSAL AREAS, MATTRESSES, AND AIRBORNE ODORS, AND FOR GENERAL RESIDENTIAL, INDUSTRIAL, COMMERCIAL, VETERINARIAN, MEDICAL, LIVESTOCK, EQUINE, BIRDS AND OTHER MAMMALS, RESIDENTIAL AND PERSONAL USE, IN CLASS 5 (U.S. CLS. 6, 18, 44, 46, 51 AND 52).



FIRST USE 8-7-2008; IN COMMERCE 8-7-2008.

THE MARK CONSISTS OF STANDARD CHARACTERS WITHOUT CLAIM TO ANY PARTICULAR FONT, STYLE, SIZE, OR COLOR.

NO CLAIM IS MADE TO THE EXCLUSIVE RIGHT TO USE "ENZYMES", APART FROM THE MARK AS SHOWN.

SER. NO. 77-886,453, FILED 12-4-2009.

RON FAIRBANKS, EXAMINING ATTORNEY

*David J. Kyjars*

Director of the United States Patent and Trademark Office

# United States of America

United States Patent and Trademark Office

# TECHNO WEB

**Reg. No. 4,123,439**

**Registered Apr. 10, 2012**

**Int. Cls.: 11 and 17**

**TRADEMARK**

**PRINCIPAL REGISTER**

FINETEX ENE, INC. (REPUBLIC OF KOREA CORPORATION)  
SEOCHO-GU  
475-31, BANGBAE-DONG  
SEOUL 137-819, REPUBLIC OF KOREA

FOR: FILTRATION MEDIA IN THE FORM OF A MEMBRANE OR MULTI-LAYER FABRIC FOR USE IN FILTERING GASES AND LIQUIDS, NAMELY, WATER FILTERS, AIR FILTERS FOR DOMESTIC USE, AIR FILTERS FOR INDUSTRIAL INSTALLATIONS; FILTRATION MEDIA IN THE FORM OF A MEMBRANE OR MULTI-LAYER FABRIC FOR USE IN AIR PURIFYING APPARATUS, WATER FILTERING APPARATUS, VENTILATION DEVICES AND INSTALLATIONS, HEATING AND COOLING SYSTEMS, IN CLASS 11 (U.S. CLS. 13, 21, 23, 31 AND 34).

FOR: PLASTIC FILM FOR COMMERCIAL OR INDUSTRIAL USE; FILTERING MATERIALS FOR FURTHER MANUFACTURE IN THE NATURE OF POLYMER SHEETS, BOARDS AND PLATES OF PLASTICS, PLASTIC FILM, AND POLYMERIC FILTER MEDIA, ALL FOR USE IN THE MANUFACTURE OF FILTERS AND FILTRATION ELEMENTS FOR DOMESTIC AND INDUSTRIAL FILTRATION, IN CLASS 17 (U.S. CLS. 1, 5, 12, 13, 35 AND 50).

PRIORITY CLAIMED UNDER SEC. 44(D) ON REPUBLIC OF KOREA APPLICATION NO. 4020090055, FILED 11-10-2009, REG. NO. 400885024, DATED 10-13-2011, EXPIRES 10-13-2021.

NO CLAIM IS MADE TO THE EXCLUSIVE RIGHT TO USE "WEB", APART FROM THE MARK AS SHOWN.

THE MARK CONSISTS OF THE WORDS "TECHNO WEB" IN STYLIZED PRINT AND A CIRCULAR DESIGN ADJACENT TO THOSE WORDS.

SER. NO. 77-887,919, FILED 12-7-2009.

REBECCA POVARCHUK, EXAMINING ATTORNEY



*David J. Kypos*

Director of the United States Patent and Trademark Office

# United States of America

United States Patent and Trademark Office

## SOUTHWEST GENERAL URGICARE

**Reg. No. 4,123,440**

**Registered Apr. 10, 2012**

**Int. Cl.: 44**

**SERVICE MARK**

**PRINCIPAL REGISTER**

SOUTHWEST GENERAL HEALTH CENTER (OHIO CORPORATION)  
18697 BAGLEY RD.,  
CLEVELAND, OH 44130

FOR: MEDICAL SERVICES, NAMELY, CONDUCTING MEDICAL PHYSICAL EXAMINATIONS FOR EMPLOYMENT ELIGIBILITY, CONDUCTING MEDICAL PHYSICAL EXAMINATIONS FOR PARTICIPATION IN SPORTS, WORKER PERMITS, CAMP AND BACK TO SCHOOL PHYSICALS, CONDUCTING TESTS FOR THE PRESENCE OF STREPTOCOCCUS, PROVIDING INFLUENZA VACCINATIONS, CONDUCTING MEDICAL DIAGNOSTIC X-RAY SERVICES, PRE-EMPLOYMENT DRUG SCREENING; PURELY MEDICAL SERVICES, NAMELY, COLLECTING SPECIMENS OF BLOOD AND URINE FOR MEDICAL TESTING, CONDUCTING DRUG SCREENS FOR WORKPLACE DRUG TESTING ON SAID SPECIMENS, PROVIDING MEDICAL LABORATORY TESTING ON SAID SPECIMENS, IN CLASS 44 (U.S. CLS. 100 AND 101).

FIRST USE 1-1-1985; IN COMMERCE 1-1-1985.

THE MARK CONSISTS OF STANDARD CHARACTERS WITHOUT CLAIM TO ANY PARTICULAR FONT, STYLE, SIZE, OR COLOR.

SEC. 2(F) AS TO "SOUTHWEST GENERAL".

SER. NO. 77-888,094, FILED 12-7-2009.

GISELLE AGOSTO, EXAMINING ATTORNEY



*David J. Kyjars*

Director of the United States Patent and Trademark Office

# United States of America

United States Patent and Trademark Office

## MOTIVATING TODAY'S LEARNER

**Reg. No. 4,123,441**

LAUREATE EDUCATION, INC. (MARYLAND CORPORATION)  
650 S. EXETER STREET  
BALTIMORE, MD 21202

**Registered Apr. 10, 2012**

**Int. Cl.: 9**

FOR: PRERECORDED DVD'S FEATURING INSTRUCTION ON TEACHING STRATEGIES FOR K-12 TEACHERS, IN CLASS 9 (U.S. CLS. 21, 23, 26, 36 AND 38).

**TRADEMARK**

FIRST USE 10-31-2006; IN COMMERCE 10-31-2006.

**PRINCIPAL REGISTER**

THE MARK CONSISTS OF STANDARD CHARACTERS WITHOUT CLAIM TO ANY PARTICULAR FONT, STYLE, SIZE, OR COLOR.

SER. NO. 77-888,921, FILED 12-8-2009.

KIMBERLY FRYE, EXAMINING ATTORNEY



*David J. Kyffers*

Director of the United States Patent and Trademark Office

# United States of America

United States Patent and Trademark Office

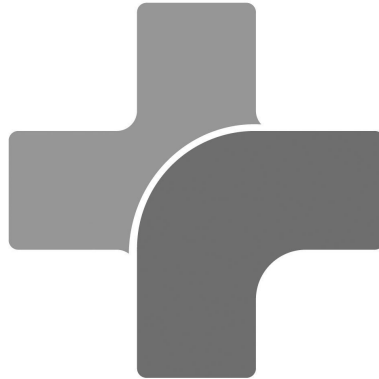

**Reg. No. 4,123,442**

**Registered Apr. 10, 2012**

**Int. Cls.: 35, 36 and 44**

**SERVICE MARK**

**PRINCIPAL REGISTER**

CAREGGI PUBLISHING LIMITED (BR. VIRGIN ISLANDS COMPANY)  
WOODBOURNE HALL  
P.O. BOX 3162  
ROAD TOWN, TORTOLA, BR. VIRGIN ISLANDS

FOR: PREPARATION OF STATISTICS FOR MEDICAL RESEARCH; PROVISION OF BUSINESS STATISTICAL INFORMATION RELATING TO MEDICAL MATTERS; COMPILATION OF STATISTICAL DATA RELATING TO MEDICAL RESEARCH; BUSINESS MANAGEMENT AND BUSINESS ORGANIZATIONAL CONSULTANCY; BUSINESS MANAGEMENT; BUSINESS ADMINISTRATION; BUSINESS RESEARCH; BILLING AND BUSINESS MANAGEMENT SERVICES; BUSINESS ACCOUNTS MANAGEMENT; ANALYSIS OF BUSINESS MANAGEMENT SYSTEMS; PROCUREMENT SERVICES, NAMELY, PURCHASING HEALTH CARE SERVICES, NAMELY, HOSPITALS, CLINICS, MEDICAL CENTERS, PHARMACIES, DIAGNOSTIC CENTERS, AND CENTERS FOR TRAINING HEALTH CARE PROVIDERS FOR OTHERS; ASSISTANCE TO COMMERCIAL ENTERPRISES IN THE MANAGEMENT OF THEIR BUSINESS; PERSONNEL RECRUITMENT; CONSULTANCY OF PERSONNEL RECRUITMENT; BUSINESS MANAGEMENT OF HOSPITALS, CLINICS, MEDICAL CENTERS, PHARMACIES, DIAGNOSTIC CENTERS AND TRAINING CENTERS FOR PERSONNEL IN HEALTHCARE; BUSINESS MANAGEMENT ASSISTANCE RELATING TO THE ESTABLISHMENT OF FRANCHISES FOR HOSPITALS, CLINICS, MEDICAL CENTERS, PHARMACIES, DIAGNOSTIC CENTERS AND TRAINING CENTERS FOR PERSONNEL IN HEALTHCARE; FRANCHISE SERVICES, NAMELY, OFFERING BUSINESS MANAGEMENT ASSISTANCE IN THE ESTABLISHMENT AND OPERATION OF HOSPITALS, CLINICS, MEDICAL CENTERS, PHARMACIES, MEDICAL DIAGNOSTIC CENTERS AND TRAINING CENTERS FOR PERSONNEL IN HEALTHCARE; PROVIDING MARKETING ADVICE AND MARKETING ANALYSIS FOR HOSPITALS, CLINICS, MEDICAL CENTERS, PHARMACIES, MEDICAL DIAGNOSTIC CENTERS AND TRAINING CENTERS FOR PERSONNEL IN HEALTHCARE; BUSINESS MARKETING CONSULTING SERVICES TO HOSPITALS, CLINICS, MEDICAL CENTERS, PHARMACIES, MEDICAL DIAGNOSTIC CENTERS AND TRAINING CENTERS FOR PERSONNEL IN HEALTHCARE; PREPARING FINANCIAL REPORTS FOR OTHERS, IN CLASS 35 (U.S. CLS. 100, 101 AND 102).



*David J. Kybas*

Director of the United States Patent and Trademark Office

FOR: FINANCIAL MANAGEMENT SERVICES FOR HOSPITALS, CLINICS, MEDICAL CENTERS, PHARMACIES, DIAGNOSTIC CENTERS AND TRAINING CENTERS FOR PERSONNEL IN HEALTHCARE; EQUITY CAPITAL INVESTMENTS; FINANCING SERVICES; VENTURE CAPITAL FUNDING SERVICES FOR HOSPITALS, CLINICS, MEDICAL CENTERS, PHARMACIES, DIAGNOSTIC CENTERS AND TRAINING CENTERS FOR PERSONNEL IN

**Reg. No. 4,123,442** HEALTHCARE; FINANCIAL ANALYSIS; FINANCIAL PLANNING AND MANAGEMENT; FISCAL ASSESSMENTS; CAPITAL INVESTMENT SERVICES; FINANCING OF LOANS, IN CLASS 36 (U.S. CLS. 100, 101 AND 102).

FOR: DENTISTRY; HEALTH CARE; CONVALESCENT HOMES; HOSPICES; HOSPITALS; MEDICAL ASSISTANCE SERVICES; MEDICAL CLINICS; NURSING HOMES; MEDICAL SERVICES, NAMELY, NURSING SERVICES; OPTICIAN'S SERVICES; PHARMACISTS' SERVICES TO MAKE UP PRESCRIPTIONS; PHARMACEUTICAL ADVICE; PHYSICAL THERAPY; PHYSIOTHERAPY; HEALTH CARE SERVICES PROVIDED THROUGH MEDICAL DIAGNOSTIC CENTERS, IN CLASS 44 (U.S. CLS. 100 AND 101).

OWNER OF SINGAPORE REG. NO. T0912801B, DATED 11-6-2009, EXPIRES 11-6-2019.

THE MARK CONSISTS OF TWO ASYMMETRICAL GEOMETRIC DESIGNS PLACED NEAR EACH OTHER TO FORM A PLUS SIGN.

SER. NO. 77-889,993, FILED 12-9-2009.

CIMMERIAN COLEMAN, EXAMINING ATTORNEY

# United States of America

United States Patent and Trademark Office

## JUST BREATHE

**Reg. No. 4,123,443**

**Registered Apr. 10, 2012**

**Int. Cls.: 10 and 42**

**TRADEMARK**

**SERVICE MARK**

**PRINCIPAL REGISTER**

PICOMOLE INSTRUMENTS INC. (CANADA CORPORATION)  
969, ROUTE DE L'ÉGLISE, SUITE 300  
SAINTE-FOY, QUEBEC, CANADA G1V3V4

FOR: MEDICAL DEVICES, NAMELY, NON-INVASIVE DEVICES FOR BREATH ANALYSIS, POINT-OF-CARE DIAGNOSTIC DEVICES FOR BREATH ANALYSIS, INFRARED LASER GAS ANALYSIS DEVICES FOR USE TO MEASURE VOLATILE COMPOUNDS IN BREATH IN THE FIELD OF DIAGNOSTICS AND DETECTION USING NON-INVASIVE BREATH ANALYSIS AND INFRARED LASER GAS ANALYSIS, IN CLASS 10 (U.S. CLS. 26, 39 AND 44).

FOR: RESEARCH SERVICES, NAMELY, MEDICAL AND SCIENTIFIC RESEARCH SERVICES IN THE FIELD OF DIAGNOSTICS AND DETECTION USING NON-INVASIVE BREATH ANALYSIS AND INFRARED LASER GAS ANALYSIS, IN CLASS 42 (U.S. CLS. 100 AND 101).

THE MARK CONSISTS OF STANDARD CHARACTERS WITHOUT CLAIM TO ANY PARTICULAR FONT, STYLE, SIZE, OR COLOR.

PRIORITY CLAIMED UNDER SEC. 44(D) ON CANADA APPLICATION NO. 1,442,703, FILED 6-25-2009, REG. NO. TMA800532, DATED 6-21-2011, EXPIRES 6-21-2026.

SER. NO. 77-893,107, FILED 12-14-2009.

LINDA POWELL, EXAMINING ATTORNEY



*David J. Kybas*

Director of the United States Patent and Trademark Office



# United States of America

United States Patent and Trademark Office



## Experience My Culture

**Reg. No. 4,123,444**

BABB, JOHN (UNITED KINGDOM INDIVIDUAL)  
FLAT 45, 45 BRIDGE STREET  
RAMSBOTTOM, UNITED KINGDOM BL09AG

**Registered Apr. 10, 2012**

**Int. Cls.: 35, 38 and 41**

FOR: ADVERTISING SERVICES; ADVERTISING SERVICES PROVIDED VIA THE INTERNET; PROVIDING AN ONLINE DIRECTORY INFORMATION SERVICE FEATURING HYPERLINKS TO OTHER WEBSITES IN THE FIELDS OF SOCIAL NETWORKING, CULTURE AND PHOTO AND VIDEO SHARING, IN CLASS 35 (U.S. CLS. 100, 101 AND 102).

**SERVICE MARK**

**PRINCIPAL REGISTER**

FOR: PROVIDING ON-LINE ELECTRONIC BULLETIN BOARDS FOR TRANSMISSION OF MESSAGES AMONG COMPUTER USERS IN THE FIELDS OF TRAVEL, TOURISM, AND WORLD CULTURES; PROVIDING INTERNET CHATROOMS; PROVIDING INTERNET CHATROOMS RELATING TO WORLD CULTURES; PROVIDING ACCESS TO DATABASES; PROVIDING FORUMS FOR THE TRANSMISSION OF VIDEOS, PHOTOGRAPHS, MUSIC AND MULTIMEDIA CONTENT AMONG COMPUTER USERS IN THE FIELD OF TRAVEL, TOURISM AND WORLD CULTURES VIA THE INTERNET, IN CLASS 38 (U.S. CLS. 100, 101 AND 104).

FOR: EDUCATION SERVICES, NAMELY, PROVIDING LIVE CLASSES, PODCASTS, AND WEBCASTS IN THE FIELDS OF TRAVEL, TOURISM AND WORLD CULTURES; ORGANIZING COMMUNITY SPORTING AND CULTURAL ACTIVITIES, IN CLASS 41 (U.S. CLS. 100, 101 AND 107).



PRIORITY CLAIMED UNDER SEC. 44(D) ON UNITED KINGDOM APPLICATION NO. 2518789, FILED 6-15-2009, REG. NO. 2518789, DATED 11-6-2009, EXPIRES 6-15-2019.

THE MARK CONSISTS OF NINE STICK FIGURES JOINING HANDS IN THE FORM OF ALTERNATING MALE AND FEMALE STICK FIGURE CHARACTERS PLACED ATOP THE WORDS "EXPERIENCE MY CULTURE".

SER. NO. 77-893,576, FILED 12-15-2009.

DAVID HOFFMAN, EXAMINING ATTORNEY

*David J. Kyffers*

Director of the United States Patent and Trademark Office

# United States of America

United States Patent and Trademark Office

# FLIPSLIDE

**Reg. No. 4,123,445**

CISCO TECHNOLOGY, INC. (CALIFORNIA CORPORATION)  
170 W. TASMAN DR.  
SAN JOSE, CA 95134

**Registered Apr. 10, 2012**

**Int. Cl.: 9**

FOR: VIDEO CAMERAS; CAMCORDERS; COMPUTER SOFTWARE TO ENABLE UPLOADING, POSTING, SHOWING, DISPLAYING, EDITING, AND TRANSMITTING IMAGES AND AUDIOVISUAL WORKS, IN CLASS 9 (U.S. CLS. 21, 23, 26, 36 AND 38).

**TRADEMARK**

THE MARK CONSISTS OF STANDARD CHARACTERS WITHOUT CLAIM TO ANY PARTICULAR FONT, STYLE, SIZE, OR COLOR.

**PRINCIPAL REGISTER**

PRIORITY CLAIMED UNDER SEC. 44(D) ON TRINIDAD/TOBAGO APPLICATION NO. 41264, FILED 8-12-2009, REG. NO. 41264, DATED 7-14-2010, EXPIRES 8-11-2019.

SER. NO. 77-910,502, FILED 1-12-2010.

BARBARA A. GOLD, EXAMINING ATTORNEY



*David J. Kyffers*

Director of the United States Patent and Trademark Office

# United States of America

United States Patent and Trademark Office

*Finestone* 

**Reg. No. 4,123,446**

**Registered Apr. 10, 2012**

**Int. Cl.: 16**

**TRADEMARK**

**PRINCIPAL REGISTER**

NAMSONGFASHION CO., LTD (REPUBLIC OF KOREA CORPORATION)  
TRADE TOWER, SAMSEONG 1-DONG, GANGNAM-GU  
RM. NO. 6, 35TH FLOOR, TRADE CENTER  
SEOUL, REPUBLIC OF KOREA 135-729

FOR: DECALS, IRON-ON HOT FIX STONE, NAMELY, CLOTHING ACCESSORIES MADE FROM ROCK CRYSTAL, GLASS OR ACRYLIC WHICH ARE STUCK BY HEATING ON CLOTH, DECALS, IRON-ON RHINESTONE, NAMELY, IMITATION DIAMONDS MADE FROM ROCK CRYSTAL, GLASS OR ACRYLIC, FOR USE IN CLOTHING ACCESSORIES WHICH ARE STUCK BY HEATING ON CLOTH, IN CLASS 16 (U.S. CLS. 2, 5, 22, 23, 29, 37, 38 AND 50).

PRIORITY CLAIMED UNDER SEC. 44(D) ON REPUBLIC OF KOREA APPLICATION NO. 2010-0001599, FILED 1-12-2010, REG. NO. 0875006, DATED 8-2-2011, EXPIRES 8-2-2021.

THE MARK CONSISTS OF A STYLIZED WORDING "FINESTONE" AND A ROSE FLOWER LOGO DISPOSED UPPER RIGHT ON THE WORD "FINESTONE".

SER. NO. 77-911,557, FILED 1-14-2010.

NAPOLEON SHARMA, EXAMINING ATTORNEY



*David J. Kyffers*

Director of the United States Patent and Trademark Office

# United States of America

United States Patent and Trademark Office



**Reg. No. 4,123,447**

INSPIREUSA, INC. (GEORGIA CORPORATION)  
3 N BOULDER COVE  
SAVANNAH, GA 31419

**Registered Apr. 10, 2012**

**Int. Cl.: 35**

FOR: PROMOTING THE GOODS AND SERVICES OF OTHERS BY PROVIDING HYPERTEXT LINKS TO THE WEB SITES OF OTHERS, IN CLASS 35 (U.S. CLS. 100, 101 AND 102).

**SERVICE MARK**

FIRST USE 11-19-2007; IN COMMERCE 1-1-2008.

**PRINCIPAL REGISTER**

THE MARK CONSISTS OF THE LETTERS "AZ" SURROUNDED BY A CIRCLE.

SER. NO. 77-912,608, FILED 1-15-2010.

MAYUR VAGHANI, EXAMINING ATTORNEY



*David J. Kyffers*

Director of the United States Patent and Trademark Office

# United States of America

United States Patent and Trademark Office

# CERAM

**Reg. No. 4,123,448**

**Registered Apr. 10, 2012**

**Int. Cls.: 9, 16, 35, 40, 42  
and 45**

**TRADEMARK**

**SERVICE MARK**

**PRINCIPAL REGISTER**

BRITISH CERAMIC RESEARCH LIMITED (UNITED KINGDOM CORPORATION)  
QUEENS ROAD, PENKHULL  
STOKE-ON-TRENT, STAFFS, UNITED KINGDOM ST47LQ

FOR: SOFTWARE RELATING TO MATERIALS TECHNOLOGY FOR COMPUTING THE COMPOSITION OF A MIXTURE TO CONFER A SET OF REQUIRED FUNCTIONAL PROPERTIES, SOFTWARE RELATING TO CERAMICS FOR COMPUTING THE COMPOSITION OF A MIXTURE TO CONFER A SET OF REQUIRED FUNCTIONAL PROPERTIES; PRE-RECORDED CD ROMS CONTAINING INFORMATION RELATING TO MATERIALS TECHNOLOGY, PRE-RECORDED CD ROMS CONTAINING INFORMATION RELATING TO CERAMICS; PRE-RECORDED USB COMPUTER MEMORY HARDWARE CONTAINING INFORMATION RELATING TO MATERIALS TECHNOLOGY, PRE-RECORDED USB COMPUTER MEMORY HARDWARE CONTAINING INFORMATION RELATING TO CERAMICS; SOFTWARE FOR MODELING INDUSTRIAL PROCESSES WITH REGARD TO ENERGY USE, ENERGY USE AUDITING, ENERGY USE ASSESSMENT, GREENHOUSE GAS EMISSIONS, AND CARBON DIOXIDE EMISSIONS; SOFTWARE FOR CREATING MODELS OF PRODUCTS WITH REGARD TO QUALITY STANDARDS, CERTIFICATION OF QUALITY STANDARDS, CERTIFICATION AND VERIFICATION SERVICES; PRE-RECORDED CD ROMS CONTAINING INFORMATION RELATING TO ENERGY USE, ENERGY USE AUDITING, ENERGY USE ASSESSMENT, GREENHOUSE GAS EMISSIONS, CARBON DIOXIDE EMISSIONS, QUALITY STANDARDS, CERTIFICATION OF QUALITY STANDARDS, CERTIFICATION AND VERIFICATION SERVICES; PRE-RECORDED USB COMPUTER MEMORY HARDWARE CONTAINING INFORMATION RELATING TO ENERGY USE, ENERGY USE AUDITING, ENERGY USE ASSESSMENT, GREENHOUSE GAS EMISSIONS, CARBON DIOXIDE EMISSIONS, QUALITY STANDARDS, CERTIFICATION OF QUALITY STANDARDS, CERTIFICATION AND VERIFICATION SERVICES, IN CLASS 9 (U.S. CLS. 21, 23, 26, 36 AND 38).

FOR: PRINTED PUBLICATIONS, NAMELY, MAGAZINES, BROCHURES, BOOKLETS, AND JOURNALS RELATING TO MATERIALS TECHNOLOGY, PRINTED PUBLICATIONS, NAMELY, MAGAZINES, BROCHURES, BOOKLETS, AND JOURNALS RELATING TO CERAMICS; PRINTED PUBLICATIONS, NAMELY, MAGAZINES, BROCHURES, BOOKLETS, AND JOURNALS RELATING TO ENERGY USE, ENERGY USE AUDITING, ENERGY USE ASSESSMENT, GREENHOUSE GAS EMISSIONS, CARBON DIOXIDE EMISSIONS, QUALITY STANDARDS, CERTIFICATION OF QUALITY STANDARDS, AND CERTIFICATION AND VERIFICATION SERVICES, IN CLASS 16 (U.S. CLS. 2, 5, 22, 23, 29, 37, 38 AND 50).



*David J. Kyffers*

Director of the United States Patent and Trademark Office

**Reg. No. 4,123,448** FOR: PROVIDING INFORMATION IN THE FIELDS OF ENERGY USAGE MANAGEMENT AND ENERGY EFFICIENCY AS IT PERTAINS TO ENERGY USE AUDITING AND ENERGY USE ASSESSMENT; CONSULTANCY AND ADVISORY SERVICES IN THE FIELD OF ENERGY USE MANAGEMENT, ENERGY USE AUDITING AND ENERGY USE ASSESSMENT SERVICES FOR THE PURPOSE OF DETERMINING ENERGY EFFICIENCY OR USAGE MANAGEMENT; PROVIDING INFORMATION IN THE FIELD OF ENERGY USE AUDITING AND ENERGY USE ASSESSMENT FOR THE PURPOSE OF DETERMINING ENERGY EFFICIENCY OR USAGE MANAGEMENT; ENERGY USE AUDITING SERVICES AND ENERGY USE ASSESSMENT SERVICES FOR THE PURPOSE OF DETERMINING ENERGY EFFICIENCY OR USAGE MANAGEMENT; CONSULTING IN THE FIELD OF ENERGY USE AUDITING AND ENERGY USE ASSESSMENT FOR THE PURPOSE OF DETERMINING ENERGY EFFICIENCY OR USAGE MANAGEMENT, IN CLASS 35 (U.S. CLS. 100, 101 AND 102).

FOR: PROVISION OF INFORMATION RELATING TO MATERIALS SCIENCE, NAMELY, MATERIAL TREATMENT INFORMATION, PROVISION OF INFORMATION RELATING TO THE TREATMENT OF CERAMICS, IN CLASS 40 (U.S. CLS. 100, 103 AND 106).

FOR: CONSULTANCY AND ADVISORY SERVICES IN THE FIELD OF PRODUCT DEVELOPMENT; PRODUCT RESEARCH AND DEVELOPMENT; PRODUCT DEVELOPMENT; CONSULTANCY AND ADVISORY SERVICES RELATING TO NEW PRODUCT DESIGN; PRODUCT RESEARCH IN THE FIELD OF PRODUCT DESIGN; NEW PRODUCT DESIGN SERVICES; CONSULTANCY AND ADVISORY SERVICE RELATING TO PROCESS ENGINEERING; RESEARCH IN THE FIELD OF PROCESS ENGINEERING; CONSULTANCY AND ADVISORY SERVICES RELATING TO COMPUTER SOFTWARE OF OTHERS FOR COMPUTER MODELING AND COMPUTER SIMULATION; CONSULTANCY AND ADVISORY SERVICES RELATING TO LABORATORY SERVICES, NAMELY, COLOR ANALYSIS; PROVIDING INFORMATION IN THE FIELD OF GREENHOUSE GAS AND CARBON DIOXIDE EMISSION MEASURING AND ANALYSIS; PROVIDING INFORMATION IN THE FIELD OF MONITORING OF GREENHOUSE GAS EMISSIONS AND CARBON DIOXIDE EMISSIONS; TESTING, ANALYSIS AND EVALUATION OF THE GREENHOUSE GAS AND CARBON DIOXIDE EMISSION MEASURING AND ANALYSIS SERVICES OF OTHERS FOR THE PURPOSE OF CERTIFICATION; PROVIDING INFORMATION IN THE FIELD OF TESTING, ANALYSIS, AND EVALUATION OF THE ENERGY USE MANAGEMENT OF OTHERS FOR THE PURPOSE OF CERTIFICATION; CONSULTING IN THE FIELD OF GREENHOUSE GAS AND CARBON DIOXIDE EMISSION MEASURING AND ANALYSIS; CONSULTING IN THE FIELD OF MONITORING OF GREENHOUSE GAS EMISSIONS AND CARBON DIOXIDE EMISSIONS; TESTING, ANALYSIS AND EVALUATION OF THE ENERGY USE MANAGEMENT OF OTHERS FOR THE PURPOSE OF CERTIFICATION; CONSULTING IN THE FIELD OF TESTING, ANALYSIS, AND EVALUATION OF THE ENERGY USE MANAGEMENT OF OTHERS FOR THE PURPOSE OF CERTIFICATION; TESTING, ANALYSIS, AND EVALUATION OF THE GOODS AND SERVICES OF OTHERS FOR THE PURPOSE OF CERTIFICATION AND VERIFICATION INCLUDING THOSE MEETING RECOGNIZED STANDARDS INCLUDING NATIONAL AND INTERNATIONAL STANDARDS SUCH AS ISO STANDARDS; TESTING, ANALYSIS, AND EVALUATION OF THE GOODS AND SERVICES OF OTHERS FOR THE PURPOSE OF CERTIFICATION AND VERIFICATION INCLUDING THOSE MEETING RECOGNIZED STANDARDS INCLUDING NATIONAL AND INTERNATIONAL STANDARDS SUCH AS ISO STANDARDS, RELATING TO ENERGY USE, GREENHOUSE GAS EMISSIONS, CARBON DIOXIDE EMISSIONS, DISPERSED OIL IN WATER, METAL RELEASE FROM MATERIALS, AND THE MANUFACTURE OF BRICKS, BLOCKS, ROOF TILES, CHIMNEYS, LININGS, FLOOR AND WALL TILES, TABLEWARE; TESTING, ANALYSIS, AND EVALUATION OF THE GOODS AND SERVICES OF OTHERS FOR THE PURPOSES OF CERTIFICATION AND VERIFICATION; INSPECTION OF ENERGY SYSTEMS TO DETERMINE ENERGY USAGE; PROVIDING INFORMATION IN THE FIELD OF MONITORING OF ENERGY USE FOR OTHERS, NAMELY, VIEWING OR RECORDING THE TIMING OR LEVEL OF USE AND CONTROL OF ELECTRICITY USED BY SELECTED DEVICES, CONSULTING IN THE FIELD OF MONITORING OF ENERGY USE FOR OTHERS,

**Reg. No. 4,123,448** NAMELY, VIEWING OR RECORDING THE TIMING OR LEVEL OF USE AND CONTROL OF ELECTRICITY USED BY SELECTED DEVICES, IN CLASS 42 (U.S. CLS. 100 AND 101).

FOR: EXPERT WITNESS SERVICES IN LEGAL MATTERS IN THE FIELD OF CERAMICS, MATERIAL TECHNOLOGY, ENERGY USE, ENERGY USE AUDITING, ENERGY USE ASSESSMENT, GREENHOUSE GAS EMISSIONS, CARBON DIOXIDE EMISSIONS, QUALITY STANDARDS, CERTIFICATION AND VERIFICATION SERVICES, BUILDING MATERIALS, AND BUILDING TECHNOLOGIES, IN CLASS 45 (U.S. CLS. 100 AND 101).

THE MARK CONSISTS OF STANDARD CHARACTERS WITHOUT CLAIM TO ANY PARTICULAR FONT, STYLE, SIZE, OR COLOR.

PRIORITY CLAIMED UNDER SEC. 44(D) ON UNITED KINGDOM APPLICATION NO. 2533378, FILED 12-2-2009, REG. NO. 2533378, DATED 12-2-2009, EXPIRES 12-2-2019.

OWNER OF ERPN CMNTY TM OFC REG. NO. 003388675, DATED 11-30-2006, EXPIRES 9-30-2013.

SER. NO. 77-914,574, FILED 1-19-2010.

SETH A. RAPPAPORT, EXAMINING ATTORNEY

# United States of America

United States Patent and Trademark Office

## FEDERATION OF ANIMAL SCIENCE SOCIETIES

**Reg. No. 4,123,449**

**Registered Apr. 10, 2012**

**Int. Cls.: 35 and 41**

**SERVICE MARK**

**PRINCIPAL REGISTER**

FEDERATION OF ANIMAL SCIENCE SOCIETIES (ILLINOIS NON-PROFIT CORPORATION)  
2441 VILLAGE GREEN PLACE  
CHAMPAIGN, IL 61822

FOR: ASSOCIATION SERVICES, NAMELY, PROMOTING THE INTERESTS OF PROFESSIONALS IN THE FIELD OF ANIMAL AND AGRICULTURAL SCIENCES; ASSOCIATION MANAGEMENT SERVICES, NAMELY, ASSISTANCE IN MANAGEMENT OF BUSINESS ACTIVITIES; ASSISTANCE WITH BUSINESS MANAGEMENT AND PLANNING; BUSINESS MANAGEMENT AND CONSULTATION IN THE FIELD OF ASSOCIATION MEMBERSHIP, MEMBERSHIP SERVICES AND CUSTOMER SERVICE; PLANNING, ORGANIZATION, MANAGEMENT AND ADMINISTRATION OF BUSINESS AND MEMBERSHIP MEETINGS AND CONFERENCES BOTH IN PERSON AND ON-LINE; CONSULTATION AND PUBLICATION OF PROMOTIONAL MATERIALS FOR OTHERS; MANAGEMENT OF BUSINESS SYSTEMS FOR OTHERS, NAMELY, MEMBERSHIP DATABASE MANAGEMENT, AND MANAGEMENT OF ABSTRACT SUBMISSION DATABASES; FINANCIAL RECORDS MANAGEMENT FOR OTHERS; BUSINESS SERVICES FOR OTHERS, NAMELY, PREPARATION OF FINANCIAL STATEMENTS, DEVELOPMENT OF BUDGETS, PAYROLL PREPARATION, AND ASSISTANCE WITH TAX PREPARATION AND AUDITS, IN CLASS 35 (U.S. CLS. 100, 101 AND 102).

FIRST USE 0-0-1998; IN COMMERCE 0-0-1998.

FOR: CONSULTATION AND PUBLICATION OF JOURNALS, MAGAZINES, NEWSLETTERS, DIRECTORIES FOR OTHERS, IN CLASS 41 (U.S. CLS. 100, 101 AND 107).

FIRST USE 0-0-1998; IN COMMERCE 0-0-1998.

THE MARK CONSISTS OF STANDARD CHARACTERS WITHOUT CLAIM TO ANY PARTICULAR FONT, STYLE, SIZE, OR COLOR.

SEC. 2(F).

SER. NO. 77-914,773, FILED 1-19-2010.

WILLIAM P. SHANAHAN, EXAMINING ATTORNEY



*David J. Kyffers*

Director of the United States Patent and Trademark Office



# United States of America

United States Patent and Trademark Office



**Reg. No. 4,123,450**

FEDERATION OF ANIMAL SCIENCE SOCIETIES (ILLINOIS NON-PROFIT CORPORATION)  
2441 VILLAGE GREEN PLACE  
CHAMPAIGN, IL 61822

**Registered Apr. 10, 2012**

**Int. Cls.: 35 and 41**

FOR: ASSOCIATION SERVICES, NAMELY, PROMOTING THE INTERESTS OF PROFESSIONALS IN THE FIELD OF ANIMAL AND AGRICULTURAL SCIENCES; ASSOCIATION MANAGEMENT SERVICES, NAMELY, ASSISTANCE IN MANAGEMENT OF BUSINESS ACTIVITIES; ASSISTANCE WITH BUSINESS MANAGEMENT AND PLANNING; BUSINESS MANAGEMENT AND CONSULTATION IN THE FIELD OF ASSOCIATION MEMBERSHIP, MEMBERSHIP SERVICES AND CUSTOMER SERVICE; PLANNING, ORGANIZATION, MANAGEMENT AND ADMINISTRATION OF BUSINESS AND MEMBERSHIP MEETINGS AND CONFERENCES BOTH IN PERSON AND ON-LINE; CONSULTATION AND PUBLICATION OF PROMOTIONAL MATERIALS FOR OTHERS; MANAGEMENT OF BUSINESS SYSTEMS FOR OTHERS, NAMELY, MEMBERSHIP DATABASE MANAGEMENT, AND MANAGEMENT OF ABSTRACT SUBMISSION DATABASES; FINANCIAL RECORDS MANAGEMENT FOR OTHERS; BUSINESS SERVICES FOR OTHERS, NAMELY, PREPARATION OF FINANCIAL STATEMENTS, DEVELOPMENT OF BUDGETS, PAYROLL PREPARATION, AND ASSISTANCE WITH TAX PREPARATION AND AUDITS, IN CLASS 35 (U.S. CLS. 100, 101 AND 102).

**SERVICE MARK**

FIRST USE 0-0-1998; IN COMMERCE 0-0-1998.

**PRINCIPAL REGISTER**

FOR: CONSULTATION AND PUBLICATION OF JOURNALS, MAGAZINES, NEWSLETTERS, DIRECTORIES FOR OTHERS, IN CLASS 41 (U.S. CLS. 100, 101 AND 107).



FIRST USE 0-0-1998; IN COMMERCE 0-0-1998.

THE MARK CONSISTS OF THE WORDS "FASS" ON THE LEFT HORIZONTALLY NEXT TO THE WORDS "FEDERATION OF ANIMAL SCIENCE SOCIETIES".

SEC. 2(F) AS TO "FEDERATION OF ANIMAL SCIENCE SOCIETIES".

SER. NO. 77-914,774, FILED 1-19-2010.

*David J. Kyros*

WILLIAM P. SHANAHAN, EXAMINING ATTORNEY

# United States of America

United States Patent and Trademark Office

# FASS

**Reg. No. 4,123,451**

**Registered Apr. 10, 2012**

**Int. Cls.: 35 and 41**

**SERVICE MARK**

**PRINCIPAL REGISTER**

FEDERATION OF ANIMAL SCIENCE SOCIETIES (ILLINOIS NON-PROFIT CORPORATION)  
2441 VILLAGE GREEN PLACE  
CHAMPAIGN, IL 61822

FOR: ASSOCIATION SERVICES, NAMELY, PROMOTING THE INTERESTS OF PROFESSIONALS IN THE FIELD OF ANIMAL AND AGRICULTURAL SCIENCES; ASSOCIATION MANAGEMENT SERVICES, NAMELY, ASSISTANCE IN MANAGEMENT OF BUSINESS ACTIVITIES; ASSISTANCE WITH BUSINESS MANAGEMENT AND PLANNING; BUSINESS MANAGEMENT AND CONSULTATION IN THE FIELD OF ASSOCIATION MEMBERSHIP, MEMBERSHIP SERVICES AND CUSTOMER SERVICE; PLANNING, ORGANIZATION, MANAGEMENT AND ADMINISTRATION OF BUSINESS AND MEMBERSHIP MEETINGS AND CONFERENCES BOTH IN PERSON AND ON-LINE; CONSULTATION AND PUBLICATION OF PROMOTIONAL MATERIALS FOR OTHERS; MANAGEMENT OF BUSINESS SYSTEMS FOR OTHERS, NAMELY, MEMBERSHIP DATABASE MANAGEMENT, AND MANAGEMENT OF ABSTRACT SUBMISSION DATABASES; FINANCIAL RECORDS MANAGEMENT FOR OTHERS; BUSINESS SERVICES FOR OTHERS, NAMELY, PREPARATION OF FINANCIAL STATEMENTS, DEVELOPMENT OF BUDGETS, PAYROLL PREPARATION, AND ASSISTANCE WITH TAX PREPARATION AND AUDITS, IN CLASS 35 (U.S. CLS. 100, 101 AND 102).

FIRST USE 0-0-1998; IN COMMERCE 0-0-1998.

FOR: CONSULTATION AND PUBLICATION OF JOURNALS, MAGAZINES, NEWSLETTERS, DIRECTORIES FOR OTHERS, IN CLASS 41 (U.S. CLS. 100, 101 AND 107).

FIRST USE 0-0-1998; IN COMMERCE 0-0-1998.

THE MARK CONSISTS OF STANDARD CHARACTERS WITHOUT CLAIM TO ANY PARTICULAR FONT, STYLE, SIZE, OR COLOR.

SER. NO. 77-914,776, FILED 1-19-2010.

WILLIAM P. SHANAHAN, EXAMINING ATTORNEY



*David J. Kyffers*

Director of the United States Patent and Trademark Office

# United States of America

United States Patent and Trademark Office

# EXSALT

**Reg. No. 4,123,452**

**Registered Apr. 10, 2012**

**Int. Cl.: 21**

**TRADEMARK**

**PRINCIPAL REGISTER**

ACRACORP LIMITED (NEW ZEALAND CORPORATION)  
84 STATION STREET  
NAPIER 4110, NEW ZEALAND

FOR: WASHING APPARATUS FOR WASHING DISC BRAKES AND WHEEL HUBS FOR TRAILERS COMPRISING A NON-METAL SPRAY NOZZLE, A LENGTH OF FLEXIBLE HOSE, HOSE CONNECTOR, HOSE SPLITTERS AND PLASTIC TIES FOR ATTACHMENT TO THE UNDERSIDE OF MOTOR VEHICLE, IN CLASS 21 (U.S. CLS. 2, 13, 23, 29, 30, 33, 40 AND 50).

THE MARK CONSISTS OF STANDARD CHARACTERS WITHOUT CLAIM TO ANY PARTICULAR FONT, STYLE, SIZE, OR COLOR.

PRIORITY CLAIMED UNDER SEC. 44(D) ON NEW ZEALAND APPLICATION NO. 818474, FILED 1-20-2010, REG. NO. 818474, DATED 1-22-2010, EXPIRES 1-22-2020.

PRIORITY CLAIMED UNDER SEC. 44(D) ON NEW ZEALAND APPLICATION NO. 818474, FILED 1-20-2010.

SER. NO. 77-919,401, FILED 1-25-2010.

MICHAEL WEBSTER, EXAMINING ATTORNEY



*David J. Kybas*

Director of the United States Patent and Trademark Office

# United States of America

United States Patent and Trademark Office

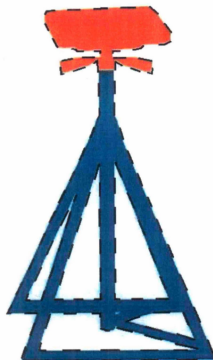

**Reg. No. 4,123,453**

**Registered Apr. 10, 2012**

**Int. Cl.: 6**

**TRADEMARK**

**PRINCIPAL REGISTER**

KAVANAUGH-BROWNELL BOAT STANDS, LLC (MASSACHUSETTS LIMITED LIABILITY COMPANY), DBA BROWNELL BOAT STANDS  
P.O. BOX 1207  
5 BOAT ROCK ROAD  
MATTAPOISETT, MA 02474

FOR: STANDS, PRIMARILY MADE OF METAL, FOR STORAGE OF BOATS, IN CLASS 6 (U.S. CLS. 2, 12, 13, 14, 23, 25 AND 50).

FIRST USE 1-1-1954; IN COMMERCE 1-1-1954.

THE MARK CONSISTS OF THE COLORS BLUE AND ORANGE USED ON BOAT STANDS. THE MATTER SHOWN IN BROKEN LINES ON THE DRAWING SHOWS POSITIONING OF THE MARK ON THE GOODS AND NEITHER THE MATTER SHOWN IN BROKEN LINES NOR THE CONFIGURATION OF THE BOAT STANDS IS CLAIMED AS A FEATURE OF THE MARK.

THE COLOR(S) BLUE AND ORANGE IS/ARE CLAIMED AS A FEATURE OF THE MARK.

SEC. 2(F).

SER. NO. 77-928,430, FILED 2-4-2010.

TRACY CROSS, EXAMINING ATTORNEY



*David J. Kyffers*

Director of the United States Patent and Trademark Office

# United States of America

United States Patent and Trademark Office

## DISCOVER NEW MUSIC

**Reg. No. 4,123,454**

HERNANDEZ, JACK D (UNITED STATES INDIVIDUAL)

**Registered Apr. 10, 2012**

1916 PALMLAND DR #D  
BOYNTON BEACH, FL 33436

**Int. Cl.: 35**

**SERVICE MARK**

**PRINCIPAL REGISTER**

FOR: ADVERTISEMENT FOR OTHERS ON THE INTERNET; ADVERTISING AND DIRECTORY SERVICES, NAMELY, PROMOTING THE SERVICES OF OTHERS BY PROVIDING A WEB PAGE FEATURING LINKS TO THE WEBSITES OF OTHERS; ADVERTISING AND MARKETING; ADVERTISING AND MARKETING SERVICES, NAMELY, PROMOTING THE GOODS AND SERVICES OF OTHERS; ADVERTISING AND PROMOTIONAL SERVICES; ADVERTISING AND PUBLICITY SERVICES; ADVERTISING AND PUBLICITY SERVICES, NAMELY, PROMOTING THE GOODS, SERVICES, BRAND IDENTITY AND COMMERCIAL INFORMATION AND NEWS OF THIRD PARTIES THROUGH PRINT, AUDIO, VIDEO, DIGITAL AND ON-LINE MEDIUM; ADVERTISING BY TRANSMISSION OF ON-LINE PUBLICITY FOR THIRD PARTIES THROUGH ELECTRONIC COMMUNICATIONS NETWORKS; ADVERTISING ON THE INTERNET FOR OTHERS; ADVERTISING SERVICES; ADVERTISING, MARKETING AND PROMOTION SERVICES; ELECTRONIC COMMERCE SERVICES, NAMELY, PROVIDING INFORMATION ABOUT PRODUCTS VIA TELECOMMUNICATION NETWORKS FOR ADVERTISING AND SALES PURPOSES; INTERNET ADVERTISING SERVICES; ON-LINE ADVERTISING ON COMPUTER NETWORKS; ON-LINE ADVERTISING SERVICES FOR OTHERS; ONLINE ADVERTISING VIA A COMPUTER COMMUNICATIONS NETWORK; PLACING ADVERTISEMENTS FOR OTHERS; PROMOTING, ADVERTISING AND MARKETING OF THE ON-LINE WEB SITES OF OTHERS; PROMOTING, ADVERTISING AND MARKETING THE ON-LINE DATABASES AND ELECTRONIC PUBLICATIONS OF OTHERS; PROMOTION, ADVERTISING AND MARKETING OF ON-LINE WEBSITES; PROVIDING A SEARCHABLE ON-LINE ADVERTISING WEBSITE AND GUIDE FEATURING THE GOODS AND SERVICES OF OTHER VENDORS VIA THE INTERNET; PROVIDING A SEARCHABLE ONLINE ADVERTISING GUIDE FEATURING THE GOODS AND SERVICES OF ONLINE VENDORS; PROVIDING A SEARCHABLE ONLINE ADVERTISING GUIDE FEATURING THE GOODS AND SERVICES OF OTHER ON-LINE VENDORS ON THE INTERNET; PROVIDING A WEB SITE WHICH FEATURES ADVERTISEMENTS FOR THE GOODS AND SERVICES OF OTHERS ON A GLOBAL COMPUTER NETWORK; PROVIDING A WEBSITE FEATURING INFORMATION AND LINKS RELATING TO THE MUSIC INDUSTRY, NAMELY, PROMOTION, MARKETING AND BUSINESS ADVICE TO MUSICIANS; PROVIDING ADVERTISING AND ADVERTISEMENT SERVICES; PROVIDING ADVERTISING SERVICE TO DISTRIBUTE ADVERTISEMENTS FOR DISPLAY ON INTERNET, NAMELY, IN WEBSITES, SOCIAL CONVERSATIONS OVER THE INTERNET, EMAILS, MICROBLOGS, BLOGS, ELECTRONIC MESSAGES, INSTANT MESSAGES, TEXT MES-



*David J. Kybas*

Director of the United States Patent and Trademark Office

**Reg. No. 4,123,454** SAGES, MULTIMEDIA MESSAGES, SOCIAL NETWORKS, STATUS UPDATES, FORUMS, ELECTRONIC BULLETIN BOARDS; PROVIDING ADVERTISING SERVICES; PROVIDING AN INTERNET WEBSITE PORTAL FEATURING LINKS TO MUSIC-RELATED MERCHANDISE FOR RETAIL PURPOSES; PROVISION OF ADVERTISING SPACE BY ELECTRONIC MEANS AND GLOBAL INFORMATION NETWORKS; PROVISION OF SPACE ON WEBSITES FOR ADVERTISING GOODS AND SERVICES, IN CLASS 35 (U.S. CLS. 100, 101 AND 102).

FIRST USE 5-31-2009; IN COMMERCE 5-31-2009.

THE MARK CONSISTS OF STANDARD CHARACTERS WITHOUT CLAIM TO ANY PARTICULAR FONT, STYLE, SIZE, OR COLOR.

SER. NO. 77-928,686, FILED 2-5-2010.

PAUL E. FAHRENKOPF, EXAMINING ATTORNEY

# United States of America

United States Patent and Trademark Office

# TAPISODES

**Reg. No. 4,123,455**

**Registered Apr. 10, 2012**

**Int. Cls.: 9, 25, 28, 38, 41  
and 42**

**TRADEMARK**

**SERVICE MARK**

**PRINCIPAL REGISTER**

TAPISODES LTD (UNITED KINGDOM LIMITED COMPANY (LTD.))  
2ND FLOOR 1 SOUTHAMPTON STREET  
MANFIELD HOUSE  
LONDON WC2R 0LR, UNITED KINGDOM

FOR: COMPUTER SOFTWARE AND FIRMWARE FEATURING ENTERTAINMENT, EDUCATIONAL, AND INFORMATIONAL CONTENT, NAMELY, COMPUTER GAMES, VIDEO GAMES, PUZZLES, MUSIC, ANIMATED VIDEOS, ANIMATED ILLUSTRATIONS, CARTOONS, ANIMATION, AND ANIMATED STORIES; COMPUTER SOFTWARE PERTAINING TO ENTERTAINMENT, EDUCATIONAL, AND INFORMATIONAL CONTENT IN THE FIELD OF ACADEMICS, PERSONAL HOBBIES AND WELLNESS, AND FOR USE IN CREATING CARTOONS, ANIMATIONS, ANIMATED BOOKS, ANIMATED VIDEOS, ANIMATED ILLUSTRATIONS, ONLINE GREETING CARDS, PICTORIAL MESSAGES, ILLUSTRATED INSTRUCTION MANUALS, ILLUSTRATIONS USED FOR EDUCATIONAL AND TRAINING PURPOSES, ILLUSTRATIONS USED FOR ADVERTISING PURPOSES, WEBSITE DESIGN, COMPUTER GAMES AND DIGITAL ENTERTAINMENT CONTENT; DIGITAL ELECTRONIC DEVICES CAPABLE OF VIEWING ANIMATED VIDEOS, CARTOONS AND ANIMATED ILLUSTRATIONS, AND SOFTWARE RELATED THERETO; CINEMATOGRAPHIC, PHOTOGRAPHIC AND ANIMATED FILMS FEATURING ENTERTAINMENT, EDUCATIONAL, AND INFORMATIONAL CONTENT, NAMELY, MUSIC, ANIMATED VIDEOS, ANIMATED ILLUSTRATIONS, CARTOONS, ANIMATION, AND ANIMATED STORIES; SOUND AND VIDEO RECORDINGS FEATURING ENTERTAINMENT, EDUCATIONAL, AND INFORMATIONAL CONTENT, NAMELY, MUSIC, ANIMATED VIDEOS, ANIMATED ILLUSTRATIONS, CARTOONS, ANIMATION, AND ANIMATED STORIES; AUDIO TAPES AND VIDEO TAPES FEATURING ENTERTAINMENT, EDUCATIONAL, AND INFORMATIONAL CONTENT, NAMELY, MUSIC, ANIMATED VIDEOS, ANIMATED ILLUSTRATIONS, CARTOONS, ANIMATION, AND ANIMATED STORIES; RECORDS, DISCS, TAPES, CASSETTES, CARTRIDGES, CARDS AND OTHER DATA CARRIERS, FEATURING SOUND RECORDINGS, VIDEO RECORDINGS, DATA, IMAGES, GRAPHICS, TEXT, PROGRAMS OR INFORMATION FEATURING ENTERTAINMENT, EDUCATIONAL, AND INFORMATIONAL CONTENT, NAMELY, COMPUTER GAMES, VIDEO GAMES, PUZZLES, MUSIC, ANIMATED VIDEOS, ANIMATED ILLUSTRATIONS, CARTOONS, ANIMATION, AND ANIMATED STORIES; PROVIDING ON-LINE DOWNLOADABLE ELECTRONIC PUBLICATIONS IN THE FORM OF CARTOONS, ANIMATIONS, ANIMATED BOOKS, VIDEOS AND ILLUSTRATIONS, ONLINE GREETING CARDS, PICTORIAL MESSAGES, ILLUSTRATED INSTRUCTION MANUALS, ILLUSTRATIONS USED FOR EDUCATIONAL AND TRAINING PURPOSES, ILLUSTRATIONS USED FOR ADVERTISING PURPOSES, WEBSITE DESIGN, COMPUTER



*David J. Kyros*

Director of the United States Patent and Trademark Office

**Reg. No. 4,123,455** GAMES AND DIGITAL ENTERTAINMENT CONTENT; DOWNLOADABLE COMPUTER GAME PROGRAMS; DOWNLOADABLE VIDEO RECORDINGS AND WEBISODES FEATURING ENTERTAINMENT, EDUCATIONAL, AND INFORMATIONAL CONTENT, NAMELY, COMPUTER GAMES, VIDEO GAMES, PUZZLES, MUSIC, ANIMATED VIDEOS, ANIMATED ILLUSTRATIONS, CARTOONS, ANIMATION, AND ANIMATED STORIES; DOWNLOADABLE PODCASTS, WEBCASTS, WEBINARS, WEBISODES FEATURING ENTERTAINMENT, EDUCATIONAL, AND INFORMATIONAL CONTENT, NAMELY, COMPUTER GAMES, VIDEO GAMES, PUZZLES, MUSIC, ANIMATED VIDEOS, ANIMATED ILLUSTRATIONS, CARTOONS, ANIMATION, AND ANIMATED STORIES; DOWNLOADABLE SOFTWARE IN THE NATURE OF A MOBILE APPLICATION FOR ENTERTAINMENT, EDUCATIONAL, INFORMATIONAL AND TRAINING PURPOSES; HAND-HELD ELECTRONIC GAMES ADAPTED FOR USE WITH TELEVISION RECEIVERS ONLY; CARRYING CASES, HOLDERS PROTECTIVE CASES AND STANDS FEATURING POWER SUPPLY CONNECTORS, ADAPTORS, SPEAKERS AND BATTERY CHARGING DEVICES, SPECIALLY ADAPTED FOR USE WITH HAND-HELD ELECTRONIC DEVICES; PARTS AND FITTINGS FOR HAND-HELD GAME APPARATUS WITH LIQUID CRYSTAL DISPLAYS, NAMELY, POWER SUPPLIES, TRANSFORMERS AND BATTERY CHARGERS, IN CLASS 9 (U.S. CLS. 21, 23, 26, 36 AND 38).

FOR: CLOTHING, NAMELY, TOPS, BOTTOMS, SHIRTS, DRESSES, JACKETS, JERSEYS, UNDERWEAR, NECKWEAR, SLEEPWEAR, SWIMWEAR, RAINWEAR, RAINCOATS, BANDANAS, BEACH WEAR, SWIM SUITS, BATHING SUIT COVER UPS, BEACH COVER UPS, BEACH SHOES, BEACH FOOTWEAR, BED JACKETS, BELTS, BOOTS, CAPS, CLOTH BIBS, COATS, FOOTWEAR, FLIP FLOPS, GLOVES, HALLOWEEN COSTUMES, HATS, HEADWEAR, BEANIES, CAPS, HOSIERY, INFANT WEAR, MASQUERADE COSTUMES, MITTENS, MUFFLERS, NIGHTGOWNS, NIGHTSHIRTS, OVERALLS, PYJAMAS, PANTS, PARKAS, PONCHOS, PULL-OVERS, HOODED SWEATSHIRTS, ROBES, SANDALS, SCARVES, SHOES, SHORTS, SLIPPERS, SMOCKS, SOCKS, STOCKINGS, SWEAT PANTS, SWEATSHIRTS, SWEATERS, T-SHIRTS, TIES, TIGHTS, TOPS, TROUSERS, VESTS, VISORS, WARM-UP SUITS, AND WRIST BANDS, IN CLASS 25 (U.S. CLS. 22 AND 39).

FOR: GAMES AND PLAYTHINGS, NAMELY, DOLLS, ACTION FIGURES, BASEBALLS, CHRISTMAS TREE ORNAMENTS AND DECORATIONS, BALLS FOR GAMES, BALLS FOR SPORTS, PLUSH TOYS, PLUSH DOLLS, STUFFED TOYS, BOXING GLOVES, BASEBALL GLOVES, FENCING GLOVES, GOLF GLOVES, WEIGHT LIFTING GLOVES, WORK-OUT GLOVES, AND TOY KEY CHAINS WITH AND WITHOUT SOUND DEVICE; HAND HELD GAMES AND VIDEO GAMES, ELECTRONIC GAME EQUIPMENT; BOARD GAMES; PARLOUR GAMES; PLAYING CARDS; SCRATCH CARDS FOR PLAYING LOTTERY GAMES; HAND HELD UNITS FOR PLAYING COMPUTER GAMES OTHER THAN THOSE ADAPTED FOR USE WITH AN EXTERNAL DISPLAY SCREEN OR MONITOR; ELECTRONIC GAME EQUIPMENT WITH A WATCH FUNCTION; CARRYING CASES FOR HAND-HELD VIDEOGAME SYSTEMS; HAND-HELD GAME MACHINES WITH LIQUID CRYSTAL DISPLAYS; HAND-HELD UNITS FOR PLAYING ELECTRONIC GAMES AND VIDEO GAMES; TRADING CARD GAMES; ARCADE-TYPE ELECTRONIC EDUCATION VIDEO GAMES; ARCADE-TYPE ELECTRONIC VIDEO GAMES; STAND-ALONE VIDEO GAME MACHINES; STAND ALONE VIDEO OUTPUT GAME MACHINES; HAND-HELD VIDEO GAME SYSTEMS, COMPRISING HAND-HELD UNITS FOR PLAYING VIDEO GAMES AND ASSOCIATED GAME CARTRIDGES OR GAME MEMORY CARDS PACKAGED AS UNIT; PROTECTIVE CARRYING CASES SPECIALLY ADAPTED FOR HAND-HELD VIDEO GAMES; AND PARTS AND FITTINGS FOR ALL THE AFORESAID, IN CLASS 28 (U.S. CLS. 22, 23, 38 AND 50).

FOR: DELIVERY OF DIGITAL ENTERTAINMENT CONTENT BY TELECOMMUNICATIONS NETWORKS, WIRELESS NETWORKS, AND THE INTERNET; ELECTRONIC TRANSMISSION VIA COMPUTER AND OTHER COMMUNICATIONS NETWORKS OF STREAMED AND DOWNLOADABLE AUDIO AND VIDEO FILES RELATING TO ENTERTAINMENT, EDUCATIONAL, AND INFORMATIONAL CONTENT, NAMELY, COMPUTER GAMES, VIDEO GAMES, PUZZLES, MUSIC, ANIMATED VIDEOS, ANIMATED ILLUSTRATIONS, CARTOONS, ANIMATION, ANIMATED STORIES, ONLINE GREETINGS CARDS, PICTORIAL



**Reg. No. 4,123,455** MESSAGES, ILLUSTRATED INSTRUCTION MANUALS, ILLUSTRATIONS USED FOR EDUCATIONAL AND TRAINING PURPOSES, ILLUSTRATIONS USED FOR ADVERTISING PURPOSES, WEBSITE DESIGN, COMPUTER GAMES AND DIGITAL ENTERTAINMENT CONTENT; COMMUNICATION SERVICES, NAMELY, MATCHING USERS FOR THE TRANSFER OF ANIMATED VIDEO AND AUDIO RECORDINGS VIA COMMUNICATION NETWORKS; PROVIDING ON-LINE BULLETIN BOARDS FOR THE TRANSMISSION OF MESSAGES AMONG COMPUTER AND ELECTRONIC DEVICE USERS CONCERNING ENTERTAINMENT, EDUCATIONAL, AND INFORMATIONAL CONTENT, NAMELY, COMPUTER GAMES, VIDEO GAMES, PUZZLES, MUSIC, ANIMATED VIDEOS, ANIMATED ILLUSTRATIONS, CARTOONS, ANIMATION, ANIMATED STORIES, ONLINE GREETINGS CARDS, PICTORIAL MESSAGES, ILLUSTRATED INSTRUCTION MANUALS, ILLUSTRATIONS USED FOR EDUCATIONAL AND TRAINING PURPOSES, ILLUSTRATIONS USED FOR ADVERTISING PURPOSES, WEBSITE DESIGN, COMPUTER GAMES AND DIGITAL ENTERTAINMENT CONTENT; PROVIDING ACCESS TO DATABASES AND DIRECTORIES VIA COMMUNICATIONS NETWORKS FOR OBTAINING DATA IN THE FIELDS OF ENTERTAINMENT, EDUCATIONAL, AND INFORMATIONAL CONTENT, NAMELY, COMPUTER GAMES, VIDEO GAMES, PUZZLES, MUSIC, ANIMATED VIDEOS, ANIMATED ILLUSTRATIONS, CARTOONS, ANIMATION, ANIMATED STORIES, ONLINE GREETINGS CARDS, PICTORIAL MESSAGES, ILLUSTRATED INSTRUCTION MANUALS, ILLUSTRATIONS USED FOR EDUCATIONAL AND TRAINING PURPOSES, ILLUSTRATIONS USED FOR ADVERTISING PURPOSES, WEBSITE DESIGN, COMPUTER GAMES AND DIGITAL ENTERTAINMENT CONTENT; BROADCASTING AND TRANSMISSION OF TELEVISION, RADIO, CABLE, SATELLITE AND INTERNET PROGRAMS; INFORMATION, ADVISORY AND CONSULTANCY SERVICES RELATING TO ALL THE AFORESAID, NAMELY, DIGITAL CONTENT DELIVERY, TELECOMMUNICATIONS, AND PROVIDING ACCESS TO ONLINE DATABASES, IN CLASS 38 (U.S. CLS. 100, 101 AND 104).

FOR: ENTERTAINMENT SERVICES, NAMELY, PROVIDING NON DOWNLOADABLE ELECTRONIC GAMES, GAME SUPPLIES, MUSICAL VIDEOS, RELATED SCREEN SHOTS, PHOTOGRAPHS AND OTHER ENTERTAINMENT-RELATED MULTIMEDIA CONTENT; PROVIDING ON-GOING INTERACTIVE WEBISODES FEATURING COMEDY, ANIMATION, CARTOONS, DRAMA, LITERATURE, EDUCATIONAL, AND INTERACTIVE CONTENT VIA A GLOBAL COMPUTER NETWORK, DIGITAL CABLE SYSTEMS, WIRELESS NETWORK, AND TELECOMMUNICATIONS NETWORK; PROVIDING NON-DOWNLOADABLE VIDEO GAMES, ELECTRONIC GAMES AND COMPUTER GAMES THAT CAN BE ACCESSED AND PLAYED OVER GLOBAL COMPUTER NETWORK, DIGITAL CABLE SYSTEMS, WIRELESS NETWORK, AND TELECOMMUNICATIONS NETWORK; ENTERTAINMENT SERVICES, NAMELY, PROVIDING ONLINE ELECTRONIC COMPUTER AND VIDEO GAMES; ENTERTAINMENT SERVICES, NAMELY, PROVIDING ON-LINE NON DOWNLOADABLE MOVIES, FILMS, ANIMATED VIDEOS, ANIMATED ILLUSTRATIONS, CARTOONS, ANIMATION, ANIMATED STORIES, MOVIE AND FILM CLIPS, VIDEO CLIPS, AND AUDIO CLIPS VIA A GLOBAL COMPUTER NETWORK, DIGITAL CABLE SYSTEMS, WIRELESS NETWORK, AND TELECOMMUNICATIONS NETWORK; PROVIDING ON-LINE NON-DOWNLOADABLE INTERACTIVE MULTIPLAYER COMPUTER AND VIDEO GAMES THAT MAY BE ACCESSED AND PLAYED OVER GLOBAL COMPUTER NETWORK, DIGITAL CABLE SYSTEMS, WIRELESS NETWORK, AND TELECOMMUNICATIONS NETWORK; PROVIDING ON-LINE NON-DOWNLOADABLE ELECTRONIC PUBLICATIONS FEATURING ENTERTAINMENT, EDUCATIONAL, AND INFORMATIONAL CONTENT, NAMELY, COMPUTER GAMES, VIDEO GAMES, PUZZLES, MUSIC, ANIMATED VIDEOS, ANIMATED ILLUSTRATIONS, CARTOONS, ANIMATION, ANIMATED STORIES, ONLINE GREETINGS CARDS, PICTORIAL MESSAGES, ILLUSTRATED INSTRUCTION MANUALS, ILLUSTRATIONS USED FOR EDUCATIONAL AND TRAINING PURPOSES, ILLUSTRATIONS USED FOR ADVERTISING PURPOSES, WEBSITE DESIGN, COMPUTER GAMES AND DIGITAL ENTERTAINMENT CONTENT; ENTERTAINMENT SERVICES IN THE NATURE OF CARTOONS, ANIMATIONS AND ANIMATED BOOKS DISTRIBUTED OVER GLOBAL COMPUTER NETWORK, DIGITAL CABLE SYSTEMS, WIRELESS NETWORK, AND TELECOMMUNICATIONS NETWORK; INFORMATION, ADVISORY AND CONSULTANCY SERVICES RELATING TO THE AFORESAID, NAMELY, PROVIDING ENTERTAINMENT

**Reg. No. 4,123,455** AND INFORMATIONAL CONTENT OVER GLOBAL COMPUTER NETWORK, DIGITAL CABLE SYSTEMS, WIRELESS NETWORK, AND TELECOMMUNICATIONS NETWORK, IN CLASS 41 (U.S. CLS. 100, 101 AND 107).

FOR: DESIGN AND DEVELOPMENT OF COMPUTER SOFTWARE AND HARDWARE; COMPUTER GRAPHIC DESIGN SERVICES, NAMELY, THE CREATION OF CARTOONS, ANIMATIONS, WEBISODES, ANIMATED BOOKS, ONLINE GREETINGS CARDS, PICTORIAL MESSAGES, ILLUSTRATED INSTRUCTION MANUALS, ILLUSTRATIONS USED FOR EDUCATIONAL AND TRAINING PURPOSES, ILLUSTRATIONS USED FOR ADVERTISING PURPOSES, WEBSITE DESIGN, COMPUTER GAMES AND DIGITAL ENTERTAINMENT CONTENT; INFORMATION, ADVISORY AND CONSULTANCY SERVICES RELATING TO ALL THE AFORESAID, NAMELY, DESIGN AND DEVELOPMENT OF COMPUTER SOFTWARE AND HARDWARE AND DESIGN SERVICES FOR ENTERTAINMENT AND INFORMATIONAL CONTENT, IN CLASS 42 (U.S. CLS. 100 AND 101).

THE MARK CONSISTS OF STANDARD CHARACTERS WITHOUT CLAIM TO ANY PARTICULAR FONT, STYLE, SIZE, OR COLOR.

PRIORITY CLAIMED UNDER SEC. 44(D) ON UNITED KINGDOM APPLICATION NO. 2523152, FILED 8-7-2009, REG. NO. 2523152, DATED 11-13-2009, EXPIRES 8-7-2019.

SER. NO. 77-929,557, FILED 2-5-2010.

C. DIONNE CLYBURN, EXAMINING ATTORNEY

# United States of America

United States Patent and Trademark Office

# SUNFORCE

**Reg. No. 4,123,456**

**Registered Apr. 10, 2012**

**Int. Cls.: 7 and 9**

**TRADEMARK**

**PRINCIPAL REGISTER**

SUNFORCE HOLDINGS INC. (CANADA CORPORATION)  
SUITE 2017  
9015 AVON ROAD  
MONTREAL WEST, QUEBEC, CANADA H4X2G8

FOR: RENEWABLE ENERGY PRODUCTS, NAMELY, SOLAR POWERED ELECTRICITY GENERATORS, WIND TURBINES, GENERATORS FOR WIND TURBINES , IN CLASS 7 (U.S. CLS. 13, 19, 21, 23, 31, 34 AND 35).

FOR: RENEWABLE ENERGY PRODUCTS, NAMELY, SOLAR PANELS FOR THE PRODUCTION OF ELECTRICITY, SOLAR BATTERIES, SOLAR CHARGERS FOR BATTERIES, ELECTRONIC CHARGERS FOR BATTERIES, INVERTERS, BATTERIES, IN CLASS 9 (U.S. CLS. 21, 23, 26, 36 AND 38).

THE MARK CONSISTS OF STANDARD CHARACTERS WITHOUT CLAIM TO ANY PARTICULAR FONT, STYLE, SIZE, OR COLOR.

PRIORITY CLAIMED UNDER SEC. 44(D) ON CANADA APPLICATION NO. 1447353, FILED 8-6-2009, REG. NO. TMA779516, DATED 10-12-2010, EXPIRES 10-12-2025.

SER. NO. 77-929,590, FILED 2-5-2010.

MARGERY A. TIERNEY, EXAMINING ATTORNEY



*David J. Kyros*

Director of the United States Patent and Trademark Office

# United States of America

United States Patent and Trademark Office

## KANNAD MARINE

**Reg. No. 4,123,457**

**Registered Apr. 10, 2012**

**Int. Cl.: 9**

**TRADEMARK**

**PRINCIPAL REGISTER**

MCMURDO LIMITED (UNITED KINGDOM LIMITED LIABILITY COMPANY)  
AIRPORT SERVICE ROAD  
SILVER POINT  
PORTSMOUTH, HAMPSHIRE, UNITED KINGDOM PO35PB

FOR: SIGNALING AND NAVIGATIONAL BUOYS; BATTERIES; EMERGENCY POSITION INDICATING RADIO BEACONS; SEARCH AND RESCUE TRANSPONDERS; ELECTRONIC LCD DISPLAY UNIT WITH MULTI-NETWORKING (TCP/IP) CAPABILITIES; LUMINOUS SAFETY BEACONS; EMERGENCY POSITION INDICATING RADIO BEACONS; DEVICES FOR WIRELESS RADIO TRANSMISSION; MARINE RADIO COMMUNICATION MACHINES AND APPARATUS; PORTABLE RADIOS; RADIO BROADCAST RECEIVING SETS; ELECTRICAL APPARATUS FOR THE LOCATING OF PERSONNEL PROGRAMMED TO USE GLOBAL POSITIONING SYSTEMS (GPS) AND CELLULAR COMMUNICATIONS; ELECTRONIC GLOBAL POSITIONING SYSTEMS; TRANSPONDERS; MARINE SIGNALING BUOYS; DISTRESS SIGNALING BEACONS; RADIO TRANSMITTERS OF ELECTRONIC SIGNALS; GLOBAL POSITIONING SYSTEM RECEIVER AND SATELLITE TRANSMITTER; EMERGENCY ALERTING AND LOCATING RADIO BEACONS WITH OR WITHOUT GPS POSITIONING FOR SEARCH AND RESCUE; RADAR APPARATUS; WEATHER INFORMATION APPARATUS, NAMELY, WEATHER STATIONS; WIND MEASUREMENT INSTRUMENT; INSTRUMENTS FOR MEASURING WIND DIRECTION; INSTRUMENTS FOR MEASURING WIND SPEED; AND MARINE LIFE-SAVING APPARATUS, NAMELY, LIFE JACKETS, REFLECTIVE AND ILLUMINATED CLOTHING FOR SAFETY PURPOSES, INFLATABLE FLOTATION DEVICES IN THE NATURE OF INFLATABLE CLOTHING, IN CLASS 9 (U.S. CLS. 21, 23, 26, 36 AND 38).



THE MARK CONSISTS OF STANDARD CHARACTERS WITHOUT CLAIM TO ANY PARTICULAR FONT, STYLE, SIZE, OR COLOR.

PRIORITY CLAIMED UNDER SEC. 44(D) ON ERPN CMNTY TM OFC APPLICATION NO. 008873804, FILED 2-10-2010, REG. NO. 008873804, DATED 8-2-2010, EXPIRES 2-10-2020.

NO CLAIM IS MADE TO THE EXCLUSIVE RIGHT TO USE "MARINE", APART FROM THE MARK AS SHOWN.

SER. NO. 77-933,461, FILED 2-11-2010.

CHRIS WELLS, EXAMINING ATTORNEY

*David J. Kypos*

Director of the United States Patent and Trademark Office

# United States of America

United States Patent and Trademark Office

## OPEN HEARTS BY JANE SEYMOUR

**Reg. No. 4,123,458**

CATFISH PRODUCTIONS, INC. (CALIFORNIA CORPORATION)  
24800 PACIFIC COAST HIGHWAY  
MALIBU, CA 90265

**Registered Apr. 10, 2012**

**Int. Cl.: 16**

FOR: GREETING CARDS, GIFT CARDS, NOTE CARDS, GIFT BOXES, IN CLASS 16 (U.S. CLS. 2, 5, 22, 23, 29, 37, 38 AND 50).

**TRADEMARK**

FIRST USE 12-0-2008; IN COMMERCE 12-0-2008.

**PRINCIPAL REGISTER**

THE MARK CONSISTS OF STANDARD CHARACTERS WITHOUT CLAIM TO ANY PARTICULAR FONT, STYLE, SIZE, OR COLOR.

OWNER OF U.S. REG. NO. 3,678,429.

THE NAME(S), PORTRAIT(S), AND/OR SIGNATURE(S) SHOWN IN THE MARK IDENTIFIES JANE SEYMOUR, WHOSE CONSENT(S) TO REGISTER IS MADE OF RECORD.

SER. NO. 77-935,002, FILED 2-12-2010.

DAVID MILLER, EXAMINING ATTORNEY



*David J. Kyffers*

Director of the United States Patent and Trademark Office

# United States of America

United States Patent and Trademark Office

# Hot G Vibe

**Reg. No. 4,123,459**

**Registered Apr. 10, 2012**

**Int. Cl.: 10**

**TRADEMARK**

**PRINCIPAL REGISTER**

7032935 CANADA LTD (CANADA CORPORATION), DBA HOT G VIBE  
SUITE 406  
5890 MONKLAND AVENUE  
MONTREAL, CANADA H4A1G2

FOR: ADULT SEXUAL STIMULATION AIDS, NAMELY, VIBRATING COCK RINGS, DILDOS, VIBRATORS, MASTURBATORS; CONDOMS, IN CLASS 10 (U.S. CLS. 26, 39 AND 44).

FIRST USE 3-28-2007; IN COMMERCE 3-28-2007.

THE MARK CONSISTS OF STANDARD CHARACTERS WITHOUT CLAIM TO ANY PARTICULAR FONT, STYLE, SIZE, OR COLOR.

NO CLAIM IS MADE TO THE EXCLUSIVE RIGHT TO USE "HOT" AND "VIBE", APART FROM THE MARK AS SHOWN.

SER. NO. 77-936,521, FILED 2-16-2010.

AMY KERTGATE, EXAMINING ATTORNEY



*David J. Kyros*

Director of the United States Patent and Trademark Office

# United States of America

United States Patent and Trademark Office

## UNIVERSAL ELECTRIC

**Reg. No. 4,123,460**

6646158 CANADA INC. (CANADA CORPORATION)  
141 FRANCOIS STREET

**Registered Apr. 10, 2012**

MONTREAL, QUEBEC, CANADA H3E1E3

**Int. Cl.: 11**

FOR: LIGHTING FIXTURES, NAMELY, WORK LIGHTS, OUTDOOR LIGHTS; ELECTRIC LIGHT DECORATIVE STRINGS AND ROPES; ELECTRIC NIGHT LIGHTS; TABLE AND FLOOR LAMPS, IN CLASS 11 (U.S. CLS. 13, 21, 23, 31 AND 34).

**TRADEMARK**

THE MARK CONSISTS OF STANDARD CHARACTERS WITHOUT CLAIM TO ANY PARTICULAR FONT, STYLE, SIZE, OR COLOR.

**PRINCIPAL REGISTER**

PRIORITY CLAIMED UNDER SEC. 44(D) ON CANADA APPLICATION NO. 1470026, FILED 2-18-2010, REG. NO. 809963, DATED 10-25-2011, EXPIRES 10-25-2026.

NO CLAIM IS MADE TO THE EXCLUSIVE RIGHT TO USE "ELECTRIC", APART FROM THE MARK AS SHOWN.

SER. NO. 77-940,249, FILED 2-19-2010.

HELENE LIWINSKI, EXAMINING ATTORNEY



*David J. Kybas*

Director of the United States Patent and Trademark Office

# United States of America

United States Patent and Trademark Office

## Artists for Community Transformation Intl

**Reg. No. 4,123,461**

**Registered Apr. 10, 2012**

**Int. Cl.: 45**

**SERVICE MARK**

**PRINCIPAL REGISTER**

ARTISTS FOR COMMUNITY TRANSFORMATION INTL, INC. (CALIFORNIA CORPORATION)  
P.O. BOX 1966  
BRENTWOOD, TN 370241966

FOR: CHRISTIAN MINISTRY SERVICES, IN CLASS 45 (U.S. CLS. 100 AND 101).

FIRST USE 6-26-2006; IN COMMERCE 6-26-2006.

THE MARK CONSISTS OF STANDARD CHARACTERS WITHOUT CLAIM TO ANY PARTICULAR FONT, STYLE, SIZE, OR COLOR.

NO CLAIM IS MADE TO THE EXCLUSIVE RIGHT TO USE "ARTISTS" AND "INTL", APART FROM THE MARK AS SHOWN.

SER. NO. 77-943,417, FILED 2-24-2010.

CHARISMA HAMPTON, EXAMINING ATTORNEY



*David J. Kyffers*

Director of the United States Patent and Trademark Office



# United States of America

United States Patent and Trademark Office



**Reg. No. 4,123,462**

**Registered Apr. 10, 2012**

**Int. Cl.: 3**

**TRADEMARK**

**PRINCIPAL REGISTER**

COACH SERVICES, INC. (MARYLAND CORPORATION)  
516 WEST 34TH STREET  
NEW YORK, NY 10001

FOR: BODY SPRAYS; COLOGNE; PERFUME, NOT INCLUDING HAIR AND SCALP CONDITIONER, IN CLASS 3 (U.S. CLS. 1, 4, 6, 50, 51 AND 52).

FIRST USE 6-1-2010; IN COMMERCE 6-1-2010.

OWNER OF U.S. REG. NOS. 3,363,873, 3,633,302, AND 3,812,170.

THE COLOR(S) RED, GOLD AND WHITE IS/ARE CLAIMED AS A FEATURE OF THE MARK.

NO CLAIM IS MADE TO THE EXCLUSIVE RIGHT TO USE "EST. 1941", APART FROM THE MARK AS SHOWN.

THE MARK CONSISTS OF THE WORDS "COACH", "POPPY" AND "EST. 1941" IN THE COLORS GOLD AND WHITE, AND HEART DESIGNS IN THE COLOR WHITE, ALL ON A RED BACKGROUND.

SER. NO. 77-948,266, FILED S.R. 3-2-2010 AM. P.R. 11-18-2011.

LINDA M. KING, EXAMINING ATTORNEY



*David J. Kyros*

Director of the United States Patent and Trademark Office

# United States of America

United States Patent and Trademark Office



**Reg. No. 4,123,463**

**Registered Apr. 10, 2012**

**Int. Cls.: 35 and 37**

**SERVICE MARK**

**PRINCIPAL REGISTER**

SOUTHERN UNION COMPANY (DELAWARE CORPORATION), DBA MISSOURI GAS ENERGY  
3420 BROADWAY  
KANSAS CITY, MO 64111

FOR: PROVIDING CUSTOMER FUNDING INCENTIVES FOR THE INSTALLATION OF ENERGY EFFICIENT NATURAL GAS APPLIANCES FOR HOMES AND BUSINESSES, INCLUDING FURNACES, BOILERS, COMBINATION UNITS, THERMOSTATS, AND WATER HEATERS; PROVIDING PUBLIC AWARENESS OF THE NEED FOR PROPER WEATHERIZATION OF STRUCTURES BY PROVIDING WEATHERIZATION KITS CONSISTING OF WEATHERIZATION AND ENERGY SAVING PRODUCTS SUCH AS COMPACT FLORESCENT LIGHT BULBS, PLASTIC SHEETING FOR SEALING WINDOWS AND INSULATING MATERIAL FOR SEALING GAPS AND WINDOWS, IN CLASS 35 (U.S. CLS. 100, 101 AND 102).

FIRST USE 9-29-2008; IN COMMERCE 9-29-2008.

FOR: PROVIDING WEATHERIZATION INFORMATION FOR THE INSULATION AND INCREASED ENERGY EFFICIENCY OF STRUCTURES, IN CLASS 37 (U.S. CLS. 100, 103 AND 106).

FIRST USE 9-29-2008; IN COMMERCE 9-29-2008.

NO CLAIM IS MADE TO THE EXCLUSIVE RIGHT TO USE "ENERGY " FOR ALL CLASSES AND "BETTER HEATING WITH NATURAL GAS" FOR CLASS 35, APART FROM THE MARK AS SHOWN.

THE COLOR(S) GREEN, BLUE, LIGHT BLUE AND WHITE ARE IS/ARE CLAIMED AS A FEATURE OF THE MARK.

THE MARK CONSISTS OF A STYLIZED YIN/YANG SYMBOL, COMPOSED OF A GREEN LEAF AND A FLAME COMPOSED OF BLUE, LIGHT BLUE AND WHITE COLORS, SURROUNDED BY AN INNER WHITE CIRCLE AND AN OUTER GREEN CIRCLE; A WHITE CURVED LINE SEPARATES THE LEAF FROM THE FLAME DESIGN. ON THE RIGHT SIDE OF THE DESIGN ELEMENT, THE WORDS "ENERGY SENSE" IN THE COLOR BLUE, APPEAR. BELOW THIS PHRASE IS THE TERM "BETTER HEATING WITH NATURAL GAS" IN THE COLOR GREEN.



*David J. Kyffers*

Director of the United States Patent and Trademark Office

**Reg. No. 4,123,463** SER. NO. 77-948,600, FILED 3-2-2010.

HENRY S. ZAK, EXAMINING ATTORNEY

# United States of America

United States Patent and Trademark Office

*Apropos*

**Reg. No. 4,123,464**

NOMADIC TRADERS INC. (CALIFORNIA CORPORATION)  
P.O. BOX 6251  
ALBANY, CA 94706

**Registered Apr. 10, 2012**

**Int. Cl.: 25**

FOR: WOMEN'S SWEATERS, DRESSES, TOPS, BOTTOMS, SHIRTS, AND ACCESSORIES,  
NAMELY, SCARVES, HATS AND GLOVES, IN CLASS 25 (U.S. CLS. 22 AND 39).

**TRADEMARK**

FIRST USE 1-5-2010; IN COMMERCE 1-5-2010.

**PRINCIPAL REGISTER**

THE MARK CONSISTS OF THE WORD "APROPOS" IN BROWN CURSIVE WRITING.

THE COLOR(S) BROWN IS/ARE CLAIMED AS A FEATURE OF THE MARK.

SER. NO. 77-959,193, FILED 3-15-2010.

MARK SHINER, EXAMINING ATTORNEY



*David J. Kybas*

Director of the United States Patent and Trademark Office

# United States of America

United States Patent and Trademark Office

# KEOUS

**Reg. No. 4,123,465**

**Registered Apr. 10, 2012**

**Int. Cl.: 9**

**TRADEMARK**

**PRINCIPAL REGISTER**

KEAL INC. (CANADA CORPORATION)  
2323 YONGE STREET, 4TH FLOOR  
TORONTO, ONTARIO, CANADA M4P2C9

FOR: COMPUTER SOFTWARE FOR MANAGING, PROCESSING, REPORTING, ANALYZING, CENTRALIZING, AND AUTOMATING DATA USED FOR HUMAN RESOURCES AND EMPLOYEE PAYROLL IN THE PUBLIC SECTOR, IN CLASS 9 (U.S. CLS. 21, 23, 26, 36 AND 38).

THE MARK CONSISTS OF STANDARD CHARACTERS WITHOUT CLAIM TO ANY PARTICULAR FONT, STYLE, SIZE, OR COLOR.

PRIORITY CLAIMED UNDER SEC. 44(D) ON CANADA APPLICATION NO. 1451993, FILED 9-16-2009, REG. NO. TMA789,728, DATED 2-4-2011, EXPIRES 2-4-2026.

SER. NO. 77-960,166, FILED 3-16-2010.

CHARLOTTE CORWIN, EXAMINING ATTORNEY



*David J. Kyjars*

Director of the United States Patent and Trademark Office

# United States of America

United States Patent and Trademark Office

# KEOUS

**Reg. No. 4,123,466**

KEAL INC. (CANADA CORPORATION)

**Registered Apr. 10, 2012**

2323 YONGE STREET, 4TH FLOOR  
TORONTO, ONTARIO, CANADA M4P2C9

**Int. Cl.: 35**

FOR: BUSINESS PROCESS CONSULTING SERVICES TO ANALYZE, DESIGN AND CUSTOMIZE THE BUSINESS PROCESSES USED FOR PROVIDING HUMAN RESOURCES AND EMPLOYEE PAYROLL IN THE PUBLIC SECTOR; COMPUTER SERVICES, NAMELY, BUSINESS ANALYSIS, IN CLASS 35 (U.S. CLS. 100, 101 AND 102).

**SERVICE MARK**

**PRINCIPAL REGISTER**

THE MARK CONSISTS OF STANDARD CHARACTERS WITHOUT CLAIM TO ANY PARTICULAR FONT, STYLE, SIZE, OR COLOR.

PRIORITY CLAIMED UNDER SEC. 44(D) ON CANADA APPLICATION NO. 1451993, FILED 9-16-2009, REG. NO. TMA789,728, DATED 2-4-2011, EXPIRES 2-4-2026.

SER. NO. 77-960,187, FILED 3-16-2010.

CHARLOTTE CORWIN, EXAMINING ATTORNEY



*David J. Kybas*

Director of the United States Patent and Trademark Office

# United States of America

United States Patent and Trademark Office

## LJUNGLÖFS ETTAN

**Reg. No. 4,123,467**

SWEDISH MATCH NORTH EUROPE AB (SWEDEN JOINT STOCK COMPANY)  
SE-118 85

**Registered Apr. 10, 2012**

STOCKHOLM, SWEDEN 00

**Int. Cl.: 34**

FOR: TOBACCO; MATCHES; TOBACCO SUBSTITUTES NOT FOR MEDICAL PURPOSES; SNUFF AND TOBACCO ALTERNATIVES IN THE FORM OF PRODUCTS BASED ON VEGETABLE FIBERS, FOR ORAL USE NOT FOR CONSUMPTION; SNUFF; TOBACCO FREE SNUFF; HERBAL SNUFF, IN CLASS 34 (U.S. CLS. 2, 8, 9 AND 17).

**TRADEMARK**

**PRINCIPAL REGISTER**

OWNER OF SWEDEN REG. NO. 411415, DATED 6-4-2010, EXPIRES 6-4-2020.

OWNER OF U.S. REG. NOS. 3,018,073 AND 3,021,119.

THE MARK CONSISTS OF THE WORDS "LJUNGLOFS ETTAN" WHEREIN THE "O" IN "LJUNGLOFS" IS A CAPITAL "O" DIERESIS.

THE ENGLISH TRANSLATION OF "ETTAN" IN THE MARK IS "THE FIRST".

SER. NO. 77-962,400, FILED 3-18-2010.

KATHERINE STOIDES, EXAMINING ATTORNEY



*David J. Kyros*

Director of the United States Patent and Trademark Office

# United States of America

United States Patent and Trademark Office

# COAST

**Reg. No. 4,123,468**

**Registered Apr. 10, 2012**

**Int. Cls.: 18, 20 and 24**

**TRADEMARK**

**PRINCIPAL REGISTER**

COAST INTERNATIONAL LIMITED (NEW ZEALAND LIMITED LIABILITY COMPANY)  
17 SALE STREET, FREEMANS BAY  
AUCKLAND, NEW ZEALAND

FOR: CANVAS AND LEATHER BAGS, NAMELY, BEACH BAGS, OVERNIGHT BAGS,  
TRAVEL BAGS, LUGGAGE, IN CLASS 18 (U.S. CLS. 1, 2, 3, 22 AND 41).

FOR: BEAN BAG CHAIRS; CUSHIONS; FURNITURE; OUTDOOR FURNITURE, IN CLASS  
20 (U.S. CLS. 2, 13, 22, 25, 32 AND 50).

FOR: CUSHION COVERS, IN CLASS 24 (U.S. CLS. 42 AND 50).

THE MARK CONSISTS OF STANDARD CHARACTERS WITHOUT CLAIM TO ANY PAR-  
TICULAR FONT, STYLE, SIZE, OR COLOR.

OWNER OF NEW ZEALAND REG. NO. 775816, DATED 9-13-2007, EXPIRES 9-13-2017.

OWNER OF NEW ZEALAND REG. NO. 703054, DATED 10-15-2003, EXPIRES 10-15-2013.

SER. NO. 77-966,597, FILED 3-23-2010.

KELLEY WELLS, EXAMINING ATTORNEY

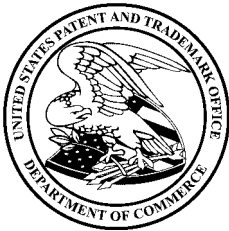

*David J. Kyfos*

Director of the United States Patent and Trademark Office



# United States of America

United States Patent and Trademark Office

## THE CONTENT EXPERTS

**Reg. No. 4,123,469**

**Registered Apr. 10, 2012**

**Int. Cls.: 9 and 42**

**TRADEMARK**

**SERVICE MARK**

**PRINCIPAL REGISTER**

OPEN TEXT SA (LUXEMBOURG PUBLIC LIMITED LIABILITY COMPANY)  
26, BOULEVARD ROYAL  
L-2449, LUXEMBOURG

FOR: COMPUTER SOFTWARE FOR THE COLLECTION, EDITING, ORGANIZING, MODIFYING, BOOK MARKING, TRANSMISSION, STORAGE AND SHARING OF DATA AND INFORMATION; DATABASE MANAGEMENT SOFTWARE; COMPUTER SOFTWARE TO AUTOMATE DATA WAREHOUSING; COMPUTER SOFTWARE FOR ARCHIVING DATABASES, IMAGES AND OTHER ELECTRONIC DATA; COMPUTER SOFTWARE FOR BUSINESS PROCESS MANAGEMENT; COMPUTER SOFTWARE FOR DIGITAL ASSET MANAGEMENT; COMPUTER SOFTWARE FOR EMAIL MANAGEMENT; COMPUTER SOFTWARE FOR DOCUMENT PROCESSING; COMPUTER SOFTWARE FOR ORGANIZING AND VIEWING DIGITAL IMAGES AND PHOTOGRAPHS; COMPUTER SOFTWARE FOR ACCESSING, SEARCHING, INDEXING, AND RETRIEVING DATA FROM NETWORKED COMPUTERS; COMPUTER SOFTWARE FOR SHARING AND DISTRIBUTING DATA, DOCUMENTS AND INFORMATION; COMPUTER SOFTWARE THAT FACILITATES COLLABORATION THROUGH THE SHARING AND DISTRIBUTING DATA, DOCUMENTS AND INFORMATION; COMPUTER SOFTWARE FOR USE IN PROVIDING A DOCUMENT RETRIEVAL SYSTEM FOR BUSINESSES; COMPUTER SOFTWARE USED BY BUSINESSES TO FACILITATE COMPLIANCE WITH LAWS AND REGULATIONS; AND COMPUTER SOFTWARE USED BY BUSINESSES TO FACILITATE COMPLIANCE WITH INTERNAL GOVERNANCE REQUIREMENTS, IN CLASS 9 (U.S. CLS. 21, 23, 26, 36 AND 38).

FIRST USE 11-1-2007; IN COMMERCE 11-1-2007.

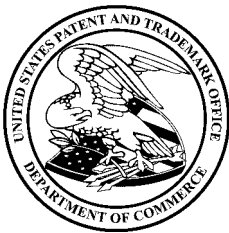

*David J. Kyffers*

Director of the United States Patent and Trademark Office

FOR: COMPUTER SOFTWARE CONSULTATION; CONSULTATION SERVICES IN THE FIELDS OF SELECTION, IMPLEMENTATION AND USE OF COMPUTER HARDWARE AND SOFTWARE SYSTEMS FOR OTHERS; COMPUTER CONSULTATION; COMPUTER CONSULTATION IN THE FIELD OF COMPUTER SECURITY; CUSTOMIZATION OF COMPUTER HARDWARE AND SOFTWARE; DESIGN, DEVELOPMENT, IMPLEMENTATION, UPDATING AND MAINTENANCE OF SOFTWARE; TECHNICAL SUPPORT SERVICES, NAMELY, TROUBLESHOOTING OF COMPUTER SOFTWARE PROBLEMS; COMPUTER SERVICE, NAMELY, ACTING AS AN APPLICATION SERVICE PROVIDER IN THE FIELD OF KNOWLEDGE MANAGEMENT TO HOST COMPUTER APPLICATION SOFTWARE FOR CREATING SEARCHABLE DATABASES OF INFORMATION AND DATA AND FOR SEARCHING AND RETRIEVING INFORMATION FROM DATABASES AND COMPUTER NETWORKS, AND FOR THE COLLECTION, EDITING, ORGANIZING, MODIFYING, BOOK

**Reg. No. 4,123,469** MARKING, TRANSMISSION, STORAGE AND SHARING OF DATA AND INFORMATION; COMPUTER SERVICES, NAMELY, REMOTE MANAGEMENT OF COMPUTER APPLICATIONS FOR OTHERS; APPLICATION SERVICE PROVIDER (ASP) FEATURING SOFTWARE FOR THE COLLECTION, EDITING, ORGANIZING, MODIFYING, BOOK MARKING, TRANSMISSION, STORAGE AND SHARING OF DATA AND INFORMATION; APPLICATION SERVICE PROVIDER (ASP) FEATURING DATABASE MANAGEMENT SOFTWARE; APPLICATION SERVICE PROVIDER (ASP) FEATURING SOFTWARE TO AUTOMATE DATA WAREHOUSING; APPLICATION SERVICE PROVIDER (ASP) FEATURING SOFTWARE FOR ARCHIVING DATABASES, IMAGES AND OTHER ELECTRONIC DATA; APPLICATION SERVICE PROVIDER (ASP) FEATURING SOFTWARE FOR BUSINESS PROCESS MANAGEMENT; APPLICATION SERVICE PROVIDER (ASP) FEATURING SOFTWARE FOR DIGITAL ASSET MANAGEMENT; APPLICATION SERVICE PROVIDER (ASP) FEATURING SOFTWARE FOR EMAIL MANAGEMENT; APPLICATION SERVICE PROVIDER (ASP) FEATURING SOFTWARE FOR DOCUMENT PROCESSING; APPLICATION SERVICE PROVIDER (ASP) FEATURING SOFTWARE FOR WEB CONTENT MANAGEMENT AND WEB SITE CREATION; APPLICATION SERVICE PROVIDER (ASP) FEATURING SOFTWARE FOR ORGANIZING AND VIEWING DIGITAL IMAGES AND PHOTOGRAPHS; APPLICATION SERVICE PROVIDER (ASP) FEATURING SOFTWARE FOR ACCESSING, SEARCHING, INDEXING, AND RETRIEVING DATA FROM NETWORKED COMPUTERS; APPLICATION SERVICE PROVIDER (ASP) FEATURING SOFTWARE FOR SHARING AND DISTRIBUTING DATA, DOCUMENTS AND INFORMATION; APPLICATION SERVICE PROVIDER (ASP) FEATURING SOFTWARE THAT FACILITATES COLLABORATION THROUGH THE SHARING AND DISTRIBUTING DATA, DOCUMENTS AND INFORMATION; APPLICATION SERVICE PROVIDER (ASP) FEATURING SOFTWARE FOR USE IN PROVIDING A DOCUMENT RETRIEVAL SYSTEM FOR BUSINESSES; APPLICATION SERVICE PROVIDER (ASP) FEATURING SOFTWARE USED BY BUSINESSES TO FACILITATE COMPLIANCE WITH LAWS AND REGULATIONS; AND APPLICATION SERVICE PROVIDER (ASP) FEATURING SOFTWARE USED BY BUSINESSES TO FACILITATE COMPLIANCE WITH INTERNAL GOVERNANCE REQUIREMENTS, IN CLASS 42 (U.S. CLS. 100 AND 101).

FIRST USE 11-1-2007; IN COMMERCE 11-1-2007.

THE MARK CONSISTS OF STANDARD CHARACTERS WITHOUT CLAIM TO ANY PARTICULAR FONT, STYLE, SIZE, OR COLOR.

NO CLAIM IS MADE TO THE EXCLUSIVE RIGHT TO USE "CONTENT", APART FROM THE MARK AS SHOWN.

SEC. 2(F).

SER. NO. 77-982,441, FILED 3-23-2010.

LAURA KOVALSKY, EXAMINING ATTORNEY

# United States of America

United States Patent and Trademark Office

# ECLIPSE

**Reg. No. 4,123,470**

SUMMIT ENTERTAINMENT, LLC (DELAWARE LIMITED LIABILITY COMPANY)  
1630 STEWART STREET, SUITE 120  
SANTA MONICA, CA 90404

**Registered Apr. 10, 2012**

**Int. Cl.: 45**

FOR: LICENSING OF MERCHANDISE ASSOCIATED WITH MOTION PICTURES, IN CLASS  
45 (U.S. CLS. 100 AND 101).

**SERVICE MARK**

FIRST USE 6-1-2008; IN COMMERCE 6-1-2008.

**PRINCIPAL REGISTER**

THE MARK CONSISTS OF STANDARD CHARACTERS WITHOUT CLAIM TO ANY PAR-  
TICULAR FONT, STYLE, SIZE, OR COLOR.

SER. NO. 77-983,041, FILED 1-28-2010.

JESSICA FATHY, EXAMINING ATTORNEY



*David J. Kybas*

Director of the United States Patent and Trademark Office

United States of America  
United States Patent and Trademark Office

Google

**Reg. No. 4,123,471**

**Registered Apr. 10, 2012**

**Int. Cl.: 35**

**SERVICE MARK**

**PRINCIPAL REGISTER**

GOOGLE INC. (DELAWARE CORPORATION)  
2400 BAYSHORE PARKWAY  
TRADEMARK DEPT  
MOUNTAIN VIEW, CA 94043

FOR: DISSEMINATION OF ADVERTISING FOR OTHERS VIA THE INTERNET, IN CLASS 35 (U.S. CLS. 100, 101 AND 102).

FIRST USE 10-0-2000; IN COMMERCE 10-0-2000.

THE MARK CONSISTS OF STANDARD CHARACTERS WITHOUT CLAIM TO ANY PARTICULAR FONT, STYLE, SIZE, OR COLOR.

OWNER OF U.S. REG. NOS. 2,806,075 AND 2,884,502.

SER. NO. 78-433,507, FILED 6-10-2004.

PATRICIA EVANKO, EXAMINING ATTORNEY



*David J. Kyffers*

Director of the United States Patent and Trademark Office

# United States of America

United States Patent and Trademark Office

## COUNTRY MUSIC ASSOCIATION

**Reg. No. 4,123,472**

**Registered Apr. 10, 2012**

**Int. Cl.: 35**

**SERVICE MARK**

**PRINCIPAL REGISTER**

COUNTRY MUSIC ASSOCIATION, INC. (TENNESSEE CORPORATION)  
ONE MUSIC CIRCLE SOUTH  
NASHVILLE, TN 37203

FOR: ASSOCIATION SERVICES, NAMELY, PROMOTING COUNTRY MUSIC, AND PROMOTING THE INTERESTS OF COUNTRY MUSIC ENTERTAINERS AND THE COUNTRY MUSIC RECORDING INDUSTRY, IN CLASS 35 (U.S. CLS. 100, 101 AND 102).

FIRST USE 9-0-1958; IN COMMERCE 9-0-1958.

THE MARK CONSISTS OF STANDARD CHARACTERS WITHOUT CLAIM TO ANY PARTICULAR FONT, STYLE, SIZE, OR COLOR.

NO CLAIM IS MADE TO THE EXCLUSIVE RIGHT TO USE "ASSOCIATION", APART FROM THE MARK AS SHOWN.

SEC. 2(F).

SER. NO. 78-906,900, FILED 6-13-2006.

JEFFERY COWARD, EXAMINING ATTORNEY



*David J. Kyros*

Director of the United States Patent and Trademark Office

# United States of America

United States Patent and Trademark Office



**Reg. No. 4,123,473**

**Registered Apr. 10, 2012**

**Int. Cls.: 3 and 5**

**TRADEMARK**

**PRINCIPAL REGISTER**

ESI S.P.A. (ITALY SOCIETE PAR ACTION)  
PIAZZA VELASCA, 5  
I-20122 MILANO  
ITALY

FOR: BLEACHING PREPARATIONS FOR LAUNDRY USE AND LAUNDRY DETERGENT; GENERAL-PURPOSE CLEANING, POLISHING, SCOURING AND ABRASIVE PREPARATIONS IN LIQUIDS AND POWDERS, IN CLASS 3 (U.S. CLS. 1, 4, 6, 50, 51 AND 52).

FOR: NUTRITIONAL INTEGRATORS, NAMELY, NON-MEDICATED NUTRITIONAL SUPPLEMENTS FOR USE IN FOODS AND BEVERAGES, IN CLASS 5 (U.S. CLS. 6, 18, 44, 46, 51 AND 52).

OWNER OF INTERNATIONAL REGISTRATION 0894520 DATED 5-29-2006, EXPIRES 5-29-2016.

SER. NO. 79-042,860, FILED 6-18-2007.

JENNIFER WILLISTON, EXAMINING ATTORNEY



*David J. Kyffers*

Director of the United States Patent and Trademark Office

# United States of America

United States Patent and Trademark Office



**Reg. No. 4,123,474**

**Registered Apr. 10, 2012**

**Int. Cls.: 9, 16, 41, 42, 44  
and 45**

**TRADEMARK**

**SERVICE MARK**

**PRINCIPAL REGISTER**

CPD INTERNATIONAL SERVICES PTE. LTD. (SINGAPORE COMPANY)  
137 TELOK AYER STREET, #03-02  
SINGAPORE 068602  
SINGAPORE

FOR: OBSERVATION APPARATUS AND DEVICES, NAMELY, DESCRIPTIVE PROMPT CARDS FOR OBSERVING AND MEASURING SAFE AND UNSAFE BEHAVIOR AND CONDITIONS IN THE WORK PLACE; COMPUTER BASED TRAINING APPARATUS, NAMELY, COMPUTER SOFTWARE IN THE FIELD OF PERSONALITY PROFILING AND RECORDING AND TRACKING OF SAFE AND UNSAFE BEHAVIOR AND CONDITIONS OBSERVED IN THE WORKPLACE; COMPUTER PROGRAMMES RELATING TO THE TRAINING OF PERSONNEL, NAMELY, COMPUTER SOFTWARE FOR USE IN NETWORK MANAGEMENT IN THE FIELD OF REDUCING ACCIDENTS AND IMPROVING WORKPLACE SAFETY AND HEALTH; TRAINING AIDS, NAMELY, PROMPT CARDS, SLIDE RULES, MANUALS AND INTERACTIVE COMPACT DISCS; TRAINING GUIDES AND MANUALS IN ELECTRONIC FORMAT IN THE FIELD OF REDUCING ACCIDENTS AND IMPROVING WORKPLACE SAFETY AND HEALTH; TRAINING GUIDES AND MANUALS IN THE FIELD OF REDUCING ACCIDENTS AND IMPROVING WORKPLACE SAFETY AND HEALTH RECORDED ON COMPUTER MEDIA; TRAINING MATERIAL APPARATUS, NAMELY, PROMPT CARDS, SLIDE RULES, MANUALS AND INTERACTIVE COMPACT DISCS; AUTOMATIC EMERGENCY REPORTING DEVICES, NAMELY, AUTOMATIC INDICATORS OF SAFE AND UNSAFE BEHAVIOR AND CONDITIONS IN THE WORKPLACE, IN CLASS 9 (U.S. CLS. 21, 23, 26, 36 AND 38).



FOR: BOOKLETS FOR USE IN CONDUCTING TRAINING WORKSHOPS IN THE FIELD OF REDUCING ACCIDENTS AND IMPROVING WORKPLACE SAFETY AND HEALTH; PRINTED INSTRUCTION MANUALS RELATING TO TRAINING SEMINARS IN THE FIELD OF REDUCING ACCIDENTS AND IMPROVING WORKPLACE SAFETY AND HEALTH; PRINTED TRAINING GUIDES AND TRAINING BOOKLETS IN THE FIELD OF REDUCING ACCIDENTS AND IMPROVING WORKPLACE SAFETY AND HEALTH; PRINTED TRAINING GUIDES AND MANUALS IN THE FIELD OF REDUCING ACCIDENTS AND IMPROVING WORKPLACE SAFETY AND HEALTH; PRINTED CARDS FOR RECORDING DATA AND INFORMATION, NAMELY, NOTE CARDS; PRINTED INFORMATION REPORTS IN THE FIELD OF REDUCING ACCIDENTS AND IMPROVING WORKPLACE SAFETY AND HEALTH, IN CLASS 16 (U.S. CLS. 2, 5, 22, 23, 29, 37, 38 AND 50).

*David J. Kyjars*

Director of the United States Patent and Trademark Office

**Reg. No. 4,123,474** FOR: ARRANGING AND CONDUCTING OF TRAINING WORKSHOPS IN THE FIELD OF WORKPLACE SAFETY AND HEALTH; CERTIFICATION OF EDUCATION AND TRAINING AWARDS, NAMELY, PROVIDING RECOGNITION AND INCENTIVES BY THE WAY OF AWARDS TO DEMONSTRATE EXCELLENCE IN THE FIELD OF WORKPLACE HEALTH AND SAFETY; COMPUTER BASED TRAINING, NAMELY, PROVIDING ON-LINE TRAINING COURSES, SEMINARS AND WORKSHOPS IN THE FIELD OF WORKPLACE SAFETY AND HEALTH; COMPUTER TRAINING ADVISORY SERVICES, NAMELY, COMPUTER EDUCATION TRAINING; CONSULTANCY SERVICES RELATING TO THE DESIGNING OF TRAINING COURSES IN THE FIELD OF WORKPLACE SAFETY AND HEALTH; CONSULTANCY SERVICES RELATING TO THE TRAINING OF EMPLOYEES IN THE FIELD OF WORKPLACE SAFETY AND HEALTH; PROFESSIONAL TRAINING SERVICES IN THE FIELD OF WORKPLACE SAFETY AND HEALTH; PROVISION OF TRAINING SERVICES FOR INDUSTRY IN THE FIELD OF WORKPLACE SAFETY AND HEALTH; PUBLICATION OF TRAINING MANUALS; STAFF TRAINING IN THE USE OF ELECTRICAL AND ELECTRONIC EQUIPMENT, NAMELY, COMPUTERS, WORKPLACE EQUIPMENT AND CONSTRUCTION MACHINERY; STAFF TRAINING SERVICES IN THE USE OF COMPUTERS, WORKPLACE EQUIPMENT AND CONSTRUCTION MACHINERY; TRAINING IN COMMUNICATION TECHNIQUES, NAMELY, TRAINING IN THE FIELD OF COMMUNICATION TECHNOLOGIES AND TECHNIQUES OF COMMUNICATION; TRAINING IN THE FIELD OF COMPUTER PROGRAMMING; TRAINING IN DATA PROCESSING TECHNIQUES; TRAINING IN THE USE OF DATA PROCESSING APPARATUS; TRAINING IN THE USE OF DATA PROCESSING PROGRAMS; WORKSHOPS FOR TRAINING PURPOSES IN THE FIELD OF WORKPLACE SAFETY AND HEALTH; TECHNICAL TRAINING RELATING TO SAFETY, NAMELY, SAFETY TRAINING IN RELATION TO THE USE OF WORKPLACE EQUIPMENT AND CONSTRUCTION MACHINERY; TRAINING SERVICES RELATING TO HEALTH AND SAFETY, NAMELY, TRAINING COURSES, SEMINARS AND WORKSHOPS IN THE FIELD OF WORKPLACE SAFETY AND HEALTH; PERSONAL COACHING SERVICES IN THE FIELD OF ORGANIZATIONAL DEVELOPMENT UTILIZING FEEDBACK SURVEYS AND OBSERVATION REPORTS ON BUSINESS CULTURES, IN CLASS 41 (U.S. CLS. 100, 101 AND 107).

FOR: RESEARCH IN THE FIELD OF SAFETY AND HEALTH, IN CLASS 42 (U.S. CLS. 100 AND 101).

FOR: CONSULTANCY SERVICES IN THE FIELD OF HEALTH , IN CLASS 44 (U.S. CLS. 100 AND 101).

FOR: CONSULTANCY SERVICES IN THE FIELD OF WORKPLACE SAFETY; CONSULTING IN THE FIELD OF WORKPLACE SAFETY, NAMELY, DEVisING AND IMPLEMENTING MEASURES AND PRACTICES INTENDED TO LOOK AFTER THE HEALTH, SAFETY AND SECURITY OF INDIVIDUALS AT WORK PREMISES; SAFETY EVALUATION, NAMELY, SAFETY INSPECTION AUDITS TO IMPROVE SAFETY OF CONSTRUCTION WORKERS ON RESIDENTIAL CONSTRUCTION SITES; SAFETY SERVICES, NAMELY, CONSULTATION SERVICES IN THE FIELD OF THE SAFETY NEEDS OF COMMERCIAL AND INDUSTRIAL COMPANIES; REPORTING AND INVESTIGATIONS OF WORKPLACE ACCIDENTS, IN CLASS 45 (U.S. CLS. 100 AND 101).

THE MARK CONSISTS OF THE LETTER "E" CONTAINED WITHIN A RED OVAL AT THE TOP OF A RED ARCH ABOVE THE WORD "EQUILIBRIA" IN BLACK. THE BACKGROUND IS WHITE BUT THE COLOR WHITE IS NOT CLAIMED AS A FEATURE OF THE MARK.

PRIORITY DATE OF 4-3-2007 IS CLAIMED.

OWNER OF INTERNATIONAL REGISTRATION 0977856 DATED 10-1-2007, EXPIRES 10-1-2017.

THE COLOR(S) RED AND BLACK IS/ARE CLAIMED AS A FEATURE OF THE MARK.



**Reg. No. 4,123,474** SER. NO. 79-059,083, FILED 10-1-2007.

JOHN HWANG, EXAMINING ATTORNEY

# United States of America

United States Patent and Trademark Office



**Reg. No. 4,123,475**

**Registered Apr. 10, 2012**

**Int. Cl.: 9**

**TRADEMARK**

**PRINCIPAL REGISTER**

MICROOLED (FRANCE LIMITED LIABILITY COMPANY)  
BHT, BÂTIMENT 52, 7 PARVIS LOUIS NEEL  
B.P. 50  
F-38040 GRENOBLE CEDEX 9, FRANCE

FOR: APPARATUS FOR RECORDING, TRANSMITTING AND REPRODUCING SOUND AND IMAGES; CENTRAL PROCESSING UNITS FOR PROCESSING SOUND OR IMAGES; MINIATURE COMPUTER DISPLAY SCREENS, IN CLASS 9 (U.S. CLS. 21, 23, 26, 36 AND 38).

THE MARK CONSISTS OF THE COLOR ORANGE IN THE TWO INSTANCES OF THE LETTERING "OO", AND THE COLOR DARK GRAY IN THE BRACKETS AND THE LETTERING "MICR" AND "LED".

PRIORITY DATE OF 2-20-2008 IS CLAIMED.

OWNER OF INTERNATIONAL REGISTRATION 0984669 DATED 7-30-2008, EXPIRES 7-30-2018.

THE COLOR(S) ORANGE AND DARK GRAY IS/ARE CLAIMED AS A FEATURE OF THE MARK.

SER. NO. 79-061,976, FILED 7-30-2008.

FRED CARL, EXAMINING ATTORNEY



*David J. Kyffers*

Director of the United States Patent and Trademark Office

# United States of America

United States Patent and Trademark Office

## FORESIGHT BEATS HINDSIGHT. [EVERY TIME].

**Reg. No. 4,123,476**

**Registered Apr. 10, 2012**

**Int. Cl.: 9**

MATTALA INTERNATIONAL PTY LTD., AN AUSTRALIAN CORPORATION, AS TRUSTEE  
FOR THE MATTALA, INTERNATIONAL TRUST (AUSTRALIA CORPORATION)  
66 GREAT VALLEY ROAD  
GLEN IRIS VIC 3146  
AUSTRALIA AND

**TRADEMARK**

**PRINCIPAL REGISTER**

GOXNOD INTERNATIONAL PTY LTD., AN AUSTRALIAN CORPORATION, AS TRUSTEE  
FOR THE SNEETCHES, INTERNATIONAL TRUST (AUSTRALIA CORPORATION)  
PO BOX 202  
MALVERN VIC 3144  
AUSTRALIA

FOR: DISASTER RECOVERY COMPUTER PROGRAMS, SOFTWARE AND FIRMWARE,  
FOR USE IN THE FIELD OF BUSINESS CONTINUITY MANAGEMENT, FOR PLANNING  
AND MANAGING THE RECOVERY AND RESTORATION OF THE CRITICAL OPERATIONS  
OF A BUSINESS THROUGH ANY CRISIS AND IRRESPECTIVE OF THE NATURE OF THE  
DISASTER, INCLUDING EMERGENCY AND CRISIS MANAGEMENT, INFORMATION  
SECURITY, BUSINESS RECOVERY, INCIDENT RESPONSE AND RISK MANAGEMENT;  
COMPUTERS; AND COMPUTER HARDWARE, IN CLASS 9 (U.S. CLS. 21, 23, 26, 36 AND  
38).

THE MARK CONSISTS OF STANDARD CHARACTERS WITHOUT CLAIM TO ANY PAR-  
TICULAR FONT, STYLE, SIZE, OR COLOR.

OWNER OF INTERNATIONAL REGISTRATION 0996753 DATED 1-27-2009, EXPIRES 1-27-  
2019.

SER. NO. 79-066,519, FILED 1-27-2009.

KELLY TRUSILO, EXAMINING ATTORNEY



*David J. Kyffers*

Director of the United States Patent and Trademark Office

# United States of America

United States Patent and Trademark Office



**Reg. No. 4,123,477**

**Registered Apr. 10, 2012**

**Int. Cl.: 30**

**TRADEMARK**

**PRINCIPAL REGISTER**

NEWTREE SA (BELGIUM SOCIÉTÉ ANONYME)  
BD. DU SOUVERAIN, 207- BOÎTE 3  
BRUXELLES, BELGIUM B1160

FOR: COCOA; COCOA PRODUCTS, NAMELY, COCOA POWDER, COCOA PASTE, COCOA MIXES; CHOCOLATE, CHOCOLATE BARS; CHOCOLATE PASTILLES; CHOCOLATE PRALINES; CHOCOLATE TRUFFLES; CHOCOLATE FOOD BEVERAGES NOT BEING DAIRY BASED AND VEGETABLE BASED; COCOA BASED BEVERAGES; PASTRY MADE WITH CHOCOLATE; CONFECTIONERY MADE WITH CHOCOLATE, NAMELY, CONFECTIONERY MADE WITH CHOCOLATE IN SPHERICAL FORM, IN THE FORM OF PEARLS; CHOCOLATE NEAPOLITANS, CHOCOLATE PASTE SPREADS, EDIBLE ICES MADE WITH CHOCOLATE, IN CLASS 30 (U.S. CL. 46).

OWNER OF U.S. REG. NO. 3,119,587.

OWNER OF INTERNATIONAL REGISTRATION 1025557 DATED 10-21-2009, EXPIRES 10-21-2019.

NO CLAIM IS MADE TO THE EXCLUSIVE RIGHT TO USE THE TERM "CERISE", THE PICTORIAL REPRESENTATION OF THE CHERRIES, AND THE TERMS "73% CACAO CHOCOLAT NOIR À LA CERISE DARK CHOCOLATE WITH CHERRY MADE IN BELGIUM", APART FROM THE MARK AS SHOWN.



*David J. Kybas*

Director of the United States Patent and Trademark Office

THE MARK CONSISTS OF A VERTICAL RECTANGLE. AT THE TOP OF THE TOP HALF OF THE VERTICAL RECTANGLE APPEARS THE TERM "NEWTREE" OVER A SMALL HORIZONTAL RECTANGLE WITH THE DESIGN OF A LEAF. IN THE CENTER OF THE TOP HALF OF THE VERTICAL RECTANGLE APPEARS THE TERM "CERISE". AT THE BOTTOM OF THE TOP HALF OF THE VERTICAL RECTANGLE APPEARS THREE CHERRIES WITH STEMS. THE BOTTOM HALF OF THE VERTICAL TRIANGLE CONSISTS OF SMALL HORIZONTAL RECTANGLES OF A CHOCOLATE BAR. ON EACH HORIZONTAL RECTANGLE APPEARS THE TERM "NEWTREE". ON THE TOP THIRD OF THE BOTTOM HALF OF THE VERTICAL RECTANGLE APPEARS THE TERM "ETERNITY". BELOW THE TERM "ETERNITY" APPEARS A SQUARE WITH "73% CACAO" INSIDE. BELOW THE SQUARE APPEARS THE WORDING "CHOCOLAT NOIR A LA CERISE". BELOW THIS WORDING APPEARS THE WORDING "DARK CHOCOLATE WITH CHERRY". BELOW THIS WORDING APPEARS THE WORDING "MADE IN BELGIUM".

**Reg. No. 4,123,477** THE ENGLISH TRANSLATION OF "CERISE" AND "CHOCOLOT NOIR A LA CERISE" IN THE MARK IS "CHERRY" AND "DARK CHOCOLATE WITH CHERRY".

SER. NO. 79-077,557, FILED 10-21-2009.

MICHAEL WIENER, EXAMINING ATTORNEY

# United States of America

United States Patent and Trademark Office



**Reg. No. 4,123,478**

**Registered Apr. 10, 2012**

**Int. Cls.: 1, 3, 5, 6, 7, 8,  
9, 10, 11, 14, 16, 17, 20,  
21, 37 and 40**

**TRADEMARK**

**SERVICE MARK**

**PRINCIPAL REGISTER**

DÜRR DENTAL AG (FED REP GERMANY AG)  
HÖPFIGHEIMER STR. 17  
74321 BIETIGHEIM-BISSINGEN  
FED REP GERMANY

FOR: CHEMICAL PREPARATIONS FOR USE IN INDUSTRY, NAMELY, MOISTURE-ABSORBING SUBSTANCES IN THE NATURE OF SILICA GEL, ACTIVATED CHARCOAL, CALCIUM, SULFATE, CALCIUM CHLORIDE, MONTMORILLONITE CLAY AND MOLECULAR SIEVES; CHEMICALS FOR USE IN SCIENCE AND PHOTOGRAPHY, IN CLASS 1 (U.S. CLS. 1, 5, 6, 10, 26 AND 46).

FOR: CLEANING, POLISHING, SCOURING AND ABRASIVE PREPARATIONS; SOAPS; BODY CARE PREPARATIONS, NAMELY, COSMETIC PREPARATIONS FOR BODY CARE; LOTIONS FOR FACE AND BODY CARE, PERFUME; DENTIFRICES, IN CLASS 3 (U.S. CLS. 1, 4, 6, 50, 51 AND 52).

FOR: PHARMACEUTICAL PREPARATIONS FOR THE TREATMENT OF DENTAL DISEASES; SANITARY PREPARATIONS FOR DENTAL AND MEDICAL USE; PREPARATIONS FOR TREATING PERIODONTOSIS; ALL PURPOSE, MEDICAL AND DENTAL DISINFECTANTS, IN CLASS 5 (U.S. CLS. 6, 18, 44, 46, 51 AND 52).

FOR: PRODUCTS MADE OF BASE METALS, NAMELY, RACKS FOR MEDICAL AND DENTAL EQUIPMENT, SOUND-ABSORBING HOODS FOR DENTAL AND MEDICAL MACHINES, PRESSURE- AND COLLAPSE-RESISTANT CONTAINERS FOR COMPRESSED AND VACUUM AIR, STERILE METAL CONTAINERS FOR USE IN THE DENTAL AND MEDICAL FIELD, IN CLASS 6 (U.S. CLS. 2, 12, 13, 14, 23, 25 AND 50).

FOR: COMPRESSORS AND VACUUM PUMPS AS PARTS OF MACHINES AND INCLUDING A MOTOR, UNITS FOR THE COMBINED PRODUCTION OF COMPRESSED AND VACUUM AIR; MACHINE PARTS, NAMELY, CONNECTION PIECES FOR COMPRESSORS AND VACUUM PUMPS; MACHINE PARTS, NAMELY, TAPS AND DAMPERS FOR COMPRESSED AIR/VACUUM APPARATUS; FILTERS FOR COMPRESSORS, VACUUM PUMPS AND MACHINES FOR PROVIDING FRESH WATER AND FOR TREATMENT OF WASTE WATER; POWER OPERATED AND MECHANICAL MOTORLESS LIQUID SEPARATORS IN THE NATURE OF CYCLONES AND CENTRIFUGES; POWER OPERATED AND MECHANICAL MOTORLESS SOLID SEPARATORS IN THE NATURE OF CYCLONES AND CENTRIFUGES; INSCRIPTION MACHINES FOR MAKING INSCRIPTIONS ON X-RAY FILMS; ALL THE



*David J. Kypos*

Director of the United States Patent and Trademark Office

**Reg. No. 4,123,478** ABOVE GOODS FOR INDUSTRIAL USE; MACHINES FOR WASHING AND RINSING MEDICAL AND DENTAL INSTRUMENTS , IN CLASS 7 (U.S. CLS. 13, 19, 21, 23, 31, 34 AND 35).

FOR: INSTALLATION HAND-TOOLS, NAMELY, SCREWDRIVERS, WRENCHES, IN CLASS 8 (U.S. CLS. 23, 28 AND 44).

FOR: PRESSURE MEASUREMENT INSTRUMENTS FOR DETERMINING THE PRESSURE OF GASES AND LIQUIDS; AUTOMATIC ELECTRICAL DISTRIBUTION APPARATUS, NAMELY, ELECTRICAL DISTRIBUTION MACHINES; WET PROCESS APPARATUS FOR DEVELOPING FILM AND PHOTOGRAPHIC PAPER; PHOTOGRAPHY DARKROOM LAMPS FOR FILM AND PHOTOGRAPHIC PAPER; BATTERY CHARGER FOR RECHARGING ELECTRIC STORAGE CELLS; ELECTRICAL HEAT SEALING MACHINES FOR THE FLUID-TIGHT CLOSING OF BAGS, IN CLASS 9 (U.S. CLS. 21, 23, 26, 36 AND 38).

FOR: MEDICAL AND SURGICAL COMPRESSORS; SUCTION DEVICES FOR DENTAL AND MEDICAL USE IN THE NATURE OF BLOOD SUCTION APPARATUS, SALIVA SUCTION APPARATUS, AUCTION CANNULA FOR MEDICAL AND DENTAL PURPOSES; VACUUM PUMPS FOR MEDICAL PURPOSES, SURGICAL COMPRESSORS AND SURGICAL FILTERS FOR PURIFYING GASES AND LIQUIDS FOR MEDICAL USE, IN CLASS 10 (U.S. CLS. 26, 39 AND 44).

FOR: PLUMBING FITTINGS, NAMELY, CONTROL VALVES FOR MEDICAL AND DENTAL APPARATUS AND FOR CONTROLLING THE FLOW OF FLUIDS IN LINES; ROOM LIGHTING INSTALLATIONS; DRYERS FOR REMOVING HUMIDITY FROM GASES; AIR-DRYING AND AIR-CLEANING APPARATUS AS PARTS OF DENTAL AND MEDICAL PRESSURE AIR AND VACUUM SOURCES, IN CLASS 11 (U.S. CLS. 13, 21, 23, 31 AND 34).

FOR: TIMEPIECES AND OTHER CHRONOMETRIC INSTRUMENTS, IN CLASS 14 (U.S. CLS. 2, 27, 28 AND 50).

FOR: PAPER FILTER CARTRIDGES; DOCUMENT FILES AND PAPER SHEETS FOR ARCHIVING X-RAY FILMS; SELF-ADHESIVE LABELS; INK RIBBONS; CARDBOARD BOXES; PAPER OR PLASTIC SHEETS AND BAGS FOR PACKAGING PURPOSES, IN CLASS 16 (U.S. CLS. 2, 5, 22, 23, 29, 37, 38 AND 50).

FOR: RUBBER GOODS, NAMELY, WASHERS, DAMPERS, RINGS, COUPLING PIECES FOR PIPING AND FLEXIBLE TUBES; SEALING AND INSULATING MATERIALS; RUBBER OR PLASTIC PACKAGING MATERIAL, NAMELY, EXPANDED PLASTIC PELLETS FOR PACKAGING; PLASTIC BAGS FOR THE HYGIENIC PACKAGING OF MEDICAL AND SURGICAL INSTRUMENTS; PLASTIC FLEXIBLE PACKAGING FILM IN ROLLS FOR THE HYGIENIC PACKAGING OF MEDICAL AND SURGICAL INSTRUMENTS; FLEXIBLE PIPES NOT OF METAL; VIBRATION-ABSORBING SUPPORT ELEMENTS, IN THE NATURE OF INSULATING MATERIALS, FOR VIBRONICALLY ISOLATING VACUUM COMPRESSORS AND PUMPS FROM A SUPPORTING SURFACE MADE OF ELASTIC GUM AND/OR OF STEEL, IN CLASS 17 (U.S. CLS. 1, 5, 12, 13, 35 AND 50).

FOR: PLASTIC CONTAINERS FOR MEDICAL AND DENTAL PRODUCTS; CUPBOARDS; SHELVING UNITS AND METAL CUPBOARDS FOR USE IN MEDICINE AND INDUSTRY, IN CLASS 20 (U.S. CLS. 2, 13, 22, 25, 32 AND 50).

FOR: WIPES IMPREGNATED WITH A DETERGENT, FOR CLEANING PURPOSES, IN CLASS 21 (U.S. CLS. 2, 13, 23, 29, 30, 33, 40 AND 50).

FOR: REPAIR AND MAINTENANCE OF VACUUM COMPRESSORS AND PUMPS, OF APPARATUS FOR DEVELOPING FILM AND PHOTOGRAPHIC PAPER, OF LIQUID SEPARATORS AND OF SOLID SEPARATORS, IN CLASS 37 (U.S. CLS. 100, 103 AND 106).

**Reg. No. 4,123,478** FOR: RECYCLING OF TOXIC WASTE FROM DENTAL OFFICES , IN CLASS 40 (U.S. CLS. 100, 103 AND 106).

OWNER OF U.S. REG. NO. 3,572,733.

OWNER OF INTERNATIONAL REGISTRATION 0594359 DATED 5-21-1992, EXPIRES 5-21-2012.

THE COLOR(S) BLUE, BLACK, WHITE AND LIGHT BLUE IS/ARE CLAIMED AS A FEATURE OF THE MARK.

NO CLAIM IS MADE TO THE EXCLUSIVE RIGHT TO USE "DENTAL", APART FROM THE MARK AS SHOWN.

THE MARK CONSISTS OF TWO DIAGONAL BARS TO THE LEFT OF THE WORDING "DURR DENTAL", THE UPPER SLANTED BAR APPEARS IN LIGHT BLUE, THE LOWER SLANTED BAR APPEARS IN BLUE AND THE WORDING "DURR DENTAL" APPEARS IN BLACK, THE COLOUR WHITE APPEARS IN THE BACKGROUND.

SER. NO. 79-077,961, FILED 5-15-2009.

ASMAT KHAN, EXAMINING ATTORNEY



# United States of America

United States Patent and Trademark Office

# ADDFIL

**Reg. No. 4,123,479**

**Registered Apr. 10, 2012**

**Int. Cls.: 17 and 19**

**TRADEMARK**

**PRINCIPAL REGISTER**

ANGLO-DANISH FIBRE INDUSTRIES LIMITED (ENGLAND LIMITED COMPANY)  
28 BERGEN WAY  
SUTTON FIELDS INDUSTRIAL ESTATE  
HULL, UNITED KINGDOM HU7 0YQ

FOR: PLASTIC SYNTHETIC FIBERS FOR USE WITH CONCRETE, IN CLASS 17 (U.S. CLS. 1, 5, 12, 13, 35 AND 50).

FOR: BUILDING PRODUCTS, NAMELY, NON-WOVEN TEXTILES MADE OF PLASTIC SYNTHETIC FIBERS FOR USE IN THE BUILDING INDUSTRY, IN CLASS 19 (U.S. CLS. 1, 12, 33 AND 50).

THE MARK CONSISTS OF STANDARD CHARACTERS WITHOUT CLAIM TO ANY PARTICULAR FONT, STYLE, SIZE, OR COLOR.

PRIORITY DATE OF 2-27-2009 IS CLAIMED.

OWNER OF INTERNATIONAL REGISTRATION 1031837 DATED 8-21-2009, EXPIRES 8-21-2019.

SER. NO. 79-080,049, FILED 8-21-2009.

SUZANNE BLANE, EXAMINING ATTORNEY



*David J. Kypos*

Director of the United States Patent and Trademark Office

# United States of America

United States Patent and Trademark Office

# bayardKids

**Reg. No. 4,123,480**

BAYARD PRESSE (FRANCE SOCIETE ANONYME)  
18, RUE BARBÈS

**Registered Apr. 10, 2012**

F-92128 MONTROUGE CEDEX, FRANCE

**Int. Cls.: 9, 16, 38 and 41**

FOR: APPARATUS FOR RECORDING, TRANSMISSION, REPRODUCTION OF SOUND OR IMAGES, PHOTOGRAPHY CAMERAS, CINEMATOGRAPHIC CAMERAS; MAGNETIC, OPTICAL, DIGITAL AND ELECTRONIC DATA CARRIERS, NAMELY, AUDIO AND VIDEO PRE-RECORDED CASSETTES CONTAINING ENCYCLOPEDIAS, STORIES, TALES, EDUCATIONAL TOYS, INTERACTIVE EDUCATIONAL TOYS, COLORINGS, POEMS, SONGS, DITTIES, RIDDLES, CARTOONS, FILMS, INTERACTIVE STORIES, EDUCATIONAL AND RECREATIONAL CONTENT FOR KIDS; INTERACTIVE DISCS, DIGITAL AUDIO COMPACT DISCS, AUDIO-VIDEO COMPACT DISCS, RECORDING DISCS, MAGNETIC DISCS, OPTICAL DISCS AND DIGITAL DISCS CONTAINING ENCYCLOPEDIAS, STORIES, TALES, EDUCATIONAL TOYS, INTERACTIVE EDUCATIONAL TOYS, COLORINGS, POEMS, SONGS, DITTIES, RIDDLES, CARTOONS, FILMS, INTERACTIVE STORIES, EDUCATIONAL AND RECREATIONAL CONTENT FOR KIDS; RECORDED COMPUTER SOFTWARE, NAMELY, EDUCATIONAL, GAME AND GENERAL ENTERTAINMENT SOFTWARE FOR KIDS; VIDEO GAME SOFTWARE, VIRTUAL REALITY GAME SOFTWARE, EDUCATIONAL SOFTWARE FOR KIDS; COMPUTER SOFTWARE FOR ORGANIZING, SEARCHING AND ACCESSING INFORMATION AND DATA FOUND IN BOOKS, NEWSPAPERS, MAGAZINES; COMPUTER GAME SOFTWARE; EXPOSED CINEMATOGRAPHIC FILMS, NAMELY, EDUCATIONAL, ENTERTAINMENT AND INFORMATIVE FILMS FOR KIDS; SOUND RECORDING STRIPS IN THE FIELD OF ENTERTAINMENT AND EDUCATION FOR KIDS; TEACHING APPARATUS, NAMELY, AUDIO AND VIDEO TAPE CONTAINING ENCYCLOPEDIAS, STORIES, TALES, EDUCATIONAL TOYS, INTERACTIVE EDUCATIONAL TOYS, COLORINGS, POEMS, SONGS, DITTIES, RIDDLES, CARTOONS, FILMS, INTERACTIVE STORIES, EDUCATIONAL AND RECREATIONAL CONTENT FOR KIDS; APPARATUS FOR GAMES ADAPTED FOR USE WITH TELEVISION RECEIVERS ONLY; ELECTRONIC PUBLICATIONS, NAMELY, DOWNLOADABLE ELECTRONIC BOOKS, MAGAZINES, NEWSPAPER, MANUALS, PERIODICALS CONTAINING ENCYCLOPAEDIAS, STORIES, TALES, EDUCATIONAL TOYS, INTERACTIVE EDUCATIONAL TOYS, COLORINGS, POEMS, SONGS, DITTIES, RIDDLES, CARTOONS, FILMS, INTERACTIVE STORIES, EDUCATIONAL AND RECREATIONAL CONTENT FOR KIDS, IN CLASS 9 (U.S. CLS. 21, 23, 26, 36 AND 38).

**TRADEMARK**

**SERVICE MARK**

**PRINCIPAL REGISTER**



*David J. Kyros*

Director of the United States Patent and Trademark Office

FOR: PRINTING PRODUCTS, NAMELY, NEWSPAPERS, BOOKS, JOURNALS, MANUALS, MAGAZINES, PROMOTIONAL PAMPHLETS, PAMPHLETS, PERIODICALS ALL CONTAINING ENCYCLOPEDIAS, STORIES, TALES, EDUCATIONAL TOYS, INTERACTIVE EDUCA-

**Reg. No. 4,123,480** TIONAL TOYS, COLORINGS, POEMS, SONGS, DITTIES, RIDDLES, CARTOONS, FILMS, INTERACTIVE STORIES, EDUCATIONAL AND RECREATIONAL CONTENT FOR KIDS; BOOKBINDING MATERIAL; PHOTOGRAPHS, POSTERS, POSTCARDS, GRAPHIC PRINTS, PICTURES; PAINTINGS, NAMELY, PICTURES; ENGRAVINGS, PRINTING BLOCKS; PRINTED TEACHING MATERIALS, NAMELY, BOOKS, MANUALS, EXERCISE BOOKS, WORKBOOKS, SCHOOLBOOKS, READING BOOKS, EDUCATIONAL CARDS IN THE FIELD OF ELEMENTARY, PRIMARY AND SECONDARY SCHOOL SUBJECTS; ARTISTS' MATERIALS, NAMELY, PAINTBRUSHES, CANVAS, ARTS AND CRAFTS PAINT KITS, AND EASELS; TYPEWRITERS; OFFICE REQUISITES, NAMELY, FOLDERS AND PAPER FILE JACKETS; PRINTING TYPE, STATIONERY, WRITING OR DRAWING BOOKS, WRITING SLATES, PENCILS, WRITING CHALK; SCHOOL SUPPLIES NAMELY, STATIONERY, DRAWING MATERIAL FOR BLACKBOARDS, LEAD PENCILS, DRAWING PENCILS, COLORED PENCILS, CRAYONS, PASTEL CRAYONS, CHARCOAL PENCILS, FELT-TIPS PENS, MECHANICAL PENCILS, PENS, MARKER PENS, RUBBER ERASERS, PENCIL HOLDERS, PENCIL CASES, PENCIL SHARPENERS, PAPER CLIPS, RULERS, NAMELY, DRAWING RULERS, DRAFTING RULERS, ADHESIVE TAPES FOR STATIONERY, ADHESIVE TAPE DISPENSERS, DESK BLOTTERS, STAPLES, STAPLERS, COLORED STICKY ADHESIVE LABELS, GREETING CARDS, NAMELY, BIRTHDAY CARDS, COLORING BOOKS, DRAWING BOOKS, NOTEBOOKS; ENVELOPES, SMALL BAGS, NAMELY, PAPER BAGS, BAGS OF PAPER OR PLASTIC FOR PACKAGING, IN CLASS 16 (U.S. CLS. 2, 5, 22, 23, 29, 37, 38 AND 50).

FOR: TELECOMMUNICATIONS SERVICES, NAMELY, PRESS AND NEWS AGENCIES FOR ELECTRONIC TRANSMISSION; BROADCASTING OF TELEVISION PROGRAMS OF MULTIMEDIA PROGRAMS; SERVICES FOR TRANSMISSION OF INFORMATION BY ALL COMMUNICATION AND TELECOMMUNICATION MEANS; SERVICES FOR COMMUNICATION VIA COMPUTER TERMINALS; SERVICES FOR COMPUTER AIDED TRANSMISSION OF MESSAGES AND IMAGES, IN CLASS 38 (U.S. CLS. 100, 101 AND 104).

FOR: EDUCATION, NAMELY, PROVIDING OF TRAINING IN THE FIELD OF SCIENCES, HUMANITIES SCIENCES, LITERATURE, EDUCATION, LINGUISTICS, PSYCHOLOGY, LIVING LANGUAGES, SOCIAL SCIENCES, MUSIC, CULTURE, ARTS, CINEMA AND THEATRE; EDUCATION SERVICES, NAMELY, PROVIDING, ORGANIZING AND CONDUCTING LESSONS, CLASSES, CONFERENCES, CONGRESS, FORUMS, COLLOQUIUMS AND SEMINARS IN THE FIELD OF SCIENCES, HUMANITIES SCIENCES, LITERATURE, EDUCATION, LINGUISTICS, PSYCHOLOGY, LIVING LANGUAGES, SOCIAL SCIENCES, MUSIC, CULTURE, ARTS, CINEMA AND THEATRE; ORGANIZATION OF EXHIBITIONS FOR CULTURAL OR EDUCATIONAL PURPOSES; ENTERTAINMENT AND CULTURAL ACTIVITIES, NAMELY, ARRANGING AND CONDUCTING CONCERTS, GUIDED TOUR AND FIELD TRIPS TO MOTION PICTURE THEATRES, GAMES FOR KIDS, COOKING COMPETITIONS, COLORING SESSIONS FOR CHILDREN, EDUCATIONAL AND RECREATIONAL PLAYS AND SHOWS FOR CHILDREN, MAGIC LESSONS, IMPROVEMENT DO-IT-YOURSELF LESSONS, DRAWING LESSONS, GUIDED TOUR AND FIELD TRIPS TO DRAWING EXHIBITIONS; PUBLICATION OF TEXTS OTHER THAN PUBLICITY TEXTS, ELECTRONIC DESKTOP PUBLISHING FOR OTHERS; ELECTRONIC AND DIGITAL PUBLISHING OF ILLUSTRATION, BOOKS, JOURNALS, NEWSPAPERS, PERIODICALS, MAGAZINES AND MANUALS; ELECTRONIC PUBLICATION OF BOOKS AND JOURNALS ONLINE; SERVICES FOR PROVISION OF ONLINE ELECTRONIC NON-DOWNLOADABLE PUBLICATIONS, NAMELY, E-BOOKS, E-NEWSPAPERS, E-MAGAZINES, E-MANUALS IN THE FIELD OF EDUCATION AND RECREATION FOR CHILDREN; PRODUCTION OF RADIO AND TELEVISION PROGRAMS, OF AUDIOVISUAL AND MULTIMEDIA PROGRAMS; PUBLICATION OF BOOKS; LENDING OF BOOKS AND OTHER PUBLICATIONS; ORGANIZATION OF EDUCATIONAL AND RECREATIONAL COMPETITIONS AND GAMES IN THE FIELD OF SCIENCES, HUMANITIES SCIENCES, LITERATURE, EDUCATION, LINGUISTICS, PSYCHOLOGY, LIVING LANGUAGES, SOCIAL SCIENCES, MUSIC, CULTURE, ARTS, CINEMA AND THEATRE; SERVICES FOR GAMES OFFERED ONLINE ON A COMPUTER NETWORK, NAMELY, PROVIDING ONLINE COMPUTER GAMES; ORGANIZATION OF CULTURAL AND RECREATIONAL SHOWS IN THE FIELD OF SCIENCES, HUMANITIES

**Reg. No. 4,123,480** SCIENCES, LITERATURE, EDUCATION, LINGUISTICS, PSYCHOLOGY, LIVING LANGUAGES, SOCIAL SCIENCES, MUSIC, CULTURE, ARTS, CINEMA AND THEATRE; PRODUCTION AND RENTAL OF FILMS, OF AUDIO, AUDIOVISUAL AND MULTIMEDIA WORKS ON MEDIA, NAMELY, AUDIO AND VIDEO PRE-RECORDED CASSETTES, INTERACTIVE DISCS, DIGITAL AUDIO COMPACT DISCS, AUDIO-VIDEO COMPACT DISCS, RECORDING DISCS, MAGNETIC DISCS, OPTICAL DISCS AND DIGITAL DISCS, EDUCATIONAL SOFTWARE, ENTERTAINMENT AND GAME SOFTWARE FOR KIDS CONTAINING ENCYCLOPEDIAS, STORIES, TALES, EDUCATIONAL TOYS, INTERACTIVE EDUCATIONAL TOYS, COLORINGS, POEMS, SONGS, DITTIES, RIDDLES, CARTOONS, FILMS, INTERACTIVE STORIES, EDUCATIONAL AND RECREATIONAL CONTENT FOR KIDS; PUBLISHING SERVICES FOR ALL KINDS OF SOUND AND VISUAL MEDIA PUBLICATIONS, NAMELY, AUDIO AND VIDEO PRE-RECORDED CASSETTES, INTERACTIVE DISCS, DIGITAL AUDIO COMPACT DISCS, AUDIO-VIDEO, COMPACT DISCS, RECORDING DISCS, MAGNETIC DISCS, OPTICAL DISCS AND DIGITAL DISCS, EDUCATIONAL SOFTWARE, ENTERTAINMENT AND GAME SOFTWARE FOR KIDS CONTAINING ENCYCLOPEDIAS, STORIES, TALES, EDUCATIONAL TOYS, INTERACTIVE EDUCATIONAL TOYS, COLORINGS, POEMS, SONGS, DITTIES, RIDDLES, CARTOONS, FILMS, INTERACTIVE STORIES, EDUCATIONAL AND RECREATIONAL CONTENT FOR KIDS; FILM PRODUCTION, PROVISION OF CINEMA THEATRES, PRODUCTION OF CULTURAL AND RECREATIONAL SHOWS IN THE FIELD OF SCIENCES, HUMANITIES SCIENCES, LITERATURE, EDUCATION, LINGUISTICS, PSYCHOLOGY, LIVING LANGUAGES, SOCIAL SCIENCES, MUSIC, CULTURE, ARTS, CINEMA AND THEATRE; ENTERTAINMENT AND RECREATION INFORMATION, INFORMATION ABOUT EDUCATION, IN CLASS 41 (U.S. CLS. 100, 101 AND 107).

OWNER OF U.S. REG. NOS. 1,759,576 AND 2,655,396.

OWNER OF INTERNATIONAL REGISTRATION 1032734 DATED 9-11-2009, EXPIRES 9-11-2019.

SER. NO. 79-080,359, FILED 9-11-2009.

SANI KHOURI, EXAMINING ATTORNEY

# United States of America

United States Patent and Trademark Office

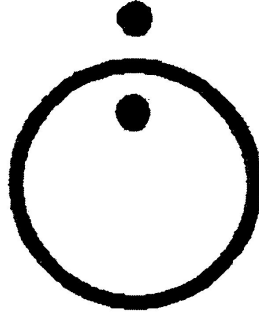

ÖZLEM SÜER

**Reg. No. 4,123,481**

**Registered Apr. 10, 2012**

**Int. Cl.: 25**

ÖZLEM SÜER TEKSTİL TASARIM; DANISMANLIK; TICARET LIMITED SİRKETİ (TURKEY LIMITED LIABILITY COMPANY)  
MAÇKA CADDESİ NARMANLI  
APARTMANI NO:12 K:4 D:29  
TESVİKİYE - İSTANBUL, TURKEY

**TRADEMARK**

**PRINCIPAL REGISTER**

FOR: CLOTHING, NAMELY, TOPS, BOTTOMS, JACKETS, COATS, GABARDINES, GLOVES, DETACHABLE COLLARS, DRESSING GOWNS, EAR MUFFS, FROCKS, LAYETTES, LEGGINGS, OUTERCLOTHING IN THE NATURE OF SWEATSHIRTS AND ANORAKS, OVERALLS, OVERCOATS, PAJAMAS, PANTS, PAPER CLOTHING, PAPER HATS, WEDDING DRESSES, WEDDING GOWNS, WITH THE FOREGOING TYPES OF CLOTHING INCLUDING THOSE MADE OF LEATHER AND PAPER; CLOTHING, NAMELY, PAPER CLOTHING IN THE NATURE OF PAPER HATS FOR USE AS CLOTHING ITEMS; FOOTWEAR; HEADGEAR, NAMELY, HEADWEAR, SKULLIES, HATS, CAPS, LEATHER HEADWEAR; SPORTSWEAR, NAMELY, SPORTS SHIRTS, SPORTS COATS, SPORTS BRAS, SPORT CAPS AND HATS, SPORTS JACKETS, SPORTS UNIFORMS, SPORT STOCKINGS, SPORTS JERSEYS, SPORTS PANTS, SPORTS VESTS, FITTINGS OF METAL FOR SHOES AND BOOTS; UNDERWEAR; BEACH CLOTHES, NAMELY, BEACH FOOTWEAR, BEACH COVER-UPS, BATHING SUITS, BEACH SHOES; BABIES' DIAPERS OF TEXTILE, TEXTILE NAPPIES, NAMELY, BABIES' NAPKINS OF TEXTILE, BABY BODYSUITS, BABY BIBS NOT OF PAPER, BABY BOTTOMS, BABY BUNTING, BABY DOLL PYJAMAS, BABY LAYETTES FOR CLOTHING, BABY TOPS; TIES, BOW-TIES, SCARVES, SHAWLS, TURBANS, HEADSCARVES, COLLARS, BANDANAS, BELTS, BRACES FOR CLOTHING, SOCKS, STOCKINGS, MUFFS, IN CLASS 25 (U.S. CLS. 22 AND 39).



THE NAME "ÖZLEM SÜER" IDENTIFIES A LIVING INDIVIDUAL WHOSE CONSENT IS OF RECORD.

OWNER OF INTERNATIONAL REGISTRATION 1038987 DATED 3-29-2010, EXPIRES 3-29-2020.

THE MARK CONSISTS OF THE PROPER NAME "ÖZLEM SÜER" APPEARING IN STYLIZED CHARACTERS WITH A LOGO CONSISTING OF A CIRCLE AND TWO VERTICALLY ALIGNED DOTS, WITH ONE OF THE DOTS APPEARING INSIDE AND THE OTHER OUTSIDE THE CIRCLE.

*David J. Kyffers*

Director of the United States Patent and Trademark Office

SER. NO. 79-082,648, FILED 3-29-2010.

**Reg. No. 4,123,481** KEVIN CORWIN, EXAMINING ATTORNEY

# United States of America

United States Patent and Trademark Office



**Reg. No. 4,123,482**

**Registered Apr. 10, 2012**

**Int. Cl.: 25**

**TRADEMARK**

**PRINCIPAL REGISTER**

PININFARINA EXTRA S.R.L. (ITALY LIMITED LIABILITY COMPANY)  
VIA BRUNO BUOZZI, 6  
I-10121 TORINO  
ITALY

FOR: CLOTHING, NAMELY, GYMNAS TIC OUTFITS, NAMELY, SHORTS, LEOTARDS AND T-SHIRTS, RAINCOATS, COATS, SHORTS, SUITS, DRESSES SUITS, SNOW SUITS, SKINS, NAMELY, DRESSES MADE FROM SKINS AND FURS, BLAZERS, BLOUSES, PANTS, SHIRTS, T-SHIRTS, SWEATSHIRTS, OVERALLS, JEANS, BATHING SUITS, MITTENS AND GLOVES, TIES, HOSIERY, BELTS, UNIFORMS, GOWNS, DRESSES, JUMPERS, SUSPENDERS, SLIPS, CULOTTES, CRAWLERS, NAMELY, CAPRIS; SHAWLS, LEGGINGS, ROBES, BIBS, UNDERWEAR, BODY SHIRTS, SOCKS, TROUSERS, EVENING DRESSES, JACKETS, PARKAS, SWEATERS, CARDIGANS, PAJAMAS; FOOTWEAR; HEADWEAR, NAMELY, BAFFLING HATS, HATS AND CAPS, IN CLASS 25 (U.S. CLS. 22 AND 39).

THE MARK CONSISTS OF A CROWN ABOVE A RECTANGLE WITH TRIANGLES IN THE TOP LEFT AND BOTTOM RIGHT CORNERS AND A STYLIZED LOWER CASE "F" IN THE CENTER.

PRIORITY DATE OF 4-14-2010 IS CLAIMED.

OWNER OF INTERNATIONAL REGISTRATION 1040514 DATED 4-22-2010, EXPIRES 4-22-2020.

SER. NO. 79-083,197, FILED 4-22-2010.

MICHELE SWAIN, EXAMINING ATTORNEY



*David J. Kybas*

Director of the United States Patent and Trademark Office

# United States of America

United States Patent and Trademark Office

# DE TOMASO

**Reg. No. 4,123,483**

**Registered Apr. 10, 2012**

**Int. Cls.: 3, 9, 12, 14, 16,  
18, 25 and 28**

**TRADEMARK**

**PRINCIPAL REGISTER**

DE TOMASO AUTOMOBILI S.P.A. (ITALY JOINT STOCK COMPANY), DBA DE TOMASO S.P.A.

VIA GIOVANNI MARCHI, 14/A

I-57121 LIVORNO

ITALY

FOR: CLEANING, POLISHING, SCOURING AND ABRASIVE PREPARATIONS; SOAPS; PERFUMERY, ESSENTIAL OILS, COSMETICS, HAIR LOTIONS, AFTER-SHAVE LOTIONS, BATH SALTS, NOT FOR MEDICAL PURPOSES, CREAM FOR LEATHER, DEODORANTS FOR PERSONAL USE, EAU DE COLOGNE, LEATHER PRESERVATIVES (POLISHES), PERFUMES, SCENTED WATER, SHAMPOOS, SHAVING PREPARATIONS, SHAVING SOAP, SHOE POLISH, SHOE WAX, SUNSCREEN PREPARATIONS, SUN-TANNING PREPARATIONS (COSMETICS), NON-MEDICATED TOILETRIES, WAXES FOR LEATHER, IN CLASS 3 (U.S. CLS. 1, 4, 6, 50, 51 AND 52).

FOR: ELECTRONIC AGENDAS, ALARMS, NAMELY, BURGLAR ALARMS, AMUSEMENT APPARATUS ADAPTED FOR USE WITH TELEVISION RECEIVERS ONLY, ANTI-THEFT WARNING APPARATUS, ELECTRIC BATTERIES FOR VEHICLES, BATTERY CHARGERS, BINOCULARS, CASES ESPECIALLY MADE FOR PHOTOGRAPHIC APPARATUS AND INSTRUMENTS, EYEGLASS CASES, CIGAR LIGHTERS FOR AUTOMOBILES, COMPACT DISC PLAYERS, COMPASSES, COMPUTER GAME PROGRAMS, COMPUTER PERIPHERAL DEVICES, DOWNLOADABLE COMPUTER SOFTWARE PROGRAMS, NAMELY, RACING GAMES SOFTWARE, COMPUTERS, CONTACT LENSES, CONTAINERS FOR CONTACT LENSES, EYEGLASS CHAINS, EYEGLASS CORDS, EYEGLASS FRAMES, EYEGLASSES, EYEPIECES, GOGGLES FOR SPORTS, PROTECTIVE HELMETS, HELMETS FOR SPORT, PROTECTIVE HELMETS FOR SPORT, LAPTOP COMPUTERS, ONBOARD COMPUTER NAVIGATION APPARATUS FOR VEHICLES, NAVIGATIONAL INSTRUMENTS FOR VEHICLES, NOTEBOOK COMPUTERS, PORTABLE TELEPHONES, SUNGLASSES, ELECTRONIC NETBOOKS, IN CLASS 9 (U.S. CLS. 21, 23, 26, 36 AND 38).

FOR: LAND VEHICLES, LAND VEHICLE ACCESSORIES AND SPARE PARTS, NAMELY, AXLES, FENDERS, DIFFERENTIALS; APPARATUS FOR LOCOMOTION BY LAND, NAMELY, LAND VEHICLES; ANTI-THEFT ALARMS FOR VEHICLES, ANTI-THEFT DEVICES FOR VEHICLES, AUTOMOBILE BODIES, AUTOMOBILE CHAINS, AUTOMOBILE CHASSIS, AUTOMOBILE HOODS, AUTOMOBILE TIRES (TYRES), AUTOMOBILES, BRAKE SEGMENTS FOR VEHICLES, BRAKE PADS FOR VEHICLES, BUMPERS FOR AUTOMOBILES, CASING FOR PNEUMATIC TIRES (TYRES), CLUTCHES FOR LAND VEHICLES,



*David J. Kybas*

Director of the United States Patent and Trademark Office



**Reg. No. 4,123,483** CONNECTING RODS FOR LAND VEHICLES, OTHER THAN PARTS OF MOTORS AND ENGINES, CONVERTERS FOR LAND VEHICLES, TORQUE CONVERTERS FOR LAND VEHICLES, COUPLINGS FOR LAND VEHICLES, DIRECTION SIGNALS FOR VEHICLES, DOORS FOR VEHICLES, ELECTRIC VEHICLES, ENGINES FOR LAND VEHICLES, FREE-WHEELS FOR LAND VEHICLES, GEAR BOXES FOR LAND VEHICLES, HEAD-RESTS FOR VEHICLE SEATS, HOODS FOR VEHICLE ENGINES, HORNS FOR VEHICLES, HUBS FOR VEHICLE WHEELS, HYDRAULIC CIRCUITS FOR VEHICLES, INNER TUBES FOR PNEUMATIC TIRES (TYRES), REPAIR OUTFITS FOR INNER TUBES, JET ENGINES FOR LAND VEHICLES, MOTOR CARS, ELECTRIC MOTORS FOR LAND VEHICLES, MOTORS FOR LAND VEHICLES, PROPULSION MECHANISM FOR LAND VEHICLES, TIRE PUMPS, AIR PUMPS (VEHICLE ACCESSORIES), REARVIEW MIRRORS, REDUCTION GEARS FOR LAND VEHICLES, RIMS FOR VEHICLE WHEELS, SAFETY BELTS FOR VEHICLE SEATS, SAFETY SEATS FOR CHILDREN (FOR VEHICLES), SEAT COVERS FOR VEHICLES, VEHICLE SEATS, SECURITY HARNESS FOR VEHICLE SEATS, SHOCK ABSORBERS FOR AUTOMOBILES, SLEEPING BERTHS FOR VEHICLES, SPIKES FOR TIRES (TYRES), SPORTS CARS, STEERING WHEELS FOR VEHICLES, TIRES FOR VEHICLE WHEELS, TORSION BARS FOR VEHICLES, TRACTION ENGINES, TRANSMISSION CHAINS FOR LAND VEHICLES, TRANSMISSION SHAFTS FOR LAND VEHICLES, TRANSMISSIONS, FOR LAND VEHICLES, TURBINES FOR LAND VEHICLES, TURN SIGNALS FOR VEHICLES, TIRES FOR VEHICLE WHEELS, VALVES FOR VEHICLE TIRES (TYRES), VEHICLES BUMPERS, VEHICLE SUSPENSION SPRINGS, VEHICLE WHEEL RIMS, VEHICLE WHEEL SPOKES, WINDOWS FOR VEHICLES, WINDSCREEN WIPERS, WINDSCREENS, IN CLASS 12 (U.S. CLS. 19, 21, 23, 31, 35 AND 44).

FOR: JEWELRY, BOXES OF PRECIOUS METAL, CUFF LINKS, KEY RINGS OF PRECIOUS METAL, ORNAMENTAL PINS, TIE PINS, IN CLASS 14 (U.S. CLS. 2, 27, 28 AND 50).

FOR: PRINTED MATTER, NAMELY, JOURNALS FEATURING AUTOMOBILE RACING; PHOTOGRAPHS; STATIONERY; PAINT BRUSHES; TYPEWRITERS AND OFFICE REQUISITES (EXCEPT FURNITURE), NAMELY, STAPLERS, RUBBER BANDS; INSTRUCTIONAL AND TEACHING MATERIAL (EXCEPT APPARATUS) IN THE FIELD OF AUTOMOBILES; CALENDARS, FOUNTAIN PENS, HOLDERS FOR CHECKBOOKS, DOCUMENT HOLDERS, PASSPORT HOLDERS, PEN CASES, PENCIL HOLDERS, PENCILS, PORTRAITS, POSTERS, WRITING INSTRUMENTS, IN CLASS 16 (U.S. CLS. 2, 5, 22, 23, 29, 37, 38 AND 50).

FOR: TRUNKS AND TRAVELLING BAGS; UMBRELLAS, PARASOLS AND WALKING STICKS; ATTACHE CASES, BACKPACKS, BEACH BAGS, BRIEFCASES, CANES, CARD CASES, COVERS FOR DOCUMENTS, UMBRELLA COVERS, HANDBAG FRAMES, HANDBAGS, KEY CASES (LEATHERWARE), LEATHER SHOULDER BELTS, POCKET WALLETS, PURSES, RUCKSACKS, SCHOOL BAGS, SCHOOL SATCHELS, SHOPPING BAGS, SUITCASES, TRAVELLING TRUNKS, TRUNKS (LUGGAGE), UMBRELLA HANDLES, VALISES, VANITY CASES (NOT FITTED), IN CLASS 18 (U.S. CLS. 1, 2, 3, 22 AND 41).

FOR: CLOTHING, NAMELY, BATH ROBES, TROUSERS, BEACH CLOTHES, BELTS, CLOTHING FOR GYMNASTICS, GLOVES, JACKETS, JERSEYS, JUMPERS, LEGGINGS, MOTORISTS' CLOTHING, OUTER CLOTHING, OVERCOATS, PAJAMAS, PANTS, PARKAS, PULLOVERS, SCARVES, SHIRTS, SKIRTS, SLIPS, SOCKS, SWEATERS, SWIMSUITS, TEE-SHIRTS, SWEAT-SHIRTS, UNDERCLOTHING, UNDERPANTS, UNDERWEAR, VESTS, WAISTCOATS; FOOTWEAR, HEADGEAR, NAMELY, HATS AND CAPS, IN CLASS 25 (U.S. CLS. 22 AND 39).

FOR: GAMES AND PLAYTHINGS, NAMELY, TOY VEHICLES, BOARD GAMES, RACING GAMES; GYMNASTIC AND SPORTING ARTICLES NOT INCLUDED IN OTHER CLASSES, NAMELY, TOY VEHICLES, BOARD GAMES, RACING GAMES; TOY MODEL VEHICLES, SCALE MODEL VEHICLES, RADIO-CONTROLLED TOY VEHICLES, TOY VEHICLES, IN CLASS 28 (U.S. CLS. 22, 23, 38 AND 50).

**Reg. No. 4,123,483** THE MARK CONSISTS OF STANDARD CHARACTERS WITHOUT CLAIM TO ANY PARTICULAR FONT, STYLE, SIZE, OR COLOR.

PRIORITY DATE OF 11-3-2009 IS CLAIMED.

OWNER OF INTERNATIONAL REGISTRATION 1040760 DATED 2-9-2010, EXPIRES 2-9-2020.

OWNER OF U.S. REG. NOS. 1,130,812, 2,113,530 AND OTHERS.

THE WORDING "DE TOMASO" HAS NO MEANING IN A FOREIGN LANGUAGE.

SEC. 2(F).

SER. NO. 79-083,295, FILED 2-9-2010.

JOHN WILKE, EXAMINING ATTORNEY

# United States of America

## United States Patent and Trademark Office



**Reg. No. 4,123,484**

**Registered Apr. 10, 2012**

**Int. Cls.: 14, 18 and 25**

THE SKULLHEAD LUXEMBOURG (LUXEMBOURG SOCIÉTÉ À RESPONSABILITÉ LIMITÉE)

412 F, ROUTE D'ESCH  
L-2086 LUXEMBOURG  
LUXEMBOURG

**TRADEMARK**

**PRINCIPAL REGISTER**

FOR: PRECIOUS METAL ALLOYS; RINGS IN THE NATURE OF JEWELRY; JEWELRY; CHRONOMETERS; JEWELRY CASKETS; WATCH CASES; EARRINGS; RINGS; CUFF-LINKS; TRINKETS; JEWELRY CHAINS; WATCH CHAINS; NECKLACES; PINS BEING JEWELRY; TIE PINS; JEWELRY, NAMELY, BRACELETS; WATCH BANDS; BROOCHES; CLOCKS; JEWELRY; MEDALLIONS; BOXES OF PRECIOUS METAL; PRECIOUS METAL, NAMELY, PLATINUM; ALARM CLOCKS; PASTE JEWELRY; PRECIOUS STONES, IN CLASS 14 (U.S. CLS. 2, 27, 28 AND 50).

FOR: LEATHER AND IMITATION LEATHER; BOXES OF LEATHER OR LEATHER BOARD; PURSES; WALKING STICKS; SCHOOL BAGS; CARD CASES IN THE NATURE OF WALLETS; TRAVELING TRUNKS; KEY CASES OF LEATHER; UNFITTED VANITY CASES; COLLARS FOR ANIMALS; UNWORKED OR SEMI-WORKED LEATHER; SLINGS FOR CARRYING INFANTS; MESH BAGS FOR SHOPPING; ANIMAL SKINS, NAMELY, FURS; HUNTER'S GAME BAGS; CLOTHING FOR ANIMALS; TRUNKS; ALL PURPOSE CARRYING BAGS MADE OF CARPET; ATTACHÉ CASES; PARASOLS; UMBRELLAS; ANIMAL SKINS, PELTS AND HIDES; PURSES; HANDBAGS; RUCKSACKS; REUSABLE SHOPPING BAG; SHOPPING BAGS WITH WHEELS ATTACHED; OVERNIGHT BAGS FOR CAMPERS; BEACH BAGS; SPORTS BAGS; TRAVELING BAGS; SCHOOL BAGS; FLEXIBLE BAGS FOR GARMENTS USED FOR TRAVELING; LEATHER TRAVELING SETS COMPOSED OF TRAVEL CASES, GROOMING ORGANIZERS FOR TRAVEL, JEWELRY ROLLS FOR TRAVEL, TOILETRY CASES SOLD EMPTY; VALISES, IN CLASS 18 (U.S. CLS. 1, 2, 3, 22 AND 41).

FOR: APPAREL, NAMELY, SHIRTS, PANTS, SHORTS, OVERALLS, MUFFLERS, LEGGINGS, VESTS, SWEATERS, SUITS, NECKTIES; LEATHER CLOTHING, NAMELY, JACKETS, COATS, SHIRTS, PANTS, DRESSES, SKIRTS; IMITATION LEATHER CLOTHING, NAMELY, JACKETS, COATS, SHIRTS, PANTS, DRESSES, SKIRTS; BIBS, NOT OF PAPER OR CLOTH; LAYETTES; UNDERCLOTHING, NAMELY, PANTIES, BRAS; SOCKS, STOCKINGS; TIGHTS; PAJAMAS; SWIMSUITS; FOOTWEAR; SPORTS SHOES; GLOVES; BELTS; BANDANAS; HATS; CLOTHING FOR SPORTS, NAMELY, T-SHIRTS, SHORTS, TRACKSUITS, IN CLASS 25 (U.S. CLS. 22 AND 39).



*David J. Kybas*

Director of the United States Patent and Trademark Office

**Reg. No. 4,123,484** THE MARK CONSISTS OF TWO CONCENTRIC CIRCLES CONTAINING A SHIELD SURROUNDED BY HOLLY LEAVES AND FEATURING A SKULL AND BONES DESIGN ABOVE THE LETTER "K".

OWNER OF INTERNATIONAL REGISTRATION 1040937 DATED 3-16-2010, EXPIRES 3-16-2020.

SER. NO. 79-083,360, FILED 3-16-2010.

LINDA ESTRADA, EXAMINING ATTORNEY

# United States of America

United States Patent and Trademark Office

## DRIVE YOUR HEALTH

**Reg. No. 4,123,485**

**Registered Apr. 10, 2012**

**Int. Cls.: 5, 16, 35, 41  
and 44**

**TRADEMARK**

**SERVICE MARK**

**PRINCIPAL REGISTER**

SCIENTIFIC FUTURE MANAGEMENT,; LIMITED LIABILITY COMPANY (RUSSIAN FED.  
LIMITED LIABILITY COMPANY)  
20, SOFIYSKAYA ST.  
RU-630056 NOVOSIBIRSK  
RUSSIAN FED.

FOR: GERMICIDES; BALMS FOR MEDICAL PURPOSES; BANDAGES FOR DRESSINGS AND SKIN WOUNDS; MAGNETIC BRACELETS FOR MEDICAL PURPOSES; PAPER FOR MEDICAL AND SURGICAL MUSTARD PLASTERS; PETROLEUM JELLY FOR MEDICAL PURPOSES; VACCINES; OXYGEN BATHS FOR MEDICAL PURPOSES; ANTISEPTIC COTTON; COTTON FOR MEDICAL PURPOSES; DIETETIC SUBSTANCES, NAMELY, FOODS ADAPTED FOR MEDICAL USE; NUTRITIVE SUBSTANCES FOR MICROORGANISMS FOR MEDICAL PURPOSES; RADIOACTIVE SUBSTANCES FOR USE IN NUCLEAR MEDICINE; MELISSA WATER FOR PHARMACEUTICAL PURPOSES; SEA WATER FOR MEDICINAL BATHING; MINERAL WATER FOR MEDICAL PURPOSES; THERMAL WATER FOR MEDICAL PURPOSES; EDIBLE PLANT FIBERS, NON-NUTRITIVE, NAMELY, DIETARY FIBER AS AN ADDITIVE FOR FOOD PRODUCTS; GASES FOR MEDICAL IMAGING USE; HEMATOGEN FOR THE TREATMENT OF IRON DEFICIENCY ANEMIA; HEMOGLOBIN; HYDRASTINE FOR MEDICAL PURPOSES; HYDRASTININE FOR MEDICAL PURPOSES; GLYCERINE FOR MEDICAL PURPOSES; GLUCOSE FOR MEDICAL PURPOSES; HORMONES FOR MEDICAL PURPOSES; MUSTARD FOR PHARMACEUTICAL PURPOSES; MUSTARD PLASTERS FOR MEDICAL PURPOSES; MUD FOR MEDICAL BATHS; MEDICINAL MUD; GAMBOGE FOR MEDICAL PURPOSES; GURJUN BALSAM FOR MEDICAL PURPOSES; ROOM DEODORANTS, OTHER THAN FOR PERSONAL USE; ADDITIVES TO FODDER FOR MEDICAL PURPOSES; MINERAL FOOD-SUPPLEMENTS; NUTRITIONAL ADDITIVES FOR MEDICAL PURPOSES USED IN FOODS AND DIETARY SUPPLEMENTS FOR HUMAN CONSUMPTION; DIETARY SUPPLEMENT; YEAST FOR PHARMACEUTICAL PURPOSES; GELATIN FOR MEDICAL PURPOSES; COD LIVER OIL; RADIO-ISOTOPE MARKERS FOR THERAPEUTIC OR DIAGNOSTIC USE; INSECTICIDES; IODINE FOR PHARMACEUTICAL PURPOSES; IODIDES FOR PHARMACEUTICAL PURPOSES; ALKALINE IODIDES FOR PHARMACEUTICAL PURPOSES; CALOMEL FOR MEDICAL PURPOSES; CREAM OF TARTAR FOR PHARMACEUTICAL PURPOSES; TARTAR FOR PHARMACEUTICAL PURPOSES; CAMPHOR FOR MEDICAL PURPOSES; CAPSULES SOLD EMPTY FOR MEDICINES; CACHETS SOLD EMPTY FOR PHARMACEUTICAL PURPOSES; MEDICATED CANDY FOR MEDICAL PURPOSES; WART REMOVING PENCILS; CAUSTIC PENCILS FOR WART REMOVAL; CARBOLINEUM PARASITICIDE; CAUSTICS FOR PHARMACEUTICAL PURPOSES; CACHOU FOR PHARMACEUTICAL PURPOSES; QUASSIA

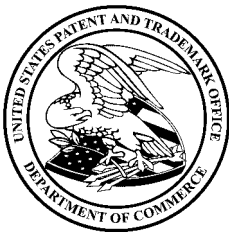

*David J. Kyros*

Director of the United States Patent and Trademark Office

**Reg. No. 4,123,485** FOR MEDICAL PURPOSES; QUEBRACHO FOR MEDICAL PURPOSES; OXYGEN FOR MEDICAL PURPOSES; GALLIC ACID FOR PHARMACEUTICAL PURPOSES; AMINO ACIDS FOR PHARMACEUTICAL PURPOSES; ADHESIVE BANDS FOR MEDICAL PURPOSES; COLLODION FOR PHARMACEUTICAL PURPOSES; CANDY, MEDICATED; BARKS FOR PHARMACEUTICAL PURPOSES; MEDICINAL ROOTS; STARCH FOR DIETETIC OR PHARMACEUTICAL PURPOSES; CREOSOTE FOR PHARMACEUTICAL PURPOSES; BLOOD FOR MEDICAL PURPOSE; CULTURES OF MICROORGANISMS FOR MEDICAL AND VETERINARY USE; CURARE FOR MEDICAL PURPOSES; DENTAL CONDUCTIVE LACQUER; LIQUORICE FOR PHARMACEUTICAL PURPOSES; LACTOSE FOR MEDICAL PURPOSES; ADHESIVE MEDICAL PLASTER; MEDICATED SKIN LOTIONS FOR VETERINARY PURPOSES; MEDICATED SKIN LOTIONS FOR PHARMACEUTICAL PURPOSES; LINIMENTS; MEDICINAL FISH OILS; DENTAL COMPOSITE MATERIALS; DRESSINGS, MEDICAL; DRUGS FOR MEDICAL PURPOSES, NAMELY, ANTICOAGULANTS, FIBRINOLYTIC AGENTS, ANTI-INFLAMMATORY AGENTS, ANTI-BACTERIAL AGENTS, ANTICARCINOGENIC AGENTS, ANTICHOLESTEREMIC AGENTS, HYPOGLYCEMIC AGENTS, HORMONES, IMMUNOLOGIC, GASTROINTESTINAL AGENTS, ANTILIPEMIC AGENTS, ANTIHYPERTENSIVE AGENTS; MEDICINES FOR VETERINARY PURPOSES, NAMELY, PAIN RELIEF MEDICATION; MEDICINES FOR HUMAN PURPOSES, NAMELY, FOR VIRAL, METABOLIC, ENDOCRINE, MUSCULOSKELETAL, CARDIOVASCULAR, CARDIOPULMONARY, GENITOURINARY, SEXUAL DYSFUNCTION, ONCOLOGICAL, HEPTOLOGICAL, OPHTHALMIC, RESPIRATORY, NEUROLOGICAL, GASTROINTESTINAL, HORMONAL, DERMATOLOGICAL, PSYCHIATRIC, AND IMMUNE SYSTEM RELATED DISEASES AND DISORDERS; MENTHOL VAPOR BATH PREPARATIONS FOR BABIES; MEDICINAL DRINKS; MOLESKIN FOR MEDICAL PURPOSES; MILK AND MILK FERMENTS FOR PHARMACEUTICAL AND MEDICAL PURPOSES; FIRST-AID KITS; DIETETIC BEVERAGES ADAPTED FOR MEDICAL PURPOSES; MALTED MILK BEVERAGES FOR MEDICAL PURPOSES; MEDICINAL INFUSIONS, NAMELY, MEDICINAL HERBAL EXTRACTS; HERBAL TINCTURES FOR MEDICAL PURPOSES; HERBAL DECOCTIONS FOR PHARMACEUTICAL PURPOSES; ANTIPARASITIC COLLARS FOR ANIMALS; PANTS, ABSORBENT, FOR INCONTINENTS; NAPKINS FOR INCONTINENTS; DIET PILLS FOR PHARMACEUTICAL PURPOSES; LEECHES FOR MEDICAL PURPOSES; BLOOD PLASMA; PLASTERS FOR MEDICAL PURPOSES; POMADES FOR MEDICAL PURPOSES; BELTS FOR SANITARY NAPKINS; MEDICAL PREPARATIONS FOR THE TREATMENT OF VIRAL, METABOLIC, ENDOCRINE, MUSCULOSKELETAL, CARDIOVASCULAR, CARDIOPULMONARY, GENITOURINARY, SEXUAL DYSFUNCTION, ONCOLOGICAL, HEPTOLOGICAL, OPHTHALMIC, RESPIRATORY, NEUROLOGICAL, GASTROINTESTINAL, HORMONAL, DERMATOLOGICAL, PSYCHIATRIC, AND IMMUNE SYSTEM RELATED DISEASES AND DISORDERS; VETERINARY PREPARATIONS FOR THE PAIN RELIEF TREATMENT; PHARMACEUTICAL PREPARATIONS FOR THE TREATMENT OF VIRAL, METABOLIC, ENDOCRINE, MUSCULOSKELETAL, CARDIOVASCULAR, CARDIOPULMONARY, GENITOURINARY, SEXUAL DYSFUNCTION, ONCOLOGICAL, HEPTOLOGICAL, OPHTHALMIC, RESPIRATORY, NEUROLOGICAL, GASTROINTESTINAL, HORMONAL, DERMATOLOGICAL, PSYCHIATRIC, AND IMMUNE SYSTEM RELATED DISEASES AND DISORDERS; BIOLOGICAL PREPARATIONS FOR MEDICAL PURPOSES; ALBUMINOUS PREPARATIONS FOR MEDICAL PURPOSES; DIAGNOSTIC PREPARATIONS FOR MEDICAL PURPOSES; DIAGNOSTIC PREPARATIONS FOR PHARMACEUTICAL PURPOSES; DIAGNOSTIC PREPARATIONS FOR VETERINARY PURPOSES; HYGIENIC PREPARATIONS FOR MEDICAL PURPOSES, NAMELY, DISINFECTANTS; VITAMIN PREPARATIONS; DIAGNOSTIC PREPARATIONS FOR MEDICAL PURPOSES; BACTERIAL PREPARATIONS FOR MEDICAL AND VETERINARY USE; THERAPEUTIC PREPARATIONS FOR THE BATH; AIR FRESHENING PREPARATIONS; AIR PURIFYING PREPARATIONS; STERILISING PREPARATIONS; PHARMACEUTICAL PREPARATIONS FOR SKIN CARE; CONTACT LENS CLEANING PREPARATIONS; BATH PREPARATIONS, MEDICATED; MEDICINAL HAIR GROWTH PREPARATIONS; PREPARATIONS OF TRACE ELEMENTS FOR HUMAN AND ANIMAL USE, NAMELY, FOOD SUPPLEMENTS; MEDICATED SUNBURN PREPARATIONS FOR PHARMACEUTICAL PURPOSES; ENZYME PREPARATIONS FOR VETERINARY PURPOSES; ENZYME PREPARATIONS FOR MEDICAL PURPOSES; PESTICIDES; HERBICIDES; FUNGICIDES; CHEMICO-PHARMACEUTICAL PREPARATIONS FOR THE

**Reg. No. 4,123,485** TREATMENT OF VIRAL, METABOLIC, ENDOCRINE, MUSCULOSKELETAL, CARDIOVASCULAR, CARDIOPULMONARY, GENITOURINARY, SEXUAL DYSFUNCTION, ONCOLOGICAL, HEPTOLOGICAL, OPHTHALMIC, RESPIRATORY, NEUROLOGICAL, GASTROINTESTINAL, HORMONAL, DERMATOLOGICAL, PSYCHIATRIC, AND IMMUNE SYSTEM RELATED DISEASES AND DISORDERS; CHEMICAL PREPARATIONS FOR THE DIAGNOSIS OF PREGNANCY; CHEMICAL CONDUCTORS FOR ELECTROCARDIOGRAPH ELECTRODES; ALBUMINOUS FOODSTUFFS FOR MEDICAL PURPOSES; FOOD FOR BABIES; DIETETIC FOODS ADAPTED FOR MEDICAL PURPOSES; BY-PRODUCTS OF THE PROCESSING OF CEREALS FOR MEDICAL PURPOSES; MENSTRUATION BANDAGES; SANITARY PANTY LINERS; VAGINAL WASHES; SOLUTIONS FOR CONTACT LENSES; CHEMICAL REAGENTS FOR MEDICAL OR VETERINARY PURPOSES; GUM FOR MEDICAL PURPOSES; CHEWING GUM FOR MEDICAL PURPOSES; INSECT REPELLENTS; SANITARY NAPKINS; TISSUES IMPREGNATED WITH PHARMACEUTICAL LOTIONS; SARSAPARILLA FOR MEDICAL PURPOSES; SUGAR FOR MEDICAL PURPOSES; ASTHMATIC HERBAL TEA; FUMIGATING STICKS FOR MEDICAL THERAPEUTIC USE; SUPPOSITORIES; LINSEED FOR PHARMACEUTICAL PURPOSES; TOBACCO-FREE CIGARETTES FOR MEDICAL PURPOSES; SICCATIVES DRYING AGENTS FOR MEDICAL PURPOSES; SYRUPS FOR PHARMACEUTICAL PURPOSES; SOPORIFIC SEDATIVE; MEDICATED SALTS FOR MINERAL WATER BATHS; BATH SALTS FOR MEDICAL PURPOSES; SALTS FOR MEDICAL PURPOSES; MINERAL WATER SALTS FOR MEDICAL PURPOSES; SEMEN FOR ARTIFICIAL INSEMINATION; ALCOHOL FOR PHARMACEUTICAL PURPOSES; ALLOYS OF PRECIOUS METALS FOR DENTAL PURPOSES; ANAESTHETICS; ANTISEPTICS; ANALGESICS; ADJUVANTS FOR MEDICAL PURPOSES; STYPTIC PREPARATIONS; ANTHELMINTICS; DISINFECTANTS FOR HYGIENE PURPOSES; DISINFECTANTS FOR CHEMICAL TOILETS; APPETITE SUPPRESSANTS FOR MEDICAL PURPOSES; MEDICAL PREPARATIONS FOR SLIMMING PURPOSES; MOUTHWASHES FOR MEDICAL PURPOSES; DEPURATIVES FOR THE BODY; MEDICATED ANIMAL WASHES; DETERGENTS FOR MEDICAL PURPOSES; VESICANTS; HEADACHE PENCILS AS A HEADACHE TREATMENT PREPARATION; PHARMACEUTICAL PREPARATION FOR TREATMENT OF PERSPIRATION; PHARMACEUTICAL PREPARATION FOR TREATMENT OF FOOT PERSPIRATION; CHEMICAL CONTRACEPTIVES; ANTIPARASITIC PREPARATIONS; LAXATIVES; MEDICATED HAIR TONICS; MEDICATED HAIR SERUMS; MENSTRUATION TAMPONS; VULNERARY CONTRACEPTIVE SPONGES; SURGICAL TISSUES; SMOKING HERBS FOR MEDICAL PURPOSES; MEDICINAL HERBS; SEDATIVES; SURGICAL IMPLANTS COMPRISING LIVING TISSUES; SANITARY KNICKERS USED AS MEDICAL GARMENT; PHENOL FOR PHARMACEUTICAL PURPOSES; ENZYMES FOR VETERINARY PURPOSES; ENZYMES FOR MEDICAL PURPOSES; FERMENTS FOR PHARMACEUTICAL PURPOSES; DIABETIC BREAD; BONE CEMENT FOR SURGICAL AND ORTHOPAEDIC PURPOSES; HERBS TEAS FOR MEDICINAL PURPOSES; REDUCING TEA FOR MEDICAL PURPOSES; MEDICINAL HERB EXTRACTS FOR PHARMACEUTICAL PURPOSES; ETHERS FOR PHARMACEUTICAL PURPOSES; ESTERS FOR PHARMACEUTICAL PURPOSES; CELLULOSE ESTERS FOR PHARMACEUTICAL PURPOSES; JUJUBE, MEDICATED; BACTERIAL POISONS, IN CLASS 5 (U.S. CLS. 6, 18, 44, 46, 51 AND 52).

FOR: ALBUMS FOR REPORTS, DRAWINGS, PHOTOGRAPHS; TABLECLOTHS OF PAPER; TICKETS; FORMS, PRINTED; NOTE BOOKS; BOOKLETS IN THE FIELD OF PHARMACEUTICAL AND MEDICAL SERVICE; PAPER FOR RADIOGRAMS; ELECTROCARDIOGRAPH PAPER; TOILET PAPER; PACKING PAPER; CARDBOARD; NEWSLETTERS IN THE FIELD OF PHARMACEUTICAL AND MEDICAL SERVICE; SIGNBOARDS OF PAPER OR CARDBOARD; NEWSPAPERS; PRINT ENGRAVINGS; SLATE PENCILS; HOLDERS FOR STATIONERY; BOOKMARKERS; PRINTED PUBLICATIONS, NAMELY, BROCHURES IN THE FIELD OF PHARMACEUTICAL AND MEDICAL SERVICE; ENVELOPES AND POUCHES OF PAPER OR PLASTICS, FOR PACKAGING; PLASTIC MATERIALS, NAMELY, BAGS FOR PACKAGING; GRAPHIC ART REPRESENTATIONS; CALENDARS; PICTURES; PAINTINGS, FRAMED OR UNFRAMED; CREDIT CARD IMPRINTERS, NON-ELECTRIC; PRINTING BLOCKS; BOOKS IN THE FIELD OF PHARMACEUTICAL AND MEDICAL SERVICE; LEDGER BOOKS; ENVELOPES; BOXES OF CARDBOARD OR PAPER; VISCOS

**Reg. No. 4,123,485** SHEETS FOR WRAPPING; PLASTIC BUBBLE PACKS FOR WRAPPING OR PACKAGING; PLASTIC SHEETS OF RECLAIMED CELLULOSE FOR WRAPPING; POSTAGE STAMPS; GRAPHIC PRINTS, PARTICULARLY MEDICAL; PRINTED TEACHING MATERIALS IN THE FIELD OF PHARMACEUTICAL AND MEDICAL SERVICE; GARBAGE BAGS OF PAPER OR OF PLASTICS; WRITING INSTRUMENTS; BIBS OF PAPER; STICKERS; FINGER-STALLS; BOTTLE ENVELOPES OF CARDBOARD OR PAPER; ADHESIVE GIFT SEALING WAFERS; DOCUMENT COVERS; OLEOGRAPHS; GREETING CARDS; POSTCARDS; ETCHINGS; CONICAL PAPER BAGS; FOLDERS FOR PAPERS; BABIES' NAPKINS OF PAPER AND CELLULOSE, DISPOSABLE; MEDICAL MAGAZINES; SEALS; HANDKERCHIEFS OF PAPER; PLASTIC FILM FOR WRAPPING; BABIES' NAPKIN-PANTS OF PAPER AND CELLULOSE, DISPOSABLE; TOWELS OF PAPER; HAND-HELD LABELING DEVICES; PRINTED MATTER, NAMELY, JOURNALS IN THE FIELD OF PHARMACEUTICAL AND MEDICAL SERVICE; PRINTED PROSPECTUSES; PRINTED TIMETABLES; NAPKINS OF PAPER FOR REMOVING MAKE-UP; FACE TOWELS OF PAPER; PLACARDS OF PAPER OR CARDBOARD; STATIONERY; NON-ELECTRIC CHART POINTERS; BOTTLE WRAPPERS OF CARDBOARD OR PAPER; MANUALS IN THE FIELD OF PHARMACEUTICAL AND MEDICAL SERVICE; TEACHING MATERIALS, NAMELY, MEDICAL MANNEQUINS; FLAGS OF PAPER; SILVER PAPER; PHOTO-ENGRAVINGS; PHOTOGRAPHS; WRITING INK; INKWELLS; BLUEPRINTS; PRINTING TYPE; PRINTS; ADVERTISEMENT BOARDS OF PAPER OR CARDBOARD; PAPER LABELS, IN CLASS 16 (U.S. CLS. 2, 5, 22, 23, 29, 37, 38 AND 50).

FOR: ARRANGING SUBSCRIPTIONS TO TELECOMMUNICATION SERVICES FOR OTHERS; IMPORT-EXPORT AGENCIES; COMMERCIAL INFORMATION AGENCIES; RENTAL OF ADVERTISING SPACE; ADVERTISING AGENCIES; COMPUTERIZED FILE MANAGEMENT; DEMONSTRATION OF GOODS; OPINION POLLING; MARKETING STUDIES; BUSINESS INFORMATION; BUSINESS INFORMATION, PARTICULARLY BUSINESS INFORMATION ABOUT PRESENCE OF PHARMACEUTICALS AT THE PHARMACY CHAIN; COMMERCIAL INFORMATION AND ADVICE FOR CONSUMERS; MARKETING RESEARCH; PERSONNEL RECRUITMENT; BUSINESS MANAGEMENT AND ORGANIZATION CONSULTANCY; LAYOUT SERVICES FOR ADVERTISING PURPOSES; NEWS CLIPPING SERVICES; UP-DATING OF ADVERTISING MATERIAL; ORGANIZATION OF EXHIBITIONS FOR COMMERCIAL OR ADVERTISING PURPOSES; ARRANGING NEWSPAPER SUBSCRIPTIONS FOR OTHERS; ORGANIZATION OF TRADE FAIRS FOR COMMERCIAL OR ADVERTISING PURPOSES; SHOP WINDOW DRESSING; PRESENTATION OF GOODS ON COMMUNICATION MEDIA, FOR RETAIL PURPOSES; SALES PROMOTION OF MEDICAL GOODS FOR OTHERS, INCLUDING WHOLESALE AND RETAIL TRADE PARTICULARLY BY THE PHARMACY CHAIN; RENTAL OF ADVERTISING TIME ON COMMUNICATION MEDIA; PUBLICITY MATERIAL RENTAL; PUBLICATION OF PUBLICITY TEXTS; RADIO ADVERTISING; BILL PRESENTMENT SERVICES; DISTRIBUTION OF SAMPLES; DISSEMINATION OF ADVERTISING MATTER; WRITING OF PUBLICITY TEXTS; ADVERTISING; ON-LINE ADVERTISING ON A COMPUTER NETWORK; ADVERTISING BY MAIL ORDER; TELEVISION ADVERTISING; PUBLICITY COLUMNS PREPARATION; PSYCHOLOGICAL TESTING FOR THE SELECTION OF PERSONNEL; COMMERCIAL ADMINISTRATION OF THE LICENSING OF THE GOODS AND SERVICES OF OTHERS; ADMINISTRATIVE PROCESSING OF PURCHASE ORDERS; PUBLIC RELATIONS; PROCUREMENT SERVICES FOR OTHERS, NAMELY, PURCHASING MEDICAL SUPPLIES, PHARMACEUTICAL PREPARATIONS, NUTRITIONAL SUPPLEMENTS; OUTSOURCING SERVICES; EFFICIENCY EXPERTS, IN CLASS 35 (U.S. CLS. 100, 101 AND 102).

FOR: ACADEMIES, NAMELY, EDUCATION SERVICES IN THE NATURE OF COURSES AT THE UNIVERSITY LEVEL; VIDEOTAPING; NURSERY SCHOOLS; PHYSICAL EDUCATION; PUBLICATION OF BOOKS, PARTICULARLY MEDICAL; EDUCATION INFORMATION; RECREATION INFORMATION; HEALTH CLUB SERVICES, NAMELY, PROVIDING INSTRUCTION AND EQUIPMENT IN THE FIELD OF PHYSICAL EXERCISE; DANCE CLUB SERVICES; LAYOUT SERVICES, OTHER THAN FOR ADVERTISING PURPOSES; MICROFILMING FOR OTHERS; VIDEOTAPE EDITING; PRODUCTION OF RADIO AND TELEVISION PROGRAMS; PROVIDING ONLINE COMPUTER GAMES FROM A COMPUTER NETWORK; PROVIDING ON-LINE ELECTRONIC PUBLICATIONS, NOT DOWNLOADABLE,



**Reg. No. 4,123,485** NAMELY, MAGAZINES IN THE FIELD OF PHARMACEUTICAL AND MEDICAL SERVICE; GYMNAS TIC INSTRUCTION; CORRESPONDENCE COURSES IN THE FIELD OF PHARMA- CEUTICAL AND MEDICAL SERVICE; PRACTICAL TRAINING IN THE FIELD OF PHAR- MACEUTICAL AND MEDICAL SERVICE; ORGANIZATION OF EXHIBITIONS FOR CUL- TURAL OR EDUCATIONAL PURPOSES; PROVIDING RECREATION FACILITIES; ARRAN- GING AND CONDUCTING OF COLLOQUIUMS IN THE FIELD OF PHARMACEUTICAL AND MEDICAL SERVICE; ARRANGING AND CONDUCTING OF CONGRESSES IN THE FIELD OF PHARMACEUTICAL AND MEDICAL SERVICE; ARRANGING AND CONDUCT- ING OF CONFERENCES IN THE FIELD OF PHARMACEUTICAL AND MEDICAL SERVICE; ARRANGING AND CONDUCTING OF CONCERTS; ARRANGING AND CONDUCTING OF WORKSHOPS IN THE FIELD OF PHARMACEUTICAL AND MEDICAL SERVICE; ARRAN- GING AND CONDUCTING OF SEMINARS IN THE FIELD OF PHARMACEUTICAL AND MEDICAL SERVICE; ARRANGING AND CONDUCTING OF SYMPOSIUMS IN THE FIELD OF PHARMACEUTICAL AND MEDICAL SERVICE; ORGANIZATION OF COMPETITIONS IN THE FIELD OF PHARMACEUTICAL AND MEDICAL SERVICE; OPERATING LOTTERIES; HOLIDAY CAMP SERVICES; ORGANIZATION OF SPORTS COMPETITIONS; VOCATIONAL GUIDANCE; EDUCATIONAL EXAMINATION; TIMING OF SPORTS EVENTS; VIDEOTAPE FILM PRODUCTION; FILM PRODUCTION; RENTAL OF SOUND RECORDINGS; RENTAL OF AUDIO EQUIPMENT; RENTAL OF CAMCORDERS; RENTAL OF VIDEO CASSETTE RECORDERS; RENTAL OF VIDEOTAPES; RENTAL OF MOVIE PROJECTORS AND AC- CESSORIES; RENTAL OF MOTION PICTURES; ELECTRONIC DESKTOP PUBLISHING; PUBLICATION OF ELECTRONIC BOOKS AND JOURNALS ON-LINE; PUBLICATION OF TEXTS, OTHER THAN PUBLICITY TEXTS; RADIO ENTERTAINMENT; ENTERTAINMENT; WRITING OF TEXTS, OTHER THAN PUBLICITY TEXTS; ZOOLOGICAL GARDENS; NEWS REPORTERS SERVICES; EDUCATIONAL SERVICES, NAMELY, RESEARCH; TRANSLA- TION SERVICES; DIGITAL IMAGING SERVICES; PHOTOGRAPHY; PHOTOGRAPHIC REPORTING; BOARDING SCHOOLS , IN CLASS 41 (U.S. CLS. 100, 101 AND 107).

FOR: MEDICAL SERVICES; VETERINARY SERVICES; HYGIENIC AND COSMETICS CARE SERVICES FOR PEOPLE AND ANIMALS; REHABILITATION FOR SUBSTANCE ABUSE PATIENTS; MEDICAL CLINICS; CONVALESCENT HOMES; HAIR IMPLANTATION; NURSING HOMES; PHARMACEUTICAL ADVICE; HOSPITALS; AROMATHERAPY SER- VICES; MANICURING; MASSAGE; ARTIFICIAL INSEMINATION SERVICES; MIDWIFE SERVICES; VETERINARY ASSISTANCE; DENTISTRY ASSISTANCE; MEDICAL ASSIST- ANCE; RENTAL OF SANITATION FACILITIES; BEAUTY SALONS; SANATORIUM SER- VICES; BLOOD BANK SERVICES; HEALTH CARE; HEALTH SPA SERVICES FOR HEALTH AND WELLNESS OF THE BODY AND SPIRIT; TATTOOING; OPTICIANS' SERVICES; IN- VITRO FERTILIZATION SERVICES; SERVICES OF A PSYCHOLOGIST; SAUNA SERVICES; SOLARIUM SERVICES; TELEMEDICINE SERVICES; PHARMACISTS' SERVICES TO MAKE UP PRESCRIPTIONS; NURSING, MEDICAL; PHYSIOTHERAPY SERVICES; CHIRO- PRACTICS; PLASTIC SURGERY; HOSPICES, IN CLASS 44 (U.S. CLS. 100 AND 101).

THE MARK CONSISTS OF STANDARD CHARACTERS WITHOUT CLAIM TO ANY PAR- TICULAR FONT, STYLE, SIZE, OR COLOR.

PRIORITY DATE OF 9-18-2009 IS CLAIMED.

OWNER OF INTERNATIONAL REGISTRATION 1041735 DATED 3-9-2010, EXPIRES 3-9- 2020.

NO CLAIM IS MADE TO THE EXCLUSIVE RIGHT TO USE "HEALTH", APART FROM THE MARK AS SHOWN.

SER. NO. 79-083,667, FILED 3-9-2010.

LINDSEY RUBIN, EXAMINING ATTORNEY

United States of America  
United States Patent and Trademark Office

# Jetip

**Reg. No. 4,123,486**

**Registered Apr. 10, 2012**

**Int. Cl.: 10**

**TRADEMARK**

**PRINCIPAL REGISTER**

B&L BIOTECH, INC. (REPUBLIC OF KOREA CORPORATION)  
502, GUNGJUN TOWER,  
727-3, GOJAN-DONG, DANWON-GU., ANSAN-SI, GYEONGGI-DO  
REPUBLIC OF KOREA

FOR: DENTAL AUTOCLAVES, NAMELY, STERILIZATION AUTOCLAVES FOR USE IN DISINFECTING DENTAL APPARATUS; CAVITY DETECTORS, NAMELY, DENTAL PROBES; DENTAL INSTRUMENTS, NAMELY, DENTAL BURS IN THE NATURE OF A PIECE OF EQUIPMENT FOR DRILLING HOLES IN THE TEETH OF DENTAL PATIENTS; UNITS FOR DENTAL PURPOSES, NAMELY, DENTAL ULTRASONIC TIP SETS, COMPRISING DRILLING AND CUTTING BITS FOR TEETH REPAIR; DENTAL INSTRUMENT SURGICAL SETS, NAMELY, DENTAL DRILLS AND PARTS THEREFOR; DENTAL HAND-TOOLS COMPRISING CURETTES, SPATULAS, SCALERS, AND PROBES; DENTAL APPARATUS, NAMELY, MICRO-SURGICAL DENTAL HAND INSTRUMENTS, NAMELY, CURETTES, SPATULAS, SCALERS, AND PROBES FOR EXAMINATION, DIAGNOSIS, TISSUE MANAGEMENT, CURETTAGE, DEBRIDEMENT AND ROOT TREATMENT; ENDODONTIC OBTURATORS; DENTAL PLUGGERS; DENTAL PLUGGER STANDS; DENTAL CONDENSERS; DENTAL WRENCH; DENTAL ULTRASONIC TIPS, NAMELY, DENTAL DRILL BITS; DENTAL IMPLANTS, DENTAL BRIDGES, DENTAL DRILLS, DENTAL HAND-PIECES, NAMELY, DENTAL CURETTES, SPATULAS, SCALERS, AND PROBES; DENTAL TRAYS; DENTAL DISPENSER GUNS, NAMELY, HAND-HELD APPLICATOR WITH TRIGGER FOR DISPENSING DENTAL FILLINGS DURING DENTAL PROCEDURES; DENTAL MIXING PALLETS; DENTAL BRUSHES; DENTAL CANULAS; DENTAL PATIENT EXAMINING AND TREATMENT TABLES; DENTAL CHAIRS FOR EXAMINATION AND TREATMENT; ALL THE AFORESAID GOODS LIMITED FOR USE BY DENTISTS, IN CLASS 10 (U.S. CLS. 26, 39 AND 44).



THE MARK CONSISTS OF STANDARD CHARACTERS WITHOUT CLAIM TO ANY PARTICULAR FONT, STYLE, SIZE, OR COLOR.

PRIORITY DATE OF 4-14-2010 IS CLAIMED.

OWNER OF INTERNATIONAL REGISTRATION 1042833 DATED 4-15-2010, EXPIRES 4-15-2020.

SER. NO. 79-084,084, FILED 4-15-2010.

*David J. Kyjars*

Director of the United States Patent and Trademark Office

**Reg. No. 4,123,486** WILLIAM ROSSMAN, EXAMINING ATTORNEY

# United States of America

United States Patent and Trademark Office



**Reg. No. 4,123,487**

**Registered Apr. 10, 2012**

**Int. Cls.: 3 and 5**

**TRADEMARK**

**PRINCIPAL REGISTER**

UNDA, SOCIÉTÉ ANONYME (BELGIUM JOINT STOCK COMPANY)  
RUE CARLI 5  
B-1140 BRUXELLES  
BELGIUM

FOR: SOAPS; PERFUMERY, ESSENTIAL OILS, COSMETICS, HAIR LOTIONS; DENTIFRICES,  
IN CLASS 3 (U.S. CLS. 1, 4, 6, 50, 51 AND 52).

FOR: FULL LINE OF HOMEOPATHIC PHARMACEUTICALS; SANITARY PREPARATIONS  
FOR MEDICAL PURPOSES; DIETETIC SUBSTANCES ADAPTED FOR MEDICAL USE,  
NAMELY, HUMAN DIETARY FOOD SUPPLEMENTS AND NUTRITIONAL SUPPLEMENTS  
COMPOSED OF TRACE ELEMENTS; PLASTERS FOR MEDICAL PURPOSES; MATERIALS  
FOR DRESSINGS, NAMELY, MEDICAL DRESSINGS; DISINFECTANTS, NAMELY, ALL  
PURPOSE DISINFECTANTS, DISINFECTING HAND WASH, IN CLASS 5 (U.S. CLS. 6, 18,  
44, 46, 51 AND 52).

OWNER OF U.S. REG. NO. 1,884,552.

PRIORITY DATE OF 12-16-2009 IS CLAIMED.

OWNER OF INTERNATIONAL REGISTRATION 1043286 DATED 5-4-2010, EXPIRES 5-4-  
2020.

THE MARK CONSISTS OF THE TERM "UNDA" SUPERIMPOSED ON A DESIGN OF THREE  
FLOWERS.

THE WORDING "UNDA" HAS NO MEANING IN A FOREIGN LANGUAGE.

SER. NO. 79-084,262, FILED 5-4-2010.

LIEF MARTIN, EXAMINING ATTORNEY



*David J. Kybas*

Director of the United States Patent and Trademark Office

# United States of America

United States Patent and Trademark Office



**ROTTAPHARM**

**Reg. No. 4,123,488**

**Registered Apr. 10, 2012**

**Int. Cl.: 5**

**TRADEMARK**

**PRINCIPAL REGISTER**

ROTTAPHARM S.P.A. (ITALY SOCIÉTÉ PAR ACTIONS)  
GALLERIA UNIONE 5  
I-20122 MILANO  
ITALY

FOR: FULL LINE OF PHARMACEUTICAL AND MEDICAL PREPARATIONS, SOLD WITH AND WITHOUT MEDICAL PRESCRIPTION, FOR HUMAN BEINGS AND FOR ANIMALS, FOOD SUPPLEMENTS FOR MEDICAL USE, IN CLASS 5 (U.S. CLS. 6, 18, 44, 46, 51 AND 52).

OWNER OF U.S. REG. NO. 3,708,765.

OWNER OF INTERNATIONAL REGISTRATION 0904575 DATED 9-26-2006, EXPIRES 9-26-2016.

THE MARK CONSISTS OF A TRIANGLE DESIGN WITH AN "R" WITHIN A CIRCLE IN ITS CENTER. TO THE RIGHT OF THE DESIGN IS THE TERM "ROTTAPHARM".

SER. NO. 79-084,319, FILED 3-2-2010.

TRACY CROSS, EXAMINING ATTORNEY



*David J. Kyfos*

Director of the United States Patent and Trademark Office

# United States of America

United States Patent and Trademark Office

## SVENSKT TENN

**Reg. No. 4,123,489**

**Registered Apr. 10, 2012**

**Int. Cls.: 6, 11, 20, 21, 24  
and 27**

**TRADEMARK**

**PRINCIPAL REGISTER**

SVENSKT TENN AKTIEBOLAG (SWEDEN JOINT STOCK COMPANY)  
STRANDVÄGEN 5  
SE-114 84 STOCKHOLM  
SWEDEN

FOR: FIGURINES OF COMMON METAL; FANCY GOODS OF COMMON METAL, NAMELY, BOXES AND DOOR STOPS OF COMMON METAL, COAT PEGS OF COMMON METAL, KNOBS OF COMMON METAL, METAL FOOT SCRAPERS; RINGS OF COMMON METAL FOR KEYS, IN CLASS 6 (U.S. CLS. 2, 12, 13, 14, 23, 25 AND 50).

FOR: LIGHTING APPARATUS AND INSTALLATIONS, NAMELY, CHANDELIERS, CEILING LIGHTS, TABLE LAMPS, WALL LAMPS, STANDARD LAMPS, ELECTRIC CANDLESTICKS, OIL LAMPS, AND LAMPSHADES; PLATE WARMERS, IN CLASS 11 (U.S. CLS. 13, 21, 23, 31 AND 34).

FOR: FURNITURE AND PARTS OF FURNITURE; CUSHIONS, PILLOWS, MIRRORS, HAT RACKS, COAT STANDS, CLOTHES HANGERS, PICTURE FRAMES, DISPLAY BOARDS, KEYBOARDS IN THE NATURE OF FURNITURE FOR HANGING KEYS; CURTAIN HOOKS, CURTAIN RODS, CURTAIN RINGS, CURTAIN TIE-BACKS IN THE NATURE OF NON-TEXTILE CURTAIN HOLDERS; SLATTED INDOOR BLINDS; CASES OF WOOD, NAMELY, BOOKCASES; FIREGUARDS; WICKERWORK, NAMELY, WICKER FURNITURE; DECORATIVE MOBILES, IN CLASS 20 (U.S. CLS. 2, 13, 22, 25, 32 AND 50).



*David J. Kybas*

Director of the United States Patent and Trademark Office

FOR: HOUSEHOLD OR KITCHEN UTENSILS AND CONTAINERS NOT OF PRECIOUS METAL OR COATED THEREWITH, NAMELY, BOTTLE OPENERS, TRIVETS, COASTERS NOT OF PAPER AND NOT BEING TABLE LINEN, NAPKIN RINGS; NAPKIN HOLDERS, PLATES, BOWLS, DRINKING GLASSES, MUGS, VASES, POTS, TABLE PLACE CARD HOLDERS NOT OF PRECIOUS METAL, JUGS, CORK HOLDERS; TABLEWARE OTHER THAN KNIVES, FORKS AND SPOONS, NOT OF PRECIOUS METAL, NAMELY, SERVING TONGS, SERVING SPOONS, BOWLS; TRAYS FOR DOMESTIC PURPOSES NOT OF PRECIOUS METAL; CANDLESTICKS, CANDLE RINGS AND CANDLE EXTINGUISHERS, NOT OF PRECIOUS METAL; FIGURINES AND WORKS OF ART, OF PORCELAIN, TERRA-COTTA OR GLASS; EARTHENWARE, NAMELY, DOORSTOPS, CANDLE HOLDERS, SCULPTURE; POTS, URNS AND VASES, NOT OF PRECIOUS METAL; WATERING CANS; GLASSWARE, PORCELAIN AND EARTHENWARE, NAMELY, PLATES, BOWLS, DRINKING GLASSES, MUGS, VASES, POTS, JUGS, ORNAMENTS, IN CLASS 21 (U.S. CLS. 2, 13, 23, 29, 30, 33, 40 AND 50).

**Reg. No. 4,123,489** FOR: TEXTILES AND TEXTILE AND PLASTIC GOODS, NAMELY, TEXTILE TABLE CLOTHS, OILCLOTHS, TEXTILE TABLE LINEN, TABLE MATS NOT OF PAPER, PLACE MATS OF TEXTILE, TOWELS OF TEXTILE, HOUSEHOLD LINEN, HANDKERCHIEFS OF TEXTILE, PILLOW SHAMS, BED SHEETS, BED LINEN, BED BLANKETS, BED COVERS, MATTRESS COVERS, UPHOLSTERY FABRICS, UNFITTED FURNITURE COVERINGS OF TEXTILE OR PLASTIC, WALL HANGINGS OF TEXTILE, DOOR CURTAINS, BLINDS IN THE NATURE OF CURTAINS OF TEXTILE, IN CLASS 24 (U.S. CLS. 42 AND 50).

FOR: CARPETS, RUGS, NON-TEXTILE WALL HANGINGS, IN CLASS 27 (U.S. CLS. 19, 20, 37, 42 AND 50).

THE MARK CONSISTS OF STANDARD CHARACTERS WITHOUT CLAIM TO ANY PARTICULAR FONT, STYLE, SIZE, OR COLOR.

OWNER OF INTERNATIONAL REGISTRATION 1043541 DATED 5-26-2010, EXPIRES 5-26-2020.

OWNER OF U.S. REG. NO. 3,520,840.

NO CLAIM IS MADE TO THE EXCLUSIVE RIGHT TO USE "TENN" AS TO THE GOODS IN INTERNATIONAL CLASSES 6 AND 11, AS TO THE "FURNITURE AND PARTS OF FURNITURE; MIRRORS, HAT RACKS, COAT STANDS, CLOTHES HANGERS, PICTURE FRAMES, DISPLAY BOARDS, KEYBOARDS IN THE NATURE OF FURNITURE FOR HANGING KEYS; CURTAIN HOOKS, CURTAIN RODS, CURTAIN RINGS, CURTAIN TIE-BACKS IN THE NATURE OF NON-TEXTILE CURTAIN HOLDERS; SLATTED INDOOR BLINDS; FIREGUARDS; DECORATIVE MOBILES" IN INTERNATIONAL CLASS 20, AND AS TO THE "HOUSEHOLD OR KITCHEN UTENSILS AND CONTAINERS NOT OF PRECIOUS METAL OR COATED THEREWITH, NAMELY, BOTTLE OPENERS, TRIVETS, COASTERS NOT OF PAPER AND NOT BEING TABLE LINEN, NAPKIN RINGS; NAPKIN HOLDERS, PLATES, BOWLS, DRINKING GLASSES, MUGS, VASES, POTS, TABLE PLACE CARD HOLDERS NOT OF PRECIOUS METAL, JUGS, CORK HOLDERS; TABLEWARE OTHER THAN KNIVES, FORKS AND SPOONS, NOT OF PRECIOUS METAL, NAMELY, SERVING TONGS, SERVING SPOONS, BOWLS; TRAYS FOR DOMESTIC PURPOSES NOT OF PRECIOUS METAL; CANDLESTICKS, CANDLE RINGS AND CANDLE EXTINGUISHERS, NOT OF PRECIOUS METAL; POTS, URNS AND VASES, NOT OF PRECIOUS METAL; WATERING CANS" IN INTERNATIONAL CLASS 21, APART FROM THE MARK AS SHOWN.

THE ENGLISH TRANSLATION OF "SVENSKT TENN" IN THE MARK IS "SWEDISH TIN".

SEC. 2(F).

SER. NO. 79-084,410, FILED 5-26-2010.

JAMES MACFARLANE, EXAMINING ATTORNEY

United States of America  
United States Patent and Trademark Office

# Breeeth

**Reg. No. 4,123,490**

**Registered Apr. 10, 2012**

**Int. Cls.: 9, 11, 37 and 42**

**TRADEMARK**

**SERVICE MARK**

**PRINCIPAL REGISTER**

LLC ECOINNOVATIONS (RUSSIAN FED. LIMITED LIABILITY COMPANY)  
UL. KLINSKAYA, 6  
RU-125414 MOSCOW  
RUSSIAN FED.

FOR: SCIENTIFIC, WEIGHING AND MEASURING APPARATUS, NAMELY, APPARATUS DESIGNED TO MEASURE POLLUTION AND AIR QUALITY CONTROL, NAMELY, APPARATUS DESIGNED TO MEASURE AIR QUALITY IN ROOMS AND TO REVEAL VOLATILE ORGANIC POLLUTANTS; SMOKE DETECTORS; AND APPARATUS AND INSTRUMENTS FOR CONDUCTING, SWITCHING, REGULATING OR CONTROLLING ELECTRICITY, NAMELY, ELECTRICAL DUCTS, IN CLASS 9 (U.S. CLS. 21, 23, 26, 36 AND 38).

FOR: APPARATUS FOR VENTILATING, WATER SUPPLY, AND SANITARY PURPOSES, NAMELY, WATER PURIFIERS, WATER PURIFICATION SYSTEMS COMPRISED OF PURIFIERS, VENTS, AND FILTERS; COOLING APPLIANCES, NAMELY, AIR CONDITIONERS AND ELECTRICAL FANS; WATER STERILIZERS; WATER FILTERS; DAMPERS, NAMELY, CONTROL DEVICES USED IN AIR DUCTS TO REGULATE THE FLOW OF AIR; FABRIC AIR DISPERSION DUCTS FOR DISTRIBUTING AND DISPENSING AIR AS PART OF A HVAC SYSTEM, IN CLASS 11 (U.S. CLS. 13, 21, 23, 31 AND 34).

FOR: REPAIR AND INSTALLATION SERVICES FOR AIR VENTILATION SYSTEMS, AIR CONDITIONERS, AIR STERILIZERS, AND AIR PURIFIERS; DISINFECTING; RAT EXTERMINATING; INSTALLATION OF BUILDING INSULATION; PROVIDING INFORMATION RELATED TO HOME REPAIRS; BUILDING CONSTRUCTION INFORMATION; RUSTPROOFING; ANTI-RUST TREATMENT FOR VEHICLES; VEHICLE MAINTENANCE; CLEANING OF EXTERIOR AND INTERIOR SURFACES OF BUILDINGS; RENTAL OF CLEANING MACHINES; VERMIN EXTERMINATING, OTHER THAN FOR AGRICULTURE; HEATING EQUIPMENT INSTALLATION AND REPAIR; AIR CONDITIONING APPARATUS INSTALLATION AND REPAIR; AIR DUCT CLEANING SERVICES, IN CLASS 37 (U.S. CLS. 100, 103 AND 106).

FOR: DESIGN AND DEVELOPMENT OF COMPUTER HARDWARE AND SOFTWARE; COMPUTER SYSTEMS ANALYSIS; CHEMICAL ANALYSIS; CONDUCTING PHYSICAL PROJECT FEASIBILITY STUDIES, HYDROLOGIC STUDY OF SURFACE AND GROUND WATER, SCIENTIFIC STUDIES IN THE FIELD OF HUSBANDRY; ENGINEERING; INSTALLATION OF COMPUTER SOFTWARE; METEOROLOGICAL INFORMATION, IN CLASS 42 (U.S. CLS. 100 AND 101).



*David J. Kyros*

Director of the United States Patent and Trademark Office



**Reg. No. 4,123,490** THE MARK CONSISTS OF STANDARD CHARACTERS WITHOUT CLAIM TO ANY PARTICULAR FONT, STYLE, SIZE, OR COLOR.

PRIORITY DATE OF 2-19-2010 IS CLAIMED.

OWNER OF INTERNATIONAL REGISTRATION 1043872 DATED 4-9-2010, EXPIRES 4-9-2020.

SER. NO. 79-084,531, FILED 4-9-2010.

CHARLOTTE CORWIN, EXAMINING ATTORNEY

# United States of America

United States Patent and Trademark Office

# Metmaxx

**Reg. No. 4,123,491**

**Registered Apr. 10, 2012**

**Int. Cls.: 8, 9, 11, 14, 16,  
21 and 34**

**TRADEMARK**

**PRINCIPAL REGISTER**

SPRANZ GMBH (FED REP GERMANY GMBH)  
ERNST-SACHS-STR. 2  
56070 KOBLENZ  
FED REP GERMANY

FOR: HAND-OPERATED TOOLS, NAMELY, SCREWDRIVERS, SCREWDRIVER BITS, NIPPERS, PLIERS, CUTTERS, HAMMERS AND MULTI-FUNCTION HAND TOOLS COMPRISED OF SCREWDRIVERS, KNIVES, CAN OPENERS, FILE, PLIERS; CUTLERY, NAMELY, KNIVES, POCKET KNIVES; UTILITY KNIVES; FORKS AND SPOONS; SIDE ARMS, NOT INCLUDING FIREARMS, NAMELY, HUNTING KNIVES, SWORDS, CUTTING WEAPONS, NAMELY, JACK KNIVES; THRUST WEAPONS, NAMELY, SPEARS; RAZORS, IN CLASS 8 (U.S. CLS. 23, 28 AND 44).

FOR: OPTICAL APPARATUS AND INSTRUMENTS, NAMELY, BINOCULARS, TELESCOPES; PHOTOGRAPHIC APPARATUS AND INSTRUMENTS, NAMELY, PHOTOGRAPHIC CAMERAS, EXPOSURE METERS, WEBCAMS; CINEMATOGRAPHIC APPARATUS AND INSTRUMENTS, NAMELY, CINEMATOGRAPHIC CAMERAS, CINEMATOGRAPHIC PROJECTORS; SIGNALLING APPARATUS AND INSTRUMENTS, NAMELY, SIGNAL LIGHTS; REFLECTORS, NAMELY, OPTICAL REFLECTORS; AND TEACHING APPARATUS AND INSTRUMENTS, NAMELY, POCKET CALCULATORS, LASER POINTER; APPARATUS FOR RECORDING, TRANSMISSION OR REPRODUCTION OF SOUND OR IMAGES; BLANK MAGNET DATA CARRIERS; BLANK OPTICAL RECORDING DISCS; CALCULATING MACHINES; DATA PROCESSING EQUIPMENT AND COMPUTERS AND PARTS THEREFORE; COMPUTER ACCESSORIES, NAMELY, COMPUTER MICE, HUBS FOR THE DISTRIBUTION OF USB EQUIPMENT AND FLASH MEMORY CARDS; CASES FOR POCKET CALCULATOR; LAPTOP BAGS; CD STORAGE WALLETS; CHEQUE CARD CASES, IN CLASS 9 (U.S. CLS. 21, 23, 26, 36 AND 38).

FOR: APPARATUS FOR LIGHTING, NAMELY, LIGHTING APPARATUS FOR VEHICLES; POCKET LAMPS; HEATING APPARATUS, NAMELY, ELECTRIC HEAT PADS; COOKING APPARATUS, NAMELY, COOKING RANGES; ELECTRIC COOKING RANGES; AND VENTILATING APPARATUS, NAMELY, VENTILATION HOODS; EXHAUST FANS; ELECTRIC LAMPS AND LIGHTING FIXTURES; TORCHES, NAMELY, ELECTRIC TORCHES FOR LIGHTING; LED LAMPS; LIGHTING FIXTURES ADAPTED FOR USE WITH COMPUTERS; FLASHLIGHTS; AND ELECTRIC FANS, IN CLASS 11 (U.S. CLS. 13, 21, 23, 31 AND 34).



*David J. Kybas*

Director of the United States Patent and Trademark Office

**Reg. No. 4,123,491** FOR: PRECIOUS METALS AND THEIR ALLOYS; GOODS IN PRECIOUS METALS AND THEIR ALLOYS OR COATED THEREWITH, NAMELY, NECKLACES; STATUETTES OF PRECIOUS METAL; JEWELRY; SEMIPRECIOUS STONES, GEMSTONES AND BEADS FOR USE IN JEWELRY; ARTICLES OF JEWELRY, NAMELY, COSTUME JEWELRY; TIE PINS AND CUFF LINKS; HOROLOGICAL AND CHRONOMETRIC INSTRUMENTS; WALL OR TABLE CLOCKS OR WRISTWATCHES; WATCH STRAPS; CASES FOR CLOCKS AND WATCH-MAKING; TRAVEL ALARM CLOCKS; KEY RINGS OF PRECIOUS METALS AND KEY RINGS OF PRECIOUS METALS FEATURING INTEGRATED CLOCKS, IN CLASS 14 (U.S. CLS. 2, 27, 28 AND 50).

FOR: PAPER, CARDBOARD AND GOODS MADE FROM THESE MATERIALS, NAMELY, PAPER GIFT BAGS; STATIONERY; CARDBOARD PACKAGING; DESKTOP VISITING CARD HOLDERS; POCKET VISITING CARD HOLDERS; DESKTOP BUSINESS CARD HOLDERS; POCKET BUSINESS CARD HOLDERS; OFFICE REQUISITES, NAMELY, PAPER EMBOSSERS, PUNCHES, RUBBER BANDS AND STATIONERY; PHOTOGRAPHS; CALENDARS, DIARIES, STATIONERY PORTFOLIOS; DESK PADS; PENHOLDERS; PENS; THUMB TACKS; PRINTED MATTER, NAMELY, NOTEBOOKS; JOTTERS; BOOKLETS FOR USE IN OFFICE WORK; MATERIAL FOR PACKAGING, NAMELY, CARDBOARD PACKAGING; PLASTIC BAGS FOR PACKAGING, IN CLASS 16 (U.S. CLS. 2, 5, 22, 23, 29, 37, 38 AND 50).

FOR: HOUSEHOLD OR KITCHEN UTENSILS, NAMELY, KITCHEN TONGS; BARBECUE TONGS; BARBECUE FORKS; BOTTLE OPENERS; CORK SCREWS; BOTTLE COOLER; CUTTING BOARDS; SALT SHAKERS; PEPPER MILLS; DRINKING BOTTLES SOLD EMPTY; AND CONTAINERS FOR HOUSEHOLD OR KITCHEN USE; BRUSHES, NAMELY, BATH BRUSHES; HAIR BRUSHES; NAIL BRUSHES; SHOE BRUSHES; ARTICLES FOR CLEANING PURPOSES, NAMELY, CLEANING CLOTHS; MOPS; UN-WORKED OR SEMI-WORKED GLASS; GLASSWARE, PORCELAIN AND EARTHENWARE, NAMELY, BEVERAGE GLASSWARE, MUGS AND CUPS; THERMAL FLASKS AND THERMAL MUGS, IN CLASS 21 (U.S. CLS. 2, 13, 23, 29, 30, 33, 40 AND 50).

FOR: SMOKERS' ARTICLES, NAMELY, CIGARETTE LIGHTERS; ASHTRAYS OF NON-PRECIOUS METALS; ASHTRAYS OF PRECIOUS METAL, IN CLASS 34 (U.S. CLS. 2, 8, 9 AND 17).

THE MARK CONSISTS OF STANDARD CHARACTERS WITHOUT CLAIM TO ANY PARTICULAR FONT, STYLE, SIZE, OR COLOR.

OWNER OF INTERNATIONAL REGISTRATION 1044538 DATED 1-22-2010, EXPIRES 1-22-2020.

SER. NO. 79-084,809, FILED 1-22-2010.

RICHARD WHITE, EXAMINING ATTORNEY

# United States of America

United States Patent and Trademark Office

## JENSEN'S STEAK HOUSE

**Reg. No. 4,123,492**

**Registered Apr. 10, 2012**

**Int. Cls.: 29 and 30**

**TRADEMARK**

**PRINCIPAL REGISTER**

DANSKE FAMILIERESTAURANTER A/S (DENMARK CORPORATION)  
LÆSSØEGADE 215  
DK-5230 ODENSE M  
DENMARK

FOR: FRESH MEAT; PREPARED MEAT; PRESERVED FRUITS AND VEGETABLES; COM-  
POTES AND EDIBLE OILS AND FATS, IN CLASS 29 (U.S. CL. 46).

FOR: SAUCES, SPICES, MARINADES FOR MEAT AND SALAD, IN CLASS 30 (U.S. CL. 46).

THE MARK CONSISTS OF STANDARD CHARACTERS WITHOUT CLAIM TO ANY PAR-  
TICULAR FONT, STYLE, SIZE, OR COLOR.

OWNER OF INTERNATIONAL REGISTRATION 1044921 DATED 6-25-2010, EXPIRES 6-25-  
2020.

NO CLAIM IS MADE TO THE EXCLUSIVE RIGHT TO USE "STEAK HOUSE", APART FROM  
THE MARK AS SHOWN.

SER. NO. 79-084,980, FILED 6-25-2010.

ESTHER A. BORSUK, EXAMINING ATTORNEY



*David J. Kybas*

Director of the United States Patent and Trademark Office

# United States of America

United States Patent and Trademark Office



**Reg. No. 4,123,493**

**Registered Apr. 10, 2012**

**Int. Cl.: 32**

**TRADEMARK**

**PRINCIPAL REGISTER**

HEINEKEN BROUWERIJEN B.V. (NETHERLANDS B.V.)  
TWEEDE WETERINGPLANTSOEN 21  
NL-1017 ZD AMSTERDAM  
NETHERLANDS

FOR: BEERS, IN CLASS 32 (U.S. CLS. 45, 46 AND 48).

OWNER OF U.S. REG. NOS. 823,033, 956,608 AND OTHERS.

PRIORITY DATE OF 4-14-2010 IS CLAIMED.

OWNER OF INTERNATIONAL REGISTRATION 1045048 DATED 5-25-2010, EXPIRES 5-25-2020.

THE COLOR(S) BLACK, GREEN AND SILVER IS/ARE CLAIMED AS A FEATURE OF THE MARK.

THE MARK CONSISTS OF A GREEN BOTTLE SHAPE WITH THE WORD "HEINEKEN" IN BLACK FOLLOWED BY A BLACK STAR ON THE NECK OF THE BOTTLE. BELOW, IN THE CENTER PORTION OF THE BOTTLE, IS A SILVER STAR. BELOW THE STAR IS A SILVER LINE FOLLOWED BY THE PARTIAL LETTERS "IN" IN GREEN ON A SILVER BACKGROUND. THE DOTTED OUTLINE OF THE BOTTLE IS INTENDED TO SHOW THE POSITIONING OF THE MARK AND IS NOT A PART OF THE MARK.

SER. NO. 79-085,019, FILED 5-25-2010.

JESSICA FATHY, EXAMINING ATTORNEY



*David J. Kybas*

Director of the United States Patent and Trademark Office

# United States of America

United States Patent and Trademark Office



**Reg. No. 4,123,494**

**Registered Apr. 10, 2012**

**Int. Cl.: 9**

AGENCE SPATIALE EUROPEENNE (ESA) (FRANCE INTER-GOVERNMENTAL SPACE AGENCY)  
8/10 RUE MARIO NIKIS  
F-75015 PARIS  
FRANCE

**TRADEMARK**

**PRINCIPAL REGISTER**

FOR: SATELLITES FOR SCIENTIFIC PURPOSES; SATELLITE NAVIGATIONAL APPARATUS, NAMELY, A GLOBAL POSITIONING SYSTEM FOR SATELLITE POSITION INDICATION AND CONTROL; COMPUTER SOFTWARE FOR DRIVING OF SPACE VEHICLES AND SATELLITES, MONITORING OF SPACE VEHICLES AND SATELLITE MOVEMENT, MANAGEMENT OF DATABASES, ARCHIVING AND TELEMETRY, ALL IN THE FIELD OF SPACE EXPLORATION AND OUTER SPACE ACTIVITY; SOFTWARE FOR NAVIGATING AND COMMUNICATING IN OUTER SPACE; BLANK MAGNETIC AND OPTICAL DATA CARRIERS FOR OUTER SPACE ACTIVITY; DATABASE MANAGEMENT SOFTWARE FOR OUTER SPACE ACTIVITY; COMPUTER SOFTWARE FOR CONTROLLING AND MANAGING DATABASE SERVER CENTERS, ALL OF THE AFORESAID PRODUCTS BEING USED FOR SPACE EXPLORATION AND ACTIVITIES, IN CLASS 9 (U.S. CLS. 21, 23, 26, 36 AND 38).

THE MARK CONSISTS OF THE STYLIZED WORD "TEVALIS" WHICH APPEARS TO THE RIGHT OF AN OVAL WITH A CURVED LINE APPEARING THERE WITHIN.

PRIORITY DATE OF 12-18-2009 IS CLAIMED.

OWNER OF INTERNATIONAL REGISTRATION 1045577 DATED 6-16-2010, EXPIRES 6-16-2020.

THE WORD "TEVALIS" HAS NO MEANING IN A FOREIGN LANGUAGE.

SER. NO. 79-085,262, FILED 6-16-2010.

JENNIFER WILLISTON, EXAMINING ATTORNEY



*David J. Kybas*

Director of the United States Patent and Trademark Office

United States of America  
United States Patent and Trademark Office

**POGOPOAO**

*J. Kemby*

**Reg. No. 4,123,495**

**Registered Apr. 10, 2012**

**Int. Cls.: 3, 18, 25 and 32**

**TRADEMARK**

**PRINCIPAL REGISTER**

JOKEMBY LIMITED (UNITED KINGDOM LIMITED COMPANY INCORPORATED)  
NOTHING HILL GATE 135  
LONDON  
UNITED KINGDOM

FOR: BLEACHING PREPARATIONS AND OTHER SUBSTANCES FOR LAUNDRY USE, NAMELY, WASHING PREPARATIONS AND LAUNDRY BLEACH; CLEANING, POLISHING, SCOURING AND ABRASIVE PREPARATIONS; SOAP; PERFUMERY, ESSENTIAL OILS, COSMETICS, HAIR LOTIONS; DENTIFRICES, IN CLASS 3 (U.S. CLS. 1, 4, 6, 50, 51 AND 52).

FOR: LEATHER AND IMITATIONS OF LEATHER, AND GOODS MADE OF THESE MATERIALS AND NOT INCLUDED IN OTHER CLASSES, NAMELY, ANIMAL SKINS, TRUNKS AND TRAVELING BAGS, UMBRELLAS, PARASOLS AND WALKING STICKS, WHIPS, HARNESS AND SADDLERY, IN CLASS 18 (U.S. CLS. 1, 2, 3, 22 AND 41).

FOR: CLOTHING, NAMELY, ADULT NOVELTY GAG CLOTHING ITEM, NAMELY, SOCKS; ATHLETIC APPAREL, NAMELY, SHIRTS, PANTS, JACKETS, FOOTWEAR, HATS AND CAPS, ATHLETIC UNIFORMS; A-SHIRTS; BALACLAVAS; BATHROBES; BELTS; BERMUDA SHORTS; BIB OVERALLS ;BLOUSES; BLOUSONS; BOARD SHORTS; BOMBER JACKETS; BOXER BRIEFS; BOXER SHORTS; BUTTON DOWN SHIRTS; BUTTON-FRONT ALOHA SHIRTS; CAMOUFLAGE JACKETS; CAMOUFLAGE PANTS; CAMOUFLAGE SHIRTS; CAMOUFLAGE VESTS; CAPES; CAPES FOR USE IN SALONS AND BARBER SHOPS; CAPS; CHILDREN'S AND INFANT'S APPAREL, NAMELY, JUMPERS, OVERALL SLEEPWEAR, PAJAMAS, ROMPERS AND ONE-PIECE GARMENTS; CLOTHING FOR ATHLETIC USE, NAMELY, PADDED SHORTS; CLOTHING FOR ATHLETIC USE, NAMELY, PADDED PANTS; CLOTHING FOR ATHLETIC USE, NAMELY, PADDED SHIRTS; CLOTHING FOR ATHLETIC USE, NAMELY, PADDED ELBOW COMPRESSION SLEEVES BEING PART OF AN ATHLETIC GARMENT; CLOTHING ITEMS, NAMELY, ADHESIVE POCKETS THAT MAY BE AFFIXED DIRECTLY TO THE BODY AS A DECORATIVE PIECE OF CLOTHING WITH UTILITY; CLOTHING ITEMS, NAMELY, ADHESIVE POCKETS THAT MAY BE AFFIXED DIRECTLY TO THE INSIDE OF CLOTHING FOR STORAGE AND SAFEKEEPING OF PERSONAL ITEMS; CLOTHING ITEMS, NAMELY, BLINDFOLDS WORN OVER THE EYES; CLOTHING ITEMS, NAMELY, GAGS WORN OVER THE MOUTH; CLOTHING SHIELDS, NAMELY, PADS APPLIED TO THE UNDERARMS OF SHIRTS, BLOUSES AND SWEATERS; COATS FOR MEN AND WOMEN; COATS MADE OF COTTON; COATS OF DENIM; COLLARED SHIRTS COSTUMES FOR USE IN ROLE-PLAYING GAMES; COS-



*David J. Kybas*

Director of the United States Patent and Trademark Office

**Reg. No. 4,123,495** TUMES FOR USE IN CHILDREN'S DRESS UP PLAY; CROP PANTS; DENIM JACKETS; DENIMS; DOWN JACKETS; DRESS PANTS; DRESS SHIRTS; DRESS SUITS; DRESSES; DRESSES MADE FROM SKINS; DRESSING GOWNS; DRESSING GOWNS AND BATH ROBES; DUNGAREES; FLEECE PULLOVERS; FLEECE SHORTS; FLEECE TOPS; FLOOD PANTS; FOULARDS; GILETS; GLOVES; GOLF PANTS, SHIRTS AND SKIRTS; GOLF SHIRTS; GOLF SHORTS; GOLF TROUSERS; HATS; HEAVY JACKETS; HOODED PULLOVERS; HOODED SWEAT SHIRTS; HOODED SWEATSHIRTS; INFANT AND TODDLER ONE PIECE CLOTHING; INFANT WEAR; INFANTS' TROUSERS; INFANTWEAR; JACKETS; JACKETS AND SOCKS; JANDALS; JOGGING OUTFITS; JOGGING PANTS; JOGGING SUITS; LEATHER COATS; LEATHER PANTS; LEATHER SHIRTS; LEATHER SKIRTS; LEATHER VESTS; LIGHT-REFLECTING COATS; LIGHT-REFLECTING JACKETS; LONG JACKETS; LONG SLEEVE PULLOVERS; LONG SLEEVED VESTS; LONG-SLEEVED SHIRTS; LOUNGE PANTS; MEN'S SOCKS; MEN'S SUITS; MEN'S SUITS, WOMEN'S SUITS; MILLINERY, NAMELY, FASCINATORS; MOTORCYCLE GLOVES; POLYMER CUSTOM CUSHIONED SHOE INSERTS FOR PRIMARILY NON-ORTHOPEDIC PURPOSES; PONCHOS PROTECTIVE NECK AND ARM GUARDS MADE OF NEOPRENE OR OTHER MATERIALS TO PREVENT WETSUIT CHAFING; PYJAMAS; RIDING SHOES; RUBBERS; SHAWLS; SHOE STRAPS; SHORT PETTICOATS; SHORT SETS; SHORT TROUSERS; SHORTALLS; SHORTS; SHORT-SLEEVED OR LONG-SLEEVED T-SHIRTS; SLEEP SHIRTS; SLEEPING GARMENTS; SPATS; SPORT COATS; SPORTS CAPS AND HATS; SPORTS JACKETS; SPORTS OVER UNIFORMS; SPORTS OVERUNIFORMS; SPORTS PANTS; SPORTS SHIRTS WITH SHORT SLEEVES; STUDS FOR FOOTBALL BOOTS; SURF WEAR; SUSPENDER BELTS; SUSPENDER BELTS FOR MEN; SWEAT PANTS; SWEAT SHIRTS; SWEATBANDS; SWEATERS; SWEATPANTS; TANKINIS; TEDDIES; TEE SHIRTS; TENNIS SHOES; THONG UNDERWEAR; TIPS FOR FOOTWEAR; TRIATHLON CLOTHING, NAMELY, TRIATHLON TIGHTS, TRIATHLON SHORTS, TRIATHLON SINGLET, TRIATHLON SHIRTS, TRIATHLON SUITS; TROUSERS FOR SWEATING; TWIN SETS; VESTED SUITS; VOLLEYBALL SHOES; WAISTCOATS; WATERPROOF FOOTWEAR; FOOTWEAR; HEADWEAR, IN CLASS 25 (U.S. CLS. 22 AND 39).

FOR: BEER, MINERAL AND AERATED WATERS AND OTHER ISOTONIC NON-ALCOHOLIC DRINKS; FRUIT DRINKS AND FRUIT JUICES; SYRUPS AND OTHER PREPARATIONS, NAMELY, SYRUP SUBSTITUTES, FOR MAKING BEVERAGES, IN CLASS 32 (U.S. CLS. 45, 46 AND 48).

THE NAME "JO KEMBY" DOES NOT IDENTIFY A LIVING INDIVIDUAL.

PRIORITY DATE OF 1-15-2010 IS CLAIMED.

OWNER OF INTERNATIONAL REGISTRATION 1045714 DATED 7-15-2010, EXPIRES 7-15-2020.

THE MARK CONSISTS OF THE WORDING "POGOPOGO JO KEMBY" IN A STYLIZED FONT WITH THE SECOND LETTER "G" IN REVERSE.

SER. NO. 79-085,318, FILED 7-15-2010.

RENEE MCCRAY, EXAMINING ATTORNEY



# United States of America

United States Patent and Trademark Office

 avenue<sup>®</sup> IVC

**Reg. No. 4,123,496**

**Registered Apr. 10, 2012**

**Int. Cls.: 19 and 27**

**TRADEMARK**

**PRINCIPAL REGISTER**

IVC LUXEMBOURG SA (LUXEMBOURG SOCIÉTÉ ANONYME)  
ROUTE DE WINSELER, 26  
L-9577 WILTZ  
LUXEMBOURG

FOR: WOODEN FLOORS; PARQUET FLOORING AND PARQUET FLOORING BOARDS, INCLUDING LAMINATED PARQUET FLOORING AND PARQUET FLOORING BOARDS; PARQUET FLOORING VENEERED WITH WOOD; SHEET MATERIAL COMPRISING LAYERS OF WOOD VENEER PRESSED AND GLUED TOGETHER, IN CLASS 19 (U.S. CLS. 1, 12, 33 AND 50).

FOR: VINYL FLOOR COVERINGS AND LINOLEUM FOR COVERING EXISTING FLOORS, IN CLASS 27 (U.S. CLS. 19, 20, 37, 42 AND 50).

THE MARK CONSISTS OF A DESIGN ELEMENT FEATURING A RED CIRCLE, INSIDE OF WHICH IS A SMALLER WHITE CIRCLE, INSIDE OF WHICH IS A SMALLER GREEN CIRCLE. TO THE RIGHT OF THE DESIGN IS THE WORDING "AVENUE", IN BLACK, WITH A SMALL BLACK CIRCLE FEATURING THE LETTERS "IVC", IN WHITE, APPEARING ABOVE AND TO THE RIGHT OF THE LAST "E" IN "AVENUE".

OWNER OF INTERNATIONAL REGISTRATION 1045895 DATED 6-28-2010, EXPIRES 6-28-2020.

THE COLOR(S) WHITE, RED (PMS 200C), GREEN (PMS 377C) AND BLACK (PMS PROCESS BLACK) IS/ARE CLAIMED AS A FEATURE OF THE MARK.

SER. NO. 79-085,381, FILED 6-28-2010.

MARTHA FROMM, EXAMINING ATTORNEY



*David J. Kypos*

Director of the United States Patent and Trademark Office

# United States of America

United States Patent and Trademark Office



**Reg. No. 4,123,497**

**Registered Apr. 10, 2012**

**Int. Cl.: 36**

**SERVICE MARK**

**PRINCIPAL REGISTER**

MAN GROUP PLC (UNITED KINGDOM PUBLIC LIMITED COMPANY)  
RIVERBANK HOUSE,  
2 SWAN LANE LONDON EC4R 3AD  
UNITED KINGDOM

FOR: FINANCIAL SERVICES, NAMELY, BROKERAGE AND ON-LINE BROKERAGE SERVICES IN THE FIELDS OF BANKING, FINANCE, AND INVESTMENTS; INVESTMENT SERVICES, NAMELY, COMMODITY INVESTMENT ADVICE, INVESTMENT MANAGEMENT, INVESTING FUNDS FOR OTHERS, INVESTMENT OF REAL-ESTATE, AND MAINTAINING ESCROW ACCOUNTS FOR INVESTMENT; INVESTMENT FUND MANAGEMENT, NAMELY, MANAGEMENT OF MUTUAL FUNDS AND CAPITAL INVESTMENT FUNDS; MANAGEMENT AND CREATION OF INVESTMENT PRODUCTS IN THE NATURE OF FINANCIAL SERVICES, NAMELY, ESTABLISHING AND MANAGING MUTUAL AND CAPITAL INVESTMENT FUNDS; CONDUCTING DERIVATIVES TRANSACTIONS IN THE FIELDS OF BANKING, FINANCE AND INVESTMENTS, NAMELY, THE TRADING OF FINANCIAL INSTRUMENTS, SECURITIES, SHARES, OPTIONS AND OTHER DERIVATIVE PRODUCTS; QUOTATION OF STOCK EXCHANGE PRICES; PROVIDING INFORMATION, ADVISORY AND CONSULTANCY SERVICES RELATING TO THE AFORESAID, NAMELY, FINANCIAL ADVISORY AND CONSULTANCY SERVICES IN THE FIELDS OF BANKING, FINANCE AND INVESTMENTS, IN CLASS 36 (U.S. CLS. 100, 101 AND 102).

OWNER OF U.S. REG. NOS. 3,147,608, 3,467,816 AND OTHERS.

PRIORITY DATE OF 5-13-2010 IS CLAIMED.

OWNER OF INTERNATIONAL REGISTRATION 1046727 DATED 6-22-2010, EXPIRES 6-22-2020.

THE MARK CONSISTS OF THE STYLIZED LETTER "M" WITH THE STYLIZED WORD "MAN" PRINTED BELOW THE "M".

SER. NO. 79-085,738, FILED 6-22-2010.

JENNIFER MARTIN, EXAMINING ATTORNEY



*David J. Kyjars*

Director of the United States Patent and Trademark Office

# United States of America

United States Patent and Trademark Office



**Reg. No. 4,123,498**

**Registered Apr. 10, 2012**

**Int. Cls.: 35, 41, 42 and 45**

**SERVICE MARK**

**PRINCIPAL REGISTER**

DANIEL JEAN VAUGHAN-WHITEHEAD (FRANCE INDIVIDUAL)  
C/O SCHWAB, FLAHERTY & ASSOCIÉS  
AVENU KRIEG 4, CP 510  
CH-1208 GENÈVE 17, SWITZERLAND

FOR: BUSINESS ADMINISTRATION AND MANAGEMENT, NAMELY, CONSULTING SERVICES AND MANAGEMENT SERVICES FOR OTHERS IN THE FIELD OF ARRANGING AND CONDUCTION OF AUCTION SALES; BUSINESS MANAGEMENT CONSULTING WITH RELATION TO STRATEGY, MARKETING, PRODUCTION, PERSONNEL AND RETAIL SALE MATTERS; BUSINESS CONSULTING SERVICES RELATING TO PRODUCT DISTRIBUTION, OPERATIONS MANAGEMENT SERVICES, LOGISTICS, REVERSE LOGISTICS, SUPPLY CHAIN, AND PRODUCTION SYSTEMS AND DISTRIBUTION SOLUTIONS; CONSULTING AND AUDITING IN THE FIELD OF EMPLOYEE COMPENSATION; CONSULTING AND AUDITING IN THE FIELD OF BUSINESS ADMINISTRATION, MANAGEMENT AND OFFICE WORK; PROFESSIONAL EMPLOYER ORGANIZATION SERVICES IN THE NATURE OF EMPLOYEE LEASING; MANAGING RETAIL PHARMACIES FOR OTHERS; CONSULTING SERVICES AND MANAGEMENT SERVICES FOR OTHERS IN THE FIELD OF RETAIL STORES, NAMELY, GROCERY STORES, CLOTHING STORES, RETAIL VARIETY STORES AND RETAIL CONVENIENCE STORES; ADVERTISING SERVICES, NAMELY, MARKETING AND BRANDING SERVICES IN THE NATURE OF CONSULTING, DEVELOPMENT, MANAGEMENT AND MARKETING OF BRANDS FOR BUSINESSES; ADVERTISING SERVICES, NAMELY, PROMOTING THE SERVICES OF BANKS THROUGH THE DISTRIBUTION OF PRINTED AND AUDIO PROMOTIONAL MATERIALS AND BY RENDERING SALES PROMOTION ADVICE, IN CLASS 35 (U.S. CLS. 100, 101 AND 102).

FOR: EDUCATIONAL SERVICES, NAMELY, CONDUCTING SEMINARS, WORKSHOPS, CLASSES, COURSES IN THE FIELD OF EMPLOYEE COMPENSATION AND WAGE POLICIES; TRAINING, NAMELY, ON EMPLOYEE COMPENSATION AND WAGE POLICIES; ENTERTAINMENT, NAMELY, ORGANIZATION OF EVENTS FOR PROFESSIONALS FOR SPORTS AND ARTS PURPOSES; SPORTS, NAMELY, ORGANIZATION OF COMMUNITY SPORTING EVENTS; CULTURAL ACTIVITIES, NAMELY, ORGANIZATION OF EVENTS FOR PROFESSIONALS, IN CLASS 41 (U.S. CLS. 100, 101 AND 107).

FOR: SCIENTIFIC RESEARCH; DESIGNING AND DEVELOPMENT OF COMPUTER SOFTWARE AND HARDWARE; FOOTWEAR DESIGN SERVICES FOR OTHERS; INDUSTRIAL RESEARCH IN THE FIELD OF EMPLOYEE COMPENSATION, WAGE POLICIES AND HU-



*David J. Kyjars*

Director of the United States Patent and Trademark Office

**Reg. No. 4,123,498** MAN RESOURCE MANAGEMENT; SURVEY DESIGN AND RESEARCH; CONDUCTING ENGINEERING SURVEYS, IN CLASS 42 (U.S. CLS. 100 AND 101).

FOR: CONSULTING IN THE FIELD OF HOMELAND SECURITY; PERSONAL SECURITY CONSULTING; SECURITY CONSULTING; SECURITY GUARD SERVICES; SECURITY SERVICES, NAMELY, PROVIDING EXECUTIVE PROTECTION; DETECTIVE AGENCIES; BABY SITTING; ESCORT SERVICES; CHAPERONING; MEDIATION; MARRIAGE BUREAUS; DATING SERVICES; HOROSCOPE CASTING; UNDERTAKING; CONDUCTING RELIGIOUS PRAYER SERVICES; CLOTHING RENTAL, IN CLASS 45 (U.S. CLS. 100 AND 101).

NO CLAIM IS MADE TO THE EXCLUSIVE RIGHT TO USE "FAIR WAGE", APART FROM THE MARK AS SHOWN.

PRIORITY DATE OF 5-31-2010 IS CLAIMED.

OWNER OF INTERNATIONAL REGISTRATION 1046743 DATED 6-21-2010, EXPIRES 6-21-2020.

SER. NO. 79-085,742, FILED 6-21-2010.

H. M. FISHER, EXAMINING ATTORNEY

# United States of America

United States Patent and Trademark Office

# ATRAL

**Reg. No. 4,123,499**

**Registered Apr. 10, 2012**

**Int. Cl.: 9**

**TRADEMARK**

**PRINCIPAL REGISTER**

HAGER SECURITY (FRANCE SOCIÉTÉ PAR ACTIONS SIMPLIFIÉE)  
RUE DU PRÉ DE L'ORME  
F-38190 CROLLES  
FRANCE

FOR: APPARATUS FOR RECORDING, TRANSMISSION OR REPRODUCTION OF SOUND OR IMAGES; BLANK MAGNETIC DATA CARRIERS, BLANK RECORDING DISCS, BLANK CD-ROMS FOR COMPUTERS, DATA PROCESSING EQUIPMENT AND COMPUTERS; FIRE EXTINGUISHERS; ELECTRICAL AND ELECTRONIC APPARATUS AND INSTRUMENTS FOR TRANSMITTING AND RECEIVING SIGNALS, NAMELY, RADIO TRANSMITTER, AND TELEPHONE TRANSMITTERS; ELECTRIC AND ELECTRONIC SECURITY ALARM AND SECURITY APPARATUS AND INSTRUMENTS, NAMELY, RADIO LINKED ALARM AND SECURITY SYSTEMS, AND STRUCTURAL PARTS THEREFOR; NAMELY, TELEPHONE TRANSMITTERS, RADIO TRANSMITTERS, REMOTE CONTROL UNITS FOR SECURITY PRODUCTS AND EQUIPMENT; DOOR OR WINDOW OPENING DETECTORS, MOTION DETECTORS, SMOKE DETECTORS, BURGLAR, FIRE AND ANTI-INTRUSION ALARMS AND SIRENS, AND CENTRAL PROCESSOR UNITS FOR PROCESSING MULTIPLE INPUTS, CENTRAL PROCESSING UNITS FOR ELECTRICAL AND ELECTRONIC EQUIPMENT FOR THE REMOTE AND AUTOMATIC OPERATION OF GATES, DOORS, SHUTTERS, BLINDS AND/OR WINDOWS; ELECTRICAL OR ELECTRONIC SECURITY AND FAULT MONITORS FOR PERSONAL PROTECTION AND FOR USE IN SECURITY OF BUILDINGS AND FACILITIES; ELECTRICAL OR ELECTRONIC CONTROLLERS FOR OPERATING ALARM SYSTEMS FOR PERSONAL PROTECTION AND FOR USE IN SECURITY OF BUILDINGS AND FACILITIES; FLOW REGULATORS FOR WATER AND GAS PIPES FOR DOMESTIC USE, SIREN AND ELECTRICAL REMOTE CONTROLLERS FOR SECURITY PRODUCTS AND EQUIPMENT IN CONNECTION WITH INTRUDER PROTECTION, HOME PROTECTION AND PERSONAL PROTECTION; SOLAR BATTERIES; ELECTRIC OR ELECTRONIC APPARATUS FOR ACTIVATING GATES, DOORS, SHUTTERS, BLINDS, WINDOWS; SOLAR-POWERED ELECTRICAL OR ELECTRONIC CONTROL AND REGULATION APPARATUS AND INSTRUMENTS FOR ACTIVATING GATES, DOORS, SHUTTERS, BLINDS, WINDOWS; ELECTRONIC APPARATUS AND INSTRUMENTS, NAMELY, CONTROL AND SURVEILLANCE APPARATUS AND INSTRUMENTS FOR THE PROTECTION OF PERSONS, BUILDINGS, APARTMENTS, HOUSES, FACTORIES AND OFFICES; BURGLAR, FIRE, AND ANTI-INTRUSION ALARMS AND DETECTORS; TELEPHONE TRANSMITTERS, RADIOS, SIRENS, RADIO TRANSMITTERS, REMOTE-CONTROL UNITS FOR SECURITY PRODUCTS AND EQUIPMENT IN CONNECTION WITH INTRUDER



*David J. Kappas*

Director of the United States Patent and Trademark Office

**Reg. No. 4,123,499** PROTECTION, HOME PROTECTION AND PERSONAL PROTECTION , IN CLASS 9 (U.S. CLS. 21, 23, 26, 36 AND 38).

THE MARK CONSISTS OF STANDARD CHARACTERS WITHOUT CLAIM TO ANY PARTICULAR FONT, STYLE, SIZE, OR COLOR.

OWNER OF INTERNATIONAL REGISTRATION 0546703 DATED 11-23-1989, EXPIRES 11-23-2019.

SER. NO. 79-085,825, FILED 4-6-2010.

TASNEEM HUSSAIN, EXAMINING ATTORNEY

# United States of America

United States Patent and Trademark Office

# NEOFLEX

**Reg. No. 4,123,500**

**Registered Apr. 10, 2012**

**Int. Cl.: 11**

**TRADEMARK**

**PRINCIPAL REGISTER**

NEOPERL INTERNATIONAL AG (SWITZERLAND STOCK CORPORATION)  
PFEFFINGERSTRASSE 21  
CH-4153 REINACH  
SWITZERLAND

FOR: SANITARY FITTINGS, FITTINGS FOR SANITARY INSTALLATIONS, COMPONENTS, AND SPARE PARTS FOR ALL THE AFORESAID GOODS INCLUDED IN THIS CLASS, NAMELY, AERATORS, FAUCETS, SHOWER HEADS, WATER FILTERS, SPOUTS AND VALVES, AND FAUCET STREAM STRAIGHTENERS, IN CLASS 11 (U.S. CLS. 13, 21, 23, 31 AND 34).

THE MARK CONSISTS OF STANDARD CHARACTERS WITHOUT CLAIM TO ANY PARTICULAR FONT, STYLE, SIZE, OR COLOR.

OWNER OF INTERNATIONAL REGISTRATION 1021823 DATED 10-7-2009, EXPIRES 10-7-2019.

SER. NO. 79-085,850, FILED 6-26-2010.

APRIL ROACH, EXAMINING ATTORNEY



*David J. Kyffers*

Director of the United States Patent and Trademark Office

# United States of America

United States Patent and Trademark Office



**Reg. No. 4,123,501**

**Registered Apr. 10, 2012**

**Int. Cls.: 9, 16, 20, 35, 38, 41 and 44**

**TRADEMARK**

**SERVICE MARK**

**PRINCIPAL REGISTER**

HOME EVENTS PTY LIMITED (AUSTRALIA COMPANY INCORPORATED UNDER THE CORPORATIONS ACT 2001 (CTH) (AUSTRALIA))  
34 COOLONG ROAD  
VAUCLUSE NSW 2030  
AUSTRALIA

FOR: APPARATUS FOR RECORDING, TRANSMISSION OR REPRODUCTION OF SOUND AND IMAGES INCLUDING, BUT NOT LIMITED TO, DVDS (DIGITAL VERSATILE DISCS), CDS (COMPACT DISCS), OPTICAL DISCS AND AUDIO AND VIDEO CASSETTES CONTAINING INFORMATION AND ENTERTAINMENT IN THE FIELDS OF FLORAL DESIGN, EVENTS MANAGEMENT, DECORATING AND CRAFTS, IN CLASS 9 (U.S. CLS. 21, 23, 26, 36 AND 38).

FOR: BOOKS, MAGAZINES, NEWSLETTERS, PRINTED INFORMATIONAL SHEETS, PRINTED VISUALS IN THE NATURE OF PROMOTIONAL MATERIALS, ALL IN THE FIELDS OF FLORAL DESIGN, EVENTS MANAGEMENT, DECORATING AND CRAFTS, IN CLASS 16 (U.S. CLS. 2, 5, 22, 23, 29, 37, 38 AND 50).

FOR: DECORATIONS, NAMELY PLAQUES, WALL PLAQUES, STATUETTES, SCULPTURES, MADE OF WOOD, CORK, REED, CANE, WICKER, HORN, BONE, IVORY, WHALEBONE, SHELL, AMBER, MOTHER-OF-PEARL, MEERSCHAUM AND SUBSTITUTES FOR ALL THESE MATERIALS, OR OF PLASTICS, IN CLASS 20 (U.S. CLS. 2, 13, 22, 25, 32 AND 50).

FOR: CORPORATE EVENT MANAGEMENT SERVICES INCLUDING THE ORGANIZATION OF CEREMONIES, EVENTS, FUNCTIONS, EXHIBITS OR TRADE FAIRS FOR BUSINESS PURPOSES, IN CLASS 35 (U.S. CLS. 100, 101 AND 102).

FOR: TELEVISION BROADCASTING SERVICES OF TELEVISION SHOWS FEATURING SUBJECT MATTER INCLUDING DEMONSTRATIONS, LIFESTYLE INFORMATION AND GENERAL ENTERTAINMENT IN THE FIELDS OF FLORAL DESIGN, EVENTS MANAGEMENT, DECORATING AND CRAFTS, IN CLASS 38 (U.S. CLS. 100, 101 AND 104).

FOR: EDUCATION AND ENTERTAINMENT SERVICES, NAMELY, A CONTINUING PROGRAM FEATURING INSTRUCTION AND TRAINING IN THE FIELDS OF FLORAL DESIGN, EVENTS MANAGEMENT, DECORATING, AND CRAFTS, ACCESSIBLE BY RADIO, TELEVISION AND COMPUTER NETWORKS, IN CLASS 41 (U.S. CLS. 100, 101 AND 107).



*David J. Kybas*

Director of the United States Patent and Trademark Office



**Reg. No. 4,123,501** FOR: FLOWER ARRANGING SERVICES FOR CEREMONIES, EVENTS, FUNCTIONS, EXHIBITS, TRADE FAIRS FOR PRIVATE, COMMERCIAL OR ADVERTISING PURPOSES AND/OR FOR PRIVATE HOMES; ADVICE AND CONSULTANCY SERVICES RELATING TO FLOWER ARRANGING, IN CLASS 44 (U.S. CLS. 100 AND 101).

NO CLAIM IS MADE TO THE EXCLUSIVE RIGHT TO USE "HOME EVENTS", APART FROM THE MARK AS SHOWN.

PRIORITY DATE OF 3-31-2010 IS CLAIMED.

OWNER OF INTERNATIONAL REGISTRATION 1048164 DATED 4-15-2010, EXPIRES 4-15-2020.

THE MARK CONSISTS OF THE STYLIZED WORDING "HELLO DARL" APPEARING ON A QUADRILATERAL CARRIER, WITH THE STYLIZED WORDING "HOME EVENTS" APPEARING BELOW THE QUADRILATERAL CARRIER.

THE WORDING "DARL" HAS NO MEANING IN A FOREIGN LANGUAGE.

SER. NO. 79-086,260, FILED 4-15-2010.

LAURA HAMMEL, EXAMINING ATTORNEY

# United States of America

United States Patent and Trademark Office

# FN 303

**Reg. No. 4,123,502**

**Registered Apr. 10, 2012**

**Int. Cls.: 13 and 28**

**TRADEMARK**

**PRINCIPAL REGISTER**

FN HERSTAL SA (BELGIUM SOCIÉTÉ ANONYME)  
VOIE DE LIÈGE 33  
B-4040 HERSTAL  
BELGIUM

FOR: FIREARMS, AMMUNITION AND PROJECTILES; LESS LETHAL COMPRESSED AIR WEAPONS IN THE NATURE OF PISTOLS AND RIFLES; NON-LETHAL PROJECTILES FOR COMPRESSED AIR WEAPONS IN THE NATURE OF PISTOLS AND RIFLES; CASES AND SLEEVES FOR GUNS AND HANDGUNS; NOISE-SUPPRESSORS FOR GUNS; NON-TELESCOPIC GUN SIGHTS FOR FIREARMS; FIRING PLATFORMS; FIREARMS ATTACHMENTS, NAMELY, MOUNTS FOR ATTACHING GUN SIGHTS TO A FIREARM FOR SHOOTING, IN CLASS 13 (U.S. CLS. 2 AND 9).

FOR: TOY MODEL AND SCALE MODEL REPLICA FIREARMS; TOY AMMUNITION AND PROJECTILES FOR TOY MODELS AND SCALE MODEL REPLICA FIREARM CASES AND HOLSTERS FOR TOY MODEL AND SCALE MODEL REPLICA FIREARMS; TOY MODEL AND SCALE MODEL REPLICA FIREARMS FOR VIRTUAL SHOOTING; APPARATUS FOR ELECTRONIC GAMES DESIGNED FOR USE WITH REPLICA TOY FIREARMS FOR VIRTUAL SHOOTING OTHER THAN FOR USE WITH AN EXTERNAL DISPLAY SCREEN OR MONITOR; TARGETS AND ELECTRONIC TARGETS FOR GAMES, IN CLASS 28 (U.S. CLS. 22, 23, 38 AND 50).

THE MARK CONSISTS OF STANDARD CHARACTERS WITHOUT CLAIM TO ANY PARTICULAR FONT, STYLE, SIZE, OR COLOR.

PRIORITY DATE OF 3-12-2010 IS CLAIMED.

OWNER OF INTERNATIONAL REGISTRATION 1048703 DATED 7-1-2010, EXPIRES 7-1-2020.

OWNER OF U.S. REG. NO. 588,170.

NO CLAIM IS MADE TO THE EXCLUSIVE RIGHT TO USE "303", APART FROM THE MARK AS SHOWN.

SER. NO. 79-086,470, FILED 7-1-2010.



*David J. Kyros*

Director of the United States Patent and Trademark Office

**Reg. No. 4,123,502** SARA BENJAMIN, EXAMINING ATTORNEY

# United States of America

United States Patent and Trademark Office



**Reg. No. 4,123,503**

DROGA KOLINSKA, ZIVILSKA INDUSTRIJA, D.D. (SLOVENIA CORPORATION)  
KOLINSKA ULICA 1

**Registered Apr. 10, 2012**

SI-1544 LJUBLJANA, SLOVENIA

**Int. Cls.: 5, 29, 30 and 32**

FOR: FOOD FOR BABIES, DIETETIC FOOD AND BEVERAGES FOR MEDICAL PURPOSES, IN CLASS 5 (U.S. CLS. 6, 18, 44, 46, 51 AND 52).

**TRADEMARK**

FOR: PRESERVED, DRIED AND COOKED FRUITS AND VEGETABLES; JELLIES, JAMS, COMPOTES; MILK; BEVERAGES CONSISTING PRINCIPALLY OF MILK; MILK BEVERAGES CONTAINING FRUIT; MILK BASED BEVERAGES CONTAINING ADDED NUTRIENTS; MILK BASED BEVERAGES WITH CHOCOLATE OR COCOA; DAIRY-BASED SNACK FOOD EXCLUDING ICE CREAM, ICE MILK AND FROZEN YOGHURT; DRIED FOOD MIXES, NAMELY, SNACK MIXES CONSISTING PRIMARILY OF DRIED FRUIT, PROCESSED NUTS, SEEDS, AND ALSO INCLUDING CHOCOLATE, IN CLASS 29 (U.S. CL. 46).

**PRINCIPAL REGISTER**

FOR: COFFEE; TEA; COCOA; SUGAR; RICE; TAPIOCA; SAGO; ARTIFICIAL COFFEE; FLOUR; PREPARATIONS MADE FROM CEREALS, NAMELY, READY TO EAT, CEREAL DERIVED FOOD BARS AND CEREAL BASED SNACK FOOD; BREAD AND PASTRY; CONFECTIONERIES, NAMELY, SNACK FOODS, NAMELY, CHOCOLATE, PASTILLES AND FRUIT JELLIES; EDIBLE ICE; HONEY; TREACLE; YEAST; BAKING-POWDER; SALT; MUSTARD; VINEGAR; COOKING SAUCES; SPICES; ICE FOR REFRESHMENT; MUESLI; CEREAL CONSISTING OF WHEAT FLAKES, CORN FLAKES, AND/OR RICE FLAKES WITH ADDED FRUITS AND/OR VEGETABLES; CEREAL CONSISTING OF WHEAT FLAKES, CORN FLAKES, AND/OR RICE FLAKES WITH ADDED CHOCOLATE AND/OR HONEY AND/OR HAZELNUTS AND/OR WALNUTS; HERBAL TEAS, IN CLASS 30 (U.S. CL. 46).



FOR: FRUIT DRINKS AND FRUIT JUICES; SYRUPS AND OTHER PREPARATIONS FOR MAKING BEVERAGES, NAMELY, FRUIT DRINKS, ISOTONIC DRINKS, SOFT DRINKS, FRUIT FLAVORED DRINKS, IN CLASS 32 (U.S. CLS. 45, 46 AND 48).

NO CLAIM IS MADE TO THE EXCLUSIVE RIGHT TO USE "PREMIUM", APART FROM THE MARK AS SHOWN.

*David J. Kyros*

OWNER OF INTERNATIONAL REGISTRATION 1049302 DATED 6-21-2010, EXPIRES 6-21-2020.

**Reg. No. 4,123,503** THE MARK CONSISTS OF "BEBI" IN STYLIZED LETTERING AND "PREMIUM" IN CAPITAL LETTERS WITHIN A RIBBON-LIKE DESIGN

SER. NO. 79-086,686, FILED 6-21-2010.

PAUL E. FAHRENKOPF, EXAMINING ATTORNEY

# United States of America

United States Patent and Trademark Office

# dc i

**Reg. No. 4,123,504**

RENAULT S.A.S. SOCIÉTÉ PAR ACTIONS SIMPLIFIÉE (FRANCE SOCIÉTÉ PAR ACTIONS SIMPLIFIÉE)

**Registered Apr. 10, 2012**

F-92100 BOULOGNE-BILLANCOURT, FRANCE

**Int. Cl.: 12**

**TRADEMARK**

**PRINCIPAL REGISTER**

FOR: LAND VEHICLES; SUSPENSION SHOCK ABSORBERS FOR VEHICLES; ANTI-THEFT DEVICES FOR LAND VEHICLES; HEAD-RESTS FOR LAND VEHICLE SEATS; AUTOMOBILES; AUTOMOBILE HOODS; AUTOMOBILE BODIES; TRANSMISSION CHAINS FOR LAND VEHICLES; BUMPERS FOR AUTOMOBILES; SUN SHIELDS AND VISORS FOR AUTOMOBILES; ANTI-THEFT ALARMS FOR VEHICLES; REVERSING ALARMS FOR VEHICLES; HORNS FOR VEHICLES; LUGGAGE CARRIERS FOR VEHICLES; TIRES FOR LAND VEHICLES; TORSION BARS FOR LAND VEHICLES; CONNECTING RODS FOR LAND VEHICLES OTHER THAN ENGINE PARTS; GEARBOXES FOR LAND VEHICLES; GAS CAPS FOR LAND VEHICLES; WINDSCREENS FOR MOTOR CARS; PICKUP TRUCKS; LIGHT TRUCKS; LORRIES; HOODS FOR LAND VEHICLES; HOODS FOR LAND VEHICLE ENGINES; VEHICLE BODIES; CRANKCASES FOR LAND VEHICLES OTHER THAN FOR ENGINES; SAFETY BELTS FOR LAND VEHICLE SEATS; ANTISKID TIRE CHAINS FOR LAND VEHICLES; TIRE CHAINS FOR LAND VEHICLES; LAND VEHICLE CHASSIS; HYDRAULIC CIRCUITS FOR VEHICLES; TORQUE CONVERTERS FOR LAND VEHICLES; REDUCTION GEARS FOR LAND VEHICLES; TURN SIGNALS FOR VEHICLES; ELECTRIC MOTORS FOR LAND VEHICLES; ELECTRIC LAND VEHICLES; CLUTCHES FOR LAND VEHICLES; VEHICLE SAFETY SEATS FOR CHILDREN; GEARING FOR LAND VEHICLES; HUBCAPS; CASINGS FOR PNEUMATIC TIRES FOR LAND VEHICLES; BALANCE WEIGHTS FOR VEHICLE WHEELS; AXLES FOR LAND VEHICLES; STEERING KNUCKLES; WINDSCREEN WIPERS; BRAKE LININGS FOR LAND VEHICLES; BRAKE SHOES FOR LAND VEHICLES; BRAKE SEGMENTS FOR LAND VEHICLES; VEHICLE BRAKES; BAND BRAKES; MOTORIZED ELEVATING TAILGATES FOR LAND VEHICLES; FITTED VEHICLE COVERS; SEAT COVERS FOR VEHICLES; VEHICLE WHEEL RIMS; ENGINES FOR LAND VEHICLES; LAND VEHICLE WHEEL HUBS; MUDGUARDS; LAND VEHICLE BUMPERS; AIR PUMPS FOR LAND VEHICLES; DOORS FOR LAND VEHICLES; SKI CARRIERS FOR CARS; TRAILERS; TRAILER COUPLINGS; SHOCK ABSORBING SPRINGS FOR LAND VEHICLES; LAND VEHICLE SUSPENSION COIL AND LEAF SPRINGS; REARVIEW MIRRORS; VEHICLE WHEELS, FREEWHEELS FOR LAND VEHICLES; SEAT SAFETY HARNESSES FOR MOTOR CARS; MOTOR CAR SEATS; SPORTS CARS; TRACTORS; SLEIGHS; TRAMCARS; TRANSMISSION SHAFTS FOR LAND VEHICLES; TRANSMISSIONS FOR LAND VEHICLES; AIR TURBINES FOR LAND VEHICLES; ANTI-GLARE DEVICES FOR LAND VEHICLES, NAMELY, VEHICLE BODY PARTS MADE OF METAL, PLASTIC AND FIBERGLASS, USED TO REDUCE AND TO PREVENT THE REFLECTION OF LIGHT FROM



*David J. Kyros*

Director of the United States Patent and Trademark Office

**Reg. No. 4,123,504** THE VEHICLE BODY; INTERIOR UPHOLSTERY FOR VEHICLES, VEHICLE TIRES; WINDOWS FOR VEHICLES; STEERING WHEELS FOR VEHICLES; CARS; BICYCLES; MOTOR SCOOTERS; TRICYCLES; ACCESSORIES FOR BICYCLES, MOTORCYCLES, MOTOR SCOOTERS, AND TRICYCLES, NAMELY, SHOCK ABSORBERS, HORNS AND LUMINOUS WARNING DIRECTIONAL SIGNALS, BELLS, ENGINE HOODS, VEHICLE BODIES, DIRECTION INDICATORS, CHAINS, BRAKES, BRAKE LININGS, BRAKE SHOES, WHEEL RIMS AND HUBS, MUDGUARDS, AIR PUMPS, TIRES, PEDALS, HANDLEBARS, KICKSTANDS, FOOTRESTS, SEATS, SADDLEBAGS, IN CLASS 12 (U.S. CLS. 19, 21, 23, 31, 35 AND 44).

THE MARK CONSISTS OF STANDARD CHARACTERS WITHOUT CLAIM TO ANY PARTICULAR FONT, STYLE, SIZE, OR COLOR.

OWNER OF INTERNATIONAL REGISTRATION 0724523 DATED 12-10-1999, EXPIRES 12-10-2019.

THE WORD "DCI" HAS NO MEANING IN A FOREIGN LANGUAGE.

SER. NO. 79-086,794, FILED 9-6-2010.

LAURA HAMMEL, EXAMINING ATTORNEY

# United States of America

United States Patent and Trademark Office

## INSTANT MASTERCLASS

**Reg. No. 4,123,505**

**Registered Apr. 10, 2012**

**Int. Cls.: 9 and 16**

**TRADEMARK**

**PRINCIPAL REGISTER**

HINKLER BOOKS PTY LTD (AUSTRALIA CORPORATION)  
44-55 FAIRCHILD STREET  
HEATHERTON VIC 3202  
AUSTRALIA

FOR: CDS, CASSETTES, PHONOGRAPH RECORDS, DVDS, AUDIO AND VIDEO TAPES FEATURING MUSIC AND INSTRUCTIONAL IMAGES, PRESENTATIONS AND DIALOGUE ON TOPICS IN THE FIELDS OF FITNESS INSTRUCTION, USING COMPUTERS AND COMPUTER PROGRAMS, BUSINESS MANAGEMENT, MUSICAL INSTRUCTION, SPORT AND SPORT INSTRUCTION, COOKING, FOOD AND BEVERAGE PREPARATION, ARTS AND CRAFTS, HEALTH, WELLBEING AND WEIGHT LOSS; MAGNETIC DATA CARRIERS FEATURING MUSIC AND INSTRUCTIONAL IMAGES, PRESENTATIONS AND DIALOGUE ON TOPICS IN THE FIELDS OF FITNESS INSTRUCTION, USING COMPUTERS AND COMPUTER PROGRAMS, BUSINESS MANAGEMENT, MUSICAL INSTRUCTION, SPORT AND SPORT INSTRUCTION, COOKING, FOOD AND BEVERAGE PREPARATION, ARTS AND CRAFTS, HEALTH, WELLBEING AND WEIGHT LOSS; AUDIO AND VIDEO RECORDINGS FEATURING MUSIC AND INSTRUCTIONAL IMAGES, PRESENTATIONS AND DIALOGUE ON TOPICS IN THE FIELDS OF FITNESS INSTRUCTION, USING COMPUTERS AND COMPUTER PROGRAMS, BUSINESS MANAGEMENT, MUSICAL INSTRUCTION, SPORT AND SPORT INSTRUCTION, COOKING, FOOD AND BEVERAGE PREPARATION, ARTS AND CRAFTS, HEALTH, WELLBEING AND WEIGHT LOSS; CINEMATOGRAPHIC FILMS FEATURING MUSIC AND INSTRUCTIONAL IMAGES, PRESENTATIONS AND DIALOGUE ON TOPICS IN THE FIELDS OF FITNESS INSTRUCTION, USING COMPUTERS AND COMPUTER PROGRAMS, BUSINESS MANAGEMENT, MUSICAL INSTRUCTION, SPORT AND SPORT INSTRUCTION, COOKING, FOOD AND BEVERAGE PREPARATION, ARTS AND CRAFTS, HEALTH, WELLBEING AND WEIGHT LOSS; COMPUTER AND VIDEO GAMES; COMPUTER AND VIDEO GAME PROGRAMS AND SOFTWARE; BUT EXCLUDING GOODS IN THIS CLASS FOR CIGARS, TRUCKS OR EDUCATIONAL SERVICES FOR THE CONDUCTING OF SEMINARS AND CLASSES IN THE FIELDS OF MONEY MANAGEMENT AND MARKETING, IN CLASS 9 (U.S. CLS. 21, 23, 26, 36 AND 38).



*David J. Kybas*

Director of the United States Patent and Trademark Office

FOR: BOOKS, MAGAZINES AND ALBUMS FEATURING SPORT, FITNESS, LIFESTYLE, EDUCATION ON TOPICS IN THE FIELDS OF FITNESS INSTRUCTION, USING COMPUTERS AND COMPUTER PROGRAMS, BUSINESS MANAGEMENT, MUSICAL INSTRUCTION, SPORT AND SPORT INSTRUCTION, COOKING, FOOD AND BEVERAGE PREPARATION, ARTS AND CRAFTS, HEALTH, WELLBEING AND WEIGHT LOSS AND ENTERTAINMENT ON TOPICS IN THE FIELDS OF FITNESS INSTRUCTION, USING COMPUTERS AND



**Reg. No. 4,123,505** COMPUTER PROGRAMS, BUSINESS MANAGEMENT, MUSICAL INSTRUCTION, SPORT AND SPORT INSTRUCTION, COOKING, FOOD AND BEVERAGE PREPARATION, ARTS AND CRAFTS, HEALTH, WELLBEING AND WEIGHT LOSS; SCRAPBOOKS; COLOURING BOOKS, NOTEBOOKS, ADDRESS BOOKS, DATE BOOKS, AUTOGRAPH BOOKS, DIARIES, REMINDER BOOKS, GUIDE BOOKS FEATURING SPORT, FITNESS, LIFESTYLE, EDUCATION ON TOPICS IN THE FIELDS OF FITNESS INSTRUCTION, USING COMPUTERS AND COMPUTER PROGRAMS, BUSINESS MANAGEMENT, MUSICAL INSTRUCTION, SPORT AND SPORT INSTRUCTION, COOKING, FOOD AND BEVERAGE PREPARATION, ARTS AND CRAFTS, HEALTH, WELLBEING AND WEIGHT LOSS AND ENTERTAINMENT ON TOPICS IN THE FIELDS OF FITNESS INSTRUCTION, USING COMPUTERS AND COMPUTER PROGRAMS, BUSINESS MANAGEMENT, MUSICAL INSTRUCTION, SPORT AND SPORT INSTRUCTION, COOKING, FOOD AND BEVERAGE PREPARATION, ARTS AND CRAFTS, HEALTH, WELLBEING AND WEIGHT LOSS, MAPS; PRINTED MATTER, NAMELY, BOOKLETS AND LEAFLETS IN THE FIELD OF SPORT, FITNESS, LIFESTYLE, EDUCATION ON TOPICS IN THE FIELDS OF FITNESS INSTRUCTION, USING COMPUTERS AND COMPUTER PROGRAMS, BUSINESS MANAGEMENT, MUSICAL INSTRUCTION, SPORT AND SPORT INSTRUCTION, COOKING, FOOD AND BEVERAGE PREPARATION, ARTS AND CRAFTS, HEALTH, WELLBEING AND WEIGHT LOSS AND ENTERTAINMENT ON TOPICS IN THE FIELDS OF FITNESS INSTRUCTION, USING COMPUTERS AND COMPUTER PROGRAMS, BUSINESS MANAGEMENT, MUSICAL INSTRUCTION, SPORT AND SPORT INSTRUCTION, COOKING, FOOD AND BEVERAGE PREPARATION, ARTS AND CRAFTS, HEALTH, WELLBEING AND WEIGHT LOSS; BOOKBINDING MATERIALS; PHOTOGRAPHS; STATIONERY; PLASTIC MATERIALS FOR PACKAGING, NAMELY, PLASTIC BAGS FOR PACKAGING AND PLASTIC BUBBLE PACKS FOR PACKAGING; POSTERS; PAPER PLACEMATS; COASTERS OF PAPER; PAPER; CARDBOARD; GOODS MADE FROM PAPER OR CARDBOARD, NAMELY, BOOKLETS, LEAFLETS AND CARDBOARD BOXES; STICKERS, SEALS AND TRANSFERS; WRITING INSTRUMENTS, PENS AND PENCILS; WRITING PAPER, NOTE PAPER; PAPER PARTY FAVORS AND DECORATIONS, BOOKS FEATURING GAMES; RULE BOOKS FOR GAMES; SCORE CARDS AND SCORE PADS; PAPER PARTY DECORATIONS FOR WALLS AND DOORS; BUT EXCLUDING GOODS IN THIS CLASS FOR CIGARS, TRUCKS OR EDUCATIONAL SERVICES FOR THE CONDUCTING OF SEMINARS AND CLASSES IN THE FIELD OF MONEY MANAGEMENT AND MARKETING, IN CLASS 16 (U.S. CLS. 2, 5, 22, 23, 29, 37, 38 AND 50).

THE MARK CONSISTS OF STANDARD CHARACTERS WITHOUT CLAIM TO ANY PARTICULAR FONT, STYLE, SIZE, OR COLOR.

PRIORITY DATE OF 6-21-2010 IS CLAIMED.

OWNER OF INTERNATIONAL REGISTRATION 1049668 DATED 7-13-2010, EXPIRES 7-13-2020.

SER. NO. 79-086,844, FILED 7-13-2010.

JASON BLAIR, EXAMINING ATTORNEY

# United States of America

United States Patent and Trademark Office

## HIGHLAND QUEEN MAJESTY

**Reg. No. 4,123,506**

**Registered Apr. 10, 2012**

**Int. Cl.: 33**

**TRADEMARK**

**PRINCIPAL REGISTER**

BOURGOGNES & DOMAINES MICHEL PICARD (FRANCE SOCIÉTÉ ANONYME)  
ROUTE DE SAINT LOUP DE LA SALLE,  
LES NOIROTS; F-71150 CHAGNY  
FRANCE

FOR: ALCOHOLIC BEVERAGES EXCEPT BEERS; HARD CIDER; DIGESTERS IN THE  
NATURE OF LIQUEURS AND SPIRITS; WINE; SPIRITS; ALCOHOLIC EXTRACTS OR ES-  
SENCES, IN CLASS 33 (U.S. CLS. 47 AND 49).

THE MARK CONSISTS OF STANDARD CHARACTERS WITHOUT CLAIM TO ANY PAR-  
TICULAR FONT, STYLE, SIZE, OR COLOR.

PRIORITY DATE OF 4-6-2010 IS CLAIMED.

OWNER OF INTERNATIONAL REGISTRATION 1049831 DATED 7-12-2010, EXPIRES 7-12-  
2020.

SER. NO. 79-086,897, FILED 7-12-2010.

JOHN KELLY, EXAMINING ATTORNEY



*David J. Kybas*

Director of the United States Patent and Trademark Office

# United States of America

United States Patent and Trademark Office

# BFXpert

**Reg. No. 4,123,507**

**Registered Apr. 10, 2012**

**Int. Cls.: 7, 9, 37 and 42**

**TRADEMARK**

**SERVICE MARK**

**PRINCIPAL REGISTER**

PAUL WURTH S.A. (LUXEMBOURG SOCIÉTÉ ANONYME)  
32, RUE D'ALSACE  
L-1122 LUXEMBOURG  
LUXEMBOURG

FOR: STEEL AND METALWORKING MACHINES AND MACHINE TOOLS; MOTORS, OTHER THAN FOR LAND VEHICLES; MACHINE COUPLING AND TRANSMISSION COMPONENTS EXCEPT FOR LAND VEHICLES, NAMELY, FOR THE IRON AND STEEL INDUSTRY, FERROUS AND NON-FERROUS METALLURGICAL INDUSTRY; EQUIPMENT FOR BLAST FURNACES, NAMELY, FOR THE IRON AND STEEL INDUSTRY, FERROUS AND NON-FERROUS METALLURGICAL INDUSTRY, NAMELY, EQUALIZATION VALVES FOR BLAST FURNACE INSTALLATIONS AND CLOSING MECHANISMS FOR BLAST FURNACE THROATS; SUPPORT, CONTROL AND DRIVE MECHANISMS FOR LOADING MACHINES FOR BLAST FURNACE THROATS, NAMELY, LOADING MECHANISMS FOR THROATS WITHOUT BELLS FOR THE IRON AND STEEL INDUSTRY, FERROUS AND NON-FERROUS METALLURGICAL INDUSTRY; EQUALIZATION VALVES AND GATES FOR BLAST FURNACES, NAMELY, FOR THE IRON AND STEEL INDUSTRY, FERROUS AND NON-FERROUS METALLURGICAL INDUSTRY, NAMELY; EXHAUST VALVES FOR THE IRON AND STEEL INDUSTRY, FERROUS AND NON-FERROUS METALLURGICAL INDUSTRY, NAMELY; VALVES AS PART OF MACHINE COMPONENTS; MACHINES FOR STOPPING THE TAPHOLE, NAMELY, FOR THE IRON AND STEEL INDUSTRY, FERROUS AND NON-FERROUS METALLURGICAL INDUSTRY; BORERS FOR HOLES FOR CASTING FOR THE IRON AND STEEL INDUSTRY, FERROUS AND NON-FERROUS METALLURGICAL INDUSTRY, NAMELY, TAP HOLE DRILLING MACHINES; LUBRICATION MACHINES FOR THE IRON AND STEEL INDUSTRY, FERROUS AND NON-FERROUS METALLURGICAL INDUSTRY; MACHINES FOR PROCESSING AND FILTERING SLAG FOR THE IRON AND STEEL INDUSTRY, FERROUS AND NON-FERROUS METALLURGICAL INDUSTRY; MACHINES FOR TRANSPORT AND INJECTION OF POWDERED MATERIALS BY PNEUMATIC MEANS IN A TANK FURNACE FOR THE IRON AND STEEL INDUSTRY, FERROUS AND NON-FERROUS METALLURGICAL INDUSTRY; SLAG GRANULATION MACHINES FOR THE IRON AND STEEL INDUSTRY, FERROUS AND NON-FERROUS METALLURGICAL INDUSTRY; MACHINERY AND MACHINE TOOLS FOR STEELWORKS IN THE NATURE OF METALWORKING FOR THE IRON AND STEEL INDUSTRY, FERROUS AND NON-FERROUS METALLURGICAL INDUSTRY; MACHINERY AND MACHINE TOOLS FOR VACUUM LADLE TREATMENT OF CAST IRON AND STEEL FOR THE IRON AND STEEL INDUSTRY, FERROUS AND NON-FERROUS METALLURGICAL INDUSTRY; CONTINUOUS CASTING MACHINES FOR STEEL FOR THE IRON AND STEEL INDUSTRY, FERROUS



*David J. Kyros*

Director of the United States Patent and Trademark Office

**Reg. No. 4,123,507** AND NON-FERROUS METALLURGICAL INDUSTRY; CRUSHING AND SCREENING MACHINES AND MACHINE TOOLS FOR THE IRON AND STEEL INDUSTRY, FERROUS AND NON-FERROUS METALLURGICAL INDUSTRY; MACHINES FOR BLOWING REFINING GASES INTO STEEL CONVERTERS NOT FOR LAND VEHICLES FOR THE IRON AND STEEL INDUSTRY, FERROUS AND NON-FERROUS METALLURGICAL INDUSTRY; MACHINE PARTS, NAMELY, BLOWING NOZZLES FOR THE IRON AND STEEL INDUSTRY, FERROUS AND NON-FERROUS METALLURGICAL INDUSTRY; INSTALLATIONS AND APPARATUS FOR CHANGING BLOWING NOZZLES, NAMELY, BRUSHES BEING PARTS OF MACHINES, ROLLER BEARINGS FOR CHANGING BLOWER NOZZLES FOR THE IRON AND STEEL INDUSTRY, FERROUS AND NON-FERROUS METALLURGICAL INDUSTRY; STEEL AND METALWORKING MACHINE TOOLS FOR FITTING A REFRACTORY LINING ON THE INTERIOR WALLS OF A FURNACE FOR THE IRON AND STEEL INDUSTRY, FERROUS AND NON-FERROUS METALLURGICAL INDUSTRY; ROLLING CRANES AND BRIDGES FOR SPECIAL USE FOR METALLURGY; MACHINERY FOR PROCESSING FINE ORE PARTICLES FOR THE IRON AND STEEL INDUSTRY, FERROUS AND NON-FERROUS METALLURGICAL INDUSTRY; MACHINERY FOR PRODUCING PIG IRON USING DIRECT REDUCTION FOR THE IRON AND STEEL INDUSTRY, FERROUS AND NON-FERROUS METALLURGICAL INDUSTRY; METAL WORKING MACHINES, NAMELY, MACHINERY FOR PRODUCING STEEL FOR THE IRON AND STEEL INDUSTRY, FERROUS AND NON-FERROUS METALLURGICAL INDUSTRY; PROCESSING AND AGGLOMERATING PLANTS FOR IRON ORES AND NON-IRON ORES, COAL, LIME, DOLOMITE, MAGNESITE AND CRYOLITH, FLUIDIZED BEDS, AND SINTERING PLANTS FOR THE IRON AND STEEL INDUSTRY, FERROUS AND NON-FERROUS METALLURGICAL INDUSTRY; STEEL AND METALWORKING MACHINES AND INSTALLATIONS FOR PRODUCING MOULDED REFRACTORY FORMS, FOR MAKING BRIQUETTES AND STOPPER HEADS AND GRANULATING, MIXING MACHINES FOR PIG IRON, STEEL, ALLOYS AND SLAG, CONVERTERS FOR MANUFACTURING STEEL AND IRON ALLOYS, LOADERS FOR USE IN METALLURGY, MACHINE PARTS, NAMELY, NOZZLES FOR BLOWERS AND HEATERS FOR USE IN METALLURGY FOR THE IRON AND STEEL INDUSTRY, FERROUS AND NON-FERROUS METALLURGICAL INDUSTRY; MACHINERY FOR COLLECTING AND SUCTION OF LOST GAS FOR USE IN METALLURGY FOR THE IRON AND STEEL INDUSTRY, FERROUS AND NON-FERROUS METALLURGICAL INDUSTRY; CASTING LADLES FOR THE IRON AND STEEL INDUSTRY, FERROUS AND NON-FERROUS METALLURGICAL INDUSTRY; POWER-OPERATED DISPENSERS FOR PIG IRON AND STEEL FOR THE IRON AND STEEL INDUSTRY, FERROUS AND NON-FERROUS METALLURGICAL INDUSTRY; MACHINERY FOR REGULATING AND OSCILLATING CHILL-MOULDS FOR THE IRON AND STEEL INDUSTRY, FERROUS AND NON-FERROUS METALLURGICAL INDUSTRY; DUMMY BARS FOR THE IRON AND STEEL INDUSTRY, FERROUS AND NON-FERROUS METALLURGICAL INDUSTRY; MACHINES FOR ROLLING STEEL AND NON-FERROUS METAL ALLOYS; ROLLING MILLS FOR THE IRON AND STEEL INDUSTRY, FERROUS AND NON-FERROUS METALLURGICAL INDUSTRY; CAGES FOR ROLLING MILLS FOR THE IRON AND STEEL INDUSTRY, FERROUS AND NON-FERROUS METALLURGICAL INDUSTRY; METAL WELDING MACHINES AND ABRADING MACHINES FOR THE IRON AND STEEL INDUSTRY, FERROUS AND NON-FERROUS METALLURGICAL INDUSTRY; MACHINE PARTS, NAMELY, ELECTRIC SCISSORS AND SAWS FOR THE IRON AND STEEL INDUSTRY, FERROUS AND NON-FERROUS METALLURGICAL INDUSTRY FOR SHEARING BILLETS FROM CONTINUOUS CASTING, SHEET METAL, STRIPS, SECTIONS, JOISTS, TUBES AND CABLES; MECHANICAL WINDERS AND MACHINES FOR FORMING COILS OF METAL STRIPS FOR THE IRON AND STEEL INDUSTRY; STEEL AND METALWORKING MACHINE TOOLS; MACHINE TOOLS, NAMELY, FOR THE IRON AND STEEL INDUSTRY, FERROUS AND NON-FERROUS METALLURGICAL INDUSTRY, NAMELY, LATHES, DRILLING MACHINES, HYDRAULIC POWERED ENGINES AND MOTORS FOR THE IRON AND STEEL INDUSTRY, FERROUS AND NON-FERROUS METALLURGICAL INDUSTRY, NAMELY, HYDRAULIC CONTROLS FOR MACHINES, MOTORS AND ENGINES; TURBINES, NAMELY, TURBINES USING HYDRAULICS, GAS AND STEAM AND COMPONENTS OF TURBINES, NAMELY, SHUT-OFF DEVICES, SPEED CONTROLLERS, ROTORS AND GUIDE VANES, OTHER THAN LAND VEHICLES FOR THE IRON AND STEEL INDUSTRY, FERROUS AND NON-FERROUS METALLURGICAL

**Reg. No. 4,123,507** INDUSTRY; SHUT-OFF DEVICES AND SPEED CONTROLLERS FOR TURBINES OTHER THAN FOR LAND VEHICLES FOR THE IRON AND STEEL INDUSTRY, FERROUS AND NON-FERROUS METALLURGICAL INDUSTRY; ROTORS AND GUIDE VANES FOR TURBINES OTHER THAN FOR LAND VEHICLES FOR THE IRON AND STEEL INDUSTRY, FERROUS AND NON-FERROUS METALLURGICAL INDUSTRY; LOCKS, NAMELY, CONTROL AND SHUTDOWN COMPONENTS FOR TURBINES, NAMELY, SHUT-OFF DEVICES, SPEED CONTROLLERS, ROTORS AND GUIDE VANES, OTHER THAN FOR LAND VEHICLES; SCREEN-CLEANING MACHINES; ELEVATING AND DESCENDING WORK PLATFORMS; CRANES; TRUCKS FOR ROLLER BRIDGES; WINCHES; CAPSTANS AND PULLEYS FOR MACHINES; MACHINES FOR PROCESSING AND RECOVERING WASTE; DUST REMOVAL MACHINES FOR THE PURPOSE OF BLOWING DUST OFF INDUSTRIAL PARTS, WORKSTATIONS OR WHEREVER NECESSARY; COMPOSTING MACHINES; DUST EXTRACTION MACHINES FOR THE IRON AND STEEL INDUSTRY, FERROUS AND NON-FERROUS METALLURGICAL INDUSTRY; THICKENING AND EVAPORATING STEEL AND METALWORKING MACHINES FOR THE IRON AND STEEL INDUSTRY, FERROUS AND NON-FERROUS METALLURGICAL INDUSTRY; ELECTRICITY GENERATORS, NAMELY, GENERATORS USING TURBINES, HYDRAULICS, MOTOR-DRIVEN AND TURBOGENERATORS, THREE-PHASE MOTORS, DIRECT AND ALTERNATING CURRENT MOTORS; PLANTS USING GAS AND STEAM, NAMELY, GAS AND STEAM OPERATED POWER GENERATORS FOR THE IRON AND STEEL INDUSTRY, FERROUS AND NON-FERROUS METALLURGICAL PLANTS; ELECTRIC MOTORS FOR MACHINES, IN CLASS 7 (U.S. CLS. 13, 19, 21, 23, 31, 34 AND 35).

FOR: SCIENTIFIC, NAUTICAL, SURVEYING, PHOTOGRAPHIC, CINEMATOGRAPHIC, OPTICAL, WEIGHING, MEASURING, SIGNALLING, CHECKING/SUPERVISION, LIFE-SAVING AND TEACHING APPARATUS AND INSTRUMENTS FOR THE IRON AND STEEL INDUSTRY, FERROUS AND NON-FERROUS METALLURGICAL INDUSTRY, NAMELY, COMPUTER SOFTWARE FOR ANALYZING, OPTIMIZING AND CONTROLLING THE OPERATION OF BLAST FURNACES; COMPUTER SOFTWARE FOR CHECKING, CONTROLLING, MONITORING, MEASURING, REGULATING, WEIGHING, AND METERING BLAST FURNACE INSTALLATIONS AND METALLURGY INSTALLATIONS FOR THE IRON AND STEEL INDUSTRY, FERROUS AND NON-FERROUS METALLURGICAL INDUSTRY; PROFILOMETERS FOR THE IRON AND STEEL INDUSTRY, FERROUS AND NON-FERROUS METALLURGICAL INDUSTRY; PROBING INSTALLATIONS AND APPARATUS FOR THE IRON AND STEEL INDUSTRY, FERROUS AND NON-FERROUS METALLURGICAL INDUSTRY, NAMELY, GAS PROBES, SOLID MATERIAL SAMPLING PROBES, AND MECHANICAL PROBES FOR BLAST FURNACES; MECHANICAL PROFILOMETERS FOR THE IRON AND STEEL INDUSTRY, FERROUS AND NON-FERROUS METALLURGICAL INDUSTRY; TRANSFORMERS; ELECTRIC BATTERIES, BATTERIES, ELECTRIC SWITCHES, WITHOUT CONTACT WITH GAS; ELECTRIC SWITCHES; POWER-LINE TRANSMISSION MACHINES AND APPARATUS; ELECTRIC CONDUCTORS, ESPECIALLY BRAIDED OR TWISTED WIRES, BARS FOR TRANPOSED ELECTRIC CONDUCTORS FOR THE IRON AND STEEL INDUSTRY, FERROUS AND NON-FERROUS METALLURGICAL INDUSTRY; BRAIDED ELECTRICAL CONDUCTORS, INSULATED ELECTRICAL CABLES; ELECTRIC INSTALLATIONS FOR THE REMOTE CONTROL OF INDUSTRIAL OPERATIONS; RECTIFIERS, CONVERTERS, INVERTERS; TEST INSTRUMENTS FOR THE IRON AND STEEL INDUSTRY, FERROUS AND NON-FERROUS METALLURGICAL INDUSTRY FOR MEASURING FOR PHYSICAL PARAMETERS, ESPECIALLY, TEMPERATURE, PRESSURE AND HUMIDITY, AND FOR CHEMICAL ANALYSES NOT INCLUDED IN OTHER CLASSES; COMPUTER HARDWARE APPARATUS FOR CONTROLLING, REGULATING, SIMULATING, VISUALIZING AND MONITORING PARAMETERS OF INDUSTRIAL INSTALLATIONS, ENVIRONMENTAL PROTECTION INSTALLATIONS, INSTALLATIONS FOR PRODUCING, DISTRIBUTING AND TRANSMITTING POWER, MACHINES AND COMPONENTS THEREOF; COMPUTER PROGRAMS FOR CONTROLLING, REGULATING, VISUALIZING AND MONITORING PROCESSES IN INDUSTRIAL INSTALLATIONS, ENVIRONMENTAL TECHNOLOGY INSTALLATIONS, POWER PLANTS AND MACHINES AND COMPONENTS THEREOF; COMPUTER PROGRAMS FOR COMPUTERS FOR SIMULATING AND VISUALIZING INDUSTRIAL INSTALLATIONS, ESPECIALLY METALLURGY INSTALLATIONS,

**Reg. No. 4,123,507** ENVIRONMENTAL TECHNOLOGY INSTALLATIONS, POWER PLANTS, MACHINES AND APPARATUS; PERSONAL COMPUTERS, MINICOMPUTERS, MICROCOMPUTERS, COMPUTER MONITORS, KEYBOARDS AND COMPUTER MICE, PRINTERS, MODEMS, VOLATILE AND NON-VOLATILE SEMI-CONDUCTOR COMPUTER MEMORY, BLANK DISKS, BLANK FLOPPY DISK DRIVES, FIBER OPTICS, NAMELY, FIBER OPTICS CABLES FOR USE IN THE IRON AND STEEL INDUSTRY, FERROUS AND NON-FERROUS METALLURGICAL INDUSTRY, ALL ABOVE-MENTIONED GOODS FOR CONTROLLING, REGULATING, SIMULATING, VISUALIZING AND MONITORING PARAMETERS OF INDUSTRIAL INSTALLATIONS, ENVIRONMENTAL PROTECTION INSTALLATIONS, INSTALLATIONS FOR PRODUCING, DISTRIBUTING AND TRANSMITTING POWER, AS WELL AS MACHINES AND COMPONENTS THEREOF; ELECTRONIC COMPONENTS, NAMELY, INTEGRATED CIRCUITS AND PRINTED CIRCUITS FOR USE IN INDUSTRIAL INSTALLATIONS, ENVIRONMENTAL PROTECTION INSTALLATIONS, INSTALLATIONS FOR PRODUCING, DISTRIBUTING AND TRANSMITTING POWER, AS WELL AS IN MACHINES AND COMPONENTS THEREOF, IN CLASS 9 (U.S. CLS. 21, 23, 26, 36 AND 38).

FOR: MAINTENANCE AND REPAIR OF METALWORKING MACHINES AND TOOLS; INSTALLATION SERVICES, NAMELY, OF METALWORKING MACHINES AND TOOLS FOR THE IRON AND STEEL INDUSTRY, FERROUS AND NON-FERROUS METALLURGICAL INDUSTRY; PROVIDING TECHNICAL SUPPORT CONCERNING THE INSTALLATION, REPAIR AND MAINTENANCE OF ELECTRIC OR ELECTRONIC APPARATUS, EQUIPMENT AND DEVICES USED FOR AUTOMATED OR PARTLY AUTOMATED INDUSTRIAL OPERATIONS FOR THE IRON AND STEEL INDUSTRY, FERROUS AND NON-FERROUS METALLURGICAL INDUSTRY; INSTALLATION OF ELECTRICAL APPARATUS, NAMELY, FOR THE IRON AND STEEL INDUSTRY, FERROUS AND NON-FERROUS METALLURGICAL INDUSTRY; INSTALLATION OF PIPES FOR LIQUID OR GASEOUS MEDIUMS, NAMELY, FOR THE IRON AND STEEL INDUSTRY, FERROUS AND NON-FERROUS METALLURGICAL INDUSTRY; SERVICING OF PRODUCTS AND/OR APPARATUS, NAMELY, STEEL AND METALWORKING PRODUCTS AND/OR APPARATUS FOR THE ELECTRICITY AND ELECTRONICS INDUSTRY, THE PRECISION ENGINEERING INDUSTRY AND GENERAL MECHANICS; MAINTENANCE AND REPAIR OF ENVIRONMENTAL TECHNOLOGY MACHINERY FOR THE IRON AND STEEL INDUSTRY, FERROUS AND NON-FERROUS METALLURGICAL INDUSTRY; MAINTENANCE AND REPAIR OF POWER PLANTS, BUILDINGS, DWELLINGS, TALL BUILDINGS, HYDRAULIC BUILDINGS, BRIDGE BUILDING, ELECTRICAL INSTALLATIONS, WATER PURIFICATION INSTALLATIONS, WASTE WATER TREATMENT, AND WASTE GAS PURIFICATION PLANTS FOR THE IRON AND STEEL INDUSTRY, FERROUS AND NON-FERROUS METALLURGICAL INDUSTRY, AS WELL AS BIOMASS AND COMPOSTING PLANTS FOR THE IRON AND STEEL INDUSTRY, FERROUS AND NON-FERROUS METALLURGICAL INDUSTRY; INSTALLING, SERVICING AND REPAIR OF INSTALLATIONS FOR METALLURGY, STEEL AND METALWORKING MACHINES, BRIDGES, CRANES AND DUCTS; DEMOLITION OF BUILDINGS WHILE RECOVERING MATERIALS FROM INDUSTRIAL, NUCLEAR, METALLURGY AND ENVIRONMENTAL PROTECTION INSTALLATIONS; SERVICING, MAINTENANCE AND REPAIR OF ELECTRIC AND ELECTRONIC MACHINES FOR INDUSTRIAL INSTALLATIONS, METALLURGY INSTALLATIONS, ENVIRONMENTAL PROTECTION INSTALLATIONS, INSTALLATIONS FOR PRODUCING, DISTRIBUTING AND TRANSMITTING POWER; INSTALLATION OF SUSPENSION CABLES AND TRANSPORT CABLES, AERIAL CABLES AND OVERHEAD TRANSMISSION LINES FOR THE IRON AND STEEL INDUSTRY, FERROUS AND NON-FERROUS METALLURGICAL INDUSTRY; MAINTAINING, AND REPAIR OF COMPUTER AND DATA PROCESSING INSTALLATIONS BEING COMPUTER HARDWARE FOR INDUSTRIAL INSTALLATIONS, METALLURGY INSTALLATIONS, ENVIRONMENTAL TECHNOLOGY INSTALLATIONS, INSTALLATIONS FOR PRODUCING, DISTRIBUTING AND TRANSMITTING POWER AND MACHINES; MODIFICATION AND REPAIR SERVICES FOR THE IRON AND STEEL INDUSTRY, FERROUS AND NON-FERROUS METALLURGICAL INDUSTRY, NAMELY, MODIFICATION AND REPAIR SERVICES FOR IMPROVING EFFICIENCY AND PERFORMANCE FOR EXISTING POWER GENERATION EQUIPMENT AND THE INSTALLATION OF FITTINGS FOR PRIMARY AND SECONDARY EMISSION REDUCTION MEASURES, FOR INCREASING THE SERVICE

**Reg. No. 4,123,507** LIFE AND THE LEVEL OF AUTOMATION OF INDUSTRIAL MACHINERY, ENVIRONMENTAL TECHNOLOGY MACHINERY AND POWER GENERATING PLANTS, IN CLASS 37 (U.S. CLS. 100, 103 AND 106).

FOR: RESEARCH AND ANALYSIS FOR THE IRON AND STEEL INDUSTRY, FERROUS AND NON-FERROUS METALLURGICAL INDUSTRY; DESIGN AND DEVELOPMENT OF COMPUTER HARDWARE AND SOFTWARE; ARCHITECTURAL DESIGN DRAWING BY COMPUTER FOR THE IRON AND STEEL INDUSTRY, FERROUS AND NON-FERROUS METALLURGICAL INDUSTRY; RESEARCH AND DESIGN SERVICES IN THE FIELD OF THE METALLURGY AND STEEL; TECHNOLOGY AND ARCHITECTURAL CONSULTATION IN THE FIELD OF METALLURGY AND STEEL; DATA CONVERSION OF COMPUTER PROGRAMS AND DATA; COMPUTER PROGRAMMING; DRAFTING OF REPORTS IN THE FIELD OF BLAST FURNACES IN THE METALLURGY AND STEEL INDUSTRY; MATERIAL TESTING, NAMELY, ANALYSIS SERVICES FOR MECHANICAL, PHYSICAL AND CHEMICAL PROPERTIES OF MATERIALS IN CONNECTION WITH ACTIVITIES IN THE AREA OF METALLURGY; DESIGN AND DEVELOPMENT OF DATA-PROCESSING PROGRAMS, ESPECIALLY VIA COMPUTING, FOR OTHERS; TECHNOLOGY AND ARCHITECTURAL CONSULTATION IN THE FIELD OF BUILDING AND TECHNICAL PROJECT STUDIES FOR THE IRON AND STEEL INDUSTRY, FERROUS AND NON-FERROUS METALLURGICAL INDUSTRY FOR INDUSTRIAL INSTALLATIONS, POWER PLANTS AND ENVIRONMENTAL TECHNOLOGY INSTALLATIONS; DRAFTING AND DESIGN OF METALLURGIC INSTALLATIONS, MACHINES, BRIDGES AND CONDUITS; DESIGN OF TECHNICAL PROCESS MODELS FOR THE IRON AND STEEL INDUSTRY, FERROUS AND NON-FERROUS METALLURGICAL INDUSTRY FOR INDUSTRIAL INSTALLATIONS, POWER PLANTS AND ENVIRONMENTAL TECHNOLOGY INSTALLATIONS; DRAFTING OF TECHNICAL PLANS IN THE FIELD OF DATA PROCESSING FOR INDUSTRIAL INSTALLATIONS, METALLURGY INSTALLATIONS, ENVIRONMENTAL PROTECTION INSTALLATIONS, INSTALLATIONS FOR PRODUCING, DISTRIBUTING AND TRANSMITTING POWER AND MACHINES; COMPUTER SOFTWARE CONSULTANCY FOR INDUSTRIAL INSTALLATIONS, METALLURGY INSTALLATIONS, ENVIRONMENTAL PROTECTION INSTALLATIONS, INSTALLATIONS FOR PRODUCING, DISTRIBUTING AND TRANSMITTING POWER AND MACHINES; COMPUTER PROGRAMMING FOR COMPUTER INSTALLATIONS FOR THE PURPOSE OF CONTROLLING, REGULATING, SIMULATING, VISUALIZING AND MONITORING PARAMETERS OF INDUSTRIAL INSTALLATIONS, ENVIRONMENTAL PROTECTION INSTALLATIONS, INSTALLATIONS FOR PRODUCING, DISTRIBUTING AND TRANSMITTING POWER, MACHINES AND COMPONENTS THEREOF; CONSULTING SERVICES IN THE FIELDS OF IMPLEMENTATION OF COMPUTER HARDWARE AND SOFTWARE SYSTEMS FOR OTHERS FOR THE IRON AND STEEL INDUSTRY, FERROUS AND NON-FERROUS METALLURGICAL INDUSTRY FOR INDUSTRIAL INSTALLATIONS, METALLURGIC INSTALLATIONS, ENVIRONMENTAL PROTECTION INSTALLATIONS, INSTALLATIONS FOR PRODUCING, DISTRIBUTING AND TRANSMITTING POWER, AND MACHINES; RENTAL OF COMPUTER INSTALLATIONS AND COMPUTER SOFTWARE FOR CONTROLLING, REGULATING, SIMULATING, VISUALIZING AND MONITORING PARAMETERS OF INDUSTRIAL INSTALLATIONS, TECHNICAL INSTALLATIONS, INSTALLATIONS FOR PRODUCING, DISTRIBUTING AND TRANSMITTING POWER, MACHINES AND COMPONENTS THEREOF; INSTALLATION AND MAINTENANCE OF SOFTWARE FOR CONTROLLING, REGULATING, SIMULATING, VISUALIZING AND MONITORING PARAMETERS OF INDUSTRIAL INSTALLATIONS, INSTALLATIONS FOR PRODUCING, DISTRIBUTING AND TRANSMITTING POWER, MACHINES AND COMPONENTS THEREOF; CREATION OF INTRANET AND INTERNET PAGES IN THE FIELD OF INDUSTRIAL INSTALLATIONS, ENVIRONMENTAL PROTECTION INSTALLATIONS, INSTALLATIONS FOR PRODUCING, DISTRIBUTING AND TRANSMITTING POWER, AND MACHINES; TECHNICAL DEVELOPMENT AND DESIGN OF ELECTRICAL INSTALLATIONS; DRAFTING OF PLANS FOR TECHNICAL PROJECT STUDIES REGARDING COMPONENTS FOR INSERTION FOR PRIMARY AND SECONDARY MEASURES FOR EMISSION REDUCTION, INCREASING THE LIFE AND DEGREE OF AUTOMATION OF INDUSTRIAL AND ENVIRONMENTAL TECHNOLOGY INSTALLATIONS AND POWER PLANTS; PRODUCT QUALITY INSPECTION FOR INDUSTRIAL INSTALLATIONS, MATERIALS

**Reg. No. 4,123,507** TESTING, WASTE WATER QUALITY CONTROL, EXHAUST GAS AND AIR QUALITY CONTROL, IN CLASS 42 (U.S. CLS. 100 AND 101).

THE MARK CONSISTS OF STANDARD CHARACTERS WITHOUT CLAIM TO ANY PARTICULAR FONT, STYLE, SIZE, OR COLOR.

PRIORITY DATE OF 11-26-2009 IS CLAIMED.

OWNER OF INTERNATIONAL REGISTRATION 1049854 DATED 5-26-2010, EXPIRES 5-26-2020.

SER. NO. 79-086,908, FILED 5-26-2010.

DOMINIC FATHY, EXAMINING ATTORNEY



# United States of America

United States Patent and Trademark Office

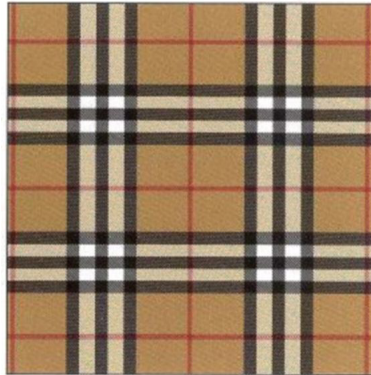

**Reg. No. 4,123,508**

**Registered Apr. 10, 2012**

**Int. Cl.: 9**

**TRADEMARK**

**PRINCIPAL REGISTER**

BURBERRY LIMITED (UNITED KINGDOM LIMITED COMPANY)  
HORSEFERRY HOUSE,  
HORSEFERRY ROAD; LONDON SW1P 2AW  
UNITED KINGDOM

FOR: TELEPHONES, MOBILE TELEPHONES, MOBILE ELECTRONIC DEVICES, NAMELY, PDAS (PERSONAL DIGITAL ASSISTANTS), SMART PHONES, PERSONAL ENTERTAINMENT DEVICES, NAMELY, ELECTRONIC BOOK READERS, TABLET COMPUTERS, NETBOOKS, ELECTRONIC NOTEBOOKS, HANDHELD COMPUTERS, PORTABLE DIGITAL AUDIO AND/OR VIDEO PLAYERS, AND ACCESSORIES FOR THE FOREGOING, NAMELY, HEADSETS, HEADPHONES, COVERS, FASCIA, LANYARDS SPECIALLY DESIGNED FOR MOBILE ELECTRONIC DEVICES AND MOBILE TELEPHONES, STYLUS, BATTERY CHARGERS, PHONE JEWELRY AND ACCESSORY CHARMS FOR MOBILE ELECTRONIC DEVICES; CASES AND HOLDERS FOR TELEPHONES, MOBILE TELEPHONES AND MOBILE ELECTRONIC DEVICES, NAMELY, FOR PDAS (PERSONAL DIGITAL ASSISTANTS), SMART PHONES, PERSONAL ENTERTAINMENT DEVICES IN THE NATURE OF ELECTRONIC BOOK READERS, TABLET COMPUTERS, NETBOOKS, ELECTRONIC NOTEBOOKS, HANDHELD COMPUTERS AND PORTABLE DIGITAL AUDIO AND/OR VIDEO PLAYERS, IN CLASS 9 (U.S. CLS. 21, 23, 26, 36 AND 38).

OWNER OF U.S. REG. NOS. 2,015,462, 2,612,272 AND OTHERS.

PRIORITY DATE OF 10-16-2009 IS CLAIMED.

OWNER OF INTERNATIONAL REGISTRATION 1050179 DATED 4-7-2010, EXPIRES 4-7-2020.

THE COLOR(S) TAN, BLACK, WHITE, RED AND SHADES THEREOF IS/ARE CLAIMED AS A FEATURE OF THE MARK.

THE MARK CONSISTS OF A TAN BACKGROUND, LIGHT TAN VERTICAL AND HORIZONTAL LINES, BLACK VERTICAL AND HORIZONTAL LINES, WHITE SQUARES, AND RED VERTICAL AND HORIZONTAL LINES, FORMING A PLAID PATTERN. THE MARK ALSO CONSISTS OF A REPEATING CHECK DESIGN APPLIED IN WHOLE OR IN PART ON OR IN CONNECTION WITH THE GOODS OR SERVICES. THE MARK IS NOT LIMITED TO POSITION OR PLACEMENT.



*David J. Kybas*

Director of the United States Patent and Trademark Office

**Reg. No. 4,123,508** SEC. 2(F).

SER. NO. 79-087,007, FILED 4-7-2010.

JAMES MACFARLANE, EXAMINING ATTORNEY

# United States of America

United States Patent and Trademark Office

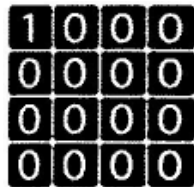

## PETA STATION

**Reg. No. 4,123,509**

**Registered Apr. 10, 2012**

**Int. Cl.: 9**

**TRADEMARK**

**PRINCIPAL REGISTER**

KABUSHIKI KAISHA BUFFALO, TRADING AS BUFFALO INC. (JAPAN CORPORATION)  
30-20, OHSU 3-CHOME,  
NAKA-KU, NAGOYA-SHI, AICHI 460-8315  
JAPAN

FOR: TELECOMMUNICATION DEVICES AND APPARATUS, NAMELY, LOCAL AREA NETWORK HARDWARE, DEVICES FOR TRANSPORTING AND AGGREGATING VOICE, DATA, AND VIDEO COMMUNICATIONS ACROSS MULTIPLE NETWORK INFRASTRUCTURES AND COMMUNICATIONS PROTOCOLS; WIRE COMMUNICATION MACHINES AND APPARATUS, NAMELY, TELEPHONE AND FACSIMILE MACHINES FOR VOICE, DATA OR IMAGE TRANSMISSION; RADIO COMMUNICATION MACHINES AND APPARATUS, NAMELY, WIRELESS COMMUNICATION DEVICES FOR VOICE, DATA OR IMAGE TRANSMISSION; ELECTRONIC MACHINES, APPARATUS AND THEIR PARTS, NAMELY, COMPUTER NETWORK HARDWARE AND COMPUTER PERIPHERALS, NETWORK INTERFACE CARDS, WIRELESS MODEMS, COMPUTER NETWORK TERMINAL ADAPTERS, COMPUTER NETWORK HUBS, SWITCHES, COMPUTER NETWORK ROUTERS, COMPUTER NETWORK SERVERS, COMPUTER HARDWARE AND COMPUTER SOFTWARE FOR USE IN TRANSMITTING AUDIO, VIDEO, TEXT AND MULTIMEDIA CONTENT, DATA PROCESSORS; COMPUTER PROGRAMS FOR CREATING SEARCHABLE DATABASES OF INFORMATION AND DATA; COMPUTER PROGRAMS FOR NETWORKING APPLICATIONS, NAMELY, SOFTWARE THAT ESTABLISHES AND CHANGES THE SETTING OF NETWORK EQUIPMENT; COMPUTER PROGRAMS FOR LOCAL AREA NETWORKING, NAMELY, LAN OPERATING SOFTWARE AND NETWORK ACCESS SERVER OPERATING SOFTWARE; COMPUTER PROGRAMS TO OPERATE OR CONTROL HOUSEHOLD ELECTRIC APPLIANCES BY LOCAL AREA NETWORK; COMPUTER PROGRAMS FOR IMAGE PROCESSING AND VIDEO EDITING; COMPUTERS; COMPUTER PERIPHERALS; HARD DISK DRIVES; COMPUTER STORAGE DEVICES, NAMELY, EXTERNAL COMPUTER HARD DRIVES, COMPUTER STORAGE HARDWARE FOR STORING PROGRAMS, DATA AND DATABASES USED FOR A LOCAL AREA NETWORK, NETWORK ATTACHED STORAGE DEVICES FOR STORING PROGRAMS, DATA AND DATABASES, DIRECT ATTACHED STORAGE DEVICES FOR STORING PROGRAMS, DATA AND DATABASES, BLANK MAGNETIC DATA CARRIERS; DISK DRIVES FOR COMPUTERS, IN CLASS 9 (U.S. CLS. 21, 23, 26, 36 AND 38).



*David J. Kappas*

Director of the United States Patent and Trademark Office

NO CLAIM IS MADE TO THE EXCLUSIVE RIGHT TO USE "STATION", APART FROM THE MARK AS SHOWN.

PRIORITY DATE OF 11-27-2009 IS CLAIMED.

**Reg. No. 4,123,509** OWNER OF INTERNATIONAL REGISTRATION 1050785 DATED 5-27-2010, EXPIRES 5-27-2020.

THE MARK CONSISTS OF A GRID FOR 16 DIGITS STARTING WITH 1 AND FOLLOWED BY A SERIES OF "0"S NEXT TO THE WORDING "PETA STATION".

SER. NO. 79-087,226, FILED 5-27-2010.

MARTHA FROMM, EXAMINING ATTORNEY

# United States of America

United States Patent and Trademark Office

# Cold Oak

**Reg. No. 4,123,510**

**Registered Apr. 10, 2012**

**Int. Cls.: 6, 7, 35, 37, 41  
and 42**

SIEMAG TECBERG GMBH (FED REP GERMANY GMBH)  
KALTEICHE-RING 28-32  
35708 HAIGER  
FED REP GERMANY

FOR: COMMON METALS AND THEIR ALLOYS, IN CLASS 6 (U.S. CLS. 2, 12, 13, 14, 23, 25 AND 50).

**TRADEMARK**

**SERVICE MARK**

**PRINCIPAL REGISTER**

FOR: MECHANICAL CONVEYORS AND MECHANICAL HOISTING DEVICES AND INSTALLATIONS COMPOSED THEREOF, CONVEYING MACHINES, SHAFT HOISTING INSTALLATIONS, NAMELY, SKIP AND CAGE HOISTING INSTALLATIONS FOR SHAFTS, INCLINE HOISTING INSTALLATIONS, HOISTING MACHINES, IN THE NATURE OF KOEPE MACHINES, NAMELY, WINDERS AND SHAFT HOISTING MACHINES, AND IN THE NATURE OF DRUM MACHINES FOR REELING, FOR ONE OR MORE ROPES, NAMELY, HAULAGE APPARATUS, REELS, WINDING TOWERS, CONVEYOR BELTS, SKIPS, AND TROLLEY CIRCULATION SYSTEMS IN THE NATURE OF LOADING RAMPS, MECHANICAL WINCHES, NAMELY, FOR ROPE HANDLING, MOBILE FRICTION WINCHES, MOBILE SHAFT WINCHES, LOADING AND UNLOADING MACHINERY, MECHANICAL TRANSFER AND UNLOADING DEVICES, NAMELY, UNLOADING MACHINES, EQUIPMENT, NAMELY, LIFTING APPARATUS FOR THE ABOVE MENTIONED HOISTING INSTALLATIONS, NAMELY, ROPE LIFTING GEARS FOR MACHINES, FIXING DEVICES IN THE NATURE OF JACKS, ROPE CHANGING DEVICES IN THE NATURE OF WINCHES AND JACKS; BRAKE SYSTEMS FOR HOISTING MACHINES AND WINDLASSES, NAMELY, DISC BRAKE SYSTEMS CONSISTING OF BRAKE SHOES, HYDRAULIC AND ELECTRICAL CONTROLS; MECHANICAL FLOW CONVEYORS AND CONVEYING APPARATUS COMPOSED OF HYDRAULIC CONVEYORS FOR THE HORIZONTAL OR VERTICAL TRANSPORT OF SOLID MATERIALS IN PIPELINES OR SHAFT PIPES, MECHANICAL CONVEYORS FOR LIQUIDS, NAMELY, COOLING LIQUIDS, PRESSURE EXCHANGERS BEING PARTS OF MACHINES, MECHANICAL CONVEYORS AND INSTALLATIONS, NAMELY, CONVEYING APPARATUS FOR DISPOSAL ENGINEERING, NAMELY, FOR DISPOSAL OF MATERIALS UNDERGROUND; MECHANICAL CONVEYORS FOR TRANSPORTING WASTE AND INSTALLATIONS FOR WASTE TRANSPORT IN THE NATURE OF RADIOACTIVE AND TOXIC WASTE; TRANSFER AND TRANSPORT CASKS BEING PARTS OF MACHINES AND USED FOR SAFELY ENCLOSING WASTE IN THE NATURE OF RADIOACTIVE AND TOXIC WASTE, CRANES FOR HANDLING TRANSFER CASKS, ROLLER-CONVEYOR APPARATUS, LIFTING AND LOADING DEVICES IN THE NATURE OF LIFTING INSTALLATIONS FOR THE TRANSPORT OF PERSONS AND GOODS, EQUIPMENT FOR PACKAGING



*David J. Kypos*

Director of the United States Patent and Trademark Office

**Reg. No. 4,123,510** APPARATUS, NAMELY, SURGE BIN AND FILLING BOX, TABLET BIN WITH OUTWARD-TRANSFER BOX, BORE-HOLE PIPES INCLUDING SAMPLE TYPES FOR HIGH ACTIVE WASTE (HAW) MOLDS AND APPARATUS FOR STORING RADIOACTIVE AND TOXIC WASTE, ALL THE AFORESAID GOODS BEING PARTS OF MACHINES, AND CONTROL DEVICES FOR AUTOMATING ALL THE AFORESAID MACHINES AND APPARATUS; RELATED PARTS FOR FIXING ROPES, NAMELY, LIFTING AND CLAMPING DEVICES FOR SHAFT HOISTING INSTALLATIONS; AND REPLACEMENT AND STRUCTURAL PARTS FOR ALL THE AFORESAID GOODS, IN CLASS 7 (U.S. CLS. 13, 19, 21, 23, 31, 34 AND 35).

FOR: ORGANIZATIONAL PROJECT MANAGEMENT AND PROJECT ANALYSIS FOR OTHERS, NAMELY, BUSINESS ORGANIZATIONAL PROJECT MANAGEMENT CONSULTANCY AND BUSINESS PROJECT ANALYSIS IN THE FIELDS OF ENGINEERING AND CONSTRUCTION, IN CLASS 35 (U.S. CLS. 100, 101 AND 102).

FOR: INSTALLATION, SERVICING, REPAIR AND MAINTENANCE OF SHAFT HOISTING, NAMELY, SKIP AND CAGE HOISTING INSTALLATIONS FOR SHAFTS; ASSEMBLY OF PRODUCTS FOR OTHERS, NAMELY, HOISTING MACHINES AND CONSTRUCTION PLANNING, CONSTRUCTION PROJECT MANAGEMENT SERVICES, CONSTRUCTION OF TECHNICAL INSTALLATIONS IN THE NATURE OF SHAFT HOISTING PLANTS, NAMELY, SKIP AND CAGE HOISTING INSTALLATIONS FOR SHAFTS, AND TECHNICAL SUPPORT SERVICES, NAMELY, PROVIDING TECHNICAL ADVICE IN THE FIELD OF INSTALLATION, SERVICING, REPAIR AND MAINTENANCE OF SHAFT HOISTING MACHINES, IN CLASS 37 (U.S. CLS. 100, 103 AND 106).

FOR: ORGANIZATION AND IMPLEMENTATION OF TRAINING IN THE FIELD OF ENGINEERING AND CONSTRUCTION; ORGANIZATION AND IMPLEMENTATION OF SEMINARS AND WORKSHOPS; ALL OF THE AFOREMENTIONED TRAINING IN THE FIELD OF ENGINEERING AND CONSTRUCTION, IN CLASS 41 (U.S. CLS. 100, 101 AND 107).

FOR: ENGINEERING SERVICES, NAMELY, ENGINEERING FOR THE UNDERGROUND MINING INDUSTRY; ENGINEERING SERVICES, NAMELY, TECHNICAL PROJECT PLANNING OF SHAFT HOISTING INSTALLATIONS; COMPUTER SOFTWARE DEVELOPMENT IN THE FIELD OF AUTOMATION SOFTWARE; TECHNICAL PROJECT MANAGEMENT IN THE NATURE OF ENGINEERING SERVICES IN THE FIELDS OF UNDERGROUND MINING AND SHAFT HOISTING INSTALLATIONS, IN CLASS 42 (U.S. CLS. 100 AND 101).

THE MARK CONSISTS OF STANDARD CHARACTERS WITHOUT CLAIM TO ANY PARTICULAR FONT, STYLE, SIZE, OR COLOR.

PRIORITY DATE OF 3-3-2010 IS CLAIMED.

OWNER OF INTERNATIONAL REGISTRATION 1052078 DATED 6-1-2010, EXPIRES 6-1-2020.

SER. NO. 79-087,689, FILED 6-1-2010.

RONALD DELGIZZI, EXAMINING ATTORNEY

# United States of America

United States Patent and Trademark Office

# MONOLIX

**Reg. No. 4,123,511**

**Registered Apr. 10, 2012**

**Int. Cls.: 9 and 42**

**TRADEMARK**

**SERVICE MARK**

**PRINCIPAL REGISTER**

INRIA (INSTITUT NATIONAL DE RECHERCHE EN INFORMATIQUE ET EN AUTOMATIQUE) (FRANCE ETABLISSEMENT PUBLIC À CARACTÈRE SCIENTIFIQUE ET TECHNOLOGIQUE, A PUBLIC SCIENTIFIC AND TECHNICAL RESEARCH ESTABLISHMENT)

DOMAINE DE VOLUCEAU,  
ROCQUENCOURT B.P. 105; F-78153 LE CHESNAY CEDEX  
FRANCE

FOR: COMPUTER PROGRAMS RECORDED ON DATA MEDIA (SOFTWARE) ENABLING MODELING AND SIMULATION OF BIOLOGICAL AND NATURAL PHENOMENA; COMPUTER PROGRAMS RECORDED ON DATA MEDIA (SOFTWARE) TO AID DECISION MAKING IN THE FIELD OF THE ANALYSIS OF NON-LINEAR MIXED EFFECTS MODELS, IN CLASS 9 (U.S. CLS. 21, 23, 26, 36 AND 38).

FOR: DESIGN, DEVELOPMENT, INSTALLATION, CUSTOMIZATION, MAINTENANCE AND UPDATING OF COMPUTER SOFTWARE; CONDUCTING SCIENTIFIC STUDY AND RESEARCH, NAMELY, TECHNICAL PROJECT STUDIES IN THE FIELDS OF PARAMETER ESTIMATION, MODEL SELECTION, GOODNESS OF FIT PLOTS, DATA SIMULATION; SCIENTIFIC AND TECHNOLOGICAL EVALUATION AND RESEARCH PROVIDED BY ENGINEERS; ENGINEERING; COMPUTER PROGRAMMING; RESEARCH AND DEVELOPMENT OF NEW COMPUTER PRODUCTS FOR OTHERS; DUPLICATION OF COMPUTER PROGRAMS; DATA CONVERSION OF COMPUTER PROGRAMS AND DATA, NOT PHYSICAL CONVERSION; CONSULTANCY, ASSISTANCE, NAMELY, TECHNOLOGICAL ASSISTANCE, AND TECHNICAL SUPPORT SERVICES IN THE NATURE OF TROUBLESHOOTING IN THE NATURE OF DIAGNOSING COMPUTER HARDWARE AND SOFTWARE PROBLEMS IN THE FIELDS OF COMPUTERS AND COMPUTER HARDWARE AND SOFTWARE, IN CLASS 42 (U.S. CLS. 100 AND 101).

PRIORITY DATE OF 3-15-2010 IS CLAIMED.

OWNER OF INTERNATIONAL REGISTRATION 1052656 DATED 9-7-2010, EXPIRES 9-7-2020.

SER. NO. 79-087,917, FILED 9-7-2010.

SOPHIA S. KIM, EXAMINING ATTORNEY



*David J. Kyffers*

Director of the United States Patent and Trademark Office

United States of America  
United States Patent and Trademark Office

# Ocuseva

**Reg. No. 4,123,512**

**Registered Apr. 10, 2012**

**Int. Cl.: 5**

**TRADEMARK**

**PRINCIPAL REGISTER**

R-TECH UENO, LTD. (JAPAN CORPORATION)  
1-1-7 UCHISAIWAICHO  
CHIYODA-KU; TOKYO 100-0011  
JAPAN

FOR: OPHTHALMIC PHARMACEUTICAL PREPARATIONS FOR TREATMENT OF RETINAL DISEASES, GLAUCOMA AND OCULAR HYPERTENSION, IN CLASS 5 (U.S. CLS. 6, 18, 44, 46, 51 AND 52).

THE MARK CONSISTS OF STANDARD CHARACTERS WITHOUT CLAIM TO ANY PARTICULAR FONT, STYLE, SIZE, OR COLOR.

PRIORITY DATE OF 4-9-2010 IS CLAIMED.

OWNER OF INTERNATIONAL REGISTRATION 1052762 DATED 9-24-2010, EXPIRES 9-24-2020.

SER. NO. 79-087,956, FILED 9-24-2010.

MATTHEW EINSTEIN, EXAMINING ATTORNEY



*David J. Kyros*

Director of the United States Patent and Trademark Office



# United States of America

United States Patent and Trademark Office



**Reg. No. 4,123,513**

**Registered Apr. 10, 2012**

**Int. Cls.: 9, 16, 35, 38  
and 41**

**TRADEMARK**

**SERVICE MARK**

**PRINCIPAL REGISTER**

RUSSKIY MIR FOUNDATION (RUSSIAN FED. NON-PROFIT ORGANIZATION)  
5, VOROSHILOVSKY PARK  
RU-121433 MOSCOW  
RUSSIAN FED.

FOR: PRERECORDED MAGNETIC DATA CARRIERS FEATURING INFORMATION RELATED TO THE POPULARIZATION AND STUDY OF THE RUSSIAN LANGUAGE, HISTORY, CULTURE, HISTORICAL SITES, CULTURAL MONUMENTS, MUSEUMS, FAMOUS PEOPLE, PUBLICATIONS, AND HISTORICAL EVENTS OF RUSSIA; RECORDED DIGITAL VIDEO DISCS, CD-ROM, AND DVD, CONTAINING INFORMATION RELATED TO THE POPULARIZATION AND STUDY OF THE RUSSIAN LANGUAGE, HISTORY, CULTURE, HISTORICAL SITES, CULTURAL MONUMENTS, MUSEUMS, FAMOUS PEOPLE, PUBLICATIONS, AND HISTORICAL EVENTS OF RUSSIA; AUDIO AND VIDEO RECORDS CONTAINING INFORMATION RELATED TO THE POPULARIZATION AND STUDY OF THE RUSSIAN LANGUAGE, HISTORY, CULTURE, HISTORICAL SITES, CULTURAL MONUMENTS, MUSEUMS, FAMOUS PEOPLE, PUBLICATIONS, AND HISTORICAL EVENTS OF RUSSIA, IN CLASS 9 (U.S. CLS. 21, 23, 26, 36 AND 38).

FOR: PRINTED MATTER, NAMELY, BOOKS, MAGAZINES, TRAINING AIDS, AND HAND-OUT CONTAINING INFORMATION RELATED TO THE POPULARIZATION AND STUDY OF THE RUSSIAN LANGUAGE, HISTORY, CULTURE, HISTORICAL SITES, CULTURAL MONUMENTS, MUSEUMS, FAMOUS PEOPLE, PUBLICATIONS, AND HISTORICAL EVENTS OF RUSSIA; EDUCATIONAL PUBLICATIONS, NAMELY, BOOKS, MAGAZINES, TRAINING AIDS, DICTIONARIES, REFERENCE LITERATURE, AND HAND-OUT CONTAINING INFORMATION RELATED TO THE POPULARIZATION AND STUDY OF THE RUSSIAN LANGUAGE, HISTORY, CULTURE, HISTORICAL SITES, CULTURAL MONUMENTS, MUSEUMS, FAMOUS PEOPLE, PUBLICATIONS, AND HISTORICAL EVENTS OF RUSSIA; LEAFLETS, CALENDARS, CATALOGUES, AND BOOKLETS CONTAINING INFORMATION RELATED TO THE POPULARIZATION AND STUDY OF THE RUSSIAN LANGUAGE, HISTORY, CULTURE, HISTORICAL SITES, CULTURAL MONUMENTS, MUSEUMS, FAMOUS PEOPLE, PUBLICATIONS, AND HISTORICAL EVENTS OF RUSSIA; SERIES OF ARTICLES CONTAINING INFORMATION RELATED TO THE POPULARIZATION AND STUDY OF THE RUSSIAN LANGUAGE, HISTORY, CULTURE, HISTORICAL SITES, CULTURAL MONUMENTS, MUSEUMS, FAMOUS PEOPLE, PUBLICATIONS, AND HISTORICAL EVENTS OF RUSSIA; PRINTED EDUCATIONAL MATERIALS AND VISUAL AIDS CONTAINING INFORMATION RELATED TO THE POPULARIZATION AND STUDY OF THE RUSSIAN LANGUAGE, HISTORY, CULTURE, HISTORICAL SITES, CULTURAL MONU-



*David J. Kyjars*

Director of the United States Patent and Trademark Office

**Reg. No. 4,123,513** MENTS, MUSEUMS, FAMOUS PEOPLE, PUBLICATIONS, AND HISTORICAL EVENTS OF RUSSIA; GRAPHIC PRINTS AND REPRESENTATIONS, STATIONERY, IN CLASS 16 (U.S. CLS. 2, 5, 22, 23, 29, 37, 38 AND 50).

FOR: ADVERTISEMENT; BUSINESS MANAGEMENT; BUSINESS ADMINISTRATION; AND OFFICE SERVICES, IN CLASS 35 (U.S. CLS. 100, 101 AND 102).

FOR: TELECOMMUNICATIONS, NAMELY, ELECTRONIC BULLETIN BOARD SERVICES, PROVIDING INTERNET CHAT ROOMS, TELECONFERENCING SERVICES; BROADCASTING OF ENTERTAINMENT, DOCUMENTARY, CULTURAL AND EDUCATIONAL TV AND VIDEO PROGRAMS CONTAINING INFORMATION RELATED TO THE POPULARIZATION AND STUDY OF THE RUSSIAN LANGUAGE, HISTORY, CULTURE, HISTORICAL SITES, CULTURAL MONUMENTS, MUSEUMS, FAMOUS PEOPLE, PUBLICATIONS, AND HISTORICAL EVENTS OF RUSSIA; BROADCASTING OF ENTERTAINMENT, DOCUMENTARY, CULTURAL AND EDUCATIONAL RADIO PROGRAMS CONTAINING INFORMATION RELATED TO THE POPULARIZATION AND STUDY OF THE RUSSIAN LANGUAGE, HISTORY, CULTURE, HISTORICAL SITES, CULTURAL MONUMENTS, MUSEUMS, FAMOUS PEOPLE, PUBLICATIONS, AND HISTORICAL EVENTS OF RUSSIA; TRANSMISSION OF MESSAGES AND IMAGES VIA COMPUTER; PROVIDING MULTIPLE-USER ACCESS TO GEOGRAPHIC DATA AND DATA OF GEOGRAPHIC AND INTERNET TRAFFIC MAPS ON THE INTERNET RELATED TO THE POPULARIZATION AND STUDY OF THE RUSSIAN LANGUAGE, HISTORY, CULTURE, HISTORICAL SITES, CULTURAL MONUMENTS, MUSEUMS, FAMOUS PEOPLE, PUBLICATIONS, AND HISTORICAL EVENTS OF RUSSIA; PROVIDING ONLINE CHAT ROOMS; PROVIDING ELECTRONIC BULLETIN BOARD SERVICES FOR ENTERTAINMENT PURPOSES; COMMUNICATION USING E-MAIL ACCOUNTS AND/OR PROVIDING E-MAIL SERVICES AND COMMUNICATION BY ELECTRONIC COMPUTER TERMINALS; INFORMATION TRANSMISSION VIA ELECTRONIC COMMUNICATIONS NETWORKS; PROVIDING ACCESS TO DATA BASES CONTAINING INFORMATION RELATED TO THE POPULARIZATION AND STUDY OF THE RUSSIAN LANGUAGE, HISTORY, CULTURE, HISTORICAL SITES, CULTURAL MONUMENTS, MUSEUMS, FAMOUS PEOPLE, PUBLICATIONS, AND HISTORICAL EVENTS OF RUSSIA, IN CLASS 38 (U.S. CLS. 100, 101 AND 104).

FOR: PROVIDING ACADEMIC ACTIVITY, NAMELY, CLASSES, SEMINARS, DISCUSSION GROUPS, TRAINING COURSES FOR RUSSIAN LANGUAGE, COMPETITIONS FOR THE BEST KNOWLEDGE OF THE RUSSIAN LANGUAGE, MASTER CLASSES, SCHOOLS, TRAININGS, AND LECTURES AIMED TO THE POPULARIZATION AND STUDY OF THE RUSSIAN LANGUAGE, HISTORY, CULTURE, HISTORICAL SITES, CULTURAL MONUMENTS, MUSEUMS, FAMOUS PEOPLE, PUBLICATIONS, AND HISTORICAL EVENTS OF RUSSIA; EDUCATION AND ENTERTAINMENT SERVICES, NAMELY, PRODUCTION AND DISTRIBUTION OF ONGOING TELEVISION PROGRAMS IN THE FIELD OF THE POPULARIZATION AND STUDY OF THE RUSSIAN LANGUAGE, HISTORY, CULTURE, HISTORICAL SITES, CULTURAL MONUMENTS, MUSEUMS, FAMOUS PEOPLE, PUBLICATIONS, AND HISTORICAL EVENTS OF RUSSIA BROADCAST OVER TELEVISION, SATELLITE AND VIDEO MEDIA; ORGANIZING CULTURAL AND EDUCATIONAL EVENTS, NAMELY, ORGANIZATION AND CARRYING CONCERTS, FESTIVALS, COMPETITIONS, ART MEETINGS, ACADEMIC COMPETITIONS, EXHIBITIONS, CONFERENCES, AND SYMPOSIUMS AIMED TO THE POPULARIZATION AND STUDY OF THE RUSSIAN LANGUAGE, HISTORY, CULTURE, HISTORICAL SITES, CULTURAL MONUMENTS, MUSEUMS, FAMOUS PEOPLE, PUBLICATIONS, AND HISTORICAL EVENTS OF RUSSIA, IN CLASS 41 (U.S. CLS. 100, 101 AND 107).

THE STYLIZED LETTERS "RM" IN WHITE INSIDE A RED CIRCLE.

OWNER OF INTERNATIONAL REGISTRATION 1052911 DATED 6-1-2010, EXPIRES 6-1-2020.

THE COLOR(S) WHITE AND RED IS/ARE CLAIMED AS A FEATURE OF THE MARK.

**Reg. No. 4,123,513** SER. NO. 79-088,013, FILED 6-1-2010.

MARIA-VICTORIA SUAREZ, EXAMINING ATTORNEY

# United States of America

United States Patent and Trademark Office



**Reg. No. 4,123,514**

**Registered Apr. 10, 2012**

**Int. Cls.: 9, 16, 35, 38  
and 41**

**TRADEMARK**

**SERVICE MARK**

**PRINCIPAL REGISTER**

RUSSKIY MIR FOUNDATION (RUSSIAN FED. NON-PROFIT ORGANIZATION)  
VOROSHILOVSKY PARK, 5  
MOSCOW, RUSSIAN FED. 121433

FOR: PRERECORDED MAGNETIC DATA CARRIERS FEATURING INFORMATION RELATED TO THE POPULARIZATION AND STUDY OF THE RUSSIAN LANGUAGE, HISTORY, CULTURE, HISTORICAL SITES, CULTURAL MONUMENTS, MUSEUMS, FAMOUS PEOPLE, PUBLICATIONS, AND HISTORICAL EVENTS OF RUSSIA; RECORDED DIGITAL VIDEO DISCS, CD-ROM, AND DVD, CONTAINING INFORMATION RELATED TO THE POPULARIZATION AND STUDY OF THE RUSSIAN LANGUAGE, HISTORY, CULTURE, HISTORICAL SITES, CULTURAL MONUMENTS, MUSEUMS, FAMOUS PEOPLE, PUBLICATIONS, AND HISTORICAL EVENTS OF RUSSIA; AUDIO AND VIDEO RECORDS CONTAINING INFORMATION RELATED TO THE POPULARIZATION AND STUDY OF THE RUSSIAN LANGUAGE, HISTORY, CULTURE, HISTORICAL SITES, CULTURAL MONUMENTS, MUSEUMS, FAMOUS PEOPLE, PUBLICATIONS, AND HISTORICAL EVENTS OF RUSSIA, IN CLASS 9 (U.S. CLS. 21, 23, 26, 36 AND 38).

FOR: PRINTED MATTER, NAMELY, BOOKS, MAGAZINES, TRAINING AIDS, AND HAND-OUT CONTAINING INFORMATION RELATED TO THE POPULARIZATION AND STUDY OF THE RUSSIAN LANGUAGE, HISTORY, CULTURE, HISTORICAL SITES, CULTURAL MONUMENTS, MUSEUMS, FAMOUS PEOPLE, PUBLICATIONS, AND HISTORICAL EVENTS OF RUSSIA; EDUCATIONAL PUBLICATIONS, NAMELY, BOOKS, MAGAZINES, TRAINING AIDS, DICTIONARIES, REFERENCE LITERATURE, AND HAND-OUT CONTAINING INFORMATION RELATED TO THE POPULARIZATION AND STUDY OF THE RUSSIAN LANGUAGE, HISTORY, CULTURE, HISTORICAL SITES, CULTURAL MONUMENTS, MUSEUMS, FAMOUS PEOPLE, PUBLICATIONS, AND HISTORICAL EVENTS OF RUSSIA; LEAFLETS, CALENDARS, CATALOGUES, AND BOOKLETS CONTAINING INFORMATION RELATED TO THE POPULARIZATION AND STUDY OF THE RUSSIAN LANGUAGE, HISTORY, CULTURE, HISTORICAL SITES, CULTURAL MONUMENTS, MUSEUMS, FAMOUS PEOPLE, PUBLICATIONS, AND HISTORICAL EVENTS OF RUSSIA; SERIES OF ARTICLES CONTAINING INFORMATION RELATED TO THE POPULARIZATION AND STUDY OF THE RUSSIAN LANGUAGE, HISTORY, CULTURE, HISTORICAL SITES, CULTURAL MONUMENTS, MUSEUMS, FAMOUS PEOPLE, PUBLICATIONS, AND HISTORICAL EVENTS OF RUSSIA; PRINTED EDUCATIONAL MATERIALS AND VISUAL AIDS CONTAINING INFORMATION RELATED TO THE POPULARIZATION AND STUDY OF THE RUSSIAN LANGUAGE, HISTORY, CULTURE, HISTORICAL SITES, CULTURAL MONUMENTS, MUSEUMS, FAMOUS PEOPLE, PUBLICATIONS, AND HISTORICAL EVENTS OF



*David J. Kybas*

Director of the United States Patent and Trademark Office

**Reg. No. 4,123,514** RUSSIA; GRAPHIC PRINTS AND REPRESENTATIONS, STATIONERY, IN CLASS 16 (U.S. CLS. 2, 5, 22, 23, 29, 37, 38 AND 50).

FOR: ADVERTISEMENT; BUSINESS MANAGEMENT; BUSINESS ADMINISTRATION; AND OFFICE SERVICES, IN CLASS 35 (U.S. CLS. 100, 101 AND 102).

FOR: TELECOMMUNICATIONS, NAMELY, ELECTRONIC BULLETIN BOARD SERVICES, PROVIDING INTERNET CHAT ROOMS, TELECONFERENCING SERVICES; BROADCASTING OF ENTERTAINMENT, DOCUMENTARY, CULTURAL AND EDUCATIONAL TV AND VIDEO PROGRAMS CONTAINING INFORMATION RELATED TO THE POPULARIZATION AND STUDY OF THE RUSSIAN LANGUAGE, HISTORY, CULTURE, HISTORICAL SITES, CULTURAL MONUMENTS, MUSEUMS, FAMOUS PEOPLE, PUBLICATIONS, AND HISTORICAL EVENTS OF RUSSIA; BROADCASTING OF ENTERTAINMENT, DOCUMENTARY, CULTURAL AND EDUCATIONAL RADIO PROGRAMS CONTAINING INFORMATION RELATED TO THE POPULARIZATION AND STUDY OF THE RUSSIAN LANGUAGE, HISTORY, CULTURE, HISTORICAL SITES, CULTURAL MONUMENTS, MUSEUMS, FAMOUS PEOPLE, PUBLICATIONS, AND HISTORICAL EVENTS OF RUSSIA; TRANSMISSION OF MESSAGES AND IMAGES VIA COMPUTER; PROVIDING MULTIPLE-USER ACCESS TO GEOGRAPHIC DATA AND DATA OF GEOGRAPHIC AND INTERNET TRAFFIC MAPS ON THE INTERNET RELATED TO THE POPULARIZATION AND STUDY OF THE RUSSIAN LANGUAGE, HISTORY, CULTURE, HISTORICAL SITES, CULTURAL MONUMENTS, MUSEUMS, FAMOUS PEOPLE, PUBLICATIONS, AND HISTORICAL EVENTS OF RUSSIA; PROVIDING ONLINE CHAT ROOMS; PROVIDING ELECTRONIC BULLETIN BOARD SERVICES FOR ENTERTAINMENT PURPOSES; COMMUNICATION USING E-MAIL ACCOUNTS AND/OR PROVIDING E-MAIL SERVICES AND COMMUNICATION BY ELECTRONIC COMPUTER TERMINALS, INFORMATION TRANSMISSION VIA ELECTRONIC COMMUNICATIONS NETWORKS; PROVIDING ACCESS TO DATA BASES CONTAINING INFORMATION RELATED TO THE POPULARIZATION AND STUDY OF THE RUSSIAN LANGUAGE, HISTORY, CULTURE, HISTORICAL SITES, CULTURAL MONUMENTS, MUSEUMS, FAMOUS PEOPLE, PUBLICATIONS, AND HISTORICAL EVENTS OF RUSSIA , IN CLASS 38 (U.S. CLS. 100, 101 AND 104).

FOR: EDUCATION AND ENTERTAINMENT SERVICES, NAMELY, PRODUCTION AND DISTRIBUTION OF ONGOING TELEVISION PROGRAMS IN THE FIELD OF THE POPULARIZATION AND STUDY OF THE RUSSIAN LANGUAGE, HISTORY, CULTURE, HISTORICAL SITES, CULTURAL MONUMENTS, MUSEUMS, FAMOUS PEOPLE, PUBLICATIONS, AND HISTORICAL EVENTS OF RUSSIA BROADCAST OVER TELEVISION, SATELLITE AND VIDEO MEDIA, IN CLASS 41 (U.S. CLS. 100, 101 AND 107).

THE MARK CONSISTS OF THE FOLLOWING: THE STYLIZED LETTERS "RM" IN RED INSIDE A WHITE CIRCLE INSIDE A RED SQUARE.

OWNER OF INTERNATIONAL REGISTRATION 1052913 DATED 6-1-2010, EXPIRES 6-1-2020.

THE COLOR(S) WHITE AND RED IS/ARE CLAIMED AS A FEATURE OF THE MARK.

SER. NO. 79-088,014, FILED 6-1-2010.

MARIA-VICTORIA SUAREZ, EXAMINING ATTORNEY

# United States of America

United States Patent and Trademark Office



**Reg. No. 4,123,515**

**Registered Apr. 10, 2012**

**Int. Cls.: 36 and 41**

**SERVICE MARK**

**PRINCIPAL REGISTER**

RICHARD PAIN (AUSTRALIA INDIVIDUAL)  
C/- CREATIVE LEGAL  
PO BOX 828; NORTH MELBOURNE VIC 3051  
AUSTRALIA

FOR: CHARITABLE FUNDRAISING, IN CLASS 36 (U.S. CLS. 100, 101 AND 102).

FOR: MANAGEMENT OF ENTERTAINMENT EVENTS, NAMELY, CONDUCTING ENTERTAINMENT EXHIBITIONS IN THE NATURE OF SWIMMING, ENDURANCE AND SPORTING ENTERTAINMENT; MANAGEMENT OF SPORTING EVENTS, NAMELY, ORGANIZING ARRANGING AND CONDUCTING SWIMMING AND ENDURANCE EVENTS; ORGANIZATION OF ENTERTAINMENT EVENTS, IN THE NATURE OF SWIMMING, ENDURANCE AND SPORTING RACES, EVENTS, COMPETITIONS AND GAMES AND EXHIBITIONS FOR ENTERTAINMENT PURPOSES; ORGANIZING EVENTS FOR ENTERTAINMENT PURPOSES, NAMELY, EXHIBITIONS FOR ENTERTAINMENT PURPOSES; ORGANIZING OF ENTERTAINMENT AND SOCIAL EVENTS; PROVISION OF RECREATIONAL EVENTS, NAMELY, ORGANIZING, ARRANGING AND CONDUCTING SWIMMING OR ENDURANCE EVENTS; ORGANIZATION OF RECREATIONAL ACTIVITIES, NAMELY, EXHIBITIONS AND CONFERENCES IN THE FIELDS OF SPORT AND ENTERTAINMENT; ARRANGING OF SPORTING EVENTS; ORGANIZATION OF SPORTING ACTIVITIES, NAMELY, SWIMMING OR ENDURANCE RACES, EVENTS, COMPETITIONS AND GAMES; ORGANIZATION OF SPORTING COMPETITIONS; ORGANIZATION OF SPORTING EVENTS, NAMELY, SWIMMING OR ENDURANCE; PRODUCTION OF SPORTING EVENTS, NAMELY, ORGANIZING ARRANGING, AND CONDUCTING SWIMMING AND ENDURANCE EVENTS; PROVISION OF SPORTING COMPETITIONS, NAMELY, ORGANIZATION OF SPORTING COMPETITIONS; PROVISION OF SPORTING EVENTS, NAMELY, ENTERTAINMENT IN THE NATURE OF SWIMMING AND ENDURANCE RACES, EVENTS, COMPETITIONS AND GAMES; SPORTING ACTIVITIES, NAMELY, ENTERTAINMENT IN THE NATURE OF SWIMMING AND ENDURANCE RACES, EVENTS, COMPETITIONS AND GAMES; PROVIDING SPORTING INFORMATION; PROVIDING INFORMATION ABOUT EDUCATION; EDUCATION AND EDUCATION SERVICES, NAMELY, PROVIDING CLASSES, SEMINARS, WORKSHOPS, CONFERENCES, INCLUDING LIVE, BROADCAST AND ONLINE, IN THE FIELDS OF ENVIRONMENTAL AND SOCIAL ISSUES AND SPORTING ACTIVITIES; EVENT MANAGEMENT SERVICES, NAMELY, ORGANIZATION OF EDUCATIONAL, ENTERTAINMENT, SPORTING, COMMUNITY OR CULTURAL EVENTS; INFORMATION RELATING TO EDUCATION, NAMELY, PROVIDING INFORMATION RELATING TO EDUCATIONAL OPPORTUNITIES; INFORMATION SERVICES RELATING TO EDUCATION; MANAGEMENT



*David J. Kybas*

Director of the United States Patent and Trademark Office

**Reg. No. 4,123,515** OF EDUCATION SERVICES, NAMELY, CONDUCTING EDUCATIONAL EXHIBITIONS IN THE NATURE OF CLASSES, SEMINARS, WORKSHOPS, CONFERENCES, INCLUDING LIVE, BROADCAST AND ONLINE, IN THE FIELDS OF ENVIRONMENTAL AND SOCIAL ISSUES AND SPORTING ACTIVITIES; MANAGEMENT OF EDUCATIONAL EVENTS, NAMELY, CONDUCTING EDUCATIONAL EXHIBITIONS IN THE NATURE OF CLASSES, SEMINARS, WORKSHOPS, CONFERENCES, INCLUDING LIVE, BROADCAST AND ONLINE, IN THE FIELDS OF ENVIRONMENTAL AND SOCIAL ISSUES AND SPORTING ACTIVITIES; ARRANGING OF COMPETITIONS FOR EDUCATIONAL OR ENTERTAINMENT PURPOSES; ARRANGING OF CONTESTS FOR EDUCATIONAL OR ENTERTAINMENT PURPOSES; PROVIDING INFORMATION AND PROVIDING ONLINE INFORMATION ABOUT EDUCATION, EDUCATIONAL TRAINING, ENTERTAINMENT, SPORTING AND CULTURAL ACTIVITIES; PROVISION OF INFORMATION ON EDUCATION; PROVISION OF INFORMATION ABOUT EDUCATION; CULTURAL ACTIVITIES, NAMELY, ORGANIZATION OF EXHIBITIONS FOR CULTURAL PURPOSES; CULTURAL INFORMATION, NAMELY, PROVISION OF INFORMATION RELATING TO THE ORGANIZING OF CULTURAL EXHIBITIONS AND CULTURAL ACTIVITIES; MANAGEMENT OF CULTURAL EVENTS, NAMELY, ORGANIZING AND HOSTING OF EVENTS FOR CULTURAL PURPOSES; ORGANISING OF EVENTS FOR CULTURAL PURPOSES, IN CLASS 41 (U.S. CLS. 100, 101 AND 107).

NO CLAIM IS MADE TO THE EXCLUSIVE RIGHT TO USE "PACIFIC" OR "CHALLENGE", APART FROM THE MARK AS SHOWN.

PRIORITY DATE OF 7-15-2010 IS CLAIMED.

OWNER OF INTERNATIONAL REGISTRATION 1053067 DATED 8-18-2010, EXPIRES 8-18-2020.

THE COLOR(S) BLUE AND WHITE IS/ARE CLAIMED AS A FEATURE OF THE MARK.

THE MARK CONSISTS OF THE FOLLOWING: A BLUE BACKGROUND COMPRISED IN PART OF A DESIGN OF PLASTIC BOTTLES ON WHICH ARE THE WORDS "PACIFIC VORTEX CHALLENGE" IN A WHITE STYLIZED FONT WITH A DESIGN OF A VORTEX IN THE LETTER. BETWEEN THE BOTTLES AND THE WORDING IS A DESIGN OF A SWIMMER IN WHITE.

SER. NO. 79-088,069, FILED 8-18-2010.

ERNEST SHOSHO, EXAMINING ATTORNEY

# United States of America

United States Patent and Trademark Office

# RESTIR

**Reg. No. 4,123,516**

**Registered Apr. 10, 2012**

**Int. Cl.: 35**

**SERVICE MARK**

**PRINCIPAL REGISTER**

RESTIR HOLDINGS INC. (JAPAN CORPORATION)  
CREATE-KOBE BUILDING 11F  
80, KYOMACHI, CHUO-KU, KOBE-SHI  
HYOGO 650-0034, JAPAN

FOR: ADVERTISING; BUSINESS MANAGEMENT ANALYSIS AND BUSINESS CONSULTANCY; MARKETING RESEARCH; PROVIDING INFORMATION ON SALES OF GOODS AND PRESENTATION OF GOODS ON COMMUNICATION MEDIA, FOR RETAIL PURPOSES; BUSINESS MANAGEMENT OF HOTELS FOR OTHERS; ORGANIZATION OF EXHIBITIONS FOR COMMERCIAL OR ADVERTISING PURPOSES; PROCUREMENT SERVICES FOR OTHERS, NAMELY, PURCHASING CLOTHING, FOOTWEAR, BAGS, POUCHES, PERSONAL ARTICLES, BELTS, PERSONAL ORNAMENTS, EARRINGS, BRACELETS, RINGS, BANGLES, NECKLACES, BROOCHES, CUFF LINKS, UMBRELLAS, VOLTAGE CONVERTER CASES, COSMETICS, TOILETRIES, DENTIFRICES, SOAPS AND DETERGENTS, CLOCKS, WATCHES AND SPECTACLES, SUNGLASSES FOR OTHER BUSINESSES; PROVIDING INFORMATION ON FASHION GOODS SALES; SALES PROMOTION RELATING TO GOODS AND SERVICES FOR OTHERS; IMPORT-EXPORT AGENCIES; RETAIL STORE SERVICES AND WHOLESALE STORE SERVICES FOR CLOTHING, FOOTWEAR, BAGS, POUCHES, PERSONAL ARTICLES, BELTS, PERSONAL ORNAMENTS, EARRINGS, BRACELETS, RINGS, BANGLES, NECKLACES, BROOCHES, CUFF LINKS, UMBRELLAS, VOLTAGE CONVERTER CASES, COSMETICS, TOILETRIES, DENTIFRICES, SOAPS AND DETERGENTS, CLOCKS, WATCHES, SPECTACLES, AND SUNGLASSES, IN CLASS 35 (U.S. CLS. 100, 101 AND 102).



OWNER OF U.S. REG. NO. 3,318,411.

PRIORITY DATE OF 2-26-2010 IS CLAIMED.

OWNER OF INTERNATIONAL REGISTRATION 1053186 DATED 5-6-2010, EXPIRES 5-6-2020.

THE MARK CONSISTS OF WORDING "RESTIR" IN STYLIZED LETTERING.

SER. NO. 79-088,100, FILED 5-6-2010.

JERI J. FICKES, EXAMINING ATTORNEY

*David J. Kyros*

Director of the United States Patent and Trademark Office



# United States of America

United States Patent and Trademark Office

# ROC CUVE

**Reg. No. 4,123,517**

**Registered Apr. 10, 2012**

**Int. Cl.: 20**

**TRADEMARK**

**PRINCIPAL REGISTER**

ALCOHOLES DE TOMELLOSO, S.A. (ALTOSA) (SPAIN SOCIEDAD ANÓNIMA)  
AVDA. DE AVILA, 4  
E-13700 CIUDAD REAL  
SPAIN

FOR: VATS, NOT OF METAL, IN CLASS 20 (U.S. CLS. 2, 13, 22, 25, 32 AND 50).

THE MARK CONSISTS OF STANDARD CHARACTERS WITHOUT CLAIM TO ANY PARTICULAR FONT, STYLE, SIZE, OR COLOR.

PRIORITY DATE OF 1-25-2010 IS CLAIMED.

OWNER OF INTERNATIONAL REGISTRATION 1053462 DATED 7-21-2010, EXPIRES 7-21-2020.

NO CLAIM IS MADE TO THE EXCLUSIVE RIGHT TO USE "CUVE", APART FROM THE MARK AS SHOWN.

THE ENGLISH TRANSLATION OF "CUVE" IN THE MARK IS "VAT".

SER. NO. 79-088,188, FILED 7-21-2010.

LOURDES AYALA, EXAMINING ATTORNEY



*David J. Kybas*

Director of the United States Patent and Trademark Office

# United States of America

United States Patent and Trademark Office



**Reg. No. 4,123,518**

**Registered Apr. 10, 2012**

**Int. Cl.: 37**

**SERVICE MARK**

**PRINCIPAL REGISTER**

BENOÎT DELAN (SPAIN INDIVIDUAL)  
CALLE CAN VERI, N°1  
E-07001 PALMA DE MALLORCA  
SPAIN

FOR: CONSTRUCTION OF YACHTS AND BOATS, REPAIR OF YACHTS AND BOATS, INSTALLATION OF PARTS OF YACHTS AND BOATS, PAINTING, VARNISHING AND PAPER HANGING SERVICES; CLEANING OF YACHTS AND BOATS AND PARTS THEREOF, IN CLASS 37 (U.S. CLS. 100, 103 AND 106).

THE MARK CONSISTS OF THE MARK, "SHINEYACHTS", 3 STARS ABOVE THE LETTER "Y".

OWNER OF INTERNATIONAL REGISTRATION 1054149 DATED 5-12-2010, EXPIRES 5-12-2020.

SER. NO. 79-088,412, FILED 5-12-2010.

CARRIE GENOVESE, EXAMINING ATTORNEY



*David J. Kybas*

Director of the United States Patent and Trademark Office

# United States of America

United States Patent and Trademark Office

## ARCHERY TRAP

**Reg. No. 4,123,519**

**Registered Apr. 10, 2012**

**Int. Cl.: 28**

**TRADEMARK**

**PRINCIPAL REGISTER**

LAPORTE HOLDING (FRANCE SOCIETÁ IN ACCOMANDITA SEMPLICE (SAS))  
357 ALLÉE DU VAL DE POME  
F-06410 BIOT  
FRANCE

FOR: ARCHERY IMPLEMENTS, NAMELY, ARM GUARDS, ARROW FLETCHING, BOW CASES, NON-TELESCOPIC BOW SIGHTS, AND QUIVERS, IN CLASS 28 (U.S. CLS. 22, 23, 38 AND 50).

NO CLAIM IS MADE TO THE EXCLUSIVE RIGHT TO USE "ARCHERY", APART FROM THE MARK AS SHOWN.

PRIORITY DATE OF 12-18-2009 IS CLAIMED.

OWNER OF INTERNATIONAL REGISTRATION 1054456 DATED 6-8-2010, EXPIRES 6-8-2020.

SER. NO. 79-088,532, FILED 6-8-2010.

ELIZABETH KAJUBI, EXAMINING ATTORNEY



*David J. Kybas*

Director of the United States Patent and Trademark Office

# United States of America

United States Patent and Trademark Office

# PAYWIZARD

**Reg. No. 4,123,520**

**Registered Apr. 10, 2012**

**Int. Cls.: 9, 16 and 36**

**TRADEMARK**

**SERVICE MARK**

**PRINCIPAL REGISTER**

MGT PUBLIC LIMITED COMPANY (UNITED KINGDOM PUBLIC LIMITED COMPANY)  
CLUNY COURT  
JOHN SMITH BUSINESS PARK; KIRKCALDY, FIFE KY2 6QJ  
UNITED KINGDOM

FOR: COMPUTER SOFTWARE FOR PROCESSING ELECTRONIC PAYMENTS AND TRANSFERRING FUNDS TO AND FROM OTHERS; AUTHENTICATION COMPUTER SOFTWARE FOR PROCESSING ELECTRONIC PAYMENTS AND TRANSFERRING FUNDS TO AND FROM OTHERS FOR THE PURCHASE OF DIGITAL CONTENT PROVIDED ACROSS SET-TOP BOXES, CONNECTED TELEVISIONS, MOBILE DEVICES, SMART PHONES, PERSONAL COMPUTERS, AND TABLET COMPUTERS AND GEARED TO DIGITAL CONTENT OWNERS, BROADCASTERS, DISTRIBUTORS, PUBLISHERS, E-RETAILERS, AND ALSO CONSUMERS OF DIGITAL CONTENT THAT MAY BE DOWNLOADED FROM A GLOBAL COMPUTER NETWORK OR RECORDED ON COMPUTER MEDIA; AUTHENTICATION COMPUTER SOFTWARE FOR PROCESSING ELECTRONIC PAYMENTS AND TRANSFERRING FUNDS TO AND FROM OTHERS FOR THE PURCHASE OF DIGITAL CONTENT PROVIDED ACROSS SET-TOP BOXES, CONNECTED TELEVISIONS, MOBILE DEVICES, SMART PHONES, PERSONAL COMPUTERS, AND TABLET COMPUTERS AND GEARED TO DIGITAL CONTENT OWNERS, BROADCASTERS, DISTRIBUTORS, PUBLISHERS, E-RETAILERS, AND ALSO CONSUMERS OF DIGITAL CONTENT, IN CLASS 9 (U.S. CLS. 21, 23, 26, 36 AND 38).



*David J. Kyjars*

Director of the United States Patent and Trademark Office

FOR: PRINTED MATTER, NAMELY, INSTRUCTION MANUALS AND LITERATURE, NAMELY, BOOKS, BROCHURES AND MANUALS RELATING TO COMPUTER SOFTWARE FOR PROCESSING ELECTRONIC PAYMENTS AND TRANSFERRING FUNDS TO AND FROM OTHERS FOR THE PURCHASE OF DIGITAL CONTENT PROVIDED ACROSS SET-TOP BOXES, CONNECTED TELEVISIONS, MOBILE DEVICES, SMART PHONES, PERSONAL COMPUTERS, AND TABLET COMPUTERS AND GEARED TO DIGITAL CONTENT OWNERS, BROADCASTERS, DISTRIBUTORS, PUBLISHERS, E-RETAILERS, AND ALSO CONSUMERS OF DIGITAL CONTENT; PRINTED INSTRUCTION MANUALS AND LITERATURE, NAMELY, BOOKS, BROCHURES AND MANUALS RELATING TO AUTHENTICATION SOFTWARE FOR THE PURCHASE OF DIGITAL CONTENT PROVIDED ACROSS SET-TOP BOXES, CONNECTED TELEVISIONS, MOBILE DEVICES, SMART PHONES, PERSONAL COMPUTERS, AND TABLET COMPUTERS AND GEARED TO DIGITAL CONTENT OWNERS, BROADCASTERS, DISTRIBUTORS, PUBLISHERS, E-RETAILERS, AND ALSO CONSUMERS OF DIGITAL CONTENT THAT MAY BE DOWNLOADED FROM A GLOBAL COMPUTER NETWORK AND/OR RECORDED ON COMPUTER MEDIA AND INSTRUCTION

**Reg. No. 4,123,520** MANUALS; PRINTED LITERATURE, NAMELY, BOOKS, BROCHURES AND MANUALS RELATING TO AUTHENTICATION SOFTWARE FOR THE PURCHASE OF DIGITAL CONTENT PROVIDED ACROSS SET-TOP BOXES, CONNECTED TELEVISIONS, MOBILE DEVICES, SMART PHONES, PERSONAL COMPUTERS, AND TABLET COMPUTERS AND GEARED TO DIGITAL CONTENT OWNERS, BROADCASTERS, DISTRIBUTORS, PUBLISHERS, E-RETAILERS, AND ALSO CONSUMERS OF DIGITAL CONTENT; PRINTED MATTER, NAMELY, BOOKS, MANUALS AND BROCHURES RELATING TO FINANCIAL SERVICES ENABLING TRANSFER OF FUNDS AND PURCHASE OF PRODUCTS AND SERVICES, NAMELY THE PURCHASE OF DIGITAL CONTENT PROVIDED ACROSS SET-TOP BOXES, CONNECTED TELEVISIONS, MOBILE DEVICES, PERSONAL COMPUTERS, AND TABLET COMPUTERS AND GEARED TO DIGITAL CONTENT OWNERS, BROADCASTERS, DISTRIBUTORS, PUBLISHERS, E-RETAILERS, AND ALSO CONSUMERS OF DIGITAL CONTENT AND RELATING TO CLEARING AND RECONCILING FINANCIAL TRANSACTIONS FOR THE PURCHASE OF DIGITAL CONTENT PROVIDED ACROSS SET-TOP BOXES, CONNECTED TELEVISIONS, MOBILE DEVICES, SMART PHONES, PERSONAL COMPUTERS, AND TABLET COMPUTERS AND GEARED TO DIGITAL CONTENT OWNERS, BROADCASTERS, DISTRIBUTORS, PUBLISHERS, E-RETAILERS, AND ALSO CONSUMERS OF DIGITAL CONTENT, IN CLASS 16 (U.S. CLS. 2, 5, 22, 23, 29, 37, 38 AND 50).

FOR: FINANCIAL SERVICES, NAMELY, MONETARY TRANSFER AND TRANSACTION SERVICES ENABLING ELECTRONIC TRANSFERS OF FUNDS FOR THE PURCHASE OF DIGITAL CONTENT PROVIDED ACROSS SET-TOP BOXES, CONNECTED TELEVISIONS, MOBILE DEVICES, SMART PHONES, PERSONAL COMPUTERS, AND TABLET COMPUTERS AND GEARED TO DIGITAL CONTENT OWNERS, BROADCASTERS, DISTRIBUTORS, PUBLISHERS, E-RETAILERS, AND ALSO CONSUMERS OF DIGITAL CONTENT, ALL VIA ELECTRONIC COMMUNICATION NETWORKS; CLEARING AND RECONCILING FINANCIAL TRANSACTIONS VIA ELECTRONIC COMMUNICATION NETWORKS FOR THE PURCHASE OF DIGITAL CONTENT PROVIDED ACROSS SET-TOP BOXES, CONNECTED TELEVISIONS, MOBILE DEVICES, SMART PHONES, PERSONAL COMPUTERS, AND TABLET COMPUTERS AND GEARED TO DIGITAL CONTENT OWNERS, BROADCASTERS, DISTRIBUTORS, PUBLISHERS, E-RETAILERS, AND ALSO CONSUMERS OF DIGITAL CONTENT, IN CLASS 36 (U.S. CLS. 100, 101 AND 102).

THE MARK CONSISTS OF STANDARD CHARACTERS WITHOUT CLAIM TO ANY PARTICULAR FONT, STYLE, SIZE, OR COLOR.

PRIORITY DATE OF 3-23-2010 IS CLAIMED.

OWNER OF INTERNATIONAL REGISTRATION 1055178 DATED 9-7-2010, EXPIRES 9-7-2020.

SER. NO. 79-088,819, FILED 9-7-2010.

BERNICE MIDDLETON, EXAMINING ATTORNEY

# United States of America

United States Patent and Trademark Office

# SARTORIAL

**Reg. No. 4,123,521**

**Registered Apr. 10, 2012**

**Int. Cl.: 3**

**TRADEMARK**

**PRINCIPAL REGISTER**

PENHALIGON'S LIMITED (UNITED KINGDOM LIMITED COMPANY)  
DRAGON HOUSE,  
37-39 ARTILLERY LANE; LONDON E1 7LP  
UNITED KINGDOM

FOR: BATH SOAPS; PERFUMERY, ESSENTIAL OILS, COSMETICS, HAIR LOTIONS; SHAMPOOS; NON-MEDICATED TOILETRIES; BODY LOTIONS; BODY CREAMS; SHOWER GELS; BATH OILS; BATH LOTIONS; NON-MEDICATED BATH PREPARATIONS; SHAVING GELS; AFTERSHAVE PREPARATIONS; SCENTED OILS; ROOM FRAGRANCES; ROOM PERFUME SPRAYS; ROOM SCENTING SPRAYS, IN CLASS 3 (U.S. CLS. 1, 4, 6, 50, 51 AND 52).

THE MARK CONSISTS OF STANDARD CHARACTERS WITHOUT CLAIM TO ANY PARTICULAR FONT, STYLE, SIZE, OR COLOR.

PRIORITY DATE OF 3-31-2010 IS CLAIMED.

OWNER OF INTERNATIONAL REGISTRATION 1055249 DATED 8-11-2010, EXPIRES 8-11-2020.

SER. NO. 79-088,839, FILED 8-11-2010.

ANDREW RHIM, EXAMINING ATTORNEY



*David J. Kyffers*

Director of the United States Patent and Trademark Office

# United States of America

United States Patent and Trademark Office

# HONEYCOMB

**Reg. No. 4,123,522**

**Registered Apr. 10, 2012**

**Int. Cl.: 11**

**TRADEMARK**

**PRINCIPAL REGISTER**

NEOPERL INTERNATIONAL AG (SWITZERLAND AKTIENGESELLSCHAFT)  
PFEFFINGERSTRASSE 21  
CH-4153 REINACH  
SWITZERLAND

FOR: SANITARY OUTLET DEVICES, NAMELY, FAUCET AERATORS AND ANTI-SPLASH TAP NOZZLES; SANITARY FITTINGS, NAMELY, PLUMBING FITTINGS, NAMELY, AERATORS FOR FAUCETS, SPOUTS AND TAPS; COMPONENTS AND SPARE PARTS FOR THE AFORESAID GOODS, NAMELY, FAUCETS, FLOW RATE REGULATORS AND FLOW RESTRICTORS FOR SANITARY WATER SUPPLY APPARATUS; FAUCET STREAM STRAIGHTENER FOR SANITARY APPARATUS WITH AND WITHOUT AERATION, NAMELY, AERATORS AND ANTI-SPLASH TAP NOZZLES; FAUCET STREAM STRAIGHTENER FOR SANITARY APPARATUS, NAMELY, AERATORS AND ANTI-SPLASH TAP NOZZLES WITH INTEGRATED CONNECTED FLOW REGULATOR, IN CLASS 11 (U.S. CLS. 13, 21, 23, 31 AND 34).

THE MARK CONSISTS OF THE WORDING "HONEYCOMB" WITH THE "O" IN "HONEY" IN THE SHAPE OF A "HONEYCOMB" CELL.

PRIORITY DATE OF 2-27-2010 IS CLAIMED.

OWNER OF INTERNATIONAL REGISTRATION 1055699 DATED 8-5-2010, EXPIRES 8-5-2020.

SER. NO. 79-088,996, FILED 8-5-2010.

AMY HELLA, EXAMINING ATTORNEY



*David J. Kybas*

Director of the United States Patent and Trademark Office

United States of America  
United States Patent and Trademark Office

**SWEEPIR**

**Reg. No. 4,123,523**

THALES OPTRONICS LIMITED (UNITED KINGDOM COMPANY)  
1 LINTHOUSE ROAD  
GLASGOW G51 4BZ, UNITED KINGDOM

**Registered Apr. 10, 2012**

**Int. Cl.: 9**

FOR: A COMPUTER AND OPTICAL SENSOR SYSTEM USED TO ACQUIRE, COLLECT, TRANSMIT AND DISPLAY DATA AND IMAGERY FROM ULTRAVIOLET LIGHT, VISIBLE LIGHT, ELECTROMAGNETIC, AND INFRARED SENSORS, NAMELY, COMPUTER, HARDWARE, COMPUTER SOFTWARE AND SENSORS, IN CLASS 9 (U.S. CLS. 21, 23, 26, 36 AND 38).

**TRADEMARK**

**PRINCIPAL REGISTER**

THE MARK CONSISTS OF STANDARD CHARACTERS WITHOUT CLAIM TO ANY PARTICULAR FONT, STYLE, SIZE, OR COLOR.

PRIORITY DATE OF 6-8-2010 IS CLAIMED.

OWNER OF INTERNATIONAL REGISTRATION 1055959 DATED 9-29-2010, EXPIRES 9-29-2020.

SER. NO. 79-089,068, FILED 9-29-2010.

FLORENTINA BLANDU, EXAMINING ATTORNEY



*David J. Kyffers*

Director of the United States Patent and Trademark Office



# United States of America

United States Patent and Trademark Office

# OXATIS

**Reg. No. 4,123,524**

**Registered Apr. 10, 2012**

**Int. Cls.: 9, 35, 36, 38, 41  
and 42**

**TRADEMARK**

**SERVICE MARK**

**PRINCIPAL REGISTER**

OXATIS (FRANCE SOCIÉTÉ ANONYME À DIRECTOIRE ET CONSEIL DE SURVEILLANCE)  
18 RUE DE LA BUTINEUSE  
F-13015 MARSEILLE  
FRANCE

FOR: COMPUTER SOFTWARE FOR MANAGING ORDERS; COMPUTER SPREADSHEET AND DATABASE MANAGEMENT SOFTWARE FOR USE IN BUSINESS ANALYSIS AND DIAGNOSTICS; TRANSACTION SYSTEM SOFTWARE, NAMELY, COMPUTER E-COMMERCE SOFTWARE TO ALLOW USERS TO PERFORM ELECTRONIC BUSINESS TRANSACTIONS VIA A GLOBAL COMPUTER NETWORK; BANKING SOFTWARE, NAMELY, COMPUTER COMMUNICATIONS SOFTWARE TO ALLOW CUSTOMERS TO ACCESS BANK ACCOUNT INFORMATION AND TRANSACT BANK BUSINESS; AND FINANCIAL SOFTWARE, NAMELY, ELECTRONIC FINANCIAL PLATFORM THAT ACCOMMODATES MULTIPLE TYPES OF PAYMENT AND DEBT TRANSACTIONS IN AN INTEGRATED MOBILE PHONE, PDA, AND WEB-BASED ENVIRONMENT; SOFTWARE FOR MONITORING, CONTROLLING, MANAGING AND TRANSMITTING PAYMENT AUTHORIZATION REQUESTS MADE TO BANKS; DRIVER SOFTWARE, NAMELY, OPERATING SYSTEM PROGRAMS; SOFTWARE FOR MANAGING STOCK PORTFOLIOS; TOOLS IN THE NATURE OF COMPUTER SPREADSHEET SOFTWARE FOR CALCULATING MARKET PROFITABILITY, IN CLASS 9 (U.S. CLS. 21, 23, 26, 36 AND 38).

FOR: ASSISTANCE TO COMMERCIAL ENTERPRISES IN BUSINESS MANAGEMENT; BUSINESS DATA ANALYSIS SERVICES FOR SALES AND CONSULTING RELATED THERETO; MARKETING STUDIES AND RESEARCH; BUSINESS ASSISTANCE IN MANAGING AND FOLLOWING UP ORDERS; STOCK MANAGEMENT, NAMELY, OFFICE FUNCTIONS IN THE NATURE OF MAINTAINING RECORDS OF OWNERSHIP OF STOCKS; DATA PROCESSING SERVICES, NAMELY, INPUT, GATHERING, SORTING, SYSTEMATIZING AND MANAGING OF DATA; COMPUTERIZED FILE MANAGEMENT; CONDUCTING BUSINESS RESEARCH IN THE NATURE OF DATA SEARCH IN COMPUTER FILES; BUSINESS DATA ANALYSES AND PROVIDING STATISTICAL EVALUATIONS OF COMPUTER MARKETING DATA; PROVIDING STATISTICAL INFORMATION, BUSINESS RESEARCH RELATED TO STATISTICS, COMPILATION OF STATISTICS; STATISTICAL STUDIES IN THE NATURE OF DEMOGRAPHIC AND MARKET RESEARCH STUDIES; INFORMATION, RESEARCH, COMPILATION AND STUDY OF MARKET PROFITABILITY; RESEARCH AND CONSULTANCY SERVICES REGARDING THE IMPACT OF ADVERTISING; ADVERTISING; CONSULTING FOR ADVERTISING PURPOSES CONCERNING THE OPTIMIZATION OF THE VISIBILITY OF INTERNET WEBSITES; RENTAL OF ADVERTISING

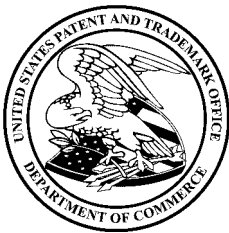

*David J. Kyros*

Director of the United States Patent and Trademark Office

**Reg. No. 4,123,524** SPACE; CONSULTING SERVICES IN THE FIELD OF INTERNET MARKETING; OPERATING ELECTRONIC DATABASES, NAMELY, MANAGEMENT OF ELECTRONIC DATABASES; PROVIDING AN ONLINE COMPUTER DATABASE FEATURING TRADE INFORMATION IN THE FIELD OF ONLINE BUSINESS; MANAGEMENT OF DATABASES CONTAINING DOMAIN NAMES, IN CLASS 35 (U.S. CLS. 100, 101 AND 102).

FOR: SECURE PAYMENT PROCESSING SERVICES FOR REMOTE PURCHASING USING BANK CARDS, OVER THE TELEPHONE OR INTERNET CONNECTIONS; FINANCIAL AND MONETARY OPERATIONS VIA ELECTRONIC DIGITAL MEANS, NAMELY, ELECTRONIC FINANCIAL TRADING SERVICES; ELECTRONIC FUNDS TRANSFER AND FOREIGN EXCHANGE TRANSACTIONS, IN CLASS 36 (U.S. CLS. 100, 101 AND 102).

FOR: TELECOMMUNICATIONS CONSULTATION; PROVIDING ACCESS TO THE INTERNET; MESSAGE COLLECTION AND TRANSMISSION; ELECTRONIC STORE AND FORWARD MESSAGING; PROVIDING INSTANT MESSAGING SERVICES; TRANSMISSION OF ELECTRONIC INFORMATION, MESSAGES AND DATA; ELECTRONIC MAIL; SECURE ELECTRONIC MAIL SERVICES; TRANSMISSION AND DISTRIBUTION OF DATA IN THE NATURE OF ADDRESS LISTS AND ELECTRONIC TELEPHONE DIRECTORIES VIA A GLOBAL COMPUTER NETWORK OR THE INTERNET; PROVIDING ACCESS FOR USERS TO DATABASES ON THE INTERNET; PROVIDING ACCESS FOR USERS TO E-COMMERCE DATABASES ON THE INTERNET; PROVIDING ACCESS FOR MULTIPLE USERS TO A SECURE INFORMATION NETWORK; TECHNICAL CONSULTING AND ADVICE IN THE FIELD OF TELECOMMUNICATIONS, IN CLASS 38 (U.S. CLS. 100, 101 AND 104).

FOR: PROVIDING OF TRAINING IN THE USE OF COMPUTER SOFTWARE IN THE FIELD OF E-COMMERCE, PROVIDING OF TRAINING IN THE FIELD OF MANAGEMENT, E-COMMERCE AND MARKETING, IN CLASS 41 (U.S. CLS. 100, 101 AND 107).

FOR: DESIGN AND DEVELOPMENT OF COMPUTER SYSTEMS; DESIGN AND DEVELOPMENT OF HIGH BANDWIDTH WIRELESS COMMUNICATION SYSTEMS FOR TRANSMISSION OF VOICE, DATA AND VIDEO; TECHNICAL CONSULTING AND ADVICE IN THE FIELD OF COMPUTING; COMPUTER SECURITY CONSULTANCY; SECURITY SERVICES ONLINE, NAMELY, PROVIDING SECURITY AND ANONYMITY FOR ELECTRONICALLY TRANSMITTED CREDIT CARD TRANSACTIONS VIA ELECTRONIC MEANS; CONSULTANCY RELATING TO CHOICE AND IMPLEMENTATION OF TELECOMMUNICATIONS TECHNOLOGY AND COMPUTER HARDWARE; INTERNET SITE DESIGN; CREATING, IMPLEMENTING, MAINTAINING AND RENTAL OF COMPUTER PROGRAMS; WEB SITE HOSTING SERVICES; DEVELOPMENT AND INTEGRATION OF COMPUTER SYSTEMS TO SUPPORT ISSUANCE AND MANAGEMENT OF DIGITAL CERTIFICATES, IN CLASS 42 (U.S. CLS. 100 AND 101).

THE MARK CONSISTS OF STANDARD CHARACTERS WITHOUT CLAIM TO ANY PARTICULAR FONT, STYLE, SIZE, OR COLOR.

PRIORITY DATE OF 12-11-2009 IS CLAIMED.

OWNER OF INTERNATIONAL REGISTRATION 1056679 DATED 6-2-2010, EXPIRES 6-2-2020.

THE WORDING "OXATIS" HAS NO MEANING IN A FOREIGN LANGUAGE.

SER. NO. 79-089,343, FILED 6-2-2010.

NELSON SNYDER, EXAMINING ATTORNEY

# United States of America

United States Patent and Trademark Office

# ACURATE TA

**Reg. No. 4,123,525**

**Registered Apr. 10, 2012**

**Int. Cls.: 5, 10, 42 and 44**

**TRADEMARK**

**SERVICE MARK**

**PRINCIPAL REGISTER**

SYMETIS SA (SWITZERLAND SOCIÉTÉ ANONYME (SA))  
AVENUE DU TEMPLE 19  
CH-1012 LAUSANNE  
SWITZERLAND

FOR: SURGICAL IMPLANTS COMPRISING LIVING TISSUE, IN CLASS 5 (U.S. CLS. 6, 18, 44, 46, 51 AND 52).

FOR: SURGICAL IMPLANTS COMPRISING ARTIFICIAL MATERIALS, IN PARTICULAR ARTIFICIAL TISSUE FOR SURGICAL PURPOSES, ARTIFICIAL HEART VALVES FOR SURGICAL PURPOSES, IN CLASS 10 (U.S. CLS. 26, 39 AND 44).

FOR: RESEARCH AND DEVELOPMENT FOR MEDICAL PRODUCTS FOR OTHERS, IN CLASS 42 (U.S. CLS. 100 AND 101).

FOR: MEDICAL SERVICES, IN CLASS 44 (U.S. CLS. 100 AND 101).

THE MARK CONSISTS OF STANDARD CHARACTERS WITHOUT CLAIM TO ANY PARTICULAR FONT, STYLE, SIZE, OR COLOR.

PRIORITY DATE OF 5-4-2010 IS CLAIMED.

OWNER OF INTERNATIONAL REGISTRATION 1056826 DATED 10-29-2010, EXPIRES 10-29-2020.

NO CLAIM IS MADE TO THE EXCLUSIVE RIGHT TO USE "TA", APART FROM THE MARK AS SHOWN.

THE WORDING "ACURATE TA" HAS NO MEANING IN A FOREIGN LANGUAGE.

SER. NO. 79-089,403, FILED 10-29-2010.

MYRIAH HABEEB, EXAMINING ATTORNEY



*David J. Kyfos*

Director of the United States Patent and Trademark Office

# United States of America

United States Patent and Trademark Office

# BILLERUD

**Reg. No. 4,123,526**

**Registered Apr. 10, 2012**

**Int. Cls.: 1, 16, 21, 35  
and 42**

**TRADEMARK**

**SERVICE MARK**

**PRINCIPAL REGISTER**

BILLERUD AB (SWEDEN LIMITED LIABILITY COMPANY)  
P.O. BOX 703  
SE-169 27 SOLNA  
SWEDEN

FOR: WOOD PULP, PAPER PULP, PAPER PULP FOR PRODUCTION OF TISSUE PRODUCTS, FINE PAPERS, PACKAGING PAPERS AND BOARDS, AND MAGAZINE PAPERS, IN CLASS 1 (U.S. CLS. 1, 5, 6, 10, 26 AND 46).

FOR: PAPER AND CARDBOARD, NEWSPRINT PAPER, MAGAZINE PAPERS, PRINTING PAPER, WRITING PAPER, KRAFT PAPERS, CORRUGATED PAPERS AND BOARDS, LAMINATED PAPERS, PAPER FOR MAKING BAGS AND SACKS, WRAPPING PAPER, FLUTED PAPER, PACKAGING PAPER, PACKAGING BOARD, PAPERBOARD AND CARDBOARD, CONTAINER BOARD, PAPER COMPRISED OF A COMBINATION OF VIRGIN PAPER FIBRE AND A BARRIER COATING TO HOLD LIQUIDS FOR HOUSEHOLD USE, MEDICAL PACKAGING PAPER AND BOARD, PAPER AND BOARD BOXES AND BAGS AND/OR IN COMBINATION WITH PLASTIC OR FOILS, COREBOARD AND CORES, TISSUE PAPER, TISSUE PAPER PRODUCTS, NAMELY, FACIAL TISSUE, PAPER TOWELS, WRAPPING TISSUE, BATHROOM TISSUE, TOILET TISSUE, HOUSEHOLD TISSUE AND TABLE NAPKINS, FINE PAPER, NAMELY, WRITING AND DRAWING PAPER, COPYING PAPER, OFFSET PAPER, CONTINUOUS STATIONERY PAPER, LABEL PAPER, ENVELOPE PAPERS, PAPERS FOR USE IN THE GRAPHIC ARTS INDUSTRY, PAPER FOR USE IN THE MANUFACTURE OF WALL PAPER; PACKING CARDBOARD AND PACKING PAPER, PAPER BOXES, PAPER AND CARDBOARD BOXES COMBINED WITH POLYETHYLENE, NAMELY, FROZEN AND CHILD FOOD BOXES; COLLAPSIBLE CARDBOARD, BOARD AND PAPER BAGS FOR PACKAGING; CORRUGATED AND PAPER CONTAINERS; COLLAPSIBLE BOXES OF PAPER; GLUED LAMINATED BOARD; TWIN SIDE COATED BOARD AND UNCOATED BOARD FOR DISPLAYS; CORRUGATED CARDBOARD COMBINED WITH AN INNER PROTECTIVE PACKAGING OF PLASTIC IN THE FORM OF FOILS AND/OR BUBBLE PACK AND/OR FOAM SHAPED PIECES FOR PACKAGING; BAGS FOR TRANSPORTATION, COLLAPSIBLE CONTAINERS OF PAPER, CARDBOARD, CORRUGATED CARDBOARD AND/OR COMBINATIONS THEREOF AND/OR COMBINED WITH PLASTIC MATERIAL, COLLAPSIBLE BOXES OF PAPER, CARDBOARD, CORRUGATED CARDBOARD AND/OR COMBINATIONS THEREOF AND/OR COMBINED WITH PLASTIC MATERIAL, IN CLASS 16 (U.S. CLS. 2, 5, 22, 23, 29, 37, 38 AND 50).



*David J. Kappas*

Director of the United States Patent and Trademark Office

**Reg. No. 4,123,526** FOR: HOUSEHOLD OR KITCHEN CONTAINERS; BOWLS, CUPS, MUGS, CUP HOLDERS, PLATES AND DISHES OF PAPER, CARDBOARD OR PLASTIC, IN CLASS 21 (U.S. CLS. 2, 13, 23, 29, 30, 33, 40 AND 50).

FOR: ADVERTISING; MARKETING; WHOLESALE ACTIVITIES, NAMELY, AS RELATED TO WOOD PULP, PACKAGING PAPER AND BOARD, AND/OR IN COMBINATION WITH PLASTIC MATERIALS; ADVERTISING AND MARKETING ON-LINE; ON-LINE CUSTOMER INFORMATION; ONLINE RETAIL STORES, NAMELY, AS RELATED TO WOOD PULP, PACKAGING PAPER AND BOARD, AND/OR IN COMBINATION WITH PLASTIC MATERIALS; SEARCHING FOR DATA BY CUSTOMERS IN DATA BASES; DEMONSTRATION OF GOODS ON INTERNET; SPECIFICATION AND DEMONSTRATION OF GOODS WITH THE PURPOSE TO ENABLE CUSTOMERS TO BUY GOODS ON INTERNET; COMPUTERIZED MANAGEMENT OF DATA BASES, IN CLASS 35 (U.S. CLS. 100, 101 AND 102).

FOR: ENGINEERING SERVICES AND TECHNICAL ADVICE RELATING TO PULP, PAPER AND BOARD PRODUCTION, DEVELOPMENT AND RESEARCH OF NEW PRODUCTS, COMPUTER PROGRAMMING, MAINTENANCE AND UPDATING OF DATABASES AND COMPUTER SOFTWARE, PACKAGING DESIGN SERVICES, SCIENTIFIC AND INDUSTRIAL RESEARCH IN THE FIELD OF PULP, PAPER AND BOARD PRODUCTION, IN CLASS 42 (U.S. CLS. 100 AND 101).

THE MARK CONSISTS OF STANDARD CHARACTERS WITHOUT CLAIM TO ANY PARTICULAR FONT, STYLE, SIZE, OR COLOR.

PRIORITY DATE OF 12-18-2009 IS CLAIMED.

OWNER OF INTERNATIONAL REGISTRATION 1056886 DATED 4-21-2010, EXPIRES 4-21-2020.

THE WORDING "BILLERUD" HAS NO MEANING IN A FOREIGN LANGUAGE.

SER. NO. 79-089,452, FILED 4-21-2010.

PAUL F. GAST, EXAMINING ATTORNEY

# United States of America

United States Patent and Trademark Office

# DORMAK

**Reg. No. 4,123,527**

**Registered Apr. 10, 2012**

**Int. Cls.: 7 and 12**

**TRADEMARK**

**PRINCIPAL REGISTER**

DORMAK, LDA. (PORTUGAL LIMITED COMPANY)  
LOTE 97/98, ZONA INDUSTRIAL  
P-3840-385 VAGOS  
PORTUGAL

FOR: AGRICULTURAL MACHINES, NAMELY, HIGH GRASS MOWERS; AGRICULTURAL MACHINES, NAMELY, AERATORS; AGRICULTURAL MACHINES, NAMELY, SHREDDERS; LAWNMOWERS; POWER OPERATED CULTIVATORS; POWER OPERATED GARDEN TILLERS, IN CLASS 7 (U.S. CLS. 13, 19, 21, 23, 31, 34 AND 35).

FOR: ELECTRICAL VEHICLES, NAMELY, MOTORCYCLES; ELECTRICAL VEHICLES, NAMELY, MOTORIZED GOLF CART VEHICLES FOR GOLF COURSES; ELECTRICAL VEHICLES, NAMELY, LOW-SPEED ELECTRIC VEHICLES, IN CLASS 12 (U.S. CLS. 19, 21, 23, 31, 35 AND 44).

THE MARK CONSISTS OF STANDARD CHARACTERS WITHOUT CLAIM TO ANY PARTICULAR FONT, STYLE, SIZE, OR COLOR.

OWNER OF INTERNATIONAL REGISTRATION 1056929 DATED 9-20-2010, EXPIRES 9-20-2020.

SER. NO. 79-089,469, FILED 9-20-2010.

SIMON TENG, EXAMINING ATTORNEY



*David J. Kyffers*

Director of the United States Patent and Trademark Office

# United States of America

United States Patent and Trademark Office

# ANGEL

**Reg. No. 4,123,528**

EMI (IP) LIMITED (UNITED KINGDOM CORPORATION)  
27 WRIGHTS LANE

**Registered Apr. 10, 2012**

LONDON, UNITED KINGDOM W8 5SW

**Int. Cls.: 9, 35, 41 and 45**

FOR: APPARATUS AND INSTRUMENTS FOR RECORDING, REPRODUCING AND/OR TRANSMITTING SOUND AND/OR VISUAL INFORMATION OR RECORDINGS; SOUND AND/OR VISUAL RECORDINGS FEATURING MUSIC AND MUSICAL ENTERTAINMENT; ENHANCED SOUND AND/OR VISUAL RECORDINGS FEATURING MUSIC AND MUSICAL ENTERTAINMENT; INTERACTIVE SOUND AND/OR VISUAL RECORDINGS FEATURING MUSIC AND MUSICAL ENTERTAINMENT; SOUND AND/OR VISUAL RECORDING MEDIA, NAMELY, UNRECORDED COMPACT DISCS, TAPES AND CASSETTES; VIDEO GAMES SOFTWARE; COMPUTER SOFTWARE AND HARDWARE FOR MUSIC RECORDING, MIXING, PRODUCING, SAMPLING, MASTERING, ARRANGING AND SEQUENCING; DOWNLOADABLE PUBLICATIONS, NAMELY, MAGAZINES AND NEWSLETTERS IN THE FIELD OF MUSIC AND MUSICAL ENTERTAINMENT PROVIDED ON-LINE FROM DATABASES, FROM THE INTERNET OR FROM ANY OTHER COMMUNICATIONS NETWORK INCLUDING WIRELESS, CABLE OR SATELLITE; COMPACT DISCS FEATURING MUSIC AND MUSICAL ENTERTAINMENT; SUPER AUDIO COMPACT DISCS FEATURING MUSIC AND MUSICAL ENTERTAINMENT; DVDS FEATURING MUSIC AND MUSICAL ENTERTAINMENT; DOWNLOADABLE DIGITAL MUSIC; MP3 PLAYERS; PERSONAL DIGITAL ASSISTANTS AND ELECTRONIC HANDHELD UNITS FOR THE WIRELESS RECEIPT AND/OR TRANSMISSION OF SOUND; DOWNLOADABLE DIGITAL MUSIC FROM THE INTERNET; HAND-HELD ELECTRONIC GAMES ADAPTED FOR USE WITH TELEVISION RECEIVERS ONLY; ELECTRONIC GAME SOFTWARE DESIGNED FOR USE WITH TELEPHONES, CELLULAR TELEPHONES; CD-ROM GAMES IN THE NATURE OF COMPUTER GAME SOFTWARE; DOWNLOADABLE TELEPHONE RING TONES; ALL OF THE FOREGOING NOT RELATING TO SPORTS, SPORTS TEAMS, OR SPORTS ENTERTAINMENT, IN CLASS 9 (U.S. CLS. 21, 23, 26, 36 AND 38).

**TRADEMARK**

**SERVICE MARK**

**PRINCIPAL REGISTER**



*David J. Kyros*

Director of the United States Patent and Trademark Office

FOR: ADVISORY SERVICES FOR BUSINESS MANAGEMENT; BUSINESS MANAGEMENT OF PERFORMING ARTISTS; BUSINESS ADMINISTRATION SERVICES FOR THE PROCESSING OF SALES MADE ON THE INTERNET; NEGOTIATION OF COMMERCIAL TRANSACTIONS FOR PERFORMING ARTISTS; TALENT CASTING SERVICES IN THE NATURE OF AUDITIONING OF PERFORMING ARTISTS; ADVERTISING AND PUBLICITY SERVICES; PROMOTION AND ADVERTISING SERVICES AND CONSULTANCY RELATED THERETO IN THE FIELD OF SOUND AND/OR VISUAL ENTERTAINMENT; RETAIL STORE SERVICES AND ONLINE RETAIL STORE SERVICES RELATING TO APPARATUS AND

**Reg. No. 4,123,528** INSTRUMENTS FOR RECORDING, REPRODUCING AND/OR TRANSMITTING SOUND AND/OR VISUAL INFORMATION OR RECORDINGS, SOUND AND/OR VISUAL RECORDINGS, ENHANCED SOUND AND/OR VISUAL RECORDINGS, INTERACTIVE SOUND AND/OR VISUAL RECORDINGS, SOUND AND/OR VISUAL RECORDING MEDIA, VIDEO GAMES, DOWNLOADABLE PUBLICATIONS, COMPACT DISCS, SUPER AUDIO COMPACT DISCS, DVDS, DOWNLOADABLE DIGITAL MUSIC, MP3 PLAYERS, ELECTRONIC GAMES, CD-ROM GAMES, TELEPHONE RING TONES, PERSONAL DIGITAL ASSISTANTS AND ELECTRONIC HANDHELD UNITS FOR THE WIRELESS RECEIPT AND/OR TRANSMISSION OF SOUND, CABLES, PRINTED MATTER, PRINTED PUBLICATIONS, BOOKS, MAGAZINES, BROCHURES, SHEET MUSIC, PAPER ARTICLES, TICKETS, LABELS, CARDS, GREETING CARDS, PHOTOGRAPHS, POSTERS, STATIONERY, STICKERS, GIFT VOUCHERS, CLOTHING, FOOTWEAR AND HEADGEAR, MUSICAL INSTRUMENTS; TALENT AGENCY SERVICES; INFORMATION AND ADVISORY SERVICES RELATING TO THE AFORESAID SERVICES; INFORMATION AND ADVISORY SERVICES RELATING TO THE AFORESAID SERVICES PROVIDED ON-LINE FROM A COMPUTER DATABASE OR THE INTERNET; INFORMATION AND ADVISORY SERVICES RELATING TO THE AFORESAID SERVICES PROVIDED OVER A TELECOMMUNICATIONS NETWORK; ALL OF THE FOREGOING NOT RELATING TO SPORTS, SPORTS TEAMS, OR SPORTS ENTERTAINMENT, IN CLASS 35 (U.S. CLS. 100, 101 AND 102).

FOR: MUSIC PUBLISHING SERVICES; RECORDING STUDIO SERVICES; INFORMATION SERVICES RELATING TO MUSIC, ENTERTAINMENT, GAMES AND ENTERTAINMENT-RELATED EVENTS PROVIDED ON-LINE FROM A COMPUTER DATABASE, FROM THE INTERNET OR ANY OTHER COMMUNICATIONS NETWORK INCLUDING WIRELESS, CABLE OR SATELLITE; PROVIDING NON-DOWNLOADABLE PLAYBACK OF MUSIC VIA THE INTERNET; PROVISION OF PLAYBACK OF NON-DOWNLOADABLE DIGITAL MUSIC FROM MP3 WEBSITES; PRODUCTION OF LIVE ENTERTAINMENT FEATURES; ORGANISATION, PRODUCTION AND PRESENTATION OF QUIZ SHOWS, ENTERTAINMENT-RELATED EXHIBITIONS, SPORTING EVENTS, ENTERTAINMENT-RELATED SHOWS AND ROAD SHOWS, ENTERTAINMENT-RELATED STAGED EVENTS, THEATRICAL PERFORMANCES, CONCERTS, ENTERTAINMENT RELATED LIVE PERFORMANCES AND AUDIENCE PARTICIPATION EVENTS; PROVISION OF ON-LINE NON-DOWNLOADABLE ELECTRONIC PUBLICATIONS, NAMELY, MAGAZINES AND NEWSLETTERS IN THE FIELD OF MUSIC AND MUSICAL ENTERTAINMENT; DIGITAL IMAGING SERVICES; EDITING SERVICES RELATING TO AUDIO AND AUDIO VISUAL RECORDINGS; ELECTRONIC GAME SERVICES, NAMELY, PROVIDING ON-LINE ELECTRONIC GAMES PROVIDED FROM A COMPUTER DATABASE, THE INTERNET OR ANY OTHER COMMUNICATIONS NETWORK INCLUDING WIRELESS, CABLE, SATELLITE; INFORMATION RELATING TO MUSIC AND THE MUSIC INDUSTRY; PROVIDING SUCH ENTERTAINMENT SERVICES OVER A GLOBAL COMPUTER NETWORK; ADVISORY AND CONSULTANCY SERVICES RELATED TO THE AFOREMENTIONED SERVICES; ALL OF THE FOREGOING NOT RELATING TO SPORTS, SPORTS TEAMS, OR SPORTS ENTERTAINMENT, IN CLASS 41 (U.S. CLS. 100, 101 AND 107).

FOR: ADMINISTRATION, EXPLOITATION AND GRANTING OF RIGHTS FOR PRODUCTION OF MUSICAL AND/OR LYRICAL WORKS; ACQUISITION, MANAGEMENT, PROTECTION AND EXPLOITATION OF COPYRIGHTS IN MUSICAL AND/OR LYRICAL WORKS FOR AND ON BEHALF OF AUTHORS, COMPOSERS, OR CONDUCTORS OF SUCH WORKS; LICENSING OF INTELLECTUAL PROPERTY; INFORMATION RELATING TO THE AFOREMENTIONED SERVICES PROVIDED ON-LINE FROM A COMPUTER DATABASE, FROM THE INTERNET OR ANY OTHER COMMUNICATIONS NETWORK INCLUDING WIRELESS, CABLE OR SATELLITE; ALL OF THE FOREGOING NOT RELATING TO SPORTS, SPORTS TEAMS, OR SPORTS ENTERTAINMENT, IN CLASS 45 (U.S. CLS. 100 AND 101).

THE MARK CONSISTS OF STANDARD CHARACTERS WITHOUT CLAIM TO ANY PARTICULAR FONT, STYLE, SIZE, OR COLOR.



**Reg. No. 4,123,528** PRIORITY DATE OF 7-13-2010 IS CLAIMED.

OWNER OF INTERNATIONAL REGISTRATION 1057035 DATED 8-10-2010, EXPIRES 8-10-2020.

OWNER OF U.S. REG. NOS. 1,193,889, 2,828,844 AND OTHERS.

SER. NO. 79-089,516, FILED 8-10-2010.

TOBY BULLOFF, EXAMINING ATTORNEY

# United States of America

United States Patent and Trademark Office

# SETL

**Reg. No. 4,123,529**

**Registered Apr. 10, 2012**

**Int. Cl.: 9**

**TRADEMARK**

**PRINCIPAL REGISTER**

TIANJIN SETL SURVEY EQUIPMENT CO., LTD. (CHINA COMPANY LIMITED)  
NO. 81 ZHANG GUI ZHUANG ROAD  
DONGLI DISTRICT  
TIANJIN, CHINA

FOR: SURVEYOR'S LEVEL, THEODOLITES, MICROMETERS, LEVELLING RODS, TELEMETERS, ELECTRONIC APPARATUS, NAMELY, MOTION DETECTORS, MEASURING APPARATUS, NAMELY, BEVELS, PLUMB BOBS, OPTICAL APPARATUS AND INSTRUMENTS, NAMELY, OPTICAL PORTS FOR SURVEY INSTRUMENTS, IN CLASS 9 (U.S. CLS. 21, 23, 26, 36 AND 38).

THE MARK CONSISTS OF THE WORD "SETL" IN BLOCK LETTERS.

OWNER OF INTERNATIONAL REGISTRATION 1057445 DATED 11-3-2010, EXPIRES 11-3-2020.

SER. NO. 79-089,683, FILED 11-3-2010.

FRANK LATTUCA, EXAMINING ATTORNEY



*David J. Kyffers*

Director of the United States Patent and Trademark Office

United States of America  
United States Patent and Trademark Office

# Starlounge

**Reg. No. 4,123,530**

**Registered Apr. 10, 2012**

**Int. Cls.: 35, 38 and 41**

**SERVICE MARK**

**PRINCIPAL REGISTER**

STARLOUNGE SVERIGE AB (SWEDEN LIMITED LIABILITY COMPANY)  
RIDDARGATAN 1  
SE-114 35 STOCKHOLM  
SWEDEN

FOR: TELEVISION ADVERTISING AGENCIES; ADVERTISING, IN CLASS 35 (U.S. CLS. 100, 101 AND 102).

FOR: INFORMATION ABOUT TELECOMMUNICATIONS NOT INCLUDING INFORMATION ABOUT MUSIC CONCERTS AND RADIO PROGRAMMING; ELECTRONIC BULLETIN BOARD SERVICES NOT INCLUDING MUSIC CONCERTS AND RADIO PROGRAMMING; TELECOMMUNICATIONS, NAMELY, MOBILE INTERACTIVE SERVICES IN THE NATURE OF COMMUNICATION BY MOBILE TELEPHONE; TELECOMMUNICATIONS CONNECTIONS TO ACCESS DATABASES, IN CLASS 38 (U.S. CLS. 100, 101 AND 104).

FOR: ENTERTAINMENT INFORMATION, NOT INCLUDING INFORMATION ABOUT MUSIC CONCERTS AND RADIO PROGRAMMING; TELEVISION ENTERTAINMENT, NAMELY, ENTERTAINMENT IN THE NATURE OF TELEVISION NEWS SHOWS NOT INCLUDING MUSIC CONCERTS AND RADIO PROGRAMMING; CLUB SERVICES, NAMELY, DANCE CLUB SERVICES AND NIGHT CLUB SERVICES NOT INCLUDING MUSIC CONCERTS AND RADIO PROGRAMMING SERVICES, IN CLASS 41 (U.S. CLS. 100, 101 AND 107).

THE MARK CONSISTS OF STANDARD CHARACTERS WITHOUT CLAIM TO ANY PARTICULAR FONT, STYLE, SIZE, OR COLOR.

OWNER OF INTERNATIONAL REGISTRATION 1057471 DATED 10-1-2010, EXPIRES 10-1-2020.

SER. NO. 79-089,692, FILED 10-1-2010.

CARYN GLASSER, EXAMINING ATTORNEY



*David J. Kyffers*

Director of the United States Patent and Trademark Office

# United States of America

United States Patent and Trademark Office

# J'ADORE

**Reg. No. 4,123,531**

**Registered Apr. 10, 2012**

**Int. Cl.: 35**

**SERVICE MARK**

**PRINCIPAL REGISTER**

BERAT TEKSTIL SANAYI VE TICARET LIMITED SIRKETI (TURKEY LIMITED COMPANY)  
MESRUTIYET MAHALLESİ  
KODAMAN SOKAK NO:66 KAT:1; NISANTASI - SISLI - ISTANBUL  
TURKEY

FOR: ADVERTISING AGENCIES; BUSINESS MANAGEMENT; BUSINESS ADMINISTRATION ASSISTANCE; PROVIDING OFFICE FUNCTIONS, IMPORT AND EXPORT AGENCIES; BUSINESS INVESTIGATIONS, BUSINESS EVALUATIONS, BUSINESS EXPERT APPRAISALS, BUSINESS INFORMATION AND BUSINESS RESEARCH, ALL OF INDUSTRIAL AND COMMERCIAL GOODS; AUCTIONEERING, IN CLASS 35 (U.S. CLS. 100, 101 AND 102).

THE MARK CONSISTS OF THE WORD "J'ADORE" WITH A PARTIAL HEART DESIGN OVER THE "J".

PRIORITY DATE OF 3-9-2010 IS CLAIMED.

OWNER OF INTERNATIONAL REGISTRATION 1057877 DATED 7-2-2010, EXPIRES 7-2-2020.

THE ENGLISH TRANSLATION OF "J'ADORE" IN THE MARK IS "I LOVE".

SER. NO. 79-089,822, FILED 7-2-2010.

FRED CARL, EXAMINING ATTORNEY



*David J. Kyfos*

Director of the United States Patent and Trademark Office

# United States of America

United States Patent and Trademark Office

# SintROC

**Reg. No. 4,123,532**

**Registered Apr. 10, 2012**

**Int. Cls.: 7, 16 and 37**

**TRADEMARK**

**SERVICE MARK**

**PRINCIPAL REGISTER**

MANN+HUMMEL GMBH (FED REP GERMANY LIMITED LIABILITY COMPANY)  
HINDENBURGSTRASSE 45  
71638 LUDWIGSBURG  
FED REP GERMANY

FOR: DIESEL PARTICULATE FILTERS TO CLEAN DIESEL EXHAUST GAS FROM PARTICULATE MATTER WHICH HAS BEEN DEVELOPED IN THE COMBUSTION PROCESS OF A DIESEL ENGINE; DIESEL PARTICULATE FILTER SYSTEMS TO CLEAN DIESEL EXHAUST GAS FROM PARTICULATE MATTER WHICH HAS BEEN DEVELOPED IN THE COMBUSTION PROCESS OF A DIESEL ENGINE, COMPRISING A DIESEL PARTICULATE FILTER TO CLEAN DIESEL EXHAUST GAS FROM PARTICULATE MATTER WHICH HAS BEEN DEVELOPED IN THE COMBUSTION PROCESS OF A DIESEL ENGINE AND A DIESEL ADDITIVE DOSING SYSTEM TO DOSE DIESEL ADDITIVE INTO THE DIESEL FUEL TANK AND COMPRISING A MONITORING DEVICE TO MONITOR AND DISPLAY EXHAUST GAS TEMPERATURE, DIFFERENTIAL PRESSURE BETWEEN INLET AND OUTLET OF THE PARTICULATE FILTER AND ADDITIVE TANK LEVEL; PARTS OF THE AFORESAID GOODS AS SPARE PARTS, NAMELY, INLET CONE, OUTLET CONE, FILTER ELEMENT, FILTER HOUSING, ELECTRONIC CONTROL UNIT, CABLE HARNESS, TEMPERATURE SENSOR, DIFFERENTIAL PRESSURE SENSOR AND DISPLAY, IN CLASS 7 (U.S. CLS. 13, 19, 21, 23, 31, 34 AND 35).

FOR: PRINTED MATTER, IN PARTICULAR PAMPHLETS, PERIODICALS, BROCHURES, PROSPECTUSES, CATALOGUES, OPERATING MANUALS, INSTALLATION GUIDES, USER INSTRUCTIONS AND PRESS KITS, NAMELY, PRE-PACKAGED SETS OF PREPARED SHORT WRITTEN ARTICLES, PRESS RELEASES CONTAINING PICTURES AND PROMOTIONAL MATERIALS CONSISTING OF BROCHURES AND FLYERS, ALL IN THE FIELD OF DIESEL PARTICULATE FILTRATION; PRINTED ADVERTISING MATERIALS, NAMELY, LEAFLETS, POSTERS, AND INFORMATIONAL SHEETS IN PROFESSIONAL JOURNALS, ALL IN THE FIELD OF DIESEL PARTICULATE FILTRATION, IN CLASS 16 (U.S. CLS. 2, 5, 22, 23, 29, 37, 38 AND 50).

FOR: REPAIR OF DIESEL PARTICULATE FILTERS AND THEIR SPARE PARTS; REPAIR OF FILTER SYSTEMS FOR DIESEL PARTICULATE FILTRATION, COMPRISING A DIESEL PARTICULATE FILTER AND A DOSING APPARATUS FOR A DIESEL FUEL ADDITIVE, AND THEIR SPARE PARTS, IN CLASS 37 (U.S. CLS. 100, 103 AND 106).



*David J. Kyjars*

Director of the United States Patent and Trademark Office

**Reg. No. 4,123,532** THE MARK CONSISTS OF STANDARD CHARACTERS WITHOUT CLAIM TO ANY PARTICULAR FONT, STYLE, SIZE, OR COLOR.

PRIORITY DATE OF 2-18-2010 IS CLAIMED.

OWNER OF INTERNATIONAL REGISTRATION 1058036 DATED 7-27-2010, EXPIRES 7-27-2020.

THE WORDING "SINTROC" HAS NO MEANING IN A FOREIGN LANGUAGE.

SER. NO. 79-089,873, FILED 7-27-2010.

JESSICA FATHY, EXAMINING ATTORNEY

United States of America  
United States Patent and Trademark Office

# STINGRAY

**Reg. No. 4,123,533**

**Registered Apr. 10, 2012**

**Int. Cl.: 12**

**TRADEMARK**

**PRINCIPAL REGISTER**

R82 A/S (DENMARK PRIVATE LIMITED COMPANY)  
PARALLELVEJ 3  
DK-8751 GEDVED  
DENMARK

FOR: PUSH-CHAIRS DESIGNED SPECIFICALLY FOR DISABLED CHILDREN AND DISABLED YOUNG PEOPLE SOLD THROUGH HOME MEDICAL AND HEALTHCARE EQUIPMENT RETAILERS NOT FURNITURE STORES, IN CLASS 12 (U.S. CLS. 19, 21, 23, 31, 35 AND 44).

THE MARK CONSISTS OF STANDARD CHARACTERS WITHOUT CLAIM TO ANY PARTICULAR FONT, STYLE, SIZE, OR COLOR.

OWNER OF INTERNATIONAL REGISTRATION 1059363 DATED 10-25-2010, EXPIRES 10-25-2020.

SER. NO. 79-090,318, FILED 10-25-2010.

SCOTT BIBB, EXAMINING ATTORNEY



*David J. Kyffers*

Director of the United States Patent and Trademark Office

# United States of America

United States Patent and Trademark Office



**Reg. No. 4,123,534**

**Registered Apr. 10, 2012**

**Int. Cls.: 3 and 25**

**TRADEMARK**

**PRINCIPAL REGISTER**

AGUA MARINA YACHT SERVICE SL OLAYA GARCÍA GARCÍA (SPAIN SOCIEDAD LIMITADA)  
URBANIZACIÓN MONTE ALTO, 7  
E-33012 OVIEDO (ASTURIAS), SPAIN

FOR: SOAP BODY, SHAVING SOAP, ALMOND SOAP, ANTIPERSPIRANT SOAP, DEODORANT SOAP, CAKES OF TOILET SOAP, SOAP FOR FOOT PERSPIRATION; PERFUMERY, ESSENTIAL OILS, COSMETICS, HAIR LOTIONS; DENTIFRICES, IN CLASS 3 (U.S. CLS. 1, 4, 6, 50, 51 AND 52).

FOR: CLOTHING, NAMELY, COATS, GABARDINES, LAYETTES, BATH ROBES, MUFFS, BIBS NOT FOR PAPER, BATHING SUITS, BATHING TRUNKS, BEACH CLOTHES, BELTS, DRESSING GOWNS, TEDDIES, SHIRTS, WAISTCOATS, SHAWLS, JACKETS, JERSEYS, STUFF JACKETS, NECKTIES, CORSETS, COLLARS, MASQUERADE COSTUMES, TEE-SHIRTS, SINGLETs, SPORTS JERSEYS, SKIRTS, SCARVES, GLOVES, UNDERWEAR, SWEAT-ABSORBENT UNDERCLOTHING, HOSIERY, TROUSERS, BREECHES FOR WEAR, BABIES'S PANT, POCKET SQUARES, ASCOTS, PYJAMAS, UNDERPANTS, SUITS, FROCKS; FOOTWEAR, HEADWEAR, IN CLASS 25 (U.S. CLS. 22 AND 39).

THE MARK CONSISTS OF AN AMPERSAND ABOVE THE WORD "SEASKIN" ALL OF WHICH APPEAR IN SILVER.

OWNER OF INTERNATIONAL REGISTRATION 1059762 DATED 10-13-2010, EXPIRES 10-13-2020.

THE COLOR(S) PANTONE SILVER 877 IS/ARE CLAIMED AS A FEATURE OF THE MARK.

SER. NO. 79-090,472, FILED 10-13-2010.

LINDA MICKLEBURGH, EXAMINING ATTORNEY



*David J. Kybas*

Director of the United States Patent and Trademark Office



# United States of America

United States Patent and Trademark Office



**Reg. No. 4,123,535**

**Registered Apr. 10, 2012**

**Int. Cls.: 9, 14, 18, 25  
and 35**

**TRADEMARK**

**SERVICE MARK**

**PRINCIPAL REGISTER**

PELLETTERIA ORLANDI MARINO (ITALY PARTNERSHIP)  
VIA CLUENTINA, 35/35A  
I-62010 MACERATA  
ITALY

FOR: SCIENTIFIC, NAUTICAL, SURVEYING, PHOTOGRAPHIC, CINEMATOGRAPHIC, OPTICAL, WEIGHING, MEASURING, SIGNALING, CHECKING BEING SUPERVISION, LIFE-SAVING AND TEACHING APPARATUS AND INSTRUMENTS, NAMELY, CONDUCTIVITY METERS, SURVEYING MACHINES AND INSTRUMENTS, PHOTOGRAPHIC CAMERAS, CINEMATOGRAPHIC PROJECTORS, OPTICAL CABLES, SCALES AND BALANCES, MEASURING CUPS, SIGNALING BUOYS, BABY MONITORS, EMERGENCY FLARES, AND MEDICAL TEACHING MANNEQUINS; APPARATUS AND INSTRUMENTS FOR CONDUCTING, SWITCHING, TRANSFORMING, ACCUMULATING, REGULATING OR CONTROLLING ELECTRICITY, NAMELY, ELECTRICITY CONDUITS, ELECTRIC CURRENT SWITCHES, ELECTRIC VOLTAGE TRANSFORMERS, ELECTRICITY VOLTAGE REGULATORS; APPARATUS FOR RECORDING, TRANSMISSION OR REPRODUCTION OF SOUND OR IMAGES; MAGNETIC DATA CARRIERS, NAMELY, BLANK MAGNETIC DATA CARRIERS; RECORDING DISCS, NAMELY, BLANK RECORDABLE OPTICAL DISCS; AUTOMATIC VENDING MACHINES AND MECHANISMS FOR COIN-OPERATED APPARATUS; CASH REGISTERS, CALCULATING MACHINES, DATA PROCESSING EQUIPMENT AND COMPUTERS; FIRE-EXTINGUISHING APPARATUS, IN CLASS 9 (U.S. CLS. 21, 23, 26, 36 AND 38).



FOR: PRECIOUS METALS AND THEIR ALLOYS AND GOODS IN PRECIOUS METALS OR COATED THEREWITH, NAMELY, BADGES OF PRECIOUS METAL, BRACELETS OF PRECIOUS METAL, CHARMS IN PRECIOUS METALS OR COATED THEREWITH, FANCY KEY RINGS OF PRECIOUS METALS, JEWELLERY CHAIN OF PRECIOUS METAL FOR BRACELETS, KEY RINGS OF PRECIOUS METALS, SHOE ORNAMENTS OF PRECIOUS METAL, WATCHES MADE OF PRECIOUS METALS OR COATED THEREWITH; JEWELLERY, PRECIOUS STONES; HOROLOGICAL AND CHRONOMETRIC INSTRUMENTS, IN CLASS 14 (U.S. CLS. 2, 27, 28 AND 50).

*David J. Kyros*

Director of the United States Patent and Trademark Office

FOR: LEATHER AND IMITATION OF LEATHER, TRUNKS AND SUITCASES, UMBRELLAS, PARASOLS, WALKING STICKS, RUCKSACKS, ALL PURPOSE SPORT BAGS, TRAVELLING BAGS, GARMENT BAGS FOR TRAVEL, DUFFEL BAGS, BRIEF CASES, PURSES, WALLETS, BAGS, NAMELY, HAND BAGS, BARREL BAGS, BOSTON BAGS, SHOULDER BAGS, RE-USABLE SHOPPING BAGS, CABIN BAGS, SACKS IN THE NATURE OF A SOFT HANDBAG,

**Reg. No. 4,123,535** CLUTCH BAGS, BACKPACKS AND CLUTCH BAGS, CARRIER BAGS MADE OF FABRIC FOR ANIMALS, SUITS, SHIRTS AND DRESSES, WHEELED CARRIER BAGS, NAMELY, WHEELED SUIT CARRIERS, WHEELED ANIMAL CARRIERS, WHEELED ALL-PURPOSE CARRYING BAGS, TOTE BAGS, LEATHER LEASHES, BOOK BAGS, SACHEL CASES, SPORT BAGS, BEACH BAGS, SHOULDER BAGS, WAIST BAGS, EMPTY COSMETIC BAGS, IN CLASS 18 (U.S. CLS. 1, 2, 3, 22 AND 41).

FOR: CLOTHING ITEMS, NAMELY, SWEATERS, CARDIGANS, WAISTCOATS, SUITS, TROUSERS, SHORTS, JUMPERS, RAINCOATS, CLOTHING MADE OF LEATHER, NAMELY, LEATHER COATS, LEATHER JACKETS, LEATHER VESTS, PANT SUITS OF LEATHER, TROUSERS OF LEATHER, STOCKINGS AND SOCKS, STOCKING SUSPENDERS, SOCK SUSPENDERS, WIND-RESISTANT JACKETS, SKI TROUSERS, FUR COATS, OVERCOATS, SKIRTS, DRESSES, JACKETS, UNDERSHIRTS, T-SHIRTS, SPORT CLOTHING, NAMELY, SPORT JERSEYS AND BREECHES FOR SPORTS, SPORT OVER UNIFORMS, BLOUSES, SHIRT COLLARS, SHIRTS, FOULARDS, BEACHWEAR, SWIMSUITS, BIKINI, TRACKSUITS; WEDDING DRESSES; UNDERWEAR, BRAS, BRASSIERE, CORSETS, UNDERPANTS, BRIEFS, VESTS, NIGHTGOWNS, NEGLIGEEES, PYJAMAS, GLOVES, SHAWLS, SCARVES, NECKTIES, BOW TIES, BELTS IN THE NATURE OF CLOTHING, SUSPENDERS, HATS, CAPS; SHOES, BOOTS, HALF BOOTS, LEATHER SHOES, GALOSHES, RAIN BOOTS, SPORT FOOTWEAR, SANDALS, SLIPPERS, SHOE SOLES, SHOE HEELS, FOOTWEAR UPPERS FOR JAPANESE STYLE SANDALS, IN CLASS 25 (U.S. CLS. 22 AND 39).

FOR: ADVERTISING; BUSINESS MANAGEMENT; BUSINESS ADMINISTRATION; PROVIDING OFFICE FUNCTIONS, IN CLASS 35 (U.S. CLS. 100, 101 AND 102).

OWNER OF U.S. REG. NOS. 2,220,254 AND 3,240,104.

OWNER OF INTERNATIONAL REGISTRATION 1059999 DATED 10-28-2010, EXPIRES 10-28-2020.

NO CLAIM IS MADE TO THE EXCLUSIVE RIGHT TO USE "MADE IN ITALY", APART FROM THE MARK AS SHOWN.

THE NAME "MARINO ORLANDI" IDENTIFIES A LIVING INDIVIDUAL WHOSE CONSENT IS OF RECORD.

THE MARK CONSISTS OF A SERIES OF CONCENTRIC OVALS WITH THE STYLIZED PHRASE "MARINO ORLANDI" AROUND THE TOP ON THE FIRST AND SECOND OVALS AND "MADE IN ITALY" AROUND THE BOTTOM OF THE FIRST AND SECOND OVALS AND WITH THE STYLIZED LETTERS "MO" IN THE CENTER WHEREIN THE LETTER "O" IS ONE OF THE CENTRIC OVALS.

THE WORDING "MARINO ORLANDI" HAS NO MEANING IN A FOREIGN LANGUAGE.

SER. NO. 79-090,560, FILED 10-28-2010.

MYRIAH HABEEB, EXAMINING ATTORNEY

# United States of America

United States Patent and Trademark Office

## SAILING ROCKS

**Reg. No. 4,123,536**

**Registered Apr. 10, 2012**

**Int. Cls.: 3, 9, 14, 16, 18,  
25, 28 and 41**

**TRADEMARK**

**SERVICE MARK**

**PRINCIPAL REGISTER**

EXTREME SAILING SERIES S.A. (SWITZERLAND COMPANY)  
C/O FIDUCIAIRE MAILLARD S.A.  
PONT CHARLES-BESSIERES 3  
CH-1005 LAUSANNE, SWITZERLAND

FOR: PREPARATIONS AND SUBSTANCES FOR USE IN THE CARE AND APPEARANCE OF THE HAIR, SCALP, LIPS, FACE, SKIN, TEETH, NAILS AND EYES, NAMELY, COSMETICS; NON-MEDICATED TOILETRIES; PERFUMES, FRAGRANCES, COLOGNES AND OILS FOR SCENTS; SOAPS AND CLEANING PREPARATIONS, NAMELY, SHAMPOOS, CONDITIONERS, MOISTURIZERS AND RINSES FOR HAIR; TOOTH CLEANING PREPARATIONS; DEPILATORY PREPARATIONS; SUN-SCREEN PREPARATIONS AND SUN TANNING PREPARATIONS; ANTI-PERSPIRANTS, PERSONAL DEODORANTS, COTTON WOOL FOR COSMETIC PURPOSES; ESSENTIAL OILS; PREPARATIONS AND SUBSTANCES FOR USE IN MASSAGE AND AROMATHERAPY, NAMELY, NON-MEDICATED OILS, WAXES, LOTIONS, AND SPRAYS, IN CLASS 3 (U.S. CLS. 1, 4, 6, 50, 51 AND 52).

FOR: PERSONAL STEREOS AND COMPUTER GAMES EQUIPMENT, NAMELY, DISCS, CASSETTES, CARTRIDGES, JOYSTICKS, SOFTWARE, PROGRAMMES, AND CONSOLES; CONSUMER DOMESTIC ELECTRIC AND ELECTRONIC APPARATUS AND INSTRUMENTS, NAMELY, BATTERY CHARGERS, CAMCORDERS, CAMERAS, CASSETTE PLAYERS, COMPACT DISC PLAYERS, COMPUTERS, COMPUTER PRINTERS, DISC DRIVES FOR COMPUTERS, BLANK COMPUTER FLOPPY DISCS, HEADPHONES, LOUDSPEAKERS, MODEMS, COMPUTER MONITORS, COMPUTER MOUSE, PERSONAL STEREOS, POCKET CALCULATORS, MOBILE PHONES, RADIOS, RECORD PLAYERS, STEREO RECEIVERS, STEREO TUNERS, STEREO AMPLIFIERS, SCANNERS, TAPE RECORDERS, TVS, VIDEO DISC PLAYERS, VISUAL DISPLAY UNITS AND DVD PLAYERS; COMMUNICATIONS, PHOTOGRAPHIC, NAUTICAL, LIFE-SAVING APPARATUS AND INSTRUMENTS, NAMELY, CAMERAS, LIFE SAVING RAFTS, BUOYANCY AIDS IN THE NATURE OF LIFE JACKETS, DIVERS' LIFE JACKETS, FLOATATION CLOTHING FOR LIFESAVING PURPOSES, INFLATABLE VESTS FOR USE IN LIFE SAVING, INFLATABLE LIFEBOATS, INFLATABLE JACKETS FOR USE IN LIFE SAVING, LIFE JACKETS, LIFE BELTS, LIFE BUOYS, AND NAUTICAL INSTRUMENTS FOR USE IN NAVIGATION OF A SAILING CRAFT, NAMELY, ELECTRONIC NAVIGATIONAL INSTRUMENTS; COMPUTER SOFTWARE FOR DATABASE MANAGEMENT FOR MANAGING SPORTING EVENTS; COMPUTER HARDWARE; COMPUTER FIRMWARE FOR OPERATING SYSTEM PROGRAMS; COMPUTER GAMES SOFTWARE; APPARATUS, INSTRUMENTS AND MEDIA FOR RECORDING, REPRODUCING, CARRYING, STORING, PROCESSING, MANIPULATING, TRANSMITTING, BROADCASTING

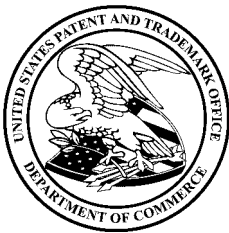

*David J. Kybas*

Director of the United States Patent and Trademark Office

**Reg. No. 4,123,536** AND RETRIEVING PUBLICATIONS, TEXT, SIGNALS, SOFTWARE, INFORMATION, DATA, CODE, SOUNDS AND IMAGES, NAMELY, DIGITAL MEDIA STREAMING DEVICES, DIGITAL MEDIA HUBS, AND MEDIA PLAYERS; AUDIO AND VIDEO RECORDINGS FEATURING SPORTING EVENTS; DOWNLOADABLE AUDIO RECORDINGS FEATURING SPORTING EVENTS; DOWNLOADABLE VIDEO RECORDINGS FEATURING SPORTING EVENTS; MUSIC DOWNLOADABLE FROM THE INTERNET; DOWNLOADABLE MUSIC SOUND RECORDINGS; DOWNLOADABLE IMAGE FILES CONTAINING IMAGES OF SPORTING EVENTS; DOWNLOADABLE PUBLICATIONS, NAMELY, MAGAZINES, PAMPHLETS, NEWSLETTERS, NEWSPAPERS, PERIODICALS, MANUALS IN THE FIELD OF SPORTS; DOWNLOADABLE SOFTWARE FOR PROCESSING IMAGES, GRAPHICS AND TEXT IN THE FIELD OF SPORTS; SOUND AND VIDEO RECORDING AND PLAYBACK MACHINES; COIN OPERATED VENDING MACHINES; ELECTRONIC ARCADE GAMES ADAPTED FOR USE WITH TV RECEIVERS; TELEVISIONS AND TELEVISION GAMES APPARATUS AND INSTRUMENTS, NAMELY, VIDEO GAME MACHINES FOR USE WITH TELEVISIONS; PHOTOGRAPHIC AND CINEMATOGRAPHIC EXPOSED FILMS PREPARED FOR EXHIBITION; PHOTOGRAPHIC TRANSPARENCIES; EDUCATIONAL AND TEACHING APPARATUS AND INSTRUMENTS, NAMELY, COMPUTER SOFTWARE FEATURING INSTRUCTION IN SPORTS, SAILING AND ORGANISATION OF SPORTING EVENTS; ELECTRONIC, MAGNETIC AND OPTICAL IDENTITY AND MEMBERSHIP CARDS FOR USE IN CONNECTION WITH PAYMENT FOR SERVICES; SUNGLASSES; MOUSE PADS; PROTECTIVE CLOTHING AND HEADGEAR FOR USE IN SPORTS, NAMELY, LIFE VESTS, IN CLASS 9 (U.S. CLS. 21, 23, 26, 36 AND 38).

FOR: JEWELRY; ARTICLES OF PRECIOUS METALS AND THEIR ALLOYS AND GOODS IN PRECIOUS METALS OR COATED THEREWITH, NAMELY, GOLD, SILVER, PLATINUM, TROPHIES, STATUES, STATUETTES, KEY RINGS, CHARMS, SCULPTURES, AND ORNAMENTS; SEMI-PRECIOUS AND PRECIOUS STONES; HOROLOGICAL AND CHRONOMETRIC INSTRUMENTS; WATCHES, CLOCKS; IMITATION JEWELRY; STATUES OF PRECIOUS METAL; CUFFLINKS; TIE PINS AND SHIRT STUDS , IN CLASS 14 (U.S. CLS. 2, 27, 28 AND 50).

FOR: PRINTED MATTER AND PUBLICATIONS, NAMELY, BOOKS, MANUALS, PAMPHLETS, NEWSLETTERS, ALBUMS, NEWSPAPERS, MAGAZINES AND PERIODICALS IN THE FIELD OF SPORTS; PRINTED TICKETS, PRINTED VOUCHERS, COUPONS AND TRAVEL DOCUMENTS, NAMELY, BUSINESS CARDS, NON-MAGNETICALLY ENCODED IDENTITY CARDS, FOREIGN RESIDENT CARDS, DRIVERS LICENSES, VOTER REGISTRATION CARDS, PASSPORTS AND PASSPORT COVERS, VISAS AND IMMIGRATION CONTROL DOCUMENTS; PAPER LABELS AND TAGS; POSTERS, POSTCARDS, CALENDARS, DIARIES, PHOTOGRAPHS, GIFT CARDS AND GREETING CARDS; PRINTED TEACHING AND INSTRUCTIONAL MATERIALS IN THE FIELD OF SPORTS; STATIONERY, ARTISTS' MATERIALS, NAMELY, BRUSHES, PENS, PENCILS, AND PASTELS, WRITING INSTRUMENTS; WRITING PAPER AND ENVELOPES SOLD IN SETS; WRITING PAPER HOLDERS; ENGAGEMENT CARDS, VISITING CARDS, INVITATION CARDS; NOTE BOOKS; BOOK COVERS; BOOK MARKS; PRINTS; PICTURES; PHOTOGRAPHS; PHOTOGRAPH ALBUMS; PEN HOLDERS; PENCIL HOLDERS; PENS; PENCILS; PEN STANDS; INK STANDS; GRADUATED RULERS, DRAWING RULERS; PENCIL SHARPENERS; LETTER OPENERS; PAPER KNIVES; LETTER TRAYS; DIARIES; ORGANIZERS FOR STATIONERY USE; WRAPPING AND PACKAGING MATERIALS OF PAPER AND CARDBOARD; PAPER GIFT TAGS; WRITING INSTRUMENT CASES FOR PENS AND PENCILS; DESK SETS, ALL BEING ITEMS OF STATIONERY; CHECK BOOK COVERS, IN CLASS 16 (U.S. CLS. 2, 5, 22, 23, 29, 37, 38 AND 50).

FOR: LEATHER AND IMITATION LEATHER; GOODS MADE OF LEATHER OR IMITATIONS OF LEATHER, NAMELY, SPORTS PACKS, ALL PURPOSE SPORTS BAGS, GENERAL PURPOSE SPORT TROLLEY BAGS, CASES, BRIEFCASES, BANDS OF LEATHER, KEY CHAINS, KEY CASES, HANDBAGS, LEADS, LEASHES, POUCHES, STRAPS, THONGS, THREAD, BELTS, AND SADDLERY; SKINS AND HIDES; TRUNKS, DUFFEL BAGS, BAGS FOR SPORT, ATHLETIC BAGS, BACKPACKS, BUM BAGS, DRY BAGS, KIT BAGS AND

**Reg. No. 4,123,536** TRAVELLING BAGS; PURSES, WALLETS, POUCHES AND HANDBAGS; LUGGAGE; SPORTS BAGS; SADDLE HORN BAGS; BACKPACKS; UMBRELLAS AND PARASOLS; HARNESSSES AND SADDLERY , IN CLASS 18 (U.S. CLS. 1, 2, 3, 22 AND 41).

FOR: CLOTHING, NAMELY, SHIRTS, SWEATERS, VESTS, PANTS, SHORTS, HATS, GLOVES, COATS, JACKETS, WETSUITS, UNDER GARMENTS, BASE LAYERS, ARM WARMERS, HAND WARMERS, ATHLETIC SLEEVES, TIES, CLOTHING FOR WEAR IN SAILING IN THE NATURE OF OILSKIN TROUSERS AND OILSKIN JACKETS, ATHLETIC UNIFORMS, POLO SHIRTS, OVER SHIRTS, SHORT SLEEVED OR LONG SLEEVED T-SHIRTS, TRACK SUITS, GLOVES, FLEECE TOPS, TRACK SINGLET, SHOWER JACKETS, BELTS, SPORT COATS, SPORTS SHIRTS, AND SPORTS OVER UNIFORMS; HEADGEAR, NAMELY, HATS AND CAPS; FOOTWEAR, NAMELY, SHOES, TRAINERS, THONGS, PUMPS, BOOTS, WATERPROOF FOOTWEAR, BOAT SHOES, AND TRAINING SHOES, IN CLASS 25 (U.S. CLS. 22 AND 39).

FOR: GAMES AND PLAYTHINGS, NAMELY, TOY BOATS, MODEL TOY VEHICLES, CONSTRUCTION TOYS, DRAWING TOYS, COLLECTABLE TOY FIGURES, SCALE MODEL KITS, STACKING TOYS, TOY ANIMALS, TOY BALLOONS, TOY BOXES, TOY BUILDING BLOCKS, WATER TOYS, GAME CARDS, AND TOY FIGURINES; GYMNASTIC AND SPORTING ARTICLES, NAMELY, SAIL BOARD MASTS, SAIL BOARD LEASHES, SAIL BOARD FOOT STRAPS, SAIL BOARD FOOT RESTRAINTS, SAILBOARDS, BOARDS FOR USE IN THE PRACTICE OF WATER SPORTS; DECORATIONS FOR CHRISTMAS TREES, SCALE MODEL AIRPLANES, TOY SCOOTERS, TEDDY BEARS, BALLS FOR GAMES, GOLF BALLS; ELECTRONIC ARCADE GAMES NOT ADAPTED FOR USE WITH TV RECEIVERS, IN CLASS 28 (U.S. CLS. 22, 23, 38 AND 50).

FOR: INFORMATION RELATING TO ENTERTAINMENT AND EDUCATION, PROVIDED ON-LINE FROM A COMPUTER DATABASE OR THE INTERNET; ENTERTAINMENT SERVICES PROVIDED ON-LINE FROM A COMPUTER DATABASE OR THE INTERNET, NAMELY, PROVIDING A WEBSITE FEATURING ENTERTAINMENT INFORMATION, PROVIDING INFORMATION, NEWS AND COMMENTARY IN THE FIELD OF ENTERTAINMENT, PROVISION OF INFORMATION RELATING TO LIVE ENTERTAINMENT; EDUCATIONAL INFORMATION PROVIDED ON-LINE FROM A COMPUTER DATABASE OR THE INTERNET, NAMELY, EDUCATIONAL INFORMATION RELATING TO SPORTING EVENTS; ENTERTAINMENT SERVICES, NAMELY, ENTERTAINMENT IN THE NATURE OF SAILING TOURNAMENTS AND RACES, ORGANIZATION OF COMPETITIONS IN THE FIELD OF SAILING, MULTIMEDIA PRODUCTION SERVICES, ORGANISING EXHIBITIONS FOR SPORTING PURPOSES, ARRANGING FOR TICKET RESERVATIONS FOR SHOWS AND OTHER ENTERTAINMENT EVENTS, ARRANGING, ORGANIZING, CONDUCTING, AND HOSTING SOCIAL ENTERTAINMENT EVENTS, ORGANIZATION OF ON-LINE COMPETITIONS IN THE FIELD OF ENTERTAINMENT, EDUCATION, CULTURE, SPORTS, AND OTHER NON-BUSINESS AND NON-COMMERCIAL FIELDS, AND ENTERTAINMENT EVENT BOOKING AGENCIES; EDUCATION SERVICES, NAMELY, PROVIDING CLASSES, SEMINARS, WORKSHOPS, LECTURES AND TUTORIAL SESSIONS IN THE FIELD OF SPORTS, SAILING, AND BOATING; PUBLISHING OF BOOKS, MANUALS, PAMPHLETS, NEWSLETTERS, ALBUMS, NEWSPAPERS, MAGAZINES, PERIODICALS, AND PUBLISHING OF SPORTS RESULTS IN THE FORM OF BOOKS OR MANUALS; PRODUCTION OF SOUND AND VIDEO RECORDINGS, ORGANISING GAMES AND SPORTS COMPETITIONS, RENTAL OF ELECTRIC AND ELECTRONIC GOODS, NAMELY, RENTAL OF AUDIO AND VISUAL APPARATUS AND EQUIPMENT, CAMCORDERS, COMPACT DISC PLAYERS, COMPACT DISCS, FRUIT MACHINES, CASSETTE PLAYERS, CASSETTE RECORDERS, CASSETTE TAPES, AUDIO TAPES, VIDEO CAMERAS, ELECTRONIC GAMES, VIDEO CASSETTES, VIDEO DISCS, VIDEO TAPES, CD-ROMS, VIDEO CASSETTES AND TV SETS, TOYS, GAMES AND PLAYTHINGS; EDUCATION, NAMELY, EDUCATIONAL COURSES AT THE LEVELS OF KINDERGARTEN TO 12TH GRADE, COLLEGE, AND ADULT EDUCATION RELATING TO THE SPORTS, SAILING, AND BOATING INDUSTRIES AND PHYSICAL EDUCATION; TRAINING, NAMELY, SPORTS TRAINING SERVICES; ORGANIZING COMMUNITY SPORTING AND CULTURAL ACTIVITIES; PROVIDING SPORTS

**Reg. No. 4,123,536** FACILITIES, LENDING LIBRARIES, DESKTOP PUBLISHING FOR OTHERS; SAILING INSTRUCTION, HOLIDAY CAMP SERVICES, PROVIDING BOAT SCHOOL FACILITIES FOR SAILING AND MOTOR BOAT INSTRUCTION, PHOTOGRAPHY, PROVIDING RECREATION FACILITIES AND WATER SPORTS FACILITIES, SPORTS CAMP SERVICES, TICKET AGENCY SERVICES FOR ENTERTAINMENT EVENTS RENTAL OF SPORTS EQUIPMENT, RENTAL OF SPORTS DIVING EQUIPMENT, ARRANGING OF SAILING AND BOATING REGATTAS; ORGANIZATION OF SPORT COMPETITIONS AND SPORTS EVENTS; ORGANIZATION OF TRAINING LECTURES AND SEMINARS IN THE FIELD OF SAILING AND BOATING AND DISTRIBUTION OF TRAINING AND EDUCATIONAL MATERIALS IN CONNECTION THEREWITH; PROVIDING INFORMATION RELATING TO SPORTING EVENTS, COMPETITIONS AND TOURNAMENTS; ORGANIZATION OF SEMINARS, CONFERENCES, AND WORKSHOPS, IN THE FIELD OF SAILING AND BOATING, IN CLASS 41 (U.S. CLS. 100, 101 AND 107).

THE MARK CONSISTS OF STANDARD CHARACTERS WITHOUT CLAIM TO ANY PARTICULAR FONT, STYLE, SIZE, OR COLOR.

OWNER OF INTERNATIONAL REGISTRATION 1060100 DATED 8-4-2010, EXPIRES 8-4-2020.

NO CLAIM IS MADE TO THE EXCLUSIVE RIGHT TO USE "SAILING" AS TO THE GOODS AND SERVICES IN CLASSES 9, 16, 28, AND 41, APART FROM THE MARK AS SHOWN.

SER. NO. 79-090,609, FILED 8-4-2010.

JAMES STEIN, EXAMINING ATTORNEY

# United States of America

United States Patent and Trademark Office

# BIOEFFECT

**Reg. No. 4,123,537**

**Registered Apr. 10, 2012**

**Int. Cls.: 3 and 44**

**TRADEMARK**

**SERVICE MARK**

**PRINCIPAL REGISTER**

ORF LIFTAEKNI HF. (ICELAND LIMITED LIABILITY COMPANY)  
VIKURHVARF 3  
IS-203 KOPAVOGUR  
ICELAND

FOR: SOAPS; PERFUMERY, ESSENTIAL OILS, COSMETICS, HAIR LOTIONS, IN CLASS 3 (U.S. CLS. 1, 4, 6, 50, 51 AND 52).

FOR: MEDICAL SERVICES; VETERINARY SERVICES; HYGIENIC AND BEAUTY CARE FOR HUMAN BEINGS OR ANIMALS, IN CLASS 44 (U.S. CLS. 100 AND 101).

THE MARK CONSISTS OF STANDARD CHARACTERS WITHOUT CLAIM TO ANY PARTICULAR FONT, STYLE, SIZE, OR COLOR.

OWNER OF INTERNATIONAL REGISTRATION 1060105 DATED 8-19-2010, EXPIRES 8-19-2020.

SER. NO. 79-090,610, FILED 8-19-2010.

JAMES STEIN, EXAMINING ATTORNEY



*David J. Kybas*

Director of the United States Patent and Trademark Office

# United States of America

United States Patent and Trademark Office

# WEEKENDER

**Reg. No. 4,123,538**

**Registered Apr. 10, 2012**

**Int. Cl.: 9**

**TRADEMARK**

**PRINCIPAL REGISTER**

DANIEL DOMBROWE (GERMAN DEM REP INDIVIDUAL)  
NORDKANALSTRASSE 76  
20097 HAMBURG  
FED REP GERMANY

FOR: APPARATUS FOR RECORDING, TRANSMISSION OR REPRODUCTION OF SOUND OR IMAGES; MAGNETIC CODED GIFT CARDS, SPORT GOGGLES, SUNGLASSES , IN CLASS 9 (U.S. CLS. 21, 23, 26, 36 AND 38).

THE MARK CONSISTS OF STANDARD CHARACTERS WITHOUT CLAIM TO ANY PARTICULAR FONT, STYLE, SIZE, OR COLOR.

OWNER OF INTERNATIONAL REGISTRATION 1060280 DATED 6-4-2010, EXPIRES 6-4-2020.

SER. NO. 79-090,688, FILED 6-4-2010.

CURTIS FRENCH, EXAMINING ATTORNEY



*David J. Kyffers*

Director of the United States Patent and Trademark Office



United States of America  
United States Patent and Trademark Office

# Arkade

**Reg. No. 4,123,539**

**Registered Apr. 10, 2012**

**Int. Cl.: 14**

**TRADEMARK**

**PRINCIPAL REGISTER**

LANGE UHREN GMBH (FED REP GERMANY GESELLSCHAFT MIT BESCHRÄNKTER  
HAFTUNG (GMBH))  
01768 GLASHÜTTE/SACHSEN  
FED REP GERMANY

FOR: WATCHES, TIME RECORDING APPARATUS, HOROLOGICAL INSTRUMENTS;  
MOVEMENTS FOR CLOCKS AND WATCHES; CLOCK AND WATCH HOUSINGS;  
BRACELETS FOR WATCHES; WATCH-MAKING MATERIALS, NAMELY, WATCH DIALS  
AND FACES, AND WATCH HANDS, IN CLASS 14 (U.S. CLS. 2, 27, 28 AND 50).

OWNER OF INTERNATIONAL REGISTRATION 0627049 DATED 10-6-1994, EXPIRES 10-  
6-2014.

SER. NO. 79-091,061, FILED 11-8-2010.

KELLY TRUSILO, EXAMINING ATTORNEY



*David J. Kybas*

Director of the United States Patent and Trademark Office

# United States of America

United States Patent and Trademark Office

# Reverse

**Reg. No. 4,123,540**

**Registered Apr. 10, 2012**

**Int. Cl.: 12**

**TRADEMARK**

**PRINCIPAL REGISTER**

RONAL AG (SWITZERLAND SOCIÉTÉ ANONYME)  
LERCHENBÜHL 3  
CH-4624 HÄRKINGEN  
SWITZERLAND

FOR: MOTOR VEHICLE WHEELS AND PARTS THEREOF, NAMELY, WHEEL HUBS, HUB CAPS, HUB CAP COVERS, VEHICLE WHEEL RIMS, INNER RIM HALVES, OUTER RIM HALVES, WHEEL COVERS, RIM SPOKES, RIM RINGS BEING STRUCTURAL PARTS OF VEHICLE WHEEL RIMS, RIM WELLS BEING STRUCTURAL PARTS OF VEHICLE WHEEL RIMS, IN CLASS 12 (U.S. CLS. 19, 21, 23, 31, 35 AND 44).

NO CLAIM IS MADE TO THE EXCLUSIVE RIGHT TO USE "REVERSE", APART FROM THE MARK AS SHOWN.

PRIORITY DATE OF 6-28-2010 IS CLAIMED.

OWNER OF INTERNATIONAL REGISTRATION 1061664 DATED 11-4-2010, EXPIRES 11-4-2020.

THE MARK CONSISTS OF THE TERM "REVERSE" WITH THE FIRST LETTER "R" PLACED BACKWARDS.

SER. NO. 79-091,243, FILED 11-4-2010.

CHRISTOPHER BUONGIORNO, EXAMINING ATTORNEY



*David J. Kyffers*

Director of the United States Patent and Trademark Office

# United States of America

United States Patent and Trademark Office

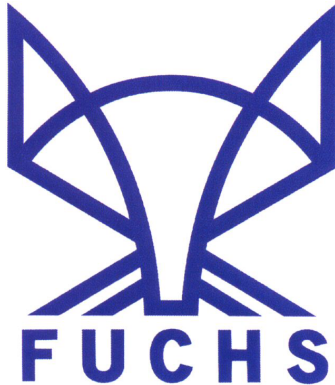

**Reg. No. 4,123,541**

**Registered Apr. 10, 2012**

**Int. Cls.: 6 and 40**

**TRADEMARK**

**SERVICE MARK**

**PRINCIPAL REGISTER**

OTTO FUCHS KG (FED REP GERMANY KG)  
DERSCHLAGER STRAÙE 26  
58540 MEINERZHAGEN  
FED REP GERMANY

FOR: COMMON METALS AND THEIR ALLOYS; BUILDING MATERIALS MADE OF METAL, NAMELY, SUPPORT PROFILES, SOLAR SUPPORT PROFILES, FRAME PROFILES, ISOLATION, SUN PROTECTION, SUN BARRIERS, RACK PROFILES, GUIDE BARS, DOOR PROFILES, VENTILATION GRILLES, WATER AND FLOOD BARRIERS, BALCONY FLOORING, BRIDGE COVER PROFILES, CATWALKS, TABLES, SCAFFOLDING, SIDE BEAMS, SCAFFOLDING FRAMES, LIGHT MASTS, FLAG POLES, MAST FITTINGS, FITTING, HINGED LIDS; GOODS OF METAL, IN PARTICULAR PRODUCTS MANUFACTURED BY EXTRUSION, CASTING AND FORGING, NAMELY, SUPPORT PROFILES, SOLAR SUPPORT PROFILES, FRAME PROFILES, ISOLATION, SUN PROTECTION, SUN BARRIERS, RACK PROFILES, GUIDE BARS, DOOR PROFILES, VENTILATION GRILLES, WATER AND FLOOD BARRIERS, BALCONY FLOORING, BRIDGE COVER PROFILES, CATWALKS, TABLES, SCAFFOLDING, SIDE BEAMS, SCAFFOLDING FRAMES, LIGHT MASTS, FLAG POLES, MAST FITTINGS, FITTING, HINGED LIDS; SHEET PILINGS OF METAL; METAL SCAFFOLDING AND COMPONENTS THEREOF; POLES, NAMELY, LAMP POLES AND FLAG POLES; RAMPS FOR CARS MADE OF METAL; CARGO COMPARTMENT FLOORS MADE OF METAL; ALL MENTIONED GOODS AS FAR AS NOT CLASSIFIED IN OTHER CLASSES, IN CLASS 6 (U.S. CLS. 2, 12, 13, 14, 23, 25 AND 50).



FOR: TREATMENT OF NON-FERROUS METALS; MANUFACTURING OF PARTS AND COMPONENTS OF AUTOMOBILES, PARTS AND COMPONENTS OF AIRPLANES, PARTS AND COMPONENTS OF SHIPS, PARTS AND COMPONENTS OF MACHINES AND CONSTRUCTIONAL PARTS OF NON-FERROUS METAL; TREATMENT OF MATERIALS, NAMELY, FORGING, EXTRUDING, RING ROLLING, IN CLASS 40 (U.S. CLS. 100, 103 AND 106).

THE MARK CONSISTS OF A STYLIZED DESIGN OF A HEAD OF A FOX IN BLUE. BENEATH THE DESIGN, THE WORDING "FUCHS" APPEARS IN BLUE AND IN STYLIZED FONT. THE ENCLOSED PORTIONS OF THE DESIGN DEPICTED IN WHITE ARE INTENDED TO BE TRANSPARENT BACKGROUND SUCH THAT THE COLOR WHITE IS NOT CLAIMED AS A FEATURE OF THE MARK.

*David J. Kypos*

Director of the United States Patent and Trademark Office

PRIORITY DATE OF 6-23-2010 IS CLAIMED.

**Reg. No. 4,123,541** OWNER OF INTERNATIONAL REGISTRATION 1061950 DATED 9-6-2010, EXPIRES 9-6-2020.

THE COLOR(S) BLUE IS/ARE CLAIMED AS A FEATURE OF THE MARK.

THE ENGLISH TRANSLATION OF "FUCHS" IN THE MARK IS "FOX".

SER. NO. 79-091,360, FILED 9-6-2010.

MARILYN IZZI, EXAMINING ATTORNEY

# United States of America

United States Patent and Trademark Office

## PROPHECY BMX

**Reg. No. 4,123,542**

**Registered Apr. 10, 2012**

**Int. Cls.: 12 and 25**

LABIGANG DENIS, AGISSANT POUR LE COMPTE DE LA SOCIÉTÉ "PROPHECY BMX"  
EN COURS DE FORMATION (FRANCE SOCIÉTÁ IN ACCOMANDITA SEMPLICE (SAS))  
2 BIS RUE D'ISSENGHIEN  
F-02100 SAINT QUENTIN  
FRANCE

**TRADEMARK**

**PRINCIPAL REGISTER**

FOR: BICYCLES, BICYCLE FRAMES, BICYCLE SADDLES, BICYCLE SEAT POSTS, BICYCLE HANDLEBAR GRIPS, BICYCLE CHAIN TENSIONERS; COMPONENTS FOR BICYCLES, NAMELY, HEADSETS WHICH PROVIDE A ROTATABLE INTERFACE BETWEEN THE BICYCLE FORK AND THE BICYCLE FRAME; BICYCLE HEAD SET SPACERS, BICYCLE FRAME PROTECTORS; BICYCLE STRUCTURAL COMPONENTS, NAMELY, BICYCLE FRONT PLATES, IN CLASS 12 (U.S. CLS. 19, 21, 23, 31, 35 AND 44).

FOR: BICYCLE RACING JERSEYS, T-SHIRTS, IN CLASS 25 (U.S. CLS. 22 AND 39).

THE MARK CONSISTS OF STANDARD CHARACTERS WITHOUT CLAIM TO ANY PARTICULAR FONT, STYLE, SIZE, OR COLOR.

OWNER OF INTERNATIONAL REGISTRATION 1062011 DATED 11-29-2010, EXPIRES 11-29-2020.

NO CLAIM IS MADE TO THE EXCLUSIVE RIGHT TO USE "BMX", APART FROM THE MARK AS SHOWN.

SER. NO. 79-091,387, FILED 11-29-2010.

JAMES MACFARLANE, EXAMINING ATTORNEY



*David J. Kypos*

Director of the United States Patent and Trademark Office

United States of America  
United States Patent and Trademark Office

# PoleAway

**Reg. No. 4,123,543**

**Registered Apr. 10, 2012**

**Int. Cls.: 20, 28 and 41**

**TRADEMARK**

**SERVICE MARK**

**PRINCIPAL REGISTER**

VERTICAL LEISURE LTD (UNITED KINGDOM LIMITED COMPANY)  
45-47 HIGH STREET  
POTTERS BAR  
HERTFORDSHIRE EN6 5AW, UNITED KINGDOM

FOR: FURNITURE MADE WHOLLY OR PRINCIPALLY OF STEEL, NAMELY, VERTICAL AND HORIZONTAL POLES AND SHELVES ATTACHED TO THE POLES, IN CLASS 20 (U.S. CLS. 2, 13, 22, 25, 32 AND 50).

FOR: SPORTING AND GYMNAS TIC EQUIPMENT, NAMELY, VERTICAL POLES FOR USE IN GYMNAS TIC, EXERCISE EQUIPMENT, NOT FOR MEDICAL USE, NAMELY, MANU- ALLY OPERATED WEIGHT AND RESISTANCE EXERCISERS FOR PHYSICAL FITNESS DEVELOPMENT, ATTACHMENTS TO SUCH EQUIPMENT TO INCREASE MUSCLE RES- ISTANCE, SUSPENDED WEIGHTS ATTACHED TO RESISTANCE CABLES FOR TWISTING, LIFTING AND STEPPING EXERCISES, ALL OF THE ABOVE ADAPTED TO BEING AT- TACHED TO THE VERTICAL POLES BY MEANS OF METAL SUPPORTS AND BRACKETS, AND REPLACEMENT PARTS AND FITTINGS THEREFOR, IN CLASS 28 (U.S. CLS. 22, 23, 38 AND 50).

FOR: EDUCATIONAL SERVICES, NAMELY, PROVIDING CLASSES, INSTRUCTION AND SEMINARS IN THE FIELD OF GYMNAS TIC AND EXERCISE, PROVIDING PHYSICAL FITNESS TRAINING, BOXING TRAINING, AND DANCE TRAINING; ENTERTAINMENT SERVICES, NAMELY, CONDUCTING AND PRODUCING GYMNAS TIC, PHYSICAL FITNESS, BOXING AND DANCE EXHIBITIONS AND PERFORMANCES, CONDUCTING SPORTING EVENTS AND COMPETITIONS, NAMELY, GYMNAS TIC AND PHYSICAL FITNESS COMPETITIONS, DANCE AND BOXING COMPETITIONS; HEALTH CLUB SERVICES, NAMELY, PROVIDING INSTRUCTION AND EQUIPMENT IN THE FIELD OF PHYSICAL EXERCISE AND TRAINING; AND PROVIDING EXERCISE FACILITIES AND GYMNAS IUMS, IN CLASS 41 (U.S. CLS. 100, 101 AND 107).

THE MARK CONSISTS OF STANDARD CHARACTERS WITHOUT CLAIM TO ANY PAR- TICULAR FONT, STYLE, SIZE, OR COLOR.

PRIORITY DATE OF 3-24-2010 IS CLAIMED.

OWNER OF INTERNATIONAL REGISTRATION 1062276 DATED 9-23-2010, EXPIRES 9-23- 2020.



*David J. Kappas*

Director of the United States Patent and Trademark Office

**Reg. No. 4,123,543** SER. NO. 79-091,481, FILED 9-23-2010.

FRED CARL, EXAMINING ATTORNEY

# United States of America

United States Patent and Trademark Office

# Mental Clock

**Reg. No. 4,123,544**

**Registered Apr. 10, 2012**

**Int. Cl.: 41**

RIVIÈRE FRANCK ALAIN RAOUL ET RIVIÈRE MARC ALAIN HERVÉ (FRANCE LIMITED LIABILITY COMPANY)  
ARCE  
F-74500 CHEVENOZ  
FRANCE

**SERVICE MARK**

**PRINCIPAL REGISTER**

FOR: ENTERTAINMENT SERVICES, NAMELY, PROVIDING BRAIN TRAINING GAMES ON-LINE AND IN MOBILE WIRELESS FORM; ORGANIZING COMMUNITY SPORTING AND CULTURAL EVENTS; PROVISION OF INFORMATION RELATING TO THE ORGANIZING OF EDUCATIONAL OR ENTERTAINMENT EXHIBITIONS; PROVIDING FACILITIES FOR RECREATION ACTIVITIES; PUBLICATION OF BOOKS; LENDING LIBRARIES; ANIMAL TRAINING; VIDEOTAPE FILM PRODUCTION; RENTAL OF MOTION PICTURES; RENTAL OF SOUND RECORDINGS; RENTAL OF SHOW SCENERY; VIDEOTAPE EDITING; PHOTOGRAPHY; ORGANIZATION OF ENTERTAINMENT SPORTS COMPETITIONS; ORGANIZATION OF EXHIBITIONS FOR CULTURAL OR EDUCATIONAL PURPOSES; BOOKING OF SEATS FOR SHOWS; ENTERTAINMENT SERVICES, NAMELY, PROVIDING AN ON-LINE COMPUTER GAME; GAMING SERVICES IN THE NATURE OF CASINO GAMING; PUBLICATION OF ELECTRONIC BOOKS AND JOURNALS ON-LINE; ELECTRONIC DESKTOP PUBLISHING, IN CLASS 41 (U.S. CLS. 100, 101 AND 107).

PRIORITY DATE OF 2-17-2010 IS CLAIMED.

OWNER OF INTERNATIONAL REGISTRATION 1062446 DATED 8-16-2010, EXPIRES 8-16-2020.

SER. NO. 79-091,598, FILED 8-16-2010.

JASON TURNER, EXAMINING ATTORNEY



*David J. Kyros*

Director of the United States Patent and Trademark Office



# United States of America

United States Patent and Trademark Office

# Gluggle Jug

**Reg. No. 4,123,545**

**Registered Apr. 10, 2012**

**Int. Cl.: 21**

**TRADEMARK**

**PRINCIPAL REGISTER**

WADE CERAMICS LIMITED (UNITED KINGDOM LIMITED COMPANY)  
BESSEMER DRIVE  
ETRURIA; STOKE-ON-TRENT, STAFFORDSHIRE ST1 5GR  
UNITED KINGDOM

FOR: JUGS, PITCHERS AND VASES, IN CLASS 21 (U.S. CLS. 2, 13, 23, 29, 30, 33, 40 AND 50).

THE MARK CONSISTS OF STANDARD CHARACTERS WITHOUT CLAIM TO ANY PARTICULAR FONT, STYLE, SIZE, OR COLOR.

OWNER OF INTERNATIONAL REGISTRATION 1062484 DATED 8-6-2010, EXPIRES 8-6-2020.

NO CLAIM IS MADE TO THE EXCLUSIVE RIGHT TO USE "JUG", APART FROM THE MARK AS SHOWN.

SER. NO. 79-091,618, FILED 8-6-2010.

JASON TURNER, EXAMINING ATTORNEY



*David J. Kyffers*

Director of the United States Patent and Trademark Office

# United States of America

United States Patent and Trademark Office

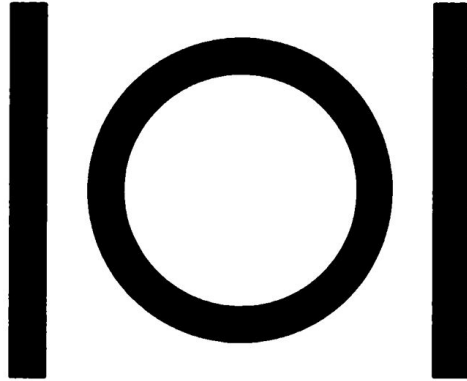

**Reg. No. 4,123,546**

**Registered Apr. 10, 2012**

**Int. Cl.: 20**

**TRADEMARK**

**PRINCIPAL REGISTER**

LABEL TOUR (FRANCE SARL)  
30 RUE DE GRANDE BRETAGNE  
F-44470 CARQUEFOU  
FRANCE AND

DAMIEN GRASSET (FRANCE INDIVIDUAL)  
4 AVENUE MONCHICOURT  
F-44500 LA BAULE  
FRANCE

FOR: FURNITURE, MIRRORS, PICTURE FRAMES; WORKS OF ART MADE OF WOOD, WAX, PLASTER, CORK, REED, CANE, WICKER, HORN, BONE, IVORY, WHALEBONE, SHELL, AMBER, MOTHER-OF-PEARL, MEERSCHAUM, SUBSTITUTES FOR ALL THESE MATERIALS, OR OF PLASTICS; CHESTS OF DRAWERS; PACKAGING CONTAINERS OF PLASTIC; ARMCHAIRS; SEATS, IN CLASS 20 (U.S. CLS. 2, 13, 22, 25, 32 AND 50).

THE ENGLISH TRANSLATION OF THE FOREIGN WORD(S) IN THE MARK IS "LOL".

OWNER OF INTERNATIONAL REGISTRATION 1063152 DATED 11-26-2010, EXPIRES 11-26-2020.

THE TRANSLITERATION OF THE NON-LATIN CHARACTERS IN THE MARK IS: LOL.

SER. NO. 79-091,842, FILED 11-26-2010.

JOSETTE BEVERLY, EXAMINING ATTORNEY



*David J. Kybas*

Director of the United States Patent and Trademark Office

# United States of America

United States Patent and Trademark Office

# COMORAN

**Reg. No. 4,123,547**

**Registered Apr. 10, 2012**

**Int. Cls.: 9, 12 and 37**

KNORR-BREMSE AG (FED REP GERMANY AKTIENGESELLSCHAFT (JOINT STOCK COMPANY))  
MOOSACHER STRASSE 80  
80809 MÜNCHEN  
FED REP GERMANY

**TRADEMARK**

**SERVICE MARK**

**PRINCIPAL REGISTER**

FOR: PHYSICAL, ELECTRO-TECHNICAL, ELECTRONIC MEASURING, SIGNALLING, CHECKING AND SUPERVISION, CONTROLLING, GOVERNING AND MONITORING DEVICES AND APPARATUSES, NAMELY, PRESSURE SENSORS, TEMPERATURE SENSORS, ACCELERATION SENSORS, SPEED SENSORS, ANGLE SENSORS, TORQUE SENSORS COMPRESSED AIR INJECTION ELECTRICAL CONTROLLERS, EITHER INTEGRATED INTO AN INTAKE FLOW CONTROL UNIT OR PROVIDED AS A STAND-ALONE COMPUTER, PRESSURE GAUGES, BRAKE CONTROLLERS FOR RAIL-BOUND VEHICLES AND COMMERCIAL VEHICLES; MECHANICAL, PNEUMATIC, HYDRAULIC, ELECTRO-MECHANIC, ELECTRO-MAGNETIC AND ELECTRO-ELECTRONIC OPERATED, CONTROLLED, CONTROLLING, MEASURING, SIGNALLING, CHECKING AND SUPERVISION, GOVERNING, CONVEYING, STORING, AMPLIFYING AND MONITORING DEVICES, APPARATUSES AND INSTALLATIONS COMPOSED OF THESE FOLLOWING ELEMENTS, NAMELY, PRESSURE SENSORS, TEMPERATURE SENSORS, ACCELERATION SENSORS, SPEED SENSORS, ANGLE SENSOR, AND COMPRESSED AIR INJECTION ELECTRICAL CONTROLLERS, EITHER INTEGRATED INTO AN INTAKE FLOW CONTROL UNIT OR PROVIDED AS A STAND-ALONE COMPUTER, BRAKE CONTROLLERS FOR RAIL-BOUND VEHICLES AND COMMERCIAL VEHICLES, IN PARTICULAR FOR VEHICLE BRAKES, FOR RAILWAY STATIONS AND FOR RAIL SYSTEMS, AND STRUCTURAL PARTS OF THE AFOREMENTIONED DEVICES AND APPARATUS; BOGIE MONITORING AND DIAGNOSING SYSTEMS COMPRISING SENSORS, NAMELY, TEMPERATURE SENSORS, ACCELERATION SENSORS, SPEED SENSORS, ANGLE SENSORS, TORQUE SENSORS, DERAILMENT DETECTORS AND ELECTRONIC APPARATUSES, NAMELY, ELECTRONIC AND ELECTRIC CONTROLLERS FOR RUNNING GEAR AND MOTOR BOGIES AND FOR THEIR STRUCTURAL PARTS THEREOF FOR THE DETECTION OF CRITICAL CONDITIONS ON THE RUNNING GEAR, SUCH AS DAMAGE ON BEARINGS IN WHEEL SETS AND AXLE WHEELS, HOT BOXES, UNSTABLE RUNNING, DERAILING AS WELL AS DATA COLLECTION ON CONDITION-BASED MAINTENANCE CONDITIONS OF BEARINGS IN WHEEL SETS AND AXLE WHEELS, WHEEL TREADS AND FLATS, GUIDANCE OF WHEEL SETS AND AXLE WHEELS, THE STABILIZING SYSTEM AND TRANSMISSIONS, AND DAMAGE TO GEAR BOXES AND ROTATION MACHINES INCLUDING MOTORS AND GENERATORS; OVAL RAILWAY VEHICLE WHEEL DETECTORS AND ELECTRONIC



*David J. Kyjars*

Director of the United States Patent and Trademark Office

**Reg. No. 4,123,547** LOCATORS, DERAILMENT DETECTORS FOR RAIL-BOUND VEHICLES; DEVICES AS PARTS OF BOGIES FOR DETECTING AND LOCATING FLATS IN THE RUNNING TREADS OF THE WHEELS ON RAIL VEHICLES, COMPRISING SENSORS, DERAILMENT DETECTORS AND ELECTRONIC APPARATUSES, NAMELY, ELECTRONIC AND ELECTRIC CONTROLLERS, STRUCTURAL PARTS OF THE AFOREMENTIONED DEVICES AND APPARATUS, IN CLASS 9 (U.S. CLS. 21, 23, 26, 36 AND 38).

FOR: MECHANICAL, PNEUMATIC, HYDRAULIC, ELECTRIC, ELECTRO-MAGNETIC, ELECTRO-MECHANIC AND ELECTRONIC CONTROLLED, OPERATED AND MONITORED BRAKES AND BRAKE INSTALLATIONS OF RAIL-BOUND VEHICLES AND COMMERCIAL VEHICLES, NAMELY, BRAKE CYLINDERS, CLUTCH FORCE AMPLIFIERS, DISC BRAKES, BRAKE DISCS, BRAKE LININGS, BRAKE BLOCKS, BRAKE CALIPERS, BRAKE LINING MOUNTS, BRAKE SHOES, BRAKE CONTROLS, WEAR ADJUSTERS, LINKAGE AND RIGGING ACTUATORS, SPRING ENERGY ACCUMULATORS, PARKING BRAKES, SERVICE BRAKES, EMERGENCY BRAKE RELEASES FOR RAILBOUND VEHICLES, NAMELY, HIGH-SPEED TRAINS, LOCOMOTIVES, PASSENGER CARRIAGES, METROPOLITAN TRAINS, PRESSURE REGULATORS, LINING MOUNTS, BRAKE CALIPER UNITS FOR DISC BRAKES, ALL OF THE AFOREMENTIONED GOODS AS COMPONENTS OF BRAKE SYSTEMS; RAIL-BOUND VEHICLE MAGNETIC TRACK BRAKES, PARTS OF RAIL-BOUND VEHICLE MAGNETIC TRACK BRAKES, NAMELY, MAGNETIC TRACK BRAKE HEATING SYSTEMS COMPRISING BRAKE SHOES; INCREMENTALLY ADJUSTABLE EDDY-CURRENT BRAKES FOR RAIL-BOUND VEHICLES; AIR SUSPENSION SYSTEMS FOR RAIL-BOUND AND COMMERCIAL VEHICLES; VEHICLE LEVEL CONTROL SYSTEMS COMPRISING AIR SUSPENSION VALVES FOR CONTROLLING SUSPENSION HEIGHT FOR RAIL-BOUND VEHICLES; AUTOMATIC AND NON-AUTOMATIC COUPLINGS FOR AIR-CONDITIONING AND TOILET INSTALLATIONS FOR RAIL-BOUND AND ROAD VEHICLES, NAMELY, TRACTION AND THRUST COUPLERS, PIPELINE COUPLERS, ELECTRIC CONDUIT COUPLERS, COMPRESSED-AIR COUPLERS AND CABLE COUPLERS NOT FOR ENGINES; HOLDING AND STEERING LINKAGES AND TRACTION AND THRUST TRANSMITTER ELEMENTS FOR THE AFOREMENTIONED COUPLERS, NAMELY, HOLDING STRUCTURES AND TIE RODS FOR ATTACHMENT COUPLINGS FOR TRANSMITTING IMPACT LOADS AND TENSIBLE FORCES; AIR SUSPENSION VALVES FOR CONTROLLING SUSPENSION HEIGHT FOR VEHICLES, EXHAUST LOAD BRAKE VALVES, BRAKE AIR VALVES FOR LAND VEHICLES; AUTOMATIC VEHICLE DOORS AND ASSOCIATED TRAIN PLATFORM DOORS; ENGINE TRACTION CONTROLLERS FOR VEHICLES; COMPRESSED-AIR GENERATION SYSTEMS FOR RAIL-BOUND AND COMMERCIAL VEHICLES COMPRISING BRAKE AIR COMPRESSORS; WINDSHIELD WIPER BLADES, WINDSHIELD WIPER DRIVES, WINDSHIELD WIPER SPRAY NOZZLES, WINDSHIELD WIPER WATER RESERVOIRS, WIND-SHIELD WIPER WATER PUMPS, WINDSHIELD WIPER OPERATING VALVES FOR RAIL-BOUND VEHICLES; COMBINATION WINDSHIELD WASHER AND WIPERS FOR RAIL-BOUND VEHICLES; RAIL-BOUND VEHICLES, NAMELY, HIGH-SPEED TRAINS, LOCOMOTIVES, PASSENGER CARRIAGES, METROPOLITAN TRAINS, IN CLASS 12 (U.S. CLS. 19, 21, 23, 31, 35 AND 44).

FOR: REPAIR AND/OR MAINTENANCE OF BOGIE COMPONENTS FOR VEHICLES, TRAINS AND RAIL CARS INCLUDING BEARINGS, DAMPERS, WHEELS, WHEEL SURFACES, GEARBOXES, UNITS, APPARATUSES AND BRAKING GEAR OPERATED ON COMPRESSED MEDIA; REPAIR AND/OR MAINTENANCE OF ELECTRICAL AND/OR ELECTRONIC BRAKING, LEVELING AND PROPULSION UNITS AND SYSTEMS FOR VEHICLES, TRAINS AND RAILCARS; REPAIR AND/OR MAINTENANCE OF ELECTRICAL AND/OR ELECTRONIC MEASURING, CONTROLLING, GOVERNING SYSTEMS FOR LEVEL CONTROLLERS, BRAKE SYSTEMS FOR RAIL-BOUND VEHICLES, NAMELY, TRAINS, RAIL CARS, METROS, TRAINS, HIGH-SPEED TRAINS, LOCOMOTIVES, IN CLASS 37 (U.S. CLS. 100, 103 AND 106).

THE MARK CONSISTS OF STANDARD CHARACTERS WITHOUT CLAIM TO ANY PARTICULAR FONT, STYLE, SIZE, OR COLOR.

**Reg. No. 4,123,547** PRIORITY DATE OF 9-9-2009 IS CLAIMED.

OWNER OF INTERNATIONAL REGISTRATION 1064120 DATED 3-5-2010, EXPIRES 3-5-2020.

SER. NO. 79-092,218, FILED 3-5-2010.

TRICIA SONNEBORN, EXAMINING ATTORNEY

# United States of America

United States Patent and Trademark Office



**Reg. No. 4,123,548**

**Registered Apr. 10, 2012**

**Int. Cl.: 30**

**TRADEMARK**

**PRINCIPAL REGISTER**

INOSTRANNOE TCHASTNOE OUNITARNOE PROIZVODSTVENNO-TORGOVOE  
PREDPRIATIE "KARAVAN" KORPORATSII "KAMBERLI MARKETING KORP."  
(BELARUS ENTREPRISE ÉTRANGÈRE UNITAIRE PRIVÉE DE PRODUCTION ET DE  
COMMERCE)

KOMM. 2, D. 1, OUL. ZAVODSKAIA  
ZASLAVL; 223034 MINSKAIA OBL.  
BELARUS

FOR: COFFEE, TEA, COCOA, SUGAR, RICE, TAPIOCA, SAGO, EDIBLE ICES; HONEY,  
TREACLE; YEAST, BAKING-POWDER; SALT, MUSTARD; VINEGAR, SAUCES; SPICES;  
ICE FOR REFRESHMENT; ARTIFICIAL COFFEE, COFFEE SUBSTITUTES, NAMELY, VE-  
GETAL PREPARATIONS FOR USE AS COFFEE SUBSTITUTES, COFFEE-BASED BEVER-  
AGES, COFFEE BEVERAGES WITH MILK, COFFEE FLAVORINGS, UNROASTED COFFEE,  
IN CLASS 30 (U.S. CL. 46).

THE MARK CONSISTS OF FOLLOWING A RECTANGLE DESIGN CONTAINING THEREIN  
A GREEN AND WHITE ADVERTISING BANNER OUTLINED IN DARK GREEN IN THE  
UPPER MIDDLE, ABOVE THE BANNER ARE STYLISED GREEN AND WHITE BUBBLES  
ATOP A STYLIZED GREEN LEAF AT THE TOP OF THE RECTANGLE, A WHITE SECTION  
GOES FROM THE LOWER LEFT OF THE RECTANGLE TO THE MIDDLE RIGHT SECTION,  
THE SECTION GRADATES FROM WHITE IN THE MIDDLE, TO LIGHT GREEN, AND THEN  
TO GREEN AND DARK GREEN ON THE LOWER RIGHT AND UPPER EDGES OF THE  
SECTION, IN THE LOWER RIGHT OF THE RECTANGLE IS A STYLIZED GREEN AND  
DARK GREEN BUNCH OF LEAVES, WITH WHITE SHADOWING, IN THE LOWER LEFT,  
WITHIN THE WHITE SECTION ARE FOUR GOLD CONCENTRIC CIRCLES CONTAINING  
TWO INNER CIRCLES AND TWO OUTER CIRCLES.

OWNER OF INTERNATIONAL REGISTRATION 1064265 DATED 12-10-2010, EXPIRES 12-  
10-2020.

THE COLOR(S) WHITE, GREEN, DARK GREEN, LIGHT GREEN AND GOLD ARE CLAIMED  
AS A FEATURE OF THE MARK IS/ARE CLAIMED AS A FEATURE OF THE MARK.

SER. NO. 79-092,276, FILED 12-10-2010.

SCOTT BIBB, EXAMINING ATTORNEY



*David J. Kybas*

Director of the United States Patent and Trademark Office

# United States of America

United States Patent and Trademark Office



**Reg. No. 4,123,549**

**Registered Apr. 10, 2012**

**Int. Cl.: 33**

**TRADEMARK**

**PRINCIPAL REGISTER**

CHIVAS HOLDINGS (IP) LIMITED (UNITED KINGDOM LIMITED COMPANY)  
111-113 RENFREW ROAD  
PAISLEY, RENFREWSHIRE PA3 4DY  
UNITED KINGDOM

FOR: ALCOHOLIC BEVERAGES EXCEPT BEERS, IN CLASS 33 (U.S. CLS. 47 AND 49).

OWNER OF U.S. REG. NOS. 325,152, 3,856,909 AND OTHERS.

PRIORITY DATE OF 10-19-2010 IS CLAIMED.

OWNER OF INTERNATIONAL REGISTRATION 1064426 DATED 12-21-2010, EXPIRES 12-21-2020.

THE COLOR(S) SILVER, GOLD, BEIGE, BLACK, BLUE, BROWN, GREY, ORANGE, PINK, RED AND WHITE IS/ARE CLAIMED AS A FEATURE OF THE MARK.

NO CLAIM IS MADE TO THE EXCLUSIVE RIGHT TO USE "BLENDED SCOTCH WHISKEY" AND "EST. 1801", APART FROM THE MARK AS SHOWN.

THE MARK CONSISTS OF PRODUCT PACKAGING FOR THE GOODS COMPRISING A LABEL APPEARING ON A BLACK SHALLOW BOTTLE WITH PROTRUDING SIDES AT THE BOTTOM. THE BLACK SHALLOW BOTTLE HAS A RED BOTTLE CAP ON WHICH APPEARS BEIGE AND RED SPIRALS AND A RED NECK ON WHICH APPEAR TWO SILVER BANDS AT THE TOP AND BOTTOM OF NECK IN BETWEEN WHICH APPEARS TWO SILVER "J" LETTERS AS WELL AS THE SILVER WORDING "JAMES" AND "JOHN". IN BETWEEN THE TWO SILVER "J" LETTERS APPEARS A BROWN "&". ON THE FRONT OF THE BOTTLE IS A BEIGE AND ORANGE SHIELD WITH A LARGE BLACK OUTLINE WITH SCALLOPED EDGES. ACROSS THE FRONT OF THE SHIELD ARE TWO CROSSED GREY SPEARS THAT ARE OUTLINED IN BLACK. AT THE TOP OF THE SHIELD AND CENTERED BETWEEN THE SPEARS APPEARS A COAT OF ARMS IN BLUE AND WHITE A BLACK OUTLINE AND WITH WHITE LEAVES SURROUNDING IT AND WITH THE BROWN WORDING "TREIBHIREAS BUNAITEACHD" ON A WHITE SCROLL ABOVE THE COAT OF ARMS AND THE BLACK WORDING "FOUNDED 1801" ON A WHITE SCROLL BELOW THE COAT OF ARMS. BELOW THE COAT OF ARMS APPEARS A RED BANNER OUTLINED IN BROWN AND BLACK, WITH THE WORDING "CHIVAS REGAL" IN THE COLOR WHITE ACROSS THE RED BANNER. BELOW THAT BANNER IS THE WORDING IF THE WORDING



*David J. Kybas*

Director of the United States Patent and Trademark Office

**Reg. No. 4,123,549** "J & J" WITH THE "J'S" IN THE COLOR GREY AND THE "&" IN THE COLOR PINK, CENTERED IN A RED OVAL THAT IS OUTLINED IN BLACK. TO THE RIGHT OF THE WORDING "J & J" IS THE WORDING "JOHN" IN THE COLOR GREY AND TO THE LEFT OF THE WORDING "J & J" IS THE WORDING "JAMES" IN THE COLOR GREY. BELOW THE OVAL IS A RED BANNER OUTLINED IN THE COLORS BROWN AND BLACK, WITH THE WORDING "BLENDED SCOTCH WHISKEY" IN THE COLOR WHITE ACROSS THE BANNER. THE WORDING "EST. 1801" IN THE COLOR BLACK IS CENTERED BELOW THE LOWER BANNER. THE GOLD WORD "CHIVAS" APPEARS BELOW THE SHIELD.

THE ENGLISH TRANSLATION OF "TREIBHIREAS BUNAITEACHD" IS "FIDELITY, STABILITY".

SER. NO. 79-092,335, FILED 12-21-2010.

MICHAEL TANNER, EXAMINING ATTORNEY



# United States of America

United States Patent and Trademark Office

## CORE ASSETS

**Reg. No. 4,123,550**

**Registered Apr. 10, 2012**

**Int. Cls.: 35, 41, 43, 44  
and 45**

**SERVICE MARK**

**PRINCIPAL REGISTER**

FOSTER CARE ASSOCIATES LIMITED (UNITED KINGDOM LIMITED COMPANY)  
MALVERN VIEW,  
SAXON BUSINESS PARK, HANBURY ROAD,, STOKE PRIOR, BROMSGROVE B60 4AD  
UNITED KINGDOM

FOR: EMPLOYMENT PLACEMENT SERVICES; RECRUITMENT SERVICES, NAMELY, RECRUITMENT AND PLACEMENT OF CHILD CARERS, CARERS FOR ADULTS, RESIDENTIAL CARERS, RESPITE CARERS, PSYCHOLOGISTS, PSYCHOTHERAPISTS, NUTRITIONISTS, COUNSELLORS AND TEACHERS; RECRUITMENT OF FOSTER CARE PROVIDERS; DATABASE SERVICES, NAMELY, COMPILATION AND SYSTEMISATION OF INFORMATION INTO COMPUTER DATABASES, DATABASE MANAGEMENT AND PROVISION OF COMMERCIAL INFORMATION SERVICES PROVIDED BY ACCESS TO A COMPUTER DATABASE; PROVISION OF STATISTICAL INFORMATION, NAMELY, COMPILATION OR EXPLOITATION OF STATISTICAL DATA AND STATISTICAL ANALYSIS FOR BUSINESS AND COMMERCIAL PURPOSES; PROVIDING INFORMATION, CONSULTANCY AND ADVISORY SERVICES RELATING TO ALL OF THE AFORESAID SERVICES, IN CLASS 35 (U.S. CLS. 100, 101 AND 102).

FOR: EDUCATION SERVICES, NAMELY, TRAINING, TEACHING AND INSTRUCTION ON THE SUBJECT OF FOSTER CARE, CHILD CARE, ADULT CARE, RESIDENTIAL CARE, SHELTERED HOUSING, RESPITE CARE, CHILD PLACEMENT, ADULT PLACEMENT, CHILD DAY CARE SERVICES, ADULT DAY CARE SERVICE, ADULT DOMICILIARY CARE SERVICES, CHILD DOMICILIARY CARE SERVICES, PARENTING, PSYCHOLOGY, PSYCHOTHERAPY, NUTRITION, EMPLOYMENT PLACEMENT, SOCIAL POLICY, SOCIAL SCIENCE, COUNSELING SERVICES, NURSING, HEALTHCARE AND MENTAL HEALTH; EDUCATIONAL EXAMINATION, EDUCATIONAL TESTING AND EDUCATIONAL ASSESSMENT SERVICES; PROVISION OF TRAINING, TEACHING AND INSTRUCTION ON THE SUBJECT OF FOSTER CARE, CHILD CARE, ADULT CARE, RESIDENTIAL CARE, SHELTERED HOUSING, RESPITE CARE, CHILD PLACEMENT, ADULT PLACEMENT, CHILD DAY CARE SERVICES, ADULT DAY CARE SERVICE, ADULT DOMICILIARY CARE SERVICES, CHILD DOMICILIARY CARE SERVICES, PARENTING, PSYCHOLOGY, PSYCHOTHERAPY, NUTRITION, EMPLOYMENT PLACEMENT, SOCIAL POLICY, SOCIAL SCIENCE, COUNSELING SERVICES, NURSING, HEALTHCARE AND MENTAL HEALTH, OFFERED ELECTRONICALLY, BY MEANS OF TELECOMMUNICATIONS NETWORKS, BY ONLINE DELIVERY, BY WAY OF THE INTERNET OR WORLD WIDE WEB; EDUCATIONAL EXAMINATION, EDUCATIONAL TESTING AND EDUCATIONAL ASSESSMENT SERVICES OFFERED ELECTRONICALLY, BY MEANS OF TELECOMMUNICATIONS



*David J. Kyffers*

Director of the United States Patent and Trademark Office

**Reg. No. 4,123,550** NETWORKS, BY ONLINE DELIVERY, BY WAY OF THE INTERNET OR WORLD WIDE WEB; PUBLICATION OF INSTRUCTION, TEACHING, TRAINING, EXAMINATION, TESTING AND ASSESSMENT MATERIAL; PUBLICATION OF TEXTS, BOOKS, TEXTBOOKS, BROCHURES, MAGAZINES, JOURNALS AND NEWSPAPERS; ELECTRONIC DESKTOP PUBLISHING; ONLINE PUBLICATION OF ELECTRONIC TEXTS, BOOKS, TEXTBOOKS, BROCHURES, MAGAZINES, JOURNALS AND NEWSPAPERS; PUBLICATION OF ELECTRONIC TEXTS, BOOKS, TEXTBOOKS, BROCHURES, MAGAZINES, JOURNALS AND NEWSPAPERS, ALL BEING DOWNLOADABLE FROM AN ON-LINE DATABASE OR FROM A GLOBAL COMPUTER NETWORK; EDUCATIONAL ASSESSMENT SERVICES, DISTANCE LEARNING COURSES IN THE FIELD OF FOSTER CARE, CHILD CARE, ADULT CARE, RESIDENTIAL CARE, SHELTERED HOUSING, RESPITE CARE, CHILD PLACEMENT, ADULT PLACEMENT, CHILD DAY CARE SERVICES, ADULT DAY CARE SERVICE, ADULT DOMICILIARY CARE SERVICES, CHILD DOMICILIARY CARE SERVICES, PARENTING, PSYCHOLOGY, PSYCHOTHERAPY, NUTRITION, EMPLOYMENT PLACEMENT, SOCIAL POLICY, SOCIAL SCIENCE, COUNSELING SERVICES, NURSING, HEALTHCARE AND MENTAL HEALTH; ORGANISATION AND PROVISION OF COURSES, EDUCATIONAL ASSESSMENT, TEACHING AND TRAINING IN THE FIELD OF FOSTER CARE, CHILD CARE, ADULT CARE, RESIDENTIAL CARE, SHELTERED HOUSING, RESPITE CARE, CHILD PLACEMENT, ADULT PLACEMENT, CHILD DAY CARE SERVICES, ADULT DAY CARE SERVICE, ADULT DOMICILIARY CARE SERVICES, CHILD DOMICILIARY CARE SERVICES, PARENTING, PSYCHOLOGY, PSYCHOTHERAPY, NUTRITION, EMPLOYMENT PLACEMENT, SOCIAL POLICY, SOCIAL SCIENCE, COUNSELING SERVICES, NURSING, HEALTHCARE AND MENTAL HEALTH; RESEARCH IN THE FIELD OF EDUCATION; PRODUCTION AND DISTRIBUTION OF EDUCATIONAL FILMS, TELEVISION PROGRAMMES AND VIDEO RECORDINGS FOR DISPLAY OVER THE INTERNET, TELEVISION AND RADIO; PROVISION OF CORRESPONDENCE COURSES IN THE FIELD OF FOSTER CARE, CHILD CARE, ADULT CARE, RESIDENTIAL CARE, SHELTERED HOUSING, RESPITE CARE, CHILD PLACEMENT, ADULT PLACEMENT, CHILD DAY CARE SERVICES, ADULT DAY CARE SERVICE, ADULT DOMICILIARY CARE SERVICES, CHILD DOMICILIARY CARE SERVICES, PARENTING, PSYCHOLOGY, PSYCHOTHERAPY, NUTRITION, EMPLOYMENT PLACEMENT, SOCIAL POLICY, SOCIAL SCIENCE, COUNSELING SERVICES, NURSING, HEALTHCARE AND MENTAL HEALTH. ARRANGING, ORGANISING AND CONDUCTING COURSES, SEMINARS, SYMPOSIUMS, CONFERENCES, CONGRESSES AND EXHIBITIONS IN THE FIELD OF FOSTER CARE, CHILD CARE, ADULT CARE, RESIDENTIAL CARE, SHELTERED HOUSING, RESPITE CARE, CHILD PLACEMENT, ADULT PLACEMENT, CHILD DAY CARE SERVICES, ADULT DAY CARE SERVICE, ADULT DOMICILIARY CARE SERVICES, CHILD DOMICILIARY CARE SERVICES, PARENTING, PSYCHOLOGY, PSYCHOTHERAPY, NUTRITION, EMPLOYMENT PLACEMENT, SOCIAL POLICY, SOCIAL SCIENCE, COUNSELING SERVICES, NURSING, HEALTHCARE AND MENTAL HEALTH AND DISTRIBUTING COURSE MATERIALS AND EXAMINATION PAPERS IN CONNECTION THEREWITH; PROVIDING EDUCATIONAL EXAMINATION SERVICES; CAREERS COUNSELING; EDUCATION LIAISON SERVICES, NAMELY, TUTORING AND EDUCATIONAL PLACEMENT SCHEMES ON THE SUBJECT OF FOSTER CARE, CHILD CARE, ADULT CARE, RESIDENTIAL CARE, SHELTERED HOUSING, RESPITE CARE, CHILD PLACEMENT, ADULT PLACEMENT, CHILD DAY CARE SERVICES, ADULT DAY CARE SERVICE, ADULT DOMICILIARY CARE SERVICES, CHILD DOMICILIARY CARE SERVICES, PARENTING, PSYCHOLOGY, PSYCHOTHERAPY, NUTRITION, EMPLOYMENT PLACEMENT, SOCIAL POLICY, SOCIAL SCIENCE, COUNSELING SERVICES, NURSING, HEALTHCARE AND MENTAL HEALTH; TRAINING AND EDUCATIONAL ASSESSMENT OF FOSTER CARE PROVIDERS; PARENTING SKILLS TRAINING; INFORMATION, ADVISORY AND CONSULTANCY SERVICES RELATING TO ALL OF THE AFORESAID SERVICES, IN CLASS 41 (U.S. CLS. 100, 101 AND 107).

FOR: CHILD CARE CENTRES; PROVISION AND ARRANGEMENT OF TEMPORARY ACCOMMODATION; PROVISION OF CARE IN RESIDENTIAL ACCOMMODATION, NAMELY, THE PROVISION OF MEALS AND TEMPORARY ACCOMMODATION; PROVISION AND ARRANGEMENT OF TEMPORARY ACCOMMODATIONS, NAMELY, PROVIDING RESIDENTIAL HOMES AND HOUSING SERVICES FOR INDIVIDUALS IN NEED OF TEMPORARY

**Reg. No. 4,123,550** CARE; INFORMATION, CONSULTANCY AND ADVISORY SERVICES RELATING TO ALL OF THE AFORESAID SERVICES, IN CLASS 43 (U.S. CLS. 100 AND 101).

FOR: PROVISION OF RESPITE CARE, NAMELY, PLANNED SHORT-TERM AND TIME LIMITED BREAKS FOR CARE GIVERS OF INDIVIDUALS WHO REQUIRE SPECIALISED CARE OR SUPERVISION; COUNSELING SERVICES, NAMELY, DRUG ADDICTION COUNSELING SERVICES, DRUG REHABILITATION COUNSELING SERVICES, PSYCHOTHERAPY COUNSELING, PSYCHOLOGY COUNSELING, PSYCHOLOGY AND PSYCHOTHERAPY COUNSELING FOR CHILDREN AND ADULTS IN INDIVIDUAL AND FAMILY SESSIONS; MENTAL HEALTH COUNSELING SERVICES; PROVIDING INFORMATION, CONSULTANCY AND ADVISORY SERVICES RELATING TO ALL OF THE AFORESAID SERVICES, IN CLASS 44 (U.S. CLS. 100 AND 101).

FOR: SOCIAL WORK CASE MANAGEMENT SERVICES, NAMELY, THE COORDINATION AND ORGANISATION OF LEGAL SERVICES, SOCIAL SERVICES, FOSTER CARE SERVICES, NURSING SERVICES, HEALTHCARE AND MENTAL HEALTH RESIDENTIAL CARE SERVICES, RESPITE CARE SERVICES, PSYCHOLOGY SERVICES, PSYCHOTHERAPY SERVICES AND COUNSELING SERVICES FOR ADULTS, CHILDREN AND FAMILIES; FOSTER CARE SERVICES; FOSTER CARE SERVICES, NAMELY, FOSTERING OF MOTHERS AND BABIES; FOSTER CARE SERVICES, NAMELY, FOSTERING OF CHILDREN; PERSONAL AND SOCIAL SERVICES RENDERED BY OTHERS, NAMELY, FOSTER PLACEMENT OF CHILDREN AND YOUNG PEOPLE; PROVISION OF PERSONAL SUPPORT SERVICES, NAMELY, PROVIDING EMOTIONAL GUIDANCE, THERAPY, COUNSELING AND ADVICE TO FOSTER CARERS; PROVISION OF PERSONAL SUPPORT SERVICES FOR YOUNG PEOPLE AND CHILDREN, NAMELY, PROVIDING EMOTIONAL REHABILITATION, GUIDANCE, COUNSELING, THERAPY, AND ADVICE TO YOUNG PEOPLE AND CHILDREN; PROVISION OF PERSONAL SUPPORT SERVICES FOR YOUNG PEOPLE AND CHILDREN, NAMELY, REHOMING SERVICES IN THE NATURE OF PROVIDING PLACEMENT OF CHILDREN AND YOUNG PEOPLE IN NEW FOSTER HOMES; ASSESSMENT SERVICES RELATING TO FOSTER CARERS, NAMELY, CONDUCTING RESEARCH ON FOSTER CARERS, INVESTIGATIONS ON FOSTER CARERS AND SCREENING OF FOSTER CARERS TO ENSURE THEIR CONTINUED SUITABILITY TO PERFORM THEIR ROLE, CARRYING OUT CHECKS AND COMPILING REPORTS ON FOSTER CARERS, NAMELY, CONDUCTING RESEARCH ON FOSTER CARERS, INVESTIGATIONS ON FOSTER CARERS AND SCREENING OF FOSTER CARERS TO ENSURE THEIR CONTINUED SUITABILITY TO PERFORM THEIR ROLE; EMPLOYMENT SCREENING SERVICES, NAMELY, CONDUCTING BACKGROUND RESEARCH ON FOSTER CARERS, BACKGROUND INVESTIGATIONS ON FOSTER CARERS AND PRE-EMPLOYMENT BACKGROUND SCREENING SERVICES ON FOSTER CARERS; LIAISON SERVICES WITH LOCAL AUTHORITIES RELATING TO FOSTER CARE, NAMELY, ACTING AS A LIAISON BETWEEN FOSTER CARE PROVIDERS AND LOCAL AUTHORITIES TO ADDRESS THE LEGAL AND PERSONAL SUPPORT NEEDS OF FOSTER CARE PROVIDERS AND INDIVIDUALS RESIDING IN FOSTER CARE; PROVIDING INFORMATION, CONSULTANCY AND ADVISORY SERVICES RELATING TO ALL OF THE AFORESAID SERVICES, IN CLASS 45 (U.S. CLS. 100 AND 101).

THE MARK CONSISTS OF STANDARD CHARACTERS WITHOUT CLAIM TO ANY PARTICULAR FONT, STYLE, SIZE, OR COLOR.

PRIORITY DATE OF 2-17-2010 IS CLAIMED.

OWNER OF INTERNATIONAL REGISTRATION 1064910 DATED 8-14-2010, EXPIRES 8-14-2020.

SER. NO. 79-092,493, FILED 8-14-2010.

KIMBERLY FRYE, EXAMINING ATTORNEY

# United States of America

United States Patent and Trademark Office

## USE THE SUN FIRST BY STW

**Reg. No. 4,123,551**

**Registered Apr. 10, 2012**

**Int. Cl.: 9**

**TRADEMARK**

**PRINCIPAL REGISTER**

NIGEL COTTON (BELGIUM INDIVIDUAL)  
AVENUE DU FOND DES CARPES 5  
B-1380 LASNE  
BELGIUM

FOR: APPARATUS FOR RECORDING, TRANSMISSION OR REPRODUCTION OF SOUND OR IMAGES; AUTOMATIC VENDING MACHINES AND MECHANISMS FOR COIN-OPERATED APPARATUS; CASH REGISTERS, CALCULATING MACHINES, DATA PROCESSING EQUIPMENT AND COMPUTERS, IN CLASS 9 (U.S. CLS. 21, 23, 26, 36 AND 38).

THE MARK CONSISTS OF STANDARD CHARACTERS WITHOUT CLAIM TO ANY PARTICULAR FONT, STYLE, SIZE, OR COLOR.

PRIORITY DATE OF 8-17-2010 IS CLAIMED.

OWNER OF INTERNATIONAL REGISTRATION 1064975 DATED 12-21-2010, EXPIRES 12-21-2020.

SER. NO. 79-092,513, FILED 12-21-2010.

FRED CARL, EXAMINING ATTORNEY



*David J. Kyfos*

Director of the United States Patent and Trademark Office

# United States of America

United States Patent and Trademark Office

 **ERDOS** 鄂尔多斯

**Reg. No. 4,123,552**

**Registered Apr. 10, 2012**

**Int. Cl.: 25**

**TRADEMARK**

**PRINCIPAL REGISTER**

INNER MONGOLIA EERDUOISI CASHMERE PRODUCTS CO., LTD (CHINA CORPORATION)  
DALATENANLU  
DONGSHENG CITY; 017000 INNER MONGOLIA  
CHINA

FOR: CLOTHING, NAMELY, SHIRTS, LEATHER COATS, LEATHER JACKETS, TROUSERS, COATS, SKIRTS, UNDERWEAR, DRESSING GOWNS, VESTS, OVERALLS, JACKETS, T-SHIRTS; KNITWEAR, NAMELY, HATS, SCARVES, SWEATERS, DRESSES; TOP COATS; LAYETTES; SHOES; HATS AND CAPS; HOSIERY; COLLARS; SCARVES; GLOVES, IN CLASS 25 (U.S. CLS. 22 AND 39).

OWNER OF U.S. REG. NO. 2,867,272.

OWNER OF INTERNATIONAL REGISTRATION 1065708 DATED 1-4-2011, EXPIRES 1-4-2021.

THE TRANSLITERATION OF THE NON-LATIN CHARACTERS IN THE MARK IS: THE TRANSLITERATION OF THE FIRST CHINESE CHARACTER IS "E"; THE TRANSLITERATION OF THE SECOND CHINESE CHARACTERS IS "ER"; THE TRANSLITERATION OF THE THIRD CHINESE CHARACTER IS "DUO"; THE TRANSLITERATION OF THE FOURTH CHINESE CHARACTER IS "SI".

THE MARK CONSISTS OF THE DESIGN OF A HIGHLY STYLIZED LETTER 'E', FOLLOWED BY THE WORDING 'ERDOS' IN STYLIZED FORM, FOLLOWED BY FOUR CHINESE CHARACTERS.

THE ENGLISH TRANSLATION OF THE FOREIGN WORD(S) IN THE MARK IS: THE TRANSLATION OF FIRST CHINESE CHARACTER IS BOUNDARY; THE TRANSLATION OF THE SECOND CHINESE CHARACTER IS YOU; THE TRANSLATION OF THE THIRD CHINESE CHARACTER IS MUCH; THE TRANSLATION OF THE FOURTH CHINESE CHARACTER IS THIS.

SER. NO. 79-092,779, FILED 1-4-2011.

MARTHA SANTOMARTINO, EXAMINING ATTORNEY



*David J. Kypos*

Director of the United States Patent and Trademark Office

# United States of America

United States Patent and Trademark Office



**Reg. No. 4,123,553**

**Registered Apr. 10, 2012**

**Int. Cl.: 25**

**TRADEMARK**

**PRINCIPAL REGISTER**

ZHANG ZHIGANG (CHINA INDIVIDUAL)  
GROUP 2, TUANJI COMMUNITY  
TIELI TOWN.; TIELI CITY; HEILONGJIANG PROVINCE  
CHINA

FOR: CLOTHING, NAMELY, JACKETS, PANTS, COATS, DRESSES; SHIRTS; SUITS; UNIFORMS; SHOES; NECKTIES; HOSIERY; HATS; CHILDREN'S DRESSES; CASUAL SHIRTS; KNIT PANTS; CHILDREN'S AND INFANT'S APPAREL, NAMELY, JUMPERS, OVERALL SLEEPWEAR, PAJAMAS, ROMPERS AND ONE-PIECE GARMENTS, IN CLASS 25 (U.S. CLS. 22 AND 39).

THE MARK CONSISTS OF THE WORDING "CHARM BULLS", TWO CHINESE CHARACTERS TRANSLITERATED AS "QIAN NIU" , AND A DESIGN OF THE LETTER "B" FORMING A NEGATIVE SPACE IMAGE OF A BULL.

OWNER OF INTERNATIONAL REGISTRATION 1066183 DATED 10-29-2010, EXPIRES 10-29-2020.

THE TRANSLITERATION OF THE NON-LATIN CHARACTERS IN THE MARK IS: QIAN NIU.

THE ENGLISH TRANSLATION OF THE FOREIGN WORD(S) IN THE MARK IS: TWO CHINESE CHARACTERS APPEARING IN THE MARK MEAN "THOUSAND" AND "CATTLE" RESPECTIVELY. THE MARK AS A WHOLE HAS NO MEANING. THE MARK HAS NO MEANING IN A FOREIGN LANGUAGE.

SER. NO. 79-092,957, FILED 10-29-2010.

HANNO RITTNER, EXAMINING ATTORNEY



*David J. Kypos*

Director of the United States Patent and Trademark Office

# United States of America

United States Patent and Trademark Office

# AYAGY

**Reg. No. 4,123,554**

**Registered Apr. 10, 2012**

**Int. Cls.: 38 and 42**

**SERVICE MARK**

**PRINCIPAL REGISTER**

AYAGY AG (SWITZERLAND SOCIÉTÉ ANONYME (SA))  
HOLBEINSTRASSE 20  
CH-8008 ZÜRICH, SWITZERLAND

FOR: TELECOMMUNICATION SERVICES, NAMELY, PROVIDING INTERNET ACCESS AND COMMUNICATIONS VIA MULTINATIONAL TELECOMMUNICATIONS NETWORKS; TRANSMISSION OF VOICE, SOUND, IMAGES AND DATA THROUGH TELECOMMUNICATION NETWORKS, WIRELESS COMMUNICATIONS NETWORKS, THE INTERNET, INFORMATION NETWORKS AND DATA NETWORKS; VOICE OVER INTERNET PROTOCOL (VOIP) SERVICES; COMMUNICATIONS SERVICES VIA COMPUTER TERMINALS, BY DIGITAL TRANSMISSION OR VIA SATELLITE; COMMUNICATIONS VIA DIGITAL OR ANALOGUE COMPUTER TERMINALS; COMMUNICATION BY MOBILE TELEPHONE; COMPUTER TELEPHONY SERVICES; LEASING TELECOMMUNICATION EQUIPMENT FOR ADVANCED TELEPHONE, WIRELESS TELEPHONE AND WIRELESS BROADBAND COMMUNICATIONS SERVICES FOR TRANSMITTING DATA AND VOICE; AUTOMATED TELEPHONE CALL SCREENING SERVICES; AUTOMATED TELEPHONE VOICE MESSAGE SERVICES; PROVIDING AUTOMATIC COMPUTER TELEPHONY SERVICES OVER THE INTERNET, IN CLASS 38 (U.S. CLS. 100, 101 AND 104).

FOR: DEVELOPMENT OF COMPUTER APPLICATION SOFTWARE FOR MOBILE TELEPHONES, NAMELY, COMPUTER SOFTWARE ALLOWING USERS TO CHOOSE AMONGST DIFFERENT TELECOMMUNICATIONS SERVICES PROVIDERS; DEVELOPMENT OF COMPUTER APPLICATION SOFTWARE FOR MOBILE TELEPHONES, NAMELY, SOFTWARE FOR USE IN MANAGEMENT OF DATABASES AND FOR USE IN ELECTRONIC DATA RECORDING; DESIGN AND DEVELOPMENT OF COMPUTER HARDWARE; DESIGN, DEVELOPMENT, INSTALLATION AND MAINTENANCE OF COMPUTER SOFTWARE; COMPUTER TECHNOLOGY SUPPORT SERVICES VIA TELEPHONE NETWORKS OR GLOBAL COMPUTER NETWORKS, NAMELY, HELP DESKS PROVIDING TECHNICAL INFORMATION UPON SPECIFIC REQUESTS BY END USERS, IN CLASS 42 (U.S. CLS. 100 AND 101).



THE MARK CONSISTS OF STANDARD CHARACTERS WITHOUT CLAIM TO ANY PARTICULAR FONT, STYLE, SIZE, OR COLOR.

*David J. Kappas*

PRIORITY DATE OF 7-21-2010 IS CLAIMED.

**Reg. No. 4,123,554** OWNER OF INTERNATIONAL REGISTRATION 1066590 DATED 1-21-2011, EXPIRES 1-21-2021.

THE WORD "AYAGY" HAS NO MEANING IN A FOREIGN LANGUAGE.

SER. NO. 79-093,082, FILED 1-21-2011.

ELI HELLMAN, EXAMINING ATTORNEY



# United States of America

United States Patent and Trademark Office

Co Co Ro  
Tu Tu Mu

**Reg. No. 4,123,555**

SHINDO CO., LTD. (JAPAN CORPORATION)

**Registered Apr. 10, 2012**

11-1-1 LI, AWARA CITY  
FUKUI 919-0614, JAPAN

**Int. Cls.: 24, 26 and 35**

FOR: NARROW WOVEN FABRICS, CHEMICAL MIXED FIBER FABRICS, INORGANIC FIBER FABRICS, OTHER THAN ASBESTOS FIBER FABRICS, MIXED FIBER FABRICS, MIXED YARN FABRICS, AND OTHER WOVEN FABRICS OTHER THAN EDGING RIBBONS FOR TATAMI MATS, NAMELY, COTTON FABRICS, HEMP YARN FABRICS, SILK FABRICS, WOOL YARN FABRICS, CHEMICAL FIBER FABRICS, INORGANIC FIBER MIXED FABRICS, MIXED FIBER FABRICS, AND PAPER YARN FABRICS; KNITTED FABRICS; FELT AND NON-WOVEN TEXTILE FABRICS; OILCLOTH; GUMMED WATERPROOF CLOTH; VINYL COATED CLOTH FOR USE IN THE MANUFACTURE OF BAGS, TABLECLOTH, SHOES, BOOTS, BELTS, HATS, UMBRELLAS, AND CLOTHES; RUBBERIZED CLOTH; LEATHER CLOTH, NAMELY, CLOTH PROCESSED WITH LEATHER AND SYNTHETIC LEATHER; FILTERING MATERIALS OF TEXTILE, NAMELY, HIGH DENSITY KNIT FABRICS AND TRICOT FABRICS FOR USE IN THE MANUFACTURE OF OIL FILTERS FOR MOTORS, ENGINES AND MECHANICAL PURPOSES, HIGH DENSITY KNIT FABRICS AND TRICOT FABRICS FOR USE IN THE MANUFACTURE OF FILTERS FOR DRINKING WATER, AND HIGH DENSITY KNIT FABRICS AND TRICOT FABRICS FOR USE IN THE MANUFACTURE OF FILTERS FOR SEWAGE; TOWELS OF TEXTILE, HANDKERCHIEFS, JAPANESE GENERAL WRAPPING CLOTH; BEDSHEETS; FUTON QUILTS; FUTON TICKS, NAMELY, UNSTUFFED FUTON COVERS NOT OF PAPER; PILLOWCASES; BED BLANKETS; TABLE NAPKINS OF TEXTILE; DISH CLOTHS; SHOWER CURTAINS; BANNERS AND FLAGS OF TEXTILE; UNFITTED SEAT COVERS OF TEXTILE; WALL HANGINGS OF TEXTILE; CURTAINS; TABLE CLOTHS NOT OF PAPER; LABELS OF CLOTH, IN CLASS 24 (U.S. CLS. 42 AND 50).

**TRADEMARK**

**SERVICE MARK**

**PRINCIPAL REGISTER**



*David J. Kypos*

Director of the United States Patent and Trademark Office

FOR: SEMI-FINISHED TAPES, NAMELY, ELASTIC TAPES, SEAM TAPES FOR SEWING PURPOSES, CHEMICAL LACE TAPES, ELASTIC TAPES FOR USE IN THE MANUFACTURE OF CLOTHING, JACQUARD TAPES, PRINTED RIBBON TAPES, TYROLISE TAPES ALL OF THE FOREGOING FOR DECORATIVE TRIMMING ON FABRICS; RIBBONS; KNITTED RASCHEL LACE FABRICS; EMBROIDERY LACE FABRICS; SEMI-FINISHED TUFTS AND TASSELS; BRAIDS; ARMBANDS; INSIGNIAS FOR WEAR, NOT OF PRECIOUS METAL; ORNAMENTAL NOVELTY BADGES NOT OF PRECIOUS METAL; BRASSARDS; TEXTILE APPLIQUE ROSETTES FOR ORNAMENT OF CLOTHING; FABRIC APPLIQUÉ; HAIR BANDS, HAIR NETS, HAIR RIBBONS AND HAIR ORNAMENTS; BEADS FOR HANDICRAFT WORK, SLIDE FASTENERS, NAMELY, ZIPPERS, HOOK AND PILE FASTENING TAPES

**Reg. No. 4,123,555** AND BUTTONS; ARTIFICIAL FLOWERS, OTHER THAN ARTIFICIAL GARLANDS AND WREATHS; SHOE ORNAMENTS, NOT OF PRECIOUS METAL; SHOE LACES; METAL FASTENERS FOR SHOES AND BOOTS, IN CLASS 26 (U.S. CLS. 37, 39, 40, 42 AND 50).

FOR: RETAIL STORE SERVICES AND WHOLESALE STORE SERVICES FEATURING NARROW WOVEN FABRICS, CHEMICAL FIBER FABRICS, INORGANIC FIBER FABRICS, OTHER THAN ASBESTOS FIBER FABRICS, MIXED FIBER FABRICS, MIXED YARN FABRICS, AND ANY OTHER WOVEN FABRICS, OTHER THAN EDGING RIBBONS FOR TATAMI MATS, KNITTED FABRICS; RETAIL STORE SERVICES AND WHOLESALE STORE SERVICES FEATURING FELT AND NON-WOVEN TEXTILE FABRICS; RETAIL STORE SERVICES AND WHOLESALE STORE SERVICES FEATURING OILCLOTH, GUMMED WATERPROOF CLOTH, VINYL COATED CLOTH, RUBBERIZED CLOTH, LEATHER CLOTH AND FILTERING MATERIALS OF TEXTILE; RETAIL STORE SERVICES AND WHOLESALE STORE SERVICES FEATURING TOWELS OF TEXTILE, HANDKERCHIEFS, JAPANESE GENERAL WRAPPING CLOTH IN THE NATURE OF FUROSHIKI, AND ANY OTHER PERSONAL ARTICLES OF WOVEN TEXTILE NOT FOR WEAR, BEDSHEETS, FUTON AND QUILTS CASES, FUTON TICKS, UNSTUFFED FUTON, PILLOWCASES, PILLOW SLIPS AND BLANKETS, TABLE NAPKINS OF TEXTILE AND DISH CLOTHS, SHOWER CURTAINS, BANNERS AND FLAGS, NOT OF PAPER, TOILET SEAT COVERS OF TEXTILE, SEAT COVERS OF TEXTILE, WALL HANGINGS OF TEXTILE, CURTAINS AND TABLE CLOTHS NOT OF PAPER, LABELS OF CLOTH, SEMI-FINISHED TAPES AND RIBBONS, KNITTED RASCHEL LACE FABRICS AND EMBROIDERY LACE FABRICS, TUFTS AND SEMI-FINISHED TASSELS, BRAIDS, ARMBANDS, INSIGNIAS FOR WEAR, NOT OF PRECIOUS METAL, BADGES FOR WEAR, NOT OF PRECIOUS METAL, ORNAMENTAL STICKERS FOR FRONT JACKETS, BRASSARDS, ROSETTES FOR ORNAMENT OF CLOTHING AND APPLIQUÉ, HAIR BANDS, HAIR NETS, HAIR RIBBONS AND ANY OTHER HAIR ORNAMENTS, BEADS FOR HANDICRAFT WORK, SLIDE FASTENERS, ZIPPERS, HOOK AND PILE FASTENING TAPES AND ANY OTHER BUTTONS AND THE LIKE, ARTIFICIAL FLOWERS, OTHER THAN ARTIFICIAL GARLANDS AND WREATHS, SHOE ORNAMENTS NOT OF PRECIOUS METAL, SHOE LACES AND METAL FASTENERS FOR SHOES AND BOOTS; ONLINE RETAIL STORE SERVICES AND ONLINE WHOLESALE STORE SERVICES FEATURING NARROW WOVEN FABRICS, CHEMICAL FIBER FABRICS, INORGANIC FIBER FABRICS, OTHER THAN ASBESTOS FIBER FABRICS, MIXED FIBER FABRICS, MIXED YARN FABRICS, AND ANY OTHER WOVEN FABRICS, OTHER THAN EDGING RIBBONS FOR TATAMI MATS, KNITTED FABRICS; ONLINE RETAIL STORE SERVICES AND ONLINE WHOLESALE STORE SERVICES FEATURING FELT AND NON-WOVEN TEXTILE FABRICS; ONLINE RETAIL STORE SERVICES AND ONLINE WHOLESALE STORE SERVICES FEATURING OILCLOTH, GUMMED WATERPROOF CLOTH, VINYL COATED CLOTH, RUBBERIZED CLOTH, LEATHER CLOTH AND FILTERING MATERIALS OF TEXTILE; ONLINE RETAIL STORE SERVICES AND ONLINE WHOLESALE STORE SERVICES FEATURING TEXTILE TOWELS, HANDKERCHIEFS, JAPANESE GENERAL WRAPPING CLOTH IN THE NATURE OF FUROSHIKI, AND ANY OTHER PERSONAL ARTICLES OF WOVEN TEXTILE NOT FOR WEAR, BEDSHEETS, FUTON AND QUILTS CASES, FUTON TICKS, UNSTUFFED FUTON, PILLOWCASES, PILLOW SLIPS AND BLANKETS, TABLE NAPKINS OF TEXTILE AND DISH CLOTHS, SHOWER CURTAINS, BANNERS AND FLAGS, NOT OF PAPER, TOILET SEAT COVERS OF TEXTILE, SEAT COVERS OF TEXTILE, WALL HANGINGS OF TEXTILE, CURTAINS AND TABLE CLOTHS NOT OF PAPER, LABELS OF CLOTH, SEMI-FINISHED TAPES AND RIBBONS, KNITTED RASCHEL LACE FABRICS AND EMBROIDERY LACE FABRICS, TUFTS AND SEMI-FINISHED TASSELS, BRAIDS, ARMBANDS, INSIGNIAS FOR WEAR, NOT OF PRECIOUS METAL, BADGES FOR WEAR, NOT OF PRECIOUS METAL, ORNAMENTAL STICKERS FOR FRONT JACKETS, BRASSARDS, ROSETTES FOR ORNAMENT OF CLOTHING AND APPLIQUÉ, HAIR BANDS, HAIR NETS, HAIR RIBBONS AND ANY OTHER HAIR ORNAMENTS, BEADS FOR HANDICRAFT WORK, SLIDE FASTENERS, ZIPPERS, HOOK AND PILE FASTENING TAPES AND ANY OTHER BUTTONS AND THE LIKE, ARTIFICIAL FLOWERS, OTHER THAN ARTIFICIAL GARLANDS AND WREATHS, SHOE ORNAMENTS NOT OF PRECIOUS METAL, SHOE LACES AND METAL FASTENERS FOR SHOES AND

**Reg. No. 4,123,555** BOOTS; SALES PROMOTION FOR OTHERS AND CONSULTING SERVICES THEREFORE,  
IN CLASS 35 (U.S. CLS. 100, 101 AND 102).

THE WORDING "CO CO RO TU TU MU" HAS NO MEANING IN A FOREIGN LANGUAGE.

PRIORITY DATE OF 11-12-2009 IS CLAIMED.

OWNER OF INTERNATIONAL REGISTRATION 1066610 DATED 5-6-2010, EXPIRES 5-6-2020.

SER. NO. 79-093,137, FILED 5-6-2010.

JEAN IM, EXAMINING ATTORNEY

# United States of America

United States Patent and Trademark Office

# AEDEKE

**Reg. No. 4,123,556**

**Registered Apr. 10, 2012**

**Int. Cl.: 7**

**TRADEMARK**

**PRINCIPAL REGISTER**

ZHAN SHI QIANG (CHINA INDIVIDUAL), DBA MANUFACTURER  
NO 111, XISONGYUAN VILLAGE  
BEIGUAN STREET OFFICE., JIAOZHOU CITY; 266300 SHANDONG PROVINCE  
CHINA

FOR: BEARING SHELLS; CYLINDER HEADS FOR ENGINES; SEALING JOINTS (PARTS OF ENGINES); FAN BELTS FOR MOTORS AND ENGINES; AUTOMOBILE OIL PUMPS; AUTOMOBILE WATER PUMPS; ENGINE AIRTIGHT PIECES; PISTON SEGMENTS; PISTONS (PARTS OF MACHINES OR ENGINES); VALVES (FOR AUTOMOBILE ENGINES), IN CLASS 7 (U.S. CLS. 13, 19, 21, 23, 31, 34 AND 35).

OWNER OF INTERNATIONAL REGISTRATION 1066809 DATED 1-4-2011, EXPIRES 1-4-2021.

SER. NO. 79-093,202, FILED 1-4-2011.

JOHN SCHUYLER YARD, EXAMINING ATTORNEY



*David J. Kybas*

Director of the United States Patent and Trademark Office

# United States of America

United States Patent and Trademark Office

# Heracoat

**Reg. No. 4,123,557**

**Registered Apr. 10, 2012**

**Int. Cls.: 7, 9 and 14**

**TRADEMARK**

**PRINCIPAL REGISTER**

W.C. HERAEUS GMBH (FED REP GERMANY LIMITED LIABILITY COMPANY)  
HERAEUSSTRASSE 12-14  
63450 HANAU  
FED REP GERMANY

FOR: ENGINES NOT FOR LAND VEHICLES; WIND POWERED ENGINES FOR POWER GENERATION, WIND POWERED ELECTRICITY GENERATORS, IN CLASS 7 (U.S. CLS. 13, 19, 21, 23, 31, 34 AND 35).

FOR: ELECTRICAL CONTACTS, ELECTRICAL CONTACTS MADE FROM PRECIOUS METAL, ELECTRICAL CONTACTS COATED WITH A COMPOSITION CONTAINING PRECIOUS METAL, ALL THE AFORESAID GOODS EXCEPT FOR THE TESTING, ELECTRONICAL AND MANUFACTURING WORKPLACES, TEACHING SYSTEMS, LABORATORY FURNITURE SYSTEMS AS WELL AS THEIR ACCESSORIES, IN CLASS 9 (U.S. CLS. 21, 23, 26, 36 AND 38).

FOR: PRECIOUS METALS AND THEIR ALLOYS FOR USE IN MANUFACTURING ELECTRICAL CONTACT COMPONENTS, IN CLASS 14 (U.S. CLS. 2, 27, 28 AND 50).

THE MARK CONSISTS OF STANDARD CHARACTERS WITHOUT CLAIM TO ANY PARTICULAR FONT, STYLE, SIZE, OR COLOR.

PRIORITY DATE OF 6-17-2010 IS CLAIMED.

OWNER OF INTERNATIONAL REGISTRATION 1066976 DATED 12-16-2010, EXPIRES 12-16-2020.

OWNER OF U.S. REG. NO. 3,155,722.

SER. NO. 79-093,289, FILED 12-16-2010.

KRISTINA MORRIS, EXAMINING ATTORNEY



*David J. Kypos*

Director of the United States Patent and Trademark Office

# United States of America

United States Patent and Trademark Office



**Reg. No. 4,123,558**

**Registered Apr. 10, 2012**

**Int. Cl.: 12**

G.B. CYCLE COMPONENTS LIMITED (UNITED KINGDOM LIMITED LIABILITY COMPANY)  
HANWORTH TRADING ESTATE, HAMPTON ROAD  
FELTHAM, MIDDLESEX TW13 6EH  
UNITED KINGDOM

**TRADEMARK**

**PRINCIPAL REGISTER**

FOR: LAND VEHICLES; CYCLES, NAMELY, BICYCLES; BICYCLES AND REPLACEMENT PARTS AND FITTINGS THEREFOR; BRAKES FOR VEHICLES; PARTS OF VEHICLE BRAKES, NAMELY, BRAKE CABLES, BRAKE CALIPERS, BRAKE PEDALS; HANDLEBARS, HANDLEBAR STEMS AND BRAKE CABLE LUBRICATORS, ALL BEING PARTS OF CYCLES; BICYCLE TOE CLIPS FOR CYCLISTS, IN CLASS 12 (U.S. CLS. 19, 21, 23, 31, 35 AND 44).

THE MARK IS COMPRISED OF THE STYLIZED LETTERS "GB" ENCOMPASSED BY A RING.

PRIORITY DATE OF 7-21-2010 IS CLAIMED.

OWNER OF INTERNATIONAL REGISTRATION 1067125 DATED 1-21-2011, EXPIRES 1-21-2021.

SEC. 2(F).

SER. NO. 79-093,383, FILED 1-21-2011.

ELI HELLMAN, EXAMINING ATTORNEY



*David J. Kyffers*

Director of the United States Patent and Trademark Office

# United States of America

United States Patent and Trademark Office



**Reg. No. 4,123,559**

**Registered Apr. 10, 2012**

**Int. Cl.: 19**

**TRADEMARK**

**PRINCIPAL REGISTER**

CEMEX RESEARCH GROUP AG (SWITZERLAND SOCIEDAD ANÓNIMA)  
RÖMERSTR. 13  
CH-2555 BRÜGG BEI BIEL  
SWITZERLAND

FOR: NON-METAL BUILDING MATERIALS, NAMELY, CONCRETE, CEMENT, MORTAR, AGGREGATE, SAND, GRAVEL, STONE, FLY-ASH, CEMENTITIOUS MATERIALS, CEMENT MIXES, AND CONCRETE MIXES; RIGID PIPES, NOT OF METAL; ASPHALT, PITCH AND BITUMEN; BUILDINGS TRANSPORTABLE, NOT OF METAL; MONUMENTS, NOT OF METAL, IN CLASS 19 (U.S. CLS. 1, 12, 33 AND 50).

NO CLAIM IS MADE TO THE EXCLUSIVE RIGHT TO USE "CO2 FOOTPRINT", APART FROM THE MARK AS SHOWN.

PRIORITY DATE OF 12-9-2010 IS CLAIMED.

OWNER OF INTERNATIONAL REGISTRATION 1067225 DATED 2-3-2011, EXPIRES 2-3-2021.

THE COLOR(S) GREEN AND BLUE IS/ARE CLAIMED AS A FEATURE OF THE MARK.

GREEN: THE PART IN THE SHAPE OF A LETTER "O" BLUE: THE PART IN THE FORM OF A LETTER "C", THE NUMBER 2 AND THE NAME "FOOTPRINT".

SER. NO. 79-093,441, FILED 2-3-2011.

ANGELA M. MICHELLI, EXAMINING ATTORNEY



*David J. Kybas*

Director of the United States Patent and Trademark Office

# United States of America

United States Patent and Trademark Office



**Reg. No. 4,123,560**

**Registered Apr. 10, 2012**

**Int. Cl.: 3**

**TRADEMARK**

**PRINCIPAL REGISTER**

LUKE NEWMAN (AUSTRALIA INDIVIDUAL)  
4/16 RIDDELL STREET  
BULIMBA QLD 4171  
AUSTRALIA

FOR: HAIR PRODUCTS, NAMELY, HAIR SHAMPOOS, HAIR CONDITIONERS, HAIR CARE PREPARATIONS, HAIR GELS, HAIR WAXES, HAIR LACQUERS, POMADES, HAIR STYLING PREPARATIONS, HAIR CREAMS, HAIR MOUSSE, BLEACHING PREPARATIONS FOR HAIR, HAIR COLOR REMOVERS, HAIR COLORANTS, AND HAIR DYES, IN CLASS 3 (U.S. CLS. 1, 4, 6, 50, 51 AND 52).

NO CLAIM IS MADE TO THE EXCLUSIVE RIGHT TO USE "DELUXE POMADE", APART FROM THE MARK AS SHOWN.

OWNER OF INTERNATIONAL REGISTRATION 1067264 DATED 1-18-2011, EXPIRES 1-18-2021.

THE MARK CONSISTS OF THE FOLLOWING: A DARK CIRCLE AND AN INNER LIGHT CONCENTRIC CIRCLE ENCOMPASSING A DESIGN ELEMENT FEATURING TWO MALE BOXERS; THE IMAGE OF THE BOXERS APPEARS OVER A STAR WITH NUMEROUS POINTS; THE WORDING "UPPERCUT DELUXE POMADE" APPEARS ON A POLYGON AND UNDERNEATH THE IMAGE OF THE BOXERS, AND THE TERM "DELUXE POMADE" APPEARS BETWEEN TWO FIVE-POINT STARS.

SER. NO. 79-093,462, FILED 1-18-2011.

RICHARD WHITE, EXAMINING ATTORNEY



*David J. Kypos*

Director of the United States Patent and Trademark Office



# United States of America

United States Patent and Trademark Office

## SUMMER CUBE

**Reg. No. 4,123,561**

**Registered Apr. 10, 2012**

**Int. Cls.: 18, 25 and 35**

**TRADEMARK**

**SERVICE MARK**

**PRINCIPAL REGISTER**

MAX MARA INTERNATIONAL S.A. (LUXEMBOURG SOCIETÁ ANONIMA)  
17, BOULEVARD ROYAL  
L-2449 LUXEMBOURG, LUXEMBOURG

FOR: LEATHER AND IMITATIONS OF LEATHER, AND GOODS MADE OF THESE MATERIALS AND NOT INCLUDED IN OTHER CLASSES, NAMELY, WALLETS, PURSES, HANDBAGS, TRAVELLING BAGS, TEXTILE BAGS, TOTE SHOPPING BAGS; ANIMAL SKINS, IN CLASS 18 (U.S. CLS. 1, 2, 3, 22 AND 41).

FOR: CLOTHING, NAMELY, JACKETS, COATS, DOWN COATS, DOWN JACKETS, SCARVES, GLOVES, CAPES, BELTS; FUR CLOTHING ACCESSORIES, NAMELY, FUR WRISTBANDS, FUR HOOD COLLARS, FUR COLLARS, FUR CAPES, HOODED FUR VEST, FUR CUFFS; EMBROIDERED CLOTHING ACCESSORIES, NAMELY, EMBROIDERED CUFFS, EMBROIDERED BELTS, EMBROIDERED HOOD COLLARS; HEADGEAR, NAMELY, HATS AND CAPS, IN CLASS 25 (U.S. CLS. 22 AND 39).

FOR: ADVERTISING SERVICES; BUSINESS MANAGEMENT; BUSINESS ADMINISTRATION; PROVIDING OFFICE FUNCTIONS, IN CLASS 35 (U.S. CLS. 100, 101 AND 102).

THE MARK CONSISTS OF STANDARD CHARACTERS WITHOUT CLAIM TO ANY PARTICULAR FONT, STYLE, SIZE, OR COLOR.

OWNER OF INTERNATIONAL REGISTRATION 1067518 DATED 2-15-2011, EXPIRES 2-15-2021.

SER. NO. 79-093,723, FILED 2-15-2011.

JAMES MACFARLANE, EXAMINING ATTORNEY



*David J. Kyros*

Director of the United States Patent and Trademark Office

United States of America  
United States Patent and Trademark Office

**kerrygum**

**Reg. No. 4,123,562**

**Registered Apr. 10, 2012**

**Int. Cls.: 5 and 30**

**TRADEMARK**

**PRINCIPAL REGISTER**

KREUTZ, WILHELM (FED REP GERMANY INDIVIDUAL)  
OVERATHER STR. 22  
51109 KÖLN  
FED REP GERMANY

FOR: CHEWING GUM FOR MEDICAL PURPOSES, IN CLASS 5 (U.S. CLS. 6, 18, 44, 46, 51 AND 52).

FOR: CHEWING GUM, NOT FOR MEDICAL PURPOSES, IN CLASS 30 (U.S. CL. 46).

THE MARK CONSISTS OF STANDARD CHARACTERS WITHOUT CLAIM TO ANY PARTICULAR FONT, STYLE, SIZE, OR COLOR.

OWNER OF INTERNATIONAL REGISTRATION 1032775 DATED 2-11-2010, EXPIRES 2-11-2020.

SER. NO. 79-093,956, FILED 1-30-2011.

KAELIE KUNG, EXAMINING ATTORNEY



*David J. Kyffers*

Director of the United States Patent and Trademark Office

# United States of America

United States Patent and Trademark Office

# VERSUS

**Reg. No. 4,123,563**

GIANNI VERSACE S.P.A. (ITALY CORPORATION)  
VIA MANZONI, 38  
I-20121 MILAN, ITALY

**Registered Apr. 10, 2012**

**Int. Cls.: 3, 8, 11, 16, 18,  
19, 20, 21, 24, 25, 27, 35  
and 42**

FOR: COSMETICS, NAMELY, NIGHT AND DAY CREAMS, CLEANING PREPARATIONS, NAMELY, SOAPS FOR FACE AND BODY CARE, BATH FOAM, SHAVING FOAM, AFTER-SHAVE PRODUCTS, FOUNDATION MAKE-UP, NAIL POLISH, DEODORANTS FOR MEN AND WOMEN, HAND AND BODY SOAPS, HAIR SHAMPOOS AND RINSING PRODUCTS, HAIR SPRAY, TOOTHPASTE AND FRAGRANCES, NAMELY PERFUME, TOILET WATER AND ESSENTIAL OILS FOR PERSONAL USE FOR MEN AND WOMEN, IN CLASS 3 (U.S. CLS. 1, 4, 6, 50, 51 AND 52).

**TRADEMARK**

**SERVICE MARK**

**PRINCIPAL REGISTER**

FOR: TABLEWARE, NAMELY, KNIVES, FORKS AND SPOONS; CUTLERY; FORKS, KNIVES AND SPOONS; STERLING SILVER TABLE FORKS, KNIVES AND SPOONS; PARTS AND FITTINGS FOR ALL THE AFORESAID GOODS; DOMESTIC FIREPLACE BELLOWS, IN CLASS 8 (U.S. CLS. 23, 28 AND 44).

FOR: APPARATUS FOR LIGHTING, NAMELY, ELECTRIC LIGHTING FIXTURES FOR USE ON CEILINGS, CHANDELIERS, ELECTRIC, INCANDESCENT AND HOLOGEN LIGHT BULBS, SAFETY LAMPS, CANDLE, ELECTRIC, OIL AND PORTABLE PAPER LANTERS, STANDARD LAMPS; FIREPLACES; DECORATIVE WATER FOUNTAINS; PARTS AND FITTINGS FOR ALL THE AFORESAID GOODS, IN CLASS 11 (U.S. CLS. 13, 21, 23, 31 AND 34).



FOR: STATIONERY ARTICLES, NAMELY PAPER, LETTER PAPER, WRITING PAPER, LOOSE-LEAF PAPER, EXERCISE BOOKS, ADDRESS BOOKS AND NOTEBOOKS, NUMERICAL AND ALPHABETICAL INSERTS FOR BINDERS, NOTEBOOKS AND JOURNALS, ENVELOPES; CARDS, NAMELY, GREETING CARDS, NOTE CARDS, THANK YOU CARDS, BUSINESS CARDS; ALBUMS FOR PHOTOGRAPHS, STAMPS AND STICKERS; NAME CARD PAPER, FILE FOLDERS AND FILE POCKETS; WRITING AND MARKING INSTRUMENTS, NAMELY FOUNTAIN PENS, BALL PENS, FELT-TIPPED PENS, ROLLER PENS, MARKERS, MARKING PENS, PENCILS AND PENCIL LEADS, PEN INK REFILLS FOR PENS, ERASERS; PRINTING CLICHES, IN CLASS 16 (U.S. CLS. 2, 5, 22, 23, 29, 37, 38 AND 50).

*David J. Kappas*

Director of the United States Patent and Trademark Office

FOR: LEATHER AND IMITATION OF LEATHER, HANDBAGS, WALLETS, LUGGAGE ATTACHÉ CASES, TOTE BAGS, BRIEFCASES, SPORT BAGS, TRAVELLING TRUNKS,

**Reg. No. 4,123,563** CARRY-ON BAGS, SHOULDER BAGS, GARMENT BAGS FOR TRAVELLING, KEY CASES, UMBRELLAS, PARASOLS, WALKING STICKS, WHIPS, HARNESSSES, BRIDLES AND SADDLERY, IN CLASS 18 (U.S. CLS. 1, 2, 3, 22 AND 41).

FOR: FIREPLACE SURROUNDS, NOT OF METAL; FLOOR TILES; WOOD TILE FLOORS; GLASS TILES; PARQUET FLOORING; STATUETTES OF STONE, CONCRETE OR MARBLE; WALL PANELS NOT MADE OF METAL; PARTS AND FITTINGS FOR THE AFORESAID GOODS, IN CLASS 19 (U.S. CLS. 1, 12, 33 AND 50).

FOR: FURNITURE; MIRRORS; PICTURE FRAMES; CHAIRS; CUPBOARDS; CUSHIONS; DESKS; DIVANS; PLASTIC AND WOOD DOORKNOBS, NOT OF METAL OR GLASS; FIGURES OF BONE, IVORY, PLASTER, PLASTIC, WAX AND WOOD; FURNITURE HANDLES FOR DOORS; MAGAZINE RACKS; OFFICE FURNITURE; PILLOWS; PARTS AND FITTINGS FOR ALL THE AFORESAID GOODS, IN CLASS 20 (U.S. CLS. 2, 13, 22, 25, 32 AND 50).

FOR: HOUSEHOLD OR KITCHEN UTENSILS AND CONTAINERS, NAMELY, POT AND PAN SCRAPERS, ROLLING PINS, SPATULAS, TURNERS, WHISKS, GRATERS, SIEVES, STRAINERS; DINNERWARE; BEVERAGE-WARE; BEVERAGE GLASSWARE; SUGAR BOWLS; BEER MUGS; BOTTLE OPENERS; BOWLS; CANDLE HOLDERS NOT OF PRECIOUS METAL; CHINA ORNAMENTS; COOKWARE, NAMELY, POTS, PANS, ROASTING PANS AND STEAMERS; CORKSCREWS; SOAP DISPENSERS; FIGURINES MADE OF CHINA, CRYSTAL, EARTHENWARE, GLASS, PORCELAIN AND TERRACOTTA; HOLDERS FOR FLOWERS AND PLANTS; PERFUME ATOMIZERS SOLD EMPTY; PLATES; POTS; SOAP BOXES; SOAP HOLDERS; VASES; PARTS AND FITTINGS FOR THE AFORESAID GOODS; FLOWER BASKETS, IN CLASS 21 (U.S. CLS. 2, 13, 23, 29, 30, 33, 40 AND 50).

FOR: FABRIC FOR TEXTILE USE, FABRIC OF IMITATION ANIMAL SKINS FABRIC FOR BOOTS AND SHOES, BATH LINEN, BED LINEN; BLANKETS, NAMELY, BED BLANKETS, BABY BLANKETS, CASHMERE BLANKETS, WOVEN BLANKETS; CURTAINS; FURNITURE COVERS, NAMELY, UNFITTED FABRIC FURNITURE COVERS, UNFITTED FURNITURE COVERS NOT OF PAPER; HANDKERCHIEFS; KITCHEN TOWELS, IN CLASS 24 (U.S. CLS. 42 AND 50).

FOR: CLOTHING FOR MEN, WOMEN AND CHILDREN, NAMELY BELTS, COATS, RAIN-COATS, WAISTCOATS, BLOUSES AND PULLOVERS, JACKETS, TROUSERS, PANTS, SKIRTS, DRESSES, SUITS, SHIRTS AND CHEMISES, T-SHIRTS, SWEATERS, UNDERWEAR, SOCKS AND STOCKINGS, GLOVES, TIES, SCARVES, HATS AND CAPS, BOOTS, SHOES AND SLIPPERS, IN CLASS 25 (U.S. CLS. 22 AND 39).

FOR: CARPETS, BATH MATS; RUGS, MATS AND MATTING, LINOLEUM AND OTHER MATERIALS FOR COVERING EXISTING FLOORS; NON-TEXTILE WALL HANGINGS, IN CLASS 27 (U.S. CLS. 19, 20, 37, 42 AND 50).

FOR: ADVERTISING; BUSINESS MANAGEMENT; BUSINESS ADMINISTRATION; CONSULTANCY PROVIDING OFFICE FUNCTIONS; DISSEMINATION OF ADVERTISEMENTS; DISSEMINATION OF ADVERTISING MATTER; RENTAL OF ADVERTISING SPACES; COMMERCIAL OR INDUSTRIAL BUSINESS MANAGEMENT CONSULTANCY AND ASSISTANCE; PROFESSIONAL BUSINESS CONSULTANCY; MODELLING FOR ADVERTISING OR BUSINESS PROMOTION; FRANCHISING, NAMELY SERVICES PROVIDED BY A FRANCHISOR IN CONSULTATION AND ASSISTANCE IN BUSINESS MANAGEMENT AND BUSINESS DEVELOPING OF COMMERCIAL ENTERPRISES FOR THIRD PARTIES; GATHERING VARIOUS GOODS ALLOWING THE CONSUMER TO VIEW AND BUY THE AFORESAID GOODS FROM THIRD PARTIES IN RETAIL STORES, IN CLASS 35 (U.S. CLS. 100, 101 AND 102).

FOR: CONSULTANCY SERVICES RENDERED ON BEHALF OF THIRD PARTIES IN THE FIELD OF PLANNING AND DESIGN OF SHOPS, INTERIOR DESIGN AND DESIGN OF

**Reg. No. 4,123,563** SIGNS, SUCH SERVICES RENDERED ON BEHALF OF THIRD PARTIES, IN CLASS 42 (U.S. CLS. 100 AND 101).

THE MARK CONSISTS OF STANDARD CHARACTERS WITHOUT CLAIM TO ANY PARTICULAR FONT, STYLE, SIZE, OR COLOR.

PRIORITY DATE OF 6-10-2010 IS CLAIMED.

OWNER OF INTERNATIONAL REGISTRATION 1068440 DATED 11-9-2010, EXPIRES 11-9-2020.

OWNER OF U.S. REG. NOS. 2,487,129, 3,481,008 AND OTHERS.

SER. NO. 79-094,078, FILED 11-9-2010.

WARREN L. OLANDRIA, EXAMINING ATTORNEY

# United States of America

United States Patent and Trademark Office

# SYMPHONY

**Reg. No. 4,123,564**

**Registered Apr. 10, 2012**

**Int. Cl.: 9**

**TRADEMARK**

**PRINCIPAL REGISTER**

ABB S.P.A. (ITALY JOINT STOCK COMPANY)  
VIA VITTOR PISANI, 16  
I-20124 MILANO  
ITALY

FOR: AUTOMATED PROCESS CONTROL SYSTEM COMPRISED OF LOGIC BASED HARDWARE USED TO MONITOR THE STATUS OF OR CONTROL THE OPERATION OF INDUSTRIAL PROCESSES IN POWER GENERATION PLANTS, PETROCHEMICAL PLANTS, WATER DISTRIBUTION NETWORKS, DESALINATION PLANTS AND PUMPING STATIONS; COMPUTER SOFTWARE AND PROGRAMS FOR USE IN PROTECTING, MONITORING, CONTROLLING, REGULATING OF POWER GENERATION PLANTS, PETROCHEMICAL PLANTS, WATER DISTRIBUTION NETWORKS, DESALINATION PLANTS AND PUMPING STATIONS, IN CLASS 9 (U.S. CLS. 21, 23, 26, 36 AND 38).

THE MARK CONSISTS OF STANDARD CHARACTERS WITHOUT CLAIM TO ANY PARTICULAR FONT, STYLE, SIZE, OR COLOR.

PRIORITY DATE OF 12-27-2010 IS CLAIMED.

OWNER OF INTERNATIONAL REGISTRATION 1068557 DATED 1-24-2011, EXPIRES 1-24-2021.

SER. NO. 79-094,111, FILED 1-24-2011.

KEVIN DINALLO, EXAMINING ATTORNEY



*David J. Kybas*

Director of the United States Patent and Trademark Office

# United States of America

United States Patent and Trademark Office



**Reg. No. 4,123,565**

**Registered Apr. 10, 2012**

**Int. Cl.: 43**

**SERVICE MARK**

**PRINCIPAL REGISTER**

COMPAGNIE DE VICHY (FRANCE SOCIÉTÉ ANONYME)  
1 ET 3 AVENUE EISENHOWER  
F-03200 VICHY  
FRANCE

FOR: SERVICES FOR PROVIDING FOOD AND DRINK; HOTELS; BAR SERVICES; FOOD AND DRINK CATERING; TEMPORARY ACCOMMODATION; RENTAL AND RESERVATION OF TEMPORARY ACCOMMODATION, IN CLASS 43 (U.S. CLS. 100 AND 101).

NO CLAIM IS MADE TO THE EXCLUSIVE RIGHT TO USE "VICHY", APART FROM THE MARK AS SHOWN.

PRIORITY DATE OF 8-6-2010 IS CLAIMED.

OWNER OF INTERNATIONAL REGISTRATION 1068657 DATED 2-1-2011, EXPIRES 2-1-2021.

THE COLOR(S) LIGHT BLUE (PANTONE 284C) AND DARK BLUE (PANTONE 661C) IS/ARE CLAIMED AS A FEATURE OF THE MARK.

THE MARK CONSISTS OF THE STYLIZED WORDING "VICHY" IN DARK BLUE (PANTONE 661C) SUPERIMPOSED OVER A STYLIZED LETTER "Y" IN LIGHT BLUE (PANTONE 284C).

SER. NO. 79-094,149, FILED 2-1-2011.

MARILYN IZZI, EXAMINING ATTORNEY



*David J. Kybas*

Director of the United States Patent and Trademark Office

# United States of America

United States Patent and Trademark Office

# INTELLICUFF

**Reg. No. 4,123,566**

**Registered Apr. 10, 2012**

**Int. Cl.: 10**

**TRADEMARK**

**PRINCIPAL REGISTER**

HAMILTON MEDICAL AG (SWITZERLAND SOCIÉTÉ ANONYME (SA))  
VIA CRUSCH 8  
CH-7402 BONADUZ  
SWITZERLAND

FOR: SURGICAL AND MEDICAL APPARATUS, NAMELY, RESPIRATORY EQUIPMENT, APPARATUS FOR ARTIFICIAL RESPIRATION, NEBULIZERS FOR RESPIRATION THERAPY, RESPIRATORY SENSORS, MEDICAL VENTILATORS, AND CLOSED LOOP MEDICAL VENTILATORS, IN CLASS 10 (U.S. CLS. 26, 39 AND 44).

THE MARK CONSISTS OF STANDARD CHARACTERS WITHOUT CLAIM TO ANY PARTICULAR FONT, STYLE, SIZE, OR COLOR.

PRIORITY DATE OF 8-20-2010 IS CLAIMED.

OWNER OF INTERNATIONAL REGISTRATION 1068710 DATED 2-4-2011, EXPIRES 2-4-2021.

SER. NO. 79-094,166, FILED 2-4-2011.

NATALIE POLZER, EXAMINING ATTORNEY



*David J. Kyffers*

Director of the United States Patent and Trademark Office



# United States of America

United States Patent and Trademark Office

# VIVA

**Reg. No. 4,123,567**

**Registered Apr. 10, 2012**

**Int. Cl.: 10**

SHELCHEN GMBH (FED REP GERMANY CORPORATION (LIMITED LIABILITY COMPANY))  
IM GEWERBEPARK 6  
15711 ZEESEN  
FED REP GERMANY

**TRADEMARK**

FOR: ORTHOPEDIC INSERTS, ORTHOPEDIC INNER SOLES AND ORTHOPEDIC FOOT BEDS BEING INSERTS, ALL FOR SHOES, IN CLASS 10 (U.S. CLS. 26, 39 AND 44).

**PRINCIPAL REGISTER**

THE MARK CONSISTS OF STANDARD CHARACTERS WITHOUT CLAIM TO ANY PARTICULAR FONT, STYLE, SIZE, OR COLOR.

PRIORITY DATE OF 7-2-2010 IS CLAIMED.

OWNER OF INTERNATIONAL REGISTRATION 1068936 DATED 12-30-2010, EXPIRES 12-30-2020.

SER. NO. 79-094,283, FILED 12-30-2010.

RUDY R. SINGLETON, EXAMINING ATTORNEY



*David J. Kyffers*

Director of the United States Patent and Trademark Office

# United States of America

United States Patent and Trademark Office



**Reg. No. 4,123,568**

**Registered Apr. 10, 2012**

**Int. Cl.: 7**

TRITURACIÓN Y MAQUINARIA AUXILIAR DE NAVARRA, S.A.U. (SPAIN SOCIEDAD ANÓNIMA UNIPERSONAL)  
YANGUAS Y MIRANDA, 1 BAJO  
E-31002 PAMPLONA (NAVARRA)  
SPAIN

**TRADEMARK**

**PRINCIPAL REGISTER**

FOR: MACHINE TOOLS FOR THE PRODUCTION OF AGGREGATES, GRAVEL AND CONCRETE; MOTORS OTHER THAN FOR LAND VEHICLES; MACHINE COUPLINGS AND TRANSMISSIONS, EXCEPT FOR LAND VEHICLES; INCUBATORS FOR EGGS, IN CLASS 7 (U.S. CLS. 13, 19, 21, 23, 31, 34 AND 35).

OWNER OF INTERNATIONAL REGISTRATION 1069122 DATED 12-28-2010, EXPIRES 12-28-2020.

THE COLOR(S) YELLOW AND GRAY IS/ARE CLAIMED AS A FEATURE OF THE MARK.

YELLOW: THE LETTER "T" AT THE BEGINNING AND THE WORD "TRIMAN"; GRAY: THE PART BELOW THE LETTER "T" AT THE BEGINNING.

SER. NO. 79-094,349, FILED 12-28-2010.

ANGELA M. MICHELI, EXAMINING ATTORNEY



*David J. Kybas*

Director of the United States Patent and Trademark Office

# United States of America

United States Patent and Trademark Office

# MODELKARMA

**Reg. No. 4,123,569**

**Registered Apr. 10, 2012**

**Int. Cls.: 35, 38 and 41**

MODELKARMA GMBH (FED REP GERMANY GESELLSCHAFT MIT BESCHRÄNKTER  
HAFTUNG)  
LEERBACHSTR. 6  
60322 FRANKFURT AM MAIN  
FED REP GERMANY

**SERVICE MARK**

**PRINCIPAL REGISTER**

FOR: MODELING AGENCIES, IN CLASS 35 (U.S. CLS. 100, 101 AND 102).

FOR: PROVIDING CHAT FORUMS UTILIZING THE INTERNET; PROVIDING OF INTERNET  
CHATROOMS; RECEIVING AND SENDING MESSAGES, DOCUMENTS AND DATA BY  
ELECTRONIC TRANSMISSION, IN CLASS 38 (U.S. CLS. 100, 101 AND 104).

FOR: ACTIVITIES OF A PUBLISHING FIRM, COMPRISING THE EDITING OF TEXTS AND  
ARTICLES INTENDED FOR PUBLICATION; ORGANISATION OF BEAUTY COMPETITIONS;  
PRODUCTION OF TELEVISION AND LIVE SHOWS IN THE FIELD OF MODELING;  
PROVIDING ONLINE NOT DOWNLOADABLE ELECTRONIC PUBLICATIONS, NAMELY,  
NEWSLETTERS IN THE FIELD OF MODELING; ONLINE PUBLICATION OF ELECTRONIC  
BOOKS AND MAGAZINES, IN CLASS 41 (U.S. CLS. 100, 101 AND 107).

THE MARK CONSISTS OF STANDARD CHARACTERS WITHOUT CLAIM TO ANY PAR-  
TICULAR FONT, STYLE, SIZE, OR COLOR.

OWNER OF INTERNATIONAL REGISTRATION 1069248 DATED 10-29-2010, EXPIRES 10-  
29-2020.

SER. NO. 79-094,386, FILED 10-29-2010.

TRACY FLETCHER, EXAMINING ATTORNEY



*David J. Kyffers*

Director of the United States Patent and Trademark Office

# United States of America

United States Patent and Trademark Office

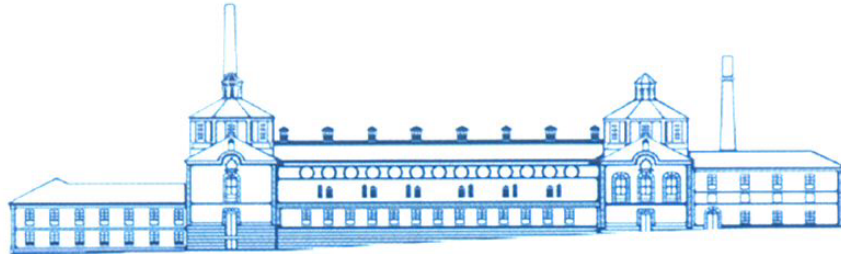

REAL FÁBRICA DE CRISTALES DE LA GRANJA  
FUNDACIÓN CENTRO NACIONAL DEL VIDRIO

**Reg. No. 4,123,570**

FUNDACION CENTRO NACIONAL DEL VIDRIO (SPAIN FUNDACIÓN)  
PASEO DEL POCILLO, 1

**Registered Apr. 10, 2012**

E-40100 LA GRANJA DE SAN ILDEFONSO (SEGO, SPAIN)

**Int. Cls.: 16, 21, 35, 40,  
41 and 42**

FOR: PRINTED PUBLICATIONS, NAMELY, BOOKS, MAGAZINES, NEWSPAPERS, PRINTED FORMS, PAMPHLETS, CATALOGS, AND INSTRUCTIONAL AND TEACHING MATERIALS, ALL REGARDING THE PROMOTION, DEVELOPMENT, HISTORY, RESEARCH AND TEACHING OF GLASS CRAFTWORK AND CULTURAL AND SCIENTIFIC ACTIVITIES RELATING TO THE TECHNIQUES AND ART OF GLASSMAKING, IN CLASS 16 (U.S. CLS. 2, 5, 22, 23, 29, 37, 38 AND 50).

**TRADEMARK**

**SERVICE MARK**

**PRINCIPAL REGISTER**

FOR: UNWORKED OR SEMI-WORKED GLASS, EXCEPT BUILDING GLASS; POWDERED GLASS FOR DECORATION EXCEPT BUILDING GLASS; ENAMELED GLASS, OPAL GLASS, PAINTED DECORATIVE GLASS NOT FOR BUILDING; ARTICLES, CONTAINERS AND UTENSILS OF GLASS AND CRYSTAL, NAMELY, BEVERAGE GLASSES, BOTTLES, JUGS, AMPHORAE, CANDELABRAS, CANDLESTICKS, VASES, PITCHERS, COMPOTES, BOWLS, CARAFES, VINEGAR BOTTLES AND DISHES, IN CLASS 21 (U.S. CLS. 2, 13, 23, 29, 30, 33, 40 AND 50).

FOR: WHOLESALE AND RETAIL STORE SERVICES FEATURING ARTICLES MADE OF GLASS AND CRYSTAL, IN CLASS 35 (U.S. CLS. 100, 101 AND 102).

FOR: PROCESSING OF UNWORKED OR SEMI-WORKED GLASS FOR THE MANUFACTURE OF ARTICLES, CONTAINERS AND UTENSILS OF GLASS AND CRYSTAL, IN CLASS 40 (U.S. CLS. 100, 103 AND 106).

FOR: PROVIDING CLASSES AND SEMINARS IN THE FIELD OF GLASSMAKING AND THE HISTORY OF GLASS AND GLASSMAKING; ORGANIZING CULTURAL ACTIVITIES AND ARTS EVENTS IN THE FIELDS OF GLASS AND GLASSMAKING, IN CLASS 41 (U.S. CLS. 100, 101 AND 107).

FOR: SCIENTIFIC AND RESEARCH SERVICES IN THE FIELD OF THE TECHNIQUES AND ART OF GLASSMAKING, IN CLASS 42 (U.S. CLS. 100 AND 101).

NO CLAIM IS MADE TO THE EXCLUSIVE RIGHT TO USE "FÁBRICA DE CRISTALES" OR "FUNDACIÓN", APART FROM THE MARK AS SHOWN.



*David J. Kappas*

Director of the United States Patent and Trademark Office

**Reg. No. 4,123,570** PRIORITY DATE OF 7-21-2010 IS CLAIMED.

OWNER OF INTERNATIONAL REGISTRATION 1069324 DATED 12-30-2010, EXPIRES 12-30-2020.

THE COLOR(S) BLUE AND WHITE IS/ARE CLAIMED AS A FEATURE OF THE MARK.

THE MARK CONSISTS OF THE WORDING "REAL FÁBRICA DE CRISTALES DE LA GRANJA" UNDER THE IMAGE OF A BUILDING AND ABOVE A SOLID HORIZONTAL LINE, BELOW WHICH THE WORDS "FUNDACIÓN CENTRO NACIONAL DEL VIDRIO" APPEAR; THE ENTIRE MARK APPEARING IN BLUE ON A WHITE BACKGROUND.

THE ENGLISH TRANSLATION OF "REAL FÁBRICA DE CRISTALES DE LA GRANJA" AND "FUNDACIÓN CENTRO NACIONAL DEL VIDRIO" IN THE MARK IS "ROYAL GLASS FACTORY AT LA GRANJA" AND "NATIONAL GLASS CENTER FOUNDATION".

SEC. 2(F) AS TO "REAL FÁBRICA DE CRISTALES DE LA GRANJA FUNDACIÓN NACIONAL DEL VIDRIO".

SER. NO. 79-094,416, FILED 12-30-2010.

DORITT L. CARROLL, EXAMINING ATTORNEY

# United States of America

United States Patent and Trademark Office



**Reg. No. 4,123,571**

**Registered Apr. 10, 2012**

**Int. Cls.: 7 and 12**

**TRADEMARK**

**PRINCIPAL REGISTER**

AKEBONO BRAKE INDUSTRY CO., LTD. (JAPAN CORPORATION)  
19-5, KOAMI-CHO  
NIHONBASHI.; CHUO-KU  
TOKYO, JAPAN 1038534

FOR: POWER TRANSMISSIONS AND GEARING FOR MACHINES NOT FOR LAND VEHICLES; BRAKES FOR MACHINES EXCEPT FOR LAND VEHICLES, IN CLASS 7 (U.S. CLS. 13, 19, 21, 23, 31, 34 AND 35).

FOR: AUTOMOBILES AND THEIR STRUCTURAL PARTS AND STRUCTURAL FITTINGS THEREFOR; TWO-WHEELED MOTOR VEHICLES, BICYCLES AND THEIR STRUCTURAL PARTS AND STRUCTURAL FITTINGS THEREFOR; RAILWAY ROLLING STOCK AND THEIR STRUCTURAL PARTS AND STRUCTURAL FITTINGS THEREFOR; POWER TRANSMISSIONS AND GEARINGS FOR LAND VEHICLES; BRAKES FOR LAND VEHICLES, IN CLASS 12 (U.S. CLS. 19, 21, 23, 31, 35 AND 44).

OWNER OF U.S. REG. NOS. 1,256,025 AND 3,761,443.

PRIORITY DATE OF 8-6-2010 IS CLAIMED.

OWNER OF INTERNATIONAL REGISTRATION 1069458 DATED 12-21-2010, EXPIRES 12-21-2020.

THE COLOR(S) RED, BLUE AND WHITE IS/ARE CLAIMED AS A FEATURE OF THE MARK.

THE MARK CONSISTS OF THE WORDING "AKEBONO" IN STYLIZED FONT WITH THE LETTERING IN WHITE AND A RED HORIZONTAL LINE IN A SOLID BLUE RECTANGLE.

THE ENGLISH TRANSLATION OF "AKEBONO" IN THE MARK IS "DAWN"; "DAYBREAK".

SER. NO. 79-094,465, FILED 12-21-2010.

KHANH LE, EXAMINING ATTORNEY



*David J. Kybas*

Director of the United States Patent and Trademark Office

# United States of America

United States Patent and Trademark Office



**Reg. No. 4,123,572**

**Registered Apr. 10, 2012**

**Int. Cl.: 11**

**TRADEMARK**

**PRINCIPAL REGISTER**

NINGBO BESTT ELECTRIC CO., LTD. (CHINA CORPORATION)  
NO. 3, MAOSHENG ROAD  
LIANGHUI ECONOMIC DEVELOPMENT ZONE., YUYAO CITY; 315403 ZHEJIANG  
CHINA

FOR: ELECTRIC KETTLES; ELECTRIC COFFEE MACHINES; ELECTRIC BREAD TOASTERS;  
ELECTRIC DEEP FRYERS; HOT WATER BOTTLES; ELECTRIC COOKING UTENSILS,  
NAMELY, ELECTRIC BEVERAGE HEATERS; BAKING OVENS; ELECTRIC WATER  
HEATERS; FANS FOR AIR CONDITIONING APPARATUS; ELECTRIC RADIATORS, IN  
CLASS 11 (U.S. CLS. 13, 21, 23, 31 AND 34).

THE MARK CONSISTS OF A STYLIZED RABBIT HEAD ABOVE THE STYLIZED WORDING  
"KINGTOO".

OWNER OF INTERNATIONAL REGISTRATION 1069485 DATED 2-22-2011, EXPIRES 2-22-  
2021.

THE WORD(S) "KINGTOO" HAS NO MEANING IN A FOREIGN LANGUAGE

SER. NO. 79-094,476, FILED 2-22-2011.

ELI HELLMAN, EXAMINING ATTORNEY



*David J. Kyfos*

Director of the United States Patent and Trademark Office

# United States of America

United States Patent and Trademark Office



**Reg. No. 4,123,573**

**Registered Apr. 10, 2012**

**Int. Cl.: 9**

**TRADEMARK**

**PRINCIPAL REGISTER**

NINGBO ZHENDONG OPTOELECTRONICS CO.,LTD (CHINA CORPORATION)  
NO. 3 MAOSHENG ROAD  
ZHEDONG ECONOMIC DEVELOPMENT ZONE, YUYAO CITY  
315400 ZHEJIANG PROVINCE, CHINA

FOR: TEMPERATURE SENSORS; FIRE ALARMS; COMPUTER KEYBOARDS; TEMPERATURE DETECTORS; OPTICAL FIBERS , IN CLASS 9 (U.S. CLS. 21, 23, 26, 36 AND 38).

THE MARK CONSISTS OF A SQUARE WITH CURVED CORNERS. INSIDE THE SQUARE ARE TWO CURVED BANDS.

OWNER OF INTERNATIONAL REGISTRATION 1069491 DATED 2-24-2011, EXPIRES 2-24-2021.

SER. NO. 79-094,479, FILED 2-24-2011.

KATHERINE E. HALMEN, EXAMINING ATTORNEY



*David J. Kybas*

Director of the United States Patent and Trademark Office



# United States of America

United States Patent and Trademark Office

## AVIRA ESSENTIAL SUITE

**Reg. No. 4,123,574**

**Registered Apr. 10, 2012**

**Int. Cls.: 9, 38, 41, 42  
and 45**

**TRADEMARK**

**SERVICE MARK**

**PRINCIPAL REGISTER**

TJARK AUERBACH (FED REP GERMANY INDIVIDUAL)  
LINDAUER STRASSE 21  
TETTANG, FED REP GERMANY 88069

FOR: COMPUTER PROGRAMS FOR THE SECURITY OF COMPUTER SYSTEMS, ANTI-VIRUS COMPUTER PROGRAMS, ANTI-SPYWARE COMPUTER PROGRAMS; PARTS AND FITTINGS FOR COMPUTER PROGRAMS, NAMELY, COMPUTER SUBPROGRAMS FOR THE SECURITY OF COMPUTER SYSTEMS, COMPUTER PROGRAM MODULES FOR THE SECURITY OF COMPUTER SYSTEMS, COMPUTER PROGRAMS FOR GENERATING COMPUTER PROGRAMS, SUPPORT SOFTWARE FOR THE SECURITY OF COMPUTER SYSTEMS, AND INTERFACES FOR COMPUTERS; PRERECORDED MAGNETIC AND OPTICAL DATA CARRIERS FEATURING DATA ABOUT COMPUTER VIRUSES, SPYWARE, AND OTHER DATA ABOUT THE SECURITY OF COMPUTER SYSTEMS, IN CLASS 9 (U.S. CLS. 21, 23, 26, 36 AND 38).

FOR: NEWS AGENCIES, NAMELY, TRANSMISSION OF NEWS; ELECTRONIC TRANSMISSION OF DATA; OPERATING AN ELECTRONIC INFORMATION AND COMMUNICATIONS SYSTEM, NAMELY, PROVIDING ACCESS TO A GLOBAL COMPUTER NETWORK, PROVIDING ACCESS TO COMPUTER PROGRAMS ON COMPUTER NETWORKS, PROVIDING USER ACCESS TO A GLOBAL COMPUTER INFORMATION NETWORK, PROVIDING INTERNET CHATROOMS, COMPUTER-AIDED TRANSMISSION OF MESSAGES AND IMAGES, TELECOMMUNICATION BY MEANS OF PLATFORMS AND PORTALS ON THE INTERNET, NAMELY, PROVIDING TELECOMMUNICATIONS CONNECTIONS TO A GLOBAL COMPUTER NETWORK VIA PLATFORMS AND PORTALS, ELECTRONIC SENDING OF MESSAGES, PROVIDING ACCESS TO COMPUTER DATABASES, WEB-MESSAGING; PROVIDING SERVICES IN CONNECTION WITH ONLINE SERVICES AND THE INTERNET, NAMELY, THE TRANSMISSION OF INFORMATION OF ALL KINDS VIA ELECTRONIC COMMUNICATIONS NETWORKS, IN CLASS 38 (U.S. CLS. 100, 101 AND 104).

FOR: EDUCATION SERVICES, NAMELY, PROVIDING CLASSES, SEMINARS, AND WORKSHOPS IN THE FIELD OF COMPUTER SYSTEM SECURITY; TRAINING SERVICES IN THE FIELD OF COMPUTER SYSTEM SECURITY; WRITING OF TEXTS AND PUBLISHING OF BOOKS, REVIEWS, MAGAZINES, AND ELECTRONIC PUBLICATIONS USING MEDIA OF ALL KINDS, IN CLASS 41 (U.S. CLS. 100, 101 AND 107).



*David J. Kyffers*

Director of the United States Patent and Trademark Office

**Reg. No. 4,123,574** FOR: COMPUTER PROGRAMMING; COMPUTER SOFTWARE CONSULTANCY WITH REGARD TO THE USE AND APPLICATION OF SOFTWARE, INSTALLATION AND MAINTENANCE OF SOFTWARE; SERVICES OF A SOFTWARE COMPANY, NAMELY, THE DESIGN OF COMPUTER SOFTWARE, DEVELOPMENT OF COMPUTER SOFTWARE, COMPUTER PROGRAMMING, UPDATING OF COMPUTER SOFTWARE, MAINTENANCE AND INSTALLATION OF SOFTWARE; COMPUTER SYSTEMS ANALYSIS; COMPUTER SOFTWARE APPLICATION CONSULTANCY WITH REGARD TO SOFTWARE; COMPUTER CONSULTANCY; TECHNOLOGICAL SERVICES TO SUPPORT AND IMPLEMENT THE LOCALISATION OF DATA STRUCTURES AND THE AMENDMENT THEREOF, NAMELY, SOFTWARE APPLICATIONS CONSULTANCY AND TECHNICAL SUPPORT IN THE NATURE OF TROUBLESHOOTING COMPUTER SOFTWARE PROBLEMS; INTERNET SERVICES, NAMELY, CREATING AND MAINTENANCE OF COMPUTER PROGRAMS FOR USE ON THE INTERNET AND/OR FOR THE USE OF THE INTERNET, AND COMPUTER SOFTWARE CONSULTANCY WITH REGARD TO THE APPLICATION AND FURTHER DEVELOPMENT OF SUCH PROGRAMS, IN CLASS 42 (U.S. CLS. 100 AND 101).

FOR: SECURITY SERVICES FOR THE PROTECTION OF PROPERTY AND INDIVIDUALS, NAMELY, PERSONAL SECURITY CONSULTATION FOR THE PROTECTION OF INDIVIDUALS AND PERSONAL SECURITY CONSULTATION FOR THE MONITORING OF COMPUTER SYSTEMS FOR SECURITY PURPOSES, IN CLASS 45 (U.S. CLS. 100 AND 101).

THE MARK CONSISTS OF STANDARD CHARACTERS WITHOUT CLAIM TO ANY PARTICULAR FONT, STYLE, SIZE, OR COLOR.

OWNER OF INTERNATIONAL REGISTRATION 1069493 DATED 2-11-2011, EXPIRES 2-11-2021.

OWNER OF U.S. REG. NO. 3,382,031.

NO CLAIM IS MADE TO THE EXCLUSIVE RIGHT TO USE "SUITE", APART FROM THE MARK AS SHOWN.

SER. NO. 79-094,481, FILED 2-11-2011.

KATHERINE E. HALMEN, EXAMINING ATTORNEY

# United States of America

United States Patent and Trademark Office

# DINAMICO

**Reg. No. 4,123,575**

**Registered Apr. 10, 2012**

**Int. Cls.: 18 and 25**

**TRADEMARK**

**PRINCIPAL REGISTER**

A.TESTONI S.P.A. (ITALY JOINT STOCK COMPANY)  
PIAZZA XX SETTEMBRE, 1  
I-40121 BOLOGNA (BO)  
ITALY

FOR: HANDBAGS; LEATHER TRAVELLING BAGS; KNITTED BAGS, NOT IN PRECIOUS METALS; SHOULDER BAGS; BACKPACKS; TRAVELLING BAGS; TEXTILE, CANVAS, AND LEATHER SHOPPING BAGS; WALLETS; PURSES; DOCUMENT CASES; NAME CARD CASES; LUGGAGE; SUITCASES; GARMENT BAGS FOR TRAVEL; BRIEFCASES; TRUNKS; UNFITTED VANITY CASES; LEATHER CASES FOR KEYS; LEATHER KEY HOLDERS, NAMELY, LEATHER KEY CASES; UNFITTED LEATHER CASES FOR NON-ELECTRIC MANICURE AND PEDICURE SETS, SOLD EMPTY; UMBRELLAS; PARASOLS AND WALKING STICKS; SADDLERY, IN CLASS 18 (U.S. CLS. 1, 2, 3, 22 AND 41).

FOR: ARTICLES OF CLOTHING, NAMELY, JERSEYS AND SWEATERS, PULLOVERS, SHIRTS, JACKETS, BOMBER JACKETS, RAINCOATS, ANORAKS, CLOAKS, BLAZERS, COATS, TROUSERS, SALOPETTES, SKIRTS, BATHING COSTUMES AND TRUNKS, BEACH ROBES, WRAP-AROUNDS, BEACHWEAR; CASUAL WEAR, NAMELY, SHIRTS, PANTS, SHORTS, DRESSES; WINDCHEATERS, POLO SHIRTS, JACKETS, BLOUSONS, RAINCOATS, OVERCOATS, TROUSERS, SKIRTS, BATHING SUITS, SHORTS, UNDERWEAR, STOCKINGS, TIES, SCARVES, FOULARDS, SILK POCKET SQUARES, GLOVES, BELTS FOR CLOTHING, SHOES, BOOTS, SLIPPERS, SPORTING FOOTWEAR, HATS, CAPS AND VISORS, IN CLASS 25 (U.S. CLS. 22 AND 39).



THE MARK CONSISTS OF STANDARD CHARACTERS WITHOUT CLAIM TO ANY PARTICULAR FONT, STYLE, SIZE, OR COLOR.

OWNER OF INTERNATIONAL REGISTRATION 1069599 DATED 1-11-2011, EXPIRES 1-11-2021.

THE ENGLISH TRANSLATION OF THE WORD "DINAMICO" IN THE MARK IS "DYNAMIC".

SER. NO. 79-094,533, FILED 1-11-2011.

JENNIFER WILLISTON, EXAMINING ATTORNEY

*David J. Kyffers*

Director of the United States Patent and Trademark Office

# United States of America

United States Patent and Trademark Office

# CSF

**Reg. No. 4,123,576**

**Registered Apr. 10, 2012**

**Int. Cl.: 14**

CSF KUYUMCULUK ITHALAT IHRACAT SANAYI VE TICARET LIMITED SIRKETI  
(TURKEY LIMITED COMPANY)  
ÇEMBERLITAS MOLLA FENARI MAHALLESİ  
KÜRKÇÜLER PAZARI SOKAK NO:63 EMINÖNÜ - ISTANBUL  
TURKEY

**TRADEMARK**

**PRINCIPAL REGISTER**

FOR: PRECIOUS STONES; JEWELRY MADE OF PRECIOUS METAL OR COATED THEREWITH, NAMELY, BRACELETS, RINGS, CHARMS, NECKLACES, EAR CLIPS, CUFF-LINKS, EARRINGS, ORNAMENTAL PINS, TIE PINS, PENDANTS, MEDALLIONS AND BROOCHES; ORNAMENTS OF PRECIOUS METAL; TRINKETS, NAMELY, KEY CHAINS AS JEWELLERY, KEY RINGS OF PRECIOUS METAL AND RINGS; STATUES OF PRECIOUS METAL; BUSTS OF PRECIOUS METAL; HOROLOGICAL AND CHRONOMETRIC INSTRUMENTS AND PARTS AND ACCESSORIES THEREOF, NAMELY, WATCH CHAINS, WATCH CLASPS, WATCH CROWNS, WATCH FACES, WATCH POUCHES, WATCH FOBS, WATCH BOXES, WATCH STRAPS MADE OF METAL, LEATHER OR PLASTIC; CHRONOMETERS; WRIST WATCHES; POCKET WATCHES; JEWELRY WATCHES; WALL CLOCKS; TABLE CLOCKS; WATCH BANDS; WATCH STRAPS; WATCH BRACELETS; WATCH CHAINS; CASES FOR WATCHES AND CLOCKS; PARTS FOR WATCHES AND CLOCKS, IN CLASS 14 (U.S. CLS. 2, 27, 28 AND 50).

OWNER OF INTERNATIONAL REGISTRATION 1069660 DATED 12-31-2010, EXPIRES 12-31-2020.

SER. NO. 79-094,567, FILED 12-31-2010.

DAVID YONTEF, EXAMINING ATTORNEY



*David J. Kyffers*

Director of the United States Patent and Trademark Office

# United States of America

United States Patent and Trademark Office

# INGENUITY

**Reg. No. 4,123,577**

**Registered Apr. 10, 2012**

**Int. Cls.: 9 and 10**

KONINKLIJKE PHILIPS ELECTRONICS N.V. (NETHERLANDS A PUBLIC LIMITED LIABILITY COMPANY)  
GROENEWOUDSEWEG 1  
NL-5621 BA EINDHOVEN  
NETHERLANDS

**TRADEMARK**

FOR: MEDICAL IMAGING SOFTWARE, NAMELY, SOFTWARE USED IN MEDICAL IMAGING APPARATUS, NAMELY, CT SCANNERS, POSITRON EMISSION TOMOGRAPHY (PET), PET/CT AND PET/MR SCANNERS, IN CLASS 9 (U.S. CLS. 21, 23, 26, 36 AND 38).

**PRINCIPAL REGISTER**

FOR: MEDICAL IMAGING APPARATUS, NAMELY, CT SCANNERS, POSITRON EMISSION TOMOGRAPHY (PET), PET/CT AND PET/MR SCANNERS, IN CLASS 10 (U.S. CLS. 26, 39 AND 44).

THE MARK CONSISTS OF STANDARD CHARACTERS WITHOUT CLAIM TO ANY PARTICULAR FONT, STYLE, SIZE, OR COLOR.

PRIORITY DATE OF 8-23-2010 IS CLAIMED.

OWNER OF INTERNATIONAL REGISTRATION 1070078 DATED 2-22-2011, EXPIRES 2-22-2021.

SER. NO. 79-094,714, FILED 2-22-2011.

SAIMA MAKHDOOM, EXAMINING ATTORNEY



*David J. Kyffers*

Director of the United States Patent and Trademark Office

United States of America  
United States Patent and Trademark Office

# BIOFOND

**Reg. No. 4,123,578**

**Registered Apr. 10, 2012**

**Int. Cl.: 3**

**TRADEMARK**

**PRINCIPAL REGISTER**

GERDA SPILLMANN AG (SWITZERLAND SOCIÉTÉ ANONYME)  
WORBLENTALSTRASSE 32  
CH-3063 ITTIGEN  
SWITZERLAND

FOR: COSMETIC PREPARATIONS, IN CLASS 3 (U.S. CLS. 1, 4, 6, 50, 51 AND 52).

THE MARK CONSISTS OF STANDARD CHARACTERS WITHOUT CLAIM TO ANY PARTICULAR FONT, STYLE, SIZE, OR COLOR.

PRIORITY DATE OF 8-16-2010 IS CLAIMED.

OWNER OF INTERNATIONAL REGISTRATION 1070084 DATED 2-15-2011, EXPIRES 2-15-2021.

OWNER OF U.S. REG. NO. 3,376,976.

SER. NO. 79-094,716, FILED 2-15-2011.

ALLISON SCHRODY, EXAMINING ATTORNEY



*David J. Kybas*

Director of the United States Patent and Trademark Office

# United States of America

United States Patent and Trademark Office

# MVOLVE

**Reg. No. 4,123,579**

**Registered Apr. 10, 2012**

**Int. Cls.: 38 and 42**

**SERVICE MARK**

**PRINCIPAL REGISTER**

MOMAC B.V. (NETHERLANDS BESLOTEN VENNOOTSCHAP (B.V.))  
RIVIUM 1E STRAAT 9  
NL-2909 LE CAPELLE AAN DEN IJSSEL  
NETHERLANDS

FOR: TELECOMMUNICATIONS, NAMELY, PROVIDING MULTIPLE-USER ACCESS TO THE INTERNET, SATELLITE TRANSMISSION SERVICES, MOBILE INTERNET SITES, NAMELY, PROVIDING REMOTE INTERNET ACCESS AND MOBILE TELEPHONE COMMUNICATIONS SERVICES; ELECTRONIC TRANSMISSION OF DATA AND INFORMATION VIA THE INTERNET, MOBILE TELEPHONES AND REMOTE INTERNET SITES; PROVIDING INTERNET ACCESS TO MOBILE INTERNET SITES; ELECTRONIC TRANSMISSION OF IMAGE, SOUND AND OTHER DATA AMONG COMPUTER USERS; INTERNET SERVICE PROVIDER SERVICES; PROVIDING INTERNET ACCESS TO DATABASES, MOBILE INTERNET SITES AND OTHER NETWORKS; E-MAIL SERVICES; PROVIDING TELECOMMUNICATIONS CONSULTATION AND INFORMATION, IN CLASS 38 (U.S. CLS. 100, 101 AND 104).

FOR: AUTOMATION SERVICES, NAMELY, DATA AUTOMATION USING PROPRIETARY SOFTWARE TO EVALUATE, ANALYZE AND COLLECT SERVICE DATA; DESIGN AND DEVELOPMENT OF SOFTWARE; HOSTING OF MOBILE INTERNET SITES; WEB SITE DESIGN; EXAMINATION, MEASURING AND ANALYSIS IN THE FIELD OF INFORMATION AND COMMUNICATION TECHNOLOGIES (ICT), NAMELY, TESTING, EVALUATION, AND ANALYSIS IN THE FIELD OF AVAILABILITY OF WEB APPLICATIONS AND IN THE FIELD OF IMPROVEMENT OF FUNCTIONING AND FINDING OF MOBILE INTERNET SITES; ADVISORY SERVICES IN THE FIELD OF AFORE-MENTIONED SERVICES, THE AFORE-MENTIONED SERVICES ALSO PROVIDED ON LINE, IN CLASS 42 (U.S. CLS. 100 AND 101).

THE MARK CONSISTS OF STANDARD CHARACTERS WITHOUT CLAIM TO ANY PARTICULAR FONT, STYLE, SIZE, OR COLOR.

PRIORITY DATE OF 2-9-2011 IS CLAIMED.

OWNER OF INTERNATIONAL REGISTRATION 1070256 DATED 2-10-2011, EXPIRES 2-10-2021.

SER. NO. 79-094,796, FILED 2-10-2011.



*David J. Kyjars*

Director of the United States Patent and Trademark Office

**Reg. No. 4,123,579** HELENE LIWINSKI, EXAMINING ATTORNEY



United States of America  
United States Patent and Trademark Office

RTFX

**Reg. No. 4,123,580**

**Registered Apr. 10, 2012**

**Int. Cl.: 36**

**SERVICE MARK**

**PRINCIPAL REGISTER**

REALTIME FINANCIAL TECHNOLOGIES SA (SWITZERLAND SOCIÉTÉ ANONYME (SA))  
48, ROUTE DES ACACIAS  
CH-1227 CAROUGE  
SWITZERLAND

FOR: FINANCIAL AFFAIRS, NAMELY, FINANCIAL INFORMATION, MANAGEMENT AND ANALYSIS SERVICES; BANKING SERVICES; MONETARY AFFAIRS, NAMELY, ELECTRONIC TRANSFER OF MONEY; REAL ESTATE AFFAIRS, NAMELY, APPRAISAL OF REAL ESTATE, LEASING OF REAL ESTATE; FINANCIAL INFORMATION; FINANCIAL ANALYSIS; HOME BANKING; STOCK EXCHANGE QUOTATIONS; SECURITIES BROKERAGE; CURRENCY EXCHANGE, NAMELY, BUYING AND SELLING OF CURRENCY; CAPITAL INVESTMENT SERVICES; FINANCIAL AND MONETARY FOREIGN EXCHANGE TRANSACTIONS; FINANCIAL CONSULTING; CAPITAL INVESTMENT CONSULTING; ELECTRONIC FUNDS TRANSFER; FINANCIAL MANAGEMENT; BANKING; QUOTATION OF STOCK MARKET PRICES; ON-LINE TECHNICAL FINANCIAL ANALYSIS; FOREIGN EXCHANGE TRANSACTIONS; CURRENCY EXCHANGE AND ADVICE; CASH AND FOREIGN EXCHANGE TRANSACTIONS; FINANCIAL INFORMATION, NAMELY, DISPLAYING REAL-TIME CURRENCY EXCHANGE RATES ON-LINE AND STREAMING OF MARKET RATES IN REAL-TIME; PROVISION OF FINANCIAL BACK-OFFICE SERVICES ON-LINE, NAMELY, CONDUCTING FINANCIAL FEASIBILITY STUDIES; CURRENCY BROKERING SERVICES AVAILABLE VIA THE INTERNET, IN CLASS 36 (U.S. CLS. 100, 101 AND 102).



THE MARK CONSISTS OF STANDARD CHARACTERS WITHOUT CLAIM TO ANY PARTICULAR FONT, STYLE, SIZE, OR COLOR.

OWNER OF INTERNATIONAL REGISTRATION 1070264 DATED 2-22-2011, EXPIRES 2-22-2021.

SER. NO. 79-094,800, FILED 2-22-2011.

ELI HELLMAN, EXAMINING ATTORNEY

*David J. Kyros*

Director of the United States Patent and Trademark Office

# United States of America

United States Patent and Trademark Office

## AVIRA ONLINE ESSENTIALS

**Reg. No. 4,123,581**

**Registered Apr. 10, 2012**

**Int. Cls.: 9, 38, 41, 42  
and 45**

**TRADEMARK**

**SERVICE MARK**

**PRINCIPAL REGISTER**

TJARK AUERBACH (FED REP GERMANY INDIVIDUAL)  
LINDAUER STRASSE 21  
88069 TETTANANG, FED REP GERMANY

FOR: COMPUTER PROGRAMS FOR THE SECURITY OF COMPUTER SYSTEMS, ANTI-VIRUS COMPUTER PROGRAMS, ANTI-SPYWARE COMPUTER PROGRAMS; PARTS AND FITTINGS FOR COMPUTER PROGRAMS, NAMELY, COMPUTER SUBPROGRAMS FOR THE SECURITY OF COMPUTER SYSTEMS, COMPUTER PROGRAM MODULES FOR THE SECURITY OF COMPUTER SYSTEMS, COMPUTER PROGRAMS FOR GENERATING COMPUTER PROGRAMS, SUPPORT SOFTWARE FOR THE SECURITY OF COMPUTER SYSTEMS, AND INTERFACES FOR COMPUTERS; PRERECORDED MAGNETIC AND OPTICAL DATA CARRIERS FEATURING DATA ABOUT COMPUTER VIRUSES, SPYWARE, AND OTHER DATA ABOUT THE SECURITY OF COMPUTER SYSTEMS, IN CLASS 9 (U.S. CLS. 21, 23, 26, 36 AND 38).

FOR: NEWS AGENCIES, NAMELY, TRANSMISSION OF NEWS; ELECTRONIC TRANSMISSION OF DATA; OPERATING AN ELECTRONIC INFORMATION AND COMMUNICATIONS SYSTEM, NAMELY, PROVIDING ACCESS TO A GLOBAL COMPUTER NETWORK, PROVIDING ACCESS TO COMPUTER PROGRAMS ON COMPUTER NETWORKS, PROVIDING USER ACCESS TO A GLOBAL COMPUTER INFORMATION NETWORK, PROVIDING INTERNET CHATROOMS, COMPUTER-AIDED TRANSMISSION OF MESSAGES AND IMAGES, TELECOMMUNICATION BY MEANS OF PLATFORMS AND PORTALS ON THE INTERNET, NAMELY, PROVIDING TELECOMMUNICATIONS CONNECTIONS TO A GLOBAL COMPUTER NETWORK VIA PLATFORMS AND PORTALS, ELECTRONIC SENDING OF MESSAGES, PROVIDING ACCESS TO COMPUTER DATABASES, WEB-MESSAGING; PROVIDING SERVICES IN CONNECTION WITH ONLINE SERVICES AND THE INTERNET, NAMELY, THE TRANSMISSION OF INFORMATION OF ALL KINDS VIA ELECTRONIC COMMUNICATIONS NETWORKS, IN CLASS 38 (U.S. CLS. 100, 101 AND 104).

FOR: EDUCATION SERVICES, NAMELY, PROVIDING CLASSES, SEMINARS, AND WORKSHOPS IN THE FIELD OF COMPUTER SYSTEM SECURITY; TRAINING SERVICES IN THE FIELD OF COMPUTER SYSTEM SECURITY; WRITING OF TEXTS AND PUBLISHING OF BOOKS, REVIEWS, MAGAZINES, AND ELECTRONIC PUBLICATIONS USING MEDIA OF ALL KINDS, IN CLASS 41 (U.S. CLS. 100, 101 AND 107).



*David J. Kyffers*

Director of the United States Patent and Trademark Office

**Reg. No. 4,123,581** FOR: COMPUTER PROGRAMMING; COMPUTER SOFTWARE CONSULTANCY WITH REGARD TO THE USE AND APPLICATION OF SOFTWARE, INSTALLATION AND MAINTENANCE OF SOFTWARE; SERVICES OF A SOFTWARE COMPANY, NAMELY, THE DESIGN OF COMPUTER SOFTWARE, DEVELOPMENT OF COMPUTER SOFTWARE, COMPUTER PROGRAMMING, UPDATING OF COMPUTER SOFTWARE, MAINTENANCE AND INSTALLATION OF SOFTWARE; COMPUTER SYSTEMS ANALYSIS; COMPUTER SOFTWARE APPLICATION CONSULTANCY WITH REGARD TO SOFTWARE; COMPUTER CONSULTANCY; TECHNOLOGICAL SERVICES TO SUPPORT AND IMPLEMENT THE LOCALISATION OF DATA STRUCTURES AND THE AMENDMENT THEREOF, NAMELY, SOFTWARE APPLICATIONS CONSULTANCY AND TECHNICAL SUPPORT IN THE NATURE OF TROUBLESHOOTING COMPUTER SOFTWARE PROBLEMS; INTERNET SERVICES, NAMELY, CREATING AND MAINTENANCE OF COMPUTER PROGRAMS FOR USE ON THE INTERNET AND/OR FOR THE USE OF THE INTERNET, AND COMPUTER SOFTWARE CONSULTANCY WITH REGARD TO THE APPLICATION AND FURTHER DEVELOPMENT OF SUCH PROGRAMS, IN CLASS 42 (U.S. CLS. 100 AND 101).

FOR: SECURITY SERVICES FOR THE PROTECTION OF PROPERTY AND INDIVIDUALS, NAMELY, PERSONAL SECURITY CONSULTATION FOR THE PROTECTION OF INDIVIDUALS AND PERSONAL SECURITY CONSULTATION FOR THE MONITORING OF COMPUTER SYSTEMS FOR SECURITY PURPOSES, IN CLASS 45 (U.S. CLS. 100 AND 101).

THE MARK CONSISTS OF STANDARD CHARACTERS WITHOUT CLAIM TO ANY PARTICULAR FONT, STYLE, SIZE, OR COLOR.

OWNER OF INTERNATIONAL REGISTRATION 1070298 DATED 2-11-2011, EXPIRES 2-11-2021.

OWNER OF U.S. REG. NO. 3,382,031.

NO CLAIM IS MADE TO THE EXCLUSIVE RIGHT TO USE "ONLINE", APART FROM THE MARK AS SHOWN.

SER. NO. 79-094,807, FILED 2-11-2011.

KATHERINE E. HALMEN, EXAMINING ATTORNEY

# United States of America

United States Patent and Trademark Office

# CloudGuard

**Reg. No. 4,123,582**

**Registered Apr. 10, 2012**

**Int. Cls.: 9, 38, 41, 42  
and 45**

**TRADEMARK**

**SERVICE MARK**

**PRINCIPAL REGISTER**

TJARK AUERBACH (FED REP GERMANY INDIVIDUAL)  
LINDAUER STRASSE 21  
88069 TETTANANG  
FED REP GERMANY

FOR: COMPUTER PROGRAMS FOR THE SECURITY OF COMPUTER SYSTEMS, ANTI-VIRUS COMPUTER PROGRAMS, ANTI-SPYWARE COMPUTER PROGRAMS; PARTS AND FITTINGS FOR COMPUTER PROGRAMS, NAMELY, COMPUTER SUBPROGRAMS FOR THE SECURITY OF COMPUTER SYSTEMS, COMPUTER PROGRAM MODULES FOR THE SECURITY OF COMPUTER SYSTEMS, COMPUTER PROGRAMS FOR GENERATING COMPUTER PROGRAMS, SUPPORT SOFTWARE FOR THE SECURITY OF COMPUTER SYSTEMS, AND INTERFACES FOR COMPUTERS; PRERECORDED MAGNETIC AND OPTICAL DATA CARRIERS FEATURING DATA ABOUT COMPUTER VIRUSES, SPYWARE, AND OTHER DATA ABOUT THE SECURITY OF COMPUTER SYSTEMS, IN CLASS 9 (U.S. CLS. 21, 23, 26, 36 AND 38).

FOR: NEWS AGENCIES, NAMELY, TRANSMISSION OF NEWS; ELECTRONIC TRANSMISSION OF DATA; OPERATING AN ELECTRONIC INFORMATION AND COMMUNICATIONS SYSTEM, NAMELY, PROVIDING ACCESS TO A GLOBAL COMPUTER NETWORK, PROVIDING ACCESS TO COMPUTER PROGRAMS ON COMPUTER NETWORKS, PROVIDING USER ACCESS TO A GLOBAL COMPUTER INFORMATION NETWORK, PROVIDING INTERNET CHATROOMS, COMPUTER-AIDED TRANSMISSION OF MESSAGES AND IMAGES, TELECOMMUNICATION BY MEANS OF PLATFORMS AND PORTALS ON THE INTERNET, NAMELY, PROVIDING TELECOMMUNICATIONS CONNECTIONS TO A GLOBAL COMPUTER NETWORK VIA PLATFORMS AND PORTALS, ELECTRONIC SENDING OF MESSAGES, PROVIDING ACCESS TO COMPUTER DATABASES, WEB-MESSAGING; PROVIDING SERVICES IN CONNECTION WITH ONLINE SERVICES AND THE INTERNET, NAMELY, THE TRANSMISSION OF INFORMATION OF ALL KINDS VIA ELECTRONIC COMMUNICATIONS NETWORKS, IN CLASS 38 (U.S. CLS. 100, 101 AND 104).

FOR: EDUCATION SERVICES, NAMELY, PROVIDING CLASSES, SEMINARS, AND WORKSHOPS IN THE FIELD OF COMPUTER SYSTEM SECURITY; TRAINING SERVICES IN THE FIELD OF COMPUTER SYSTEM SECURITY; WRITING OF TEXTS AND PUBLISHING OF BOOKS, REVIEWS, MAGAZINES, AND ELECTRONIC PUBLICATIONS USING MEDIA OF ALL KINDS, IN CLASS 41 (U.S. CLS. 100, 101 AND 107).



*David J. Kyjars*

Director of the United States Patent and Trademark Office

**Reg. No. 4,123,582** FOR: COMPUTER PROGRAMMING; COMPUTER SOFTWARE CONSULTANCY WITH REGARD TO THE USE AND APPLICATION OF SOFTWARE, INSTALLATION AND MAINTENANCE OF SOFTWARE; SERVICES OF A SOFTWARE COMPANY, NAMELY, THE DESIGN OF COMPUTER SOFTWARE, DEVELOPMENT OF COMPUTER SOFTWARE, COMPUTER PROGRAMMING, UPDATING OF COMPUTER SOFTWARE, MAINTENANCE AND INSTALLATION OF SOFTWARE; COMPUTER SYSTEMS ANALYSIS; COMPUTER SOFTWARE APPLICATION CONSULTANCY WITH REGARD TO SOFTWARE; COMPUTER CONSULTANCY; TECHNOLOGICAL SERVICES TO SUPPORT AND IMPLEMENT THE LOCALISATION OF DATA STRUCTURES AND THE AMENDMENT THEREOF, NAMELY, SOFTWARE APPLICATIONS CONSULTANCY AND TECHNICAL SUPPORT IN THE NATURE OF TROUBLESHOOTING COMPUTER SOFTWARE PROBLEMS; INTERNET SERVICES, NAMELY, CREATING AND MAINTENANCE OF COMPUTER PROGRAMS FOR USE ON THE INTERNET AND/OR FOR THE USE OF THE INTERNET, AND COMPUTER SOFTWARE CONSULTANCY WITH REGARD TO THE APPLICATION AND FURTHER DEVELOPMENT OF SUCH PROGRAMS, IN CLASS 42 (U.S. CLS. 100 AND 101).

FOR: SECURITY SERVICES FOR THE PROTECTION OF PROPERTY AND INDIVIDUALS, NAMELY, PERSONAL SECURITY CONSULTATION FOR THE PROTECTION OF INDIVIDUALS AND PERSONAL SECURITY CONSULTATION FOR THE MONITORING OF COMPUTER SYSTEMS FOR SECURITY PURPOSES, IN CLASS 45 (U.S. CLS. 100 AND 101).

THE MARK CONSISTS OF STANDARD CHARACTERS WITHOUT CLAIM TO ANY PARTICULAR FONT, STYLE, SIZE, OR COLOR.

OWNER OF INTERNATIONAL REGISTRATION 1070299 DATED 2-11-2011, EXPIRES 2-11-2021.

SER. NO. 79-094,808, FILED 2-11-2011.

KATHERINE E. HALMEN, EXAMINING ATTORNEY

# United States of America

United States Patent and Trademark Office

# CLEANBOX

**Reg. No. 4,123,583**

**Registered Apr. 10, 2012**

**Int. Cls.: 9, 38, 41, 42  
and 45**

**TRADEMARK**

**SERVICE MARK**

**PRINCIPAL REGISTER**

TJARK AUERBACH (FED REP GERMANY INDIVIDUAL)  
LINDAUER STRASSE 21  
TETTANG, FED REP GERMANY 88069

FOR: COMPUTER PROGRAMS FOR THE SECURITY OF COMPUTER SYSTEMS, ANTI-VIRUS COMPUTER PROGRAMS, ANTI-SPYWARE COMPUTER PROGRAMS; PARTS AND FITTINGS FOR COMPUTER PROGRAMS, NAMELY, COMPUTER SUBPROGRAMS FOR THE SECURITY OF COMPUTER SYSTEMS, COMPUTER PROGRAM MODULES FOR THE SECURITY OF COMPUTER SYSTEMS, COMPUTER PROGRAMS FOR GENERATING COMPUTER PROGRAMS, SUPPORT SOFTWARE FOR THE SECURITY OF COMPUTER SYSTEMS, AND INTERFACES FOR COMPUTERS; PRERECORDED MAGNETIC AND OPTICAL DATA CARRIERS FEATURING DATA ABOUT COMPUTER VIRUSES, SPYWARE, AND OTHER DATA ABOUT THE SECURITY OF COMPUTER SYSTEMS, IN CLASS 9 (U.S. CLS. 21, 23, 26, 36 AND 38).

FOR: NEWS AGENCIES, NAMELY, TRANSMISSION OF NEWS; ELECTRONIC TRANSMISSION OF DATA; OPERATING AN ELECTRONIC INFORMATION AND COMMUNICATIONS SYSTEM, NAMELY, PROVIDING ACCESS TO A GLOBAL COMPUTER NETWORK, PROVIDING ACCESS TO COMPUTER PROGRAMS ON COMPUTER NETWORKS, PROVIDING USER ACCESS TO A GLOBAL COMPUTER INFORMATION NETWORK, PROVIDING INTERNET CHATROOMS, COMPUTER-AIDED TRANSMISSION OF MESSAGES AND IMAGES, TELECOMMUNICATION BY MEANS OF PLATFORMS AND PORTALS ON THE INTERNET, NAMELY, PROVIDING TELECOMMUNICATIONS CONNECTIONS TO A GLOBAL COMPUTER NETWORK VIA PLATFORMS AND PORTALS, ELECTRONIC SENDING OF MESSAGES, PROVIDING ACCESS TO COMPUTER DATABASES, WEB-MESSAGING; PROVIDING SERVICES IN CONNECTION WITH ONLINE SERVICES AND THE INTERNET, NAMELY, THE TRANSMISSION OF INFORMATION OF ALL KINDS VIA ELECTRONIC COMMUNICATIONS NETWORKS, IN CLASS 38 (U.S. CLS. 100, 101 AND 104).

FOR: EDUCATION SERVICES, NAMELY, PROVIDING CLASSES, SEMINARS, AND WORKSHOPS IN THE FIELD OF COMPUTER SYSTEM SECURITY; TRAINING SERVICES IN THE FIELD OF COMPUTER SYSTEM SECURITY; WRITING OF TEXTS AND PUBLISHING OF BOOKS, REVIEWS, MAGAZINES, AND ELECTRONIC PUBLICATIONS USING MEDIA OF ALL KINDS, IN CLASS 41 (U.S. CLS. 100, 101 AND 107).

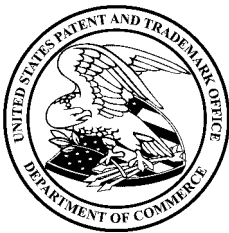

*David J. Kyffers*

Director of the United States Patent and Trademark Office

**Reg. No. 4,123,583** FOR: COMPUTER PROGRAMMING; COMPUTER SOFTWARE CONSULTANCY WITH REGARD TO THE USE AND APPLICATION OF SOFTWARE, INSTALLATION AND MAINTENANCE OF SOFTWARE; SERVICES OF A SOFTWARE COMPANY, NAMELY, THE DESIGN OF COMPUTER SOFTWARE, DEVELOPMENT OF COMPUTER SOFTWARE, COMPUTER PROGRAMMING, UPDATING OF COMPUTER SOFTWARE, MAINTENANCE AND INSTALLATION OF SOFTWARE; COMPUTER SYSTEMS ANALYSIS; COMPUTER SOFTWARE APPLICATION CONSULTANCY WITH REGARD TO SOFTWARE; COMPUTER CONSULTANCY; TECHNOLOGICAL SERVICES TO SUPPORT AND IMPLEMENT THE LOCALISATION OF DATA STRUCTURES AND THE AMENDMENT THEREOF, NAMELY, SOFTWARE APPLICATIONS CONSULTANCY AND TECHNICAL SUPPORT IN THE NATURE OF TROUBLESHOOTING COMPUTER SOFTWARE PROBLEMS; INTERNET SERVICES, NAMELY, CREATING AND MAINTENANCE OF COMPUTER PROGRAMS FOR USE ON THE INTERNET AND/OR FOR THE USE OF THE INTERNET, AND COMPUTER SOFTWARE CONSULTANCY WITH REGARD TO THE APPLICATION AND FURTHER DEVELOPMENT OF SUCH PROGRAMS, IN CLASS 42 (U.S. CLS. 100 AND 101).

FOR: SECURITY SERVICES FOR THE PROTECTION OF PROPERTY AND INDIVIDUALS, NAMELY, PERSONAL SECURITY CONSULTATION FOR THE PROTECTION OF INDIVIDUALS AND PERSONAL SECURITY CONSULTATION FOR THE MONITORING OF COMPUTER SYSTEMS FOR SECURITY PURPOSES, IN CLASS 45 (U.S. CLS. 100 AND 101).

THE MARK CONSISTS OF STANDARD CHARACTERS WITHOUT CLAIM TO ANY PARTICULAR FONT, STYLE, SIZE, OR COLOR.

OWNER OF INTERNATIONAL REGISTRATION 1070301 DATED 2-14-2011, EXPIRES 2-14-2021.

SER. NO. 79-094,810, FILED 2-14-2011.

KATHERINE E. HALMEN, EXAMINING ATTORNEY

# United States of America

United States Patent and Trademark Office

# ColorYZe

**Reg. No. 4,123,584**

**Registered Apr. 10, 2012**

**Int. Cl.: 1**

**TRADEMARK**

**PRINCIPAL REGISTER**

SOCIETE EUROPEENNE DES PRODUITS REFRACTAIRES (FRANCE SOCIÉTÉ ANONYME)  
LES MIROIRS  
18 AVENUE D'ALSACE  
F-92400 COURBEVOIE, FRANCE

FOR: INDUSTRIAL CHEMICAL COMPOSITION OR INDUSTRIAL MINERAL COMPOSITION, NAMELY, COMPOSITION FOR MAKING PIGMENTED OR COLORED TECHNICAL CERAMICS; ZIRCONIA PARTICULARLY COLORED ZIRCONIA; INDUSTRIAL CHEMICAL COMPOSITION OR INDUSTRIAL MINERAL COMPOSITION, NAMELY, COMPOSITION FOR MAKING PIGMENTED OR COLORED TECHNICAL CERAMICS USED IN MAKING CUTLERY; INDUSTRIAL CHEMICAL COMPOSITION OR INDUSTRIAL MINERAL COMPOSITION, NAMELY, COMPOSITIONS FOR MAKING PIGMENTED OR COLOR TECHNICAL CERAMICS USED IN MAKING CLOCKS, WATCHES AND MOBILE PHONES; ;INDUSTRIAL CHEMICAL COMPOSITION OR INDUSTRIAL MINERAL COMPOSITION, NAMELY, COMPOSITION FOR MAKING PIGMENTED OR COLORED TECHNICAL CERAMICS USED FOR MAKING PIGMENTED OR COLORED TECHNICAL CERAMICS USED IN MAKING JEWELRY, IN CLASS 1 (U.S. CLS. 1, 5, 6, 10, 26 AND 46).

THE MARK CONSISTS OF STANDARD CHARACTERS WITHOUT CLAIM TO ANY PARTICULAR FONT, STYLE, SIZE, OR COLOR.

PRIORITY DATE OF 8-25-2010 IS CLAIMED.

OWNER OF INTERNATIONAL REGISTRATION 1070376 DATED 2-2-2011, EXPIRES 2-2-2021.

SER. NO. 79-094,832, FILED 2-2-2011.

KATHRYN COWARD, EXAMINING ATTORNEY



*David J. Kyfos*

Director of the United States Patent and Trademark Office



# United States of America

United States Patent and Trademark Office

## TRICELLITE ACTIVE

**Reg. No. 4,123,585**

**Registered Apr. 10, 2012**

**Int. Cl.: 3**

**TRADEMARK**

**PRINCIPAL REGISTER**

PHOSPHAGENICS LIMITED (AUSTRALIA CORPORATION)  
11 DUERDIN STREET  
CLAYTON VIC 3168, AUSTRALIA

FOR: NON-MEDICATED INGREDIENTS SOLD AS AN INTEGRAL COMPONENT PART OF THE FINISHED COSMETIC PREPARATIONS, NAMELY, BODY CREAMS; COLOUR COSMETICS FOR THE SKIN; COSMETICS; COSMETICS FOR EYELASHES; COSMETICS FOR PERSONAL USE; COSMETICS FOR THE TREATMENT OF DRY SKIN; COSMETICS FOR USE ON THE SKIN; COSMETICS IN THE FORM OF CREAMS; COSMETICS IN THE FORM OF GELS; COSMETICS IN THE FORM OF LOTIONS; COSMETICS IN THE FORM OF OILS; COSMETICS PREPARATIONS; MOISTURIZERS; OILS FOR THE SKIN; SKIN CARE COSMETICS; SKIN CARE PREPARATIONS, BODY CARE PREPARATIONS AND FACE CARE PREPARATIONS; ANTI-WRINKLE SKIN CARE PREPARATIONS, ANTI-WRINKLE BODY CARE PREPARATIONS AND ANTI-WRINKLE FACE CARE PREPARATIONS; ANTI-CELLULITE SKIN CARE PREPARATIONS, ANTI-CELLULITE BODY CARE PREPARATIONS AND ANTI-CELLULITE FACE CARE PREPARATIONS, IN CLASS 3 (U.S. CLS. 1, 4, 6, 50, 51 AND 52).

THE MARK CONSISTS OF STANDARD CHARACTERS WITHOUT CLAIM TO ANY PARTICULAR FONT, STYLE, SIZE, OR COLOR.

PRIORITY DATE OF 1-27-2011 IS CLAIMED.

OWNER OF INTERNATIONAL REGISTRATION 1070397 DATED 2-23-2011, EXPIRES 2-23-2021.

SER. NO. 79-094,840, FILED 2-23-2011.

DAVID HOFFMAN, EXAMINING ATTORNEY



*David J. Kyfos*

Director of the United States Patent and Trademark Office

United States of America  
United States Patent and Trademark Office

# ITHETIS

**Reg. No. 4,123,586**

**Registered Apr. 10, 2012**

**Int. Cl.: 10**

**TRADEMARK**

**PRINCIPAL REGISTER**

ANTLIA SA (SWITZERLAND SOCIÉTÉ ANONYME (SA))  
PARC SCIENTIFIQUE PSE - BÂT C  
CH-1015 LAUSANNE, SWITZERLAND

FOR: SURGICAL, MEDICAL, DENTAL AND VETERINARY APPARATUS AND INSTRUMENTS, NAMELY, INFUSION AND INJECTION DEVICES FOR ADMINISTERING DRUGS AND SOLUTIONS; PUMPS FOR MEDICAL PURPOSES, NAMELY, INFUSION PUMPS FOR USE IN ADMINISTERING DRUGS AND SOLUTIONS TO PATIENTS, IN CLASS 10 (U.S. CLS. 26, 39 AND 44).

THE MARK CONSISTS OF STANDARD CHARACTERS WITHOUT CLAIM TO ANY PARTICULAR FONT, STYLE, SIZE, OR COLOR.

PRIORITY DATE OF 9-3-2010 IS CLAIMED.

OWNER OF INTERNATIONAL REGISTRATION 1070426 DATED 2-22-2011, EXPIRES 2-22-2021.

SER. NO. 79-094,848, FILED 2-22-2011.

LIEF MARTIN, EXAMINING ATTORNEY



*David J. Kyfos*

Director of the United States Patent and Trademark Office

United States of America  
United States Patent and Trademark Office

J-chord

**Reg. No. 4,123,587**

**Registered Apr. 10, 2012**

**Int. Cl.: 33**

**TRADEMARK**

**PRINCIPAL REGISTER**

OVAL ONE CO., LTD. (JAPAN CORPORATION)  
4-2-11, SHIBA  
MINATO-KU; TOKYO 108-0014  
JAPAN

FOR: JAPANESE LIQUORS; SAKE; JAPANESE WHITE LIQUOR (SHOCHU); WHISKY;  
VODKA; RUM; BRANDY; GIN; FLAVORED TONIC LIQUORS; HYDROMEL (MEAD); HARD  
CIDER; WINE, IN CLASS 33 (U.S. CLS. 47 AND 49).

PRIORITY DATE OF 9-14-2010 IS CLAIMED.

OWNER OF INTERNATIONAL REGISTRATION 1070458 DATED 2-24-2011, EXPIRES 2-24-  
2021.

SER. NO. 79-094,867, FILED 2-24-2011.

KATHERINE E. HALMEN, EXAMINING ATTORNEY



*David J. Kyffers*

Director of the United States Patent and Trademark Office

United States of America  
United States Patent and Trademark Office

**SANDSDALE**

**Reg. No. 4,123,588**

**Registered Apr. 10, 2012**

**Int. Cl.: 25**

**TRADEMARK**

**PRINCIPAL REGISTER**

DALE AND SANDS LIMITED (UNITED KINGDOM LIMITED LIABILITY COMPANY)  
71 PARK STREET  
LONDON W1K 7HN  
UNITED KINGDOM

FOR: CLOTHING, NAMELY, UNDERGARMENTS, BEACHWEAR, SWIMWEAR, SHIRTS, T-SHIRTS, AND SHORTS; HEADWEAR; FOOTWEAR, FLIP-FLOPS, SANDALS; ARTICLES OF CLOTHING FOR SPORTSWEAR, NAMELY, SPORTS TOPS AND SPORTS BOTTOMS, IN CLASS 25 (U.S. CLS. 22 AND 39).

THE MARK CONSISTS OF STANDARD CHARACTERS WITHOUT CLAIM TO ANY PARTICULAR FONT, STYLE, SIZE, OR COLOR.

PRIORITY DATE OF 8-27-2010 IS CLAIMED.

OWNER OF INTERNATIONAL REGISTRATION 1070560 DATED 2-25-2011, EXPIRES 2-25-2021.

SER. NO. 79-094,899, FILED 2-25-2011.

DEIRDRE ROBERTSON, EXAMINING ATTORNEY



*David J. Kyjars*

Director of the United States Patent and Trademark Office

# United States of America

United States Patent and Trademark Office

# BMW i1

**Reg. No. 4,123,589**

**Registered Apr. 10, 2012**

**Int. Cl.: 12**

**TRADEMARK**

**PRINCIPAL REGISTER**

BAYERISCHE MOTOREN WERKE AKTIENGESELLSCHAFT (FED REP GERMANY  
AKTIENGESELLSCHAFT (JOINT STOCK COMPANY))  
PETUELRING 130  
80809 MÜNCHEN, FED REP GERMANY

FOR: LAND VEHICLES, NAMELY, AUTOMOBILES AND STRUCTURAL PARTS THEREFOR,  
IN CLASS 12 (U.S. CLS. 19, 21, 23, 31, 35 AND 44).

THE MARK CONSISTS OF STANDARD CHARACTERS WITHOUT CLAIM TO ANY PAR-  
TICULAR FONT, STYLE, SIZE, OR COLOR.

PRIORITY DATE OF 9-8-2010 IS CLAIMED.

OWNER OF INTERNATIONAL REGISTRATION 1070711 DATED 1-28-2011, EXPIRES 1-28-  
2021.

OWNER OF U.S. REG. NOS. 611,710, 613,465, AND 3,627,334.

SER. NO. 79-094,962, FILED 1-28-2011.

MICHELLE DUBOIS, EXAMINING ATTORNEY



*David J. Kyffers*

Director of the United States Patent and Trademark Office

# United States of America

United States Patent and Trademark Office

# MOBIVEN

**Reg. No. 4,123,590**

**Registered Apr. 10, 2012**

**Int. Cls.: 5, 29 and 30**

**TRADEMARK**

**PRINCIPAL REGISTER**

HARTFORD MEDICALS S. R. O. (SLOVAKIA LIMITED LIABILITY COMPANY)  
PRI MLYNE 5  
SK-080 01 PRE OV  
SLOVAKIA

FOR: MEDICINES AND MEDICINAL PREPARATIONS FOR HUMAN PURPOSES, NAMELY, TO SUPPORT TREATMENT OF HEMORRHOIDS, CHRONIC VENOUS INSUFFICIENCY AND LYMPHEDEMA; SANITARY EQUIPMENT, NAMELY, SANITARY NAPKINS AND TAMPONS; SANITARY PREPARATIONS FOR MEDICAL PURPOSES; PHARMACEUTICAL PREPARATIONS TO SUPPORT TREATMENT OF HEMORRHOIDS, CHRONIC VENOUS INSUFFICIENCY AND LYMPHEDEMA; HOMEOPATHIC PHARMACEUTICS FOR USE IN SUPPORT TREATMENT OF HEMORRHOIDS, CHRONIC VENOUS INSUFFICIENCY AND LYMPHEDEMA AND VITAMIN PREPARATIONS, ALL IN THE FORM OF TABLETS OR POWDER OR SOFT GELATIN CAPSULES OR HARD GELATIN CAPSULES; HOMEOPATHIC PREPARATIONS, NAMELY, HOMEOPATHIC SUPPLEMENTS AND HOMEOPATHIC-STYLE HCG (HUMAN CHORIONIC GONADOTROPIN) ORAL SPRAYS FOR WEIGHT LOSS PURPOSES; PREPARATIONS CONTAINING HERBS FOR MEDICAL PURPOSES; THERAPEUTIC MEDICINAL TEAS; DIETETIC FOOD PREPARATIONS ADAPTED FOR MEDICAL PURPOSES; FOOD SUPPLEMENTS FOR MEDICAL PURPOSES, NAMELY, FOOD SUPPLEMENTS FOR ENHANCING THE IMMUNE SYSTEM'S RESISTANCE AND IMPROVING BODILY HEALTH, IN CLASS 5 (U.S. CLS. 6, 18, 44, 46, 51 AND 52).

FOR: FOOD SUPPLEMENTS NOT FOR MEDICAL PURPOSES CONTAINING ANIMAL-BASED SUBSTANCES, NAMELY, NATURAL FOOD EXTRACTS DERIVED FROM FISH, FISH OIL, FISH PROTEIN, ALGAE, SEAWEED, FISH OR SHARK CARTILAGE, OR SEA-SHELLS FOR HUMAN CONSUMPTION, IN CLASS 29 (U.S. CL. 46).

FOR: FOOD SUPPLEMENTS NOT FOR MEDICAL PURPOSES CONTAINING PLANT-BASED SUBSTANCES, NAMELY, PROCESSED GRAINS, IN CLASS 30 (U.S. CL. 46).

THE MARK CONSISTS OF STANDARD CHARACTERS WITHOUT CLAIM TO ANY PARTICULAR FONT, STYLE, SIZE, OR COLOR.

OWNER OF INTERNATIONAL REGISTRATION 1070723 DATED 2-28-2011, EXPIRES 2-28-2021.

SER. NO. 79-094,966, FILED 2-28-2011.



*David J. Kyros*

Director of the United States Patent and Trademark Office

**Reg. No. 4,123,590** GENE MACIOL, EXAMINING ATTORNEY

# United States of America

United States Patent and Trademark Office

# E-Grade

**Reg. No. 4,123,591**

**Registered Apr. 10, 2012**

**Int. Cls.: 7, 9 and 11**

PETER HUBER KÄLTEMASCHINENBAU GMBH (FED REP GERMANY LIMITED LIABILITY COMPANY)

WERNER-VON-SIEMENS-STR. 1

77656 OFFENBURG

FED REP GERMANY

**TRADEMARK**

**PRINCIPAL REGISTER**

FOR: PUMPS, INCLUDED IN THIS CLASS, NAMELY, CIRCULATION PUMPS, IN PARTICULAR FOR HEATING AND COOLING APPARATUS AND FOR TEMPERATURE CONTROL SYSTEMS; ACCESSORIES FOR THE AFORESAID GOODS, INCLUDED IN THIS CLASS, IN CLASS 7 (U.S. CLS. 13, 19, 21, 23, 31, 34 AND 35).

FOR: MEASURING AND REGULATING APPARATUS, INCLUDING TEMPERATURE REGULATING APPARATUS, NAMELY, COLD AND HEAT THERMOSTATS, BATH THERMOSTATS, PENDANT THERMOSTATS AND CIRCULATORY THERMOSTATS; ELECTRICAL LABORATORY APPARATUS FOR SCIENTIFIC AND INDUSTRIAL PURPOSES, NAMELY, COLD AND/OR HEAT THERMOSTATS, BATH THERMOSTATS, PENDANT THERMOSTATS AND CIRCULATORY THERMOSTATS; SPECIAL FURNITURE FOR LABORATORIES FOR USE AS COLD AND HOT BATH CONTAINERS; ACCESSORIES FOR THE AFORESAID GOODS, INCLUDED IN THIS CLASS, IN CLASS 9 (U.S. CLS. 21, 23, 26, 36 AND 38).

FOR: COLD AND/OR HEAT THERMOSTATS, BATH THERMOSTATS, PENDANT THERMOSTATS, AS WELL AS CIRCULATORY THERMOSTATS AS PARTS OF HEATING SYSTEMS AND/OR COOLING SYSTEMS; ACCESSORIES FOR THE AFORESAID GOODS, INCLUDED IN THIS CLASS, IN CLASS 11 (U.S. CLS. 13, 21, 23, 31 AND 34).

THE MARK CONSISTS OF STANDARD CHARACTERS WITHOUT CLAIM TO ANY PARTICULAR FONT, STYLE, SIZE, OR COLOR.

PRIORITY DATE OF 9-16-2009 IS CLAIMED.

OWNER OF INTERNATIONAL REGISTRATION 1070907 DATED 3-16-2010, EXPIRES 3-16-2020.

SER. NO. 79-095,032, FILED 3-16-2010.

MICHAEL WIENER, EXAMINING ATTORNEY



*David J. Kyros*

Director of the United States Patent and Trademark Office



United States of America  
United States Patent and Trademark Office

# VAN GOGH

**Reg. No. 4,123,592**

**Registered Apr. 10, 2012**

**Int. Cls.: 2 and 16**

**TRADEMARK**

**PRINCIPAL REGISTER**

KONINKLIJKE TALENS B.V. (NETHERLANDS B.V.)  
SOPHIALAAN 46  
NL-7311 PD APELDOORN  
NETHERLANDS

FOR: PAINTS FOR PAINTERS AND ARTISTS; MEDIA FOR PAINTERS AND ARTISTS, NAMELY, METAL IN FOIL AND POWDER FORM FOR PAINTERS AND ARTISTS, OIL PAINTS, POWDERED PAINTS, WATER-COLORS; VARNISHES; MATERIALS FOR PAINTERS AND ARTISTS, NAMELY, PAINTING SETS FOR PAINTERS AND ARTISTS, POWDERS OF PRECIOUS METALS FOR USE BY PAINTERS AND ARTISTS, PAINT THINNER, IN CLASS 2 (U.S. CLS. 6, 11 AND 16).

FOR: MATERIALS FOR PAINTERS AND ARTISTS, NAMELY, PAINT BRUSHES; PENCILS; PASTEL CRAYONS, NAMELY, SQUARE-SHAPED PASTELS AND OIL PASTELS; PAPER; CANVAS FOR PAINTING, IN CLASS 16 (U.S. CLS. 2, 5, 22, 23, 29, 37, 38 AND 50).

OWNER OF U.S. REG. NOS. 1,639,459 AND 2,657,477.

OWNER OF INTERNATIONAL REGISTRATION 0208537 DATED 3-28-1958, EXPIRES 3-28-2018.

SER. NO. 79-095,034, FILED 1-19-2011.

LINDSEY RUBIN, EXAMINING ATTORNEY



*David J. Kyjars*

Director of the United States Patent and Trademark Office

# United States of America

United States Patent and Trademark Office



**Reg. No. 4,123,593**

**Registered Apr. 10, 2012**

**Int. Cls.: 17, 19, 20 and 37**

**TRADEMARK**

**SERVICE MARK**

**PRINCIPAL REGISTER**

SAINT-GOBAIN ISOVER (FRANCE SOCIÉTÉ ANONYME)  
"LES MIROIRS"  
18 AVENUE D'ALSACE  
F-92400 COURBEVOIE, FRANCE

FOR: PACKING, STOPPING AND INSULATING MATERIALS, INSULATING MATERIALS MADE OF MINERAL WOOL OR MINERAL FIBRES IN THE FORM OF LOOSE WOOL, TAPES, WEBS, FELTS, BATTS, PLATES, SLABS, ROLLS, WRAPS, PIPES, CYLINDRICAL AND MOULDED SECTIONS DESIGNED FOR THERMAL AND ACOUSTIC INSULATION AND FOR WATERPROOFING; FACED INSULATING MATERIALS MADE OF MINERAL WOOL OR MINERAL FIBRES, IN CLASS 17 (U.S. CLS. 1, 5, 12, 13, 35 AND 50).

FOR: BITUMINOUS MATERIALS, NAMELY, BITUMEN, BITUMEN ASPHALT, BITUMEN SEALANTS FOR DRIVEWAYS, ROOFING AND ASPHALT, BITUMEN ROOF COATINGS; NON-METALLIC SUPPORTING STRUCTURES FOR CONSTRUCTION PURPOSES, NAMELY, SUPPORTS, SHORES, BRACES AND TRESTLES; NON-METALLIC PANELS, NON-METALLIC SHEETS, NON-METALLIC ROLLS, FACED OR NOT, FOR THERMAL AND ACOUSTIC INSULATION AND FOR PROTECTION AGAINST HUMIDITY AND FIRE AND USED IN THE CONSTRUCTION OF WALLS, PARTITIONS, CEILINGS, FALSE CEILINGS, FLOORS, ROOFS, FALSE ROOFS, CLADDING AND WATERPROOF INSULATING MODULAR UNITS, IN CLASS 19 (U.S. CLS. 1, 12, 33 AND 50).



FOR: NON-METALLIC HARDWARE IN THE NATURE OF PLASTIC FASTENING DEVICES FOR CONSTRUCTION MATERIALS MADE OF MINERAL WOOL OR MINERAL FIBRES, NAMELY, BOLTS, NAILS, RIVETS, SCREWS AND THREADED FASTENERS; NON-METALLIC HARDWARE IN THE NATURE OF FASTENING DEVICES FOR CONSTRUCTION PURPOSES, NAMELY, BOLTS, NAILS, RIVETS, SCREWS AND THREADED FASTENERS; NON-METALLIC HARDWARE IN THE NATURE OF PLASTIC FASTENING DEVICES FOR INSULATION AND WATERPROOFING PRODUCTS MADE OF MINERAL WOOL OR MINERAL FIBRES, NAMELY, BOLTS, NAILS, RIVETS, SCREWS AND THREADED FASTENERS, IN CLASS 20 (U.S. CLS. 2, 13, 22, 25, 32 AND 50).

FOR: BUILDING CONSTRUCTION INFORMATION; INSTALLATION AND REPAIR SERVICES IN THE FIELD OF INSULATION, IN CLASS 37 (U.S. CLS. 100, 103 AND 106).

OWNER OF U.S. REG. NO. 2,699,084.

*David J. Kybas*

Director of the United States Patent and Trademark Office

**Reg. No. 4,123,593** OWNER OF INTERNATIONAL REGISTRATION 0906562 DATED 4-7-2006, EXPIRES 4-7-2016.

THE COLOR(S) YELLOW, BLACK AND GRAY IS/ARE CLAIMED AS A FEATURE OF THE MARK.

NO CLAIM IS MADE TO THE EXCLUSIVE RIGHT TO USE "HOUSE", APART FROM THE MARK AS SHOWN.

THE MARK CONSISTS OF A DESIGN OF A YELLOW CHEVRON WITH FOUR YELLOW VERTICAL LINES UNDERNEATH AND TO THE RIGHT OF THE CHEVRON. UNDERNEATH THE CHEVRON ARE THE WORDS "ISOVER" AND "MULTI-COMFORT HOUSE". THE WORD "ISOVER" IS IN A BLACK STYLIZED FONT WITH THE LETTER "O" SHOWN AS A DESIGN OF BLACK CRESCENT SHAPES WITH A YELLOW CENTER. THE WORDS "MULTI-COMFORT HOUSE" ARE IN A GRAY STYLIZED FONT. THE COLOR WHITE REPRESENTS BACKGROUND AND IS NOT PART OF THE MARK.

SER. NO. 79-095,045, FILED 2-3-2011.

ERNEST SHOSHO, EXAMINING ATTORNEY

# United States of America

United States Patent and Trademark Office

## GILLES & BOISSIER

**Reg. No. 4,123,594**

**Registered Apr. 10, 2012**

**Int. Cl.: 42**

**SERVICE MARK**

**PRINCIPAL REGISTER**

GILLES ET BOISSIER SARL (FRANCE SARL)  
91 RUE DU FAUBOURG SAINT HONORÉ  
F-75008 PARIS, FRANCE

FOR: DESIGN OF INTERIOR DECOR, IN CLASS 42 (U.S. CLS. 100 AND 101).

THE MARK CONSISTS OF THE WORDING "GILLES & BOISSIER" IN A STYLIZED FORMAT.

OWNER OF INTERNATIONAL REGISTRATION 1070931 DATED 2-23-2011, EXPIRES 2-23-2021.

SER. NO. 79-095,059, FILED 2-23-2011.

DAVID HOFFMAN, EXAMINING ATTORNEY



*David J. Kyffers*

Director of the United States Patent and Trademark Office

# United States of America

United States Patent and Trademark Office

十三朝

**Reg. No. 4,123,595**

**Registered Apr. 10, 2012**

**Int. Cl.: 33**

**TRADEMARK**

**PRINCIPAL REGISTER**

SHAANXI BAI SHUI DUKANG LIQUOR DEVELOPMENT CO., LTD. (CHINA CORPORATION)  
MIDDLE PART OF SIMA ROAD  
COUNTY TOWN OF BAISHUI COUNTY; 715600 SHAANXI PROVINCE  
CHINA

FOR: BRANDY; ALCOHOLIC FRUIT EXTRACTS; ALCOHOLIC ESSENCES; ALCOHOLIC BEVERAGES CONTAINING FRUIT; LIQUEURS; SPIRITS; APERITIFS; SAKE; RICE-BASED ALCOHOLIC BEVERAGES; ALCOHOLIC CIDER; WINE, IN CLASS 33 (U.S. CLS. 47 AND 49).

THE MARK CONSISTS OF ASIAN CHARACTERS IN STYLIZED FORMAT.

OWNER OF INTERNATIONAL REGISTRATION 1071033 DATED 3-10-2011, EXPIRES 3-10-2021.

THE TRANSLITERATION OF THE NON-LATIN CHARACTERS IN THE MARK IS: SHI SAN CHAO.

THE NON-LATIN CHARACTERS IN THE MARK HAVE NO MEANING IN A FOREIGN LANGUAGE.

SER. NO. 79-095,087, FILED 3-10-2011.

DAVID HOFFMAN, EXAMINING ATTORNEY



*David J. Kyros*

Director of the United States Patent and Trademark Office

# United States of America

United States Patent and Trademark Office



**Reg. No. 4,123,596**

**Registered Apr. 10, 2012**

**Int. Cls.: 35 and 41**

STARGEN SAS REPRÉSENTÉE PAR LABONNE VALÉRY, PRÉSIDENT (FRANCE CORPORATION)  
22-23 QUAI CARNOT  
F-92210 SAINT CLOUD  
FRANCE

**SERVICE MARK**

FOR: BUSINESS MANAGEMENT AND ORGANIZATION CONSULTANCY, PUBLIC RELATIONS, IN CLASS 35 (U.S. CLS. 100, 101 AND 102).

**PRINCIPAL REGISTER**

FOR: TRAINING SERVICES IN THE FIELDS OF ECONOMICS, MARKETING AND BUSINESS MANAGEMENT DISCIPLINES IN THE HEALTHCARE FIELD; ARRANGING AND CONDUCTING OF EDUCATIONAL COLLOQUIUMS, CONFERENCES, CONGRESSES IN THE FIELDS OF ECONOMICS, MARKETING AND BUSINESS MANAGEMENT DISCIPLINES IN THE HEALTHCARE FIELD, IN CLASS 41 (U.S. CLS. 100, 101 AND 107).

NO CLAIM IS MADE TO THE EXCLUSIVE RIGHT TO USE "STRATEGY CONSULTANTS", APART FROM THE MARK AS SHOWN.

PRIORITY DATE OF 9-7-2010 IS CLAIMED.

OWNER OF INTERNATIONAL REGISTRATION 1071310 DATED 1-27-2011, EXPIRES 1-27-2021.



THE COLOR(S) RED, GRAY AND WHITE IS/ARE CLAIMED AS A FEATURE OF THE MARK.

THE MARK CONSISTS OF A RED SQUARE CONTAINING A WHITE STAR ABOVE THE WORDING "STARGEN" AND "STRATEGY CONSULTANTS" IN STYLIZED WHITE FONT. A GRAY STRIP SUGGESTING A SHADOW APPEARS TO THE RIGHT AND BELOW THE RED SQUARE.

SER. NO. 79-095,152, FILED 1-27-2011.

STEVEN PEREZ, EXAMINING ATTORNEY

*David J. Kybas*

Director of the United States Patent and Trademark Office

# United States of America

United States Patent and Trademark Office

## TARTUFERIA FIORENTINA

**Reg. No. 4,123,597**

**Registered Apr. 10, 2012**

**Int. Cls.: 29, 30 and 43**

**TRADEMARK**

**SERVICE MARK**

**PRINCIPAL REGISTER**

P. ANTINORI S.P.A. (ITALY JOINT STOCK COMPANY)  
PIAZZA ANTINORI, 3  
I-50123 FIRENZE  
ITALY

FOR: MEAT, FISH, POULTRY AND GAME; MEAT EXTRACTS; PRESERVED, FROZEN, DRIED AND COOKED FRUITS AND VEGETABLES; JELLIES, JAMS, COMPOTES; EGGS, MILK, BUTTER, DIARY-BASED SPREADS; EDIBLE OILS AND FATS, IN CLASS 29 (U.S. CL. 46).

FOR: COFFEE, TEA, COCOA, SUGAR, RICE, TAPIOCA, SAGO, ARTIFICIAL COFFEE; BREAD; HONEY, TREACLE; YEAST, BAKING-POWDER; SALT, MUSTARD; VINEGAR, SAUCES; COCKTAIL SAUCES; COOKING SAUCES; DIPPING SAUCES; PASTA SAUCES; READY-MADE SAUCES; SALAD SAUCES; SWEET MUSTARD; FRUIT MUSTARD; SPICES; ICE, IN CLASS 30 (U.S. CL. 46).

FOR: RESTAURANTS; CAFÉS; BISTROS; BAR SERVICES; SNACK BARS; WINE BARS; COFFEE BARS, IN CLASS 43 (U.S. CLS. 100 AND 101).

NO CLAIM IS MADE TO THE EXCLUSIVE RIGHT TO USE "FIORENTINA", APART FROM THE MARK AS SHOWN.

PRIORITY DATE OF 11-22-2010 IS CLAIMED.

OWNER OF INTERNATIONAL REGISTRATION 1071376 DATED 2-2-2011, EXPIRES 2-2-2021.

THE MARK CONSISTS OF THE INSCRIPTION "TARTUFERIA FIORENTINA".

THE ENGLISH TRANSLATION OF "FIORENTINA" IN THE MARK IS FLORENTINE. THE WORD, "TARTUFERIA", AS SPELLED, HAS NO MEANING IN A FOREIGN LANGUAGE.

SER. NO. 79-095,182, FILED 2-2-2011.

BARBARA A. GOLD, EXAMINING ATTORNEY



*David J. Kyffers*

Director of the United States Patent and Trademark Office

# United States of America

United States Patent and Trademark Office

## WATCH-THAT-LABEL

**Reg. No. 4,123,598**

**Registered Apr. 10, 2012**

**Int. Cl.: 35**

**SERVICE MARK**

**PRINCIPAL REGISTER**

JIL-VALERIE DIANE WENSAUER (FED REP GERMANY INDIVIDUAL)  
UHLANDSTR. 29  
10719 BERLIN  
FED REP GERMANY

FOR: RETAIL STORE AND ONLINE RETAIL STORE SERVICES FEATURING CLOTHING, FOOTWEAR, HEADGEAR AND FASHION ACCESSORIES, HOME ACCESSORIES AND PET ACCESSORIES; THE BRINGING TOGETHER, FOR THE BENEFIT OF OTHERS, OF A VARIETY OF CLOTHING, FOOTWEAR, HEADGEAR AND FASHION ACCESSORIES, HOME ACCESSORIES AND PET ACCESSORIES, ENABLING CUSTOMERS TO CONVENIENTLY VIEW AND PURCHASE THOSE GOODS, INCLUDING FROM AN INTERNET WEBSITE SPECIALISING IN THE SAME; MAIL ORDER RETAIL STORE SERVICES FEATURING CLOTHING, FOOTWEAR, HEADGEAR AND FASHION ACCESSORIES, HOME ACCESSORIES AND PET ACCESSORIES; CONSULTANCY, ADVISORY AND INFORMATION SERVICES FOR OR IN RELATION TO ANY OR ALL OF THE AFOREMENTIONED SERVICES IN THIS CLASS, NAMELY, IN THE FIELD OF RETAIL STORE, ONLINE RETAIL STORE AND MAIL ORDER RETAIL STORE SERVICES FEATURING CLOTHING, FOOTWEAR, HEADGEAR AND FASHION ACCESSORIES, HOME ACCESSORIES AND PET ACCESSORIES, IN CLASS 35 (U.S. CLS. 100, 101 AND 102).

THE MARK CONSISTS OF STANDARD CHARACTERS WITHOUT CLAIM TO ANY PARTICULAR FONT, STYLE, SIZE, OR COLOR.

OWNER OF INTERNATIONAL REGISTRATION 1071434 DATED 2-21-2011, EXPIRES 2-21-2021.

SER. NO. 79-095,203, FILED 2-21-2011.

SANDRA BUJA, EXAMINING ATTORNEY



*David J. Kybas*

Director of the United States Patent and Trademark Office



# United States of America

United States Patent and Trademark Office

## D i g i t a l   D i s p l a c e m e n t

**Reg. No. 4,123,599**

**Registered Apr. 10, 2012**

**Int. Cls.: 7, 9 and 12**

**TRADEMARK**

**PRINCIPAL REGISTER**

MITSUBISHI HEAVY INDUSTRIES, LTD. (JAPAN CORPORATION)  
16-5 KONAN 2-CHOME  
MINATO-KU;  
TOKYO 108-8215, JAPAN

FOR: HYDRAULIC POWERED ENGINES AND MOTORS EXCEPT FOR LAND VEHICLES; ACTUATORS FOR HYDRAULIC POWERED ENGINES AND MOTORS; RAMS FOR HYDRAULIC POWERED ENGINES AND MOTORS; PARTS OF MACHINES OR ENGINES, NAMELY, PISTONS; PISTONS FOR HYDRAULIC POWERED ENGINES AND MOTORS; PUMPS AS PARTS OF MACHINES, MOTORS AND ENGINES; PUMPS FOR HYDRAULIC POWERED ENGINES AND MOTORS; MACHINE ELEMENTS NOT FOR LAND VEHICLES, NAMELY, VALVES; AUTOMATIC CONTROL VALVES FOR USE WITH HYDRAULIC POWERED ENGINES AND MOTORS, NOT FOR LAND VEHICLES; CONTROL MECHANISMS FOR USE WITH HYDRAULIC POWERED ENGINES AND MOTORS, NOT FOR LAND VEHICLES; TRANSMISSIONS, OTHER THAN FOR LAND VEHICLES; HYDRAULIC TRANSMISSIONS FOR WIND TURBINE GENERATORS AND TIDAL CURRENT GENERATORS; WIND TURBINE GENERATORS; TIDAL CURRENT ELECTRICITY GENERATORS, IN CLASS 7 (U.S. CLS. 13, 19, 21, 23, 31, 34 AND 35).

FOR: COMPUTER CONTROLLED SOLENOID VALVES; ELECTROMAGNETIC SWITCHES, NAMELY, SOLENOID VALVES, IN CLASS 9 (U.S. CLS. 21, 23, 26, 36 AND 38).

FOR: HYDRAULIC POWERED ENGINES AND MOTORS FOR LAND VEHICLES; TRANSMISSIONS FOR LAND VEHICLES; HYDRAULIC TRANSMISSIONS FOR ENGINES AND MOTORS FOR LAND VEHICLES, IN CLASS 12 (U.S. CLS. 19, 21, 23, 31, 35 AND 44).

THE MARK CONSISTS OF STANDARD CHARACTERS WITHOUT CLAIM TO ANY PARTICULAR FONT, STYLE, SIZE, OR COLOR.

PRIORITY DATE OF 12-16-2010 IS CLAIMED.

OWNER OF INTERNATIONAL REGISTRATION 1071439 DATED 2-7-2011, EXPIRES 2-7-2021.

SER. NO. 79-095,207, FILED 2-7-2011.

MATTHEW KLINE, EXAMINING ATTORNEY



*David J. Kypas*

Director of the United States Patent and Trademark Office

# United States of America

United States Patent and Trademark Office

# DALÍ

**Reg. No. 4,123,600**

**Registered Apr. 10, 2012**

**Int. Cl.: 18**

**TRADEMARK**

**PRINCIPAL REGISTER**

FUNDACIÓN GALA-SALVADOR DALÍ (SPAIN PRIVATE FOUNDATION)  
PUJADA DEL CASTELL, 28 -  
TORRE GALATEA; E-17600 FIGUERAS (GIRONA)  
SPAIN

FOR: LEATHER AND IMITATIONS OF LEATHER, AND GOODS MADE OF THESE MATERIALS, NAMELY, BRIEFCASES, CASES, KEY CHAINS, PURSES, SHOPPING BAGS; ANIMAL SKINS; TRUNKS AND TRAVELLING BAGS; UMBRELLAS, PARASOLS AND WALKING STICKS; WHIPS, HARNESS AND SADDLERY; BAGS FOR CLIMBERS, CAMPERS AND THE BEACH BAGS FOR CLIMBERS IN THE NATURE OF ALL-PURPOSE CARRYING BAGS; HANDBAG FRAMES; FRAMES FOR UMBRELLAS OR PARASOLS; MOUNTAINEERING STICKS; PURSES; BAGS; LEATHER LINING FOR FOOTWEAR; LEATHERWARE, NAMELY, TRAVELING CASES AND KEY CASES; ATTACHÉ CASES; COIN PURSES, NOT OF PRECIOUS METAL; GARMENT BAGS FOR TRAVEL; HAT BOXES OF LEATHER; SLING BAGS FOR CARRYING INFANTS; WHEELED SHOPPING BAGS; CONTAINERS AND BOXES OF LEATHER OR LEATHER-BOARD; BOXES OF VULCANIZED FIBER; POCKET WALLETS; BRIEFCASES; HANDBAGS; SCHOOL SATCHELS AND DOCUMENT HOLDERS; SCHOOL SATCHELS; UNFITTED VANITY CASES; COLLARS FOR ANIMALS; LEATHER LEASHES; LEATHER LEADS; UMBRELLA COVERS; COVERS FOR HORSE-SADDLES; HAVERSACKS; BACKPACKS; DOCUMENT CASES FOR USE WITH SHEET MUSIC; HORSE HALTERS; LEATHER BAGS AND POUCHES FOR PACKAGING; LEATHER THREAD; SUITCASE HANDLES; HANDLES FOR WALKING STICKS AND UMBRELLAS; HORSE BLANKETS; FURNITURE COVERINGS OF LEATHER; PADS FOR HORSE SADDLES; UMBRELLA RINGS; HARNESS FITTINGS OF IRON; HARNESES FOR ANIMALS; HARNESS FOR ANIMALS; HARNESS FITTINGS NOT OF PRECIOUS METAL; WALKING STICK SEATS; SHOULDER BELTS OF LEATHER; UNFITTED LEATHER TOOL BAGS; CHAIN MESH PURSES NOT OF PRECIOUS METAL; BEACH BAGS; MUZZLES; BRIDLES; LEATHER-BOARD; BANDS OF LEATHER; TRAVELING TRUNKS; SHOPPING BAGS; STRAPS FOR HANDBAGS, LUGGAGE, AND CARRYALLS; HARNESS STRAPS; LEATHER STRAPS FOR USE WITH SADDLERY; LEATHER STRAPS FOR SKATES; IMITATION LEATHER; TRIMMINGS OF LEATHER FOR FURNITURE; LEATHER STRAPS; CURRIED ANIMAL SKINS; CAT O'NINE TAILS; FUR PELTS FOR USE AS COVERINGS FOR COATS OR DECORATION; STIRRUP LEATHERS; PARTS OF RUBBER FOR STIRRUPS; BITS FOR ANIMALS; REINS; ATTACHÉ CASES; MOLESKIN IN THE NATURE OF IMITATION LEATHER; FURS SOLD IN BULK; CHAMOIS LEATHER OTHER THAN FOR CLEANING PURPOSES; FEED BAGS FOR ANIMALS IN THE NATURE OF NOSE BAGS; NET BAGS FOR SHOPPING; CASINGS OF LEATHER FOR SPRINGS; KNEE-PADS FOR HORSES;



*David J. Kyjars*

Director of the United States Patent and Trademark Office

**Reg. No. 4,123,600** RIDING SADDLES; FASTENINGS FOR SADDLES; CARD CASES, NAMELY, CALLING CARD CASES AND NAME CARD CASES; HARNESS TRACES, IN CLASS 18 (U.S. CLS. 1, 2, 3, 22 AND 41).

THE MARK CONSISTS OF STANDARD CHARACTERS WITHOUT CLAIM TO ANY PARTICULAR FONT, STYLE, SIZE, OR COLOR.

PRIORITY DATE OF 8-3-2010 IS CLAIMED.

OWNER OF INTERNATIONAL REGISTRATION 1071526 DATED 2-3-2011, EXPIRES 2-3-2021.

OWNER OF U.S. REG. NOS. 1,478,193, 2,237,320, AND 2,831,053.

SER. NO. 79-095,230, FILED 2-3-2011.

ERNEST SHOSHO, EXAMINING ATTORNEY

# United States of America

United States Patent and Trademark Office

# Jungle Jewels

**Reg. No. 4,123,601**

**Registered Apr. 10, 2012**

**Int. Cls.: 9, 28, 38 and 41**

**TRADEMARK**

**SERVICE MARK**

**PRINCIPAL REGISTER**

GAMEDUELL GMBH (FED REP GERMANY LIMITED LIABILITY COMPANY)  
GREIFSWALDERSTR. 212-213  
10405 BERLIN  
FED REP GERMANY

FOR: COMPUTER PROGRAMS, NAMELY, DOWNLOADABLE COMPUTER AND VIDEO GAME SOFTWARE; COMPUTER PROGRAMS, RECORDED, NAMELY, COMPUTER AND VIDEO GAME SOFTWARE; STORED AND DOWNLOADABLE COMPUTER PROGRAMS, NAMELY, COMPUTER AND VIDEO GAMES; STORED AND DOWNLOADABLE COMPUTER PROGRAMS ESPECIALLY FOR USE WITH COMPUTER, VIDEO AND OTHER ELECTRONIC AND/OR VISUAL GAMES, NAMELY, FOR USE IN PROGRAMMING AND CREATING COMPUTER AND VIDEO GAMES; ELECTRONIC PUBLICATIONS, DOWNLOADABLE, IN THE NATURE OF REPORTS, DIRECTORIES, BROCHURES, REFERENCE MATERIALS, LEAFLETS, NEWSLETTERS, NEWSPAPERS, BOOKLETS, PAMPHLETS, POST CARDS, FLYERS, MAGAZINE SUPPLEMENTS TO NEWSPAPERS, MAGAZINES AND TRADE AND PROFESSIONAL BOOKS IN THE FIELD OF COMPUTER SOFTWARE, ESPECIALLY COMPUTER, VIDEO, ONLINE AND BROWSER GAMES AND OTHER ELECTRONIC AND/OR VISUAL GAMES; COMPUTER AND APPARATUS FOR VIDEO GAMES ADAPTED FOR USE WITH AN EXTERNAL DISPLAY SCREEN OR MONITOR; DATA PROCESSING APPARATUS, NAMELY, DATA PROCESSORS; PRE-RECORDED DATA CARRIERS, NAMELY, PRE-RECORDED ROMS FEATURING WITH COMPUTER AND VIDEO GAME SOFTWARE; PRE-RECORDED COMPACT DISCS, NAMELY, CD- AND DVD-ROMS, FEATURING COMPUTER AND VIDEO GAME SOFTWARE; PRE-RECORDED COMPACT DISCS CONTAINING SOUNDS AND IMAGES, NAMELY, CONTAINING COMPUTER AND VIDEO GAMES; PRE-RECORDED IMAGE, SOUND AND DATA CARRIERS, FEATURING COMPUTER AND VIDEO GAMES; VIDEO RECORDINGS ON DIGITAL MEDIA, NAMELY, CDS, DVDS AND CD-ROMS, FEATURING COMPUTER, VIDEO AND OTHER ELECTRONIC AND/OR VISUAL GAMES; COMPUTER HARDWARE FOR COMPUTER GAMES AND ONLINE COMPUTER GAMES, IN CLASS 9 (U.S. CLS. 21, 23, 26, 36 AND 38).

FOR: APPARATUS FOR ELECTRONIC GAMES, IN PARTICULAR COMPUTER, VIDEO, ONLINE AND BROWSER GAMES, NOT BEING FOR USE WITH AN EXTERNAL DISPLAY SCREEN OR MONITOR, INCLUDED IN THIS CLASS, IN CLASS 28 (U.S. CLS. 22, 23, 38 AND 50).

FOR: PROVIDING INTERNET CHATROOMS; ELECTRONIC MAIL; TELECOMMUNICATION SERVICES, NAMELY, ELECTRONIC BULLETIN BOARD SERVICES; COMMUNICATION



*David J. Kyjars*

Director of the United States Patent and Trademark Office

**Reg. No. 4,123,601** BY COMPUTER TERMINALS; COMPUTER AIDED TRANSMISSION OF MESSAGES AND IMAGES; SERVICE OF AN ONLINE SERVICE PROVIDER, NAMELY, COLLECTION, PROVISION AND TRANSMISSION OF INFORMATION IN THE NATURE OF E-MAIL DATA SERVICES, TRANSMISSION OF ELECTRONIC MAIL, AND MANAGEMENT OF CHAT ROOMS, NAMELY, PROVIDING ELECTRONIC MESSAGE AND IMAGE SENDING, IN CLASS 38 (U.S. CLS. 100, 101 AND 104).

FOR: GAME SERVICES PROVIDED ON-LINE FROM A COMPUTER NETWORK, NAMELY, PROVIDING ONLINE COMPUTER GAMES, ONLINE VIDEO COMPUTER GAMES AND ONLINE BROWSER COMPUTER GAMES AND COMPUTER GAMES FOR MOBILE TELEPHONES, IN PARTICULAR VIA PORTALS AND PLATFORMS ON THE INTERNET; ORGANIZATION OF COMPETITIONS FOR EDUCATION OR ENTERTAINMENT PURPOSES, IN PARTICULAR ON THE INTERNET, NAMELY, COMPETITIONS IN THE FIELD OF ONLINE COMPUTER GAMES, ONLINE VIDEO COMPUTER GAMES AND ONLINE BROWSER COMPUTER GAMES AND COMPUTER GAMES FOR MOBILE TELEPHONES, IN PARTICULAR VIA PORTALS AND PLATFORMS ON THE INTERNET; PROVIDING ON-LINE ELECTRONIC PUBLICATIONS, NOT DOWNLOADABLE, IN THE NATURE OF REPORTS, DIRECTORIES, BROCHURES, REFERENCE MATERIALS, LEAFLETS, NEWSLETTERS, NEWSPAPERS, BOOKLETS, PAMPHLETS, POST CARDS, FLYERS, MAGAZINE SUPPLEMENTS TO NEWSPAPERS, MAGAZINES AND TRADE AND PROFESSIONAL BOOKS IN THE FIELD OF COMPUTER SOFTWARE, ESPECIALLY COMPUTER, VIDEO, ONLINE AND BROWSER GAMES AND OTHER ELECTRONIC AND/OR VISUAL GAMES; ELECTRONIC DESKTOP PUBLISHING; ENTERTAINMENT SERVICES OFFERED VIA THE INTERNET, IN PARTICULAR IN RELATION WITH COMPUTER AND VIDEO GAMES, NAMELY, INTERACTIVE ENTERTAINMENT AND COMPETITION SERVICES IN THE NATURE OF ONLINE COMPUTER GAMES PROVIDED OVER A COMPUTER NETWORK OR THE INTERNET, ONLINE VIDEO COMPUTER GAMES, AND ONLINE BROWSER COMPUTER GAMES AND ONLINE COMPUTER GAMES FOR MOBILE TELEPHONES; ENTERTAINMENT SERVICES OFFERED VIA OTHER WIRELESS MEDIA OR OVER CABLE CONNECTIONS, NAMELY, INTERACTIVE ENTERTAINMENT AND COMPETITION SERVICES IN THE NATURE OF ONLINE COMPUTER GAMES PROVIDED OVER A COMPUTER NETWORK OR THE INTERNET, ONLINE VIDEO COMPUTER GAMES, AND ONLINE BROWSER COMPUTER GAMES AND ONLINE COMPUTER GAMES FOR MOBILE TELEPHONES; ONLINE ENTERTAINMENT IN THE RANGE OF VIDEO AND COMPUTER GAMES, NAMELY, INTERACTIVE ENTERTAINMENT AND COMPETITION SERVICES IN THE NATURE OF ONLINE COMPUTER GAMES PROVIDED OVER A COMPUTER NETWORK OR THE INTERNET, ONLINE VIDEO COMPUTER GAMES, AND ONLINE BROWSER COMPUTER GAMES AND ONLINE COMPUTER GAMES FOR MOBILE TELEPHONES; ENTERTAINMENT, NAMELY, PROVIDING INFORMATION ABOUT ONLINE COMPUTER GAMES, ONLINE VIDEO COMPUTER GAMES, ONLINE BROWSER COMPUTER GAMES AND ONLINE COMPUTER GAMES FOR MOBILE TELEPHONES AND PROVIDING CONTINUING GAME SHOWS BROADCAST VIA THE INTERNET; ORGANIZING AND CONDUCTING GAMING EVENTS, NAMELY, COMPUTER GAMING COMPETITIONS, GAMING LEAGUES AND GAMING TOURNAMENTS IN THE FIELD OF ONLINE VIDEO COMPUTER GAMES, ONLINE BROWSER COMPUTER GAMES AND ONLINE COMPUTER GAMES FOR MOBILE TELEPHONES, IN PARTICULAR ON THE INTERNET; OFFERING OF ENTERTAINMENT SERVICES TO ORGANIZE COMPUTER GAMING TOURNAMENTS IN THE FIELD OF ONLINE VIDEO COMPUTER GAMES, AND ONLINE BROWSER COMPUTER GAMES AND ONLINE COMPUTER GAMES FOR MOBILE TELEPHONES, IN PARTICULAR ON THE INTERNET; ORGANIZATION OF COMPETITIVE COMPUTER AND VIDEO GAME COMPETITIONS, IN CLASS 41 (U.S. CLS. 100, 101 AND 107).

THE MARK CONSISTS OF STANDARD CHARACTERS WITHOUT CLAIM TO ANY PARTICULAR FONT, STYLE, SIZE, OR COLOR.

PRIORITY DATE OF 8-24-2010 IS CLAIMED.

**Reg. No. 4,123,601** OWNER OF INTERNATIONAL REGISTRATION 1071567 DATED 2-15-2011, EXPIRES 2-15-2021.

SER. NO. 79-095,243, FILED 2-15-2011.

JAMES MACFARLANE, EXAMINING ATTORNEY

# United States of America

United States Patent and Trademark Office

# ZEGUL

**Reg. No. 4,123,602**

**Registered Apr. 10, 2012**

**Int. Cls.: 12 and 35**

**TRADEMARK**

**SERVICE MARK**

**PRINCIPAL REGISTER**

OÜ WATERSPORT TRADING (ESTONIA CORPORATION)  
AIANDI TEE 21, VIIMSI ALEVIK  
EE-74001 VIIMSI VALD  
ESTONIA

FOR: WATER VEHICLES, NAMELY, HYDROFOIL BOATS SUPPORTED BY SINGLE OR MULTI HULLS, AND STRUCTURAL PARTS THEREFOR; AIR AND WATER VEHICLES, NAMELY, BOATS, TRIMARANS IN THE NATURE OF A MULTIHULLED BOAT, SECTIONAL BOATS WITH ROOFS, CANOES, KAYAKS, CANADIAN CANOES, DINGHIES, RUBBER DINGHIES, STRUCTURAL PARTS FOR BOATS, THWART BAGS ADAPTED FOR USE ON CANOES, BOAT HOOKS, FITTED CANVAS COVERS FOR BOATS, SUNSHADES FOR BOATS, WHEELS FOR BOATS, OARS, SCULLING OARS, PADDLES FOR CANOES, KAYAKS AND CANADIAN CANOES, TRAILERS OR TWO-WHEELED TRAILERS FOR WATER VEHICLES, IN CLASS 12 (U.S. CLS. 19, 21, 23, 31, 35 AND 44).

FOR: MARKETING SERVICES, NAMELY, PROMOTING WATER VEHICLES OF OTHERS; RETAIL STORE SERVICES FEATURING WATER SPORT EQUIPMENT, WATER VEHICLES, FLOATS, FLOATING STAGES, LANDING STAGES, PONTOONS, CLOTHING, FOOTWEAR, HEADGEAR FOR WATERSPORTS, CLOTHING, FOOTWEAR AND HEADGEAR FOR FISHING; ON-LINE RETAIL STORES FEATURING BOATS, KAYAKS AND CANOES, IN CLASS 35 (U.S. CLS. 100, 101 AND 102).

THE MARK CONSISTS OF THE STYLIZED WORD "ZEGUL".

OWNER OF INTERNATIONAL REGISTRATION 1071626 DATED 2-17-2011, EXPIRES 2-17-2021.

THE WORDING "ZEGUL" HAS NO MEANING IN A FOREIGN LANGUAGE.

SER. NO. 79-095,259, FILED 2-17-2011.

SIMON TENG, EXAMINING ATTORNEY



*David J. Kyffers*

Director of the United States Patent and Trademark Office

# United States of America

United States Patent and Trademark Office

# QUIOSELS

**Reg. No. 4,123,603**

**Registered Apr. 10, 2012**

**Int. Cls.: 1, 3 and 5**

**TRADEMARK**

**PRINCIPAL REGISTER**

LIPOTEC, S.A. (SPAIN SOCIEDAD ANÓNIMA)  
ISAAC PERAL, 17 -  
POL. IND. CAMÍ RAL  
E-08850 GAVÁ (BARCELONA), SPAIN

FOR: CHEMICALS FOR USE IN SCIENCE AND IN THE COSMETICS, TEXTILE AND FOOD INDUSTRIES FOR USE IN MANUFACTURING COSMETICS, FABRIC AND FOODSTUFFS, IN CLASS 1 (U.S. CLS. 1, 5, 6, 10, 26 AND 46).

FOR: SOAPS IN BAR FORM; BATH SOAP; HAND SOAPS; COSMETIC SOAP; PERFUMES; ESSENTIAL OILS; HAIR LOTIONS; COSMETICS; DENTIFRICES, IN CLASS 3 (U.S. CLS. 1, 4, 6, 50, 51 AND 52).

FOR: BANDAGES AND GAUZE FOR DRESSINGS; PLASTER FOR MEDICAL PURPOSES; MATERIALS FOR DRESSING WOUNDS; MEDICATED COMPRESSES; SANITARY TOWELS; ADHESIVE STRIPS AND PATCHES FOR MEDICAL PURPOSES, NAMELY, DERMATOLOGICAL PURPOSES, IN CLASS 5 (U.S. CLS. 6, 18, 44, 46, 51 AND 52).

THE MARK CONSISTS OF STANDARD CHARACTERS WITHOUT CLAIM TO ANY PARTICULAR FONT, STYLE, SIZE, OR COLOR.

OWNER OF INTERNATIONAL REGISTRATION 1071728 DATED 2-2-2011, EXPIRES 2-2-2021.

SER. NO. 79-095,286, FILED 2-2-2011.

DAVID HOFFMAN, EXAMINING ATTORNEY



*David J. Kyfos*

Director of the United States Patent and Trademark Office



# United States of America

United States Patent and Trademark Office

## E-EQUIPMENT<sup>®</sup>

**Reg. No. 4,123,604**

RÖHM GMBH (FED REP GERMANY GMBH)  
HEINRICH-RÖHM-STR. 50  
89567 SONTHEIM, FED REP GERMANY

**Registered Apr. 10, 2012**

**Int. Cls.: 7 and 9**

**TRADEMARK**

**PRINCIPAL REGISTER**

FOR: MACHINES AND MACHINE TOOLS FOR THE CLAMPING, CUTTING AND FORMING OF MATERIALS; POWER -OPERATED DRILL AND LATHE CLAMPING TOOLS AND REPLACEMENT PARTS THEREFOR, NAMELY, FASTENER COLLETS, CLAMPING CHUCKS, CLAMPING SLEEVES, CLAMPING WEDGES, GRIP HEADS, TURN BUCKLE SLEEVES, CHUCKING GROOVES, CLAMPING RINGS, CLAMPING SLOTS, CHUCK KEYS, CLAMPING CARRIAGES, CLAMPING CLIPS, LATHE CHUCKS, DRIVING CENTERS, GEAR DRIVES FOR USE WITH ELECTRIC, ELECTROMECHANICAL OR MECHANICAL POWER-OPERATED CLAMPING SYSTEMS, AND FOR USE WITH MACHINE TOOLS; MOTORS AND ENGINES EXCEPT FOR LAND VEHICLES; MACHINE COUPLING AND TRANSMISSION COMPONENTS EXCEPT FOR LAND VEHICLES; TRANSMISSION CHAINS, OTHER THAN FOR LAND VEHICLES; DRIVING MOTORS FOR MACHINES, NAMELY, ELECTRIC MOTORS FOR MACHINES; ELECTRIC MOTORS FOR POWER TOOLS; ELECTRIC MOTORS NOT FOR LAND VEHICLES; TRANSMISSION SHAFTS, OTHER THAN FOR LAND VEHICLES; DRILL CHUCKS FOR POWER DRILLS; POWER DRILL HEADS; POWER DRILL BITS; DRILLING MACHINES; MACHINE LATHES; SPEED GOVERNORS FOR MACHINES, ENGINES AND MOTORS; ELECTRIC MOTORS, EXCEPT FOR LAND VEHICLES; MACHINE TOOLS, NAMELY, HOLLOW CLAMPS AND UNCLAMPING UNITS FOR USE IN THE PRECISION CLAMPING AND UNCLAMPING OF WORK PIECES; CLAMPS FOR USE IN GRIPPING PIECE PARTS ON MACHINE TOOL TABLES; MACHINE TOOLS AND APPARATUS FOR CLAMPING CHUCKS TO POWER DRILLS; MECHATRONIC CLAMPING DEVICES FOR USE IN CONNECTION WITH MACHINE TABLE TOOLS; MACHINE CLAMPING SYSTEMS FOR LOCKING POWER TOOLS WHILE IN USE; GEAR BOXES OTHER THAN FOR LAND VEHICLES; DIE-CUTTING AND TAPPING MACHINES; ELECTRIC FILLETING MACHINES; HYDRAULIC CONTROLS FOR MACHINES AND MOTORS; ELECTRICAL AND ELECTRONIC CONTROLS FOR MACHINES, MOTORS AND ENGINES; COUPLINGS OTHER THAN FOR LAND VEHICLES; MACHINE MATERIAL HANDLING MACHINES FOR LOADING AND UNLOADING, NAMELY, PALLETIZERS; BEARINGS AS PARTS OF MACHINES; BEARING BRACKETS FOR MACHINES; PIVOT PINS FOR USE WITH PNEUMATIC BLOW GUNS; MACHINE PARTS, NAMELY, JOURNAL BOXES; MACHINE TOOLS, NAMELY, HYDRAULIC, PNEUMATIC, ELECTRIC AND ELECTRONICALLY POWERED CLAMPS FOR USE IN CLAMPING WORK PIECES; WOOD PROCESSING MACHINES, NAMELY, PLANING MACHINES, BORING MACHINES, LATHES, POWER SAWS; MACHINES FOR PROCESSING PLASTIC, NAMELY, JET MOLDING MACHINES, POLISHING



*David J. Kybas*

Director of the United States Patent and Trademark Office

**Reg. No. 4,123,604** MACHINES; METAL WORKING MACHINES, NAMELY, MACHINING CENTERS; PNEUMATIC CONTROLS FOR MACHINES, MOTORS AND ENGINES; STATORS; CONTROL MECHANISMS FOR MACHINES IN THE NATURE OF HYDRAULIC AND PNEUMATIC CONTROLS FOR ENGINES AND MOTORS; CYLINDERS FOR MACHINES, IN CLASS 7 (U.S. CLS. 13, 19, 21, 23, 31, 34 AND 35).

FOR: APPARATUS AND INSTRUMENTS FOR CONDUCTING, SWITCHING, TRANSFORMING, ACCUMULATING, REGULATING OR CONTROLLING ELECTRICITY, NAMELY, ELECTRIC SWITCHES, ELECTRIC TRANSFORMERS, ELECTRIC ACCUMULATORS, VOLTAGE REGULATORS, AND ELECTRIC PANEL CONTROLS; BLANK MAGNETIC DATA CARRIERS, IN CLASS 9 (U.S. CLS. 21, 23, 26, 36 AND 38).

NO CLAIM IS MADE TO THE EXCLUSIVE RIGHT TO USE "EQUIPMENT", APART FROM THE MARK AS SHOWN.

PRIORITY DATE OF 12-17-2010 IS CLAIMED.

OWNER OF INTERNATIONAL REGISTRATION 1071754 DATED 2-2-2011, EXPIRES 2-2-2021.

THE MARK CONSISTS OF THE TERM "E-EQUIPMENT" BEGINNING WITH A STYLIZED LOWER CASE "E" AND FOLLOWED BY UPPER CASE LETTERS "QUIPMENT". THE LETTERING IS FOLLOWED BY THE DESIGN OF AN ELECTRICAL PLUG INSIDE A SINGLE LINE CIRCLE TO THE UPPER RIGHT OF THE LETTER "T".

SER. NO. 79-095,298, FILED 2-2-2011.

BARBARA A. GOLD, EXAMINING ATTORNEY

# United States of America

United States Patent and Trademark Office

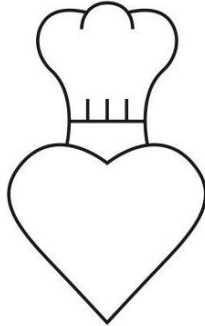

FOOD FRIEND

**Reg. No. 4,123,605**

**Registered Apr. 10, 2012**

**Int. Cls.: 9, 43 and 45**

**TRADEMARK**

**SERVICE MARK**

**PRINCIPAL REGISTER**

ALEXANDER KÜHNE (SWITZERLAND INDIVIDUAL)  
STEINHOLDENSTRASSE 67A  
ZÜRICH, SWITZERLAND CH8002

FOR: COMPUTER SOFTWARE FOR CREATING AND EDITING RECIPES, IN CLASS 9 (U.S. CLS. 21, 23, 26, 36 AND 38).

FOR: PROVIDING A DATABASE IN THE FIELD OF RECIPES AND COOKING INFORMATION; PROVIDING AN INTERACTIVE WEBSITE IN THE FIELD OF RECIPES FOR ALCOHOLIC BEVERAGES AND COCKTAILS; PROVIDING AN ONLINE COMPUTER DATABASE TO CONSUMERS CONCERNING RECIPES, INGREDIENTS AND COOKING INFORMATION; PROVIDING NEWS AND INFORMATION IN THE FIELD OF DRINKS; PROVIDING INFORMATION, NEWS AND COMMENTARY IN THE FIELD OF DINING, IN CLASS 43 (U.S. CLS. 100 AND 101).

FOR: LICENSING OF COMPUTER SOFTWARE, IN CLASS 45 (U.S. CLS. 100 AND 101).

NO CLAIM IS MADE TO THE EXCLUSIVE RIGHT TO USE "FOOD", APART FROM THE MARK AS SHOWN.

PRIORITY DATE OF 10-21-2010 IS CLAIMED.

OWNER OF INTERNATIONAL REGISTRATION 1071759 DATED 3-3-2011, EXPIRES 3-3-2021.

THE MARK CONSISTS OF A DESIGN OF A HEART WEARING A CHEF'S HAT ABOVE THE WORDS "FOOD FRIEND".

SER. NO. 79-095,301, FILED 3-3-2011.

LEIGH CAROLINE CASE, EXAMINING ATTORNEY

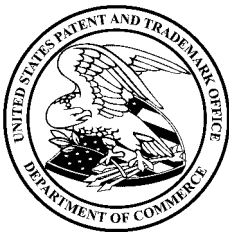

*David J. Kybas*

Director of the United States Patent and Trademark Office

# United States of America

United States Patent and Trademark Office



**Reg. No. 4,123,606**

**Registered Apr. 10, 2012**

**Int. Cls.: 3, 7 and 40**

**TRADEMARK**

**SERVICE MARK**

**PRINCIPAL REGISTER**

WINOA (FRANCE SOCIÉTÉ ANONYME)  
528 AVENUE DE SAVOIE  
F-38570 LE CHEYLAS  
FRANCE

FOR: SURFACE CLEANING PREPARATIONS IN THE NATURE OF BALLS OR GRAINS MADE OF ABRASIVE METAL OR MINERAL PARTICLES USED TO CLEAN METAL STRUCTURES BEFORE PAINTING, IN CLASS 3 (U.S. CLS. 1, 4, 6, 50, 51 AND 52).

FOR: TRANSPORTABLE MACHINES FOR SUCTION, SORTING, AND RECYCLING OF ABRASIVE PARTICLES USED TO CLEAN METAL STRUCTURES BEFORE PAINTING, IN CLASS 7 (U.S. CLS. 13, 19, 21, 23, 31, 34 AND 35).

FOR: RENTAL OF TRANSPORTABLE PREPARATORY TREATMENT OF MATERIAL MACHINES FOR SUCTION, SORTING, AND RECYCLING OF ABRASIVE PARTICLES USED TO CLEAN METAL STRUCTURES BEFORE PAINTING, IN CLASS 40 (U.S. CLS. 100, 103 AND 106).

THE MARK CONSISTS OF THE WORD "PHENICS" FEATURING TWO CURVED ARROWS MOVING COUNTER CLOCKWISE.

PRIORITY DATE OF 8-20-2010 IS CLAIMED.

OWNER OF INTERNATIONAL REGISTRATION 1071836 DATED 2-17-2011, EXPIRES 2-17-2021.

SER. NO. 79-095,327, FILED 2-17-2011.

SIMON TENG, EXAMINING ATTORNEY



*David J. Kybas*

Director of the United States Patent and Trademark Office

# United States of America

United States Patent and Trademark Office



**Reg. No. 4,123,607**

**Registered Apr. 10, 2012**

**Int. Cls.: 9 and 42**

**TRADEMARK**

**SERVICE MARK**

**PRINCIPAL REGISTER**

COGISEN S.R.L. (ITALY LIMITED LIABILITY COMPANY)  
PIAZZA CASTELLO, 1  
MILANO  
ITALY

FOR: SCIENTIFIC, NAUTICAL, SURVEYING, PHOTOGRAPHIC, CINEMATOGRAPHIC, OPTICAL, WEIGHING, MEASURING, SIGNALING, SUPERVISORY CHECKING, LIFE-SAVING AND TEACHING APPARATUS AND INSTRUMENTS, NAMELY, APPARATUSES FOR EYE TRACKING, FOR 3D VISUAL CUEING, FOR 3D MOTION RECOGNITION, FOR SEMANTIC SENSOR WEB USED TO ANNOTATE SENSOR DATA WITH SPATIAL, TEMPORAL, AND THEMATIC SEMANTIC METADATA, FOR SMART 4G TRANSMISSION OF TELEMETRY DATA, FOR INTERACTIVE AUGMENTED REALITY; APPARATUS AND INSTRUMENTS FOR CONDUCTING, SWITCHING, TRANSFORMING, ACCUMULATING, REGULATING OR CONTROLLING ELECTRICITY, NAMELY, ELECTRICAL CONDUCTORS, ELECTRIC SWITCHES, ELECTRIC TRANSFORMERS, ELECTRIC ACCUMULATORS, ELECTRIC CABLES; APPARATUS FOR RECORDING, TRANSMISSION OR REPRODUCTION OF SOUND OR IMAGES; PRE-RECORDED MAGNETIC DATA CARRIERS FEATURING COMPUTING AND AMBIENT INTELLIGENCE ; PRE-RECORDED COMPACT DISCS AND DIGITAL VIDEO DISCS FEATURING COMPUTING AND AMBIENT INTELLIGENCE; AUTOMATIC VENDING MACHINES AND MECHANISMS FOR COIN-OPERATED APPARATUS; CASH REGISTERS, CALCULATING MACHINES, DATA PROCESSING EQUIPMENT AND COMPUTERS; FIRE-EXTINGUISHING APPARATUS, NAMELY, FIRE-EXTINGUISHERS; COMPUTER SYSTEMS, NAMELY, DATA PROCESSING SYSTEMS COMPRISED OF COMPUTER HARDWARE AND COMPUTER SOFTWARE FOR THE COLLECTION, EDITING, ORGANIZING, MODIFYING, TRANSMISSION, STORAGE AND SHARING OF DATA VIA, AD-HOC WIRELESS NETWORKS AND WIRELESS BANDWIDTH; NETWORKS COMPRISED OF NETWORK ROUTERS, NETWORK SERVERS, NETWORK ACCESS SERVER HARDWARE AND NETWORK ACCESS SERVER OPERATING SOFTWARE; COMPUTER NETWORKS COMPRISED OF COMPUTER NETWORK ADAPTERS, SWITCHES, ROUTERS AND HUBS; VOICE OVER INTERNET PROTOCOL (VOIP) PHONE ADAPTER; ELECTRIC SMART SENSORS; COMPUTER HARDWARE, SOFTWARE, SIMULATION PROGRAMS, SIMULATORS, DIAGNOSTIC AND PROGNOSTIC PROGRAMS, ALL FOR SMART VEHICLES, GAMING CONSOLES, RACING CARS, SMARTPHONES, SMART EQUIPMENT AND APPARATUS; SMART PHONE, IN CLASS 9 (U.S. CLS. 21, 23, 26, 36 AND 38).

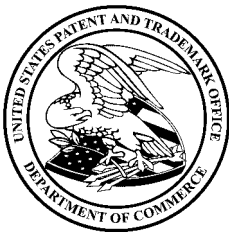

*David J. Kyros*

Director of the United States Patent and Trademark Office

FOR: SCIENTIFIC AND TECHNOLOGICAL SERVICES, NAMELY, SCIENTIFIC RESEARCH AND NEW PRODUCT DESIGN SERVICES IN THE FIELDS OF AEROSPACE, AUTOMOTIVE

**Reg. No. 4,123,607** ENGINEERING, INDUSTRIAL ENGINEERING, MECHANICAL ENGINEERING, BIOENGINEERING AND ENVIRONMENTAL ENGINEERING; TECHNICAL INDUSTRIAL ANALYSIS AND RESEARCH SERVICES IN THE FIELDS OF AEROSPACE, AUTOMOTIVE ENGINEERING, INDUSTRIAL ENGINEERING, MECHANICAL ENGINEERING, BIOENGINEERING AND ENVIRONMENTAL ENGINEERING; DESIGN AND DEVELOPMENT OF COMPUTER HARDWARE AND SOFTWARE IN THE FIELDS OF AEROSPACE, AUTOMOTIVE ENGINEERING, INDUSTRIAL ENGINEERING, MECHANICAL ENGINEERING, BIOENGINEERING AND ENVIRONMENTAL ENGINEERING; COMPUTER SOFTWARE DESIGN, COMPUTER PROGRAMMING, COMPUTER SYSTEMS INTEGRATION AND IMPLEMENTATION OF SMART SENSOR COMPUTER TECHNOLOGIES FOR OTHERS; INTEGRATION SERVICES, DEVELOPMENT, ANALYSIS AND OPTIMIZATION OF EXISTING HARDWARE AND SOFTWARE FOR QUALITY SYSTEMS; COMPUTER HARDWARE AND SOFTWARE DEVELOPMENT AND COMPUTER PROJECT MANAGEMENT OF PRODUCTION LINES; ENGINEERING DESIGN, DEVELOPMENT AND TESTING SERVICES FOR OTHERS IN THE FIELDS OF SIMULATION PROGRAMS, SIMULATORS, DIAGNOSTIC AND PROGNOSTIC PROGRAMS FOR SMART VEHICLES, SMART EQUIPMENT AND MACHINERY, MODULES FOR THE DYNAMIC OF SMART VEHICLES; OPTIMIZATION OF COMPUTER SOFTWARE FOR THIRD PARTIES REGARDING THE DEVELOPMENT PROCESS IN THE PERFORMANCE OF DIFFERENT SERIES OF RACING CARS; COMPUTER SYSTEMS INTEGRATION WITH COMPONENTS OF EXISTING HARDWARE AND SOFTWARE FOR CREATING NEW SERVICES, IN CLASS 42 (U.S. CLS. 100 AND 101).

THE MARK CONSISTS OF THE WORD "SENCOGI", WRITTEN IN FANCY SMALL CHARACTERS. SAID WORD IS CROSSED BY THREE SINUSOIDAL LINES, THE CONCAVITIES OF WHICH ARE TOPPED BY A CIRCLET AND SET AGAINST THREE CIRCLET OF DIFFERENT SIZES. ALL THE ABOVE RESEMBLES THE SYMBOL OF INFINITY.

PRIORITY DATE OF 9-22-2010 IS CLAIMED.

OWNER OF INTERNATIONAL REGISTRATION 1071877 DATED 2-4-2011, EXPIRES 2-4-2021.

THE WORDING "SENCOGI" HAS NO MEANING IN A FOREIGN LANGUAGE.

SER. NO. 79-095,341, FILED 2-4-2011.

NATALIE POLZER, EXAMINING ATTORNEY

# United States of America

United States Patent and Trademark Office

# OPENTOUCH

**Reg. No. 4,123,608**

**Registered Apr. 10, 2012**

**Int. Cl.: 9**

**TRADEMARK**

**PRINCIPAL REGISTER**

ALCATEL LUCENT (FRANCE SOCIÉTÉ ANONYME)  
3 AVENUE OCTAVE GRÉARD  
F-75007 PARIS  
FRANCE

FOR: TELEPHONES, MOBILE TELECOMMUNICATION TERMINALS, TELECOMMUNICATION SERVERS AND TELECOMMUNICATION SWITCHES, IN CLASS 9 (U.S. CLS. 21, 23, 26, 36 AND 38).

THE MARK CONSISTS OF STANDARD CHARACTERS WITHOUT CLAIM TO ANY PARTICULAR FONT, STYLE, SIZE, OR COLOR.

PRIORITY DATE OF 1-21-2011 IS CLAIMED.

OWNER OF INTERNATIONAL REGISTRATION 1071902 DATED 2-15-2011, EXPIRES 2-15-2021.

OWNER OF U.S. REG. NO. 3,478,220.

SER. NO. 79-095,349, FILED 2-15-2011.

ALLISON SCHRODY, EXAMINING ATTORNEY



*David J. Kyffers*

Director of the United States Patent and Trademark Office

# United States of America

United States Patent and Trademark Office

# ActivePro

**Reg. No. 4,123,609**

**Registered Apr. 10, 2012**

**Int. Cls.: 9, 38, 41, 42  
and 45**

**TRADEMARK**

**SERVICE MARK**

**PRINCIPAL REGISTER**

TJARK AUERBACH (FED REP GERMANY INDIVIDUAL)  
LINDAUER STRASSE 21  
TETTANG, FED REP GERMANY 88069

FOR: COMPUTER PROGRAMS FOR THE SECURITY OF COMPUTER SYSTEMS, ANTI-VIRUS COMPUTER PROGRAMS, ANTI-SPYWARE COMPUTER PROGRAMS; PARTS AND FITTINGS FOR COMPUTER PROGRAMS, NAMELY, COMPUTER SUBPROGRAMS FOR THE SECURITY OF COMPUTER SYSTEMS, COMPUTER PROGRAM MODULES FOR THE SECURITY OF COMPUTER SYSTEMS, COMPUTER PROGRAMS FOR GENERATING COMPUTER PROGRAMS, SUPPORT SOFTWARE FOR THE SECURITY OF COMPUTER SYSTEMS, AND INTERFACES FOR COMPUTERS; PRERECORDED MAGNETIC AND OPTICAL DATA CARRIERS FEATURING DATA ABOUT COMPUTER VIRUSES, SPYWARE, AND OTHER DATA ABOUT THE SECURITY OF COMPUTER SYSTEMS, IN CLASS 9 (U.S. CLS. 21, 23, 26, 36 AND 38).

FOR: NEWS AGENCIES, NAMELY, TRANSMISSION OF NEWS; ELECTRONIC TRANSMISSION OF DATA; OPERATING AN ELECTRONIC INFORMATION AND COMMUNICATIONS SYSTEM, NAMELY, PROVIDING ACCESS TO A GLOBAL COMPUTER NETWORK, PROVIDING ACCESS TO COMPUTER PROGRAMS ON COMPUTER NETWORKS, PROVIDING USER ACCESS TO A GLOBAL COMPUTER INFORMATION NETWORK, PROVIDING INTERNET CHATROOMS, COMPUTER-AIDED TRANSMISSION OF MESSAGES AND IMAGES, TELECOMMUNICATION BY MEANS OF PLATFORMS AND PORTALS ON THE INTERNET, NAMELY, PROVIDING TELECOMMUNICATIONS CONNECTIONS TO A GLOBAL COMPUTER NETWORK VIA PLATFORMS AND PORTALS, ELECTRONIC SENDING OF MESSAGES, PROVIDING ACCESS TO COMPUTER DATABASES, WEB-MESSAGING; PROVIDING SERVICES IN CONNECTION WITH ONLINE SERVICES AND THE INTERNET, NAMELY, THE TRANSMISSION OF INFORMATION OF ALL KINDS VIA ELECTRONIC COMMUNICATIONS NETWORKS, IN CLASS 38 (U.S. CLS. 100, 101 AND 104).

FOR: EDUCATION SERVICES, NAMELY, PROVIDING CLASSES, SEMINARS, AND WORKSHOPS IN THE FIELD OF COMPUTER SYSTEM SECURITY; TRAINING SERVICES IN THE FIELD OF COMPUTER SYSTEM SECURITY; WRITING OF TEXTS AND PUBLISHING OF BOOKS, REVIEWS, MAGAZINES, AND ELECTRONIC PUBLICATIONS USING MEDIA OF ALL KINDS, IN CLASS 41 (U.S. CLS. 100, 101 AND 107).

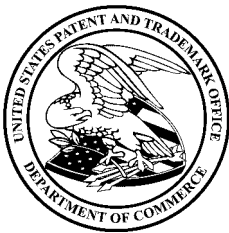

*David J. Kappas*

Director of the United States Patent and Trademark Office



**Reg. No. 4,123,609** FOR: COMPUTER PROGRAMMING; COMPUTER SOFTWARE CONSULTANCY WITH REGARD TO THE USE AND APPLICATION OF SOFTWARE, INSTALLATION AND MAINTENANCE OF SOFTWARE; SERVICES OF A SOFTWARE COMPANY, NAMELY, THE DESIGN OF COMPUTER SOFTWARE, DEVELOPMENT OF COMPUTER SOFTWARE, COMPUTER PROGRAMMING, UPDATING OF COMPUTER SOFTWARE, MAINTENANCE AND INSTALLATION OF SOFTWARE; COMPUTER SYSTEMS ANALYSIS; COMPUTER SOFTWARE APPLICATION CONSULTANCY WITH REGARD TO SOFTWARE; COMPUTER CONSULTANCY; TECHNOLOGICAL SERVICES TO SUPPORT AND IMPLEMENT THE LOCALISATION OF DATA STRUCTURES AND THE AMENDMENT THEREOF, NAMELY, SOFTWARE APPLICATIONS CONSULTANCY AND TECHNICAL SUPPORT IN THE NATURE OF TROUBLESHOOTING COMPUTER SOFTWARE PROBLEMS; INTERNET SERVICES, NAMELY, CREATING AND MAINTENANCE OF COMPUTER PROGRAMS FOR USE ON THE INTERNET AND/OR FOR THE USE OF THE INTERNET, AND COMPUTER SOFTWARE CONSULTANCY WITH REGARD TO THE APPLICATION AND FURTHER DEVELOPMENT OF SUCH PROGRAMS, IN CLASS 42 (U.S. CLS. 100 AND 101).

FOR: SECURITY SERVICES FOR THE PROTECTION OF PROPERTY AND INDIVIDUALS, NAMELY, PERSONAL SECURITY CONSULTATION FOR THE PROTECTION OF INDIVIDUALS AND PERSONAL SECURITY CONSULTATION FOR THE MONITORING OF COMPUTER SYSTEMS FOR SECURITY PURPOSES, IN CLASS 45 (U.S. CLS. 100 AND 101).

THE MARK CONSISTS OF STANDARD CHARACTERS WITHOUT CLAIM TO ANY PARTICULAR FONT, STYLE, SIZE, OR COLOR.

OWNER OF INTERNATIONAL REGISTRATION 1071949 DATED 2-11-2011, EXPIRES 2-11-2021.

SER. NO. 79-095,361, FILED 2-11-2011.

KATHERINE E. HALMEN, EXAMINING ATTORNEY

# United States of America

United States Patent and Trademark Office

# RTPS

**Reg. No. 4,123,610**

**Registered Apr. 10, 2012**

**Int. Cls.: 9, 38, 41, 42  
and 45**

**TRADEMARK**

**SERVICE MARK**

**PRINCIPAL REGISTER**

TJARK AUERBACH (GERMAN DEM REP INDIVIDUAL)  
LINDAUER STRASSE 21  
TETTANG, FED REP GERMANY 88069

FOR: COMPUTER PROGRAMS FOR THE SECURITY OF COMPUTER SYSTEMS, ANTI-VIRUS COMPUTER PROGRAMS, ANTI-SPYWARE COMPUTER PROGRAMS; PARTS AND FITTINGS FOR COMPUTER PROGRAMS, NAMELY, COMPUTER SUBPROGRAMS FOR THE SECURITY OF COMPUTER SYSTEMS, COMPUTER PROGRAM MODULES FOR THE SECURITY OF COMPUTER SYSTEMS, COMPUTER PROGRAMS FOR GENERATING COMPUTER PROGRAMS, SUPPORT SOFTWARE FOR THE SECURITY OF COMPUTER SYSTEMS, AND INTERFACES FOR COMPUTERS; PRERECORDED MAGNETIC AND OPTICAL DATA CARRIERS FEATURING DATA ABOUT COMPUTER VIRUSES, SPYWARE, AND OTHER DATA ABOUT THE SECURITY OF COMPUTER SYSTEMS, IN CLASS 9 (U.S. CLS. 21, 23, 26, 36 AND 38).

FOR: NEWS AGENCIES, NAMELY, TRANSMISSION OF NEWS; ELECTRONIC TRANSMISSION OF DATA; OPERATING AN ELECTRONIC INFORMATION AND COMMUNICATIONS SYSTEM, NAMELY, PROVIDING ACCESS TO A GLOBAL COMPUTER NETWORK, PROVIDING ACCESS TO COMPUTER PROGRAMS ON COMPUTER NETWORKS, PROVIDING USER ACCESS TO A GLOBAL COMPUTER INFORMATION NETWORK, PROVIDING INTERNET CHATROOMS, COMPUTER-AIDED TRANSMISSION OF MESSAGES AND IMAGES, TELECOMMUNICATION BY MEANS OF PLATFORMS AND PORTALS ON THE INTERNET, NAMELY, PROVIDING TELECOMMUNICATIONS CONNECTIONS TO A GLOBAL COMPUTER NETWORK VIA PLATFORMS AND PORTALS, ELECTRONIC SENDING OF MESSAGES, PROVIDING ACCESS TO COMPUTER DATABASES, WEB-MESSAGING; PROVIDING SERVICES IN CONNECTION WITH ONLINE SERVICES AND THE INTERNET, NAMELY, THE TRANSMISSION OF INFORMATION OF ALL KINDS VIA ELECTRONIC COMMUNICATIONS NETWORKS, IN CLASS 38 (U.S. CLS. 100, 101 AND 104).

FOR: EDUCATION SERVICES, NAMELY, PROVIDING CLASSES, SEMINARS, AND WORKSHOPS IN THE FIELD OF COMPUTER SYSTEM SECURITY; TRAINING SERVICES IN THE FIELD OF COMPUTER SYSTEM SECURITY; WRITING OF TEXTS AND PUBLISHING OF BOOKS, REVIEWS, MAGAZINES, AND ELECTRONIC PUBLICATIONS USING MEDIA OF ALL KINDS, IN CLASS 41 (U.S. CLS. 100, 101 AND 107).

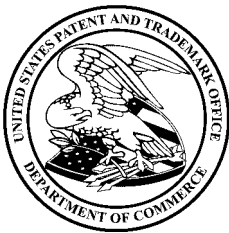

*David J. Kappas*

Director of the United States Patent and Trademark Office

**Reg. No. 4,123,610** FOR: COMPUTER PROGRAMMING; COMPUTER SOFTWARE CONSULTANCY WITH REGARD TO THE USE AND APPLICATION OF SOFTWARE, INSTALLATION AND MAINTENANCE OF SOFTWARE; SERVICES OF A SOFTWARE COMPANY, NAMELY, THE DESIGN OF COMPUTER SOFTWARE, DEVELOPMENT OF COMPUTER SOFTWARE, COMPUTER PROGRAMMING, UPDATING OF COMPUTER SOFTWARE, MAINTENANCE AND INSTALLATION OF SOFTWARE; COMPUTER SYSTEMS ANALYSIS; COMPUTER SOFTWARE APPLICATION CONSULTANCY WITH REGARD TO SOFTWARE; COMPUTER CONSULTANCY; TECHNOLOGICAL SERVICES TO SUPPORT AND IMPLEMENT THE LOCALISATION OF DATA STRUCTURES AND THE AMENDMENT THEREOF, NAMELY, SOFTWARE APPLICATIONS CONSULTANCY AND TECHNICAL SUPPORT IN THE NATURE OF TROUBLESHOOTING COMPUTER SOFTWARE PROBLEMS; INTERNET SERVICES, NAMELY, CREATING AND MAINTENANCE OF COMPUTER PROGRAMS FOR USE ON THE INTERNET AND/OR FOR THE USE OF THE INTERNET, AND COMPUTER SOFTWARE CONSULTANCY WITH REGARD TO THE APPLICATION AND FURTHER DEVELOPMENT OF SUCH PROGRAMS, IN CLASS 42 (U.S. CLS. 100 AND 101).

FOR: SECURITY SERVICES FOR THE PROTECTION OF PROPERTY AND INDIVIDUALS, NAMELY, PERSONAL SECURITY CONSULTATION FOR THE PROTECTION OF INDIVIDUALS AND PERSONAL SECURITY CONSULTATION FOR THE MONITORING OF COMPUTER SYSTEMS FOR SECURITY PURPOSES, IN CLASS 45 (U.S. CLS. 100 AND 101).

THE MARK CONSISTS OF STANDARD CHARACTERS WITHOUT CLAIM TO ANY PARTICULAR FONT, STYLE, SIZE, OR COLOR.

OWNER OF INTERNATIONAL REGISTRATION 1071951 DATED 2-14-2011, EXPIRES 2-14-2021.

SER. NO. 79-095,363, FILED 2-14-2011.

KATHERINE E. HALMEN, EXAMINING ATTORNEY

United States of America  
United States Patent and Trademark Office

INNOSYN

**Reg. No. 4,123,611**

**Registered Apr. 10, 2012**

**Int. Cl.: 42**

**SERVICE MARK**

**PRINCIPAL REGISTER**

DSM IP ASSETS B.V. (NETHERLANDS BESLOTEN VENNOOTSCHAP)  
HET OVERLOON 1  
NL-6411 TE HEERLEN  
NETHERLANDS

FOR: SPECIALIZED SCIENTIFIC AND TECHNOLOGICAL SERVICES AND RESEARCH AND DESIGN IN THE FIELD OF THE DEVELOPMENT AND IMPROVEMENT OF PRODUCTS AND OF PRODUCTION PROCESSES COMPRISING BIOCATALYSIS, HOMOGENEOUS CATALYSIS, ORGANIC SYNTHESIS AND MICROREACTOR TECHNOLOGY; SPECIALIZED LABORATORY RESEARCH IN THE FIELD OF BIOCATALYSIS, HOMOGENEOUS CATALYSIS, ORGANIC SYNTHESIS, AND ORGANIC PROCESSES WITH RESPECT TO THE DEVELOPMENT AND IMPROVEMENT OF PRODUCTS AND OF PRODUCTION PROCESSES; SPECIALIZED SERVICES PROVIDED BY PERSONS IN RELATION TO THE THEORETICAL AND PRACTICAL ASPECTS OF COMPLEX FIELDS OF ACTIVITIES, NAMELY, DEVELOPMENT OF SCIENTIFIC CONCEPTS OF PROCESS INTENSIFICATION IN THE FIELD OF THE DEVELOPMENT AND IMPROVEMENT OF PRODUCTS, OF PRODUCTION PROCESSES AND OF MICROREACTOR TECHNOLOGY; SPECIALIZED SCIENTIFIC SERVICES RELATED TO THE SCALE-UP OF PRODUCTION PROCESSES, NAMELY, ENGINEERING SERVICES IN THE FIELD OF SCIENTIFIC SCALE-UP OF PRODUCTION PROCESSES, IN CLASS 42 (U.S. CLS. 100 AND 101).

THE MARK CONSISTS OF STANDARD CHARACTERS WITHOUT CLAIM TO ANY PARTICULAR FONT, STYLE, SIZE, OR COLOR.

PRIORITY DATE OF 8-20-2010 IS CLAIMED.

OWNER OF INTERNATIONAL REGISTRATION 1071981 DATED 2-4-2011, EXPIRES 2-4-2021.

SER. NO. 79-095,381, FILED 2-4-2011.

NAPOLEON SHARMA, EXAMINING ATTORNEY



*David J. Kyjars*

Director of the United States Patent and Trademark Office

United States of America  
United States Patent and Trademark Office

**INSTANT  
UPRIGHT**

**Reg. No. 4,123,612**

**Registered Apr. 10, 2012**

**Int. Cls.: 6, 19 and 37**

**TRADEMARK**

**SERVICE MARK**

**PRINCIPAL REGISTER**

INSTANT UPRIGHT LIMITED (IRELAND A LIMITED COMPANY)  
UNIT S1, PARK WEST INDUSTRIAL PARK  
FRIEL AVENUE, NANGOR ROAD  
DUBLIN 12, IRELAND

FOR: SCAFFOLDING, SCAFFOLD SYSTEMS AND SCAFFOLD ASSEMBLIES, ALL OF METAL AND THEIR ALLOYS; TUBULAR FRAMEWORKS FOR ASSEMBLING INTO SCAFFOLDS, MADE OF METAL; BUILDING MATERIALS, NAMELY, WORK PLATFORMS, LADDERS, WORK DECKS AND CATWALKS, CASTORS, STANDS, TOWERS, STAIRWAYS, PLATFORMS, STAGES AND STAGING COMPONENTS, ALL MADE OF COMMON METAL, IN CLASS 6 (U.S. CLS. 2, 12, 13, 14, 23, 25 AND 50).

FOR: BUILDING MATERIALS, NAMELY, SCAFFOLDING BOARDS AND WORK PLATFORMS, NOT OF METAL, AND PARTS AND FITTINGS FOR THE AFORESAID GOODS, IN CLASS 19 (U.S. CLS. 1, 12, 33 AND 50).

FOR: REPAIR AND INSTALLATION OF SCAFFOLDING AND BUILDINGS; RENTAL OF CONSTRUCTION EQUIPMENT, SCAFFOLDING, SCAFFOLD SYSTEMS AND SCAFFOLD ASSEMBLIES AND APPARATUS; ERECTION AND DISMANTLING OF SCAFFOLDING AND SCAFFOLD SYSTEMS; ADVISORY AND CONSULTANCY RELATING TO THE AFORESAID, IN CLASS 37 (U.S. CLS. 100, 103 AND 106).

THE MARK CONSISTS OF THE TERM "INSTANT UPRIGHT" IN BLACK LETTERS WITH A SECTION OF WHITE AND RED FORMING THE LETTER "A" IN "INSTANT".

OWNER OF INTERNATIONAL REGISTRATION 1071991 DATED 1-28-2011, EXPIRES 1-28-2021.

THE COLOR(S) BLACK, WHITE AND RED IS/ARE CLAIMED AS A FEATURE OF THE MARK.

SER. NO. 79-095,384, FILED 1-28-2011.

SUSAN LESLIE DUBOIS, EXAMINING ATTORNEY



*David J. Kyros*

Director of the United States Patent and Trademark Office

# United States of America

United States Patent and Trademark Office

## CAMERON FIX

**Reg. No. 4,123,613**

**Registered Apr. 10, 2012**

**Int. Cls.: 9 and 42**

**TRADEMARK**

**SERVICE MARK**

**PRINCIPAL REGISTER**

CAMERONTEC AB (SWEDEN CORPORATION)  
BOX 7742  
SE-103 95 STOCKHOLM  
SWEDEN

FOR: COMPUTER SOFTWARE FOR E-COMMERCE, FOR THE EXCHANGE OF FINANCIAL INFORMATION, FOR FINANCIAL TRANSACTIONS, AND FOR ELECTRONICALLY TRADING SECURITIES; TRADING ENGINES, NAMELY, DOWNLOADABLE COMPUTER SEARCH ENGINE SOFTWARE FOR E-COMMERCE; FINANCIAL INFORMATION EXCHANGE ENGINES, NAMELY, DOWNLOADABLE COMPUTER SEARCH ENGINE SOFTWARE FOR THE EXCHANGE OF FINANCIAL INFORMATION, IN CLASS 9 (U.S. CLS. 21, 23, 26, 36 AND 38).

FOR: DESIGN AND DEVELOPMENT OF COMPUTER SOFTWARE; DESIGN AND DEVELOPMENT OF TRADING ENGINES AND FINANCIAL INFORMATION EXCHANGE ENGINES, NAMELY, DESIGN AND DEVELOPMENT OF SEARCH ENGINES FOR E-COMMERCE AND SEARCH ENGINES FOR THE EXCHANGE OF FINANCIAL INFORMATION, IN CLASS 42 (U.S. CLS. 100 AND 101).

THE MARK CONSISTS OF STANDARD CHARACTERS WITHOUT CLAIM TO ANY PARTICULAR FONT, STYLE, SIZE, OR COLOR.

OWNER OF INTERNATIONAL REGISTRATION 0873134 DATED 11-7-2005, EXPIRES 11-7-2015.

NO CLAIM IS MADE TO THE EXCLUSIVE RIGHT TO USE "FIX", APART FROM THE MARK AS SHOWN.

THE PHRASE "CAMERON FIX" SHOWN IN THE TRADEMARK DOES NOT IDENTIFY A LIVING INDIVIDUAL.

SER. NO. 79-095,406, FILED 2-24-2011.

SHAILA SETTLES, EXAMINING ATTORNEY



*David J. Kyffers*

Director of the United States Patent and Trademark Office

# United States of America

United States Patent and Trademark Office



**Reg. No. 4,123,614**

**Registered Apr. 10, 2012**

**Int. Cl.: 30**

**TRADEMARK**

**PRINCIPAL REGISTER**

ANGEL YEAST CO., LTD. (CHINA CORPORATION)  
NO.24 ZHONGNAN ROAD  
YICHANG; 443003 HUBEI  
CHINA

FOR: CAKES; STEAMED BREAD; NOODLES; SOYA FLOUR; SEASONINGS; YEAST, IN  
CLASS 30 (U.S. CL. 46).

OWNER OF INTERNATIONAL REGISTRATION 1023090 DATED 9-23-2009, EXPIRES 9-23-  
2019.

SER. NO. 79-095,410, FILED 1-28-2011.

APRIL ROACH, EXAMINING ATTORNEY



*David J. Kyffers*

Director of the United States Patent and Trademark Office

# United States of America

United States Patent and Trademark Office



**Reg. No. 4,123,615**

**Registered Apr. 10, 2012**

**Int. Cls.: 33 and 35**

**TRADEMARK**

**SERVICE MARK**

**PRINCIPAL REGISTER**

VIGNERONS INDEPENDANTS DE FRANCE (FRANCE CONFEDERATION)  
4 PLACE FÉLIX EBOUÉ  
PARIS, FRANCE F75012

FOR: ALCOHOLIC BEVERAGES EXCEPT BEERS; ALCOHOLIC FRUIT EXTRACTS; ALCOHOLIC ESSENCES; ALCOHOLIC EXTRACTS; SWEET CIDER AND DRY CIDER; PREPARED ALCOHOLIC COCKTAILS; DISTILLED BEVERAGES, NAMELY, DISTILLED SPIRITS; SPIRITS; WINES; ALCOHOLIC BEVERAGES, NAMELY, DIGESTIFS; EAUX-DE-VIE, NAMELY, EAUX-DE-VIE MADE WITH FRUITS, EAUX-DE-VIE MADE WITH HERBS, EAUX-DE-VIE MADE WITH GRAIN; LIQUEURS, IN CLASS 33 (U.S. CLS. 47 AND 49).

FOR: BUSINESS MANAGEMENT ASSISTANCE FOR INDUSTRIAL AND COMMERCIAL COMPANIES, ASSISTANCE TO VINEYARD OPERATORS IN RUNNING THEIR VINEYARDS, BUSINESS ADMINISTRATION TO WINE MERCHANTS AND DISTRIBUTORS, DISTRIBUTION OF SAMPLES, DISSEMINATION OF ADVERTISING MATTER, DISTRIBUTION OF ADVERTISING MATERIALS, PUBLICATION OF ADVERTISING TEXTS, DOCUMENT REPRODUCTION, EXPORT AGENCY SERVICES FOR THE GOODS OF OTHERS, NAMELY, WINES, VINES, WINE PRODUCTS AND EQUIPMENT AND INSTALLATIONS FOR THE WINE-MAKING AND VINE-GROWING INDUSTRY; ORGANIZATION OF EXHIBITIONS, TRADE SHOWS, TRADE FAIRS AND ALL TYPES OF EVENT FOR COMMERCIAL OR ADVERTISING PURPOSES; COMPETITION ORGANIZATION SERVICES FOR PROMOTIONAL PURPOSES WITH OR WITHOUT AWARD OF PRIZES OR ALLOCATION OF REWARDS, ESPECIALLY PERTAINING TO TRADE SHOWS, COLLOQUIUMS, CONFERENCES, CONGRESSES, EXHIBITIONS, TRADE FAIRS; ADMINISTRATIVE MANAGEMENT OF EXHIBITION SITES; SERVICES FOR ORGANIZING BUSINESS MEETINGS IN THE CONTEXT OF TRADE SHOWS, COLLOQUIUMS, CONFERENCES, CONGRESSES, EXHIBITIONS, TRADE FAIRS, NAMELY, PUTTING EXHIBITORS AND VISITORS IN CONTACT WITH EACH OTHER FOR THE PURPOSES OF HOLDING BUSINESS MEETINGS; DIRECT MAIL ADVERTISING; SALES PROMOTION FOR OTHERS; PRESENTATION AND DEMONSTRATION OF GOODS AND SERVICES FOR PROMOTIONAL ENDS; STATISTICAL, BUSINESS AND COMMERCIAL INFORMATION IN THE FIELD OF EXHIBITIONS AND ESPECIALLY IN CONNECTION WITH ORGANIZING EXHIBITIONS; ADVERTISING BY MAIL ORDER, RADIO AND TELEVISION; ONLINE ADVERTISING ON A COMPUTER NETWORK; PUBLICITY COLUMNS PREPARATION; RENTAL OF ADVERTISING TIME ON ALL MEANS OF COMMUNICATION; RENTAL OF ADVERTISING SPACE; DISSEMINATION OF ADVERTISEMENTS AND CLASSIFIED ADVERTISEMENTS, ESPECIALLY FOR EMPLOYMENT, INCLUDING VIA THE INTERNET; ORGANIZATION OF PROMOTIONAL ACTIVITIES



*David J. Kyros*

Director of the United States Patent and Trademark Office



**Reg. No. 4,123,615** WITH A VIEW TO DEVELOPING CUSTOMER LOYALTY; ORGANIZING REGIONAL AND NATIONAL PROMOTIONAL CAMPAIGNS; ARRANGING NEWSPAPER SUBSCRIPTIONS FOR OTHERS; SUBSCRIPTION SERVICES FOR OTHERS FOR INFORMATION MEDIA OF ALL KINDS, TEXTS, SOUND AND/OR IMAGES, AND ESPECIALLY IN THE FORM OF ELECTRONIC AND DIGITAL PUBLICATIONS; COMPUTERIZED FILE MANAGEMENT, IN CLASS 35 (U.S. CLS. 100, 101 AND 102).

NO CLAIM IS MADE TO THE EXCLUSIVE RIGHT TO USE "VIGNERON INDEPENDANT", APART FROM THE MARK AS SHOWN.

PRIORITY DATE OF 11-26-2010 IS CLAIMED.

OWNER OF INTERNATIONAL REGISTRATION 1072024 DATED 12-30-2010, EXPIRES 12-30-2020.

THE ENGLISH TRANSLATION OF "VIGNERON INDÉPENDANT" IN THE MARK IS "INDEPENDENT WINE GROWER".

SER. NO. 79-095,420, FILED 12-30-2010.

PATRICIA EVANKO, EXAMINING ATTORNEY

# United States of America

United States Patent and Trademark Office

## BUBI DOWNHOLE TUBULAR

**Reg. No. 4,123,616**

**Registered Apr. 10, 2012**

**Int. Cls.: 6, 7 and 11**

H. BUTTING GMBH & CO. KG (FED REP GERMANY LIMITED PARTNERSHIP WITH A LIMITED LIABILITY COMPANY AS GENERAL PARTNER)  
GIFHORNER STRAÙE 59  
29379 WITTINGEN-KNESBECK  
FED REP GERMANY

**TRADEMARK**

**PRINCIPAL REGISTER**

FOR: COMMON METALS AND THEIR ALLOYS; METAL BUILDING MATERIALS, NAMELY, METAL PIPE COUPLINGS AND JOINTS; TRANSPORTABLE BUILDINGS OF METAL, IN PARTICULAR HIGH-TIDE PROTECTION INSTALLATIONS IN THE NATURE OF PORTABLE METAL FREESTANDING BARRIERS; RETRACTABLE BARRIER DEVICES, NAMELY, BOLLARDS OF METAL; GOODS OF COMMON METAL, INCLUDED IN THIS CLASS, NAMELY, PIPING SPOOLS IN THE NATURE OF PRE-FABRICATED SECTIONS OF METAL PIPING SYSTEMS, LINE PIPES FOR GAS AND CHEMICAL TANKERS, VESSELS, NAMELY, WATER-VESSELS AND STORAGE TANKS, AND RISER PIPES AND CASINGS; METALLIC PIPES AND TUBES IN PARTICULAR DOUBLE-WALLED PIPES FOR USE IN THE MINING OF NATURAL RESOURCES AND GEOTHERMAL ENERGY; METAL FITTINGS, IN PARTICULAR PIPE BENDS, FLANGES AND FLANGED WHEELS, IN CLASS 6 (U.S. CLS. 2, 12, 13, 14, 23, 25 AND 50).

FOR: PIPES AND TUBES BEING PARTS OF MACHINES FOR USE IN THE MINING OF NATURAL RESOURCES AND GEOTHERMAL ENERGY, IN CLASS 7 (U.S. CLS. 13, 19, 21, 23, 31, 34 AND 35).

FOR: BOILER PIPES AND TUBES FOR HEATING INSTALLATIONS AND BEING PARTS FOR WATER, GAS, CRUDE OIL AND VENTILATING INSTALLATIONS; FAUCETS FOR PIPES; FLARE STACKS FOR USE IN OIL REFINERIES, IN CLASS 11 (U.S. CLS. 13, 21, 23, 31 AND 34).

THE MARK CONSISTS OF STANDARD CHARACTERS WITHOUT CLAIM TO ANY PARTICULAR FONT, STYLE, SIZE, OR COLOR.

PRIORITY DATE OF 4-12-2010 IS CLAIMED.

OWNER OF INTERNATIONAL REGISTRATION 1072082 DATED 10-12-2010, EXPIRES 10-12-2020.

OWNER OF U.S. REG. NO. 2,624,017.



*David J. Kypos*

Director of the United States Patent and Trademark Office

**Reg. No. 4,123,616** NO CLAIM IS MADE TO THE EXCLUSIVE RIGHT TO USE "DOWNHOLE TUBULAR",  
APART FROM THE MARK AS SHOWN.

THE WORDING "BUBI" HAS NO MEANING IN A FOREIGN LANGUAGE.

SER. NO. 79-095,433, FILED 10-12-2010.

MELISSA VALLILLO, EXAMINING ATTORNEY

# United States of America

United States Patent and Trademark Office

## SUITE 341

**Reg. No. 4,123,617**

**Registered Apr. 10, 2012**

**Int. Cls.: 14, 18 and 25**

**TRADEMARK**

**PRINCIPAL REGISTER**

341SMCP (FRANCE SOCIÉTÉ PAR ACTIONS SIMPLIFIÉE)  
24 RUE DU MAIL  
F-75002 PARIS  
FRANCE

FOR: PRECIOUS METALS AND THEIR ALLOYS AND GOODS IN PRECIOUS METALS OR COATED THEREWITH NOT INCLUDED IN OTHER CLASSES, NAMELY, WORKS OF ART OF PRECIOUS METAL, BOXES OF PRECIOUS METAL, FIGURINES IN THE NATURE OF STATUETTES OF PRECIOUS METAL, NOVELTY KEY RINGS MADE OF PRECIOUS METAL; JEWELRY, PRECIOUS STONES; TIMEPIECES AND CHRONOMETRIC INSTRUMENTS, IN CLASS 14 (U.S. CLS. 2, 27, 28 AND 50).

FOR: LEATHER AND IMITATION LEATHER; HANDBAGS; BAGS FOR CARRYING INFANTS, DOCUMENT CASES, TEXTILE SHOPPING BAGS, AND LEATHER BINDERS FOR HOLDING TRAVEL DOCUMENTS; ALL-PURPOSE CARRYING BAGS WITH HANDLES; SHOULDER BAGS; BAGS WORN AT THE WAIST IN THE NATURE OF WAIST POUCHES; WRIST BAGS; POUCHES BEING HANDBAGS; EVENING BAGS; BACKPACKS; MESH SHOPPING BAGS; CARRYING BAGS; WHEELED BAGS; GARMENT BAGS FOR TRAVEL; LEATHER TRAVEL SETS IN THE NATURE OF LEATHER TRAVEL BAGGAGE; VANITY CASES THAT ARE SOLD EMPTY; SUIT BAGS; TRAVEL BAGS; BEACH BAGS; GYM BAGS; SPORTS BAGS; BAGS FOR CLIMBERS IN THE NATURE OF ALL-PURPOSE CARRYING BAGS; BAGS FOR CAMPERS IN THE NATURE OF ALL-PURPOSE CARRYING BAGS; SCHOOL SATCHELS; SCHOOL BAGS; BRIEFCASES; WALLETS; CHANGE PURSES; TRUNKS AND SUITCASES; UMBRELLAS; PARASOLS; LEASHES FOR ANIMALS; WHIPS, IN CLASS 18 (U.S. CLS. 1, 2, 3, 22 AND 41).

FOR: CLOTHING PARTICULARLY, LINGERIE, SHIRTS, TEE-SHIRTS, SWEATSHIRTS, BLOUSES, PULLOVERS, SLACKS, SKIRTS, DRESSES, BERMUDA SHORTS, SHORTS, SOCKS, STOCKINGS, TIGHTS, BELTS, NECKTIES, STOLES AND SCARVES, JACKETS, COATS, ANORAKS, RAINCOATS, PARKAS, AND UNDERCLOTHING, NAMELY, UNDERWEAR, BRAS, BODY SUITS, CAMISOLES, WASP-WAISTED CORSETS, BOXER SHORTS, BRIEFS, PANTIES; SHOES, SLIPPERS, BOOTIES, BOOTS; HEADGEAR PARTICULARLY HATS, CAPS, BONNETS AND BERETS, IN CLASS 25 (U.S. CLS. 22 AND 39).

THE MARK CONSISTS OF STANDARD CHARACTERS WITHOUT CLAIM TO ANY PARTICULAR FONT, STYLE, SIZE, OR COLOR.



*David J. Kyros*

Director of the United States Patent and Trademark Office

**Reg. No. 4,123,617** PRIORITY DATE OF 9-9-2010 IS CLAIMED.

OWNER OF INTERNATIONAL REGISTRATION 1072132 DATED 2-24-2011, EXPIRES 2-24-2021.

SER. NO. 79-095,444, FILED 2-24-2011.

SHAILA SETTLES, EXAMINING ATTORNEY

# United States of America

United States Patent and Trademark Office

# GLYST@T

**Reg. No. 4,123,618**

**Registered Apr. 10, 2012**

**Int. Cls.: 35, 38 and 42**

**SERVICE MARK**

**PRINCIPAL REGISTER**

JEAN PODVIN (FRANCE INDIVIDUAL)  
350 RUE HENRI FIÉVET  
F-59310 BEUVRY-LA-FORÊT  
FRANCE

FOR: OFFICE FUNCTIONS; COMPUTERIZED FILE MANAGEMENT, IN CLASS 35 (U.S. CLS. 100, 101 AND 102).

FOR: PROVIDING TELECOMMUNICATIONS CONNECTIONS TO A GLOBAL COMPUTER NETWORK; RENTAL OF TELECOMMUNICATION EQUIPMENT; TELECONFERENCING SERVICES; ELECTRONIC MESSAGING, IN CLASS 38 (U.S. CLS. 100, 101 AND 104).

FOR: EVALUATIONS, ASSESSMENTS AND RESEARCH IN THE FIELDS OF SCIENCE AND TECHNOLOGY PROVIDED BY ENGINEERS; DESIGN AND DEVELOPMENT OF COMPUTERS AND SOFTWARE; CONVERSION OF DATA OR DOCUMENTS FROM PHYSICAL TO ELECTRONIC MEDIA, IN CLASS 42 (U.S. CLS. 100 AND 101).

THE MARK CONSISTS OF STANDARD CHARACTERS WITHOUT CLAIM TO ANY PARTICULAR FONT, STYLE, SIZE, OR COLOR.

PRIORITY DATE OF 7-28-2010 IS CLAIMED.

OWNER OF INTERNATIONAL REGISTRATION 1072210 DATED 1-28-2011, EXPIRES 1-28-2021.

SER. NO. 79-095,462, FILED 1-28-2011.

APRIL ROACH, EXAMINING ATTORNEY



*David J. Kyros*

Director of the United States Patent and Trademark Office

# United States of America

United States Patent and Trademark Office

# NUXE

**Reg. No. 4,123,619**

**Registered Apr. 10, 2012**

**Int. Cls.: 3 and 44**

**TRADEMARK**

**SERVICE MARK**

**PRINCIPAL REGISTER**

LABORATOIRE NUXE (FRANCE SOCIÉTÉ PAR ACTIONS SIMPLIFIÉE)  
19 RUE PÉCLET  
F-75015 PARIS  
FRANCE

FOR: PERFUMES, EAUX DE TOILETTE, COLOGNE, PERSONAL DEODORANTS; ESSENTIAL OILS FOR PERSONAL USE; SOAPS NOT FOR MEDICAL USE, CLEANSING MILKS; COSMETIC PREPARATIONS NOT FOR MEDICAL USE IN THE FORM OF CREAMS, GELS, MILKS, LOTIONS, MASKS, POMADES AND POWDERS; COSMETIC SKIN-CARE PREPARATIONS NOT FOR MEDICAL USE IN THE FORM OF CREAMS, GELS, MILKS, OILS AND LOTIONS; COSMETIC ANTI-WRINKLE PREPARATIONS NOT FOR MEDICAL USE IN THE FORM OF CREAMS, GELS, MILKS, OILS, LOTIONS, MASKS AND POMADES; COSMETIC LIP CARE PREPARATIONS NOT FOR MEDICAL USE IN THE FORM OF CREAMS, BALMS AND STICKS; COSMETIC SUNSCREEN PREPARATIONS IN THE FORM OF CREAMS, GELS, MILKS, OILS AND LOTIONS; COSMETIC SUN-TANNING PREPARATIONS IN THE FORM OF CREAMS, GELS, MILKS, OILS AND LOTIONS; COSMETIC AFTER-SUN PREPARATIONS IN THE FORM OF CREAMS, GELS, MILKS, OILS AND LOTIONS; COSMETIC SLIMMING PREPARATIONS NOT FOR MEDICAL USE; DEPILATORY PREPARATIONS IN THE FORM OF MOUSSES, CREAMS AND GELS; HAIR PRODUCTS, NAMELY, HAIR AND SCALP CARE PREPARATIONS, NAMELY, HAIR LOTIONS, SHAMPOOS, AFTER-SHAMPOOS, OILS AND MASKS FOR THE HAIR; COSMETIC BATH PREPARATIONS NOT FOR MEDICAL USE IN THE FORM OF CREAMS, GELS, MILKS, OILS, PEARLS AND SALTS; MAKE-UP AND MAKE-UP REMOVING PREPARATIONS IN THE FORM OF MOUSSES, GELS, MILKS, OILS AND LOTIONS; PREPARATIONS FOR SHAVING AND FOR AFTER-SHAVING IN THE FORM OF MOUSSES, GELS, MILKS, OILS AND LOTIONS; TISSUES AND WIPES IMPREGNATED WITH COSMETIC LOTIONS; ROOM PERFUMES, IN CLASS 3 (U.S. CLS. 1, 4, 6, 50, 51 AND 52).

FOR: BEAUTY CARE; MASSAGES; BEAUTY SALONS; CARE SERVICES, NAMELY, SAUNA AND HAMMAM SERVICES, NAMELY, PROVIDING TURKISH BATH FACILITIES; BEAUTY SPA SERVICES IN THE NATURE OF COSMETIC BODY CARE; BALNEOTHERAPY, PHYSIOTHERAPY, AROMATHERAPY SERVICES, IN CLASS 44 (U.S. CLS. 100 AND 101).



*David J. Kyjars*

Director of the United States Patent and Trademark Office

OWNER OF U.S. REG. NO. 2,447,296.

OWNER OF INTERNATIONAL REGISTRATION 1072247 DATED 2-14-2011, EXPIRES 2-14-2021.

**Reg. No. 4,123,619** THE WORD "NUXE" HAS NO MEANING IN A FOREIGN LANGUAGE.

SER. NO. 79-095,482, FILED 2-14-2011.

JAMES STEIN, EXAMINING ATTORNEY



# United States of America

United States Patent and Trademark Office

# WALLYFLEX

**Reg. No. 4,123,620**

**Registered Apr. 10, 2012**

**Int. Cl.: 7**

**TRADEMARK**

**PRINCIPAL REGISTER**

LES INDUSTRIES TROVAC EUROPE (FRANCE SOCIÉTÉ PAR ACTIONS SIMPLIFIÉE)  
16 RUE DU STADE  
F-44170 TREFFIEUX  
FRANCE

FOR: DUST-REMOVING INSTALLATIONS FOR CLEANING PURPOSES, NAMELY, APPARATUS USED FOR AIR FILTRATION, THE REMOVAL OF DUST, SMOKE AND ALLERGENS FROM THE AIR, VACUUM CLEANERS, VACUUM CLEANER ATTACHMENTS, VACUUM CLEANER SUCKING NOZZLES, VACUUM CLEANER BAGS, VACUUM CLEANER FILTERS, IN CLASS 7 (U.S. CLS. 13, 19, 21, 23, 31, 34 AND 35).

THE MARK CONSISTS OF STANDARD CHARACTERS WITHOUT CLAIM TO ANY PARTICULAR FONT, STYLE, SIZE, OR COLOR.

PRIORITY DATE OF 10-4-2010 IS CLAIMED.

OWNER OF INTERNATIONAL REGISTRATION 1072254 DATED 3-11-2011, EXPIRES 3-11-2021.

SER. NO. 79-095,483, FILED 3-11-2011.

JOHN DWYER, EXAMINING ATTORNEY



*David J. Kyros*

Director of the United States Patent and Trademark Office

# United States of America

United States Patent and Trademark Office

## TouchFineArt.com

**Reg. No. 4,123,621**

ANGELIKA DÜNNER (SWITZERLAND INDIVIDUAL)  
STEINBRÜCHELSTRASSE 14C  
CH-8053 ZÜRICH, SWITZERLAND

**Registered Apr. 10, 2012**

**Int. Cls.: 16, 20, 35 and  
41**

FOR: PRINTED MATTER, NAMELY, STATIONERY, CALENDAR, PAINTINGS, PICTURES, PHOTOGRAPHS, AQUARELLES, OLEOGRAPHS, IN CLASS 16 (U.S. CLS. 2, 5, 22, 23, 29, 37, 38 AND 50).

**TRADEMARK**

FOR: STATUES OF PLASTER, PLASTIC, WAX, WOOD, IN CLASS 20 (U.S. CLS. 2, 13, 22, 25, 32 AND 50).

**SERVICE MARK**

**PRINCIPAL REGISTER**

FOR: BUSINESS MANAGEMENT OF PERFORMING ARTISTS, ORGANIZATION OF TRADE FAIRS FOR COMMERCIAL OR ADVERTISING PURPOSES, IN CLASS 35 (U.S. CLS. 100, 101 AND 102).

FOR: CULTURAL ACTIVITIES AS ORGANIZATION OF EVENTS FOR CULTURAL PURPOSES, IN CLASS 41 (U.S. CLS. 100, 101 AND 107).

THE MARK CONSISTS OF THE UNDERLINED WORDING "TOUCHFINEART.COM" IN STYLIZED FONT.

PRIORITY DATE OF 10-13-2010 IS CLAIMED.

OWNER OF INTERNATIONAL REGISTRATION 1072315 DATED 2-23-2011, EXPIRES 2-23-2021.

SER. NO. 79-095,507, FILED 2-23-2011.

DAVID HOFFMAN, EXAMINING ATTORNEY



*David J. Kybas*

Director of the United States Patent and Trademark Office

United States of America  
United States Patent and Trademark Office

# Atoposcur e

**Reg. No. 4,123,622**

**Registered Apr. 10, 2012**

**Int. Cl.: 5**

**TRADEMARK**

**PRINCIPAL REGISTER**

NIPPON ZENYAKU KOGYO CO., LTD. (JAPAN CORPORATION)  
1-1, AZA-TAIRANOUE  
SASAGAWA,; ASAKA-MACHI,; KORIYAMA-SHI;  
FUKUSHIMA 963-0196, JAPAN

FOR: PHARMACEUTICAL AND VETERINARY PREPARATIONS, NAMELY, PREVENTIVE PREPARATIONS FOR ALLERGY DISEASES OF ANIMALS; AND TREATMENT PREPARATIONS FOR ALLERGY DISEASES FOR ANIMALS, IN CLASS 5 (U.S. CLS. 6, 18, 44, 46, 51 AND 52).

THE MARK CONSISTS OF STANDARD CHARACTERS WITHOUT CLAIM TO ANY PARTICULAR FONT, STYLE, SIZE, OR COLOR.

OWNER OF INTERNATIONAL REGISTRATION 1072382 DATED 3-11-2011, EXPIRES 3-11-2021.

SER. NO. 79-095,522, FILED 3-11-2011.

ZACHARY BELLO, EXAMINING ATTORNEY



*David J. Kyffers*

Director of the United States Patent and Trademark Office

United States of America  
United States Patent and Trademark Office

# Atopimmune

**Reg. No. 4,123,623**

**Registered Apr. 10, 2012**

**Int. Cl.: 5**

**TRADEMARK**

**PRINCIPAL REGISTER**

NIPPON ZENYAKU KOGYO CO., LTD. (JAPAN CORPORATION)  
1-1, AZA-TAIRANOUE  
SASAGAWA,; ASAKA-MACHI,; KORIYAMA-SHI;  
FUKUSHIMA 963-0196, JAPAN

FOR: PHARMACEUTICAL AND VETERINARY PREPARATIONS, NAMELY, PREVENTIVE PREPARATIONS FOR ALLERGY DISEASES OF ANIMALS; AND TREATMENT PREPARATIONS FOR ALLERGY DISEASES FOR ANIMALS, IN CLASS 5 (U.S. CLS. 6, 18, 44, 46, 51 AND 52).

THE MARK CONSISTS OF STANDARD CHARACTERS WITHOUT CLAIM TO ANY PARTICULAR FONT, STYLE, SIZE, OR COLOR.

OWNER OF INTERNATIONAL REGISTRATION 1072383 DATED 3-11-2011, EXPIRES 3-11-2021.

SER. NO. 79-095,523, FILED 3-11-2011.

ZACHARY BELLO, EXAMINING ATTORNEY



*David J. Kypos*

Director of the United States Patent and Trademark Office

# United States of America

United States Patent and Trademark Office

はぐまむ  
hugmamamu

**Reg. No. 4,123,624**

SANKEI INC. (JAPAN CORPORATION)

**Registered Apr. 10, 2012**

10-12, MIYUKI CHOU

GAMAGORI-CITY; AICHI 443-0042, JAPAN

**Int. Cl.: 24**

**TRADEMARK**

**PRINCIPAL REGISTER**

FOR: WOVEN FABRICS OTHER THAN EDGING RIBBONS FOR TATAMI MATS; COTTON FABRICS; WASTE COTTON FABRICS; HEMP YARN FABRICS; FLAX FABRICS; JUTE FABRICS; TRUE HEMP FABRICS; RAMIE FABRICS; SILK FABRICS; SPUN SILK FABRICS; HAND SPUN SILK FABRICS; WOOL YARN FABRICS; WORSTED FABRICS; WOOLLEN FABRICS; CHEMICAL FIBER FABRICS; SYNTHETIC FIBER FABRICS; REGENERATED FIBER YARN FABRICS; SEMI-SYNTHETIC FIBER FABRICS; INORGANIC FIBER MIXED FABRICS OTHER THAN ASBESTOS FIBER FABRICS; GLASS FIBER FABRICS FOR TEXTILE USE; METAL FIBER FABRICS FOR TEXTILE USE; MIXED FIBER FABRICS; HEMP BASE MIXED FABRICS; CHEMICAL FIBER BASE MIXED FABRICS; SILK BASE MIXED FABRICS; WOOL BASE MIXED FABRICS; COTTON BASE MIXED FABRICS; MIXED YARN FABRICS BEING UNION FABRICS; HEMP-SILK MIXED FABRICS; HEMP-WOOL MIXED FABRICS; HEMP-COTTON MIXED FABRICS; MULTIPLE CHEMICAL FIBER FABRICS; WOOL-COTTON MIXED FABRICS; SILK-COTTON MIXED FABRICS; SILK-WOOL MIXED FABRICS; ELASTIC YARN MIXED FABRICS; INORGANIC FIBER MIXED FABRICS; NARROW WOVEN FABRICS; PUTTEES CLOTH FOR THE MANUFACTURE OF CLOTHING; SUSPENDERS CLOTH FOR THE MANUFACTURE OF CLOTHING; BELT CLOTH FOR THE MANUFACTURE OF CLOTHING; PAPER YARN FABRICS; COVERED RUBBER YARN FABRICS FOR TEXTILE USE; GAUZE FABRIC; PILE-WOVEN CLOTH FOR THE MANUFACTURE OF CLOTHING; KNITTED FABRICS; KNITTED FABRICS OF CHEMICAL-FIBER YARN; KNITTED FABRICS OF SILK YARN; KNITTED FABRICS OF WOOL YARN; KNITTED FABRICS OF COTTON YARN; FELT AND NON-WOVEN TEXTILE FABRICS; FELTS; PRESS FELT; WOVEN FELT; NON-WOVEN TEXTILE FABRICS; PERSONAL ARTICLES OF WOVEN TEXTILE NOT FOR WEAR, NAMELY, TOWELS OF TEXTILE, JAPANESE COTTON TOWELS (TENUGUI), HANDKERCHIEFS; JAPANESE CEREMONIAL WRAPPING CLOTH (FUKUSA), JAPANESE GENERAL WRAPPING CLOTH (FUROSHIKI), BABY BLANKETS, BATH MITTS; MOSQUITO NETS; BED SHEETS; FUTON QUILTS; FUTON CASES IN THE NATURE OF FITTED FUTON COVERS NOT OF PAPER AND QUILTS CASES BEING LINEN; FUTON TICKS, NAMELY, UNSTUFFED FUTON COVERS NOT OF PAPER; PILLOWCASES BEING PILLOW SLIPS; BLANKETS, NAMELY, BED BLANKETS, BLANKET THROWS; COTTON BLANKETS, NAMELY, BED BLANKETS, BLANKET THROWS; TEXTILE BED SHEETS; TOWELLING BED SHEETS; BED SHEETS MADE OF GAUZE FABRIC; BED SHEETS FOR YOUNG CHILDREN; TABLE NAPKINS OF TEXTILE; DISH TOWELS FOR DRYING, IN CLASS 24 (U.S. CLS. 42 AND 50).



*David J. Kypos*

Director of the United States Patent and Trademark Office

**Reg. No. 4,123,624** THE MARK CONSISTS OF OCHER JAPANESE CHARACTERS ABOVE THE OCHER STYLIZED WORDING "HUGMAMU".

OWNER OF INTERNATIONAL REGISTRATION 1072386 DATED 10-25-2010, EXPIRES 10-25-2020.

THE COLOR(S) OCHER IS/ARE CLAIMED AS A FEATURE OF THE MARK.

THE NON-LATIN CHARACTERS IN THE MARK TRANSLITERATE TO "HAGUMAMU", AND THIS HAS NO MEANING IN A FOREIGN LANGUAGE.

THE WORDING "HUGMAMU" HAS NO MEANING IN A FOREIGN LANGUAGE.

SER. NO. 79-095,524, FILED 10-25-2010.

KRISTINA MORRIS, EXAMINING ATTORNEY

# United States of America

United States Patent and Trademark Office

# CARAVA

**Reg. No. 4,123,625**

**Registered Apr. 10, 2012**

**Int. Cl.: 25**

**TRADEMARK**

**PRINCIPAL REGISTER**

JIONGBO LI (CHINA INDIVIDUAL)  
2ND. FLOOR  
NO. 1, TWENTY LAI COURT  
DONGGUAN; GUANGDONG, CHINA

FOR: CLOTHING, NAMELY, JACKETS, SHIRTS, PANTS; MEN'S CLOTHING, NAMELY, JACKETS, SHIRTS, PANTS; FEMALE ATTIRE, NAMELY, JACKETS, PANTS, SHIRTS; CHILDREN'S CLOTHING, NAMELY, JACKETS, PANTS, SHIRTS; WATERPROOF CLOTHING, NAMELY, WATERPROOF JACKETS AND PANTS, IN CLASS 25 (U.S. CLS. 22 AND 39).

THE WORD(S) "CARAVA" HAS NO MEANING IN A FOREIGN LANGUAGE.

OWNER OF INTERNATIONAL REGISTRATION 1072412 DATED 3-1-2011, EXPIRES 3-1-2021.

SER. NO. 79-095,533, FILED 3-1-2011.

CARYN GLASSER, EXAMINING ATTORNEY



*David J. Kyros*

Director of the United States Patent and Trademark Office

# United States of America

United States Patent and Trademark Office

# Allermmune

**Reg. No. 4,123,626**

**Registered Apr. 10, 2012**

**Int. Cl.: 5**

**TRADEMARK**

**PRINCIPAL REGISTER**

NIPPON ZENYAKU KOGYO CO., LTD. (JAPAN CORPORATION)  
1-1, AZA-TAIRANOUE  
SASAGAWA,; ASAKA-MACHI,; KORIYAMA-SHI;  
FUKUSHIMA 963-0196, JAPAN

FOR: PHARMACEUTICAL AND VETERINARY PREPARATIONS, NAMELY, PREVENTIVE PREPARATIONS FOR ALLERGY DISEASES OF ANIMALS; AND TREATMENT PREPARATIONS FOR ALLERGY DISEASES FOR ANIMALS, IN CLASS 5 (U.S. CLS. 6, 18, 44, 46, 51 AND 52).

THE MARK CONSISTS OF STANDARD CHARACTERS WITHOUT CLAIM TO ANY PARTICULAR FONT, STYLE, SIZE, OR COLOR.

OWNER OF INTERNATIONAL REGISTRATION 1072498 DATED 3-11-2011, EXPIRES 3-11-2021.

SER. NO. 79-095,550, FILED 3-11-2011.

ZACHARY BELLO, EXAMINING ATTORNEY



*David J. Kyffers*

Director of the United States Patent and Trademark Office



United States of America  
United States Patent and Trademark Office

# TRIBVIT

**Reg. No. 4,123,627**

**Registered Apr. 10, 2012**

**Int. Cl.: 5**

**TRADEMARK**

**PRINCIPAL REGISTER**

MEDA AB (SWEDEN AKTIEBOLAG (AB))  
PIPERS VÄG 2 A  
BOX 906; SE-170 09 SOLNA  
SWEDEN

FOR: PHARMACEUTICAL PREPARATIONS, NAMELY, FOOD SUPPLEMENTS, VITAMINS, VITAMIN SUPPLEMENTS, DIETARY SUPPLEMENTS AND NUTRITIONAL SUPPLEMENTS FOR THE TREATMENT OF VITAMIN DEFICIENCY, FOLIC ACID DEFICIENCY, MALABSORPTION DEFICIENCY, ANEMIA, ALZHEIMER, MILD COGNITIVE IMPAIRMENT, BRAIN SHRINKAGE, AND MEMORY LOSS, IN CLASS 5 (U.S. CLS. 6, 18, 44, 46, 51 AND 52).

THE MARK CONSISTS OF STANDARD CHARACTERS WITHOUT CLAIM TO ANY PARTICULAR FONT, STYLE, SIZE, OR COLOR.

PRIORITY DATE OF 11-19-2010 IS CLAIMED.

OWNER OF INTERNATIONAL REGISTRATION 1072608 DATED 2-24-2011, EXPIRES 2-24-2021.

SER. NO. 79-095,587, FILED 2-24-2011.

SHAILA SETTLES, EXAMINING ATTORNEY



*David J. Kyffers*

Director of the United States Patent and Trademark Office

# United States of America

United States Patent and Trademark Office



**Reg. No. 4,123,628**

RAXY LINE S.R.L. (ITALY LIMITED LIABILITY COMPANY)  
VIA A. VOLTA, 5  
SPRESIANO (TV), ITALY

**Registered Apr. 10, 2012**

**Int. Cls.: 25 and 26**

FOR: BANDANAS, WRISTBANDS, HEADBANDS, SWEATBANDS, SCARVES; SPORTS JERSEYS, IN CLASS 25 (U.S. CLS. 22 AND 39).

**TRADEMARK**

FOR: RIBBONS , IN CLASS 26 (U.S. CLS. 37, 39, 40, 42 AND 50).

**PRINCIPAL REGISTER**

THE MARK CONSISTS OF A SIGN DEPICTING THE FANCY WORDING "RAXYLINE", IN FANCY CHARACTERS, FLANKED ON THE RIGHT BY A SUBSTANTIALLY OVAL SIGN THAT EXTENDS DOWNWARDS UNDER THE WORDING "RAXYLINE".

OWNER OF INTERNATIONAL REGISTRATION 1072641 DATED 11-9-2010, EXPIRES 11-9-2020.

SER. NO. 79-095,595, FILED 11-9-2010.

KAREN SEVERSON, EXAMINING ATTORNEY



*David J. Kybas*

Director of the United States Patent and Trademark Office

United States of America  
United States Patent and Trademark Office

**CADUM**

**Reg. No. 4,123,629**

**Registered Apr. 10, 2012**

**Int. Cl.: 3**

**TRADEMARK**

**PRINCIPAL REGISTER**

CADUM (FRANCE SOCIÉTÉ ANONYME)  
TOUR GAMMA B  
193 RUE DE BERCY  
F-75012 PARIS, FRANCE

FOR: BLEACHING PREPARATIONS; CLEANING, POLISHING, SCOURING AND ABRASIVE PREPARATIONS; SOAPS; PERFUMERY, ESSENTIAL OILS, COSMETICS, HAIR CARE PREPARATIONS AND LOTIONS FOR COSMETIC PURPOSES; DENTIFRICES AND TOOTH CLEANING PREPARATIONS, IN CLASS 3 (U.S. CLS. 1, 4, 6, 50, 51 AND 52).

OWNER OF INTERNATIONAL REGISTRATION 0278896B DATED 1-24-1964, EXPIRES 1-24-2014.

SER. NO. 79-095,612, FILED 3-10-2011.

DAVID HOFFMAN, EXAMINING ATTORNEY

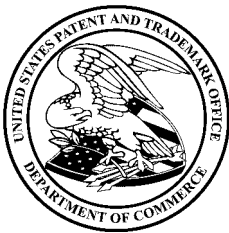

*David J. Kyffers*

Director of the United States Patent and Trademark Office

# United States of America

United States Patent and Trademark Office

# Steca

**Reg. No. 4,123,630**

**Registered Apr. 10, 2012**

**Int. Cls.: 9, 11, 40 and 42**

STECA ELEKTRONIK GMBH (FED REP GERMANY COMPANY WITH LIMITED LIABILITY (GMBH))

MAMMOSTRAßE 1  
87700 MEMMINGEN

FED REP GERMANY

**TRADEMARK**

**SERVICE MARK**

**PRINCIPAL REGISTER**

FOR: BATTERY CHARGERS, NAMELY, CHARGING SETS, DISCHARGERS, TESTING APPARATUS AS WELL AS SWITCHGEARS AND CONTROL GEARS, SOFTWARE, PARTICULARLY FOR MONITORING CHARGING CYCLES FOR BATTERIES, FOR MANAGEMENT OF BUS WORK YARDS AND FOR CONTROLLING AND COLLECTING DATA AND STATES THROUGH NETWORK CHARGING UNITS; ELECTRIC AND ELECTRONIC HEATING CONTROL APPARATUS, CONTROLLERS FOR CHARGING CONTROLLERS FOR HEATING SYSTEMS, SOLAR THERMIC SYSTEMS OR THERMAL SOLAR SYSTEMS; APPARATUS FOR PHOTOVOLTAIC PURPOSES, PARTICULARLY SOLAR CELLS, CHARGING CONTROLLERS BATTERIES AND CHARGING CONTROLLERS WITH CHARGE REGULATION, PARTICULARLY FOR THE AFOREMENTIONED SOLAR CELLS; SENSOR APPARATUS, NAMELY, ELECTRICAL AND ELECTRONIC SENSORS, SENSORS FOR RECOGNITION OF PHYSICAL QUANTITIES, THERMAL PROBES, PRINTED BOARDS, NON EQUIPPED AND EQUIPPED; WIRE TECHNOLOGY, NAMELY, ELECTRIC WIRES, WIRE HARNESES, SWITCH CABINETS, BATTERIES, BATTERY CHARGING SYSTEMS, BATTERY TESTERS, AUTOMATIC ROLLING UP DEVICES FOR ELECTRIC WIRES, CONNECTIONS AND CONNECTOR PLUGS FOR CURRENT, VOLUME FLOW METERS OR WATER METERS, METERS FOR QUANTITY OF HEAT, TEMPERATURE PROBES, PLUNGER TUBES, MAINS WIRES, REMOTE DISPLAYS, DISPLAY APPARATUS, DATA LOGGERS, INTERFACE CONVERTERS, MODEMS, HEAT CONTROLLERS, NON METALLIC RELAY BOXES, WIRE UNWINDERS; SCIENTIFIC, NAVIGATION, SURVEYING, PHOTOGRAPHIC, FILM, OPTICAL, WEIGHING, MEASURING, SIGNAL, CONTROLLING, RESCUE AND EDUCATIONAL APPARATUS AND EQUIPMENT, NAMELY, ELECTRICAL AND ELECTRONIC SENSORS AND WIRE CABLES; APPARATUS FOR RECORDING, TRANSMITTING AND REPRODUCING SOUND AND PICTURE; MAGNETIC RECORDING MEDIA, NAMELY, ELECTRONIC RECORDING COMPONENTS; DATA PROCESSING APPARATUS AND COMPUTERS, COMPUTER PROGRAMS FEATURING PROGRAMS FOR MEASURING, RECORDING AND MANAGING POWER USAGE; ELECTRIC MEASURING, SIGNAL AND CONTROL INSTRUMENTS INCLUDED IN THIS CLASS, NAMELY, METERS, CIRCUIT BREAKERS, SOLAR CHARGING SYSTEMS AND INVERTERS, DATA PROCESSORS, PROGRAMMED DATA PROCESSORS, PARTICULARLY FOR THE AFOREMENTIONED GOODS; CURRENT AND VOLTAGE CONVERTERS, TRANSFORMERS, PHOTOVOLTAIC



*David J. Kyjars*

Director of the United States Patent and Trademark Office

**Reg. No. 4,123,630** SYSTEMS CONSISTING OF NAMELY, CELLS, INVERTERS AND CHARGE CONTROLLERS, FOR USE IN CONVERTING ENERGY, VOLTAGE CONVERTERS, PARTICULARLY DC CONVERTERS OR INVERTERS, CONTROLLERS FOR MAXIMUM ADAPTATION OF OUTPUT TO SOLAR CELLS (MPP TRACKER); LIGHTING, HEATING, COOKING, COOLING AND VENTILATION APPARATUS CONTROL SYSTEMS, NAMELY, CONTROL DEVICES, IN CLASS 9 (U.S. CLS. 21, 23, 26, 36 AND 38).

FOR: APPARATUS FOR SOLAR THERMAL PURPOSES, PARTICULARLY SOLAR COLLECTORS, REFRIGERATORS, PARTICULARLY SOLAR-OPERATED REFRIGERATORS, POWER SAVING LAMPS, LED LAMPS, INCANDESCENT LAMPS, EXHAUST VENTILATORS FOR HEATERS, SOLAR CONNECTORS, REFRIGERATORS, VENTILATION GRIDS FOR HEATERS, SOLAR CONNECTORS AND REFRIGERATORS, VENTILATION DUCTS FOR HEATERS, SOLAR CONNECTORS AND REFRIGERATORS; LIGHTING, HEATING, COOKING, COOLING AND VENTILATION APPARATUS FOR USE IN HEATERS, SOLAR CONNECTORS AND REFRIGERATORS, IN CLASS 11 (U.S. CLS. 13, 21, 23, 31 AND 34).

FOR: HARDFACING OF PRINTED BOARDS WITH ELECTRIC OR ELECTRONIC COMPONENTS SUCH AS RESISTORS, INTEGRATED CIRCUITS, TRANSISTORS OR SIMILAR COMPONENTS; MATERIAL PROCESSING, PARTICULARLY MECHANICAL PROCESSING OF MATERIAL SUCH AS TURNING ON A LATHE, DRILLING, MILLING, ENAMELLING AND PRINTING, MANUFACTURE OF WIRE HARNESSSES, CUTTING WIRE HARNESSSES WITH PLUGS INTO LENGTHS, IN CLASS 40 (U.S. CLS. 100, 103 AND 106).

FOR: SERVICES OF AN ENGINEER, NAMELY PLANNING, DEVELOPMENT AND CONSTRUCTION OF ELECTRONIC AND/OR ELECTRIC APPLIANCES, DEVELOPMENT OF ELECTRONIC CIRCUITS, DESIGN AND DRAFTING OF HOUSINGS FOR ELECTRIC OR ELECTRONIC APPLIANCES, LAYOUT DESIGN OF ELECTRONIC DRAWINGS, LAYOUT DESIGN OF MECHANICAL COMPONENT PARTS SUCH AS HOUSINGS, EXECUTION OF TESTS REGARDING THE ELECTROMAGNETIC COMPATIBILITY OF ELECTRIC AND ELECTRONIC APPLIANCES, ELABORATION OF SPECIFICATIONS FOR SOFTWARE, TECHNICAL CONSULTANCY, PREPARATION OF DOCUMENTATION AND SPECIFICATIONS FOR SOFTWARE, CONCEPTION AND PLANNING OF TEST ADAPTERS AND TEST SYSTEMS, PLANNING OF QUALITY ASSURANCE MEASURES, PROGRAMMING OF MICROCONTROLLERS OF MICROPROCESSORS, COMPUTER PROGRAMMING, TECHNICAL PROJECT PLANNING AND CONSULTANCY IN THE FIELD OF MANUFACTURING CHARGING SYSTEMS FOR BATTERY CHARGING CENTERS, TECHNICAL PROJECT PLANNING OF WORKS PREMISES IN THIS CONNECTION, CONCEPTION OR DEVELOPMENT OF PROJECTS IN THE FIELD PERTAINING TO TECHNICAL CONSULTING FOR THIRD PARTIES IN THE FIELD OF MICROPROCESSORS, TECHNICAL PROJECT PLANNING, CONSULTANCY, AND LAYOUT OF WIRE HARNESSSES, DEVELOPMENT, PROGRAMMING AND MAINTENANCE OF SOFTWARE, RESEARCH AND DEVELOPMENT FOR THIRD PARTIES IN THE ELECTROTECHNICS AND ELECTRONIC DOMAINS, PROJECT MANAGEMENT IN TECHNICAL FIELDS, RELIABILITY TESTS, PARTICULARLY WITH REGARD TO THE DURABILITY OF PRODUCTS AND CLIMATIC AND MECHANICAL ENVIRONMENTAL REQUIREMENTS, TESTING OF STRUCTURAL COMPONENTS, PARTICULARLY ELECTRONIC, ELECTRIC STRUCTURAL COMPONENTS, LINKING OF CHARGING APPARATUSES, ERROR ANALYSIS, MICROGRAPH TESTS, TYPE EXAMINATION OF COMPONENTS AND APPARATUS, PROVIDING ENGINEERING SUPPORT IN PLANNING OR DEVELOPMENT OF ELECTRIC AND ELECTRONIC APPARATUS, CIRCUITS, STRUCTURAL COMPONENTS AND CONTROL SYSTEMS IN INTERNATIONAL CLASS 42, IN CLASS 42 (U.S. CLS. 100 AND 101).

THE MARK CONSISTS OF THE WORDING "STECA" IN RED COLOR; THE LETTER "S" IS HIGHLY STYLIZED.

OWNER OF INTERNATIONAL REGISTRATION 0743570 DATED 6-10-2000, EXPIRES 6-10-2020.

**Reg. No. 4,123,630** THE COLOR(S) RED IS/ARE CLAIMED AS A FEATURE OF THE MARK.

THE WORDING "STECA" HAS NO MEANING IN A FOREIGN LANGUAGE.

SER. NO. 79-095,622, FILED 1-24-2011.

ZACHARY BELLO, EXAMINING ATTORNEY

# United States of America

United States Patent and Trademark Office

# myBEKO

**Reg. No. 4,123,631**

**Registered Apr. 10, 2012**

**Int. Cls.: 7, 11, 35, 38, 41  
and 42**

BEKO TECHNOLOGIES GMBH (FED REP GERMANY GMBH)  
IM TAUBENTAL 7  
41468 NEUSS  
FED REP GERMANY

FOR: STEAM TRAPS BEING PARTS OF MACHINES, IN CLASS 7 (U.S. CLS. 13, 19, 21, 23, 31, 34 AND 35).

**TRADEMARK**

**SERVICE MARK**

**PRINCIPAL REGISTER**

FOR: APPARATUS FOR HEATING, COOLING, DRYING, AIR DISTRIBUTION AND FILTERING IN COMPRESSED AIR SYSTEMS, NAMELY, FILTERS FOR COMPRESSED AIR NOT BEING FILTERS HAVING A POROUS STRUCTURE; COMPRESSED AIR COOLERS; DRYING MODULES FOR THE REMOVAL OF SOLID, LIQUID AND VAPOR CONTAMINANTS FROM COMPRESSED AIR AND PRESSURIZED GASES; SEPARATORS FOR THE CLEANING AND PURIFICATION OF GASES; DRYING MODULES FOR THE CLEANING AND PURIFICATION OF GASES; STEAM ACCUMULATORS; CONDENSATE DRAINERS FOR GAS PIPES; CONDENSATE DRAINERS FOR CONTAINERS; APPARATUS FOR SEPARATING MIXTURES OF LIQUIDS INTO THEIR COMPONENTS, NAMELY, OIL-WATER MIXTURES; PIPE LINE COCKS, NAMELY, PIPE LINE SPIGOTS, IN CLASS 11 (U.S. CLS. 13, 21, 23, 31 AND 34).

FOR: COMPILATION AND SYSTEMATISATION OF DATA IN COMPUTER DATABASES; UPDATING AND MAINTENANCE OF DATA IN COMPUTER DATABASES; PROVIDING INFORMATION VIA THE INTERNET, NAMELY PROVIDING BUSINESS INFORMATION FOR CUSTOMERS, IN PARTICULAR FOR THE CHECKING OF ORDERS AND PAYMENTS, IN CLASS 35 (U.S. CLS. 100, 101 AND 102).

FOR: PROVIDING ACCESS TO GLOBAL COMPUTER NETWORKS, PROVIDING ACCESS TO DATABASES AND NETWORKS, INCLUDING THE INTERNET, IN CLASS 38 (U.S. CLS. 100, 101 AND 104).

FOR: PRODUCT TRAINING, NAMELY, PROVIDING TRAINING COURSES IN THE FIELD OF COMPRESSED AIR SYSTEMS AND CONDENSATE TECHNOLOGY; PROVIDING ONLINE TRAINING COURSES AND PUBLICATIONS IN THE FIELD OF COMPRESSED AIR SYSTEMS AND CONDENSATE TECHNOLOGY, IN CLASS 41 (U.S. CLS. 100, 101 AND 107).

FOR: TECHNICAL TESTING RELATED TO COMPRESSED AIR SYSTEMS; TECHNICAL DEVELOPMENT, NAMELY, DEVELOPMENT OF NEW TECHNOLOGY FOR OTHERS IN THE FIELDS OF STEAM TRAPS FOR WATER SEPARATION, AND OF COMPONENTS FOR



*David J. Kyjars*

Director of the United States Patent and Trademark Office

**Reg. No. 4,123,631** COMPRESSED AIR SYSTEMS AND COMPRESSED AIR PROCESSING, STEAM TRAP SYSTEMS, COMPRESSED AIR DISTRIBUTION, MEASURING SYSTEMS AND PROCESS SYSTEMS; PROVIDING TEMPORARY NON-DOWNLOADABLE SOFTWARE PROGRAMS FOR DESIGNING THE TECHNICAL STRUCTURE OF TECHNICAL INSTALLATIONS, IN CLASS 42 (U.S. CLS. 100 AND 101).

THE MARK CONSISTS OF STANDARD CHARACTERS WITHOUT CLAIM TO ANY PARTICULAR FONT, STYLE, SIZE, OR COLOR.

PRIORITY DATE OF 7-20-2010 IS CLAIMED.

OWNER OF INTERNATIONAL REGISTRATION 1072802 DATED 1-19-2011, EXPIRES 1-19-2021.

OWNER OF U.S. REG. NO. 3,882,682.

SER. NO. 79-095,686, FILED 1-19-2011.

MICHAEL WIENER, EXAMINING ATTORNEY



# United States of America

United States Patent and Trademark Office

# FlexoDrive

**Reg. No. 4,123,632**

**Registered Apr. 10, 2012**

**Int. Cls.: 7 and 37**

**TRADEMARK**

**SERVICE MARK**

**PRINCIPAL REGISTER**

AS DRIVES & SERVICES GMBH (FED REP GERMANY GMBH)  
INDUSTRIESTRAÙE 17  
48734 REKEN  
FED REP GERMANY

FOR: MOTORS, ELECTRIC, OTHER THAN FOR LAND VEHICLES; MOTORS, EXCEPT FOR LAND VEHICLES; DRIVING MOTORS AND DRIVE SHAFTS, OTHER THAN FOR LAND VEHICLES; GEAR-BOXES, NOT FOR LAND VEHICLES, IN CLASS 7 (U.S. CLS. 13, 19, 21, 23, 31, 34 AND 35).

FOR: MACHINERY INSTALLATION, MAINTENANCE AND REPAIR, IN CLASS 37 (U.S. CLS. 100, 103 AND 106).

THE MARK CONSISTS OF STANDARD CHARACTERS WITHOUT CLAIM TO ANY PARTICULAR FONT, STYLE, SIZE, OR COLOR.

OWNER OF INTERNATIONAL REGISTRATION 1072814 DATED 3-11-2011, EXPIRES 3-11-2021.

SER. NO. 79-095,689, FILED 3-11-2011.

JASON BLAIR, EXAMINING ATTORNEY



*David J. Kyffers*

Director of the United States Patent and Trademark Office

# United States of America

United States Patent and Trademark Office



**Reg. No. 4,123,633**

**Registered Apr. 10, 2012**

**Int. Cls.: 35, 38 and 41**

**SERVICE MARK**

**PRINCIPAL REGISTER**

BEACTIVE - PRODUÇÕES INTERATIVAS, S.A. (PORTUGAL CORPORATION)  
AVENIDA DUQUE D'ÁVILA 23, 1º DTO.  
P-1000-138 LISBOA  
PORTUGAL

FOR: ADVERTISING SERVICES; BUSINESS MANAGEMENT; BUSINESS ADMINISTRATION; PROVISION OF OFFICE FUNCTIONS, IN CLASS 35 (U.S. CLS. 100, 101 AND 102).

FOR: TELECOMMUNICATIONS, NAMELY, TRANSMISSION OF PODCASTS AND WEBCASTS, IN CLASS 38 (U.S. CLS. 100, 101 AND 104).

FOR: EDUCATION SERVICES, NAMELY, PROVIDING CLASSES, SEMINARS, WORKSHOPS AND LECTURES IN THE FIELD OF MEDIA AND CROSS MEDIA ENTERTAINMENT CONTENT; TRAINING SERVICES, NAMELY, PROVIDING CLASSES, SEMINARS, WORKSHOPS AND LECTURES IN THE FIELD OF MEDIA AND CROSS MEDIA ENTERTAINMENT CONTENT; ENTERTAINMENT SERVICES, NAMELY, PROVISION OF INFORMATION AND ENTERTAINMENT IN THE FIELDS OF NEWS, SPORTS AND FITNESS; ENTERTAINMENT SERVICES, NAMELY, PROVIDING TEMPORARY USE OF NON-DOWNLOADABLE INTERACTIVE GAMES, IN CLASS 41 (U.S. CLS. 100, 101 AND 107).

THE MARK CONSISTS OF THE WORDING "BEAT GENERATION" WRITTEN IN A STYLIZED FONT, AND APPEARING TO THE RIGHT OF AND BELOW, A STYLIZED ILLUSTRATION OF MUSIC DISCS.

OWNER OF INTERNATIONAL REGISTRATION 1072996 DATED 11-16-2010, EXPIRES 11-16-2020.

SER. NO. 79-095,768, FILED 11-16-2010.

RICHARD WHITE, EXAMINING ATTORNEY



*David J. Kyffers*

Director of the United States Patent and Trademark Office

# United States of America

## United States Patent and Trademark Office



**Reg. No. 4,123,634**

**Registered Apr. 10, 2012**

**Int. Cl.: 33**

**TRADEMARK**

**PRINCIPAL REGISTER**

LAURENT-PERRIER (FRANCE SOCIÉTÉ ANONYME (SA))  
32 AVENUE DE CHAMPAGNE  
F-51150 TOURS-SUR-MARNE, FRANCE

FOR: CHAMPAGNE AOC WINES BEING WINES WITH PROTECTED APPELLATION OF ORIGIN, IN CLASS 33 (U.S. CLS. 47 AND 49).

OWNER OF U.S. REG. NOS. 2,783,573, 2,797,559, AND 3,114,399.

PRIORITY DATE OF 1-24-2011 IS CLAIMED.

OWNER OF INTERNATIONAL REGISTRATION 1073017 DATED 2-8-2011, EXPIRES 2-8-2021.

THE COLOR(S) GREEN, GOLD, WHITE AND BLACK IS/ARE CLAIMED AS A FEATURE OF THE MARK.

NO CLAIM IS MADE TO THE EXCLUSIVE RIGHT TO USE "CHAMPAGNE", "2002", "MAISON FONDEE", "1812", "MILLESIME", "TOURS-SUR-MARNE", "BY APPOINTMENT TO H.R.M. THE PRINCE OF WALES PURVEYORS OF CHAMPAGNE" AND THE SHAPE OF THE BOTTLE AND THE WRAPPED CORK, APART FROM THE MARK AS SHOWN.

THE NAME(S), PORTRAIT(S), AND/OR SIGNATURE(S) SHOWN IN THE MARK DOES NOT IDENTIFY A PARTICULAR LIVING INDIVIDUAL.



*David J. Kyros*

Director of the United States Patent and Trademark Office

THE MARK CONSISTS OF A THREE DIMENSIONAL CONFIGURATION OF A CHAMPAGNE BOTTLE APPEARING IN GREEN WITH A CORK WRAPPED IN BLACK FOIL, WITH THE LETTERS "LP" AND "2002" IN WHITE APPEARING AGAINST BLACK ON THE NECK OF THE BOTTLE BELOW THE CORK, WITH A WIDE HORIZONTAL BAND IN WHITE, BLACK, AND GOLD BENEATH THE "LP 2002" WHICH HAS A BLACK BAND IN THE CENTER WITH THE WORDS "LAURENT" AND "PERRIER" IN WHITE APPEARING ON THE BAND, WITH GOLD BANDS WITH FANCIFUL DESIGNS IN BLACK ABOVE AND BELOW THE BLACK BAND, WITH WHITE BANDS WITH HORIZONTAL LINES AND FANCIFUL DESIGNS IN BLACK APPEARING ABOVE AND BELOW THE GOLD BANDS, AND WITH A SHIELD DESIGN IN GOLD WITH WORDING AND DESIGNS IN BLACK SUPERIMPOSED OVER THE CENTER OF THE WIDE HORIZONTAL BAND, WITH THE SHIELD DESIGN CONTAINING WITHIN IT A SMALLER SHIELD CONTAINING AN EAGLE DESIGN WITH

**Reg. No. 4,123,634** RECTANGULAR FIGURES BELOW THE WINGS ON EITHER SIDE, AND AT THE BOTTOM OF THE SHIELD DESIGN THE LATIN WORDS "DE TURII SUPER MATRONAM QUO NON ASCENDAM" APPEARING ON A ROUGHLY U-SHAPED BAND EXTENDING UP TO THE MIDDLE OF THE SMALLER SHIELD ON EITHER SIDE TO ELABORATE SCROLLWORK DESIGNS CONSISTING OF CURVING LINES AND CIRCULAR FIGURES APPEARING TO THE LEFT AND RIGHT AND ABOVE THE SMALLER SHIELD, AND WITH A BLACK LABEL APPEARING NEAR THE BOTTOM OF THE BOTTLE, CONTAINING THE WORDING "LAURENT-PERRIER" IN WHITE INSIDE A GOLD SCROLLWORK DESIGN WHICH IS GENERALLY OVAL WITH CURVING INTERSECTING LINES, WITH THE WORD "CHAMPAGNE" IN WHITE ABOVE THE DESIGN AND WITH A PLANT DESIGN IN WHITE APPEARING ABOVE THE WORDS IN WHITE "BY APPOINTMENT TO H.R.M. THE PRINCE OF WALES PURVEYORS OF CHAMPAGNE CHAMPAGNE LAURENT-PERRIER" IN THE UPPER RIGHT CORNER OF THE BLACK LABEL, WITH THE WORDS "MAISON FONDEE" APPEARING BELOW THE GOLD SCROLL DESIGN AND ABOVE "1812" IN WHITE, AND WITH THE WORD "MILLESIME" IN WHITE ON THE BOTTOM LEFT OF THE LABEL AND THE WORD "TOURS-SUR-MARNE" IN WHITE APPEARING ON THE BOTTOM RIGHT OF THE LABEL. THE BROKEN LINES DEPICT THE PLACEMENT OF THE MARK BENEATH THE CORK AND ON THE BOTTLE AND ARE NOT PART OF THE MARK. THE OVERALL CONFIGURATION OF THE BOTTLE, THE WRAPPED CORK, AND THE FOIL ARE NOT CLAIMED AS FEATURES OF THE MARK.

THE ENGLISH TRANSLATION OF "MAISON FONDEE" AND "MILLESIME" IN THE MARK IS "HOUSE FOUNDED" AND "VINTAGE".

SER. NO. 79-095,775, FILED 2-8-2011.

ELLEN B. AWRICH, EXAMINING ATTORNEY

# United States of America

United States Patent and Trademark Office

## SDL AutoSuggest

**Reg. No. 4,123,635**

**Registered Apr. 10, 2012**

**Int. Cls.: 9, 35, 41 and 42**

**TRADEMARK**

**SERVICE MARK**

**PRINCIPAL REGISTER**

SDL PLC (UNITED KINGDOM PUBLIC LIMITED COMPANY)  
GLOBE HOUSE, CLIVEMONT ROAD  
MAIDENHEAD, BERKSHIRE SL6 7DY  
UNITED KINGDOM

FOR: COMPUTER SOFTWARE PROVIDING WEBSITE AUTHORING, COLLABORATION, AND ADMINISTRATION TOOLS OF WEB CONTENT; COMPUTER SOFTWARE AND COMPUTER PROGRAMS FOR REVISING AND UPDATING INTERNET WEB SITES AND INTRANETS; COMPUTER SOFTWARE FOR LANGUAGE TRANSLATION; COMPUTER PROGRAMS AND COMPUTER SOFTWARE FOR CREATING, SEARCHING OF, AND EXTRACTION FROM TRANSLATION MEMORY DATABASES AND EXISTING TRANSLATIONS; COMPUTER PROGRAMS AND COMPUTER SOFTWARE ENABLING CREATION, STORING AND SHARING OF AND ADHERENCE TO BRANDING, LINGUISTIC AND STYLE GUIDELINES; COMPUTER PROGRAMS AND COMPUTER SOFTWARE FOR BRAND MANAGEMENT, FOR MARKETING AND FOR PROMOTION; COMPUTER PROGRAMS AND COMPUTER SOFTWARE TO GATHER INFORMATION ABOUT USER PREFERENCES, INTERESTS AND CHARACTERISTICS; COMPUTER PROGRAMS AND COMPUTER SOFTWARE FOR USER FEEDBACK; SOFTWARE DEVELOPMENT KITS AND SOFTWARE APPLICATION PROGRAMMER INTERFACES FOR THE AFORESAID; ELECTRONIC PUBLICATIONS, NAMELY, MANUALS FOR COMPUTER SOFTWARE; DOWNLOADABLE DATABASES IN THE FIELD OF LANGUAGE TRANSLATION, IN CLASS 9 (U.S. CLS. 21, 23, 26, 36 AND 38).

FOR: COMPILATION OF INFORMATION INTO COMPUTER DATABASES IN THE FIELD OF LANGUAGE TRANSLATION; COMPILATION AND SYSTEMIZATION OF CONTENT, INFORMATION AND DATA INTO COMPUTER DATABASES FOR USE IN AUTHORING AND EDITING DOCUMENTS; ADVISORY, CONSULTANCY AND INFORMATION SERVICES RELATED TO THE AFORESAID, IN CLASS 35 (U.S. CLS. 100, 101 AND 102).

FOR: AUTHORING, EDITING, AND PUBLISHING COMPUTER DATABASES FOR USE IN LANGUAGE TRANSLATION; TRAINING ON THE USE OF COMPUTER SOFTWARE AND IN THE FIELD OF LANGUAGE TRANSLATION; PLANNING, ARRANGING AND CONDUCTING OF SEMINARS IN THE FIELD OF LANGUAGE TRANSLATION; PRODUCTION OF COURSE MATERIALS, NAMELY, DEVELOPMENT AND DISSEMINATION OF EDUCATIONAL MATERIALS ON THE USE OF COMPUTER SOFTWARE AND IN THE FIELD OF LANGUAGE TRANSLATION; ADVISORY, CONSULTANCY AND INFORMATION SERVICES RELATED TO THE AFORESAID, IN CLASS 41 (U.S. CLS. 100, 101 AND 107).



*David J. Kyros*

Director of the United States Patent and Trademark Office

**Reg. No. 4,123,635** FOR: DATA CONVERSION OF ELECTRONIC DATA IN THE FORM OF DATABASES, DOCUMENTS, PHRASES, TEXT, AND WORDS; CREATION OF COMPUTER DATABASES FOR USE IN LANGUAGE TRANSLATION, AND IN AUTHORIZING AND EDITING DOCUMENTS; HOSTING OF COMPUTER SOFTWARE PROVIDING WEBSITE AUTHORIZING, COLLABORATION, AND ADMINISTRATION TOOLS OF WEB CONTENT; HOSTING OF COMPUTER SOFTWARE AND COMPUTER PROGRAMS FOR REVISING AND UPDATING INTERNET WEB SITES AND INTRANETS; HOSTING OF COMPUTER SOFTWARE FOR LANGUAGE TRANSLATION; HOSTING OF COMPUTER PROGRAMS AND COMPUTER SOFTWARE FOR CREATING, SEARCHING OF, EXTRACTION FROM AND SECURITY FOR TRANSLATION MEMORY DATABASES AND EXISTING TRANSLATIONS; HOSTING OF COMPUTER PROGRAMS AND COMPUTER SOFTWARE ENABLING CREATION, STORING AND SHARING OF AND ADHERENCE TO BRANDING, LINGUISTIC AND STYLE GUIDELINES; HOSTING OF COMPUTER PROGRAMS AND COMPUTER SOFTWARE FOR BRAND MANAGEMENT, FOR MARKETING AND FOR PROMOTION; HOSTING OF COMPUTER PROGRAMS AND COMPUTER SOFTWARE TO GATHER INFORMATION ABOUT USER PREFERENCES, INTERESTS AND CHARACTERISTICS; HOSTING OF COMPUTER PROGRAMS AND COMPUTER SOFTWARE FOR USER FEEDBACK; HOSTING OF WEBSITES PROVIDING ACCESS TO DATABASES IN THE FIELD OF LANGUAGE TRANSLATION; ADVISORY, CONSULTANCY AND INFORMATION SERVICES RELATED TO THE AFORESAID, IN CLASS 42 (U.S. CLS. 100 AND 101).

THE MARK CONSISTS OF STANDARD CHARACTERS WITHOUT CLAIM TO ANY PARTICULAR FONT, STYLE, SIZE, OR COLOR.

PRIORITY DATE OF 6-14-2010 IS CLAIMED.

OWNER OF INTERNATIONAL REGISTRATION 1073119 DATED 6-30-2010, EXPIRES 6-30-2020.

NO CLAIM IS MADE TO THE EXCLUSIVE RIGHT TO USE "AUTOSUGGEST" , APART FROM THE MARK AS SHOWN.

SER. NO. 79-095,810, FILED 6-30-2010.

MARK SHINER, EXAMINING ATTORNEY

# United States of America

United States Patent and Trademark Office

# S G R I P

**Reg. No. 4,123,636**

AMADA CO., LTD. (JAPAN CORPORATION)  
200, ISHIDA

**Registered Apr. 10, 2012**

ISEHARA-SHI; KANAGAWA 259-1196, JAPAN

**Int. Cl.: 7**

FOR: TOOL HOLDERS FOR METAL WORKING MACHINES; BENDING MACHINES; METAL WORKING MACHINES, NAMELY, PRESS BRAKES; HYDRAULIC PRESSES FOR SHEET METAL; ELECTRIC PRESSES FOR SHEET METAL; MECHANICAL PRESSES FOR SHEET METAL; METALWORKING MACHINE TOOLS; INDUSTRIAL ROBOTS FOR METAL WORKING MACHINES, IN CLASS 7 (U.S. CLS. 13, 19, 21, 23, 31, 34 AND 35).

**TRADEMARK**

**PRINCIPAL REGISTER**

THE MARK CONSISTS OF STANDARD CHARACTERS WITHOUT CLAIM TO ANY PARTICULAR FONT, STYLE, SIZE, OR COLOR.

PRIORITY DATE OF 10-21-2010 IS CLAIMED.

OWNER OF INTERNATIONAL REGISTRATION 1073198 DATED 3-7-2011, EXPIRES 3-7-2021.

SER. NO. 79-095,837, FILED 3-7-2011.

TASNEEM HUSSAIN, EXAMINING ATTORNEY



*David J. Kyfos*

Director of the United States Patent and Trademark Office

# United States of America

United States Patent and Trademark Office

# BIOTAGE ZIP

**Reg. No. 4,123,637**

**Registered Apr. 10, 2012**

**Int. Cl.: 9**

**TRADEMARK**

**PRINCIPAL REGISTER**

BIOTAGE AB (SWEDEN JOINT STOCK COMPANY)  
KUNGSGATAN 76  
SE-753 18 UPPSALA  
SWEDEN

FOR: LABORATORY APPARATUS, NAMELY, FLASH PURIFICATION CARTRIDGES FOR PURIFICATION OF ORGANIC AND NON-ORGANIC COMPOUNDS IN LABORATORY SCALE PURIFICATIONS AND USE WITH MANUAL, SEMI-AUTOMATED AND FULLY AUTOMATED FLASH PURIFICATION INSTRUMENTS; AND CHROMATOGRAPHY COLUMNS, IN CLASS 9 (U.S. CLS. 21, 23, 26, 36 AND 38).

THE MARK CONSISTS OF STANDARD CHARACTERS WITHOUT CLAIM TO ANY PARTICULAR FONT, STYLE, SIZE, OR COLOR.

PRIORITY DATE OF 2-11-2011 IS CLAIMED.

OWNER OF INTERNATIONAL REGISTRATION 1073243 DATED 2-23-2011, EXPIRES 2-23-2021.

OWNER OF U.S. REG. NOS. 2,642,941 AND 3,775,113.

SER. NO. 79-095,850, FILED 2-23-2011.

DAVID HOFFMAN, EXAMINING ATTORNEY



*David J. Kyffers*

Director of the United States Patent and Trademark Office



# United States of America

United States Patent and Trademark Office

# MGRIP

**Reg. No. 4,123,638**

AMADA CO., LTD. (JAPAN CORPORATION)  
200, ISHIDA

**Registered Apr. 10, 2012**

ISEHARA-SHI; KANAGAWA 259-1196, JAPAN

**Int. Cl.: 7**

FOR: TOOL HOLDERS FOR METAL WORKING MACHINES; BENDING MACHINES; METAL WORKING MACHINES, NAMELY, PRESS BRAKES; HYDRAULIC PRESSES FOR SHEET METAL; ELECTRIC PRESSES FOR SHEET METAL; MECHANICAL PRESSES FOR SHEET METAL; METALWORKING MACHINE TOOLS; INDUSTRIAL ROBOTS FOR METAL WORKING MACHINES, IN CLASS 7 (U.S. CLS. 13, 19, 21, 23, 31, 34 AND 35).

**TRADEMARK**

**PRINCIPAL REGISTER**

THE MARK CONSISTS OF STANDARD CHARACTERS WITHOUT CLAIM TO ANY PARTICULAR FONT, STYLE, SIZE, OR COLOR.

PRIORITY DATE OF 10-21-2010 IS CLAIMED.

OWNER OF INTERNATIONAL REGISTRATION 1073344 DATED 3-7-2011, EXPIRES 3-7-2021.

SER. NO. 79-095,883, FILED 3-7-2011.

TASNEEM HUSSAIN, EXAMINING ATTORNEY



*David J. Kyfos*

Director of the United States Patent and Trademark Office

United States of America  
United States Patent and Trademark Office

**GIGAMAX**

**Reg. No. 4,123,639**

**Registered Apr. 10, 2012**

**Int. Cls.: 1, 7 and 42**

**TRADEMARK**

**SERVICE MARK**

**PRINCIPAL REGISTER**

SÜD-CHEMIE AG (FED REP GERMANY AG)  
LENBACHPLATZ 6  
80333 MÜNCHEN  
FED REP GERMANY

FOR: CHEMICALS IN THE NATURE OF ADSORBENTS, CATALYST CARRIERS AND CATALYSTS FOR USE IN INDUSTRY , IN CLASS 1 (U.S. CLS. 1, 5, 6, 10, 26 AND 46).

FOR: CATALYTIC CONVERTERS, IN CLASS 7 (U.S. CLS. 13, 19, 21, 23, 31, 34 AND 35).

FOR: SCIENTIFIC AND TECHNOLOGICAL SERVICES, NAMELY, RESEARCH IN THE FIELD CATALYSTS, CATALYST CARRIERS AND ADSORBENTS; INDUSTRIAL ANALYSIS AND RESEARCH IN THE FIELD OF CATALYSTS, CATALYST CARRIERS AND ADSORBENTS, IN CLASS 42 (U.S. CLS. 100 AND 101).

THE MARK CONSISTS OF STANDARD CHARACTERS WITHOUT CLAIM TO ANY PARTICULAR FONT, STYLE, SIZE, OR COLOR.

PRIORITY DATE OF 9-20-2010 IS CLAIMED.

OWNER OF INTERNATIONAL REGISTRATION 1073364 DATED 3-16-2011, EXPIRES 3-16-2021.

SER. NO. 79-095,892, FILED 3-16-2011.

DEZMONA MIZELLE, EXAMINING ATTORNEY



*David J. Kypos*

Director of the United States Patent and Trademark Office

# United States of America

United States Patent and Trademark Office

# UNS-SEAL

**Reg. No. 4,123,640**

**Registered Apr. 10, 2012**

**Int. Cl.: 17**

**TRADEMARK**

**PRINCIPAL REGISTER**

NETZSCH-MOHNOPUMPEN GMBH (FED REP GERMANY LIMITED LIABILITY COMPANY)  
GEBRÜDER-NETZSCH-STRASSE 19  
95100 SELB  
FED REP GERMANY

FOR: NON-METAL SEALS FOR USE WITH PUMPS FOR CONVEYING LOW TO HIGH VISCOSITY MATERIAL FOR USE IN THE MECHANICAL ENGINEERING, CHEMICAL, COSMETIC, PHARMACEUTICAL AND FOOD INDUSTRIES, IN CLASS 17 (U.S. CLS. 1, 5, 12, 13, 35 AND 50).

THE MARK CONSISTS OF STANDARD CHARACTERS WITHOUT CLAIM TO ANY PARTICULAR FONT, STYLE, SIZE, OR COLOR.

PRIORITY DATE OF 4-8-2010 IS CLAIMED.

OWNER OF INTERNATIONAL REGISTRATION 1073404 DATED 10-8-2010, EXPIRES 10-8-2020.

SER. NO. 79-095,905, FILED 10-8-2010.

REBECCA SMITH, EXAMINING ATTORNEY



*David J. Kyffers*

Director of the United States Patent and Trademark Office

# United States of America

United States Patent and Trademark Office

# SUZENJOU

**Reg. No. 4,123,641**

**Registered Apr. 10, 2012**

**Int. Cls.: 9, 16 and 28**

**TRADEMARK**

**PRINCIPAL REGISTER**

TROMP XAVIER (FRANCE INDIVIDUAL)  
25 RUE DES TILLEULS  
F-67380 LINGOLSHEIM  
FRANCE

FOR: DOWNLOADABLE ELECTRONIC PUBLICATIONS, NAMELY, NEWSLETTERS, BROCHURES, BOOKLETS, LEAFLETS, FLYERS, JOURNALS, BOOKS, MAGAZINES, AND NEWSPAPERS IN THE FIELD OF LOGIC GAMES AND PUZZLES USING NUMBERS, IN CLASS 9 (U.S. CLS. 21, 23, 26, 36 AND 38).

FOR: PRINT MATERIALS AND PRINTED PUBLICATIONS, NAMELY, NEWSLETTERS, BROCHURES, BOOKLETS, LEAFLETS, FLYERS, JOURNALS, BOOKS, MAGAZINES, AND NEWSPAPERS FEATURING LOGIC GAMES AND PUZZLES USING NUMBERS, IN CLASS 16 (U.S. CLS. 2, 5, 22, 23, 29, 37, 38 AND 50).

FOR: LOGIC BOARD GAMES AND PUZZLES USING NUMBERS, IN CLASS 28 (U.S. CLS. 22, 23, 38 AND 50).

THE MARK CONSISTS OF STANDARD CHARACTERS WITHOUT CLAIM TO ANY PARTICULAR FONT, STYLE, SIZE, OR COLOR.

OWNER OF INTERNATIONAL REGISTRATION 1073436 DATED 3-10-2011, EXPIRES 3-10-2021.

THE WORDING "SUZENJOU" HAS NO MEANING IN A FOREIGN LANGUAGE.

SER. NO. 79-095,911, FILED 3-10-2011.

ANNE FARRELL, EXAMINING ATTORNEY



*David J. Kybas*

Director of the United States Patent and Trademark Office

# United States of America

United States Patent and Trademark Office

# BIM

**Reg. No. 4,123,642**

**Registered Apr. 10, 2012**

**Int. Cl.: 35**

**SERVICE MARK**

**PRINCIPAL REGISTER**

BIM BIRLESIK MAGAZALAR ANONIM SIRKETI (TURKEY JOINT STOCK COMPANY)  
ABDURRAHMAN GAZI MAHALLESI  
EBUBEKIR CADDESI 289; SAMANDIRA, ISTANBUL  
TURKEY

FOR: ADVERTISEMENT AGENCY SERVICES; ADVERTISEMENT AGENCIES; ADVERTISEMENT AND COMMERCIAL ANNOUNCEMENT SERVICES VIA TELEVISION, RADIO, AND MAIL; PREPARATION OF ADVERTISEMENT COLUMNS, DISTRIBUTION OF ADVERTISEMENT MATERIALS, ORGANIZATION OF EXHIBITIONS AND FAIRS FOR COMMERCIAL AND ADVERTISEMENT PURPOSES, MODELING FOR ADVERTISEMENT AND SALE PURPOSES, MARKETING STUDIES SERVICES, INFORMATION SERVICES RELATED TO MARKETING, PROMOTION SERVICES IN THE NATURE OF SALE INCREASE, SHOP WINDOW DECORATION AND ARRANGEMENT, PUBLIC OPINION POLLING SERVICES, PUBLIC RELATIONS; THE BRINGING TOGETHER FOR THE BENEFIT OF OTHERS OF A VARIETY OF GOODS, EXCLUDING THE TRANSPORT, ENABLING CUSTOMERS TO CONVENIENTLY VIEW AND PURCHASE THOSE GOODS IN THE FIELD OF HYGIENIC AND BEAUTY PRODUCTS, TOILETRIES, PERSONAL CARE PRODUCTS, CLEANING AND LAUNDRY PRODUCTS, MACHINES FOR HOUSEHOLD USE, HAND TOOLS, OPTICAL GOODS, CAMERAS MULTIMEDIA, COMPUTER, AUDIO VISUAL, TELEPHONY, MUSICAL AND PHOTOGRAPHIC PRODUCTS, PRINTED MATTER, STATIONERY, BOOKS, GOODS FOR ARTISTIC AND CULTURAL PURSUITS, GAMES AND PLAYTHINGS, DOMESTIC ELECTRICAL AND ELECTRONIC EQUIPMENT, INCLUDING WHITE GOODS, JEWELRY, CLOCKS, WATCHES, PUBLICATIONS, LEATHER GOODS, LUGGAGE, FURNITURE, HOUSEHOLD CONTAINERS AND UTENSILS, FURNISHINGS, TEXTILES, CLOTHING, FOOTWEAR, HEADWEAR, HABERDASHERY, TOYS AND GAMES, SPORTS EQUIPMENT, FOODSTUFFS AND BEVERAGES, DRINKS AND TOBACCO PRODUCTS, GOODS FOR THE GARDEN, GARDENING TOOLS AND ARTICLES, ARTICLES FOR SPORTS AND OUTDOOR ACTIVITIES, LIGHTING ARTICLES, HOUSEHOLD OR KITCHEN UTENSILS, STORAGE ARTICLES, HOUSEHOLD GOODS, CONTAINERS, LINEN, METAL HARDWARE, DIY ARTICLES, TOOLS, GOODS FOR CARS AND BICYCLES, ARTICLES FOR BABY CARE, PARAPHARMACY ARTICLES, GOODS FOR ANIMALS, SOAPS, PERFUMERY, ESSENTIAL OILS, COSMETICS, HAIR LOTIONS, DENTIFRICES, CANDLES AND WICKS FOR LIGHTING, SANITARY PREPARATIONS FOR MEDICAL PURPOSES, PERSONAL CARE PRODUCTS, DIETETIC SUBSTANCES ADAPTED FOR MEDICAL USE, FOOD FOR BABIES, PLASTERS, MATERIALS FOR DRESSINGS, MATERIAL FOR STOPPING TEETH, DENTAL WAX, DISINFECTANTS, HAND TOOLS AND HAND OPERATED IMPLEMENTS, RAZORS, CALCULATING MACHINES, DATA PROCESSING

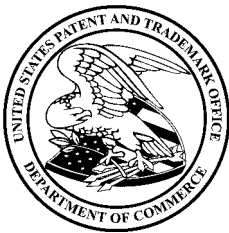

*David J. Kybas*

Director of the United States Patent and Trademark Office

**Reg. No. 4,123,642** EQUIPMENT, AND COMPUTERS, PLASTIC MATERIALS FOR PACKAGING, HOUSEHOLD FOR KITCHEN UTENSILS AND CONTAINERS, COMBS AND SPONGES, BRUSHES, ARTICLES FOR CLEANING PURPOSES, GLASSWARE, PORCELAIN AND EARTHENWARE, STRINGS, YARNS AND THREADS FOR TEXTILE USE, TEXTILES AND TEXTILE GOODS, BED AND TABLE COVERS, ARTIFICIAL FLOWERS, CARPETS, RUGS, MATS AND MATTING, LINOLEUM AND OTHER MATERIALS FOR COVERING EXISTING FLOORS, WALL HANGINGS, GYMNASTICS AND SPORTING ARTICLES, FOODSTUFFS, ICE, AGRICULTURAL, HORTICULTURAL, AND FORESTRY PRODUCTS AND GRAINS, SEEDS, NATURAL PLANTS AND FLOWERS, MINERAL AND AERATED WATERS AND OTHER NON-ALCOHOLIC DRINKS, FRUIT DRINKS AND FRUIT JUICES SYRUPS AND OTHER PREPARATIONS FOR MAKING BEVERAGES, IN CLASS 35 (U.S. CLS. 100, 101 AND 102).

THE MARK CONSISTS OF THE LETTERS "BIM" ON A ROUNDED RECTANGULAR BACKGROUND INTERRUPTED BY A TRIANGLE REPRESENTING THE DOT ON THE LETTER "I".

OWNER OF INTERNATIONAL REGISTRATION 0938106 DATED 6-7-2007, EXPIRES 6-7-2017.

SER. NO. 79-095,939, FILED 2-21-2011.

HEATHER BIDDULPH, EXAMINING ATTORNEY

# United States of America

United States Patent and Trademark Office

# FiberForm

**Reg. No. 4,123,643**

**Registered Apr. 10, 2012**

**Int. Cls.: 7 and 9**

**TRADEMARK**

**PRINCIPAL REGISTER**

KRAUSSMAFFEI TECHNOLOGIES GMBH (FED REP GERMANY GMBH)  
KRAUSS-MAFFEI STR. 2  
80997 MÜNCHEN  
FED REP GERMANY

FOR: PLASTIC PROCESSING MACHINES AND PARTS THEREFOR, AND DOWNSTREAM UNITS, NAMELY, INJECTION MOULDING MACHINES, EXTRUSION MACHINE INSTALLATIONS FOR PLASTIC, EXTRUDERS IN THE NATURE OF EXTRUSION MOULDING MACHINES AND REACTION CASTING MACHINES; TOOLS AND FORMING DEVICES FOR PLASTIC PROCESSING MACHINES, NAMELY, FEED DEVICES IN THE NATURE OF CONVEYORS, MIXING AND DOSING MACHINES FOR PLASTIC PROCESSING MACHINES, MIXING HEADS, IN CLASS 7 (U.S. CLS. 13, 19, 21, 23, 31, 34 AND 35).

FOR: ELECTRIC AND ELECTRONIC CONTROL INSTALLATIONS FOR PLASTIC PROCESSING MACHINES, NAMELY, INJECTION MOULDING MACHINES, EXTRUSION INSTALLATIONS, EXTRUDERS AND REACTION CASTING MACHINES; COMPUTER OPERATING PROGRAMS FOR CONTROLLING PLASTIC PROCESSING MACHINES, IN CLASS 9 (U.S. CLS. 21, 23, 26, 36 AND 38).

THE MARK CONSISTS OF STANDARD CHARACTERS WITHOUT CLAIM TO ANY PARTICULAR FONT, STYLE, SIZE, OR COLOR.

PRIORITY DATE OF 9-21-2010 IS CLAIMED.

OWNER OF INTERNATIONAL REGISTRATION 1073461 DATED 3-1-2011, EXPIRES 3-1-2021.

SER. NO. 79-095,954, FILED 3-1-2011.

CARYN GLASSER, EXAMINING ATTORNEY



*David J. Kyfos*

Director of the United States Patent and Trademark Office

# United States of America

United States Patent and Trademark Office

# CENS

**Reg. No. 4,123,644**

**Registered Apr. 10, 2012**

**Int. Cls.: 10 and 25**

**TRADEMARK**

**PRINCIPAL REGISTER**

PURETONE LTD. (UNITED KINGDOM LIMITED COMPANY (LTD.))  
9-10 HENLEY BUSINESS PARK  
TRIDENT CLOSE; MEDWAY CITY ESTATE; ROCHESTER, KENT ME2 4FR  
UNITED KINGDOM

FOR: HEARING, ELECTRONIC NOISE, AND EAR PROTECTORS, NAMELY, EAR PLUGS FOR MEDICAL PURPOSES; ACCESSORIES FOR NOISE SUPPRESSORS, NAMELY, EAR MOULDS FOR MEDICAL PURPOSES, IN CLASS 10 (U.S. CLS. 26, 39 AND 44).

FOR: CLOTHING, NAMELY, HAND WARMERS; FOOTWEAR; HEADGEAR, NAMELY, BASEBALL CAPS, EAR WARMERS; PEAK CAPS, IN CLASS 25 (U.S. CLS. 22 AND 39).

THE MARK CONSISTS OF STANDARD CHARACTERS WITHOUT CLAIM TO ANY PARTICULAR FONT, STYLE, SIZE, OR COLOR.

PRIORITY DATE OF 8-11-2010 IS CLAIMED.

OWNER OF INTERNATIONAL REGISTRATION 1073473 DATED 2-10-2011, EXPIRES 2-10-2021.

SER. NO. 79-095,961, FILED 2-10-2011.

KRISTIN CARLSON, EXAMINING ATTORNEY



*David J. Kybas*

Director of the United States Patent and Trademark Office



# United States of America

United States Patent and Trademark Office

## IT'S VERY, VERY RICH

**Reg. No. 4,123,645**

**Registered Apr. 10, 2012**

**Int. Cls.: 3 and 35**

**TRADEMARK**

**SERVICE MARK**

**PRINCIPAL REGISTER**

LANOLIPS PTY LTD (AUSTRALIA PROPRIETARY LIMITED COMPANY (P/L OR PTY. LTD.))

15B  
5-13 ROSEBERY AVENUE  
ROSEBERY; NSW 2018, AUSTRALIA

FOR: COSMETICS FOR LIPS INCLUDING LIP BALMS, LIP CREAMS, LIP TREATMENTS, LIP PREPARATIONS, LIPSTICKS, LIP-GLOSS; HAND, FACE AND BODY LOTION AND MOISTURISER; BEAUTY CREAMS; COSMETIC CREAMS; BODY OIL; COSMETICS FOR TREATMENT OF DRY SKIN; COSMETIC SKIN MOISTURISERS; FACIAL CLEANSERS; HAND AND BODY CLEANSERS; SOAP; OINTMENT FOR COSMETIC USE, IN CLASS 3 (U.S. CLS. 1, 4, 6, 50, 51 AND 52).

FOR: WHOLESALE STORES FEATURING COSMETICS, SKINCARE, LIP CARE AND CLEANSERS; RETAIL STORE SERVICES FEATURING COSMETICS, SKINCARE, LIP CARE AND CLEANSERS; DISTRIBUTORSHIP SERVICES IN THE FIELD OF COSMETICS, SKINCARE, LIP CARE AND CLEANSERS; DISTRIBUTION OF COSMETIC, SKINCARE AND CLEANSING SAMPLES FOR ADVERTISING PURPOSES; MARKETING, PROMOTIONAL AND ADVERTISING SERVICES; INCLUDING ALL THE AFORESAID SERVICES PROVIDED ONLINE VIA THE INTERNET, IN CLASS 35 (U.S. CLS. 100, 101 AND 102).

THE MARK CONSISTS OF STANDARD CHARACTERS WITHOUT CLAIM TO ANY PARTICULAR FONT, STYLE, SIZE, OR COLOR.

PRIORITY DATE OF 8-19-2010 IS CLAIMED.

OWNER OF INTERNATIONAL REGISTRATION 1073575 DATED 2-18-2011, EXPIRES 2-18-2021.

SER. NO. 79-096,006, FILED 2-18-2011.

KRISTIN CARLSON, EXAMINING ATTORNEY



*David J. Kyffers*

Director of the United States Patent and Trademark Office

# United States of America

United States Patent and Trademark Office

## QANTAS WALKABOUT PASS

**Reg. No. 4,123,646**

**Registered Apr. 10, 2012**

**Int. Cl.: 39**

QANTAS AIRWAYS LIMITED (AUSTRALIA AUSTRALIAN PUBLIC COMPANY, LIMITED BY SHARES)  
LEVEL 9 QANTAS CENTRE  
203 COWARD STREET; MASCOT NSW 2020  
AUSTRALIA

**SERVICE MARK**

**PRINCIPAL REGISTER**

FOR: TRANSPORT OF TRAVELLERS AND GOODS; AIR TRANSPORT; PASSENGER TRANSPORT; TRANSPORTATION RESERVATION AND TRAVEL TICKET RESERVATION SERVICES; AIRLINE TRANSPORTATION SERVICES; TRAVEL AGENCY SERVICES, NAMELY, MAKING RESERVATIONS AND BOOKINGS FOR TRANSPORTATION AND ON-LINE TRANSPORTATION RESERVATION AND TRAVEL TICKET RESERVATION SERVICES, IN CLASS 39 (U.S. CLS. 100 AND 105).

THE MARK CONSISTS OF STANDARD CHARACTERS WITHOUT CLAIM TO ANY PARTICULAR FONT, STYLE, SIZE, OR COLOR.

PRIORITY DATE OF 12-22-2010 IS CLAIMED.

OWNER OF INTERNATIONAL REGISTRATION 1073594 DATED 3-7-2011, EXPIRES 3-7-2021.

OWNER OF U.S. REG. NOS. 1,178,528, 3,164,813, AND 3,749,968.

NO CLAIM IS MADE TO THE EXCLUSIVE RIGHT TO USE "PASS", APART FROM THE MARK AS SHOWN.

SER. NO. 79-096,016, FILED 3-7-2011.

TASNEEM HUSSAIN, EXAMINING ATTORNEY



*David J. Kyffers*

Director of the United States Patent and Trademark Office

# United States of America

United States Patent and Trademark Office

BLU CONNECTION  
people. passion. projects.



**Reg. No. 4,123,647**

**Registered Apr. 10, 2012**

**Int. Cls.: 1, 2 and 42**

BLU CONNECTION PTE. LTD. (SINGAPORE PRIVATE COMPANY LIMITED BY SHARES (PTE. LTD.))  
2 JIAK CHUAN ROAD  
SINGAPORE 089260  
SINGAPORE

**TRADEMARK**

FOR: INDUSTRIAL CHEMICALS AND INDUSTRIAL ORGANIC BLEACHING CHEMICALS, IN CLASS 1 (U.S. CLS. 1, 5, 6, 10, 26 AND 46).

**SERVICE MARK**

FOR: COLORANTS; PIGMENTS; DYES FOR TEXTILES, IN CLASS 2 (U.S. CLS. 6, 11 AND 16).

**PRINCIPAL REGISTER**

FOR: SCIENTIFIC AND TECHNOLOGICAL SERVICES, NAMELY, TECHNOLOGICAL CONSULTANCY, SCIENTIFIC RESEARCH, ANALYSIS, AND TESTING IN THE FIELD OF COLORATION, IN CLASS 42 (U.S. CLS. 100 AND 101).

THE MARK CONSISTS OF THE WORDING "BLU CONNECTION" ABOVE THE WORDING "PEOPLE.PASSION.PROJECTS", ALL TO THE LEFT OF THE LETTERS BC, DISPLAYED SUCH THAT THE LETTERS "BLU" IN "BLU CONNECTION" AND "B" IN BC APPEAR IN THE COLOR BLUE, THE REMAINING WORDING APPEARS IN THE COLOR GRAY AND THE LETTERS "C" IN THE TERM "CONNECTION" AND "BC" ARE COMPRISED IN PART OF AN ARROW DESIGN.

PRIORITY DATE OF 9-2-2010 IS CLAIMED.

OWNER OF INTERNATIONAL REGISTRATION 1073650 DATED 2-28-2011, EXPIRES 2-28-2021.

THE COLOR(S) LIGHT BLUE, DARK BLUE, AND GREY IS/ARE CLAIMED AS A FEATURE OF THE MARK.

LIGHT BLUE ARE THE LETTERS "BLU" AND MOST PART OF THE STYLIZED "B", GREY ARE THE LETTERS "CONNECTION", "PEOPLE, PASSION, PROJECTS" AND MOST PART OF THE STYLIZED "C". DARK BLUE IS THE PART WHERE THE STYLIZED LETTERS "B" AND "C" OVERLAP.



*David J. Kyjars*

Director of the United States Patent and Trademark Office

SER. NO. 79-096,035, FILED 2-28-2011.

**Reg. No. 4,123,647** GENE MACIOL, EXAMINING ATTORNEY

# United States of America

United States Patent and Trademark Office

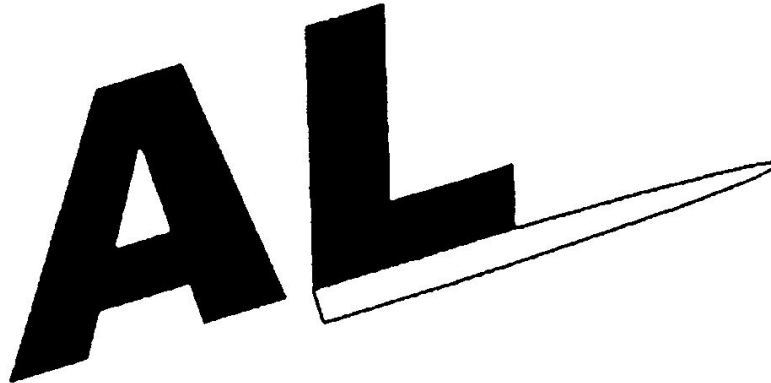

**Reg. No. 4,123,648**

**Registered Apr. 10, 2012**

**Int. Cl.: 9**

VL. MARKO BORO AK, A - ELEKTRONIK, OBRT ZA TRGOVINU I USLUGE (CROATIA  
INDIVIDUAL)  
HINKA WURTHA 12  
HR-10000 ZAGREB  
CROATIA

**TRADEMARK**

**PRINCIPAL REGISTER**

FOR: LASERS, NOT FOR MEDICAL PURPOSES; DETECTORS, NAMELY, LASER SPEED DETECTORS, LASER RECEIVERS FOR USE WITH SPEED MEASURING DEVICES, LASER RECEIVERS FOR USE IN DETECTORS OF LASER SPEED MEASURING DEVICES, LASER TRANSCIVERS FOR DISABLING A LASER-BASED SPEED MONITOR, LASER PARKING SENSORS; DISTANCE MEASURING APPARATUS; LASER SPEED MEASURING APPARATUS, IN CLASS 9 (U.S. CLS. 21, 23, 26, 36 AND 38).

THE MARK CONSISTS OF THE LETTERS "AL" WITH THE DESIGN OF A NEEDLE SHAPED LINE BELOW THE LETTER "L".

OWNER OF INTERNATIONAL REGISTRATION 1073712 DATED 2-23-2011, EXPIRES 2-23-2021.

SER. NO. 79-096,074, FILED 2-23-2011.

DAVID HOFFMAN, EXAMINING ATTORNEY



*David J. Kyffers*

Director of the United States Patent and Trademark Office

# United States of America

United States Patent and Trademark Office



**Reg. No. 4,123,649**

**Registered Apr. 10, 2012**

**Int. Cl.: 17**

**TRADEMARK**

**PRINCIPAL REGISTER**

KEEPER CO., LTD. (JAPAN CORPORATION)  
4-36, TSUJIDO-KANDAI 2-CHOME  
FUJISAWA KANAGAWA 251-8515  
JAPAN

FOR: GASKETS OF PLASTIC OR RUBBER FOR USE IN VEHICLES, RAILWAY CARS AND INDUSTRIAL MACHINES; JOINT PACKINGS, NOT OF METAL, FOR PIPES FOR FLUIDS; WATERPROOF PACKINGS FOR VEHICLES, RAILWAY CARS AND INDUSTRIAL MACHINES; SEALS OF PLASTIC OR RUBBER FOR USE IN VEHICLES, RAILWAY CARS AND INDUSTRIAL MACHINES; OIL SEALS OF PLASTIC OR RUBBER FOR USE IN VEHICLES, RAILWAY CARS AND INDUSTRIAL MACHINES; LIP SEALS OF PLASTIC OR RUBBER FOR USE IN VEHICLES, RAILWAY CARS AND INDUSTRIAL MACHINES; DUST COVERS FOR USE IN VEHICLES, RAILWAY CARS AND INDUSTRIAL MACHINES; O RINGS FOR USE IN KEEPING FLUIDS FROM LEAKING OUT OF JOINTS USED IN VEHICLES, RAILWAY CARS AND INDUSTRIAL MACHINES; RUBBER PACKINGS FOR PISTONS; RUBBER OR PLASTIC BOOT SEALS FOR CONSTANT VELOCITY JOINTS FOR USE IN VEHICLES AND INDUSTRIAL MACHINES; RUBBER OR PLASTIC BOOT SEALS FOR STEERING FOR USE IN VEHICLES; WASHERS OF RUBBER AND CIRCULAR DISC FOR USE AS SEALS; SEALS FOR USE IN CONNECTION WITH TANKS OR ENGINES OF VEHICLES AND INDUSTRIAL MACHINES THAT VENTILATE, ADJUST INSIDE AIR PRESSURE, AND PROTECT AGAINST INGRESS OF DUST, FOR THE PURPOSE OF PROTECTING THE TANKS OR ENGINES FROM DAMAGE; VALVES OF RUBBER, IN CLASS 17 (U.S. CLS. 1, 5, 12, 13, 35 AND 50).



THE MARK CONSISTS OF THE STYLIZED CAPITAL LETTERS "SKM" PRECEDED BY WHAT APPEARS TO BE A MUCH LARGER CAPITAL "C" STYLIZED WITH A WHITE LINE ONE-FOURTH OF AN INCH IN FROM ITS INTERIOR, TIPPED SO THAT THE "SK" ARE PARTIALLY ENCLOSED WITHIN THE OPENING OF "C".

PRIORITY DATE OF 9-21-2010 IS CLAIMED.

OWNER OF INTERNATIONAL REGISTRATION 1073721 DATED 9-22-2010, EXPIRES 9-22-2020.

SER. NO. 79-096,078, FILED 9-22-2010.

JILL C. ALT, EXAMINING ATTORNEY

*David J. Kypos*

Director of the United States Patent and Trademark Office

United States of America  
United States Patent and Trademark Office

OXANTI

**Reg. No. 4,123,650**

**Registered Apr. 10, 2012**

**Int. Cl.: 30**

**TRADEMARK**

**PRINCIPAL REGISTER**

PURATOS NV (BELGIUM NAAMLOZE VENNOOTSCHAP)  
INDUSTRIALAAN 25  
B-1702 GROOT-BIJGAARDEN  
BELGIUM

FOR: COCOA, CHOCOLATE, BREAD, BAKERY AND PASTRY PRODUCTS, IN CLASS 30  
(U.S. CL. 46).

THE MARK CONSISTS OF STANDARD CHARACTERS WITHOUT CLAIM TO ANY PARTICULAR FONT, STYLE, SIZE, OR COLOR.

OWNER OF INTERNATIONAL REGISTRATION 1073791 DATED 3-25-2011, EXPIRES 3-25-2021.

THE WORDING "OXANTI" HAS NO MEANING IN A FOREIGN LANGUAGE.

SER. NO. 79-096,113, FILED 3-25-2011.

LAURA KOVALSKY, EXAMINING ATTORNEY



*David J. Kyffers*

Director of the United States Patent and Trademark Office

United States of America  
United States Patent and Trademark Office

**ALIXIO**

**Reg. No. 4,123,651**

**Registered Apr. 10, 2012**

**Int. Cls.: 35 and 41**

**SERVICE MARK**

**PRINCIPAL REGISTER**

ALIXIO (FRANCE SOCIÉTÉ PAR ACTIONS SIMPLIFIÉE)  
137 RUE DE L'UNIVERSITÉ  
F-75007 PARIS  
FRANCE

FOR: BUSINESS MANAGEMENT ASSISTANCE SERVICES; BUSINESS MANAGEMENT AND ORGANIZATION CONSULTANCY; BUSINESS MANAGEMENT CONSULTANCY; PROFESSIONAL BUSINESS CONSULTANCY; COMMERCIAL OR INDUSTRIAL MANAGEMENT ASSISTANCE; BUSINESS-RELATED RESEARCH AND ADVICE IN THE FIELD OF BUSINESS STRATEGIC PLANNING, ORGANIZATION, BUSINESS MANAGEMENT, BUSINESS DEVELOPMENT ON A REGIONAL BASIS, HUMAN RESOURCES, BUSINESS MANAGEMENT OF INTERNAL AND EXTERNAL BUSINESS COMMUNICATIONS, CHANGE MANAGEMENT, INTERNAL HUMAN RESOURCE-RELATED SOCIAL POLICIES AND RELATIONS, MANAGERIAL OFFICE SUPPORT, RECRUITMENT AND CAREER MANAGEMENT, AND MANAGEMENT CONSULTATION IN THE FIELD OF CRISIS COMMUNICATION; PUBLIC RELATIONS, PUBLIC RELATIONS IN THE NATURE OF PRESS RELATIONS; ADVERTISING AND MARKETING; CONDUCTING PUBLIC OPINION STUDIES AND SURVEYS; EMPLOYMENT AGENCIES, CONSULTANCY IN CONNECTION WITH PERSONNEL ISSUES, PERSONNEL SELECTION USING PSYCHOLOGICAL TESTING, IN CLASS 35 (U.S. CLS. 100, 101 AND 102).

FOR: PROVIDING TRAINING AND VOCATIONAL TRAINING SERVICES IN THE FIELD OF BUSINESS MANAGEMENT, HUMAN RESOURCES, COMMUNICATION AND BUSINESS COMMUNICATION, IN CLASS 41 (U.S. CLS. 100, 101 AND 107).

THE MARK CONSISTS OF STANDARD CHARACTERS WITHOUT CLAIM TO ANY PARTICULAR FONT, STYLE, SIZE, OR COLOR.

PRIORITY DATE OF 9-22-2010 IS CLAIMED.

OWNER OF INTERNATIONAL REGISTRATION 1073794 DATED 3-8-2011, EXPIRES 3-8-2021.

THE WORDING "ALIXIO" HAS NO MEANING IN A FOREIGN LANGUAGE.

SER. NO. 79-096,114, FILED 3-8-2011.



*David J. Kyjars*

Director of the United States Patent and Trademark Office



**Reg. No. 4,123,651** ELISSA GARBER KON, EXAMINING ATTORNEY

# United States of America

United States Patent and Trademark Office

# Fluffy

**Reg. No. 4,123,652**

**Registered Apr. 10, 2012**

**Int. Cls.: 9, 28, 38 and 41**

**TRADEMARK**

**SERVICE MARK**

**PRINCIPAL REGISTER**

GAMEDUELL GMBH (FED REP GERMANY LIMITED LIABILITY COMPANY)  
GREIFSWALDERSTR. 212-213  
10405 BERLIN  
FED REP GERMANY

FOR: COMPUTER PROGRAMS, NAMELY, DOWNLOADABLE COMPUTER AND VIDEO GAME SOFTWARE; COMPUTER PROGRAMS, RECORDED, NAMELY, COMPUTER AND VIDEO GAME SOFTWARE; STORED AND DOWNLOADABLE COMPUTER PROGRAMS, NAMELY, COMPUTER AND VIDEO GAMES; STORED AND DOWNLOADABLE COMPUTER PROGRAMS ESPECIALLY FOR USE WITH COMPUTER, VIDEO AND OTHER ELECTRONIC AND/OR VISUAL GAMES, NAMELY, FOR USE IN PROGRAMMING AND CREATING COMPUTER AND VIDEO GAMES; ELECTRONIC PUBLICATIONS, DOWNLOADABLE, IN THE NATURE OF REPORTS, DIRECTORIES, BROCHURES, REFERENCE MATERIALS, LEAFLETS, NEWSLETTERS, NEWSPAPERS, BOOKLETS, PAMPHLETS, POST CARDS, FLYERS, MAGAZINE SUPPLEMENTS TO NEWSPAPERS, MAGAZINES AND TRADE AND PROFESSIONAL BOOKS IN THE FIELD OF COMPUTER SOFTWARE, ESPECIALLY COMPUTER, VIDEO, ONLINE AND BROWSER GAMES AND OTHER ELECTRONIC AND/OR VISUAL GAMES; COMPUTER AND APPARATUS FOR VIDEO GAMES ADAPTED FOR USE WITH AN EXTERNAL DISPLAY SCREEN OR MONITOR; DATA PROCESSING APPARATUS, NAMELY, DATA PROCESSORS; PRE-RECORDED DATA CARRIERS, NAMELY, PRE-RECORDED ROMS FEATURING WITH COMPUTER AND VIDEO GAME SOFTWARE; PRE-RECORDED COMPACT DISCS, NAMELY, CD- AND DVD-ROMS, FEATURING COMPUTER AND VIDEO GAME SOFTWARE; PRE-RECORDED COMPACT DISCS CONTAINING SOUNDS AND IMAGES, NAMELY, CONTAINING COMPUTER AND VIDEO GAMES; PRE-RECORDED IMAGE, SOUND AND DATA CARRIERS, FEATURING COMPUTER AND VIDEO GAMES; VIDEO RECORDINGS ON DIGITAL MEDIA, NAMELY, CDS, DVDS AND CD-ROMS, FEATURING COMPUTER, VIDEO AND OTHER ELECTRONIC AND/OR VISUAL GAMES; COMPUTER HARDWARE FOR COMPUTER GAMES AND ONLINE COMPUTER GAMES, IN CLASS 9 (U.S. CLS. 21, 23, 26, 36 AND 38).

FOR: APPARATUS FOR ELECTRONIC GAMES, IN PARTICULAR COMPUTER, VIDEO, ONLINE AND BROWSER GAMES, NOT BEING FOR USE WITH AN EXTERNAL DISPLAY SCREEN OR MONITOR, INCLUDED IN THIS CLASS, IN CLASS 28 (U.S. CLS. 22, 23, 38 AND 50).

FOR: PROVIDING INTERNET CHATROOMS; ELECTRONIC MAIL; TELECOMMUNICATION SERVICES, NAMELY, ELECTRONIC BULLETIN BOARD SERVICES; COMMUNICATION

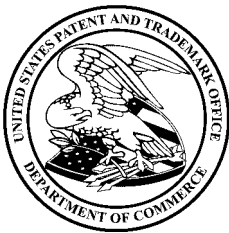

*David J. Kypas*

Director of the United States Patent and Trademark Office

**Reg. No. 4,123,652** BY COMPUTER TERMINALS; COMPUTER AIDED TRANSMISSION OF MESSAGES AND IMAGES; SERVICE OF AN ONLINE SERVICE PROVIDER, NAMELY, COLLECTION, PROVISION AND TRANSMISSION OF INFORMATION IN THE NATURE OF E-MAIL DATA SERVICES, TRANSMISSION OF ELECTRONIC MAIL, AND MANAGEMENT OF CHAT ROOMS, NAMELY, PROVIDING ELECTRONIC MESSAGE AND IMAGE SENDING, IN CLASS 38 (U.S. CLS. 100, 101 AND 104).

FOR: GAME SERVICES PROVIDED ON-LINE FROM A COMPUTER NETWORK, NAMELY, PROVIDING ONLINE COMPUTER GAMES, ONLINE VIDEO COMPUTER GAMES AND ONLINE BROWSER COMPUTER GAMES AND COMPUTER GAMES FOR MOBILE TELEPHONES, IN PARTICULAR VIA PORTALS AND PLATFORMS ON THE INTERNET; ORGANIZATION OF COMPETITIONS FOR EDUCATION OR ENTERTAINMENT PURPOSES, IN PARTICULAR ON THE INTERNET, NAMELY, COMPETITIONS IN THE FIELD OF ONLINE COMPUTER GAMES, ONLINE VIDEO COMPUTER GAMES AND ONLINE BROWSER COMPUTER GAMES AND COMPUTER GAMES FOR MOBILE TELEPHONES, IN PARTICULAR VIA PORTALS AND PLATFORMS ON THE INTERNET; PROVIDING ON-LINE ELECTRONIC PUBLICATIONS, NOT DOWNLOADABLE, IN THE NATURE OF REPORTS, DIRECTORIES, BROCHURES, REFERENCE MATERIALS, LEAFLETS, NEWSLETTERS, NEWSPAPERS, BOOKLETS, PAMPHLETS, POST CARDS, FLYERS, MAGAZINE SUPPLEMENTS TO NEWSPAPERS, MAGAZINES AND TRADE AND PROFESSIONAL BOOKS IN THE FIELD OF COMPUTER SOFTWARE, ESPECIALLY COMPUTER, VIDEO, ONLINE AND BROWSER GAMES AND OTHER ELECTRONIC AND/OR VISUAL GAMES; ELECTRONIC DESKTOP PUBLISHING; ENTERTAINMENT SERVICES OFFERED VIA THE INTERNET, IN PARTICULAR IN RELATION WITH COMPUTER AND VIDEO GAMES, NAMELY, INTERACTIVE ENTERTAINMENT AND COMPETITION SERVICES IN THE NATURE OF ONLINE COMPUTER GAMES PROVIDED OVER A COMPUTER NETWORK OR THE INTERNET, ONLINE VIDEO COMPUTER GAMES, AND ONLINE BROWSER COMPUTER GAMES AND ONLINE COMPUTER GAMES FOR MOBILE TELEPHONES; ENTERTAINMENT SERVICES OFFERED VIA OTHER WIRELESS MEDIA OR OVER CABLE CONNECTIONS, NAMELY, INTERACTIVE ENTERTAINMENT AND COMPETITION SERVICES IN THE NATURE OF ONLINE COMPUTER GAMES PROVIDED OVER A COMPUTER NETWORK OR THE INTERNET, ONLINE VIDEO COMPUTER GAMES, AND ONLINE BROWSER COMPUTER GAMES AND ONLINE COMPUTER GAMES FOR MOBILE TELEPHONES; ONLINE ENTERTAINMENT IN THE RANGE OF VIDEO AND COMPUTER GAMES, NAMELY, INTERACTIVE ENTERTAINMENT AND COMPETITION SERVICES IN THE NATURE OF ONLINE COMPUTER GAMES PROVIDED OVER A COMPUTER NETWORK OR THE INTERNET, ONLINE VIDEO COMPUTER GAMES, AND ONLINE BROWSER COMPUTER GAMES AND ONLINE COMPUTER GAMES FOR MOBILE TELEPHONES; ENTERTAINMENT, NAMELY, PROVIDING INFORMATION ABOUT ONLINE COMPUTER GAMES, ONLINE VIDEO COMPUTER GAMES, ONLINE BROWSER COMPUTER GAMES AND ONLINE COMPUTER GAMES FOR MOBILE TELEPHONES AND PROVIDING CONTINUING GAME SHOWS BROADCAST VIA THE INTERNET; ORGANIZING AND CONDUCTING GAMING EVENTS, NAMELY, COMPUTER GAMING COMPETITIONS, GAMING LEAGUES AND GAMING TOURNAMENTS IN THE FIELD OF ONLINE VIDEO COMPUTER GAMES, ONLINE BROWSER COMPUTER GAMES AND ONLINE COMPUTER GAMES FOR MOBILE TELEPHONES, IN PARTICULAR ON THE INTERNET; OFFERING OF ENTERTAINMENT SERVICES TO ORGANIZE COMPUTER GAMING TOURNAMENTS IN THE FIELD OF ONLINE VIDEO COMPUTER GAMES, AND ONLINE BROWSER COMPUTER GAMES AND ONLINE COMPUTER GAMES FOR MOBILE TELEPHONES, IN PARTICULAR ON THE INTERNET; ORGANIZATION OF COMPETITIVE COMPUTER AND VIDEO GAME COMPETITIONS, IN CLASS 41 (U.S. CLS. 100, 101 AND 107).

THE MARK CONSISTS OF STANDARD CHARACTERS WITHOUT CLAIM TO ANY PARTICULAR FONT, STYLE, SIZE, OR COLOR.

PRIORITY DATE OF 8-24-2010 IS CLAIMED.

**Reg. No. 4,123,652** OWNER OF INTERNATIONAL REGISTRATION 1073823 DATED 2-15-2011, EXPIRES 2-15-2021.

SER. NO. 79-096,128, FILED 2-15-2011.

JAMES MACFARLANE, EXAMINING ATTORNEY

# United States of America

United States Patent and Trademark Office

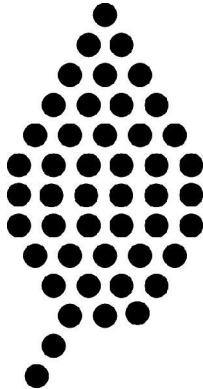

**Reg. No. 4,123,653**

**Registered Apr. 10, 2012**

**Int. Cls.: 11 and 30**

**TRADEMARK**

**PRINCIPAL REGISTER**

KONINKLIJKE PHILIPS ELECTRONICS N.V. (NETHERLANDS LIMITED LIABILITY COMPANY)  
GROENEWOUDSEWEG 1  
NL-5621 BA EINDHOVEN, NETHERLANDS

FOR: ELECTRIC APPLIANCES FOR PREPARING TEA AND OTHER HOT DRINKS, NAMELY, TEA KETTLES, COFFEEPOTS, COFFEE MACHINES; ELECTRIC KETTLES AND WATER BOILERS, NAMELY, HOT WATER HEATERS, GAS WATER HEATERS; ELECTRIC APPLIANCES FOR FILTERING AND PREPARING TEA, NAMELY, TEA MAKERS, TEAPOTS, IN CLASS 11 (U.S. CLS. 13, 21, 23, 31 AND 34).

FOR: TEAS, IN CLASS 30 (U.S. CL. 46).

THE MARK CONSISTS OF A STYLIZED IMAGE OF A DOTTED LEAF AND STEM MADE FROM SOLID DOTS.

PRIORITY DATE OF 10-8-2010 IS CLAIMED.

OWNER OF INTERNATIONAL REGISTRATION 1073855 DATED 4-5-2011, EXPIRES 4-5-2021.

SER. NO. 79-096,138, FILED 4-5-2011.

SAIMA MAKHDOOM, EXAMINING ATTORNEY



*David J. Kybas*

Director of the United States Patent and Trademark Office

# United States of America

United States Patent and Trademark Office

# Bubble Popp

**Reg. No. 4,123,654**

**Registered Apr. 10, 2012**

**Int. Cls.: 9, 28, 38 and 41**

**TRADEMARK**

**SERVICE MARK**

**PRINCIPAL REGISTER**

GAMEDUELL GMBH (FED REP GERMANY LIMITED LIABILITY COMPANY)  
GREIFSWALDERSTR. 212-213  
10405 BERLIN  
FED REP GERMANY

FOR: COMPUTER PROGRAMS, NAMELY, DOWNLOADABLE COMPUTER AND VIDEO GAME SOFTWARE; COMPUTER PROGRAMS, RECORDED, NAMELY, COMPUTER AND VIDEO GAME SOFTWARE; STORED AND DOWNLOADABLE COMPUTER PROGRAMS, NAMELY, COMPUTER AND VIDEO GAMES; STORED AND DOWNLOADABLE COMPUTER PROGRAMS ESPECIALLY FOR USE WITH COMPUTER, VIDEO AND OTHER ELECTRONIC AND/OR VISUAL GAMES, NAMELY, FOR USE IN PROGRAMMING AND CREATING COMPUTER AND VIDEO GAMES; ELECTRONIC PUBLICATIONS, DOWNLOADABLE, IN THE NATURE OF REPORTS, DIRECTORIES, BROCHURES, REFERENCE MATERIALS, LEAFLETS, NEWSLETTERS, NEWSPAPERS, BOOKLETS, PAMPHLETS, POST CARDS, FLYERS, MAGAZINE SUPPLEMENTS TO NEWSPAPERS, MAGAZINES AND TRADE AND PROFESSIONAL BOOKS IN THE FIELD OF COMPUTER SOFTWARE, ESPECIALLY COMPUTER, VIDEO, ONLINE AND BROWSER GAMES AND OTHER ELECTRONIC AND/OR VISUAL GAMES; COMPUTER AND APPARATUS FOR VIDEO GAMES ADAPTED FOR USE WITH AN EXTERNAL DISPLAY SCREEN OR MONITOR; DATA PROCESSING APPARATUS, NAMELY, DATA PROCESSORS; PRE-RECORDED DATA CARRIERS, NAMELY, PRE-RECORDED ROMS FEATURING WITH COMPUTER AND VIDEO GAME SOFTWARE; PRE-RECORDED COMPACT DISCS, NAMELY, CD- AND DVD-ROMS, FEATURING COMPUTER AND VIDEO GAME SOFTWARE; PRE-RECORDED COMPACT DISCS CONTAINING SOUNDS AND IMAGES, NAMELY, CONTAINING COMPUTER AND VIDEO GAMES; PRE-RECORDED IMAGE, SOUND AND DATA CARRIERS, FEATURING COMPUTER AND VIDEO GAMES; VIDEO RECORDINGS ON DIGITAL MEDIA, NAMELY, CDS, DVDS AND CD-ROMS, FEATURING COMPUTER, VIDEO AND OTHER ELECTRONIC AND/OR VISUAL GAMES; COMPUTER HARDWARE FOR COMPUTER GAMES AND ONLINE COMPUTER GAMES, IN CLASS 9 (U.S. CLS. 21, 23, 26, 36 AND 38).

FOR: APPARATUS FOR ELECTRONIC GAMES, IN PARTICULAR COMPUTER, VIDEO, ONLINE AND BROWSER GAMES, NOT BEING FOR USE WITH AN EXTERNAL DISPLAY SCREEN OR MONITOR, INCLUDED IN THIS CLASS, IN CLASS 28 (U.S. CLS. 22, 23, 38 AND 50).

FOR: PROVIDING INTERNET CHATROOMS; ELECTRONIC MAIL; TELECOMMUNICATION SERVICES, NAMELY, ELECTRONIC BULLETIN BOARD SERVICES; COMMUNICATION



*David J. Kyjars*

Director of the United States Patent and Trademark Office

**Reg. No. 4,123,654** BY COMPUTER TERMINALS; COMPUTER AIDED TRANSMISSION OF MESSAGES AND IMAGES; SERVICE OF AN ONLINE SERVICE PROVIDER, NAMELY, COLLECTION, PROVISION AND TRANSMISSION OF INFORMATION IN THE NATURE OF E-MAIL DATA SERVICES, TRANSMISSION OF ELECTRONIC MAIL, AND MANAGEMENT OF CHAT ROOMS, NAMELY, PROVIDING ELECTRONIC MESSAGE AND IMAGE SENDING, IN CLASS 38 (U.S. CLS. 100, 101 AND 104).

FOR: GAME SERVICES PROVIDED ON-LINE FROM A COMPUTER NETWORK, NAMELY, PROVIDING ONLINE COMPUTER GAMES, ONLINE VIDEO COMPUTER GAMES AND ONLINE BROWSER COMPUTER GAMES AND COMPUTER GAMES FOR MOBILE TELEPHONES, IN PARTICULAR VIA PORTALS AND PLATFORMS ON THE INTERNET; ORGANIZATION OF COMPETITIONS FOR EDUCATION OR ENTERTAINMENT PURPOSES, IN PARTICULAR ON THE INTERNET, NAMELY, COMPETITIONS IN THE FIELD OF ONLINE COMPUTER GAMES, ONLINE VIDEO COMPUTER GAMES AND ONLINE BROWSER COMPUTER GAMES AND COMPUTER GAMES FOR MOBILE TELEPHONES, IN PARTICULAR VIA PORTALS AND PLATFORMS ON THE INTERNET; PROVIDING ON-LINE ELECTRONIC PUBLICATIONS, NOT DOWNLOADABLE, IN THE NATURE OF REPORTS, DIRECTORIES, BROCHURES, REFERENCE MATERIALS, LEAFLETS, NEWSLETTERS, NEWSPAPERS, BOOKLETS, PAMPHLETS, POST CARDS, FLYERS, MAGAZINE SUPPLEMENTS TO NEWSPAPERS, MAGAZINES AND TRADE AND PROFESSIONAL BOOKS IN THE FIELD OF COMPUTER SOFTWARE, ESPECIALLY COMPUTER, VIDEO, ONLINE AND BROWSER GAMES AND OTHER ELECTRONIC AND/OR VISUAL GAMES; ELECTRONIC DESKTOP PUBLISHING; ENTERTAINMENT SERVICES OFFERED VIA THE INTERNET, IN PARTICULAR IN RELATION WITH COMPUTER AND VIDEO GAMES, NAMELY, INTERACTIVE ENTERTAINMENT AND COMPETITION SERVICES IN THE NATURE OF ONLINE COMPUTER GAMES PROVIDED OVER A COMPUTER NETWORK OR THE INTERNET, ONLINE VIDEO COMPUTER GAMES, AND ONLINE BROWSER COMPUTER GAMES AND ONLINE COMPUTER GAMES FOR MOBILE TELEPHONES; ENTERTAINMENT SERVICES OFFERED VIA OTHER WIRELESS MEDIA OR OVER CABLE CONNECTIONS, NAMELY, INTERACTIVE ENTERTAINMENT AND COMPETITION SERVICES IN THE NATURE OF ONLINE COMPUTER GAMES PROVIDED OVER A COMPUTER NETWORK OR THE INTERNET, ONLINE VIDEO COMPUTER GAMES, AND ONLINE BROWSER COMPUTER GAMES AND ONLINE COMPUTER GAMES FOR MOBILE TELEPHONES; ONLINE ENTERTAINMENT IN THE RANGE OF VIDEO AND COMPUTER GAMES, NAMELY, INTERACTIVE ENTERTAINMENT AND COMPETITION SERVICES IN THE NATURE OF ONLINE COMPUTER GAMES PROVIDED OVER A COMPUTER NETWORK OR THE INTERNET, ONLINE VIDEO COMPUTER GAMES, AND ONLINE BROWSER COMPUTER GAMES AND ONLINE COMPUTER GAMES FOR MOBILE TELEPHONES; ENTERTAINMENT, NAMELY, PROVIDING INFORMATION ABOUT ONLINE COMPUTER GAMES, ONLINE VIDEO COMPUTER GAMES, ONLINE BROWSER COMPUTER GAMES AND ONLINE COMPUTER GAMES FOR MOBILE TELEPHONES AND PROVIDING CONTINUING GAME SHOWS BROADCAST VIA THE INTERNET; ORGANIZING AND CONDUCTING GAMING EVENTS, NAMELY, COMPUTER GAMING COMPETITIONS, GAMING LEAGUES AND GAMING TOURNAMENTS IN THE FIELD OF ONLINE VIDEO COMPUTER GAMES, ONLINE BROWSER COMPUTER GAMES AND ONLINE COMPUTER GAMES FOR MOBILE TELEPHONES, IN PARTICULAR ON THE INTERNET; OFFERING OF ENTERTAINMENT SERVICES TO ORGANIZE COMPUTER GAMING TOURNAMENTS IN THE FIELD OF ONLINE VIDEO COMPUTER GAMES, AND ONLINE BROWSER COMPUTER GAMES AND ONLINE COMPUTER GAMES FOR MOBILE TELEPHONES, IN PARTICULAR ON THE INTERNET; ORGANIZATION OF COMPETITIVE COMPUTER AND VIDEO GAME COMPETITIONS, IN CLASS 41 (U.S. CLS. 100, 101 AND 107).

THE MARK CONSISTS OF STANDARD CHARACTERS WITHOUT CLAIM TO ANY PARTICULAR FONT, STYLE, SIZE, OR COLOR.

PRIORITY DATE OF 8-24-2010 IS CLAIMED.

**Reg. No. 4,123,654** OWNER OF INTERNATIONAL REGISTRATION 1073863 DATED 2-15-2011, EXPIRES 2-15-2021.

SER. NO. 79-096,140, FILED 2-15-2011.

JAMES MACFARLANE, EXAMINING ATTORNEY



# United States of America

United States Patent and Trademark Office

# Zentriform

**Reg. No. 4,123,655**

**Registered Apr. 10, 2012**

**Int. Cls.: 8, 9, 10, 11, 21  
and 42**

ANDREAS HETTICH GMBH & CO. KG (FED REP GERMANY GMBH & CO. KG)  
FÖHRENSTRASSE 12  
78532 TUTTLINGEN, FED REP GERMANY

FOR: HAND-HELD IMPLEMENTS FOR DECANTING LIQUIDS, IN CLASS 8 (U.S. CLS. 23, 28 AND 44).

**TRADEMARK**

**SERVICE MARK**

**PRINCIPAL REGISTER**

FOR: LABORATORY CENTRIFUGES; DOSING DEVICES, NAMELY DISPENSERS FOR ADMITTING SAMPLES INTO LABORATORY EQUIPMENT, NAMELY, VESSELS, CENTRIFUGES, AND BLOOD ANALYZERS; SUCTION DEVICES, NAMELY, DISPENSING PIPETTES BEING LABORATORY INSTRUMENTS; VESSEL HOLDERS FOR LABORATORY CENTRIFUGES; CENTRIFUGE RACKS FOR TEST TUBES BEING PARTS OF LABORATORY CENTRIFUGES; LABORATORY EQUIPMENT, NAMELY, TEST TUBE RACKS; CENTRIFUGE BEAKERS; TEMPERATURE CONTROLLERS FOR CENTRIFUGES AND BLOOD ANALYZERS FOR THE PURPOSE OF CONTROLLING THE BLOOD SPECIMEN TEMPERATURE; LABORATORY APPARATUS, NAMELY, CIRCULAR CENTRIFUGE CHAMBERS FOR THE SEPARATION OF BLOOD; CENTRIFUGE CHAMBERS BEING PARTS OF LABORATORY CENTRIFUGES; PARTS OF LABORATORY CENTRIFUGES, NAMELY, ELECTRICAL AND ELECTRONIC OPERATING, REGULATING, MONITORING, AND CONTROLLING INSTRUMENTATION FOR CENTRIFUGES, BLOOD HOMOGENIZATION AND BLOOD ANALYZERS; FUNCTION AND OPERATION OF KEYPADS AS PARTS OF AUTOMATIC CONTROL UNITS FOR LABORATORY CENTRIFUGES, BLOOD HOMOGENIZATION AND BLOOD ANALYZERS; MICROPROCESSORS; DRIVES AS PARTS OF LABORATORY CENTRIFUGES AND DRIVE SYSTEMS CONSISTING THEREOF; PARTS OF LABORATORY CENTRIFUGES, NAMELY, SPEED CONTROL INSTRUMENTATION FOR THE DRIVES; PARTS OF LABORATORY CENTRIFUGES, NAMELY, DATA STORAGE FOR CENTRIFUGES AND BLOOD ANALYZERS, NAMELY HARD DISKS, REMOVABLE DISKS, FLASH DEVICES; PARTS OF LABORATORY CENTRIFUGES, NAMELY, FILTERS; INCUBATORS FOR BACTERIA CULTURE; INCUBATORS BEING LABORATORY EQUIPMENT; DNA CHIPS; RETORTS BEING LABORATORY EQUIPMENT; FERMENTATION APPARATUS FOR TESTING BLOOD; LABORATORY EQUIPMENT NAMELY LABORATORY TRAYS; MEASURING GLASSWARE; MEASURING INSTRUMENTS, NAMELY BLOOD ANALYZERS; OSCILLOGRAPHS; PARTS OF CENTRIFUGES, NAMELY, WEIGHING EQUIPMENT BEING PRECISION BALANCES; LABORATORY DEVICES FOR PRODUCTION OF MICROSTRUCTURES, NAMELY CENTRIFUGES AND MOLDS; BLOOD HANDLING DEVICES, NAMELY, SMALL SURFACE STRUCTURES FOR THE HOMOGENIZATION OF BLOOD, FOR BLOOD ANALYSIS AND THE MOVEMENT AND STORAGE OF BLOOD; CRYSTAL OSCILLATORS



*David J. Kyros*

Director of the United States Patent and Trademark Office

**Reg. No. 4,123,655** FOR FLUID ANALYSIS, ELECTROCHEMISTRY, INSTRUMENTAL ANALYSIS, PROCESS ENGINEERING AND FLUIDIC ANALYSIS; RAPID PROTOTYPING EQUIPMENT FOR FLUIDIC MICROCHIPS, NAMELY, CENTRIFUGES, ROTORS, MOLDS, DISC SPACERS, INSERTS, PDMS (POLYDIMETHYLSILOXANE), MICROFLUIDIC CHIPS, AND SILICONE; FERMENTATION APPARATUSES; LEVEL INDICATORS NAMELY, LEVELING STAFFS; MULTIDOSE DROPPERS FOR LABORATORY USE AND NOT FOR MEDICAL USE; AND, BEAKERS, IN CLASS 9 (U.S. CLS. 21, 23, 26, 36 AND 38).

FOR: DEVICES FOR ANALYZING BLOOD; DIAGNOSTIC EQUIPMENT OF MEDICAL PURPOSES, NAMELY, CENTRIFUGES, INCUBATORS AND BLOOD ANALYZERS; CRYSTAL OSCILLATOR FOR MEDICAL DIAGNOSIS; MEASURING DEVICES FOR ANALYZING BLOOD, NAMELY; CENTRIFUGES AND BLOOD ANALYZERS; BLOOD ANALYSIS DEVICES, NAMELY, EVALUATION DEVICES FOR THE HEMATOCRIT DETERMINATION OF BLOOD, IN CLASS 10 (U.S. CLS. 26, 39 AND 44).

FOR: COOLING AND HEATING DEVICES, NAMELY, PARTS OF CENTRIFUGES, INCUBATORS AND BLOOD ANALYZERS; AIR CONDITIONERS FOR ANALYSIS AND BIOTECHNOLOGY, FOR INSTRUMENTAL ANALYSIS, AND FOR CELL CULTURES, IN CLASS 11 (U.S. CLS. 13, 21, 23, 31 AND 34).

FOR: GLASS VESSELS, NAMELY, VESSELS FOR THE TRANSPORTATION AND STORAGE OF SPECIMENS AND BLOOD, IN CLASS 21 (U.S. CLS. 2, 13, 23, 29, 30, 33, 40 AND 50).

FOR: TECHNICAL CONSULTATION IN REGARD TO THE USE OF CENTRIFUGES AND BLOOD ANALYZERS FOR THE HOMOGENIZATION, SEPARATION, AND ANALYSIS OF BLOOD; DESIGN AND DEVELOPMENT OF COMPUTER HARDWARE AND SOFTWARE; AND, ENGINEERING SERVICES IN THE FIELDS OF SCIENCE AND TECHNOLOGY, IN CLASS 42 (U.S. CLS. 100 AND 101).

THE MARK CONSISTS OF STANDARD CHARACTERS WITHOUT CLAIM TO ANY PARTICULAR FONT, STYLE, SIZE, OR COLOR.

PRIORITY DATE OF 6-22-2010 IS CLAIMED.

OWNER OF INTERNATIONAL REGISTRATION 1073883 DATED 12-21-2010, EXPIRES 12-21-2020.

SER. NO. 79-096,150, FILED 12-21-2010.

ANDREA HACK, EXAMINING ATTORNEY

# United States of America

United States Patent and Trademark Office

# SENQUIK

**Reg. No. 4,123,656**

**Registered Apr. 10, 2012**

**Int. Cl.: 9**

**TRADEMARK**

**PRINCIPAL REGISTER**

TALARIAX PTE LTD (SINGAPORE COMPANY)  
13A MACKENZIE ROAD  
SINGAPORE 228676  
SINGAPORE

FOR: COMPUTER SOFTWARE AND HARDWARE FOR FACILITATING SHORT MESSAGING SERVICES (SMS) AND MULTIMEDIA MESSAGING SERVICES (MMS); APPARATUS FOR RECORDING, TRANSMISSION OR REPRODUCTION OF SOUND, IMAGE AND TEXT, IN CLASS 9 (U.S. CLS. 21, 23, 26, 36 AND 38).

OWNER OF U.S. REG. NO. 3,048,905.

OWNER OF INTERNATIONAL REGISTRATION 1073905 DATED 2-24-2011, EXPIRES 2-24-2021.

SER. NO. 79-096,161, FILED 2-24-2011.

COLLEEN DOMBROW, EXAMINING ATTORNEY



*David J. Kyffers*

Director of the United States Patent and Trademark Office

# United States of America

United States Patent and Trademark Office



—BELLAGUARDIA—

**Reg. No. 4,123,657**

**Registered Apr. 10, 2012**

**Int. Cls.: 33 and 35**

**TRADEMARK**

**SERVICE MARK**

**PRINCIPAL REGISTER**

BELLAGUARDIA SOCIETA' AGRICOLA S.S. (ITALY PARTNERSHIP)  
VIA ZIGGIOTTI  
MONTECCHIO MAGGIORE (VI)  
ITALY

FOR: ALCOHOLIC BEVERAGES OF FRUITS; WINES; SPIRITS AND LIQUEURS; APERITIFS WITH A WINE BASE; PREPARED WINE COCKTAILS, IN CLASS 33 (U.S. CLS. 47 AND 49).

FOR: THE BRINGING TOGETHER, FOR THE BENEFIT OF OTHERS, OF WINES, EXCLUDING THE TRANSPORT THEREOF, ENABLING CUSTOMERS TO CONVENIENTLY VIEW AND PURCHASE WINES; PRODUCT MERCHANDISING, WHOLESALE AND RETAIL STORE SERVICES FEATURING WINES; WINE IMPORT-EXPORT AGENCIES, IN CLASS 35 (U.S. CLS. 100, 101 AND 102).

THE MARK CONSISTS OF A SIGN DEPICTING THE WORDING "BELLAGUARDIA" IN FANCY CHARACTERS, AT THE RIGHT AND LEFT ENDS OF WHICH THERE ARE RESPECTIVELY TWO BROKEN LINES AND ABOVE THERE IS A BROKEN STYLIZED LINE RESEMBLING THE SHAPE OF A STYLIZED CASTLE.

PRIORITY DATE OF 7-15-2010 IS CLAIMED.

OWNER OF INTERNATIONAL REGISTRATION 1074070 DATED 11-10-2010, EXPIRES 11-10-2020.

THE WORDING "BELLAGUARDIA" HAS NO MEANING IN A FOREIGN LANGUAGE.

SER. NO. 79-096,227, FILED 11-10-2010.

PATRICIA EVANKO, EXAMINING ATTORNEY



*David J. Kyros*

Director of the United States Patent and Trademark Office

# United States of America

United States Patent and Trademark Office

# charm rose

**Reg. No. 4,123,658**

**Registered Apr. 10, 2012**

**Int. Cl.: 3**

THOMAS SABO GMBH & CO. SCHMUCKHANDEL KG (FED REP GERMANY  
KOMMANDITGESELLSCHAFT)  
MARTIN-LUTHER-STRASSE 20  
91207 LAUF  
FED REP GERMANY

**TRADEMARK**

**PRINCIPAL REGISTER**

FOR: SOAPS; PERFUMERY, ESSENTIAL OILS, COSMETICS AND PRODUCTS FOR THE CARE OF THE BODY, NAMELY, BODY CREAMS, LOTIONS, AND GELS, FOUNDATION MAKE UP, FACE POWDER, BLUSHER, MAKE UP REMOVER, LIPSTICK, LIP LINER, EYE SHADOW, EYE LINER, MASCARA, NAIL POLISH, MAKEUP, NAIL LACQUER, NAIL POLISH REMOVER, FACIAL MASKS, EYE REVITALIZING GEL, SKIN CLEANSERS, SKIN TONERS, BODY SCRUBS AND WASHES, CELLULAR REVITALIZING FLUID FOR THE BODY IN THE NATURE OF BODY OILS, BODY OIL, EXFOLIANTS FOR SKIN, HAIR, FEET, BODY AND BODY REFRESHER IN THE NATURE OF BODY CREAM, BODY MOISTURIZING LOTION, BODY POWDER, HAIR LOTION, IN CLASS 3 (U.S. CLS. 1, 4, 6, 50, 51 AND 52).

THE MARK CONSISTS OF STANDARD CHARACTERS WITHOUT CLAIM TO ANY PARTICULAR FONT, STYLE, SIZE, OR COLOR.

OWNER OF INTERNATIONAL REGISTRATION 1074109 DATED 10-25-2010, EXPIRES 10-25-2020.

NO CLAIM IS MADE TO THE EXCLUSIVE RIGHT TO USE "ROSE", APART FROM THE MARK AS SHOWN.

SER. NO. 79-096,246, FILED 10-25-2010.

JENNIFER MARTIN, EXAMINING ATTORNEY



*David J. Kypos*

Director of the United States Patent and Trademark Office

# United States of America

United States Patent and Trademark Office

# TRICOLIT

**Reg. No. 4,123,659**

**Registered Apr. 10, 2012**

**Int. Cls.: 1, 4 and 40**

**TRADEMARK**

**SERVICE MARK**

**PRINCIPAL REGISTER**

APPLIED NANO SURFACES SWEDEN AB (SWEDEN JOINT STOCK COMPANY)  
KNIVSTAGATAN 12  
SE-753 23 UPPSALA  
SWEDEN

FOR: FRICTION-REDUCING COATING AGENTS FOR AUTOMOTIVE AND INDUSTRIAL USE; CHEMICAL ADDITIVES FOR LUBRICANTS; CHEMICALS FOR USE IN INDUSTRY; TRANSMISSION FLUIDS; CHEMICALS FOR METAL WORKING, IN CLASS 1 (U.S. CLS. 1, 5, 6, 10, 26 AND 46).

FOR: INDUSTRIAL OILS AND GREASES, INDUSTRIAL AND AUTOMOTIVE LUBRICANTS, LUBRICATING OILS AND GREASES; NON-CHEMICAL ADDITIVES FOR LUBRICANTS AND GREASES, IN CLASS 4 (U.S. CLS. 1, 6 AND 15).

FOR: TREATMENT AND PROCESSING OF MATERIALS BY FRICTION-REDUCING COATING AND METAL SURFACE FINISHING, IN CLASS 40 (U.S. CLS. 100, 103 AND 106).

THE MARK CONSISTS OF STANDARD CHARACTERS WITHOUT CLAIM TO ANY PARTICULAR FONT, STYLE, SIZE, OR COLOR.

PRIORITY DATE OF 6-16-2010 IS CLAIMED.

OWNER OF INTERNATIONAL REGISTRATION 1074139 DATED 12-16-2010, EXPIRES 12-16-2020.

SER. NO. 79-096,259, FILED 12-16-2010.

ZACHARY BELLO, EXAMINING ATTORNEY



*David J. Kypos*

Director of the United States Patent and Trademark Office

United States of America  
United States Patent and Trademark Office

**BiPorEx**

**Reg. No. 4,123,660**

**Registered Apr. 10, 2012**

**Int. Cl.: 10**

**TRADEMARK**

**PRINCIPAL REGISTER**

WALDEMAR LINK GMBH & CO. KG (FED REP GERMANY LIMITED PARTNERSHIP)  
BARKHAUSENWEG 10  
22339 HAMBURG  
FED REP GERMANY

FOR: IMPLANTABLE MEDICAL DEVICES WITH ANTI-ALLERGENIC COATING, NAMELY, ENDOPROTHESES WITH ANTI-ALLERGENIC COATING, IN CLASS 10 (U.S. CLS. 26, 39 AND 44).

THE MARK CONSISTS OF STANDARD CHARACTERS WITHOUT CLAIM TO ANY PARTICULAR FONT, STYLE, SIZE, OR COLOR.

PRIORITY DATE OF 10-5-2010 IS CLAIMED.

OWNER OF INTERNATIONAL REGISTRATION 1074140 DATED 12-27-2010, EXPIRES 12-27-2020.

SER. NO. 79-096,260, FILED 12-27-2010.

ANN E. SAPPENFIELD, EXAMINING ATTORNEY



*David J. Kyffers*

Director of the United States Patent and Trademark Office

# United States of America

United States Patent and Trademark Office

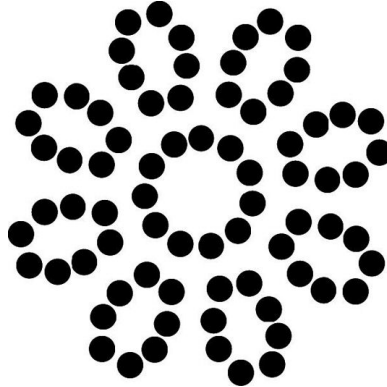

**Reg. No. 4,123,661**

**Registered Apr. 10, 2012**

**Int. Cls.: 11 and 30**

**TRADEMARK**

**PRINCIPAL REGISTER**

KONINKLIJKE PHILIPS ELECTRONICS N.V. (NETHERLANDS LIMITED LIABILITY COMPANY)  
GROENEWOUDSEWEG 1  
NL-5621 BA EINDHOVEN, NETHERLANDS

FOR: ELECTRIC APPLIANCES FOR PREPARING TEA AND OTHER HOT DRINKS, NAMELY, TEA KETTLES, COFFEEPOTS, COFFEE MACHINES; ELECTRIC KETTLES AND WATER BOILERS, NAMELY, HOT WATER HEATERS, GAS WATER HEATERS; ELECTRIC APPLIANCES FOR FILTERING AND PREPARING TEA, NAMELY, TEA MAKERS, TEAPOTS, IN CLASS 11 (U.S. CLS. 13, 21, 23, 31 AND 34).

FOR: TEAS, IN CLASS 30 (U.S. CL. 46).

THE MARK CONSISTS OF A STYLIZED IMAGE OF A DOTTED FLOWER MADE FROM SOLID DOTS.

PRIORITY DATE OF 10-8-2010 IS CLAIMED.

OWNER OF INTERNATIONAL REGISTRATION 1074259 DATED 4-5-2011, EXPIRES 4-5-2021.

SER. NO. 79-096,314, FILED 4-5-2011.

SAIMA MAKHDOOM, EXAMINING ATTORNEY



*David J. Kybas*

Director of the United States Patent and Trademark Office



# United States of America

United States Patent and Trademark Office

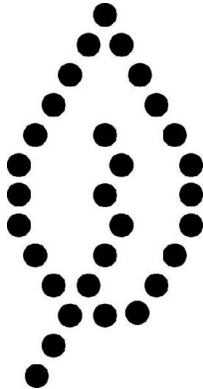

**Reg. No. 4,123,662**

**Registered Apr. 10, 2012**

**Int. Cls.: 11 and 30**

**TRADEMARK**

**PRINCIPAL REGISTER**

KONINKLIJKE PHILIPS ELECTRONICS N.V. (NETHERLANDS LIMITED LIABILITY COMPANY)  
GROENEWOUDSEWEG 1  
NL-5621 BA EINDHOVEN, NETHERLANDS

FOR: ELECTRIC APPLIANCES FOR PREPARING TEA AND OTHER HOT DRINKS, NAMELY, TEA KETTLES, COFFEEPOTS, COFFEE MACHINES; ELECTRIC KETTLES AND WATER BOILERS, NAMELY, HOT WATER HEATERS, GAS WATER HEATERS; ELECTRIC APPLIANCES FOR FILTERING AND PREPARING TEA, NAMELY, TEA MAKERS, TEAPOTS, IN CLASS 11 (U.S. CLS. 13, 21, 23, 31 AND 34).

FOR: TEAS, IN CLASS 30 (U.S. CL. 46).

THE MARK CONSISTS OF AN IMAGE OF A LEAF AND STEM MADE FROM SOLID DOTS.

PRIORITY DATE OF 10-8-2010 IS CLAIMED.

OWNER OF INTERNATIONAL REGISTRATION 1074260 DATED 4-5-2011, EXPIRES 4-5-2021.

SER. NO. 79-096,315, FILED 4-5-2011.

SAIMA MAKHDOOM, EXAMINING ATTORNEY



*David J. Kybas*

Director of the United States Patent and Trademark Office

# United States of America

United States Patent and Trademark Office

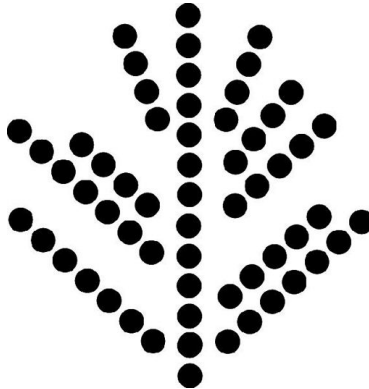

**Reg. No. 4,123,663**

**Registered Apr. 10, 2012**

**Int. Cls.: 11 and 30**

KONINKLIJKE PHILIPS ELECTRONICS N.V. (NETHERLANDS LIMITED LIABILITY COMPANY)  
GROENEWOUDSEWEG 1  
NL-5621 BA EINDHOVEN  
NETHERLANDS

**TRADEMARK**

**PRINCIPAL REGISTER**

FOR: ELECTRIC APPLIANCES FOR PREPARING TEA AND OTHER HOT DRINKS, NAMELY, TEA KETTLES, COFFEEPOTS, COFFEE MACHINES; ELECTRIC KETTLES AND WATER BOILERS, NAMELY, HOT WATER HEATERS, GAS WATER HEATERS; ELECTRIC APPLIANCES FOR FILTERING AND PREPARING TEA, NAMELY, TEA MAKERS, TEAPOTS, IN CLASS 11 (U.S. CLS. 13, 21, 23, 31 AND 34).

FOR: TEAS, IN CLASS 30 (U.S. CL. 46).

THE MARK CONSISTS OF A STYLIZED IMAGE OF A PLANT MADE FROM SOLID DOTS.

PRIORITY DATE OF 10-8-2010 IS CLAIMED.

OWNER OF INTERNATIONAL REGISTRATION 1074261 DATED 4-5-2011, EXPIRES 4-5-2021.

SER. NO. 79-096,316, FILED 4-5-2011.

SAIMA MAKHDOOM, EXAMINING ATTORNEY



*David J. Kybas*

Director of the United States Patent and Trademark Office

# United States of America

United States Patent and Trademark Office



**Reg. No. 4,123,664**

**Registered Apr. 10, 2012**

**Int. Cl.: 1**

**TRADEMARK**

**PRINCIPAL REGISTER**

SEDERMA (FRANCE S.A.S.)  
29 RUE DU CHEMIN VERT  
F-78610 LE PERRAY EN YVELINES  
FRANCE

FOR: PEPTIDES USED IN THE MANUFACTURE OF COSMETICS, IN CLASS 1 (U.S. CLS. 1, 5, 6, 10, 26 AND 46).

OWNER OF U.S. REG. NO. 3,115,957.

PRIORITY DATE OF 12-3-2010 IS CLAIMED.

OWNER OF INTERNATIONAL REGISTRATION 1074376 DATED 3-21-2011, EXPIRES 3-21-2021.

THE TRANSLITERATION OF THE NON-LATIN CHARACTERS IN THE MARK IS "MATRIXYL INSIDE".

THE MARK CONSISTS OF A DIAMOND WITH THE WORDS "MATRIXYL INSIDE" AND A CURVED ARROW WITHIN THE DIAMOND AND A SHADOW APPEARING BEHIND THE DIAMOND.

SER. NO. 79-096,371, FILED 3-21-2011.

CHARLOTTE CORWIN, EXAMINING ATTORNEY



*David J. Kybas*

Director of the United States Patent and Trademark Office

United States of America  
United States Patent and Trademark Office

# El Grande

**Reg. No. 4,123,665**

**Registered Apr. 10, 2012**

**Int. Cls.: 25 and 28**

**TRADEMARK**

**PRINCIPAL REGISTER**

ELAN, D.O.O. (SLOVENIA LIMITED LIABILITY COMPANY)  
BEGUNJE NE GORENJSKEM 1 SI-4275  
BEGUNJE NE GORENJSKEM, SLOVENIA

FOR: CLOTHING, NAMELY, SWEATERS, SWEAT SHIRTS, TOPS, T-SHIRTS, JACKETS, COATS, JERSEYS, BELTS, SOCKS, SNOW BOARDING AND SKI SUITS, SNOWBOARD AND SKI PANTS, SNOWBOARD AND SKI MITTENS, SNOWBOARD AND SKI GLOVES, SNOWBOARD AND SKI JACKETS, SNOWBOARD AND SKI MASKS; FOOTWEAR; HEADGEAR, NAMELY, HATS AND CAPS; SKI BOOTS; SNOWBOARD BOOTS, IN CLASS 25 (U.S. CLS. 22 AND 39).

FOR: GYMNASTIC AND SPORTING ARTICLES, NAMELY, WAKEBOARDS, WAKE SKATES, SKI CASES, SKI COVERS, SKI ROPES, SKI SCRAPERS, SNOWBOARD DECKS, HARNESES SPECIALLY ADAPTED FOR CARRYING SNOWBOARDS; SKIS; WATERSKIS; SKI BINDINGS; SKI POLES; SNOWBOARDS; SNOWBOARD BINDINGS; EDGES OF SKIS; SNOWSHOES; SLEIGHS; BOB-SLEIGHS; WAX FOR SKIS; BAGS FOR SKIS, IN CLASS 28 (U.S. CLS. 22, 23, 38 AND 50).

THE MARK CONSISTS OF STANDARD CHARACTERS WITHOUT CLAIM TO ANY PARTICULAR FONT, STYLE, SIZE, OR COLOR.

PRIORITY DATE OF 9-22-2010 IS CLAIMED.

OWNER OF INTERNATIONAL REGISTRATION 1074521 DATED 3-18-2011, EXPIRES 3-18-2021.

THE ENGLISH TRANSLATION OF "EL GRANDE" IN THE MARK IS "THE BIG ONE".

SER. NO. 79-096,419, FILED 3-18-2011.

CHARISMA HAMPTON, EXAMINING ATTORNEY



*David J. Kypos*

Director of the United States Patent and Trademark Office

# United States of America

United States Patent and Trademark Office

# JACK PIERRE

**Reg. No. 4,123,666**

**Registered Apr. 10, 2012**

**Int. Cl.: 14**

CSF KUYUMCULUK ITHALAT IHRACAT SANAYI VE TICARET LIMITED SIRKETI  
(TURKEY LIMITED COMPANY)  
ÇEMBERLITAS MOLLA FENARI MAHALLESİ,  
KÜRKÇÜLER PAZARI SOKAK NO:63; EMINÖNÜ -ISTANBUL  
TURKEY

**TRADEMARK**

**PRINCIPAL REGISTER**

FOR: PRECIOUS METALS AND THEIR ALLOYS, NAMELY, GOLD, SILVER, PLATINUM; PRECIOUS STONES, JEWELRY MADE OF PRECIOUS METAL OR COATED THEREWITH, NAMELY, BRACELETS, RINGS, CHARMS, NECKLACES, EAR CLIPS, CUFF-LINKS, EARRINGS, ORNAMENTAL PINS, TIE PINS, PENDANTS, RINGS BEING JEWELRY, MEDALLIONS, BROOCHES, ORNAMENTS OF PRECIOUS METAL, TRINKETS AS KEY RINGS OF PRECIOUS METAL, STATUES OF PRECIOUS METAL, BUSTS OF PRECIOUS METAL; HOROLOGICAL AND CHRONOMETRIC INSTRUMENTS AND PARTS AND ACCESSORIES THEREOF, NAMELY, CHRONOMETERS, WRIST WATCHES, POCKET WATCHES, JEWELRY WATCHES, WALL CLOCKS, TABLE CLOCKS, WATCH BANDS, WATCH STRAPS, WATCH BRACELETS, WATCH CHAINS, CASES FOR WATCHES AND CLOCKS, PARTS FOR WATCHES AND CLOCKS, IN CLASS 14 (U.S. CLS. 2, 27, 28 AND 50).

THE MARK CONSISTS OF STANDARD CHARACTERS WITHOUT CLAIM TO ANY PARTICULAR FONT, STYLE, SIZE, OR COLOR.

OWNER OF INTERNATIONAL REGISTRATION 1074608 DATED 12-24-2010, EXPIRES 12-24-2020.

THE NAME(S), PORTRAIT(S), AND/OR SIGNATURE(S) SHOWN IN THE MARK DOES NOT IDENTIFY A PARTICULAR LIVING INDIVIDUAL.

SER. NO. 79-096,445, FILED 12-24-2010.

TASNEEM HUSSAIN, EXAMINING ATTORNEY



*David J. Kyros*

Director of the United States Patent and Trademark Office

# United States of America

United States Patent and Trademark Office

# MICROBURST

**Reg. No. 4,123,667**

**Registered Apr. 10, 2012**

**Int. Cl.: 21**

**TRADEMARK**

**PRINCIPAL REGISTER**

KONINKLIJKE PHILIPS ELECTRONICS N.V. (NETHERLANDS A PUBLIC LIMITED LIABILITY COMPANY)  
GROENEWOUDSEWEG 1  
NL-5621 BA EINDHOVEN, NETHERLANDS

FOR: TOOTHBRUSHES AND ELECTRIC TOOTHBRUSHES AND PARTS, WATER APPARATUS FOR CLEANING TEETH AND GUMS FOR HOME USE, APPARATUS FOR CLEANING TEETH AND GUMS USING HIGH PRESSURE WATER FOR HOME USE; FLOSSING INSTRUMENTS FOR DENTAL CARE, NAMELY, DENTAL FLOSS; APPARATUS USING WATER AND AIR FOR CLEANING TEETH AND GUMS, IN CLASS 21 (U.S. CLS. 2, 13, 23, 29, 30, 33, 40 AND 50).

THE MARK CONSISTS OF STANDARD CHARACTERS WITHOUT CLAIM TO ANY PARTICULAR FONT, STYLE, SIZE, OR COLOR.

PRIORITY DATE OF 8-12-2010 IS CLAIMED.

OWNER OF INTERNATIONAL REGISTRATION 1074618 DATED 2-10-2011, EXPIRES 2-10-2021.

SER. NO. 79-096,449, FILED 2-10-2011.

SAIMA MAKHDOOM, EXAMINING ATTORNEY



*David J. Kyffers*

Director of the United States Patent and Trademark Office

# United States of America

United States Patent and Trademark Office

## BOLSIUS FRAGRANCE YOUR HOME

**Reg. No. 4,123,668**

**Registered Apr. 10, 2012**

**Int. Cls.: 4 and 21**

**TRADEMARK**

**PRINCIPAL REGISTER**

BOLSIUS INTERNATIONAL B.V. (NETHERLANDS BESLOTEN VENNOOTSCHAP)  
KERKENDIJK 126  
NL-5482 KK SCHIJNDEL  
NETHERLANDS

FOR: OILS AND FATS BEING FUELS FOR THE ILLUMINATION OF CANDLES, LAMP OIL, LAMP FUEL, LIGHTING FUELS, AROMATHERAPY FRAGRANCE CANDLES, PERFUMED CANDLES, SCENTED CANDLES, CANDLES FOR ILLUMINATION, TEA LIGHT CANDLES, DEVOTION, GRAVE AND BEDROOM CANDLES, CANDLES AND WICKS FOR CANDLES FOR LIGHTING, CANDLES FOR NIGHT LIGHTS, WICKS FOR CANDLES, WICKS FOR LAMPS AND OIL LAMPS, IN CLASS 4 (U.S. CLS. 1, 6 AND 15).

FOR: CANDLE HOLDERS AND CANDLE PLATES MADE OF GLASSWARE, PORCELAIN AND EARTHENWARE, CANDLESTICKS, CANDLE HOLDERS, CANDLE PLATES, CANDLE RINGS, NON-ELECTRIC WALL SCONCES, CANDLE SNUFFERS, CERAMIC SOOT BLOCKER FOR USE ON CANDLE JARS, IN CLASS 21 (U.S. CLS. 2, 13, 23, 29, 30, 33, 40 AND 50).

THE MARK CONSISTS OF STANDARD CHARACTERS WITHOUT CLAIM TO ANY PARTICULAR FONT, STYLE, SIZE, OR COLOR.

PRIORITY DATE OF 2-4-2011 IS CLAIMED.

OWNER OF INTERNATIONAL REGISTRATION 1074738 DATED 2-11-2011, EXPIRES 2-11-2021.

OWNER OF U.S. REG. NO. 1,604,286.

NO CLAIM IS MADE TO THE EXCLUSIVE RIGHT TO USE "FRAGRANCE" IN CLASS 4, APART FROM THE MARK AS SHOWN.

SER. NO. 79-096,498, FILED 2-11-2011.

DOUGLAS LEE, EXAMINING ATTORNEY



*David J. Kyffers*

Director of the United States Patent and Trademark Office

# United States of America

United States Patent and Trademark Office

## HC ELEMENT

**Reg. No. 4,123,669**

**Registered Apr. 10, 2012**

**Int. Cls.: 11 and 37**

**TRADEMARK**

**SERVICE MARK**

**PRINCIPAL REGISTER**

HOWDEN UK LIMITED (UNITED KINGDOM LIMITED COMPANY)  
NEW SIROCCO WORKS  
CHANNEL COMMERCIAL PARK, QUEEN'S ROAD, BELFAST  
NORTHERN IRELAND, UNITED KINGDOM BT3 9DT

FOR: HEATING INSTALLATIONS AND APPARATUS FOR HEATING, NAMELY, REGENERATIVE AIR AND GAS HEATER ELEMENTS FOR USE IN REGENERATIVE HEAT EXCHANGERS, HEAT TRANSFER ELEMENTS FOR ROTARY HEAT EXCHANGERS FOR INDUSTRIAL USE; REGENERATIVE AIR AND GAS HEATER ELEMENTS; AIR PRE-HEATER ELEMENTS AND GAS RE-HEATER ELEMENTS; PARTS AND FITTINGS FOR ALL THE AFORESAID GOODS, IN CLASS 11 (U.S. CLS. 13, 21, 23, 31 AND 34).

FOR: MAINTENANCE, INSTALLATION, REPAIR, UPGRADING, RETROFIT AND REFURBISHMENT OF INDUSTRIAL PLANTS AND MACHINERY; MAINTENANCE, UPGRADE, RETROFIT, REPAIR AND UPGRADING OF HEATING AND ENVIRONMENTAL CONTROL APPARATUS AND INSTALLATIONS, HEAT REGENERATORS, AIR RE-HEATERS, PRE-HEATERS, HEAT EXCHANGERS, GEARBOXES AND PARTS AND FITTINGS INCLUDING HEAT TRANSFER ELEMENTS FOR ALL OF THE AFORESAID; INFORMATION, ADVISORY AND CONSULTANCY SERVICES RELATING TO ALL OF THE AFORESAID SERVICES, IN CLASS 37 (U.S. CLS. 100, 103 AND 106).

THE MARK CONSISTS OF STANDARD CHARACTERS WITHOUT CLAIM TO ANY PARTICULAR FONT, STYLE, SIZE, OR COLOR.

PRIORITY DATE OF 2-15-2011 IS CLAIMED.

OWNER OF INTERNATIONAL REGISTRATION 1074744 DATED 3-4-2011, EXPIRES 3-4-2021.

NO CLAIM IS MADE TO THE EXCLUSIVE RIGHT TO USE "ELEMENT", APART FROM THE MARK AS SHOWN.

SER. NO. 79-096,501, FILED 3-4-2011.

BARBARA RUTLAND, EXAMINING ATTORNEY



*David J. Kyffers*

Director of the United States Patent and Trademark Office



# United States of America

United States Patent and Trademark Office

# HUAYRA

**Reg. No. 4,123,670**

**Registered Apr. 10, 2012**

**Int. Cls.: 12, 14, 16, 18,  
25 and 28**

HORACIO PAGANI S.P.A. (ITALY JOINT STOCK COMPANY)  
VIA ARTIGIANATO, 5  
I-41018 SAN CESARIO SUL PANARO (MO)  
ITALY

FOR: ALL TERRAIN VEHICLES; AUTOMOBILES; CARS; LAND VEHICLES; RACING CARS, IN CLASS 12 (U.S. CLS. 19, 21, 23, 31, 35 AND 44).

**TRADEMARK**

**PRINCIPAL REGISTER**

FOR: PRECIOUS METALS AND THEIR ALLOYS; GOODS IN PRECIOUS METALS OR COATED THEREWITH, NAMELY, ANKLE BRACELETS, BANGLE BRACELETS, BRACELETS, CHOKERS, EARRINGS, CUFFLINKS, CLOCKS, FIGURES OF PRECIOUS METAL, KEY CHAINS, KEY HOLDERS, KEY RINGS, MEDALLIONS, MEDALS, ORNAMENTAL PINS, PENDANTS, RINGS, COMMEMORATIVE COINS, COLLECTIBLE COINS, STATUETTES OF PRECIOUS METAL, STATUES OF PRECIOUS METALS, BOXES OF PRECIOUS METALS; JEWELLERY, PRECIOUS STONES; HOROLOGICAL AND CHRONOMETRIC INSTRUMENTS; WATCHES AND CLOCKS, IN CLASS 14 (U.S. CLS. 2, 27, 28 AND 50).

FOR: PAPER CARDBOARD AND GOODS MADE FROM THESE MATERIALS, NAMELY, AGENDAS, ALBUMS FOR STICKERS, AUTOGRAPH BOOKS, BLANK NOTE CARDS, BOOK MARKERS, FILE FOLDERS, MEMO BLOCKS, LOOSE LEAF PAPER, LOOSE LEAF PADS, MEMORANDUM BOARDS, MEMORANDUM BOOKS, NOTE BOOKS, NOTE CARDS, NOTE PAPERS, NOTEBOOKS, NOTEPADS, NOTE MOUNTING BOARDS, PAPER STATIONERY, PERSONAL ORGANIZERS, POCKET MEMORANDUM BOOKS, SCRAP BOOKS, STICKERS; IRON-ON OR PLASTIC TRANSFERS; PRINTED MATTER, NAMELY, CALENDARS AND DIARIES, CORRESPONDENCE CARDS, DAILY NEWSPAPERS, DAY PLANNERS, DESK CALENDARS, DESKTOP ORGANIZERS, POST CARDS, PRINTED PERIODICALS IN THE FIELD OF VEHICLES, CARS AND AUTOMOBILES; PHOTOGRAPHS; STATIONERY; TYPEWRITERS AND OFFICE REQUISITES, NAMELY, DESK SETS, PENCILS, PENS, PAPER CLIPS, PAPER CLIP HOLDERS, AUTOMATIC PENCILS, BALL PENS, BALL POINT PENS, COLOURED PENCILS, COLORED PENS, CRAYONS, GEL ROLLER PENS, HIGHLIGHTER PENS, MARKERS, ERASERS, PEN AND PENCIL CASES AND BOXES, PEN CLIPS, PEN INK REFILLS, PEN CARTRIDGES, RETRACTABLE PENCILS, ROLLER BALL PENS; PRINTERS' TYPE; PRINTING BLOCKS, IN CLASS 16 (U.S. CLS. 2, 5, 22, 23, 29, 37, 38 AND 50).



*David J. Kyjars*

Director of the United States Patent and Trademark Office

**Reg. No. 4,123,670** FOR: LEATHER AND IMITATIONS OF LEATHER AND GOODS MADE OF THESE MATERIALS, NAMELY, ALL PURPOSE SPORT BAGS, ALL-PURPOSE ATHLETIC BAGS, ALL-PURPOSE CARRYING BAGS, ATTACHÉ CASES, BACKPACKS, BAGS FOR SPORTS, BANK NOTE HOLDERS, BEACH BAGS, BELT BAGS, BILLFOLDS, BOOK BAGS, CARD WALLETS, CARRYALLS, CARRYING CASES, CARRYING CASES FOR DOCUMENTS, CARRY-ALL BAGS, CARRY-ON BAGS, COIN PURSES, COSMETIC BAGS SOLD EMPTY, CREDIT CARD CASES, DOCUMENT CASES, EVENING HANDBAGS, FASHION HANDBAGS, FLIGHT BAGS, GYM BAGS, HANDBAGS, HOLDALLS, HUNTING BAGS, KEY BAGS, KEY CASES, KEY WALLETS; ANIMAL SKINS; ANIMAL HIDES; TRUNKS AND TRAVELING BAGS; UMBRELLAS, PARASOLS AND WALKING STICKS; WHIPS, HARNESSSES AND SADDLERY, IN CLASS 18 (U.S. CLS. 1, 2, 3, 22 AND 41).

FOR: CLOTHING, NAMELY, BANDANAS, BATHING COSTUMES, BATHING SUITS, BATHING TRUNKS, BEACH COVER-UPS, BEACHWEAR, BELTS, BERMUDA SHORTS, BIKINIS, BLAZERS, BLOUSES, BLOUSONS, BOARD SHORTS, BOAS, BODICES, BODY LINEN, BOLEROS, BOW TIES, BOXER BRIEFS, BOXER SHORTS, BRAS, BRASSIERES, BREECHES, BRIEFS, CAMISETTES, CAMISOLES, CAMP SHIRTS, CARDIGANS, CHEMISES, CHEMISETTES, COATS, CORSELETS, CORSETS, CRAVATS, CUFFS, CULOTTES, DENIM JACKETS, DRESS SHIELDS, DRESS SHIRTS, DRESS SUITS, DRESSES, DRESSING GOWNS, GILETS, GLOVES, GOLF PANTS, SHIRTS AND SKIRTS, GOLF TROUSERS, GOWNS, GREATCOAT, GYM PANTS, GYM SHORTS, GYM SUITS, HEAD SCARVES, HOODED PULLOVERS, HOODED SWEATSHIRTS, HOODS, HOSIERY, JACKETS, JEANS, JERSEYS, JERKINS, JUMPERS, KNICKERS, LEISURE SUITS, LEGGINGS, LINGERIE, MINISKIRTS, NECKTIES, NEGLIGEEES, NIGHT SHIRTS, NIGHTDRESSES, NIGHTIES, NIGHTWEAR, PYJAMAS, PETTICOATS, PLAY SUITS, POLO SHIRTS, PULLOVERS, RAINWEAR, RIDING COATS, RIDING GLOVES, ROBES, SHAWLS, SHIRTS, SHORTS, SHORT TROUSERS, SILK SCARVES, SINGLETES, SKI GLOVES, SKI SUITS, SKI WEAR, SKI MASKS, SKI PANTS, SKI TROUSERS, SKI JACKETS, SKIRTS, SLEEPING GARMENTS, SLIPS, SLIPPERS, SNOW SUITS, SNOW PANTS, SNOW GLOVES, SOCKS, SOCK SUSPENDERS, SPORT COATS, SPORT SHIRTS, SPORTS JACKETS, SPORTS JERSEYS, SPORTS PANTS, SPORTS SHIRTS, STOCKINGS, SUITS, SURF WEAR, SWIM TRUNKS, SWIM WEAR, SWIMSUITS, SWIMWEAR, TAILLEURS, TEE SHIRTS, TENNIS DRESSES, TENNIS WEAR, TIES, TIGHTS, TOPS, TRACK JACKETS, TRACK PANTS, TRACK SUITS, TRAINING SUITS, TRUNKS, TROUSERS, TUXEDOS, TWIN SETS, UNDER GARMENTS, UNDERCLOTHES, UNDERSHIRTS, UNDERPANTS, UNDERWEAR, UNDERSKIRTS, WATERPROOF JACKETS AND PANTS; SWEATERS, JUMPSUITS, BODY SUITS, SWEAT SHORTS, T-SHIRTS, VESTS, WAISTCOATS, PANTIES, OVERCOATS, ANORAKS, RAINCOATS, SHORT PETTICOATS, PETTI-PANTS, NIGHT GOWNS, TANKINIS, BATH ROBES, PAREOS, CAFTANS, KIMONOS, GARTER BELTS, WRAPS, FOULARDS, SCARVES, STOLEES; FOOTWEAR, BEACH FOOTWEAR, BEACH SHOES; HEADGEAR, NAMELY, BATHING CAPS, BERETS, BONNETS, BOOTIES, BOOTS, CAPELETS, CAPS, SHOES, DANCE SHOES, DECK-SHOES, GOLF CAPS, GOLF SHOES, GYMNASTIC SHOES, HATS, HORSE-RIDING BOOTS, LEATHER SHOES, LEATHER HEADWEAR, LEISURE SHOES, MOCCASINS, RAIN HATS, RUBBER SHOES, RUNNING SHOES, SABOT, SANDALS, SHOWER CAPS, SKI BOOTS, SKIING SHOES, SMALL HATS, SNEAKERS, SNOW BOOTS, SNOWBOARD BOOTS, SWIM CAPS, TENNIS SHOES, TRACK AND FIELD SHOES, TRAINING SHOES, IN CLASS 25 (U.S. CLS. 22 AND 39).

FOR: GAMES, NAMELY, CARD GAMES, BOARD GAMES, ELECTRONIC DART GAMES, PLAYING CARDS, CONSTRUCTION TOYS, MODEL CARS, TOY MODEL CARS, MODEL TOYS STEAM ENGINES, MODEL TOYS STEAM OPERATED ENGINES, MODEL PLASTIC TOYS FIGURINES, MODEL TOY FIGURES, TOY VEHICLES AND ACCESSORIES THEREFORE, TOY VEHICLES WITH TRANSFORMING PARTS; SPORTING ARTICLES, NAMELY, GOLF CLUBS, BAGS SPECIALLY ADAPTED FOR SPORTS EQUIPMENT, GOLF BAGS, GOLF IRONS, GOLF GLOVES, GOLF PUTTERS, GOLF PUTTERS COVERS, GOLF TEES, GOLF BALLS, TENNIS RACKETS; GYMNASTIC APPARATUS, IN CLASS 28 (U.S. CLS. 22, 23, 38 AND 50).

**Reg. No. 4,123,670** THE MARK CONSISTS OF STANDARD CHARACTERS WITHOUT CLAIM TO ANY PARTICULAR FONT, STYLE, SIZE, OR COLOR.

PRIORITY DATE OF 6-9-2010 IS CLAIMED.

OWNER OF INTERNATIONAL REGISTRATION 1074764 DATED 8-6-2010, EXPIRES 8-6-2020.

THE WORDING "HUAYRA" HAS NO MEANING IN A FOREIGN LANGUAGE.

SER. NO. 79-096,516, FILED 8-6-2010.

TRACY FLETCHER, EXAMINING ATTORNEY

# United States of America

United States Patent and Trademark Office

## MagnaCleanse

**RapidFlush Filter**

**Reg. No. 4,123,671**

**Registered Apr. 10, 2012**

**Int. Cls.: 9 and 11**

**TRADEMARK**

**PRINCIPAL REGISTER**

ADEY HOLDINGS (2008) LIMITED (UNITED KINGDOM LIMITED COMPANY)  
UK HEAD OFFICE, GLOUCESTER ROAD  
CHELTENHAM, GLOUCESTERSHIRE GL51 8NR  
UNITED KINGDOM

FOR: APPARATUS AND INSTRUMENTS FOR MEASURING AND CHECKING OR SUPERVISION, NAMELY, WATER TESTING INSTRUMENTATION FOR MONITORING AND DETECTING CONTAMINATION; APPARATUS AND INSTRUMENTS FOR CONDITION MONITORING, NAMELY, INDICATORS FOR MONITORING THE LEVEL AND CONTENT OF FLUID CONTAINED IN CENTRAL HEATING AND COOLING SYSTEMS; WATER TESTING APPARATUS AND INSTRUMENTS, NAMELY, WATER TESTING APPARATUS AND INSTRUMENTS FOR MONITORING AND DETECTING CONTAMINATION; WATER MONITORING APPARATUS AND INSTRUMENTS, NAMELY, WATER MONITORING APPARATUS AND INSTRUMENTS FOR MONITORING AND DETECTING CONTAMINATION; APPARATUS AND INSTRUMENTS FOR TESTING CENTRAL HEATING WATER, NAMELY, A PLASTIC WATER TESTER DEVICE CONTAINING A MAGNET FOR USE IN TESTING FOR THE EFFECTS OF CORROSION IN THE SYSTEM; APPARATUS AND INSTRUMENTS FOR MONITORING CENTRAL HEATING WATER, NAMELY, WATER MONITORING APPARATUS AND INSTRUMENTS FOR DETECTING CONTAMINATION; PARTS AND FITTINGS FOR ALL OF THE AFORESAID GOODS, IN CLASS 9 (U.S. CLS. 21, 23, 26, 36 AND 38).



*David J. Kyros*

Director of the United States Patent and Trademark Office

FOR: APPARATUS AND INSTALLATIONS FOR HEATING AND WATER SUPPLY, NAMELY, LIQUID FILTERS FOR THE CLEANING AND MAINTENANCE OF CENTRAL HEATING AND COOLING SYSTEMS AND FLUID CONTAINED THEREIN; CENTRAL HEATING APPARATUS AND INSTALLATIONS, NAMELY, LIQUID FILTERS FOR THE CLEANING AND MAINTENANCE OF CENTRAL HEATING AND COOLING SYSTEMS AND FLUID CONTAINED THEREIN; MAGNETIC FILTERS BEING PARTS OF HOUSEHOLD OR INDUSTRIAL INSTALLATIONS FOR THE CLEANING AND MAINTENANCE OF CENTRAL HEATING AND COOLING SYSTEMS AND FLUID CONTAINED THEREIN; NON-MAGNETIC FILTERS BEING PARTS OF HOUSEHOLD OR INDUSTRIAL INSTALLATIONS FOR THE CLEANING AND MAINTENANCE OF CENTRAL HEATING AND COOLING SYSTEMS AND FLUID CONTAINED THEREIN; MAGNETIC POWER FLUSHING FILTERS, AS PARTS OF HEATING APPARATUS AND INSTALLATIONS FOR THE CLEANING AND MAINTENANCE OF CENTRAL HEATING AND COOLING SYSTEMS AND FLUID CONTAINED THEREIN; POWER FLUSHING FILTERS BEING PARTS OF HOUSEHOLD OR INDUSTRIAL INSTALLATIONS FOR THE CLEANING AND MAINTENANCE OF CENTRAL HEATING AND

**Reg. No. 4,123,671** COOLING SYSTEMS AND FLUID CONTAINED THEREIN; MAGNETIC FILTERS BEING PARTS OF CENTRAL HEATING APPARATUS AND INSTALLATIONS FOR THE CLEANING AND MAINTENANCE OF CENTRAL HEATING AND COOLING SYSTEMS AND FLUID CONTAINED THEREIN; NON-MAGNETIC FILTERS BEING PARTS OF CENTRAL HEATING APPARATUS AND INSTALLATIONS FOR THE CLEANING AND MAINTENANCE OF CENTRAL HEATING AND COOLING SYSTEMS AND FLUID CONTAINED THEREIN; POWER FLUSHING FILTERS BEING PARTS OF CENTRAL HEATING APPARATUS AND INSTALLATIONS FOR THE CLEANING AND MAINTENANCE OF CENTRAL HEATING AND COOLING SYSTEMS AND FLUID CONTAINED THEREIN; MAGNETIC FILTERS BEING FOR USE IN CENTRAL HEATING SYSTEMS FOR THE CLEANING AND MAINTENANCE OF CENTRAL HEATING AND COOLING SYSTEMS AND FLUID CONTAINED THEREIN; NON-MAGNETIC FILTERS BEING FOR USE IN CENTRAL HEATING SYSTEMS FOR THE CLEANING AND MAINTENANCE OF CENTRAL HEATING AND COOLING SYSTEMS AND FLUID CONTAINED THEREIN; POWER FLUSHING FILTERS BEING FOR USE IN CENTRAL HEATING SYSTEMS FOR THE CLEANING AND MAINTENANCE OF CENTRAL HEATING AND COOLING SYSTEMS AND FLUID CONTAINED THEREIN; WATER FILTRATION APPARATUS AND INSTALLATIONS; WATER FILTRATION APPARATUS AND INSTALLATIONS FOR CENTRAL HEATING APPARATUS AND INSTALLATIONS; PARTS AND FITTINGS FOR ALL OF THE AFORESAID GOODS, IN CLASS 11 (U.S. CLS. 13, 21, 23, 31 AND 34).

OWNER OF U.S. REG. NOS. 3,523,260 AND 3,892,039.

PRIORITY DATE OF 8-16-2010 IS CLAIMED.

OWNER OF INTERNATIONAL REGISTRATION 1074781 DATED 12-30-2010, EXPIRES 12-30-2020.

NO CLAIM IS MADE TO THE EXCLUSIVE RIGHT TO USE "RAPID FLUSH FILTER", APART FROM THE MARK AS SHOWN.

SER. NO. 79-096,522, FILED 12-30-2010.

SANDRA BUJA, EXAMINING ATTORNEY

# United States of America

United States Patent and Trademark Office

## ALFA ROMEO 4C

**Reg. No. 4,123,672**

**Registered Apr. 10, 2012**

**Int. Cls.: 12, 25 and 28**

**TRADEMARK**

**PRINCIPAL REGISTER**

FIAT GROUP AUTOMOBILES S.P.A. (ITALY JOINT STOCK COMPANY)  
CORSO GIOVANNI AGNELLI, 200  
I-10135 TORINO  
ITALY

FOR: MOTOR VEHICLES, NAMELY, AUTOMOBILES, TRUCKS, VANS, SPORT UTILITY VEHICLES AND STRUCTURAL PARTS THEREFOR; BODYWORKS FOR MOTOR VEHICLES; WINDSCREEN WIPERS; VEHICLE PARTS, NAMELY, SHOCK ABSORBERS; WHEEL RIMS; ORNAMENTAL HUB CAPS; SAFETY BELTS FOR VEHICLES FOR MOTOR CARS; ROOF RACKS; TYRES; VEHICLE SEATS; ENGINES AND GAS TANKS FOR MOTOR VEHICLES; VEHICLE SEAT COVERS; MOTOR CAR DOORS; VEHICLE PARTS, NAMELY, STEERING WHEELS, IN CLASS 12 (U.S. CLS. 19, 21, 23, 31, 35 AND 44).

FOR: CLOTHING, NAMELY, SHIRTS, PANTS, COATS AND DRESSES; FOOTWEAR; HEADGEAR, NAMELY, HATS AND CAPS, IN CLASS 25 (U.S. CLS. 22 AND 39).

FOR: GAMES AND PLAYTHINGS, NAMELY, RADIO CONTROLLED MODEL VEHICLES, TOY CARS AND HAND HELD UNITS FOR PLAYING VIDEO GAMES OTHER THAN THOSE ADAPTED FOR USE WITH AN EXTERNAL DISPLAY SCREEN OR MONITOR; GYMNAS TIC AND SPORTING ARTICLES, NAMELY, BALLS FOR SPORTS, FOOTBALL OR SOCCER GOALS AND EXERCISE MACHINES, IN CLASS 28 (U.S. CLS. 22, 23, 38 AND 50).

THE MARK CONSISTS OF STANDARD CHARACTERS WITHOUT CLAIM TO ANY PARTICULAR FONT, STYLE, SIZE, OR COLOR.

PRIORITY DATE OF 3-2-2011 IS CLAIMED.

OWNER OF INTERNATIONAL REGISTRATION 1074830 DATED 3-25-2011, EXPIRES 3-25-2021.

OWNER OF U.S. REG. NO. 3,956,737.

SER. NO. 79-096,540, FILED 3-25-2011.

MARIA-VICTORIA SUAREZ, EXAMINING ATTORNEY



*David J. Kyffers*

Director of the United States Patent and Trademark Office

# United States of America

United States Patent and Trademark Office

# HaidiLao

**Reg. No. 4,123,673**

**Registered Apr. 10, 2012**

**Int. Cls.: 30 and 43**

**TRADEMARK**

**SERVICE MARK**

**PRINCIPAL REGISTER**

SICHUAN HAIDILAO CATERING COMPANY LIMITED. (CHINA CORPORATION)  
NO.115, WEST STREET  
JIANCHENG TOWN, JIANYANG CITY  
SICHUAN PROVINCE, CHINA

FOR: COFFEE FLAVORINGS; TEA-BASED BEVERAGES; CONDIMENTS, NAMELY, PEPPER SAUCE; PASTRIES; FARINACEOUS FOOD PASTES FOR HUMAN CONSUMPTION, IN CLASS 30 (U.S. CL. 46).

FOR: CAFÉS; RESTAURANTS; SNACK-BARS; RENTAL OF ROOMS FOR SOCIAL FUNCTIONS, NAMELY, RENTAL OF MEETING ROOMS; RETIREMENT HOMES; DAY-NURSERIES; BOARDING FOR ANIMALS; RENTAL OF CHAIRS, TABLES, TABLE LINEN, GLASSWARE, IN CLASS 43 (U.S. CLS. 100 AND 101).

THE MARK CONSISTS OF THE STYLIZED WORDING "HAIDILAO".

OWNER OF INTERNATIONAL REGISTRATION 1074847 DATED 4-11-2011, EXPIRES 4-11-2021.

THE ENGLISH TRANSLATION OF "HAI DI LAO" IN THE MARK IS "OCEAN BOTTOM DREDGE".

SER. NO. 79-096,549, FILED 4-11-2011.

PAUL MORENO, EXAMINING ATTORNEY



*David J. Kyros*

Director of the United States Patent and Trademark Office

# United States of America

United States Patent and Trademark Office

## MUSIC SAVE MY LIFE

**Reg. No. 4,123,674**

**Registered Apr. 10, 2012**

**Int. Cls.: 3, 9, 14, 15, 16,  
18, 25, 32, 33, 35, 38, 41  
and 43**

PEDRI JEAN-ROCH (RIVOLI) (FRANCE INDIVIDUAL)  
188 BIS RUE DE RIVOLI  
F-75001 PARIS  
FRANCE

FOR: BLEACHING PREPARATIONS AND DETERGENT FOR LAUNDRY USE; CLEANING, POLISHING, AND SCOURING PREPARATIONS; ABRASIVE LIQUIDS AND POWDERS FOR GENERAL PURPOSE CLEANING; SOAP FOR HOUSEHOLD AND PERSONAL USE; PERFUMERY, ESSENTIAL OILS, COSMETICS, HAIR LOTIONS; DENTIFRICES, IN CLASS 3 (U.S. CLS. 1, 4, 6, 50, 51 AND 52).

**TRADEMARK**

**SERVICE MARK**

**PRINCIPAL REGISTER**

FOR: APPARATUS FOR RECORDING, TRANSMISSION OR REPRODUCTION OF SOUND OR IMAGES; RECORDINGS FEATURING MUSIC, NAMELY, AUDIO DISCS, COMPACT DISCS, DIGITAL AUDIO DISKS, DIGITAL AUDIO COMPACT DISKS, AUDIO TAPES, AUDIO CASSETTES, VIDEO TAPES, VIDEO CASSETTES, MAGNETIC TAPES, AND MAGNETIC DISKS, ALL CONTAINING AUDIO OR VIDEO RECORDINGS FEATURING MUSIC; OPTICAL DISKS CONTAINING AUDIO OR VIDEO RECORDINGS FEATURING MUSIC; CABLES FOR CARRYING AUDIO AND VIDEO; COMPUTER PROGRAMS USED FOR DOWNLOADING MUSIC; COMPUTER SOFTWARE USED FOR PROCESSING DIGITAL MUSIC FILES; DOWNLOADABLE COMPUTER SOFTWARE USED FOR COMPOSING MUSIC; DOWNLOADABLE ELECTRONIC NEWSLETTERS FEATURING MUSIC REVIEWS AND NEWS IN THE NATURE OF CURRENT EVENTS IN THE MUSIC INDUSTRY; CD-ROMS FEATURING MUSIC; DVDS FEATURING MUSIC; DIGITAL MUSIC DOWNLOADABLE FROM THE INTERNET; DOWNLOADABLE MP3 FILES AND MP3 RECORDINGS FEATURING MUSIC; MP3 PLAYERS, IN CLASS 9 (U.S. CLS. 21, 23, 26, 36 AND 38).

FOR: PRECIOUS METALS AND THEIR ALLOYS OTHER THAN FOR DENTAL USE; JEWELRY, COSTUME JEWELRY, PRECIOUS STONES; TIMEPIECES AND CHRONOMETRIC INSTRUMENTS, NAMELY, WATCHES, WRISTWATCHES, CLOCKS, ELECTRIC CLOCKS, WALL CLOCKS, ALARM CLOCKS, CLOCK HOUSINGS, WATCH CASES, WATCH STRAPS, WATCH CHAINS, WATCH GLASSES, CHRONOMETERS, CLOCK HANDS, PENDULUMS, DIALS, CASES AND PRESENTATION CASES FOR TIMEPIECES, IN CLASS 14 (U.S. CLS. 2, 27, 28 AND 50).

FOR: MUSICAL INSTRUMENTS, IN CLASS 15 (U.S. CLS. 2, 21 AND 36).



*David J. Kappas*

Director of the United States Patent and Trademark Office



**Reg. No. 4,123,674** FOR: PAPER AND CARDBOARD, NAMELY, SEMI-PROCESSED PAPER AND CARDBOARD, PAPER AND CARDBOARD FOR STATIONERY USE, PAPER AND CARDBOARD FOR PRINTING USE, AND UNPROCESSED PAPER, NAMELY, UNSENSITIZED PHOTO PAPER; PRINTED MATTER, NAMELY, MAGAZINES AND NEWSLETTERS IN THE FIELD OF MUSIC; BOOKBINDING MATERIAL; PHOTOGRAPHS; STATIONERY; POSTERS, PHOTO ALBUMS, ALMANACS, AQUARELLES, PRINT ENGRAVINGS, GRAPHIC PRINTS, ATLASES, NOTEPADS, NEWSPAPERS, LITHOGRAPHS, BOOKS IN THE FIELD OF MUSIC, PAPER BAGS FOR PACKAGING, BOOKENDS, BOOKMARKERS, DRAWING PADS, PAMPHLETS IN THE FIELD OF MUSIC, BLOTTERS, NOTE BOOKS, CALENDARS, CATALOGS IN THE FIELD OF MUSIC, INDEX BOOKS, BOOKBINDINGS, CHECKBOOK HOLDERS, STORAGE CASES FOR STATIONERY, WRAPPING PAPER, ENVELOPES, WRITING PADS, WRITING INK, DESK STANDS FOR HOLDING INK, CHARCOAL PENCILS, PENCILS, PENCIL HOLDERS, PENCIL LEADS, PENS; BALLS FOR BALL-POINT PENS, NAMELY, PEN TIPS; PEN NIBS, PENHOLDERS, DRAWING PENS, PEN CASES, STANDS FOR PENS AND PENCILS; GLUE FOR STATIONERY OR HOUSEHOLD PURPOSES; ARTISTS' MATERIALS, NAMELY, PENS AND PENCILS; PAINTBRUSHES; TYPEWRITERS; OFFICE REQUISITES, NAMELY, STAPLERS; PRINTED INSTRUCTIONAL AND TEACHING MATERIAL IN THE FIELD OF MUSIC; PRINTING TYPE; PRINTING BLOCKS, IN CLASS 16 (U.S. CLS. 2, 5, 22, 23, 29, 37, 38 AND 50).

FOR: LEATHER AND IMITATIONS OF LEATHER; ARTICLES MADE OF LEATHER AND IMITATION LEATHER, NAMELY, LUGGAGE; TRAVELING BAGS, SPORTS BAGS; LEATHERWARE, NAMELY, LEATHER POCKETBOOKS; UNFITTED VANITY CASES; TOILETRY BAGS SOLD EMPTY, HANDBAGS, BEACH BAGS, RUCKSACKS; TENNIS BAGS, NAMELY, SPORTS BAGS NOT SPECIALLY ADAPTED FOR SPORTS EQUIPMENT; GYM BAGS; HEALTH CLUB BAGS, NAMELY, ATHLETIC BAGS; SHOE BAGS FOR TRAVEL, BRIEFCASES, SCHOOL BAGS, POCKET WALLETS, CREDIT CARD CASES, BUSINESS CARD CASES, PURSES, WEARABLE STRAP-ON POUCHES TO BE WORN AROUND THE WAIST, DRAWSTRING POUCHES; ANIMAL SKINS; TRUNKS AND TRAVELLING BAGS; UMBRELLAS, PARASOLS AND WALKING STICKS; WHIPS, HARNESS AND SADDLERY, IN CLASS 18 (U.S. CLS. 1, 2, 3, 22 AND 41).

FOR: CLOTHING, NAMELY, SHIRTS, TEE-SHIRTS, PANTS, PANTIES, SWEATSHIRTS, SOCKS; OUTERWEAR, NAMELY, JACKETS AND COATS; KNITWEAR, NAMELY, KNIT SWEATERS; TOPS, DRESS SHIRTS; DRESS SUITS; DRESSES, UNDERWEAR AND LINGERIE, BELTS, BATHING SUITS, BIKINIS; SWIM WEAR, BLAZERS; BLOOMERS; BLOUSES, GLOVES, KNIT SHIRTS, PULLOVERS, SLEEPWEAR; FOOTWEAR; HEADWEAR, IN CLASS 25 (U.S. CLS. 22 AND 39).

FOR: BEER; MINERAL AND AERATED WATERS; SOFT DRINKS; PREPARATIONS FOR MAKING BEVERAGES EXCEPT THOSE MADE WITH COFFEE, TEA OR COCOA AND MILK BEVERAGES, NAMELY, CONCENTRATES, SYRUPS OR POWDERS USED IN THE PREPARATION OF SOFT DRINKS; FRUIT DRINKS AND FRUIT JUICES; SYRUPS FOR MAKING FRUIT-FLAVORED DRINKS , IN CLASS 32 (U.S. CLS. 45, 46 AND 48).

FOR: ALCOHOLIC BEVERAGES, EXCEPT BEER, IN CLASS 33 (U.S. CLS. 47 AND 49).

FOR: ADVERTISING, PROMOTION AND MARKETING SERVICES; BUSINESS MANAGEMENT AND BUSINESS ADMINISTRATION; RETAIL STORE SERVICES IN THE FIELD OF SOUND RECORDING DISKS, COMPACT DISKS, AUDIO AND VIDEO CASSETTES, TAPES AND CARTRIDGES, MAGNETIC CASSETTES, TAPES, AND DISKS, ALL CONTAINING AUDIO OR VIDEO RECORDINGS, CD-ROMS, AND MP3 PLAYERS; COMPILATION OF ADVERTISEMENTS FOR USE AS WEB PAGES ON THE INTERNET; RENTAL OF ADVERTISING SPACE ON WEBSITES FOR ADVERTISING THE GOODS AND SERVICES OF OTHERS, IN CLASS 35 (U.S. CLS. 100, 101 AND 102).

FOR: TELECOMMUNICATION ACCESS SERVICES; COMMUNICATIONS VIA COMPUTER TERMINALS AND VIA FIBER-OPTIC NETWORKS; RADIO AND TELEPHONE COMMU-

**Reg. No. 4,123,674** NICATION; INTERNET BROADCASTING OF RADIO AND TELEVISION ENTERTAINMENT; AUDIO BROADCASTING OF MUSIC; NEWS AGENCY SERVICES FOR ELECTRONIC TRANSMISSION; ELECTRONIC TRANSMISSION OF DATA OR DOCUMENTS BY MEANS OF COMPUTER TERMINALS, RADIO, CABLE, SATELLITE, AND THE INTERNET; ELECTRONIC MAIL SERVICES, IN CLASS 38 (U.S. CLS. 100, 101 AND 104).

FOR: TEACHING IN THE FIELD OF MUSIC; TRAINING SERVICES IN THE FIELD OF MUSIC; ENTERTAINMENT IN THE NATURE OF VISUAL AND AUDIO PERFORMANCES, AND MUSICAL, VARIETY, NEWS AND COMEDY SHOWS; ORGANIZING COMMUNITY SPORTING AND CULTURAL EVENTS; INFORMATION ON ENTERTAINMENT AND EDUCATION; PROVIDING RECREATION FACILITIES; ORGANIZATION OF SINGING AND DANCE COMPETITIONS; EDUCATIONAL SERVICES, NAMELY, ARRANGING AND CONDUCTING OF EDUCATIONAL COLLOQUIUMS, CONFERENCES, AND CONGRESSES IN THE FIELD OF MUSIC; ORGANIZATION OF EXHIBITIONS FOR CULTURAL OR EDUCATIONAL PURPOSES; PRESENTATION OF LIVE SHOW PERFORMANCES OF VOCAL AND INSTRUMENTAL GROUPS; AUDIO AND VIDEO RECORDING SERVICES; PRODUCTION OF RADIO AND TELEVISION PROGRAMS; AUDIO AND VIDEO PRODUCTION OF AUDIO AND VIDEO RECORDINGS; PRODUCTION OF LIVE THEATER SHOWS, MUSICAL ENTERTAINMENT LIVE SHOWS, CONCERTS, VIDEOS, MULTIMEDIA VIDEOS AND RADIO AND TELEVISION PROGRAMS; RECORDING STUDIO SERVICES; CINEMA THEATERS; VIDEO AND TELEVISION SHOW PRODUCTION SERVICES; AUDIO RECORDING SERVICES; CINEMATOGRAPHIC SERVICES, NAMELY, MOVIE FILMING SERVICES; VIDEO AND TELEVISION FILMING SERVICES; MUSIC PUBLISHING SERVICES; PRODUCTION SERVICES FOR SOUND RECORDINGS, FILMS AND VIDEOS; ENTERTAINMENT SERVICES, NAMELY, PROVIDING NON-DOWNLOADABLE PLAYBACK OF MUSIC VIA GLOBAL COMMUNICATIONS NETWORKS; ENTERTAINMENT SERVICES, NAMELY, NON-DOWNLOADABLE PRE-RECORDED MUSIC PRESENTED TO MOBILE COMMUNICATIONS DEVICES VIA A GLOBAL COMPUTER NETWORK AND WIRELESS NETWORKS; PUBLISHING OF ELECTRONIC PUBLICATIONS, NAMELY, ON-LINE PUBLISHING OF NON-DOWNLOADABLE ELECTRONIC PUBLICATIONS; ARRANGING AND CONDUCTING NIGHTCLUB ENTERTAINMENT EVENTS; DISCOTHEQUE SERVICES, IN CLASS 41 (U.S. CLS. 100, 101 AND 107).

FOR: BAR SERVICES, CAFÉS, CAFETERIAS, HOTELS, FOOD AND DRINK CATERING, IN CLASS 43 (U.S. CLS. 100 AND 101).

THE MARK CONSISTS OF STANDARD CHARACTERS WITHOUT CLAIM TO ANY PARTICULAR FONT, STYLE, SIZE, OR COLOR.

PRIORITY DATE OF 7-28-2010 IS CLAIMED.

OWNER OF INTERNATIONAL REGISTRATION 1074958 DATED 12-14-2010, EXPIRES 12-14-2020.

NO CLAIM IS MADE TO THE EXCLUSIVE RIGHT TO USE "MUSIC", APART FROM THE MARK AS SHOWN.

SER. NO. 79-096,600, FILED 12-14-2010.

ELLEN B. AWRICH, EXAMINING ATTORNEY

# United States of America

United States Patent and Trademark Office



**Reg. No. 4,123,675**

**Registered Apr. 10, 2012**

**Int. Cl.: 6**

POLISAC METAL MAKINA PETROL ÜRÜNLERİ SANAYİ VE TİCARET ANONİM ŞİRKETİ  
(TURKEY ANONİM ŞİRKETİ (A.S.))  
10002 SOKAK NO. 25 A.O.S.B.  
ÇİGLI - İZMİR  
TURKEY

**TRADEMARK**

**PRINCIPAL REGISTER**

FOR: ORES OF METALS, NAMELY, ZINC ORES, NICKEL ORES, IRON ORES, LEAD ORES, MANGANESE ORES, CHROME ORES; CAST IRON FOR USE IN BUILDING; STEEL FRAMES FOR BUILDING; METAL FOR CONSTRUCTION AND BUILDING, NAMELY, BRACES, CLADDING; METAL BUILDING MATERIALS, NAMELY, METAL SOFFITS, METAL FASCIA, PORTABLE METAL BUILDINGS, METAL FLOORS, METAL STAIRCASES, PORTABLE METAL STAIRCASES, METAL GATES AND FENCES, METAL RAILINGS FOR FENCES, METAL ROOFING, METAL PALINGS; PREFABRICATED METAL DIVING PLATFORMS; METAL TELEPHONE BOOTHS; VENDOR BOOTHS MADE PRIMARILY OF METAL; TRANSPORTABLE GREENHOUSES OF METAL FOR HOUSEHOLD USE; METAL SWIMMING POOLS; METAL DIVING BOARDS; METAL SILOS; CRASH BARRIERS OF METAL FOR ROADS; METAL WINDOW SCREENS; METAL SIEVES BEING PARTS OF DRAINS; METALLIC DOORS; METALLIC WINDOWS; METALLIC SHUTTERS; METALLIC SLATTED SHUTTERS; METAL JALOUSIES; METAL SCAFFOLDING; METAL CASTING FORMS FOR CONCRETE; METAL POSTS; CONSTRUCTION ELEMENTS MADE OF METAL, NAMELY, SHORES AND SUPPORTS; NON-ELECTRIC CABLES MADE OF METAL; METAL CABLE WIRE; METAL RODS FOR BRAZING AND WELDING; METAL ROPES; BELTS OF METAL FOR HANDLING LOADS; TOW ROPES OF METAL; DUCTS OF METAL FOR VENTILATING AND AIR CONDITIONING AND HEATING INSTALLATIONS; METAL ROOF VENTS FOR RESIDENTIAL AND COMMERCIAL BUILDINGS; BOARDS OF METAL, NAMELY, ADVERTISING SIGNBOARDS; WALL BOARDS OF METAL; METAL LICENSE PLATES; NON-LUMINOUS AND NON-MECHANICAL METAL ROAD SIGNS; LOADING AND UNLOADING PALLETS OF METAL; HIGH PRESSURE METAL CONTAINERS; GENERAL PURPOSE METAL STORAGE CONTAINERS; CONTAINERS OF METAL FOR CHEMICALS, COMPRESSED GASES AND LIQUIDS; METAL CONTAINERS FOR THE STORAGE AND TRANSPORTATION OF GOODS; METAL BARRELS; VATS OF METAL; FLEXIBLE METAL FOILS FOR USE IN THE MANUFACTURE OF POUCHES, BAGS AND LIDS; METAL TOOL BOXES; METAL MAIL BOXES; METAL SHELF BRACKETS; METALLIC MOULDS FOR METAL CASTING; COMMON METALS, UNWROUGHT AND SEMI-WORKED, FOR FURTHER MANUFACTURE, NAMELY, IRONS AND STEELS, CAST IRON FOR USE IN BUILDING, STEEL PLATES AND SHEETS, NICKEL, TIN AND ITS ALLOYS, ZINC BASED



*David J. Kybas*

Director of the United States Patent and Trademark Office

**Reg. No. 4,123,675** ALLOYS, COPPER BASED ALLOYS, IRON ALLOYS, LEAD-TIN ALLOYS, AND ALUMINIUM AND ITS ALLOYS, IN CLASS 6 (U.S. CLS. 2, 12, 13, 14, 23, 25 AND 50).

THE MARK CONSISTS OF A STYLIZED DESIGN OF A METAL STAMPING MACHINE FORMING THE LETTER "P" IN RED AND THE WORDING "POLISAC" IN WHITE. THE REMAINING WHITE REPRESENTS BACKGROUND AND DOES NOT FORM PART OF THE MARK.

OWNER OF INTERNATIONAL REGISTRATION 1075035 DATED 11-26-2010, EXPIRES 11-26-2020.

THE COLOR(S) RED AND WHITE IS/ARE CLAIMED AS A FEATURE OF THE MARK.

THE WORD "POLISAC" HAS NO MEANING IN A FOREIGN LANGUAGE.

SER. NO. 79-096,630, FILED 11-26-2010.

TRACY FLETCHER, EXAMINING ATTORNEY

United States of America  
United States Patent and Trademark Office

STRELA

**Reg. No. 4,123,676**

JOURI LEVENBERG (FED REP GERMANY INDIVIDUAL)  
MARSSTR. 21

**Registered Apr. 10, 2012**

80335 MÜNCHEN, FED REP GERMANY

**Int. Cl.: 14**

FOR: WATCHES AND CLOCKS, WATCH STRAPS, IN CLASS 14 (U.S. CLS. 2, 27, 28 AND 50).

**TRADEMARK**

THE MARK CONSISTS OF STANDARD CHARACTERS WITHOUT CLAIM TO ANY PARTICULAR FONT, STYLE, SIZE, OR COLOR.

**PRINCIPAL REGISTER**

OWNER OF INTERNATIONAL REGISTRATION 1075040 DATED 1-5-2011, EXPIRES 1-5-2021.

THE ENGLISH TRANSLATION OF THE FOREIGN WORD(S) IN THE MARK IS: "ARROW".

SER. NO. 79-096,632, FILED 1-5-2011.

TIMOTHY FINNEGAN, EXAMINING ATTORNEY



*David J. Kyffers*

Director of the United States Patent and Trademark Office

# United States of America

United States Patent and Trademark Office

# MM100

**Reg. No. 4,123,677**

REPOWER SYSTEMS AG (FED REP GERMANY JOINT STOCK COMPANY)  
ÜBERSEERING 10

**Registered Apr. 10, 2012**

22297 HAMBURG, FED REP GERMANY

**Int. Cls.: 6, 7, 9, 35, 37,  
38 and 42**

FOR: MASTS AND TOWERS OF METAL FOR WIND POWER PLANTS; BUILDING MATERIALS OF METAL FOR THE CONSTRUCTION OF FOUNDATIONS FOR MACHINES FOR WIND POWER PLANTS, NAMELY, FOUNDATION PLATES, FOUNDATION FLANGES, FOUNDATION MOUNTING MATERIAL, METAL REINFORCEMENT MATERIALS FOR BUILDING, IN CLASS 6 (U.S. CLS. 2, 12, 13, 14, 23, 25 AND 50).

**TRADEMARK**

**SERVICE MARK**

**PRINCIPAL REGISTER**

FOR: WIND-POWERED MACHINES AND APPARATUS FOR ENERGY PRODUCTION, NAMELY, WIND TURBINES, WIND POWERED ELECTRICITY GENERATORS AND WIND-POWERED MACHINES FOR GENERATING ELECTRICAL AND MECHANICAL ENERGY, PARTS AND ACCESSORIES FOR SUCH WIND-POWERED MACHINES, NAMELY, ROTOR BLADES, ROTOR CONSOLES, BLADE HUBS, MACHINE HOUSINGS, YAW RINGS, YAW GEARS, BRAKES, MAIN DRIVE SHAFTS, UNIVERSAL JOINTS, GEARS, GEAR BOXES, COUPLINGS, MOTORS, MECHANICAL ROTOR ADJUSTERS, ELECTRIC GENERATORS AND EMERGENCY POWER SUPPLIES, IN CLASS 7 (U.S. CLS. 13, 19, 21, 23, 31, 34 AND 35).

FOR: SWITCH CABINETS FOR RECORDING, PROCESSING, STORAGE AND TRANSMISSION OF DATA FROM WIND POWER PLANTS AND WIND FARMS; SWITCH CABINETS FOR CONTROLLING ACTUATOR SYSTEMS FOR WIND POWER PLANTS AND WIND FARMS AND FOR REGULATING ELECTRICAL CURRENT, POWER, AND VOLTAGE; ELECTRICAL AND ELECTRONIC REGULATING, SUPERVISORY CHECKING, CONTROL AND MONITORING APPARATUS AND INSTRUMENTS, NAMELY, METERS AND SENSORS FOR MEASURING TURBINE PERFORMANCE AND POWER GENERATION IN WIND POWER PLANTS AND WIND FARMS; DATA PROCESSING EQUIPMENT, COMPUTERS AND COMPUTER SOFTWARE FOR RECORDING, ANALYZING, SORTING, SUMMARIZING, CALCULATING, DISSEMINATING AND STORING DATA FROM WIND POWER PLANTS AND WIND FARMS; COMPUTER INTERFACES AND COMPUTER INTERFACE PROGRAMS FOR MONITORING AND REGULATING WIND POWER PLANTS AND WIND FARMS; VOLTAGE SURGE PROTECTORS; VIBRATION SENSORS; WATT-HOUR METERS; INVERTERS; ELECTRIC TRANSFORMERS; ALL AFORE-MENTIONED GOODS FOR USE WITH WIND POWER PLANTS AND WIND FARMS, IN CLASS 9 (U.S. CLS. 21, 23, 26, 36 AND 38).



*David J. Kappas*

Director of the United States Patent and Trademark Office

**Reg. No. 4,123,677** FOR: PROFESSIONAL BUSINESS CONSULTATION SERVICES FOR WIND POWER PLANTS AND WIND FARMS, IN CLASS 35 (U.S. CLS. 100, 101 AND 102).

FOR: BUILDING CONSTRUCTION IN THE FIELD OF WIND POWER PLANTS; INSTALLATION, MAINTENANCE AND REPAIR OF TOWERS, TURBINES, ELECTRICAL AND COMPUTER MONITORING AND OPERATION SYSTEMS FOR WIND POWER PLANTS AND FARMS; REPAIR, MAINTENANCE AND REBUILDING OF WIND TURBINES, WIND POWERED ELECTRICITY GENERATORS AND WIND-POWERED MACHINES THAT HAVE BEEN WORN OR PARTIALLY DESTROYED; CONSTRUCTION OF ROTOR BLADES, IN CLASS 37 (U.S. CLS. 100, 103 AND 106).

FOR: TELECOMMUNICATIONS SERVICES, NAMELY, ELECTRONIC DATA TRANSMISSION FOR WIND POWER PLANTS AND WIND FARMS, IN CLASS 38 (U.S. CLS. 100, 101 AND 104).

FOR: REMOTE MAINTENANCE, REMOTE CONTROL AND REMOTE MONITORING OF WIND POWER PLANTS AND WIND FARMS BY COMPUTERIZED RETRIEVAL OF DATA OVER THE INTERNET; CONDUCTING TECHNICAL MEASUREMENT EVALUATIONS AND INSPECTIONS OF WIND POWER PLANTS AND WIND FARMS; ELECTRONIC DATA STORAGE; DESIGN AND DEVELOPMENT OF COMPUTER SOFTWARE IN THE FIELD OF WIND POWER PLANTS AND WIND FARMS; TECHNICAL CONSULTATION, TECHNICAL PLANNING AND DEVELOPMENT SERVICES AS WELL AS TECHNICAL PROJECT MANAGEMENT IN MATTERS OF WIND POWER PLANT PROJECTS; ENGINEERING SERVICES FOR CALCULATION, DIMENSIONING AND DESIGN OF ROTOR BLADES; TECHNICAL RESEARCH IN THE FIELD OF WIND POWER PLANTS AND WIND FARMS; PROVIDING TECHNICAL INFORMATION IN MATTERS OF WIND POWER PLANTS AND WIND FARMS; TECHNICAL CONDITION MONITORING OF ROTOR BLADES, IN CLASS 42 (U.S. CLS. 100 AND 101).

THE MARK CONSISTS OF STANDARD CHARACTERS WITHOUT CLAIM TO ANY PARTICULAR FONT, STYLE, SIZE, OR COLOR.

PRIORITY DATE OF 9-22-2010 IS CLAIMED.

OWNER OF INTERNATIONAL REGISTRATION 1075064 DATED 3-1-2011, EXPIRES 3-1-2021.

SER. NO. 79-096,643, FILED 3-1-2011.

GIANCARLO CASTRO, EXAMINING ATTORNEY

# United States of America

United States Patent and Trademark Office

## BOTTEGA VENETA

**Reg. No. 4,123,678**

**Registered Apr. 10, 2012**

**Int. Cl.: 14**

**TRADEMARK**

**PRINCIPAL REGISTER**

BOTTEGA VENETA INTERNATIONAL S.A.R.L. (LUXEMBOURG SARL)  
124, BOULEVARD DE LA PETRUSSE  
L-1637 LUXEMBOURG  
LUXEMBOURG

FOR: HOROLOGICAL AND CHRONOMETRIC INSTRUMENTS, NAMELY WRIST WATCHES, TIME CLOCKS, TRAVEL CLOCKS, WATCH CHAINS, WATCH SPRINGS, WATCH GLASSES, CHRONOMETERS, CHRONOGRAPHS FOR USE AS WATCHES, ALARM CLOCKS, MOVEMENTS FOR CLOCKS AND WATCHES, WATCH CASES, CLOCK CASES, JEWELRY AND COSTUME JEWELRY NAMELY EARRINGS, RINGS, CHAINS, BRACELETS, PENDANTS, BROOCHES, IN CLASS 14 (U.S. CLS. 2, 27, 28 AND 50).

THE MARK CONSISTS OF STANDARD CHARACTERS WITHOUT CLAIM TO ANY PARTICULAR FONT, STYLE, SIZE, OR COLOR.

PRIORITY DATE OF 8-10-2010 IS CLAIMED.

OWNER OF INTERNATIONAL REGISTRATION 1075105 DATED 2-3-2011, EXPIRES 2-3-2021.

OWNER OF U.S. REG. NOS. 1,086,395, 3,683,246 AND OTHERS.

THE ENGLISH TRANSLATION OF "BOTTEGA VENETA" IN THE MARK IS "SHOP OF THE VENETO REGION" OF ITALY.

SEC. 2(F).

SER. NO. 79-096,658, FILED 2-3-2011.

DOUGLAS LEE, EXAMINING ATTORNEY



*David J. Kyffers*

Director of the United States Patent and Trademark Office



# United States of America

United States Patent and Trademark Office

# HIGH FLIER

**Reg. No. 4,123,679**

**Registered Apr. 10, 2012**

**Int. Cl.: 34**

**TRADEMARK**

**PRINCIPAL REGISTER**

LODESTAR ANSTALT (LIECHTENSTEIN ANSTALT)  
LOVA-CENTER  
PO BOX 1150; FL-9490 VADUZ  
LIECHTENSTEIN

FOR: TOBACCO; CIGARETTES; CIGARS; CIGARILLOS; CIGARETTE PAPERS; LIGHTERS FOR SMOKERS; MATCHES; SMOKERS' ARTICLES, NAMELY, POCKET MACHINES FOR ROLLING CIGARETTES, CIGAR CUTTERS, CIGAR TUBES, CIGAR CASES NOT OF PRECIOUS METAL, CIGAR HOLDERS NOT OF PRECIOUS METAL, CIGARETTE ROLLING PAPERS, CIGARETTE FILTER TIPS, CIGARETTE FILTERS, CIGARETTE CASES NOT OF PRECIOUS METAL, MATCHBOXES NOT OF PRECIOUS METAL, MATCH HOLDERS NOT OF PRECIOUS METAL, TOBACCO POUCHES, TOBACCO PIPES, ASHTRAYS NOT OF PRECIOUS METAL, IN CLASS 34 (U.S. CLS. 2, 8, 9 AND 17).

THE MARK CONSISTS OF STANDARD CHARACTERS WITHOUT CLAIM TO ANY PARTICULAR FONT, STYLE, SIZE, OR COLOR.

PRIORITY DATE OF 4-29-2010 IS CLAIMED.

OWNER OF INTERNATIONAL REGISTRATION 1075234 DATED 10-28-2010, EXPIRES 10-28-2020.

SER. NO. 79-096,712, FILED 10-28-2010.

JASON LOTT, EXAMINING ATTORNEY



*David J. Kyffers*

Director of the United States Patent and Trademark Office

# United States of America

United States Patent and Trademark Office



**Reg. No. 4,123,680**

**Registered Apr. 10, 2012**

**Int. Cl.: 7**

**TRADEMARK**

**PRINCIPAL REGISTER**

NINGBO HONGYI MANUFACTURE ELECTRONICS CO., LTD. (CHINA CORPORATION)  
GUANHAIWEI INDUSTRIAL AREA EAST ZONE  
CIXI CITY; 315314 ZHEJIANG, CHINA

FOR: BREAD CUTTING MACHINES; MACHINES, NAMELY, WINE PRESSES; ELECTRIC FOOD GRINDERS FOR HOUSEHOLD PURPOSES; ELECTRIC COFFEE GRINDERS, OTHER THAN HAND-OPERATED; KITCHEN MACHINES, NAMELY, ELECTRIC STAND MIXERS; ELECTRIC WHISKS FOR HOUSEHOLD PURPOSES; ELECTRIC FRUIT PRESSES FOR HOUSEHOLD PURPOSES; POWER OPERATED MEAT GRINDERS, ELECTRIC JUICERS; VACUUM CLEANERS, IN CLASS 7 (U.S. CLS. 13, 19, 21, 23, 31, 34 AND 35).

THE MARK "HY" SHOWS TWO FIRST LETTERS OF CHINESE PHONETIC ALPHABET (PIN YIN) "HONG YI".

OWNER OF INTERNATIONAL REGISTRATION 1075243 DATED 11-26-2010, EXPIRES 11-26-2020.

SER. NO. 79-096,714, FILED 11-26-2010.

MARK T. MULLEN, EXAMINING ATTORNEY



*David J. Kyffers*

Director of the United States Patent and Trademark Office

# United States of America

United States Patent and Trademark Office

# DECORESS

**Reg. No. 4,123,681**

AB GUSTAF KÄHR (SWEDEN LIMITED LIABILITY COMPANY)  
DUNDERBERGSG. 10

**Registered Apr. 10, 2012**

SE-382 28 NYBRO, SWEDEN

**Int. Cls.: 19, 20, 40 and  
42**

FOR: NON-METALLIC BUILDING MATERIALS, NAMELY, FASCIA, SOFFIT AND CLADDING; WOODEN FLOORING; FLOOR BOARDS AND PARQUET FLOOR BOARDS AND PANELS OF WOOD FLOORING BOUND TO A PARTICLE BOARD OR FIBRE BOARD BACKING; WOODEN BUILDING MATERIALS, NAMELY, WALL PANELS, DOOR PANELS, CEILING PANELS, ALL OF THE AFORESAID GOODS NOT RELATED TO GLASS PRODUCTS FOR THE BUILDING INDUSTRIES, IN CLASS 19 (U.S. CLS. 1, 12, 33 AND 50).

**TRADEMARK**

**SERVICE MARK**

**PRINCIPAL REGISTER**

FOR: FURNITURE, MIRRORS, PICTURE FRAMES; DRAWER PULLS OF WOOD, CORK, REED, CANE AND WICKER, IN CLASS 20 (U.S. CLS. 2, 13, 22, 25, 32 AND 50).

FOR: MATERIAL TREATMENT OF WOOD FOR OTHERS FOR USE IN THE FURNITURE, FURNISHINGS, AND FLOORING INDUSTRIES; CUSTOM MANUFACTURING OF WOOD PRODUCTS FOR THE FURNITURE, FURNISHINGS, AND FLOORING INDUSTRIES, ALL OF THE AFORESAID GOODS NOT RELATED TO GLASS PRODUCTS FOR THE BUILDING INDUSTRIES, IN CLASS 40 (U.S. CLS. 100, 103 AND 106).

FOR: RESEARCH AND PRODUCT DEVELOPMENT WITHIN THE TIMBER INDUSTRY; DESIGN SERVICES, NAMELY, INDUSTRIAL DESIGN; INTERIOR DESIGN, IN PARTICULAR FOR FURNITURE, FLOOR AND WALL COVERINGS; CONSULTANCY RELATING TO TECHNOLOGICAL RESEARCH AND PRODUCT DEVELOPMENT FOR INTERIOR DESIGN, IN PARTICULAR, FOR FURNITURE, FLOOR AND WALL COVERINGS, ALL OF THE AFORESAID GOODS NOT RELATED TO GLASS PRODUCTS FOR THE BUILDING INDUSTRIES, IN CLASS 42 (U.S. CLS. 100 AND 101).



THE MARK CONSISTS OF STANDARD CHARACTERS WITHOUT CLAIM TO ANY PARTICULAR FONT, STYLE, SIZE, OR COLOR.

PRIORITY DATE OF 6-10-2010 IS CLAIMED.

*David J. Kyros*

OWNER OF INTERNATIONAL REGISTRATION 1075374 DATED 12-2-2010, EXPIRES 12-2-2020.

Director of the United States Patent and Trademark Office

THE WORDING "DECORESS" HAS NO MEANING IN A FOREIGN LANGUAGE.

**Reg. No. 4,123,681** SER. NO. 79-096,773, FILED 12-2-2010.

KAREN SEVERSON, EXAMINING ATTORNEY

# United States of America

United States Patent and Trademark Office



**Reg. No. 4,123,682**

**Registered Apr. 10, 2012**

**Int. Cl.: 6**

**TRADEMARK**

**PRINCIPAL REGISTER**

JIANGDE XU (CHINA INDIVIDUAL)  
ANNEX 1, NO. 31, SUPOQIAO STREET  
QINGYANG DISTRICT  
CHENGDU; 610000 SICHUAN, CHINA

FOR: DOORS OF METAL; DOOR CASES OF METAL; DOOR FRAMES OF METAL; WINDOWS OF METAL; KEYS OF METAL FOR LOCKS; LOCKS OF METAL, OTHER THAN ELECTRIC; HOUSEHOLD METAL PULLEY RAILS; LATCH BARS OF METAL; CHAINS OF METAL; SASH PULLEYS AND WINDOW PULLEYS BOTH OF METAL; FURNITURE CASTERS OF METAL; DOOR HANDLES OF METAL; HINGES OF METAL; RUNNERS OF METAL FOR SLIDING DOORS; DOOR STOPS OF METAL, IN CLASS 6 (U.S. CLS. 2, 12, 13, 14, 23, 25 AND 50).

THE MARK CONSISTS OF THE STYLIZED LETTERS "OPK" IN WHICH THE "O" IS INCOMPLETE AT ITS BASE AND A SEMICIRCLE JOINS THE ARM AND LEG OF THE "K".

OWNER OF INTERNATIONAL REGISTRATION 1075417 DATED 4-11-2011, EXPIRES 4-11-2021.

SER. NO. 79-096,785, FILED 4-11-2011.

HANNO RITTNER, EXAMINING ATTORNEY



*David J. Kyfos*

Director of the United States Patent and Trademark Office

# United States of America

United States Patent and Trademark Office

# KOSMODISK

**Reg. No. 4,123,683**

**Registered Apr. 10, 2012**

**Int. Cls.: 3, 5 and 10**

**TRADEMARK**

**PRINCIPAL REGISTER**

STUDIO MODERNA SA (SWITZERLAND SOCIÉTÉ ANONYME (SA) / JOINT STOCK COMPANY)  
VIA FERRUCCIO PELLI 13  
CH-6900 LUGANO, SWITZERLAND

FOR: BLEACHING PREPARATIONS, WASHING PREPARATIONS AND LAUNDRY BLEACH ALL FOR LAUNDRY USE; LAUNDRY DETERGENT, LAUNDRY PRE-SOAK; LAUNDRY SOAP; LAUNDRY FABRIC SOFTENERS; CLEANING, POLISHING, SCOURING AND ABRASIVE PREPARATIONS; FACIAL, BODY AND HAND SOAPS; PERFUMERY, ESSENTIAL OILS, COSMETICS, BODY AND HAND LOTIONS; HAIR LOTIONS; SHAMPOO; HAIR SPRAY, IN CLASS 3 (U.S. CLS. 1, 4, 6, 50, 51 AND 52).

FOR: PHARMACEUTICAL PREPARATIONS FOR TREATING BACK, SPINAL OR OTHER MUSCULAR OR JOINT CONDITIONS; SANITARY PREPARATIONS FOR MEDICAL PURPOSES; DIETETIC FOODS ADAPTED FOR MEDICAL USE, FOOD FOR BABIES; OINTMENTS FOR THERAPEUTIC PURPOSES FOCUSING ON THE BACK, SPINE, MUSCLES AND JOINTS; OINTMENTS FOR PAIN RELIEF; ANALGESIC PREPARATIONS; ADHESIVE PATCHES CONTAINING PREPARATIONS FOR PAIN RELIEF AND FOR THERAPEUTIC PURPOSES FOCUSING ON THE BACK, SPINE, MUSCLES AND JOINTS; OINTMENTS FOR MEDICAL AND PHARMACEUTICAL PURPOSES, NAMELY, ANTI-INFLAMMATORY OINTMENTS; PLASTERS FOR MEDICAL PURPOSES, GAUZE AND BANDAGES FOR DRESSINGS; MATERIAL FOR STOPPING TEETH, DENTAL WAX; DISINFECTANTS FOR SANITARY PURPOSES; PREPARATIONS FOR DESTROYING VERMIN; FUNGICIDES, HERBICIDES, IN CLASS 5 (U.S. CLS. 6, 18, 44, 46, 51 AND 52).

FOR: ORTHOPEDIC APPARATUS; MEDICAL DEVICE, NAMELY, APPARATUS FOR SPINAL SYSTEM ENERGY ACTIVATION; MASSAGE APPARATUS, IN CLASS 10 (U.S. CLS. 26, 39 AND 44).

OWNER OF U.S. REG. NOS. 1,964,953, 3,395,655, AND 3,774,874.

PRIORITY DATE OF 10-5-2010 IS CLAIMED.

OWNER OF INTERNATIONAL REGISTRATION 1075495 DATED 3-28-2011, EXPIRES 3-28-2021.



*David J. Kyros*

Director of the United States Patent and Trademark Office

**Reg. No. 4,123,683** THE MARK CONSISTS OF THE WORDING "KOSMODISK" WITH AN ACCENT OVER THE LETTER "I" AND A CURVED LINE UNDERNEATH.

SER. NO. 79-096,804, FILED 3-28-2011.

SHAILA SETTLES, EXAMINING ATTORNEY

# United States of America

United States Patent and Trademark Office

# Tarent

**Reg. No. 4,123,684**

**Registered Apr. 10, 2012**

**Int. Cls.: 35 and 42**

TARENT GESELLSCHAFT FÜR SOFTWAREENTWICKLUNG UND IT-BERATUNG MBH  
(FED REP GERMANY LIMITED LIABILITY COMPANY (GMBH))  
HEILSBACHSTR. 24  
53123 BONN  
FED REP GERMANY

**SERVICE MARK**

**PRINCIPAL REGISTER**

FOR: COLLECTION AND SYSTEMATIZATION OF DATA IN COMPUTER DATABASES; BUSINESS MANAGEMENT AND ORGANIZATION CONSULTANCY; BUSINESS MANAGEMENT CONSULTANCY; ADVISORY SERVICES FOR BUSINESS MANAGEMENT; PROCUREMENT SERVICES FOR OTHERS IN THE NATURE OF PURCHASING OF GOODS AND SERVICES FOR OTHER COMPANIES; PROFESSIONAL BUSINESS CONSULTANCY; COMPUTERIZED FILE MANAGEMENT; COMMERCIAL ADMINISTRATION OF THE LICENSING OF THE GOODS AND SERVICES OF OTHERS; SEARCH OF COMPUTER FILES OF BUSINESSES FOR DATA ABOUT BUSINESS SUPPLIERS; BUSINESS PROJECT MANAGEMENT SERVICES FOR OTHERS IN THE FIELD OF ELECTRONIC DATA PROCESSING; OUTSOURCING SERVICES IN THE NATURE OF BUSINESS ASSISTANCE; BUSINESS STRATEGY DEVELOPMENT SERVICES; SERVICES WITH REGARD TO PRESENTATION OF COMPANIES TO THE PUBLIC FOR MARKETING PURPOSES ON THE INTERNET AND OTHER MEDIA; SYSTEMIZATION OF INFORMATION INTO COMPUTER DATABASES; RENTAL OF ADVERTISING SPACE ON THE INTERNET; COMPILATION OF INFORMATION INTO COMPUTER DATABASES, IN CLASS 35 (U.S. CLS. 100, 101 AND 102).



*David J. Kyffers*

Director of the United States Patent and Trademark Office

FOR: UPDATING OF COMPUTER SOFTWARE FOR OTHERS; UPDATING OF COMPUTER WEBSITES FOR OTHERS; COMPUTER NETWORK ADMINISTRATION SERVICES FOR OTHERS; CONSULTANCY WITH REGARD TO THE DESIGN OF INTERNET HOMEPAGES AND INTERNET WEB PAGES; CONSULTANCY WITH REGARD TO THE DEVELOPMENT OF INFORMATION TECHNOLOGY; CONSULTANCY WITH REGARD TO THE USE OF INFORMATION TECHNOLOGY; COMPUTER HARDWARE AND SOFTWARE CONSULTANCY; CONSULTANCY IN THE FIELD OF COMPUTER HARDWARE AND SOFTWARE; COMPUTER SYSTEMS ANALYSIS; DESIGN AND CREATION OF COMPUTER HOMEPAGES AND INTERNET WEB PAGES FOR OTHERS; COMPUTER SOFTWARE DESIGN FOR OTHERS; COMPUTER SYSTEM DESIGN FOR OTHERS; TESTING, ANALYSIS AND EVALUATION OF DIGITAL CODES AND/OR DIGITAL SIGNATURES USED IN THE WORKPLACE FOR THE PURPOSE OF CERTIFICATION; COMPUTER PROGRAMMING; GRAPHIC ARTS DESIGNING; COMPUTER VIRUS PROTECTION SERVICES; GRAPHIC DESIGN; CONSULTANCY IN THE DESIGN OF COMPUTER PROGRAMS FOR USE IN ELECTRONIC DATA PROCESSING; DESIGN AND DEVELOPMENT OF ELECTRONIC



**Reg. No. 4,123,684** DATA SECURITY; RECORDING DATA FOR OTHERS ON MAGNETIC MEDIA FOR ELECTRONIC STORAGE; DEVELOPMENT OF COMPUTER SOFTWARE; COMPUTER SOFTWARE PROGRAMMING; COMPUTER PROGRAMMING; PROGRAMMING OF COMPUTER ANIMATIONS FOR OTHERS; CREATING AND MAINTAINING WEB SITES FOR OTHERS; COMPUTER SOFTWARE INSTALLATION AND MAINTENANCE; INSTALLATION AND MAINTENANCE OF INTERNET ACCESS SOFTWARE; INSTALLATION OF COMPUTER SOFTWARE; CONFIGURATION OF COMPUTER NETWORKS FOR OTHERS; DATA CONVERSION OF COMPUTER PROGRAMS AND DATA, NOT PHYSICAL CONVERSION; CONVERSION OF DATA OR DOCUMENTS FROM PHYSICAL TO ELECTRONIC MEDIA; DUPLICATION OF COMPUTER PROGRAMS; TECHNICAL ADMINISTRATION OF SERVERS FOR OTHERS IN THE NATURE OF DIAGNOSING SERVER PROBLEMS; TECHNICAL CONSULTANCY RELATING TO COMPUTER SYSTEMS; TECHNICAL PROJECT PLANNING AND DESIGN FOR THE PROCESSING OF WEB SITES; TECHNICAL PROJECT MANAGEMENT, NAMELY, ADMINISTRATION OF SOFTWARE APPLICATIONS AND DATABASES IN THE FIELD OF ELECTRONIC DATA PROCESSING SYSTEMS; DESIGN AND IMPLEMENTATION OF SOFTWARE FOR AUTHENTICATING DIGITAL SIGNATURES; HOSTING COMPUTER SITES FOR OTHERS; RENTAL OF COMPUTER HARDWARE AND SOFTWARE; RENTAL OF COMPUTER SOFTWARE; RENTAL OF COMPUTER HARDWARE; RENTAL OF WEB SERVERS; MAINTENANCE OF COMPUTER SOFTWARE; RECOVERY OF COMPUTER DATA; DEVELOPING QUALITY CONTROL STANDARDS FOR THE PURPOSES OF CERTIFICATION; CLOUD HOSTING PROVIDER SERVICES; RENTAL OF VIRTUAL COMPUTER WEB SITES THROUGH CLOUD COMPUTING ON THE INTERNET, IN CLASS 42 (U.S. CLS. 100 AND 101).

THE MARK CONSISTS OF STANDARD CHARACTERS WITHOUT CLAIM TO ANY PARTICULAR FONT, STYLE, SIZE, OR COLOR.

OWNER OF INTERNATIONAL REGISTRATION 1075709 DATED 1-21-2011, EXPIRES 1-21-2021.

THE WORDING TARENT HAS NO MEANING IN A FOREIGN LANGUAGE.

SER. NO. 79-096,875, FILED 1-21-2011.

RUSS HERMAN, EXAMINING ATTORNEY

United States of America  
United States Patent and Trademark Office

ARMANI

Hotels & Resorts

**Reg. No. 4,123,685**

**Registered Apr. 10, 2012**

**Int. Cls.: 43 and 44**

GIORGIO ARMANI S.P.A., MILAN, SWISS BRANCH MENDRISIO (SWITZERLAND JOINT STOCK COMPANY)  
VIA PENATE 4  
CH-6850 MENDRISIO  
SWITZERLAND

**SERVICE MARK**

FOR: HOTELS; PROVIDING OF FOOD AND DRINK; BARS AND RECEPTION HALLS; TEMPORARY ACCOMMODATION, IN CLASS 43 (U.S. CLS. 100 AND 101).

**PRINCIPAL REGISTER**

FOR: BEAUTY SALONS AND HAIRDRESSING SERVICES; MEDICAL SERVICES; VETERINARY SERVICES; HYGIENIC AND BEAUTY CARE FOR HUMAN BEINGS OR ANIMALS, IN CLASS 44 (U.S. CLS. 100 AND 101).

OWNER OF U.S. REG. NOS. 3,055,615, 3,154,223 AND OTHERS.

PRIORITY DATE OF 11-24-2010 IS CLAIMED.

OWNER OF INTERNATIONAL REGISTRATION 1075756 DATED 3-14-2011, EXPIRES 3-14-2021.

NO CLAIM IS MADE TO THE EXCLUSIVE RIGHT TO USE "HOTELS & RESORTS", APART FROM THE MARK AS SHOWN.

SEC. 2(F) AS TO "ARMANI".

SER. NO. 79-096,888, FILED 3-14-2011.

NATALIE POLZER, EXAMINING ATTORNEY



*David J. Kybas*

Director of the United States Patent and Trademark Office

# United States of America

United States Patent and Trademark Office

# RUDID-Point

**Reg. No. 4,123,686**

**Registered Apr. 10, 2012**

**Int. Cls.: 6, 7, 8 and 9**

RUD KETTEN RIEGER & DIETZ GMBH U. CO. KG (FED REP GERMANY A COMPANY ORGANIZED UNDER GERMAN LAW)  
FRIEDENSINSEL  
73432 AALEN-UNTERKOCHEN  
FED REP GERMANY

**TRADEMARK**

**PRINCIPAL REGISTER**

FOR: CHAINS, CHAIN LINKS, LINK PINS, CHAIN JOINTS, CHAIN SPROCKETS, AND SWIVEL SHACKLE, ALL MADE OF METAL; METAL DEVICES AND COMPONENTS OF METAL FOR THE SECURING, COUPLING, SHORTENING, GUIDING AND TENSIONING OF CHAINS, BELTS AND/OR ROPES; GRABS, HOOKS, EYES, RETAINING LOOPS, EXPANSION BRACES, CLAWS AND SHACKLES, ALL OF METAL, FOR USE IN CONNECTION WITH CHAINS, BELTS AND/OR ROPES; SHAPED METAL PARTS; METAL CHAIN HARNESSSES FOR LIFTING AND SUSPENDING LOADS, COMPRISING METAL CHAIN ASSEMBLIES; ALL THE AFORESAID GOODS IN PARTICULAR WITH INTEGRATED DATA TRANSMISSION AND DATA RECORDING DEVICES, IN PARTICULAR RFID TRANSPONDERS, AND/OR SENSORS, IN PARTICULAR LOAD SENSORS, IN CLASS 6 (U.S. CLS. 2, 12, 13, 14, 23, 25 AND 50).

FOR: MECHANICAL APPARATUS FOR LIFTING AND SUSPENDING LOADS WITH THE AID OF CHAINS, STRAPS AND/OR ROPES; CHAIN CONVEYORS, AND COGGED WHEELS, DEFLECTOR WHEELS, CONVEYOR WHEELS, CONVEYOR ROLLERS, TRACK ROLLERS AND CONVEYOR RAILS; MECHANICAL EXPANSION DEVICES FOR CHAIN HARNESSSES, OTHER THAN HAND-OPERATED; MECHANICAL TENSIONING APPARATUS AND SPRING BUFFERS FOR LASHING LOADS, OTHER THAN HAND-OPERATED; ALL THE AFORESAID GOODS IN PARTICULAR WITH INTEGRATED DATA TRANSMISSION AND DATA RECORDING DEVICES, IN PARTICULAR RFID TRANSPONDERS, AND/OR SENSORS, IN PARTICULAR LOAD SENSORS, IN CLASS 7 (U.S. CLS. 13, 19, 21, 23, 31, 34 AND 35).

FOR: HAND-OPERATED EXPANSION DEVICES FOR CHAIN HARNESSSES; HAND-OPERATED TENSIONING APPARATUS AND SPRING BUFFERS FOR LASHING LOADS; HAND-OPERATED APPARATUS FOR LIFTING AND SUSPENDING LOADS WITH THE AID OF CHAINS, STRAPS AND/OR ROPES; ALL THE AFORESAID GOODS IN PARTICULAR WITH INTEGRATED DATA TRANSMISSION AND DATA RECORDING DEVICES, IN PARTICULAR RFID TRANSPONDERS, AND/OR SENSORS, IN PARTICULAR LOAD SENSORS, IN CLASS 8 (U.S. CLS. 23, 28 AND 44).



*David J. Kyjars*

Director of the United States Patent and Trademark Office

**Reg. No. 4,123,686** FOR: MEASURING, SIGNALING AND TESTING AND REGULATING APPARATUS AND INSTRUMENTS, NAMELY, ELECTRIC SENSORS, LOAD SENSORS, WEAR SENSORS, STRAIN SENSORS, AND STRESS SENSORS, FOR USE IN MEASURING AND INSPECTING THE WEAR, LIFETIME, LOAD, STRAIN AND STRESS OF LIFTING, SUSPENDING AND LASHING MEANS; APPARATUS FOR RECORDING, TRANSMISSION AND REPRODUCTION OF ELECTRIC DATA; BLANK MAGNETIC DATA CARRIERS, DATA PROCESSING EQUIPMENT AND COMPUTERS; COMPUTER PERIPHERAL DEVICES, IN PARTICULAR DOCKING STATIONS; ELECTRIC DISPLAY APPARATUS; COMPUTER PROGRAMS AND COMPUTER SOFTWARE FOR USE IN MAINTENANCE, ANALYSIS, ADMINISTRATION AND DOCUMENTATION OF DATA, REPORTS AND DOCUMENTS, FOR USE IN TEST INSPECTION, FOR USE IN FORMING A CONNECTION TO INFORMATION AND DOCUMENTS AS WELL AS IN ACCESSING A WEB PORTAL; BLANK DATA CARRIERS; MATERIALS TESTING APPARATUS AND MACHINES FOR USE IN THE INSPECTION OF LIFTING, SUSPENDING AND LASHING MEANS; ELECTRICAL SIGNAL TRANSMITTERS AND RECEIVERS; TRANSPONDERS; IN PARTICULAR RADIO-FREQUENCY TRANSPONDERS; WRITING AND READING APPARATUS FOR ELECTRIC DATA; RFID HARDWARE AND ACCESSORIES, NAMELY, RFID-CHIPS, RFID-TAGS, RFID-TRANSPONDERS, RFID-READERS; ELECTRIC IDENTIFICATION SYSTEMS, IN PARTICULAR RFID SYSTEMS, NAMELY, RFID-CHIPS, RFID-TAGS, REID-TRANSPONDERS, RFID-READERS; ELECTRONIC TESTING SYSTEMS, IN PARTICULAR INSPECTION TESTING SYSTEMS FOR MEASURING AND INSPECTING THE WEAR, LIFETIME, LOAD, STRAIN AND STRESS OF LIFTING, SUSPENDING AND LASHING MEANS; ELECTRONIC INFORMATION DELIVERY SYSTEMS COMPRISING AN ELECTRONIC INTERFACE EQUIPMENT TO INPUT OR OUTPUT OF DATA AND AT LEAST ONE OF AN IDENTIFICATION TAG AND A SENSOR, IN PARTICULAR A LOAD SENSOR; ELECTRONIC LOAD AND OVERLOAD INDICATOR DEVICES AND ELEMENTS FOR CHAINS, ROPES AND/OR STRAPS, AND LOADING FORKS, IN PARTICULAR WITH INTEGRATED DATA TRANSMISSION AND DATA RECORDING DEVICES AND/OR SENSORS, IN PARTICULAR LOAD SENSORS; ALL THE AFORESAID GOODS IN PARTICULAR FOR THE MONITORING AND/OR TESTING, CONTROLLING AND/OR LOAD MONITORING OF LOAD-SECURING AND LASHING DEVICES, IN CLASS 9 (U.S. CLS. 21, 23, 26, 36 AND 38).

THE MARK CONSISTS OF STANDARD CHARACTERS WITHOUT CLAIM TO ANY PARTICULAR FONT, STYLE, SIZE, OR COLOR.

PRIORITY DATE OF 7-28-2010 IS CLAIMED.

OWNER OF INTERNATIONAL REGISTRATION 1075758 DATED 1-19-2011, EXPIRES 1-19-2021.

SER. NO. 79-096,889, FILED 1-19-2011.

JOHN WILKE, EXAMINING ATTORNEY

# United States of America

United States Patent and Trademark Office



**Reg. No. 4,123,687**

**Registered Apr. 10, 2012**

**Int. Cls.: 18 and 25**

**TRADEMARK**

**PRINCIPAL REGISTER**

CHILLNORWAY AS (NORWAY LIMITED COMPANY)  
ASLAKVEIEN 20  
N-0753 OSLO  
NORWAY

FOR: LEATHER AND IMITATIONS OF LEATHER, AND GOODS MADE OF THESE MATERIALS AND NOT INCLUDED IN OTHER CLASSES, NAMELY, PURSES, WALLETS, CARRY-ALL BAGS, TOTE BAGS, AND BACKPACKS; ANIMAL SKINS, HIDES; TRUNKS AND TRAVELLING BAGS; UMBRELLAS, PARASOLS AND WALKING STICKS; WHIPS, HARNESS AND SADDLERY, IN CLASS 18 (U.S. CLS. 1, 2, 3, 22 AND 41).

FOR: CLOTHING, NAMELY, TOPS, BOTTOMS, DRESSES, SWEATERS, SWEATSHIRTS, SCARVES, BODY SUITS, AND FOUL WEATHER GEAR; FOOTWEAR; HEADWEAR, IN CLASS 25 (U.S. CLS. 22 AND 39).

NO CLAIM IS MADE TO THE EXCLUSIVE RIGHT TO USE "DESIGN" AND "EST. 2004 OSLO", APART FROM THE MARK AS SHOWN.

PRIORITY DATE OF 11-22-2010 IS CLAIMED.

OWNER OF INTERNATIONAL REGISTRATION 1075987 DATED 2-15-2011, EXPIRES 2-15-2021.

THE MARK CONSISTS OF THE TERMS "A CHILLNORWAY DESIGN EST. 2004 OSLO" WITH STYLIZED BIRDS SHOWN ABOVE THE TERMS.

SER. NO. 79-096,956, FILED 2-15-2011.

NAPOLEON SHARMA, EXAMINING ATTORNEY



*David J. Kyros*

Director of the United States Patent and Trademark Office

# United States of America

United States Patent and Trademark Office

## LOVE FOOD WITH LURPAK

**Reg. No. 4,123,688**

**Registered Apr. 10, 2012**

**Int. Cl.: 29**

**TRADEMARK**

**PRINCIPAL REGISTER**

MEJERIFORENINGEN DANISH DAIRY BOARD (DENMARK AN ASSOCIATION OF DANISH DAIRIES)  
SØNDERHØJ 1  
DK-8260 VIBY J, DENMARK

FOR: BUTTER, BUTTER WITH FLAVOUR ADDITIVES, GHEE, BUTTER SPREAD, IN CLASS 29 (U.S. CL. 46).

THE MARK CONSISTS OF STANDARD CHARACTERS WITHOUT CLAIM TO ANY PARTICULAR FONT, STYLE, SIZE, OR COLOR.

PRIORITY DATE OF 1-17-2011 IS CLAIMED.

OWNER OF INTERNATIONAL REGISTRATION 1076059 DATED 2-14-2011, EXPIRES 2-14-2021.

OWNER OF U.S. REG. NOS. 1,875,725, 3,302,726, AND 3,715,532.

NO CLAIM IS MADE TO THE EXCLUSIVE RIGHT TO USE "FOOD", APART FROM THE MARK AS SHOWN.

SER. NO. 79-097,007, FILED 2-14-2011.

TRACY CROSS, EXAMINING ATTORNEY



*David J. Kyfos*

Director of the United States Patent and Trademark Office

# United States of America

United States Patent and Trademark Office

# ALTARIVA

**Reg. No. 4,123,689**

**Registered Apr. 10, 2012**

**Int. Cls.: 3, 6 and 19**

**TRADEMARK**

**PRINCIPAL REGISTER**

POOL COVER S.A. (BELGIUM JOINT STOCK COMPANY)  
ZONIG INDUSTRIEL 26  
B-5660 MARIEMBOURG  
BELGIUM

FOR: CLEANING, POLISHING, SCOURING AND ABRASIVE PREPARATIONS; SOAPS AND DETERGENTS FOR SWIMMING POOL MAINTENANCE, SWIMMING POOL COVERS AND SWIMMING POOL SHELTERS, IN CLASS 3 (U.S. CLS. 1, 4, 6, 50, 51 AND 52).

FOR: TRANSPORTABLE BUILDINGS OF METAL, PARTICULARLY SWIMMING POOLS, SWIMMING POOL COVERS AND SWIMMING POOL SHELTERS, IN CLASS 6 (U.S. CLS. 2, 12, 13, 14, 23, 25 AND 50).

FOR: TRANSPORTABLE BUILDINGS NOT MADE OF METAL, PARTICULARLY SWIMMING POOLS, SWIMMING POOL COVERS AND SWIMMING POOL SHELTERS, IN CLASS 19 (U.S. CLS. 1, 12, 33 AND 50).

THE MARK CONSISTS OF STANDARD CHARACTERS WITHOUT CLAIM TO ANY PARTICULAR FONT, STYLE, SIZE, OR COLOR.

OWNER OF INTERNATIONAL REGISTRATION 1076199 DATED 4-11-2011, EXPIRES 4-11-2021.

SER. NO. 79-097,039, FILED 4-11-2011.

KATINA MISTER, EXAMINING ATTORNEY



*David J. Kyffers*

Director of the United States Patent and Trademark Office

# United States of America

United States Patent and Trademark Office

# 404

**Reg. No. 4,123,690**

**Registered Apr. 10, 2012**

**Int. Cls.: 13 and 28**

**TRADEMARK**

**PRINCIPAL REGISTER**

BLASER FINANZHOLDING GMBH (FED REP GERMANY GMBH)  
ZIEGELSTADEL 1  
88316 ISNY IM ALLGÄU  
FED REP GERMANY

FOR: FIREARMS; AMMUNITION AND PROJECTILES; EXPLOSIVES; ACCESSORIES FOR THE AFORESAID GOODS, NAMELY, GUN BAGS, GUN CASES, CARTRIDGE BELTS, GUN SLINGS, AND CARTRIDGE CASES, IN CLASS 13 (U.S. CLS. 2 AND 9).

FOR: HAND-HELD TOY GUNS; TOYS, NAMELY, MODEL AND REPLICAS GUNS; BULLETS AND AMMUNITION FOR MODEL AND REPLICAS WEAPONS; MODEL AND REPLICAS GUNS FOR VIRTUAL SHOOTING FOR USE WITH VIRTUAL SHOOTING GAME SOFTWARE; MODEL AND REPLICAS GUNS FOR USE WITH ELECTRONIC TARGETS AND ELECTRONIC DISPLAYS; STRUCTURAL OR REPLACEMENT PARTS FOR THE AFORESAID GOODS, IN CLASS 28 (U.S. CLS. 22, 23, 38 AND 50).

THE MARK CONSISTS OF STANDARD CHARACTERS WITHOUT CLAIM TO ANY PARTICULAR FONT, STYLE, SIZE, OR COLOR.

PRIORITY DATE OF 10-14-2010 IS CLAIMED.

OWNER OF INTERNATIONAL REGISTRATION 1076232 DATED 4-12-2011, EXPIRES 4-12-2021.

SER. NO. 79-097,054, FILED 4-12-2011.

MARIA-VICTORIA SUAREZ, EXAMINING ATTORNEY



*David J. Kybas*

Director of the United States Patent and Trademark Office



# United States of America

United States Patent and Trademark Office

# Zircostar

**Reg. No. 4,123,691**

**Registered Apr. 10, 2012**

**Int. Cls.: 5 and 10**

KEROX IPARI ÉS KERESKEDELMI KORLÁTOLT FELELOSSÉGU TÁRSASÁG (HUNGARY  
LIMITED LIABILITY)  
HOMOKBÁNYA ÚT 77  
H-2049 DIÓSD  
HUNGARY

**TRADEMARK**

**PRINCIPAL REGISTER**

FOR: PHARMACEUTICAL PREPARATIONS, NAMELY, CERAMIC MATERIALS FOR DENTAL USE FOR FILLINGS, CROWNS, AND BRIDGES; MEDICAL PLASTERS; DENTAL CEMENTS AND ADHESIVES, MATERIAL FOR STOPPING TEETH, AND DENTAL WAX FOR PORCELAINE DENTURES, IN CLASS 5 (U.S. CLS. 6, 18, 44, 46, 51 AND 52).

FOR: ORTHOPEDIC ARTICLES, NAMELY, SURGICAL IMPLANTS COMPRISING ARTIFICIAL MATERIAL, BONE PROSTHESES, DENTAL PROSTHESES, AND MEDICAL APPARATUS IN THE NATURE OF IMPLANTABLE PORTS; ARTIFICIAL JAWS; ARTIFICIAL TEETH; DENTURES; CERAMIC DENTURES, IN CLASS 10 (U.S. CLS. 26, 39 AND 44).

THE MARK CONSISTS OF STANDARD CHARACTERS WITHOUT CLAIM TO ANY PARTICULAR FONT, STYLE, SIZE, OR COLOR.

PRIORITY DATE OF 3-17-2011 IS CLAIMED.

OWNER OF INTERNATIONAL REGISTRATION 1076352 DATED 3-29-2011, EXPIRES 3-29-2021.

SER. NO. 79-097,094, FILED 3-29-2011.

SUSAN RICHARDS, EXAMINING ATTORNEY



*David J. Kypos*

Director of the United States Patent and Trademark Office

# United States of America

United States Patent and Trademark Office



**Reg. No. 4,123,692**

**Registered Apr. 10, 2012**

**Int. Cls.: 35, 39 and 43**

**SERVICE MARK**

**PRINCIPAL REGISTER**

LIBERATE, S.L.U. (SPAIN SOCIEDAD LIMITADA UNIPERSONAL)  
COMPLEJO MIRALL BALEAR,  
CAMÍ DE SON FANGOS, 100.; TORRE A 5ª PLANTA; E-07007 PALMA DE MALLORCA  
SPAIN

FOR: ADVERTISING AGENCIES; DISSEMINATION OF ADVERTISING MATERIALS FOR OTHERS IN THE FIELD OF TOURISM; BUSINESS MANAGEMENT; BRINGING TOGETHER, FOR THE BENEFIT OF OTHERS, OF A VARIETY OF HOTEL SERVICES, ALLOWING CONSUMERS TO EXAMINE AND BUY THESE SERVICES IN COMFORT FROM AN INTERNET WEB SITE; BUSINESS ADMINISTRATION; PROVIDING OFFICE FUNCTIONS; CUSTOMER LOYALTY SERVICES AND SERVICES INVOLVING CLIENT CLUBS FOR COMMERCIAL, PROMOTIONAL AND/OR ADVERTISING PURPOSES; ADMINISTRATION OF A CONSUMER LOYALTY PROGRAM TO PROMOTE HOTEL SERVICES OF OTHERS; ADMINISTRATION OF A CUSTOMER LOYALTY PROGRAM WHICH PROVIDES FREE OR DISCOUNT HOTEL STAYS IF CUSTOMERS STAY A CERTAIN NUMBER OF TIMES AT A MEMBER HOTEL; BUSINESS MANAGEMENT SERVICES AND CONSULTANCY RELATING TO TRAVEL MANAGEMENT AND MANAGING HOTEL BUSINESSES, IN CLASS 35 (U.S. CLS. 100, 101 AND 102).

FOR: PROVIDING INFORMATION ON TOURS AND TRAVEL; ADVICE AND CONSULTANCY SERVICES RELATING TO TRAVEL TRANSPORTATION RESERVATION SERVICES; TRAVEL AGENCY SERVICES, NAMELY, MAKING RESERVATIONS AND BOOKINGS FOR TRANSPORTATION, IN CLASS 39 (U.S. CLS. 100 AND 105).

FOR: MAKING RESERVATIONS AND BOOKINGS FOR OTHERS FOR ACCOMMODATION FOR TRAVELERS; PROVIDING TEMPORARY ACCOMMODATION; AGENCY SERVICES FOR THE RESERVATION OF TEMPORARY ACCOMMODATIONS, IN CLASS 43 (U.S. CLS. 100 AND 101).



*David J. Kyffers*

Director of the United States Patent and Trademark Office

THE MARK CONSISTS OF THE WORDING "LIBERATE" SHOWN IN DARK GREEN, WITH THE "RATE" PORTION OF THE TERM SHOWN IN BOLDER FONT AND INSIDE A DESIGN OF A SIDEWAYS HANG TAG, WITH THE HANG TAG HAVING A HOLE ON THE RIGHT SHOWN IN THE COLOR IVORY, WITH A BROWN STRING LOOPED THROUGH THE HOLE AND EXTENDING TO THE RIGHT OF THE HANG TAG DESIGN, AND THE HANG TAG BEING SHOWN IN VARYING SHADES OF GREEN WITH THE DARKEST GREEN BEING ON THE LEFT AND GRADUALLY LIGHTENING UNTIL THE MIDDLE OF THE HANG TAG WHERE DARKEST GREEN STARTS AGAIN TO THE RIGHT OF A CURVED VERTICAL

**Reg. No. 4,123,692** DIVIDING LINE, AND AROUND THE OUTSIDE EDGE OF THE HANG TAG IS A WHITE OUTLINE AND THEN A THIN DARK GREEN OUTLINE. BELOW THE THIN DARK GREEN OUTLINE IS A GRAY SHADOW EXTENDING FROM THE MIDDLE TO THE RIGHT SIDE OF THE HANG TAG. OTHER THAN THE WHITE OUTLINE OF THE HANG TAG, ALL OTHER WHITE IN THE DRAWING REPRESENTS TRANSPARENT BACKGROUND AND IS NOT CLAIMED AS A FEATURE OF THE MARK.

OWNER OF INTERNATIONAL REGISTRATION 1076432 DATED 1-20-2011, EXPIRES 1-20-2021.

THE COLOR(S) GREEN, DARK GREEN, BROWN, IVORY, GRAY AND WHITE IS/ARE CLAIMED AS A FEATURE OF THE MARK.

THE ENGLISH TRANSLATION OF THE WORD "LIBERATE" IN THE MARK IS "FREE YOURSELF".

SER. NO. 79-097,118, FILED 1-20-2011.

JENNIFER DIXON, EXAMINING ATTORNEY

# United States of America

United States Patent and Trademark Office

# SOLNEVA

**Reg. No. 4,123,693**

**Registered Apr. 10, 2012**

**Int. Cls.: 7, 9, 40 and 42**

**TRADEMARK**

**SERVICE MARK**

**PRINCIPAL REGISTER**

SOLNEVA SA (SWITZERLAND SOCIÉTÉ ANONYME (SA))  
ALTE LYSSSTRASSE 2  
CH-3270 AARBERG  
SWITZERLAND

FOR: MACHINES, NAMELY, MACHINES FOR MATERIAL TREATMENT BY MEANS OF LASERS, MACHINES FOR PROCESSING SOLAR MODULES AND SOLAR CELLS BY MEANS OF LASERS, AND MACHINE-TOOLS, NAMELY, GUIDEWAYS FOR MACHINES AND THEIR PARTS, LINEAR GUIDEWAYS AS PARTS OF MACHINES, PROFILED RAIL GUIDEWAYS AS PARTS OF MACHINES, BEARING TABLES AS PARTS OF MACHINES AND CROSS MOVEMENT BEARING TABLES AS PARTS OF MACHINES EACH WITH BEARING PARTS; SUPPORT PADS, AS PARTS OF MACHINES, FOR INFINITE MOVEMENTS; COMPLETE MULTI-AXIS POSITIONING MACHINES COMPOSED OF AN UPPER AND LOWER PART, PROFILED RAIL GUIDEWAYS, A BALL SCREW, AN ENGINE COUPLING AND A MEASURING INSTRUMENT, IN CLASS 7 (U.S. CLS. 13, 19, 21, 23, 31, 34 AND 35).

FOR: MEASURING APPARATUS AND INSTRUMENTS FOR PROFILED RAIL GUIDEWAYS, NAMELY, ABSOLUTE AND INCREMENTAL LINEAR DISPLACEMENT MEASURING DEVICES CONSISTING OF A SCALE INTEGRATED INTO THE RAIL GUIDEWAY AND OPTICAL OR ELECTRONIC READERS INTEGRATED INTO THE MOVEABLE SLIDER; AND ACCESSORIES FOR MEASURING APPARATUS AND INSTRUMENTS FOR PROFILED RAIL GUIDEWAYS, NAMELY, ELECTRONIC CONTROLLERS AND ELECTRONIC SENSORS FOR SIGNAL-CONDITIONING, SENSORS TO IDENTIFY THE DIRECTION OF MOTION, ELECTRONIC DATA LOGGERS AND ELECTRONIC DATA RECORDERS TO REMEMBER CERTAIN POSITION EVEN DURING POWER OUTAGE, ALL COMPRISING AN INTEGRATED MEASURING SYSTEM COMPRISED OF A SCALE INTEGRATED INTO THE RAIL GUIDEWAY AND A READING OPTICAL OR ELECTRONIC READERS INTEGRATED INTO THE MOVEABLE BEARING SLIDER, FOR LINEAR ROLLER OR BALL GUIDEWAYS WITH ANALOG OR DIGITAL INTERFACE FOR USE WITH MACHINE TOOLS AND AUTOMATION OF MANUFACTURING SEQUENCES; LASERS, NOT FOR MEDICAL PURPOSES, IN CLASS 9 (U.S. CLS. 21, 23, 26, 36 AND 38).

FOR: MATERIAL TREATMENT, NAMELY, BY MEANS OF LASER BEAM, IN CLASS 40 (U.S. CLS. 100, 103 AND 106).



*David J. Kyjars*

Director of the United States Patent and Trademark Office

**Reg. No. 4,123,693** FOR: SCIENTIFIC AND TECHNOLOGICAL SERVICES, NAMELY, DEVELOPMENT, PLANNING AND TESTING FOR THE MANUFACTURE OF MACHINES; RESEARCH SERVICES, NAMELY, IN THE DEVELOPMENT AND FACILITATION OF THE MANUFACTURE OF MACHINES, IN CLASS 42 (U.S. CLS. 100 AND 101).

THE MARK CONSISTS OF STANDARD CHARACTERS WITHOUT CLAIM TO ANY PARTICULAR FONT, STYLE, SIZE, OR COLOR.

OWNER OF INTERNATIONAL REGISTRATION 1076542 DATED 2-3-2011, EXPIRES 2-3-2021.

THE WORDING "SOLNEVA" HAS NO MEANING IN A FOREIGN LANGUAGE.

SER. NO. 79-097,151, FILED 2-3-2011.

SANDRA BUJA, EXAMINING ATTORNEY

United States of America  
United States Patent and Trademark Office

TARIQUET



**Reg. No. 4,123,694**

**Registered Apr. 10, 2012**

**Int. Cl.: 33**

**TRADEMARK**

**PRINCIPAL REGISTER**

SOCIÉTÉ CIVILE D'EXPLOITATION AGRICOLE SCV CHATEAU DU TARIQUET (FRANCE  
SOCIÉTÉ CIVILE D'EXPLOITATION AGRICOLE)  
"SAINT-AMAND"  
F-32800 EAUZE, FRANCE

FOR: ALCOHOLIC BEVERAGES EXCEPT BEER, IN CLASS 33 (U.S. CLS. 47 AND 49).

THE MARK CONSISTS OF THE WORDING "TARIQUET" UNDERLINED AND REPRESENTED IN STYLIZED FONT WITH A DESIGN OF A GRAPE BUNCH DANGLING FROM THE LEFT END OF THE UNDERLINE.

OWNER OF INTERNATIONAL REGISTRATION 0793370 DATED 11-21-2002, EXPIRES 11-21-2012.

THE TERM "TARIQUET" DOES NOT HAVE ANY MEANING IN A FOREIGN LANGUAGE.

SER. NO. 79-097,240, FILED 11-8-2010.

WARREN L. OLANDRIA, EXAMINING ATTORNEY



*David J. Kybas*

Director of the United States Patent and Trademark Office

United States of America  
United States Patent and Trademark Office

YESIR

**Reg. No. 4,123,695**

**Registered Apr. 10, 2012**

**Int. Cl.: 25**

**TRADEMARK**

**PRINCIPAL REGISTER**

WANG BIN (CHINA INDIVIDUAL)  
GROUP 2, PEACH GARDEN COMMITTEE  
LIANGSHI TOWN,; SHAODONG DISTRICT; 422800 HUNAN PROVINCE  
CHINA

FOR: CLOTHING, NAMELY, PANTS, SHIRTS, JACKETS; CLOTHING FOR BABIES, TODDLERS AND CHILDREN, NAMELY, JACKETS, SHIRTS, PANTS; CLOTHING FOR GYMNASTICS, NAMELY, SHIRTS, SHORTS; WATERPROOF JACKETS AND PANTS; MASQUERADE COSTUMES; TRACK AND FIELD SHOES; SHOES; HATS; HOSIERY; GLOVES AS CLOTHING; NECKTIES; LEATHER BELTS BEING CLOTHING; WEDDING DRESSES; UNDERPANTS, IN CLASS 25 (U.S. CLS. 22 AND 39).

THE MARK CONSISTS OF THE TERM "YESIR" IN STYLIZED TEXT.

OWNER OF INTERNATIONAL REGISTRATION 1076873 DATED 4-27-2011, EXPIRES 4-27-2021.

THE WORDING "YESIR" HAS NO MEANING IN A FOREIGN LANGUAGE.

SER. NO. 79-097,298, FILED 4-27-2011.

LAURA HAMMEL, EXAMINING ATTORNEY



*David J. Kyffers*

Director of the United States Patent and Trademark Office

# United States of America

United States Patent and Trademark Office

## GOLDEN EAGLE

**Reg. No. 4,123,696**

SHETLAND OY (FINLAND LIMITED LIABILITY COMPANY)  
YRITYSPIHA 4

**Registered Apr. 10, 2012**

FI-00390 HELSINKI, FINLAND

**Int. Cls.: 5 and 31**

FOR: PHARMACEUTICAL PREPARATIONS FOR THE TREATMENT OF DISORDERS OF THE IMMUNE SYSTEM AND THE METABOLIC SYSTEM; VETERINARY PREPARATIONS FOR STRENGTHENING THE IMMUNE SYSTEM AND THE METABOLISM OF CATS, DOGS AND FERRETS; SANITARY PREPARATIONS FOR MEDICAL PURPOSES; PLASTERS FOR MEDICAL PURPOSES; GAUZE AND BANDAGES FOR DRESSINGS; MATERIAL FOR STOPPING TEETH, DENTAL WAX; DISINFECTANTS; PREPARATIONS FOR DESTROYING VERMIN; FUNGICIDES, HERBICIDES, IN CLASS 5 (U.S. CLS. 6, 18, 44, 46, 51 AND 52).

**TRADEMARK**

**PRINCIPAL REGISTER**

FOR: NATURAL PLANTS AND FLOWERS; FOODSTUFFS FOR ANIMALS, IN CLASS 31 (U.S. CLS. 1 AND 46).

THE MARK CONSISTS OF STANDARD CHARACTERS WITHOUT CLAIM TO ANY PARTICULAR FONT, STYLE, SIZE, OR COLOR.

OWNER OF INTERNATIONAL REGISTRATION 1076959 DATED 3-8-2011, EXPIRES 3-8-2021.

SER. NO. 79-097,331, FILED 3-8-2011.

CHRISIE B. KING, EXAMINING ATTORNEY



*David J. Kyros*

Director of the United States Patent and Trademark Office



United States of America  
United States Patent and Trademark Office

**OPARYL**

**Reg. No. 4,123,697**

GIOVANNI BOZZETTO S.P.A. (ITALY JOINT STOCK COMPANY)  
VIA MONTE GRAPPA, 7  
I-24121 BERGAMO  
ITALY

**Registered Apr. 10, 2012**

**Int. Cl.: 1**

FOR: CHEMICALS USED IN AGRICULTURE, HORTICULTURE AND FORESTRY EXCEPT FUNGICIDES, HERBICIDES, INSECTICIDES AND PARASITICIDES; MANURES, IN CLASS 1 (U.S. CLS. 1, 5, 6, 10, 26 AND 46).

**TRADEMARK**

**PRINCIPAL REGISTER**

THE MARK CONSISTS OF STANDARD CHARACTERS WITHOUT CLAIM TO ANY PARTICULAR FONT, STYLE, SIZE, OR COLOR.

PRIORITY DATE OF 11-16-2010 IS CLAIMED.

OWNER OF INTERNATIONAL REGISTRATION 1077114 DATED 4-15-2011, EXPIRES 4-15-2021.

SER. NO. 79-097,377, FILED 4-15-2011.

HAI-LY LAM, EXAMINING ATTORNEY



*David J. Kyffers*

Director of the United States Patent and Trademark Office

United States of America  
United States Patent and Trademark Office

**LIGNUM**

**Reg. No. 4,123,698**

**Registered Apr. 10, 2012**

**Int. Cls.: 25 and 28**

**TRADEMARK**

**PRINCIPAL REGISTER**

CHRISTOPH SCHWARA (AUSTRIA INDIVIDUAL)  
CANONGASSE 12/8  
A-1180 VIENNA  
AUSTRIA

FOR: CLOTHING, NAMELY, GOLF CLOTHING, NAMELY, SHIRTS, PULLOVERS, JACKETS, SWEATERS, TROUSERS SHORTS AND SOCKS; FOOTWEAR, NAMELY, GOLF SHOES; HEADGEAR, NAMELY, GOLF CAPS, HEADBANDS, AND PEAKED CAPS, IN CLASS 25 (U.S. CLS. 22 AND 39).

FOR: PLAYTHINGS, NAMELY, GOLF BALLS; GYMNASTIC AND SPORTING ARTICLES, NAMELY, GOLF CLUBS, GOLF TEES, GOLF BALLS, GOLF GLOVES, AND GOLF BAGS, IN CLASS 28 (U.S. CLS. 22, 23, 38 AND 50).

THE MARK CONSISTS OF THE WORD "LIGNUM" IN A STYLIZED FONT.

OWNER OF INTERNATIONAL REGISTRATION 1077179 DATED 3-2-2011, EXPIRES 3-2-2021.

SER. NO. 79-097,395, FILED 3-2-2011.

TASNEEM HUSSAIN, EXAMINING ATTORNEY



*David J. Kybas*

Director of the United States Patent and Trademark Office

# United States of America

United States Patent and Trademark Office



**Reg. No. 4,123,699**

**Registered Apr. 10, 2012**

**Int. Cls.: 20 and 21**

**TRADEMARK**

**PRINCIPAL REGISTER**

PETER BARTH (FED REP GERMANY INDIVIDUAL)  
SCHUELESTRASSE 9  
KIRCHHEIM/TECK, FED REP GERMANY 73230

FOR: PLASTIC CONTAINERS FOR PACKAGING, IN PARTICULAR TRANSPORT CONTAINERS, IN CLASS 20 (U.S. CLS. 2, 13, 22, 25, 32 AND 50).

FOR: INSULATING CONTAINERS FOR FOODSTUFF; THERMAL INSULATED CONTAINERS FOR FOOD OR BEVERAGES, IN CLASS 21 (U.S. CLS. 2, 13, 23, 29, 30, 33, 40 AND 50).

NO CLAIM IS MADE TO THE EXCLUSIVE RIGHT TO USE "THERMO" AND "BOX", APART FROM THE MARK AS SHOWN.

OWNER OF INTERNATIONAL REGISTRATION 1077182 DATED 11-12-2010, EXPIRES 11-12-2020.

THE COLOR(S) RED AND BLUE IS/ARE CLAIMED AS A FEATURE OF THE MARK.

BLUE: LETTERS "THERMO" AND "BOX"; RED: LETTERS "FUTURE" AND THE SQUARE IN THE UPPER RIGHT CORNER.

THE MARK CONSISTS OF THE FOLLOWING: AN INCOMPLETE RED SQUARE IN THE UPPER RIGHT HAND CORNER. THE TERMS "THERMO FUTURE BOX". THE TERMS "THERMO" AND "BOX" ARE IN BLUE. THE TERM "FUTURE" IS IN RED. THERE IS A SQUARE IN THE LETTER "O" IN THE TERM "THERMO".

SER. NO. 79-097,396, FILED 11-12-2010.

JANICE L. MCMORROW, EXAMINING ATTORNEY



*David J. Kybas*

Director of the United States Patent and Trademark Office

# United States of America

United States Patent and Trademark Office

**PICCHIOTTI**  
SINCE 1600

**Reg. No. 4,123,700**

**Registered Apr. 10, 2012**

**Int. Cls.: 12, 25 and 37**

**TRADEMARK**

**SERVICE MARK**

**PRINCIPAL REGISTER**

PICCHIOTTI S.R.L. (ITALY LIMITED LIABILITY COMPANY)  
VIALE S. BARTOLOMEO, 428 -  
FRAZ. RUFFINO; I-19126 LA SPEZIA  
ITALY

FOR: MOTOR SHIPS, SAILING VESSELS, MOTOR BOATS, SAILING BOATS , IN CLASS 12 (U.S. CLS. 19, 21, 23, 31, 35 AND 44).

FOR: SPORTS AND LEISURE CLOTHING ARTICLES, NAMELY, JACKETS, COATS, PULLOVERS, CARDIGANS, SWEATERS, SHIRTS, POLO SHIRTS, SCARVES, HATS, CAPS, MEN'S AND WOMEN'S SHOES, IN CLASS 25 (U.S. CLS. 22 AND 39).

FOR: BUILDING CONSTRUCTION; REPAIR, MAINTENANCE INSTALLATION SERVICES OF SHIPS , BOATS, SHIPYARDS, TOURISTIC PORTS, INDUSTRIAL BUILDINGS, IN CLASS 37 (U.S. CLS. 100, 103 AND 106).

NO CLAIM IS MADE TO THE EXCLUSIVE RIGHT TO USE "SINCE 1600", APART FROM THE MARK AS SHOWN.

PRIORITY DATE OF 12-14-2010 IS CLAIMED.

OWNER OF INTERNATIONAL REGISTRATION 1077253 DATED 4-4-2011, EXPIRES 4-4-2021.

THE COLOR(S) BLACK, WHITE AND GOLD IS/ARE CLAIMED AS A FEATURE OF THE MARK.

THE MARK CONSISTS OF THE WORD "PICCHIOTTI" IN BLACK CAPITAL LETTERING OVER A GOLD AND WHITE HORIZONTAL BAND WITH THE WORDS "SINCE 1600" IN GOLD IN THE CENTER BETWEEN THE RIGHT AND LEFT SIDES OF THE BAND.

SER. NO. 79-097,423, FILED 4-4-2011.

DOMINICK J. SALEMI, EXAMINING ATTORNEY



*David J. Kyffers*

Director of the United States Patent and Trademark Office

# United States of America

United States Patent and Trademark Office

# DODISTAB

**Reg. No. 4,123,701**

**Registered Apr. 10, 2012**

**Int. Cl.: 1**

**TRADEMARK**

**PRINCIPAL REGISTER**

CLARIANT AG (SWITZERLAND CORPORATION)  
ROTHAUSSTRASSE 61  
CH-4132 MUTTENZ  
SWITZERLAND

FOR: CHEMICALS USED IN INDUSTRY, SCIENCE AND PHOTOGRAPHY; CHEMICALS FOR USE IN AGRICULTURE, HORTICULTURE AND FORESTRY, EXCEPT FUNGICIDES, HERBICIDES, INSECTICIDES AND PARASITICIDES; UNPROCESSED ARTIFICIAL RESINS, UNPROCESSED PLASTICS; FERTILIZERS; FIRE EXTINGUISHING COMPOSITIONS; TEMPERING PREPARATIONS; SOLDERING PREPARATIONS, NAMELY, SOLDERING CHEMICALS; CHEMICAL SUBSTANCES FOR PRESERVING FOODSTUFFS; TANNING SUBSTANCES, NAMELY, TANNING AGENTS FOR USE IN THE MANUFACTURE OF ADDITIVES; ADHESIVES USED IN THE INDUSTRY; ANTIOXIDANTS FOR USE IN INDUSTRY, NAMELY, CHEMICAL AGENTS CAPABLE OF SLOWING OR PREVENTING THE OXIDATION IN FOOD AND INDUSTRIAL PRODUCTS; CHEMICALS ADDITIVES FOR FUEL TREATMENT FOR USE WITH MOTOR FUEL, AVIATION FUEL, FOSSIL FUELS, BIO-FUELS AND FUEL OILS, IN CLASS 1 (U.S. CLS. 1, 5, 6, 10, 26 AND 46).

THE MARK CONSISTS OF STANDARD CHARACTERS WITHOUT CLAIM TO ANY PARTICULAR FONT, STYLE, SIZE, OR COLOR.

PRIORITY DATE OF 12-6-2010 IS CLAIMED.

OWNER OF INTERNATIONAL REGISTRATION 1077262 DATED 2-9-2011, EXPIRES 2-9-2021.

OWNER OF U.S. REG. NO. 3,790,394.

THE WORDING "DODISTAB" HAS NO MEANING IN A FOREIGN LANGUAGE.

SER. NO. 79-097,427, FILED 2-9-2011.

JIM RINGLE, EXAMINING ATTORNEY



*David J. Kyffers*

Director of the United States Patent and Trademark Office

# United States of America

United States Patent and Trademark Office

## Wiebold Cuptruffles

**Reg. No. 4,123,702**

**Registered Apr. 10, 2012**

**Int. Cl.: 30**

WIEBOLD-CONFISERIE GMBH & CO. KG (FED REP GERMANY LIMITED PARTNERSHIP  
WITH A LIMITED LIABILITY COMPANY AS GENERAL PARTNER)  
ERNST-ABBE-STR. 2  
25337 ELMSHORN  
FED REP GERMANY

**TRADEMARK**

FOR: CONFECTIONERY IN THE NATURE OF FONDANTS; CONFECTIONERY MADE OF SUGAR; CONFECTIONERY, NAMELY, CHOCOLATES, CARAMELS, NOUGAT, MARZIPAN, PRALINES AND CHOCOLATE TRUFFLES, IN CLASS 30 (U.S. CL. 46).

**PRINCIPAL REGISTER**

THE MARK CONSISTS OF STANDARD CHARACTERS WITHOUT CLAIM TO ANY PARTICULAR FONT, STYLE, SIZE, OR COLOR.

PRIORITY DATE OF 9-2-2010 IS CLAIMED.

OWNER OF INTERNATIONAL REGISTRATION 1077331 DATED 3-1-2011, EXPIRES 3-1-2021.

OWNER OF U.S. REG. NO. 3,924,931.

THE WORDING "WIEBOLD" HAS NO MEANING IN A FOREIGN LANGUAGE.

SER. NO. 79-097,448, FILED 3-1-2011.

TRACY FLETCHER, EXAMINING ATTORNEY



*David J. Kyffers*

Director of the United States Patent and Trademark Office

United States of America  
United States Patent and Trademark Office

innova

**Reg. No. 4,123,703**

SARSILMAZ SILAH SANAYI ANONIM SIRKETI (TURKEY CORPORATION)  
UZUN ÇARSI CAD. NO.: 50  
MERCAN-ISTANBUL, TURKEY

**Registered Apr. 10, 2012**

**Int. Cl.: 13**

FOR: FIREARMS; AIR PISTOLS; SPRING-POWERED GUNS; CASES AND SHOULDER STRAPS FOR FIREARMS, AIR PISTOLS, GUNS, WEAPONS, NAMELY, RIFLES; ARTILLERY GUNS; FIREARMS, NAMELY, MORTARS; ROCKETS; FIREWORKS; SPRAYS FOR PERSONAL DEFENSE PURPOSES, IN CLASS 13 (U.S. CLS. 2 AND 9).

**TRADEMARK**

**PRINCIPAL REGISTER**

PRIORITY DATE OF 12-14-2010 IS CLAIMED.

OWNER OF INTERNATIONAL REGISTRATION 1077364 DATED 1-7-2011, EXPIRES 1-7-2021.

SER. NO. 79-097,460, FILED 1-7-2011.

ALICE BENMAMAN, EXAMINING ATTORNEY



*David J. Kyros*

Director of the United States Patent and Trademark Office

# United States of America

United States Patent and Trademark Office

# SLANT

**Reg. No. 4,123,704**

**Registered Apr. 10, 2012**

**Int. Cl.: 28**

GLOBE INTERNATIONAL NOMINEES PTY LTD (AUSTRALIA AN AUSTRALIAN  
COMPANY LIMITED BY SHARES)  
1 FENNEL STREET  
PORT MELBOURNE VIC 3207  
AUSTRALIA

**TRADEMARK**

**PRINCIPAL REGISTER**

FOR: SKATEBOARDS, SKATEBOARD WHEELS SOLD BOTH SEPARATELY AND TOGETHER WITH THE SKATEBOARD AS A UNIT, SKATEBOARD HARDWARE AND PARTS THEREFOR, NAMELY, TRUCKS, BEARINGS, MOUNTING HARDWARE, DECKS, GRIP TAPE, AND RISER PADS; WATER SKIS; SURF SKIS; SKIS; EDGES OF SKIS; SCRAPERS FOR SKIS; SKI BINDINGS; SOLE COVERINGS FOR SKIS; WAX FOR SKIS; SURFBOARDS; SURFBOARD LEASHES; BAGS ESPECIALLY DESIGNED FOR SKIS AND SURFBOARDS; BODY BOARDS; WAKE BOARDS; SNOW BOARDS; SAILBOARDS; HARNESS FOR SAILBOARDS; MASTS FOR SAILBOARDS; ICE SKATES; ROLLER SKATES; TOYS, NAMELY, BOBBLE HEAD DOLLS, ACTION FIGURES, MINIATURE SKATEBOARD FOR USE AS TOYS, MINIATURE SURFBOARDS FOR USE AS TOYS; PLAY ARTICLES FOR SWIMMING POOLS, NAMELY, BALLS, RINGS FOR DIVING, PLASTIC TOY TORPEDOES, ARM FLOATS FOR RECREATIONAL USE AND WATER TOYS; BOARD GAMES; HAND HELD ELECTRONIC UNITS FOR PLAYING ELECTRONIC GAMES OTHER THAN THOSE ADAPTED FOR USE WITH AN EXTERNAL DISPLAY SCREEN OR MONITOR; PARLOUR GAMES, IN CLASS 28 (U.S. CLS. 22, 23, 38 AND 50).

THE MARK CONSISTS OF STANDARD CHARACTERS WITHOUT CLAIM TO ANY PARTICULAR FONT, STYLE, SIZE, OR COLOR.

OWNER OF INTERNATIONAL REGISTRATION 1077517 DATED 2-9-2011, EXPIRES 2-9-2021.

SER. NO. 79-097,513, FILED 2-9-2011.

FRED CARL, EXAMINING ATTORNEY



*David J. Kypos*

Director of the United States Patent and Trademark Office



# United States of America

United States Patent and Trademark Office

The logo for "TShop" features a large, stylized letter "T". The top horizontal bar of the "T" is replaced by a wavy, leaf-like shape. To the right of the vertical stem of the "T", the word "Shop" is written in a bold, sans-serif font.

**Reg. No. 4,123,705**

**Registered Apr. 10, 2012**

**Int. Cls.: 11 and 30**

**TRADEMARK**

**PRINCIPAL REGISTER**

TPRESSO SA  
ROUTE DU VILLAGE 76  
CH-1040 SAINT-BARTHÉLEMY  
SWITZERLAND

FOR: MACHINES FOR THE PREPARATION OF HOT BEVERAGES, PARTICULARLY MACHINES FOR INJECTING HOT WATER AND PRESSURIZED STEAM FOR THE PREPARATION, FROM CAPSULES, OF NON-MEDICINAL INFUSIONS AND TEAS, IN CLASS 11 (U.S. CLS. 13, 21, 23, 31 AND 34).

FOR: TEAS; NON-MEDICINAL HERBAL INFUSIONS AND HERBAL TEAS; TEA EXTRACTS; TEA-BASED PREPARATIONS AND BEVERAGES; NON-MEDICINAL INFUSIONS, HERBAL TEAS AND TEAS IN CAPSULES, PREPARATIONS AND BEVERAGES MADE WITH NON-MEDICINAL TEA IN CAPSULES, IN CLASS 30 (U.S. CL. 46).

THE MARK CONSISTS OF THE WORDING "TSHOP" WITH A WAVY LINE FORMING THE TOP PORTION OF THE LETTER "T" AND A CURVED LINE ABOVE THE RIGHT TOP HALF OF THE LETTER "T" WHICH FORMS THE SHAPE OF A LEAF.

PRIORITY DATE OF 6-16-2010 IS CLAIMED.

OWNER OF INTERNATIONAL REGISTRATION 1077697 DATED 12-15-2010, EXPIRES 12-15-2020.

SER. NO. 79-097,573, FILED 12-15-2010.

RENEE MCCRAY, EXAMINING ATTORNEY



*David J. Kyffers*

Director of the United States Patent and Trademark Office

# United States of America

United States Patent and Trademark Office

# AZIATIX

**Reg. No. 4,123,706**

**Registered Apr. 10, 2012**

**Int. Cls.: 35 and 41**

**SERVICE MARK**

**PRINCIPAL REGISTER**

ASTAR INC.  
73-32 NONHEON-DONG,  
GANGNAM-GUSEOUL  
REPUBLIC OF KOREA

FOR: BUSINESS MANAGEMENT OF PERFORMING ARTISTS; PLANNING SERVICES OF ADVERTISING, NAMELY, BUSINESS PLANNING FOR PROMOTING AND MARKETING THE GOODS AND SERVICES OF OTHERS; ADVERTISING AGENCIES; DISSEMINATION OF ADVERTISING FOR OTHERS VIA THE INTERNET; ACCOUNTING SERVICES; BUSINESS MANAGEMENT AND ORGANIZATION CONSULTANCY; PROVIDING BUSINESS INFORMATION; COMPILATION OF INFORMATION INTO COMPUTER DATABASES; SYSTEMIZATION OF INFORMATION INTO COMPUTER DATABASES; OFFICE FUNCTIONS, IN CLASS 35 (U.S. CLS. 100, 101 AND 102).

FOR: ORGANIZATION OF EXHIBITIONS FOR EDUCATIONAL PURPOSES; ORGANIZATION OF EXHIBITIONS FOR ENTERTAINMENT PURPOSES; PROVIDING INFORMATION IN THE FIELD OF ENTERTAINMENT; ENTERTAINMENT PERFORMED BY SINGERS, NAMELY, LIVE PERFORMANCES BY SINGERS; PRESENTATION OF KOREAN CLASSICAL MUSIC PERFORMANCE, NAMELY, LIVE PERFORMANCES BY KOREAN CLASSICAL MUSIC SINGERS; PROVIDING THEATRE FACILITIES IN THE NATURE OF RENTING FACILITIES FOR THE PRODUCTION OF THEATRICAL PRODUCTIONS, NAMELY, PERFORMANCE VENUES, STUDIOS, SETS, DRESSING ROOMS; ENTERTAINMENT SERVICES IN THE NATURE OF LIVE INSTRUMENTAL PERFORMANCES BY MUSICAL GROUPS; RECORDING STUDIO SERVICES; RENTAL OF AUDIO RECORDINGS AND AUDIO RECORDINGS ON DISCS FEATURING A VARIETY OF GENRES; PRODUCTION OF DOCUMENTARIES; SCRIPT WRITING SERVICES; SUBTITLING; ORGANIZATION OF POP MUSIC CONCERTS; DUBBING SERVICES; DIGITAL IMAGING SERVICES; PRODUCTION OF RADIO AND TELEVISION PROGRAMS; PROVIDING OF RADIO STUDIOS, NAMELY, RENTAL OF FACILITIES AND EQUIPMENT FOR THE PRODUCTION OF RADIO PROGRAMS, NAMELY, PERFORMANCE VENUES, STUDIOS, SETS, DRESSING ROOMS; RADIO ENTERTAINMENT SERVICES, NAMELY, RADIO ENTERTAINMENT PRODUCTION, PROVIDING AN ONGOING RADIO PROGRAM IN THE FIELD OF MUSIC; PRESENTATION OF LIVE MUSICAL PERFORMANCES; PRODUCTION OF LIVE MUSIC PERFORMANCES; PRODUCTION OF LIVE SHOWS; PLANNING ARRANGEMENT OF PERFORMANCES OF LIVE MUSIC; RENTAL OF SOUND RECORDINGS; RENTAL OF SOUND-RECORDED MAGNETIC TAPES; STAGE DIRECTION OF PLAYS; ORGANIZATION OF DANCE EVENTS, NAMELY, BALLS; ENTERTAINMENT IN THE NATURE OF DANCE PERFORMANCES;



*David J. Kyffers*

Director of the United States Patent and Trademark Office

**Reg. No. 4,123,706** DIRECTING OF DANCE PERFORMANCES; PRESENTATION OF MUSICAL PERFORMANCES; PRODUCTION OF MUSICAL PRODUCTIONS; PRODUCTION OF MUSIC VIDEOS; PRODUCTION OF VIDEOTAPE FILM FEATURING DRAMAS, COMEDIES; ENTERTAINMENT, NAMELY, PRODUCTION OF SHOWS; BOOKING OF SEATS FOR SHOWS; ORGANIZATION OF SHOWS FOR ENTERTAINMENT PURPOSES; ENTERTAINMENT SERVICES, NAMELY, LIVE PERFORMANCES BY A MUSICAL GROUP; PRODUCTION OF ANIMATIONS; PRESENTATION OF PLAY PERFORMANCE; PRODUCTION OF PLAYS; ORGANIZATION OF ENTERTAINMENT GROUPS, NAMELY, MUSICAL BANDS, ROCK GROUPS, GYMNAS TIC GROUPS, DANCE GROUPS; PERFORMANCE OF ENTERTAINMENT, NAMELY, THE PLANNING AND ARRANGEMENT OF LIVE PERFORMANCES FEATURING ON-GOING SPECIAL VARIETY MUSIC SHOWS; ENTERTAINMENT SERVICES, NAMELY, PRODUCTION AND DISTRIBUTION OF ON-GOING SPECIAL VARIETY MUSIC SHOWS; ENTERTAINMENT INFORMATION; CINEMATOG RAPHIC ADAPTATION AND EDITING; DISTRIBUTION OF CINE FILMS; MOTION PICTURE SONG PRODUCTION; CINEMA PRESENTATIONS, NAMELY, PROVIDING FACILITIES FOR THE PRESENTATION OF MOVIES, PLANNING ARRANGEMENT OF SHOWING MOVIES; PRODUCTION OF SPECIAL EFFECTS FOR FILMS; PREPARING SUBTITLES FOR MOVIES; PROVISION OF FILM INFORMATION; ARRANGING A SERIES OF FILM FESTIVALS; FILM PRODUCTION; MOVIE STUDIOS; RENTAL OF CINE-FILMS; RENTAL OF AUDIO EQUIPMENT; PRODUCTION OF AUDIO TAPE, NAMELY, PRODUCTION OF AUDIO RECORDING; EDITING OF SOUNDS FOR AUDIO-TAPES; ENTERTAINMENT IN THE NATURE OF ORCHESTRA PERFORMANCES; ORCHESTRA SERVICES; PRESENTATION OF OPERAS, NAMELY, PROVIDING FACILITIES FOR THE PRESENTATION OF OPERAS, PLANNING ARRANGEMENT OF SHOWING OPERAS; DISC RECORDING, NAMELY, RECORDING STUDIO SERVICES; DISTRIBUTION OF AUDIO RECORDINGS; PRODUCTION OF AUDIO RECORDINGS; MUSIC PERFORMANCES, NAMELY, PLANNING ARRANGEMENT OF LIVE MUSICAL PERFORMANCES; MUSIC COMPOSITION SERVICES; MUSIC-HALLS; SONG WRITING SERVICES; ARRANGING AND CONDUCTING OF CONCERTS; PRESENTATION OF CONCERTS, NAMELY, PROVIDING FACILITIES FOR THE PRESENTATION OF MUSICAL CONCERTS, PLANNING ARRANGEMENT OF SHOWING MUSICAL CONCERTS; TELEVISION SHOW PRODUCTION; TELEVISION ENTERTAINMENT IN THE NATURE OF ON-GOING SPECIAL VARIETY MUSIC SHOWS; DISTRIBUTION OF TELEVISION PROGRAMS; PRODUCTION OF TELEVISION PROGRAMS; TELEVISION STUDIO OPERATION, NAMELY, RENTAL OF FACILITIES AND EQUIPMENT FOR THE PRODUCTION OF TELEVISION PROGRAMS, NAMELY, PERFORMANCE VENUES, STUDIOS, SETS, DRESSING ROOMS; PUBLICATION OF PERIODICALS; ARRANGING EXHIBITIONS FOR ENTERTAINMENT PURPOSES; ARRANGING AND CONDUCTING OF EDUCATIONAL EVENTS IN THE NATURE OF EDUCATIONAL CONFERENCES IN THE FIELD OF ENTERTAINMENT; SONG ACADEMIES, NAMELY, TEACHING IN THE FIELD OF MUSIC; DANCE INSTRUCTION; VIDEOTAPING; PHOTOGRAPHY SERVICES; NEWS REPORTERS SERVICES, IN CLASS 41 (U.S. CLS. 100, 101 AND 107).

THE MARK CONSISTS OF STANDARD CHARACTERS WITHOUT CLAIM TO ANY PARTICULAR FONT, STYLE, SIZE, OR COLOR.

PRIORITY DATE OF 2-28-2011 IS CLAIMED.

OWNER OF INTERNATIONAL REGISTRATION 1077931 DATED 3-17-2011, EXPIRES 3-17-2021.

THE WORDING "AZIATIX" HAS NO MEANING IN A FOREIGN LANGUAGE.

SER. NO. 79-097,645, FILED 3-17-2011.

MICHAEL WIENER, EXAMINING ATTORNEY

# United States of America

United States Patent and Trademark Office

## PLANET EARTH ENTRY PASS

**Reg. No. 4,123,707**

**Registered Apr. 10, 2012**

**Int. Cl.: 16**

**TRADEMARK**

**PRINCIPAL REGISTER**

ROGER HENRY ERNEST GOODMAN (AUSTRALIA INDIVIDUAL)  
9 CARRIGG CRESCENT  
MT NASURA WA 6112  
AUSTRALIA

FOR: ALBUMS, NAMELY, ALBUMS FOR AUTOGRAPHS; PHOTOGRAPH ALBUMS; DISPLAY CARDS PRIMARILY COMPOSED OF CARDBOARD; DISPLAY CARDS PRIMARILY COMPOSED OF PAPER; DISPLAY BINDERS; DISPLAY FOLDERS; GIFT BOXES; DOCUMENT PORTFOLIOS; PRESENTATION PORTFOLIOS BEING STATIONERY TYPE; ART AND PHOTOGRAPH PORTFOLIO CASES; PORTFOLIOS BEING STATIONERY CASES FOR HOLDING DOCUMENTS; PORTFOLIOS BEING STATIONERY CASES FOR HOLDING ARCHITECTURE PLANS; DOCUMENT PORTFOLIOS MADE FROM PLASTIC ADAPTED FOR CARRYING ARTWORK; CASES FOR STATIONERY; STATIONERY DOCUMENT CASES; BIRTHDAY BOOKS; BOOKLETS FOR THE PURPOSE OF DOCUMENTING AND RECORDING INDIVIDUALS LIFE HISTORY, PERSONAL DATA, INFORMATION AND EVENTS; BOOKS FOR THE PURPOSE OF DOCUMENTING AND RECORDING INDIVIDUALS LIFE HISTORY, PERSON, DATA, INFORMATION AND EVENTS; BOOKS FOR CELEBRATING IMPORTANT EVENTS FOR THE PURPOSE OF DOCUMENTING AND RECORDING INDIVIDUALS LIFE HISTORY, PERSONAL DATA, INFORMATION AND EVENTS; BOOKS FOR CHILDREN; BOOKS FOR RECORDING INFORMATION ABOUT BABIES; BOOKS FOR RECORDING INFORMATION ABOUT CHILDREN; DATE BOOKS; YEAR-BOOKS FOR THE PURPOSE OF DOCUMENTING AND RECORDING INDIVIDUALS LIFE HISTORY, PERSONAL DATA, INFORMATION AND EVENTS; AUTOGRAPH BOOKS; PASSPORT CASES; PASSPORT COVERS, IN CLASS 16 (U.S. CLS. 2, 5, 22, 23, 29, 37, 38 AND 50).



THE MARK CONSISTS OF STANDARD CHARACTERS WITHOUT CLAIM TO ANY PARTICULAR FONT, STYLE, SIZE, OR COLOR.

PRIORITY DATE OF 5-10-2010 IS CLAIMED.

OWNER OF INTERNATIONAL REGISTRATION 1078013 DATED 11-8-2010, EXPIRES 11-8-2020.

SER. NO. 79-097,673, FILED 11-8-2010.

ANN E. SAPPENFIELD, EXAMINING ATTORNEY

*David J. Kypos*

Director of the United States Patent and Trademark Office

United States of America  
United States Patent and Trademark Office

ITiggy

**Reg. No. 4,123,708**

**Registered Apr. 10, 2012**

**Int. Cl.: 45**

**SERVICE MARK**

**PRINCIPAL REGISTER**

DANIEL HUA (AUSTRALIA INDIVIDUAL)  
171 JERRANG STREET  
CHAPEL HILL QLD 4069  
AUSTRALIA AND

JADEN LE (AUSTRALIA INDIVIDUAL)  
171 JERRANG STREET  
CHAPEL HILL QLD 4069  
AUSTRALIA

FOR: DATING AND SOCIAL INTRODUCTION SERVICES PROVIDED VIA ONLINE PERSONAL ADVERTISEMENTS; COMPUTER DATING SERVICES; PROVIDING INFORMATION, INCLUDING ONLINE, ABOUT INTERNET-BASED SOCIAL NETWORKING SERVICES, IN CLASS 45 (U.S. CLS. 100 AND 101).

THE MARK CONSISTS OF STANDARD CHARACTERS WITHOUT CLAIM TO ANY PARTICULAR FONT, STYLE, SIZE, OR COLOR.

PRIORITY DATE OF 3-14-2011 IS CLAIMED.

OWNER OF INTERNATIONAL REGISTRATION 1078052 DATED 4-20-2011, EXPIRES 4-20-2021.

SER. NO. 79-097,679, FILED 4-20-2011.

WILLIAM ROSSMAN, EXAMINING ATTORNEY



*David J. Kyros*

Director of the United States Patent and Trademark Office

# United States of America

United States Patent and Trademark Office

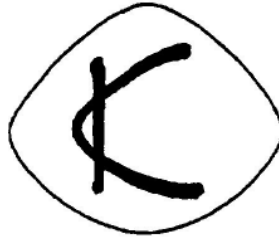

## KESSLORD

**Reg. No. 4,123,709**

**Registered Apr. 10, 2012**

**Int. Cls.: 14, 18 and 25**

**TRADEMARK**

**PRINCIPAL REGISTER**

KESSLORD SAS (FRANCE SOCIÉTÉ PAR ACTIONS SIMPLIFIÉE (SAS))  
65 RUE BEAUBOURG  
F-75003 PARIS  
FRANCE

FOR: JEWELRY, PRECIOUS STONES; TIMEPIECES AND CHRONOMETRIC INSTRUMENTS, IN CLASS 14 (U.S. CLS. 2, 27, 28 AND 50).

FOR: LEATHERWARE OF LEATHER OR IMITATION LEATHER, NAMELY, WALLETS, ENVELOPES, POUCHES, BRIEFCASES, SUITCASES, KEY CHAINS, PURSES; HANDBAGS, TRAVELING BAGS, SCHOOL BAGS; HARNESS ARTICLES, NAMELY, HARNESSES, HARNESS STRAPS, HARNESS TRACES; UMBRELLAS, PARASOLS AND WALKING STICKS, IN CLASS 18 (U.S. CLS. 1, 2, 3, 22 AND 41).

FOR: CLOTHING, NAMELY, UNDERWEAR, SHIRTS, PANTS, SKIRTS, BLOUSES, SWEATERS, DRESSES, SHORTS, TANK TOPS, STOCKINGS, TIGHTS, SWIMSUITS, BERMUDA SHORTS; NECKTIES, SCARVES, SASHES FOR WEAR; GLOVES; BELTS; FOOTWEAR, EXCLUDING ORTHOPEDIC FOOTWEAR; HEADGEAR, NAMELY, HATS AND CAPS, IN CLASS 25 (U.S. CLS. 22 AND 39).

THE MARK CONSISTS OF THE WORDING "KESSLORD" WITH AN OVAL-LIKE SHAPE APPEARING ABOVE THE WORDING WITH A HIGHLY STYLIZED LETTER "K" APPEARING INSIDE.

OWNER OF INTERNATIONAL REGISTRATION 0943793 DATED 10-16-2007, EXPIRES 10-16-2017.

SER. NO. 79-097,738, FILED 4-5-2011.

GENE MACIOL, EXAMINING ATTORNEY



*David J. Kyffers*

Director of the United States Patent and Trademark Office

# United States of America

United States Patent and Trademark Office

# HPSC

**Reg. No. 4,123,710**

**Registered Apr. 10, 2012**

**Int. Cls.: 7, 9 and 12**

**TRADEMARK**

**PRINCIPAL REGISTER**

PALFINGER AG (AUSTRIA AKTIENGESELLSCHAFT)  
F.W.SCHERER-STRASSE 24-28  
A-5101 BERGHEIM (SALZBURG)  
AUSTRIA

FOR: LOADING CRANES FOR LORRIES, IN CLASS 7 (U.S. CLS. 13, 19, 21, 23, 31, 34 AND 35).

FOR: REGULATING DEVICES AND SOFTWARE FOR LOADING CRANES, IN PARTICULAR TO INCREASE STABILITY, IN CLASS 9 (U.S. CLS. 21, 23, 26, 36 AND 38).

FOR: LORRIES WITH LOADING CRANES, IN CLASS 12 (U.S. CLS. 19, 21, 23, 31, 35 AND 44).

THE MARK CONSISTS OF STANDARD CHARACTERS WITHOUT CLAIM TO ANY PARTICULAR FONT, STYLE, SIZE, OR COLOR.

PRIORITY DATE OF 11-5-2010 IS CLAIMED.

OWNER OF INTERNATIONAL REGISTRATION 1078319 DATED 4-19-2011, EXPIRES 4-19-2021.

SER. NO. 79-097,795, FILED 4-19-2011.

SHANNON TWOHIG, EXAMINING ATTORNEY



*David J. Kybas*

Director of the United States Patent and Trademark Office

# United States of America

United States Patent and Trademark Office

## BOLSIUS AROMATIC

**Reg. No. 4,123,711**

**Registered Apr. 10, 2012**

**Int. Cls.: 4 and 21**

**TRADEMARK**

**PRINCIPAL REGISTER**

BOLSIUS INTERNATIONAL B.V. (NETHERLANDS BESLOTEN VENNOOTSCHAP)  
KERKENDIJK 126  
NL-5482 KK SCHIJNDEL  
NETHERLANDS

FOR: OILS AND FATS BEING FUELS FOR THE ILLUMINATION OF CANDLES, LAMP OIL, LAMP FUEL, LIGHTING FUELS, AROMATHERAPY FRAGRANCE CANDLES, PERFUMED CANDLES, SCENTED CANDLES, CANDLES FOR ILLUMINATION, TEA LIGHT CANDLES, DEVOTION, GRAVE AND BEDROOM CANDLES, CANDLES AND WICKS FOR CANDLES FOR LIGHTING, CANDLES FOR NIGHT LIGHTS, WICKS FOR CANDLES, WICKS FOR LAMPS AND OIL LAMPS, IN CLASS 4 (U.S. CLS. 1, 6 AND 15).

FOR: CANDLE HOLDERS AND CANDLE PLATES MADE OF GLASSWARE, PORCELAIN AND EARTHENWARE; CANDLESTICKS, CANDLE HOLDERS, CANDLE PLATES, CANDLE RINGS, NON-ELECTRIC WALL SCONCES, CANDLE SNUFFERS, CERAMIC SOOT BLOCKER FOR USE ON CANDLE JARS, IN CLASS 21 (U.S. CLS. 2, 13, 23, 29, 30, 33, 40 AND 50).

THE MARK CONSISTS OF STANDARD CHARACTERS WITHOUT CLAIM TO ANY PARTICULAR FONT, STYLE, SIZE, OR COLOR.

PRIORITY DATE OF 2-4-2011 IS CLAIMED.

OWNER OF INTERNATIONAL REGISTRATION 1078616 DATED 2-11-2011, EXPIRES 2-11-2021.

OWNER OF U.S. REG. NO. 1,604,286.

NO CLAIM IS MADE TO THE EXCLUSIVE RIGHT TO USE "AROMATIC" IN INTERNATIONAL CLASS 4, APART FROM THE MARK AS SHOWN.

SER. NO. 79-097,861, FILED 2-11-2011.

LINDA MICKLEBURGH, EXAMINING ATTORNEY



*David J. Kyffers*

Director of the United States Patent and Trademark Office



United States of America  
United States Patent and Trademark Office

**PYSIO**

**Reg. No. 4,123,712**

**Registered Apr. 10, 2012**

**Int. Cl.: 32**

**TRADEMARK**

**PRINCIPAL REGISTER**

AGROS NOVA BRANDS SPZ O.O. (POLAND CORPORATION)  
AL. STANÓW ZJEDNOCZONYCH 61A  
PL-04-028 WARSZAWA  
POLAND

FOR: VEGETABLE JUICE; VEGETABLE BEVERAGES; MIXED FRUIT AND VEGETABLE JUICES AND BEVERAGES; VEGETABLE JUICE AND BEVERAGES FOR CHILDREN; MIXED FRUIT AND VEGETABLE JUICES AND BEVERAGES FOR CHILDREN; VEGETABLE- FRUIT JUICES AND DRINKS AND VEGETABLE JUICES AND DRINKS ENHANCED WITH VITAMINS AND MINERAL TRACE ELEMENTS; FRUIT JUICES; FRUIT NECTARS; FRUIT BEVERAGES; FRUIT JUICES, FRUIT NECTARS AND FRUIT BEVERAGES FOR CHILDREN; FRUIT JUICES, FRUIT NECTARS AND FRUIT BEVERAGES ENHANCED WITH MINERAL TRACE ELEMENTS AND VITAMINS; MINERAL WATERS; FLAVORED WATERS; FRUIT-BASED BEVERAGES; PREPARATIONS FOR MAKING NON-ALCOHOLIC BEVERAGES, NAMELY, NON-ALCOHOLIC FRUIT EXTRACTS, ESSENCES, CONCENTRATES AND SYRUPS; POWDERS AND PASTILLES FOR PREPARING SPARKLING SOFT DRINKS, IN CLASS 32 (U.S. CLS. 45, 46 AND 48).

THE MARK CONSISTS OF STANDARD CHARACTERS WITHOUT CLAIM TO ANY PARTICULAR FONT, STYLE, SIZE, OR COLOR.

OWNER OF INTERNATIONAL REGISTRATION 1078721 DATED 2-18-2011, EXPIRES 2-18-2021.

THE ENGLISH TRANSLATION OF "PYSIO" IN THE MARK IS "HUMAN FACE".

SER. NO. 79-097,903, FILED 2-18-2011.

EVELYN BRADLEY, EXAMINING ATTORNEY



*David J. Kyros*

Director of the United States Patent and Trademark Office

United States of America  
United States Patent and Trademark Office

ELIXI

**Reg. No. 4,123,713**

**Registered Apr. 10, 2012**

**Int. Cl.: 5**

**TRADEMARK**

**PRINCIPAL REGISTER**

ELIXI OIL OY (FINLAND A LIMITED COMPANY)  
JOENSUUNTIE 49  
FI-31400 SOMERO  
FINLAND

FOR: DIETARY SUPPLEMENTS, IN CLASS 5 (U.S. CLS. 6, 18, 44, 46, 51 AND 52).

PRIORITY DATE OF 11-29-2010 IS CLAIMED.

OWNER OF INTERNATIONAL REGISTRATION 1078745 DATED 2-8-2011, EXPIRES 2-8-2021.

SER. NO. 79-097,909, FILED 2-8-2011.

MICHAEL WIENER, EXAMINING ATTORNEY



*David J. Kyffers*

Director of the United States Patent and Trademark Office

# United States of America

United States Patent and Trademark Office



**Reg. No. 4,123,714**

**Registered Apr. 10, 2012**

**Int. Cls.: 29, 30, 41 and 42**

**TRADEMARK**

**SERVICE MARK**

**PRINCIPAL REGISTER**

BARRY CALLEBAUT AG (SWITZERLAND SOCIÉTÉ ANONYME)  
WESTPARK,  
PFINGSTWEIDSTRASSE 60; CH-8005 ZÜRICH  
SWITZERLAND

FOR: COCOA BUTTER FOR FOOD PURPOSES, IN CLASS 29 (U.S. CL. 46).

FOR: COCOA; COCOA POWDER; COCOA PRODUCTS, NAMELY, COCOA-BASED CONFECTIONERY PRODUCTS, COCOA-BASED BEVERAGES, CHOCOLATE CONFECTIONS, CHOCOLATE CANDIES, PRALINES, AND FOOD ADDITIVES CONTAINING COCOA, NAMELY, COCOA MIXES AND NATURAL FOOD EXTRACTS DERIVED FROM COCOA; CHOCOLATE, IN CLASS 30 (U.S. CL. 46).

FOR: EDUCATION, TRAINING, THEORETICAL AND PRACTICAL TRAINING, NAMELY, PERSONNEL DEVELOPMENT THROUGH TRAINING AND CONTINUING PROFESSIONAL DEVELOPMENT IN THE FIELD OF GASTRONOMY; ENTERTAINMENT, NAMELY, ORGANIZING COOKING AND PASTRY COMPETITIONS; ORGANIZATION OF COMPETITIONS, SPORTING AND CULTURAL ACTIVITIES, NAMELY, CLASSES IN THE FIELD OF CHOCOLATE PRODUCTION AND CHOCOLATE GASTRONOMY, IN CLASS 41 (U.S. CLS. 100, 101 AND 107).

FOR: SCIENTIFIC AND TECHNICAL SERVICES IN THE NATURE OF SCIENTIFIC RESEARCH AND TECHNICAL CONSULTATION IN CONNECTION WITH AGRICULTURAL METHODS AND METHODS OF CULTIVATING COCOA AS WELL AS IN CONNECTION WITH THE PRODUCTION AND PROCESSING OF CHOCOLATE AND CHOCOLATE PRODUCTS, IN CLASS 42 (U.S. CLS. 100 AND 101).



OWNER OF U.S. REG. NO. 3,679,971.

PRIORITY DATE OF 10-28-2010 IS CLAIMED.

OWNER OF INTERNATIONAL REGISTRATION 1078935 DATED 4-26-2011, EXPIRES 4-26-2021.

*David J. Kyros*

Director of the United States Patent and Trademark Office

NO CLAIM IS MADE TO THE EXCLUSIVE RIGHT TO USE "QUALITY COCOA" FOR INTERNATIONAL CLASSES 29 AND 30 AND "QUALITY PARTNER PROGRAM" FOR INTERNATIONAL CLASSES 41 AND 42, APART FROM THE MARK AS SHOWN.

**Reg. No. 4,123,714** THE MARK CONSISTS OF A STYLIZED LETTER "Q" WITH THE CENTER OF THE "Q" FORMED BY A COCOA BEAN. TO THE RIGHT OF THE DESIGN, THE STYLIZED WORDING "QUALITY COCOA FOR A BETTER LIFE QUALITY PARTNER PROGRAM" APPEARS.

SER. NO. 79-097,962, FILED 4-26-2011.

MARILYN IZZI, EXAMINING ATTORNEY

# United States of America

United States Patent and Trademark Office

## METO EAGLE

**Reg. No. 4,123,715**

**Registered Apr. 10, 2012**

**Int. Cls.: 16 and 24**

**TRADEMARK**

**PRINCIPAL REGISTER**

CHECKPOINT SYSTEMS INTERNATIONAL GMBH (FED REP GERMANY GMBH)  
ERSHEIMER STRASSE 69  
69434 HIRSCHHORN/NECKAR  
FED REP GERMANY

FOR: HAND LABELERS, NAMELY, HAND-HELD MACHINES FOR IMPRINTING AND DISPENSING LABELS; PAPER LABELS; ADHESIVE LABELS; INK ROLLS FOR LABEL MACHINES, IN CLASS 16 (U.S. CLS. 2, 5, 22, 23, 29, 37, 38 AND 50).

FOR: LABELS MADE OF FABRICS, IN CLASS 24 (U.S. CLS. 42 AND 50).

THE MARK CONSISTS OF STANDARD CHARACTERS WITHOUT CLAIM TO ANY PARTICULAR FONT, STYLE, SIZE, OR COLOR.

PRIORITY DATE OF 10-21-2010 IS CLAIMED.

OWNER OF INTERNATIONAL REGISTRATION 1078975 DATED 4-7-2011, EXPIRES 4-7-2021.

OWNER OF U.S. REG. NOS. 950,316, 1,837,338, AND 3,953,571.

THE WORDING "METO" HAS NO MEANING IN A FOREIGN LANGUAGE.

SER. NO. 79-097,977, FILED 4-7-2011.

LAURA KOVALSKY, EXAMINING ATTORNEY



*David J. Kybas*

Director of the United States Patent and Trademark Office

# United States of America

United States Patent and Trademark Office



**Reg. No. 4,123,716**

**Registered Apr. 10, 2012**

**Int. Cl.: 32**

BRAUEREI SCHÖNRAM, INH. ALFRED OBERLINDOBER JUN. E. KFM. (FED REP GERMANY SOLE PROPRIETORSHIP)  
SALZBURGER STR. 10-14  
83367 PETTING/SCHÖNRAM  
FED REP GERMANY

**TRADEMARK**

FOR: BEERS, IN CLASS 32 (U.S. CLS. 45, 46 AND 48).

**PRINCIPAL REGISTER**

NO CLAIM IS MADE TO THE EXCLUSIVE RIGHT TO USE "BAVIARAS BEST" AND "ALC. 8% VOL" AND "INDIA PALE ALE", APART FROM THE MARK AS SHOWN.

PRIORITY DATE OF 11-19-2010 IS CLAIMED.

OWNER OF INTERNATIONAL REGISTRATION 1078991 DATED 5-2-2011, EXPIRES 5-2-2021.

THE COLOR(S) GOLD, BLUE, GREEN, BLACK AND WHITE IS/ARE CLAIMED AS A FEATURE OF THE MARK.

THE MARK CONSISTS OF A BLACK OVAL DESIGN WITH A GOLDEN BORDER AND THE WORDS "BAVIARAS" AND "BEST" IN WHITE STYLIZED FONT IN ITS CENTER. THE OVAL DESIGN FEATURES THE WORD "SCHONRAMER" APPEARING AT ITS TOP IN BLACK STYLIZED FONT ON A GOLDEN BANNER. BETWEEN THE WORDS "SCHONRAMER" AND "BAVIARAS" IS A DIAMOND PATTERN, FORMED OF TWO WHITE AND TWO BLUE RHOMBS, THAT FEATURES A GOLDEN BORDER. BELOW THE WORD "BEST" IS A DESIGN OF HOPS IN SHADES OF GREEN AND CEREAL EARS IN LIGHT BROWN, WITH THE WORDING "ALC. 8,0% VOL". IN WHITE UNDERNEATH. AT THE BOTTOM OF THE OVAL ARE THE WORDS "INDIA PALE ALE" IN WHITE ON A DARK GREEN BACKGROUND.



SER. NO. 79-097,983, FILED 5-2-2011.

MATTHEW KLINE, EXAMINING ATTORNEY

*David J. Kappas*

Director of the United States Patent and Trademark Office

United States of America  
United States Patent and Trademark Office

**XCEED**

**Reg. No. 4,123,717**

**Registered Apr. 10, 2012**

**Int. Cl.: 3**

ERTE KOZMETIK SANAYI VE TICARET ANONIM SIRKETI (TURKEY JOINT STOCK COMPANY)  
YAKUPLU MAHALLESİ  
BEYSAN SANAYI SITESİ,; DEREBOYU CADDESİ.NO:4;  
BEYLIKDÜZÜ-İSTANBUL, TURKEY

**TRADEMARK**

FOR: PERFUMES, EAU DE PERFUME, EAU DE TOILETTE, ANTIPERSPIRANTS AND DEODORANTS FOR PERSONAL USE, IN CLASS 3 (U.S. CLS. 1, 4, 6, 50, 51 AND 52).

**PRINCIPAL REGISTER**

THE MARK CONSISTS OF THE WORD "XCEED" IN STYLIZED FORM.

OWNER OF INTERNATIONAL REGISTRATION 1079090 DATED 1-31-2011, EXPIRES 1-31-2021.

SER. NO. 79-098,012, FILED 1-31-2011.

Laurie Kaufman, Examining Attorney



*David J. Kyffers*

Director of the United States Patent and Trademark Office

United States of America  
United States Patent and Trademark Office

# GARANT

**Reg. No. 4,123,718**

**Registered Apr. 10, 2012**

**Int. Cl.: 33**

OBSHESTVO S OGRANICHENNOY OTVETSTVENNOSTJU "AALTO" (LIMITED COMPANY "AALTO") (RUSSIAN FED. OBSHESTVO S OGRANICHENNOY OTVETSTVENNOSTJU (LIMITED COMPANY))  
ULITSA SOVETSKAYA, DOM 69, LAHDENPOHJA,  
RU-186730 RESPUBLICA KARELIA  
RUSSIAN FED.

**TRADEMARK**

**PRINCIPAL REGISTER**

FOR: APERITIFS; ARAK; ARRACK; BRANDY; WINE; WHISKY; VODKA; GIN; LIQUEURS AND SPIRITS, NAMELY, DIGESTERS; PREPARED ALCOHOLIC COCKTAILS; LIQUEURS; ALCOHOLIC BEVERAGES, EXCEPT BEER; ALCOHOLIC BEVERAGES CONTAINING FRUIT; BEVERAGES, NAMELY, SPIRITS; DISTILLED SPIRITS; MEAD AND HYDROMEL; PEPPERMINT LIQUEURS; ALCOHOLIC BITTERS; RUM; SAKE; HARD CIDER; ALCOHOLIC RICE-BASED BEVERAGE; ALCOHOLIC EXTRACTS; FRUIT EXTRACTS, ALCOHOLIC; ALCOHOLIC ESSENCES, IN CLASS 33 (U.S. CLS. 47 AND 49).

THE MARK CONSISTS OF STANDARD CHARACTERS WITHOUT CLAIM TO ANY PARTICULAR FONT, STYLE, SIZE, OR COLOR.

OWNER OF INTERNATIONAL REGISTRATION 1079192 DATED 4-21-2011, EXPIRES 4-21-2021.

THE ENGLISH TRANSLATION OF WORDING "GARANT" IN THE MARK IS "GUARANTOR".

SER. NO. 79-098,048, FILED 4-21-2011.

CIMMERIAN COLEMAN, EXAMINING ATTORNEY



*David J. Kyfos*

Director of the United States Patent and Trademark Office



# United States of America

United States Patent and Trademark Office

## Kuehne + Nagel

**Reg. No. 4,123,719**

**Registered Apr. 10, 2012**

**Int. Cls.: 35, 36 and 39**

**SERVICE MARK**

**PRINCIPAL REGISTER**

KÜHNE + NAGEL INTERNATIONAL AG (SWITZERLAND SOCIÉTÉ ANONYME)  
DORFSTRASSE 50  
CH-8834 SCHINDELLEGI  
SWITZERLAND

FOR: BUSINESS ORGANIZATION CONSULTANCY, PARTICULARLY IN THE FIELD OF THE TRANSPORTATION OF GOODS; BUSINESS MANAGEMENT CONSULTANCY; PROVIDING STATISTICAL INFORMATION FOR BUSINESS OR COMMERCIAL PURPOSES, IN CLASS 35 (U.S. CLS. 100, 101 AND 102).

FOR: INSURANCE BROKERAGE, CUSTOMS BROKERAGE, IN CLASS 36 (U.S. CLS. 100, 101 AND 102).

FOR: FREIGHT FORWARDING SERVICES, PARTICULARLY THE TRANSPORT OF GOODS BY AUTOMOBILE, RAILWAY, AIRCRAFT AND BOATS; SUPPLY CHAIN LOGISTICS SERVICES, NAMELY, STORAGE, TRANSPORTATION AND DELIVERY OF DOCUMENTS, PACKAGES, RAW MATERIALS, AND OTHER FREIGHT FOR OTHERS BY AIR, RAIL, SHIP OR TRUCK; DISTRIBUTION OF FREIGHT FOR CUSTOMERS, CONSULTATION IN THE FIELD OF TRANSPORTATION OF THE GOODS OF OTHERS; MAIL SERVICES, NAMELY, COURIER SERVICES; STORAGE OF GOODS; PACKAGING OF GOODS, NAMELY, PACKING ARTICLES FOR TRANSPORTATION; LOADING AND UNLOADING OF FREIGHT; SHIPPING BROKERAGE; REMOVAL SERVICES, NAMELY, FURNITURE MOVING; TRAVEL AGENCY SERVICES, NAMELY, MAKING RESERVATIONS AND BOOKING FOR TRANSPORTATION, IN CLASS 39 (U.S. CLS. 100 AND 105).

THE MARK CONSISTS OF STANDARD CHARACTERS WITHOUT CLAIM TO ANY PARTICULAR FONT, STYLE, SIZE, OR COLOR.

PRIORITY DATE OF 2-8-2011 IS CLAIMED.

OWNER OF INTERNATIONAL REGISTRATION 1078423 DATED 4-12-2011, EXPIRES 4-12-2021.

SER. NO. 79-098,105, FILED 4-12-2011.

JANICE L. MCMORROW, EXAMINING ATTORNEY



*David J. Kyffers*

Director of the United States Patent and Trademark Office

# United States of America

United States Patent and Trademark Office



**Reg. No. 4,123,720**

**Registered Apr. 10, 2012**

**Int. Cl.: 25**

**TRADEMARK**

**PRINCIPAL REGISTER**

CORNELIS J.M. VISSER H.O.D.N. GREANZ (NETHERLANDS INDIVIDUAL)  
CRUQUIUS 64 A  
NL-3825 MH AMERSFOORT  
NETHERLANDS

FOR: FOOTWEAR; SOCKS; HEAD WEAR; BATHING COSTUMES, BATHROBES; BELTS FOR CLOTHING; CRAVATS; DRESSES, GOWNS, SKIRTS, BLOUSES, PANTIES, LEGGINGS; TOPS BEING CLOTHING; SUITS, TROUSERS, BLAZERS, CARDIGANS, CLOAKS, PANTS, SHORTS, SHIRTS, SWEATERS; JEANS, JOGGING SUITS, OVERALLS, JACKETS BEING CLOTHING, COATS, SCARVES, PARKAS, PONCHOS; UNDERWEAR, IN CLASS 25 (U.S. CLS. 22 AND 39).

THE MARK CONSISTS OF FIVE SEPARATE ICON LOGOS ARRANGED HORIZONTALLY REPRESENTING FROM LEFT TO RIGHT (1) A STYLIZED SUN CONSISTING OF A TWIRL AND TWELVE OUTWARD POINTING STRIPES, (2) A STYLIZED HEART CONTAINING A CIRCLE WHICH CONTAINS AN X, (3) A STYLIZED REPRESENTATION OF A SMILING HUMAN FACE CONSISTING OF A CIRCLE MADE OF STRIPES, CONTAINING TWO X'S AND AN ARC MAKING UP THE EYES AND MOUTH, (4) A STYLIZED REPRESENTATION OF A HEART MADE UP OF THREE BENDING ARROWS WITH THE HEAD OF EACH ARROW REACHING THE TAIL OF ANOTHER AND (5) A REPRESENTATION OF A LEAF CONTAINING THE OUTLINES OF A FROG.

PRIORITY DATE OF 10-1-2010 IS CLAIMED.

OWNER OF INTERNATIONAL REGISTRATION 1079368 DATED 3-25-2011, EXPIRES 3-25-2021.

SER. NO. 79-098,152, FILED 3-25-2011.

KELLY TRUSILO, EXAMINING ATTORNEY



*David J. Kyjars*

Director of the United States Patent and Trademark Office

# United States of America

United States Patent and Trademark Office

## SONIC GENERATIONS

**Reg. No. 4,123,721**

**Registered Apr. 10, 2012**

**Int. Cl.: 9**

**TRADEMARK**

**PRINCIPAL REGISTER**

KABUSHIKI KAISHA SEGA, D/B/A SEGA CORPORATION (JAPAN CORPORATION)  
1-2-12, HANEDA  
OHTA-KU; TOKYO 144-8531  
JAPAN

FOR: COMPUTER GAME PROGRAMS; COMPUTER GAME SOFTWARE; VIDEO GAME SOFTWARE; VIDEO GAME PROGRAMS; VIDEO GAME DISCS AND CARTRIDGES , IN CLASS 9 (U.S. CLS. 21, 23, 26, 36 AND 38).

THE MARK CONSISTS OF STANDARD CHARACTERS WITHOUT CLAIM TO ANY PARTICULAR FONT, STYLE, SIZE, OR COLOR.

PRIORITY DATE OF 4-6-2011 IS CLAIMED.

OWNER OF INTERNATIONAL REGISTRATION 1079588 DATED 4-28-2011, EXPIRES 4-28-2021.

OWNER OF U.S. REG. NOS. 3,009,472, 3,548,012 AND OTHERS.

SER. NO. 79-098,228, FILED 4-28-2011.

BERYL GARDNER, EXAMINING ATTORNEY



*David J. Kyfos*

Director of the United States Patent and Trademark Office

# United States of America

United States Patent and Trademark Office



**Reg. No. 4,123,722**

**Registered Apr. 10, 2012**

**Int. Cl.: 7**

**TRADEMARK**

**PRINCIPAL REGISTER**

OLIMAC S.R.L. (ITALY LIMITED LIABILITY COMPANY)  
VIA CUNCO, 41  
I-12040 MARGARITA CN  
ITALY

FOR: AGRICULTURAL MACHINE TOOLS, NAMELY, CORN HEADS, IN CLASS 7 (U.S. CLS. 13, 19, 21, 23, 31, 34 AND 35).

THE MARK CONSISTS OF THE WORD "OLIMAC" WHICH APPEARS IN THE COLOR RED.

OWNER OF INTERNATIONAL REGISTRATION 1079907 DATED 4-5-2011, EXPIRES 4-5-2021.

THE COLOR(S) RED IS/ARE CLAIMED AS A FEATURE OF THE MARK.

THE WORDING "OLIMAC" HAS NO MEANING IN A FOREIGN LANGUAGE.

SER. NO. 79-098,363, FILED 4-5-2011.

EDWARD NELSON, EXAMINING ATTORNEY



*David J. Kyffers*

Director of the United States Patent and Trademark Office

# United States of America

United States Patent and Trademark Office

# RESFINITY

**Reg. No. 4,123,723**

**Registered Apr. 10, 2012**

**Int. Cls.: 9 and 42**

ANIXE POLSKA SPÓLKA Z OGRANICZONA ODPOWIEDZIALNOSCIA (POLAND LIMITED LIABILITY COMPANY)  
UL. GRABISZYNSKA 241A  
PL-53-234 WROCLAW  
POLAND

**TRADEMARK**

FOR: COMPUTER PROGRAMS FOR SELLING GOODS AND SERVICES ONLINE VIA INTERNET INCLUDING BOOKINGS AND PAYMENTS ONLINE VIA INTERNET, IN CLASS 9 (U.S. CLS. 21, 23, 26, 36 AND 38).

**SERVICE MARK**

**PRINCIPAL REGISTER**

FOR: COMPUTER SOFTWARE CONSULTING, COMPUTER SOFTWARE INSTALLATION, COMPUTER SOFTWARE MAINTENANCE, COPYING OF COMPUTER SOFTWARE, COMPUTER SOFTWARE DESIGN, COMPUTER SOFTWARE RENTAL, IN CLASS 42 (U.S. CLS. 100 AND 101).

OWNER OF INTERNATIONAL REGISTRATION 1079936 DATED 4-28-2011, EXPIRES 4-28-2021.

SER. NO. 79-098,375, FILED 4-28-2011.

KIMBERLY FRYE, EXAMINING ATTORNEY



*David J. Kyfos*

Director of the United States Patent and Trademark Office

# United States of America

United States Patent and Trademark Office

# THINKANALYSE

**Reg. No. 4,123,724**

**Registered Apr. 10, 2012**

**Int. Cls.: 35 and 41**

**SERVICE MARK**

**PRINCIPAL REGISTER**

THINKANALYSE PTY LTD (AUSTRALIA COMPANY)  
28 LLEWELLYN STREET  
RHODES NSW 2138, AUSTRALIA

FOR: BUSINESS ADVISORY SERVICES; BUSINESS CONSULTANCY; BUSINESS MANAGEMENT; BUSINESS MANAGEMENT CONSULTANCY; PROVISION OF INFORMATION IN RELATION TO BUSINESS MANAGEMENT; PROVIDING BUSINESS ADVICE AND INFORMATION REGARDING BUSINESS REQUIREMENTS ANALYSIS AND BUSINESS PROCESS RE-ENGINEERING; BUSINESS RECORDS KEEPING; COMMERCIAL BUSINESS MANAGEMENT; PREPARATION OF BUSINESS REPORTS; BUSINESS ADVICE RELATING TO MARKETING; BUSINESS RESEARCH; BUSINESS SUPERVISION ON BEHALF OF OTHERS; ECONOMIC ANALYSIS FOR BUSINESS PURPOSES; MARKETING ADVISORY SERVICES; ECONOMIC FORECASTING; PERSONNEL MANAGEMENT CONSULTANCY; ORGANIZING OF TRADE SHOWS FOR COMMERCIAL AND ADVERTISING PURPOSES, IN CLASS 35 (U.S. CLS. 100, 101 AND 102).

FOR: EDUCATION SERVICES, NAMELY, PROVIDING CLASSES, SEMINARS, WORKSHOPS IN THE FIELD OF BUSINESS REQUIREMENTS ANALYSIS AND BUSINESS RE-ENGINEERING; EDUCATIONAL SERVICES, NAMELY, MENTORING IN THE FIELD OF BUSINESS REQUIREMENTS ANALYSIS AND BUSINESS RE-ENGINEERING; LIFE COACHING SERVICES IN THE FIELD OF BUSINESS REQUIREMENTS ANALYSIS AND BUSINESS RE-ENGINEERING; CHARITABLE SERVICES, NAMELY, PROVIDING EDUCATION AND TRAINING IN THE FIELD OF BUSINESS REQUIREMENTS ANALYSIS AND BUSINESS RE-ENGINEERING; CONDUCTING TRAINING WORKSHOPS IN THE FIELD OF BUSINESS REQUIREMENTS ANALYSIS AND BUSINESS RE-ENGINEERING; BUSINESS EDUCATIONAL SERVICES, NAMELY, PROVIDING CLASSES, SEMINARS AND WORKSHOPS IN THE FIELD OF BUSINESS REQUIREMENTS ANALYSIS AND BUSINESS RE-ENGINEERING; EDUCATIONAL SERVICES, NAMELY, CONDUCTING TRAINING WORKSHOPS IN THE FIELD OF BUSINESS REQUIREMENTS ANALYSIS AND BUSINESS RE-ENGINEERING; EDUCATIONAL ADVISORY SERVICES, NAMELY, CAREER COUNSELLING; EDUCATIONAL CONSULTANCY SERVICES IN THE FIELD OF BUSINESS REQUIREMENTS ANALYSIS AND BUSINESS RE-ENGINEERING; EDUCATIONAL INSTRUCTION, NAMELY, PROVIDING CLASSES, SEMINARS AND WORKSHOPS IN THE FIELD OF BUSINESS REQUIREMENTS ANALYSIS AND BUSINESS RE-ENGINEERING; EDUCATIONAL SEMINARS IN THE FIELD OF BUSINESS REQUIREMENTS ANALYSIS AND BUSINESS RE-ENGINEERING; PROVISION OF EDUCATIONAL COURSES IN THE FIELD OF BUSINESS REQUIREMENTS ANALYSIS AND BUSINESS RE-ENGINEERING; PROVISION OF EDUCA-



*David J. Kyffers*

Director of the United States Patent and Trademark Office

**Reg. No. 4,123,724** TIONAL INFORMATION; TECHNICAL TRAINING IN BUSINESS, INDUSTRY AND INFORMATION TECHNOLOGY; EDUCATIONAL TRAINING SERVICES, NAMELY, PROVIDING CLASSES, SEMINARS, WORKSHOPS IN THE FIELD OF BUSINESS REQUIREMENTS ANALYSIS AND BUSINESS RE-ENGINEERING; ARRANGING AND CONDUCTING CONFERENCES, IN CLASS 41 (U.S. CLS. 100, 101 AND 107).

THE MARK CONSISTS OF STANDARD CHARACTERS WITHOUT CLAIM TO ANY PARTICULAR FONT, STYLE, SIZE, OR COLOR.

OWNER OF INTERNATIONAL REGISTRATION 1080122 DATED 4-11-2011, EXPIRES 4-11-2021.

SER. NO. 79-098,453, FILED 4-11-2011.

JEFF DEFORD, EXAMINING ATTORNEY

# United States of America

United States Patent and Trademark Office



**Reg. No. 4,123,725**

**Registered Apr. 10, 2012**

**Int. Cl.: 24**

AYDIN MENSUCAT DÖSEMELİK KUMAS SANAYİ VE TİCARET ANONİM ŞİRKETİ  
(TURKEY JOINT STOCK COMPANY)  
İKİTELLİ ORGANİZE SANAYİ BÖLGESİ  
TURGUT ÖZAL CADDESİ NO: 124.; KÜÇÜKÇEKMECE;  
İSTANBUL, TURKEY

**TRADEMARK**

**PRINCIPAL REGISTER**

FOR: WOVEN AND NON-WOVEN TEXTILE FABRICS FOR USE IN THE MANUFACTURE OF CLOTHING; FIBERGLASS FABRICS FOR TEXTILE USE; FABRIC IMPERVIOUS TO GASES FOR AERONAUTICAL BALLOONS; WATERPROOF FABRICS OF COTTON; FABRIC OF IMITATION ANIMAL SKINS; TEXTILE USED AS LINING FOR CLOTHING; BUCKRAM; QUILTS OF TEXTILE, BED BLANKETS; WASHING MITTS, BATH LINEN, HAND TOWELS, FACE TOWELS OF TEXTILE, BATHING TOWELS; TAPESTRIES OF TEXTILE, BANNERS OF TEXTILE; FLAGS NOT OF PAPER, NAMELY, CLOTH FLAGS, FABRIC FLAGS; CLOTH LABELS, IN CLASS 24 (U.S. CLS. 42 AND 50).

THE MARK CONSISTS OF THE WORD "AYDIN" IN STYLIZED FONT WITHIN A RECTANGULAR BACKGROUND. THERE APPEARS A VERTICAL LINE ON THE RIGHT SIDE OF THE RECTANGLE THAT EXTENDS ABOVE AND BELOW THE RIGHT EDGE OF THE RECTANGLE.

OWNER OF INTERNATIONAL REGISTRATION 1043350 DATED 2-9-2010, EXPIRES 2-9-2020.

THE ENGLISH TRANSLATION OF THE FOREIGN WORD(S) IN THE MARK IS: "INTELLECTUAL".

SER. NO. 79-098,495, FILED 4-8-2011.

ANDREA HACK, EXAMINING ATTORNEY



*David J. Kybas*

Director of the United States Patent and Trademark Office



# United States of America

United States Patent and Trademark Office

# SECOOP

**Reg. No. 4,123,726**

**Registered Apr. 10, 2012**

**Int. Cls.: 7 and 9**

**TRADEMARK**

**PRINCIPAL REGISTER**

SECOOP GMBH (FED REP GERMANY LIMITED LIABILITY COMPANY)  
MADS CLAUSEN STR. 7  
24939 FLENSBURG, FED REP GERMANY

FOR: COMPRESSORS FOR MACHINES; COMPRESSORS FOR REFRIGERATORS, IN CLASS 7 (U.S. CLS. 13, 19, 21, 23, 31, 34 AND 35).

FOR: ELECTRONIC CONTROLS FOR COMPRESSORS; ELECTRONIC STARTERS FOR COMPRESSORS; SOFTWARE FOR ALLOWING CUSTOMERS TO SELECT AND CONFIGURE COMPONENTS AND CONTROLS NECESSARY TO BUILD COLD ROOMS AND MEET COLD ROOM REQUIREMENTS; AND FREQUENCY CONVERTERS, IN CLASS 9 (U.S. CLS. 21, 23, 26, 36 AND 38).

THE MARK CONSISTS OF STANDARD CHARACTERS WITHOUT CLAIM TO ANY PARTICULAR FONT, STYLE, SIZE, OR COLOR.

PRIORITY DATE OF 9-7-2010 IS CLAIMED.

OWNER OF INTERNATIONAL REGISTRATION 1080314 DATED 2-17-2011, EXPIRES 2-17-2021.

SER. NO. 79-098,541, FILED 2-17-2011.

DAVID HOFFMAN, EXAMINING ATTORNEY



*David J. Kyfos*

Director of the United States Patent and Trademark Office

# United States of America

United States Patent and Trademark Office



**Reg. No. 4,123,727**

**Registered Apr. 10, 2012**

**Int. Cl.: 10**

**TRADEMARK**

**PRINCIPAL REGISTER**

MYOFUNCTIONAL RESEARCH CORPORATION PTY. LIMITED (AUSTRALIA COMPANY)  
44 SIGANTO DRIVE  
HELENSVALE QLD 4212, AUSTRALIA

FOR: ORTHODONTIC APPLIANCES; ORTHODONTIC AIDS, NAMELY, ORTHODONTIC TRAINING APPLIANCES WHICH ASSIST IN STRAIGHTENING TEETH, CORRECTING ARCH DEVELOPMENT, IMPROVING JAW GROWTH AND FACIAL DEVELOPMENT, BRACES FOR TEETH, DENTAL BITE TRAYS, DENTAL PLATES, TEETH RETAINERS; DENTAL APPARATUS, NAMELY, DENTAL HANDPIECES, DENTAL IMPRESSION TRAYS, DENTAL INLAYS; TRAINING DEVICES FOR TEETH, TONGUES AND FACIAL MUSCLES IN THE NATURE OF MOUTH GUARDS FOR MEDICAL PURPOSES, IN CLASS 10 (U.S. CLS. 26, 39 AND 44).

OWNER OF U.S. REG. NO. 3,879,284.

OWNER OF INTERNATIONAL REGISTRATION 1080342 DATED 4-12-2011, EXPIRES 4-12-2021.

THE MARK CONSISTS OF AN OVAL DESIGN CONTAINING THE DESIGNATION "T4K".

SER. NO. 79-098,550, FILED 4-12-2011.

JANICE L. MCMORROW, EXAMINING ATTORNEY



*David J. Kyffers*

Director of the United States Patent and Trademark Office

# United States of America

United States Patent and Trademark Office



**Reg. No. 4,123,728**

**Registered Apr. 10, 2012**

**Int. Cls.: 35, 38, 41 and 42**

**SERVICE MARK**

**PRINCIPAL REGISTER**

GUANGZHOU CCM INFORMATION SCIENCE & TECHNOLOGY CO., LTD. (CHINA CORPORATION)  
ROOM 2413,  
NO.80 XIANLIE ZHONG ROAD; 510070 GUANGZHOU  
CHINA

FOR: ON-LINE ADVERTISING ON A COMPUTER NETWORK; COST PRICE ANALYSIS; BUSINESS ORGANIZATION AND MANAGEMENT CONSULTING; CONDUCTING MARKETING STUDIES; MARKETING RESEARCH SERVICES; PERSONNEL MANAGEMENT CONSULTATION; GOODS IMPORT-EXPORT AGENCIES; COMPILATION AND SYSTEMIZATION OF INFORMATION INTO COMPUTER DATABASES, IN CLASS 35 (U.S. CLS. 100, 101 AND 102).

FOR: WIRELESS BROADBAND COMMUNICATION SERVICE; COMPUTER AIDED TRANSMISSION OF MESSAGES AND IMAGES; ELECTRONIC MAIL; ELECTRONIC MESSAGE SENDING; TELECONFERENCING SERVICES; PROVIDING INTERNET CHAT-ROOMS; PROVIDING ACCESS TO DATABASES; VOICE MAIL SERVICES, IN CLASS 38 (U.S. CLS. 100, 101 AND 104).

FOR: EDUCATION INFORMATION; SPORTS INSTRUCTION SERVICES; ARRANGING AND CONDUCTING OF CONFERENCES AND SYMPOSIA IN THE FIELDS OF AGRICULTURE, BIOTECHNOLOGY, MEDICINE, FOOD SUPPLEMENTS, CHEMICAL INDUSTRY, RENEWABLE ENERGY, PRINTING, PACKAGING, AND MATERIALS; LENDING LIBRARIES; BOOKMOBILE SERVICES; PUBLICATION OF ELECTRONIC BOOKS AND JOURNALS ON-LINE; PUBLICATION OF TEXTS, OTHER THAN PUBLICITY TEXTS; PUBLISHING OF ELECTRONIC PUBLICATIONS; PHOTOGRAPHIC REPORTING; PROVIDING ON-LINE PUBLICATIONS IN THE NATURE OF MAGAZINES, JOURNALS, NEWSPAPERS, PERIODICALS, RESEARCH REPORTS IN THE FIELD OF MARKET RESEARCH, BUSINESS TRENDS, TRADING ANALYSIS OF STOCKS, DERIVATIVES, FUTURES, INVESTMENTS, EQUITIES AND SECURITIES AND MARKETING CONSULTANCY, IN CLASS 41 (U.S. CLS. 100, 101 AND 107).

FOR: SCIENTIFIC STUDY AND RESEARCH IN THE FIELDS OF CHEMISTRY, BIOLOGY AND PHYSICS; COMPUTER SOFTWARE DESIGN; DATA CONVERSION OF COMPUTER PROGRAMS AND DATA, NOT PHYSICAL CONVERSION; CONVERSION OF DATA OR DOCUMENTS FROM PHYSICAL TO ELECTRONIC MEDIA, IN CLASS 42 (U.S. CLS. 100 AND 101).



*David J. Kyjars*

Director of the United States Patent and Trademark Office

**Reg. No. 4,123,728** THE MARK CONSISTS OF THE TERM "VALOTRACER" WITH A CURVED LINE GOING FROM THE LEFT OF THE "V" TO ABOVE IT, POINTING TO A BUTTERFLY.

OWNER OF INTERNATIONAL REGISTRATION 1080373 DATED 3-1-2011, EXPIRES 3-1-2021.

SER. NO. 79-098,559, FILED 3-1-2011.

IRA J. GOODSaid, EXAMINING ATTORNEY

# United States of America

United States Patent and Trademark Office

# KBAC TAPAC

**Reg. No. 4,123,729**

**Registered Apr. 10, 2012**

**Int. Cl.: 32**

PUBLIC JOINT STOCK COMPANY SLAVUTICH BREWERY (UKRAINE PUBLIC JOINT STOCK COMPANY)  
VUL. SAPOZHNIKOVA, 6  
M. ZAPORIZHZHYA 69076  
UKRAINE

**TRADEMARK**

FOR: NON-ALCOHOLIC BEVERAGES, NAMELY, KVASS, IN CLASS 32 (U.S. CLS. 45, 46 AND 48).

**PRINCIPAL REGISTER**

NO CLAIM IS MADE TO THE EXCLUSIVE RIGHT TO USE THE NON-LATIN CHARACTERS THAT TRANSLITERATE TO "KVASS", APART FROM THE MARK AS SHOWN.

PRIORITY DATE OF 3-12-2011 IS CLAIMED.

OWNER OF INTERNATIONAL REGISTRATION 1080503 DATED 5-23-2011, EXPIRES 5-23-2021.

THE TRANSLITERATION OF THE NON-LATIN CHARACTERS IN THE MARK IS: "KVASS TARAS".

THE MARK CONSISTS OF THE NON-LATIN CHARACTERS "KBAC TAPAC" IN STYLIZED TEXT.

THE ENGLISH TRANSLATION OF THE FOREIGN WORD(S) IN THE MARK IS: "KVASS TARAS", WHEREIN "KVASS" MEANS A NON-ALCOHOLIC BEVERAGE, AND "TARAS" MEANS A UKRAINIAN MALE FIRST NAME.

SER. NO. 79-098,599, FILED 5-23-2011.

SHANNON TWOHIG, EXAMINING ATTORNEY



*David J. Kyffers*

Director of the United States Patent and Trademark Office

# United States of America

United States Patent and Trademark Office



**Reg. No. 4,123,730**

**Registered Apr. 10, 2012**

**Int. Cls.: 35 and 41**

**SERVICE MARK**

**PRINCIPAL REGISTER**

THINKANALYSE PTY LTD (AUSTRALIA COMPANY)  
28 LLEWELLYN STREET  
RHODES NSW 2138, AUSTRALIA

FOR: BUSINESS ADVISORY SERVICES; BUSINESS CONSULTANCY; BUSINESS MANAGEMENT; BUSINESS MANAGEMENT CONSULTANCY; PROVISION OF INFORMATION IN RELATION TO BUSINESS MANAGEMENT; PROVIDING BUSINESS ADVICE AND INFORMATION REGARDING BUSINESS REQUIREMENTS ANALYSIS AND BUSINESS PROCESS RE-ENGINEERING; BUSINESS RECORDS KEEPING; COMMERCIAL BUSINESS MANAGEMENT; PREPARATION OF BUSINESS REPORTS; BUSINESS ADVICE RELATING TO MARKETING; BUSINESS RESEARCH; BUSINESS SUPERVISION ON BEHALF OF OTHERS; ECONOMIC ANALYSIS FOR BUSINESS PURPOSES; MARKETING ADVISORY SERVICES; ECONOMIC FORECASTING; PERSONNEL MANAGEMENT CONSULTANCY; ORGANIZING OF TRADE SHOWS FOR COMMERCIAL AND ADVERTISING PURPOSES, IN CLASS 35 (U.S. CLS. 100, 101 AND 102).

FOR: EDUCATION SERVICES, NAMELY, PROVIDING CLASSES, SEMINARS, WORKSHOPS IN THE FIELD OF BUSINESS REQUIREMENTS ANALYSIS AND BUSINESS RE-ENGINEERING; EDUCATIONAL SERVICES, NAMELY, MENTORING IN THE FIELD OF BUSINESS REQUIREMENTS ANALYSIS AND BUSINESS RE-ENGINEERING; LIFE COACHING SERVICES IN THE FIELD OF BUSINESS REQUIREMENTS ANALYSIS AND BUSINESS RE-ENGINEERING; CHARITABLE SERVICES, NAMELY, PROVIDING EDUCATION AND TRAINING IN THE FIELD OF BUSINESS REQUIREMENTS ANALYSIS AND BUSINESS RE-ENGINEERING; CONDUCTING TRAINING WORKSHOPS IN THE FIELD OF BUSINESS REQUIREMENTS ANALYSIS AND BUSINESS RE-ENGINEERING; BUSINESS EDUCATIONAL SERVICES, NAMELY, PROVIDING CLASSES SEMINARS, WORKSHOPS IN THE FIELD OF BUSINESS REQUIREMENTS ANALYSIS AND BUSINESS RE-ENGINEERING; EDUCATIONAL SERVICES, NAMELY, CONDUCTING TRAINING WORKSHOPS IN THE FIELD OF BUSINESS REQUIREMENTS ANALYSIS AND BUSINESS RE-ENGINEERING; EDUCATIONAL ADVISORY SERVICES, NAMELY, CAREER COUNSELING; EDUCATIONAL CONSULTANCY SERVICES IN THE FIELD BUSINESS REQUIREMENTS ANALYSIS AND BUSINESS RE-ENGINEERING; EDUCATIONAL INSTRUCTION, NAMELY, PROVIDING CLASSES, SEMINARS WORKSHOPS IN THE FIELD OF BUSINESS REQUIREMENTS ANALYSIS AND BUSINESS RE-ENGINEERING; EDUCATIONAL SEMINARS IN THE FIELD OF BUSINESS REQUIREMENTS ANALYSIS AND BUSINESS RE-ENGINEERING; PROVISION OF EDUCATIONAL COURSES IN THE FIELD OF BUSINESS REQUIREMENTS ANALYSIS AND BUSINESS RE-ENGINEERING; PROVISION OF EDUCATIONAL INFORM-

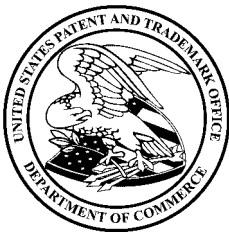

*David J. Kyffers*

Director of the United States Patent and Trademark Office

**Reg. No. 4,123,730** ATION; TECHNICAL TRAINING IN BUSINESS, INDUSTRY AND INFORMATION TECHNOLOGY; EDUCATIONAL TRAINING SERVICES, NAMELY, PROVIDING CLASSES, SEMINARS, WORKSHOPS IN THE FIELD OF BUSINESS REQUIREMENTS ANALYSIS AND BUSINESS RE-ENGINEERING; ARRANGING AND CONDUCTING EDUCATIONAL CONFERENCES, IN CLASS 41 (U.S. CLS. 100, 101 AND 107).

OWNER OF INTERNATIONAL REGISTRATION 1080690 DATED 4-11-2011, EXPIRES 4-11-2021.

SER. NO. 79-098,654, FILED 4-11-2011.

JEFF DEFORD, EXAMINING ATTORNEY

# United States of America

United States Patent and Trademark Office



**Reg. No. 4,123,731**

**Registered Apr. 10, 2012**

**Int. Cl.: 7**

**TRADEMARK**

**PRINCIPAL REGISTER**

ROTZLER GMBH + CO. KG (FED REP GERMANY GMBH + CO. KG)  
ROBERT-BOSCH-STR. 4  
79585 STEINEN, FED REP GERMANY

FOR: MECHANICAL OPERATED WINCHES WITH MECHANICAL, HYDRAULIC, ELECTRIC AND PNEUMATIC GEAR; HOISTING EQUIPMENT, NAMELY, HOISTS, PORTABLE HOIST SYSTEMS, WIRE HOISTS; HOISTING WINCHES, WINCHES, WINCHES FOR SEA FISHING APPLICATIONS; HYDRAULIC GEAR FOR MACHINES AND ENGINES NOT FOR LAND VEHICLES, HYDRAULIC ENGINES NOT FOR LAND VEHICLES, PNEUMATIC GEARS FOR MACHINES AND ENGINES NOT FOR LAND VEHICLES, IN CLASS 7 (U.S. CLS. 13, 19, 21, 23, 31, 34 AND 35).

OWNER OF U.S. REG. NO. 3,168,358.

PRIORITY DATE OF 2-10-2011 IS CLAIMED.

OWNER OF INTERNATIONAL REGISTRATION 1080788 DATED 5-11-2011, EXPIRES 5-11-2021.

THE MARK CONSISTS OF TWO INCOMPLETE CIRCLES SURROUNDING ONE COMPLETE CIRCLE APPEARING TO THE LEFT OF THE STYLIZED WORDS "ROTZLER" AND "TITAN", BOTH IN CAPITAL LETTERS, WITH "ROTZLER" APPEARING ABOVE "TITAN" AND "TITAN" IS UNDERLINED.

SER. NO. 79-098,667, FILED 5-11-2011.

SAIMA MAKHDOOM, EXAMINING ATTORNEY



*David J. Kybas*

Director of the United States Patent and Trademark Office



# United States of America

United States Patent and Trademark Office

# Bioconfident

**Reg. No. 4,123,732**

**Registered Apr. 10, 2012**

**Int. Cls.: 1, 3 and 5**

**TRADEMARK**

**PRINCIPAL REGISTER**

APPLICHEM GMBH (FED REP GERMANY GMBH (GESELLSCHAFT MIT BESCHRÄNKTER HAFTUNG))  
OTTOWEG 10B  
64291 DARMSTADT, FED REP GERMANY

FOR: CHEMICALS USED IN INDUSTRY, SCIENCE AND PHOTOGRAPHY, AS WELL AS IN AGRICULTURE, HORTICULTURE AND FORESTRY, IN PARTICULAR FOR THE REGENERATION OF COLUMNS FOR THE PURIFICATION OF DNA AND RNA; CHEMICALS FOR USE IN SCIENCE, NAMELY, CHEMICALS, CHEMICAL SOLUTIONS, CHEMICAL BUFFER SOLUTIONS AND CHEMICAL MEASURED SOLUTIONS FOR THE REGENERATION OF COLUMNS; UNPROCESSED ARTIFICIAL RESINS, UNPROCESSED PLASTICS; MANURES; FIRE EXTINGUISHING COMPOSITIONS; TEMPERING PREPARATIONS AND SOLDERING CHEMICALS; CHEMICAL SUBSTANCES FOR PRESERVING FOODSTUFFS; TANNING AGENTS FOR USE IN THE MANUFACTURE OF LEATHER; FINE CHEMICALS USED IN BIOCHEMISTRY MICROBIOLOGY, MOLECULAR BIOLOGY AND CELL BIOLOGY; LABORATORY CHEMICALS, IN PARTICULAR ACIDS, ALKALIS, SOLVENTS, SALTS, MEASURED SOLUTIONS AND BUFFER SOLUTIONS; ALL THE AFORESAID GOODS INCLUDED IN CLASS 01, IN CLASS 1 (U.S. CLS. 1, 5, 6, 10, 26 AND 46).

FOR: CLEANING PREPARATIONS, NAMELY, WASHING SODA FOR CLEANING; OILS FOR CLEANING PURPOSES; CLEANING PREPARATIONS; BLEACHING PREPARATIONS FOR LAUNDRY USE; OTHER SUBSTANCES FOR LAUNDRY USE, NAMELY, LAUNDRY DETERGENT, LAUNDRY PRE-SOAK, LAUNDRY STARCH AND FABRIC SOFTENERS; CLEANING, POLISHING, AND ABRASIVE PREPARATIONS; DEGREASING PREPARATIONS NOT FOR MANUFACTURING PROCESSES FOR USE IN HOUSEHOLD CLEANING; DRY CLEANING PREPARATIONS, IN CLASS 3 (U.S. CLS. 1, 4, 6, 50, 51 AND 52).

FOR: AIR PURIFYING PREPARATIONS; PHARMACEUTICAL AND VETERINARY PREPARATIONS, NAMELY, SEDATIVES, ANALGESIC, CARDIAC, VACCINE, APERIENT, PURGATIVE, CONTRACEPTIVE, APHRODISIACS; SANITARY PREPARATIONS FOR MEDICAL USE; DIETETIC FOODS ADAPTED FOR MEDICAL USE; FOOD FOR BABIES; MEDICAL PLASTERS, MATERIALS FOR DRESSINGS, NAMELY, GAUZE FOR DRESSINGS; MATERIAL FOR STOPPING TEETH, DENTAL WAX; DISINFECTANTS FOR SANITARY PURPOSES; PREPARATIONS FOR DESTROYING VERMIN; FUNGICIDES, HERBICIDES; DISINFECTANTS FOR HYGIENIC PURPOSES, IN CLASS 5 (U.S. CLS. 6, 18, 44, 46, 51 AND 52).



*David J. Kyjars*

Director of the United States Patent and Trademark Office

**Reg. No. 4,123,732** THE MARK CONSISTS OF STANDARD CHARACTERS WITHOUT CLAIM TO ANY PARTICULAR FONT, STYLE, SIZE, OR COLOR.

PRIORITY DATE OF 3-15-2011 IS CLAIMED.

OWNER OF INTERNATIONAL REGISTRATION 1080822 DATED 5-26-2011, EXPIRES 5-26-2021.

SER. NO. 79-098,686, FILED 5-26-2011.

CHARLOTTE CORWIN, EXAMINING ATTORNEY

# United States of America

United States Patent and Trademark Office

# Cinevator

**Reg. No. 4,123,733**

CINEVATION AS (NORWAY JOINT STOCK COMPANY)  
GRØNLAND 56

**Registered Apr. 10, 2012**

N-3045 DRAMMEN, NORWAY

**Int. Cls.: 9, 41 and 42**

FOR: DEVICE FOR RECORDING, TRANSMITTING AND RECREATING SOUNDS AND PICTURES, IN CLASS 9 (U.S. CLS. 21, 23, 26, 36 AND 38).

**TRADEMARK**

FOR: EDUCATIONAL SERVICES, NAMELY, CLASSES AND SEMINARS IN THE FIELD OF FILM PRODUCTION, IN CLASS 41 (U.S. CLS. 100, 101 AND 107).

**SERVICE MARK**

FOR: DESIGN AND DEVELOPMENT OF COMPUTER HARDWARE AND SOFTWARE, IN CLASS 42 (U.S. CLS. 100 AND 101).

**PRINCIPAL REGISTER**

THE MARK CONSISTS OF STANDARD CHARACTERS WITHOUT CLAIM TO ANY PARTICULAR FONT, STYLE, SIZE, OR COLOR.

OWNER OF INTERNATIONAL REGISTRATION 1080911 DATED 3-17-2011, EXPIRES 3-17-2021.

SER. NO. 79-098,719, FILED 3-17-2011.

AISHA CLARKE, EXAMINING ATTORNEY



*David J. Kybas*

Director of the United States Patent and Trademark Office

# United States of America

United States Patent and Trademark Office



**Reg. No. 4,123,734**

FINPROJECT S.R.L. (ITALY LIMITED LIABILITY COMPANY)  
CONTRADA CAMPOMAGGIO, SNC  
I-62010 MORROVALLE (MC), ITALY

**Registered Apr. 10, 2012**

**Int. Cl.: 12**

FOR: HEAD-RESTS FOR VEHICLE SEATS, UPHOLSTERY FOR VEHICLES, DOOR PANELS FOR LAND VEHICLES, BOAT FENDERS, CUP HOLDERS FOR USE IN VEHICLES, ROOF RACKS FOR VEHICLES, IN CLASS 12 (U.S. CLS. 19, 21, 23, 31, 35 AND 44).

**TRADEMARK**

OWNER OF U.S. REG. NO. 1,983,884.

**PRINCIPAL REGISTER**

OWNER OF INTERNATIONAL REGISTRATION 1080957 DATED 4-12-2011, EXPIRES 4-12-2021.

NO CLAIM IS MADE TO THE EXCLUSIVE RIGHT TO USE "EXTRALIGHT", APART FROM THE MARK AS SHOWN.

THE MARK CONSISTS OF THE WORDING "XL EXTRALIGHT" IN ORIGINAL BOLD CAPITAL LETTERS, PLACED INSIDE AN OVAL FRAME; THE LETTERS "XL" ARE BIGGER AND PLACED ABOVE THE WORD "EXTRALIGHT".

SER. NO. 79-098,750, FILED 4-12-2011.

JANICE L. MCMORROW, EXAMINING ATTORNEY



*David J. Kybas*

Director of the United States Patent and Trademark Office

United States of America  
United States Patent and Trademark Office

DORMEO

**Reg. No. 4,123,735**

**Registered Apr. 10, 2012**

**Int. Cl.: 35**

**SERVICE MARK**

**PRINCIPAL REGISTER**

STUDIO MODERNA SA (SWITZERLAND SOCIÉTÉ ANONYME (SA) / JOINT STOCK COMPANY)  
VIA FERRUCCIO PELLI 13  
CH-6900 LUGANO, SWITZERLAND

FOR: ADVERTISING; MARKETING AND SALES PROMOTION SERVICES; ADVERTISING AGENCIES; ADVERTISING THROUGH ALL PUBLIC COMMUNICATION MEANS; DISTRIBUTION AND DISSEMINATION OF ADVERTISING MATERIAL; RENTAL OF ADVERTISING SPACE; DEMONSTRATION OF GOODS FOR ADVERTISING PURPOSES; PUBLIC RELATIONS; MARKETING STUDIES; PRESENTATION OF GOODS ON ALL COMMUNICATIONS MEANS FOR RETAIL PURPOSES; ADVERTISING VIA ELECTRONIC MEDIA AND THE INTERNET; PUBLICITY SERVICES, INCLUDING PROMOTING GOODS, SERVICES, BRAND IDENTITY AND COMMERCIAL INFORMATION AND NEWS THROUGH PRINT, AUDIO, VIDEO, DIGITAL MEDIA AND ONLINE; ADVERTISING AND COMMERCIAL INFORMATION SERVICES, VIA GLOBAL COMPUTER NETWORKS (THE INTERNET); ADVERTISING SERVICES IN CONNECTION WITH THE COMMERCIALIZATION AND SALE OF PRODUCTS FOR HOUSEHOLD USE, THE PROVISION OF GOODS, CLOTHING; CREATING AND UPDATING ADVERTISING MATERIAL, NAMELY, PRINTED MATTER; DISTRIBUTION AND DISSEMINATION OF ADVERTISING MATERIALS, LEAFLETS, PROSPECTUSES, PRINTED MATERIAL, AND PRODUCT SAMPLES, IN CLASS 35 (U.S. CLS. 100, 101 AND 102).

THE MARK CONSISTS OF STANDARD CHARACTERS WITHOUT CLAIM TO ANY PARTICULAR FONT, STYLE, SIZE, OR COLOR.

PRIORITY DATE OF 11-25-2010 IS CLAIMED.

OWNER OF INTERNATIONAL REGISTRATION 1081055 DATED 5-25-2011, EXPIRES 5-25-2021.

OWNER OF U.S. REG. NOS. 3,039,845, 3,564,930 AND OTHERS.

THE WORDING "DORMEO" HAS NO MEANING IN A FOREIGN LANGUAGE.

SER. NO. 79-098,786, FILED 5-25-2011.

LIEF MARTIN, EXAMINING ATTORNEY



*David J. Kybas*

Director of the United States Patent and Trademark Office

# United States of America

United States Patent and Trademark Office



**Reg. No. 4,123,736**

**Registered Apr. 10, 2012**

**Int. Cl.: 25**

**TRADEMARK**

**PRINCIPAL REGISTER**

HUB BUB B.V. (NETHERLANDS PRIVATE LIMITED COMPANY)  
TURFSCHIPPER 70-72  
NL-2292 JB WATERINGEN  
NETHERLANDS

FOR: FOOTWEAR, NAMELY, MEN'S SHOES; WOMEN'S SHOES; BOOTS; SANDALS;  
SLIPPERS; SNEAKERS, IN CLASS 25 (U.S. CLS. 22 AND 39).

THE MARK CONSISTS OF AN ORANGE STITCH FORMING A LETTER "Z".

PRIORITY DATE OF 11-12-2010 IS CLAIMED.

OWNER OF INTERNATIONAL REGISTRATION 1081072 DATED 5-11-2011, EXPIRES 5-11-2021.

THE COLOR(S) ORANGE IS/ARE CLAIMED AS A FEATURE OF THE MARK.

SER. NO. 79-098,793, FILED 5-11-2011.

SAIMA MAKHDOOM, EXAMINING ATTORNEY



*David J. Kyffers*

Director of the United States Patent and Trademark Office

# United States of America

United States Patent and Trademark Office

## SOIN DE LA ROSERAIE

**Reg. No. 4,123,737**

**Registered Apr. 10, 2012**

**Int. Cl.: 3**

**TRADEMARK**

**PRINCIPAL REGISTER**

L'OCCITANE INTERNATIONAL S.A. (LUXEMBOURG SOCIÉTÉ ANONYME)  
1, RUE DU FORT RHEINSHEIM  
L-2419 LUXEMBOURG, LUXEMBOURG

FOR: PERFUMERY; TOILET WATER; SCENTED WATER; ESSENTIAL OILS; COSMETICS;  
OILS FOR COSMETIC PURPOSES; OILS FOR TOILET PURPOSES; BEAUTY MASKS;  
COSMETIC PREPARATIONS FOR SKIN CARE; COSMETIC CREAMS; COSMETIC PENCILS;  
MAKE-UP AND MAKE-UP REMOVING PREPARATIONS; CLEANSING MILK FOR TOILET  
PURPOSES; LOTIONS FOR COSMETIC PURPOSES; NON-MEDICATED TOILETRIES;  
SUNSCREEN PREPARATIONS; COSMETIC SUN-SCREEN PREPARATIONS, IN CLASS 3  
(U.S. CLS. 1, 4, 6, 50, 51 AND 52).

NO CLAIM IS MADE TO THE EXCLUSIVE RIGHT TO USE "SOIN" , APART FROM THE  
MARK AS SHOWN.

PRIORITY DATE OF 11-18-2010 IS CLAIMED.

OWNER OF INTERNATIONAL REGISTRATION 1081165 DATED 5-12-2011, EXPIRES 5-12-  
2021.

THE ENGLISH TRANSLATION OF "SOIN DE LA ROSERAIE" IN THE MARK IS "ROSE  
GARDEN SKINCARE".

SER. NO. 79-098,827, FILED 5-12-2011.

CAROLINE WOOD, EXAMINING ATTORNEY



*David J. Kybas*

Director of the United States Patent and Trademark Office

# United States of America

United States Patent and Trademark Office



**Reg. No. 4,123,738**

**Registered Apr. 10, 2012**

**Int. Cl.: 35**

**SERVICE MARK**

**PRINCIPAL REGISTER**

ECO MODUS, LDA. (PORTUGAL CORPORATION)  
AVENIDA DA REPÚBLICA, N° 3000,  
ESCRITÓRIO 17, 2°; P-2649-517 ALCABIDECHÉ  
PORTUGAL

FOR: IMPORT AND EXPORT AGENCIES, IN CLASS 35 (U.S. CLS. 100, 101 AND 102).

NO CLAIM IS MADE TO THE EXCLUSIVE RIGHT TO USE "ECO," "ECOLOGY," AND "THE DEPICTION OF A RECYCLING SYMBOL", APART FROM THE MARK AS SHOWN.

OWNER OF INTERNATIONAL REGISTRATION 1081302 DATED 5-23-2011, EXPIRES 5-23-2021.

THE COLOR(S) GREEN, WHITE, BLACK AND YELLOW IS/ARE CLAIMED AS A FEATURE OF THE MARK.

THE MARK CONSISTS OF THE FOLLOWING: A RECYCLING SYMBOL IN WHITE AGAINST A GREEN SHAPE WITH FOUR EDGES SHAPED LIKE ARCS, THE WORD "ECO" IS IN BLACK TO THE RIGHT OF THE DESIGN AND IS UNDERLINED IN YELLOW. BELOW THE LINE IS THE WORD "MODUS" IN BLACK. UNDERNEATH THE DESIGN AND WORDING IS "ECOLOGY ABOVE ALL" IN GREEN.

SER. NO. 79-098,867, FILED 5-23-2011.

SHANNON TWOHIG, EXAMINING ATTORNEY



*David J. Kybas*

Director of the United States Patent and Trademark Office



# United States of America

United States Patent and Trademark Office

# DANNENMANN

**Reg. No. 4,123,739**

**Registered Apr. 10, 2012**

**Int. Cl.: 25**

**TRADEMARK**

**PRINCIPAL REGISTER**

DANNENMANN PETRA (FED REP GERMANY INDIVIDUAL)  
ENDERSBACHERSTR. 71  
71384 WEINSTADT  
FED REP GERMANY

FOR: CLOTHING, NAMELY, SUITS, SHIRTS, PANTS, SHORTS, COATS, JACKETS, SWEATERS, SKIRTS, DRESSES, BLOUSES, STOCKINGS; FOOTWEAR, NAMELY, SHOES AND BOOTS; HEADGEAR, NAMELY, HATS AND CAPS, IN CLASS 25 (U.S. CLS. 22 AND 39).

THE MARK CONSISTS OF STANDARD CHARACTERS WITHOUT CLAIM TO ANY PARTICULAR FONT, STYLE, SIZE, OR COLOR.

OWNER OF INTERNATIONAL REGISTRATION 1081319 DATED 4-7-2011, EXPIRES 4-7-2021.

THE WORDING "DANNENMANN" HAS NO MEANING IN A FOREIGN LANGUAGE.

SER. NO. 79-098,872, FILED 4-7-2011.

LAURA KOVALSKY, EXAMINING ATTORNEY



*David J. Kyffers*

Director of the United States Patent and Trademark Office

# United States of America

United States Patent and Trademark Office

# VETEX

**Reg. No. 4,123,740**

**Registered Apr. 10, 2012**

**Int. Cls.: 24, 26 and 40**

**TRADEMARK**

**SERVICE MARK**

**PRINCIPAL REGISTER**

VETEX, NAAMLOZE VENNOOTSCHAP (BELGIUM JOINT STOCK COMPANY)  
LEON BEKAERTSTRAAT 14  
B-8770 INGELMUNSTER  
BELGIUM

FOR: TEXTILES AND TEXTILE GOODS, NAMELY, NON-WOVEN TEXTILE FABRICS, TEXTILE COASTERS IN THE NATURE OF TABLE LINEN, TOWELS, BED SHEETS, COTTON FABRIC; BED COVERS; TABLE COVERS NOT OF PAPER, IN CLASS 24 (U.S. CLS. 42 AND 50).

FOR: RIBBONS AND BRAID, PARTICULARLY RIBBONS FOR THERMAL WELDING SEAMS OF TEXTILE MATERIAL, NAMELY, SEAM SEALING TAPE FOR SEWING PURPOSES; SEALING ELEMENTS FOR TEXTILE AND GARMENTS, NAMELY, BUTTONS, HOOKS AND EYES, ZIP FASTENERS, CLOTHING FASTENERS IN THE NATURE OF SNAP BUTTONS, SNAP HOOKS, SLIDE FASTENERS, AND HOOK AND PILE FASTENING TAPES, IN CLASS 26 (U.S. CLS. 37, 39, 40, 42 AND 50).

FOR: TREATMENT OF TEXTILE MATERIAL, NAMELY, FINISHING, COATING AND LAMINATING OF TEXTILE MATERIAL, IN CLASS 40 (U.S. CLS. 100, 103 AND 106).

THE MARK CONSISTS OF STANDARD CHARACTERS WITHOUT CLAIM TO ANY PARTICULAR FONT, STYLE, SIZE, OR COLOR.

OWNER OF INTERNATIONAL REGISTRATION 0922977 DATED 3-6-2007, EXPIRES 3-6-2017.

SER. NO. 79-098,927, FILED 4-14-2011.

MICHAEL KEATING, EXAMINING ATTORNEY



*David J. Kyros*

Director of the United States Patent and Trademark Office

# United States of America

United States Patent and Trademark Office

# I J P R

**Reg. No. 4,123,741**

TAIYO HOLDINGS CO., LTD. (JAPAN CORPORATION)  
2-7-1 HAZAWA

**Registered Apr. 10, 2012**

NERIMA-KU; TOKYO 176-8508, JAPAN

**Int. Cls.: 1, 2 and 17**

FOR: CHEMICALS FOR USE IN THE PROCESS OF PRODUCING PRINTED CIRCUIT BOARDS, NAMELY, SOLDER RESISTS; PHOTORESISTS; CHEMICALS, NAMELY, PHOTSENSITIVE RESISTS USED IN THE MANUFACTURE OF PRINTED CIRCUIT BOARDS; CHEMICAL COATINGS USED IN THE MANUFACTURE OF PRINTED CIRCUIT BOARDS, IN CLASS 1 (U.S. CLS. 1, 5, 6, 10, 26 AND 46).

**TRADEMARK**

**PRINCIPAL REGISTER**

FOR: INKS FOR USE IN THE PROCESS OF PRODUCING PRINTED CIRCUIT BOARDS, NAMELY, MARKING INKS, PRINTING INKS, HOLE PLUGGING INKS AND SOLDER RESIST INKS, IN CLASS 2 (U.S. CLS. 6, 11 AND 16).

FOR: LIQUID ELECTRICAL INSULATING MATERIALS FOR USE WITH PRINTED CIRCUIT BOARDS; INSULATING RESIN MATERIALS FOR USE WITH PRINTED CIRCUIT BOARDS; INSULATING COATING MATERIALS FOR USE WITH PRINTED CIRCUIT BOARDS; INSULATING COATING MATERIALS FOR USE WITH PACKAGE APPLICATION BOARDS; INSULATING COATING MATERIALS FOR USE WITH FLEXIBLE PRINTED BOARDS, IN CLASS 17 (U.S. CLS. 1, 5, 12, 13, 35 AND 50).

THE MARK CONSISTS OF STANDARD CHARACTERS WITHOUT CLAIM TO ANY PARTICULAR FONT, STYLE, SIZE, OR COLOR.

OWNER OF INTERNATIONAL REGISTRATION 1081674 DATED 2-16-2011, EXPIRES 2-16-2021.

SER. NO. 79-099,012, FILED 2-16-2011.

NICHOLAS COLEMAN, EXAMINING ATTORNEY



*David J. Kypos*

Director of the United States Patent and Trademark Office

# United States of America

United States Patent and Trademark Office

## OISEAUX DE PARADIS

**Reg. No. 4,123,742**

VAN CLEEF & ARPELS S.A. (SWITZERLAND SOCIÉTÉ ANONYME)  
8 ROUTE DE BICHES

**Registered Apr. 10, 2012**

CH-1752 VILLARS-SUR-GLÂNE, SWITZERLAND

**Int. Cl.: 14**

FOR: CUFF LINKS, TIE CLIPS, RINGS, BRACELETS, EARRINGS, BROOCHES, PRECIOUS METAL KEY RINGS; WATCHES, CHRONOMETERS, CLOCKS, WATCH BANDS, BOXES OF PRECIOUS METAL FOR WATCHES AND JEWELRY, IN CLASS 14 (U.S. CLS. 2, 27, 28 AND 50).

**TRADEMARK**

**PRINCIPAL REGISTER**

THE MARK CONSISTS OF STANDARD CHARACTERS WITHOUT CLAIM TO ANY PARTICULAR FONT, STYLE, SIZE, OR COLOR.

PRIORITY DATE OF 11-22-2010 IS CLAIMED.

OWNER OF INTERNATIONAL REGISTRATION 1081684 DATED 4-19-2011, EXPIRES 4-19-2021.

THE ENGLISH TRANSLATION OF "OISEAUX DE PARADIS" IS "BIRDS OF PARADISE".

SER. NO. 79-099,017, FILED 4-19-2011.

TINA BROWN, EXAMINING ATTORNEY



*David J. Kybas*

Director of the United States Patent and Trademark Office

# United States of America

United States Patent and Trademark Office

## LOUNGEZONE

**Reg. No. 4,123,743**

**Registered Apr. 10, 2012**

**Int. Cls.: 18, 25 and 35**

PIATEX ULUSLARARAI TEKSTIL ÜRÜNLERİ PAZARLAMA VE TICARET LIMITED  
SIRKETI (TURKEY LIMITED COMPANY)  
M.NEZIH ÖZMEN MAHALLESİ  
LADIN SOKAK NO:9A/2  
MERTER-GÜNGÖREN-ISTANBUL, TURKEY

**TRADEMARK**

**SERVICE MARK**

**PRINCIPAL REGISTER**

FOR: LEATHER AND IMITATION LEATHER, ANIMAL SKINS; ANIMAL HIDES, ARTIFICIAL LEATHERS, STOUT LEATHERS, LINING LEATHER, GUT FOR MAKING SAUSAGE CASINGS, GOODS MADE OF LEATHER, IMITATION LEATHER OR SYNTHETIC MATERIALS, NAMELY, TRAVEL BAGS, VALISES, WALLETS, BACKPACKS FOR CARRYING BABIES, LEATHER AND STOUT LEATHER BOXES FOR STORING GREETING CARDS, LEATHER HAT BOXES FOR TRAVEL; MAKE-UP CASES SOLD EMPTY, TOILETRY BAGS SOLD EMPTY, VANITY CASES SOLD EMPTY, TOOL BAGS SOLD EMPTY; BOOK BAGS; CARRYING CASES FOR DOCUMENTS, BRIEFCASES, BACKPACKS, SCHOOL BAGS, LEATHER SHOPPING BAGS, LEATHER CASES FOR BANKNOTES, WHIPS, HARNESSSES AND SADDLERY, STIRRUPS, HORSE BRIDLES, UMBRELLAS, SUN UMBRELLAS, NAMELY, PARASOLS AND CANES, IN CLASS 18 (U.S. CLS. 1, 2, 3, 22 AND 41).

FOR: CLOTHING, NAMELY, TROUSERS, JACKETS, OVERCOATS, COATS, SKIRTS, SUITS, JERSEYS, WAISTCOATS, SHIRTS, T-SHIRTS, SWEATSHIRTS, DRESSES, BERMUDA SHORTS, SHORTS, PAJAMAS, PULLOVERS, JEANS, TRACKSUITS, RAINWEAR, BEACHWEAR, BATHING SUITS, SWIMMING SUITS; CLOTHING FOR SPORTS FOR EXCLUSIVE USE FOR SPORTS, NAMELY, SHIRTS, SHORTS, CLOTHING FOR BABIES, NAMELY, SHIRTS, PANTS, COATS, DRESSES; UNDERCLOTHING, NAMELY, BOXER SHORTS, BRASSIERES, BRIEFS, PANTS, SOCKS, IN CLASS 25 (U.S. CLS. 22 AND 39).

FOR: ADVERTISING AGENCIES SERVICES, MARKETING AND PUBLICITY BUREAUS SERVICES; ADVERTISEMENT AND PUBLICITY SERVICES BY TELEVISION, RADIO, MAIL; DISSEMINATION OF ADVERTISING MATTER, PUBLICITY CONSULTATION FEATURING PREPARATION SERVICES FOR PUBLICITY COLUMNS, ORGANIZATION OF COMMERCIAL AND ADVERTISEMENT EXHIBITION FOR COMMERCIAL AND ADVERTISING PURPOSES AND TRADE FAIR ORGANIZATION SERVICES, NAMELY, ORGANIZATION OF TRADE FAIRS FOR BUSINESS AND PROMOTIONAL PURPOSES, ADVERTISING SERVICES, NAMELY, ADVERTISING AND ADVERTISEMENT SERVICES, ADVERTISING AGENCIES, NAMELY, PROMOTING THE GOODS AND SERVICES OF OTHERS; PRODUCTION AND DISTRIBUTION OF RADIO AND TELEVISION COMMERCIALS; ORGANIZATION OF EXHIBITIONS FOR COMMERCIAL OR ADVERTISING PUR-



*David J. Kybas*

Director of the United States Patent and Trademark Office

**Reg. No. 4,123,743** POSES FOR PROMOTING THE SALE OF CLOTHING AND TEXTILES, MODELING FOR ADVERTISING OR SALES PROMOTION, CONDUCTING MARKETING STUDIES; PUBLICITY AND SALES PROMOTION SERVICES; WINDOW DRESSING AND DISPLAY ARRANGEMENT SERVICES; PUBLIC OPINION POLLING; PUBLIC RELATIONS; PROVIDING OFFICE FUNCTIONS, BUSINESS MANAGEMENT OF PERFORMING ARTISTS, SECRETARIAL SERVICES, DOCUMENT REPRODUCTION, PHOTOCOPYING, TYPING SERVICES, WORD PROCESSING, COMPILATION OF INFORMATION INTO COMPUTER DATABASES, SYSTEMIZATION OF INFORMATION INTO COMPUTER DATABASES, TELEPHONE ANSWERING SERVICES, ARRANGING NEWSPAPER SUBSCRIPTIONS FOR OTHERS, RENTAL OF OFFICE MACHINES AND EQUIPMENT, RENTAL OF VENDING MACHINES; BUSINESS ADMINISTRATION CONSULTANCY; COMMERCIAL AND INDUSTRIAL MANAGEMENT ASSISTANCE, BUSINESS MANAGEMENT AND ORGANIZATION CONSULTANCY, BUSINESS MANAGEMENT OF HOTELS FOR OTHERS; BUSINESS INVESTIGATION; PROVIDING STATISTICAL INFORMATION FOR BUSINESS OR COMMERCIAL PURPOSES, PERSONNEL MANAGEMENT CONSULTANCY, PERSONNEL RECRUITMENT, ACCOUNTING, FINANCIAL STATEMENT PREPARATION AND ANALYSIS FOR BUSINESSES; BUSINESS AUDITING; COST PRICE ANALYSIS; ECONOMIC FORECASTING AND ANALYSIS; PAYROLL PREPARATION, TAX PREPARATION; IMPORT AND EXPORT AGENCIES; BUSINESS DATA ANALYSIS FOR BUSINESSES; AUCTIONEERING; THE BRINGING TOGETHER, FOR THE BENEFIT OF OTHERS, OF LEATHER, IMITATION LEATHER AND GOODS MADE OF LEATHER, CLOTHING, FOOTWEAR, AND HEADGEAR, ENABLING CUSTOMERS TO CONVENIENTLY VIEW AND PURCHASE THOSE GOODS; RETAIL STORE SERVICES FEATURING CLOTHING, WHOLESALE OUTLET STORE SERVICES FEATURING CLOTHING, MAIL ORDER CATALOG SERVICES FEATURING CLOTHING, ON-LINE RETAIL STORE SERVICES FEATURING CLOTHING, IN CLASS 35 (U.S. CLS. 100, 101 AND 102).

OWNER OF INTERNATIONAL REGISTRATION 1081694 DATED 4-21-2011, EXPIRES 4-21-2021.

SER. NO. 79-099,021, FILED 4-21-2011.

SETH A. RAPPAPORT, EXAMINING ATTORNEY

# United States of America

United States Patent and Trademark Office



**Reg. No. 4,123,744**

**Registered Apr. 10, 2012**

**Int. Cl.: 24**

**TRADEMARK**

**PRINCIPAL REGISTER**

JIANGSU KASEN HOMETEXTILE CO., LTD. (CHINA CORPORATION)  
NO.858, RENMIN ROAD WEST  
HAIMEN TOWN; HAIMEN CITY JIANGSU PROVINCE  
CHINA

FOR: FABRICS FOR TEXTILE USE; TAPESTRIES, NAMELY, WALL HANGINGS OF TEXTILE; TOWEL OF TEXTILE; BED COVERS; QUILTS; MATTRESS COVERS; EIDEROWNS, NAMELY, DOWN COVERLETS; BED CLOTHS, NAMELY, BED COVERS AND SHEETS AND PILLOWCASES; BED BLANKETS; UNFITTED FURNITURE COVERINGS OF TEXTILE, IN CLASS 24 (U.S. CLS. 42 AND 50).

THE MARK CONSISTS OF THE WORDING "K KAISHENG" WITH THE TERM "KAISHENG" IN STYLIZED FONT AND THE "K" COMPRISE OF VARIOUS GEOMETRIC LINES AND CURVED LINES.

OWNER OF INTERNATIONAL REGISTRATION 1081883 DATED 6-15-2011, EXPIRES 6-15-2021.

THE TERM "KAISHENG" HAS NO MEANING IN A FOREIGN LANGUAGE.

SER. NO. 79-099,080, FILED 6-15-2011.

ERNEST SHOSHO, EXAMINING ATTORNEY



*David J. Kyffers*

Director of the United States Patent and Trademark Office

# United States of America

United States Patent and Trademark Office

## IMERYS SHALEPROP

**Reg. No. 4,123,745**

**Registered Apr. 10, 2012**

**Int. Cl.: 1**

**TRADEMARK**

**PRINCIPAL REGISTER**

IMERYS (FRANCE SOCIÉTÉ ANONYME)  
154, RUE DE L'UNIVERSITÉ  
F-75007 PARIS  
FRANCE

FOR: PROPPANTS, NAMELY, PROPPING AGENTS USED DURING HYDRAULIC FRAC-  
TURING OPERATIONS IN OIL WELLS AND GAS WELLS, IN CLASS 1 (U.S. CLS. 1, 5, 6,  
10, 26 AND 46).

THE MARK CONSISTS OF STANDARD CHARACTERS WITHOUT CLAIM TO ANY PAR-  
TICULAR FONT, STYLE, SIZE, OR COLOR.

PRIORITY DATE OF 4-13-2011 IS CLAIMED.

OWNER OF INTERNATIONAL REGISTRATION 1081924 DATED 4-29-2011, EXPIRES 4-29-  
2021.

OWNER OF U.S. REG. NO. 2,708,297.

THE WORDING "IMERYS" HAS NO MEANING IN A FOREIGN LANGUAGE.

SER. NO. 79-099,099, FILED 4-29-2011.

ROBIN MITTLER, EXAMINING ATTORNEY



*David J. Kybas*

Director of the United States Patent and Trademark Office



# United States of America

United States Patent and Trademark Office



**Reg. No. 4,123,746**

**Registered Apr. 10, 2012**

**Int. Cls.: 8 and 34**

**TRADEMARK**

**PRINCIPAL REGISTER**

FABBRICA D'ARMI PIETRO BERETTA S.P.A. (ITALY JOINT-STOCK COMPANY)  
VIA PIETRO BERETTA, 18  
I-25063 GARDONE VAL TROMPIA (BRESCIA)  
ITALY

FOR: SIDE ARMS, NOT INCLUDING FIREARMS, NAMELY, SWORDS, DOUBLE EDGE KNIVES, FOLDING KNIVES, HUNTING KNIVES, SPORT KNIVES; BLADES FOR DOUBLE EDGE KNIVES, FOLDING KNIVES, HUNTING KNIVES, SPORT KNIVES, IN CLASS 8 (U.S. CLS. 23, 28 AND 44).

FOR: TOBACCO, RAW OR MANUFACTURED, NAMELY, CIGARS, CIGARETTES, CIGARILLOS, TOBACCO FOR ROLL YOUR OWN CIGARETTES, PIPE TOBACCO, CHEWING TOBACCO, SNUFF TOBACCO, TOBACCO SUBSTITUTES NOT FOR MEDICAL PURPOSES; SMOKERS' ARTICLES, NAMELY, CIGARETTE PAPER AND TUBES, CIGARETTE FILTERS, TOBACCO TINS, CIGARETTE CASES AND ASHTRAYS NOT OF PRECIOUS METALS, THEIR ALLOYS OR COATED THEREWITH; SMOKING PIPES, POCKET APPARATUS FOR ROLLING CIGARETTES, LIGHTERS NOT OF PRECIOUS METALS, AND MATCHES, IN CLASS 34 (U.S. CLS. 2, 8, 9 AND 17).

OWNER OF U.S. REG. NOS. 1,181,044, 1,241,996 AND OTHERS.

PRIORITY DATE OF 2-16-2011 IS CLAIMED.

OWNER OF INTERNATIONAL REGISTRATION 1082033 DATED 2-24-2011, EXPIRES 2-24-2021.

THE MARK CONSISTS OF THE REPRESENTATION OF THREE ARROWS COMBINED WITH THREE CIRCULAR SHAPES, WITHIN A CIRCULAR SHAPE.

SER. NO. 79-099,136, FILED 2-24-2011.

KRISTINA MORRIS, EXAMINING ATTORNEY



*David J. Kybas*

Director of the United States Patent and Trademark Office

# United States of America

United States Patent and Trademark Office

## CHICCO SNAPPY

**Reg. No. 4,123,747**

**Registered Apr. 10, 2012**

**Int. Cl.: 12**

**TRADEMARK**

**PRINCIPAL REGISTER**

ARTSANA S.P.A (ITALY SOCIETA PER AZIONI)  
VIA SALDARINI CATELLI, 1  
I-22070 GRANDATE (COMO)  
ITALY

FOR: STROLLERS, PRAMS, BABY CARRIAGE, CHILD SAFETY SEATS FOR VEHICLES,  
IN CLASS 12 (U.S. CLS. 19, 21, 23, 31, 35 AND 44).

THE MARK CONSISTS OF STANDARD CHARACTERS WITHOUT CLAIM TO ANY PAR-  
TICULAR FONT, STYLE, SIZE, OR COLOR.

PRIORITY DATE OF 5-24-2011 IS CLAIMED.

OWNER OF INTERNATIONAL REGISTRATION 1082119 DATED 5-31-2011, EXPIRES 5-31-  
2021.

OWNER OF U.S. REG. NOS. 1,316,861, 3,682,120 AND OTHERS.

THE ENGLISH TRANSLATION OF "CHICCO" IN THE MARK IS "GRAIN, COFFEE BEAN,  
GRAPESTONE OR HAILSTONE" AND IS SOMETIMES THE NICKNAME OF ENRICO.

SER. NO. 79-099,168, FILED 5-31-2011.

SEAN CROWLEY, EXAMINING ATTORNEY



*David J. Kybas*

Director of the United States Patent and Trademark Office

# United States of America

United States Patent and Trademark Office



# E-MAK

**Reg. No. 4,123,748**

**Registered Apr. 10, 2012**

**Int. Cls.: 7 and 11**

E-MAK MAKINE INSAAT TICARET VE SANAYI LIMITED SIRKETI (TURKEY CORPORATION LIMITED)  
M. FUAT KUSÇUOĞLU, CAD. NO.63  
YUNUSELI  
OSMANGAZI BURSA, TURKEY

**TRADEMARK**

**PRINCIPAL REGISTER**

FOR: MACHINES, MACHINE TOOLS AND INDUSTRIAL ROBOTS TO PROCESS MATERIALS, NAMELY, ASPHALT AND AGGREGATE; HEAVY MACHINERY AND ROBOTIC MECHANISMS, NAMELY, CRUSHERS, ELEVATORS, SIEVING UNITS, MIXERS, FILLER MACHINES, FILTERING MACHINES, MIXER MACHINES, AND RECYCLING MACHINES FOR USE WITH ASPHALT PLANTS AND AGGREGATE PLANTS, IN CLASS 7 (U.S. CLS. 13, 19, 21, 23, 31, 34 AND 35).

FOR: DEVICES FOR HEATING AND VAPOR PRODUCING INSTALLATIONS, NAMELY, ASPHALT HEATERS FOR USE WITH ASPHALT PLANTS AND AGGREGATE PLANTS; ACCLIMATIZATION AND AIR-CONDITIONING DEVICES FOR USE WITH ASPHALT PLANTS AND AGGREGATE PLANTS; AND COOLERS AND REFRIGERATORS FOR USE WITH ASPHALT PLANTS AND AGGREGATE PLANTS, IN CLASS 11 (U.S. CLS. 13, 21, 23, 31 AND 34).

THE MARK CONSISTS OF THE TERM "E-MAK" TO THE LEFT OF A DIAMOND DESIGN ON A CIRCLE.

OWNER OF INTERNATIONAL REGISTRATION 1082280 DATED 3-18-2011, EXPIRES 3-18-2021.

SER. NO. 79-099,254, FILED 3-18-2011.

LEIGH CAROLINE CASE, EXAMINING ATTORNEY



*David J. Kyffers*

Director of the United States Patent and Trademark Office

# United States of America

United States Patent and Trademark Office

## PRISMA SHINE

**Reg. No. 4,123,749**

**Registered Apr. 10, 2012**

**Int. Cl.: 3**

**TRADEMARK**

**PRINCIPAL REGISTER**

INTERCOS S.P.A. (ITALY JOINT STOCK COMPANY)  
VIA S. TECLA, 3  
I-20122 MILANO  
ITALY

FOR: COSMETICS, NAMELY, EYE-SHADOW, ROUGE, MASCARA, FOUNDATION CREAM, LIPSTICK, FACE POWDER, NIGHT AND DAY CREAM, IN CLASS 3 (U.S. CLS. 1, 4, 6, 50, 51 AND 52).

THE MARK CONSISTS OF STANDARD CHARACTERS WITHOUT CLAIM TO ANY PARTICULAR FONT, STYLE, SIZE, OR COLOR.

PRIORITY DATE OF 4-20-2011 IS CLAIMED.

OWNER OF INTERNATIONAL REGISTRATION 1082395 DATED 5-13-2011, EXPIRES 5-13-2021.

NO CLAIM IS MADE TO THE EXCLUSIVE RIGHT TO USE "SHINE", APART FROM THE MARK AS SHOWN.

THE ENGLISH TRANSLATION OF "PRISMA" IN THE MARK IS "PRISM".

SER. NO. 79-099,302, FILED 5-13-2011.

DAVID HOFFMAN, EXAMINING ATTORNEY



*David J. Kyfos*

Director of the United States Patent and Trademark Office

# United States of America

United States Patent and Trademark Office

# PlasmaBox

**Reg. No. 4,123,750**

OERLIKON SOLAR AG, TRÜBBACH (SWITZERLAND SOCIÉTÉ ANONYME (SA))  
HAUPTSTRASSE 1A

**Registered Apr. 10, 2012**

TRÜBBACH, SWITZERLAND CH9477

**Int. Cls.: 7, 9, 37 and 42**

FOR: PLASMA GLOW DISCHARGE REACTORS FOR THE PRODUCTION OF PHOTOVOLTAIC SOLAR MODULES, PANELS, CELLS; AND GENERATORS, NAMELY, VACUUM DEPOSITION MACHINES FOR DEPOSITING THIN FILMS, NAMELY, PVD, PECVD AND CVD, IN CLASS 7 (U.S. CLS. 13, 19, 21, 23, 31, 34 AND 35).

**TRADEMARK**

**SERVICE MARK**

FOR: PHOTOVOLTAIC SOLAR MODULES, PANELS AND GENERATORS COMPOSED OF SOLAR CELLS, PHOTOELECTRIC CONVERTERS; PHOTOVOLTAIC METERS USED IN CONJUNCTION WITH MODULES, CELLS, PANELS AND GENERATORS FOR PROCESSING CURRENT, IN CLASS 9 (U.S. CLS. 21, 23, 26, 36 AND 38).

**PRINCIPAL REGISTER**

FOR: INSTALLATION OF PLANTS FOR THE PRODUCTION, MAINTENANCE AND REPAIR OF PHOTOVOLTAIC SOLAR MODULES, PANELS, CELLS AND GENERATORS; MAINTENANCE AND REPAIR OF PHOTOVOLTAIC SOLAR GENERATORS, IN CLASS 37 (U.S. CLS. 100, 103 AND 106).

FOR: SCIENTIFIC AND RESEARCH SERVICES, NAMELY, THE DEVELOPMENT, DESIGN AND ANALYSIS OF PHOTOVOLTAIC SOLAR MODULES, PANELS, CELLS AND GENERATORS; RESEARCH RELATING TO THE DEPOSITING OF THIN FILMS, PARTICULARLY FOR SEMICONDUCTORS AND CONDUCTORS; DEVELOPMENT OF PHOTOVOLTAIC SOLAR MODULES, PANELS, CELLS AND GENERATORS, IN CLASS 42 (U.S. CLS. 100 AND 101).



THE MARK CONSISTS OF STANDARD CHARACTERS WITHOUT CLAIM TO ANY PARTICULAR FONT, STYLE, SIZE, OR COLOR.

PRIORITY DATE OF 12-14-2010 IS CLAIMED.

OWNER OF INTERNATIONAL REGISTRATION 1082561 DATED 4-19-2011, EXPIRES 4-19-2021.

*David J. Kyjars*

THE WORD(S) "PLASMAX" HAS NO MEANING IN A FOREIGN LANGUAGE.

Director of the United States Patent and Trademark Office

SER. NO. 79-099,367, FILED 4-19-2011.

**Reg. No. 4,123,750** DAVID C. REIHNER, EXAMINING ATTORNEY

# United States of America

United States Patent and Trademark Office



**Reg. No. 4,123,751**

**Registered Apr. 10, 2012**

**Int. Cl.: 9**

**TRADEMARK**

**PRINCIPAL REGISTER**

MASCHINENFABRIK REINHAUSEN GMBH (FED REP GERMANY LIMITED LIABILITY COMPANY)  
FALKENSTEINSTRASSE 8  
93059 REGENSBURG, FED REP GERMANY

FOR: ELECTRIC TAP CHANGERS FOR THE UNINTERRUPTIBLE OPERATION OF REGULATING TRANSFORMERS FOR USE IN THE TECHNICAL FIELD OF HIGH-VOLTAGE ENGINEERING, IN CLASS 9 (U.S. CLS. 21, 23, 26, 36 AND 38).

THE MARK CONSISTS OF STANDARD CHARACTERS WITHOUT CLAIM TO ANY PARTICULAR FONT, STYLE, SIZE, OR COLOR.

PRIORITY DATE OF 2-3-2011 IS CLAIMED.

OWNER OF INTERNATIONAL REGISTRATION 1082603 DATED 5-14-2011, EXPIRES 5-14-2021.

OWNER OF U.S. REG. NO. 3,663,845.

SER. NO. 79-099,385, FILED 5-14-2011.

CARYN GLASSER, EXAMINING ATTORNEY



*David J. Kyjars*

Director of the United States Patent and Trademark Office

# United States of America

United States Patent and Trademark Office

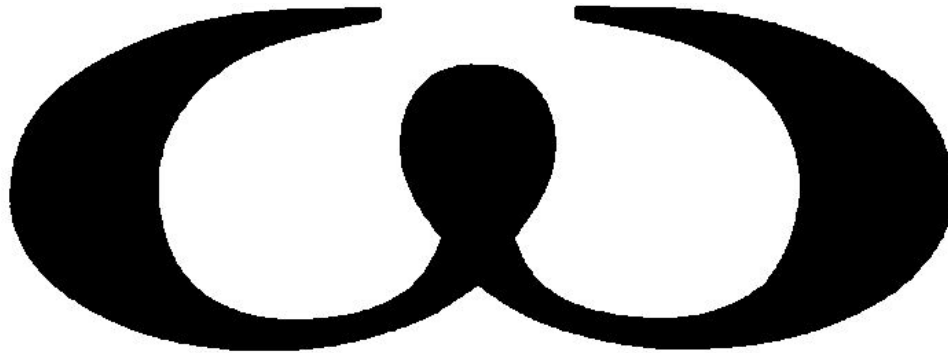

**Reg. No. 4,123,752**

**Registered Apr. 10, 2012**

**Int. Cls.: 10, 20, 25 and 28**

**TRADEMARK**

**PRINCIPAL REGISTER**

WAFF (FRANCE SOCIÉTÉ À RESPONSABILITÉ LIMITÉE)  
60 RUE DU SERGENT LEBOEUF  
F-77190 DAMMARIÉ-LES-LYS  
FRANCE

FOR: INFLATABLE CUSHIONS, MATTRESSES AND PILLOWS FOR MEDICAL PURPOSES, IN CLASS 10 (U.S. CLS. 26, 39 AND 44).

FOR: INFLATABLE FURNITURE; INFLATABLE CUSHIONS, MATTRESSES AND PILLOWS NOT FOR MEDICAL PURPOSES, IN CLASS 20 (U.S. CLS. 2, 13, 22, 25, 32 AND 50).

FOR: CLOTHING, NAMELY, SWEATSHIRTS, SWEATPANTS, SWEATSUITS, WIND SUITS, SWEAT BANDS, SWEATERS, JACKETS, COATS, SHIRTS, T-SHIRTS, BELTS, RAINCOATS, PONCHOS, BANDANAS, RUNNING AND ATHLETIC SHORTS, SCARVES, TANK TOPS, JERSEYS, TIGHTS, LEOTARDS, BIKER SHORTS, SOCKS, BOXER SHORTS, AND TIES, FOOTWEAR, AND HEADGEAR, NAMELY, HATS AND CAPS, IN CLASS 25 (U.S. CLS. 22 AND 39).

FOR: GYMNAS TIC APPARATUS AND SPORTING ARTICLES, NAMELY, INFLATABLE BALLS AND CUSHIONS FOR USE AS EXERCISE EQUIPMENT AND SPORTS TRAINING DEVICES TO IMPROVE STRENGTH, TONING, CONDITIONING, BALANCE, AND PROPRIOCEPTION; PLAY BALLS; BALLS FOR PHYSICAL EXERCISE, IN CLASS 28 (U.S. CLS. 22, 23, 38 AND 50).

THE MARK CONSISTS OF A STYLIZED "W".

PRIORITY DATE OF 10-22-2010 IS CLAIMED.

OWNER OF INTERNATIONAL REGISTRATION 1082866 DATED 4-19-2011, EXPIRES 4-19-2021.

SER. NO. 79-099,465, FILED 4-19-2011.

KRISTINA MORRIS, EXAMINING ATTORNEY



*David J. Kyffers*

Director of the United States Patent and Trademark Office



# United States of America

United States Patent and Trademark Office

## TUSCAN SOUL BIANCO DI CARRARA

**Reg. No. 4,123,753**

**Registered Apr. 10, 2012**

**Int. Cl.: 3**

**TRADEMARK**

**PRINCIPAL REGISTER**

SALVATORE FERRAGAMO S.P.A. (ITALY JOINT STOCK COMPANY)  
VIA DEI TORNABUONI, 2  
I-50123 FIRENZE, ITALY

FOR: PERFUMES, EAU DE PARFUM, EAU DE COLOGNE, TOILET WATER, AFTER SHAVE CREAMS, AFTER SHAVE LOTIONS, SHAVING LOTIONS, SHAVING CREAMS AND FOAMS, HAIR LOTIONS, SHAMPOOS, HAIR CONDITIONERS, ESSENTIAL OILS FOR PERSONAL USE, BEAUTY MASKS, COLD CREAMS, HAND CREAMS, BODY AND FACIAL CREAMS, DEODORANTS FOR PERSONAL USE, ANTIPERSPIRANTS FOR PERSONAL USE, SKIN CLEANSERS, SOAPS FOR PERSONAL USE, TOILET SOAPS, BATH SOAPS, BATH AND SHOWER FOAMS, BATH AND SHOWER GELS, BODY OILS, BODY LOTIONS, SKIN LOTIONS, IN CLASS 3 (U.S. CLS. 1, 4, 6, 50, 51 AND 52).

THE MARK CONSISTS OF STANDARD CHARACTERS WITHOUT CLAIM TO ANY PARTICULAR FONT, STYLE, SIZE, OR COLOR.

PRIORITY DATE OF 4-11-2011 IS CLAIMED.

OWNER OF INTERNATIONAL REGISTRATION 1082897 DATED 5-30-2011, EXPIRES 5-30-2021.

OWNER OF U.S. REG. NOS. 3,356,588 AND 3,543,819.

NO CLAIM IS MADE TO THE EXCLUSIVE RIGHT TO USE "CARRARA", APART FROM THE MARK AS SHOWN.

THE ENGLISH TRANSLATION OF "BIANCO DI CARRARA" IS "WHITE OF CARRARA".

SEC. 2(F) AS TO "TUSCAN".

SER. NO. 79-099,488, FILED 5-30-2011.

KRISTINA MORRIS, EXAMINING ATTORNEY



*David J. Kyffers*

Director of the United States Patent and Trademark Office

United States of America  
United States Patent and Trademark Office

**DROME**

**Reg. No. 4,123,754**

**Registered Apr. 10, 2012**

**Int. Cl.: 25**

**TRADEMARK**

**PRINCIPAL REGISTER**

SAFIN S.R.L. (ITALY LIMITED LIABILITY COMPANY)  
VIA B. AMMANNATI, 4  
I-50053 EMPOLI (FI)  
ITALY

FOR: CLOTHING, NAMELY, SHIRTS, SHORTS, PANTS, JACKETS, COATS, DRESSES, TANK TOPS, SUITS, SCARVES, UNDERWEAR, GLOVES; CLOTHING MADE OF LEATHER, NAMELY, SHIRTS, SHORTS, PANTS, JACKETS, COATS, DRESSES, TANK TOPS, SUITS, SCARVES, GLOVES; CLOTHING MADE OF IMITATION LEATHER, NAMELY, SHIRTS, SHORTS, PANTS, JACKETS, COATS, DRESSES, TANK TOPS, SUITS, SCARVES, GLOVES; HATS; SHOES; BELTS FOR CLOTHING, IN CLASS 25 (U.S. CLS. 22 AND 39).

THE WORDING DROME HAS NO MEANING IN A FOREIGN LANGUAGE.

PRIORITY DATE OF 3-11-2011 IS CLAIMED.

OWNER OF INTERNATIONAL REGISTRATION 1082910 DATED 6-1-2011, EXPIRES 6-1-2021.

SER. NO. 79-099,492, FILED 6-1-2011.

DAVID ELTON, EXAMINING ATTORNEY



*David J. Kyfos*

Director of the United States Patent and Trademark Office

# United States of America

United States Patent and Trademark Office

## TUSCAN SOUL CONVIVIO

**Reg. No. 4,123,755**

SALVATORE FERRAGAMO S.P.A. (ITALY JOINT STOCK COMPANY)  
VIA DEI TORNABUONI, 2  
I-50123 FIRENZE (FI), ITALY

**Registered Apr. 10, 2012**

**Int. Cl.: 3**

FOR: PERFUMES, EAU DE PARFUM, EAU DE COLOGNE, TOILET WATER, AFTER SHAVE CREAMS, AFTER SHAVE LOTIONS, SHAVING LOTIONS, SHAVING CREAMS AND FOAMS, HAIR LOTIONS, SHAMPOOS, HAIR CONDITIONERS, ESSENTIAL OILS FOR PERSONAL USE, BEAUTY MASKS, COLD CREAMS, HAND CREAMS, BODY AND FACIAL CREAMS, DEODORANTS FOR PERSONAL USE, ANTIPERSPIRANTS FOR PERSONAL USE, SKIN CLEANSERS, SOAPS FOR PERSONAL USE, TOILET SOAPS, BATH SOAPS, BATH AND SHOWER FOAMS, BATH AND SHOWER GELS, BODY OILS, BODY LOTIONS, SKIN LOTIONS, IN CLASS 3 (U.S. CLS. 1, 4, 6, 50, 51 AND 52).

**TRADEMARK**

**PRINCIPAL REGISTER**

THE MARK CONSISTS OF STANDARD CHARACTERS WITHOUT CLAIM TO ANY PARTICULAR FONT, STYLE, SIZE, OR COLOR.

PRIORITY DATE OF 4-11-2011 IS CLAIMED.

OWNER OF INTERNATIONAL REGISTRATION 1082969 DATED 5-30-2011, EXPIRES 5-30-2021.

OWNER OF U.S. REG. NOS. 3,356,588 AND 3,543,819.

THE ENGLISH TRANSLATION OF THE WORD "CONVIVIO" IN THE MARK IS "BANQUET".

SEC. 2(F) AS TO "TUSCAN".

SER. NO. 79-099,521, FILED 5-30-2011.

KRISTINA MORRIS, EXAMINING ATTORNEY



*David J. Kyros*

Director of the United States Patent and Trademark Office

# United States of America

United States Patent and Trademark Office

## TUSCAN SOUL VENDEMMIA

**Reg. No. 4,123,756**

**Registered Apr. 10, 2012**

**Int. Cl.: 3**

**TRADEMARK**

**PRINCIPAL REGISTER**

SALVATORE FERRAGAMO S.P.A. (ITALY JOINT STOCK COMPANY)  
VIA DEI TORNABUONI, 2  
I-50123 FIRENZE  
ITALY

FOR: PERFUMES, EAU DE PARFUM, EAU DE COLOGNE, TOILET WATER, AFTER SHAVE CREAMS, AFTER SHAVE LOTIONS, SHAVING LOTIONS, SHAVING CREAMS AND FOAMS, HAIR LOTIONS, SHAMPOOS, HAIR CONDITIONERS, ESSENTIAL OILS FOR PERSONAL USE, BEAUTY MASKS, COLD CREAMS, HAND CREAMS, BODY AND FACIAL CREAMS, DEODORANTS FOR PERSONAL USE, ANTIPERSPIRANTS FOR PERSONAL USE, SKIN CLEANSERS, SOAPS FOR PERSONAL USE, TOILET SOAPS, BATH SOAPS, BATH AND SHOWER FOAMS, BATH AND SHOWER GELS, BODY OILS, BODY LOTIONS, SKIN LOTIONS, IN CLASS 3 (U.S. CLS. 1, 4, 6, 50, 51 AND 52).

THE MARK CONSISTS OF STANDARD CHARACTERS WITHOUT CLAIM TO ANY PARTICULAR FONT, STYLE, SIZE, OR COLOR.

PRIORITY DATE OF 4-11-2011 IS CLAIMED.

OWNER OF INTERNATIONAL REGISTRATION 1082971 DATED 5-30-2011, EXPIRES 5-30-2021.

OWNER OF U.S. REG. NOS. 3,356,588 AND 3,543,819.

THE ENGLISH TRANSLATION OF THE WORD "VENDEMMIA" IN THE MARK IS "VINTAGE".

SEC. 2(F) AS TO "TUSCAN".

SER. NO. 79-099,522, FILED 5-30-2011.

KRISTINA MORRIS, EXAMINING ATTORNEY



*David J. Kyros*

Director of the United States Patent and Trademark Office

# United States of America

United States Patent and Trademark Office



**Reg. No. 4,123,757**

**Registered Apr. 10, 2012**

**Int. Cls.: 9, 12 and 25**

**TRADEMARK**

**PRINCIPAL REGISTER**

ORBEA, S. COOP. LTDA. (SPAIN SOCIEDAD COOPERATIVA LIMITADA)  
POLÍGONO INDUSTRIAL GOITONDO, 48  
E-48269 MALLABIA (BIZKAIA)  
SPAIN

FOR: HELMETS, NAMELY, PROTECTIVE HELMETS, HELMETS FOR BICYCLES; SPECTACLES; SUNGLASSES; SLEEVES FOR SPECTACLES; CHAINS FOR SPECTACLES; HEADLAMPS IN THE NATURE OF HELMET SAFETY LIGHTS; WARNING DEVICES, NAMELY, BELLS; BELLS, NAMELY, SIGNAL BELLS; PROTECTIVE ARTICLES, NAMELY, PROTECTIVE EYEWEAR; EMERGENCY WARNING LIGHTS; NEON SIGNS; SCIENTIFIC AND TECHNICAL APPARATUS, NAMELY, OPTICAL MIRRORS; AND IN GENERAL, SCIENTIFIC, NAUTICAL, SURVEYING, PHOTOGRAPHIC, CINEMATOGRAPHIC, OPTICAL, WEIGHING, MEASURING, SIGNALING, CHECKING AND SUPERVISION, LIFE-SAVING AND TEACHING APPARATUS AND INSTRUMENTS, NAMELY, CAMERAS, BICYCLE SPEEDOMETERS; APPARATUS FOR RECORDING, TRANSMISSION, REPRODUCTION OF SOUND OR IMAGES; BLANK MAGNETIC DATA CARRIERS AND RECORDING DISCS; PRERECORDED MAGNETIC DATA CARRIERS AND RECORDING DISCS FEATURING BICYCLES; DATA PROCESSING EQUIPMENT AND COMPUTERS, IN CLASS 9 (U.S. CLS. 21, 23, 26, 36 AND 38).

FOR: BICYCLES; BELLS, BRAKES, CHAINS, HANDLEBARS, FRAMES, SADDLES, SADDLE COVERS, MIRRORS, DIRECTIONAL SIGNALS, WHEELS AND MUDGUARDS, ALL FOR BICYCLES AND VEHICLES IN THE NATURE OF MOTORCYCLES, MOPEDS, SCOOTERS; APPARATUS FOR LOCOMOTION BY LAND, AIR OR SEA, NAMELY, MOTORCYCLES, BICYCLES, MOPEDS, SCOOTERS, IN CLASS 12 (U.S. CLS. 19, 21, 23, 31, 35 AND 44).

FOR: SPORTSWEAR, NAMELY, JACKETS, LEGGINGS, LEOTARDS, MAILLOTS, OVERCOATS, RAIN COATS, SHIRTS, SHORTS, T-SHIRTS, THERMAL UNDERWEAR, SINGLET, CAPS, CULOTTES, GLOVES, SOCKS, LEOTARDS, JACKETS, CAGOULES, TROUSERS, CHEMISETTES, JERSEYS, SWEAT SHIRTS, SPORTS FOOTWEAR AND, IN GENERAL, CLOTHING, NAMELY, JACKETS, LEGGINGS, LEOTARDS, MAILLOTS, OVERCOATS, RAIN COATS, SHIRTS, SHORTS, T-SHIRTS AND THERMAL UNDERWEAR; HEADWEAR, IN CLASS 25 (U.S. CLS. 22 AND 39).



*David J. Kyjars*

Director of the United States Patent and Trademark Office

OWNER OF U.S. REG. NOS. 2,576,631 AND 3,211,473.

PRIORITY DATE OF 9-22-2010 IS CLAIMED.

**Reg. No. 4,123,757** OWNER OF INTERNATIONAL REGISTRATION 1083078 DATED 3-15-2011, EXPIRES 3-15-2021.

THE MARK CONSISTS OF STYLIZED WORDING "ORBEA" UNDER A PARTIAL OVAL.

SER. NO. 79-099,564, FILED 3-15-2011.

KRISTINA MORRIS, EXAMINING ATTORNEY

# United States of America

United States Patent and Trademark Office

## TUSCAN SOUL VIOLA ESSENZIALE

**Reg. No. 4,123,758**

**Registered Apr. 10, 2012**

**Int. Cl.: 3**

**TRADEMARK**

**PRINCIPAL REGISTER**

SALVATORE FERRAGAMO S.P.A. (ITALY JOINT STOCK COMPANY)  
VIA DEI TORNABUONI, 2  
I-50123 FIRENZE (FI)  
ITALY

FOR: PERFUMES, EAU DE PARFUM, EAU DE COLOGNE, TOILET WATER, AFTER SHAVE CREAMS, AFTER SHAVE LOTIONS, SHAVING LOTIONS, SHAVING CREAMS AND FOAMS, HAIR LOTIONS, SHAMPOOS, HAIR CONDITIONERS, ESSENTIAL OILS FOR PERSONAL USE, BEAUTY MASKS, COLD CREAMS, HAND CREAMS, BODY AND FACIAL CREAMS, DEODORANTS FOR PERSONAL USE, ANTIPERSPIRANTS FOR PERSONAL USE, SKIN CLEANSERS, SOAPS FOR PERSONAL USE, TOILET SOAPS, BATH SOAPS, BATH AND SHOWER FOAMS, BATH AND SHOWER GELS, BODY OILS, BODY LOTIONS, SKIN LOTIONS, IN CLASS 3 (U.S. CLS. 1, 4, 6, 50, 51 AND 52).

THE MARK CONSISTS OF STANDARD CHARACTERS WITHOUT CLAIM TO ANY PARTICULAR FONT, STYLE, SIZE, OR COLOR.

PRIORITY DATE OF 5-10-2011 IS CLAIMED.

OWNER OF INTERNATIONAL REGISTRATION 1083208 DATED 5-30-2011, EXPIRES 5-30-2021.

OWNER OF U.S. REG. NOS. 3,356,588 AND 3,543,819.

THE ENGLISH TRANSLATION OF "VIOLA ESSENZIALE" IS "ESSENTIAL PURPLE".

SEC. 2(F) AS TO "TUSCAN".

SER. NO. 79-099,610, FILED 5-30-2011.

KRISTINA MORRIS, EXAMINING ATTORNEY



*David J. Kyjars*

Director of the United States Patent and Trademark Office

**United States of America**  
United States Patent and Trademark Office

# OCTALITE

**Reg. No. 4,123,759**

**Registered Apr. 10, 2012**

**Int. Cl.: 5**

**TRADEMARK**

**PRINCIPAL REGISTER**

CLAYTONE (FRANCE SOCIÉTÉ PAR ACTIONS SIMPLIFIÉE)  
134 AVENUE DU 14 JUILLET  
F-76300 SOTTEVILLE-LES-ROUEN  
FRANCE

FOR: NATURAL MINERAL SUPPLEMENTS FOR DIETETIC AND MEDICAL USE, IN CLASS  
5 (U.S. CLS. 6, 18, 44, 46, 51 AND 52).

OWNER OF INTERNATIONAL REGISTRATION 0649784 DATED 9-8-1995, EXPIRES 9-8-  
2015.

SER. NO. 79-099,672, FILED 5-4-2011.

DAVID HOFFMAN, EXAMINING ATTORNEY



*David J. Kyffers*

Director of the United States Patent and Trademark Office



**United States of America**  
United States Patent and Trademark Office

# YOURTONE

**Reg. No. 4,123,760**

**Registered Apr. 10, 2012**

**Int. Cl.: 10**

**TRADEMARK**

**PRINCIPAL REGISTER**

DENSEI, INC. (JAPAN CORPORATION)  
8-13 KOEI-CHO  
EBETSU-SHI; HOKKAIDO  
JAPAN

FOR: MEDICAL APPARATUS, NAMELY, ELECTRONIC SPEECH SYNTHESIZER FOR GENERATING SPEECH, IN CLASS 10 (U.S. CLS. 26, 39 AND 44).

OWNER OF INTERNATIONAL REGISTRATION 0737672 DATED 7-12-2000, EXPIRES 7-12-2020.

SER. NO. 79-099,679, FILED 4-21-2011.

SUSAN STIGLITZ, EXAMINING ATTORNEY



*David J. Kybas*

Director of the United States Patent and Trademark Office

United States of America  
United States Patent and Trademark Office

Lasea

**Reg. No. 4,123,761**

DR. WILLMAR SCHWABE GMBH & CO. KG (FED REP GERMANY GMBH & CO. KG)  
WILLMAR-SCHWABE-STRASSE 4

**Registered Apr. 10, 2012**

76227 KARLSRUHE, FED REP GERMANY

**Int. Cl.: 5**

FOR: PHARMACEUTICAL PREPARATIONS FOR THE TREATMENT OF STATES OF ANXIETY, RESTLESSNESS AND DEPRESSION; PREPARATIONS FOR HEALTH CARE, NAMELY, DIETARY SUBSTANCES ADAPTED FOR MEDICAL USE, NAMELY, BEVERAGES AND DIETARY SUPPLEMENTS ADAPTED FOR MEDICAL USE IN THE FORM OF TABLETS, CAPSULES, LIQUIDS, BARS AND SACHETS, IN CLASS 5 (U.S. CLS. 6, 18, 44, 46, 51 AND 52).

**TRADEMARK**

**PRINCIPAL REGISTER**

THE MARK CONSISTS OF STANDARD CHARACTERS WITHOUT CLAIM TO ANY PARTICULAR FONT, STYLE, SIZE, OR COLOR.

OWNER OF INTERNATIONAL REGISTRATION 0937309 DATED 8-13-2007, EXPIRES 8-13-2017.

SER. NO. 79-099,696, FILED 5-27-2011.

MARLENE BELL, EXAMINING ATTORNEY



*David J. Kyffers*

Director of the United States Patent and Trademark Office

# United States of America

United States Patent and Trademark Office

# BENARX

**Reg. No. 4,123,762**

**Registered Apr. 10, 2012**

**Int. Cls.: 1, 2 and 17**

**TRADEMARK**

**PRINCIPAL REGISTER**

BEERENBERG CORP. AS (NORWAY LIMITED LIABILITY COMPANY)  
POSTBOKS 273 SLÁTTHAUG  
N-5851 BERGEN  
NORWAY

FOR: FIREPROOFING PREPARATIONS; PRESERVATIVES FOR CONCRETE, EXCEPT PAINTS AND OILS, IN CLASS 1 (U.S. CLS. 1, 5, 6, 10, 26 AND 46).

FOR: SURFACE TREATMENT AGENTS AND PREPARATIONS, NAMELY, PAINTS, VARNISHES, LACQUERS, ANTI-CORROSION PREPARATIONS, ANTI-RUST PREPARATIONS AND WOOD PRESERVING PREPARATIONS, COLORANTS AND WOOD STAINS; UNPROCESSED RESINS, IN CLASS 2 (U.S. CLS. 6, 11 AND 16).

FOR: SEALING, PACKING AND INSULATING MATERIALS FOR THERMAL, ACOUSTIC, ELECTRIC AND FIRE INSULATION, NAMELY, INSULATION BOXES, INSULATION JACKETS, INSULATION PANELS, INSULATION MATS AND INSULATION CLADDING, IN CLASS 17 (U.S. CLS. 1, 5, 12, 13, 35 AND 50).

THE MARK CONSISTS OF STANDARD CHARACTERS WITHOUT CLAIM TO ANY PARTICULAR FONT, STYLE, SIZE, OR COLOR.

OWNER OF INTERNATIONAL REGISTRATION 0944237 DATED 10-2-2007, EXPIRES 10-2-2017.

SER. NO. 79-099,698, FILED 3-31-2011.

LAURA KOVALSKY, EXAMINING ATTORNEY



*David J. Kyjars*

Director of the United States Patent and Trademark Office

**United States of America**  
United States Patent and Trademark Office

**IODICA**

**Reg. No. 4,123,763**

**Registered Apr. 10, 2012**

**Int. Cl.: 32**

**TRADEMARK**

**PRINCIPAL REGISTER**

MARIO TURDÍK (SLOVAKIA INDIVIDUAL)  
A TÍNSKA 23  
SK-841 04 BRATISLAVA  
SLOVAKIA

FOR: BEVERAGES, NAMELY, MINERAL WATER; NON-ALCOHOLIC BEVERAGES IN THE NATURE OF MINERAL WATER FEATURING NATURAL IODINE, IN CLASS 32 (U.S. CLS. 45, 46 AND 48).

THE MARK CONSISTS OF STANDARD CHARACTERS WITHOUT CLAIM TO ANY PARTICULAR FONT, STYLE, SIZE, OR COLOR.

OWNER OF INTERNATIONAL REGISTRATION 0982982 DATED 7-14-2008, EXPIRES 7-14-2018.

SER. NO. 79-099,700, FILED 4-1-2011.

JORDAN BAKER, EXAMINING ATTORNEY



*David J. Kyffers*

Director of the United States Patent and Trademark Office

# United States of America

United States Patent and Trademark Office

V M

**Reg. No. 4,123,764**

**Registered Apr. 10, 2012**

**Int. Cl.: 9**

MASCHINENFABRIK REINHAUSEN GMBH (FED REP GERMANY LIMITED LIABILITY COMPANY)  
FALKENSTEINSTRASSE 8  
93059 REGENSBURG  
FED REP GERMANY

**TRADEMARK**

**PRINCIPAL REGISTER**

FOR: ELECTRIC TAP CHANGERS FOR TRANSFORMERS FOR THE REGULATION OF THE OUTPUT VOLTAGE TO REQUIRED LEVELS FOR USE IN THE TECHNICAL FIELD OF HIGH-VOLTAGE ENGINEERING, IN CLASS 9 (U.S. CLS. 21, 23, 26, 36 AND 38).

THE MARK CONSISTS OF STANDARD CHARACTERS WITHOUT CLAIM TO ANY PARTICULAR FONT, STYLE, SIZE, OR COLOR.

PRIORITY DATE OF 2-3-2011 IS CLAIMED.

OWNER OF INTERNATIONAL REGISTRATION 1083464 DATED 5-14-2011, EXPIRES 5-14-2021.

SER. NO. 79-099,756, FILED 5-14-2011.

CARYN GLASSER, EXAMINING ATTORNEY



*David J. Kyffers*

Director of the United States Patent and Trademark Office

United States of America  
United States Patent and Trademark Office

**SIVARC**

**Reg. No. 4,123,765**

**Registered Apr. 10, 2012**

**Int. Cl.: 9**

**TRADEMARK**

**PRINCIPAL REGISTER**

SIEMENS AKTIENGESELLSCHAFT (FED REP GERMANY JOINT STOCK COMPANY)  
WITTELSBACHERPLATZ 2  
80333 MÜNCHEN  
FED REP GERMANY

FOR: HUMAN MACHINE INTERFACE COMPUTER SOFTWARE FOR USE IN INDUSTRIAL OPERATIONS AND PROCESSES; COMPUTER SOFTWARE FOR ACQUIRING AND PRESENTING DATA RELATING TO INDUSTRIAL OPERATIONS AND PROCESSES AND FOR USE IN MONITORING, ANALYZING, CONTROLLING, AND MANAGING INDUSTRIAL OPERATIONS AND PROCESSES, IN CLASS 9 (U.S. CLS. 21, 23, 26, 36 AND 38).

THE MARK CONSISTS OF STANDARD CHARACTERS WITHOUT CLAIM TO ANY PARTICULAR FONT, STYLE, SIZE, OR COLOR.

OWNER OF INTERNATIONAL REGISTRATION 1083488 DATED 6-15-2011, EXPIRES 6-15-2021.

SER. NO. 79-099,766, FILED 6-15-2011.

JAMES A. RAUEN, EXAMINING ATTORNEY



*David J. Kyffers*

Director of the United States Patent and Trademark Office

# United States of America

United States Patent and Trademark Office

# OPTOD

**Reg. No. 4,123,766**

**Registered Apr. 10, 2012**

**Int. Cl.: 9**

**TRADEMARK**

**PRINCIPAL REGISTER**

NEOTEK PONSEL (FRANCE SOCIÉTÉ ANONYME À CONSEIL D'ADMINISTRATION)  
35 RUE MICHEL MARION  
F-56850 CAUDAN  
FRANCE

FOR: SCIENTIFIC SENSORS, APPARATUS AND INSTRUMENTS FOR MEASURING THE LEVEL OF OXYGEN IN WATER, IN CLASS 9 (U.S. CLS. 21, 23, 26, 36 AND 38).

THE MARK CONSISTS OF STANDARD CHARACTERS WITHOUT CLAIM TO ANY PARTICULAR FONT, STYLE, SIZE, OR COLOR.

PRIORITY DATE OF 4-12-2011 IS CLAIMED.

OWNER OF INTERNATIONAL REGISTRATION 1083601 DATED 4-13-2011, EXPIRES 4-13-2021.

THE WORDING "OPTOD" HAS NO MEANING IN A FOREIGN LANGUAGE.

SER. NO. 79-099,801, FILED 4-13-2011.

MATTHEW MCDOWELL, EXAMINING ATTORNEY



*David J. Kyffers*

Director of the United States Patent and Trademark Office

# United States of America

United States Patent and Trademark Office

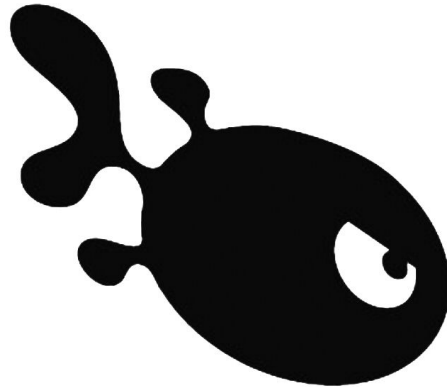

**Reg. No. 4,123,767**

**Registered Apr. 10, 2012**

**Int. Cl.: 9**

**TRADEMARK**

**PRINCIPAL REGISTER**

HANS DEPRETTERE (BELGIUM INDIVIDUAL)  
WAASLANDLAAN 8 C  
LOKEREN, BELGIUM 9160

FOR: CASES ESPECIALLY ADOPTED FOR HANDHELD OR MOBILE PHONES, MP3 PLAYERS, AND COMPUTERS; CASES ESPECIALLY MADE FOR PHOTOGRAPHIC APPARATUS AND INSTRUMENTS, NAMELY, CAMERA CASES; CASES SPECIALLY ADAPTED FOR HOLDING OR CARRYING PORTABLE TELEPHONES, LAPTOPS, AND EQUIPMENT, AND FOR INSTRUMENTS FOR RECORDING, TRANSMISSION OR REPRODUCTION OF SOUNDS AND IMAGES, IN CLASS 9 (U.S. CLS. 21, 23, 26, 36 AND 38).

THE MARK CONSISTS OF A STYLIZED REPRESENTATION OF A FISH.

PRIORITY DATE OF 5-17-2011 IS CLAIMED.

OWNER OF INTERNATIONAL REGISTRATION 1083803 DATED 5-18-2011, EXPIRES 5-18-2021.

SER. NO. 79-099,871, FILED 5-18-2011.

JOHN E. MICHOS, EXAMINING ATTORNEY



*David J. Kyffers*

Director of the United States Patent and Trademark Office



# United States of America

United States Patent and Trademark Office

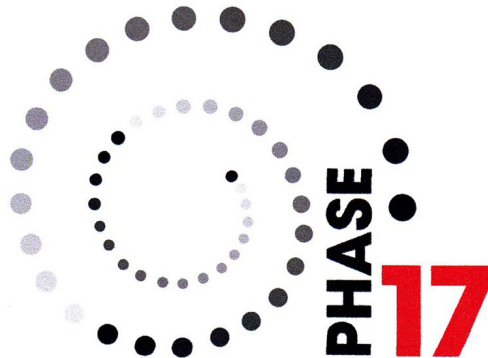

**Reg. No. 4,123,768**

**Registered Apr. 10, 2012**

**Int. Cls.: 35, 41 and 42**

**SERVICE MARK**

**PRINCIPAL REGISTER**

DR. MARTIN BREUCKER (FED REP GERMANY GMBH/LIMITED LIABILITY COMPANY)  
BIRKENSTRASSE 20  
45731 WALTROP  
FED REP GERMANY AND

PHASE 17 GMBH (FED REP GERMANY GMBH/LIMITED LIABILITY COMPANY)  
BIRKENSTRASSE 20  
45731 WALTROP  
FED REP GERMANY

FOR: CONSULTING IN BUSINESS ADMINISTRATION, IN CLASS 35 (U.S. CLS. 100, 101 AND 102).

FOR: EDUCATIONAL SERVICES, NAMELY, CONDUCTING WORKSHOPS FOR BUSINESSES AND INDIVIDUALS IN THE FIELD OF BUSINESS PROCESSES AND DISTRIBUTION OF TRAINING MATERIALS IN CONNECTION THEREWITH, IN CLASS 41 (U.S. CLS. 100, 101 AND 107).

FOR: TECHNICAL CONSULTANCY IN THE FIELD OF BUSINESS PROCESSES FOR THE IMPROVEMENT OF BUSINESS PRODUCTION AND BUSINESS WORK PROJECTS, IN CLASS 42 (U.S. CLS. 100 AND 101).

THE MARK CONSISTS OF A SPIRAL CONSISTING OF THREE SEQUENCES OF "17" DOTS EACH, STARTING AT LIGHT GREY, INCREASINGLY DARKENING TO THE "17TH" DOT BEING ALMOST BLACK, LEADING TO THE TOP OF THE NUMBER "1" IN "17", THE NUMBER "17" BEING RED, NEXT TO THE WORD "PHASE" (UPWARD, BLACK).

PRIORITY DATE OF 11-24-2010 IS CLAIMED.

OWNER OF INTERNATIONAL REGISTRATION 1083900 DATED 3-1-2011, EXPIRES 3-1-2021.

THE COLOR(S) BLACK, GREY AND RED IS/ARE CLAIMED AS A FEATURE OF THE MARK.

BLACK: "PHASE"; GREY: DOTS THAT REPRESENT A SPIRAL; RED: NUMBER "17".



*David J. Kybas*

Director of the United States Patent and Trademark Office

**Reg. No. 4,123,768** SER. NO. 79-099,902, FILED 3-1-2011.

STEPHANIE ALI, EXAMINING ATTORNEY

# United States of America

United States Patent and Trademark Office

**Leev**   
mobility

**Reg. No. 4,123,769**

LEEV MOBILITY B.V. (NETHERLANDS LIMITED LIABILITY COMPANY)  
KNSM-LAAN 131

**Registered Apr. 10, 2012**

AMSTERDAM, NETHERLANDS NL1019 LB

**Int. Cls.: 12, 35 and 42**

FOR: VEHICLES, NAMELY, LIGHT ELECTRIC LAND VEHICLES IN THE NATURE OF GOLF CARTS, FOLDING SCOOTERS AND MOTOR SCOOTERS, IN CLASS 12 (U.S. CLS. 19, 21, 23, 31, 35 AND 44).

**TRADEMARK**

FOR: ADVERTISING AND PROMOTIONAL SERVICES FOR THE GOODS OF OTHERS, NAMELY, FOR LIGHT ELECTRIC VEHICLES, IN CLASS 35 (U.S. CLS. 100, 101 AND 102).

**SERVICE MARK**

**PRINCIPAL REGISTER**

FOR: DESIGN SERVICES, NAMELY, INDUSTRIAL AND NEW PRODUCT DESIGN, IN CLASS 42 (U.S. CLS. 100 AND 101).

NO CLAIM IS MADE TO THE EXCLUSIVE RIGHT TO USE "MOBILITY", APART FROM THE MARK AS SHOWN.

OWNER OF INTERNATIONAL REGISTRATION 1083902 DATED 3-11-2011, EXPIRES 3-11-2021.

THE MARK CONSISTS OF THE WORDING "LEEV" IN LARGE LETTERS WITH THE WORD "MOBILITY" SMALLER BENEATH THE LETTER "V" AND THE DESIGN OF A SINGLE LEAF THE RIGHT OF "LEEV".

THE WORD(S) "LEEV" HAS NO MEANING IN A FOREIGN LANGUAGE.

SER. NO. 79-099,903, FILED 3-11-2011.

SUE LAWRENCE, EXAMINING ATTORNEY



*David J. Kybas*

Director of the United States Patent and Trademark Office

# United States of America

United States Patent and Trademark Office



**Reg. No. 4,123,770**

**Registered Apr. 10, 2012**

**Int. Cls.: 25 and 35**

**TRADEMARK**

**SERVICE MARK**

**PRINCIPAL REGISTER**

BOYNER HOLDING ANONIM SIRKETI (TURKEY JOINT STOCK COMPANY)  
ESKI BÜYÜKDERE CAD NO:22 KAT:15-16  
MASLAK ISTANBUL  
TURKEY

FOR: INNER AND OUTER CLOTHING, NAMELY, OUTER JACKETS, VESTS, GLOVES, SHAWLS, TRENCHCOAT, BATHING SUITS, BODICES, CAMISOLES, COATS, JEANS, PAJAMAS, PANTS, PARKAS, PULLOVERS, SCARVES, DRESSES, SHIRTS, SKIRTS, SLIPS, SHORTS, SWEATERS, KNEE WARMERS, HOODS, JERSEYS, CORSETS, BRAS, UNDERWEAR, TIES, AND SOCKS MADE FROM ALL KINDS OF MATERIALS; FOOTWEAR; HEADGEAR, NAMELY, HATS AND CAPS, IN CLASS 25 (U.S. CLS. 22 AND 39).

FOR: ADVERTISING, MARKETING AND PUBLIC RELATIONS SERVICES; BUSINESS ADMINISTRATION; BUSINESS MANAGEMENT; BUSINESS CONSULTATION; ORGANIZATION AND ARRANGEMENT OF PUBLIC AUCTIONS; THE BRINGING TOGETHER, FOR THE BENEFIT OF OTHERS, OF A WIDE VARIETY OF CONSUMER GOODS, ENABLING CUSTOMERS TO CONVENIENTLY VIEW AND PURCHASE THOSE GOODS THROUGH RETAIL AND WHOLESALE STORES, THE INTERNET AND CATALOGUES, IN CLASS 35 (U.S. CLS. 100, 101 AND 102).

NO CLAIM IS MADE TO THE EXCLUSIVE RIGHT TO USE "SAFARIS", APART FROM THE MARK AS SHOWN.

PRIORITY DATE OF 4-7-2011 IS CLAIMED.

OWNER OF INTERNATIONAL REGISTRATION 1083927 DATED 5-13-2011, EXPIRES 5-13-2021.

THE MARK CONSISTS OF THE WORDING "PUMBU SAFARIS" AND A CURVED BAND WHICH FORMS A SHAPE APPEARING LIKE THE LETTER "W".

THE WORDING "PUMBU" HAS NO MEANING IN A FOREIGN LANGUAGE.

SER. NO. 79-099,915, FILED 5-13-2011.

EVELYN BRADLEY, EXAMINING ATTORNEY



*David J. Kyros*

Director of the United States Patent and Trademark Office

# United States of America

United States Patent and Trademark Office

# POZI-GRIP

**Reg. No. 4,123,771**

TEXO AB (SWEDEN JOINT STOCK COMPANY)  
BOX 602

**Registered Apr. 10, 2012**

ÄLMHULT, SWEDEN SE343 24

**Int. Cl.: 7**

FOR: WEAVING MACHINES; POWER WEAVING LOOMS, LOOMS AS MACHINES; HEALD LOOMS AND JACQUARD MACHINES; YARN WARPING MACHINES; MACHINES FOR PREPARING FOR WEAVING, NAMELY, MACHINES FOR RESETTING WARP THREADS, MACHINES FOR ATTACHING WARP THREADS, MACHINES FOR WELDING WARP THREADS, MACHINES FOR PREPARING THREADS; ELECTRIC MOTORS FOR CONTROLLING HANDLING MACHINES, INDUSTRIAL ROBOTS, TEXTILE MACHINES, WEAVING LOOMS, LOOMS AS MACHINES, HEALD LOOMS, JACQUARD MACHINES AND WARPING MACHINES, IN CLASS 7 (U.S. CLS. 13, 19, 21, 23, 31, 34 AND 35).

**TRADEMARK**

**PRINCIPAL REGISTER**

PRIORITY DATE OF 12-14-2010 IS CLAIMED.

OWNER OF INTERNATIONAL REGISTRATION 1083944 DATED 6-14-2011, EXPIRES 6-14-2021.

SER. NO. 79-099,921, FILED 6-14-2011.

REBECCA POVARCHUK, EXAMINING ATTORNEY



*David J. Kyfos*

Director of the United States Patent and Trademark Office

United States of America  
United States Patent and Trademark Office

# Dynophen

**Reg. No. 4,123,772**

**Registered Apr. 10, 2012**

**Int. Cls.: 1, 2 and 17**

CHEMISCHE WERKE KLUTHE GMBH (FED REP GERMANY GESELLSCHAFT MIT  
BESCHRÄNKTER HAFTUNG)  
GOTTLIEB-DAIMLER-STRASSE 12  
69115 HEIDELBERG  
FED REP GERMANY

**TRADEMARK**

**PRINCIPAL REGISTER**

FOR: CHEMICALS USED IN INDUSTRY, IN PARTICULAR BASE MATERIALS, RAW MATERIALS, AUXILIARY MATERIALS AND ACTIVE SUBSTANCES FOR THE MANUFACTURE OF PAINTS, VARNISHES, LACQUERS AND COATINGS, IN PARTICULAR FOR THE ADJUSTMENT OF ELECTROINSULATING AND ELECTROCONDUCTING PROPERTIES, IN CLASS 1 (U.S. CLS. 1, 5, 6, 10, 26 AND 46).

FOR: PAINTS, VARNISHES, LACQUERS, GLAZES, BAKING ENAMELS, UNDERCOATINGS, PRIMERS AND COATINGS, BASED ON PHENOLIC RESIN, FOR THE ADJUSTMENT OF ELECTROINSULATING AND ELECTROCONDUCTING PROPERTIES, IN CLASS 2 (U.S. CLS. 6, 11 AND 16).

FOR: ELECTRIC INSULATING MATERIALS, NAMELY, ELECTRIC INSULATORS, INSULATING LACQUER, INSULATING VARNISH AND INSULATING PAINTS, IN CLASS 17 (U.S. CLS. 1, 5, 12, 13, 35 AND 50).

THE MARK CONSISTS OF STANDARD CHARACTERS WITHOUT CLAIM TO ANY PARTICULAR FONT, STYLE, SIZE, OR COLOR.

PRIORITY DATE OF 1-21-2011 IS CLAIMED.

OWNER OF INTERNATIONAL REGISTRATION 1084060 DATED 6-17-2011, EXPIRES 6-17-2021.

SER. NO. 79-099,969, FILED 6-17-2011.

ADA HAN, EXAMINING ATTORNEY



*David J. Kypos*

Director of the United States Patent and Trademark Office

# United States of America

United States Patent and Trademark Office

## DANNENMANN-PURE

**Reg. No. 4,123,773**

**Registered Apr. 10, 2012**

**Int. Cls.: 23 and 25**

**TRADEMARK**

**PRINCIPAL REGISTER**

DANNENMANN, PETRA (FED REP GERMANY INDIVIDUAL)  
ENDERSBACHERSTR. 71  
71384 WEINSTADT  
FED REP GERMANY

FOR: YARNS AND THREADS, FOR TEXTILE USE, IN CLASS 23 (U.S. CL. 43).

FOR: CLOTHING, NAMELY, SUITS, SHIRTS, PANTS, SHORTS, COATS, JACKETS, SWEATERS, SKIRTS, DRESSES, BLOUSES, STOCKINGS; FOOTWEAR, NAMELY, SHOES AND BOOTS; HEADGEAR, NAMELY, HATS AND CAPS, IN CLASS 25 (U.S. CLS. 22 AND 39).

THE MARK CONSISTS OF STANDARD CHARACTERS WITHOUT CLAIM TO ANY PARTICULAR FONT, STYLE, SIZE, OR COLOR.

OWNER OF INTERNATIONAL REGISTRATION 1084077 DATED 4-7-2011, EXPIRES 4-7-2021.

SER. NO. 79-099,980, FILED 4-7-2011.

SHANNON TWOHIG, EXAMINING ATTORNEY



*David J. Kyfos*

Director of the United States Patent and Trademark Office

# United States of America

United States Patent and Trademark Office

# abberior

**Reg. No. 4,123,774**

**Registered Apr. 10, 2012**

**Int. Cls.: 2, 9 and 42**

**TRADEMARK**

**SERVICE MARK**

**PRINCIPAL REGISTER**

GERALD DONNERT (FED REP GERMANY INDIVIDUAL)  
SCHOPENHAUERSTR. 97  
80809 MÜNCHEN  
FED REP GERMANY

FOR: COLORANTS FOR DYEING BIOLOGICAL PREPARATIONS, IN CLASS 2 (U.S. CLS. 6, 11 AND 16).

FOR: SCIENTIFIC INSTRUMENTS, NAMELY, TOOLS FOR DYEING PREPARATIONS FOR MICROSCOPES, IN CLASS 9 (U.S. CLS. 21, 23, 26, 36 AND 38).

FOR: SCIENTIFIC RESEARCH AND CONSULTANCY IN THE FIELD OF DYEING BIOLOGICAL PREPARATIONS, IN CLASS 42 (U.S. CLS. 100 AND 101).

THE MARK CONSISTS OF STANDARD CHARACTERS WITHOUT CLAIM TO ANY PARTICULAR FONT, STYLE, SIZE, OR COLOR.

PRIORITY DATE OF 12-13-2010 IS CLAIMED.

OWNER OF INTERNATIONAL REGISTRATION 1084190 DATED 5-4-2011, EXPIRES 5-4-2021.

THE WORDING "ABBERIOR" HAS NO MEANING IN A FOREIGN LANGUAGE.

SER. NO. 79-100,017, FILED 5-4-2011.

DAVID HOFFMAN, EXAMINING ATTORNEY



*David J. Kyfos*

Director of the United States Patent and Trademark Office



# United States of America

United States Patent and Trademark Office

## ISOVER VacuPad 007

**Reg. No. 4,123,775**

**Registered Apr. 10, 2012**

**Int. Cls.: 17 and 19**

**TRADEMARK**

**PRINCIPAL REGISTER**

SAINT-GOBAIN ISOVER G+H AG (FED REP GERMANY CORPORATION)  
BÜRGERMEISTER-GRÜNZWEIG-STRASSE 1  
67059 LUDWIGSHAFEN, FED REP GERMANY

FOR: INSULATING MATERIALS, NAMELY, INSULATING BOARDS, INSULATION PANELS, VACUUM-INSULATING PANEL; AND INSULATING ELEMENTS FOR FACADES, WALLS, ROOFS, NAMELY, BUILDING INSTALLATION; AND INSULATION COMPONENTS, NAMELY, STRUCTURAL PANELS FOR PLACEMENT ON EDIFICES, IN CLASS 17 (U.S. CLS. 1, 5, 12, 13, 35 AND 50).

FOR: CONSTRUCTION MATERIALS PRIMARILY OF NON-METALLIC MATERIALS, SPECIFICALLY IN THE FORM OF NON-METAL FIRE-RESISTANT BOARDS AND PANELS FOR CONSTRUCTION, IN CLASS 19 (U.S. CLS. 1, 12, 33 AND 50).

THE MARK CONSISTS OF STANDARD CHARACTERS WITHOUT CLAIM TO ANY PARTICULAR FONT, STYLE, SIZE, OR COLOR.

OWNER OF INTERNATIONAL REGISTRATION 1084218 DATED 5-19-2011, EXPIRES 5-19-2021.

SER. NO. 79-100,035, FILED 5-19-2011.

KIMBERLY PERRY, EXAMINING ATTORNEY



*David J. Kyffers*

Director of the United States Patent and Trademark Office

# United States of America

United States Patent and Trademark Office

## CameronTec Catalys

**Reg. No. 4,123,776**

**Registered Apr. 10, 2012**

**Int. Cls.: 9 and 42**

**TRADEMARK**

**SERVICE MARK**

**PRINCIPAL REGISTER**

CAMERONTEC AB (SWEDEN CORPORATION)  
BOX 7742  
SE-103 95 STOCKHOLM  
SWEDEN

FOR: COMPUTER SOFTWARE FOR E-COMMERCE, FOR THE EXCHANGE OF FINANCIAL INFORMATION, FOR FINANCIAL TRANSACTIONS, AND FOR ELECTRONICALLY TRADING SECURITIES; DOWNLOADABLE COMPUTER SEARCH ENGINE SOFTWARE FOR E-COMMERCE; DOWNLOADABLE COMPUTER SEARCH ENGINE SOFTWARE FOR THE EXCHANGE OF FINANCIAL INFORMATION, IN CLASS 9 (U.S. CLS. 21, 23, 26, 36 AND 38).

FOR: DESIGN AND DEVELOPMENT OF COMPUTER SOFTWARE; DESIGN AND DEVELOPMENT OF SEARCH ENGINES FOR E-COMMERCE AND SEARCH ENGINES FOR THE EXCHANGE OF FINANCIAL INFORMATION, IN CLASS 42 (U.S. CLS. 100 AND 101).

PRIORITY DATE OF 7-27-2010 IS CLAIMED.

OWNER OF INTERNATIONAL REGISTRATION 1084387 DATED 1-25-2011, EXPIRES 1-25-2021.

SER. NO. 79-100,100, FILED 1-25-2011.

ELIZABETH KAJUBI, EXAMINING ATTORNEY



*David J. Kyffers*

Director of the United States Patent and Trademark Office

# United States of America

United States Patent and Trademark Office



**Reg. No. 4,123,777**

**Registered Apr. 10, 2012**

**Int. Cls.: 18 and 25**

**TRADEMARK**

**PRINCIPAL REGISTER**

UPHILL CO., LTD. (JAPAN CORPORATION)  
1-9-6, EBISU-MINAMI  
SHIBUYA-KU; TOKYO 150-0022  
JAPAN

FOR: BAGS, NAMELY, HANDBAGS, BRIEFCASES, ATTACHÉ CASES, LEATHER SHOPPING BAGS, TEXTILE SHOPPING BAGS, SHOULDER BAGS, TRAVEL BAGS, GYM BAGS, ALL-PURPOSE SPORT BAGS, BEACH BAGS, SCHOOL BAGS, SHOPPING BAGS WITH WHEELS ATTACHED, TRAVEL BAGS WITH WHEELS ATTACHED, OVERNIGHT BAGS, BACKPACKS, SUITCASES AND BRIEFCASES; WALLET NOT OF PRECIOUS METALS, PURSES NOT OF PRECIOUS METALS, DRAWSTRING POUCHES, KEY CASES NOT OF PRECIOUS METALS; FURS SOLD IN BULK, IN CLASS 18 (U.S. CLS. 1, 2, 3, 22 AND 41).

FOR: OVERCOATS, TOPCOATS, RAINCOATS, SUITS, DRESSES, JACKETS, VESTS AND WAISTCOATS, JUMPERS, TROUSERS, SKIRTS, JEANS PANTS, FUR COATS, FUR VESTS, LEATHER COATS, LEATHER JACKETS, LEATHER PANTS, LEATHER SUITS, LEATHER JUMPSUITS, SCHOOL UNIFORMS, EVENING DRESSES AND DINNER JACKETS, NAMELY, TUXEDO JACKETS; SWEATERS, PULLOVERS, CARDIGANS, SHIRTS FOR SUITS, BLOUSES, SPORT SHIRTS, POLO SHIRTS AND T-SHIRTS; UNDERWEAR, NAMELY, UNDERSHIRTS, SHORTS, BRIEFS, CORSETS, BRASSIERES, GIRDLES, PETTICOATS, AND CAMISOLES; NIGHTWEAR, NAMELY, PAJAMAS, NIGHT GOWNS, NEGLIGÉES AND BATH ROBES; BATHING WEAR, NAMELY, SWIMMING PANTS, SWIMMING SUITS AND SWIMMING CAPS; TIES, BOW TIES, STOCKINGS NOT FOR SPORTS, SOCKS, SHAWLS, BANDANAS, NECKERCHIEFS, SCARVES, FUR STOLE, EAR MUFFS AND GLOVES; HEADGEAR, NAMELY, HATS AND CAPS, NIGHT CAPS; GARTERS, SOCK SUSPENDERS, SUSPENDERS, WAISTBANDS AND BELTS FOR CLOTHING; SHOES; BOOTS; SNEAKERS, IN CLASS 25 (U.S. CLS. 22 AND 39).



THE MARK CONSISTS OF A HEART WITH A CROSS AT THE TOP.

OWNER OF INTERNATIONAL REGISTRATION 1084850 DATED 5-23-2011, EXPIRES 5-23-2021.

SER. NO. 79-100,279, FILED 5-23-2011.

SUE LAWRENCE, EXAMINING ATTORNEY

*David J. Kyros*

Director of the United States Patent and Trademark Office

# United States of America

United States Patent and Trademark Office

## SOLARIS HERITAGE

**Reg. No. 4,123,778**

**Registered Apr. 10, 2012**

**Int. Cl.: 9**

**TRADEMARK**

**PRINCIPAL REGISTER**

SOLARIS (FRANCE SOCIÉTÉ PAR ACTIONS SIMPLIFIÉE)  
BÂTIMENT EOLE  
1 RUE JEAN PIERRE TIMBAUD; F-78180 MONTIGNY LE BRETONNEUX  
FRANCE

FOR: SPECTACLES, SPECTACLE FRAMES, PRESCRIPTION GLASSES AND SUNGLASSES, GOGGLES FOR SPORTS EXCLUDING FENCING MASKS, SPECTACLE LENSES AND OPTICAL LENSES, LENSES FOR SUNGLASSES, CORRECTIVE LENSES, CONTACT LENSES, LENSES FOR EYEGLASSES, SPECTACLE CASES, CONTAINERS FOR CONTACT LENSES, CORDS, CHAINS AND TIES FOR HOLDING SPECTACLES, BINOCULARS, MAGNIFYING GLASSES, IN CLASS 9 (U.S. CLS. 21, 23, 26, 36 AND 38).

THE MARK CONSISTS OF STANDARD CHARACTERS WITHOUT CLAIM TO ANY PARTICULAR FONT, STYLE, SIZE, OR COLOR.

PRIORITY DATE OF 12-24-2010 IS CLAIMED.

OWNER OF INTERNATIONAL REGISTRATION 1081163 DATED 5-16-2011, EXPIRES 5-16-2021.

SER. NO. 79-100,329, FILED 5-16-2011.

LIEF MARTIN, EXAMINING ATTORNEY



*David J. Kybas*

Director of the United States Patent and Trademark Office

# United States of America

United States Patent and Trademark Office



**Reg. No. 4,123,779**

**Registered Apr. 10, 2012**

**Int. Cls.: 6 and 16**

**TRADEMARK**

**PRINCIPAL REGISTER**

JENNY LANE DESIGN AS (NORWAY AKSJESELSKAP)  
KONVALLVEIEN 10  
N-3080 HOLMESTRAND  
NORWAY

FOR: GOODS OF COMMON METAL NOT INCLUDED IN OTHER CLASSES, NAMELY, POSTBOXES, LETTER BOXES, MAILBOXES, CANTILEVERED BRACKETS, SHELF BRACKETS, GENERAL USE BRACKETS, WALL BRACKETS FOR GENERAL USE AND SHELVES, HOOKS, PULLS, TRANSPORT CONTAINERS, COMMERCIAL WASTE CONTAINERS, GENERAL PURPOSE STORAGE CONTAINERS AND HOLIDAY ORNAMENTS, IN CLASS 6 (U.S. CLS. 2, 12, 13, 14, 23, 25 AND 50).

FOR: PAPER, CARDBOARD AND GOODS MADE FROM THESE MATERIALS, NOT INCLUDED IN OTHER CLASSES, NAMELY, PAPER BAGS; CARDBOARD BOXES; PRINTED MATTER, NAMELY, PRINTED CALENDARS; POSTCARDS; LETTERS, NAMELY, ADHESIVE-BACKED LETTERS FOR USE IN MAKING SIGNS AND POSTERS; BOOKBINDING MATERIALS; PHOTOGRAPHS; STATIONERY; PRINTED INSTRUCTIONAL MATERIAL IN THE FIELD OF CRAFTING AND SCRAPBOOKING; PLASTIC MATERIALS FOR PACKAGING NOT INCLUDED IN OTHER CLASSES, NAMELY, PLASTIC BAGS FOR PACKAGING, IN CLASS 16 (U.S. CLS. 2, 5, 22, 23, 29, 37, 38 AND 50).

THE NAME "JENNY LANE" IDENTIFIES A LIVING INDIVIDUAL WHOSE CONSENT IS OF RECORD.

OWNER OF INTERNATIONAL REGISTRATION 1084925 DATED 5-10-2011, EXPIRES 5-10-2021.

THE MARK CONSISTS OF THE STYLIZED LETTERS "JL" WITH THE WORDING "JENNY LANE" CENTERED BELOW THE LETTERS.

SER. NO. 79-100,350, FILED 5-10-2011.

TINA BROWN, EXAMINING ATTORNEY



*David J. Kybas*

Director of the United States Patent and Trademark Office

# United States of America

United States Patent and Trademark Office

Pandear 汎蒂尔

**Reg. No. 4,123,780**

**Registered Apr. 10, 2012**

**Int. Cls.: 3 and 44**

**TRADEMARK**

**SERVICE MARK**

**PRINCIPAL REGISTER**

HANGZHOU YES BEAUTY CO., LTD. (CHINA CORPORATION)  
THE GROUND FLOOR, DONGFENG MANSION  
92 ZHAOHUI ROAD, XIACHENG DISTRICT  
HANGZHOU; ZHEJIANG PROVINCE, CHINA

FOR: COSMETIC SUNSCREEN PREPARATIONS; COSMETICS; PERFUME; BEAUTY MASKS; SKIN WHITENING CREAMS; SCENTED LINEN WATER; ESSENTIAL OILS; AROMATIC ESSENTIAL OILS; BATH SALTS, IN CLASS 3 (U.S. CLS. 1, 4, 6, 50, 51 AND 52).

FOR: PROVIDING PUBLIC BATHS FOR SANITARY PURPOSES; HAIRDRESSING SALONS; MANICURING; PROVIDING TURKISH BATH FACILITIES; MASSAGE; TATTOOING; BEAUTY SALONS, IN CLASS 44 (U.S. CLS. 100 AND 101).

THE ENGLISH TRANSLATION OF "PANDEAR FAN DI ER" IN THE MARK IS "TO WARP", "FLOAT", "STALK OF A FRUIT" OR "FLOWER", "FIGURE".

OWNER OF INTERNATIONAL REGISTRATION 1085067 DATED 3-10-2011, EXPIRES 3-10-2021.

THE NON-LATIN CHARACTERS IN THE MARK TRANSLITERATE TO "FAN DI ER"

SER. NO. 79-100,407, FILED 3-10-2011.

DAVID TOOLEY, EXAMINING ATTORNEY



*David J. Kypos*

Director of the United States Patent and Trademark Office

# United States of America

United States Patent and Trademark Office

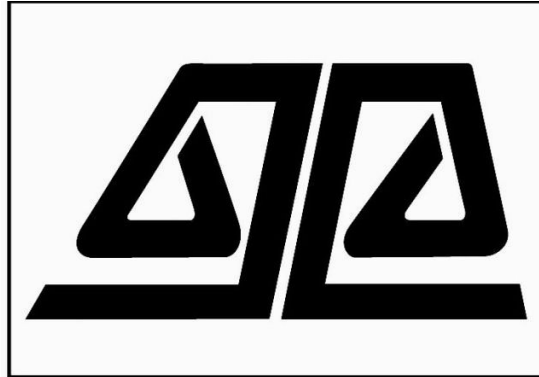

**Reg. No. 4,123,781**

**Registered Apr. 10, 2012**

**Int. Cl.: 42**

**SERVICE MARK**

**PRINCIPAL REGISTER**

AUS-MEAT LIMITED (AUSTRALIA CORPORATION)  
UNIT 1  
333 QUEENSPORT ROAD NORTH; MURARRIE QLD4172  
AUSTRALIA

FOR: ACCREDITATION SERVICES, NAMELY, EVALUATING ORGANIZATIONS TO DETERMINE WHETHER THE ORGANIZATIONS CONFORM TO AN ESTABLISHED STANDARD; ACCREDITATION SERVICES, NAMELY, ADMINISTERING STANDARDS AND PROCEDURES FOR CERTIFYING PROFESSIONALS IN THE FIELD OF AGRICULTURE, HORTICULTURE, FOOD PROCESSING, INDUSTRIAL CATERING, INDUSTRY TRAINING, RESEARCH AND TECHNICAL SERVICES, COMMERCIAL BUSINESS MANAGEMENT AND ADMINISTRATION SERVICES; TESTING, ANALYSIS, AND EVALUATION OF THE PRODUCTS AND PROCEDURES OF OTHERS IN THE FIELD OF AGRICULTURE, HORTICULTURE, FOOD PROCESSING, INDUSTRIAL CATERING, INDUSTRY TRAINING, RESEARCH AND TECHNICAL SERVICES, COMMERCIAL BUSINESS MANAGEMENT AND ADMINISTRATION SERVICES FOR THE PURPOSE OF CERTIFICATION; TESTING, ANALYSIS, AND EVALUATION OF THE KNOWLEDGE, SKILLS AND ABILITIES OF OTHERS FOR THE PURPOSE OF CERTIFICATION IN THE FIELD OF AGRICULTURE, HORTICULTURE, FOOD PROCESSING, INDUSTRIAL CATERING, INDUSTRY TRAINING, RESEARCH AND TECHNICAL SERVICES, COMMERCIAL BUSINESS MANAGEMENT AND ADMINISTRATION SERVICES; QUALITY CONTROL SERVICES, NAMELY, AUDITING QUALITY, STANDARDS AND PROCEDURES COMPLIANCE OF OTHERS IN THE FIELD OF AGRICULTURE, HORTICULTURE, FOOD PROCESSING, INDUSTRIAL CATERING, INDUSTRY TRAINING, RESEARCH AND TECHNICAL SERVICES, COMMERCIAL BUSINESS MANAGEMENT AND ADMINISTRATION SERVICES, IN CLASS 42 (U.S. CLS. 100 AND 101).



THE MARK CONSISTS OF A STYLIZED SCALE COMPOSED OF TWO ABUTTING QUADRILATERAL SHAPES FACING LEFT AND RIGHT WITH A TRIANGLE HANGING FROM THE CENTER OF EACH. THE MARK APPEARS WITHIN A RECTANGULAR OUTLINE.

PRIORITY DATE OF 8-18-2010 IS CLAIMED.

*David J. Kybas*

OWNER OF INTERNATIONAL REGISTRATION 1085121 DATED 2-1-2011, EXPIRES 2-1-2021.

**Reg. No. 4,123,781** SER. NO. 79-100,426, FILED 2-1-2011.

INGRID C. EULIN, EXAMINING ATTORNEY



# United States of America

United States Patent and Trademark Office

# TROPHYscope

**Reg. No. 4,123,782**

**Registered Apr. 10, 2012**

**Int. Cls.: 10 and 16**

**TRADEMARK**

**PRINCIPAL REGISTER**

KARL STORZ GMBH & CO. KG (FED REP GERMANY GMBH & CO. KG)  
MITTELSTRASSE 8  
78532 TUTTLINGEN, FED REP GERMANY

FOR: SURGICAL AND MEDICAL APPARATUS FOR USE IN GENERAL AND ENDOSCOPIC SURGERY, NAMELY, ENDOSCOPES AND HYSTEROSCOPES , IN CLASS 10 (U.S. CLS. 26, 39 AND 44).

FOR: PRINTED MATERIAL, NAMELY CATALOGUES, MAGAZINES, JOURNALS, BROCHURES AND INFORMATIONAL FLYERS, LETTERS AND SHEETS IN THE FIELD OF MEDICAL TECHNOLOGY; PRINTED TEACHING AND INSTRUCTIONAL MANUALS IN THE FIELD OF MEDICAL TECHNOLOGY; PHOTOGRAPHS, IN CLASS 16 (U.S. CLS. 2, 5, 22, 23, 29, 37, 38 AND 50).

THE MARK CONSISTS OF STANDARD CHARACTERS WITHOUT CLAIM TO ANY PARTICULAR FONT, STYLE, SIZE, OR COLOR.

PRIORITY DATE OF 9-8-2010 IS CLAIMED.

OWNER OF INTERNATIONAL REGISTRATION 1085246 DATED 3-2-2011, EXPIRES 3-2-2021.

SER. NO. 79-100,466, FILED 3-2-2011.

DANIEL CAPSHAW, EXAMINING ATTORNEY



*David J. Kyfos*

Director of the United States Patent and Trademark Office

# United States of America

United States Patent and Trademark Office

# ThermaSmart

**Reg. No. 4,123,783**

THERMAFLEX ISOLATIE B.V. (NETHERLANDS PRIVATE COMPANY)  
1, VEERWEG

**Registered Apr. 10, 2012**

NL-5145 NS WAALWIJK, NETHERLANDS

**Int. Cls.: 16 and 17**

FOR: PRINTED INSTRUCTIONAL AND TEACHING MATERIAL IN THE FIELD OF INSULATION MATERIALS USED IN HEATING, VENTILATING, AIR CONDITIONING AND COOLING APPARATUS, IN CLASS 16 (U.S. CLS. 2, 5, 22, 23, 29, 37, 38 AND 50).

**TRADEMARK**

FOR: RAW OR SEMI-WORKED RUBBER; GUTTA-PERCHA, GUM BEING RAW OR SEMI-WORKED RUBBER; GOODS MADE OF RUBBER, NAMELY, RUBBER TUBES AND PIPES; PLASTICS IN EXTRUDED FORM FOR USE IN PRODUCTION; PLASTICS IN EXTRUDED FORM FOR USE IN THE PRODUCTION OF PACKING, STOPPING AND INSULATING MATERIALS; NON-METALLIC FLEXIBLE PIPES; ALL THE AFORE-MENTIONED GOODS FOR USE WITH HEATING, VENTILATING, AIR-CONDITIONING AND COOLING APPARATUS, IN CLASS 17 (U.S. CLS. 1, 5, 12, 13, 35 AND 50).

**PRINCIPAL REGISTER**

THE MARK CONSISTS OF STANDARD CHARACTERS WITHOUT CLAIM TO ANY PARTICULAR FONT, STYLE, SIZE, OR COLOR.

PRIORITY DATE OF 1-10-2011 IS CLAIMED.

OWNER OF INTERNATIONAL REGISTRATION 1085630 DATED 5-13-2011, EXPIRES 5-13-2021.

SER. NO. 79-100,625, FILED 5-13-2011.

EVELYN BRADLEY, EXAMINING ATTORNEY



*David J. Kypos*

Director of the United States Patent and Trademark Office

# United States of America

United States Patent and Trademark Office



**Reg. No. 4,123,784**

**Registered Apr. 10, 2012**

**Int. Cl.: 25**

BERNER OSAKEYHTIÖ (FINLAND CORPORATION)  
ETELÄRANTA 4 B  
FI-00130 HELSINKI  
FINLAND

FOR: FOOTWEAR, IN CLASS 25 (U.S. CLS. 22 AND 39).

**TRADEMARK**

OWNER OF U.S. REG. NO. 2,466,012.

**PRINCIPAL REGISTER**

OWNER OF INTERNATIONAL REGISTRATION 1085686 DATED 7-6-2011, EXPIRES 7-6-2021.

NO CLAIM IS MADE TO THE EXCLUSIVE RIGHT TO USE "NOKIAN FOOTWEAR", APART FROM THE MARK AS SHOWN.

THE MARK CONSISTS OF THE WORDING "NOKIAN FOOTWEAR" IN STYLIZED FONT, WITH THE WORD "NOKIAN" SET INSIDE A RECTANGULAR BORDER WITH ROUNDED CORNERS AND WITH THE INDIVIDUAL LETTERS PRESENTED IN ALTERNATING CONTRASTING TONES.

SER. NO. 79-100,659, FILED 7-6-2011.

STEVEN PEREZ, EXAMINING ATTORNEY



*David J. Kyffers*

Director of the United States Patent and Trademark Office

# United States of America

United States Patent and Trademark Office

# Super-TIX

**Reg. No. 4,123,785**

**Registered Apr. 10, 2012**

**Int. Cl.: 6**

**TRADEMARK**

**PRINCIPAL REGISTER**

SHIN NIPPON SEITETSU KABUSHIKI KAISHA (ALSO DOING BUSINESS AS NIPPON STEEL CORPORATION) (JAPAN CORPORATION)  
NO. 6-1, MARUNOUCHI 2-CHOME  
CHIYODA-KU; TOKYO 100-8071  
JAPAN

FOR: TITANIUM ALLOY IN SHEET, TUBE, ROD, BAR AND/OR BILLET FORM; STEEL IN SHEET, ROD, BAR AND/OR BILLET FORM, IN CLASS 6 (U.S. CLS. 2, 12, 13, 14, 23, 25 AND 50).

OWNER OF U.S. REG. NO. 2,982,935.

OWNER OF INTERNATIONAL REGISTRATION 1085689 DATED 6-23-2011, EXPIRES 6-23-2021.

SER. NO. 79-100,660, FILED 6-23-2011.

ALLISON HOLTZ, EXAMINING ATTORNEY



*David J. Kybas*

Director of the United States Patent and Trademark Office

# United States of America

United States Patent and Trademark Office

# CRISTALMAX

**Reg. No. 4,123,786**

ECM TECHNOLOGIES (FRANCE SOCIÉTÉ PAR ACTIONS SIMPLIFIÉE)  
46 RUE JEAN VAUJANY, TECHNISUD  
F-38000 GRENOBLE, FRANCE

**Registered Apr. 10, 2012**

**Int. Cls.: 9, 11 and 40**

FOR: AUTOMATIC CONTROL AND MONITORING SOFTWARE FOR REGULATING INDUSTRIAL FURNACES USED IN THE MANUFACTURE OF MULTICRYSTALLINE SILICON INGOTS AND FOR REGULATING THE QUALITATIVE PARAMETERS OF THE SAID INGOTS, IN CLASS 9 (U.S. CLS. 21, 23, 26, 36 AND 38).

**TRADEMARK**

**SERVICE MARK**

FOR: FURNACES FOR INDUSTRIAL USE, OTHER THAN FOR EXPERIMENTAL PURPOSES, PARTICULARLY LOW-PRESSURE THERMO-CHEMICAL TREATMENT FURNACES, VACUUM AND PRESSURE FURNACES, CRYSTAL GROWTH FURNACES FOR THE AUTOMOTIVE, AERONAUTICS, ELECTRONICS, STEEL, MICROELECTRONICS, NUCLEAR, PHOTOVOLTAICS INDUSTRIES; COMPONENT PARTS FOR FURNACES FOR INDUSTRIAL USE OTHER THAN FOR EXPERIMENTAL PURPOSES, NAMELY, LOADING APPARATUS, NAMELY, LOADING APPARATUS SOLD AS INTEGRAL PARTS OF FURNACES, FITTED FURNACE COVERS, FITTINGS THEREFOR, LOADING SUPPORTS, NAMELY, LOADING SUPPORTS SOLD AS INTEGRAL PARTS OF FURNACES, IN CLASS 11 (U.S. CLS. 13, 21, 23, 31 AND 34).

**PRINCIPAL REGISTER**

FOR: SERVICES FOR THE THERMO-CHEMICAL TREATMENT OF MATERIALS, NAMELY, THERMO-CHEMICAL TREATMENT OF SILICON INGOTS; CUSTOM ASSEMBLY OF MATERIALS FOR THIRD PARTIES, IN CLASS 40 (U.S. CLS. 100, 103 AND 106).



THE ENGLISH TRANSLATION OF "CRISTAL" IN THE MARK IS INDEED "CRYSTAL".

PRIORITY DATE OF 2-1-2011 IS CLAIMED.

OWNER OF INTERNATIONAL REGISTRATION 1086375 DATED 6-28-2011, EXPIRES 6-28-2021.

SER. NO. 79-100,916, FILED 6-28-2011.

BERNICE MIDDLETON, EXAMINING ATTORNEY

*David J. Kyffers*

Director of the United States Patent and Trademark Office

# United States of America

United States Patent and Trademark Office

JEANRICHARD CREATIVE CRAFTSMANSHIP SINCE 1681

**Reg. No. 4,123,787**

**Registered Apr. 10, 2012**

**Int. Cl.: 14**

**TRADEMARK**

**PRINCIPAL REGISTER**

SOWIND S.A. (SWITZERLAND SOCIÉTÉ ANONYME)  
1, PLACE GIRARDET  
CH-2301 LA CHAUX-DE-FONDS  
SWITZERLAND

FOR: TIMEPIECES AND CHRONOMETRIC INSTRUMENTS, NAMELY, WATCHES, WRISTWATCHES, CHRONOMETERS, CLOCKS, TABLE CLOCKS, MOVEMENTS FOR CLOCKS AND WATCHES; JEWELRY, PRECIOUS STONES, IN CLASS 14 (U.S. CLS. 2, 27, 28 AND 50).

THE MARK CONSISTS OF STANDARD CHARACTERS WITHOUT CLAIM TO ANY PARTICULAR FONT, STYLE, SIZE, OR COLOR.

PRIORITY DATE OF 2-8-2011 IS CLAIMED.

OWNER OF INTERNATIONAL REGISTRATION 1086627 DATED 6-22-2011, EXPIRES 6-22-2021.

OWNER OF U.S. REG. NOS. 1,606,339 AND 3,431,475.

NO CLAIM IS MADE TO THE EXCLUSIVE RIGHT TO USE "SINCE 1681", APART FROM THE MARK AS SHOWN.

THE NAME "JEANRICHARD" DOES NOT IDENTIFY A LIVING INDIVIDUAL.

SER. NO. 79-100,994, FILED 6-22-2011.

MARK PILARO, EXAMINING ATTORNEY



*David J. Kybas*

Director of the United States Patent and Trademark Office

United States of America  
United States Patent and Trademark Office

GET

**Reg. No. 4,123,788**

**Registered Apr. 10, 2012**

**Int. Cl.: 10**

**TRADEMARK**

**PRINCIPAL REGISTER**

OTICON A/S (DENMARK AKTIESELSKAB)  
KONGEBAKKEN 9  
DK-2765 SMØRUM  
DENMARK

FOR: HEARING AIDS AND REPLACEMENT AND STRUCTURAL PARTS THEREFOR, IN CLASS 10 (U.S. CLS. 26, 39 AND 44).

THE MARK CONSISTS OF STANDARD CHARACTERS WITHOUT CLAIM TO ANY PARTICULAR FONT, STYLE, SIZE, OR COLOR.

PRIORITY DATE OF 1-20-2011 IS CLAIMED.

OWNER OF INTERNATIONAL REGISTRATION 1086731 DATED 7-13-2011, EXPIRES 7-13-2021.

SER. NO. 79-101,038, FILED 7-13-2011.

APRIL HESIK, EXAMINING ATTORNEY



*David J. Kyffers*

Director of the United States Patent and Trademark Office

# United States of America

United States Patent and Trademark Office

# VROOAM

**Reg. No. 4,123,789**

**Registered Apr. 10, 2012**

**Int. Cls.: 1 and 4**

VROOAM LUBRICANTS HOLDING B.V. (NETHERLANDS BESLOTEN VENNOOTSCHAP,  
PRIVATE LIM LIABILITY COMP)  
LICHTENAUERLAAN 102-120  
NL-3062 ME ROTTERDAM  
NETHERLANDS

**TRADEMARK**

**PRINCIPAL REGISTER**

FOR: CHEMICALS USED IN INDUSTRY, NAMELY, BRAKE FLUIDS, TRANSMISSION FLUIDS; CHEMICAL ENGINE TREATMENTS AND ADDITIVES FOR ENHANCING THE PERFORMANCE OF ENGINE OILS, LUBRICATING OILS, GREASES AND INTERNAL COMBUSTION ENGINE FUELS, CHEMICAL PRODUCTS FOR NEUTRALIZING BATTERY ACID, CORROSION AND RUST, HYDRAULIC FLUIDS ESPECIALLY FOR BRAKING SYSTEMS, CLUTCHES AND AUTOMATIC GEARBOXES, CHEMICAL TREATMENT FLUIDS AND ANTIFREEZE FOR COOLING CIRCUITS; THE ABOVEMENTIONED PRODUCTS FOR USE IN POWERSPORTS INDUSTRY, WATERCRAFT INDUSTRY, GO-KART INDUSTRY, AUTOMOTIVE INDUSTRY, OEM (ORIGINAL EQUIPMENT MANUFACTURING) INDUSTRY, ENGINEERING INDUSTRY, TECHNOLOGY INDUSTRY, RECREATIONAL INDUSTRY AND ALLIED INDUSTRIES, IN CLASS 1 (U.S. CLS. 1, 5, 6, 10, 26 AND 46).

FOR: INDUSTRIAL OILS AND GREASES; LUBRICANTS, NAMELY, INDUSTRIAL OILS, INDUSTRIAL LUBRICANTS, LUBRICATING OILS, LUBRICATING GREASES, ALL-PURPOSE LUBRICANTS, LUBRICANTS FOR VEHICLES, SILICONE LUBRICANTS FOR MOTOR VEHICLES, GRAPHITE LUBRICANTS, ALL PURPOSE LUBRICANTS IN SPRAY FORM, SOLID FILM DRY LUBRICANTS, LUBRICANTS FOR SPROCKETS CHAINS, NON-MINERAL EMULSION OILS FOR USE AS A COOLING ADDITIVE FOR RADIATOR SYSTEMS, INDUSTRIAL LUBRICANTS FOR ABSORBING MOISTURE FROM PETROLEUM BASED ENGINE FUELS AND ENGINE LIQUIDS SUCH AS PETROLEUM, KEROSENE, DIESEL, BIODIESEL, METHANOL, ETHANOL AND BUTANOL; ENGINE OILS; NON-CHEMICAL MOTOR OIL ADDITIVES; NON-CHEMICAL GASOLINE ADDITIVES; NON-CHEMICAL ADDITIVES FOR FUELS; NON-CHEMICAL ADDITIVES FOR LUBRICANTS, GREASES AND OILS; PETROLEUM BASED DUST ABSORBING PRODUCTS FOR USE ON VEHICLE CHAINS, FENDERS AND BODYWORK TO ATTRACT DUST, MUD AND GRIME; PETROLEUM BASED WETTING AND BINDING COMPOSITIONS FOR MAINTENANCE OF MOTOR VEHICLES; INDUSTRIAL CHEMICAL LUBRICANTS; PENETRATING OILS; THE ABOVEMENTIONED PRODUCTS FOR USE IN THE POWERSPORTS INDUSTRY, WATERCRAFT INDUSTRY, GO-KART INDUSTRY, AUTOMOTIVE INDUSTRY, OEM (ORIGINAL EQUIPMENT MANUFACTURING) INDUSTRY, ENGINEERING INDUSTRY, TECHNOLOGY



*David J. Kyjars*

Director of the United States Patent and Trademark Office



**Reg. No. 4,123,789** INDUSTRY, RECREATIONAL INDUSTRY AND ALLIED INDUSTRIES; ANTI-RUST LUBRICANT, IN CLASS 4 (U.S. CLS. 1, 6 AND 15).

THE MARK CONSISTS OF STANDARD CHARACTERS WITHOUT CLAIM TO ANY PARTICULAR FONT, STYLE, SIZE, OR COLOR.

PRIORITY DATE OF 6-3-2010 IS CLAIMED.

OWNER OF INTERNATIONAL REGISTRATION 1086850 DATED 11-23-2010, EXPIRES 11-23-2020.

THE WORD "VROOAM" HAS NO MEANING IN A FOREIGN LANGUAGE.

SER. NO. 79-101,082, FILED 11-23-2010.

LAURIE KAUFMAN, EXAMINING ATTORNEY

# United States of America

United States Patent and Trademark Office

# 35..COM

**Reg. No. 4,123,790**

**Registered Apr. 10, 2012**

**Int. Cls.: 9 and 38**

**TRADEMARK**

**SERVICE MARK**

**PRINCIPAL REGISTER**

XIAMEN 35.COM TECHNOLOGY CO., LTD (CHINA CORPORATION)  
1ST FLOOR, NO. 8 GUANRI ROAD  
SOFTWARE PARK PHASE II, HUOJU HIGH-TECH INDUSTRIAL DEVELOPMENT ZONE  
XIAMEN; FUJIAN, CHINA

FOR: TELEPHONES; VIDEO TELEPHONES; PORTABLE TELEPHONES; FIBER OPTIC CABLES; SATELLITE NAVIGATIONAL APPARATUS, NAMELY, GLOBAL POSITIONING SYSTEM (GPS); RADIOTELEPHONY SETS; NAVIGATION APPARATUS FOR VEHICLES IN THE NATURE OF ON-BOARD COMPUTERS; RADAR APPARATUS, NAMELY, RADAR; WALKIE-TALKIES, IN CLASS 9 (U.S. CLS. 21, 23, 26, 36 AND 38).

FOR: MESSAGE SENDING; INFORMATION ABOUT TELECOMMUNICATION; COMMUNICATIONS BY COMPUTER TERMINALS; RENTAL OF MODEMS; RENTAL OF MESSAGE SENDING APPARATUS; ELECTRONIC BULLETIN BOARD SERVICES; ELECTRONIC MAIL; COMPUTER AIDED TRANSMISSION OF MESSAGES AND IMAGES; PROVIDING USER ACCESS TO A GLOBAL COMPUTER NETWORK, IN CLASS 38 (U.S. CLS. 100, 101 AND 104).

THE MARK CONSISTS OF THE WORDING "35.COM" IN WHICH A DESIGN OF A HEDGEHOG REPRESENTS THE LETTER "C".

OWNER OF INTERNATIONAL REGISTRATION 1086868 DATED 4-27-2011, EXPIRES 4-27-2021.

SER. NO. 79-101,087, FILED 4-27-2011.

HAI-LY LAM, EXAMINING ATTORNEY



*David J. Kyros*

Director of the United States Patent and Trademark Office

# United States of America

United States Patent and Trademark Office



**Reg. No. 4,123,791**

**Registered Apr. 10, 2012**

**Int. Cl.: 34**

**TRADEMARK**

**PRINCIPAL REGISTER**

ALTADIS S.A. (SPAIN SOCIEDAD LIMITADA)  
CENTRO EMPRESARIAL CRISTALIA  
C/VIA DE LOS POBLADOS, NO. 3.; EDIFISIO7/8, PLANTAS 3 Y 4; E-28033 MADRID  
SPAIN

FOR: TOBACCO; CIGARETTES; LIGHTERS FOR SMOKERS; ASHTRAYS FOR SMOKERS  
NOT OF PRECIOUS METAL; CIGARETTE BOXES AND CASES, IN CLASS 34 (U.S. CLS. 2,  
8, 9 AND 17).

THE MARK CONSISTS OF A LABEL WITH WORD "FORTUNA" ON A RECTANGULAR  
BACKGROUND AND A CREST OF A SHIELD WITH FOUR STARS THEREIN, BELOW A  
SUN WITH TWO HERALDIC LIONS ON BOTH SIDES OF THE SHIELD AND A BANNER  
BELOW.

OWNER OF INTERNATIONAL REGISTRATION 0923681 DATED 3-30-2007, EXPIRES 3-30-  
2017.

SER. NO. 79-101,170, FILED 3-21-2011.

WILLIAM VERHOSEK, EXAMINING ATTORNEY



*David J. Kybas*

Director of the United States Patent and Trademark Office

# United States of America

United States Patent and Trademark Office

# R T M

**Reg. No. 4,123,792**

**Registered Apr. 10, 2012**

**Int. Cls.: 6, 17 and 19**

**TRADEMARK**

**PRINCIPAL REGISTER**

UPONOR INNOVATION AB C/O UPONOR AB (SWEDEN JOINT STOCK COMPANY)  
BOX 101  
SE-730 61 VIRSBO  
SWEDEN

FOR: FITTINGS OF METAL FOR JOINTING PIPES, IN CLASS 6 (U.S. CLS. 2, 12, 13, 14, 23, 25 AND 50).

FOR: NON-METALLIC FITTINGS FOR JOINTING FLEXIBLE PIPES, IN CLASS 17 (U.S. CLS. 1, 5, 12, 13, 35 AND 50).

FOR: NON-METALLIC FITTINGS FOR JOINTING RIGID PIPES FOR BUILDING, IN CLASS 19 (U.S. CLS. 1, 12, 33 AND 50).

THE MARK CONSISTS OF STANDARD CHARACTERS WITHOUT CLAIM TO ANY PARTICULAR FONT, STYLE, SIZE, OR COLOR.

OWNER OF INTERNATIONAL REGISTRATION 1074273 DATED 3-11-2011, EXPIRES 3-11-2021.

SER. NO. 79-101,180, FILED 6-30-2011.

KRISTIN CARLSON, EXAMINING ATTORNEY



*David J. Kybas*

Director of the United States Patent and Trademark Office

# United States of America

United States Patent and Trademark Office

I do it...  
outdoors  
**step into life**  
Group Outdoor Personal Training

**Reg. No. 4,123,793**

**Registered Apr. 10, 2012**

**Int. Cls.: 25, 41 and 44**

STEP INTO LIFE INTERNATIONAL PTY LTD (AUSTRALIA LIMITED LIABILITY COMPANY)  
UNIT 24  
148 CHESTERVILLE ROAD; MOORABBIN VIC 3189  
AUSTRALIA

**TRADEMARK**

**SERVICE MARK**

**PRINCIPAL REGISTER**

FOR: CLOTHING, NAMELY, GLOVES, JACKETS, JERSEYS, JUMPERS, LEGGINGS, OUTER CLOTHING, NAMELY, COATS, PANTS, PARKAS, PULLOVERS, SHIRTS, SINGLET, SOCKS, SPORTS JERSEYS, SWEAT ABSORBENT UNDER CLOTHING, NAMELY, UNDERSHIRTS, SWEATERS, TEE SHIRTS, TIGHTS, UNDER CLOTHING, NAMELY, UNDERSHIRTS, UNDERWEAR, UNIFORMS, VESTS AND WATERPROOF CLOTHING, NAMELY, RAINCOATS; FOOTWEAR; HEADGEAR, NAMELY, CAP PEAKS, CAPS, EAR MUFFS, HATS, HEAD BANDS AND SUN VISORS, IN CLASS 25 (U.S. CLS. 22 AND 39).

FOR: FITNESS AND EXERCISE CLINICS AND CLUBS FEATURING INSTRUCTION IN PHYSICAL FITNESS AND OFFERING FACILITIES AND EQUIPMENT FOR PHYSICAL EXERCISE; HEALTH CLUB SERVICES, NAMELY, PROVIDING INSTRUCTION AND EQUIPMENT IN THE FIELD OF PHYSICAL EXERCISE; OPERATION OF PHYSICAL FITNESS CENTERS; PHYSICAL FITNESS TUITION IN THE NATURE OF PERSONAL TRAINING, IN CLASS 41 (U.S. CLS. 100, 101 AND 107).

FOR: MEDICAL TESTING FOR FITNESS EVALUATION, IN CLASS 44 (U.S. CLS. 100 AND 101).

NO CLAIM IS MADE TO THE EXCLUSIVE RIGHT TO USE "GROUP OUTDOOR PERSONAL TRAINING", APART FROM THE MARK AS SHOWN.

OWNER OF INTERNATIONAL REGISTRATION 1087173 DATED 2-21-2011, EXPIRES 2-21-2021.

SER. NO. 79-101,220, FILED 2-21-2011.

DORITT L. CARROLL, EXAMINING ATTORNEY



*David J. Kyffers*

Director of the United States Patent and Trademark Office

United States of America  
United States Patent and Trademark Office

DCA

**Reg. No. 4,123,794**

**Registered Apr. 10, 2012**

**Int. Cl.: 9**

**TRADEMARK**

**PRINCIPAL REGISTER**

JIANGSU DONGCHENG POWER TOOLS CO., LTD. (CHINA CORPORATION)  
INDUSTRIAL PARK  
TIANFEN TOWN, QIDONG CITY, JIANGSU, CHINA

FOR: ELECTRIC WIRES; ELECTRIC CABLES; ARMATURES FOR USE IN ELECTRICAL APPARATUS; CURRENT RECTIFIERS; COMMUTATORS; ELECTRICAL CELLS AND BATTERIES; ELECTRIC ACCUMULATORS; CHARGERS FOR ELECTRIC BATTERIES; PLOTTERS; MEASURING APPARATUS, NAMELY, LASER LEVELS, SURVEYORS' LEVELS, BEVELS, LASER DISTANCE METERS, LASER RANGEFINDERS, DIGITIZERS; DISTANCE MEASURING APPARATUS; LEVEL MEASURING MACHINES FOR SURVEYING; MATERIAL TESTING INSTRUMENTS AND MACHINES, NAMELY, WALL SCANNERS, LASER DETECTORS, METAL DETECTORS; OPTICAL INSPECTION APPARATUS; ELECTRONIC APPARATUS FOR THE REMOTE CONTROL OF INDUSTRIAL OPERATIONS; PROTECTION DEVICES FOR PERSONAL USE AGAINST ACCIDENTS, NAMELY, DUST PROTECTIVE GOGGLES AND MASKS, SAFETY GOGGLES; SOUND ALARMS, IN CLASS 9 (U.S. CLS. 21, 23, 26, 36 AND 38).

THE MARK CONSISTS OF STANDARD CHARACTERS WITHOUT CLAIM TO ANY PARTICULAR FONT, STYLE, SIZE, OR COLOR.

OWNER OF INTERNATIONAL REGISTRATION 1087310 DATED 7-5-2011, EXPIRES 7-5-2021.

OWNER OF U.S. REG. NO. 3,602,781.

SER. NO. 79-101,272, FILED 7-5-2011.

MATTHEW EINSTEIN, EXAMINING ATTORNEY



*David J. Kypos*

Director of the United States Patent and Trademark Office

# United States of America

United States Patent and Trademark Office

## Sweet La Vida Cookies

**Reg. No. 4,123,795**

**Registered Apr. 10, 2012**

**Int. Cls.: 16, 29 and 30**

**TRADEMARK**

**PRINCIPAL REGISTER**

AGI-1 OOD (BULGARIA LIMITED LIABILITY COMPANY)  
BUL. 6-TI SEPTEMVRI 220,  
FL. 7, AP. 21; BG-4000 PLOVDIV  
BULGARIA

FOR: PAPER, CARDBOARD AND GOODS MADE FROM THESE MATERIALS, NAMELY, BOXES, CONTAINERS, PACKAGING; PRINTED MATTER, NAMELY, PHOTOGRAPHS, MAGAZINES, BOOKS, NEWSLETTERS, AND BROCHURES ALL IN THE FIELDS OF PRODUCTION OF PASTRIES, COOKIES, CAKES, SWEETS; PRINTED INSTRUCTIONAL AND TEACHING MATERIAL IN THE FIELD OF PRODUCTION OF PASTRIES, COOKIES, CAKES, SWEETS; PLASTIC MATERIALS FOR PACKAGING, NAMELY, PLASTIC BAGS FOR PACKAGING; POLYETHYLENE AND PAPER PACKAGING FOR FOOD PRODUCTS, NAMELY, PLASTIC FOOD STORAGE BAGS FOR HOUSEHOLD USE, CONTAINERS OF PAPER FOR PACKAGING FOOD, IN CLASS 16 (U.S. CLS. 2, 5, 22, 23, 29, 37, 38 AND 50).

FOR: MEAT, FISH, POULTRY AND GAME; MEAT EXTRACTS; PRESERVED, FROZEN, DRIED, COOKED FRUITS AND VEGETABLES; JELLIES, JAMS, COMPOTES; EGGS, MILK AND MILK PRODUCTS, EXCLUDING ICE CREAM, ICE MILK AND FROZEN YOGURT; EDIBLE OILS AND FATS; CANDIED FRUIT; FRUIT PEELS; BUTTER CREAM; COCOA BUTTER FOR FOOD PURPOSES; COCONUT BUTTER FOR FOOD PURPOSES; FRUIT CHIPS, IN CLASS 29 (U.S. CL. 46).

FOR: COFFEE, TEA, COCOA, SUGAR, RICE, TAPIOCA, SAGO, ARTIFICIAL COFFEE; FLOUR; PREPARATIONS MADE FROM CEREALS, NAMELY, PROCESSED CEREALS, CEREAL BASED SNACK FOOD, BREAKFAST CEREAL; BREAD, PASTRY; CONFECTIONARY, NAMELY, CONFECTIONERY MADE OF SUGAR, FROZEN CONFECTIONERY; ICES; HONEY, TREACLE; YEAST, BAKING POWDER; SALT, MUSTARD; VINEGAR, CONDIMENT SAUCES, NAMELY, HOT SAUCE, FISH SAUCE, DIPPING SAUCES; SPICES; ICE; FRUIT JELLIES IN THE NATURE OF EDIBLE ICES; COCOA BASED BEVERAGES; BUNS; CHOCOLATE; WAFFLES; CHOCOLATE DESSERTS, NAMELY, BAKERY DESSERTS, DESSERT MOUSE, DESSERT PUDDING; BISCUITS; ÉCLAIRS; SWEETS; CAKES; TURKISH DELIGHT, CHOCOLATE SPREAD, WITH NUTS; HARD CARAMEL, IN CLASS 30 (U.S. CL. 46).



*David J. Kyppas*

Director of the United States Patent and Trademark Office

THE MARK CONSISTS OF STANDARD CHARACTERS WITHOUT CLAIM TO ANY PARTICULAR FONT, STYLE, SIZE, OR COLOR.

**Reg. No. 4,123,795** PRIORITY DATE OF 2-2-2011 IS CLAIMED.

OWNER OF INTERNATIONAL REGISTRATION 1087608 DATED 3-15-2011, EXPIRES 3-15-2021.

NO CLAIM IS MADE TO THE EXCLUSIVE RIGHT TO USE "SWEET AND COOKIES", APART FROM THE MARK AS SHOWN.

THE ENGLISH TRANSLATION OF THE WORDS "LA VIDA" IN THE MARK IS "THE LIFE".

SER. NO. 79-101,389, FILED 3-15-2011.

HEATHER BIDDULPH, EXAMINING ATTORNEY



# United States of America

United States Patent and Trademark Office

# LIKA MIMIKA

**Reg. No. 4,123,796**

**Registered Apr. 10, 2012**

**Int. Cl.: 25**

**TRADEMARK**

**PRINCIPAL REGISTER**

LEIPZIGER, LISA KATHERINA (FED REP GERMANY INDIVIDUAL)  
SCHMIDSTRABE 12  
60326 FRANKFURT AM MAIN  
FED REP GERMANY AND

CONDIC, MARIJANA (CROATIA INDIVIDUAL)  
SCHMIDSTRABE 12  
60326 FRANKFURT AM MAIN  
FED REP GERMANY

FOR: CLOTHING, NAMELY, MEN'S, WOMEN'S AND CHILDREN'S CLOTHING, NAMELY, SUITS, COATS, SUIT COATS, JACKETS, OVERALLS, BLOUSES, BODY SUITS, BELTS, UNDERGARMENTS, UNDERWEAR, LINGERIE, SHIRTS, T-SHIRTS, PULLOVERS, SWEATERS, SWEAT SUITS, SWEAT BANDS, SKIRTS, DRESSES, TIGHTS, SOCKS, STOCKINGS, HOSIERY, TROUSERS, SLACKS, SHORTS, PANTS, SCARVES, SHAWLS, MITTENS, GLOVES, TIES, BOW TIES, PAJAMAS, SLEEP WEAR, PINAFORES, BATHING TRUNKS, BATHING SUITS, BIKINIS, BRASSIERES, BODICES AND BRAS; FOOTWEAR; HEADGEAR, NAMELY, HATS, CAPS, HEAD BANDS, VISORS, IN CLASS 25 (U.S. CLS. 22 AND 39).

THE MARK CONSISTS OF STANDARD CHARACTERS WITHOUT CLAIM TO ANY PARTICULAR FONT, STYLE, SIZE, OR COLOR.

PRIORITY DATE OF 11-23-2010 IS CLAIMED.

OWNER OF INTERNATIONAL REGISTRATION 1087811 DATED 5-23-2011, EXPIRES 5-23-2021.

"LIKA MIMIKA" DOES NOT IDENTIFY A LIVING INDIVIDUAL.

SER. NO. 79-101,476, FILED 5-23-2011.

HAI-LY LAM, EXAMINING ATTORNEY



*David J. Kyffers*

Director of the United States Patent and Trademark Office

# United States of America

United States Patent and Trademark Office



**Reg. No. 4,123,797**

**Registered Apr. 10, 2012**

**Int. Cls.: 1 and 16**

**TRADEMARK**

**PRINCIPAL REGISTER**

TOAGOSEI CO.,LTD. (JAPAN CORPORATION)  
1-14-1, NISHI SHIMBASHI  
MINATO-KU;  
TOKYO 105-8419, JAPAN

FOR: INDUSTRIAL CHEMICALS FOR USE IN THE MANUFACTURE OF INK, PAINTS, COATINGS, ADHESIVES, PHOTSENSITIVE PLASTICS, FILMS, PAPER, OPTICAL, ELECTRIC AND ELECTRONIC PRODUCTS, TEXTILE FIBERS, FABRICS, PHARMACEUTICALS, QUASI-DRUGS, COSMETICS, TOILETRIES AND FOR WIDE VARIETY OF OTHER GOODS; ADHESIVES FOR INDUSTRIAL PURPOSES; CHEMICAL PREPARATIONS FOR USE IN PHOTOGRAPHY; UNPROCESSED SYNTHETIC RESINS AND PLASTICS, IN CLASS 1 (U.S. CLS. 1, 5, 6, 10, 26 AND 46).

FOR: ADHESIVES FOR STATIONERY OR HOUSEHOLD PURPOSES, IN CLASS 16 (U.S. CLS. 2, 5, 22, 23, 29, 37, 38 AND 50).

OWNER OF U.S. REG. NO. 1,950,593.

OWNER OF INTERNATIONAL REGISTRATION 1088849 DATED 7-7-2011, EXPIRES 7-7-2021.

THE MARK CONSISTS OF THE LETTER "G" WITH THREE CIRCLES ON A VARIEGATED SQUARE BACKGROUND.

SER. NO. 79-101,862, FILED 7-7-2011.

CARYN GLASSER, EXAMINING ATTORNEY



*David J. Kybas*

Director of the United States Patent and Trademark Office

# United States of America

United States Patent and Trademark Office



**Reg. No. 4,123,798**

**Registered Apr. 10, 2012**

**Int. Cls.: 5 and 10**

**TRADEMARK**

**PRINCIPAL REGISTER**

SIC INVENT AG (SWITZERLAND SOCIÉTÉ ANONYME (SA))  
BIRMANNSGASSE 3  
CH-4055 BASEL  
SWITZERLAND

FOR: SYNTHETIC MATERIAL FOR DENTAL FILLINGS AND MATERIALS FOR MAKING DENTAL IMPRESSIONS; ADHESIVES FOR DENTAL AND DENTISTRY USE; ALLOYS OF PRECIOUS METALS FOR DENTAL PURPOSES; COMPOSITE MATERIALS FOR DENTAL AND DENTAL TECHNICAL PURPOSES; MATERIAL FOR REPAIRING TEETH AND FOR DENTAL CROWNS AND BRIDGES; BIOLOGICAL BONE TISSUE INTENDED FOR SUBSEQUENT IMPLANTATION; DENTAL IMPRESSION MATERIALS; MATERIALS FOR ARTIFICIAL TEETH, IN CLASS 5 (U.S. CLS. 6, 18, 44, 46, 51 AND 52).

FOR: SURGICAL, MEDICAL AND DENTAL APPARATUS AND INSTRUMENTS, NAMELY, ARTIFICIAL LIMBS, ARTIFICIAL EYES AND TEETH; DENTAL AND MEDICAL DRILL BITS FOR CUTTING TEETH OR BONE; DENTAL IMPLANTS; DENTAL INSTRUMENTS FOR USE IN DENTAL IMPLANT SURGERY; ORTHODONTIC MACHINES AND INSTRUMENTS FOR DENTAL PURPOSES; ORTHOPEDIC DEVICES FOR DIAGNOSTIC AND THERAPEUTIC USE, IN CLASS 10 (U.S. CLS. 26, 39 AND 44).

THE MARK CONSISTS OF THE ACRONYM "SIC" IN STYLIZED LETTERS INSIDE AN INCOMPLETE CIRCLE DESIGN.

OWNER OF INTERNATIONAL REGISTRATION 1088934 DATED 5-31-2011, EXPIRES 5-31-2021.

SER. NO. 79-101,897, FILED 5-31-2011.

PATRICIA EVANKO, EXAMINING ATTORNEY



*David J. Kybas*

Director of the United States Patent and Trademark Office

# United States of America

United States Patent and Trademark Office

# TIRECOMM

**Reg. No. 4,123,799**

**Registered Apr. 10, 2012**

**Int. Cls.: 7, 9, 12, 16, 35  
and 42**

**TRADEMARK**

**SERVICE MARK**

**PRINCIPAL REGISTER**

MICHAELIDES, ROBERT (UNITED KINGDOM INDIVIDUAL)  
MAXIMILIAN-KOLBE-STR. 2  
36037 FULDA  
FED REP GERMANY

FOR: PRESSURE REDUCERS BEING PARTS OF MACHINES; PRESSURE REGULATORS AS PARTS OF MACHINES; PRESSURE VALVES BEING PARTS OF MACHINES, IN CLASS 7 (U.S. CLS. 13, 19, 21, 23, 31, 34 AND 35).

FOR: SCIENTIFIC, MEASURING, PHOTOGRAPHIC, FILM, OPTICAL, WEIGHING, MEASURING APPARATUS, SIGNALING APPARATUS, REGULATING APPARATUS, LIFE-SAVING APPARATUS AND TEACHING APPARATUS AND INSTRUMENTS, NAMELY, TIRE-PRESSURE MEASURES, ELECTRICAL AND OPTICAL CABLES, SENSORS TO CONTROL PRESSURE AND TEMPERATURE; APPARATUS AND INSTRUMENTS FOR CONDUCTING, SWITCHING, TRANSFORMING, STORING, REGULATING OR CONTROLLING OF ELECTRICITY, NAMELY, ADAPTERS, ELECTRICAL CABLES, ELECTRICAL COILS, ELECTRICAL CIRCUIT OPENERS, POWER SUPPLIES; APPARATUS FOR RECORDING, TRANSMISSION AND REPRODUCTION OF SOUND AND IMAGES; MAGNETIC DATA CARRIERS, I.E., FEATURING MANUALS, USER GUIDES AND SALES LITERATURE; OPTICAL DATA CARRIERS, I.E., FEATURING PICTURES, FILMS, MUSIC, WORDS AND PROMOTION MATERIAL; COMPUTER SOFTWARE FOR REGULATING TIRE PRESSURE AND TEMPERATURE IN THE FIELD OF AUTOMOTIVES AND INDUSTRIAL APPLICATION; DATA PROCESSING EQUIPMENT AND COMPUTERS; ELECTRONIC CONTROL SYSTEMS FOR USE IN VEHICLES AND MACHINERY; APPARATUS AND INSTRUMENTS FOR MEASUREMENT, TRANSMITTING, RECEIVING AND EVALUATING TIRE PRESSURE SIGNAL DATA, NAMELY, PRESSURES TRANSMITTERS AND RECEIVERS, PRESSURE GAUGES, AUTOMATIC INDICATORS OF LOW PRESSURE IN TIRES; PRESSURE MEASURING DEVICES, NAMELY, TIRE PRESSURE MONITORING SYSTEMS FEATURING TIRE PRESSURE GAUGES, PRESSURE SENSORS, AND PRESSURE RECORDERS; TELEMETRIC SIGNAL TRANSMISSION APPARATUS, ELECTRONIC DEVICES FOR SENDING AND/OR RECEIVING OF SIGNALS OF TIRE PRESSURE MONITORING SYSTEMS; ELECTRONIC CONTROL APPARATUS FOR TIRE PRESSURE MONITORING SYSTEMS; ELECTRIC AND ELECTRONIC APPARATUS FOR SIGNAL PRODUCTION AND TELEMETRIC TRANSMISSION OF SIGNAL DATA, NAMELY, DIGITAL SIGNAL PROCESSORS, CABLES FOR OPTICAL SIGNAL TRANSMISSION; AERIALS; SIGNAL RECEIVERS, NAMELY, RADIO RECEIVERS AND RECEIVERS OF ELECTRICAL SIGNALS; SIGNAL CONTROL APPARATUS, NAMELY, MONITOR SIGNAL AMPLIFIER; DISPLAYS, NAMELY, LIQUID CRYSTAL DISPLAYS,



*David J. Kyros*

Director of the United States Patent and Trademark Office

**Reg. No. 4,123,799** ELECTROPHORETIC DISPLAYS; ALARMS, NAMELY, ACOUSTIC SOUND ALARMS, ANTI-THEFT AUTOMOTIVE ALARMS, VISUAL ALARMS; TIRE PRESSURE CONTROL EQUIPMENT FOR PNEUMATIC TIRES FOR VEHICLES, INCLUDING CARS, TRUCKS, BUSES AND OTHER COMMERCIAL VEHICLES, AND THOSE WITH TWIN OR MULTIPLE TIRE EQUIPMENT, NAMELY, ELECTRONIC TIRE PRESSURE MONITORS AND AUTOMATIC TIRE PRESSURE CONTROL INSTRUMENTS; WIRELESS SIGNAL TRANSMITTERS AND RECEIVERS FOR TIRE PRESSURE CONTROL EQUIPMENT FOR PNEUMATIC TIRES FOR VEHICLES, INCLUDING CARS, TRUCKS, BUSES AND OTHER COMMERCIAL VEHICLES, AND THOSE WITH TWIN OR MULTIPLE TIRE EQUIPMENT; FIXED VEHICLE CONTROL UNIT AND PORTABLE CONTROL UNIT WITHIN A WHEEL MODULE OR WHEEL ELECTRONICS FOR MONITORING TIRES WITH PRESSURE-CONTROL EQUIPMENT FOR PNEUMATIC TIRES FOR VEHICLES, INCLUDING CARS, TRUCKS, BUSES AND OTHER COMMERCIAL VEHICLES, AND THOSE WITH TWIN OR MULTIPLE TIRE EQUIPMENT, NAMELY, PRESSURE INDICATORS, PRESSURE SENSORS, PRESSURE RECORDERS, AND PRESSURE TRANSMITTERS; ELECTRICAL AND ELECTRONIC EQUIPMENT FOR THE ELECTRONIC SIGNAL GENERATION AND TRANSMISSION OF TELEMETRIC DATA SIGNAL, NAMELY, WHEEL MODULES AND WHEEL ELECTRONICS IN THE NATURE OF AUTOMATIC INDICATORS OF LOW PRESSURE AND CHANGES IN TEMPERATURE AND PRESSURE INDICATING PLUGS FOR VALVES; ANTENNAS FOR RECEPTION OF SUCH SIGNAL DATA; RECEIVERS FOR RECEIVING WIRELESS AND RADIO DATA; CONTROL UNITS FOR EVALUATION OF SUCH SIGNAL DATA, NAMELY, COMPUTER HARDWARE AND SOFTWARE FOR EVALUATING TIRE PRESSURE DATA; COMBINED DEVICES TO RECEIVE AND EVALUATE SUCH SIGNAL DATA COMPRISED OF ANTENNAS, COMPUTER HARDWARE, AND WIRELESS TRANSMITTERS; VIDEO DISPLAY DEVICES FOR DISPLAYING TIRE PRESSURE INFORMATION; WARNING AND ALARM SYSTEMS COMPRISED OF VISUAL AND ACOUSTIC SOUND ALARMS; ALL THE ABOVE COMPONENTS AS CONSTITUENTS OF TIRE PRESSURE CONTROL DEVICES FOR PNEUMATIC TIRES OF VEHICLES, INCLUDING CARS, TRUCKS, BUSES AND OTHER COMMERCIAL VEHICLES, AND THOSE WITH TWIN OR MULTIPLE TIRE EQUIPMENT; SENSORS, NAMELY, ELECTRIC SENSORS, PRESSURE SENSORS; TRANSDUCERS, NAMELY, ELECTRICAL TRANSDUCERS; DRY CABINETS SPECIALLY ADAPTED TO PROTECT AND KEEP DRY PRINTED CIRCUIT BOARDS, IN CLASS 9 (U.S. CLS. 21, 23, 26, 36 AND 38).

FOR: VALVES FOR VEHICLES TIRES; VALVES FOR VEHICLE TIRES WITH INTEGRATED TIRE PRESSURE MONITORING SYSTEM; VALVES FOR VEHICLE TIRES WITH ADD-ON TIRE PRESSURE MONITORING SYSTEM, IN CLASS 12 (U.S. CLS. 19, 21, 23, 31, 35 AND 44).

FOR: PACKAGING MATERIAL MADE OF CARDBOARD, PAPER, RECLAIMED CELLULOSE AND STARCHES IN THE NATURE OF A PAPER SUBSTITUTE; PAPER; PRINTED PUBLICATIONS, NAMELY, MAGAZINES, FLYERS, BROCHURES, CATALOGS, MANUALS OF OPERATION, USER GUIDES, WORKBOOKS AND SPECIFICATION DOCUMENTS IN THE FIELD OF AUTOMOTIVES; PAMPHLETS IN THE FIELD OF AUTOMOTIVES; BOOKS IN THE FIELD OF AUTOMOTIVES; PRINTED TEACHING MATERIAL EXCEPT APPARATUS PAMPHLETS IN THE FIELD OF AUTOMOTIVES; FOILS, NAMELY, PLASTIC FOILS, IN CLASS 16 (U.S. CLS. 2, 5, 22, 23, 29, 37, 38 AND 50).

FOR: ONLINE, WHOLESALE, AND RETAIL STORE SERVICES FEATURING PRESSURE REDUCERS BEING PARTS OF MACHINES, PRESSURE REGULATORS AS PARTS OF MACHINES, PRESSURE VALVES BEING PARTS OF MACHINES, SCIENTIFIC, MEASURING, PHOTOGRAPHIC, FILM, OPTICAL, WEIGHING, MEASURING APPARATUS, SIGNALING APPARATUS, REGULATING APPARATUS, LIFE-SAVING APPARATUS AND TEACHING APPARATUS AND INSTRUMENTS, APPARATUS AND INSTRUMENTS FOR CONDUCTING, SWITCHING, TRANSFORMING, STORING, REGULATING OR CONTROLLING OF ELECTRICITY, APPARATUS FOR RECORDING, TRANSMISSION AND REPRODUCTION OF SOUND AND IMAGES, MAGNETIC DATA CARRIERS, OPTICAL DATA CARRIERS, COMPUTER SOFTWARE, DATA PROCESSING EQUIPMENT AND COMPUTER, ELECTRON-

**Reg. No. 4,123,799** IC CONTROL SYSTEMS FOR USE IN VEHICLES AND MACHINERY, APPARATUS AND INSTRUMENTS FOR MEASUREMENT, TRANSMITTING, RECEIVING AND/OR EVALUATING TIRE PRESSURE SIGNAL DATA, PRESSURE MEASURING DEVICES, INCLUDING TIRE PRESSURE MONITORING SYSTEMS, TELEMETRIC SIGNAL TRANSMISSION APPARATUS, ELECTRONIC DEVICES FOR SENDING AND/OR RECEIVING OF SIGNALS OF TIRE PRESSURE MONITORING SYSTEMS, ELECTRONIC CONTROL APPARATUS FOR TIRE PRESSURE MONITORING SYSTEMS, ELECTRIC AND ELECTRONIC APPARATUS FOR SIGNAL PRODUCTION AND TELEMETRIC TRANSMISSION OF SIGNAL DATA, AERIALS, SIGNAL RECEIVERS, SIGNAL CONTROL APPARATUS, DISPLAYS, ALARMS, TIRE PRESSURE CONTROL EQUIPMENT FOR PNEUMATIC TIRES OF VEHICLES, INCLUDING CARS, TRUCKS, BUSES AND OTHER COMMERCIAL VEHICLES, ALSO WITH TWIN OR MULTIPLE TIRE EQUIPMENT, WITH WIRELESS SIGNAL TRANSMISSION OPERATING TIRE PRESSURE CONTROL EQUIPMENT FOR PNEUMATIC TIRES FOR VEHICLES, INCLUDING CARS, TRUCKS, BUSES AND OTHER COMMERCIAL VEHICLES, ALSO WITH TWIN OR MULTIPLE TIRE EQUIPMENT, VEHICLE FIXED CONTROL UNIT OR PORTABLE CONTROL UNIT WITHIN A WHEEL MODULE OR WHEEL ELECTRONICS FOR MONITORING TIRES WITH PRESSURE-CONTROL EQUIPMENT FOR PNEUMATIC TIRES FOR VEHICLES, INCLUDING CARS, TRUCKS, BUSES AND OTHER COMMERCIAL VEHICLES, ALSO WITH TWIN OR MULTIPLE TIRE EQUIPMENT, ELECTRICAL AND ELECTRONIC EQUIPMENT FOR THE ELECTRONIC SIGNAL GENERATION AND TRANSMISSION OF TELEMETRIC DATA SIGNAL, NAMELY, TIRE VALVES, WHEEL MODULE WITH ATTACHED OR MOUNTED WHEEL ELECTRONICS, WHEEL MODULES, WHEEL ELECTRONICS, WHEEL MODULES AND WHEEL ELECTRONICS, ANTENNAS FOR RECEPTION OF SUCH SIGNAL DATA, RECEIVERS TO RECEIVE SUCH SIGNAL DATA, CONTROL UNITS FOR EVALUATION OF SUCH SIGNAL DATA, COMBINED DEVICES TO RECEIVE AND EVALUATE SUCH SIGNAL DATA, DISPLAY DEVICES FOR DISPLAYING TIRE PRESSURE INFORMATION, WARNING AND/OR ALARM SYSTEMS, ALL THE ABOVE COMPONENTS AS CONSTITUENTS OF TIRE PRESSURE CONTROL DEVICES FOR PNEUMATIC TIRES OF VEHICLES, INCLUDING CARS, TRUCKS, BUSES AND OTHER COMMERCIAL VEHICLES, ALSO WITH TWIN OR MULTIPLE TIRE EQUIPMENT, SENSORS AND TRANSDUCERS, CABINETS AND RACKS TO MOUNT OR KEEP ELECTRONIC COMPONENTS, ASSEMBLIES AND PRINTED CIRCUIT BOARDS DRY IN THE NATURE OF DRY CABINETS, VALVES FOR VEHICLE TIRES, VALVES FOR TIRES WITH INTEGRATED AND/OR ADD-ON TIRE PRESSURE MONITORING SYSTEM, PACKAGING MATERIAL MADE OF CARDBOARD, PAPER, RECLAIMED CELLULOSE AND/OR STARCHES, PAPERS, PRINTED PUBLICATION, PAMPHLETS, BOOKS, PRINTED MATTER, TEACHING MATERIAL EXCEPT APPARATUS, FOILS, IN CLASS 35 (U.S. CLS. 100, 101 AND 102).

FOR: DESIGN AND DEVELOPMENT OF ELECTRIC AND ELECTRONIC CIRCUITS, ELECTRONIC EQUIPMENT, COMPUTER HARDWARE AND COMPUTER SOFTWARE, IN CLASS 42 (U.S. CLS. 100 AND 101).

THE MARK CONSISTS OF STANDARD CHARACTERS WITHOUT CLAIM TO ANY PARTICULAR FONT, STYLE, SIZE, OR COLOR.

OWNER OF INTERNATIONAL REGISTRATION 1089300 DATED 1-18-2011, EXPIRES 1-18-2021.

SER. NO. 79-102,034, FILED 1-18-2011.

MARK SHINER, EXAMINING ATTORNEY

# United States of America

United States Patent and Trademark Office

# AURÉATE

**Reg. No. 4,123,800**

**Registered Apr. 10, 2012**

**Int. Cls.: 3, 29 and 30**

**TRADEMARK**

**PRINCIPAL REGISTER**

XINJIANG HOTAN SUN DESERT ROSE CO., LTD. (CHINA CORPORATION)  
NO. 9 TIANMUSHAN ROAD  
ZHEJIANG INDUSTRIAL ZONE; HOTAN CITY XINJIANG  
CHINA

FOR: CAKES OF TOILET SOAP; CLEANSING MILK, NAMELY, FACIAL WASHING MILK; HAIR LOTIONS; BATH LOTION; BATH SALTS, NOT FOR MEDICAL PURPOSES; ESSENTIAL OILS; BASES FOR FLOWER PERFUMES, NAMELY, PERFUME OILS FOR THE MANUFACTURE OF COSMETIC PREPARATIONS; ROSE OIL FOR COSMETIC PURPOSES; COSMETICS; PERFUMES; OILS FOR COSMETIC PURPOSES; BREATH FRESHENING SPRAYS; POTPOURRIS; COSMETICS FOR ANIMALS, IN CLASS 3 (U.S. CLS. 1, 4, 6, 50, 51 AND 52).

FOR: PROCESSED EDIBLE DRIED FLOWERS; CRYSTALLIZED FRUITS; JAMS; POLLEN PREPARED AS FOODSTUFF; MILK PRODUCTS EXCLUDING ICE CREAM, ICE MILK AND FROZEN YOGURT; EDIBLE FATS; PROCESSED NUTS; CANNED FRUITS; PACKAGED MEALS CONSISTING PRIMARILY OF FISH; JELLIES FOR FOOD, IN CLASS 29 (U.S. CL. 46).

FOR: COFFEE; TEA; SUGAR; HONEY; CONDIMENTS, NAMELY, MUSTARD, KETCHUP, PEPPER SAUCE; AROMATIC PREPARATIONS FOR FOOD, NAMELY, SPICES AND DRIED HERBS; SOYA SAUCE; ICE CREAM, IN CLASS 30 (U.S. CL. 46).

THE MARK CONSISTS OF THE STYLIZED WORDING "AUREATE".

PRIORITY DATE OF 12-14-2010 IS CLAIMED.

OWNER OF INTERNATIONAL REGISTRATION 1089375 DATED 3-31-2011, EXPIRES 3-31-2021.

SER. NO. 79-102,053, FILED 3-31-2011.

PAUL MORENO, EXAMINING ATTORNEY

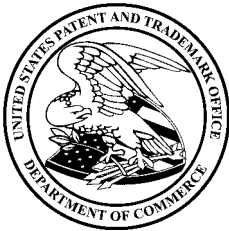

*David J. Kyffers*

Director of the United States Patent and Trademark Office

# United States of America

United States Patent and Trademark Office

# FUSAPEX

**Reg. No. 4,123,801**

**Registered Apr. 10, 2012**

**Int. Cls.: 17 and 19**

**TRADEMARK**

**PRINCIPAL REGISTER**

REHAU AG + CO. (FED REP GERMANY LIMITED PARTNERSHIP)  
RHENIUMHAUS  
REHAU, FED REP GERMANY 95111

FOR: NON-METAL FITTINGS FOR FLEXIBLE PIPES, NAMELY, PIPE SOCKETS AND PIPE CONNECTORS NOT OF METAL FOR USE IN HEATING, REFRIGERATION AND VENTILATION INSTALLATIONS, HEATING ENGINEERING, DOMESTIC AND PLUMBING ENGINEERING, PROCESS ENGINEERING, THE CHEMICAL AND PETROCHEMICAL INDUSTRIES, THE STEEL, METALLURGICAL AND GLASS INDUSTRIES, THE MINING INDUSTRIES, THE POWER STATION INDUSTRY, CONVENTIONAL POWER STATIONS AND NUCLEAR POWER STATIONS, THE FOOD PROCESSING INDUSTRY, PRIME MOVERS AND PROCESSING MACHINES, LAND VEHICLES AND FOR USE IN SHIPS AS COVERED BY THIS CLASS; NON-METAL WELDING COLLARS; NON-METAL FLANGES; NON-METAL FLEXIBLE PIPES, NON-METAL FLEXIBLE PIPELINES AND NON-METAL MOLDABLE JOINTING COMPONENTS FOR USE IN HEATING, REFRIGERATION AND VENTILATION INSTALLATIONS, HEATING ENGINEERING, DOMESTIC AND PLUMBING ENGINEERING, IN PARTICULAR FOR GAS, AIR, VAPOUR AND LIQUIDS, PROCESS ENGINEERING, THE CHEMICAL AND PETROCHEMICAL INDUSTRIES, THE STEEL, METALLURGICAL AND GLASS INDUSTRIES, THE MINING INDUSTRIES, THE POWER STATION INDUSTRY, CONVENTIONAL POWER STATIONS AND NUCLEAR POWER STATIONS, THE FOOD PROCESSING INDUSTRY, FOR PRIME MOVERS AND PROCESSING MACHINES, FOR LAND VEHICLES AND FOR USE IN SHIPS AS COVERED BY THIS CLASS, IN CLASS 17 (U.S. CLS. 1, 5, 12, 13, 35 AND 50).



FOR: NON-METAL RIGID DRAIN PIPES; RIGID BRANCH PIPES, NOT OF METAL; NON-METAL RIGID PRESSURE PIPES FOR USE AS COMPONENTS; RIGID PIPES FOR CONSTRUCTION WORK, NOT OF METAL; BUILDING MATERIALS ENTIRELY OR PREDOMINANTLY MADE OF NON-METALLIC MATERIALS, NAMELY, FITTINGS AND MOULDINGS, IN PARTICULAR CONNECTION, TRANSITION, REDUCTION AND CLOSURE PIECES FOR PIPES; PARTS OF ALL THE AFOREMENTIONED GOODS, NAMELY, NON-METAL PIPE FITTINGS, IN CLASS 19 (U.S. CLS. 1, 12, 33 AND 50).

THE MARK CONSISTS OF STANDARD CHARACTERS WITHOUT CLAIM TO ANY PARTICULAR FONT, STYLE, SIZE, OR COLOR.

OWNER OF INTERNATIONAL REGISTRATION 0846537 DATED 7-15-2004, EXPIRES 7-15-2014.

*David J. Kyffers*

Director of the United States Patent and Trademark Office



**Reg. No. 4,123,801** SER. NO. 79-102,192, FILED 6-30-2011.

KRISTIN CARLSON, EXAMINING ATTORNEY

# United States of America

United States Patent and Trademark Office

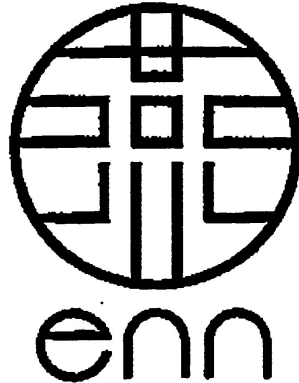

**Reg. No. 4,123,802**

**Registered Apr. 10, 2012**

**Int. Cls.: 8 and 21**

TSUBAME CHAMBER OF COMMERCE AND INDUSTRY (JAPAN CHAMBER OF  
COMMERCE AND INDUSTRY)  
6856, HIGASHIOHTA  
TSUBAME-SHI  
NIIGATA 959-1200, JAPAN

**TRADEMARK**

FOR: TABLE KNIVES; SPOONS; FORKS, IN CLASS 8 (U.S. CLS. 23, 28 AND 44).

**PRINCIPAL REGISTER**

FOR: JAPANESE STYLE TEA-SERVING POTS (KYUSU); DRINKING CUPS, NOT OF PRE-  
CIOUS METAL; SAKE CUPS, NOT OF PRECIOUS METAL; DISHES AND PLATES, NOT OF  
PRECIOUS METAL; SAKE SERVING BOTTLES (TOKKURI); TEA CANISTERS; BREAD  
BOXES; ICE PAILS, NAMELY, WINE COOLERS, IN CLASS 21 (U.S. CLS. 2, 13, 23, 29, 30,  
33, 40 AND 50).

THE MARK CONSISTS OF A CIRCULAR SEAL CONTAINING LINES, SQUARES, ANGLES  
AND RECTANGLES, OVER THE WORDING "ENN".

OWNER OF INTERNATIONAL REGISTRATION 1090153 DATED 6-8-2011, EXPIRES 6-8-  
2021.

SER. NO. 79-102,345, FILED 6-8-2011.

FRED CARL, EXAMINING ATTORNEY



*David J. Kyfos*

Director of the United States Patent and Trademark Office

United States of America  
United States Patent and Trademark Office

LOKAWAY

**Reg. No. 4,123,803**

**Registered Apr. 10, 2012**

**Int. Cls.: 6 and 35**

**TRADEMARK**

**SERVICE MARK**

**PRINCIPAL REGISTER**

LOKAWAY PTY LTD (AUSTRALIA COMPANY)  
FACTORY 24C  
PRINCESS HIGHWAY; DOVETON VIC 3177  
AUSTRALIA

FOR: METAL SECURITY SAFES, METAL GUN SAFES, METAL TOOL BOXES, METAL SITE BOXES, METAL SECURITY DOORS, SECURITY CONTAINERS OF METAL FOR TRANSPORT AND PARTS AND FITTINGS FOR THE SAME, IN CLASS 6 (U.S. CLS. 2, 12, 13, 14, 23, 25 AND 50).

FOR: RETAILING AND WHOLESALING SECURITY PRODUCTS INCLUDING SAFES, CABINETS AND DOORS, IN CLASS 35 (U.S. CLS. 100, 101 AND 102).

THE MARK CONSISTS OF STANDARD CHARACTERS WITHOUT CLAIM TO ANY PARTICULAR FONT, STYLE, SIZE, OR COLOR.

OWNER OF INTERNATIONAL REGISTRATION 1090993 DATED 5-25-2011, EXPIRES 5-25-2021.

SER. NO. 79-102,672, FILED 5-25-2011.

JESSICA A. POWERS, EXAMINING ATTORNEY



*David J. Kybas*

Director of the United States Patent and Trademark Office

# United States of America

United States Patent and Trademark Office



**Reg. No. 4,123,804**

**Registered Apr. 10, 2012**

**Int. Cl.: 33**

**TRADEMARK**

**PRINCIPAL REGISTER**

LODESTAR ANSTALT (A LIECHTENSTEIN COMPANY) (LIECHTENSTEIN ANSTALT)  
LOVA-CENTER  
PO BOX 1150; FL-9490 VADUZ  
LIECHTENSTEIN

FOR: ALCOHOLIC BEVERAGES EXCEPT BEERS; ALCOHOLIC WINES; SPIRITS AND LIQUEURS; ALCOPOPS; RUM; RUM BASED BEVERAGES; PREPARED ALCOHOLIC COCKTAILS , IN CLASS 33 (U.S. CLS. 47 AND 49).

THE MARK CONSISTS OF A STYLIZED DEPICTION OF A BEJEWELED HUMAN SKULL.

PRIORITY DATE OF 10-11-2010 IS CLAIMED.

OWNER OF INTERNATIONAL REGISTRATION 1091067 DATED 4-11-2011, EXPIRES 4-11-2021.

SER. NO. 79-102,693, FILED 4-11-2011.

KRISTIN CARLSON, EXAMINING ATTORNEY



*David J. Kybas*

Director of the United States Patent and Trademark Office

# United States of America

United States Patent and Trademark Office



**Reg. No. 4,123,805**

**Registered Apr. 10, 2012**

**Int. Cls.: 24, 26 and 40**

**TRADEMARK**

**SERVICE MARK**

**PRINCIPAL REGISTER**

VETEX, NAAMLOZE VENNOOTSCHAP (BELGIUM JOINT STOCK COMPANY)  
LEON BEKAERTSTRAAT 14  
B-8770 INGELMUNSTER  
BELGIUM

FOR: FABRICS AND TEXTILE GOODS, NAMELY, NON-WOVEN TEXTILE FABRICS, TEXTILE COASTERS IN THE NATURE OF TABLE LINEN, TOWELS, BED SHEETS, COTTON FABRIC; WATERPROOF FABRIC FOR MANUFACTURING CLOTHING, FURNITURE AND AUTOMOBILE UPHOLSTERY, AND LUGGAGE; LAMINATED FABRICS TO BE AFFIXED TO THE SURFACE OF FURNITURE; FABRICS IMPREGNATED WITH THERMOPLASTIC COATINGS FOR USE IN MANUFACTURING IN A WIDE VARIETY OF INDUSTRIES, IN CLASS 24 (U.S. CLS. 42 AND 50).

FOR: BANDS AND STRIPS, NAMELY, BANDS FOR SOLDERING THE SEAMS OF TEXTILE GOODS, NAMELY, SEAM SEALING TAPE FOR SEWING PURPOSES; ACCESSORIES FOR TEXTILE GOODS AND CLOTHING, NAMELY, BUTTONS, HOOKS AND EYELETS, ZIPPERS, CLOTHING FASTENERS IN THE NATURE OF SNAP BUTTONS, SNAP HOOKS, SLIDE FASTENERS AND SELF-GRIPPING MATERIALS IN THE NATURE OF HOOK AND PILE FASTENING TAPES, ELASTIC TAPE, IN CLASS 26 (U.S. CLS. 37, 39, 40, 42 AND 50).

FOR: TREATMENT OF TEXTILE MATERIAL, NAMELY, FINISHING, COATING AND LAMINATING OF TEXTILE MATERIAL, IN CLASS 40 (U.S. CLS. 100, 103 AND 106).

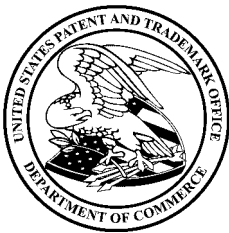

THE MARK CONSISTS OF A CIRCLE BORDERED IN LIGHT GREEN, GRAY AND SILVER. THE CIRCLE HAS A DARK GREEN INTERIOR THAT LIGHTENS TO LIGHT GREEN MOVING FROM BOTTOM LEFT TO TOP RIGHT AND BORDERED IN WHITE. THERE IS A WHITE CHECK MARK AND SMALL WHITE CIRCLE INSIDE THE LARGER CIRCLE WITH 3 HORIZONTAL WAVY WHITE LINES. THE ENTIRE CIRCLE DESIGN IS SHADOWED ON THE BOTTOM IN BLUE-GREEN. THE TERM "VETEX" IS BELOW THE CIRCLE DESIGN IN BLACK STYLIZED LETTERS.

PRIORITY DATE OF 4-14-2011 IS CLAIMED.

*David J. Kyjars*

OWNER OF INTERNATIONAL REGISTRATION 1091400 DATED 8-18-2011, EXPIRES 8-18-2021.

**Reg. No. 4,123,805** THE COLOR(S) DARK GREEN, LIGHT GREEN, BLACK, WHITE, GRAY, SILVER AND BLUE-GREEN IS/ARE CLAIMED AS A FEATURE OF THE MARK.

SER. NO. 79-102,801, FILED 8-18-2011.

MICHAEL KEATING, EXAMINING ATTORNEY

United States of America  
United States Patent and Trademark Office

# ARTRODAR

**Reg. No. 4,123,806**

LABORATOIRE MEDIDOM SA (SWITZERLAND SOCIÉTÉ ANONYME)  
ENETRIEDERSTRASSE 44

**Registered Apr. 10, 2012**

SARNEN, SWITZERLAND CH6060

**Int. Cl.: 5**

FOR: PHARMACEUTICAL PRODUCTS, NAMELY, DRUGS FOR USE IN THE TREATMENT OF DEGENERATIVE JOINT DISEASES, ANTI-INFLAMMATORIES FOR USE AGAINST ARTHROSIS, OSTEOARTHRITIS, OR DISEASES OF THE JOINTS, ANALGESICS FOR USE AGAINST ARTHRITIS OR DISEASES OF THE JOINTS, IN CLASS 5 (U.S. CLS. 6, 18, 44, 46, 51 AND 52).

**TRADEMARK**

**PRINCIPAL REGISTER**

THE MARK CONSISTS OF STANDARD CHARACTERS WITHOUT CLAIM TO ANY PARTICULAR FONT, STYLE, SIZE, OR COLOR.

OWNER OF INTERNATIONAL REGISTRATION 0638443 DATED 6-22-1995, EXPIRES 6-22-2015.

OWNER OF U.S. REG. NO. 3,014,468.

SER. NO. 79-102,842, FILED 3-31-2011.

JAY BESCH, EXAMINING ATTORNEY



*David J. Kyffers*

Director of the United States Patent and Trademark Office

# United States of America

United States Patent and Trademark Office



**Reg. No. 4,123,807**

**Registered Apr. 10, 2012**

**Int. Cl.: 9**

**TRADEMARK**

**PRINCIPAL REGISTER**

PARK, HYUNG JIN (REPUBLIC OF KOREA INDIVIDUAL)  
1-305 DONGSUNG VILLA  
138-1 GUGI-DONG,; JONGNO-GU; SEOUL  
REPUBLIC OF KOREA

FOR: DUSTPROOF GLASSES; ANTI-GLARE GLASSES; EYESHADES; EYEGLASSES; SUNGLASSES; SWIMMING GOGGLES; GOGGLES FOR SPORTS; SPECTACLE GLASSES; EYEGLASS CHAINS; EYEGLASS CASES; EYEGLASS FRAMES; PINCE-NEZ; PINCE-NEZ CORDS; PINCE-NEZ CASES; PINCE-NEZ MOUNTINGS; CONTACT LENSES, IN CLASS 9 (U.S. CLS. 21, 23, 26, 36 AND 38).

THE MARK CONSISTS OF THE TERM "ALO" IN STYLIZED BLUE FONT.

OWNER OF INTERNATIONAL REGISTRATION 1091637 DATED 6-7-2011, EXPIRES 6-7-2021.

THE COLOR(S) BLUE IS/ARE CLAIMED AS A FEATURE OF THE MARK.

THE WORDING "ALO" HAS NO MEANING IN A FOREIGN LANGUAGE.

SER. NO. 79-102,913, FILED 6-7-2011.

KAREN SEVERSON, EXAMINING ATTORNEY



*David J. Kybas*

Director of the United States Patent and Trademark Office



# United States of America

United States Patent and Trademark Office

## BMW Flex Case

**Reg. No. 4,123,808**

**Registered Apr. 10, 2012**

**Int. Cl.: 12**

**TRADEMARK**

**PRINCIPAL REGISTER**

BAYERISCHE MOTOREN WERKE AKTIENGESELLSCHAFT (FED REP GERMANY  
AKTIENGESELLSCHAFT (JOINT STOCK COMPANY))  
PETUELRING 130  
80809 MÜNCHEN  
FED REP GERMANY

FOR: MOTORCYCLES AND THEIR PARTS, NAMELY, TRUNKS, UNDERSEAT STORAGE  
COMPARTMENTS, TANK BAGS, SADDLE BAGS, TAIL BAGS, IN CLASS 12 (U.S. CLS. 19,  
21, 23, 31, 35 AND 44).

THE MARK CONSISTS OF STANDARD CHARACTERS WITHOUT CLAIM TO ANY PAR-  
TICULAR FONT, STYLE, SIZE, OR COLOR.

PRIORITY DATE OF 3-30-2011 IS CLAIMED.

OWNER OF INTERNATIONAL REGISTRATION 1093961 DATED 7-13-2011, EXPIRES 7-13-  
2021.

OWNER OF U.S. REG. NOS. 611,710, 3,627,334 AND OTHERS.

NO CLAIM IS MADE TO THE EXCLUSIVE RIGHT TO USE "CASE", APART FROM THE  
MARK AS SHOWN.

SER. NO. 79-103,831, FILED 7-13-2011.

SUE LAWRENCE, EXAMINING ATTORNEY



*David J. Kyffers*

Director of the United States Patent and Trademark Office

# United States of America

United States Patent and Trademark Office

## STORA ENSO RETHINK.

**Reg. No. 4,123,809**

**Registered Apr. 10, 2012**

**Int. Cls.: 1, 16 and 19**

**TRADEMARK**

**PRINCIPAL REGISTER**

STORA ENSO OYJ (FINLAND PUBLIC LIMITED COMPANY)  
KANAVARANTA 1  
FI-00160 HELSINKI  
FINLAND

FOR: WOOD PULP, PAPER PULP AND FLUFF PULP, ALL FOR MANUFACTURING PURPOSES, IN CLASS 1 (U.S. CLS. 1, 5, 6, 10, 26 AND 46).

FOR: PAPER, CARDBOARD; STATIONERY; PLASTIC BAGS FOR PACKAGING, PLASTIC BUBBLE PACKS FOR PACKAGING; PAPER AND CARDBOARD FOR MULTIPLE PURPOSES; PAPER AND CARDBOARD FOR PACKAGING PURPOSES; PAPER AND CARDBOARD FOR GRAPHIC AND PRINTING PURPOSES; CORRUGATED PAPER AND CARDBOARD; PAPER CORES AND PAPER COREBOARD; PAPER FOR PRINTING BOOKS AND PRINTING PAPER, IN CLASS 16 (U.S. CLS. 2, 5, 22, 23, 29, 37, 38 AND 50).

FOR: SAWN TIMBER FOR USE IN JOINERY, FURNITURE AND CONSTRUCTION; SAWN WOOD PRODUCTS AND COMPONENTS, NAMELY, BOARDS OF WOOD, FLOOR TILES OF WOOD, AND WOODEN BEAMS FOR CONSTRUCTION; GLUE-LAMINATED WOOD FOR BUILDING AND CONSTRUCTION; PREFABRICATED CONSTRUCTION ELEMENTS FOR USE IN JOINERY, FURNITURE AND CONSTRUCTION, NAMELY, PREFABRICATED HOUSES, PREFABRICATED INNER AND OUTER NON-METAL WALL PANELS FOR BUILDINGS, PREFABRICATED INNER AND OUTER NON-METAL ROOF COVERINGS, IN CLASS 19 (U.S. CLS. 1, 12, 33 AND 50).

THE MARK CONSISTS OF STANDARD CHARACTERS WITHOUT CLAIM TO ANY PARTICULAR FONT, STYLE, SIZE, OR COLOR.

OWNER OF INTERNATIONAL REGISTRATION 1093967 DATED 5-9-2011, EXPIRES 5-9-2021.

OWNER OF U.S. REG. NOS. 2,705,718, 3,190,385 AND OTHERS.

THE WORDING "STORA ENSO" HAS NO MEANING IN A FOREIGN LANGUAGE.

SER. NO. 79-103,833, FILED 5-9-2011.

KATHERINE E. HALMEN, EXAMINING ATTORNEY

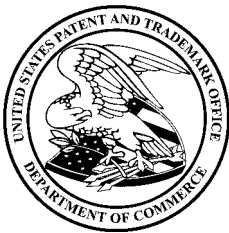

*David J. Kyffers*

Director of the United States Patent and Trademark Office

# United States of America

United States Patent and Trademark Office



**Reg. No. 4,123,810**

**Registered Apr. 10, 2012**

**Int. Cl.: 9**

**TRADEMARK**

**PRINCIPAL REGISTER**

WORLDWIDE VAPOR, INC. (NEVADA CORPORATION)  
17852 GOTHARD STREET  
HUNTINGTON BEACH, CA 92647

FOR: ELECTRICAL APPARATUS FOR TESTING A CLOSED FLUID SYSTEM OF A MOTOR VEHICLE FOR LEAKS BY MEANS OF GENERATING AND INTRODUCING TO THE SYSTEM BEING TESTED SMOKE OR A VAPOR UNDER PRESSURE SO THAT THE SYSTEM CAN BE VISUALLY INSPECTED FOR THE ESCAPE OF THE SMOKE OR VAPOR TO INDICATE THE PRESENCE AND LOCATION OF A LEAK, IN CLASS 9 (U.S. CLS. 21, 23, 26, 36 AND 38).

FIRST USE 0-0-1994; IN COMMERCE 0-0-1994.

THE MARK CONSISTS OF THE LETTERS OF THE MARK "VACUTECH" FROM INCREASING SIZE UP TO THE U AND THEN DECREASING IN SIZE WITHIN AN ELLIPTICAL SHAPE.

SER. NO. 85-004,011, FILED 4-1-2010.

REGINA DRUMMOND, EXAMINING ATTORNEY



*David J. Kyjars*

Director of the United States Patent and Trademark Office

# United States of America

United States Patent and Trademark Office

## Information Blinding

**Reg. No. 4,123,811**

MITSUBISHI ELECTRIC CORPORATION (JAPAN CORPORATION)  
7-3 MARUNOUCHI 2-CHOME  
CHIYODA-KU, TOKYO, JAPAN

**Registered Apr. 10, 2012**

**Int. Cls.: 9, 35, 38 and 42**

FOR: COMPUTER SOFTWARE FOR ENCRYPTION, RETRIEVAL AND VERIFICATION OF DATA; COMPUTERS FOR STORAGE OF ENCRYPTED DATA, IN CLASS 9 (U.S. CLS. 21, 23, 26, 36 AND 38).

**TRADEMARK**

FOR: PROVISION OR COMPILATION OF STATISTICAL DATA OR INFORMATION BASED ON ENCRYPTED DATA FILES, IN CLASS 35 (U.S. CLS. 100, 101 AND 102).

**SERVICE MARK**

**PRINCIPAL REGISTER**

FOR: ENCRYPTED DATA TRANSMISSION COMMUNICATION BY COMPUTER TERMINALS; ELECTRONIC MAIL COMMUNICATION; PROVISION OF ACCESS TO DATA OR DOCUMENTS STORED ELECTRONICALLY IN CENTRAL FILES FOR REMOTE CONSULTATION, IN CLASS 38 (U.S. CLS. 100, 101 AND 104).

FOR: DEVELOPMENT AND MAINTENANCE OF COMPUTER SOFTWARE FOR ENCRYPTION, RETRIEVAL AND VERIFICATION; ON-LINE RENTAL SERVICES OF COMPUTER SOFTWARE FOR ENCRYPTION, RETRIEVAL AND VERIFICATION; ELECTRONIC DATA ENCRYPTION; SEARCH ENGINE SERVICES VIA COMPUTER NETWORKS, IN CLASS 42 (U.S. CLS. 100 AND 101).



THE MARK CONSISTS OF STANDARD CHARACTERS WITHOUT CLAIM TO ANY PARTICULAR FONT, STYLE, SIZE, OR COLOR.

OWNER OF JAPAN REG. NO. 5366096, DATED 11-5-2010, EXPIRES 11-2-2020.

NO CLAIM IS MADE TO THE EXCLUSIVE RIGHT TO USE "INFORMATION" , APART FROM THE MARK AS SHOWN.

SER. NO. 85-004,410, FILED 4-1-2010.

EDWARD NELSON, EXAMINING ATTORNEY

*David J. Kyffers*

Director of the United States Patent and Trademark Office

# United States of America

United States Patent and Trademark Office

## NME NO MORE EXCUSES

**Reg. No. 4,123,812**

**Registered Apr. 10, 2012**

**Int. Cl.: 41**

**SERVICE MARK**

**PRINCIPAL REGISTER**

HARRIS, FRAN (UNITED STATES INDIVIDUAL)  
5600 W. LOVERS LN #116-190  
DALLAS, TX 75209

FOR: DIGITAL VIDEO, AUDIO, AND MULTIMEDIA PUBLISHING SERVICES; EDUCATIONAL SERVICES, NAMELY, PROVIDING ONLINE WORKSHOPS, SEMINARS, TRAINING AND CLASSES IN THE FIELDS OF FITNESS, EXERCISE, WELLNESS AND SPORTS; PROVIDING ASSISTANCE, PERSONAL TRAINING AND PHYSICAL FITNESS CONSULTATION TO INDIVIDUALS TO HELP THEM MAKE PHYSICAL FITNESS, STRENGTH, CONDITIONING, AND EXERCISE IMPROVEMENT IN THEIR DAILY LIVING; PROVIDING FITNESS AND EXERCISE FACILITIES, IN CLASS 41 (U.S. CLS. 100, 101 AND 107).

FIRST USE 1-1-2006; IN COMMERCE 1-29-2007.

THE MARK CONSISTS OF STANDARD CHARACTERS WITHOUT CLAIM TO ANY PARTICULAR FONT, STYLE, SIZE, OR COLOR.

SER. NO. 85-005,840, FILED 4-4-2010.

ANGELA DUONG, EXAMINING ATTORNEY



*David J. Kyjars*

Director of the United States Patent and Trademark Office

# United States of America

United States Patent and Trademark Office



# semyou

**Reg. No. 4,123,813**

**Registered Apr. 10, 2012**

**Int. Cls.: 9 and 38**

**TRADEMARK**

**SERVICE MARK**

**PRINCIPAL REGISTER**

JAHNS, VOLKER (FED REP GERMANY INDIVIDUAL)  
SCHWARZWALDSTR. 16  
NEUSTETTEN, FED REP GERMANY D-72149

FOR: COMPUTER SOFTWARE FOR PROVIDING ACCESS TO THE INTERNET; COMPUTER SOFTWARE THAT PROVIDES WEB-BASED ACCESS TO APPLICATIONS AND SERVICES THROUGH A WEB OPERATING SYSTEM OR PORTAL DEVICE; COMPUTER SOFTWARE THAT PROVIDES WEB BASED ACCESS TO APPLICATIONS AND SERVICES THROUGH A WEB OPERATING SYSTEM OR PORTAL INTERFACE; COMPUTER OPERATING SOFTWARE; COMPUTER SOFTWARE FOR USE IN CLOUD COMPUTING DATABASE MANAGEMENT, IN CLASS 9 (U.S. CLS. 21, 23, 26, 36 AND 38).

FOR: PROVIDING TELECOMMUNICATIONS CONNECTIONS TO A GLOBAL COMPUTER NETWORK; PROVIDING TELECOMMUNICATION CONNECTIONS TO THE INTERNET OR DATABASES; PROVIDING THIRD PARTY USERS WITH ACCESS TO TELECOMMUNICATION INFRASTRUCTURE; TELECOMMUNICATION ACCESS SERVICES; TELECOMMUNICATION SERVICES, NAMELY, PROVIDING INTERNET ACCESS VIA BROADBAND OPTICAL OR WIRELESS NETWORKS; TELECOMMUNICATIONS GATEWAY SERVICES; INTERNET ACCESS PROVIDER SERVICES; INTERNET SERVICE PROVIDER (ISP); COMPUTER SERVICES, NAMELY, PROVIDING ON-LINE FACILITIES FOR REAL-TIME INTERACTION WITH OTHER COMPUTER USERS CONCERNING TOPICS OF GENERAL INTEREST; RENTAL OF ACCESS TIME TO GLOBAL COMPUTER NETWORKS; PROVIDING ACCESS TO DATABASES; PROVIDING USER ACCESS TO A GLOBAL COMPUTER NETWORK, IN CLASS 38 (U.S. CLS. 100, 101 AND 104).

OWNER OF ERPN CMNTY TM OFC REG. NO. 008989964, DATED 2-13-2011, EXPIRES 3-29-2020.

THE COLOR(S) LIGHT BLUE, TEAL, DARK TEAL, DARK TEAL AND WHITE IS/ARE CLAIMED AS A FEATURE OF THE MARK.

THE MARK CONSISTS OF A SQUARE DESIGN CONSISTING OF LIGHT BLUE, TEAL, AND DARK TEAL TRIANGULAR SECTIONS WITH A WHITE LINE DISPLAYED DIAGONALLY WITHIN THE SQUARE, AND ANOTHER WHITE LINE EXTENDING FROM THE MIDDLE OF THE DIAGONAL LINE TOWARD THE LEFT CORNER OF THE SQUARE DESIGN. THE STYLIZED WORD "SEMYOU" IS DISPLAYED IN DARK TEAL TO THE RIGHT OF THE SQUARE DESIGN.



*David J. Kyffers*

Director of the United States Patent and Trademark Office

**Reg. No. 4,123,813** SER. NO. 85-007,682, FILED 4-6-2010.

JOHN GARTNER, EXAMINING ATTORNEY

# United States of America

United States Patent and Trademark Office

## LIGHT ACTION

**Reg. No. 4,123,814**

**Registered Apr. 10, 2012**

**Int. Cl.: 11**

**TRADEMARK**

**PRINCIPAL REGISTER**

GALAXIA ELECTRONICS CO., LTD. (REPUBLIC OF KOREA CORPORATION)  
SANGDAEWON-DONG, JUNGWON-GU, SEONGNAM  
#1307, TECH-CENTER, SK TECHNOPARK 190-1  
GYEONGGI-DO, REPUBLIC OF KOREA 462-705

FOR: LIGHTING APPARATUS, NAMELY, LED LIGHTING FIXTURES; FLUORESCENT LAMPS; INCANDESCENT LAMPS; STREET LAMPS; SAFETY LAMPS FOR UNDERGROUND USE; GERMICIDAL LAMPS FOR PURIFYING AIR; MINERS' LAMPS; NEON LAMPS; LANTERNS; DYNAMO LAMPS; ULTRAVIOLET RAY LAMPS, NOT FOR MEDICAL PURPOSES; GERMICIDAL LAMPS; CHANDELIERS; MINIATURE LIGHT BULBS; LIGHTING DEVICES FOR SHOWCASES; WATER SURFACE LAMPS; MERCURY LAMPS; AQUARIUM LIGHTS; SPOTLIGHTS; ACETYLENE FLARES; ARC LAMPS; SAFETY LAMPS; LAMPS FOR OUTDOOR USE; PROJECTOR LAMPS; OVERHEAD LAMPS; DIVING LIGHTS; DECORATION LAMPS; INFRARED LAMPS; ELECTRIC LAMPS; FILAMENTS FOR ELECTRIC LAMPS; ELECTRIC POCKET TORCHES FOR LIGHTING; ELECTRIC LIGHTING FIXTURES; ELECTRIC LIGHTING FIXTURES NOT FOR VEHICLES; SOCKETS FOR ELECTRIC LIGHTS; LANTERNS FOR LIGHTING; LIGHTING TUBES; FLUORESCENT LIGHTING TUBES; LIGHT DIFFUSERS; DISCHARGE LAMPS AND THEIR FITTINGS; ELECTRIC DISCHARGE TUBES FOR LIGHTING; LIGHTING APPARATUS AND INSTALLATIONS, NAMELY, LIGHTING FIXTURES; ELECTRIC TORCHES FOR LIGHTING; FISH GATHERING LAMP; CEILING LIGHTS; LAMPS WITH FAIRY DECORATIONS FOR FESTIVE PURPOSES; ELECTRIC LIGHTS FOR CHRISTMAS TREES; STANDARD LAMPS; SEARCHLIGHTS; ARTIFICIAL SOLAR POWERED LAMP; FLOODLIGHTS; FLUORESCENT LAMP TUBES; FLASHLIGHTS, IN CLASS 11 (U.S. CLS. 13, 21, 23, 31 AND 34).



THE MARK CONSISTS OF STANDARD CHARACTERS WITHOUT CLAIM TO ANY PARTICULAR FONT, STYLE, SIZE, OR COLOR.

PRIORITY CLAIMED UNDER SEC. 44(D) ON REPUBLIC OF KOREA APPLICATION NO. 40-2010-0018, FILED 4-8-2010, REG. NO. 0873668, DATED 7-21-2011, EXPIRES 7-21-2021.

NO CLAIM IS MADE TO THE EXCLUSIVE RIGHT TO USE "LIGHT", APART FROM THE MARK AS SHOWN.

SER. NO. 85-012,481, FILED 4-13-2010.

DAWN HAN, EXAMINING ATTORNEY

*David J. Kypos*

Director of the United States Patent and Trademark Office



# United States of America

United States Patent and Trademark Office



**Reg. No. 4,123,815**

**Registered Apr. 10, 2012**

**Int. Cl.: 12**

**TRADEMARK**

**PRINCIPAL REGISTER**

ILLINOIS TOOL WORKS INC. (DELAWARE CORPORATION)  
3600 WEST LAKE AVENUE  
GLENVIEW, IL 60026

FOR: REPLACEMENT DRIVE LINE COMPONENTS FOR TRUCKS, DRIVE LINE BEARINGS AND CENTER BEARINGS, UNIVERSAL JOINTS, BRAKE FOUNDATION PARTS, BRAKE OVERHAUL KITS CONSISTING PRIMARILY OF ROLLERS, ANCHOR PINS, BUSHINGS, AND SPRINGS SOLD AS A UNIT; U-JOINT BEARINGS AND CLUTCH BEARINGS, IN CLASS 12 (U.S. CLS. 19, 21, 23, 31, 35 AND 44).

FIRST USE 6-0-1997; IN COMMERCE 6-0-1997.

NO CLAIM IS MADE TO THE EXCLUSIVE RIGHT TO USE "PRODUCTS", APART FROM THE MARK AS SHOWN.

THE MARK CONSISTS OF THE WORDS "COMPETITIVE PRICED PRODUCTS" WITH A CENTS SYMBOL IN PLACE OF THE "C" IN "COMPETITIVE", WITHIN A RECTANGULAR BOX.

SEC. 2(F) AS TO "COMPETITIVE PRICED PRODUCTS" .

SER. NO. 85-014,732, FILED 4-15-2010.

BRIAN NEVILLE, EXAMINING ATTORNEY



*David J. Kyros*

Director of the United States Patent and Trademark Office

# United States of America

United States Patent and Trademark Office

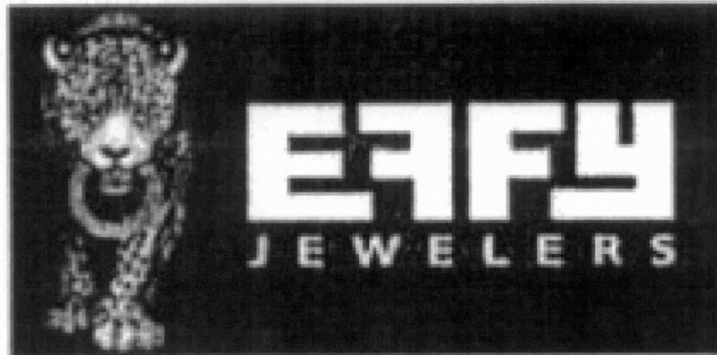

**Reg. No. 4,123,816**

**Registered Apr. 10, 2012**

**Int. Cl.: 14**

**TRADEMARK**

**PRINCIPAL REGISTER**

HEMATIAN, FATOLLAH (UNITED STATES INDIVIDUAL)  
11 LOCUST COVE LANE  
KINGS POINT, NY 11024

FOR: JEWELRY, IN CLASS 14 (U.S. CLS. 2, 27, 28 AND 50).

FIRST USE 1-1-2010; IN COMMERCE 1-1-2010.

OWNER OF U.S. REG. NOS. 3,297,438, 3,297,444, AND 3,402,216.

NO CLAIM IS MADE TO THE EXCLUSIVE RIGHT TO USE "JEWELERS", APART FROM THE MARK AS SHOWN.

THE MARK CONSISTS OF A LEOPARD WITH THE WORDS "EFFY JEWELERS" ADJACENT TO IT AND THE "F" CHARACTERS FLIPPED TO FACE OPPOSITE DIRECTIONS.

SER. NO. 85-015,070, FILED 4-15-2010.

KEVIN DINALLO, EXAMINING ATTORNEY



*David J. Kybas*

Director of the United States Patent and Trademark Office

# United States of America

United States Patent and Trademark Office

# GEVAS

**Reg. No. 4,123,817**

**Registered Apr. 10, 2012**

**Int. Cl.: 7**

**TRADEMARK**

**PRINCIPAL REGISTER**

OPTIMA PACKAGING GROUP GMBH (FED REP GERMANY GESELLSCHAFT MIT  
BESCHRÄNKTER HAFTUNG (GMBH))  
STEINBEISWEG 20  
SCHWABISCH HALL, FED REP GERMANY D-74523

FOR: PACKAGING MACHINES, ESPECIALLY FOR HYGIENIC PRODUCTS AS PAPER  
TISSUES, WET WIPES, PADS, DIAPERS, INCONTINENCE PRODUCTS, FEMININE CARE  
PRODUCTS AND THE LIKE, FILLING MACHINES, SEALING MACHINES, FILLING AND  
SEALING MACHINES, BAG FILLING MACHINES, BAG SEALING MACHINES, ALL FOR  
USE WITH FOR PHARMACEUTICAL, COSMETIC AND HEALTH CARE PRODUCTS, IN  
CLASS 7 (U.S. CLS. 13, 19, 21, 23, 31, 34 AND 35).

THE MARK CONSISTS OF STANDARD CHARACTERS WITHOUT CLAIM TO ANY PAR-  
TICULAR FONT, STYLE, SIZE, OR COLOR.

PRIORITY CLAIMED UNDER SEC. 44(D) ON ERPN CMNTY TM OFC APPLICATION NO.  
008980691, FILED 3-25-2010, REG. NO. 008980691, DATED 9-20-2010, EXPIRES 3-25-2020.

THE WORDING "GEVAS" HAS NO MEANING IN A FOREIGN LANGUAGE.

SER. NO. 85-024,232, FILED 4-27-2010.

BARBARA RUTLAND, EXAMINING ATTORNEY



*David J. Kyjars*

Director of the United States Patent and Trademark Office

# United States of America

United States Patent and Trademark Office

## PLANETCLEANDIRECT

**Reg. No. 4,123,818**

**Registered Apr. 10, 2012**

**Int. Cls.: 35, 37, 41 and 43**

**SERVICE MARK**

**PRINCIPAL REGISTER**

PLANET CLEAN INTERNATIONAL, INC. (CANADA CORPORATION)  
1607 DERWENT WAY  
DELTA, BRITISH COLUMBIA, CANADA V3M-6K8

FOR: ON-LINE RETAIL STORE SERVICES, ON-LINE RETAIL STORE SERVICES THROUGH AUTHORIZED AGENTS, FRANCHISEES, AND AUTHORIZED DEALERS, ON-LINE AUCTIONS, AND ON-LINE RETAIL STORE SERVICES VIA WEBSITE, ALL OF THE ABOVE FEATURING CLEANING, SANITATION AND JANITORIAL SUPPLIES, EQUIPMENT AND CLOTHING; ON-LINE RETAIL STORE SERVICES, ON-LINE RETAIL STORE SERVICES THROUGH AUTHORIZED AGENTS, FRANCHISEES, AND AUTHORIZED DEALERS, ON-LINE AUCTIONS, AND ON-LINE RETAIL STORE SERVICES VIA WEBSITE, ALL OF THE ABOVE FEATURING SAFETY EQUIPMENT, PROTECTIVE WEAR, PEST CONTROL SUPPLIES, VENDING MACHINES, AND FOOD SERVICE SUPPLIES; ON-LINE RETAIL STORE SERVICES, ON-LINE RETAIL STORE SERVICES THROUGH AUTHORIZED AGENTS, FRANCHISEES, AND AUTHORIZED DEALERS, ON-LINE AUCTIONS, AND ON-LINE RETAIL STORE SERVICES VIA WEBSITE, ALL OF THE ABOVE FEATURING CLEANING PRODUCTS, GARBAGE BAGS, PAPER PRODUCTS, CHEMICALS, OFFICE SUPPLIES, SNACK FOODS, BEVERAGES; FRANCHISE SERVICES, NAMELY, CONSULTING IN THE RUNNING OF ESTABLISHMENTS AS FRANCHISES AND OFFERING BUSINESS MANAGEMENT ASSISTANCE IN THE ESTABLISHMENT AND OPERATION OF CLEANING, SANITATION AND JANITORIAL SUPPLY BUSINESSES; PROMOTION OF THE SALE OF CLEANING, SANITATION AND JANITORIAL WARES AND SERVICES THROUGH THE OPERATION OF A CONSUMER LOYALTY PROGRAM, IN CLASS 35 (U.S. CLS. 100, 101 AND 102).

FOR: LEASING OF CLEANING, SANITATION AND JANITORIAL SUPPLIES, EQUIPMENT AND RELATED CLOTHING; LEASING OF PEST CONTROL SUPPLIES AND SAFETY EQUIPMENT AND PROTECTIVE WEAR FOR USE IN PEST CONTROL, IN CLASS 37 (U.S. CLS. 100, 103 AND 106).

FOR: PROVIDING ON-LINE EDUCATIONAL DEMONSTRATION TRAINING, AND EDUCATIONAL TUTORIAL SESSIONS IN THE FIELD OF TECHNIQUES AND REQUIREMENTS OF CLEANING, SANITATION AND USE OF JANITORIAL SUPPLIES AND EQUIPMENT; PROVIDING IN-PERSON AND ON-LINE TRAINING AND EDUCATIONAL TUTORIAL SESSIONS IN THE FIELD OF FRANCHISE OPERATIONS, IN CLASS 41 (U.S. CLS. 100, 101 AND 107).



*David J. Kyffers*

Director of the United States Patent and Trademark Office

**Reg. No. 4,123,818** FOR: LEASING OF FOOD SERVICE SUPPLIES, IN CLASS 43 (U.S. CLS. 100 AND 101).

THE MARK CONSISTS OF STANDARD CHARACTERS WITHOUT CLAIM TO ANY PARTICULAR FONT, STYLE, SIZE, OR COLOR.

PRIORITY CLAIMED UNDER SEC. 44(D) ON CANADA APPLICATION NO. 1478643, FILED 4-27-2010, REG. NO. TMA812,974, DATED 11-29-2011, EXPIRES 11-29-2026.

OWNER OF U.S. REG. NO. 3,539,445.

SER. NO. 85-027,586, FILED 4-30-2010.

ALICIA COLLINS, EXAMINING ATTORNEY

# United States of America

United States Patent and Trademark Office

# VDX

**Reg. No. 4,123,819**

**Registered Apr. 10, 2012**

**Int. Cls.: 42 and 44**

**SERVICE MARK**

**PRINCIPAL REGISTER**

VDX (CALIFORNIA CORPORATION)  
2019 ANDERSON RD., SUITE C  
DAVIS, CA 95616

FOR: PROVIDING MEDICAL AND SCIENTIFIC RESEARCH AND LABORATORY RESEARCH IN THE FIELD OF MEDICAL DEVICES AND PHARMACEUTICALS; MEDICAL AND SCIENTIFIC RESEARCH IN THE FIELD OF PATHOLOGY SERVICES FOR BIOMEDICAL RESEARCH AND PRECLINICAL EVALUATION OF MEDICAL DEVICES AND PHARMACEUTICALS; MEDICAL LABORATORY SERVICES, NAMELY, PATHOLOGY AND HISTOLOGY SERVICES FOR MEDICAL RESEARCH PURPOSES; VETERINARY LABORATORY RESEARCH SERVICES, IN CLASS 42 (U.S. CLS. 100 AND 101).

FIRST USE 8-6-2001; IN COMMERCE 6-28-2002.

FOR: VETERINARY SERVICES, NAMELY, VETERINARY CONSULTING, VETERINARY DIAGNOSTIC TESTING, AND VETERINARY PATHOLOGY AND HISTOLOGY SERVICES FOR THE DIAGNOSIS AND TREATMENT OF DISEASE, IN CLASS 44 (U.S. CLS. 100 AND 101).

FIRST USE 5-7-2001; IN COMMERCE 7-13-2001.

OWNER OF U.S. REG. NO. 3,008,890.

THE MARK CONSISTS OF CAPITAL LETTER "V", CAPITAL LETTER "D", LOWER CASE LETTER "X".

SER. NO. 85-032,170, FILED 5-6-2010.

KIMBERLY FRYE, EXAMINING ATTORNEY



*David J. Kypos*

Director of the United States Patent and Trademark Office

# United States of America

United States Patent and Trademark Office



# VDX



**Reg. No. 4,123,820**

**Registered Apr. 10, 2012**

**Int. Cls.: 42 and 44**

**SERVICE MARK**

**PRINCIPAL REGISTER**

VDX (CALIFORNIA CORPORATION)  
2019 ANDERSON RD., SUITE C  
DAVIS, CA 95616

FOR: PROVIDING MEDICAL AND SCIENTIFIC RESEARCH AND LABORATORY RESEARCH IN THE FIELD OF MEDICAL DEVICES AND PHARMACEUTICALS; MEDICAL AND SCIENTIFIC RESEARCH IN THE FIELD OF PATHOLOGY SERVICES FOR BIOMEDICAL RESEARCH AND PRECLINICAL EVALUATION OF MEDICAL DEVICES AND PHARMACEUTICALS; MEDICAL LABORATORY SERVICES, NAMELY, PATHOLOGY AND HISTOLOGY SERVICES FOR MEDICAL RESEARCH PURPOSES; VETERINARY LABORATORY RESEARCH SERVICES, IN CLASS 42 (U.S. CLS. 100 AND 101).

FIRST USE 8-6-2001; IN COMMERCE 6-28-2002.

FOR: VETERINARY SERVICES, NAMELY, VETERINARY CONSULTING, VETERINARY DIAGNOSTIC TESTING, AND VETERINARY PATHOLOGY AND HISTOLOGY SERVICES FOR THE DIAGNOSIS AND TREATMENT OF DISEASE, IN CLASS 44 (U.S. CLS. 100 AND 101).

FIRST USE 5-7-2001; IN COMMERCE 7-13-2001.

OWNER OF U.S. REG. NO. 3,008,890.

THE COLOR(S) BLACK, WHITE, BLUE IS/ARE CLAIMED AS A FEATURE OF THE MARK.

THE MARK CONSISTS OF A WHITE MICROSCOPE ON A BLUE SQUARE-SHAPED BACKGROUND NEXT TO A BLACK OUTLINED CAPITAL "V", A SOLID BLACK CAPITAL "D", A SOLID BLACK LOWER CASE "X", WITH A SOLID BLUE LINE UNDERNEATH THE THREE LETTERS. THE WHITE IN THE LETTER "V" REPRESENTS A TRANSPARENT AREA AND IS NOT CLAIMED AS A FEATURE OF THE MARK.

SER. NO. 85-032,193, FILED 5-6-2010.

KIMBERLY FRYE, EXAMINING ATTORNEY



*David J. Kyffers*

Director of the United States Patent and Trademark Office

# United States of America

United States Patent and Trademark Office

# cenovus

E N E R G Y

**Reg. No. 4,123,821**

CENOVUS ENERGY INC. (CANADA CORPORATION)  
4000, 421 - 7TH AVENUE S.W.  
CALGARY, AB T2P 4K9, CANADA

**Registered Apr. 10, 2012**

**Int. Cls.: 4, 7, 35, 36, 37,  
39, 40 and 42**

FOR: PETROLEUM AND FUELS, NAMELY, CRUDE OIL, NATURAL GAS, NATURAL GAS LIQUIDS, NATURAL GASOLINE, GASOLINE AND DIESEL; COAL AND FUEL OIL, IN CLASS 4 (U.S. CLS. 1, 6 AND 15).

**TRADEMARK**

FOR: ELECTRICAL POWER GENERATORS FOR COMMERCIAL, RESIDENTIAL OR INDUSTRIAL APPLICATIONS, IN CLASS 7 (U.S. CLS. 13, 19, 21, 23, 31, 34 AND 35).

**SERVICE MARK**

**PRINCIPAL REGISTER**

FOR: BUSINESS MARKETING SERVICES FOR OTHERS IN THE FIELD OF ELECTRICITY; BUSINESS MARKETING SERVICES FOR OTHERS IN THE FIELD OF PETROLEUM, NATURAL GAS AND RELATED HYDROCARBONS, IN CLASS 35 (U.S. CLS. 100, 101 AND 102).

FOR: BROKERAGE SERVICES, NAMELY, TRADING, BUYING AND RESELLING OF ELECTRICITY, PETROLEUM, NATURAL GAS AND RELATED HYDROCARBONS FOR OTHERS; BROKERAGE SERVICES IN THE FIELD OF PETROLEUM, NATURAL GAS AND RELATED HYDROCARBONS; BROKERAGE SERVICES IN THE FIELD OF ELECTRICITY, IN CLASS 36 (U.S. CLS. 100, 101 AND 102).

FOR: EXTRACTION OF PETROLEUM, NATURAL GAS AND RELATED HYDROCARBONS, IN CLASS 37 (U.S. CLS. 100, 103 AND 106).



FOR: TRANSPORTATION OF PETROLEUM, NATURAL GAS AND RELATED HYDROCARBONS VIA PIPELINE, RAIL OR TRUCK; STORAGE OF PETROLEUM, NATURAL GAS AND RELATED HYDROCARBONS; TRANSMISSION OF ELECTRICITY, IN CLASS 39 (U.S. CLS. 100 AND 105).

FOR: PRODUCTION OF PETROLEUM, NATURAL GAS AND RELATED HYDROCARBONS; GENERATION AND PRODUCTION OF ELECTRICITY; REFINING AND UPGRADING OF CRUDE OIL, IN CLASS 40 (U.S. CLS. 100, 103 AND 106).

*David J. Kyros*

FOR: EXPLORATION FOR PETROLEUM, NATURAL GAS AND RELATED HYDROCARBONS, IN CLASS 42 (U.S. CLS. 100 AND 101).

Director of the United States Patent and Trademark Office

OWNER OF CANADA REG. NO. TMA807305, DATED 9-22-2011, EXPIRES 9-22-2026.



**Reg. No. 4,123,821** THE COLOR(S) SLATE BLUE AND SIENNA IS/ARE CLAIMED AS A FEATURE OF THE MARK.

NO CLAIM IS MADE TO THE EXCLUSIVE RIGHT TO USE "ENERGY", APART FROM THE MARK AS SHOWN.

THE MARK CONSISTS OF THE STYLIZED WORDING "CENOVUS ENERGY" WITH "CENOVUS" IN THE COLOR SLATE BLUE AND "ENERGY" IN THE COLOR SIENNA.

SER. NO. 85-033,117, FILED 5-7-2010.

GENE MACIOL, EXAMINING ATTORNEY

# United States of America

United States Patent and Trademark Office

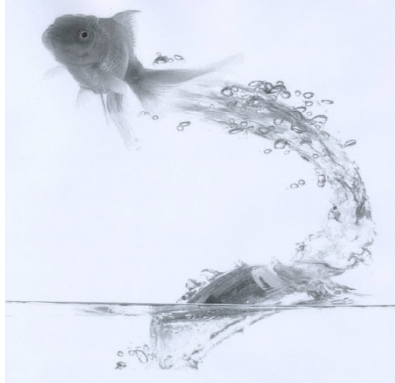

**Reg. No. 4,123,822**

**Registered Apr. 10, 2012**

**Int. Cls.: 11 and 20**

**TRADEMARK**

**PRINCIPAL REGISTER**

WET MANUFACTURING INC./MANUFACTURIER WET INC. (CANADA CORPORATION)  
276 ST-JACQUES STREET  
SUITE G-02  
MONTREAL, QUEBEC, CANADA H2Y1N3

FOR: BATHROOM AND KITCHEN FIXTURES, NAMELY, BATHTUBS, SOAKING BATHTUBS, SINKS, VESSEL SINKS, IN CLASS 11 (U.S. CLS. 13, 21, 23, 31 AND 34).

FOR: BATHROOM FURNITURE IN THE NATURE OF WOODEN FIXTURES WITH A CONSOLE BASE UPON WHICH TO REST BATHTUBS, LAVATORIES, SINKS OR VESSEL SINKS, NAMELY, VANITIES AND WASHSTAND, IN CLASS 20 (U.S. CLS. 2, 13, 22, 25, 32 AND 50).

PRIORITY CLAIMED UNDER SEC. 44(D) ON CANADA APPLICATION NO. 1458921, FILED 11-12-2009, REG. NO. TMA791767, DATED 2-28-2011, EXPIRES 2-28-2026.

THE MARK CONSISTS OF A GOLDFISH LEAPING OUT OF WATER WITH A TRAIL OF WATER DROPLETS BEHIND THE FISH.

SER. NO. 85-036,158, FILED 5-12-2010.

DOMINIC FATHY, EXAMINING ATTORNEY



*David J. Kybas*

Director of the United States Patent and Trademark Office

# United States of America

United States Patent and Trademark Office



**Reg. No. 4,123,823**

HENRY, VERNON R. (UNITED STATES INDIVIDUAL), DBA FLEXERCISE  
17515 SPRING CYPRESS #C206  
CYPRESS, TX 77429

**Registered Apr. 10, 2012**

**Int. Cls.: 16 and 35**

FOR: NEWSLETTERS IN THE FIELD OF HEALTH AND WELLNESS, IN CLASS 16 (U.S. CLS. 2, 5, 22, 23, 29, 37, 38 AND 50).

**TRADEMARK**

FIRST USE 6-21-1986; IN COMMERCE 6-21-1986.

**SERVICE MARK**

FOR: PROVIDING ASSISTANCE, FITNESS EVALUATION AND CONSULTATION TO CORPORATE CLIENTS TO HELP THEIR EMPLOYEES MAKE HEALTH, WELLNESS AND NUTRITIONAL CHANGES IN THEIR DAILY LIVING TO INCREASE PRODUCTIVITY AND LOWER HEALTH CARE COSTS, IN CLASS 35 (U.S. CLS. 100, 101 AND 102).

**PRINCIPAL REGISTER**

FIRST USE 6-21-1986; IN COMMERCE 6-21-1986.

THE MARK CONSISTS OF BLACK LETTERS THAT SPELL THE WORD "FLEXERCISE", WITH THE LETTER "X" REPLACED BY A RED DESIGN OF THE DYNAMIC MAN WITHIN TWO RED CONCENTRIC CIRCLES. THE BACKGROUND IS TRANSLUCENT.

THE COLOR(S) RED AND BLACK IS/ARE CLAIMED AS A FEATURE OF THE MARK.

SER. NO. 85-042,069, FILED 5-18-2010.

ROBERT STRUCK, EXAMINING ATTORNEY



*David J. Kybas*

Director of the United States Patent and Trademark Office

# United States of America

United States Patent and Trademark Office

# PLASTRON

**Reg. No. 4,123,824**

**Registered Apr. 10, 2012**

**Int. Cls.: 7 and 9**

**TRADEMARK**

**PRINCIPAL REGISTER**

COSMO CORPORATION (DELAWARE CORPORATION)  
30201 AURORA ROAD  
CLEVELAND, OH 44139

FOR: PLASTIC COIL BOBBINS BEING ELECTRIC MACHINE PARTS FOR USE INSIDE ELECTRIC MOTORS AND ALTERNATORS FOR MACHINES; PLASTIC ENCAPSULATION CASES BEING ENCLOSURES FOR PLASTIC COIL RIBBONS, SOLD AS AN INTEGRAL COMPONENT OF ALTERNATORS AND ELECTRIC MOTORS FOR MACHINES, IN CLASS 7 (U.S. CLS. 13, 19, 21, 23, 31, 34 AND 35).

FIRST USE 12-31-1972; IN COMMERCE 12-31-1972.

FOR: PLASTIC COIL BOBBINS BEING INTERNAL ELECTRICAL PARTS OF ELECTRICAL TRANSFORMERS, ELECTRIC RELAYS, ELECTRICAL CHOKES, LIGHTING BALLASTS, SOLENOID VALVES, ELECTRIC SWITCHES, ELECTRICAL INDUCTORS, AND ELECTRICAL CONNECTORS; PLASTIC ENCAPSULATION CASES BEING ENCLOSURES SOLD AS AN INTEGRAL COMPONENT OF PLASTIC COIL BOBBINS BEING INTERNAL PARTS OF ELECTRICAL TRANSFORMERS, ELECTRIC RELAYS, ELECTRICAL CHOKES, LIGHTING BALLASTS, SOLENOID VALVES, ELECTRIC SWITCHES, ELECTRICAL INDUCTORS, AND ELECTRICAL CONNECTORS, IN CLASS 9 (U.S. CLS. 21, 23, 26, 36 AND 38).

FIRST USE 12-31-1972; IN COMMERCE 12-31-1972.

THE MARK CONSISTS OF STANDARD CHARACTERS WITHOUT CLAIM TO ANY PARTICULAR FONT, STYLE, SIZE, OR COLOR.

SER. NO. 85-044,911, FILED 5-21-2010.

EVELYN BRADLEY, EXAMINING ATTORNEY



*David J. Kyros*

Director of the United States Patent and Trademark Office

# United States of America

United States Patent and Trademark Office

## HEALTH AFFAIRS BLOG

**Reg. No. 4,123,825**

**Registered Apr. 10, 2012**

**Int. Cl.: 41**

**SERVICE MARK**

**PRINCIPAL REGISTER**

PROJECT HOPE-THE PEOPLE-TO-PEOPLE HEALTH FOUNDATION, INC. (D.C. CORPORATION)  
255 CARTER HALL LANE  
MILLWOOD, VA 22646

FOR: ONLINE JOURNALS, NAMELY, BLOGS FEATURING HEALTHCARE AND HEALTH POLICY ISSUES, IN CLASS 41 (U.S. CLS. 100, 101 AND 107).

FIRST USE 10-5-2006; IN COMMERCE 2-9-2010.

THE MARK CONSISTS OF STANDARD CHARACTERS WITHOUT CLAIM TO ANY PARTICULAR FONT, STYLE, SIZE, OR COLOR.

OWNER OF U.S. REG. NO. 1,591,960.

NO CLAIM IS MADE TO THE EXCLUSIVE RIGHT TO USE "BLOG", APART FROM THE MARK AS SHOWN.

SEC. 2(F) AS TO "HEALTH AFFAIRS".

SER. NO. 85-046,000, FILED 5-24-2010.

ANNE E. GUSTASON, EXAMINING ATTORNEY



*David J. Kyffers*

Director of the United States Patent and Trademark Office

# United States of America

United States Patent and Trademark Office

# KULAMULA

**Reg. No. 4,123,826**

**Registered Apr. 10, 2012**

**Int. Cls.: 35 and 36**

**SERVICE MARK**

**PRINCIPAL REGISTER**

MICRONOTES, INC. (DELAWARE CORPORATION)  
14TH FLOOR  
ONE BROADWAY  
CAMBRIDGE, MA 021421100

FOR: PROMOTING THE GOODS AND SERVICES OF OTHERS BY OFFERING ONLINE BANKING CUSTOMERS OFFERS TO PURCHASE GOODS OR SERVICES FOR TAKING A SURVEY OR INTERVIEW , IN CLASS 35 (U.S. CLS. 100, 101 AND 102).

FIRST USE 11-30-2009; IN COMMERCE 11-30-2009.

FOR: PROVIDING ELECTRONIC PROCESSING OF ELECTRONIC PAYMENTS TO ONLINE BANKING CUSTOMERS FOR TAKING A SURVEY OR INTERVIEW, IN CLASS 36 (U.S. CLS. 100, 101 AND 102).

FIRST USE 11-30-2009; IN COMMERCE 11-30-2009.

THE MARK CONSISTS OF STANDARD CHARACTERS WITHOUT CLAIM TO ANY PARTICULAR FONT, STYLE, SIZE, OR COLOR.

SER. NO. 85-048,170, FILED 5-26-2010.

MARIA-VICTORIA SUAREZ, EXAMINING ATTORNEY



*David J. Kybas*

Director of the United States Patent and Trademark Office

**United States of America**  
United States Patent and Trademark Office

# EMBRACE

**Reg. No. 4,123,827**

BOND LABORATORIES, INC. (NEVADA CORPORATION)  
11011 Q STREET, SUITE 106A  
OMAHA, NE 68137

**Registered Apr. 10, 2012**

**Int. Cl.: 5**

FOR: DIETARY SUPPLEMENTS, NAMELY, WEIGHT LOSS SUPPLEMENTS IN CAPSULE FORM, IN CLASS 5 (U.S. CLS. 6, 18, 44, 46, 51 AND 52).

**TRADEMARK**

FIRST USE 2-5-2010; IN COMMERCE 2-5-2010.

**PRINCIPAL REGISTER**

THE MARK CONSISTS OF STANDARD CHARACTERS WITHOUT CLAIM TO ANY PARTICULAR FONT, STYLE, SIZE, OR COLOR.

SER. NO. 85-048,549, FILED 5-26-2010.

CYNTHIA TRIPI, EXAMINING ATTORNEY



*David J. Kybas*

Director of the United States Patent and Trademark Office

# United States of America

United States Patent and Trademark Office

## AERO UNION

**Reg. No. 4,123,828**

**Registered Apr. 10, 2012**

**Int. Cls.: 9 and 41**

**TRADEMARK**

**SERVICE MARK**

**PRINCIPAL REGISTER**

AERO UNION CORPORATION (CALIFORNIA CORPORATION)  
747 FORTRESS STREET  
CHICO, CA 95973

FOR: FIRE EXTINGUISHING APPARATUS; FIRE-EXTINGUISHING SYSTEMS, IN CLASS 9 (U.S. CLS. 21, 23, 26, 36 AND 38).

FIRST USE 6-13-1973; IN COMMERCE 6-13-1973.

FOR: AERIAL FIREFIGHTING FLIGHT INSTRUCTION; EDUCATION SERVICES, NAMELY, PROVIDING CLASSES AND WORKSHOPS IN THE FIELD OF AERIAL FIREFIGHTING FLIGHT INSTRUCTION, IN CLASS 41 (U.S. CLS. 100, 101 AND 107).

FIRST USE 12-0-2008; IN COMMERCE 12-0-2008.

THE MARK CONSISTS OF STANDARD CHARACTERS WITHOUT CLAIM TO ANY PARTICULAR FONT, STYLE, SIZE, OR COLOR.

NO CLAIM IS MADE TO THE EXCLUSIVE RIGHT TO USE "AERO", APART FROM THE MARK AS SHOWN.

SER. NO. 85-048,571, FILED 5-26-2010.

MICHELLE DUBOIS, EXAMINING ATTORNEY



*David J. Kyffers*

Director of the United States Patent and Trademark Office



# United States of America

United States Patent and Trademark Office

# MODUS

**Reg. No. 4,123,829**

**Registered Apr. 10, 2012**

**Int. Cl.: 14**

**TRADEMARK**

**PRINCIPAL REGISTER**

SANTORINOS INC. (CALIFORNIA CORPORATION), AKA SANTORINOS USA  
WWW.SANTORINOSUSA.COM  
1001 LAWSON STREET  
CITY OF INDUSTRY, CA 91748

FOR: WATCHES; COMPLICATION WATCHES; DIVING WATCHES; DRESS WATCHES;  
MECHANICAL AND AUTOMATIC WATCHES; SPORTS WATCHES; WRIST WATCHES ,  
IN CLASS 14 (U.S. CLS. 2, 27, 28 AND 50).

FIRST USE 2-0-2011; IN COMMERCE 2-0-2011.

THE MARK CONSISTS OF STANDARD CHARACTERS WITHOUT CLAIM TO ANY PAR-  
TICULAR FONT, STYLE, SIZE, OR COLOR.

SER. NO. 85-048,698, FILED 5-26-2010.

ROBERT STRUCK, EXAMINING ATTORNEY



*David J. Kyros*

Director of the United States Patent and Trademark Office

# United States of America

United States Patent and Trademark Office

## CHEERLEADING COMPANY

**Reg. No. 4,123,830**

**Registered Apr. 10, 2012**

**Int. Cls.: 25, 28 and 35**

**TRADEMARK**

**SERVICE MARK**

**PRINCIPAL REGISTER**

MOVIE SHOW VIDEO MGT., INC. (TEXAS CORPORATION), DBA CHEERLEADING COMPANY  
11350 HILLGUARD RD.  
DALLAS, TX 75243

FOR: CHEERLEADING UNIFORMS AND CLOTHING, NAMELY, SHIRTS, PANTS, SKIRTS, SOCKS, SHOES, UNDERWEAR, GLOVES, HATS, BODY SUITS, WARM-UPS AND MASCOT COSTUMES, IN CLASS 25 (U.S. CLS. 22 AND 39).

FIRST USE 0-0-2000; IN COMMERCE 0-0-2000.

FOR: CHEERLEADING POM-POMS, SPORTS BALLS; TOY NOISEMAKERS; PARTY FAVORS IN THE NATURE OF NOISEMAKERS, IN CLASS 28 (U.S. CLS. 22, 23, 38 AND 50).

FIRST USE 0-0-2000; IN COMMERCE 0-0-2000.

FOR: ON-LINE RETAIL STORE AND CATALOG ORDERING SERVICES FEATURING CHEERLEADING CLOTHING, UNIFORMS, POM-POMS AND CHEERLEADING-RELATED ITEMS, IN CLASS 35 (U.S. CLS. 100, 101 AND 102).

FIRST USE 0-0-2000; IN COMMERCE 0-0-2000.

THE MARK CONSISTS OF STANDARD CHARACTERS WITHOUT CLAIM TO ANY PARTICULAR FONT, STYLE, SIZE, OR COLOR.

NO CLAIM IS MADE TO THE EXCLUSIVE RIGHT TO USE "COMPANY", APART FROM THE MARK AS SHOWN.

SEC. 2(F).

SER. NO. 85-049,053, FILED 5-27-2010.

NATALIE POLZER, EXAMINING ATTORNEY



*David J. Kyffers*

Director of the United States Patent and Trademark Office

# United States of America

United States Patent and Trademark Office

## THE GREAT ESCAPE

**Reg. No. 4,123,831**

UNIVERSAL POOL CO., INC. (ILLINOIS CORPORATION)  
300 WEST ARMORY DRIVE  
SOUTH HOLLAND, IL 60473

**Registered Apr. 10, 2012**

**Int. Cl.: 35**

FOR: RETAIL STORE SERVICES FEATURING OUTDOOR FURNITURE, BARS, BAR STOOLS AND SPAS, IN CLASS 35 (U.S. CLS. 100, 101 AND 102).

**SERVICE MARK**

FIRST USE 10-31-2004; IN COMMERCE 10-31-2004.

**PRINCIPAL REGISTER**

THE MARK CONSISTS OF STANDARD CHARACTERS WITHOUT CLAIM TO ANY PARTICULAR FONT, STYLE, SIZE, OR COLOR.

OWNER OF U.S. REG. NO. 3,204,391.

SER. NO. 85-054,675, FILED 6-4-2010.

STEVEN PEREZ, EXAMINING ATTORNEY



*David J. Kybas*

Director of the United States Patent and Trademark Office

# United States of America

United States Patent and Trademark Office

# INSUBUY

**Reg. No. 4,123,832**

INSUBUY, INC. (TEXAS CORPORATION)  
4700 DEXTER DR, SUITE 100  
PLANO, TX 75093

**Registered Apr. 10, 2012**

**Int. Cl.: 36**

FOR: INSURANCE AGENCY, INSURANCE BROKERAGE AND INSURANCE PLAN ADMINISTRATION IN THE FIELD OF MEDICAL, LIFE, DISABILITY, PERSONAL ACCIDENT, TRAVEL, FLIGHT, MEDICAL EVACUATION AND VISITORS INSURANCE, IN CLASS 36 (U.S. CLS. 100, 101 AND 102).

**SERVICE MARK**

**PRINCIPAL REGISTER**

FIRST USE 4-16-2002; IN COMMERCE 4-16-2002.

THE MARK CONSISTS OF STANDARD CHARACTERS WITHOUT CLAIM TO ANY PARTICULAR FONT, STYLE, SIZE, OR COLOR.

OWNER OF U.S. REG. NOS. 2,932,871 AND 3,339,155.

SER. NO. 85-055,580, FILED 6-5-2010.

REBECCA SMITH, EXAMINING ATTORNEY



*David J. Kyffers*

Director of the United States Patent and Trademark Office

# United States of America

United States Patent and Trademark Office

## APP-SOLUTELY

**Reg. No. 4,123,833**

**Registered Apr. 10, 2012**

**Int. Cl.: 42**

**SERVICE MARK**

**PRINCIPAL REGISTER**

APP SERVICES, INC. (DELAWARE CORPORATION)  
9360 W. FLAMINGO RD.  
SUITE 110422  
LAS VEGAS, NV 89147

FOR: APPLICATION SERVICE PROVIDER, NAMELY, PROVIDING, HOSTING, MANAGING, DEVELOPING, AND MAINTAINING APPLICATIONS, SOFTWARE, WEB SITES, AND DATABASES IN THE FIELDS OF PERSONAL PRODUCTIVITY, WIRELESS COMMUNICATION, MOBILE INFORMATION ACCESS, AND REMOTE DATA MANAGEMENT FOR WIRELESS DELIVERY OF CONTENT TO HANDHELD COMPUTERS, LAPTOPS AND MOBILE ELECTRONIC DEVICES; DESIGN, CREATION, HOSTING AND MAINTENANCE OF INTERNET SITES FOR THIRD PARTIES; DESIGN, CREATION, HOSTING, MAINTENANCE OF WEBSITES FOR OTHERS; WEB SITE HOSTING SERVICES; WEBSITE DESIGN AND DEVELOPMENT FOR OTHERS, IN CLASS 42 (U.S. CLS. 100 AND 101).

FIRST USE 2-1-2009; IN COMMERCE 2-1-2009.

THE MARK CONSISTS OF STANDARD CHARACTERS WITHOUT CLAIM TO ANY PARTICULAR FONT, STYLE, SIZE, OR COLOR.

SER. NO. 85-059,303, FILED 6-10-2010.

JESSICA A. POWERS, EXAMINING ATTORNEY



*David J. Kyros*

Director of the United States Patent and Trademark Office

# United States of America

United States Patent and Trademark Office

# ChartTraderPro

**Reg. No. 4,123,834**

**Registered Apr. 10, 2012**

**Int. Cl.: 9**

**TRADEMARK**

**PRINCIPAL REGISTER**

MPOWER TRADING SYSTEMS, LLC (PENNSYLVANIA LIMITED LIABILITY COMPANY)  
521 W. LANCASTER AVENUE  
HAVERFORD, PA 19041

FOR: DOWNLOADABLE SOFTWARE FUNCTIONING AS AN AUTOMATED TRADING SYSTEM FOR PROFESSIONAL AND INSTITUTIONAL INVESTORS TO ANALYZE THE OVERALL INVESTMENT MARKET, INITIATE ORDERS, MANAGE POSITIONS, QUANTIFY RISK, AND EFFECTIVELY EXECUTE SIMULTANEOUS SOPHISTICATED ORDERS, IN CLASS 9 (U.S. CLS. 21, 23, 26, 36 AND 38).

FIRST USE 7-0-2008; IN COMMERCE 7-0-2008.

THE MARK CONSISTS OF CAPITAL LETTER "C" FOLLOWED BY LOWER CASE LETTERS "HART", FOLLOWED BY A CAPITAL LETTER "T" FOLLOWED BY LOWER CASE LETTERS "RADER", FOLLOWED BY A CAPITAL LETTER "P" FOLLOWED BY LOWER CASE "RO", FORMING THE STYLIZED WORD "CHARTTRADERPRO".

SER. NO. 85-060,648, FILED 6-11-2010.

ARETHA SOMERVILLE, EXAMINING ATTORNEY



*David J. Kyjars*

Director of the United States Patent and Trademark Office

# United States of America

United States Patent and Trademark Office



**Reg. No. 4,123,835**

**Registered Apr. 10, 2012**

**Int. Cl.: 35**

**SERVICE MARK**

**PRINCIPAL REGISTER**

SWEET AND SOUR USA, LTD. (DELAWARE LIMITED LIABILITY COMPANY)  
49B GERMAY DRIVE  
WILMINGTON, DE 19804

FOR: WHOLESALE AND RETAIL STORE SERVICES FEATURING LICORICE, IN CLASS 35 (U.S. CLS. 100, 101 AND 102).

FIRST USE 6-1-2010; IN COMMERCE 6-1-2010.

NO CLAIM IS MADE TO THE EXCLUSIVE RIGHT TO USE "SWEET & SOUR" AND "USA", APART FROM THE MARK AS SHOWN.

THE COLOR(S) PINK, BLUE, GREEN, WHITE, YELLOW, ORANGE AND BLACK IS/ARE CLAIMED AS A FEATURE OF THE MARK.

THE MARK CONSISTS OF THE WORD "SWEET" IN PINK, THE WORD "SOUR" IN GREEN, THE WORD "USA" IN WHITE, THE "&" IN BLUE AND A STAR IN YELLOW AND PINK WITH BLUE, ORANGE AND GREEN RAYS BEHIND THE STAR. ALL THE ABOVE IS OUTLINED IN BLACK.

SER. NO. 85-061,019, FILED 6-11-2010.

KELLEY WELLS, EXAMINING ATTORNEY



*David J. Kyffers*

Director of the United States Patent and Trademark Office

# United States of America

United States Patent and Trademark Office

# TradeOptics

**Reg. No. 4,123,836**

**Registered Apr. 10, 2012**

**Int. Cl.: 9**

**TRADEMARK**

**PRINCIPAL REGISTER**

MPOWER TRADING SYSTEMS, LLC (PENNSYLVANIA LIMITED LIABILITY COMPANY)  
521 W. LANCASTER AVENUE  
2 E. LANCASTER AVENUE  
HAVERFORD, PA 19041

FOR: DOWNLOADABLE SOFTWARE FUNCTIONING AS AN AUTOMATED TRADING SYSTEM FOR PROFESSIONAL AND INSTITUTIONAL INVESTORS TO ANALYZE THE OVERALL INVESTMENT MARKET, INITIATE ORDERS, MANAGE POSITIONS, QUANTIFY RISK, AND EFFECTIVELY EXECUTE SIMULTANEOUS SOPHISTICATED ORDERS, IN CLASS 9 (U.S. CLS. 21, 23, 26, 36 AND 38).

FIRST USE 7-0-2008; IN COMMERCE 7-0-2008.

THE MARK CONSISTS OF CAPITAL LETTER "T" FOLLOWED BY LOWERCASE "RADE" FOLLOWED BY CAPITAL LETTER "O" FOLLOWED BY LOWERCASE "OPTICS" TO FORM THE WORD TRADEOPTICS.

SER. NO. 85-063,439, FILED 6-15-2010.

ARETHA SOMERVILLE, EXAMINING ATTORNEY



*David J. Kyffers*

Director of the United States Patent and Trademark Office



# United States of America

United States Patent and Trademark Office

# MYCOR

**Reg. No. 4,123,837**

**Registered Apr. 10, 2012**

**Int. Cl.: 37**

**SERVICE MARK**

**PRINCIPAL REGISTER**

SIEMENS ENTERPRISE COMMUNICATIONS GMBH & CO. KG (FED REP GERMANY CORPORATION)  
HOFMANNSTRASSE 51  
MUNCHEN, FED REP GERMANY 81379

FOR: INSTALLATION AND REPAIR OF ELECTRICAL TELECOMMUNICATION DEVICES USED FOR RECORDING, EMISSION, TRANSMISSION, RECEPTION, REPRODUCTION AND PROCESSING OF SOUNDS, SIGNALS, CHARACTERS AND/OR IMAGES, AND FOR INTEGRATION OF VOICE, IMAGES, TEXT, DATA, MULTIMEDIA DATA, AND FULL-MOTION VIDEO FOR COMMUNICATIONS OVER COMPUTER NETWORKS, EXCLUDING COMPUTER SOFTWARE; REPAIR OF TELECOMMUNICATION DEVICES USED FOR RECORDING, PROCESSING, EMITTING, TRANSMISSION, SWITCHING, STORAGE AND OUTPUT OF MESSAGES, INFORMATION AND DATA, EXCLUDING COMPUTER SOFTWARE; REPAIR OF OPTICAL, ELECTROTECHNICAL AND ELECTRONIC TELECOMMUNICATIONS EQUIPMENT FOR USE IN VOICE, IMAGE, TEXT, DATA, MULTIMEDIA DATA AND FULL-MOTION VIDEO COMMUNICATION TECHNOLOGY, ESPECIALLY FOR VOICE, NAMELY, FOR SPEECH RECOGNITION, SPEECH ANALYSIS FOR PROVIDING OR ENABLING ACCESS TO AN ELECTRONIC DEVICE OR SYSTEM COMMUNICATION, FOR CONTROLLING COMMUNICATIONS DEVICES OR SYSTEMS, FOR ANALYZING COMMUNICATION CONTENT, FOR INTERACTIVE VOICE RESPONSE, FOR DIGITAL VOICE RESPONSE, FOR PROCESSING COMMUNICATION CONTENT, AND FOR SPEECH TO TEXT AND TEXT TO SPEECH CONVERSATIONS, EXCLUDING COMPUTER SOFTWARE; REPAIR OF OPTICAL ELECTROTECHNICAL AND ELECTRONIC EQUIPMENT FOR VOICE, IMAGE, TEXT, DATA OR IMAGE TRANSMISSION, TELEPHONES, VIDEO TELEPHONES, VOICE BOXES IN THE NATURE OF DIGITAL VOICE RECORDERS, AUTOMATIC TELEPHONE DIALERS, INTERNAL TELEPHONES, TELEPHONE EXTENSION SWITCHBOARDS, EXCLUDING COMPUTER SOFTWARE; REPAIR OF TELECOMMUNICATION NETWORKS CONSISTING OF CONNECTING AND TRANSMISSION EQUIPMENT, NAMELY, ELECTRONIC COMPUTER HARDWARE, COMPUTER SERVERS, ELECTRIC POWER SUPPLIES, BATTERIES, ELECTRIC ACCUMULATORS, POWER ADAPTERS IN THE NATURE OF ELECTRIC TRANSFORMERS, TELECOMMUNICATION CABLES, OPTICAL FIBERS AND ELECTRIC CONNECTIONS, EXCLUDING COMPUTER SOFTWARE; REPAIR OF INDIVIDUAL MODULES AND COMPONENTS OF TELECOMMUNICATION NETWORKS AND TRANSMISSION MEDIA, NAMELY, ELECTRIC POWER SUPPLIES, BATTERIES, ELECTRIC ACCUMULATORS, POWER ADAPTERS IN THE NATURE OF ELECTRIC TRANSFORMERS, TELECOMMUNICATION CABLES, OPTICAL FIBERS AND ELECTRIC CONNECTIONS, EXCLUDING COMPUTER SOFTWARE; REPAIR OF DEVICES FOR WIRELESS TRANSMIS-



*David J. Kybas*

Director of the United States Patent and Trademark Office

**Reg. No. 4,123,837** SION VIA ELECTROMAGNETIC WAVES, ULTRASONIC TRANSMISSION, NAMELY, INFRARED, ELECTROMAGNETIC AND ULTRASONIC APPARATUS FOR TRANSMISSION OF COMMUNICATION, DEVICES FOR WIRELESS RADIO TRANSMISSION, EXCLUDING COMPUTER SOFTWARE; INSTALLATION OF A COMBINATION OF SOME OF THE AFOREMENTIONED APPARATUS AND DEVICES, NAMELY, ELECTRICAL APPARATUS FOR RECORDING, TRANSMISSION, PROCESSING, REPRODUCTION, BROADCASTING, AND RECEIVING OF SOUND, IMAGES, AND DATA, AND TELEPHONES, VIDEO TELEPHONES, VOICE BOXES IN THE NATURE OF DIGITAL VOICE RECORDERS, AUTOMATIC TELEPHONE DIALERS, INTERNAL TELEPHONE EXTENSION SWITCHBOARDS; INSTALLATION AND REPAIR OF DATA COMMUNICATION, AND OF TELEPHONES, VIDEO PHONES, VOICE BOXES IN THE NATURE OF DIGITAL VOICE RECORDERS, AUTOMATIC TELEPHONE DIALING DEVICES, INTERNAL TELEPHONE DEVICES AND TELEPHONE EXTENSION SWITCH BOARDS, EXCLUDING COMPUTER SOFTWARE; REPAIR OF PHOTOCOPIERS, EXCLUDING COMPUTER SOFTWARE; REPAIR OF TELECOMMUNICATION NETWORKING HARDWARE CONSISTING OF CONNECTING AND TRANSMISSION EQUIPMENT, INDIVIDUAL MODULES AND COMPONENTS OF SUCH DEVICES SUCH AS POWER SUPPLY UNITS, EXCLUDING COMPUTER SOFTWARE; REPAIR OF BATTERIES, ELECTRIC ACCUMULATORS, POWER ADAPTERS IN THE NATURE OF TRANSFORMERS, TRANSMISSION MEDIA, NAMELY, TELECOMMUNICATION CABLE AND OPTICAL FIBERS, ELECTRIC CONNECTORS, AND DEVICES FOR WIRELESS TRANSMISSION VIA INFRARED AND RADIO TRANSMISSION, EXCLUDING COMPUTER SOFTWARE; REPAIR OF EQUIPMENT COMPRISING A COMBINATION OF THE AFOREMENTIONED APPARATUS AND DEVICES, EXCLUDING COMPUTER SOFTWARE; INSTALLATION OF COMPUTER HARDWARE AND COMPUTER NETWORKING HARDWARE, IN CLASS 37 (U.S. CLS. 100, 103 AND 106).

THE MARK CONSISTS OF STANDARD CHARACTERS WITHOUT CLAIM TO ANY PARTICULAR FONT, STYLE, SIZE, OR COLOR.

PRIORITY CLAIMED UNDER SEC. 44(D) ON FED REP GERMANY APPLICATION NO. 302009074222, FILED 12-16-2009, REG. NO. 302009074222, DATED 8-23-2010, EXPIRES 12-31-2019.

SER. NO. 85-063,457, FILED 6-15-2010.

ERIN FALK, EXAMINING ATTORNEY

# United States of America

United States Patent and Trademark Office



**ROSATOM**

**Reg. No. 4,123,838**

**Registered Apr. 10, 2012**

**Int. Cl.: 35**

**SERVICE MARK**

**PRINCIPAL REGISTER**

STATE ATOMIC ENERGY CORPORATION "ROSATOM" (RUSSIAN FED. STATE CORPORATION)  
B. ORDYNKA STREET 24  
119017 MOSCOW, RUSSIAN FED.

FOR: BUSINESS ADMINISTRATION AND MANAGEMENT; BUSINESS ADMINISTRATION AND OFFICE WORK; BUSINESS ADMINISTRATION CONSULTANCY; BUSINESS ADMINISTRATION ASSISTANCE; CONDUCTING MARKETING STUDIES; BUSINESS ENQUIRIES AND INVESTIGATIONS; MARKETING RESEARCH; BUSINESS MANAGEMENT AND ORGANIZATION CONSULTANCY; BUSINESS ORGANIZATION CONSULTANCY; BUSINESS MANAGEMENT CONSULTANCY; PROFESSIONAL BUSINESS CONSULTANCY; MARKETING CONSULTING; MARKETING PLAN DEVELOPMENT; BUSINESS MARKETING SERVICES; MARKETING SERVICES, NAMELY, PROMOTING OR ADVERTISING THE GOODS AND SERVICES OF OTHERS; IMPORT-EXPORT AGENCIES; IMPORT-EXPORT AGENCIES IN THE FIELDS OF NUCLEAR INDUSTRY AND ENERGY; ORGANIZATION OF EXHIBITIONS FOR COMMERCIAL OR ADVERTISING PURPOSES; BUSINESS MANAGEMENT ASSISTANCE; COMMERCIAL AND INDUSTRIAL MANAGEMENT ASSISTANCE; ASSISTANCE AND CONSULTANCY SERVICES IN THE FIELD OF BUSINESS MANAGEMENT OF COMPANIES IN THE ENERGY SECTOR; ECONOMIC FORECASTING AND ANALYSIS; ADVERTISING SERVICES; ADVERTISING AND MARKETING; COMPILATION AND SYSTEMIZATION OF INFORMATION INTO COMPUTER DATABASE; PROMOTIONAL SPONSORSHIP OF CULTURAL ACTIVITIES IN THE FIELD OF NUCLEAR INDUSTRY AND ENERGY; CORPORATE MANAGEMENT ASSISTANCE; BUSINESS STRATEGY DEVELOPMENT SERVICES; COMMERCIAL BUSINESS MANAGEMENT; ASSOCIATION SERVICES, NAMELY, PROMOTING THE INTERESTS OF THE NUCLEAR INDUSTRY AND ENERGY; ADVERTISING AND PUBLICITY SERVICES, NAMELY, PROMOTING THE GOODS, SERVICES, BRAND IDENTITY AND COMMERCIAL INFORMATION AND NEWS OF THIRD PARTIES THROUGH PRINT, AUDIO, VIDEO DIGITAL AND ON-LINE MEDIUM; EFFICIENCY EXPERTS, IN CLASS 35 (U.S. CLS. 100, 101 AND 102).



PRIORITY CLAIMED UNDER SEC. 44(D) ON RUSSIAN FED. APPLICATION NO. 2010712051, FILED 4-14-2010, REG. NO. 427878, DATED 1-18-2011, EXPIRES 4-14-2020.

*David J. Kyjars*

THE COLOR(S) WHITE, BLACK, DARK BLUE, BLUE, LIGHT BLUE, DARK GREY AND GREY IS/ARE CLAIMED AS A FEATURE OF THE MARK.

**Reg. No. 4,123,838** THE MARK CONSISTS OF A BULLSEYE DESIGN WITH A SOLID TWISTING RIBBON DESIGN IN THE COLORS BLACK, DARK BLUE, BLUE AND LIGHT BLUE FORMING THE BORDER OF A CIRCLE, BROKEN INTO THREE SECTIONS BY THREE WHITE CURVED LINES, WITH AN INTERIOR IRREGULAR TRIANGLE IN WHITE AROUND AN INNER SOLID BLACK, DARK BLUE, BLUE CIRCLE, ALL APPEARING ABOVE THE WORD "ROSATOM" IN WHICH THE LETTERS "ROS" IN DARK GREY AND THE LETTERS "ATOM" IN GREY.

SER. NO. 85-064,032, FILED 6-16-2010.

JOHN SCHUYLER YARD, EXAMINING ATTORNEY

# United States of America

United States Patent and Trademark Office

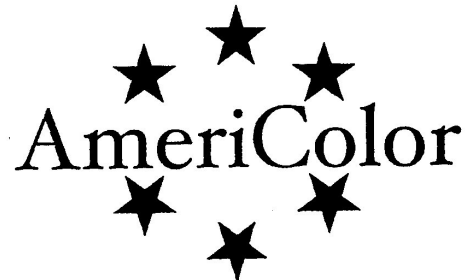

**Reg. No. 4,123,839**

**Registered Apr. 10, 2012**

**Int. Cl.: 2**

**TRADEMARK**

**PRINCIPAL REGISTER**

AMERICOLOR CORPORATION (CALIFORNIA CORPORATION)  
#C  
341 C MELROSE STREET  
PLACENTIA, CA 92870

FOR: SOFT GEL PASTE FOOD COLORING, AIR BRUSH FOOD COLORING, AND FOOD COLORING PIPING GEL, IN CLASS 2 (U.S. CLS. 6, 11 AND 16).

FIRST USE 1-12-1996; IN COMMERCE 1-12-1996.

THE MARK CONSISTS OF THE STYLIZED WORDS "AMERICOLOR". THREE STAR ABOVE AND BELOW THE TEXT IN A CIRCULAR MOTION.

SER. NO. 85-065,262, FILED 6-17-2010.

TRACY CROSS, EXAMINING ATTORNEY



*David J. Kyffers*

Director of the United States Patent and Trademark Office

# United States of America

United States Patent and Trademark Office



**Reg. No. 4,123,840**

**Registered Apr. 10, 2012**

**Int. Cls.: 19 and 20**

**TRADEMARK**

**PRINCIPAL REGISTER**

ARMOIRES FABRITEC LTÉE (CANADA LIMITED LIABILITY COMPANY)  
375 GRAND-BERNIER NORD  
JEAN-SUR-RICHELIEU., CANADA QUEBEC, J3

FOR: BUILDING MATERIALS, NAMELY, NON-METAL COUNTERTOPS, NAMELY, WOODEN AND QUARTZ KITCHEN COUNTERTOPS FOR FURTHER INSTALLATION, IN CLASS 19 (U.S. CLS. 1, 12, 33 AND 50).

FOR: KITCHEN CABINETS, KITCHEN CABINET DOORS, NON-METAL KITCHEN CABINET ACCESSORIES, NAMELY, HANDLES AND HINGES; STORAGE FURNITURE FOR THE BASEMENT AND GARAGE, NAMELY, FREE STANDING ARMOIRES, AND WALL MOUNTED STORAGE RACKS; STORAGE FURNITURE DOORS, SHELVES FOR STORAGE FURNITURE, DRAWERS FOR STORAGE FURNITURE AND NON-METAL ACCESSORIES FOR STORAGE FURNITURE, NAMELY, HANDLES, HINGES AND DRAWER DIVIDERS; BATHROOM CABINETS, BATHROOM CABINET DOORS, BATHROOM VANITIES AND NON-METAL ACCESSORIES FOR BATHROOM CABINETS, NAMELY, HANDLES AND HINGES, IN CLASS 20 (U.S. CLS. 2, 13, 22, 25, 32 AND 50).

PRIORITY CLAIMED UNDER SEC. 44(D) ON CANADA APPLICATION NO. 1,484,471, FILED 6-10-2010, REG. NO. TMA803,116, DATED 7-28-2011, EXPIRES 7-28-2026.

THE MARK CONSISTS OF THE WORDS "BLACK BOX" WITH THE WORD BOX SUPERIMPOSED OVER A "BLACK BOX" DESIGN.

SER. NO. 85-068,008, FILED 6-21-2010.

SCOTT BIBB, EXAMINING ATTORNEY



*David J. Kybas*

Director of the United States Patent and Trademark Office

# United States of America

## United States Patent and Trademark Office

Cuisine : Salle de bain  
**:instant**  
Kitchen : Bathroom

**Reg. No. 4,123,841**

**Registered Apr. 10, 2012**

**Int. Cls.: 19 and 20**

**TRADEMARK**

**PRINCIPAL REGISTER**

ARMOIRES FABRITEC LTÉE (CANADA LIMITED LIABILITY COMPANY)  
375 GRAND-BERNIER NORD  
JEAN-SUR-RICHELIEU., CANADA QUEBEC, J3

FOR: BUILDING MATERIALS, NAMELY, NON-METAL COUNTERTOPS, NAMELY, WOODEN AND QUARTZ KITCHEN COUNTERTOPS FOR FURTHER INSTALLATION, IN CLASS 19 (U.S. CLS. 1, 12, 33 AND 50).

FOR: KITCHEN CABINETS, KITCHEN CABINET DOORS, NON-METAL KITCHEN CABINET ACCESSORIES, NAMELY, HANDLES AND HINGES; STORAGE FURNITURE FOR THE BASEMENT AND GARAGE, NAMELY, FREE STANDING ARMOIRES, AND WALL MOUNTED STORAGE RACKS; STORAGE FURNITURE DOORS, SHELVES FOR STORAGE FURNITURE, DRAWERS FOR STORAGE FURNITURE AND NON-METAL ACCESSORIES FOR STORAGE FURNITURE, NAMELY, HANDLES, HINGES AND DRAWER DIVIDERS; BATHROOM CABINETS, BATHROOM CABINET DOORS, BATHROOM VANITIES AND NON-METAL ACCESSORIES FOR BATHROOM CABINETS, NAMELY, HANDLES AND HINGES, IN CLASS 20 (U.S. CLS. 2, 13, 22, 25, 32 AND 50).

PRIORITY CLAIMED UNDER SEC. 44(D) ON CANADA APPLICATION NO. 1,484,475, FILED 6-10-2010, REG. NO. TMA803,134, DATED 7-28-2011, EXPIRES 7-28-2026.

NO CLAIM IS MADE TO THE EXCLUSIVE RIGHT TO USE "CUISINE", "SALLE DE BAIN", "KITCHEN" AND "BATHROOM", APART FROM THE MARK AS SHOWN.

THE MARK CONSISTS OF "CUISINE" AND "SALLE DE BAIN", WITH A COLON SEPARATING THE WORDS, SET ABOVE: THE STYLIZED WORD "INSTANT" WITH THE "I" IN "INSTANT" REPLACED WITH A ":", WHICH IS SET ABOVE "KITCHEN" "BATHROOM" WITH A COLON SEPARATING THE WORDS.

THE ENGLISH TRANSLATION OF "CUISINE: SALLE DE BAIN" IN THE MARK IS "KITCHEN: BATHROOM".

SER. NO. 85-068,025, FILED 6-21-2010.

SCOTT BIBB, EXAMINING ATTORNEY



*David J. Kyffers*

Director of the United States Patent and Trademark Office

# United States of America

United States Patent and Trademark Office

**expressive**

**Reg. No. 4,123,842**

**Registered Apr. 10, 2012**

**Int. Cls.: 19 and 20**

**TRADEMARK**

**PRINCIPAL REGISTER**

ARMOIRES FABRITEC LTÉE (CANADA LIMITED LIABILITY COMPANY)  
375 GRAND-BERNIER NORD  
JEAN-SUR-RICHELIEU., CANADA QUEBEC, J3

FOR: BUILDING MATERIALS, NAMELY, NON-METAL COUNTERTOPS, NAMELY, WOODEN AND QUARTZ KITCHEN COUNTERTOPS FOR FURTHER INSTALLATION, IN CLASS 19 (U.S. CLS. 1, 12, 33 AND 50).

FOR: KITCHEN CABINETS, KITCHEN CABINET DOORS, NON-METAL KITCHEN CABINET ACCESSORIES, NAMELY, HANDLES AND HINGES; STORAGE FURNITURE FOR THE BASEMENT AND GARAGE, NAMELY, FREE STANDING ARMOIRES, AND WALL MOUNTED STORAGE RACKS; STORAGE FURNITURE DOORS, SHELVES FOR STORAGE FURNITURE, DRAWERS FOR STORAGE FURNITURE AND NON-METAL ACCESSORIES FOR STORAGE FURNITURE, NAMELY, HANDLES, HINGES AND DRAWER DIVIDERS; BATHROOM CABINETS, BATHROOM CABINET DOORS, BATHROOM VANITIES AND NON-METAL ACCESSORIES FOR BATHROOM CABINETS, NAMELY, HANDLES AND HINGES, IN CLASS 20 (U.S. CLS. 2, 13, 22, 25, 32 AND 50).

PRIORITY CLAIMED UNDER SEC. 44(D) ON CANADA APPLICATION NO. 1,484,476, FILED 6-10-2010, REG. NO. TMA803133, DATED 7-28-2011, EXPIRES 7-28-2026.

THE MARK CONSISTS OF THE WORD "EXPRESSIVE" WITH A BLACK DOT OVER THE "X".

SER. NO. 85-068,033, FILED 6-21-2010.

SCOTT BIBB, EXAMINING ATTORNEY



*David J. Kybas*

Director of the United States Patent and Trademark Office



# United States of America

United States Patent and Trademark Office

# Detroit Diva

**Reg. No. 4,123,843**

DENNINGS, TERI L. (UNITED STATES INDIVIDUAL)  
29756 CITY CENTER DR. NO. 4  
WARREN, MI 48093

**Registered Apr. 10, 2012**

**Int. Cl.: 25**

FOR: BASEBALL CAPS AND HATS; SHIRTS; T-SHIRTS; TEE SHIRTS, IN CLASS 25 (U.S. CLS. 22 AND 39).

**TRADEMARK**

FIRST USE 3-10-2009; IN COMMERCE 4-10-2009.

**PRINCIPAL REGISTER**

THE MARK CONSISTS OF STANDARD CHARACTERS WITHOUT CLAIM TO ANY PARTICULAR FONT, STYLE, SIZE, OR COLOR.

NO CLAIM IS MADE TO THE EXCLUSIVE RIGHT TO USE "DETROIT", APART FROM THE MARK AS SHOWN.

SER. NO. 85-068,682, FILED 6-22-2010.

REBECCA SMITH, EXAMINING ATTORNEY



*David J. Kyffers*

Director of the United States Patent and Trademark Office

# United States of America

United States Patent and Trademark Office

## CENTER FOR VEIN RESTORATION



**Reg. No. 4,123,844**

**Registered Apr. 10, 2012**

**Int. Cl.: 44**

**SERVICE MARK**

**PRINCIPAL REGISTER**

LAKHANPAL, SANJIV (UNITED STATES INDIVIDUAL)  
2523 COXSHIRE LANE  
DAVIDSONVILLE, MD 21035

FOR: PHYSICAL THERAPY EVALUATION, IDENTIFICATION, AND MANAGEMENT OF MOVEMENT DYSFUNCTION TO RESTORE, MAINTAIN, AND PROMOTE OPTIMAL PHYSICAL FUNCTION PREVENTING THE ONSET, SYMPTOMS AND PROGRESSION OF IMPAIRMENTS, FUNCTIONAL LIMITATIONS, AND DISABILITIES RESULTING FROM DISEASE, DISORDERS, CONDITIONS, OR INJURIES, IN CLASS 44 (U.S. CLS. 100 AND 101).

FIRST USE 10-17-2005; IN COMMERCE 10-17-2005.

OWNER OF U.S. REG. NO. 3,441,985.

THE COLOR(S) BLACK, APRICOT AND SAGE GREEN IS/ARE CLAIMED AS A FEATURE OF THE MARK.

NO CLAIM IS MADE TO THE EXCLUSIVE RIGHT TO USE "CENTER FOR VEIN RESTORATION", APART FROM THE MARK AS SHOWN.

THE MARK CONSISTS OF THE WORDING "CENTER FOR VEIN RESTORATION" IN BLACK AT THE TOP, "LOVE YOUR LEGS" IS BLACK AT THE BOTTOM TO THE RIGHT OF THE HEART, THE TWO STROKES AT THE BOTTOM OF THE HEART ARE BLACK, THE HEART IS OUTLINED IN APRICOT, THE LEGS ARE OUTLINED IN SAGE GREEN IN THE HEART, AND THE CURSIVE WORD "AGAIN" AND THE EXCLAMATION POINT ARE APRICOT. THE COLOR WHITE CONSTITUTES BACKGROUND AND IS NOT PART OF THE MARK.

SER. NO. 85-069,609, FILED 6-23-2010.

RAMONA ORTIGA, EXAMINING ATTORNEY



*David J. Kybas*

Director of the United States Patent and Trademark Office

# United States of America

United States Patent and Trademark Office

# STICS

**Reg. No. 4,123,845**

**Registered Apr. 10, 2012**

**Int. Cls.: 9 and 35**

**TRADEMARK**

**SERVICE MARK**

**PRINCIPAL REGISTER**

STICS, INC. (CALIFORNIA CORPORATION), FORMERLY STONE ANALYTICS, INC.  
SUITE 303  
10650 TREENA ST.  
SAN DIEGO, CA 92128

FOR: COMPUTER SOFTWARE FOR THE CREATION OF STATISTICAL AND PREDICTIVE ANALYSIS IN THE FIELD OF STATISTICAL MODELING, ANALYSIS, AND FORECASTING APPLIED TO CUSTOMER BEHAVIOR, MARKING ACTIVITIES AND PROFITABILITY ACROSS THE CASINO AND HOSPITALITY INDUSTRIES, IN CLASS 9 (U.S. CLS. 21, 23, 26, 36 AND 38).

FIRST USE 2-24-2004; IN COMMERCE 2-24-2004.

FOR: STATISTICAL ANALYSIS AND FORECASTING APPLIED TO CUSTOMER BEHAVIOR, MARKETING ACTIVITIES AND PROFITABILITY ACROSS THE CASINO AND HOSPITALITY INDUSTRIES, IN CLASS 35 (U.S. CLS. 100, 101 AND 102).

FIRST USE 2-24-2004; IN COMMERCE 2-24-2004.

THE MARK CONSISTS OF STANDARD CHARACTERS WITHOUT CLAIM TO ANY PARTICULAR FONT, STYLE, SIZE, OR COLOR.

SER. NO. 85-069,736, FILED 6-23-2010.

SUNG IN, EXAMINING ATTORNEY



*David J. Kyfos*

Director of the United States Patent and Trademark Office

# United States of America

United States Patent and Trademark Office



# comsciences

**Reg. No. 4,123,846**

COMSCIENCES, INC. (CALIFORNIA CORPORATION)  
13600 MARINA POINTE DR., UNIT 1415  
MARINA DEL REY, CA 90292

**Registered Apr. 10, 2012**

**Int. Cl.: 35**

FOR: MARKET RESEARCH AND BRAND CONSULTING FOR NEW PRODUCTS, SERVICES AND APPLICATIONS IN THE NATURE OF SOFTWARE IN THE FIELD OF COMMUNICATIONS, MARKETING AND CORPORATE MANAGEMENT, IN CLASS 35 (U.S. CLS. 100, 101 AND 102).

**SERVICE MARK**

**PRINCIPAL REGISTER**

FIRST USE 1-30-1993; IN COMMERCE 1-30-1993.

SER. NO. 85-070,202, FILED 6-23-2010.

MARK RADEMACHER, EXAMINING ATTORNEY



*David J. Kyffers*

Director of the United States Patent and Trademark Office

# United States of America

United States Patent and Trademark Office



## The Medical Concierge

**Reg. No. 4,123,847**

**Registered Apr. 10, 2012**

**Int. Cl.: 35**

**SERVICE MARK**

**PRINCIPAL REGISTER**

EAST COAST MEDICAL NETWORK, INC. (FLORIDA CORPORATION), DBA THE MEDICAL CONCIERGE  
6000 TURKEY LAKE ROAD, SUITE 209  
ORLANDO, FL 32819

FOR: REFERRAL SERVICES TO PROVIDE HOTELS, RESORTS, BUSINESSES, AND RESIDENCES WITH APPOINTMENTS AND SAME-DAY VISITS WITH PRE-SCREENED MEDICAL PROFESSIONALS, NAMELY, FAMILY PRACTICE DOCTORS, PEDIATRIC DOCTORS, DENTISTS, OPHTHALMOLOGISTS, ORTHOPEDIC DOCTORS, OBSTETRICS DOCTORS, GYNECOLOGISTS, CHIROPRACTORS, REGISTERED NURSES, CERTIFIED COMPANIONS, AND OTHER HEALTH PROFESSIONALS; MOBILE AND PORTABLE RETAIL PHARMACY SERVICES FOR HOTELS, RESORTS, BUSINESSES, AND RESIDENCES, IN CLASS 35 (U.S. CLS. 100, 101 AND 102).

FIRST USE 8-26-2009; IN COMMERCE 8-26-2009.

OWNER OF U.S. REG. NO. 3,694,517.

THE COLOR(S) GOLD IS/ARE CLAIMED AS A FEATURE OF THE MARK.

THE MARK CONSISTS OF A GOLD BELL, SIMILAR TO A BELL USED TO SUMMON A HOTEL CONCIERGE, WITH A GOLD CADUCEUS CENTERED ON TOP OF THE BELL, WITH THE WORDS, "THE MEDICAL CONCIERGE" IN GOLD LETTERING, TO THE RIGHT OF AND BELOW THE BELL WITH THE CADUCEUS.

SEC. 2(F) AS TO "THE MEDICAL CONCIERGE".

SER. NO. 85-070,445, FILED 6-24-2010.

KARANENDRA S. CHHINA, EXAMINING ATTORNEY



*David J. Kybas*

Director of the United States Patent and Trademark Office

# United States of America

United States Patent and Trademark Office



**SIZZLE**

**Reg. No. 4,123,848**

**Registered Apr. 10, 2012**

**Int. Cl.: 43**

**SERVICE MARK**

**PRINCIPAL REGISTER**

STEAK N SHAKE LLC (INDIANA LIMITED LIABILITY COMPANY)  
500 CENTURY BUILDING  
36 SOUTH PENNSYLVANIA STREET  
INDIANAPOLIS, IN 46204

FOR: RESTAURANT SERVICES, IN CLASS 43 (U.S. CLS. 100 AND 101).

FIRST USE 4-9-2010; IN COMMERCE 4-9-2010.

OWNER OF U.S. REG. NOS. 649,868, 2,233,542 AND OTHERS.

THE MARK CONSISTS OF A DESIGN OF AN ANIMATED CHARACTER HAVING A BODY IN THE SHAPE OF A SANDWICH WEARING A CHEF'S HAT IN THE FORM OF AN ENVELOPE-TYPE GARRISON CAP WITH A LOGO THAT SAYS "STEAK 'N SHAKE FAMOUS FOR STEAKBURGERS" WITHIN A CIRCULAR SHAPE WITH WINGS ON EACH SIDE. THE WORD "SIZZLE" IS POSITIONED BELOW THE BODY, REPRESENTING THE NAME OF THE CHARACTER.

SEC. 2(F) AS TO "FAMOUS FOR STEAKBURGERS".

SER. NO. 85-071,144, FILED 6-24-2010.

BARBARA RUTLAND, EXAMINING ATTORNEY



*David J. Kyros*

Director of the United States Patent and Trademark Office

# United States of America

United States Patent and Trademark Office



**Reg. No. 4,123,849**

**Registered Apr. 10, 2012**

**Int. Cl.: 43**

**SERVICE MARK**

**PRINCIPAL REGISTER**

STEAK N SHAKE LLC (INDIANA LIMITED LIABILITY COMPANY)  
500 CENTURY BUILDING  
36 SOUTH PENNSYLVANIA STREET  
INDIANAPOLIS, IN 46204

FOR: RESTAURANT SERVICES, IN CLASS 43 (U.S. CLS. 100 AND 101).

FIRST USE 4-9-2010; IN COMMERCE 4-9-2010.

OWNER OF U.S. REG. NOS. 649,868, 2,233,542 AND OTHERS.

THE MARK CONSISTS OF A DESIGN OF AN ANIMATED CHARACTER HAVING A BODY IN THE SHAPE OF A FRENCH FRY CONTAINER AND A HEAD IN THE SHAPE OF FRENCH FRIES EXTENDING FROM THE CONTAINER AND THE CHARACTER IS WEARING A VISOR WITH THE LOGO "STEAK 'N SHAKE FAMOUS FOR STEAKBURGERS" WITHIN A CIRCULAR SHAPE WITH WINGS ON EACH SIDE. THE WORD "GOLDIE" IS POSITIONED NEXT TO THE BODY, REPRESENTING THE NAME OF THE CHARACTER.

SEC. 2(F) AS TO "FAMOUS FOR STEAKBURGERS".

SER. NO. 85-071,154, FILED 6-24-2010.

BARBARA RUTLAND, EXAMINING ATTORNEY



*David J. Kypos*

Director of the United States Patent and Trademark Office

# United States of America

United States Patent and Trademark Office



**KOMPRESSOR**

**Reg. No. 4,123,850**

**Registered Apr. 10, 2012**

**Int. Cl.: 7**

**TRADEMARK**

**PRINCIPAL REGISTER**

LG ELECTRONICS INC. (REPUBLIC OF KOREA CORPORATION)  
20, YEOUIDO-DONG, YEONGDEUNGPO-GU  
SEOUL, REPUBLIC OF KOREA 150-721

FOR: CLOTHES WASHING MACHINES; DISHWASHERS; VACUUM CLEANERS, IN CLASS  
7 (U.S. CLS. 13, 19, 21, 23, 31, 34 AND 35).

PRIORITY CLAIMED UNDER SEC. 44(D) ON REPUBLIC OF KOREA APPLICATION NO.  
40-2010-0030, FILED 6-10-2010, REG. NO. 0879681, DATED 9-7-2011, EXPIRES 9-7-2021.

NO CLAIM IS MADE TO THE EXCLUSIVE RIGHT TO USE "KOMPRESSOR", APART FROM  
THE MARK AS SHOWN.

THE MARK CONSISTS OF THE WORDING "KOMPRESSOR" IN A STYLIZED FONT UN-  
DERNEATH A SQUARE WITH ROUNDED EDGES. WITHIN THE SQUARE IS A LETTER  
"K" IN A STYLIZED FONT, TO THE RIGHT OF WHICH IS A CURVED LINE.

THE ENGLISH TRANSLATION OF "KOMPRESSOR" IN THE MARK IS "COMPRESSOR".

SER. NO. 85-071,668, FILED 6-25-2010.

JACQUELINE A. LAVINE, EXAMINING ATTORNEY

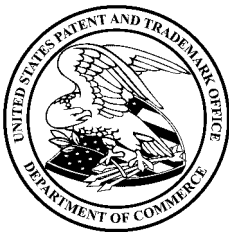

*David J. Kybas*

Director of the United States Patent and Trademark Office



# United States of America

United States Patent and Trademark Office

## GLOBAL SOLAR

**Reg. No. 4,123,851**

**Registered Apr. 10, 2012**

**Int. Cls.: 9, 37 and 42**

**TRADEMARK**

**SERVICE MARK**

**PRINCIPAL REGISTER**

GLOBAL SOLAR ENERGY, INC. (ARIZONA CORPORATION)  
8500 RITA ROAD  
TUCSON, AZ 85747

FOR: SOLAR CELLS; PHOTOVOLTAIC SOLAR MODULES FOR PRODUCTION OF ENERGY; SOLAR COLLECTOR PANELS; SOLAR PANELS FOR ENERGY AND ELECTRICITY GENERATION; PHOTOVOLTAIC CELLS; PHOTOVOLTAIC MODULES; PHOTOVOLTAIC GENERATORS CONSISTING OF SOLAR CELLS, SOLAR MODULES, AND SOLAR PANELS; PHOTOVOLTAIC SYSTEMS THAT CONVERT SOLAR ENERGY OR RADIATION INTO OTHER TYPES OF ENERGY, NAMELY, PHOTOVOLTAIC SOLAR MODULES; PHOTOVOLTAIC MODULES IN THE NATURE OF SOLAR PANELS ADAPTED FOR INCORPORATION IN ROOFS, RESIDENTIAL AND COMMERCIAL BUILDINGS, AND BUILDING PRODUCTS FOR PRODUCTION OF ELECTRICITY, IN CLASS 9 (U.S. CLS. 21, 23, 26, 36 AND 38).

FIRST USE 11-30-2001; IN COMMERCE 11-30-2001.

FOR: INSTALLATION OF SOLAR POWER SYSTEMS IN THE NATURE OF PHOTOVOLTAIC SYSTEMS FOR OTHERS; INSTALLATION OF RENEWABLE ENERGY GENERATION EQUIPMENT, IN CLASS 37 (U.S. CLS. 100, 103 AND 106).

FIRST USE 7-31-1999; IN COMMERCE 7-31-1999.

FOR: DESIGN, DRAFTING, AND DEVELOPMENT OF SOLAR PHOTOVOLTAIC SYSTEMS; ENGINEERING, PHYSICS RESEARCH, AND TECHNICAL CONSULTANCY IN CONNECTION WITH SOLAR ENGINEERING IN THE NATURE OF ENGINEERING, CALCULATION, AND PLANNING OF SOLAR POWER INSTALLATIONS; ARCHITECTURAL, CONSTRUCTION AND TECHNICAL CONSULTANCY WITH REGARD TO THE PLANNING OF SOLAR POWER INSTALLATIONS IN COMMERCIAL BUILDINGS, IN CLASS 42 (U.S. CLS. 100 AND 101).

FIRST USE 8-31-2001; IN COMMERCE 11-30-2002.

THE MARK CONSISTS OF STANDARD CHARACTERS WITHOUT CLAIM TO ANY PARTICULAR FONT, STYLE, SIZE, OR COLOR.

THE 2(F) CLAIM IS RESTRICTED TO CLASS(ES) 37 AND 42

OWNER OF U.S. REG. NO. 3,671,723.



*David J. Kyros*

Director of the United States Patent and Trademark Office

**Reg. No. 4,123,851** NO CLAIM IS MADE TO THE EXCLUSIVE RIGHT TO USE "SOLAR", APART FROM THE MARK AS SHOWN.

SEC. 2(F).

SER. NO. 85-075,529, FILED 6-30-2010.

SARA BENJAMIN, EXAMINING ATTORNEY

# United States of America

United States Patent and Trademark Office

# MALIBU

**Reg. No. 4,123,852**

**Registered Apr. 10, 2012**

**Int. Cl.: 6**

**TRADEMARK**

**PRINCIPAL REGISTER**

J. BAXTER BRINKMANN INTERNATIONAL CORPORATION (TEXAS CORPORATION)  
4215 MCEWEN ROAD  
DALLAS, TX 75244

FOR: METAL ACCESSORIES AND REPLACEMENT PARTS FOR ELECTRIC LIGHTING FIXTURES, NAMELY, CABLE CLIPS, GASKETS, METAL CLIPS FOR TIMERS, PIVOTS, HOOKS, KNOBS, RISERS, SCREWS, STAKES, AND WIRE ROPE FITTINGS OF METAL, NAMELY, SOCKETS, IN CLASS 6 (U.S. CLS. 2, 12, 13, 14, 23, 25 AND 50).

FIRST USE 10-20-1965; IN COMMERCE 10-20-1965.

THE MARK CONSISTS OF STANDARD CHARACTERS WITHOUT CLAIM TO ANY PARTICULAR FONT, STYLE, SIZE, OR COLOR.

OWNER OF U.S. REG. NOS. 816,551, 3,424,575, AND 3,617,647.

SER. NO. 85-077,471, FILED 7-2-2010.

JENNY PARK, EXAMINING ATTORNEY



*David J. Kyffers*

Director of the United States Patent and Trademark Office

# United States of America

United States Patent and Trademark Office

# Calm Dental

**Reg. No. 4,123,853**

CALM DENTAL, LLC (CALIFORNIA LIMITED LIABILITY COMPANY)  
1100 WILSHIRE BLVD., SUITE 2406  
LOS ANGELES, CA 90017

**Registered Apr. 10, 2012**

**Int. Cl.: 44**

FOR: DENTAL SERVICES, IN CLASS 44 (U.S. CLS. 100 AND 101).

**SERVICE MARK**

FIRST USE 4-24-2006; IN COMMERCE 4-24-2006.

**PRINCIPAL REGISTER**

THE MARK CONSISTS OF STANDARD CHARACTERS WITHOUT CLAIM TO ANY PARTICULAR FONT, STYLE, SIZE, OR COLOR.

NO CLAIM IS MADE TO THE EXCLUSIVE RIGHT TO USE "DENTAL", APART FROM THE MARK AS SHOWN.

SER. NO. 85-079,372, FILED 7-7-2010.

LINDA E. BLOHM, EXAMINING ATTORNEY



*David J. Kyffers*

Director of the United States Patent and Trademark Office

# United States of America

United States Patent and Trademark Office

# THERMA

**Reg. No. 4,123,854**

THERMA CORPORATION (CALIFORNIA CORPORATION)  
1601 LAS PLUMAS AVENUE  
SAN JOSE, CA 95133

**Registered Apr. 10, 2012**

**Int. Cls.: 6, 11, 37, 40  
and 42**

FOR: CLADDING OF METAL FOR CONSTRUCTION AND BUILDING; METAL TUBING; DUCTS AND PIPES OF METAL FOR CENTRAL HEATING INSTALLATIONS; ELBOWS OF METAL FOR PIPES; METAL PIPES; METAL JUNCTIONS FOR PIPES; METAL PIPE CLIPS, COLLARS, CONNECTORS, COUPLINGS, JOINTS, AND FITTINGS; METAL STORAGE TANKS; PRESSURE VESSELS MADE OF METAL ALLOYS, NAMELY, PRESSURIZED METAL FLUID STORAGE TANKS, PRESSURIZED METAL GAS STORAGE TANKS; ROOF GUARDS MADE OF METAL, IN CLASS 6 (U.S. CLS. 2, 12, 13, 14, 23, 25 AND 50).

**TRADEMARK**

**SERVICE MARK**

**PRINCIPAL REGISTER**

FIRST USE 1-1-1984; IN COMMERCE 1-1-1984.

FOR: HVAC UNITS, IN CLASS 11 (U.S. CLS. 13, 21, 23, 31 AND 34).

FIRST USE 1-1-1984; IN COMMERCE 1-1-1984.

FOR: BUILDING CONSTRUCTION, REMODELING, AND REPAIR; CONSTRUCTION CONSULTATION; CONSTRUCTION OF CLEAN ROOMS; CONSTRUCTION PLANNING; CONSTRUCTION PROJECT MANAGEMENT SERVICES; CONSTRUCTION SUPERVISION; LAYING AND CONSTRUCTION OF PIPELINES; PIPELINE CONSTRUCTION AND MAINTENANCE; GENERAL CONTRACTOR SERVICES, NAMELY, PLUMBING, HEATING AND AIR CONDITIONING, CARPENTRY, DRYWALL, PAINTING, ELECTRICAL, FOUNDATION, BUILDING, MECHANICAL, PAVING, PLASTERING, AND FRAMING CONTRACTOR SERVICES; INSTALLATION, REPAIR, AND MAINTENANCE OF PLUMBING; HVAC CONTRACTOR SERVICES; INSPECTION SERVICES IN THE COURSE OF CONSTRUCTION OF BUILDINGS, CLEAN ROOMS, PLUMBING, AND VENTILATION SYSTEMS; POLISHING OF METAL PIPES AND TUBING, IN CLASS 37 (U.S. CLS. 100, 103 AND 106).

FIRST USE 1-1-1984; IN COMMERCE 1-1-1984.

FOR: CUSTOM MANUFACTURING IN THE FIELD OF SHEET METAL SHAPING, CUTTING, AND FABRICATION; CUSTOM MANUFACTURE OF STEEL PIPE AND TUBING; CUSTOM MANUFACTURE OF FRAMING, PIPING, AND SUPPORT STRUCTURES FOR INDUSTRIAL EQUIPMENT SYSTEMS, IN CLASS 40 (U.S. CLS. 100, 103 AND 106).



*David J. Kyjars*

Director of the United States Patent and Trademark Office

**Reg. No. 4,123,854** FIRST USE 1-1-1984; IN COMMERCE 1-1-1984.

FOR: ARCHITECTURAL AND ENGINEERING SERVICES; CONSULTING IN THE FIELDS OF ENGINEERING AND ARCHITECTURE; CUSTOM DESIGN AND ENGINEERING OF CLEAN ROOMS, HVAC SYSTEMS, AND PLUMBING SYSTEMS; INSPECTIONS OF PLUMBING AND VENTILATION SYSTEMS; TESTING AND INSPECTION OF CLEAN ROOMS OF OTHERS FOR CERTIFICATION PURPOSES; INSPECTING AND TESTING OF WELDING OF OTHERS FOR CERTIFICATION PURPOSES; PURGE GAS MONITORING, IN CLASS 42 (U.S. CLS. 100 AND 101).

FIRST USE 1-1-1984; IN COMMERCE 1-1-1984.

THE MARK CONSISTS OF STANDARD CHARACTERS WITHOUT CLAIM TO ANY PARTICULAR FONT, STYLE, SIZE, OR COLOR.

SER. NO. 85-080,324, FILED 7-8-2010.

ALEX KEAM, EXAMINING ATTORNEY

# United States of America

United States Patent and Trademark Office

**GREEN PLANET 21**

[www.greenplanet21.com](http://www.greenplanet21.com)

**Recycling for the 21<sup>st</sup> Century**

**Reg. No. 4,123,855**

**Registered Apr. 10, 2012**

**Int. Cl.: 40**

**SERVICE MARK**

**PRINCIPAL REGISTER**

GREEN PLANET 21, LLC (DELAWARE LIMITED LIABILITY COMPANY), DBA GREEN PLANET 21, LLC  
1221 3RD ST.  
OAKLAND, CA 94607

FOR: RECYCLING SERVICES, NAMELY, SORTING AND COMPACTING OF NONHAZARDOUS USED PAPER, CARDBOARD AND PLASTIC CONTAINERS, FOR ULTIMATE USE AS RAW INPUTS BY MANUFACTURERS, IN CLASS 40 (U.S. CLS. 100, 103 AND 106).

FIRST USE 6-18-2008; IN COMMERCE 6-18-2008.

NO CLAIM IS MADE TO THE EXCLUSIVE RIGHT TO USE "GREEN", APART FROM THE MARK AS SHOWN.

THE COLOR(S) GREEN, WHITE, BLACK, AND GRAY IS/ARE CLAIMED AS A FEATURE OF THE MARK.

THE MARK CONSISTS OF "GREEN PLANET 21 WWW.GREENPLANET21.COM RECYCLING FOR THE 21ST CENTURY". THE WORDING "GREEN PLANET" APPEARS IN WHITE WITH BLACK OUTLINING, SUPERIMPOSED ON A PARTIAL GREEN SPHERE WITH A GRAY SHADOW. THE TERM "21" APPEARS IN A GREEN WITH BLACK OUTLINING, AND THE WORDING "WWW.GREENPLANET21.COM" AND "RECYCLING FOR THE 21ST CENTURY" APPEARS IN GREEN ON TWO LINES AT THE BOTTOM OF THE MARK.

SER. NO. 85-080,608, FILED 7-8-2010.

LIEF MARTIN, EXAMINING ATTORNEY



*David J. Kybas*

Director of the United States Patent and Trademark Office

# United States of America

United States Patent and Trademark Office



**Reg. No. 4,123,856**

**Registered Apr. 10, 2012**

**Int. Cl.: 43**

**SERVICE MARK**

**PRINCIPAL REGISTER**

WINSTEAD ENTERPRISES HOLDING COMPANY, LLC (FLORIDA LIMITED LIABILITY COMPANY), DBA B2 CAFE  
POST OFFICE BOX 2350  
WINTER PARK, FL 32790

FOR: CAFE AND RESTAURANT SERVICES, IN CLASS 43 (U.S. CLS. 100 AND 101).

FIRST USE 5-1-2004; IN COMMERCE 1-1-2005.

OWNER OF U.S. REG. NO. 3,176,044.

THE COLOR(S) RED, YELLOW, BLACK, WHITE AND KHAKI IS/ARE CLAIMED AS A FEATURE OF THE MARK.

NO CLAIM IS MADE TO THE EXCLUSIVE RIGHT TO USE "EST. 1991" AND "CAFE", APART FROM THE MARK AS SHOWN.

THE MARK CONSISTS OF THE WORDING "B2 CAFE EST. 1991 MORNING, NOON & NIGHT" AND THE DESIGN OF A CHECKERBOARD OVAL SURROUNDED BY CONCENTRIC OVALS. THE COLOR RED IS IN THE WORDING "B2" AND IN THE CONCENTRIC OVALS. THE COLOR YELLOW IS IN THE WORDING "CAFE". THE COLOR BLACK IS IN THE OUTLINING OF THE WORDING "B2", "CAFE", AND "EST. 1991" AND IN THE CONCENTRIC OVALS. THE COLOR WHITE IS IN THE WORDING "EST. 1991" AND "MORNING, NOON & NIGHT", IN THE OUTLINING OF THE WORDING "B2" AND "CAFE", AND IN THE CONCENTRIC OVALS. THE COLOR KHAKI IS IN THE DESIGN OF THE CHECKERBOARD OVAL AND IN THE CONCENTRIC OVALS.

SER. NO. 85-082,766, FILED 7-12-2010.

MARGARET POWER, EXAMINING ATTORNEY



*David J. Kybas*

Director of the United States Patent and Trademark Office



# United States of America

United States Patent and Trademark Office

## PLUM DISTRICT

**Reg. No. 4,123,857**

PLUM DISTRICT, INC (DELAWARE CORPORATION)  
609 MISSION ST, 6TH FLOOR  
SAN FRANCISCO, CA 94105

**Registered Apr. 10, 2012**

**Int. Cl.: 35**

FOR: PROMOTING THE GOODS AND SERVICES OF OTHERS BY PROVIDING A WEBSITE FEATURING COUPONS, REBATES, PRICE-COMPARISON INFORMATION, PRODUCT REVIEWS, LINKS TO THE RETAIL WEBSITES OF OTHERS, AND DISCOUNT INFORMATION, IN CLASS 35 (U.S. CLS. 100, 101 AND 102).

**SERVICE MARK**

**PRINCIPAL REGISTER**

FIRST USE 5-19-2010; IN COMMERCE 5-19-2010.

THE MARK CONSISTS OF STANDARD CHARACTERS WITHOUT CLAIM TO ANY PARTICULAR FONT, STYLE, SIZE, OR COLOR.

SER. NO. 85-086,060, FILED 7-15-2010.

LESLIE RICHARDS, EXAMINING ATTORNEY



*David J. Kybas*

Director of the United States Patent and Trademark Office

# United States of America

United States Patent and Trademark Office

## KILLER B NITROUS MONSTER ENERGY

**Reg. No. 4,123,858**

**Registered Apr. 10, 2012**

**Int. Cls.: 5 and 32**

**TRADEMARK**

**PRINCIPAL REGISTER**

HANSEN BEVERAGE COMPANY (DELAWARE CORPORATION)  
SUITE 201  
550 MONICA CIRCLE  
CORONA, CA 92880

FOR: NUTRITIONAL SUPPLEMENTS IN LIQUID FORM CONTAINING SIGNIFICANT VITAMIN B, IN CLASS 5 (U.S. CLS. 6, 18, 44, 46, 51 AND 52).

FIRST USE 7-0-2009; IN COMMERCE 7-0-2009.

FOR: BEVERAGES, NAMELY, CARBONATED SOFT DRINKS; NON-ALCOHOLIC CARBONATED DRINKS ENHANCED WITH VITAMINS, MINERALS, NUTRIENTS, PROTEINS, AMINO ACIDS AND/OR HERBS; CARBONATED ENERGY DRINKS AND SPORTS DRINKS; ALL THE FOREGOING GOODS EXCLUDE PERISHABLE BEVERAGE PRODUCTS THAT CONTAIN FRUIT JUICE OR SOY, WHETHER SUCH PRODUCTS ARE PASTEURIZED OR NOT; ALL THE FOREGOING GOODS CONTAINING SIGNIFICANT VITAMIN B, IN CLASS 32 (U.S. CLS. 45, 46 AND 48).

FIRST USE 7-0-2009; IN COMMERCE 7-0-2009.

THE MARK CONSISTS OF STANDARD CHARACTERS WITHOUT CLAIM TO ANY PARTICULAR FONT, STYLE, SIZE, OR COLOR.

OWNER OF U.S. REG. NOS. 3,044,314, 3,134,842 AND OTHERS.

NO CLAIM IS MADE TO THE EXCLUSIVE RIGHT TO USE "NITROUS" OR "ENERGY", APART FROM THE MARK AS SHOWN.

SER. NO. 85-086,125, FILED 7-16-2010.

LEIGH LOWRY, EXAMINING ATTORNEY



*David J. Kypos*

Director of the United States Patent and Trademark Office

# United States of America

United States Patent and Trademark Office



**Reg. No. 4,123,859**

**Registered Apr. 10, 2012**

**Int. Cls.: 9, 38, 41, 42  
and 45**

**TRADEMARK**

**SERVICE MARK**

**PRINCIPAL REGISTER**

GAME PARK TRADING LIMITED (BR.VIRGIN ISLANDS LIMITED COMPANY (LTD.))  
TRIDENT CHAMBERS, P.O. BOX 146  
ROAD TOWN, TORTOLA, BR.VIRGIN ISLANDS

FOR: DOWNLOADABLE SOFTWARE, PRE-RECORDED DATA CARRIERS AND HARDWARE, ALL FOR GAMING, GAMBLING, ON-LINE GAMING AND ON-LINE GAMBLING, REAL-TIME ANIMATION AND VIDEO-STREAMING OF ON-LINE GAMING AND GAMBLING; DOWNLOADABLE SOFTWARE, PRE-RECORDED DATA CARRIERS AND HARDWARE, ALL FOR CREATING, OPERATING, MANAGING, MONITORING AND SUPERVISING ON-LINE GAMING AND GAMBLING PORTALS, CONTESTS AND TOURNAMENTS, AND FOR MANAGEMENT OF CUSTOMER RELATIONSHIP AND CUSTOMER ACCOUNTS, IN CLASS 9 (U.S. CLS. 21, 23, 26, 36 AND 38).

FOR: STREAMING OF GAMING AND GAMBLING VIDEO MATERIAL ON THE INTERNET, IN CLASS 38 (U.S. CLS. 100, 101 AND 104).

FOR: GAMING SERVICES IN THE NATURE OF CASINO GAMING INCLUDING ON-LINE, AND GAMBLING SERVICES INCLUDING ON-LINE; PROVIDING A WEB-BASED SYSTEM AND ON-LINE PORTAL FOR CUSTOMERS TO PARTICIPATE IN ON-LINE GAMING AND GAMBLING; PROVIDING AN INTERNET WEBSITE PORTAL FEATURING LINKS TO WEBSITES OF OTHERS FEATURING ON-LINE GAMING SERVICES IN THE NATURE OF CASINO GAMING AND ON-LINE GAMBLING SERVICES; PROVIDING INFORMATION IN THE FIELD OF GAMING AND GAMBLING ENTERTAINMENT, FEATURING ANIMATION RENDERED BY MEANS OF A GLOBAL COMPUTER NETWORK; ENTERTAINMENT SERVICES, NAMELY, PROVIDING AN ONGOING SHOW FEATURING ILLUSTRATIONS OF GAMING AND GAMBLING SESSIONS VIA THE INTERNET, IN CLASS 41 (U.S. CLS. 100, 101 AND 107).

FOR: DEVELOPMENT AND DESIGN OF COMPUTER SOFTWARE AND HARDWARE FOR GAMING, GAMBLING, ON-LINE GAMING AND ON-LINE GAMBLING; DEVELOPMENT AND DESIGN OF COMPUTER SOFTWARE AND HARDWARE FOR CREATING, OPERATING, MANAGING, MONITORING AND SUPERVISING ON-LINE GAMING AND GAMBLING PORTALS, CONTESTS AND TOURNAMENTS, AND FOR MANAGEMENT OF CUSTOMER RELATIONSHIP AND CUSTOMER ACCOUNTS; TECHNICAL SUPPORT, NAMELY, TROUBLESHOOTING OF COMPUTER SOFTWARE AND COMPUTER NETWORK PROBLEMS; PROVIDING TEMPORARY USE OF NON-DOWNLOADABLE SOFTWARE FOR GAMING, GAMBLING, ON-LINE GAMING AND ON-LINE GAMBLING; PROVIDING



*David J. Kybas*

Director of the United States Patent and Trademark Office

**Reg. No. 4,123,859** TEMPORARY USE OF NON-DOWNLOADABLE SOFTWARE FOR CREATING, OPERATING, MANAGING, MONITORING AND SUPERVISING FOR OTHERS ON-LINE GAMING AND GAMBLING PORTALS, CONTESTS AND TOURNAMENTS, AND FOR MANAGEMENT OF CUSTOMER RELATIONSHIP AND CUSTOMER ACCOUNTS, IN CLASS 42 (U.S. CLS. 100 AND 101).

FOR: FRAUD DETECTION SERVICES IN THE FIELD OF ON-LINE GAMING AND GAMBLING, NAMELY, MONITORING, DETECTING AND PREVENTING COLLUSION BETWEEN ON-LINE PLAYERS FOR OTHERS, IN CLASS 45 (U.S. CLS. 100 AND 101).

PRIORITY CLAIMED UNDER SEC. 44(D) ON ERPN CMNTY TM OFC APPLICATION NO. 009191354, FILED 6-1-2010, REG. NO. 009191354, DATED 1-27-2011, EXPIRES 6-1-2020.

THE COLOR(S) RED AND BLACK IS/ARE CLAIMED AS A FEATURE OF THE MARK.

OWNER OF U.S. REG. NO. 3,497,624.

NO CLAIM IS MADE TO THE EXCLUSIVE RIGHT TO USE "IPOKER", APART FROM THE MARK AS SHOWN.

THE MARK CONSISTS OF THE LETTER "I" IN THE COLOR RED SURROUNDED BY A SWOOSH IN THE COLOR BLACK AND FOLLOWED BY THE LETTERS "POKER ALWAYS A FULL HOUSE" IN THE COLOR BLACK.

SER. NO. 85-087,496, FILED 7-19-2010.

JOHN DWYER, EXAMINING ATTORNEY

# United States of America

United States Patent and Trademark Office



**Reg. No. 4,123,860**

**Registered Apr. 10, 2012**

**Int. Cls.: 9, 38, 41, 42  
and 45**

**TRADEMARK**

**SERVICE MARK**

**PRINCIPAL REGISTER**

GAME PARK TRADING LIMITED (BR.VIRGIN ISLANDS LIMITED COMPANY (LTD.))  
TRIDENT CHAMBERS, P.O. BOX 146  
ROAD TOWN, TORTOLA, BR.VIRGIN ISLANDS

FOR: DOWNLOADABLE SOFTWARE, PRE-RECORDED DATA CARRIERS AND HARDWARE, ALL FOR GAMING, GAMBLING, ON-LINE GAMING AND ON-LINE GAMBLING, REAL-TIME ANIMATION AND VIDEO-STREAMING OF ON-LINE GAMING AND GAMBLING; DOWNLOADABLE SOFTWARE, PRE-RECORDED DATA CARRIERS AND HARDWARE, ALL FOR CREATING, OPERATING, MANAGING, MONITORING AND SUPERVISING ON-LINE GAMING AND GAMBLING PORTALS, CONTESTS AND TOURNAMENTS, AND FOR MANAGEMENT OF CUSTOMER RELATIONSHIP AND CUSTOMER ACCOUNTS, IN CLASS 9 (U.S. CLS. 21, 23, 26, 36 AND 38).

FOR: STREAMING OF GAMING AND GAMBLING VIDEO MATERIAL ON THE INTERNET, IN CLASS 38 (U.S. CLS. 100, 101 AND 104).

FOR: GAMING SERVICES IN THE NATURE OF CASINO GAMING INCLUDING ON-LINE, AND GAMBLING SERVICES INCLUDING ON-LINE; PROVIDING A WEB-BASED SYSTEM AND ON-LINE PORTAL FOR CUSTOMERS TO PARTICIPATE IN ON-LINE GAMING AND GAMBLING; PROVIDING AN INTERNET WEBSITE PORTAL FEATURING LINKS TO WEBSITES OF OTHERS FEATURING ON-LINE GAMING SERVICES IN THE NATURE OF CASINO GAMING AND ON-LINE GAMBLING SERVICES; PROVIDING INFORMATION IN THE FIELD OF GAMING AND GAMBLING ENTERTAINMENT, FEATURING ANIMATION RENDERED BY MEANS OF A GLOBAL COMPUTER NETWORK; ENTERTAINMENT SERVICES, NAMELY, PROVIDING AN ONGOING SHOW FEATURING ILLUSTRATIONS OF GAMING AND GAMBLING SESSIONS VIA THE INTERNET, IN CLASS 41 (U.S. CLS. 100, 101 AND 107).

FOR: DEVELOPMENT AND DESIGN OF COMPUTER SOFTWARE AND HARDWARE FOR GAMING, GAMBLING, ON-LINE GAMING AND ON-LINE GAMBLING; DEVELOPMENT AND DESIGN OF COMPUTER SOFTWARE AND HARDWARE FOR CREATING, OPERATING, MANAGING, MONITORING AND SUPERVISING ON-LINE GAMING AND GAMBLING PORTALS, CONTESTS AND TOURNAMENTS, AND FOR MANAGEMENT OF CUSTOMER RELATIONSHIP AND CUSTOMER ACCOUNTS; TECHNICAL SUPPORT, NAMELY, TROUBLESHOOTING OF COMPUTER SOFTWARE AND COMPUTER NETWORK PROBLEMS; PROVIDING TEMPORARY USE OF NON-DOWNLOADABLE SOFTWARE FOR GAMING, GAMBLING, ON-LINE GAMING AND ON-LINE GAMBLING; PROVIDING



*David J. Kyros*

Director of the United States Patent and Trademark Office

**Reg. No. 4,123,860** TEMPORARY USE OF NON-DOWNLOADABLE SOFTWARE FOR CREATING, OPERATING, MANAGING, MONITORING AND SUPERVISING FOR OTHERS ON-LINE GAMING AND GAMBLING PORTALS, CONTESTS AND TOURNAMENTS, AND FOR MANAGEMENT OF CUSTOMER RELATIONSHIP AND CUSTOMER ACCOUNTS, IN CLASS 42 (U.S. CLS. 100 AND 101).

FOR: FRAUD DETECTION SERVICES IN THE FIELD OF ON-LINE GAMING AND GAMBLING, NAMELY, MONITORING, DETECTING AND PREVENTING COLLUSION BETWEEN ON-LINE PLAYERS FOR OTHERS, IN CLASS 45 (U.S. CLS. 100 AND 101).

PRIORITY CLAIMED UNDER SEC. 44(D) ON ERPN CMNTY TM OFC APPLICATION NO. 009191347, FILED 6-1-2010, REG. NO. 009191347, DATED 1-27-2011, EXPIRES 6-1-2020.

THE COLOR(S) RED AND BLACK IS/ARE CLAIMED AS A FEATURE OF THE MARK.

OWNER OF U.S. REG. NO. 3,497,624.

NO CLAIM IS MADE TO THE EXCLUSIVE RIGHT TO USE "IPOKER", APART FROM THE MARK AS SHOWN.

THE MARK CONSISTS OF THE LETTER "I" IN THE COLOR RED SURROUNDED BY A SWOOSH IN THE COLOR BLACK AND FOLLOWED BY THE LETTERS "POKER" IN THE COLOR BLACK.

SER. NO. 85-087,500, FILED 7-19-2010.

JOHN DWYER, EXAMINING ATTORNEY

# United States of America

United States Patent and Trademark Office

## JOURNAL AFRIQUE EXPANSION

**Reg. No. 4,123,861**

BANQUE DE DEVELOPPEMENT AFRIQUE AMERIQUE (FRANCE CORPORATION)

**Registered Apr. 10, 2012**

6-8 AVENUE DE CREIL  
60300 SENLIS, FRANCE

**Int. Cls.: 16, 35, 38 and  
41**

FOR: PRINTS, NEWSPAPERS AND PRINTED PERIODICALS IN THE FIELD OF BUSINESS, ECONOMICS, POLITICS, CULTURE IN AFRICA AND AFRICAN NEWS; BOOKBINDING MATERIAL, IN CLASS 16 (U.S. CLS. 2, 5, 22, 23, 29, 37, 38 AND 50).

**TRADEMARK**

FIRST USE 12-31-2007; IN COMMERCE 12-31-2007.

**SERVICE MARK**

FOR: ADVERTISING; BUSINESS MANAGEMENT, ASSISTANCE WITH BUSINESS MANAGEMENT, BUSINESS ORGANIZATION AND MANAGEMENT CONSULTING, BUSINESS INFORMATION, BUSINESS INQUIRIES, DISSEMINATION OF ADVERTISING MATERIAL IN THE NATURE OF LEAFLETS, PROSPECTUSES, PRINTED MATTER, SAMPLES, NEWSPAPER SUBSCRIPTION SERVICES, RENTAL OF ADVERTISING TIME VIA ANY MEANS OF COMMUNICATION, PUBLICATION OF ADVERTISING TEXTS, DISSEMINATION OF ADVERTISING MATTER; COMMERCIAL INFORMATION AGENCIES; PRESS AGENCIES, NAMELY, ADVERTISING AGENCIES; CONDUCTING BUSINESS CONFERENCES, IN CLASS 35 (U.S. CLS. 100, 101 AND 102).

**PRINCIPAL REGISTER**

FOR: COMMUNICATIONS VIA COMPUTER TERMINALS; RADIO BROADCASTING, TELEGRAPH COMMUNICATIONS, TELEPHONE COMMUNICATIONS, RADIO AND TELEVISION BROADCASTING; NEWS AGENCIES, NAMELY, THE TRANSMISSION OF NEWS ITEMS TO NEWS REPORTING ORGANIZATIONS, IN CLASS 38 (U.S. CLS. 100, 101 AND 104).



FOR: EDUCATIONAL SERVICES, NAMELY, CONDUCTING CLASSES, SEMINARS, CONFERENCES, WORKSHOPS AND LECTURES IN THE FIELDS OF ECONOMICS, POLITICS AND CULTURE RELATING TO AFRICA AND DISTRIBUTION OF TRAINING MATERIAL IN CONNECTION THEREWITH; TRAINING IN THE FIELDS OF BANKING, ECONOMICS AND TEACHING; ENTERTAINMENT SERVICES, NAMELY, PROVIDING MOTIVATIONAL AND EDUCATIONAL SPEAKERS; ORGANIZING COMMUNITY SPORTING AND CULTURAL ACTIVITIES; INFORMATION ON EDUCATIONAL OR ENTERTAINMENT EVENTS; BOOK PUBLISHING, IN CLASS 41 (U.S. CLS. 100, 101 AND 107).

*David J. Kyffers*

Director of the United States Patent and Trademark Office

THE MARK CONSISTS OF STANDARD CHARACTERS WITHOUT CLAIM TO ANY PARTICULAR FONT, STYLE, SIZE, OR COLOR.

**Reg. No. 4,123,861** OWNER OF FRANCE REG. NO. 103754474, DATED 7-19-2010, EXPIRES 7-19-2020.

NO CLAIM IS MADE TO THE EXCLUSIVE RIGHT TO USE "JOURNAL AFRIQUE" FOR INTERNATIONAL CLASSES 16, 41 AND "AFRIQUE" FOR INTERNATIONAL CLASSES 35, 38, APART FROM THE MARK AS SHOWN.

THE ENGLISH TRANSLATION OF "AFRIQUE" IN THE MARK IS "AFRICA".

SER. NO. 85-087,567, FILED 7-19-2010.

BRIAN CALLAGHAN, EXAMINING ATTORNEY



# United States of America

United States Patent and Trademark Office



**Reg. No. 4,123,862**

**Registered Apr. 10, 2012**

**Int. Cl.: 12**

**TRADEMARK**

**PRINCIPAL REGISTER**

PIAGGIO & C. S.P.A. (ITALY CORPORATION)  
VIALE RINALDO PIAGGIO 25  
PONTEDERA (PISA), ITALY 56025

FOR: THREE-WHEELED MOTOR VEHICLES AND THEIR SPARE PARTS AND ACCESSORIES, NAMELY, MAGNETIC TANK BAGS, MOTORCYCLE BAGS IN THE NATURE OF SEAT STORAGE BAGS, MOTORCYCLE BAGS IN THE NATURE OF SEAT STORAGE BAGS LATERAL STORAGE BAGS, MOTOR CASES BEING STRUCTURAL PARTS OF MOTORCYCLES, WHEEL RIM COVERS, VEHICLE WINDSCREENS AND WINDSHIELDS, VEHICLE WINDSHIELD SHADE SCREENS, AUTOMOTIVE WINDSHIELD SHADE SCREENS, ANTI-THEFT ALARMS FOR VEHICLES, DISC BRAKES FOR THREE-WHEELED MOTOR VEHICLES, VEHICLE RUNNING BOARDS, FITTED AND SEMI-FITTED HANDLE BAR GRIP COVERS, HANDLE BARS, LUGGAGE CARRIERS FOR VEHICLES, STRUCTURAL PARTS OF VEHICLES IN THE NATURE OF SIDE LEG SHIELDS TO PROTECT LEGS FROM THE ELEMENTS, MOTORCYCLE SEAT BACKS, GAS AND STORAGE TANK COVERS, IN CLASS 12 (U.S. CLS. 19, 21, 23, 31, 35 AND 44).

FIRST USE 5-0-2006; IN COMMERCE 4-1-2007.

OWNER OF U.S. REG. NOS. 1,284,198, 3,133,207 AND OTHERS.

THE MARK CONSISTS OF THE ALPHANUMERIC CHARACTERS "MP3" IN STYLIZED LETTERS IN WHICH THE NUMBER "3" APPEARS BELOW THE LETTER "P" WHILE THE LETTER "M" IS UNDERLINED BY A TAIL COMING FROM THE LETTER "P"; THE WORD "PIAGGIO" APPEARS ON THE LETTER "P"'S TAIL.

THE WORDING "PIAGGIO" HAS NO MEANING IN A FOREIGN LANGUAGE.

SER. NO. 85-087,760, FILED 7-19-2010.

JAY BESCH, EXAMINING ATTORNEY



*David J. Kyros*

Director of the United States Patent and Trademark Office

# United States of America

United States Patent and Trademark Office

## HAIR TAMING SYSTEM

**Reg. No. 4,123,863**

**Registered Apr. 10, 2012**

**Int. Cl.: 3**

**TRADEMARK**

**PRINCIPAL REGISTER**

GK WORLD HOLDING LLC (FLORIDA LIMITED LIABILITY COMPANY)  
SUITE 16B  
5555 ANGLERS AVENUE  
FORT LAUDERDALE, FL 33312

FOR: HAIR CARE PREPARATIONS; HAIR SHAMPOOS AND CONDITIONERS; HAIR STRAIGHTENING PREPARATIONS, IN CLASS 3 (U.S. CLS. 1, 4, 6, 50, 51 AND 52).

FIRST USE 1-0-2010; IN COMMERCE 1-0-2010.

THE MARK CONSISTS OF STANDARD CHARACTERS WITHOUT CLAIM TO ANY PARTICULAR FONT, STYLE, SIZE, OR COLOR.

NO CLAIM IS MADE TO THE EXCLUSIVE RIGHT TO USE "SYSTEM", APART FROM THE MARK AS SHOWN.

SEC. 2(F).

SER. NO. 85-088,526, FILED 7-20-2010.

JUDITH HELFMAN, EXAMINING ATTORNEY



*David J. Kyffers*

Director of the United States Patent and Trademark Office

# United States of America

United States Patent and Trademark Office



**Reg. No. 4,123,864**

CAPITA MARKETING LTD. (CANADA LIMITED COMPANY (LTD.))  
UNIT 170-190, 12868 CLARKE PLACE  
RICHMOND, B.C., CANADA V6V2H1

**Registered Apr. 10, 2012**

**Int. Cl.: 5**

FOR: HERBAL AND NUTRITIONAL SUPPLEMENTS, IN CLASS 5 (U.S. CLS. 6, 18, 44, 46, 51 AND 52).

**TRADEMARK**

PRIORITY CLAIMED UNDER SEC. 44(D) ON CANADA APPLICATION NO. 1488108, FILED 7-9-2010, REG. NO. TMA803,470, DATED 8-3-2011, EXPIRES 8-3-2026.

**PRINCIPAL REGISTER**

THE MARK CONSISTS OF AN IMAGE OF A STYLIZED HOUSE WITH TWO LEAVES INSIDE THE HOUSE IMMEDIATELY FOLLOWED BY THE WORD "VITAHOUSE".

SER. NO. 85-088,958, FILED 7-20-2010.

MARTHA FROMM, EXAMINING ATTORNEY



*David J. Kyros*

Director of the United States Patent and Trademark Office

# United States of America

United States Patent and Trademark Office

# PIEZOFLUSH

**Reg. No. 4,123,865**

CONE EDITIONS PRESS, LTD (VERMONT CORPORATION)  
P.O. BOX 51, 17 POWDER SPRINGS ROAD  
E. TOPSHAM, VT 05076

**Registered Apr. 10, 2012**

**Int. Cl.: 2**

FOR: INK JET CARTRIDGES; INK JET PRINTER INK, IN CLASS 2 (U.S. CLS. 6, 11 AND 16).

**TRADEMARK**

FIRST USE 10-30-2006; IN COMMERCE 10-30-2006.

**PRINCIPAL REGISTER**

THE MARK CONSISTS OF STANDARD CHARACTERS WITHOUT CLAIM TO ANY PARTICULAR FONT, STYLE, SIZE, OR COLOR.

OWNER OF U.S. REG. NO. 2,655,513.

SEC. 2(F).

SER. NO. 85-089,430, FILED 7-21-2010.

MARK RADEMACHER, EXAMINING ATTORNEY



*David J. Kyros*

Director of the United States Patent and Trademark Office

# United States of America

United States Patent and Trademark Office

# TENSABOWL

**Reg. No. 4,123,866**

**Registered Apr. 10, 2012**

**Int. Cl.: 20**

**TRADEMARK**

**PRINCIPAL REGISTER**

TENSATOR GROUP LIMITED (UNITED KINGDOM CORPORATION)  
DANBURY COURT, LINFORD WOOD  
MILTON KEYNES, UNITED KINGDOM MK146TS

FOR: MERCHANDISING DISPLAY FIXTURE IN THE SHAPE OF A PLASTIC BOWL USED TO DISPLAY VARIOUS GOODS AND PRODUCTS TO CONSUMERS AS THEY WAIT IN THE CHECK OUT LINE, IN CLASS 20 (U.S. CLS. 2, 13, 22, 25, 32 AND 50).

FIRST USE 6-1-2006; IN COMMERCE 6-1-2006.

THE MARK CONSISTS OF STANDARD CHARACTERS WITHOUT CLAIM TO ANY PARTICULAR FONT, STYLE, SIZE, OR COLOR.

OWNER OF U.S. REG. NOS. 1,438,074, 3,666,276 AND OTHERS.

SER. NO. 85-092,649, FILED 7-26-2010.

ROBERT STRUCK, EXAMINING ATTORNEY



*David J. Kyffers*

Director of the United States Patent and Trademark Office

# United States of America

United States Patent and Trademark Office

## COLLECTION RENO CARTON 3D

**Reg. No. 4,123,867**

**Registered Apr. 10, 2012**

**Int. Cl.: 28**

**TRADEMARK**

**PRINCIPAL REGISTER**

CASCADES CANADA INC. (CANADA CORPORATION)  
772, RUE SHERBROOKE OUEST, BUREAU 100  
MONTREAL, QUEBEC, CANADA H3A1G1

FOR: CARDBOARD THREE-DIMENSIONAL JIGSAW PUZZLES, IN CLASS 28 (U.S. CLS. 22, 23, 38 AND 50).

THE MARK CONSISTS OF STANDARD CHARACTERS WITHOUT CLAIM TO ANY PARTICULAR FONT, STYLE, SIZE, OR COLOR.

OWNER OF CANADA REG. NO. TMA811977, DATED 11-17-2011, EXPIRES 11-17-2026.

NO CLAIM IS MADE TO THE EXCLUSIVE RIGHT TO USE "COLLECTION" AND "3D", APART FROM THE MARK AS SHOWN.

SER. NO. 85-092,971, FILED 7-26-2010.

KAREN BRACEY, EXAMINING ATTORNEY



*David J. Kybas*

Director of the United States Patent and Trademark Office

# United States of America

United States Patent and Trademark Office

# Ofis

**Reg. No. 4,123,868**

**Registered Apr. 10, 2012**

**Int. Cls.: 37 and 39**

**SERVICE MARK**

**PRINCIPAL REGISTER**

OFFICE FURNITURE INSTALLATION SPECIALISTS, INC. (GEORGIA CORPORATION)  
2498 TUCKERSTONE PARKWAY SUITE B  
TUCKER, GA 30084

FOR: FURNITURE MAINTENANCE; FURNITURE REPAIR; FURNITURE RESTORATION; FURNITURE RESTORATION CONSULTATION; FURNITURE RESTORATION, REPAIR AND MAINTENANCE; INSTALLATION AND MAINTENANCE OF MODULAR OFFICE FURNITURE SYSTEMS, PARTITIONS AND FILE CABINETS, DESK, SHELVING AND CHAIRS; INSTALLATION, MAINTENANCE AND REPAIR OF MODULAR OFFICE FURNITURE SYSTEMS, PARTITIONS AND FILE CABINETS, DESK, SHELVING AND CHAIRS; MAINTENANCE AND/OR REPAIR OF MODULAR OFFICE FURNITURE SYSTEMS, PARTITIONS, FILE CABINETS, DESK, SHELVING AND CHAIRS; REFINISHING OF MODULAR OFFICE FURNITURE SYSTEMS, PARTITIONS AND FILE CABINETS, DESK, SHELVING AND CHAIRS; RENOVATION IN THE FIELD OF MODULAR OFFICE FURNITURE SYSTEMS, PARTITIONS AND FILE CABINETS, DESK, SHELVING AND CHAIRS, IN CLASS 37 (U.S. CLS. 100, 103 AND 106).

FIRST USE 6-1-1999; IN COMMERCE 6-1-1999.

FOR: FURNITURE MOVING; FURNITURE STORAGE; STORAGE OF MODULAR OFFICE FURNITURE SYSTEMS, PARTITIONS AND FILE CABINETS, DESK, SHELVING AND CHAIRS; TRANSPORTATION OF FURNITURE OF OTHERS BY TRUCKS, IN CLASS 39 (U.S. CLS. 100 AND 105).

FIRST USE 6-1-1999; IN COMMERCE 6-1-1999.

THE MARK CONSISTS OF STANDARD CHARACTERS WITHOUT CLAIM TO ANY PARTICULAR FONT, STYLE, SIZE, OR COLOR.

OWNER OF U.S. REG. NO. 3,792,681.

THE WORDING "OFIS" HAS NO MEANING IN A FOREIGN LANGUAGE.

SER. NO. 85-093,180, FILED 7-26-2010.

SALLY SHIH, EXAMINING ATTORNEY



*David J. Kyffers*

Director of the United States Patent and Trademark Office

# United States of America

United States Patent and Trademark Office



**Reg. No. 4,123,869**

**Registered Apr. 10, 2012**

**Int. Cl.: 32**

**TRADEMARK**

**PRINCIPAL REGISTER**

MOLSON CANADA 2005 (CANADA PARTNERSHIP)  
33 CARLINGVIEW DRIVE  
TORONTO, ONTARIO, CANADA M9W5E4

FOR: BREWED ALCOHOLIC BEVERAGES, NAMELY, BEER, IN CLASS 32 (U.S. CLS. 45, 46 AND 48).

FIRST USE 4-0-2010; IN COMMERCE 4-0-2010.

PRIORITY CLAIMED UNDER SEC. 44(D) ON CANADA APPLICATION NO. 1468164, FILED 2-3-2010, REG. NO. TMA789823, DATED 2-7-2011, EXPIRES 2-7-2026.

OWNER OF U.S. REG. NOS. 820,874, 3,003,324 AND OTHERS.

NO CLAIM IS MADE TO THE EXCLUSIVE RIGHT TO USE "CANADIAN", APART FROM THE MARK AS SHOWN.

THE MARK CONSISTS OF A MAPLE LEAF DESIGN ABOVE THE STYLIZED TEXT "MOLSON CANADIAN".

SER. NO. 85-097,109, FILED 7-30-2010.

AISHA SALEM, EXAMINING ATTORNEY



*David J. Kybas*

Director of the United States Patent and Trademark Office



# United States of America

United States Patent and Trademark Office

# BACCHI

**Reg. No. 4,123,870**

BACCHI, INC. (FLORIDA CORPORATION)  
1801 GULF SHORE BLVD N PH 01  
NAPLES, FL 34102

**Registered Apr. 10, 2012**

**Int. Cl.: 25**

FOR: RUGBY SHIRTS; SPORT SHIRTS; WEARABLE GARMENTS AND CLOTHING,  
NAMELY, SHIRTS, IN CLASS 25 (U.S. CLS. 22 AND 39).

**TRADEMARK**

FIRST USE 4-1-2007; IN COMMERCE 4-10-2010.

**PRINCIPAL REGISTER**

THE MARK CONSISTS OF STANDARD CHARACTERS WITHOUT CLAIM TO ANY PAR-  
TICULAR FONT, STYLE, SIZE, OR COLOR.

THE WORD "BACCHI" HAS NO MEANING IN A FOREIGN LANGUAGE.

SER. NO. 85-097,398, FILED 7-30-2010.

KATHY DE JONGE, EXAMINING ATTORNEY



*David J. Kybas*

Director of the United States Patent and Trademark Office

# United States of America

United States Patent and Trademark Office



**Reg. No. 4,123,871**

**Registered Apr. 10, 2012**

**Int. Cl.: 41**

**SERVICE MARK**

**PRINCIPAL REGISTER**

BLUE TRAIL ENTERTAINMENT (PENNSYLVANIA CORPORATION)  
1850 W. HAMILTON ST.  
ALLENTOWN, PA 18104

FOR: ENTERTAINMENT IN THE NATURE OF BMX RACES; ENTERTAINMENT SERVICES, NAMELY, CONDUCTING CONTESTS; ENTERTAINMENT SERVICES, NAMELY, PARTICIPATION IN BMX CONTEST, IN CLASS 41 (U.S. CLS. 100, 101 AND 107).

FIRST USE 9-0-2009; IN COMMERCE 9-0-2009.

THE MARK CONSISTS OF YELLOW BACKGROUND WITH 3 INDIVIDUALS ON BIKES; ORANGE SPLASH SECONDARY BACKGROUND; THEY ARE OUTLINED IN BLACK WITH TAN SKIN, WITH YELLOW SUNGLASSES AND BROWN SHIRTS, HATS AND BIKES WITH THE CENTER BIKE DISPLAYING A YELLOW NUMBER 1; BELOW THE BIKERS ARE THE WORDS "HEROES OF DIRT" IN BLACK STYLIZED LETTERS; THEY ARE RIDING OVER ORANGE AND BLACK SKULLS.

THE COLOR(S) YELLOW, BROWN, ORANGE, BLACK, TAN IS/ARE CLAIMED AS A FEATURE OF THE MARK.

SER. NO. 85-098,925, FILED 8-3-2010.

HOWARD B. LEVINE, EXAMINING ATTORNEY



*David J. Kyffers*

Director of the United States Patent and Trademark Office

# United States of America

United States Patent and Trademark Office

# SKYWATER

**Reg. No. 4,123,872**

SKYWATER GROUP LLC (FLORIDA LIMITED LIABILITY COMPANY)  
2300 SE 14TH ST.

**Registered Apr. 10, 2012**

POMPANO, FL 33062

**Int. Cl.: 36**

FOR: YACHT AND AIRCRAFT BROKERAGE SERVICES, IN CLASS 36 (U.S. CLS. 100, 101 AND 102).

**SERVICE MARK**

FIRST USE 9-1-2006; IN COMMERCE 9-1-2006.

**PRINCIPAL REGISTER**

THE MARK CONSISTS OF STANDARD CHARACTERS WITHOUT CLAIM TO ANY PARTICULAR FONT, STYLE, SIZE, OR COLOR.

SER. NO. 85-099,662, FILED 8-4-2010.

FRED CARL, EXAMINING ATTORNEY



*David J. Kybas*

Director of the United States Patent and Trademark Office

# United States of America

United States Patent and Trademark Office

# gift2jewelry.com

**Reg. No. 4,123,873**

**Registered Apr. 10, 2012**

**Int. Cl.: 35**

**SERVICE MARK**

**PRINCIPAL REGISTER**

HELEN BRETT ENTERPRISES, INC. (ILLINOIS CORPORATION)  
5111 ACADEMY DRIVE  
LISLE, IL 60532

FOR: ON-LINE RETAIL AND WHOLESALE DISTRIBUTION SERVICES FEATURING JEWELRY AND GIFTS; PROMOTING THE GOODS AND SERVICES OF OTHERS BY PREPARING AND PLACING ADVERTISEMENTS ON A WORLDWIDE WEB SITE ACCESSED THROUGH A GLOBAL COMPUTER NETWORK; AND PROVIDING NEWS AND INFORMATION ABOUT THE RETAIL JEWELRY AND GIFT INDUSTRY AND COMPANIES OPERATING THEREIN VIA A GLOBAL COMPUTER NETWORK, IN CLASS 35 (U.S. CLS. 100, 101 AND 102).

FIRST USE 8-31-2000; IN COMMERCE 8-31-2000.

OWNER OF U.S. REG. NO. 2,496,044.

NO CLAIM IS MADE TO THE EXCLUSIVE RIGHT TO USE ".COM", APART FROM THE MARK AS SHOWN.

THE MARK CONSISTS OF THE STYLIZED WORDS "GIFT2JEWELRY.COM".

SEC. 2(F).

SER. NO. 85-101,740, FILED 8-6-2010.

CORY BOONE, EXAMINING ATTORNEY



*David J. Kyffers*

Director of the United States Patent and Trademark Office

# United States of America

United States Patent and Trademark Office



**Reg. No. 4,123,874**

TWEED-JEFFRIES, LLC (KENTUCKY LIMITED LIABILITY COMPANY)  
9750 ORMSBY STATION ROAD  
LOUISVILLE, KY 40223

**Registered Apr. 10, 2012**

**Int. Cls.: 35 and 45**

FOR: BUSINESS SERVICES, NAMELY, REGISTERING, SCREENING, CREDENTIALING, AND ORGANIZING INFORMATION ABOUT THIRD-PARTY SERVICE PROVIDERS FOR THE BENEFIT OF CONSUMERS OF IN-HOME SERVICES IN MAKING HIRING DECISIONS; PRE-EMPLOYMENT TESTING TO DETERMINE EMPLOYMENT SKILLS AND PROFESSIONAL COMPETENCY PROVIDED TO OTHERS WITHIN THE HEALTHCARE INDUSTRY; PRE-EMPLOYMENT ASSESSMENT SERVICES PROVIDED TO OTHERS WITHIN THE HEALTHCARE INDUSTRY, NAMELY, PSYCHOLOGICAL TESTING FOR SELECTION OF PERSONNEL, IN CLASS 35 (U.S. CLS. 100, 101 AND 102).

**SERVICE MARK**

FIRST USE 12-1-2009; IN COMMERCE 12-1-2009.

**PRINCIPAL REGISTER**

FOR: PRE-EMPLOYMENT TESTING AND ASSESSMENT SERVICES PROVIDED TO OTHERS WITHIN THE HEALTHCARE INDUSTRY, NAMELY, BACKGROUND SCREENING, IN CLASS 45 (U.S. CLS. 100 AND 101).

FIRST USE 12-1-2009; IN COMMERCE 12-1-2009.

NO CLAIM IS MADE TO THE EXCLUSIVE RIGHT TO USE "CERTIFIED" AND "CAREGIVER QUALITY ASSURANCE", APART FROM THE MARK AS SHOWN.



THE COLOR(S) YELLOW, BLACK, GOLD AND GRAY IS/ARE CLAIMED AS A FEATURE OF THE MARK.

THE MARK CONSISTS OF THE LETTERS "CQA" IN YELLOW, WITH THE WORD "CERTIFIED" APPEARING UNDERNEATH IN BLACK. BELOW THESE ELEMENTS IS A YELLOW HORIZONTAL LINE AND THE TEXT "CAREGIVER QUALITY ASSURANCE" IN BLACK. ALL OF THESE ELEMENTS ARE CONTAINED IN A GOLD CIRCLE WITH GRAY SHADING.

SER. NO. 85-101,928, FILED 8-6-2010.

*David J. Kyros*

REBECCA EISINGER, EXAMINING ATTORNEY

# United States of America

United States Patent and Trademark Office

## JIMMY'S LOUNGE

**Reg. No. 4,123,875**

POR ENTERPRISES, INC. (ALABAMA CORPORATION)  
8700 HIGHWAY 72 WEST  
MADISON, AL 357589582

**Registered Apr. 10, 2012**

**Int. Cl.: 41**

FOR: ADULT ENTERTAINMENT SERVICES, NAMELY, EXOTIC DANCING SERVICES EXCLUDING NIGHT CLUB SERVICES, IN CLASS 41 (U.S. CLS. 100, 101 AND 107).

**SERVICE MARK**

FIRST USE 10-4-1995; IN COMMERCE 10-4-1995.

**PRINCIPAL REGISTER**

THE MARK CONSISTS OF STANDARD CHARACTERS WITHOUT CLAIM TO ANY PARTICULAR FONT, STYLE, SIZE, OR COLOR.

NO CLAIM IS MADE TO THE EXCLUSIVE RIGHT TO USE "LOUNGE", APART FROM THE MARK AS SHOWN.

SER. NO. 85-102,297, FILED 8-6-2010.

HEATHER THOMPSON, EXAMINING ATTORNEY



*David J. Kybas*

Director of the United States Patent and Trademark Office

# United States of America

United States Patent and Trademark Office

# SALICINIUM

**Reg. No. 4,123,876**

**Registered Apr. 10, 2012**

**Int. Cl.: 5**

COGNATE 3 LLC (WASHINGTON LIMITED LIABILITY COMPANY), DBA COGNATE 3  
LLC  
SUITE 287  
218 MAIN STREET  
KIRKLAND, WA 98033

**TRADEMARK**

**PRINCIPAL REGISTER**

FOR: DRUG PREPARATIONS, LIQUID DRUG FORMULATIONS, PRESCRIPTION AND NON-PRESCRIPTION MEDICATIONS, NAMELY, CAPSULES, TABLETS, POWDERS, AND PHARMACEUTICAL PREPARATIONS, INJECTABLE PHARMACEUTICALS, TOPICAL FORMULATIONS AND PATCHES, INFUSION PHARMACEUTICAL PREPARATIONS, INTRAVENOUS PHARMACEUTICAL FORMULATIONS, AND PHARMACEUTICAL SOLUTIONS FOR MEDICAL AND NUTRITIONAL PURPOSES AND USES, NAMELY, FOR TREATMENT OF IMMUNE DISORDERS, IMMUNE DEFICIENCIES, CELLULAR PROLIFERATIVE DISORDERS, NAMELY, CANCER, BACTERIAL, VIRAL AND FUNGAL INFECTIONS, PHYSIOLOGICAL PH IMBALANCES, DIGESTIVE DISORDERS, AND NUTRITIONAL AND DIETARY DEFICIENCIES; DRUGS AND MEDICATIONS NAMELY, ANTI-INFLAMMATORIES, PHARMACEUTICAL PREPARATIONS USED IN CANCER THERAPEUTICS, ANTISEPTICS, ANTIBIOTICS, ANTIVIRALS, ANTIFUNGAL PREPARATIONS, ANTIMICROBIAL PRESERVATIVES FOR COSMETICS AND PHARMACEUTICALS, PHARMACEUTICAL PREPARATIONS FOR THE TREATMENT OF IMMUNE SYSTEM RELATED DISEASES AND DISORDERS, IMMUNE SUPPLEMENTAL, NUTRITIONAL SUPPLEMENTS FOR STIMULATING THE IMMUNITY SYSTEM, PHARMACEUTICAL PREPARATIONS FOR WOUND HEALING, NUTRITIONAL SUPPLEMENTS FOR BALANCING IMMUNE SYSTEM-RELATED FACTORS, NAMELY, BLOOD SUGAR AND PH LEVELS, NUTRITIONAL SUPPLEMENTS FOR ADJUSTING AND BALANCING PH LEVELS AND OTHER IMMUNE SYSTEM-RELATED FACTORS, AND DIETARY SUPPLEMENTS AND BALANCING DRUGS AND MEDICATIONS, NAMELY, MEDICATIONS INCORPORATING ACTIVE DRUGS AND OTHER THERAPEUTIC AGENTS EFFECTIVE FOR ALLEVIATING IMMUNE DISORDERS, IMMUNE DEFICIENCIES, CELLULAR PROLIFERATIVE DISORDERS, PHYSIOLOGICAL PH IMBALANCES, DIGESTIVE DISORDERS, AND NUTRITIONAL AND DIETARY DEFICIENCIES, ALL FOR ORAL, TOPICAL, INTRAVENOUS, INJECTION AND INFUSION THERAPY, IN CLASS 5 (U.S. CLS. 6, 18, 44, 46, 51 AND 52).



*David J. Kyros*

Director of the United States Patent and Trademark Office

FIRST USE 2-10-2009; IN COMMERCE 2-10-2009.

THE MARK CONSISTS OF STANDARD CHARACTERS WITHOUT CLAIM TO ANY PARTICULAR FONT, STYLE, SIZE, OR COLOR.

**Reg. No. 4,123,876** OWNER OF U.S. REG. NO. 3,616,425.

SER. NO. 85-102,816, FILED 8-9-2010.

DARRYL SPRUILL, EXAMINING ATTORNEY



# United States of America

United States Patent and Trademark Office



**Reg. No. 4,123,877**

**Registered Apr. 10, 2012**

**Int. Cl.: 36**

**SERVICE MARK**

**PRINCIPAL REGISTER**

PATRICIA JIMENEZ (TEXAS CORPORATION), DBA THE RAUL JIMENEZ ANNUAL  
THANKSGIVING DINNER FUND, INC.  
8700 CROWNHILL BOULEVARD, SUITE 802  
SAN ANTONIO, TX 78209

FOR: CHARITABLE FUNDRAISING SERVICES BY MEANS OF ORGANIZING AND CONDUCTING SPECIAL EVENTS, IN CLASS 36 (U.S. CLS. 100, 101 AND 102).

FIRST USE 11-20-1980; IN COMMERCE 11-20-1998.

NO CLAIM IS MADE TO THE EXCLUSIVE RIGHT TO USE "MEXICAN GOURMET", APART FROM THE MARK AS SHOWN.

THE NAME(S), PORTRAIT(S), AND/OR SIGNATURE(S) SHOWN IN THE MARK DOES NOT IDENTIFY A PARTICULAR LIVING INDIVIDUAL.

THE MARK CONSISTS OF A PORTRAIT OF RAUL JIMENEZ. THE WORDING, "MEXICAN" AND "GOURMET", APPEAR AS WORD TAGS ON THE UPPER RIGHT AND LEFT POCKET AREAS OF THE OUTFIT.

SEC. 2(F).

SER. NO. 85-106,365, FILED 8-12-2010.

C. DIONNE CLYBURN, EXAMINING ATTORNEY



*David J. Kybas*

Director of the United States Patent and Trademark Office

# United States of America

United States Patent and Trademark Office

# DYNACLEAN

**Reg. No. 4,123,878**

**Registered Apr. 10, 2012**

**Int. Cls.: 9, 37 and 42**

**TRADEMARK**

**SERVICE MARK**

**PRINCIPAL REGISTER**

FRAS TECHNOLOGY AS (NORWAY AKSJESELSKAP (AS))  
VERKSVEGEN 1  
6884 ØVRE ÅRDAL, NORWAY

FOR: APPARATUS AND DEVICES, NAMELY, TECHNICAL MEASURING, TESTING AND CHECKING APPARATUS AND INSTRUMENTS FOR MEASURING, CONTROLLING, SAMPLING AND ANALYZING FLUIDS IN INDUSTRIAL AND MARITIME PIPING BEFORE, DURING AND AFTER CLEANING; LASER INSTRUMENTS FOR THE ANALYSIS OF FLUIDS IN PIPING BEFORE, DURING AND AFTER CLEANING; PARTS AND FITTINGS FOR ALL OF THE AFORESAID GOODS, IN CLASS 9 (U.S. CLS. 21, 23, 26, 36 AND 38).

FOR: CLEANING AND MAINTENANCE OF INDUSTRIAL AND MARITIME PIPING SYSTEMS, IN CLASS 37 (U.S. CLS. 100, 103 AND 106).

FOR: SCIENTIFIC AND TECHNOLOGICAL SERVICES, NAMELY, RESEARCH AND DESIGN IN THE FIELD OF COOLING AND LUBRICATION FOR AUTOMOTIVE COOLING SYSTEMS, AND FOR AUTOMOTIVE LUBRICANTS AND LUBRICATION GREASES FOR INDUSTRIAL PURPOSES, NAMELY, AUTOMOTIVE GREASES; TECHNICAL CONSULTANCY IN THE FIELD OF INDUSTRIAL AND MARITIME PIPING SYSTEMS; CERTIFICATION IN THE NATURE OF TESTING, ANALYSIS, AND EVALUATION OF THE GOODS OF OTHERS, NAMELY, INDUSTRIAL AND MARITIME PIPING, AND THE SERVICES OF OTHERS, NAMELY, INDUSTRIAL AND MARITIME PIPE CLEANING SERVICES FOR THE PURPOSE OF CERTIFICATION; PROVIDING QUALITY CONTROL OF INDUSTRIAL AND MARITIME PIPING SYSTEMS FOR OTHERS; TESTING, ANALYSIS AND EVALUATION OF INDUSTRIAL AND MARITIME PIPING AND PIPE CLEANING SERVICES OF OTHERS FOR THE PURPOSE OF CERTIFICATION, IN CLASS 42 (U.S. CLS. 100 AND 101).

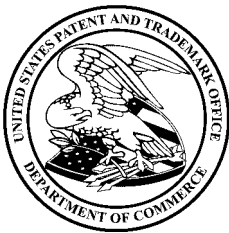

THE MARK CONSISTS OF STANDARD CHARACTERS WITHOUT CLAIM TO ANY PARTICULAR FONT, STYLE, SIZE, OR COLOR.

PRIORITY CLAIMED UNDER SEC. 44(D) ON NORWAY APPLICATION NO. 201001804, FILED 2-17-2010, REG. NO. 258593, DATED 2-8-2011, EXPIRES 2-8-2021.

SER. NO. 85-107,319, FILED 8-13-2010.

RONALD DELGIZZI, EXAMINING ATTORNEY

*David J. Kyffers*

Director of the United States Patent and Trademark Office

# United States of America

United States Patent and Trademark Office

## MATHEMATICAL RESEARCH LETTERS

**Reg. No. 4,123,879**

**Registered Apr. 10, 2012**

**Int. Cl.: 9**

**TRADEMARK**

**PRINCIPAL REGISTER**

INTERNATIONAL PRESS OF BOSTON, INC. (MASSACHUSETTS CORPORATION)  
530 VIRGINIA ROAD, P.O. BOX 9133  
CONCORD, MA 017429133

FOR: DOWNLOADABLE ELECTRONIC PUBLICATIONS IN THE NATURE OF JOURNALS  
IN THE FIELD OF MATHEMATICS, APPLIED MATHEMATICS, AND PHYSICS, IN CLASS  
9 (U.S. CLS. 21, 23, 26, 36 AND 38).

FIRST USE 1-31-1994; IN COMMERCE 1-31-1994.

THE MARK CONSISTS OF STANDARD CHARACTERS WITHOUT CLAIM TO ANY PAR-  
TICULAR FONT, STYLE, SIZE, OR COLOR.

OWNER OF U.S. REG. NO. 3,707,597.

SEC. 2(F).

SER. NO. 85-108,057, FILED 8-16-2010.

ROBIN CHOSID, EXAMINING ATTORNEY



*David J. Kyffers*

Director of the United States Patent and Trademark Office

# United States of America

United States Patent and Trademark Office

## PEARLS FOR TEEN GIRLS

**Reg. No. 4,123,880**

**Registered Apr. 10, 2012**

**Int. Cl.: 41**

**SERVICE MARK**

**PRINCIPAL REGISTER**

PEARLS FOR TEEN GIRLS, INC. (WISCONSIN CORPORATION)  
2100 NORTH PALMER STREET  
MILWAUKEE, WI 53212

FOR: CONDUCTING CLASSES, SEMINARS AND WORKSHOPS FOR YOUTH AND YOUNG ADULTS IN THE FIELD OF YOUTH LEADERSHIP SKILLS, SELF-REFLECTION SKILLS, CRITICAL THINKING SKILLS, DECISION MAKING SKILLS, COMMUNICATION SKILLS, PERSONAL ACCOUNTABILITY AND PERSONAL DEVELOPMENT AND GROWTH, ALL OFFERED IN SCHOOLS AND YOUTH SERVICE ORGANIZATIONS; YOUTH EDUCATIONAL COUNSELING SERVICES IN THE NATURE OF MENTORING PROGRAMS IN THE FIELD OF PRE-KINDERGARTEN THROUGH 12TH GRADE CLASSROOM INSTRUCTION; PROVIDING TRAINING IN THE FIELD OF LEADERSHIP DEVELOPMENT, CAREER COUNSELING, AND WORKSHOPS IN THE FIELD OF PERSONAL GROWTH, IN CLASS 41 (U.S. CLS. 100, 101 AND 107).

FIRST USE 4-30-1992; IN COMMERCE 4-30-1992.

THE MARK CONSISTS OF STANDARD CHARACTERS WITHOUT CLAIM TO ANY PARTICULAR FONT, STYLE, SIZE, OR COLOR.

NO CLAIM IS MADE TO THE EXCLUSIVE RIGHT TO USE "TEEN GIRLS", APART FROM THE MARK AS SHOWN.

SER. NO. 85-110,616, FILED 8-18-2010.

ALYSSA STEEL, EXAMINING ATTORNEY



*David J. Kyjars*

Director of the United States Patent and Trademark Office

# United States of America

United States Patent and Trademark Office

## Narrow Sparrow

**Reg. No. 4,123,881**

PORTILLO, RICHARD S. (UNITED STATES INDIVIDUAL)  
1102 HUNTINGTON DR  
SHOREWOOD, IL 60404

**Registered Apr. 10, 2012**

**Int. Cl.: 41**

FOR: ENTERTAINMENT, NAMELY, LIVE PERFORMANCES BY A MUSICAL BAND; SONG WRITING SERVICES; MUSIC PRODUCTION SERVICES, IN CLASS 41 (U.S. CLS. 100, 101 AND 107).

**SERVICE MARK**

FIRST USE 5-3-2008; IN COMMERCE 5-3-2008.

**PRINCIPAL REGISTER**

THE MARK CONSISTS OF STANDARD CHARACTERS WITHOUT CLAIM TO ANY PARTICULAR FONT, STYLE, SIZE, OR COLOR.

SER. NO. 85-111,001, FILED 8-19-2010.

ANDREA HACK, EXAMINING ATTORNEY



*David J. Kyffers*

Director of the United States Patent and Trademark Office

# United States of America

United States Patent and Trademark Office



**Reg. No. 4,123,882**

**Registered Apr. 10, 2012**

**Int. Cl.: 5**

**TRADEMARK**

**PRINCIPAL REGISTER**

PROPHASE LABS, INC. (NEVADA CORPORATION)  
621 SHADY RETREAT ROAD  
DOYLESTOWN, PA 18901

FOR: COUGH DROPS; COUGH LOZENGES; COUGH TREATMENT PREPARATIONS; DE-  
CONGESTANTS; PREPARATIONS FOR TREATING COLDS; ALL THE FOREGOING CON-  
TAINING ORGANIC INGREDIENTS, IN CLASS 5 (U.S. CLS. 6, 18, 44, 46, 51 AND 52).

FIRST USE 12-16-2009; IN COMMERCE 1-7-2010.

OWNER OF U.S. REG. NO. 3,609,267.

NO CLAIM IS MADE TO THE EXCLUSIVE RIGHT TO USE "ORGANIX RX", APART FROM  
THE MARK AS SHOWN.

THE MARK CONSISTS OF THE WORDS "ORGANIX DEFENSE" WITH AN "RX" SYMBOL  
FORMED BY AN EXTENDED PORTION OF THE LETTER "R", A LEAF FORMING THE  
DOT ON THE "I", TWO ADDITIONAL LEAVES LOCATED BELOW THE LETTER "R", TWO  
ADDITIONAL LEAVES LOCATED BELOW THE LETTERS "ENS", A PERSPECTIVE VIEW  
OF A PLOWED FIELD BELOW THE WORDS, WITH ALL PREVIOUSLY DESCRIBED ELE-  
MENTS SURROUNDED BY A SOLID BORDER ON ALL SIDES.

SER. NO. 85-111,469, FILED 8-19-2010.

RUSS HERMAN, EXAMINING ATTORNEY



*David J. Kybas*

Director of the United States Patent and Trademark Office

# United States of America

United States Patent and Trademark Office

## Novati at the heart of inNOVATION

**Reg. No. 4,123,883**

**Registered Apr. 10, 2012**

**Int. Cl.: 36**

**SERVICE MARK**

**PRINCIPAL REGISTER**

NOVATI, LLC (NORTH CAROLINA LIMITED LIABILITY COMPANY)  
870 MARTIN LUTHER KING BLVD  
CHAPEL HILL, NC 27514

FOR: FINANCIAL ADVICE AND CONSULTANCY SERVICES; INCUBATION SERVICES, NAMELY, PROVIDING FINANCING TO FREELANCERS, START-UPS, EXISTING BUSINESSES AND NON-PROFITS; INTELLECTUAL PROPERTY VENTURE FUND DEVELOPMENT AND FORMATION SERVICES FOR OTHERS; INTELLECTUAL PROPERTY VENTURE FUND MANAGEMENT SERVICES, IN CLASS 36 (U.S. CLS. 100, 101 AND 102).

FIRST USE 2-28-2006; IN COMMERCE 2-28-2006.

THE MARK CONSISTS OF STANDARD CHARACTERS WITHOUT CLAIM TO ANY PARTICULAR FONT, STYLE, SIZE, OR COLOR.

SER. NO. 85-111,877, FILED 8-19-2010.

DEBRA LEE, EXAMINING ATTORNEY



*David J. Kyffers*

Director of the United States Patent and Trademark Office

# United States of America

United States Patent and Trademark Office

## LIQUIDITY CONNECT

**Reg. No. 4,123,884**

SMART TRADE TECHNOLOGIES (FRANCE SOCIEDAD ANONIMA (SA))  
140 RUE DU FAUBOURG SAINT HONORÉ  
PARIS, FRANCE 75008

**Registered Apr. 10, 2012**

**Int. Cl.: 9**

FOR: SOFTWARE FOR ORDER ROUTING IN CONNECTION WITH FINANCIAL INSTRUMENTS; ELECTRONIC DATABASES IN THE FIELD OF FINANCIAL ORDER EXECUTION AND IN THE FIELD OF FINANCIAL MANAGEMENT RECORDED ON COMPUTER MEDIA, IN CLASS 9 (U.S. CLS. 21, 23, 26, 36 AND 38).

**TRADEMARK**

**PRINCIPAL REGISTER**

FIRST USE 8-1-2009; IN COMMERCE 8-1-2009.

THE MARK CONSISTS OF STANDARD CHARACTERS WITHOUT CLAIM TO ANY PARTICULAR FONT, STYLE, SIZE, OR COLOR.

OWNER OF U.S. REG. NOS. 3,676,607 AND 3,767,533.

NO CLAIM IS MADE TO THE EXCLUSIVE RIGHT TO USE "LIQUIDITY", APART FROM THE MARK AS SHOWN.

SER. NO. 85-112,116, FILED 8-20-2010.

MICHAEL ENGEL, EXAMINING ATTORNEY



*David J. Kyffers*

Director of the United States Patent and Trademark Office



# United States of America

United States Patent and Trademark Office

# #PAIN

**Reg. No. 4,123,885**

**Registered Apr. 10, 2012**

**Int. Cl.: 38**

**SERVICE MARK**

**PRINCIPAL REGISTER**

EASY DIAL, LLC (FLORIDA LIMITED LIABILITY COMPANY)  
710 OAKFIELD DRIVE  
SUITE 113  
BRANDON, FL 33511

FOR: TELECOMMUNICATION SERVICES RELATED TO THE HEALTHCARE INDUSTRY AND HEALTHCARE PROVIDERS, NAMELY, PROVIDING CALL ROUTING SERVICES FOR THE OFFERING AND MARKETING OF HEALTHCARE, HEALTHCARE-RELATED SERVICES, AND HEALTHCARE PROVIDERS; COMMUNICATION SERVICES, NAMELY, TRANSMISSION OF VOICE, AUDIO, VISUAL IMAGES AND DATA BY TELECOMMUNICATIONS NETWORKS, WIRELESS COMMUNICATION NETWORKS, THE INTERNET, INFORMATION SERVICES NETWORKS AND DATA NETWORKS, NAMELY, FOR ENABLING USERS TO ACCESS HEALTHCARE INDUSTRY INSIDERS, HEALTHCARE-RELATED SERVICES, AND HEALTHCARE PROVIDERS FOR INDIVIDUALS VIA WIRELESS MOBILE TELEPHONES AND TOUCH TONE TELEPHONES, IN CLASS 38 (U.S. CLS. 100, 101 AND 104).

FIRST USE 7-5-2011; IN COMMERCE 7-5-2011.

THE MARK CONSISTS OF STANDARD CHARACTERS WITHOUT CLAIM TO ANY PARTICULAR FONT, STYLE, SIZE, OR COLOR.

OWNER OF U.S. REG. NOS. 3,240,906, 3,240,942 AND OTHERS.

SER. NO. 85-117,684, FILED S.R. 8-27-2010 AM. P.R. 12-7-2011.

BENJAMIN OKEKE, EXAMINING ATTORNEY



*David J. Kybas*

Director of the United States Patent and Trademark Office

# United States of America

United States Patent and Trademark Office

# AppleGate

RECOVERY

**Reg. No. 4,123,886**

**Registered Apr. 10, 2012**

**Int. Cl.: 44**

**SERVICE MARK**

**PRINCIPAL REGISTER**

APPLEGATE RECOVERY, LLC (LOUISIANA LIMITED LIABILITY COMPANY)  
1605 BENTON RD, SUITE D  
BOSSIER CITY, LA 71111

FOR: ADDICTION TREATMENT SERVICES, IN CLASS 44 (U.S. CLS. 100 AND 101).

FIRST USE 4-1-2009; IN COMMERCE 4-1-2009.

NO CLAIM IS MADE TO THE EXCLUSIVE RIGHT TO USE "RECOVERY", APART FROM THE MARK AS SHOWN.

THE COLOR(S) BLUE AND WHITE IS/ARE CLAIMED AS A FEATURE OF THE MARK.

THE MARK CONSISTS OF THE (STYLIZED) BLUE WORD "APPLEGATE" AND THE (STYLIZED) WHITE WORD "RECOVERY" APPEARING BENEATH IN A BLUE BOX.

SER. NO. 85-118,391, FILED 8-30-2010.

TRICIA SONNEBORN, EXAMINING ATTORNEY

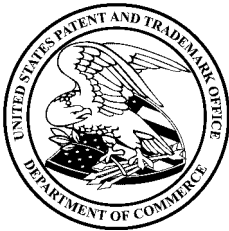

*David J. Kyffers*

Director of the United States Patent and Trademark Office

# United States of America

United States Patent and Trademark Office

## EMERGENSEE

**Reg. No. 4,123,887**

**Registered Apr. 10, 2012**

**Int. Cl.: 9**

**TRADEMARK**

**PRINCIPAL REGISTER**

EMERGENSEE, LLC (PENNSYLVANIA LIMITED LIABILITY COMPANY)  
1260 VALLEY FORGE ROAD, SUITE 103  
RELTNOUR INVESTMENTS PROPERTIES  
PHOENIXVILLE, PA 19460

FOR: COMPUTER APPLICATION SOFTWARE FOR TRANSMITTING INFORMATION FROM A MOBILE DEVICE; ONLINE COMPUTER SYSTEM FOR RETRIEVING AND STORING INFORMATION TRANSMITTED FROM A MOBILE DEVICE; COMPUTER SOFTWARE FOR RECEIVING AND TRACKING THE ELECTRONIC GEOGRAPHICAL LOCATION OF A MOBILE DEVICE; COMPUTER SOFTWARE USED FOR RELAYING ELECTRONIC AND WIRELESS MESSAGES AND DATA CONCERNING INDIVIDUAL USERS VIA GLOBAL COMMUNICATION NETWORKS AND ELECTRONIC AND WIRELESS DEVICES, NAMELY, VIA MOBILE PHONES, COMMUNICATION DEVICES, PERSONAL DIGITAL ASSISTANTS AND COMPUTERS; COMPUTER AND MOBILE DEVICE SOFTWARE FOR TRANSMITTING INFORMATION FROM A USER'S MOBILE DEVICE TO A SECURITY SERVICE OR FIRST RESPONDERS; COMPUTER AND MOBILE DEVICE SOFTWARE FOR MONITORING AND MANAGING INFORMATION FROM A USER DURING EMERGENCIES, IN CLASS 9 (U.S. CLS. 21, 23, 26, 36 AND 38).

FIRST USE 10-8-2010; IN COMMERCE 10-8-2010.

THE MARK CONSISTS OF STANDARD CHARACTERS WITHOUT CLAIM TO ANY PARTICULAR FONT, STYLE, SIZE, OR COLOR.

SER. NO. 85-119,989, FILED 8-31-2010.

DOMINIC J. FERRAIUOLO, EXAMINING ATTORNEY



*David J. Kypos*

Director of the United States Patent and Trademark Office

# United States of America

United States Patent and Trademark Office

## KIT'S ORIGINAL MUD

**Reg. No. 4,123,888**

**Registered Apr. 10, 2012**

**Int. Cl.: 29**

**TRADEMARK**

**PRINCIPAL REGISTER**

KITSMUD, LLC (ILLINOIS LIMITED LIABILITY COMPANY)  
782 N. HENDERSON STREET  
GALESBURG, IL 61401

FOR: CHEESE FOOD; CHEESE, NAMELY, CHEESE DIP; DIPS; SNACK DIPS, IN CLASS 29  
(U.S. CL. 46).

FIRST USE 6-16-2010; IN COMMERCE 6-16-2010.

THE MARK CONSISTS OF STANDARD CHARACTERS WITHOUT CLAIM TO ANY PARTICULAR FONT, STYLE, SIZE, OR COLOR.

OWNER OF U.S. REG. NO. 3,954,633.

NO CLAIM IS MADE TO THE EXCLUSIVE RIGHT TO USE "ORIGINAL", APART FROM THE MARK AS SHOWN.

SER. NO. 85-120,393, FILED 8-31-2010.

ZACHARY BELLO, EXAMINING ATTORNEY



*David J. Kyffers*

Director of the United States Patent and Trademark Office

# United States of America

United States Patent and Trademark Office

# AUDIMATED

**Reg. No. 4,123,889**

EQUITY MUSIC CORPORATION (FLORIDA CORPORATION)  
3346 SW 25TH STREET  
MIAMI, FL 33133

**Registered Apr. 10, 2012**

**Int. Cls.: 9, 15, 16, 35, 41  
and 42**

FOR: DIGITAL MUSIC DOWNLOADABLE FROM THE INTERNET, IN CLASS 9 (U.S. CLS. 21, 23, 26, 36 AND 38).

FIRST USE 2-17-2009; IN COMMERCE 7-5-2010.

**TRADEMARK**

FOR: MUSICAL INSTRUMENTS, NAMELY, GUITAR PICKS, IN CLASS 15 (U.S. CLS. 2, 21 AND 36).

**SERVICE MARK**

**PRINCIPAL REGISTER**

FIRST USE 2-17-2009; IN COMMERCE 7-5-2010.

FOR: PRINTED MATERIALS, NAMELY, INFORMATIONAL FLYERS FEATURING INFORMATION ABOUT AN ONLINE NETWORKING SERVICES FOR MUSICIANS AND THEIR FANS; BUSINESS CARDS; TRADESHOW DISPLAY, NAMELY, ADVERTISING SIGNS OF PAPER OR CARDBOARD, IN CLASS 16 (U.S. CLS. 2, 5, 22, 23, 29, 37, 38 AND 50).

FIRST USE 2-17-2009; IN COMMERCE 7-5-2010.

FOR: ADVERTISING AND BUSINESS SERVICES, NAMELY, PROVIDING AN ONLINE WEBSITE WHERE INDEPENDENT MUSICAL ARTISTS, ADVERTISERS, MARKETERS, AND CONTENT PROVIDERS CAN INTERACT WITH USERS FOR ADVERTISING, BRANDING, AND PROMOTING PRODUCTS AND SERVICES ON BEHALF OF THEMSELVES AND OTHERS, IN CLASS 35 (U.S. CLS. 100, 101 AND 102).

FIRST USE 2-17-2009; IN COMMERCE 7-5-2010.

FOR: EDUCATIONAL SERVICES, NAMELY, PROVIDING ONLINE INSTRUCTION IN THE FIELD OF EDUCATING MUSICAL ARTISTS IN HOW TO REACH A LARGER MARKET OF POTENTIAL FAN-BASE; ENTERTAINMENT SERVICES, NAMELY, PROVIDING NON-DOWNLOADABLE PRERECORDED MUSIC ON-LINE VIA A GLOBAL COMPUTER NETWORK, IN CLASS 41 (U.S. CLS. 100, 101 AND 107).

FIRST USE 2-17-2009; IN COMMERCE 7-5-2010.



*David J. Kybas*

Director of the United States Patent and Trademark Office

**Reg. No. 4,123,889** FOR: HOSTING AN ONLINE WEBSITE FEATURING SOCIAL-NETWORKING IN THE FIELD OF MUSIC FOR OTHERS; CREATING AN ON-LINE COMMUNITY FOR REGISTERED USERS TO ENGAGE IN SOCIAL NETWORKING FOR MUSICIANS AND THEIR FAN BASE IN THE INDEPENDENT MUSIC COMMUNITY, IN CLASS 42 (U.S. CLS. 100 AND 101).

FIRST USE 2-17-2009; IN COMMERCE 7-5-2010.

THE MARK CONSISTS OF STANDARD CHARACTERS WITHOUT CLAIM TO ANY PARTICULAR FONT, STYLE, SIZE, OR COLOR.

OWNER OF U.S. REG. NO. 3,874,818.

SER. NO. 85-122,035, FILED 9-2-2010.

DAVID I, EXAMINING ATTORNEY

# United States of America

United States Patent and Trademark Office

## Green Harbor Group

**Reg. No. 4,123,890**

**Registered Apr. 10, 2012**

**Int. Cls.: 35, 36 and 37**

**SERVICE MARK**

**PRINCIPAL REGISTER**

PITCHER, SCOTT (UNITED STATES INDIVIDUAL)  
721 E. THIRD ST.  
HINSDALE, IL 60521

FOR: BUSINESS MANAGEMENT AND OPERATION SERVICES, NAMELY, MANAGING AND OPERATING SENIOR HOUSING, MEDICAL FACILITIES, RETIREMENT COMMUNITIES, APARTMENT COMPLEXES AND OTHER COMMERCIAL AND HEALTH CARE FACILITIES; CONSULTING SERVICES RELATED TO BUSINESS MANAGEMENT OF COMMERCIAL AND HEALTH CARE FACILITIES, IN CLASS 35 (U.S. CLS. 100, 101 AND 102).

FIRST USE 12-31-2008; IN COMMERCE 12-31-2008.

FOR: REAL ESTATE AND FINANCIAL AFFAIRS, NAMELY, REAL ESTATE SERVICES, NAMELY, ACQUISITION AND DISPOSITION OF REAL ESTATE, AND REAL ESTATE BROKERAGE; CONSULTING IN THE FIELD OF REAL ESTATE, NAMELY, PROVIDING INFORMATION REGARDING OWNING AND LEASING OF PROPERTY AND REAL ESTATE INVESTMENT INFORMATION FOR EQUITY INVESTORS; CONSULTING ON FINANCING RELATED TO REAL ESTATE ASSETS, IN CLASS 36 (U.S. CLS. 100, 101 AND 102).

FIRST USE 12-31-2008; IN COMMERCE 12-31-2008.

FOR: REAL ESTATE DEVELOPMENT, NAMELY, CONSTRUCTION SITE DEVELOPMENT, CONSTRUCTION PROJECT MANAGEMENT AND CONSULTING IN THE FIELD OF SITE SELECTION, IN CLASS 37 (U.S. CLS. 100, 103 AND 106).

FIRST USE 12-31-2008; IN COMMERCE 12-31-2008.

THE MARK CONSISTS OF STANDARD CHARACTERS WITHOUT CLAIM TO ANY PARTICULAR FONT, STYLE, SIZE, OR COLOR.

NO CLAIM IS MADE TO THE EXCLUSIVE RIGHT TO USE "GROUP", APART FROM THE MARK AS SHOWN.

SER. NO. 85-122,760, FILED 9-3-2010.

DEZMONA MIZELLE, EXAMINING ATTORNEY

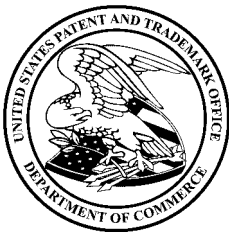

*David J. Kyffers*

Director of the United States Patent and Trademark Office

# United States of America

## United States Patent and Trademark Office



**Reg. No. 4,123,891**

**Registered Apr. 10, 2012**

**Int. Cls.: 35, 36 and 37**

**SERVICE MARK**

**PRINCIPAL REGISTER**

PITCHER, SCOTT (UNITED STATES INDIVIDUAL)  
721 E. THIRD ST.  
HINSDALE, IL 60521

FOR: BUSINESS MANAGEMENT AND OPERATION SERVICES, NAMELY, MANAGING AND OPERATING SENIOR HOUSING, MEDICAL FACILITIES, RETIREMENT COMMUNITIES, APARTMENT COMPLEXES AND OTHER COMMERCIAL AND HEALTH CARE FACILITIES; CONSULTING SERVICES RELATED TO BUSINESS MANAGEMENT OF COMMERCIAL AND HEALTH CARE FACILITIES, IN CLASS 35 (U.S. CLS. 100, 101 AND 102).

FIRST USE 12-31-2008; IN COMMERCE 12-31-2008.

FOR: REAL ESTATE AND FINANCIAL AFFAIRS, NAMELY, REAL ESTATE SERVICES, NAMELY, ACQUISITION AND DISPOSITION OF REAL ESTATE, AND REAL ESTATE BROKERAGE; CONSULTING IN THE FIELD OF REAL ESTATE, NAMELY, PROVIDING INFORMATION REGARDING OWNING AND LEASING OF PROPERTY AND REAL ESTATE INVESTMENT INFORMATION FOR EQUITY INVESTORS; CONSULTING ON FINANCING RELATED TO REAL ESTATE ASSETS, IN CLASS 36 (U.S. CLS. 100, 101 AND 102).

FIRST USE 12-31-2008; IN COMMERCE 12-31-2008.

FOR: REAL ESTATE DEVELOPMENT, NAMELY, CONSTRUCTION SITE DEVELOPMENT, CONSTRUCTION PROJECT MANAGEMENT AND CONSULTING IN THE FIELD OF SITE SELECTION, IN CLASS 37 (U.S. CLS. 100, 103 AND 106).

FIRST USE 12-31-2008; IN COMMERCE 12-31-2008.

THE MARK CONSISTS OF A BROKEN YIN YANG SYMBOL WITH A BLUE TOP PORTION AND A GREEN BOTTOM PORTION. THE COLOR WHITE REPRESENTS BACKGROUND AND IS NOT A PART OF THE MARK.

THE COLOR(S) BLUE AND GREEN IS/ARE CLAIMED AS A FEATURE OF THE MARK.

SER. NO. 85-122,864, FILED 9-3-2010.

DEZMONA MIZELLE, EXAMINING ATTORNEY



*David J. Kyffers*

Director of the United States Patent and Trademark Office



# United States of America

United States Patent and Trademark Office



**Reg. No. 4,123,892**

**Registered Apr. 10, 2012**

**Int. Cls.: 20 and 29**

**TRADEMARK**

**PRINCIPAL REGISTER**

ZWYERCAVIAR GMBH (SWITZERLAND GESELLSCHAFT MIT BESCHRÄNKTER HAFTUNG (GMBH))  
SPEICHERSTRASSE 11  
TEUFEN, SWITZERLAND 9053

FOR: PACKAGING CONTAINERS MADE OF PLASTIC, IN CLASS 20 (U.S. CLS. 2, 13, 22, 25, 32 AND 50).

FOR: FISH, CAVIAR, IN CLASS 29 (U.S. CL. 46).

OWNER OF SWITZERLAND REG. NO. 579820, DATED 12-1-2008, EXPIRES 8-13-2018.

OWNER OF U.S. REG. NO. 3,760,931.

NO CLAIM IS MADE TO THE EXCLUSIVE RIGHT TO USE "CAVIAR" AS TO CLASSES 20 AND 29 AND THE THREE DIMENSIONAL SPHERICAL DESIGN OF THE GOODS AS TO CLASS 20, APART FROM THE MARK AS SHOWN.

THE MARK CONSISTS OF, IN CLASS 20, A THREE-DIMENSIONAL CONFIGURATION OF THE GOODS WHICH IS A SPHERICAL SHAPE, AND DISPLAYING AT THE TOP OF THE SPHERE AS VIEWED FROM ABOVE AS IT SITS ON ITS FLATTENED BOTTOM THE WORD "ZWYER" IN CAPITAL LETTERS, WITH THE LETTERS "Z" AND "R" LARGER THAN THE OTHER LETTERS, THE WORD "CAVIAR" IN CAPITAL LETTERS SMALLER THAN ANY OF THOSE IN "ZWYER" AND POSITIONED PARALLEL TO AND BENEATH THE WORD "ZWYER", AND AN OUTLINE DEPICTION OF A FANCIFUL SPOTTED BEAST IN PROFILE, WITH ITS SPOTS REPLACED BY LEAVES WITH VEINS. THE BEAST HAS IN ITS MOUTH A BALL AND ITS RIGHT PAW HOLDS A FISH, WHILE ITS LEFT PAW RESTS ON THE TOP OF THE LETTER "Z" IN THE WORD "ZWYER", AND ITS HIND PAWS REST ON THE TOP OF THE LETTER "R" IN THE WORD "ZWYER". THE MATTER SHOWN IN BROKEN OR DOTTED LINES IS NOT PART OF THE MARK AND SERVES ONLY TO SHOW THE POSITION OR PLACEMENT OF THE MARK. IN CLASS 29 THE MARK CONSISTS OF A THREE-DIMENSIONAL CONFIGURATION OF PACKAGING FOR THE GOODS WHICH IS A SPHERICAL SHAPE, AND DISPLAYING AT THE TOP OF THE SPHERE AS VIEWED FROM ABOVE AS IT SITS ON ITS FLATTENED BOTTOM THE WORD "ZWYER" IN CAPITAL LETTERS, WITH THE LETTERS "Z" AND "R" LARGER THAN THE OTHER LETTERS, THE WORD "CAVIAR" IN CAPITAL LETTERS SMALLER THAN ANY OF THOSE IN "ZWYER" AND POSITIONED PARALLEL TO AND BENEATH THE WORD "ZWYER", AND



*David J. Kybas*

Director of the United States Patent and Trademark Office

**Reg. No. 4,123,892** AN OUTLINE DEPICTION OF A FANCIFUL SPOTTED BEAST IN PROFILE, WITH ITS SPOTS REPLACED BY LEAVES WITH VEINS. THE BEAST HAS IN ITS MOUTH A BALL AND ITS RIGHT PAW HOLDS A FISH, WHILE ITS LEFT PAW RESTS ON THE TOP OF THE LETTER "Z" IN THE WORD "ZWYER", AND ITS HIND PAWS REST ON THE TOP OF THE LETTER "R" IN THE WORD "ZWYER". THE MATTER SHOWN IN BROKEN OR DOTTED LINES IS NOT PART OF THE MARK AND SERVES ONLY TO SHOW THE POSITION OR PLACEMENT OF THE MARK.

SER. NO. 85-123,311, FILED 9-3-2010.

DANIEL CAPSHAW, EXAMINING ATTORNEY

# United States of America

United States Patent and Trademark Office



**THE WINEHOUSE**  
CREATE A TRADITION

**Reg. No. 4,123,893**

**Registered Apr. 10, 2012**

**Int. Cl.: 43**

**SERVICE MARK**

**PRINCIPAL REGISTER**

THE WINE HOUSE LLC (VIRGINIA LIMITED LIABILITY COMPANY)  
SUITE 212  
3915 UNIVERSITY DRIVE  
FAIRFAX, VA 22030

FOR: BAR AND RESTAURANT SERVICES; CATERING SERVICES; WINE BARS, IN CLASS 43 (U.S. CLS. 100 AND 101).

FIRST USE 1-1-2008; IN COMMERCE 8-1-2009.

NO CLAIM IS MADE TO THE EXCLUSIVE RIGHT TO USE "WINE HOUSE", APART FROM THE MARK AS SHOWN.

THE COLOR(S) RED, WHITE, AND BLACK IS/ARE CLAIMED AS A FEATURE OF THE MARK.

THE MARK CONSISTS OF FOUR RED BOXES RESEMBLING A WINDOW ON A WHITE BACKGROUND. WHITE WINE GLASS OVERLAY WITH QUARTER RED CIRCLE OVERLAY; BELOW TEXT READS AS FOLLOWS: IN ALL CAPITAL LETTERS AND IN THE COLOR BLACK, "THE" FOLLOWED BY IN ALL CAPITAL LETTERS AND IN THE COLOR RED "WINE" FOLLOWED BY IN ALL CAPITAL LETTERS AND IN THE COLOR BLACK, "HOUSE" FOLLOWED BY IN A SMALLER FONT AND ALL CAPITAL LETTERS AND IN THE COLOR BLACK, "CREATE A TRADITION".

SER. NO. 85-123,605, FILED 9-6-2010.

ANNE FARRELL, EXAMINING ATTORNEY

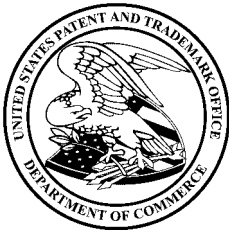

*David J. Kybas*

Director of the United States Patent and Trademark Office

# United States of America

United States Patent and Trademark Office

## AmeXPREPAGO

**Reg. No. 4,123,894**

**Registered Apr. 10, 2012**

**Int. Cl.: 9**

**TRADEMARK**

**PRINCIPAL REGISTER**

PAPAGAYO HOSPITALITY, S.A. (COSTA RICA CORPORATION)  
DE ESQUINA SUROESTE DEL PARQUE, 250 M SU  
TIBAS, COSTA RICA TIBAS

FOR: COMPUTER COMMUNICATIONS SOFTWARE TO ALLOW CUSTOMERS TO ACCESS BANK ACCOUNT INFORMATION AND TRANSACT BANK BUSINESS; COMPUTER SOFTWARE THAT PROVIDES WEB-BASED ACCESS TO APPLICATIONS AND SERVICES THROUGH A WEB OPERATING SYSTEM OR PORTAL INTERFACE; ELECTRONIC AND MAGNETIC ID CARDS FOR USE IN CONNECTION WITH PAYMENT FOR SERVICES, IN CLASS 9 (U.S. CLS. 21, 23, 26, 36 AND 38).

FIRST USE 8-18-2010; IN COMMERCE 8-18-2010.

THE MARK CONSISTS OF STANDARD CHARACTERS WITHOUT CLAIM TO ANY PARTICULAR FONT, STYLE, SIZE, OR COLOR.

SER. NO. 85-127,789, FILED 9-13-2010.

ANDREA HACK, EXAMINING ATTORNEY



*David J. Kyffers*

Director of the United States Patent and Trademark Office

# United States of America

United States Patent and Trademark Office

## Diplomate of Oriental Medicine (NCCAOM)

**Reg. No. 4,123,895**

**Registered Apr. 10, 2012**

**CERTIFICATION MARK**

**PRINCIPAL REGISTER**

NATIONAL CERTIFICATION COMMISSION FOR ACUPUNCTURE AND ORIENTAL  
MEDICINE (D.C. CORPORATION)  
SUITE 1290  
76 SOUTH LAURA STREET  
JACKSONVILLE, FL 32202

FOR: ORIENTAL MEDICINE SERVICES, IN CLASS B (U.S. CL. B).

FIRST USE 2-28-2004; IN COMMERCE 2-28-2004.

THE MARK CONSISTS OF STANDARD CHARACTERS WITHOUT CLAIM TO ANY PAR-  
TICULAR FONT, STYLE, SIZE, OR COLOR.

OWNER OF U.S. REG. NOS. 3,655,928, 3,690,647 AND OTHERS.

NO CLAIM IS MADE TO THE EXCLUSIVE RIGHT TO USE "DIPLOMATE OF ORIENTAL  
MEDICINE", APART FROM THE MARK AS SHOWN.

THE CERTIFICATION MARK, AS USED OR INTENDED TO BE USED BY PERSONS AU-  
THORIZED BY THE CERTIFIER, CERTIFIES OR IS INTENDED TO CERTIFY THAT THE  
SERVICES PROVIDED HAVE MET THE ELIGIBILITY REQUIREMENTS AND SUCCESS-  
FULLY PASSED A CERTIFICATION EXAMINATION THAT DEMONSTRATES A LEVEL  
OF KNOWLEDGE IN THE FIELD OF ORIENTAL MEDICINE.

SER. NO. 85-128,063, FILED 9-13-2010.

DARRYL SPRUILL, EXAMINING ATTORNEY



*David J. Kyffers*

Director of the United States Patent and Trademark Office

# United States of America

United States Patent and Trademark Office

## Dipl. C.H. (NCCAOM)

**Reg. No. 4,123,896**

**Registered Apr. 10, 2012**

**CERTIFICATION MARK**

**PRINCIPAL REGISTER**

NATIONAL CERTIFICATION COMMISSION FOR ACUPUNCTURE AND ORIENTAL  
MEDICINE (D.C. CORPORATION)  
SUITE 1290  
76 SOUTH LAURA STREET  
JACKSONVILLE, FL 32202

FOR: CHINESE HERBOLOGY SERVICES, IN CLASS B (U.S. CL. B).

FIRST USE 2-28-1995; IN COMMERCE 2-28-1995.

THE MARK CONSISTS OF STANDARD CHARACTERS WITHOUT CLAIM TO ANY PARTICULAR FONT, STYLE, SIZE, OR COLOR.

OWNER OF U.S. REG. NOS. 3,655,928, 3,690,647 AND OTHERS.

THE CERTIFICATION MARK CERTIFIES THAT THE CERTIFICATION MARK, AS USED OR INTENDED TO BE USED BY PERSONS AUTHORIZED BY THE CERTIFIER, CERTIFIES OR IS INTENDED TO CERTIFIES THAT THE SERVICES PROVIDED HAVE MET THE ELIGIBILITY REQUIREMENTS AND SUCCESSFULLY PASSED A CERTIFICATION EXAMINATION THAT DEMONSTRATES A LEVEL OF KNOWLEDGE IN THE FIELD OF CHINESE HERBOLOGY.

SEC. 2(F) AS TO "DIPL. C.H.".

SER. NO. 85-128,101, FILED 9-13-2010.

DARRYL SPRUILL, EXAMINING ATTORNEY



*David J. Kybas*

Director of the United States Patent and Trademark Office

# United States of America

United States Patent and Trademark Office

## Dipl. ABT (NCCAOM)

**Reg. No. 4,123,897**

**Registered Apr. 10, 2012**

**CERTIFICATION MARK**

**PRINCIPAL REGISTER**

NATIONAL CERTIFICATION COMMISSION FOR ACUPUNCTURE AND ORIENTAL  
MEDICINE (D.C. CORPORATION)  
SUITE 1290  
76 SOUTH LAURA STREET  
JACKSONVILLE, FL 32202

FOR: ASIAN BODY THERAPY SERVICES, IN CLASS B (U.S. CL. B).

FIRST USE 6-30-2000; IN COMMERCE 6-30-2000.

THE MARK CONSISTS OF STANDARD CHARACTERS WITHOUT CLAIM TO ANY PARTICULAR FONT, STYLE, SIZE, OR COLOR.

OWNER OF U.S. REG. NOS. 3,655,928, 3,700,368 AND OTHERS.

THE CERTIFICATION MARK CERTIFIES THAT THE CERTIFICATION MARK, AS USED OR INTENDED TO BE USED BY PERSONS AUTHORIZED BY THE CERTIFIER, CERTIFIES OR IS INTENDED TO CERTIFIES THAT THE SERVICES PROVIDED HAVE MET THE ELIGIBILITY REQUIREMENTS AND SUCCESSFULLY PASSED A CERTIFICATION EXAMINATION THAT DEMONSTRATES A LEVEL OF KNOWLEDGE IN THE FIELD OF ASIAN BODYWORK THERAPY.

SEC. 2(F) AS TO "DIPL. ABT".

SER. NO. 85-128,119, FILED 9-13-2010.

DARRYL SPRUILL, EXAMINING ATTORNEY



*David J. Kybas*

Director of the United States Patent and Trademark Office

# United States of America

United States Patent and Trademark Office

## Dipl. O.M. (NCCAOM)

**Reg. No. 4,123,898**

**Registered Apr. 10, 2012**

**CERTIFICATION MARK**

**PRINCIPAL REGISTER**

NATIONAL CERTIFICATION COMMISSION FOR ACUPUNCTURE AND ORIENTAL  
MEDICINE (D.C. CORPORATION)  
SUITE 1290  
76 SOUTH LAURA STREET  
JACKSONVILLE, FL 32202

FOR: ORIENTAL MEDICINE SERVICES, IN CLASS B (U.S. CL. B).

FIRST USE 2-28-2004; IN COMMERCE 2-28-2004.

THE MARK CONSISTS OF STANDARD CHARACTERS WITHOUT CLAIM TO ANY PARTICULAR FONT, STYLE, SIZE, OR COLOR.

OWNER OF U.S. REG. NOS. 3,655,928, 3,690,647 AND OTHERS.

THE CERTIFICATION MARK CERTIFIES THAT THE CERTIFICATION MARK, AS USED OR INTENDED TO BE USED BY PERSONS AUTHORIZED BY THE CERTIFIER, CERTIFIES OR IS INTENDED TO CERTIFIES THAT THE SERVICES PROVIDED HAVE MET THE ELIGIBILITY REQUIREMENTS AND SUCCESSFULLY PASSED A CERTIFICATION EXAMINATION THAT DEMONSTRATES A LEVEL OF KNOWLEDGE IN THE FIELD OF ORIENTAL MEDICINE.

SEC. 2(F) AS TO "DIPL. O.M.".

SER. NO. 85-128,129, FILED 9-13-2010.

DARRYL SPRUILL, EXAMINING ATTORNEY



*David J. Kybas*

Director of the United States Patent and Trademark Office



# United States of America

United States Patent and Trademark Office



**Reg. No. 4,123,899**

**Registered Apr. 10, 2012**

**Int. Cl.: 11**

**TRADEMARK**

**PRINCIPAL REGISTER**

FLOS S.P.A. (ITALY JOINT STOCK COMPANY)  
VIA A. FAINI 2  
BOVEZZO (BS), ITALY 25073

FOR: LIGHTING APPARATUS, NAMELY, LAMPS, IN CLASS 11 (U.S. CLS. 13, 21, 23, 31 AND 34).

FIRST USE 12-31-1966; IN COMMERCE 12-31-1966.

THE MARK CONSISTS OF A THREE-DIMENSIONAL CONFIGURATION OF A FLOOR LAMP INCLUDING A RECTANGULAR CUBOID BASE WITH A SMALL FOOTPRINT, A SINGLE-PIECE ARCING ARM, AND A HEMISPHERICAL LAMP FIXTURE WITH ORNAMENTAL HOLES.

SEC. 2(F).

SER. NO. 85-129,360, FILED 9-14-2010.

LAKEISHA LEWIS, EXAMINING ATTORNEY



*David J. Kybas*

Director of the United States Patent and Trademark Office

# United States of America

United States Patent and Trademark Office

## PYRO SPECTACULARS BY SOUZA

**Reg. No. 4,123,900**

PYRO SPECTACULARS, INC. (CALIFORNIA CORPORATION)

**Registered Apr. 10, 2012**

P.O. BOX 2329  
RIALTO, CA 92377

**Int. Cl.: 41**

FOR: ENTERTAINMENT SERVICES, NAMELY, PRODUCTION OF FIREWORKS DISPLAYS AND LIGHT SHOWS PRIMARILY FEATURING PYROTECHNICS, IN CLASS 41 (U.S. CLS. 100, 101 AND 107).

**SERVICE MARK**

FIRST USE 12-0-1999; IN COMMERCE 12-0-1999.

**PRINCIPAL REGISTER**

THE MARK CONSISTS OF STANDARD CHARACTERS WITHOUT CLAIM TO ANY PARTICULAR FONT, STYLE, SIZE, OR COLOR.

OWNER OF U.S. REG. NOS. 1,123,014 AND 2,828,126.

NO CLAIM IS MADE TO THE EXCLUSIVE RIGHT TO USE "PYRO", APART FROM THE MARK AS SHOWN.

SER. NO. 85-130,567, FILED 9-15-2010.

BERYL GARDNER, EXAMINING ATTORNEY



*David J. Kyffers*

Director of the United States Patent and Trademark Office

# United States of America

United States Patent and Trademark Office

## THE MIGHTY BOOSH

**Reg. No. 4,123,901**

**Registered Apr. 10, 2012**

**Int. Cls.: 9, 16, 25, 28  
and 41**

**TRADEMARK**

**SERVICE MARK**

**PRINCIPAL REGISTER**

JULIAN BARRATT (UNITED KINGDOM INDIVIDUAL)  
C/O PBJ MANAGEMENT LTD.  
5 SOHO SQUARE  
LONDON W1D 3QA, UNITED KINGDOM AND

NOEL FIELDING (UNITED KINGDOM INDIVIDUAL)  
C/O PBJ MANAGEMENT LTD.  
5 SOHO SQUARE  
LONDON W1D 3QA, UNITED KINGDOM

FOR: PRE-RECORDED COMPACT DISCS FEATURING COMEDY AND MUSIC; COMPUTER GAME PROGRAMMES; INTERACTIVE VIDEO GAME PROGRAMMES; PRE-RECORDED DVDS FEATURING COMEDY AND MUSIC; PRE-RECORDED VIDEO TAPES FEATURING COMEDY AND MUSIC; PRE-RECORDED AUDIO TAPES FEATURING COMEDY AND MUSIC; MOTION PICTURE FILMS ABOUT COMEDY AND MUSIC; MOBILE TELEPHONE COVERS; MOBILE TELEPHONE CASES; DOWNLOADABLE MOBILE TELEPHONE RING TONES; MOBILE TELEPHONE GAMES, NAMELY, ELECTRONIC GAME SOFTWARE FOR CELLULAR TELEPHONES; MEDIA CARRYING ELECTRONIC RECORDINGS OF SOUND, IMAGES OR AUDIO-VISUAL RECORDINGS, AND DATA DOWNLOADABLE FROM THE INTERNET, NAMELY, MP3 PLAYERS; DOWNLOADABLE ELECTRONIC PUBLICATIONS, NAMELY, E-BOOKS IN THE FIELD OF COMEDY AND MUSIC; DOWNLOADABLE AUDIO AND VIDEO RECORDINGS FEATURING COMEDY AND MUSIC; DOWNLOADABLE MOTION PICTURES AND TELEVISION PROGRAMS ABOUT COMEDY AND MUSIC; DOWNLOADABLE GRAPHICS, WALLPAPER GRAPHICS, AND MUSIC VIA A GLOBAL COMPUTER NETWORK AND WIRELESS DEVICES; COMPUTER SCREEN SAVER SOFTWARE; MOUSE PADS; DECORATIVE MAGNETS; REFRIGERATOR MAGNETS; EYEGLASSES; SUNGLASSES, IN CLASS 9 (U.S. CLS. 21, 23, 26, 36 AND 38).

FOR: PAPER, CARDBOARD AND GOODS MADE FROM THESE MATERIALS, NAMELY, POSTERS, EVENT PROGRAMS, GREETING CARDS, CALENDARS; STATIONERY; BOOKS IN THE FIELD OF COMEDY AND MUSIC; BOOK COVERS; NOVELS; JOKE BOOKS; GRAPHIC NOVELS; COMICS; CALENDARS; DECALCOMANIAS; GREETING CARDS; GRAPHIC REPRESENTATIONS; PASSPORT HOLDERS; NEWSPAPERS; NOTE BOOKS; WRITING PADS; DIARIES; POSTCARDS; PAINTINGS; PENS; PEN HOLDERS; PENCILS; PENCIL HOLDERS; PENCIL SHARPENERS; PHOTOGRAPHS; PICTURES; POSTERS; POSTAGE STAMPS; PRINTS; SCRAP BOOKS; STICKERS; WRAPPING PAPER; ADDRESS



*David J. Kyros*

Director of the United States Patent and Trademark Office

**Reg. No. 4,123,901** BOOKS; PERSONAL ORGANISERS; ERASERS; BOOK MARKS; PAPER BAGS; MONEY CLIPS, IN CLASS 16 (U.S. CLS. 2, 5, 22, 23, 29, 37, 38 AND 50).

FOR: HEADWEAR; CLOTHING, NAMELY, SHIRTS, T-SHIRTS, VESTS, SWEATSHIRTS, HOODED SWEATSHIRTS, SWEATERS, JACKETS, JUMPERS, TROUSERS, BOXER SHORTS, UNDERWEAR, SOCKS, HOSIERY, BELTS; VISORS; HATS; CAPS; SCARVES AND NECKWEAR; ARTICLES OF CLOTHING FOR CHILDREN, NAMELY, T-SHIRTS; SLEEPWEAR; SWIMWEAR; BEACHWEAR; BATHROBES; SLIPPERS; FANCY DRESS COSTUMES BASED ON CHARACTERS FROM A TV SHOW; DRESSING GOWNS; DRESSES; SKIRTS; NECKTIES; PYJAMAS; WRISTBANDS; HEADBANDS, IN CLASS 25 (U.S. CLS. 22 AND 39).

FOR: DECORATIONS FOR CHRISTMAS TREES; BALLOONS; BALLS FOR GAMES; BOARD GAMES; BOXING GLOVES; PLAYING CARDS; DICE; DOLLS; DOLLS' CLOTHES; DOLLS' HOUSES; DOMINOS; KALEIDOSCOPES; KITES; TOY MASKS; PUPPETS; SNOW GLOBES; SPINNING TOPS; TABLES FOR TABLE TENNIS; TABLES FOR INDOOR FOOTBALL; TEDDY BEARS; TOY PISTOLS; TOY VEHICLES; ACTION FIGURES; BATHTUB TOYS; PLUSH TOYS; FLYING DISCS; ELECTRONIC HAND HELD GAME UNITS FOR PLAYING VIDEO GAMES OTHER THAN THOSE ADAPTED FOR USE WITH AN EXTERNAL DISPLAY SCREEN OR MONITOR; CARD GAMES; JIGSAW PUZZLES; CUBE PUZZLES; MANIPULATIVE PUZZLES; WATER SQUIRTING TOYS; SWIMMING FLOATS FOR RECREATIONAL USE; CHRISTMAS CRACKERS; CARDBOARD TOY AND NOVELTY FACE MASKS, IN CLASS 28 (U.S. CLS. 22, 23, 38 AND 50).

FOR: PRESENTATION OF LIVE COMEDY SHOWS; ENTERTAINMENT, NAMELY, PRODUCTION AND PERFORMANCE OF LIVE COMEDY SHOWS; ENTERTAINMENT IN THE NATURE OF STAND UP COMEDY PERFORMANCES; LIVE ENTERTAINMENT SERVICES BY A GROUP OF COMEDIC PERFORMERS; ENTERTAINMENT IN THE NATURE OF LIVE PERFORMANCES BY A GROUP OF COMEDIC PERFORMERS; ORGANISATION OF MUSIC FESTIVALS; ENTERTAINMENT IN THE NATURE OF LIVE PERFORMANCES BY A MUSICAL GROUP; FILM PRODUCTION; MUSIC COMPOSITION SERVICES FOR OTHERS; PRODUCTION OF RADIO PROGRAMMES; PRODUCTION OF TELEVISION PROGRAMMES; ENTERTAINMENT, NAMELY, PRODUCTION OF TELEVISION SHOWS; PROVIDING ON-LINE NON-DOWNLOADABLE ELECTRONIC PUBLICATIONS IN THE NATURE OF ELECTRONIC NEWSLETTERS ABOUT COMEDY AND MUSIC; RADIO ENTERTAINMENT, NAMELY, PROVIDING AN ON-GOING RADIO PROGRAM IN THE FIELD OF COMEDY AND MUSIC; TELEVISION ENTERTAINMENT IN THE NATURE OF ON-GOING TELEVISION PROGRAMS IN THE FIELD OF COMEDY AND MUSIC; THEATRICAL ENTERTAINMENT, NAMELY, THEATRICAL, COMEDIC, AND MUSICAL FLOOR SHOWS PROVIDED AT PERFORMANCE VENUES; PRODUCTION OF VIDEOS; PROVIDING ON-LINE ENTERTAINMENT INFORMATION IN THE FIELD OF MOTION PICTURE FILM, TELEVISION PROGRAMMING, THEATRE, VIDEOTAPES, AND DVDS, ALL RELATING TO COMEDY AND MUSIC, VIA A GLOBAL COMMUNICATIONS NETWORK, IN CLASS 41 (U.S. CLS. 100, 101 AND 107).

THE MARK CONSISTS OF STANDARD CHARACTERS WITHOUT CLAIM TO ANY PARTICULAR FONT, STYLE, SIZE, OR COLOR.

PRIORITY CLAIMED UNDER SEC. 44(D) ON UNITED KINGDOM APPLICATION NO. 2542395, FILED 3-16-2010, REG. NO. 2542395, DATED 7-30-2010, EXPIRES 3-16-2020.

SER. NO. 85-131,611, FILED 9-16-2010.

BARBARA GAYNOR, EXAMINING ATTORNEY

# United States of America

United States Patent and Trademark Office

# FIRSTCALL

**Reg. No. 4,123,902**

REACH AIR MEDICAL SERVICES, LLC (CALIFORNIA LIMITED LIABILITY COMPANY)  
451 AVIATION BLVD., NO. 201  
SANTA ROSA, CA 95403

**Registered Apr. 10, 2012**

**Int. Cls.: 35, 38 and 39**

FOR: OPERATION OF TELECOMMUNICATION CENTER SERVICES FOR OTHERS IN THE FIELD OF EMERGENCY MEDICAL TRANSPORT FOR THE PURPOSE OF ORDERING EMERGENCY MEDICAL TRANSPORT, IDENTIFYING APPROPRIATE AND AVAILABLE HEALTH CARE PROVIDERS AND PROVIDING FOLLOW-UP INFORMATION ABOUT THE PROGRESS AND STATUS OF THE EMERGENCY TRANSPORT THAT WAS REQUESTED, IN CLASS 35 (U.S. CLS. 100, 101 AND 102).

**SERVICE MARK**

**PRINCIPAL REGISTER**

FIRST USE 6-0-2009; IN COMMERCE 9-0-2009.

FOR: TELECOMMUNICATION SERVICES, NAMELY, FACILITATING COMMUNICATION BY PROVIDING A COMMUNICATION BRIDGE BETWEEN HEALTH CARE PROVIDERS AND RE-ROUTING CALLS TO LOCAL THIRD PARTY MEDICAL TRANSPORT DISPATCHERS IN THE VICINITY OF THE CALLER, IN CLASS 38 (U.S. CLS. 100, 101 AND 104).

FIRST USE 6-0-2009; IN COMMERCE 9-0-2009.

FOR: MEDICAL TRANSPORT SERVICES, NAMELY, MAKING ARRANGEMENTS FOR EMERGENCY MEDICAL TRANSPORT BY COORDINATING CALLS FOR TRANSPORT WITH PROVIDERS OF TRANSPORT AND CONFIRMING THE AVAILABILITY OF THE REQUIRED MEANS OF TRANSPORTATION FOR EMERGENCY RESPONSE, IN CLASS 39 (U.S. CLS. 100 AND 105).

FIRST USE 6-0-2009; IN COMMERCE 6-0-2009.

THE MARK CONSISTS OF STANDARD CHARACTERS WITHOUT CLAIM TO ANY PARTICULAR FONT, STYLE, SIZE, OR COLOR.

SER. NO. 85-134,993, FILED 9-21-2010.

SUZANNE BLANE, EXAMINING ATTORNEY



*David J. Kyffers*

Director of the United States Patent and Trademark Office

# United States of America

## United States Patent and Trademark Office



**Reg. No. 4,123,903**

**Registered Apr. 10, 2012**

**Int. Cls.: 14 and 42**

NAVAL RESEARCH LABORATORY (UNITED STATES AGENCY OF THE UNITED STATES GOVERNMENT)  
CODE 1008.2  
4555 OVERLOOK AVE. SW  
WASHINGTON, DC 20375

**TRADEMARK**

FOR: COMMEMORATIVE COINS, NON-MONETARY COINS, IN CLASS 14 (U.S. CLS. 2, 27, 28 AND 50).

**SERVICE MARK**

FIRST USE 9-2-2010; IN COMMERCE 9-2-2010.

**PRINCIPAL REGISTER**

FOR: SCIENTIFIC SERVICES FOR CONDUCTING RESEARCH IN THE FIELDS OF SPACE-BASED COMMAND CONTROL AND COMMUNICATIONS SYSTEMS, IN CLASS 42 (U.S. CLS. 100 AND 101).

FIRST USE 9-2-2010; IN COMMERCE 9-2-2010.

NO CLAIM IS MADE TO THE EXCLUSIVE RIGHT TO USE "NAVAL RESEARCH LABORATORY" AND "C4I BRANCH CODE 8140", APART FROM THE MARK AS SHOWN.

THE MARK CONSISTS OF A STYLIZED CIRCULAR IMAGE THAT INCLUDES IMAGES OF A SATELLITE, SHIP, SUBMARINE, GLOBE, LIGHTNING BOLTS, BOUNDED BY THE WORDING "NAVAL RESEARCH LABORATORY" AND "C4I BRANCH CODE 8140" WITH ROPE PERIMETER.

SER. NO. 85-136,273, FILED 9-23-2010.

NAKIA HENRY, EXAMINING ATTORNEY



*David J. Kybas*

Director of the United States Patent and Trademark Office

# United States of America

United States Patent and Trademark Office

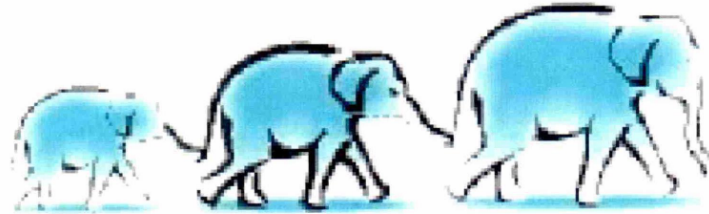

## LIFE ELEPHANT

**Reg. No. 4,123,904**

**Registered Apr. 10, 2012**

**Int. Cls.: 38 and 39**

**SERVICE MARK**

**PRINCIPAL REGISTER**

LIFE ELEPHANT, LLC (VERMONT LIMITED LIABILITY COMPANY)  
182 HEGEMAN AVENUE, STUDIO ONE  
COLCHESTER, VT 05446

FOR: PROVISION OF ACCESS TO DATA OR DOCUMENTS STORED ELECTRONICALLY  
IN CENTRAL FILES FOR REMOTE CONSULTATION, IN CLASS 38 (U.S. CLS. 100, 101  
AND 104).

FIRST USE 6-22-2010; IN COMMERCE 6-22-2010.

FOR: STORAGE SERVICES FOR ARCHIVING ELECTRONIC DATA, IN CLASS 39 (U.S.  
CLS. 100 AND 105).

FIRST USE 6-22-2010; IN COMMERCE 6-22-2010.

THE MARK CONSISTS OF THREE ELEPHANTS OUTLINED IN BLACK WITH BLUE  
SHADING WALKING IN A SINGLE FILE ABOVE THE WORDS "LIFE ELEPHANT" WRITTEN  
IN BLACK.

THE COLOR(S) BLACK AND BLUE IS/ARE CLAIMED AS A FEATURE OF THE MARK.

SER. NO. 85-136,692, FILED 9-23-2010.

SHAUNIA CARLYLE, EXAMINING ATTORNEY



*David J. Kybas*

Director of the United States Patent and Trademark Office

United States of America  
United States Patent and Trademark Office

NURSE

FUNSHINE

**Reg. No. 4,123,905**

**Registered Apr. 10, 2012**

**Int. Cl.: 44**

**SERVICE MARK**

**PRINCIPAL REGISTER**

CHERYL B. FELL R.N. (UNITED STATES INDIVIDUAL), AKA NURSE FUNSHINE  
305 JOHN FELL LOOP  
305 JOHN FELL LOOP  
SCOTT, LA 70583

FOR: CONSULTING IN THE FIELD OF HEALTH AND WELLNESS TO BRING ABOUT  
PERSONAL HAPPINESS, IN CLASS 44 (U.S. CLS. 100 AND 101).

FIRST USE 10-1-1995; IN COMMERCE 10-1-2001.

THE MARK CONSISTS OF STANDARD CHARACTERS WITHOUT CLAIM TO ANY PAR-  
TICULAR FONT, STYLE, SIZE, OR COLOR.

THE NAME "NURSE FUNSHINE" IDENTIFIES A LIVING INDIVIDUAL WHOSE CONSENT  
IS OF RECORD.

SER. NO. 85-137,530, FILED 9-24-2010.

JASON BLAIR, EXAMINING ATTORNEY



*David J. Kybas*

Director of the United States Patent and Trademark Office



# United States of America

United States Patent and Trademark Office



**Reg. No. 4,123,906**

**Registered Apr. 10, 2012**

**Int. Cl.: 36**

**SERVICE MARK**

**PRINCIPAL REGISTER**

STARTUP: EDUCATION (CALIFORNIA CORPORATION)  
2440 WEST EL CAMINO REAL, SUITE 300  
MOUNTAIN VIEW, CA 94040

FOR: CHARITABLE FOUNDATION SERVICES, NAMELY, PROVIDING FUNDRAISING ACTIVITIES, SCHOLARSHIPS AND FINANCIAL ASSISTANCE FOR PROGRAMS AND SERVICES OF OTHERS, IN CLASS 36 (U.S. CLS. 100, 101 AND 102).

FIRST USE 9-24-2010; IN COMMERCE 9-24-2010.

NO CLAIM IS MADE TO THE EXCLUSIVE RIGHT TO USE "STARTUP:EDUCATION", APART FROM THE MARK AS SHOWN.

THE COLOR(S) MAROON, RED, AND GREEN IS/ARE CLAIMED AS A FEATURE OF THE MARK.

THE MARK CONSISTS OF THE WORDS "STARTUP:EDUCATION" IN MAROON, STYLIZED FONT, BELOW AN INCOMPLETE RED CIRCLE, A MAROON VERTICAL LINE, AND A GREEN LEAF DESIGN.

SER. NO. 85-137,689, FILED 9-24-2010.

DORITT L. CARROLL, EXAMINING ATTORNEY



*David J. Kybas*

Director of the United States Patent and Trademark Office

# United States of America

United States Patent and Trademark Office



**Reg. No. 4,123,907**

DON BUMGARDNER (UNITED STATES INDIVIDUAL)  
6801 SNODEN ROAD  
FORT WORTH, TX 76140

**Registered Apr. 10, 2012**

**Int. Cl.: 35**

FOR: RETAIL STORE SERVICES FEATURING CHILDREN'S FURNITURE, IN CLASS 35 (U.S. CLS. 100, 101 AND 102).

**SERVICE MARK**

FIRST USE 1-1-2010; IN COMMERCE 1-1-2010.

**PRINCIPAL REGISTER**

NO CLAIM IS MADE TO THE EXCLUSIVE RIGHT TO USE "KIDS", APART FROM THE MARK AS SHOWN.

THE COLOR(S) BLUE, PURPLE, GREEN, PINK, BLACK AND WHITE IS/ARE CLAIMED AS A FEATURE OF THE MARK.

THE MARK CONSISTS OF THE FOLLOWING: THE MARK CONSISTS OF A BLACK BACKGROUND IN THE SHAPE OF A SQUARE WITH "DONCO" IN WHITE. UNDER "DONCO" ARE BLUE, PURPLE, GREEN AND PINK BOXES WITH THE WHITE LETTERS "K", "I", "D" AND "S" ON THEM IN LOWERCASE IN WHITE.

SER. NO. 85-138,289, FILED 9-25-2010.

DEZMONA MIZELLE, EXAMINING ATTORNEY



*David J. Kyros*

Director of the United States Patent and Trademark Office

# United States of America

United States Patent and Trademark Office

# VALORE

**Reg. No. 4,123,908**

GREEN BAY CONVERTING, INC. (WISCONSIN CORPORATION)  
P.O. BOX 12500  
GREEN BAY, WI 543072500

**Registered Apr. 10, 2012**

**Int. Cl.: 16**

FOR: BATHROOM TISSUE; FACE TOWELS OF PAPER; FACIAL TISSUE; HAND TOWELS OF PAPER; NAPKIN PAPER; PAPER HAND-TOWELS; PAPER NAPKINS; PAPER TISSUES; PAPER TOWELS; TOILET TISSUE, IN CLASS 16 (U.S. CLS. 2, 5, 22, 23, 29, 37, 38 AND 50).

**TRADEMARK**

FIRST USE 4-1-2010; IN COMMERCE 9-1-2010.

**PRINCIPAL REGISTER**

THE MARK CONSISTS OF STANDARD CHARACTERS WITHOUT CLAIM TO ANY PARTICULAR FONT, STYLE, SIZE, OR COLOR.

THE ENGLISH TRANSLATION OF THE WORD "VALORE" IN THE MARK IS "VALUE".

SER. NO. 85-138,880, FILED 9-27-2010.

MYRIAH HABEEB, EXAMINING ATTORNEY



*David J. Kybas*

Director of the United States Patent and Trademark Office

# United States of America

United States Patent and Trademark Office

# XERACALM

**Reg. No. 4,123,909**

**Registered Apr. 10, 2012**

**Int. Cls.: 3 and 5**

**TRADEMARK**

**PRINCIPAL REGISTER**

PIERRE FABRE DERMO-COSMETIQUE (FRANCE SOCIÉTÉ PAR ACTIONS SIMPLIFIÉE (SAS))  
45, PLACE ABEL GANCE  
BOULOGNE, FRANCE 92100

FOR: SOAPS; ESSENTIAL OILS; COSMETICS; COSMETIC PREPARATIONS FOR SKIN AND HAIR CARE AND PROTECTION, IN CLASS 3 (U.S. CLS. 1, 4, 6, 50, 51 AND 52).

FOR: PHARMACEUTICAL PREPARATIONS AND MEDICATED HYGIENIC PREPARATIONS FOR THE TREATMENT OF SKIN CONDITIONS; DERMATOLOGICALS; MEDICATED DERMO-COSMETIC PREPARATIONS FOR THE TREATMENT OF SKIN AND HAIR; DIETETIC SUBSTANCES, NAMELY, FOODS FOR MEDICAL USE; FOOD AND NUTRITIONAL SUPPLEMENTS FOR MEDICAL USE, IN CLASS 5 (U.S. CLS. 6, 18, 44, 46, 51 AND 52).

THE MARK CONSISTS OF STANDARD CHARACTERS WITHOUT CLAIM TO ANY PARTICULAR FONT, STYLE, SIZE, OR COLOR.

PRIORITY CLAIMED UNDER SEC. 44(D) ON FRANCE APPLICATION NO. 103729025, FILED 4-12-2010, REG. NO. 103729025, DATED 4-12-2010, EXPIRES 4-12-2020.

SER. NO. 85-142,016, FILED 9-30-2010.

GENE MACIOL, EXAMINING ATTORNEY



*David J. Kyros*

Director of the United States Patent and Trademark Office

# United States of America

United States Patent and Trademark Office

# PROSPER

**Reg. No. 4,123,910**

**Registered Apr. 10, 2012**

**Int. Cls.: 9, 16 and 41**

**TRADEMARK**

**SERVICE MARK**

**PRINCIPAL REGISTER**

FELIX DENNIS (UNITED KINGDOM INDIVIDUAL)  
2ND FLOOR  
9-11 KINGLY STREET  
LONDON, UNITED KINGDOM W1B5PN

FOR: DOWNLOADABLE ELECTRONIC PUBLICATIONS, NAMELY, MAGAZINES, NEWSPAPERS, NEWSLETTERS, PERIODICALS IN THE FIELD OF FINANCIAL INFORMATION, IN CLASS 9 (U.S. CLS. 21, 23, 26, 36 AND 38).

FOR: MAGAZINES, NEWSPAPERS, NEWSLETTERS, PERIODICALS IN THE FIELD OF FINANCIAL INFORMATION, IN CLASS 16 (U.S. CLS. 2, 5, 22, 23, 29, 37, 38 AND 50).

FOR: PUBLICATION OF MAGAZINES, NEWSPAPERS, NEWSLETTERS, PERIODICALS, ELECTRONIC MAGAZINES, IN CLASS 41 (U.S. CLS. 100, 101 AND 107).

THE MARK CONSISTS OF STANDARD CHARACTERS WITHOUT CLAIM TO ANY PARTICULAR FONT, STYLE, SIZE, OR COLOR.

PRIORITY CLAIMED UNDER SEC. 44(D) ON UNITED KINGDOM APPLICATION NO. 2543558, FILED 3-30-2010, REG. NO. 2543558, DATED 10-15-2010, EXPIRES 3-30-2020.

SER. NO. 85-142,670, FILED 9-30-2010.

ELIZABETH KAJUBI, EXAMINING ATTORNEY



*David J. Kyros*

Director of the United States Patent and Trademark Office

# United States of America

United States Patent and Trademark Office

# SELEXIR<sup>®</sup>

**Reg. No. 4,123,911**

**Registered Apr. 10, 2012**

**Int. Cl.: 3**

**TRADEMARK**

**PRINCIPAL REGISTER**

3TRINITY (SWITZERLAND LIMITED LIABILITY COMPANY)  
C/O RA PETER HODEL  
INDUSTRIESTRASSE 13C  
ZUG, SWITZERLAND 6304

FOR: BODY AND BEAUTY CARE COSMETICS, IN CLASS 3 (U.S. CLS. 1, 4, 6, 50, 51 AND 52).

PRIORITY CLAIMED UNDER SEC. 44(D) ON ERPN CMNTY TM OFC APPLICATION NO. 009001736, FILED 4-1-2010, REG. NO. 009001736, DATED 9-20-2010, EXPIRES 4-1-2020.

THE MARK CONSISTS OF THE WORD "SELEXIR" IN COMBINATION WITH A CIRCLED LETTER "S".

THE WORDING "SELEXIR" HAS NO MEANING IN A FOREIGN LANGUAGE.

SER. NO. 85-142,779, FILED 10-1-2010.

BILL DAWE, EXAMINING ATTORNEY



*David J. Kybas*

Director of the United States Patent and Trademark Office

# United States of America

United States Patent and Trademark Office

## INNOVATORS MARKET GAME

**Reg. No. 4,123,912**

**Registered Apr. 10, 2012**

**Int. Cls.: 9, 28 and 41**

**TRADEMARK**

**SERVICE MARK**

**PRINCIPAL REGISTER**

YUKIO OHSAWA (JAPAN INDIVIDUAL)  
C/O SCHOOL OF ENGR., THE UNIV. OF TOKYO  
7-3-1, HONGO, BUNKYO-KU  
TOKYO, JAPAN 113-8656

FOR: COMPUTER PROGRAMS FOR USE IN VISUALIZATION OF KNOWLEDGE AND IDEAS AND ONLINE INTERFACE FOR HUMAN COMMUNICATION; COMPUTER GAME CONSOLES FOR USE WITH AN EXTERNAL DISPLAY SCREEN OR MONITOR; ELECTRONIC CIRCUITS RECORDING PROGRAMS FOR AMUSEMENT APPARATUS FOR USE WITH LIQUID CRYSTAL SCREENS; AMUSEMENT MACHINES, NAMELY, HAND-HELD ELECTRONIC GAME UNITS ADAPTED FOR USE WITH AN EXTERNAL DISPLAY SCREEN OR MONITOR, IN CLASS 9 (U.S. CLS. 21, 23, 26, 36 AND 38).

FOR: JAPANESE CHESS (SHOGI GAMES); JAPANESE PLAYING CARDS (UTAGARUTA); DICE; JAPANESE DICE GAMES (SUGOROKU); DICE CUPS; CHESS GAMES; CHECKERS (CHECKER SETS); DOMINOES; PLAYING CARDS; JAPANESE PLAYING CARDS (HANAFUDA), IN CLASS 28 (U.S. CLS. 22, 23, 38 AND 50).

FOR: EDUCATIONAL SERVICES, NAMELY, CONDUCTING SEMINARS, CLASSROOM LESSONS, AND WORKSHOPS IN THE FIELD OF CREATIVITY TRAINING FOR NEW TECHNOLOGY, SERVICE SYSTEMS AND BUSINESS IDEAS; ARRANGING, CONDUCTING AND ORGANIZATION OF SEMINARS RELATING TO METHODS FOR CONCEIVING AND THINKING OF NEW TECHNOLOGIES AND SERVICES; ORGANIZING, ARRANGING, AND CONDUCTING OF EDUCATIONAL SEMINARS FOR CREATIVITY TRAINING AND BUSINESS IDEA TRAINING; PUBLISHING OF ELECTRONIC PUBLICATIONS; REFERENCE LIBRARIES FOR LITERATURE AND DOCUMENTARY RECORDS; PUBLICATION OF BOOKS; ORGANIZING AND ARRANGING EXHIBITIONS OF GAMES FOR EDUCATIONAL AND FOR ENTERTAINMENT PURPOSES; ORGANIZATION OF GAMES, IN CLASS 41 (U.S. CLS. 100, 101 AND 107).



THE MARK CONSISTS OF STANDARD CHARACTERS WITHOUT CLAIM TO ANY PARTICULAR FONT, STYLE, SIZE, OR COLOR.

*David J. Kybas*

PRIORITY CLAIMED UNDER SEC. 44(D) ON JAPAN APPLICATION NO. 2010-032099, FILED 4-21-2010, REG. NO. 5359314, DATED 10-8-2010, EXPIRES 11-8-2020.

**Reg. No. 4,123,912** NO CLAIM IS MADE TO THE EXCLUSIVE RIGHT TO USE "GAME", APART FROM THE MARK AS SHOWN.

SER. NO. 85-145,163, FILED 10-5-2010.

SANJEEV VOHRA, EXAMINING ATTORNEY



# United States of America

United States Patent and Trademark Office



**Reg. No. 4,123,913**

**Registered Apr. 10, 2012**

**Int. Cl.: 44**

**SERVICE MARK**

**PRINCIPAL REGISTER**

DAVID A. BRESLER D.D.S., P.C. (PENNSYLVANIA CORPORATION)  
240 GEIGER ROAD  
PHILADELPHIA, PA 19115

FOR: DENTISTRY; PEDIATRIC DENTISTRY; COSMETIC DENTISTRY; ORTHODONTIC SERVICES; DENTAL HYGIENIST SERVICES, IN CLASS 44 (U.S. CLS. 100 AND 101).

FIRST USE 7-15-1997; IN COMMERCE 10-1-1997.

NO CLAIM IS MADE TO THE EXCLUSIVE RIGHT TO USE "CAVITY", APART FROM THE MARK AS SHOWN.

THE NAME "DOC BRESLER" IDENTIFIES DAVID A. BRESLER, A LIVING INDIVIDUAL WHOSE CONSENT IS OF RECORD.

THE MARK CONSISTS OF A DRAWING OF A TOOTH WITH A FACE AND HANDS AND BANDAGES ON THE UPPER RIGHT AND LOWER LEFT OF THE TOOTH, INSIDE A CIRCLE WITH A TOOTH BRUSH LAID DIAGONALLY ACROSS THE IMAGE AND THE WORDS "DOC BRESLER'S CAVITY BUSTERS" AROUND THE OUTSIDE OF THE CIRCLE.

SER. NO. 85-148,733, FILED 10-8-2010.

DEBRA LEE, EXAMINING ATTORNEY



*David J. Kybas*

Director of the United States Patent and Trademark Office

# United States of America

United States Patent and Trademark Office

## DOC BRESLER'S CAVITY BUSTERS

**Reg. No. 4,123,914**

DAVID A. BRESLER D.D.S., P.C. (PENNSYLVANIA CORPORATION)  
240 GEIGER ROAD  
PHILADELPHIA, PA 19115

**Registered Apr. 10, 2012**

**Int. Cl.: 44**

FOR: DENTISTRY; PEDIATRIC DENTISTRY; COSMETIC DENTISTRY; ORTHODONTIC SERVICES; DENTAL HYGIENIST SERVICES, IN CLASS 44 (U.S. CLS. 100 AND 101).

**SERVICE MARK**

FIRST USE 7-15-1997; IN COMMERCE 10-1-1997.

**PRINCIPAL REGISTER**

THE MARK CONSISTS OF STANDARD CHARACTERS WITHOUT CLAIM TO ANY PARTICULAR FONT, STYLE, SIZE, OR COLOR.

NO CLAIM IS MADE TO THE EXCLUSIVE RIGHT TO USE "CAVITY", APART FROM THE MARK AS SHOWN.

THE NAME "DOC BRESLER" IDENTIFIES DAVID A. BRESLER, A LIVING INDIVIDUAL WHOSE CONSENT IS OF RECORD.

SER. NO. 85-148,789, FILED 10-8-2010.

DEBRA LEE, EXAMINING ATTORNEY



*David J. Kybas*

Director of the United States Patent and Trademark Office

# United States of America

United States Patent and Trademark Office

# Killer Burger

**Reg. No. 4,123,915**

**Registered Apr. 10, 2012**

**Int. Cl.: 30**

**TRADEMARK**

**PRINCIPAL REGISTER**

KILLER BURGER (OREGON CORPORATION)  
3069 NE 158TH AVE  
PORTLAND, OR 97230

FOR: BURGERS CONTAINED IN BREAD ROLLS, IN CLASS 30 (U.S. CL. 46).

FIRST USE 8-1-2010; IN COMMERCE 9-27-2010.

THE MARK CONSISTS OF STANDARD CHARACTERS WITHOUT CLAIM TO ANY PARTICULAR FONT, STYLE, SIZE, OR COLOR.

NO CLAIM IS MADE TO THE EXCLUSIVE RIGHT TO USE "BURGER", APART FROM THE MARK AS SHOWN.

SER. NO. 85-150,131, FILED 10-11-2010.

DOMINIC J. FERRAIUOLO, EXAMINING ATTORNEY



*David J. Kyffers*

Director of the United States Patent and Trademark Office

# United States of America

United States Patent and Trademark Office



**Reg. No. 4,123,916**

**Registered Apr. 10, 2012**

**Int. Cl.: 10**

**TRADEMARK**

**PRINCIPAL REGISTER**

BIOLIGHT PATENT HOLDING AB (SWEDEN CORPORATION)  
TOMTEBOGATAN 4  
STOCKHOLM, SWEDEN 11339

FOR: MEDICAL APPARATUS AND INSTRUMENTS FOR LIGHT THERAPY TREATMENT OF WOUNDS, SKIN DISORDERS, INFLAMMATORY CONDITIONS AND INJURIES; MEDICAL APPARATUS AND INSTRUMENTS THAT USE LIGHT THERAPY FOR REDUCING PAIN AND SWELLING, ALL OF THE ABOVE FOR USE WITH HUMANS AND ANIMALS, IN CLASS 10 (U.S. CLS. 26, 39 AND 44).

PRIORITY CLAIMED UNDER SEC. 44(D) ON ERPN CMNTY TM OFC APPLICATION NO. 009409848, FILED 9-29-2010, REG. NO. 009409848, DATED 2-18-2011, EXPIRES 9-29-2020.

THE MARK CONSISTS OF A VERTICAL WAVY LINE.

SER. NO. 85-151,863, FILED 10-13-2010.

KIM SAITO, EXAMINING ATTORNEY



*David J. Kybas*

Director of the United States Patent and Trademark Office

# United States of America

United States Patent and Trademark Office

# DECOREX

**Reg. No. 4,123,917**

**Registered Apr. 10, 2012**

**Int. Cl.: 35**

**SERVICE MARK**

**PRINCIPAL REGISTER**

UBM INFORMATION LIMITED (UNITED KINGDOM COMPANY)  
LUDGATE HOUSE, 245 BLACKFRIARS ROAD  
LONDON, UNITED KINGDOM SE19UY

FOR: ARRANGING TRADE SHOWS IN THE FIELDS OF FURNITURE, FURNISHINGS, FABRICS AND TEXTILES AND OF INTERIOR DESIGN MERCHANDISE, IN CLASS 35 (U.S. CLS. 100, 101 AND 102).

THE MARK CONSISTS OF STANDARD CHARACTERS WITHOUT CLAIM TO ANY PARTICULAR FONT, STYLE, SIZE, OR COLOR.

OWNER OF ERPN CMNTY TM OFC REG. NO. 000206268, DATED 4-1-1996, EXPIRES 4-2-2016.

SER. NO. 85-151,890, FILED 10-13-2010.

KHANH LE, EXAMINING ATTORNEY



*David J. Kyffers*

Director of the United States Patent and Trademark Office

# United States of America

United States Patent and Trademark Office

# GELINO

**Reg. No. 4,123,918**

**Registered Apr. 10, 2012**

**Int. Cl.: 30**

**TRADEMARK**

**PRINCIPAL REGISTER**

LES ALIMENTS CANDARA INC. (CANADA CORPORATION)  
7785, BOMBARDIER STREET  
ANJOU, CANADA

FOR: CANDIES, IN CLASS 30 (U.S. CL. 46).

THE MARK CONSISTS OF STANDARD CHARACTERS WITHOUT CLAIM TO ANY PARTICULAR FONT, STYLE, SIZE, OR COLOR.

PRIORITY CLAIMED UNDER SEC. 44(D) ON CANADA APPLICATION NO. 1499414, FILED 10-12-2010, REG. NO. TMA805833, DATED 9-1-2011, EXPIRES 9-1-2026.

THE WORD "GELINO" HAS NO MEANING IN A FOREIGN LANGUAGE.

SER. NO. 85-151,998, FILED 10-13-2010.

BERNICE MIDDLETON, EXAMINING ATTORNEY



*David J. Kyffers*

Director of the United States Patent and Trademark Office

# United States of America

United States Patent and Trademark Office

# CASTLE

**Reg. No. 4,123,919**

**Registered Apr. 10, 2012**

**Int. Cls.: 9, 16 and 41**

**TRADEMARK**

**SERVICE MARK**

**PRINCIPAL REGISTER**

THE SECRETAN CENTER INC. (CANADA CORPORATION)  
1177 CATARACT ROAD  
CALEDON, ONTARIO, CANADA L7K1P2

FOR: PRERECORDED AUDIO AND VIDEO TAPES AND CD-ROMS NOT CONTAINING SOFTWARE ON TOPICS OF BUSINESS MANAGEMENT, BUSINESS CONSULTATION AND BUSINESS PLANNING, PERSONNEL MANAGEMENT CONSULTATION, BUSINESS AND PERSONAL RELATIONSHIPS, TEAM RELATIONSHIP ENHANCEMENT, AND ENHANCEMENT OF COMMUNITY SERVICES, IN CLASS 9 (U.S. CLS. 21, 23, 26, 36 AND 38).

FOR: BOOKS ON THE TOPICS OF BUSINESS MANAGEMENT BUSINESS CONSULTATION AND BUSINESS PLANNING SERVICES; NEWSLETTERS IN THE FIELDS OF BUSINESS MANAGEMENT, BUSINESS CONSULTATION AND BUSINESS PLANNING, PERSONNEL MANAGEMENT CONSULTATION, BUSINESS AND PERSONAL RELATIONSHIPS, TEAM RELATIONSHIP ENHANCEMENT, AND ENHANCEMENT OF COMMUNITY SERVICES; MOTIVATIONAL CARDS; PRINTED INFORMATIONAL CARDS IN THE FIELD OF LIFE ISSUES FOR THE PURPOSE OF CONTEMPLATION, IN CLASS 16 (U.S. CLS. 2, 5, 22, 23, 29, 37, 38 AND 50).

FOR: TRAINING SERVICES IN THE FIELDS OF BUSINESS AND PERSONAL RELATIONSHIPS, TEAM RELATIONSHIP ENHANCEMENT, ENHANCEMENT OF COMMUNITY SERVICES, BUSINESS MANAGEMENT, PERSONNEL MANAGEMENT CONSULTATION, BUSINESS PLANNING, BUSINESS ACQUISITION AND MERGER CONSULTATION, BUSINESS APPRAISAL, THE CONDUCT OF BUSINESS AND MARKET RESEARCH SURVEYS, BUSINESS RESEARCH, THE USE OF COMPUTER MODELS FOR THE ENHANCEMENT OF BUSINESS, PERSONAL AND TEAM RELATIONSHIPS, THE DEVELOPMENT AND IMPLEMENTATION OF MANAGEMENT LEADERSHIP AND DEVELOPMENT PROGRAMS, PROGRAMS FOR THE ENHANCEMENT OF COMMUNITY SERVICES AND PROGRAMS FOR THE IMPROVEMENT OF QUALITY CONTROL OF BUSINESSES, AND SPIRITUALITY, VALUES, RELATIONSHIPS, STRATEGY, COMMUNICATIONS AND TEAMWORK IN THE WORKPLACE, IN CLASS 41 (U.S. CLS. 100, 101 AND 107).

THE MARK CONSISTS OF STANDARD CHARACTERS WITHOUT CLAIM TO ANY PARTICULAR FONT, STYLE, SIZE, OR COLOR.

PRIORITY CLAIMED UNDER SEC. 44(D) ON CANADA APPLICATION NO. 1476868, FILED 4-14-2010, REG. NO. TMA807843, DATED 9-28-2011, EXPIRES 9-28-2026.



*David J. Kyffers*

Director of the United States Patent and Trademark Office

**Reg. No. 4,123,919** SER. NO. 85-152,475, FILED 10-14-2010.

IRA J. GOODSaid, EXAMINING ATTORNEY



# United States of America

United States Patent and Trademark Office

## Anti-Sabotage Certified, ASC

**Reg. No. 4,123,920**

THE TRUSTEE OF THE ROBERT L. O'BLOCK REVOCABLE TRUST (MISSOURI TRUST)  
2750 EAST SUNSHINE  
SPRINGFIELD, MO 65804

**Registered Apr. 10, 2012**

**Int. Cl.: 42**

FOR: TESTING, ANALYSIS, AND EVALUATION OF THE GOODS AND SERVICES OF OTHERS FOR THE PURPOSE OF CERTIFICATION, IN CLASS 42 (U.S. CLS. 100 AND 101).

**SERVICE MARK**

FIRST USE 9-22-2010; IN COMMERCE 9-22-2010.

**PRINCIPAL REGISTER**

THE MARK CONSISTS OF STANDARD CHARACTERS WITHOUT CLAIM TO ANY PARTICULAR FONT, STYLE, SIZE, OR COLOR.

NO CLAIM IS MADE TO THE EXCLUSIVE RIGHT TO USE "ANTI-SABOTAGE CERTIFIED", APART FROM THE MARK AS SHOWN.

SER. NO. 85-153,002, FILED 10-14-2010.

MATTHEW MCDOWELL, EXAMINING ATTORNEY



*David J. Kybas*

Director of the United States Patent and Trademark Office

# United States of America

United States Patent and Trademark Office

# iCarbons

**Reg. No. 4,123,921**

ICARBONS INC. (FLORIDA CORPORATION)  
1535 GLEN HAVEN DR.  
MERRITT ISLAND, FL 32952

**Registered Apr. 10, 2012**

**Int. Cl.: 9**

FOR: PROTECTIVE COVERS FOR CELL PHONES, LAPTOPS, VIDEO GAME CONSOLES,  
AND PORTABLE MEDIA PLAYERS, IN CLASS 9 (U.S. CLS. 21, 23, 26, 36 AND 38).

**TRADEMARK**

FIRST USE 5-21-2010; IN COMMERCE 5-21-2010.

**PRINCIPAL REGISTER**

THE MARK CONSISTS OF STANDARD CHARACTERS WITHOUT CLAIM TO ANY PAR-  
TICULAR FONT, STYLE, SIZE, OR COLOR.

SER. NO. 85-154,094, FILED 10-15-2010.

ALEX KEAM, EXAMINING ATTORNEY



*David J. Kybas*

Director of the United States Patent and Trademark Office

# United States of America

United States Patent and Trademark Office

# BIOFILL

**Reg. No. 4,123,922**

**Registered Apr. 10, 2012**

**Int. Cl.: 22**

**TRADEMARK**

**PRINCIPAL REGISTER**

GEBR. KREMERS GMBH (FED REP GERMANY LIMITED LIABILITY COMPANY)  
RAYENER STR. 14  
NEUKIRCHEN-VLUYN, FED REP GERMANY 47506

FOR: FILLINGS OF NATURAL OR SYNTHETIC FIBERS FOR BEDDING ARTICLES, IN CLASS 22 (U.S. CLS. 1, 2, 7, 19, 22, 42 AND 50).

THE MARK CONSISTS OF STANDARD CHARACTERS WITHOUT CLAIM TO ANY PARTICULAR FONT, STYLE, SIZE, OR COLOR.

OWNER OF ERPN CMNTY TM OFC REG. NO. 000063271, DATED 1-26-1999, EXPIRES 4-1-2016.

OWNER OF U.S. REG. NOS. 2,887,576 AND 2,902,386.

SER. NO. 85-154,635, FILED 10-18-2010.

ZACHARY BELLO, EXAMINING ATTORNEY



*David J. Kyros*

Director of the United States Patent and Trademark Office

# United States of America

United States Patent and Trademark Office

# DATAPIPE

**Reg. No. 4,123,923**

**Registered Apr. 10, 2012**

**Int. Cls.: 39 and 42**

**SERVICE MARK**

**PRINCIPAL REGISTER**

DATAPIPE, INC. (DELAWARE CORPORATION)  
10 EXCHANGE PLACE  
JERSEY CITY, NJ 07302

FOR: ELECTRONIC DATA STORAGE SERVICES, NAMELY, STORING ELECTRONIC DATA AT DATA CENTERS; COMPUTER SERVICES IN THE NATURE OF PROVIDING AN INTEGRATED SUITE OF DATA AND COMPUTER RELATED SERVICES, NAMELY, ELECTRONIC DATA STORAGE, IN CLASS 39 (U.S. CLS. 100 AND 105).

FIRST USE 6-30-2000; IN COMMERCE 6-30-2000.

FOR: COMPUTER SERVICES IN THE NATURE OF PROVIDING AN INTEGRATED SUITE OF DATA AND COMPUTER RELATED SERVICES, NAMELY, PROVIDING COMPUTER SECURITY CONSULTING IN THE AREA OF DATA STORAGE, ONLINE SECURITY AND INFORMATION SECURITY VULNERABILITY; PROVIDING A SECURE AND SAFE ENVIRONMENT FOR THE INFORMATION TECHNOLOGY SYSTEMS OF OTHERS, NAMELY, PROVIDING COMPUTER CO-LOCATION SERVICES IN THE NATURE OF PROVIDING FACILITIES FOR THE LOCATION OF COMPUTER SERVERS AND EQUIPMENT OF OTHERS; COMPUTER SERVICES IN THE NATURE OF MONITORING AND MANAGING COMPUTER NETWORK SYSTEMS; NETWORK SECURITY SERVICES IN THE NATURE OF COMPUTER NETWORK SECURITY SERVICES, NAMELY, RESTRICTING ACCESS TO AND BY COMPUTER NETWORKS TO AND OF UNDESIREED WEB SITES, MEDIA AND INDIVIDUALS AND FACILITIES; SECURITY MANAGEMENT SERVICES, NAMELY, COMPUTER CONSULTATION IN THE FIELD OF COMPUTER SECURITY; DISASTER RECOVERY SERVICES, NAMELY, COMPUTER DISASTER RECOVERY PLANNING AND RECOVERY OF COMPUTER DATA; SERVER MANAGEMENT SERVICES, NAMELY, HOSTING THE WEB SITES OF OTHERS ON A COMPUTER SERVER FOR A GLOBAL COMPUTER NETWORK; DATA BACKUP SERVICES, NAMELY, BACK-UP SERVICES FOR COMPUTER HARD DRIVE DATA; WEB SITE HOSTING SERVICES; COMPUTER SERVICES, NAMELY, REMOTE AND ON-SITE MANAGEMENT OF THE INFORMATION TECHNOLOGY CLOUD COMPUTING SYSTEMS OF OTHERS; TECHNICAL SUPPORT SERVICES, NAMELY, REMOTE AND ON-SITE INFRASTRUCTURE MANAGEMENT SERVICES FOR MONITORING, ADMINISTRATION AND MANAGEMENT OF PUBLIC AND PRIVATE CLOUD COMPUTING AND APPLICATION SYSTEMS; CONSULTING SERVICES IN THE FIELD OF CLOUD COMPUTING, NAMELY, CONSULTING IN CONNECTION WITH CLOUD COMPUTING APPLICATIONS AND NETWORKS; TECHNICAL CONSULTING SERVICES IN THE FIELDS OF PUBLIC AND PRIVATE CLOUD COMPUTING, NAMELY, CONSULTING



*David J. Kyjars*

Director of the United States Patent and Trademark Office

**Reg. No. 4,123,923** SERVICES IN THE FIELD OF DESIGN, SELECTION, IMPLEMENTATION AND USE OF COMPUTER HARDWARE AND SOFTWARE SYSTEMS FOR OTHERS; TECHNICAL SUPPORT SERVICES, NAMELY, MONITORING OF NETWORK SYSTEMS, SERVERS AND WEB AND DATABASE APPLICATIONS AND NOTIFICATION OF RELATED EVENTS AND ALERTS; PROVIDING ON-DEMAND RESOURCE ALLOCATION FOR COMPUTER SYSTEMS INCLUDING ACCESS TO VIRTUAL SERVERS AND VIRTUAL MACHINES; HOSTING THE SOFTWARE AND OTHER COMPUTER APPLICATIONS OF OTHERS ON A VIRTUAL PRIVATE AND PUBLIC SERVER; TECHNICAL SUPPORT SERVICES FOR HARDWARE, SOFTWARE AND OPERATING SYSTEMS IN THE NATURE OF MONITORING, DIAGNOSING AND PROBLEM RESOLUTION RELATED TO SOFTWARE APPLICATIONS; COMPUTER SERVICES, NAMELY, REMOTE AND ON-SITE MANAGEMENT OF ELECTRONIC MESSAGING SYSTEMS OF OTHERS INCLUDING TROUBLESHOOTING, OPTIMIZING, PATCHING, HARDENING, STORAGE MANAGEMENT, MAILBOX MOVEMENT, INSTALLATION AND CONFIGURATION AND MIGRATION OF ELECTRONIC MESSAGES AND MESSAGE SYSTEMS, SUCH AS E-MAIL, IN CLASS 42 (U.S. CLS. 100 AND 101).

FIRST USE 12-31-2009; IN COMMERCE 12-31-2009.

THE MARK CONSISTS OF STANDARD CHARACTERS WITHOUT CLAIM TO ANY PARTICULAR FONT, STYLE, SIZE, OR COLOR.

OWNER OF U.S. REG. NOS. 3,404,027, 3,826,385 AND OTHERS.

SEC. 2(F).

SER. NO. 85-155,359, FILED 10-18-2010.

KAELIE KUNG, EXAMINING ATTORNEY

# United States of America

United States Patent and Trademark Office

## TILT TRANSFORMER

**Reg. No. 4,123,924**

LENSBABY, LLC (OREGON COMPANY)  
824 SE 16TH AVE  
PORTLAND, OR 972142676

**Registered Apr. 10, 2012**

**Int. Cl.: 9**

FOR: ADAPTER FOR ATTACHING LENSES AND OBJECTIVES ON CAMERAS; CAMERA LENS ADAPTER; PORTABLE PHOTOGRAPHY EQUIPMENT, NAMELY CAMERA LENSES AND LENS ADAPTERS, IN CLASS 9 (U.S. CLS. 21, 23, 26, 36 AND 38).

**TRADEMARK**

FIRST USE 7-7-2010; IN COMMERCE 9-21-2010.

**PRINCIPAL REGISTER**

THE MARK CONSISTS OF STANDARD CHARACTERS WITHOUT CLAIM TO ANY PARTICULAR FONT, STYLE, SIZE, OR COLOR.

SER. NO. 85-155,436, FILED 10-18-2010.

DOMINICK J. SALEMI, EXAMINING ATTORNEY



*David J. Kybas*

Director of the United States Patent and Trademark Office

# United States of America

United States Patent and Trademark Office

## VARITHEK KPORT

**Reg. No. 4,123,925**

**Registered Apr. 10, 2012**

**Int. Cls.: 9, 11, 20, 21  
and 42**

**TRADEMARK**

**SERVICE MARK**

**PRINCIPAL REGISTER**

MAIER, MAX (FED REP GERMANY INDIVIDUAL)  
RHEINLANDSTRASSE 10  
71636 LUDWIGSBURG, FED REP GERMANY

FOR: TILL STATIONS, NAMELY, CASH REGISTERS FOR SYSTEMIZED CATERING WITHIN THE FRAME WORK OF BUSINESS AND PERSONNEL CATERING, AS WELL AS HOTELS, IN CLASS 9 (U.S. CLS. 21, 23, 26, 36 AND 38).

FOR: STEAM TABLES FOR FOOD SERVING AND KEEPING, NAMELY, WOK STATIONS, GRILL AND PASTA STATIONS AS MODULAR SYSTEMS FOR FRONTLINE COOKING, WARM FOOD DISPENSING STATIONS, COFFEE STATIONS, FOOD DISPENSING COUNTERS, SOUP STATIONS; VENTILATION UNITS FOR COMMERCIAL FOOD PREPARATION AND FOOD SERVING, NAMELY, COLD FOOD DISPENSING STATIONS FOR SALADS, ANTIPASTI AND BEVERAGES; ALL OF THE AFORESAID GOODS ALSO FOR SYSTEMIZED CATERING WITHIN THE FRAMEWORK OF BUSINESS AND PERSONNEL CATERING, AS WELL AS HOTELS; FOOD COOLING APPARATUS, NAMELY, REFRIGERATING PLATES AND TRAYS; BARBECUES; PARTS AND ACCESSORIES FOR BARBECUES, NAMELY, GRILL HOUSINGS AS ADAPTED PARTS FOR BARBECUES, CHARCOAL TRAYS, CHARCOAL GRIDS AS OVEN GRIDS, ASH COLLECTING PANS AND ASH CONTAINERS AS ADAPTED PARTS FOR BARBECUES; ELECTRIC DEEP FAT FRYING APPLIANCES, NAMELY, ELECTRIC FRYING PANS; HOT PLATES; KILNS; HOT PLATES; GAS COOKERS; BAKING OVENS; ELECTRIC WAFFLE MAKERS; SINKS FOR RINSING; KITCHEN SINKS; VENTILATION HOODS; ROTISSERIES; ICE CUBE MAKING MACHINES AND ICE APPARATUS; REFRIGERATORS; AIR FILTERS AS PARTS OF INDUSTRIAL SYSTEMS; UPRIGHT FREEZERS AND CHEST-TYPE FREEZERS; BEVERAGE COOLING APPARATUS; ROASTING SPITS; WATER HEATERS; ELECTRIC COFFEE PERCOLATORS; ELECTRIC STOVES; REFRIGERATORS; ELECTRIC PRESSURE COOKERS; WATER COOLING INSTALLATIONS, NAMELY, WATER COOLING AND WATER DISPENSING APPLIANCES, NAMELY, WATER COOLERS, IN CLASS 11 (U.S. CLS. 13, 21, 23, 31 AND 34).

FOR: DINING HALL FURNITURE FOR SYSTEMIZED CATERING WITHIN THE FRAMEWORK OF BUSINESS AND PERSONNEL CATERING, AS WELL AS HOTELS, IN CLASS 20 (U.S. CLS. 2, 13, 22, 25, 32 AND 50).

FOR: KITCHEN ACCESSORIES, NAMELY, GASTRONORM HOUSEHOLD AND KITCHEN CONTAINERS AND LIDS FOR SUCH CONTAINERS, ALSO MADE OF METALLIC MULTILAYER MATERIAL; FRYING PANS; POTS; POT LIDS; ELECTRIC COOKING UTENSILS,



*David J. Kyffers*

Director of the United States Patent and Trademark Office

**Reg. No. 4,123,925** NAMELY, GRILLS AND ELECTRIC COOKING UTENSILS FOR NOODLES, NAMELY, GRILLS AS HEAT DISPENSING STATIONS FOR OUTDOOR CATERING, HOTELS AND GASTRONOMY PREPLINE COOKING THAT CAN BE SETUP IN A MODULAR FASHION, AND GRILLS IN THE FORM OF KITCHEN APPLIANCES; GRILLS WITH A ROTISSERIE, IN CLASS 21 (U.S. CLS. 2, 13, 23, 29, 30, 33, 40 AND 50).

FOR: ENGINEERING SERVICES, NAMELY, TECHNICAL PROJECT PLANNING AND DESIGN ENGINEERING FOR THE PROCESSING OF NEW PRODUCTS IN THE FIELD OF OUTDOOR CATERING AND, IN PARTICULAR, FOR CATERING FOR GUESTS IN SELF-SERVICE RESTAURANTS, NAMELY, FUNCTIONAL APPLIANCES AND FURNITURE FOR SYSTEMIZED CATERING WITHIN THE FRAMEWORK OF OUTDOOR CATERING, HOTELS AND GASTRONOMY, IN PARTICULAR, FOR CAMPAIGN MODULES AND FOOD DISPENSING COUNTERS, IN CLASS 42 (U.S. CLS. 100 AND 101).

THE MARK CONSISTS OF STANDARD CHARACTERS WITHOUT CLAIM TO ANY PARTICULAR FONT, STYLE, SIZE, OR COLOR.

PRIORITY CLAIMED UNDER SEC. 44(D) ON FED REP GERMANY APPLICATION NO. 302010016965, FILED 4-23-2010, REG. NO. 302010016965, DATED 9-8-2010, EXPIRES 4-23-2020.

THE WORDING "VARITHEK KPORT" HAS NO MEANING IN A FOREIGN LANGUAGE.

SER. NO. 85-155,659, FILED 10-19-2010.

RENEE MCCRAY, EXAMINING ATTORNEY



# United States of America

United States Patent and Trademark Office

## COAST WELLNESS

**Reg. No. 4,123,926**

MIKHAIL, NADER (UNITED STATES INDIVIDUAL)  
PO BOX 2802

**Registered Apr. 10, 2012**

NEWPORT BEACH, CA 92659

**Int. Cl.: 44**

FOR: HEALTHCARE, IN CLASS 44 (U.S. CLS. 100 AND 101).

**SERVICE MARK**

FIRST USE 2-1-2007; IN COMMERCE 8-1-2009.

**PRINCIPAL REGISTER**

THE MARK CONSISTS OF STANDARD CHARACTERS WITHOUT CLAIM TO ANY PARTICULAR FONT, STYLE, SIZE, OR COLOR.

NO CLAIM IS MADE TO THE EXCLUSIVE RIGHT TO USE "WELLNESS", APART FROM THE MARK AS SHOWN.

SER. NO. 85-156,123, FILED 10-19-2010.

PAM WILLIS, EXAMINING ATTORNEY



*David J. Kybas*

Director of the United States Patent and Trademark Office

# United States of America

United States Patent and Trademark Office

# LARRY

**Reg. No. 4,123,927**

**Registered Apr. 10, 2012**

**Int. Cl.: 32**

**TRADEMARK**

**PRINCIPAL REGISTER**

WACHUSETT BREWING COMPANY, INC. (MASSACHUSETTS CORPORATION)  
175 STATE ROAD EAST  
WESTMINSTER, MA 01473

FOR: BEER, IN CLASS 32 (U.S. CLS. 45, 46 AND 48).

FIRST USE 7-25-2009; IN COMMERCE 7-25-2009.

THE MARK CONSISTS OF STANDARD CHARACTERS WITHOUT CLAIM TO ANY PARTICULAR FONT, STYLE, SIZE, OR COLOR.

SER. NO. 85-159,088, FILED 10-22-2010.

BARBARA A. GOLD, EXAMINING ATTORNEY



*David J. Kybas*

Director of the United States Patent and Trademark Office

# United States of America

## United States Patent and Trademark Office



**Reg. No. 4,123,928**

**Registered Apr. 10, 2012**

**Int. Cls.: 35, 41 and 42**

**SERVICE MARK**

**PRINCIPAL REGISTER**

CORELAB PARTNERS, INC. (DELAWARE CORPORATION)  
100 OVERLOOK CENTER  
PRINCETON, NJ 08540

FOR: BUSINESS CONSULTING AND MANAGEMENT IN THE FIELD OF CLINICAL TRIALS, NAMELY, PROVIDING INFORMATION MANAGEMENT SERVICES; BUSINESS CONSULTING AND MANAGEMENT IN THE FIELD OF CLINICAL TRIALS, NAMELY, CLINICAL DATA AND REGULATORY SUBMISSION MANAGEMENT ON BEHALF OF MEDICAL, BIOPHARMACEUTICAL AND BIOTECHNOLOGY COMPANIES TO ASSIST THEM WITH CLINICAL RESEARCH, CLINICAL TRIALS AND APPLICATIONS FOR DRUG APPROVAL; BUSINESS CONSULTING AND MANAGEMENT IN THE FIELD OF CLINICAL TRIALS, NAMELY, MANAGEMENT AND COMPILATION OF COMPUTERIZED DATABASES IN THE FIELD OF CLINICAL TRIALS FOR BUSINESS PURPOSES; PROVIDING INDEPENDENT REVIEW OF CLINICAL TRIALS FOR BUSINESS PURPOSES, IN CLASS 35 (U.S. CLS. 100, 101 AND 102).

FIRST USE 2-11-2010; IN COMMERCE 2-11-2010.

FOR: TRAINING AND DEVELOPMENT IN THE FIELD OF CONDUCTING CLINICAL TRIALS, NAMELY, CONDUCTING SEMINARS AND WORKSHOPS IN THE FIELD OF CLINICAL TRIALS; TRAINING IN THE FIELD OF COMPUTER SOFTWARE SUPPORT, NAMELY, CONDUCTING SEMINARS AND WORKSHOPS IN THE FIELD OF SOFTWARE SUPPORT, IN CLASS 41 (U.S. CLS. 100, 101 AND 107).

FIRST USE 2-11-2010; IN COMMERCE 2-11-2010.

FOR: PROVIDING MEDICAL RESEARCH IN THE FIELD OF MEDICAL IMAGING SERVICES FOR CLINICAL TRIALS; PROVIDING MEDICAL AND SCIENTIFIC RESEARCH INFORMATION IN THE FIELD OF CLINICAL TRIALS; LABORATORY SERVICES, NAMELY, CLINICAL LABORATORY SERVICES IN THE FIELD OF DRUG DEVELOPMENT PROGRAMS OF GLOBAL AND DOMESTIC BIO-PHARMACEUTICAL AND MEDICAL DEVICE ORGANIZATIONS, DIAGNOSTIC LABORATORY SERVICES IN THE FIELD OF DRUG DEVELOPMENT PROGRAMS OF GLOBAL AND DOMESTIC BIO-PHARMACEUTICAL AND MEDICAL DEVICE ORGANIZATIONS, MEDICAL LABORATORY SERVICES; TECHNICAL CONSULTING SERVICES IN THE FIELD OF CLINICAL TRIALS IN THE FIELD OF DRUG DEVELOPMENT PROGRAMS OF GLOBAL AND DOMESTIC BIO-PHARMACEUTICAL AND MEDICAL DEVICE ORGANIZATIONS; PROVIDING AN ON-LINE COMPUTER



*David J. Kybas*

Director of the United States Patent and Trademark Office

**Reg. No. 4,123,928** DATABASE IN THE FIELD OF CLINICAL TRIALS DRUG DEVELOPMENT PROGRAMS OF GLOBAL AND DOMESTIC BIO-PHARMACEUTICAL AND MEDICAL DEVICE ORGANIZATIONS; DATA AUTOMATION AND COLLECTION SERVICE USING PROPRIETARY SOFTWARE TO EVALUATE, ANALYZE AND COLLECT SERVICE DATA; COMPUTER TECHNOLOGY SUPPORT SERVICES, NAMELY, HELPDESK SERVICES, IN CLASS 42 (U.S. CLS. 100 AND 101).

FIRST USE 2-11-2010; IN COMMERCE 2-11-2010.

THE MARK CONSISTS OF THE LETTER "C" SURROUNDING A STYLIZED HALF CIRCLE.

SER. NO. 85-159,141, FILED 10-22-2010.

DAVID HOFFMAN, EXAMINING ATTORNEY

# United States of America

United States Patent and Trademark Office

# ॐ mg Yoga

**Reg. No. 4,123,929**

LE FALLE, KRISTEN (UNITED STATES INDIVIDUAL)  
5400 ALVERN CIRCLE  
WESTCHESTER, CA 90045

**Registered Apr. 10, 2012**

**Int. Cl.: 41**

FOR: PROVIDING YOGA INSTRUCTION AND CLASSES; PROVIDING SEASONAL YOGA RETREATS; PROVIDING A WEBSITE FEATURING INFORMATION, NON-DOWNLOADABLE ARTICLES ABOUT, AND PERTAINING TO, YOGA, IN CLASS 41 (U.S. CLS. 100, 101 AND 107).

**SERVICE MARK**

**PRINCIPAL REGISTER**

FIRST USE 5-21-2010; IN COMMERCE 5-21-2010.

NO CLAIM IS MADE TO THE EXCLUSIVE RIGHT TO USE "YOGA", APART FROM THE MARK AS SHOWN.

THE MARK CONSISTS OF AN OM SYMBOL FOLLOWED BY LETTERS "M" AND "G" THEN THE STYLIZED TEXT "YOGA".

SER. NO. 85-160,136, FILED 10-25-2010.

FRANK LATTUCA, EXAMINING ATTORNEY



*David J. Kybas*

Director of the United States Patent and Trademark Office

# United States of America

United States Patent and Trademark Office

# iGEN

**Reg. No. 4,123,930**

**Registered Apr. 10, 2012**

**Int. Cl.: 41**

**SERVICE MARK**

**PRINCIPAL REGISTER**

IDEX CORPORATION (DELAWARE CORPORATION)  
SUITE 200  
1925 WEST FIELD COURT  
LAKE FOREST, IL 60045

FOR: ITERATIVE PROGRAM FOR USE BY GROUPS OR INDIVIDUALS FOR GENERATION AND ALIGNIZATION OF PROSPECTIVE SOLUTIONS FOR A SELECTED TARGET QUESTION IN BUSINESS PRODUCT AND TECHNOLOGICAL IDEATION, NAMELY, BUSINESS EDUCATION AND TRAINING SERVICES PROVIDING GROUP AND INDIVIDUAL WORKSHOPS AND SEMINARS TO TEACH GENERATION AND ALIGNIZATION OF SOLUTIONS FOR SELECTED TARGET QUESTIONS IN BUSINESS PRODUCT AND TECHNOLOGICAL IDEATION, IN CLASS 41 (U.S. CLS. 100, 101 AND 107).

FIRST USE 10-7-2010; IN COMMERCE 10-7-2010.

THE MARK CONSISTS OF STANDARD CHARACTERS WITHOUT CLAIM TO ANY PARTICULAR FONT, STYLE, SIZE, OR COLOR.

SER. NO. 85-160,622, FILED 10-25-2010.

JAMES STEIN, EXAMINING ATTORNEY



*David J. Kyffers*

Director of the United States Patent and Trademark Office

United States of America  
United States Patent and Trademark Office

**TRIZ** *Lite*

**Reg. No. 4,123,931**

**Registered Apr. 10, 2012**

**Int. Cl.: 41**

**SERVICE MARK**

**PRINCIPAL REGISTER**

IDEX CORPORATION (DELAWARE CORPORATION)  
SUITE 200  
1925 WEST FIELD COURT  
LAKE FOREST, IL 60045

FOR: PROGRAM FOR SELECTING THE OPTIMAL SUBSET OF TRIZ PRINCIPALS APPLICABLE FOR A SELECTED TARGET QUESTION IN BUSINESS IDEATION PROCESSES; NAMELY, BUSINESS EDUCATION AND TRAINING SERVICES PROVIDING WORKSHOPS AND SEMINARS IN DEVELOPING AND FACILITATING THE USE OF TRIZ PRINCIPALS FOR A SELECTED TARGET QUESTION IN BUSINESS IDEATION PROCESSES, IN CLASS 41 (U.S. CLS. 100, 101 AND 107).

FIRST USE 10-7-2010; IN COMMERCE 10-7-2010.

NO CLAIM IS MADE TO THE EXCLUSIVE RIGHT TO USE "TRIZ", APART FROM THE MARK AS SHOWN.

THE MARK CONSISTS OF THE WORD "TRIZ" IN BLOCK LETTERS FOLLOWED BY THE WORD "LITE" IN SCRIPTED FORM.

SER. NO. 85-160,640, FILED 10-25-2010.

JAMES STEIN, EXAMINING ATTORNEY



*David J. Kybas*

Director of the United States Patent and Trademark Office

# United States of America

United States Patent and Trademark Office

## SIMPLICI-TEE

**Reg. No. 4,123,932**

THE FULL PACKAGE (CALIFORNIA LIMITED LIABILITY COMPANY)  
3131 E. MARIA ST.

**Registered Apr. 10, 2012**

RANCHO DOMINGUEZ, CA 90221

**Int. Cl.: 25**

FOR: KNIT TOPS; SWEATERS; T-SHIRTS; TOPS, IN CLASS 25 (U.S. CLS. 22 AND 39).

**TRADEMARK**

FIRST USE 9-28-2010; IN COMMERCE 9-28-2010.

**PRINCIPAL REGISTER**

THE MARK CONSISTS OF STANDARD CHARACTERS WITHOUT CLAIM TO ANY PARTICULAR FONT, STYLE, SIZE, OR COLOR.

SER. NO. 85-160,791, FILED 10-25-2010.

FLORENTINA BLANDU, EXAMINING ATTORNEY



*David J. Kyffers*

Director of the United States Patent and Trademark Office



# United States of America

United States Patent and Trademark Office



**Reg. No. 4,123,933**

**Registered Apr. 10, 2012**

**Int. Cl.: 35**

**SERVICE MARK**

**PRINCIPAL REGISTER**

AMERICAN MAJORITY (VIRGINIA CORPORATION)  
P.O. BOX 87  
PURCELLVILLE, VA 20134

FOR: PROVIDING INFORMATION ABOUT POLITICAL ELECTIONS, NAMELY, KNOWING HOW TO VOTE AND KNOWING HOW TO REGISTER TO VOTE; PROMOTING THE INTERESTS OF A POLITICAL ORGANIZATION; PROVIDING A WEBSITE FEATURING INFORMATION ABOUT POLITICAL ISSUES, IN CLASS 35 (U.S. CLS. 100, 101 AND 102).

FIRST USE 9-30-2010; IN COMMERCE 9-30-2010.

NO CLAIM IS MADE TO THE EXCLUSIVE RIGHT TO USE "AMERICAN", APART FROM THE MARK AS SHOWN.

THE MARK CONSISTS OF THE CAPITAL LETTER "A" AND A LOWER CASE "M" BELOW THE LETTERS "CTION" WHERE THE CROSS BAR OF THE "A" IS A STAR CONNECTING TO THE LETTERS "CTION" FORMING THE WORD "ACTION" ALL OVER THE WORDS "AMERICAN MAJORITY" IN CAPITAL LETTERS.

SER. NO. 85-160,983, FILED 10-26-2010.

JANET LEE, EXAMINING ATTORNEY



*David J. Kyffers*

Director of the United States Patent and Trademark Office

# United States of America

United States Patent and Trademark Office

**Channel Sales** Cloud

**Reg. No. 4,123,934**

**Registered Apr. 10, 2012**

**Int. Cl.: 42**

**SERVICE MARK**

**PRINCIPAL REGISTER**

SERVICEMOURCE INTERNATIONAL, LLC (DELAWARE LIMITED LIABILITY COMPANY)  
634 2ND STREET  
SAN FRANCISCO, CA 94107

FOR: PROVIDING TEMPORARY USE OF NON-DOWNLOADABLE SOFTWARE TO HELP TECHNOLOGY COMPANIES, THEIR RESELLERS, AND OTHER DISTRIBUTION PARTNERS MANAGE THE RENEWAL OF MAINTENANCE AND SUPPORT AGREEMENTS AND OTHER TECHNOLOGY SUBSCRIPTION AGREEMENTS, IN CLASS 42 (U.S. CLS. 100 AND 101).

FIRST USE 5-27-2010; IN COMMERCE 5-27-2010.

NO CLAIM IS MADE TO THE EXCLUSIVE RIGHT TO USE "SALES CLOUD", APART FROM THE MARK AS SHOWN.

THE COLOR(S) BLACK AND BLUE IS/ARE CLAIMED AS A FEATURE OF THE MARK.

THE MARK CONSISTS OF THE WORDS "CHANNEL SALES" IN BLACK COLOR, AND THE WORD "CLOUD" IN BLUE COLOR.

SER. NO. 85-161,109, FILED 10-26-2010.

MICHAEL WIENER, EXAMINING ATTORNEY



*David J. Kybas*

Director of the United States Patent and Trademark Office

# United States of America

United States Patent and Trademark Office

## MONOMOUNT

**Reg. No. 4,123,935**

**Registered Apr. 10, 2012**

**Int. Cls.: 6 and 19**

**TRADEMARK**

**PRINCIPAL REGISTER**

PIZAZZ INTERNATIONAL LTD (NEW ZEALAND LIMITED LIABILITY COMPANY)  
19 AIRBORNE ROAD, ALBANY  
AUCKLAND, NEW ZEALAND

FOR: PANELS AND CONNECTORS OF METAL; SMALL ITEMS OF METAL HARDWARE, NAMELY, NAILS, SCREWS, TACKS, NUTS, BOLTS, WASHERS AND RIVETS; METAL STANDOFFS, NAMELY, METAL FASTENERS IN THE NATURE OF NAILS, SCREWS, TACKS, NUTS, BOLTS, WASHERS AND RIVETS, AND METAL THREADED FASTENERS; SIGN SUPPORTS AND PANEL FASTENERS OF METAL, IN CLASS 6 (U.S. CLS. 2, 12, 13, 14, 23, 25 AND 50).

FOR: NON-METALLIC STANDOFFS, SIGN SUPPORTS AND PANEL FASTENERS, IN CLASS 19 (U.S. CLS. 1, 12, 33 AND 50).

THE MARK CONSISTS OF STANDARD CHARACTERS WITHOUT CLAIM TO ANY PARTICULAR FONT, STYLE, SIZE, OR COLOR.

PRIORITY CLAIMED UNDER SEC. 44(D) ON NEW ZEALAND APPLICATION NO. 823355, FILED 4-29-2010, REG. NO. 823355, DATED 10-29-2010, EXPIRES 4-29-2020.

SER. NO. 85-162,530, FILED 10-27-2010.

ZACHARY BELLO, EXAMINING ATTORNEY



*David J. Kypos*

Director of the United States Patent and Trademark Office

# United States of America

United States Patent and Trademark Office

# MeeSo

**Reg. No. 4,123,936**

**Registered Apr. 10, 2012**

**Int. Cl.: 41**

**SERVICE MARK**

**PRINCIPAL REGISTER**

CRABB, SHEREE S (UNITED STATES INDIVIDUAL)  
10808 FOOTHILL BLVD, STE 160, BOX 509  
RANCHO CUCAMONGA, CA 91730

FOR: ENTERTAINMENT SERVICES IN THE NATURE OF LIVE MUSICAL PERFORMANCES; ENTERTAINMENT SERVICES, NAMELY, PROVIDING A WEB SITE FEATURING NON-DOWNLOADABLE MUSICAL PERFORMANCES, MUSICAL VIDEOS, RELATED FILM CLIPS, PHOTOGRAPHS, AND OTHER MULTIMEDIA MATERIALS FEATURING MUSIC, IN CLASS 41 (U.S. CLS. 100, 101 AND 107).

FIRST USE 2-0-2010; IN COMMERCE 2-0-2010.

THE MARK CONSISTS OF STANDARD CHARACTERS WITHOUT CLAIM TO ANY PARTICULAR FONT, STYLE, SIZE, OR COLOR.

THE NAME(S), PORTRAIT(S), AND/OR SIGNATURE(S) SHOWN IN THE MARK IDENTIFIES SHEREE S. CRABB, WHOSE CONSENT(S) TO REGISTER IS MADE OF RECORD.

THE WORDING "MEESO" HAS NO MEANING IN A FOREIGN LANGUAGE.

SER. NO. 85-164,537, FILED 10-29-2010.

AMY HELLA, EXAMINING ATTORNEY



*David J. Kyffers*

Director of the United States Patent and Trademark Office

# United States of America

United States Patent and Trademark Office

## Project Management for Everyone

**Reg. No. 4,123,937**

**Registered Apr. 10, 2012**

**Int. Cl.: 35**

**SERVICE MARK**

**PRINCIPAL REGISTER**

TWICHELL, EILEEN (UNITED STATES INDIVIDUAL), DBA PME LEARNING  
53 CHEQUESSETT RD.  
READING, MA 01867 AND

MURPHY, MARK W (UNITED STATES INDIVIDUAL), DBA PME LEARNING  
3003 DOUGLAS AVE. #19  
DALLAS, TX 75219

FOR: BUSINESS CONSULTING SERVICES IN THE FIELD OF PROJECT MANAGEMENT,  
IN CLASS 35 (U.S. CLS. 100, 101 AND 102).

FIRST USE 4-1-2005; IN COMMERCE 4-1-2005.

THE MARK CONSISTS OF STANDARD CHARACTERS WITHOUT CLAIM TO ANY PAR-  
TICULAR FONT, STYLE, SIZE, OR COLOR.

NO CLAIM IS MADE TO THE EXCLUSIVE RIGHT TO USE "PROJECT MANAGEMENT",  
APART FROM THE MARK AS SHOWN.

SER. NO. 85-165,079, FILED 10-29-2010.

STEVEN R. FINE, EXAMINING ATTORNEY



*David J. Kybas*

Director of the United States Patent and Trademark Office

# United States of America

United States Patent and Trademark Office

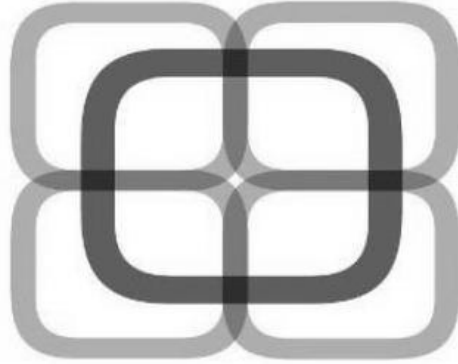

**Reg. No. 4,123,938**

**Registered Apr. 10, 2012**

**Int. Cls.: 30, 37 and 42**

**TRADEMARK**

**SERVICE MARK**

**PRINCIPAL REGISTER**

BUTAMAX ADVANCED BIOFUELS LLC (DELAWARE LIMITED LIABILITY COMPANY)  
1209 ORANGE STREET  
WILMINGTON, DE 19801

FOR: YEAST EXTRACTS; YEAST FOR THE MANUFACTURE OF ALCOHOL AND BUTANOL, IN CLASS 30 (U.S. CL. 46).

FOR: CONSTRUCTION, MAINTENANCE AND REPAIR OF PLANTS FOR THE PRODUCTION OF BUTANOL, INCLUDING RETRO-FITTING OF ETHANOL PLANTS TO ENABLE BIOBUTANOL PRODUCTION, IN CLASS 37 (U.S. CLS. 100, 103 AND 106).

FOR: SCIENTIFIC AND TECHNOLOGICAL SERVICES RELATED TO BUTANOL DEVELOPMENT, NAMELY, SCIENTIFIC AND TECHNOLOGICAL RESEARCH AND CONSULTATION REGARDING BUTANOL DEVELOPMENT, IN CLASS 42 (U.S. CLS. 100 AND 101).

OWNER OF ERPN CMNTY TM OFC REG. NO. 8344764, DATED 4-5-2010, EXPIRES 6-5-2019.

THE MARK CONSISTS OF FIVE OVERLAPPING ROUND EDGED SQUARES.

SER. NO. 85-165,080, FILED 10-29-2010.

STEVEN R. FINE, EXAMINING ATTORNEY



*David J. Kyffers*

Director of the United States Patent and Trademark Office

# United States of America

United States Patent and Trademark Office

## Spread the Word

**Reg. No. 4,123,939**

YOVIA, LLC (FLORIDA LIMITED LIABILITY COMPANY)

**Registered Apr. 10, 2012**

P.O. BOX 330951  
ATLANTIC BEACH, FL 32233

**Int. Cl.: 35**

FOR: ADVERTISING SERVICES, NAMELY, PROMOTING AND MARKETING THE GOODS AND SERVICES OF OTHERS THROUGH ALL PUBLIC COMMUNICATION MEANS, IN CLASS 35 (U.S. CLS. 100, 101 AND 102).

**SERVICE MARK**

FIRST USE 9-30-2007; IN COMMERCE 9-30-2007.

**PRINCIPAL REGISTER**

THE MARK CONSISTS OF STANDARD CHARACTERS WITHOUT CLAIM TO ANY PARTICULAR FONT, STYLE, SIZE, OR COLOR.

SER. NO. 85-170,572, FILED 11-5-2010.

LINDSEY RUBIN, EXAMINING ATTORNEY



*David J. Kyffers*

Director of the United States Patent and Trademark Office

# United States of America

United States Patent and Trademark Office



**Reg. No. 4,123,940**

BAYCARE HEALTH SYSTEMS LLC (WISCONSIN LIMITED LIABILITY COMPANY)  
164 N. BROADWAY  
GREEN BAY, WI 54303

**Registered Apr. 10, 2012**

**Int. Cl.: 44**

FOR: PHYSICIAN SERVICES PROVIDED THROUGH A MULTI-SPECIALTY CLINIC, IN CLASS 44 (U.S. CLS. 100 AND 101).

**SERVICE MARK**

FIRST USE 5-0-2005; IN COMMERCE 5-0-2005.

**PRINCIPAL REGISTER**

OWNER OF U.S. REG. NOS. 2,793,431 AND 2,826,810.

THE COLOR(S) WHITE, LIGHT GREEN, MAROON, GREY AND BLACK IS/ARE CLAIMED AS A FEATURE OF THE MARK.

NO CLAIM IS MADE TO THE EXCLUSIVE RIGHT TO USE "CLINIC", APART FROM THE MARK AS SHOWN.

THE MARK CONSISTS OF A CROSS, DIVIDED INTO FOUR EQUAL "L" SHAPES BY A VERTICAL MAROON LINE OF EQUAL HEIGHT TO THE CROSS, AND A HORIZONTAL MAROON LINE THAT EXTENDS TO THE RIGHT OF THE CROSS. THE UPPER LEFT AND LOWER RIGHT "L" SHAPES ARE STRIPED LIGHT GREEN AND WHITE, WHILE THE UPPER RIGHT AND LOWER LEFT SHAPES ARE A GRADIENT THAT BEGINS WITH A WHITE TOWARDS THE CENTER PROGRESSING TO LIGHT GRAY AND EVENTUALLY BLACK NEAR THE OUTSIDE EDGES. THE WORD "BAYCARE" APPEARS ABOVE THE HORIZONTAL MAROON LINE IN BLACK, AND THE WORD "CLINIC" APPEARS BELOW IT ALSO IN BLACK.



SER. NO. 85-170,614, FILED 11-5-2010.

FRED CARL, EXAMINING ATTORNEY

*David J. Kypos*

Director of the United States Patent and Trademark Office



# United States of America

United States Patent and Trademark Office



**Reg. No. 4,123,941**

**Registered Apr. 10, 2012**

**Int. Cls.: 3, 5 and 30**

**TRADEMARK**

**PRINCIPAL REGISTER**

ORGANIKA HEALTH PRODUCTS INC. (CANADA CORPORATION)  
11871 HAMMERSMITH WAY  
RICHMOND, B.C., CANADA V7A5E5

FOR: COSMETICS; NON-MEDICATED FACIAL AND EYE SERUM CONTAINING ANTIOXIDANTS; HEALTH AND BEAUTY AIDS FOR USE ON THE SKIN AND THE BODY, NAMELY, FACIAL AND BODY CLEANSERS, BODY LOTIONS, CONDITIONERS, SKIN CREAMS, SKIN LIGHTENERS, BEAUTY MASKS, SKIN PEELS, TONERS, SCRUBS, GELS, PORE REFINERS, EXFOLIATORS, MISTS, SERUMS, BATH POWDER, BATH TALC, MOISTURIZERS, SHAMPOOS, CONDITIONERS, SHAVING GELS AND FOAMS, BRONZERS AND SUNSCREENS; NEUTRACEUTICALS, NAMELY, ANTI-AGING CREAMS AND SUN BLOCK PREPARATIONS, IN CLASS 3 (U.S. CLS. 1, 4, 6, 50, 51 AND 52).

FOR: VITAMINS AND MINERAL SUPPLEMENTS; APPETITE SUPPRESSANTS; HERBAL SUPPLEMENTS USED FOR THE TREATMENT OF WEIGHT LOSS; HERBAL SUPPLEMENTS FOR THE TREATMENT OF COLD AND FLU SYMPTOMS AND TO ENHANCE IMMUNITY; HERBAL SUPPLEMENTS FOR THE TREATMENT OF ARTHRITIS; HERBAL SUPPLEMENTS TO AID IN DIGESTION; HERBAL SUPPLEMENTS USED FOR THE NATURAL CLEANSING OF THE HUMAN BODY; HERBAL SUPPLEMENTS FOR THE TREATMENT OF ERECTILE DYSFUNCTION AND TO INCREASE ENERGY AND STAMINA; HERBAL SUPPLEMENTS USED FOR THE TREATMENT OF SLEEP DISORDERS; HERBAL SUPPLEMENTS FOR THE TREATMENT OF CANDIDIASIS; HERBAL SUPPLEMENTS USED FOR THE TREATMENT OF JOINT PAIN, STRESS, FIBROMYALGIA, INFLAMMATION, ALLERGY SYMPTOMS, ASTHMA, MYOPIA, EYE STRAIN, IMMUNE DEFICIENCIES, THYROID CONDITIONS, AND/OR MENOPAUSE; HERBAL SUPPLEMENTS USED FOR THE TREATMENT OF BLOATING, FLATULENCE, ABDOMINAL CRAMPS, GAS AND DIARRHEA; HERBAL SUPPLEMENTS USED TO REDUCE THE SEVERITY AND DURATION OF MIGRAINE HEADACHES; HERBAL SUPPLEMENTS USED TO MAINTAIN AND SUPPORT CARDIOVASCULAR HEALTH; HERBAL SUPPLEMENTS USED TO REDUCE THE RECURRENCE OF HERPES SIMPLEX VIRUS; HERBAL SUPPLEMENTS USED TO IMPROVE THE SYMPTOMS ASSOCIATED WITH POOR BLOOD CIRCULATION; HERBAL SUPPLEMENTS USED FOR THE DEVELOPMENT AND MAINTENANCE OF BONES AND TEETH; HERBAL SUPPLEMENTS USED FOR THE PREVENTION OF BONE RESORPTION AND OSTEOPOROSIS; DIETARY AND HERBAL SUPPLEMENTS USED FOR THE PREVENTION OF URINARY TRACT INFECTIONS AND TO MAINTAIN URINARY TRACT HEALTH; DIETARY SUPPLEMENTS, NAMELY, FISH OIL IN CAPSULE FORM; DIETARY FOOD SUPPLEMENTS FOR THE TREATMENT OF GASTROENTEROLOGICAL, INTESTINE, BOWEL, STOMACH AND



*David J. Kyros*

Director of the United States Patent and Trademark Office

**Reg. No. 4,123,941** DIGESTIVE DISORDERS; DIETETIC SUGAR SUBSTITUTES FOR MEDICAL USE; DIETARY SUPPLEMENTS IN POWDER, CAPSULE OR TABLET FORM CONTAINING METABOLITES, DIETARY FIBRE AS A FOOD ADDITIVE, DIETARY SUPPLEMENTS IN POWDER, CAPSULE OR TABLET FORM CONTAINING FLAX SEED OIL, MEAL REPLACEMENT BARS, PROTEIN SHAKES, PROTEIN FOR USE AS A FOOD FILLER; PROTEIN FOR USE AS A FOOD ADDITIVE AND SOY SUPPLEMENTS; BEE POLLEN USED AS A DIETARY SUPPLEMENT; FOOD AND DIETARY SUPPLEMENTS IN POWDER, CAPSULE OR TABLET FORM CONTAINING NATURAL ESSENTIAL FATTY ACIDS; NUTRITIONAL SUPPLEMENTS, NAMELY, OMEGA 3 OILS; NUTRITIONAL SUPPLEMENTS USED FOR MAINTAINING AND IMPROVING EYE HEALTH; NUTRITIONAL SUPPLEMENTS USED FOR HEALTHY AGING; DIETARY SUPPLEMENTS IN POWDER, CAPSULE OR TABLET FORM CONTAINING FOLIC ACID; AMINO ACIDS FOR NUTRITIONAL PURPOSES, IN CLASS 5 (U.S. CLS. 6, 18, 44, 46, 51 AND 52).

FOR: SUGAR SUBSTITUTES, IN CLASS 30 (U.S. CL. 46).

OWNER OF CANADA REG. NO. TMA806,754, DATED 9-14-2011, EXPIRES 9-14-2026.

OWNER OF U.S. REG. NO. 2,611,037.

NO CLAIM IS MADE TO THE EXCLUSIVE RIGHT TO USE "HEALTH PRODUCTS INC.", APART FROM THE MARK AS SHOWN.

THE MARK CONSISTS OF IN PART, A MAP OF THE WORLD IN AN OVAL SHAPE. THE BORDER AROUND THE OVAL CONTAINS THE WORDS "TRUTH IN A BOTTLE" AT THE TOP OF THE OVAL AND THE WORDS "HEALTH PRODUCTS INC." AT THE BOTTOM OF THE OVAL. THE WORD "ORGANIKA" APPEARS IN A RECTANGLE RUNNING THROUGH THE CENTRE OF THE OVAL.

SER. NO. 85-170,713, FILED 11-5-2010.

TEJBIR SINGH, EXAMINING ATTORNEY

# United States of America

United States Patent and Trademark Office

# SocialStay:)

**Reg. No. 4,123,942**

**Registered Apr. 10, 2012**

**Int. Cls.: 9 and 42**

**TRADEMARK**

**SERVICE MARK**

**PRINCIPAL REGISTER**

SOCIAL STAY, LLC (DELAWARE LIMITED LIABILITY COMPANY)  
71 EUCALYPTUS LANE  
MONTECITO, CA 93108

FOR: COMPUTER APPLICATION SOFTWARE FOR MOBILE PHONES, INTERNET BROWSERS AND TABLET COMPUTER DEVICES, NAMELY, SOFTWARE FOR INDIVIDUALS AND BUSINESSES THAT GIVES USERS THE ABILITY TO SEND AND RECEIVE TEXT MESSAGES, ACCESS A SOCIAL NETWORK, SEND AND RECEIVE INFORMATION ABOUT PROMOTIONS AND ENGAGE IN E-COMMERCE, IN CLASS 9 (U.S. CLS. 21, 23, 26, 36 AND 38).

FIRST USE 3-1-2010; IN COMMERCE 8-1-2010.

FOR: APPLICATION SERVICE PROVIDER, NAMELY, PROVIDING, HOSTING, MANAGING, DEVELOPING, AND MAINTAINING APPLICATIONS, SOFTWARE, WEB SITES, AND DATABASES IN THE FIELDS OF PERSONAL PRODUCTIVITY, WIRELESS COMMUNICATION, MOBILE INFORMATION ACCESS, AND REMOTE DATA MANAGEMENT FOR WIRELESS DELIVERY OF CONTENT TO HANDHELD COMPUTERS, LAPTOPS AND MOBILE ELECTRONIC DEVICES, IN CLASS 42 (U.S. CLS. 100 AND 101).

FIRST USE 3-1-2010; IN COMMERCE 8-1-2010.

THE MARK CONSISTS OF THE WORDING SOCIALSTAY, A SMILING FACE EMOTICON CONSISTING OF A COLON AND A CLOSED PARENTHESIS.

SER. NO. 85-174,677, FILED 11-11-2010.

EDWARD NELSON, EXAMINING ATTORNEY



*David J. Kypos*

Director of the United States Patent and Trademark Office

# United States of America

United States Patent and Trademark Office



**Reg. No. 4,123,943**

THE ALLAN CANDY COMPANY LIMITED (CANADA CORPORATION)  
3 ROBERT SPECK PARKWAY, SUITE 250  
MISSISSAUGA, ONTARIO, CANADA L4Z2G5

**Registered Apr. 10, 2012**

**Int. Cl.: 30**

FOR: LICORICE, IN CLASS 30 (U.S. CL. 46).

**TRADEMARK**

PRIORITY CLAIMED UNDER SEC. 44(D) ON CANADA APPLICATION NO. 1502627, FILED 11-4-2010, REG. NO. TMA807858, DATED 9-28-2011, EXPIRES 9-28-2026.

**PRINCIPAL REGISTER**

THE MARK CONSISTS OF STYLIZED LETTERS FORMING THE WORD "LACES".

SER. NO. 85-175,224, FILED 11-12-2010.

NAAKWAMA ANKRAH, EXAMINING ATTORNEY



*David J. Kybas*

Director of the United States Patent and Trademark Office

# United States of America

United States Patent and Trademark Office

## OAK STREET SERVICING

**Reg. No. 4,123,944**

**Registered Apr. 10, 2012**

**Int. Cl.: 36**

**SERVICE MARK**

**PRINCIPAL REGISTER**

OAK STREET FUNDING LLC (INDIANA LIMITED LIABILITY COMPANY)  
SUITE 390  
11555 NORTH MERIDIAN STREET  
INDIANAPOLIS, IN 46032

FOR: CREDIT AND LOAN SERVICES, IN CLASS 36 (U.S. CLS. 100, 101 AND 102).

FIRST USE 12-4-2008; IN COMMERCE 12-4-2008.

THE MARK CONSISTS OF STANDARD CHARACTERS WITHOUT CLAIM TO ANY PARTICULAR FONT, STYLE, SIZE, OR COLOR.

OWNER OF U.S. REG. NOS. 2,929,595 AND 3,041,510.

NO CLAIM IS MADE TO THE EXCLUSIVE RIGHT TO USE "SERVICING", APART FROM THE MARK AS SHOWN.

SER. NO. 85-175,500, FILED 11-12-2010.

WENDY JUN, EXAMINING ATTORNEY



*David J. Kybas*

Director of the United States Patent and Trademark Office

# United States of America

United States Patent and Trademark Office

## Treasures Ahoy

**Reg. No. 4,123,945**

WILLIAM PRICE WOOD (UNITED STATES INDIVIDUAL), DBA TREASURES AHOY, LTD.  
4802 CHARMIAN RD.  
RICHMOND, VA 23226

**Registered Apr. 10, 2012**

**Int. Cl.: 28**

FOR: EDUCATIONAL BOARD GAMES, IN CLASS 28 (U.S. CLS. 22, 23, 38 AND 50).

**TRADEMARK**

FIRST USE 3-31-1999; IN COMMERCE 3-31-1999.

**PRINCIPAL REGISTER**

THE MARK CONSISTS OF STANDARD CHARACTERS WITHOUT CLAIM TO ANY PARTICULAR FONT, STYLE, SIZE, OR COLOR.

SER. NO. 85-176,139, FILED 11-13-2010.

MATTHEW PAPPAS, EXAMINING ATTORNEY



*David J. Kyppas*

Director of the United States Patent and Trademark Office

# United States of America

United States Patent and Trademark Office



**Reg. No. 4,123,946**

**Registered Apr. 10, 2012**

**Int. Cls.: 9, 36, 41 and 42**

**TRADEMARK**

**SERVICE MARK**

**PRINCIPAL REGISTER**

UNIVERSITY COLLEGE LONDON (UNITED KINGDOM UNIVERSITY)  
C/O NICK TYLER DEPT OF CIVIL ENVIRONMENT  
GOWER STREET  
LONDON, UNITED KINGDOM WC1E6BT AND

ROSSETTO, TIZIANA (UNITED KINGDOM INDIVIDUAL)  
FLAT 3 VERDE HOUSE  
189 TWYFORD ABBEY ROAD  
LONDON, UNITED KINGDOM NW107DQ AND

TWIGG, JOHN (UNITED KINGDOM INDIVIDUAL)  
FLAT 3 VERDE HOUSE  
189 TWYFORD ABBEY ROAD  
LONDON, UNITED KINGDOM NW107DQ

FOR: LABORATORY EQUIPMENT, NAMELY, SHAKING TABLES USED TO SIMULATE EARTHQUAKES IN A LABORATORY ENVIRONMENT IN ORDER TO EVALUATE SEISMIC PERFORMANCE OF VARIOUS MODEL STRUCTURES; TSUNAMI GENERATOR IN THE NATURE OF A WAVE GENERATOR FOR CREATING WAVES IN A LABORATORY ENVIRONMENT, IN CLASS 9 (U.S. CLS. 21, 23, 26, 36 AND 38).

FOR: INSURANCE SERVICES, NAMELY, APPRAISALS FOR INSURANCE CLAIMS OF REAL ESTATE, CONSULTATION AND INFORMATION CONCERNING INSURANCE, INSURANCE ADMINISTRATION, INSURANCE INFORMATION, INSURANCE AND RE-INSURANCE UNDERWRITING SERVICES, PROVIDING DETAILED INFORMATION REGARDING AVAILABLE INSURANCE PRODUCTS FOR COMMERCIAL PROPERTY AND CASUALTY, PROFESSIONAL AND PERSONAL LINES, IN CLASS 36 (U.S. CLS. 100, 101 AND 102).

FOR: EDUCATIONAL SERVICES, NAMELY, CONDUCTING CLASSES, COURSES, SEMINARS, WORKSHOPS, IN THE FIELD OF EARTHQUAKE ENGINEERING, TSUNAMI ENGINEERING, EARTHQUAKE PROTECTION, TSUNAMI PROTECTION, DISASTER RISK REDUCTION, AND DISASTER MANAGEMENT; PROVIDING OF TRAINING FOR EARTHQUAKE ENGINEERING, TSUNAMI ENGINEERING, EARTHQUAKE PROTECTION, TSUNAMI PROTECTION, DISASTER RISK REDUCTION, AND DISASTER MANAGEMENT, IN CLASS 41 (U.S. CLS. 100, 101 AND 107).



*David J. Kybas*

Director of the United States Patent and Trademark Office

**Reg. No. 4,123,946** FOR: SCIENTIFIC AND TECHNOLOGICAL SERVICES, NAMELY, RESEARCH AND DESIGN IN THE FIELD OF EARTHQUAKE ENGINEERING, TSUNAMI ENGINEERING, EARTHQUAKE PROTECTION, TSUNAMI PROTECTION, DISASTER RISK REDUCTION, AND DISASTER MANAGEMENT; INDUSTRIAL RESEARCH SERVICES IN THE FIELD OF EARTHQUAKE ENGINEERING, TSUNAMI ENGINEERING, EARTHQUAKE PROTECTION, TSUNAMI PROTECTION, DISASTER RISK REDUCTION, AND DISASTER MANAGEMENT; DESIGN AND DEVELOPMENT OF COMPUTER HARDWARE AND SOFTWARE; ENGINEERING SERVICES FOR BUILDING AND PROPERTY CONDITION ASSESSMENT, IN CLASS 42 (U.S. CLS. 100 AND 101).

OWNER OF ERPN CMNTY TM OFC REG. NO. 009383365, DATED 3-20-2011, EXPIRES 9-17-2020.

THE MARK CONSISTS OF THE WORDING "EPICENTRE", ALL WITHIN A DARK OVAL, WITH THE "EPICE" PORTION WITHIN A SMALLER SHADED OVAL WHICH IS INSIDE THE BIGGER OVAL.

SER. NO. 85-177,616, FILED 11-16-2010.

SUE LAWRENCE, EXAMINING ATTORNEY



# United States of America

United States Patent and Trademark Office

## G-HAP GOD HAS A PLAN

**Reg. No. 4,123,947**

**Registered Apr. 10, 2012**

**Int. Cl.: 41**

**SERVICE MARK**

**PRINCIPAL REGISTER**

UPTON, DAVID (UNITED STATES INDIVIDUAL)  
P.O. BOX 1033  
TRABUCO CANYON, CA 92678 AND

UPTON, SUSAN (UNITED STATES INDIVIDUAL)  
P.O. BOX 1033  
TRABUCO CANYON, CA 92678

FOR: EDUCATION SERVICES, NAMELY, ONLINE RELIGIOUS INSTRUCTION PROMOTING CHRISTIAN VALUES AND LIFESTYLE, IN CLASS 41 (U.S. CLS. 100, 101 AND 107).

FIRST USE 5-2-2009; IN COMMERCE 5-2-2009.

THE MARK CONSISTS OF STANDARD CHARACTERS WITHOUT CLAIM TO ANY PARTICULAR FONT, STYLE, SIZE, OR COLOR.

SER. NO. 85-177,872, FILED 11-16-2010.

TASNEEM HUSSAIN, EXAMINING ATTORNEY



*David J. Kybas*

Director of the United States Patent and Trademark Office

# United States of America

United States Patent and Trademark Office



**Reg. No. 4,123,948**

**Registered Apr. 10, 2012**

**Int. Cl.: 1**

**TRADEMARK**

**PRINCIPAL REGISTER**

MARTIN MARIETTA MAGNESIA SPECIALTIES, LLC (DELAWARE LIMITED LIABILITY COMPANY)  
8140 CORPORATE DRIVE, SUITE 220  
BALTIMORE, MD 21236

FOR: MAGNESIUM HYDROXIDE POWDER IN RAW FORM FOR USE AS A FLAME RETARDANT AND SMOKE SUPPRESSANT, IN CLASS 1 (U.S. CLS. 1, 5, 6, 10, 26 AND 46).

FIRST USE 8-0-1995; IN COMMERCE 8-0-1995.

OWNER OF U.S. REG. NO. 2,036,729.

NO CLAIM IS MADE TO THE EXCLUSIVE RIGHT TO USE "MAG", APART FROM THE MARK AS SHOWN.

THE MARK CONSISTS OF A SHIELD DISPLAYING THREE UPSIDE DOWN TRIANGLES AND FLAMES AND THE WORDS "MAG SHIELD".

SER. NO. 85-179,111, FILED 11-17-2010.

BARBARA GAYNOR, EXAMINING ATTORNEY



*David J. Kybas*

Director of the United States Patent and Trademark Office

# United States of America

## United States Patent and Trademark Office



**Reg. No. 4,123,949**

**Registered Apr. 10, 2012**

**Int. Cl.: 35**

**SERVICE MARK**

**PRINCIPAL REGISTER**

MOTHERS2MOTHERS INTERNATIONAL, INC. (DELAWARE CORPORATION)  
7441 W. SUNSET BOULEVARD, SUITE 205  
LOS ANGELES, CA 90046

FOR: PUBLIC ADVOCACY TO PROMOTE AWARENESS OF HIV AND AIDS IN DEVELOPING COUNTRIES; PUBLIC ADVOCACY TO PROMOTE AWARENESS OF PREGNANT WOMEN AND NEW MOTHERS LIVING WITH HIV AND AIDS, IN CLASS 35 (U.S. CLS. 100, 101 AND 102).

FIRST USE 11-16-2006; IN COMMERCE 11-16-2006.

THE MARK CONSISTS OF A CIRCLE CONTAINING VARIOUS GEOMETRIC SHAPES IN THE COLORS BLUE, RED, BLACK, ORANGE, GREEN, LIGHT BLUE, LAVENDER, AND YELLOW, WHICH ARE EACH OUTLINED IN WHITE.

THE COLOR(S) BLUE, RED, BLACK, ORANGE, GREEN, LIGHT BLUE, LAVENDER, YELLOW AND WHITE IS/ARE CLAIMED AS A FEATURE OF THE MARK.

SER. NO. 85-179,639, FILED 11-18-2010.

TINA L. SNAPP, EXAMINING ATTORNEY



*David J. Kybas*

Director of the United States Patent and Trademark Office

# United States of America

United States Patent and Trademark Office



**Reg. No. 4,123,950**

**Registered Apr. 10, 2012**

**Int. Cl.: 36**

**SERVICE MARK**

**PRINCIPAL REGISTER**

MOTHERS2MOTHERS INTERNATIONAL, INC. (DELAWARE CORPORATION)  
7441 W. SUNSET BOULEVARD, SUITE 205  
LOS ANGELES, CA 90046

FOR: CHARITABLE FUNDRAISING, IN CLASS 36 (U.S. CLS. 100, 101 AND 102).

FIRST USE 11-16-2006; IN COMMERCE 11-16-2006.

THE MARK CONSISTS OF A CIRCLE CONTAINING VARIOUS GEOMETRIC SHAPES IN THE COLORS BLUE, RED, BLACK, ORANGE, GREEN, LIGHT BLUE, LAVENDER, AND YELLOW, WHICH ARE EACH OUTLINED IN WHITE.

THE COLOR(S) BLUE, RED, BLACK, ORANGE, GREEN, LIGHT BLUE, LAVENDER, YELLOW AND WHITE IS/ARE CLAIMED AS A FEATURE OF THE MARK.

SER. NO. 85-179,641, FILED 11-18-2010.

TINA L. SNAPP, EXAMINING ATTORNEY



*David J. Kyffers*

Director of the United States Patent and Trademark Office

# United States of America

United States Patent and Trademark Office



**Reg. No. 4,123,951**

**Registered Apr. 10, 2012**

**Int. Cls.: 41 and 44**

**SERVICE MARK**

**PRINCIPAL REGISTER**

MOTHERS2MOTHERS INTERNATIONAL, INC. (DELAWARE CORPORATION)  
7441 W. SUNSET BOULEVARD, SUITE 205  
LOS ANGELES, CA 90046

FOR: PROVIDING INFORMATION RELATING TO EDUCATIONAL SERVICES DESIGNED SPECIFICALLY FOR PREGNANT WOMEN AND NEW MOTHERS LIVING WITH HIV AND AIDS, IN CLASS 41 (U.S. CLS. 100, 101 AND 107).

FIRST USE 11-16-2006; IN COMMERCE 11-16-2006.

FOR: PROVIDING INFORMATION IN THE FIELD OF HIV AND AIDS IN DEVELOPING COUNTRIES AND PROVIDING MEDICAL TREATMENT INFORMATION RELATING TO PREGNANT WOMEN AND NEW MOTHERS LIVING WITH HIV AND AIDS, IN CLASS 44 (U.S. CLS. 100 AND 101).

FIRST USE 11-16-2006; IN COMMERCE 11-16-2006.

THE MARK CONSISTS OF A CIRCLE CONTAINING VARIOUS GEOMETRIC SHAPES IN THE COLORS BLUE, RED, BLACK, ORANGE, GREEN, LIGHT BLUE, LAVENDER, AND YELLOW, WHICH ARE EACH OUTLINED IN WHITE.

THE COLOR(S) BLUE, RED, BLACK, ORANGE, GREEN, LIGHT BLUE, LAVENDER, YELLOW AND WHITE IS/ARE CLAIMED AS A FEATURE OF THE MARK.

SER. NO. 85-179,644, FILED 11-18-2010.

TINA L. SNAPP, EXAMINING ATTORNEY



*David J. Kybas*

Director of the United States Patent and Trademark Office

# United States of America

United States Patent and Trademark Office



**Reg. No. 4,123,952**

**Registered Apr. 10, 2012**

**Int. Cl.: 28**

**TRADEMARK**

**PRINCIPAL REGISTER**

KONA OFFSHORE PRODUCTS, LLC (FLORIDA LIMITED LIABILITY COMPANY), AKA  
KONA OFFSHORE  
2033 HERITAGE PKWY  
NAVARRE, FL 32566

FOR: ARTIFICIAL FISHING LURES; FISH ATTRACTANTS; FISH HOOKS; FISHING EQUIPMENT, NAMELY, WINGING MATERIAL FOR FISHING JIGS AND STREAMERS; FISHING GAFFS; FISHING HOOKS; FISHING LEADERS; FISHING LURE PARTS; FISHING LURES; FISHING PLUGS; FISHING TACKLE; LEADER ORGANIZERS, NAMELY, BAGS SPECIALLY ADAPTED FOR FISHING LEADERS; LINES FOR FISHING; LURES FOR FISHING, IN CLASS 28 (U.S. CLS. 22, 23, 38 AND 50).

FIRST USE 10-15-2010; IN COMMERCE 11-3-2010.

NO CLAIM IS MADE TO THE EXCLUSIVE RIGHT TO USE "OFFSHORE", APART FROM THE MARK AS SHOWN.

THE MARK CONSISTS OF THE WORD "KONA" IN ALL CAPITAL LETTERS IS CENTERED WITH A LARGER FONT OVER THE WORD "OFFSHORE" IN ALL CAPITAL LETTERS WITH THE WORD "KONA" HAVING A STYLIZED "O" WITH A MARLIN BILLFISH SILHOUETTE AS THE CENTER PART OF THAT "O". A FISHHOOK IS OVERLAYED OVER THE WORD "KONA" STARTING THE SHANK OF THE HOOK AT THE TOP OF THE "A" IN "KONA" CUTTING DOWN AND TO THE LEFT ACROSS THE LETTER "N" IN THE WORD "KONA" AND AROUND THE "O" ON THE WORD "KONA" WITH THE POINT OF THE HOOK ENDING ATOP THE "O" ON THE WORD "KONA".

SER. NO. 85-179,870, FILED 11-18-2010.

Laurie Kaufman, Examining Attorney



*David J. Kybas*

Director of the United States Patent and Trademark Office

# United States of America

United States Patent and Trademark Office

The logo for HIDROX features the word "HIDROX" in a bold, black, sans-serif font. The letter "O" is replaced by a realistic illustration of a green olive with a short stem and two dark green leaves. The "X" is also in a bold, black, sans-serif font.

**Reg. No. 4,123,953**

CREAGRI, INC. (CALIFORNIA CORPORATION)  
25565 WHITESELL STREET  
HAYWARD, CA 94545

**Registered Apr. 10, 2012**

**Int. Cl.: 1**

FOR: ANTIOXIDANTS AND PROTEINS USED IN THE MANUFACTURE OF COSMETICS, BEVERAGES, FOOD PRODUCTS AND FOOD SUPPLEMENTS, IN CLASS 1 (U.S. CLS. 1, 5, 6, 10, 26 AND 46).

**TRADEMARK**

FIRST USE 9-1-2010; IN COMMERCE 9-1-2010.

**PRINCIPAL REGISTER**

OWNER OF U.S. REG. NO. 2,804,064.

THE COLOR(S) BLACK, LIGHT GREEN, DARK GREEN, GRAY AND WHITE IS/ARE CLAIMED AS A FEATURE OF THE MARK.

THE MARK CONSISTS OF THE TERM "HIDROX" WITH "HIDR" AND "X" IN BLACK AND THE "O" IN THE SHAPE OF A LIGHT GREEN OLIVE WITH A GRAY COLORED STEM, TWO DARK GREEN LEAVES AND A WHITE SPOT ON THE OLIVE.

SER. NO. 85-180,554, FILED 11-18-2010.

TARA PATE, EXAMINING ATTORNEY



*David J. Kyros*

Director of the United States Patent and Trademark Office

# United States of America

United States Patent and Trademark Office

## TIMETREASURE

**Reg. No. 4,123,954**

AMOREPACIFIC CORPORATION (REPUBLIC OF KOREA CORPORATION)  
181, 2-KA, HANGANG-RO, YONGSAN-KU  
SEOUL, REPUBLIC OF KOREA

**Registered Apr. 10, 2012**

**Int. Cl.: 3**

FOR: COSMETICS; MAKE-UP FOUNDATIONS; BEAUTY CREAMS; COSMETIC PREPARATIONS FOR SKIN CARE; EYE CREAMS; HAIR CARE LOTIONS; INCENSE; HAIR SHAMPOOS; COSMETIC SOAPS; DENTIFRICES, IN CLASS 3 (U.S. CLS. 1, 4, 6, 50, 51 AND 52).

**TRADEMARK**

**PRINCIPAL REGISTER**

THE MARK CONSISTS OF STANDARD CHARACTERS WITHOUT CLAIM TO ANY PARTICULAR FONT, STYLE, SIZE, OR COLOR.

PRIORITY CLAIMED UNDER SEC. 44(D) ON REPUBLIC OF KOREA APPLICATION NO. 40-2010-0053, FILED 10-18-2010, REG. NO. 0891251, DATED 11-23-2011, EXPIRES 11-23-2021.

SER. NO. 85-180,713, FILED 11-19-2010.

MIDGE BUTLER, EXAMINING ATTORNEY



*David J. Kybas*

Director of the United States Patent and Trademark Office



# United States of America

United States Patent and Trademark Office

# NAT & C

**Reg. No. 4,123,955**

**Registered Apr. 10, 2012**

**Int. Cl.: 9**

**TRADEMARK**

**PRINCIPAL REGISTER**

3702537 CANADA INC. (CANADA CORPORATION)  
169 BRAESIDE  
DOLLARD-DES-ORMEAUX  
QUEBEC, CANADA H9A2B1

FOR: EYEWEAR, NAMELY, EYEGLASSES, SUNGLASSES, READING GLASSES, SPECTACLES; EYEGLASS BAGS AND CASES, EYEGLASS CHAINS AND CORDS, OPTICAL FRAMES, CLIP-ON LENSES, CLIP-ON SUNGLASSES, FLIP-UP SUNGLASSES, IN CLASS 9 (U.S. CLS. 21, 23, 26, 36 AND 38).

THE MARK CONSISTS OF STANDARD CHARACTERS WITHOUT CLAIM TO ANY PARTICULAR FONT, STYLE, SIZE, OR COLOR.

PRIORITY CLAIMED UNDER SEC. 44(D) ON CANADA APPLICATION NO. 1501725, FILED 10-29-2010, REG. NO. TMA812,436, DATED 11-23-2011, EXPIRES 11-23-2026.

SER. NO. 85-180,993, FILED 11-19-2010.

MICHAEL WIENER, EXAMINING ATTORNEY



*David J. Kyros*

Director of the United States Patent and Trademark Office

# United States of America

United States Patent and Trademark Office

# VONIGO

**Reg. No. 4,123,956**

**Registered Apr. 10, 2012**

**Int. Cls.: 9 and 42**

**TRADEMARK**

**SERVICE MARK**

**PRINCIPAL REGISTER**

VONIGO SOFTWARE LTD. (CANADA CORPORATION), DBA VONIGO  
SUITE 301  
887 GREAT NORTHERN WAY  
VANCOUVER, BC, CANADA V5T4T5

FOR: COMPUTER SOFTWARE FOR USE IN CUSTOMER RELATIONSHIP MANAGEMENT (CRM), IN CLASS 9 (U.S. CLS. 21, 23, 26, 36 AND 38).

FIRST USE 10-1-2010; IN COMMERCE 10-1-2010.

FOR: PROVIDING TEMPORARY USE OF ON-LINE NON-DOWNLOADABLE SOFTWARE FOR CUSTOMER RELATIONSHIP MANAGEMENT AND SCHEDULING, IN CLASS 42 (U.S. CLS. 100 AND 101).

FIRST USE 10-1-2010; IN COMMERCE 10-1-2010.

THE MARK CONSISTS OF STANDARD CHARACTERS WITHOUT CLAIM TO ANY PARTICULAR FONT, STYLE, SIZE, OR COLOR.

SER. NO. 85-181,195, FILED 11-19-2010.

KAREN BRACEY, EXAMINING ATTORNEY



*David J. Kybas*

Director of the United States Patent and Trademark Office

# United States of America

United States Patent and Trademark Office

## IPG Invisible Phone Guard

**Reg. No. 4,123,957**

**Registered Apr. 10, 2012**

**Int. Cl.: 9**

**TRADEMARK**

**PRINCIPAL REGISTER**

SERVI, SENA H. (NEW YORK SOLE PROPRIETORSHIP), DBA SCENTS & MORE  
14 BOSTON PLACE  
HUNTINGTON STATION, NY 11746

FOR: CARRYING CASES FOR CELL PHONES; CASES FOR MOBILE PHONES; CELL PHONE BACKPLATES; CELL PHONE BATTERY CHARGERS; CELL PHONE BATTERY CHARGERS FOR USE IN VEHICLES; CELL PHONE CASES; CELL PHONE COVERS; CELL PHONE FACEPLATES; CELLULAR PHONE ACCESSORY CHARMS; DEVICES FOR HANDS-FREE USE OF MOBILE PHONES; EAR PHONES; FITTED PLASTIC FILMS KNOWN AS SKINS FOR COVERING AND PROTECTING ELECTRONIC APPARATUS, NAMELY, HAND HELD DEVICES LIKE CELL PHONES, DIGITAL CAMERAS, TABLETS; HANDS FREE DEVICES FOR MOBILE-PHONES; HANDS FREE KITS FOR PHONES; HEAD-CLIP CELL PHONE HOLDERS; HEADSETS FOR CELLULAR OR MOBILE PHONES; KEYBOARDS FOR MOBILE PHONES; MOBILE PHONE STRAPS; PROTECTIVE COVERS AND CASES FOR CELL PHONES, LAPTOPS AND PORTABLE MEDIA PLAYERS; SPECIALTY HOLSTER FOR CARRYING PERSONAL DIGITAL ASSISTANTS; STRAPS FOR MOBILE PHONES; VINYL COVERS SPECIALLY ADAPTED FOR CELL PHONES, MP3 PLAYERS, LAPTOPS, COMPUTERS, PORTABLE SATELLITE RADIOS, PERSONAL DIGITAL ASSISTANTS, REMOTE CONTROLS, AND TELEVISION SATELLITE RECORDERS; WIRELESS CELLULAR PHONE HEADSETS, IN CLASS 9 (U.S. CLS. 21, 23, 26, 36 AND 38).

FIRST USE 6-20-2010; IN COMMERCE 6-20-2010.

THE MARK CONSISTS OF STANDARD CHARACTERS WITHOUT CLAIM TO ANY PARTICULAR FONT, STYLE, SIZE, OR COLOR.

NO CLAIM IS MADE TO THE EXCLUSIVE RIGHT TO USE "PHONE GUARD", APART FROM THE MARK AS SHOWN.

SER. NO. 85-181,868, FILED 11-20-2010.

FONG HSU, EXAMINING ATTORNEY



*David J. Kyros*

Director of the United States Patent and Trademark Office

# United States of America

United States Patent and Trademark Office



**Reg. No. 4,123,958**

JOYTEQ LLC (TEXAS LIMITED LIABILITY COMPANY)  
4917 EVERGREEN WAY #434  
EVERETT, WA 98203

**Registered Apr. 10, 2012**

**Int. Cls.: 35, 41, 42 and 45**

FOR: BUSINESS CONSULTING AND INFORMATION SERVICES, IN CLASS 35 (U.S. CLS. 100, 101 AND 102).

FIRST USE 5-21-2010; IN COMMERCE 5-27-2010.

**SERVICE MARK**

FOR: ENTERTAINMENT SERVICES, NAMELY, PROVIDING ON-LINE COMPUTER GAMES; INFORMATION RELATING TO ENTERTAINMENT AND EDUCATION, PROVIDED ON-LINE FROM A COMPUTER DATABASE OR THE INTERNET, EXPRESSLY EXCLUDING BLOGS IN THE FIELDS OF THIRD-PARTY VIDEO GAMES, THIRD-PARTY COMPUTER GAMES, AND THE GAMING INDUSTRY, IN CLASS 41 (U.S. CLS. 100, 101 AND 107).

FIRST USE 5-21-2010; IN COMMERCE 5-27-2010.

**PRINCIPAL REGISTER**

FOR: COMPUTER SOFTWARE DESIGN; ENGINEERING, IN CLASS 42 (U.S. CLS. 100 AND 101).

FIRST USE 5-21-2010; IN COMMERCE 5-27-2010.

FOR: PROVIDING ON-LINE COMPUTER DATABASES AND ON-LINE SEARCHABLE DATABASES IN THE FIELD OF SOCIAL NETWORKING, IN CLASS 45 (U.S. CLS. 100 AND 101).

FIRST USE 5-21-2010; IN COMMERCE 5-27-2010.



THE MARK CONSISTS OF THE LOWERCASE LETTERS "JOY" IN GRAY, EXCEPT FOR A GREEN AND YELLOW DOT ON THE LETTER "J", AND THE LOWERCASE LETTERS "TEQ" IN GREEN, ALL SURROUNDED BY A GREEN, TILTED ELLIPSE THICKENED ON THE SIDES THAT TAPERS OFF TO NOTHING ALONG THE TOP AND BOTTOM.

*David J. Kyros*

THE COLOR(S) GREEN, GRAY, AND YELLOW IS/ARE CLAIMED AS A FEATURE OF THE MARK.

Director of the United States Patent and Trademark Office

SER. NO. 85-181,969, FILED 11-21-2010.

**Reg. No. 4,123,958** JOHN KELLY, EXAMINING ATTORNEY

# United States of America

United States Patent and Trademark Office



**Reg. No. 4,123,959**

**Registered Apr. 10, 2012**

**Int. Cl.: 16**

**TRADEMARK**

**PRINCIPAL REGISTER**

SUNSHINE FITNESS RESOURCES (COLORADO LIMITED LIABILITY COMPANY)  
6525 GUNPARK SR  
SUITE 370-508  
BOULDER, CO 80301

FOR: EDUCATIONAL PUBLICATIONS, NAMELY, HANDOUTS, TRAININGS DOCUMENTS ON BALLESTONE IN THE FIELDS OF FITNESS AND WELLNESS, IN CLASS 16 (U.S. CLS. 2, 5, 22, 23, 29, 37, 38 AND 50).

FIRST USE 9-15-2003; IN COMMERCE 9-15-2003.

THE MARK CONSISTS OF TWO BLUE CIRCLES WITH WHITE AND LIGHT BLUE HIGHLIGHTS AROUND THE DETAIL OF THE CIRCLES INTENDED TO LOOK LIKE A PERSON'S HEAD AND ARMS ARCHED OVERHEAD IN A BALLET POSE WITH THE STYLIZED WORD "BALLESTONE" AND PHRASE "SOMETHING FOR EVERYBODY!" IN BLUE.

THE COLOR(S) BLUE, LIGHT BLUE AND WHITE IS/ARE CLAIMED AS A FEATURE OF THE MARK.

SER. NO. 85-182,129, FILED 11-22-2010.

PRISCILLA MILTON, EXAMINING ATTORNEY



*David J. Kyffers*

Director of the United States Patent and Trademark Office

# United States of America

United States Patent and Trademark Office



**Reg. No. 4,123,960**

**Registered Apr. 10, 2012**

**Int. Cls.: 42, 44 and 45**

**SERVICE MARK**

**PRINCIPAL REGISTER**

K2 MANAGEMENT A/S (DENMARK CORPORATION)  
JEGSTRUPVEJ 34  
HASSELAGER, DENMARK 8361

FOR: OPERABILITY STUDIES RELATED TO CONSTRUCTION PROJECTS PRIMARILY WITH THE ENERGY SECTOR, NAMELY, TESTING OF MACHINERY AND EQUIPMENT FOR SAFE AND PROPER OPERATION, IN CLASS 42 (U.S. CLS. 100 AND 101).

FOR: CONSULTANCY SERVICES IN THE AREA OF HEALTH RELATED TO CONSTRUCTION PROJECTS PRIMARILY WITHIN THE ENERGY SECTOR, IN CLASS 44 (U.S. CLS. 100 AND 101).

FOR: LEGAL SERVICES RELATED TO CONSTRUCTION PROJECTS PRIMARILY WITHIN THE ENERGY SECTOR IN THE FIELDS OF CONTRACT STRATEGIES, CONTRACT NEGOTIATIONS, CONTRACT MANAGEMENT, INSURANCE CLAIMS MANAGEMENT, DISPUTE RESOLUTION, BUSINESS AND FINANCIAL RISK MANAGEMENT, DEBT TENDERING; CONSULTANCY SERVICES IN THE AREA OF SAFETY REGARDING HAZARD ASSESSMENT AND ABATEMENT PROCEDURES RELATED TO CONSTRUCTION PROJECTS PRIMARILY WITHIN THE ENERGY SECTOR; HAZARD STUDIES RELATED TO CONSTRUCTION PROJECTS PRIMARILY WITHIN THE ENERGY SECTOR, NAMELY, STUDIES ON HAZARD ASSESSMENT AND ABATEMENT PROCEDURES, IN CLASS 45 (U.S. CLS. 100 AND 101).



OWNER OF ERPN CMNTY TM OFC REG. NO. 008974933, DATED 9-14-2010, EXPIRES 3-8-2020.

THE COLOR(S) WHITE AND BLUE IS/ARE CLAIMED AS A FEATURE OF THE MARK.

THE MARK CONSISTS OF THE LETTER "K", IN WHITE, ROTATED 90 DEGREES CLOCKWISE ABOVE THE NUMBER "2", IN WHITE, WITHIN A BLUE BOX.

SER. NO. 85-183,534, FILED 11-23-2010.

MARY CRAWFORD, EXAMINING ATTORNEY

*David J. Kyffers*

Director of the United States Patent and Trademark Office

# United States of America

United States Patent and Trademark Office



**Reg. No. 4,123,961**

**Registered Apr. 10, 2012**

**Int. Cl.: 35**

**SERVICE MARK**

**PRINCIPAL REGISTER**

HIRE THE WORLD ENTERPRISES INC. (CANADA CORPORATION), DBA  
HIRETHEWORLD.COM  
222 FELL AVE.  
BURNABY, CANADA V5B3Y3

FOR: CROWDSOURCING SERVICES, NAMELY, PROVIDING A WEB SITE THAT FEATURES AN ON-LINE MARKET FOR USERS TO LIST OFFERED OR WANTED PERSONAL AND BUSINESS ASSETS AND SKILLS FOR HIRE, RENT, SALE OR AUCTION TRANSACTED ON THE BASIS OF PREDEFINED PERFORMANCE AND CLOSING TERMS AND CONDITIONS, IN CLASS 35 (U.S. CLS. 100, 101 AND 102).

FIRST USE 11-1-2010; IN COMMERCE 11-1-2010.

THE MARK CONSISTS OF A TILTED 3D BOX WITH THE WORDS "HIRETHEWORLD.COM" ON THE RIGHT HAND SIDE.

SER. NO. 85-183,814, FILED 11-23-2010.

FLORENTINA BLANDU, EXAMINING ATTORNEY



*David J. Kybas*

Director of the United States Patent and Trademark Office



# United States of America

United States Patent and Trademark Office



**Reg. No. 4,123,962**

OZ FACTOR PTY. LTD. (AUSTRALIA LIMITED LIABILITY COMPANY)  
7 BURNELL STREET DRUMMOYNE  
SYDNEY, AUSTRALIA 2047

**Registered Apr. 10, 2012**

**Int. Cl.: 25**

FOR: BRIEFS; MEN'S UNDERWEAR; SWIMWEAR, IN CLASS 25 (U.S. CLS. 22 AND 39).

**TRADEMARK**

FIRST USE 1-3-2006; IN COMMERCE 1-3-2006.

**PRINCIPAL REGISTER**

THE MARK CONSISTS OF A BLACK RECTANGULAR BACKGROUND, ENCOMPASSING THE WORDING "COCKSOX", WITH "COCK" IN WHITE AND "SOX" IN RED.

THE COLOR(S) BLACK, WHITE AND RED IS/ARE CLAIMED AS A FEATURE OF THE MARK.

SER. NO. 85-185,067, FILED 11-24-2010.

BRIAN CALLAGHAN, EXAMINING ATTORNEY



*David J. Kyffers*

Director of the United States Patent and Trademark Office

# United States of America

United States Patent and Trademark Office

# BUG BRUSH

**Reg. No. 4,123,963**

**Registered Apr. 10, 2012**

**Int. Cl.: 6**

**TRADEMARK**

**PRINCIPAL REGISTER**

TOP ROLLSHUTTERS INC. (CANADA CORPORATION)  
P.O. BOX 3279  
5501 46TH AVENUE S.E.  
SALMON ARM, B.C., CANADA V0E4S1

FOR: A METAL STRIP ATTACHMENT FOR EXTERIOR WINDOW AND DOOR SCREENS TO PREVENT ACCESS BY INSECTS INTO THE PANEL BOX, IN CLASS 6 (U.S. CLS. 2, 12, 13, 14, 23, 25 AND 50).

THE MARK CONSISTS OF STANDARD CHARACTERS WITHOUT CLAIM TO ANY PARTICULAR FONT, STYLE, SIZE, OR COLOR.

PRIORITY CLAIMED UNDER SEC. 44(D) ON CANADA APPLICATION NO. 1482446, FILED 5-25-2010, REG. NO. TMA811099, DATED 11-4-2011, EXPIRES 11-4-2026.

NO CLAIM IS MADE TO THE EXCLUSIVE RIGHT TO USE "BUG", APART FROM THE MARK AS SHOWN.

SER. NO. 85-185,319, FILED 11-25-2010.

LINDA M. KING, EXAMINING ATTORNEY



*David J. Kybas*

Director of the United States Patent and Trademark Office

# United States of America

United States Patent and Trademark Office



**Reg. No. 4,123,964**

**Registered Apr. 10, 2012**

**Int. Cls.: 9, 12, 28, 37  
and 41**

**TRADEMARK**

**SERVICE MARK**

**PRINCIPAL REGISTER**

EUROCOPTER (FRANCE SOCIÉTÉ PAR ACTIONS SIMPLIFIÉE (SAS))  
AEROPORT INT'L MARSEILLE PROVENCE  
MARNIGNANE CEDEX, FRANCE 13725

FOR: SCIENTIFIC, NAUTICAL, SURVEYING, PHOTOGRAPHIC, CINEMATOGRAPHIC, OPTICAL, WEIGHING, MEASURING, SIGNALING, SUPERVISION, LIFE-SAVING AND TEACHING APPARATUS AND INSTRUMENTS, NAMELY, COMPUTERS, TELECOMMUNICATION MACHINES AND APPARATUS, COMPUTER HARDWARE, APPARATUS FOR RECORDING, TRANSMISSION, PROCESSING AND REPRODUCTION OF SOUND, IMAGES OR DATA, CAMERAS, SURVEYING INSTRUMENTS, CINEMATOGRAPHIC MACHINES AND APPARATUS, OPTICAL INSPECTION APPARATUS, WEIGHING MACHINES, INSTRUMENTS FOR MEASURING LENGTH, SIGNAL PROCESSORS, LIFE SAVING RAFTS AND EDUCATIONAL SOFTWARE FEATURING INSTRUCTION IN AIRPLANE, HELICOPTER AND ROTORCRAFT FLIGHT INSTRUCTIONS; APPARATUS AND INSTRUMENTS FOR THE SUPPLY, DISTRIBUTION, TRANSFORMATION, ACCUMULATION, REGULATION AND CONTROL OF ELECTRIC CURRENT, NAMELY, ELECTRIC CURRENT SWITCHES, CURRENT CONVERTERS, CURRENT RECTIFIERS AND FUSES; APPARATUS FOR RECORDING, TRANSMITTING, PROCESSING AND REPRODUCING SOUND, IMAGES OR DATA; ELECTRONIC APPARATUS AND INSTRUMENTS, NAMELY, DATA PROCESSORS; AUDIOVISUAL TELECOMMUNICATIONS AND DATA TRANSMISSION APPARATUS AND INSTRUMENTS, NAMELY, AUDIOVISUAL RECEIVERS, COMPUTERS AND COMPUTER HARDWARE AND PERIPHERAL DEVICES AND SOFTWARE FOR TRANSMITTING DATA SOLD THEREWITH; ELECTRIC CALCULATING INSTRUMENTS, NAMELY, CALCULATORS, ANALOG CALCULATORS, DIGITAL CALCULATORS, OPTICAL CALCULATORS AND HYBRID CALCULATORS; COMPUTERS; COMPUTER PERIPHERALS; COMPUTER MEMORIES; DATA PROCESSORS; MICROPROCESSORS; DIGITAL COMPUTER, DISC AND ELECTRONIC MEMORIES UTILIZING OPTICAL ELEMENTS; COMPUTER TERMINALS, SECURE DATA TRANSMISSION TERMINALS FOR ELECTRONIC TRANSACTIONS AND TELEPHONE TERMINALS FOR ACCESSING GLOBAL TELECOMMUNICATIONS NETWORKS AND PRIVATE ACCESS NETWORKS; INTERFACES FOR COMPUTERS AND MICROPROCESSORS FOR PROVIDING ACCESS TO DATABASES; ENCODING AND DECODING APPARATUS; ACCESS CONTROL AND ALARM MONITORING SYSTEMS FOR DATA PROCESSING APPARATUS; DIGITAL COMPUTER AND TELEPHONE TERMINALS; DIGITAL SECURE TERMINALS FOR ELECTRONIC TRANSACTIONS; WIRELESS AND SATELLITE ONBOARD COMPUTERS AND DATA NETWORKS OF DATA PROCESSORS; MULTIPLATFORM INTERFACES FOR COMPUTERS; ARCHITECTURAL NETWORKS OF COMPUTERS FOR PROCESSING SOUND AND IMAGES; RADIO RECEIVERS



*David J. Kybas*

Director of the United States Patent and Trademark Office

**Reg. No. 4,123,964** AND RADIO SIGNAL TUNERS; RADIO TRANSMITTERS AND RECEIVERS; VISUAL DISPLAY UNITS, NAMELY, FLAT PANEL DISPLAY SCREENS, LIQUID CRYSTAL DISPLAYS AND HEAD-MOUNTED VIDEO DISPLAYS; CASSETTE RECORDERS; VIDEO RECORDERS; IMAGE REPRODUCERS, NAMELY, PHOTOCOPIERS, PRINTERS, TV SETS, TV, COMPUTER AND LIQUID CRYSTAL DISPLAY (LCD) MONITORS; CAMERAS; CAMCORDERS; PHOTOGRAPHIC APPARATUS, NAMELY, PHOTOGRAPHIC CAMERAS, PHOTOGRAPHIC FLASH UNITS, PHOTOGRAPHIC FILTERS AND PHOTOGRAPHIC PROJECTORS; TELEPHONES; ELECTRONIC CARD READERS; ANTENNAS; AERIALS; SATELLITE DISHES; MODEMS; HEADPHONES FOR PERSONAL USE IN SOUND COMMUNICATIONS SYSTEMS; HEADPHONES; MICROPHONES; TELEPHONE RECEIVERS; LOUDSPEAKERS; BLANK RECORDING MEDIA FOR SOUND AND IMAGES, NAMELY, BLANK MAGNETIC TAPES FOR TAPE RECORDERS, MAGNETIC AND OPTICAL INTEGRATED CIRCUIT, ELECTRONIC CHIP AND SMART CARDS, RECORDABLE OPTICAL DISCS, RECORDABLE CD-ROMS, DVD-ROMS, RECORDING DISCS AND BLANK RECORDABLE DVDS; DIGITAL MEDIA, NAMELY, PRE-RECORDED VIDEO CASSETTES, DIGITAL VIDEO DISCS, DIGITAL VERSATILE DISCS, DOWNLOADABLE AUDIO AND VIDEO RECORDINGS, DVDS, AND HIGH DEFINITION DIGITAL DISCS FEATURING NAVIGATION AND FLIGHT INSTRUCTIONS FOR HELICOPTER AND ROTORCRAFT PILOTS; DIGITAL COMPUTERS AND DATA PROCESSORS FOR GENERATING RECORDS RELATING TO DESIGNS, MANUFACTURERS, CONTROLS, FLIGHTS, GUIDES, NAVIGATIONAL SURVEILLANCE, SAFETY INSTRUCTIONS AND MAINTENANCE AND REPAIR SCHEDULES OF HELICOPTERS AND ROTORCRAFTS; COMPUTERS AND DATA PROCESSORS FOR GENERATING SIGNALS TO CLOCKS; SOUND AND IMAGE GENERATORS, NAMELY, LASER SOUND AND IMAGE RADIO, SATELLITE AND WIRELESS TRANSMITTERS AND RECEIVERS; ELECTRONIC SOUND WAVE SYNTHESIZING APPARATUS; COMPUTERS AND DATA PROCESSORS FOR GENERATING IMAGE SIGNALS; COMPUTERS AND DATA PROCESSORS FOR GENERATING SYMBOLS; ELECTROACOUSTIC AND ELECTRICAL RESONANT TRANSDUCERS, MAGNETOSTRICTIVE TRANSDUCERS, PIEZOELECTRIC TRANSDUCERS, ELECTROSTATIC TRANSDUCERS AND VARIABLE-RESISTANCE TRANSDUCERS; STEREO SYSTEMS COMPRISING PERSONAL STEREOS, STEREO AMPLIFIERS, STEREO CABLES, STEREO HEADPHONES, STEREO TUNERS AND STEREO RECEIVERS, MULTIPLEX COMMUNICATION SYSTEMS COMPRISING COMPUTERS, DATA PROCESSORS, COMPUTER TERMINALS, SECURE DATA TRANSMISSION TERMINALS FOR ELECTRONIC TRANSACTIONS AND TELEPHONE TERMINALS, AND RADIO-BROADCASTING AND TELEVISION SYSTEMS COMPRISING RADIOS, TELEVISION SETS, AND RADIO, SATELLITE AND WIRELESS TRANSMITTERS AND RECEIVERS ALL FOR ESTABLISHING, VISUALIZING AND TRANSMITTING CHARACTERISTICS AND PARAMETERS OF HELICOPTER AND ROTORCRAFT FLIGHTS FOR DESIGNERS, MANUFACTURERS, PILOTS, FLIGHT INSTRUCTORS, NAVIGATION GUIDES, SAFETY INSTRUCTORS AND MAINTENANCE AND REPAIR SERVICE PROVIDERS OF THE AFORESAID HELICOPTERS AND ROTORCRAFTS; IMAGE TRANSMISSION AND REPRODUCTION SYSTEMS COMPRISING COMPUTERS, APPARATUS FOR TRANSMISSION OR REPRODUCTION OF IMAGES AND WIRELESS COMMUNICATION DEVICES FOR IMAGE TRANSMISSION FOR ESTABLISHING, VISUALIZING AND TRANSMITTING CHARACTERISTICS AND PARAMETERS OF HELICOPTER AND ROTORCRAFT FLIGHTS FOR DESIGNERS, MANUFACTURERS, PILOTS, FLIGHT INSTRUCTORS, NAVIGATION GUIDES, SAFETY INSTRUCTORS AND MAINTENANCE AND REPAIR SERVICE PROVIDERS OF THE AFORESAID HELICOPTERS AND ROTORCRAFTS; ELECTRONIC AND ELECTRIC EQUIPMENT DEPLOYMENT SYSTEMS COMPRISING COMPUTERS, COMPUTER HARDWARE AND ELECTRIC SENSORS FOR DEPLOYING AIR FRAMES IN HELICOPTERS AND ROTORCRAFTS; RADAR OBSERVATION AND AIRSPACE ZONE SURVEILLANCE SYSTEMS FOR HELIPORTS COMPRISING RADAR, COMPUTERS AND ELECTRIC AND ELECTRONIC VIDEO SURVEILLANCE INSTALLATIONS; AVIONIC SENSOR SYSTEMS, NAMELY, NAVIGATION SYSTEMS; UNDERWATER, MARITIME, LAND, AIR AND SPACE ELECTRIC AND ELECTRONIC NAVIGATIONAL INSTRUMENTS; RADIO-NAVIGATION INSTRUMENTS, NAMELY, RADIOS AND RADIO TRANSMITTERS AND RECEIVERS; ENGINE CONTROL INSTRUMENTS, NAMELY, ELECTRONIC CONTROLS FOR GASOLINE ENGINES FOR HELICOPTERS AND ROTORCRAFTS AND ELECTRONIC HELICOPTER

**Reg. No. 4,123,964** AND ROTORCRAFT IGNITION TUNING KITS COMPRISED OF AN ELECTRONIC CONTROL UNIT THAT MONITORS ENGINE PERFORMANCES AND DELIVERS RE-CALCULATED SENSOR VALUES TO THE ORIGINAL ENGINE CONTROL UNIT TO INCREASE ENGINE PERFORMANCE; APPARATUS FOR CHECKING FLIGHT PARAMETERS; SPEED AND ACCELERATION ALARM CALCULATORS, OBSTACLE AVOIDANCE CALCULATORS AND NAVIGATION CALCULATORS; AUTOMATIC FLIGHT SYSTEMS COMPRISING AUTOMATIC FLIGHT DATA ELECTRIC SENSORS, AUTOMATIC FLIGHT DATA SOFTWARE FOR CHECKING AND MONITORING FLIGHT PARAMETERS AND TRACKING AIRCRAFT PILOT COMMANDS TO ENABLE THE COMPUTER-ASSISTED PILOTING OF HELICOPTERS OR ROTORCRAFTS; SYSTEMS FOR DEVELOPING ELECTRICAL SIGNALS AND METHODS FOR PROCESSING ELECTRICAL SIGNALS, IN PARTICULAR, ELECTRICAL SIGNAL SENSORS; ELECTRIC SENSORS; AVIONIC SENSOR SYSTEMS, NAMELY, AIRCRAFT AIRSPEED SENSORS; TEMPERATURE SENSORS AND INDICATORS; PRESSURE SENSORS AND INDICATORS; ELECTRIC SENSORS, AND TEMPERATURE AND PRESSURE SENSORS AND INDICATORS ALL FOR SENSING AND INDICATING ICE BUILD-UP ON HELICOPTERS AND ROTORCRAFTS; ELONGATION TEMPERATURE AND PRESSURE SENSORS AND INDICATORS; SPEED SENSORS AND INDICATORS; ACCELERATION SENSORS AND INDICATORS; LEVEL SENSORS AND INDICATORS; NOISEMETERS; ELECTRIC SENSORS FOR SENSING NOISE LEVELS; ELECTRIC SENSORS FOR ALARMING HELICOPTER AND ROTORCRAFT PILOTS OF DANGEROUS AND HAZARDOUS FLIGHT CONDITIONS; VEHICLE DETECTION EQUIPMENT, NAMELY, IMAGE SENSORS TO DETECT VEHICLE LOCATION; VELOCIMETERS, NAMELY, SENSORS FOR DETERMINING VELOCITY; ACCELEROMETERS; FLOWMETERS; TACHOMETERS; RATE GYROSCOPES; GYROSCOPES; RADAR; ALTIMETERS; VERTICAL VELOCITY INDICATORS, NAMELY, SENSORS FOR DETERMINING VELOCITY; THERMOMETERS; SPEED INDICATORS; PRESSURE GAUGES; ANEMOMETERS; ANEMOMETER/BAROMETER INSTRUMENTS, NAMELY, ANEMOMETERS AND BAROMETERS; RANGE FINDERS; SYMBOL AND ALARM GENERATORS, NAMELY, ALARM INSTALLATIONS AND ALARMS; SIGNAL GENERATORS, NAMELY, SIGNAL PROCESSORS AND RECEIVERS AND TRANSMITTERS OF ELECTRONIC SIGNALS; VIDEO, COMPUTER AND LIQUID CRYSTAL DISPLAY (LCD) MONITORS FOR INDICATING CARGO AND PASSENGER LOADS ON HELICOPTERS AND ROTORCRAFTS; FUEL GAUGES; THERMIONIC AMPLIFIERS; FREQUENCY METERS; ELECTRONIC FREQUENCY SOUND SYNTHESIZING APPARATUS; ELECTRONIC SOUND MIXING, PROCESSING AND SYNTHESIZING APPARATUS; SPECTRUM ANALYZERS, NAMELY, ELECTRONIC PRODUCTS FOR THE ANALYSIS OF AUDIO SPECTRUM SIGNALS IN THE NATURE OF AUDIO ANALYZERS AND ELECTRONIC MAGNETOSTRICTIVE EQUIPMENT IN THE NATURE OF WAVE SPECTRUM ANALYZERS; ELECTROMAGNETIC RADIATION ANALYZERS, NAMELY, RADIATION ANALYZING DETECTORS, AND REMOTE SENSORS FOR USE IN ANALYZING THERMAL AND INFRARED RADIATION ENERGY WAVES; MULTIPLEXERS; REVOLUTION COUNTERS; ARTIFICIAL HORIZONS, NAMELY, AUTOMATIC ALTITUDE INDICATORS; TURN INDICATORS, NAMELY, VEHICLE MOUNTED GPS FLIGHT SENSORS FOR DETERMINING THE RATE OF TURNING MOTION FOR AIRCRAFTS, HELICOPTERS AND ROTORCRAFTS; COMPASSES; COMPASSES UTILIZING RADIO WAVES; HEADING INDICATORS, NAMELY, FLIGHT COMPUTERS FOR INFORMING THE PILOT OF THE AIRCRAFT'S HEADING; GROUND CONTROL APPROACH SYSTEMS COMPRISING COMPUTERS, RADAR AND SATELLITE TRANSMITTERS AND RECEIVERS FOR GUIDING HELICOPTER AND ROTORCRAFT PILOTS TO SAFELY LAND AIRCRAFTS; INSTRUMENT LANDING SYSTEMS (ILS) COMPRISING COMPUTERS, RADAR AND SATELLITE TRANSMITTERS AND RECEIVERS FOR GUIDING HELICOPTER AND ROTORCRAFT PILOTS TO SAFELY LAND AIRCRAFTS; GLOBAL POSITIONING SYSTEMS (GPS), AUTOMATIC DIRECTION FINDER (ADF) AUDIOVISUAL, RADIO AND SATELLITE RECEIVERS; VISUAL OMNI RANGE (VOR) SYSTEMS COMPRISING COMPUTERS, AUDIOVISUAL RECEIVERS AND SATELLITE TRANSMITTERS AND RECEIVERS FOR GUIDING HELICOPTER AND ROTORCRAFT PILOTS TO SAFELY LAND AIRCRAFTS; RADIO MAGNETIC INDICATORS (RMI), NAMELY, LEVEL, SPEED, TEMPERATURE AND PRESSURE INDICATORS; FUEL FLOW REGULATORS FOR COMMERCIAL USE; SENSORS FOR DETECTING ACTUAL AND PROJECTED ELECTRICAL FAULTS; DEVICES FOR PERFORMING ACTUAL

**Reg. No. 4,123,964** OR PROJECTED DIAGNOSIS AND MAINTENANCE ON THE ELECTRIC, ELECTRONIC, COMPUTER, MECHANICAL AND STRUCTURAL DEVICES OF HELICOPTERS AND ROTORCRAFT, IN PARTICULAR, ELECTRONIC ULTRASONIC TEST EQUIPMENT IN THE NATURE OF ULTRASONIC FLAW DETECTORS, THICKNESS TESTERS AND HARDNESS TESTERS, FOR NON-MEDICAL USE, CALCULATORS USED WHILE ASSESSING HEALTH CONDITIONS, DAMAGES AND SERVICE LIFE OF HELICOPTERS AND ROTORCRAFT AND ELECTRONIC FLIGHT MODE LOGIC ANALYZERS; RADIO TRANSMITTERS; OPTICAL TRANSMITTERS; COMPUTER SOFTWARE FOR HELICOPTER AND ROTORCRAFT NAVIGATION AND PILOTING ASSISTANCE; COMPUTER SOFTWARE FOR HELICOPTER AND ROTORCRAFT FLIGHT CONTROL; COMPUTER SOFTWARE FOR CALCULATING, READING AND USING MAP DATA; ADAPTABLE COMPUTER SOFTWARE ENABLING AIRCRAFT TO BE LOCATED BY MEANS OF INERTIAL REFERENCES; SOFTWARE FOR GROUPING ELEMENTARY DIGITAL OBJECTS REPRESENTATIVE OF REAL MOVING OBJECTS FROM CARTOGRAPHIC DATA AND ALGORITHMS OBTAINED FROM STUDYING THE MOVEMENTS OF THESE OBJECTS; MERGE SOFTWARE THAT UTILIZES DATA FOR SIMULATING MOVING OBJECTS; COMPUTER SOFTWARE TO ASSIST IN REGULATING PARAMETERS OF DEVICES USED FOR DESIGNING, MANUFACTURING, PILOTING, GUIDING, FLYING, NAVIGATING, SURVEYING, MAINTAINING AND REPAIRING HELICOPTERS AND ROTORCRAFTS; DATA ACQUISITION AND PROCESSING SOFTWARE FOR THE DESIGN, MANUFACTURE, PILOTING, FLIGHT, GUIDANCE, NAVIGATION, SURVEILLANCE, SAFETY, MAINTENANCE AND REPAIR OF HELICOPTERS AND ROTORCRAFTS; COMPUTER SOFTWARE TO ASSIST IN TROUBLESHOOTING ELECTRICAL FAULTS, AIRCRAFT DAMAGE, MECHANICAL FAILURE AND THE REPLACEMENT OF TIME-EXPIRED PARTS FOR HELICOPTERS AND ROTORCRAFTS; COMPUTER SOFTWARE FOR INDICATING POWER FAILURES AND ELECTRICAL FAULTS IN HELICOPTERS AND ROTORCRAFTS AND PROPOSING REPARATIVE ACTIONS FOR THE AFORESAID FAILURES AND FAULTS; FLIGHT REPORT PRESENTATION SOFTWARE; COMPUTER AND ELECTRONIC GAMES SOFTWARE; HELICOPTER AND ROTORCRAFT FLIGHT SIMULATION SOFTWARE; DATA PROCESSING GROUND WORK STATIONS COMPRISING DATA PROCESSORS FOR THE DESIGN, MANUFACTURE, PILOTING, FLIGHT, GUIDANCE, NAVIGATION, SURVEILLANCE, MAINTENANCE, REPAIR OF HELICOPTERS AND ROTORCRAFT; DEVICES FOR REMOTELY TRANSMITTING INFORMATION BETWEEN HELICOPTERS OR ROTORCRAFT AND AT LEAST ONE GROUND STATION, NAMELY, COMPUTER AND RADIO TRANSMITTERS; INERTIAL MEASUREMENT UNITS COMPRISING ACCELEROMETERS AND GYROSCOPES FOR MEASURING AND REPORTING ON AIRCRAFT'S VELOCITY, ORIENTATION AND GRAVITATIONAL FORCES; COMPUTERS FOR PREPARING FLIGHT PLANS; ALTITUDE AND SPEED SYSTEMS COMPRISING COMPUTERS, AUTOMATIC ALTITUDE INDICATORS AND SPEED INDICATORS FOR GUIDING HELICOPTER AND ROTORCRAFT PILOTS TO SAFELY LAND AIRCRAFTS; IDENTIFICATION, DETECTION AND CONTROL, CARTOGRAPHY EQUIPMENT, NAMELY, RADIO FREQUENCY IDENTIFICATION (RFID) CREDENTIALS, NAMELY, CARDS AND TAGS, AND READERS FOR RADIO FREQUENCY IDENTIFICATION CREDENTIALS, ELECTRONIC MOTION DETECTORS, ELECTRIC CONTROL PANELS AND GPS NAVIGATION DEVICE; ELECTRIC AND ELECTRONIC EQUIPMENT FOR RADIOLOCATION AND RADIO NAVIGATION, NAMELY, RADIO AND RADIO TRANSMITTERS AND RECEIVERS; AIRPORT GROUND SURVEILLANCE AND RECONNAISSANCE SYSTEMS BASED ON RADAR IMAGERY COMPRISING COMPUTERS, SATELLITES, SATELLITE AERIALS AND SATELLITE TRANSMITTERS AND RECEIVERS; SIGHTING AND FIRING CONTROL DEVICES AND SYSTEMS COMPRISING COMPUTERS AND TELESCOPIC SIGHTS; ELECTRONIC EQUIPMENT FOR METERING, MANAGEMENT, LOCATION AND IDENTIFICATION OF MOBILE RESOURCES, NAMELY, MEASURING APPARATUS IN THE NATURE OF LASER DISTANCE METERS, COMPUTERS AND RADIO FREQUENCY IDENTIFICATION (RFID) CREDENTIALS, NAMELY, CARDS AND TAGS, AND READERS FOR RADIO FREQUENCY IDENTIFICATION CREDENTIALS; CRYPTOGRAPHY, ENCODING AND DECODING EQUIPMENT, NAMELY, ENCODING AND DECODING APPARATUS; ELECTRONIC EQUIPMENT AND SYSTEMS FOR CONTROLLING THE MISSIONS OF COMBAT AIRCRAFT OR HELICOPTERS, NAMELY, COMPUTERS; ELECTRIC CONVERTERS; RADAR APPARATUS, NAMELY, RADAR DETECTORS AND

**Reg. No. 4,123,964** RADAR RECEIVERS WITH AMPLIFIERS; TELESCOPIC SIGHTS; SUN PROTECTION GLASSES; FLIGHT SIMULATORS; ELECTRONIC CONTROLLERS FOR HELICOPTERS AND ROTORCRAFT; ELECTRONIC AND COMPUTER GAME SOFTWARE AND PROGRAMS AND COMPUTER GAME CONSOLES FOR USE WITH AN EXTERNAL DISPLAY SCREEN OR MONITOR; EYEWEAR CASES; ELECTRIC GENERATORS, NAMELY, BATTERIES, IN CLASS 9 (U.S. CLS. 21, 23, 26, 36 AND 38).

FOR: VEHICLES AND APPARATUS FOR LOCOMOTION BY LAND, AIR OR WATER, NAMELY, AIRCRAFTS, HELICOPTERS AND ROTORCRAFTS AND STRUCTURAL PARTS AND FITTINGS THEREFOR, IN CLASS 12 (U.S. CLS. 19, 21, 23, 31, 35 AND 44).

FOR: GAMES AND PLAYTHINGS, NAMELY, TOY VEHICLES, RADIO-CONTROLLED TOY VEHICLES AND SCALE MODELS OF HELICOPTERS AND ROTORCRAFTS; CHRISTMAS TREE DECORATIONS, IN CLASS 28 (U.S. CLS. 22, 23, 38 AND 50).

FOR: BUILDING CONSTRUCTION; REPAIR, INSTALLATION AND MAINTENANCE OF AIRCRAFTS, HELICOPTERS, ROTORCRAFT AND STRUCTURAL PARTS THEREFOR; CONSTRUCTION, MAINTENANCE, SERVICING AND REPAIR OF AERONAUTIC AIRCRAFTS, HELICOPTERS AND ROTORCRAFTS AND HELICOPTER AND ROTORCRAFT FLIGHT SIMULATORS; INSTALLATION, REPAIR AND MAINTENANCE OF TELECOMMUNICATIONS MACHINES AND APPARATUS, COMPUTER HARDWARE, APPARATUS FOR RECORDING, TRANSMISSION, PROCESSING AND REPRODUCTION OF SOUND, IMAGES OR DATA, CAMERAS, SURVEYING INSTRUMENTS, CINEMATOGRAPHIC MACHINES AND APPARATUS, OPTICAL INSPECTION APPARATUS, WEIGHING MACHINES, INSTRUMENTS FOR MEASURING LENGTH, SIGNAL PROCESSORS AND LIFE-SAVING RAFTS; MAINTENANCE AND REPAIR OF FLEETS OF HELICOPTERS AND ROTORCRAFTS AND INSTALLATION AND TECHNICAL UPDATING OF COMPUTER HARDWARE ASSOCIATED THEREWITH TO SATISFY THE REQUIREMENTS OF NATIONAL, FOREIGN, CIVILIAN, MILITARY, LEGISLATORIAL AND REGULATORY PROVISIONS, IN CLASS 37 (U.S. CLS. 100, 103 AND 106).

FOR: EDUCATIONAL AND ENTERTAINMENT SERVICES, NAMELY, CONDUCTING CLASSES, SEMINARS AND TRAINING PROGRAMS IN THE FIELD OF AERONAUTICS, AIRCRAFT, HELICOPTERS AND ROTORCRAFT; PROVIDING TRAINING AND ADVANCED TECHNICAL AND SCIENTIFIC TRAINING FOR HELICOPTER PILOTS; PROVIDING TECHNICAL TRAINING AND ADVANCED TECHNICAL TRAINING IN THE FIELD OF PILOTING AND MAINTENANCE OF APPARATUS FOR LOCOMOTION BY AIR, AND IN PARTICULAR HELICOPTERS; PROVIDING TECHNICAL TRAINING AND ADVANCED TECHNICAL TRAINING IN THE FIELD OF COMPUTERS AND THE USE OF COMPUTER PROGRAMS; PROVIDING TECHNICAL TRAINING AND ADVANCED TECHNICAL TRAINING FOR INDIVIDUALS AND CUSTOMERS IN THE FIELD OF AERONAUTICS, AIRCRAFT, HELICOPTERS AND ROTORCRAFT; TRAINING SERVICES IN THE FIELD OF AERONAUTICS, AIRCRAFT, HELICOPTERS AND ROTORCRAFT USING AIRCRAFT, HELICOPTER AND ROTORCRAFT FLIGHT SIMULATORS; PRODUCTION OF VIDEO AND COMPUTER GAME SOFTWARE; PRODUCTION OF CDS, DVDS AND MAGNETIC VIDEOTAPES FEATURING FLIGHT INSTRUCTION; PRODUCTION OF FILMS FOR AIRCRAFT, HELICOPTER AND ROTORCRAFT FLIGHT SIMULATORS, IN CLASS 41 (U.S. CLS. 100, 101 AND 107).

PRIORITY CLAIMED UNDER SEC. 44(D) ON ERPN CMNTY TM OFC APPLICATION NO. 9378068, FILED 9-15-2010, REG. NO. 9378068, DATED 2-28-2011, EXPIRES 9-15-2020.

OWNER OF U.S. REG. NOS. 1,856,692, 2,915,482 AND OTHERS.

THE MARK CONSISTS OF A STYLIZED HELICOPTER DESIGN CONTAINED WITHIN A SPHERE FOLLOWED BY THE WORD "EUROCOPTER" IN STYLIZED CAPITAL LETTERS.

SER. NO. 85-186,334, FILED 11-29-2010.

**Reg. No. 4,123,964** DAVID YONTEF, EXAMINING ATTORNEY



# United States of America

United States Patent and Trademark Office

# Don Chaos

**Reg. No. 4,123,965**

**Registered Apr. 10, 2012**

**Int. Cl.: 9**

**TRADEMARK**

**PRINCIPAL REGISTER**

TADIAN, JOSHUA ABEL (UNITED STATES INDIVIDUAL)  
1005 E LAS TUNAS  
#103  
SAN GABRIEL, CA 91776

FOR: AUDIO AND VIDEO RECORDINGS FEATURING MUSIC AND ARTISTIC PERFORMANCES, IN CLASS 9 (U.S. CLS. 21, 23, 26, 36 AND 38).

FIRST USE 1-1-2010; IN COMMERCE 11-21-2010.

THE MARK CONSISTS OF STANDARD CHARACTERS WITHOUT CLAIM TO ANY PARTICULAR FONT, STYLE, SIZE, OR COLOR.

THE NAME(S), PORTRAIT(S), AND/OR SIGNATURE(S) SHOWN IN THE MARK IDENTIFIES JOSHUA ABEL TADIAN, WHOSE CONSENT(S) TO REGISTER IS MADE OF RECORD.

SER. NO. 85-186,404, FILED 11-29-2010.

NAAKWAMA ANKRAH, EXAMINING ATTORNEY



*David J. Kyffers*

Director of the United States Patent and Trademark Office

# United States of America

United States Patent and Trademark Office

# POLLEN

**Reg. No. 4,123,966**

POLLEN MUSIC GROUP (CALIFORNIA PARTNERSHIP)  
1583 SANCHEZ ST.

**Registered Apr. 10, 2012**

SAN FRANCISCO, CA 94131

**Int. Cl.: 41**

FOR: MUSIC COMPOSITION FOR OTHERS; MUSIC PRODUCTION SERVICES; MUSIC SELECTION SERVICES FOR USE IN TELEVISION, FILM, RADIO AND VIDEO GAMES, IN CLASS 41 (U.S. CLS. 100, 101 AND 107).

**SERVICE MARK**

FIRST USE 5-25-2010; IN COMMERCE 5-25-2010.

**PRINCIPAL REGISTER**

THE MARK CONSISTS OF STANDARD CHARACTERS WITHOUT CLAIM TO ANY PARTICULAR FONT, STYLE, SIZE, OR COLOR.

SER. NO. 85-187,354, FILED 11-30-2010.

NATALIE POLZER, EXAMINING ATTORNEY



*David J. Kybas*

Director of the United States Patent and Trademark Office

# United States of America

United States Patent and Trademark Office

## An Established Tradition of Medical Excellence

**Reg. No. 4,123,967**

**Registered Apr. 10, 2012**

**Int. Cl.: 44**

**SERVICE MARK**

**PRINCIPAL REGISTER**

BURRELL H. WOLK, M.D. (ARIZONA CORPORATION), DBA SKIN AND CANCER CENTER  
OF ARIZONA  
725 S. DOBSON RD., STE. 200  
725 S. DOBSON RD., STE. 200  
CHANDLER, AZ 85224

FOR: MEDICAL SKIN CARE SERVICES, IN CLASS 44 (U.S. CLS. 100 AND 101).

FIRST USE 10-1-1987; IN COMMERCE 10-1-1987.

THE MARK CONSISTS OF STANDARD CHARACTERS WITHOUT CLAIM TO ANY PARTICULAR FONT, STYLE, SIZE, OR COLOR.

SER. NO. 85-187,973, FILED 12-1-2010.

WILLIAM BRECKENFELD, EXAMINING ATTORNEY



*David J. Kyffers*

Director of the United States Patent and Trademark Office

# United States of America

United States Patent and Trademark Office

# PIXI

**Reg. No. 4,123,968**

**Registered Apr. 10, 2012**

**Int. Cl.: 10**

**TRADEMARK**

**PRINCIPAL REGISTER**

RESMED LIMITED (AUSTRALIA CORPORATION)  
1 ELIZABETH MACARTHUR DRIVE  
BELLA VISTA NSW 2153, AUSTRALIA

FOR: MEDICAL DEVICES FOR THE TREATMENT OF RESPIRATORY DISORDERS, NAMELY, MEDICAL RESPIRATORY MASKS INCLUDING NASAL MASKS, FULL FACE MASKS, ORO-NASAL MASKS AND NASAL PILLOWS, NASAL CANNULAE, NASAL PRONGS, CUSHIONS FOR MEDICAL RESPIRATORY MASKS; HEADGEAR FOR MEDICAL RESPIRATORY MASKS, AND PARTS AND FITTINGS THEREFOR FOR ALL THE FOREGOING, IN CLASS 10 (U.S. CLS. 26, 39 AND 44).

THE MARK CONSISTS OF STANDARD CHARACTERS WITHOUT CLAIM TO ANY PARTICULAR FONT, STYLE, SIZE, OR COLOR.

OWNER OF AUSTRALIA REG. NO. 1365535, DATED 6-8-2010, EXPIRES 6-8-2020.

SER. NO. 85-189,180, FILED 12-2-2010.

PAUL MORENO, EXAMINING ATTORNEY



*David J. Kyffers*

Director of the United States Patent and Trademark Office

# United States of America

United States Patent and Trademark Office

## NATURE'S PATH

**Reg. No. 4,123,969**

NATURE'S PATH FOODS INC. (CANADA CORPORATION)  
9100 VAN HORNE WAY

**Registered Apr. 10, 2012**

RICHMOND, BC, CANADA V6X1W3

**Int. Cls.: 8, 9, 16, 18, 21,  
25, 28, 36 and 44**

FOR: SPOONS , IN CLASS 8 (U.S. CLS. 23, 28 AND 44).

FIRST USE 12-31-2006; IN COMMERCE 12-31-2006.

**TRADEMARK**

FOR: BLANK USB FLASH DRIVES, IN CLASS 9 (U.S. CLS. 21, 23, 26, 36 AND 38).

**SERVICE MARK**

FIRST USE 12-31-2008; IN COMMERCE 12-31-2008.

**PRINCIPAL REGISTER**

FOR: PENS, PADFOLIOS, PRINTED PRODUCTS, NAMELY, LISTS FEATURING SHOPPING; NOTEBOOKS, BOOKMARKS; COUPONS; POSTERS; NEWSLETTERS IN THE FIELD OF NUTRITION AND ORGANIC FOOD, CALENDARS; FACT SHEETS AND BOOKLETS CONCERNING NUTRITION, CATALOGUES IN THE FIELD OF NUTRITION AND ORGANIC FOOD; RECIPE PAMPHLETS, IN CLASS 16 (U.S. CLS. 2, 5, 22, 23, 29, 37, 38 AND 50).

FIRST USE 12-31-2007; IN COMMERCE 12-31-2007.

FOR: REUSABLE SHOPPING BAGS, IN CLASS 18 (U.S. CLS. 1, 2, 3, 22 AND 41).

FIRST USE 12-31-2008; IN COMMERCE 12-31-2008.

FOR: FREEZER GLOVES; BOWLS; ALUMINUM WATER BOTTLES SOLD EMPTY, IN CLASS 21 (U.S. CLS. 2, 13, 23, 29, 30, 33, 40 AND 50).

FIRST USE 12-31-2002; IN COMMERCE 12-31-2002.

FOR: T-SHIRTS; HATS; SWEATSHIRTS; JACKETS; APRONS , IN CLASS 25 (U.S. CLS. 22 AND 39).

FIRST USE 12-31-1999; IN COMMERCE 12-31-1999.

FOR: GOLF BALLS, GOLF TEES, IN CLASS 28 (U.S. CLS. 22, 23, 38 AND 50).

FIRST USE 12-31-2002; IN COMMERCE 12-31-2002.

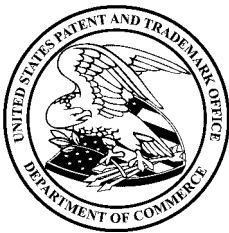

*David J. Kyjars*

Director of the United States Patent and Trademark Office

**Reg. No. 4,123,969** FOR: FINANCIAL SPONSORSHIP OF THE CHARITABLE, ENVIRONMENTAL, ATHLETIC AND LIFESTYLE-ORIENTED EVENTS OF OTHERS; FINANCIAL SPONSORSHIP OF ATHLETES OR TEAMS AT SPORTING OR ATHLETIC EVENTS, IN CLASS 36 (U.S. CLS. 100, 101 AND 102).

FIRST USE 12-31-1986; IN COMMERCE 12-31-1986.

FOR: PROVIDING INFORMATION TO THE PUBLIC REGARDING HEALTHY LIVING, NUTRITION AND ORGANIC FOOD, BY RADIO, TELEVISION, AND INTERNET, IN CLASS 44 (U.S. CLS. 100 AND 101).

FIRST USE 12-31-1985; IN COMMERCE 12-31-1985.

THE MARK CONSISTS OF STANDARD CHARACTERS WITHOUT CLAIM TO ANY PARTICULAR FONT, STYLE, SIZE, OR COLOR.

PRIORITY CLAIMED UNDER SEC. 44(D) ON CANADA APPLICATION NO. 1487118, FILED 6-30-2010, REG. NO. TMA806395, DATED 9-12-2011, EXPIRES 9-12-2026.

SER. NO. 85-189,287, FILED 12-2-2010.

MICHAEL ENGEL, EXAMINING ATTORNEY

# United States of America

United States Patent and Trademark Office

## GOLD & SILVER PAWN

**Reg. No. 4,123,970**

GOLD AND SILVER COIN SHOP, INC. (NEVADA CORPORATION)  
713 LAS VEGAS BLVD. SOUTH  
LAS VEGAS, NV 89101

**Registered Apr. 10, 2012**

**Int. Cl.: 36**

FOR: FINANCING AND LOAN SERVICES; PAWN BROKERAGE; PAWN SHOPS;  
PROVIDING TEMPORARY LOANS, IN CLASS 36 (U.S. CLS. 100, 101 AND 102).

**SERVICE MARK**

FIRST USE 8-1-1988; IN COMMERCE 8-1-1988.

**PRINCIPAL REGISTER**

THE MARK CONSISTS OF STANDARD CHARACTERS WITHOUT CLAIM TO ANY PARTICULAR FONT, STYLE, SIZE, OR COLOR.

NO CLAIM IS MADE TO THE EXCLUSIVE RIGHT TO USE "PAWN", APART FROM THE MARK AS SHOWN.

SEC. 2(F).

SER. NO. 85-189,466, FILED 12-2-2010.

ANNE E. GUSTASON, EXAMINING ATTORNEY



*David J. Kybas*

Director of the United States Patent and Trademark Office

# United States of America

United States Patent and Trademark Office



**Reg. No. 4,123,971**

DESIGNATED DRIVERS OF BUFFALO (NEW YORK CORPORATION)  
300 INTERNATIONAL DRIVE  
WILLIAMSVILLE, NY 14221

**Registered Apr. 10, 2012**

**Int. Cl.: 39**

FOR: TAXI TRANSPORT, IN CLASS 39 (U.S. CLS. 100 AND 105).

**SERVICE MARK**

FIRST USE 3-31-2010; IN COMMERCE 3-31-2010.

**PRINCIPAL REGISTER**

NO CLAIM IS MADE TO THE EXCLUSIVE RIGHT TO USE "AMERICA", APART FROM THE MARK AS SHOWN.

THE COLOR(S) DARK BLUE, RED, BLACK AND WHITE IS/ARE CLAIMED AS A FEATURE OF THE MARK.

THE MARK CONSISTS OF THE WORDS "DESIGNATED DRIVERS ACROSS AMERICA" IN BLOCK LETTERS. THE FIRST LINE READS "DESIGNATED DRIVERS". "DESIGNATED" IS IN DARK BLUE BLOCK LETTERS WITH RED OUTLINE. THE FIRST "D" IN "DESIGNATED" IS CAPITALIZED. THE "I" IN "DESIGNATED" IS DOTTED WITH A RED STAR WITH DARK BLUE OUTLINE. "DRIVERS" IS IN RED BLOCK LETTERS WITH A DARK BLUE OUTLINE. THE "D" IN "DRIVERS" IS CAPITALIZED. THERE IS NO SPACE BETWEEN "DESIGNATED" AND "DRIVERS". THE SECOND LINE CONTAINS THE WORDS "ACROSS AMERICA" IN RED BLOCK LETTERS WITH A DARK BLUE OUTLINE. THE "A" IN "ACROSS" IN THE SECOND LINE IS LOCATED IN LINE TWO UNDER THE "D" IN "DRIVERS". TO RIGHT OF THE TEXT IS A GRAPHIC OF TWO KEYS. THE KEYS ARE CAR KEYS WITH A RING AT THE TOP. THE KEYS ARE ARRANGED IN A SCISSOR-LIKE SHAPE. THE TOP CIRCLE SHAPE OF THE KEYS ARE COLORED IN BLACK. THE ENTIRE KEY GRAPHIC IS BLACK AND WHITE.



SER. NO. 85-189,483, FILED 12-2-2010.

LAKEISHA LEWIS, EXAMINING ATTORNEY

*David J. Kybas*

Director of the United States Patent and Trademark Office



# United States of America

United States Patent and Trademark Office

## THEN AND NOW

**Reg. No. 4,123,972**

ROSE PUBLISHING, INC. (CALIFORNIA CORPORATION)  
4733 TORRANCE BLVD. #259  
TORRANCE, CA 90503

**Registered Apr. 10, 2012**

**Int. Cl.: 16**

FOR: PUBLICATIONS, NAMELY, BOOKS, CHARTS, PAMPHLETS AND MAPS IN THE  
FIELDS OF BIBLE MAPS, IN CLASS 16 (U.S. CLS. 2, 5, 22, 23, 29, 37, 38 AND 50).

**TRADEMARK**

FIRST USE 12-31-1998; IN COMMERCE 12-31-1998.

**PRINCIPAL REGISTER**

THE MARK CONSISTS OF STANDARD CHARACTERS WITHOUT CLAIM TO ANY PAR-  
TICULAR FONT, STYLE, SIZE, OR COLOR.

SER. NO. 85-190,301, FILED 12-3-2010.

ELI HELLMAN, EXAMINING ATTORNEY



*David J. Kybas*

Director of the United States Patent and Trademark Office

# United States of America

United States Patent and Trademark Office

## EARTHLY ELEMENTS

**Reg. No. 4,123,973**

MANNINGTON MILLS, INC. (NEW JERSEY CORPORATION)  
75 MANNINGTON MILLS RD.  
SALEM, NJ 08079

**Registered Apr. 10, 2012**

**Int. Cl.: 19**

FOR: WOOD TILE FLOORS; WOODEN FLOORING, IN CLASS 19 (U.S. CLS. 1, 12, 33 AND 50).

**TRADEMARK**

FIRST USE 2-15-2010; IN COMMERCE 2-15-2010.

**PRINCIPAL REGISTER**

THE MARK CONSISTS OF STANDARD CHARACTERS WITHOUT CLAIM TO ANY PARTICULAR FONT, STYLE, SIZE, OR COLOR.

SER. NO. 85-195,456, FILED 12-10-2010.

VIVIAN MICZNIK FIRST, EXAMINING ATTORNEY



*David J. Kybas*

Director of the United States Patent and Trademark Office

# United States of America

United States Patent and Trademark Office

The 1 is in the middle  
because love is the center  
of everything.

**Reg. No. 4,123,974**

ONE MEANING (NEW YORK PARTNERSHIP)  
321 E 54TH STREET, #10B  
NEW YORK, NY 10022

**Registered Apr. 10, 2012**

**Int. Cl.: 14**

FOR: BRACELETS; BRONZE JEWELRY; BROOCHES; CHARMS; CHARMS FOR COLLAR JEWELRY AND BRACELET; COSTUME JEWELRY; DIAMOND JEWELRY; GEMSTONE JEWELRY; IDENTIFICATION BRACELETS; JEWELRY; JEWELRY AND IMITATION JEWELRY; JEWELRY, NAMELY, NECKLACES; JEWELRY, NAMELY, ARM CUFFS; JEWELRY, NAMELY, DOG TAGS FOR WEAR BY HUMANS FOR DECORATIVE PURPOSES; PET JEWELRY; PLASTIC BRACELETS IN THE NATURE OF JEWELRY; RINGS; STAINLESS STEEL JEWELRY BRACELETS; WOMEN'S JEWELRY, IN CLASS 14 (U.S. CLS. 2, 27, 28 AND 50).

**TRADEMARK**

**PRINCIPAL REGISTER**

FIRST USE 10-1-2008; IN COMMERCE 12-30-2008.

THE MARK CONSISTS OF STANDARD CHARACTERS WITHOUT CLAIM TO ANY PARTICULAR FONT, STYLE, SIZE, OR COLOR.

SER. NO. 85-195,786, FILED 12-11-2010.

INGA ERVIN, EXAMINING ATTORNEY



*David J. Kypos*

Director of the United States Patent and Trademark Office

# United States of America

United States Patent and Trademark Office

813 MEANS I LOVE YOU. 8  
LETTERS, 3 WORDS, 1  
MEANING. THE 1 IS IN THE  
MIDDLE BECAUSE LOVE IS THE  
CENTER OF EVERYTHING.

**Reg. No. 4,123,975**

**Registered Apr. 10, 2012**

**Int. Cl.: 14**

**TRADEMARK**

**PRINCIPAL REGISTER**

ONE MEANING (NEW YORK PARTNERSHIP)  
321 E. 54TH STREET  
APT. 10B  
NEW YORK, NY 10022

FOR: BEADS FOR USE IN THE MANUFACTURE OF JEWELRY; BODY JEWELRY; BRACELETS; BRACELETS AND JEWELRY FEATURING ELECTRONIC CHIPS FOR ATTRACTING ENERGY TO THE BODY WHEREIN THE ELECTRONIC CHIPS INCREASE IN POWER IN THE PRESENCE OF ELECTROMAGNETIC FIELDS, FOR THE PURPOSE OF RE-BALANCING THE HUMAN ENERGY FIELD; BROACHES; BRONZE JEWELRY; BROOCHES; CAMEOS; CHARMS; CHARMS FOR COLLAR JEWELRY AND BRACELET; COSTUME JEWELRY; DIAMOND JEWELRY; GEMSTONE JEWELRY; GOLD THREAD JEWELRY; HAIR JEWELRY IN THE NATURE OF JEWELRY FOR USE IN THE HAIR; IDENTIFICATION BRACELETS; INEXPENSIVE NON-JEWELRY WATCHES; JEWELRY; JEWELRY AND IMITATION JEWELRY; JEWELRY ARMOIRES; JEWELRY BOXES; JEWELRY BOXES NOT OF METAL; JEWELRY BOXES OF METAL; JEWELRY BOXES OF PRECIOUS METAL; JEWELRY BROOCHES; JEWELRY CASES; JEWELRY CASES NOT OF PRECIOUS METAL; JEWELRY CASES OF PRECIOUS METAL; JEWELRY CASKETS; JEWELRY CASKETS OF PRECIOUS METAL; JEWELRY CHAINS; JEWELRY FINDINGS; JEWELRY FOR ATTACHMENT TO CLOTHING; JEWELRY FOR THE HEAD; JEWELRY IN THE NATURE OF ARMBANDS; JEWELRY INCORPORATING A COMPUTER STORAGE DEVICE CONTAINING MEDICAL INFORMATION FOR MEDICAL ALERT PURPOSES; JEWELRY MAKING KITS; JEWELRY ORGANIZERS; JEWELRY PINS FOR USE ON HATS; JEWELRY RING HOLDERS; JEWELRY STICKPINS; JEWELRY THAT FITS OVER THE FRONT TEETH; JEWELRY THAT INCORPORATES TECHNOLOGY FOR REBALANCING THE HUMAN ENERGY FIELD; JEWELRY TO BE AFFIXED TO BIKINIS; JEWELRY WATCHES; JEWELRY, NAMELY, AMULETS; JEWELRY, NAMELY, ANKLETS; JEWELRY, NAMELY, ARM CUFFS; JEWELRY, NAMELY, BRACELETS, WRISTBANDS AND NECKLACES THAT ALSO PROVIDES NOTIFICATION TO THE WEARER OF A PENDING MEDICAL RELATED TASK; JEWELRY, NAMELY, CROSSES; JEWELRY, NAMELY, DOG TAGS FOR WEAR BY HUMANS FOR DECORATIVE PURPOSES; JEWELRY, NAMELY, MAGNETIC NECKLACES; JEWELRY, NAMELY, MAGNETIC PENDANTS; JEWELRY, NAMELY, PRECIOUS METAL PLATED REAL LEAVES AND FLOWERS; JEWELRY, NAMELY, STONE PENDANTS; LAPEL PINS; LEATHER JEWELRY AND ACCESSORY BOXES; METAL WIRE FOR USE IN THE MAKING OF JEWELRY, NAMELY, JEWELRY CABLE; PET JEWELRY; PINS BEING JEWELRY; PLASTIC BRACELETS IN THE NATURE OF JEWELRY; PRECIOUS AND SEMI-PRECIOUS CRYSTAL STONES AND BEADS FOR USE IN JEWELRY; RINGS;



*David J. Kappas*

Director of the United States Patent and Trademark Office

**Reg. No. 4,123,975** RINGS BEING JEWELRY; STAINLESS STEEL JEWELRY BRACELETS; WATCHES AND JEWELRY; WATCHES, CLOCKS, JEWELRY AND IMITATION JEWELRY; WOMEN'S JEWELRY, IN CLASS 14 (U.S. CLS. 2, 27, 28 AND 50).

FIRST USE 8-1-2008; IN COMMERCE 12-30-2008.

THE MARK CONSISTS OF STANDARD CHARACTERS WITHOUT CLAIM TO ANY PARTICULAR FONT, STYLE, SIZE, OR COLOR.

SER. NO. 85-195,985, FILED 12-12-2010.

INGA ERVIN, EXAMINING ATTORNEY

# United States of America

United States Patent and Trademark Office

# ECOTREC

**Reg. No. 4,123,976**

**Registered Apr. 10, 2012**

**Int. Cls.: 7, 37, 40 and 42**

**TRADEMARK**

**SERVICE MARK**

**PRINCIPAL REGISTER**

PALLMANN MASCHINENFABRIK GMBH & CO. KG (FED REP GERMANY CORPORATION)  
WOLFSLOCHSTRASSE 51  
ZWEIBRUECKEN, FED REP GERMANY 66482

FOR: MACHINES AND MECHANICAL APPARATUS FOR MECHANICAL PROCESS ENGINEERING AND INSTALLATIONS CONSTRUCTED FROM THE AFORESAID GOODS, NAMELY, CRUSHERS, IMPACT MILLS, BREAKERS, PULVERIZERS, MIXERS AND BLENDERS AND PARTS THEREFOR, FOR INDUSTRIAL AND COMMERCIAL APPLICATIONS; MACHINES AND MACHINE ELEMENTS FOR THE RECYCLING, CRUSHING, PULPING, SEPARATING AND GRANULATING OF MATERIALS, NAMELY, CRUSHERS, BREAKERS, SHREDDERS, SINGLE-SHAFT SHREDDERS, DOUBLE-SHAFT SHREDDERS, MULTI-SHAFT SHREDDERS, WOOD CHIPPING MACHINES, DRUM WOOD CHIPPING MACHINES, SCRAP SHEARS, INDUSTRIAL MACHINE PRESSES FOR SCRAPS, VERTICAL CRUSHERS, MILLING CUTTERS IN THE NATURE OF GUILLOTINES FOR LINEAR CUTTING OF MATERIAL, DRUM SHREDDERS, BALE BREAKERS, IMPACT MILLS AS MACHINES, WING BEATER MILLS, VORTEX MILLS, TURBO MILLS, TOOTHED DISC MILLS, BARK SHREDDERS, PULPING MILLS, PRECISION MILLS, PULVERISING MILLS, KNIFE MILLS IN ALL SIZES AND FOR ALL TASKS, KNIFE MILLS, HAMMER MILLS, IMPACT HAMMER MILLS, IMPELLER BREAKER MILLS, BEATER PLATE MILLS, PIN MILLS, UNIVERSAL MILLS, JET MILLS, BALL MILLS, DOUBLE STREAM MILLS, COUNTER-JET MILLS, WET-GRINDING MILLS, PULP REFINING MACHINES, REFINER PULPING MACHINES, WOOD CHIPPING MACHINES; MACHINES AND MACHINE ELEMENTS FOR THE CONVEYING AND DOSING OF MATERIALS, NAMELY, MACHINES FOR CONVEYING SOLIDS, WASTE MATERIAL CONVEYING MACHINES; BLOWERS FOR PNEUMATIC FEEDERS FOR MACHINES USED IN MECHANICAL PROCESS ENGINEERING, PLATE CONVEYORS, LIVE BOTTOM CONVEYORS, BELT CONVEYORS, BUCKET ELEVATORS, TUBULAR CHAIN CONVEYORS, LOADING CONVEYORS, VIBRATING TROUGHS AS PART OF MACHINES, VIBRATING CONVEYOR TROUGHS, DRAG CHAIN CONVEYORS, CONVEYING AND METERING SCREW CONVEYORS, GATES AS A MECHANICAL APPARATUS FOR FEEDING OR DISCHARGING OF MATERIAL TO MACHINES, NAMELY, ASSEMBLY LINE CONVEYOR MACHINERY, VALVES AS MACHINE COMPONENTS; MECHANICAL BUCKET WHEEL DISCHARGING HOPPERS; MACHINES AND MACHINE ELEMENTS FOR THE SEPARATION, CLASSIFYING AND ELIMINATION OF MATERIALS, NAMELY, MACHINES FOR SEPARATING TARGET MATERIALS FROM MIXTURES OF MATERIALS, MACHINES FOR SEPARATING RECYCLABLE MATERIALS, CENTRIFUGAL SEPARATORS FOR SEPARATING TARGET MATERIALS FROM MIXTURES OF MATERIALS, MACHINES FOR SEPARATING RECYCLABLE MATERIALS, DYNAMIC AND



*David J. Kypos*

Director of the United States Patent and Trademark Office

**Reg. No. 4,123,976** STATIC PNEUMATIC SEPARATORS FOR SEPARATING TARGET MATERIALS FROM MIXTURES OF MATERIALS AND FOR SEPARATING RECYCLABLE MATERIALS, CROSS-FLOW SEPARATORS FOR SEPARATING TARGET MATERIALS FROM MIXTURES OF MATERIALS AND FOR SEPARATING RECYCLABLE MATERIALS, CENTRIFUGAL SEPARATORS FOR SEPARATING TARGET MATERIALS FROM MIXTURES OF MATERIALS AND FOR SEPARATING RECYCLABLE MATERIALS, BASKET CLASSIFIER SORTING MACHINES FOR BULK SOLIDS, REVERSE CLASSIFIER SORTING MACHINES FOR BULK SOLIDS, CASCADE CLASSIFIERS SORTING MACHINES FOR BULK SOLIDS, ZIGZAG CLASSIFIER SORTING MACHINES FOR BULK SOLIDS, HEAVY PARTICLE CLASSIFIER SORTING MACHINES FOR BULK SOLIDS, MACHINES FOR SEPARATING IN THE NATURE OF SIFTING MACHINES, VACUUM SIFTERS, VIBRATING SIFTERS, DRUM SIFTERS, OSCILLATING SIFTERS, FLAT SIFTERS, VORTEX SIFTERS, TUMBLER SIFTERS, ROLLER SEPARATORS FOR SEPARATING MAGNETIC MATERIALS, FILTERS FOR INDUSTRIAL MACHINE PARTS, HOSE FILTERS FOR INDUSTRIAL MACHINE PARTS, CARTRIDGE FILTERS FOR INDUSTRIAL MACHINE PARTS, BAG FILTERS FOR INDUSTRIAL MACHINE PARTS, CYCLONES AS MACHINE PARTS, MAGNETIC DRUMS AS MACHINE PARTS, MAGNETIC ROLLERS AS MACHINE PARTS, MAGNETIC GRATES AS MACHINE PARTS, OVER-BELT MAGNETIC SEPARATORS AS MACHINE PARTS, INDUCTION SEPARATORS AS MACHINE PARTS, METAL SENSOR COILS AS MACHINE PARTS; MACHINES AND MACHINE ELEMENTS FOR MIXING MATERIALS, NAMELY, AGITATORS FOR CIRCULATING LIQUID MEDIA AND BULK MATERIALS, TUMBLING MIXERS, CONICAL MIXERS, BATCH MIXERS, SCREW MIXERS ALL FOR INDUSTRIAL AND COMMERCIAL APPLICATIONS; MACHINES FOR USE IN THE WOOD-PROCESSING INDUSTRY AND RUBBER AND POLYMER INDUSTRY MANUFACTURING FOR COMPRESSING, COMPACTING, AGGLOMERATING, COMPOUNDING AND COATING MATERIALS, NAMELY, EXTRUDERS, AGGLOMERATORS, HEATING AND COOLING MIXERS, COMPACTORS, PAPER CALENDARING MACHINES, PELLETISERS, BRIQUETTING MACHINES, PELLET MILLS, WET COMPRESSORS FOR MACHINES, SCREW COMPRESSORS FOR MACHINES, INDUSTRIAL DOUBLE-BAND MACHINE PRESSES; MACHINES FOR CONDITIONING MATERIALS, IN PARTICULAR FOR DRYING OR HUMIDIFYING MATERIALS, NAMELY, FLUIDISED-BED AIR DRYERS, DRUM DRYERS, SPIRAL COOLERS, NAMELY, AIR-COOLED CONDENSERS; ALL THE AFORESAID GOODS FOR THE PROCESSING OF PIECE GOODS AND BULK GOODS, IN PARTICULAR PLASTICS AND PLASTICS WITH ADDITIVES, WOOD, WASTE WOOD, PAPER, CARDBOARD, CELLULOSE, TEXTILES, WASTE, GUM, RUBBER, RESINS, LEATHER, FOODSTUFFS, NATURAL STIMULANTS AND FOODSTUFFS FOR ANIMALS, MINERALS, METALS, COMPOSITE MATERIALS, ELECTRONIC SCRAP, CABLES, ALUMINIUM SCRAP, SLAG, LIGHT SHREDDER FRACTIONS, SCRAP TYRES, AND USED TYRES, IN CLASS 7 (U.S. CLS. 13, 19, 21, 23, 31, 34 AND 35).

FOR: INSTALLATION, MAINTENANCE AND REPAIR SERVICES FOR MACHINES; RENTAL OF MACHINERY, IN CLASS 37 (U.S. CLS. 100, 103 AND 106).

FOR: PROCESSING TREATMENT OF MATERIALS, NAMELY, CRUSHING, CHOPPING, CHIPPING, DEFIBERING, GRINDING, CRYOGENIC GRINDING, PRECISION GRINDING, MIXING, COATING, PELLETISING, COMPOUNDING, COMPACTING, GRANULATING AND AGGLOMERATING, BEING SERVICES, FOR OTHERS, IN CLASS 40 (U.S. CLS. 100, 103 AND 106).

FOR: ENGINEERING SERVICES IN THE NATURE OF TECHNICAL PROJECT PLANNING AND DESIGN OF MACHINES AND INSTALLATIONS FOR MECHANICAL PROCESS ENGINEERING; ENGINEERING IN CONNECTION WITH THE AFORESAID SERVICES, IN CLASS 42 (U.S. CLS. 100 AND 101).

THE MARK CONSISTS OF STANDARD CHARACTERS WITHOUT CLAIM TO ANY PARTICULAR FONT, STYLE, SIZE, OR COLOR.

PRIORITY CLAIMED UNDER SEC. 44(D) ON ERPN CMNTY TM OFC APPLICATION NO. 009296484, FILED 7-20-2010, REG. NO. 009296484, DATED 1-14-2011, EXPIRES 7-20-2020.

**Reg. No. 4,123,976** SER. NO. 85-196,640, FILED 12-13-2010.

CARYN GLASSER, EXAMINING ATTORNEY



# United States of America

United States Patent and Trademark Office



**Reg. No. 4,123,977**

ITC LIMITED (INDIA CORPORATION)  
37 J.L. NEHRU ROAD  
KOLKATA, INDIA 700071

**Registered Apr. 10, 2012**

**Int. Cl.: 34**

FOR: CIGARETTES, IN CLASS 34 (U.S. CLS. 2, 8, 9 AND 17).

**TRADEMARK**

OWNER OF INDIA REG. NO. 1355296, DATED 5-5-2005, EXPIRES 5-5-2015.

**PRINCIPAL REGISTER**

NO CLAIM IS MADE TO THE EXCLUSIVE RIGHT TO USE "KINGS", APART FROM THE MARK AS SHOWN.

THE NAME(S), PORTRAIT(S), AND/OR SIGNATURE(S) SHOWN IN THE MARK DOES NOT IDENTIFY A PARTICULAR LIVING INDIVIDUAL.

THE MARK CONSISTS OF THE WORDS "HONEYDEW SMOOTH" SET FORTH IN UPPERCASE LETTERING ON A DARK RECTANGULAR BAR, WHICH APPEARS BENEATH A STYLIZED OVERLAPPED EIGHT-POINT STAR DESIGN; THE FOREGOING IS SET FORTH ABOVE A BACKGROUND DESIGN COMPRISED OF 13 THIN VERTICAL BARS; A STYLIZED BANNER/EMBLEM GRAPHIC IS SUPERIMPOSED ON THE FOREGOING BAR DESIGN; THE WORDING "W.D. & H.O. WILLS" APPEARS IN UPPERCASE LETTERING WITHIN THE UPPER CURVE OF THE EMBLEM GRAPHIC AND THE WORDING "HONEY DEW". APPEARS IN UPPERCASE LETTERING WITHIN THE LOWER CURVE OF THE EMBLEM GRAPHIC; THE WORDS "GOLD FLAKE" APPEARS IN UPPERCASE LETTERING ON A RECTANGULAR BACKGROUND ACROSS THE EMBLEM GRAPHIC; THE WORD "KINGS" APPEARS IN SCRIPT LETTERING BENEATH ALL OF THE FOREGOING.



SER. NO. 85-197,557, FILED 12-14-2010.

JAMES GRIFFIN, EXAMINING ATTORNEY

*David J. Kybas*

Director of the United States Patent and Trademark Office

# United States of America

United States Patent and Trademark Office



# TATONKA

**Reg. No. 4,123,978**

**Registered Apr. 10, 2012**

**Int. Cls.: 5, 9, 18 and 25**

**TRADEMARK**

**PRINCIPAL REGISTER**

TATONKA GMBH QUALITAETS AUSTRUSTUNG FUER FREIZEITAKTIVE (FED REP GERMANY LIMITED LIABILITY COMPANY)  
ROBERT-BOSCH-STRASSE 3  
D-86453 DASING, FED REP GERMANY

FOR: FIRST AID KITS, NAMELY, BAGS AND CASES FILLED WITH MEDICAL AND FIRST AID SUPPLIES FOR DOMESTIC OR OTHER NON-PROFESSIONAL USE; PLASTIC BAGS FOR USE AS RAIN COVERS FOR FIRST AID KITS, IN CLASS 5 (U.S. CLS. 6, 18, 44, 46, 51 AND 52).

FOR: BAGS AND CASES FOR COMPUTERS, MOBILE TELEPHONES AND PHOTOGRAPHIC APPARATUS; PLASTIC BAGS FOR USE AS RAIN COVERS FOR COMPUTER BAGS AND CASES, MOBILE PHONE BAGS AND CASES, CASES FOR PHOTOGRAPHIC EQUIPMENT, IN CLASS 9 (U.S. CLS. 21, 23, 26, 36 AND 38).

FOR: GOODS OF LEATHER AND IMITATIONS OF LEATHER AND TEXTILE MATERIAL, NAMELY, BEACH BAGS, TOTE BAGS, PURSES, POCKET WALLETS, KEY WALLETS, TRUNKS AND TRAVELING BAGS, HANDBAGS, BRIEFCASES, REUSABLE SHOPPING BAGS, SCHOOL SATCHELS, SPORTS BAGS AND LEISURE ALL-PURPOSE CARRYING BAGS, TRAVELING BAGS, CASES FOR CREDIT CARDS, TRAVELING KNAPSACKS, BACKPACKS, RUCKSACKS, TRAVELING SETS COMPRISED OF TRAVEL CASES AND LUGGAGE; SMALL LEATHER GOODS, NAMELY, BUSINESS CARD CASES AND CALLING CARD CASES; PLASTIC BAGS FOR USE AS RAIN COVERS FOR PURSES, POCKET WALLETS, KEY WALLETS, TRUNKS, TRAVELING BAGS, HANDBAGS, BRIEFCASES, SCHOOL SATCHELS, SPORTS BAGS, BACKPACKS AND RUCKSACKS, IN CLASS 18 (U.S. CLS. 1, 2, 3, 22 AND 41).

FOR: CLOTHING, NAMELY, T-SHIRTS, SHORTS, JEANS AND SOCKS; TRAVEL CLOTHING; FUNCTIONAL CLOTHING, NAMELY, HEADWEAR, JEANS, JACKETS AND GLOVES; LEISUREWEAR, NAMELY, TRACK SUITS, SWEATPANTS, SWEAT SHIRTS AND SHORTS; SPORTSWEAR, NAMELY, SHORTS, SPORTS BRAS, ATHLETIC SHOES AND SPORTS JERSEYS; OUTER CLOTHING, NAMELY, TROUSERS, SHIRTS, BLOUSES, JACKETS, COATS, T-SHIRTS AND POLO SHIRTS; WEATHER-RESISTANT AND CLIMATE RESISTANT OUTER CLOTHING, NAMELY, ANORAKS, PARKAS, MUKLUKS, RAIN BOOTS, RAIN HATS AND RAIN SLICKERS; UNDERWEAR; UNDERGARMENTS; SWEAT-ABSORBENT AND SWEAT RESISTANT UNDERGARMENTS; SPORTS UNDERGARMENTS; THERMAL UNDERGARMENTS; PONCHOS; FOOTWEAR; SPORT SHOES; CASUAL FOOTWEAR;



*David J. Kybas*

Director of the United States Patent and Trademark Office

**Reg. No. 4,123,978** HIKING SHOES AND BOOTS; MOUNTAINEERING SHOES AND BOOTS; SLIPPERS SANDALS, IN CLASS 25 (U.S. CLS. 22 AND 39).

OWNER OF ERPN CMNTY TM OFC REG. NO. 009052713, DATED 11-8-2010, EXPIRES 4-23-2020.

THE MARK CONSISTS OF THE LETTERS "TATONKA" WITH AN ARC APPEARING ABOVE A BUFFALO DESIGN CONNECTING THE LETTERS "T" AND "N" AND THE "O" IN THE MARK IN THE SHAPE OF A BUFFALO.

SER. NO. 85-197,570, FILED 12-14-2010.

AMY C. KEAN, EXAMINING ATTORNEY

# United States of America

United States Patent and Trademark Office

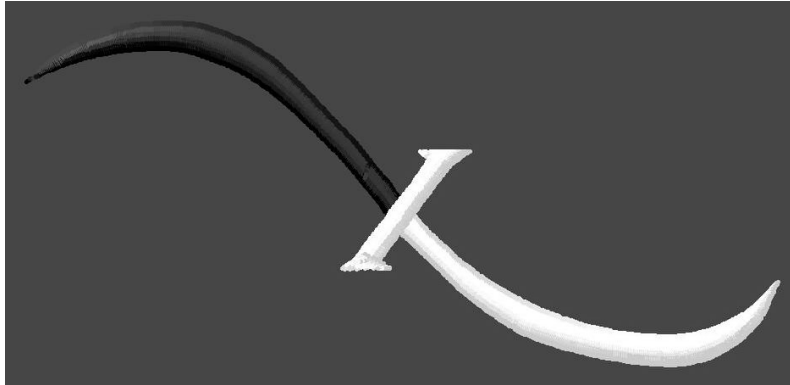

**Reg. No. 4,123,979**

FLEXICORPS, INC. (ILLINOIS CORPORATION)  
1652 E. MAIN STREET, SUITE 150  
ST. CHARLES, IL 60174

**Registered Apr. 10, 2012**

**Int. Cl.: 35**

FOR: CONSULTING SERVICES IN THE FIELD OF HUMAN RESOURCES DEVELOPMENT, NAMELY, FOR THE PROMOTION OF EMPLOYEE RETENTION, CAREER GROWTH, AND INCREASED PRODUCTIVITY FOR EMPLOYEES AND EMPLOYERS; EMPLOYMENT AGENCIES; TEMPORARY EMPLOYMENT AGENCIES; EMPLOYMENT COUNSELING AND RECRUITING; EMPLOYMENT HIRING, RECRUITING, PLACEMENT, STAFFING AND CAREER NETWORKING SERVICES; EMPLOYMENT OUTPLACEMENT SERVICES; EMPLOYMENT VERIFICATION, IN CLASS 35 (U.S. CLS. 100, 101 AND 102).

**SERVICE MARK**

**PRINCIPAL REGISTER**

FIRST USE 12-0-2010; IN COMMERCE 12-0-2010.

THE MARK CONSISTS OF A HIGHLY STYLIZED VERSION OF THE LETTER "X".

SER. NO. 85-197,720, FILED 12-14-2010.

MARK T. MULLEN, EXAMINING ATTORNEY



*David J. Kyffers*

Director of the United States Patent and Trademark Office

# United States of America

United States Patent and Trademark Office

# NRBQ

**Reg. No. 4,123,980**

**Registered Apr. 10, 2012**

**Int. Cls.: 9 and 25**

**TRADEMARK**

**PRINCIPAL REGISTER**

ADAMS, TERRY (UNITED STATES INDIVIDUAL), DBA NRBQ  
PO BOX 60309  
FLORENCE, MA 01062

FOR: AUDIO AND VIDEO RECORDINGS FEATURING MUSIC AND ARTISTIC PERFORMANCES; AUDIO TAPES FEATURING MUSIC; COMPACT DISCS FEATURING MUSIC; DIGITAL MUSIC DOWNLOADABLE FROM THE INTERNET; DOWNLOADABLE VIDEO RECORDINGS FEATURING MUSIC; MUSICAL SOUND RECORDINGS; MUSICAL VIDEO RECORDINGS; PHONOGRAPH RECORDS FEATURING MUSIC; PRERECORDED AUDIO TAPES FEATURING MUSIC; PRERECORDED VIDEO CASSETTES FEATURING MUSIC; PRERECORDED VIDEO TAPES FEATURING MUSIC, IN CLASS 9 (U.S. CLS. 21, 23, 26, 36 AND 38).

FIRST USE 1-1-1966; IN COMMERCE 1-1-1966.

FOR: BASEBALL CAPS AND HATS; HATS FOR INFANTS, BABIES, TODDLERS AND CHILDREN; HEADGEAR, NAMELY, HATS; JACKETS; JERSEYS; TIES; TOPS, IN CLASS 25 (U.S. CLS. 22 AND 39).

FIRST USE 1-1-1966; IN COMMERCE 1-1-1966.

THE MARK CONSISTS OF STANDARD CHARACTERS WITHOUT CLAIM TO ANY PARTICULAR FONT, STYLE, SIZE, OR COLOR.

SER. NO. 85-198,152, FILED 12-15-2010.

KEVON CHISOLM, EXAMINING ATTORNEY



*David J. Kybas*

Director of the United States Patent and Trademark Office

# United States of America

United States Patent and Trademark Office

# Sleepy Baby

**Reg. No. 4,123,981**

BRAINY ACQUISITIONS, INC. (GEORGIA CORPORATION)  
460 BROGDON ROAD, SUITE 400  
SUWANEE, GA 30024

**Registered Apr. 10, 2012**

**Int. Cl.: 9**

FOR: COMPACT DISCS FEATURING MUSIC, IN CLASS 9 (U.S. CLS. 21, 23, 26, 36 AND 38).

**TRADEMARK**

FIRST USE 9-1-2002; IN COMMERCE 9-1-2002.

**PRINCIPAL REGISTER**

THE MARK CONSISTS OF STANDARD CHARACTERS WITHOUT CLAIM TO ANY PARTICULAR FONT, STYLE, SIZE, OR COLOR.

NO CLAIM IS MADE TO THE EXCLUSIVE RIGHT TO USE "BABY", APART FROM THE MARK AS SHOWN.

SER. NO. 85-198,400, FILED 12-15-2010.

RICHARD WHITE, EXAMINING ATTORNEY



*David J. Kybas*

Director of the United States Patent and Trademark Office

# United States of America

United States Patent and Trademark Office

# Playful Baby

**Reg. No. 4,123,982**

BRAINY ACQUISITIONS, INC. (GEORGIA CORPORATION)  
460 BROGDON ROAD, SUITE 400  
SUWANEE, GA 30024

**Registered Apr. 10, 2012**

**Int. Cl.: 9**

FOR: COMPACT DISCS FEATURING MUSIC, IN CLASS 9 (U.S. CLS. 21, 23, 26, 36 AND 38).

**TRADEMARK**

FIRST USE 9-1-2002; IN COMMERCE 9-1-2002.

**PRINCIPAL REGISTER**

THE MARK CONSISTS OF STANDARD CHARACTERS WITHOUT CLAIM TO ANY PARTICULAR FONT, STYLE, SIZE, OR COLOR.

NO CLAIM IS MADE TO THE EXCLUSIVE RIGHT TO USE "BABY", APART FROM THE MARK AS SHOWN.

SER. NO. 85-198,409, FILED 12-15-2010.

RICHARD WHITE, EXAMINING ATTORNEY



*David J. Kyffers*

Director of the United States Patent and Trademark Office

# United States of America

United States Patent and Trademark Office

## Cheerful Baby

**Reg. No. 4,123,983**

BRAINY ACQUISITIONS, INC. (GEORGIA CORPORATION)  
460 BROGDON ROAD, SUITE 400  
SUWANEE, GA 30024

**Registered Apr. 10, 2012**

**Int. Cl.: 9**

FOR: COMPACT DISCS FEATURING MUSIC, IN CLASS 9 (U.S. CLS. 21, 23, 26, 36 AND 38).

**TRADEMARK**

FIRST USE 9-1-2002; IN COMMERCE 9-1-2002.

**PRINCIPAL REGISTER**

THE MARK CONSISTS OF STANDARD CHARACTERS WITHOUT CLAIM TO ANY PARTICULAR FONT, STYLE, SIZE, OR COLOR.

NO CLAIM IS MADE TO THE EXCLUSIVE RIGHT TO USE "BABY", APART FROM THE MARK AS SHOWN.

SER. NO. 85-198,422, FILED 12-15-2010.

RICHARD WHITE, EXAMINING ATTORNEY



*David J. Kyffers*

Director of the United States Patent and Trademark Office



# United States of America

United States Patent and Trademark Office

## Peaceful Baby

**Reg. No. 4,123,984**

BRAINY ACQUISITIONS, INC. (GEORGIA CORPORATION)  
460 BROGDON ROAD, SUITE 400  
SUWANEE, GA 30024

**Registered Apr. 10, 2012**

**Int. Cl.: 9**

FOR: COMPACT DISCS FEATURING MUSIC, IN CLASS 9 (U.S. CLS. 21, 23, 26, 36 AND 38).

**TRADEMARK**

FIRST USE 9-1-2002; IN COMMERCE 9-1-2002.

**PRINCIPAL REGISTER**

THE MARK CONSISTS OF STANDARD CHARACTERS WITHOUT CLAIM TO ANY PARTICULAR FONT, STYLE, SIZE, OR COLOR.

NO CLAIM IS MADE TO THE EXCLUSIVE RIGHT TO USE "BABY", APART FROM THE MARK AS SHOWN.

SER. NO. 85-198,432, FILED 12-15-2010.

RICHARD WHITE, EXAMINING ATTORNEY



*David J. Kyffers*

Director of the United States Patent and Trademark Office

# United States of America

United States Patent and Trademark Office



**Reg. No. 4,123,985**

**Registered Apr. 10, 2012**

**Int. Cl.: 35**

**SERVICE MARK**

**PRINCIPAL REGISTER**

GRIFCO INCORPORATED (FLORIDA CORPORATION), DBA GRIFCO CONSULTING  
P.O. BOX 327203  
FORT LAUDERDALE, FL 33332

FOR: ADVERTISING AND PROMOTION SERVICES AND RELATED CONSULTING; BUSINESS CONSULTATION AND MANAGEMENT REGARDING MARKETING ACTIVITIES AND LAUNCHING OF NEW PRODUCTS; BUSINESS DEVELOPMENT CONSULTING SERVICES; BUSINESS MANAGEMENT AND BUSINESS CONSULTATION IN THE FIELDS OF BUSINESS DEVELOPMENT AND REVENUE GROWTH; BUSINESS MANAGEMENT CONSULTANCY AS WELL AS DEVELOPMENT OF PROCESSES FOR THE ANALYSIS AND THE IMPLEMENTATION OF STRATEGY PLANS AND MANAGEMENT PROJECTS; BUSINESS MANAGEMENT CONSULTING WITH RELATION TO STRATEGY, MARKETING, SALES, OPERATION, PRODUCT DESIGN PARTICULARLY SPECIALIZING IN THE USE OF ANALYTIC AND STATISTIC MODELS FOR THE UNDERSTANDING AND PREDICTING OF CONSUMERS, BUSINESSES, AND MARKET TRENDS AND ACTIONS; MANAGEMENT CONSULTING AND ADVISORY SERVICES IN THE AREAS OF CORPORATE GROWTH STRATEGY, INNOVATION AND GROWTH PROCESSES, ORGANIZATIONAL TRANSFORMATION, AND TALENT MANAGEMENT AND DEVELOPMENT STRATEGIES; MARKETING CONSULTING, IN CLASS 35 (U.S. CLS. 100, 101 AND 102).

FIRST USE 3-1-2010; IN COMMERCE 3-3-2010.

NO CLAIM IS MADE TO THE EXCLUSIVE RIGHT TO USE "INCORPORATED", APART FROM THE MARK AS SHOWN.

THE COLOR(S) LIGHT BLUE, DARK BLUE AND GREEN IS/ARE CLAIMED AS A FEATURE OF THE MARK.

THE MARK CONSISTS OF THE STYLIZED OVER-SIZED WORD "GRIFCO" IN GRADUATED COLORS OF LIGHT BLUE TO DARK BLUE WITH THE HORIZONTAL BAR FORMING THE LETTER "G" IN "GRIFCO" IN THE COLOR GREEN, AND WITH THE LETTER "O" IN "GRIFCO" FORMING A GLOBE FEATURING LIGHT BLUE MERIDIANS AND PARALLELS AND GREEN CONTINENTS, ALL WITH A LIGHT BLUE UNDERLINE. THE WORD "INCORPORATED" APPEARS IN THE COLOR GREEN UNDERNEATH THE UNDERLINE.

SER. NO. 85-198,581, FILED 12-15-2010.



*David J. Kyjars*

Director of the United States Patent and Trademark Office

**Reg. No. 4,123,985** ZHALEH DELANEY, EXAMINING ATTORNEY

# United States of America

United States Patent and Trademark Office

# HERSOL

**Reg. No. 4,123,986**

HERSOL (FLORIDA CORPORATION)

**Registered Apr. 10, 2012**

P. O. BOX 521850  
MIAMI, FL 33152

**Int. Cls.: 35, 36 and 41**

**SERVICE MARK**

**PRINCIPAL REGISTER**

FOR: ACCOUNT AUDITING; ACCOUNTING CONSULTATION; ACQUISITION AND MERGER CONSULTATION; ADMINISTRATION OF A DISCOUNT PROGRAM FOR ENABLING PARTICIPANTS TO OBTAIN DISCOUNTS ON GOODS AND SERVICES THROUGH USE OF A DISCOUNT MEMBERSHIP CARD; ADMINISTRATION OF A DISCOUNT PROGRAM FOR ENABLING PARTICIPANTS TO OBTAIN DISCOUNTS ON THE COST OF SERVICES OR RECEIVE IMPROVED SERVICES THROUGH USE OF A MEMBERSHIP CARD; ADMINISTRATION OF A PROGRAM FOR ENABLING PARTICIPANTS TO OBTAIN DISCOUNTS ON THE COST OF SERVICES OR RECEIVE IMPROVED SERVICES; ADMINISTRATION OF BUSINESS PAYROLL FOR OTHERS; ADVERTISING AND BUSINESS MANAGEMENT CONSULTANCY; ADVERTISING AND MARKETING CONSULTANCY; ADVERTISING CONSULTATION; ADVERTISING OF COMMERCIAL OR RESIDENTIAL REAL ESTATE; ADVICE AND INFORMATION CONCERNING COMMERCIAL BUSINESS MANAGEMENT; ADVICE IN THE FIELD OF BUSINESS MANAGEMENT AND MARKETING; ADVICE RELATING TO THE ORGANIZATION AND MANAGEMENT OF BUSINESS; ADVISORY SERVICE FOR ORGANIZATIONAL ISSUES AND BUSINESS ADMINISTRATION, WITH AND WITHOUT THE HELP OF ELECTRONIC DATA BASES; ADVISORY SERVICES RELATING TO BUSINESS MANAGEMENT AND BUSINESS OPERATIONS; ARRANGING AND CONDUCTING BUSINESS CONFERENCES; ARRANGING AND CONDUCTING SPECIAL EVENTS FOR BUSINESS PURPOSES; ASSISTANCE AND ADVICE REGARDING BUSINESS ORGANIZATION AND MANAGEMENT; ASSISTANCE AND CONSULTANCY SERVICES IN THE FIELD OF BUSINESS MANAGEMENT OF COMPANIES IN THE ENERGY SECTOR; ASSISTANCE IN MANAGEMENT OF BUSINESS ACTIVITIES; ASSISTANCE TO INDUSTRIAL OR COMMERCIAL ENTERPRISES IN THE RUNNING OF THEIR BUSINESS; ASSISTANCE WITH BUSINESS MANAGEMENT AND PLANNING; ASSISTANCE, ADVICE AND CONSULTANCY WITH REGARD TO BUSINESS PLANNING, BUSINESS ANALYSIS, BUSINESS MANAGEMENT AND BUSINESS ORGANIZATION RELATING TO PURCHASING FUNCTIONS; ASSISTANCE, ADVISORY SERVICES AND CONSULTANCY WITH REGARD TO BUSINESS PLANNING, BUSINESS ANALYSIS, BUSINESS MANAGEMENT, AND BUSINESS ORGANIZATION; ASSISTANCE, ADVISORY SERVICES AND CONSULTANCY WITH REGARD TO BUSINESS PLANNING, BUSINESS ANALYSIS, BUSINESS MANAGEMENT, BUSINESS ORGANIZATION, MARKETING AND CUSTOMER ANALYSIS; BUSINESS ACQUISITION AND MERGER CONSULTATION; BUSINESS ACQUISITIONS CONSULTATION; BUSINESS ADMINISTRATION AND MANAGEMENT; BUSINESS ADMINISTRATION



*David J. Kyjars*

Director of the United States Patent and Trademark Office

**Reg. No. 4,123,986** AND OFFICE WORK; BUSINESS ADMINISTRATION ASSISTANCE; BUSINESS ADMINISTRATION CONSULTANCY; BUSINESS ADVICE AND ANALYSIS OF MARKETS; BUSINESS ADVICE AND COMMERCIAL INFORMATION; BUSINESS ADVICE AND INFORMATION; BUSINESS ADVICE AND INFORMATION RELATING TO LOANS, FINANCE AND CAPITAL; BUSINESS ADVICE, INQUIRIES OR INFORMATION; BUSINESS ADVISORY SERVICES, CONSULTANCY AND INFORMATION; BUSINESS AND MANAGEMENT CONSULTING FOR HEALTHCARE PROVIDERS AND RELATED BUSINESSES; BUSINESS ASSISTANCE, MANAGEMENT AND INFORMATION SERVICES; BUSINESS AUDITING; BUSINESS CONSULTATION; BUSINESS CONSULTATION AND MANAGEMENT REGARDING MARKETING ACTIVITIES AND LAUNCHING OF NEW PRODUCTS; BUSINESS CONSULTATION IN THE FIELD OF BUSINESS LEADERSHIP DEVELOPMENT; BUSINESS CONSULTATION IN THE FIELD OF FINANCE, INSURANCE, BUSINESS, MEDICAL, AND REAL ESTATE; BUSINESS CONSULTATION SERVICES; BUSINESS CONSULTING AND ADVISORY SERVICES IN THE FIELD OF ENERGY EFFICIENCY; BUSINESS CONSULTING AND BUSINESS INFORMATION FOR ENTERPRISES; BUSINESS CONSULTING AND INFORMATION SERVICES; BUSINESS CONSULTING IN THE CONSUMER PRODUCTS INDUSTRY; BUSINESS CONSULTING SERVICE IN THE FIELD OF MEDICAL IMAGING CENTERS; BUSINESS CONSULTING SERVICES IN THE FIELD OF ORGANIZATIONAL CHANGE MANAGEMENT; BUSINESS CONSULTING SERVICES IN THE FIELD OF FINANCE, INSURANCE, BUSINESS, MEDICAL, AND REAL ESTATE; BUSINESS CONSULTING SERVICES RELATING TO PRODUCT DISTRIBUTION, OPERATIONS MANAGEMENT SERVICES, LOGISTICS, REVERSE LOGISTICS, SUPPLY CHAIN, AND PRODUCTION SYSTEMS AND DISTRIBUTION SOLUTIONS; BUSINESS CONSULTING SERVICES, NAMELY, PROVIDING ASSISTANCE IN DEVELOPMENT OF BUSINESS STRATEGIES AND CREATIVE IDEATION; BUSINESS CONSULTING, INQUIRIES OR INFORMATION; BUSINESS CONSULTING, MANAGEMENT, PLANNING AND SUPERVISION; BUSINESS DATA ANALYSIS; BUSINESS DEVELOPMENT CONSULTING SERVICES; BUSINESS DEVELOPMENT SERVICES; BUSINESS EFFICIENCY ADVICE; BUSINESS FEASIBILITY STUDIES; BUSINESS INFORMATION AND ACCOUNTING ADVISORY SERVICES; BUSINESS INFORMATION AND INQUIRIES; BUSINESS MANAGEMENT ADVICE; BUSINESS MANAGEMENT AND ADVICE; BUSINESS MANAGEMENT AND CONSULTATION; BUSINESS MANAGEMENT AND CONSULTATION IN THE FIELD OF FINANCE, INSURANCE, BUSINESS, MEDICAL, AND REAL ESTATE; BUSINESS MANAGEMENT AND CONSULTING SERVICES FOR THE HEALTH CARE INDUSTRY, NAMELY, CUSTOMER SERVICE, ACCOUNTING SERVICES, AND MARKETING SERVICES; BUSINESS MANAGEMENT AND CONSULTING SERVICES FOR THE HEALTH CARE INDUSTRY, NAMELY, CUSTOMER SERVICE, ACCOUNTING SERVICES, AND WEB-BASED ADVERTISING AND MARKETING SERVICES; BUSINESS MANAGEMENT AND CONSULTING SERVICES FOR THE HEALTH CARE INDUSTRY, NAMELY, PROVIDING INDUSTRY EXPERTISE AND SUPPLIER PARTNERSHIPS; BUSINESS MANAGEMENT AND ENTERPRISE ORGANIZATION CONSULTANCY; BUSINESS MANAGEMENT CONSULTANCY AND ADVISORY SERVICES; BUSINESS MANAGEMENT CONSULTANCY AS WELL AS DEVELOPMENT OF PROCESSES FOR THE ANALYSIS AND THE IMPLEMENTATION OF STRATEGY PLANS AND MANAGEMENT PROJECTS; BUSINESS MANAGEMENT CONSULTANCY IN THE FIELD OF PURCHASES, NAMELY, ASSISTING BUSINESSES IN IMPROVEMENT OF PURCHASING FUNCTIONS; BUSINESS MANAGEMENT CONSULTANCY SERVICES; BUSINESS MANAGEMENT CONSULTANCY, ALSO VIA THE INTERNET; BUSINESS MANAGEMENT CONSULTATION; BUSINESS MANAGEMENT CONSULTATION IN THE FIELD OF EXECUTIVE AND LEADERSHIP DEVELOPMENT; BUSINESS MANAGEMENT CONSULTING; BUSINESS MANAGEMENT CONSULTING AND ADVISORY SERVICES; BUSINESS MANAGEMENT CONSULTING AND ADVISORY SERVICES FOR THE FINANCE, INSURANCE, BUSINESS, MEDICAL, AND REAL ESTATE INDUSTRY; BUSINESS MANAGEMENT CONSULTING WITH RELATION TO STRATEGY, MARKETING, PRODUCTION, PERSONNEL AND RETAIL SALE MATTERS; BUSINESS MANAGEMENT PLANNING; BUSINESS MARKETING CONSULTING SERVICES; BUSINESS MERGER CONSULTATION; BUSINESS OPERATION, BUSINESS ADMINISTRATION AND OFFICE FUNCTIONS; BUSINESS ORGANIZATION AND MANAGEMENT CONSULTING SERVICES; BUSINESS ORGANIZATION CONSULTING; BUSINESS ORGANIZATION ADVICE; BUSINESS ORGANIZATION AND MANAGEMENT

**Reg. No. 4,123,986** CONSULTANCY INCLUDING PERSONNEL MANAGEMENT; BUSINESS ORGANIZATION AND MANAGEMENT CONSULTING; BUSINESS ORGANIZATION AND OPERATION CONSULTANCY; BUSINESS ORGANIZATION CONSULTING; BUSINESS ORGANIZATIONAL CONSULTATION; BUSINESS PLANNING; BUSINESS RECORDS MANAGEMENT; BUSINESS RECORDS MANAGEMENT SERVICES RELATING TO BUSINESS ENTITY FORMATION AND ASSOCIATED STATE REPORTING REQUIREMENTS; BUSINESS RELOCATION CONSULTING; BUSINESS RELOCATION SERVICES; BUSINESS RESEARCH; BUSINESS RESEARCH CONSULTATION; BUSINESS RISK ASSESSMENT SERVICES; BUSINESS RISK MANAGEMENT; BUSINESS RISK MANAGEMENT CONSULTATION; BUSINESS SERVICES, NAMELY, ASSISTING OTHERS IN THE ESTABLISHMENT OF CHARITABLE ORGANIZATIONS; BUSINESS SERVICES, NAMELY, ASSISTING THE OWNERS OF INTELLECTUAL PROPERTY AND INTANGIBLE ASSETS IN FINDING INVESTORS; BUSINESS SERVICES, NAMELY, MATCHING POTENTIAL PRIVATE INVESTORS WITH ENTREPRENEURS NEEDING FUNDING; BUSINESS SERVICES, NAMELY, PROCURING QUALIFIED AND CREDENTIALLED THIRD-PARTY EXPERTS, PROFESSIONALS AND OTHER QUALIFIED PERSONNEL, AND DOCUMENTATION AND INFORMATION ALL ON BEHALF OF OTHERS; BUSINESS STRATEGIC PLANNING SERVICES; BUSINESS STRATEGY DEVELOPMENT SERVICES; BUSINESS SUPERVISION; BUSINESS SUPPORT SERVICES, NAMELY, BUSINESS CONSULTING TO FREELANCERS, START-UPS, EXISTING BUSINESSES AND NON-PROFIT ORGANIZATIONS; COMMERCIAL CONSULTANCY; COMPANY MANAGEMENT, INCLUDING CONSULTANCY IN DEMOGRAPHIC MATTERS; COMPILING FINANCIAL, SECURITIES, STOCK EXCHANGE, TRADE AND QUOTE, INDEX VALUE AND OTHER FINANCIAL MARKET INFORMATION FOR BUSINESS PURPOSES; CONSULTANCY AND ADVISORY SERVICES IN THE FIELD OF BUSINESS STRATEGY; CONSULTANCY OF PERSONNEL RECRUITMENT; CONSULTANCY REGARDING THE ORGANIZATION OR MANAGING OF A TRADE COMPANY; CONSULTANCY SERVICES REGARDING BUSINESS STRATEGIES; CONSULTATION IN THE FIELD OF BUSINESS ACQUISITIONS; CONSULTATION RELATING TO TRADE FAIRS; CONSULTATION SERVICES IN THE FIELD OF COMPANY, BUSINESS SECTOR AND INDUSTRY DATA AND RESEARCH; CONSULTING AND INFORMATION CONCERNING ACCOUNTING; CONSULTING IN SALES TECHNIQUES AND SALES PROGRAMMES; CONSULTING IN THE FIELD OF SALES METHODS, SALES MANAGEMENT, AND SALES IMPROVEMENT; CONSULTING SERVICES IN BUSINESS LEADERSHIP DEVELOPMENT AND BUSINESS MANAGEMENT; CONSULTING SERVICES IN BUSINESS ORGANIZATION AND MANAGEMENT; CONSULTING SERVICES IN THE AREA OF SUSTAINABLE BUSINESS SOLUTIONS; CONSULTING SERVICES IN THE COST AND PAYMENT MANAGEMENT OF HEALTH CARE; CONSULTING SERVICES IN THE FIELD OF HUMAN RESOURCES DEVELOPMENT, NAMELY, FOR THE PROMOTION OF EMPLOYEE RETENTION, CAREER GROWTH, AND INCREASED PRODUCTIVITY FOR EMPLOYEES AND EMPLOYERS; CONSULTING SERVICES IN THE FIELD OF HUMAN RESOURCES DEVELOPMENT, NAMELY, UTILIZING TECHNOLOGY FOR THE PROMOTION OF EMPLOYEE RETENTION, CAREER GROWTH AND INCREASED PRODUCTIVITY FOR EMPLOYEES AND EMPLOYERS; CONSULTING SERVICES IN THE FIELD OF MANAGING INTELLECTUAL PROPERTIES; CONSULTING SERVICES IN THE FIELDS OF BUSINESS MANAGEMENT, HUMAN RESOURCES, AND BUSINESS ORGANIZATIONAL DESIGN; CONSULTING SERVICES, NAMELY, TO EMPLOYERS, COMMUNITY ORGANIZATIONS, BROKERS AND BENEFICIARIES, RELATED TO CONSUMER INFORMATION REGARDING HEALTH CARE PLAN OPTIONS, PRODUCTS AND PROGRAMS IN THE FIELD OF MANAGED CARE AND STATE AND FEDERAL MEDICAL CARE PROGRAMS; CONSULTING SERVICES, NAMELY, EXPERT ANALYSIS AND MANAGEMENT CONSULTING IN ECONOMICS AND ACCOUNTING; EMPLOYMENT RECRUITING CONSULTATION; EMPLOYMENT STAFFING CONSULTATION SERVICES; EXPERT EVALUATIONS AND REPORTS RELATING TO BUSINESS MATTERS; FINANCIAL STATEMENT PREPARATION AND ANALYSIS FOR BUSINESSES; FRANCHISING, NAMELY, CONSULTATION AND ASSISTANCE IN BUSINESS MANAGEMENT, ORGANIZATION AND PROMOTION; HELP IN THE MANAGEMENT OF BUSINESS AFFAIRS OR COMMERCIAL FUNCTIONS OF AN INDUSTRIAL OR COMMERCIAL ENTERPRISE; HUMAN RESOURCE ANALYSIS AND CONSULTING SERVICES; HUMAN RESOURCES CONSULTANCY; HUMAN RESOURCES CONSULTATION; INCOME TAX CONSULTATION;

**Reg. No. 4,123,986** INCOME TAX PREPARATION; INFORMATION AND DATA COMPILING AND ANALYZING RELATING TO BUSINESS MANAGEMENT; INFORMATION AND EXPERT OPINIONS RELATING TO COMPANIES AND BUSINESS; INFORMATION IN BUSINESS MATTERS; INFORMATION OR ENQUIRIES ON BUSINESS AND MARKETING; INFORMATION SERVICES RELATING TO BUSINESS MATTERS; MANAGEMENT AND BUSINESS CONSULTING SERVICES IN THE FIELD OF TRAINING AND RECRUITMENT; MANAGEMENT AND BUSINESS CONSULTING SERVICES IN THE FIELD OF FINANCE, INSURANCE, BUSINESS, MEDICAL, AND REAL ESTATE; MANAGEMENT CONSULTING AND ADVISORY SERVICES IN THE AREAS OF CORPORATE GROWTH STRATEGY, INNOVATION AND GROWTH PROCESSES, ORGANIZATIONAL TRANSFORMATION, AND TALENT MANAGEMENT AND DEVELOPMENT STRATEGIES; MARKET RESEARCH AND BUSINESS ANALYSES; MARKET RESEARCH CONSULTATION; MARKETING CONSULTATION IN THE FIELD OF FINANCE, INSURANCE, BUSINESS, MEDICAL, AND REAL ESTATE; MARKETING CONSULTING; MARKETING SERVICES, NAMELY, PROVIDING ON-LINE NON-DOWNLOADABLE VIDEOS TO PROMOTE DOCTORS AND MEDICAL PRACTICES; MATCHING BORROWERS WITH POTENTIAL LENDERS IN THE FIELD OF CONSUMER AND MORTGAGE LENDING; MATCHING BORROWERS WITH POTENTIAL LENDERS IN THE FIELD OF MORTGAGE LENDING; MATCHING CONSUMERS WITH REAL ESTATE PROFESSIONALS IN THE FIELD OF REAL ESTATE SERVICES VIA COMPUTER NETWORK; MEDICAL COST MANAGEMENT; MEDICAL REFERRALS; MEMBERSHIP CLUB SERVICES PROVIDING DISCOUNTS TO MEMBERS ON REAL ESTATE COMMISSIONS AND MORTGAGE FEES; NEGOTIATION AND RENEGOTIATION FOR OTHERS OF LEASES AND SUBLEASES AND REAL ESTATE PURCHASE AGREEMENTS; NEW BUSINESS VENTURE DEVELOPMENT AND FORMATION CONSULTING SERVICES; OPERATIONAL BUSINESS ASSISTANCE TO ENTERPRISES; PLANNING CONCERNING BUSINESS MANAGEMENT, NAMELY, SEARCHING FOR PARTNERS FOR AMALGAMATIONS AND BUSINESS TAKE-OVERS AS WELL AS FOR BUSINESS ESTABLISHMENTS; PREPARATION AND PRESENTATION OF BUSINESS PROSPECTUSES; PREPARATION OF BUSINESS REPORTS; PREPARATION OF CUSTOM OR NON-CUSTOM ADVERTISING FOR BUSINESSES FOR DISSEMINATION VIA THE WEB, CD OR DVD FOR OPTIONAL UPLOAD OR DOWNLOAD TO A COMPUTER; PREPARATION OF REPORTS RELATING TO FINANCE AND INVESTMENTS; PREPARING BUSINESS REPORTS; PREPARING COMPUTER SLIDE TRANSPARENCIES FOR USE BY BUSINESS; PROFESSIONAL BUSINESS CONSULTATION; PROFESSIONAL BUSINESS CONSULTING; PROMOTION OF BUSINESS OPPORTUNITIES; PROMOTION OF FINANCIAL AND INSURANCE SERVICES, ON BEHALF OF THIRD PARTIES; PROVIDING A WEB SITE FEATURING BUSINESS INFORMATION IN THE FORM OF AUDIO AND VIDEO INTERVIEWS, TRANSCRIPTS AND OTHER EDUCATIONAL MATERIALS; PROVIDING ADVICE AND ASSISTANCE TO COMMERCIAL ENTITIES RELATING TO THE ESTABLISHMENT AND MAINTENANCE OF BUSINESS AND CONTRACTUAL RELATIONSHIPS WITH FEDERAL, STATE AND LOCAL GOVERNMENTS; PROVIDING AN ON-LINE COMPUTER DATABASE IN THE FIELD OF BUSINESS INFORMATION AND BUSINESS CONTACTS; PROVIDING AN ON-LINE DATABASE PROVIDING BUSINESS INTELLIGENCE IN THE FIELDS OF MEDICAL DEVICES, PHARMACEUTICALS AND LIFE SCIENCES; PROVIDING BUSINESS INTELLIGENCE SERVICES; PROVIDING BUSINESS MANAGEMENT INFORMATION IN CONNECTION WITH CONSULTING AND ADVISORY SERVICES IN THE FIELD OF STRATEGIC PLANNING; PROVIDING BUSINESS MARKETING INFORMATION; PROVIDING BUSINESS PLANNING AND MARKETING SOLUTIONS FOR REAL ESTATE PROFESSIONALS; PROVIDING CONSULTING SERVICES IN THE FIELD OF REGULATORY SUBMISSION MANAGEMENT TO MEDICAL COMPANIES TO ASSIST THEM WITH APPLICATIONS FOR MEDICAL DEVICE APPROVAL; PROVIDING CONSUMER NEWS AND INFORMATION IN THE FIELD OF EDUCATIONAL PRODUCTS AND SERVICES THAT HELP INDIVIDUALS AND BUSINESSES MAKE AND SAVE MONEY; PROVIDING INFORMATION AND ANALYSIS IN THE FIELDS OF ECONOMICS AND BUSINESS; PROVIDING INFORMATION AND NEWS IN THE FIELD OF BUSINESS; PROVIDING INFORMATION AND NEWS IN THE FIELD OF BUSINESS, NAMELY, INFORMATION AND NEWS ON CURRENT EVENTS AND ON ECONOMIC, LEGISLATIVE, AND REGULATORY DEVELOPMENTS AS IT RELATES TO AND CAN IMPACT BUSINESSES; PROVIDING INFORMATION IN THE FIELD OF TIME MANAGEMENT FOR BUSINESS

**Reg. No. 4,123,986** PURPOSES; PROVIDING INFORMATION IN THE FIELDS OF BUSINESS INNOVATION PROCESS, BUSINESS MANAGEMENT AND BUSINESS OPPORTUNITIES; PROVIDING INSURANCE AGENT REFERRALS; PROVIDING ONLINE BUSINESS MANAGEMENT SERVICES INCLUDING ACCOUNTING, MARKETING, BUSINESS PROJECT MANAGEMENT, AND BUSINESS DEVELOPMENT; PROVIDING ONLINE BUSINESS RISK MANAGEMENT SERVICE FOR USE IN PROJECT MANAGEMENT; PROVIDING ORGANIZATIONAL DEVELOPMENT CONSULTING SERVICES; PROVIDING SALES LEADS FOR THE AUTOMOTIVE FINANCE AND INSURANCE INDUSTRIES; TAX ADVISORY SERVICES; TAX AND TAXATION PLANNING, ADVICE, INFORMATION AND CONSULTANCY SERVICES; TAX CONSULTATION; TAX FILING SERVICES; TAX PREPARATION, IN CLASS 35 (U.S. CLS. 100, 101 AND 102).

FIRST USE 11-20-1997; IN COMMERCE 11-20-1997.

FOR: ACCOUNTS RECEIVABLES FINANCING; ADMINISTRATION OF PRE-PAID HEALTH CARE PLANS; ADVICE RELATING TO INVESTMENTS; ADVISORY SERVICES IN THE FIELD OF EMPLOYEE BENEFITS FOR GROUP HEALTHCARE AND BUSINESS INSURANCE OFFERED TO EMPLOYEES IN ADDITION TO STANDARD BENEFITS SUCH AS MEDICAL, DENTAL, LIFE INSURANCE INCLUDING SHORT TERM DISABILITY, LONG TERM DISABILITY, CANCER INSURANCE, ACCIDENTAL DEATH AND DISMEMBERMENT; ADVISORY SERVICES RELATING TO CREDIT AND DEBIT CONTROL, INVESTMENT, GRANTS AND FINANCING OF LOANS; AIRCRAFT FINANCING SERVICES; AUTOMOBILE LEASE FINANCING; BANKING CONSULTATION; BUSINESS BROKERAGE; BUSINESS BROKERAGE SERVICES AND RELATED CONSULTING PERTAINING TO BUSINESS SALES, MERGERS, ACQUISITIONS AND BUSINESS VALUATIONS; BUSINESS BROKERAGE SERVICES AND RELATED CONSULTING PERTAINING TO PROCUREMENT, BUYING, SELLING AND TENDERING INFORMATION AND OPPORTUNITIES; CAPITAL INVESTMENT CONSULTING; CONSULTANCY CONCERNING FINANCING OF ENERGY PROJECTS; CONSULTANCY OF CAPITAL INVESTMENT; CONSULTING AND INFORMATION CONCERNING INSURANCE; CONSULTING SERVICES IN THE FIELD OF RETIREMENT PLAN ADMINISTRATION AND FIDUCIARY COMPLIANCE; CONSULTING SERVICES IN THE FIELD OF STATE AND FEDERAL EMPLOYEE BENEFIT PLANS CONCERNING INSURANCE AND FINANCE; CORPORATE FINANCE SERVICES, NAMELY, CONSULTATION IN THE FIELD OF ASSET SALES; CORPORATE FINANCE SERVICES, NAMELY, CONSULTATION IN THE FIELD OF CAPITAL STRUCTURE; CREDIT AND FINANCIAL CONSULTATION; DEBT MANAGEMENT CONSULTATION; EQUIPMENT FINANCING SERVICES; FINANCIAL ADVICE; FINANCIAL ADVICE AND CONSULTANCY SERVICES; FINANCIAL ADVISORY AND CONSULTANCY SERVICES; FINANCIAL ADVISORY AND CONSULTANCY SERVICES, NAMELY, THE CREATION OF PERSONALIZED STRATEGIES TO ACHIEVE FINANCIAL INDEPENDENCE; FINANCIAL ANALYSIS AND CONSULTATION; FINANCIAL CONSULTANCY; FINANCIAL CONSULTANCY AND INSURANCE CONSULTANCY; FINANCIAL CONSULTANCY SERVICES IN THE AREA OF HEALTHCARE; FINANCIAL CONSULTATION; FINANCIAL CONSULTATION IN THE FIELD OF FINANCE, INSURANCE, BUSINESS, MEDICAL, AND REAL ESTATE; FINANCIAL CONSULTING; FINANCIAL CONSULTING AND ADVISING IN THE FIELD OF MERGERS AND ACQUISITIONS; FINANCIAL CONSULTING IN THE FIELD OF REAL ESTATE NOTE BROKERAGE; FINANCIAL CONSULTING SERVICES, NAMELY, EXPERT ANALYSIS IN FINANCE; FINANCIAL EVALUATION FOR INSURANCE PURPOSES; FINANCIAL EVALUATION, TRACKING, ANALYSIS, FORECASTING, CONSULTANCY, ADVISORY AND RESEARCH SERVICES RELATING TO SECURITIES AND OTHER FINANCIAL INSTRUMENTS; FINANCIAL LOAN CONSULTATION; FINANCIAL PLANNING; FINANCIAL PLANNING AND INVESTMENT ADVISORY SERVICES; FINANCIAL PLANNING CONSULTATION; FINANCIAL PLANNING FOR RETIREMENT; FINANCIAL PLANNING, NAMELY, THE CREATION OF PERSONALIZED STRATEGIES TO ACHIEVE FINANCIAL INDEPENDENCE; FINANCIAL RISK MANAGEMENT CONSULTATION; FINANCIAL SERVICES, NAMELY, INVESTMENT ADVICE, INVESTMENT MANAGEMENT, INVESTMENT CONSULTATION AND INVESTMENT OF FUNDS FOR OTHERS, INCLUDING PRIVATE AND PUBLIC EQUITY AND DEBT INVESTMENT SERVICES; FINANCIAL



**Reg. No. 4,123,986** SERVICES, NAMELY, MORTGAGE PLANNING; FINANCIAL SERVICES, NAMELY, MORTGAGE REFINANCING; FINANCIAL SERVICES, NAMELY, PROVIDING AN INVESTMENT OPTION AVAILABLE FOR VARIABLE ANNUITY AND VARIABLE LIFE INSURANCE PRODUCTS; FINANCING AND LOAN SERVICES; FINANCING OF DEVELOPMENT AND OPERATION OF MEDICAL IMAGING CENTERS; FINANCING OF LOANS; FINANCING OF PURCHASES; FINANCING OF REAL ESTATE DEVELOPMENT PROJECTS; FINANCING RELATING TO AUTOMOBILES; FINANCING SERVICES; FUND INVESTMENT CONSULTATION; INCUBATION SERVICES, NAMELY, PROVIDING FINANCING TO FREELANCERS, START-UPS, EXISTING BUSINESSES AND NON-PROFITS; INFORMATION, ADVISORY, CONSULTANCY AND RESEARCH SERVICES RELATING TO FINANCE AND INVESTMENTS; INSURANCE AGENCIES; INSURANCE AGENCIES IN THE FIELD OF LIFE, HEALTH, VARIABLE ANNUITIES, AUTO, PROPERTY AND CASUALTY, AVIATION, MARINE, WORKMAN'S COMPENSATION, CRIME, AND SURETY BONDS; INSURANCE AGENCY AND BROKERAGE; INSURANCE AND FINANCIAL INFORMATION AND CONSULTANCY SERVICES; INSURANCE BROKERAGE; INSURANCE BROKERAGE IN THE FIELD OF LIFE, HEALTH, VARIABLE ANNUITIES, AUTO, PROPERTY AND CASUALTY, AVIATION, MARINE, WORKMAN'S COMPENSATION, CRIME, AND SURETY BONDS; INSURANCE BROKERAGE SERVICES; INSURANCE CONSULTANCY; INSURANCE CONSULTANCY SERVICES, NAMELY, PROVIDING ADVICE IN THE FIELD OF PROPERTY AND CASUALTY INSURANCE; INSURANCE CONSULTATION; INSURANCE CONSULTING IN THE FIELD OF LIFE, HEALTH, VARIABLE ANNUITIES, AUTO, PROPERTY AND CASUALTY, AVIATION, MARINE, WORKMAN'S COMPENSATION, CRIME, AND SURETY BONDS INSURANCE; INSURANCE INFORMATION AND CONSULTANCY; INSURANCE SERVICES, NAMELY, INSURANCE ELIGIBILITY REVIEW AND VERIFICATION AND CONSULTATION IN THE LIFE, HEALTH, VARIABLE ANNUITIES, AUTO, PROPERTY AND CASUALTY, AVIATION, MARINE, WORKMAN'S COMPENSATION, CRIME, AND SURETY BONDS INDUSTRY; INSURANCE SERVICES, PROVIDING PREMIUM RATE QUOTES VIA ON-LINE, TELEPHONE AND MAIL MEANS; INSURANCE UNDERWRITING CONSULTATION; INVESTMENT ADVICE; INVESTMENT BANKING SERVICES; INVESTMENT CONSULTANCY; INVESTMENT CONSULTATION; INVESTMENT SERVICES, NAMELY, ASSET ACQUISITION, CONSULTATION, DEVELOPMENT AND MANAGEMENT SERVICES; LAND ACQUISITION, NAMELY, REAL ESTATE BROKERAGE; LEASE OF REAL ESTATE; LEASE-PURCHASE FINANCING; LEASING OF REAL ESTATE; LENDING CONSULTANT SERVICES; LIFE INSURANCE BROKERAGE; LOAN FINANCING; MEMBERSHIP CLUB SERVICES, NAMELY, PROVIDING INFORMATION TO MEMBERS IN THE FIELDS OF REAL ESTATE, MORTGAGES AND DEBT ELIMINATION; MORTGAGE BANKING; MORTGAGE BROKERAGE; MORTGAGE COMPLIANCE CONSULTING SERVICES CONCERNING FINANCIAL REQUIREMENTS FOR MORTGAGES FOR MORTGAGE LENDERS AND SERVICERS AND MORTGAGE BROKERS; MORTGAGE LENDING; MORTGAGE SERVICES, NAMELY, BUYER PRE-QUALIFICATION OF MORTGAGES FOR MORTGAGE BROKERS AND BANKS; ORGANIZING PRE-PAID HEALTH CARE PLANS; PROJECT FINANCING; PROVIDING A WEB SITE FEATURING NON-DOWNLOADABLE INSTRUCTIONAL VIDEOS IN THE FIELD OF FINANCE; PROVIDING A WEBSITE FEATURING NON-DOWNLOADABLE VIDEOS IN THE FIELD OF FINANCIAL PLANNING; PROVIDING COUNSELING AND CONSULTING IN THE FIELD OF HEALTHCARE BENEFITS; PROVIDING DETAILED INFORMATION REGARDING AVAILABLE INSURANCE PRODUCTS FOR COMMERCIAL PROPERTY AND CASUALTY, PROFESSIONAL AND PERSONAL LINES; PROVIDING INFORMATION AND ADVICE IN THE FIELD OF FINANCE, FINANCIAL INVESTMENTS, FINANCIAL VALUATIONS, AND THE FINANCIAL ASPECTS OF RETIREMENT; PROVIDING INFORMATION IN INSURANCE MATTERS; PROVIDING INFORMATION IN THE FIELD OF FINANCE; PROVIDING INFORMATION IN THE FIELD OF PERSONAL FINANCE; PROVIDING INFORMATION IN THE FIELD OF REAL ESTATE VIA THE INTERNET; PROVIDING ON-LINE NEWS IN THE FIELD OF FINANCE; PROVIDING VEHICLE INSURANCE RATE QUOTES; PROVIDING WORKING CAPITAL FINANCING TO SMALL BUSINESSES AND SMALL BUSINESS OWNERS; REAL ESTATE ACQUISITION SERVICES; REAL ESTATE BROKERAGE; REAL ESTATE CONSULTANCY; REAL ESTATE CONSULTATION; REAL ESTATE FINANCING SERVICES; REAL ESTATE LENDING SERVICES; REAL ESTATE MANAGEMENT CONSULTATION; REAL ESTATE

**Reg. No. 4,123,986** RENTAL SERVICES, NAMELY, RENTAL OF RESIDENTIAL HOUSING; REAL ESTATE SERVICE, NAMELY, RENTAL PROPERTY MANAGEMENT; REAL ESTATE SERVICES TO STOP FORECLOSURE, NAMELY, MORTGAGE DEBT MANAGEMENT; REAL ESTATE SERVICES, NAMELY, RENTAL, BROKERAGE, LEASING AND MANAGEMENT OF COMMERCIAL PROPERTY, OFFICES AND OFFICE SPACE; REAL ESTATE SERVICES, NAMELY, TAX APPRAISALS; SOCIAL SECURITY AND MEDICARE CLAIMS ADMINISTRATION AND CONSULTING SERVICES RENDERED TO INDIVIDUALS; VENTURE CAPITAL FINANCING; VENTURE CAPITAL SERVICES, NAMELY, PROVIDING FINANCING TO EMERGING AND START-UP COMPANIES; YACHT FINANCING SERVICES, IN CLASS 36 (U.S. CLS. 100, 101 AND 102).

FIRST USE 11-20-1997; IN COMMERCE 11-20-1997.

FOR: BUSINESS EDUCATION AND TRAINING SERVICES, NAMELY, DEVELOPING, AND FACILITATING CUSTOMIZED IN-COMPANY LEADERSHIP AND EXECUTIVE DEVELOPMENT PROGRAMS, PROVIDING EXECUTIVE COACHING SERVICES, AND PROVIDING PUBLIC AND IN-COMPANY KEYNOTE PRESENTATIONS TO BUSINESS LEADERS; BUSINESS TRAINING; BUSINESS TRAINING CONSULTANCY SERVICES; EDUCATIONAL SERVICES, NAMELY, CONDUCTING CLASSES, SEMINARS, WORKSHOPS IN THE FIELD OF FINANCE, INSURANCE, BUSINESS, MEDICAL, AND REAL ESTATE AND DISTRIBUTION OF COURSE AND EDUCATIONAL MATERIALS IN CONNECTION THEREWITH; EDUCATIONAL SERVICES, NAMELY, CONDUCTING CLASSES, SEMINARS, WORKSHOPS IN THE FIELD OF FINANCE, INSURANCE, BUSINESS, MEDICAL, AND REAL ESTATE AND DISTRIBUTION OF EDUCATIONAL MATERIALS IN CONNECTION THEREWITH; EDUCATIONAL SERVICES, NAMELY, PROVIDING EDUCATIONAL SPEAKERS IN THE FIELD OF FINANCE, INSURANCE, BUSINESS, MEDICAL, AND REAL ESTATE; MEMBERSHIP CLUB SERVICES, NAMELY, PROVIDING TRAINING TO MEMBERS IN THE FIELD OF FINANCE, INSURANCE, BUSINESS, MEDICAL, AND REAL ESTATE; PROVIDING CONTINUING BUSINESS EDUCATION COURSES; REVIEW COURSES FOR STATE EXAMINATIONS; TRAINING COURSES IN STRATEGIC PLANNING RELATING TO ADVERTISING, PROMOTION, MARKETING AND BUSINESS, IN CLASS 41 (U.S. CLS. 100, 101 AND 107).

FIRST USE 11-20-1997; IN COMMERCE 11-20-1997.

THE MARK CONSISTS OF STANDARD CHARACTERS WITHOUT CLAIM TO ANY PARTICULAR FONT, STYLE, SIZE, OR COLOR.

SER. NO. 85-198,715, FILED 12-15-2010.

KHANH LE, EXAMINING ATTORNEY

# United States of America

United States Patent and Trademark Office

## INFINITY BODYWEAR SYSTEM

**Reg. No. 4,123,987**

**Registered Apr. 10, 2012**

**Int. Cl.: 35**

**SERVICE MARK**

**PRINCIPAL REGISTER**

C BRADFIELD LLC (GEORGIA LIMITED LIABILITY COMPANY)  
1227 ROCKBRIDGE ROAD  
SUITE 802-109  
STONE MOUNTAIN, GA 30087

FOR: RETAIL STORE AND ON-LINE RETAIL STORE SERVICES FEATURING CLOTHING AND FASHION ACCESSORIES, NAMELY, TOPS, SHIRTS, SKIRTS, SASHES, BELTS, CORSETS, JACKETS, UNDERGARMENTS, COMPRESSION GARMENTS, DRESSES, PANTS, AND LEGGINGS, IN CLASS 35 (U.S. CLS. 100, 101 AND 102).

FIRST USE 9-30-2010; IN COMMERCE 12-10-2010.

THE MARK CONSISTS OF STANDARD CHARACTERS WITHOUT CLAIM TO ANY PARTICULAR FONT, STYLE, SIZE, OR COLOR.

NO CLAIM IS MADE TO THE EXCLUSIVE RIGHT TO USE "BODYWEAR SYSTEM", APART FROM THE MARK AS SHOWN.

SER. NO. 85-199,393, FILED 12-16-2010.

MICHAEL GAAFAR, EXAMINING ATTORNEY



*David J. Kyfos*

Director of the United States Patent and Trademark Office

# United States of America

United States Patent and Trademark Office

# CORTINA

**Reg. No. 4,123,988**

**Registered Apr. 10, 2012**

**Int. Cl.: 9**

**TRADEMARK**

**PRINCIPAL REGISTER**

CORTINA SYSTEMS, INC. (DELAWARE CORPORATION)  
1376 BORDEAUX DRIVE  
SUNNYVALE, CA 94089

FOR: SEMICONDUCTOR CHIPS FOR USE IN THE FIELD OF DATA AND TELECOMMUNICATIONS NETWORKS; COMPUTER AND TELECOMMUNICATIONS HARDWARE, NAMELY, INTEGRATED CIRCUIT MODULES, CHIPS, RECEIVER, FREQUENCY TRANSLATOR AND TRANSMITTER SUB-SYSTEMS COMPRISED OF ETHERNET MEDIA ACCESS CONTROLLERS, ETHERNET OVERSUBSCRIPTION AGGREGATORS, ELECTRONIC DISPERSION COMPENSATION PHY (PHYSICAL LAYER) DEVICES, ETHERNET PHY (PHYSICAL LAYER) DEVICES, OPTICAL TRANSPORT NETWORK PROCESSORS, OPTICAL TRANSPORT NETWORK PROCESSORS WITH FORWARD ERROR CORRECTION, DIGITAL WRAPPER DEVICES, SYNCHRONOUS OPTICAL NETWORKING AND SYNCHRONOUS DIGITAL HIERARCHY FRAMERS AND MAPPERS, BANDWIDTH AGGREGATION AND CHANNELIZER DEVICES, DIGITAL HOME PROCESSORS, OPTICAL LINE TERMINAL CHIPS, OPTICAL NETWORK UNIT CHIPS, REPEATERS FOR USE IN CONNECTION WITH DATA AND TELECOMMUNICATION NETWORKS, IN CLASS 9 (U.S. CLS. 21, 23, 26, 36 AND 38).

FIRST USE 5-15-2008; IN COMMERCE 5-15-2008.

THE MARK CONSISTS OF STANDARD CHARACTERS WITHOUT CLAIM TO ANY PARTICULAR FONT, STYLE, SIZE, OR COLOR.

OWNER OF U.S. REG. NOS. 2,807,114 AND 3,688,781.

SER. NO. 85-200,868, FILED 12-17-2010.

SUZANNE BLANE, EXAMINING ATTORNEY



*David J. Kyros*

Director of the United States Patent and Trademark Office

# United States of America

United States Patent and Trademark Office

# REVROI

**Reg. No. 4,123,989**

**Registered Apr. 10, 2012**

**Int. Cl.: 9**

**TRADEMARK**

**PRINCIPAL REGISTER**

AXONOM INC. (MINNESOTA CORPORATION)  
7401 METRO BOULEVARD, SUITE 200  
MINNEAPOLIS, MN 55439

FOR: COMPUTER SOFTWARE FOR ORDERING, PRICE MANAGEMENT, LOYALTY MARKETING AND CHARGEABLE SERVICE MANAGEMENT, IN CLASS 9 (U.S. CLS. 21, 23, 26, 36 AND 38).

FIRST USE 12-5-2010; IN COMMERCE 12-5-2010.

THE MARK CONSISTS OF STANDARD CHARACTERS WITHOUT CLAIM TO ANY PARTICULAR FONT, STYLE, SIZE, OR COLOR.

SER. NO. 85-201,716, FILED 12-20-2010.

ROSELLE HERRERA, EXAMINING ATTORNEY



*David J. Kyffers*

Director of the United States Patent and Trademark Office

# United States of America

United States Patent and Trademark Office

WE'RE BRINGING YUMMY BACK

**Reg. No. 4,123,990**

CHOICE FOODSERVICES, INC. (CALIFORNIA CORPORATION)  
2000 CROW CANYON PLACE #130  
SAN RAMON, CA 94583

**Registered Apr. 10, 2012**

**Int. Cl.: 43**

FOR: PROVIDING CATERING FOR SCHOOL CAFETERIAS AND OTHER FACILITIES, NOT INCLUDING RESTAURANTS AND BARS, IN CLASS 43 (U.S. CLS. 100 AND 101).

**SERVICE MARK**

FIRST USE 5-0-2010; IN COMMERCE 8-0-2010.

**PRINCIPAL REGISTER**

THE MARK CONSISTS OF STANDARD CHARACTERS WITHOUT CLAIM TO ANY PARTICULAR FONT, STYLE, SIZE, OR COLOR.

SER. NO. 85-201,753, FILED 12-20-2010.

LINDA ORNDORFF, EXAMINING ATTORNEY



*David J. Kybas*

Director of the United States Patent and Trademark Office

# United States of America

United States Patent and Trademark Office

# MITSUBISHI

**Reg. No. 4,123,991**

**Registered Apr. 10, 2012**

**Int. Cls.: 1, 2, 3, 5, 10  
and 30**

**TRADEMARK**

**PRINCIPAL REGISTER**

MITSUBISHI SHOJI KAISHA, LTD. (JAPAN CORPORATION)  
3-1, MARUNOUCHI 2-CHOME  
CHIYODA-KU, TOKYO, JAPAN

FOR: INDUSTRIAL CHEMICALS, NAMELY, INORGANIC ACIDS, ALKALIS, INORGANIC SALTS, HYDROGEN, HELIUM, BORON, CARBON, NITROGEN, OXYGEN, FLUORINE, NEON, PHOSPHORUS, SULFUR, CHLORINE, ARGON, ARSENIC, BROMINE, IODINE, SODIUM, POTASSIUM AND CALCIUM ALL FOR USE IN THE MANUFACTURE OF CHEMICAL PRODUCTS INCLUDING DYESTUFFS, FRAGRANCES, FLAVORINGS, PHARMACEUTICALS, COSMETICS; OXIDES, SULFIDES, CARBIDES ALL FOR USE IN THE MANUFACTURE OF CHEMICAL PRODUCTS; WATER, NAMELY, HEAVY WATER FOR USE IN NUCLEAR REACTORS; DISTILLED WATER; HYDROCARBONS, ORGANIC HALOGENIDES, ALCOHOLS, PHENOLS, ETHERS, ALDEHYDES AND KETONES, ORGANIC ACIDS AND THEIR SALTS, ESTERS, NITROGEN COMPOUNDS, HETEROCYCLIC COMPOUNDS, CARBOHYDRATES, TERPENES, TARS AND PITCHES, PROTEINS AND ENZYMES, ORGANO-PHOSPHORUS COMPOUNDS AND ORGANOARSENIC COMPOUNDS, ORGANOMETALLIC COMPOUNDS, SURFACE-ACTIVE AGENTS, PASTES AND ADHESIVES, ALL FOR USE IN THE MANUFACTURE OF PAPER AND LEATHER; PHOTOGRAPHIC CHEMICALS; INDUSTRIAL CHEMICAL PREPARATIONS, NAMELY, SPINNING AGENTS, WEAVING AGENTS, SCOURING AGENTS, DYEING AGENTS, WETTING AGENTS, ANTI-STATIC AGENTS, WATER REPELLING AGENTS, DEFOAMING AGENTS, FOAMING AGENTS, DEFATTING AGENTS, DECOLORING AGENTS, ABSORBENTS, ANTI-RUST AGENTS, MOLD RELEASING AGENTS, FLATTENING AGENTS, STRIPPING AGENTS, RUBBER TREATING AGENTS, FILTERING AND CLARIFYING AGENTS, SOFTENING AGENTS, FIRE PROOFING AGENTS, WATER RESISTING AGENTS, LAGGING AGENTS, HEATING AGENTS, ANTI-FREEZE AGENTS, DAMP PROOFING AGENTS, STEEL FORGING AGENTS, CASTING AND TEMPERING AGENTS, ALL FOR USE IN THE MANUFACTURE OF TEXTILE, METAL AND AUTOMOBILES; REFRIGERANT CHEMICALS FOR AIR CONDITIONING UNITS; SOLDERING FLUX; PUNCTURE PROOFING AGENTS FOR TIRES; WATER PROOFING AGENTS FOR BUILDING AND CONSTRUCTION SURFACES; ANTI-SULPHURIZING AGENTS FOR USE IN THE MANUFACTURE OF BATTERIES; FOOD PRESERVATIVES; FUEL ECONOMIZING AGENTS FOR MOTOR VEHICLES; SOLVENT TYPE PROCESSING COMPOSITIONS FOR USE IN THE OIL FIELD INDUSTRY; AGRICULTURAL FERTILIZERS, CATALYST AGENTS FOR USE IN PETROCHEMICAL PLANTS AND OIL REFINERIES; CHEMICALS, NAMELY, VULCANIZING ACCELERATORS, ANTI-AGING AGENTS, PLEATING AGENTS FOR CLOTHES, ANTI-CREASING AGENTS AND ANTI-SHRINK AGENTS ALL FOR USE IN THE MANUFACTURE OF DRY CLEANING



*David J. Kyjars*

Director of the United States Patent and Trademark Office

**Reg. No. 4,123,991** CHEMICALS; PLANT FERTILIZER FOR AGRICULTURAL USE; COLORING AGENTS FOR USE IN THE MANUFACTURE OF PHARMACEUTICAL PREPARATIONS; ADHESIVES FOR USE IN THE PLASTICS INDUSTRY; SYNTHETIC FRAGRANCES USED IN THE MANUFACTURE OF COSMETICS; PLANT REARING AGENTS AND SOIL IMPROVEMENT AGENTS FOR AGRICULTURAL USE; CHEMICALS IN THE NATURE OF EXCIPIENTS, OINTMENT BASES, SOLVENTS, FLAVORING AND COLORING AGENTS, AND DEODORIZERS, ALL FOR USE IN THE MANUFACTURE OF PHARMACEUTICALS; DIAGNOSTIC REAGENTS FOR RESEARCH USE, IN CLASS 1 (U.S. CLS. 1, 5, 6, 10, 26 AND 46).

FOR: DYESTUFFS, NAMELY, INDIGO, MADDER, LOGWOOD, COCHINEAL, DIRECT DYES, ACID DYES, BASIC DYES, MORDANT DYES, SULFUR DYES, VAT DYES, NAPHTHOL DYES, RAPID DYES, OIL SOLUBLE DYES, ALCOHOL SOLUBLE DYES, FOOD COLORANTS AND FLUORESCENT WHITENING DYES, ALL FOR USE IN THE MANUFACTURE OF TEXTILE, PAPER, PULP; COLOR PIGMENTS, NAMELY, WHITE LEAD, TITANIUM WHITE, RED LEAD, VERMILION, ULTRAMARINE, PRUSSIAN BLUE, LAKE; TONER FOR PRINTERS AND PHOTOCOPIERS; PAINTING MATERIALS FOR INTERIOR AND EXTERIOR USE, NAMELY, OIL BASED PAINTS, VARNISHES, ENAMELS IN THE NATURE OF HOUSE PAINT, LACQUERS IN THE NATURE OF A COATING, SYNTHETIC RESIN PAINTS, WATER BASED PAINTS, SHIP BOTTOM PAINTS, CHEMICALLY RESISTANT PAINTS, ANTI-RUST PAINTS, FLUORESCENT PAINTS AND WOOD STAINS; PRINTING INKS, NAMELY, TYPOGRAPHIC INKS, PLANOGRAPHIC INKS AND INTAGLIO INKS; NATURAL RESINS FOR USE IN THE MANUFACTURE OF PAPER AND LEATHER, IN CLASS 2 (U.S. CLS. 6, 11 AND 16).

FOR: PAINT REMOVERS; SHOE POLISHES; POLISHING AGENTS, NAMELY, LEATHER POLISH, AUTOMOBILE BODY POLISH, FLOOR POLISH, FURNITURE POLISH AND POLISHING OILS FOR LEATHER; NON-MEDICATED SKIN SOAPS, TOILET SOAP, LAUNDRY SOAP, SOAP FOR INDUSTRIAL USE; WASHING POWDERS FOR HAND AND FACE; HAIR SHAMPOOS AND HAIR-WASHING POWDERS; DRY CLEANING FLUIDS; CLEANSERS AND CLEANING POWDERS USED TO CLEAN HANDS, OVENS, PANS, POTS, SINKS AND TUBS; DENTIFRICES; COSMETICS, NAMELY, POWDERS, TOILET WATERS, CREAMS AND ROUGES, EYE SHADOW; EYEBROW PENCILS, MASCARA; HAIR COSMETICS, NAMELY, HAIR SHAMPOO, HAIR CONDITIONER, POMADES, HAIR OIL, HAIR CREAMS, HAIR FIXING OILS AND CREAMS, COMBING OIL, HAIR TONICS, SETTING LOTIONS, HAIR LACQUERS, PERMANENT WAVE SOLUTIONS, COLD WAVING SOLUTIONS, COLOR RINSES AND HAIR DYEING PREPARATIONS; PERFUMES; NAIL ENAMELS; NAIL ENAMEL REMOVERS; TALCUM POWDERS; DEPILATORIES; NON-MEDICATED BATH SALTS; SKIN MOISTURIZERS; BABY POWDERS; BABY OILS; PERSONAL FRAGRANCES IN THE NATURE OF ESSENTIAL OILS FOR PERSONAL USE, NAMELY, LAVENDER OIL, CLOVE OIL, PEPPERMINT OIL, MUSK, AMBERGRIS AND COMPOUND ESSENCES; ESSENTIAL OILS FOR FOOD FLAVORINGS; SACHET POWDERS; PERFUMED INCENSES AND INCENSE STICKS; TIN CLEANERS; MEDICATED SOAP, IN CLASS 3 (U.S. CLS. 1, 4, 6, 50, 51 AND 52).

FOR: PHARMACEUTICALS RELATING TO THE CENTRAL NERVOUS SYSTEM, NAMELY, GENERAL ANESTHETICS FOR SURGICAL USE, HYPNOTICS AND SEDATIVES FOR USE IN THE TREATMENT OF INSOMNIA AND SOMNIPATHY, ANTI-EPILEPTICS USED TO TREAT EPILEPSY, ANTI-PYRETICS AND ANALGESICS USED TO TREAT COLDS AND HEADACHES, NERVOUS SYSTEM STIMULANTS AND ANALEPTICS USED TO TREAT MELANCHOLIA, AND ANTI-DIZZINESS AGENTS USED TO TREAT MENIERE'S DISEASE; PHARMACEUTICALS RELATING TO THE PERIPHERAL NERVOUS SYSTEM, NAMELY, LOCAL ANESTHETICS FOR SURGICAL USE IN OPERATIONS FOR SPINAL PARALYSIS, SKELETAL MUSCLE RELAXANTS USED TO TREAT LUMBAGO, AUTONOMICS USED TO TREAT AMYOSTHENIA, ANTI-SPASMODICS USED TO TREAT GASTRIC ULCERS; PHARMACEUTICALS RELATING TO THE SENSORY ORGANS, NAMELY, OPHTHALMIC USE AGENTS USED TO TREAT GLAUCOMA, OTORHINOLAR USE AGENTS USED TO TREAT TYMPANITIS; PHARMACEUTICALS RELATING TO ALLERGIES, NAMELY, ANTI-HISTAMINES USED TO TREAT URTICARIA AND STIMULATION THERAPY AGENTS



**Reg. No. 4,123,991** USED TO TREAT RHEUMARTHRTIS; PHARMACEUTICALS RELATING TO THE CIRCULATORY ORGANS, NAMELY, CARDIOTONICS USED TO TREAT STENOCARDIA, ARRHYTHMIA TREATING AGENTS USED IN OPERATIONS FOR PROPHYLAXIS OF ARRHYTHMIA, DIURETICS AND HYPOTENSORS USED TO TREAT HYPERTENSION, VASOCONSTRICTORS USED TO TREAT HYPOTENSION INVOLVED IN AN ANESTHETIC; ANTI-TUSSIVES AND EXPECTORANTS USED TO TREAT ASTHMATIC BRONCHITIS; PHARMACEUTICALS RELATING TO THE DIGESTIVE ORGANS, NAMELY, STOMACHICS AND DIGESTIVES USED TO TREAT APEPSIA AND ESOGASTRITIS, ANTACIDS USED TO TREAT DUODENAL ULCERS AND GASTRIC ULCERS, ANTI-EMETICS USED TO TREAT PROPHYLAXIS OF NAUSEA OF THE STOMACH, CHOLERETICS USED TO TREAT CHOLANGITIS, ANTIDIARRHEALS USED TO TREAT DIARRHEA AND ENTERITIS, PURGATIVES AND CLYSTERS USED TO TREAT CONSTIPATION AND TO AID EXAMINATION OF THE DIGESTIVE SYSTEM; DENTAL USE AGENTS USED TO TREAT GINGIVITIS AND PYORRHEA ALVEOLARIS; ORAL USE AGENTS USED TO TREAT PHARYNGOLARYNGITIS; PHARMACEUTICALS IN THE NATURE OF PITUITARY HORMONE PREPARATION USED TO TREAT DYSADRENOCORTICISM; PHARMACEUTICALS IN THE NATURE OF SALIVARY GLAND HORMONE PREPARATIONS USED TO TREAT BATHYGASTRY; PHARMACEUTICALS IN THE NATURE OF THYROID AND PARATHYROID HORMONE PREPARATIONS USED TO TREAT CRETINISM; PHARMACEUTICALS IN THE NATURE OF ADRENAL HORMONE PREPARATIONS USED TO TREAT HEMORRHAGIC SHOCK, PHARMACEUTICALS IN THE NATURE OF ANDROGENS USED TO TREAT GERMINAL APLASIA; PHARMACEUTICALS IN THE NATURE OF ESTROGENS USED TO TREAT A MENSTRUAL OVULATION; PHARMACEUTICALS IN THE NATURE OF MIXED HORMONE PREPARATIONS USED TO TREAT MENOPAUSAL SYNDROME; PHARMACEUTICALS RELATING TO THE URINARY, GENITAL AND ANAL ORGANS, NAMELY, URINARY ANTISEPTICS USED TO TREAT CYSTITIS, OXYTOCICS USED IN ABORTIONS OR CESAREAN OPERATIONS; AGENTS RELATING TO EPIDERMIS, NAMELY, DISINFECTANTS USED TO DISINFECT FINGERS, HANDS AND ARMS, ASTRINGENTS AND CATAPLASMS USED TO TREAT DERMATITIS AND SUNBURN, ANTI-DERMOINFECTIVES USED TO TREAT FILARIAL DERMOTOSIS AND CORROSIVES USED TO TREAT KERATODERMA PALMARIS PLANTARIS; VACCINES FOR THE TREATMENT OF CHOLERA AND INFLUENZA; TOXINS USED TO TREAT CONTACT WITH OR INGESTION OF POISONS PRODUCED BY PLANTS, ANIMALS OR BACTERIA, NAMELY, VIPER TOXIN AND BOTULINUS TOXIN; TOXOIDS USED AS AN ANTIGEN TO PRODUCE IMMUNITY TO A SPECIFIC BACTERIAL TOXIN, NAMELY, DIPHTHERIA TOXOID AND ADSORBED TETANUS TOXOID; ANTITOXINS INJECTED INTO HUMANS TO PREVENT DISEASE, NAMELY, ANTIBODIES FORMED TO ACT AGAINST AN ANTIGENIC POISON AND AS A SERUM CONTAINING AN ANTITOXIN, NAMELY, BOVINE ANTITOXIN AND DIPHTHERIA ANTITOXIN; DIAGNOSTIC REAGENTS FOR CLINICAL AND MEDICAL LABORATORY USE, NAMELY, X-RAY CONTRAST MEDIA USED FOR TAKING AN X-RAY PHOTOGRAPH OF CEREBRAL BLOOD VESSELS, MAIN ARTERIES, OR THE BLADDER; DIAGNOSTIC REAGENTS FOR CLINICAL AND MEDICAL LABORATORY USE, NAMELY, FOR THE EXAMINATION OF THE CAPACITY OF THE LIVER OR KIDNEY; MEDICAL DIAGNOSTIC CULTURE MEDIA FOR BACTERIOLOGICAL EXAMINATION PURPOSES; ANESTHETIC NARCOTICS FOR NON-SURGICAL USE, NAMELY, OPIUM ALKALOIDS, DERIVATIVES AND PREPARATIONS AND COCA ALKALOIDS, DERIVATIVES AND PREPARATIONS; VETERINARY PHARMACEUTICAL PREPARATIONS FOR USE IN THE TREATMENT OF DISTEMPER IN LIVESTOCK AND POULTRY; AGENTS FOR AGRICULTURE, NAMELY, ANTIVIRUS DISINFECTANTS, INSECTICIDES, FUMIGANTS, RODENTICIDES, HERBICIDES, GERMICIDES AND HORMONES FOR PLANTS; MOTH REPELLANTS; AIR DEODORANTS; ANTISEPTICS; DENTAL CEMENTS; FILLINGS FOR TEETH; MEDICAL OIL PAPERS, NAMELY, WATERPROOF OILED PAPERS COATED WITH PURIFIED LINSEED OIL TO BE USED IN PREVENTING SEEPAGE FROM EXTERNALLY AND INTERNALLY APPLIED MEDICAL OINTMENTS; COTTON SWABS FOR MEDICAL USE; OBLATES, NAMELY, FILMS MADE FROM STARCH AND GELATIN USED AS WRAPPING FOR ASSISTANCE IN THE INGESTION OF POWDERED MEDICINES; CAPSULES OF GELATIN SOLD EMPTY FOR FILLING WITH POWDERED MEDICINE, USED TO ASSIST THE INGESTION OF POWDERED MEDICINE; SMELLING SALTS; ADHESIVE

**Reg. No. 4,123,991** MEDICAL PLASTERS; SURGICAL BANDAGES; EAR BANDAGES, IN CLASS 5 (U.S. CLS. 6, 18, 44, 46, 51 AND 52).

FOR: EYE PATCHES FOR MEDICAL USE; SANITARY MASKS FOR USE BY MEDICAL PERSONNEL; ABDOMINAL BELTS; FINGER STALLS FOR MEDICAL USE; MEDICAL ICE PACKS AND SUSPENDERS THEREFOR; CUPS ADAPTED FOR FEEDING BABIES AND CHILDREN; ENTERAL FEEDING APPLIANCES; EAR IMPLANTS IN THE NATURE OF ARTIFICIAL TYMPANIC MEMBRANE MATERIALS; PROSTHETIC TEETH; CONDOMS; TWEEZERS FOR MEDICAL USE, IN CLASS 10 (U.S. CLS. 26, 39 AND 44).

FOR: FOOD ADDITIVES FOR NON-NUTRITIONAL PURPOSES FOR USE AS A FLAVORING, INGREDIENT OR FILLER, IN CLASS 30 (U.S. CL. 46).

THE MARK CONSISTS OF STANDARD CHARACTERS WITHOUT CLAIM TO ANY PARTICULAR FONT, STYLE, SIZE, OR COLOR.

OWNER OF JAPAN REG. NO. 4319478, DATED 10-1-1999, EXPIRES 10-1-2019.

OWNER OF U.S. REG. NOS. 2,911,931, 3,498,138 AND OTHERS.

THE ENGLISH TRANSLATION OF THE WORD "MITSUBISHI" IN THE MARK IS "THREE RHOMBOIDS".

SER. NO. 85-202,524, FILED 12-21-2010.

FLORENTINA BLANDU, EXAMINING ATTORNEY

# United States of America

United States Patent and Trademark Office



**Reg. No. 4,123,992**

**Registered Apr. 10, 2012**

**Int. Cl.: 28**

**TRADEMARK**

**PRINCIPAL REGISTER**

BLUE BOX TOY FACTORY LIMITED (HONG KONG CORPORATION)  
ROOM 1203, EAST OCEAN CENTRE,  
98 GRANVILLE ROAD, TSIM SHA TSUI EAST  
KOWLOON, HONG KONG

FOR: GAMES AND PLAYTHINGS FOR INFANTS AND PRE-SCHOOL CHILDREN, NAMELY, BABY MULTIPLE ACTIVITY TOYS, BATH TOYS, BATHTUB TOYS, CHILDREN'S MULTIPLE ACTIVITY TOYS, CRIB TOYS, INFANT ACTION CRIB TOYS, INFANT DEVELOPMENT TOYS, INFANT TOYS, MUSICAL BOX TOYS, SANDBOX TOYS, SQUEEZABLE SQUEAKING TOYS, BABY RATTLES INCORPORATING TEETHING RINGS, BABY RATTLES, INFANT'S RATTLES, PLUSH TOYS, INFLATABLE TOYS, SOFT TOYS, PLASTIC TOYS, FABRIC TOYS, TOY BUILDING BLOCKS, DOLLS, IN CLASS 28 (U.S. CLS. 22, 23, 38 AND 50).

PRIORITY CLAIMED UNDER SEC. 44(D) ON HONG KONG APPLICATION NO. 301787752, FILED 12-13-2010, REG. NO. 301787752, DATED 12-13-2010, EXPIRES 12-13-2020.

THE COLOR(S) BLUE, WHITE, GREEN, ORANGE AND YELLOW IS/ARE CLAIMED AS A FEATURE OF THE MARK.

NO CLAIM IS MADE TO THE EXCLUSIVE RIGHT TO USE "KIDS", APART FROM THE MARK AS SHOWN.

THE MARK CONSISTS OF (CLOCKWISE, FROM TOP LEFT) A BLUE ROUNDED SQUARE, WITHIN WHICH THE WORDS "B KIDS" APPEARS IN WHITE TEXT; A ROUNDED SQUARE OUTLINED IN GREEN; A ROUNDED SQUARE OUTLINED IN ORANGE; A ROUNDED SQUARE OUTLINED IN YELLOW.

SER. NO. 85-202,534, FILED 12-21-2010.

REBECCA SMITH, EXAMINING ATTORNEY



*David J. Kyffers*

Director of the United States Patent and Trademark Office

# United States of America

United States Patent and Trademark Office



*Candy Pantry Caramels*

**Reg. No. 4,123,993**

**Registered Apr. 10, 2012**

**Int. Cls.: 30 and 35**

**TRADEMARK**

**SERVICE MARK**

**PRINCIPAL REGISTER**

CANDY PANTRY CARAMELS, LLC (OKLAHOMA LIMITED LIABILITY COMPANY)  
16513 COUNTY ROAD 3560  
ADA, OK 74820

FOR: CANDY WITH CARAMEL; GIFT BASKETS CONTAINING CANDY, IN CLASS 30 (U.S. CL. 46).

FIRST USE 7-1-2010; IN COMMERCE 7-1-2010.

FOR: RETAIL STORE AND ON-LINE RETAIL STORE SERVICES FEATURING CARAMEL CANDY AND GIFT BASKETS, IN CLASS 35 (U.S. CLS. 100, 101 AND 102).

FIRST USE 7-1-2010; IN COMMERCE 7-1-2010.

NO CLAIM IS MADE TO THE EXCLUSIVE RIGHT TO USE "CANDY" AND "CARAMELS", APART FROM THE MARK AS SHOWN.

THE MARK CONSISTS OF THE WORDING "CANDY PANTRY CARAMELS" IN A STYLIZED FONT, WITH A DOOR PLATE WITH A DOORKNOB AND KEYHOLE TO THE LEFT OF THE WORDING AND A FANCY SWIRL DESIGN UNDERNEATH THE WORDING.

SER. NO. 85-203,405, FILED 12-21-2010.

SUE LAWRENCE, EXAMINING ATTORNEY



*David J. Kyjars*

Director of the United States Patent and Trademark Office

# United States of America

United States Patent and Trademark Office

## TOWNSEND VINEYARD

**Reg. No. 4,123,994**

**Registered Apr. 10, 2012**

**Int. Cl.: 33**

**TRADEMARK**

**PRINCIPAL REGISTER**

ANTINORI CALIFORNIA (CALIFORNIA CORPORATION)  
3149 SODA CANYON ROAD  
NAPA, CA 94558

FOR: WINE, IN CLASS 33 (U.S. CLS. 47 AND 49).

FIRST USE 1-25-2010; IN COMMERCE 1-25-2010.

THE MARK CONSISTS OF STANDARD CHARACTERS WITHOUT CLAIM TO ANY PARTICULAR FONT, STYLE, SIZE, OR COLOR.

NO CLAIM IS MADE TO THE EXCLUSIVE RIGHT TO USE "VINEYARD", APART FROM THE MARK AS SHOWN.

SER. NO. 85-203,825, FILED 12-22-2010.

JILL C. ALT, EXAMINING ATTORNEY



*David J. Kybas*

Director of the United States Patent and Trademark Office

# United States of America

United States Patent and Trademark Office

# ARANDO

**Reg. No. 4,123,995**

**Registered Apr. 10, 2012**

**Int. Cls.: 35 and 41**

**SERVICE MARK**

**PRINCIPAL REGISTER**

ENDENER, MAIK (FED REP GERMANY INDIVIDUAL)  
MARIENSTRASSE 24  
GOETTINGEN, FED REP GERMANY

FOR: (BASED ON 44(E) PURSUANT TO EUROPEAN COMMUNITY FOREIGN REGISTRATION NUMBER 3006292) ON-LINE ADVERTISING SERVICES FOR OTHERS , IN CLASS 35 (U.S. CLS. 100, 101 AND 102).

FOR: (BASED ON 44(E) PURSUANT TO EUROPEAN COMMUNITY FORCER REGISTRATION NUMBER 00962574) PROVIDING TRAINING TO MEMBERSHIP CLUB MEMBERS IN THE FIELD OF PROFESSIONAL DEVELOPMENT AND SELF-IMPROVEMENT; EDUCATION SERVICES IN THE NATURE OF CONDUCTING WORKSHOPS AND SEMINARS IN THE FIELD OF PROFESSIONAL DEVELOPMENT AND SELF-IMPROVEMENT, IN CLASS 41 (U.S. CLS. 100, 101 AND 107).

THE MARK CONSISTS OF STANDARD CHARACTERS WITHOUT CLAIM TO ANY PARTICULAR FONT, STYLE, SIZE, OR COLOR.

OWNER OF ERPN CMNTY TM OFC REG. NO. 009621574, DATED 10-28-2011, EXPIRES 12-23-2020.

OWNER OF ERPN CMNTY TM OFC REG. NO. 30069292, DATED 9-15-2000, EXPIRES 9-30-2020.

THE ENGLISH TRANSLATION OF "ARANDO" IN THE MARK IS "BLUEBERRY".

SER. NO. 85-204,734, FILED 12-23-2010.

DAWN HAN, EXAMINING ATTORNEY



*David J. Kybas*

Director of the United States Patent and Trademark Office

# United States of America

United States Patent and Trademark Office

## THE DEETER GROUP

**Reg. No. 4,123,996**

**Registered Apr. 10, 2012**

**Int. Cls.: 9, 40 and 42**

**TRADEMARK**

**SERVICE MARK**

**PRINCIPAL REGISTER**

DEETER ENGINEERING SERVICES LIMITED (ENGLAND CORPORATION)  
DEETER HOUSE  
VALLEY ROAD, HUGHENDEN VALLEY  
BUCKINGHAMSHIRE, ENGLAND HP144LW

FOR: WEIGHING APPARATUS; MEASURING APPARATUS, NAMELY, FOR MEASURING THE LEVEL, TEMPERATURE, FLOW OR VOLUME OF LIQUIDS; WIRELESS SENSOR SYSTEM CONSISTING PRIMARILY OF A BASE STATION AND A SENSOR NODE; LIQUID LEVEL SENSORS; FLOW SWITCHES FOR MONITORING AND CONTROLLING THE FLOW OF LIQUIDS; LEVEL INDICATORS; LEVEL GAUGES; WATER LEVEL INDICATORS; PROXIMITY SENSORS; FLOATS USED IN FLUID LEVEL MONITORING; LIQUID LEVEL FLOATS USED FOR REED SWITCH ACTIVATION; SENSOR FLOATS USED IN OPEN TANK APPLICATIONS; INDUSTRIAL FLOATS FOR MEASURING THE LEVEL, TEMPERATURE, FLOW OR VOLUME OF LIQUIDS; PROGRAMMABLE LOGIC CONTROLLER (PLC); FLOW METERS; WEIGHING MACHINES; WEIGHING APPARATUS AND INSTRUMENTS; WEIGHING SYSTEMS FOR INDUSTRIAL APPLICATIONS CONSISTING PRIMARILY OF WEIGH INDICATORS AND CONTROLLERS, LOAD CELLS AND AMPLIFIERS, WEIGH PLATFORMS AND LOAD BEAMS; REED SWITCHES FOR POWER SWITCHING; REED RELAYS FOR POWER, ATE AND INSTRUMENTATION APPLICATIONS; SENSORS USED FOR RANGE MEASUREMENTS, TANK LEVEL CONTROL, WEB BRAKE AND PROXIMITY DETECTION; CAGE CLAMP TERMINALS; SAFETY LITZ WIRES; SOLAR PANELS FOR PRODUCTION OF ELECTRICITY; SOLAR CELLS; PHOTOVOLTAIC CELLS; PHOTOVOLTAIC INVERTERS; PHOTOVOLTAIC SOLAR MODULES FOR PRODUCTION OF ELECTRICITY; INTEGRATED BOILER CONTROL SYSTEMS CONSISTING OF SENSORS AND MODULATING CONTROLS; SECURITY EQUIPMENT, NAMELY, MAGNET-REED SWITCHES SENSORS AND CONNECTING WIRES, IN CLASS 9 (U.S. CLS. 21, 23, 26, 36 AND 38).

FIRST USE 1-1-2000; IN COMMERCE 1-1-2000.

FOR: CUSTOM MANUFACTURE OF SENSORS, INSTRUMENTATION AND CONTROL EQUIPMENT AND OF A WIDE VARIETY OF PCB ASSEMBLIES, MACHINE TOOL CONTROL CABINETS, PROCESS CONTROL CABINETS; CUSTOM MANUFACTURE OF PROCESS TEST EQUIPMENT, AND OF INDUSTRIAL WEIGHING SYSTEMS, IN CLASS 40 (U.S. CLS. 100, 103 AND 106).

FIRST USE 1-1-2000; IN COMMERCE 1-1-2000.



*David J. Kyros*

Director of the United States Patent and Trademark Office

**Reg. No. 4,123,996** FOR: SCIENTIFIC AND TECHNOLOGICAL SERVICES AND RESEARCH AND DESIGN RELATING THERETO IN THE FIELD OF WEIGHING AND MEASURING APPARATUS, ELECTRONIC SENSORS, INSTRUMENTATION, CONTROL AND PROCESS EQUIPMENT, INDUSTRIAL ANALYSIS AND RESEARCH SERVICES AND DESIGN AND DEVELOPMENT OF COMPUTER HARDWARE AND SOFTWARE, INCLUDING DESIGN AND DEVELOPMENT OF PROTOTYPES; DESIGN OF A WIDE VARIETY OF PCB ASSEMBLIES; DESIGN OF MACHINE TOOL CONTROL CABINETS; DESIGN OF PROCESS CONTROL CABINETS; DESIGN OF INDUSTRIAL WEIGHING SYSTEMS; COMPUTER SOFTWARE DESIGN FOR OTHERS, IN CLASS 42 (U.S. CLS. 100 AND 101).

FIRST USE 1-1-2000; IN COMMERCE 1-1-2000.

THE MARK CONSISTS OF STANDARD CHARACTERS WITHOUT CLAIM TO ANY PARTICULAR FONT, STYLE, SIZE, OR COLOR.

NO CLAIM IS MADE TO THE EXCLUSIVE RIGHT TO USE "GROUP", APART FROM THE MARK AS SHOWN.

SEC. 2(F).

SER. NO. 85-205,098, FILED 12-23-2010.

BRIAN NEVILLE, EXAMINING ATTORNEY



United States of America  
United States Patent and Trademark Office



**Reg. No. 4,123,997**

HOME EXPO DESIGN CENTER (TENNESSEE CORPORATION)  
2960 SIDCO DRIVE  
NASHVILLE, TN 37204

**Registered Apr. 10, 2012**

**Int. Cl.: 35**

FOR: PROVIDING SHOWROOMS FOR THE GOODS OF OTHERS IN THE FIELD OF REMODELING, IN CLASS 35 (U.S. CLS. 100, 101 AND 102).

**SERVICE MARK**

FIRST USE 11-15-2010; IN COMMERCE 11-15-2010.

**PRINCIPAL REGISTER**

NO CLAIM IS MADE TO THE EXCLUSIVE RIGHT TO USE "HOME EXPO" AND "DESIGN CENTER", APART FROM THE MARK AS SHOWN.

THE MARK CONSISTS OF A ROOF LINE WITH THE WORDS "HOME EXPO" BELOW IT, THEN A SOLID HORIZONTAL LINE WITH THE WORDS "DESIGN CENTER" BELOW IT.

SER. NO. 85-209,146, FILED S.R. 1-3-2011 AM. P.R. 1-3-2011.

SANDRA BUJA, EXAMINING ATTORNEY



*David J. Kyros*

Director of the United States Patent and Trademark Office

# United States of America

United States Patent and Trademark Office

# GALAXY

**Reg. No. 4,123,998**

**Registered Apr. 10, 2012**

**Int. Cl.: 9**

**TRADEMARK**

**PRINCIPAL REGISTER**

SARIN TECHNOLOGIES LTD. (ISRAEL COMPANY)  
7 ATIR YEDA STEET  
KFAR SABA, ISRAEL 44643

FOR: COMPUTER SYSTEM COMPRISING COMPUTER SOFTWARE, HARDWARE AND COMPUTER OPERATED MACHINE, FOR USE IN THE DIAMOND INDUSTRY, NAMELY, FOR SCANNING THE EXTERNAL SURFACE OF THE DIAMOND AND DETECTING AND MAPPING IMPERFECTIONS IN THE DIAMOND, IN CLASS 9 (U.S. CLS. 21, 23, 26, 36 AND 38).

THE MARK CONSISTS OF STANDARD CHARACTERS WITHOUT CLAIM TO ANY PARTICULAR FONT, STYLE, SIZE, OR COLOR.

PRIORITY CLAIMED UNDER SEC. 44(D) ON ISRAEL APPLICATION NO. 234620, FILED 1-2-2011, REG. NO. 234620, DATED 11-2-2011, EXPIRES 1-2-2021.

SER. NO. 85-209,759, FILED 1-4-2011.

DARRYL SPRUILL, EXAMINING ATTORNEY



*David J. Kyros*

Director of the United States Patent and Trademark Office

# United States of America

United States Patent and Trademark Office

## MR-AUTOMATION

**Reg. No. 4,123,999**

**Registered Apr. 10, 2012**

**Int. Cls.: 7, 9, 37 and 42**

**TRADEMARK**

**SERVICE MARK**

**PRINCIPAL REGISTER**

M & R AUTOMATION GMBH (AUSTRIA GESELLSCHAFT MIT BESCHRÄNKTER HAFTUNG (GMBH))  
TESLASTRASSE 8  
GRAMBACH, AUSTRIA 8074

FOR: MACHINES AND MACHINE TOOLS USED IN PRODUCTION LINES AND PRODUCTION FACILITIES OF THE AUTOMOBILE, ELECTRONICS, CONSUMER GOODS AND MEDICAL TECHNOLOGY INDUSTRIES, IN CLASS 7 (U.S. CLS. 13, 19, 21, 23, 31, 34 AND 35).

FOR: DATA PROCESSING EQUIPMENT AND COMPUTERS; SCIENTIFIC, OPTICAL, WEIGHING, MEASURING, CONTROLLING, SIGNALLING AND CHECKING BEING SUPERVISION APPARATUS AND INSTRUMENTS INTENDED FOR USE IN THE PRODUCTION LINES AND PRODUCTION FACILITIES OF THE AUTOMOBILE, ELECTRONICS, CONSUMER GOODS AND MEDICAL TECHNOLOGY INDUSTRIES; INDUSTRIAL AUTOMATION CONTROLS; COMPUTER PROGRAMS AND SOFTWARE, NAMELY, FOR THE CONTROLLING, MONITORING AND VISUALISATION OF MANUFACTURING PROCESSES, IN CLASS 9 (U.S. CLS. 21, 23, 26, 36 AND 38).

FOR: BUILDING CONSTRUCTION; REPAIR, MAINTENANCE AND INSTALLATION OF PRODUCTION LINES AND PRODUCTION FACILITIES OF THE AUTOMOBILE, ELECTRONICS, CONSUMER GOODS AND MEDICAL TECHNOLOGY INDUSTRIES; CONSTRUCTION OF INDUSTRIAL ASSEMBLY INSTALLATIONS AND PRODUCTION LINES, IN CLASS 37 (U.S. CLS. 100, 103 AND 106).

FOR: SCIENTIFIC AND TECHNOLOGICAL SERVICES AND RESEARCH AND DESIGN RELATING THERETO, NAMELY, SCIENTIFIC RESEARCH, ANALYSIS AND DESIGN IN THE FIELDS OF PRODUCTION TECHNOLOGY, MEASURING, AND TESTING TECHNOLOGY; TECHNICAL PLANNING OF INDUSTRIAL ASSEMBLY INSTALLATIONS AND PRODUCTION LINES FOR SCIENTIFIC PURPOSES; INDUSTRIAL ANALYSIS AND RESEARCH SERVICES IN THE FIELD OF INDUSTRIAL ASSEMBLY INSTALLATION ENGINEERING; DESIGN AND DEVELOPMENT OF COMPUTER HARDWARE AND SOFTWARE, IN CLASS 42 (U.S. CLS. 100 AND 101).



*David J. Kyjars*

THE MARK CONSISTS OF STANDARD CHARACTERS WITHOUT CLAIM TO ANY PARTICULAR FONT, STYLE, SIZE, OR COLOR.

**Reg. No. 4,123,999** OWNER OF AUSTRIA REG. NO. 263132, DATED 7-21-2011, EXPIRES 7-21-2021.

SER. NO. 85-210,726, FILED 1-5-2011.

LINDA MICKLEBURGH, EXAMINING ATTORNEY

# United States of America

United States Patent and Trademark Office

# MR

**Reg. No. 4,124,000**

**Registered Apr. 10, 2012**

**Int. Cls.: 7, 9, 37 and 42**

**TRADEMARK**

**SERVICE MARK**

**PRINCIPAL REGISTER**

M & R AUTOMATION GMBH (AUSTRIA GESELLSCHAFT MIT BESCHRÄNKTER HAFTUNG (GMBH))  
TESLA STRASSE 8  
GRAMBACH, AUSTRIA 8074

FOR: MACHINES AND MACHINE TOOLS USED IN PRODUCTION LINES AND PRODUCTION FACILITIES OF THE AUTOMOBILE, ELECTRONICS, CONSUMER GOODS AND MEDICAL TECHNOLOGY INDUSTRIES, IN CLASS 7 (U.S. CLS. 13, 19, 21, 23, 31, 34 AND 35).

FOR: DATA PROCESSING EQUIPMENT AND COMPUTERS; SCIENTIFIC, OPTICAL, WEIGHING, MEASURING, CONTROLLING, SIGNALLING AND CHECKING BEING SUPERVISION APPARATUS AND INSTRUMENTS INTENDED FOR USE IN THE PRODUCTION LINES AND PRODUCTION FACILITIES OF THE AUTOMOBILE, ELECTRONICS, CONSUMER GOODS AND MEDICAL TECHNOLOGY INDUSTRIES; INDUSTRIAL AUTOMATION CONTROLS; COMPUTER PROGRAMS AND SOFTWARE, NAMELY, FOR THE CONTROLLING, MONITORING AND VISUALISATION OF MANUFACTURING PROCESSES, IN CLASS 9 (U.S. CLS. 21, 23, 26, 36 AND 38).

FOR: BUILDING CONSTRUCTION; REPAIR, MAINTENANCE AND INSTALLATION OF PRODUCTION LINES AND PRODUCTION FACILITIES OF THE AUTOMOBILE, ELECTRONICS, CONSUMER GOODS AND MEDICAL TECHNOLOGY INDUSTRIES; CONSTRUCTION OF INDUSTRIAL ASSEMBLY INSTALLATIONS AND PRODUCTION LINES, IN CLASS 37 (U.S. CLS. 100, 103 AND 106).

FOR: SCIENTIFIC AND TECHNOLOGICAL SERVICES AND RESEARCH AND DESIGN RELATING THERETO, NAMELY, SCIENTIFIC RESEARCH, ANALYSIS AND DESIGN IN THE FIELDS OF PRODUCTION TECHNOLOGY, MEASURING, AND TESTING TECHNOLOGY; TECHNICAL PLANNING OF INDUSTRIAL ASSEMBLY INSTALLATIONS AND PRODUCTION LINES FOR SCIENTIFIC PURPOSES; INDUSTRIAL ANALYSIS AND RESEARCH SERVICES IN THE FIELD OF INDUSTRIAL ASSEMBLY INSTALLATION ENGINEERING; DESIGN AND DEVELOPMENT OF COMPUTER HARDWARE AND SOFTWARE, IN CLASS 42 (U.S. CLS. 100 AND 101).

THE MARK CONSISTS OF STANDARD CHARACTERS WITHOUT CLAIM TO ANY PARTICULAR FONT, STYLE, SIZE, OR COLOR.



*David J. Kyjars*

Director of the United States Patent and Trademark Office

**Reg. No. 4,124,000** OWNER OF AUSTRIA REG. NO. 263133, DATED 7-21-2011, EXPIRES 7-21-2021.

SER. NO. 85-210,731, FILED 1-5-2011.

LINDA MICKLEBURGH, EXAMINING ATTORNEY

# United States of America

United States Patent and Trademark Office

# MUDTeCH

**Reg. No. 4,124,001**

JOHNSON, CLINT (UNITED STATES INDIVIDUAL)  
S30 W36550 HIGHWAY D  
DOUSMAN, WI 53118

**Registered Apr. 10, 2012**

**Int. Cl.: 37**

FOR: CONSTRUCTION SERVICES, NAMELY ASPHALT, CONCRETE, PIERING, MUDJACKING AND FOUNDATION REPAIR SERVICES, IN CLASS 37 (U.S. CLS. 100, 103 AND 106).

**SERVICE MARK**

FIRST USE 6-1-2007; IN COMMERCE 6-1-2007.

**PRINCIPAL REGISTER**

THE MARK CONSISTS OF STANDARD CHARACTERS WITHOUT CLAIM TO ANY PARTICULAR FONT, STYLE, SIZE, OR COLOR.

SER. NO. 85-210,979, FILED 1-5-2011.

GISELLE AGOSTO, EXAMINING ATTORNEY



*David J. Kyffers*

Director of the United States Patent and Trademark Office

# United States of America

United States Patent and Trademark Office



**Reg. No. 4,124,002**

TECHNICON INDUSTRIES, INC. (NORTH CAROLINA CORPORATION)  
4412 REPUBLIC DRIVE  
CONCORD, NC 28027

**Registered Apr. 10, 2012**

**Int. Cl.: 17**

FOR: ACOUSTIC PRODUCTS FOR INDUSTRIAL EQUIPMENT MANUFACTURERS, NAMELY, SOUND ABSORBERS, SOUND TRANSMISSION BARRIERS, SOUND VIBRATION DAMPENERS AND ACOUSTIC INSULATION FOR USE IN THE MANUFACTURE OF INDUSTRIAL EQUIPMENT, IN CLASS 17 (U.S. CLS. 1, 5, 12, 13, 35 AND 50).

**TRADEMARK**

**PRINCIPAL REGISTER**

FIRST USE 1-31-2009; IN COMMERCE 1-31-2009.

THE MARK CONSISTS OF AN IMAGE OF A TUNING FORK.

SER. NO. 85-211,083, FILED 1-5-2011.

HOWARD B. LEVINE, EXAMINING ATTORNEY



*David J. Kyjars*

Director of the United States Patent and Trademark Office



# United States of America

United States Patent and Trademark Office

## Operation Salsa Drop

**Reg. No. 4,124,003**

JACK ENTERPRISES, INC. (NORTH CAROLINA CORPORATION)  
4002 OLEANDER DR.  
WILMINGTON, NC 28403

**Registered Apr. 10, 2012**

**Int. Cl.: 35**

FOR: CHARITABLE SERVICES, NAMELY, COORDINATION OF NON-MONETARY CONTRIBUTIONS TO CHARITIES AND NON-PROFITS; CHARITABLE SERVICES, NAMELY, ORGANIZING AND CONDUCTING VOLUNTEER PROGRAMS AND COMMUNITY SERVICE PROJECTS AIMED AT INCREASING SUPPORT AND MORALE OF FAMILIES OF DECEASED WAR VETERANS, WAR VETERANS, CURRENT MEMBERS AND FUTURE MEMBERS OF THE U.S. MILITARY, IN CLASS 35 (U.S. CLS. 100, 101 AND 102).

**SERVICE MARK**

**PRINCIPAL REGISTER**

FIRST USE 4-17-2010; IN COMMERCE 4-17-2010.

THE MARK CONSISTS OF STANDARD CHARACTERS WITHOUT CLAIM TO ANY PARTICULAR FONT, STYLE, SIZE, OR COLOR.

SER. NO. 85-211,487, FILED 1-5-2011.

CHERYL CLAYTON, EXAMINING ATTORNEY



*David J. Kyffers*

Director of the United States Patent and Trademark Office

# United States of America

United States Patent and Trademark Office



**Reg. No. 4,124,004**

**Registered Apr. 10, 2012**

**Int. Cl.: 41**

**SERVICE MARK**

**PRINCIPAL REGISTER**

THE COLONIAL STATES ATHLETIC CONFERENCE (PENNSYLVANIA CORPORATION)  
ONE NEUMANN DRIVE  
ASTON, PA 19014

FOR: ATHLETIC SERVICES, NAMELY, COORDINATING THE PRESENTATION OF ATHLETIC EVENTS AND CONTESTS, IN CLASS 41 (U.S. CLS. 100, 101 AND 107).

FIRST USE 7-1-2008; IN COMMERCE 7-1-2008.

NO CLAIM IS MADE TO THE EXCLUSIVE RIGHT TO USE "ATHLETIC CONFERENCE", APART FROM THE MARK AS SHOWN.

THE MARK CONSISTS OF A LIBERTY BELL ENCLOSED IN A CIRCLE. THIS THEN IS ENCIRCLED WITH 13 STARS ON A STYLIZED BACKGROUND. THE LETTERS "CSAC" APPEAR TO THE RIGHT OF THE LIBERTY BELL WITH A FLAG SHAPED STRIPPED IMAGE IN THE BACKGROUND. THE WORDING "COLONIAL STATES ATHLETIC CONFERENCE" APPEARS BELOW THE STYLED DESIGN.

SER. NO. 85-211,867, FILED 1-6-2011.

DAVID TAYLOR, EXAMINING ATTORNEY



*David J. Kyffers*

Director of the United States Patent and Trademark Office

# United States of America

United States Patent and Trademark Office



**Reg. No. 4,124,005**

**Registered Apr. 10, 2012**

**Int. Cl.: 35**

**SERVICE MARK**

**PRINCIPAL REGISTER**

SYMFONIC MARKETING LLC (ARIZONA LIMITED LIABILITY COMPANY)  
SUITE B  
6938 E. 1ST STREET  
SCOTTSDALE, AZ 85251

FOR: ASSOCIATION SERVICES, NAMELY, PROMOTING THE INTERESTS OF NON-PROFIT ORGANIZATIONS; BUSINESS NETWORKING FOR WOMEN IN BUSINESS AND FEMALE COMMUNITY LEADERS; ON-LINE BUSINESS NETWORKING SERVICES FOR WOMEN IN BUSINESS AND FEMALE COMMUNITY LEADERS, IN CLASS 35 (U.S. CLS. 100, 101 AND 102).

FIRST USE 6-15-2010; IN COMMERCE 6-15-2010.

NO CLAIM IS MADE TO THE EXCLUSIVE RIGHT TO USE "GIRLS", APART FROM THE MARK AS SHOWN.

THE MARK CONSISTS OF THE STYLIZED TEXT "THE GIVING GIRLS" WRITTEN INSIDE A SKETCHED HEART; TWO LEAVES APPEAR OUTSIDE THE BOTTOM OF THE POINT OF THE HEART.

SER. NO. 85-212,052, FILED 1-6-2011.

MICHELLE DUBOIS, EXAMINING ATTORNEY



*David J. Kyffers*

Director of the United States Patent and Trademark Office

# United States of America

United States Patent and Trademark Office

# MUDTECH

**Reg. No. 4,124,006**

JOHNSON, CLINT (UNITED STATES INDIVIDUAL)  
S30 W36550 HIGHWAY D  
DOUSMAN, WI 53118

**Registered Apr. 10, 2012**

**Int. Cl.: 37**

FOR: CONSTRUCTION SERVICES, NAMELY ASPHALT, CONCRETE, PIERING, MUDJACKING AND FOUNDATION REPAIR SERVICES, IN CLASS 37 (U.S. CLS. 100, 103 AND 106).

**SERVICE MARK**

FIRST USE 6-1-2007; IN COMMERCE 6-1-2007.

**PRINCIPAL REGISTER**

THE MARK CONSISTS OF THE STYLIZED LETTERS "MUD" WITH THE STYLIZED LETTERS "TECH" UNDER A HORIZONTAL LINE EXTENDING FROM THE STYLIZED "D".

SER. NO. 85-212,690, FILED 1-7-2011.

GISELLE AGOSTO, EXAMINING ATTORNEY



*David J. Kyffers*

Director of the United States Patent and Trademark Office

# United States of America

United States Patent and Trademark Office



**Reg. No. 4,124,007**

GRACIE'S, INC. (UTAH CORPORATION)  
326 SOUTH WEST TEMPLE  
SALT LAKE CITY, UT 84101

**Registered Apr. 10, 2012**

**Int. Cl.: 43**

FOR: BAR AND RESTAURANT SERVICES, IN CLASS 43 (U.S. CLS. 100 AND 101).

**SERVICE MARK**

FIRST USE 5-0-2009; IN COMMERCE 5-0-2009.

**PRINCIPAL REGISTER**

THE MARK CONSISTS OF THE STYLIZED SHADED WORD "GRACIE'S" WITH AN UN-SHADED BORDER WITH THE LETTER "G" LARGER THAN THE LETTERS, "RACIE'S," WITH A SHADOW BEHIND THE WORDING. THE COLOR GRAY REPRESENTS SHADING AND IS NOT PART OF THE MARK.

SER. NO. 85-212,998, FILED 1-7-2011.

ODESSA BIBBINS, EXAMINING ATTORNEY



*David J. Kyffers*

Director of the United States Patent and Trademark Office

# United States of America

United States Patent and Trademark Office



Since 1992

**Reg. No. 4,124,008**

**Registered Apr. 10, 2012**

**Int. Cl.: 3**

**TRADEMARK**

**PRINCIPAL REGISTER**

SUN LOK WAH INTERNATIONAL COMPANY LIMITED (HONG KONG LIMITED LIABILITY COMPANY)  
18 TIN HAU RD., TUEN MUN  
FLAT 10, 3/F, BLK 2, NAM FUNG IND. CITY  
NEW TERRITORIES, HONG KONG

FOR: HAIR LOTION, SOAP, FRAGRANCE ESSENCE, COSMETICS, PERSONAL HYGIENE PRODUCTS, NAMELY, BATH SOAPS, BUBBLE BATH, FOAM BATH, HAIR SHAMPOO, HAIR CONDITIONERS, SKIN LOTIONS, IN CLASS 3 (U.S. CLS. 1, 4, 6, 50, 51 AND 52).

OWNER OF HONG KONG REG. NO. 301275174, DATED 1-20-2009, EXPIRES 1-19-2019.

NO CLAIM IS MADE TO THE EXCLUSIVE RIGHT TO USE "NATURAL" AND "SINCE 1992", APART FROM THE MARK AS SHOWN.

THE MARK CONSISTS OF THE STYLIZED LETTERS "O'NAOMI" ABOVE THE WORD "NATURAL" INSIDE AN OVAL ABOVE THE WORDING "SINCE 1992".

SER. NO. 85-214,542, FILED 1-10-2011.

MARTHA SANTOMARTINO, EXAMINING ATTORNEY



*David J. Kyffers*

Director of the United States Patent and Trademark Office

# United States of America

United States Patent and Trademark Office

## POWER SCREENER

**Reg. No. 4,124,009**

AFFINNOVA, INC. (DELAWARE CORPORATION)  
265 WINTER STREET  
WALTHAM, MA 02451

**Registered Apr. 10, 2012**

**Int. Cl.: 42**

FOR: PROVIDING TEMPORARY USE OF ONLINE NON-DOWNLOADABLE ADVERTISING CONSULTING SOFTWARE, NAMELY, SOFTWARE TO ASSIST OTHERS IN ANALYZING DATA RELATED TO BRANDING, PROMOTIONAL COMMUNICATIONS AND GROUP MARKET PREFERENCES, IN CLASS 42 (U.S. CLS. 100 AND 101).

**SERVICE MARK**

**PRINCIPAL REGISTER**

FIRST USE 1-4-2010; IN COMMERCE 1-4-2010.

THE MARK CONSISTS OF STANDARD CHARACTERS WITHOUT CLAIM TO ANY PARTICULAR FONT, STYLE, SIZE, OR COLOR.

NO CLAIM IS MADE TO THE EXCLUSIVE RIGHT TO USE "SCREENER", APART FROM THE MARK AS SHOWN.

SER. NO. 85-215,079, FILED 1-11-2011.

MARK SPARACINO, EXAMINING ATTORNEY



*David J. Kyffers*

Director of the United States Patent and Trademark Office

# United States of America

United States Patent and Trademark Office

## BLUE PLANET NETWORK

**Reg. No. 4,124,010**

BLUE PLANET NETWORK (CALIFORNIA NON-PROFIT CORPORATION)  
P.O. BOX 3059

**Registered Apr. 10, 2012**

REDWOOD CITY, CA 94064

**Int. Cls.: 35, 36 and 41**

FOR: PROMOTING PUBLIC AWARENESS OF ISSUES RELATED TO DRINKING WATER, HYGIENE AND SANITATION, IN CLASS 35 (U.S. CLS. 100, 101 AND 102).

**SERVICE MARK**

FIRST USE 6-20-2010; IN COMMERCE 6-20-2010.

**PRINCIPAL REGISTER**

FOR: CHARITABLE FUND RAISING SERVICES, IN CLASS 36 (U.S. CLS. 100, 101 AND 102).

FIRST USE 6-20-2010; IN COMMERCE 6-20-2010.

FOR: EDUCATION SERVICES, NAMELY, CONDUCTING SEMINARS RELATED TO DRINKING WATER, HYGIENE AND SANITATION, IN CLASS 41 (U.S. CLS. 100, 101 AND 107).

FIRST USE 6-20-2010; IN COMMERCE 6-20-2010.

THE MARK CONSISTS OF STANDARD CHARACTERS WITHOUT CLAIM TO ANY PARTICULAR FONT, STYLE, SIZE, OR COLOR.

OWNER OF U.S. REG. NOS. 3,561,177, 3,658,118 AND OTHERS.

NO CLAIM IS MADE TO THE EXCLUSIVE RIGHT TO USE "NETWORK", APART FROM THE MARK AS SHOWN.

SER. NO. 85-216,677, FILED 1-13-2011.

JASON BLAIR, EXAMINING ATTORNEY



*David J. Kybas*

Director of the United States Patent and Trademark Office



# United States of America

United States Patent and Trademark Office

# iTranShip

**Reg. No. 4,124,011**

**Registered Apr. 10, 2012**

**Int. Cl.: 39**

**SERVICE MARK**

**PRINCIPAL REGISTER**

TRANSFAIR NORTH AMERICA INTERNATIONAL FREIGHT SERVICES, INC.  
(WASHINGTON CORPORATION), DBA TRANSGROUP WORLDWIDE LOGISTICS  
18850 8TH AVENUE SOUTH  
SEATTLE, WA 98149

FOR: FREIGHT FORWARDING SERVICES, IN CLASS 39 (U.S. CLS. 100 AND 105).

FIRST USE 3-1-2010; IN COMMERCE 3-1-2010.

OWNER OF U.S. REG. NOS. 2,340,847, 2,405,890 AND OTHERS.

THE MARK CONSISTS OF A ONE-WORD IN STYLIZED FORMAT WITH THE LETTER "I" IN SMALL CASE, FOLLOWED BY "TRANSHIP" WITH THE LETTERS "T" AND "S" IN UPPER CASE.

SER. NO. 85-217,328, FILED 1-13-2011.

KATHERINE CHANG, EXAMINING ATTORNEY



*David J. Kybas*

Director of the United States Patent and Trademark Office

# United States of America

United States Patent and Trademark Office



**Reg. No. 4,124,012**

**Registered Apr. 10, 2012**

**Int. Cl.: 35**

**SERVICE MARK**

**PRINCIPAL REGISTER**

COMPUTER SCIENCES CORPORATION (NEVADA CORPORATION)  
3170 FAIRVIEW PARK DRIVE  
FALLS CHURCH, VA 22042

FOR: BUSINESS MANAGEMENT CONSULTING; BUSINESS MANAGEMENT AND BUSINESS OPERATION RESEARCH SERVICES; OUTSOURCING OF TELEPHONE CALL CENTERS AND DATA CENTER OPERATIONS; BUSINESS PROCESS OUTSOURCING SERVICES; OUTSOURCING IN THE FIELD OF INFORMATION TECHNOLOGY; OUTSOURCING IN THE FIELD OF COMPUTER AND COMPUTER APPLICATIONS SERVICES; BUSINESS CONSULTING SERVICES; DATA PROCESSING SERVICES; AUDITING OF LEGAL BILLS; CONSULTING TO REVIEW BUSINESS EFFICIENCY OF LEGAL SERVICE PROVIDERS; SUPPLY CHAIN CONSULTING AND MANAGEMENT SERVICES; ADMINISTRATION FOR OTHERS OF ELECTRONIC VOICE AND DATA TELECOMMUNICATION TRANSMISSION SYSTEMS AND NETWORKS FOR OTHERS; DISASTER RECOVERY SERVICES, NAMELY, BUSINESS CONTINUITY PLANNING SERVICES; PROVIDING A WEB-BASED SERVICE THAT ENABLES HOSPITALS AND OTHER HEALTHCARE FACILITIES TO ANALYZE FOR BUSINESS PURPOSES THE EFFECTIVE USE OF HOSPITAL SPACE AND FOR ASSISTING IN PLANNING AND MODIFICATION FOR BETTER SPACE USAGE, IN CLASS 35 (U.S. CLS. 100, 101 AND 102).

FIRST USE 6-0-2008; IN COMMERCE 6-0-2008.

OWNER OF U.S. REG. NO. 914,451.

THE MARK CONSISTS OF A POLYGONAL SHIELD CONTAINING THE LETTERS "CSC".

SER. NO. 85-217,397, FILED 1-13-2011.

TIMOTHY FINNEGAN, EXAMINING ATTORNEY



*David J. Kyffers*

Director of the United States Patent and Trademark Office

# United States of America

United States Patent and Trademark Office



**Reg. No. 4,124,013**

EVANESCENCE TECHNOLOGIES, LLC (MARYLAND LIMITED LIABILITY COMPANY)  
3511 O'DONNELL ST  
BALTIMORE, MD 21224

**Registered Apr. 10, 2012**

**Int. Cl.: 21**

FOR: AIR-TIGHT, MOISTURE-PROOF, AND ANTI-STATIC RE-SEALABLE CONTAINERS FOR HOUSEHOLD USE FEATURING A DESICCANT FOR USE IN DE-HUMIDIFYING WATER DAMAGED HANDHELD ELECTRONICS TO A SPECIFIED HUMIDITY LEVEL SO AS TO FACILITATE RECOVERY OF FUNCTIONAL OPERABILITY, IN CLASS 21 (U.S. CLS. 2, 13, 23, 29, 30, 33, 40 AND 50).

**TRADEMARK**

**PRINCIPAL REGISTER**

FIRST USE 10-31-2010; IN COMMERCE 11-2-2010.

NO CLAIM IS MADE TO THE EXCLUSIVE RIGHT TO USE "CELL PHONE RESCUE" AND "WET CELL PHONE AND HANDHELD ELECTRONICS RECOVERY SYSTEM", APART FROM THE MARK AS SHOWN.

THE STIPPLING IS FOR SHADING PURPOSES ONLY.

THE MARK CONSISTS OF THE STYLIZED WORDING "CELL PHONE RESCUE" SET ABOVE THE STYLIZED WORDING "WET CELL PHONE AND HANDHELD ELECTRONICS RECOVERY SYSTEM", ALL SET TO THE LEFT OF A DESIGN ELEMENT COMPRISED OF A STYLIZED DEPICTION OF A LIFE VEST SET INSIDE A CIRCLE, WITH CURVED BAND EXTENDING FROM THE CIRCLE TO THE AREA UNDERNEATH THE WORDING.

SER. NO. 85-217,526, FILED 1-13-2011.

MICHAEL GAAFAR, EXAMINING ATTORNEY



*David J. Kyffers*

Director of the United States Patent and Trademark Office

# United States of America

United States Patent and Trademark Office

# ifancy

**Reg. No. 4,124,014**

**Registered Apr. 10, 2012**

**Int. Cl.: 45**

**SERVICE MARK**

**PRINCIPAL REGISTER**

PLENTYMORE LLP (ENGLAND LIMITED PARTNERSHIP)  
108 THE CUSTARD FACTORY, GIBB STREET  
BIRMINGHAM, UNITED KINGDOM B94AA

FOR: COMPUTER DATING SERVICES; DATING SERVICES; DATING SERVICES, NAMELY, PROVIDING AN ON-LINE COMPUTER DATABASE FEATURING SINGLE PEOPLE INTERESTED IN MEETING OTHER SINGLE PEOPLE; INTERNET BASED SOCIAL NETWORKING, INTRODUCTION, AND DATING SERVICES; INTERNET-BASED DATING, SOCIAL INTRODUCTION AND SOCIAL NETWORKING SERVICES; MARRIAGE PARTNER INTRODUCTION OR DATING SERVICES; PROVIDING A WEB SITE FEATURING INFORMATION AND CONTENT IN THE FIELDS OF PERSONAL RELATIONSHIPS, DATING AND FASHION; WEB SITE SERVICES FEATURING ON-LINE DATING CLUB, IN CLASS 45 (U.S. CLS. 100 AND 101).

FIRST USE 12-12-2009; IN COMMERCE 2-1-2010.

THE MARK CONSISTS OF STANDARD CHARACTERS WITHOUT CLAIM TO ANY PARTICULAR FONT, STYLE, SIZE, OR COLOR.

PRIORITY CLAIMED UNDER SEC. 44(D) ON UNITED KINGDOM APPLICATION NO. 2011501113, FILED 1-18-2011.

SER. NO. 85-219,503, FILED 1-18-2011.

MELISSA VALLILLO, EXAMINING ATTORNEY



*David J. Kybas*

Director of the United States Patent and Trademark Office

# United States of America

United States Patent and Trademark Office

## Spindel Farms

**Reg. No. 4,124,015**

**Registered Apr. 10, 2012**

**Int. Cl.: 30**

**TRADEMARK**

**PRINCIPAL REGISTER**

SPINDEL FARMS (CALIFORNIA PARTNERSHIP)  
491 BLACKHAWK DRIVE  
NEWBURY PARK, CA 91320

FOR: GOURMET AND SPECIALTY VINEGARS, IN CLASS 30 (U.S. CL. 46).

FIRST USE 11-1-1996; IN COMMERCE 10-15-2006.

THE MARK CONSISTS OF STANDARD CHARACTERS WITHOUT CLAIM TO ANY PARTICULAR FONT, STYLE, SIZE, OR COLOR.

NO CLAIM IS MADE TO THE EXCLUSIVE RIGHT TO USE "FARMS", APART FROM THE MARK AS SHOWN.

THE ENGLISH TRANSLATION OF "SPINDEL" IN THE MARK IS "SPINDLE".

SER. NO. 85-219,673, FILED 1-18-2011.

MARC LEIPZIG, EXAMINING ATTORNEY



*David J. Kyffers*

Director of the United States Patent and Trademark Office

# United States of America

United States Patent and Trademark Office

## Doctor Bonejangles

**Reg. No. 4,124,016**

**Registered Apr. 10, 2012**

**Int. Cl.: 9**

DESIGN WORKS STUDIOS LLC (ARIZONA LIMITED LIABILITY COMPANY), DBA DESIGN WORKS GAMING  
6263 N. SCOTTSDALE RD.  
SUITE 205  
SCOTTSDALE, AZ 85250

**TRADEMARK**

**PRINCIPAL REGISTER**

FOR: COMPUTER GAME PROGRAMMES; COMPUTER GAME PROGRAMMES DOWNLOADABLE VIA THE INTERNET; COMPUTER GAME PROGRAMS; COMPUTER GAME SOFTWARE; COMPUTER GAME SOFTWARE DOWNLOADABLE FROM A GLOBAL COMPUTER NETWORK; COMPUTER GAME SOFTWARE FOR GAMING MACHINES INCLUDING SLOT MACHINES OR VIDEO LOTTERY TERMINALS; COMPUTER GAME SOFTWARE FOR GAMING MACHINES, NAMELY, SLOT MACHINES AND VIDEO LOTTERY TERMINALS; COMPUTER GAME SOFTWARE FOR USE ON MOBILE AND CELLULAR PHONES; COMPUTER GAME SOFTWARE FOR USE WITH PERSONAL COMPUTERS, HOME VIDEO GAME CONSOLES USED WITH TELEVISIONS, AND FOR ARCADE-BASED VIDEO GAME CONSOLES; DOWNLOADABLE COMPUTER GAME PROGRAMS; DOWNLOADABLE COMPUTER GAME SOFTWARE VIA A GLOBAL COMPUTER NETWORK AND WIRELESS DEVICES; ELECTRONIC GAME SOFTWARE; ELECTRONIC GAME SOFTWARE FOR CELLULAR TELEPHONES; ELECTRONIC GAME SOFTWARE FOR HANDHELD ELECTRONIC DEVICES; ELECTRONIC GAME SOFTWARE FOR WIRELESS DEVICES; ELECTRONIC GAMING MACHINES, NAMELY, DEVICES WHICH ACCEPT A WAGER; GAME SOFTWARE; GAMING DEVICES, NAMELY, GAMING MACHINES, SLOT MACHINES, BINGO MACHINES, WITH OR WITHOUT VIDEO OUTPUT; GAMING MACHINES INCLUDING SLOT MACHINES OR VIDEO LOTTERY TERMINALS; GAMING MACHINES, NAMELY SLOT MACHINES AND VIDEO LOTTERY TERMINALS; VIDEO GAME SOFTWARE, IN CLASS 9 (U.S. CLS. 21, 23, 26, 36 AND 38).



FIRST USE 11-2-2010; IN COMMERCE 11-2-2010.

THE MARK CONSISTS OF STANDARD CHARACTERS WITHOUT CLAIM TO ANY PARTICULAR FONT, STYLE, SIZE, OR COLOR.

NO CLAIM IS MADE TO THE EXCLUSIVE RIGHT TO USE "DOCTOR", APART FROM THE MARK AS SHOWN.

SER. NO. 85-219,760, FILED 1-18-2011.

*David J. Kybas*

Director of the United States Patent and Trademark Office

**Reg. No. 4,124,016** KIMBERLY PERRY, EXAMINING ATTORNEY

# United States of America

United States Patent and Trademark Office

## EZI-CHANGE

**Reg. No. 4,124,017**

**Registered Apr. 10, 2012**

**Int. Cl.: 7**

**TRADEMARK**

**PRINCIPAL REGISTER**

WELL FLOW INTERNATIONAL, W.L.L. (BAHRAIN LIMITED LIABILITY COMPANY)  
404 DIPLOMAT TOWER, DIPLOMATIC AREA  
MANAMA, BAHRAIN

FOR: POWER TOOLS, NAMELY, CLEANING TOOLS FOR USE IN THE FIELD OF OIL AND GAS EXPLORATION AND PRODUCTION, NAMELY, POWER TOOLS HAVING SCRAPERS FOR CLEANING CASINGS AND TUBULARS, AND POWER TOOLS HAVING BRUSHES FOR CLEANING CASINGS AND TUBULARS, IN CLASS 7 (U.S. CLS. 13, 19, 21, 23, 31, 34 AND 35).

FIRST USE 2-17-1998; IN COMMERCE 6-29-1998.

THE MARK CONSISTS OF STANDARD CHARACTERS WITHOUT CLAIM TO ANY PARTICULAR FONT, STYLE, SIZE, OR COLOR.

SER. NO. 85-219,884, FILED 1-18-2011.

MARC LEIPZIG, EXAMINING ATTORNEY



*David J. Kyffers*

Director of the United States Patent and Trademark Office



# United States of America

United States Patent and Trademark Office

## Chocolate Soop

**Reg. No. 4,124,018**

**Registered Apr. 10, 2012**

**Int. Cls.: 9, 28 and 42**

**TRADEMARK**

**SERVICE MARK**

**PRINCIPAL REGISTER**

CHOCOLATE SOOP, INC. (CANADA CORPORATION)  
#52, 1243 THURLOW STREET  
VANCOUVER, BC, CANADA V6E1X4

FOR: VIDEO GAMES SOFTWARE AND ELECTRONIC APPLICATIONS IN THE NATURE OF EDUCATIONAL SOFTWARE IN THE FIELD OF EARLY CHILDHOOD DEVELOPMENT FOR ALL MOBILE PLATFORMS SUCH AS MOBILE DEVICES, PERSONAL COMPUTERS, CONSOLES, AND TABLET PERSONAL COMPUTERS; ELECTRONIC GAME PROGRAMS; DOWNLOADABLE ELECTRONIC GAME PROGRAMS; ELECTRONIC GAME SOFTWARE; COMPUTER GAME PROGRAMS; INTERACTIVE GAME PROGRAMS, IN CLASS 9 (U.S. CLS. 21, 23, 26, 36 AND 38).

FIRST USE 5-22-2005; IN COMMERCE 5-22-2005.

FOR: TOY FIGURES, NAMELY, COLLECTIBLE TOY FIGURES; MODELED PLASTIC TOY FIGURINES; MOLDED TOY FIGURES; PLASTIC CHARACTER TOYS; POSITIONABLE TOY FIGURES; SOFT SCULPTURE PLUSH TOYS; SOFT SCULPTURE TOYS; STUFFED TOYS; TOY ACTION FIGURES; TOY ACTION FIGURES AND ACCESSORIES THEREFOR; TOY FIGURES; PLUSH TOYS; STUFFED AND PLUSH TOYS, IN CLASS 28 (U.S. CLS. 22, 23, 38 AND 50).

FIRST USE 5-22-2005; IN COMMERCE 5-22-2005.

FOR: GRAPHIC DESIGN SERVICES, NAMELY, CHARACTER DEVELOPMENT FOR CLIENTS FOR VARIOUS PURPOSES INCLUDING ADVERTISING AND BRANDING CAMPAIGNS, VIDEO GAMES, AND APPLICATIONS FOR MOBILE DEVICES ETC, IN CLASS 42 (U.S. CLS. 100 AND 101).

FIRST USE 5-22-2005; IN COMMERCE 5-22-2005.

THE MARK CONSISTS OF STANDARD CHARACTERS WITHOUT CLAIM TO ANY PARTICULAR FONT, STYLE, SIZE, OR COLOR.

NO CLAIM IS MADE TO THE EXCLUSIVE RIGHT TO USE "CHOCOLATE", APART FROM THE MARK AS SHOWN.

SER. NO. 85-221,239, FILED 1-19-2011.



*David J. Kyffers*

Director of the United States Patent and Trademark Office

**Reg. No. 4,124,018** REBECCA EISINGER, EXAMINING ATTORNEY

# United States of America

United States Patent and Trademark Office

## PUMP IN A DRUM

**Reg. No. 4,124,019**

RIVERDALE COLOR MANUFACTURING, INC. (NEW JERSEY CORPORATION)  
1 WALNUT STREET

**Registered Apr. 10, 2012**

PERTH AMBOY, NJ 08861

**Int. Cl.: 7**

FOR: MACHINES, NAMELY, APPARATUS FOR DELIVERING CONTROLLED AMOUNTS OF LIQUID COLOR FOR MIXING WITH PLASTIC RESIN MATERIALS PRIOR TO MOLDING, EXTRUSION OR OTHER PROCESSING, IN CLASS 7 (U.S. CLS. 13, 19, 21, 23, 31, 34 AND 35).

**TRADEMARK**

**PRINCIPAL REGISTER**

FIRST USE 4-30-2002; IN COMMERCE 4-30-2002.

THE MARK CONSISTS OF STANDARD CHARACTERS WITHOUT CLAIM TO ANY PARTICULAR FONT, STYLE, SIZE, OR COLOR.

OWNER OF U.S. REG. NO. 2,955,931.

SEC. 2(F).

SER. NO. 85-221,772, FILED 1-20-2011.

KELLY CHOE, EXAMINING ATTORNEY



*David J. Kyffers*

Director of the United States Patent and Trademark Office

# United States of America

United States Patent and Trademark Office

## Feel The Steel

**Reg. No. 4,124,020**

**Registered Apr. 10, 2012**

**Int. Cl.: 6**

**TRADEMARK**

**PRINCIPAL REGISTER**

KVA, INC. (NEVADA CORPORATION)  
124 S. MARKET PLACE  
SUITE 200  
ESCONDIDO, CA 92029

FOR: METAL TUBES; METAL TUBING; METALLIC PIPES AND TUBES; PIPE TUBES OF METAL; TUBES OF METAL; TUBES OF STAINLESS STEEL, IN CLASS 6 (U.S. CLS. 2, 12, 13, 14, 23, 25 AND 50).

FIRST USE 1-1-2005; IN COMMERCE 6-1-2005.

THE MARK CONSISTS OF STANDARD CHARACTERS WITHOUT CLAIM TO ANY PARTICULAR FONT, STYLE, SIZE, OR COLOR.

SER. NO. 85-221,946, FILED 1-20-2011.

TIMOTHY FINNEGAN, EXAMINING ATTORNEY



*David J. Kybas*

Director of the United States Patent and Trademark Office

# United States of America

## United States Patent and Trademark Office



**Reg. No. 4,124,021**

**Registered Apr. 10, 2012**

**Int. Cl.: 25**

**TRADEMARK**

**PRINCIPAL REGISTER**

PRL USA HOLDINGS, INC. (DELAWARE CORPORATION)  
550 SEVENTH AVENUE  
NEW YORK, NY 10018

FOR: BEACHWEAR; CAPS; COATS; DRESSES; HATS; JACKETS; PANTS; RAINCOATS;  
SHIRTS; T-SHIRTS; UNDERWEAR, IN CLASS 25 (U.S. CLS. 22 AND 39).

FIRST USE 7-0-2007; IN COMMERCE 7-0-2007.

OWNER OF U.S. REG. NOS. 3,199,839, 3,733,341 AND OTHERS.

NO CLAIM IS MADE TO THE EXCLUSIVE RIGHT TO USE "OFFICIAL SPONSOR" "COM-  
PETITION POLO TEAM" AND "CO.", APART FROM THE MARK AS SHOWN.

THE MARK CONSISTS OF A CREST COMPOSED OF TWO INTERSECTING POLO MALLETS  
WITH A FANCIFUL REPRESENTATION OF A POLO PLAYER MOUNTED ON A HORSE  
SUPERIMPOSED AT THE POINT WHERE THE POLO MALLETS INTERSECT AND  
BETWEEN THE LITERAL ELEMENTS "BLACK" AND "WATCH". A FIRST BANNER WITH  
THE LITERAL ELEMENTS "OFFICIAL SPONSOR" APPEARS ABOVE THE POLO PLAYER  
AND A CREST WITH THE LITERAL ELEMENTS "RLC" IN A STYLIZED FONT IS SUPER-  
IMPOSED ON THE BANNER. A SECOND BANNER WITH THE LITERAL ELEMENTS  
"COMPETITION POLO TEAM" APPEARS BELOW THE POLO PLAYER MOUNTED ON A  
HORSE. A THIRD BANNER WITH THE LITERAL ELEMENTS "POLO RALPH LAUREN  
CO." APPEARS BELOW THE SECOND BANNER.

SER. NO. 85-222,090, FILED S.R. 1-20-2011 AM. P.R. 1-26-2011.

DAVID H. STINE, EXAMINING ATTORNEY



*David J. Kyffers*

Director of the United States Patent and Trademark Office

# United States of America

United States Patent and Trademark Office

# ACUITAS

**Reg. No. 4,124,022**

ACUITAS, LLC (MICHIGAN LIMITED LIABILITY COMPANY)  
110 W. MICHIGAN AVE., SUITE 100  
LANSING, MI 48933

**Registered Apr. 10, 2012**

**Int. Cl.: 35**

FOR: BUSINESS CONSULTING AND INFORMATION SERVICES; BUSINESS CONSULTING SERVICES, NAMELY, PROVIDING ASSISTANCE IN DEVELOPMENT OF BUSINESS STRATEGIES AND CREATIVE IDEATION; COMMERCIAL LOBBYING SERVICES; POLITICAL CONSULTANCY, IN CLASS 35 (U.S. CLS. 100, 101 AND 102).

**SERVICE MARK**

**PRINCIPAL REGISTER**

FIRST USE 2-0-2007; IN COMMERCE 8-0-2008.

THE MARK CONSISTS OF STANDARD CHARACTERS WITHOUT CLAIM TO ANY PARTICULAR FONT, STYLE, SIZE, OR COLOR.

THE ENGLISH TRANSLATION OF "ACUITAS" IN THE MARK IS "INSIGHT, SHARPNESS, PERCEPTION".

SER. NO. 85-222,861, FILED 1-21-2011.

TRACY WHITTAKER-BROWN, EXAMINING ATTORNEY



*David J. Kyffers*

Director of the United States Patent and Trademark Office

# United States of America

United States Patent and Trademark Office



**Reg. No. 4,124,023**

**Registered Apr. 10, 2012**

**Int. Cl.: 9**

**TRADEMARK**

**PRINCIPAL REGISTER**

SCUD BATTERY CO. LTD. (CHINA LIMITED LIABILITY COMPANY)  
SCUD INDUSTRIAL PARK, MAWEI ECONOMIC  
AND, TECHNOLOGY DEVELOPMENT ZONE  
FUZHOU CITY, FUJIAN PROVINCE, CHINA

FOR: (BASED ON 44(E)), REG. NO. 3969454) COMPUTERS; COMPUTER PERIPHERAL DEVICES; PORTABLE TELEPHONES; (BASED ON 44 (E)), REG. NO. 1247075) BATTERIES, BATTERY CHARGERS; SOLAR BATTERIES; BATTERIES FOR LIGHTING, IN CLASS 9 (U.S. CLS. 21, 23, 26, 36 AND 38).

OWNER OF CHINA REG. NO. 1247075, DATED 2-14-1999, RENEWED AS REG. NO. 1247075, DATED 2-14-2009, EXPIRES 2-13-2019.

OWNER OF CHINA REG. NO. 3969454, DATED 4-21-2006, EXPIRES 4-20-2016.

THE MARK CONSISTS OF THE STYLIZED WORDING "SCUD" IN THE MIDDLE OF A WAVE DESIGN.

THE WORDING "SCUD" HAS NO MEANING IN A FOREIGN LANGUAGE.

SER. NO. 85-223,077, FILED 1-21-2011.

BRENDAN REGAN, EXAMINING ATTORNEY



*David J. Kyffers*

Director of the United States Patent and Trademark Office

# United States of America

United States Patent and Trademark Office

## THE SWEET REMAINS

**Reg. No. 4,124,024**

**Registered Apr. 10, 2012**

**Int. Cl.: 41**

**SERVICE MARK**

**PRINCIPAL REGISTER**

CHARTRAND, BRIAN (UNITED STATES INDIVIDUAL)  
C/O LOEB & LOEB LLP  
1906 ACKLEN AVENUE  
NASHVILLE, TN 37212 AND

PRICE, RICH (UNITED STATES INDIVIDUAL)  
C/O LOEB & LOEB LLP  
1906 ACKLEN AVENUE  
NASHVILLE, TN 37212 AND

NAUGHTON, GREG (UNITED STATES INDIVIDUAL)  
C/O LOEB & LOEB LLP  
1906 ACKLEN AVENUE  
NASHVILLE, TN 37212

FOR: ENTERTAINMENT SERVICES, NAMELY, LIVE PERFORMANCES, PERSONAL APPEARANCES AS WELL AS LIVE TELEVISION AND RADIO PERFORMANCES BY A MUSICAL ARTIST; ENTERTAINMENT, NAMELY, PRODUCTION OF LIVE THEATRICAL SHOWS, LIVE MUSICAL SHOWS, CONCERTS, VIDEOS, MULTIMEDIA VIDEOS AND RADIO AND TELEVISION PROGRAMS; AUDIO AND VIDEO RECORDING SERVICES; PRODUCTION OF VIDEO AND AUDIO RECORDINGS ON CASSETTES, DVDS, COMPACT DISCS, RECORDS AND IN DIGITAL FORMAT, FEATURING MUSIC; ENTERTAINMENT SERVICES, NAMELY, PROVIDING THE ONLINE PLAYBACK OF NONDOWNLOADABLE PRERECORDED MUSIC AND VIDEOS FEATURING MUSIC ONLINE VIA A GLOBAL COMPUTER NETWORK; PROVIDING A WEBSITE FEATURING INFORMATION ON A MUSICAL ARTIST, INCLUDING PERFORMANCES, RECORDS, APPEARANCES AND BIOGRAPHICAL INFORMATION ONLINE VIA A GLOBAL COMPUTER NETWORK; MUSIC PUBLISHING SERVICES; CONDUCTING ONLINE SWEEPSTAKES AND CONTESTS, IN CLASS 41 (U.S. CLS. 100, 101 AND 107).

FIRST USE 10-11-2008; IN COMMERCE 10-13-2008.

THE MARK CONSISTS OF STANDARD CHARACTERS WITHOUT CLAIM TO ANY PARTICULAR FONT, STYLE, SIZE, OR COLOR.

SER. NO. 85-223,825, FILED 1-22-2011.



*David J. Kyros*

Director of the United States Patent and Trademark Office



**Reg. No. 4,124,024** JEFFREY LOOK, EXAMINING ATTORNEY

# United States of America

United States Patent and Trademark Office

## SMARTMEDS PHARMACY

**Reg. No. 4,124,025**

PHARMACAN PHARMACY INNOVATIONS INC. (CANADA CORPORATION)

**Registered Apr. 10, 2012**

176 CREEK PATH AVENUE  
OAKVILLE, ONTARIO, CANADA L6L6T5

**Int. Cl.: 35**

FOR: RETAIL PHARMACY SERVICES, IN CLASS 35 (U.S. CLS. 100, 101 AND 102).

**SERVICE MARK**

THE MARK CONSISTS OF STANDARD CHARACTERS WITHOUT CLAIM TO ANY PARTICULAR FONT, STYLE, SIZE, OR COLOR.

**PRINCIPAL REGISTER**

PRIORITY CLAIMED UNDER SEC. 44(D) ON CANADA APPLICATION NO. 1511904, FILED 1-19-2011, REG. NO. TMA812944, DATED 11-29-2011, EXPIRES 11-29-2026.

OWNER OF U.S. REG. NO. 3,898,743.

NO CLAIM IS MADE TO THE EXCLUSIVE RIGHT TO USE "PHARMACY", APART FROM THE MARK AS SHOWN.

SER. NO. 85-225,301, FILED 1-25-2011.

KIMBERLY FRYE, EXAMINING ATTORNEY



*David J. Kybas*

Director of the United States Patent and Trademark Office

# United States of America

United States Patent and Trademark Office

# BITZ

**Reg. No. 4,124,026**

**Registered Apr. 10, 2012**

**Int. Cl.: 31**

**TRADEMARK**

**PRINCIPAL REGISTER**

WELLPET LLC (DELAWARE LIMITED LIABILITY COMPANY)  
200 AMES POND DRIVE  
TEWKSBURY, MA 018761274

FOR: PET TREATS, IN CLASS 31 (U.S. CLS. 1 AND 46).

FIRST USE 3-29-2001; IN COMMERCE 3-29-2001.

THE MARK CONSISTS OF STANDARD CHARACTERS WITHOUT CLAIM TO ANY PARTICULAR FONT, STYLE, SIZE, OR COLOR.

OWNER OF U.S. REG. NOS. 2,005,061 AND 3,016,391.

SEC. 2(F).

SER. NO. 85-225,521, FILED 1-25-2011.

KIM SAITO, EXAMINING ATTORNEY



*David J. Kybas*

Director of the United States Patent and Trademark Office

# United States of America

United States Patent and Trademark Office

# APPTRICITY

**Reg. No. 4,124,027**

**Registered Apr. 10, 2012**

**Int. Cls.: 9 and 42**

**TRADEMARK**

**SERVICE MARK**

**PRINCIPAL REGISTER**

APPTRICITY CORPORATION (DELAWARE CORPORATION)  
5605 N. MACARTHUR BLVD., SUITE 900  
IRVING, TX 75038

FOR: ENTERPRISE SOFTWARE FOR USE IN INTEGRATION, SYNCHRONIZATION AND PROCESSING OF DATA FOR EBUSINESS AND CUSTOM APPLICATIONS TO AUTOMATE SUPPLY CHAIN, WORKFORCE AND FINANCE MANAGEMENT ACCESSIBLE FROM THE INTERNET USING DESKTOP OR WIRELESS DEVICES, IN CLASS 9 (U.S. CLS. 21, 23, 26, 36 AND 38).

FIRST USE 2-2-2000; IN COMMERCE 2-2-2000.

FOR: DESIGN, DEVELOPMENT AND IMPLEMENTATION OF ON-PREMISE SOFTWARE AND SOFTWARE-AS-A-SERVICE (SAAS) FOR USE IN INTEGRATION, SYNCHRONIZATION AND PROCESSING OF DATA FOR EBUSINESS AND CUSTOM APPLICATIONS TO AUTOMATE SUPPLY CHAIN, WORKFORCE AND FINANCE MANAGEMENT ACCESSIBLE FROM THE INTERNET USING DESKTOP OR WIRELESS DEVICES, IN CLASS 42 (U.S. CLS. 100 AND 101).

FIRST USE 2-2-2000; IN COMMERCE 2-2-2000.

THE MARK CONSISTS OF STANDARD CHARACTERS WITHOUT CLAIM TO ANY PARTICULAR FONT, STYLE, SIZE, OR COLOR.

SER. NO. 85-225,844, FILED 1-25-2011.

SALLY SHIH, EXAMINING ATTORNEY



*David J. Kyffers*

Director of the United States Patent and Trademark Office

# United States of America

United States Patent and Trademark Office



**Reg. No. 4,124,028**

**Registered Apr. 10, 2012**

**Int. Cl.: 18**

**TRADEMARK**

**PRINCIPAL REGISTER**

MRM HOLDINGS LIMITED (MAURITIUS LIMITED LIABILITY COMPANY)  
SUITE 802  
ST JAMES COURT, ST DENIS STREET  
PORT LOUIS, MAURITIUS

FOR: SPECIALIZED SECURITY, ANTI-THEFT BAGS AND ACCESSORIES SOLD THROUGH SPECIALTY AND TRAVEL STORES AND WEBSITES, NAMELY, SUITCASES; ALL-PURPOSE CARRYING BAGS; TRAVEL BAGS; WIRE AND POLYMER REINFORCED ALL-PURPOSE CARRYING BAGS; WIRE AND POLYMER REINFORCED TRAVEL BAGS; LOCKABLE REINFORCED ALL-PURPOSE CARRYING BAGS; LOCKABLE REINFORCED TRAVEL BAGS; LOCKABLE ALL-PURPOSE CARRYING BAGS; LOCKABLE TRAVEL BAGS; BAGS FOR TRAVEL IN THE NATURE OF TRAVEL BAGS; ALL-PURPOSE CARRYING BAGS FOR CAMPING; TRAVEL BAGS FOR CAMPING; BACKPACKS; DAYPACKS; ACROSS BODY PACKS, NAMELY, SLING BAGS THAT EXTEND ACROSS OR ON FRONT OF A BODY; ACROSS BODY TRAVEL PACKS, NAMELY, SLING BAGS THAT EXTEND ACROSS OR ON FRONT OF A BODY; WAIST BAGS; WRIST BAGS IN THE NATURE OF WRIST MOUNTED CARRYALL BAGS; SPORT EQUIPMENT BAGS IN THE NATURE OF ALL PURPOSE SPORT BAGS; LOCKABLE SECURITY TRAVEL BAGS; SECURITY POUCHES OF TEXTILE; COURIER BAGS IN THE NATURE OF MESSENGER BAGS; DOCUMENT BAGS IN THE NATURE OF BACKPACKS AND BRIEFCASES; HUNTING BAGS; ALL-PURPOSE CARRYING BAGS FOR SECURING PERSONAL ITEMS; TOTE BAGS FOR SECURING PERSONAL ITEMS; DUFFEL BAGS FOR SECURING PERSONAL ITEMS; LUGGAGE; WEATHER PROOF LUGGAGE; BAG COVERS AND CONTAINERS, NAMELY, LOCKABLE COVERS TO PROTECT TRAVEL BAGS; WALLETS; PURSES; CREDIT CARD HOLDERS; FANNY PACKS, IN CLASS 18 (U.S. CLS. 1, 2, 3, 22 AND 41).



FIRST USE 11-23-2010; IN COMMERCE 11-23-2010.

PRIORITY CLAIMED UNDER SEC. 44(D) ON HONG KONG APPLICATION NO. 301674199, FILED 7-27-2010.

THE MARK CONSISTS OF THE WORDING "OUTSMART" IN STYLIZED LIGHT SCRIPT LETTERING WITHIN A DARK OVAL SURROUNDED BY SLASH MARKS THAT COULD BE SAID TO REPRESENT A ROPE OR CABLE AROUND THE OVAL.

SER. NO. 85-226,221, FILED 1-26-2011.

*David J. Kyffers*

Director of the United States Patent and Trademark Office

**Reg. No. 4,124,028** MATTHEW MCDOWELL, EXAMINING ATTORNEY

# United States of America

United States Patent and Trademark Office

## A TOUCH OF CLASS

**Reg. No. 4,124,029**

**Registered Apr. 10, 2012**

**Int. Cls.: 1, 2, 3, 35, 36  
and 37**

**TRADEMARK**

**SERVICE MARK**

**PRINCIPAL REGISTER**

CAL-TEX PROTECTIVE COATINGS, INCORPORATED (TEXAS CORPORATION)  
7455 NATURAL BRIDGE CAVERNS ROAD  
SCHERTZ, TX 781543210

FOR: LEATHER AND VINYL PROTECTANTS FOR VEHICLES' INTERIOR LEATHER SURFACES; CHEMICAL SEALANTS TO BE APPLIED TO VEHICLE INTERIOR LEATHER AND VINYL SURFACES TO PREVENT STAINS, PREMATURE AGING, OR FADING OR TO RETAIN SOFTNESS, IN CLASS 1 (U.S. CLS. 1, 5, 6, 10, 26 AND 46).

FIRST USE 3-21-1983; IN COMMERCE 9-22-1987.

FOR: PAINT SEALERS, IN CLASS 2 (U.S. CLS. 6, 11 AND 16).

FIRST USE 3-21-1983; IN COMMERCE 9-22-1987.

FOR: VEHICLE WAX; POLYMER SEALANT FOR CLEANING, SHINING AND PROTECTING VEHICLE EXTERIOR SURFACES; VEHICLE CLEANERS, NAMELY, SOAPS, DETERGENTS AND CLEANING PREPARATIONS, VEHICLE WASH PREPARATIONS, VEHICLE UPHOLSTERY CLEANERS, VEHICLE CARPET CLEANERS, VEHICLE WINDOW CLEANING PREPARATIONS, WHEEL CLEANING PREPARATIONS, TIRE CLEANING PREPARATIONS, TIRE DRESSINGS, GLASS CLEANERS, TAR REMOVERS, BUG REMOVING PREPARATIONS; VEHICLE GLAZES TO BE APPLIED TO VEHICLE EXTERIORS FOR ENHANCING THE SHINE OF AND PREVENTING FADING AND LOSS OF GLOSS OF A VEHICLE'S EXTERIOR PAINT, POLISHES, AND DEGREASING SOLUTIONS, IN CLASS 3 (U.S. CLS. 1, 4, 6, 50, 51 AND 52).

FIRST USE 3-21-1983; IN COMMERCE 9-22-1987.

FOR: PROCESSING WARRANTY REGISTRATION DOCUMENTS FOR VEHICULAR CARE PRODUCTS, IN CLASS 35 (U.S. CLS. 100, 101 AND 102).

FIRST USE 3-21-1983; IN COMMERCE 9-22-1987.

FOR: UNDERWRITING WARRANTY PROGRAMS IN THE FIELD OF VEHICULAR CARE PRODUCTS; WARRANTY CLAIMS ADMINISTRATION SERVICES, NAMELY, PROCESSING WARRANTY CLAIMS FOR VEHICULAR CARE PRODUCTS, IN CLASS 36 (U.S. CLS. 100, 101 AND 102).



*David J. Kyffers*

Director of the United States Patent and Trademark Office

**Reg. No. 4,124,029** FIRST USE 3-21-1983; IN COMMERCE 9-22-1987.

FOR: APPLYING PROTECTIVE COATINGS AND SEALANTS TO VEHICULAR INTERIOR UPHOLSTERY AND CARPET, LEATHER SURFACES, AND VEHICULAR INTERIOR VINYL SURFACE; REPAIRING DAMAGED VEHICULAR INTERIOR UPHOLSTERY AND CARPET, LEATHER SURFACES AND VEHICULAR INTERIOR VINYL SURFACES BY REMOVING STAINS AND REAPPLYING PROTECTIVE COATINGS AND SEALANTS, IN CLASS 37 (U.S. CLS. 100, 103 AND 106).

FIRST USE 3-21-1983; IN COMMERCE 9-22-1987.

THE MARK CONSISTS OF STANDARD CHARACTERS WITHOUT CLAIM TO ANY PARTICULAR FONT, STYLE, SIZE, OR COLOR.

SER. NO. 85-226,333, FILED 1-26-2011.

DEZMONA MIZELLE, EXAMINING ATTORNEY



# United States of America

United States Patent and Trademark Office

## CPH CLEVELAND PLAY HOUSE

**Reg. No. 4,124,030**

THE CLEVELAND PLAY HOUSE (OHIO CORPORATION)  
1901 EAST 13TH STREET, SUITE 200  
CLEVELAND, OH 44114

**Registered Apr. 10, 2012**

**Int. Cl.: 41**

FOR: ENTERTAINMENT IN THE NATURE OF LIVE THEATER PRODUCTIONS AND TOURING PERFORMANCES; EDUCATIONAL SERVICES, NAMELY, PROVIDING CLASSES, SEMINARS, WORKSHOPS AND ON-LINE LEARNING IN THE FIELD OF THEATER ARTS, IN CLASS 41 (U.S. CLS. 100, 101 AND 107).

**SERVICE MARK**

**PRINCIPAL REGISTER**

FIRST USE 3-17-2011; IN COMMERCE 3-17-2011.

THE MARK CONSISTS OF STANDARD CHARACTERS WITHOUT CLAIM TO ANY PARTICULAR FONT, STYLE, SIZE, OR COLOR.

NO CLAIM IS MADE TO THE EXCLUSIVE RIGHT TO USE "PLAY HOUSE", APART FROM THE MARK AS SHOWN.

SEC. 2(F) AS TO "CLEVELAND PLAY HOUSE".

SER. NO. 85-226,546, FILED 1-26-2011.

KAELIE KUNG, EXAMINING ATTORNEY



*David J. Kyffers*

Director of the United States Patent and Trademark Office

# United States of America

United States Patent and Trademark Office

## PIZZA RUSTICA

**Reg. No. 4,124,031**

**Registered Apr. 10, 2012**

**Int. Cl.: 43**

**SERVICE MARK**

**PRINCIPAL REGISTER**

RUSTICA FRANCHISE COMPANY, INC (FLORIDA CORPORATION)  
SUITE 240  
605 LINCOLN ROAD  
MIAMI BEACH, FL 33139

FOR: RESTAURANT AND TAKE-OUT SERVICES, IN CLASS 43 (U.S. CLS. 100 AND 101).

FIRST USE 4-15-1996; IN COMMERCE 4-15-1996.

THE MARK CONSISTS OF STANDARD CHARACTERS WITHOUT CLAIM TO ANY PARTICULAR FONT, STYLE, SIZE, OR COLOR.

OWNER OF U.S. REG. NOS. 3,266,540 AND 3,371,902.

NO CLAIM IS MADE TO THE EXCLUSIVE RIGHT TO USE "PIZZA", APART FROM THE MARK AS SHOWN.

THE ENGLISH TRANSLATION OF "RUSTICA" IN THE MARK IS "RUSTIC".

SEC. 2(F).

SER. NO. 85-226,594, FILED 1-26-2011.

JOHN DWYER, EXAMINING ATTORNEY



*David J. Kyffers*

Director of the United States Patent and Trademark Office

# United States of America

United States Patent and Trademark Office

## We've got your seat

**Reg. No. 4,124,032**

JIFFY TICKETS (CALIFORNIA CORPORATION)

**Registered Apr. 10, 2012**

3053 FILLMORE ST., SUITE #150  
SAN FRANCISCO, CA 94123

**Int. Cls.: 35 and 41**

FOR: MANAGEMENT OF EVENT TICKETING FOR OTHERS; PROCUREMENT, NAMELY, PURCHASING TICKETS TO ENTERTAINMENT EVENTS FOR OTHERS, IN CLASS 35 (U.S. CLS. 100, 101 AND 102).

**SERVICE MARK**

FIRST USE 1-1-2011; IN COMMERCE 1-1-2011.

**PRINCIPAL REGISTER**

FOR: ARRANGING FOR TICKET RESERVATIONS FOR SHOWS AND OTHER ENTERTAINMENT EVENTS; ENTERTAINMENT TICKET AGENCY SERVICES; ON-LINE ADMISSION TICKET AGENCY SERVICES FOR ENTERTAINMENT, EDUCATIONAL, SPORTING AND CULTURAL EVENTS; ON-LINE ENTERTAINMENT TICKET AGENCY SERVICES; PROVIDING WILL-CALL TICKET SERVICES; TICKET AGENCY SERVICES FOR ENTERTAINMENT EVENTS; TICKET RESERVATION AND BOOKING SERVICES FOR ENTERTAINMENT, SPORTING AND CULTURAL EVENTS, IN CLASS 41 (U.S. CLS. 100, 101 AND 107).

FIRST USE 1-1-2011; IN COMMERCE 1-1-2011.

THE MARK CONSISTS OF STANDARD CHARACTERS WITHOUT CLAIM TO ANY PARTICULAR FONT, STYLE, SIZE, OR COLOR.

SER. NO. 85-226,681, FILED 1-26-2011.

KAELIE KUNG, EXAMINING ATTORNEY



*David J. Kyffers*

Director of the United States Patent and Trademark Office

# United States of America

United States Patent and Trademark Office

## BUSINESS DESIGN

**Reg. No. 4,124,033**

**Registered Apr. 10, 2012**

**Int. Cl.: 41**

**SERVICE MARK**

**PRINCIPAL REGISTER**

THE GOVERNING COUNCIL OF THE UNIVERSITY OF TORONTO (CANADA NON-SHARE CORPORATION)  
27 KING'S COLLEGE CIRCLE  
TORONTO, ONTARIO, CANADA M5S1A1

FOR: EDUCATIONAL SERVICES, NAMELY, THE PRESENTATION OF LECTURES, CONFERENCES, WORKSHOPS, SEMINARS AND CLASSES, BOTH IN PERSON AND BY ELECTRONIC MEANS, IN THE FIELD OF BUSINESS, IN CLASS 41 (U.S. CLS. 100, 101 AND 107).

FIRST USE 7-26-2005; IN COMMERCE 7-26-2005.

THE MARK CONSISTS OF STANDARD CHARACTERS WITHOUT CLAIM TO ANY PARTICULAR FONT, STYLE, SIZE, OR COLOR.

NO CLAIM IS MADE TO THE EXCLUSIVE RIGHT TO USE "BUSINESS", APART FROM THE MARK AS SHOWN.

SEC. 2(F).

SER. NO. 85-226,945, FILED 1-26-2011.

CHRISTINA SOBRAL, EXAMINING ATTORNEY



*David J. Kyjars*

Director of the United States Patent and Trademark Office

# United States of America

United States Patent and Trademark Office

# F1

**Reg. No. 4,124,034**

FORMULA ONE LICENSING BV (NETHERLANDS CORPORATION)  
BEURSPLEIN 37

**Registered Apr. 10, 2012**

ROTTERDAM, NETHERLANDS 3011AA

**Int. Cl.: 9**

**TRADEMARK**

**PRINCIPAL REGISTER**

FOR: PHOTOGRAPHIC, CINEMATOGRAPHIC, OPTICAL, WEIGHING, MEASURING, TEACHING APPARATUS AND INSTRUMENTS, NAMELY, CAMERAS, WEIGHING SCALES; APPARATUS FOR RECORDING, TRANSMISSION OR REPRODUCTION OF SOUND OR IMAGES; BLANK MAGNETIC DATA CARRIERS, RECORDING DISCS, NAMELY, BLANK RECORDABLE OPTICAL DISC; AUTOMATIC VENDING MACHINES AND MECHANISMS FOR COIN-OPERATED APPARATUS; DATA PROCESSING EQUIPMENT AND COMPUTERS; CALCULATORS; ADAPTERS FOR USE WITH TELEPHONES; ELECTRONIC AGENDAS; AMPLIFIERS; AMUSEMENT APPARATUS ADAPTED FOR USE WITH AN EXTERNAL DISPLAY SCREEN OR MONITOR; ANIMATED CARTOONS, NAMELY, VIDEO DISKS AND VIDEO TAPES WITH RECORDED ANIMATED CARTOONS; ANSWERING MACHINES; ANTIDAZZLE SHADES; ANTI-GLARE GLASSES; ANTIGLARE SCREENS FOR COMPUTERS; ANTIGLARE VISORS; ANTI-THEFT WARNING APPARATUS, NAMELY, THEFT ALARMS; APPLICATION DEVELOPMENT TOOL PROGRAMS FOR PERSONAL AND HANDHELD COMPUTERS AUDIO RECEIVERS; AUDIOVISUAL TEACHING APPARATUS, NAMELY, MULTIMEDIA PROJECTORS; AUDIO VIDEO RECEIVERS FOR HOME THEATRES; AUTOMATIC TELLER MACHINES; BAGS AND CASES SPECIALLY ADAPTED FOR HOLDING OR CARRYING PORTABLE TELEPHONES AND TELEPHONE EQUIPMENT AND ACCESSORIES; BANK CARDS, NAMELY, MAGNETIC CODED BANK CARD FOR USE IN PERFORMING TRANSACTIONS, CHECKING STATUS OF BANK ACCOUNTS; BATTERIES, ELECTRIC; BATTERIES, ELECTRIC, FOR VEHICLES; BATTERY CHARGERS; BINOCULARS; BLANK COMPACT DISKS, CD ROMS, DVDS, BLANK MAGNETIC DATA MEDIA, BLANK OPTICAL DATA MEDIA, MAGNETIC TAPES, OPTICAL DISCS, BLANK MAGNETIC DISKS, VIDEO TAPES; BRACELETS, NAMELY, MAGNETICALLY ENCODED IDENTIFICATION BRACELETS; CABINETS FOR LOUDSPEAKERS; CAMCORDERS; CINEMATOGRAPHIC CAMERAS; CAMERAS; CAMERAS INCORPORATING SECONDARY FUNCTIONALITY; CAR INFOTAINMENT DEVICES IN THE NATURE OF PERSONAL DIGITAL ASSISTANCE AND COMPUTER; CASES FOR CAMERAS; CASES FOR COMPACT DISCS; MAGNETICALLY CODED CASH CARDS; CASSETTE PLAYERS; CD ROM DRIVES; CENTRAL PROCESSING UNITS; MAGNETICALLY CODED CHARGE CARDS; CINEMATOGRAPHIC EQUIPMENT, NAMELY, CINEMATOGRAPHIC MACHINES AND APPARATUS; CINEMATOGRAPHIC FILM FEATURING AUTO RACING; CLEANING APPARATUS FOR PHONOGRAPH RECORDS, NAMELY, CLEANING SHEETS, CLEANING PAPERS, CLEANING WIPES, CLEANING CLOTHS, CLEANING SWABS; CLEANING APPARATUS



*David J. Kybas*

Director of the United States Patent and Trademark Office

**Reg. No. 4,124,034** FOR SOUND RECORDING DISCS, NAMELY, MAGNETIC TAPE CLEANERS; TIME RECORDING DEVICES IN THE NATURE OF TIME CLOCKS; COMPACT DISC PLAYERS/RECORDERS; COMPACT DISCS COMPACT DISCS FEATURING AUTO RACING; COMPUTER GAME PROGRAMS; DOWNLOADABLE COMPUTER SOFTWARE PROGRAMS FOR USE IN DATABASE MANAGEMENT; COMPUTER KEYBOARDS; COMPUTER MEMORIES; COMPUTER PERIPHERAL DEVICES; RECORDED COMPUTER OPERATING PROGRAMS; COMPUTER PROGRAMS FOR PLAYING GAMES; COMPUTER SOFTWARE DESIGNED TO ENABLE SMART CARDS TO INTERACT WITH TERMINALS AND READERS; COMPUTER SOFTWARE FOR BETTING, GAMING AND GAMBLING AND FOR GAMING MACHINES; COMPUTER SOFTWARE FOR IMPLEMENTING SECURITY METHODOLOGY INVOLVING ENCRYPTION OF PAYMENT CARD NUMBERS AND RELATED DATA AND TRANSMISSION OVER COMPUTER NETWORKS; COMPUTER SOFTWARE FOR INTERACTIVE REEL AND SLOT GAMES; COMPUTER APPLICATION SOFTWARE FOR MOBILE PHONES; COMPUTER SOFTWARE FOR PROGRAMMING TELEVISIONS; COMPUTERS; CREDIT CARD MACHINES; MAGNETICALLY ENCODED CREDIT CARDS; CURRENCY-CONVERTING APPARATUS, NAMELY, ELECTRONIC CURRENCY CONVERTERS; CURSOR ICONS, NAMELY, COMPUTER SOFTWARE FOR CHANGING THE APPEARANCE AND FUNCTION OF COMPUTER CURSORS; DATA PROCESSING APPARATUS; MAGNETICALLY ENCODED DEBIT CARDS; DECORATIVE MAGNETS; DIGITAL CAMERAS; DIGITAL PICTURE FRAMES; DIGITAL DIRECTIONAL SIGNAGE; DISK DRIVES FOR COMPUTERS; COMPACT DISK PLAYERS AND RECORDERS; DISPOSABLE CAMERAS; DISTANCE MEASURING APPARATUS; DISTANCE RECORDING APPARATUS, NAMELY, ODOMETER; DOOR CLOSERS, ELECTRIC; DOOR OPENERS, ELECTRIC; DOWNLOADABLE RINGTONES AND GRAPHICS FOR MOBILE PHONES; DVD AUDIOVISUAL PLAYERS/RECORDERS; BLANK RECORDABLE DVDS; EAR PLUGS FOR SOUNDPROOFING, ELECTRONIC COMPUTER GAMES ADAPTED FOR USE WITH TV RECEIVERS; ELECTRONIC NOTICE BOARDS; ELECTRONIC DOWNLOADABLE PUBLICATIONS, NAMELY, BOOKS AND MAGAZINES IN THE FIELD OF AUTO RACING; ELECTRONIC TAGS FOR GOODS; ELECTRONIC VERIFICATION APPARATUS, NAMELY, COMPUTER HARDWARE AND SOFTWARE FOR VERIFYING AUTHENTICATION OF CHARGE CARDS, BANK CARDS, CREDIT CARDS, DEBIT CARDS, PREPAID CARDS AND PAYMENT CARDS; MAGNETIC ENCODED CARDS, NAMELY, MAGNETICALLY CODED STORED VALUE CARDS FOR MAKING PURCHASES AT RETAIL STORES; MAGNETICALLY ENCODED USER INCENTIVE LOYALTY CARDS; ENCRYPTION SOFTWARE; EYEGLASS FRAMES; EYEGLASSES; EYEWEAR, NAMELY, EYESHADES; FACSIMILE MACHINES; EXPOSED CAMERA FILM, EXPOSED CINEMATOGRAPHIC FILM, EXPOSED PHOTOGRAPHIC FILM, EXPOSED SLIDE FILM; FIRE ALARMS; FIRE-EXTINGUISHING APPARATUS; FLASH-BULBS; FLAT IRONS, ELECTRIC; BLANK FLOPPY DISKS; GOGGLES FOR SPORT; HAIR-CURLERS, ELECTRICALLY HEATED; HAND FREE KITS FOR PHONES; HEAD CLEANING TAPES FOR AUDIO RECORDERS AND VIDEO RECORDERS; HEADPHONES; PROTECTIVE HELMETS FOR SPORT; HOLDERS FOR MOBILE TELEPHONES; HOLDERS FOR PHOTOGRAPHIC CAMERAS; HOLOGRAMS, NAMELY, DATA CARRIERS, NAMELY, PRERECORDED OPTICAL DATA CARRIERS FEATURING HOLOGRAMS; IDENTITY CARDS, MAGNETIC; IN-CAR TELEPHONE HANDSET CRADLES; BLANK INTEGRATED CIRCUIT CARDS IN THE NATURE OF SMART CARDS; INTERACTIVE GAMES, NAMELY, INTERACTIVE GAME SOFTWARE, INTERACTIVE GAMES PROGRAMS; INTERCOMMUNICATION APPARATUS, NAMELY, CELLULAR PHONES; INTERFACES FOR COMPUTERS; INTERNET GAMES, NAMELY, COMPUTER GAME PROGRAMS DOWNLOADABLE VIA THE INTERNET; LAPTOP BAGS; LAPTOP COMPUTERS; MAGNETIC ENCODERS; MAGNETIC TAPE UNITS FOR COMPUTERS; BLANK MAGNETIC TAPES; MAGNETS; MECHANICAL SIGNS; MICROPROCESSORS; MINI DISC PLAYERS/RECORDERS; EARPHONES, HEADSETS FOR WIRELESS EXCHANGE OF INFORMATION, CASES, CHARGERS FOR MOBILE PHONES; MOBILE PHONE CHARGERS; MOBILE TELEPHONE COVERS; MOBILE TELEPHONES; MOBILE TELEPHONES INCORPORATING SECONDARY FUNCTIONALITY; MODEMS; MONITORS; COMPUTER MOUSE; COMPUTER MOUSE PADS; MPEG AUDIO LAYER-3 PLAYERS; NAVIGATION APPARATUS FOR VEHICLES (ON BOARD COMPUTERS); NAVIGATIONAL INSTRUMENTS, NAMELY, ELECTRICAL NAVIGATIONAL INSTRUMENTS; NEEDLES FOR RECORD PLAYERS; NEON SIGNS; NOTEBOOK COM-

**Reg. No. 4,124,034** PUTTERS; OPTICAL APPARATUS AND INSTRUMENTS, NAMELY, CAMERAS, MAGNIFYING GLASSES, SPECTACLE LENSES; BLANK OPTICAL DISCS; OPTICAL FIBERS; PAYMENT CARDS IN THE NATURE OF A MAGNETICALLY ENCODED DEBIT CARDS; PEDOMETERS. ELECTRONIC PENS FOR VISUAL DISPLAY UNITS; PERSONAL DIGITAL ASSISTANTS; PERSONAL STEREOS; PHONE CARDS, NAMELY, PRE-PAID TELEPHONE CALLING CARDS, MAGNETICALLY ENCODED; PHONOGRAPH RECORDS FEATURING MUSIC; PHOTOCOPIERS; PHOTOGRAPHIC EQUIPMENT, NAMELY, PHOTOCOPYING APPARATUS; POCKET CALCULATORS; POCKET TRANSLATORS; POINT OF SALE TRANSACTION TERMINALS FOR TRANSMITTING, DISPLAYING AND STORING TRANSACTION, IDENTIFICATION AND FINANCIAL INFORMATION FOR USE IN THE FINANCIAL SERVICES, BANKING, INSURANCE AND TELECOMMUNICATIONS INDUSTRIES; PORTABLE CAMERAS WITH INTEGRATED VIDEO RECORDERS; PORTABLE COMMUNICATIONS APPARATUS, NAMELY, HANDSETS; PORTABLE MULTIMEDIA VIEWING TERMINALS, NAMELY, AUDIO, VIDEO AND DATA RECEIVERS; PORTABLE TELEPHONES; PORTABLE UNITS FOR WORD PROCESSING; PRE-PAID CARDS, NAMELY, PRE-PAID TELEPHONE CARDS, MAGNETICALLY ENCODED; PRE-RECORDED COMPACT DISKS, CD ROMS, DDS MAGNETIC DATA MEDIA, MAGNETIC TAPES, OPTICAL DISCS, VIDEO TAPES FEATURING AUTO RACING; PRINTERS FOR USE WITH COMPUTERS; PROJECTION APPARATUS, NAMELY, MOVIE EDITING PROJECTORS, MOVIE PROJECTORS, SLIDE PROJECTORS; PROJECTORS FOR HOME THEATERS; RADIO PAGERS; RADIOS; AUDIO-VIDEO RECEIVERS; RECORD PLAYERS; BLANK RECORDING DISCS; REMOTE CONTROL APPARATUS FOR RADIO, TELEVISIONS, STEREOS; COMPUTER ROUTERS; NETWORK ROUTERS; SAFETY CLOTHING WITH REFLECTING BANDS; SCANNERS; SCREENSAVERS, NAMELY, COMPUTER SCREEN SAVER SOFTWARE; SELF REGULATING FUEL PUMPS FOR SERVICE STATIONS; SIGNALING DEVICES USING LIGHT, SOUND OR VIBRATION, AS ACCESSORIES FOR MOBILE TELEPHONES; SIMULATORS FOR THE STEERING AND CONTROL OF VEHICLES; BLANK SMART CARDS; SOCKETS, PLUGS AND OTHER CONTACTS, NAMELY, ELECTRICAL SOCKETS, SOLAR BATTERIES; SOUND RECORDING APPARATUS; SOUND RECORDING CARRIERS, NAMELY, BLANK RECORDING DISCS, BLANK TAPES, BLANK RECORDABLE OPTICAL DISCS; SOUND RECORDING DISCS; SOUND REPRODUCTION APPARATUS; SOUND TRANSMITTING APPARATUS; SPEAKERS FOR HOME THEATRES; SPECTACLES; SPEED CHECKING APPARATUS FOR VEHICLES; PRE-PAID STORE CARDS MAGNETICALLY ENCODED; SUBWOOFERS; SUNGLASSES; TAPE RECORDERS; TELETYPEWRITERS; TELEVISION APPARATUS FOR PROJECTION PURPOSES; COMPUTER TERMINALS; TIME RECORDING APPARATUS; TRAVEL CASES FOR PORTABLE COMPUTERS AND COMPUTER EQUIPMENT AND ACCESSORIES; STEREO TUNERS; UNIVERSAL SERIAL BUS HARDWARE; VEHICLE BREAKDOWN WARNING TRIANGLES; VEHICLE RADIOS; VENDING MACHINES; BLANK VIDEO CASSETTES; VIDEO GAME CARTRIDGES; COMPUTER PROGRAMS FOR VIDEO GAMES AND AUDIOVISUAL GAMES; VIDEO ON DEMAND SET-TOP BOXES; VIDEO PROJECTORS; VIDEO RECEIVERS; VIDEO RECORDERS; VIDEO SCREENS; VIDEO TELEPHONES; VISUAL DISPLAY UNITS; WALKIE-TALKIES; DOWNLOADABLE WALLPAPER FOR COMPUTER SCREENS; WORD PROCESSORS; WRIST REST FOR USE WITH COMPUTERS, IN CLASS 9 (U.S. CLS. 21, 23, 26, 36 AND 38).

THE MARK CONSISTS OF STANDARD CHARACTERS WITHOUT CLAIM TO ANY PARTICULAR FONT, STYLE, SIZE, OR COLOR.

OWNER OF BENELUX REG. NO. 0892023, DATED 6-29-2010, EXPIRES 6-29-2020.

OWNER OF U.S. REG. NO. 3,031,049.

SER. NO. 85-227,380, FILED 1-27-2011.

LINDA E. BLOHM, EXAMINING ATTORNEY

# United States of America

United States Patent and Trademark Office

# F1

**Reg. No. 4,124,035**

FORMULA ONE LICENSING BV (NETHERLANDS CORPORATION)  
BEURSPLEIN 37

**Registered Apr. 10, 2012**

ROTTERDAM, NETHERLANDS 3011AA

**Int. Cl.: 11**

FOR: AIR CONDITIONING APPARATUS; ELECTRIC HOT AIR HAND DRYERS; PORTABLE ELECTRIC WARM AIR DRYER; AIR PURIFYING APPARATUS AND MACHINES; BARBECUES; BREAD BAKING MACHINES; BREAD TOASTERS; COFFEE MACHINES, ELECTRIC; ELECTRIC RICE COOKERS; GAS COOKERS; APPARATUS FOR COOKING, NAMELY, COOKTOPS; MICROWAVE OVENS; AIR-CONDITIONING, AIR COOLING AND VENTILATION APPARATUS AND INSTRUMENTS; COLD PACKS FOR COOLING THE BODY AND NOT FOR MEDICAL PURPOSES; ICE-COOLING REFRIGERATORS; DRYING APPARATUS FOR USE IN HEATING, VENTILATION SYSTEMS, AIR CONDITIONING SYSTEMS AND REFRIGERATION SYSTEMS; EXTRACTOR HOODS FOR KITCHENS; TORCHES, NAMELY, FLASHLIGHTS; FREEZERS; CHEMICALLY-ACTIVATED LIGHT STICKS; HAIR DRYERS; HEATING APPARATUS FOR DEFROSTING WINDOWS OF VEHICLES; HOT-AIR SPACE HEATING APPARATUS; HUMIDIFIERS; ICE BOXES; KETTLES, ELECTRIC; LAMP SHADES; LAMPS; LAUNDRY DRYERS, ELECTRIC; LIGHTING APPARATUS FOR SPORTS ARENAS; LIGHTING APPARATUS, NAMELY, LIGHTING INSTALLATIONS; LIGHTING APPARATUS FOR VEHICLES; MICROWAVE OVENS; PRESSURE COOKING SAUCEPANS, ELECTRIC; REFRIGERATING APPLIANCES AND INSTALLATIONS; REFRIGERATORS; STEAM GENERATING INSTALLATIONS; TEMPERATURE CONTROLLED ELECTRIC WINE CELLARS FOR HOUSEHOLD PURPOSES; POCKET TORCHES, ELECTRIC; ELECTRIC TORCHES FOR LIGHTING; AIR-CONDITIONING, AIR COOLING AND VENTILATION APPARATUS AND INSTRUMENTS; VENTILATION UNITS FOR COMMERCIAL FOOD PREPARATION AND FOOD SERVING; TEMPERATURE CONTROLLED DISPENSING UNITS FOR BEVERAGES, IN CLASS 11 (U.S. CLS. 13, 21, 23, 31 AND 34).

**TRADEMARK**

**PRINCIPAL REGISTER**

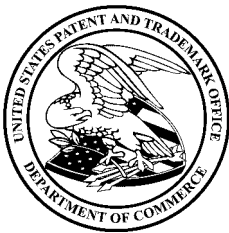

THE MARK CONSISTS OF STANDARD CHARACTERS WITHOUT CLAIM TO ANY PARTICULAR FONT, STYLE, SIZE, OR COLOR.

OWNER OF BENELUX REG. NO. 0892023, DATED 6-29-2010, EXPIRES 6-29-2020.

OWNER OF U.S. REG. NOS. 2,586,148, 3,587,198 AND OTHERS.

SER. NO. 85-227,385, FILED 1-27-2011.

*David J. Kyros*

Director of the United States Patent and Trademark Office

MARIA-VICTORIA SUAREZ, EXAMINING ATTORNEY



# United States of America

United States Patent and Trademark Office

# F1

**Reg. No. 4,124,036**

FORMULA ONE LICENSING BV (NETHERLANDS CORPORATION)  
BEURSPLEIN 37

**Registered Apr. 10, 2012**

ROTTERDAM, NETHERLANDS 3011AA

**Int. Cl.: 16**

**TRADEMARK**

**PRINCIPAL REGISTER**

FOR: PAPER, CARDBOARD AND GOODS MADE FROM THESE MATERIALS, NAMELY, PAPER STOCK; CARDBOARD; CONTAINERS FOR STORAGE OR TRANSPORT MADE OF PAPER OR CARDBOARD; PRINTED MATTER, NAMELY, PAMPHLETS, BROCHURES, NEWSLETTERS, JOURNALS, MAGAZINES FEATURING AUTO RACING; PHOTOGRAPHS; STATIONERY; TYPEWRITERS AND OFFICE REQUISITES, NAMELY, STAPLERS; PRINTED INSTRUCTIONAL AND TEACHING MATERIALS IN THE FIELD OF AUTO RACING; PLASTIC MATERIALS FOR PACKAGING, NAMELY, PLASTIC BUBBLE PACKS FOR WRAPPING OR PACKAGING; PLASTIC BAGS FOR MERCHANDISE PACKAGING; CHILDREN'S ACTIVITY BOOKS; ADDRESS STAMPS; ADVERTISEMENT BOARDS OF PAPER OR CARDBOARD; ALBUMS FOR COINS, PHOTOGRAPHS, STAMPS; ALMANACS; ANNUALS FEATURING AUTO RACING; AUTOGRAPH BOOKS; BAGS OF PAPER OR PLASTICS FOR PACKAGING; LOOSE-LEAF BINDERS; BOOKENDS; BOOKLETS FEATURING AUTO RACING; BOOKMARKERS; BOOKS FEATURING AUTO RACING; BOOKS FOR CHILDREN; BOTTLE WRAPPERS OF CARDBOARD OR PAPER; BOWS OF PAPER; BOXES FOR PENS; CARDBOARD OR PAPER; BROCHURES FEATURING AUTO RACING; BUMPER STICKERS; DESKTOP BUSINESS CARD HOLDERS; BUSINESS CARDS; CALENDARS; ARTICLES MADE OF CARDBOARD, NAMELY, CARDBOARD BOXES, CARDBOARD TUBES; PAPER GIFT CARDS; NOTE CARDS; CARTOON PRINTS; CARTOON STRIPS; CATALOGUES FEATURING AUTO RACING; CHARTS IN THE FIELD OF AUTO RACING; CHECKBOOKS; CLIPBOARDS; COASTERS OF PAPER; COLORING BOOKS; COMIC BOOKS; PASSPORT COVERS; CREDIT CARD OTHER THAN ENCODED OR MAGNETIC FOR USE IN RELATION TO ELECTRONIC TRANSFER OF FUNDS; DECALCOMANIAS; DESK ACCESSORIES MADE OF LEATHER, NAMELY, DIARY COVERS, BOOK COVERS, PEN HOLDERS, BLOTTER PAPER HOLDERS, NOTEPAPER FOLDERS; DIARIES; DOCUMENT FILES; DRAWING BOARDS; DRAWING INSTRUMENTS; DRAWING PADS; DRAWING PENCILS; DRAWING PENS; DRAWING SETS COMPRISING DRAWING PADS, DRAWING PENCILS, DRAWING RULERS; ENVELOPES; ERASERS; FACE TOWELS OF PAPER; FELT-TIP PENS; FIBER TIP PENS; FIGURINES OF PAPIER MACHE; FLAGS OF PAPER; INFORMATIONAL FLYERS FEATURING AUTO RACING; FOLDERS FOR PAPERS; PRINTED FORMS; FOUNTAIN PENS; GEOGRAPHICAL MAPS; GRAPHIC PRINTS; GREETING CARDS; GUIDEBOOKS AND HANDBOOKS IN THE FIELD OF AUTO RACING; HANDKERCHIEFS OF PAPER; HEADED LETTER PAPER; HOLDERS FOR CHEQUE BOOKS; INFORMATIONAL LEAFLETS FEATURING AUTO RACING; MAGAZINES FEATURING AUTO RACING; MANUALS IN



*David J. Kybas*

Director of the United States Patent and Trademark Office

**Reg. No. 4,124,036** THE FIELD OF AUTO RACING; MARKER PENS; PAPER MATS FOR BEER GLASSES; ENVELOPES AND GUMMED PAPER SURFACES; MONEY CLIPS; MUSICAL GREETING CARDS; NEWSLETTERS IN THE FIELD OF AUTO RACING; NEWSPAPERS; NOTE BOOKS; NOTE PADS; NOTEPAD HOLDERS; NOVELTY BOOKS IN THE FIELD OF AUTO RACING; PACKING PAPER; PAINT BOXES; PAINTBRUSHES; PAINTINGS FRAMED OR UNFRAMED; PAMPHLETS IN THE FIELD OF AUTO RACING; PAPERWEIGHTS; PASSES, NAMELY, ENTRY TICKETS; PASSPORT HOLDERS; PASTELS; PEN CASES; PENCIL HOLDERS; PENCILS; PENHOLDERS; PENNANTS OF PAPER; PENS; PRINTED PERIODICALS IN THE FIELD OF AUTO RACING; PHOTOGRAPH STANDS; PICTURE BOOKS; PICTURES; PLACARDS OF PAPER OR CARDBOARD; PLACE MATS OF PAPER; PORTRAITS; POSTAGE STAMPS; POSTCARDS; POSTERS; PRINTED FORMS; PRINTED PUBLICATIONS, NAMELY, PAMPHLETS, BROCHURES, NEWSLETTERS, JOURNALS, MAGAZINE IN THE FIELD OF AUTO RACING; PRINTED TIMETABLES; EVENT PROGRAMS; REFERENCE BOOKS IN THE FIELD OF AUTO RACING; ROAD MAPS; ROUTE MAPS; DRAWING RULERS; SCRAPBOOKS; SCRATCH CARDS; STICKER ALBUMS; STICKERS; TABLE CLOTHS OF PAPER; TABLE LINEN OF PAPER; TABLE MATS OF PAPER; TABLE NAPKINS OF PAPER; TEAR-OFF CALENDARS; PRINTED TICKETS; TOWELS OF PAPER; TRACING PAPER; IRON-ON TRANSFERS; TYPEWRITERS ELECTRIC OR NON-ELECTRIC; VIGNETTES, NAMELY, ILLUSTRATIONS; PRINTED VOUCHERS; WALL PLANNERS; WRAPPING PAPER; WRISTBANDS FOR THE RETENTION OF WRITING INSTRUMENTS; WRITING CASES; WRITING INSTRUMENTS; WRITING OR DRAWING BOOKS; WRITING PADS; WRITING PAPER, IN CLASS 16 (U.S. CLS. 2, 5, 22, 23, 29, 37, 38 AND 50).

THE MARK CONSISTS OF STANDARD CHARACTERS WITHOUT CLAIM TO ANY PARTICULAR FONT, STYLE, SIZE, OR COLOR.

OWNER OF BENELUX REG. NO. 0892023, DATED 6-29-2010, EXPIRES 6-29-2020.

OWNER OF U.S. REG. NOS. 2,586,148, 3,587,198 AND OTHERS.

SER. NO. 85-227,390, FILED 1-27-2011.

MARIA-VICTORIA SUAREZ, EXAMINING ATTORNEY

# United States of America

United States Patent and Trademark Office

# F1

**Reg. No. 4,124,037**

**Registered Apr. 10, 2012**

**Int. Cl.: 18**

**TRADEMARK**

**PRINCIPAL REGISTER**

FORMULA ONE LICENSING BV (NETHERLANDS CORPORATION)  
BEURSPLEIN 37  
ROTTERDAM, NETHERLANDS 3011AA

FOR: LEATHER AND IMITATION LEATHER; TRUNKS AND TRAVELLING BAGS; UMBRELLAS, PARASOLS ATTACHÉ CASES; BACKPACKS; ALL PURPOSE SPORT BAGS; BAGS FOR PACKAGING OF LEATHER; BAGS FOR TRAVEL; BEACH BAGS; BEACH UMBRELLAS; LEATHER SHOULDER BELTS; BOXES OF LEATHER OR LEATHER BOARD; BRIEFCASES; BUSINESS CARD CASES; CASES, OF LEATHER OR LEATHER BOARD; COIN HOLDERS IN THE NATURE OF WALLETS; CREDIT CARD HOLDERS; DISPATCH BAGS; CARRYING CASES FOR DOCUMENTS; GARMENT BAGS FOR TRAVEL; GYM BAG; HANDBAGS; WALKING STICK HANDLES ; HAVERSACKS; KEY CASES; LUGGAGE FOR TRAVELLING; LUGGAGE TAGS; NET BAGS FOR SHOPPING; POCKET WALLETS; POUCHES OF LEATHER FOR PACKAGING; PURSES; RUCKSACKS; SACHELS; SCHOOL BAGS; REUSABLE SHOPPING BAGS; TEXTILE SHOPPING BAGS; SLINGS BAGS FOR CARRYING INFANTS; SPORT AND LEISURE BAGS; LEATHER STRAPS; SUIT CARRIER; SUITCASES; TOILETRY BAGS SOLD EMPTY; TOTE BAGS; TRAVEL AND GROOMING CASES SOLD EMPTY; TRAVELLING BAGS; LUGGAGE TAGS MADE OF LEATHER; TRAVELLING SETS COMPRISING LUGGAGE, GARMENT BAGS FOR TRAVEL, VANITY CASES SOLD EMPTY; TRAVELLING TRUNKS; VALISES; VANITY CASES SOLD EMPTY; WALKING-STICKS; WHEELED SHOPPING BAGS, IN CLASS 18 (U.S. CLS. 1, 2, 3, 22 AND 41).



THE MARK CONSISTS OF STANDARD CHARACTERS WITHOUT CLAIM TO ANY PARTICULAR FONT, STYLE, SIZE, OR COLOR.

OWNER OF BENELUX REG. NO. 0892023, DATED 6-29-2010, EXPIRES 6-29-2020.

OWNER OF U.S. REG. NOS. 2,586,148, 3,587,198 AND OTHERS.

SER. NO. 85-227,391, FILED 1-27-2011.

MARIA-VICTORIA SUAREZ, EXAMINING ATTORNEY

*David J. Kyffers*

Director of the United States Patent and Trademark Office

# United States of America

United States Patent and Trademark Office

# F1

**Reg. No. 4,124,038**

FORMULA ONE LICENSING BV (NETHERLANDS CORPORATION)  
BEURSPLEIN 37

**Registered Apr. 10, 2012**

ROTTERDAM, NETHERLANDS 3011AA

**Int. Cl.: 25**

FOR: CLOTHING, NAMELY, SHIRTS, PANTS, COATS, DRESSES; FOOTWEAR, HEADGEAR, NAMELY, HATS, CAPS; ANORAKS; APRONS; BABIES' PANTS; BANDANAS; BASEBALL CAPS; BATH ROBES; BATH SANDALS; BATHING SUITS; BATHING TRUNKS; BEACH CLOTHING, NAMELY, SWIMWEAR, BEACH COVER-UPS AND FLIP FLOPS; BEACH SHOES; BELTS; BERETS; BIBS NOT OF PAPER; BLAZERS; LINGERIE BODICES; BOOTS ; BOOTS FOR SPORT; BRACES FOR CLOTHING; BRASSIERES; CAMISOLES; CAPS; CARDIGANS; CHILDREN'S WEAR, NAMELY, JUMPERS, OVERALL SLEEPWEAR, PAJAMAS, ROMPERS AND ONE-PIECE GARMENTS; CLOTHING OF IMITATION LEATHER, NAMELY, SHIRTS, PANTS, SHORTS; CLOTHING OF LEATHER, NAMELY, SHIRTS, PANTS, SHORTS; COATS; DRESSING GOWNS; EAR MUFFS; ESPARTO SHOES OR SANDALS; FROCKS; GLOVES; HATS; HEADBANDS; HEADSCARVES; HOODS; HOSIERY; JACKETS; JEANS; JERSEYS; JUMPERS; KIMONOS; KNITWEAR, NAMELY, KNIT DRESSES, KNIT CAPS, POLO KNIT TOPS; LAYETTES; LEGGINGS; LEISURE SHOES; MITTENS; MONEY BELTS; MOTORISTS' CLOTHING, NAMELY, JUMPSUITS; NECK SCARVES; NECKTIES; OUTER CLOTHING, NAMELY, COATS, JACKETS, PARKAS; OVERALLS; OVERCOATS; PANTS; PARKAS; PEAK CAPS; POCKET SQUARES; PULLOVERS; PAJAMAS; RAINWEAR; READY MADE CLOTHING, NAMELY, SHIRTS, PANTS, SHORTS; SANDALS; SARIS; SCARVES; SHAWLS; SHIRTS; SHOES ; SHORTS; SHOULDER SASHES TO BE WORN OVER CLOTHING; SHOULDER WRAPS; SINGLETs; SKIRTS; SLIPPERS; SOCKS; SOCKS; SPORTS JERSEYS; SPORTS SHOES; STOCKINGS; SUITS; SUN VISORS; SWEATERS; SWIMSUITS; TABARDS; TEE-SHIRTS; THREE-PIECE SUITS; TIGHTS; TRACKSUITS; TROUSERS; UNDERWEAR; UNIFORMS; VESTS; WAISTCOATS; WATERPROOF CLOTHING, NAMELY, WATERPROOF JACKETS AND PANTS; WRISTBANDS, IN CLASS 25 (U.S. CLS. 22 AND 39).

**TRADEMARK**

**PRINCIPAL REGISTER**



THE MARK CONSISTS OF STANDARD CHARACTERS WITHOUT CLAIM TO ANY PARTICULAR FONT, STYLE, SIZE, OR COLOR.

OWNER OF BENELUX REG. NO. 0892023, DATED 6-29-2010, EXPIRES 6-29-2020.

*David J. Kybas*

OWNER OF U.S. REG. NOS. 2,586,148, 3,587,198 AND OTHERS.

SER. NO. 85-227,395, FILED 1-27-2011.

**Reg. No. 4,124,038** MARIA-VICTORIA SUAREZ, EXAMINING ATTORNEY

# United States of America

United States Patent and Trademark Office

# F1

**Reg. No. 4,124,039**

**Registered Apr. 10, 2012**

**Int. Cl.: 38**

**SERVICE MARK**

**PRINCIPAL REGISTER**

FORMULA ONE LICENSING BV (NETHERLANDS CORPORATION)  
BEURSPLEIN 37  
ROTTERDAM, NETHERLANDS 3011AA

FOR: BROADCASTING AND TRANSMISSION OF ANALOGUE TELEVISION, DIGITAL TELEVISION, CABLE TELEVISION, SATELLITE TELEVISION, PAY TELEVISION, INTERACTIVE TELEVISION, INTERACTIVE ENTERTAINMENT AND INTERACTIVE COMPETITIONS, RADIO AND INTERNET PROGRAMMES; BROADCASTING OF ENTERTAINMENT PROGRAMMES VIA TELEVISION AND RADIO; BROADCASTING OF MUSIC EVENTS VIA TELEVISION AND RADIO; BROADCASTING OF PROGRAMMES PROVIDED OVER THE INTERNET; BROADCASTING OF SPORTS PROGRAMMES VIA TELEVISION AND RADIO; INTERNET BROADCASTING SERVICES; TELECOMMUNICATIONS SERVICES, NAMELY, WIRELESS TELEPHONE SERVICES; COMMUNICATIONS BY AND/OR BETWEEN COMPUTER TERMINALS; COMMUNICATIONS BY CELLULAR TELEPHONE; COMMUNICATIONS BY FIBRE OPTIC NETWORKS; COMMUNICATIONS BY TELEGRAMS; COMMUNICATIONS BY TELEPHONE; COMMUNICATIONS BY FACSIMILE COMMUNICATION; PROVIDING ACCESS TO A DATABASE; COMPUTER AIDED TRANSMISSION OF MESSAGES AND IMAGES; STREAMING OF AUDIO, VIDEO, AUDIOVISUAL MATERIAL ON THE INTERNET; TRANSFER OF DATA BY TELECOMMUNICATIONS; DISSEMINATION OF TELEVISION PROGRAMS RELAYED BY SATELLITE, NAMELY, TELEVISION BROADCASTING; ELECTRONIC MAIL; COMMUNICATIONS SERVICES FOR THE ELECTRONIC, DIGITAL AND ANALOGUE DISPLAY OF INFORMATION, MESSAGES, IMAGES AND DATA; FACSIMILE TRANSMISSION; ELECTRONIC MESSAGE SENDING; MOBILE TELEPHONE SERVICES; MULTIMEDIA TELECOMMUNICATIONS SERVICES, NAMELY, LOCAL AND LONG DISTANCE TRANSMISSION OF VOICE, DATA BY MEANS OF TELEPHONE, TELEGRAPH, CABLE AND SATELLITE TRANSMISSION; NEWS AGENCY SERVICES FOR ELECTRONIC TRANSMISSION; PROVIDING INTERNET ACCESS, NAMELY, PROVIDING ACCESS TO REAL TIME DATA VIA THE INTERNET; PROVIDING ACCESS TO A MULTIPLE USER NETWORK SYSTEM WHICH ALLOWS FOR THE ACCESS TO GAMING AND BETTING INFORMATION AND SERVICES OVER THE INTERNET; PROVIDING TELECOMMUNICATIONS CONNECTIONS TO A GLOBAL COMPUTER NETWORK; PROVISION OF ACCESS TO INTERACTIVE COMPUTER DATABASES IN THE FIELD OF SPORTS; PROVISION OF BROADCASTING EQUIPMENT FOR OUTSIDE BROADCASTS; PROVISION OF TELECOMMUNICATIONS FACILITIES FOR INTERACTIVE DISCUSSION AND CONVERSATION; RADIO BROADCASTING; RECEIVING AND EXCHANGE OF INFORMATION, MESSAGES, IMAGES, AND DATA VIA MOBILE PHONE NETWORKS; RENTAL OF MESSAGE SENDING APPARATUS; SATELLITE COMMUNICA-



*David J. Kybas*

Director of the United States Patent and Trademark Office

**Reg. No. 4,124,039** TIONS SERVICES. SENDING OF TELEGRAMS; PROVIDING TELECOMMUNICATIONS CONNECTIONS TO THE INTERNET, INTRANET AND EXTRANET; TELECONFERENCING SERVICES; TELEGRAPH SERVICES; TELEPHONE COMMUNICATION SERVICES; TRANSFERRING AND DISSEMINATING INFORMATION AND DATA VIA COMPUTER NETWORKS AND THE INTERNET; TRANSMISSION OF DIGITAL INFORMATION BY MEANS OF CABLE, WIRE OR FIBRE; TRANSMISSION OF INFORMATION BY COMMUNICATIONS SATELLITE, MICROWAVE OR ELECTRONIC, DIGITAL OR ANALOGUE MEANS; TRANSMISSION OF INFORMATION BY MOBILE TELEPHONES, FACSIMILES AND FACSIMILE COMMUNICATION; TRANSMISSION OF TELEGRAMS; TRANSMISSION SERVICES, NAMELY, TRANSMISSION OF DIGITAL FILES; VIDEO TEXT AND TELETXT TRANSMISSION SERVICES; VOICE MAIL SERVICES; WIRE SERVICES, NAMELY, TELEPHONY COMMUNICATION SERVICES; TRANSMISSION OF SOUND AND VIDEO RECORDINGS VIA THE INTERNET, IN CLASS 38 (U.S. CLS. 100, 101 AND 104).

THE MARK CONSISTS OF STANDARD CHARACTERS WITHOUT CLAIM TO ANY PARTICULAR FONT, STYLE, SIZE, OR COLOR.

OWNER OF BENELUX REG. NO. 0892023, DATED 6-29-2010, EXPIRES 6-29-2020.

OWNER OF U.S. REG. NO. 2,975,282.

SER. NO. 85-227,419, FILED 1-27-2011.

LINDA E. BLOHM, EXAMINING ATTORNEY

# United States of America

United States Patent and Trademark Office

# F1

**Reg. No. 4,124,040**

**Registered Apr. 10, 2012**

**Int. Cl.: 39**

**SERVICE MARK**

**PRINCIPAL REGISTER**

FORMULA ONE LICENSING BV (NETHERLANDS CORPORATION)  
BEURSPLEIN 37  
ROTTERDAM, NETHERLANDS 3011AA

FOR: TRANSPORT OF GOODS; TRANSPORT BY FERRY, BOAT, RAIL, AIR; PACKAGING GOODS FOR TRANSPORTATION; PACKAGING GOODS TO THE ORDER AND SPECIFICATION OF OTHERS; STORAGE OF GOODS; TRAVEL ARRANGEMENTS; AIR TRANSPORT; ARRANGING OF TOURS; BOOKING OF SEATS FOR TRAVEL; BUS TRANSPORT; CAR RENTAL; CHAUFFEUR SERVICES; COACH RENTAL; COURIER SERVICES; MESSAGE DELIVERY; DELIVERY OF GOODS; DELIVERY OF GOODS BY MAIL ORDER; FREIGHT TRANSPORTATION BY TRUCK, TRAIN, AIR; FREIGHT FORWARDING; ISSUING TRANSPORTATION DOCUMENTS; ISSUING OF TRANSPORTATION EXCHANGE VOUCHERS; PARCEL DELIVERY; PASSENGER TRANSPORT; RAILWAY TRANSPORT RESERVATION SERVICES REGARDING TRIPS AND EXCURSIONS; TAXI TRANSPORT; TRANSPORTATION AND STORAGE OF LETTERS, DOCUMENTS, MESSAGES, PRINTED MATTER, PARCELS AND OTHER GOODS BY LAND, SEA OR AIR; TRANSPORTATION OF PEOPLE BY AIRPLANE, TRAIN, BUS, TRUCK OR BOAT; TRANSPORT RESERVATION; RESERVATION OF SEATS FOR TRAVEL; VEHICLE RENTAL; PHYSICAL ARCHIVING OF ELECTRONICALLY STORED STILL AND MOVING IMAGES, IN CLASS 39 (U.S. CLS. 100 AND 105).

THE MARK CONSISTS OF STANDARD CHARACTERS WITHOUT CLAIM TO ANY PARTICULAR FONT, STYLE, SIZE, OR COLOR.

OWNER OF BENELUX REG. NO. 0892023, DATED 6-29-2010, EXPIRES 6-29-2020.

OWNER OF U.S. REG. NOS. 2,586,148, 3,587,198 AND OTHERS.

SER. NO. 85-227,421, FILED 1-27-2011.

MARIA-VICTORIA SUAREZ, EXAMINING ATTORNEY



*David J. Kyjars*

Director of the United States Patent and Trademark Office



# United States of America

United States Patent and Trademark Office

# F1

**Reg. No. 4,124,041**

FORMULA ONE LICENSING BV (NETHERLANDS CORPORATION)  
BEURSPLEIN 37

**Registered Apr. 10, 2012**

ROTTERDAM, NETHERLANDS 3011AA

**Int. Cl.: 41**

**SERVICE MARK**

**PRINCIPAL REGISTER**

FOR: EDUCATIONAL SERVICES, NAMELY, CLASSES, SEMINARS, WORKSHOPS IN THE FIELD OF AUTO RACING; ENTERTAINMENT IN THE NATURE OF AUTO RACING; ENTERTAINMENT MEDIA PRODUCTION SERVICES FOR MOTION PICTURES, TELEVISION AND INTERNET; ENTERTAINMENT SERVICES IN THE NATURE OF LIVE MUSICAL PERFORMANCES; ORGANIZING COMMUNITY SPORTING AND CULTURAL EVENTS; AMUSEMENT PARKS; AMUSEMENT CENTERS; ARRANGING AND CONDUCTING OF CONCERTS; ARRANGING AND CONDUCTING EDUCATIONAL CONFERENCES AND WORKSHOPS; ARRANGING OF BEAUTY CONTESTS; BETTING, GAMING AND GAMBLING; BOOKING OF SEATS FOR SHOWS; BOOKING OF SEATS FOR SPORTING EVENTS; CINEMA PRESENTATIONS; DISCOTHEQUE SERVICES; ENTERTAINMENT SERVICES, NAMELY, PROVIDING NON-DOWNLOADABLE PLAYBACK OF AUDIO AND VIDEO VIA GLOBAL COMMUNICATIONS NETWORKS; DUBBING; ELECTRONIC GAMES SERVICES PROVIDED ON LINE BY MEANS OF THE INTERNET; ENTERTAINMENT INFORMATION; FILM PRODUCTION; PROVIDING GOLF FACILITIES; ENTERTAINMENT SERVICES, NAMELY, PRODUCTION AND DISTRIBUTION OF A GAME SHOW; ENTERTAINMENT SERVICES, NAMELY, AN ON-GOING TELEVISION GAME SHOW AND GAMES OF CHANCE TO BE PLAYED AT A CASINO; ENTERTAINMENT SERVICES, NAMELY, PROVIDING ON-LINE COMPUTER GAMES; PROVIDING ON-LINE POKER GAMES; PROVIDING A WEB-BASED SYSTEM AND ONLINE PORTAL FOR CUSTOMERS TO PARTICIPATE IN ON-LINE GAMING, OPERATION AND COORDINATION OF GAME TOURNAMENTS, LEAGUES AND TOURS; LOTTERY AND GAMING SERVICES IN THE NATURE OF CASINO GAMING; LOTTERY SERVICES PROVIDED ON-LINE FROM A COMPUTER NETWORK; NEWS REPORTERS SERVICES; NIGHT CLUBS; OPERATING LOTTERIES; OPERATION OF LEISURE FACILITIES FOR SPORTING EVENTS, TOURNAMENTS AND COMPETITIONS; ORGANISATION AND PROVISION OF AMUSEMENT GAMES, GAMING, GAMBLING, WAGERING, SKILL-BASED GAMES, COMPETITIONS, CONTESTS AND GAMES INCLUDING THOSE WHICH ARE LAND-BASED AND THOSE PROVIDED BY MEANS OF THE INTERNET; ORGANISATION OF MUSIC EVENTS; ORGANIZING SPORTING EVENTS, NAMELY, AUTO RACES; ORGANISATION OF CULTURAL EVENTS AND ACTIVITIES; ORGANIZATION OF BALLS; ENTERTAINMENT SERVICES, NAMELY, ARRANGING AND CONDUCTING OF AUTO RACES; EDUCATIONAL SERVICES, NAMELY, CONDUCTING CLASSES, SEMINARS, CONFERENCES, WORKSHOPS IN THE FIELD OF AUTO RACING; CONDUCTING ENTERTAINMENT EXHIBITIONS IN THE



*David J. Kybas*

Director of the United States Patent and Trademark Office

**Reg. No. 4,124,041** NATURE OF AUTO RACES; ORGANIZATION OF EXHIBITIONS FOR CULTURAL OR EDUCATIONAL PURPOSES; ENTERTAINMENT IN THE NATURE OF LIGHT SHOWS; ENTERTAINMENT, NAMELY, A CONTINUING NEWS SHOW BROADCAST OVER TELEVISION, SATELLITE, AUDIO, AND VIDEO MEDIA; ORGANIZATION OF SHOWS FOR CULTURAL PURPOSES; ENTERTAINMENT, NAMELY, PRODUCTION OF AUTO RACES; ORGANIZATION OF SPORTS COMPETITIONS; OUTDOOR SCREEN PRESENTATIONS; PHOTOGRAPHIC REPORTING; PRODUCTION OF RADIO AND TELEVISION PROGRAMS; PROVIDING AMUSEMENT ARCADE SERVICES; PROVIDING CASINO FACILITIES; PROVISION OF INFORMATION RELATING TO SPORTS AND SPORTING EVENTS; PROVIDING A WEB SITE THAT PROVIDES SPORTS LEAGUE PLAYER STATISTICS; PROVIDING MUSEUM FACILITIES; PROVIDING OF RECREATION AND LEISURE RIDE FACILITIES; NON-DOWNLOADABLE ELECTRONIC PUBLICATIONS IN THE NATURE OF MAGAZINES IN THE FIELD OF AUTO RACING; PROVIDING SPORTS FACILITIES; PROVIDING SPORTS INFORMATION BY ELECTRONIC MEANS (INTERNET); PROVISION OF RECREATION FACILITIES FOR SPORTS EVENTS, TOURNAMENTS AND COMPETITIONS; PUBLICATION OF BOOKS; PUBLICATION OF MAGAZINES; PUBLICATION OF ELECTRONIC BOOKS AND JOURNALS ON-LINE; PUBLICATION OF TEXTS, OTHER THAN PUBLICITY TEXTS; ENTERTAINMENT, NAMELY, A CONTINUING SPORT SHOW BROADCAST OVER TELEVISION AND RADIO; PROVIDING RADIO AND TELEVISION NEWS IN THE NATURE OF CURRENT EVENT REPORTING IN THE FIELD OF SPORTS; ENTERTAINMENT SERVICES, NAMELY, PROVIDING AN ON-GOING RADIO AND TELEVISION PROGRAM IN THE FIELD OF AUTO RACING; RADIO ENTERTAINMENT AND TELEVISION SHOW PRODUCTION; RENTAL OF CINE-FILMS; RENTAL OF SOUND AND IMAGE RECORDINGS; VIDEO RECORDING SERVICES; THEME PARK SERVICES; ENTERTAINMENT TICKET AGENCY SERVICES; TIMING AND TIME RECORDING FOR SPORTING EVENTS; VIDEOTAPE EDITING; VIDEOTAPE FILM PRODUCTION; DISTRIBUTION OF TELEVISION PROGRAMMING TO CABLE TELEVISION SYSTEMS; PROVIDING INFORMATION VIA THE INTERNET IN THE FIELD OF SPORTS AND SPORTS LEAGUE PLAYER STATISTICS FOR GAMING AND BETTING PURPOSES, IN CLASS 41 (U.S. CLS. 100, 101 AND 107).

THE MARK CONSISTS OF STANDARD CHARACTERS WITHOUT CLAIM TO ANY PARTICULAR FONT, STYLE, SIZE, OR COLOR.

OWNER OF BENELUX REG. NO. 0892023, DATED 6-29-2010, EXPIRES 6-29-2020.

OWNER OF U.S. REG. NOS. 2,586,148, 3,587,198 AND OTHERS.

SER. NO. 85-227,426, FILED 1-27-2011.

MARIA-VICTORIA SUAREZ, EXAMINING ATTORNEY

# United States of America

United States Patent and Trademark Office

## FORMULA 1

**Reg. No. 4,124,042**

**Registered Apr. 10, 2012**

**Int. Cl.: 41**

**SERVICE MARK**

**PRINCIPAL REGISTER**

FORMULA ONE LICENSING BV (NETHERLANDS CORPORATION)  
BEURSPLEIN 37  
ROTTERDAM, NETHERLANDS 3011AA

FOR: EDUCATIONAL SERVICES, NAMELY, CLASSES, SEMINARS, WORKSHOPS IN THE FIELD OF AUTO RACING; ENTERTAINMENT IN THE NATURE OF AUTO RACING; ENTERTAINMENT MEDIA PRODUCTION SERVICES FOR MOTION PICTURES, TELEVISION AND INTERNET; ENTERTAINMENT SERVICES IN THE NATURE OF LIVE MUSICAL PERFORMANCES; ORGANIZING COMMUNITY SPORTING AND CULTURAL EVENTS; AMUSEMENT PARKS; AMUSEMENT CENTERS; ARRANGING AND CONDUCTING OF CONCERTS; ARRANGING AND CONDUCTING EDUCATIONAL CONFERENCES AND WORKSHOPS; ARRANGING OF BEAUTY CONTESTS; BETTING, GAMING AND GAMBLING; BOOKING OF SEATS FOR SHOWS; BOOKING OF SEATS FOR SPORTING EVENTS; CINEMA PRESENTATIONS; DISCOTHEQUE SERVICES; ENTERTAINMENT SERVICES, NAMELY, PROVIDING NON-DOWNLOADABLE PLAYBACK OF AUDIO AND VIDEO VIA GLOBAL COMMUNICATIONS NETWORKS; DUBBING; ELECTRONIC GAMES SERVICES PROVIDED ON LINE BY MEANS OF THE INTERNET; ENTERTAINMENT INFORMATION; FILM PRODUCTION; PROVIDING GOLF FACILITIES; ENTERTAINMENT SERVICES, NAMELY, PRODUCTION AND DISTRIBUTION OF A GAME SHOW; ENTERTAINMENT SERVICES, NAMELY, AN ON-GOING TELEVISION GAME SHOW AND GAMES OF CHANCE TO BE PLAYED AT A CASINO; ENTERTAINMENT SERVICES, NAMELY, PROVIDING ON-LINE COMPUTER GAMES; PROVIDING ON-LINE POKER GAMES; PROVIDING A WEB-BASED SYSTEM AND ONLINE PORTAL FOR CUSTOMERS TO PARTICIPATE IN ON-LINE GAMING, OPERATION AND COORDINATION OF GAME TOURNAMENTS, LEAGUES AND TOURS; LOTTERY AND GAMING SERVICES IN THE NATURE OF CASINO GAMING; LOTTERY SERVICES PROVIDED ON-LINE FROM A COMPUTER NETWORK; NEWS REPORTERS SERVICES; NIGHT CLUBS; OPERATING LOTTERIES; OPERATION OF LEISURE FACILITIES FOR SPORTING EVENTS, TOURNAMENTS AND COMPETITIONS; ORGANISATION AND PROVISION OF AMUSEMENT GAMES, GAMING, GAMBLING, WAGERING, SKILL-BASED GAMES, COMPETITIONS, CONTESTS AND GAMES INCLUDING THOSE WHICH ARE LAND-BASED AND THOSE PROVIDED BY MEANS OF THE INTERNET; ORGANISATION OF MUSIC EVENTS; ORGANIZING SPORTING EVENTS, NAMELY, AUTO RACES; ORGANISATION OF CULTURAL EVENTS AND ACTIVITIES; ORGANIZATION OF BALLS; ENTERTAINMENT SERVICES, NAMELY, ARRANGING AND CONDUCTING OF AUTO RACES; EDUCATIONAL SERVICES, NAMELY, CONDUCTING CLASSES, SEMINARS, CONFERENCES, WORKSHOPS IN THE FIELD OF AUTO RACING; CONDUCTING ENTERTAINMENT EXHIBITIONS IN THE



*David J. Kyros*

Director of the United States Patent and Trademark Office

**Reg. No. 4,124,042** NATURE OF AUTO RACES; ORGANIZATION OF EXHIBITIONS FOR CULTURAL OR EDUCATIONAL PURPOSES; ENTERTAINMENT IN THE NATURE OF LIGHT SHOWS; ENTERTAINMENT, NAMELY, A CONTINUING NEWS SHOW BROADCAST OVER TELEVISION, SATELLITE, AUDIO, AND VIDEO MEDIA; ORGANIZATION OF SHOWS FOR CULTURAL PURPOSES; ENTERTAINMENT, NAMELY, PRODUCTION OF AUTO RACES; ORGANIZATION OF SPORTS COMPETITIONS; OUTDOOR SCREEN PRESENTATIONS; PHOTOGRAPHIC REPORTING; PRODUCTION OF RADIO AND TELEVISION PROGRAMS; PROVIDING AMUSEMENT ARCADE SERVICES; PROVIDING CASINO FACILITIES; PROVISION OF INFORMATION RELATING TO SPORTS AND SPORTING EVENTS; PROVIDING A WEB SITE THAT PROVIDES SPORTS LEAGUE PLAYER STATISTICS; PROVIDING MUSEUM FACILITIES; PROVIDING OF RECREATION AND LEISURE RIDE FACILITIES; NON-DOWNLOADABLE ELECTRONIC PUBLICATIONS IN THE NATURE OF MAGAZINES IN THE FIELD OF AUTO RACING; PROVIDING SPORTS FACILITIES; PROVIDING SPORTS INFORMATION BY ELECTRONIC MEANS (INTERNET); PROVISION OF RECREATION FACILITIES FOR SPORTS EVENTS, TOURNAMENTS AND COMPETITIONS; PUBLICATION OF BOOKS; PUBLICATION OF MAGAZINES; PUBLICATION OF ELECTRONIC BOOKS AND JOURNALS ON-LINE; PUBLICATION OF TEXTS, OTHER THAN PUBLICITY TEXTS; ENTERTAINMENT, NAMELY, A CONTINUING SPORT SHOW BROADCAST OVER TELEVISION AND RADIO; PROVIDING RADIO AND TELEVISION NEWS IN THE NATURE OF CURRENT EVENT REPORTING IN THE FIELD OF SPORTS; ENTERTAINMENT SERVICES, NAMELY, PROVIDING AN ON-GOING RADIO AND TELEVISION PROGRAM IN THE FIELD OF AUTO RACING; RADIO ENTERTAINMENT AND TELEVISION SHOW PRODUCTION; RENTAL OF CINE-FILMS; RENTAL OF SOUND AND IMAGE RECORDINGS; VIDEO RECORDING SERVICES; THEME PARK SERVICES; ENTERTAINMENT TICKET AGENCY SERVICES; TIMING AND TIME RECORDING FOR SPORTING EVENTS; VIDEOTAPE EDITING; VIDEOTAPE FILM PRODUCTION; DISTRIBUTION OF TELEVISION PROGRAMMING TO CABLE TELEVISION SYSTEMS; PROVIDING INFORMATION VIA THE INTERNET IN THE FIELD OF SPORTS AND SPORTS LEAGUE PLAYER STATISTICS FOR GAMING AND BETTING PURPOSES, IN CLASS 41 (U.S. CLS. 100, 101 AND 107).

THE MARK CONSISTS OF STANDARD CHARACTERS WITHOUT CLAIM TO ANY PARTICULAR FONT, STYLE, SIZE, OR COLOR.

OWNER OF BENELUX REG. NO. 0891900, DATED 6-29-2010, EXPIRES 6-29-2020.

OWNER OF U.S. REG. NOS. 2,586,148, 3,587,198 AND OTHERS.

SER. NO. 85-227,586, FILED 1-27-2011.

MARIA-VICTORIA SUAREZ, EXAMINING ATTORNEY

# United States of America

United States Patent and Trademark Office

# FORMULA 1

**Reg. No. 4,124,043**

**Registered Apr. 10, 2012**

**Int. Cl.: 42**

**SERVICE MARK**

**PRINCIPAL REGISTER**

FORMULA ONE LICENSING BV (NETHERLANDS CORPORATION)  
BEURSPLEIN 37  
ROTTERDAM, NETHERLANDS 3011AA

FOR: SCIENTIFIC AND TECHNOLOGICAL SERVICES, NAMELY, SCIENTIFIC RESEARCH, ANALYSIS, TESTING IN THE FIELD OF AUTO RACING; INDUSTRIAL DESIGN AND COMPUTER SYSTEMS ANALYSIS; DESIGN AND DEVELOPMENT OF COMPUTER HARDWARE AND SOFTWARE; APPLICATION SERVICE PROVIDER SERVICES FEATURING SOFTWARE FOR USE IN CONNECTION WITH ONLINE MUSIC SUBSCRIPTION SERVICE, SOFTWARE THAT ENABLES USERS TO PLAY AND PROGRAM MUSIC AND ENTERTAINMENT-RELATED AUDIO, VIDEO, TEXT AND MULTIMEDIA CONTENT, AND SOFTWARE FEATURING MUSICAL SOUND RECORDINGS, ENTERTAINMENT-RELATED AUDIO, VIDEO, TEXT AND MULTIMEDIA CONTENT; COMPUTER SOFTWARE CONSULTANCY; DEVELOPMENT AND MAINTENANCE OF SOFTWARE AND DATA BASES; PROVIDING TEMPORARY USE OF ON-LINE NON-DOWNLOADABLE SOFTWARE TO ENABLE USERS TO ACCESS PROGRAMMES OF AUDIO, VIDEO, TEXT AND OTHER MULTIMEDIA CONTENT, INCLUDING MUSIC, CONCERTS, VIDEOS, RADIO, TELEVISION, NEWS, SPORTS, GAMES, CULTURAL EVENTS, AND ENTERTAINMENT-RELATED PROGRAMS; RECOVERY OF COMPUTER DATA, IN CLASS 42 (U.S. CLS. 100 AND 101).

THE MARK CONSISTS OF STANDARD CHARACTERS WITHOUT CLAIM TO ANY PARTICULAR FONT, STYLE, SIZE, OR COLOR.

OWNER OF BENELUX REG. NO. 0891900, DATED 6-29-2010, EXPIRES 6-29-2020.

OWNER OF U.S. REG. NOS. 2,586,148, 3,587,198 AND OTHERS.

SER. NO. 85-227,589, FILED 1-27-2011.

MARIA-VICTORIA SUAREZ, EXAMINING ATTORNEY



*David J. Kyjars*

Director of the United States Patent and Trademark Office

# United States of America

United States Patent and Trademark Office

# BUCKLEY'S

**Reg. No. 4,124,044**

NOVARTIS AG (SWITZERLAND AKTIENGESELLSCHAFT)  
CH 4002

**Registered Apr. 10, 2012**

BASEL, SWITZERLAND

**Int. Cl.: 5**

FOR: COUGH AND COLD MEDICINES, IN CLASS 5 (U.S. CLS. 6, 18, 44, 46, 51 AND 52).

**TRADEMARK**

FIRST USE 1-0-1936; IN COMMERCE 1-0-1936.

**PRINCIPAL REGISTER**

THE MARK CONSISTS OF STANDARD CHARACTERS WITHOUT CLAIM TO ANY PARTICULAR FONT, STYLE, SIZE, OR COLOR.

SEC. 2(F).

SER. NO. 85-227,800, FILED 1-27-2011.

STEVEN R. FINE, EXAMINING ATTORNEY



*David J. Kybas*

Director of the United States Patent and Trademark Office

# United States of America

United States Patent and Trademark Office

# CashX

**Reg. No. 4,124,045**

**Registered Apr. 10, 2012**

**Int. Cl.: 36**

**SERVICE MARK**

**PRINCIPAL REGISTER**

CASHX, LLC (NEVADA LIMITED LIABILITY COMPANY)  
4-2706 45TH AVENUE  
VERNON, BC, CANADA V1T3N4

FOR: FINANCIAL SERVICES, NAMELY, ELECTRONIC FUNDS TRANSFER VIA ELECTRONIC COMMUNICATIONS NETWORKS; MONEY TRANSFER SERVICES; ELECTRONIC FUNDS TRANSFER SERVICES; CLEARING AND RECONCILING FINANCIAL TRANSACTIONS VIA A GLOBAL COMPUTER NETWORK; PROVIDING A WIDE VARIETY OF PAYMENT AND FINANCIAL SERVICES, NAMELY, CREDIT CARD SERVICES, ISSUING PREPAID CREDIT CARDS, CURRENCY EXCHANGE SERVICES, CHEQUE CASHING, ELECTRONIC PAYMENT, NAMELY, ELECTRONIC PROCESSING AND TRANSMISSION OF BILL PAYMENT DATA; BILL PAYMENT SERVICES WITH GUARANTEED PAYMENT DELIVERY; ELECTRONIC COMMERCE PAYMENT SERVICES, NAMELY, ESTABLISHING FUNDED ACCOUNTS USED TO PURCHASE GOODS AND SERVICES ON THE INTERNET; BILL PAYMENT SERVICES TO ONLINE RETAILERS, MERCHANTS AND CONTENT PROVIDERS USING CASH ACCOUNT INFORMATION STORED IN A CENTRALIZED DATABASE; ELECTRONIC PAYMENT, NAMELY, ELECTRONIC PROCESSING OF PREPAID ELECTRONIC BILL PAYMENT DATA, ALL CONDUCTED VIA A GLOBAL COMMUNICATIONS NETWORK, IN CLASS 36 (U.S. CLS. 100, 101 AND 102).

FIRST USE 3-23-2009; IN COMMERCE 3-23-2009.

NO CLAIM IS MADE TO THE EXCLUSIVE RIGHT TO USE "CASH", APART FROM THE MARK AS SHOWN.

THE MARK CONSISTS OF A FIGURE OF A PERSON EVOKING THE LETTER X, PRECEDED BY 'CASH'.

SER. NO. 85-228,086, FILED 1-27-2011.

MARK SPARACINO, EXAMINING ATTORNEY



*David J. Kyjars*

Director of the United States Patent and Trademark Office

# United States of America

United States Patent and Trademark Office



**Reg. No. 4,124,046**

RAYMOND COWZER (IRELAND INDIVIDUAL)  
17 ST. JOHNS DRIVE, ST. JOHNS GROVE  
KILDARE, IRELAND

**Registered Apr. 10, 2012**

**Int. Cl.: 28**

FOR: GOLF ACCESSORIES, NAMELY, HOLDERS FOR GOLF TEES, IN CLASS 28 (U.S. CLS. 22, 23, 38 AND 50).

**TRADEMARK**

PRIORITY CLAIMED UNDER SEC. 44(D) ON ERPN CMNTY TM OFC APPLICATION NO. 009657347, FILED 1-13-2011, REG. NO. 009657347, DATED 6-21-2011, EXPIRES 1-13-2021.

**PRINCIPAL REGISTER**

THE COLOR(S) BLACK, WHITE, GREEN, BLUE, ORANGE, YELLOW AND GREY IS/ARE CLAIMED AS A FEATURE OF THE MARK.

THE MARK CONSISTS OF THE STYLIZED WORDING "TEEBALLZ" DISPLAYED IN STYLIZED BUBBLE LETTERING SHOWN AT AN ANGLE. A SWOOSH DESIGN EXTENDS AT ITS NARROWEST POINT FROM THE GOLF BALL DESIGN LOCATED ON THE LEFT SIDE OF THE MARK AND EXTENDS TO THE RIGHT AND BELOW OF THE WORDING "TEEBALLZ" AND THEN EXTENDS BEHIND AND ABOVE THE WORDING "TEEBALLZ" AND ENDS AT ITS WIDEST POINT WITH THE DESIGN OF THE SECOND GOLF BALL OPENING TO SHOW GOLF TEES. THE WORDING "TEEBALLZ" IS SUPERIMPOSED ON A PORTION OF THE SWOOSH DESIGN. THE LETTER "T" IN THE MARK IS SHOWN IN BLUE, THE FIRST LETTER "E" IN THE MARK IS SHOWN IN ORANGE AND THE THIRD LETTER "E" IN THE MARK IS SHOWN IN YELLOW. THE TERM "BALLZ" IN THE MARK IS SHOWN IN SHADED GREEN. THE LITERAL ELEMENT OF THE MARK IS SURROUNDED BY A WHITE BORDER WITH BLACK IN BETWEEN. THE SWOOSH DESIGN IS SHOWN IN SHADED GREEN SURROUNDED BY A WHITE BORDER. BOTH GOLF BALL DESIGNS IN THE MARK ARE SHOWN IN WHITE. THE SECOND OPEN GOLF BALL DESIGN PICTURED ABOVE THE LITERAL ELEMENT OF THE MARK IS SHOWN WITH A WHITE BORDER. THE GOLF TEE DESIGNS ARE SHOWN IN BLUE, ORANGE, YELLOW AND WHITE. THE COLOR GREY APPEARS AT THE EDGE OF THE WHITE BORDER THAT SURROUNDS THE SWOOSH DESIGN, BOTH GOLF BALLS AND THE WORDS.



*David J. Kypas*

SER. NO. 85-228,967, FILED 1-28-2011.

NAPOLEON SHARMA, EXAMINING ATTORNEY



# United States of America

United States Patent and Trademark Office

## RESIDENTIAL REMODELING INDEX

**Reg. No. 4,124,047**

**Registered Apr. 10, 2012**

**Int. Cls.: 16 and 41**

HANLEY-WOOD, LLC (DELAWARE LIMITED LIABILITY COMPANY)  
SUITE 600  
ONE THOMAS CIRCLE, N.W.  
WASHINGTON, DC 20005

**TRADEMARK**

FOR: PRINTED REPORTS FEATURING A COMPILATION OF STATISTICAL AND NUMERICAL INFORMATION RELATING TO THE U.S. HOUSING MARKET, IN CLASS 16 (U.S. CLS. 2, 5, 22, 23, 29, 37, 38 AND 50).

**SERVICE MARK**

FIRST USE 1-0-2010; IN COMMERCE 1-0-2010.

**PRINCIPAL REGISTER**

FOR: ONLINE NON-DOWNLOADABLE PUBLICATION, NAMELY, REPORTS FEATURING A COMPILATION OF STATISTICAL AND NUMERICAL INFORMATION RELATING TO THE U.S. HOUSING MARKET, IN CLASS 41 (U.S. CLS. 100, 101 AND 107).

FIRST USE 12-0-2010; IN COMMERCE 12-0-2010.

THE MARK CONSISTS OF STANDARD CHARACTERS WITHOUT CLAIM TO ANY PARTICULAR FONT, STYLE, SIZE, OR COLOR.

OWNER OF U.S. REG. NO. 1,731,008.

NO CLAIM IS MADE TO THE EXCLUSIVE RIGHT TO USE "RESIDENTIAL" AND "INDEX", APART FROM THE MARK AS SHOWN.

SEC. 2(F) AS TO "REMODELING".

SER. NO. 85-229,029, FILED 1-28-2011.

KELLY CHOE, EXAMINING ATTORNEY



*David J. Kybas*

Director of the United States Patent and Trademark Office

# United States of America

United States Patent and Trademark Office

## CRANBERRY RELIEF

**Reg. No. 4,124,048**

**Registered Apr. 10, 2012**

**Int. Cls.: 5 and 31**

**TRADEMARK**

**PRINCIPAL REGISTER**

GARMON CORPORATION (CALIFORNIA CORPORATION)  
27461 VIA INDUSTRIA  
TEMECULA, CA 92590

FOR: ANIMAL NUTRACEUTICALS FOR USE AS A DIETARY SUPPLEMENT, PET FOOD CONTAINING A THERAPEUTIC INGREDIENT, PET TREAT CONTAINING A THERAPEUTIC INGREDIENT, PET FOOD AND DIETARY SUPPLEMENTS THAT PROMOTE A HEALTHY URINARY TRACT; ALL THE AFOREMENTIONED GOODS MADE IN WHOLE OR SUBSTANTIAL PART OF CRANBERRY EXTRACT, IN CLASS 5 (U.S. CLS. 6, 18, 44, 46, 51 AND 52).

FIRST USE 1-1-1997; IN COMMERCE 1-1-1997.

FOR: ANIMAL FOOD, PET FOOD, PET TREATS, ORGANIC PET FOOD; ALL OF THE AFOREMENTIONED GOODS MADE IN WHOLE OR SUBSTANTIAL PART OF CRANBERRY EXTRACT, IN CLASS 31 (U.S. CLS. 1 AND 46).

FIRST USE 1-1-1997; IN COMMERCE 1-1-1997.

THE MARK CONSISTS OF STANDARD CHARACTERS WITHOUT CLAIM TO ANY PARTICULAR FONT, STYLE, SIZE, OR COLOR.

NO CLAIM IS MADE TO THE EXCLUSIVE RIGHT TO USE "CRANBERRY", APART FROM THE MARK AS SHOWN.

SEC. 2(F).

SER. NO. 85-229,094, FILED 1-28-2011.

JULIE WATSON, EXAMINING ATTORNEY

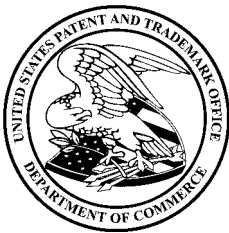

*David J. Kyffers*

Director of the United States Patent and Trademark Office

# United States of America

United States Patent and Trademark Office



**Reg. No. 4,124,049**

**Registered Apr. 10, 2012**

**Int. Cl.: 41**

**SERVICE MARK**

**PRINCIPAL REGISTER**

INSTITUTE FOR HABITS OF MIND, LLC (DELAWARE LIMITED LIABILITY COMPANY)  
12 CROOKED MILE ROAD  
WESTPORT, CT 06880

FOR: EDUCATIONAL SERVICES, NAMELY, PROVIDING ONLINE AND IN PERSON PROGRAMS IN THE FIELD OF EFFECTIVE THINKING AND PROBLEM SOLVING, LEADERSHIP AND PERSONAL IMPROVEMENT FOR CHILDREN AND ADULTS AND DISTRIBUTING COURSE MATERIAL THEREWITH, IN CLASS 41 (U.S. CLS. 100, 101 AND 107).

FIRST USE 12-7-2009; IN COMMERCE 12-7-2009.

NO CLAIM IS MADE TO THE EXCLUSIVE RIGHT TO USE "INSTITUTE", APART FROM THE MARK AS SHOWN.

THE MARK CONSISTS OF THE WORDING "THE INSTITUTE FOR HABITS OF MIND" AND A CONCENTRIC CONFIGURATION OF THREE OFFSET THREE-QUARTER CIRCLES.

SER. NO. 85-230,439, FILED 1-31-2011.

DAWN FELDMAN, EXAMINING ATTORNEY



*David J. Kyros*

Director of the United States Patent and Trademark Office

# United States of America

United States Patent and Trademark Office

## FOREX PROFIT MULTIPLIER

**Reg. No. 4,124,050**

PROFITS RUN, INC. (MICHIGAN CORPORATION)  
28339 BECK RD, UNIT F1  
WIXOM, MI 48393

**Registered Apr. 10, 2012**

**Int. Cls.: 9 and 16**

FOR: PRE-RECORDED CD-ROMS, OPTICAL DISCS AND VIDEOS FEATURING EDUCATIONAL STUDY COURSE MATERIAL IN THE FIELDS OF INVESTMENTS AND TRADING; COMPUTER SOFTWARE FOR SETTING UP AND RECEIVING INVESTMENT AND TRADING ALERTS, IN CLASS 9 (U.S. CLS. 21, 23, 26, 36 AND 38).

**TRADEMARK**

**PRINCIPAL REGISTER**

FIRST USE 10-7-2010; IN COMMERCE 10-7-2010.

FOR: PRINTED MATERIALS, NAMELY, GUIDES, MANUALS AND BOOKS FEATURING EDUCATIONAL STUDY COURSE MATERIAL IN THE FIELDS OF INVESTMENTS AND TRADING, IN CLASS 16 (U.S. CLS. 2, 5, 22, 23, 29, 37, 38 AND 50).

FIRST USE 10-7-2010; IN COMMERCE 10-7-2010.

THE MARK CONSISTS OF STANDARD CHARACTERS WITHOUT CLAIM TO ANY PARTICULAR FONT, STYLE, SIZE, OR COLOR.

NO CLAIM IS MADE TO THE EXCLUSIVE RIGHT TO USE "MULTIPLIER", APART FROM THE MARK AS SHOWN.

SER. NO. 85-230,486, FILED 1-31-2011.

SUSAN STIGLITZ, EXAMINING ATTORNEY



*David J. Kybas*

Director of the United States Patent and Trademark Office

# United States of America

United States Patent and Trademark Office

## HEALTHY BY BRAVO

**Reg. No. 4,124,051**

NBCUNIVERSAL MEDIA, LLC (DELAWARE LIMITED LIABILITY COMPANY)  
30 ROCKEFELLER PLAZA  
NEW YORK, NY 10020

**Registered Apr. 10, 2012**

**Int. Cl.: 35**

FOR: PROMOTING AWARENESS OF HEALTH-RELATED ISSUES, IN CLASS 35 (U.S. CLS. 100, 101 AND 102).

**SERVICE MARK**

FIRST USE 6-14-2010; IN COMMERCE 6-14-2010.

**PRINCIPAL REGISTER**

THE MARK CONSISTS OF STANDARD CHARACTERS WITHOUT CLAIM TO ANY PARTICULAR FONT, STYLE, SIZE, OR COLOR.

OWNER OF U.S. REG. NOS. 1,670,590, 1,934,929 AND OTHERS.

NO CLAIM IS MADE TO THE EXCLUSIVE RIGHT TO USE "HEALTHY", APART FROM THE MARK AS SHOWN.

SER. NO. 85-230,609, FILED 1-31-2011.

HAI-LY LAM, EXAMINING ATTORNEY



*David J. Kybas*

Director of the United States Patent and Trademark Office

# United States of America

United States Patent and Trademark Office

## CONSTRULITA

**Reg. No. 4,124,052**

STRAWBERRY FARMS LIMITED (UNITED KINGDOM LIMITED COMPANY (LTD.))  
6TH FLOOR QUEENS HOUSE 55-56

**Registered Apr. 10, 2012**

LINCOLNS INN FIELDS, UNITED KINGDOM WC2A3LJ

**Int. Cl.: 11**

FOR: APPARATUS FOR ENVIRONMENTAL CONTROL, NAMELY, LIGHTING FIXTURES,  
IN CLASS 11 (U.S. CLS. 13, 21, 23, 31 AND 34).

**TRADEMARK**

FIRST USE 7-1-1982; IN COMMERCE 3-9-1995.

**PRINCIPAL REGISTER**

THE MARK CONSISTS OF STANDARD CHARACTERS WITHOUT CLAIM TO ANY PAR-  
TICULAR FONT, STYLE, SIZE, OR COLOR.

THE WORDING "CONSTRULITA" HAS NO MEANING IN A FOREIGN LANGUAGE.

SER. NO. 85-230,820, FILED 2-1-2011.

JULIE GUTTADAURO, EXAMINING ATTORNEY



*David J. Kybas*

Director of the United States Patent and Trademark Office

# United States of America

United States Patent and Trademark Office

# FRIIS

**Reg. No. 4,124,053**

WING ENTERPRISES, INC. (UTAH CORPORATION)  
1198 NORTH SPRING CREEK PLACE  
SPRINGVILLE, UT 84663

**Registered Apr. 10, 2012**

**Int. Cls.: 20 and 21**

FOR: NON-METAL REPLACEMENT VALVES FOR USE WITH HOUSEHOLD CONTAINERS FOR FOOD, IN CLASS 20 (U.S. CLS. 2, 13, 22, 25, 32 AND 50).

**TRADEMARK**

FIRST USE 5-4-2009; IN COMMERCE 5-4-2009.

**PRINCIPAL REGISTER**

FOR: HOUSEHOLD CONTAINERS FOR FOOD, IN CLASS 21 (U.S. CLS. 2, 13, 23, 29, 30, 33, 40 AND 50).

FIRST USE 5-4-2009; IN COMMERCE 5-4-2009.

THE MARK CONSISTS OF STANDARD CHARACTERS WITHOUT CLAIM TO ANY PARTICULAR FONT, STYLE, SIZE, OR COLOR.

SER. NO. 85-230,904, FILED 2-1-2011.

JEFFREY LOOK, EXAMINING ATTORNEY



*David J. Kybas*

Director of the United States Patent and Trademark Office

# United States of America

United States Patent and Trademark Office

# GOOD JUJU

**Reg. No. 4,124,054**

**Registered Apr. 10, 2012**

**Int. Cl.: 32**

**TRADEMARK**

**PRINCIPAL REGISTER**

INDIAN PEAKS BREWING COMPANY (COLORADO CORPORATION), DBA LEFT HAND  
BREWING COMPANY  
1265 BOSTON AVENUE  
LONGMONT, CO 80501

FOR: BREWED MALT BASED ALCOHOLIC BEVERAGES IN THE NATURE OF BEER, ALE,  
LAGER, PORTER, STOUT, PILSNER, MALT LIQUOR, IN CLASS 32 (U.S. CLS. 45, 46 AND  
48).

FIRST USE 2-1-2010; IN COMMERCE 2-1-2010.

THE MARK CONSISTS OF STANDARD CHARACTERS WITHOUT CLAIM TO ANY PAR-  
TICULAR FONT, STYLE, SIZE, OR COLOR.

NO CLAIM IS MADE TO THE EXCLUSIVE RIGHT TO USE "GOOD", APART FROM THE  
MARK AS SHOWN.

SER. NO. 85-231,264, FILED 2-1-2011.

BRENDAN REGAN, EXAMINING ATTORNEY



*David J. Kyffers*

Director of the United States Patent and Trademark Office



# United States of America

United States Patent and Trademark Office

# GenOptics

**Reg. No. 4,124,055**

**Registered Apr. 10, 2012**

**Int. Cl.: 9**

**TRADEMARK**

**PRINCIPAL REGISTER**

KOREA ELECTRIC TERMINAL CO., LTD. (REPUBLIC OF KOREA CORPORATION)  
7-38, SONG-DONG, YEONSO-GU  
INCHEON-SI, REPUBLIC OF KOREA 406-130

FOR: ELECTRONIC COMPONENTS, NAMELY, OPTICAL JUMPER CORD, OPTICAL ATTENUATOR, OPTICAL FIBER COUPLER, OPTICAL ISOLATOR, OPTICAL CIRCULATOR, WAVELENGTH DIVISIONAL MULTIPLEXER, OPTICAL TRANSCEIVER, OPTICAL SWITCH, OPTICAL SENSOR, ADAPTER, OPTICAL FILTER, IN CLASS 9 (U.S. CLS. 21, 23, 26, 36 AND 38).

THE MARK CONSISTS OF STANDARD CHARACTERS WITHOUT CLAIM TO ANY PARTICULAR FONT, STYLE, SIZE, OR COLOR.

OWNER OF REPUBLIC OF KOREA REG. NO. 504776, DATED 10-29-2001, RENEWED AS REG. NO. 0504776, DATED 10-29-2011, EXPIRES 10-29-2020.

OWNER OF U.S. REG. NO. 2,921,913.

SER. NO. 85-231,411, FILED 2-1-2011.

JOHN HWANG, EXAMINING ATTORNEY



*David J. Kybas*

Director of the United States Patent and Trademark Office

# United States of America

United States Patent and Trademark Office

## Turbo Sculpt HCG

**Reg. No. 4,124,056**

THE KEYS TO LIFE, INC. (GEORGIA CORPORATION)  
3405 HIGHCROFT CIRCLE  
NORCROSS, GA 30092

**Registered Apr. 10, 2012**

**Int. Cl.: 5**

FOR: HOMEOPATHIC-STYLE HCG (HUMAN CHORIONIC GONADOTROPIN) IN THE FORM OF DROPS FOR WEIGHT LOSS PURPOSES, IN CLASS 5 (U.S. CLS. 6, 18, 44, 46, 51 AND 52).

**TRADEMARK**

FIRST USE 2-1-2011; IN COMMERCE 2-1-2011.

**PRINCIPAL REGISTER**

THE MARK CONSISTS OF STANDARD CHARACTERS WITHOUT CLAIM TO ANY PARTICULAR FONT, STYLE, SIZE, OR COLOR.

NO CLAIM IS MADE TO THE EXCLUSIVE RIGHT TO USE "HCG", APART FROM THE MARK AS SHOWN.

SER. NO. 85-231,889, FILED 2-1-2011.

NELSON SNYDER, EXAMINING ATTORNEY



*David J. Kybas*

Director of the United States Patent and Trademark Office

# United States of America

United States Patent and Trademark Office

## MIND GENOMICS

**Reg. No. 4,124,057**

LUXTON ENTERPRISES, INC. (NEW YORK CORPORATION)  
1025 WESTCHESTER AVENUE  
WHITE PLAINS, NY 10604

**Registered Apr. 10, 2012**

**Int. Cl.: 35**

FOR: MARKET RESEARCH SERVICES, IN CLASS 35 (U.S. CLS. 100, 101 AND 102).

**SERVICE MARK**

FIRST USE 1-1-2007; IN COMMERCE 1-1-2007.

**PRINCIPAL REGISTER**

THE MARK CONSISTS OF STANDARD CHARACTERS WITHOUT CLAIM TO ANY PARTICULAR FONT, STYLE, SIZE, OR COLOR.

SER. NO. 85-231,991, FILED 2-2-2011.

DEZMONA MIZELLE, EXAMINING ATTORNEY



*David J. Kyffers*

Director of the United States Patent and Trademark Office

# United States of America

United States Patent and Trademark Office

## HIGHLAND CHIEF

**Reg. No. 4,124,058**

**Registered Apr. 10, 2012**

**Int. Cl.: 33**

**TRADEMARK**

**PRINCIPAL REGISTER**

JOHN MACLAREN & SONS LIMITED (UNITED KINGDOM LIMITED COMPANY (LTD.))  
102 BATH STREET  
GLASGOW, LANARKSHIRE, UNITED KINGDOM G22EN

FOR: SCOTCH WHISKY; ALCOHOLIC BEVERAGES, EXCLUDING BEER, IN CLASS 33  
(U.S. CLS. 47 AND 49).

THE MARK CONSISTS OF STANDARD CHARACTERS WITHOUT CLAIM TO ANY PARTICULAR FONT, STYLE, SIZE, OR COLOR.

OWNER OF ERPN CMNTY TM OFC REG. NO. 004711586, DATED 2-11-2010, EXPIRES 11-10-2015.

SER. NO. 85-232,227, FILED 2-2-2011.

JANICE L. MCMORROW, EXAMINING ATTORNEY



*David J. Kybas*

Director of the United States Patent and Trademark Office

# United States of America

United States Patent and Trademark Office

# SUPER TRIO

**Reg. No. 4,124,059**

FACE AND BODY PROFESSIONALS, INC. (CALIFORNIA CORPORATION)

**Registered Apr. 10, 2012**

371 BEL MARIN KEYS BLVD., #220  
NOVATO, CA 94949

**Int. Cl.: 5**

FOR: TOPICAL ANALGESIC CREAM FOR PAIN RELIEF FROM LASERS, TATTOOING, PERMANENT MAKEUP AND OTHER PAINFUL PROCEDURES, IN CLASS 5 (U.S. CLS. 6, 18, 44, 46, 51 AND 52).

**TRADEMARK**

FIRST USE 4-7-2003; IN COMMERCE 4-7-2003.

**PRINCIPAL REGISTER**

THE MARK CONSISTS OF STANDARD CHARACTERS WITHOUT CLAIM TO ANY PARTICULAR FONT, STYLE, SIZE, OR COLOR.

SEC. 2(F).

SER. NO. 85-232,285, FILED 2-2-2011.

MICHELE SWAIN, EXAMINING ATTORNEY



*David J. Kyffers*

Director of the United States Patent and Trademark Office

# United States of America

United States Patent and Trademark Office

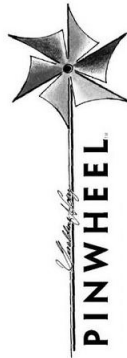

**Reg. No. 4,124,060**

NOVY, GERALDINE (UNITED STATES INDIVIDUAL)  
213 FOX DEN CIRCLE  
NAPLES, FL 34104

**Registered Apr. 10, 2012**

**Int. Cl.: 41**

FOR: EDUCATIONAL SERVICES, NAMELY, THE PRESENTATION OF SEMINARS, LECTURES, WORKSHOPS ALL IN THE FIELD OF HEALTH, HOME, IMAGE, NUTRITION, FITNESS AND COMPANIONS, IN CLASS 41 (U.S. CLS. 100, 101 AND 107).

**SERVICE MARK**

FIRST USE 5-30-2008; IN COMMERCE 5-30-2008.

**PRINCIPAL REGISTER**

THE NAME(S), PORTRAIT(S), AND/OR SIGNATURE(S) SHOWN IN THE MARK IDENTIFIES GERALDINE NOVY, WHOSE CONSENT(S) TO REGISTER IS MADE OF RECORD.

THE MARK CONSISTS OF AN IMAGE OF A PINWHEEL WITH THE WORDING "GERALDINE NOVY" (IN STYLIZED FORMAT) APPEARING VERTICALLY IN THE STICK OF THE PINWHEEL; THE WORDING "PINWHEEL" (IN STYLIZED FORMAT) ALSO APPEARING VERTICALLY ALONGSIDE THE STICK OF THE PINWHEEL.

SER. NO. 85-232,461, FILED 2-2-2011.

GENE MACIOL, EXAMINING ATTORNEY



*David J. Kyffers*

Director of the United States Patent and Trademark Office

# United States of America

United States Patent and Trademark Office

# LOLA B

**Reg. No. 4,124,061**

LOLA B, INC. (CONNECTICUT CORPORATION)  
24 EAST AVENUE #134  
NEW CANAAN, CT 06840

**Registered Apr. 10, 2012**

**Int. Cl.: 18**

FOR: HANDBAGS, PURSES, POCKETBOOKS, TOTE BAGS, MESSENGER BAGS, SHOULDER BAGS, AND DIAPER BAGS, IN CLASS 18 (U.S. CLS. 1, 2, 3, 22 AND 41).

**TRADEMARK**

FIRST USE 4-0-2010; IN COMMERCE 4-0-2010.

**PRINCIPAL REGISTER**

THE MARK CONSISTS OF STANDARD CHARACTERS WITHOUT CLAIM TO ANY PARTICULAR FONT, STYLE, SIZE, OR COLOR.

THE NAME "LOLA B" DOES NOT IDENTIFY A LIVING INDIVIDUAL.

SER. NO. 85-232,562, FILED 2-2-2011.

DANNEAN HETZEL, EXAMINING ATTORNEY



*David J. Kybas*

Director of the United States Patent and Trademark Office

# United States of America

United States Patent and Trademark Office

# WOVTEX

**Reg. No. 4,124,062**

SOUTHERN WEAVING COMPANY (NORTH CAROLINA CORPORATION)  
1005 W. BRAMLETT RD.  
GREENVILLE, SC 29611

**Registered Apr. 10, 2012**

**Int. Cls.: 9 and 17**

FOR: COVERS, IN THE NATURE OF WOVEN TEXTILE SLEEVES SPECIALLY ADAPTED FOR ELECTRIC WIRES, USED TO MANAGE, CONTAIN, AND PROTECT ELECTRIC WIRES, INCLUDING FOR PURPOSES OF ABRASION CONTROL AND WIRE BUNDLING, IN CLASS 9 (U.S. CLS. 21, 23, 26, 36 AND 38).

**TRADEMARK**

**PRINCIPAL REGISTER**

FIRST USE 12-31-2004; IN COMMERCE 12-31-2004.

FOR: COVERS, IN THE NATURE OF WOVEN TEXTILE SLEEVES SPECIALLY ADAPTED FOR HOSES, USED TO MANAGE, CONTAIN, AND PROTECT HOSES, INCLUDING FOR PURPOSES OF ABRASION CONTROL AND HOSE PROTECTION, IN CLASS 17 (U.S. CLS. 1, 5, 12, 13, 35 AND 50).

FIRST USE 12-31-2004; IN COMMERCE 12-31-2004.

THE MARK CONSISTS OF STANDARD CHARACTERS WITHOUT CLAIM TO ANY PARTICULAR FONT, STYLE, SIZE, OR COLOR.

THE WORDING "WOVTEX" HAS NO MEANING IN A FOREIGN LANGUAGE.

SER. NO. 85-233,037, FILED 2-3-2011.

MICHAEL GAAFAR, EXAMINING ATTORNEY



*David J. Kyfos*

Director of the United States Patent and Trademark Office



# United States of America

United States Patent and Trademark Office

## KRESGE EYE INSTITUTE

**Reg. No. 4,124,063**

**Registered Apr. 10, 2012**

**Int. Cls.: 41, 42 and 44**

**SERVICE MARK**

**PRINCIPAL REGISTER**

WAYNE STATE UNIVERSITY (MICHIGAN NON-PROFIT CORPORATION)  
4043 FACULTY/ADMINISTRATION BUILDING  
656 WEST KIRBY  
DETROIT, MI 48202

FOR: PROVIDING EDUCATION SERVICES, NAMELY, PROVIDING COURSES OF INSTRUCTION AT THE GRADUATE, POST GRADUATE AND CONTINUING EDUCATION LEVELS IN THE FIELD OF VISION AND THE HUMAN EYE TO INCREASE KNOWLEDGE OF THE EYE AND THE MECHANISM OF VISION, IMPROVE METHODS OF DIAGNOSING AND TREATING VISION DISORDER, AND ERADICATE EYE DISEASES AND BLINDNESS AND DISTRIBUTION OF COURSE MATERIAL IN CONNECTION THEREWITH; AND MEDICAL TRAINING AND TEACHING IN THE FIELD OF VISION AND THE HUMAN EYE, IN CLASS 41 (U.S. CLS. 100, 101 AND 107).

FIRST USE 12-31-1966; IN COMMERCE 12-31-1966.

FOR: PROVIDING MEDICAL RESEARCH TO INCREASE KNOWLEDGE OF THE EYE AND THE MECHANISM OF VISION, IMPROVE METHODS OF DIAGNOSING AND TREATING VISION DISORDER, AND ERADICATE EYE DISEASES AND BLINDNESS, IN CLASS 42 (U.S. CLS. 100 AND 101).

FIRST USE 11-19-1964; IN COMMERCE 11-19-1964.

FOR: PROVIDING MEDICAL SERVICES TO INCREASE KNOWLEDGE OF THE EYE AND THE MECHANISM OF VISION, IMPROVE METHODS OF DIAGNOSING AND TREATING VISION DISORDER, AND ERADICATE EYE DISEASES AND BLINDNESS, IN CLASS 44 (U.S. CLS. 100 AND 101).

FIRST USE 11-19-1964; IN COMMERCE 11-19-1964.

THE MARK CONSISTS OF STANDARD CHARACTERS WITHOUT CLAIM TO ANY PARTICULAR FONT, STYLE, SIZE, OR COLOR.

NO CLAIM IS MADE TO THE EXCLUSIVE RIGHT TO USE "EYE INSTITUTE", APART FROM THE MARK AS SHOWN.

SEC. 2(F).



*David J. Kyjars*

Director of the United States Patent and Trademark Office

**Reg. No. 4,124,063** SER. NO. 85-233,210, FILED 2-3-2011.

KATHERINE CONNOLLY, EXAMINING ATTORNEY

# United States of America

United States Patent and Trademark Office

## DEADLINE DEALS

**Reg. No. 4,124,064**

THE DOUGLAS GROUP, INC. (ILLINOIS CORPORATION)  
317 N. 11TH STREET, SUITE 200  
ST. LOUIS, MO 63101

**Registered Apr. 10, 2012**

**Int. Cls.: 35 and 42**

FOR: ADVERTISING AND PROMOTIONAL SERVICES; PROMOTING THE GOODS AND SERVICES OF OTHERS, NAMELY, PROVIDING INFORMATION REGARDING DISCOUNTS, COUPONS, REBATES, VOUCHERS AND SPECIAL OFFERS FOR THE GOODS AND SERVICES OF OTHERS, IN CLASS 35 (U.S. CLS. 100, 101 AND 102).

**SERVICE MARK**

**PRINCIPAL REGISTER**

FIRST USE 9-1-2010; IN COMMERCE 9-1-2010.

FOR: PROVIDING A WEBSITE THAT GIVES COMPUTER USERS THE ABILITY TO UPLOAD COUPONS, PRODUCT REVIEWS, AND DISCOUNT INFORMATION, IN CLASS 42 (U.S. CLS. 100 AND 101).

FIRST USE 9-1-2010; IN COMMERCE 9-1-2010.

THE MARK CONSISTS OF STANDARD CHARACTERS WITHOUT CLAIM TO ANY PARTICULAR FONT, STYLE, SIZE, OR COLOR.

NO CLAIM IS MADE TO THE EXCLUSIVE RIGHT TO USE "DEALS", APART FROM THE MARK AS SHOWN.

SER. NO. 85-233,381, FILED 2-3-2011.

NAPOLEON SHARMA, EXAMINING ATTORNEY



*David J. Kyros*

Director of the United States Patent and Trademark Office

# United States of America

United States Patent and Trademark Office

# MAGNUM

**Reg. No. 4,124,065**

NORTHWOODS GAMES, LLC (WISCONSIN LIMITED LIABILITY COMPANY)  
644 HILLCREST DRIVE  
WAUPACA, WI 54981

**Registered Apr. 10, 2012**

**Int. Cl.: 12**

FOR: PARTS, FITTINGS, AND ACCESSORIES FOR LAND VEHICLES, NAMELY, MUDFLAPS FOR VEHICLES, AND FRAMES FOR MOUNTING MUDFLAPS TO VEHICLES, IN CLASS 12 (U.S. CLS. 19, 21, 23, 31, 35 AND 44).

**TRADEMARK**

FIRST USE 1-4-2011; IN COMMERCE 1-4-2011.

**PRINCIPAL REGISTER**

THE MARK CONSISTS OF STANDARD CHARACTERS WITHOUT CLAIM TO ANY PARTICULAR FONT, STYLE, SIZE, OR COLOR.

SER. NO. 85-233,517, FILED 2-3-2011.

BRIAN CALLAGHAN, EXAMINING ATTORNEY



*David J. Kyffers*

Director of the United States Patent and Trademark Office

# United States of America

United States Patent and Trademark Office

## HOME SELECT

**Reg. No. 4,124,066**

DELTA BRANDS, INC. (NEW YORK CORPORATION)

**Registered Apr. 10, 2012**

1890 PALMER AVENUE  
LARCHMONT, NY 10538

**Int. Cl.: 5**

FOR: AIR FRESHENER SPRAYS; CARPET FRESHENERS AND ODOR ELIMINATORS;  
CLEANING PREPARATIONS, NAMELY, ODOR NEUTRALIZERS NOT FOR PERSONAL  
USE; ALL PURPOSE DISINFECTANTS, IN CLASS 5 (U.S. CLS. 6, 18, 44, 46, 51 AND 52).

**TRADEMARK**

FIRST USE 1-8-2009; IN COMMERCE 1-8-2009.

**PRINCIPAL REGISTER**

THE MARK CONSISTS OF STANDARD CHARACTERS WITHOUT CLAIM TO ANY PAR-  
TICULAR FONT, STYLE, SIZE, OR COLOR.

OWNER OF U.S. REG. NO. 3,341,481.

NO CLAIM IS MADE TO THE EXCLUSIVE RIGHT TO USE "HOME", APART FROM THE  
MARK AS SHOWN.

SER. NO. 85-234,148, FILED 2-4-2011.

AMY KERTGATE, EXAMINING ATTORNEY



*David J. Kyffers*

Director of the United States Patent and Trademark Office

# United States of America

United States Patent and Trademark Office



**Reg. No. 4,124,067**

LA LOGGIA, ROBERT A. (UNITED STATES INDIVIDUAL)  
13951 N. SCOTTSDALE RD., SUITE 110  
SCOTTSDALE, AZ 85254

**Registered Apr. 10, 2012**

**Int. Cl.: 42**

FOR: CLOUD COMPUTING FEATURING SOFTWARE FOR USE BY OTHERS FOR BUSINESS AND CONSUMER ON-LINE SCHEDULING, IN CLASS 42 (U.S. CLS. 100 AND 101).

**SERVICE MARK**

FIRST USE 2-1-2002; IN COMMERCE 2-1-2002.

**PRINCIPAL REGISTER**

THE MARK CONSISTS OF THE WORDS "APPOINTMENT PLUS" WHICH ARE HYPHENATED. THE WORDS CONSIST OF BLACK LETTERING EXCEPT FOR THE LETTER "E" IN "APPOINTMENT" WHICH IS BLUE. THERE ARE 6 BLUE DOTS AROUND THE LETTER "A" IN "APPOINTMENT".

THE COLOR(S) BLACK AND BLUE IS/ARE CLAIMED AS A FEATURE OF THE MARK.

SER. NO. 85-234,263, FILED 2-4-2011.

ANN E. SAPPENFIELD, EXAMINING ATTORNEY



*David J. Kyffers*

Director of the United States Patent and Trademark Office

# United States of America

United States Patent and Trademark Office

# Rocks and Robots

**Reg. No. 4,124,068**

**Registered Apr. 10, 2012**

**Int. Cl.: 41**

**SERVICE MARK**

**PRINCIPAL REGISTER**

ALBERCOOK, GEORGE M. (UNITED STATES INDIVIDUAL)  
424 LITTLE LAKE DR. #37  
ANN ARBOR, MI 48103

FOR: SUMMER CAMPS, IN CLASS 41 (U.S. CLS. 100, 101 AND 107).

FIRST USE 5-1-2003; IN COMMERCE 5-1-2003.

THE MARK CONSISTS OF THE WORDS "ROCKS AND ROBOTS" WHERE THE "O" IN "ROCKS" LOOKS LIKE A ROCK AND THE "O" IN "ROBOTS" LOOKS LIKE A GEAR.

SER. NO. 85-234,427, FILED 2-4-2011.

DOMINICK J. SALEMI, EXAMINING ATTORNEY



*David J. Kyffers*

Director of the United States Patent and Trademark Office

# United States of America

United States Patent and Trademark Office

## American Spirits Exchange Limited

**Reg. No. 4,124,069**

REDEMPTION SPIRITS LLC (DELAWARE LIMITED LIABILITY COMPANY)  
205 MILL ST.

**Registered Apr. 10, 2012**

BRIDGEPORT, PA 19405

**Int. Cl.: 35**

FOR: OPERATIONAL BUSINESS ASSISTANCE TO ENTERPRISES, IN CLASS 35 (U.S. CLS. 100, 101 AND 102).

**SERVICE MARK**

FIRST USE 10-5-2010; IN COMMERCE 12-15-2010.

**PRINCIPAL REGISTER**

THE MARK CONSISTS OF STANDARD CHARACTERS WITHOUT CLAIM TO ANY PARTICULAR FONT, STYLE, SIZE, OR COLOR.

NO CLAIM IS MADE TO THE EXCLUSIVE RIGHT TO USE "AMERICAN SPIRITS" AND "LIMITED", APART FROM THE MARK AS SHOWN.

SER. NO. 85-234,840, FILED 2-4-2011.

KEVON CHISOLM, EXAMINING ATTORNEY



*David J. Kyffers*

Director of the United States Patent and Trademark Office



# United States of America

United States Patent and Trademark Office

# MPANION

**Reg. No. 4,124,070**

**Registered Apr. 10, 2012**

**Int. Cl.: 9**

**TRADEMARK**

**PRINCIPAL REGISTER**

MPANION, INC. (DELAWARE CORPORATION)  
601 108TH AVE NE  
STE 1900  
BELLEVUE, WA 98004

FOR: COMPUTER APPLICATION SOFTWARE FOR MOBILE PHONES, NAMELY, SOFTWARE FOR LOCATION BASED SERVICES USED FOR IDENTIFYING THE GEOGRAPHIC LOCATION AND PRESENCE STATUS OF REGISTERED USERS USING A MOBILE PHONE ON A CELLULAR OR WIRELESS NETWORK, AND FURTHER ENABLING LOCATION PRIVACY MANAGEMENT, LOCAL SEARCH AND LOCATION BASED ADVERTISING BASED ON USER'S LOCATION AND PRIVACY SETTINGS, IN CLASS 9 (U.S. CLS. 21, 23, 26, 36 AND 38).

FIRST USE 4-13-2007; IN COMMERCE 4-19-2007.

THE MARK CONSISTS OF STANDARD CHARACTERS WITHOUT CLAIM TO ANY PARTICULAR FONT, STYLE, SIZE, OR COLOR.

SER. NO. 85-234,996, FILED 2-5-2011.

ANTHONY RINKER, EXAMINING ATTORNEY



*David J. Kybas*

Director of the United States Patent and Trademark Office

# United States of America

United States Patent and Trademark Office



**Reg. No. 4,124,071**

**Registered Apr. 10, 2012**

**Int. Cl.: 36**

**SERVICE MARK**

**PRINCIPAL REGISTER**

CARRILLO, SERGIO, E. (UNITED STATES INDIVIDUAL), DBA COMPRADORES DE ORO DE NEW MEXICO  
5459 SALEM COURT, NE  
RIO RANCHO, NM 87144

FOR: PROVIDING MONETARY EXCHANGE SERVICES, NAMELY, EXCHANGING GOLD OF OTHERS FOR CASH, IN CLASS 36 (U.S. CLS. 100, 101 AND 102).

FIRST USE 1-1-2009; IN COMMERCE 1-1-2009.

NO CLAIM IS MADE TO THE EXCLUSIVE RIGHT TO USE "COMPRADORES DE ORO DE NEW MEXICO", APART FROM THE MARK AS SHOWN.

THE COLOR(S) BLUE, RED AND YELLOW IS/ARE CLAIMED AS A FEATURE OF THE MARK.

THE MARK CONSISTS OF THE WORDS "COMPRADORES DE ORO" IN BLUE BELOW WHICH APPEARS A ZIA SUN SYMBOL IN YELLOW AND OUTLINED IN RED, ON WHICH APPEARS THE STYLIZED WORDING "DE NEW MEXICO" IN BLUE.

THE ENGLISH TRANSLATION OF "COMPRADORES DE ORO DE NEW MEXICO" IN THE MARK IS "BUYERS OF GOLD OF NEW MEXICO".

SER. NO. 85-235,069, FILED 2-5-2011.

EDWARD FENNESSY, EXAMINING ATTORNEY



*David J. Kyffers*

Director of the United States Patent and Trademark Office

# United States of America

United States Patent and Trademark Office

## THE ORIGINAL DONKEY BALLS BY LIKA

**Reg. No. 4,124,072**

ALOHA HAWAIIAN STORES, INC. (HAWAII CORPORATION)  
79-7411 MAMALAHOA HIGHWAY  
KAINALIU, HI 96750

**Registered Apr. 10, 2012**

**Int. Cl.: 30**

FOR: CANDY; CHOCOLATE CANDIES; CHOCOLATE COVERED NUTS, IN CLASS 30 (U.S. CL. 46).

**TRADEMARK**

FIRST USE 1-1-2011; IN COMMERCE 1-1-2011.

**PRINCIPAL REGISTER**

THE MARK CONSISTS OF STANDARD CHARACTERS WITHOUT CLAIM TO ANY PARTICULAR FONT, STYLE, SIZE, OR COLOR.

NO CLAIM IS MADE TO THE EXCLUSIVE RIGHT TO USE "ORIGINAL DONKEY BALLS", APART FROM THE MARK AS SHOWN.

SER. NO. 85-235,086, FILED 2-5-2011.

C. DIONNE CLYBURN, EXAMINING ATTORNEY



*David J. Kyffers*

Director of the United States Patent and Trademark Office

# United States of America

United States Patent and Trademark Office



**Reg. No. 4,124,073**

FANTASTIC ENERGY SOLUTIONS, INC. (NEW YORK CORPORATION)  
3500 SUNRISE HIGHWAY, BDG. 200 SUITE 210  
GREAT RIVER, NY 11739

**Registered Apr. 10, 2012**

**Int. Cls.: 37 and 42**

FOR: INSTALLATION, MAINTENANCE AND REPAIR SERVICES OF THERMAL EQUALIZATION ENERGY EFFICIENT FAN SYSTEMS, IN CLASS 37 (U.S. CLS. 100, 103 AND 106).

**SERVICE MARK**

FIRST USE 5-0-2010; IN COMMERCE 5-0-2010.

**PRINCIPAL REGISTER**

FOR: DESIGN OF THERMAL EQUALIZATION ENERGY EFFICIENT FAN SYSTEMS, IN CLASS 42 (U.S. CLS. 100 AND 101).

FIRST USE 5-0-2010; IN COMMERCE 5-0-2010.

THE MARK CONSISTS OF INTERLOCKING HORSESHOE IMAGES NEXT TO THE WORD "FANTASTIC".

SER. NO. 85-235,401, FILED 2-7-2011.

ROSELLE HERRERA, EXAMINING ATTORNEY



*David J. Kybas*

Director of the United States Patent and Trademark Office

# United States of America

United States Patent and Trademark Office

## There Is A Difference

**Reg. No. 4,124,074**

P.C. RICHARD & SON LONG ISLAND CORPORATION (NEW YORK CORPORATION)  
150 PRICE PARKWAY

**Registered Apr. 10, 2012**

FARMINGDALE, NY 11735

**Int. Cl.: 35**

FOR: RETAIL STORE AND ON-LINE RETAIL STORE SERVICES FEATURING APPLIANCES,  
TELEVISIONS, ELECTRONICS, IN CLASS 35 (U.S. CLS. 100, 101 AND 102).

**SERVICE MARK**

FIRST USE 10-6-2003; IN COMMERCE 10-6-2003.

**PRINCIPAL REGISTER**

THE MARK CONSISTS OF STANDARD CHARACTERS WITHOUT CLAIM TO ANY PAR-  
TICULAR FONT, STYLE, SIZE, OR COLOR.

SER. NO. 85-235,521, FILED 2-7-2011.

JAMES STEIN, EXAMINING ATTORNEY



*David J. Kyffers*

Director of the United States Patent and Trademark Office

# United States of America

United States Patent and Trademark Office



**Reg. No. 4,124,075**

**Registered Apr. 10, 2012**

**Int. Cl.: 36**

**SERVICE MARK**

**PRINCIPAL REGISTER**

STANDARD LIFE EMPLOYEE SERVICES LIMITED (UNITED KINGDOM LIMITED LIABILITY COMPANY)  
STANDARD LIFE HOUSE, 30 LOTHIAN ROAD  
EDINBURGH, MIDLOTHIAN, SCOTLAND EH12DH

FOR: FINANCIAL ADVISORY AND CONSULTANCY SERVICES; FINANCIAL ASSET MANAGEMENT SERVICES; FINANCIAL MANAGEMENT AND ADMINISTRATION OF CAPITAL INVESTMENTS, INVESTMENT FUNDS, MUTUAL FUNDS, RETIREMENT FUNDS AND PENSION FUNDS; FINANCIAL ANALYSIS AND EVALUATION; FINANCIAL PORTFOLIO MANAGEMENT SERVICES; PROVISION OF FINANCIAL INFORMATION; BANKING SERVICES; INVESTMENT ADVICE; ESTATE TRUST MANAGEMENT, UNIT TRUST SERVICES NAMELY INVESTMENT AND TRUST COMPANY SERVICES, EMPLOYEE PENSION FUND AND MUTUAL FUND INVESTMENT MANAGEMENT SERVICES; PERSONAL LOAN FINANCING; MORTGAGE BANKING AND MORTGAGE BROKERAGE SERVICES; REAL ESTATE AGENCY, REAL ESTATE MANAGEMENT AND REAL ESTATE LEASING SERVICES; LEASING OF COMMERCIAL PROPERTIES; PROPERTY AND REAL ESTATE FINANCING AND INVESTMENT; RENTAL PROPERTY MANAGEMENT AND FINANCIAL VALUATION OF REAL ESTATE; CREDIT AND FINANCIAL CONSULTATION SERVICES; ACTUARIAL SERVICES; FINANCIAL APPRAISAL OF PERSONAL PROPERTY AND REAL ESTATE; FINANCIAL GUARANTEE AND ASSURANCE UNDERWRITING SERVICES; LIFE AND HEALTH INSURANCE UNDERWRITING SERVICES; INSURANCE BROKERAGE; FINANCIAL RISK ASSESSMENT AND FINANCIAL RISK CONSULTANCY SERVICES; ADVISORY, CONSULTANCY AND INFORMATION SERVICES RELATING TO ALL THE AFORESAID SERVICES; ALL THE AFORESAID SERVICES INCLUDING THOSE PROVIDED ONLINE FROM A COMPUTER DATABASE OR THE INTERNET, IN CLASS 36 (U.S. CLS. 100, 101 AND 102).



PRIORITY CLAIMED UNDER SEC. 44(D) ON UNITED KINGDOM APPLICATION NO. 2555164, FILED 12-3-2010, REG. NO. 2555164, DATED 12-3-2010, EXPIRES 8-9-2020.

THE COLOR(S) BLUE, WHITE, AND YELLOW IS/ARE CLAIMED AS A FEATURE OF THE MARK.

OWNER OF U.S. REG. NO. 3,395,106.

NO CLAIM IS MADE TO THE EXCLUSIVE RIGHT TO USE "LIFE", APART FROM THE MARK AS SHOWN.

*David J. Kybas*

Director of the United States Patent and Trademark Office

**Reg. No. 4,124,075** THE MARK CONSISTS OF THE WORDS "STANDARD LIFE" SHOWN IN INITIAL CAPITAL LETTERS IN WHITE REVERSED OUT OF A BACKGROUND COMPRISED OF A BLUE RECTANGLE. IMMEDIATELY TO THE RIGHT AND ABOVE THE "E" IS A YELLOW TRIANGULAR DESIGN. IN THE UPPER RIGHT CORNER OF THE BLUE RECTANGLE IS A DESIGN COMPRISED OF A SERIES OF TRIANGULAR DESIGNS IN PARALLEL ROWS. THE TRIANGLES ARE SHOWN IN A LIGHTER SHADE OF BLUE, EXCEPT FOR ONE WHICH IS SHOWN IN YELLOW.

SER. NO. 85-235,578, FILED 2-7-2011.

KAREN SEVERSON, EXAMINING ATTORNEY

# United States of America

United States Patent and Trademark Office

# AUTERRA

**Reg. No. 4,124,076**

AUTERRA, INC. (NEW YORK CORPORATION)  
10 HERMES ROAD  
MALTA, NY 12020

**Registered Apr. 10, 2012**

**Int. Cl.: 40**

FOR: PROCESSING AND MODIFICATION IN THE NATURE OF PURIFICATION OF COAL, PETROLEUM, NATURAL GAS AND TAR SANDS, IN CLASS 40 (U.S. CLS. 100, 103 AND 106).

**SERVICE MARK**

FIRST USE 7-23-2010; IN COMMERCE 7-23-2010.

**PRINCIPAL REGISTER**

THE MARK CONSISTS OF STANDARD CHARACTERS WITHOUT CLAIM TO ANY PARTICULAR FONT, STYLE, SIZE, OR COLOR.

SER. NO. 85-235,611, FILED 2-7-2011.

KRISTINA MORRIS, EXAMINING ATTORNEY



*David J. Kyffers*

Director of the United States Patent and Trademark Office



# United States of America

United States Patent and Trademark Office

# NESSET

**Reg. No. 4,124,077**

**Registered Apr. 10, 2012**

**Int. Cl.: 5**

**TRADEMARK**

**PRINCIPAL REGISTER**

TAKEDA PHARMACEUTICAL COMPANY LIMITED (JAPAN CORPORATION)  
1-1, DOSHOMACHI 4-CHOME  
CHUO-KU, OSAKA, JAPAN

FOR: PHARMACEUTICAL PREPARATIONS FOR THE TREATMENT AND PREVENTION  
OF DIABETIC DISEASES, IN CLASS 5 (U.S. CLS. 6, 18, 44, 46, 51 AND 52).

THE MARK CONSISTS OF STANDARD CHARACTERS WITHOUT CLAIM TO ANY PAR-  
TICULAR FONT, STYLE, SIZE, OR COLOR.

PRIORITY CLAIMED UNDER SEC. 44(D) ON JAPAN APPLICATION NO. 2011-001690,  
FILED 1-13-2011, REG. NO. 5419685, DATED 6-17-2011, EXPIRES 6-17-2021.

THE WORDING "NESSET" HAS NO MEANING IN A FOREIGN LANGUAGE.

SER. NO. 85-235,865, FILED 2-7-2011.

WON TEAK OH, EXAMINING ATTORNEY



*David J. Kybas*

Director of the United States Patent and Trademark Office

# United States of America

United States Patent and Trademark Office



**Reg. No. 4,124,078**

**Registered Apr. 10, 2012**

**Int. Cl.: 36**

**SERVICE MARK**

**PRINCIPAL REGISTER**

PARKMOBILE GROUP B.V. (NETHERLANDS BESLOTEN VENNOOTSCHAP (B.V.))  
WISSELWERKING 40  
1112 XR DIEMEN, NETHERLANDS

FOR: FINANCIAL TRANSACTIONS, NAMELY, ASSISTING OTHERS WITH THE COMPLETION OF FINANCIAL TRANSACTIONS IN THE FIELD OF TRAFFIC PAYMENTS AND CAR PARKING PAYMENTS, USING ON-LINE SYSTEMS, THE INTERNET OR MOBILE PHONES; FINANCIAL AFFAIRS, NAMELY, FINANCIAL INFORMATION, MANAGEMENT AND ANALYSIS SERVICES IN THE FIELD OF TRAFFIC PAYMENTS AND CAR PARKING PAYMENTS; MAKING PAYMENTS FOR OTHERS ON-LINE, VIA THE INTERNET OR BY MOBILE PHONE; ELECTRONIC FUNDS TRANSFERS TRAFFIC PAYMENTS AND CAR PARKING PAYMENTS, IN CLASS 36 (U.S. CLS. 100, 101 AND 102).

OWNER OF ERPN CMNTY TM OFC REG. NO. 009025065, DATED 9-2-2010, EXPIRES 4-14-2020.

THE COLOR(S) GREEN AND WHITE IS/ARE CLAIMED AS A FEATURE OF THE MARK.

THE MARK CONSISTS OF A WHITE LETTER "P" INSIDE OF A WHITE CIRCLE THAT IS OPEN AT THE BOTTOM LEFT, ALL AGAINST A GREEN BACKGROUND.

SER. NO. 85-235,873, FILED 2-7-2011.

FRED CARL, EXAMINING ATTORNEY



*David J. Kybas*

Director of the United States Patent and Trademark Office

# United States of America

United States Patent and Trademark Office

## LAWNOPEDIA

**Reg. No. 4,124,079**

**Registered Apr. 10, 2012**

**Int. Cls.: 37 and 44**

**SERVICE MARK**

**PRINCIPAL REGISTER**

OMS INVESTMENTS, INC. (DELAWARE CORPORATION)  
10250 CONSTELLATION BOULEVARD  
SUITE 2800  
LOS ANGELES, CA 90067

FOR: PROVIDING A WEBSITE FEATURING INFORMATION FOR PEST CONTROL, IN CLASS 37 (U.S. CLS. 100, 103 AND 106).

FIRST USE 3-10-2011; IN COMMERCE 3-10-2011.

FOR: PROVIDING A WEBSITE FEATURING INFORMATION IN THE FIELD OF LAWN CARE AND GARDEN CARE; PROVIDING A WEBSITE FEATURING INFORMATION FOR DETERMINING THE CORRECT TREATMENT FOR LAWNS AND GARDENS; PROVIDING A WEBSITE FEATURING INFORMATION FOR LAWN AND GARDEN MAINTENANCE AND DISEASE CONTROL, IN CLASS 44 (U.S. CLS. 100 AND 101).

FIRST USE 3-10-2011; IN COMMERCE 3-10-2011.

THE MARK CONSISTS OF STANDARD CHARACTERS WITHOUT CLAIM TO ANY PARTICULAR FONT, STYLE, SIZE, OR COLOR.

SER. NO. 85-235,887, FILED 2-7-2011.

RAMONA ORTIGA, EXAMINING ATTORNEY



*David J. Kyffers*

Director of the United States Patent and Trademark Office

# United States of America

United States Patent and Trademark Office

# VYNESS

**Reg. No. 4,124,080**

**Registered Apr. 10, 2012**

**Int. Cl.: 5**

**TRADEMARK**

**PRINCIPAL REGISTER**

TAKEDA PHARMACEUTICAL COMPANY LIMITED (JAPAN CORPORATION)  
1-1, DOSHOMACHI 4-CHOME  
CHUO-KU, OSAKA, JAPAN

FOR: PHARMACEUTICAL PREPARATIONS FOR THE TREATMENT AND PREVENTION  
OF DIABETIC DISEASES, IN CLASS 5 (U.S. CLS. 6, 18, 44, 46, 51 AND 52).

THE MARK CONSISTS OF STANDARD CHARACTERS WITHOUT CLAIM TO ANY PAR-  
TICULAR FONT, STYLE, SIZE, OR COLOR.

PRIORITY CLAIMED UNDER SEC. 44(D) ON JAPAN APPLICATION NO. 2011-001702,  
FILED 1-13-2011, REG. NO. 5419693, DATED 6-17-2001, EXPIRES 6-17-2021.

THE WORDING "VYNESS" HAS NO MEANING IN A FOREIGN LANGUAGE.

SER. NO. 85-235,954, FILED 2-7-2011.

WON TEAK OH, EXAMINING ATTORNEY



*David J. Kybas*

Director of the United States Patent and Trademark Office

# United States of America

United States Patent and Trademark Office

## TULSA METRO CHAMBER

**Reg. No. 4,124,081**

**Registered Apr. 10, 2012**

**Int. Cl.: 35**

**SERVICE MARK**

**PRINCIPAL REGISTER**

METROPOLITAN TULSA CHAMBER OF COMMERCE, INC. (OKLAHOMA CHARITABLE CORPORATION)  
2 WEST SECOND STREET, SUITE 150  
TULSA, OK 74103

FOR: CHAMBER OF COMMERCE SERVICES, NAMELY, PROMOTING BUSINESS AND TOURISM IN TULSA AND THE GREATER TULSA METROPOLITAN AREA, IN CLASS 35 (U.S. CLS. 100, 101 AND 102).

FIRST USE 9-28-2000; IN COMMERCE 9-28-2000.

NO CLAIM IS MADE TO THE EXCLUSIVE RIGHT TO USE "CHAMBER", APART FROM THE MARK AS SHOWN.

THE MARK CONSISTS OF A PARTIAL SOLID CRESCENT SHAPE WITH POINTED ENDS THAT CURVE UPWARD WITH THE RIGHT SIDE PIVOTED HIGHER THAN THE LEFT WITH THE WORDS "TULSA METRO CHAMBER" IN CAPITAL BLOCK LETTERS BELOW THE CRESCENT.

SEC. 2(F) AS TO "TULSA METRO CHAMBER".

SER. NO. 85-235,977, FILED 2-7-2011.

NICHOLAS ALTREE, EXAMINING ATTORNEY



*David J. Kyffers*

Director of the United States Patent and Trademark Office

# United States of America

United States Patent and Trademark Office



**Reg. No. 4,124,082**

**Registered Apr. 10, 2012**

**Int. Cls.: 38 and 42**

**SERVICE MARK**

**PRINCIPAL REGISTER**

SAFE COMMUNICATIONS, INC. (NEVADA CORPORATION)  
7740 E. EVANS ROAD  
STE A101  
SCOTTSDALE, AZ 85260

FOR: ELECTRONIC MAIL SERVICES, IN CLASS 38 (U.S. CLS. 100, 101 AND 104).

FIRST USE 8-10-2010; IN COMMERCE 8-10-2010.

FOR: PROVIDING TEMPORARY USE OF ON-LINE NON-DOWNLOADABLE SOFTWARE FOR USE IN TRANSMITTING ELECTRONIC COMMUNICATIONS SUCH AS ELECTRONIC MAIL, TEXT MESSAGING, CREATING AND MANAGING CALENDARS, AND MAINTAINING A SYSTEM OF POINTS, SCHEDULES, AND TASKS FOR AN AWARDS PROGRAM FOR CHILDREN, IN CLASS 42 (U.S. CLS. 100 AND 101).

FIRST USE 8-10-2010; IN COMMERCE 8-10-2011.

THE MARK CONSISTS OF A MOUSE IN THE CENTER OF THE PICTURE HOLDING A SOCCER BALL IN ONE HAND WITH THE OTHER HAND ON IT'S HIP. THE MOUSE IS WEARING SHORTS AND A T-SHIRT WITH THE WORD "MAX" ON IT. THE WORD "MOUSE" IS IN THE UPPER LEFT OF THE MOUSE'S HEAD AND THE WORDING "MAIL.COM" IS TO THE RIGHT OF THE MOUSE'S HEAD.

SER. NO. 85-236,078, FILED 2-7-2011.

SCOTT BIBB, EXAMINING ATTORNEY



*David J. Kybas*

Director of the United States Patent and Trademark Office

# United States of America

United States Patent and Trademark Office



**Reg. No. 4,124,083**

IDEAL ENERGY LLC (ARIZONA LIMITED LIABILITY COMPANY)  
822 W. ORION ST.  
TEMPE, AZ 85283

**Registered Apr. 10, 2012**

**Int. Cl.: 35**

FOR: CONDUCTING ENERGY AUDITS OF RESIDENTIAL HOMES FOR THE PURPOSE OF IMPROVING ENERGY EFFICIENCY, IN CLASS 35 (U.S. CLS. 100, 101 AND 102).

**SERVICE MARK**

FIRST USE 2-12-2009; IN COMMERCE 2-12-2009.

**PRINCIPAL REGISTER**

THE MARK CONSISTS OF THE WORDING "IDEALENERGY" AND DESIGN. THE DESIGN CONSISTS OF A CUBE WITH A LEAF PARTIALLY WRAPPED AROUND THE FRONT FACETS OF THE CUBE. TO THE RIGHT OF THE DESIGN IS THE WORDING "IDEALENERGY".

SER. NO. 85-236,608, FILED 2-8-2011.

MARLENE BELL, EXAMINING ATTORNEY



*David J. Kybas*

Director of the United States Patent and Trademark Office

# United States of America

United States Patent and Trademark Office

# COBRAEYES

**Reg. No. 4,124,084**

**Registered Apr. 10, 2012**

**Int. Cl.: 11**

**TRADEMARK**

**PRINCIPAL REGISTER**

STANLEY ELECTRIC CO., LTD. (JAPAN CORPORATION)  
9-13, NAKAMEGURO 2-CHOME, MEGURO-KU  
TOKYO, JAPAN

FOR: HEADLAMPS FOR MOTOR VEHICLES, LENSES FOR HEADLAMPS FOR MOTOR VEHICLES, LENSES FOR LIGHTING APPARATUS FOR DIFFUSING OR FOCUSING LIGHT FROM AN LED , IN CLASS 11 (U.S. CLS. 13, 21, 23, 31 AND 34).

THE MARK CONSISTS OF STANDARD CHARACTERS WITHOUT CLAIM TO ANY PARTICULAR FONT, STYLE, SIZE, OR COLOR.

OWNER OF JAPAN REG. NO. 2008-045551, DATED 5-1-2009, EXPIRES 5-1-2019.

OWNER OF U.S. REG. NO. 3,812,662.

SER. NO. 85-236,862, FILED 2-8-2011.

FRANK LATTUCA, EXAMINING ATTORNEY



*David J. Kyffers*

Director of the United States Patent and Trademark Office



# United States of America

United States Patent and Trademark Office

# ECHO

**Reg. No. 4,124,085**

**Registered Apr. 10, 2012**

**Int. Cl.: 42**

**SERVICE MARK**

**PRINCIPAL REGISTER**

NEW TECHNOLOGY NETWORK, LLC (OHIO LIMITED LIABILITY COMPANY)  
SUITE 302  
1040 MAIN STREET  
NAPA, CA 94559

FOR: SOFTWARE AS A SERVICE (SAAS) SERVICES FEATURING AN ONLINE LEARNING MANAGEMENT SYSTEM, NAMELY, SOFTWARE FOR USE BY EDUCATIONAL INSTITUTIONS AND STUDENTS FACULTY AND ADMINISTRATION OF EDUCATIONAL INSTITUTIONS THAT FEATURES SOFTWARE FOR ONLINE ACCESS TO TYPICAL ACADEMIC COURSE FEATURES AND ARTIFACTS INCLUDING AGENDAS GRADING SYSTEMS GRADING TOOLS AND ACCESS TO GRADES EFFECTIVENESS ASSESSMENT TOOLS PROJECT MANAGEMENT TOOLS STUDENT TOOLS TEACHER AND ADMINISTRATION TOOLS, DISCUSSION FORUMS, PEER FEEDBACK TOOLS, BEHAVIOR TRACKING TOOLS, SCHOOL WIDE AND NETWORK WIDE TOOLS TO ENABLE GROUP WORK AND COMMUNICATION, SCHOOL WIDE AND NETWORK COMMUNITY WIDE NETWORKING TOOLS, TRAINING AND MATERIALS FOR PRINCIPALS TEACHERS AND SUPPORT STAFF, SEARCHABLE LIBRARIES OF STANDARDS-BASED PROJECTS DEVELOPED BY TEACHERS NETWORK WIDE, SAMPLE TEMPLATES TO INCLUDE SAMPLE SCHOOL POLICIES AND PROCEDURES STUDENT/PARENT HANDBOOKS, DIGITAL PORTFOLIO GUIDELINES, STAFF RECRUITMENT SAMPLES AND TOOLS, PARTNERSHIP DEVELOPMENT MATERIALS AND TOOLS, MASTER SCHEDULE AND CALENDAR SAMPLES AND TOOLS, COUNSELING AND COLLEGE PLANNING MATERIALS AND TOOLS, TECHNOLOGY INFRASTRUCTURE AND SUPPORT GUIDELINES AND TOOLS, AND SOFTWARE TUTORIALS, IN CLASS 42 (U.S. CLS. 100 AND 101).



FIRST USE 7-26-2010; IN COMMERCE 7-26-2010.

THE MARK CONSISTS OF STANDARD CHARACTERS WITHOUT CLAIM TO ANY PARTICULAR FONT, STYLE, SIZE, OR COLOR.

SER. NO. 85-237,031, FILED 2-8-2011.

JENNY PARK, EXAMINING ATTORNEY

*David J. Kyffers*

Director of the United States Patent and Trademark Office

# United States of America

United States Patent and Trademark Office



**Reg. No. 4,124,086**

**Registered Apr. 10, 2012**

**Int. Cl.: 7**

**TRADEMARK**

**PRINCIPAL REGISTER**

SASE COMPANY (WASHINGTON CORPORATION)  
26423 79TH AVENUE SOUTH  
KENT, WA 98032

FOR: MACHINES FOR SURFACE PREPARATION OF CONCRETE AND OTHER HARD SURFACES, NAMELY, GRINDING MACHINES, DIAMOND GRINDERS, AND POLISHERS AND THE PARTS AND FITTINGS FOR THE AFORESAID MACHINES, NAMELY, CUTTERS, DRUMS, FOIL SHAFTS, RESIN BONDS, AND DIAMOND CUP WHEELS AND ABRASIVE DISKS, IN CLASS 7 (U.S. CLS. 13, 19, 21, 23, 31, 34 AND 35).

FIRST USE 10-20-2010; IN COMMERCE 10-20-2010.

THE MARK CONSISTS OF A STYLIZED WOLF HEAD SILHOUETTE THAT IS TAKEN FROM A SIDE VIEW ANGLE. THE WOLF'S MOUTH IS OPEN AND SHOWS FOUR SHARP TEETH, TWO ON THE TOP AND TWO ON THE BOTTOM OF THE MOUTH. THE TEXT "WÜLF" APPEARS NEAR THE MARK.

SER. NO. 85-237,331, FILED 2-8-2011.

DOUGLAS LEE, EXAMINING ATTORNEY



*David J. Kybas*

Director of the United States Patent and Trademark Office

# United States of America

United States Patent and Trademark Office

# AGUARIBAY

**Reg. No. 4,124,087**

**Registered Apr. 10, 2012**

**Int. Cl.: 33**

**TRADEMARK**

**PRINCIPAL REGISTER**

FLECHAS DE LOS ANDES (ARGENTINA SOCIEDAD ANONIMA (SA))  
CLODOMIRO SILVA S/N- VISTA FLORES  
TUNUYAN, MENDOZA, ARGENTINA C.P.:5565

FOR: ALCOHOLIC BEVERAGES EXCEPT BEERS, IN CLASS 33 (U.S. CLS. 47 AND 49).

FIRST USE 7-25-2007; IN COMMERCE 8-11-2008.

THE MARK CONSISTS OF STANDARD CHARACTERS WITHOUT CLAIM TO ANY PARTICULAR FONT, STYLE, SIZE, OR COLOR.

SER. NO. 85-237,635, FILED 2-9-2011.

ANN E. SAPPENFIELD, EXAMINING ATTORNEY



*David J. Kybas*

Director of the United States Patent and Trademark Office

# United States of America

United States Patent and Trademark Office

## FLECHAS DE LOS ANDES

**Reg. No. 4,124,088**

**Registered Apr. 10, 2012**

**Int. Cl.: 33**

**TRADEMARK**

**PRINCIPAL REGISTER**

FLECHAS DE LOS ANDES (ARGENTINA SOCIEDAD ANONIMA (SA))  
CLODOMIRO SILVA S/N- VISTA FLORES  
TUNUYAN, MENDOZA, ARGENTINA C.P.:5565

FOR: ALCOHOLIC BEVERAGES EXCEPT BEERS, IN CLASS 33 (U.S. CLS. 47 AND 49).

FIRST USE 7-7-2006; IN COMMERCE 7-1-2008.

THE MARK CONSISTS OF STANDARD CHARACTERS WITHOUT CLAIM TO ANY PARTICULAR FONT, STYLE, SIZE, OR COLOR.

NO CLAIM IS MADE TO THE EXCLUSIVE RIGHT TO USE "DE LOS ANDES", APART FROM THE MARK AS SHOWN.

THE ENGLISH TRANSLATION OF "FLECHAS DE LOS ANDES" IN THE MARK IS "ARROWS OF THE ANDES".

SER. NO. 85-237,649, FILED 2-9-2011.

ANN E. SAPPENFIELD, EXAMINING ATTORNEY



*David J. Kyffers*

Director of the United States Patent and Trademark Office

# United States of America

United States Patent and Trademark Office

## WEXFORD IRISH CREAM ALE

**Reg. No. 4,124,089**

**Registered Apr. 10, 2012**

**Int. Cl.: 32**

**TRADEMARK**

**PRINCIPAL REGISTER**

GREENE KING BREWING AND RETAILING LIMITED (UNITED KINGDOM LIMITED LIABILITY COMPANY)  
WESTGATE BREWERY, BURY ST. EDMUNDS  
SUFFOLK, UNITED KINGDOM IP331QT

FOR: ALE, IN CLASS 32 (U.S. CLS. 45, 46 AND 48).

FIRST USE 0-0-2003; IN COMMERCE 0-0-2003.

THE MARK CONSISTS OF STANDARD CHARACTERS WITHOUT CLAIM TO ANY PARTICULAR FONT, STYLE, SIZE, OR COLOR.

NO CLAIM IS MADE TO THE EXCLUSIVE RIGHT TO USE "IRISH CREAM ALE", APART FROM THE MARK AS SHOWN.

SEC. 2(F).

SER. NO. 85-237,750, FILED 2-9-2011.

MAYUR VAGHANI, EXAMINING ATTORNEY



*David J. Kyffers*

Director of the United States Patent and Trademark Office

# United States of America

United States Patent and Trademark Office

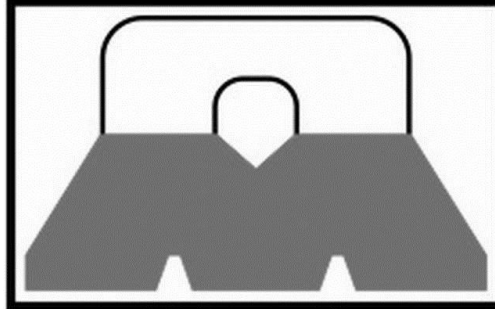

**O'MEARA, L.L.C.**

**Reg. No. 4,124,090**

**Registered Apr. 10, 2012**

**Int. Cls.: 37 and 42**

**SERVICE MARK**

**PRINCIPAL REGISTER**

O'MEARA, L.L.C. (LOUISIANA LIMITED LIABILITY COMPANY), FORMERLY O'MEARA, INC.  
650 POYDRAS ST., SUITE 2235  
NEW ORLEANS, LA 70130

FOR: OIL AND GAS WELL CONTRACTING SERVICES AND DRILLING AND PUMPING OF OIL AND GAS, IN CLASS 37 (U.S. CLS. 100, 103 AND 106).

FIRST USE 1-9-2006; IN COMMERCE 1-9-2006.

FOR: GEOPHYSICAL EXPLORATION FOR THE OIL AND GAS INDUSTRY, TECHNICAL CONSULTATION AND RESEARCH IN THE FIELD OF OIL AND GAS EXPLORATION, WELL LOGGING AND OIL FIELD SURVEYING, IN CLASS 42 (U.S. CLS. 100 AND 101).

FIRST USE 1-9-2006; IN COMMERCE 1-9-2006.

OWNER OF U.S. REG. NO. 2,886,008.

NO CLAIM IS MADE TO THE EXCLUSIVE RIGHT TO USE "L.L.C.", APART FROM THE MARK AS SHOWN.

THE MARK CONSISTS OF THE LETTER "O" SITTING ON TOP OF THE LETTER "M" ALL WITHIN A PLAIN SINGLE LINE RECTANGLE. THE NAME "O'MEARA, L.L.C." BELOW THE RECTANGLE.

SER. NO. 85-237,963, FILED 2-9-2011.

REBECCA EISINGER, EXAMINING ATTORNEY



*David J. Kybas*

Director of the United States Patent and Trademark Office

# United States of America

United States Patent and Trademark Office

# eZVUE

**Reg. No. 4,124,091**

**Registered Apr. 10, 2012**

**Int. Cl.: 9**

**TRADEMARK**

**PRINCIPAL REGISTER**

CAPITAL LEGAL SOLUTIONS, LLC (VIRGINIA LIMITED LIABILITY COMPANY)  
300  
10521 ROSEHAVEN ST,  
FAIRFAX, VA 22030

FOR: COMPUTER APPLICATION SOFTWARE FOR DATA PROCESSING, NAMELY, FOR USE IN ELECTRONIC DISCOVERY, HOSTING, TRIAL CONSULTING AND SUPPORT SERVICES; COMPUTER PROGRAMS FOR ASSISTING IN DATA DISCOVERY REQUESTED BY CLIENTS FOR USE IN ELECTRONIC DISCOVERY SERVICES, TRIAL CONSULTING SERVICES AND ELECTRONIC MEDICAL RECORDS AND SUPPORT SERVICES; COMPUTER SOFTWARE FOR CREATING SEARCHABLE DATABASES OF INFORMATION AND DATA; COMPUTER SOFTWARE FOR PROCESSING DIGITAL IMAGES; COMPUTER SOFTWARE FOR PROCESSING DIGITAL MUSIC FILES; COMPUTER SOFTWARE FOR PROVIDING AN ON-LINE DATABASE IN THE FIELD OF TRANSACTION PROCESSING TO UPLOAD TRANSACTIONAL DATA, PROVIDE STATISTICAL ANALYSIS, AND PRODUCE NOTIFICATIONS AND REPORTS; COMPUTER SOFTWARE FOR THE COLLECTION, EDITING, ORGANIZING, MODIFYING, BOOK MARKING, TRANSMISSION, STORAGE AND SHARING OF DATA AND INFORMATION; COMPUTER SOFTWARE FOR DATA MINING OR USE IN ELECTRONIC DISCOVERY SERVICES, TRIAL CONSULTING SERVICES AND ELECTRONIC MEDICAL RECORDS AND SUPPORT SERVICES; COMPUTER SOFTWARE FOR DATA MINING FOR USE IN ELECTRONIC DISCOVERY SERVICES, TRIAL CONSULTING SERVICES AND ELECTRONIC MEDICAL RECORDS AND SUPPORT SERVICES THAT MAY BE DOWNLOADED FROM A GLOBAL COMPUTER NETWORK; COMPUTER SOFTWARE TO AUTOMATE DATA WAREHOUSING; DATA COMPRESSION SOFTWARE; DATA PROCESSORS; DOWNLOADABLE COMPUTER SOFTWARE FOR DATA MINING FOR USE IN ELECTRONIC DISCOVERY SERVICES, TRIAL CONSULTING SERVICES AND ELECTRONIC MEDICAL RECORDS AND SUPPORT SERVICES; DOWNLOADABLE ELECTRONIC DATA FILES AND DATABASES, NAMELY, BUSINESS AND TAX FORMS, FOR USE WITH COMPUTER SOFTWARE; DOWNLOADABLE SOFTWARE FOR DATA MINING FOR USE IN ELECTRONIC DISCOVERY SERVICES, TRIAL CONSULTING SERVICES AND ELECTRONIC MEDICAL RECORDS AND SUPPORT SERVICES; DOWNLOADABLE SOFTWARE IN THE NATURE OF A MOBILE APPLICATION FOR DATA MINING FOR USE IN ELECTRONIC DISCOVERY SERVICES, TRIAL CONSULTING SERVICES AND ELECTRONIC MEDICAL RECORDS AND SUPPORT SERVICES; ENTERPRISE SOFTWARE IN THE NATURE OF A DATABASE FOR NON-TRANSACTIONAL DATA AND A SEARCH ENGINE FOR DATABASE CONTENT; SOFTWARE FOR PROCESSING IMAGES, GRAPHICS AND TEXT, IN CLASS 9 (U.S. CLS. 21, 23, 26, 36 AND 38).



*David J. Kybas*

Director of the United States Patent and Trademark Office

**Reg. No. 4,124,091** FIRST USE 3-9-2010; IN COMMERCE 6-8-2010.

THE MARK CONSISTS OF STANDARD CHARACTERS WITHOUT CLAIM TO ANY PARTICULAR FONT, STYLE, SIZE, OR COLOR.

SER. NO. 85-238,281, FILED 2-9-2011.

ALAIN LAPTER, EXAMINING ATTORNEY



# United States of America

United States Patent and Trademark Office

## Cheesy Grillwich

**Reg. No. 4,124,092**

**Registered Apr. 10, 2012**

**Int. Cl.: 30**

**TRADEMARK**

**PRINCIPAL REGISTER**

FLAVA FUSION (SOUTH DAKOTA LIMITED LIABILITY COMPANY), DBA PALMA SOLA  
3025 WHITTEN ROAD  
LAKELAND, FL 33811

FOR: SANDWICHES, IN CLASS 30 (U.S. CL. 46).

FIRST USE 1-15-2011; IN COMMERCE 1-15-2011.

THE MARK CONSISTS OF STANDARD CHARACTERS WITHOUT CLAIM TO ANY PARTICULAR FONT, STYLE, SIZE, OR COLOR.

NO CLAIM IS MADE TO THE EXCLUSIVE RIGHT TO USE "CHEESY", APART FROM THE MARK AS SHOWN.

SER. NO. 85-238,737, FILED 2-10-2011.

BRIAN PINO, EXAMINING ATTORNEY



*David J. Kyffers*

Director of the United States Patent and Trademark Office

# United States of America

United States Patent and Trademark Office

## TATTOOCULTUREDIFFUSION

**Reg. No. 4,124,093**

**Registered Apr. 10, 2012**

**Int. Cls.: 14 and 25**

**TRADEMARK**

**PRINCIPAL REGISTER**

GASTEL GIOVANNI CARLO GUIDO MARIA (ITALY INDIVIDUAL)  
VIA SAN SISTO 6  
MILANO, ITALY 20123

FOR: WRISTWATCHES, POCKET WATCHES; ALARM CLOCKS; DIGITAL ALARM CLOCKS; WATCH CASES; WATCH CHAINS; WATCH GLASSES; WATCH STRAPS; CHRONOGRAPHS AS WATCHES; JEWELRY ARTICLES AND COSTUME JEWELRY ARTICLES, NAMELY, RINGS, EARRINGS, BRACELETS, NECK LACES, PENDANTS, CUFFLINKS, ORNAMENTAL PINS, TIE PINS, IN CLASS 14 (U.S. CLS. 2, 27, 28 AND 50).

FOR: CLOTHING, NAMELY, COATS, MANTLES, RAINCOATS, DUSTERS, FURS COATS AND FUR JACKETS, DRESSES, SUITS, SKIRTS, JACKETS, TROUSERS, SHORTS SETS, BERMUDA SHORTS, JEANS, WAISTCOATS, SHIRTS, T-SHIRTS, TOPS, BLOUSES, JERSEYS, SWEATERS, BLAZERS, CARDIGANS, STOCKINGS, SOCKS, UNDERWEAR, CORSETS, BRASSIERE, UNDERPANTS, NIGHT-GOWNS, SHIFTS, PAJAMAS, BATHROBES, BATHING SUITS, BEACH-WRAPPS, SUN SWIMSUITS, SPORT JACKETS, WATERPROOF JACKETS AND WATERPROOF TROUSERS, WIND-RESISTANT JACKETS, ANORAKS, SWEATSUITS, TIES, NECKTIES, SCARVES, SHAWLS, MUFFLERS, FOULARDS, CAPS, HATS, HOODS, GLOVES, SASHES, BELTS; KNITWEAR, NAMELY, JACKETS, SWEATERS AND HATS; FOOTWEAR, BEACH FOOTWEAR, ATHLETIC FOOTWEAR, BOOTS, SHOES AND SLIPPERS, IN CLASS 25 (U.S. CLS. 22 AND 39).

THE MARK CONSISTS OF STANDARD CHARACTERS WITHOUT CLAIM TO ANY PARTICULAR FONT, STYLE, SIZE, OR COLOR.

OWNER OF ERPN CMNTY TM OFC REG. NO. 009587353, DATED 4-21-2011, EXPIRES 12-10-2020.

SER. NO. 85-239,087, FILED 2-10-2011.

JOSETTE BEVERLY, EXAMINING ATTORNEY



*David J. Kypos*

Director of the United States Patent and Trademark Office

# United States of America

United States Patent and Trademark Office

## ENVIRO VAULT

**Reg. No. 4,124,094**

**Registered Apr. 10, 2012**

**Int. Cls.: 6 and 37**

**TRADEMARK**

**SERVICE MARK**

**PRINCIPAL REGISTER**

ENVIRO VAULT INC. (CANADA CORPORATION)  
6448 SOUTH ISLAND HIGHWAY  
UNION BAY, BC, CANADA V0R 3B0

FOR: METAL FLUID STORAGE TANKS WITH VALVE AND SPILL CONTAINMENT SYSTEMS, AND VALVE AND SPILL CONTAINMENT SYSTEMS FOR INSTALLATION IN EXISTING FLUID STORAGE TANKS, IN CLASS 6 (U.S. CLS. 2, 12, 13, 14, 23, 25 AND 50).

FIRST USE 8-31-1996; IN COMMERCE 2-28-2001.

FOR: INSTALLATION OF VALVE AND SPILL CONTAINMENT SYSTEMS IN FLUID STORAGE TANKS, IN CLASS 37 (U.S. CLS. 100, 103 AND 106).

FIRST USE 8-31-1996; IN COMMERCE 2-28-2001.

THE MARK CONSISTS OF STANDARD CHARACTERS WITHOUT CLAIM TO ANY PARTICULAR FONT, STYLE, SIZE, OR COLOR.

OWNER OF CANADA REG. NO. TMA485804, DATED 11-19-1997, EXPIRES 11-19-2012.

OWNER OF U.S. REG. NO. 3,748,146.

NO CLAIM IS MADE TO THE EXCLUSIVE RIGHT TO USE "VAULT", APART FROM THE MARK AS SHOWN.

SER. NO. 85-239,313, FILED 2-10-2011.

KELLY BOULTON, EXAMINING ATTORNEY



*David J. Kyjars*

Director of the United States Patent and Trademark Office

# United States of America

United States Patent and Trademark Office

## IN SCHOOL AND ON TRACK.

**Reg. No. 4,124,095**

SCHOOL LOOP, INC. (CALIFORNIA CORPORATION)

**Registered Apr. 10, 2012**

P.O. BOX 2416  
SAN FRANCISCO, CA 94126

**Int. Cls.: 38, 41 and 42**

FOR: PROVIDING ON-LINE FORUMS FOR TRANSMISSION OF MESSAGES AMONG COMPUTER USERS; PROVIDING ONLINE FORUMS FOR THE TRANSMISSION OF MESSAGES BETWEEN PARENTS, TEACHERS, SCHOOL OFFICIALS AND STUDENTS IN A PRIVATE ENVIRONMENT; ONLINE SERVICES, NAMELY, PROVIDING ONLINE TEXT AND GRAPHICAL BULLETIN BOARDS FOR TEACHERS, STUDENTS, PARENTS, AND SCHOOL OFFICIALS FOR THE POSTING OF MESSAGES IN THE FIELD OF EDUCATION; ELECTRONIC MAIL SERVICES, IN CLASS 38 (U.S. CLS. 100, 101 AND 104).

**SERVICE MARK**

**PRINCIPAL REGISTER**

FIRST USE 6-1-2010; IN COMMERCE 6-1-2010.

FOR: NON-DOWNLOADABLE ELECTRONIC PUBLICATIONS SENT VIA E-MAIL IN THE NATURE OF NEWSLETTERS FOR PARENTS AND STUDENTS REGARDING HOMEWORK ASSIGNMENT INFORMATION, IN CLASS 41 (U.S. CLS. 100, 101 AND 107).

FIRST USE 6-1-2010; IN COMMERCE 6-1-2010.

FOR: WEBSITE HOSTING SERVICES FOR OTHERS; APPLICATION SERVICE PROVIDER (ASP), NAMELY, HOSTING COMPUTER SOFTWARE APPLICATIONS FOR THE PURPOSE OF INTEGRATED COMMUNICATIONS IN THE FIELD OF EDUCATION, IN CLASS 42 (U.S. CLS. 100 AND 101).

FIRST USE 6-1-2010; IN COMMERCE 6-1-2010.

THE MARK CONSISTS OF STANDARD CHARACTERS WITHOUT CLAIM TO ANY PARTICULAR FONT, STYLE, SIZE, OR COLOR.

SER. NO. 85-239,379, FILED 2-10-2011.

ANGELA DUONG, EXAMINING ATTORNEY



*David J. Kyffers*

Director of the United States Patent and Trademark Office

# United States of America

United States Patent and Trademark Office

# ALURATEK

**Reg. No. 4,124,096**

**Registered Apr. 10, 2012**

**Int. Cl.: 9**

**TRADEMARK**

**PRINCIPAL REGISTER**

ALURATEK, INC. (CALIFORNIA CORPORATION)  
14831 MYFORD ROAD  
TUSTIN, CA 92780

FOR: PORTABLE ELECTRONIC DEVICES FOR RECEIVING AND READING TEXT AND IMAGES AND SOUND THROUGH WIRELESS INTERNET ACCESS AND FOR DISPLAYING ELECTRONICALLY PUBLISHED MATERIALS, NAMELY, BOOKS, JOURNALS, NEWSPAPERS, MAGAZINES, MULTIMEDIA PRESENTATIONS; COMPUTER HARDWARE AND SOFTWARE IN THE FIELD OF TEXT, IMAGE AND SOUND TRANSMISSION AND DISPLAY; PORTABLE COMPUTERS, NAMELY, TABLETS; MULTIMEDIA PLAYER AND ENTERTAINMENT DEVICES, NAMELY, PORTABLE VIDEO, MP3 AND DIGITAL MUSIC PLAYERS, AND INTERNET RADIOS; PERIPHERALS AND ACCESSORIES FOR USE WITH MULTIMEDIA PLAYER ENTERTAINMENT AND COMMUNICATIONS DEVICES, NAMELY, EARPHONES, AND SPEAKERS; DOCKING STATIONS FOR USE WITH MULTIMEDIA PLAYERS; WIRELESS REMOTE CONTROL DEVICES FOR USE WITH MULTIMEDIA PLAYERS; BATTERY CHARGERS; ELECTRICAL CONNECTORS, WIRES, CABLES AND ADAPTORS; AUTOMOBILE STEREO ADAPTERS; HARDWARE FOR CONNECTING MULTIMEDIA PLAYERS TO EXISTING AUDIOVISUAL SYSTEMS IN HOMES AND OFFICES, NAMELY, ELECTRONIC INTERCONNECTORS FOR AUDIO AND VIDEO SIGNALS; CARRYING CASES FOR USE WITH MULTIMEDIA PLAYER AND ENTERTAINMENT DEVICES; DIGITAL VIDEO CAMCORDERS; DIGITAL PHOTO FRAMES; WIRELESS 3G ROUTERS WIRELESS FOR ACCESSING BROADBAND COMMUNICATIONS VIA MOBILE WIRELESS NETWORKS; USB DEVICES, NAMELY, COMPUTER CARDS FOR READING AND TRANSFERRING DATA, USB CABLES, USB HUBS, AND USB CARD READERS; VIDEO ADAPTERS FOR THE TRANSFER OF HIGH-RESOLUTION MEDIA; USB AND MULTIMEDIA ACCESSORIES, NAMELY, AUDIO, ELECTRIC, AND COMPUTER CABLES, POWER ADAPTERS, SIGNAL SPLITTERS FOR ELECTRONIC APPARATUS, POWER SPLITTERS, AUDIO SPLITTERS, AND POWER, COMPUTER NETWORK, ELECTRONIC TOUCH SENSITIVE SWITCHES, IN CLASS 9 (U.S. CLS. 21, 23, 26, 36 AND 38).

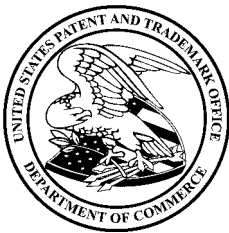

FIRST USE 5-1-2006; IN COMMERCE 5-1-2006.

THE MARK CONSISTS OF STANDARD CHARACTERS WITHOUT CLAIM TO ANY PARTICULAR FONT, STYLE, SIZE, OR COLOR.

SER. NO. 85-239,391, FILED 2-10-2011.

*David J. Kyros*

Director of the United States Patent and Trademark Office

**Reg. No. 4,124,096** SAIMA MAKHDOOM, EXAMINING ATTORNEY

# United States of America

United States Patent and Trademark Office



**Reg. No. 4,124,097**

CBA PROPERTIES, INC. (FLORIDA CORPORATION)  
1857 HELM DRIVE

**Registered Apr. 10, 2012**

LAS VEGAS, NV 89119

**Int. Cl.: 44**

FOR: MEDICAL SERVICES, NAMELY, THE COLLECTION OF BLOOD AND STEM CELLS FOR TESTING, PROCESSING AND PRESERVATION FOR MEDICAL RESEARCH, TREATMENT AND DIAGNOSTICS, IN CLASS 44 (U.S. CLS. 100 AND 101).

**SERVICE MARK**

FIRST USE 9-9-2010; IN COMMERCE 9-9-2010.

**PRINCIPAL REGISTER**

THE MARK CONSISTS OF THE FOLLOWING: THE WORDS "COLLECT-A-CORD" IN DARK PURPLE AND THE HYPHEN IN DARK PINK, WITH THE DRAWING OF A SPHERE IN THE MIDDLE WHICH IS VARIOUS SHADES OF LIGHT PINK, DARK PINK, LIGHT PURPLE, AND DARK PURPLE WITH A WHITE SPOT IN THE UPPER LEFT PORTION OF THE SPHERE, SURROUNDED BY FOUR CRESCENT MOON SHAPED OBJECTS WHICH OVERLAP BUT DO NOT TOUCH EACH OTHER AND FORM A CIRCLE AROUND THE SPHERE.

THE COLOR(S) LIGHT PINK, DARK PINK, LIGHT PURPLE, DARK PURPLE, AND WHITE IS/ARE CLAIMED AS A FEATURE OF THE MARK.

SER. NO. 85-240,010, FILED 2-11-2011.

ANNE E. GUSTASON, EXAMINING ATTORNEY



*David J. Kybas*

Director of the United States Patent and Trademark Office

# United States of America

United States Patent and Trademark Office

## DON'T DRINK AND DRAW

**Reg. No. 4,124,098**

**Registered Apr. 10, 2012**

**Int. Cl.: 28**

**TRADEMARK**

**PRINCIPAL REGISTER**

UNIVERSITY GAMES CORPORATION (CALIFORNIA CORPORATION)  
2030 HARRISON STREET  
SAN FRANCISCO, CA 94110

FOR: BOARD GAMES AND CARD GAMES, IN CLASS 28 (U.S. CLS. 22, 23, 38 AND 50).

FIRST USE 9-15-2010; IN COMMERCE 9-15-2010.

THE MARK CONSISTS OF STANDARD CHARACTERS WITHOUT CLAIM TO ANY PARTICULAR FONT, STYLE, SIZE, OR COLOR.

NO CLAIM IS MADE TO THE EXCLUSIVE RIGHT TO USE "DRAW", APART FROM THE MARK AS SHOWN.

SER. NO. 85-240,222, FILED 2-11-2011.

LEIGH CAROLINE CASE, EXAMINING ATTORNEY



*David J. Kyffers*

Director of the United States Patent and Trademark Office



# United States of America

United States Patent and Trademark Office



**Reg. No. 4,124,099**

**Registered Apr. 10, 2012**

**Int. Cl.: 43**

**SERVICE MARK**

**PRINCIPAL REGISTER**

PRIMARY HOSPITALITY GROUP, LLC. (ILLINOIS LIMITED LIABILITY COMPANY)  
125 S WACKER DR.  
STE 3010  
CHICAGO, IL 60606

FOR: BAR AND RESTAURANT SERVICES, IN CLASS 43 (U.S. CLS. 100 AND 101).

FIRST USE 5-30-2008; IN COMMERCE 5-30-2008.

THE MARK CONSISTS OF A LOWER CASE "G" ON TOP OF A LOWER CASE "E". THE LETTERS APPEAR AS ONE SINGLE UNIT, THE "G" FLOWING DIRECTLY INTO THE "E".

SER. NO. 85-240,455, FILED 2-11-2011.

APRIL ROACH, EXAMINING ATTORNEY



*David J. Kyffers*

Director of the United States Patent and Trademark Office

# United States of America

United States Patent and Trademark Office

## Intego Group

**Reg. No. 4,124,100**

**Registered Apr. 10, 2012**

**Int. Cl.: 35**

**SERVICE MARK**

**PRINCIPAL REGISTER**

INTEGO GROUP (FLORIDA LIMITED LIABILITY COMPANY)  
1800 PEMBROOK DR., SUITE 300  
ORLANDO, FL 32810

FOR: BUSINESS PROCESS OUTSOURCING SERVICES IN THE FIELD OF INFORMATION TECHNOLOGY; EXCLUDING BUSINESS PROCESS OUTSOURCING SERVICES PERTAINING TO SERVICES IN THE FIELDS OF COMPUTER AND INTERNET SECURITY, EXCEPT WHEN THE SERVICES IN THE FIELDS OF COMPUTER AND INTERNET SECURITY ARE PROVIDED BY THIRD PARTIES; CONSULTING SERVICES IN THE FIELDS OF BUSINESS MANAGEMENT, HUMAN RESOURCES, AND BUSINESS ORGANIZATIONAL DESIGN; HUMAN CAPITAL MANAGEMENT OUTSOURCING SERVICES; HUMAN RESOURCE ANALYSIS AND CONSULTING SERVICES; HUMAN RESOURCES CONSULTANCY; HUMAN RESOURCES SERVICES, NAMELY, PERSONNEL SELECTION FOR OTHERS; INTERNATIONAL BUSINESS CONSULTING SERVICES RELATING TO MERCHANDISE TRADING, HUMAN RESOURCE INTERCHANGE, MANAGEMENT SUPPORT, MARKETING, ADVERTISING, PROMOTION, AND DOMESTIC AND INTERNATIONAL MARKET RESEARCH AND DEVELOPMENT; OUTSOURCING IN THE FIELD OF SALES AND MARKETING OF COMPUTER SOFTWARE FOR THIRD PARTIES; EXCLUDING SALES AND MARKETING OF COMPUTER SOFTWARE FOR USE IN COMPUTER AND INTERNET SECURITY, IN CLASS 35 (U.S. CLS. 100, 101 AND 102).

FIRST USE 1-1-2007; IN COMMERCE 1-1-2007.

THE MARK CONSISTS OF STANDARD CHARACTERS WITHOUT CLAIM TO ANY PARTICULAR FONT, STYLE, SIZE, OR COLOR.

NO CLAIM IS MADE TO THE EXCLUSIVE RIGHT TO USE "GROUP", APART FROM THE MARK AS SHOWN.

SER. NO. 85-240,893, FILED 2-12-2011.

MARY CRAWFORD, EXAMINING ATTORNEY



*David J. Kyffers*

Director of the United States Patent and Trademark Office

# United States of America

United States Patent and Trademark Office

# HomePulse

**Reg. No. 4,124,101**

**Registered Apr. 10, 2012**

**Int. Cl.: 9**

**TRADEMARK**

**PRINCIPAL REGISTER**

PASSIVSYSTEMS LIMITED (UNITED KINGDOM LIMITED LIABILITY COMPANY)  
MEDWAY HOUSE, BUSINESS PARK, LONDON RD  
NEWBURY, UNITED KINGDOM RG142PZ

FOR: COMPUTER SOFTWARE RUNNING AS A SERVICE FOR PROCESSING SIGNALS FROM SENSORS AND ACTUATORS; FIRMWARE FOR MONITORING, SWITCHING OR CONTROLLING THE FLOW OF ELECTRICITY TO ELECTRICAL DEVICES; COMPUTER SOFTWARE SYSTEM FOR REMOTELY MONITORING ENVIRONMENTAL CONDITIONS AND CONTROLLING DEVICES WITHIN A BUILDING, FACILITY, GROUNDS, OR DESIGNATED SPATIAL AREA; SOFTWARE FOR MANAGING ENERGY CONSUMPTION AND FOR PROVIDING ASSISTED LIVING AND SECURITY MONITORING SERVICES WHICH IS DOWNLOADABLE FROM THE INTERNET, IN CLASS 9 (U.S. CLS. 21, 23, 26, 36 AND 38).

FIRST USE 1-20-2011; IN COMMERCE 1-20-2011.

THE MARK CONSISTS OF STANDARD CHARACTERS WITHOUT CLAIM TO ANY PARTICULAR FONT, STYLE, SIZE, OR COLOR.

SER. NO. 85-240,973, FILED 2-13-2011.

JAMES STEIN, EXAMINING ATTORNEY



*David J. Kybas*

Director of the United States Patent and Trademark Office

# United States of America

United States Patent and Trademark Office

# Cordy-O

**Reg. No. 4,124,102**

UNITECH MEDICAL, INC. (OREGON CORPORATION)  
2929 UNIVERSITY AVE. SE SUITE102  
MINNEAPOLIS, MN 55414

**Registered Apr. 10, 2012**

**Int. Cl.: 5**

FOR: NUTRITIONAL SUPPLEMENTS AND HERBAL SUPPLEMENTS CONTAINING  
CORDYCEPS SINESIS, IN CLASS 5 (U.S. CLS. 6, 18, 44, 46, 51 AND 52).

**TRADEMARK**

FIRST USE 1-1-2010; IN COMMERCE 6-1-2010.

**PRINCIPAL REGISTER**

THE MARK CONSISTS OF STANDARD CHARACTERS WITHOUT CLAIM TO ANY PAR-  
TICULAR FONT, STYLE, SIZE, OR COLOR.

SER. NO. 85-240,980, FILED S.R. 2-13-2011 AM. P.R. 11-14-2011.

BARBARA BROWN, EXAMINING ATTORNEY



*David J. Kyffers*

Director of the United States Patent and Trademark Office

# United States of America

United States Patent and Trademark Office



**Reg. No. 4,124,103**

SITEMED NORTH AMERICA LLC (GEORGIA LIMITED LIABILITY COMPANY)  
112 DONMOOR COURT  
GARNER, NC 27529

**Registered Apr. 10, 2012**

**Int. Cl.: 44**

FOR: CONDUCTING MEDICAL PHYSICAL EVALUATIONS; CONSULTING SERVICES IN THE FIELD OF MEDICAL CARE, NAMELY, ADVISING EMPLOYERS REGARDING MEDICAL ISSUES AFFECTING THEIR EMPLOYEES; DRUG AND ALCOHOL SCREENING FOR MEDICAL PURPOSES, IN CLASS 44 (U.S. CLS. 100 AND 101).

**SERVICE MARK**

**PRINCIPAL REGISTER**

FIRST USE 1-1-2006; IN COMMERCE 1-1-2006.

THE MARK CONSISTS OF THE WORD "SITEMED" AND A HARDHAT IN BROWN; THE HAT IS RESTING ON THE WORD "SITE" WITH A GREEN CROSS OUTLINED IN WHITE DISPLAYED ON THE HAT.

THE COLOR(S) GREEN, WHITE AND BROWN IS/ARE CLAIMED AS A FEATURE OF THE MARK.

SER. NO. 85-240,984, FILED 2-13-2011.

CHRISIE B. KING, EXAMINING ATTORNEY



*David J. Kyjars*

Director of the United States Patent and Trademark Office

# United States of America

United States Patent and Trademark Office

LISTEN-  
EMPATHIZE-  
AGREE-  
PARTNER

**Reg. No. 4,124,104**

**Registered Apr. 10, 2012**

**Int. Cl.: 41**

**SERVICE MARK**

**PRINCIPAL REGISTER**

LEAP INSTITUTE (UNITED STATES INDIVIDUAL)  
1150 SMITH ROAD  
PECONIC, NY 11958

FOR: WORKSHOPS AND SEMINARS IN THE FIELD OF PSYCHOLOGICAL COUNSELING AND CONFLICT MANAGEMENT, IN CLASS 41 (U.S. CLS. 100, 101 AND 107).

FIRST USE 1-1-2000; IN COMMERCE 1-1-2000.

THE MARK CONSISTS OF STANDARD CHARACTERS WITHOUT CLAIM TO ANY PARTICULAR FONT, STYLE, SIZE, OR COLOR.

SER. NO. 85-241,027, FILED 2-13-2011.

JUSTINE D. PARKER, EXAMINING ATTORNEY



*David J. Kybas*

Director of the United States Patent and Trademark Office

# United States of America

United States Patent and Trademark Office

## FLAVOR KITCHEN

**Reg. No. 4,124,105**

FRITO-LAY NORTH AMERICA, INC. (DELAWARE CORPORATION)

**Registered Apr. 10, 2012**

7701 LEGACY DRIVE  
PLANO, TX 75024

**Int. Cl.: 41**

FOR: ENTERTAINMENT SERVICES IN THE NATURE OF ON-GOING WEBISODES FEATURING FOOD AND FOOD PREPARATION, IN CLASS 41 (U.S. CLS. 100, 101 AND 107).

**SERVICE MARK**

FIRST USE 2-6-2011; IN COMMERCE 2-6-2011.

**PRINCIPAL REGISTER**

THE MARK CONSISTS OF STANDARD CHARACTERS WITHOUT CLAIM TO ANY PARTICULAR FONT, STYLE, SIZE, OR COLOR.

NO CLAIM IS MADE TO THE EXCLUSIVE RIGHT TO USE "KITCHEN", APART FROM THE MARK AS SHOWN.

SER. NO. 85-241,380, FILED 2-14-2011.

LAURIE KAUFMAN, EXAMINING ATTORNEY



*David J. Kyffers*

Director of the United States Patent and Trademark Office

# United States of America

United States Patent and Trademark Office

## HORSE-OPOLY

**Reg. No. 4,124,106**

NORTHRUP, LORI (UNITED STATES INDIVIDUAL)  
P.O. BOX 6

**Registered Apr. 10, 2012**

ELLCOTTVILLE, NY 14731

**Int. Cl.: 28**

FOR: ARENA SKILL GAME PLAYED WITH LIVE HORSES MODELED AFTER A GAME BOARD, IN CLASS 28 (U.S. CLS. 22, 23, 38 AND 50).

**TRADEMARK**

FIRST USE 1-26-2005; IN COMMERCE 1-26-2005.

**PRINCIPAL REGISTER**

THE MARK CONSISTS OF STANDARD CHARACTERS WITHOUT CLAIM TO ANY PARTICULAR FONT, STYLE, SIZE, OR COLOR.

SER. NO. 85-241,439, FILED 2-14-2011.

CHRIS WELLS, EXAMINING ATTORNEY



*David J. Kybas*

Director of the United States Patent and Trademark Office



# United States of America

United States Patent and Trademark Office

# SYCODE

**Reg. No. 4,124,107**

3D SYSTEMS, INC. (CALIFORNIA CORPORATION)  
333 THREE D SYSTEMS CIRCLE  
ROCK HILL, SC 29730

**Registered Apr. 10, 2012**

**Int. Cl.: 9**

FOR: COMPUTER APPLICATION SOFTWARE FOR CAD SYSTEMS, NAMELY, SOFTWARE FOR USE IN DESIGNING, MODIFYING, SHARING, OR TRANSFERRING COMPUTER GENERATED REPRESENTATIONS OF TWO AND THREE DIMENSIONAL OBJECTS, IN CLASS 9 (U.S. CLS. 21, 23, 26, 36 AND 38).

**TRADEMARK**

**PRINCIPAL REGISTER**

FIRST USE 9-8-2004; IN COMMERCE 9-8-2004.

THE MARK CONSISTS OF STANDARD CHARACTERS WITHOUT CLAIM TO ANY PARTICULAR FONT, STYLE, SIZE, OR COLOR.

SER. NO. 85-241,559, FILED 2-14-2011.

AMY KERTGATE, EXAMINING ATTORNEY



*David J. Kyffers*

Director of the United States Patent and Trademark Office

# United States of America

United States Patent and Trademark Office



**Reg. No. 4,124,108**

**Registered Apr. 10, 2012**

**Int. Cls.: 9 and 42**

**TRADEMARK**

**SERVICE MARK**

**PRINCIPAL REGISTER**

THUNDERHEAD LIMITED (UNITED KINGDOM CORPORATION)  
CENTENNIAL PARK  
CATALYST HOUSE, 720 CENTENNIAL COURT  
ELSTREE, HERTFORDSHIRE, UNITED KINGDOM WD63SY

FOR: SCIENTIFIC, NAUTICAL, SURVEYING, PHOTOGRAPHIC, CINEMATOGRAPHIC, OPTICAL, WEIGHING, MEASURING, SIGNALING, CHECKING, LIFE-SAVING AND TEACHING APPARATUS AND INSTRUMENTS, NAMELY, COMPUTER HARDWARE AND PERIPHERAL APPARATUS AND INSTRUMENTS FOR USE WITH COMPUTERS; APPARATUS FOR RECORDING, TRANSMISSION OR REPRODUCTION OF SOUND OR IMAGES; PRE-RECORDED RECORDING DISCS FEATURING SOFTWARE FOR USE IN CREATING, ASSEMBLING AND DELIVERING LARGE VOLUMES OF TRANSACTIONAL AND PERSONALIZED DOCUMENTS ACROSS MULTIPLE CHANNELS ENSURING THE ENFORCEMENT OF THE RELEVANT REGULATORY AND QUALITY CONTROLS ON CONTENT ACROSS MULTIPLE JURISDICTIONS, AND PROVIDING CONTEXT REFLECTING CUSTOMER/TRANSACTION HISTORY, STANDING, LANGUAGE, IDIOM AND OTHER PREFERENCES; AUTOMATIC VENDING MACHINES AND MECHANISMS FOR COIN-OPERATED APPARATUS; CASH REGISTERS, CALCULATING MACHINES, DATA PROCESSING EQUIPMENT AND COMPUTERS; FIRE-EXTINGUISHING APPARATUS; COMPUTER SOFTWARE FOR USE IN CREATING, ASSEMBLING AND DELIVERING LARGE VOLUMES OF TRANSACTIONAL AND PERSONALIZED DOCUMENTS ACROSS MULTIPLE CHANNELS ENSURING THE ENFORCEMENT OF THE RELEVANT REGULATORY AND QUALITY CONTROLS ON CONTENT ACROSS MULTIPLE JURISDICTIONS, AND PROVIDING CONTEXT REFLECTING CUSTOMER/TRANSACTION HISTORY, STANDING, LANGUAGE, IDIOM AND OTHER PREFERENCES; COMPUTER SOFTWARE DOWNLOADED FROM THE INTERNET FOR USE IN CREATING, ASSEMBLING AND DELIVERING LARGE VOLUMES OF TRANSACTIONAL AND PERSONALIZED DOCUMENTS ACROSS MULTIPLE CHANNELS ENSURING THE ENFORCEMENT OF THE RELEVANT REGULATORY AND QUALITY CONTROLS ON CONTENT ACROSS MULTIPLE JURISDICTIONS, AND PROVIDING CONTEXT REFLECTING CUSTOMER/TRANSACTION HISTORY, STANDING, LANGUAGE, IDIOM AND OTHER PREFERENCES; COMPUTER SOFTWARE FOR ANALYZING ADDRESS FILES; COMPUTER SOFTWARE FOR ANALYZING MARKET INFORMATION; COMPUTER SOFTWARE FOR ANALYZING NAME AND ADDRESS FILES; COMPUTER SOFTWARE FOR COMMUNICATING WITH USERS OF HAND-HELD COMPUTERS; COMPUTER SOFTWARE FOR PROCESSING ADDRESS FILES; COMPUTER SOFTWARE FOR PROCESSING MARKET INFORMATION; COMPUTER SOFTWARE FOR PROCESSING NAME AND ADDRESS FILES; COMPUTER SOFTWARE PROGRAMS FOR USE IN CREAT-



*David J. Kyjars*

Director of the United States Patent and Trademark Office

**Reg. No. 4,124,108** ING, ASSEMBLING AND DELIVERING LARGE VOLUMES OF TRANSACTIONAL AND PERSONALIZED DOCUMENTS ACROSS MULTIPLE CHANNELS ENSURING THE ENFORCEMENT OF THE RELEVANT REGULATORY AND QUALITY CONTROLS ON CONTENT ACROSS MULTIPLE JURISDICTIONS, AND PROVIDING CONTEXT REFLECTING CUSTOMER/TRANSACTION HISTORY, STANDING, LANGUAGE, IDIOM AND OTHER PREFERENCES; COMPUTER SOFTWARE PROGRAMS FOR DATABASE MANAGEMENT; COMPUTER SOFTWARE PROGRAMS FOR SPREADSHEET MANAGEMENT; COMPUTER SOFTWARE FOR STORING DATA USED USE IN CREATING, ASSEMBLING AND DELIVERING LARGE VOLUMES OF TRANSACTIONAL AND PERSONALIZED DOCUMENTS ACROSS MULTIPLE CHANNELS ENSURING THE ENFORCEMENT OF THE RELEVANT REGULATORY AND QUALITY CONTROLS ON CONTENT ACROSS MULTIPLE JURISDICTIONS, AND PROVIDING CONTEXT REFLECTING CUSTOMER/TRANSACTION HISTORY, STANDING, LANGUAGE, IDIOM AND OTHER PREFERENCES; COMPUTER SOFTWARE FOR PROCESSING AND HANDLING OF FINANCIAL TRANSACTIONS, IN CLASS 9 (U.S. CLS. 21, 23, 26, 36 AND 38).

FOR: SCIENTIFIC AND TECHNOLOGICAL SERVICES AND RESEARCH AND DESIGN ALL RELATING TO COMPUTERS; DESIGN AND DEVELOPMENT OF COMPUTER HARDWARE AND SOFTWARE; ADVISORY SERVICES RELATING TO PRODUCT DEVELOPMENT AND QUALITY IMPROVEMENT OF COMPUTER SOFTWARE; COMPUTER AND COMPUTER SOFTWARE RENTAL; COMPUTER SOFTWARE ADVISORY SERVICES IN THE FIELD OF PRODUCT DEVELOPMENT AND QUALITY IMPROVEMENT OF SOFTWARE; COMPUTER SOFTWARE CONSULTANCY; COMPUTER SOFTWARE CONSULTANCY SERVICES; COMPUTER SOFTWARE MAINTENANCE; COMPUTER SOFTWARE RENTAL; COMPUTER SOFTWARE CONSULTANCY; CONSULTANCY AND ADVICE ON THE DESIGN OF COMPUTER SOFTWARE AND HARDWARE; CONSULTANCY IN THE FIELD OF COMPUTER SOFTWARE; CONSULTANCY RELATING TO COMPUTER SOFTWARE, IN CLASS 42 (U.S. CLS. 100 AND 101).

PRIORITY CLAIMED UNDER SEC. 44(D) ON ERPN CMNTY TM OFC APPLICATION NO. 9724121, FILED 2-9-2011, REG. NO. 9424121, DATED 2-9-2011, EXPIRES 9-6-2021.

THE COLOR(S) GREEN IS/ARE CLAIMED AS A FEATURE OF THE MARK.

OWNER OF U.S. REG. NOS. 3,002,322 AND 3,625,283.

THE MARK CONSISTS OF THE WORDS "THUNDERHEAD JUICE" IN AN GREEN COLORED OVAL BOX WITH TWO TRIANGULAR SHAPED EDGES.

SER. NO. 85-241,861, FILED 2-14-2011.

LAURIE MAYES, EXAMINING ATTORNEY

# United States of America

United States Patent and Trademark Office

## CHOOSE MEANINGFULLY

**Reg. No. 4,124,109**

**Registered Apr. 10, 2012**

**Int. Cl.: 42**

**SERVICE MARK**

**PRINCIPAL REGISTER**

QUALIFACTS SYSTEMS, INC. (DELAWARE CORPORATION)  
200 2ND AVENUE SOUTH  
NASHVILLE, TN 37201

FOR: SOFTWARE AS A SERVICE (SAAS) SERVICES, NAMELY, HOSTING SOFTWARE FOR USE BY OTHERS FOR USE IN PATIENT INTAKE AND SCHEDULING, CASE MANAGEMENT, MEDICAL RECORD-KEEPING, MEDICAL BILLING AND CLAIMS PROCESSING, REGULATORY AND PAYOR COMPLIANCE, REQUESTING AND MONITORING THE STATUS OF MEDICAL REIMBURSEMENTS, AND PROVIDING BUSINESS INTELLIGENCE IN THE FIELD OF BEHAVIORAL HEALTH, IN CLASS 42 (U.S. CLS. 100 AND 101).

FIRST USE 12-1-2010; IN COMMERCE 12-1-2010.

THE MARK CONSISTS OF STANDARD CHARACTERS WITHOUT CLAIM TO ANY PARTICULAR FONT, STYLE, SIZE, OR COLOR.

SER. NO. 85-241,886, FILED 2-14-2011.

YAT SYE, LEE, EXAMINING ATTORNEY



*David J. Kybas*

Director of the United States Patent and Trademark Office

# United States of America

United States Patent and Trademark Office



**Reg. No. 4,124,110**

**Registered Apr. 10, 2012**

**Int. Cls.: 35 and 42**

**SERVICE MARK**

**PRINCIPAL REGISTER**

INFORMATION SERVICES GROUP, INC. (DELAWARE CORPORATION), AKA ISG  
281 TRESSER BOULEVARD  
STAMFORD, CT 06901

FOR: BUSINESS CONSULTING SERVICES USING COMPARATIVE ANALYSIS METHODS; BUSINESS CONSULTANCY USING ANALYSIS OF A CLIENT'S OR THIRD PARTY'S OPERATION AND PERFORMANCE RELATIVE TO THE OPERATIONS AND PERFORMANCES OF OTHER ENTITIES; BUSINESS CONSULTANCY USING COMPARATIVE ANALYSIS OF A CLIENT'S OR THIRD PARTY'S PERFORMANCE; BUSINESS CONSULTANCY USING COMPARATIVE ANALYSIS OF A CLIENT'S OR THIRD PARTY'S INFORMATION TECHNOLOGY OPERATIONS; BUSINESS CONSULTANCY USING A FRAMEWORK OF MATHEMATICAL MODELS FOR ANALYSIS OF A CLIENT'S OR THIRD PARTY'S INFORMATION TECHNOLOGY AND BUSINESS PROCESSES; BUSINESS CONSULTANCY RELATING TO OUTSOURCING USING ANALYSIS OF BUSINESS ENTITY'S OPERATIONS AND PERFORMANCE RELATIVE TO THE OPERATIONS AND PERFORMANCE OF OTHER ENTITIES; CONSULTANCY RELATING BUSINESS OUTSOURCING USING COMPARATIVE ANALYSIS OF A BUSINESS ENTITY'S PERFORMANCE; BUSINESS CONSULTATION SERVICES, NAMELY, INSOURCING AND OUTSOURCING ADVISORY SERVICES IN THE FIELDS OF APPLICATIONS DEVELOPMENT AND MAINTENANCE, CORPORATE REAL ESTATE, CUSTOMER RELATIONSHIP MANAGEMENT, BUSINESS PROCESS, FINANCE AND ACCOUNTING, HUMAN RESOURCES, INFORMATION TECHNOLOGY AND PROCUREMENT; BUSINESS CONSULTING SERVICES IN THE FIELDS OF STRATEGY AND BUSINESS CASE FOR CHANGE, OPERATIONAL ASSESSMENTS, SERVICE MANAGEMENT AND GOVERNANCE, MERGERS, ACQUISITIONS AND DIVESTITURES, FINANCIAL ANALYSIS, INSOURCING, SHARED SERVICES, OUTSOURCING, OFFSHORING AND CAPTIVE OFFSHORE; BUSINESS ADVISORY SERVICES IN THE FIELD OF ENTERPRISE RESOURCE PLANNING (ERP) AND ENTERPRISE ADMINISTRATIVE AND MANAGEMENT SYSTEMS; BUSINESS CONSULTANCY RELATING TO THE ADMINISTRATION OF INFORMATION TECHNOLOGY, IN CLASS 35 (U.S. CLS. 100, 101 AND 102).

FIRST USE 2-7-2007; IN COMMERCE 11-16-2007.

FOR: PROFESSIONAL CONSULTANCY BASED ON COMPARATIVE ANALYSIS IN THE FIELD OF DESIGN, SELECTION, IMPLEMENTATION AND USE OF COMPUTER HARDWARE AND SOFTWARE SYSTEMS FOR OTHERS; PROFESSIONAL CONSULTANCY USING ANALYSIS OF A CLIENT'S OR THIRD PARTY'S OPERATION AND PERFORMANCE RELATIVE TO THE OPERATIONS AND PERFORMANCES OF OTHER ENTITIES IN THE FIELD



*David J. Kyffers*

Director of the United States Patent and Trademark Office

**Reg. No. 4,124,110** OF DESIGN, SELECTION, IMPLEMENTATION AND USE OF COMPUTER HARDWARE AND SOFTWARE SYSTEMS FOR OTHERS; PROFESSIONAL CONSULTANCY USING COMPARATIVE ANALYSIS OF A CLIENT'S OR THIRD PARTY'S PERFORMANCE IN THE FIELD OF DESIGN, SELECTION, IMPLEMENTATION AND USE OF COMPUTER HARDWARE AND SOFTWARE SYSTEMS FOR OTHERS; PROFESSIONAL CONSULTANCY USING COMPARATIVE ANALYSIS OF A CLIENT'S OR THIRD PARTY'S INFORMATION TECHNOLOGY OPERATION IN THE FIELD OF DESIGN, SELECTION, IMPLEMENTATION AND USE OF COMPUTER HARDWARE AND SOFTWARE SYSTEMS FOR OTHERS; PROFESSIONAL CONSULTANCY USING A FRAMEWORK OF MATHEMATICAL MODELS FOR ANALYSIS OF A CLIENT'S THIRD PARTY'S INFORMATION TECHNOLOGY AND BUSINESS PROCESSES IN THE FIELD OF DESIGN, SELECTION, IMPLEMENTATION AND USE OF COMPUTER HARDWARE AND SOFTWARE SYSTEMS FOR OTHERS; INFORMATION TECHNOLOGY CONSULTING SERVICES, IN CLASS 42 (U.S. CLS. 100 AND 101).

FIRST USE 2-7-2007; IN COMMERCE 1-4-2011.

NO CLAIM IS MADE TO THE EXCLUSIVE RIGHT TO USE "INFORMATION SERVICES GROUP", APART FROM THE MARK AS SHOWN.

THE MARK CONSISTS OF THE LETTER "I" SEPARATED BY A LINE FROM "ISG" POSITIONED ABOVE "INFORMATION SERVICES GROUP".

SER. NO. 85-242,771, FILED 2-15-2011.

NAAKWAMA ANKRAH, EXAMINING ATTORNEY

# United States of America

United States Patent and Trademark Office

# ISG

**Reg. No. 4,124,111**

**Registered Apr. 10, 2012**

**Int. Cls.: 35 and 42**

**SERVICE MARK**

**PRINCIPAL REGISTER**

INFORMATION SERVICES GROUP, INC. (DELAWARE CORPORATION), AKA ISG  
281 TRESSER BOULEVARD  
STAMFORD, CT 06901

FOR: BUSINESS CONSULTING SERVICES USING COMPARATIVE ANALYSIS METHODS; BUSINESS CONSULTANCY USING ANALYSIS OF A CLIENT'S OR THIRD PARTY'S OPERATION AND PERFORMANCE RELATIVE TO THE OPERATIONS AND PERFORMANCES OF OTHER ENTITIES; BUSINESS CONSULTANCY USING COMPARATIVE ANALYSIS OF A CLIENT'S OR THIRD PARTY'S PERFORMANCE; BUSINESS CONSULTANCY USING COMPARATIVE ANALYSIS OF A CLIENT'S OR THIRD PARTY'S INFORMATION TECHNOLOGY OPERATIONS; BUSINESS CONSULTANCY USING A FRAMEWORK OF MATHEMATICAL MODELS FOR ANALYSIS OF A CLIENT'S OR THIRD PARTY'S INFORMATION TECHNOLOGY AND BUSINESS PROCESSES; BUSINESS CONSULTANCY RELATING TO OUTSOURCING USING ANALYSIS OF BUSINESS ENTITY'S OPERATIONS AND PERFORMANCE RELATIVE TO THE OPERATIONS AND PERFORMANCE OF OTHER ENTITIES; CONSULTANCY RELATING TO BUSINESS OUTSOURCING USING COMPARATIVE ANALYSIS OF A BUSINESS ENTITY'S PERFORMANCE; BUSINESS CONSULTATION SERVICES, NAMELY, INSOURCING AND OUTSOURCING ADVISORY SERVICES IN THE FIELDS OF APPLICATIONS DEVELOPMENT AND MAINTENANCE, CORPORATE REAL ESTATE, CUSTOMER RELATIONSHIP MANAGEMENT, BUSINESS PROCESS, FINANCE AND ACCOUNTING, HUMAN RESOURCES, INFORMATION TECHNOLOGY AND PROCUREMENT; BUSINESS CONSULTING SERVICES IN THE FIELDS OF STRATEGY AND BUSINESS CASE FOR CHANGE, OPERATIONAL ASSESSMENTS, SERVICE MANAGEMENT AND GOVERNANCE, MERGERS, ACQUISITIONS AND DIVESTITURES, FINANCIAL ANALYSIS, INSOURCING, SHARED SERVICES, OUTSOURCING, OFFSHORING AND CAPTIVE OFFSHORE; BUSINESS ADVISORY SERVICES IN THE FIELD OF ENTERPRISE RESOURCE PLANNING (ERP) AND ENTERPRISE ADMINISTRATIVE AND MANAGEMENT SYSTEMS; BUSINESS CONSULTANCY RELATING TO THE ADMINISTRATION OF INFORMATION TECHNOLOGY, IN CLASS 35 (U.S. CLS. 100, 101 AND 102).



FIRST USE 7-31-2006; IN COMMERCE 11-16-2007.

*David J. Kyffers*

Director of the United States Patent and Trademark Office

FOR: PROFESSIONAL CONSULTANCY BASED ON COMPARATIVE ANALYSIS IN THE FIELD OF DESIGN, SELECTION, IMPLEMENTATION AND USE OF COMPUTER HARDWARE AND SOFTWARE SYSTEMS FOR OTHERS PROFESSIONAL CONSULTANCY USING ANALYSIS OF A CLIENT'S OR THIRD PARTY'S OPERATION AND PERFORMANCE RELATIVE TO THE OPERATIONS AND PERFORMANCES OF OTHER ENTITIES IN THE FIELD

**Reg. No. 4,124,111** OF DESIGN, SELECTION, IMPLEMENTATION AND USE OF COMPUTER HARDWARE AND SOFTWARE SYSTEMS FOR OTHERS; PROFESSIONAL CONSULTANCY USING COMPARATIVE ANALYSIS OF A CLIENT'S OR THIRD PARTY'S PERFORMANCE IN THE FIELD OF DESIGN, SELECTION, IMPLEMENTATION AND USE OF COMPUTER HARDWARE AND SOFTWARE SYSTEMS FOR OTHERS; PROFESSIONAL CONSULTANCY USING COMPARATIVE ANALYSIS OF A CLIENT'S OR THIRD PARTY'S INFORMATION TECHNOLOGY OPERATION IN THE FIELD OF DESIGN, SELECTION, IMPLEMENTATION AND USE OF COMPUTER HARDWARE AND SOFTWARE SYSTEMS FOR OTHERS; PROFESSIONAL CONSULTANCY USING A FRAMEWORK OF MATHEMATICAL MODELS FOR ANALYSIS OF A CLIENT'S THIRD PARTY'S INFORMATION TECHNOLOGY AND BUSINESS PROCESSES IN THE FIELD OF DESIGN, SELECTION, IMPLEMENTATION AND USE OF COMPUTER HARDWARE AND SOFTWARE SYSTEMS FOR OTHERS; INFORMATION TECHNOLOGY CONSULTING SERVICES, IN CLASS 42 (U.S. CLS. 100 AND 101).

FIRST USE 7-31-2006; IN COMMERCE 1-4-2011.

THE MARK CONSISTS OF STANDARD CHARACTERS WITHOUT CLAIM TO ANY PARTICULAR FONT, STYLE, SIZE, OR COLOR.

SER. NO. 85-242,775, FILED 2-15-2011.

NAAKWAMA ANKRAH, EXAMINING ATTORNEY



# United States of America

United States Patent and Trademark Office

## HUSTLERCASH

**Reg. No. 4,124,112**

**Registered Apr. 10, 2012**

**Int. Cl.: 35**

**SERVICE MARK**

**PRINCIPAL REGISTER**

LFP IP, LLC (DELAWARE LIMITED LIABILITY COMPANY)  
SUITE 900  
8484 WILSHIRE BOULEVARD  
BEVERLY HILLS, CA 90211

FOR: ADVERTISING AND ON-LINE MARKETING SERVICES OFFERED VIA GLOBAL COMPUTER NETWORKS AND GLOBAL COMMUNICATION NETWORKS, IN CLASS 35 (U.S. CLS. 100, 101 AND 102).

FIRST USE 10-31-2005; IN COMMERCE 10-31-2005.

THE MARK CONSISTS OF STANDARD CHARACTERS WITHOUT CLAIM TO ANY PARTICULAR FONT, STYLE, SIZE, OR COLOR.

SER. NO. 85-242,831, FILED 2-15-2011.

MARK SPARACINO, EXAMINING ATTORNEY



*David J. Kyffers*

Director of the United States Patent and Trademark Office

# United States of America

United States Patent and Trademark Office



**Reg. No. 4,124,113**

SAM GROUP HOLDING AG (SWITZERLAND CORPORATION)  
JOSEFSTRASSE 218

**Registered Apr. 10, 2012**

ZURICH, SWITZERLAND CH-8005

**Int. Cls.: 9, 16, 35 and 36**

FOR: ELECTRIC DATABASES IN THE FIELD OF SUSTAINABLE INVESTMENTS AND COMMERCIAL ENTERPRISES WITH SUSTAINABLE BUSINESS MODELS RECORDED ON COMPUTER MEDIA; DOWNLOADABLE ELECTRIC PUBLICATIONS IN THE NATURE OF BROCHURES AND LEAFLETS IN THE FIELD OF SUSTAINABLE INVESTMENTS AND COMMERCIAL ENTERPRISES WITH SUSTAINABLE BUSINESS MODELS; COMPUTER SOFTWARE FOR USE IN DATABASE MANAGEMENT, USE AS A SPREADSHEET, AND FOR THE ANALYSIS OF BUSINESS MODELS IN RESPECT OF THE SUSTAINABILITY OF INVESTMENTS AND COMMERCIAL ENTERPRISES; COMPUTER APPLICATION SOFTWARE FOR USE IN DATABASE MANAGEMENT, USE AS A SPREADSHEET, AND FOR THE ANALYSIS OF BUSINESS MODELS IN RESPECT OF THE SUSTAINABILITY OF INVESTMENTS AND COMMERCIAL ENTERPRISES, IN CLASS 9 (U.S. CLS. 21, 23, 26, 36 AND 38).

**TRADEMARK**

**SERVICE MARK**

**PRINCIPAL REGISTER**

FOR: PRINTED MATERIAL OF ALL KIND, NAMELY, BOOKS, BROCHURES, MAGAZINES, LEAFLETS, LOOSE-LEAF COLLECTIONS, ALL IN THE FIELD OF SUSTAINABLE INVESTMENTS AND COMMERCIAL ENTERPRISES WITH SUSTAINABLE BUSINESS MODELS; PRINTED INSTRUCTIONAL AND TEACHING MATERIALS IN THE FIELD OF SUSTAINABLE INVESTMENTS AND COMMERCIAL ENTERPRISES WITH SUSTAINABLE BUSINESS MODELS, IN CLASS 16 (U.S. CLS. 2, 5, 22, 23, 29, 37, 38 AND 50).



FOR: ECONOMIC FORECASTING; BUSINESS FAILURE ANALYSIS SERVICES; BUSINESS ORGANIZATION AND MANAGEMENT CONSULTANCY; EVALUATIONS RELATING TO COMMERCIAL MATTERS; BUSINESS APPRAISALS OF COMMERCIAL ENTERPRISES WITH QUALIFICATION AND CERTIFICATION SCHEMES IN THE FIELD OF SUSTAINABLE INVESTMENT POSSIBILITIES; COMPILATION AND SYSTEMIZATION OF INFORMATION INTO COMPUTER DATABASES; DATABASE MANAGEMENT, NAMELY, UPDATING CONTENT; CONSULTING SERVICES IN THE AREA OF SUSTAINABLE BUSINESS SOLUTIONS; ELECTRONIC COMMERCE SERVICES, NAMELY, PROVIDING INFORMATION ABOUT PRODUCTS VIA TELECOMMUNICATIONS NETWORKS FOR ADVERTISING AND SALES PURPOSES IN THE FIELD OF SUSTAINABLE INVESTMENTS, IN CLASS 35 (U.S. CLS. 100, 101 AND 102).

*David J. Kyjars*

Director of the United States Patent and Trademark Office

**Reg. No. 4,124,113** FOR: FINANCIAL ANALYSIS AND APPRAISALS OF COMMERCIAL ENTERPRISES; FINANCIAL AFFAIRS AND MONETARY AFFAIRS, NAMELY, FINANCIAL INFORMATION, MANAGEMENT AND ANALYSIS SERVICES; FINANCIAL CONSULTATION AND ADVICE; ASSET MANAGEMENT AND INVESTMENT ADVICE; FINANCIAL CONSULTING IN THE FIELD OF REAL ESTATE BROKERAGE; INSURANCE AND FINANCIAL INFORMATION AND CONSULTANCY SERVICES IN THE FIELD OF SUSTAINABLE INVESTMENTS AND COMMERCIAL ENTERPRISES WITH SUSTAINABLE BUSINESS MODELS, NONE OF THE AFORESAID SERVICES IN CONNECTION WITH CREDIT, DEBIT, CHARGE AND/OR PAYMENT CARDS, IN CLASS 36 (U.S. CLS. 100, 101 AND 102).

PRIORITY CLAIMED UNDER SEC. 44(D) ON SWITZERLAND APPLICATION NO. 63942/2009, FILED 1-18-2011, REG. NO. 610976, DATED 1-18-2011, EXPIRES 1-18-2021.

THE COLOR(S) DARK BLUE, TEAL, LIGHT GREEN AND WHITE IS/ARE CLAIMED AS A FEATURE OF THE MARK.

OWNER OF U.S. REG. NOS. 3,606,158, 3,889,207 AND OTHERS.

NO CLAIM IS MADE TO THE EXCLUSIVE RIGHT TO USE "SUSTAINABILITY INVESTING", APART FROM THE MARK AS SHOWN.

THE MARK CONSISTS OF THE WORD "SAM" IN DARK BLUE NEXT TO TWO OVERLAPPING OVALS, THE SMALLER OVAL IN DARK BLUE AND WHITE, THE LARGER ONE IN LIGHT GREEN, AND THE OVERLAPPING PIECE IN TEAL. UNDER "SAM" ARE THE WORDS SUSTAINABILITY INVESTING IN DARK BLUE.

SER. NO. 85-242,940, FILED 2-15-2011.

MARK SHINER, EXAMINING ATTORNEY

# United States of America

United States Patent and Trademark Office

## MAMMOTH BLACK

**Reg. No. 4,124,114**

MAMMOTH MOUNTAIN SKI AREA, LLC (DELAWARE LIMITED LIABILITY COMPANY)  
1 MINARET ROAD

**Registered Apr. 10, 2012**

MAMMOTH LAKES, CA 93546

**Int. Cls.: 41, 43 and 45**

FOR: ENTERTAINMENT SERVICES, NAMELY, ARRANGING AND CONDUCTING SPECIAL EVENTS AT A SKI RESORT; SKI RESORT SERVICES THAT PROVIDE PRIORITY ACCESS TO MEMBERS; PROVIDING INFORMATION AND ADVICE CONCERNING SKI EQUIPMENT, IN CLASS 41 (U.S. CLS. 100, 101 AND 107).

**SERVICE MARK**

**PRINCIPAL REGISTER**

FIRST USE 12-1-2011; IN COMMERCE 12-1-2011.

FOR: ARRANGING HOTEL AND TEMPORARY HOUSING ACCOMMODATIONS; MAKING DINING RESERVATIONS; RESTAURANT AND CATERING SERVICES FEATURING PRIVATE DINING, IN CLASS 43 (U.S. CLS. 100 AND 101).

FIRST USE 12-1-2011; IN COMMERCE 12-1-2011.

FOR: CONCIERGE SERVICES FOR OTHERS COMPRISING MAKING REQUESTED PERSONAL ARRANGEMENTS AND RESERVATIONS AND PROVIDING CUSTOMER-SPECIFIC INFORMATION TO MEET INDIVIDUAL NEEDS RENDERED TOGETHER IN A SKI RESORT ENVIRONMENT, ALL CONCERNING THE FIELDS OF TRAVEL, DINING, AND ACCOMMODATION ARRANGEMENTS, PREFERRED VEHICLE PARKING, PRIORITY ACCESS TO SKI RESORTS AND SPECIAL EVENTS, SKI EQUIPMENT, AND WEATHER CONDITIONS, IN CLASS 45 (U.S. CLS. 100 AND 101).

FIRST USE 12-1-2010; IN COMMERCE 12-1-2010.

THE MARK CONSISTS OF STANDARD CHARACTERS WITHOUT CLAIM TO ANY PARTICULAR FONT, STYLE, SIZE, OR COLOR.

OWNER OF U.S. REG. NOS. 2,720,400, 3,698,482 AND OTHERS.

SER. NO. 85-243,186, FILED 2-15-2011.

JASON BLAIR, EXAMINING ATTORNEY



*David J. Kyffers*

Director of the United States Patent and Trademark Office

# United States of America

United States Patent and Trademark Office



**Reg. No. 4,124,115**

**Registered Apr. 10, 2012**

**Int. Cl.: 6**

**TRADEMARK**

**PRINCIPAL REGISTER**

REOSURE L.L.C. (MICHIGAN LIMITED LIABILITY COMPANY), DBA REOSURE  
6001 N ADAMS ROAD  
SUITE 205  
BLOOMFIELD HILLS, MI 48304

FOR: METAL GUARD BARRIERS FOR AIR CONDITIONERS AND CONDENSERS TO PROTECT THE COPPER COMPONENTS FROM VANDALISM OR THEFT, IN CLASS 6 (U.S. CLS. 2, 12, 13, 14, 23, 25 AND 50).

FIRST USE 3-18-2010; IN COMMERCE 3-18-2010.

NO CLAIM IS MADE TO THE EXCLUSIVE RIGHT TO USE "AC", APART FROM THE MARK AS SHOWN.

THE COLOR(S) BLACK, WHITE, GRAY AND RED IS/ARE CLAIMED AS A FEATURE OF THE MARK.

THE MARK CONSISTS OF A SHIELD SHAPED BACKGROUND WITH A PRIMARY FILL COLOR OF GRAY WITH RED ACCENTS AND A BLACK OUTLINE. THE SHIELD HAS ADDITIONAL ELEMENTS INCLUDING A ROW OF GRAY AND BLACK RIVETS AROUND THE PERIMETER AND A SERIES OF GRAY AND BLACK VENTS IN THE CENTER AREA OF THE SHIELD. THE VENTED PORTION OF THE SHIELD HAS A RED BORDER WITH A BLACK OUTLINE. THE STYLIZED LETTERS "AC" ARE CAPITALIZED, THEY ARE RED WITH A BLACK BORDER AND HAVE A GRAY BAR WITH A BLACK OUTLINE ACROSS THE CENTER OF THE TWO LETTERS. THE STYLIZED WORD BANDIT IS CAPITALIZED AND IS WHITE WITH A BLACK OUTLINE. THE TAG LINE "DON'T LOSE YOUR COOL!" IS CAPITALIZED, IS LOCATED ACROSS THE TOP OF THE SHIELD AND IS WHITE WITH A BLACK OUTLINE.

SER. NO. 85-243,463, FILED 2-16-2011.

WILLIAM BRECKENFELD, EXAMINING ATTORNEY



*David J. Kyjars*

Director of the United States Patent and Trademark Office

# United States of America

United States Patent and Trademark Office

# aplaceformusic

**Reg. No. 4,124,116**

**Registered Apr. 10, 2012**

**Int. Cls.: 38 and 42**

**SERVICE MARK**

**PRINCIPAL REGISTER**

APLACEFORMUSIC LLC (NEW JERSEY LIMITED LIABILITY COMPANY)  
4 CANDLEWOOD DRIVE  
MADISON, NJ 07940

FOR: PROVIDING ELECTRONIC BULLETIN BOARDS FOR THE TRANSMISSION OF MESSAGES AND DATA AMONG REGISTERED USERS; PROVIDING ACCESS TO COMPUTER, ELECTRONIC AND ON-LINE DATABASES FOR CLASSIFIED LISTINGS AND PERSONAL PROFILES RELATING TO THE FIELD OF MUSIC; PROVIDING ON-LINE FORUMS FOR COMMUNICATION ON TOPICS OF MUSIC, ENTERTAINMENT, AND MUSIC-RELATED SUBJECT MATTER; PROVIDING EMAIL AND COMMUNICATION SERVICES, NAMELY, ELECTRONIC TRANSMISSION OF DATA, MESSAGES AND INFORMATION; BROADCASTING SERVICES OVER COMPUTER, NAMELY, POSTING, DISPLAYING, AND ELECTRONICALLY TRANSMITTING DATA, INFORMATION, AUDIO, PHOTOGRAPHIC AND VIDEO IMAGES; DELIVERY OF DIGITAL MUSIC AND VIDEO BY ELECTRONIC TRANSMISSION, IN CLASS 38 (U.S. CLS. 100, 101 AND 104).

FIRST USE 2-13-2011; IN COMMERCE 2-13-2011.

FOR: COMPUTER SERVICES, NAMELY, CREATING ON-LINE VIRTUAL PLATFORMS FOR REGISTERED USERS TO ENGAGE IN SOCIAL AND BUSINESS NETWORKING IN FIELDS RELATING TO MUSIC; PLATFORM AS A SERVICE (PAAS) FEATURING COMPUTER SOFTWARE PLATFORMS FOR ORGANIZING GATHERINGS, CONDUCTING BUSINESS IN THE FIELD OF MUSIC AND FORMING MUSICAL GROUPS OR BANDS; APPLICATION SERVICE PROVIDER (ASP) FEATURING SOFTWARE TO ENABLE THE UPLOADING, DOWNLOADING, STREAMING, POSTING, DISPLAYING, LINKING, SHARING, AND PROVIDING ELECTRONIC DATA AND MEDIA OVER COMMUNICATION NETWORKS; PLATFORM AS A SERVICE (PAAS) FEATURING COMPUTER SOFTWARE PLATFORMS THAT ENABLE REGISTERED MEMBERS TO CREATE PERSONAL PROFILES AND CLASSIFIED LISTINGS, NAMELY, IN THE FIELD OF MUSIC, IN CLASS 42 (U.S. CLS. 100 AND 101).

FIRST USE 2-13-2011; IN COMMERCE 2-13-2011.

THE MARK CONSISTS OF STANDARD CHARACTERS WITHOUT CLAIM TO ANY PARTICULAR FONT, STYLE, SIZE, OR COLOR.

SER. NO. 85-243,820, FILED 2-16-2011.



*David J. Kappas*

Director of the United States Patent and Trademark Office

**Reg. No. 4,124,116** CHARLES L. JENKINS, EXAMINING ATTORNEY

# United States of America

United States Patent and Trademark Office



**Reg. No. 4,124,117**

FIXED POINT FOUNDATION (ALABAMA NON-PROFIT CORPORATION)  
2828 CULVER ROAD  
BIRMINGHAM, AL 35223

**Registered Apr. 10, 2012**

**Int. Cls.: 41 and 45**

FOR: EDUCATION AND ENTERTAINMENT SERVICES, NAMELY, ONGOING PUBLIC SERVICE ANNOUNCEMENTS IN THE FIELD OF MINISTRY SERVICES AND PROMOTING HOPE PROVIDED VIA TELEVISION AND THE INTERNET, IN CLASS 41 (U.S. CLS. 100, 101 AND 107).

**SERVICE MARK**

**PRINCIPAL REGISTER**

FIRST USE 12-15-2010; IN COMMERCE 12-15-2010.

FOR: MINISTERIAL SERVICES PROVIDED VIA A WEBSITE WHICH SPREADS MESSAGES OF HOPE, IN CLASS 45 (U.S. CLS. 100 AND 101).

FIRST USE 12-15-2010; IN COMMERCE 12-15-2010.

THE MARK CONSISTS OF AN OVAL FOOTBALL DESIGN WITH AN OUTLINE BORDER AND CROSSHATCH STITCHING AND WITH THE STYLIZED WORDING "316 LOOKUP" INSIDE THE FOOTBALL DESIGN.

SER. NO. 85-244,048, FILED 2-16-2011.

JENNIFER MARTIN, EXAMINING ATTORNEY



*David J. Kybas*

Director of the United States Patent and Trademark Office



# United States of America

United States Patent and Trademark Office

## PLATINUM SMART UNDERWRITER

**Reg. No. 4,124,118**

**Registered Apr. 10, 2012**

**Int. Cl.: 36**

**SERVICE MARK**

**PRINCIPAL REGISTER**

PLATINUM HOME MORTGAGE CORPORATION (ILLINOIS CORPORATION)  
SUITE 101  
2200 HICKS ROAD  
ROLLING MEADOWS, IL 60008

FOR: MORTGAGE LENDING; MORTGAGE BANKING; MORTGAGE BROKERAGE; PROCUREMENT OF MORTGAGES FOR OTHERS; EVALUATING THE CREDIT WORTHINESS OF PRIVATE INDIVIDUALS, IN CLASS 36 (U.S. CLS. 100, 101 AND 102).

FIRST USE 10-31-2010; IN COMMERCE 10-31-2010.

THE MARK CONSISTS OF STANDARD CHARACTERS WITHOUT CLAIM TO ANY PARTICULAR FONT, STYLE, SIZE, OR COLOR.

OWNER OF U.S. REG. NOS. 2,297,278 AND 2,297,279.

NO CLAIM IS MADE TO THE EXCLUSIVE RIGHT TO USE "SMART UNDERWRITER", APART FROM THE MARK AS SHOWN.

SER. NO. 85-244,077, FILED 2-16-2011.

ELISSA GARBER KON, EXAMINING ATTORNEY



*David J. Kybas*

Director of the United States Patent and Trademark Office

# United States of America

United States Patent and Trademark Office

## LOOKUP 316

**Reg. No. 4,124,119**

FIXED POINT FOUNDATION (ALABAMA NON-PROFIT CORPORATION)  
2828 CULVER ROAD  
BIRMINGHAM, AL 35223

**Registered Apr. 10, 2012**

**Int. Cls.: 41 and 45**

FOR: EDUCATION AND ENTERTAINMENT SERVICES, NAMELY, ONGOING PUBLIC SERVICE ANNOUNCEMENTS IN THE FIELD OF MINISTRY SERVICES AND PROMOTING HOPE PROVIDED VIA TELEVISION AND THE INTERNET, IN CLASS 41 (U.S. CLS. 100, 101 AND 107).

**SERVICE MARK**

**PRINCIPAL REGISTER**

FIRST USE 12-15-2010; IN COMMERCE 12-15-2010.

FOR: MINISTERIAL SERVICES PROVIDED VIA A WEBSITE WHICH SPREADS MESSAGES OF HOPE, IN CLASS 45 (U.S. CLS. 100 AND 101).

FIRST USE 12-15-2010; IN COMMERCE 12-15-2010.

THE MARK CONSISTS OF STANDARD CHARACTERS WITHOUT CLAIM TO ANY PARTICULAR FONT, STYLE, SIZE, OR COLOR.

SER. NO. 85-244,107, FILED 2-17-2011.

JENNIFER MARTIN, EXAMINING ATTORNEY



*David J. Kybas*

Director of the United States Patent and Trademark Office

# United States of America

United States Patent and Trademark Office

## LEADER KEYS

**Reg. No. 4,124,120**

**Registered Apr. 10, 2012**

**Int. Cls.: 16, 41 and 42**

DEPARTMENT OF EDUCATION (GEORGIA STATE AGENCY)  
SUITE 1854 TWIN TOWERS EAST  
205 JESSE HILL JR. DRIVE, SE  
ATLANTA, GA 30334

FOR: EDUCATIONAL PUBLICATIONS, NAMELY, TRAINING MANUALS AND WORK-BOOKS IN THE FIELD OF LEADERSHIP PERFORMANCE APPRAISAL, IN CLASS 16 (U.S. CLS. 2, 5, 22, 23, 29, 37, 38 AND 50).

**TRADEMARK**

**SERVICE MARK**

FIRST USE 3-6-2009; IN COMMERCE 3-6-2009.

**PRINCIPAL REGISTER**

FOR: EDUCATIONAL ASSESSMENT; PROVIDING TRAINING AND CONDUCTING WORKSHOPS IN THE FIELD OF LEADERSHIP PERFORMANCE APPRAISAL, IN CLASS 41 (U.S. CLS. 100, 101 AND 107).

FIRST USE 7-1-2008; IN COMMERCE 7-1-2008.

FOR: DEVELOPING AND ADMINISTERING LEADERSHIP PERFORMANCE EVALUATION AND APPRAISAL STANDARDS FOR PROFESSIONALS WHO GUIDE, MONITOR, OR EVALUATE THE WORK OF OTHERS IN A PUBLIC SCHOOL OR PUBLIC SCHOOL SYSTEM, IN CLASS 42 (U.S. CLS. 100 AND 101).

FIRST USE 7-1-2008; IN COMMERCE 7-1-2008.

THE MARK CONSISTS OF STANDARD CHARACTERS WITHOUT CLAIM TO ANY PARTICULAR FONT, STYLE, SIZE, OR COLOR.

NO CLAIM IS MADE TO THE EXCLUSIVE RIGHT TO USE "LEADER", APART FROM THE MARK AS SHOWN.

SER. NO. 85-244,605, FILED 2-17-2011.

RONALD MCMORROW, EXAMINING ATTORNEY

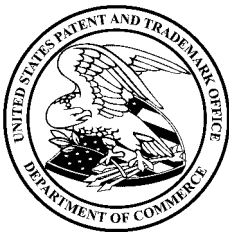

*David J. Kyffers*

Director of the United States Patent and Trademark Office

# United States of America

United States Patent and Trademark Office

# FLYNN

**Reg. No. 4,124,121**

**Registered Apr. 10, 2012**

**Int. Cl.: 33**

FIRESTEED CORPORATION (WASHINGTON CORPORATION)  
1809 7TH AVENUE  
SUITE 801  
SEATTLE, WA 98101

FOR: WINE, IN CLASS 33 (U.S. CLS. 47 AND 49).

**TRADEMARK**

FIRST USE 12-31-1985; IN COMMERCE 12-31-1985.

**PRINCIPAL REGISTER**

THE MARK CONSISTS OF STANDARD CHARACTERS WITHOUT CLAIM TO ANY PARTICULAR FONT, STYLE, SIZE, OR COLOR.

SEC. 2(F).

SER. NO. 85-244,690, FILED 2-17-2011.

DORITT L. CARROLL, EXAMINING ATTORNEY



*David J. Kybas*

Director of the United States Patent and Trademark Office

# United States of America

United States Patent and Trademark Office

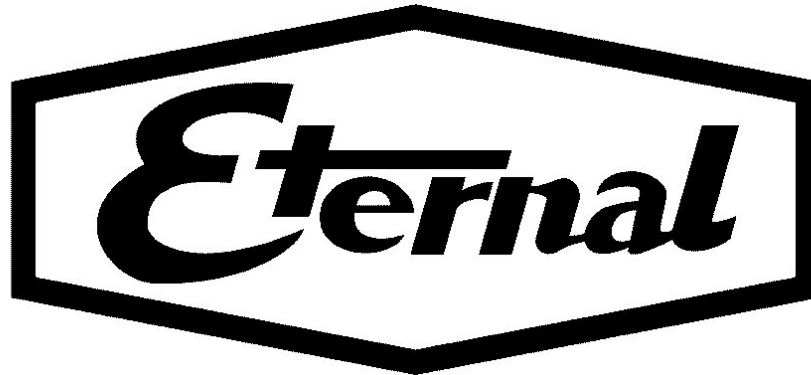

**Reg. No. 4,124,122**

**Registered Apr. 10, 2012**

**Int. Cls.: 1 and 2**

**TRADEMARK**

**PRINCIPAL REGISTER**

ETERNAL CHEMICAL CO., LTD. (TAIWAN CORPORATION)  
NO. 578, CHIEN-KUNG ROAD  
KAOHSIUNG, TAIWAN

FOR: PHOTO RESISTANT AGENTS, EPOXY GLUE FOR GENERAL BONDING AND REPAIR PURPOSES, MINERAL-BASED HIGHER WATER ABSORBENT RESIN AND RUBBER COMPOUNDING AGENTS; CHEMICALS, NAMELY, ACRYLATE MONOMERS, OLIGOMERS, REACTIVE SYNERGIST AND PHOTOINITIATORS, UNPROCESSED ARTIFICIAL RESINS, UNPROCESSED SYNTHETIC RESINS AND UNPROCESSED PLASTICS, VINYL ESTER RESINS, ACRYLIC RESINS, AMINO RESINS, ALKYD RESINS, POLYESTER RESINS, FLUOROCARBON RESINS, IN CLASS 1 (U.S. CLS. 1, 5, 6, 10, 26 AND 46).

FIRST USE 11-29-2006; IN COMMERCE 11-29-2006.

FOR: UV INK APPLICATION FOR OFFSET, SCREEN, FLEXO, GRAVURE INKJET, IN CLASS 2 (U.S. CLS. 6, 11 AND 16).

FIRST USE 11-29-2006; IN COMMERCE 11-29-2006.

OWNER OF U.S. REG. NOS. 2,161,904, 2,598,855 AND OTHERS.

THE MARK CONSISTS OF THE WORD "ETERNAL" IN A STYLIZED FONT INSIDE AN ELONGATED HEXAGON.

SER. NO. 85-244,703, FILED 2-17-2011.

TINA L. SNAPP, EXAMINING ATTORNEY



*David J. Kyffers*

Director of the United States Patent and Trademark Office

# United States of America

United States Patent and Trademark Office

## MEN'S EDGE MEDICAL CENTERS

**Reg. No. 4,124,123**

MEN'S EDGE MEDICAL CENTER, LLC (TEXAS LIMITED LIABILITY COMPANY)  
5550 LYNDON B JOHNSON FREEWAY, SUITE 360  
DALLAS, TX 75240

**Registered Apr. 10, 2012**

**Int. Cl.: 44**

FOR: MEDICAL AND HOSPITAL SERVICES; MEDICAL CLINICS; HEALTHCARE SERVICES, NAMELY, DISEASE MANAGEMENT PROGRAMS, WELLNESS PROGRAMS, PROGRAMS FOR THE TREATMENT AND MANAGEMENT OF HEALTH CONDITIONS; MEDICAL ASSISTANCE SERVICES; HEALTH CARE; HEALTH CARE IN THE NATURE OF HEALTH MAINTENANCE ORGANIZATIONS; PROVIDING HEALTHCARE INFORMATION; MEDICAL CONSULTATIONS; MEDICAL TESTING FOR DIAGNOSTIC OR TREATMENT PURPOSES; WELLNESS SERVICES, NAMELY, PERSONAL ASSESSMENTS, PERSONALIZED ROUTINES, MAINTENANCE SCHEDULES AND COUNSELING, WEIGHT LOSS PROGRAMS, AND AESTHETIC SKIN CARE COUNSELING AND SERVICES; HEALTH CARE SERVICES, NAMELY, PREVENTIVE HEALTH CARE AND FOLLOW UP SERVICES, IN CLASS 44 (U.S. CLS. 100 AND 101).

**SERVICE MARK**

**PRINCIPAL REGISTER**

FIRST USE 3-1-2010; IN COMMERCE 3-1-2010.

THE MARK CONSISTS OF STANDARD CHARACTERS WITHOUT CLAIM TO ANY PARTICULAR FONT, STYLE, SIZE, OR COLOR.

NO CLAIM IS MADE TO THE EXCLUSIVE RIGHT TO USE "MEN'S" AND "MEDICAL CENTER", APART FROM THE MARK AS SHOWN.

SER. NO. 85-244,757, FILED 2-17-2011.

LINDA ORNDORFF, EXAMINING ATTORNEY



*David J. Kybas*

Director of the United States Patent and Trademark Office

# United States of America

United States Patent and Trademark Office

## SCHOOL KEYS

**Reg. No. 4,124,124**

**Registered Apr. 10, 2012**

**Int. Cls.: 16, 41 and 42**

DEPARTMENT OF EDUCATION (GEORGIA STATE AGENCY)  
SUITE 1854 TWIN TOWERS EAST  
205 JESSE HILL JR. DRIVE, SE  
ATLANTA, GA 30334

**TRADEMARK**

FOR: EDUCATIONAL PUBLICATIONS, NAMELY, TRAINING MANUALS AND WORK-BOOKS IN THE FIELD OF EFFECTIVE PRACTICES FOR SCHOOLS, IN CLASS 16 (U.S. CLS. 2, 5, 22, 23, 29, 37, 38 AND 50).

**SERVICE MARK**

FIRST USE 5-20-2007; IN COMMERCE 5-20-2007.

**PRINCIPAL REGISTER**

FOR: EDUCATIONAL ASSESSMENT; PROVIDING TRAINING AND CONDUCTING WORKSHOPS IN THE FIELD OF EFFECTIVE PRACTICES FOR SCHOOLS, IN CLASS 41 (U.S. CLS. 100, 101 AND 107).

FIRST USE 5-20-2007; IN COMMERCE 5-20-2007.

FOR: DEVELOPING, EVALUATING AND TESTING PERFORMANCE EVALUATION AND APPRAISAL STANDARDS FOR PUBLIC ELEMENTARY AND PUBLIC SECONDARY SCHOOLS, IN CLASS 42 (U.S. CLS. 100 AND 101).

FIRST USE 5-20-2007; IN COMMERCE 5-20-2007.

THE MARK CONSISTS OF STANDARD CHARACTERS WITHOUT CLAIM TO ANY PARTICULAR FONT, STYLE, SIZE, OR COLOR.

NO CLAIM IS MADE TO THE EXCLUSIVE RIGHT TO USE "SCHOOL", APART FROM THE MARK AS SHOWN.

SER. NO. 85-244,868, FILED 2-17-2011.

RONALD MCMORROW, EXAMINING ATTORNEY

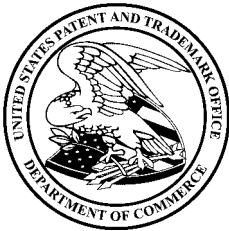

*David J. Kyffers*

Director of the United States Patent and Trademark Office

**United States of America**  
United States Patent and Trademark Office

# HOMESPUN

**Reg. No. 4,124,125**

**Registered Apr. 10, 2012**

**Int. Cl.: 23**

**TRADEMARK**

**PRINCIPAL REGISTER**

ORCHARD YARN AND THREAD COMPANY, INC. (NEW YORK CORPORATION), DBA  
LION BRAND YARN COMPANY  
34 WEST 15TH STREET  
NEW YORK, NY 10011

FOR: YARN, IN CLASS 23 (U.S. CL. 43).

FIRST USE 5-1-1996; IN COMMERCE 5-1-1996.

THE MARK CONSISTS OF STANDARD CHARACTERS WITHOUT CLAIM TO ANY PARTICULAR FONT, STYLE, SIZE, OR COLOR.

OWNER OF U.S. REG. NO. 2,048,494.

SEC. 2(F).

SER. NO. 85-244,951, FILED 2-17-2011.

STEVEN R. FINE, EXAMINING ATTORNEY



*David J. Kybas*

Director of the United States Patent and Trademark Office



# United States of America

United States Patent and Trademark Office

# Coopermatics

**Reg. No. 4,124,126**

**Registered Apr. 10, 2012**

**Int. Cl.: 7**

**TRADEMARK**

**PRINCIPAL REGISTER**

BTI-COOPERMATICS, INC. (PENNSYLVANIA CORPORATION)  
600 HELD AVENUE  
NORTHAMPTON, PA 18067

FOR: OIL FILTRATION SYSTEMS COMPRISED OF OIL FILTERS, FILTER TUBES, MEDIA, CIRCULATION PUMPS, TANKS AND CONTROL SYSTEM AND COMPONENT PARTS FOR OIL FILTRATION SYSTEMS, NAMELY, OIL FILTERS, FILTER TUBES, GASKETS, PUMPS, VALVES, FITTINGS, INSTRUMENTATION, CONTROL COMPONENTS AND OIL FILTER ADAPTORS, IN CLASS 7 (U.S. CLS. 13, 19, 21, 23, 31, 34 AND 35).

FIRST USE 1-1-1990; IN COMMERCE 1-1-1990.

THE MARK CONSISTS OF STANDARD CHARACTERS WITHOUT CLAIM TO ANY PARTICULAR FONT, STYLE, SIZE, OR COLOR.

SER. NO. 85-244,978, FILED 2-17-2011.

CURTIS FRENCH, EXAMINING ATTORNEY



*David J. Kyffers*

Director of the United States Patent and Trademark Office

# United States of America

United States Patent and Trademark Office

## PALM SPRINGS SUMMER SPLASH

**Reg. No. 4,124,127**

DESERT GAY TOURISM GUILD (CALIFORNIA CORPORATION)

**Registered Apr. 10, 2012**

P.O. BOX 2881  
PALM SPRINGS, CA 922632881

**Int. Cl.: 35**

FOR: ARRANGING AND CONDUCTING SPECIAL EVENTS FOR COMMERCIAL, PROMOTIONAL OR ADVERTISING PURPOSES; PROMOTING THE SALE OF GOODS AND SERVICES OF OTHERS THROUGH THE DISTRIBUTION OF PRINTED MATERIAL AND PROMOTIONAL CONTESTS; PUBLICITY AND SALES PROMOTION SERVICES, IN CLASS 35 (U.S. CLS. 100, 101 AND 102).

**SERVICE MARK**

**PRINCIPAL REGISTER**

FIRST USE 1-1-2008; IN COMMERCE 1-1-2008.

THE MARK CONSISTS OF STANDARD CHARACTERS WITHOUT CLAIM TO ANY PARTICULAR FONT, STYLE, SIZE, OR COLOR.

NO CLAIM IS MADE TO THE EXCLUSIVE RIGHT TO USE "PALM SPRINGS SUMMER", APART FROM THE MARK AS SHOWN.

SER. NO. 85-244,994, FILED 2-17-2011.

NANCY CLARKE, EXAMINING ATTORNEY



*David J. Kybas*

Director of the United States Patent and Trademark Office

# United States of America

United States Patent and Trademark Office

# STARDOLL

**Reg. No. 4,124,128**

**Registered Apr. 10, 2012**

**Int. Cl.: 9**

**TRADEMARK**

**PRINCIPAL REGISTER**

STARDOLL AB (SWEDEN CORPORATION)  
HUDIKSVALLSGATAN 8  
STOCKHOLM, SWEDEN 11330

FOR: PHOTOGRAPHIC MEDIA, NAMELY, DIGITAL CAMERAS, EXPOSED AND UNEXPOSED CAMERA FILM; RECORDING MEDIA, NAMELY, VIDEO CAMERAS, BLANK MEMORY CARDS, BLANK DVDS, BLANK CDS, BLANK VIDEO TAPE; RECORDED RECORDING MEDIA, NAMELY, AUDIO AND VIDEO RECORDINGS FEATURING MUSIC AND ARTISTIC PERFORMANCES; COMPUTER HARDWARE; ELECTRONIC PUBLICATIONS IN THE FIELD OF E-BOOKS DOWNLOADABLE FROM THE INTERNET; BLANK COMPACT DISCS; DIGITAL MUSIC DOWNLOADABLE FROM THE INTERNET; TELECOMMUNICATION APPARATUS, NAMELY, MOBILE PHONES; COMPUTER GAMES EQUIPMENT ADAPTED FOR USE WITH AN EXTERNAL DISPLAY SCREEN OR MONITOR, NAMELY, COMPUTER GAME CONSOLES FOR USE WITH AN EXTERNAL DISPLAY SCREEN OR MONITOR; MOUSE MATS; MOBILE PHONE ACCESSORIES, NAMELY, MOBILE PHONE CASES, MOBILE PHONE SKIN AND DESIGN COVERS, MOBILE PHONE EARPHONES, MOBILE PHONE DANGLERS AND CHARMS; SPECTACLES; SUN GLASSES; WALL MOUNTED RULERS FOR MEASURING A PERSON'S HEIGHT, IN CLASS 9 (U.S. CLS. 21, 23, 26, 36 AND 38).

THE MARK CONSISTS OF STANDARD CHARACTERS WITHOUT CLAIM TO ANY PARTICULAR FONT, STYLE, SIZE, OR COLOR.

PRIORITY CLAIMED UNDER SEC. 44(D) ON SWEDEN APPLICATION NO. 2011/01357, FILED 2-15-2011, REG. NO. 417433, DATED 3-25-2011, EXPIRES 3-25-2021.

OWNER OF U.S. REG. NO. 3,410,951.

SER. NO. 85-245,101, FILED 2-17-2011.

RONALD AIKENS, EXAMINING ATTORNEY



*David J. Kyffers*

Director of the United States Patent and Trademark Office

# United States of America

United States Patent and Trademark Office

## RILEY STEELE

**Reg. No. 4,124,129**

DIGITAL PLAYGROUND, INC. (CALIFORNIA CORPORATION)  
16134 HART STREET  
VAN NUYS, CA 91406

**Registered Apr. 10, 2012**

**Int. Cls.: 9, 10 and 41**

FOR: MOTION PICTURE AND TELEVISION FILMS AND PRERECORDED DVDS FEATURING DRAMATIC PERFORMANCES; PRERECORDED DVDS FEATURING ADULT ENTERTAINMENT, IN CLASS 9 (U.S. CLS. 21, 23, 26, 36 AND 38).

**TRADEMARK**

FIRST USE 4-18-2008; IN COMMERCE 5-16-2008.

**SERVICE MARK**

FOR: ADULT SEXUAL AIDS, NAMELY, ARTIFICIAL PENISES AND VIBRATORS, IN CLASS 10 (U.S. CLS. 26, 39 AND 44).

**PRINCIPAL REGISTER**

FIRST USE 2-16-2010; IN COMMERCE 2-16-2010.

FOR: ENTERTAINMENT SERVICES, NAMELY, LIVE AND RECORDED PERFORMANCES VIA SATELLITE, CABLE, RADIO, BROADBAND AND GLOBAL COMPUTER NETWORKS, FEATURING ADULT ENTERTAINMENT; RADIO ENTERTAINMENT SERVICES, NAMELY, RADIO PROGRAMS FEATURING PERFORMANCES BY A FILM PERSONALITY BROADCAST VIA SATELLITE, RADIO, CABLE, BROADBAND AND GLOBAL COMPUTER NETWORKS; ENTERTAINMENT SERVICES IN THE NATURE OF LIVE-ACTION, DRAMA PROGRAMS, ACTION MOTION PICTURE FILMS FOR SATELLITE, BROADBAND AND GLOBAL COMPUTER NETWORKS; LIVE THEATRICAL PERFORMANCES, IN CLASS 41 (U.S. CLS. 100, 101 AND 107).

FIRST USE 9-0-2007; IN COMMERCE 9-0-2007.

THE MARK CONSISTS OF STANDARD CHARACTERS WITHOUT CLAIM TO ANY PARTICULAR FONT, STYLE, SIZE, OR COLOR.

"RILEY STEELE" DOES NOT IDENTIFY A PARTICULAR LIVING INDIVIDUAL.

SER. NO. 85-245,208, FILED 2-17-2011.

DAVID ELTON, EXAMINING ATTORNEY



*David J. Kyros*

Director of the United States Patent and Trademark Office

# United States of America

United States Patent and Trademark Office

## SOUNDSCARF

**Reg. No. 4,124,130**

**Registered Apr. 10, 2012**

**Int. Cls.: 9 and 12**

**TRADEMARK**

**PRINCIPAL REGISTER**

DAIMLER AG (FED REP GERMANY CORPORATION)  
MERCEDESSTRASSE 137  
STUTTGART, FED REP GERMANY 70327

FOR: APPARATUS FOR RECORDING, TRANSMISSION OR REPRODUCTION OF SOUND OR IMAGES; APPARATUS FOR TRANSMITTING AND REPRODUCING SOUND FOR IN-CAR COMMUNICATION FUNCTION FOR INCREASING THE SOUND INTENSITY OF THE IN-CAR COMMUNICATION BETWEEN THE BACK SEAT PASSENGERS AND FRONT SEAT PASSENGERS, AND FOR INCREASING THE VOLUME OF THE HANDS-FREE SPEAKING FUNCTION FOR ALL PASSENGERS, IN CLASS 9 (U.S. CLS. 21, 23, 26, 36 AND 38).

FOR: AUTOMOBILES AND THEIR STRUCTURAL PARTS, IN CLASS 12 (U.S. CLS. 19, 21, 23, 31, 35 AND 44).

THE MARK CONSISTS OF STANDARD CHARACTERS WITHOUT CLAIM TO ANY PARTICULAR FONT, STYLE, SIZE, OR COLOR.

PRIORITY CLAIMED UNDER SEC. 44(D) ON FED REP GERMANY APPLICATION NO. 302010055821, FILED 9-23-2010, REG. NO. 302010055821, DATED 10-26-2010, EXPIRES 9-30-2020.

SER. NO. 85-245,228, FILED 2-17-2011.

BRENDAN MCCAULEY, EXAMINING ATTORNEY



*David J. Kyjars*

Director of the United States Patent and Trademark Office

# United States of America

United States Patent and Trademark Office



**Reg. No. 4,124,131**

**Registered Apr. 10, 2012**

**Int. Cl.: 41**

**SERVICE MARK**

**PRINCIPAL REGISTER**

BAIBAKOVA, MARIA O (UNITED STATES INDIVIDUAL)  
80 COLUMBUS CIR  
APT 72-E  
NEW YORK, NY 10023

FOR: ART EXHIBITION SERVICES; ART EXHIBITIONS; EDUCATIONAL SERVICES, NAMELY, CONDUCTING LECTURES, SEMINARS AND WORKSHOPS IN THE FIELD OF ART; ORGANIZING CULTURAL AND ARTS EVENTS; PUBLICATION OF BOOKS, CATALOGS, ART POSTERS, AND INFORMATIONAL MATERIALS IN THE FIELD OF ART, IN CLASS 41 (U.S. CLS. 100, 101 AND 107).

FIRST USE 9-0-2008; IN COMMERCE 9-0-2008.

THE MARK CONSISTS OF THE STYLIZED WORDING "BAI BAK OV".

SER. NO. 85-245,525, FILED 2-17-2011.

JANICE KIM, EXAMINING ATTORNEY



*David J. Kyffers*

Director of the United States Patent and Trademark Office

# United States of America

United States Patent and Trademark Office



**Reg. No. 4,124,132**

**Registered Apr. 10, 2012**

**Int. Cls.: 35 and 37**

**SERVICE MARK**

**PRINCIPAL REGISTER**

BIG O TIRES, LLC (NEVADA LIMITED LIABILITY COMPANY)  
823 DONALD ROSS ROAD  
JUNO BEACH, FL 33408

FOR: RETAIL TIRE STORE SERVICES; RETAIL STORES FEATURING VEHICLE PARTS AND ACCESSORIES; FRANCHISING, NAMELY, CONSULTATION AND ASSISTANCE IN BUSINESS MANAGEMENT, ORGANIZATION AND PROMOTION, IN CLASS 35 (U.S. CLS. 100, 101 AND 102).

FIRST USE 4-0-2004; IN COMMERCE 4-0-2004.

FOR: VEHICLE REPAIR AND MAINTENANCE; VEHICLE LUBRICATION; TIRE ROTATING, BALANCING, INSTALLATION, MOUNTING, PRESSURE CHECK AND REPAIR SERVICES, IN CLASS 37 (U.S. CLS. 100, 103 AND 106).

FIRST USE 4-0-2004; IN COMMERCE 4-0-2004.

OWNER OF U.S. REG. NOS. 1,611,160, 3,857,070 AND OTHERS.

THE COLOR(S) RED, WHITE AND BLACK IS/ARE CLAIMED AS A FEATURE OF THE MARK.

NO CLAIM IS MADE TO THE EXCLUSIVE RIGHT TO USE "TIRES" , APART FROM THE MARK AS SHOWN.

THE MARK CONSISTS OF THE BLACK SILHOUETTES OF FIVE PEOPLE ON A RED BACKGROUND, SUPERIMPOSED OVER WHICH ARE THE WORDS "BIG O TIRES THE TEAM YOU TRUST" IN A STYLIZED FORMAT IN WHITE.

SER. NO. 85-245,680, FILED 2-18-2011.

DAVID ELTON, EXAMINING ATTORNEY

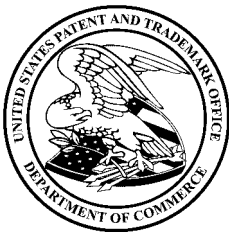

*David J. Kyffers*

Director of the United States Patent and Trademark Office

# United States of America

United States Patent and Trademark Office

# Conover

**Reg. No. 4,124,133**

**Registered Apr. 10, 2012**

**Int. Cls.: 9 and 42**

**TRADEMARK**

**SERVICE MARK**

**PRINCIPAL REGISTER**

OAKWOOD SOLUTIONS, LLC (WISCONSIN LIMITED LIABILITY COMPANY), DBA THE CONOVER COMPANY  
4 BROOKWOOD COURT  
APPLETON, WI 54914

FOR: COMPUTER SOFTWARE USED FOR ASSESSING AND REMEDIATING INDIVIDUAL STRENGTHS AND WEAKNESSES , IN CLASS 9 (U.S. CLS. 21, 23, 26, 36 AND 38).

FIRST USE 7-1-1982; IN COMMERCE 7-1-1982.

FOR: PROVIDING TEMPORARY USE OF ONLINE NON-DOWNLOADABLE SOFTWARE USED FOR ASSESSING AND REMEDIATING INDIVIDUAL STRENGTHS AND WEAKNESSES, IN CLASS 42 (U.S. CLS. 100 AND 101).

FIRST USE 7-1-1982; IN COMMERCE 7-1-1982.

THE MARK CONSISTS OF STANDARD CHARACTERS WITHOUT CLAIM TO ANY PARTICULAR FONT, STYLE, SIZE, OR COLOR.

SEC. 2(F).

SER. NO. 85-245,946, FILED 2-18-2011.

SUE LAWRENCE, EXAMINING ATTORNEY



*David J. Kybas*

Director of the United States Patent and Trademark Office



# United States of America

United States Patent and Trademark Office

# ISOFRAME

**Reg. No. 4,124,134**

**Registered Apr. 10, 2012**

**Int. Cls.: 6 and 20**

**TRADEMARK**

**PRINCIPAL REGISTER**

DISPLAY MAKERS UK, LTD. (UNITED KINGDOM CORPORATION)  
SOVEREIGN HOUSE, 10 LANCASTER PARK  
NEEDWOOD, BURTON UPON TRENT  
STAFFORDSHIRE, UNITED KINGDOM DE13 9PD

FOR: METAL FRAMES, NAMELY, METAL DISPLAY FRAMES AND METAL DISPLAY STAND FRAMES ALL FOR USE AS STRUCTURAL PARTS OF PORTABLE TRADE SHOW DISPLAY BOOTHS MADE PRIMARILY OF METAL; ALUMINUM FRAMES, NAMELY, ALUMINUM DISPLAY FRAMES AND ALUMINUM DISPLAY STAND FRAMES ALL FOR USE AS STRUCTURAL PARTS OF PORTABLE TRADE SHOW DISPLAY BOOTHS MADE PRIMARILY OF METAL; DISPLAY UNITS, NAMELY, FREE-STANDING METAL PANEL UNITS FOR DISPLAYS; PORTABLE TRADE SHOW DISPLAY BOOTHS MADE OF METAL AND STRUCTURAL PARTS THEREFOR, NAMELY, MAGNETIC, METAL DISPLAY PANELS AND METAL BEAMS; METAL BEAMS FOR DISPLAY STANDS AND DISPLAY BOARDS; PARTS AND FITTINGS FOR ALL THE AFORESAID GOODS, NAMELY, METAL SHELF BRACKETS AND METAL SCREWS, IN CLASS 6 (U.S. CLS. 2, 12, 13, 14, 23, 25 AND 50).

FOR: DISPLAY APPARATUS, NAMELY, PORTABLE DISPLAY STANDS; FURNITURE, NAMELY, DISPLAY UNITS; DISPLAY STANDS; DISPLAY BOARDS; MODULAR DISPLAY SYSTEMS COMPRISED OF MODULAR DISPLAY STANDS; PORTABLE DISPLAY STANDS AND DISPLAY BOARDS; PHOTO FRAMES FOR DISPLAY STANDS AND DISPLAY BOARDS; STRUCTURAL PARTS FOR DISPLAY STANDS AND DISPLAY BOARDS, NAMELY, DISPLAY FRAMES AND NON-METAL BEAMS; NON-METAL SIGNBOARD HOLDERS, NON-METAL CLIPS, AND NON-METAL CLAMPS FOR ASSEMBLY INTO DISPLAY STANDS AND DISPLAY BOARDS; COLLAPSIBLE DISPLAY STANDS AND DISPLAY BOARDS; DISMOUNTABLE DISPLAY STANDS AND DISPLAY BOARDS; CASES SPECIALLY ADAPTED FOR DISPLAY STANDS, DISPLAY BOARDS AND DISPLAY MATERIALS, NAMELY, METAL DISPLAY STANDS; METAL DISPLAY BOARDS; PORTABLE METAL DISPLAY STANDS AND METAL DISPLAY BOARDS; STRUCTURAL PARTS FOR DISPLAY STANDS AND DISPLAY BOARDS, NAMELY, FRAMES FOR DISPLAY STANDS AND DISPLAY BOARDS; DISPLAY FRAMES FOR MEMORABILIA; PICTURE FRAMES FOR ASSEMBLY INTO DISPLAY STANDS AND DISPLAY BOARDS; COLLAPSIBLE DISPLAY STANDS AND DISPLAY BOARDS; DISMOUNTABLE DISPLAY STANDS AND DISPLAY BOARDS; PARTS AND FITTINGS FOR ALL THE AFORESAID GOODS, NAMELY, NON-METAL SHELF BRACKETS AND NON-METAL SCREWS; DISPLAY APPARATUS, NAMELY, PORTABLE DISPLAY STANDS; MODULAR DISPLAY SYSTEMS COMPRISED OF MODULAR DISPLAY STANDS, DISPLAY PANELS, METAL BEAMS, METAL SIGN-



*David J. Kyffers*

Director of the United States Patent and Trademark Office

**Reg. No. 4,124,134** BOARD HOLDERS, METAL CLIPS, METAL TUBES, METAL CLAMPS AND METAL LINKING RODS FOR ASSEMBLY INTO DISPLAY STANDS AND DISPLAY BOARDS; METAL CASES SPECIALLY ADAPTED FOR DISPLAY MATERIALS, NAMELY, FOR PORTABLE DISPLAY STANDS; DISPLAY ASSEMBLIES COMPOSED PRIMARILY OF FIBERGLASS COMPRISING BRACKETS, CLAMPS, POLES, AND PLASTIC BANNERS FOR EXTERIOR AND INTERIOR USE AND STRUCTURAL PARTS THEREOF, IN CLASS 20 (U.S. CLS. 2, 13, 22, 25, 32 AND 50).

THE MARK CONSISTS OF STANDARD CHARACTERS WITHOUT CLAIM TO ANY PARTICULAR FONT, STYLE, SIZE, OR COLOR.

OWNER OF ERPN CMNTY TM OFC REG. NO. 008707226, DATED 6-22-2010, EXPIRES 11-24-2019.

SER. NO. 85-246,135, FILED 2-18-2011.

MEGHAN REINHART, EXAMINING ATTORNEY

United States of America  
United States Patent and Trademark Office

# TASSERON

**Reg. No. 4,124,135**

TASSERON SENSORS, INC. (DELAWARE CORPORATION)  
2401 REACH ROAD  
WILLIAMSPORT, PA 17701

**Registered Apr. 10, 2012**

**Int. Cl.: 9**

FOR: TEMPERATURE SENSORS; THERMISTORS, IN CLASS 9 (U.S. CLS. 21, 23, 26, 36 AND 38).

**TRADEMARK**

FIRST USE 7-12-2002; IN COMMERCE 7-12-2002.

**PRINCIPAL REGISTER**

THE MARK CONSISTS OF STANDARD CHARACTERS WITHOUT CLAIM TO ANY PARTICULAR FONT, STYLE, SIZE, OR COLOR.

SEC. 2(F).

SER. NO. 85-246,172, FILED 2-18-2011.

HAI-LY LAM, EXAMINING ATTORNEY



*David J. Kybas*

Director of the United States Patent and Trademark Office

# United States of America

United States Patent and Trademark Office

## 60minutepayday

**Reg. No. 4,124,136**

**Registered Apr. 10, 2012**

**Int. Cl.: 35**

**SERVICE MARK**

**PRINCIPAL REGISTER**

AFFLUENT ADS, LLC (NEW JERSEY LIMITED LIABILITY COMPANY)  
AFFLUENT ADS, LLC  
600 NORTH SECOND ST. SUITE 401  
HARRISBURG, PA 17101

FOR: ADVERTISING SERVICES; ADVERTISING AND MARKETING; ADVERTISING SERVICES, NAMELY, PROMOTING THE BRANDS, GOODS AND SERVICES OF OTHERS; ADVERTISING VIA ELECTRONIC MEDIA AND SPECIFICALLY THE INTERNET; ADVERTISING ON A COMPUTER NETWORK; PROVIDING DEMAND CREATION AND LEAD GENERATION ACTIVITIES AND SERVICES; ADVERTISING, MARKETING, DEMAND CREATION, AND LEAD GENERATION SERVICES FOR FINANCIAL PRODUCTS, NAMELY, DEFERRED DEPOSITS AND SHORT-TERM CONSUMER LOANS; REFERRAL SERVICES FOR FINANCIAL LENDERS WHO PROVIDE DEFERRED DEPOSITS AND SHORT-TERM CONSUMER LOANS; LEAD GENERATION SERVICES FOR FINANCIAL PRODUCTS, NAMELY, DEFERRED DEPOSITS AND SHORT-TERM CONSUMER LOANS, IN CLASS 35 (U.S. CLS. 100, 101 AND 102).

FIRST USE 6-24-2008; IN COMMERCE 7-1-2008.

THE MARK CONSISTS OF STANDARD CHARACTERS WITHOUT CLAIM TO ANY PARTICULAR FONT, STYLE, SIZE, OR COLOR.

SER. NO. 85-246,200, FILED 2-18-2011.

COLLEEN KEARNEY, EXAMINING ATTORNEY



*David J. Kybas*

Director of the United States Patent and Trademark Office

# United States of America

United States Patent and Trademark Office

# cashadvancer

**Reg. No. 4,124,137**

**Registered Apr. 10, 2012**

**Int. Cl.: 35**

**SERVICE MARK**

**PRINCIPAL REGISTER**

AFFLUENT ADS, LLC (NEW JERSEY LIMITED LIABILITY COMPANY)  
600 NORTH SECOND ST. SUITE 401  
HARRISBURG, PA 17101

FOR: ADVERTISING SERVICES; ADVERTISING AND MARKETING; ADVERTISING SERVICES, NAMELY, PROMOTING THE BRANDS, GOODS AND SERVICES OF OTHERS; ADVERTISING VIA ELECTRONIC MEDIA AND SPECIFICALLY THE INTERNET; ADVERTISING ON A COMPUTER NETWORK; PROVIDING DEMAND CREATION AND LEAD GENERATION ACTIVITIES AND SERVICES; ADVERTISING, MARKETING, DEMAND CREATION, AND LEAD GENERATION SERVICES FOR FINANCIAL PRODUCTS, NAMELY, DEFERRED DEPOSITS AND SHORT-TERM CONSUMER LOANS; REFERRAL SERVICES FOR FINANCIAL LENDERS WHO PROVIDE DEFERRED DEPOSITS AND SHORT-TERM CONSUMER LOANS; LEAD GENERATION SERVICES FOR FINANCIAL PRODUCTS, NAMELY, DEFERRED DEPOSITS AND SHORT-TERM CONSUMER LOANS, IN CLASS 35 (U.S. CLS. 100, 101 AND 102).

FIRST USE 7-20-2002; IN COMMERCE 5-17-2010.

THE MARK CONSISTS OF STANDARD CHARACTERS WITHOUT CLAIM TO ANY PARTICULAR FONT, STYLE, SIZE, OR COLOR.

SER. NO. 85-246,231, FILED 2-18-2011.

COLLEEN KEARNEY, EXAMINING ATTORNEY



*David J. Kyros*

Director of the United States Patent and Trademark Office

# United States of America

United States Patent and Trademark Office



**Reg. No. 4,124,138**

**Registered Apr. 10, 2012**

**Int. Cl.: 21**

**TRADEMARK**

**PRINCIPAL REGISTER**

BRUMIS IMPORTS INC. (NEW YORK CORPORATION), DBA CORE BAMBOO  
SUITE 1204  
109 WEST 38TH STREET  
NEW YORK, NY 10018

FOR: HOUSEWARES, NAMELY, BOWLS, PLATES, SERVING FORKS, SERVING SPOONS, SERVING LADLES, POT AND PAN SCRAPERS, ROLLING PINS, SPATULAS, COASTERS NOT MADE OF PAPER AND NOT BEING TABLE LINEN, UTENSIL HOLDERS, SPOON RESTS, NAPKIN HOLDERS AND NAPKIN RINGS, CONDIMENT CUPS, CUTTING BOARDS AND SERVING TRAYS, ALL MADE IN WHOLE OR IN SIGNIFICANT PART OF RENEWABLE AND OR SUSTAINABLE MATERIALS AND RESOURCES, IN CLASS 21 (U.S. CLS. 2, 13, 23, 29, 30, 33, 40 AND 50).

FIRST USE 1-1-2009; IN COMMERCE 1-1-2010.

NO CLAIM IS MADE TO THE EXCLUSIVE RIGHT TO USE "MANGO WOOD", APART FROM THE MARK AS SHOWN.

THE COLOR(S) DARK ORANGE AND LIGHT ORANGE IS/ARE CLAIMED AS A FEATURE OF THE MARK.

THE MARK CONSISTS OF THE WORD "CORE" IN LARGE LOWER CASE STANDARD TYPEFACE DARK ORANGE LETTERS UNDERLINED IN LIGHT ORANGE, WITH THE LETTER "R" APPEARING AS A FANCIFUL BAMBOO REED GRAPHIC WITH THE STEM IN DARK ORANGE AND THE LEAF IN LIGHT ORANGE; THE WORDS "MANGO WOOD" APPEARING SMALLER UNDERNEATH IN ALL UPPER CASE STANDARD TYPEFACE IN LIGHT ORANGE.

SER. NO. 85-246,517, FILED 2-18-2011.

MARK SPARACINO, EXAMINING ATTORNEY



*David J. Kybas*

Director of the United States Patent and Trademark Office

# United States of America

United States Patent and Trademark Office

**CORE**  
ROOT CRAFTS

**Reg. No. 4,124,139**

**Registered Apr. 10, 2012**

**Int. Cl.: 21**

**TRADEMARK**

**PRINCIPAL REGISTER**

BRUMIS IMPORTS INC. (NEW YORK CORPORATION), DBA CORE BAMBOO  
SUITE #1204  
109 WEST 38TH STREET  
NEW YORK, NY 10018

FOR: HOUSEWARES, NAMELY, BOWLS, PLATES, SERVING FORKS, SERVING SPOONS, SERVING LADLES, POT AND PAN SCRAPERS, ROLLING PINS, SPATULAS, COASTERS NOT MADE OF PAPER AND NOT BEING TABLE LINEN, UTENSIL HOLDERS, SPOON RESTS, NAPKIN HOLDERS AND NAPKIN RINGS, CONDIMENT CUPS, CUTTING BOARDS AND SERVING TRAYS, ALL MADE IN WHOLE OR IN SIGNIFICANT PART OF RENEWABLE AND OR SUSTAINABLE MATERIALS AND RESOURCES, IN CLASS 21 (U.S. CLS. 2, 13, 23, 29, 30, 33, 40 AND 50).

FIRST USE 1-1-2009; IN COMMERCE 1-1-2010.

NO CLAIM IS MADE TO THE EXCLUSIVE RIGHT TO USE "ROOT CRAFTS", APART FROM THE MARK AS SHOWN.

THE COLOR(S) DARK RED AND LIGHT RED IS/ARE CLAIMED AS A FEATURE OF THE MARK.

THE MARK CONSISTS OF THE WORD "CORE" IN LARGE LOWER CASE STANDARD TYPEFACE DARK RED LETTERS UNDERLINED IN LIGHT RED, WITH THE LETTER "R" APPEARING AS A FANCIFUL BAMBOO REED GRAPHIC WITH THE STEM IN DARK RED AND THE LEAF IN LIGHT RED; THE WORD "ROOT CRAFTS" APPEARING SMALLER UNDERNEATH IN ALL UPPER CASE STANDARD TYPEFACE IN LIGHT RED.

SER. NO. 85-246,601, FILED 2-18-2011.

MARK SPARACINO, EXAMINING ATTORNEY



*David J. Kybas*

Director of the United States Patent and Trademark Office

# United States of America

United States Patent and Trademark Office

## DYNAMATIC

**Reg. No. 4,124,140**

**Registered Apr. 10, 2012**

**Int. Cls.: 7 and 9**

**TRADEMARK**

**PRINCIPAL REGISTER**

OMNIDRIVE HOLDINGS, LLC (DELAWARE LIMITED LIABILITY COMPANY)  
7900 DURAND AVENUE  
STURTEVANT, WI 51377

FOR: ELECTRIC MOTORS AND ELECTRO MECHANICAL PRESS DRIVES; ELECTRO-MAGNETIC CLUTCHES OR COUPLINGS FOR USE AS ELECTRICAL VARIABLE SPEED TRANSMISSIONS; EDDY CURRENT CLUTCHES AND BRAKES; ADJUSTABLE FREQUENCY DRIVES; ELECTRIC CLUTCHES; ELECTRIC BRAKES; NON-ELECTRIC, MECHANICAL VALVES TO REGULATE OVERRUNNING POWER-TRANSMISSION CLUTCHES; AND ELECTRO-MECHANICAL METAL WORKING PRESS DRIVE SYSTEMS COMPRISING ELECTRO-MECHANICAL METAL WORKING PRESS DRIVES, PARTS AND ELECTRICAL CONTROLS THEREFOR, IN CLASS 7 (U.S. CLS. 13, 19, 21, 23, 31, 34 AND 35).

FIRST USE 3-5-1934; IN COMMERCE 3-5-1934.

FOR: ELECTRIC VALVES TO REGULATE OVERRUNNING POWER-TRANSMISSION CLUTCHES; ELECTRICAL COUNTERS, NAMELY, ELECTRICAL PULSE COUNTERS; DYNAMOMETERS; ELECTRONIC EDDY CURRENT AND ADJUSTABLE FREQUENCY CONTROLLER UNITS; VOLTAGE REGULATORS AND VOLTAGE STABILIZERS, IN CLASS 9 (U.S. CLS. 21, 23, 26, 36 AND 38).

FIRST USE 3-31-1938; IN COMMERCE 3-31-1938.

THE MARK CONSISTS OF STANDARD CHARACTERS WITHOUT CLAIM TO ANY PARTICULAR FONT, STYLE, SIZE, OR COLOR.

SER. NO. 85-246,650, FILED 2-18-2011.

RONALD AIKENS, EXAMINING ATTORNEY



*David J. Kybas*

Director of the United States Patent and Trademark Office



# United States of America

United States Patent and Trademark Office

## DSI/DYNAMATIC

**Reg. No. 4,124,141**

**Registered Apr. 10, 2012**

**Int. Cls.: 7 and 9**

**TRADEMARK**

**PRINCIPAL REGISTER**

OMNIDRIVE HOLDINGS, LLC (DELAWARE LIMITED LIABILITY COMPANY)  
7900 DURAND AVENUE  
STURTEVANT, WI 51377

FOR: ELECTRIC MOTORS AND ELECTRO MECHANICAL PRESS DRIVES; ELECTRO-MAGNETIC CLUTCHES OR COUPLINGS FOR USE AS ELECTRICAL VARIABLE SPEED TRANSMISSIONS; EDDY CURRENT CLUTCHES AND BRAKES; ADJUSTABLE FREQUENCY DRIVES; ELECTRIC CLUTCHES; ELECTRIC BRAKES; NON-ELECTRIC, MECHANICAL VALVES TO REGULATE OVERRUNNING POWER-TRANSMISSION CLUTCHES; AND ELECTRO-MECHANICAL METAL WORKING PRESS DRIVE SYSTEMS COMPRISING ELECTRO-MECHANICAL METAL WORKING PRESS DRIVES, PARTS AND ELECTRICAL CONTROLS THEREFOR, IN CLASS 7 (U.S. CLS. 13, 19, 21, 23, 31, 34 AND 35).

FIRST USE 2-28-2002; IN COMMERCE 2-28-2002.

FOR: ELECTRIC VALVES TO REGULATE OVERRUNNING POWER-TRANSMISSION CLUTCHES; ELECTRICAL COUNTERS, NAMELY, ELECTRICAL PULSE COUNTERS; DYNAMOMETERS; ELECTRONIC EDDY CURRENT AND ADJUSTABLE FREQUENCY CONTROLLER UNITS; VOLTAGE REGULATORS AND VOLTAGE STABILIZERS, IN CLASS 9 (U.S. CLS. 21, 23, 26, 36 AND 38).

FIRST USE 2-28-2002; IN COMMERCE 2-28-2002.

THE MARK CONSISTS OF STANDARD CHARACTERS WITHOUT CLAIM TO ANY PARTICULAR FONT, STYLE, SIZE, OR COLOR.

SER. NO. 85-246,667, FILED 2-18-2011.

RONALD AIKENS, EXAMINING ATTORNEY



*David J. Kyros*

Director of the United States Patent and Trademark Office

# United States of America

United States Patent and Trademark Office

## ProShip Autobahn

**Reg. No. 4,124,142**

**Registered Apr. 10, 2012**

**Int. Cl.: 9**

**TRADEMARK**

**PRINCIPAL REGISTER**

BEST WAY TECHNOLOGIES, LLC (WISCONSIN LIMITED LIABILITY COMPANY)  
530 NORTH 108TH PLACE  
SUITE 100  
WAUWATOSA, WI 53226

FOR: COMPUTER SOFTWARE FOR SHIPPING, NAMELY, FOR RATING, ROUTING, MANIFESTING, REPORTING AND PRODUCING CARRIER REQUIRED SHIPPING DOCUMENTS FOR CUSTOMERS WHO UTILIZE SAP SOFTWARE, IN CLASS 9 (U.S. CLS. 21, 23, 26, 36 AND 38).

FIRST USE 6-1-2010; IN COMMERCE 6-1-2010.

THE MARK CONSISTS OF STANDARD CHARACTERS WITHOUT CLAIM TO ANY PARTICULAR FONT, STYLE, SIZE, OR COLOR.

OWNER OF U.S. REG. NO. 3,137,910.

SER. NO. 85-246,705, FILED 2-18-2011.

PATRICIA EVANKO, EXAMINING ATTORNEY



*David J. Kybas*

Director of the United States Patent and Trademark Office

# United States of America

United States Patent and Trademark Office

The logo features a stylized silhouette of a dancer in a dynamic pose on the left. To the right of the dancer, the word "Le Ombre" is written in a cursive, script font. The letter "L" is integrated into the design, appearing to sit inside the "O".

**Reg. No. 4,124,143**

ENTERTAINMENT PLUS PRODUCTIONS, INC. (CALIFORNIA CORPORATION)  
2324 SOUTH HALM AVE.  
LOS ANGELES, CA 90034

**Registered Apr. 10, 2012**

**Int. Cl.: 41**

FOR: ENTERTAINMENT IN THE NATURE OF A THEATRICAL SHOW COMBINING ACROBATICS, CONTEMPORARY DANCE, AND SHADOW ART, IN CLASS 41 (U.S. CLS. 100, 101 AND 107).

**SERVICE MARK**

FIRST USE 6-1-2008; IN COMMERCE 6-1-2008.

**PRINCIPAL REGISTER**

THE MARK CONSISTS OF A SILHOUETTE OF A DANCER TO THE LEFT OF "LE OMBRÉ". INSIDE THE "O" OF "OMBRÉ" SITS THE "LE". THERE IS AN ACCENT OVER THE "E" IN THE WORD "OMBRE". "LE OMBRÉ" IS SPELLED IN A CURSIVE STYLED FONT.

THE ENGLISH TRANSLATION OF "LE OMBRE" IN THE MARK IS "THE SHADOW".

SER. NO. 85-246,808, FILED 2-18-2011.

MICHAEL ENGEL, EXAMINING ATTORNEY



*David J. Kyffers*

Director of the United States Patent and Trademark Office

# United States of America

United States Patent and Trademark Office

## Romana's Pilates

**Reg. No. 4,124,144**

**Registered Apr. 10, 2012**

**Int. Cl.: 41**

**SERVICE MARK**

**PRINCIPAL REGISTER**

TRUE PILATES, LLC (DELAWARE LIMITED LIABILITY COMPANY), AKA ROMANA'S PILATES  
4320 NE 20TH AVE  
FORT LAUDERDALE, FL 33308

FOR: EDUCATIONAL SERVICES, NAMELY, CONDUCTING CLASSES, SEMINARS, CONFERENCES, WORKSHOPS IN THE FIELD OF PILATES AND DISTRIBUTION OF COURSE MATERIAL IN CONNECTION THEREWITH, IN CLASS 41 (U.S. CLS. 100, 101 AND 107).

FIRST USE 3-10-2003; IN COMMERCE 3-10-2003.

THE MARK CONSISTS OF STANDARD CHARACTERS WITHOUT CLAIM TO ANY PARTICULAR FONT, STYLE, SIZE, OR COLOR.

NO CLAIM IS MADE TO THE EXCLUSIVE RIGHT TO USE "PILATES", APART FROM THE MARK AS SHOWN.

THE NAME(S), PORTRAIT(S), AND/OR SIGNATURE(S) SHOWN IN THE MARK DOES NOT IDENTIFY A PARTICULAR LIVING INDIVIDUAL.

SER. NO. 85-246,883, FILED 2-19-2011.

CAROLINE WOOD, EXAMINING ATTORNEY



*David J. Kyfos*

Director of the United States Patent and Trademark Office

# United States of America

United States Patent and Trademark Office

# MED180°

**Reg. No. 4,124,145**

MEDMANAGEMENT, INC. (TENNESSEE CORPORATION)  
725 COOL SPRINGS BLVD., SUITE 550  
FRANKLIN, TN 37067

**Registered Apr. 10, 2012**

**Int. Cls.: 5 and 44**

FOR: DIETARY AND NUTRITIONAL SUPPLEMENTS USED FOR WEIGHT LOSS, IN CLASS 5 (U.S. CLS. 6, 18, 44, 46, 51 AND 52).

**TRADEMARK**

FIRST USE 1-3-2011; IN COMMERCE 4-18-2011.

**SERVICE MARK**

FOR: MEDICAL CLINICS; MEDICAL SERVICES, NAMELY, WEIGHT LOSS AND WELLNESS AND PRINTABLE MATERIALS DISTRIBUTED THEREWITH; PROVIDING A WEBSITE FEATURING INFORMATION AND ADVICE IN THE FIELDS OF DIET, WEIGHT LOSS, DIET PLANNING AND LIFESTYLE WELLNESS, IN CLASS 44 (U.S. CLS. 100 AND 101).

**PRINCIPAL REGISTER**

FIRST USE 1-3-2011; IN COMMERCE 4-18-2011.

THE MARK CONSISTS OF STANDARD CHARACTERS WITHOUT CLAIM TO ANY PARTICULAR FONT, STYLE, SIZE, OR COLOR.

SER. NO. 85-246,939, FILED 2-19-2011.

LINDA ESTRADA, EXAMINING ATTORNEY



*David J. Kybas*

Director of the United States Patent and Trademark Office

# United States of America

United States Patent and Trademark Office



**Reg. No. 4,124,146**

**Registered Apr. 10, 2012**

**Int. Cls.: 9 and 41**

**TRADEMARK**

**SERVICE MARK**

**PRINCIPAL REGISTER**

THE NATIONAL WORLD WAR II MUSEUM, INC. (LOUISIANA CORPORATION),  
FORMERLY THE NATIONAL D-DAY MUSEUM FOUNDATION INC.  
945 MAGAZINE ST.  
NEW ORLEANS, LA 70130

FOR: PRERECORDED CDS FEATURING MUSICAL PERFORMANCE , IN CLASS 9 (U.S. CLS. 21, 23, 26, 36 AND 38).

FIRST USE 10-14-2011; IN COMMERCE 10-14-2011.

FOR: EDUCATIONAL AND ENTERTAINMENT SERVICES IN THE NATURE OF LIVE MUSICAL AND DANCE PERFORMANCES, IN CLASS 41 (U.S. CLS. 100, 101 AND 107).

FIRST USE 7-15-2010; IN COMMERCE 7-15-2010.

THE MARK CONSISTS OF THE TERM "VICTORY" IN WHICH THE LETTER "V" IS ENLARGED OVER A CIRCLE WITH STARS ON ITS BORDER AND THE TERM "BELLES" BELOW IT.

SER. NO. 85-247,050, FILED 2-20-2011.

SALLY SHIH, EXAMINING ATTORNEY



*David J. Kyros*

Director of the United States Patent and Trademark Office

# United States of America

United States Patent and Trademark Office

## CELIACS HELPING CELIACS

**Reg. No. 4,124,147**

**Registered Apr. 10, 2012**

**Int. Cls.: 16, 35 and 41**

**TRADEMARK**

**SERVICE MARK**

**PRINCIPAL REGISTER**

CELIAC SPRUE ASSOCIATION/UNITED STATES OF AMERICA, INC. (NEBRASKA  
NON-PROFIT CORPORATION)  
P.O. BOX 31700  
OMAHA, NE 68131

FOR: LITERATURE AND WRITTEN MATERIALS, NAMELY, NEWSLETTERS, INFORMATIONAL AND EDUCATIONAL WRITTEN PAMPHLETS, BROCHURES, HANDBOOKS, CATALOGS IN THE FIELD OF PRODUCTS FOR PATIENTS WITH CELIAC SPRUE DISEASE AND GLUTEN-INDUCED SENSITIVITIES, INCLUDING, BUT NOT LIMITED TO, DERMATITIS HERPETIFORMIS; COOKBOOKS, BOOKLETS, LEAFLETS, INFORMATIONAL FLYERS, WALLET-SIZED INFORMATIONAL CARDS, POSTERS, INFORMATIONAL SHEETS, RESEARCH MONOGRAPHS, JOURNALS AND JOURNAL REPRINTS, CHARTS, DIAGRAMS, AND ADHESIVE-BACKED STICKERS, ALL RELATING TO CELIAC SPRUE DISEASE AND GLUTEN-INDUCED SENSITIVITIES, INCLUDING, BUT NOT LIMITED TO, DERMATITIS HERPETIFORMIS; KITS COMPRISING OF ONE OR MORE OF THE FOREGOING MATERIALS; AND BOOKS, PERIODICALS AND OTHER INFORMATIONAL DOCUMENTS, ALL RELATING TO CELIAC SPRUE DISEASE AND GLUTEN-INDUCED SENSITIVITIES, INCLUDING, BUT NOT LIMITED TO, DERMATITIS HERPETIFORMIS, IN CLASS 16 (U.S. CLS. 2, 5, 22, 23, 29, 37, 38 AND 50).

FIRST USE 1-31-1987; IN COMMERCE 1-31-1987.

FOR: ASSOCIATION SERVICES, NAMELY, PROMOTING THE INTERESTS OF PERSONS AFFECTED BY CELIAC SPRUE DISEASE AND GLUTEN-INDUCED SENSITIVITIES, INCLUDING, BUT NOT LIMITED TO, DERMATITIS HERPETIFORMIS, IN CLASS 35 (U.S. CLS. 100, 101 AND 102).

FIRST USE 1-31-1987; IN COMMERCE 1-31-1987.

FOR: EDUCATIONAL AND TRAINING SERVICES, NAMELY, CONDUCTING SEMINARS, COURSES, CONFERENCES, LECTURES, WORKSHOPS RELATING TO CELIAC SPRUE DISEASE AND GLUTEN-INDUCED SENSITIVITIES, INCLUDING, BUT NOT LIMITED TO, DERMATITIS HERPETIFORMIS AND CONDUCTING COLLABORATIVE MEETINGS WITH PHYSICIANS, MEDICAL TECHNICIANS AND OTHERS IN THE SCIENTIFIC COMMUNITY TO DISCUSS, LEARN AND EVALUATE MEDICAL RESEARCH AND OTHER MEDICAL ADVANCES RELATING TO CELIAC SPRUE DISEASE AND GLUTEN-INDUCED SENSIT-



*David J. Kyjars*

Director of the United States Patent and Trademark Office

**Reg. No. 4,124,147** IVITIES, INCLUDING, BUT NOT LIMITED TO, DERMATITIS HERPETIFORMIS, IN CLASS 41 (U.S. CLS. 100, 101 AND 107).

FIRST USE 1-31-1987; IN COMMERCE 1-31-1987.

THE MARK CONSISTS OF STANDARD CHARACTERS WITHOUT CLAIM TO ANY PARTICULAR FONT, STYLE, SIZE, OR COLOR.

SER. NO. 85-247,081, FILED 2-20-2011.

SUNG IN, EXAMINING ATTORNEY



# United States of America

United States Patent and Trademark Office

## LIVING A FULL LIFE WITH CELIAC DISEASE

**Reg. No. 4,124,148**

**Registered Apr. 10, 2012**

**Int. Cls.: 16, 35 and 41**

**TRADEMARK**

**SERVICE MARK**

**PRINCIPAL REGISTER**

CELIAC SPRUE ASSOCIATION/UNITED STATES OF AMERICA, INC. (NEBRASKA  
NON-PROFIT CORPORATION)  
P.O. BOX 31700  
OMAHA, NE 68131

FOR: LITERATURE AND WRITTEN MATERIALS, NAMELY, NEWSLETTERS, INFORMATIONAL AND EDUCATIONAL WRITTEN PAMPHLETS, BROCHURES, HANDBOOKS, CATALOGS IN THE FIELD OF PRODUCTS FOR PATIENTS WITH CELIAC SPRUE DISEASE AND GLUTEN-INDUCED SENSITIVITIES, INCLUDING, BUT NOT LIMITED TO, DERMATITIS HERPETIFORMIS; COOKBOOKS, BOOKLETS, LEAFLETS, INFORMATIONAL FLYERS, WALLET-SIZED INFORMATIONAL CARDS, POSTERS, INFORMATIONAL SHEETS, RESEARCH MONOGRAPHS, JOURNALS AND JOURNAL REPRINTS, CHARTS, DIAGRAMS, AND ADHESIVE-BACKED STICKERS, ALL RELATING TO CELIAC SPRUE DISEASE AND GLUTEN-INDUCED SENSITIVITIES, INCLUDING, BUT NOT LIMITED TO, DERMATITIS HERPETIFORMIS; KITS COMPRISING OF ONE OR MORE OF THE FOREGOING MATERIALS; AND BOOKS, PERIODICALS AND OTHER INFORMATIONAL DOCUMENTS, ALL RELATING TO CELIAC SPRUE DISEASE AND GLUTEN-INDUCED SENSITIVITIES, INCLUDING, BUT NOT LIMITED TO, DERMATITIS HERPETIFORMIS, IN CLASS 16 (U.S. CLS. 2, 5, 22, 23, 29, 37, 38 AND 50).

FIRST USE 3-31-2004; IN COMMERCE 3-31-2004.

FOR: ASSOCIATION SERVICES, NAMELY, PROMOTING THE INTERESTS OF PERSONS AFFECTED BY CELIAC SPRUE DISEASE AND GLUTEN-INDUCED SENSITIVITIES, INCLUDING, BUT NOT LIMITED TO, DERMATITIS HERPETIFORMIS, IN CLASS 35 (U.S. CLS. 100, 101 AND 102).

FIRST USE 3-31-2004; IN COMMERCE 3-31-2004.

FOR: EDUCATIONAL AND TRAINING SERVICES, NAMELY, CONDUCTING SEMINARS, COURSES, CONFERENCES, LECTURES, WORKSHOPS RELATING TO CELIAC SPRUE DISEASE AND GLUTEN-INDUCED SENSITIVITIES, INCLUDING, BUT NOT LIMITED TO, DERMATITIS HERPETIFORMIS AND CONDUCTING COLLABORATIVE MEETINGS WITH PHYSICIANS, MEDICAL TECHNICIANS AND OTHERS IN THE SCIENTIFIC COMMUNITY TO DISCUSS, LEARN AND EVALUATE MEDICAL RESEARCH AND OTHER MEDICAL ADVANCES RELATING TO CELIAC SPRUE DISEASE AND GLUTEN-INDUCED SENSIT-



*David J. Kyjars*

Director of the United States Patent and Trademark Office

**Reg. No. 4,124,148** IVITIES, INCLUDING, BUT NOT LIMITED TO, DERMATITIS HERPETIFORMIS, IN CLASS 41 (U.S. CLS. 100, 101 AND 107).

FIRST USE 3-31-2004; IN COMMERCE 3-31-2004.

THE MARK CONSISTS OF STANDARD CHARACTERS WITHOUT CLAIM TO ANY PARTICULAR FONT, STYLE, SIZE, OR COLOR.

NO CLAIM IS MADE TO THE EXCLUSIVE RIGHT TO USE "CELIAC DISEASE", APART FROM THE MARK AS SHOWN.

SER. NO. 85-247,090, FILED 2-20-2011.

SUNG IN, EXAMINING ATTORNEY

# United States of America

United States Patent and Trademark Office

## Generation Echo

**Reg. No. 4,124,149**

LEVY, FRANK (UNITED STATES INDIVIDUAL)  
17111 SHELBY LANE  
N. FT. MYERS, FL 33917 AND

**Registered Apr. 10, 2012**

**Int. Cl.: 41**

SANTANA, MATTY (UNITED STATES INDIVIDUAL)  
2000 UNIVERSAL PLAZA  
ORLANDO, FL 32819 AND

**SERVICE MARK**

**PRINCIPAL REGISTER**

MENENDEZ, JOEY (UNITED STATES INDIVIDUAL)  
2000 UNIVERSAL PLAZA  
ORLANDO, FL 32819

FOR: ENTERTAINMENT, NAMELY, A CONTINUING SITCOM SHOW BROADCAST OVER TELEVISION AND INTERNET, IN CLASS 41 (U.S. CLS. 100, 101 AND 107).

FIRST USE 12-22-2010; IN COMMERCE 12-22-2010.

THE MARK CONSISTS OF STANDARD CHARACTERS WITHOUT CLAIM TO ANY PARTICULAR FONT, STYLE, SIZE, OR COLOR.

SER. NO. 85-247,161, FILED 2-20-2011.

JOHN SCHUYLER YARD, EXAMINING ATTORNEY



*David J. Kyros*

Director of the United States Patent and Trademark Office

# United States of America

United States Patent and Trademark Office

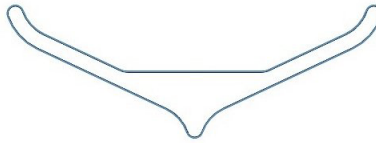

**Reg. No. 4,124,150**

**Registered Apr. 10, 2012**

**Int. Cl.: 6**

**TRADEMARK**

**PRINCIPAL REGISTER**

RONIN METAL MASTERS (CALIFORNIA LIMITED LIABILITY COMPANY), DBA RONIN METAL MASTERS  
624 VICTOR WAY #4  
MOUNTAIN VIEW, CA 94040

FOR: SHEET METAL, IN CLASS 6 (U.S. CLS. 2, 12, 13, 14, 23, 25 AND 50).

FIRST USE 1-1-2011; IN COMMERCE 2-14-2011.

THE MARK CONSISTS OF A MISCELLANEOUS TRIANGULAR SHAPE COMPRISING A HAWK-LIKE FORM FROM THE FRONT WITH THE WINGS SPREAD OUTWARD AND HEAD LOWERED AND ROUNDED.

SER. NO. 85-247,163, FILED 2-20-2011.

JOHN SCHUYLER YARD, EXAMINING ATTORNEY



*David J. Kyffers*

Director of the United States Patent and Trademark Office

# United States of America

United States Patent and Trademark Office

# BLUAVA

**Reg. No. 4,124,151**

**Registered Apr. 10, 2012**

**Int. Cl.: 30**

**TRADEMARK**

**PRINCIPAL REGISTER**

SOCIALIZE, INC. (DELAWARE CORPORATION)  
153 TOWNSEND ST., #9057  
SAN FRANCISCO, CA 94107

FOR: AGAVE SYRUP FOR FLAVORING, IN CLASS 30 (U.S. CL. 46).

FIRST USE 8-1-2010; IN COMMERCE 8-1-2010.

THE MARK CONSISTS OF STANDARD CHARACTERS WITHOUT CLAIM TO ANY PARTICULAR FONT, STYLE, SIZE, OR COLOR.

SER. NO. 85-247,198, FILED 2-21-2011.

DOMINIC J. FERRAIUOLO, EXAMINING ATTORNEY



*David J. Kyffers*

Director of the United States Patent and Trademark Office

# United States of America

United States Patent and Trademark Office

**USHER BRAND**

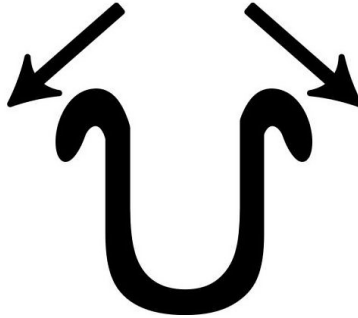

**Reg. No. 4,124,152**

**Registered Apr. 10, 2012**

**Int. Cls.: 5 and 18**

**TRADEMARK**

**PRINCIPAL REGISTER**

USHER, CLELL (UNITED STATES INDIVIDUAL)  
P.O. BOX 475  
WADDELL, AZ 85355

FOR: NUTRITIONAL SUPPLEMENTS FOR HORSES, IN CLASS 5 (U.S. CLS. 6, 18, 44, 46, 51 AND 52).

FIRST USE 1-8-2010; IN COMMERCE 2-12-2010.

FOR: SADDLES; HORSE TACK, IN CLASS 18 (U.S. CLS. 1, 2, 3, 22 AND 41).

FIRST USE 1-8-2010; IN COMMERCE 2-12-2010.

NO CLAIM IS MADE TO THE EXCLUSIVE RIGHT TO USE "BRAND", APART FROM THE MARK AS SHOWN.

THE MARK CONSISTS OF THE WORDS "USHER BRAND" AND BELOW THE WORDS THERE IS LETTER "U" WITH ITS END LITTLE CURVED OUTSIDE. THERE ARE TWO ARROWS POINTING DOWNWARDS ONE IN LEFT HAND SIDE AND THE OTHER IN RIGHT HAND SIDE.

SER. NO. 85-247,211, FILED 2-21-2011.

DOMINIC J. FERRAIUOLO, EXAMINING ATTORNEY



*David J. Kybas*

Director of the United States Patent and Trademark Office

# United States of America

United States Patent and Trademark Office

## YOUR MAINE HOOK-UP

**Reg. No. 4,124,153**

**Registered Apr. 10, 2012**

**Int. Cls.: 35 and 43**

**SERVICE MARK**

**PRINCIPAL REGISTER**

RED HOOK LOBSTER POUND, LLC (NEW YORK LIMITED LIABILITY COMPANY)  
269 COLUMBIA STREET  
BROOKLYN, NY 11231

FOR: WHOLESALE AND RETAIL SEAFOOD STORE SERVICES AND ON-LINE RETAIL AND WHOLESALE SEAFOOD STORE SERVICES, IN CLASS 35 (U.S. CLS. 100, 101 AND 102).

FIRST USE 6-1-2009; IN COMMERCE 6-1-2009.

FOR: RESTAURANT AND CATERING SERVICES; MOBILE RESTAURANT SERVICES, IN CLASS 43 (U.S. CLS. 100 AND 101).

FIRST USE 6-1-2009; IN COMMERCE 6-1-2009.

THE MARK CONSISTS OF STANDARD CHARACTERS WITHOUT CLAIM TO ANY PARTICULAR FONT, STYLE, SIZE, OR COLOR.

SER. NO. 85-247,224, FILED 2-21-2011.

DOMINIC J. FERRAIUOLO, EXAMINING ATTORNEY



*David J. Kyffers*

Director of the United States Patent and Trademark Office

# United States of America

United States Patent and Trademark Office



**Reg. No. 4,124,154**

VOGEL, DWAYNE (UNITED STATES INDIVIDUAL)  
2795 MANDY CT.  
ODENTON, MD 21113

**Registered Apr. 10, 2012**

**Int. Cl.: 37**

FOR: REFINISHING OF WOODEN FURNITURE AND FIXTURES IN A GREEN ENERGY CONSCIOUS MANNER; RESTORATION IN THE FIELD OF WOODEN FURNITURE AND FIXTURES IN A GREEN ENERGY CONSCIOUS MANNER, IN CLASS 37 (U.S. CLS. 100, 103 AND 106).

**SERVICE MARK**

**PRINCIPAL REGISTER**

FIRST USE 6-1-2009; IN COMMERCE 6-1-2009.

NO CLAIM IS MADE TO THE EXCLUSIVE RIGHT TO USE "GREEN" AND "ENVIRONMENTALLY RESPONSIBLE WOOD FINISHING", APART FROM THE MARK AS SHOWN.

THE STIPLING IS FOR SHADING PURPOSES ONLY.

THE MARK CONSISTS OF THE WORDS "FINISH IT GREEN ENVIRONMENTALLY RESPONSIBLE WOOD FINISHING" AND A BAR LOCATED OVER TOP OF THE WORDS, CONTAIN A "WOOD" GRAIN FIGURE FOR THE BACKGROUND, WITH A LEAF ON THE BAR AS IF IT WERE BEING USED AS A BRUSH TO APPLY PAINT TO THE "WOOD" GRAIN ON THE BAR.

SER. NO. 85-247,446, FILED 2-21-2011.

KAPIL BHANOT, EXAMINING ATTORNEY



*David J. Kyros*

Director of the United States Patent and Trademark Office



# United States of America

United States Patent and Trademark Office

## Lobstah Rockah

**Reg. No. 4,124,155**

JACKSON, DONALD J. (UNITED STATES INDIVIDUAL)  
6 BANAGHER WAY  
SCARBOROUGH, ME 04074

**Registered Apr. 10, 2012**

**Int. Cl.: 20**

FOR: ROCKING CHAIRS, IN CLASS 20 (U.S. CLS. 2, 13, 22, 25, 32 AND 50).

**TRADEMARK**

FIRST USE 10-9-2010; IN COMMERCE 10-9-2010.

**PRINCIPAL REGISTER**

THE MARK CONSISTS OF STANDARD CHARACTERS WITHOUT CLAIM TO ANY PARTICULAR FONT, STYLE, SIZE, OR COLOR.

SER. NO. 85-247,527, FILED 2-21-2011.

BERYL GARDNER, EXAMINING ATTORNEY



*David J. Kyffers*

Director of the United States Patent and Trademark Office

# United States of America

United States Patent and Trademark Office

## WE SELL FRIGHT RIGHT

**Reg. No. 4,124,156**

PAPERKING INC. (MASSACHUSETTS CORPORATION)

**Registered Apr. 10, 2012**

109 BARRY ROAD  
WORCESTER, MA 01609

**Int. Cl.: 35**

FOR: RETAIL STORE SERVICES FEATURING HALLOWEEN AND HALLOWEEN RELATED ITEMS, IN CLASS 35 (U.S. CLS. 100, 101 AND 102).

**SERVICE MARK**

FIRST USE 10-1-1989; IN COMMERCE 10-1-1989.

**PRINCIPAL REGISTER**

THE MARK CONSISTS OF STANDARD CHARACTERS WITHOUT CLAIM TO ANY PARTICULAR FONT, STYLE, SIZE, OR COLOR.

SER. NO. 85-247,828, FILED 2-22-2011.

DEZMONA MIZELLE, EXAMINING ATTORNEY



*David J. Kybas*

Director of the United States Patent and Trademark Office

# United States of America

United States Patent and Trademark Office

## ADTOURNAMENT

**Reg. No. 4,124,157**

**Registered Apr. 10, 2012**

**Int. Cl.: 35**

**SERVICE MARK**

**PRINCIPAL REGISTER**

CROWD SOURCE CREATIVES, LLC (HAWAII LIMITED LIABILITY COMPANY)  
866 IWILEI ROAD  
SUITE 234  
HONOLULU, HI 96817

FOR: ADVERTISING SERVICES, NAMELY, PROVIDING A WEBSITE FOR THE CREATION OF ADVERTISING, MARKETING AND RETAIL MATERIALS FOR OTHERS , IN CLASS 35 (U.S. CLS. 100, 101 AND 102).

FIRST USE 2-1-2010; IN COMMERCE 2-15-2011.

THE MARK CONSISTS OF STANDARD CHARACTERS WITHOUT CLAIM TO ANY PARTICULAR FONT, STYLE, SIZE, OR COLOR.

SER. NO. 85-247,849, FILED 2-22-2011.

ALEXANDER L. POWERS, EXAMINING ATTORNEY



*David J. Kyffers*

Director of the United States Patent and Trademark Office

# United States of America

United States Patent and Trademark Office



**Reg. No. 4,124,158**

**Registered Apr. 10, 2012**

**Int. Cl.: 35**

**SERVICE MARK**

**PRINCIPAL REGISTER**

CROWD SOURCE CREATIVES, LLC (HAWAII LIMITED LIABILITY COMPANY)  
866 IWILEI ROAD  
SUITE 234  
HONOLULU, HI 96817

FOR: ADVERTISING SERVICES, NAMELY, PROVIDING A WEBSITE FOR THE CREATION OF ADVERTISING, MARKETING AND RETAIL MATERIALS FOR OTHERS, IN CLASS 35 (U.S. CLS. 100, 101 AND 102).

FIRST USE 2-1-2010; IN COMMERCE 2-15-2011.

NO CLAIM IS MADE TO THE EXCLUSIVE RIGHT TO USE "AD", APART FROM THE MARK AS SHOWN.

THE COLOR(S) GREEN, BLACK, WHITE AND GRAY IS/ARE CLAIMED AS A FEATURE OF THE MARK.

THE MARK CONSISTS OF THE WORD "ADTOURNAMENT" IN GREEN COLOR WHEREIN THERE IS A SOLDIER LIKE IMAGE HAVING A PENCIL AS A WEAPON IN HIS HAND IN BLACK COLOR WITH A SHIELD IN GRAY AND WHITE COLOR HAVING GREEN COLOR BORDER IS PLACED BETWEEN THE LETTERS "AD" AND "TOURNAMENT" AS SHOWN IN THE MARK.

SER. NO. 85-247,860, FILED 2-22-2011.

ALEXANDER L. POWERS, EXAMINING ATTORNEY



*David J. Kyffers*

Director of the United States Patent and Trademark Office

# United States of America

United States Patent and Trademark Office



**Reg. No. 4,124,159**

**Registered Apr. 10, 2012**

**Int. Cl.: 43**

**SERVICE MARK**

**PRINCIPAL REGISTER**

?MOSES RESTAURANT (ISRAEL PARTNERSHIP)  
35 ROTHSHILD BLV.  
TEL AVIV, ISRAEL 66883

FOR: PROVIDING OF FOOD AND DRINK; RESTAURANT SERVICES, IN CLASS 43 (U.S. CLS. 100 AND 101).

OWNER OF ISRAEL REG. NO. 192206, DATED 4-6-2008, EXPIRES 7-26-2016.

THE COLOR(S) BLACK, WHITE AND RED IS/ARE CLAIMED AS A FEATURE OF THE MARK.

THE MARK CONSISTS OF THE FOLLOWING: A DESIGN OF THE HEAD OF A SMILING CAT WITH A RED NOSE, BLACK HEAD AND EARS, BLACK AND WHITE EYES, WHITE TONGUE WITH A BLACK ZIG-ZAG LINE IN THE MIDDLE, AND WHITE LIPS WITH BLACK DOTS ON THEIR UPPER PART.

SER. NO. 85-247,896, FILED 2-22-2011.

ALICE BENMAMAN, EXAMINING ATTORNEY



*David J. Kyffers*

Director of the United States Patent and Trademark Office

# United States of America

United States Patent and Trademark Office

## CREMATION SOCIETY OF TEXAS

**Reg. No. 4,124,160**

CARING FUNERAL SERVICES LIMITED PARTNERSHIP (TEXAS LIMITED PARTNERSHIP)  
7723 BEECHNUT  
HOUSTON, TX 77075

**Registered Apr. 10, 2012**

**Int. Cls.: 40 and 45**

FOR: CREMATION SERVICES, IN CLASS 40 (U.S. CLS. 100, 103 AND 106).

**SERVICE MARK**

FIRST USE 9-2-2002; IN COMMERCE 9-2-2002.

**PRINCIPAL REGISTER**

FOR: FUNERAL SERVICE UNDERTAKING; FUNERAL SERVICES ACCOMPANYING  
CREMATION, IN CLASS 45 (U.S. CLS. 100 AND 101).

FIRST USE 9-2-2002; IN COMMERCE 9-2-2002.

THE MARK CONSISTS OF STANDARD CHARACTERS WITHOUT CLAIM TO ANY PARTICULAR FONT, STYLE, SIZE, OR COLOR.

NO CLAIM IS MADE TO THE EXCLUSIVE RIGHT TO USE "CREMATION", APART FROM THE MARK AS SHOWN.

SEC. 2(F).

SER. NO. 85-247,952, FILED 2-22-2011.

KATHERINE CONNOLLY, EXAMINING ATTORNEY



*David J. Kybas*

Director of the United States Patent and Trademark Office

# United States of America

United States Patent and Trademark Office

## THE NEW WAY TO X-RAY

**Reg. No. 4,124,161**

**Registered Apr. 10, 2012**

**Int. Cl.: 37**

**SERVICE MARK**

**PRINCIPAL REGISTER**

GROUND PENETRATING RADAR SYSTEMS, INC. (OHIO CORPORATION)  
8534 WEST CENTRAL AVENUE  
SYLVANIA, OH 43560

FOR: SERVICES AUXILIARY TO BUILDING CONSTRUCTION AND REPAIR, NAMELY, PROVIDING CRITICAL INFORMATION ON UTILITIES, MATERIALS, AND OTHER POTENTIAL OBSTRUCTIONS WITHIN STRUCTURES OR UNDERGROUND THROUGH X-RAY TECHNOLOGY WHICH AIDS IN THE MAKING OR REPAIRING OF PERMANENT STRUCTURES, IN CLASS 37 (U.S. CLS. 100, 103 AND 106).

FIRST USE 8-1-2009; IN COMMERCE 8-1-2009.

THE MARK CONSISTS OF STANDARD CHARACTERS WITHOUT CLAIM TO ANY PARTICULAR FONT, STYLE, SIZE, OR COLOR.

SER. NO. 85-247,956, FILED 2-22-2011.

TRICIA SONNEBORN, EXAMINING ATTORNEY



*David J. Kyffers*

Director of the United States Patent and Trademark Office

# United States of America

United States Patent and Trademark Office

## HOME OF THE SMALL DOWN PAYMENT

**Reg. No. 4,124,162**

EASY AUTO CREDIT, INC. (TENNESSEE CORPORATION)  
1800 MT. VERNON DRIVE NW  
CLEVELAND, TN 37311

**Registered Apr. 10, 2012**

**Int. Cls.: 35 and 36**

FOR: DEALERSHIPS IN THE FIELD OF USED CARS, IN CLASS 35 (U.S. CLS. 100, 101 AND 102).

**SERVICE MARK**

FIRST USE 2-0-2004; IN COMMERCE 2-0-2004.

**PRINCIPAL REGISTER**

FOR: FINANCING RELATING TO AUTOMOBILES, IN CLASS 36 (U.S. CLS. 100, 101 AND 102).

FIRST USE 2-0-2004; IN COMMERCE 2-0-2004.

THE MARK CONSISTS OF STANDARD CHARACTERS WITHOUT CLAIM TO ANY PARTICULAR FONT, STYLE, SIZE, OR COLOR.

NO CLAIM IS MADE TO THE EXCLUSIVE RIGHT TO USE "SMALL DOWN PAYMENT", APART FROM THE MARK AS SHOWN.

SER. NO. 85-247,961, FILED 2-22-2011.

LINDA ORNDORFF, EXAMINING ATTORNEY



*David J. Kybas*

Director of the United States Patent and Trademark Office



# United States of America

United States Patent and Trademark Office

# WALK ON

**Reg. No. 4,124,163**

**Registered Apr. 10, 2012**

**Int. Cl.: 35**

**SERVICE MARK**

**PRINCIPAL REGISTER**

BENNETT, STORM (UNITED STATES INDIVIDUAL), AKA STORM BENNETT  
463 OHIO PIKE, SUITE 206  
CINCINNATI, OH 45255

FOR: ADVERTISING AND PUBLICITY SERVICES, NAMELY, PROMOTING THE GOODS, SERVICES, BRAND IDENTITY, COMMERCIAL INFORMATION AND NEWS OF THIRD PARTIES THROUGH THE USE OF CUSTOMIZED VIDEOS AND ANIMATIONS TRANSMITTED OVER A COMPUTER NETWORK, IN CLASS 35 (U.S. CLS. 100, 101 AND 102).

FIRST USE 3-20-2008; IN COMMERCE 6-1-2008.

THE MARK CONSISTS OF STANDARD CHARACTERS WITHOUT CLAIM TO ANY PARTICULAR FONT, STYLE, SIZE, OR COLOR.

SER. NO. 85-248,209, FILED 2-22-2011.

TIMOTHY FINNEGAN, EXAMINING ATTORNEY



*David J. Kyros*

Director of the United States Patent and Trademark Office

**United States of America**  
United States Patent and Trademark Office

**SASSEEZ**

**Reg. No. 4,124,164**

**Registered Apr. 10, 2012**

**Int. Cls.: 9 and 14**

**TRADEMARK**

**PRINCIPAL REGISTER**

ELKINS, KARI LYNN (UNITED STATES INDIVIDUAL), DBA ELKINS, KARI LYNN  
9527 CANYON PASS DRIVE  
HAMILTON, OH 45011

FOR: PROTECTIVE DEVICE FOR ATHLETIC USE IN THE NATURE OF ELASTIC INSERTS THAT COVER THE DERMAL OPENINGS OF BODY PIERCINGS, IN CLASS 9 (U.S. CLS. 21, 23, 26, 36 AND 38).

FIRST USE 9-1-2010; IN COMMERCE 1-1-2011.

FOR: BODY PIERCING JEWELRY, IN CLASS 14 (U.S. CLS. 2, 27, 28 AND 50).

FIRST USE 9-1-2010; IN COMMERCE 1-1-2011.

THE MARK CONSISTS OF STANDARD CHARACTERS WITHOUT CLAIM TO ANY PARTICULAR FONT, STYLE, SIZE, OR COLOR.

SER. NO. 85-248,238, FILED 2-22-2011.

CHRISTOPHER BUONGIORNO, EXAMINING ATTORNEY



*David J. Kybas*

Director of the United States Patent and Trademark Office

# United States of America

United States Patent and Trademark Office

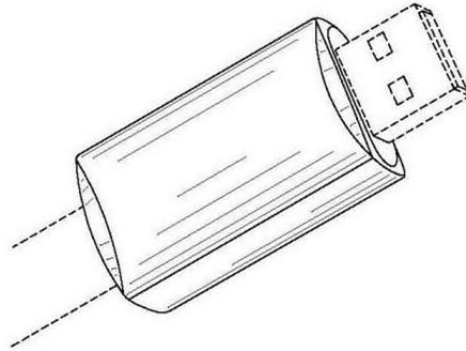

**Reg. No. 4,124,165**

**Registered Apr. 10, 2012**

**Int. Cl.: 9**

**TRADEMARK**

**PRINCIPAL REGISTER**

WIREWORLD BY DAVID SALZ, INC. (FLORIDA CORPORATION)  
6545 NOVA DRIVE #204  
DAVIE, FL 33317

FOR: HIGH DEFINITION MULTIMEDIA DIGITAL VIDEO AND AUDIO CABLES, UNIVERSAL SERIAL BUS CABLES, SPEAKER CABLES AND POWER CORDS, IN CLASS 9 (U.S. CLS. 21, 23, 26, 36 AND 38).

FIRST USE 9-30-2005; IN COMMERCE 9-30-2005.

THE MARK CONSISTS OF A THREE-DIMENSIONAL PRODUCT CONFIGURATION OF A CONNECTOR FOR ELECTRONIC CABLES. THE MARK FEATURES A GENERALLY RECTANGULAR CONNECTOR WITH SLIGHT CURVATURE ALONG THE TOP, BOTTOM AND SIDES, SEMI-SPHERICAL BEVELED EDGES AND A CURVED SURFACE AT ONE END. THE LINING SHOWN IN THE DRAWING IS FOR SHADING AND CONTOUR PURPOSES ONLY. THE MATERIAL SHOWN IN THE BROKEN LINES SERVICES ONLY TO SHOW THE POSITION OF THE MARK ON THE GOODS AND DOES NOT FORM A PART OF THE MARK.

SEC. 2(F).

SER. NO. 85-248,407, FILED 2-22-2011.

FRANK LATTUCA, EXAMINING ATTORNEY



*David J. Kybas*

Director of the United States Patent and Trademark Office

# United States of America

United States Patent and Trademark Office



**Reg. No. 4,124,166**

**Registered Apr. 10, 2012**

**Int. Cls.: 31 and 35**

**TRADEMARK**

**SERVICE MARK**

**PRINCIPAL REGISTER**

DIRECTOR-GENERAL OF AGRICULTURAL PRODUCTION BUREAU OF MINISTRY OF AGRICULTURE, FORESTRY AND FISHERIES (JAPAN GOVERNMENT AGENCY)  
1-2-1 KASUMIGASEKI, CHIYODA-KU  
TOKYO, JAPAN

FOR: FRESH FRUITS PRODUCED IN JAPAN, IN CLASS 31 (U.S. CLS. 1 AND 46).

FOR: RETAIL STORE SERVICES AND WHOLESALE STORE SERVICES FEATURING FRUITS PRODUCED IN JAPAN, IN CLASS 35 (U.S. CLS. 100, 101 AND 102).

OWNER OF JAPAN REG. NO. 5201838, DATED 2-6-2009, EXPIRES 2-6-2019.

THE COLOR(S) GREEN, OLIVE, RED AND WHITE IS/ARE CLAIMED AS A FEATURE OF THE MARK.

THE NON-LATIN CHARACTERS IN THE MARK TRANSLITERATE TO "NI HON SAN KA JITSU" AND THIS MEANS "FRUITS PRODUCED IN JAPAN" IN ENGLISH.

NO CLAIM IS MADE TO THE EXCLUSIVE RIGHT TO USE "JAPAN QUALITY", "JAPANESE FRUIT", OR THE NON-LATIN CHARACTERS THAT TRANSLITERATE TO "NI HON SAN KA JITSU", APART FROM THE MARK AS SHOWN.



THE MARK CONSISTS OF A MOUNTAIN DESIGN IN WHITE AND OLIVE WITH WHITE JAPANESE CHARACTERS APPEARING AT THE BASE OF THE MOUNTAIN DESIGN, SURROUNDED BY A RED CIRCULAR CARRIER WITH THE WORDING "JAPAN QUALITY" IN WHITE APPEARING AT THE BOTTOM OF THE CIRCULAR CARRIER AND A WHITE CIRCLE APPEARING AROUND THE RED CIRCULAR CARRIER, WITH THE IMAGE OF TWO GREEN AND WHITE LEAVES APPEARING TO THE RIGHT OF THE MOUNTAIN DESIGN, AND WITH AN OLIVE-COLORED CIRCULAR BAND APPEARING AROUND ALL OF THE FOREGOING WITH THE WORDING "JAPANESE FRUIT" IN WHITE APPEARING WITHIN THE OLIVE CIRCULAR BAND.

SER. NO. 85-248,429, FILED 2-22-2011.

*David J. Kappas*

ANDREW LEASER, EXAMINING ATTORNEY

# United States of America

United States Patent and Trademark Office

# DURAC

**Reg. No. 4,124,167**

**Registered Apr. 10, 2012**

**Int. Cls.: 9, 11 and 14**

**TRADEMARK**

**PRINCIPAL REGISTER**

H-B INSTRUMENT COMPANY (PENNSYLVANIA CORPORATION)  
102 WEST SEVENTH AVENUE  
TRAPPE, PA 194260770

FOR: THERMOMETERS; CLINICAL THERMOMETERS; INFRA-RED THERMOMETERS; BAROMETERS AND ANEMOMETERS; DIGITAL INDOOR AND OUTDOOR WEATHER STATION SYSTEM COMPRISED OF WIRELESS REMOTE AIR TEMPERATURE SENSOR, HUMIDITY SENSOR, WIND DIRECTION SENSOR, PRECIPITATION SENSOR, LCD ALARM CLOCK SOLD AS A UNIT; HYGROMETERS; HUMIDITY MEASURING INSTRUMENTS, NAMELY, ELECTRONIC INSTRUMENTS WITH THERMOMETER, NAMELY, ELECTRONIC THERMOMETERS; PSYCHROMETERS; TIMERS; ELECTRONIC TIMERS; HYDROMETERS; AND ACCESSORIES FOR ALL THE AFOREMENTIONED GOODS, NAMELY, TRAYS AND CASES SPECIALLY ADAPTED FOR HOLDING OR CARRYING THERMOMETERS, IN CLASS 9 (U.S. CLS. 21, 23, 26, 36 AND 38).

FIRST USE 12-7-1926; IN COMMERCE 12-7-1926.

FOR: FLASHLIGHTS, IN CLASS 11 (U.S. CLS. 13, 21, 23, 31 AND 34).

FIRST USE 12-7-1926; IN COMMERCE 2-26-2010.

FOR: CLOCKS; STOPWATCHES, IN CLASS 14 (U.S. CLS. 2, 27, 28 AND 50).

FIRST USE 12-7-1926; IN COMMERCE 2-26-2010.

THE MARK CONSISTS OF STANDARD CHARACTERS WITHOUT CLAIM TO ANY PARTICULAR FONT, STYLE, SIZE, OR COLOR.

OWNER OF U.S. REG. NOS. 1,300,294 AND 3,476,379.

SER. NO. 85-248,464, FILED 2-22-2011.

DEIRDRE ROBERTSON, EXAMINING ATTORNEY



*David J. Kyffers*

Director of the United States Patent and Trademark Office

# United States of America

United States Patent and Trademark Office

## e-Key

**Reg. No. 4,124,168**

**Registered Apr. 10, 2012**

**Int. Cl.: 42**

**SERVICE MARK**

**PRINCIPAL REGISTER**

STENOGRAPH (DELAWARE LIMITED LIABILITY COMPANY)  
596 W. LAMONT ROAD  
ELMHURST, IL 60126

FOR: PROVIDING PERIODIC USE OF A TEMPORARY WEB-BASED SOFTWARE APPLICATION FOR DONGLE-FREE SOFTWARE SECURITY AND USER ACCESS TO THE APPLICANT'S CASE CATALYST SOFTWARE, IN CLASS 42 (U.S. CLS. 100 AND 101).

FIRST USE 9-17-2010; IN COMMERCE 12-1-2010.

THE MARK CONSISTS OF STANDARD CHARACTERS WITHOUT CLAIM TO ANY PARTICULAR FONT, STYLE, SIZE, OR COLOR.

SER. NO. 85-248,480, FILED 2-22-2011.

NATALIE POLZER, EXAMINING ATTORNEY



*David J. Kyjars*

Director of the United States Patent and Trademark Office

# United States of America

United States Patent and Trademark Office



**Reg. No. 4,124,169**

**Registered Apr. 10, 2012**

**Int. Cl.: 43**

**SERVICE MARK**

**PRINCIPAL REGISTER**

JUICY BURGER SHAKES N FRIES, LLC (CALIFORNIA LIMITED LIABILITY COMPANY)  
P.O. BOX 16325  
BEVERLY HILLS, CA 90209

FOR: FAST FOOD AND NON-STOP RESTAURANT SERVICES; RESTAURANT SERVICES;  
RESTAURANT SERVICES, INCLUDING SIT-DOWN SERVICE OF FOOD AND TAKE-OUT  
RESTAURANT SERVICES, IN CLASS 43 (U.S. CLS. 100 AND 101).

FIRST USE 12-10-2010; IN COMMERCE 1-12-2011.

NO CLAIM IS MADE TO THE EXCLUSIVE RIGHT TO USE "JUICY BURGER SHAKES-N-FRIES" AND THE DESIGN OF HAMBURGER, APART FROM THE MARK AS SHOWN.

THE COLOR(S) ORANGE, BROWN, RED AND GREEN IS/ARE CLAIMED AS A FEATURE OF THE MARK.

THE MARK CONSISTS OF A STYLIZED BROWN, RED, ORANGE AND GREEN HAMBURGER ADJACENT TO THE STYLIZED WORDS "JUICY" BURGER SHAKES-N-FRIES" IN WHICH "JUICY" IS IN ORANGE IN-BETWEEN TWO ORANGE DRIPS AND ON TOP OF "BURGER" WHICH IS IN RED, ON TOP OF A RED BOX WITH THE WORDS "SHAKES-N-FRIES" IN WHITE.

SER. NO. 85-248,494, FILED 2-22-2011.

ZACHARY BELLO, EXAMINING ATTORNEY



*David J. Kyjars*

Director of the United States Patent and Trademark Office

# United States of America

United States Patent and Trademark Office

## APPRECIATION ENGINE

**Reg. No. 4,124,170**

**Registered Apr. 10, 2012**

**Int. Cls.: 42 and 45**

**SERVICE MARK**

**PRINCIPAL REGISTER**

GOLDEN TICKET LIMITED (NEW ZEALAND CORPORATION)  
5A RIDDIFORD STREET, NEWTOWN  
WELLINGTON, NEW ZEALAND

FOR: PROVIDING TEMPORARY USE OF NON-DOWNLOADABLE SOFTWARE THAT RECORDS, MANIPULATES, AND/OR EXTENDS THE RECORD OF A PERSON'S LIKES AND DISLIKES, IN CLASS 42 (U.S. CLS. 100 AND 101).

FOR: PERSONAL AND SOCIAL SERVICES RENDERED BY OTHERS TO MEET THE NEEDS OF INDIVIDUALS, NAMELY ON-LINE SOCIAL NETWORKING SERVICES FOR RECORDING, MANIPULATING, AND/OR EXTENDING AN ONLINE RECORD OF A PERSON'S LIKES AND DISLIKES, IN CLASS 45 (U.S. CLS. 100 AND 101).

THE MARK CONSISTS OF STANDARD CHARACTERS WITHOUT CLAIM TO ANY PARTICULAR FONT, STYLE, SIZE, OR COLOR.

OWNER OF NEW ZEALAND REG. NO. 828903, DATED 2-16-2011, EXPIRES 8-16-2020.

NO CLAIM IS MADE TO THE EXCLUSIVE RIGHT TO USE "ENGINE", APART FROM THE MARK AS SHOWN.

SER. NO. 85-248,582, FILED 2-22-2011.

CARRIE GENOVESE, EXAMINING ATTORNEY



*David J. Kybas*

Director of the United States Patent and Trademark Office



# United States of America

United States Patent and Trademark Office

# Patio Heaven

**Reg. No. 4,124,171**

AXCSS INC (CALIFORNIA CORPORATION), AKA PATIO HEAVEN  
15000 S. FIGUEROA ST.  
GARDENA, CA 90248

**Registered Apr. 10, 2012**

**Int. Cl.: 20**

FOR: PATIO FURNITURE, IN CLASS 20 (U.S. CLS. 2, 13, 22, 25, 32 AND 50).

**TRADEMARK**

FIRST USE 1-1-2008; IN COMMERCE 1-1-2008.

**PRINCIPAL REGISTER**

THE MARK CONSISTS OF STANDARD CHARACTERS WITHOUT CLAIM TO ANY PARTICULAR FONT, STYLE, SIZE, OR COLOR.

NO CLAIM IS MADE TO THE EXCLUSIVE RIGHT TO USE "PATIO", APART FROM THE MARK AS SHOWN.

SER. NO. 85-248,602, FILED 2-22-2011.

HEATHER THOMPSON, EXAMINING ATTORNEY



*David J. Kybas*

Director of the United States Patent and Trademark Office

# United States of America

United States Patent and Trademark Office



**Reg. No. 4,124,172**

**Registered Apr. 10, 2012**

**Int. Cl.: 41**

**SERVICE MARK**

**PRINCIPAL REGISTER**

AMERICAN KETTLEBELL CLUB, LLC (OHIO LIMITED LIABILITY COMPANY), AKA  
AMERICAN KETTLEBELL CLUB  
6488 LIBERTY KNOLL DRIVE  
HAMILTON, OH 45011

FOR: ATHLETIC AND SPORTS EVENT SERVICES, NAMELY, ARRANGING, ORGANIZING,  
OPERATING AND CONDUCTING EXERCISE AND FITNESS PROGRAMS AND COMPETI-  
TIONS INCORPORATING KETTLEBELLS, IN CLASS 41 (U.S. CLS. 100, 101 AND 107).

FIRST USE 12-18-2006; IN COMMERCE 12-18-2006.

OWNER OF U.S. REG. NO. 3,649,323.

THE COLOR(S) RED, WHITE AND BLUE IS/ARE CLAIMED AS A FEATURE OF THE MARK.

THE MARK CONSISTS OF A BLUE KETTLEBELL; WHITE STARS APPEAR ON THE  
HANDLE OF THE KETTLEBELL; THE SPHERICAL PORTION OF THE KETTLEBELL IN-  
CLUDES WHITE STARS AND A MUSCULAR FIGURE WITH A WHITE HEAD AND WHITE  
HAND, CONNECTED BY AN ARM OF ALTERNATING RED AND WHITE STRIPES.

SER. NO. 85-248,652, FILED 2-22-2011.

TINA L. SNAPP, EXAMINING ATTORNEY



*David J. Kyjars*

Director of the United States Patent and Trademark Office

# United States of America

United States Patent and Trademark Office

# TENARIS

**Reg. No. 4,124,173**

**Registered Apr. 10, 2012**

**Int. Cls.: 16 and 39**

**TRADEMARK**

**SERVICE MARK**

**PRINCIPAL REGISTER**

TENARIS CONNECTIONS BV (NETHERLANDS COMPANY)  
1076 AZ  
LOCATELLIKADE 1,  
AMSERDAM, NETHERLANDS

FOR: PAPER GOODS AND PRINTED MATTER, NAMELY, PERIODICAL PUBLICATIONS IN THE FORM OF NEWSLETTERS RELATED TO THE PIPE INDUSTRY AND ITS MARKETS, IN CLASS 16 (U.S. CLS. 2, 5, 22, 23, 29, 37, 38 AND 50).

FIRST USE 10-16-2001; IN COMMERCE 10-16-2001.

FOR: TRANSPORTATION SERVICES, NAMELY, FREIGHT FORWARDING; FREIGHT TRANSPORTATION BY TRUCK, TRAIN, AIR AND WATER VESSELS; CARGO HANDLING; RENTAL OF WAREHOUSE SPACE, AND WAREHOUSING SERVICES, IN CLASS 39 (U.S. CLS. 100 AND 105).

FIRST USE 5-6-2002; IN COMMERCE 5-6-2002.

THE MARK CONSISTS OF STANDARD CHARACTERS WITHOUT CLAIM TO ANY PARTICULAR FONT, STYLE, SIZE, OR COLOR.

OWNER OF U.S. REG. NOS. 2,679,032, 2,838,964, AND 3,072,461.

SER. NO. 85-248,673, FILED 2-22-2011.

DAVID ELTON, EXAMINING ATTORNEY



*David J. Kyfos*

Director of the United States Patent and Trademark Office

# United States of America

United States Patent and Trademark Office



**Reg. No. 4,124,174**

**Registered Apr. 10, 2012**

**Int. Cl.: 1**

**TRADEMARK**

**PRINCIPAL REGISTER**

FLORADIS ENTERPRISES, INC. (MARYLAND CORPORATION)  
2884 SPRING LAKES DRIVE  
DAVIDSONVILLE, MD 21035

FOR: FERTILIZERS, IN CLASS 1 (U.S. CLS. 1, 5, 6, 10, 26 AND 46).

FIRST USE 2-15-2000; IN COMMERCE 2-15-2000.

NO CLAIM IS MADE TO THE EXCLUSIVE RIGHT TO USE "TURF", APART FROM THE MARK AS SHOWN.

THE COLOR(S) PURPLE AND TEAL IS/ARE CLAIMED AS A FEATURE OF THE MARK.

THE MARK CONSISTS OF A BROKEN ELLIPSE IN PURPLE WITH THE WORDS "TURF" AND "TRUST" IN TEAL. THE WORD "TURF" IS BISECTED BY THE BROKEN ELLIPSE AND THE WORD "TRUST" SITS INSIDE THE ELLIPSE.

SER. NO. 85-248,830, FILED 2-22-2011.

REBECCA EISINGER, EXAMINING ATTORNEY



*David J. Kyfos*

Director of the United States Patent and Trademark Office

# United States of America

United States Patent and Trademark Office



**Reg. No. 4,124,175**

FLORADIS ENTERPRISES, INC. (MARYLAND CORPORATION)  
2884 SPRING LAKES DRIVE  
DAVIDSONVILLE, MD 21035

**Registered Apr. 10, 2012**

**Int. Cl.: 1**

FOR: FERTILIZERS, IN CLASS 1 (U.S. CLS. 1, 5, 6, 10, 26 AND 46).

**TRADEMARK**

FIRST USE 7-10-2000; IN COMMERCE 7-10-2000.

**PRINCIPAL REGISTER**

NO CLAIM IS MADE TO THE EXCLUSIVE RIGHT TO USE "PLANT", APART FROM THE MARK AS SHOWN.

THE COLOR(S) PURPLE AND GOLD IS/ARE CLAIMED AS A FEATURE OF THE MARK.

THE MARK CONSISTS OF A BROKEN ELLIPSE IN PURPLE WITH THE WORDS "PLANT" AND "TRUST" IN GOLD. THE WORD "PLANT" IS BISECTED BY THE BROKEN ELLIPSE AND THE WORD "TRUST" SITS INSIDE THE ELLIPSE.

SER. NO. 85-248,855, FILED 2-22-2011.

REBECCA EISINGER, EXAMINING ATTORNEY



*David J. Kyffers*

Director of the United States Patent and Trademark Office

# United States of America

United States Patent and Trademark Office



**Reg. No. 4,124,176**

**Registered Apr. 10, 2012**

**Int. Cl.: 20**

**TRADEMARK**

**PRINCIPAL REGISTER**

ORION ORNAMENTAL IRON, INC. (CALIFORNIA CORPORATION)  
6918 TUJUNGA AVE  
NORTH HOLLYWOOD, CA 91605

FOR: DECORATIVE DRAPERY HARDWARE, NAMELY, CURTAIN RAILS, CURTAIN RODS, CURTAIN RAIL AND CURTAIN ROD CEILING SUPPORTS, SPACER SUPPORTS, CURTAIN HOOKS, CURTAIN RINGS, RUNNERS, END STOPS FOR CURTAIN RAILS AND CURTAIN RODS, FINIALS, MANUALLY OPERATED MECHANISMS FOR OPENING AND CLOSING CURTAINS, SLATS AND BLINDS, IN CLASS 20 (U.S. CLS. 2, 13, 22, 25, 32 AND 50).

FIRST USE 0-0-2010; IN COMMERCE 0-0-2010.

OWNER OF U.S. REG. NOS. 3,721,487, 3,721,488, AND 3,799,110.

NO CLAIM IS MADE TO THE EXCLUSIVE RIGHT TO USE "DESIGN ART", APART FROM THE MARK AS SHOWN.

THE MARK CONSISTS OF THE STYLIZED WORD "DESIGN" ABOVE THE STYLIZED WORD "ART". TO THE RIGHT OF THE WORD "ART" ARE THE WORDS "BY ORION" IN STYLIZED FONT. BEHIND THE DESCRIBED WORDS IS A DRAWING OF A DECORATIVE CURTAIN ROD AND END CAP.

SER. NO. 85-248,861, FILED 2-22-2011.

REBECCA EISINGER, EXAMINING ATTORNEY



*David J. Kyjars*

Director of the United States Patent and Trademark Office

# United States of America

United States Patent and Trademark Office

## International Fight Showdown

**Reg. No. 4,124,177**

**Registered Apr. 10, 2012**

**Int. Cls.: 25 and 41**

**TRADEMARK**

**SERVICE MARK**

**PRINCIPAL REGISTER**

SHILATI, SHAWN (UNITED STATES INDIVIDUAL)  
P.O. BOX 5778  
GARDEN GROVE, CA 92846

FOR: PROMOTIONAL AND SOUVENIR GOODS, NAMELY, SHIRTS AND HATS, IN CLASS 25 (U.S. CLS. 22 AND 39).

FIRST USE 3-10-2010; IN COMMERCE 3-10-2010.

FOR: ORGANIZE AND PRODUCE MARTIAL ARTS COMPETITIONS AND DEMONSTRATION EVENTS, IN CLASS 41 (U.S. CLS. 100, 101 AND 107).

FIRST USE 3-10-2010; IN COMMERCE 3-10-2010.

THE MARK CONSISTS OF STANDARD CHARACTERS WITHOUT CLAIM TO ANY PARTICULAR FONT, STYLE, SIZE, OR COLOR.

NO CLAIM IS MADE TO THE EXCLUSIVE RIGHT TO USE "INTERNATIONAL FIGHT", APART FROM THE MARK AS SHOWN.

SER. NO. 85-248,887, FILED 2-22-2011.

WILLIAM VERHOSEK, EXAMINING ATTORNEY



*David J. Kypos*

Director of the United States Patent and Trademark Office

# United States of America

United States Patent and Trademark Office

## There's an Ab for that

**Reg. No. 4,124,178**

GENETEX ASIA LTD (TAIWAN CORPORATION)

**Registered Apr. 10, 2012**

6F-2, NO.89, DONGMEI RD  
HSINCHU CITY, TAIWAN 300

**Int. Cl.: 1**

FOR: REAGENTS FOR SCIENTIFIC OR MEDICAL RESEARCH USE, IN CLASS 1 (U.S. CLS. 1, 5, 6, 10, 26 AND 46).

**TRADEMARK**

FIRST USE 2-21-2011; IN COMMERCE 7-29-2011.

**PRINCIPAL REGISTER**

THE MARK CONSISTS OF STANDARD CHARACTERS WITHOUT CLAIM TO ANY PARTICULAR FONT, STYLE, SIZE, OR COLOR.

SER. NO. 85-248,970, FILED 2-22-2011.

MICHAEL GAAFAR, EXAMINING ATTORNEY



*David J. Kybas*

Director of the United States Patent and Trademark Office



# United States of America

United States Patent and Trademark Office

## THE MUSIC TIN

**Reg. No. 4,124,179**

PWM E-TAIL INC (DELAWARE CORPORATION)  
1842 WILLIAM PENN WAY  
LANCASTER, PA 17601

**Registered Apr. 10, 2012**

**Int. Cl.: 9**

FOR: EMBOSSED TIN CASES FOR HOLDING CDS AND DVDS, IN CLASS 9 (U.S. CLS. 21, 23, 26, 36 AND 38).

**TRADEMARK**

FIRST USE 3-1-2008; IN COMMERCE 3-1-2008.

**PRINCIPAL REGISTER**

THE MARK CONSISTS OF STANDARD CHARACTERS WITHOUT CLAIM TO ANY PARTICULAR FONT, STYLE, SIZE, OR COLOR.

NO CLAIM IS MADE TO THE EXCLUSIVE RIGHT TO USE "TIN", APART FROM THE MARK AS SHOWN.

SER. NO. 85-249,076, FILED 2-23-2011.

KRISTIN CARLSON, EXAMINING ATTORNEY



*David J. Kyffers*

Director of the United States Patent and Trademark Office

# United States of America

United States Patent and Trademark Office

## Doctor Manuka

**Reg. No. 4,124,180**

**Registered Apr. 10, 2012**

**Int. Cl.: 30**

HONEY NEW ZEALAND (INTERNATIONAL) LIMITED (NEW ZEALAND PRIVATE LIMITED COMPANY)  
UNITS 5 AND 6A  
114 ST. GEORGES BAY ROAD  
PARNELL, AUCKLAND, NEW ZEALAND

**TRADEMARK**

**PRINCIPAL REGISTER**

FOR: MANUKA HONEY, PROPOLIS AND ROYAL JELLY FOR HUMAN CONSUMPTION; BREAD; BISCUITS; CEREAL PREPARATIONS FOR BREAKFAST; SAUCES; SALAD DRESSINGS; SPREADS CONTAINING MANUKA HONEY, MANUKA OIL, AND NATIVE NEW ZEALAND FLORA OIL; CONFECTIONERY, NAMELY, CANDY, CANDY BARS, LOLLIPOPS, CHOCOLATES AND MINTS; CEREAL-BASED SNACK FOOD; RICE-BASED SNACK FOOD; TEAS; TEAS CONTAINING MANUKA HONEY, PROPOLIS, ROYAL JELLY AND POLLEN, MANUKA OIL, AND NATIVE NEW ZEALAND FLORA OIL; HERBAL INFUSIONS, IN CLASS 30 (U.S. CL. 46).

THE MARK CONSISTS OF STANDARD CHARACTERS WITHOUT CLAIM TO ANY PARTICULAR FONT, STYLE, SIZE, OR COLOR.

OWNER OF NEW ZEALAND REG. NO. 828779, DATED 8-12-2010, EXPIRES 8-12-2020.

NO CLAIM IS MADE TO THE EXCLUSIVE RIGHT TO USE "MANUKA", APART FROM THE MARK AS SHOWN.

THE NAME "DOCTOR MANUKA" DOES NOT IDENTIFY A LIVING INDIVIDUAL.

SER. NO. 85-249,151, FILED 2-23-2011.

LESLEY LAMOTHE, EXAMINING ATTORNEY



*David J. Kyjars*

Director of the United States Patent and Trademark Office

# United States of America

United States Patent and Trademark Office

## Manuka Doctor

**Reg. No. 4,124,181**

**Registered Apr. 10, 2012**

**Int. Cl.: 30**

HONEY NEW ZEALAND (INTERNATIONAL) LIMITED (NEW ZEALAND PRIVATE LIMITED COMPANY)  
UNITS 5 & 6A  
114 ST. GEORGES BAY ROAD  
PARNELL, AUCKLAND, NEW ZEALAND

**TRADEMARK**

**PRINCIPAL REGISTER**

FOR: MANUKA HONEY, PROPOLIS AND ROYAL JELLY FOR HUMAN CONSUMPTION; BREAD; BISCUITS; CEREAL PREPARATIONS FOR BREAKFAST; SAUCES; SALAD DRESSINGS; SPREADS CONTAINING MANUKA HONEY, MANUKA OIL, AND NATIVE NEW ZEALAND FLORA OIL; CONFECTIONERY, NAMELY, CANDY, CANDY BARS, LOLLIPOPS, CHOCOLATES AND MINTS; CEREAL-BASED SNACK FOOD; RICE-BASED SNACK FOOD; TEAS; TEAS CONTAINING MANUKA HONEY, PROPOLIS, ROYAL JELLY AND POLLEN, MANUKA OIL, AND NATIVE NEW ZEALAND FLORA OIL; HERBAL INFUSIONS, IN CLASS 30 (U.S. CL. 46).

THE MARK CONSISTS OF STANDARD CHARACTERS WITHOUT CLAIM TO ANY PARTICULAR FONT, STYLE, SIZE, OR COLOR.

OWNER OF NEW ZEALAND REG. NO. 827658, DATED 7-22-2010, EXPIRES 7-22-2020.

NO CLAIM IS MADE TO THE EXCLUSIVE RIGHT TO USE "MANUKA", APART FROM THE MARK AS SHOWN.

SER. NO. 85-249,157, FILED 2-23-2011.

LESLEY LAMOTHE, EXAMINING ATTORNEY



*David J. Kyffers*

Director of the United States Patent and Trademark Office

# United States of America

United States Patent and Trademark Office

## DESSERT MATTERS

**Reg. No. 4,124,182**

**Registered Apr. 10, 2012**

**Int. Cls.: 30 and 40**

**TRADEMARK**

**SERVICE MARK**

**PRINCIPAL REGISTER**

MYERS, JULIA K (UNITED STATES INDIVIDUAL), DBA DESSERT MATTERS  
7076 DIXON AVE EAST  
DIXON, CA 95620

FOR: BAKERY DESSERTS; BUTTERCREAM FILLINGS FOR CAKES; CAKE FROSTING;  
CAKES; CUP CAKES; SPONGE CAKES, IN CLASS 30 (U.S. CL. 46).

FIRST USE 11-15-2010; IN COMMERCE 11-15-2010.

FOR: CUSTOM CAKE DECORATING SERVICES, IN CLASS 40 (U.S. CLS. 100, 103 AND  
106).

FIRST USE 11-15-2010; IN COMMERCE 11-15-2010.

THE MARK CONSISTS OF STANDARD CHARACTERS WITHOUT CLAIM TO ANY PAR-  
TICULAR FONT, STYLE, SIZE, OR COLOR.

NO CLAIM IS MADE TO THE EXCLUSIVE RIGHT TO USE "DESSERT", APART FROM  
THE MARK AS SHOWN.

SER. NO. 85-249,440, FILED 2-23-2011.

ALLISON SCHRODY, EXAMINING ATTORNEY

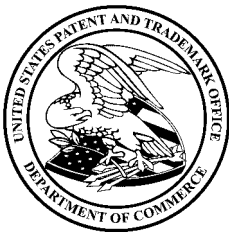

*David J. Kybas*

Director of the United States Patent and Trademark Office

# United States of America

United States Patent and Trademark Office

## Life Reference

**Reg. No. 4,124,183**

**Registered Apr. 10, 2012**

**Int. Cl.: 16**

**TRADEMARK**

**PRINCIPAL REGISTER**

CLINT PHARMACEUTICALS, INC. (TENNESSEE CORPORATION)  
629 SHUTE LANE  
OLD HICKORY, TN 37138

FOR: BOOKS IN THE FIELD OF CHRISTIAN SPIRITUAL GUIDANCE AS IT PERTAINS TO PARTICULARITIES OF OCCUPATION, CITIZENSHIP, HOBBIES, ATHLETICS AND INTERESTS , IN CLASS 16 (U.S. CLS. 2, 5, 22, 23, 29, 37, 38 AND 50).

FIRST USE 12-29-2006; IN COMMERCE 1-20-2007.

THE MARK CONSISTS OF STANDARD CHARACTERS WITHOUT CLAIM TO ANY PARTICULAR FONT, STYLE, SIZE, OR COLOR.

NO CLAIM IS MADE TO THE EXCLUSIVE RIGHT TO USE "REFERENCE", APART FROM THE MARK AS SHOWN.

SER. NO. 85-249,444, FILED 2-23-2011.

ALLISON SCHRODY, EXAMINING ATTORNEY



*David J. Kybas*

Director of the United States Patent and Trademark Office

# United States of America

United States Patent and Trademark Office

# PERQS

**Reg. No. 4,124,184**

**Registered Apr. 10, 2012**

**Int. Cl.: 43**

**SERVICE MARK**

**PRINCIPAL REGISTER**

QUALITY COMPANIES, INC., THE (FLORIDA CORPORATION), DBA PERQS COFFEE SERVICE  
1491 QUALITY WAY  
TALLAHASSEE, FL 32303

FOR: COFFEE SUPPLY SERVICES FOR OFFICES, IN CLASS 43 (U.S. CLS. 100 AND 101).

FIRST USE 11-20-2010; IN COMMERCE 11-20-2010.

THE MARK CONSISTS OF STANDARD CHARACTERS WITHOUT CLAIM TO ANY PARTICULAR FONT, STYLE, SIZE, OR COLOR.

SER. NO. 85-249,569, FILED 2-23-2011.

ALYSSA STEEL, EXAMINING ATTORNEY



*David J. Kybas*

Director of the United States Patent and Trademark Office

# United States of America

United States Patent and Trademark Office

## HOCHMEISTER

**Reg. No. 4,124,185**

**Registered Apr. 10, 2012**

**Int. Cls.: 9, 11, 19, 20, 21  
and 27**

HOCHTIEF AKTIENGESELLSCHAFT (FED REP GERMANY CORPORATION)  
OPERNPLATZ 2, UNTERNEHMENSZENTRALE  
ESSEN, FED REP GERMANY 45128

FOR: COMMUTATORS, PRESSURE SWITCHES FOR COMMERCIAL AND INDUSTRIAL EQUIPMENT, ELECTRIC SWITCHES, IN CLASS 9 (U.S. CLS. 21, 23, 26, 36 AND 38).

**TRADEMARK**

**PRINCIPAL REGISTER**

FOR: SANITARY APPARATUS AND INSTALLATIONS, NAMELY, BIDETS, SHOWERS, COMPLETE SHOWER CUBICLES, SHOWER HEADS AND TAPS, HANDLES FOR SHOWERS, BATH TUBS, TOILETS, TOILET BOWLS, TOILET SEATS, URINALS, SHOWER TUBS, WHIRLPOOL BATHS, BATH INSTALLATIONS, SINK TRAPS, SINK SPRAYERS; SINK UNITS, NAMELY, SINKS, SINK PEDESTALS, SINK TRAPS, SINK STRAINERS, SINK SPRAYERS; FLUSHING APPARATUS, NAMELY, AUTOMATIC FLUSH VALVES FOR TOILETS, FLUSH LEVERS; PARTITIONS FOR BATH TUBS OR SHOWERS, NAMELY, SHOWER STANDS, SHOWER PLATFORMS AND SHOWER SURROUNDS; TOILET FLUSHING TANKS; BATH AND SANITARY PLUMBING FITTINGS, NAMELY, AERATORS FOR FAUCETS, DRAINS, SPOUTS, SHOWER CONTROL VALVES AND SHOWER MIXERS; HAND HELD SHOWER HEADS; LIGHTS, NAMELY, CEILING LIGHTS, PENDANT LIGHT FIXTURES, STANDARD LAMPS AND WALL LIGHTS; HEATING APPARATUS, NAMELY, HEAT GENERATORS, HEAT PUMPS AND HEAT REGISTERS; HEATING INSTALLATIONS; RADIATORS; ELECTRICAL CONVECTORS, NAMELY, PORCELAIN STONEWARE HEATERS; ELECTRIC RADIANT HEATERS; ELECTRIC SPACE HEATERS; GAS WATER HEATERS; AIR-CONDITIONING INSTALLATIONS AND APPARATUS, IN CLASS 11 (U.S. CLS. 13, 21, 23, 31 AND 34).



FOR: FIGURINES AND STATUETTES OF STONE, CONCRETE OR MARBLE; WORKS OF ART OF STONE, CONCRETE OR MARBLE; NON-METALLIC BUILDING MATERIALS, NAMELY, PLASTIC PIPE SUPPORTS, FLY ASH, STAIR NOSINGS NOT OF METAL AND PRE-CAST CONCRETE WALL FORMS; GLAZED CERAMIC TILES; NATURAL STONE; ARTIFICIAL STONE; TILES, NOT OF METAL; NON-METALLIC WALL TILES; STONE PANELS FOR FLOORING; WALL PANELING; CEILING, FIREPLACE SURROUNDS, COUNTERTOPS AND FURNITURE; TILE FLOORING, NOT OF METAL; NON-METAL CERAMIC OR WOOD FLOOR TILES; NON-METALLIC DOORS AND DOOR FRAMES; GLASS DOORS, IN CLASS 19 (U.S. CLS. 1, 12, 33 AND 50).

*David J. Kybas*

Director of the United States Patent and Trademark Office

FOR: DOOR FITTINGS, NOT OF METAL; WINDOW FITTINGS, NOT OF METAL; WORKS OF ART OF WOOD, WAX, PLASTER OR PLASTIC; FIGURINES AND STATUETTES OF

**Reg. No. 4,124,185** WOOD, WAX, PLASTER OR PLASTIC; MIRRORS; MIRROR TILES; BATHROOM FURNITURE AND PARTS AND COMPONENTS THEREFORE; WASHSTANDS; FURNITURE, NAMELY, CHAIRS, ARMCHAIRS, CUPBOARDS, CHESTS OF DRAWERS, BEDS; TOWEL RACKS, IN CLASS 20 (U.S. CLS. 2, 13, 22, 25, 32 AND 50).

FOR: BATHING ACCESSORIES, NAMELY, SOAP DISPENSERS, WASTE BINS, BEAKERS, NAMELY, WIDE MOUTHED DRINKING CUPS FOR HOUSEHOLD USE, HAIR BRUSHES, NAIL BRUSHES, TOOTHBRUSHES, FLASKS, BOXES OF GLASS, BEVERAGE GLASSWARE, TOWEL RAILS AND TOWEL RINGS, COMBS; CERAMICS FOR HOUSEHOLD PURPOSES, NAMELY, KNOBS AND PULLS FOR CABINETS, DRAWERS AND FURNITURE; TISSUE BOX COVERS AND DECORATIVE TILE NOT FOR USE AS BUILDING MATERIALS; NON-METAL BASKETS FOR DOMESTIC USE; PERFUME VAPORIZERS SOLD EMPTY; PORCELAINWARE, NAMELY, CAKE DECORATIONS, FLOWER POTS, JARS FOR JAMS AND JELLIES AND DOORKNOBS; BRUSHES FOR SHAVING PURPOSES; STANDS FOR SHAVING BRUSHES; BASINS; SOAPBOXES, NON-METAL SOAP BASKETS; DISHES FOR SOAPS; CROCKERY, NAMELY, DISHES, PLATES, CUPS, SAUCERS, BOWLS, SERVING BOWLS AND TRAYS; TOILET PAPER HOLDERS, DISPENSERS FOR TOILET PAPER, POTTERY, NAMELY, DISHES, PLATES, CUPS, SAUCERS, BOWLS, SERVING BOWLS AND TRAYS; WASH-HAND BASINS; WORKS OF ART OF PORCELAIN, TERRA COTTA OR GLASS; FIGURINES AND STATUETTES OF PORCELAIN, TERRA COTTA OR GLASS; GLASS JARS, IN CLASS 21 (U.S. CLS. 2, 13, 23, 29, 30, 33, 40 AND 50).

FOR: NON-TEXTILE FLOOR COVERINGS AND WALL HANGINGS; CARPETS, RUGS, MATS AND MATTING; LINOLEUM FOR COVERING EXISTING FLOORS, IN CLASS 27 (U.S. CLS. 19, 20, 37, 42 AND 50).

THE MARK CONSISTS OF STANDARD CHARACTERS WITHOUT CLAIM TO ANY PARTICULAR FONT, STYLE, SIZE, OR COLOR.

OWNER OF ERPN CMNTY TM OFC REG. NO. 008374787, DATED 1-21-2010, EXPIRES 6-19-2019.

THE ENGLISH TRANSLATION OF "HOCHMEISTER" IN THE MARK IS "GRANDMASTER".

SER. NO. 85-249,772, FILED 2-23-2011.

AMY C. KEAN, EXAMINING ATTORNEY



# United States of America

United States Patent and Trademark Office

# ECAD

**Reg. No. 4,124,186**

**Registered Apr. 10, 2012**

**Int. Cl.: 41**

**SERVICE MARK**

**PRINCIPAL REGISTER**

DALE PICARD (UNITED STATES INDIVIDUAL)  
P.O. BOX 831  
TORRINGTON, CT 06790 AND

LUCILLE PICARD (UNITED STATES INDIVIDUAL)  
P.O. BOX 831  
TORRINGTON, CT 06790

FOR: CHARITABLE SERVICES, NAMELY, TRAINING SERVICE DOGS FOR DISABLED INDIVIDUALS, IN CLASS 41 (U.S. CLS. 100, 101 AND 107).

FIRST USE 5-1-2001; IN COMMERCE 5-1-2001.

THE MARK CONSISTS OF STANDARD CHARACTERS WITHOUT CLAIM TO ANY PARTICULAR FONT, STYLE, SIZE, OR COLOR.

SER. NO. 85-250,525, FILED 2-24-2011.

JOHN KELLY, EXAMINING ATTORNEY



*David J. Kybas*

Director of the United States Patent and Trademark Office

# United States of America

United States Patent and Trademark Office

# AJUA

**Reg. No. 4,124,187**

**Registered Apr. 10, 2012**

**Int. Cl.: 38**

**SERVICE MARK**

**PRINCIPAL REGISTER**

I LATINA ENTERTAINMENT (CALIFORNIA CORPORATION)  
6221 AGNES AVE  
NORTH HOLLYWOOD, CA 91606

FOR: STREAMING OF AUDIO AND VIDEO MATERIAL ON THE INTERNET; BROADCASTING OF RADIO AND TELEVISION PROGRAMS; TELEVISION AND RADIO BROADCASTING SERVICES, IN CLASS 38 (U.S. CLS. 100, 101 AND 104).

FIRST USE 10-1-2010; IN COMMERCE 10-1-2010.

THE MARK CONSISTS OF STANDARD CHARACTERS WITHOUT CLAIM TO ANY PARTICULAR FONT, STYLE, SIZE, OR COLOR.

THE WORDING "AJUA" HAS NO MEANING IN A FOREIGN LANGUAGE.

SER. NO. 85-250,568, FILED 2-24-2011.

SETH A. RAPPAPORT, EXAMINING ATTORNEY



*David J. Kyffers*

Director of the United States Patent and Trademark Office

# United States of America

United States Patent and Trademark Office



**Reg. No. 4,124,188**

**Registered Apr. 10, 2012**

**Int. Cl.: 25**

**TRADEMARK**

**PRINCIPAL REGISTER**

LIVE THE DARE, LLC (FLORIDA LIMITED LIABILITY COMPANY)  
4181 INGRAHAM HWY.  
COCONUT GROVE, FL 33133

FOR: A-SHIRTS; APPAREL FOR DANCERS, NAMELY, TEE SHIRTS, SWEATSHIRTS, PANTS, LEGGINGS, SHORTS AND JACKETS; ATHLETIC APPAREL, NAMELY, SHIRTS, PANTS, JACKETS, FOOTWEAR, HATS AND CAPS, ATHLETIC UNIFORMS; BODY SHIRTS; BUTTON DOWN SHIRTS; CLOTHING FOR ATHLETIC USE, NAMELY, PADDED SHIRTS; CLOTHING FOR BABIES, TODDLERS AND CHILDREN, TREATED WITH FIRE AND HEAT RETARDANTS, NAMELY, PAJAMAS, JACKETS, SHIRTS, PANTS, JUMPERS; COLLARED SHIRTS; DRESS SHIRTS; FISHING SHIRTS; GOLF PANTS, SHIRTS AND SKIRTS; GOLF SHIRTS; HOODED SWEAT SHIRTS; KNIT SHIRTS; LONG-SLEEVED SHIRTS; NIGHT SHIRTS; OPEN-NECKED SHIRTS; POLO SHIRTS; SHIRTS; SHIRTS AND SHORT-SLEEVED SHIRTS; SHIRTS AND SLIPS; SHIRTS FOR INFANTS, BABIES, TODDLERS AND CHILDREN; SHORT-SLEEVED OR LONG-SLEEVED T-SHIRTS; SHORT-SLEEVED SHIRTS; SLEEP SHIRTS; SPORT SHIRTS; SPORTS SHIRTS WITH SHORT SLEEVES; SWEAT SHIRTS; T-SHIRTS; WEARABLE GARMENTS AND CLOTHING, NAMELY, SHIRTS; WOMEN'S CLOTHING, NAMELY, SHIRTS, DRESSES, SKIRTS, BLOUSES; YOGA SHIRTS, IN CLASS 25 (U.S. CLS. 22 AND 39).

FIRST USE 4-30-2010; IN COMMERCE 6-5-2010.

THE MARK CONSISTS OF CUSTOM LETTERING THE WORDS "THINK", "BELIEVE", "DREAM" AND "DARE" IN A BORDER SURROUNDING THE LOGO IN A RECTANGLE; INSIDE THE RECTANGLE THE WORDS "LIVE", "THE", "DARE"; IN THE CENTER OF THE LOGO IS AN OVAL WITH THE WORD "THE" IN THE CENTER OF A FLOWER BURST.

SER. NO. 85-250,593, FILED 2-24-2011.

H. M. FISHER, EXAMINING ATTORNEY



*David J. Kybas*

Director of the United States Patent and Trademark Office

# United States of America

United States Patent and Trademark Office



**Reg. No. 4,124,189**

**Registered Apr. 10, 2012**

**Int. Cl.: 38**

**SERVICE MARK**

**PRINCIPAL REGISTER**

I LATINA ENTERTAINMENT (CALIFORNIA CORPORATION)  
6221 AGNES AVE  
NORTH HOLLYWOOD, CA 91606

FOR: STREAMING OF AUDIO AND VIDEO MATERIAL ON THE INTERNET; BROADCASTING OF RADIO AND TELEVISION PROGRAMS; TELEVISION AND RADIO BROADCASTING SERVICES, IN CLASS 38 (U.S. CLS. 100, 101 AND 104).

FIRST USE 10-1-2010; IN COMMERCE 10-1-2010.

NO CLAIM IS MADE TO THE EXCLUSIVE RIGHT TO USE "TV", APART FROM THE MARK AS SHOWN.

THE COLOR(S) YELLOW, ORANGE IS/ARE CLAIMED AS A FEATURE OF THE MARK.

THE MARK CONSISTS OF THE WORDING "AJUA" IN YELLOW WITH ORANGE OUTLINING TO THE LEFT OF AN EXCLAMATION POINT IN ORANGE WITH YELLOW OUTLINING. THE WORDING TV APPEARS IN YELLOW INSIDE THE POINT IN THE EXCLAMATION POINT. THE WORDING "WWW.AJUATV.COM" APPEARS IN ORANGE BELOW THE WORDING "AJUA". ALL OF THE WORDING APPEARS ON A YELLOW BACKGROUND.

THE WORDING "AJUA" HAS NO MEANING IN A FOREIGN LANGUAGE.

SER. NO. 85-250,595, FILED 2-24-2011.

SETH A. RAPPAPORT, EXAMINING ATTORNEY



*David J. Kyros*

Director of the United States Patent and Trademark Office

# United States of America

United States Patent and Trademark Office

## HURISE

**Reg. No. 4,124,190**

**Registered Apr. 10, 2012**

**Int. Cl.: 7**

**TRADEMARK**

**PRINCIPAL REGISTER**

HURISE CO., LTD. (TAIWAN CORPORATION)  
1F., NO. 57, TIANYI ST., EAST DISTRICT  
TAICHUNG CITY, TAIWAN

FOR: INDUSTRIAL ROBOTS, ROBOTIC ARMS FOR INDUSTRIAL PURPOSES, GRINDING AND POLISHING MACHINES, GRINDING MACHINES FOR METAL WORKING, DRILLING MACHINES, POLISHING MACHINES FOR USE IN GRINDING AND POLISHING METAL, WOOD, CERAMICS AND PLASTICS; METAL CUTTING MACHINES, POWER-OPERATED POLISHERS; METAL WORKING MACHINES, NAMELY, MACHINING CENTERS; METAL WORKING MACHINES, LATHES; MACHINE PARTS, NAMELY, GRINDING DISCS, CHUCKS, GRINDING WHEELS, CASTING MOLDS FOR USE IN MANUFACTURING OF METAL MACHINE PARTS, SPINDLES, IN CLASS 7 (U.S. CLS. 13, 19, 21, 23, 31, 34 AND 35).

PRIORITY CLAIMED UNDER SEC. 44(D) ON TAIWAN APPLICATION NO. 100000526, FILED 1-5-2011, REG. NO. 01484164, DATED 11-16-2011, EXPIRES 11-15-2021.

THE COLOR(S) BLACK AND RED IS/ARE CLAIMED AS A FEATURE OF THE MARK.

THE MARK CONSISTS OF STYLIZED WORD "HURISE"; THE COLOR BLACK APPEARS IN THE STYLIZED LETTERS "H", "R", "I", "S", AND "E"; THE COLOR RED APPEARS IN STYLIZED LETTER "U".

SER. NO. 85-250,609, FILED 2-24-2011.

JANET LEE, EXAMINING ATTORNEY



*David J. Kybas*

Director of the United States Patent and Trademark Office

# United States of America

United States Patent and Trademark Office

CREATE YOUR OWN JUICY BURGER.

**Reg. No. 4,124,191**

JUICY BURGER SHAKES N FRIES, LLC (CALIFORNIA LIMITED LIABILITY COMPANY)  
P.O. BOX 16325  
BEVERLY HILLS, CA 90209

**Registered Apr. 10, 2012**

**Int. Cl.: 43**

FOR: FAST FOOD AND NON-STOP RESTAURANT SERVICES; RESTAURANT SERVICES;  
RESTAURANT SERVICES, INCLUDING SIT-DOWN SERVICE OF FOOD AND TAKE-OUT  
RESTAURANT SERVICES, IN CLASS 43 (U.S. CLS. 100 AND 101).

**SERVICE MARK**

FIRST USE 12-10-2010; IN COMMERCE 1-12-2011.

**PRINCIPAL REGISTER**

NO CLAIM IS MADE TO THE EXCLUSIVE RIGHT TO USE "CREATE YOUR OWN JUICY  
BURGER", APART FROM THE MARK AS SHOWN.

THE COLOR(S) ORANGE AND RED IS/ARE CLAIMED AS A FEATURE OF THE MARK.

THE MARK CONSISTS OF THE STYLIZED WORDS "CREATE YOUR OWN JUICY BURGER."  
WITH THE WORD "JUICY" IN ORANGE IN BETWEEN TWO ORANGE DRIPS AND THE  
REMAINING WORDS IN RED.

SER. NO. 85-250,696, FILED 2-24-2011.

ZACHARY BELLO, EXAMINING ATTORNEY



*David J. Kypos*

Director of the United States Patent and Trademark Office

# United States of America

United States Patent and Trademark Office

 **ALWAYS FRESH.**  
**ALWAYS JUICY.** 

**Reg. No. 4,124,192**

JUICY BURGER SHAKES N FRIES, LLC (CALIFORNIA LIMITED LIABILITY COMPANY)  
P.O. BOX 16325  
BEVERLY HILLS, CA 90209

**Registered Apr. 10, 2012**

**Int. Cl.: 43**

FOR: FAST FOOD AND NON-STOP RESTAURANT SERVICES; RESTAURANT SERVICES;  
RESTAURANT SERVICES, INCLUDING SIT-DOWN SERVICE OF FOOD AND TAKE-OUT  
RESTAURANT SERVICES, IN CLASS 43 (U.S. CLS. 100 AND 101).

**SERVICE MARK**

FIRST USE 12-10-2010; IN COMMERCE 1-12-2011.

**PRINCIPAL REGISTER**

NO CLAIM IS MADE TO THE EXCLUSIVE RIGHT TO USE "ALWAYS FRESH. ALWAYS  
JUICY", APART FROM THE MARK AS SHOWN.

THE COLOR(S) ORANGE AND RED IS/ARE CLAIMED AS A FEATURE OF THE MARK.

THE MARK CONSISTS OF THE STYLIZED WORDS "ALWAYS FRESH." IN ORANGE ON  
TOP OF THE STYLIZED WORDS "ALWAYS JUICY." IN RED IN BETWEEN TWO ORANGE  
DRIPS.

SER. NO. 85-250,706, FILED 2-24-2011.

ZACHARY BELLO, EXAMINING ATTORNEY



*David J. Kyffers*

Director of the United States Patent and Trademark Office

# United States of America

United States Patent and Trademark Office



**Reg. No. 4,124,193**

**Registered Apr. 10, 2012**

**Int. Cl.: 41**

**SERVICE MARK**

**PRINCIPAL REGISTER**

STRETCH U, L.L.C. (OKLAHOMA LIMITED LIABILITY COMPANY)  
6488 AVONDALE DR.  
NICHOLS HILLS, OK 73116

FOR: PHYSICAL FITNESS SERVICES, NAMELY, PROVIDING ASSISTANCE WITH STRETCHING EXERCISES TO INCREASE MUSCLE STRENGTH AND FLEXIBILITY, IN CLASS 41 (U.S. CLS. 100, 101 AND 107).

FIRST USE 12-2-2010; IN COMMERCE 12-2-2010.

NO CLAIM IS MADE TO THE EXCLUSIVE RIGHT TO USE "STRETCH", APART FROM THE MARK AS SHOWN.

"THE COLOR GRAY REPRESENTS SHADING AND IS NOT A FEATURE OF THE MARK."

THE MARK CONSISTS OF A BANNER LINE AT THE TOP OF THE MARK AND AT THE BOTTOM OF THE MARK, THE WORD "STRETCH" IN A BANNER ACROSS THE MIDDLE OF THE MARK SUPERIMPOSED ON A STYLIZED LETTER "U", AND AN OVAL IN THE CENTER OF THE MARK THAT IS BRIGHTER AT ITS CENTER, WHEREIN THE OVAL IS SUPERIMPOSED BETWEEN THE WORD "STRETCH" AND THE LETTER "U" SUCH THAT IT OBSCURES A PORTION OF THE "U" EXTENDING FROM THE FIRST LETTER "T" IN "STRETCH" TO THE LETTER "C".

SER. NO. 85-250,808, FILED 2-24-2011.

ERIN FALK, EXAMINING ATTORNEY



*David J. Kyros*

Director of the United States Patent and Trademark Office



# United States of America

United States Patent and Trademark Office

## AXELL WIRELESS

**Reg. No. 4,124,194**

**Registered Apr. 10, 2012**

**Int. Cls.: 9, 37, 38 and 42**

**TRADEMARK**

**SERVICE MARK**

**PRINCIPAL REGISTER**

AXELL WIRELESS LTD. (UNITED KINGDOM CORPORATION)  
AERIAL HOUSE, ASHERIDGE ROAD  
CHESHAM, UNITED KINGDOM HP52QD

FOR: TELECOMMUNICATIONS APPARATUS, NAMELY, REPEATERS, REPEATERS FOR THE PROVISION OF WIRELESS TELECOMMUNICATIONS NETWORKS IN BUILDINGS AND CONFINED SPACES, INCLUDING TUNNELS, TRANSPORT SYSTEMS, TRAINS, METRO OR UNDERGROUND SYSTEMS, AIRPLANES, STADIUMS, AIRPORTS, LARGE BUILDINGS AND INDUSTRIAL COMPLEXES; DISTRIBUTED ANTENNA SYSTEMS, COMPRISING OF ANTENNAS, REMOTE BOOSTER UNITS, BI-DIRECTIONAL AMPLIFIERS, CELL ENHANCERS, HEAD-END DISTRIBUTION SYSTEMS, AND CABLING INFRASTRUCTURE; SPECTRUM DIVIDING FILTERS, DIRECTIONAL COUPLERS, CROSSBAND COUPLERS, DIPLEXERS AND SPLITTERS; RF ATTENUATORS, RF AMPLIFIER MODULES, ANTENNA VSWR MONITORS, FIBRE OPTIC TRANSCEIVERS AND EMERGENCY BACK-UP BATTERIES FOR TELECOMMUNICATIONS APPARATUS; TELECOMMUNICATION CABLES, FIBRE OPTIC CABLES, OPTICAL FIBRE LINKS AND ELECTRIC AND ELECTRONIC CIRCUITS; TELECOMMUNICATIONS SOFTWARE TO FACILITATE THE PROVISION OF WIRELESS TELECOMMUNICATIONS NETWORKS IN BUILDINGS AND CONFINED SPACES, INCLUDING TUNNELS, TRANSPORT SYSTEMS, TRAINS, METRO OR UNDERGROUND SYSTEMS, AIRPLANES, STADIUMS, AIRPORTS, LARGE BUILDINGS AND INDUSTRIAL COMPLEXES, IN CLASS 9 (U.S. CLS. 21, 23, 26, 36 AND 38).

FOR: INSTALLATION, MAINTENANCE AND REPAIR OF TELECOMMUNICATIONS APPARATUS AND NETWORKS; CONSULTANCY SERVICES RELATING TO THE INSTALLATION OF TELECOMMUNICATIONS APPARATUS AND NETWORKS, IN CLASS 37 (U.S. CLS. 100, 103 AND 106).

FOR: DIGITAL AND ANALOGUE NETWORK TELECOMMUNICATION SERVICES; WIRELESS TELECOMMUNICATIONS SERVICES, NAMELY, PROVIDING WIRELESS NETWORK SERVICES; TELECOMMUNICATIONS NETWORK SERVICES, NAMELY, COMMUNICATION VIA FIBRE OPTIC, ETHERNET OR WIRELESS NETWORKS; PROVIDING TELECOMMUNICATION CONNECTIONS TO A GLOBAL COMPUTER NETWORK OR THE INTERNET; PROVIDING TELECOMMUNICATION ACCESS SERVICES TO A WIRELESS NETWORK; TELECOMMUNICATIONS CONSULTATION, IN CLASS 38 (U.S. CLS. 100, 101 AND 104).



*David J. Kyros*

Director of the United States Patent and Trademark Office

**Reg. No. 4,124,194** FOR: DESIGN AND DEVELOPMENT OF TELECOMMUNICATIONS NETWORKS, EQUIPMENT AND TELECOMMUNICATIONS SOFTWARE; DESIGN FOR OTHERS OF INTEGRATED CIRCUITS AND INTEGRATED CIRCUIT CORES FOR USE IN WIRELESS COMMUNICATIONS AND WIRELESS COMMUNICATION EQUIPMENT AND APPARATUS AND DIGITAL SIGNAL PROCESSORS; CONDUCTING ENGINEERING SURVEYS; ENGINEERING PROJECT MANAGEMENT SERVICES; TECHNOLOGICAL RESEARCH RELATING TO TELECOMMUNICATIONS APPARATUS AND NETWORKS, IN CLASS 42 (U.S. CLS. 100 AND 101).

THE MARK CONSISTS OF STANDARD CHARACTERS WITHOUT CLAIM TO ANY PARTICULAR FONT, STYLE, SIZE, OR COLOR.

PRIORITY CLAIMED UNDER SEC. 44(D) ON ERPN CMNTY TM OFC APPLICATION NO. 009742438, FILED 2-16-2011.

OWNER OF ERPN CMNTY TM OFC REG. NO. 009742438, DATED 7-21-2011, EXPIRES 2-16-2021.

NO CLAIM IS MADE TO THE EXCLUSIVE RIGHT TO USE "WIRELESS", APART FROM THE MARK AS SHOWN.

SER. NO. 85-250,974, FILED 2-24-2011.

REBECCA SMITH, EXAMINING ATTORNEY

# United States of America

United States Patent and Trademark Office

## CASINO LAWYER

**Reg. No. 4,124,195**

**Registered Apr. 10, 2012**

**Int. Cls.: 16, 41 and 45**

**TRADEMARK**

**SERVICE MARK**

**PRINCIPAL REGISTER**

INTERNATIONAL MASTERS OF GAMING LAW (NEVADA CORPORATION)  
3993 HOWARD HUGHES PARKWAY  
LAS VEGAS, NV 89169

FOR: MAGAZINES IN THE FIELD OF GAMING LAW, IN CLASS 16 (U.S. CLS. 2, 5, 22, 23, 29, 37, 38 AND 50).

FIRST USE 4-30-2005; IN COMMERCE 4-30-2005.

FOR: PROVIDING ON-LINE PUBLICATIONS, NAMELY, MAGAZINES IN THE FIELD OF GAMING LAW, IN CLASS 41 (U.S. CLS. 100, 101 AND 107).

FIRST USE 4-30-2005; IN COMMERCE 4-30-2005.

FOR: PROVIDING ONLINE INFORMATION IN THE FIELD OF GAMING LAW, IN CLASS 45 (U.S. CLS. 100 AND 101).

FIRST USE 4-30-2005; IN COMMERCE 4-30-2005.

THE MARK CONSISTS OF STANDARD CHARACTERS WITHOUT CLAIM TO ANY PARTICULAR FONT, STYLE, SIZE, OR COLOR.

SEC. 2(F).

SER. NO. 85-251,035, FILED 2-24-2011.

JAY FLOWERS, EXAMINING ATTORNEY



*David J. Kyffers*

Director of the United States Patent and Trademark Office

# United States of America

United States Patent and Trademark Office

## Constellation VCM

**Reg. No. 4,124,196**

STEVE KLEIN (UNITED STATES INDIVIDUAL)  
10960 VENTURA BOULEVARD  
STUDIO CITY, CA 91604

**Registered Apr. 10, 2012**

**Int. Cl.: 9**

FOR: COMPUTER SOFTWARE FOR THE COLLECTION, EDITING, ORGANIZING, MODIFYING, BOOK MARKING, TRANSMISSION, STORAGE AND SHARING OF DATA AND INFORMATION, IN CLASS 9 (U.S. CLS. 21, 23, 26, 36 AND 38).

**TRADEMARK**

FIRST USE 3-26-2009; IN COMMERCE 3-26-2009.

**PRINCIPAL REGISTER**

THE MARK CONSISTS OF STANDARD CHARACTERS WITHOUT CLAIM TO ANY PARTICULAR FONT, STYLE, SIZE, OR COLOR.

NO CLAIM IS MADE TO THE EXCLUSIVE RIGHT TO USE "VCM", APART FROM THE MARK AS SHOWN.

SER. NO. 85-251,228, FILED 2-24-2011.

SUSAN STIGLITZ, EXAMINING ATTORNEY



*David J. Kybas*

Director of the United States Patent and Trademark Office

# United States of America

United States Patent and Trademark Office

## Hawle AktiveKey

**Reg. No. 4,124,197**

**Registered Apr. 10, 2012**

**Int. Cls.: 7, 9 and 12**

HAWLE TREPPENLIFTE GMBH (FED REP GERMANY GESELLSCHAFT MIT  
BESCHRÄNKTER HAFTUNG (GMBH))  
INDUSTRIEGEBIET NORD  
AM BACHERBUSCH 1  
RUPPICHTEROTH, FED REP GERMANY 53809

**TRADEMARK**

**PRINCIPAL REGISTER**

FOR: STAIR LIFTS, IN CLASS 7 (U.S. CLS. 13, 19, 21, 23, 31, 34 AND 35).

FOR: ELECTRIC CONTROLS AND REMOTE CONTROLS FOR STAIR LIFTS, LIFTS,  
ELECTRIC CARS, WHEELCHAIRS AND DOORS; TRANSMITTERS OF ELECTRONIC  
SIGNALS, RADIO TRANSMITTER-RECEIVERS, AERIALS, ELECTRIC SENSORS; APPAR-  
ATUS FOR THE RETRIEVAL, TRANSMISSION AND ANALYSIS OF SOUNDS, IMAGE OR  
DATA, ACCESS CONTROL SYSTEMS, ELECTRONIC LOCKS; PARTS FOR ALL THE  
AFORESAID GOODS, IN CLASS 9 (U.S. CLS. 21, 23, 26, 36 AND 38).

FOR: SELF-PROPELLED ELECTRIC VEHICLES; WHEELCHAIRS; VEHICLES FOR THE  
PHYSICALLY HANDICAPPED AND THOSE OF REDUCED MOBILITY, IN CLASS 12 (U.S.  
CLS. 19, 21, 23, 31, 35 AND 44).

THE MARK CONSISTS OF STANDARD CHARACTERS WITHOUT CLAIM TO ANY PAR-  
TICULAR FONT, STYLE, SIZE, OR COLOR.

OWNER OF ERPN CMNTY TM OFC REG. NO. 009460908, DATED 4-26-2011, EXPIRES 10-  
5-2020.

SER. NO. 85-251,425, FILED 2-25-2011.

JESSICA A. POWERS, EXAMINING ATTORNEY



*David J. Kybas*

Director of the United States Patent and Trademark Office

# United States of America

## United States Patent and Trademark Office



**Reg. No. 4,124,198**

**Registered Apr. 10, 2012**

**Int. Cl.: 25**

**TRADEMARK**

**PRINCIPAL REGISTER**

LIVE THE DARE, LLC (FLORIDA LIMITED LIABILITY COMPANY)  
4181 INGRAHAM HWY  
COCONUT GROVE, FL 33133

FOR: A-SHIRTS; APPAREL FOR DANCERS, NAMELY, TEE SHIRTS, SWEATSHIRTS, PANTS, LEGGINGS, SHORTS AND JACKETS; ATHLETIC APPAREL, NAMELY, SHIRTS, PANTS, JACKETS, FOOTWEAR, HATS AND CAPS, ATHLETIC UNIFORMS; BODY SHIRTS; BUTTON DOWN SHIRTS; BUTTON-FRONT ALOHA SHIRTS; CAMOUFLAGE SHIRTS; CAMP SHIRTS; CLOTHING FOR ATHLETIC USE, NAMELY, PADDED SHIRTS; CLOTHING FOR BABIES, TODDLERS AND CHILDREN, TREATED WITH FIRE AND HEAT RETARDANTS, NAMELY, PAJAMAS, JACKETS, SHIRTS, PANTS, JUMPERS; CLOTHING SHIELDS, NAMELY, PADS APPLIED TO THE UNDERARMS OF SHIRTS, BLOUSES AND SWEATERS; COLLARED SHIRTS; DRESS SHIRTS; FISHING SHIRTS; GOLF PANTS, SHIRTS AND SKIRTS; GOLF SHIRTS; HOODED SWEAT SHIRTS; HUNTING SHIRTS; KNIT SHIRTS; LEATHER SHIRTS; LONG-SLEEVED SHIRTS; MOISTURE-WICKING SPORTS SHIRTS; NIGHT SHIRTS; OPEN-NECKED SHIRTS; OVER SHIRTS; PIQUE SHIRTS; POLO SHIRTS; RUGBY SHIRTS; SCIENTIFIC AND TECHNOLOGICAL APPAREL, NAMELY, SHIRTS, PANTS, JACKETS, FOOTWEAR, HATS AND CAPS, UNIFORMS; SHIRT FRONTS; SHIRT INSERTS, NAMELY, DICKIES; SHIRT YOKES; SHIRTS; SHIRTS AND SHORT-SLEEVED SHIRTS; SHIRTS AND SLIPS; SHIRTS FOR INFANTS, BABIES, TODDLERS AND CHILDREN; SHIRTS FOR SUITS; SHORT-SLEEVED OR LONG-SLEEVED T-SHIRTS; SHORT-SLEEVED SHIRTS; SLEEP SHIRTS; SLEEVES WORN SEPARATE AND APART FROM BLOUSES, SHIRTS AND OTHER TOPS; SPORT SHIRTS; SPORTS SHIRTS; SPORTS SHIRTS WITH SHORT SLEEVES; SWEAT SHIRTS; T-SHIRTS; TEE SHIRTS; TRIATHLON CLOTHING, NAMELY, TRIATHLON TIGHTS, TRIATHLON SHORTS, TRIATHLON SINGLET, TRIATHLON SHIRTS, TRIATHLON SUITS; TURTLE NECK SHIRTS; WEARABLE GARMENTS AND CLOTHING, NAMELY, SHIRTS; WIND SHIRTS; WOMEN'S CLOTHING, NAMELY, SHIRTS, DRESSES, SKIRTS, BLOUSES; YOGA SHIRTS, IN CLASS 25 (U.S. CLS. 22 AND 39).



FIRST USE 4-30-2010; IN COMMERCE 6-5-2010.

THE MARK CONSISTS OF A CUSTOM FIGURE ASSOCIATED WITH THE WORD "THINK".

SER. NO. 85-251,484, FILED 2-25-2011.

H. M. FISHER, EXAMINING ATTORNEY

*David J. Kyros*

Director of the United States Patent and Trademark Office

United States of America  
United States Patent and Trademark Office

# DOUGH

**Reg. No. 4,124,199**

DONNEY MCMULLIN (UNITED STATES INDIVIDUAL)  
409 WEST BANCROFT STREET, APT. 104  
TOLEDO, OH 43620

**Registered Apr. 10, 2012**

**Int. Cl.: 25**

FOR: HATS; JACKETS; PANTS; SHIRTS; SWEAT SHIRTS, IN CLASS 25 (U.S. CLS. 22 AND 39).

**TRADEMARK**

FIRST USE 1-1-2006; IN COMMERCE 1-1-2006.

**PRINCIPAL REGISTER**

THE MARK CONSISTS OF STANDARD CHARACTERS WITHOUT CLAIM TO ANY PARTICULAR FONT, STYLE, SIZE, OR COLOR.

SER. NO. 85-251,500, FILED 2-25-2011.

JACQUELINE A. LAVINE, EXAMINING ATTORNEY



*David J. Kybas*

Director of the United States Patent and Trademark Office

# United States of America

United States Patent and Trademark Office

# PRORAMAN

**Reg. No. 4,124,200**

**Registered Apr. 10, 2012**

**Int. Cl.: 9**

**TRADEMARK**

**PRINCIPAL REGISTER**

ENWAVE OPTRONICS, INC. (CALIFORNIA CORPORATION)  
SUITE A  
18200 MCDURMOTT STREET  
IRVINE, CA 92614

FOR: SPECTROMETERS, AND PARTS AND FITTINGS THEREFOR, IN CLASS 9 (U.S. CLS. 21, 23, 26, 36 AND 38).

FIRST USE 1-1-2009; IN COMMERCE 2-1-2009.

THE MARK CONSISTS OF STANDARD CHARACTERS WITHOUT CLAIM TO ANY PARTICULAR FONT, STYLE, SIZE, OR COLOR.

SER. NO. 85-251,590, FILED 2-25-2011.

JAMES GRIFFIN, EXAMINING ATTORNEY



*David J. Kyffers*

Director of the United States Patent and Trademark Office



# United States of America

United States Patent and Trademark Office

# 024 LOFT

**Reg. No. 4,124,201**

**Registered Apr. 10, 2012**

**Int. Cl.: 43**

**SERVICE MARK**

**PRINCIPAL REGISTER**

SEAFOOD VENTURES, LTD. (TEXAS LIMITED PARTNERSHIP)  
820 GESSNER  
SUITE 1800  
HOUSTON, TX 77024

FOR: BAR AND RESTAURANT SERVICES, IN CLASS 43 (U.S. CLS. 100 AND 101).

FIRST USE 12-0-2008; IN COMMERCE 12-0-2008.

THE MARK CONSISTS OF STANDARD CHARACTERS WITHOUT CLAIM TO ANY PARTICULAR FONT, STYLE, SIZE, OR COLOR.

SER. NO. 85-252,020, FILED 2-25-2011.

JAMES STEIN, EXAMINING ATTORNEY



*David J. Kybas*

Director of the United States Patent and Trademark Office

# United States of America

United States Patent and Trademark Office

"IF YOU'RE NOT HAPPY WE'RE  
NOT FINISHED"

**Reg. No. 4,124,202**

WOLFGRAM, GERALD (UNITED STATES INDIVIDUAL)  
1011 LYNN DRIVE  
INDIAN RIVER, MI 49749

**Registered Apr. 10, 2012**

**Int. Cl.: 37**

FOR: BUILDING CONSTRUCTION, REMODELING AND REPAIR; BUILDING RESTORA-  
TION, IN CLASS 37 (U.S. CLS. 100, 103 AND 106).

**SERVICE MARK**

FIRST USE 5-2-2002; IN COMMERCE 5-2-2002.

**PRINCIPAL REGISTER**

THE MARK CONSISTS OF STANDARD CHARACTERS WITHOUT CLAIM TO ANY PAR-  
TICULAR FONT, STYLE, SIZE, OR COLOR.

SER. NO. 85-252,500, FILED 2-26-2011.

ESTHER A. BORSUK, EXAMINING ATTORNEY



*David J. Kybas*

Director of the United States Patent and Trademark Office

# United States of America

United States Patent and Trademark Office



**Reg. No. 4,124,203**

**Registered Apr. 10, 2012**

**Int. Cls.: 21, 25 and 30**

**TRADEMARK**

**PRINCIPAL REGISTER**

TOOTIE PIE COMPANY, INC. (NEVADA CORPORATION)  
129 INDUSTRIAL DRIVE  
BOERNE, TX 78006

FOR: MUGS, IN CLASS 21 (U.S. CLS. 2, 13, 23, 29, 30, 33, 40 AND 50).

FIRST USE 6-15-2005; IN COMMERCE 6-15-2005.

FOR: T-SHIRTS , IN CLASS 25 (U.S. CLS. 22 AND 39).

FIRST USE 6-15-2005; IN COMMERCE 6-15-2005.

FOR: PIES, IN CLASS 30 (U.S. CL. 46).

FIRST USE 7-31-1990; IN COMMERCE 7-31-1990.

OWNER OF U.S. REG. NO. 3,400,537.

THE NAME(S), PORTRAIT(S), AND/OR SIGNATURE(S) SHOWN IN THE MARK DOES NOT IDENTIFY A PARTICULAR LIVING INDIVIDUAL.

THE MARK CONSISTS OF HEAD AND SHOULDERS OF A MATURE WOMAN, GRAND-MOTHER-TYPE, FACING FORWARD THAT IS INSIDE TWO HALF-CIRCLES

SER. NO. 85-252,603, FILED 2-26-2011.

ANNE MADDEN, EXAMINING ATTORNEY



*David J. Kybas*

Director of the United States Patent and Trademark Office

United States of America  
United States Patent and Trademark Office

WOW BRA

**Reg. No. 4,124,204**

IDEAL DRTV LLC (FLORIDA LIMITED LIABILITY COMPANY)  
10480 NW 37 TERRACE  
DORAL, FL 33178

**Registered Apr. 10, 2012**

**Int. Cl.: 25**

FOR: ANTI-WRINKLE BRASSIERES, IN CLASS 25 (U.S. CLS. 22 AND 39).

**TRADEMARK**

FIRST USE 2-11-2011; IN COMMERCE 2-11-2011.

**PRINCIPAL REGISTER**

THE MARK CONSISTS OF STANDARD CHARACTERS WITHOUT CLAIM TO ANY PARTICULAR FONT, STYLE, SIZE, OR COLOR.

NO CLAIM IS MADE TO THE EXCLUSIVE RIGHT TO USE "BRA", APART FROM THE MARK AS SHOWN.

SER. NO. 85-252,616, FILED 2-26-2011.

DORITT L. CARROLL, EXAMINING ATTORNEY



*David J. Kyffers*

Director of the United States Patent and Trademark Office

# United States of America

United States Patent and Trademark Office

## The Kids' Ark

**Reg. No. 4,124,205**

THE KIDS' ARK (TEXAS CORPORATION)  
104 BANYAN CT.  
VICTORIA, TX 77901

**Registered Apr. 10, 2012**

**Int. Cl.: 45**

FOR: CHILDREN'S CHRISTIAN MINISTERIAL SERVICES, IN CLASS 45 (U.S. CLS. 100 AND 101).

**SERVICE MARK**

FIRST USE 8-1-2003; IN COMMERCE 12-1-2003.

**PRINCIPAL REGISTER**

THE MARK CONSISTS OF STANDARD CHARACTERS WITHOUT CLAIM TO ANY PARTICULAR FONT, STYLE, SIZE, OR COLOR.

NO CLAIM IS MADE TO THE EXCLUSIVE RIGHT TO USE "KIDS'", APART FROM THE MARK AS SHOWN.

SER. NO. 85-252,671, FILED 2-26-2011.

DAVID TAYLOR, EXAMINING ATTORNEY



*David J. Kyffers*

Director of the United States Patent and Trademark Office

# United States of America

United States Patent and Trademark Office

The logo for the 'Ruyi' trademark features a vertical red bar on the left, followed by the word 'Ruyi' in a black serif font. A gold Chinese fortune charm is superimposed over the letters 'y' and 'i'.

**Reg. No. 4,124,206**

**Registered Apr. 10, 2012**

**Int. Cl.: 25**

**TRADEMARK**

**PRINCIPAL REGISTER**

RUYI DESIGN AND MANUFACTURING INC (NORTH CAROLINA CORPORATION)  
SUITE 501  
1410 BROADWAY  
NEW YORK, NY 10018

FOR: CLOTHING, NAMELY, SCARVES, BELTS, SHIRTS, SWEATERS, COATS, SUITS, HATS, SOCKS, CAPS, DRESSES, SKIRTS, JACKETS, SHORTS, PANTS, SLEEPWEAR, TUNIC, VESTS, BLOUSES, TEE SHIRTS, STOCKINGS, TIGHTS, PAJAMAS, KNIT TOPS, GLOVES, EARMUFF, HEADBAND, HEADWRAP, CAPES, PONCHOS, NECKWEAR, SHAWL, IN CLASS 25 (U.S. CLS. 22 AND 39).

FIRST USE 1-2-2011; IN COMMERCE 1-2-2011.

THE MARK CONSISTS OF A VERTICAL RED LINE NEXT TO THE WORD "RUYI" IN BLACK SUPERIMPOSED OVER A DESIGN OF A GOLD CHINESE FORTUNE CHARM.

THE COLOR(S) RED, GOLD AND BLACK IS/ARE CLAIMED AS A FEATURE OF THE MARK.

THE ENGLISH TRANSLATION OF THE WORD "RUYI" IN THE MARK IS "AS ONE WISHES".

SER. NO. 85-252,922, FILED 2-28-2011.

ESTHER A. BORSUK, EXAMINING ATTORNEY



*David J. Kybas*

Director of the United States Patent and Trademark Office

# United States of America

## United States Patent and Trademark Office

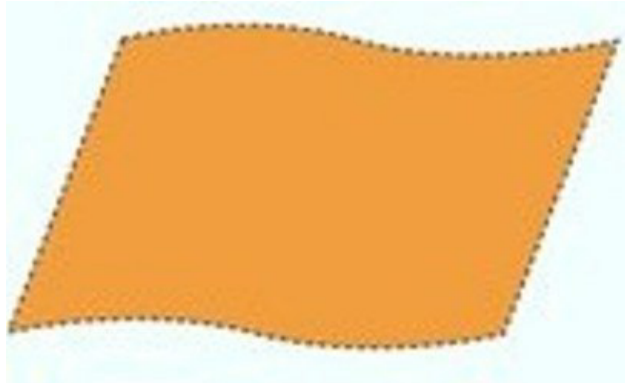

**Reg. No. 4,124,207**

**Registered Apr. 10, 2012**

**Int. Cl.: 19**

**TRADEMARK**

**PRINCIPAL REGISTER**

SCHLUTER SYSTEMS L.P. (NEW YORK LIMITED PARTNERSHIP)  
194 PLEASANT RIDGE RD.  
PLATTSBURGH, NY 129015841

FOR: WATERPROOFING AND DRAINAGE MEMBRANES FOR USE IN CONNECTION WITH TILE INSTALLATIONS, IN CLASS 19 (U.S. CLS. 1, 12, 33 AND 50).

FIRST USE 12-0-1990; IN COMMERCE 12-0-1990.

THE MARK CONSISTS OF THE COLOR ORANGE APPLIED TO THE ENTIRETY OF THE GOODS. THE BROKEN OUTLINE OF THE GOODS IS INTENDED TO SHOW THE POSITION OF THE COLOR ON THE GOODS AND FORMS NO PART OF THE MARK, SERVING AS POSITIONAL REFERENCE ONLY.

THE COLOR(S) ORANGE IS/ARE CLAIMED AS A FEATURE OF THE MARK.

SEC. 2(F).

SER. NO. 85-253,308, FILED 2-28-2011.

HANNO RITTNER, EXAMINING ATTORNEY



*David J. Kybas*

Director of the United States Patent and Trademark Office

# United States of America

United States Patent and Trademark Office



**Reg. No. 4,124,208**

**Registered Apr. 10, 2012**

**Int. Cl.: 35**

**SERVICE MARK**

**PRINCIPAL REGISTER**

GOT FOR SALE TRUST (CALIFORNIA TRUST)  
MARIO B. GUTIERREZ, TRUSTEE  
PO BOX 10255  
SANTA ANA, CA 92711

FOR: COOPERATIVE ADVERTISING AND MARKETING, IN CLASS 35 (U.S. CLS. 100, 101 AND 102).

FIRST USE 9-25-2007; IN COMMERCE 9-25-2007.

NO CLAIM IS MADE TO THE EXCLUSIVE RIGHT TO USE "FORSALE.COM NEW & USED", APART FROM THE MARK AS SHOWN.

THE COLOR(S) RED, WHITE, BLACK AND YELLOW IS/ARE CLAIMED AS A FEATURE OF THE MARK.

THE MARK CONSISTS OF A RED LABEL WITH A YELLOW STRING ATTACHED TO ONE END, WITH THE BLACK WORDING "GOT FORSALE.COM NEW & USED" APPEARING UPON THE WHITE RECTANGLE ABOVE A BLACK BAR CODE DESIGN. THERE IS A SMALLER RED RECTANGLE BEHIND THE BLACK WORDING "FORSALE.COM", WITH SUCH WORDING OUTLINED IN WHITE.

SER. NO. 85-253,423, FILED 2-28-2011.

KRISTIN CARLSON, EXAMINING ATTORNEY



*David J. Kybas*

Director of the United States Patent and Trademark Office



# United States of America

United States Patent and Trademark Office

## Mechanicsburg Chiropractic

**Reg. No. 4,124,209**

**Registered Apr. 10, 2012**

**Int. Cl.: 44**

**SERVICE MARK**

**PRINCIPAL REGISTER**

MECHANICSBURG CHIROPRACTIC, P.C. (PENNSYLVANIA CORPORATION), DBA  
MECHANICSBURG CHIROPRACTIC CENTER  
1010 WESLEY DRIVE  
MECHANICSBURG, PA 17055

FOR: CHIROPRACTIC SERVICES, IN CLASS 44 (U.S. CLS. 100 AND 101).

FIRST USE 3-7-2005; IN COMMERCE 3-7-2005.

THE MARK CONSISTS OF STANDARD CHARACTERS WITHOUT CLAIM TO ANY PARTICULAR FONT, STYLE, SIZE, OR COLOR.

NO CLAIM IS MADE TO THE EXCLUSIVE RIGHT TO USE "CHIROPRACTIC", APART FROM THE MARK AS SHOWN.

SEC. 2(F).

SER. NO. 85-253,448, FILED 2-28-2011.

JAMES LOVELACE, EXAMINING ATTORNEY



*David J. Kyffers*

Director of the United States Patent and Trademark Office

United States of America  
United States Patent and Trademark Office

Healthy  
IDAHO

**Reg. No. 4,124,210**

**Registered Apr. 10, 2012**

**Int. Cl.: 16**

CITIHEALTH, LLC. (NEVADA LIMITED LIABILITY COMPANY), FORMERLY CITIHEALTH, INC.

256 N. MAIN STREET, SUITE F  
256 N. MAIN STREET, SUITE F  
ALPINE, UT 84004

**TRADEMARK**

FOR: GENERAL FEATURE MAGAZINE IN THE FIELD OF HEALTH, IN CLASS 16 (U.S. CLS. 2, 5, 22, 23, 29, 37, 38 AND 50).

**PRINCIPAL REGISTER**

FIRST USE 11-1-2009; IN COMMERCE 11-1-2009.

OWNER OF U.S. REG. NOS. 3,426,498, 3,443,785 AND OTHERS.

NO CLAIM IS MADE TO THE EXCLUSIVE RIGHT TO USE "IDAHO", APART FROM THE MARK AS SHOWN.

THE MARK CONSISTS OF THE WORDS "HEALTHY IDAHO", WITH THE WORD "HEALTHY" IN A LARGER FONT, AND THE WORD "IDAHO" PLACED JUST BELOW THE WORD "HEALTHY".

SER. NO. 85-253,708, FILED 2-28-2011.

MICHAEL SOUDERS, EXAMINING ATTORNEY



*David J. Kyffers*

Director of the United States Patent and Trademark Office

# United States of America

United States Patent and Trademark Office



**Reg. No. 4,124,211**

**Registered Apr. 10, 2012**

**Int. Cl.: 45**

**SERVICE MARK**

**PRINCIPAL REGISTER**

GAPNOTE, INC. (DELAWARE CORPORATION)  
SUITE 1116  
795 FOLSOM STREET  
SAN FRANCISCO, CA 94107

FOR: ONLINE SOCIAL NETWORKING SERVICES, IN CLASS 45 (U.S. CLS. 100 AND 101).

FIRST USE 2-6-2011; IN COMMERCE 2-6-2011.

THE MARK CONSISTS OF A DESIGN OF FOUR NODES NEXT TO THE WORD "HAPPEO" IN BLACK. THE COLOR PINK APPEARS IN ONE NODE, THE COLOR ORANGE APPEARS IN ONE NODE, THE COLOR BLUE APPEARS IN ONE NODE, AND THE COLOR GREEN APPEARS IN ONE NODE.

THE COLOR(S) PINK, ORANGE, BLUE, GREEN, AND BLACK IS/ARE CLAIMED AS A FEATURE OF THE MARK.

SER. NO. 85-253,812, FILED 2-28-2011.

CAROLYN CATALDO, EXAMINING ATTORNEY



*David J. Kybas*

Director of the United States Patent and Trademark Office

# United States of America

United States Patent and Trademark Office



**Reg. No. 4,124,212**

VERDE DESIGNS, LLC (ARIZONA LIMITED LIABILITY COMPANY)  
1565 W. UNIVERSITY DRIVE  
TEMPE, AZ 85224

**Registered Apr. 10, 2012**

**Int. Cl.: 9**

FOR: ENVIRONMENTALLY SUSTAINABLE LIGHTING PRODUCTS, NAMELY, LED DRIVERS AND CONTROL BOARDS, IN CLASS 9 (U.S. CLS. 21, 23, 26, 36 AND 38).

**TRADEMARK**

FIRST USE 11-1-2009; IN COMMERCE 5-1-2010.

**PRINCIPAL REGISTER**

NO CLAIM IS MADE TO THE EXCLUSIVE RIGHT TO USE "VERDE DESIGNS", APART FROM THE MARK AS SHOWN.

THE MARK CONSISTS OF TWO LEAVES SPROUTING UPWARDS AT THE UPPER RIGHT-END CORNER OF THE WORDS "VERDE DESIGNS".

THE ENGLISH TRANSLATION OF "VERDE" IN THE MARK IS "GREEN".

SER. NO. 85-253,857, FILED 2-28-2011.

SCOTT BIBB, EXAMINING ATTORNEY



*David J. Kyffers*

Director of the United States Patent and Trademark Office

# United States of America

United States Patent and Trademark Office

## HER CATWALK

**Reg. No. 4,124,213**

**Registered Apr. 10, 2012**

**Int. Cl.: 41**

**SERVICE MARK**

**PRINCIPAL REGISTER**

742 COMMERCIAL, INC. (CALIFORNIA CORPORATION)  
SUITE 614  
625 BROADWAY  
SAN DIEGO, CA 92101

FOR: ON-LINE JOURNALS, NAMELY, BLOGS FEATURING FASHION INFORMATION AND FASHION CONSULTING INFORMATION, IN CLASS 41 (U.S. CLS. 100, 101 AND 107).

FIRST USE 10-15-2010; IN COMMERCE 12-22-2010.

THE MARK CONSISTS OF STANDARD CHARACTERS WITHOUT CLAIM TO ANY PARTICULAR FONT, STYLE, SIZE, OR COLOR.

NO CLAIM IS MADE TO THE EXCLUSIVE RIGHT TO USE "CATWALK", APART FROM THE MARK AS SHOWN.

SER. NO. 85-253,952, FILED 2-28-2011.

SANJEEV VOHRA, EXAMINING ATTORNEY



*David J. Kybas*

Director of the United States Patent and Trademark Office

# United States of America

United States Patent and Trademark Office

## GROWING VALUE

**Reg. No. 4,124,214**

CHURCH BROTHERS, LLC (CALIFORNIA LIMITED LIABILITY COMPANY)  
19065 PORTOLA DRIVE, SUITE C  
SALINAS, CA 93908

**Registered Apr. 10, 2012**

**Int. Cl.: 31**

FOR: FRESH VEGETABLES, IN CLASS 31 (U.S. CLS. 1 AND 46).

**TRADEMARK**

FIRST USE 1-19-2011; IN COMMERCE 1-19-2011.

**PRINCIPAL REGISTER**

THE MARK CONSISTS OF STANDARD CHARACTERS WITHOUT CLAIM TO ANY PARTICULAR FONT, STYLE, SIZE, OR COLOR.

SER. NO. 85-254,078, FILED 2-28-2011.

KELLY BOULTON, EXAMINING ATTORNEY



*David J. Kybas*

Director of the United States Patent and Trademark Office

# United States of America

United States Patent and Trademark Office



**Reg. No. 4,124,215**

HAVRAN, LEIGHANN (UNITED STATES INDIVIDUAL)  
12797 BEACH BL.  
STANTON, CA 90680 AND

**Registered Apr. 10, 2012**

**Int. Cl.: 35**

HAVRAN, MARC (UNITED STATES INDIVIDUAL)  
12797 BEACH BL.  
STANTON, CA 90680

**SERVICE MARK**

**PRINCIPAL REGISTER**

FOR: RETAIL STORE SERVICES AND ONLINE WEBSITE BASED RETAIL STORE SERVICES FEATURING GARDENING PRODUCTS, IN CLASS 35 (U.S. CLS. 100, 101 AND 102).

FIRST USE 9-1-2000; IN COMMERCE 9-1-2000.

NO CLAIM IS MADE TO THE EXCLUSIVE RIGHT TO USE "HYDROPONICS", APART FROM THE MARK AS SHOWN.

THE COLOR(S) ORANGE, GREEN, YELLOW, WHITE, RED AND BLACK IS/ARE CLAIMED AS A FEATURE OF THE MARK.

THE MARK CONSISTS OF TWO SQUARE OUTLINES, ONE WHITE AND THE OTHER ORANGE, WITH CURVED CORNERS. WITHIN THE OUTLINES IS A STYLIZED PICTURE WITH THE TOP THIRD OF THE PICTURE BEING AN ORANGE AND YELLOW SUNBURST BEHIND TWO MOUNTAIN PEAKS COLORED RED, ORANGE, YELLOW, AND BLACK. BELOW THE MOUNTAINS AND IN THE CENTER OF THE MARK ARE THREE ROWS OF GREEN AND BLACK TREES ON EITHER SIDE, WITH A TRIANGULAR PATCH OF GREEN GRASS BELOW THE MOUNTAINS RADIATING OUT BETWEEN THE TREES. AN IMAGE OF AN ORANGE AND A SLICED HALF OF AN ORANGE APPEARS IN SHADES OF YELLOW AND ORANGE, IS SHADOWED IN BLACK, IS CENTERED WITHIN THE SQUARE AND IS SUPER IMPOSED OVER THE GRASS. "ORANGE COUNTY" IS PRESENTED IN WHITE STYLIZED FONT OUTLINED IN RED AND APPEARS ACROSS THE TOP OF SQUARE IN AN ARCED PATTERN. "HYDROPONICS" APPEARS BELOW THE ORANGES IN WHITE STYLIZED FONT OUTLINED IN RED. "OCHYDRO.COM" IS PRESENTED IN YELLOW STYLIZED FONT AND IS BELOW "HYDROPONICS". THE MARK IS ORIENTED IN A LEFTWARD ANGLE AND CONTAINS WHITE SHADING AND WHITE BLURRED AREAS RANDOMLY PLACED OVER THE ENTIRETY OF THE MARK. THE MARK IN ITS ENTIRETY APPEARS ON A WHITE BACKGROUND.



*David J. Kybas*

Director of the United States Patent and Trademark Office

**Reg. No. 4,124,215** SEC. 2(F) AS TO "ORANGE COUNTY".

SER. NO. 85-254,287, FILED 3-1-2011.

GRETCHEN ULRICH, EXAMINING ATTORNEY



# United States of America

United States Patent and Trademark Office

## WINGS OF THE WORLD

**Reg. No. 4,124,216**

KLAESS-FOLK (CALIFORNIA LIMITED PARTNERSHIP)  
18552 BEACH BLVD.

**Registered Apr. 10, 2012**

HUNTINGTON BEACH, CA 92648

**Int. Cl.: 29**

FOR: POULTRY, NAMELY, CHICKEN WINGS, IN CLASS 29 (U.S. CL. 46).

FIRST USE 8-20-2010; IN COMMERCE 8-20-2010.

**TRADEMARK**

THE MARK CONSISTS OF STANDARD CHARACTERS WITHOUT CLAIM TO ANY PARTICULAR FONT, STYLE, SIZE, OR COLOR.

**PRINCIPAL REGISTER**

NO CLAIM IS MADE TO THE EXCLUSIVE RIGHT TO USE "WINGS", APART FROM THE MARK AS SHOWN.

SER. NO. 85-254,334, FILED 3-1-2011.

ALEXANDER L. POWERS, EXAMINING ATTORNEY



*David J. Kybas*

Director of the United States Patent and Trademark Office

# United States of America

United States Patent and Trademark Office



**Reg. No. 4,124,217**

**Registered Apr. 10, 2012**

**Int. Cl.: 41**

**SERVICE MARK**

**PRINCIPAL REGISTER**

THE ADIRONDACK TRUST COMPANY (NEW YORK CORPORATION)  
473 BROADWAY  
SARATOGA SPRINGS, NY 12866

FOR: ORGANIZING AND CONDUCTING A COLLEGIATE FOOTBALL EVENT THE PROCEEDS OF WHICH ARE DONATED TO A LOCAL COMMUNITY NON-PROFIT ORGANIZATION OR CHARITY, IN CLASS 41 (U.S. CLS. 100, 101 AND 107).

FIRST USE 6-30-2005; IN COMMERCE 6-30-2005.

OWNER OF U.S. REG. NO. 3,171,279.

NO CLAIM IS MADE TO THE EXCLUSIVE RIGHT TO USE "BOWL", APART FROM THE MARK AS SHOWN.

THE MARK CONSISTS OF THE WORDING "ADIRONDACK TRUST ALLEGIANCE BOWL" PLUS A DRAWING OF A FOOTBALL AND FIVE STARS IN A ROW DIRECTLY ABOVE THE FOOTBALL WHICH IS CONTAINED BETWEEN THE WORDS "ADIRONDACK TRUST" AND THE WORDS "ALLEGIANCE BOWL".

SER. NO. 85-254,343, FILED 3-1-2011.

NICHOLAS COLEMAN, EXAMINING ATTORNEY



*David J. Kybas*

Director of the United States Patent and Trademark Office

# United States of America

United States Patent and Trademark Office



**Reg. No. 4,124,218**

FRANZ SMITH (UNITED STATES INDIVIDUAL)  
292 HOWARD STREET  
BROCKTON, MA 02302

**Registered Apr. 10, 2012**

**Int. Cl.: 25**

FOR: SHORT-SLEEVED OR LONG-SLEEVED T-SHIRTS, IN CLASS 25 (U.S. CLS. 22 AND 39).

**TRADEMARK**

FIRST USE 5-12-2009; IN COMMERCE 5-12-2009.

**PRINCIPAL REGISTER**

THE MARK CONSISTS OF THE LETTERS "HN" TO THE LEFT OF AN IMAGE OF THE PLANET EARTH ORIENTED WITH NORTH AMERICA AND SOUTH AMERICA FACING FORWARD, UPON A SHADED RECTANGLE BACKGROUND.

SER. NO. 85-254,424, FILED 3-1-2011.

WILLIAM P. SHANAHAN, EXAMINING ATTORNEY



*David J. Kyffers*

Director of the United States Patent and Trademark Office

# United States of America

United States Patent and Trademark Office

## L.A.C.E Ladies About Creating Excellence

**Reg. No. 4,124,219**

**Registered Apr. 10, 2012**

**Int. Cl.: 36**

**SERVICE MARK**

**PRINCIPAL REGISTER**

BOWLES, NICOLE D. (NEW YORK LIMITED PARTNERSHIP), DBA L.A.C.E LADIES ABOUT  
CREATING EXCELLENCE  
413 ST. MARKS AVENUE, SUITE B  
BROOKLYN, NY 11238 AND

MATTHEWS-MCCLAM, SHANIQUA C. (NEW YORK LIMITED PARTNERSHIP), DBA  
L.A.C.E LADIES ABOUT CREATING EXCELLENCE  
22 JOURNEY STREET  
STATEN ISLAND, NY 10303

FOR: PROVIDING CHARITABLE FUNDRAISING FOR DISADVANTAGED INDIVIDUALS,  
IN CLASS 36 (U.S. CLS. 100, 101 AND 102).

FIRST USE 6-1-2007; IN COMMERCE 6-1-2007.

THE MARK CONSISTS OF STANDARD CHARACTERS WITHOUT CLAIM TO ANY PAR-  
TICULAR FONT, STYLE, SIZE, OR COLOR.

SER. NO. 85-254,743, FILED 3-1-2011.

ANNE MADDEN, EXAMINING ATTORNEY



*David J. Kyros*

Director of the United States Patent and Trademark Office

# United States of America

United States Patent and Trademark Office

# SUPERBAND

**Reg. No. 4,124,220**

**Registered Apr. 10, 2012**

**Int. Cl.: 5**

**TRADEMARK**

**PRINCIPAL REGISTER**

EVERGREEN RESEARCH AND MARKETING LLC (CALIFORNIA LIMITED LIABILITY COMPANY)  
3227 RIM ROCK CIRCLE  
ENCINITAS, CA 92024

FOR: INSECT REPELLENT, NAMELY, PLASTIC WRISTBANDS INJECTED WITH OILS WITH INSECT REPELLING PROPERTIES, IN CLASS 5 (U.S. CLS. 6, 18, 44, 46, 51 AND 52).

FIRST USE 3-1-2001; IN COMMERCE 3-1-2001.

THE MARK CONSISTS OF STANDARD CHARACTERS WITHOUT CLAIM TO ANY PARTICULAR FONT, STYLE, SIZE, OR COLOR.

NO CLAIM IS MADE TO THE EXCLUSIVE RIGHT TO USE "BAND", APART FROM THE MARK AS SHOWN.

SEC. 2(F).

SER. NO. 85-254,751, FILED 3-1-2011.

SCOTT BIBB, EXAMINING ATTORNEY



*David J. Kyffers*

Director of the United States Patent and Trademark Office

# United States of America

United States Patent and Trademark Office



**Reg. No. 4,124,221**

4 WHAT IT'S WORTH, INC. (CALIFORNIA CORPORATION)  
6565 EAST WASHINGTON BOULEVARD  
COMMERCE, CA 90040

**Registered Apr. 10, 2012**

**Int. Cl.: 25**

FOR: CLOTHING, NAMELY, BOTTOMS, PANTS, SKINS, SHORTS, CAPRIS, BERMUDA SHORTS AND LEGGINGS, IN CLASS 25 (U.S. CLS. 22 AND 39).

**TRADEMARK**

FIRST USE 2-24-2011; IN COMMERCE 2-24-2011.

**PRINCIPAL REGISTER**

THE MARK CONSISTS OF STYLIZED LETTER "B".

SER. NO. 85-255,162, FILED 3-1-2011.

JANICE L. MCMORROW, EXAMINING ATTORNEY



*David J. Kybas*

Director of the United States Patent and Trademark Office

# United States of America

United States Patent and Trademark Office



**Reg. No. 4,124,222**

**Registered Apr. 10, 2012**

**Int. Cl.: 44**

ONCOLOGY CONSULTANTS PA (TEXAS CORPORATION)  
SUITE 600  
925 GESSNER  
HOUSTON, TX 77024

FOR: MEDICAL SERVICES, IN CLASS 44 (U.S. CLS. 100 AND 101).

**SERVICE MARK**

FIRST USE 7-1-2010; IN COMMERCE 7-1-2010.

**PRINCIPAL REGISTER**

NO CLAIM IS MADE TO THE EXCLUSIVE RIGHT TO USE "ONCOLOGY CONSULTANTS" AND "CANCER", APART FROM THE MARK AS SHOWN.

THE MARK CONSISTS OF THE STYLIZED WORDING "ONCOLOGY CONSULTANTS" ABOVE THE STYLIZED WORDING "OVERCOMING CANCER" ALL TO THE RIGHT OF A SHADED CIRCLE FEATURING THE VERTICALLY STYLIZED LETTERS "OC".

SER. NO. 85-255,181, FILED 3-1-2011.

BERYL GARDNER, EXAMINING ATTORNEY



*David J. Kyjars*

Director of the United States Patent and Trademark Office

# United States of America

United States Patent and Trademark Office

## HEATDIAMONDS

**Reg. No. 4,124,223**

**Registered Apr. 10, 2012**

**Int. Cl.: 4**

**TRADEMARK**

**PRINCIPAL REGISTER**

GREAT HARBOUR HOLDINGS COMPANY LIMITED (HONG KONG LIMITED LIABILITY COMPANY)  
OFFICE A, 15TH FLOOR, KINGS TOWER  
111 LAM KING STREET  
KOWLOON, HONG KONG

FOR: CHARCOAL BRIQUETTES, IN CLASS 4 (U.S. CLS. 1, 6 AND 15).

FIRST USE 6-22-2010; IN COMMERCE 12-30-2010.

THE MARK CONSISTS OF STANDARD CHARACTERS WITHOUT CLAIM TO ANY PARTICULAR FONT, STYLE, SIZE, OR COLOR.

SER. NO. 85-255,183, FILED 3-1-2011.

BERYL GARDNER, EXAMINING ATTORNEY



*David J. Kyffers*

Director of the United States Patent and Trademark Office



# United States of America

United States Patent and Trademark Office

# VYOO.IT

**Reg. No. 4,124,224**

ZILLOW, INC. (WASHINGTON CORPORATION)  
1301 2ND AVE., FLOOR 31  
SEATTLE, WA 98101

**Registered Apr. 10, 2012**

**Int. Cl.: 36**

FOR: CLASSIFIED REAL ESTATE LISTINGS OF APARTMENT RENTALS AND HOUSING RENTALS; PROVIDING REAL ESTATE LISTINGS AND REAL ESTATE INFORMATION VIA THE INTERNET; REAL ESTATE LISTING SERVICES FOR HOUSING RENTALS AND APARTMENT RENTALS, IN CLASS 36 (U.S. CLS. 100, 101 AND 102).

**SERVICE MARK**

**PRINCIPAL REGISTER**

FIRST USE 7-29-2010; IN COMMERCE 7-29-2010.

THE MARK CONSISTS OF STANDARD CHARACTERS WITHOUT CLAIM TO ANY PARTICULAR FONT, STYLE, SIZE, OR COLOR.

SER. NO. 85-255,251, FILED 3-2-2011.

DOUGLAS LEE, EXAMINING ATTORNEY



*David J. Kybas*

Director of the United States Patent and Trademark Office

# United States of America

United States Patent and Trademark Office

# VYOO.IT

**Reg. No. 4,124,225**

ZILLOW, INC. (WASHINGTON CORPORATION)  
1301 2ND AVE., FLOOR 31  
SEATTLE, WA 98101

**Registered Apr. 10, 2012**

**Int. Cl.: 42**

FOR: COMPUTER SERVICES, NAMELY, SEARCH ENGINE OPTIMIZATION; WEB SITE DESIGN; WEB SITE DEVELOPMENT FOR OTHERS; PROVIDING A WEB SITE FEATURING TECHNOLOGY THAT ENABLES INTERNET USERS TO CREATE A SHORT UNIFORM RESOURCE LOCATOR FROM A LONG UNIFORM RESOURCE LOCATOR; ALL OF THE FOREGOING RELATED TO THE FIELD OF REAL ESTATE, IN CLASS 42 (U.S. CLS. 100 AND 101).

**SERVICE MARK**

**PRINCIPAL REGISTER**

FIRST USE 7-29-2010; IN COMMERCE 7-29-2010.

THE MARK CONSISTS OF STANDARD CHARACTERS WITHOUT CLAIM TO ANY PARTICULAR FONT, STYLE, SIZE, OR COLOR.

SER. NO. 85-255,253, FILED 3-2-2011.

DOUGLAS LEE, EXAMINING ATTORNEY



*David J. Kyfos*

Director of the United States Patent and Trademark Office

# United States of America

United States Patent and Trademark Office

# 4DMAPP

**Reg. No. 4,124,226**

VANDAMMEDIA CORP. (NEW YORK CORPORATION)  
32 W. 20TH STREET  
NEW YORK, NY 10011

**Registered Apr. 10, 2012**

**Int. Cl.: 9**

FOR: SOFTWARE IN THE FIELD TRAVEL GUIDES FOR USE IN LOCATING AND LEARNING ABOUT SITES AND LOCATIONS OF INTEREST; SOFTWARE IN THE FIELD OF MAPS FOR USE IN NAVIGATING LOCATIONS; SOFTWARE FOR GENERATING LOCATIONS ON MAPS AND FOR USE IN NAVIGATING LOCATIONS; SOFTWARE IN THE FIELD OF ENTERTAINMENT FOR USE IN LOCATING ENTERTAINMENT DESTINATIONS; SOFTWARE IN THE FIELD OF ENTERTAINMENT FOR USE IN INTERACTING WITH A THREE-DIMENSIONAL DIGITAL ENVIRONMENT FEATURING MAPS OF CITIES; SOFTWARE IN THE FIELD OF SOCIAL NETWORKING AND INFORMATION SHARING FOR USE IN UPDATING USER PROFILES AND SHARING LOCATION AND PERSONALIZED MESSAGES, IN CLASS 9 (U.S. CLS. 21, 23, 26, 36 AND 38).

**TRADEMARK**

**PRINCIPAL REGISTER**

FIRST USE 1-2-2011; IN COMMERCE 3-1-2011.

THE MARK CONSISTS OF STANDARD CHARACTERS WITHOUT CLAIM TO ANY PARTICULAR FONT, STYLE, SIZE, OR COLOR.

SER. NO. 85-255,523, FILED 3-2-2011.

JAMES LOVELACE, EXAMINING ATTORNEY



*David J. Kybas*

Director of the United States Patent and Trademark Office

# United States of America

United States Patent and Trademark Office

# 4DmApp

**Reg. No. 4,124,227**

VANDAMMEDIA CORP. (NEW YORK CORPORATION)  
32 W. 20TH STREET  
NEW YORK, NY 10011

**Registered Apr. 10, 2012**

**Int. Cl.: 9**

FOR: SOFTWARE IN THE FIELD TRAVEL GUIDES FOR USE IN LOCATING AND LEARNING ABOUT SITES AND LOCATIONS OF INTEREST; SOFTWARE IN THE FIELD OF MAPS FOR USE IN NAVIGATING LOCATIONS; SOFTWARE FOR GENERATING LOCATIONS ON MAPS AND FOR USE IN NAVIGATING LOCATIONS; SOFTWARE IN THE FIELD OF ENTERTAINMENT FOR USE IN LOCATING ENTERTAINMENT DESTINATIONS; SOFTWARE IN THE FIELD OF ENTERTAINMENT FOR USE IN INTERACTING WITH A THREE-DIMENSIONAL DIGITAL ENVIRONMENT FEATURING MAPS OF CITIES; SOFTWARE IN THE FIELD OF SOCIAL NETWORKING AND INFORMATION SHARING FOR USE IN UPDATING USER PROFILES AND SHARING LOCATION AND PERSONALIZED MESSAGES, IN CLASS 9 (U.S. CLS. 21, 23, 26, 36 AND 38).

**TRADEMARK**

**PRINCIPAL REGISTER**

FIRST USE 1-2-2011; IN COMMERCE 3-1-2011.

THE MARK CONSISTS OF THE STYLIZED TEXT "4DMAPP", WITH THE LETTERS "D" AND "A" CAPITALIZED, AND THE LETTER "M" AND TWO LETTERS "P" IN LOWER CASE.

SER. NO. 85-255,547, FILED 3-2-2011.

JAMES LOVELACE, EXAMINING ATTORNEY



*David J. Kyros*

Director of the United States Patent and Trademark Office

# United States of America

United States Patent and Trademark Office



**Reg. No. 4,124,228**

CRANE, DEMETRIUS M. (UNITED STATES INDIVIDUAL)  
4898 STONE ACRES CIRCLE  
ST. CLOUD, FL 34771

**Registered Apr. 10, 2012**

**Int. Cl.: 25**

FOR: COLLARED SHIRTS, IN CLASS 25 (U.S. CLS. 22 AND 39).

FIRST USE 9-19-2000; IN COMMERCE 1-1-2011.

**TRADEMARK**

**PRINCIPAL REGISTER**

THE MARK CONSISTS OF THE WORDS "SOLD", "OUT", "CHRIST" AND THE NUMERAL "2" CREATING THE SINGLE WORD "SOLDOUT2CHRIS". THE "SOLDOUT2CHRIS" PORTION OF THE MARK IS IN THE COLOR WHITE AND THE LETTER "T" AT THE END IS IN THE COLOR RED. THE WORD "SOLD" AND THE NUMERAL "2" ARE IN BOLD. THE BLACK IN THE DRAWING REPRESENTS THE BACKGROUND AREA AND IS NOT CLAIMED AS A FEATURE OF THE MARK.

THE COLOR(S) RED AND WHITE IS/ARE CLAIMED AS A FEATURE OF THE MARK.

SER. NO. 85-255,553, FILED 3-2-2011.

JAMES LOVELACE, EXAMINING ATTORNEY



*David J. Kybas*

Director of the United States Patent and Trademark Office

# United States of America

United States Patent and Trademark Office



**Reg. No. 4,124,229**

**Registered Apr. 10, 2012**

**Int. Cls.: 25 and 30**

**TRADEMARK**

**PRINCIPAL REGISTER**

SHEHADEH FOREVER INC. (CALIFORNIA CORPORATION)  
14962 NORTON ST.  
SAN LEANDRO, CA 94579

FOR: T-SHIRTS, IN CLASS 25 (U.S. CLS. 22 AND 39).

FIRST USE 10-6-2010; IN COMMERCE 10-6-2010.

FOR: SAUCES, IN CLASS 30 (U.S. CL. 46).

FIRST USE 10-6-2010; IN COMMERCE 10-6-2010.

NO CLAIM IS MADE TO THE EXCLUSIVE RIGHT TO USE "SAUCE", APART FROM THE MARK AS SHOWN.

THE COLOR(S) SILVER, BLACK, TAN, BROWN, GREEN, WHITE, PALE LAVENDER, RED, YELLOW, PURPLE AND PINK. IS/ARE CLAIMED AS A FEATURE OF THE MARK.

THE NAME(S), PORTRAIT(S), AND/OR SIGNATURE(S) SHOWN IN THE MARK IDENTIFIES IKE SHEHADEH, WHOSE CONSENT(S) TO REGISTER IS MADE OF RECORD.

THE MARK CONSISTS OF THE WORDS "IKE'S DIRTY SECRET SAUCE" IN STYLIZED FONT IN THE SHAPE OF A CIRCLE IN THE COLOR SILVER, WITH ALL THE LETTERING IN SILVER, WITH A PICTURE OF A SANDWICH IN THE MIDDLE OF THE CIRCLE, WHICH SANDWICH ELEMENTS ARE OUTLINED IN BLACK AND INCLUDE THE FOLLOWING COLORS: TAN AND BROWN FOR THE BREAD; GREEN FOR THE LETTUCE; WHITE AND PALE LAVENDER FOR THE SAUCE SPREAD ON THE BREAD; RED FOR THE TOMATOES; PALE YELLOW FOR THE CHEESE; PURPLE FOR THE RED ONION; AND PINK FOR THE MEAT.

SER. NO. 85-255,728, FILED 3-2-2011.

WILLIAM ROSSMAN, EXAMINING ATTORNEY



*David J. Kypos*

Director of the United States Patent and Trademark Office

# United States of America

United States Patent and Trademark Office



**Reg. No. 4,124,230**

ALBANY INTERNATIONAL CORP. (NEW YORK CORPORATION)  
1373 BROADWAY  
ALBANY, NY 12204

**Registered Apr. 10, 2012**

**Int. Cls.: 17, 20, 22, 24  
and 25**

FOR: FIBERS, FABRICS AND FELTS ALL FOR INSULATING PURPOSES COMPOSED WHOLLY OR MAINLY OF PLASTIC, IN CLASS 17 (U.S. CLS. 1, 5, 12, 13, 35 AND 50).

FIRST USE 1-31-2002; IN COMMERCE 1-31-2002.

**TRADEMARK**

FOR: BED PILLOWS, DECORATIVE PILLOWS, PET BEDS, SLEEPING BAGS, FEATHER BEDS AND FIBER BEDS, IN CLASS 20 (U.S. CLS. 2, 13, 22, 25, 32 AND 50).

**PRINCIPAL REGISTER**

FIRST USE 1-31-2002; IN COMMERCE 1-31-2002.

FOR: ARTIFICIAL TEXTILE FIBERS, DOWN FEATHERS, FIBERS, FEATHERS AND DOWN FOR STUFFING, PADDING AND FILLING MATERIALS; NAMELY, SYNTHETIC FIBERS FOR USE AS INSULATING MATERIAL, IN CLASS 22 (U.S. CLS. 1, 2, 7, 19, 22, 42 AND 50).

FIRST USE 1-31-2002; IN COMMERCE 1-31-2002.

FOR: BEDDING, NAMELY, COMFORTERS, MATTRESS PADS AND INSULATED BED BLANKETS, IN CLASS 24 (U.S. CLS. 42 AND 50).

FIRST USE 1-31-2002; IN COMMERCE 1-31-2002.

FOR: THERMALLY INSULATED CLOTHING; NAMELY, GLOVES, THERMAL UNDERWEAR, JACKETS, TOPS, TROUSERS, HATS, AND COATS, IN CLASS 25 (U.S. CLS. 22 AND 39).

FIRST USE 1-31-2002; IN COMMERCE 1-31-2002.

OWNER OF U.S. REG. NOS. 1,849,912 AND 2,444,085.

THE MARK CONSISTS OF THE WORD "PRIMALOFT" INSIDE A SEMI SHAPED OVAL.

SER. NO. 85-255,822, FILED 3-2-2011.

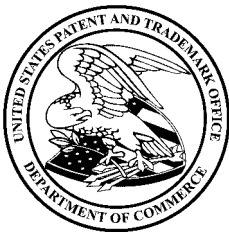

*David J. Kybas*

Director of the United States Patent and Trademark Office

**Reg. No. 4,124,230** SALLY SHIH, EXAMINING ATTORNEY



# United States of America

United States Patent and Trademark Office

## KENMORE LIVE STUDIO

**Reg. No. 4,124,231**

KCD IP, LLC (DELAWARE LIMITED LIABILITY COMPANY)  
3333 BEVERLY ROAD  
HOFFMAN ESTATES, IL 60179

**Registered Apr. 10, 2012**

**Int. Cls.: 35, 38 and 41**

FOR: ENTERTAINMENT SERVICES, NAMELY, PROVIDING PRODUCT DEMONSTRATIONS RELATING TO HOME APPLIANCES, LAUNDRY APPLIANCES, LARGE AND SMALL KITCHEN APPLIANCES, GRILLS AND SMOKERS, COOKWARE AND BAKEWARE, KITCHEN TOOLS AND UTENSILS, FLOORCARE PRODUCTS, SEWING MACHINES, AIR CONDITIONERS AND PURIFIERS, WATER HEATERS, AND WATER SOFTENERS AND FILTRATION SYSTEMS, IN CLASS 35 (U.S. CLS. 100, 101 AND 102).

**SERVICE MARK**

**PRINCIPAL REGISTER**

FIRST USE 3-11-2010; IN COMMERCE 3-11-2010.

FOR: STREAMING OF AUDIO, VISUAL AND AUDIOVISUAL MATERIAL ON THE INTERNET, IN CLASS 38 (U.S. CLS. 100, 101 AND 104).

FIRST USE 3-11-2010; IN COMMERCE 3-11-2010.

FOR: ENTERTAINMENT SERVICES, NAMELY, PROVIDING PODCASTS AND VIDEO PODCASTS RELATING TO HOME APPLIANCES, LAUNDRY APPLIANCES, LARGE AND SMALL KITCHEN APPLIANCES, GRILLS AND SMOKERS, COOKWARE AND BAKEWARE, KITCHEN TOOLS AND UTENSILS, FLOORCARE PRODUCTS, SEWING MACHINES, AIR CONDITIONERS AND PURIFIERS, WATER HEATERS, AND WATER SOFTENERS AND FILTRATION SYSTEMS, IN CLASS 41 (U.S. CLS. 100, 101 AND 107).

FIRST USE 3-11-2010; IN COMMERCE 3-11-2010.

THE MARK CONSISTS OF STANDARD CHARACTERS WITHOUT CLAIM TO ANY PARTICULAR FONT, STYLE, SIZE, OR COLOR.

OWNER OF U.S. REG. NOS. 522,973, 2,913,066 AND OTHERS.

NO CLAIM IS MADE TO THE EXCLUSIVE RIGHT TO USE "LIVE STUDIO", APART FROM THE MARK AS SHOWN.

SER. NO. 85-255,940, FILED 3-2-2011.



*David J. Kyffers*

Director of the United States Patent and Trademark Office

**Reg. No. 4,124,231** KATHERINE STOIDES, EXAMINING ATTORNEY

# United States of America

United States Patent and Trademark Office

## grombomb healthy rehydration

**Reg. No. 4,124,232**

MCCORMICK, ERIC T (UNITED STATES INDIVIDUAL)  
1435 SANTA MARTA COURT  
SOLANA BEACH, CA 92075

**Registered Apr. 10, 2012**

**Int. Cl.: 32**

FOR: ENERGY DRINKS; FRUIT FLAVOURED DRINKS; SPORTS DRINKS CONTAINING ELECTROLYTES, IN CLASS 32 (U.S. CLS. 45, 46 AND 48).

**TRADEMARK**

FIRST USE 1-26-2011; IN COMMERCE 1-26-2011.

**PRINCIPAL REGISTER**

THE MARK CONSISTS OF STANDARD CHARACTERS WITHOUT CLAIM TO ANY PARTICULAR FONT, STYLE, SIZE, OR COLOR.

NO CLAIM IS MADE TO THE EXCLUSIVE RIGHT TO USE "HEALTHY REHYDRATION", APART FROM THE MARK AS SHOWN.

SER. NO. 85-256,011, FILED 3-2-2011.

ELIZABETH KAJUBI, EXAMINING ATTORNEY



*David J. Kybas*

Director of the United States Patent and Trademark Office

# United States of America

United States Patent and Trademark Office

## FREEDOMISGREEN

**Reg. No. 4,124,233**

**Registered Apr. 10, 2012**

**Int. Cl.: 45**

**SERVICE MARK**

**PRINCIPAL REGISTER**

FREEDOM IS GREEN MEDIA GROUP LLC (NEW JERSEY LIMITED LIABILITY COMPANY)  
SUITE 209  
110 MARTER AVE  
MOORESTOWN, NJ 08057

FOR: PROVIDING AN EDUCATIONAL, INTERACTIVE WEBSITE IN THE FIELDS OF  
CANNABIS LAW REFORM, CIVIL RIGHTS, AND PATENT RIGHTS, IN CLASS 45 (U.S.  
CLS. 100 AND 101).

FIRST USE 1-24-2011; IN COMMERCE 2-25-2011.

THE MARK CONSISTS OF STANDARD CHARACTERS WITHOUT CLAIM TO ANY PAR-  
TICULAR FONT, STYLE, SIZE, OR COLOR.

SER. NO. 85-256,423, FILED 3-3-2011.

LINDSEY RUBIN, EXAMINING ATTORNEY



*David J. Kybas*

Director of the United States Patent and Trademark Office

# United States of America

United States Patent and Trademark Office

**freedomisgreen**

**Reg. No. 4,124,234**

**Registered Apr. 10, 2012**

**Int. Cl.: 45**

**SERVICE MARK**

**PRINCIPAL REGISTER**

FREEDOM IS GREEN MEDIA GROUP LLC (NEW JERSEY LIMITED LIABILITY COMPANY)  
SUITE 209  
110 MARTER AVE  
MOORESTOWN, NJ 08057

FOR: PROVIDING AN EDUCATIONAL, INTERACTIVE WEBSITE IN THE FIELDS OF CANNABIS LAW REFORM, CIVIL RIGHTS, AND PATENT RIGHTS, IN CLASS 45 (U.S. CLS. 100 AND 101).

FIRST USE 1-24-2011; IN COMMERCE 2-25-2011.

THE MARK CONSISTS OF THE LITERAL ELEMENT "FREEDOMISGREEN" WHEREIN THE WORD "FREEDOM" IS IN MAROON AND THE WORDS "IS GREEN" ARE IN GREEN AND THE DOT OF THE LETTER "I" DEPICTS A MARIJUANA LEAF IN GREEN.

THE COLOR(S) MAROON AND GREEN IS/ARE CLAIMED AS A FEATURE OF THE MARK.

SER. NO. 85-256,429, FILED 3-3-2011.

LINDSEY RUBIN, EXAMINING ATTORNEY



*David J. Kybas*

Director of the United States Patent and Trademark Office

# United States of America

United States Patent and Trademark Office

## BIG SCREEN BOOKS

**Reg. No. 4,124,235**

**Registered Apr. 10, 2012**

**Int. Cl.: 9**

**TRADEMARK**

**PRINCIPAL REGISTER**

FABLEVISION LEARNING, LLC (MASSACHUSETTS LIMITED LIABILITY COMPANY)  
6 ALLEN LANE  
DEDHAM, MA 02026

FOR: COMPUTER SOFTWARE ALLOWING USERS TO READ INTERACTIVE BOOKS ON A COMPUTER OR WHITEBOARD WITH A VARIETY OF CUSTOMIZABLE SETTINGS AND BUILT-IN TOOLS AND ACTIVITIES, IN CLASS 9 (U.S. CLS. 21, 23, 26, 36 AND 38).

FIRST USE 6-12-2009; IN COMMERCE 2-22-2010.

THE MARK CONSISTS OF STANDARD CHARACTERS WITHOUT CLAIM TO ANY PARTICULAR FONT, STYLE, SIZE, OR COLOR.

NO CLAIM IS MADE TO THE EXCLUSIVE RIGHT TO USE "BOOKS", APART FROM THE MARK AS SHOWN.

SER. NO. 85-256,451, FILED 3-3-2011.

JOHN KELLY, EXAMINING ATTORNEY



*David J. Kyffers*

Director of the United States Patent and Trademark Office

# United States of America

United States Patent and Trademark Office

# Be the Cure

**Reg. No. 4,124,236**

PATTON, CASEY (UNITED STATES INDIVIDUAL)  
8340 MENDING WALL DRIVE  
WOODRIDGE, IL 60517

**Registered Apr. 10, 2012**

**Int. Cl.: 36**

FOR: CHARITABLE FUNDRAISING IN CONNECTION WITH CHILDREN'S CANCER, IN CLASS 36 (U.S. CLS. 100, 101 AND 102).

**SERVICE MARK**

FIRST USE 5-31-2007; IN COMMERCE 5-31-2007.

**PRINCIPAL REGISTER**

THE MARK CONSISTS OF STANDARD CHARACTERS WITHOUT CLAIM TO ANY PARTICULAR FONT, STYLE, SIZE, OR COLOR.

SER. NO. 85-256,677, FILED 3-3-2011.

SUSAN RICHARDS, EXAMINING ATTORNEY



*David J. Kybas*

Director of the United States Patent and Trademark Office

# United States of America

United States Patent and Trademark Office



**Reg. No. 4,124,237**

**Registered Apr. 10, 2012**

**Int. Cl.: 41**

**SERVICE MARK**

**PRINCIPAL REGISTER**

DONALD, WILLIAM (UNITED STATES INDIVIDUAL)  
13126 MELON AVENUE  
CHINO, CA 91710

FOR: PERSONAL TRAINING SERVICES, NAMELY, STRENGTH AND CONDITIONING TRAINING; ATHLETIC TRAINING SERVICES; EDUCATIONAL SERVICES, NAMELY, PROVIDING CLASSES, WORKSHOPS IN THE FIELDS OF FITNESS AND EXERCISE; CONSULTING SERVICES IN THE FIELDS OF FITNESS AND EXERCISE; CONSULTING WITH CLIENTS AND OTHER TRAINERS IN THE FIELDS OF FITNESS AND EXERCISE, IN CLASS 41 (U.S. CLS. 100, 101 AND 107).

FIRST USE 2-20-2011; IN COMMERCE 2-20-2011.

NO CLAIM IS MADE TO THE EXCLUSIVE RIGHT TO USE "TRAINING", APART FROM THE MARK AS SHOWN.

THE MARK CONSISTS OF THE STYLIZED TEXT "STRICTLY TRAINING" WITH AN ABSTRACT HUMAN SHAPED FIGURE CROSSING A FINISH LINE.

SER. NO. 85-256,741, FILED 3-3-2011.

KELLEY WELLS, EXAMINING ATTORNEY



*David J. Kybas*

Director of the United States Patent and Trademark Office



# United States of America

United States Patent and Trademark Office

# Pancreum

**Reg. No. 4,124,238**

**Registered Apr. 10, 2012**

**Int. Cl.: 10**

**TRADEMARK**

**PRINCIPAL REGISTER**

PANCREUM, LLC (FLORIDA LIMITED LIABILITY COMPANY)  
336 N. BIRCH ROAD, SUITE 12A  
FORT LAUDERDALE, FL 33304

FOR: MEDICAL APPARATUS AND UNITS FOR DOSAGE, MEASURING AND MONITORING, NAMELY, DRUG DELIVERY DEVICES AND SYSTEMS, IN CLASS 10 (U.S. CLS. 26, 39 AND 44).

FIRST USE 5-1-2008; IN COMMERCE 5-1-2008.

THE MARK CONSISTS OF STANDARD CHARACTERS WITHOUT CLAIM TO ANY PARTICULAR FONT, STYLE, SIZE, OR COLOR.

SER. NO. 85-256,852, FILED 3-3-2011.

RON FAIRBANKS, EXAMINING ATTORNEY



*David J. Kyffers*

Director of the United States Patent and Trademark Office

# United States of America

United States Patent and Trademark Office

## Archive Station

**Reg. No. 4,124,239**

STEVE KLEIN (UNITED STATES INDIVIDUAL)  
10960 VENTURA BOULEVARD  
STUDIO CITY, CA 91604

**Registered Apr. 10, 2012**

**Int. Cl.: 9**

FOR: COMPUTER SOFTWARE AND HARDWARE FOR ARCHIVING VIDEO CONTENT FROM ANY ELECTRONIC MEDIA SOURCE, IN CLASS 9 (U.S. CLS. 21, 23, 26, 36 AND 38).

**TRADEMARK**

FIRST USE 3-26-2009; IN COMMERCE 3-26-2009.

**PRINCIPAL REGISTER**

THE MARK CONSISTS OF STANDARD CHARACTERS WITHOUT CLAIM TO ANY PARTICULAR FONT, STYLE, SIZE, OR COLOR.

NO CLAIM IS MADE TO THE EXCLUSIVE RIGHT TO USE "ARCHIVE", APART FROM THE MARK AS SHOWN.

SER. NO. 85-256,879, FILED 3-3-2011.

SUSAN STIGLITZ, EXAMINING ATTORNEY



*David J. Kappas*

Director of the United States Patent and Trademark Office

**United States of America**  
United States Patent and Trademark Office

# Andromeda

**Reg. No. 4,124,240**

STEVE KLEIN (UNITED STATES INDIVIDUAL)  
10960 VENTURA BOULEVARD  
STUDIO CITY, CA 91604

**Registered Apr. 10, 2012**

**Int. Cl.: 9**

FOR: DIGITAL MEDIA STORAGE MANAGEMENT EQUIPMENT, NAMELY COMPUTER HARDWARE, IN CLASS 9 (U.S. CLS. 21, 23, 26, 36 AND 38).

**TRADEMARK**

FIRST USE 3-26-2009; IN COMMERCE 3-26-2009.

**PRINCIPAL REGISTER**

THE MARK CONSISTS OF STANDARD CHARACTERS WITHOUT CLAIM TO ANY PARTICULAR FONT, STYLE, SIZE, OR COLOR.

SER. NO. 85-256,914, FILED 3-3-2011.

SUSAN STIGLITZ, EXAMINING ATTORNEY



*David J. Kybas*

Director of the United States Patent and Trademark Office

**United States of America**  
United States Patent and Trademark Office

# Polaris RAID

**Reg. No. 4,124,241**

STEVE KLEIN (UNITED STATES INDIVIDUAL)  
10960 VENTURA BOULEVARD  
STUDIO CITY, CA 91604

**Registered Apr. 10, 2012**

**Int. Cl.: 9**

FOR: DIGITAL MEDIA STORAGE MANAGEMENT HARDWARE, IN CLASS 9 (U.S. CLS. 21, 23, 26, 36 AND 38).

**TRADEMARK**

FIRST USE 3-26-2009; IN COMMERCE 3-26-2009.

**PRINCIPAL REGISTER**

THE MARK CONSISTS OF STANDARD CHARACTERS WITHOUT CLAIM TO ANY PARTICULAR FONT, STYLE, SIZE, OR COLOR.

NO CLAIM IS MADE TO THE EXCLUSIVE RIGHT TO USE "RAID", APART FROM THE MARK AS SHOWN.

SER. NO. 85-256,948, FILED 3-3-2011.

SUSAN STIGLITZ, EXAMINING ATTORNEY



*David J. Kyffers*

Director of the United States Patent and Trademark Office

**United States of America**  
United States Patent and Trademark Office

# EUROGEAR

**Reg. No. 4,124,242**

SHALAM IMPORTS, INC. (NEW YORK CORPORATION)  
4013 13TH AVENUE  
BROOKLYN, NY 11218

**Registered Apr. 10, 2012**

**Int. Cl.: 18**

FOR: BACKPACKS, LUGGAGE, DUFFLE BAGS AND TRAVEL BAGS, IN CLASS 18 (U.S. CLS. 1, 2, 3, 22 AND 41).

**TRADEMARK**

FIRST USE 12-15-2009; IN COMMERCE 12-15-2009.

**PRINCIPAL REGISTER**

THE MARK CONSISTS OF STANDARD CHARACTERS WITHOUT CLAIM TO ANY PARTICULAR FONT, STYLE, SIZE, OR COLOR.

SER. NO. 85-256,972, FILED 3-3-2011.

LINDA MICKLEBURGH, EXAMINING ATTORNEY



*David J. Kyffers*

Director of the United States Patent and Trademark Office

# United States of America

United States Patent and Trademark Office

## Ground Observer 80

**Reg. No. 4,124,243**

**Registered Apr. 10, 2012**

**Int. Cl.: 9**

**TRADEMARK**

**PRINCIPAL REGISTER**

THALES DEFENCE & SECURITY SYSTEMS GMBH (FED REP GERMANY LIMITED LIABILITY COMPANY)  
OSTENDSTRASSE 3  
PFORZHEIM, FED REP GERMANY 75175

FOR: RADAR; RADAR FOR AIRCRAFT DEFENSE, MISSILE WARNING, SURFACE SHIPS, PERISCOPES AT SEA, GROUND SURVEILLANCE, AND FIRE CONTROL OF MISSILES AND GUNS, AND PARTS THEREFOR, AND ACCESSORIES FOR RADAR, NAMELY, SENSORS, FLAT PANEL DISPLAYS, RADAR DOMES, COMPUTER SOFTWARE FOR RADAR FOR USE IN MONITORING AND DISPLAYING RADAR SIGNALS, AND DISPLAYS, NAMELY, ELECTRONIC DISPLAY BOARDS, ELECTRONIC DISPLAY SCREENS, ELECTRONIC DISPLAY INTERFACES, HEAD-MOUNTED VIDEO DISPLAYS, LIQUID CRYSTAL DISPLAYS, AND TRANSPARENT ELECTRONIC DISPLAYS FIXED AT HEAD-LEVEL OR HEAD-DOWN POSITIONS FOR USE IN MILITARY AND COMMERCIAL AIRCRAFT, VESSELS AND VEHICLES FOR PROVIDING CREW MEMBERS WITH NAVIGATIONAL AND OPERATIONAL INFORMATION, IN CLASS 9 (U.S. CLS. 21, 23, 26, 36 AND 38).

THE MARK CONSISTS OF STANDARD CHARACTERS WITHOUT CLAIM TO ANY PARTICULAR FONT, STYLE, SIZE, OR COLOR.

PRIORITY CLAIMED UNDER SEC. 44(D) ON FED REP GERMANY APPLICATION NO. 302011004519, FILED 1-25-2011, REG. NO. 302011004519, DATED 2-22-2011, EXPIRES 1-31-2021.

SER. NO. 85-257,063, FILED 3-3-2011.

LESLEY LAMOTHE, EXAMINING ATTORNEY



*David J. Kyffers*

Director of the United States Patent and Trademark Office

# United States of America

United States Patent and Trademark Office

# GO80

**Reg. No. 4,124,244**

**Registered Apr. 10, 2012**

**Int. Cl.: 9**

**TRADEMARK**

**PRINCIPAL REGISTER**

THALES DEFENCE & SECURITY SYSTEMS GMBH (FED REP GERMANY LIMITED LIABILITY COMPANY)  
OSTENDSTRASSE 3  
PFORZHEIM, FED REP GERMANY 75175

FOR: RADAR; RADAR FOR AIRCRAFT DEFENSE, MISSILE WARNING, SURFACE SHIPS, PERISCOPES AT SEA, GROUND SURVEILLANCE, AND FIRE CONTROL OF MISSILES AND GUNS, AND PARTS THEREFOR, AND ACCESSORIES FOR RADAR, NAMELY, SENSORS, FLAT PANEL DISPLAYS, RADAR DOMES, COMPUTER SOFTWARE FOR RADAR FOR USE IN MONITORING AND DISPLAYING RADAR SIGNALS, AND DISPLAYS, NAMELY, ELECTRONIC DISPLAY BOARDS, ELECTRONIC DISPLAY SCREENS, ELECTRONIC DISPLAY INTERFACES, HEAD-MOUNTED VIDEO DISPLAYS, LIQUID CRYSTAL DISPLAYS, AND TRANSPARENT ELECTRONIC DISPLAYS FIXED AT HEAD-LEVEL OR HEAD-DOWN POSITIONS FOR USE IN MILITARY AND COMMERCIAL AIRCRAFT, VESSELS AND VEHICLES FOR PROVIDING CREW MEMBERS WITH NAVIGATIONAL AND OPERATIONAL INFORMATION, IN CLASS 9 (U.S. CLS. 21, 23, 26, 36 AND 38).

THE MARK CONSISTS OF STANDARD CHARACTERS WITHOUT CLAIM TO ANY PARTICULAR FONT, STYLE, SIZE, OR COLOR.

OWNER OF FED REP GERMANY REG. NO. 302011004520, DATED 2-22-2011, EXPIRES 1-31-2021.

SER. NO. 85-257,091, FILED 3-3-2011.

LESLEY LAMOTHE, EXAMINING ATTORNEY



*David J. Kybas*

Director of the United States Patent and Trademark Office

# United States of America

United States Patent and Trademark Office

## POSTINGSPLUS

**Reg. No. 4,124,245**

POSTINGSPLUS LLC (DELAWARE LIMITED LIABILITY COMPANY)  
P.O. BOX 291

**Registered Apr. 10, 2012**

OYSTER BAY, NY 117710291

**Int. Cls.: 35, 38, 41 and 45**

FOR: PROMOTING THE GOODS AND SERVICES OF OTHERS BY PROVIDING A WEB SITE FEATURING COUPONS, REBATES, PRICE-COMPARISON INFORMATION, PRODUCT REVIEWS, LINKS TO THE RETAIL WEB SITES OF OTHERS, AND DISCOUNT INFORMATION; PROVIDING NETWORKING OPPORTUNITIES FOR INDIVIDUALS SEEKING EMPLOYMENT, IN CLASS 35 (U.S. CLS. 100, 101 AND 102).

**SERVICE MARK**

**PRINCIPAL REGISTER**

FIRST USE 9-24-2010; IN COMMERCE 9-24-2010.

FOR: INTERNET RADIO SERVICES, NAMELY, TRANSMISSION OF AUDIO MATERIAL VIA THE INTERNET; PROVIDING E-MAIL SERVICES; PROVIDING ON-LINE CHAT ROOMS AND ELECTRONIC BULLETIN BOARDS FOR TRANSMISSION OF MESSAGES AMONG USERS IN THE FIELD OF GENERAL INTEREST; TRANSMISSION OF SOUND, VIDEO AND INFORMATION, IN CLASS 38 (U.S. CLS. 100, 101 AND 104).

FIRST USE 9-24-2010; IN COMMERCE 9-24-2010.

FOR: ENTERTAINMENT SERVICES, NAMELY, PROVIDING ON-LINE COMPUTER GAMES; ON-LINE JOURNALS, NAMELY, BLOGS FEATURING COMMENTARY AND OPINIONS IN THE FIELDS OF POLITICS, BUSINESS, NEWS, TRAVEL, DINING, SPORTS, ENTERTAINMENT AND CURRENT EVENTS; PROVIDING A WEBSITE FOR ENTERTAINMENT PURPOSES WHERE USERS CAN VIEW AND POST BLOGS, EVENT INFORMATION, MESSAGES, COMMENTS, MULTIMEDIA CONTENT, VIDEOS, PHOTOS, IMAGES, TEXT, AUDIO AND INFORMATION FEATURING ENTERTAINMENT EVENTS, SPECIAL EVENTS, SPORTS EVENTS, MUSICAL CONCERTS, ART, PERFORMING ARTS, MUSIC, DANCE, THEATER, COMMUNITY ACTIVITIES, NEWS, BUSINESS, TRAVEL, HUMOR, SATIRE, POLITICAL COMMENTARY, SOCIAL COMMENTARY AND CURRENT EVENTS; PROVIDING AN INTERNET NEWS PORTAL FEATURING LINKS TO NEWS STORIES AND ARTICLES IN THE FIELD OF CURRENT EVENTS; PROVIDING CURRENT EVENT NEWS AND INFORMATION VIA A GLOBAL COMPUTER NETWORK, IN CLASS 41 (U.S. CLS. 100, 101 AND 107).



*David J. Kyffers*

FIRST USE 9-24-2010; IN COMMERCE 9-24-2010.



**Reg. No. 4,124,245** FOR: INTERNET BASED SOCIAL NETWORKING, INTRODUCTION, AND DATING SERVICES; INTERNET-BASED SOCIAL NETWORKING SERVICES; PROVIDING A SOCIAL NETWORKING WEBSITE FOR ENTERTAINMENT PURPOSES, IN CLASS 45 (U.S. CLS. 100 AND 101).

FIRST USE 9-24-2010; IN COMMERCE 9-24-2010.

THE MARK CONSISTS OF STANDARD CHARACTERS WITHOUT CLAIM TO ANY PARTICULAR FONT, STYLE, SIZE, OR COLOR.

SER. NO. 85-257,270, FILED 3-3-2011.

ANNE MADDEN, EXAMINING ATTORNEY

# United States of America

United States Patent and Trademark Office

# BAVIA

**Reg. No. 4,124,246**

**Registered Apr. 10, 2012**

**Int. Cl.: 44**

HEAR ME ROAR PRODUCTIONS, LLC (MINNESOTA LIMITED LIABILITY COMPANY),  
DBA BAVIA HEALTH, INC.  
SUITE 226  
6135 KELLOGG AVENUE  
EDINA, MN 55424

**SERVICE MARK**

**PRINCIPAL REGISTER**

FOR: IN HOSPITAL RECOVERY CARE AND WELLNESS SERVICES FOR PATIENTS, CARE GIVERS, AND HEALTHCARE PROVIDERS, NAMELY, BODY THERAPY TREATMENTS IN THE NATURE OF MASSAGE THERAPY AND SPA TREATMENTS IN THE NATURE OF COSMETIC BODY CARE SERVICES; IN HOSPITAL HOLISTIC HEALING SERVICES FOR PATIENTS, CARE GIVERS, AND HEALTHCARE PROVIDERS, NAMELY, THERAPEUTIC TOUCH SERVICES; POSTNATAL BODY THERAPY SERVICES IN THE NATURE OF MASSAGE THERAPY AND SPA TREATMENTS IN THE NATURE OF COSMETIC BODY CARE SERVICES, IN CLASS 44 (U.S. CLS. 100 AND 101).

FIRST USE 10-14-2010; IN COMMERCE 11-1-2010.

THE MARK CONSISTS OF STANDARD CHARACTERS WITHOUT CLAIM TO ANY PARTICULAR FONT, STYLE, SIZE, OR COLOR.

THE WORDING "BAVIA" HAS NO MEANING IN A FOREIGN LANGUAGE.

SER. NO. 85-257,338, FILED 3-3-2011.

HAI-LY LAM, EXAMINING ATTORNEY



*David J. Kybas*

Director of the United States Patent and Trademark Office

# United States of America

United States Patent and Trademark Office



**Reg. No. 4,124,247**

**Registered Apr. 10, 2012**

**Int. Cl.: 33**

**TRADEMARK**

**PRINCIPAL REGISTER**

BURROWING OWL VINEYARDS LTD. (CANADA CORPORATION)  
RR # 1, S-52, C-20  
OLIVER, BC, CANADA V0H1T0

FOR: ALCOHOLIC BEVERAGES, NAMELY, WINE, IN CLASS 33 (U.S. CLS. 47 AND 49).

FIRST USE 0-0-1998; IN COMMERCE 0-0-1998.

THE MARK CONSISTS OF A SET OF THREE LEAVES AND ONE SET OF GRAPES TO WRAP AROUND THE TOP PORTION OF THE NECK AND CAP OF A BOTTLE.

SEC. 2(F).

SER. NO. 85-257,392, FILED S.R. 3-3-2011 AM. P.R. 12-7-2011.

CARYN GLASSER, EXAMINING ATTORNEY



*David J. Kybas*

Director of the United States Patent and Trademark Office

# United States of America

United States Patent and Trademark Office



**Reg. No. 4,124,248**

**Registered Apr. 10, 2012**

**Int. Cls.: 35, 37, 38 and  
42**

**SERVICE MARK**

**PRINCIPAL REGISTER**

SMOOTHSTONE IP COMMUNICATIONS CORPORATION (DELAWARE CORPORATION)  
200 SMOOTHSTONE CENTER  
401 S. FOURTH STREET  
LOUISVILLE, KY 40202

FOR: BUSINESS CONSULTING SERVICES IN THE FIELDS OF TELECOMMUNICATIONS, UNIFIED IP COMMUNICATIONS, VOICE OVER INTERNET-PROTOCOL (VOIP), WIDE AREA NETWORKING (WAN), AND NETWORK MANAGEMENT, IN CLASS 35 (U.S. CLS. 100, 101 AND 102).

FIRST USE 9-3-2009; IN COMMERCE 9-3-2009.

FOR: INSTALLATION, MAINTENANCE AND REPAIR OF TELECOMMUNICATIONS AND DATA NETWORKING HARDWARE FOR PROVIDING UNIFIED IP COMMUNICATIONS SERVICES ACROSS MULTIPLE NETWORK INFRASTRUCTURES AND COMMUNICATION PROTOCOLS, IN CLASS 37 (U.S. CLS. 100, 103 AND 106).

FIRST USE 9-3-2009; IN COMMERCE 9-3-2009.

FOR: UNIFIED IP COMMUNICATIONS SERVICES THAT FACILITATE COMMUNICATIONS ACROSS VARIOUS NETWORKS, MEDIA AND DEVICES, NAMELY, COMMUNICATION VIA COMPUTER TERMINALS, BY DIGITAL TRANSMISSION, OR BY SATELLITE; VOICE OVER INTERNET-PROTOCOL (VOIP) SERVICES; VIDEO, AUDIO AND DATA CONFERRING SERVICES, IN CLASS 38 (U.S. CLS. 100, 101 AND 104).

FIRST USE 9-3-2009; IN COMMERCE 9-3-2009.

FOR: SOFTWARE AS A SERVICE (SAAS) PROVIDER FEATURING SOFTWARE FOR ENABLING UNIFIED COMMUNICATIONS ACROSS VARIOUS NETWORKS, MEDIA AND DEVICES, NAMELY, SOFTWARE FOR QUEUING, HANDLING, LOGGING, RECORDING, MONITORING, TRACKING, SUPERVISION, MANAGEMENT AND ROUTING OF TELEPHONE CALLS, VIDEO, E-MAILS, AND WEB BASED MESSAGES, AND SOFTWARE FOR MONITORING AND MANAGEMENT OF COMPUTER AND NETWORK SYSTEMS FOR SECURITY AND APPLICATION OPTIMIZATION PURPOSES; INSTALLATION, SERVICING, MAINTENANCE AND REPAIR OF APPLICATION SOFTWARE FOR PROVIDING UNIFIED IP COMMUNICATIONS SERVICES ACROSS MULTIPLE NETWORK INFRASTRUCTURES AND COMMUNICATION PROTOCOLS; INTEGRATION OF TELECOMMUNICATIONS



*David J. Kyffers*

Director of the United States Patent and Trademark Office

**Reg. No. 4,124,248** AND DATA NETWORKING EQUIPMENT AND APPLICATION SOFTWARE FOR PROVIDING UNIFIED IP COMMUNICATIONS SERVICES ACROSS MULTIPLE NETWORK INFRASTRUCTURES AND COMMUNICATION PROTOCOLS; COMPUTER SERVICES, NAMELY, WAN DESIGN; APPLICATION OPTIMIZATION SERVICES, NAMELY, UPDATING OF COMPUTER NETWORK CONFIGURATIONS; DEVELOPMENT OF SECURITY SYSTEMS AND CONTINGENCY PLANNING FOR COMPUTER NETWORKS; PROVIDING TEMPORARY USE OF NON-DOWNLOADABLE COMPUTER SOFTWARE FOR ENABLING UNIFIED IP COMMUNICATIONS ACROSS VARIOUS NETWORKS, MEDIA AND DEVICES; COMPUTER SECURITY CONSULTANCY, IN CLASS 42 (U.S. CLS. 100 AND 101).

FIRST USE 9-3-2009; IN COMMERCE 9-3-2009.

THE MARK CONSISTS OF A STYLIZED LETTER "X" TO THE RIGHT OF WHICH APPEARS A SUPERSCRIPED LETTER "S", CIRCUMSCRIBED BY A FANCIFUL CIRCULAR DESIGN.

SER. NO. 85-257,447, FILED 3-3-2011.

VIVIAN MICZNIK FIRST, EXAMINING ATTORNEY

# United States of America

United States Patent and Trademark Office

# VOICEMAXX

**Reg. No. 4,124,249**

**Registered Apr. 10, 2012**

**Int. Cls.: 35, 37, 38 and  
42**

**SERVICE MARK**

**PRINCIPAL REGISTER**

SMOOTHSTONE IP COMMUNICATIONS CORPORATION (DELAWARE CORPORATION)  
200 SMOOTHSTONE CENTER  
401 S. FOURTH STREET  
LOUISVILLE, KY 40202

FOR: BUSINESS CONSULTING SERVICES IN THE FIELDS OF TELECOMMUNICATIONS, UNIFIED IP COMMUNICATIONS, VOICE OVER INTERNET-PROTOCOL (VOIP), WIDE AREA NETWORKING (WAN), AND NETWORK MANAGEMENT, IN CLASS 35 (U.S. CLS. 100, 101 AND 102).

FIRST USE 2-25-2011; IN COMMERCE 2-25-2011.

FOR: INSTALLATION, MAINTENANCE AND REPAIR OF TELECOMMUNICATIONS AND DATA NETWORKING HARDWARE FOR PROVIDING UNIFIED IP COMMUNICATIONS SERVICES ACROSS MULTIPLE NETWORK INFRASTRUCTURES AND COMMUNICATION PROTOCOLS, IN CLASS 37 (U.S. CLS. 100, 103 AND 106).

FIRST USE 2-25-2011; IN COMMERCE 2-25-2011.

FOR: UNIFIED IP COMMUNICATIONS SERVICES THAT FACILITATE COMMUNICATIONS ACROSS VARIOUS NETWORKS, MEDIA AND DEVICES, NAMELY, COMMUNICATION VIA COMPUTER TERMINALS, BY DIGITAL TRANSMISSION, OR BY SATELLITE; VOICE OVER INTERNET-PROTOCOL (VOIP) SERVICES; VIDEO, AUDIO AND DATA CONFERENCING SERVICES, IN CLASS 38 (U.S. CLS. 100, 101 AND 104).

FIRST USE 2-25-2011; IN COMMERCE 2-25-2011.

FOR: SOFTWARE AS A SERVICE (SAAS) PROVIDER FEATURING SOFTWARE FOR ENABLING UNIFIED COMMUNICATIONS ACROSS VARIOUS NETWORKS, MEDIA AND DEVICES, NAMELY, SOFTWARE FOR QUEUING, HANDLING, LOGGING, RECORDING, MONITORING, TRACKING, SUPERVISION, MANAGEMENT AND ROUTING OF TELEPHONE CALLS, VIDEO, E-MAILS, AND WEB BASED MESSAGES, AND SOFTWARE FOR MONITORING AND MANAGEMENT OF COMPUTER AND NETWORK SYSTEMS FOR SECURITY AND APPLICATION OPTIMIZATION PURPOSES; INSTALLATION, MAINTENANCE AND REPAIR OF APPLICATION SOFTWARE FOR PROVIDING UNIFIED IP COMMUNICATIONS SERVICES ACROSS MULTIPLE NETWORK INFRASTRUCTURES AND COMMUNICATION PROTOCOLS; INTEGRATION OF TELECOMMUNICATIONS AND



*David J. Kyjars*

Director of the United States Patent and Trademark Office

**Reg. No. 4,124,249** DATA NETWORKING EQUIPMENT AND APPLICATION SOFTWARE FOR PROVIDING UNIFIED IP COMMUNICATIONS SERVICES ACROSS MULTIPLE NETWORK INFRASTRUCTURES AND COMMUNICATION PROTOCOLS; COMPUTER SERVICES, NAMELY, WAN DESIGN; APPLICATION OPTIMIZATION SERVICES, NAMELY, UPDATING OF COMPUTER NETWORK CONFIGURATIONS; DEVELOPMENT OF SECURITY SYSTEMS AND CONTINGENCY PLANNING FOR COMPUTER NETWORKS; PROVIDING TEMPORARY USE OF NON-DOWNLOADABLE COMPUTER SOFTWARE FOR ENABLING UNIFIED IP COMMUNICATIONS ACROSS VARIOUS NETWORKS, MEDIA AND DEVICES; COMPUTER SECURITY CONSULTANCY, IN CLASS 42 (U.S. CLS. 100 AND 101).

FIRST USE 2-25-2011; IN COMMERCE 2-25-2011.

THE MARK CONSISTS OF STANDARD CHARACTERS WITHOUT CLAIM TO ANY PARTICULAR FONT, STYLE, SIZE, OR COLOR.

SER. NO. 85-257,519, FILED 3-3-2011.

VIVIAN MICZNIK FIRST, EXAMINING ATTORNEY

# United States of America

United States Patent and Trademark Office

## PROPERTYRATE

**Reg. No. 4,124,250**

**Registered Apr. 10, 2012**

**Int. Cl.: 36**

**SERVICE MARK**

**PRINCIPAL REGISTER**

PROPERTYRATE CORPORATION (CALIFORNIA CORPORATION)  
SUITE 201  
1403 N. BATAVIA ST.  
ORANGE, CA 928673525

FOR: APPRAISAL AND EVALUATION OF REAL ESTATE, IN CLASS 36 (U.S. CLS. 100, 101 AND 102).

FIRST USE 4-23-2004; IN COMMERCE 4-23-2004.

THE MARK CONSISTS OF STANDARD CHARACTERS WITHOUT CLAIM TO ANY PARTICULAR FONT, STYLE, SIZE, OR COLOR.

SEC. 2(F).

SER. NO. 85-257,633, FILED 3-3-2011.

ELIZABETH KAJUBI, EXAMINING ATTORNEY



*David J. Kybas*

Director of the United States Patent and Trademark Office



# United States of America

United States Patent and Trademark Office

# Axlor

**Reg. No. 4,124,251**

**Registered Apr. 10, 2012**

**Int. Cl.: 45**

**SERVICE MARK**

**PRINCIPAL REGISTER**

AXLOR CONSULTING LLC (MASSACHUSETTS LIMITED LIABILITY COMPANY)  
SUITE 400  
ONE MIFFLIN PLACE  
CAMBRIDGE, MA 02138

FOR: EXPERT TESTIMONY AND WITNESS SERVICES IN LEGAL MATTERS IN THE FIELD OF PRODUCT LIABILITY CLAIM VALUATION AND ENVIRONMENTAL ECONOMICS; LITIGATION SERVICES, IN CLASS 45 (U.S. CLS. 100 AND 101).

FIRST USE 7-22-2010; IN COMMERCE 2-1-2011.

THE MARK CONSISTS OF STANDARD CHARACTERS WITHOUT CLAIM TO ANY PARTICULAR FONT, STYLE, SIZE, OR COLOR.

THE WORDING "AXLOR" HAS NO MEANING IN A FOREIGN LANGUAGE.

SER. NO. 85-257,799, FILED 3-4-2011.

SALLY SHIH, EXAMINING ATTORNEY



*David J. Kybas*

Director of the United States Patent and Trademark Office

# United States of America

United States Patent and Trademark Office

# FULLAXS

**Reg. No. 4,124,252**

TYCO ELECTRONICS CORPORATION (PENNSYLVANIA CORPORATION)  
1050 WESTLAKES DRIVE  
BERWYN, PA 19312

**Registered Apr. 10, 2012**

**Int. Cl.: 9**

FOR: ELECTRICAL CONNECTORS AND FIBER OPTIC CONNECTORS, IN CLASS 9 (U.S. CLS. 21, 23, 26, 36 AND 38).

**TRADEMARK**

FIRST USE 7-8-2010; IN COMMERCE 7-8-2010.

**PRINCIPAL REGISTER**

THE MARK CONSISTS OF STANDARD CHARACTERS WITHOUT CLAIM TO ANY PARTICULAR FONT, STYLE, SIZE, OR COLOR.

PRIORITY CLAIMED UNDER SEC. 44(D) ON ERPN CMNTY TM OFC APPLICATION NO. 009693623, FILED 1-28-2011.

SER. NO. 85-257,800, FILED 3-4-2011.

INGRID C. EULIN, EXAMINING ATTORNEY



*David J. Kybas*

Director of the United States Patent and Trademark Office

# United States of America

United States Patent and Trademark Office

## CRAWLSPACE DEPOT

**Reg. No. 4,124,253**

NISUS CORPORATION (TENNESSEE CORPORATION)  
100 NISUS DRIVE  
ROCKFORD, TN 37853

**Registered Apr. 10, 2012**

**Int. Cl.: 35**

FOR: ON-LINE, CATALOG AND RETAIL STORE SERVICES IN THE FIELD OF A WIDE VARIETY OF PRODUCTS FOR USE IN THE CONSTRUCTION, REPAIR, AND CLOSING OF CRAWLSPACES, IN CLASS 35 (U.S. CLS. 100, 101 AND 102).

**SERVICE MARK**

FIRST USE 6-1-2011; IN COMMERCE 6-1-2011.

**PRINCIPAL REGISTER**

THE MARK CONSISTS OF STANDARD CHARACTERS WITHOUT CLAIM TO ANY PARTICULAR FONT, STYLE, SIZE, OR COLOR.

NO CLAIM IS MADE TO THE EXCLUSIVE RIGHT TO USE "CRAWLSPACE", APART FROM THE MARK AS SHOWN.

SER. NO. 85-257,837, FILED 3-4-2011.

ANNE MADDEN, EXAMINING ATTORNEY



*David J. Kyjars*

Director of the United States Patent and Trademark Office

# United States of America

United States Patent and Trademark Office



**Reg. No. 4,124,254**

**Registered Apr. 10, 2012**

**Int. Cls.: 6, 11, 19 and 20**

**TRADEMARK**

**PRINCIPAL REGISTER**

COLUMBIA SYSTEMS INTERNATIONAL OF SOUTH CAROLINA LLC (SOUTH CAROLINA LIMITED LIABILITY COMPANY)  
825 GARLAND STREET  
COLUMBIA, SC 29201

FOR: CONSTRUCTION MATERIALS, NAMELY, METAL TOILET PARTITIONS, IN CLASS 6 (U.S. CLS. 2, 12, 13, 14, 23, 25 AND 50).

FIRST USE 5-31-2010; IN COMMERCE 5-31-2010.

FOR: ELECTRIC HAND DRYING APPARATUS FOR WASHROOMS, IN CLASS 11 (U.S. CLS. 13, 21, 23, 31 AND 34).

FIRST USE 5-31-2010; IN COMMERCE 5-31-2010.

FOR: CONSTRUCTION MATERIALS, NAMELY, NONMETAL TOILET PARTITIONS, IN CLASS 19 (U.S. CLS. 1, 12, 33 AND 50).

FIRST USE 5-31-2010; IN COMMERCE 5-31-2010.

FOR: LOCKERS; WALL-MOUNTED DIAPER CHANGING PLATFORMS, IN CLASS 20 (U.S. CLS. 2, 13, 22, 25, 32 AND 50).

FIRST USE 5-31-2010; IN COMMERCE 5-31-2010.

NO CLAIM IS MADE TO THE EXCLUSIVE RIGHT TO USE "COLUMBIA SYSTEMS INTERNATIONAL OF SOUTH CAROLINA, LLC", APART FROM THE MARK AS SHOWN.

THE COLOR(S) GREEN AND RED IS/ARE CLAIMED AS A FEATURE OF THE MARK.

THE MARK CONSISTS OF THE STYLIZED WORDING "CSISC COLUMBIA SYSTEMS INTERNATIONAL OF SOUTH CAROLINA, LLC"; THE COLOR GREEN IS USED FOR THE LETTERS "CS" AND "SC" IN "CSISC", AND THE WORDING "COLUMBIA SYSTEMS" AND "OF SOUTH CAROLINA, LLC"; THE COLOR RED IS USED FOR THE LETTER "I" IN "CSISC" AND THE WORD "INTERNATIONAL".



*David J. Kyffers*

Director of the United States Patent and Trademark Office

SER. NO. 85-257,906, FILED 3-4-2011.

**Reg. No. 4,124,254** B. PARADEWELAI, EXAMINING ATTORNEY

# United States of America

United States Patent and Trademark Office

# Pow Crunch

**Reg. No. 4,124,255**

OTTOGI AMERICA, INC. (CALIFORNIA CORPORATION)  
5660 LINDBERGH LANE  
BELL, CA 90201

**Registered Apr. 10, 2012**

**Int. Cl.: 30**

FOR: CEREAL BASED SNACK FOOD; WHEAT-BASED SNACK FOODS, IN CLASS 30 (U.S. CL. 46).

**TRADEMARK**

FIRST USE 7-28-2010; IN COMMERCE 7-28-2010.

**PRINCIPAL REGISTER**

THE MARK CONSISTS OF STANDARD CHARACTERS WITHOUT CLAIM TO ANY PARTICULAR FONT, STYLE, SIZE, OR COLOR.

SER. NO. 85-257,998, FILED 3-4-2011.

ALLISON SCHRODY, EXAMINING ATTORNEY



*David J. Kyffers*

Director of the United States Patent and Trademark Office

# United States of America

United States Patent and Trademark Office

## DYNAMIC INFLATION STRATEGY INDEX

**Reg. No. 4,124,256**

EAM PARTNERS L.P. (TEXAS LIMITED PARTNERSHIP)  
1139 SOUTH MAIN STREET  
GRAPEVINE, TX 76051

**Registered Apr. 10, 2012**

**Int. Cl.: 35**

FOR: COMPILING AND PROVIDING A FINANCIAL INDEX CONSISTING OF PHYSICAL  
COMMODITY FUTURES, IN CLASS 35 (U.S. CLS. 100, 101 AND 102).

**SERVICE MARK**

FIRST USE 3-1-2011; IN COMMERCE 3-1-2011.

**PRINCIPAL REGISTER**

THE MARK CONSISTS OF STANDARD CHARACTERS WITHOUT CLAIM TO ANY PAR-  
TICULAR FONT, STYLE, SIZE, OR COLOR.

OWNER OF U.S. REG. NOS. 2,825,073, 3,347,561, AND 3,835,827.

NO CLAIM IS MADE TO THE EXCLUSIVE RIGHT TO USE "INFLATION STRATEGY IN-  
DEX", APART FROM THE MARK AS SHOWN.

SER. NO. 85-258,130, FILED 3-4-2011.

LESLIE RICHARDS, EXAMINING ATTORNEY



*David J. Kyffers*

Director of the United States Patent and Trademark Office

# United States of America

United States Patent and Trademark Office

# Dapco

**Reg. No. 4,124,257**

NORDCO INC. (DELAWARE CORPORATION)  
245 WEST FOREST HILL AVENUE  
OAK CREEK, WI 53154

**Registered Apr. 10, 2012**

**Int. Cl.: 45**

FOR: INSPECTION OF PRESSURE TANKS, RAILS AND PIPES FOR SAFETY PURPOSES,  
IN CLASS 45 (U.S. CLS. 100 AND 101).

**SERVICE MARK**

FIRST USE 1-1-1976; IN COMMERCE 1-1-1976.

**PRINCIPAL REGISTER**

THE MARK CONSISTS OF THE WORDING "DAPCO" WITH PARALLEL LINES EXTENDING  
FROM THE LEFT AND UPPER LEFT STEMS OF THE LETTER "D" WITH AN UNDERLINE  
BENEATH THE WORDING "DAPCO".

SER. NO. 85-258,191, FILED 3-4-2011.

SAMUEL E. SHARPER JR., EXAMINING ATTORNEY



*David J. Kybas*

Director of the United States Patent and Trademark Office



# United States of America

United States Patent and Trademark Office



**Reg. No. 4,124,258**

**Registered Apr. 10, 2012**

**Int. Cl.: 3**

**TRADEMARK**

**PRINCIPAL REGISTER**

JACK BLACK, L.L.C. (DELAWARE LIMITED LIABILITY COMPANY)  
2025 BELTLINE ROAD, SUITE 120  
CARROLLTON, TX 75006

FOR: AFTER-SHAVE LOTIONS; AFTER-SHAVE BALMS; SHAVING BALMS; SHAVING CREAMS; SHAVING LOTIONS; SHAVING GELS; SHAVING SOAPS; SHAVING PREPARATIONS, PRE-SHAVE CREAMS, PRE-SHAVE OILS; NON-MEDICATED LIP BALMS; EYE CREAMS; HAND CREAMS; ASTRINGENTS FOR COSMETIC PURPOSES; BEAUTY MASKS; FACIAL SCRUBS; FACIAL LOTIONS; FACIAL CLEANSERS; FACIAL MOISTURIZERS, FACIAL HYDRATORS AND FACIAL SKIN SERUM; FACIAL CLEANING PREPARATION, NAMELY, SALICYLIC ACNE CLEANSER NOT FOR MEDICAL PURPOSES; NON-MEDICATED ACNE TREATMENT PREPARATIONS; SKIN CLEANSING CREAMS; SKIN CLEANSING LOTIONS; SKIN CREAMS; SKIN MOISTURIZERS; SKIN EMOLLIENTS; AND WRINKLE REMOVING SKIN CARE PREPARATIONS; SKIN LOTIONS; SKIN TONERS; SKIN CONDITIONERS, SKIN REFRESHERS; ANTIPERSPIRANTS; PERSONAL DEODORANTS; DEODORANTS; BATH GELS; SHOWER GELS; BODY CREAMS; BODY LOTIONS; BODY POWDERS; BODY WASHES; BODY SCRUBS; SUN BLOCK PREPARATIONS; SUN SCREEN PREPARATIONS; SUNSCREENS; SKIN SOAPS; BAR SOAPS; LIQUID SOAPS FOR HANDS, FACE AND BODY; NON-MEDICATED FOOT POWDERS; PERFUMES; COLOGNES; FRAGRANCES FOR PERSONAL USE; HAIR GELS; HAIR SHAMPOOS; HAIR CONDITIONERS; HAIR STYLING PREPARATIONS; HAIR LOTIONS; HAIR POMADES, IN CLASS 3 (U.S. CLS. 1, 4, 6, 50, 51 AND 52).

FIRST USE 4-5-2000; IN COMMERCE 4-5-2000.

OWNER OF U.S. REG. NOS. 2,476,740, 2,823,989 AND OTHERS.

THE NAME(S), PORTRAIT(S), AND/OR SIGNATURE(S) SHOWN IN THE MARK DOES NOT IDENTIFY A PARTICULAR LIVING INDIVIDUAL.

THE MARK CONSISTS OF THE LETTERS "JB" IN AN OVAL ABOVE THE WORDS "JACK BLACK" IN STYLIZED TYPE ABOVE A STRAIGHT LINE ABOVE THE WORDS "AUTHENTIC AND ORIGINAL".

SEC. 2(F) AS TO "AUTHENTIC AND ORIGINAL".

SER. NO. 85-258,419, FILED 3-4-2011.



*David J. Kybas*

Director of the United States Patent and Trademark Office

**Reg. No. 4,124,258** CAROLYN CATALDO, EXAMINING ATTORNEY

# United States of America

United States Patent and Trademark Office

## PENNY HARVEST RUN FOR CHANGE!

**Reg. No. 4,124,259**

COMMON CENTS NEW YORK, INC. (NEW YORK CORPORATION)  
570 COLUMBUS AVENUE  
NEW YORK, NY 10024

**Registered Apr. 10, 2012**

**Int. Cl.: 36**

FOR: CHARITABLE FUNDRAISING SERVICES, IN CLASS 36 (U.S. CLS. 100, 101 AND 102).

**SERVICE MARK**

FIRST USE 3-1-2011; IN COMMERCE 3-1-2011.

**PRINCIPAL REGISTER**

THE MARK CONSISTS OF STANDARD CHARACTERS WITHOUT CLAIM TO ANY PARTICULAR FONT, STYLE, SIZE, OR COLOR.

OWNER OF U.S. REG. NO. 2,543,159.

NO CLAIM IS MADE TO THE EXCLUSIVE RIGHT TO USE "RUN", APART FROM THE MARK AS SHOWN.

SER. NO. 85-258,566, FILED 3-4-2011.

JOHN KELLY, EXAMINING ATTORNEY



*David J. Kybas*

Director of the United States Patent and Trademark Office

# United States of America

United States Patent and Trademark Office

# Natural

FOOD HOLDINGS

**Reg. No. 4,124,260**

NIMAN RANCH, INC. (CALIFORNIA CORPORATION)  
1600 HARBOR BAY PARKWAY, SUITE 250  
ALAMEDA, CA 94502

**Registered Apr. 10, 2012**

**Int. Cl.: 29**

FOR: FRESH, FROZEN AND PROCESSED MEAT; BEEF; POULTRY; PORK; PROCESSED LAMB; EGGS; PREPACKAGED MEALS CONSISTING PRIMARILY OF MEAT, FISH, POULTRY, OR VEGETABLES; FROZEN, PREPARED OR PACKAGED READY-TO-EAT MEALS CONSISTING PRIMARILY OF MEAT, FISH, POULTRY, OR VEGETABLES; MEAT-BASED SNACK FOODS; CHEESE, IN CLASS 29 (U.S. CL. 46).

**TRADEMARK**

**PRINCIPAL REGISTER**

FIRST USE 10-10-2011; IN COMMERCE 10-10-2011.

NO CLAIM IS MADE TO THE EXCLUSIVE RIGHT TO USE "NATURAL FOOD HOLDINGS", APART FROM THE MARK AS SHOWN.

THE MARK CONSISTS OF A STYLIZED FORM OF THE WORDS "NATURAL FOOD HOLDINGS" WITH A STALK OF WHEAT THROUGH THE LETTER "N."

SER. NO. 85-258,639, FILED 3-4-2011.

SAIMA MAKHDOOM, EXAMINING ATTORNEY



*David J. Kyros*

Director of the United States Patent and Trademark Office

# United States of America

United States Patent and Trademark Office

# Curvy

**Reg. No. 4,124,261**

**Registered Apr. 10, 2012**

**Int. Cls.: 9 and 16**

**TRADEMARK**

**PRINCIPAL REGISTER**

DILLARD, MARKETA (UNITED STATES INDIVIDUAL)  
29914 SPARKLEBERRY  
SOUTHFIELD, MI 48076

FOR: DOWNLOADABLE ELECTRONIC PUBLICATIONS IN THE NATURE OF MAGAZINES AND NEWSLETTERS IN THE FIELD OF BEAUTY, FASHION, COOKING, MUSIC, THEATER, HEALTH, CINEMA, SPORTS, LITERATURE, ARTS, EDUCATION, HOME DECORATION, GARDENING, LANDSCAPING; DOWNLOADABLE RING TONES, LOGOS, PHOTOS, FASHION AND BEAUTY VIDEOS, GAMES AND HOROSCOPES VIA A GLOBAL COMPUTER NETWORK AND WIRELESS DEVICES, IN CLASS 9 (U.S. CLS. 21, 23, 26, 36 AND 38).

FIRST USE 4-25-2010; IN COMMERCE 4-25-2010.

FOR: A PRINTED PUBLICATION IN THE NATURE OF A MAGAZINE AND NEWSLETTER IN THE FIELD OF BEAUTY, FASHION, COOKING, MUSIC, THEATER, HEALTH, CINEMA, LITERATURE, ARTS, EDUCATION, HOME DECORATION, SPORTS, GARDENING, LANDSCAPING; LOGOS, PHOTOS, FASHION, GAMES, AND HOROSCOPES, IN CLASS 16 (U.S. CLS. 2, 5, 22, 23, 29, 37, 38 AND 50).

FIRST USE 4-25-2010; IN COMMERCE 4-25-2010.

THE MARK CONSISTS OF STANDARD CHARACTERS WITHOUT CLAIM TO ANY PARTICULAR FONT, STYLE, SIZE, OR COLOR.

SER. NO. 85-258,889, FILED 3-5-2011.

PAUL F. GAST, EXAMINING ATTORNEY



*David J. Kybas*

Director of the United States Patent and Trademark Office

# United States of America

United States Patent and Trademark Office

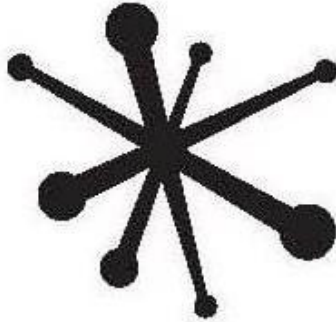

**Reg. No. 4,124,262**

SNOOZE, LLC (COLORADO LIMITED LIABILITY COMPANY)  
2262 LARIMER STREET  
DENVER, CO 80205

**Registered Apr. 10, 2012**

**Int. Cl.: 43**

FOR: CATERING; RESTAURANT SERVICES; TAKE-OUT RESTAURANT SERVICES, IN CLASS 43 (U.S. CLS. 100 AND 101).

**SERVICE MARK**

FIRST USE 3-1-2006; IN COMMERCE 3-1-2006.

**PRINCIPAL REGISTER**

OWNER OF U.S. REG. NO. 3,461,567.

THE MARK CONSISTS OF A CUSTOM JACK DESIGN.

SER. NO. 85-259,209, FILED 3-6-2011.

ALICE BENMAMAN, EXAMINING ATTORNEY



*David J. Kyffers*

Director of the United States Patent and Trademark Office

# United States of America

United States Patent and Trademark Office

# CRESCENDO

**Reg. No. 4,124,263**

L'OREAL (FRANCE SOCIÉTÉ ANONYME (SA))  
14 RUE ROYALE  
PARIS, FRANCE 75008

**Registered Apr. 10, 2012**

**Int. Cl.: 3**

FOR: HAIR COLORING PREPARATIONS, IN CLASS 3 (U.S. CLS. 1, 4, 6, 50, 51 AND 52).

**TRADEMARK**

THE MARK CONSISTS OF STANDARD CHARACTERS WITHOUT CLAIM TO ANY PARTICULAR FONT, STYLE, SIZE, OR COLOR.

**PRINCIPAL REGISTER**

OWNER OF FRANCE REG. NO. 1251384, DATED 11-18-1983, EXPIRES 11-18-2013.

SER. NO. 85-259,527, FILED 3-7-2011.

SIMON TENG, EXAMINING ATTORNEY



*David J. Kyffers*

Director of the United States Patent and Trademark Office

# United States of America

United States Patent and Trademark Office



inner balance  
W E L L N E S S

**Reg. No. 4,124,264**

**Registered Apr. 10, 2012**

**Int. Cl.: 10**

**TRADEMARK**

**PRINCIPAL REGISTER**

JOHNSON HEALTH TECH NORTH AMERICA, INC. (WISCONSIN CORPORATION), AKA  
INNER BALANCE WELLNESS  
1600 LANDMARK DRIVE  
COTTAGE GROVE, WI 53527

FOR: ELECTRIC MASSAGE APPARATUS FOR HOUSEHOLD USE, NAMELY, MASSAGE OTTOMAN FOR MASSAGING LEGS; MASSAGE CHAIRS, NAMELY, RECLINING UP-HOLSTERED ARM CHAIR WITH BUILT-IN MASSAGE ELEMENT; MASSAGERS IN THE NATURE OF ELECTROMECHANICAL MASSAGE MECHANISM FOR CHAIRS; HAND-HELD MASSAGERS; ELECTRIC MASSAGE CUSHION; INFRARED RADIATOR UNITS FOR THERAPEUTIC PURPOSES; THERAPEUTIC SAUNAS, NAMELY, STAND-ALONE FULL BODY SAUNA UNITS, IN CLASS 10 (U.S. CLS. 26, 39 AND 44).

FIRST USE 9-1-2010; IN COMMERCE 9-1-2010.

OWNER OF U.S. REG. NOS. 3,773,156, 3,939,696, AND 3,945,789.

NO CLAIM IS MADE TO THE EXCLUSIVE RIGHT TO USE "WELLNESS", APART FROM THE MARK AS SHOWN.

THE MARK CONSISTS OF THE WORDING "INNER BALANCE WELLNESS", A SHADED SQUARE AND, INSET INTO THE SQUARE, A LOWERCASE LETTER "B" WITH A LEAF SPROUTING OUT OF THE TOP OF THE LETTER "B".

SER. NO. 85-259,698, FILED 3-7-2011.

MARC LEIPZIG, EXAMINING ATTORNEY



*David J. Kybas*

Director of the United States Patent and Trademark Office



# United States of America

United States Patent and Trademark Office

*Jack Black*  
Authentic and Original

**Reg. No. 4,124,265**

JACK BLACK, L.L.C. (DELAWARE LIMITED LIABILITY COMPANY)  
2025 BELTLINE ROAD, SUITE 120  
CARROLLTON, TX 75006

**Registered Apr. 10, 2012**

**Int. Cl.: 21**

FOR: SHAVING BRUSH HOLDERS; SHAVING BRUSH STANDS; SHAVING BRUSHES, IN CLASS 21 (U.S. CLS. 2, 13, 23, 29, 30, 33, 40 AND 50).

**TRADEMARK**

FIRST USE 10-15-2008; IN COMMERCE 10-15-2008.

**PRINCIPAL REGISTER**

OWNER OF U.S. REG. NOS. 2,476,740, 2,823,989 AND OTHERS.

THE NAME(S), PORTRAIT(S), AND/OR SIGNATURE(S) SHOWN IN THE MARK DOES NOT IDENTIFY A PARTICULAR LIVING INDIVIDUAL.

THE MARK CONSISTS OF THE WORDS "JACK BLACK" IN STYLIZED TYPE ABOVE A STRAIGHT LINE ABOVE THE WORDS "AUTHENTIC AND ORIGINAL".

SEC. 2(F) AS TO "AUTHENTIC AND ORIGINAL".

SER. NO. 85-259,720, FILED 3-7-2011.

CAROLYN CATALDO, EXAMINING ATTORNEY



*David J. Kybas*

Director of the United States Patent and Trademark Office

# United States of America

United States Patent and Trademark Office

## JEAN LAFITTE

**Reg. No. 4,124,266**

EMMI ROTH USA, INC. (WISCONSIN CORPORATION)  
657 2ND STREET  
MONROE, WI 53566

**Registered Apr. 10, 2012**

**Int. Cl.: 29**

FOR: CHEESE, IN CLASS 29 (U.S. CL. 46).

**TRADEMARK**

FIRST USE 2-1-2009; IN COMMERCE 2-1-2009.

**PRINCIPAL REGISTER**

THE MARK CONSISTS OF STANDARD CHARACTERS WITHOUT CLAIM TO ANY PARTICULAR FONT, STYLE, SIZE, OR COLOR.

THE NAME(S), PORTRAIT(S), AND/OR SIGNATURE(S) SHOWN IN THE MARK DOES NOT IDENTIFY A PARTICULAR LIVING INDIVIDUAL.

SER. NO. 85-260,093, FILED 3-7-2011.

SUNG IN, EXAMINING ATTORNEY



*David J. Kyffers*

Director of the United States Patent and Trademark Office

# United States of America

United States Patent and Trademark Office



**Reg. No. 4,124,267**

**Registered Apr. 10, 2012**

**Int. Cls.: 29 and 30**

**TRADEMARK**

**PRINCIPAL REGISTER**

INTERNATIONAL FOOD SECURITY, LTD. (NEVADA CORPORATION)  
STE. C  
550 EAST CHARLESTON BOULEVARD  
LAS VEGAS, NV 89104

FOR: PREPARED MEALS CONSISTING PRIMARILY OF MEAT, VEGETABLES AND DRIED FRUIT; PREPARED FOOD KITS COMPOSED OF MEAT, AND/OR VEGETABLES AND ALSO INCLUDING SAUCES OR SEASONINGS, READY FOR COOKING AND ASSEMBLY AS A MEAL, IN CLASS 29 (U.S. CL. 46).

FIRST USE 1-15-2010; IN COMMERCE 12-30-2010.

FOR: PREPARED MEALS CONSISTING PRIMARILY OF PASTA OR RICE, IN CLASS 30 (U.S. CL. 46).

FIRST USE 1-15-2010; IN COMMERCE 12-30-2010.

THE MARK CONSISTS OF AN INCOMPLETE CIRCLE DESIGN FORMED FROM THREE SMALL CIRCLES AND THREE CURVED LINES WITH AN INVERTED V INSIDE. THE STYLIZED WORD "BIOARMOR" APPEARS TO THE RIGHT OF THE DESIGN. THE WORDING "BODY FUEL" APPEARS BELOW THE TERM "BIOARMOR".

SER. NO. 85-260,335, FILED 3-7-2011.

JENNIFER MARTIN, EXAMINING ATTORNEY



*David J. Kybas*

Director of the United States Patent and Trademark Office

# United States of America

United States Patent and Trademark Office

# decus

**Reg. No. 4,124,268**

TERRAZAS ELEANE (CANADA INDIVIDUAL)  
1229 WEST 8TH AVE.  
VANCOUVER, CANADA

**Registered Apr. 10, 2012**

**Int. Cl.: 14**

FOR: BODY JEWELRY; BRACELETS; EARRINGS; JEWELRY; JEWELRY CHAINS; RINGS;  
SILVER, IN CLASS 14 (U.S. CLS. 2, 27, 28 AND 50).

**TRADEMARK**

FIRST USE 3-9-2011; IN COMMERCE 3-9-2011.

**PRINCIPAL REGISTER**

THE MARK CONSISTS OF THE WORD DECUS WRITTEN WITH A CUSTOM FONT.

SER. NO. 85-260,445, FILED 3-8-2011.

NATALIE POLZER, EXAMINING ATTORNEY



*David J. Kybas*

Director of the United States Patent and Trademark Office

# United States of America

United States Patent and Trademark Office

## LUTH RESEARCH

**Reg. No. 4,124,269**

LUTH RESEARCH LLC (DELAWARE LIMITED LIABILITY COMPANY)

**Registered Apr. 10, 2012**

1365 FOURTH AVENUE  
SAN DIEGO, CA 92101

**Int. Cls.: 9, 16, 35 and 42**

FOR: AUDIO AND VIDEO RECORDINGS USED FOR THE PURPOSES OF CONDUCTING MARKET RESEARCH AND CONSULTING SERVICES, AND COLLECTING AND ANALYZING CONSUMER DATA AND STATISTICS FOR ANALYZING, UNDERSTANDING, REPORTING AND PREDICTING CONSUMER BEHAVIOR, IN CLASS 9 (U.S. CLS. 21, 23, 26, 36 AND 38).

**TRADEMARK**

**SERVICE MARK**

**PRINCIPAL REGISTER**

FIRST USE 6-30-1977; IN COMMERCE 6-30-1977.

FOR: PRINTED REPORTS CONTAINING THE RESULTS AND ANALYSIS OF MARKET RESEARCH SURVEYS, CONSUMER OPINION SURVEYS AND CONSULTING SERVICES, PRINTED REPORTS OF AGGREGATE MARKET RESEARCH RESULTS, CONSUMER DATA AND STATISTICS FOR ANALYZING, UNDERSTANDING, REPORTING AND PREDICTING CONSUMER BEHAVIOR, WHITE PAPERS SUMMARIZING THE RESULTS OF MARKET RESEARCH AND DATA COLLECTION EFFORTS, DESCRIBING EXISTING TRENDS AND PREDICTING FUTURE CONSUMER BEHAVIOR, IN CLASS 16 (U.S. CLS. 2, 5, 22, 23, 29, 37, 38 AND 50).

FIRST USE 6-30-1977; IN COMMERCE 6-30-1977.

FOR: MARKET RESEARCH AND CONSULTING SERVICES, CONDUCTING MARKET RESEARCH SURVEYS, INTERVIEWS, FOCUS GROUPS, MALL INTERCEPTS, ONLINE SURVEYS, MARKETING STUDIES AND CONSUMER OPINION SURVEYS AND COLLECTING AND ANALYZING CONSUMER DATA AND STATISTICS, AGGREGATING MARKET RESEARCH RESULTS, DATA AND STATISTICS FOR ANALYZING, UNDERSTANDING, REPORTING AND PREDICTING CONSUMER BEHAVIOR, IN CLASS 35 (U.S. CLS. 100, 101 AND 102).

FIRST USE 6-30-1977; IN COMMERCE 6-30-1977.

FOR: DEVELOPMENT OF INFORMATION TECHNOLOGY SYSTEMS USED TO PERFORM MARKET RESEARCH AND CONSULTING SERVICES, DESIGN AND DEVELOPMENT OF HARDWARE, SOFTWARE AND COMPUTER NETWORKS USED FOR HOSTING ONLINE MARKET RESEARCH PANELS AND CONDUCTING ONLINE MARKET RESEARCH SUR-



*David J. Kybas*

Director of the United States Patent and Trademark Office

**Reg. No. 4,124,269** VEYS, DESIGN AND DEVELOPMENT OF HARDWARE, SOFTWARE AND COMPUTER NETWORKS USED FOR GATHERING CONSUMER DATA AND STATISTICS FOR ANALYZING, UNDERSTANDING, REPORTING AND PREDICTING CONSUMER BEHAVIOR, IN CLASS 42 (U.S. CLS. 100 AND 101).

FIRST USE 6-30-1977; IN COMMERCE 6-30-1977.

THE MARK CONSISTS OF STANDARD CHARACTERS WITHOUT CLAIM TO ANY PARTICULAR FONT, STYLE, SIZE, OR COLOR.

NO CLAIM IS MADE TO THE EXCLUSIVE RIGHT TO USE "RESEARCH" , APART FROM THE MARK AS SHOWN.

SER. NO. 85-260,583, FILED 3-8-2011.

JOHN HWANG, EXAMINING ATTORNEY

# United States of America

United States Patent and Trademark Office

## CARPETURN.COM

**Reg. No. 4,124,270**

CARPETURN.COM (ARIZONA CORPORATION), DBA CARPETURN.COM  
2130 SOUTH 7TH AVENUE, STE 150  
PHOENIX, AZ 85007

**Registered Apr. 10, 2012**

**Int. Cl.: 37**

FOR: GENERAL CONTRACTING SERVICES IN THE FIELD OF FLOORING; INSTALLING CARPET; INSTALLING WOOD FLOORING; INSTALLING FLOOR VINYL AND TILE; INSTALLATION, MAINTENANCE AND REPAIR OF FLOORING, IN CLASS 37 (U.S. CLS. 100, 103 AND 106).

**SERVICE MARK**

**PRINCIPAL REGISTER**

FIRST USE 6-1-2010; IN COMMERCE 6-1-2010.

THE MARK CONSISTS OF STANDARD CHARACTERS WITHOUT CLAIM TO ANY PARTICULAR FONT, STYLE, SIZE, OR COLOR.

SER. NO. 85-260,679, FILED 3-8-2011.

INGA ERVIN, EXAMINING ATTORNEY



*David J. Kybas*

Director of the United States Patent and Trademark Office

# United States of America

United States Patent and Trademark Office

## URBAN-STYLE

**Reg. No. 4,124,271**

DAIMLER AG (FED REP GERMANY CORPORATION)  
MERCEDSTRASSE 137

**Registered Apr. 10, 2012**

STUTTGART, FED REP GERMANY 70327

**Int. Cls.: 12 and 28**

FOR: AUTOMOBILES AND THEIR STRUCTURAL PARTS, IN CLASS 12 (U.S. CLS. 19, 21, 23, 31, 35 AND 44).

**TRADEMARK**

FOR: TOY MODEL VEHICLES , IN CLASS 28 (U.S. CLS. 22, 23, 38 AND 50).

**PRINCIPAL REGISTER**

THE MARK CONSISTS OF STANDARD CHARACTERS WITHOUT CLAIM TO ANY PARTICULAR FONT, STYLE, SIZE, OR COLOR.

PRIORITY CLAIMED UNDER SEC. 44(D) ON FED REP GERMANY APPLICATION NO. 302010068395, FILED 11-19-2010.

OWNER OF ERPN CMNTY TM OFC REG. NO. 00973911, DATED 7-20-2011, EXPIRES 8-3-2021.

SER. NO. 85-260,680, FILED 3-8-2011.

BRENDAN MCCAULEY, EXAMINING ATTORNEY



*David J. Kybas*

Director of the United States Patent and Trademark Office



# United States of America

United States Patent and Trademark Office

## STRETCHTECH

**Reg. No. 4,124,272**

LAYFIELD GROUP LIMITED (CANADA CORPORATION)  
11120 SILVERSMITH PLACE

**Registered Apr. 10, 2012**

RICHMOND, B.C., CANADA V7A5E4

**Int. Cl.: 17**

FOR: PLASTIC FILM FOR INDUSTRIAL OR COMMERCIAL PALLET WRAPPING, NAMELY, STRETCH HOODER FILM, IN CLASS 17 (U.S. CLS. 1, 5, 12, 13, 35 AND 50).

**TRADEMARK**

THE MARK CONSISTS OF STANDARD CHARACTERS WITHOUT CLAIM TO ANY PARTICULAR FONT, STYLE, SIZE, OR COLOR.

**PRINCIPAL REGISTER**

PRIORITY CLAIMED UNDER SEC. 44(D) ON CANADA APPLICATION NO. 1495046, FILED 9-8-2010, REG. NO. TMA808,090, DATED 9-30-2011, EXPIRES 9-30-2026.

SER. NO. 85-260,697, FILED 3-8-2011.

ANNE E. GUSTASON, EXAMINING ATTORNEY



*David J. Kybas*

Director of the United States Patent and Trademark Office

# United States of America

United States Patent and Trademark Office



## Kirkland Smiles

DENTAL CARE

**Reg. No. 4,124,273**

BERNARD S. PAK, D.D.S., P.S. (WASHINGTON CORPORATION)  
312 11TH AVENUE WEST, SUITE 101  
KIRKLAND, WA 98033

**Registered Apr. 10, 2012**

**Int. Cl.: 44**

FOR: DENTISTRY, IN CLASS 44 (U.S. CLS. 100 AND 101).

**SERVICE MARK**

FIRST USE 8-1-2005; IN COMMERCE 8-1-2005.

**PRINCIPAL REGISTER**

NO CLAIM IS MADE TO THE EXCLUSIVE RIGHT TO USE "KIRKLAND" AND "DENTAL CARE", APART FROM THE MARK AS SHOWN.

THE MARK CONSISTS OF THE STYLIZED WORDS "KIRKLAND SMILES DENTAL CARE". AN IMAGE OF A TOOTH WITH A CURVED LINE REPRESENTING FLOSS ABOVE THE TEXT.

SER. NO. 85-260,744, FILED 3-8-2011.

MARILYN IZZI, EXAMINING ATTORNEY



*David J. Kappas*

Director of the United States Patent and Trademark Office

# United States of America

United States Patent and Trademark Office

# Ausculette

**Reg. No. 4,124,274**

EXCELLUS TECHNOLOGIES, INC. (SOUTH DAKOTA CORPORATION)  
160 SOUTH LAKE DRIVE  
WATERTOWN, SD 57201

**Registered Apr. 10, 2012**

**Int. Cl.: 9**

FOR: LINE OPERATED TELEMEDICINE AUSCULTATION TRANSMITTERS, IN CLASS 9  
(U.S. CLS. 21, 23, 26, 36 AND 38).

**TRADEMARK**

FIRST USE 12-31-1974; IN COMMERCE 12-31-1981.

**PRINCIPAL REGISTER**

THE MARK CONSISTS OF STANDARD CHARACTERS WITHOUT CLAIM TO ANY PARTICULAR FONT, STYLE, SIZE, OR COLOR.

SER. NO. 85-261,167, FILED 3-8-2011.

ERIN FALK, EXAMINING ATTORNEY



*David J. Kybas*

Director of the United States Patent and Trademark Office

**United States of America**  
United States Patent and Trademark Office

# OFFWRLD

**Reg. No. 4,124,275**

OFFWRLD, LLC (MARYLAND LIMITED LIABILITY COMPANY)  
3641 ADDISON WOODS ROAD  
FREDERICK, MD 21704

**Registered Apr. 10, 2012**

**Int. Cl.: 38**

FOR: BROADCASTING OF VIDEO AND AUDIO PROGRAMMING OVER THE INTERNET,  
IN CLASS 38 (U.S. CLS. 100, 101 AND 104).

**SERVICE MARK**

FIRST USE 6-29-2010; IN COMMERCE 2-7-2011.

**PRINCIPAL REGISTER**

THE MARK CONSISTS OF STANDARD CHARACTERS WITHOUT CLAIM TO ANY PAR-  
TICULAR FONT, STYLE, SIZE, OR COLOR.

SER. NO. 85-261,525, FILED 3-8-2011.

WILLIAM VERHOSEK, EXAMINING ATTORNEY



*David J. Kybas*

Director of the United States Patent and Trademark Office

# United States of America

United States Patent and Trademark Office

## Nursing Buddies

**Reg. No. 4,124,276**

**Registered Apr. 10, 2012**

**Int. Cl.: 10**

**TRADEMARK**

**PRINCIPAL REGISTER**

THERAPEARL, LLC (MARYLAND LIMITED LIABILITY COMPANY)  
SUITE 307  
8600 SNOWDEN RIVER PARKWAY  
COLUMBIA, MD 21045

FOR: HEATABLE AND FREEZABLE BEAD FILLED THERAPEUTIC PACKS, IN CLASS 10  
(U.S. CLS. 26, 39 AND 44).

FIRST USE 7-31-2010; IN COMMERCE 7-31-2010.

THE MARK CONSISTS OF STANDARD CHARACTERS WITHOUT CLAIM TO ANY PARTICULAR FONT, STYLE, SIZE, OR COLOR.

SER. NO. 85-261,653, FILED 3-9-2011.

HOWARD SMIGA, EXAMINING ATTORNEY



*David J. Kyffers*

Director of the United States Patent and Trademark Office

# United States of America

United States Patent and Trademark Office

## Raffling Done Right

**Reg. No. 4,124,277**

HITECH SPECIALISTS INC. (GEORGIA CORPORATION), DBA HITECH SPECIALISTS INC.  
2992 NORMANDY RIDGE  
LAWRENCEVILLE, GA 30044

**Registered Apr. 10, 2012**

**Int. Cl.: 41**

FOR: SWEEPSTAKE SERVICES PROVIDED OVER A GLOBAL COMPUTER NETWORK,  
IN CLASS 41 (U.S. CLS. 100, 101 AND 107).

**SERVICE MARK**

FIRST USE 1-29-2011; IN COMMERCE 6-7-2011.

**PRINCIPAL REGISTER**

THE MARK CONSISTS OF STANDARD CHARACTERS WITHOUT CLAIM TO ANY PARTICULAR FONT, STYLE, SIZE, OR COLOR.

NO CLAIM IS MADE TO THE EXCLUSIVE RIGHT TO USE "RAFFLING", APART FROM THE MARK AS SHOWN.

SER. NO. 85-262,053, FILED 3-9-2011.

ZACHARY BELLO, EXAMINING ATTORNEY



*David J. Kyffers*

Director of the United States Patent and Trademark Office

# United States of America

United States Patent and Trademark Office

# TATI

**Reg. No. 4,124,278**

**Registered Apr. 10, 2012**

**Int. Cl.: 33**

**TRADEMARK**

**PRINCIPAL REGISTER**

GAIARIN, EMANUELE (UNITED STATES INDIVIDUAL)  
11811 WAYLAND STREET  
OAKTON, VA 22124 AND

MARY ELIZABETH GAIARIN (UNITED STATES INDIVIDUAL)  
11811 WAYLAND STREET  
OAKTON, VA 22124

FOR: ALCOHOLIC BEVERAGES, NAMELY, WINE, LIQUEUR , IN CLASS 33 (U.S. CLS. 47 AND 49).

FIRST USE 12-1-2007; IN COMMERCE 12-1-2007.

THE MARK CONSISTS OF STANDARD CHARACTERS WITHOUT CLAIM TO ANY PARTICULAR FONT, STYLE, SIZE, OR COLOR.

OWNER OF U.S. REG. NO. 3,516,876.

THE ENGLISH TRANSLATION OF "TATI" IN THE MARK IS "BOYS".

SER. NO. 85-262,215, FILED 3-9-2011.

JANET LEE, EXAMINING ATTORNEY

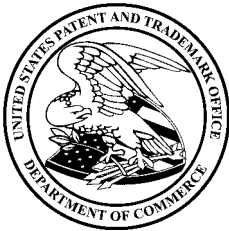

*David J. Kyffers*

Director of the United States Patent and Trademark Office

# United States of America

United States Patent and Trademark Office



**Reg. No. 4,124,279**

**Registered Apr. 10, 2012**

**Int. Cl.: 35**

**SERVICE MARK**

**PRINCIPAL REGISTER**

GLOBAL TRADE INFORMATION SERVICES, INC. (VIRGINIA CORPORATION)  
2218 DIVINE STREET  
COLUMBIA, SC 29205

FOR: PROVIDING AN ONLINE COMPUTER DATABASE VIA A GLOBAL COMPUTER NETWORK FEATURING IMPORT AND EXPORT TRADE INFORMATION FOR ALL PRODUCTS AND COUNTRIES , IN CLASS 35 (U.S. CLS. 100, 101 AND 102).

FIRST USE 3-8-2011; IN COMMERCE 3-8-2011.

OWNER OF U.S. REG. NOS. 2,630,842 AND 3,043,363.

NO CLAIM IS MADE TO THE EXCLUSIVE RIGHT TO USE "ATLAS", APART FROM THE MARK AS SHOWN.

THE MARK CONSISTS OF CAPITAL LETTERS "WTA", WITH EACH LETTER INSIDE A RECTANGULAR DESIGN, UNDER A DEPICTION OF A GLOBE AND THE WORDS "WORLD TRADE ATLAS" UNDER THE LETTERS

SEC. 2(F) AS TO "WORLD TRADE ATLAS".

SER. NO. 85-262,299, FILED 3-9-2011.

ALICE BENMAMAN, EXAMINING ATTORNEY



*David J. Kyjars*

Director of the United States Patent and Trademark Office



# United States of America

United States Patent and Trademark Office



**Reg. No. 4,124,280**

**Registered Apr. 10, 2012**

**Int. Cl.: 35**

**SERVICE MARK**

**PRINCIPAL REGISTER**

GLOBAL TRADE INFORMATION SERVICES, INC. (VIRGINIA CORPORATION)  
2218 DIVINE STREET  
COLUMBIA, SC 29205

FOR: PROVIDING AN ONLINE COMPUTER DATABASE VIA A GLOBAL COMPUTER NETWORK FEATURING IMPORT AND EXPORT TRADE INFORMATION FOR ALL PRODUCTS AND COUNTRIES, IN CLASS 35 (U.S. CLS. 100, 101 AND 102).

FIRST USE 3-8-2011; IN COMMERCE 3-8-2011.

OWNER OF U.S. REG. NO. 2,780,120.

NO CLAIM IS MADE TO THE EXCLUSIVE RIGHT TO USE "GLOBAL TRADE ATLAS", APART FROM THE MARK AS SHOWN.

THE MARK CONSISTS OF CAPITAL LETTERS "GTA", WITH EACH LETTER INSIDE A RECTANGULAR DESIGN, UNDER A DEPICTION OF A GLOBE AND THE WORDS "GLOBAL TRADE ATLAS" UNDER THE LETTERS.

SER. NO. 85-262,329, FILED 3-9-2011.

ALICE BENMAMAN, EXAMINING ATTORNEY



*David J. Kypos*

Director of the United States Patent and Trademark Office

# United States of America

United States Patent and Trademark Office

## SEPTEMBER SEEDS

**Reg. No. 4,124,281**

**Registered Apr. 10, 2012**

**Int. Cl.: 16**

**TRADEMARK**

**PRINCIPAL REGISTER**

MADISON, STEPHANIE (UNITED STATES INDIVIDUAL)  
3063 CHAPMAN AVENUE #2202  
ORANGE, CA 92867

FOR: CARDS BEARING UNIVERSAL GREETINGS; CARDS, NAMELY, GREETING CARDS; GREETING CARDS; GREETING CARDS HAVING A CHRISTIAN MESSAGE; GREETINGS CARDS AND POSTCARDS; MUSICAL GREETING CARDS; POSTCARDS AND GREETING CARDS; PRINTED GREETING CARDS WITH ELECTRONIC INFORMATION STORED THEREIN, IN CLASS 16 (U.S. CLS. 2, 5, 22, 23, 29, 37, 38 AND 50).

FIRST USE 9-1-2010; IN COMMERCE 9-1-2010.

THE MARK CONSISTS OF STANDARD CHARACTERS WITHOUT CLAIM TO ANY PARTICULAR FONT, STYLE, SIZE, OR COLOR.

SER. NO. 85-262,616, FILED 3-9-2011.

ELIZABETH HUGHITT, EXAMINING ATTORNEY



*David J. Kybas*

Director of the United States Patent and Trademark Office

# United States of America

United States Patent and Trademark Office

## BODY SHIELD PRO

**Reg. No. 4,124,282**

**Registered Apr. 10, 2012**

**Int. Cl.: 3**

**TRADEMARK**

**PRINCIPAL REGISTER**

PITCH WORLD LIMITED (UNITED KINGDOM LIMITED LIABILITY COMPANY)  
4TH FLOOR, SUTHERLAND HOUSE  
70-78 WEST HENDON BROADWAY  
LONDON, UNITED KINGDOM NW9---7BT

FOR: CLEANING, POLISHING, SCOURING AND ABRASIVE PREPARATIONS; DRY WASH CLEANING PREPARATIONS FOR VEHICLES; CAR WASHING PREPARATIONS; CAR SHAMPOO; POLISHING PREPARATIONS; AUTOMOBILE WAXES; LIQUID, PASTES AND POWDERED SUBSTANCES FOR WASHING AND PREWASHING; RUST REMOVING PREPARATIONS; CLEANING AND WASHING PREPARATIONS FOR MOTORS AND ENGINES; WINDSCREEN AND WINDSHIELD CLEANING PREPARATIONS, IN CLASS 3 (U.S. CLS. 1, 4, 6, 50, 51 AND 52).

THE MARK CONSISTS OF STANDARD CHARACTERS WITHOUT CLAIM TO ANY PARTICULAR FONT, STYLE, SIZE, OR COLOR.

PRIORITY CLAIMED UNDER SEC. 44(D) ON UNITED KINGDOM APPLICATION NO. 2560174, FILED 9-30-2010, REG. NO. 2560174, DATED 1-28-2011, EXPIRES 9-30-2020.

SER. NO. 85-262,632, FILED 3-9-2011.

DOUGLAS LEE, EXAMINING ATTORNEY



*David J. Kyfos*

Director of the United States Patent and Trademark Office

# United States of America

United States Patent and Trademark Office

## MALLY BEAUTY

**Reg. No. 4,124,283**

**Registered Apr. 10, 2012**

**Int. Cl.: 3**

**TRADEMARK**

**PRINCIPAL REGISTER**

MALLYGIRL LLC (DELAWARE LIMITED LIABILITY COMPANY)  
SUITE 902  
901 DULANEY VALLEY ROAD  
TOWSON, MD 21204

FOR: FRAGRANCES, IN CLASS 3 (U.S. CLS. 1, 4, 6, 50, 51 AND 52).

FIRST USE 10-0-2009; IN COMMERCE 10-0-2009.

THE MARK CONSISTS OF STANDARD CHARACTERS WITHOUT CLAIM TO ANY PARTICULAR FONT, STYLE, SIZE, OR COLOR.

OWNER OF U.S. REG. NOS. 3,099,460, 3,870,730, AND 3,877,149.

SER. NO. 85-262,785, FILED 3-9-2011.

JULIE GUTTADAURO, EXAMINING ATTORNEY



*David J. Kybas*

Director of the United States Patent and Trademark Office

# United States of America

United States Patent and Trademark Office



**Reg. No. 4,124,284**

**Registered Apr. 10, 2012**

**Int. Cl.: 35**

**SERVICE MARK**

**PRINCIPAL REGISTER**

CHINA SOURCING SOLUTIONS (CHINA LIMITED LIABILITY COMPANY)  
ROOM A3005, 30F  
NO.20,GANGWAN ROAD, ZHONGSHAN DISTRICT  
DALIAN, CHINA

FOR: BUSINESS CONSULTATION SERVICES; BUSINESS INFORMATION AND INQUIRIES;  
BUSINESS MANAGEMENT CONSULTATION; COST PRICE ANALYSIS; GOODS IMPORT-  
EXPORT AGENCIES; ORGANISATION OF EXHIBITIONS FOR COMMERCIAL OR ADVERT-  
ISING PURPOSES; PRICE COMPARING SERVICES; PROCURING OF CONTRACTS FOR  
THE PURCHASE AND SALE OF GOODS; PUBLICITY AGENTS; SALES PROMOTION, IN  
CLASS 35 (U.S. CLS. 100, 101 AND 102).

FIRST USE 12-30-2010; IN COMMERCE 12-30-2010.

THE MARK CONSISTS OF A DESIGNED CLOUD WITH SIX STARS ON IT.

SER. NO. 85-262,850, FILED 3-9-2011.

LAURIE MAYES, EXAMINING ATTORNEY



*David J. Kyffers*

Director of the United States Patent and Trademark Office

United States of America  
United States Patent and Trademark Office

3 **CLICK**

**Reg. No. 4,124,285**

EMMETT J. MURPHY (UNITED STATES INDIVIDUAL)  
1515 BROADWAY 11TH FLOOR  
NEW YORK, NY 10036

**Registered Apr. 10, 2012**

**Int. Cls.: 35 and 42**

**SERVICE MARK**

**PRINCIPAL REGISTER**

FOR: ADVERTISING AND MARKETING CONSULTANCY; ADVERTISING AND MARKETING SERVICES PROVIDED BY MEANS OF INDIRECT METHODS OF MARKETING COMMUNICATIONS, NAMELY, SOCIAL MEDIA, SEARCH ENGINE MARKETING, INQUIRY MARKETING, INTERNET MARKETING, MOBILE MARKETING, BLOGGING AND OTHER FORMS OF PASSIVE, SHARABLE OR VIRAL COMMUNICATIONS CHANNELS; ADVERTISING VIA ELECTRONIC MEDIA AND SPECIFICALLY THE INTERNET; CREATIVE MARKETING DESIGN SERVICES; DESIGN OF INTERNET ADVERTISING; DEVELOPMENT OF MARKETING STRATEGIES AND CONCEPTS; DEVELOPMENT OF MARKETING STRATEGIES, CONCEPTS AND TACTICS, NAMELY, AUDIENCE DEVELOPMENT, BRAND AWARENESS, CUSTOMER RELATIONS, ONLINE COMMUNITY BUILDING AND DIGITAL WORD OF MOUTH COMMUNICATIONS; GOVERNMENT RELATIONS CONSULTANCY SERVICES; INFORMATION, ADVISORY, CONSULTING, BUSINESS RESEARCH AND PLANNING SERVICES RELATING TO PUBLICITY, MARKETING COMMUNICATIONS, REPUTATION MANAGEMENT OR BUSINESS ADMINISTRATION, INCLUDING SUCH SERVICES PROVIDED ONLINE OR VIA THE INTERNET; INTERNATIONAL BUSINESS CONSULTING SERVICES RELATING TO MERCHANDISE TRADING, HUMAN RESOURCE INTERCHANGE, MANAGEMENT SUPPORT, MARKETING, ADVERTISING, PROMOTION, AND DOMESTIC AND INTERNATIONAL MARKET RESEARCH AND DEVELOPMENT; MARKETING AND CONSULTING SERVICES IN THE FIELD OF PROMOTING AND TRACKING THE GOODS, SERVICES, AND BRANDS OF OTHERS THROUGH ALL PUBLIC COMMUNICATION MEANS, PARTICULARLY SPECIALIZING IN THE USE OF MOBILE, SOCIAL, AND PRINT MEDIA TO DRIVE CONSUMER INTEREST, ENGAGEMENT AND ACTION; POLITICAL CONSULTANCY; POLITICAL PARTY SERVICES, NAMELY, PROMOTING THE INTERESTS OF A POLITICAL ORGANIZATION; PROVIDING A WEBSITE FEATURING INFORMATION ABOUT POLITICAL ISSUES; PROVIDING AN INTERNET WEBSITE FEATURING NEWS AND INFORMATION IN THE FIELD OF NATIONAL AND INTERNATIONAL POLITICS; SOCIAL MEDIA STRATEGY AND MARKETING CONSULTANCY FOCUSING ON HELPING CLIENTS CREATE AND EXTEND THEIR PRODUCT AND BRAND STRATEGIES BY BUILDING VIRALLY ENGAGING MARKETING SOLUTIONS, IN CLASS 35 (U.S. CLS. 100, 101 AND 102).



*David J. Kappas*

FIRST USE 3-1-2009; IN COMMERCE 6-1-2009.

**Reg. No. 4,124,285** FOR: COMPUTER SOFTWARE DEVELOPMENT IN THE FIELD OF MOBILE APPLICATIONS; DESIGNING AND DEVELOPING WEBPAGES ON THE INTERNET; DESIGNING WEBSITES FOR ADVERTISING PURPOSES; PLANNING, DESIGN, DEVELOPMENT, MAINTENANCE AND OPTIMIZATION OF ONLINE WEBSITES FOR THIRD PARTIES, IN CLASS 42 (U.S. CLS. 100 AND 101).

FIRST USE 3-1-2009; IN COMMERCE 6-1-2009.

SER. NO. 85-262,886, FILED 3-10-2011.

KATHLEEN LORENZO, EXAMINING ATTORNEY

# United States of America

United States Patent and Trademark Office

# HIP STREET

**Reg. No. 4,124,286**

2048450 ONTARIO INC. (CANADA CORPORATION), DBA DATATECH  
10 MAYBERRY COURT

**Registered Apr. 10, 2012**

MARKHAM, ONTRARIO, CANADA L3P6J4

**Int. Cl.: 2**

FOR: INKJET REFILL KITS, CONSISTING OF BOTTLES OF INK, PRINTER HEAD CLEANER, TOOLS FOR REFILLING CARTRIDGES, AND REFILL INSTRUCTIONS , IN CLASS 2 (U.S. CLS. 6, 11 AND 16).

**TRADEMARK**

THE MARK CONSISTS OF STANDARD CHARACTERS WITHOUT CLAIM TO ANY PARTICULAR FONT, STYLE, SIZE, OR COLOR.

**PRINCIPAL REGISTER**

PRIORITY CLAIMED UNDER SEC. 44(D) ON CANADA APPLICATION NO. 1282156(1), FILED 9-15-2010, REG. NO. 695287, DATED 8-23-2011, EXPIRES 8-23-2026.

OWNER OF U.S. REG. NO. 3,414,563.

SER. NO. 85-262,931, FILED 3-10-2011.

JOHN DWYER, EXAMINING ATTORNEY



*David J. Kyffers*

Director of the United States Patent and Trademark Office



# United States of America

United States Patent and Trademark Office

# OBEX

**Reg. No. 4,124,287**

**Registered Apr. 10, 2012**

**Int. Cl.: 5**

**TRADEMARK**

**PRINCIPAL REGISTER**

CATALYSIS S.L. (SPAIN CORPORATION)  
MACARENA, 14  
28016 MADRID, SPAIN

FOR: NUTRITIONAL SUPPLEMENTS, IN CLASS 5 (U.S. CLS. 6, 18, 44, 46, 51 AND 52).

THE MARK CONSISTS OF STANDARD CHARACTERS WITHOUT CLAIM TO ANY PARTICULAR FONT, STYLE, SIZE, OR COLOR.

OWNER OF ERPN CMNTY TM OFC REG. NO. 9168097, DATED 1-10-2011, EXPIRES 6-11-2020.

THE WORDING "OBEX" HAS NO MEANING IN A FOREIGN LANGUAGE.

SER. NO. 85-262,932, FILED 3-10-2011.

ANNE MADDEN, EXAMINING ATTORNEY



*David J. Kyffers*

Director of the United States Patent and Trademark Office

# United States of America

United States Patent and Trademark Office

## PJ LIBRARY

**Reg. No. 4,124,288**

**Registered Apr. 10, 2012**

**Int. Cl.: 16**

**TRADEMARK**

**PRINCIPAL REGISTER**

THE HAROLD GRINSPOON FOUNDATION (MASSACHUSETTS NON-PROFIT ORGANIZATION)  
380 UNION STREET  
WEST SPRINGFIELD, MA 01089

FOR: PRINTED PRODUCTS, NAMELY, BOOKS AND BROCHURES IN THE FIELD OF CHARITY, IN CLASS 16 (U.S. CLS. 2, 5, 22, 23, 29, 37, 38 AND 50).

FIRST USE 3-28-2007; IN COMMERCE 3-28-2007.

THE MARK CONSISTS OF STANDARD CHARACTERS WITHOUT CLAIM TO ANY PARTICULAR FONT, STYLE, SIZE, OR COLOR.

OWNER OF U.S. REG. NOS. 3,484,125, 3,578,760 AND OTHERS.

NO CLAIM IS MADE TO THE EXCLUSIVE RIGHT TO USE "LIBRARY", APART FROM THE MARK AS SHOWN.

SER. NO. 85-262,943, FILED 3-10-2011.

ODESSA BIBBINS, EXAMINING ATTORNEY



*David J. Kyfos*

Director of the United States Patent and Trademark Office

# United States of America

United States Patent and Trademark Office

**POS O**

**Point Of Sale Outdoor Media**

**Reg. No. 4,124,289**

**Registered Apr. 10, 2012**

**Int. Cl.: 35**

**SERVICE MARK**

**PRINCIPAL REGISTER**

POS OUTDOOR MEDIA (FLORIDA LIMITED LIABILITY COMPANY)  
324 SW 4TH ST.  
FLORIDA CITY, FL 33024

FOR: PROVIDING ADVERTISING, MARKETING AND PROMOTIONAL SERVICES, NAMELY, DEVELOPMENT OF ADVERTISING CAMPAIGNS PROVIDED THROUGH CABLE TELEVISION BROADCAST, WEB CASTS, RADIO BROADCASTS, NEWSPAPERS, MAGAZINES, ONLINE BANNERS, OUTDOOR BILLBOARDS, WILD POSTINGS, BUS AND SUBWAY ADS, IN CLASS 35 (U.S. CLS. 100, 101 AND 102).

FIRST USE 11-0-2007; IN COMMERCE 11-0-2007.

NO CLAIM IS MADE TO THE EXCLUSIVE RIGHT TO USE "POINT OF SALE OUTDOOR MEDIA", APART FROM THE MARK AS SHOWN.

THE COLOR(S) WHITE, GREEN AND ORANGE IS/ARE CLAIMED AS A FEATURE OF THE MARK.

THE MARK CONSISTS OF THE LETTERS "P" "O" "S" IN WHITE SURROUNDED BY GREEN, FOLLOWED BY THE LETTER "O" IN WHITE SURROUNDED BY ORANGE. BELOW THE LETTERS ARE THE TERMS "POINT OF SALE" IN GREEN, NEXT TO THE TERMS "OUTDOOR MEDIA" IN ORANGE.

SER. NO. 85-262,968, FILED 3-10-2011.

ANDREW RHIM, EXAMINING ATTORNEY



*David J. Kybas*

Director of the United States Patent and Trademark Office

# United States of America

United States Patent and Trademark Office



**Reg. No. 4,124,290**

**Registered Apr. 10, 2012**

**Int. Cl.: 30**

**TRADEMARK**

**PRINCIPAL REGISTER**

P.T. SINDHU AMRITHA (INDONESIA CORPORATION)  
DJALAN SUMATRA 26-28  
PASURUAN, INDONESIA 67114

FOR: CANDY, IN CLASS 30 (U.S. CL. 46).

FIRST USE 0-0-1937; IN COMMERCE 0-0-1986.

NO CLAIM IS MADE TO THE EXCLUSIVE RIGHT TO USE "PABERIK KEMBANG GULA",  
APART FROM THE MARK AS SHOWN.

THE COLOR(S) RED AND WHITE IS/ARE CLAIMED AS A FEATURE OF THE MARK.

THE NON-LATIN CHARACTERS IN THE MARK TRANSLITERATE TO XIN YA AND THIS  
MEANS NEW ASIA IN ENGLISH.

THE MARK CONSISTS OF A CIRCLE CONTAINING THE RED WORDS "PABERICK  
KEMBANG GULA" AROUND THE TOP HALF, WITH THE WHITE WORD "PASURUAN"  
ON A RED BACKGROUND ON THE BOTTOM HALF, ALL ENCIRCLING THE WHITE  
CIRCLES, WITH THE WHITE WORD "SINA" IN THE MIDDLE. TO THE LEFT OF THE 3  
CIRCLES ARE 2 INDONESIAN CHARACTERS ABOVE EACH OTHER WITH A "R" WITH  
A CIRCLE AROUND IT BELOW THOSE, ALL IN WHITE. THERE IS A WHITE LINE IN THE  
SHAPE OF A 90 DEGREE ANGLE ENCLOSING THESE CHARACTERS.

THE ENGLISH TRANSLATION OF "SINA PABERIK KEMBANG GULA" IN THE MARK IS  
"NEW ASIA CANDY FACTORY". THE WORDING "PASURUAN" HAS NO MEANING IN A  
FOREIGN LANGUAGE.

SER. NO. 85-263,002, FILED 3-10-2011.

BRIAN NEVILLE, EXAMINING ATTORNEY



*David J. Kybas*

Director of the United States Patent and Trademark Office

# United States of America

United States Patent and Trademark Office

## FAMOUS FLAMING STONE BEER

**Reg. No. 4,124,291**

ROMA POMODORI, INC. (TENNESSEE CORPORATION)  
827 SOUTH MAIN  
MEMPHIS, TN 38106

**Registered Apr. 10, 2012**

**Int. Cl.: 32**

FOR: BEER, IN CLASS 32 (U.S. CLS. 45, 46 AND 48).

FIRST USE 12-26-1992; IN COMMERCE 12-26-1992.

**TRADEMARK**

THE MARK CONSISTS OF STANDARD CHARACTERS WITHOUT CLAIM TO ANY PARTICULAR FONT, STYLE, SIZE, OR COLOR.

**PRINCIPAL REGISTER**

NO CLAIM IS MADE TO THE EXCLUSIVE RIGHT TO USE "FAMOUS" AND "BEER", APART FROM THE MARK AS SHOWN.

SER. NO. 85-263,147, FILED 3-10-2011.

GRETCHEN ULRICH, EXAMINING ATTORNEY



*David J. Kyffers*

Director of the United States Patent and Trademark Office

# United States of America

United States Patent and Trademark Office



**Reg. No. 4,124,292**

**Registered Apr. 10, 2012**

**Int. Cl.: 35**

**SERVICE MARK**

**PRINCIPAL REGISTER**

ANEWWORLD (FRANCE COMPANY)  
21 BOULEVARD LAZARE CARNOT  
TOULOUSE, FRANCE 31000

FOR: BUSINESS CONSULTING FOR THE AERONAUTICS INDUSTRY, IN CLASS 35 (U.S. CLS. 100, 101 AND 102).

FIRST USE 9-30-2008; IN COMMERCE 9-30-2008.

THE MARK CONSISTS OF THE DESIGN OF A PLANET IN THE COLOR BLACK WITH A FLYING TAILED STAR IN THE COLOR GOLD ABOVE THE WORDING "ANEWWORLD", WITH THE WORDING "A" AND "WORLD" IN THE COLOR WHITE AND THE WORD "NEW" IN THE COLOR GOLD, ALL ON A BLACK BACKGROUND.

THE COLOR(S) BLACK, GOLD AND WHITE IS/ARE CLAIMED AS A FEATURE OF THE MARK.

SER. NO. 85-263,286, FILED 3-10-2011.

JOHN DALIER, EXAMINING ATTORNEY



*David J. Kybas*

Director of the United States Patent and Trademark Office

# United States of America

United States Patent and Trademark Office

## PRIMEGUARD

**Reg. No. 4,124,293**

BIRCHER REGLOMAT AG (SWITZERLAND AKTIENGESELLSCHAFT)  
WIESENGASSE 20

**Registered Apr. 10, 2012**

BERINGEN, SWITZERLAND 8222

**Int. Cl.: 9**

FOR: ELECTRIC SWITCHING ELEMENTS, IN PARTICULAR SWITCHING COLUMNS, SAFETY MATS, MOVEMENT INDICATORS, LIGHT SCANNERS, PHOTOELECTRIC BARRIERS AND SENSORS, IN CLASS 9 (U.S. CLS. 21, 23, 26, 36 AND 38).

**TRADEMARK**

THE MARK CONSISTS OF STANDARD CHARACTERS WITHOUT CLAIM TO ANY PARTICULAR FONT, STYLE, SIZE, OR COLOR.

**PRINCIPAL REGISTER**

PRIORITY CLAIMED UNDER SEC. 44(D) ON ERPN CMNTY TM OFC APPLICATION NO. 009731183, FILED 2-11-2011, REG. NO. 009731183, DATED 10-19-2011, EXPIRES 2-11-2021.

SER. NO. 85-263,365, FILED 3-10-2011.

TOBY BULLOFF, EXAMINING ATTORNEY



*David J. Kyfos*

Director of the United States Patent and Trademark Office

# United States of America

United States Patent and Trademark Office

# EZ WEAR

**Reg. No. 4,124,294**

**Registered Apr. 10, 2012**

**Int. Cl.: 14**

**TRADEMARK**

**PRINCIPAL REGISTER**

FINDINGS INCORPORATED (NEW HAMPSHIRE CORPORATION)  
160 WATER STREET  
KEENE, NH 03431

FOR: JEWELRY, IN CLASS 14 (U.S. CLS. 2, 27, 28 AND 50).

FIRST USE 3-17-2011; IN COMMERCE 3-17-2011.

THE MARK CONSISTS OF STANDARD CHARACTERS WITHOUT CLAIM TO ANY PARTICULAR FONT, STYLE, SIZE, OR COLOR.

NO CLAIM IS MADE TO THE EXCLUSIVE RIGHT TO USE "WEAR", APART FROM THE MARK AS SHOWN.

SER. NO. 85-263,675, FILED 3-10-2011.

WILLIAM P. SHANAHAN, EXAMINING ATTORNEY



*David J. Kybas*

Director of the United States Patent and Trademark Office



# United States of America

United States Patent and Trademark Office

## PT HELMETS

**Reg. No. 4,124,295**

**Registered Apr. 10, 2012**

**Int. Cl.: 9**

**TRADEMARK**

**PRINCIPAL REGISTER**

MILITARY & RESCUE SUPPLY LLC (OHIO LIMITED LIABILITY COMPANY)  
5656 OPPORTUNITY DRIVE, UNIT 1  
TOLEDO, OH 43612

FOR: BICYCLE HELMETS; CHIN STRAPS FOR FOOTBALL HELMETS; FOOTBALL HELMETS; HELMETS FOR MOTORCYCLISTS; HOCKEY HELMETS; MOTORCYCLE HELMETS; PROTECTIVE FACE-SHIELDS FOR PROTECTIVE HELMETS; PROTECTIVE HELMETS; PROTECTIVE HELMETS FOR SPORTS; SAFETY HELMETS; SPORTS HELMETS; PROTECTIVE HELMET ACCESSORIES THAT ATTACH TO HELMETS, NAMELY: BRACKETS AND MOUNTS FOR THE ATTACHMENT OF HELMET LIGHTS AND NIGHT VISION GOGGLES; PROTECTIVE HELMETS FOR TACTICAL USE; BASEBALL BATTING HELMETS; CATCHERS HELMETS; DIVING HELMETS; RIDING HELMETS; PROTECTIVE HELMETS FOR MILITARY USE; AND PROTECTIVE HELMETS MADE OF BALLISTIC SYNTHETIC FIBER MATERIAL, IN CLASS 9 (U.S. CLS. 21, 23, 26, 36 AND 38).

FIRST USE 7-0-2006; IN COMMERCE 7-0-2006.

THE MARK CONSISTS OF STANDARD CHARACTERS WITHOUT CLAIM TO ANY PARTICULAR FONT, STYLE, SIZE, OR COLOR.

NO CLAIM IS MADE TO THE EXCLUSIVE RIGHT TO USE "HELMETS", APART FROM THE MARK AS SHOWN.

SER. NO. 85-263,718, FILED 3-10-2011.

STEVEN PEREZ, EXAMINING ATTORNEY



*David J. Kybas*

Director of the United States Patent and Trademark Office

# United States of America

United States Patent and Trademark Office

## Council for Life

**Reg. No. 4,124,296**

**Registered Apr. 10, 2012**

**Int. Cl.: 36**

**SERVICE MARK**

**PRINCIPAL REGISTER**

COUNCIL FOR LIFE (TEXAS NON-PROFIT CORPORATION)  
6201 ARMSTRONG PARKWAY  
DALLAS, TX 75205

FOR: ACCEPTING AND ADMINISTERING MONETARY CHARITABLE CONTRIBUTIONS; CHARITABLE FOUNDATION SERVICES, NAMELY, PROVIDING FINANCIAL ASSISTANCE FOR PROGRAMS AND SERVICES OF OTHERS; CHARITABLE FOUNDATION SERVICES, NAMELY, PROVIDING FUNDRAISING ACTIVITIES, FUNDING, SCHOLARSHIPS AND/OR FINANCIAL ASSISTANCE FOR PRO-LIFE ORGANIZATIONS; CHARITABLE FUNDRAISING; CHARITABLE FUNDRAISING SERVICES; CHARITABLE FUNDRAISING SERVICES BY MEANS OF RUNNING AND WALKING EVENTS; CHARITABLE FUNDRAISING SERVICES FOR PROMOTING RESEARCH, EDUCATION AND OTHER ACTIVITIES RELATING TO PRO-LIFE CAUSES; CHARITABLE FUNDRAISING TO SUPPORT PRO-LIFE ORGANIZATIONS AND CAUSES; CHARITABLE SERVICES, NAMELY, ORGANIZING FUNDRAISING SERVICES AND EVENTS TO RAISE FUNDS IN THE FIELD OF PRO-LIFE ORGANIZATIONS AND CAUSES, IN CLASS 36 (U.S. CLS. 100, 101 AND 102).

FIRST USE 8-3-2006; IN COMMERCE 8-8-2006.

THE MARK CONSISTS OF STANDARD CHARACTERS WITHOUT CLAIM TO ANY PARTICULAR FONT, STYLE, SIZE, OR COLOR.

NO CLAIM IS MADE TO THE EXCLUSIVE RIGHT TO USE "COUNCIL", APART FROM THE MARK AS SHOWN.

SEC. 2(F).

SER. NO. 85-263,798, FILED 3-10-2011.

HOWARD SMIGA, EXAMINING ATTORNEY



*David J. Kybas*

Director of the United States Patent and Trademark Office

# United States of America

United States Patent and Trademark Office

Julia Lennon

**Reg. No. 4,124,297**

JOHN CHARLES JULIAN LENNON (UNITED KINGDOM INDIVIDUAL)  
C/O COUSINS BRETT, 20 BULSTRODE STREET  
LONDON, UNITED KINGDOM W1V2JW

**Registered Apr. 10, 2012**

**Int. Cls.: 9, 16, 25 and 41**

FOR: MUSICAL SOUND AND MUSICAL VIDEO RECORDINGS; MUSICAL SOUND AND MUSICAL VIDEO RECORDINGS DOWNLOADABLE FROM THE INTERNET; PRERECORDED AUDIO AND VIDEO TAPES, CASSETTES, CD-ROMS, DISCS, DVDS AND COMPACT DISCS FEATURING MUSIC AND CONCERTS; AND ELECTRONIC PUBLICATIONS, NAMELY, BOOKS, MAGAZINES AND MANUALS FEATURING MUSIC AND CONCERTS RECORDED ON COMPUTER MEDIA; AND PRE-RECORDED ELECTRONIC AND DIGITAL MEDIA FEATURING MUSICAL PERFORMANCES, IN CLASS 9 (U.S. CLS. 21, 23, 26, 36 AND 38).

**TRADEMARK**

**SERVICE MARK**

**PRINCIPAL REGISTER**

FOR: BOOKS, MAGAZINES, PERIODICALS, BROCHURES, CATALOGUES, FACT SHEETS, MAGAZINE SUPPLEMENTS TO NEWSPAPERS, AND PAMPHLETS, ALL FEATURING INFORMATION PERTAINING TO MUSICAL CONCERTS AND OTHER MUSICAL PERFORMANCES AND TO ENTERTAINMENT INDUSTRY PERSONALITIES AND PUBLIC CELEBRITIES; POSTERS, PICTURES, PRINTS AND STICKERS; PRINTED MUSICAL SCORES AND LIBRETTOS; AND SHEET MUSIC; STATIONERY; DECALCOMANIAS; IRON-ON OR PLASTIC TRANSFERS; PENS, PENCILS, CRAYONS, PENCIL CASES, ERASERS, POSTERS, MARKERS, PENCIL SHARPENERS, PICTURES AND PRINTS, STICKERS, PAPERWEIGHTS, DIARIES AND CALENDARS; PAINT BRUSHES AND BOXES; APPARATUS FOR DRAWING, NAMELY, PENS, PENCILS, CRAYONS, BRUSHES, PALETTES, EASELS, RUBBER ERASERS, ARTIST'S PAPER, PAINTING CANVAS, TRACING CLOTH, PAINTING AND DRAWING BOARDS, IN CLASS 16 (U.S. CLS. 2, 5, 22, 23, 29, 37, 38 AND 50).



FOR: ARTICLES OF CLOTHING, NAMELY, SHIRTS, JUMPERS, SKIRTS, BLOUSES, COATS, JACKETS, WIND-RESISTANT JACKETS, TRACKSUITS, SLACKS, TROUSERS, SHORTS, OVERALLS, DUNGAREES, SWEATERS, T-SHIRTS, SWEATSHIRTS, BLOUSONS, JEANS, BELTS AND BRACES, TIES, SCARVES AND GLOVES; HATS, CAPS, BERETS, HEADBANDS, HOODS; SHOES, BOOTS, SANDALS, SLIPPERS, TRAINERS, SPORT SHOES, HOSE, TIGHTS, SOCKS AND STOCKINGS, IN CLASS 25 (U.S. CLS. 22 AND 39).

David J. Kybas

FOR: ENTERTAINMENT SERVICES, NAMELY, LIVE PERFORMANCES BY MUSICAL BANDS OR GROUPS OR INDIVIDUALS; PROVISION OF ONLINE INFORMATION ON LIVE PERFORMANCES BY MUSICAL BANDS OR GROUPS OR INDIVIDUALS, IN CLASS 41 (U.S. CLS. 100, 101 AND 107).

Director of the United States Patent and Trademark Office

**Reg. No. 4,124,297** PRIORITY CLAIMED UNDER SEC. 44(D) ON ERPN CMNTY TM OFC APPLICATION NO. 009605361, FILED 12-16-2010, REG. NO. 009605361, DATED 5-13-2011, EXPIRES 12-16-2020.

OWNER OF U.S. REG. NO. 3,651,194.

THE NAME(S), PORTRAIT(S), AND/OR SIGNATURE(S) SHOWN IN THE MARK IDENTIFIES JOHN CHARLES JULIAN LENNON, WHOSE CONSENT(S) TO REGISTER IS MADE OF RECORD.

THE MARK CONSISTS OF AUTOGRAPH SIGNATURE OF "JULIAN LENNON".

SER. NO. 85-263,915, FILED 3-10-2011.

MIDGE BUTLER, EXAMINING ATTORNEY

# United States of America

United States Patent and Trademark Office



**Reg. No. 4,124,298**

FORD MOTOR COMPANY (DELAWARE CORPORATION)  
ONE AMERICAN ROAD  
DEARBORN, MI 48126

**Registered Apr. 10, 2012**

**Int. Cl.: 37**

FOR: VEHICLE REPAIR AND MAINTENANCE; EMERGENCY ROADSIDE ASSISTANCE SERVICES, NAMELY, RESPONDING TO CALLS FOR ROADSIDE ASSISTANCE, FLAT TIRE CHANGING, EMERGENCY FUEL SUPPLYING AND BATTERY JUMP STARTING, IN CLASS 37 (U.S. CLS. 100, 103 AND 106).

**SERVICE MARK**

**PRINCIPAL REGISTER**

FIRST USE 12-31-1955; IN COMMERCE 12-31-1955.

THE MARK CONSISTS OF A SIX-SIDED FIGURE CONTAINING A CROSS-LIKE STAR FIGURE IN THE MIDDLE OF THE FIGURE WHERE THE LINE SHOWING THE HEIGHT OF THE FIGURE IS CONTAINED IN THE FIGURE AND THE LINE SHOWING THE WIDTH OF THE RECTANGLE EXTENDS OUT OF THE FIGURE SLIGHTLY.

SER. NO. 85-264,209, FILED 3-11-2011.

DAWN FELDMAN, EXAMINING ATTORNEY



*David J. Kybas*

Director of the United States Patent and Trademark Office

# United States of America

United States Patent and Trademark Office

# FuzeBuy

**Reg. No. 4,124,299**

**Registered Apr. 10, 2012**

**Int. Cls.: 35, 40 and 42**

**SERVICE MARK**

**PRINCIPAL REGISTER**

JET LITHOCOLOR, INC. (ILLINOIS CORPORATION)  
2500 CENTRE CIRCLE  
DOWNERS GROVE, IL 60515

FOR: ADVERTISING AND MARKETING SERVICES; INFORMATION AND DATA COMPILING AND ANALYZING RELATING TO BUSINESS MANAGEMENT; PREPARING MAILING LISTS; ON-LINE PROFILING SURVEY AND ANALYSIS, NAMELY, ANALYSIS OF MARKET RESEARCH DATA AND STATISTICS PERTAINING TO ON-LINE AND IN-STORE SHOPPING, IN CLASS 35 (U.S. CLS. 100, 101 AND 102).

FIRST USE 3-1-2011; IN COMMERCE 3-1-2011.

FOR: CUSTOM MANUFACTURING AND PRINTING OF PLASTIC CARDS; PRINTING, IN CLASS 40 (U.S. CLS. 100, 103 AND 106).

FIRST USE 3-1-2011; IN COMMERCE 3-1-2011.

FOR: PROVIDING ON-LINE, NON-DOWNLOADABLE COMPUTER SOFTWARE FOR ACCOUNT MANAGEMENT OF CUSTOMER LOYALTY REWARDS PROGRAMS IN THE NATURE OF EXCHANGING, PURCHASING, EARNING AND TRACKING CUSTOMER LOYALTY REWARDS FOR THE PURPOSE OF INCREASING FLEXIBILITY, DRIVING MEMBER ENGAGEMENT AND GROWING REVENUE, IN CLASS 42 (U.S. CLS. 100 AND 101).

FIRST USE 3-1-2011; IN COMMERCE 3-1-2011.

THE MARK CONSISTS OF STANDARD CHARACTERS WITHOUT CLAIM TO ANY PARTICULAR FONT, STYLE, SIZE, OR COLOR.

SER. NO. 85-264,249, FILED 3-11-2011.

TINA BROWN, EXAMINING ATTORNEY



*David J. Kybas*

Director of the United States Patent and Trademark Office

# United States of America

United States Patent and Trademark Office



**Reg. No. 4,124,300**

FEED THE CHILDREN, INC. (OKLAHOMA CORPORATION)  
333 N. MERIDIAN AVE.

**Registered Apr. 10, 2012**

OKLAHOMA CITY, OK 73107

**Int. Cls.: 36, 41, 43 and  
44**

FOR: CHARITABLE FUNDRAISING, IN CLASS 36 (U.S. CLS. 100, 101 AND 102).

FIRST USE 1-1-1998; IN COMMERCE 1-1-1998.

**SERVICE MARK**

FOR: CHARITABLE SERVICES, NAMELY, PROVIDING ARTS AND CRAFTS AND EDUCATIONAL MATERIALS IN THE NATURE OF BOOKS, BOOK COVERS, WRITING UTENSILS, PENCIL SHARPENERS, ERASERS, GLUE, RULERS, SCISSORS, PAPER, BINDERS, FOLDERS, NOTEBOOKS, AND EDUCATIONAL ACTIVITY BOOKS TO UNDERPRIVILEGED CHILDREN, IN CLASS 41 (U.S. CLS. 100, 101 AND 107).

FIRST USE 1-1-1998; IN COMMERCE 1-1-1998.

**PRINCIPAL REGISTER**

FOR: CHARITABLE SERVICES, NAMELY, PROVIDING FOOD TO NEEDY PERSONS, IN CLASS 43 (U.S. CLS. 100 AND 101).

FIRST USE 1-1-1998; IN COMMERCE 1-1-1998.

FOR: CHARITABLE SERVICES, NAMELY, PROVIDING PERSONAL HYGIENE PRODUCTS AND MEDICINE TO NEEDY PERSONS, IN CLASS 44 (U.S. CLS. 100 AND 101).

FIRST USE 1-1-1998; IN COMMERCE 1-1-1998.

OWNER OF U.S. REG. NOS. 2,132,295, 2,144,790, AND 2,410,884.

THE MARK CONSISTS OF THE SILHOUETTE OF A MAN HOLDING A BOWL UPWARD NEXT TO A RECTANGULAR BOX WITH THE WORDS "FEED THE CHILDREN" IN CAPITAL LETTERS, WITH THE "F" IN "FEED" AND THE "C" IN "CHILDREN" IN SLIGHTLY LARGER FONT, AND A STRAIGHT HORIZONTAL LINE ABOVE "FEED THE" AND STRAIGHT HORIZONTAL LINE BELOW "CHILDREN".



*David J. Kyros*

SEC. 2(F) AS TO "FEED THE CHILDREN".

Director of the United States Patent and Trademark Office

SER. NO. 85-264,329, FILED 3-11-2011.

**Reg. No. 4,124,300** KAREN K. BUSH, EXAMINING ATTORNEY



# United States of America

United States Patent and Trademark Office

## STREET BOULEVARD

**Reg. No. 4,124,301**

**Registered Apr. 10, 2012**

**Int. Cl.: 42**

**SERVICE MARK**

**PRINCIPAL REGISTER**

STREET BOULEVARD LTD (NEW JERSEY LIMITED LIABILITY COMPANY), DBA  
STREETBOULEVARD.COM  
P.O. BOX 127  
EAST HANOVER, NJ 07936

FOR: COMPUTER SERVICES ON A WEBSITE, NAMELY, ON-LINE VIRTUAL COMMUNIT-  
IES FOR REGISTERED USERS TO ORGANIZE GROUPS AND EVENTS, PARTICIPATE IN  
DISCUSSIONS, AND ENGAGE IN SOCIAL, BUSINESS AND COMMUNITY NETWORKING;  
COMPUTER SERVICES, NAMELY, HOSTING ELECTRONIC FACILITIES FOR OTHERS  
FOR ORGANIZING AND CONDUCTING MEETINGS, EVENTS AND INTERACTIVE DIS-  
CUSSIONS VIA COMMUNICATION NETWORKS; APPLICATION SERVICE PROVIDER  
(ASP) SERVICES, NAMELY, HOSTING COMPUTER SOFTWARE APPLICATIONS OF  
OTHERS; APPLICATION SERVICE PROVIDER (ASP) FEATURING SOFTWARE TO ENABLE  
OR FACILITATE THE UPLOADING, DOWNLOADING, STREAMING, POSTING, DISPLAY-  
ING, BLOGGING, LINKING, SHARING OR OTHERWISE PROVIDING ELECTRONIC MEDIA  
OR INFORMATION OVER COMMUNICATION NETWORKS; PROVIDING AN ONLINE  
NETWORK SERVICE THAT ENABLES USERS TO TRANSFER PERSONAL IDENTITY  
DATA TO AND SHARE PERSONAL IDENTITY DATA WITH AND AMONG MULTIPLE  
WEBSITES; PROVIDING A WEB SITE FEATURING TECHNOLOGY THAT ENABLES ON-  
LINE USERS TO CREATE PERSONAL PROFILES FEATURING SOCIAL NETWORKING  
INFORMATION AND TO TRANSFER AND SHARE SUCH INFORMATION AMONG MUL-  
TIPLE WEBSITES; COMPUTER SERVICES, NAMELY, CREATING INDEXES OF INFORM-  
ATION, SITES AND OTHER RESOURCES AVAILABLE ON COMPUTER NETWORKS;  
PROVIDING TEMPORARY USE OF NON-DOWNLOADABLE SOFTWARE APPLICATIONS  
FOR SOCIAL NETWORKING, CREATING A VIRTUAL COMMUNITY, AND TRANSMISSION  
OF AUDIO, VIDEO, PHOTOGRAPHIC IMAGES, TEXT, GRAPHICS AND DATA; COMPUTER  
SERVICES IN THE NATURE OF CUSTOMIZED WEB PAGES FEATURING USER-DEFINED  
OR SPECIFIED INFORMATION, PERSONAL PROFILES, AUDIO, VIDEO, PHOTOGRAPHIC  
IMAGES, TEXT, GRAPHICS AND DATA; PEER-TO-BROWSER PHOTO SHARING SERVICES,  
NAMELY, PROVIDING A WEBSITE FEATURING TECHNOLOGY ENABLING USERS TO  
UPLOAD, VIEW, AND DOWNLOAD DIGITAL PHOTOS; PROVIDING A WEB SITE FEAT-  
URING TECHNOLOGY THAT ENABLES USERS TO UPLOAD AND SHARE VIDEO,  
PHOTOS, TEXT, GRAPHICS AND DATA; CREATING AND MAINTAINING BLOGS FOR  
OTHERS. PROVIDING A WEB HOSTING PLATFORM FOR USE OF NON-DOWNLOADABLE  
SOFTWARE IN CONNECTION WITH INTERACTIVE, MULTIPLAYER AND SINGLE  
PLAYER GAMES FOR THIRD PARTIES AND WEBSITES, IN CLASS 42 (U.S. CLS. 100 AND  
101).



*David J. Kyros*

Director of the United States Patent and Trademark Office

**Reg. No. 4,124,301** FIRST USE 1-12-2010; IN COMMERCE 4-4-2010.

THE MARK CONSISTS OF STANDARD CHARACTERS WITHOUT CLAIM TO ANY PARTICULAR FONT, STYLE, SIZE, OR COLOR.

SER. NO. 85-264,350, FILED 3-11-2011.

CAROLYN CATALDO, EXAMINING ATTORNEY

# United States of America

United States Patent and Trademark Office

# STEALTH

**Reg. No. 4,124,302**

**Registered Apr. 10, 2012**

**Int. Cl.: 19**

**TRADEMARK**

**PRINCIPAL REGISTER**

WOLFPAC TECHNOLOGIES, INC. (PENNSYLVANIA CORPORATION)  
400 STEEL STREET  
ALIQUPPA, PA 15001

FOR: CELLULAR PVC BUILDING MATERIALS, NAMELY, TRIM BOARD, CORNER BOARD, BEAD BOARD, FASCIA, FRIEZE AND SKIRT BOARD, IN CLASS 19 (U.S. CLS. 1, 12, 33 AND 50).

FIRST USE 9-0-2005; IN COMMERCE 9-0-2005.

THE MARK CONSISTS OF STANDARD CHARACTERS WITHOUT CLAIM TO ANY PARTICULAR FONT, STYLE, SIZE, OR COLOR.

SER. NO. 85-264,487, FILED 3-11-2011.

GRETCHEN ULRICH, EXAMINING ATTORNEY



*David J. Kybas*

Director of the United States Patent and Trademark Office

# United States of America

United States Patent and Trademark Office

# Maija Event

**Reg. No. 4,124,303**

OHARA, TEIJI JOHN (UNITED STATES INDIVIDUAL), AKA JOHN MCKLAIN  
1456 CLEVELAND RD.  
GLENDALE, CA 91202

**Registered Apr. 10, 2012**

**Int. Cl.: 35**

FOR: ENTERTAINMENT MARKETING SERVICES, NAMELY, MARKETING, PROMOTION AND ADVERTISING FOR RECORDING AND PERFORMING ARTISTS, IN CLASS 35 (U.S. CLS. 100, 101 AND 102).

**SERVICE MARK**

FIRST USE 2-1-1996; IN COMMERCE 11-20-2009.

**PRINCIPAL REGISTER**

THE MARK CONSISTS OF STANDARD CHARACTERS WITHOUT CLAIM TO ANY PARTICULAR FONT, STYLE, SIZE, OR COLOR.

NO CLAIM IS MADE TO THE EXCLUSIVE RIGHT TO USE "EVENT", APART FROM THE MARK AS SHOWN.

SER. NO. 85-264,631, FILED 3-11-2011.

LAURA KOVALSKY, EXAMINING ATTORNEY



*David J. Kyffers*

Director of the United States Patent and Trademark Office

# United States of America

United States Patent and Trademark Office

# GLADIATOR

**Reg. No. 4,124,304**

LE VIAN CORP. (NEW YORK CORPORATION)  
235 GREAT NECK ROAD  
GREAT NECK, NY 11021

**Registered Apr. 10, 2012**

**Int. Cl.: 14**

FOR: BRACELETS; EARRINGS; GEMS; JEWELRY; NECKLACES; PENDANTS; RINGS;  
WATCHES, IN CLASS 14 (U.S. CLS. 2, 27, 28 AND 50).

**TRADEMARK**

FIRST USE 10-19-2007; IN COMMERCE 7-30-2009.

**PRINCIPAL REGISTER**

THE MARK CONSISTS OF STANDARD CHARACTERS WITHOUT CLAIM TO ANY PARTICULAR FONT, STYLE, SIZE, OR COLOR.

SER. NO. 85-264,941, FILED 3-11-2011.

EVELYN BRADLEY, EXAMINING ATTORNEY



*David J. Kybas*

Director of the United States Patent and Trademark Office

# United States of America

United States Patent and Trademark Office

## DIAMOND FAIRY

**Reg. No. 4,124,305**

**Registered Apr. 10, 2012**

**Int. Cl.: 14**

**TRADEMARK**

**PRINCIPAL REGISTER**

GOLD-N-BRONZE, INC. (OKLAHOMA CORPORATION), DBA J. DAVID JEWELRY  
613 N ASPEN AVE  
BROKEN ARROW, OK 74012

FOR: DIAMOND JEWELRY, IN CLASS 14 (U.S. CLS. 2, 27, 28 AND 50).

FIRST USE 2-23-2010; IN COMMERCE 2-23-2010.

THE MARK CONSISTS OF STANDARD CHARACTERS WITHOUT CLAIM TO ANY PARTICULAR FONT, STYLE, SIZE, OR COLOR.

NO CLAIM IS MADE TO THE EXCLUSIVE RIGHT TO USE "DIAMOND", APART FROM THE MARK AS SHOWN.

SER. NO. 85-265,023, FILED 3-11-2011.

ELI HELLMAN, EXAMINING ATTORNEY



*David J. Kyffers*

Director of the United States Patent and Trademark Office

# United States of America

United States Patent and Trademark Office

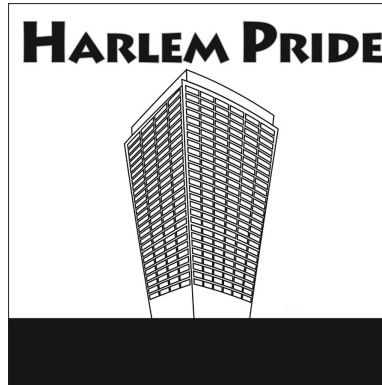

**Reg. No. 4,124,306**

**Registered Apr. 10, 2012**

**Int. Cl.: 36**

**SERVICE MARK**

**PRINCIPAL REGISTER**

NEELY, CARMEN JOY (UNITED STATES INDIVIDUAL)  
112 W.138TH ST., APT. 4H  
NEW YORK, NY 10030

FOR: CHARITABLE FUNDRAISING SERVICES BY MEANS OF ORGANIZING AND CONDUCTING SPECIAL EVENTS FOR USE IN PROVIDING FINANCIAL ASSISTANCE FOR USE IN UNITING DIVERSE COMMUNITIES, BUSINESSES AND ORGANIZATIONS FOR THE PURPOSE OF FOSTERING TOLERANCE OF DIFFERENCES AND ENSURING EQUALITY FOR ALL, IN CLASS 36 (U.S. CLS. 100, 101 AND 102).

FIRST USE 2-7-2010; IN COMMERCE 4-13-2010.

NO CLAIM IS MADE TO THE EXCLUSIVE RIGHT TO USE "HARLEM", APART FROM THE MARK AS SHOWN.

THE MARK CONSISTS OF THE WORDING "HARLEM PRIDE", A SKYSCRAPER, WITH MULTIPLE SMALL WINDOWS, PRESENTING TWO OF ITS BUILDING FACES, THAT IS CENTERED IN THE LOGO AND A SOLID BAR ACROSS THE LOWER PORTION OF THE BOTTOM OF THE LOGO.

SER. NO. 85-265,314, FILED 3-12-2011.

AMY C. KEAN, EXAMINING ATTORNEY



*David J. Kyffers*

Director of the United States Patent and Trademark Office

# United States of America

United States Patent and Trademark Office

## Keeping Dogs Active and Engaged

**Reg. No. 4,124,307**

**Registered Apr. 10, 2012**

**Int. Cl.: 28**

**TRADEMARK**

**PRINCIPAL REGISTER**

THE KYJEN COMPANY, INC. (COLORADO CORPORATION)  
15514 EAST HINSDALE CIRCLE  
CENTENNIAL, CO 80112

FOR: DOG TOYS, IN CLASS 28 (U.S. CLS. 22, 23, 38 AND 50).

FIRST USE 10-1-2010; IN COMMERCE 12-1-2010.

THE MARK CONSISTS OF STANDARD CHARACTERS WITHOUT CLAIM TO ANY PARTICULAR FONT, STYLE, SIZE, OR COLOR.

SER. NO. 85-265,684, FILED 3-13-2011.

FONG HSU, EXAMINING ATTORNEY



*David J. Kyjens*

Director of the United States Patent and Trademark Office



# United States of America

United States Patent and Trademark Office

# FRAY

**Reg. No. 4,124,308**

**Registered Apr. 10, 2012**

**Int. Cls.: 9 and 41**

**TRADEMARK**

**SERVICE MARK**

**PRINCIPAL REGISTER**

BRAIN CANDY, SARL (FRANCE LIMITED LIABILITY COMPANY)  
20 RUE VOLTAIRE  
MONTREUIL, FRANCE 93100

FOR: VIDEO GAME SOFTWARE FOR, AND DELIVERED DIGITALLY TO, PERSONAL COMPUTERS, VIDEO GAME CONSOLES, TABLET COMPUTERS, MOBILE PHONES, AND HANDHELD ELECTRONIC DEVICES, IN THE FIELD OF A SCIENCE-FICTION MULTI-PLAYER STRATEGY GAMES, NOT FOR SLOT MACHINES, CASINO GAMING MACHINES, WAGER GAMING MACHINES, OR MACHINES FOR PLAYING GAMES OF CHANCE, IN CLASS 9 (U.S. CLS. 21, 23, 26, 36 AND 38).

FOR: ENTERTAINMENT SERVICES, NAMELY, PROVIDING ONLINE VIDEO GAMES IN THE FIELD OF A SCIENCE-FICTION MULTI-PLAYER STRATEGY GAMES, NOT IN THE NATURE OF ONLINE SLOT MACHINES, CASINO GAMING MACHINES, WAGER GAMING MACHINES, OR MACHINES FOR PLAYING GAMES OF CHANCE, IN CLASS 41 (U.S. CLS. 100, 101 AND 107).

THE MARK CONSISTS OF STANDARD CHARACTERS WITHOUT CLAIM TO ANY PARTICULAR FONT, STYLE, SIZE, OR COLOR.

PRIORITY CLAIMED UNDER SEC. 44(D) ON FRANCE APPLICATION NO. 103765956, FILED 9-13-2010, REG. NO. 103765956, DATED 1-28-2011, EXPIRES 9-13-2020.

SER. NO. 85-265,794, FILED 3-14-2011.

NICHOLAS COLEMAN, EXAMINING ATTORNEY



*David J. Kybas*

Director of the United States Patent and Trademark Office

# United States of America

United States Patent and Trademark Office

## GRUPO JOVENES BROOKLYN

**Reg. No. 4,124,309**

GRUPO JOVENES BROOKLYN, INC. (NEW YORK CORPORATION)  
8212 3RD AVENUE  
BROOKLYN, NY 11209

**Registered Apr. 10, 2012**

**Int. Cl.: 44**

FOR: REHABILITATION OF ALCOHOL ADDICTED PATIENTS, IN CLASS 44 (U.S. CLS. 100 AND 101).

**SERVICE MARK**

FIRST USE 2-26-1994; IN COMMERCE 2-26-1994.

**PRINCIPAL REGISTER**

THE MARK CONSISTS OF STANDARD CHARACTERS WITHOUT CLAIM TO ANY PARTICULAR FONT, STYLE, SIZE, OR COLOR.

NO CLAIM IS MADE TO THE EXCLUSIVE RIGHT TO USE "GRUPO JOVENES", APART FROM THE MARK AS SHOWN.

THE ENGLISH TRANSLATION OF "GRUPO JOVENES" IN THE MARK IS "YOUTH GROUP".

SEC. 2(F).

SER. NO. 85-265,849, FILED 3-14-2011.

CHARLOTTE CORWIN, EXAMINING ATTORNEY



*David J. Kybas*

Director of the United States Patent and Trademark Office

# United States of America

United States Patent and Trademark Office

# W2W4Life

**Reg. No. 4,124,310**

**Registered Apr. 10, 2012**

**Int. Cls.: 16 and 44**

**TRADEMARK**

**SERVICE MARK**

**PRINCIPAL REGISTER**

NINA BELL (UNITED STATES INDIVIDUAL)  
400 WHITE OAKS BLVD  
C/O STEPTOE & JOHNSON PLLC  
BRIDGEPORT, WV 26330

FOR: PRINTED INSTRUCTIONAL, EDUCATIONAL AND TEACHING MATERIALS IN THE FIELD OF HEALTH CARE FOR CHILDREN AND FAMILIES, IN CLASS 16 (U.S. CLS. 2, 5, 22, 23, 29, 37, 38 AND 50).

FIRST USE 1-31-2006; IN COMMERCE 1-31-2006.

FOR: PROVIDING INFORMATION IN THE FIELD OF HEALTH CARE FOR CHILDREN AND FAMILIES VIA THE INTERNET, IN CLASS 44 (U.S. CLS. 100 AND 101).

FIRST USE 1-31-2006; IN COMMERCE 1-31-2006.

THE MARK CONSISTS OF STANDARD CHARACTERS WITHOUT CLAIM TO ANY PARTICULAR FONT, STYLE, SIZE, OR COLOR.

SER. NO. 85-265,915, FILED 3-14-2011.

ELI HELLMAN, EXAMINING ATTORNEY



*David J. Kypos*

Director of the United States Patent and Trademark Office

# United States of America

United States Patent and Trademark Office



**Reg. No. 4,124,311**

**Registered Apr. 10, 2012**

**Int. Cls.: 9, 35, 36, 38, 41,  
42 and 44**

**TRADEMARK**

**SERVICE MARK**

**PRINCIPAL REGISTER**

UNIVERSITY HEALTHSYSTEM CONSORTIUM (ILLINOIS NOT-FOR-PROFIT CORPORATION)  
155 NORTH WACKER DRIVE  
CHICAGO, IL 60606

FOR: NON-DOWNLOADABLE COMPUTER PROGRAMS FOR ELECTRONIC DATA ENTRY OF MEDICAL ERRORS AND ADVERSE EVENTS AT THE POINT OF CARE; NON-DOWNLOADABLE COMPUTER PROGRAMS FOR ELECTRONIC DATA ENTRY TO SUPPORT THE CLINICAL OPERATION OF UNIVERSITY HOSPITALS BY ANALYZING PATIENT OUTCOMES AND RESOURCES APPLIED TO SAID PATIENTS TO THEN PRODUCE MANAGEMENT REPORTS THAT ALERT THE USER TO TRENDS, AREAS OF IMPROVEMENTS AND OPPORTUNITIES TO IMPROVE PATIENT TREATMENT, IN CLASS 9 (U.S. CLS. 21, 23, 26, 36 AND 38).

FIRST USE 6-13-2011; IN COMMERCE 6-13-2011.

FOR: PROVIDING BUSINESS MANAGEMENT ASSISTANCE TO MEMBERS OF AN ALLIANCE OF UNIVERSITY HOSPITALS IN PROVIDING COST-EFFECTIVE SERVICES; GROUP PURCHASING SERVICES, NAMELY NEGOTIATING CONTRACTS WITH PROVIDERS OF MEDICAL SERVICES AND PURCHASING MEDICAL AND HOSPITAL SUPPLIES FOR OTHERS; PROVIDING COMMERCIAL INFORMATION ON CAPITAL EQUIPMENT PRICING FOR UNIVERSITY HOSPITALS; COLLECTING, AGGREGATING, ANALYZING AND PROVIDING COMPARATIVE DATA, BENCHMARKING, AND BEST PRACTICE INFORMATION TO HEALTHCARE RELATED GROUPS AND THEIR BUSINESS PARTNERS TO IDENTIFY MEDICAL, SURGICAL, PHARMACY AND OTHER SUPPLY ITEM COST SAVINGS OPPORTUNITIES, OPERATIONAL AND CLINICAL PERFORMANCE IMPROVEMENT, AND TRENDS, NAMELY, BUSINESS ADMINISTRATION ASSISTANCE AND CONSULTANCY IN THE FIELD OF HEALTHCARE OPERATIONS; BUSINESS CONSULTATION SERVICES, NAMELY, PROVIDING ON-SITE ASSISTANCE TO ACADEMIC MEDICAL CENTERS TO REDUCE NON-LABOR EXPENSES AND IMPROVE PROVIDER PERFORMANCE, NAMELY, BUSINESS ADMINISTRATION CONSULTANCY; PROVIDING INFORMATION AND ANALYSIS OF BUSINESS INFORMATION TO ADDRESS STRATEGIC BUSINESS AND PUBLIC POLICY ISSUES AFFECTING ACADEMIC MEDICAL CENTERS, NAMELY, BUSINESS RESEARCH SERVICES; BUSINESS COLLABORATION SERVICES, NAMELY, PROVIDING A NATIONAL COMPUTER-BASED NETWORKING WEBSITE FOR HEALTHCARE EDUCATORS AND MEDICAL EDUCATORS TO COLLABORATE ACROSS DISCIPLINES TO HELP IMPROVE HEALTHCARE PROVISION AND REDUCE COSTS;



*David J. Kappas*

Director of the United States Patent and Trademark Office

**Reg. No. 4,124,311** BUSINESS RISK MANAGEMENT SERVICES, NAMELY PROVIDING A WEBSITE WHERE MEDICAL PERSONNEL MAY REPORT MEDICAL ERRORS AND ADVERSE EVENTS AT THE POINT OF CARE VIA A GLOBAL COMPUTER NETWORK, IN CLASS 35 (U.S. CLS. 100, 101 AND 102).

FIRST USE 6-13-2011; IN COMMERCE 6-13-2011.

FOR: FINANCIAL MANAGEMENT SERVICES; INSURANCE ADMINISTRATION IN THE FIELD OF PROFESSIONAL LIABILITY INSURANCE SERVICES; AND CAPITAL EQUIPMENT MAINTENANCE INSURANCE SERVICES, ALL PROVIDED TO MEMBERS OF AN ALLIANCE OF UNIVERSITY HOSPITALS, IN CLASS 36 (U.S. CLS. 100, 101 AND 102).

FIRST USE 6-13-2011; IN COMMERCE 6-13-2011.

FOR: ELECTRONIC TRANSMISSION OF NEWS AND INFORMATION RELATED TO THE HEALTHCARE FIELD, VIA COMPUTER; PROVIDING ELECTRONIC BULLETIN BOARDS FOR TRANSMISSION OF MESSAGES AMONG USERS IN THE FIELD OF HEALTHCARE TO FACILITATE THE SHARING OF KNOWLEDGE AND IDEAS BY HEALTHCARE PROVIDERS; COMMUNICATIONS SERVICES, NAMELY, PROVIDING ELECTRONIC TRANSMISSION OF INFORMATION STORED IN A DATABASE VIA INTERACTIVELY COMMUNICATING COMPUTER SYSTEMS CONTAINING EVENT REPORTS THAT DETAIL MEDICAL ERRORS AND ADVERSE PATIENT OUTCOMES FOR REVIEW AND ANALYSIS BY GOVERNMENTAL AGENCIES, IN CLASS 38 (U.S. CLS. 100, 101 AND 104).

FIRST USE 6-13-2011; IN COMMERCE 6-13-2011.

FOR: EDUCATIONAL SERVICES, NAMELY, CONDUCTING COURSES, CLASSES, SEMINARS AND WORKSHOPS, AND ON-LINE CLASSES IN THE FIELD OF MEDICINE TO ASSIST PRACTITIONERS IN SOLVING REAL-LIFE HEALTHCARE-RELATED PROBLEMS; EDUCATIONAL SERVICES, NAMELY, CONDUCTING COURSES OF INSTRUCTION IN THE FIELDS OF CONTINUING MEDICAL AND CLINICAL EDUCATION, HEALTHCARE OPERATIONS MANAGEMENT EDUCATION, AND CONDUCTING ON-LINE EXHIBITIONS AND DISPLAYS AND INTERACTIVE EXHIBITS IN THE FIELDS OF CONTINUING MEDICAL AND CLINICAL EDUCATION, HUMAN RESOURCE AND HEALTHCARE OPERATIONS MANAGEMENT EDUCATION; EDUCATIONAL COURSE MONITORING, NAMELY, DEVELOPMENT OF CURRICULUM AND REPORTING RESULTS ON COMPLETION RATES FOR COURSES OF INSTRUCTION BY OTHERS; EDUCATIONAL SERVICES, NAMELY, PROVIDING A NURSING RESIDENCY PROGRAM, IN CLASS 41 (U.S. CLS. 100, 101 AND 107).

FIRST USE 6-13-2011; IN COMMERCE 6-13-2011.

FOR: PROVIDING TEMPORARY USE OF ONLINE NON-DOWNLOADABLE COMPUTER SOFTWARE TO HEALTHCARE RELATED GROUPS AND THEIR BUSINESS PARTNERS FOR EVALUATING AND MANAGING MEDICAL, SURGICAL, PHARMACY AND OTHER SUPPLY ITEM COST SAVINGS OPPORTUNITIES AND TRENDS; CONDUCTING STRATEGIC RESEARCH STUDIES IN THE FIELDS OF MEDICINE, HEALTH CARE DELIVERY AND THE SCIENTIFIC ASPECTS OF HEALTHCARE POLICY, HEALTHCARE COST MANAGEMENT AND FINANCING AS THESE FIELDS IMPACT ON QUALITY OF HEALTHCARE , IN CLASS 42 (U.S. CLS. 100 AND 101).

FIRST USE 6-13-2011; IN COMMERCE 6-13-2011.

FOR: PROVIDING AN ONLINE COMPUTER DATABASE IN THE FIELD OF HEALTHCARE AND NURSING CONTAINING INFORMATION USED TO TRACK, MEASURE, AND BENCHMARK NURSING QUALITY AMONG MEMBER PROVIDERS, IN CLASS 44 (U.S. CLS. 100 AND 101).

**Reg. No. 4,124,311** FIRST USE 6-13-2011; IN COMMERCE 6-13-2011.

OWNER OF U.S. REG. NOS. 1,809,491, 2,817,053 AND OTHERS.

THE MARK CONSISTS OF A PORTION OF A SPHERICAL GLOBE SHAPE, WITH THE SURFACE BEING DEFINED BY GENERALLY CIRCULAR SHAPES; THE INITIALS UHC APPEAR TO THE RIGHT OF THE DESIGN.

SER. NO. 85-266,070, FILED 3-14-2011.

MATTHEW MCDOWELL, EXAMINING ATTORNEY

# United States of America

United States Patent and Trademark Office

# LUVD

**Reg. No. 4,124,312**

CORY O'KEEFE (UNITED STATES INDIVIDUAL)  
P.O. BOX 543

**Registered Apr. 10, 2012**

ARROYO GRANDE, CA 93421

**Int. Cl.: 25**

FOR: APPAREL, NAMELY, T-SHIRTS, SHIRTS, SHORTS, PANTS, SWEATSHIRTS, SWEATPANTS, JACKETS, HATS, VISORS, SHOES, SANDALS, JACKETS, UNDERWEAR, SOCKS, AND BELTS, IN CLASS 25 (U.S. CLS. 22 AND 39).

**TRADEMARK**

FIRST USE 8-1-2010; IN COMMERCE 8-1-2010.

**PRINCIPAL REGISTER**

THE MARK CONSISTS OF STANDARD CHARACTERS WITHOUT CLAIM TO ANY PARTICULAR FONT, STYLE, SIZE, OR COLOR.

SER. NO. 85-266,772, FILED 3-14-2011.

TINA MAI, EXAMINING ATTORNEY



*David J. Kybas*

Director of the United States Patent and Trademark Office

# United States of America

United States Patent and Trademark Office



**Reg. No. 4,124,313**

**Registered Apr. 10, 2012**

**Int. Cl.: 29**

**TRADEMARK**

**PRINCIPAL REGISTER**

NUTTY GUYS, INC. (UTAH CORPORATION)  
3528 WEST 500 SOUTH, STE. A  
SALT LAKE CITY, UT 84104

FOR: PRE-PACKAGED AND BULK PROCESSED, CANDIED AND DRIED FOODS, NAMELY, DRIED FRUIT, NUTS, SEASONED NUTS, CANDIED NUTS, PROCESSED EDIBLE SEEDS, IN CLASS 29 (U.S. CL. 46).

FIRST USE 1-1-2000; IN COMMERCE 1-1-2000.

OWNER OF U.S. REG. NOS. 3,099,291 AND 3,977,295.

THE MARK CONSISTS OF STYLIZED NUTS WITH FACES AND SUNGLASSES POSITIONED BACK TO BACK WITH THE WORDS "NUTTY GUYS" TO THE RIGHT.

SER. NO. 85-267,158, FILED 3-15-2011.

MICHAEL TANNER, EXAMINING ATTORNEY



*David J. Kyffers*

Director of the United States Patent and Trademark Office



# United States of America

United States Patent and Trademark Office

## HELP ME, RHONDA!

**Reg. No. 4,124,314**

**Registered Apr. 10, 2012**

**Int. Cl.: 9**

**TRADEMARK**

**PRINCIPAL REGISTER**

4 S TECHNOLOGIES, LLC (NEW JERSEY LIMITED LIABILITY COMPANY)  
200 SHEFFIELD STREET  
SUITE 101  
MOUNTAINSIDE, NJ 07092

FOR: COMPUTER PROGRAMS AND SOFTWARE FOR THE AUTOMATED GATHERING, RECOGNITION, FORMATTING AND TRANSMISSION OF DATA AND INFORMATION TO AND FROM COMPUTERS, WEB PORTALS, OR COMPUTER NETWORKS; ALL OF THE ABOVE FOR USE IN THE BANKING, FINANCE, CAPITAL MARKETS, CONSUMER CREDIT, CREDIT RATING AGENCIES, INSURANCE, REAL ESTATE, JUDICIARY AND LEGAL FIELDS, IN CLASS 9 (U.S. CLS. 21, 23, 26, 36 AND 38).

FIRST USE 2-1-2011; IN COMMERCE 2-1-2011.

THE MARK CONSISTS OF STANDARD CHARACTERS WITHOUT CLAIM TO ANY PARTICULAR FONT, STYLE, SIZE, OR COLOR.

SER. NO. 85-267,260, FILED 3-15-2011.

RONALD MCMORROW, EXAMINING ATTORNEY



*David J. Kybas*

Director of the United States Patent and Trademark Office

# United States of America

United States Patent and Trademark Office

# LEAF

Leadership for Educational  
Achievement Foundation, Inc.

LEAD • EDUCATE • ACHIEVE

**Reg. No. 4,124,315**

**Registered Apr. 10, 2012**

**Int. Cl.: 35**

**SERVICE MARK**

**PRINCIPAL REGISTER**

LEADERSHIP FOR EDUCATIONAL ACHIEVEMENT FOUNDATION, INC. (NEW YORK CORPORATION)  
7 ELK STREET  
ALBANY, NY 12207

FOR: EDUCATION LEADERSHIP DEVELOPMENT, IN CLASS 35 (U.S. CLS. 100, 101 AND 102).

FIRST USE 1-0-2008; IN COMMERCE 1-0-2008.

NO CLAIM IS MADE TO THE EXCLUSIVE RIGHT TO USE "LEADERSHIP FOR EDUCATIONAL ACHIEVEMENT FOUNDATION, INC." AND "LEAD EDUCATE ACHIEVE", APART FROM THE MARK AS SHOWN.

THE COLOR(S) WITH, LIGHT GREEN AND DARK GREEN IS/ARE CLAIMED AS A FEATURE OF THE MARK.

THE MARK CONSISTS OF THE STYLIZED DARK GREEN WORDING "LEAF" FEATURING A LIGHT GREEN LEAF DESIGN OVERLAPPING PART OF THE WORD. BELOW THE WORD IS THE LIGHT GREEN STYLIZED WORDING "LEADERSHIP FOR EDUCATIONAL ACHIEVEMENT FOUNDATION, INC." AND BELOW THAT WORDING IS THE STYLIZED LIGHT GREEN WORDING "LEAD EDUCATE ACHIEVE" WITH A SMALL LIGHT GREEN DOT BETWEEN BEFORE AND AFTER "EDUCATE".

SER. NO. 85-267,568, FILED 3-15-2011.

BERYL GARDNER, EXAMINING ATTORNEY



*David J. Kybas*

Director of the United States Patent and Trademark Office

# United States of America

United States Patent and Trademark Office

## EXCEEDING EXPECTATIONS

**Reg. No. 4,124,316**

**Registered Apr. 10, 2012**

**Int. Cl.: 35**

**SERVICE MARK**

**PRINCIPAL REGISTER**

BRODY & ASSOCIATES, P.A. (FLORIDA CORPORATION)  
19495 BISCAYNE BOULEVARD, SUITE 850  
AVENTURA, FL 33180

FOR: ACCOUNTING SERVICES, IN CLASS 35 (U.S. CLS. 100, 101 AND 102).

FIRST USE 9-15-2007; IN COMMERCE 9-15-2007.

THE MARK CONSISTS OF STANDARD CHARACTERS WITHOUT CLAIM TO ANY PARTICULAR FONT, STYLE, SIZE, OR COLOR.

SER. NO. 85-267,695, FILED 3-15-2011.

JAMES LOVELACE, EXAMINING ATTORNEY



*David J. Kybas*

Director of the United States Patent and Trademark Office

# United States of America

United States Patent and Trademark Office

# PURATHON

**Reg. No. 4,124,317**

**Registered Apr. 10, 2012**

**Int. Cl.: 11**

**TRADEMARK**

**PRINCIPAL REGISTER**

PURGENIX, INC. (KENTUCKY CORPORATION)  
528 SOUTH SIXTH STREET  
MURRAY, KY 42071

FOR: ULTRAVIOLET GERMICIDAL IRRADIATION LIGHTING FIXTURES, IN CLASS 11  
(U.S. CLS. 13, 21, 23, 31 AND 34).

FIRST USE 6-2-2004; IN COMMERCE 6-2-2004.

THE MARK CONSISTS OF STANDARD CHARACTERS WITHOUT CLAIM TO ANY PARTICULAR FONT, STYLE, SIZE, OR COLOR.

OWNER OF U.S. REG. NO. 2,934,056.

SER. NO. 85-267,799, FILED 3-15-2011.

SANJEEV VOHRA, EXAMINING ATTORNEY



*David J. Kybas*

Director of the United States Patent and Trademark Office

# United States of America

United States Patent and Trademark Office

## ALLIED FORCES ROOFING



WINDOWS SIDING GUTTERS

**Reg. No. 4,124,318**

**Registered Apr. 10, 2012**

**Int. Cl.: 37**

**SERVICE MARK**

**PRINCIPAL REGISTER**

SUCCESS ROOFING AND CONTRACTING, LLC (COLORADO LIMITED LIABILITY COMPANY), DBA ALLIED FORCES ROOFING  
7350 W. 1ST AVENUE  
LAKEWOOD, CO 80226

FOR: ROOFING CONSULTATION, INSTALLATION AND REPAIR SERVICES AND HOME RESTORATION SERVICES, IN CLASS 37 (U.S. CLS. 100, 103 AND 106).

FIRST USE 6-20-2010; IN COMMERCE 10-15-2010.

NO CLAIM IS MADE TO THE EXCLUSIVE RIGHT TO USE "ROOFING" AND "WINDOWS SIDING GUTTERS", APART FROM THE MARK AS SHOWN.

THE MARK CONSISTS OF THE WORDING "ALLIED FORCES ROOFING" CENTERED ABOVE A BANNER WITH 3 STRIPES AND A STAR CENTERED IN A CIRCLE IN THE CENTER OF THE BANNER AND THE WORDING "WINDOWS SIDING GUTTERS" APPEARING CENTERED BELOW THE BANNER.

SER. NO. 85-267,831, FILED 3-15-2011.

B. PARADEWELAI, EXAMINING ATTORNEY



*David J. Kyros*

Director of the United States Patent and Trademark Office

# United States of America

United States Patent and Trademark Office

# Angry Acorn

**Reg. No. 4,124,319**

ANGRY ACORN LLC (NEW HAMPSHIRE LIMITED LIABILITY COMPANY)  
1277 ELM ST  
CONCORD, MA 01742

**Registered Apr. 10, 2012**

**Int. Cl.: 25**

FOR: TRIATHLON CLOTHING, NAMELY, TRIATHLON TIGHTS, TRIATHLON SHORTS, TRIATHLON SINGLET, TRIATHLON SHIRTS, TRIATHLON SUITS, IN CLASS 25 (U.S. CLS. 22 AND 39).

**TRADEMARK**

FIRST USE 3-23-2009; IN COMMERCE 3-23-2009.

**PRINCIPAL REGISTER**

THE MARK CONSISTS OF STANDARD CHARACTERS WITHOUT CLAIM TO ANY PARTICULAR FONT, STYLE, SIZE, OR COLOR.

SER. NO. 85-267,964, FILED 3-15-2011.

ALYSSA STEEL, EXAMINING ATTORNEY



*David J. Kyffers*

Director of the United States Patent and Trademark Office

# United States of America

United States Patent and Trademark Office

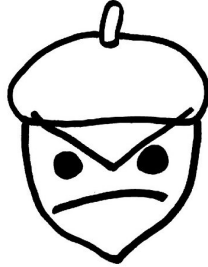

**Reg. No. 4,124,320**

**Registered Apr. 10, 2012**

**Int. Cl.: 25**

**TRADEMARK**

**PRINCIPAL REGISTER**

ANGRY ACORN LLC (NEW HAMPSHIRE LIMITED LIABILITY COMPANY)  
1277 ELM STREET  
CONCORD, MA 01742

FOR: TRIATHLON CLOTHING, NAMELY, TRIATHLON TIGHTS, TRIATHLON SHORTS, TRIATHLON SINGLETS, TRIATHLON SHIRTS, TRIATHLON SUITS, IN CLASS 25 (U.S. CLS. 22 AND 39).

FIRST USE 3-23-2009; IN COMMERCE 3-23-2009.

THE MARK CONSISTS OF AN OUTLINE OF A TWO DIMENSIONAL ACORN WITH AN ANGRY FACIAL EXPRESSION PLACED OVER THE ACORN OUTLINE.

SER. NO. 85-267,983, FILED 3-15-2011.

ALYSSA STEEL, EXAMINING ATTORNEY



*David J. Kybas*

Director of the United States Patent and Trademark Office

# United States of America

United States Patent and Trademark Office



**Reg. No. 4,124,321**

SOMALIFE CONSULTING LTD. (CANADA CORPORATION)  
2189 CAMPBELL PLACE  
KELOWNA, CANADA V1Z1S9

**Registered Apr. 10, 2012**

**Int. Cl.: 5**

FOR: DIETARY SUPPLEMENTS FOR HUMANS AND DIETARY SUPPLEMENTS FOR DOMESTICATED ANIMALS, IN CLASS 5 (U.S. CLS. 6, 18, 44, 46, 51 AND 52).

**TRADEMARK**

FIRST USE 3-1-2001; IN COMMERCE 9-4-2001.

**PRINCIPAL REGISTER**

THE MARK CONSISTS OF "S" AND MAPLE LEAF WITHIN A CIRCLE.

SER. NO. 85-267,991, FILED 3-15-2011.

JOHN WILKE, EXAMINING ATTORNEY



*David J. Kyffers*

Director of the United States Patent and Trademark Office



# United States of America

United States Patent and Trademark Office

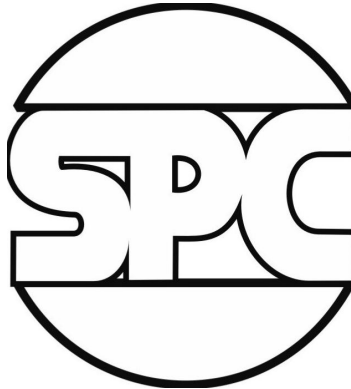

**Reg. No. 4,124,322**

**Registered Apr. 10, 2012**

**Int. Cls.: 5, 10 and 25**

**TRADEMARK**

**PRINCIPAL REGISTER**

SAN PABLO COMMERCIAL CORP. (CALIFORNIA CORPORATION)  
45 W EASY STREET  
SIMI VALLEY, CA 93065

FOR: ADULT DIAPERS; DISPOSABLE ADULT DIAPERS; INCONTINENCE DIAPERS; INCONTINENCE GARMENTS; INCONTINENCE PADS, IN CLASS 5 (U.S. CLS. 6, 18, 44, 46, 51 AND 52).

FIRST USE 9-9-2007; IN COMMERCE 9-9-2007.

FOR: INCONTINENCE BED PADS; INCONTINENCE SHEETS, IN CLASS 10 (U.S. CLS. 26, 39 AND 44).

FIRST USE 6-15-2011; IN COMMERCE 6-15-2011.

FOR: BRIEFS; DISPOSABLE UNDERWEAR; LADIES' UNDERWEAR; MEN'S UNDERWEAR; WOVEN OR KNITTED UNDERWEAR, IN CLASS 25 (U.S. CLS. 22 AND 39).

FIRST USE 6-15-2011; IN COMMERCE 6-15-2011.

THE MARK CONSISTS OF A SPLIT CIRCLE WITH THE LETTERING "SPC" APPEARING BETWEEN THE TWO HALVES OF THE CIRCLE.

SER. NO. 85-268,522, FILED 3-16-2011.

LINDSEY RUBIN, EXAMINING ATTORNEY



*David J. Kybas*

Director of the United States Patent and Trademark Office

# United States of America

United States Patent and Trademark Office

## The World's Travel Inspiration Engine

**Reg. No. 4,124,323**

**Registered Apr. 10, 2012**

**Int. Cl.: 39**

**SERVICE MARK**

**PRINCIPAL REGISTER**

LIVEGLOBE, INC. (DELAWARE CORPORATION)  
#410  
1840 PARK NEWPORT  
NEWPORT BEACH, CA 92660

FOR: ARRANGING AND COORDINATING TRAVEL ARRANGEMENTS FOR INDIVIDUALS AND GROUPS, NAMELY, DESTINATIONS STAYS, HONEYMOONS, FAMILY VACATIONS, AND DESTINATION WEDDINGS; ARRANGING FOR TRAVEL VISAS, PASSPORTS AND TRAVEL DOCUMENTS FOR PERSONS TRAVELING ABROAD; ARRANGING TRAVEL TOURS; ARRANGING TRAVEL TOURS AS A BONUS PROGRAM FOR CREDIT CARDS CUSTOMERS; BOOKING OF SEATS FOR TRAVEL; COORDINATING TRAVEL ARRANGEMENTS FOR INDIVIDUALS AND FOR GROUPS; ESCORTING OF TRAVELLERS; ESCORTING TRAVELLERS; MAKING TRAVEL AND EXCURSION ARRANGEMENTS FOR BANDS AND ORCHESTRAS; MEDICAL TOURISM SERVICES, NAMELY, MAKING TRANSPORTATION RESERVATIONS AND BOOKINGS FOR TRAVEL TO ANOTHER COUNTRY IN ORDER TO OBTAIN HEALTH CARE; ON-LINE TRANSPORTATION RESERVATION AND TRAVEL TICKET RESERVATION SERVICES; ONLINE TRIP AND TRAVEL RESERVATION SERVICES; ORGANISATION OF TRAVEL; ORGANIZATION OF EXCURSIONS, SIGHTSEEING TOURS, HOLIDAYS, TOURS AND TRAVEL; ORGANIZATION OF TRAVEL AND BOAT TRIPS; PROVIDE A WEBSITE FOR THE ARRANGEMENT AND BOOKING OF ECO-TRAVEL AND ECO-TOURS; PROVIDING A WEB SITE FEATURING TRAVEL INFORMATION AND COMMENTARY; PROVIDING A WEBSITE FEATURING INFORMATION ON TRAVEL; PROVIDING AN ON-LINE COMPUTER DATABASE IN THE FIELD OF TRAVEL INFORMATION SERVICES; PROVIDING AN ON-LINE SEARCHABLE COMPUTER DATABASE FEATURING INFORMATION ON TRAVEL; PROVIDING AUTOMATED CHECK-IN AND TICKETING SERVICES FOR AIR TRAVELERS; PROVIDING INFORMATION, NEWS AND COMMENTARY IN THE FIELD OF TRAVEL; PROVIDING LINKS TO WEB SITES OF OTHERS FEATURING TRAVEL; PROVIDING REVIEWS OF TRAVEL SERVICE PROVIDERS; PROVIDING TRAVEL INFORMATION TO TRAVELERS REGARDING FARES, TIMETABLES AND PUBLIC TRANSPORT; PROVISION OF TRAVEL INFORMATION; RESERVATION AND BOOKING OF SEATS FOR TRAVEL; TRANSPORT OF TRAVELLERS; TRANSPORTATION OF GOODS, PASSENGERS AND TRAVELLERS BY AIR; TRAVEL AGENCY SERVICES, NAMELY, MAKING RESERVATIONS AND BOOKINGS FOR TRANSPORTATION; TRAVEL AGENCY SERVICES, NAMELY, MAKING RESERVATIONS AND BOOKINGS FOR TRANSPORTATION FOR DOGS; TRAVEL AND TOUR INFORMATION SERVICE; TRAVEL AND TOUR TICKET RESERVATION SERVICE; TRAVEL ASSISTANCE SERVICES, NAMELY, ARRANGING FOR THE EMERGENCY REPLACEMENT OF AIRLINE TICKETS;

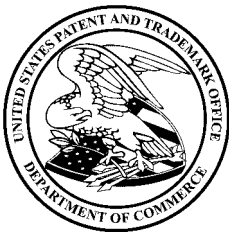

*David J. Kybas*

Director of the United States Patent and Trademark Office

**Reg. No. 4,124,323** TRAVEL BOOKING AGENCIES; TRAVEL CLUBS; TRAVEL COURIER AND TRAVEL GUIDE SERVICES; TRAVEL DEMAND MANAGEMENT SERVICE, NAMELY, PROVIDING CUSTOMIZED DRIVING INSTRUCTIONS THROUGH USE OF AN ON-LINE PARKING RESERVATION SYSTEM; TRAVEL GUIDE AND TRAVEL INFORMATION SERVICES; TRAVEL GUIDE SERVICES; TRAVEL INFORMATION; TRAVEL INFORMATION SERVICES; TRAVEL INFORMATION SERVICES, NAMELY, PROVIDING A WEB SITE THAT NOTIFIES PEOPLE WHEN SOMEONE IS DUE BACK FROM A TRIP BUT HAS NOT YET ARRIVED; TRAVEL PLANNING FOR INDIVIDUALS, FAMILIES, AND GROUPS FOR SPECIAL OCCASIONS SUCH AS DESTINATION WEDDINGS AND HONEYMOONS; TRAVEL, EXCURSION AND CRUISE ARRANGEMENT; WEBSITE PROVIDING TRAVEL BOOKING AND RESERVATION SERVICES FOR DIVERS, IN CLASS 39 (U.S. CLS. 100 AND 105).

FIRST USE 1-1-2010; IN COMMERCE 1-1-2010.

THE MARK CONSISTS OF STANDARD CHARACTERS WITHOUT CLAIM TO ANY PARTICULAR FONT, STYLE, SIZE, OR COLOR.

NO CLAIM IS MADE TO THE EXCLUSIVE RIGHT TO USE "TRAVEL" AND "ENGINE", APART FROM THE MARK AS SHOWN.

SER. NO. 85-268,545, FILED 3-16-2011.

ROBERT C. CLARK JR., EXAMINING ATTORNEY

# United States of America

United States Patent and Trademark Office

## THE TRASH PACK

**Reg. No. 4,124,324**

**Registered Apr. 10, 2012**

**Int. Cl.: 28**

**TRADEMARK**

**PRINCIPAL REGISTER**

MOOSE CREATIVE PTY LTD (AUSTRALIA LIMITED LIABILITY COMPANY)  
7-13 ARDENA COURT  
EAST BENTLEIGH, AUSTRALIA

FOR: TOYS, GAMES AND PLAYTHINGS, NAMELY, COLLECTIBLE FIGURINES, COLLECTIBLE ANIMAL FIGURINES, COLLECTIBLE TOYS, NAMELY, TOY FIGURES AND COLLECTIBLE TOY CHARACTERS AND COLLECTABLE BENDABLE TOY CHARACTERS, OUTFITS FOR TOYS, POUCHES FOR TOYS AND COLLECTOR CASES FOR TOYS; PUPPETS; PUZZLES; PACKAGED AMUSEMENT AND EDUCATIONAL GAMES, NAMELY, ELECTRONIC EDUCATIONAL GAME MACHINES FOR CHILDREN; TOY ENVIRONMENTS FOR USE WITH TOY CHARACTERS, NAMELY, PLAY PIECES IN THE NATURE OF TOY BUILDINGS, TOY VEHICLES, TOY BUILDING STRUCTURES, TOY CONSTRUCTION SETS; PLAY SETS FOR TOY CHARACTERS, PLAY TOY COSTUMES, FANTASY CHARACTER TOYS, TOY ACTION FIGURES AND ACCESSORIES THERE FOR, IN CLASS 28 (U.S. CLS. 22, 23, 38 AND 50).

THE MARK CONSISTS OF STANDARD CHARACTERS WITHOUT CLAIM TO ANY PARTICULAR FONT, STYLE, SIZE, OR COLOR.

PRIORITY CLAIMED UNDER SEC. 44(D) ON AUSTRALIA APPLICATION NO. 1399990, FILED 12-15-2010, REG. NO. 1399990, DATED 12-15-2010, EXPIRES 12-15-2020.

NO CLAIM IS MADE TO THE EXCLUSIVE RIGHT TO USE "PACK", APART FROM THE MARK AS SHOWN.

SER. NO. 85-269,114, FILED 3-17-2011.

MARY CRAWFORD, EXAMINING ATTORNEY



*David J. Kyros*

Director of the United States Patent and Trademark Office

# United States of America

United States Patent and Trademark Office

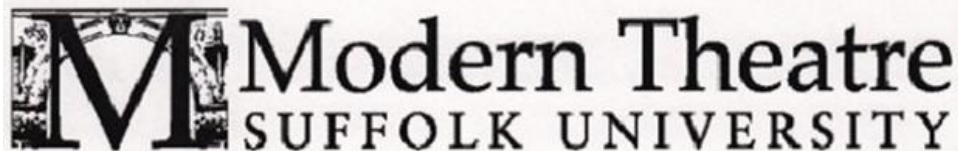

**Reg. No. 4,124,325**

SUFFOLK UNIVERSITY (MASSACHUSETTS CORPORATION)  
8 ASHBURTON PLACE  
BOSTON, MA 02108

**Registered Apr. 10, 2012**

**Int. Cl.: 41**

FOR: ENTERTAINMENT SERVICES, NAMELY, ORGANIZING AND CONDUCTING THEATER PRODUCTIONS, FILM PERFORMANCES; EDUCATIONAL AND ENTERTAINMENT SERVICES, NAMELY, ORGANIZING AND CONDUCTING LECTURES, WORKSHOPS, AND DISCUSSIONS IN THE FIELD OF THE ARTS, IN CLASS 41 (U.S. CLS. 100, 101 AND 107).

**SERVICE MARK**

**PRINCIPAL REGISTER**

FIRST USE 11-30-2010; IN COMMERCE 11-30-2010.

NO CLAIM IS MADE TO THE EXCLUSIVE RIGHT TO USE "MODERN THEATRE" AND "UNIVERSITY", APART FROM THE MARK AS SHOWN.

THE MARK CONSISTS OF THE CAPITAL LETTER "M" SUPERIMPOSED ONTO AN ARCH STRUCTURE, WITH THE WORDING, "MODERN THEATRE" TO THE RIGHT, PRINTED ABOVE THE WORDING "SUFFOLK UNIVERSITY" IN ALL CAPS.

SEC. 2(F) AS TO "SUFFOLK" .

SER. NO. 85-269,209, FILED 3-17-2011.

ODESSA BIBBINS, EXAMINING ATTORNEY



*David J. Kyjars*

Director of the United States Patent and Trademark Office

# United States of America

United States Patent and Trademark Office

## WAYPOINT HEALTH INNOVATIONS

**Reg. No. 4,124,326**

**Registered Apr. 10, 2012**

**Int. Cl.: 44**

**SERVICE MARK**

**PRINCIPAL REGISTER**

WAYPOINT HEALTH INNOVATIONS (WISCONSIN LIMITED LIABILITY COMPANY)  
137 E. WILSON STREET, SUITE 812  
MADISON, WI 53703

FOR: PROVIDING WEBSITES FEATURING HEALTH AND HEALTH CARE INFORMATION  
IN THE FIELD OF BEHAVIORAL AND BEHAVIOR-RELATED HEALTH CONDITIONS , IN  
CLASS 44 (U.S. CLS. 100 AND 101).

FIRST USE 8-15-2008; IN COMMERCE 8-15-2008.

THE MARK CONSISTS OF STANDARD CHARACTERS WITHOUT CLAIM TO ANY PAR-  
TICULAR FONT, STYLE, SIZE, OR COLOR.

NO CLAIM IS MADE TO THE EXCLUSIVE RIGHT TO USE "HEALTH", APART FROM THE  
MARK AS SHOWN.

SER. NO. 85-269,401, FILED 3-17-2011.

KEVIN DINALLO, EXAMINING ATTORNEY



*David J. Kyffers*

Director of the United States Patent and Trademark Office

# United States of America

United States Patent and Trademark Office

# FUZEBUY

**Reg. No. 4,124,327**

**Registered Apr. 10, 2012**

**Int. Cls.: 35, 40 and 42**

**SERVICE MARK**

**PRINCIPAL REGISTER**

JET LITHOCOLOR, INC. (ILLINOIS CORPORATION)  
2500 CENTRE CIRCLE  
DOWNERS GROVE, IL 60515

FOR: ADVERTISING AND MARKETING SERVICES; INFORMATION AND DATA COMPILING AND ANALYZING RELATING TO BUSINESS MANAGEMENT; PREPARING MAILING LISTS; ON-LINE PROFILING SURVEY AND ANALYSIS, NAMELY, ANALYSIS OF MARKET RESEARCH DATA AND STATISTICS PERTAINING TO ON-LINE AND IN-STORE SHOPPING, IN CLASS 35 (U.S. CLS. 100, 101 AND 102).

FIRST USE 3-1-2011; IN COMMERCE 3-1-2011.

FOR: CUSTOM MANUFACTURING AND PRINTING OF PLASTIC CARDS; PRINTING, IN CLASS 40 (U.S. CLS. 100, 103 AND 106).

FIRST USE 3-1-2011; IN COMMERCE 3-1-2011.

FOR: PROVIDING ON-LINE, NON-DOWNLOADABLE COMPUTER SOFTWARE FOR ACCOUNT MANAGEMENT OF CUSTOMER LOYALTY REWARDS PROGRAMS IN THE NATURE OF EXCHANGING, PURCHASING, EARNING AND TRACKING CUSTOMER LOYALTY REWARDS FOR THE PURPOSE OF INCREASING FLEXIBILITY, DRIVING MEMBER ENGAGEMENT AND GROWING REVENUE, IN CLASS 42 (U.S. CLS. 100 AND 101).

FIRST USE 3-1-2011; IN COMMERCE 3-1-2011.

THE MARK CONSISTS OF THE WORDING "FUZEBUY" IN STYLIZED FONT WHERE THERE ARE TWO PARALLEL HORIZONTAL BANDS IN THE TOP PORTION OF THE LETTER "Y" AND TWO CIRCLES BELOW THE BOTTOM PORTION OF THE LETTER "Y" FORMING A STYLIZED SHOPPING CART.

SER. NO. 85-269,483, FILED 3-17-2011.

TINA BROWN, EXAMINING ATTORNEY



*David J. Kyffers*

Director of the United States Patent and Trademark Office

**United States of America**  
United States Patent and Trademark Office

**ABACAN**

**Reg. No. 4,124,328**

MARANDA ENTERPRISES (WISCONSIN LIMITED LIABILITY COMPANY)  
6350 W. DONGES BAY ROAD  
MEQUON, WI 53092

**Registered Apr. 10, 2012**

**Int. Cl.: 28**

FOR: STRATEGY GAMES, NAMELY, BOARD TYPE GAME OF STRATEGY, IN CLASS 28  
(U.S. CLS. 22, 23, 38 AND 50).

**TRADEMARK**

FIRST USE 2-13-2011; IN COMMERCE 2-13-2011.

**PRINCIPAL REGISTER**

THE MARK CONSISTS OF STANDARD CHARACTERS WITHOUT CLAIM TO ANY PARTICULAR FONT, STYLE, SIZE, OR COLOR.

SER. NO. 85-269,501, FILED 3-17-2011.

PRISCILLA MILTON, EXAMINING ATTORNEY



*David J. Kybas*

Director of the United States Patent and Trademark Office



# United States of America

United States Patent and Trademark Office

## Dr. RECOMMENDS

**Reg. No. 4,124,329**

**Registered Apr. 10, 2012**

**Int. Cl.: 5**

**TRADEMARK**

**PRINCIPAL REGISTER**

MEDIRAL INTERNATIONAL INC. (COLORADO CORPORATION)  
6090 E. 39TH AVE  
DENVER, CO 80207

FOR: HOMEOPATHIC PHARMACEUTICALS FOR USE IN THE TREATMENT OF ACNE, ALLERGIES, COLD AND FLU, DETOXIFICATION, EMOTIONAL UPSET, ENURESIS, INFECTION, INFLAMMATION, MENOPAUSE, PAIN, PMS, POOR DIGESTION, SKIN DISORDERS, TISSUE AND GLANDULAR WEAKNESS, IN CLASS 5 (U.S. CLS. 6, 18, 44, 46, 51 AND 52).

FIRST USE 11-26-1991; IN COMMERCE 3-23-1992.

THE MARK CONSISTS OF STANDARD CHARACTERS WITHOUT CLAIM TO ANY PARTICULAR FONT, STYLE, SIZE, OR COLOR.

SER. NO. 85-269,542, FILED 3-17-2011.

THOMAS MANOR, EXAMINING ATTORNEY



*David J. Kyffers*

Director of the United States Patent and Trademark Office

# United States of America

United States Patent and Trademark Office

## PALM BEACH BRIDES AN IDEA BOOK

**Reg. No. 4,124,330**

PALM BEACH NEWSPAPERS, INC. (DELAWARE CORPORATION)  
6205 PEACHTREE DUNWOODY ROAD  
ATLANTA, GA 30328

**Registered Apr. 10, 2012**

**Int. Cls.: 16 and 35**

FOR: PRINT PUBLICATIONS, NAMELY, MAGAZINES FEATURING INFORMATION ABOUT VENDORS WHO SPECIALIZE IN GOODS AND SERVICES FOR BRIDES AND WEDDINGS, IN CLASS 16 (U.S. CLS. 2, 5, 22, 23, 29, 37, 38 AND 50).

**TRADEMARK**

FIRST USE 9-26-2010; IN COMMERCE 9-26-2010.

**SERVICE MARK**

FOR: PROMOTING THE GOODS AND SERVICES OF OTHERS IN THE FIELD OF WEDDINGS AND BRIDAL FASHIONS VIA AN ONLINE ADVERTISING WEBSITE, IN CLASS 35 (U.S. CLS. 100, 101 AND 102).

**PRINCIPAL REGISTER**

FIRST USE 9-26-2010; IN COMMERCE 9-26-2010.

THE MARK CONSISTS OF STANDARD CHARACTERS WITHOUT CLAIM TO ANY PARTICULAR FONT, STYLE, SIZE, OR COLOR.

NO CLAIM IS MADE TO THE EXCLUSIVE RIGHT TO USE "PALM BEACH BRIDES" AND THE TERM "BOOK", APART FROM THE MARK AS SHOWN.

SER. NO. 85-269,579, FILED 3-17-2011.

KAREN BRACEY, EXAMINING ATTORNEY



*David J. Kybas*

Director of the United States Patent and Trademark Office

**United States of America**  
United States Patent and Trademark Office

**PATHAGON**

**Reg. No. 4,124,331**

MARANDA ENTERPRISES (WISCONSIN LIMITED LIABILITY COMPANY)  
6350 W. DONGES BAY ROAD  
MEQUON, WI 53092

**Registered Apr. 10, 2012**

**Int. Cl.: 28**

FOR: STRATEGY GAMES, NAMELY, BOARD TYPE GAME OF STRATEGY, IN CLASS 28  
(U.S. CLS. 22, 23, 38 AND 50).

**TRADEMARK**

FIRST USE 2-13-2011; IN COMMERCE 2-13-2011.

**PRINCIPAL REGISTER**

THE MARK CONSISTS OF STANDARD CHARACTERS WITHOUT CLAIM TO ANY PARTICULAR FONT, STYLE, SIZE, OR COLOR.

SER. NO. 85-269,582, FILED 3-17-2011.

PRISCILLA MILTON, EXAMINING ATTORNEY



*David J. Kyros*

Director of the United States Patent and Trademark Office

# United States of America

United States Patent and Trademark Office

## PALM BEACH BRIDES AN IDEA SHOW

**Reg. No. 4,124,332**

PALM BEACH NEWSPAPERS, INC. (DELAWARE CORPORATION)  
6205 PEACHTREE DUNWOODY ROAD  
ATLANTA, GA 30328

**Registered Apr. 10, 2012**

**Int. Cl.: 35**

FOR: ORGANIZING BUSINESS TRADE-SHOWS AND EXPOSITIONS FEATURING EXHIBITORS OF GOODS AND SERVICES FOR WEDDINGS AND BRIDES; PROMOTING THE GOODS AND SERVICES OF OTHERS IN THE FIELD OF WEDDINGS AND BRIDAL FASHIONS VIA AN ONLINE ADVERTISING WEBSITE, IN CLASS 35 (U.S. CLS. 100, 101 AND 102).

**SERVICE MARK**

**PRINCIPAL REGISTER**

FIRST USE 9-26-2010; IN COMMERCE 9-26-2010.

THE MARK CONSISTS OF STANDARD CHARACTERS WITHOUT CLAIM TO ANY PARTICULAR FONT, STYLE, SIZE, OR COLOR.

NO CLAIM IS MADE TO THE EXCLUSIVE RIGHT TO USE "PALM BEACH BRIDES" AND THE TERM "SHOW", APART FROM THE MARK AS SHOWN.

SER. NO. 85-269,585, FILED 3-17-2011.

KAREN BRACEY, EXAMINING ATTORNEY



*David J. Kyffers*

Director of the United States Patent and Trademark Office

# United States of America

United States Patent and Trademark Office

# TRAPPEX

**Reg. No. 4,124,333**

MARANDA ENTERPRISES (WISCONSIN LIMITED LIABILITY COMPANY)  
6350 W. DONGES BAY ROAD  
MEQUON, WI 53092

**Registered Apr. 10, 2012**

**Int. Cl.: 28**

FOR: STRATEGY GAMES, NAMELY, BOARD TYPE GAME OF STRATEGY, IN CLASS 28 (U.S. CLS. 22, 23, 38 AND 50).

**TRADEMARK**

FIRST USE 2-13-2011; IN COMMERCE 2-13-2011.

**PRINCIPAL REGISTER**

THE MARK CONSISTS OF STANDARD CHARACTERS WITHOUT CLAIM TO ANY PARTICULAR FONT, STYLE, SIZE, OR COLOR.

SER. NO. 85-269,594, FILED 3-17-2011.

PRISCILLA MILTON, EXAMINING ATTORNEY



*David J. Kybas*

Director of the United States Patent and Trademark Office

# United States of America

United States Patent and Trademark Office

## EXOTIC ELEMENTS

**Reg. No. 4,124,334**

EXOTIC ELEMENTS, INC. (CALIFORNIA CORPORATION)  
401 E. 8TH STREET STE 214-286  
SIOUX FALLS, SD 57103

**Registered Apr. 10, 2012**

**Int. Cl.: 5**

FOR: NUTRACEUTICALS FOR USE AS A DIETARY SUPPLEMENT FOR SEXUAL ENERGY AND ENHANCEMENT, IN CLASS 5 (U.S. CLS. 6, 18, 44, 46, 51 AND 52).

**TRADEMARK**

FIRST USE 10-1-2008; IN COMMERCE 2-1-2009.

**PRINCIPAL REGISTER**

THE MARK CONSISTS OF STANDARD CHARACTERS WITHOUT CLAIM TO ANY PARTICULAR FONT, STYLE, SIZE, OR COLOR.

NO CLAIM IS MADE TO THE EXCLUSIVE RIGHT TO USE "ELEMENTS", APART FROM THE MARK AS SHOWN.

SER. NO. 85-269,793, FILED 3-17-2011.

IRA J. GOODSAY, EXAMINING ATTORNEY



*David J. Kyffers*

Director of the United States Patent and Trademark Office

# United States of America

United States Patent and Trademark Office

# SOFIEZ

**Reg. No. 4,124,335**

**Registered Apr. 10, 2012**

**Int. Cl.: 18**

**TRADEMARK**

**PRINCIPAL REGISTER**

NISSAN JIDOSHA KABUSHIKI KAISHA (JAPAN CORPORATION), TA NISSAN MOTOR CO., LTD.  
NO. 2 TAKARACHO, KANAGAWA-KU  
YOKOHAMA-SHI, KANAGAWA, JAPAN 2208623

FOR: LEATHER, UNWORKED AND SEMI-WORKED; FUR, UNWORKED AND SEMI-WORKED, IN CLASS 18 (U.S. CLS. 1, 2, 3, 22 AND 41).

THE MARK CONSISTS OF STANDARD CHARACTERS WITHOUT CLAIM TO ANY PARTICULAR FONT, STYLE, SIZE, OR COLOR.

OWNER OF JAPAN REG. NO. 5432667, DATED 8-19-2011, EXPIRES 8-19-2021.

SER. NO. 85-269,859, FILED 3-17-2011.

BRIDGETT SMITH, EXAMINING ATTORNEY



*David J. Kyros*

Director of the United States Patent and Trademark Office

# United States of America

United States Patent and Trademark Office

## COOL 2 MIX

**Reg. No. 4,124,336**

**Registered Apr. 10, 2012**

**Int. Cl.: 35**

**SERVICE MARK**

**PRINCIPAL REGISTER**

ACERAY LLC (COLORADO LIMITED LIABILITY COMPANY)  
104 BROADWAY  
SUITE 200  
DENVER, CO 80203

FOR: DISTRIBUTORSHIPS IN THE FIELD OF FURNITURE, IN CLASS 35 (U.S. CLS. 100, 101 AND 102).

FIRST USE 1-30-2011; IN COMMERCE 1-30-2011.

THE MARK CONSISTS OF STANDARD CHARACTERS WITHOUT CLAIM TO ANY PARTICULAR FONT, STYLE, SIZE, OR COLOR.

SER. NO. 85-269,931, FILED 3-17-2011.

CHERYL CLAYTON, EXAMINING ATTORNEY



*David J. Kyffers*

Director of the United States Patent and Trademark Office



# United States of America

United States Patent and Trademark Office

# AFT

**Reg. No. 4,124,337**

COBRA GOLF INCORPORATED (DELAWARE CORPORATION)  
1818 ASTON AVENUE  
CARLSBAD, CA 92008

**Registered Apr. 10, 2012**

**Int. Cl.: 28**

FOR: GOLF EQUIPMENT, NAMELY, GOLF CLUBS, IN CLASS 28 (U.S. CLS. 22, 23, 38 AND 50).

**TRADEMARK**

FIRST USE 9-1-2008; IN COMMERCE 10-1-2008.

**PRINCIPAL REGISTER**

THE MARK CONSISTS OF STANDARD CHARACTERS WITHOUT CLAIM TO ANY PARTICULAR FONT, STYLE, SIZE, OR COLOR.

SER. NO. 85-270,358, FILED 3-18-2011.

BRIAN PINO, EXAMINING ATTORNEY



*David J. Kyffers*

Director of the United States Patent and Trademark Office

# United States of America

United States Patent and Trademark Office



**Reg. No. 4,124,338**

**Registered Apr. 10, 2012**

**Int. Cl.: 18**

**TRADEMARK**

**PRINCIPAL REGISTER**

MAQUILADORA ITALMEX, S.A. DE C.V. (MEXICO CORPORATION)  
POTRERO 8, FRACC. BRISAS DEL CAMPO  
LEÓN, GUANAJUATO, MEXICO 37297

FOR: BRIEFCASES; LEATHER BAGS, SUITCASES AND WALLETS, IN CLASS 18 (U.S. CLS. 1, 2, 3, 22 AND 41).

FIRST USE 2-16-2011; IN COMMERCE 2-16-2011.

NO CLAIM IS MADE TO THE EXCLUSIVE RIGHT TO USE "LEATHER CO", APART FROM THE MARK AS SHOWN.

THE MARK CONSISTS OF THE WORDS "PIKES PEAK" ABOVE A DEPICTION OF A BULL'S HEAD. THE WORDS "LEATHER. CO" ARE BENEATH THE BULL'S HEAD DEPICTION, THE WORD "GENERATION" IS AT THE LEFT SIDE OF THE DEPICTION, AND THE WORD "GUARANTEED" IS TO THE RIGHT SIDE OF IT.

SER. NO. 85-270,948, FILED 3-18-2011.

WANDA KAY PRICE, EXAMINING ATTORNEY



*David J. Kyffers*

Director of the United States Patent and Trademark Office

# United States of America

United States Patent and Trademark Office

# från krämer

**Reg. No. 4,124,339**

**Registered Apr. 10, 2012**

**Int. Cl.: 3**

**TRADEMARK**

**PRINCIPAL REGISTER**

FRAN, KRAMER, LLC (MICHIGAN LIMITED LIABILITY COMPANY)  
2153 WEALTHY STREET, SE  
EAST GRAND RAPIDS, MI 49506

FOR: BODY CREAM; BODY CREAMS; COCOA BUTTER FOR COSMETIC PURPOSES; COSMETIC HAND CREAMS; COSMETIC MASSAGE CREAMS; HAND CREAM; HAND CREAMS; LIP CREAM; MASSAGE CREAMS; MOISTURIZING CREAMS; NATURAL COCOA BUTTER BASED PERSONAL CARE PRODUCTS, NAMELY, BODY LOTION, SHOWER GEL, SOAP, BODY POLISH, BODY AND FOOT SCRUB AND NON-MEDICATED SKIN CREAMS; NON-MEDICATED SKIN CARE CREAMS AND LOTIONS; NON-MEDICATED SKIN CREAMS; NON-MEDICATED SKIN CREAMS WITH ESSENTIAL OILS FOR USE IN AROMATHERAPY; PERFUMED CREAMS; SCENTED BODY LOTIONS AND CREAMS; SHEA BUTTER FOR COSMETIC PURPOSES; SKIN CONDITIONING CREAMS FOR COSMETIC PURPOSES; SKIN CREAM; SKIN CREAMS; SKIN CREAMS IN LIQUID AND IN SOLID FORM; SKIN CREAMS IN LIQUID AND SOLID; SKIN CREAMS IN LIQUID AND SOLID FORM, IN CLASS 3 (U.S. CLS. 1, 4, 6, 50, 51 AND 52).

FIRST USE 1-1-2011; IN COMMERCE 1-1-2011.

THE MARK CONSISTS OF STANDARD CHARACTERS WITHOUT CLAIM TO ANY PARTICULAR FONT, STYLE, SIZE, OR COLOR.

NO CLAIM IS MADE TO THE EXCLUSIVE RIGHT TO USE "KRAMER", APART FROM THE MARK AS SHOWN.

THE NAME(S), PORTRAIT(S), AND/OR SIGNATURE(S) SHOWN IN THE MARK DOES NOT IDENTIFY A PARTICULAR LIVING INDIVIDUAL.

THE ENGLISH TRANSLATION OF "FRÅN KRÄMER" IN THE MARK IS "FROM CREAMS".

SER. NO. 85-271,044, FILED 3-18-2011.

COLLEEN KEARNEY, EXAMINING ATTORNEY



*David J. Kyros*

Director of the United States Patent and Trademark Office

# United States of America

United States Patent and Trademark Office

## WORKING TOGETHER EMERGENCY SERVICES MIDWEST CONFERENCE AND EXPOSITION

**Reg. No. 4,124,340**

**Registered Apr. 10, 2012**

**Int. Cl.: 35**

**SERVICE MARK**

**PRINCIPAL REGISTER**

WISCONSIN EMERGENCY MEDICAL TECHNICIANS ASSOCIATION, INC (WISCONSIN CORPORATION), DBA WISCONSIN EMS ASSOCIATION  
26422 OAKRIDGE DRIVE  
WIND LAKE, WI 53195

FOR: ADVERTISING AND MARKETING; DISSEMINATION OF ADVERTISING, SCHEDULING AND MANAGING OF TRAINING COURSES AND PROGRAMS FOR OTHERS VIA A GLOBAL COMPUTER NETWORK, IN CLASS 35 (U.S. CLS. 100, 101 AND 102).

FIRST USE 1-5-2006; IN COMMERCE 1-5-2006.

THE MARK CONSISTS OF STANDARD CHARACTERS WITHOUT CLAIM TO ANY PARTICULAR FONT, STYLE, SIZE, OR COLOR.

NO CLAIM IS MADE TO THE EXCLUSIVE RIGHT TO USE "EMERGENCY SERVICES MIDWEST CONFERENCE & EXPOSITION", APART FROM THE MARK AS SHOWN.

SEC. 2(F).

SER. NO. 85-271,176, FILED 3-18-2011.

JILL PRATER, EXAMINING ATTORNEY



*David J. Kybas*

Director of the United States Patent and Trademark Office

# United States of America

United States Patent and Trademark Office

## Crazy Sweet Deals

**Reg. No. 4,124,341**

**Registered Apr. 10, 2012**

**Int. Cl.: 35**

**SERVICE MARK**

**PRINCIPAL REGISTER**

CRAZY SWEET DEALS LLC (NEW JERSEY LIMITED LIABILITY COMPANY)  
31 PHILLIP ST  
SOUTH RIVER, NJ 08882

FOR: ON-LINE RETAIL STORE SERVICES FEATURING ELECTRONICS, COMPUTER HARDWARE AND SOFTWARE, AND ELECTRONICS AND COMPUTER ACCESSORIES , IN CLASS 35 (U.S. CLS. 100, 101 AND 102).

FIRST USE 4-10-2010; IN COMMERCE 4-10-2010.

THE MARK CONSISTS OF STANDARD CHARACTERS WITHOUT CLAIM TO ANY PARTICULAR FONT, STYLE, SIZE, OR COLOR.

NO CLAIM IS MADE TO THE EXCLUSIVE RIGHT TO USE "SWEET DEALS", APART FROM THE MARK AS SHOWN.

SER. NO. 85-271,724, FILED 3-20-2011.

APRIL HESIK, EXAMINING ATTORNEY



*David J. Kyffers*

Director of the United States Patent and Trademark Office

# United States of America

United States Patent and Trademark Office



**Reg. No. 4,124,342**

TEL-A-CAR OF NEW YORK, LLC (NEW YORK LIMITED LIABILITY COMPANY)  
30-55 VERNON BOULEVARD  
LONG ISLAND CITY, NY 11102

**Registered Apr. 10, 2012**

**Int. Cl.: 39**

FOR: TRANSPORT OF PERSONS, IN CLASS 39 (U.S. CLS. 100 AND 105).

**SERVICE MARK**

FIRST USE 3-5-2003; IN COMMERCE 3-5-2003.

**PRINCIPAL REGISTER**

NO CLAIM IS MADE TO THE EXCLUSIVE RIGHT TO USE "SERVICE", APART FROM THE MARK AS SHOWN.

THE MARK CONSISTS OF THE WORD "ACCELERATING" BRACKETED BETWEEN HORIZONTAL LINES INTENDED TO CONVEY MOTION. THE WORD "SERVICE" IS SET BELOW THE WORD "ACCELERATING" STARTING SLIGHTLY AFTER THE SECOND A.

SER. NO. 85-271,880, FILED 3-21-2011.

ANNE MADDEN, EXAMINING ATTORNEY



*David J. Kyffers*

Director of the United States Patent and Trademark Office

# United States of America

United States Patent and Trademark Office

# USG

**Reg. No. 4,124,343**

**Registered Apr. 10, 2012**

**Int. Cl.: 8**

**TRADEMARK**

**PRINCIPAL REGISTER**

USG CORPORATION (DELAWARE CORPORATION)  
550 WEST ADAMS STREET, DEPT. 189  
CHICAGO, IL 606613676

FOR: HAND TOOLS, NAMELY, DRYWALL JOINT TAPING KNIVES AND MUD PANS, CORNER BEAD APPLICATORS IN THE NATURE OF MANUALLY-OPERATED ROLLER TOOLS FOR USE IN POSITIONING AND SECURING CORNER BEADS, AND SAWS, IN CLASS 8 (U.S. CLS. 23, 28 AND 44).

FIRST USE 2-28-2008; IN COMMERCE 2-28-2008.

THE MARK CONSISTS OF STANDARD CHARACTERS WITHOUT CLAIM TO ANY PARTICULAR FONT, STYLE, SIZE, OR COLOR.

OWNER OF U.S. REG. NOS. 260,739, 276,997, AND 1,281,267.

SER. NO. 85-271,950, FILED 3-21-2011.

CYNTHIA TRIPI, EXAMINING ATTORNEY



*David J. Kybas*

Director of the United States Patent and Trademark Office

United States of America  
United States Patent and Trademark Office

sterne  
agee

**Reg. No. 4,124,344**

**Registered Apr. 10, 2012**

**Int. Cl.: 36**

**SERVICE MARK**

**PRINCIPAL REGISTER**

STERNE AGEE GROUP, INC. (DELAWARE CORPORATION)  
SUITE 700  
800 SHADES CREEK PARKWAY  
BIRMINGHAM, AL 35209

FOR: BROKERAGE IN THE FIELD OF SECURITIES, INVESTMENT BANKING, TRADING, INVESTMENT ADVISORY AND RELATED FINANCIAL CONSULTING SERVICES TO INDIVIDUAL INVESTORS, PROFESSIONAL MONEY MANAGERS, BUSINESSES AND MUNICIPALITIES, IN CLASS 36 (U.S. CLS. 100, 101 AND 102).

FIRST USE 3-31-2005; IN COMMERCE 3-31-2005.

THE MARK CONSISTS OF THE WORD "STERNE" POSITIONED ON TOP OF THE WORD "AGEE" AND OFFSET SLIGHTLY TO THE RIGHT.

SER. NO. 85-272,414, FILED 3-21-2011.

ANGELA M. MICHELI, EXAMINING ATTORNEY



*David J. Kyffers*

Director of the United States Patent and Trademark Office



# United States of America

United States Patent and Trademark Office

# TECH2TECH

**Reg. No. 4,124,345**

HONDA MOTOR CO., LTD. (JAPAN CORPORATION)  
1-1, 2-CHOME, MINAMI-AOYAMA, MINATO-KU  
TOKYO, JAPAN 107-8556

**Registered Apr. 10, 2012**

**Int. Cl.: 37**

FOR: PROVIDING ONLINE AUTOMOTIVE REPAIR RELATED SERVICE INFORMATION TO AUTOMOTIVE DEALERSHIPS THROUGH NON-DOWNLOADABLE VIDEO, IN CLASS 37 (U.S. CLS. 100, 103 AND 106).

**SERVICE MARK**

FIRST USE 1-29-2009; IN COMMERCE 1-29-2009.

**PRINCIPAL REGISTER**

THE MARK CONSISTS OF STANDARD CHARACTERS WITHOUT CLAIM TO ANY PARTICULAR FONT, STYLE, SIZE, OR COLOR.

SER. NO. 85-272,656, FILED 3-21-2011.

ZACHARY BELLO, EXAMINING ATTORNEY



*David J. Kybas*

Director of the United States Patent and Trademark Office

# United States of America

United States Patent and Trademark Office

# ACTIVAR

**Reg. No. 4,124,346**

OPTIGENEX, INC. (DELAWARE CORPORATION)  
PO BOX 3521 UPTOWN STATION  
HOBOKEN, NJ 07030

**Registered Apr. 10, 2012**

**Int. Cl.: 3**

FOR: TOPICAL SKIN CREAMS AND LOTIONS; NON-MEDICATED SKIN CARE CREAMS AND LOTIONS; COSMETIC PREPARATIONS FOR SKIN RENEWAL; NIGHT CREAMS; SKIN AND BODY TOPICAL CREAMS FOR COSMETIC USE; EYE CREAM; NON-MEDICATED ANTI-AGING SERUM, IN CLASS 3 (U.S. CLS. 1, 4, 6, 50, 51 AND 52).

**TRADEMARK**

**PRINCIPAL REGISTER**

FIRST USE 3-1-2006; IN COMMERCE 3-1-2006.

THE MARK CONSISTS OF STANDARD CHARACTERS WITHOUT CLAIM TO ANY PARTICULAR FONT, STYLE, SIZE, OR COLOR.

OWNER OF U.S. REG. NO. 3,152,471.

THE ENGLISH TRANSLATION OF "ACTIVAR" IN THE MARK IS "ACTIVATE OR ENABLE".

SER. NO. 85-273,036, FILED 3-22-2011.

JOHN KELLY, EXAMINING ATTORNEY



*David J. Kyfos*

Director of the United States Patent and Trademark Office

# United States of America

United States Patent and Trademark Office



**Reg. No. 4,124,347**

**Registered Apr. 10, 2012**

**Int. Cl.: 35**

NORMAN SPENCER MCKERNAN, INC. (PENNSYLVANIA CORPORATION), DBA NSM  
INSURANCE GROUP  
555 NORTH LANE  
SUITE 6060  
CONSHOHOCKEN, PA 19428

**SERVICE MARK**

FOR: PROMOTION OF FINANCIAL AND INSURANCE SERVICES ON BEHALF OF THIRD  
PARTIES, IN CLASS 35 (U.S. CLS. 100, 101 AND 102).

**PRINCIPAL REGISTER**

FIRST USE 5-21-2010; IN COMMERCE 5-21-2010.

THE NAME "CONDON SKELLY" DOES NOT IDENTIFY A LIVING INDIVIDUAL.

THE COLOR(S) BLUE AND GREEN IS/ARE CLAIMED AS A FEATURE OF THE MARK.

THE MARK CONSISTS OF THE ELEMENTS "CONDON SKELLY" WITH THE ELEMENT  
"CONDON" IN GREEN AND THE ELEMENT "SKELLY" IN BLUE; THE BLUE WORDING  
"WE INSURE YOUR FUN" APPEARS UNDERNEATH THE ELEMENT "SKELLY"; TO THE  
LEFT OF THE AFOREMENTIONED ELEMENTS APPEAR TWO CURVED BANDS, ONE  
GREEN AND THE OTHER BLUE.

SER. NO. 85-273,266, FILED 3-22-2011.

CHRISTOPHER BUONGIORNO, EXAMINING ATTORNEY



*David J. Kybas*

Director of the United States Patent and Trademark Office

# United States of America

United States Patent and Trademark Office

OUR FAMILY, DEDICATED TO  
YOURS.

**Reg. No. 4,124,348**

**Registered Apr. 10, 2012**

**Int. Cl.: 36**

**SERVICE MARK**

**PRINCIPAL REGISTER**

AMERICAN FIDELITY ASSURANCE COMPANY (OKLAHOMA CORPORATION)  
PO BOX 25523  
2000 NORTH CLASSEN BLVD.  
OKLAHOMA CITY, OK 731250523

FOR: INSURANCE AND FINANCIAL SERVICES, NAMELY, UNDERWRITING, ISSUING AND ADMINISTRATION OF LIFE, HEALTH AND DISABILITY INCOME INSURANCE, LONG-TERM CARE INSURANCE, ACCIDENT INSURANCE, SECTION 125 CAFETERIA INSURANCE PLANS, HEALTH SAVINGS ACCOUNTS, FLEXIBLE SPENDING ACCOUNTS AND HEALTH REIMBURSEMENT ACCOUNTS; ANNUITY BROKERAGE SERVICES; ANNUITY UNDERWRITING, IN CLASS 36 (U.S. CLS. 100, 101 AND 102).

FIRST USE 3-19-2011; IN COMMERCE 3-19-2011.

THE MARK CONSISTS OF STANDARD CHARACTERS WITHOUT CLAIM TO ANY PARTICULAR FONT, STYLE, SIZE, OR COLOR.

SER. NO. 85-273,299, FILED 3-22-2011.

ARETHA SOMERVILLE, EXAMINING ATTORNEY



*David J. Kyffers*

Director of the United States Patent and Trademark Office

# United States of America

United States Patent and Trademark Office

# COLUMBO

**Reg. No. 4,124,349**

**Registered Apr. 10, 2012**

**Int. Cl.: 35**

**SERVICE MARK**

**PRINCIPAL REGISTER**

4 S TECHNOLOGIES, LLC (NEW JERSEY LIMITED LIABILITY COMPANY)  
SUITE 101  
200 SHEFFIELD STREET  
MOUNTAINSIDE, NJ 07092

FOR: BUSINESS DATA ANALYSIS SERVICES IN THE BANKING, FINANCE, CAPITAL MARKETS, CONSUMER CREDIT, CREDIT RATING AGENCIES, INSURANCE, REAL ESTATE, JUDICIARY AND LEGAL FIELDS, IN CLASS 35 (U.S. CLS. 100, 101 AND 102).

FIRST USE 4-22-2009; IN COMMERCE 4-22-2009.

THE MARK CONSISTS OF STANDARD CHARACTERS WITHOUT CLAIM TO ANY PARTICULAR FONT, STYLE, SIZE, OR COLOR.

SER. NO. 85-273,410, FILED 3-22-2011.

RONALD MCMORROW, EXAMINING ATTORNEY



*David J. Kyffers*

Director of the United States Patent and Trademark Office

# United States of America

United States Patent and Trademark Office

## Kelly Rutherford

**Reg. No. 4,124,350**

KELLY, RUTHERFORD (UNITED STATES INDIVIDUAL)  
10390 SANTA MONICA BLVD, SUITE 360  
LOS ANGELES, CA 90025

**Registered Apr. 10, 2012**

**Int. Cls.: 18 and 41**

FOR: HANDBAGS FOR LADIES, IN CLASS 18 (U.S. CLS. 1, 2, 3, 22 AND 41).

**TRADEMARK**

FIRST USE 2-26-2011; IN COMMERCE 2-26-2011.

**SERVICE MARK**

FOR: ENTERTAINMENT SERVICES, NAMELY, LIVE, TELEVISED AND MOVIE APPEARANCES BY A PROFESSIONAL ENTERTAINER, IN CLASS 41 (U.S. CLS. 100, 101 AND 107).

**PRINCIPAL REGISTER**

FIRST USE 1-15-1988; IN COMMERCE 1-15-1988.

THE MARK CONSISTS OF STANDARD CHARACTERS WITHOUT CLAIM TO ANY PARTICULAR FONT, STYLE, SIZE, OR COLOR.

THE NAME "KELLY RUTHERFORD" IDENTIFIES A LIVING INDIVIDUAL WHOSE CONSENT IS OF RECORD.

SER. NO. 85-273,488, FILED 3-22-2011.

NANCY CLARKE, EXAMINING ATTORNEY



*David J. Kybas*

Director of the United States Patent and Trademark Office

# United States of America

United States Patent and Trademark Office

# WonderActive

**Reg. No. 4,124,351**

WONDERACTIVE (DELAWARE LIMITED LIABILITY COMPANY)  
1367 SEVIER AVE  
MENLO PARK, CA 94025

**Registered Apr. 10, 2012**

**Int. Cl.: 41**

FOR: ENTERTAINMENT SERVICES, NAMELY, PROVIDING GAMES PLAYED ONLINE FOR NETWORKED DEVICES, NAMELY, COMPUTERS, MOBILE PHONES, HANDHELD PERSONAL COMPUTERS, GAME CONSOLES, HANDHELD GAME CONSOLES, TABLET COMPUTERS, NETWORK-ENABLED MEDIA PLAYERS, CABLE AND SATELLITE SET-TOP BOXES, NETWORK-ENABLED TELEVISIONS, NETWORK-ENABLED APPLIANCES, AND MULTIMEDIA RECEIVERS, IN CLASS 41 (U.S. CLS. 100, 101 AND 107).

**SERVICE MARK**

**PRINCIPAL REGISTER**

FIRST USE 12-1-2011; IN COMMERCE 12-1-2011.

THE MARK CONSISTS OF STANDARD CHARACTERS WITHOUT CLAIM TO ANY PARTICULAR FONT, STYLE, SIZE, OR COLOR.

SER. NO. 85-273,648, FILED 3-22-2011.

MARK PILARO, EXAMINING ATTORNEY



*David J. Kybas*

Director of the United States Patent and Trademark Office

# United States of America

United States Patent and Trademark Office

# SPOKEFEST

**Reg. No. 4,124,352**

SPOKEFEST ASSOCIATION (WASHINGTON CORPORATION)

**Registered Apr. 10, 2012**

P.O. BOX 786  
SPOKANE, WA 99210

**Int. Cls.: 35, 36 and 41**

FOR: PROMOTIONAL SERVICES RELATING TO THE ADVANCEMENT OF ALL ASPECTS OF BICYCLING, INCLUDING BICYCLE SAFETY, BICYCLE COMMUTING AND HEALTH ADVANCES OF BICYCLING; PROMOTIONAL SPONSORSHIP AND PROMOTION OF AN ORGANIZED COMMUNITY-WIDE BIKE RIDES, IN CLASS 35 (U.S. CLS. 100, 101 AND 102).

**SERVICE MARK**

**PRINCIPAL REGISTER**

FIRST USE 3-4-2008; IN COMMERCE 3-4-2008.

FOR: FINANCIAL SPONSORSHIP OF ORGANIZED COMMUNITY-WIDE BICYCLE RIDES, BICYCLE EDUCATION AND EVENTS RELATING TO PROMOTING AND DEMONSTRATING BICYCLE SAFETY, IN CLASS 36 (U.S. CLS. 100, 101 AND 102).

FIRST USE 3-4-2008; IN COMMERCE 3-4-2008.

FOR: ORGANIZING AND CONDUCTING SPORTING EVENTS IN THE NATURE OF VARIOUS BICYCLING DEMONSTRATIONS AND EXHIBITIONS AND BIKE-TO-SCHOOL ACTIVITIES, IN CLASS 41 (U.S. CLS. 100, 101 AND 107).

FIRST USE 3-4-2008; IN COMMERCE 3-4-2008.

THE MARK CONSISTS OF STANDARD CHARACTERS WITHOUT CLAIM TO ANY PARTICULAR FONT, STYLE, SIZE, OR COLOR.

SER. NO. 85-273,885, FILED 3-22-2011.

MELISSA VALLILLO, EXAMINING ATTORNEY



*David J. Kyffers*

Director of the United States Patent and Trademark Office



# United States of America

United States Patent and Trademark Office



**Reg. No. 4,124,353**

**Registered Apr. 10, 2012**

**Int. Cl.: 16**

**TRADEMARK**

**PRINCIPAL REGISTER**

OVERLY, MICHAEL (UNITED STATES INDIVIDUAL)  
900 WATERVLIEET AVE  
DAYTON, OH 45420

FOR: MUSIC PUBLICATIONS, NAMELY, MUSIC BOOKS, SHEET MUSIC AND MUSIC INSTRUCTION BOOKS, MUSIC FLASH CARDS; BOOKS IN THE FIELD OF MUSIC INSTRUCTION; EDUCATIONAL FLASHCARDS FEATURING MUSIC INSTRUCTION, IN CLASS 16 (U.S. CLS. 2, 5, 22, 23, 29, 37, 38 AND 50).

FIRST USE 11-1-2002; IN COMMERCE 11-1-2002.

THE MARK CONSISTS OF A TREBLE CLEF SIGN AND BASS CLEF SIGN OF MUSIC COMBINED TO CREATE ONE GUITAR CLEF SIGN.

SER. NO. 85-274,037, FILED 3-22-2011.

JOSETTE BEVERLY, EXAMINING ATTORNEY



*David J. Kybas*

Director of the United States Patent and Trademark Office

# United States of America

United States Patent and Trademark Office

# TUTUDO

**Reg. No. 4,124,354**

**Registered Apr. 10, 2012**

**Int. Cl.: 36**

**SERVICE MARK**

**PRINCIPAL REGISTER**

SCHURMANN, PIERRE (BRAZIL INDIVIDUAL)  
JOAQUIM FLORIANO 466 ITAIM  
SÃO PAULO, BRAZIL 04534-002

FOR: FINANCIAL SERVICES, NAMELY, PROVIDING A VIRTUAL CURRENCY FOR USE BY MEMBERS OF DIFFERENT ONLINE COMMUNITIES SUCH AS SOCIAL WEBSITES AND GAMING AND VIRTUAL GOODS WEBSITES, AND FINANCIAL TRANSACTION SERVICES, NAMELY, PROVIDING SECURE COMMERCIAL TRANSACTIONS INCLUDING ELECTRONIC TRANSFER OF MICRO-TRANSACTIONS, ALL VIA AN ONLINE GLOBAL COMPUTER NETWORK, IN CLASS 36 (U.S. CLS. 100, 101 AND 102).

FIRST USE 2-14-2011; IN COMMERCE 2-21-2011.

THE MARK CONSISTS OF STANDARD CHARACTERS WITHOUT CLAIM TO ANY PARTICULAR FONT, STYLE, SIZE, OR COLOR.

THE WORDING "TUTUDO" HAS NO MEANING IN A FOREIGN LANGUAGE.

SER. NO. 85-274,113, FILED 3-23-2011.

MARTHA SANTOMARTINO, EXAMINING ATTORNEY



*David J. Kyros*

Director of the United States Patent and Trademark Office

# United States of America

United States Patent and Trademark Office

## PINK COOKIE

**Reg. No. 4,124,355**

**Registered Apr. 10, 2012**

**Int. Cls.: 3, 9, 14, 16, 18,  
24, 25 and 26**

**TRADEMARK**

**PRINCIPAL REGISTER**

PINK COOKIE DESIGN, LLC (DELAWARE LIMITED LIABILITY COMPANY)  
6TH FLOOR  
10 EAST 34TH STREET  
NEW YORK, NY 10016

FOR: BATH AND SHOWER GELS AND SALTS NOT FOR MEDICAL PURPOSES; BODY AND BEAUTY CARE COSMETICS; BODY SPRAYS; BUBBLE BATH; LOTIONS FOR FACE AND BODY CARE, IN CLASS 3 (U.S. CLS. 1, 4, 6, 50, 51 AND 52).

FIRST USE 2-1-2009; IN COMMERCE 2-1-2009.

FOR: SUNGLASSES, IN CLASS 9 (U.S. CLS. 21, 23, 26, 36 AND 38).

FIRST USE 2-1-2009; IN COMMERCE 2-1-2009.

FOR: JEWELRY, IN CLASS 14 (U.S. CLS. 2, 27, 28 AND 50).

FIRST USE 2-1-2008; IN COMMERCE 2-1-2008.

FOR: STATIONERY, IN CLASS 16 (U.S. CLS. 2, 5, 22, 23, 29, 37, 38 AND 50).

FIRST USE 2-1-2008; IN COMMERCE 2-1-2008.

FOR: BACKPACKS; HANDBAGS; MESSENGER BAGS; TOTE BAGS, IN CLASS 18 (U.S. CLS. 1, 2, 3, 22 AND 41).

FIRST USE 2-1-2008; IN COMMERCE 2-1-2008.

FOR: BED BLANKETS; BED SHEETS; COMFORTERS; PILLOW CASES, IN CLASS 24 (U.S. CLS. 42 AND 50).

FIRST USE 5-1-2010; IN COMMERCE 5-1-2010.

FOR: FOOTWEAR; GLOVES; HEADWEAR; LINGERIE; MITTENS; PANTS; SCARVES; SHIRTS; SWEATSHIRTS; T-SHIRTS; UNDERWEAR, IN CLASS 25 (U.S. CLS. 22 AND 39).

FIRST USE 1-1-2005; IN COMMERCE 1-1-2005.



*David J. Kyffers*

Director of the United States Patent and Trademark Office

**Reg. No. 4,124,355** FOR: HAIR ACCESSORIES, NAMELY, SNAP CLIPS; HAIR ACCESSORIES, NAMELY, TWISTERS; HAIR BANDS, IN CLASS 26 (U.S. CLS. 37, 39, 40, 42 AND 50).

FIRST USE 3-1-2008; IN COMMERCE 3-1-2008.

THE MARK CONSISTS OF STANDARD CHARACTERS WITHOUT CLAIM TO ANY PARTICULAR FONT, STYLE, SIZE, OR COLOR.

OWNER OF U.S. REG. NO. 2,967,112.

SER. NO. 85-274,176, FILED 3-23-2011.

ROBIN CHOSID, EXAMINING ATTORNEY

# United States of America

United States Patent and Trademark Office

# CHEVIN

**Reg. No. 4,124,356**

**Registered Apr. 10, 2012**

**Int. Cl.: 9**

**TRADEMARK**

**PRINCIPAL REGISTER**

FISS AUDIO LIMITED (UNITED KINGDOM PRIVATE LIMITED COMPANY)  
NETWORK HOUSE, WEST 26,  
STUBS BECK LANE, CLEKHEATON  
WEST YORKSHIRE, UNITED KINGDOM BD194TT

FOR: AUDIO AMPLIFIERS, IN CLASS 9 (U.S. CLS. 21, 23, 26, 36 AND 38).

THE MARK CONSISTS OF STANDARD CHARACTERS WITHOUT CLAIM TO ANY PARTICULAR FONT, STYLE, SIZE, OR COLOR.

OWNER OF UNITED KINGDOM REG. NO. 1,489,899, DATED 2-5-1993, EXPIRES 2-4-2019.

SER. NO. 85-274,286, FILED 3-23-2011.

JOHN DWYER, EXAMINING ATTORNEY



*David J. Kyffers*

Director of the United States Patent and Trademark Office

# United States of America

United States Patent and Trademark Office

## InterGlobal Exhibits

**Reg. No. 4,124,357**

**Registered Apr. 10, 2012**

**Int. Cl.: 42**

**SERVICE MARK**

**PRINCIPAL REGISTER**

INTER-GLOBAL EXHIBITIONS, INC. (COLORADO CORPORATION), DBA INTERGLOBAL EXHIBITS  
8674 CONCORD CENTER DRIVE  
ENGLEWOOD, CO 80112

FOR: PRODUCT DESIGN AND DEVELOPMENT IN THE FIELD OF EXHIBIT DESIGN, IN CLASS 42 (U.S. CLS. 100 AND 101).

FIRST USE 3-1-2011; IN COMMERCE 3-1-2011.

THE MARK CONSISTS OF STANDARD CHARACTERS WITHOUT CLAIM TO ANY PARTICULAR FONT, STYLE, SIZE, OR COLOR.

NO CLAIM IS MADE TO THE EXCLUSIVE RIGHT TO USE "EXHIBITS", APART FROM THE MARK AS SHOWN.

SER. NO. 85-274,325, FILED 3-23-2011.

DANNEAN HETZEL, EXAMINING ATTORNEY



*David J. Kyffers*

Director of the United States Patent and Trademark Office

# United States of America

United States Patent and Trademark Office



**Reg. No. 4,124,358**

**Registered Apr. 10, 2012**

**Int. Cl.: 5**

**TRADEMARK**

**PRINCIPAL REGISTER**

MEDTECH PRODUCTS INC. (DELAWARE CORPORATION)  
90 NORTH BROADWAY  
IRVINGTON, NY 10533

FOR: PHARMACEUTICAL PREPARATION FOR THE RELIEF OF THROAT AND MOUTH SORENESS; LOZENGES, LOZENGE LOLLIPOPS AND THROAT SPRAYS FOR THE RELIEF OF THROAT AND MOUTH SORENESS , IN CLASS 5 (U.S. CLS. 6, 18, 44, 46, 51 AND 52).

FIRST USE 1-31-2003; IN COMMERCE 1-31-2003.

THE MARK CONSISTS OF THE HEAD OF A BOY WITH A SMILING FACE AND ARMS.

SER. NO. 85-274,370, FILED 3-23-2011.

RENEE MCCRAY, EXAMINING ATTORNEY



*David J. Kyffers*

Director of the United States Patent and Trademark Office

# United States of America

United States Patent and Trademark Office

## CFE MEDIA

**Reg. No. 4,124,359**

CFE MEDIA LLC (ILLINOIS LIMITED LIABILITY COMPANY)

**Registered Apr. 10, 2012**

1111 W. 22ND STREET  
OAK BROOK, IL 60523

**Int. Cls.: 16, 35 and 41**

FOR: PRINTED MATTER, NAMELY, MAGAZINES, BOOKS, PRINTED PERIODICALS, NEWSLETTERS, AND BROCHURES ABOUT ENGINEERING, IN CLASS 16 (U.S. CLS. 2, 5, 22, 23, 29, 37, 38 AND 50).

**TRADEMARK**

FIRST USE 7-30-2010; IN COMMERCE 7-30-2010.

**SERVICE MARK**

**PRINCIPAL REGISTER**

FOR: PROMOTING THE GOODS AND SERVICES OF OTHERS THROUGH THE DISTRIBUTION OF PRINTED ADVERTISING MATERIALS AND VIA ELECTRONIC MEDIA; MARKETING CONSULTING, NAMELY, DESIGN AND DEVELOPMENT OF MARKETING CAMPAIGNS FOR OTHERS, TRACKING AND REPORTING ONLINE MARKETING ACTIVITIES OF OTHERS; ARRANGING AND CONDUCTING TRADE SHOWS IN THE FIELD OF ENGINEERING; PROVIDING AN ONLINE MARKETING COLLABORATION NETWORK FOR SOCIAL MEDIA AND ONLINE MARKETING PROFESSIONALS FOR THE PURPOSE OF SYNDICATING CONTENT THROUGH THE NETWORK TO BE SHARED BY OTHERS, IN CLASS 35 (U.S. CLS. 100, 101 AND 102).

FIRST USE 7-30-2010; IN COMMERCE 7-30-2010.



FOR: PUBLISHING OF PRINTED MATTER, NAMELY, MAGAZINES AND BOOKS; ONLINE ELECTRONIC PUBLISHING OF BOOKS AND PERIODICALS; PROVIDING ONLINE NEWSLETTERS IN THE FIELD OF ENGINEERING; PROVIDING WEBSITES FEATURING NON-DOWNLOADABLE PUBLICATIONS IN THE NATURE OF MAGAZINES AND NEWSLETTERS IN THE FIELD OF ENGINEERING; ENTERTAINMENT SERVICES, NAMELY, PROVIDING WEBCASTS IN THE FIELD OF ENGINEERING, IN CLASS 41 (U.S. CLS. 100, 101 AND 107).

FIRST USE 7-30-2010; IN COMMERCE 7-30-2010.

THE MARK CONSISTS OF STANDARD CHARACTERS WITHOUT CLAIM TO ANY PARTICULAR FONT, STYLE, SIZE, OR COLOR.

NO CLAIM IS MADE TO THE EXCLUSIVE RIGHT TO USE "MEDIA", APART FROM THE MARK AS SHOWN.

*David J. Kyros*

Director of the United States Patent and Trademark Office



**Reg. No. 4,124,359** SER. NO. 85-274,393, FILED 3-23-2011.

HOWARD B. LEVINE, EXAMINING ATTORNEY

# United States of America

United States Patent and Trademark Office

# Pro-flo

**Reg. No. 4,124,360**

**Registered Apr. 10, 2012**

**Int. Cl.: 10**

**TRADEMARK**

**PRINCIPAL REGISTER**

ROYAL INDUSTRIES PUBLIC COMPANY LIMITED (THAILAND CORPORATION)  
126 MOO 6, SEDTHAKIJ 1 ROAD  
OMNOI, KRATHUMBAN  
SAMUTSAKORN, THAILAND

FOR: BABY BOTTLES, NIPPLES FOR BABY BOTTLES, AND PACIFIERS FOR BABIES, IN  
CLASS 10 (U.S. CLS. 26, 39 AND 44).

FIRST USE 6-16-2010; IN COMMERCE 6-16-2010.

OWNER OF U.S. REG. NO. 3,832,961.

THE MARK CONSISTS OF THE STYLIZED WORDS "PRO-FLO".

SER. NO. 85-274,546, FILED 3-23-2011.

NELSON SNYDER, EXAMINING ATTORNEY



*David J. Kyfos*

Director of the United States Patent and Trademark Office

# United States of America

United States Patent and Trademark Office

## PROSOFT I-VIEW

**Reg. No. 4,124,361**

**Registered Apr. 10, 2012**

**Int. Cl.: 9**

**TRADEMARK**

**PRINCIPAL REGISTER**

PROSOFT TECHNOLOGY, INC. (CALIFORNIA CORPORATION)  
5201 TRUXTUN AVENUE, 3RD FLOOR  
BAKERSFIELD, CA 93309

FOR: COMPUTER SOFTWARE, NAMELY, DOWNLOADABLE MOBILE, HANDHELD AND WIRELESS COMPUTER APPLICATION FOR USE IN THE FIELD OF TELECOMMUNICATIONS, NAMELY, LIVE MONITORING OF PROCESS DATA THAT ALLOWS FOR REMOTE MONITORING AND CONTROL OF PROCESS VALUES WITHIN A TCP/IP ETHERNET NETWORK UTILIZING A WIRELESS LAN AND/OR CELLULAR CONNECTION, AND INSTRUCTIONAL MANUALS, SOLD AS A UNIT, IN CLASS 9 (U.S. CLS. 21, 23, 26, 36 AND 38).

FIRST USE 7-1-2010; IN COMMERCE 7-1-2010.

THE MARK CONSISTS OF STANDARD CHARACTERS WITHOUT CLAIM TO ANY PARTICULAR FONT, STYLE, SIZE, OR COLOR.

OWNER OF U.S. REG. NO. 3,198,546.

SER. NO. 85-274,629, FILED 3-23-2011.

JUSTINE D. PARKER, EXAMINING ATTORNEY



*David J. Kyros*

Director of the United States Patent and Trademark Office

# United States of America

United States Patent and Trademark Office

# i am MIAMI

**Reg. No. 4,124,362**

**Registered Apr. 10, 2012**

**Int. Cl.: 25**

**TRADEMARK**

**PRINCIPAL REGISTER**

SHARE THE LOVE LLC (MASSACHUSETTS LIMITED LIABILITY COMPANY)  
5A SPRUCE STREET  
ACTON, MA 01720

FOR: APRONS; BABY BIBS NOT OF PAPER; BABY BODYSUITS; BASEBALL CAPS AND HATS; BOXER SHORTS; CHILDREN'S AND INFANTS' CLOTH BIBS; CHILDREN'S CLOTH EATING BIBS; GYM SHORTS; HOODED SWEATSHIRTS; HOODED SWEATSHIRTS FOR BABIES, ADULTS, CHILDREN, WOMEN, MEN; LADIES' UNDERWEAR; LOUNGE PANTS; MEN'S UNDERWEAR; SHORT-SLEEVED OR LONG-SLEEVED T-SHIRTS; SWEATPANTS; SWEATSHIRTS; SWEATSHIRTS FOR BABIES, ADULTS, CHILDREN, WOMEN, MEN; T-SHIRTS; T-SHIRTS FOR BABIES, ADULTS, CHILDREN, WOMEN, MEN, IN CLASS 25 (U.S. CLS. 22 AND 39).

FIRST USE 2-20-2011; IN COMMERCE 2-20-2011.

THE MARK CONSISTS OF STANDARD CHARACTERS WITHOUT CLAIM TO ANY PARTICULAR FONT, STYLE, SIZE, OR COLOR.

SER. NO. 85-274,765, FILED 3-23-2011.

DANNEAN HETZEL, EXAMINING ATTORNEY



*David J. Kypos*

Director of the United States Patent and Trademark Office

# United States of America

United States Patent and Trademark Office

## INTENTIONAL FUTURES

**Reg. No. 4,124,363**

**Registered Apr. 10, 2012**

**Int. Cl.: 35**

**SERVICE MARK**

**PRINCIPAL REGISTER**

INTENTIONAL FUTURES, LLC (WASHINGTON LIMITED LIABILITY COMPANY)  
PO BOX 22490  
SEATTLE, WA 981220490

FOR: CONSULTING SERVICES IN THE FIELDS OF MARKETING, ADVERTISING AND PROMOTION, BRAND IMAGERY, BUSINESS STRATEGIES, AND CREATIVE IDEATION , IN CLASS 35 (U.S. CLS. 100, 101 AND 102).

FIRST USE 3-3-2011; IN COMMERCE 3-3-2011.

THE MARK CONSISTS OF STANDARD CHARACTERS WITHOUT CLAIM TO ANY PARTICULAR FONT, STYLE, SIZE, OR COLOR.

SER. NO. 85-274,772, FILED 3-23-2011.

MARTHA SANTOMARTINO, EXAMINING ATTORNEY



*David J. Kyffers*

Director of the United States Patent and Trademark Office

# United States of America

United States Patent and Trademark Office

## INTENTIONAL FUTURES

**Reg. No. 4,124,364**

INTENTIONAL FUTURES, LLC (WASHINGTON LIMITED LIABILITY COMPANY)  
PO BOX 22490  
SEATTLE, WA 981220490

**Registered Apr. 10, 2012**

**Int. Cl.: 42**

FOR: CONSULTING SERVICES IN THE FIELD OF INFORMATION TECHNOLOGY, COMPUTER HARDWARE AND SOFTWARE, AND TECHNOLOGY-ORIENTED PRODUCT DEVELOPMENT AND DESIGN, IN CLASS 42 (U.S. CLS. 100 AND 101).

**SERVICE MARK**

FIRST USE 3-3-2011; IN COMMERCE 3-3-2011.

**PRINCIPAL REGISTER**

THE MARK CONSISTS OF STANDARD CHARACTERS WITHOUT CLAIM TO ANY PARTICULAR FONT, STYLE, SIZE, OR COLOR.

SER. NO. 85-274,808, FILED 3-23-2011.

MARTHA SANTOMARTINO, EXAMINING ATTORNEY



*David J. Kyffers*

Director of the United States Patent and Trademark Office

# United States of America

United States Patent and Trademark Office

## MOTHERS2MOTHERS

**Reg. No. 4,124,365**

MOTHERS2MOTHERS INTERNATIONAL, INC. (DELAWARE CORPORATION)

**Registered Apr. 10, 2012**

7441 W. SUNSET BOULEVARD, SUITE 205  
LOS ANGELES, CA 90046

**Int. Cl.: 35**

FOR: PUBLIC ADVOCACY TO PROMOTE AWARENESS OF HIV AND AIDS IN DEVELOPING COUNTRIES; PUBLIC ADVOCACY TO PROMOTE AWARENESS OF WOMEN LIVING WITH HIV AND AIDS, IN CLASS 35 (U.S. CLS. 100, 101 AND 102).

**SERVICE MARK**

FIRST USE 3-22-2006; IN COMMERCE 3-22-2006.

**PRINCIPAL REGISTER**

THE MARK CONSISTS OF STANDARD CHARACTERS WITHOUT CLAIM TO ANY PARTICULAR FONT, STYLE, SIZE, OR COLOR.

SER. NO. 85-274,809, FILED 3-23-2011.

JERI J. FICKES, EXAMINING ATTORNEY



*David J. Kyffers*

Director of the United States Patent and Trademark Office

# United States of America

United States Patent and Trademark Office

## MOTHERS2MOTHERS

**Reg. No. 4,124,366**

MOTHERS2MOTHERS INTERNATIONAL, INC. (DELAWARE CORPORATION)

**Registered Apr. 10, 2012**

7441 W. SUNSET BOULEVARD, SUITE 205  
LOS ANGELES, CA 90046

**Int. Cl.: 44**

FOR: PROVIDING MEDICAL TREATMENT INFORMATION IN THE FIELD OF HIV AND AIDS IN DEVELOPING COUNTRIES AND ISSUES RELATING TO HIV AND AIDS , IN CLASS 44 (U.S. CLS. 100 AND 101).

**SERVICE MARK**

FIRST USE 3-22-2006; IN COMMERCE 3-22-2006.

**PRINCIPAL REGISTER**

THE MARK CONSISTS OF STANDARD CHARACTERS WITHOUT CLAIM TO ANY PARTICULAR FONT, STYLE, SIZE, OR COLOR.

SER. NO. 85-274,824, FILED 3-23-2011.

JERI J. FICKES, EXAMINING ATTORNEY



*David J. Kyjars*

Director of the United States Patent and Trademark Office



# United States of America

United States Patent and Trademark Office

## SHARE THE LOVE

**Reg. No. 4,124,367**

**Registered Apr. 10, 2012**

**Int. Cl.: 25**

**TRADEMARK**

**PRINCIPAL REGISTER**

SHARE THE LOVE LLC (MASSACHUSETTS LIMITED LIABILITY COMPANY)  
5A SPRUCE STREET  
ACTON, MA 01720

FOR: APRONS; BABY BIBS NOT OF PAPER; BABY BODYSUITS; BASEBALL CAPS AND HATS; BOXER SHORTS; CHILDREN'S AND INFANTS' CLOTH BIBS; CHILDREN'S CLOTH EATING BIBS; GYM SHORTS; HOODED SWEATSHIRTS; HOODED SWEATSHIRTS FOR BABIES, ADULTS, CHILDREN, WOMEN, MEN; LOUNGE PANTS; MEN'S UNDERWEAR; SHORT-SLEEVED OR LONG-SLEEVED T-SHIRTS; SWEATPANTS; SWEATSHIRTS; SWEATSHIRTS FOR BABIES, ADULTS, CHILDREN, WOMEN, MEN; T-SHIRTS; T-SHIRTS FOR BABIES, ADULTS, CHILDREN, WOMEN, MEN; TANK TOPS; TANK-TOPS; WOMEN'S UNDERWEAR, IN CLASS 25 (U.S. CLS. 22 AND 39).

FIRST USE 2-20-2011; IN COMMERCE 2-20-2011.

THE MARK CONSISTS OF STANDARD CHARACTERS WITHOUT CLAIM TO ANY PARTICULAR FONT, STYLE, SIZE, OR COLOR.

SER. NO. 85-274,852, FILED 3-23-2011.

DANNEAN HETZEL, EXAMINING ATTORNEY



*David J. Kypos*

Director of the United States Patent and Trademark Office

# United States of America

United States Patent and Trademark Office

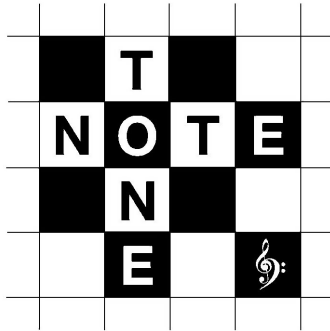

**Reg. No. 4,124,368**

**Registered Apr. 10, 2012**

**Int. Cl.: 16**

**TRADEMARK**

**PRINCIPAL REGISTER**

OVERLY, MICHAEL (UNITED STATES INDIVIDUAL)  
900 WATERVLIIET AVE.  
DAYTON, OH 45420

FOR: MUSIC PUBLICATIONS, NAMELY, MUSIC BOOKS, SHEET MUSIC AND MUSIC INSTRUCTION BOOKS, MUSIC FLASH CARDS; BOOKS IN THE FIELD OF MUSIC INSTRUCTION; EDUCATIONAL FLASHCARDS FEATURING MUSIC INSTRUCTION, IN CLASS 16 (U.S. CLS. 2, 5, 22, 23, 29, 37, 38 AND 50).

FIRST USE 1-1-2011; IN COMMERCE 1-1-2011.

THE MARK CONSISTS OF THE WORDS "TONE AND NOTE" IN CROSSWORD FORM SHARING THE LETTER "O" AS A CROSSWORD IMAGE WITH TREBLE CLEF SIGN AND BASS CLEF SIGN OF MUSIC COMBINED TO CREATE ONE GUITAR CLEF SIGN IN RIGHT CORNER.

SER. NO. 85-274,936, FILED 3-23-2011.

JOSETTE BEVERLY, EXAMINING ATTORNEY



*David J. Kyffers*

Director of the United States Patent and Trademark Office

# United States of America

United States Patent and Trademark Office

# ANASMA

**Reg. No. 4,124,369**

VUONG, ANH-ASMA (FRANCE INDIVIDUAL)  
27 AVENUE D'ITALIE  
PARIS, FRANCE 75013

**Registered Apr. 10, 2012**

**Int. Cl.: 41**

FOR: DANCE EVENTS; DANCE INSTRUCTION; ENTERTAINMENT AND EDUCATION SERVICES IN THE NATURE OF LIVE DANCE AND MUSICAL PERFORMANCES; ENTERTAINMENT IN THE NATURE OF DANCE PERFORMANCES; ENTERTAINMENT IN THE NATURE OF VISUAL AND AUDIO PERFORMANCES, NAMELY, MUSICAL BAND, ROCK GROUP, GYMNASTIC, DANCE, AND BALLET PERFORMANCES; ENTERTAINMENT SERVICES, NAMELY, DANCE EVENTS BY A RECORDING ARTIST; ORGANIZING COMMUNITY FESTIVALS FEATURING PRIMARILY ETHNIC DANCE PERFORMANCES AND ALSO PROVIDING COLLECTIVE DANCE CLASSES, INDIVIDUAL DANCE CLASSES, DANCE SHOWS, ETHNIC DANCES, PANEL DISCUSSIONS AND LECTURES IN THE FIELD OF DANCE, IN CLASS 41 (U.S. CLS. 100, 101 AND 107).

**SERVICE MARK**

**PRINCIPAL REGISTER**

FIRST USE 1-1-2006; IN COMMERCE 1-1-2006.

THE MARK CONSISTS OF STANDARD CHARACTERS WITHOUT CLAIM TO ANY PARTICULAR FONT, STYLE, SIZE, OR COLOR.

THE NAME "ANASMA" IDENTIFIES THE STAGE NAME OF ANH-ASMA VUONG, A LIVING INDIVIDUAL WHOSE CONSENT IS OF RECORD.

SER. NO. 85-275,400, FILED 3-24-2011.

BRIAN CALLAGHAN, EXAMINING ATTORNEY



*David J. Kybas*

Director of the United States Patent and Trademark Office

# United States of America

United States Patent and Trademark Office

## SOYRING CONSULTING

**Reg. No. 4,124,370**

**Registered Apr. 10, 2012**

**Int. Cl.: 35**

**SERVICE MARK**

**PRINCIPAL REGISTER**

SOYRING CONSULTING, INC. (FLORIDA CORPORATION)  
880 21ST AVENUE NORTH  
ST. PETERSBURG, FL 33704

FOR: CONSULTING IN THE FIELDS OF HEALTHCARE OPERATIONS MANAGEMENT, HEALTHCARE COST REDUCTION AND HEALTHCARE REVENUE ENHANCEMENT, IN CLASS 35 (U.S. CLS. 100, 101 AND 102).

FIRST USE 2-19-2003; IN COMMERCE 4-7-2003.

THE MARK CONSISTS OF STANDARD CHARACTERS WITHOUT CLAIM TO ANY PARTICULAR FONT, STYLE, SIZE, OR COLOR.

NO CLAIM IS MADE TO THE EXCLUSIVE RIGHT TO USE "CONSULTING", APART FROM THE MARK AS SHOWN.

SEC. 2(F).

SER. NO. 85-275,408, FILED 3-24-2011.

DANIEL CAPSHAW, EXAMINING ATTORNEY



*David J. Kyffers*

Director of the United States Patent and Trademark Office

# United States of America

United States Patent and Trademark Office

# DuraCover

**Reg. No. 4,124,371**

BEN NYE COMPANY, INC. (CALIFORNIA CORPORATION)  
3655 LENAWEE AVENUE  
LOS ANGELES, CA 90016

**Registered Apr. 10, 2012**

**Int. Cl.: 3**

FOR: COSMETICS, NAMELY, CONCEALERS, IN CLASS 3 (U.S. CLS. 1, 4, 6, 50, 51 AND 52).

**TRADEMARK**

FIRST USE 1-28-2011; IN COMMERCE 2-15-2011.

**PRINCIPAL REGISTER**

THE MARK CONSISTS OF STANDARD CHARACTERS WITHOUT CLAIM TO ANY PARTICULAR FONT, STYLE, SIZE, OR COLOR.

SER. NO. 85-275,660, FILED 3-24-2011.

RAUL CORDOVA, EXAMINING ATTORNEY



*David J. Kyffers*

Director of the United States Patent and Trademark Office

# United States of America

United States Patent and Trademark Office

## CAPTIV8 PROMOTIONS

**Reg. No. 4,124,372**

CAPTIV8, INC. (NEW YORK CORPORATION)  
57 EAST 11TH STREET, 8TH FLOOR  
NEW YORK, NY 10003

**Registered Apr. 10, 2012**

**Int. Cl.: 35**

FOR: CUSTOM DESIGN OF PROMOTIONAL PRODUCTS IN THE NATURE OF ADVERTISING AND PROMOTIONAL MATERIALS BASED ON PERSONAL SELECTIONS MADE BY THE CUSTOMER, IN CLASS 35 (U.S. CLS. 100, 101 AND 102).

**SERVICE MARK**

FIRST USE 9-1-1992; IN COMMERCE 9-1-1992.

**PRINCIPAL REGISTER**

THE MARK CONSISTS OF STANDARD CHARACTERS WITHOUT CLAIM TO ANY PARTICULAR FONT, STYLE, SIZE, OR COLOR.

NO CLAIM IS MADE TO THE EXCLUSIVE RIGHT TO USE "PROMOTIONS", APART FROM THE MARK AS SHOWN.

SER. NO. 85-275,787, FILED 3-24-2011.

RAUL CORDOVA, EXAMINING ATTORNEY



*David J. Kyffers*

Director of the United States Patent and Trademark Office

# United States of America

United States Patent and Trademark Office

## Sample-Pre Watcher

**Reg. No. 4,124,373**

**Registered Apr. 10, 2012**

**Int. Cl.: 9**

**TRADEMARK**

**PRINCIPAL REGISTER**

INTRAVIS, INC. (GEORGIA CORPORATION)  
INTRAVIS, INC.  
3070 BUSINESS PARK DR STE H  
NORCROSS, GA 300711451

FOR: OPTICAL METROLOGY SYSTEM FOR QUALITY ASSURANCE INSPECTION OF PREFORMS, CONSISTING OF COMPUTER SOFTWARE FOR CONTROLLING THE OPERATIONS OF CAMERAS, PERSONAL COMPUTER, DATA PROCESSING EQUIPMENT FOR SEQUENCE CONTROL, COMPUTER MONITORS, LIGHT SOURCES, AND MECHANICAL INSPECTION FRAMES WHICH ARE USED TO PRESENT THE PREFORMS TO THE CAMERAS IN AN ACCURATE AND TIMELY MANNER, ALL OF THE FORGOING SOLD AS A UNIT, IN CLASS 9 (U.S. CLS. 21, 23, 26, 36 AND 38).

FIRST USE 0-0-2009; IN COMMERCE 0-0-2009.

THE MARK CONSISTS OF STANDARD CHARACTERS WITHOUT CLAIM TO ANY PARTICULAR FONT, STYLE, SIZE, OR COLOR.

OWNER OF U.S. REG. NO. 3,793,743.

SER. NO. 85-275,799, FILED 3-24-2011.

CHARISMA HAMPTON, EXAMINING ATTORNEY



*David J. Kyfos*

Director of the United States Patent and Trademark Office

# United States of America

United States Patent and Trademark Office

## Morgan Avery

**Reg. No. 4,124,374**

**Registered Apr. 10, 2012**

**Int. Cls.: 3 and 4**

**TRADEMARK**

**PRINCIPAL REGISTER**

U.S. KINGKING, LLC (DELAWARE LIMITED LIABILITY COMPANY)  
3721 BRIARPARK DR. SUITE 155  
HOUSTON, TX 77042

FOR: BATH BEADS; BATH CRYSTALS; BATH FOAM; BATH FOAMS; BATH GEL; BATH GELS; BATH LOTION; BATH MILKS; BATH OIL; BATH OILS; BATH SALTS; BATH SALTS; BATH SOAPS IN LIQUID, SOLID OR GEL FORM; BATHING LOTIONS; BEAUTY GELS; BUBBLE BATH; FOAM BATH; LIQUID BATH SOAPS; LIQUID SOAP USED IN FOOT BATH; SHAVING GELS; SHOWER AND BATH FOAM; SHOWER AND BATH GEL; SHOWER GEL; SHOWER GELS, BODY LOTIONS, CREAMS, SCRUBS, OILS, POWDERS, IN CLASS 3 (U.S. CLS. 1, 4, 6, 50, 51 AND 52).

FIRST USE 8-1-2010; IN COMMERCE 11-1-2010.

FOR: BEESWAX FOR USE IN THE MANUFACTURE OF CANDLES; CANDLE TORCHES; CANDLE-MAKING KITS; CANDLES; CANDLES FOR LIGHTING; PERFUMED CANDLES; SCENTED CANDLES; TALLOW CANDLES. SOY CANDLES, VEGETABLE WAX CANDLES, IN CLASS 4 (U.S. CLS. 1, 6 AND 15).

FIRST USE 8-1-2010; IN COMMERCE 11-1-2010.

THE MARK CONSISTS OF STANDARD CHARACTERS WITHOUT CLAIM TO ANY PARTICULAR FONT, STYLE, SIZE, OR COLOR.

"MORGAN AVERY" DOES NOT IDENTIFY A LIVING INDIVIDUAL.

SER. NO. 85-275,883, FILED S.R. 3-24-2011 AM. P.R. 12-14-2011.

ARETHA SOMERVILLE, EXAMINING ATTORNEY



*David J. Kybas*

Director of the United States Patent and Trademark Office



# United States of America

United States Patent and Trademark Office

## GOLDEN LUSTRE

**Reg. No. 4,124,375**

**Registered Apr. 10, 2012**

**Int. Cl.: 3**

**TRADEMARK**

**PRINCIPAL REGISTER**

L'OREAL (UK) LIMITED (UNITED KINGDOM PRIVATE LIMITED COMPANY)  
255 HAMMERSMITH ROAD  
LONDON, UNITED KINGDOM W68AZ

FOR: MAKE-UP PREPARATIONS, IN CLASS 3 (U.S. CLS. 1, 4, 6, 50, 51 AND 52).

THE MARK CONSISTS OF STANDARD CHARACTERS WITHOUT CLAIM TO ANY PARTICULAR FONT, STYLE, SIZE, OR COLOR.

PRIORITY CLAIMED UNDER SEC. 44(D) ON ERPN CMNTY TM OFC APPLICATION NO. 9783259, FILED 3-3-2011, REG. NO. 009783259, DATED 7-13-2011, EXPIRES 3-3-2021.

NO CLAIM IS MADE TO THE EXCLUSIVE RIGHT TO USE "GOLDEN", APART FROM THE MARK AS SHOWN.

SER. NO. 85-275,930, FILED 3-24-2011.

COURTNEY ALVAREZ, EXAMINING ATTORNEY



*David J. Kyffers*

Director of the United States Patent and Trademark Office

# United States of America

United States Patent and Trademark Office

## LabelWatcher

**Reg. No. 4,124,376**

**Registered Apr. 10, 2012**

**Int. Cl.: 9**

**TRADEMARK**

**PRINCIPAL REGISTER**

INTRAVIS, INC. (GEORGIA CORPORATION)  
INTRAVIS, INC.  
3070 BUSINESS PARK DR STE H  
NORCROSS, GA 300711451

FOR: OPTICAL METROLOGY SYSTEM FOR THE QUALITY ASSURANCE INSPECTION OF LABELS, CONSISTING OF COMPUTER SOFTWARE FOR CONTROLLING THE OPERATIONS OF CAMERAS, PERSONAL COMPUTER, DATA PROCESSING EQUIPMENT FOR SEQUENCE CONTROL, COMPUTER MONITORS, LIGHT SOURCES, AND MECHANICAL MOUNTING PARTS FOR THE INSTALLATION OF THE CAMERAS DOWNSTREAM OF THE MACHINERY, ALL OF THE FORGOING SOLD AS A UNIT, IN CLASS 9 (U.S. CLS. 21, 23, 26, 36 AND 38).

FIRST USE 0-0-2006; IN COMMERCE 0-0-2006.

THE MARK CONSISTS OF STANDARD CHARACTERS WITHOUT CLAIM TO ANY PARTICULAR FONT, STYLE, SIZE, OR COLOR.

OWNER OF U.S. REG. NO. 3,793,743.

SER. NO. 85-275,980, FILED 3-24-2011.

CHARISMA HAMPTON, EXAMINING ATTORNEY



*David J. Kypos*

Director of the United States Patent and Trademark Office

# United States of America

United States Patent and Trademark Office

## Bottle Watcher

**Reg. No. 4,124,377**

**Registered Apr. 10, 2012**

**Int. Cl.: 9**

**TRADEMARK**

**PRINCIPAL REGISTER**

INTRAVIS, INC. (GEORGIA CORPORATION)  
INTRAVIS, INC.  
3070 BUSINESS PARK DR STE H  
NORCROSS, GA 300711451

FOR: OPTICAL METROLOGY SYSTEM FOR QUALITY ASSURANCE INSPECTION OF PLASTIC BOTTLES, CONSISTING OF COMPUTER SOFTWARE FOR CONTROLLING THE OPERATIONS OF CAMERAS, PERSONAL COMPUTER, DATA PROCESSING EQUIPMENT FOR SEQUENCE CONTROL, COMPUTER MONITORS, LIGHT SOURCES, AND MECHANICAL INSPECTION FRAMES WHICH ARE USED TO PRESENT THE BOTTLES TO THE CAMERA IN AN ACCURATE AND TIMELY MANNER, ALL OF THE FORGOING SOLD AS A UNIT, IN CLASS 9 (U.S. CLS. 21, 23, 26, 36 AND 38).

FIRST USE 0-0-2006; IN COMMERCE 0-0-2006.

THE MARK CONSISTS OF STANDARD CHARACTERS WITHOUT CLAIM TO ANY PARTICULAR FONT, STYLE, SIZE, OR COLOR.

OWNER OF U.S. REG. NO. 3,793,743.

SER. NO. 85-276,091, FILED 3-24-2011.

CHARISMA HAMPTON, EXAMINING ATTORNEY



*David J. Kyffers*

Director of the United States Patent and Trademark Office

# United States of America

United States Patent and Trademark Office

# DECA-ALT

**Reg. No. 4,124,378**

DYNAMIC SPORTS NUTRITION, LLC (TEXAS LIMITED LIABILITY COMPANY)  
1330 POST OAK BLVD., STE. 2900  
HOUSTON, TX 77056

**Registered Apr. 10, 2012**

**Int. Cl.: 5**

FOR: DIETARY AND NUTRITIONAL SUPPLEMENTS, IN CLASS 5 (U.S. CLS. 6, 18, 44, 46, 51 AND 52).

**TRADEMARK**

FIRST USE 11-0-2009; IN COMMERCE 11-0-2009.

**PRINCIPAL REGISTER**

THE MARK CONSISTS OF STANDARD CHARACTERS WITHOUT CLAIM TO ANY PARTICULAR FONT, STYLE, SIZE, OR COLOR.

SER. NO. 85-276,188, FILED 3-24-2011.

SEAN CROWLEY, EXAMINING ATTORNEY



*David J. Kybas*

Director of the United States Patent and Trademark Office

# United States of America

United States Patent and Trademark Office

## GOLDEN IMAGE

**Reg. No. 4,124,379**

**Registered Apr. 10, 2012**

**Int. Cls.: 9 and 10**

**TRADEMARK**

**PRINCIPAL REGISTER**

LIGHTLAB IMAGING, INC. (DELAWARE CORPORATION)  
ONE TECHNOLOGY PARK DRIVE  
WESTFORD, MA 01886

FOR: SOFTWARE, NAMELY, OPTICAL COHERENCE TOMOGRAPHY SOFTWARE FOR MEDICAL IMAGING, IN CLASS 9 (U.S. CLS. 21, 23, 26, 36 AND 38).

FIRST USE 0-0-2003; IN COMMERCE 0-0-2003.

FOR: MEDICAL DEVICES, NAMELY, VASCULAR IMAGING APPARATUSES AND MODALITIES FOR MEDICAL IMAGING AND CLINICAL MICROSCOPY APPLICATIONS, IN CLASS 10 (U.S. CLS. 26, 39 AND 44).

FIRST USE 0-0-2003; IN COMMERCE 0-0-2003.

THE MARK CONSISTS OF STANDARD CHARACTERS WITHOUT CLAIM TO ANY PARTICULAR FONT, STYLE, SIZE, OR COLOR.

NO CLAIM IS MADE TO THE EXCLUSIVE RIGHT TO USE "IMAGE", APART FROM THE MARK AS SHOWN.

SER. NO. 85-276,699, FILED 3-25-2011.

KIMBERLY PERRY, EXAMINING ATTORNEY



*David J. Kyros*

Director of the United States Patent and Trademark Office

# United States of America

United States Patent and Trademark Office



**Reg. No. 4,124,380**

**Registered Apr. 10, 2012**

**Int. Cl.: 30**

**TRADEMARK**

**PRINCIPAL REGISTER**

GRUPO BIMBO, S.A. B. DE C.V. (MEXICO CORPORATION)  
PROLONGACION PASEO DE LA REFORMA  
NO. 1000, COL. PENA BLANCA SANTA FE  
MEXICO CITY, MEXICO 01210

FOR: CORN BASED SNACK FOODS, IN CLASS 30 (U.S. CL. 46).

FIRST USE 12-31-1999; IN COMMERCE 12-31-1999.

OWNER OF U.S. REG. NOS. 3,711,316, 3,847,239 AND OTHERS.

THE NAME(S), PORTRAIT(S), AND/OR SIGNATURE(S) SHOWN IN THE MARK DOES NOT IDENTIFY A PARTICULAR LIVING INDIVIDUAL.

THE MARK CONSISTS OF THE LETTER "B" APPEARING OVER THE WORD "BARCEL" INSIDE A SHADED TRAPEZOID DESIGN.

THE WORDING "BARCEL" HAS NO MEANING IN A FOREIGN LANGUAGE.

SER. NO. 85-276,702, FILED 3-25-2011.

SETH A. RAPPAPORT, EXAMINING ATTORNEY



*David J. Kyfos*

Director of the United States Patent and Trademark Office

# United States of America

United States Patent and Trademark Office

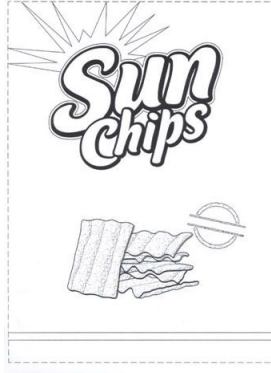

**Reg. No. 4,124,381**

**Registered Apr. 10, 2012**

**Int. Cl.: 30**

**TRADEMARK**

**PRINCIPAL REGISTER**

FRITO-LAY NORTH AMERICA, INC. (DELAWARE CORPORATION)  
MAIL STOP 3A-421  
7701 LEGACY DRIVE  
PLANO, TX 75024

FOR: MULTIGRAIN-BASED SNACK FOODS, IN CLASS 30 (U.S. CL. 46).

FIRST USE 1-15-2011; IN COMMERCE 1-15-2011.

OWNER OF U.S. REG. NOS. 986,097, 3,293,236 AND OTHERS.

NO CLAIM IS MADE TO THE EXCLUSIVE RIGHT TO USE "CHIPS", APART FROM THE MARK AS SHOWN.

THE MARK CONSISTS OF PACKAGING CONFIGURATION FOR THE GOODS FEATURING THE STYLIZED WORDING "SUN CHIPS" WITH A SUNBURST BEHIND THE LETTER "S", A STACK OF WAVY-SHAPED CHIPS UNDER THE WORDING, AND A ROUND STAMP COMPRISED OF TWO HALF-CIRCLES BISECTED BY A BANNER. THE DOTTED OUTLINE OF THE SHAPE OF THE SNACK FOOD BAG IS NOT BEING CLAIMED AS PART OF THE MARK, BUT IS MERELY INTENDED TO SHOW THE POSITION OF THE MARK ON THE GOODS.

SEC. 2(F).

SER. NO. 85-276,792, FILED 3-25-2011.

TASNEEM HUSSAIN, EXAMINING ATTORNEY



*David J. Kyros*

Director of the United States Patent and Trademark Office

# United States of America

United States Patent and Trademark Office

## UN GRAN PERIODICO

**Reg. No. 4,124,382**

EL DIA, INC. (PUERTO RICO CORPORATION)

**Registered Apr. 10, 2012**

# CARRETERA  
165 GUAYNABO, PUERTO RICO 00968

**Int. Cl.: 16**

FOR: NEWSPAPERS FOR GENERAL CIRCULATION; MAGAZINE SUPPLEMENTS TO NEWSPAPERS ON THE SUBJECT OF BUSINESS, FASHION, LITERATURE, ART, GASTRONOMY, CRITICAL COMMENTARY ON INTELLECTUAL ISSUES, REAL ESTATE AND LOCAL SOCIAL EVENTS, IN CLASS 16 (U.S. CLS. 2, 5, 22, 23, 29, 37, 38 AND 50).

**TRADEMARK**

**PRINCIPAL REGISTER**

FIRST USE 12-1-1986; IN COMMERCE 12-1-1986.

THE MARK CONSISTS OF STANDARD CHARACTERS WITHOUT CLAIM TO ANY PARTICULAR FONT, STYLE, SIZE, OR COLOR.

NO CLAIM IS MADE TO THE EXCLUSIVE RIGHT TO USE "PERIODICO", APART FROM THE MARK AS SHOWN.

THE ENGLISH TRANSLATION OF "UN GRAN PERIODICO" IN THE MARK IS "A GREAT NEWSPAPER".

SEC. 2(F).

SER. NO. 85-277,098, FILED 3-25-2011.

JERI J. FICKES, EXAMINING ATTORNEY



*David J. Kyffers*

Director of the United States Patent and Trademark Office



# United States of America

United States Patent and Trademark Office

## AMERICA'S TOY-FRIENDLY COMMUNITY

**Reg. No. 4,124,383**

**Registered Apr. 10, 2012**

**Int. Cls.: 36 and 37**

**SERVICE MARK**

**PRINCIPAL REGISTER**

SILVER SPRINGS SHORES INVESTMENTS, LLC (DELAWARE LIMITED LIABILITY COMPANY)  
301 SKYLINE DRIVE, SUITE 4  
LADY LAKE, FL 32159

FOR: REAL ESTATE MANAGEMENT, LEASING, AND RENTAL OF CONDOMINIUMS, HOUSES, RESIDENTIAL PROPERTIES AND COMMERCIAL PROPERTIES IN PLANNED COMMUNITIES, IN CLASS 36 (U.S. CLS. 100, 101 AND 102).

FIRST USE 6-0-2010; IN COMMERCE 6-0-2010.

FOR: REAL ESTATE DEVELOPMENT SERVICES, IN CLASS 37 (U.S. CLS. 100, 103 AND 106).

FIRST USE 6-0-2010; IN COMMERCE 6-0-2010.

THE MARK CONSISTS OF STANDARD CHARACTERS WITHOUT CLAIM TO ANY PARTICULAR FONT, STYLE, SIZE, OR COLOR.

NO CLAIM IS MADE TO THE EXCLUSIVE RIGHT TO USE "AMERICA'S" AND "COMMUNITY", APART FROM THE MARK AS SHOWN.

SER. NO. 85-277,419, FILED 3-25-2011.

SUNG IN, EXAMINING ATTORNEY



*David J. Kypos*

Director of the United States Patent and Trademark Office

# United States of America

United States Patent and Trademark Office

# COAST

**Reg. No. 4,124,384**

**Registered Apr. 10, 2012**

**Int. Cl.: 11**

**TRADEMARK**

**PRINCIPAL REGISTER**

COAST PRODUCTS, L.L.C. (FLORIDA LIMITED LIABILITY COMPANY)  
17740 ASHLEY DRIVE, SUITE 111  
PANAMA CITY, FL 32413

FOR: TOILET ACCESSORY DEVICES, NAMELY, BALLCOCK VALVES, FLUSH VALVES, FILL VALVES, TRIP LEVERS, FLAPPERS, FLOAT BALLS AND SPUDS; AND REPAIR AND REPLACEMENT PARTS FOR THE SAME, IN CLASS 11 (U.S. CLS. 13, 21, 23, 31 AND 34).

FIRST USE 0-0-1949; IN COMMERCE 0-0-1949.

THE MARK CONSISTS OF STANDARD CHARACTERS WITHOUT CLAIM TO ANY PARTICULAR FONT, STYLE, SIZE, OR COLOR.

SER. NO. 85-277,438, FILED 3-25-2011.

RICHARD WHITE, EXAMINING ATTORNEY



*David J. Kyfos*

Director of the United States Patent and Trademark Office

# United States of America

United States Patent and Trademark Office

## LAKE WEIR LIVING

**Reg. No. 4,124,385**

**Registered Apr. 10, 2012**

**Int. Cls.: 36 and 37**

**SERVICE MARK**

**PRINCIPAL REGISTER**

SILVER SPRINGS SHORES INVESTMENTS, LLC (DELAWARE LIMITED LIABILITY COMPANY)  
301 SKYLINE DRIVE, SUITE 4  
LADY LAKE, FL 32159

FOR: REAL ESTATE MANAGEMENT, LEASING, AND RENTAL OF CONDOMINIUMS, HOUSES, RESIDENTIAL PROPERTIES AND COMMERCIAL PROPERTIES IN PLANNED COMMUNITIES, IN CLASS 36 (U.S. CLS. 100, 101 AND 102).

FIRST USE 4-0-2009; IN COMMERCE 4-0-2009.

FOR: REAL ESTATE DEVELOPMENT SERVICES, IN CLASS 37 (U.S. CLS. 100, 103 AND 106).

FIRST USE 4-0-2009; IN COMMERCE 4-0-2009.

THE MARK CONSISTS OF STANDARD CHARACTERS WITHOUT CLAIM TO ANY PARTICULAR FONT, STYLE, SIZE, OR COLOR.

NO CLAIM IS MADE TO THE EXCLUSIVE RIGHT TO USE "LAKE WEIR", APART FROM THE MARK AS SHOWN.

SER. NO. 85-277,447, FILED 3-25-2011.

SUNG IN, EXAMINING ATTORNEY



*David J. Kyfos*

Director of the United States Patent and Trademark Office

# United States of America

United States Patent and Trademark Office

# KaleidoScapes

**Reg. No. 4,124,386**

LANKFORD, LEE ANN (UNITED STATES INDIVIDUAL)  
4243 E MONTGOMERY RD  
CAVE CREEK, AZ 85331 AND

**Registered Apr. 10, 2012**

**Int. Cl.: 9**

LANKFORD, DAVID L (UNITED STATES INDIVIDUAL)  
4243 E MONTGOMERY RD  
CAVE CREEK, AZ 85331

**TRADEMARK**

**PRINCIPAL REGISTER**

FOR: DIGITAL MEDIA, NAMELY, PRE-RECORDED DVDS, DOWNLOADABLE AUDIO AND VIDEO RECORDINGS, AND CDS FEATURING AND PROMOTING NATURE, IN CLASS 9 (U.S. CLS. 21, 23, 26, 36 AND 38).

FIRST USE 1-1-2011; IN COMMERCE 3-1-2011.

THE MARK CONSISTS OF STANDARD CHARACTERS WITHOUT CLAIM TO ANY PARTICULAR FONT, STYLE, SIZE, OR COLOR.

SER. NO. 85-277,979, FILED 3-26-2011.

DAWN FELDMAN, EXAMINING ATTORNEY



*David J. Kyffers*

Director of the United States Patent and Trademark Office

# United States of America

United States Patent and Trademark Office

# ProAudioStar

**Reg. No. 4,124,387**

LOBONAV CORP. (NEW YORK CORPORATION), DBA PROAUDIOSTAR  
368 NEW HEMPSTEAD RD. #239  
NEW CITY, NY 10956

**Registered Apr. 10, 2012**

**Int. Cl.: 35**

FOR: ONLINE RETAIL STORE FEATURING PROFESSIONAL AND CONSUMER AUDIO EQUIPMENT AND ACCESSORIES, DISC JOCKEY EQUIPMENT AND ACCESSORIES, AND MUSICAL INSTRUMENTS AND ACCESSORIES, IN CLASS 35 (U.S. CLS. 100, 101 AND 102).

**SERVICE MARK**

**PRINCIPAL REGISTER**

FIRST USE 5-1-2007; IN COMMERCE 5-1-2007.

THE MARK CONSISTS OF THREE ARCHES OF VARYING SIZE TO THE LEFT OF THE "P" IN "PROAUDIOSTAR".

SER. NO. 85-278,121, FILED 3-27-2011.

PAULA MAHONEY, EXAMINING ATTORNEY



*David J. Kyffers*

Director of the United States Patent and Trademark Office

# United States of America

United States Patent and Trademark Office

## GOLDEN WAVE

**Reg. No. 4,124,388**

BUCHANAN COUNTY SCHOOL BOARD (VIRGINIA CORPORATION)  
P.O. BOX 833  
GRUNDY, VA 24614

**Registered Apr. 10, 2012**

**Int. Cl.: 25**

FOR: CLOTHING, NAMELY, T-SHIRTS, POLO SHIRTS AND JACKETS; CLOTHING, NAMELY, HATS, VISORS, SWEATSHIRTS, SHIRTS, SWEATPANTS, BUTTON DOWN SHIRTS, SHORTS, COATS, SOCKS, HEADBANDS, GLOVES AND SCARVES, IN CLASS 25 (U.S. CLS. 22 AND 39).

**TRADEMARK**

**PRINCIPAL REGISTER**

FIRST USE 0-0-1979; IN COMMERCE 0-0-1979.

THE MARK CONSISTS OF STANDARD CHARACTERS WITHOUT CLAIM TO ANY PARTICULAR FONT, STYLE, SIZE, OR COLOR.

SER. NO. 85-278,334, FILED 3-28-2011.

KEVIN CORWIN, EXAMINING ATTORNEY



*David J. Kyfos*

Director of the United States Patent and Trademark Office

# United States of America

United States Patent and Trademark Office

## AUSTIN VENTURES

**Reg. No. 4,124,389**

AVP MANAGEMENT SERVICES, INC. (TEXAS CORPORATION)  
300 W. 6TH STREET, SUITE 2300  
AUSTIN, TX 78701

**Registered Apr. 10, 2012**

**Int. Cl.: 36**

FOR: EQUITY CAPITAL INVESTMENT; VENTURE CAPITAL FINANCING, IN CLASS 36  
(U.S. CLS. 100, 101 AND 102).

**SERVICE MARK**

FIRST USE 12-31-1991; IN COMMERCE 12-31-1991.

**PRINCIPAL REGISTER**

THE MARK CONSISTS OF STANDARD CHARACTERS WITHOUT CLAIM TO ANY PARTICULAR FONT, STYLE, SIZE, OR COLOR.

NO CLAIM IS MADE TO THE EXCLUSIVE RIGHT TO USE "VENTURES", APART FROM THE MARK AS SHOWN.

SEC. 2(F).

SER. NO. 85-278,475, FILED 3-28-2011.

ZACHARY BELLO, EXAMINING ATTORNEY



*David J. Kyffers*

Director of the United States Patent and Trademark Office

# United States of America

United States Patent and Trademark Office



**Reg. No. 4,124,390**

**Registered Apr. 10, 2012**

**Int. Cls.: 9 and 19**

**TRADEMARK**

**PRINCIPAL REGISTER**

JIANGYIN HAREON POWER CO., LTD. (CHINA LIMITED LIABILITY COMPANY)  
HUANGTANG INDUSTRIAL ZONE, XUXIAKE TOWN  
JIANGYIN CITY, JIANGSU, CHINA

FOR: ACIDIMETERS FOR BATTERIES; APPARATUS FOR CONVERTING ELECTRONIC RADIATION TO ELECTRICAL ENERGY, NAMELY, PHOTOVOLTAIC ROOFING MEMBERS; BATTERIES, ELECTRIC, FOR VEHICLES; PLATES FOR BATTERIES; SILICON WAFERS; SOLAR BATTERIES, IN CLASS 9 (U.S. CLS. 21, 23, 26, 36 AND 38).

FIRST USE 7-30-2008; IN COMMERCE 11-2-2009.

FOR: ROOFING, NOT OF METAL, INCORPORATING SOLAR CELLS, IN CLASS 19 (U.S. CLS. 1, 12, 33 AND 50).

FIRST USE 7-30-2008; IN COMMERCE 11-2-2009.

THE MARK CONSISTS OF A RED RHOMBOID GEOMETRIC DESIGN REFLECTING SUN-LIGHT IN YELLOW AND ORANGE IN THE UPPER LEFT SIDE WITH THREE WHITE LINES THAT CUT THROUGH THE DESIGN CREATING SIX PARTS.

THE COLOR(S) RED, YELLOW, ORANGE AND WHITE IS/ARE CLAIMED AS A FEATURE OF THE MARK.

SER. NO. 85-278,907, FILED 3-28-2011.

KELLY CHOE, EXAMINING ATTORNEY



*David J. Kybas*

Director of the United States Patent and Trademark Office



United States of America  
United States Patent and Trademark Office

KRAMER

**Reg. No. 4,124,391**

BLADESMITHS INC. (WASHINGTON CORPORATION), DBA KRAMER KNIVES INC.  
6245 RICH ROAD SE STE A  
OLYMPIA, WA 98501

**Registered Apr. 10, 2012**

**Int. Cl.: 8**

FOR: BLADES FOR KITCHEN KNIVES; CHEF KNIVES; KNIVES KITCHEN; PARING KNIVES; UTILITY KNIVES; VEGETABLE KNIVES, IN CLASS 8 (U.S. CLS. 23, 28 AND 44).

**TRADEMARK**

FIRST USE 2-1-2002; IN COMMERCE 2-1-2002.

**PRINCIPAL REGISTER**

THE MARK CONSISTS OF STANDARD CHARACTERS WITHOUT CLAIM TO ANY PARTICULAR FONT, STYLE, SIZE, OR COLOR.

THE NAME "KRAMER" IDENTIFIES A LIVING INDIVIDUAL WHOSE CONSENT IS OF RECORD.

SEC. 2(F).

SER. NO. 85-279,128, FILED 3-28-2011.

MARGERY A. TIERNEY, EXAMINING ATTORNEY



*David J. Kybas*

Director of the United States Patent and Trademark Office

# United States of America

United States Patent and Trademark Office



**Reg. No. 4,124,392**

**Registered Apr. 10, 2012**

**Int. Cl.: 11**

**TRADEMARK**

**PRINCIPAL REGISTER**

GUANGDONG CHIGO AIR CONDITIONING CO., LTD. (CHINA CORPORATION)  
FENGGANG ROAD, LISHUI TOWN, NANHAI  
GUANGDONG, 528244, CHINA

FOR: REFRIGERATORS, ICE CREAM MAKERS, REFRIGERATED SHIPPING CONTAINERS; MICROWAVE OVENS FOR COOKING, STERILIZERS NOT FOR MEDICAL USE; EXHAUST HOODS FOR KITCHENS AND ELECTRIC FANS; INDUCTION OVENS, ELECTRIC PRESSURE COOKERS, COFFEE ROASTERS, ELECTRIC DEEP FRYERS AND GAS KITCHEN RANGES; WATER DESALINATION PLANTS, WATER STERILIZERS, FILTERS FOR DRINKING WATER, PASTEURIZERS FOR USE IN FOOD AND BEVERAGES; AND DISPENSING UNITS FOR DISPENSING TOILET DISINFECTANTS; ELECTRIC RICE COOKERS; ELECTRIC FOOD STEAMERS; WATER COOLERS WITH INTEGRATED DISPENSERS, ELECTROMAGNETIC OVEN BURNERS FOR DOMESTIC USE; HOME DEHUMIDIFIERS; HUMIDIFIERS; AIR PURIFYING UNITS FOR DOMESTIC USE; HAND-HELD ELECTRIC HAIR DRYERS; ELECTRIC FREEZERS; DISH DISINFECTING APPARATUS FOR INDUSTRIAL PURPOSES; PORTABLE ELECTRIC HEATERS; ELECTRIC BED WARMERS FOR DOMESTIC USE; ELECTRIC BREAD TOASTERS; ELECTRIC WATER HEATERS FOR DOMESTIC USE; ELECTRIC LIGHT BULBS, ELECTRIC LANTERNS FOR LIGHTING ELECTRIC CHINESE LANTERNS, LAMP CASINGS, CHANDELIERS, LASER LIGHT PROJECTOR LAMPS, FILM STAGE LIGHTING APPARATUS; AIR PURIFYING APPARATUS, NAMELY, GERMICIDAL LAMPS FOR PURIFYING AIR; HIGH INTENSITY SEARCHLIGHTS; BATH TUB INSTALLATIONS, NAMELY, BATH TUBS, PORTABLE TURKISH BATH TUBS, WATER HEATERS FOR DOMESTIC USE IN HEATING SHOWERS, SPA BATH TUBS, AND BATHROOM EXHAUST FANS; COOLING UNITS, NAMELY, REFRIGERATING CABINETS, ICE CHEST FOR HOUSEHOLD PURPOSES; PLUMBING FITTINGS AND FIXTURES, NAMELY, HYDRANTS, ANTI-SPLASH TAP NOZZLES, FAUCETS FOR PIPES, PIPELINE COCKS, SPIGOTS, WATER FOUNTAINS, PRESSURE TOILET TANKS; MIXER FAUCETS FOR WATER PIPES; AIR CONDITIONING INSTALLATIONS AND AIR CONDITIONING APPARATUS, IN CLASS 11 (U.S. CLS. 13, 21, 23, 31 AND 34).



FIRST USE 3-6-2000; IN COMMERCE 3-6-2000.

OWNER OF U.S. REG. NO. 2,891,608.

*David J. Kybas*

THE MARK CONSISTS OF A STYLIZED THREE PANELED WINDMILL ABOVE THE STYLIZED WORD "CHIGO".

**Reg. No. 4,124,392** SER. NO. 85-279,483, FILED 3-29-2011.

BERYL GARDNER, EXAMINING ATTORNEY

# United States of America

United States Patent and Trademark Office

## ARMOR-CRETE

**Reg. No. 4,124,393**

**Registered Apr. 10, 2012**

**Int. Cls.: 1, 2 and 19**

**TRADEMARK**

**PRINCIPAL REGISTER**

ACS ADVANCED CONCRETE SOLUTIONS LIMITED (CANADA CORPORATION)  
24701 - 108TH AVENUE  
MAPLE RIDGE, BC, CANADA V2W1G7

FOR: CONCRETE ADDITIVES, NAMELY, LIQUID POLYMER ADDITIVE FOR USE IN DECORATIVE CONCRETE RE-SURFACING, IN CLASS 1 (U.S. CLS. 1, 5, 6, 10, 26 AND 46).

FOR: CONCRETE SEALER IN THE FORM OF A COATING FOR USE IN DECORATIVE CONCRETE RE-SURFACING, IN CLASS 2 (U.S. CLS. 6, 11 AND 16).

FOR: CEMENT BASED GROUT AND FLOOR PATCHING MATERIALS, NAMELY, CONCRETE SEALER FOR USE IN DECORATIVE CONCRETE RE-SURFACING, IN CLASS 19 (U.S. CLS. 1, 12, 33 AND 50).

THE MARK CONSISTS OF STANDARD CHARACTERS WITHOUT CLAIM TO ANY PARTICULAR FONT, STYLE, SIZE, OR COLOR.

OWNER OF CANADA REG. NO. TMA657,844, DATED 2-2-2006, EXPIRES 2-2-2021.

SER. NO. 85-279,825, FILED 3-29-2011.

ERNEST SHOSHO, EXAMINING ATTORNEY



*David J. Kypos*

Director of the United States Patent and Trademark Office

# United States of America

United States Patent and Trademark Office

## LAST STAND FOR LUCY

**Reg. No. 4,124,394**

LAST STAND FOR LUCY PARTNERSHIP (NEW YORK PARTNERSHIP)  
102 E. 31ST ST. APT. #4D  
NEW YORK, NY 10016

**Registered Apr. 10, 2012**

**Int. Cls.: 9 and 41**

FOR: VIDEO DISCS, LASER DISCS, CD-ROM DISCS, DIGITAL VIDEO DISCS, DIGITAL VERSATILE DISCS, COMPACT DISCS, AUDIO CASSETTES AND VIDEO CASSETTES FEATURING MUSIC AND PERFORMANCES BY A MUSICAL BAND, IN CLASS 9 (U.S. CLS. 21, 23, 26, 36 AND 38).

**TRADEMARK**

**SERVICE MARK**

FIRST USE 8-1-2009; IN COMMERCE 4-1-2010.

**PRINCIPAL REGISTER**

FOR: ENTERTAINMENT, NAMELY, LIVE PERFORMANCES BY A MUSICAL BAND; PRODUCTION OF FILMS AND TELEVISION PROGRAMS FEATURING PERFORMANCES BY A MUSICAL BAND; ENTERTAINMENT, NAMELY, PROVIDING NON-DOWNLOADABLE PRERECORDED MUSICAL PERFORMANCES ON-LINE VIA A GLOBAL COMPUTER NETWORK, FAN CLUB SERVICES; PROVIDING A WEBSITE FEATURING ENTERTAINMENT INFORMATION, NAMELY, REVIEWS, ARTICLES, INTERVIEWS, MUSIC VIDEOS, MUSIC CHARTS, PERSONAL BIOGRAPHIES, DIARIES, INFORMATION ON MUSIC INSTRUMENTS, TOUR DATES, TRIVIA, ENTERTAINMENT INFORMATION ABOUT MEMORABILIA, PHOTOGRAPHS, VIDEO CLIPS, AND AUDIO CLIPS, ALL AVAILABLE VIA A GLOBAL COMPUTER NETWORK, IN CLASS 41 (U.S. CLS. 100, 101 AND 107).

FIRST USE 8-1-2009; IN COMMERCE 4-1-2010.

THE MARK CONSISTS OF STANDARD CHARACTERS WITHOUT CLAIM TO ANY PARTICULAR FONT, STYLE, SIZE, OR COLOR.

SER. NO. 85-280,299, FILED 3-29-2011.

CHARLOTTE CORWIN, EXAMINING ATTORNEY



*David J. Kypos*

Director of the United States Patent and Trademark Office

# United States of America

United States Patent and Trademark Office

# Longstar

**Reg. No. 4,124,395**

**Registered Apr. 10, 2012**

**Int. Cl.: 11**

**TRADEMARK**

**PRINCIPAL REGISTER**

QINGSONG LI (CHINA INDIVIDUAL)  
5328 SPICEWOOD LANE  
FRISCO, TX 75034

FOR: ELECTRIC BULBS; ELECTRIC LIGHT BULBS; ELECTRIC LIGHTS FOR CHRISTMAS TREES; ELECTRIC NIGHT LIGHTS; FLUORESCENT ELECTRIC LIGHT BULBS; LAMP BULBS; LED (LIGHT EMITTING DIODE) LIGHTING FIXTURES; LED LANDSCAPE LIGHTS; LED LIGHT ASSEMBLIES FOR STREET LIGHTS, SIGNS, COMMERCIAL LIGHTING, AUTOMOBILES, BUILDINGS, AND OTHER ARCHITECTURAL USES; LED LIGHT BULBS; LED LIGHTING FIXTURES FOR INDOOR AND OUTDOOR LIGHTING APPLICATIONS; LED LIGHTS FOR LIGHTING PURPOSES INCORPORATED INTO KEY CHAINS, SMALL TOYS OR OTHER SIMILAR PERSONAL ITEMS; LED UNDERWATER LIGHTS; LIGHT BULBS; LIGHT EMITTING DIODE (LED) PLANT GROW LIGHT; LIGHT BULBS; LIGHTING FIXTURES; OUTDOOR PORTABLE LIGHTING PRODUCTS, NAMELY, HEAD LAMPS, IN CLASS 11 (U.S. CLS. 13, 21, 23, 31 AND 34).

FIRST USE 0-0-1997; IN COMMERCE 0-0-1997.

THE MARK CONSISTS OF STANDARD CHARACTERS WITHOUT CLAIM TO ANY PARTICULAR FONT, STYLE, SIZE, OR COLOR.

SER. NO. 85-280,308, FILED 3-29-2011.

CHARLOTTE CORWIN, EXAMINING ATTORNEY



*David J. Kybas*

Director of the United States Patent and Trademark Office

# United States of America

United States Patent and Trademark Office



**Reg. No. 4,124,396**

**Registered Apr. 10, 2012**

**Int. Cl.: 25**

**TRADEMARK**

**PRINCIPAL REGISTER**

CURBEAN DESIGNS CORPORATION (MARYLAND CORPORATION)  
3725 TRAIL WOOD CT.  
ABINGDON, MD 21009

FOR: DENIM JACKETS; HEAD SCARVES; JEANS; LEATHER VESTS; T-SHIRTS; VESTS;  
WOMEN'S CLOTHING, NAMELY, SHIRTS, DRESSES, SKIRTS, BLOUSES, IN CLASS 25  
(U.S. CLS. 22 AND 39).

FIRST USE 3-7-2011; IN COMMERCE 3-7-2011.

THE MARK CONSISTS OF A WOMAN WEARING MOTORCYCLE HELMET AND BOOTS  
RIDING A MOTORCYCLE IN THE SHAPE OF THE LETTERS "T" AND "M".

SER. NO. 85-280,517, FILED 3-29-2011.

MARK RADEMACHER, EXAMINING ATTORNEY



*David J. Kybas*

Director of the United States Patent and Trademark Office

# United States of America

United States Patent and Trademark Office

## ATHLETE'S ADVANTAGE

**Reg. No. 4,124,397**

**Registered Apr. 10, 2012**

**Int. Cl.: 41**

**SERVICE MARK**

**PRINCIPAL REGISTER**

UNITED STATES ANTI-DOPING AGENCY (COLORADO NON-PROFIT CORPORATION),  
AKA USADA  
5555 TECH CENTER DRIVE, SUITE 200  
COLORADO SPRINGS, CO 80919

FOR: EDUCATIONAL SERVICES, NAMELY, PROVIDING TUTORIALS IN THE FIELD OF ANTI-DOPING AND ILLEGAL OR PROHIBITED PERFORMANCE ENHANCING SUBSTANCES OR METHODS; EDUCATIONAL SERVICES, NAMELY, CONDUCTING PROGRAMS IN THE FIELD OF ANTI-DOPING AND ILLEGAL OR PROHIBITED PERFORMANCE ENHANCING SUBSTANCES OR METHODS; EDUCATIONAL SERVICES, NAMELY CONDUCTING PROGRAMS IN THE FIELD OF ANTI-DOPING AND ILLEGAL OR PROHIBITED PERFORMANCE ENHANCING SUBSTANCES OR METHODS USING ON-LINE ACTIVITIES AND INTERACTIVE EXHIBITS AND WRITTEN AND PRINTABLE MATERIALS DISTRIBUTED THEREWITH; EDUCATIONAL SERVICES, NAMELY, CONDUCTING ON-LINE EXHIBITIONS AND DISPLAYS AND INTERACTIVE EXHIBITS IN THE FIELD OF ANTI-DOPING AND ILLEGAL OR PROHIBITED PERFORMANCE ENHANCING SUBSTANCES OR METHODS, IN CLASS 41 (U.S. CLS. 100, 101 AND 107).

FIRST USE 11-1-2002; IN COMMERCE 11-1-2002.

THE MARK CONSISTS OF STANDARD CHARACTERS WITHOUT CLAIM TO ANY PARTICULAR FONT, STYLE, SIZE, OR COLOR.

NO CLAIM IS MADE TO THE EXCLUSIVE RIGHT TO USE "ATHLETE'S", APART FROM THE MARK AS SHOWN.

SER. NO. 85-280,523, FILED 3-29-2011.

ALICE BENMAMAN, EXAMINING ATTORNEY



*David J. Kyros*

Director of the United States Patent and Trademark Office



# United States of America

United States Patent and Trademark Office

## ATHLETE'S ADVANTAGE

**Reg. No. 4,124,398**

**Registered Apr. 10, 2012**

**Int. Cl.: 16**

**TRADEMARK**

**PRINCIPAL REGISTER**

UNITED STATES ANTI-DOPING AGENCY (COLORADO NON-PROFIT CORPORATION),  
AKA USADA  
5555 TECH CENTER DRIVE, SUITE 200  
COLORADO SPRINGS, CO 80919

FOR: PRINTED INSTRUCTIONAL, EDUCATIONAL, AND TEACHING MATERIALS IN THE  
FIELD OF ANTI-DOPING AND ILLEGAL OR PROHIBITED PERFORMANCE ENHANCING  
SUBSTANCES OR METHODS; PRINTED CERTIFICATES; CALENDARS, IN CLASS 16 (U.S.  
CLS. 2, 5, 22, 23, 29, 37, 38 AND 50).

FIRST USE 11-1-2002; IN COMMERCE 11-1-2002.

THE MARK CONSISTS OF STANDARD CHARACTERS WITHOUT CLAIM TO ANY PAR-  
TICULAR FONT, STYLE, SIZE, OR COLOR.

NO CLAIM IS MADE TO THE EXCLUSIVE RIGHT TO USE "ATHLETE'S", APART FROM  
THE MARK AS SHOWN.

SER. NO. 85-280,527, FILED 3-29-2011.

ALICE BENMAMAN, EXAMINING ATTORNEY



*David J. Kyffers*

Director of the United States Patent and Trademark Office

# United States of America

United States Patent and Trademark Office



**Reg. No. 4,124,399**

TWISTED SPIDERS (UTAH PARTNERSHIP)

**Registered Apr. 10, 2012**

P.O. BOX 95109  
SOUTH JORDAN, UT 84095

**Int. Cl.: 14**

FOR: ORNAMENTAL PINS, PENDANTS, AND EARRINGS MADE OF BEAD AND WIRE,  
IN CLASS 14 (U.S. CLS. 2, 27, 28 AND 50).

**TRADEMARK**

FIRST USE 11-9-2010; IN COMMERCE 12-4-2010.

**PRINCIPAL REGISTER**

THE MARK CONSISTS OF THE WORDS "TWISTED SPIDERS" WITH LINES ABOVE AND  
BELOW THE WORDS AND A UNIQUE SPIDER IMAGE SEPARATING "TWISTED" FROM  
"SPIDERS".

SER. NO. 85-280,587, FILED 3-29-2011.

CHARLOTTE CORWIN, EXAMINING ATTORNEY



*David J. Kyffers*

Director of the United States Patent and Trademark Office

# United States of America

United States Patent and Trademark Office



**Reg. No. 4,124,400**

**Registered Apr. 10, 2012**

**Int. Cl.: 1**

**TRADEMARK**

**PRINCIPAL REGISTER**

ARGAN OILS LLC (ILLINOIS LIMITED LIABILITY COMPANY)  
SUITE # 300  
4500 N. MALDEN ST.  
CHICAGO, IL 60640 AND

ZERHOUNI, HICHAM (UNITED STATES INDIVIDUAL)  
SUITE # 300  
4500 N. MALDEN ST.  
CHICAGO, IL 60640

FOR: BOTANICAL EXTRACTS, NAMELY, ARGAN OILS FOR USE IN MAKING COSMETICS,  
IN CLASS 1 (U.S. CLS. 1, 5, 6, 10, 26 AND 46).

FIRST USE 6-1-2007; IN COMMERCE 1-1-2008.

NO CLAIM IS MADE TO THE EXCLUSIVE RIGHT TO USE "ARGAN OILS", APART FROM  
THE MARK AS SHOWN.

THE COLOR(S) GRAY AND RED IS/ARE CLAIMED AS A FEATURE OF THE MARK.

THE MARK CONSISTS OF A GRAY OUTLINED DISTINCTIVELY-SHAPED TREE WITH  
VISIBLE DEEP ROOTS ABOVE THE WORDS "ARGAN" IN RED WHICH IS ABOVE THE  
WORD "OILS" IN GRAY, AND BELOW ARE THE STACKED WORDS "EMPOWER PROTECT  
PRESERVE" ALL IN RED.

SEC. 2(F).

SER. NO. 85-280,711, FILED S.R. 3-30-2011 AM. P.R. 12-8-2011.

WILLIAM VERHOSEK, EXAMINING ATTORNEY



*David J. Kybas*

Director of the United States Patent and Trademark Office

# United States of America

United States Patent and Trademark Office

## THE TECHNOLOGY OF SMALLER, BETTER GOVERNMENT

**Reg. No. 4,124,401**

**Registered Apr. 10, 2012**

**Int. Cls.: 35 and 42**

**SERVICE MARK**

**PRINCIPAL REGISTER**

AVUE TECHNOLOGIES CORPORATION (DELAWARE CORPORATION)  
SUITE 800  
1145 BROADWAY PLAZA  
TACOMA, WA 98402

FOR: BUSINESS CONSULTING SERVICES IN THE FIELD OF WORKFORCE MANAGEMENT AND HUMAN RESOURCES, PROVIDED VIA TELEPHONE, FACSIMILE, AND E-MAIL, INCLUDING TRANSACTION PROCESSING, DECISION SUPPORT, AND WORKFLOW ENABLING, ALL IN THE AREAS OF PERSONNEL FORECASTING, POSITION DESIGN, STAFFING, RECRUITMENT, HIRING, TRAINING, EVALUATION, DEVELOPMENT, COMPENSATION, COMPLIANCE, ANALYSIS, ORGANIZATIONAL ARCHITECTURE ANALYSIS, AND MANAGEMENT AND SUCCESSION PLANNING, IN CLASS 35 (U.S. CLS. 100, 101 AND 102).

FIRST USE 3-24-2011; IN COMMERCE 3-24-2011.

FOR: PROVIDING USE OF ON-LINE NON-DOWNLOADABLE SOFTWARE FOR USE IN WORKFORCE MANAGEMENT AND HUMAN RESOURCES, INCLUDING TRANSACTION PROCESSING, DECISION SUPPORT, AND WORKFLOW ENABLING, ALL IN THE AREAS OF PERSONNEL FORECASTING, POSITION DESIGN, STAFFING, RECRUITMENT, HIRING, TRAINING, EVALUATION, DEVELOPMENT, COMPENSATION, COMPLIANCE, ANALYSIS, ORGANIZATIONAL ARCHITECTURE ANALYSIS, MANAGEMENT AND SUCCESSION PLANNING, IN CLASS 42 (U.S. CLS. 100 AND 101).

FIRST USE 3-24-2011; IN COMMERCE 3-24-2011.

THE MARK CONSISTS OF STANDARD CHARACTERS WITHOUT CLAIM TO ANY PARTICULAR FONT, STYLE, SIZE, OR COLOR.

SER. NO. 85-281,072, FILED 3-30-2011.

RON FAIRBANKS, EXAMINING ATTORNEY



*David J. Kyros*

Director of the United States Patent and Trademark Office

# United States of America

United States Patent and Trademark Office

## UMI CONNECT

**Reg. No. 4,124,402**

CISCO TECHNOLOGY, INC. (CALIFORNIA CORPORATION)  
170 WEST TASMAN DRIVE  
SAN JOSE, CA 95134

**Registered Apr. 10, 2012**

**Int. Cl.: 42**

FOR: PROVIDING A WEBSITE FEATURING TECHNOLOGY THAT ENABLES USERS TO UPLOAD, SHARE, STORE AND VIEW VIDEOS, IN CLASS 42 (U.S. CLS. 100 AND 101).

**SERVICE MARK**

FIRST USE 11-15-2010; IN COMMERCE 11-15-2010.

**PRINCIPAL REGISTER**

THE MARK CONSISTS OF STANDARD CHARACTERS WITHOUT CLAIM TO ANY PARTICULAR FONT, STYLE, SIZE, OR COLOR.

NO CLAIM IS MADE TO THE EXCLUSIVE RIGHT TO USE "CONNECT", APART FROM THE MARK AS SHOWN.

SER. NO. 85-281,843, FILED 3-30-2011.

JOHN SCHUYLER YARD, EXAMINING ATTORNEY



*David J. Kybas*

Director of the United States Patent and Trademark Office

# United States of America

United States Patent and Trademark Office



# R-JetTek

Inkjet Technology Solutions

**Reg. No. 4,124,403**

**Registered Apr. 10, 2012**

**Int. Cl.: 7**

**TRADEMARK**

**PRINCIPAL REGISTER**

TRI-CENTURY CORPORATION (COLORADO CORPORATION), DBA R-JET TEK, INC.  
385 S. 31ST STREET  
COLORADO SPRINGS, CO 80904

FOR: MACHINES FOR REFILLING INKJET CARTRIDGES, IN CLASS 7 (U.S. CLS. 13, 19, 21, 23, 31, 34 AND 35).

FIRST USE 2-20-2011; IN COMMERCE 2-20-2011.

NO CLAIM IS MADE TO THE EXCLUSIVE RIGHT TO USE "INKJET TECHNOLOGY SOLUTIONS", APART FROM THE MARK AS SHOWN.

THE COLOR(S) RED, BLUE, YELLOW, AND BLACK IS/ARE CLAIMED AS A FEATURE OF THE MARK.

THE MARK CONSISTS OF THE LETTERS "R-JETTEK" IN BLACK ABOVE THE WORDS "INKJET TECHNOLOGY SOLUTIONS" IN BLACK AND A CIRCULAR DESIGN, THE TOP ONE-THIRD OF WHICH IS RED, THE RIGHT LOWER ONE-THIRD OF WHICH IS BLUE, AND THE LEFT LOWER ONE-THIRD OF WHICH IS YELLOW.

SER. NO. 85-281,863, FILED 3-30-2011.

LEIGH CAROLINE CASE, EXAMINING ATTORNEY



*David J. Kypos*

Director of the United States Patent and Trademark Office

# United States of America

United States Patent and Trademark Office

## Ô de LANCÔME

**Reg. No. 4,124,404**

**Registered Apr. 10, 2012**

**Int. Cl.: 3**

**TRADEMARK**

**PRINCIPAL REGISTER**

LANCÔME PARFUMS ET BEAUTE & CIE (FRANCE SOCIÉTÉ EN NOM COLLECTIF (SENC))  
29, RUE DU FAUBOURG SAINT-HONORE  
PARIS, FRANCE 75008

FOR: PERFUMES AND TOILET WATER, IN CLASS 3 (U.S. CLS. 1, 4, 6, 50, 51 AND 52).

OWNER OF FRANCE REG. NO. 1396098, DATED 2-26-1987, EXPIRES 2-26-2017.

OWNER OF U.S. REG. NOS. 425,129 AND 3,888,441.

THE MARK CONSISTS OF "O DE LANCÔME" IN A STYLIZED FORMAT WITH A CIRCUM-FLEX ABOVE EACH OF THE LETTER "O'S".

THE ENGLISH TRANSLATION OF "DE" IN THE MARK IS "OF". THE WORDING "LANCÔME" HAS NO MEANING IN A FOREIGN LANGUAGE.

SER. NO. 85-282,016, FILED 3-31-2011.

EDWARD NELSON, EXAMINING ATTORNEY



*David J. Kybas*

Director of the United States Patent and Trademark Office

# United States of America

United States Patent and Trademark Office



**Reg. No. 4,124,405**

**Registered Apr. 10, 2012**

**Int. Cl.: 30**

**TRADEMARK**

**PRINCIPAL REGISTER**

NEW YORK FROZEN FOODS, INC. (OHIO CORPORATION)  
37 WEST BROAD STREET  
COLUMBUS, OH 43215

FOR: FROZEN BREADS, IN CLASS 30 (U.S. CL. 46).

FIRST USE 10-0-2006; IN COMMERCE 10-0-2006.

OWNER OF U.S. REG. NO. 2,702,151.

THE COLOR(S) GREEN, WHITE, RED, YELLOW, BLACK AND GRAY IS/ARE CLAIMED AS A FEATURE OF THE MARK.

NO CLAIM IS MADE TO THE EXCLUSIVE RIGHT TO USE "BRAND", APART FROM THE MARK AS SHOWN.

THE MARK CONSISTS OF THE WORDS "NEW YORK BRAND", WITH NEW YORK BEING IN YELLOW LETTERING OUTLINED IN BLACK WITH GRAY SHADING IN FRONT OF A GREEN, WHITE AND RED STRIPED, ARCED RIBBON THAT IS BORDERED BY BLACK WITH GRAY SHADING, WITH THE WORDING "BRAND" IN BLACK LETTERING ON THE WHITE PORTION OF THE RIBBON AND TO THE RIGHT OF THE WORDING "NEW YORK".

SER. NO. 85-282,108, FILED 3-31-2011.

SUZANNE BLANE, EXAMINING ATTORNEY



*David J. Kybas*

Director of the United States Patent and Trademark Office



# United States of America

United States Patent and Trademark Office



**Reg. No. 4,124,406**

BUCHANAN COUNTY SCHOOL BOARD (VIRGINIA CORPORATION)  
P.O. BOX 833  
GRUNDY, VA 24614

**Registered Apr. 10, 2012**

**Int. Cl.: 25**

FOR: CLOTHING, NAMELY, T-SHIRTS; CLOTHING, NAMELY, HATS, VISORS, SWEAT-SHIRTS, SHIRTS, SWEATPANTS, POLO SHIRTS, BUTTON DOWN SHIRTS, SHORTS, JACKETS, COATS, SOCKS, HEADBANDS, GLOVES AND SCARVES, IN CLASS 25 (U.S. CLS. 22 AND 39).

**TRADEMARK**

**PRINCIPAL REGISTER**

FIRST USE 0-0-2004; IN COMMERCE 0-0-2004.

THE MARK CONSISTS OF A STYLIZED LETTER "G" WITH THE DESIGN OF A WAVE ON TOP.

SER. NO. 85-282,179, FILED 3-31-2011.

KEVIN CORWIN, EXAMINING ATTORNEY



*David J. Kybas*

Director of the United States Patent and Trademark Office

# United States of America

United States Patent and Trademark Office



**Reg. No. 4,124,407**

**Registered Apr. 10, 2012**

**Int. Cl.: 31**

**TRADEMARK**

**PRINCIPAL REGISTER**

THE BEAR & THE RAT: COOL TREATS FOR DOGS, LLC (COLORADO LIMITED LIABILITY COMPANY)  
4841 ALCOTT STREET  
DENVER, CO 80221

FOR: DOG FOOD; DOG TREATS, IN CLASS 31 (U.S. CLS. 1 AND 46).

FIRST USE 6-16-2010; IN COMMERCE 3-31-2011.

THE MARK CONSISTS OF CARICATURES OF TWO DOGS HIGH-FIVING, OR TOUCHING PAWS, BETWEEN THEM. THE DOG ON THE LEFT RESEMBLES A LHASA APSO WITH BLACK EARS, A BLACK PATCH ON HIS HEAD, A BLACK TAIL AND BLACK PAWS. HIS FACE IS SQUARE AND HIS EYES ARE OVAL. THE DOG ON THE RIGHT RESEMBLES A RAT TERRIER WITH BLACK EARS, A BLACK TAIL AND WHITE PAWS. HIS FACE IS ROUND, AND HIS EYES ARE OVAL-SHAPED. THE PHRASE "THE BEAR & THE RAT" ARE DIRECTLY BENEATH AND CENTERED UNDER THE DOGS IN KAVALERKURSIVE FONT. THE PHRASE "COOLTREATSFORDOGS.COM" IS BENEATH THE PHRASE "THE BEAR & THE RAT" IN SMALLER, PRINT-TYPE FONT.

SER. NO. 85-282,297, FILED 3-31-2011.

ANNE FARRELL, EXAMINING ATTORNEY



*David J. Kyros*

Director of the United States Patent and Trademark Office

# United States of America

United States Patent and Trademark Office

# ALMEX

**Reg. No. 4,124,408**

**Registered Apr. 10, 2012**

**Int. Cl.: 39**

**SERVICE MARK**

**PRINCIPAL REGISTER**

AUTOLINEAS MEXICANAS, S.A. DE C.V. (MEXICO CORPORATION)  
AVENIDA GUERRERO 3530 NTE. COL.DEL NORTE  
MONTERREY, NUEVO LEON, MEXICO 64500 AND

LOGISTICA ALM, S.A. DE C.V. (MEXICO CORPORATION)  
7305 SAN DARIO AVE.  
SUITE 202  
LAREDO, TX 78045

FOR: FREIGHT TRANSPORTATION AND HAULING BY TRUCK; CARGO LOADING AND UNLOADING, IN CLASS 39 (U.S. CLS. 100 AND 105).

FIRST USE 6-3-1996; IN COMMERCE 6-3-1996.

THE MARK CONSISTS OF STANDARD CHARACTERS WITHOUT CLAIM TO ANY PARTICULAR FONT, STYLE, SIZE, OR COLOR.

SER. NO. 85-282,570, FILED 3-31-2011.

LEIGH CAROLINE CASE, EXAMINING ATTORNEY



*David J. Kyfos*

Director of the United States Patent and Trademark Office

# United States of America

United States Patent and Trademark Office



**Reg. No. 4,124,409**

**Registered Apr. 10, 2012**

**Int. Cl.: 39**

**SERVICE MARK**

**PRINCIPAL REGISTER**

AUTOLINEAS MEXICANAS, S.A. DE C.V. (MEXICO CORPORATION)  
AVENIDA GUERRERO 3530 NTE. COL.DEL NORTE  
MONTERREY, NUEVO LEON, MEXICO 64500 AND

LOGISTICA ALM, S.A. DE C.V. (MEXICO CORPORATION)  
7305 SAN DARIO AVE.  
SUITE 202  
LAREDO, TX 78045

FOR: FREIGHT TRANSPORTATION AND HAULING BY TRUCK; CARGO LOADING AND UNLOADING, IN CLASS 39 (U.S. CLS. 100 AND 105).

FIRST USE 6-3-1996; IN COMMERCE 6-3-1996.

THE MARK CONSISTS OF THE WORD "ALMEX" TOUCHING A STYLIZED EAGLE'S HEAD SET INTO A CIRCLE WITH THREE CURVED STRIPES FORMING HIGHWAY LANES. THESE LANES CONNECT TO BECOME THE LOWER PORTION OF THE EAGLE'S BEAK.

SER. NO. 85-282,595, FILED 3-31-2011.

LEIGH CAROLINE CASE, EXAMINING ATTORNEY



*David J. Kybas*

Director of the United States Patent and Trademark Office

# United States of America

United States Patent and Trademark Office



**Reg. No. 4,124,410**

SYNERGY SOLUTIONS, INC. (NORTH CAROLINA CORPORATION)  
210 JOSEPH POND LANE  
CARY, NC 27519

**Registered Apr. 10, 2012**

**Int. Cl.: 42**

FOR: SOFTWARE DEVELOPMENT CONSULTING IN THE FIELD OF DATA WAREHOUSING, REPORTING, DATA ANALYSIS, STATISTICAL ANALYSIS, PERFORMANCE MANAGEMENT, DASH BOARD, BUSINESS INTELLIGENCE AND BUSINESS ANALYTICS, IN CLASS 42 (U.S. CLS. 100 AND 101).

**SERVICE MARK**

**PRINCIPAL REGISTER**

FIRST USE 4-9-2002; IN COMMERCE 4-9-2002.

NO CLAIM IS MADE TO THE EXCLUSIVE RIGHT TO USE "REPORTING", APART FROM THE MARK AS SHOWN.

THE COLOR(S) ORANGE, LIGHT GRAY, DARK GRAY, BLACK, WHITE IS/ARE CLAIMED AS A FEATURE OF THE MARK.

THE MARK CONSISTS OF AN ORANGE ARC STARTING AT THE TOP LEFT CORNER THAT IS THICKER AT THE BEGINNING AND TAPERS TO A THIN LINE AT THE END. UNDER THE ORANGE ARC IS ANOTHER SIMILAR ARC WHICH IS LIGHT GRAY AT THE BEGINNING AND DARK GRAY AT THE END. UNDER THE TWO ARCS ARE THE WORDS "REPORTING HOUSE." THE COLOR OF THE LETTERS "R", "E", "P", "R", "T", "I", "N", "G" ARE BLACK. THE LETTER "O" IS REPRESENTED BY AN ORANGE SPHERE WITH WHITE LIGHT REFLECTION AND THE SHADOW OF THE SPHERE UNDERNEATH IT WHICH IS LIGHT GRAY IN COLOR. THE COLOR OF THE LETTERS "H", "U", "S", "E" ARE BLACK. THE LETTER "O" IS REPRESENTED BY AN ORANGE SPHERE WITH WHITE LIGHT REFLECTION AND THE SHADOW OF THE SPHERE UNDERNEATH IT WHICH IS LIGHT GRAY IN COLOR. BELOW THIS ARE THE WORDS "LEVERAGE ON ANALYTICS" IN ORANGE COLOR.



SER. NO. 85-282,597, FILED 3-31-2011.

LESLIE RICHARDS, EXAMINING ATTORNEY

*David J. Kyjars*

Director of the United States Patent and Trademark Office

# United States of America

United States Patent and Trademark Office



**Reg. No. 4,124,411**

**Registered Apr. 10, 2012**

**Int. Cl.: 9**

**TRADEMARK**

**PRINCIPAL REGISTER**

SOQUE HOLDINGS (BERMUDA) LTD. (BERMUDA LIMITED COMPANY (LTD.))  
41 CEDER AVENUE  
HAMILTON, BERMUDA

FOR: COMPUTER PERIPHERALS, NAMELY, SCANNERS; COMPUTER SOFTWARE FOR USE IN SENDING AND RETRIEVING DOCUMENTS VIA ELECTRONIC MAIL AND ELECTRONIC FAX, AND FOR WORD PROCESSING, EDITING AND PRINTING OF DOCUMENTS, IN CLASS 9 (U.S. CLS. 21, 23, 26, 36 AND 38).

FIRST USE 1-19-1994; IN COMMERCE 2-11-1994.

OWNER OF U.S. REG. NOS. 2,129,198, 3,332,100 AND OTHERS.

THE MARK CONSISTS OF THE LETTER "V" CONTAINING A STYLIZED EYE IN THE FORM OF A DOT WITH AN ARCH ABOVE, AND THE WORD "VISIONEER" ADJACENT TO THE DESIGN.

SER. NO. 85-282,610, FILED 3-31-2011.

WILLIAM VERHOSEK, EXAMINING ATTORNEY



*David J. Kyffers*

Director of the United States Patent and Trademark Office

# United States of America

United States Patent and Trademark Office

# MeetingOne

**Reg. No. 4,124,412**

**Registered Apr. 10, 2012**

**Int. Cl.: 38**

**SERVICE MARK**

**PRINCIPAL REGISTER**

MEETINGONE.COM CORP. (COLORADO CORPORATION), DBA MEETINGONE  
SUITE 1000  
501 SOUTH CHERRY STREET  
DENVER, CO 80246

FOR: TELECOMMUNICATIONS, NAMELY, VIDEO, DATA, AND TELEPHONY CONFERENCING SERVICES CONSISTING OF TELECONFERENCING SERVICES, VIDEO CONFERENCING SERVICES, AND WEB CONFERENCING SERVICES, IN CLASS 38 (U.S. CLS. 100, 101 AND 104).

FIRST USE 10-10-1999; IN COMMERCE 10-10-1999.

THE MARK CONSISTS OF STANDARD CHARACTERS WITHOUT CLAIM TO ANY PARTICULAR FONT, STYLE, SIZE, OR COLOR.

SER. NO. 85-282,815, FILED 3-31-2011.

STEVEN PEREZ, EXAMINING ATTORNEY



*David J. Kyffers*

Director of the United States Patent and Trademark Office

# United States of America

United States Patent and Trademark Office

## BELLA VICTORIA'S GOURMET DESSERTS

**Reg. No. 4,124,413**

**Registered Apr. 10, 2012**

**Int. Cl.: 30**

**TRADEMARK**

**PRINCIPAL REGISTER**

ASTERI OF NY INC. (NEW YORK CORPORATION)  
51 COURT STREET  
WHITE PLAINS, NY 10601

FOR: BAKERY DESSERTS, IN CLASS 30 (U.S. CL. 46).

FIRST USE 11-12-2010; IN COMMERCE 11-12-2010.

THE MARK CONSISTS OF STANDARD CHARACTERS WITHOUT CLAIM TO ANY PARTICULAR FONT, STYLE, SIZE, OR COLOR.

NO CLAIM IS MADE TO THE EXCLUSIVE RIGHT TO USE "GOURMET DESSERTS", APART FROM THE MARK AS SHOWN.

THE NAME "BELLA VICTORIA" DOES NOT IDENTIFY A LIVING INDIVIDUAL.

SER. NO. 85-282,896, FILED 3-31-2011.

JAMES A. RAUEN, EXAMINING ATTORNEY



*David J. Kyffers*

Director of the United States Patent and Trademark Office



# United States of America

United States Patent and Trademark Office

# AudioOne

**Reg. No. 4,124,414**

**Registered Apr. 10, 2012**

**Int. Cl.: 38**

**SERVICE MARK**

**PRINCIPAL REGISTER**

MEETINGONE.COM CORP. (COLORADO CORPORATION), DBA MEETINGONE  
SUITE 1000  
501 SOUTH CHERRY STREET  
DENVER, CO 80246

FOR: TELECOMMUNICATIONS, NAMELY, VIDEO, DATA, AND TELEPHONY CONFERENCING SERVICES CONSISTING OF TELECONFERENCING SERVICES, VIDEO CONFERENCING SERVICES, AND WEB CONFERENCING SERVICES, IN CLASS 38 (U.S. CLS. 100, 101 AND 104).

FIRST USE 4-1-2008; IN COMMERCE 4-1-2008.

THE MARK CONSISTS OF STANDARD CHARACTERS WITHOUT CLAIM TO ANY PARTICULAR FONT, STYLE, SIZE, OR COLOR.

SER. NO. 85-283,032, FILED 3-31-2011.

STEVEN PEREZ, EXAMINING ATTORNEY



*David J. Kyffers*

Director of the United States Patent and Trademark Office

# United States of America

United States Patent and Trademark Office

## Positive Striving

**Reg. No. 4,124,415**

SHAAIM FAMILY LLC (NEW YORK LIMITED LIABILITY COMPANY)  
819 MARCY AVE.

**Registered Apr. 10, 2012**

BROOKLYN, NY 11216

**Int. Cl.: 41**

FOR: EDUCATION SERVICES, NAMELY, PROVIDING KINDERGARTEN THROUGH 12TH GRADE (K-12) CLASSROOM INSTRUCTION, IN CLASS 41 (U.S. CLS. 100, 101 AND 107).

**SERVICE MARK**

FIRST USE 9-1-2009; IN COMMERCE 9-1-2009.

**PRINCIPAL REGISTER**

THE MARK CONSISTS OF STANDARD CHARACTERS WITHOUT CLAIM TO ANY PARTICULAR FONT, STYLE, SIZE, OR COLOR.

SER. NO. 85-283,333, FILED 4-1-2011.

COLLEEN KEARNEY, EXAMINING ATTORNEY



*David J. Kybas*

Director of the United States Patent and Trademark Office

# United States of America

United States Patent and Trademark Office

... WE HAVE YOU COVERED

**Reg. No. 4,124,416**

**Registered Apr. 10, 2012**

**Int. Cl.: 35**

**SERVICE MARK**

**PRINCIPAL REGISTER**

CANOPY MEDICAL STAFFING LLC (TEXAS LIMITED LIABILITY COMPANY)  
SUITE 1100  
2828 N. HARWOOD STREET  
DALLAS, TX 75201

FOR: EMPLOYMENT HIRING, RECRUITING, PLACEMENT, STAFFING AND CAREER NETWORKING SERVICES; EMPLOYMENT STAFFING IN THE FIELD OF MEDICAL; PROFESSIONAL STAFFING AND RECRUITING SERVICES, IN CLASS 35 (U.S. CLS. 100, 101 AND 102).

FIRST USE 2-15-2011; IN COMMERCE 2-15-2011.

THE MARK CONSISTS OF STANDARD CHARACTERS WITHOUT CLAIM TO ANY PARTICULAR FONT, STYLE, SIZE, OR COLOR.

SER. NO. 85-283,594, FILED 4-1-2011.

MARGARET POWER, EXAMINING ATTORNEY



*David J. Kybas*

Director of the United States Patent and Trademark Office

# United States of America

United States Patent and Trademark Office

## BLUE CLOUD

**Reg. No. 4,124,417**

BLUECLOUD MINERAL CO., INC. (CALIFORNIA CORPORATION)  
25375 ORCHARD VILLAGE ROAD, SUITE 105  
VALENCIA, CA 91355

**Registered Apr. 10, 2012**

**Int. Cl.: 1**

FOR: CRUSHED MINERALS, NAMELY, VOLCANIC MINERALS IN STONE OR POWDERED FORM FOR USE IN ANIMAL FUR, FEATHERS AND HAIR BATH, ANIMAL LITTER, POTTING SOIL, AND PET CHEWS; POTTING SOIL MADE FROM CRUSHED MINERALS IN STONE OR POWDER FORM, IN CLASS 1 (U.S. CLS. 1, 5, 6, 10, 26 AND 46).

**TRADEMARK**

**PRINCIPAL REGISTER**

FIRST USE 1-0-1950; IN COMMERCE 1-0-1950.

THE MARK CONSISTS OF STANDARD CHARACTERS WITHOUT CLAIM TO ANY PARTICULAR FONT, STYLE, SIZE, OR COLOR.

SER. NO. 85-283,763, FILED 4-1-2011.

EUGENIA MARTIN, EXAMINING ATTORNEY



*David J. Kyffers*

Director of the United States Patent and Trademark Office

# United States of America

United States Patent and Trademark Office

# 1996

**Reg. No. 4,124,418**

**Registered Apr. 10, 2012**

**Int. Cl.: 8**

**TRADEMARK**

**PRINCIPAL REGISTER**

STANLEY LOGISTICS, L.L.C. (DELAWARE LIMITED LIABILITY COMPANY)  
1000 STANLEY DRIVE  
NEW BRITAIN, CT 06053

FOR: BLADES FOR UTILITY KNIVES, IN CLASS 8 (U.S. CLS. 23, 28 AND 44).

FIRST USE 12-31-1996; IN COMMERCE 12-31-1996.

THE MARK CONSISTS OF STANDARD CHARACTERS WITHOUT CLAIM TO ANY PARTICULAR FONT, STYLE, SIZE, OR COLOR.

OWNER OF U.S. REG. NOS. 1,170,953, 1,236,066, AND 1,248,826.

SEC. 2(F).

SER. NO. 85-284,033, FILED 4-1-2011.

RON FAIRBANKS, EXAMINING ATTORNEY



*David J. Kybas*

Director of the United States Patent and Trademark Office

# United States of America

United States Patent and Trademark Office

## INVESTING IN SOCIAL RESPONSIBILITY

**Reg. No. 4,124,419**

**Registered Apr. 10, 2012**

**Int. Cl.: 41**

**SERVICE MARK**

**PRINCIPAL REGISTER**

UNION BANK, NATIONAL ASSOCIATION (UNITED STATES NATIONAL BANKING  
ASSOCIATION)  
400 CALIFORNIA STREET  
SAN FRANCISCO, CA 94104

FOR: PROVIDING ON-LINE NEWSLETTERS IN THE FIELD OF BANKING SERVICES, IN  
CLASS 41 (U.S. CLS. 100, 101 AND 107).

FIRST USE 9-0-2010; IN COMMERCE 9-0-2010.

THE MARK CONSISTS OF STANDARD CHARACTERS WITHOUT CLAIM TO ANY PAR-  
TICULAR FONT, STYLE, SIZE, OR COLOR.

SER. NO. 85-284,412, FILED 4-1-2011.

ANDREA BUTLER, EXAMINING ATTORNEY



*David J. Kybas*

Director of the United States Patent and Trademark Office

# United States of America

United States Patent and Trademark Office

## I NEED AN ELF

**Reg. No. 4,124,420**

AUDREY SHAPIRO, INC. (NEW YORK CORPORATION)  
2821 BELLMORE AVENUE  
BELLMORE, NY 11710

**Registered Apr. 10, 2012**

**Int. Cl.: 45**

FOR: PROVIDING NON-MEDICAL PERSONAL ASSISTANT SERVICES FOR OTHERS IN THE NATURE OF PLANNING, ORGANIZING, COORDINATING, ARRANGING AND ASSISTING INDIVIDUALS IN THE PERFORMANCE OF DAILY TASKS, IN CLASS 45 (U.S. CLS. 100 AND 101).

**SERVICE MARK**

**PRINCIPAL REGISTER**

FIRST USE 1-29-2011; IN COMMERCE 1-29-2011.

THE MARK CONSISTS OF STANDARD CHARACTERS WITHOUT CLAIM TO ANY PARTICULAR FONT, STYLE, SIZE, OR COLOR.

SER. NO. 85-284,595, FILED 4-2-2011.

DORITT L. CARROLL, EXAMINING ATTORNEY



*David J. Kybas*

Director of the United States Patent and Trademark Office

# United States of America

United States Patent and Trademark Office

# Black Frog

**Reg. No. 4,124,421**

HOFFMAN, TODD C. (UNITED STATES INDIVIDUAL)  
1409 83RD STREET  
KENOSHA, WI 53143 AND

**Registered Apr. 10, 2012**

**Int. Cl.: 41**

KLASSEN, ERIC D. (UNITED STATES INDIVIDUAL)  
3410 NORTH NEWHALL STREET  
MILWAUKEE, WI 53211

**SERVICE MARK**

**PRINCIPAL REGISTER**

FOR: ENTERTAINMENT IN THE NATURE OF LIVE PERFORMANCES BY A MUSICAL GROUP; MUSIC PRODUCTION SERVICES; ENTERTAINMENT IN THE NATURE OF LIVE MUSIC SHOWS, IN CLASS 41 (U.S. CLS. 100, 101 AND 107).

FIRST USE 6-1-2001; IN COMMERCE 6-1-2001.

THE MARK CONSISTS OF STANDARD CHARACTERS WITHOUT CLAIM TO ANY PARTICULAR FONT, STYLE, SIZE, OR COLOR.

OWNER OF U.S. REG. NO. 2,862,852.

SER. NO. 85-284,896, FILED 4-4-2011.

NORA BUCHANAN WILL, EXAMINING ATTORNEY



*David J. Kybas*

Director of the United States Patent and Trademark Office



# United States of America

United States Patent and Trademark Office

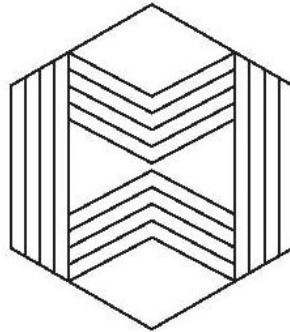

**Reg. No. 4,124,422**

**Registered Apr. 10, 2012**

**Int. Cl.: 18**

**TRADEMARK**

**PRINCIPAL REGISTER**

KOTUR LIMITED (HONG KONG LIMITED COMPANY (LTD.))  
NO. 38 LOK KU ROAD  
UNITS 101-102, 10 A&B, CASEY BUILDING  
SHEUNG WAN, HONG KONG

FOR: CARRY-ALL BAGS, HANDBAGS, TOTE BAGS, PURSES, WALLETS, TRAVELING BAGS, SUITCASES AND LUGGAGE, UMBRELLAS, CLUTCH BAGS, SACHELS, KEY CASES, SHOULDER BAGS, EVENING PURSES, VANITY CASES SOLD EMPTY, IN CLASS 18 (U.S. CLS. 1, 2, 3, 22 AND 41).

PRIORITY CLAIMED UNDER SEC. 44(D) ON HONG KONG APPLICATION NO. 301867960, FILED 3-24-2011, REG. NO. 301867960, DATED 3-24-2011, EXPIRES 3-24-2021.

THE MARK CONSISTS OF STYLIZED LETTERS "M" AND AN UPSIDE DOWN "M", BOTH LETTERS CONSISTING OF FOUR THICK LINES SHARING THE SAME VERTICAL OUTER LINES, ALL EMBEDDED INTO A HEXAGON.

SER. NO. 85-285,087, FILED 4-4-2011.

SUSAN RICHARDS, EXAMINING ATTORNEY



*David J. Kyffers*

Director of the United States Patent and Trademark Office

# United States of America

United States Patent and Trademark Office



**Reg. No. 4,124,423**

**Registered Apr. 10, 2012**

**Int. Cl.: 43**

**SERVICE MARK**

**PRINCIPAL REGISTER**

MATTHEW ABRAMCYK (UNITED STATES INDIVIDUAL)  
C/O WARREN 77 BAR  
77 WARREN STREET  
NEW YORK, NY 10007

FOR: COCKTAIL LOUNGE SERVICES; RESTAURANT AND BAR SERVICES, IN CLASS 43 (U.S. CLS. 100 AND 101).

FIRST USE 6-30-2009; IN COMMERCE 6-30-2009.

THE MARK CONSISTS OF THE WORD "WARREN" IN ALL CAPITAL LETTERS FANCIFULLY WRITTEN AND CENTERED ABOVE TWO FANCIFUL DEPICTIONS OF THE NUMBER "77", EACH NUMERAL APPEARING AS WHITE NUMBERS IN A BLACK RECTANGLE, AS IF PAINTED ON AN OLD FASHIONED SCOREBOARD OR ON A SPORTS JERSEY, THE LETTERS AND NUMBERS BEING DELIBERATELY SLIGHTLY INCOMPLETE AS IF HAND STAMPED OR PAINTED.

SER. NO. 85-285,169, FILED 4-4-2011.

RUDY R. SINGLETON, EXAMINING ATTORNEY



*David J. Kybas*

Director of the United States Patent and Trademark Office

# United States of America

United States Patent and Trademark Office

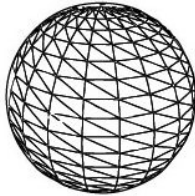

**PANGEA**  
LIFE ESSENTIALS

**Reg. No. 4,124,424**

**Registered Apr. 10, 2012**

**Int. Cl.: 14**

**TRADEMARK**

**PRINCIPAL REGISTER**

TESFAYE, MICHAEL (UNITED STATES INDIVIDUAL)  
6058 METROPOLITAN PLAZA, UNIT 1760  
LOS ANGELES, CA 90036

FOR: BODY JEWELRY; BRACELETS; CHARMS; DIAMOND JEWELRY; GEMSTONE JEWELRY; GOLD THREAD JEWELRY; JEWELRY; JEWELRY AND IMITATION JEWELRY; JEWELRY CASES; JEWELRY CHAINS; JEWELRY IN THE NATURE OF ARMBANDS; JEWELRY, NAMELY, AMULETS; JEWELRY, NAMELY, ANKLETS; JEWELRY, NAMELY, ARM CUFFS; JEWELRY, NAMELY, STONE PENDANTS; STAINLESS STEEL JEWELRY BRACELETS; WOMEN'S JEWELRY, IN CLASS 14 (U.S. CLS. 2, 27, 28 AND 50).

FIRST USE 3-1-2011; IN COMMERCE 3-1-2011.

THE MARK CONSISTS OF 3 DIMENSIONAL GLOBE WITH LATITUDE AND LONGITUDINAL MARKS CROSSED WITH DIAGONAL LINES ABOVE THE COMPANY NAME SPELLED OUT AS "PANGEA LIFE ESSENTIALS".

SER. NO. 85-285,206, FILED 4-4-2011.

ELIZABETH KAJUBI, EXAMINING ATTORNEY



*David J. Kyffers*

Director of the United States Patent and Trademark Office

# United States of America

United States Patent and Trademark Office

# Little Guy

**Reg. No. 4,124,425**

**Registered Apr. 10, 2012**

**Int. Cl.: 41**

**SERVICE MARK**

**PRINCIPAL REGISTER**

NEFF, SCOTT, D (UNITED STATES INDIVIDUAL), AKA LITTLE GUY  
4211 SEBALD AVE  
WWW.INFOJUSTICE.COM  
REDONDO BEACH, CA 90278

FOR: PROVIDING A WEBSITE FEATURING BLOGS AND NON-DOWNLOADABLE PUBLICATIONS IN THE NATURE OF ARTICLES IN THE FIELD OF CONSUMER NEWS, CURRENT EVENTS, POLITICS, HEALTH AND THE LAW, IN CLASS 41 (U.S. CLS. 100, 101 AND 107).

FIRST USE 1-1-1996; IN COMMERCE 1-1-1996.

THE MARK CONSISTS OF STANDARD CHARACTERS WITHOUT CLAIM TO ANY PARTICULAR FONT, STYLE, SIZE, OR COLOR.

SER. NO. 85-285,230, FILED 4-4-2011.

MARLENE BELL, EXAMINING ATTORNEY



*David J. Kyffers*

Director of the United States Patent and Trademark Office

# United States of America

United States Patent and Trademark Office



**Reg. No. 4,124,426**

**Registered Apr. 10, 2012**

**Int. Cl.: 41**

**SERVICE MARK**

**PRINCIPAL REGISTER**

CROWNED PRINCESS, LLC (KENTUCKY LIMITED LIABILITY COMPANY), DBA DISTINCT IMPRESSIONS  
16 SHEFFIELD LN  
FRANKFORT, KY 40601

FOR: ENTERTAINMENT IN THE NATURE OF BEAUTY PAGEANTS, IN CLASS 41 (U.S. CLS. 100, 101 AND 107).

FIRST USE 6-1-2010; IN COMMERCE 6-1-2010.

NO CLAIM IS MADE TO THE EXCLUSIVE RIGHT TO USE "CHARM PAGEANT", APART FROM THE MARK AS SHOWN.

THE COLOR(S) PINK AND PURPLE IS/ARE CLAIMED AS A FEATURE OF THE MARK.

THE MARK CONSISTS OF PINK CROWN/TIARA ATOP THE WORDS "CROWNED PRINCESS CHARM PAGEANT" WRITTEN IN PURPLE ALL CAP LETTERS. THERE IS A PINK LINE IN-BETWEEN THE WORDS "CROWNED" AND "PRINCESS" AND A PURPLE AND PINK LINE IN-BETWEEN THE WORDS "PRINCESS AND CHARM PAGEANT".

SER. NO. 85-285,360, FILED 4-4-2011.

SHAUNIA CARLYLE, EXAMINING ATTORNEY



*David J. Kyros*

Director of the United States Patent and Trademark Office

# United States of America

United States Patent and Trademark Office

## Roommate Mixer

**Reg. No. 4,124,427**

**Registered Apr. 10, 2012**

**Int. Cls.: 41 and 45**

**SERVICE MARK**

**PRINCIPAL REGISTER**

ROOMMATE HAPPY HOUR, LLC (NEW YORK LIMITED LIABILITY COMPANY)  
SUITE 5D  
327 E 101ST ST.  
NEW YORK, NY 10029

FOR: ARRANGING AND CONDUCTING SPECIAL EVENTS FOR SOCIAL ENTERTAINMENT PURPOSES, IN CLASS 41 (U.S. CLS. 100, 101 AND 107).

FIRST USE 12-1-2010; IN COMMERCE 12-1-2010.

FOR: ON-LINE SOCIAL NETWORKING SERVICES, IN CLASS 45 (U.S. CLS. 100 AND 101).

FIRST USE 12-1-2010; IN COMMERCE 12-1-2010.

THE MARK CONSISTS OF STANDARD CHARACTERS WITHOUT CLAIM TO ANY PARTICULAR FONT, STYLE, SIZE, OR COLOR.

NO CLAIM IS MADE TO THE EXCLUSIVE RIGHT TO USE "MIXER" FOR INTERNATIONAL CLASS 41, APART FROM THE MARK AS SHOWN.

SER. NO. 85-285,775, FILED 4-4-2011.

SUNG IN, EXAMINING ATTORNEY



*David J. Kyfos*

Director of the United States Patent and Trademark Office

# United States of America

United States Patent and Trademark Office

# BETAR

**Reg. No. 4,124,428**

**Registered Apr. 10, 2012**

**Int. Cl.: 9**

**TRADEMARK**

**PRINCIPAL REGISTER**

KELLY RESEARCH TECHNOLOGIES, INC. (GEORGIA CORPORATION), DBA BETAR USA  
PO BOX 987  
ATHENS, GA 30603

FOR: SOUND THERAPY DEVICES, NAMELY, ELECTRONIC TONE GENERATORS AND SOUND THERAPY SYSTEMS PRIMARILY COMPRISED OF AUDIO SPEAKERS, NAMELY, VIBROACOUSTIC SPEAKER ARRAYS AND ALSO CONTAINING MULTICHANNEL AMPLIFIERS AND SOUND PLAYBACK MACHINES, IN CLASS 9 (U.S. CLS. 21, 23, 26, 36 AND 38).

FIRST USE 7-0-1986; IN COMMERCE 10-0-1987.

THE MARK CONSISTS OF STANDARD CHARACTERS WITHOUT CLAIM TO ANY PARTICULAR FONT, STYLE, SIZE, OR COLOR.

SEC. 2(F).

SER. NO. 85-286,247, FILED 4-5-2011.

SETH A. RAPPAPORT, EXAMINING ATTORNEY



*David J. Kyffers*

Director of the United States Patent and Trademark Office

# United States of America

United States Patent and Trademark Office

# encryptics

**Reg. No. 4,124,429**

**Registered Apr. 10, 2012**

**Int. Cl.: 9**

**TRADEMARK**

**PRINCIPAL REGISTER**

NL SYSTEMS (DELAWARE LIMITED LIABILITY COMPANY)  
SUITE 820  
1111 W. MOCKINGBIRD LANE  
DALLAS, TX 75247

FOR: COMPUTER SOFTWARE FOR ENCRYPTION; COMPUTER SOFTWARE FOR USE IN THE ENCRYPTION AND DECRYPTION OF DIGITAL FILES, INCLUDING AUDIO, VIDEO, TEXT, BINARY, STILL IMAGES, GRAPHICS AND MULTIMEDIA FILES, IN CLASS 9 (U.S. CLS. 21, 23, 26, 36 AND 38).

FIRST USE 11-1-2010; IN COMMERCE 11-1-2010.

THE MARK CONSISTS OF STANDARD CHARACTERS WITHOUT CLAIM TO ANY PARTICULAR FONT, STYLE, SIZE, OR COLOR.

SER. NO. 85-286,770, FILED 4-5-2011.

MATTHEW MCDOWELL, EXAMINING ATTORNEY



*David J. Kybas*

Director of the United States Patent and Trademark Office



# United States of America

United States Patent and Trademark Office

## Chronic AllStars

**Reg. No. 4,124,430**

CHRONIC ALLSTARS (COLORADO LIMITED LIABILITY COMPANY)

**Registered Apr. 10, 2012**

PO BOX 17392  
BOULDER, CO 80308

**Int. Cl.: 25**

FOR: HATS; HOODED SWEAT SHIRTS; LONG-SLEEVED SHIRTS; SHIRTS; SHORTS; TANK TOPS; THONGS; TOPS; UNDERGARMENTS; UNDERWEAR; UNDERWEAR, NAMELY, BOY SHORTS, IN CLASS 25 (U.S. CLS. 22 AND 39).

**TRADEMARK**

FIRST USE 4-1-2011; IN COMMERCE 4-4-2011.

**PRINCIPAL REGISTER**

THE MARK CONSISTS OF STANDARD CHARACTERS WITHOUT CLAIM TO ANY PARTICULAR FONT, STYLE, SIZE, OR COLOR.

SER. NO. 85-286,825, FILED 4-5-2011.

ELIZABETH KAJUBI, EXAMINING ATTORNEY



*David J. Kybas*

Director of the United States Patent and Trademark Office

# United States of America

United States Patent and Trademark Office

# Doodle Divas

**Reg. No. 4,124,431**

**Registered Apr. 10, 2012**

**Int. Cl.: 25**

**TRADEMARK**

**PRINCIPAL REGISTER**

HALL, WALTER STEVEN (UNITED STATES INDIVIDUAL), DBA DOODLE DIVAS  
UNIT 301  
176 BRICKTON VILLAGE CIRCLE  
FLETCHER, NC 28732

FOR: ATHLETIC APPAREL, NAMELY, SHIRTS, PANTS, JACKETS, HATS AND CAPS,  
ATHLETIC UNIFORMS, IN CLASS 25 (U.S. CLS. 22 AND 39).

FIRST USE 3-1-2011; IN COMMERCE 3-1-2011.

THE MARK CONSISTS OF STANDARD CHARACTERS WITHOUT CLAIM TO ANY PAR-  
TICULAR FONT, STYLE, SIZE, OR COLOR.

SER. NO. 85-287,116, FILED 4-5-2011.

JACQUELINE A. LAVINE, EXAMINING ATTORNEY



*David J. Kybas*

Director of the United States Patent and Trademark Office

# United States of America

United States Patent and Trademark Office

## Worlds apart in a world of parts

**Reg. No. 4,124,432**

SCHEMBRI, CRAIG R. (UNITED STATES INDIVIDUAL)  
3981 SW 30TH AVENUE  
FORT LAUDERDALE, FL 33312

**Registered Apr. 10, 2012**

**Int. Cls.: 35 and 37**

FOR: ONLINE RETAIL SERVICES THROUGH DIRECT SOLICITATION BY DISTRIBUTORS DIRECTED TO END-USERS FEATURING COMPUTER HARDWARE; RESELLER SERVICES, NAMELY, DISTRIBUTORSHIP SERVICES IN THE FIELD OF COMPUTER HARDWARE; RETAIL SERVICES THROUGH DIRECT SOLICITATION BY DISTRIBUTORS DIRECTED TO END-USERS FEATURING COMPUTER HARDWARE, IN CLASS 35 (U.S. CLS. 100, 101 AND 102).

**SERVICE MARK**

**PRINCIPAL REGISTER**

FIRST USE 5-4-2004; IN COMMERCE 5-4-2004.

FOR: COMPUTER HARDWARE INSTALLATION AND REPAIR, INCLUDING MOBILE PERFORMANCE OF SUCH SERVICES ON CUSTOMER PREMISES; COMPUTER INSTALLATION AND REPAIR; INSTALLATION AND REPAIR OF COMPUTER HARDWARE; INSTALLATION, MAINTENANCE AND REPAIR OF COMPUTER HARDWARE; INSTALLATION, REPAIR AND MAINTENANCE OF COMPUTERS AND COMPUTER PERIPHERALS; MAINTENANCE AND REPAIR OF COMPUTER HARDWARE; MAINTENANCE AND REPAIR OF COMPUTER NETWORKING HARDWARE; MAINTENANCE AND/OR REPAIR OF COMPUTERS; MAINTENANCE OF COMPUTER HARDWARE; REPAIR OF COMPUTER HARDWARE; REPAIR OF DAMAGED COMPUTERS; TECHNICAL SUPPORT SERVICES, NAMELY, TROUBLESHOOTING IN THE NATURE OF THE REPAIR OF COMPUTER HARDWARE, IN CLASS 37 (U.S. CLS. 100, 103 AND 106).

FIRST USE 5-4-2004; IN COMMERCE 5-4-2004.

THE MARK CONSISTS OF STANDARD CHARACTERS WITHOUT CLAIM TO ANY PARTICULAR FONT, STYLE, SIZE, OR COLOR.

SER. NO. 85-287,336, FILED 4-6-2011.

REBECCA EISINGER, EXAMINING ATTORNEY



*David J. Kyffers*

Director of the United States Patent and Trademark Office

# United States of America

United States Patent and Trademark Office



**Reg. No. 4,124,433**

**Registered Apr. 10, 2012**

**Int. Cls.: 9, 35, 36, 41  
and 42**

**TRADEMARK**

**SERVICE MARK**

**PRINCIPAL REGISTER**

EYEFINITY, INC. (CALIFORNIA CORPORATION), DBA EYEFINITY  
MS163  
3333 QUALITY DRIVE  
RANCHO CORDOVA, CA 95670

FOR: COMPUTER PROGRAMS FOR USE IN OFFICE ACCOUNTING, PRACTICE MANAGEMENT, WORD PROCESSING, AND SCHEDULING BY HEALTH CARE PROFESSIONALS, INCLUDING OPTOMETRISTS, OPHTHALMOLOGISTS AND OPTICIANS, IN CLASS 9 (U.S. CLS. 21, 23, 26, 36 AND 38).

FIRST USE 3-2-2011; IN COMMERCE 3-2-2011.

FOR: WHOLESALE AND RETAIL STORE SERVICES FEATURING EYE HEALTH AND EYE CARE RELATED PRODUCTS; DISSEMINATION OF ADVERTISING FOR OTHERS VIA A GLOBAL COMPUTER NETWORK; BUSINESS MANAGEMENT SERVICES FOR EYE CARE PROVIDERS; BUSINESS MANAGEMENT CONSULTING SERVICE FOR EYE CARE PROVIDERS; PROMOTING THE SALE OF GOODS AND SERVICES OF OTHERS THROUGH THE DISTRIBUTION OF INFORMATION FEATURING MARKET AND PRODUCT DATA TO VENDORS AND SUPPLIERS OF EYE HEALTH AND EYE CARE PRODUCTS AND SERVICES; PERSONNEL PLACEMENT AND RECRUITING SERVICES IN THE FIELD OF EYE HEALTH AND EYE CARE; SCHEDULING BUSINESS APPOINTMENTS FOR OTHERS; SCHEDULING PERSONAL APPOINTMENTS FOR OTHERS, NAMELY, MEDICAL APPOINTMENTS, IN CLASS 35 (U.S. CLS. 100, 101 AND 102).

FIRST USE 3-2-2011; IN COMMERCE 3-2-2011.

FOR: ELECTRONIC PROCESSING OF INSURANCE CLAIMS AND PAYMENT DATA, IN CLASS 36 (U.S. CLS. 100, 101 AND 102).

FIRST USE 3-2-2011; IN COMMERCE 3-2-2011.

FOR: EDUCATIONAL CLASSES SEMINARS AND CONTINUING EDUCATION COURSES IN THE FIELD OF EYE HEALTH AND EYE CARE, PROVIDED DIRECTLY OR BY MEANS OF A GLOBAL COMPUTER NETWORK, IN CLASS 41 (U.S. CLS. 100, 101 AND 107).

FIRST USE 3-2-2011; IN COMMERCE 3-2-2011.



*David J. Kybas*

Director of the United States Patent and Trademark Office

**Reg. No. 4,124,433** FOR: COMPUTER SERVICES, NAMELY, THE DESIGN, IMPLEMENTATION AND HOSTING OF WEB SITES FOR OTHERS ON A COMPUTER SERVER FOR A GLOBAL COMPUTER NETWORK; PROVIDING A WEB SITE FEATURING TECHNOLOGY WHICH ENABLES LABORATORIES TO RECEIVE, PROCESS AND MANAGE PRESCRIPTION INFORMATION FROM DOCTORS' OFFICES, IN CLASS 42 (U.S. CLS. 100 AND 101).

FIRST USE 3-2-2011; IN COMMERCE 3-2-2011.

OWNER OF U.S. REG. NOS. 2,559,899, 2,724,779 AND OTHERS.

THE COLOR(S) BLACK, BLUE AND GREEN IS/ARE CLAIMED AS A FEATURE OF THE MARK.

THE MARK CONSISTS OF THE WORD "EYEFINITY" IN LOWER CASE BLACK LETTERS WITH TWO OVERLAPPING CIRCLES ABOVE THE WORD. THE LEFTMOST CIRCLE IS GREEN AND THE RIGHTMOST CIRCLE IS BLUE.

SER. NO. 85-288,111, FILED 4-6-2011.

JEFFREY LOOK, EXAMINING ATTORNEY

# United States of America

United States Patent and Trademark Office

## CINCINNATI FINANCIAL CORPORATION

**Reg. No. 4,124,434**

**Registered Apr. 10, 2012**

**Int. Cl.: 36**

**SERVICE MARK**

**PRINCIPAL REGISTER**

CINCINNATI FINANCIAL CORPORATION (OHIO CORPORATION)  
6200 S. GILMORE ROAD  
FAIRFIELD, OH 450145141

FOR: INSURANCE SERVICES, NAMELY, PROPERTY AND CASUALTY UNDERWRITING,  
IN CLASS 36 (U.S. CLS. 100, 101 AND 102).

FIRST USE 9-20-1967; IN COMMERCE 9-20-1967.

THE MARK CONSISTS OF STANDARD CHARACTERS WITHOUT CLAIM TO ANY PAR-  
TICULAR FONT, STYLE, SIZE, OR COLOR.

OWNER OF U.S. REG. NO. 2,186,224.

NO CLAIM IS MADE TO THE EXCLUSIVE RIGHT TO USE "FINANCIAL CORPORATION",  
APART FROM THE MARK AS SHOWN.

SEC. 2(F).

SER. NO. 85-288,550, FILED 4-7-2011.

SHANNON TWOHIG, EXAMINING ATTORNEY



*David J. Kyfos*

Director of the United States Patent and Trademark Office

# United States of America

United States Patent and Trademark Office

# LOLLITUPS

**Reg. No. 4,124,435**

DART INDUSTRIES INC. (DELAWARE CORPORATION)  
14901 S. ORANGE BLOSSOM TRAIL  
ORLANDO, FL 32837

**Registered Apr. 10, 2012**

**Int. Cl.: 21**

FOR: PLASTIC STORAGE CONTAINERS AND COVERS THEREFOR FOR HOUSEHOLD OR DOMESTIC USE; PLASTIC CONTAINERS FOR MAKING FROZEN CONFECTIONERIES AND COVERS THEREFOR FOR HOUSEHOLD OR DOMESTIC USE, IN CLASS 21 (U.S. CLS. 2, 13, 23, 29, 30, 33, 40 AND 50).

**TRADEMARK**

**PRINCIPAL REGISTER**

FIRST USE 6-11-2011; IN COMMERCE 6-11-2011.

THE MARK CONSISTS OF STANDARD CHARACTERS WITHOUT CLAIM TO ANY PARTICULAR FONT, STYLE, SIZE, OR COLOR.

OWNER OF U.S. REG. NOS. 633,394, 3,635,000 AND OTHERS.

SER. NO. 85-288,615, FILED 4-7-2011.

JULIE GUTTADAURO, EXAMINING ATTORNEY



*David J. Kyffers*

Director of the United States Patent and Trademark Office

# United States of America

United States Patent and Trademark Office

## THE CINCINNATI SPECIALTY UNDERWRITERS INSURANCE COMPANY

**Reg. No. 4,124,436**

CINCINNATI FINANCIAL CORPORATION (OHIO CORPORATION)  
6200 S. GILMORE ROAD  
FAIRFIELD, OH 450145141

**Registered Apr. 10, 2012**

**Int. Cl.: 36**

FOR: INSURANCE SERVICES, NAMELY, UNDERWRITING EXCESS AND SURPLUS LINES OF PROPERTY AND CASUALTY INSURANCE, IN CLASS 36 (U.S. CLS. 100, 101 AND 102).

**SERVICE MARK**

FIRST USE 11-2-2007; IN COMMERCE 11-2-2007.

**PRINCIPAL REGISTER**

THE MARK CONSISTS OF STANDARD CHARACTERS WITHOUT CLAIM TO ANY PARTICULAR FONT, STYLE, SIZE, OR COLOR.

OWNER OF U.S. REG. NO. 2,186,224.

NO CLAIM IS MADE TO THE EXCLUSIVE RIGHT TO USE "SPECIALTY UNDERWRITERS INSURANCE COMPANY", APART FROM THE MARK AS SHOWN.

SEC. 2(F).

SER. NO. 85-288,774, FILED 4-7-2011.

SHANNON TWOHIG, EXAMINING ATTORNEY



*David J. Kyffers*

Director of the United States Patent and Trademark Office



# United States of America

United States Patent and Trademark Office

## PALM GARDENS

**Reg. No. 4,124,437**

**Registered Apr. 10, 2012**

**Int. Cls.: 29 and 30**

**TRADEMARK**

**PRINCIPAL REGISTER**

PEXIM, INC. (GEORGIA CORPORATION)  
1440 LAKES PARKWAY, SUITE # 400  
LAWRENCEVILLE, GA 30043

FOR: CANNED FRUITS; VEGETABLES, NAMELY, FROZEN AND CANNED VEGETABLES; PICKLES; SPICY PICKLES; PEANUT BUTTER; FRUIT BASED PIE FILLING; AND CANNED COOKED MEAT; MEAT, FISH, POULTRY AND GAME; MEAT EXTRACTS; PRESERVED FRUITS, DRIED AND COOKED FRUITS; JELLIES, JAMS, CRANBERRY SAUCE, APPLE SAUCE; EGGS, MILK AND MILK PRODUCTS EXCLUDING ICE CREAM, ICE MILK AND FROZEN YOGURT; EDIBLE OILS, FROZEN ENTREES CONSISTING PRIMARILY OF MEAT, FISH, POULTRY OR VEGETABLES; FROZEN MEALS CONSISTING PRIMARILY OF MEAT, FROZEN VEGETABLE-BASED ENTREES; CANOLA OIL; COCONUT OIL; COCONUT POWDER; CONDENSED MILK; COOKING OIL; CORN OIL; DAL; DRIED BEANS; DRIED FRUITS; DRIED FRUIT-BASED SNACKS; DRIED LENTILS; EVAPORATED MILK; FALAFEL; FROZEN APPETIZERS CONSISTING PRIMARILY OF CHICKEN OR SEAFOOD; FROZEN PRE-PACKAGED ENTREES CONSISTING PRIMARILY OF SEAFOOD; FRUIT PASTE; FRUIT PULPS; GHEE; GROUND ALMONDS; JAMS AND MARMALADES; JELLIES FOR FOOD; PULSES; SOYBEAN OIL; VEGETABLE OILS; PEANUT OIL; DRIED BLACK EYED PEAS; DRIED GREEN PEAS; PROCESSED BEANS; PROCESSED NUTS; SNACK FOODS, NAMELY, SOY-BASED SNACK FOODS AND CHICK-PEA BASED SNACK FOODS; FROZEN FRUIT AND VEGETABLES; BUTTER; FRUIT PUREE; FROZEN AND PREPARED MEALS CONSISTING PRIMARILY OF MEAT, FISH, POULTRY, OR VEGETABLES; PRESERVED PEAS; PROCESSED CHICK PEAS; PROCESSED BEANS; CANNED TUNA FISH; SARDINES, IN CLASS 29 (U.S. CL. 46).

FIRST USE 1-20-2011; IN COMMERCE 1-20-2011.

FOR: SUGAR; COFFEE; TEA; COCOA; RICE; TAPIOCA; SAGO; ARTIFICIAL COFFEE, NAMELY, COFFEE SUBSTITUTES; FLOUR AND PREPARATIONS MADE FROM CEREALS, NAMELY, BREAKFAST CEREALS, CEREAL BASED SNACK FOODS; READY TO EAT, CEREAL DERIVED FOOD BARS; BREAD, PASTRIES AND CONFECTIONERY ICES, NAMELY, FROZEN YOGURT, ICE CREAM, ICE MILK; TREACLE, YEAST, BAKING POWDER; SALT, MUSTARD; VINEGAR; SAUCES; CONDIMENTS, NAMELY, PICKLED GINGER, PIMIENTO USED AS A CONDIMENT; HOT SAUCE; MAYONNAISE; KETCHUP; SPICES; ICE; MACARONI; FRUIT SAUCES EXCLUDING CRANBERRY SAUCE AND APPLESAUCE; FLOUR; FROZEN CONFECTIONS; EDIBLE ICES; HONEY; PEPPER; SAUCES USED AS CONDIMENTS; SPICES; ICE; SAFFRON FOR USE AS A FOOD SEASONING;



*David J. Kyffers*

Director of the United States Patent and Trademark Office

**Reg. No. 4,124,437** FROZEN ENTREES CONSISTING PRIMARILY OF PASTA OR RICE; FROZEN MEALS CONSISTING PRIMARILY OF PASTA OR RICE; ALLSPICE; BAKERY GOODS; BISCUITS AND BREAD; BREAD AND PASTRY; CAKES; CHILI POWDERS; CHILI SAUCE; CHUTNEY; CURRY PASTES; CURRY POWDER; CUSTARDS; HOT PEPPER POWDER; HOT SAUCE; MASALA POWDER AND SPICES; MEAT TENDERIZERS; PEPPER; PEPPER POWDER; RICE FLOUR; TEA BAGS; VERMICELLI; RICE BASED SNACK FOODS; PROCESSED GRAINS; PROCESSED WHEAT; DESSERTS, NAMELY, BAKERY DESSERTS AND DAIRY BASED DESSERTS, NAMELY, CHILLED OR WARM CAKE OR DUMPLING HAVING A MILK BASED FILLING; SEASONINGS; COOKIES; FROZEN AND PREPARED MEALS CONSISTING PRIMARILY OF PASTA AND RICE; BEAN FLOURS; WAFERS, IN CLASS 30 (U.S. CL. 46).

FIRST USE 1-20-2011; IN COMMERCE 1-20-2011.

THE MARK CONSISTS OF STANDARD CHARACTERS WITHOUT CLAIM TO ANY PARTICULAR FONT, STYLE, SIZE, OR COLOR.

NO CLAIM IS MADE TO THE EXCLUSIVE RIGHT TO USE "PALM", APART FROM THE MARK AS SHOWN.

SER. NO. 85-288,775, FILED 4-7-2011.

KATINA MISTER, EXAMINING ATTORNEY

# United States of America

United States Patent and Trademark Office



**Reg. No. 4,124,438**

**Registered Apr. 10, 2012**

**Int. Cl.: 16**

**TRADEMARK**

**PRINCIPAL REGISTER**

WATERMAN SAS (FRANCE CORPORATION)  
122, AVENUE DU GÉNÉRAL LECLERC  
BOULOGNE-BILLANCOURT, FRANCE 92100

FOR: WRITING INSTRUMENTS; DRAWING INSTRUMENTS; INK FOR WRITING INSTRUMENTS; INK REFILLS FOR WRITING INSTRUMENTS; INK CARTRIDGES FOR WRITING INSTRUMENTS; INK CARTRIDGES FOR DRAWING INSTRUMENTS; INK REFILLS AND INK CARTRIDGES FOR BALL-POINT WRITING DEVICES AND THOSE WITH POROUS TIPS AS WELL AS FOR BALL-POINT FELT PENS; NIBS AND POINTS FOR WRITING INSTRUMENTS; NIBS AND POINTS FOR DRAWING INSTRUMENTS, IN CLASS 16 (U.S. CLS. 2, 5, 22, 23, 29, 37, 38 AND 50).

FIRST USE 12-31-2008; IN COMMERCE 3-1-2009.

OWNER OF U.S. REG. NO. 2,063,450.

THE MARK CONSISTS OF A STYLIZED LETTER "W" WITH A RIBBON-LIKE LOOP EXTENDING FROM THE CENTER OF THE LETTER.

SER. NO. 85-288,969, FILED 4-7-2011.

CORY BOONE, EXAMINING ATTORNEY



*David J. Kybas*

Director of the United States Patent and Trademark Office

# United States of America

United States Patent and Trademark Office

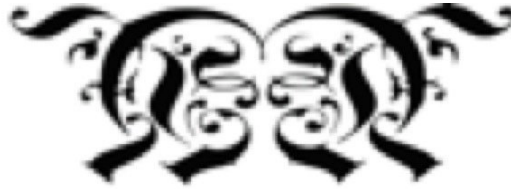

# MUJAE

**Reg. No. 4,124,439**

MUJAE GROUP, INC. (CANADA CORPORATION)  
4325 STEELES AVE. WEST, SUITE 913  
TORONTO, ONTARIO, CANADA M3N1V7

**Registered Apr. 10, 2012**

**Int. Cl.: 18**

FOR: BRIEFCASES; DUFFEL BAGS; FASHION HANDBAGS; GENTLEMEN'S HANDBAGS;  
LEATHER AND IMITATION LEATHER BAGS; LEATHER CASES; LEATHER HANDBAGS;  
MESSENGER BAGS; OVERNIGHT BAGS; POUCHES MADE FROM IMITATION LEATHER,  
IN CLASS 18 (U.S. CLS. 1, 2, 3, 22 AND 41).

**TRADEMARK**

**PRINCIPAL REGISTER**

FIRST USE 3-4-2011; IN COMMERCE 3-4-2011.

THE MARK CONSISTS OF THE WORDING "MUJAE" & AN "M" RIBBON DESIGN.

THE WORDING "MUJAE" HAS NO MEANING IN A FOREIGN LANGUAGE.

SER. NO. 85-289,157, FILED 4-7-2011.

TINA MAI, EXAMINING ATTORNEY



*David J. Kyffers*

Director of the United States Patent and Trademark Office

# United States of America

United States Patent and Trademark Office

## THE UNIVERSAL CHURCH

**Reg. No. 4,124,440**

THE UNIVERSAL CHURCH (NEW YORK NON-PROFIT CORPORATION)  
247 WALNUT STREET  
NEWARK, NJ 07105

**Registered Apr. 10, 2012**

**Int. Cls.: 16, 25 and 45**

FOR: NEWSLETTERS AND INFORMATIONAL BROCHURES ALL ABOUT RELIGIOUS BELIEFS AND PRACTICES , IN CLASS 16 (U.S. CLS. 2, 5, 22, 23, 29, 37, 38 AND 50).

**TRADEMARK**

FIRST USE 0-0-1987; IN COMMERCE 0-0-1987.

**SERVICE MARK**

FOR: T-SHIRTS DISTRIBUTED IN CONNECTION WITH A RELIGIOUS GROUP, IN CLASS 25 (U.S. CLS. 22 AND 39).

**PRINCIPAL REGISTER**

FIRST USE 0-0-1987; IN COMMERCE 0-0-1987.

FOR: RELIGIOUS COUNSELING AND MINISTERIAL SERVICES, IN CLASS 45 (U.S. CLS. 100 AND 101).

FIRST USE 0-0-1987; IN COMMERCE 0-0-1987.

THE MARK CONSISTS OF STANDARD CHARACTERS WITHOUT CLAIM TO ANY PARTICULAR FONT, STYLE, SIZE, OR COLOR.

OWNER OF U.S. REG. NOS. 3,037,551, 3,040,029, AND 3,930,709.

NO CLAIM IS MADE TO THE EXCLUSIVE RIGHT TO USE "CHURCH", APART FROM THE MARK AS SHOWN.

SEC. 2(F).

SER. NO. 85-289,166, FILED 4-7-2011.

JEFFREY LOOK, EXAMINING ATTORNEY



*David J. Kybas*

Director of the United States Patent and Trademark Office

# United States of America

United States Patent and Trademark Office



## Prince Institute

**Reg. No. 4,124,441**

STENOGRAPH, L.L.C. (DELAWARE LIMITED LIABILITY COMPANY)

**Registered Apr. 10, 2012**

596 W. LAMONT ROAD  
ELMHURST, IL 60126

**Int. Cl.: 41**

FOR: PROVIDING COURSES OF INSTRUCTION AT THE POST HIGH SCHOOL OR POST HIGH SCHOOL EQUIVALENCY TEST LEVEL, IN CLASS 41 (U.S. CLS. 100, 101 AND 107).

**SERVICE MARK**

FIRST USE 8-27-2010; IN COMMERCE 9-15-2010.

**PRINCIPAL REGISTER**

NO CLAIM IS MADE TO THE EXCLUSIVE RIGHT TO USE "INSTITUTE", APART FROM THE MARK AS SHOWN.

THE COLOR(S) BLACK, WHITE, BLUE, AND PURPLE IS/ARE CLAIMED AS A FEATURE OF THE MARK.

THE MARK CONSISTS OF A CREST IN SHADES OF BLUE AND PURPLE WITH A THREE POINTED CROWN IN WHITE ON TOP, WITH THIS UNITARY DESIGN BEING TO THE LEFT SIDE OF THE FOLLOWING BLACK TEXT: "PRINCE INSTITUTE".

SER. NO. 85-289,190, FILED 4-7-2011.

KARANENDRA S. CHHINA, EXAMINING ATTORNEY



*David J. Kybas*

Director of the United States Patent and Trademark Office

# United States of America

United States Patent and Trademark Office

# YOGIIZA

**Reg. No. 4,124,442**

**Registered Apr. 10, 2012**

**Int. Cls.: 25 and 41**

**TRADEMARK**

**SERVICE MARK**

**PRINCIPAL REGISTER**

OLIVER, MARK THOMAS (UNITED STATES INDIVIDUAL)  
1500 BAY ROAD  
#1408  
MIAMI BEACH, FL 33139

FOR: CLOTHING, NAMELY, PANTS, SHORTS, T-SHIRTS, SHORTS, TANK TOPS, SPORTS BRAS, BRAS, UNDERWEAR, SWEATSHIRTS, HOODED SWEATSHIRTS, JACKETS, COATS, HATS, TIGHTS, SOCKS, HEADBANDS, WRAPS, IN CLASS 25 (U.S. CLS. 22 AND 39).

FIRST USE 4-27-2011; IN COMMERCE 4-27-2011.

FOR: EDUCATIONAL SERVICES, NAMELY, DEVELOPING AND CONDUCTING RETREATS IN THE FIELD OF YOGA; INSTRUCTION AND CONSULTATION IN THE FIELD OF YOGA, IN CLASS 41 (U.S. CLS. 100, 101 AND 107).

FIRST USE 5-31-2011; IN COMMERCE 5-31-2011.

THE MARK CONSISTS OF STANDARD CHARACTERS WITHOUT CLAIM TO ANY PARTICULAR FONT, STYLE, SIZE, OR COLOR.

THE WORD(S) "YOGIIZA" HAS NO MEANING IN A FOREIGN LANGUAGE.

SER. NO. 85-289,330, FILED 4-7-2011.

TINA L. SNAPP, EXAMINING ATTORNEY



*David J. Kybas*

Director of the United States Patent and Trademark Office

# United States of America

United States Patent and Trademark Office

## INTELLIGENT DECISIONS

**Reg. No. 4,124,443**

INTELLIGENT DECISIONS, INC. (VIRGINIA CORPORATION)  
21445 BEAUMEADE CIRCLE  
ASHBURN, VA 20147

**Registered Apr. 10, 2012**

**Int. Cls.: 35, 37 and 42**

FOR: ONLINE RETAIL AND WHOLESALE STORE SERVICES FEATURING INFORMATION TECHNOLOGY AND COMPUTER HARDWARE, IN CLASS 35 (U.S. CLS. 100, 101 AND 102).

**SERVICE MARK**

FIRST USE 12-31-1988; IN COMMERCE 10-20-2008.

**PRINCIPAL REGISTER**

FOR: INSTALLATION OF SECURITY SYSTEMS; REPAIR AND MAINTENANCE OF SECURITY SYSTEMS, IN CLASS 37 (U.S. CLS. 100, 103 AND 106).

FIRST USE 12-31-1988; IN COMMERCE 10-20-2008.

FOR: COMPUTER NETWORK PROJECT MANAGEMENT SERVICES; TECHNICAL ADVICE CONCERNING THE REPAIR OF INFORMATION TECHNOLOGY AND COMPUTER HARDWARE AND SOFTWARE; TECHNICAL ADVICE CONCERNING THE MAINTENANCE OF INFORMATION TECHNOLOGY AND COMPUTER HARDWARE AND SOFTWARE; PROVIDING CONSULTING, PLANNING AND ENGINEERING SERVICES IN THE FIELD OF INFORMATION AND COMMUNICATIONS NETWORKS; DESIGN AND DEVELOPMENT OF ELECTRONIC DATA SECURITY SYSTEMS; DATABASE DEVELOPMENT SERVICES AND MAINTENANCE OF ONLINE DATABASES FOR OTHERS; CONSULTING IN THE FIELD OF CONFIGURATION MANAGEMENT FOR COMPUTER HARDWARE AND SOFTWARE; DEVELOPMENT OF SECURITY SYSTEMS AND CONTINGENCY PLANNING FOR INFORMATION SYSTEMS, IN CLASS 42 (U.S. CLS. 100 AND 101).

FIRST USE 12-31-1988; IN COMMERCE 10-20-2008.

THE MARK CONSISTS OF STANDARD CHARACTERS WITHOUT CLAIM TO ANY PARTICULAR FONT, STYLE, SIZE, OR COLOR.

OWNER OF U.S. REG. NO. 2,443,863.

SER. NO. 85-290,027, FILED 4-8-2011.

JANICE KIM, EXAMINING ATTORNEY



*David J. Kyffers*

Director of the United States Patent and Trademark Office



# United States of America

United States Patent and Trademark Office

## South Dakota State

**Reg. No. 4,124,444**

**Registered Apr. 10, 2012**

**Int. Cl.: 25**

**TRADEMARK**

**PRINCIPAL REGISTER**

SOUTH DAKOTA BOARD OF REGENTS (SOUTH DAKOTA STATE AGENCY)  
306 E. CAPITOL AVENUE  
PIERRE, SD 575012545

FOR: CLOTHING, NAMELY, SHIRTS, SWEATSHIRTS, JACKETS, HEADWEAR, PANTS, SHORTS, SOCKS, GLOVES, SCARVES, INFANT AND TODDLER WEAR IN THE NATURE OF SHIRTS, SWEATSHIRTS, CAPS, AND SOCKS, IN CLASS 25 (U.S. CLS. 22 AND 39).

FIRST USE 0-0-1989; IN COMMERCE 0-0-1989.

THE MARK CONSISTS OF STANDARD CHARACTERS WITHOUT CLAIM TO ANY PARTICULAR FONT, STYLE, SIZE, OR COLOR.

OWNER OF U.S. REG. NOS. 3,255,405, 3,827,190 AND OTHERS.

NO CLAIM IS MADE TO THE EXCLUSIVE RIGHT TO USE "STATE", APART FROM THE MARK AS SHOWN.

SEC. 2(F).

SER. NO. 85-290,709, FILED 4-8-2011.

JUDITH HELFMAN, EXAMINING ATTORNEY



*David J. Kyros*

Director of the United States Patent and Trademark Office

# United States of America

United States Patent and Trademark Office

## TOM RAPER RVS

**Reg. No. 4,124,445**

TOM RAPER, INC. (INDIANA CORPORATION)  
2250 WILLIAMSBURG PIKE  
RICHMOND, IN 47374

**Registered Apr. 10, 2012**

**Int. Cl.: 35**

FOR: RETAIL DEALERSHIPS FEATURING MOTOR VEHICLES AND MANUFACTURED HOUSING, IN CLASS 35 (U.S. CLS. 100, 101 AND 102).

**SERVICE MARK**

FIRST USE 12-31-1964; IN COMMERCE 12-31-1964.

**PRINCIPAL REGISTER**

THE MARK CONSISTS OF STANDARD CHARACTERS WITHOUT CLAIM TO ANY PARTICULAR FONT, STYLE, SIZE, OR COLOR.

OWNER OF U.S. REG. NO. 2,552,543.

NO CLAIM IS MADE TO THE EXCLUSIVE RIGHT TO USE "RVS", APART FROM THE MARK AS SHOWN.

THE NAME(S), PORTRAIT(S), AND/OR SIGNATURE(S) SHOWN IN THE MARK IDENTIFIES "TOM RAPER", WHOSE CONSENT(S) TO REGISTER IS MADE OF RECORD.

SER. NO. 85-291,896, FILED 4-11-2011.

ELIZABETH HUGHITT, EXAMINING ATTORNEY



*David J. Kybas*

Director of the United States Patent and Trademark Office

# United States of America

United States Patent and Trademark Office

## The History Chicks

**Reg. No. 4,124,446**

GRAHAM, REBECCA ERIN (UNITED STATES INDIVIDUAL), DBA THE HISTORY CHICKS  
417 E. 59TH ST.

**Registered Apr. 10, 2012**

KANSAS CITY, MO 64110

**Int. Cl.: 41**

FOR: EDUCATIONAL SERVICES, NAMELY, PROVIDING A CONTINUING PRERECORDED AUDIO PROGRAM IN THE FIELD OF HISTORY ACCESSIBLE OVER THE INTERNET; ENTERTAINMENT SERVICES, NAMELY, PROVIDING A WEB SITE FEATURING PHOTOGRAPHIC, AUDIO, VIDEO AND PROSE PRESENTATIONS FEATURING HISTORY; ENTERTAINMENT SERVICES, NAMELY, PROVIDING PODCASTS IN THE FIELD OF HISTORY, IN CLASS 41 (U.S. CLS. 100, 101 AND 107).

**SERVICE MARK**

**PRINCIPAL REGISTER**

FIRST USE 1-9-2011; IN COMMERCE 1-9-2011.

THE MARK CONSISTS OF STANDARD CHARACTERS WITHOUT CLAIM TO ANY PARTICULAR FONT, STYLE, SIZE, OR COLOR.

NO CLAIM IS MADE TO THE EXCLUSIVE RIGHT TO USE "HISTORY", APART FROM THE MARK AS SHOWN.

SER. NO. 85-292,361, FILED 4-11-2011.

RAUL CORDOVA, EXAMINING ATTORNEY



*David J. Kybas*

Director of the United States Patent and Trademark Office

# United States of America

United States Patent and Trademark Office

## The Game Guy

**Reg. No. 4,124,447**

**Registered Apr. 10, 2012**

**Int. Cls.: 16 and 41**

**TRADEMARK**

**SERVICE MARK**

**PRINCIPAL REGISTER**

IMAGINATION HOLDINGS PTY LTD (AUSTRALIA LIMITED LIABILITY COMPANY)  
LEVEL 1, 300 RUNDLE STREET  
ADELAIDE, AUSTRALIA 5000

FOR: PRINTED MATTER, NAMELY, BOOKS, MAGAZINES, NEWSPAPERS AND NEWS-LETTERS IN THE FIELDS OF SOCIALLY INTERACTIVE BOARD GAMES, DICE GAMES, CARD GAMES, FAMILY GAMES, PARTY GAMES, DVD GAMES, DOWNLOADABLE GAMES ON TELEVISIONS AND COMPUTERS, GAME REVIEWS, GAME DEVELOPMENT, GAME-PLAYING ADVICE AND GAME-PLAYING INSTRUCTION, IN CLASS 16 (U.S. CLS. 2, 5, 22, 23, 29, 37, 38 AND 50).

FIRST USE 3-1-2008; IN COMMERCE 3-1-2008.

FOR: EDUCATIONAL AND ENTERTAINMENT SERVICES, NAMELY, CONDUCTING WORKSHOPS AND SEMINARS, PERSONAL APPEARANCES, RADIO APPEARANCES, TELEVISION APPEARANCES, WEB CONTENT APPEARANCES AND EDUCATIONAL SPEAKING ENGAGEMENTS BY A GAMING EXPERT, ALL IN THE FIELDS OF SOCIALLY INTERACTIVE BOARD GAMES, DICE GAMES, CARD GAMES, FAMILY GAMES, PARTY GAMES, DVD GAMES, DOWNLOADABLE GAMES ON TELEVISIONS AND COMPUTERS, GAME REVIEWS, GAME DEVELOPMENT, GAME-PLAYING ADVICE AND GAME-PLAYING INSTRUCTION, IN CLASS 41 (U.S. CLS. 100, 101 AND 107).

FIRST USE 3-1-2008; IN COMMERCE 3-1-2008.

THE MARK CONSISTS OF STANDARD CHARACTERS WITHOUT CLAIM TO ANY PARTICULAR FONT, STYLE, SIZE, OR COLOR.

NO CLAIM IS MADE TO THE EXCLUSIVE RIGHT TO USE "GAME", APART FROM THE MARK AS SHOWN.

SER. NO. 85-292,410, FILED 4-12-2011.

DAVID H. STINE, EXAMINING ATTORNEY



*David J. Kyffers*

Director of the United States Patent and Trademark Office

# United States of America

United States Patent and Trademark Office

## OPERATION ORGANIZATION

**Reg. No. 4,124,448**

**Registered Apr. 10, 2012**

**Int. Cl.: 39**

**SERVICE MARK**

**PRINCIPAL REGISTER**

OPERATION ORGANIZATION, INC. (CALIFORNIA CORPORATION)  
15206 BURBANK BOULEVARD, SUITE 309  
SHERMAN OAKS, CA 91411

FOR: MOVING SERVICES, NAMELY, FURNITURE, PACKED BOXES, OFFICE ITEMS AND PERSONAL BELONGINGS; TRAVEL INFORMATION SERVICES, IN CLASS 39 (U.S. CLS. 100 AND 105).

FIRST USE 6-26-2005; IN COMMERCE 6-26-2005.

THE MARK CONSISTS OF STANDARD CHARACTERS WITHOUT CLAIM TO ANY PARTICULAR FONT, STYLE, SIZE, OR COLOR.

OWNER OF U.S. REG. NO. 3,966,657.

NO CLAIM IS MADE TO THE EXCLUSIVE RIGHT TO USE "ORGANIZATION", APART FROM THE MARK AS SHOWN.

SER. NO. 85-292,445, FILED 4-12-2011.

BARBARA BROWN, EXAMINING ATTORNEY



*David J. Kyffers*

Director of the United States Patent and Trademark Office

# United States of America

United States Patent and Trademark Office

## FAIRBANKS MORSE

**Reg. No. 4,124,449**

PENTAIR PUMP GROUP, INC. (DELAWARE CORPORATION)  
5500 WAYZATA BLVD.

**Registered Apr. 10, 2012**

GOLDEN VALLEY, MN 55416

**Int. Cl.: 7**

FOR: PUMPS, NAMELY, SOLIDS HANDLING PUMPS, HORIZONTAL SPLIT CASE PUMPS, VERTICAL TURBINE PUMPS, PROPELLER PUMPS, FIRE PUMPS, VERTICAL MULTI-STAGE PUMPS, CHOPPER PUMPS, VORTEX PUMPS, TURBINE PUMPS, CENTRIFUGAL PUMPS, ROTARY PUMPS, AND SUBMERSIBLE PUMPS, IN CLASS 7 (U.S. CLS. 13, 19, 21, 23, 31, 34 AND 35).

**TRADEMARK**

**PRINCIPAL REGISTER**

FIRST USE 0-0-1914; IN COMMERCE 0-0-1914.

THE MARK CONSISTS OF STANDARD CHARACTERS WITHOUT CLAIM TO ANY PARTICULAR FONT, STYLE, SIZE, OR COLOR.

SER. NO. 85-292,546, FILED 4-12-2011.

NICHOLAS COLEMAN, EXAMINING ATTORNEY



*David J. Kyffers*

Director of the United States Patent and Trademark Office

# United States of America

United States Patent and Trademark Office

## ACCENT IT ALL

**Reg. No. 4,124,450**

**Registered Apr. 10, 2012**

**Int. Cl.: 20**

**TRADEMARK**

**PRINCIPAL REGISTER**

RS INDUSTRIAL, INC. (GEORGIA CORPORATION)  
1060 PARKWAY INDUSTRIAL DRIVE  
BUFORD, GA 30518

FOR: VINYL APPLIQUÉS FOR ATTACHMENT TO WINDOWS, MIRRORS, WALLS, CARS, FURNITURE AND OTHER SOLID SURFACES FOR DECORATING PURPOSES, IN CLASS 20 (U.S. CLS. 2, 13, 22, 25, 32 AND 50).

FIRST USE 3-27-2011; IN COMMERCE 3-27-2011.

THE MARK CONSISTS OF STANDARD CHARACTERS WITHOUT CLAIM TO ANY PARTICULAR FONT, STYLE, SIZE, OR COLOR.

SER. NO. 85-293,309, FILED 4-12-2011.

NELSON SNYDER, EXAMINING ATTORNEY



*David J. Kyfos*

Director of the United States Patent and Trademark Office

# United States of America

United States Patent and Trademark Office

## Garance Doré

**Reg. No. 4,124,451**

GARANCE DORÉ (FRANCE INDIVIDUAL)  
29 EAST 10TH STREET, 6TH FLOOR  
NEW YORK, NY 10003

**Registered Apr. 10, 2012**

**Int. Cls.: 38 and 41**

FOR: PROVIDING AN INTERACTIVE ELECTRONIC MESSAGE BOARD FOR TRANSMISSION OF MESSAGES AMONG USERS BY MEANS OF A GLOBAL COMPUTER NETWORK IN THE FIELDS OF FASHION, CLOTHING STYLE, CELEBRITIES, ENTERTAINMENT AND POPULAR CULTURE, IN CLASS 38 (U.S. CLS. 100, 101 AND 104).

**SERVICE MARK**

**PRINCIPAL REGISTER**

FIRST USE 6-1-2006; IN COMMERCE 6-1-2006.

FOR: PROVIDING INFORMATION BY MEANS OF A GLOBAL COMPUTER NETWORK IN THE FIELDS OF CELEBRITIES, ENTERTAINMENT AND POPULAR CULTURE; PROVIDING AN INTERACTIVE WEB BLOG BY MEANS OF A GLOBAL COMPUTER NETWORK IN THE FIELDS OF FASHION, CLOTHING STYLE, CELEBRITIES, ENTERTAINMENT AND POPULAR CULTURE, IN CLASS 41 (U.S. CLS. 100, 101 AND 107).

FIRST USE 6-1-2006; IN COMMERCE 6-1-2006.

THE MARK CONSISTS OF STANDARD CHARACTERS WITHOUT CLAIM TO ANY PARTICULAR FONT, STYLE, SIZE, OR COLOR.

THE NAME(S), PORTRAIT(S), AND/OR SIGNATURE(S) SHOWN IN THE MARK IDENTIFIES THE PROFESSIONAL NAME OF MARILINE FIORI, WHOSE CONSENT(S) TO REGISTER IS MADE OF RECORD.

SER. NO. 85-293,384, FILED S.R. 4-12-2011 AM. P.R. 4-18-2011.

ANNE MADDEN, EXAMINING ATTORNEY



*David J. Kyjars*

Director of the United States Patent and Trademark Office



# United States of America

United States Patent and Trademark Office

# LPLP

**Reg. No. 4,124,452**

IMAGE HOLDINGS CO., LTD. (JAPAN CORPORATION)  
694-1, SHINMYO, KOKUBUNJI-CHO  
TAKAMATSU-SHI, KAGAWA, JAPAN

**Registered Apr. 10, 2012**

**Int. Cls.: 3, 5, 18, 21 and 25**

FOR: HAIR TONICS; NON-MEDICATED HAIR GROWTH PREPARATIONS FOR STIMULATING HAIR GROWTH; HAIR DYES; CREAMY HAIR DYES; NON-MEDICATED HAIR TREATMENT PREPARATIONS FOR COSMETIC PURPOSES; HAIR CONDITIONERS; CLEANSING PREPARATIONS FOR SCALP; HAIR RINSES; HAIR SHAMPOOS; HAIR CARE PREPARATIONS; COSMETIC PREPARATIONS FOR THE HAIR AND SCALP; COSMETIC PREPARATIONS, IN CLASS 3 (U.S. CLS. 1, 4, 6, 50, 51 AND 52).

**TRADEMARK**

**PRINCIPAL REGISTER**

FOR: FOOD SUPPLEMENTS; FOOD SUPPLEMENTS CONSISTING PRIMARILY OF KELP; FOOD SUPPLEMENTS CONSISTING PRIMARILY OF FUCOIDAN EXTRACTED FROM SEAWEED; FOOD SUPPLEMENTS CONSISTING PRIMARILY OF SEAWEED EXTRACTS OR SEAWEED POWDERS, IN CLASS 5 (U.S. CLS. 6, 18, 44, 46, 51 AND 52).

FOR: HANDBAGS; TRAVELLING BAGS; POUCHES FOR HOLDING MAKE-UP, KEYS AND OTHER PERSONAL ITEMS; WALLETS; PURSES; UNFITTED VANITY CASES; UMBRELLAS; PARASOLS, IN CLASS 18 (U.S. CLS. 1, 2, 3, 22 AND 41).

FOR: HAIR BRUSHES; COMBS; COMB CASES; COSMETIC BRUSHES, IN CLASS 21 (U.S. CLS. 2, 13, 23, 29, 30, 33, 40 AND 50).

FOR: SHOWER CAPS; NIGHTCAPS; HEADWEAR; GLOVES; MITTENS; WOMEN'S CLOTHING, NAMELY, SHIRTS, DRESSES, SKIRTS, BLOUSES; UNDERWEAR; SOCKS; STOCKINGS; SHOES, IN CLASS 25 (U.S. CLS. 22 AND 39).

THE MARK CONSISTS OF STANDARD CHARACTERS WITHOUT CLAIM TO ANY PARTICULAR FONT, STYLE, SIZE, OR COLOR.

OWNER OF JAPAN REG. NO. 5438960, DATED 9-16-2011, EXPIRES 9-16-2021.

OWNER OF JAPAN REG. NO. 5429180, DATED 7-29-2011, EXPIRES 7-29-2021.

SER. NO. 85-293,797, FILED 4-13-2011.

CHRISTINA SOBRAL, EXAMINING ATTORNEY



*David J. Kappas*

Director of the United States Patent and Trademark Office

# United States of America

United States Patent and Trademark Office



**Reg. No. 4,124,453**

**Registered Apr. 10, 2012**

**Int. Cls.: 36 and 37**

**SERVICE MARK**

**PRINCIPAL REGISTER**

RIVERPORT TRADEMARK LLC (TEXAS LIMITED LIABILITY COMPANY)  
5949 SHERRY LANE, SUITE 1750  
DALLAS, TX 75225

FOR: LEASING AND MANAGEMENT OF REAL ESTATE FOR COMMERCIAL AND INDUSTRIAL USES FOR WAREHOUSE STORAGE, IN CLASS 36 (U.S. CLS. 100, 101 AND 102).

FIRST USE 4-1-2009; IN COMMERCE 4-1-2009.

FOR: CONSTRUCTION OF WAREHOUSES AND FREIGHT TERMINALS; LAND DEVELOPMENT OF A COMMERCIAL AND INDUSTRIAL PARK, IN CLASS 37 (U.S. CLS. 100, 103 AND 106).

FIRST USE 4-1-2009; IN COMMERCE 4-1-2009.

THE MARK CONSISTS OF THE LITERAL ELEMENT "RIVERPORT" WITH "RIVER" IN SOLID LETTERS AND "PORT" IN OUTLINED LETTERS, WITH HORIZONTAL LINES ABOVE AND BELOW THE LITERAL ELEMENT, A SUSPENSION BRIDGE ABOVE THE UPPER HORIZONTAL LINE AND AN ARCH ABOVE THE BRIDGE.

SER. NO. 85-294,421, FILED 4-13-2011.

KAREN K. BUSH, EXAMINING ATTORNEY



*David J. Kybas*

Director of the United States Patent and Trademark Office

United States of America  
United States Patent and Trademark Office

amazingrace

**Reg. No. 4,124,454**

**Registered Apr. 10, 2012**

**Int. Cl.: 41**

**SERVICE MARK**

**PRINCIPAL REGISTER**

SANDERS, DARCIE (UNITED STATES INDIVIDUAL)  
365 VASQUEZ CT, # 2507  
BOX 2507  
LYONS, CO 80540 AND

KARPEL, LEONARD, C. (UNITED STATES INDIVIDUAL)  
365 VASQUEZ CT., # 2507  
BOX 2507  
LYONS, CO 80540

FOR: ENTERTAINMENT SERVICES, NAMELY, PROVIDING A WEB SITE FEATURING PHOTOGRAPHIC, AUDIO, VIDEO AND PROSE PRESENTATIONS FEATURING MUSICAL PERFORMANCES, IN CLASS 41 (U.S. CLS. 100, 101 AND 107).

FIRST USE 10-22-1998; IN COMMERCE 10-22-1998.

THE MARK CONSISTS OF STANDARD CHARACTERS WITHOUT CLAIM TO ANY PARTICULAR FONT, STYLE, SIZE, OR COLOR.

OWNER OF U.S. REG. NO. 1,109,706.

SER. NO. 85-294,493, FILED 4-13-2011.

EVELYN BRADLEY, EXAMINING ATTORNEY



*David J. Kyffers*

Director of the United States Patent and Trademark Office

# United States of America

United States Patent and Trademark Office

## CHUCK A DUCK

**Reg. No. 4,124,455**

DOSKOCIL MANUFACTURING COMPANY, INC. (TEXAS CORPORATION)  
4209 BARNETT BOULEVARD  
ARLINGTON, TX 76017

**Registered Apr. 10, 2012**

**Int. Cl.: 28**

FOR: PET TOYS, IN CLASS 28 (U.S. CLS. 22, 23, 38 AND 50).

**TRADEMARK**

FIRST USE 8-15-2002; IN COMMERCE 8-15-2002.

**PRINCIPAL REGISTER**

THE MARK CONSISTS OF STANDARD CHARACTERS WITHOUT CLAIM TO ANY PARTICULAR FONT, STYLE, SIZE, OR COLOR.

NO CLAIM IS MADE TO THE EXCLUSIVE RIGHT TO USE "DUCK", APART FROM THE MARK AS SHOWN.

SER. NO. 85-294,874, FILED 4-14-2011.

DOMINICK J. SALEMI, EXAMINING ATTORNEY



*David J. Kybas*

Director of the United States Patent and Trademark Office

# United States of America

United States Patent and Trademark Office

## The Roommate Room

**Reg. No. 4,124,456**

**Registered Apr. 10, 2012**

**Int. Cl.: 36**

**SERVICE MARK**

**PRINCIPAL REGISTER**

ROOMMATE HAPPY HOUR, LLC (NEW YORK LIMITED LIABILITY COMPANY)  
SUITE 5D  
327 E 101ST ST  
NEW YORK, NY 10029

FOR: PROVIDING A WEBSITE WITH CLASSIFIED REAL ESTATE LISTINGS OF APARTMENT RENTALS FOR USERS LOOKING FOR A ROOMMATE OR PLACE TO LIVE , IN CLASS 36 (U.S. CLS. 100, 101 AND 102).

FIRST USE 12-1-2010; IN COMMERCE 12-1-2010.

THE MARK CONSISTS OF STANDARD CHARACTERS WITHOUT CLAIM TO ANY PARTICULAR FONT, STYLE, SIZE, OR COLOR.

NO CLAIM IS MADE TO THE EXCLUSIVE RIGHT TO USE "ROOMMATE", APART FROM THE MARK AS SHOWN.

SER. NO. 85-295,592, FILED 4-14-2011.

SUNG IN, EXAMINING ATTORNEY



*David J. Kyfos*

Director of the United States Patent and Trademark Office

# United States of America

United States Patent and Trademark Office

## MAKI MADNESS

**Reg. No. 4,124,457**

RA SUSHI HOLDING CORP. (DELAWARE CORPORATION)

**Registered Apr. 10, 2012**

6263 N. SCOTTSDALE ROAD  
SCOTTSDALE, AZ 85250

**Int. Cl.: 41**

FOR: ENTERTAINMENT SERVICES, NAMELY, ARRANGING AND CONDUCTING COMMUNITY EVENTS IN THE NATURE OF FOOD EATING CONTESTS WHICH ALSO FEATURE A VARIETY OF ENTERTAINMENT ACTIVITIES SUCH AS RAFFLES AND LIVE MUSICAL PERFORMANCES, IN CLASS 41 (U.S. CLS. 100, 101 AND 107).

**SERVICE MARK**

**PRINCIPAL REGISTER**

FIRST USE 3-1-2009; IN COMMERCE 3-1-2009.

THE MARK CONSISTS OF STANDARD CHARACTERS WITHOUT CLAIM TO ANY PARTICULAR FONT, STYLE, SIZE, OR COLOR.

NO CLAIM IS MADE TO THE EXCLUSIVE RIGHT TO USE "MAKI", APART FROM THE MARK AS SHOWN.

SER. NO. 85-296,027, FILED 4-15-2011.

TINA L. SNAPP, EXAMINING ATTORNEY



*David J. Kyffers*

Director of the United States Patent and Trademark Office

# United States of America

United States Patent and Trademark Office

# UCheck

**Reg. No. 4,124,458**

**Registered Apr. 10, 2012**

**Int. Cl.: 42**

**SERVICE MARK**

**PRINCIPAL REGISTER**

UNIVERSAL BUILDING MAINTENANCE, LLC (CALIFORNIA LIMITED LIABILITY COMPANY)  
1551 NORTH TUSTIN AVE. SUITE 650  
SANTA ANA, CA 92705

FOR: PROVIDING TEMPORARY USE OF ON-LINE NON-DOWNLOADABLE SOFTWARE THAT ENABLES USERS TO REQUEST, TRACK AND MAINTAIN CLEANING AND JANITORIAL SERVICES FOR BUILDINGS AND PROPERTY, IN CLASS 42 (U.S. CLS. 100 AND 101).

FIRST USE 4-6-2011; IN COMMERCE 4-6-2011.

THE MARK CONSISTS OF STANDARD CHARACTERS WITHOUT CLAIM TO ANY PARTICULAR FONT, STYLE, SIZE, OR COLOR.

OWNER OF U.S. REG. NOS. 3,711,567 AND 3,714,573.

SER. NO. 85-296,854, FILED 4-15-2011.

BRIAN CALLAGHAN, EXAMINING ATTORNEY



*David J. Kyffers*

Director of the United States Patent and Trademark Office

# United States of America

United States Patent and Trademark Office

## TIPPY'S TACO HOUSE

**Reg. No. 4,124,459**

LOCKLIER COMPANY, INC. (TEXAS CORPORATION), DBA TIPPY'S TACO HOUSE  
5919 LACUMBRE  
MCKINNEY, TX 75070

**Registered Apr. 10, 2012**

**Int. Cl.: 43**

FOR: RESTAURANT SERVICES, IN CLASS 43 (U.S. CLS. 100 AND 101).

**SERVICE MARK**

FIRST USE 8-1-1967; IN COMMERCE 8-1-1967.

**PRINCIPAL REGISTER**

THE MARK CONSISTS OF STANDARD CHARACTERS WITHOUT CLAIM TO ANY PARTICULAR FONT, STYLE, SIZE, OR COLOR.

NO CLAIM IS MADE TO THE EXCLUSIVE RIGHT TO USE "TACO HOUSE", APART FROM THE MARK AS SHOWN.

SER. NO. 85-296,863, FILED 4-15-2011.

ADA HAN, EXAMINING ATTORNEY



*David J. Kybas*

Director of the United States Patent and Trademark Office



# United States of America

United States Patent and Trademark Office

## JILLJOANNE.COM

**Reg. No. 4,124,460**

**Registered Apr. 10, 2012**

**Int. Cls.: 18 and 25**

**TRADEMARK**

**PRINCIPAL REGISTER**

JILL JOANNE, LLC (CALIFORNIA LIMITED LIABILITY COMPANY)  
21163 NEWPORT COAST DR  
STE 456  
NEWPORT COAST, CA 92657

FOR: PURSES AND HANDBAGS MADE OF LEATHER AND CLOTH, IN CLASS 18 (U.S. CLS. 1, 2, 3, 22 AND 41).

FIRST USE 6-1-2010; IN COMMERCE 1-3-2011.

FOR: CLOTHING, NAMELY, TOPS, BOTTOMS, GOWNS, DRESSES, BLOUSES, IN CLASS 25 (U.S. CLS. 22 AND 39).

FIRST USE 6-1-2010; IN COMMERCE 1-3-2011.

THE MARK CONSISTS OF STANDARD CHARACTERS WITHOUT CLAIM TO ANY PARTICULAR FONT, STYLE, SIZE, OR COLOR.

THE NAME(S), PORTRAIT(S), AND/OR SIGNATURE(S) SHOWN IN THE MARK IDENTIFIES "JILL JOANNE", WHOSE CONSENT(S) TO REGISTER IS MADE OF RECORD.

SER. NO. 85-297,015, FILED 4-16-2011.

NICHOLAS ALTREE, EXAMINING ATTORNEY



*David J. Kybas*

Director of the United States Patent and Trademark Office

# United States of America

United States Patent and Trademark Office



**Reg. No. 4,124,461**

SOLARX EYEWEAR, LLC (OHIO LIMITED LIABILITY COMPANY)  
35490 LORAIN ROAD  
NORTH RIDGEVILLE, OH 44039

**Registered Apr. 10, 2012**

**Int. Cl.: 9**

FOR: SUNGLASSES AND SPECTACLES NOT INCLUDING OPHTHALMIC LENSES, IN CLASS 9 (U.S. CLS. 21, 23, 26, 36 AND 38).

**TRADEMARK**

FIRST USE 10-31-2007; IN COMMERCE 10-31-2007.

**PRINCIPAL REGISTER**

NO CLAIM IS MADE TO THE EXCLUSIVE RIGHT TO USE "SOLAR" AND "EYEWEAR", APART FROM THE MARK AS SHOWN.

THE MARK CONSISTS OF THE WORDING "SOLAR X EYEWEAR" WITH THE "X" APPEARING AS A LARGE CAPITAL LETTER TO THE RIGHT OF THE WORD "SOLAR", WHICH IS ABOVE THE WORD "EYEWEAR", ALL ENCLOSED IN DESIGN ELEMENTS COMPRISING PARENTHESES.

SER. NO. 85-297,344, FILED 4-18-2011.

TARA PATE, EXAMINING ATTORNEY



*David J. Kybas*

Director of the United States Patent and Trademark Office

# United States of America

United States Patent and Trademark Office



**Reg. No. 4,124,462**

**Registered Apr. 10, 2012**

**Int. Cls.: 41, 44 and 45**

**SERVICE MARK**

**PRINCIPAL REGISTER**

RHAMA: THE CENTER OF HEALING ARTS LLC (TENNESSEE LIMITED LIABILITY COMPANY)  
5417 LONAS DRIVE  
KNOXVILLE, TN 37909

FOR: PROVIDING A FACILITY FOR YOGA INSTRUCTION; PROVIDING A FACILITY FOR LIFE COACHING SERVICES IN THE FIELD OF HEALTH AND WELLNESS; PROVIDING A FACILITY FOR SPIRITUAL EDUCATION SERVICES, NAMELY, WORKSHOPS IN THE FIELD OF SPIRITUALITY, IN CLASS 41 (U.S. CLS. 100, 101 AND 107).

FIRST USE 7-26-2010; IN COMMERCE 7-26-2010.

FOR: HEALTH AND WELLNESS SERVICES, NAMELY, PROVIDING A FACILITY FOR MASSAGE THERAPY, MEDICAL COUNSELING, PSYCHOLOGICAL COUNSELING, HOMEOPATHY SERVICES, ART THERAPY, AND MEDICAL SERVICES USING ALTERNATIVE REMEDIES, IN CLASS 44 (U.S. CLS. 100 AND 101).

FIRST USE 7-26-2010; IN COMMERCE 7-26-2010.

FOR: PROVIDING A FACILITY FOR SPIRITUAL HEALING COUNSELING, IN CLASS 45 (U.S. CLS. 100 AND 101).

FIRST USE 7-26-2010; IN COMMERCE 7-26-2010.

NO CLAIM IS MADE TO THE EXCLUSIVE RIGHT TO USE "CENTER OF HEALING ARTS", APART FROM THE MARK AS SHOWN.

THE MARK CONSISTS OF THE WORDS "RHAMA" AND "THE CENTER OF HEALING ARTS". THE WORD "RHAMA" APPEARS IN DARK PRINT ON A LIGHT BACKGROUND AT THE TOP CENTER OF THE MARK IN LARGE TEXT. THE WORDS "THE CENTER OF HEALING ARTS" APPEARS IN LIGHT PRINT ON A DARK BACKGROUND ON TWO LINES OF SMALLER TEXT ON THE BOTTOM OF THE MARK. IN THE MIDDLE, BETWEEN THE WORD PORTIONS OF THE MARK, IS A DESIGN PORTION CONSISTING OF FOUR DARKLY COLORED BOX-LIKE SHAPES THAT ARE ARRANGED IN A SQUARE PATTERN. EACH OF THE BOX-LIKE SHAPES INCLUDES A FLORAL-TYPE PATTERN EMANATING FROM THE CENTER OUTWARDS.



*David J. Kyjars*

Director of the United States Patent and Trademark Office

**Reg. No. 4,124,462** THE WORDING "RHAMA" HAS NO MEANING IN A FOREIGN LANGUAGE.

SER. NO. 85-297,469, FILED 4-18-2011.

SETH A. RAPPAPORT, EXAMINING ATTORNEY

# United States of America

United States Patent and Trademark Office

## ANDRES GUTIERREZ

**Reg. No. 4,124,463**

LAMPO LICENSING, LLC (TENNESSEE LIMITED LIABILITY COMPANY)  
1749 MALLORY LANE  
BRENTWOOD, TN 37027

**Registered Apr. 10, 2012**

**Int. Cl.: 41**

FOR: CONDUCTING WORKSHOPS AND SEMINARS IN FINANCIAL AFFAIRS, IN CLASS 41 (U.S. CLS. 100, 101 AND 107).

**SERVICE MARK**

FIRST USE 7-30-2010; IN COMMERCE 7-30-2010.

**PRINCIPAL REGISTER**

THE MARK CONSISTS OF STANDARD CHARACTERS WITHOUT CLAIM TO ANY PARTICULAR FONT, STYLE, SIZE, OR COLOR.

THE NAME(S), PORTRAIT(S), AND/OR SIGNATURE(S) SHOWN IN THE MARK IDENTIFIES "ANDRES GUTIERREZ", WHOSE CONSENT(S) TO REGISTER IS MADE OF RECORD.

SER. NO. 85-297,570, FILED 4-18-2011.

KHANH LE, EXAMINING ATTORNEY



*David J. Kybas*

Director of the United States Patent and Trademark Office

# United States of America

United States Patent and Trademark Office

## DREW TECHNOLOGIES

**Reg. No. 4,124,464**

**Registered Apr. 10, 2012**

**Int. Cls.: 9 and 42**

**TRADEMARK**

**SERVICE MARK**

**PRINCIPAL REGISTER**

DREW TECHNOLOGIES, INC. (MICHIGAN CORPORATION)  
3915 RESEARCH PARK DRIVE  
ANN ARBOR, MI 48108

FOR: COMPUTER HARDWARE, NAMELY, ELECTRONIC INTERFACE MODULES USED FOR INTERFACING BETWEEN MOTOR VEHICLE ON-BOARD COMPUTER INFORMATION TO A PERSONAL COMPUTER; LCD COMPUTER DISPLAYS AND OPERATING SOFTWARE THEREFOR USED TO COMMUNICATE WITH MOTOR VEHICLE ON-BOARD DATA EQUIPMENT, AND TO DISPLAY MOTOR VEHICLE ENGINE PARAMETERS OTHER VEHICLE DATA IN NUMERIC AND GRAPHICAL FORMATS; VEHICLE DIAGNOSTIC APPARATUS, NAMELY, COMPUTERS FOR USE IN DIAGNOSING VEHICLE MECHANICAL AND ELECTRICAL PROBLEMS, IN CLASS 9 (U.S. CLS. 21, 23, 26, 36 AND 38).

FIRST USE 11-8-1999; IN COMMERCE 11-8-1999.

FOR: COMPUTER AND SCIENTIFIC SERVICES, NAMELY, COMPUTER ENGINEERING, REVERSE ENGINEERING FOR COMPATIBILITY PURPOSES AND COMPUTER PROGRAMMING; COMPUTER ENGINEERING, CONSULTING, PROGRAMMING, AND TECHNICAL SUPPORT SERVICES, NAMELY, HELP DESK SERVICES ASSOCIATED WITH COMPUTER HARDWARE AND SOFTWARE EMPLOYED IN, OR IN CONNECTION WITH, MOTOR VEHICLE DATA ACQUISITION, PROGRAMMING, DIAGNOSTIC, INTERFACE, AND TESTING TOOLS AND EQUIPMENT, IN CLASS 42 (U.S. CLS. 100 AND 101).

FIRST USE 11-8-1999; IN COMMERCE 11-8-1999.

THE MARK CONSISTS OF STANDARD CHARACTERS WITHOUT CLAIM TO ANY PARTICULAR FONT, STYLE, SIZE, OR COLOR.

NO CLAIM IS MADE TO THE EXCLUSIVE RIGHT TO USE "TECHNOLOGIES", APART FROM THE MARK AS SHOWN.

SER. NO. 85-297,739, FILED 4-18-2011.

ELISSA GARBER KON, EXAMINING ATTORNEY



*David J. Kyros*

Director of the United States Patent and Trademark Office

# United States of America

United States Patent and Trademark Office

# 4RAIN

**Reg. No. 4,124,465**

**Registered Apr. 10, 2012**

**Int. Cl.: 24**

**TRADEMARK**

**PRINCIPAL REGISTER**

LORO PIANA S.P.A. (ITALY SOCIETÀ PER AZIONI (SPA))  
CORSO ROLANDI 10  
QUARONA (VC), ITALY 13017

FOR: FABRICS FOR USE IN THE MANUFACTURE OF CLOTHING, NIGHTWEAR AND BEDDING MATERIAL, NAMELY, BLANKETS AND COVERLETS; WOVEN FABRICS MADE OF WOOL, WORSTED FABRIC BLENDS OF WOOL AND COTTON FABRIC, SILK AND WOOL BLEND FABRICS, COTTON KNIT FABRICS AND WOOL KNIT FABRICS, IN CLASS 24 (U.S. CLS. 42 AND 50).

THE MARK CONSISTS OF STANDARD CHARACTERS WITHOUT CLAIM TO ANY PARTICULAR FONT, STYLE, SIZE, OR COLOR.

OWNER OF ITALY REG. NO. 1361792, DATED 10-18-2010, EXPIRES 10-18-2020.

SER. NO. 85-297,841, FILED 4-18-2011.

KAELIE KUNG, EXAMINING ATTORNEY



*David J. Kyffers*

Director of the United States Patent and Trademark Office

# United States of America

United States Patent and Trademark Office



**Reg. No. 4,124,466**

**Registered Apr. 10, 2012**

**Int. Cl.: 42**

**SERVICE MARK**

**PRINCIPAL REGISTER**

UNIVERSAL BUILDING MAINTENANCE, LLC (CALIFORNIA LIMITED LIABILITY COMPANY)  
1551 NORTH TUSTIN AVE. SUITE 650  
SANTA ANA, CA 92705

FOR: PROVIDING TEMPORARY USE OF AN ON-LINE NON-DOWNLOADABLE SOFTWARE THAT ENABLES USERS TO REQUEST, TRACK AND MAINTAIN CLEANING AND JANITORIAL SERVICES FOR BUILDINGS AND PROPERTY, IN CLASS 42 (U.S. CLS. 100 AND 101).

FIRST USE 4-6-2011; IN COMMERCE 4-6-2011.

OWNER OF U.S. REG. NOS. 3,711,567 AND 3,714,573.

THE COLOR(S) BLUE, GREEN AND BLACK IS/ARE CLAIMED AS A FEATURE OF THE MARK.

NO CLAIM IS MADE TO THE EXCLUSIVE RIGHT TO USE "BUILDING MAINTENANCE", APART FROM THE MARK AS SHOWN.

THE MARK CONSISTS OF THE BLUE LETTER "U" NEXT TO A GREEN CHECK MARK SYMBOL NEXT TO THE BLACK WORDS "BY UNIVERSAL BUILDING MAINTENANCE".

SER. NO. 85-298,067, FILED 4-18-2011.

BRIAN CALLAGHAN, EXAMINING ATTORNEY



*David J. Kybas*

Director of the United States Patent and Trademark Office



# United States of America

United States Patent and Trademark Office

# IDEABYTES

**Reg. No. 4,124,467**

**Registered Apr. 10, 2012**

**Int. Cl.: 42**

**SERVICE MARK**

**PRINCIPAL REGISTER**

IDEABYTES INC (CANADA CORPORATION)  
142 GOLFLINKS DRIVE,  
IDEABYTES INC.,  
OTTAWA, CANADA K2J5N5

FOR: CONSULTING SERVICES IN THE FIELD OF DESIGN, SELECTION, IMPLEMENTATION AND USE OF COMPUTER HARDWARE AND SOFTWARE SYSTEMS FOR OTHERS; RESEARCH, DEVELOPMENT, DESIGN AND UPGRADING OF COMPUTER SOFTWARE BUT NOT INCLUDING SERVICES RELATING TO AUDITING OR STATISTICAL SAMPLING OR FORENSIC ANALYSIS OR SERVICES SPECIFICALLY MARKETED TO ACCOUNTANTS AND AUDITORS, IN CLASS 42 (U.S. CLS. 100 AND 101).

FIRST USE 9-11-2009; IN COMMERCE 4-4-2011.

THE MARK CONSISTS OF STANDARD CHARACTERS WITHOUT CLAIM TO ANY PARTICULAR FONT, STYLE, SIZE, OR COLOR.

SER. NO. 85-298,294, FILED 4-19-2011.

BRENDAN REGAN, EXAMINING ATTORNEY



*David J. Kybas*

Director of the United States Patent and Trademark Office

# United States of America

United States Patent and Trademark Office



**Reg. No. 4,124,468**

CHESAPEAKE REHAB EQUIPMENT, INC. (MARYLAND CORPORATION)  
2700 LORD BALTIMORE DRIVE  
BALTIMORE, MD 21207

**Registered Apr. 10, 2012**

**Int. Cls.: 35 and 37**

FOR: DISTRIBUTORSHIPS IN THE FIELD OF DURABLE MEDICAL EQUIPMENT AND REHABILITATION PARTS AND SUPPLIES; RETAIL STORE AND ON-LINE RETAIL STORE SERVICES FEATURING DURABLE MEDICAL EQUIPMENT AND REHABILITATION PARTS AND SUPPLIES, IN CLASS 35 (U.S. CLS. 100, 101 AND 102).

**SERVICE MARK**

**PRINCIPAL REGISTER**

FIRST USE 8-1-1988; IN COMMERCE 8-1-1988.

FOR: MAINTENANCE AND/OR REPAIR OF DURABLE MEDICAL EQUIPMENT AND REHABILITATION SUPPLIES, IN CLASS 37 (U.S. CLS. 100, 103 AND 106).

FIRST USE 8-1-1988; IN COMMERCE 8-1-1988.

NO CLAIM IS MADE TO THE EXCLUSIVE RIGHT TO USE "REHAB EQUIPMENT", APART FROM THE MARK AS SHOWN.

THE MARK CONSISTS OF THE TERM "CHESAPEAKE", WITH A SEATED FIGURE SUPERIMPOSED ON THE OPENING IN THE "C" AND THE TERMS "REHAB EQUIPMENT" CENTERED IMMEDIATELY BENEATH.

SER. NO. 85-298,687, FILED 4-19-2011.

JORDAN BAKER, EXAMINING ATTORNEY



*David J. Kyros*

Director of the United States Patent and Trademark Office

# United States of America

United States Patent and Trademark Office

# Wel Yo

**Reg. No. 4,124,469**

**Registered Apr. 10, 2012**

**Int. Cl.: 29**

**TRADEMARK**

**PRINCIPAL REGISTER**

TRAN, NGUYEN B (CALIFORNIA CORPORATION), DBA WEL NUTRITION COMPANY  
(WNC)  
119 S. ATLANTIC BOULEVARD, SUITE 302  
MONTEREY PARK, CA 91754

FOR: MILK POWDER FOR FOOD PURPOSES; MILK PRODUCTS EXCLUDING ICE CREAM,  
ICE MILK AND FROZEN YOGURT, IN CLASS 29 (U.S. CL. 46).

FIRST USE 4-1-2011; IN COMMERCE 4-1-2011.

THE MARK CONSISTS OF STANDARD CHARACTERS WITHOUT CLAIM TO ANY PAR-  
TICULAR FONT, STYLE, SIZE, OR COLOR.

THE WORD(S) "WEL YO" HAS NO MEANING IN A FOREIGN LANGUAGE.

SER. NO. 85-299,128, FILED 4-19-2011.

DEZMONA MIZELLE, EXAMINING ATTORNEY



*David J. Kybas*

Director of the United States Patent and Trademark Office

# United States of America

United States Patent and Trademark Office

# D.HEDRAL

**Reg. No. 4,124,470**

**Registered Apr. 10, 2012**

**Int. Cl.: 25**

**TRADEMARK**

**PRINCIPAL REGISTER**

SIDNEY S.R.L. (ITALY LIMITED LIABILITY COMPANY)  
STRADA MAGGIORE, 42  
40125 BOLOGNA, ITALY

FOR: BATHING SUITS; BELTS; BLOUSES; BODY SUITS; BOXER SHORTS; BRAS; BUSTIERS; FOULARDS; GARTER BELTS; GIRDLES; HATS; JACKETS; JERSEYS; LINGERIE; NIGHT SHIRTS; OVERCOATS; PAJAMAS; PANTIES; RAIN COATS; SCARVES; SHIRTS; SHOES; SHORTS; SKI PANTS; SKIRTS; SLEEPWEAR; SLIPPERS; SLIPS; SOCKS; SWEAT PANTS; T-SHIRTS; TIES; TOP COATS; TROUSERS; UNDERPANTS; UNDERWEAR; VESTS; WIND RESISTANT JACKETS, IN CLASS 25 (U.S. CLS. 22 AND 39).

THE MARK CONSISTS OF STANDARD CHARACTERS WITHOUT CLAIM TO ANY PARTICULAR FONT, STYLE, SIZE, OR COLOR.

PRIORITY CLAIMED UNDER SEC. 44(D) ON ERPN CMNTY TM OFC APPLICATION NO. 009466038, FILED 10-21-2010, REG. NO. 009466038, DATED 3-28-2011, EXPIRES 10-21-2020.

THE NAME "D. HEDRAL" IS A FANCIFUL TERM AND DOES NOT IDENTIFY A LIVING INDIVIDUAL.

SER. NO. 85-299,927, FILED 4-20-2011.

LESLEY LAMOTHE, EXAMINING ATTORNEY



*David J. Kybas*

Director of the United States Patent and Trademark Office

# United States of America

United States Patent and Trademark Office

## COQUI DESIGN

**Reg. No. 4,124,471**

**Registered Apr. 10, 2012**

**Int. Cl.: 16**

**TRADEMARK**

**PRINCIPAL REGISTER**

COQUI DESIGN, LLC (WISCONSIN LIMITED LIABILITY COMPANY)  
606 EAST JUNEAU AVENUE #511175  
MILWAUKEE, WI 53202

FOR: STATIONERY WRITING PAPER AND ENVELOPES, IN CLASS 16 (U.S. CLS. 2, 5, 22, 23, 29, 37, 38 AND 50).

FIRST USE 5-20-2005; IN COMMERCE 5-20-2005.

THE MARK CONSISTS OF STANDARD CHARACTERS WITHOUT CLAIM TO ANY PARTICULAR FONT, STYLE, SIZE, OR COLOR.

NO CLAIM IS MADE TO THE EXCLUSIVE RIGHT TO USE "DESIGN", APART FROM THE MARK AS SHOWN.

SER. NO. 85-299,988, FILED 4-20-2011.

KRISTINA MORRIS, EXAMINING ATTORNEY



*David J. Kyffers*

Director of the United States Patent and Trademark Office

# United States of America

United States Patent and Trademark Office



**Reg. No. 4,124,472**

**Registered Apr. 10, 2012**

**Int. Cl.: 41**

**SERVICE MARK**

**PRINCIPAL REGISTER**

CABLE NEWS NETWORK, INC. (DELAWARE CORPORATION)  
ONE CNN CENTER, 10N  
C/O TURNER BROADCASTING SYSTEM, INC.  
ATLANTA, GA 30303

FOR: ENTERTAINMENT SERVICES, NAMELY, MULTIMEDIA PROGRAM SERIES FEATURING INFORMATION ABOUT CURRENT EVENTS, SPORTS, WEATHER, GOVERNMENT, EDUCATION, ENTERTAINMENT, DINING, TRAVEL AND LEISURE DISTRIBUTED VIA VARIOUS PLATFORMS ACROSS MULTIPLE FORMS OF TRANSMISSION MEDIA, IN CLASS 41 (U.S. CLS. 100, 101 AND 107).

FIRST USE 2-13-1985; IN COMMERCE 2-13-1985.

OWNER OF U.S. REG. NOS. 1,597,839, 3,675,555 AND OTHERS.

THE COLOR(S) RED AND WHITE IS/ARE CLAIMED AS A FEATURE OF THE MARK.

THE MARK CONSISTS OF THE LETTER "C" CONNECTED TO THE LETTERS "NN" ALL IN RED WITH A WHITE SPLIT LINE THROUGH THE LETTERS.

SER. NO. 85-300,139, FILED 4-20-2011.

JENNY PARK, EXAMINING ATTORNEY



*David J. Kyffers*

Director of the United States Patent and Trademark Office

# United States of America

United States Patent and Trademark Office

# SB

**Reg. No. 4,124,473**

MAGBAG, ALLAN F. (UNITED STATES INDIVIDUAL)  
150-15 95TH ST. UNIT 1-A  
OZONE PARK, NY 11417

**Registered Apr. 10, 2012**

**Int. Cl.: 35**

**SERVICE MARK**

**PRINCIPAL REGISTER**

FOR: ADVERTISING AND BUSINESS SERVICES, NAMELY, PROVIDING AN ONLINE WEBSITE WHERE ADVERTISERS, MARKETERS, AND CONTENT PROVIDERS CAN INTERACT WITH USERS FOR ADVERTISING, BRANDING, AND PROMOTING KNOWLEDGE, PRODUCTS, AND SERVICES, AND TRADESHOWS, ON BEHALF OF THEMSELVES AND OTHERS, AND FOR EVALUATING AND RATING THE SAME, ALL THE FOREGOING RELEVANT TO HUMAN ACTIVITIES AFFECTING CLIMATE CHANGE AND RELATED FIELDS; ADVERTISING AND DIRECTORY SERVICES, NAMELY, PROMOTING THE SERVICES OF OTHERS BY PROVIDING A WEB PAGE FEATURING LINKS TO THE WEBSITES OF OTHERS; PROMOTING THE GOODS AND SERVICES OF OTHERS BY PROVIDING A WEBSITE FEATURING COUPONS, REBATES, PRICE-COMPARISON INFORMATION, PRODUCT REVIEWS, LINKS TO THE RETAIL WEBSITES OF OTHERS, AND DISCOUNT INFORMATION; PROMOTING THE GOODS AND SERVICES OF OTHERS BY PROVIDING A WEBSITE FEATURING DISCOUNT VOUCHERS, REBATES, PRICE-COMPARISON INFORMATION, PRODUCT REVIEWS, LINKS TO THE RETAIL WEBSITES OF OTHERS, AND DISCOUNT INFORMATION; PROMOTING, ADVERTISING AND MARKETING OF THE BRANDS, PRODUCTS, SERVICES OR ONLINE WEBSITES OF INDIVIDUALS, BUSINESSES AND NONPROFIT ORGANIZATIONS; PROMOTION, ADVERTISING AND MARKETING OF ON-LINE WEBSITES; PROVIDING A SEARCHABLE WEBSITE FEATURING THE GOODS AND SERVICES OF OTHER VENDORS; PROVIDING ADVERTISING SERVICE TO DISTRIBUTE ADVERTISEMENTS FOR DISPLAY ON INTERNET, NAMELY, IN WEBSITES, SOCIAL CONVERSATIONS OVER THE INTERNET, E-MAILS, MICROBLOGS, BLOGS, ELECTRONIC MESSAGES, INSTANT MESSAGES, TEXT MESSAGES, MULTIMEDIA MESSAGES, SOCIAL NETWORKS, STATUS UPDATES, FORUMS, ELECTRONIC BULLETIN BOARDS, IN CLASS 35 (U.S. CLS. 100, 101 AND 102).



FIRST USE 11-2-2010; IN COMMERCE 11-2-2010.

THE MARK CONSISTS OF THE CAPITALIZED LETTERS "SB" IN ORANGE.

THE COLOR(S) ORANGE IS/ARE CLAIMED AS A FEATURE OF THE MARK.

SER. NO. 85-300,622, FILED 4-20-2011.

*David J. Kybas*

Director of the United States Patent and Trademark Office

**Reg. No. 4,124,473** SHAILA SETTLES, EXAMINING ATTORNEY



# United States of America

United States Patent and Trademark Office

# Objective<sup>dx</sup>

**Reg. No. 4,124,474**

**Registered Apr. 10, 2012**

**Int. Cl.: 44**

**SERVICE MARK**

**PRINCIPAL REGISTER**

OBJECTIVE DIAGNOSTICS LLC (INDIANA LIMITED LIABILITY COMPANY)  
6745 THOROUGHbred DRIVE  
INDIANAPOLIS, IN 46278

FOR: CONSULTING SERVICES IN THE FIELD OF MEDICAL CARE; CONSULTING SERVICES IN THE FIELDS OF DIAGNOSTIC MEDICAL TESTING AND NUTRITION; MEDICAL CONSULTATIONS; MEDICAL COUNSELING; MEDICAL DIAGNOSTIC TESTING, MONITORING AND REPORTING SERVICES; MEDICAL EVALUATION SERVICES, NAMELY, FUNCTIONAL ASSESSMENT PROGRAM FOR PATIENTS RECEIVING MEDICAL REHABILITATION SERVICES FOR PURPOSES OF GUIDING TREATMENT AND ASSESSING PROGRAM EFFECTIVENESS; MEDICAL IMAGING SERVICES; MEDICAL IMAGING SERVICES, NAMELY, CONSULTING SERVICES IN THE FIELD OF USING AND OPERATING MEDICAL IMAGING APPARATUS INCLUDING X-RAY, COMPUTED TOMOGRAPHY, MAGNETIC RESONANCE IMAGING, ULTRASOUND, AND POSITRON EMISSION TOMOGRAPHY APPARATUS; MEDICAL RADIOLOGY SERVICES; MEDICAL SERVICES, IN CLASS 44 (U.S. CLS. 100 AND 101).

FIRST USE 4-1-2011; IN COMMERCE 4-1-2011.

NO CLAIM IS MADE TO THE EXCLUSIVE RIGHT TO USE "DX", APART FROM THE MARK AS SHOWN.

THE COLOR(S) DARK GREEN AND LIGHT GREEN IS/ARE CLAIMED AS A FEATURE OF THE MARK.

THE MARK CONSISTS OF THE WORDING "OBJECTIVE DX" AND A THREE QUARTER CIRCLE DESIGN AROUND THE LETTERS "DX". THE WORDING "OBJECTIVE" IS IN DARK GREEN WITH THE DOTS ABOVE THE SMALL CASE LETTERS "J" AND "I" IN LIGHT GREEN. AT THE END OF THE WORD "OBJECTIVE", THERE IS A THREE-QUARTER CIRCLE WITH THE OPENING AROUND THE LETTER "E" OF "OBJECTIVE". INSIDE THE CIRCLE, THERE ARE THE LETTERS "DX" WITH THE LETTER "D" BEING LIGHT GREEN AND THE LETTER "X" IS SUPERIMPOSED OVER THE LETTER "D". THE LETTER "X" IS DARK GREEN IN COLOR. THE CIRCLE STARTS AT THE TOP IN DARK GREEN THEN FADES TO LIGHT GREEN TO DARK GREEN AND FINALLY TO LIGHT GREEN AT THE BOTTOM.



*David J. Kyffers*

Director of the United States Patent and Trademark Office

SER. NO. 85-300,940, FILED 4-21-2011.

**Reg. No. 4,124,474** SHARON MEIER, EXAMINING ATTORNEY

# United States of America

United States Patent and Trademark Office



**Reg. No. 4,124,475**

MALBER USA, INC. (NEW YORK CORPORATION)  
40 FOX RIDGE  
ROSLYN, NY 11576

**Registered Apr. 10, 2012**

**Int. Cls.: 7 and 11**

FOR: CLOTHES WASHING MACHINES, IN CLASS 7 (U.S. CLS. 13, 19, 21, 23, 31, 34 AND 35).

**TRADEMARK**

FIRST USE 1-1-1988; IN COMMERCE 1-1-1988.

**PRINCIPAL REGISTER**

FOR: CLOTHES DRYING MACHINES , IN CLASS 11 (U.S. CLS. 13, 21, 23, 31 AND 34).

FIRST USE 1-1-1988; IN COMMERCE 1-1-1988.

THE MARK CONSISTS OF AN ARROW SUPERIMPOSED UPON A OUTLINED CIRCLE, ENCLOSED WITHIN A OUTLINED SQUARE AND FOLLOWED BY THE WORD "MALBER".

THE WORDING "MALBER" HAS NO MEANING IN A FOREIGN LANGUAGE.

SER. NO. 85-301,055, FILED 4-21-2011.

DEIRDRE ROBERTSON, EXAMINING ATTORNEY



*David J. Kybas*

Director of the United States Patent and Trademark Office

# United States of America

United States Patent and Trademark Office



U.S. Department of Energy

**Reg. No. 4,124,476**

**Registered Apr. 10, 2012**

**Int. Cl.: 35**

**SERVICE MARK**

**PRINCIPAL REGISTER**

DEPARTMENT OF ENERGY (D.C. FEDERAL AGENCY)  
GC-62, 6F-067  
1000 INDEPENDENCE AVENUE, SW  
WASHINGTON, DC 20585

FOR: AN ASSOCIATION OF GOVERNMENT/INDUSTRY PARTNERS PROMOTING PUBLIC AWARENESS OF THE NEED FOR ALTERNATIVE FUEL VEHICLES BY PROVIDING INFORMATION REGARDING ALTERNATIVE FUEL VEHICLES AND REFUELING INFRASTRUCTURES, VIA A GLOBAL COMPUTER NETWORK, IN CLASS 35 (U.S. CLS. 100, 101 AND 102).

FIRST USE 4-1-1993; IN COMMERCE 4-1-1993.

OWNER OF U.S. REG. NO. 4,052,269.

NO CLAIM IS MADE TO THE EXCLUSIVE RIGHT TO USE "U.S. DEPARTMENT OF ENERGY", APART FROM THE MARK AS SHOWN.

SER. NO. 85-301,240, FILED 4-21-2011.

KATHRYN COWARD, EXAMINING ATTORNEY



*David J. Kyjars*

Director of the United States Patent and Trademark Office

# United States of America

United States Patent and Trademark Office



**Reg. No. 4,124,477**

**Registered Apr. 10, 2012**

**Int. Cl.: 32**

**TRADEMARK**

**PRINCIPAL REGISTER**

BUTTERNUTS BEER & ALE, LLC (NEW YORK LIMITED LIABILITY COMPANY)  
4020 STATE HWY 51  
GARRATTSVILLE, NY 13342

FOR: BEER, IN CLASS 32 (U.S. CLS. 45, 46 AND 48).

FIRST USE 6-29-2005; IN COMMERCE 2-16-2006.

NO CLAIM IS MADE TO THE EXCLUSIVE RIGHT TO USE "WEISSEBIER" "FARMHOUSE ALE" AND "ALL MALT", APART FROM THE MARK AS SHOWN.

THE MARK CONSISTS OF THE LITERAL ELEMENT "HEINNIWEISSE WEISSEBIER FARMHOUSE ALE ALL MALT" REPRESENTED IN STYLIZED FONT AND SUPERIMPOSED UPON A PRIMARY OVAL CARRIER, AND A DESIGN CONSISTING OF GRAPHIC REPRESENTATIONS OF THE CONE OF THE HOPS PLANT LOCATED WITHIN THE CENTER OF TWO EARS OF THE WHEAT PLANT, THE TWO EARS OF WHEAT BEING POSITIONED SUCH THAT THEY FORM THE SHAPE OF A LETTER "V", WHEREIN THE TERM "HEINNIWEISSE" APPEARS IN AN ARC SHAPE INSIDE THE TOP OF THE PRIMARY OVAL, THE TERMS "FARMHOUSE ALE" APPEAR IN CURSIVE FONT INSIDE THE LOWER PART OF THE OVAL IN AN ARC SHAPE, AND WHEREIN WITHIN THE PRIMARY OVAL CARRIER, AND BETWEEN THE TERMS "HEINNIWEISSE" AND "FARMHOUSE ALE" APPEAR THE DESIGN OF THE HOPS CONE AT THE CENTER OF TWO WHEAT EARS, AND WHEREIN FURTHER THE TERM "WEISSEBIER" IS LOCATED INSIDE A SMALL OVAL CIRCLE THAT COVERS THE INTERSECTING POINT OF THE TWO EARS OF WHEAT, AND THE TERMS "ALL MALT" ARE LOCATED IN A CIRCLE TO THE RIGHT OF ONE OF THE WHEAT EARS.

THE ENGLISH TRANSLATION OF "WEISSEBIER" IN THE MARK IS "WHITE BEER". THE WORDING "HEINNIWEISSE" HAS NO MEANING IN A FOREIGN LANGUAGE.

SER. NO. 85-301,850, FILED 4-21-2011.

RONALD DELGIZZI, EXAMINING ATTORNEY



*David J. Kyffers*

Director of the United States Patent and Trademark Office

# United States of America

United States Patent and Trademark Office

## KITCHEN IS SOUL

**Reg. No. 4,124,478**

**Registered Apr. 10, 2012**

**Int. Cls.: 16 and 41**

EARL'S RESTAURANTS ROYALTY LIMITED PARTNERSHIP (CANADA LIMITED PARTNERSHIP)  
SUITE 108B  
949 WEST THIRD STREET  
NORTH VANCOUVER, BC, CANADA V7P3P7

**TRADEMARK**

**SERVICE MARK**

**PRINCIPAL REGISTER**

FOR: EDUCATIONAL PUBLICATIONS, NAMELY, TRAINING MANUALS IN THE FIELD OF RESTAURANTS AND BARS; PUBLICATIONS, NAMELY, BROCHURES, BOOKLETS, AND TEACHING MATERIALS IN THE FIELD OF RESTAURANTS AND BARS, AND EMPLOYEE TRAINING AND MANAGEMENT, IN CLASS 16 (U.S. CLS. 2, 5, 22, 23, 29, 37, 38 AND 50).

FOR: TRAINING SERVICES IN THE FIELDS OF RESTAURANT AND BAR SERVICES; AND TRAINING OF EMPLOYEES IN THE RESTAURANT BUSINESS, IN CLASS 41 (U.S. CLS. 100, 101 AND 107).

THE MARK CONSISTS OF STANDARD CHARACTERS WITHOUT CLAIM TO ANY PARTICULAR FONT, STYLE, SIZE, OR COLOR.

PRIORITY CLAIMED UNDER SEC. 44(D) ON CANADA APPLICATION NO. 1500880, FILED 10-22-2010, REG. NO. TMA811524, DATED 11-9-2011, EXPIRES 11-9-2026.

SER. NO. 85-302,186, FILED 4-22-2011.

NAAKWAMA ANKRAH, EXAMINING ATTORNEY



*David J. Kyffers*

Director of the United States Patent and Trademark Office

# United States of America

United States Patent and Trademark Office

## ATOMIC MONKEY

**Reg. No. 4,124,479**

ATOMIC MONKEY INC. (CALIFORNIA CORPORATION)

**Registered Apr. 10, 2012**

37304 CALLE MAZATLAN  
PALMDALE, CA 93552

**Int. Cl.: 42**

FOR: DESIGN SERVICES FOR OTHERS, NAMELY, CREATION AND PRODUCTION OF DIGITAL AND PHYSICAL CONTENT IN THE FIELDS OF ANIMATION, SCULPTING, SET DESIGN AND THE TOY INDUSTRY , IN CLASS 42 (U.S. CLS. 100 AND 101).

**SERVICE MARK**

FIRST USE 3-15-2001; IN COMMERCE 3-15-2001.

**PRINCIPAL REGISTER**

THE MARK CONSISTS OF STANDARD CHARACTERS WITHOUT CLAIM TO ANY PARTICULAR FONT, STYLE, SIZE, OR COLOR.

SER. NO. 85-302,623, FILED 4-22-2011.

HOWARD SMIGA, EXAMINING ATTORNEY



*David J. Kyffers*

Director of the United States Patent and Trademark Office

# United States of America

United States Patent and Trademark Office

## Cisco EnergyWise

**Reg. No. 4,124,480**

**Registered Apr. 10, 2012**

**Int. Cl.: 9**

**TRADEMARK**

**PRINCIPAL REGISTER**

CISCO TECHNOLOGY, INC. (CALIFORNIA CORPORATION)  
170 WEST TASMAN DRIVE  
SAN JOSE, CA 95134

FOR: COMPUTER NETWORKING SOFTWARE FOR MONITORING, MANAGING, CONTROLLING AND REPORTING ENERGY USAGE AND POWER CONSUMPTION, IN CLASS 9 (U.S. CLS. 21, 23, 26, 36 AND 38).

FIRST USE 3-7-2009; IN COMMERCE 3-7-2009.

THE MARK CONSISTS OF STANDARD CHARACTERS WITHOUT CLAIM TO ANY PARTICULAR FONT, STYLE, SIZE, OR COLOR.

PRIORITY CLAIMED UNDER SEC. 44(D) ON ERPN CMNTY TM OFC APPLICATION NO. 009651639, FILED 1-11-2011.

OWNER OF U.S. REG. NOS. 3,709,076, 3,759,451 AND OTHERS.

SER. NO. 85-302,663, FILED 4-22-2011.

JOHN SCHUYLER YARD, EXAMINING ATTORNEY



*David J. Kyffers*

Director of the United States Patent and Trademark Office



# United States of America

United States Patent and Trademark Office



**Naturo**

**Reg. No. 4,124,481**

**Registered Apr. 10, 2012**

**Int. Cl.: 5**

**TRADEMARK**

**PRINCIPAL REGISTER**

JOSEPH OOI (SINGAPORE INDIVIDUAL)  
10 JALAN BESAR, #05-10 E. SIN LIM TOWER  
SINGAPORE, SINGAPORE 208787

FOR: DIETARY AND NUTRITIONAL SUPPLEMENTS, IN CLASS 5 (U.S. CLS. 6, 18, 44, 46, 51 AND 52).

FIRST USE 2-14-2010; IN COMMERCE 2-14-2010.

THE MARK CONSISTS OF THE UPPER PART IS THE MAIN LOGO, IT IS A LARGE LETTER "N" WITH THICK BODY, THERE IS AN IMAGINARY LIGHT SOURCE SITS IN THE UPPER INNER JOINT OF LETTER "N", WHICH IRRADIATES 9 ARROW-LIKE WHITE COLORED BEAMS INTO THE MIDDLE AND RIGHT BODIES OF LETTER "N", FOR THE LEFT AND MIDDLE 7 BEAMS, THEIR LENGTH ARE ROUGHLY EQUAL, BUT THE LENGTH OF THE SOUTHEAST DIRECTION ARE LONGER THAN THE REST AND THIS BEAM SHOWS A BLUE TINT IN IT. THERE ARE TWO LEAF-SHAPED DESIGN SITS ON THE LEFT BODY OF LETTER "N", THE UPPER ONE IS COLORED DARK GREEN, THE LOWER ONE IS COLORED DARK GREEN ON THE UPPER PART AND GREENISH YELLOW ON THE LOWER PART. THE COLOR OF THE LETTER "N" IS AFFECTED BY THE IMAGINARY LIGHT SOURCE, THE AREA WITH THE LIGHT IRRADIATION APPEARS (FROM TOP TO BOTTOM): DARK ORANGE, YELLOWISH ORANGE, YELLOW, YELLOWISH GREEN, AND DARK GREEN. THE BACKGROUND OF THE LETTER "N" (FROM TOP TO BOTTOM) IS COLORED FROM WHITE TO LIGHT BLUE COLOR, THEN TO DARK BLUE IN TAPERING MANNER. THE BOTTOM OF LETTER "N" IS BOXED IN, AND THERE IS A LARGE BLACK-COLORED WORD "NATURO" SITS RIGHT BELOW THE BOX OF LETTER "N".

THE COLOR(S) ORANGE, BLUE, GREEN, YELLOW, WHITE, AND BLACK IS/ARE CLAIMED AS A FEATURE OF THE MARK.

SER. NO. 85-302,685, FILED 4-22-2011.

JULIE WATSON, EXAMINING ATTORNEY



*David J. Kyros*

Director of the United States Patent and Trademark Office

# United States of America

United States Patent and Trademark Office

## GoPure Soy Protein

**Reg. No. 4,124,482**

**Registered Apr. 10, 2012**

**Int. Cl.: 32**

**TRADEMARK**

**PRINCIPAL REGISTER**

WINDWARD SALES & MARKETING, INC. (NEW JERSEY CORPORATION), DBA BENEFIT  
NUTRITION  
PO BOX 724  
RIDGEWOOD, NJ 07451

FOR: HEXANE FREE SOY-BASED BEVERAGES NOT BEING MILK SUBSTITUTES, IN  
CLASS 32 (U.S. CLS. 45, 46 AND 48).

FIRST USE 6-1-2010; IN COMMERCE 10-12-2010.

THE MARK CONSISTS OF STANDARD CHARACTERS WITHOUT CLAIM TO ANY PAR-  
TICULAR FONT, STYLE, SIZE, OR COLOR.

NO CLAIM IS MADE TO THE EXCLUSIVE RIGHT TO USE "SOY PROTEIN", APART FROM  
THE MARK AS SHOWN.

SER. NO. 85-302,779, FILED 4-22-2011.

MARIA-VICTORIA SUAREZ, EXAMINING ATTORNEY



*David J. Kyros*

Director of the United States Patent and Trademark Office

# United States of America

United States Patent and Trademark Office

## SOCIAL COMPASS

**Reg. No. 4,124,483**

**Registered Apr. 10, 2012**

**Int. Cl.: 35**

**SERVICE MARK**

**PRINCIPAL REGISTER**

ROOT & MADISON, LLC (OKLAHOMA LIMITED LIABILITY COMPANY), DBA SOCIAL COMPASS  
5307 E. MOCKINGBIRD LANE, FIFTH FLOOR  
DALLAS, TX 75206

FOR: ONLINE MARKETING CONSULTATION SERVICES, IN CLASS 35 (U.S. CLS. 100, 101 AND 102).

FIRST USE 1-29-2009; IN COMMERCE 1-29-2009.

THE MARK CONSISTS OF STANDARD CHARACTERS WITHOUT CLAIM TO ANY PARTICULAR FONT, STYLE, SIZE, OR COLOR.

SER. NO. 85-303,426, FILED 4-25-2011.

MICHAEL KEATING, EXAMINING ATTORNEY



*David J. Kybas*

Director of the United States Patent and Trademark Office

# United States of America

United States Patent and Trademark Office

# JEFFERSON

**Reg. No. 4,124,484**

JEFFERSON ELECTRIC, INC. (WISCONSIN CORPORATION)  
9650 W. FRANKLIN DRIVE  
FRANKLIN, WI 531328847

**Registered Apr. 10, 2012**

**Int. Cl.: 9**

FOR: ELECTROMAGNETIC TRANSFORMERS; ELECTRICAL REACTORS; CHOKES, NAMELY, ALTERNATING CURRENT AND DIRECT CURRENT CHOKES; AND RIPPLE FILTERS, NAMELY, ALTERNATING CURRENT, DIRECT CURRENT AND HARMONIC RIPPLE FILTERS, IN CLASS 9 (U.S. CLS. 21, 23, 26, 36 AND 38).

**TRADEMARK**

**PRINCIPAL REGISTER**

FIRST USE 2-10-1916; IN COMMERCE 2-10-1916.

THE MARK CONSISTS OF STANDARD CHARACTERS WITHOUT CLAIM TO ANY PARTICULAR FONT, STYLE, SIZE, OR COLOR.

OWNER OF U.S. REG. NO. 2,179,377.

SER. NO. 85-303,881, FILED 4-25-2011.

STEVEN JACKSON, EXAMINING ATTORNEY



*David J. Kyffers*

Director of the United States Patent and Trademark Office

# United States of America

United States Patent and Trademark Office

## JEFFERSON ELECTRIC

**Reg. No. 4,124,485**

**Registered Apr. 10, 2012**

**Int. Cl.: 9**

**TRADEMARK**

**PRINCIPAL REGISTER**

JEFFERSON ELECTRIC, INC. (WISCONSIN CORPORATION)  
9650 W. FRANKLIN DRIVE  
FRANKLIN, WI 531328847

FOR: ELECTROMAGNETIC TRANSFORMERS; ELECTRICAL REACTORS; CHOKES, NAMELY, ALTERNATING CURRENT AND DIRECT CURRENT CHOKES; AND RIPPLE FILTERS, NAMELY, ALTERNATING CURRENT, DIRECT CURRENT AND HARMONIC RIPPLE FILTERS, IN CLASS 9 (U.S. CLS. 21, 23, 26, 36 AND 38).

FIRST USE 7-1-1998; IN COMMERCE 7-1-1998.

THE MARK CONSISTS OF STANDARD CHARACTERS WITHOUT CLAIM TO ANY PARTICULAR FONT, STYLE, SIZE, OR COLOR.

OWNER OF U.S. REG. NO. 2,179,377.

NO CLAIM IS MADE TO THE EXCLUSIVE RIGHT TO USE "ELECTRIC", APART FROM THE MARK AS SHOWN.

SER. NO. 85-303,916, FILED 4-25-2011.

STEVEN JACKSON, EXAMINING ATTORNEY



*David J. Kyfos*

Director of the United States Patent and Trademark Office

# United States of America

United States Patent and Trademark Office



**Reg. No. 4,124,486**

WAY HER MANUFACTURING CORP. (TAIWAN CORPORATION)  
36, KUNG CHUNG ST., GANGSHAN DIST.  
KAOHSIUNG CITY, TAIWAN

**Registered Apr. 10, 2012**

**Int. Cl.: 6**

FOR: METAL FITTINGS FOR FURNITURE; METAL FITTINGS FOR WINDOWS; METAL COTTER PINS; METAL PIPE HOLDERS; METAL HINGES; METAL KNOBS; METAL FITTINGS FOR DOORS; METAL DOOR KNOBS; METAL DOOR BOLTS; METAL DOOR RINGS; METAL SLIDE BOLTS, IN CLASS 6 (U.S. CLS. 2, 12, 13, 14, 23, 25 AND 50).

**TRADEMARK**

**PRINCIPAL REGISTER**

FIRST USE 2-15-2011; IN COMMERCE 2-15-2011.

THE MARK CONSISTS OF THE WORDING "ATOP" BELOW A TRIANGULAR DESIGN WITH UNEVEN LINES.

SER. NO. 85-304,460, FILED 4-26-2011.

SUSAN STIGLITZ, EXAMINING ATTORNEY



*David J. Kybas*

Director of the United States Patent and Trademark Office

# United States of America

United States Patent and Trademark Office

# Giroux Glass

**Reg. No. 4,124,487**

GIROUX GLASS, INC. (CALIFORNIA CORPORATION)  
850 W. WASHINGTON BLVD. #200  
LOS ANGELES, CA 90015

**Registered Apr. 10, 2012**

**Int. Cl.: 37**

FOR: PLATE GLASS AND GLAZING INSTALLATION, REPAIR, AND CONTRACTOR SERVICES, IN CLASS 37 (U.S. CLS. 100, 103 AND 106).

**SERVICE MARK**

FIRST USE 1-1-1946; IN COMMERCE 1-1-1946.

**PRINCIPAL REGISTER**

THE MARK CONSISTS OF STANDARD CHARACTERS WITHOUT CLAIM TO ANY PARTICULAR FONT, STYLE, SIZE, OR COLOR.

NO CLAIM IS MADE TO THE EXCLUSIVE RIGHT TO USE "GLASS", APART FROM THE MARK AS SHOWN.

SEC. 2(F).

SER. NO. 85-304,621, FILED 4-26-2011.

CAROLYN CATALDO, EXAMINING ATTORNEY



*David J. Kybas*

Director of the United States Patent and Trademark Office

# United States of America

United States Patent and Trademark Office

## LIVING AS A LEADER

**Reg. No. 4,124,488**

**Registered Apr. 10, 2012**

**Int. Cls.: 16 and 41**

**TRADEMARK**

**SERVICE MARK**

**PRINCIPAL REGISTER**

IMPACT CONSULTING GROUP, LLC (WISCONSIN LIMITED LIABILITY COMPANY)  
125 NORTH EXECUTIVE DRIVE #378  
BROOKFIELD, WI 53005

FOR: EDUCATIONAL PUBLICATIONS, NAMELY, TRAINING WORKBOOKS, PAMPHLETS, AND BROCHURES IN THE FIELDS OF BUSINESS MANAGEMENT, SALES, INDIVIDUALIZED COACHING, CUSTOMER SERVICE, AND INTERPERSONAL SKILLS, IN CLASS 16 (U.S. CLS. 2, 5, 22, 23, 29, 37, 38 AND 50).

FIRST USE 6-1-2002; IN COMMERCE 6-1-2004.

FOR: EDUCATION SERVICES, NAMELY, PROVIDING CLASSES, SEMINARS AND WORKSHOPS IN THE FIELDS OF BUSINESS MANAGEMENT, SALES, INDIVIDUALIZED COACHING, CUSTOMER SERVICE, AND INTERPERSONAL SKILLS, IN CLASS 41 (U.S. CLS. 100, 101 AND 107).

FIRST USE 1-1-2002; IN COMMERCE 6-1-2004.

THE MARK CONSISTS OF STANDARD CHARACTERS WITHOUT CLAIM TO ANY PARTICULAR FONT, STYLE, SIZE, OR COLOR.

SER. NO. 85-304,650, FILED 4-26-2011.

DAVID ELTON, EXAMINING ATTORNEY



*David J. Kyffers*

Director of the United States Patent and Trademark Office



# United States of America

United States Patent and Trademark Office



LIVING  
AS A  
LEADER

**Reg. No. 4,124,489**

IMPACT CONSULTING GROUP, LLC (WISCONSIN LIMITED LIABILITY COMPANY)  
125 NORTH EXECUTIVE DRIVE #378  
BROOKFIELD, WI 53005

**Registered Apr. 10, 2012**

**Int. Cls.: 16 and 41**

FOR: EDUCATIONAL PUBLICATIONS, NAMELY, TRAINING WORKBOOKS, PAMPHLETS, AND BROCHURES IN THE FIELDS OF BUSINESS MANAGEMENT, SALES, INDIVIDUALIZED COACHING, CUSTOMER SERVICE, AND INTERPERSONAL SKILLS, IN CLASS 16 (U.S. CLS. 2, 5, 22, 23, 29, 37, 38 AND 50).

**TRADEMARK**

**SERVICE MARK**

FIRST USE 6-1-2002; IN COMMERCE 6-1-2004.

**PRINCIPAL REGISTER**

FOR: EDUCATION SERVICES, NAMELY, PROVIDING CLASSES, SEMINARS AND WORKSHOPS IN THE FIELDS OF BUSINESS MANAGEMENT, SALES, INDIVIDUALIZED COACHING, CUSTOMER SERVICE, AND INTERPERSONAL SKILLS, IN CLASS 41 (U.S. CLS. 100, 101 AND 107).

FIRST USE 1-1-2002; IN COMMERCE 6-1-2004.

THE MARK CONSISTS OF A HUMAN FORM WITH ONE ARM RAISED AND ANOTHER ARM DOWN, STANDING IN A CIRCLE FORMED FROM DOTS, TO THE LEFT OF THE PHRASE "LIVING AS A LEADER".

SER. NO. 85-304,795, FILED 4-26-2011.

DAVID ELTON, EXAMINING ATTORNEY



*David J. Kybas*

Director of the United States Patent and Trademark Office

# United States of America

United States Patent and Trademark Office

## IMMUNO COMPLEX

**Reg. No. 4,124,490**

QUALITY OF LIFE LABORATORIES, INC. (NEW YORK CORPORATION)  
2975 WESTCHESTER AVENUE  
PURCHASE, NY 10577

**Registered Apr. 10, 2012**

**Int. Cl.: 5**

FOR: DIETARY AND NUTRITIONAL SUPPLEMENTS, IN CLASS 5 (U.S. CLS. 6, 18, 44, 46, 51 AND 52).

**TRADEMARK**

FIRST USE 8-26-2003; IN COMMERCE 8-26-2003.

**PRINCIPAL REGISTER**

THE MARK CONSISTS OF STANDARD CHARACTERS WITHOUT CLAIM TO ANY PARTICULAR FONT, STYLE, SIZE, OR COLOR.

OWNER OF U.S. REG. NO. 3,148,400.

NO CLAIM IS MADE TO THE EXCLUSIVE RIGHT TO USE "COMPLEX", APART FROM THE MARK AS SHOWN.

SER. NO. 85-304,948, FILED 4-26-2011.

KEVIN CORWIN, EXAMINING ATTORNEY



*David J. Kybas*

Director of the United States Patent and Trademark Office

# United States of America

United States Patent and Trademark Office

## NO MORE MESSY FLOORS

**Reg. No. 4,124,491**

TOWERSTAR PETS, LLC (DELAWARE LIMITED LIABILITY COMPANY)  
2350 YELLOW SPRINGS ROAD  
MALVERN, PA 19355

**Registered Apr. 10, 2012**

**Int. Cl.: 21**

FOR: FEEDING VESSELS FOR PETS, NAMELY, PET FEEDING AND DRINKING BOWLS AND PET FEEDING DISHES, IN CLASS 21 (U.S. CLS. 2, 13, 23, 29, 30, 33, 40 AND 50).

**TRADEMARK**

FIRST USE 12-1-2010; IN COMMERCE 12-1-2010.

**PRINCIPAL REGISTER**

THE MARK CONSISTS OF STANDARD CHARACTERS WITHOUT CLAIM TO ANY PARTICULAR FONT, STYLE, SIZE, OR COLOR.

SER. NO. 85-305,102, FILED 4-26-2011.

MATTHEW KLINE, EXAMINING ATTORNEY



*David J. Kappas*

Director of the United States Patent and Trademark Office

# United States of America

United States Patent and Trademark Office



**Reg. No. 4,124,492**

MEIJER, INC. (MICHIGAN CORPORATION)  
2929 WALKER AVE., N.W.  
GRAND RAPIDS, MI 49544

**Registered Apr. 10, 2012**

**Int. Cl.: 35**

FOR: ADVERTISING AND MARKETING SERVICES, NAMELY, PROMOTING THE GOODS AND SERVICES OF OTHERS, IN CLASS 35 (U.S. CLS. 100, 101 AND 102).

**SERVICE MARK**

FIRST USE 2-15-2010; IN COMMERCE 2-15-2010.

**PRINCIPAL REGISTER**

NO CLAIM IS MADE TO THE EXCLUSIVE RIGHT TO USE "NETWORK", APART FROM THE MARK AS SHOWN.

THE COLOR(S) RED, BLUE AND WHITE IS/ARE CLAIMED AS A FEATURE OF THE MARK.

THE MARK CONSISTS OF THE WORD "MEIJER" SHOWN IN RED WITH TWO BLUE CIRCLES ABOVE THE LETTERS "IJ", THE WORD "INSITE" WHEREBY THE LETTERS "IN" APPEAR IN WHITE WITHIN A RED CIRCLE AND ARE ADJOINED TO THE LETTERS "SITE" SHOWN IN BLUE AND THE WORD "NETWORK" SHOWN IN THE COLOR BLUE.

SER. NO. 85-305,579, FILED 4-27-2011.

ALICE BENMAMAN, EXAMINING ATTORNEY



*David J. Kybas*

Director of the United States Patent and Trademark Office

**United States of America**  
United States Patent and Trademark Office

# HESSIAN

**Reg. No. 4,124,493**

MCFARLAND, ANGUS FRANCISCO (UNITED STATES INDIVIDUAL)  
P.O. BOX 5442  
PORTLAND, ME 04101

**Registered Apr. 10, 2012**

**Int. Cl.: 9**

FOR: MUSICAL RECORDINGS, IN CLASS 9 (U.S. CLS. 21, 23, 26, 36 AND 38).

**TRADEMARK**

FIRST USE 5-18-2009; IN COMMERCE 6-18-2010.

**PRINCIPAL REGISTER**

THE MARK CONSISTS OF STANDARD CHARACTERS WITHOUT CLAIM TO ANY PARTICULAR FONT, STYLE, SIZE, OR COLOR.

SER. NO. 85-306,707, FILED 4-27-2011.

JEFFREY LOOK, EXAMINING ATTORNEY



*David J. Kybas*

Director of the United States Patent and Trademark Office

# United States of America

United States Patent and Trademark Office

# TransNav

**Reg. No. 4,124,494**

TRANSHAV TECHNOLOGIES, INC. (MICHIGAN CORPORATION)  
35105 CRICKLEWOOD  
NEW BALTIMORE, MI, MI 48047

**Registered Apr. 10, 2012**

**Int. Cls.: 7, 35, 39, 40  
and 42**

FOR: INJECTION MOLDS AND PROTOTYPE MOLDS, NAMELY, MOLDS FOR USE IN THE MANUFACTURE OF PLASTIC AUTOMOBILE PARTS; PRESSES, NAMELY, INDUSTRIAL MACHINE PRESSES AND DIES FOR USE WITH MACHINE TOOLS, IN CLASS 7 (U.S. CLS. 13, 19, 21, 23, 31, 34 AND 35).

**TRADEMARK**

FIRST USE 1-1-1981; IN COMMERCE 1-1-1981.

**SERVICE MARK**

**PRINCIPAL REGISTER**

FOR: GOODS IMPORT/EXPORT AGENCY SERVICES; MAIL ORDER AND ONLINE RETAIL STORE SERVICES FEATURING LEATHERETTE FOR USE IN VEHICLES, IN CLASS 35 (U.S. CLS. 100, 101 AND 102).

FIRST USE 1-1-1981; IN COMMERCE 1-1-1981.

FOR: DISTRIBUTION SERVICES, NAMELY, THE DELIVERY OF INDUSTRIAL TOOLS, MOLDS, DIES, PRESSES, INJECTION MOLDING EQUIPMENT AND COMPONENTS FOR USE THEREWITH, IN CLASS 39 (U.S. CLS. 100 AND 105).

FIRST USE 1-1-1981; IN COMMERCE 1-1-1981.

FOR: CUSTOM PRODUCTION AND MANUFACTURING SERVICES FOR OTHERS IN THE FIELD OF INDUSTRIAL TOOLS, DIES AND MOLDS; ASSEMBLY OF PRODUCTS FOR OTHERS, IN CLASS 40 (U.S. CLS. 100, 103 AND 106).

FIRST USE 1-1-1981; IN COMMERCE 1-1-1981.

FOR: ENGINEERING SERVICES; TOOLING SERVICES, NAMELY, THE PLANNING AND DESIGN FOR OTHERS OF TOOLS FOR USE MANUFACTURING, ASSEMBLY LINES AND IN THE AUTOMOTIVE INDUSTRY, IN CLASS 42 (U.S. CLS. 100 AND 101).

FIRST USE 1-1-1981; IN COMMERCE 1-1-1981.

THE MARK CONSISTS OF STANDARD CHARACTERS WITHOUT CLAIM TO ANY PARTICULAR FONT, STYLE, SIZE, OR COLOR.



*David J. Kyjars*

Director of the United States Patent and Trademark Office

**Reg. No. 4,124,494** SER. NO. 85-306,716, FILED 4-27-2011.

JEFFREY LOOK, EXAMINING ATTORNEY

# United States of America

United States Patent and Trademark Office

# ORE

**Reg. No. 4,124,495**

**Registered Apr. 10, 2012**

**Int. Cls.: 16 and 21**

**TRADEMARK**

**PRINCIPAL REGISTER**

ORE ORIGINALS, INC. (CALIFORNIA CORPORATION)  
1357 CORONADO AVE.  
LONG BEACH, CA 90804

FOR: LUNCH BAGS, IN CLASS 16 (U.S. CLS. 2, 5, 22, 23, 29, 37, 38 AND 50).

FIRST USE 1-1-2009; IN COMMERCE 1-1-2009.

FOR: BOWLS; CUPS; PLATES, IN CLASS 21 (U.S. CLS. 2, 13, 23, 29, 30, 33, 40 AND 50).

FIRST USE 12-31-1987; IN COMMERCE 12-31-1987.

THE MARK CONSISTS OF STANDARD CHARACTERS WITHOUT CLAIM TO ANY PARTICULAR FONT, STYLE, SIZE, OR COLOR.

OWNER OF U.S. REG. NO. 2,558,402.

SER. NO. 85-306,746, FILED 4-28-2011.

JERI J. FICKES, EXAMINING ATTORNEY

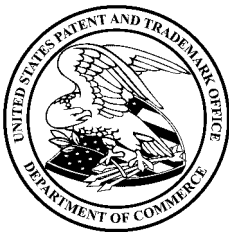

*David J. Kybas*

Director of the United States Patent and Trademark Office



# United States of America

United States Patent and Trademark Office

## MESS-PROOF PET BOWLS!

**Reg. No. 4,124,496**

TOWERSTAR PETS, LLC (DELAWARE LIMITED LIABILITY COMPANY)  
2350 YELLOW SPRINGS ROAD  
MALVERN, PA 19355

**Registered Apr. 10, 2012**

**Int. Cl.: 21**

FOR: FEEDING VESSELS FOR PETS; PET FEEDING AND DRINKING BOWLS; PET FEEDING DISHES, IN CLASS 21 (U.S. CLS. 2, 13, 23, 29, 30, 33, 40 AND 50).

**TRADEMARK**

FIRST USE 12-1-2010; IN COMMERCE 12-1-2010.

**PRINCIPAL REGISTER**

THE MARK CONSISTS OF STANDARD CHARACTERS WITHOUT CLAIM TO ANY PARTICULAR FONT, STYLE, SIZE, OR COLOR.

NO CLAIM IS MADE TO THE EXCLUSIVE RIGHT TO USE "PET BOWLS", APART FROM THE MARK AS SHOWN.

SER. NO. 85-306,825, FILED 4-28-2011.

MATTHEW KLINE, EXAMINING ATTORNEY



*David J. Kappas*

Director of the United States Patent and Trademark Office

# United States of America

United States Patent and Trademark Office

# WiseMechanical

**Reg. No. 4,124,497**

CSOFT AS (NORWAY AKSJESELSKAP (AS))  
STORGATEN 26

**Registered Apr. 10, 2012** LILLESTROM, NORWAY 2000

**Int. Cl.: 9**

FOR: COMPUTER SOFTWARE RECORDED ON DATA CARRIER MEDIA AND DOWNLOADABLE SOFTWARE ALL FOR MECHANICAL COMPUTER AIDED DESIGN (CAD) FOR USE IN MECHANICAL ENGINEERING AND DRAFTING , IN CLASS 9 (U.S. CLS. 21, 23, 26, 36 AND 38).

**TRADEMARK**

**PRINCIPAL REGISTER**

THE MARK CONSISTS OF STANDARD CHARACTERS WITHOUT CLAIM TO ANY PARTICULAR FONT, STYLE, SIZE, OR COLOR.

PRIORITY CLAIMED UNDER SEC. 44(D) ON NORWAY APPLICATION NO. 201011626, FILED 11-4-2010, REG. NO. 259376, DATED 3-28-2011, EXPIRES 11-4-2020.

SER. NO. 85-306,831, FILED 4-28-2011.

DAVID YONTEF, EXAMINING ATTORNEY



*David J. Kyffers*

Director of the United States Patent and Trademark Office

# United States of America

United States Patent and Trademark Office

## KEEP THE FOCUS ON PROTECTING CHILDREN BY STRENGTHENING AND SUPPORTING FAMILIES

**Reg. No. 4,124,498**

**Registered Apr. 10, 2012**

**Int. Cls.: 43 and 45**

ILLINOIS DEPARTMENT OF CHILDREN AND FAMILY SERVICES (ILLINOIS STATE AGENCY)  
6TH FLOOR  
100 WEST RANDOLPH STREET  
CHICAGO, IL 60601

**SERVICE MARK**

FOR: CHILD WELFARE SERVICES, NAMELY, PROVIDING RESIDENTIAL HOMES AND HOUSING FOR AT-RISK CHILDREN AND YOUTH, IN CLASS 43 (U.S. CLS. 100 AND 101).

**PRINCIPAL REGISTER**

FIRST USE 10-28-2008; IN COMMERCE 10-28-2008.

FOR: INVESTIGATION SERVICES RELATED TO SUSPECTED CHILD ABUSE OR CHILD NEGLECT; FOSTER CARE; ADOPTION PLACEMENT; LICENSING OF DAY CARE CENTERS AND DAY CARE HOMES OF OTHERS, IN CLASS 45 (U.S. CLS. 100 AND 101).

FIRST USE 10-28-2008; IN COMMERCE 10-28-2008.

THE MARK CONSISTS OF STANDARD CHARACTERS WITHOUT CLAIM TO ANY PARTICULAR FONT, STYLE, SIZE, OR COLOR.

SER. NO. 85-307,221, FILED 4-28-2011.

DAVID H. STINE, EXAMINING ATTORNEY



*David J. Kybas*

Director of the United States Patent and Trademark Office

# United States of America

United States Patent and Trademark Office

## VITAL FARMS

**Reg. No. 4,124,499**

**Registered Apr. 10, 2012**

**Int. Cl.: 29**

**TRADEMARK**

**PRINCIPAL REGISTER**

VITAL FARMS INC. (TEXAS CORPORATION)  
4507 BRANDT RD.  
AUSTIN, TX 78744

FOR: EGGS; MEAT; POULTRY, IN CLASS 29 (U.S. CL. 46).

FIRST USE 1-0-2007; IN COMMERCE 1-0-2007.

THE MARK CONSISTS OF STANDARD CHARACTERS WITHOUT CLAIM TO ANY PARTICULAR FONT, STYLE, SIZE, OR COLOR.

NO CLAIM IS MADE TO THE EXCLUSIVE RIGHT TO USE "FARMS", APART FROM THE MARK AS SHOWN.

SER. NO. 85-307,314, FILED 4-28-2011.

INGRID C. EULIN, EXAMINING ATTORNEY



*David J. Kyffers*

Director of the United States Patent and Trademark Office

# United States of America

United States Patent and Trademark Office



**Reg. No. 4,124,500**

**Registered Apr. 10, 2012**

**Int. Cl.: 36**

**SERVICE MARK**

**PRINCIPAL REGISTER**

THE RETIREMENT PLANNING GROUP, INC. (KANSAS CORPORATION)  
11512 W. 119TH STREET  
OVERLAND PARK, KS 66213

FOR: INSURANCE SERVICES, NAMELY, UNDERWRITING LIFE AND HEALTH INSURANCE; INVESTMENT ADVICE AND FINANCIAL PLANNING ADVISORY SERVICES; ESTATE PLANNING ADVISORY SERVICES, IN CLASS 36 (U.S. CLS. 100, 101 AND 102).

FIRST USE 0-0-2006; IN COMMERCE 0-0-2006.

THE MARK CONSISTS OF A CREST WITH MIRRORED CHESS KNIGHTS APPEARING THEREIN AND A FLEUR DI LIS ABOVE.

SER. NO. 85-307,492, FILED 4-28-2011.

ANNE E. GUSTASON, EXAMINING ATTORNEY



*David J. Kybas*

Director of the United States Patent and Trademark Office

United States of America  
United States Patent and Trademark Office

# FUNBRAIN

**Reg. No. 4,124,501**

**Registered Apr. 10, 2012**

**Int. Cl.: 41**

**SERVICE MARK**

**PRINCIPAL REGISTER**

FUNBRAIN.COM, L.L.C. (DELAWARE LIMITED LIABILITY COMPANY)  
6454 NORTH BOSWORTH  
CHICAGO, IL 60626

FOR: EDUCATIONAL AND ENTERTAINMENT SERVICES, NAMELY, PROVIDING A WEBSITE FEATURING ONLINE ELECTRONIC EDUCATIONAL QUIZZES FEATURING A VARIETY OF SUBJECTS FOR ELEMENTARY AND MIDDLE SCHOOL LEVEL STUDENTS AND ONLINE ELECTRONIC EDUCATIONAL GAMES, IN CLASS 41 (U.S. CLS. 100, 101 AND 107).

FIRST USE 0-0-1997; IN COMMERCE 0-0-1997.

THE MARK CONSISTS OF STANDARD CHARACTERS WITHOUT CLAIM TO ANY PARTICULAR FONT, STYLE, SIZE, OR COLOR.

SER. NO. 85-307,604, FILED 4-29-2011.

EMILY CARLSEN, EXAMINING ATTORNEY



*David J. Kyffers*

Director of the United States Patent and Trademark Office

# United States of America

United States Patent and Trademark Office

# MES

**Reg. No. 4,124,502**

CEBI USA, INC. (MICHIGAN CORPORATION)  
15101 CENTURY DRIVE, SUITE 501  
DEARBORN, MI 48120

**Registered Apr. 10, 2012**

**Int. Cls.: 7, 9, 11 and 12**

FOR: COMPONENTS FOR ELECTRO-DOMESTIC APPLIANCES, NAMELY, EXHAUST PUMPS AND FAN MOTORS; COMPONENTS FOR AUTOMOTIVE APPLICATIONS, NAMELY, WINDSHIELD WASHER PUMPS AND HEADLAMP WASHER PUMPS; COMPONENTS FOR ELECTRIC LAND VEHICLES, NAMELY, CIRCULATION PUMPS FOR HEATING AND COOLING SYSTEMS, VACUUM PUMPS, AC INDUCTION MOTOR DRIVES, IN CLASS 7 (U.S. CLS. 13, 19, 21, 23, 31, 34 AND 35).

**TRADEMARK**

**PRINCIPAL REGISTER**

FIRST USE 0-0-1993; IN COMMERCE 0-0-1993.

FOR: ELECTRIC COMPONENTS FOR AUTOMOTIVE APPLICATIONS, NAMELY, HEAD-LAMP LEVELING ACTUATORS AND ROTARY SOLENOID VALVES, AIR CONDITIONING ACTUATORS, WINDOW ACTUATORS, DOOR LOCK ACTUATORS AND AIR GRILLE SHUTTER ACTUATORS; COMPONENTS FOR ELECTRIC LAND VEHICLES, NAMELY, AC/DC CONVERTERS, DC/DC CONVERTERS, BATTERY CHARGERS AND ELECTRONIC DISPLAY INTERFACES, IN CLASS 9 (U.S. CLS. 21, 23, 26, 36 AND 38).

FIRST USE 0-0-1993; IN COMMERCE 0-0-1993.

FOR: COMPONENTS FOR ELECTRIC LAND VEHICLES, NAMELY, FLUID HEATERS FOR AUTOMOTIVE HEATING AND COOLING SYSTEMS, IN CLASS 11 (U.S. CLS. 13, 21, 23, 31 AND 34).

FIRST USE 0-0-1993; IN COMMERCE 0-0-1993.

FOR: COMPONENTS FOR ELECTRIC LAND VEHICLES, NAMELY, AC INDUCTION MOTORS, IN CLASS 12 (U.S. CLS. 19, 21, 23, 31, 35 AND 44).

FIRST USE 0-0-1993; IN COMMERCE 0-0-1993.

THE MARK CONSISTS OF STANDARD CHARACTERS WITHOUT CLAIM TO ANY PARTICULAR FONT, STYLE, SIZE, OR COLOR.

OWNER OF U.S. REG. NO. 2,452,910.



*David J. Kybas*

Director of the United States Patent and Trademark Office

**Reg. No. 4,124,502** SER. NO. 85-308,594, FILED 4-29-2011.

JENNIFER VASQUEZ, EXAMINING ATTORNEY



# United States of America

United States Patent and Trademark Office

## POWER TITANIUM

**Reg. No. 4,124,503**

POWER TITANIUM LLC (UTAH LIMITED LIABILITY COMPANY)  
1300 EAST LOWER RIVER ROAD  
KAMAS, UT 84036

**Registered Apr. 10, 2012**

**Int. Cl.: 14**

FOR: NECK BANDS AND WRISTBANDS IN THE NATURE OF NECKLACES AND BRACELETS, MADE IN PART OR WHOLE OF TITANIUM, IN CLASS 14 (U.S. CLS. 2, 27, 28 AND 50).

**TRADEMARK**

FIRST USE 4-18-2011; IN COMMERCE 4-18-2011.

**PRINCIPAL REGISTER**

THE MARK CONSISTS OF STANDARD CHARACTERS WITHOUT CLAIM TO ANY PARTICULAR FONT, STYLE, SIZE, OR COLOR.

NO CLAIM IS MADE TO THE EXCLUSIVE RIGHT TO USE "TITANIUM", APART FROM THE MARK AS SHOWN.

SER. NO. 85-308,881, FILED 4-29-2011.

DANNEAN HETZEL, EXAMINING ATTORNEY



*David J. Kyffers*

Director of the United States Patent and Trademark Office

**United States of America**  
United States Patent and Trademark Office

**NAQURA**

**Reg. No. 4,124,504**

PORTER, CHRISTOPHER (UNITED STATES INDIVIDUAL)  
6401 HUNTLEIGH WAY  
AUSTIN, TX 78725

**Registered Apr. 10, 2012**

**Int. Cl.: 25**

FOR: MEN'S, WOMEN'S AND CHILDREN'S CLOTHING NAMELY, DENIM JACKETS, DENIM JEANS, DENIM OVERALLS, SHIRTS NAMELY, SWEATSHIRTS, T-SHIRTS, DRESS SHIRTS, RUGBY SHIRTS, WOVEN KNITTED SHIRTS, KNITTED VESTS, AND SOCKS, IN CLASS 25 (U.S. CLS. 22 AND 39).

**TRADEMARK**

**PRINCIPAL REGISTER**

FIRST USE 1-4-1999; IN COMMERCE 1-7-1999.

THE MARK CONSISTS OF STANDARD CHARACTERS WITHOUT CLAIM TO ANY PARTICULAR FONT, STYLE, SIZE, OR COLOR.

SER. NO. 85-308,969, FILED S.R. 4-29-2011 AM. P.R. 11-28-2011.

JAY FLOWERS, EXAMINING ATTORNEY



*David J. Kyfos*

Director of the United States Patent and Trademark Office

# United States of America

United States Patent and Trademark Office



**Reg. No. 4,124,505**

**Registered Apr. 10, 2012**

**Int. Cls.: 3 and 5**

**TRADEMARK**

**PRINCIPAL REGISTER**

THE BRITISH DISPENSARY (L.P.) CO., LTD. (THAILAND CORPORATION)  
272 MOO 1, SOI PATTANASUK, TEPARUK ROAD  
TEPARUK, MUANG  
SAMUTPRAKARN, THAILAND 10270

FOR: TALCUM POWDER, BODY CREAM SOAP, HAIR SHAMPOO, HAIR CONDITIONER,  
TOOTHPASTE, AND PERFUMED POWDER, IN CLASS 3 (U.S. CLS. 1, 4, 6, 50, 51 AND 52).

FOR: PHARMACEUTICAL PREPARATIONS FOR THE TREATMENT OF FEVERS, ANAL-  
GESICS, MEDICATED BALM FOR THE TREATMENT OF SKIN, IN CLASS 5 (U.S. CLS. 6,  
18, 44, 46, 51 AND 52).

OWNER OF THAILAND REG. NO. KOR157221, DATED 10-25-2011, EXPIRES 9-30-2021.

OWNER OF THAILAND REG. NO. KOR154113, DATED 10-19-2011, EXPIRES 9-30-2021.

THE MARK CONSISTS OF A REPRESENTATION OF A SNAKE, AN ARROW AND GRASS.

SER. NO. 85-309,159, FILED 4-30-2011.

BILL DAWE, EXAMINING ATTORNEY



*David J. Kyfos*

Director of the United States Patent and Trademark Office

# United States of America

United States Patent and Trademark Office

## Integrated Defensive Safety Systems IDSS

**Reg. No. 4,124,506**

GUINEE JR DAYTON (UNITED STATES INDIVIDUAL)  
153 WALTER AVENUE  
THORNWOOD, NY 10594

**Registered Apr. 10, 2012**

**Int. Cl.: 45**

FOR: PROVIDING INFORMATION IN THE FIELD OF SELF-DEFENSE, IN CLASS 45 (U.S. CLS. 100 AND 101).

**SERVICE MARK**

FIRST USE 4-29-2011; IN COMMERCE 4-29-2011.

**PRINCIPAL REGISTER**

THE MARK CONSISTS OF STANDARD CHARACTERS WITHOUT CLAIM TO ANY PARTICULAR FONT, STYLE, SIZE, OR COLOR.

NO CLAIM IS MADE TO THE EXCLUSIVE RIGHT TO USE "INTEGRATED DEFENSIVE SAFETY SYSTEMS", APART FROM THE MARK AS SHOWN.

SER. NO. 85-309,249, FILED 4-30-2011.

ELLEN B. AWRICH, EXAMINING ATTORNEY



*David J. Kyffers*

Director of the United States Patent and Trademark Office

# United States of America

United States Patent and Trademark Office

# Simarri

**Reg. No. 4,124,507**

**Registered Apr. 10, 2012**

**Int. Cl.: 3**

**TRADEMARK**

**PRINCIPAL REGISTER**

TILLER, TWANNA (UNITED STATES INDIVIDUAL), DBA SIMARRI  
700 MCCONNELL RUN CROSSINGS  
GRAYSON, GA 30017

FOR: HAIR, BODY AND BEAUTY CARE COSMETICS AND PREPARATIONS, NAMELY, NAIL POLISH, NAIL GELS, LOTIONS, EYE SHADOWS, BLUSHERS, CONCEALERS, FOUNDATIONS, LIP GLOSSES, LIP STICKS, ROUGES, HAIR SHAMPOOS, HAIR CONDITIONERS, HAIR MOUSSES, HAIR GELS, HAIR SPRAYS; PERFUMES, IN CLASS 3 (U.S. CLS. 1, 4, 6, 50, 51 AND 52).

FIRST USE 4-29-2011; IN COMMERCE 4-29-2011.

THE MARK CONSISTS OF STANDARD CHARACTERS WITHOUT CLAIM TO ANY PARTICULAR FONT, STYLE, SIZE, OR COLOR.

SER. NO. 85-309,276, FILED 5-1-2011.

MARK RADEMACHER, EXAMINING ATTORNEY



*David J. Kybas*

Director of the United States Patent and Trademark Office

# United States of America

United States Patent and Trademark Office

KOMANDO  
LATEX CONDOMS

**SPIKE**



**Reg. No. 4,124,508**

**Registered Apr. 10, 2012**

**Int. Cl.: 10**

**TRADEMARK**

**PRINCIPAL REGISTER**

RISING SUN ENTERPRISE LLC (GEORGIA LIMITED LIABILITY COMPANY)  
30102 WALDEN BROOK DR  
LITHONIA, GA 30038

FOR: CONDOMS, IN CLASS 10 (U.S. CLS. 26, 39 AND 44).

FIRST USE 8-1-2010; IN COMMERCE 8-1-2010.

NO CLAIM IS MADE TO THE EXCLUSIVE RIGHT TO USE "LATEX CONDOMS", APART FROM THE MARK AS SHOWN.

THE MARK CONSISTS OF THE STYLIZED TEXT "KOMANDO LATEX CONDOMS SPIKE" WITH A DESIGN OF A STRONGMAN FIGURE.

SER. NO. 85-309,615, FILED 5-2-2011.

JOSETTE BEVERLY, EXAMINING ATTORNEY



*David J. Kyffers*

Director of the United States Patent and Trademark Office

# United States of America

United States Patent and Trademark Office

# NANOSCALE

**Reg. No. 4,124,509**

**Registered Apr. 10, 2012**

**Int. Cls.: 1, 6 and 42**

**TRADEMARK**

**SERVICE MARK**

**PRINCIPAL REGISTER**

NANOSCALE CORPORATION (DELAWARE CORPORATION)  
1310 RESEARCH PARK DRIVE  
MANHATTAN, KS 66502

FOR: CHEMICALS, NAMELY, METAL OXIDES FOR USE IN DESTRUCTIVE ABSORPTION OF TOXIC CHEMICALS AND BIOLOGICAL AGENTS, NEUTRALIZATION OF TOXIC INDUSTRIAL CHEMICALS, AIR FILTRATION, SILICA, ACID GAS TREATMENT, POLISHING APPLICATIONS, ENHANCING THE PHYSICAL PROPERTIES OF PAINTS AND INDUSTRIAL COATINGS, AND TRANSPARENT ULTRAVIOLET ATTENUATION, IN CLASS 1 (U.S. CLS. 1, 5, 6, 10, 26 AND 46).

FIRST USE 6-2-2003; IN COMMERCE 6-2-2003.

FOR: NANOCRYSTALLINE METALS FOR USE IN DESTRUCTIVE ABSORPTION OF TOXIC CHEMICALS AND BIOLOGICAL AGENTS, NEUTRALIZATION OF TOXIC INDUSTRIAL CHEMICALS, AIR FILTRATION, SILICA, ACID GAS TREATMENT, POLISHING APPLICATIONS, ENHANCING THE PHYSICAL PROPERTIES OF PAINTS AND INDUSTRIAL COATINGS, AND TRANSPARENT ULTRAVIOLET ATTENUATION, IN CLASS 6 (U.S. CLS. 2, 12, 13, 14, 23, 25 AND 50).

FIRST USE 6-2-2003; IN COMMERCE 6-2-2003.

FOR: CHEMICAL RESEARCH, NAMELY, RESEARCH IN THE FIELD OF NANOPARTICLES, IN CLASS 42 (U.S. CLS. 100 AND 101).

FIRST USE 7-8-2002; IN COMMERCE 6-2-2003.

THE MARK CONSISTS OF STANDARD CHARACTERS WITHOUT CLAIM TO ANY PARTICULAR FONT, STYLE, SIZE, OR COLOR.

OWNER OF U.S. REG. NOS. 2,622,443, 3,578,667 AND OTHERS.

SEC. 2(F).

SER. NO. 85-309,835, FILED 5-2-2011.

EMILY CARLSEN, EXAMINING ATTORNEY



*David J. Kyros*

Director of the United States Patent and Trademark Office

# United States of America

United States Patent and Trademark Office

# EVATHERM

**Reg. No. 4,124,510**

**Registered Apr. 10, 2012**

**Int. Cl.: 10**

**TRADEMARK**

**PRINCIPAL REGISTER**

FISHER & PAYKEL HEALTHCARE LIMITED (NEW ZEALAND LIMITED LIABILITY COMPANY)  
15 MAURICE PAYKEL PLACE, EAST TAMAKI  
AUCKLAND, NEW ZEALAND 2013

FOR: MEDICAL APPARATUS FOR BREATHING PURPOSES, NAMELY, RESPIRATORS AND ARTIFICIAL RESPIRATION APPARATUS; MEDICAL APPARATUS FOR BREATHING PURPOSES, NAMELY, BREATHING TUBES USED IN DELIVERY OF AIR AND GASES TO AND WAY FROM PATIENTS; MEDICAL APPARATUS, NAMELY, NON-INVASIVE VENTILATION APPARATUS AND INSTRUMENTS; TUBES FOR MEDICAL PURPOSES, NAMELY, TRACHEOSTOMY TUBES, NASAL TUBES AND TUBE CONNECTORS; BREATHING TUBES FOR MEDICAL PURPOSES; RE-USEABLE AND DISPOSABLE BREATHING TUBES FOR MEDICAL PURPOSES; CONNECTIONS FOR USE WITH BREATHING APPARATUS; BREATHING MASKS FOR USE IN TREATING OBSTRUCTIVE SLEEP APNEA; FACIAL MASKS, NASAL MASKS, NASAL CANNULA, MOUTHPIECES, HEADGEAR, ALL BEING FOR MEDICAL PURPOSES; PARTS AND FITTINGS FOR ALL THE AFOREMENTIONED GOODS, IN CLASS 10 (U.S. CLS. 26, 39 AND 44).

THE MARK CONSISTS OF STANDARD CHARACTERS WITHOUT CLAIM TO ANY PARTICULAR FONT, STYLE, SIZE, OR COLOR.

PRIORITY CLAIMED UNDER SEC. 44(D) ON NEW ZEALAND APPLICATION NO. 839508, FILED 3-31-2011, REG. NO. 839508, DATED 3-31-2011, EXPIRES 3-31-2021.

SER. NO. 85-309,990, FILED 5-2-2011.

REBECCA SMITH, EXAMINING ATTORNEY



*David J. Kypos*

Director of the United States Patent and Trademark Office



# United States of America

United States Patent and Trademark Office

# TopFan

**Reg. No. 4,124,511**

**Registered Apr. 10, 2012**

**Int. Cls.: 35 and 42**

**SERVICE MARK**

**PRINCIPAL REGISTER**

TOPFAN, INC. (COLORADO CORPORATION)  
P.O. BOX 6731  
DENVER, CO 80206

FOR: PROMOTING GOODS AND SERVICES OF OTHERS BY PROVIDING A MOBILE APPLICATION FEATURING COUPONS, REBATES, DISCOUNTS OR SPECIAL OFFERINGS ON GOODS AND SERVICE; CONTESTS AND INCENTIVE AWARD PROGRAMS TO PROMOTE THE SALE OF PRODUCTS AND SERVICES OF OTHERS; PROMOTING THE INTERACTION OF FANS WITH THEIR FAVORITE TEAMS, ATHLETES, CELEBRITIES, POLITICIANS, MUSICAL GROUPS AND ARTISTS AND WITH THE RESPECTIVE ADVERTISING SPONSORS OF THEIR FAVORITE TEAMS, ATHLETES, CELEBRITIES, POLITICIANS, MUSICAL GROUPS AND ARTISTS FOR THE PURPOSE OF SPONSOR BRAND ACTIVATION, SALES, AND MARKETING BY PROVIDING A MOBILE APPLICATION FEATURING SOCIAL MEDIA FEEDS, STATISTICS, UPCOMING EVENTS, AND CONTESTS, IN CLASS 35 (U.S. CLS. 100, 101 AND 102).

FIRST USE 4-28-2011; IN COMMERCE 4-28-2011.

FOR: PROVIDING AN INTERACTIVE WEBSITE FEATURING TECHNOLOGY THAT ALLOWS USERS TO FOLLOW AND INTERACT WITH THEIR FAVORITE TEAMS, GROUPS, AND ARTISTS, AND THEIR RESPECTIVE ADVERTISING SPONSORS, IN CLASS 42 (U.S. CLS. 100 AND 101).

FIRST USE 4-28-2011; IN COMMERCE 4-28-2011.

THE MARK CONSISTS OF THE WORD "TOP" IN GREY WITH THE WORD "FAN" IN GREEN.

THE COLOR(S) GREY AND GREEN IS/ARE CLAIMED AS A FEATURE OF THE MARK.

SER. NO. 85-310,421, FILED 5-2-2011.

PRISCILLA MILTON, EXAMINING ATTORNEY



*David J. Kybas*

Director of the United States Patent and Trademark Office

# United States of America

United States Patent and Trademark Office

# WHEATON

**Reg. No. 4,124,512**

**Registered Apr. 10, 2012**

**Int. Cls.: 9, 35 and 40**

**TRADEMARK**

**SERVICE MARK**

**PRINCIPAL REGISTER**

WHEATON INDUSTRIES, INC. (DELAWARE CORPORATION)  
1501 N. 10TH STREET  
MILLVILLE, NJ 08332

FOR: LABORATORY EQUIPMENT AND SUPPLIES, NAMELY, LABORATORY BOTTLES, VIALS, TEST TUBES, GLASS TUBING FOR SCIENTIFIC PURPOSES, DISPENSER SYRINGES FOR LABORATORY USE, PIPETTES, PIPETTE TIPS; LABORATORY EQUIPMENT, NAMELY, PLASTIC, RUBBER AND ELASTOMER CLOSURES, SEALS AND STOPPERS FOR LABORATORY BOTTLES AND VIALS; LABORATORY GLASSWARE; CONDENSERS; LABORATORY GLASSWARE RACKS; PIPETTE RACKS; LABORATORY INCUBATORS; LABORATORY APPARATUS AND INSTRUMENTS, NAMELY, LABORATORY APPARATUS, COMPUTER HARDWARE AND SOFTWARE FOR STORING, ROTATING, MONITORING AND RECORDING CELL CULTURES; CONTROLLED VOLUME PUMPS; LABORATORY EQUIPMENT, NAMELY, AUTOMATIC FLUID DISPENSERS; LABORATORY EQUIPMENT, NAMELY, BARCODE SCANNERS, IN CLASS 9 (U.S. CLS. 21, 23, 26, 36 AND 38).

FIRST USE 4-26-2011; IN COMMERCE 4-26-2011.

FOR: INVENTORY MANAGEMENT SERVICES, NAMELY, BAR CODING FOR PRODUCT IDENTIFICATION, PRODUCT IDENTIFICATION LABELING, AND INVENTORY CONTROL LABELING, IN CLASS 35 (U.S. CLS. 100, 101 AND 102).

FIRST USE 1-19-2006; IN COMMERCE 1-19-2006.

FOR: CUSTOM MANUFACTURE OF CONTAINERS TO THE SPECIFICATIONS OF OTHERS; STERILIZATION OF LABORATORY VIALS, VIAL INSERTS, AND LABORATORY GLASSWARE; SILANIZATION OF LABORATORY VIALS, VIAL INSERTS, AND LABORATORY GLASSWARE; SILICONIZATION OF LABORATORY VIALS, VIAL INSERTS, AND LABORATORY GLASSWARE; TREATMENT OF LABORATORY VIALS, VIAL INSERTS, AND LABORATORY GLASSWARE WITH AMMONIUM SULFATE, IN CLASS 40 (U.S. CLS. 100, 103 AND 106).

FIRST USE 1-19-2006; IN COMMERCE 1-19-2006.

THE MARK CONSISTS OF STANDARD CHARACTERS WITHOUT CLAIM TO ANY PARTICULAR FONT, STYLE, SIZE, OR COLOR.



*David J. Kyjars*

Director of the United States Patent and Trademark Office

**Reg. No. 4,124,512** OWNER OF U.S. REG. NOS. 1,103,791 AND 1,125,938.

SER. NO. 85-310,547, FILED 5-3-2011.

CHARLES L. JENKINS, EXAMINING ATTORNEY

# United States of America

United States Patent and Trademark Office

## ORIGO MathEd

**Reg. No. 4,124,513**

**Registered Apr. 10, 2012**

**Int. Cls.: 9, 16 and 41**

JAMCAL CORPORATION PTY LTD (AUSTRALIA PROPRIETARY COMPANY, LIMITED  
BY SHARES)  
UNIT 1  
209 LEITCHS ROAD  
BRENDALE QLD 4514, AUSTRALIA

**TRADEMARK**

FOR: DOWNLOADABLE VIDEO RECORDINGS RELATING TO PROFESSIONAL DEVELOPMENT FOR TEACHERS AND PARENTS FEATURING MATHEMATICS EDUCATION, IN CLASS 9 (U.S. CLS. 21, 23, 26, 36 AND 38).

**SERVICE MARK**

FIRST USE 2-0-2011; IN COMMERCE 2-0-2011.

**PRINCIPAL REGISTER**

FOR: PRINTED INSTRUCTIONAL, EDUCATIONAL AND TEACHING MATERIALS FOR PROFESSIONAL DEVELOPMENT FOR TEACHERS AND PARENTS IN THE FIELD OF MATHEMATICS, IN CLASS 16 (U.S. CLS. 2, 5, 22, 23, 29, 37, 38 AND 50).

FIRST USE 2-0-2011; IN COMMERCE 2-0-2011.

FOR: PROVIDING ON-LINE TRAINING IN THE FORM OF SEMINARS AND WORKSHOPS IN THE FIELD OF MATHEMATICS, IN CLASS 41 (U.S. CLS. 100, 101 AND 107).

FIRST USE 2-0-2011; IN COMMERCE 2-0-2011.

THE MARK CONSISTS OF STANDARD CHARACTERS WITHOUT CLAIM TO ANY PARTICULAR FONT, STYLE, SIZE, OR COLOR.

NO CLAIM IS MADE TO THE EXCLUSIVE RIGHT TO USE "MATH ED", APART FROM THE MARK AS SHOWN.

THE ENGLISH TRANSLATION OF "ORIGO" IN THE MARK IS "SOURCE OR ORIGIN".

SER. NO. 85-310,688, FILED 5-3-2011.

CIMMERIAN COLEMAN, EXAMINING ATTORNEY



*David J. Kypas*

Director of the United States Patent and Trademark Office

# United States of America

United States Patent and Trademark Office



**Reg. No. 4,124,514**

**Registered Apr. 10, 2012**

**Int. Cls.: 35 and 36**

**SERVICE MARK**

**PRINCIPAL REGISTER**

BANKRATE, INC. (DELAWARE CORPORATION)  
SUITE #200  
11760 US HIGHWAY 1  
NORTH PALM BEACH, FL 33408

FOR: CAREER ADVICE IN THE NATURE OF ADVISING ABOUT JOB PLACEMENT; TAX INFORMATION; GATHERING AND COMPILING FINANCIAL MARKET DATA AND PERSONAL OPINION SURVEY DATA REGARDING PERSONAL FINANCES, EMPLOYMENT, DEBT FEARS, SAVING FRUSTRATIONS; PROVIDING STATISTICAL REPORTS REGARDING MORTGAGES AND INTEREST RATES, IN CLASS 35 (U.S. CLS. 100, 101 AND 102).

FIRST USE 5-1-1999; IN COMMERCE 5-1-1999.

FOR: FINANCIAL SERVICES IN THE NATURE OF PROVIDING FINANCIAL INFORMATION THROUGH A GLOBAL COMPUTER NETWORK, NAMELY, FINANCIAL AND INSURANCE ADVICE; PROVIDING FINANCIAL INFORMATION ABOUT LENDERS; PROVIDING FINANCIAL TOOLS IN THE NATURE OF ON-LINE FINANCIAL CALCULATORS; PROVISION OF FINANCIAL REPORTS; FINANCIAL RESEARCH AND ANALYSIS OF FINANCIAL INSTITUTIONS, IN CLASS 36 (U.S. CLS. 100, 101 AND 102).

FIRST USE 5-1-1999; IN COMMERCE 5-1-1999.

THE MARK CONSISTS OF A CIRCLE ENCLOSING A FEWER DESIGN.

SER. NO. 85-310,723, FILED 5-3-2011.

MICHELLE DUBOIS, EXAMINING ATTORNEY



*David J. Kyffers*

Director of the United States Patent and Trademark Office

# United States of America

United States Patent and Trademark Office

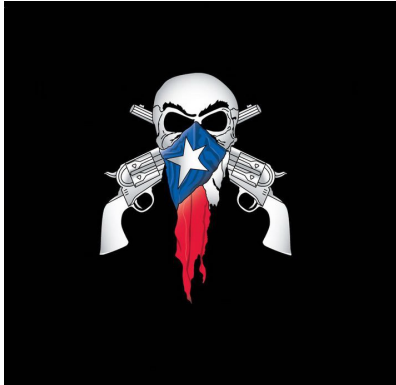

**Reg. No. 4,124,515**

**Registered Apr. 10, 2012**

**COLLECTIVE  
MEMBERSHIP**

**PRINCIPAL REGISTER**

JAMES KOSUB (UNITED STATES INDIVIDUAL)  
5080 TABBERER RD  
POTEET, TX 78065

FOR: INDICATING MEMBERSHIP IN A MOTORCYCLE CLUB THAT PROMOTES MOTORCYCLE SAFETY AND AWARENESS, IN CLASS 200 (U.S. CL. 200).

FIRST USE 1-0-2006; IN COMMERCE 1-0-2006.

THE MARK CONSISTS OF A DESIGN THAT DEPICTS A SKULL WEARING A TATTERED BANDANA THAT COVERS THE JAW, CHEEK AND NOSE PORTIONS OF THE SKULL. THE SKULL IS GRAY WITH BLACK LINING, BLACK EYES, AND BLACK EYEBROWS. THE BANDANA FEATURES A BLUE SQUARE WITH A WHITE STAR WITHIN THE BLUE SQUARE, THE TATTERED BANDANA ALSO FEATURES THE COLORS RED AND WHITE BELOW THE BLUE SQUARE. DIRECTLY BEHIND THE SKULL DESIGN IS A DESIGN OF TWO HAND GUNS CRISSCROSSING, THE GUNS ARE OUTLINED IN THE COLOR OF BLACK, THE HANDLE OF THE GUN IS IN THE COLOR OF WHITE AND THE BARREL PORTION IS IN THE COLOR OF GRAY WITH SHADES OF WHITE. THE COLOR BLACK APPEARING IN THE BACKGROUND OF THE MARK IS BACKGROUND COLOR AND IS NOT CLAIMED AS A FEATURE OF THE MARK.

THE COLOR(S) GRAY, RED, WHITE, BLUE AND BLACK IS/ARE CLAIMED AS A FEATURE OF THE MARK.

SER. NO. 85-310,793, FILED 5-3-2011.

MICHELLE DUBOIS, EXAMINING ATTORNEY



*David J. Kybas*

Director of the United States Patent and Trademark Office

# United States of America

United States Patent and Trademark Office

# PhoneView

**Reg. No. 4,124,516**

ECAMM NETWORK, LLC (MASSACHUSETTS LIMITED LIABILITY COMPANY)  
1132 SALEM STREET

**Registered Apr. 10, 2012**

NORTH ANDOVER, MA 01845

**Int. Cl.: 9**

FOR: COMPUTER SOFTWARE FOR ACCESSING PHONE, TABLET COMPUTER AND MP3 PLAYER SMS/MMS MESSAGES, CONTACTS, CALL HISTORY, VOICEMAILS, APPLICATIONS DATA, WEB BOOKMARKS, WEB HISTORY, MUSIC LIBRARY MEDIA, PHOTOS, BOOKS, NOTES AND VOICE MEMOS, IN CLASS 9 (U.S. CLS. 21, 23, 26, 36 AND 38).

**TRADEMARK**

**PRINCIPAL REGISTER**

FIRST USE 5-15-2008; IN COMMERCE 5-15-2008.

THE MARK CONSISTS OF STANDARD CHARACTERS WITHOUT CLAIM TO ANY PARTICULAR FONT, STYLE, SIZE, OR COLOR.

SER. NO. 85-310,873, FILED 5-3-2011.

JASON TURNER, EXAMINING ATTORNEY



*David J. Kyffers*

Director of the United States Patent and Trademark Office

# United States of America

United States Patent and Trademark Office



**Reg. No. 4,124,517**

**Registered Apr. 10, 2012**

**Int. Cls.: 10, 18, 25 and 35**

AGB INC (OREGON CORPORATION)  
4287 SE INTERNATIONAL WAY  
SUITE D  
MILWAUKIE, OR 97222

FOR: ADULT SEXUAL STIMULATION AIDS, NAMELY, NIPPLE AND GENITAL CLIPS AND RINGS OF RUBBER, METAL AND LEATHER; ADULT SEXUAL STIMULATION AIDS, NAMELY, VIBRATING CLIPS AND RINGS, AND WEIGHTS FOR CLIPS AND RINGS, IN CLASS 10 (U.S. CLS. 26, 39 AND 44).

**TRADEMARK**

**SERVICE MARK**

FIRST USE 1-1-1987; IN COMMERCE 1-1-1987.

**PRINCIPAL REGISTER**

FOR: ADULT SEXUAL STIMULATION AIDS, NAMELY, HARNESSSES, LEATHER WRISTS AND ANKLE STRAPS, WHIPS, PADDLES, AND CROPS, IN CLASS 18 (U.S. CLS. 1, 2, 3, 22 AND 41).

FIRST USE 1-1-1987; IN COMMERCE 1-1-1987.

FOR: LINGERIE FOR MEN AND WOMEN; LEATHER WEAR, NAMELY, PANTS, TOPS, BRAS, AND PANTIES; ADULT SEXUAL STIMULATION AIDS, NAMELY, HOODS, BLINDFOLDS, COLLARS, GAGS, CUFFS AND VESTS, IN CLASS 25 (U.S. CLS. 22 AND 39).

FIRST USE 1-1-1987; IN COMMERCE 1-1-1987.

FOR: CATALOG ORDERING SERVICE FEATURING SEXUALLY ORIENTED LINGERIE, LEATHER WEAR, LEATHER ACCESSORIES AND MARITAL AIDS; WEB-BASED CATALOG SERVICES FEATURING SEXUALLY ORIENTED LINGERIE, LEATHER WEAR, LEATHER ACCESSORIES AND MARITAL AIDS, IN CLASS 35 (U.S. CLS. 100, 101 AND 102).

FIRST USE 1-1-1987; IN COMMERCE 1-1-1987.

THE MARK CONSISTS OF A CIRCLE WITH A HEAD OF A ROMAN STYLE HELMET ON. HE LOOKS LIKE A SPARTAN AND/OR A ROMAN CENTURION/SOLDIER.

SER. NO. 85-311,332, FILED 5-3-2011.



*David J. Kyffers*

Director of the United States Patent and Trademark Office



**Reg. No. 4,124,517** DEIRDRE ROBERTSON, EXAMINING ATTORNEY

# United States of America

United States Patent and Trademark Office



**Reg. No. 4,124,518**

HUBEI WILD TREES TEXTILES CO., LTD (CHINA LIMITED LIABILITY COMPANY)  
C1-402, NO.27 YONGQING ROAD  
WUHAN, HUBEI, CHINA

**Registered Apr. 10, 2012**

**Int. Cl.: 25**

FOR: SHIRTS; TROUSERS; JACKETS; PARKAS; TEE-SHIRTS; FISHING VESTS; CAPS; MITTENS; WATERPROOF CLOTHING, NAMELY, RAINWEAR, RAIN COATS, RAIN PONCHOS, DRY SUITS, SHIRTS, PANTS, HATS, JACKETS, COATS, SHOES AND GLOVES, IN CLASS 25 (U.S. CLS. 22 AND 39).

**TRADEMARK**

**PRINCIPAL REGISTER**

FIRST USE 9-1-2010; IN COMMERCE 9-1-2010.

THE MARK CONSISTS OF THE WORDING "WILD TREES" IN STYLIZED FORM WITH THE LETTER "T" IN "TREES" REPLACED BY THE IMAGE OF A TREE. THE REMAINING LETTERS IN THE MARK CONTAIN A CAMOUFLAGE PATTERN.

SER. NO. 85-311,611, FILED 5-3-2011.

JEFFREY LOOK, EXAMINING ATTORNEY



*David J. Kyros*

Director of the United States Patent and Trademark Office

# United States of America

United States Patent and Trademark Office

## MOTORVAC YOUR PARTNER IN PREVENTIVE MAINTENANCE

**Reg. No. 4,124,519**

UVIEW ULTRAVIOLET SYSTEMS INC. (CANADA CORPORATION)  
1324 BLUNDELL ROAD

**Registered Apr. 10, 2012**

MISSISSAUGA, ONTARIO, CANADA L4Y1M5

**Int. Cl.: 35**

FOR: ENGINE CLEANING SERVICE FOR GASOLINE AND DIESEL POWERED ENGINES TO IMPROVE MILEAGE, PERFORMANCE AND EMISSIONS REDUCTION IN VEHICLES, IN CLASS 35 (U.S. CLS. 100, 101 AND 102).

**SERVICE MARK**

FIRST USE 4-28-2011; IN COMMERCE 4-28-2011.

**PRINCIPAL REGISTER**

THE MARK CONSISTS OF STANDARD CHARACTERS WITHOUT CLAIM TO ANY PARTICULAR FONT, STYLE, SIZE, OR COLOR.

OWNER OF U.S. REG. NOS. 2,829,315 AND 3,915,868.

NO CLAIM IS MADE TO THE EXCLUSIVE RIGHT TO USE "PREVENTIVE MAINTENANCE", APART FROM THE MARK AS SHOWN.

SER. NO. 85-311,780, FILED 5-4-2011.

ALEX KEAM, EXAMINING ATTORNEY



*David J. Kybas*

Director of the United States Patent and Trademark Office

# United States of America

United States Patent and Trademark Office

# Beef It Up

**Reg. No. 4,124,520**

PHILLIP ALEXANDER JR. (UNITED STATES INDIVIDUAL)  
1221 GRANDE VIEW  
LOGANVILLE, GA 30052

**Registered Apr. 10, 2012**

**Int. Cl.: 9**

FOR: AUDIO AND VIDEO RECORDINGS FEATURING MUSIC AND ARTISTIC PERFORMANCES, IN CLASS 9 (U.S. CLS. 21, 23, 26, 36 AND 38).

**TRADEMARK**

FIRST USE 8-9-2009; IN COMMERCE 8-9-2009.

**PRINCIPAL REGISTER**

THE MARK CONSISTS OF STANDARD CHARACTERS WITHOUT CLAIM TO ANY PARTICULAR FONT, STYLE, SIZE, OR COLOR.

SER. NO. 85-312,474, FILED 5-4-2011.

CAROLYN CATALDO, EXAMINING ATTORNEY



*David J. Kybas*

Director of the United States Patent and Trademark Office

# United States of America

United States Patent and Trademark Office



**Reg. No. 4,124,521**

**Registered Apr. 10, 2012**

**Int. Cl.: 25**

**TRADEMARK**

**PRINCIPAL REGISTER**

WILLIAMS, TIVAL (UNITED STATES INDIVIDUAL)  
879 EAST 21ST STREET  
BROOKLYN, NY 11210 AND

DOUGLAS, DAREN (UNITED STATES INDIVIDUAL)  
243 3RD STREET 3RD FL.  
JERSEY CITY, NJ 07302

FOR: A-SHIRTS; APPAREL FOR DANCERS, NAMELY, TEE SHIRTS, SWEATSHIRTS, PANTS, LEGGINGS, SHORTS AND JACKETS; ATHLETIC APPAREL, NAMELY, SHIRTS, PANTS, JACKETS, FOOTWEAR, HATS AND CAPS, ATHLETIC UNIFORMS; BALLOON PANTS; BASKETBALL SNEAKERS; BODY SHIRTS; BUTTON DOWN SHIRTS; BUTTON-FRONT ALOHA SHIRTS; CAMOUFLAGE PANTS; CAMOUFLAGE SHIRTS; CAMP SHIRTS; CAPRI PANTS; CARGO PANTS; CLOTHING FOR ATHLETIC USE, NAMELY, PADDED PANTS; CLOTHING FOR ATHLETIC USE, NAMELY, PADDED SHIRTS; CLOTHING FOR BABIES, TODDLERS AND CHILDREN, TREATED WITH FIRE AND HEAT RETARDANTS, NAMELY, PAJAMAS, JACKETS, SHIRTS, PANTS, JUMPERS; CLOTHING SHIELDS, NAMELY, PADS APPLIED TO THE UNDERARMS OF SHIRTS, BLOUSES AND SWEATERS; COLLARED SHIRTS; CROP PANTS; DENIMS; DRESS PANTS; DRESS SHIRTS; FISHING SHIRTS; FLOOD PANTS; GOLF PANTS, SHIRTS AND SKIRTS; GOLF SHIRTS; GYM PANTS; HOODED SWEAT SHIRTS; HUNTING PANTS; HUNTING SHIRTS; JEGGINGS, NAMELY, PANTS THAT ARE PARTIALLY JEANS AND PARTIALLY LEGGINGS; JOGGING PANTS; KNIT SHIRTS; LEATHER PANTS; LEATHER SHIRTS; LEG SHIELDING DEVICE, ATTACHABLE TO AND DETACHABLE FROM A PERSON'S PANTS, COMPRISED OF PADDING TO SHIELD THE LEGS FROM FLYING DEBRIS WHEN MOWING WITH A STRING TRIMMER; LONG-SLEEVED SHIRTS; LOUNGE PANTS; MATERNITY CLOTHING, NAMELY, TOPS; MOISTURE-WICKING SPORTS PANTS; MOISTURE-WICKING SPORTS SHIRTS; NIGHT SHIRTS; NON-DISPOSABLE CLOTH TRAINING PANTS; NURSE PANTS; OPEN-NECKED SHIRTS; OVER SHIRTS; PANTS; PETTI-PANTS; PIQUE SHIRTS; POLO SHIRTS; RUGBY SHIRTS; SCIENTIFIC AND TECHNOLOGICAL APPAREL, NAMELY, SHIRTS, PANTS, JACKETS, FOOTWEAR, HATS AND CAPS, UNIFORMS; SHIRT FRONTS; SHIRT INSERTS, NAMELY, DICKIES; SHIRT YOKES; SHIRTS; SHIRTS AND SHORT-SLEEVED SHIRTS; SHIRTS AND SLIPS; SHIRTS FOR INFANTS, BABIES, TODDLERS AND CHILDREN; SHIRTS FOR SUITS; SHORT-SLEEVED OR LONG-SLEEVED T-SHIRTS; SHORT-SLEEVED SHIRTS; SKI PANTS; SLEEP PANTS; SLEEP SHIRTS; SLEEVES WORN SEPARATE AND APART FROM BLOUSES, SHIRTS AND OTHER TOPS; SNAP CROTCH SHIRTS FOR INFANTS AND TODDLERS; SNEAKERS; SNOW PANTS; SNOWBOARD PANTS; SPORT SHIRTS; SPORTS



*David J. Kyros*

Director of the United States Patent and Trademark Office

**Reg. No. 4,124,521** PANTS; SPORTS SHIRTS; SPORTS SHIRTS WITH SHORT SLEEVES; STRETCH PANTS; SWEAT PANTS; SWEAT SHIRTS; T-SHIRTS; T-SHIRTS FOR MEN WOMEN KIDS; TAP PANTS; TEE SHIRTS; TOBOGGAN HATS, PANTS AND CAPS; TRACK PANTS; TRAVEL CLOTHING CONTAINED IN A PACKAGE COMPRISING REVERSIBLE JACKETS, PANTS, SKIRTS, TOPS AND A BELT OR SCARF; TRIATHLON CLOTHING, NAMELY, TRIATHLON TIGHTS, TRIATHLON SHORTS, TRIATHLON SINGLETS, TRIATHLON SHIRTS, TRIATHLON SUITS; TURTLE NECK SHIRTS; WATERPROOF JACKETS AND PANTS; WEARABLE GARMENTS AND CLOTHING, NAMELY, SHIRTS; WIND PANTS; WIND SHIRTS; WOMEN'S CLOTHING, NAMELY, SHIRTS, DRESSES, SKIRTS, BLOUSES; YOGA PANTS; YOGA SHIRTS, IN CLASS 25 (U.S. CLS. 22 AND 39).

FIRST USE 4-15-2010; IN COMMERCE 2-1-2011.

NO CLAIM IS MADE TO THE EXCLUSIVE RIGHT TO USE "PREMIUM GOODS" AND "N.Y.C" AND "BKLYN" AND "JPN" AND "JAMAICA", APART FROM THE MARK AS SHOWN.

THE MARK CONSISTS OF THE WORDING "SHOTTA" WITH THE LETTER "S" IN STYLIZED FORM WITH A LION HEAD FACING OUTWARDS FROM THE BACK OF THE "S". A CROWN DESIGN WITH LIGHTNING BOLTS POINTING TOWARDS IT APPEARS ABOVE THE LETTERING "HOTTA" IN "SHOTTA". THE WORDING "PREMIUM GOODS" APPEARS IN A BANNER BELOW THE WORDING "SHOTTA" WITH THE WORDING "N.Y.C." IN STYLIZED FORM IN THE MIDDLE OF THE BANNER. THE WORDING "ESTABLISHED CLASSIC" APPEARS BELOW THE BANNER DESIGN. THE WORDING "BKLYN // JPN // JAMAICA // UNIVERSAL" APPEARS BELOW THE WORDING "ESTABLISHED CLASSIC".

THE WORDING "SHOTTA" HAS NO MEANING IN A FOREIGN LANGUAGE.

SER. NO. 85-312,777, FILED S.R. 5-4-2011 AM. P.R. 12-13-2011.

SETH A. RAPPAPORT, EXAMINING ATTORNEY

# United States of America

United States Patent and Trademark Office

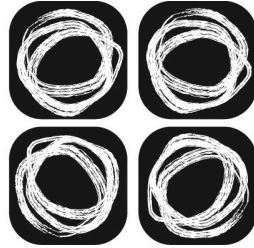

## chalkspinner

**Reg. No. 4,124,522**

KODO KIDS, LLLP (COLORADO LIMITED PARTNERSHIP)  
1259 HAWK RIDGE ROAD  
LAFAYETTE, CO 80026

**Registered Apr. 10, 2012**

**Int. Cl.: 28**

FOR: CHILDREN'S MULTIPLE ACTIVITY TOY, IN CLASS 28 (U.S. CLS. 22, 23, 38 AND 50).

**TRADEMARK**

FIRST USE 11-8-2008; IN COMMERCE 11-24-2008.

**PRINCIPAL REGISTER**

THE MARK CONSISTS OF FOUR SQUARES WITH ROUNDED CORNERS, ARRANGED IN A SQUARE SHAPE, WITH A DESIGN OF CIRCLES IN EACH OF THE FOUR SQUARES, WITH THE WORDING CHALK SPINNER IN STYLIZED FONT UNDER THE SQUARES.

SER. NO. 85-312,906, FILED 5-5-2011.

ERNEST SHOSHO, EXAMINING ATTORNEY



*David J. Kyffers*

Director of the United States Patent and Trademark Office

# United States of America

United States Patent and Trademark Office

## FUNDS DIVERSIFIED PORTFOLIOS

**Reg. No. 4,124,523**

BANK OF AMERICA CORPORATION (DELAWARE CORPORATION)  
100 NORTH TRYON STREET  
CHARLOTTE, NC 28255

**Registered Apr. 10, 2012**

**Int. Cl.: 36**

FOR: FINANCIAL SERVICES, NAMELY, PROVIDING MUTUAL FUND INVESTMENT SERVICES THAT OFFER REBALANCING BACK TO PREESTABLISHED TARGETS ON A STANDING INSTRUCTIONS BASIS, IN CLASS 36 (U.S. CLS. 100, 101 AND 102).

**SERVICE MARK**

FIRST USE 5-0-2004; IN COMMERCE 5-0-2004.

**PRINCIPAL REGISTER**

THE MARK CONSISTS OF STANDARD CHARACTERS WITHOUT CLAIM TO ANY PARTICULAR FONT, STYLE, SIZE, OR COLOR.

OWNER OF U.S. REG. NO. 2,950,612.

NO CLAIM IS MADE TO THE EXCLUSIVE RIGHT TO USE "DIVERSIFIED PORTFOLIOS", APART FROM THE MARK AS SHOWN.

SEC. 2(F).

SER. NO. 85-313,051, FILED 5-5-2011.

LINDA E. BLOHM, EXAMINING ATTORNEY

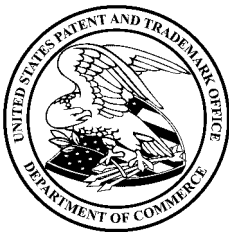

*David J. Kybas*

Director of the United States Patent and Trademark Office



# United States of America

United States Patent and Trademark Office



**Reg. No. 4,124,524**

**Registered Apr. 10, 2012**

**Int. Cl.: 41**

**SERVICE MARK**

**PRINCIPAL REGISTER**

UNITED SOCIAL SPORTS INC. (DELAWARE CORPORATION)  
315 EVARTS ST NE #111  
WASHINGTON, DC 20002

FOR: ENTERTAINMENT IN THE NATURE OF COMPETITIONS IN THE FIELD OF ARCADE GAMES OF SKILL; ENTERTAINMENT IN THE NATURE OF ARCADE GAMES PLAYED ON AN INCLINED LANE WHERE THE PLAYER SCORES POINTS BY GETTING THE BALL INTO HOLES WITH DESIGNATED POINT VALUES; PROVIDING A WEBSITE FOR ENTERTAINMENT PURPOSES WHERE USERS CAN VIEW AND POST LEAGUE AND COMPETITION INFORMATION FEATURING ARCADE GAME EVENTS; PROVIDING RECOGNITION AND INCENTIVES BY THE WAY OF AWARDS AND CONTESTS TO DEMONSTRATE EXCELLENCE IN THE FIELD OF ARCADE GAMES OF SKILL, IN CLASS 41 (U.S. CLS. 100, 101 AND 107).

FIRST USE 1-1-2010; IN COMMERCE 1-1-2010.

THE MARK CONSISTS OF A SET OF THREE RINGS ENCIRCLED BY A LARGER RING ABOVE THE STYLIZED TEXT "BAR-SKEE".

SER. NO. 85-313,578, FILED 5-5-2011.

KATINA MISTER, EXAMINING ATTORNEY



*David J. Kyjars*

Director of the United States Patent and Trademark Office

# United States of America

United States Patent and Trademark Office

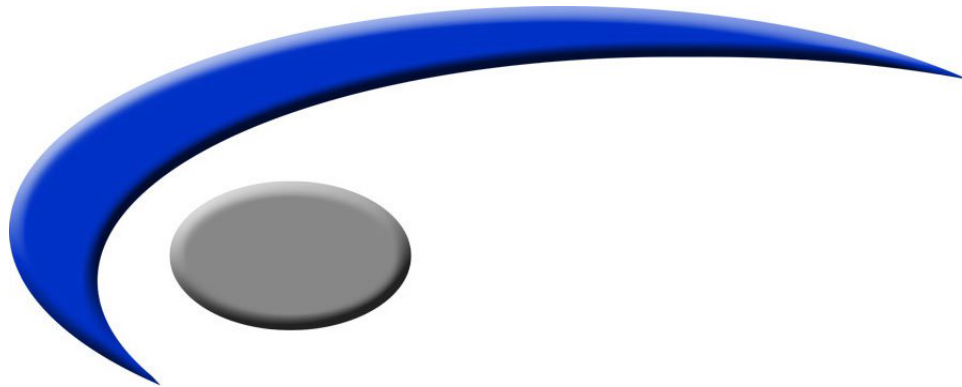

**Reg. No. 4,124,525**

**Registered Apr. 10, 2012**

**Int. Cl.: 11**

**TRADEMARK**

**PRINCIPAL REGISTER**

EURO-KITCHEN, INC. (CALIFORNIA CORPORATION), DBA EURO-KITCHEN, INC.  
2341 INDUSTRIAL PARKWAY WEST  
HAYWARD, CA 94545

FOR: EXHAUST HOODS FOR KITCHENS; EXTRACTOR HOODS FOR KITCHENS; HOODS FOR RANGES; KITCHEN SINKS; OVEN VENTILATOR HOODS; RANGE HOODS; VENTILATION HOODS; VENTILATION HOODS FOR STOVES, IN CLASS 11 (U.S. CLS. 13, 21, 23, 31 AND 34).

FIRST USE 2-1-2004; IN COMMERCE 2-1-2004.

THE MARK CONSISTS OF A BLUE ARCH EXTENDING FROM BOTTOM LEFT CORNER UP TO THE UPPER RIGHT CORNER WITH WHITE SHADING ON THE UPPER EDGE AND BLACK SHADING ON THE LOWER EDGE, ABOVE A GRAY OVAL SHAPED DOT THAT ALSO FEATURES WHITE SHADING ON THE UPPER EDGE AND BLACK SHADING ON THE LOWER EDGE. THE REMAINING WHITE REPRESENTS BACKGROUND AND DOES NOT FORM PART OF THE MARK.

THE COLOR(S) BLUE, GRAY, BLACK AND WHITE IS/ARE CLAIMED AS A FEATURE OF THE MARK.

SER. NO. 85-313,926, FILED 5-6-2011.

TRACY FLETCHER, EXAMINING ATTORNEY



*David J. Kyros*

Director of the United States Patent and Trademark Office

# United States of America

United States Patent and Trademark Office



**Reg. No. 4,124,526**

**Registered Apr. 10, 2012**

**Int. Cl.: 30**

**TRADEMARK**

**PRINCIPAL REGISTER**

VOSGES IP, LLC (ILLINOIS LIMITED LIABILITY COMPANY)  
2211 N. ELSTON AVENUE, SUITE 203  
CHICAGO, IL 60614

FOR: SPECIALTY CONFECTIONERY PRODUCTS, NAMELY, SPECIALTY CHOCOLATES, CHOCOLATE BARS, CHOCOLATE TRUFFLES, CAKES, TOFFEES, BRITTLES, CARMELS, COCOA, BONBONS, BROWNIES, COOKIES, PANCAKE MIXES, BAKING MIXES IN THE NATURE OF MIXES FOR BAKERY GOODS, CHOCOLATE COVERED FRUITS AND NUTS, CHOCOLATES CONTAINING FRUITS AND NUTS, AND ICE CREAM; SPECIALTY CONFECTIONERY PRODUCTS IN THE NATURE OF CHOCOLATE COLLECTIONS COMPRISED PRIMARILY OF CHOCOLATES, CHOCOLATE TRUFFLES, TOFFEES, BRITTLES, CARMELS, BONBONS, AND CHOCOLATE BARS, IN CLASS 30 (U.S. CL. 46).

FIRST USE 12-7-2010; IN COMMERCE 12-7-2010.

NO CLAIM IS MADE TO THE EXCLUSIVE RIGHT TO USE "CHOCOLAT", APART FROM THE MARK AS SHOWN.

THE MARK CONSISTS OF THE WORD "VOSGES", CONTAINED IN AN OVAL SHAPED DESIGN, THE WORDS "HAUT" AND "CHOCOLAT" EACH CONTAINED IN A SCROLL AND BANNER DESIGN, AND ADDITIONAL DESIGN WORK INCLUDING SCROLLWORK, CURVED AND ROUNDED LINES, AND A FLOWER DESIGN LOCATED IN THE TOP PORTION OF THE MARK.

THE ENGLISH TRANSLATION OF "HAUT CHOCOLAT" IN THE MARK IS "HIGH CHOCOLATE".

THE WORDING "VOSGES" HAS NO MEANING IN A FOREIGN LANGUAGE.

SER. NO. 85-313,934, FILED 5-6-2011.

NAKIA HENRY, EXAMINING ATTORNEY



*David J. Kyros*

Director of the United States Patent and Trademark Office

# United States of America

United States Patent and Trademark Office



**Reg. No. 4,124,527**

RUIZ, BEN (UNITED STATES INDIVIDUAL)  
2841 TEMPLE COURT  
EAST PALO ALTO, CA 94303

**Registered Apr. 10, 2012**

**Int. Cl.: 44**

FOR: LANDSCAPE GARDENING; TREE REMOVAL SERVICES; TREE CARE SERVICES,  
IN CLASS 44 (U.S. CLS. 100 AND 101).

**SERVICE MARK**

FIRST USE 1-1-2002; IN COMMERCE 1-1-2002.

**PRINCIPAL REGISTER**

NO CLAIM IS MADE TO THE EXCLUSIVE RIGHT TO USE "TREE SERVICE AND MAINTENANCE", APART FROM THE MARK AS SHOWN.

THE COLOR(S) GREEN, WHITE, LIGHT BROWN, BLACK AND RED IS/ARE CLAIMED AS A FEATURE OF THE MARK.

THE NAME(S), PORTRAIT(S), AND/OR SIGNATURE(S) SHOWN IN THE MARK IDENTIFIES "BEN RUIZ", WHOSE CONSENT(S) TO REGISTER IS MADE OF RECORD.

THE MARK CONSISTS OF THE LITERAL ELEMENTS "BEN RUIZ", "TREE SERVICE AND MAINTENANCE" WRITTEN IN GREEN COLOR WHEREIN AN IMAGE OF RED ANT WITH WHITE GLOVES AND BLACK EYES HOLDING A TREE TRUNK IN LIGHT BROWN COLOR, WITH AN ATTACHED GREEN LEAF IS PLACED BETWEEN THE WORDS "BEN RUIZ" AND "TREE SERVICE AND MAINTENANCE" AS SHOWN IN THE MARK.

SER. NO. 85-313,944, FILED 5-6-2011.

NAKIA HENRY, EXAMINING ATTORNEY



*David J. Kybas*

Director of the United States Patent and Trademark Office

# United States of America

United States Patent and Trademark Office



**Reg. No. 4,124,528**

**Registered Apr. 10, 2012**

**Int. Cl.: 42**

**SERVICE MARK**

**PRINCIPAL REGISTER**

HEALCODE LLC (TEXAS LIMITED LIABILITY COMPANY)  
1101 HAVRE LAFITTE DR.  
AUSTIN, TX 78746

FOR: APPLICATION SERVICE PROVIDER (ASP) FEATURING SOFTWARE FOR USE WITH OTHER BUSINESS SOFTWARE-AS-A-SERVICE PLATFORMS FOR BUSINESS, CLIENT AND PROSPECT DATABASE MANAGEMENT AND INTEGRATION AND STORING, MANAGING, TRACKING AND ANALYZING DATA IN THE FIELD OF MANAGEMENT OF HEALTH, WELLNESS AND FITNESS FACILITIES; PROVIDING TEMPORARY USE OF ONLINE NON-DOWNLOADABLE BUSINESS MANAGEMENT SOFTWARE FOR USE BY HEALTH, WELLNESS AND FITNESS BUSINESSES, IN CLASS 42 (U.S. CLS. 100 AND 101).

FIRST USE 2-11-2009; IN COMMERCE 2-11-2009.

THE MARK CONSISTS OF THE END OF A BRANCH WITH TWO LEAVES WITH WATER DROPLETS TO THE LEFT OF THE TEXT "HEALCODE".

SER. NO. 85-314,006, FILED 5-6-2011.

ELLEN PERKINS, EXAMINING ATTORNEY



*David J. Kyjars*

Director of the United States Patent and Trademark Office

# United States of America

United States Patent and Trademark Office



**Reg. No. 4,124,529**

**Registered Apr. 10, 2012**

**Int. Cl.: 35**

**SERVICE MARK**

**PRINCIPAL REGISTER**

HULAFROG, INC. (NEW JERSEY CORPORATION)  
PO BOX 498  
ATLANTIC HIGHLANDS, NJ 07716

FOR: PROVIDING A WEBSITE FOR PARENTS LOOKING FOR ACTIVITIES FOR THEIR CHILDREN IN THEIR LOCAL COMMUNITY, TO BE USED AS AN ONLINE GUIDE TO FIND LOCAL EVENTS, CLASSES, CAMPS, DESTINATIONS AND OTHER RESOURCES FOR FAMILIES; ON-LINE BUSINESS DIRECTORIES FEATURING KID-FRIENDLY RESTAURANTS, MUSEUMS, PLAY CENTERS, PARKS AND OTHER ATTRACTIONS FOR FAMILIES, IN CLASS 35 (U.S. CLS. 100, 101 AND 102).

FIRST USE 10-1-2009; IN COMMERCE 10-1-2009.

THE STIPPLING IS FOR SHADING PURPOSES ONLY.

THE MARK CONSISTS OF A PAINTED FROG IN A DRESS WITH OUTSTRETCHED ARMS AND FEET POINTED INWARD. THE FROG WEARS A CROWN ON ITS HEAD AND IS USING A HULA HOOP. THE FROG IS FURTHER DISTINGUISHED BY ITS LARGE, CHILD-LIKE EYES THAT SIT ON TOP OF THE HEAD. THE CROWN AND DRESS FEATURE LETTERS OR WORDS, BUT THE SPECIFIC LETTERS OR WORDS ON THE CROWN AND DRESS ARE NOT CLAIMED AS A FEATURE OF THE MARK.

SER. NO. 85-314,043, FILED 5-6-2011.

STEVEN R. FINE, EXAMINING ATTORNEY



*David J. Kybas*

Director of the United States Patent and Trademark Office

# United States of America

United States Patent and Trademark Office

## SIGNIFICANT HOMES

**Reg. No. 4,124,530**

NEWBY, WILLIAM DOUGLAS (UNITED STATES INDIVIDUAL)  
4912 TREMONT  
DALLAS, TX 75214

**Registered Apr. 10, 2012**

**Int. Cls.: 35 and 36**

FOR: PROMOTING THE GOODS AND SERVICES OF OTHERS BY PLACING ADVERTISEMENTS AND PROMOTIONAL DISPLAYS IN AN ELECTRONIC SITE ACCESSED THROUGH COMPUTER NETWORKS; REAL ESTATE ADVERTISING SERVICES; REAL ESTATE MARKETING SERVICES, IN CLASS 35 (U.S. CLS. 100, 101 AND 102).

**SERVICE MARK**

**PRINCIPAL REGISTER**

FIRST USE 4-0-1996; IN COMMERCE 4-0-1996.

FOR: RESIDENTIAL REAL ESTATE AGENCY SERVICES; PROVIDING INFORMATION IN THE FIELD OF REAL ESTATE VIA THE INTERNET; PROVIDING REAL ESTATE LISTINGS VIA THE INTERNET, IN CLASS 36 (U.S. CLS. 100, 101 AND 102).

FIRST USE 4-0-1996; IN COMMERCE 4-0-1996.

THE MARK CONSISTS OF STANDARD CHARACTERS WITHOUT CLAIM TO ANY PARTICULAR FONT, STYLE, SIZE, OR COLOR.

NO CLAIM IS MADE TO THE EXCLUSIVE RIGHT TO USE "HOMES", APART FROM THE MARK AS SHOWN.

SER. NO. 85-314,124, FILED 5-6-2011.

ALEXANDER L. POWERS, EXAMINING ATTORNEY



*David J. Kyros*

Director of the United States Patent and Trademark Office

# United States of America

United States Patent and Trademark Office



**Reg. No. 4,124,531**

**Registered Apr. 10, 2012**

**Int. Cl.: 43**

**SERVICE MARK**

**PRINCIPAL REGISTER**

GONZALEZ GARRO, LUIS (SPAIN INDIVIDUAL)  
PLAZA CORCUBION, NO 9. B-1  
MADRID, SPAIN 28029

FOR: SERVICES FOR PROVIDING FOOD AND DRINK, IN CLASS 43 (U.S. CLS. 100 AND 101).

PRIORITY CLAIMED UNDER SEC. 44(D) ON ERPN CMNTY TM OFC APPLICATION NO. 009781857, FILED 3-3-2011, REG. NO. 009781857, DATED 8-10-2011, EXPIRES 3-3-2021.

NO CLAIM IS MADE TO THE EXCLUSIVE RIGHT TO USE "PIZZITAS", APART FROM THE MARK AS SHOWN.

THE MARK CONSISTS OF A THREE QUARTER CIRCULAR DESIGN REPRESENTING A PORTION OF A PIZZA PIE AND THE NUMBER "100" AND THE WORD "PIZZITAS" IN STYLIZED LETTERS.

SER. NO. 85-314,226, FILED 5-6-2011.

ANNE MADDEN, EXAMINING ATTORNEY



*David J. Kybas*

Director of the United States Patent and Trademark Office



# United States of America

United States Patent and Trademark Office



**Reg. No. 4,124,532**

EPIX HEALTHCARE ASSOCIATES LLC (DELAWARE LIMITED LIABILITY COMPANY)  
5455 WENTWORTH STREET N.E.  
ATLANTA, GA 30342

**Registered Apr. 10, 2012**

**Int. Cl.: 35**

FOR: BUSINESS MANAGEMENT AND BILLING SERVICES IN THE FIELD OF HEALTHCARE SERVICES FOR HOSPITALS, SURGERY CENTERS AND PHYSICIAN OFFICES , IN CLASS 35 (U.S. CLS. 100, 101 AND 102).

**SERVICE MARK**

FIRST USE 4-30-2011; IN COMMERCE 4-30-2011.

**PRINCIPAL REGISTER**

NO CLAIM IS MADE TO THE EXCLUSIVE RIGHT TO USE "HEALTHCARE ASSOCIATES", APART FROM THE MARK AS SHOWN.

THE COLOR(S) BLUE AND GRAY IS/ARE CLAIMED AS A FEATURE OF THE MARK.

THE MARK CONSISTS OF A GRAY WORD ELEMENT "EPIX" AND A BLUE WORD ELEMENT "HEALTHCARE ASSOCIATES" AND THE "I" IN "EPIX" IS A STAFF WITH A SINGLE, BLUE SNAKE WRAPPED AROUND THE STAFF AND THE RIGHT BOTTOM CORNER OF THE "X" IN "EPIX" CURVES UNDER THE WORD ELEMENTS TRANSITIONING FROM GRAY TO BLUE.

SER. NO. 85-314,344, FILED S.R. 5-6-2011 AM. P.R. 11-21-2011.

NAAKWAMA ANKRAH, EXAMINING ATTORNEY



*David J. Kyros*

Director of the United States Patent and Trademark Office

# United States of America

United States Patent and Trademark Office

## CPEA

**Reg. No. 4,124,533**

**Registered Apr. 10, 2012**

**Int. Cls.: 41 and 42**

**SERVICE MARK**

**PRINCIPAL REGISTER**

BOARD OF ENVIRONMENTAL, HEALTH & SAFETY AUDITOR CERTIFICATIONS  
(VIRGINIA CORPORATION)  
247 MAITLAND AVENUE  
ALTAMONTE SPRINGS, FL 327014201

FOR: EDUCATIONAL SERVICES, NAMELY, PREPARING, ADMINISTERING AND SCORING EDUCATIONAL EXAMINATIONS IN THE FIELD OF ENVIRONMENTAL, HEALTH AND SAFETY AUDITING, NAMELY, COMPLIANCE WITH ENVIRONMENTAL, HEALTH AND SAFETY LAWS AND REGULATIONS FOR PROFESSIONAL ENVIRONMENTAL, HEALTH AND SAFETY AUDITING PRACTICES, ENVIRONMENTAL HEALTH AND SAFETY MANAGEMENT SYSTEMS AUDITING, AND THE APPLICATION OF PROFESSIONAL AUDITING STANDARDS FOR ENVIRONMENTAL HEALTH AND SAFETY MANAGEMENT PROGRAMS, IN CLASS 41 (U.S. CLS. 100, 101 AND 107).

FIRST USE 10-1-1997; IN COMMERCE 10-1-1997.

FOR: TESTING ANALYSIS, AND EVALUATION OF THE KNOWLEDGE, SKILLS AND ABILITIES OF OTHERS FOR THE PURPOSE OF CERTIFICATION AND RE-CERTIFICATION IN THE FIELD OF ENVIRONMENTAL HEALTH AND SAFETY AUDITING, NAMELY, COMPLIANCE WITH ENVIRONMENTAL HEALTH AND SAFETY MANAGEMENT LAWS AND REGULATIONS FOR PROFESSIONAL ENVIRONMENTAL HEALTH AND SAFETY AUDITING PRACTICES, ENVIRONMENTAL HEALTH AND SAFETY MANAGEMENT SYSTEMS AUDITING, AND THE APPLICATION OF PROFESSIONAL AUDITING STANDARDS FOR ENVIRONMENTAL HEALTH AND SAFETY MANAGEMENT PROGRAMS, IN CLASS 42 (U.S. CLS. 100 AND 101).

FIRST USE 10-1-1997; IN COMMERCE 10-1-1997.

THE MARK CONSISTS OF STANDARD CHARACTERS WITHOUT CLAIM TO ANY PARTICULAR FONT, STYLE, SIZE, OR COLOR.

SER. NO. 85-314,350, FILED 5-6-2011.

JOHN WILKE, EXAMINING ATTORNEY



*David J. Kyffers*

Director of the United States Patent and Trademark Office

# United States of America

United States Patent and Trademark Office

## KARLSSON'S GOLD

**Reg. No. 4,124,534**

SPIRITS OF GOLD AB (SWEDEN CORPORATION)  
REGERINGSGATAN 25  
5 TR. STOCKHOLM, SWEDEN

**Registered Apr. 10, 2012**

**Int. Cl.: 33**

FOR: ALCOHOLIC BEVERAGES, EXCEPT BEER; VODKA, IN CLASS 33 (U.S. CLS. 47 AND 49).

**TRADEMARK**

FIRST USE 6-1-2007; IN COMMERCE 6-1-2007.

**PRINCIPAL REGISTER**

THE MARK CONSISTS OF STANDARD CHARACTERS WITHOUT CLAIM TO ANY PARTICULAR FONT, STYLE, SIZE, OR COLOR.

OWNER OF U.S. REG. NO. 3,699,231.

SER. NO. 85-314,353, FILED 5-6-2011.

DAVID H. STINE, EXAMINING ATTORNEY



*David J. Kyffers*

Director of the United States Patent and Trademark Office

# United States of America

United States Patent and Trademark Office

# SWINGASAN

**Reg. No. 4,124,535**

**Registered Apr. 10, 2012**

**Int. Cl.: 20**

**TRADEMARK**

**PRINCIPAL REGISTER**

MANAGING TRUSTEE OF PIER 1 SERVICES COMPANY (DELAWARE STATUTORY TRUST)  
100 PIER 1 PLACE  
FORT WORTH, TX 76102

FOR: FURNITURE; OUTDOOR FURNITURE, IN CLASS 20 (U.S. CLS. 2, 13, 22, 25, 32 AND 50).

FIRST USE 4-0-2010; IN COMMERCE 3-0-2011.

THE MARK CONSISTS OF STANDARD CHARACTERS WITHOUT CLAIM TO ANY PARTICULAR FONT, STYLE, SIZE, OR COLOR.

OWNER OF U.S. REG. NO. 3,990,604.

SER. NO. 85-314,560, FILED 5-6-2011.

MICHELLE DUBOIS, EXAMINING ATTORNEY



*David J. Kyffers*

Director of the United States Patent and Trademark Office

# United States of America

United States Patent and Trademark Office

## Les Portes de Paris

**Reg. No. 4,124,536**

**Registered Apr. 10, 2012**

**Int. Cl.: 44**

**SERVICE MARK**

**PRINCIPAL REGISTER**

UNE PETITE BEAUTEE BY MARLENE GUIBOR, LTD. (NEW YORK CORPORATION), DBA  
LES PORTES DE PARIS  
826 LEXINGTON AVENUE  
NEW YORK, NY 10065

FOR: DAY SPA SERVICES, NAMELY, NAIL CARE, MANICURES, PEDICURES AND NAIL ENHANCEMENTS; HAIR SALON SERVICES, NAMELY, HAIR CUTTING, STYLING, COLORING, AND HAIR EXTENSION SERVICES; HAIR SALON SERVICES, NAMELY, TREATMENTS TO PROTECT HAIR FROM EFFECTS OF EXPOSURE TO SUNLIGHT, HEAT, HUMIDITY AND CHLORINATED WATER; MAKE-UP APPLICATION SERVICES, IN CLASS 44 (U.S. CLS. 100 AND 101).

FIRST USE 3-20-2011; IN COMMERCE 3-20-2011.

THE MARK CONSISTS OF STANDARD CHARACTERS WITHOUT CLAIM TO ANY PARTICULAR FONT, STYLE, SIZE, OR COLOR.

NO CLAIM IS MADE TO THE EXCLUSIVE RIGHT TO USE "DE PARIS", APART FROM THE MARK AS SHOWN.

THE ENGLISH TRANSLATION OF "LES PORTES DE PARIS" IN THE MARK IS "THE PARIS DOORS".

SER. NO. 85-315,394, FILED 5-9-2011.

B. PARADEWELAI, EXAMINING ATTORNEY



*David J. Kyros*

Director of the United States Patent and Trademark Office

# United States of America

United States Patent and Trademark Office

THE  
SISTERHOOD



**Reg. No. 4,124,537**

**Registered Apr. 10, 2012**

**Int. Cl.: 25**

**TRADEMARK**

**PRINCIPAL REGISTER**

MSK, LLC (NEVADA LIMITED LIABILITY COMPANY)  
3225 MCLEOD DRIVE  
SUITE 100  
LAS VEGAS, NV 89121

FOR: DRESSES; HATS; JACKETS; SCARVES; SHORTS; SWEAT SHIRTS; T-SHIRTS; TANK  
TOPS, IN CLASS 25 (U.S. CLS. 22 AND 39).

FIRST USE 12-1-2009; IN COMMERCE 1-14-2010.

THE STIPLING IS FOR SHADING PURPOSES ONLY.

THE MARK CONSISTS OF A SWORD/ANKH/FEMALE SYMBOL WITH SPECIFIC MARK-  
INGS ON THE HILT. ON THE TOP THERE IS THE STYLIZED TEXT "THE SISTERHOOD".

SER. NO. 85-315,553, FILED 5-9-2011.

MEGHAN REINHART, EXAMINING ATTORNEY



*David J. Kybas*

Director of the United States Patent and Trademark Office

# United States of America

## United States Patent and Trademark Office



**Reg. No. 4,124,538**

**Registered Apr. 10, 2012**

**Int. Cls.: 35, 42 and 45**

**SERVICE MARK**

**PRINCIPAL REGISTER**

WELCOME HOME RELOCATION, INC. (FLORIDA CORPORATION)  
1115 PONCE DE LEON BOULEVARD, SUIT A5  
BELLEAIR, FL 33756

FOR: MOVING AND RELOCATION SERVICES, NAMELY, PLANNING AND IMPLEMENTING MOVES OF HOMES AND OFFICES; MOVING AND RELOCATION SERVICES, NAMELY, PLANNING AND IMPLEMENTING MOVES OF HOMES FOR OTHERS; MOVING AND RELOCATION SERVICES, NAMELY, PLANNING AND PROJECT OVERSIGHT OF HOME MOVING FOR OTHERS; ESTATE MANAGEMENT, NAMELY, ASSISTANCE IN THE GATHERING AND ORGANIZATION OF PERSONAL VITAL AND FINANCIAL RECORDS IN CONJUNCTION WITH INSTRUCTIONS FOR HANDLING OF SUCH DOCUMENTS BY OTHERS, INCLUDING EXECUTORS AND ATTORNEYS, UPON DEATH OR WHEN OTHERWISE NECESSARY; PROVIDING ORGANIZING SERVICES FOR BELONGINGS AND SPACES IN A RESIDENCE OR BUSINESS; PROVIDING ORGANIZING SERVICES FOR BELONGINGS AND SPACES IN A RESIDENCE OR BUSINESS; PROVIDING COUNSELING AND CONSULTING SERVICES IN THE FIELD OF SPATIAL ORGANIZATION FOR RESIDENTIAL OR BUSINESS PURPOSES, NAMELY, COUNSELING AND CONSULTING A RESIDENT OR BUSINESS ENTITY REGARDING THE ORGANIZATION OF BELONGINGS AND PHYSICAL SPACES IN A HOME OR OFFICE SPACE, IN CLASS 35 (U.S. CLS. 100, 101 AND 102).

FIRST USE 1-1-2007; IN COMMERCE 1-1-2007.



FOR: INTERIOR DESIGN SERVICES INCLUDING SPACE PLANNING, FURNITURE SELECTION, MATERIAL AND SURFACE SELECTION; HOME STAGING CONSULTATION, NAMELY, TEMPORARY INTERIOR AND EXTERIOR HOME DECORATION CONSULTATION FOR THE PURPOSE OF MAKING HOMES MORE APPEALING TO PROSPECTIVE BUYERS; HOME STAGING CONSULTATION, NAMELY, TEMPORARY INTERIOR AND EXTERIOR HOME DECORATION CONSULTATION FOR THE PURPOSE OF MAKING HOMES MORE APPEALING TO PROSPECTIVE BUYERS, IN CLASS 42 (U.S. CLS. 100 AND 101).

FIRST USE 1-1-2007; IN COMMERCE 1-1-2007.

*David J. Kybas*

Director of the United States Patent and Trademark Office

FOR: IN-HOME SUPPORT SERVICES TO SENIOR PERSONS, NAMELY, GERIATRIC CARE MANAGEMENT SERVICES AND PERSONAL AFFAIRS MANAGEMENT SERVICES IN THE NATURE OF THE COORDINATION OF NECESSARY SERVICES AND CARE FOR

**Reg. No. 4,124,538** OLDER INDIVIDUALS; ORGANIZATIONAL SERVICES FOR HOME OR PERSONAL PURPOSES, NAMELY, ORGANIZING CLOSET SPACE, ORGANIZING FURNITURE, ORGANIZING SHELVES, ORGANIZING CABINETS; PROVIDING COUNSELING AND CONSULTING SERVICES IN THE FIELD OF SPATIAL ORGANIZATION FOR PERSONAL PURPOSES, NAMELY, COUNSELING AND CONSULTING AN INDIVIDUAL REGARDING THE ORGANIZATION OF BELONGINGS AND PHYSICAL SPACES IN A RESIDENCY, NAMELY, CLOSET SPACE, DRAWERS, SHELVES OR CABINETS, IN CLASS 45 (U.S. CLS. 100 AND 101).

FIRST USE 1-1-2007; IN COMMERCE 1-1-2007.

THE MARK CONSISTS OF A STYLIZED RED DOOR WITH LIGHT RED AND DARK RED SHADOWS WITH A GOLD, LIGHT GOLD, AND DARK GOLD DOOR KNOB CASTING A BLACK SHADOW IN FRONT OF A GOLD, LIGHT GOLD, AND DARK GOLD DOOR KNOB PLATE WITH A BLACK KEYHOLE.

THE COLOR(S) RED, LIGHT RED, DARK RED, BLACK, GOLD, LIGHT GOLD, AND DARK GOLD IS/ARE CLAIMED AS A FEATURE OF THE MARK.

SER. NO. 85-315,638, FILED 5-9-2011.

DAVID TOOLEY, EXAMINING ATTORNEY



# United States of America

United States Patent and Trademark Office

## BABY GOOROO

**Reg. No. 4,124,539**

AMY SPANGLER (UNITED STATES INDIVIDUAL), DBA BABYGOOROO  
12 BALL CREEK WAY  
ATLANTA, GA 303504402

**Registered Apr. 10, 2012**

**Int. Cl.: 25**

FOR: BIBS NOT OF PAPER; CAPS, IN CLASS 25 (U.S. CLS. 22 AND 39).

**TRADEMARK**

FIRST USE 2-1-2009; IN COMMERCE 2-1-2009.

**PRINCIPAL REGISTER**

THE MARK CONSISTS OF STANDARD CHARACTERS WITHOUT CLAIM TO ANY PARTICULAR FONT, STYLE, SIZE, OR COLOR.

OWNER OF U.S. REG. NO. 3,367,747.

NO CLAIM IS MADE TO THE EXCLUSIVE RIGHT TO USE "BABY", APART FROM THE MARK AS SHOWN.

SER. NO. 85-316,632, FILED 5-10-2011.

GEOFFREY FOSDICK, EXAMINING ATTORNEY



*David J. Kyfos*

Director of the United States Patent and Trademark Office

# United States of America

United States Patent and Trademark Office

## NWP NATURAL WOOD PROTECTANT

**Reg. No. 4,124,540**

YENKIN-MAJESTIC PAINT CORPORATION (OHIO CORPORATION)  
1920 LEONARD AVENUE  
COLUMBUS, OH 43219

**Registered Apr. 10, 2012**

**Int. Cl.: 2**

FOR: COATINGS, NAMELY, STAINS FOR EXTERIOR USE ON WOOD SURFACES, IN CLASS 2 (U.S. CLS. 6, 11 AND 16).

**TRADEMARK**

FIRST USE 3-15-2011; IN COMMERCE 3-15-2011.

**PRINCIPAL REGISTER**

THE MARK CONSISTS OF STANDARD CHARACTERS WITHOUT CLAIM TO ANY PARTICULAR FONT, STYLE, SIZE, OR COLOR.

NO CLAIM IS MADE TO THE EXCLUSIVE RIGHT TO USE "NATURAL WOOD PROTECTANT", APART FROM THE MARK AS SHOWN.

SER. NO. 85-316,654, FILED 5-10-2011.

TIMOTHY FINNEGAN, EXAMINING ATTORNEY



*David J. Kybas*

Director of the United States Patent and Trademark Office

# United States of America

United States Patent and Trademark Office

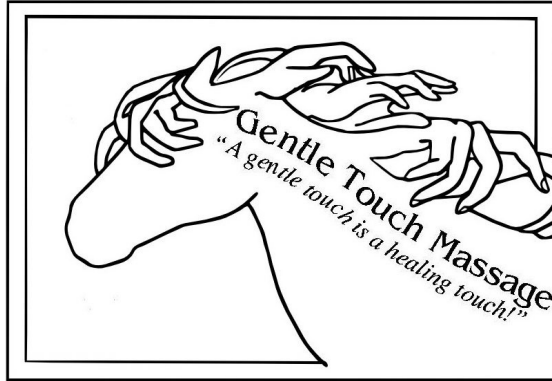

**Reg. No. 4,124,541**

**Registered Apr. 10, 2012**

**Int. Cl.: 44**

**SERVICE MARK**

**PRINCIPAL REGISTER**

GENTLE TOUCH MASSAGE & HOLISTIC ALTERNATIVES, LLC (NEW JERSEY LIMITED LIABILITY COMPANY)  
P.O. BOX 23  
WEST MILFORD, NJ 07480

FOR: EQUINE MASSAGE AND KINESIOLOGY SERVICES; INFORMATION RELATING TO EQUINE MASSAGE; EQUINE MASSAGE THERAPY SERVICES; EQUINE MESSAGES, IN CLASS 44 (U.S. CLS. 100 AND 101).

FIRST USE 0-0-2007; IN COMMERCE 0-0-2007.

NO CLAIM IS MADE TO THE EXCLUSIVE RIGHT TO USE "MASSAGE", APART FROM THE MARK AS SHOWN.

THE MARK CONSISTS OF A RECTANGLE WITH AN INNER RECTANGLE WHICH IS INCOMPLETE AT THE RIGHT LOWER CORNER. INSIDE THE INNER RECTANGLE IS THE IMAGE OF A HORSE'S HEAD, WITH HUMAN FINGERS IN PLACE OF ITS MANE. ALONG THE HORSE'S NECK ARE THE WORDS "GENTLE TOUCH MASSAGE "A GENTLE TOUCH IS A HEALING TOUCH!"

SER. NO. 85-316,810, FILED 5-10-2011.

JASON BLAIR, EXAMINING ATTORNEY



*David J. Kybas*

Director of the United States Patent and Trademark Office

# United States of America

United States Patent and Trademark Office



**Herrero** Contractors, Inc.

**Reg. No. 4,124,542**

**Registered Apr. 10, 2012**

**Int. Cl.: 37**

**SERVICE MARK**

**PRINCIPAL REGISTER**

HERRERO CONTRACTORS, INC. (CALIFORNIA CORPORATION)  
2100 OAKDALE AVENUE  
SAN FRANCISCO, CA 94124

FOR: CONSTRUCTION AND RENOVATION OF BUILDINGS; CONSTRUCTION MANAGEMENT; GENERAL CONSTRUCTION CONTRACTING, IN CLASS 37 (U.S. CLS. 100, 103 AND 106).

FIRST USE 2-19-2002; IN COMMERCE 2-19-2002.

NO CLAIM IS MADE TO THE EXCLUSIVE RIGHT TO USE "CONTRACTORS, INC.", APART FROM THE MARK AS SHOWN.

THE MARK CONSISTS OF THE WORDING "H HERRERO CONTRACTORS, INC." APPEARING WITHIN A RECTANGULAR SPACE, WITH THE FIRST LETTER H COMPRISED OF A BOLD BLOCK LETTER EMBEDDED AND CENTERED IN A SQUARE SPACE TO THE FAR LEFT OF THE RECTANGULAR AREA WITH THE REMAINDER OF THE SQUARE SHADED IN; THE WORD "HERRERO" APPEARING JUST TO THE RIGHT OF THE H (AND OUTSIDE AND TO THE RIGHT OF THE SHADED SQUARE), IN BOLD STYLIZED LETTERING OF A FONT SIZE APPROXIMATELY 2/3 SMALLER THAN THE LETTER H; AND THE WORDS "CONTRACTORS, INC." APPEARING TO THE RIGHT OF "HERRERO" IN NARROW NON-BOLDED STYLIZED LETTERING OF THE SAME FONT SIZE AS "HERRERO".

SER. NO. 85-316,844, FILED 5-10-2011.

MARCIE MILONE, EXAMINING ATTORNEY



*David J. Kyjars*

Director of the United States Patent and Trademark Office

# United States of America

United States Patent and Trademark Office

## BEND RESEARCH

**Reg. No. 4,124,543**

BEND RESEARCH, INC. (OREGON CORPORATION)  
64550 RESEARCH ROAD  
BEND, OR 977018599

**Registered Apr. 10, 2012**

**Int. Cls.: 40 and 42**

FOR: MANUFACTURING SERVICES FOR OTHERS IN THE PHARMACEUTICAL AND HEALTH SCIENCE INDUSTRIES, IN CLASS 40 (U.S. CLS. 100, 103 AND 106).

**SERVICE MARK**

FIRST USE 4-1-1975; IN COMMERCE 4-1-1975.

**PRINCIPAL REGISTER**

FOR: RESEARCH AND DEVELOPMENT OF PHARMACEUTICAL FORMULATIONS; ANALYTICAL TESTING AND ENGINEERING SERVICES FOR THE PHARMACEUTICAL AND HEALTH SERVICES INDUSTRIES, IN CLASS 42 (U.S. CLS. 100 AND 101).

FIRST USE 4-1-1975; IN COMMERCE 4-1-1975.

THE MARK CONSISTS OF STANDARD CHARACTERS WITHOUT CLAIM TO ANY PARTICULAR FONT, STYLE, SIZE, OR COLOR.

NO CLAIM IS MADE TO THE EXCLUSIVE RIGHT TO USE "RESEARCH", APART FROM THE MARK AS SHOWN.

SER. NO. 85-317,435, FILED 5-10-2011.

ALICIA COLLINS, EXAMINING ATTORNEY



*David J. Kybas*

Director of the United States Patent and Trademark Office

# United States of America

United States Patent and Trademark Office



**Reg. No. 4,124,544**

**Registered Apr. 10, 2012**

**Int. Cl.: 35**

**SERVICE MARK**

**PRINCIPAL REGISTER**

MONROE COUNTY TOURIST DEVELOPMENT COUNCIL (FLORIDA ADVISORY BOARD  
TO THE COUNTY COMMISSION OF MONROE COUNTY, FLORIDA)  
P.O. BOX 866  
KEY WEST, FL 33040

FOR: CHAMBER OF COMMERCE SERVICES, NAMELY, PROMOTING BUSINESS AND  
TOURISM IN THE MONROE COUNTY, FLORIDA AREA, IN CLASS 35 (U.S. CLS. 100, 101  
AND 102).

FIRST USE 7-11-2011; IN COMMERCE 7-11-2011.

OWNER OF U.S. REG. NOS. 1,770,368, 2,678,884 AND OTHERS.

THE MARK CONSISTS OF THE STYLIZED WORDING "WELCOME TO KEY LARGO THE  
FLORIDA KEYS" ON AN OVAL DESIGN WITH A WOOD PLANK BACKGROUND, A  
TROPICAL FISH IN THE UPPER RIGHT PORTION, A GROUP OF THREE FISH IN THE  
LOWER LEFT PORTION, AND VARIOUS CORALS ALONG THE BOTTOM PORTION OF  
THE OVAL.

SEC. 2(F) AS TO "KEY LARGO THE FLORIDA KEYS".

SER. NO. 85-317,690, FILED 5-11-2011.

NELSON SNYDER, EXAMINING ATTORNEY

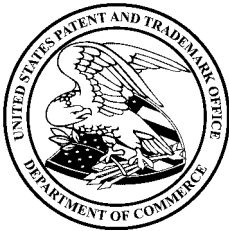

*David J. Kyros*

Director of the United States Patent and Trademark Office

# United States of America

United States Patent and Trademark Office



**Reg. No. 4,124,545**

**Registered Apr. 10, 2012**

**Int. Cl.: 35**

**SERVICE MARK**

**PRINCIPAL REGISTER**

MONROE COUNTY TOURIST DEVELOPMENT COUNCIL (FLORIDA ADVISORY BOARD  
TO THE COUNTY COMMISSION OF MONROE COUNTY, FLORIDA)  
P.O. BOX 866  
KEY WEST, FL 33040

FOR: CHAMBER OF COMMERCE SERVICES, NAMELY, PROMOTING BUSINESS AND  
TOURISM IN THE MONROE COUNTY, FLORIDA AREA, IN CLASS 35 (U.S. CLS. 100, 101  
AND 102).

FIRST USE 7-11-2011; IN COMMERCE 7-11-2011.

OWNER OF U.S. REG. NOS. 1,770,368, 2,678,884 AND OTHERS.

THE MARK CONSISTS OF THE STYLIZED WORDING "LEAVING THE FLORIDA KEYS  
KEY LARGO BACK TO REALITY" ON AN OVAL DESIGN WITH A WOOD PLANK  
BACKGROUND. THE WORDING "LEAVING" APPEARS INSIDE THE TOP EDGE OF THE  
OVAL, "BACK TO REALITY" APPEARS INSIDE THE BOTTOM EDGE OF THE OVAL, AND  
THE REMAINING WORDING APPEARS IN THE MIDDLE PORTION OF THE OVAL ABOVE  
A SEA TURTLE AND VARIOUS CORALS WHICH APPEAR ALONG THE BOTTOM PORTION  
OF THE OVAL.

SEC. 2(F) AS TO "THE FLORIDA KEYS KEY LARGO".

SER. NO. 85-317,693, FILED 5-11-2011.

NELSON SNYDER, EXAMINING ATTORNEY



*David J. Kybas*

Director of the United States Patent and Trademark Office

United States of America  
United States Patent and Trademark Office

PPM

**Reg. No. 4,124,546**

**Registered Apr. 10, 2012**

**Int. Cl.: 9**

**TRADEMARK**

**PRINCIPAL REGISTER**

ARBITRON INC. (DELAWARE CORPORATION)  
9705 PATUXENT WOODS DRIVE  
COLUMBIA, MD 21046

FOR: DOWNLOADABLE ELECTRONIC PUBLICATIONS IN THE NATURE OF REPORTS IN THE FIELDS OF AUDIENCE MEASUREMENT, MEDIA EXPOSURE MEASUREMENT, MARKET RESEARCH AND BUSINESS RESEARCH; ELECTRONIC PUBLICATIONS, NAMELY, REPORTS IN THE FIELDS OF AUDIENCE MEASUREMENT, MEDIA EXPOSURE MEASUREMENT, MARKET RESEARCH AND BUSINESS RESEARCH RECORDED ON COMPUTER MEDIA, IN CLASS 9 (U.S. CLS. 21, 23, 26, 36 AND 38).

FIRST USE 5-31-2002; IN COMMERCE 7-1-2002.

THE MARK CONSISTS OF STANDARD CHARACTERS WITHOUT CLAIM TO ANY PARTICULAR FONT, STYLE, SIZE, OR COLOR.

SER. NO. 85-317,772, FILED 5-11-2011.

ELI HELLMAN, EXAMINING ATTORNEY



*David J. Kyffers*

Director of the United States Patent and Trademark Office



# United States of America

United States Patent and Trademark Office



**Reg. No. 4,124,547**

**Registered Apr. 10, 2012**

**Int. Cl.: 12**

**TRADEMARK**

**PRINCIPAL REGISTER**

CATERPILLAR INC. (DELAWARE CORPORATION)  
100 N.E. ADAMS STREET  
PEORIA, IL 61629

FOR: TRUCKS; VOCATIONAL TRUCKS FOR CONSTRUCTION, EARTH MOVING, AGRICULTURE, LOGGING, MINING, OIL AND GAS, QUARRY, PAVING, TRANSPORTATION, AND WASTE MANAGEMENT APPLICATIONS, IN CLASS 12 (U.S. CLS. 19, 21, 23, 31, 35 AND 44).

FIRST USE 9-9-2011; IN COMMERCE 9-9-2011.

OWNER OF U.S. REG. NOS. 564,272, 2,421,077 AND OTHERS.

THE MARK CONSISTS OF THE WORD "CAT" WITH A TRIANGLE BELOW THE LETTER "A".

SER. NO. 85-318,067, FILED 5-11-2011.

NELSON SNYDER, EXAMINING ATTORNEY



*David J. Kypos*

Director of the United States Patent and Trademark Office

# United States of America

United States Patent and Trademark Office

# CAT

**Reg. No. 4,124,548**

**Registered Apr. 10, 2012**

**Int. Cl.: 12**

**TRADEMARK**

**PRINCIPAL REGISTER**

CATERPILLAR INC. (DELAWARE CORPORATION)  
100 N.E. ADAMS STREET  
PEORIA, IL 61629

FOR: TRUCKS; VOCATIONAL TRUCKS FOR CONSTRUCTION, EARTH MOVING, AGRICULTURE, LOGGING, MINING, OIL AND GAS, QUARRY, PAVING, TRANSPORTATION, AND WASTE MANAGEMENT APPLICATIONS , IN CLASS 12 (U.S. CLS. 19, 21, 23, 31, 35 AND 44).

FIRST USE 9-9-2011; IN COMMERCE 9-9-2011.

THE MARK CONSISTS OF STANDARD CHARACTERS WITHOUT CLAIM TO ANY PARTICULAR FONT, STYLE, SIZE, OR COLOR.

OWNER OF U.S. REG. NOS. 564,272, 984,444 AND OTHERS.

SER. NO. 85-318,073, FILED 5-11-2011.

NELSON SNYDER, EXAMINING ATTORNEY



*David J. Kybas*

Director of the United States Patent and Trademark Office

# United States of America

United States Patent and Trademark Office

# MOST

**Reg. No. 4,124,549**

**Registered Apr. 10, 2012**

**Int. Cls.: 16 and 41**

**TRADEMARK**

**SERVICE MARK**

**PRINCIPAL REGISTER**

MITCHELL CLIONSKY (UNITED STATES INDIVIDUAL)  
155 MAPLE STREET, SUITE 203  
SPRINGFIELD, MA 01105 AND

EMILYMARIE CLIONSKY (UNITED STATES INDIVIDUAL)  
155 MAPLE STREET, SUITE 203  
SPRINGFIELD, MA 01105

FOR: PRINTED TEST FORMS AND MATERIALS, NAMELY, PRINTED TESTS, PRINTED INSTRUCTIONAL MANUALS, AND PRINTED TEST SCORING SHEETS FOR USE IN DETECTING, EVALUATING, ASSESSING AND TRACKING DEMENTIA AND OTHER NEUROLOGICAL CONDITIONS IN PATIENTS; PRINTED DIAGNOSTIC TEST USED FOR THE DETECTION, EVALUATION, ASSESSMENT AND TRACKING OF DEMENTIA AND OTHER NEUROLOGICAL CONDITIONS IN PATIENTS, IN CLASS 16 (U.S. CLS. 2, 5, 22, 23, 29, 37, 38 AND 50).

FIRST USE 1-1-2008; IN COMMERCE 1-1-2008.

FOR: PROVIDING EDUCATIONAL INFORMATION AND DIAGNOSTIC TEST QUESTIONS IN FIELD OF DETECTION, EVALUATION, ASSESSMENT AND TRACKING OF DEMENTIA AND OTHER NEUROLOGICAL CONDITIONS IN PATIENTS, IN CLASS 41 (U.S. CLS. 100, 101 AND 107).

FIRST USE 1-1-2008; IN COMMERCE 1-1-2008.

THE MARK CONSISTS OF STANDARD CHARACTERS WITHOUT CLAIM TO ANY PARTICULAR FONT, STYLE, SIZE, OR COLOR.

SER. NO. 85-318,250, FILED 5-11-2011.

CAROLYN CATALDO, EXAMINING ATTORNEY



*David J. Kybas*

Director of the United States Patent and Trademark Office

# United States of America

United States Patent and Trademark Office



**Reg. No. 4,124,550**

**Registered Apr. 10, 2012**

**Int. Cl.: 44**

**SERVICE MARK**

**PRINCIPAL REGISTER**

VETERINARY DIAGNOSTICS INSTITUTE, INC. (CALIFORNIA CORPORATION)  
4685 RUNWAY STREET  
SUITE K  
SIMI VALLEY, CA 93063

FOR: SPECIALTY ANIMAL DIAGNOSTIC TESTING SERVICE USING BLOOD-BASED BIOMARKERS, IN CLASS 44 (U.S. CLS. 100 AND 101).

FIRST USE 3-15-2011, THE MARK WAS FIRST USED ANYWHERE IN A DIFFERENT FORM OTHER THAN THAT SOUGHT TO BE REGISTERED AT LEAST AS EARLY AS 03/31/2006; IN COMMERCE 3-15-2011, THE MARK WAS FIRST USED IN COMMERCE IN A DIFFERENT FORM OTHER THAN THAT SOUGHT TO BE REGISTERED AT LEAST AS EARLY AS 03/31/2006.

OWNER OF U.S. REG. NOS. 3,240,938 AND 3,244,450.

NO CLAIM IS MADE TO THE EXCLUSIVE RIGHT TO USE "VETERINARY DIAGNOSTICS INSTITUTE", APART FROM THE MARK AS SHOWN.

THE MARK CONSISTS OF THE WORDS "VETERINARY DIAGNOSTICS INSTITUTE" AND TO THE LEFT OF THE WORDS IS A PAW PRINT IN WHITE SUPERIMPOSED OVER A CIRCLE IN BLACK WITH THREE HORIZONTAL WHITE LINES AND THREE VERTICAL WHITE LINES AND WHITE LINES FORMING A SQUARE WITH LINES WAVED INWARD IN A CONCAVE FASHION.

SER. NO. 85-318,672, FILED 5-11-2011.

DAVID TAYLOR, EXAMINING ATTORNEY



*David J. Kybas*

Director of the United States Patent and Trademark Office

# United States of America

United States Patent and Trademark Office

# get lazed

**Reg. No. 4,124,551**

**Registered Apr. 10, 2012**

**Int. Cl.: 44**

**SERVICE MARK**

**PRINCIPAL REGISTER**

GET LAZED, LLC (MINNESOTA LIMITED LIABILITY COMPANY), DBA GET LAZED  
2513 EAST 22ND STREET  
MINNEAPOLIS, MN 55406

FOR: HEALTH SPA SERVICES, NAMELY, LASER TREATMENTS FOR ACNE, REJUVENATION, SCARS, TATTOO REMOVAL AND FOR FACIALS AND MASSAGE; LASER HAIR REMOVAL SERVICES; PERMANENT HAIR REMOVAL AND REDUCTION SERVICES; PERSONAL HAIR REMOVAL SERVICES, IN CLASS 44 (U.S. CLS. 100 AND 101).

FIRST USE 8-2-2010; IN COMMERCE 1-1-2011.

THE MARK CONSISTS OF STANDARD CHARACTERS WITHOUT CLAIM TO ANY PARTICULAR FONT, STYLE, SIZE, OR COLOR.

SER. NO. 85-318,680, FILED 5-11-2011.

DAVID TAYLOR, EXAMINING ATTORNEY



*David J. Kyffers*

Director of the United States Patent and Trademark Office

# United States of America

United States Patent and Trademark Office

# FUTRIX

**Reg. No. 4,124,552**

**Registered Apr. 10, 2012**

**Int. Cl.: 9**

**TRADEMARK**

**PRINCIPAL REGISTER**

FUTRIXIP LIMITED (NEW ZEALAND CORPORATION), TA FUTRIX  
LEVEL 2, 79 BOULCOTT STREET  
WELLINGTON, WELLINGTON, NEW ZEALAND 6011

FOR: COMPUTER SOFTWARE FOR USE AS A DATABASE AND SPREADSHEET, NAMELY, FOR TABULAR, GRAPHICAL, AND SPATIAL REPORTING AND ANALYSIS THAT MAY BE DOWNLOADED FROM A GLOBAL COMPUTER NETWORK, IN CLASS 9 (U.S. CLS. 21, 23, 26, 36 AND 38).

PRIORITY CLAIMED UNDER SEC. 44(D) ON NEW ZEALAND APPLICATION NO. 841606, FILED 5-10-2011, REG. NO. 841606, DATED 5-10-2011, EXPIRES 5-10-2021.

THE COLOR(S) BLUE AND LIGHT BLUE IS/ARE CLAIMED AS A FEATURE OF THE MARK.

OWNER OF U.S. REG. NOS. 2,476,068 AND 3,678,904.

THE MARK CONSISTS OF THE WORD "FUTRIX" IN BLUE CAPITAL LETTERS WITH THE LEFT PORTION OF THE LETTER "X" APPEARING IN LIGHT BLUE. THE BACKGROUND OF THE MARK IS TRANSPARENT.

SER. NO. 85-318,783, FILED 5-12-2011.

ANDREA HACK, EXAMINING ATTORNEY



*David J. Kyjars*

Director of the United States Patent and Trademark Office

# United States of America

United States Patent and Trademark Office

# CafoPro

**Reg. No. 4,124,553**

ENVIRO-AG ENGINEERING, INC. (TEXAS CORPORATION)  
3404 AIRWAY BLVD.  
AMARILLO, TX 79118

**Registered Apr. 10, 2012**

**Int. Cl.: 35**

FOR: DATA MANAGEMENT SERVICES FOR USE BY CONCENTRATED ANIMAL FEEDING OPERATIONS, IN CLASS 35 (U.S. CLS. 100, 101 AND 102).

**SERVICE MARK**

FIRST USE 12-31-2004; IN COMMERCE 12-31-2004.

**PRINCIPAL REGISTER**

THE MARK CONSISTS OF STANDARD CHARACTERS WITHOUT CLAIM TO ANY PARTICULAR FONT, STYLE, SIZE, OR COLOR.

SER. NO. 85-318,886, FILED 5-12-2011.

ELISSA GARBER KON, EXAMINING ATTORNEY



*David J. Kybas*

Director of the United States Patent and Trademark Office

# United States of America

United States Patent and Trademark Office



**Reg. No. 4,124,554**

**Registered Apr. 10, 2012**

**Int. Cls.: 35 and 41**

**SERVICE MARK**

**PRINCIPAL REGISTER**

GLOBAL FILMDEMIC, LTD (CAYMAN ISLANDS CORPORATION)  
MAPLES CORPORATE SERVICES LIMITED  
P.O. BOX 309, UGLAND HOUSE  
GRAND CAYMAN KY1-1104, CAYMAN ISLANDS

FOR: ADVERTISING, MARKETING AND PROMOTION SERVICES IN THE FIELD OF INDEPENDENT FILMS, IN CLASS 35 (U.S. CLS. 100, 101 AND 102).

FIRST USE 10-28-2010; IN COMMERCE 10-28-2010.

FOR: DISTRIBUTION OF MOTION PICTURE FILMS, IN CLASS 41 (U.S. CLS. 100, 101 AND 107).

FIRST USE 10-28-2010; IN COMMERCE 10-28-2010.

THE MARK CONSISTS OF A TRIANGLE WITH A YELLOW BORDER AND BLACK SHADING INSIDE THE TRIANGLE, A YELLOW CIRCLE LOCATED IN THE UPPER PORTION OF THE TRIANGLE WITH A BLACK MOVIE REEL CONTAINED INSIDE THE CIRCLE, A YELLOW ROLL OF FILM WRAPS AROUND THE TRIANGLE ENDING IN FRONT OF THE LOWER, CENTER PORTION OF THE TRIANGLE. THE WORD, "FILMDEMIC" IS LOCATED INSIDE THE ROLL OF FILM LOCATED ACROSS THE LOWER, CENTER PORTION OF THE TRIANGLE. THE LETTERS ARE UPPER CASE AND IN BLACK.

THE COLOR(S) YELLOW AND BLACK IS/ARE CLAIMED AS A FEATURE OF THE MARK.

SER. NO. 85-319,438, FILED 5-12-2011.

ESTHER BELENKER, EXAMINING ATTORNEY



*David J. Kybas*

Director of the United States Patent and Trademark Office



# United States of America

United States Patent and Trademark Office

## FUTRIX HEALTH

**Reg. No. 4,124,555**

**Registered Apr. 10, 2012**

**Int. Cl.: 9**

**TRADEMARK**

**PRINCIPAL REGISTER**

FUTRIXIP LIMITED (NEW ZEALAND LIMITED LIABILITY COMPANY), TA FUTRIX  
LEVEL 2, 79 BOULCOTT STREET  
WELLINGTON, WELLINGTON, NEW ZEALAND 6011

FOR: COMPUTER SOFTWARE FOR USE AS A DATABASE AND SPREADSHEET, NAMELY,  
FOR TABULAR, GRAPHICAL, AND SPATIAL REPORTING AND ANALYSIS THAT MAY  
BE DOWNLOADED FROM A GLOBAL COMPUTER NETWORK, IN CLASS 9 (U.S. CLS.  
21, 23, 26, 36 AND 38).

THE MARK CONSISTS OF STANDARD CHARACTERS WITHOUT CLAIM TO ANY PAR-  
TICULAR FONT, STYLE, SIZE, OR COLOR.

OWNER OF NEW ZEALAND REG. NO. 841578, DATED 5-10-2011, EXPIRES 5-10-2021.

OWNER OF U.S. REG. NOS. 2,476,068 AND 3,678,904.

NO CLAIM IS MADE TO THE EXCLUSIVE RIGHT TO USE "HEALTH", APART FROM THE  
MARK AS SHOWN.

SER. NO. 85-319,736, FILED 5-12-2011.

ANDREA HACK, EXAMINING ATTORNEY



*David J. Kybas*

Director of the United States Patent and Trademark Office

# United States of America

United States Patent and Trademark Office

# 4 WISHES

**Reg. No. 4,124,556**

**Registered Apr. 10, 2012**

**Int. Cl.: 33**

**TRADEMARK**

**PRINCIPAL REGISTER**

SIXTY-FIVE ENTERPRISE, LLC (CALIFORNIA LIMITED LIABILITY COMPANY)  
780 CHADBOURNE ROAD  
SUITE A  
FAIRFIELD, CA 94534

FOR: ALCOHOLIC BEVERAGES, NAMELY, WINE, IN CLASS 33 (U.S. CLS. 47 AND 49).

FIRST USE 1-1-2010; IN COMMERCE 11-1-2010.

THE MARK CONSISTS OF STANDARD CHARACTERS WITHOUT CLAIM TO ANY PARTICULAR FONT, STYLE, SIZE, OR COLOR.

SER. NO. 85-319,778, FILED 5-12-2011.

H. M. FISHER, EXAMINING ATTORNEY



*David J. Kybas*

Director of the United States Patent and Trademark Office

# United States of America

United States Patent and Trademark Office

## ZIERER VISA SERVICE

**Reg. No. 4,124,557**

CIBT, INC. (DELAWARE CORPORATION)  
1650 TYSON'S BOULEVARD, SUITE 1350  
MCLEAN, VA 22102

**Registered Apr. 10, 2012**

**Int. Cl.: 39**

FOR: ARRANGING FOR TRAVEL VISAS, PASSPORTS AND TRAVEL DOCUMENTS FOR PERSONS TRAVELING ABROAD, IN CLASS 39 (U.S. CLS. 100 AND 105).

**SERVICE MARK**

FIRST USE 2-0-2005; IN COMMERCE 2-0-2005.

**PRINCIPAL REGISTER**

THE MARK CONSISTS OF STANDARD CHARACTERS WITHOUT CLAIM TO ANY PARTICULAR FONT, STYLE, SIZE, OR COLOR.

NO CLAIM IS MADE TO THE EXCLUSIVE RIGHT TO USE "VISA SERVICE", APART FROM THE MARK AS SHOWN.

SEC. 2(F).

SER. NO. 85-320,142, FILED 5-13-2011.

ELLEN B. AWRICH, EXAMINING ATTORNEY



*David J. Kybas*

Director of the United States Patent and Trademark Office

# United States of America

United States Patent and Trademark Office

## FINGER SLAYER

**Reg. No. 4,124,558**

RV APPSTUDIOS, LLC (DELAWARE LIMITED LIABILITY COMPANY)  
3422 OLD CAPITOL TRAIL, STE 1600  
WILMINGTON, DE 19808

**Registered Apr. 10, 2012**

**Int. Cl.: 9**

FOR: COMPUTER GAME SOFTWARE; VIDEO GAME SOFTWARE; SOFTWARE FOR COMPUTER GAMES FOR USE ON MOBILE AND CELLULAR PHONES, PERSONAL COMPUTERS, TABLET COMPUTERS, HAND-HELD PERSONAL GAMING DEVICES, AND HOME VIDEO GAME CONSOLES, IN CLASS 9 (U.S. CLS. 21, 23, 26, 36 AND 38).

**TRADEMARK**

**PRINCIPAL REGISTER**

FIRST USE 3-23-2011; IN COMMERCE 3-23-2011.

THE MARK CONSISTS OF STANDARD CHARACTERS WITHOUT CLAIM TO ANY PARTICULAR FONT, STYLE, SIZE, OR COLOR.

SER. NO. 85-321,401, FILED 5-16-2011.

JORDAN BAKER, EXAMINING ATTORNEY



*David J. Kyffers*

Director of the United States Patent and Trademark Office

# United States of America

United States Patent and Trademark Office

# MARBOX

**Reg. No. 4,124,559**

CEVA SANTÉ ANIMALE (FRANCE SOCIÉTÉ ANONYME (SA))  
10 AVENUE DE LA BALLASTIÈRE  
LIBOURNE, FRANCE 33500

**Registered Apr. 10, 2012**

**Int. Cl.: 5**

FOR: ANTI-INFECTIVE PRODUCTS FOR VETERINARY USE, IN CLASS 5 (U.S. CLS. 6, 18, 44, 46, 51 AND 52).

**TRADEMARK**

THE MARK CONSISTS OF STANDARD CHARACTERS WITHOUT CLAIM TO ANY PARTICULAR FONT, STYLE, SIZE, OR COLOR.

**PRINCIPAL REGISTER**

PRIORITY CLAIMED UNDER SEC. 44(D) ON FRANCE APPLICATION NO. 2010-018967, FILED 11-17-2010, REG. NO. 3761750, DATED 8-24-2010, EXPIRES 8-24-2020.

PRIORITY CLAIMED UNDER SEC. 44(D) ON VENEZUELA APPLICATION NO. 2010-018967, FILED 11-17-2010, REG. NO. 3761750, DATED 8-24-2010, EXPIRES 8-24-2020.

THE WORDING "MARBOX" HAS NO MEANING IN A FOREIGN LANGUAGE.

SER. NO. 85-321,978, FILED 5-16-2011.

MICHAEL SOUDERS, EXAMINING ATTORNEY



*David J. Kyros*

Director of the United States Patent and Trademark Office

# United States of America

United States Patent and Trademark Office

## THE SOFTWARE IS THE INSTRUMENT

**Reg. No. 4,124,560**

**Registered Apr. 10, 2012**

**Int. Cl.: 35**

**SERVICE MARK**

**PRINCIPAL REGISTER**

NATIONAL INSTRUMENTS CORPORATION (DELAWARE CORPORATION)  
BUILDING "B"  
11500 NORTH MOPAC  
AUSTIN, TX 78759

FOR: ON-LINE RETAIL STORE SERVICES, MAIL ORDERING, TELEPHONE ORDERING, AND CATALOG ORDERING SERVICES FEATURING COMPUTER HARDWARE AND COMPUTER SOFTWARE, FOR INDUSTRIAL AUTOMATION AND SCIENTIFIC AND ENGINEERING DATA ACQUISITION, CONTROL, AND ANALYSIS, IN CLASS 35 (U.S. CLS. 100, 101 AND 102).

FIRST USE 7-19-1988; IN COMMERCE 7-19-1988.

THE MARK CONSISTS OF STANDARD CHARACTERS WITHOUT CLAIM TO ANY PARTICULAR FONT, STYLE, SIZE, OR COLOR.

SER. NO. 85-322,020, FILED 5-16-2011.

ANDREA HACK, EXAMINING ATTORNEY



*David J. Kyfos*

Director of the United States Patent and Trademark Office

# United States of America

United States Patent and Trademark Office

## THE SOFTWARE IS THE INSTRUMENT

**Reg. No. 4,124,561**

**Registered Apr. 10, 2012**

**Int. Cl.: 42**

**SERVICE MARK**

**PRINCIPAL REGISTER**

NATIONAL INSTRUMENTS CORPORATION (DELAWARE CORPORATION)  
BUILDING "B"  
11500 NORTH MOPAC  
AUSTIN, TX 78759

FOR: UPDATING COMPUTER SOFTWARE IN THE FIELD OF SCIENTIFIC AND ENGINEERING DATA ACQUISITION, CONTROL, AND ANALYSIS; TECHNICAL SUPPORT SERVICES, NAMELY, TROUBLESHOOTING OF COMPUTER SOFTWARE PROBLEMS VIA ON-LINE COMMUNICATIONS IN THE FIELDS OF SCIENTIFIC AND ENGINEERING DATA ACQUISITION, CONTROL AND ANALYSIS; CONSULTING IN THE FIELD OF SCIENTIFIC AND ENGINEERING DATA ACQUISITION, CONTROL AND ANALYSIS, IN CLASS 42 (U.S. CLS. 100 AND 101).

FIRST USE 7-19-1988; IN COMMERCE 7-19-1988.

THE MARK CONSISTS OF STANDARD CHARACTERS WITHOUT CLAIM TO ANY PARTICULAR FONT, STYLE, SIZE, OR COLOR.

SER. NO. 85-322,027, FILED 5-16-2011.

ANDREA HACK, EXAMINING ATTORNEY



*David J. Kypos*

Director of the United States Patent and Trademark Office

# United States of America

United States Patent and Trademark Office

# EVERTEX

**Reg. No. 4,124,562**

**Registered Apr. 10, 2012**

**Int. Cl.: 1**

**TRADEMARK**

**PRINCIPAL REGISTER**

EVERLIGHT CHEMICAL INDUSTRIAL CORPORATION (TAIWAN CORPORATION)  
5-6F, NO. 77, SEC. 2, TUN HUA SOUTH ROAD  
TAIPEI, TAIWAN R.O.C.

FOR: CHEMICAL REAGENTS, OTHER THAN FOR MEDICAL OR VETERINARY PURPOSES;  
INDUSTRIAL CHEMICALS; CHEMICAL AGENTS FOR IMPREGNATING, BINDING OR  
COATING OF TEXTILES; CHEMICAL PREPARATIONS TO BE APPLIED TO TEXTILES,  
PLASTICS AND COATINGS TO PREVENT DAMAGE FROM ULTRAVIOLET LIGHT;  
CHEMICALS USED IN THE MANUFACTURE OF FABRIC OR TEXTILES; WATERPROOFING  
CHEMICAL COMPOSITIONS FOR ARTICLES OF FABRIC, IN CLASS 1 (U.S. CLS. 1, 5, 6,  
10, 26 AND 46).

FIRST USE 1-5-2004; IN COMMERCE 5-6-2004.

THE MARK CONSISTS OF STANDARD CHARACTERS WITHOUT CLAIM TO ANY PAR-  
TICULAR FONT, STYLE, SIZE, OR COLOR.

SER. NO. 85-322,036, FILED 5-16-2011.

ANGELA DUONG, EXAMINING ATTORNEY



*David J. Kyffers*

Director of the United States Patent and Trademark Office



# United States of America

United States Patent and Trademark Office

## Know Yourself Well

**Reg. No. 4,124,563**

**Registered Apr. 10, 2012**

**Int. Cl.: 9**

**TRADEMARK**

**PRINCIPAL REGISTER**

WELLAPPS INC (DELAWARE CORPORATION)  
83 HAMPSHIRE HILL ROAD  
UPPER SADDLE RIVER, NJ 07458

FOR: COMPUTER APPLICATION SOFTWARE THAT ALLOWS USERS TO SELF-REPORT OBSERVATIONS OF DAILY LIVING AND OBJECTIVE DATA FOR THE PURPOSE OF IMPROVED QUALITY OF LIFE AVAILABLE VIA MOBILE PHONES, OTHER MOBILE DEVICES AND THE INTERNET AND ALSO ALLOWS USERS TO RECEIVE NOTIFICATIONS AND REMINDERS, CREATE REPORTS AND ANALYZE INTERACTIVE CHARTS, IN CLASS 9 (U.S. CLS. 21, 23, 26, 36 AND 38).

FIRST USE 11-1-2010; IN COMMERCE 11-1-2010.

THE MARK CONSISTS OF STANDARD CHARACTERS WITHOUT CLAIM TO ANY PARTICULAR FONT, STYLE, SIZE, OR COLOR.

SER. NO. 85-322,223, FILED 5-16-2011.

AMY HELLA, EXAMINING ATTORNEY



*David J. Kyffers*

Director of the United States Patent and Trademark Office

# United States of America

United States Patent and Trademark Office

# FRUIT 66

**Reg. No. 4,124,564**

4U2U, LLC (VIRGINIA LIMITED LIABILITY COMPANY)  
20 NORTH 20TH STREET  
RICHMOND, VA 23223

**Registered Apr. 10, 2012**

**Int. Cl.: 32**

FOR: NON-ALCOHOLIC BEVERAGES CONTAINING FRUIT JUICES, IN CLASS 32 (U.S. CLS. 45, 46 AND 48).

**TRADEMARK**

FIRST USE 9-1-2007; IN COMMERCE 10-1-2008.

**PRINCIPAL REGISTER**

THE MARK CONSISTS OF STANDARD CHARACTERS WITHOUT CLAIM TO ANY PARTICULAR FONT, STYLE, SIZE, OR COLOR.

OWNER OF U.S. REG. NO. 3,728,046.

SER. NO. 85-322,384, FILED 5-16-2011.

KHANH LE, EXAMINING ATTORNEY



*David J. Kybas*

Director of the United States Patent and Trademark Office

# United States of America

United States Patent and Trademark Office

## AGAIN FASTER

**Reg. No. 4,124,565**

**Registered Apr. 10, 2012**

**Int. Cls.: 25 and 28**

**TRADEMARK**

**PRINCIPAL REGISTER**

AGAIN FASTER, LLC (DELAWARE LIMITED LIABILITY COMPANY)  
56 LORD VIEW DRIVE  
JEFFREY, NH 03452

FOR: T-SHIRTS, SWEATSHIRTS, ATHLETIC SHOES, IN CLASS 25 (U.S. CLS. 22 AND 39).

FIRST USE 7-27-2006; IN COMMERCE 7-27-2006.

FOR: PULLUP BAR, KETTLEBELLS, BARBELLS, PERSONAL EXERCISE MATS, EXERCISE WEIGHTS, RESISTANCE BANDS, GYMNAS TIC RINGS, ATHLETIC SPORTING GOODS IN THE NATURE OF WORK-OUT HAND GRIPS FOR GRIPPING ATHLETIC EQUIPMENT, CLIMBING ROPES, JUMP ROPES, BUMPER PLATES, AND PLYO BOXES, IN CLASS 28 (U.S. CLS. 22, 23, 38 AND 50).

FIRST USE 1-2-2007; IN COMMERCE 1-2-2007.

THE MARK CONSISTS OF STANDARD CHARACTERS WITHOUT CLAIM TO ANY PARTICULAR FONT, STYLE, SIZE, OR COLOR.

SER. NO. 85-322,581, FILED 5-17-2011.

MAYUR VAGHANI, EXAMINING ATTORNEY



*David J. Kypos*

Director of the United States Patent and Trademark Office

# United States of America

United States Patent and Trademark Office



**Reg. No. 4,124,566**

**Registered Apr. 10, 2012**

**Int. Cls.: 25 and 28**

**TRADEMARK**

**PRINCIPAL REGISTER**

AGAIN FASTER, LLC (DELAWARE LIMITED LIABILITY COMPANY)  
56 LORD VIEW DRIVE  
JEFFREY, NH 03452

FOR: T-SHIRTS, SWEATSHIRTS, ATHLETIC SHOES, IN CLASS 25 (U.S. CLS. 22 AND 39).

FIRST USE 7-27-2006; IN COMMERCE 7-27-2006.

FOR: PULLUP BAR, KETTLEBELLS, BARBELLS, PERSONAL EXERCISE MATS, EXERCISE WEIGHTS, RESISTANCE BANDS, GYMNASTIC RINGS, ATHLETIC SPORTING GOODS IN THE NATURE OF WORK-OUT HAND GRIPS FOR GRIPPING ATHLETIC EQUIPMENT, CLIMBING ROPES, JUMP ROPES, BUMPER PLATES, AND PLYO BOXES, IN CLASS 28 (U.S. CLS. 22, 23, 38 AND 50).

FIRST USE 1-2-2007; IN COMMERCE 1-2-2007.

THE MARK CONSISTS OF IMAGE OF A RUNNING MAN.

SER. NO. 85-322,584, FILED 5-17-2011.

MAYUR VAGHANI, EXAMINING ATTORNEY



*David J. Kybas*

Director of the United States Patent and Trademark Office

# United States of America

United States Patent and Trademark Office

## uniform aggression

**Reg. No. 4,124,567**

**Registered Apr. 10, 2012**

**Int. Cl.: 25**

**TRADEMARK**

**PRINCIPAL REGISTER**

DACZKO, BRIANNE (UNITED STATES INDIVIDUAL)  
APT. #307A  
83 LEDGE ROAD  
NORTHFIELD, OH 44067

FOR: PANTS; SHIRTS; UNDERGARMENTS, IN CLASS 25 (U.S. CLS. 22 AND 39).

FIRST USE 4-21-2011; IN COMMERCE 4-21-2011.

THE MARK CONSISTS OF STANDARD CHARACTERS WITHOUT CLAIM TO ANY PARTICULAR FONT, STYLE, SIZE, OR COLOR.

SER. NO. 85-322,662, FILED 5-17-2011.

LEIGH LOWRY, EXAMINING ATTORNEY



*David J. Kybas*

Director of the United States Patent and Trademark Office

# United States of America

United States Patent and Trademark Office

## HOPE CRUTCH

**Reg. No. 4,124,568**

**Registered Apr. 10, 2012**

**Int. Cl.: 10**

**TRADEMARK**

**PRINCIPAL REGISTER**

CAREBORNE, LLC (NEVADA LIMITED LIABILITY COMPANY)  
P.O. BOX 7018  
RENO, NV 89510

FOR: CRUTCHES, IN CLASS 10 (U.S. CLS. 26, 39 AND 44).

FIRST USE 10-7-1992; IN COMMERCE 6-11-1993.

THE MARK CONSISTS OF STANDARD CHARACTERS WITHOUT CLAIM TO ANY PARTICULAR FONT, STYLE, SIZE, OR COLOR.

NO CLAIM IS MADE TO THE EXCLUSIVE RIGHT TO USE "CRUTCH", APART FROM THE MARK AS SHOWN.

SER. NO. 85-322,783, FILED 5-17-2011.

DEIRDRE ROBERTSON, EXAMINING ATTORNEY



*David J. Kyffers*

Director of the United States Patent and Trademark Office

# United States of America

United States Patent and Trademark Office

## SUTHERLAND WOMEN STEPPING UP

**Reg. No. 4,124,569**

SUTHERLAND ASBILL & BRENNAN LLP (GEORGIA LIMITED LIABILITY PARTNERSHIP)  
999 PEACHTREE STREET NE  
ATLANTA, GA 303093996

**Registered Apr. 10, 2012**

**Int. Cls.: 35 and 36**

FOR: CHARITABLE SERVICES AND ACTIVITIES, NAMELY, OUTREACH SERVICES TO PROMOTE AWARENESS OF THE NEED TO ENHANCE THE WELFARE OF WOMEN AND GIRLS, IN CLASS 35 (U.S. CLS. 100, 101 AND 102).

**SERVICE MARK**

FIRST USE 5-11-2011; IN COMMERCE 5-11-2011.

**PRINCIPAL REGISTER**

FOR: CHARITABLE SERVICES AND ACTIVITIES, NAMELY, FUNDRAISING SERVICES, IN CLASS 36 (U.S. CLS. 100, 101 AND 102).

FIRST USE 5-11-2011; IN COMMERCE 5-11-2011.

THE MARK CONSISTS OF STANDARD CHARACTERS WITHOUT CLAIM TO ANY PARTICULAR FONT, STYLE, SIZE, OR COLOR.

SER. NO. 85-322,931, FILED 5-17-2011.

RUDY R. SINGLETON, EXAMINING ATTORNEY



*David J. Kyfos*

Director of the United States Patent and Trademark Office

United States of America  
United States Patent and Trademark Office

# OrthoView

**Reg. No. 4,124,570**

**Registered Apr. 10, 2012**

**Int. Cl.: 9**

**TRADEMARK**

**PRINCIPAL REGISTER**

MERIDIAN TECHNIQUE LIMITED (UNITED KINGDOM CORPORATION)  
2 VENTURE ROAD, SOUTHAMPTON SCIENCE PARK  
SOUTHAMPTON, UNITED KINGDOM SO157PY

FOR: MEDICAL SOFTWARE FOR PLANNING ORTHOPAEDIC SURGICAL PROCEDURES  
AND FOR POST-OPERATIVE ANALYSIS, IN CLASS 9 (U.S. CLS. 21, 23, 26, 36 AND 38).

PRIORITY CLAIMED UNDER SEC. 44(D) ON ERPN CMNTY TM OFC APPLICATION NO.  
009971201, FILED 5-16-2011, REG. NO. 009971201, DATED 10-19-2011, EXPIRES 5-16-2021.

OWNER OF U.S. REG. NO. 3,016,739.

THE MARK CONSISTS OF THE TERM "ORTHOVIEW" IN STYLIZED LETTERING.

SER. NO. 85-322,960, FILED 5-17-2011.

JOHN DWYER, EXAMINING ATTORNEY



*David J. Kybas*

Director of the United States Patent and Trademark Office



# United States of America

United States Patent and Trademark Office

# DocWorks

**Reg. No. 4,124,571**

**Registered Apr. 10, 2012**

**Int. Cl.: 9**

**TRADEMARK**

**PRINCIPAL REGISTER**

INTERACTIVE PRACTICE MANAGEMENT (ALABAMA LIMITED LIABILITY COMPANY),  
DBA DOCWORKS  
45 MEDICAL PARK DRIVE SUITE B  
GUNTERSVILLE, AL 35976

FOR: COMPUTER SOFTWARE FOR CONTROLLING AND MANAGING PATIENT MEDICAL  
INFORMATION, IN CLASS 9 (U.S. CLS. 21, 23, 26, 36 AND 38).

FIRST USE 5-22-1997; IN COMMERCE 11-12-1999.

THE MARK CONSISTS OF STANDARD CHARACTERS WITHOUT CLAIM TO ANY PAR-  
TICULAR FONT, STYLE, SIZE, OR COLOR.

SER. NO. 85-322,972, FILED 5-17-2011.

JACLYN KIDWELL WALKER, EXAMINING ATTORNEY



*David J. Kyjars*

Director of the United States Patent and Trademark Office

# United States of America

United States Patent and Trademark Office

## CAMCONTACTS

**Reg. No. 4,124,572**

**Registered Apr. 10, 2012**

**Int. Cls.: 38 and 41**

**SERVICE MARK**

**PRINCIPAL REGISTER**

CC NETWORK, INC. (BR.VIRGIN ISLANDS CORPORATION)  
PO BOX 3162 ROAD TOWN  
WOODBOURNE HALL  
TORTOLA, BR.VIRGIN ISLANDS VG1110

FOR: VIDEO TELECONFERENCING AND AUDIO TELECONFERENCING SERVICES RENDERED VIA THE GLOBAL COMPUTER NETWORK, PROVIDING ON-LINE CHAT ROOM SERVICES AND PROVIDING ON-LINE ELECTRONIC BULLETIN BOARDS FOR TRANSMISSION OF MESSAGES AMONG COMPUTER USERS CONCERNING INTERPERSONAL RELATIONSHIPS; PROVIDING MULTIPLE USER ACCESS TO A GLOBAL COMPUTER INFORMATION NETWORK, IN CLASS 38 (U.S. CLS. 100, 101 AND 104).

FIRST USE 11-1-1999; IN COMMERCE 11-1-2000.

FOR: ENTERTAINMENT SERVICES, NAMELY, CONTINUING LIVE PERFORMANCES IN THE NATURE OF ADULT THEMED AND GENERAL-INTEREST VARIETY SHOWS DISTRIBUTED OVER THE GLOBAL COMPUTER NETWORK , IN CLASS 41 (U.S. CLS. 100, 101 AND 107).

FIRST USE 11-1-1999; IN COMMERCE 11-1-2000.

THE MARK CONSISTS OF STANDARD CHARACTERS WITHOUT CLAIM TO ANY PARTICULAR FONT, STYLE, SIZE, OR COLOR.

SER. NO. 85-323,018, FILED 5-17-2011.

NAKIA HENRY, EXAMINING ATTORNEY



*David J. Kyffers*

Director of the United States Patent and Trademark Office

# United States of America

United States Patent and Trademark Office

## Skinny Wannabe

**Reg. No. 4,124,573**

FELIU, DAISY (UNITED STATES INDIVIDUAL)  
4370 KISSENA BLVD #15K  
FLUSHING, NY 11355

**Registered Apr. 10, 2012**

**Int. Cl.: 44**

FOR: PROVIDING A WEBSITE FEATURING INFORMATION ABOUT HEALTH, WELLNESS AND NUTRITION, IN CLASS 44 (U.S. CLS. 100 AND 101).

**SERVICE MARK**

FIRST USE 1-1-2011; IN COMMERCE 1-21-2011.

**PRINCIPAL REGISTER**

THE MARK CONSISTS OF STANDARD CHARACTERS WITHOUT CLAIM TO ANY PARTICULAR FONT, STYLE, SIZE, OR COLOR.

SER. NO. 85-323,167, FILED 5-17-2011.

EMILY CARLSEN, EXAMINING ATTORNEY



*David J. Kybas*

Director of the United States Patent and Trademark Office

# United States of America

United States Patent and Trademark Office

# PURERITE

**Reg. No. 4,124,574**

**Registered Apr. 10, 2012**

**Int. Cl.: 11**

**TRADEMARK**

**PRINCIPAL REGISTER**

KEMFLO (NANJING) ENVIRONMENTAL TECHNICAL CO., LTD (CHINA CORPORATION)  
NO. 19 AITAO ROAD, JIANGNING  
ECONOMIC AND TECHNICAL DEVELOP ZONE  
NANJING, CHINA

FOR: WATER FILTERS, IN CLASS 11 (U.S. CLS. 13, 21, 23, 31 AND 34).

FIRST USE 9-0-2003; IN COMMERCE 9-0-2003.

THE MARK CONSISTS OF STANDARD CHARACTERS WITHOUT CLAIM TO ANY PARTICULAR FONT, STYLE, SIZE, OR COLOR.

SER. NO. 85-323,901, FILED 5-18-2011.

HOWARD SMIGA, EXAMINING ATTORNEY



*David J. Kybas*

Director of the United States Patent and Trademark Office

# United States of America

United States Patent and Trademark Office



**Reg. No. 4,124,575**

ESCENT TECHNOLOGIES, LLC (KENTUCKY LIMITED LIABILITY COMPANY)  
ASTECC A44, 145 GRAHAM AVENUE  
LEXINGTON, KY 40506

**Registered Apr. 10, 2012**

**Int. Cl.: 9**

FOR: DIAGNOSTIC SUBSTANCE IDENTIFICATION APPARATUS, NAMELY, SCANNER FOR NON-DESTRUCTIVE MATERIAL EXAMINATION FOR IDENTIFICATION OF CHEMICAL MARKERS OF ORGANIC SUBSTANCES FOR USE IN LAW ENFORCEMENT, IN CLASS 9 (U.S. CLS. 21, 23, 26, 36 AND 38).

**TRADEMARK**

**PRINCIPAL REGISTER**

FIRST USE 6-1-2010; IN COMMERCE 6-1-2010.

THE MARK CONSISTS OF THE BLUE WORDING "ESCENT" AND THREE BLUE SEMI-CIRCLES, EACH ONE SLIGHTLY LARGER THAN THE NEXT.

THE COLOR(S) BLUE IS/ARE CLAIMED AS A FEATURE OF THE MARK.

SER. NO. 85-323,971, FILED 5-18-2011.

TRACY FLETCHER, EXAMINING ATTORNEY



*David J. Kypos*

Director of the United States Patent and Trademark Office

# United States of America

United States Patent and Trademark Office

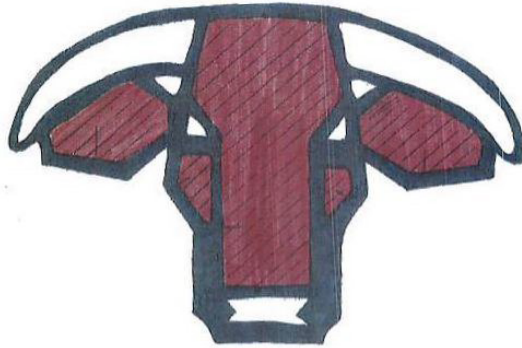

**Reg. No. 4,124,576**

**Registered Apr. 10, 2012**

**Int. Cl.: 35**

**SERVICE MARK**

**PRINCIPAL REGISTER**

SANTA GERTRUDIS BREEDERS INTERNATIONAL CORPORATION (TEXAS CORPORATION)  
P.O. BOX 1257  
KINGSVILLE, TX 78364

FOR: ASSOCIATION SERVICES, NAMELY, PROMOTING THE INTERESTS OF CATTLE BREEDERS, IN CLASS 35 (U.S. CLS. 100, 101 AND 102).

FIRST USE 9-1-1973; IN COMMERCE 9-1-1973.

THE MARK CONSISTS OF A DESIGN OF A BULL HEAD. THE HEAD IS BROWN AND OUTLINED IN BLACK WITH WHITE EYES, WHITE HORNS AND WHITE NOSE.

THE COLOR(S) BROWN, BLACK AND WHITE IS/ARE CLAIMED AS A FEATURE OF THE MARK.

SEC. 2(F).

SER. NO. 85-324,181, FILED 5-18-2011.

JOHN DWYER, EXAMINING ATTORNEY



*David J. Kyros*

Director of the United States Patent and Trademark Office

# United States of America

United States Patent and Trademark Office

## PARK AVENUE SPINE

**Reg. No. 4,124,577**

**Registered Apr. 10, 2012**

**Int. Cl.: 44**

**SERVICE MARK**

**PRINCIPAL REGISTER**

PAUL SALINAS (UNITED STATES INDIVIDUAL)  
APT. 8E  
98-05 67TH STREET  
REGO PARK, NY 11374

FOR: CHIROPRACTIC SERVICES; CHIROPRACTICS; MEDICAL, PHYSICAL REHABILITATION AND PHYSICAL THERAPY SERVICES; PROVIDING A WEBSITE FEATURING INFORMATION ABOUT HEALTH, WELLNESS AND NUTRITION, IN CLASS 44 (U.S. CLS. 100 AND 101).

FIRST USE 2-1-2005; IN COMMERCE 2-1-2005.

THE MARK CONSISTS OF STANDARD CHARACTERS WITHOUT CLAIM TO ANY PARTICULAR FONT, STYLE, SIZE, OR COLOR.

NO CLAIM IS MADE TO THE EXCLUSIVE RIGHT TO USE "SPINE", APART FROM THE MARK AS SHOWN.

SEC. 2(F).

SER. NO. 85-324,221, FILED 5-18-2011.

DEBRA LEE, EXAMINING ATTORNEY



*David J. Kybas*

Director of the United States Patent and Trademark Office

# United States of America

United States Patent and Trademark Office

Where Jocks Buy and Sell their Gear.

**JOCK  
SALE**



**Reg. No. 4,124,578**

JOCK SALE, LLC (TENNESSEE LIMITED LIABILITY COMPANY)  
7701 NIGHT HAWK ROAD  
CHATTANOOGA, TN 37421

**Registered Apr. 10, 2012**

**Int. Cl.: 35**

FOR: ARRANGING AND CONDUCTING CONSIGNMENT EVENTS WHERE PEOPLE CAN BUY AND SELL USED SPORTING GOODS, IN CLASS 35 (U.S. CLS. 100, 101 AND 102).

**SERVICE MARK**

FIRST USE 12-1-2010; IN COMMERCE 12-1-2010.

**PRINCIPAL REGISTER**

NO CLAIM IS MADE TO THE EXCLUSIVE RIGHT TO USE "SALE .COM", APART FROM THE MARK AS SHOWN.

THE MARK CONSISTS OF THE STYLIZED TEXT "JOCK SALE" WITH A ".COM" PRICE TAG HANGING FROM THE E IN "SALE". ON THE TOP THERE IS THE STYLIZED TEXT "WHERE JOCKS BUY AND SELL THEIR GEAR.".

SER. NO. 85-324,379, FILED 5-18-2011.

MARK RADEMACHER, EXAMINING ATTORNEY



*David J. Kyffers*

Director of the United States Patent and Trademark Office



# United States of America

United States Patent and Trademark Office

Color Wars: My favourite  
colour is Blue/Black/Cyan/Brown/Pink/Yellow/ White/Violet/Red/Orange/Green/Gray

**Reg. No. 4,124,579**

BELING, JOEL L (AUSTRALIA INDIVIDUAL), DBA SUPA CHARACTERS PTY LTD  
1 MIRBOO COURT

**Registered Apr. 10, 2012**

DALLAS, VICTORIA, AUSTRALIA 3047

**Int. Cl.: 25**

**TRADEMARK**

**PRINCIPAL REGISTER**

FOR: ADULT NOVELTY GAG CLOTHING ITEM, NAMELY, SOCKS; BABY LAYETTES FOR CLOTHING; BELTS; BELTS FOR CLOTHING; BELTS MADE OUT OF CLOTH; BIBS NOT OF CLOTH OR PAPER; BOTTOMS; CHILDREN'S AND INFANT'S APPAREL, NAMELY, JUMPERS, OVERALL SLEEPWEAR, PAJAMAS, ROMPERS AND ONE-PIECE GARMENTS; CHILDREN'S AND INFANTS' APPAREL TREATED WITH FIRE AND HEAT RETARDANTS, NAMELY, JUMPERS, OVERALL SLEEPWEAR, PAJAMAS, ROMPERS AND ONE-PIECE GARMENTS; CHILDREN'S AND INFANTS' CLOTH BIBS; CHILDREN'S CLOTH EATING BIBS; CHILDREN'S HEADWEAR; CLOTH BIBS; CLOTH BIBS FOR ADULT DINERS; CLOTH BIBS FOR USE BY SENIOR CITIZENS OR PHYSICALLY- OR MENTALLY-CHALLENGED PERSONS; CLOTH DIAPERS; CLOTHING EXTENSION USED TO EXTEND THE NORMAL SIZE RANGE OF CLOTHING ITEMS TO ACCOMMODATE PREGNANCY SIZE CHANGES; CLOTHING FOR ATHLETIC USE, NAMELY, PADDED ELBOW COMPRESSION SLEEVES BEING PART OF AN ATHLETIC GARMENT; CLOTHING FOR ATHLETIC USE, NAMELY, PADDED PANTS; CLOTHING FOR ATHLETIC USE, NAMELY, PADDED SHIRTS; CLOTHING FOR ATHLETIC USE, NAMELY, PADDED SHORTS; CLOTHING FOR BABIES, TODDLERS AND CHILDREN, TREATED WITH FIRE AND HEAT RETARDANTS, NAMELY, PAJAMAS, JACKETS, SHIRTS, PANTS, JUMPERS; CLOTHING FOR WEAR IN JUDO PRACTICES; CLOTHING FOR WEAR IN WRESTLING GAMES; CLOTHING ITEMS, NAMELY, ADHESIVE POCKETS THAT MAY BE AFFIXED DIRECTLY TO THE BODY AS A DECORATIVE PIECE OF CLOTHING WITH UTILITY; CLOTHING ITEMS, NAMELY, ADHESIVE POCKETS THAT MAY BE AFFIXED DIRECTLY TO THE INSIDE OF CLOTHING FOR STORAGE AND SAFEKEEPING OF PERSONAL ITEMS; CLOTHING ITEMS, NAMELY, BLINDFOLDS WORN OVER THE EYES; CLOTHING ITEMS, NAMELY, GAGS WORN OVER THE MOUTH; CLOTHING SHIELDS, NAMELY, PADS APPLIED TO THE UNDERARMS OF SHIRTS, BLOUSES AND SWEATERS; CLOTHING, NAMELY, ARM WARMERS; CLOTHING, NAMELY, ATHLETIC SLEEVES; CLOTHING, NAMELY, BASE LAYERS; CLOTHING, NAMELY, COWLS AND SMOKE RING SCARVES; CLOTHING, NAMELY, CROPS; CLOTHING, NAMELY, FOLK COSTUMES; CLOTHING, NAMELY, HAND-WARMERS; CLOTHING, NAMELY, KHAKIS; CLOTHING, NAMELY, KNEE WARMERS; CLOTHING, NAMELY, MATERNITY BANDS; CLOTHING, NAMELY, NECK TUBES; CLOTHING, NAMELY, THOBES; CLOTHING, NAMELY, WRAP-AROUNDS; CORSETS; COSTUMES FOR USE IN CHILDREN'S DRESS UP PLAY; COSTUMES FOR USE IN ROLE-PLAYING GAMES; COSTUMES FOR USE IN THE AMUSEMENT INDUSTRY; DANCE COSTUMES;



*David J. Kappas*

Director of the United States Patent and Trademark Office

**Reg. No. 4,124,579** DUSTERS; EYESHADES; FABRIC SOLD AS AN INTEGRAL COMPONENT OF FINISHED CLOTHING ITEMS, NAMELY, TOPS, BOTTOMS; FIGURE SKATING CLOTHING, NAMELY, TOPS AND BOTTOMS; FITTED SWIMMING COSTUMES WITH BRA CUPS; FOOTWEAR; FOULARDS; GLOVES AS CLOTHING; HALLOWEEN COSTUMES; HALLOWEEN COSTUMES AND MASKS SOLD IN CONNECTION THEREWITH; HEADBANDS FOR CLOTHING; HEADGEAR, NAMELY, CAPS, HATS, AND SKI AND SLEEP MASKS; KNIT MACE MASKS; HOODS; INFANT AND TODDLER ONE PIECE CLOTHING; INFANT CLOTH DIAPERS; INSERTS SPECIALLY ADAPTED FOR CLOTH DIAPERS MADE OF BAMBOO; INSERTS SPECIALLY ADAPTED FOR CLOTH DIAPERS MADE OF HEMP; INSERTS SPECIALLY ADAPTED FOR CLOTH DIAPERS MADE OF MICROFIBER; JACKETS; JERSEYS; LEATHER BELTS; MANTLES; MASQUERADE COSTUMES; MASQUERADE COSTUMES AND MASKS SOLD IN CONNECTION THEREWITH; MATERNITY CLOTHING, NAMELY, TOPS AND BOTTOMS; MEN'S AND WOMEN'S JACKETS, COATS, TROUSERS, VESTS; MEN'S DRESS SOCKS; MEN'S SOCKS; MEN'S SUITS; MEN'S SUITS, WOMEN'S SUITS; MEN'S UNDERWEAR; MUFFLERS; NON-DISPOSABLE CLOTH TRAINING PANTS; PAPER HATS FOR USE AS CLOTHING ITEMS; PARTS OF CLOTHING, NAMELY, GUSSETS FOR TIGHTS, GUSSETS FOR STOCKINGS, GUSSETS FOR BATHING SUITS, GUSSETS FOR UNDERWEAR, GUSSETS FOR LEOTARDS AND GUSSETS FOR FOOTLETS; PARTS OF CLOTHING, NAMELY, UNDERARM GUSSETS; PARTY HATS; PERSPIRATION ABSORBENT UNDERWEAR CLOTHING; POCKET SQUARES; SHIFTS; SHORT SETS; SHOULDER WRAPS; SHOULDER WRAPS FOR CLOTHING; SUN PROTECTIVE CLOTHING, NAMELY, TOPS AND BOTTOMS AND HATS; SWADDLING CLOTHES; SWIMMING COSTUMES; TIES; TOPS; TRAVEL CLOTHING CONTAINED IN A PACKAGE COMPRISING REVERSIBLE JACKETS, PANTS, SKIRTS, TOPS AND A BELT OR SCARF; TRIATHLON CLOTHING, NAMELY, TRIATHLON TIGHTS, TRIATHLON SHORTS, TRIATHLON SINGLET, TRIATHLON SHIRTS, TRIATHLON SUITS; UNDERARM CLOTHING SHIELDS; WEARABLE GARMENTS AND CLOTHING, NAMELY, SHIRTS; WOMEN'S CLOTHING, NAMELY, SHIRTS, DRESSES, SKIRTS, BLOUSES; WRAPS, IN CLASS 25 (U.S. CLS. 22 AND 39).

THE MARK CONSISTS OF STANDARD CHARACTERS WITHOUT CLAIM TO ANY PARTICULAR FONT, STYLE, SIZE, OR COLOR.

PRIORITY CLAIMED UNDER SEC. 44(D) ON AUSTRALIA APPLICATION NO. 1414541, FILED 3-16-2011, REG. NO. 1414541, DATED 10-17-2011, EXPIRES 10-17-2021.

SER. NO. 85-324,453, FILED 5-18-2011.

GEOFFREY FOSDICK, EXAMINING ATTORNEY

# United States of America

United States Patent and Trademark Office

## Advancing Science, Improving Lives

**Reg. No. 4,124,580**

**Registered Apr. 10, 2012**

**Int. Cl.: 42**

**SERVICE MARK**

**PRINCIPAL REGISTER**

INTEGRATED LABORATORY SYSTEMS (NORTH CAROLINA CORPORATION), AKA ILS  
PO BOX 13501  
RESEARCH TRIANGLE PARK, NC 27709

FOR: AGRICULTURAL RESEARCH; AGROCHEMICAL RESEARCH SERVICES; ANALYSIS OF INDUSTRIAL FLUIDS; ARCHITECTURAL RESEARCH; BACTERIOLOGICAL CONSULTATION AND RESEARCH; CONDUCTING EARLY EVALUATIONS IN THE FIELD OF NEW PHARMACEUTICALS; CONSULTING SERVICES IN THE FIELD OF ENVIRONMENTAL ASSESSMENT AND PLANNING; CONSULTING SERVICES IN THE FIELDS OF BIOTECHNOLOGY, PHARMACEUTICAL RESEARCH AND DEVELOPMENT, LABORATORY TESTING, DIAGNOSTICS, AND PHARMACOGENETICS; ENVIRONMENTAL SERVICES, NAMELY, TECHNICAL CONSULTATION IN THE FIELD OF ENVIRONMENTAL SCIENCE; ENVIRONMENTAL TESTING AND INSPECTION SERVICES; EVALUATING AND TESTING THE ENVIRONMENTAL QUALITIES AND IMPACT OF CONSUMER PRODUCTS OF OTHERS; PHARMACEUTICAL DRUG DEVELOPMENT SERVICES; PHARMACEUTICAL RESEARCH SERVICES; PRODUCT SAFETY TESTING; RESEARCH IN THE FIELD OF ENVIRONMENTAL PROTECTION; SCIENTIFIC CONSULTING SERVICES RELATING TO HAZARDOUS MATERIALS MANAGEMENT; SURVEY DESIGN AND RESEARCH; TESTING OR RESEARCH ON MACHINES, APPARATUS AND INSTRUMENTS; TESTING, ANALYSIS AND EVALUATION OF THE GOODS OF OTHERS FOR THE PURPOSE OF CERTIFICATION; TESTING, INSPECTION OR RESEARCH OF PHARMACEUTICALS, COSMETICS OR FOODSTUFF; TESTING, INSPECTION, RESEARCH, OR DEVELOPMENT OF PHARMACEUTICAL PREPARATIONS FOR GENE THERAPY, IN CLASS 42 (U.S. CLS. 100 AND 101).

FIRST USE 1-1-2011; IN COMMERCE 1-1-2011.

THE MARK CONSISTS OF STANDARD CHARACTERS WITHOUT CLAIM TO ANY PARTICULAR FONT, STYLE, SIZE, OR COLOR.

SER. NO. 85-324,671, FILED 5-19-2011.

DOMINIC FATHY, EXAMINING ATTORNEY



*David J. Kyjars*

Director of the United States Patent and Trademark Office

# United States of America

United States Patent and Trademark Office



**Reg. No. 4,124,581**

**Registered Apr. 10, 2012**

**Int. Cl.: 41**

**SERVICE MARK**

**PRINCIPAL REGISTER**

A LA MODA EVENTS, LLC (ILLINOIS LIMITED LIABILITY COMPANY)  
6065 RUSSELL DR.  
HOFFMAN ESTATES, IL 60192

FOR: ARRANGING AND CONDUCTING SPECIAL EVENTS FOR SOCIAL ENTERTAINMENT PURPOSES; PARTY AND WEDDING PLANNING, COORDINATION AND CONSULTATION SERVICES, IN CLASS 41 (U.S. CLS. 100, 101 AND 107).

FIRST USE 3-25-2011; IN COMMERCE 3-25-2011.

NO CLAIM IS MADE TO THE EXCLUSIVE RIGHT TO USE "EVENTS", APART FROM THE MARK AS SHOWN.

THE MARK CONSISTS OF THE STYLIZED TEXT "A LA MODA EVENTS" WITH A LARGE STYLIZED LETTER "M" IN THE BACKGROUND.

THE ENGLISH TRANSLATION OF "A LA MODA" IN THE MARK IS "IN STYLE".

SER. NO. 85-324,980, FILED 5-19-2011.

ELLEN B. AWRICH, EXAMINING ATTORNEY



*David J. Kyros*

Director of the United States Patent and Trademark Office

# United States of America

United States Patent and Trademark Office

## choice personal care

**Reg. No. 4,124,582**

GOOD HOUSEKEEPING PRODUCTS, LLC (MICHIGAN LIMITED LIABILITY COMPANY)  
21170 W 8 MILE ROAD  
SOUTHFIELD, MI 48075

**Registered Apr. 10, 2012**

**Int. Cl.: 3**

FOR: BABY OIL; BABY POWDER; PETROLEUM JELLY FOR COSMETIC PURPOSES, IN CLASS 3 (U.S. CLS. 1, 4, 6, 50, 51 AND 52).

**TRADEMARK**

FIRST USE 1-1-2010; IN COMMERCE 1-1-2010.

**PRINCIPAL REGISTER**

THE MARK CONSISTS OF STANDARD CHARACTERS WITHOUT CLAIM TO ANY PARTICULAR FONT, STYLE, SIZE, OR COLOR.

NO CLAIM IS MADE TO THE EXCLUSIVE RIGHT TO USE "PERSONAL CARE", APART FROM THE MARK AS SHOWN.

SER. NO. 85-325,062, FILED 5-19-2011.

FRANK LATTUCA, EXAMINING ATTORNEY



*David J. Kybas*

Director of the United States Patent and Trademark Office

# United States of America

United States Patent and Trademark Office



**Reg. No. 4,124,583**

ANALYTICS8, LLC (ILLINOIS LIMITED LIABILITY COMPANY)  
500 N. MICHIGAN AVENUE, SUITE 810  
CHICAGO, IL 60611

**Registered Apr. 10, 2012**

**Int. Cls.: 9, 35 and 42**

FOR: COMPUTER SOFTWARE FOR THE AUTOMATION OF DATA WAREHOUSING; COMPUTER SOFTWARE FOR USE IN THE ANALYSIS OF BUSINESS INTELLIGENCE; COMPUTER SOFTWARE THAT PROVIDES REAL-TIME INTEGRATED BUSINESS MANAGEMENT INTELLIGENCE BY COMBINING INFORMATION FROM VARIOUS DATABASES, IN CLASS 9 (U.S. CLS. 21, 23, 26, 36 AND 38).

**TRADEMARK**

**SERVICE MARK**

FIRST USE 10-31-2008; IN COMMERCE 10-31-2008.

**PRINCIPAL REGISTER**

FOR: BUSINESS CONSULTING SERVICES IN THE FIELDS OF INFORMATION TECHNOLOGY, INFORMATION MANAGEMENT, DATA WAREHOUSING, DATA INTEGRATION AND BUSINESS INTELLIGENCE, IN CLASS 35 (U.S. CLS. 100, 101 AND 102).

FIRST USE 10-31-2008; IN COMMERCE 10-31-2008.

FOR: TECHNOLOGY CONSULTATION SERVICES IN THE FIELDS OF INFORMATION TECHNOLOGY, INFORMATION MANAGEMENT, DATA WAREHOUSING, DATA INTEGRATION AND BUSINESS INTELLIGENCE; PLANNING, DESIGN AND MANAGEMENT OF INFORMATION TECHNOLOGY, INFORMATION MANAGEMENT, DATA WAREHOUSING, DATA INTEGRATION AND BUSINESS INTELLIGENCE COMPUTER NETWORK SYSTEMS; DATA WAREHOUSING; DATA MINING; COMPUTER PROGRAMMING SERVICES IN THE FIELDS OF INFORMATION TECHNOLOGY, INFORMATION MANAGEMENT, DATA WAREHOUSING, DATA INTEGRATION AND BUSINESS INTELLIGENCE, IN CLASS 42 (U.S. CLS. 100 AND 101).

FIRST USE 10-31-2008; IN COMMERCE 10-31-2008.

THE MARK CONSISTS OF THE WORDING "ANALYTICS8" IN THE COLOR BLUE AND THE STYLIZED DESIGN OF THE NUMBER "8" IN DARK ORANGE WITH A LIGHT ORANGE CIRCULAR DESIGN AROUND THE MIDDLE..

THE COLOR(S) BLUE, DARK ORANGE AND LIGHT ORANGE IS/ARE CLAIMED AS A FEATURE OF THE MARK.



*David J. Kyjars*

Director of the United States Patent and Trademark Office

**Reg. No. 4,124,583** SER. NO. 85-325,064, FILED 5-19-2011.

KAREN BRACEY, EXAMINING ATTORNEY

# United States of America

United States Patent and Trademark Office

# Analytics8

**Reg. No. 4,124,584**

ANALYTICS8, LLC (ILLINOIS LIMITED LIABILITY COMPANY)  
500 N. MICHIGAN AVENUE, SUITE 810  
CHICAGO, IL 60611

**Registered Apr. 10, 2012**

**Int. Cls.: 9, 35 and 42**

FOR: COMPUTER SOFTWARE FOR THE AUTOMATION OF DATA WAREHOUSING; COMPUTER SOFTWARE FOR USE IN THE ANALYSIS OF BUSINESS INTELLIGENCE; COMPUTER SOFTWARE THAT PROVIDES REAL-TIME INTEGRATED BUSINESS MANAGEMENT INTELLIGENCE BY COMBINING INFORMATION FROM VARIOUS DATABASES, IN CLASS 9 (U.S. CLS. 21, 23, 26, 36 AND 38).

**TRADEMARK**

**SERVICE MARK**

FIRST USE 10-31-2002; IN COMMERCE 10-31-2007.

**PRINCIPAL REGISTER**

FOR: BUSINESS CONSULTING SERVICES IN THE FIELDS OF INFORMATION TECHNOLOGY, INFORMATION MANAGEMENT, DATA WAREHOUSING, DATA INTEGRATION AND BUSINESS INTELLIGENCE, IN CLASS 35 (U.S. CLS. 100, 101 AND 102).

FIRST USE 10-31-2002; IN COMMERCE 7-31-2005.

FOR: TECHNOLOGY CONSULTATION SERVICES IN THE FIELDS OF INFORMATION TECHNOLOGY, INFORMATION MANAGEMENT, DATA WAREHOUSING, DATA INTEGRATION AND BUSINESS INTELLIGENCE; PLANNING, DESIGN AND MANAGEMENT OF INFORMATION TECHNOLOGY, INFORMATION MANAGEMENT, DATA WAREHOUSING, DATA INTEGRATION AND BUSINESS INTELLIGENCE COMPUTER NETWORK SYSTEMS; DATA WAREHOUSING; DATA MINING; COMPUTER PROGRAMMING SERVICES IN THE FIELDS OF INFORMATION TECHNOLOGY, INFORMATION MANAGEMENT, DATA WAREHOUSING, DATA INTEGRATION AND BUSINESS INTELLIGENCE, IN CLASS 42 (U.S. CLS. 100 AND 101).

FIRST USE 10-31-2002; IN COMMERCE 7-31-2005.

THE MARK CONSISTS OF STANDARD CHARACTERS WITHOUT CLAIM TO ANY PARTICULAR FONT, STYLE, SIZE, OR COLOR.

SER. NO. 85-325,073, FILED 5-19-2011.

KAREN BRACEY, EXAMINING ATTORNEY



*David J. Kyjars*

Director of the United States Patent and Trademark Office



# United States of America

United States Patent and Trademark Office

## SIMPLE SIMON

**Reg. No. 4,124,585**

GREGORY GODEK (CALIFORNIA TRUST)  
5641 LA JOLLA HERMOSA AVENUE  
LAJOLLA, CA 92037

**Registered Apr. 10, 2012**

**Int. Cl.: 16**

FOR: PRINTED MATERIALS, NAMELY, SERIES OF BOOKS AND PERIODICALS MATERIALS FEATURING A FICTIONAL CHARACTER WHO TEACHES LESSONS IN THE FIELDS OF BUSINESS, LIFE, RELATIONSHIPS, CREATIVITY, INNOVATION AND PROBLEM-SOLVING, IN CLASS 16 (U.S. CLS. 2, 5, 22, 23, 29, 37, 38 AND 50).

**TRADEMARK**

**PRINCIPAL REGISTER**

FIRST USE 6-1-2009; IN COMMERCE 6-1-2009.

THE MARK CONSISTS OF STANDARD CHARACTERS WITHOUT CLAIM TO ANY PARTICULAR FONT, STYLE, SIZE, OR COLOR.

THE NAME "SIMPLE SIMON" DOES NOT IDENTIFY A LIVING INDIVIDUAL.

SER. NO. 85-325,716, FILED 5-20-2011.

MARGERY A. TIERNEY, EXAMINING ATTORNEY



*David J. Kybas*

Director of the United States Patent and Trademark Office

# United States of America

United States Patent and Trademark Office

## BRINLEY CO.

**Reg. No. 4,124,586**

KNS INTERNATIONAL, L.L.C. (UTAH LIMITED LIABILITY COMPANY)  
12577 S. 265 W., BLD. 3B  
DRAPER, UT 84020

**Registered Apr. 10, 2012**

**Int. Cls.: 18 and 25**

FOR: LEATHER GOODS, NAMELY, WALLETS, HANDBAGS AND PURSES, IN CLASS 18 (U.S. CLS. 1, 2, 3, 22 AND 41).

**TRADEMARK**

FIRST USE 8-31-2009; IN COMMERCE 8-31-2009.

**PRINCIPAL REGISTER**

FOR: CLOTHING, NAMELY, SHIRTS, TIES, DRESS SUITS, BLOUSES, PANTS, SWEATERS, JACKETS, SHORTS, T-SHIRTS, SWEATSHIRTS, FOOTWEAR, GLOVES AND BELTS, IN CLASS 25 (U.S. CLS. 22 AND 39).

FIRST USE 8-31-2009; IN COMMERCE 8-31-2009.

THE MARK CONSISTS OF STANDARD CHARACTERS WITHOUT CLAIM TO ANY PARTICULAR FONT, STYLE, SIZE, OR COLOR.

NO CLAIM IS MADE TO THE EXCLUSIVE RIGHT TO USE "CO.", APART FROM THE MARK AS SHOWN.

SER. NO. 85-325,909, FILED 5-20-2011.

CHRIS WELLS, EXAMINING ATTORNEY



*David J. Kybas*

Director of the United States Patent and Trademark Office

# United States of America

United States Patent and Trademark Office



**Reg. No. 4,124,587**

KANAWA, KUNIKO (JAPAN INDIVIDUAL)  
P.O. BOX 1273  
TEMPLE CITY, CA 91780

**Registered Apr. 10, 2012**

**Int. Cl.: 14**

FOR: TRADITIONAL JAPANESE JEWELRY, NAMELY, JEWELRY FOR HAIR, RINGS, EARRINGS, PENDANT NECKLACES, BROOCHES, KEY CHAINS AND LAPEL PINS, IN CLASS 14 (U.S. CLS. 2, 27, 28 AND 50).

**TRADEMARK**

FIRST USE 3-31-2011; IN COMMERCE 3-31-2011.

**PRINCIPAL REGISTER**

THE MARK CONSISTS OF JAPANESE CHARACTERS IN BLACK LETTERS.

THE JAPANESE CHARACTERS THAT FORM THE MARK TRANSLITERATE TO "KANA", WHICH MEANS "PLAYS A TUNE", AND "WA", WHICH MEANS "HARMONY" OR "PEACE" IN ENGLISH.

SER. NO. 85-325,923, FILED 5-20-2011.

IRA J. GOODSaid, EXAMINING ATTORNEY



*David J. Kyros*

Director of the United States Patent and Trademark Office

# United States of America

United States Patent and Trademark Office

# TORK

**Reg. No. 4,124,588**

**Registered Apr. 10, 2012**

**Int. Cl.: 28**

**TRADEMARK**

**PRINCIPAL REGISTER**

DISRUPTIVE DISTRIBUTION INC. (NORTH CAROLINA CORPORATION)  
1404 NEWBARY CT  
CHARLOTTE, NC 28269

FOR: SKATEBOARDS, SKATEBOARD ACCESSORIES AND STRUCTURAL PARTS FOR SKATEBOARDS, NAMELY, WHEELS, TRUCKS, AND BEARINGS; MOUNTING HARDWARE, NAMELY, SCREWS, BOLTS, NUTS, AND WASHERS USED TO FASTEN SKATEBOARD TRUCKS TO THE DECK; RECREATIONAL EQUIPMENT, NAMELY, LONG SKATEBOARDS FOR USE ON VARIOUS TERRAIN AND SURFACES, IN CLASS 28 (U.S. CLS. 22, 23, 38 AND 50).

FIRST USE 4-3-2011; IN COMMERCE 4-3-2011.

THE MARK CONSISTS OF STANDARD CHARACTERS WITHOUT CLAIM TO ANY PARTICULAR FONT, STYLE, SIZE, OR COLOR.

SER. NO. 85-325,984, FILED 5-20-2011.

JENNIFER WILLISTON, EXAMINING ATTORNEY



*David J. Kybas*

Director of the United States Patent and Trademark Office

# United States of America

United States Patent and Trademark Office

## COUNTERPOINT

**Reg. No. 4,124,589**

**Registered Apr. 10, 2012**

**Int. Cl.: 41**

**SERVICE MARK**

**PRINCIPAL REGISTER**

YESHIVA UNIVERSITY (NEW YORK NOT-FOR-PROFIT CORPORATION)  
500 WEST 185TH STREET  
NEW YORK, NY 100333201

FOR: EDUCATIONAL SERVICES, NAMELY, CONDUCTING EDUCATIONAL PROGRAMS IN THE FIELD OF RELIGION; ORGANIZING AND CONDUCTING COMMUNITY RECREATIONAL SPORTING EVENTS; EDUCATIONAL SERVICES, NAMELY, PROVIDING ENGLISH LANGUAGE INSTRUCTION AND RELIGIOUS INSTRUCTION; DEVELOPING AND PROVIDING DAY AND OVERNIGHT CAMPS FOR STUDENTS IN THE FIELD OF RELIGION; DEVELOPING INTERNATIONAL STUDENT EXCHANGE PROGRAMS, IN CLASS 41 (U.S. CLS. 100, 101 AND 107).

FIRST USE 12-31-1974; IN COMMERCE 12-31-1974.

THE MARK CONSISTS OF STANDARD CHARACTERS WITHOUT CLAIM TO ANY PARTICULAR FONT, STYLE, SIZE, OR COLOR.

SER. NO. 85-326,333, FILED 5-20-2011.

SIMON TENG, EXAMINING ATTORNEY



*David J. Kyffers*

Director of the United States Patent and Trademark Office

# United States of America

United States Patent and Trademark Office

## DE-STRESS THE HEALTHY WAY

**Reg. No. 4,124,590**

NEUROBRANDS, LLC (CALIFORNIA LIMITED LIABILITY COMPANY)  
501 SANTA MONICA BLVD, SECOND FLOOR  
SANTA MONICA, CA 90401

**Registered Apr. 10, 2012**

**Int. Cls.: 5 and 32**

FOR: DIETARY SUPPLEMENTAL DRINKS; NUTRITIONAL FORTIFIED BEVERAGES;  
VITAMIN FORTIFIED BEVERAGES, IN CLASS 5 (U.S. CLS. 6, 18, 44, 46, 51 AND 52).

**TRADEMARK**

FIRST USE 10-21-2008; IN COMMERCE 4-16-2009.

**PRINCIPAL REGISTER**

FOR: NON-ALCOHOLIC BEVERAGES, NAMELY, MINERAL AND AERATED WATERS,  
FRUIT DRINKS, ENERGY DRINKS, FRUIT FLAVORED DRINKS, HERBAL JUICES AND  
ISOTONIC DRINKS, IN CLASS 32 (U.S. CLS. 45, 46 AND 48).

FIRST USE 10-21-2008; IN COMMERCE 4-16-2009.

THE MARK CONSISTS OF STANDARD CHARACTERS WITHOUT CLAIM TO ANY PAR-  
TICULAR FONT, STYLE, SIZE, OR COLOR.

SER. NO. 85-326,481, FILED 5-20-2011.

WON TEAK OH, EXAMINING ATTORNEY



*David J. Kyfos*

Director of the United States Patent and Trademark Office

# United States of America

United States Patent and Trademark Office



# PLUG-IN

VEHICLE SOLUTIONS

**Reg. No. 4,124,591**

PLUG-IN VEHICLE SOLUTIONS (ILLINOIS CORPORATION)  
1104 COVENTRY CIRCLE  
GLENDALE HEIGHTS, IL 60139

**Registered Apr. 10, 2012**

**Int. Cl.: 9**

FOR: ELECTRICAL APPARATUS, NAMELY, CHARGING STATIONS FOR CHARGING ELECTRIC VEHICLES, IN CLASS 9 (U.S. CLS. 21, 23, 26, 36 AND 38).

**TRADEMARK**

FIRST USE 2-1-2010; IN COMMERCE 6-1-2010.

**PRINCIPAL REGISTER**

NO CLAIM IS MADE TO THE EXCLUSIVE RIGHT TO USE "PLUG-IN VEHICLE", APART FROM THE MARK AS SHOWN.

THE MARK CONSISTS OF A CAR WITH A PLUG CONNECTED TO THE BACK/TOP, SPIRALING COUNTER CLOCKWISE. THE BOTTOM OF THE VEHICLE WHERE THE TIRES WOULD BE LOCATED LOOKS LIKE A PLUG; TO THE RIGHT IF THE TEXT "PLUG-IN VEHICLE SOLUTIONS", WITH "PLUG-IN" ABOVE, AND "VEHICLE SOLUTIONS" BELOW.

SER. NO. 85-326,499, FILED 5-20-2011.

MARTHA FROMM, EXAMINING ATTORNEY



*David J. Kybas*

Director of the United States Patent and Trademark Office

# United States of America

United States Patent and Trademark Office

## SLEEP THE HEALTHY WAY

**Reg. No. 4,124,592**

NEUROBRANDS, LLC (CALIFORNIA LIMITED LIABILITY COMPANY)  
501 SANTA MONICA BLVD, SECOND FLOOR  
SANTA MONICA, CA 90401

**Registered Apr. 10, 2012**

**Int. Cls.: 5 and 32**

FOR: DIETARY SUPPLEMENTAL DRINKS; NUTRITIONAL FORTIFIED BEVERAGES;  
VITAMIN FORTIFIED BEVERAGES, IN CLASS 5 (U.S. CLS. 6, 18, 44, 46, 51 AND 52).

**TRADEMARK**

FIRST USE 2-11-2009; IN COMMERCE 4-16-2009.

**PRINCIPAL REGISTER**

FOR: NON-ALCOHOLIC BEVERAGES, NAMELY, MINERAL AND AERATED WATERS,  
FRUIT DRINKS, ENERGY DRINKS, FRUIT FLAVORED DRINKS, HERBAL JUICES AND  
ISOTONIC DRINKS, IN CLASS 32 (U.S. CLS. 45, 46 AND 48).

FIRST USE 2-11-2009; IN COMMERCE 4-16-2009.

THE MARK CONSISTS OF STANDARD CHARACTERS WITHOUT CLAIM TO ANY PAR-  
TICULAR FONT, STYLE, SIZE, OR COLOR.

SER. NO. 85-326,546, FILED 5-20-2011.

WON TEAK OH, EXAMINING ATTORNEY



*David J. Kyfos*

Director of the United States Patent and Trademark Office



# United States of America

United States Patent and Trademark Office

## PLAY THE HEALTHY WAY

**Reg. No. 4,124,593**

NEUROBRANDS, LLC (CALIFORNIA LIMITED LIABILITY COMPANY)  
501 SANTA MONICA BLVD, SECOND FLOOR  
SANTA MONICA, CA 90401

**Registered Apr. 10, 2012**

**Int. Cls.: 5 and 32**

FOR: DIETARY SUPPLEMENTAL DRINKS; NUTRITIONAL FORTIFIED BEVERAGES;  
VITAMIN FORTIFIED BEVERAGES, IN CLASS 5 (U.S. CLS. 6, 18, 44, 46, 51 AND 52).

**TRADEMARK**

FIRST USE 10-21-2008; IN COMMERCE 4-16-2009.

**PRINCIPAL REGISTER**

FOR: NON-ALCOHOLIC BEVERAGES, NAMELY, MINERAL AND AERATED WATERS,  
FRUIT DRINKS, ENERGY DRINKS, FRUIT FLAVORED DRINKS, HERBAL JUICES AND  
ISOTONIC DRINKS, IN CLASS 32 (U.S. CLS. 45, 46 AND 48).

FIRST USE 10-21-2008; IN COMMERCE 4-16-2009.

THE MARK CONSISTS OF STANDARD CHARACTERS WITHOUT CLAIM TO ANY PAR-  
TICULAR FONT, STYLE, SIZE, OR COLOR.

SER. NO. 85-326,565, FILED 5-20-2011.

WON TEAK OH, EXAMINING ATTORNEY



*David J. Kyfos*

Director of the United States Patent and Trademark Office

# United States of America

United States Patent and Trademark Office

## HYDRATE THE HEALTHY WAY

**Reg. No. 4,124,594**

NEUROBRANDS, LLC (CALIFORNIA LIMITED LIABILITY COMPANY)  
501 SANTA MONICA BLVD, SECOND FLOOR  
SANTA MONICA, CA 90401

**Registered Apr. 10, 2012**

**Int. Cls.: 5 and 32**

FOR: DIETARY SUPPLEMENTAL DRINKS; NUTRITIONAL FORTIFIED BEVERAGES;  
VITAMIN FORTIFIED BEVERAGES, IN CLASS 5 (U.S. CLS. 6, 18, 44, 46, 51 AND 52).

**TRADEMARK**

FIRST USE 6-1-2009; IN COMMERCE 6-23-2009.

**PRINCIPAL REGISTER**

FOR: NON-ALCOHOLIC BEVERAGES, NAMELY, MINERAL AND AERATED WATERS,  
FRUIT DRINKS, ENERGY DRINKS, FRUIT FLAVORED DRINKS, HERBAL JUICES AND  
ISOTONIC DRINKS, IN CLASS 32 (U.S. CLS. 45, 46 AND 48).

FIRST USE 6-1-2009; IN COMMERCE 6-23-2009.

THE MARK CONSISTS OF STANDARD CHARACTERS WITHOUT CLAIM TO ANY PAR-  
TICULAR FONT, STYLE, SIZE, OR COLOR.

SER. NO. 85-326,583, FILED 5-20-2011.

WON TEAK OH, EXAMINING ATTORNEY



*David J. Kyfos*

Director of the United States Patent and Trademark Office

# United States of America

United States Patent and Trademark Office

# ePal

**Reg. No. 4,124,595**

EPAL INC (ILLINOIS CORPORATION)  
23W122 KINGS CT  
GLEN ELLYN, IL 60137

**Registered Apr. 10, 2012**

**Int. Cl.: 35**

FOR: ON-LINE RETAIL STORE SERVICES FEATURING A WIDE VARIETY OF CONSUMER GOODS OF OTHERS, IN CLASS 35 (U.S. CLS. 100, 101 AND 102).

**SERVICE MARK**

FIRST USE 7-1-2006; IN COMMERCE 7-1-2006.

**PRINCIPAL REGISTER**

THE MARK CONSISTS OF STANDARD CHARACTERS WITHOUT CLAIM TO ANY PARTICULAR FONT, STYLE, SIZE, OR COLOR.

SER. NO. 85-327,151, FILED 5-23-2011.

CHERYL CLAYTON, EXAMINING ATTORNEY



*David J. Kybas*

Director of the United States Patent and Trademark Office

# United States of America

United States Patent and Trademark Office

# SUBERRA

**Reg. No. 4,124,596**

**Registered Apr. 10, 2012**

**Int. Cl.: 19**

**TRADEMARK**

**PRINCIPAL REGISTER**

WY FAST, LLC (WYOMING LIMITED LIABILITY COMPANY)  
C/O LAW OFFICES OF KAREN J. BERNSTEIN  
NEW YORK, NY 10017

FOR: CORK BUILDING MATERIALS, NAMELY, KITCHEN COUNTERTOPS, BATHROOM SURFACE APPLICATIONS FOR COUNTERTOPS AND VANITY TOPS, FLOORING, WALL PANELS, IN CLASS 19 (U.S. CLS. 1, 12, 33 AND 50).

FIRST USE 12-1-2008; IN COMMERCE 12-1-2008.

THE MARK CONSISTS OF STANDARD CHARACTERS WITHOUT CLAIM TO ANY PARTICULAR FONT, STYLE, SIZE, OR COLOR.

THE WORDING "SUBERRA" HAS NO MEANING IN A FOREIGN LANGUAGE.

SER. NO. 85-327,348, FILED 5-23-2011.

JUDITH HELFMAN, EXAMINING ATTORNEY



*David J. Kybas*

Director of the United States Patent and Trademark Office

# United States of America

United States Patent and Trademark Office

## Taste Connections

**Reg. No. 4,124,597**

TASTE CONNECTIONS (CALIFORNIA SOLE PROPRIETORSHIP)  
612 MEYER LANE, SUITE 13  
REDONDO BEACH, CA 90278

**Registered Apr. 10, 2012**

**Int. Cls.: 29 and 30**

FOR: LOW PROTEIN DRY MIXES, NAMELY, SALAD TOPPINGS IN THE NATURE OF BACON BITS, IN CLASS 29 (U.S. CL. 46).

**TRADEMARK**

FIRST USE 9-1-2010; IN COMMERCE 9-1-2010.

**PRINCIPAL REGISTER**

FOR: LOW PROTEIN DRY MIXES, NAMELY, BREAD MIXES, COOKIE MIXES, AND CAKE MIXES, ALL PURPOSE BAKING MIXES, READY BAKED BREADS, ROLLS AND CRACKERS, IN CLASS 30 (U.S. CL. 46).

FIRST USE 6-21-2003; IN COMMERCE 7-29-2003.

THE MARK CONSISTS OF STANDARD CHARACTERS WITHOUT CLAIM TO ANY PARTICULAR FONT, STYLE, SIZE, OR COLOR.

SER. NO. 85-327,508, FILED 5-23-2011.

FLORENTINA BLANDU, EXAMINING ATTORNEY



*David J. Kybas*

Director of the United States Patent and Trademark Office

# United States of America

United States Patent and Trademark Office

## Spatial Surround

**Reg. No. 4,124,598**

**Registered Apr. 10, 2012**

**Int. Cls.: 9 and 41**

**TRADEMARK**

**SERVICE MARK**

**PRINCIPAL REGISTER**

ADVANCED BRAIN TECHNOLOGIES, LLC (UTAH LIMITED LIABILITY COMPANY)  
5748 SOUTH ADAMS AVENUE PARKWAY  
OGDEN, UT 84405

FOR: MEDIA, NAMELY, DVDS, PRE-RECORDED COMPACT DISCS, CASSETTE TAPES AND FLOPPY DISCS CONTAINING MUSIC, IN CLASS 9 (U.S. CLS. 21, 23, 26, 36 AND 38).

FIRST USE 7-28-2003; IN COMMERCE 7-29-2003.

FOR: SOUND RECORDING SERVICES FOR RECORDING MUSIC WHICH ENHANCES AUDITORY PROCESSING AND STIMULATES AWARENESS, IN CLASS 41 (U.S. CLS. 100, 101 AND 107).

FIRST USE 7-28-2003; IN COMMERCE 7-29-2003.

THE MARK CONSISTS OF STANDARD CHARACTERS WITHOUT CLAIM TO ANY PARTICULAR FONT, STYLE, SIZE, OR COLOR.

OWNER OF U.S. REG. NO. 2,955,945.

NO CLAIM IS MADE TO THE EXCLUSIVE RIGHT TO USE "SURROUND", APART FROM THE MARK AS SHOWN.

SEC. 2(F).

SER. NO. 85-328,051, FILED 5-23-2011.

ALICE BENMAMAN, EXAMINING ATTORNEY



*David J. Kypos*

Director of the United States Patent and Trademark Office

# United States of America

United States Patent and Trademark Office

# Pro Vector

**Reg. No. 4,124,599**

KOLLARS, THOMAS M. (UNITED STATES INDIVIDUAL)  
260 LANGSTON CHAPEL RD  
STATESBORO, GA 30458

**Registered Apr. 10, 2012**

**Int. Cl.: 5**

FOR: INSECTICIDES, IN CLASS 5 (U.S. CLS. 6, 18, 44, 46, 51 AND 52).

**TRADEMARK**

FIRST USE 12-17-2008; IN COMMERCE 8-10-2010.

**PRINCIPAL REGISTER**

THE MARK CONSISTS OF STANDARD CHARACTERS WITHOUT CLAIM TO ANY PARTICULAR FONT, STYLE, SIZE, OR COLOR.

SER. NO. 85-328,219, FILED 5-24-2011.

JOHN KELLY, EXAMINING ATTORNEY



*David J. Kybas*

Director of the United States Patent and Trademark Office

# United States of America

United States Patent and Trademark Office

## Saguenay Strathmore Capital

**Reg. No. 4,124,600**

**Registered Apr. 10, 2012**

**Int. Cl.: 36**

**SERVICE MARK**

**PRINCIPAL REGISTER**

SAGUENAY STRATHMORE HOLDINGS (JERSEY CORPORATION), AKA SAGUENAY STRATHMORE CAPITAL  
3RD FLOOR, SOUTH TOWER, 29/31 ESPLANADE  
ST HELIER, JERSEY JE45SJ

FOR: FINANCIAL ASSET MANAGEMENT, IN CLASS 36 (U.S. CLS. 100, 101 AND 102).

FIRST USE 5-24-2011; IN COMMERCE 5-24-2011.

THE MARK CONSISTS OF STANDARD CHARACTERS WITHOUT CLAIM TO ANY PARTICULAR FONT, STYLE, SIZE, OR COLOR.

OWNER OF U.S. REG. NO. 3,430,097.

NO CLAIM IS MADE TO THE EXCLUSIVE RIGHT TO USE "CAPITAL", APART FROM THE MARK AS SHOWN.

SEC. 2(F).

SER. NO. 85-328,463, FILED 5-24-2011.

DOMINICK J. SALEMI, EXAMINING ATTORNEY



*David J. Kyffers*

Director of the United States Patent and Trademark Office



# United States of America

United States Patent and Trademark Office

# AUGIMMUNE

**Reg. No. 4,124,601**

SIMREG INC. (MASSACHUSETTS CORPORATION)  
1329 WILLOUGHBY AVE.  
BROOKLYN, NY 11237

**Registered Apr. 10, 2012**

**Int. Cl.: 5**

FOR: DIETARY FOOD SUPPLEMENTS AND PHARMACEUTICALS, NAMELY, PHARMACEUTICALS FOR THE TREATMENT OF AUTOIMMUNE DISEASE AND FOR BOOSTING THE IMMUNE SYSTEM FOR THE MAINTENANCE OF BODY BALANCE AND GENERAL WELLBEING OF BODY, IN CLASS 5 (U.S. CLS. 6, 18, 44, 46, 51 AND 52).

**TRADEMARK**

**PRINCIPAL REGISTER**

FIRST USE 1-1-2009; IN COMMERCE 3-25-2011.

THE MARK CONSISTS OF STANDARD CHARACTERS WITHOUT CLAIM TO ANY PARTICULAR FONT, STYLE, SIZE, OR COLOR.

SER. NO. 85-328,600, FILED 5-24-2011.

SAIMA MAKHDOOM, EXAMINING ATTORNEY



*David J. Kybas*

Director of the United States Patent and Trademark Office

# United States of America

United States Patent and Trademark Office



KANZIUS CANCER  
RESEARCH FOUNDATION

**Reg. No. 4,124,602**

KANZIUS CANCER RESEARCH FOUNDATION (PENNSYLVANIA CORPORATION)  
130 WEST 8TH STREET  
ERIE, PA 16501

**Registered Apr. 10, 2012**

**Int. Cl.: 36**

FOR: FUND RAISING SERVICES FOR THE PROMOTION OF EDUCATION, RESEARCH,  
AND OTHER ACTIVITIES RELATING TO CANCER RESEARCH AND CANCER TREATMENT  
, IN CLASS 36 (U.S. CLS. 100, 101 AND 102).

**SERVICE MARK**

FIRST USE 12-1-2007; IN COMMERCE 4-1-2008.

**PRINCIPAL REGISTER**

NO CLAIM IS MADE TO THE EXCLUSIVE RIGHT TO USE "CANCER RESEARCH  
FOUNDATION", APART FROM THE MARK AS SHOWN.

THE MARK CONSISTS OF FOUR VERTICAL NESTED WAVE SHAPES OF INCREASING  
SIZE FROM LEFT TO RIGHT WITH EACH LARGER SHAPE SHADED DARKER THAN THE  
SHAPE BEFORE. THE LITERAL ELEMENT TO THE RIGHT OF THE LARGEST WAVE  
SHAPE WITH THE WORDS "KANZIUS CANCER" POSITIONED ABOVE THE WORDS  
"RESEARCH FOUNDATION". THE TERM "KANZIUS" OF THE SAME SHADE AS THE  
LARGEST WAVE SHAPE AND THE TERMS "CANCER RESEARCH FOUNDATION" THE  
SAME SHADE AS THE SMALLEST WAVE SHAPE.

SER. NO. 85-328,664, FILED 5-24-2011.

ALICE BENMAMAN, EXAMINING ATTORNEY

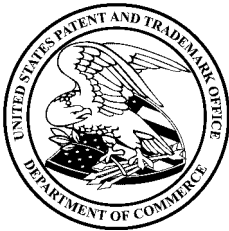

*David J. Kyjars*

Director of the United States Patent and Trademark Office

# United States of America

United States Patent and Trademark Office

## QONNECTIONS

**Reg. No. 4,124,603**

QLIKTECH INTERNATIONAL, AB (SWEDEN AKTIEBOLAG (AB))  
FORSKNINGSBYN IDEON SE-223 70  
LUND, SWEDEN

**Registered Apr. 10, 2012**

**Int. Cls.: 35 and 41**

FOR: BUSINESS CONSULTING AND BUSINESS MARKETING SERVICES IN CONNECTION WITH THE IMPLEMENTATION OF PROGRAMS FOR THE PURPOSE OF CERTIFYING RESELLERS TO MARKET AND PROVIDE SOFTWARE DESIGN, DEVELOPMENT, INTEGRATION AND MAINTENANCE SERVICES; BUSINESS RESEARCH SERVICES; PROVIDING BUSINESS CONSULTING AND BUSINESS MARKETING IN CONNECTION WITH THE PROMOTION OF VALUE-ADDED RESELLER SERVICES IN THE FIELD OF COMPUTER SOFTWARE FOR USE BY SOFTWARE DEVELOPERS, PROGRAMMERS, DISTRIBUTORS, OEMS, AND OTHER SOFTWARE RESELLERS; SOFTWARE MARKETING SERVICES FOR OTHERS; RESELLER SERVICES, NAMELY, DISTRIBUTORSHIP SERVICES IN THE FIELD OF COMPUTER SOFTWARE, IN CLASS 35 (U.S. CLS. 100, 101 AND 102).

**SERVICE MARK**

**PRINCIPAL REGISTER**

FIRST USE 11-30-2006; IN COMMERCE 11-30-2006.

FOR: PROVIDING EDUCATIONAL SERVICES, NAMELY, CONDUCTING CONFERENCES, WORKSHOPS, SEMINARS, SUMMITS, SESSIONS AND CLASSROOM INSTRUCTION IN THE FIELDS OF COMPUTER SOFTWARE PROGRAMMING, SOFTWARE DESIGN, SOFTWARE DEVELOPMENT, SOFTWARE INSTALLATION, SOFTWARE RESELLING, SOFTWARE INTEGRATION, SOFTWARE DEPLOYMENT, SOFTWARE MAINTENANCE AND SOFTWARE UPDATING, ALL RELATED TO MOBILE APPLICATIONS FOR USE IN THE FIELD OF BUSINESS INTELLIGENCE; PROVIDING EDUCATIONAL SERVICES, NAMELY, CONDUCTING CONFERENCES, WORKSHOPS, SEMINARS, SUMMITS, SESSIONS AND CLASSROOM INSTRUCTION IN THE FIELDS OF COMPUTER SYSTEMS ANALYSIS, COMPUTER TECHNICAL SUPPORT IN THE NATURE OF TROUBLESHOOTING, AND COMPUTER DATABASE DEVELOPMENT; BUSINESS TRAINING SERVICES; TRAINING OTHERS IN THE USE OF COMPUTER SOFTWARE, IN CLASS 41 (U.S. CLS. 100, 101 AND 107).

FIRST USE 11-30-2006; IN COMMERCE 11-30-2006.

THE MARK CONSISTS OF STANDARD CHARACTERS WITHOUT CLAIM TO ANY PARTICULAR FONT, STYLE, SIZE, OR COLOR.



*David J. Kappas*

Director of the United States Patent and Trademark Office

SER. NO. 85-328,759, FILED 5-24-2011.

**Reg. No. 4,124,603** RUSS HERMAN, EXAMINING ATTORNEY

# United States of America

United States Patent and Trademark Office

# QONNECT

**Reg. No. 4,124,604**

QLIKTECH INTERNATIONAL, AB (SWEDEN AKTIEBOLAG (AB))  
FORSKNINGSBYN IDEON SE-223 70  
LUND, SWEDEN

**Registered Apr. 10, 2012**

**Int. Cls.: 35 and 41**

FOR: BUSINESS CONSULTING AND BUSINESS MARKETING SERVICES IN CONNECTION WITH THE IMPLEMENTATION OF PROGRAMS FOR THE PURPOSE OF CERTIFYING RESELLERS TO PROVIDE SOFTWARE DESIGN, DEVELOPMENT, INTEGRATION AND MAINTENANCE SERVICES; BUSINESS RESEARCH SERVICES; PROVIDING BUSINESS CONSULTING AND BUSINESS MARKETING IN CONNECTION WITH THE PROMOTION OF VALUE-ADDED RESELLER SERVICES IN THE FIELD OF COMPUTER SOFTWARE FOR USE BY SOFTWARE DEVELOPERS, PROGRAMMERS, DISTRIBUTORS, OEMS, AND OTHER SOFTWARE RESELLERS; SOFTWARE MARKETING SERVICES FOR OTHERS; RESELLER SERVICES, NAMELY, DISTRIBUTORSHIP SERVICES IN THE FIELD OF COMPUTER SOFTWARE, IN CLASS 35 (U.S. CLS. 100, 101 AND 102).

**SERVICE MARK**

**PRINCIPAL REGISTER**

FIRST USE 11-30-2006; IN COMMERCE 11-30-2006.

FOR: BUSINESS TRAINING SERVICES; TRAINING OTHERS IN THE USE OF COMPUTER SOFTWARE; PROVIDING EDUCATIONAL SERVICES, NAMELY, CONDUCTING CONFERENCES, WORKSHOPS, SEMINARS, SUMMITS, SESSIONS AND CLASSROOM INSTRUCTION IN THE FIELDS OF COMPUTER SOFTWARE, BUSINESS CONSULTING, SOFTWARE PROGRAMMING, DESIGN, TRAINING, DEVELOPMENT, ANALYSIS, IMPLEMENTATION, INSTALLATION, MARKETING, RESELLING, RESEARCH, MANAGEMENT, INTEGRATION, DEPLOYMENT, MAINTENANCE, UPDATING AND IMPROVEMENT OF COMPUTER PROGRAMS, SOFTWARE AND MOBILE APPLICATIONS, NEW BUSINESS SOFTWARE PRODUCTS AND SYSTEMS FOR BUSINESS INTELLIGENCE AND BUSINESS OPERATIONS FOR OTHERS, COMPUTER SYSTEMS ANALYSIS, DISSEMINATION, LEASING AND RENTAL OF COMPUTER SOFTWARE, TECHNICAL SUPPORT, TROUBLESHOOTING, AND COMPUTER DATABASE DEVELOPMENT SERVICES, IN CLASS 41 (U.S. CLS. 100, 101 AND 107).

FIRST USE 11-30-2006; IN COMMERCE 11-30-2006.

THE MARK CONSISTS OF STANDARD CHARACTERS WITHOUT CLAIM TO ANY PARTICULAR FONT, STYLE, SIZE, OR COLOR.



*David J. Kyros*

Director of the United States Patent and Trademark Office

SER. NO. 85-328,768, FILED 5-24-2011.

**Reg. No. 4,124,604** RUSS HERMAN, EXAMINING ATTORNEY

# United States of America

United States Patent and Trademark Office

## Planet Battery

**Reg. No. 4,124,605**

**Registered Apr. 10, 2012**

**Int. Cl.: 35**

**SERVICE MARK**

**PRINCIPAL REGISTER**

MULE LIGHTING, INC. (RHODE ISLAND CORPORATION)  
46 BAKER STREET  
PROVIDENCE, RI 02905

FOR: RETAIL STORE AND ON-LINE RETAIL STORE SERVICES FEATURING BATTERIES, PRODUCTS THAT USE BATTERIES AND BATTERY RELATED PRODUCTS, IN CLASS 35 (U.S. CLS. 100, 101 AND 102).

FIRST USE 11-1-1997; IN COMMERCE 11-1-1997.

THE MARK CONSISTS OF STANDARD CHARACTERS WITHOUT CLAIM TO ANY PARTICULAR FONT, STYLE, SIZE, OR COLOR.

NO CLAIM IS MADE TO THE EXCLUSIVE RIGHT TO USE "BATTERY", APART FROM THE MARK AS SHOWN.

SER. NO. 85-328,828, FILED 5-24-2011.

KEVIN CORWIN, EXAMINING ATTORNEY



*David J. Kybas*

Director of the United States Patent and Trademark Office

# United States of America

United States Patent and Trademark Office

## Mad Hatter's Smoke Shop

**Reg. No. 4,124,606**

INANE ENTERPRISES, LLC (COLORADO LIMITED LIABILITY COMPANY)  
6091 W. COLFAX

**Registered Apr. 10, 2012**

LAKWOOD, CO 80214

**Int. Cl.: 35**

FOR: RETAIL STORE SERVICES FEATURING NOVELTY GIFT ACCESSORIES AND GIFT ITEMS, NAMELY, TOBACCO PIPES, SMOKING ARTICLES AND ACCESSORIES RELATED THERETO, IN CLASS 35 (U.S. CLS. 100, 101 AND 102).

**SERVICE MARK**

FIRST USE 2-13-2011; IN COMMERCE 4-1-2011.

**PRINCIPAL REGISTER**

THE MARK CONSISTS OF STANDARD CHARACTERS WITHOUT CLAIM TO ANY PARTICULAR FONT, STYLE, SIZE, OR COLOR.

NO CLAIM IS MADE TO THE EXCLUSIVE RIGHT TO USE "SMOKE SHOP", APART FROM THE MARK AS SHOWN.

SER. NO. 85-328,852, FILED 5-24-2011.

MARK SHINER, EXAMINING ATTORNEY



*David J. Kybas*

Director of the United States Patent and Trademark Office



# United States of America

United States Patent and Trademark Office

## SPREAD THE WAVE

**Reg. No. 4,124,607**

KANZIUS CANCER RESEARCH FOUNDATION (PENNSYLVANIA CORPORATION)  
130 WEST 8TH STREET  
ERIE, PA 16501

**Registered Apr. 10, 2012**

**Int. Cl.: 36**

FOR: FUND RAISING SERVICES FOR THE PROMOTION OF EDUCATION, RESEARCH,  
AND OTHER ACTIVITIES RELATING TO CANCER RESEARCH AND CANCER TREATMENT  
, IN CLASS 36 (U.S. CLS. 100, 101 AND 102).

**SERVICE MARK**

FIRST USE 12-1-2007; IN COMMERCE 4-1-2008.

**PRINCIPAL REGISTER**

THE MARK CONSISTS OF STANDARD CHARACTERS WITHOUT CLAIM TO ANY PAR-  
TICULAR FONT, STYLE, SIZE, OR COLOR.

SER. NO. 85-328,895, FILED 5-24-2011.

ALICE BENMAMAN, EXAMINING ATTORNEY



*David J. Kyffers*

Director of the United States Patent and Trademark Office

# United States of America

United States Patent and Trademark Office

# durare

**Reg. No. 4,124,608**

**Registered Apr. 10, 2012**

**Int. Cl.: 35**

**SERVICE MARK**

**PRINCIPAL REGISTER**

OWEN, PAMELA F. (UNITED STATES INDIVIDUAL), FORMERLY MCMULLIN, PAMELA F.  
6942 FM 1960 RD E, PMB 517  
HUMBLE, TX 773462706 AND

OWEN, TOM C. (UNITED STATES INDIVIDUAL)  
6942 FM 1960 RD E, PMB 517  
HUMBLE, TX 773462706

FOR: BUSINESS CONSULTING SERVICES FOR THE ELECTRIC ENERGY INDUSTRY; BUSINESS CONSULTING SERVICES RELATING TO THE INTEGRATION OF THE AREAS OF BUSINESS PROCESS TECHNOLOGY, ORGANIZATIONAL LEARNING, CHANGE MANAGEMENT, AND OPERATIONAL SUSTAINABILITY, IN CLASS 35 (U.S. CLS. 100, 101 AND 102).

FIRST USE 5-18-2011; IN COMMERCE 5-23-2011.

THE MARK CONSISTS OF STANDARD CHARACTERS WITHOUT CLAIM TO ANY PARTICULAR FONT, STYLE, SIZE, OR COLOR.

THE ENGLISH TRANSLATION OF "DURARE" IN THE MARK IS "DURABLE".

SER. NO. 85-329,402, FILED 5-24-2011.

THEODORE MCBRIDE, EXAMINING ATTORNEY



*David J. Kyros*

Director of the United States Patent and Trademark Office

# United States of America

United States Patent and Trademark Office

## CRAZY WHISPERER

**Reg. No. 4,124,609**

WILLIAMS, WENDY (UNITED STATES INDIVIDUAL)  
1103 ANDOVER DR.  
PEARLAND, TX 77584 AND

**Registered Apr. 10, 2012**

**Int. Cl.: 35**

WILLIAMS, MICHAEL (UNITED STATES INDIVIDUAL)  
1103 ANDOVER DR.  
PEARLAND, TX 77584

**SERVICE MARK**

**PRINCIPAL REGISTER**

FOR: PUBLIC ADVOCACY TO PROMOTE AWARENESS OF MENTAL ILLNESSES, IN CLASS 35 (U.S. CLS. 100, 101 AND 102).

FIRST USE 3-0-2011; IN COMMERCE 3-0-2011.

THE MARK CONSISTS OF STANDARD CHARACTERS WITHOUT CLAIM TO ANY PARTICULAR FONT, STYLE, SIZE, OR COLOR.

SER. NO. 85-329,661, FILED 5-25-2011.

STEVEN PEREZ, EXAMINING ATTORNEY



*David J. Kybas*

Director of the United States Patent and Trademark Office

# United States of America

United States Patent and Trademark Office

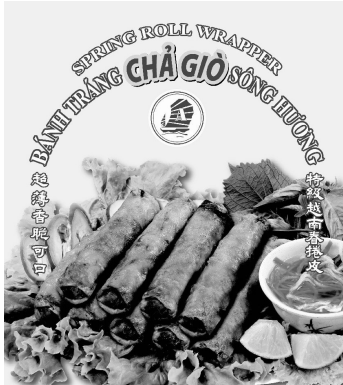

**Reg. No. 4,124,610**

**Registered Apr. 10, 2012**

**Int. Cl.: 30**

**TRADEMARK**

**PRINCIPAL REGISTER**

ANHING CORPORATION (CALIFORNIA CORPORATION)  
418 NORTH AVENUE 19  
LOS ANGELES, CA 90031

FOR: SPRING ROLL WRAPPERS, IN CLASS 30 (U.S. CL. 46).

FIRST USE 3-29-2011; IN COMMERCE 3-29-2011.

OWNER OF U.S. REG. NOS. 1,266,472, 1,653,810 AND OTHERS.

THE NON-LATIN CHARACTERS IN THE MARK TRANSLITERATE TO CHAO BO XIANG CUI KE KOU AND TE JI YUE NAN CHUN JUAN PI AND THIS MEANS EXTRA THIN, AROMATIC, CRISPY, DELICIOUS, AND SPECIAL GRADE VIETNAMESE SPRING ROLL WRAPPER IN ENGLISH.

NO CLAIM IS MADE TO THE EXCLUSIVE RIGHT TO USE "SPRING ROLL WRAPPER" AND "BANH TRANG CHA GIO" AND THE NON-LATIN CHARACTERS IN THE MARK THAT TRANSLITERATE TO "CHAO BO XIANG CUI KE KOU" AND "TE JIYUE NAN CHUN JUAN PI", AS WELL AS THE PICTORIAL REPRESENTATION OF THE FOOD ITEMS, NAMELY, SPRING ROLLS ON A BED OF LETTUCE, WITH SLICES OF PEPPERS TO THE LEFT OF THE SPRING ROLLS, SLICES OF CUCUMBERS BEHIND THE SPRING ROLLS, A BOWL OF SHREDDED VEGETABLES TO THE RIGHT OF THE SPRING ROLLS, AND TWO WEDGES OF LIMES IN FRONT OF THE BOWL OF SHREDDED VEGETABLES, APART FROM THE MARK AS SHOWN.

THE STIPLING IS FOR SHADING PURPOSES ONLY.

THE MARK CONSISTS OF THE WORDS "SPRING ROLL WRAPPER" DISPLAYED IN AN ARCH LOCATED ABOVE ANOTHER ARCH CONTAINING CHINESE AS WELL AS VIETNAMESE CHARACTERS. THE SIX CHINESE CHARACTERS LOCATED ON THE LEFT SIDE OF THE ARCH TRANSLITERATE TO "CHAO BO XIANG CUI KE KOU"; THE SEVEN CHINESE CHARACTERS LOCATED ON THE RIGHT SIDE OF THE ARCH TRANSLITERATE TO "TE JI YUE NAN CHUN JUAN PI"; IN BETWEEN THE CHINESE CHARACTERS IS THE VIETNAMESE WORDING "BANH TRANG CHA GIO SONG HUONG". BELOW THE ARCH CONTAINING THE FOREIGN WORDING IS THE DEPICTION OF A CIRCLE WITHIN WHICH IS A CHINESE JUNK BOAT WITH SAILS FLOATING ON WAVES WITH THE MAIN SAIL HAVING A STYLIZED LETTER "A". UNDERNEATH THE DESIGN OF THE CHINESE JUNK



*David J. Kybas*

Director of the United States Patent and Trademark Office

**Reg. No. 4,124,610** BOAT IS AN IMAGE CONSISTING OF NINE SPRING ROLLS ON A BED OF LETTUCE, WITH SLICES OF PEPPERS TO THE LEFT OF THE SPRING ROLLS, SLICES OF CUCUMBERS BEHIND THE SPRING ROLLS, A BOWL OF SHREDDED VEGETABLES TO THE RIGHT OF THE SPRING ROLLS, AND TWO WEDGES OF LIMES IN FRONT OF THE BOWL OF SHREDDED VEGETABLES.

THE ENGLISH TRANSLATION OF "BANH TRANG CHA GIO SONG HUONG" IN THE MARK IS "RICE PAPER FOR SPRING ROLL RIVER FRAGRANCE".

SER. NO. 85-329,809, FILED 5-25-2011.

HELENE LIWINSKI, EXAMINING ATTORNEY

# United States of America

United States Patent and Trademark Office

## Rusty Truck Brewing Co.

**Reg. No. 4,124,611**

**Registered Apr. 10, 2012**

**Int. Cl.: 32**

**TRADEMARK**

**PRINCIPAL REGISTER**

WHITEHEAD ENTERPRISES, LLC (OREGON LIMITED LIABILITY COMPANY), DBA  
RUSTY TRUCK BREWING COMPANY  
1610 12TH STREET SE  
SALEM, OR 97302

FOR: ALCOHOL-FREE BEERS; BEER; BEER MAKING KIT; BEER WORT; BEER, ALE AND LAGER; BEER, ALE AND PORTER; BEER, ALE, LAGER, STOUT AND PORTER; BEER, ALE, LAGER, STOUT, PORTER, SHANDY; BEER-BASED COOLERS; BEERS; BLACK BEER; BREWED MALT-BASED ALCOHOLIC BEVERAGE IN THE NATURE OF A BEER; COFFEE-FLAVORED BEER; DE-ALCOHOLISED BEER; EXTRACTS OF HOPS FOR MAKING BEER; FLAVORED BEERS; GINGER BEER; HOP EXTRACTS FOR MANUFACTURING BEER; IMITATION BEER; MALT BEER; MALT EXTRACTS FOR MAKING BEER; MALT LIQUOR; NON-ALCOHOLIC BEER; PALE BEER; PORTER, IN CLASS 32 (U.S. CLS. 45, 46 AND 48).

FIRST USE 10-13-2010; IN COMMERCE 10-13-2010.

THE MARK CONSISTS OF STANDARD CHARACTERS WITHOUT CLAIM TO ANY PARTICULAR FONT, STYLE, SIZE, OR COLOR.

NO CLAIM IS MADE TO THE EXCLUSIVE RIGHT TO USE "BREWING CO.", APART FROM THE MARK AS SHOWN.

SER. NO. 85-329,810, FILED 5-25-2011.

HELENE LIWINSKI, EXAMINING ATTORNEY



*David J. Kyros*

Director of the United States Patent and Trademark Office

# United States of America

United States Patent and Trademark Office



**Reg. No. 4,124,612**

**Registered Apr. 10, 2012**

**Int. Cl.: 30**

**TRADEMARK**

**PRINCIPAL REGISTER**

SHRI LAL MAHAL LIMITED (INDIA LIMITED LIABILITY COMPANY)  
B-6, BHAGWAN DASS NAGAR  
NEW DELHI, INDIA 110026

FOR: RICE, IN CLASS 30 (U.S. CL. 46).

PRIORITY CLAIMED UNDER SEC. 44(D) ON ERPN CMNTY TM OFC APPLICATION NO. 009893512, FILED 4-14-2011, REG. NO. 009893512, DATED 11-24-2011, EXPIRES 4-14-2021.

THE COLOR(S) RED, SHADES OF GREEN, MUSTARD YELLOW, ORANGE, BROWN, BLACK AND WHITE IS/ARE CLAIMED AS A FEATURE OF THE MARK.

NO CLAIM IS MADE TO THE EXCLUSIVE RIGHT TO USE "GROUP", APART FROM THE MARK AS SHOWN.

THE MARK CONSISTS OF MUSTARD YELLOW COLOURED RECTANGULAR BORDER WHICH SURROUNDS THE ENTIRE MARK. THE DESIGN OF THE PALACE IS IN RED AND BROWN COLOUR AND IS ON THE TOP LEFT SIDE OF THE LABEL WITH THE WORDS "SHRILALMAHAL" WRITTEN BELOW IT IN SHADES OF RED AND ORANGE OUTLINED IN BLACK. BELOW IS A SPHERE IN ORANGE AND RED WITH A RIBBON OF GREEN WITH THE WORD "GROUP" WRITTEN IN WHITE COLOUR. FROM THE SEMI CIRCLE OF ORANGE COLOURS THIN BRANCHES SHOWING LEAVES IN GREEN SHADES ARE THERE WITH A CHAFF OF WHEAT IN GREEN ABOVE THE WORDING "SHRILALMAHAL". ON THE RIGHT HAND SIDE THE WORDS "SHRILALMAHAL" ARE WRITTEN IN THE SHADES OF RED AND YELLOW UNDERLINED BY SHADES OF BLACK COLOUR AND BELOW THE SAME THE WORD "EMPIRE" IS WRITTEN IN SHADES OF RED OUTLINED IN WHITE.

THE ENGLISH TRANSLATION OF "SHRILALMAHAL" IN THE MARK IS "AUSPICIOUS RED PALACE".

SER. NO. 85-330,050, FILED 5-25-2011.

REBECCA SMITH, EXAMINING ATTORNEY



*David J. Kappas*

Director of the United States Patent and Trademark Office

# United States of America

United States Patent and Trademark Office

## STARVING STUDENTS

**Reg. No. 4,124,613**

STARVING STUDENTS, INC. (CALIFORNIA CORPORATION)

**Registered Apr. 10, 2012**

1850 SAWTELLE BLVD., SUITE 300  
LOS ANGELES, CA 90026

**Int. Cl.: 39**

FOR: MOVING AND STORAGE OF GOODS AND PERSONAL PROPERTY OF OTHERS, IN CLASS 39 (U.S. CLS. 100 AND 105).

**SERVICE MARK**

FIRST USE 1-11-1973; IN COMMERCE 1-11-1973.

**PRINCIPAL REGISTER**

THE MARK CONSISTS OF STANDARD CHARACTERS WITHOUT CLAIM TO ANY PARTICULAR FONT, STYLE, SIZE, OR COLOR.

SER. NO. 85-330,128, FILED 5-25-2011.

CHRIS WELLS, EXAMINING ATTORNEY



*David J. Kybas*

Director of the United States Patent and Trademark Office



# United States of America

United States Patent and Trademark Office

## THE FARM2U COLLABORATIVE

**Reg. No. 4,124,614**

**Registered Apr. 10, 2012**

**Int. Cls.: 35 and 41**

**SERVICE MARK**

**PRINCIPAL REGISTER**

COLLABORATIVE FOR THE 21ST CENTURY APPALACHIA, INC. (WEST VIRGINIA CORPORATION)  
1511 PENNSYLVANIA AVENUE  
CHARLESTON, WV 25302

FOR: PROVIDING EDUCATIONAL INFORMATION IN THE FIELD OF AGRICULTURE AND CULINARY ARTS FOR BUSINESS DEVELOPMENT PURPOSES; PROMOTING THE ECONOMIC DEVELOPMENT IN THE STATE OF WEST VIRGINIA; PROVIDING A WEBSITE FEATURING AN ONLINE MARKETPLACE FOR EXCHANGING GOODS AND SERVICES WITH OTHER USERS; PROVIDING AN ON-LINE DIRECTORY INFORMATION SERVICE FEATURING INFORMATION REGARDING AGRICULTURAL AND CULINARY PRODUCTS AND SERVICES, IN CLASS 35 (U.S. CLS. 100, 101 AND 102).

FIRST USE 11-17-2010; IN COMMERCE 11-17-2010.

FOR: EDUCATIONAL SERVICES, NAMELY, PROVIDING SEMINARS IN THE FIELDS OF AGRICULTURE AND CULINARY ARTS; ORGANIZING AND HOSTING OF EVENTS FOR CULTURAL PURPOSES, IN CLASS 41 (U.S. CLS. 100, 101 AND 107).

FIRST USE 11-17-2010; IN COMMERCE 11-17-2010.

THE MARK CONSISTS OF STANDARD CHARACTERS WITHOUT CLAIM TO ANY PARTICULAR FONT, STYLE, SIZE, OR COLOR.

NO CLAIM IS MADE TO THE EXCLUSIVE RIGHT TO USE "COLLABORATIVE", APART FROM THE MARK AS SHOWN.

SER. NO. 85-330,448, FILED 5-25-2011.

ANTHONY RINKER, EXAMINING ATTORNEY



*David J. Kyffers*

Director of the United States Patent and Trademark Office

# United States of America

United States Patent and Trademark Office



**Reg. No. 4,124,615**

**Registered Apr. 10, 2012**

**Int. Cl.: 22**

**TRADEMARK**

**PRINCIPAL REGISTER**

YIXING WELLKNIT CONTAINER-BAG CO., LTD. (CHINA CORPORATION)  
SOUTH AREA INDUSTRY PARK, WANSHI TOWN  
YIXING CITY, JIANGSU, CHINA 214216

FOR: SACKS OR BAGS FOR THE TRANSPORTATION OR STORAGE OF MATERIALS IN BULK, IN CLASS 22 (U.S. CLS. 1, 2, 7, 19, 22, 42 AND 50).

FIRST USE 1-1-2006; IN COMMERCE 12-1-2010.

THE MARK CONSISTS OF THE STYLIZED REPRESENTATION OF A MISCELLANEOUS GEOMETRIC DESIGN WITH ITS UPPER HALF DEPICTED IN RED, AND THE LOWER HALF DEPICTED IN BLUE, OVER THE WORD "WELLKNIT" IN STYLIZED BLUE LETTERING.

THE COLOR(S) RED AND BLUE IS/ARE CLAIMED AS A FEATURE OF THE MARK.

SER. NO. 85-330,990, FILED 5-26-2011.

DAVID H. STINE, EXAMINING ATTORNEY



*David J. Kybas*

Director of the United States Patent and Trademark Office

# United States of America

United States Patent and Trademark Office

## PERFECT SANDWICH

**Reg. No. 4,124,616**

**Registered Apr. 10, 2012**

**Int. Cl.: 21**

**TRADEMARK**

**PRINCIPAL REGISTER**

CONTAIN THIS!, LLC (CALIFORNIA LIMITED LIABILITY COMPANY)  
#196  
205 DE ANZA BOULEVARD  
SAN MATEO, CA 94402

FOR: PLASTIC CONTAINERS FOR CARRYING AND STORING A SANDWICH OR THE INGREDIENTS FOR MAKING A SANDWICH FOR HOUSEHOLD OR KITCHEN OR PERSONAL USE, IN CLASS 21 (U.S. CLS. 2, 13, 23, 29, 30, 33, 40 AND 50).

FIRST USE 3-0-2010; IN COMMERCE 3-0-2010.

THE MARK CONSISTS OF STANDARD CHARACTERS WITHOUT CLAIM TO ANY PARTICULAR FONT, STYLE, SIZE, OR COLOR.

NO CLAIM IS MADE TO THE EXCLUSIVE RIGHT TO USE "SANDWICH", APART FROM THE MARK AS SHOWN.

SER. NO. 85-330,996, FILED 5-26-2011.

JENNY PARK, EXAMINING ATTORNEY



*David J. Kybas*

Director of the United States Patent and Trademark Office

# United States of America

United States Patent and Trademark Office

## Model Explorer

**Reg. No. 4,124,617**

**Registered Apr. 10, 2012**

**Int. Cl.: 9**

**TRADEMARK**

**PRINCIPAL REGISTER**

JINAN PROPLUS ELECTRONICS CO. LTD. (CHINA CORPORATION), DBA KHAI-LONG  
PROPLUS  
B-5, NO.1768 XINLUO AVE, HIGH-TECH ZONE  
JINAN, CHINA 250101

FOR: COMPUTER AIDED DESIGN SOFTWARE USED FOR THE SEMICONDUCTOR INDUSTRY TO BROWSE, ANALYZE AND VALIDATE SPICE (SIMULATION PROGRAM WITH INTEGRATED CIRCUIT EMPHASIS) MODELS IN BOTH SEMICONDUCTOR DEVICE LEVEL AND INTEGRATED CIRCUIT LEVEL, IN CLASS 9 (U.S. CLS. 21, 23, 26, 36 AND 38).

FIRST USE 1-1-2009; IN COMMERCE 1-1-2009.

THE MARK CONSISTS OF STANDARD CHARACTERS WITHOUT CLAIM TO ANY PARTICULAR FONT, STYLE, SIZE, OR COLOR.

NO CLAIM IS MADE TO THE EXCLUSIVE RIGHT TO USE "MODEL", APART FROM THE MARK AS SHOWN.

SER. NO. 85-331,110, FILED 5-26-2011.

KEVON CHISOLM, EXAMINING ATTORNEY



*David J. Kyfos*

Director of the United States Patent and Trademark Office

# United States of America

United States Patent and Trademark Office

## BEERE MEDICAL

**Reg. No. 4,124,618**

**Registered Apr. 10, 2012**

**Int. Cl.: 10**

**TRADEMARK**

**PRINCIPAL REGISTER**

TELEFLEX INCORPORATED (DELAWARE CORPORATION)  
155 SOUTH LIMERICK RD.  
LIMERICK, PA 15468

FOR: SURGICAL INSTRUMENTS FOR ORTHOPEDIC SURGERY, NAMELY, RATCHETING SCREWDRIVERS, HANDLES FOR SCREW-, NUT- AND BOLT-DRIVERS, TORQUE-LIMITING SCREWDRIVERS, TORQUE WRENCHES, TORQUE MEASURING DEFLECTION BEAMS, BONE AWLS, BONE PROBES, BONE TAPS, MALLEABLE RODS, ROD CUTTERS, ROD BENDERS, LOCKING GRIPS, SCALES FOR ROD LENGTH MEASUREMENT, COMPRESSION AND DISTRACTION INSTRUMENTS, SOUNDERS, AND ORTHOPEDIC IMPLANT REMOVAL KITS COMPRISING DRIVERS, REAMERS, BROKEN SCREW REMOVERS, SCREW EXTRACTORS, HANDLES FOR SCREW-, NUT- AND BOLT-DRIVERS, WRENCHES, EXTENSIONS, COUNTER-TORQUE DRIVES, PLIERS, TREPHINES, AND INSTRUMENT TRAYS, IN CLASS 10 (U.S. CLS. 26, 39 AND 44).

FIRST USE 0-0-2003; IN COMMERCE 0-0-2003.

THE MARK CONSISTS OF STANDARD CHARACTERS WITHOUT CLAIM TO ANY PARTICULAR FONT, STYLE, SIZE, OR COLOR.

OWNER OF U.S. REG. NO. 2,963,773.

NO CLAIM IS MADE TO THE EXCLUSIVE RIGHT TO USE "MEDICAL", APART FROM THE MARK AS SHOWN.

SEC. 2(F).

SER. NO. 85-331,115, FILED 5-26-2011.

DAVID HOFFMAN, EXAMINING ATTORNEY



*David J. Kyfos*

Director of the United States Patent and Trademark Office

# United States of America

United States Patent and Trademark Office



## *Anam Chara*

**Reg. No. 4,124,619**

**Registered Apr. 10, 2012**

**Int. Cl.: 44**

**SERVICE MARK**

**PRINCIPAL REGISTER**

ANAM CHARA (COLORADO NON-PROFIT CORPORATION)  
1790 VIOLET AVE  
BOULDER, CO 80304

FOR: HOSPICE AND HOME HEALTH CARE, IN CLASS 44 (U.S. CLS. 100 AND 101).

FIRST USE 11-1-1991; IN COMMERCE 11-1-1991.

OWNER OF U.S. REG. NO. 3,227,427.

THE MARK CONSISTS OF THE WORDING "ANAM CHARA" ACCOMPANIED BY A DESIGN OF A CELTIC KNOT. THE ENGLISH TRANSLATION OF "ANAM CHARA" IN THE MARK IS "SOUL FRIEND".

SER. NO. 85-331,152, FILED 5-26-2011.

DORITT L. CARROLL, EXAMINING ATTORNEY



*David J. Kyffers*

Director of the United States Patent and Trademark Office

# United States of America

United States Patent and Trademark Office

# Spartacus

**Reg. No. 4,124,620**

**Registered Apr. 10, 2012**

**Int. Cls.: 10, 18, 25 and 35**

AGB INC (OREGON CORPORATION)  
SUITE D  
4287 SE INTERNATIONAL WAY  
MILWAUKIE, OR 97222

FOR: ADULT SEXUAL STIMULATION AIDS, NAMELY, NIPPLE AND GENITAL CLIPS AND RINGS OF RUBBER, METAL AND LEATHER; ADULT SEXUAL STIMULATION AIDS, NAMELY, VIBRATING CLIPS AND RINGS, AND WEIGHTS FOR CLIPS AND RINGS, IN CLASS 10 (U.S. CLS. 26, 39 AND 44).

**TRADEMARK**

**SERVICE MARK**

FIRST USE 1-1-1987; IN COMMERCE 1-1-1987.

**PRINCIPAL REGISTER**

FOR: ADULT SEXUAL STIMULATION AIDS, NAMELY, HARNESSSES, LEATHER WRISTS AND ANKLE STRAPS, WHIPS, PADDLES, AND CROPS, IN CLASS 18 (U.S. CLS. 1, 2, 3, 22 AND 41).

FIRST USE 1-1-1987; IN COMMERCE 1-1-1987.

FOR: LINGERIE FOR MEN AND WOMEN; LEATHER WEAR, NAMELY, PANTS, TOPS, BRAS, AND PANTIES; ADULT SEXUAL STIMULATION AIDS, NAMELY, HOODS, BLINDFOLDS, COLLARS, GAGS, CUFFS AND VESTS, IN CLASS 25 (U.S. CLS. 22 AND 39).

FIRST USE 1-1-1987; IN COMMERCE 1-1-1987.

FOR: CATALOG ORDERING SERVICE FEATURING SEXUALLY ORIENTED LINGERIE, LEATHER WEAR, LEATHER ACCESSORIES AND MARITAL AIDS; WEB-BASED CATALOG SERVICES FEATURING SEXUALLY ORIENTED LINGERIE, LEATHER WEAR, LEATHER ACCESSORIES AND MARITAL AIDS, IN CLASS 35 (U.S. CLS. 100, 101 AND 102).

FIRST USE 1-1-1987; IN COMMERCE 1-1-1987.

THE MARK CONSISTS OF STANDARD CHARACTERS WITHOUT CLAIM TO ANY PARTICULAR FONT, STYLE, SIZE, OR COLOR.

SER. NO. 85-331,342, FILED 5-26-2011.



*David J. Kyffers*

Director of the United States Patent and Trademark Office

**Reg. No. 4,124,620** DEIRDRE ROBERTSON, EXAMINING ATTORNEY



# United States of America

United States Patent and Trademark Office

## Restaurant Sales Builder STOP WAITING For Your Customers To Return!

**Reg. No. 4,124,621**

**Registered Apr. 10, 2012**

**Int. Cl.: 42**

**SERVICE MARK**

**PRINCIPAL REGISTER**

CASHCOWCREATORS (OHIO LIMITED LIABILITY COMPANY)  
709 HARBOR ST.  
CONNEAUT, OH 44030

FOR: SOFTWARE AS A SERVICE (SAAS) SERVICES FEATURING SOFTWARE FOR ENABLING RESTAURANT OWNERS AND MANAGERS TO AUTOMATICALLY COMMUNICATE WITH THEIR CUSTOMERS IN VARIOUS FORMS OF MEDIA, NAMELY, EMAIL, DIRECT MAIL, TEXT MESSAGE, VOICE BROADCAST AND SOCIAL MEDIA, FOR DELIVERING TIMELY, PERSONALIZED, RESPONSE DRIVEN COMMUNICATIONS TO RESTAURANT CUSTOMERS, FOR COLLECTING FEEDBACK VIA ONLINE SURVEYS, AND FOR GENERATING NEW REFERRALS, IN CLASS 42 (U.S. CLS. 100 AND 101).

FIRST USE 8-23-2008; IN COMMERCE 10-12-2008.

THE MARK CONSISTS OF STANDARD CHARACTERS WITHOUT CLAIM TO ANY PARTICULAR FONT, STYLE, SIZE, OR COLOR.

NO CLAIM IS MADE TO THE EXCLUSIVE RIGHT TO USE "RESTAURANT SALES BUILDER", APART FROM THE MARK AS SHOWN.

SER. NO. 85-331,351, FILED 5-26-2011.

DEZMONA MIZELLE, EXAMINING ATTORNEY



*David J. Kybas*

Director of the United States Patent and Trademark Office

# United States of America

United States Patent and Trademark Office



**Reg. No. 4,124,622**

**Registered Apr. 10, 2012**

**Int. Cls.: 6 and 7**

**TRADEMARK**

**PRINCIPAL REGISTER**

ACTUANT CORPORATION (WISCONSIN CORPORATION)  
P.O. BOX 3241  
MILWAUKEE, WI 532013241

FOR: CONSTRUCTION ELEMENTS MADE OF METAL USED IN CONCRETE AND OTHER ANCHORING SYSTEMS, NAMELY WEDGES, ANCHORS, ANCHORHEADS, CHUCKS, AND COUPLERS, IN CLASS 6 (U.S. CLS. 2, 12, 13, 14, 23, 25 AND 50).

FIRST USE 4-30-2007; IN COMMERCE 4-30-2007.

FOR: POWER-OPERATED HYDRAULIC CABLE LIFTING JACKS, AND CABLE STRESSING JACKS, IN CLASS 7 (U.S. CLS. 13, 19, 21, 23, 31, 34 AND 35).

FIRST USE 4-30-2007; IN COMMERCE 4-30-2007.

THE MARK CONSISTS OF THE LETTERS "TT", IN A THREE DIMENSIONAL STYLIZED FORM, WITH THE INTERIOR PORTION OF EACH LETTER LINED WITH ARCS OF CONCENTRIC CIRCLES.

SER. NO. 85-331,355, FILED 5-26-2011.

BRIAN NEVILLE, EXAMINING ATTORNEY



*David J. Kybas*

Director of the United States Patent and Trademark Office

# United States of America

United States Patent and Trademark Office

# ULTIMATE

**Reg. No. 4,124,623**

MILLENNIUM LOCK, INC. (TEXAS CORPORATION)  
3776 GREENBRIAR DRIVE  
STAFFORD, TX 77477

**Registered Apr. 10, 2012**

**Int. Cl.: 6**

FOR: METAL LOCKS FOR RESIDENTIAL AND COMMERCIAL DOORS AND ACCESS BARRIERS, IN CLASS 6 (U.S. CLS. 2, 12, 13, 14, 23, 25 AND 50).

**TRADEMARK**

FIRST USE 9-0-2005; IN COMMERCE 9-0-2005.

**PRINCIPAL REGISTER**

THE MARK CONSISTS OF STANDARD CHARACTERS WITHOUT CLAIM TO ANY PARTICULAR FONT, STYLE, SIZE, OR COLOR.

SEC. 2(F).

SER. NO. 85-331,561, FILED 5-26-2011.

DANIEL CAPSHAW, EXAMINING ATTORNEY



*David J. Kyffers*

Director of the United States Patent and Trademark Office

# United States of America

United States Patent and Trademark Office



**Reg. No. 4,124,624**

ZOO TOYS, S.A. (PANAMA SOCIEDAD ANONIMA (SA))  
AVE. BALBOA, EDF. DESTINY, PLANTA BAJA  
CIUDAD DE PANAMA, PANAMA

**Registered Apr. 10, 2012**

**Int. Cl.: 28**

FOR: PLUSH TOYS; STUFFED TOYS; PARLOR GAMES; AND TOY ANIMALS AND ACCESSORIES THEREFOR, IN CLASS 28 (U.S. CLS. 22, 23, 38 AND 50).

**TRADEMARK**

OWNER OF PANAMA REG. NO. 192396, DATED 8-11-2010, EXPIRES 8-11-2020.

**PRINCIPAL REGISTER**

THE COLOR(S) GREEN, BLUE, FUCHSIA, ORANGE, YELLOW, BROWN, BLACK AND WHITE IS/ARE CLAIMED AS A FEATURE OF THE MARK.

NO CLAIM IS MADE TO THE EXCLUSIVE RIGHT TO USE "TOYS", APART FROM THE MARK AS SHOWN.

THE MARK CONSISTS OF THE WORD "ZOO" WRITTEN IN UPPERCASE LETTERS WITH A BLACK BOLD LINE AT THE BORDERS OF THE LETTERS. THE LETTER "Z" IS FOUND IN ORANGE, THE FIRST LETTER "O" IN BLUE AND THE SECOND LETTER "O" IN FUCHSIA. ON TOP OF THE FUCHSIA "O" APPEARS A DIAGONAL BLUE STRIPE WITH THE WORD "TOYS" INSIDE WRITTEN IN UPPERCASE WHITE LETTERS. ABOVE THE WORD "ZOO" APPEARS A LION CARTOON. THE HAIR OF THE LION IS ORANGE, THE FACE WHITE, THE NOSE IS BEING REPRESENTED BY A BROWN TRIANGLE, THE EYES AND A LINE SIMULATING THE MOUTH ARE BLACK AND TWO CIRCLES SIMULATING THE LEGS OF THE LION YELLOW. BEHIND THE ABOVE MENTIONED DESIGN THERE IS A SIMULATION OF A JUNGLE WITH A GREEN FIELD AND GREEN LEAVES THAT FORMS AN OVAL LIKE FIGURE.

SER. NO. 85-331,639, FILED 5-26-2011.

ALEXANDER L. POWERS, EXAMINING ATTORNEY



*David J. Kyros*

Director of the United States Patent and Trademark Office

# United States of America

United States Patent and Trademark Office



**Reg. No. 4,124,625**

**Registered Apr. 10, 2012**

**Int. Cl.: 9**

PEACOCK GALLERY ENTERTAINMENT RECORD CO., LTD. (CHINA LIMITED LIABILITY COMPANY)  
NO. 6, CHENGFENG ROAD  
FENGXIANG INDUSTRIAL ZONE, DALIANG  
SHUNDE, FOSHAN, CHINA

**TRADEMARK**

**PRINCIPAL REGISTER**

FOR: ELECTRICAL PHONOGRAPH RECORD TURNTABLE CARTRIDGES; PHONOGRAPH RECORD PLAYERS; PHONOGRAPH RECORD SLEEVES; PHONOGRAPH RECORDS FEATURING MUSIC AND MOVIES; DIGITAL MEDIA, NAMELY, PRE-RECORDED AUDIO AND VIDEO CASSETTES, DIGITAL VIDEO DISCS, DIGITAL VERSATILE DISCS, DOWNLOADABLE AUDIO AND VIDEO RECORDINGS AND DVDS FEATURING MUSIC, MOVIES AND DOCUMENTARIES; COMPACT DISCS FEATURING MUSIC, MOVIES AND DOCUMENTARIES; VIDEO DISCS FEATURING MOVIES, MUSIC, DOCUMENTARIES; VIDEO GAME CARTRIDGES, IN CLASS 9 (U.S. CLS. 21, 23, 26, 36 AND 38).

FIRST USE 7-10-1996; IN COMMERCE 9-1-1998.

THE MARK CONSISTS OF A PEACOCK WITH THREE CHINESE CHARACTERS.

THE NON-LATIN CHARACTERS IN THE MARK TRANSLITERATE TO KONG QUE LANG AND THIS MEANS PEACOCK CORRIDOR IN ENGLISH.

THE ENGLISH TRANSLATION OF THE CHINESE CHARACTERS IN THE MARK IS "PEACOCK CORRIDOR".

SER. NO. 85-331,965, FILED 5-27-2011.

FONG HSU, EXAMINING ATTORNEY



*David J. Kybas*

Director of the United States Patent and Trademark Office

# United States of America

United States Patent and Trademark Office

# QikSlim

**Reg. No. 4,124,626**

VINELAND LIFE SCIENCES LLC (CALIFORNIA LIMITED LIABILITY COMPANY)  
331 NORTH VINELAND AVE  
CITY OF INDUSTRY, CA 91746

**Registered Apr. 10, 2012**

**Int. Cl.: 5**

FOR: DIETARY AND NUTRITIONAL SUPPLEMENTS, IN CLASS 5 (U.S. CLS. 6, 18, 44, 46, 51 AND 52).

**TRADEMARK**

FIRST USE 3-1-2011; IN COMMERCE 3-1-2011.

**PRINCIPAL REGISTER**

NO CLAIM IS MADE TO THE EXCLUSIVE RIGHT TO USE "SLIM", APART FROM THE MARK AS SHOWN.

THE COLOR(S) YELLOW AND RED IS/ARE CLAIMED AS A FEATURE OF THE MARK.

THE MARK CONSISTS OF A STYLIZED WORD "QIKSLIM" IN YELLOW AND RED.

SER. NO. 85-332,582, FILED 5-27-2011.

TRACY WHITTAKER-BROWN, EXAMINING ATTORNEY



*David J. Kyros*

Director of the United States Patent and Trademark Office

# United States of America

United States Patent and Trademark Office

# LOCA LA

**Reg. No. 4,124,627**

RV DISTRIBUTION (CALIFORNIA LIMITED LIABILITY COMPANY)  
1015 S. WALL STREET, SUITE 115  
LOS ANGELES, CA 90015

**Registered Apr. 10, 2012**

**Int. Cl.: 25**

FOR: BOMBER JACKETS; BUTTON DOWN SHIRTS; CROP TOPS; DENIM JACKETS; DOWN JACKETS; DRESS PANTS; DRESS SHIRTS; DRESSES; FLEECE TOPS; FUR COATS AND JACKETS; JEANS; JEGGINGS, NAMELY, PANTS THAT ARE PARTIALLY JEANS AND PARTIALLY LEGGINGS; KNIT DRESSES; KNIT JACKETS; KNIT SHIRTS; OUTER JACKETS; RAIN JACKETS; SHIRTS; SLEEVED OR SLEEVELESS JACKETS; SWEAT SHIRTS; T-SHIRTS; TANK TOPS; TOPS; WIND-JACKETS; WOVEN TOPS, IN CLASS 25 (U.S. CLS. 22 AND 39).

**TRADEMARK**

**PRINCIPAL REGISTER**

FIRST USE 1-5-2011; IN COMMERCE 2-8-2011.

THE MARK CONSISTS OF STANDARD CHARACTERS WITHOUT CLAIM TO ANY PARTICULAR FONT, STYLE, SIZE, OR COLOR.

NO CLAIM IS MADE TO THE EXCLUSIVE RIGHT TO USE "LA" , APART FROM THE MARK AS SHOWN.

THE ENGLISH TRANSLATION OF "LOCA LA" IN THE MARK IS "CRAZY LA".

SER. NO. 85-332,884, FILED 5-27-2011.

SHAILA SETTLES, EXAMINING ATTORNEY



*David J. Kypos*

Director of the United States Patent and Trademark Office

# United States of America

United States Patent and Trademark Office

## education & employment adapting to change!

**Reg. No. 4,124,628**

**Registered Apr. 10, 2012**

**Int. Cl.: 41**

**SERVICE MARK**

**PRINCIPAL REGISTER**

SCENEWISE, INC. (CALIFORNIA CORPORATION)  
105 A PASEO DE LA PLAYA  
REDONDO BEACH, CA 90277

FOR: "PROVIDING A WEBSITE FEATURING NON-DOWNLOADABLE VIDEOS, NAMELY, VIDEO PRESENTATIONS OF A EDUCATIONAL NATURE IN THE FIELD OF CAREER COUNSELING, NAMELY, ADVICE CONCERNING EDUCATION OPTIONS; EDUCATIONAL SERVICES, NAMELY, PROVIDING TEMPORARY USE OF NON-DOWNLOADABLE COMPUTER LEARNING GAMES IN THE FIELD OF LIFE MANAGEMENT PERTAINING TO EDUCATION AND CAREER CHOICES", IN CLASS 41 (U.S. CLS. 100, 101 AND 107).

FIRST USE 3-30-2011; IN COMMERCE 3-30-2011.

THE MARK CONSISTS OF STANDARD CHARACTERS WITHOUT CLAIM TO ANY PARTICULAR FONT, STYLE, SIZE, OR COLOR.

NO CLAIM IS MADE TO THE EXCLUSIVE RIGHT TO USE "EDUCATION & EMPLOYMENT", APART FROM THE MARK AS SHOWN.

SER. NO. 85-332,959, FILED 5-27-2011.

ZACHARY BELLO, EXAMINING ATTORNEY



*David J. Kyffers*

Director of the United States Patent and Trademark Office



# United States of America

United States Patent and Trademark Office

## RAMEN JINYA

**Reg. No. 4,124,629**

JINYA USA INC (CALIFORNIA CORPORATION)  
10759 STEPHON TERRACE  
CULVERCITY, CA 90230

**Registered Apr. 10, 2012**

**Int. Cl.: 43**

FOR: RESTAURANT; RESTAURANT AND BAR SERVICES, IN CLASS 43 (U.S. CLS. 100 AND 101).

**SERVICE MARK**

FIRST USE 4-1-2010; IN COMMERCE 4-1-2010.

**PRINCIPAL REGISTER**

THE MARK CONSISTS OF STANDARD CHARACTERS WITHOUT CLAIM TO ANY PARTICULAR FONT, STYLE, SIZE, OR COLOR.

NO CLAIM IS MADE TO THE EXCLUSIVE RIGHT TO USE "RAMEN", APART FROM THE MARK AS SHOWN.

THE WORDING "JINYA" HAS NO MEANING IN A FOREIGN LANGUAGE.

SER. NO. 85-332,980, FILED 5-27-2011.

GEORGE LORENZO, EXAMINING ATTORNEY



*David J. Kyffers*

Director of the United States Patent and Trademark Office

# United States of America

United States Patent and Trademark Office

# AQAVA

**Reg. No. 4,124,630**

**Registered Apr. 10, 2012**

**Int. Cls.: 35 and 41**

**SERVICE MARK**

**PRINCIPAL REGISTER**

ENDENER, MAIK (FED REP GERMANY INDIVIDUAL), DBA ENDENER MEDIA & MARKETING  
MARIENSTRASSE 24  
GOETTINGEN, FED REP GERMANY

FOR: COMPUTERIZED ON-LINE RETAIL STORE SERVICES IN THE FIELD OF AUDIO RECORDINGS, AUDIO BOOKS, E-BOOKS, MULTIMEDIA DOCUMENTS, VIDEO RECORDINGS, PODCASTS, WEBCASTS AND SOFTWARE; DISTRIBUTORSHIP SERVICES IN THE FIELD OF AUDIO RECORDINGS, AUDIO BOOKS, E-BOOKS, MULTIMEDIA DOCUMENTS, VIDEO RECORDINGS, PODCASTS, WEBCASTS AND SOFTWARE; ONLINE ADVERTISING VIA A COMPUTER COMMUNICATIONS NETWORK; PROVIDING A WEB SITE WHERE USERS CAN POST RATINGS, REVIEWS AND RECOMMENDATIONS ON PRODUCTS AND SERVICES FOR COMMERCIAL PURPOSES; PROVIDING CONSUMER PRODUCT INFORMATION VIA THE INTERNET, IN CLASS 35 (U.S. CLS. 100, 101 AND 102).

FOR: AUDIO RECORDING AND PRODUCTION; PUBLISHING OF BOOKS, E-BOOKS, AUDIO BOOKS, MUSIC AND ILLUSTRATIONS, IN CLASS 41 (U.S. CLS. 100, 101 AND 107).

THE MARK CONSISTS OF STANDARD CHARACTERS WITHOUT CLAIM TO ANY PARTICULAR FONT, STYLE, SIZE, OR COLOR.

PRIORITY CLAIMED UNDER SEC. 44(D) ON ERPN CMNTY TM OFC APPLICATION NO. 010005171, FILED 5-28-2011, REG. NO. 010005171, DATED 11-2-2011, EXPIRES 5-28-2021.

THE WORDING "AQAVA" HAS NO MEANING IN A FOREIGN LANGUAGE.

SER. NO. 85-333,030, FILED 5-28-2011.

TINA BROWN, EXAMINING ATTORNEY



*David J. Kyffers*

Director of the United States Patent and Trademark Office

# United States of America

United States Patent and Trademark Office



**Reg. No. 4,124,631**

**Registered Apr. 10, 2012**

**Int. Cl.: 3**

**TRADEMARK**

**PRINCIPAL REGISTER**

GRAVES, MICHELLE Y. (UNITED STATES INDIVIDUAL)  
SUITE 237  
10979 REED HARTMAN HWY.  
CINCINNATI, OH 452422882

FOR: ORGANIC, ALL NATURAL, MINIMALLY PROCESSED, SOY-FREE, GLUTEN-FREE, VEGAN, AND SYNTHETIC PRESERVATIVE-FREE NON-MEDICATED SKIN CARE PREPARATIONS AND COSMETICS, IN CLASS 3 (U.S. CLS. 1, 4, 6, 50, 51 AND 52).

FIRST USE 3-19-2011; IN COMMERCE 3-19-2011.

NO CLAIM IS MADE TO THE EXCLUSIVE RIGHT TO USE "ORGANICS", APART FROM THE MARK AS SHOWN.

THE MARK CONSISTS OF THE STYLIZED TEXT "SHÉOLOGY ORGANICS" WITH A CURVED LINE ABOVE "SHÉOLOGY" AND A DESIGN WITH TWO LEAVES BELOW "SHÉOLOGY". THE WORD "ORGANICS" IS BELOW THE LEAVES.

SER. NO. 85-333,083, FILED 5-28-2011.

ANNE FARRELL, EXAMINING ATTORNEY



*David J. Kybas*

Director of the United States Patent and Trademark Office

# United States of America

United States Patent and Trademark Office

# ELBOW

**Reg. No. 4,124,632**

GRAVETTE, PATRICK LINDSAY (UNITED STATES INDIVIDUAL), DBA ELBOW  
1155 TENNESSEE STREET  
SAN FRANCISCO, CA 94107

**Registered Apr. 10, 2012**

**Int. Cl.: 42**

FOR: GRAPHIC ART DESIGN; GRAPHIC DESIGN; GRAPHIC DESIGN SERVICES; MULTIDISCIPLINARY GRAPHIC DESIGN SERVICES, IN CLASS 42 (U.S. CLS. 100 AND 101).

**SERVICE MARK**

FIRST USE 0-0-1996; IN COMMERCE 2-13-1997.

**PRINCIPAL REGISTER**

THE MARK CONSISTS OF STANDARD CHARACTERS WITHOUT CLAIM TO ANY PARTICULAR FONT, STYLE, SIZE, OR COLOR.

SER. NO. 85-333,277, FILED 5-29-2011.

KAREN K. BUSH, EXAMINING ATTORNEY



*David J. Kybas*

Director of the United States Patent and Trademark Office

# United States of America

United States Patent and Trademark Office



**Reg. No. 4,124,633**

GUANG HUAN MI ZONG INC. (NEW YORK CORPORATION)  
262 E. MAIN STREET  
AMSTERDAM, NY 12010

**Registered Apr. 10, 2012**

**Int. Cl.: 41**

FOR: MEDITATION TRAINING, IN CLASS 41 (U.S. CLS. 100, 101 AND 107).

**SERVICE MARK**

FIRST USE 4-23-2011; IN COMMERCE 5-4-2011.

**PRINCIPAL REGISTER**

NO CLAIM IS MADE TO THE EXCLUSIVE RIGHT TO USE "MEDITATION", APART FROM THE MARK AS SHOWN.

THE COLOR(S) WHITE, ORANGE AND BLUE IS/ARE CLAIMED AS A FEATURE OF THE MARK.

THE MARK CONSISTS OF A STYLIZED PERSON OUTLINED IN BLUE MEDITATING SURROUNDED BY AN ORANGE CIRCLE. THE WORDS "MAHA MEDITATION" APPEAR TO THE RIGHT OF THE DESIGN IN BLUE. THE WHITE IN THE DRAWING REPRESENTS BACKGROUND AND IS A FEATURE OF THE MARK.

SER. NO. 85-333,382, FILED 5-30-2011.

KATHRYN COWARD, EXAMINING ATTORNEY



*David J. Kyros*

Director of the United States Patent and Trademark Office

# United States of America

United States Patent and Trademark Office

## INTEGRATION

**Reg. No. 4,124,634**

**Registered Apr. 10, 2012**

**Int. Cl.: 35**

**SERVICE MARK**

**PRINCIPAL REGISTER**

INTEGRATION CONSULTORIA EMPRESARIAL LTDA. (BRAZIL CORPORATION)  
RUA JERONIMO DA VEIGA, 45, 15 ANDAR  
SAO PAULO, BRAZIL

FOR: BUSINESS MANAGEMENT PLANNING AND CONSULTATION FOR OTHERS,  
NAMELY, CONDUCTING RESEARCH AND ANALYZING THE RESULTS OF STUDIES  
RELATED TO COSTS AND PRICES, IN CLASS 35 (U.S. CLS. 100, 101 AND 102).

FIRST USE 3-21-1997; IN COMMERCE 6-16-2005.

THE MARK CONSISTS OF STANDARD CHARACTERS WITHOUT CLAIM TO ANY PAR-  
TICULAR FONT, STYLE, SIZE, OR COLOR.

OWNER OF U.S. REG. NO. 3,845,529.

SEC. 2(F).

SER. NO. 85-333,434, FILED 5-30-2011.

DAWN HAN, EXAMINING ATTORNEY



*David J. Kyffers*

Director of the United States Patent and Trademark Office

# United States of America

United States Patent and Trademark Office

## FAITHFULL GEAR

**Reg. No. 4,124,635**

WISHFULLS LLC (ARIZONA LIMITED LIABILITY COMPANY)  
6525 EAST BAR Z LANE  
PARADISE VALLEY, AZ 85253

**Registered Apr. 10, 2012**

**Int. Cl.: 21**

FOR: REUSABLE STAINLESS STEEL, ALUMINUM, OR PLASTIC WATER BOTTLES SOLD EMPTY; REUSABLE STAINLESS STEEL OR ALUMINUM TRAVEL MUGS SOLD EMPTY, IN CLASS 21 (U.S. CLS. 2, 13, 23, 29, 30, 33, 40 AND 50).

**TRADEMARK**

FIRST USE 5-15-2011; IN COMMERCE 5-15-2011.

**PRINCIPAL REGISTER**

THE MARK CONSISTS OF STANDARD CHARACTERS WITHOUT CLAIM TO ANY PARTICULAR FONT, STYLE, SIZE, OR COLOR.

NO CLAIM IS MADE TO THE EXCLUSIVE RIGHT TO USE "GEAR", APART FROM THE MARK AS SHOWN.

SER. NO. 85-333,758, FILED 5-31-2011.

COLLEEN DOMBROW, EXAMINING ATTORNEY



*David J. Kybas*

Director of the United States Patent and Trademark Office

# United States of America

United States Patent and Trademark Office

# PERIFLEX

**Reg. No. 4,124,636**

PULSAFEEDER, INC. (DELAWARE CORPORATION)  
2883 BRIGHTON HENRIETTA TOWN LINE RD  
ROCHESTER, NY 14623

**Registered Apr. 10, 2012**

**Int. Cl.: 7**

FOR: HOSES AND PIPES MADE OF RUBBER AS REPLACEMENT PARTS FOR PERISTALTIC PUMPS, IN CLASS 7 (U.S. CLS. 13, 19, 21, 23, 31, 34 AND 35).

**TRADEMARK**

FIRST USE 9-15-2003; IN COMMERCE 9-15-2003.

**PRINCIPAL REGISTER**

THE MARK CONSISTS OF STANDARD CHARACTERS WITHOUT CLAIM TO ANY PARTICULAR FONT, STYLE, SIZE, OR COLOR.

SER. NO. 85-334,167, FILED 5-31-2011.

HELENE LIWINSKI, EXAMINING ATTORNEY



*David J. Kybas*

Director of the United States Patent and Trademark Office



# United States of America

United States Patent and Trademark Office

## Sassy Ladies Shopping Night Out

**Reg. No. 4,124,637**

**Registered Apr. 10, 2012**

**Int. Cl.: 35**

**SERVICE MARK**

**PRINCIPAL REGISTER**

EVENTS BY CHEREESE, INC. (NEW YORK CORPORATION), DBA EVENTS TO REMEMBER  
LEFT SUITE  
14 JEROME DRIVE  
CORTLANDT MANOR, NY 10567

FOR: ORGANIZING, ARRANGING, AND CONDUCTING TRADE SHOW EXHIBITIONS  
FOR SHOPPING EVENTS IN THE FIELD OF CLOTHING AND APPAREL ACCESSORIES,  
IN CLASS 35 (U.S. CLS. 100, 101 AND 102).

FIRST USE 12-1-2010; IN COMMERCE 12-1-2010.

THE MARK CONSISTS OF STANDARD CHARACTERS WITHOUT CLAIM TO ANY PAR-  
TICULAR FONT, STYLE, SIZE, OR COLOR.

NO CLAIM IS MADE TO THE EXCLUSIVE RIGHT TO USE "LADIES SHOPPING", APART  
FROM THE MARK AS SHOWN.

SER. NO. 85-334,283, FILED 5-31-2011.

DANNEAN HETZEL, EXAMINING ATTORNEY



*David J. Kyffers*

Director of the United States Patent and Trademark Office

# United States of America

United States Patent and Trademark Office

# Bex

**Reg. No. 4,124,638**

**Registered Apr. 10, 2012**

**Int. Cl.: 41**

**SERVICE MARK**

**PRINCIPAL REGISTER**

PORT M TALENT, INC. (NEW YORK CORPORATION)  
50 JEFFERSON LANDING CIRCLE  
PORT JEFFERSON, NY 11777

FOR: ENTERTAINMENT SERVICES, NAMELY, LIVE MUSIC PERFORMANCES AND PROVIDING PUBLIC APPEARANCES BY A PERFORMING ARTIST, NAMELY, A MUSICIAN AND MUSICAL RECORDING ARTIST; ENTERTAINMENT SERVICES, NAMELY, PROVIDING ONLINE NON-DOWNLOADABLE PRERECORDED MUSIC, AND NON-DOWNLOADABLE AUDIO RECORDINGS, AUDIOVISUAL RECORDINGS AND INFORMATION REGARDING A PERFORMING ARTIST ALL VIA A GLOBAL COMPUTER NETWORK AND/OR MOBILE DEVICE AND/OR SATELLITE TRANSMISSION; ENTERTAINMENT SERVICES, NAMELY, PROVIDING A WEBSITE FEATURING INFORMATION ON A PERFORMING ARTIST, INCLUDING TOURING, APPEARANCES, NEWS, BIOGRAPHY, PHOTOGRAPHS, AND OTHER ENTERTAINMENT INFORMATION; ONLINE JOURNALS, NAMELY, BLOGS FEATURING INFORMATION ON A PERFORMING ARTIST; FAN CLUBS; ENTERTAINMENT SERVICES, NAMELY, PROVIDING WEBCASTS FEATURING MUSIC, MUSICAL AUDIO RECORDINGS, MUSICAL AUDIOVISUAL RECORDINGS, AND MUSICAL-BASED ENTERTAINMENT, IN CLASS 41 (U.S. CLS. 100, 101 AND 107).

FIRST USE 3-1-2010; IN COMMERCE 3-1-2010.

THE MARK CONSISTS OF STANDARD CHARACTERS WITHOUT CLAIM TO ANY PARTICULAR FONT, STYLE, SIZE, OR COLOR.

THE NAME "BEX" IDENTIFIES A LIVING INDIVIDUAL WHOSE CONSENT IS OF RECORD.

SER. NO. 85-334,728, FILED 6-1-2011.

MAUREEN DALL, EXAMINING ATTORNEY



*David J. Kyjars*

Director of the United States Patent and Trademark Office

United States of America  
United States Patent and Trademark Office

CYNIATRIA

**Reg. No. 4,124,639**

FUNCTIONAL PRODUCTS, LLC (MINNESOTA LIMITED LIABILITY COMPANY)  
7269 BENT BOW TRAIL  
CHANHASSEN, MN 55317

**Registered Apr. 10, 2012**

**Int. Cl.: 31**

FOR: PET FOOD; PET TREATS, IN CLASS 31 (U.S. CLS. 1 AND 46).

**TRADEMARK**

FIRST USE 2-14-2011; IN COMMERCE 2-14-2011.

**PRINCIPAL REGISTER**

THE MARK CONSISTS OF STANDARD CHARACTERS WITHOUT CLAIM TO ANY PARTICULAR FONT, STYLE, SIZE, OR COLOR.

SER. NO. 85-334,852, FILED 6-1-2011.

MAYUR VAGHANI, EXAMINING ATTORNEY



*David J. Kybas*

Director of the United States Patent and Trademark Office

# United States of America

United States Patent and Trademark Office



**Reg. No. 4,124,640**

**Registered Apr. 10, 2012**

**Int. Cl.: 31**

**TRADEMARK**

**PRINCIPAL REGISTER**

FUNCTIONAL PRODUCTS, LLC (MINNESOTA LIMITED LIABILITY COMPANY)  
7269 BENT BOW TRAIL  
CHANHASSEN, MN 55317

FOR: PET FOOD; PET TREATS, IN CLASS 31 (U.S. CLS. 1 AND 46).

FIRST USE 2-14-2011; IN COMMERCE 2-14-2011.

NO CLAIM IS MADE TO THE EXCLUSIVE RIGHT TO USE "NUTRITION", APART FROM THE MARK AS SHOWN.

THE COLOR(S) WHITE, ORANGE, YELLOW, PINK, TURQUOISE IS/ARE CLAIMED AS A FEATURE OF THE MARK.

THE MARK CONSISTS OF A WHITE CIRCLE WITH WHITE WORDS "PURPOSEFUL NUTRITION" IN ALL CAPITALS ARCED OVER THE TOP OF THE CIRCLE AND THE WHITE WORD "CYNIAATRIA" IN ALL CAPITALS ARCED UNDER THE BOTTOM OF THE CIRCLE. IN THE CIRCLE ARE FOUR INTERSECTING SHAPES RESEMBLING FLOWER PETALS, WHICH CONSIST OF A 270 DEGREE PORTION OF A CIRCLE AND A 90 DEGREE CORNER. THE "PETALS" POINT AWAY FROM THE CENTER AND, GOING CLOCKWISE FROM THE TOP LEFT, ARE ORANGE, YELLOW, TURQUOISE AND PINK. THE COLOR GRAY REPRESENTS BACKGROUND, OUTLINING, SHADING AND/OR TRANSPARENT AREAS AND IS NOT PART OF THE MARK.

SER. NO. 85-334,978, FILED 6-1-2011.

MAYUR VAGHANI, EXAMINING ATTORNEY



*David J. Kybas*

Director of the United States Patent and Trademark Office

# United States of America

United States Patent and Trademark Office

## HAILEY JEANS CO.

**Reg. No. 4,124,641**

KNS INTERNATIONAL, L.L.C. (UTAH LIMITED LIABILITY COMPANY)  
12577 S. 265 W., BLD. 3B  
DRAPER, UT 84020

**Registered Apr. 10, 2012**

**Int. Cls.: 18 and 25**

FOR: LEATHER GOODS, NAMELY, WALLETS, HANDBAGS AND PURSES, IN CLASS 18 (U.S. CLS. 1, 2, 3, 22 AND 41).

**TRADEMARK**

FIRST USE 9-30-2008; IN COMMERCE 9-30-2008.

**PRINCIPAL REGISTER**

FOR: CLOTHING, NAMELY, SHIRTS, TIES, DRESS SUITS, BLOUSES, PANTS, SWEATERS, JACKETS, SHORTS, T-SHIRTS, SWEATSHIRTS, FOOTWEAR, GLOVES AND BELTS, IN CLASS 25 (U.S. CLS. 22 AND 39).

FIRST USE 9-30-2008; IN COMMERCE 9-30-2008.

THE MARK CONSISTS OF STANDARD CHARACTERS WITHOUT CLAIM TO ANY PARTICULAR FONT, STYLE, SIZE, OR COLOR.

NO CLAIM IS MADE TO THE EXCLUSIVE RIGHT TO USE "JEANS CO.", APART FROM THE MARK AS SHOWN.

SER. NO. 85-335,135, FILED 6-1-2011.

CHRIS WELLS, EXAMINING ATTORNEY



*David J. Kybas*

Director of the United States Patent and Trademark Office

# United States of America

## United States Patent and Trademark Office



**Reg. No. 4,124,642**

**Registered Apr. 10, 2012**

**Int. Cls.: 35, 36 and 37**

**SERVICE MARK**

**PRINCIPAL REGISTER**

PATRON CAPITAL ADVISERS LLP (UNITED KINGDOM LIMITED LIABILITY PARTNERSHIP)  
7 HANOVER SQUARE  
LONDON, UNITED KINGDOM W1S1HQ

FOR: BUSINESS MANAGEMENT; BUSINESS ADMINISTRATION; BUSINESS DEVELOPMENT SERVICES, NAMELY, PROVIDING START-UP SUPPORT FOR BUSINESSES OF OTHERS; MANAGEMENT AND ADMINISTRATION OF A BUSINESS THAT PROVIDES FINANCIAL SERVICES, ASSET MANAGEMENT, PROPERTY MANAGEMENT AND INVESTMENT SERVICES; BUSINESS MANAGEMENT SERVICES RELATING TO PROPERTY, REAL ESTATE, BUILDINGS, SHOPPING CENTRES AND MALLS; ADVERTISING SERVICES RELATING TO FINANCIAL INVESTMENT; ADVISORY AND CONSULTANCY SERVICES IN THE FIELDS OF BUSINESS MANAGEMENT, BUSINESS ADMINISTRATION AND ADVERTISING; PROVIDING INFORMATION VIA THE INTERNET AND EXTRANETS IN THE FIELDS OF BUSINESS MANAGEMENT, BUSINESS ADMINISTRATION AND ADVERTISING; REAL ESTATE SERVICES, NAMELY, ADVERTISING AND MARKETING, IN CLASS 35 (U.S. CLS. 100, 101 AND 102).

FOR: FINANCIAL SERVICES, IN THE NATURE OF INVESTMENT SECURITY, FINANCIAL SERVICES, NAMELY, MONEY LENDING, INVESTMENT FUND TRANSFER AND TRANSACTION SERVICES, MANAGEMENT OF AND DISTRIBUTION OF INSURANCE AND VARIABLE ANNUITIES AND PROVIDING ON-LINE STORED VALUE ACCOUNTS IN AN ELECTRONIC ENVIRONMENT; REAL ESTATE SERVICES, NAMELY, ACQUISITION, APPRAISAL, BROKERAGE, DEVELOPMENT, ESCROW SERVICES, EQUITY SHARING, LISTING, MANAGEMENT, PROCUREMENT FOR OTHERS, RESEARCH, SYNDICATION, AND TRUSTEE SERVICES; CAPITAL INVESTMENT CONSULTATION; VENTURE CAPITAL INVESTMENT; REAL ESTATE INVESTMENT, RETAIL REAL ESTATE INVESTMENT; INVESTMENT OF CAPITAL AND FUNDS; ASSET MANAGEMENT INVESTMENT; MANAGEMENT OF INVESTMENT; ACQUISITION FOR FINANCIAL INVESTMENT; ADMINISTRATION OF CAPITAL INVESTMENTS, FUND INVESTMENTS; COMMERCIAL PROPERTY INVESTMENT SERVICES; FINANCIAL INVESTMENT SERVICES, NAMELY, INVESTMENT FUND TRANSFER AND TRANSACTION SERVICES; FUND INVESTMENT SERVICES; FUND MANAGEMENT; PROPERTY MANAGEMENT; PROPERTY PORTFOLIO MANAGEMENT; RENTAL OF PROPERTY, NAMELY, RETAIL REAL ESTATE, RESIDENTIAL PROPERTY, OFFICE BUILDINGS, AND INDUSTRIAL FACILITIES; ADVISORY AND CONSULTANCY SERVICES IN THE FIELD OF INVESTMENT AND REAL ESTATE;



*David J. Kyjars*

Director of the United States Patent and Trademark Office

**Reg. No. 4,124,642** PROVIDING INFORMATION IN THE FIELD OF INVESTMENT AND REAL ESTATE VIA THE INTERNET OR EXTRANETS, IN CLASS 36 (U.S. CLS. 100, 101 AND 102).

FOR: BUILDING AND PROPERTY SERVICES, NAMELY, CONSTRUCTION, CONSTRUCTION SUPERVISION, DEMOLITION, DEVELOPMENT, INSPECTION IN THE COURSE OF CONSTRUCTION, MAINTENANCE, REDEVELOPMENT, REFURBISHMENT, RENOVATION, REPAIR, AND RESTORATION; BUILDING CONSTRUCTION SERVICES; BUILDING PROJECT MANAGEMENT; BUILDING REPAIR AND REFURBISHMENT SERVICES; DEVELOPMENT OF BUILDINGS AND BUILDING PROJECTS; INSTALLATION OF FITTING FOR BUILDINGS; MAINTENANCE AND REPAIR OF BUILDINGS, BUILDING CONTENT, UTILITIES IN BUILDINGS AND PARTS AND FITTINGS FOR BUILDINGS; PAINTING AND DECORATING OF BUILDINGS; REAL ESTATE DEVELOPMENT; ADVISORY AND CONSULTANCY SERVICES IN THE FIELDS OF BUILDING AND PROPERTY CONSTRUCTION, DEVELOPMENT AND PROJECT MANAGEMENT; PROVIDING INFORMATION IN THE FIELDS OF BUILDING AND PROPERTY CONSTRUCTION, DEVELOPMENT AND PROJECT MANAGEMENT; REAL ESTATE SERVICES, NAMELY, REAL ESTATE SITE SELECTION SERVICES, IN CLASS 37 (U.S. CLS. 100, 103 AND 106).

PRIORITY CLAIMED UNDER SEC. 44(D) ON ERPN CMNTY TM OFC APPLICATION NO. 9854795, FILED 3-30-2011, REG. NO. 9854795, DATED 9-12-2011, EXPIRES 3-30-2021.

OWNER OF U.S. REG. NO. 4,024,334.

THE MARK CONSISTS OF SILHOUETTE OF A LANDSCAPE OF BUILDINGS.

SER. NO. 85-335,346, FILED 6-1-2011.

MICHAEL ENGEL, EXAMINING ATTORNEY

# United States of America

United States Patent and Trademark Office

The logo consists of the letters "LED" in a bold, sans-serif font. The letter "L" is positioned to the left of the "E" and "D". The top horizontal bar of the "L" is elevated and extends to the left, resembling a wire. The right side of the "D" is rounded, resembling the surface of a light bulb.

**Reg. No. 4,124,643**

LEDTRONICS, INC. (CALIFORNIA CORPORATION)  
23105 KASHIWA COURT  
TORRANCE, CA 90505

**Registered Apr. 10, 2012**

**Int. Cl.: 40**

FOR: CUSTOM MANUFACTURE OF LIGHT EMITTING DIODE DEVICES, NAMELY, ARRAYS, CLUSTERS AND DISPLAYS OF LED DEVICES FOR INSTRUMENTATION, INDICATION AND ILLUMINATION WITHIN THE VISIBLE LIGHT AND INFRARED SPECTRUM, IN CLASS 40 (U.S. CLS. 100, 103 AND 106).

**SERVICE MARK**

**PRINCIPAL REGISTER**

FIRST USE 1-0-1984; IN COMMERCE 1-0-1984.

NO CLAIM IS MADE TO THE EXCLUSIVE RIGHT TO USE "LED", APART FROM THE MARK AS SHOWN.

THE MARK CONSISTS OF THE LETTERS "LED" ARRANGED TO RESEMBLE A LIGHT; SPECIFICALLY, THE LETTER "L" IS ELEVATED AND APPEARS TO BE A WIRE ATTACHED TO THE CENTER OF THE LEFT SIDE OF THE LETTER "E", AND THE ROUNDED PORTION OF THE LETTER "D" APPEARS TO BE THE SURFACE OF A BULB.

SER. NO. 85-335,516, FILED 6-1-2011.

C. DIONNE CLYBURN, EXAMINING ATTORNEY



*David J. Kybas*

Director of the United States Patent and Trademark Office



# United States of America

United States Patent and Trademark Office

# GET SWOLE

**Reg. No. 4,124,644**

**Registered Apr. 10, 2012**

**Int. Cl.: 25**

SWOLE SPORTS NUTRITION, LLC (FLORIDA LIMITED LIABILITY COMPANY), DBA  
SWOLE, SWOLE SPORTS, SWOLE SPORTS NUTRITION  
221  
6574 N. STATE ROAD 7  
COCONUT CREEK, FL 33073

**TRADEMARK**

FOR: ATHLETIC APPAREL, NAMELY, SHIRTS, PANTS, JACKETS, FOOTWEAR, HATS  
AND CAPS, ATHLETIC UNIFORMS, IN CLASS 25 (U.S. CLS. 22 AND 39).

**PRINCIPAL REGISTER**

FIRST USE 5-4-2011; IN COMMERCE 5-12-2011.

THE MARK CONSISTS OF STANDARD CHARACTERS WITHOUT CLAIM TO ANY PAR-  
TICULAR FONT, STYLE, SIZE, OR COLOR.

SER. NO. 85-335,645, FILED 6-1-2011.

KATHERINE E. HALMEN, EXAMINING ATTORNEY



*David J. Kyffers*

Director of the United States Patent and Trademark Office

# United States of America

United States Patent and Trademark Office

## Keep Austin Recycling

**Reg. No. 4,124,645**

**Registered Apr. 10, 2012**

**Int. Cl.: 40**

**SERVICE MARK**

**PRINCIPAL REGISTER**

AUSTIN METAL & IRON CO LP (TEXAS LIMITED PARTNERSHIP)  
P.O. BOX 2115 AUSTIN, TEXAS 78768-2115  
1000 EAST 4TH ST.  
AUSTIN, TX 78702

FOR: RECYCLING, IN CLASS 40 (U.S. CLS. 100, 103 AND 106).

FIRST USE 5-1-2006; IN COMMERCE 6-1-2011.

THE MARK CONSISTS OF STANDARD CHARACTERS WITHOUT CLAIM TO ANY PARTICULAR FONT, STYLE, SIZE, OR COLOR.

NO CLAIM IS MADE TO THE EXCLUSIVE RIGHT TO USE "AUSTIN RECYCLING", APART FROM THE MARK AS SHOWN.

SER. NO. 85-335,691, FILED 6-1-2011.

PAUL MORENO, EXAMINING ATTORNEY



*David J. Kyffers*

Director of the United States Patent and Trademark Office

# United States of America

United States Patent and Trademark Office

## Perfect Power Seal of Approval

**Reg. No. 4,124,646**

GALVIN PROJECT, INC. (ILLINOIS CORPORATION)

**Registered Apr. 10, 2012**

160 DUNDEE ROAD  
BARRINGTON, IL 60010

**Int. Cl.: 42**

**SERVICE MARK**

**PRINCIPAL REGISTER**

FOR: ACCREDITATION SERVICES, NAMELY, DEVELOPING AND ADMINISTERING STANDARDS AND PROCEDURES FOR CERTIFYING PROFESSIONALS IN THE FIELD OF CONSUMER ELECTRICITY; ACCREDITATION SERVICES, NAMELY, DEVELOPING, EVALUATING, AND TESTING STANDARDS FOR THE GENERATION, DISTRIBUTION AND TRANSMISSION OF ELECTRICITY FOR THE PURPOSE OF ACCREDITATION; ACCREDITATION SERVICES, NAMELY, EVALUATING ORGANIZATIONS TO DETERMINE WHETHER THE ORGANIZATIONS CONFORM TO AN ESTABLISHED STANDARD; ACCREDITATION SERVICES, NAMELY, SETTING AND PROVIDING STANDARDS FOR CONSUMER ELECTRICITY; CONSULTING IN THE FIELD OF ENGINEERING; CONSULTING SERVICES IN THE FIELDS OF ENERGY MEASUREMENT TO IMPROVE ENERGY EFFICIENCY; CONSULTING SERVICES PROVIDED TO LOCAL GOVERNMENTS IN THE FIELD OF DEVELOPMENT OF ELECTRICAL SERVICES AND RENEWABLE ENERGY RESOURCES; ENGINEERING SERVICES IN THE FIELD OF ENERGY EFFICIENCY; METERING AND MONITORING ELECTRIC POWER CONSUMPTION BY THIRD PARTIES FOR ELECTRIC POWER PROVIDERS; PROVIDING QUALITY ASSURANCE SERVICES IN THE FIELD OF CONSUMER ELECTRICITY; PROVIDING SCIENTIFIC INFORMATION IN THE FIELD OF CONSUMER ELECTRICITY; RESEARCH AND DEVELOPMENT IN THE FIELD OF CONSUMER ELECTRICITY; RESEARCH IN THE FIELD OF ENERGY; TECHNICAL CONSULTATION IN THE FIELD OF POWER PLANT ENGINEERING, NAMELY, TESTING AND EVALUATION OF POWER PLANT EQUIPMENT TO IMPROVE PERFORMANCE AND EFFICIENCY OF SUCH EQUIPMENT; TECHNOLOGICAL PLANNING AND CONSULTING SERVICES IN THE FIELD OF CONSUMER ELECTRICITY, IN CLASS 42 (U.S. CLS. 100 AND 101).



FIRST USE 2-1-2011; IN COMMERCE 5-15-2011.

THE MARK CONSISTS OF STANDARD CHARACTERS WITHOUT CLAIM TO ANY PARTICULAR FONT, STYLE, SIZE, OR COLOR.

*David J. Kyjars*

NO CLAIM IS MADE TO THE EXCLUSIVE RIGHT TO USE "POWER SEAL OF APPROVAL", APART FROM THE MARK AS SHOWN.

Director of the United States Patent and Trademark Office

SER. NO. 85-335,766, FILED 6-1-2011.

**Reg. No. 4,124,646** CHRISTOPHER BUONGIORNO, EXAMINING ATTORNEY

# United States of America

United States Patent and Trademark Office

WE'RE MAKING  
REAL FASHION  
STATEMENTS,  
BY PUTTING  
REAL  
STATEMENTS IN  
FASHION

**Reg. No. 4,124,647**

**Registered Apr. 10, 2012**

**Int. Cl.: 25**

**TRADEMARK**

**PRINCIPAL REGISTER**

BLAQ INC. APPAREL (MICHIGAN CORPORATION)  
236 DEPOT ST. 2B  
DALTON, GA 30720 AND

JAMES WALKER (MICHIGAN INDIVIDUAL), DBA BLAQ INC. APPAREL  
236 DEPOT ST 2B  
DALTON, GA 30720 AND

TONI BLACKWELL (MICHIGAN INDIVIDUAL), DBA BLAQ INC. APPAREL  
236 DEPOT ST 2B  
DALTON, GA 30720

FOR: APPAREL FOR DANCERS, NAMELY, TEE SHIRTS, SWEATSHIRTS, PANTS, LEGGINGS, SHORTS AND JACKETS; ATHLETIC APPAREL, NAMELY, SHIRTS, PANTS, JACKETS, FOOTWEAR, HATS AND CAPS, ATHLETIC UNIFORMS, IN CLASS 25 (U.S. CLS. 22 AND 39).

FIRST USE 6-1-2009; IN COMMERCE 6-1-2009.

THE MARK CONSISTS OF STANDARD CHARACTERS WITHOUT CLAIM TO ANY PARTICULAR FONT, STYLE, SIZE, OR COLOR.

SER. NO. 85-335,985, FILED 6-2-2011.

MEGHAN REINHART, EXAMINING ATTORNEY



*David J. Kybas*

Director of the United States Patent and Trademark Office

# United States of America

United States Patent and Trademark Office

## Wallflower Press

**Reg. No. 4,124,648**

COLUMBIA UNIVERSITY PRESS (NEW YORK NON-PROFIT CORPORATION)  
61 WEST 62ND STREET  
NEW YORK, NY 10019

**Registered Apr. 10, 2012**

**Int. Cls.: 16 and 41**

FOR: PUBLICATIONS; NAMELY, SCHOLARLY AND REFERENCE BOOKS CONTAINING GENERAL INFORMATION ON FILM, TV, VIDEO, DIRECTORS, PERFORMERS, CAMERA TECHNIQUES AND POPULAR CULTURE; BOOKS, PAMPHLETS, ALL BEING OF A TRADE, SCHOLARLY AND PROFESSIONAL NATURE IN THE FIELD OF FILM, TV, VIDEO, RADIO, DIRECTORS, PERFORMERS, CINEMATOGRAPHY, SOUND TECHNIQUE, AND POPULAR CULTURE, IN CLASS 16 (U.S. CLS. 2, 5, 22, 23, 29, 37, 38 AND 50).

**TRADEMARK**

**SERVICE MARK**

**PRINCIPAL REGISTER**

FIRST USE 12-31-2001; IN COMMERCE 12-31-2001.

FOR: DEVELOPMENT, NAMELY, WRITING OF TEXTS OTHER THAN PUBLICITY TEXTS, AND PUBLICATION OF PRINTED REFERENCE WORKS AND COMPILATIONS OF ACADEMIC AND SCHOLARLY WRITINGS ON FILM, TV, VIDEO, DIRECTORS, PERFORMERS, CAMERA TECHNIQUES AND POPULAR CULTURE; PROVIDING ON-LINE PUBLICATIONS IN THE NATURE OF REFERENCE WORKS AND COMPILATIONS OF ACADEMIC AND SCHOLARLY WRITINGS ON FILM, TV, VIDEO, DIRECTORS, PERFORMERS, CAMERA TECHNIQUES AND POPULAR CULTURE, IN CLASS 41 (U.S. CLS. 100, 101 AND 107).

FIRST USE 12-31-2001; IN COMMERCE 12-31-2001.

THE MARK CONSISTS OF STANDARD CHARACTERS WITHOUT CLAIM TO ANY PARTICULAR FONT, STYLE, SIZE, OR COLOR.

NO CLAIM IS MADE TO THE EXCLUSIVE RIGHT TO USE "PRESS", APART FROM THE MARK AS SHOWN.

SER. NO. 85-336,151, FILED 6-2-2011.

THEODORE MCBRIDE, EXAMINING ATTORNEY



*David J. Kypos*

Director of the United States Patent and Trademark Office

# United States of America

United States Patent and Trademark Office

## RIGHT QUESTION

**Reg. No. 4,124,649**

THE RIGHT QUESTION PROJECT, INC. (MASSACHUSETTS CORPORATION)  
2464 MASSACHUSETTS AVENUE, SUITE 314  
CAMBRIDGE, MA 02140

**Registered Apr. 10, 2012**

**Int. Cls.: 9, 16 and 41**

FOR: ELECTRONIC DOWNLOADABLE EDUCATIONAL PUBLICATIONS, NAMELY, EDUCATIONAL WORKBOOKS, TEXTBOOKS, ACTIVITY BOOKS, GUIDES AND MANUALS IN THE FIELD OF ADULT SELF-ADVOCACY, IN CLASS 9 (U.S. CLS. 21, 23, 26, 36 AND 38).

**TRADEMARK**

**SERVICE MARK**

FIRST USE 9-27-1990; IN COMMERCE 9-27-1990.

**PRINCIPAL REGISTER**

FOR: PRINTED EDUCATIONAL PUBLICATIONS, NAMELY, EDUCATIONAL WORKBOOKS, TEXTBOOKS, ACTIVITY BOOKS, GUIDES AND MANUALS IN THE FIELD OF ADULT SELF-ADVOCACY, IN CLASS 16 (U.S. CLS. 2, 5, 22, 23, 29, 37, 38 AND 50).

FIRST USE 9-27-1990; IN COMMERCE 9-27-1990.

FOR: EDUCATIONAL SERVICES, NAMELY, TEACHING INDIVIDUALS ESSENTIAL DEMOCRATIC SKILLS TO HELP THEM PARTICIPATE IN DECISIONS MADE IN THEIR ORDINARY ENCOUNTERS WITH PUBLIC INSTITUTIONS; NON-DOWNLOADABLE ELECTRONIC EDUCATIONAL PUBLICATIONS, NAMELY, EDUCATIONAL WORKBOOKS, TEXTBOOKS, ACTIVITY BOOKS, GUIDES AND MANUALS IN THE FIELD OF ADULT SELF-ADVOCACY, IN CLASS 41 (U.S. CLS. 100, 101 AND 107).

FIRST USE 9-27-1990; IN COMMERCE 9-27-1990.

THE MARK CONSISTS OF STANDARD CHARACTERS WITHOUT CLAIM TO ANY PARTICULAR FONT, STYLE, SIZE, OR COLOR.

SER. NO. 85-336,211, FILED 6-2-2011.

JERI J. FICKES, EXAMINING ATTORNEY



*David J. Kyros*

Director of the United States Patent and Trademark Office

# United States of America

United States Patent and Trademark Office

☼ **FAST BEAUTY**

**Reg. No. 4,124,650**

**Registered Apr. 10, 2012**

**Int. Cls.: 3 and 44**

**TRADEMARK**

**SERVICE MARK**

**PRINCIPAL REGISTER**

AMBER LIFESTYLE HOLDINGS LIMITED (HONG KONG LIMITED LIABILITY COMPANY)  
203-204 HOLLYWOOD COMMERCIAL HOUSE  
3-5 OLD BAILEY STREET  
CENTRAL, HONG KONG, HONG KONG

FOR: COSMETICS; NON-MEDICATED SKIN CARE PREPARATIONS; NON-MEDICATED BODY POWDER; SKIN SOAP; BATH GEL; BATH OILS; BATH SALTS; NON-MEDICATED SKIN CARE LOTIONS; SKIN CREAMS; SKIN CLEANSERS; SKIN SCRUBS; SKIN MASKS; SKIN TONERS; HAIR CARE AND HAIR STYLING SHAMPOOS; HAIR CONDITIONERS; HAIR SPRAYS; HAIR GEL; PERSONAL DEODORANTS; SUN-TANNING PREPARATIONS; SUNSCREEN OILS; SUNSCREEN LOTIONS; SHAVING PREPARATIONS; PERFUME; ESSENTIAL OILS; PERFUMED OILS FOR PERSONAL USE; NAIL CARE PREPARATIONS; NAIL ENAMEL FOR MANICURES; COTTON STICKS FOR COSMETIC PURPOSES; COTTON WOOL FOR COSMETIC PURPOSES; COTTON WOOL AND COTTON STICKS FOR COSMETIC PURPOSES; INCENSE STICKS; POTPOURRI; PRE-MOISTENED COSMETIC TISSUES; TISSUES IMPREGNATED WITH COSMETIC LOTIONS, IN CLASS 3 (U.S. CLS. 1, 4, 6, 50, 51 AND 52).

FOR: BEAUTY SALON SERVICES; BEAUTY CONSULTATION SERVICES RELATING TO BEAUTY TREATMENT; BEAUTY SALON AND HAIR SALON SERVICES; MASSAGE THERAPY SERVICES; MASSAGES; HEALTH SPA SERVICES FOR HEALTH AND WELLNESS OF BODY AND SPIRIT; BEAUTY SPA SERVICES, NAMELY, COSMETIC BODY CARE AND COSMETIC SKIN CARE SERVICES; DAY SPA SERVICES, NAMELY, NAIL CARE, MANICURES, PEDICURES AND NAIL ENHANCEMENTS; WELLNESS AND HEALTH-RELATED CONSULTING SERVICES, IN CLASS 44 (U.S. CLS. 100 AND 101).

OWNER OF HONG KONG REG. NO. 301731645, DATED 7-4-2011, EXPIRES 7-4-2021.

NO CLAIM IS MADE TO THE EXCLUSIVE RIGHT TO USE "BEAUTY", APART FROM THE MARK AS SHOWN.

THE MARK CONSISTS OF THE STYLIZED WORDING "FAST BEAUTY" WITH "BEAUTY" IN BOLD, AND WITH A CIRCULAR ARRAY OF 12 DIAMOND-SHAPED POINTS APPEARING TO THE LEFT OF THE WORDING. ONE OF THE POINTS OF THE ARRAY IS OF EXTENDED LENGTH, PROJECTING OUTWARDLY FROM THE CENTER OF THE ARRAY.



*David J. Kyffers*

Director of the United States Patent and Trademark Office

SER. NO. 85-336,299, FILED 6-2-2011.



**Reg. No. 4,124,650** AMY KERTGATE, EXAMINING ATTORNEY

# United States of America

United States Patent and Trademark Office

## ICED BAMBOO

**Reg. No. 4,124,651**

J. & P. COATS, LIMITED (UNITED KINGDOM COMPANY)

**Registered Apr. 10, 2012**

1 GEORGE SQUARE  
GLASGOW, UNITED KINGDOM G2 1AL

**Int. Cl.: 23**

FOR: YARNS FOR CROCHET AND THREADS FOR CROCHET, IN CLASS 23 (U.S. CL. 43).

**TRADEMARK**

FIRST USE 3-24-2011; IN COMMERCE 3-24-2011.

**PRINCIPAL REGISTER**

THE MARK CONSISTS OF STANDARD CHARACTERS WITHOUT CLAIM TO ANY PARTICULAR FONT, STYLE, SIZE, OR COLOR.

NO CLAIM IS MADE TO THE EXCLUSIVE RIGHT TO USE "BAMBOO", APART FROM THE MARK AS SHOWN.

SER. NO. 85-336,334, FILED 6-2-2011.

CHERYL CLAYTON, EXAMINING ATTORNEY

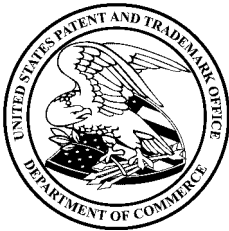

*David J. Kybas*

Director of the United States Patent and Trademark Office

# United States of America

United States Patent and Trademark Office

ContourLase  
BODY INSTITUTE

**Reg. No. 4,124,652**

**Registered Apr. 10, 2012**

**Int. Cl.: 44**

**SERVICE MARK**

**PRINCIPAL REGISTER**

LIPOLASE INSTITUTE, LLC (TEXAS LIMITED LIABILITY COMPANY), DBA  
CONTOURLASE BODY INSTITUTE  
19141 STONE OAK PARKWAY, SUITE 307  
SAN ANTONIO, TX 78258

FOR: LIPOSUCTION AND SURGICAL BODY SHAPING SERVICES; MEDICAL CLINIC PROVIDING WEIGHT LOSS SOLUTIONS, SERVICES AND PROGRAMS, NUTRITION COUNSELING, HORMONE THERAPY, INCLUDING, BIOIDENTICAL HORMONE REPLACEMENT, ANTIAGING THERAPY, AND NATURAL HORMONE THERAPY, MEDICAL AESTHETIC PROCEDURES, INCLUDING LASER HAIR REMOVAL, LASER PEELS, BOTULINUM TOXIN TREATMENTS, MICRODERMABRASION, LIPOSUCTION, VEIN TREATMENTS, VEIN THERAPY, CELLULITE TREATMENTS, BODY CONTOURING TREATMENTS, INJECTABLE FILLER TREATMENTS, FACIALS, AND SKIN CARE, IN CLASS 44 (U.S. CLS. 100 AND 101).

FIRST USE 2-1-2010; IN COMMERCE 3-1-2010.

NO CLAIM IS MADE TO THE EXCLUSIVE RIGHT TO USE "BODY INSTITUTE", APART FROM THE MARK AS SHOWN.

THE COLOR(S) LIGHT BLUE AND LIGHT ORANGE IS/ARE CLAIMED AS A FEATURE OF THE MARK.

THE MARK CONSISTS OF THE WORD "CONTOUR" IN A LIGHT BLUE COLOR WITH A STYLIZED LETTER "T" THAT HAS AN ELONGATED LINE RUNNING THROUGH THE LETTER "T" STRETCHING ABOVE THE LETTERS "O" AND "N" IN THE WORD "CONTOUR". THE WORD "CONTOUR" IS IMMEDIATELY FOLLOWED BY THE WORD "LASE" WHICH APPEARS IN A LIGHT ORANGE COLOR WITHOUT A SPACE IN BETWEEN. THE WORDS "BODY INSTITUTE" APPEAR IN ALL CAPITAL LETTERS IMMEDIATELY BELOW THE WORD "LASE" IN A LIGHT BLUE COLOR AND A SMALLER SIZE FONT.

SER. NO. 85-336,785, FILED 6-2-2011.

PRISCILLA MILTON, EXAMINING ATTORNEY



*David J. Kyjars*

Director of the United States Patent and Trademark Office

# United States of America

United States Patent and Trademark Office

## NBTV NATIONAL BLACK TELEVISION

**Reg. No. 4,124,653**

**Registered Apr. 10, 2012**

**Int. Cls.: 35, 38 and 41**

**SERVICE MARK**

**PRINCIPAL REGISTER**

NATIONAL BLACK YOUNG MEN & WOMAN OF AMERICA (GEORGIA CORPORATION),  
DBA NBTV NATIONAL BLACK TELEVISION  
3290 MEMORIAL DR. SUITE A - 3  
DECATUR, GA 30032

FOR: ADVERTISING, INCLUDING PROMOTION RELATING TO THE SALE OF ARTICLES AND SERVICES FOR THIRD PARTIES BY THE TRANSMISSION OF ADVERTISING MATERIAL AND THE DISSEMINATION OF ADVERTISING MESSAGES ON COMPUTER NETWORKS, IN CLASS 35 (U.S. CLS. 100, 101 AND 102).

FIRST USE 5-24-2005; IN COMMERCE 5-24-2005.

FOR: INTERNET TELEVISION BROADCASTING SERVICES, NAMELY, BROADCASTING OF VIDEO AND AUDIO PROGRAMMING; LIVE STREAMING OF VIDEO MATERIAL ON THE INTERNET; VIDEO-ON-DEMAND TRANSMISSION SERVICES; PROVIDING OF ACCESS TO DATA OR DOCUMENTS STORED ELECTRONICALLY IN CENTRAL FILES FOR REMOTE CONSULTATION, NAMELY PROVIDING ONLINE ACCESS TO NEWS FEATURE ARCHIVES, IN CLASS 38 (U.S. CLS. 100, 101 AND 104).

FIRST USE 5-24-2005; IN COMMERCE 5-24-2005.

FOR: ENTERTAINMENT SERVICES, NAMELY, THE PROVISION OF CONTINUING PROGRAMS FEATURING NEWS, COMEDY, SPORTS, EDUCATION ALL SUBJECTS, TALK SHOWS, REALITY SHOWS, VARIETY SHOWS, SOAP OPERAS, CARTOONS, CHILDREN PROGRAMMING, RELIGIOUS PROGRAMMING, POLITICAL, POLITICAL PROGRAMMING, AND NEWS SHOWS, IN CLASS 41 (U.S. CLS. 100, 101 AND 107).

FIRST USE 5-24-2005; IN COMMERCE 5-24-2005.

THE MARK CONSISTS OF STANDARD CHARACTERS WITHOUT CLAIM TO ANY PARTICULAR FONT, STYLE, SIZE, OR COLOR.

NO CLAIM IS MADE TO THE EXCLUSIVE RIGHT TO USE "TELEVISION", APART FROM THE MARK AS SHOWN.

SEC. 2(F) AS TO "NATIONAL BLACK TELEVISION".



*David J. Kyffers*

Director of the United States Patent and Trademark Office

**Reg. No. 4,124,653** SER. NO. 85-336,849, FILED 6-2-2011.

ESTHER BELENKER, EXAMINING ATTORNEY

# United States of America

United States Patent and Trademark Office



**Reg. No. 4,124,654**

FAKHRUDDIN HOLDINGS FZC (UNITED ARAB EMIR. LIMITED LIABILITY COMPANY)  
P.O.BOX: 121423  
SHARJAH, UNITED ARAB EMIR.

**Registered Apr. 10, 2012**

**Int. Cl.: 3**

FOR: BODY DEODORANTS; COSMETICS; DEODORANTS FOR PERSONAL USE; FRAGRANCES; PERFUMES; PERSONAL DEODORANTS, IN CLASS 3 (U.S. CLS. 1, 4, 6, 50, 51 AND 52).

**TRADEMARK**

FIRST USE 4-1-2011; IN COMMERCE 4-30-2011.

**PRINCIPAL REGISTER**

THE MARK CONSISTS OF FOUR CIRCLES WITH SMALLER CIRCLES INSIDE THE LARGER CIRCLES. INSIDE THE SMALLEST CIRCLE IS A WORDING "ARMAF" IN STYLIZED. THERE ARE REPEATED STYLIZED LETTER "F" AROUND THE CIRCUMFERENCE BETWEEN THE SMALLEST CIRCLE AND THE SECOND CIRCLE.

THE WORD(S) "ARMAF" HAS NO MEANING IN A FOREIGN LANGUAGE.

SER. NO. 85-337,042, FILED 6-3-2011.

JASON TURNER, EXAMINING ATTORNEY



*David J. Kybas*

Director of the United States Patent and Trademark Office

# United States of America

United States Patent and Trademark Office

DE<sup>2</sup>

**Reg. No. 4,124,655**

CERTA PROPAINTERS, LTD. (MASSACHUSETTS CORPORATION)  
150 GREEN TREE ROAD, SUITE 1003  
OAKS, PA 19456

**Registered Apr. 10, 2012**

**Int. Cl.: 37**

FOR: PAINTING SERVICES, NAMELY, PAINTING RESIDENTIAL AND COMMERCIAL BUILDINGS, IN CLASS 37 (U.S. CLS. 100, 103 AND 106).

**SERVICE MARK**

FIRST USE 1-4-2011; IN COMMERCE 1-4-2011.

**PRINCIPAL REGISTER**

THE MARK CONSISTS OF THE LETTERS "D", "E" FOLLOWED BY THE NUMBER "2" IN SUPERSCRIPIT SUCH THAT THE NUMBER "2" SERVES AS AN EXPONENT. THE LETTER "E" OVERLAPS A PORTION OF THE LETTER "D" SUCH THAT A PORTION OF THE CURVE IN THE LETTER "D" CAN BE SEEN BEHIND THE STRAIGHT VERTICAL LINE IN THE LETTER "E". SIMILARLY, A MINISCULE PORTION OF THE "2" EXPONENT OVERLAPS A SMALL PORTION OF THE TOP HORIZONTAL LINE IN THE LETTER "E".

SER. NO. 85-337,106, FILED 6-3-2011.

MARY BOAGNI, EXAMINING ATTORNEY



*David J. Kybas*

Director of the United States Patent and Trademark Office

# United States of America

United States Patent and Trademark Office

## DISCOVER RETIREMENT LIVING THAT SUITS YOU TO A "T"

**Reg. No. 4,124,656**

**Registered Apr. 10, 2012**

**Int. Cl.: 35**

**SERVICE MARK**

**PRINCIPAL REGISTER**

TUTERA INVESTMENTS, L.L.C. (MISSOURI LIMITED LIABILITY COMPANY)  
7611 STATE LINE RD., SUITE 303  
KANSAS CITY, MO 64114

FOR: BUSINESS MANAGEMENT SERVICES, IN CLASS 35 (U.S. CLS. 100, 101 AND 102).

FIRST USE 5-31-2010; IN COMMERCE 5-31-2010.

THE MARK CONSISTS OF STANDARD CHARACTERS WITHOUT CLAIM TO ANY PARTICULAR FONT, STYLE, SIZE, OR COLOR.

NO CLAIM IS MADE TO THE EXCLUSIVE RIGHT TO USE "RETIREMENT LIVING", APART FROM THE MARK AS SHOWN.

SER. NO. 85-337,439, FILED 6-3-2011.

MICHELE SWAIN, EXAMINING ATTORNEY



*David J. Kybas*

Director of the United States Patent and Trademark Office



# United States of America

United States Patent and Trademark Office



**Reg. No. 4,124,657**

WILLIAMS, KEITH A (UNITED STATES INDIVIDUAL), DBA P.S.I. REPORT  
P.O. BOX 4933

**Registered Apr. 10, 2012**

LITTLE ROCK, AR 72214

**Int. Cl.: 16**

FOR: GENERAL FEATURE MAGAZINE IN THE FIELD OF URBAN IMAGES AND RELATIVE ARTICLES, IN CLASS 16 (U.S. CLS. 2, 5, 22, 23, 29, 37, 38 AND 50).

**TRADEMARK**

FIRST USE 4-1-2011; IN COMMERCE 4-1-2011.

**PRINCIPAL REGISTER**

NO CLAIM IS MADE TO THE EXCLUSIVE RIGHT TO USE "REPORT", APART FROM THE MARK AS SHOWN.

THE COLOR(S) BLACK, WHITE, RED, GRAY IS/ARE CLAIMED AS A FEATURE OF THE MARK.

THE MARK CONSISTS OF THE LETTERS ("P.S.I.") ARE WHITE IN COLOR WITH A BLACK BACKGROUND. THE WORD ("REPORT") IS BLACK WITH BLACK AND WHITE VERTICAL STRIPES BEHIND IT. THE WORD ("PERSONAL") IS WHITE ON A BLACK BACKGROUND. THE WORD ("SEXY") IS RED ON A BLACK BACKGROUND. ("INFORMAT") PARTIAL IS WHITE ON A BLACK GROUND. ("IVE") IS BLACK ON THE WHITE AND BLACK STRIPED BACKGROUND. THE LOGO ITSELF HAS A GREY SHADOW BEHIND IT.

SER. NO. 85-337,706, FILED 6-3-2011.

ANN E. SAPPENFIELD, EXAMINING ATTORNEY



*David J. Kyjars*

Director of the United States Patent and Trademark Office

# United States of America

United States Patent and Trademark Office

## TORAH TOURS

**Reg. No. 4,124,658**

YESHIVA UNIVERSITY (NEW YORK NOT-FOR-PROFIT CORPORATION)  
500 WEST 185TH STREET  
NEW YORK, NY 100333201

**Registered Apr. 10, 2012**

**Int. Cls.: 39 and 41**

FOR: ARRANGING OF WORLDWIDE TRAVEL TOURS FOR STUDENTS, IN CLASS 39 (U.S. CLS. 100 AND 105).

**SERVICE MARK**

FIRST USE 12-31-1982; IN COMMERCE 12-31-1982.

**PRINCIPAL REGISTER**

FOR: EDUCATIONAL SERVICES, NAMELY, PROVIDING RELIGIOUS INSTRUCTION; EDUCATIONAL SERVICES, NAMELY, DEVELOPING AND ARRANGING WORLDWIDE TRAVEL EDUCATIONAL PROGRAMS IN THE FIELD OF RELIGION FOR STUDENTS, IN CLASS 41 (U.S. CLS. 100, 101 AND 107).

FIRST USE 12-31-1982; IN COMMERCE 12-31-1982.

THE MARK CONSISTS OF STANDARD CHARACTERS WITHOUT CLAIM TO ANY PARTICULAR FONT, STYLE, SIZE, OR COLOR.

NO CLAIM IS MADE TO THE EXCLUSIVE RIGHT TO USE "TOURS", APART FROM THE MARK AS SHOWN.

SEC. 2(F).

SER. NO. 85-337,738, FILED 6-3-2011.

SIMON TENG, EXAMINING ATTORNEY



*David J. Kybas*

Director of the United States Patent and Trademark Office

# United States of America

United States Patent and Trademark Office

# Satellites

**Reg. No. 4,124,659**

**Registered Apr. 10, 2012**

**Int. Cl.: 38**

**SERVICE MARK**

**PRINCIPAL REGISTER**

JUST HOLDINGS LLC (NEW YORK LIMITED LIABILITY COMPANY)  
1333A NORTH AVENUE, SUITE 315  
NEW ROCHELLE, NY 10804

FOR: PROVIDING ELECTRONIC TRANSMISSION AND DELIVERY OF INFORMATION AND DATA OVER GLOBAL COMPUTER NETWORKS, IN CLASS 38 (U.S. CLS. 100, 101 AND 104).

FIRST USE 4-11-2011; IN COMMERCE 4-11-2011.

THE MARK CONSISTS OF STANDARD CHARACTERS WITHOUT CLAIM TO ANY PARTICULAR FONT, STYLE, SIZE, OR COLOR.

SER. NO. 85-337,810, FILED 6-3-2011.

EMILY CARLSEN, EXAMINING ATTORNEY



*David J. Kyffers*

Director of the United States Patent and Trademark Office

# United States of America

United States Patent and Trademark Office

# TOFFLY

**Reg. No. 4,124,660**

ROTO-CART SPA (ITALY CORPORATION)  
VIA MUSSA, 30 Z.I.

**Registered Apr. 10, 2012**

PIOMBINO DESE (PD), ITALY 35017

**Int. Cl.: 16**

FOR: TOILET PAPER, PAPER HANDKERCHIEFS, PAPER KITCHEN ROLLS, NAMELY, PAPER TOWELS; PAPER MULTI-USE ROLLS, NAMELY, PAPER TOWELS; PAPER NAPKINS, IN CLASS 16 (U.S. CLS. 2, 5, 22, 23, 29, 37, 38 AND 50).

**TRADEMARK**

FIRST USE 0-0-1993; IN COMMERCE 12-0-2009.

**PRINCIPAL REGISTER**

THE MARK CONSISTS OF STANDARD CHARACTERS WITHOUT CLAIM TO ANY PARTICULAR FONT, STYLE, SIZE, OR COLOR.

THE WORDING "TOFFLY" HAS NO MEANING IN A FOREIGN LANGUAGE.

SER. NO. 85-337,857, FILED 6-3-2011.

BARBARA RUTLAND, EXAMINING ATTORNEY



*David J. Kybas*

Director of the United States Patent and Trademark Office

# United States of America

United States Patent and Trademark Office

## SPECTRUM INFORMATION SERVICES NW

**Reg. No. 4,124,661**

SPECTRUM INFORMATION SERVICES NW, INC. (WASHINGTON CORPORATION)  
2701 NW VAUGHN ST., SUITE 148  
PORTLAND, OR 97210

**Registered Apr. 10, 2012**

**Int. Cl.: 42**

FOR: COMPUTER SERVICES, NAMELY, ELECTRONIC IMAGING OF RECORDS AND/OR DOCUMENTS, NAMELY, LARGE FORMAT DOCUMENTS, MICROFILM, AND MICROFICHE, IN CLASS 42 (U.S. CLS. 100 AND 101).

**SERVICE MARK**

FIRST USE 2-2-2007; IN COMMERCE 2-2-2007.

**PRINCIPAL REGISTER**

THE MARK CONSISTS OF STANDARD CHARACTERS WITHOUT CLAIM TO ANY PARTICULAR FONT, STYLE, SIZE, OR COLOR.

NO CLAIM IS MADE TO THE EXCLUSIVE RIGHT TO USE "INFORMATION SERVICES", APART FROM THE MARK AS SHOWN.

SER. NO. 85-337,934, FILED 6-3-2011.

HOWARD B. LEVINE, EXAMINING ATTORNEY



*David J. Kyffers*

Director of the United States Patent and Trademark Office

# United States of America

United States Patent and Trademark Office

# Stick n Hold

**Reg. No. 4,124,662**

OCHOA, JESUS (UNITED STATES INDIVIDUAL)  
6119 BREWER CREEK DR  
BAKERSFIELD, CA 93313

**Registered Apr. 10, 2012**

**Int. Cl.: 16**

FOR: GREETING CARD HOLDER USED TO KEEP GREETING CARDS IN PLACE AND UPRIGHT, IN CLASS 16 (U.S. CLS. 2, 5, 22, 23, 29, 37, 38 AND 50).

**TRADEMARK**

FIRST USE 5-7-2010; IN COMMERCE 7-1-2010.

**PRINCIPAL REGISTER**

THE MARK CONSISTS OF STANDARD CHARACTERS WITHOUT CLAIM TO ANY PARTICULAR FONT, STYLE, SIZE, OR COLOR.

SER. NO. 85-338,057, FILED 6-3-2011.

GRETТА YAO, EXAMINING ATTORNEY



*David J. Kyffers*

Director of the United States Patent and Trademark Office

# United States of America

United States Patent and Trademark Office

## Solar Support Works

**Reg. No. 4,124,663**

**Registered Apr. 10, 2012**

**Int. Cl.: 6**

**TRADEMARK**

**PRINCIPAL REGISTER**

CANTSINK MANUFACTURING, INC. (GEORGIA CORPORATION), DBA SOLAR SUPPORT WORKS  
71 FIRST AVENUE  
LILBURN, GA 30047

FOR: CARBON STEELS; COLD-FINISHED STEEL BARS; COMMON METALS AND THEIR ALLOYS INCLUDING STAINLESS STEEL; IRONS AND STEELS; PIPEWORK OF METAL INCLUDING THOSE FROM ALLOY STEEL AND TITANIUM; STEEL; STEEL PIPES AND TUBES, IN CLASS 6 (U.S. CLS. 2, 12, 13, 14, 23, 25 AND 50).

FIRST USE 5-16-2011; IN COMMERCE 5-16-2011.

THE MARK CONSISTS OF STANDARD CHARACTERS WITHOUT CLAIM TO ANY PARTICULAR FONT, STYLE, SIZE, OR COLOR.

NO CLAIM IS MADE TO THE EXCLUSIVE RIGHT TO USE "SOLAR", APART FROM THE MARK AS SHOWN.

SER. NO. 85-338,477, FILED 6-6-2011.

CAROLINE WOOD, EXAMINING ATTORNEY



*David J. Kyffers*

Director of the United States Patent and Trademark Office

# United States of America

United States Patent and Trademark Office

# Aloha Editor

**Reg. No. 4,124,664**

**Registered Apr. 10, 2012**

**Int. Cls.: 9 and 42**

**TRADEMARK**

**SERVICE MARK**

**PRINCIPAL REGISTER**

GENTICS SOFTWARE GMBH (AUSTRIA LIMITED LIABILITY COMPANY)  
GONZAGAGASSE 11/25  
VIENNA, AUSTRIA 1010

FOR: DOWNLOADABLE VIRTUAL GOODS, NAMELY, COMPUTER PROGRAMS FEATURING ONLINE EDITING SOFTWARE FOR USE IN ONLINE VIRTUAL WORLDS, IN CLASS 9 (U.S. CLS. 21, 23, 26, 36 AND 38).

FIRST USE 8-1-2010; IN COMMERCE 8-1-2010.

FOR: PROVIDING A WEB SITE THAT GIVES MULTIPLE COMPUTER USERS SIMULTANEOUSLY THE ABILITY TO UPLOAD, CREATE AND EDIT DOCUMENTS, PRINTED PUBLICATIONS, ONLINE PUBLICATIONS, PHOTOGRAPHS, PRODUCT PACKAGING AND ADVERTISEMENTS, IN CLASS 42 (U.S. CLS. 100 AND 101).

FIRST USE 8-1-2010; IN COMMERCE 8-1-2010.

THE MARK CONSISTS OF STANDARD CHARACTERS WITHOUT CLAIM TO ANY PARTICULAR FONT, STYLE, SIZE, OR COLOR.

PRIORITY CLAIMED UNDER SEC. 44(D) ON AUSTRIA APPLICATION NO. 009924978, FILED 4-27-2011.

NO CLAIM IS MADE TO THE EXCLUSIVE RIGHT TO USE "EDITOR", APART FROM THE MARK AS SHOWN.

SER. NO. 85-338,538, FILED 6-6-2011.

INGRID C. EULIN, EXAMINING ATTORNEY



*David J. Kyros*

Director of the United States Patent and Trademark Office



# United States of America

United States Patent and Trademark Office

# ProCare Occ

**Reg. No. 4,124,665**

**Registered Apr. 10, 2012**

**Int. Cl.: 35**

**SERVICE MARK**

**PRINCIPAL REGISTER**

NETCARE ADMINISTRATORS, LLC (SOUTH DAKOTA LIMITED LIABILITY COMPANY)  
2301 RESEARCH PARK WAY, SUITE 221  
BROOKINGS, SD 57006

FOR: CONSULTING SERVICES, NAMELY, TO EMPLOYERS, COMMUNITY ORGANIZATIONS, BROKERS AND BENEFICIARIES, RELATED TO CONSUMER INFORMATION REGARDING HEALTH CARE PLAN OPTIONS, PRODUCTS AND PROGRAMS IN THE FIELD OF MANAGED CARE AND STATE AND FEDERAL MEDICAL CARE PROGRAMS, IN CLASS 35 (U.S. CLS. 100, 101 AND 102).

FIRST USE 4-26-2011; IN COMMERCE 4-26-2011.

THE MARK CONSISTS OF STANDARD CHARACTERS WITHOUT CLAIM TO ANY PARTICULAR FONT, STYLE, SIZE, OR COLOR.

SER. NO. 85-338,643, FILED 6-6-2011.

NAPOLEON SHARMA, EXAMINING ATTORNEY



*David J. Kyffers*

Director of the United States Patent and Trademark Office

# United States of America

United States Patent and Trademark Office

## ProCare Sports

**Reg. No. 4,124,666**

NETCARE ADMINISTRATORS, LLC (SOUTH DAKOTA LIMITED LIABILITY COMPANY)  
2301 RESEARCH PARK WAY, SUITE 221  
BROOKINGS, SD 57006

**Registered Apr. 10, 2012**

**Int. Cl.: 35**

FOR: CONSULTING SERVICES, NAMELY, TO EMPLOYERS, COMMUNITY ORGANIZATIONS, BROKERS AND BENEFICIARIES, RELATED TO CONSUMER INFORMATION REGARDING HEALTH CARE PLAN OPTIONS, PRODUCTS AND PROGRAMS IN THE FIELD OF MANAGED CARE AND STATE AND FEDERAL MEDICAL CARE PROGRAMS, IN CLASS 35 (U.S. CLS. 100, 101 AND 102).

**SERVICE MARK**

**PRINCIPAL REGISTER**

FIRST USE 8-8-2011; IN COMMERCE 8-8-2011.

THE MARK CONSISTS OF STANDARD CHARACTERS WITHOUT CLAIM TO ANY PARTICULAR FONT, STYLE, SIZE, OR COLOR.

NO CLAIM IS MADE TO THE EXCLUSIVE RIGHT TO USE "SPORTS", APART FROM THE MARK AS SHOWN.

SER. NO. 85-338,660, FILED 6-6-2011.

NAPOLEON SHARMA, EXAMINING ATTORNEY



*David J. Kyffers*

Director of the United States Patent and Trademark Office

# United States of America

United States Patent and Trademark Office

## ProCare Wellness

**Reg. No. 4,124,667**

NETCARE ADMINISTRATORS, LLC (SOUTH DAKOTA LIMITED LIABILITY COMPANY)  
2301 RESEARCH PARK WAY, SUITE 221  
BROOKINGS, SD 57006

**Registered Apr. 10, 2012**

**Int. Cl.: 35**

FOR: CONSULTING SERVICES, NAMELY, TO EMPLOYERS, COMMUNITY ORGANIZATIONS, BROKERS AND BENEFICIARIES, RELATED TO CONSUMER INFORMATION REGARDING HEALTH CARE PLAN OPTIONS, PRODUCTS AND PROGRAMS IN THE FIELD OF MANAGED CARE AND STATE AND FEDERAL MEDICAL CARE PROGRAMS, IN CLASS 35 (U.S. CLS. 100, 101 AND 102).

**SERVICE MARK**

**PRINCIPAL REGISTER**

FIRST USE 11-30-2010; IN COMMERCE 11-30-2010.

THE MARK CONSISTS OF STANDARD CHARACTERS WITHOUT CLAIM TO ANY PARTICULAR FONT, STYLE, SIZE, OR COLOR.

NO CLAIM IS MADE TO THE EXCLUSIVE RIGHT TO USE "WELLNESS", APART FROM THE MARK AS SHOWN.

SER. NO. 85-338,769, FILED 6-6-2011.

NAPOLEON SHARMA, EXAMINING ATTORNEY



*David J. Kyffers*

Director of the United States Patent and Trademark Office

# United States of America

United States Patent and Trademark Office

## EVERGREEN PAYMENT SOLUTIONS

**Reg. No. 4,124,668**

**Registered Apr. 10, 2012**

**Int. Cl.: 36**

**SERVICE MARK**

**PRINCIPAL REGISTER**

FORT KNOX NATIONAL COMPANY (KENTUCKY CORPORATION)  
POST OFFICE BOX 1270  
1201 NORTH DIXIE AVENUE SUITE 105  
ELIZABETHTOWN, KY 427021270

FOR: FINANCIAL SERVICES, NAMELY, BILL PAYMENT SERVICES, IN CLASS 36 (U.S. CLS. 100, 101 AND 102).

FIRST USE 12-21-2010; IN COMMERCE 12-21-2010.

THE MARK CONSISTS OF STANDARD CHARACTERS WITHOUT CLAIM TO ANY PARTICULAR FONT, STYLE, SIZE, OR COLOR.

NO CLAIM IS MADE TO THE EXCLUSIVE RIGHT TO USE "PAYMENT SOLUTIONS", APART FROM THE MARK AS SHOWN.

SER. NO. 85-339,126, FILED 6-6-2011.

BENJAMIN OKEKE, EXAMINING ATTORNEY



*David J. Kyfos*

Director of the United States Patent and Trademark Office

# United States of America

United States Patent and Trademark Office

# Ingeteam

READY FOR YOUR CHALLENGES

**Reg. No. 4,124,669**

**Registered Apr. 10, 2012**

**Int. Cl.: 42**

**SERVICE MARK**

**PRINCIPAL REGISTER**

INGETEAM, S.A. (SPAIN SOCIEDAD ANONIMA (SA))  
EDIFICIO 106  
PARQUE TECNOLÓGICO DE BIZKAIA  
ZAMUDIO, SPAIN 48170

FOR: SCIENTIFIC AND TECHNOLOGICAL SERVICES, NAMELY, RESEARCH AND DESIGN IN THE FIELD OF PRODUCTS WHERE THERE IS INTERCHANGE OF ENERGY, BOTH IN GENERATION AND IN CONSUMPTION, NAMELY, PROCESS AUTOMATION SYSTEMS, FREQUENCY CONVERTERS, ELECTRICAL GENERATORS, ELECTRIC ENGINES, SUBMERSIBLE PUMPS, ELECTRICAL SWITCHBOARDS AND ELECTRICAL DISTRIBUTION BOXES, SYSTEMS FOR RECHARGING ELECTRIC VEHICLES, AND PHOTOVOLTAIC INVERTERS; RESEARCH IN THE FIELD OF THE ENERGY; DESIGN AND DEVELOPMENT OF COMPUTER HARDWARE AND SOFTWARE; ELECTRICAL ENGINEERING, NAMELY, IN THE FIELD OF POWER ELECTRONICS, IN CLASS 42 (U.S. CLS. 100 AND 101).

PRIORITY CLAIMED UNDER SEC. 44(D) ON ERPN CMNTY TM OFC APPLICATION NO. 009696287, FILED 1-29-2011, REG. NO. 009696287, DATED 7-5-2011, EXPIRES 1-29-2021.

THE COLOR(S) RED AND BLACK IS/ARE CLAIMED AS A FEATURE OF THE MARK.

OWNER OF U.S. REG. NOS. 3,597,351 AND 3,673,281.

THE MARK CONSISTS OF THE WORDING "INGETEAM" IN RED AND IN STYLIZED TEXT ABOVE THE WORDING "READY FOR YOUR CHALLENGES" IN BLACK AND IN STYLIZED TEXT.

SER. NO. 85-339,622, FILED 6-7-2011.

DOMINIC FATHY, EXAMINING ATTORNEY



*David J. Kyros*

Director of the United States Patent and Trademark Office

# United States of America

United States Patent and Trademark Office

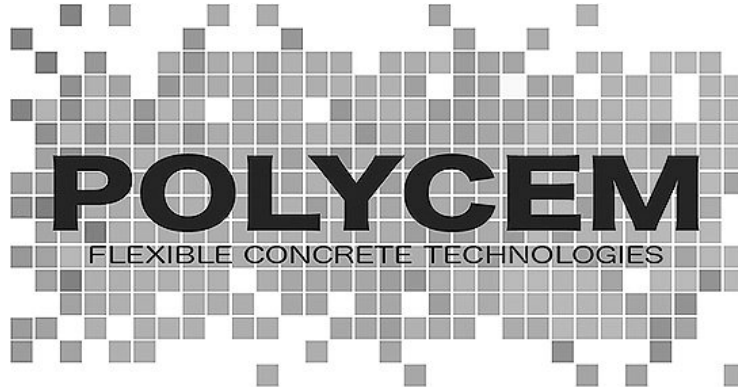

**Reg. No. 4,124,670**

POLYCEM, LLC (WISCONSIN LIMITED LIABILITY COMPANY)  
1271 JUDSON ROAD  
SPRING LAKE, MI 49456

**Registered Apr. 10, 2012**

**Int. Cl.: 40**

FOR: CUSTOM MANUFACTURE OF TILES MADE OF CONCRETE AND POLYMERS FOR INTERIOR AND EXTERIOR USE ON WALLS AND FLOORS, IN CLASS 40 (U.S. CLS. 100, 103 AND 106).

**SERVICE MARK**

FIRST USE 3-0-2005; IN COMMERCE 4-0-2005.

**PRINCIPAL REGISTER**

NO CLAIM IS MADE TO THE EXCLUSIVE RIGHT TO USE "FLEXIBLE CONCRETE TECHNOLOGIES", APART FROM THE MARK AS SHOWN.

SER. NO. 85-340,050, FILED 6-7-2011.

KATHRYN COWARD, EXAMINING ATTORNEY



*David J. Kyros*

Director of the United States Patent and Trademark Office

# United States of America

United States Patent and Trademark Office

# POLYCEM

**Reg. No. 4,124,671**

POLYCEM, LLC (WISCONSIN LIMITED LIABILITY COMPANY)  
1271 JUDSON ROAD  
SPRING LAKE, MI 49456

**Registered Apr. 10, 2012**

**Int. Cl.: 40**

FOR: CUSTOM MANUFACTURE OF TILES MADE OF CONCRETE AND POLYMERS FOR INTERIOR AND EXTERIOR USE ON WALLS AND FLOORS, IN CLASS 40 (U.S. CLS. 100, 103 AND 106).

**SERVICE MARK**

FIRST USE 3-0-2005; IN COMMERCE 4-0-2005.

**PRINCIPAL REGISTER**

THE MARK CONSISTS OF STANDARD CHARACTERS WITHOUT CLAIM TO ANY PARTICULAR FONT, STYLE, SIZE, OR COLOR.

SER. NO. 85-340,057, FILED 6-7-2011.

KATHRYN COWARD, EXAMINING ATTORNEY



*David J. Kyffers*

Director of the United States Patent and Trademark Office

# United States of America

United States Patent and Trademark Office

# SPINSHOT

**Reg. No. 4,124,672**

VMC PECHE (FRANCE SOCIÉTÉ PAR ACTIONS SIMPLIFIÉE (SAS))  
12, RUE DU GENERAL DE GAULLE  
MORVILLARS, FRANCE 90120

**Registered Apr. 10, 2012**

**Int. Cl.: 28**

FOR: FISHING TACKLE, TERMINAL TACKLE AND FISHING HOOKS, IN CLASS 28 (U.S. CLS. 22, 23, 38 AND 50).

**TRADEMARK**

THE MARK CONSISTS OF STANDARD CHARACTERS WITHOUT CLAIM TO ANY PARTICULAR FONT, STYLE, SIZE, OR COLOR.

**PRINCIPAL REGISTER**

PRIORITY CLAIMED UNDER SEC. 44(D) ON FRANCE APPLICATION NO. 113836379, FILED 6-3-2011, REG. NO. 113836379, DATED 6-3-2011, EXPIRES 6-3-2021.

SER. NO. 85-340,189, FILED 6-7-2011.

KEVIN DINALLO, EXAMINING ATTORNEY



*David J. Kybas*

Director of the United States Patent and Trademark Office



# United States of America

United States Patent and Trademark Office



**Reg. No. 4,124,673**

**Registered Apr. 10, 2012**

**Int. Cl.: 44**

**SERVICE MARK**

**PRINCIPAL REGISTER**

REMEDY WEIGHT LOSS SYSTEMS, LLC (MISSISSIPPI LIMITED LIABILITY COMPANY)  
201 PALMERS CT  
201 PALMERS CT  
MADISON, MS 39110

FOR: MEDICAL CLINIC PROVIDING WEIGHT LOSS PROGRAMS, IN CLASS 44 (U.S. CLS. 100 AND 101).

FIRST USE 11-30-2009; IN COMMERCE 11-30-2009.

NO CLAIM IS MADE TO THE EXCLUSIVE RIGHT TO USE "WEIGHT LOSS", APART FROM THE MARK AS SHOWN.

THE COLOR(S) DARK BLUE AND LIGHT BLUE IS/ARE CLAIMED AS A FEATURE OF THE MARK.

THE MARK CONSISTS OF A LIGHT BLUE OVAL, DARK BLUE SWIRL LINE, LIGHT BLUE SWIRL LINE, WORD "REMEDY" IN DARK BLUE LOWERCASE, BENEATH "WEIGHT LOSS" IN LIGHT BLUE.

SER. NO. 85-340,380, FILED 6-7-2011.

BRENDAN MCCAULEY, EXAMINING ATTORNEY



*David J. Kybas*

Director of the United States Patent and Trademark Office

# United States of America

United States Patent and Trademark Office

# PAGEMODO

**Reg. No. 4,124,674**

WEBS, INC. (DELAWARE CORPORATION)  
1100 WAYNE AVENUE, SUITE 801  
SILVER SPRING, MD 20910

**Registered Apr. 10, 2012**

**Int. Cl.: 42**

FOR: PROVIDING ONLINE NON-DOWNLOADABLE SOFTWARE AND SOFTWARE APPLICATIONS FOR CREATING AND PROMOTING WEB AND SOCIAL MEDIA PRESENCE IN THE NATURE OF BUILDING CUSTOM PAGES FOR USE ON SOCIAL NETWORKING WEBSITES, IN CLASS 42 (U.S. CLS. 100 AND 101).

**SERVICE MARK**

**PRINCIPAL REGISTER**

FIRST USE 4-29-2010; IN COMMERCE 4-29-2010.

THE MARK CONSISTS OF STANDARD CHARACTERS WITHOUT CLAIM TO ANY PARTICULAR FONT, STYLE, SIZE, OR COLOR.

SER. NO. 85-341,551, FILED 6-8-2011.

KATHERINE CONNOLLY, EXAMINING ATTORNEY



*David J. Kybas*

Director of the United States Patent and Trademark Office

# United States of America

United States Patent and Trademark Office

# EVOJETS

**Reg. No. 4,124,675**

EVOJETS LLC (COLORADO LIMITED LIABILITY COMPANY)  
630 EAST HYMAN AVE, SUITE 4  
ASPEN, CO 81611

**Registered Apr. 10, 2012**

**Int. Cls.: 36 and 39**

FOR: AIRCRAFT AND JET BROKERAGE SERVICES, IN CLASS 36 (U.S. CLS. 100, 101 AND 102).

**SERVICE MARK**

FIRST USE 2-26-2008; IN COMMERCE 2-26-2008.

**PRINCIPAL REGISTER**

FOR: PRIVATE JET CHARTER SERVICES; JET SHARING SERVICES, IN CLASS 39 (U.S. CLS. 100 AND 105).

FIRST USE 2-26-2008; IN COMMERCE 2-26-2008.

THE MARK CONSISTS OF STANDARD CHARACTERS WITHOUT CLAIM TO ANY PARTICULAR FONT, STYLE, SIZE, OR COLOR.

SER. NO. 85-341,684, FILED 6-8-2011.

JEFFREY LOOK, EXAMINING ATTORNEY



*David J. Kybas*

Director of the United States Patent and Trademark Office

# United States of America

United States Patent and Trademark Office

## ARROWHEAD VANTAGE

**Reg. No. 4,124,676**

**Registered Apr. 10, 2012**

**Int. Cl.: 35**

**SERVICE MARK**

**PRINCIPAL REGISTER**

ARROWHEAD DENTAL, INC. (UTAH CORPORATION), DBA ARROWHEAD DENTAL  
LABORATORY  
11170 SOUTH STATE STREET  
SANDY, UT 84070

FOR: ON-LINE WHOLESALE AND RETAIL STORE SERVICES FEATURING DENTAL  
PRODUCTS, IN CLASS 35 (U.S. CLS. 100, 101 AND 102).

FIRST USE 8-0-2010; IN COMMERCE 8-0-2010.

THE MARK CONSISTS OF STANDARD CHARACTERS WITHOUT CLAIM TO ANY PAR-  
TICULAR FONT, STYLE, SIZE, OR COLOR.

OWNER OF U.S. REG. NO. 2,779,187.

SER. NO. 85-342,004, FILED 6-9-2011.

MYRIAH HABEEB, EXAMINING ATTORNEY



*David J. Kybas*

Director of the United States Patent and Trademark Office

# United States of America

United States Patent and Trademark Office

# AMO

**Reg. No. 4,124,677**

ARTIST MENTORS ONLINE, LLC (OHIO LIMITED LIABILITY COMPANY)  
4508 ST. ANDREWS COURT  
MIDDLETOWN, OH 45042

**Registered Apr. 10, 2012**

**Int. Cl.: 41**

FOR: PROVIDING EDUCATIONAL MENTORING SERVICES AND PROGRAMS IN THE FIELD OF ART AND BUSINESS GEARED TOWARDS ARTISTS, IN CLASS 41 (U.S. CLS. 100, 101 AND 107).

**SERVICE MARK**

FIRST USE 8-1-2010; IN COMMERCE 8-1-2010.

**PRINCIPAL REGISTER**

THE MARK CONSISTS OF STANDARD CHARACTERS WITHOUT CLAIM TO ANY PARTICULAR FONT, STYLE, SIZE, OR COLOR.

SER. NO. 85-342,123, FILED 6-9-2011.

MATTHEW MCDOWELL, EXAMINING ATTORNEY



*David J. Kyffers*

Director of the United States Patent and Trademark Office

# United States of America

United States Patent and Trademark Office

## TALK TO WRITE, WRITE TO LEARN

**Reg. No. 4,124,678**

**Registered Apr. 10, 2012**

**Int. Cl.: 41**

**SERVICE MARK**

**PRINCIPAL REGISTER**

MINDWING CONCEPTS, INC. (MASSACHUSETTS CORPORATION)  
BUILDING 101-R  
ONE FEDERAL STREET  
SPRINGFIELD, MA 011051222

FOR: EDUCATIONAL SERVICES, NAMELY, CONDUCTING TEACHING SEMINARS IN THE FIELD OF LANGUAGE ARTS AND DISTRIBUTION OF TRAINING MATERIALS IN CONNECTION THEREWITH, IN CLASS 41 (U.S. CLS. 100, 101 AND 107).

FIRST USE 1-15-2007; IN COMMERCE 1-15-2007.

THE MARK CONSISTS OF STANDARD CHARACTERS WITHOUT CLAIM TO ANY PARTICULAR FONT, STYLE, SIZE, OR COLOR.

SER. NO. 85-342,147, FILED 6-9-2011.

PAUL E. FAHRENKOPF, EXAMINING ATTORNEY



*David J. Kybas*

Director of the United States Patent and Trademark Office

# United States of America

United States Patent and Trademark Office

## PEACEMAKER

**Reg. No. 4,124,679**

**Registered Apr. 10, 2012**

**Int. Cl.: 11**

**TRADEMARK**

**PRINCIPAL REGISTER**

SYNECO SYSTEMS, INC. (MINNESOTA CORPORATION)  
SUITE 133  
80 WEST 78TH STREET  
CHANHASSEN, MN 55317

FOR: DRY AIR SCRUBBERS, INFLOW FILTERS AND VENT FILTERS FOR USE IN ODOR CONTROL FOR VENTILATION, WATER SUPPLY AND SANITARY SYSTEMS , IN CLASS 11 (U.S. CLS. 13, 21, 23, 31 AND 34).

FIRST USE 12-31-1995; IN COMMERCE 12-31-1995.

THE MARK CONSISTS OF STANDARD CHARACTERS WITHOUT CLAIM TO ANY PARTICULAR FONT, STYLE, SIZE, OR COLOR.

SER. NO. 85-342,326, FILED 6-9-2011.

ROBIN CHOSID, EXAMINING ATTORNEY



*David J. Kyffers*

Director of the United States Patent and Trademark Office

# United States of America

United States Patent and Trademark Office

# Doc Rabbit

**Reg. No. 4,124,680**

TRACY WELLS (UNITED STATES INDIVIDUAL), DBA THE WELLS COMPANY  
1018 E. WISHKAH #109  
ABERDEEN, WA 98520

**Registered Apr. 10, 2012**

**Int. Cl.: 35**

FOR: ON-LINE RETAIL STORE SERVICES FEATURING CUSTOMIZABLE FORMS AND DOCUMENTS IN THE NATURE OF AN ONLINE MARKETPLACE FEATURING DOCUMENTS RANGING ACROSS A WIDE FIELD OF TOPICS FOR VIEWING, DOWNLOADING AND PRINTING, IN CLASS 35 (U.S. CLS. 100, 101 AND 102).

**SERVICE MARK**

**PRINCIPAL REGISTER**

FIRST USE 1-30-2011; IN COMMERCE 1-30-2011.

THE MARK CONSISTS OF STANDARD CHARACTERS WITHOUT CLAIM TO ANY PARTICULAR FONT, STYLE, SIZE, OR COLOR.

SER. NO. 85-342,401, FILED 6-9-2011.

RONALD DELGIZZI, EXAMINING ATTORNEY



*David J. Kyffers*

Director of the United States Patent and Trademark Office



# United States of America

United States Patent and Trademark Office



**Reg. No. 4,124,681**

**Registered Apr. 10, 2012**

**Int. Cl.: 9**

**TRADEMARK**

**PRINCIPAL REGISTER**

HDMI LICENSING, L.L.C. (DELAWARE LIMITED LIABILITY COMPANY)  
1140 EAST ARQUES AVENUE  
SUNNYVALE, CA 94085

FOR: CABLES, IN CLASS 9 (U.S. CLS. 21, 23, 26, 36 AND 38).

FIRST USE 11-18-2010; IN COMMERCE 11-18-2010.

OWNER OF U.S. REG. NOS. 3,268,924 AND 3,442,135.

NO CLAIM IS MADE TO THE EXCLUSIVE RIGHT TO USE "HIGH SPEED", APART FROM THE MARK AS SHOWN.

THE MARK CONSISTS OF A RECTANGLE CONTAINING THE WORDS "HDMI HIGH SPEED".

SER. NO. 85-342,751, FILED 6-9-2011.

PRISCILLA MILTON, EXAMINING ATTORNEY



*David J. Kyffers*

Director of the United States Patent and Trademark Office

# United States of America

United States Patent and Trademark Office



**Reg. No. 4,124,682**

**Registered Apr. 10, 2012**

**Int. Cl.: 9**

**TRADEMARK**

**PRINCIPAL REGISTER**

HDMI LICENSING, L.L.C. (DELAWARE LIMITED LIABILITY COMPANY)  
1140 EAST ARQUES AVENUE  
SUNNYVALE, CA 94085

FOR: CABLES, IN CLASS 9 (U.S. CLS. 21, 23, 26, 36 AND 38).

FIRST USE 11-18-2010; IN COMMERCE 11-18-2010.

OWNER OF U.S. REG. NOS. 3,268,924 AND 3,442,135.

NO CLAIM IS MADE TO THE EXCLUSIVE RIGHT TO USE "STANDARD", APART FROM THE MARK AS SHOWN.

THE MARK CONSISTS OF A RECTANGLE CONTAINING THE WORDS "HDMI STANDARD".

SER. NO. 85-342,758, FILED 6-9-2011.

PRISCILLA MILTON, EXAMINING ATTORNEY



*David J. Kyffers*

Director of the United States Patent and Trademark Office

# United States of America

United States Patent and Trademark Office

## A ROCKIN ICE

**Reg. No. 4,124,683**

**Registered Apr. 10, 2012**

**Int. Cl.: 30**

**TRADEMARK**

**PRINCIPAL REGISTER**

A ROCKIN ICE (CALIFORNIA PARTNERSHIP)  
8633 N W KNOLL DR. #205  
WEST HOLLYWOOD, CA 90069

FOR: SHAVED ICE AND SHAVED ICE BASED DESSERTS COMBINED WITH FLAVORED SYRUPS, FRUIT, NUTS CEREAL, CANDY, ICE CREAM, YOGURT AND SOY BASED PRODUCTS; ICE CREAM AND ICE CREAM BASED DESSERTS COMBINED WITH COOKIES, NUTS, CEREAL, FRUIT, CANDY AND SHAVED ICE; BEVERAGES MADE OF COFFEE; BEVERAGES MADE OF TEA; COFFEE FLAVORED SYRUP USED IN MAKING FOOD BEVERAGES AND SHAVED ICE DESSERTS; ICE BASED BEVERAGES COMBINED WITH FLAVORED SYRUPS; ICE CREAM BASED BEVERAGES COMBINED WITH FLAVORED SYRUPS; ICE BASED BEVERAGES COMBINED WITH ALCOHOL; SHAVED ICE AND SHAVED ICE BASED DESSERTS COMBINED WITH ALCOHOL; COFFEE FLAVORED SYRUPS USED IN MAKING FOOD BEVERAGES AND DESSERTS, IN CLASS 30 (U.S. CL. 46).

FIRST USE 10-1-2010; IN COMMERCE 5-27-2011.

THE MARK CONSISTS OF STANDARD CHARACTERS WITHOUT CLAIM TO ANY PARTICULAR FONT, STYLE, SIZE, OR COLOR.

NO CLAIM IS MADE TO THE EXCLUSIVE RIGHT TO USE "ICE", APART FROM THE MARK AS SHOWN.

SER. NO. 85-342,821, FILED 6-10-2011.

MARILYN IZZI, EXAMINING ATTORNEY



*David J. Kyros*

Director of the United States Patent and Trademark Office

# United States of America

United States Patent and Trademark Office

## Novi Galleries

**Reg. No. 4,124,684**

MAREFAT, MOHSEN (UNITED STATES INDIVIDUAL)  
2706 LOMA ST.

**Registered Apr. 10, 2012**

SILVER SPRING, MD 20902

**Int. Cl.: 14**

FOR: JEWELRY, IN CLASS 14 (U.S. CLS. 2, 27, 28 AND 50).

**TRADEMARK**

FIRST USE 3-21-2011; IN COMMERCE 5-1-2011.

**PRINCIPAL REGISTER**

THE MARK CONSISTS OF STANDARD CHARACTERS WITHOUT CLAIM TO ANY PARTICULAR FONT, STYLE, SIZE, OR COLOR.

NO CLAIM IS MADE TO THE EXCLUSIVE RIGHT TO USE "GALLERIES", APART FROM THE MARK AS SHOWN.

THE WORDING "NOVI" HAS NO MEANING IN A FOREIGN LANGUAGE.

SER. NO. 85-343,029, FILED 6-10-2011.

ALICE BENMAMAN, EXAMINING ATTORNEY



*David J. Kyffers*

Director of the United States Patent and Trademark Office

# United States of America

United States Patent and Trademark Office

## ROYAL OAK PEANUTS

**Reg. No. 4,124,685**

**Registered Apr. 10, 2012**

**Int. Cls.: 29 and 30**

**TRADEMARK**

**PRINCIPAL REGISTER**

ROYAL OAK PEANUTS, LLC (VIRGINIA LIMITED LIABILITY COMPANY)  
13009 CEDAR VIEW ROAD  
DREWRYVILLE, VA 23844

FOR: SHELLED, PROCESSED, FLAVORED AND CANDIED GOURMET NUTS CONSISTING OF JUMBO SALTED AND UNSALTED PEANUTS, REDSKIN PEANUTS, CRAB-FLAVORED PEANUTS, CAJUN-SPICED PEANUTS, JALEPENO-SPICED PEANUTS, SALTED-IN-THE-SHELL PEANUTS, CANDIED PEANUTS, BUTTER TOFFEE PEANUTS, HONEY ROASTED PEANUTS, AND SHELLED AND PROCESSED CASHEWS, IN CLASS 29 (U.S. CL. 46).

FIRST USE 3-28-2002; IN COMMERCE 10-28-2002.

FOR: SHELLED, PROCESSED AND FLAVORED CHOCOLATE COVERED PEANUTS, CHOCOLATE COVERED PEANUT BRITTLE, CHOCOLATE COVERED CASHEWS; PEANUT BRITTLE; PEANUT CLUSTER CANDY, NAMELY, A CONFECTION COMPRISED OF PEANUTS HELD TOGETHER WITH CORN SYRUP, SUGAR, SALT AND PEANUTS; AND CASHEW BRITTLE, IN CLASS 30 (U.S. CL. 46).

FIRST USE 3-28-2002; IN COMMERCE 10-28-2002.

THE MARK CONSISTS OF STANDARD CHARACTERS WITHOUT CLAIM TO ANY PARTICULAR FONT, STYLE, SIZE, OR COLOR.

NO CLAIM IS MADE TO THE EXCLUSIVE RIGHT TO USE "PEANUTS", APART FROM THE MARK AS SHOWN.

SER. NO. 85-343,081, FILED 6-10-2011.

PAUL E. FAHRENKOPF, EXAMINING ATTORNEY



*David J. Kyffers*

Director of the United States Patent and Trademark Office

# United States of America

United States Patent and Trademark Office



**Total  
Water**

Treatment Systems, Inc.

**Reg. No. 4,124,686**

**Registered Apr. 10, 2012**

**Int. Cls.: 11, 37 and 42**

**TRADEMARK**

**SERVICE MARK**

**PRINCIPAL REGISTER**

TOTAL WATER TREATMENT SYSTEMS, INC. (WISCONSIN CORPORATION)  
5002 WORLD DAIRY DRIVE  
MADISON, WI 53718

FOR: WATER TREATMENT EQUIPMENT FOR COMMERCIAL, INSTITUTIONAL OR INDUSTRIAL USE, NAMELY, ION EXCHANGE, DEIONIZATION, SEMICONDUCTOR, HEMODIALYSIS, STERILIZING, ULTRAVIOLET DISINFECTING AND REVERSE OSMOSIS FILTRATION UNITS; WATER CONDITIONING AND PURIFYING UNITS FOR COMMERCIAL, INSTITUTIONAL OR INDUSTRIAL USE, WHICH SOFTEN, RECYCLE, DEIONIZE OR FILTER WATER; WATER FILTERS FOR FILTERING WATER; WASTEWATER TREATMENT EQUIPMENT FOR COMMERCIAL, INSTITUTIONAL OR INDUSTRIAL USE, IN CLASS 11 (U.S. CLS. 13, 21, 23, 31 AND 34).

FIRST USE 9-1-2003; IN COMMERCE 9-1-2003.

FOR: INSTALLATION, SERVICE AND REPAIR OF WATER FILTERING AND TREATMENT UNITS FOR COMMERCIAL, INSTITUTIONAL OR INDUSTRIAL USE, IN CLASS 37 (U.S. CLS. 100, 103 AND 106).

FIRST USE 9-1-2003; IN COMMERCE 9-1-2003.

FOR: RESEARCH, SCIENTIFIC AND DEVELOPMENT SERVICES IN THE FIELD OF WATER TREATMENT AND WATER FILTRATION, IN CLASS 42 (U.S. CLS. 100 AND 101).

FIRST USE 9-1-2003; IN COMMERCE 9-1-2003.

NO CLAIM IS MADE TO THE EXCLUSIVE RIGHT TO USE "TOTAL WATER TREATMENT SYSTEMS, INC.", APART FROM THE MARK AS SHOWN.

THE MARK CONSISTS OF STYLIZED WAVES OF WATER FALLING DIAGONALLY FROM UPPER LEFT QUADRANT TO LOWER RIGHT QUADRANT OF THE MARK. THE STACKED WORDING "TOTAL WATER TREATMENT" IS TO THE LEFT OF THE DESIGN. THE WORDING "SYSTEMS, INC." IS TO THE RIGHT OF THE WORDING "TREATMENT" AND EXTENDS UNDER THE WATER DESIGN.

SER. NO. 85-343,353, FILED 6-10-2011.



*David J. Kyjars*

Director of the United States Patent and Trademark Office

**Reg. No. 4,124,686** PAULA MAHONEY, EXAMINING ATTORNEY

# United States of America

United States Patent and Trademark Office

**BIG  
BUS  
TOURS**

**Reg. No. 4,124,687**

**Registered Apr. 10, 2012**

**Int. Cl.: 39**

**SERVICE MARK**

**PRINCIPAL REGISTER**

THE BIG BUS COMPANY LIMITED (UNITED KINGDOM CORPORATION)  
GROSVENOR GARDENS HOUSE  
35/37 GROSVENOR GARDENS  
LONDON, UNITED KINGDOM SW1W0BS

FOR: BUS TRANSPORT SERVICES, SIGHTSEEING SERVICES, NAMELY, ORGANIZING AND CONDUCTING SIGHTSEEING TOURS; PROVIDING AND ARRANGING TOURS, TOURIST INFORMATION SERVICES, NAMELY, PROVIDING TRAVEL AND TOUR INFORMATION; RENTAL OF BUSES, IN CLASS 39 (U.S. CLS. 100 AND 105).

PRIORITY CLAIMED UNDER SEC. 44(D) ON ERPN CMNTY TM OFC APPLICATION NO. 009687146, FILED 1-26-2011, REG. NO. 9687146, DATED 7-5-2011, EXPIRES 1-26-2021.

OWNER OF U.S. REG. NO. 3,110,822.

NO CLAIM IS MADE TO THE EXCLUSIVE RIGHT TO USE "BUS TOURS", APART FROM THE MARK AS SHOWN.

THE MARK CONSISTS OF THE WORDING "BIG BUS TOURS" WITH A REPRESENTATION OF A BUS INSIDE THE "U" OF "BUS".

SER. NO. 85-343,509, FILED 6-10-2011.

MATTHEW EINSTEIN, EXAMINING ATTORNEY



*David J. Kybas*

Director of the United States Patent and Trademark Office



# United States of America

United States Patent and Trademark Office

## C-Nav Subscription Service

**Reg. No. 4,124,688**

C&C TECHNOLOGIES, INC. (LOUISIANA CORPORATION)  
730 EAST KALISTE SALOOM ROAD  
LAFAYETTE, LA 70508

**Registered Apr. 10, 2012**

**Int. Cl.: 39**

FOR: GPS NAVIGATION SERVICES PROVIDED BY GEOSTATIONARY COMMUNICATION SATELLITES, IN CLASS 39 (U.S. CLS. 100 AND 105).

**SERVICE MARK**

FIRST USE 12-31-2000; IN COMMERCE 12-31-2000.

**PRINCIPAL REGISTER**

THE MARK CONSISTS OF STANDARD CHARACTERS WITHOUT CLAIM TO ANY PARTICULAR FONT, STYLE, SIZE, OR COLOR.

OWNER OF U.S. REG. NOS. 3,168,556, 3,989,042, AND 3,992,776.

NO CLAIM IS MADE TO THE EXCLUSIVE RIGHT TO USE "SUBSCRIPTION SERVICE", APART FROM THE MARK AS SHOWN.

SER. NO. 85-343,608, FILED 6-10-2011.

STEPHANIE ALI, EXAMINING ATTORNEY



*David J. Kybas*

Director of the United States Patent and Trademark Office

# United States of America

United States Patent and Trademark Office

# Vendetta Red

**Reg. No. 4,124,689**

DAVIDSON, ZACHARY H. (UNITED STATES INDIVIDUAL)  
1622 E. VICTOR CT.  
VISALIA, CA 93292

**Registered Apr. 10, 2012**

**Int. Cl.: 9**

FOR: AUDIO AND VIDEO RECORDINGS FEATURING MUSIC AND ARTISTIC PERFORMANCES, IN CLASS 9 (U.S. CLS. 21, 23, 26, 36 AND 38).

**TRADEMARK**

FIRST USE 1-1-1998; IN COMMERCE 1-1-1998.

**PRINCIPAL REGISTER**

THE MARK CONSISTS OF STANDARD CHARACTERS WITHOUT CLAIM TO ANY PARTICULAR FONT, STYLE, SIZE, OR COLOR.

OWNER OF U.S. REG. NO. 2,659,064.

SER. NO. 85-343,889, FILED 6-11-2011.

PAULA MAHONEY, EXAMINING ATTORNEY



*David J. Kyffers*

Director of the United States Patent and Trademark Office

# United States of America

United States Patent and Trademark Office



**Reg. No. 4,124,690**

**Registered Apr. 10, 2012**

**Int. Cl.: 35**

**SERVICE MARK**

**PRINCIPAL REGISTER**

TRACY WELLS (UNITED STATES INDIVIDUAL), DBA THE WELLS COMPANY  
1018 E. WISHKAH #109  
ABERDEEN, WA 98520

FOR: ON-LINE RETAIL STORE SERVICES FEATURING CUSTOMIZABLE FORMS AND DOCUMENTS IN THE NATURE OF AN ONLINE MARKETPLACE FEATURING DOCUMENTS RANGING ACROSS A WIDE FIELD OF TOPICS FOR VIEWING, DOWNLOADING AND PRINTING, IN CLASS 35 (U.S. CLS. 100, 101 AND 102).

FIRST USE 6-11-2011; IN COMMERCE 6-11-2011.

THE MARK CONSISTS OF A BROWN AND WHITE COLOR RABBIT WITH BROWN COLOR BODY EXCEPT FOR THE COLOR WHITE ON ITS STOMACH, BOTTOM HALF OF ITS FACE AND TAIL, AND AS OUTLINE OF ITS FEET AND HANDS AND ON THE INSIDE OF ITS EYE, AND WHEREIN THE RABBIT HAS A BURGUNDY COLOR BOW AND BURGUNDY COLOR SCARF AND A TAN COLOR INNER EAR AND IS HOLDING GRAY COLORED DOCUMENTS. THE RABBIT IS OUTLINED IN THE COLOR BLACK, ITS EYEBALL IS IN THE COLOR BLACK AND THERE ARE BLACK COLOR ACCENT MARKS NEAR THE RABBIT'S EARS, SCARF, KNEE AND FOOT TO INDICATE MOTION AND SPEED.

THE COLOR(S) BROWN, WHITE, BURGUNDY, TAN, BLACK AND GRAY IS/ARE CLAIMED AS A FEATURE OF THE MARK.

SER. NO. 85-343,935, FILED 6-11-2011.

RONALD DELGIZZI, EXAMINING ATTORNEY



*David J. Kybas*

Director of the United States Patent and Trademark Office

# United States of America

United States Patent and Trademark Office

## THE FOUR FIRKINS

**Reg. No. 4,124,691**

**Registered Apr. 10, 2012**

**Int. Cl.: 35**

**SERVICE MARK**

**PRINCIPAL REGISTER**

THE FOUR FIRKINS - LAGERS, ALES & WINES LLC (MINNESOTA LIMITED LIABILITY COMPANY)  
3618 6TH STREET  
MINNEAPOLIS, MN 55412

FOR: RETAIL LIQUOR STORE SERVICES, IN CLASS 35 (U.S. CLS. 100, 101 AND 102).

FIRST USE 4-1-2008; IN COMMERCE 4-1-2008.

THE MARK CONSISTS OF STANDARD CHARACTERS WITHOUT CLAIM TO ANY PARTICULAR FONT, STYLE, SIZE, OR COLOR.

NO CLAIM IS MADE TO THE EXCLUSIVE RIGHT TO USE "FIRKINS", APART FROM THE MARK AS SHOWN.

SER. NO. 85-344,172, FILED 6-13-2011.

DEZMONA MIZELLE, EXAMINING ATTORNEY



*David J. Kyffers*

Director of the United States Patent and Trademark Office

# United States of America

United States Patent and Trademark Office



FLORIDA ORANGE GROVES  
**WINERY**  
Finally! Wines That Taste Good!

**Reg. No. 4,124,692**

FLORIDA ORANGE GROVES INC (FLORIDA CORPORATION)  
1500 PASADENA AVE S  
ST. PETERSBURG, FL 33707

**Registered Apr. 10, 2012**

**Int. Cl.: 40**

FOR: WINERY SERVICES, IN CLASS 40 (U.S. CLS. 100, 103 AND 106).

**SERVICE MARK**

FIRST USE 1-1-2011; IN COMMERCE 1-1-2011.

**PRINCIPAL REGISTER**

NO CLAIM IS MADE TO THE EXCLUSIVE RIGHT TO USE "FLORIDA ORANGE GROVES WINERY", APART FROM THE MARK AS SHOWN.

THE COLOR(S) RED AND BLACK IS/ARE CLAIMED AS A FEATURE OF THE MARK.

THE MARK CONSISTS OF A LADY IN A HAMMOCK HUNG FROM TWO PALM TREES HOLDING A GLASS OF WINE IN BLACK, BELOW IS THE WORDING "FLORIDA ORANGE GROVES" ON ONE LINE IN BLACK, BELOW IT THE WORD "WINERY" IN RED, AND BELOW IS THE PHRASE "FINALLY! WINES THAT TASTE GOOD!" IN BLACK. THE COLOR WHITE REPRESENTS BACKGROUND.

SER. NO. 85-344,486, FILED 6-13-2011.

CHERYL CLAYTON, EXAMINING ATTORNEY



*David J. Kybas*

Director of the United States Patent and Trademark Office

# United States of America

United States Patent and Trademark Office

# NAVILUX

**Reg. No. 4,124,693**

**Registered Apr. 10, 2012**

**Int. Cl.: 11**

**TRADEMARK**

**PRINCIPAL REGISTER**

MULE LIGHTING, INC. (RHODE ISLAND CORPORATION)  
46 BAKER STREET  
PROVIDENCE, RI 02905

FOR: LED (LIGHT EMITTING DIODE) LIGHTING FIXTURES; LED (LIGHT EMITTING DIODES) LIGHTING FIXTURES FOR USE IN DISPLAY, COMMERCIAL, INDUSTRIAL, RESIDENTIAL, AND ARCHITECTURAL ACCENT LIGHTING APPLICATIONS; LED AND HID LIGHT FIXTURES; LED LANDSCAPE LIGHTS; LED LIGHT BULBS; LED LIGHTING SYSTEMS, NAMELY, LED MODULES, POWER SUPPLIES, AND WIRING; LED LUMINAIRES, IN CLASS 11 (U.S. CLS. 13, 21, 23, 31 AND 34).

FIRST USE 1-15-2009; IN COMMERCE 1-15-2009.

THE MARK CONSISTS OF STANDARD CHARACTERS WITHOUT CLAIM TO ANY PARTICULAR FONT, STYLE, SIZE, OR COLOR.

SER. NO. 85-344,615, FILED 6-13-2011.

KEVIN CORWIN, EXAMINING ATTORNEY



*David J. Kyros*

Director of the United States Patent and Trademark Office

# United States of America

United States Patent and Trademark Office

# EZ-CUP

**Reg. No. 4,124,694**

RIVERA, ADRIAN (UNITED STATES INDIVIDUAL)  
14979 LODOSA DRIVE  
WHITTIER, CA 90605

**Registered Apr. 10, 2012**

**Int. Cl.: 11**

FOR: ELECTRIC COFFEE BREWER ACCESSORIES, NAMELY, A REUSABLE PLASTIC HOLDER FOR BREWING COFFEE BY HOLDING PAPER COFFEE FILTERS AND COFFEE FOR USE IN AN ELECTRIC COFFEE MACHINE, IN CLASS 11 (U.S. CLS. 13, 21, 23, 31 AND 34).

**TRADEMARK**

**PRINCIPAL REGISTER**

FIRST USE 1-31-2010; IN COMMERCE 1-31-2010.

THE MARK CONSISTS OF STANDARD CHARACTERS WITHOUT CLAIM TO ANY PARTICULAR FONT, STYLE, SIZE, OR COLOR.

SER. NO. 85-344,817, FILED 6-13-2011.

LEIGH LOWRY, EXAMINING ATTORNEY



*David J. Kyffers*

Director of the United States Patent and Trademark Office

# United States of America

United States Patent and Trademark Office

## AIRCRAFT ELECTRONICS ASSOCIATION

**Reg. No. 4,124,695**

AIRCRAFT ELECTRONICS ASSOCIATION, INC. (MISSOURI CORPORATION)  
3570 N. E. RALPH POWELL ROAD

**Registered Apr. 10, 2012**

LEE'S SUMMIT, MO 64064

**Int. Cl.: 35**

FOR: TRADE ASSOCIATION SERVICES, NAMELY, PROMOTING THE INTERESTS OF ITS MEMBERS IN THE GENERAL AVIATION ELECTRONICS INDUSTRY, IN CLASS 35 (U.S. CLS. 100, 101 AND 102).

**SERVICE MARK**

FIRST USE 4-1-1958; IN COMMERCE 4-1-1958.

**PRINCIPAL REGISTER**

THE MARK CONSISTS OF STANDARD CHARACTERS WITHOUT CLAIM TO ANY PARTICULAR FONT, STYLE, SIZE, OR COLOR.

NO CLAIM IS MADE TO THE EXCLUSIVE RIGHT TO USE "ASSOCIATION", APART FROM THE MARK AS SHOWN.

SEC. 2(F).

SER. NO. 85-345,357, FILED 6-14-2011.

CARYN GLASSER, EXAMINING ATTORNEY



*David J. Kyjars*

Director of the United States Patent and Trademark Office



# United States of America

United States Patent and Trademark Office

## Altitude MMA

**Reg. No. 4,124,696**

ALTITUDE ATHLETIC (COLORADO LIMITED LIABILITY COMPANY)  
529 ARRAWANNA ST  
COLORADO SPRINGS, CO 80909

**Registered Apr. 10, 2012**

**Int. Cl.: 41**

FOR: PROVIDING GENERAL FITNESS AND MIXED MARTIAL ARTS FACILITIES THAT REQUIRE MEMBERSHIPS AND ARE FOCUSED IN THE FIELDS OF GENERAL FITNESS, EXERCISE, AND MIXED MARTIAL ARTS, IN CLASS 41 (U.S. CLS. 100, 101 AND 107).

**SERVICE MARK**

FIRST USE 12-22-2010; IN COMMERCE 12-22-2010.

**PRINCIPAL REGISTER**

THE MARK CONSISTS OF STANDARD CHARACTERS WITHOUT CLAIM TO ANY PARTICULAR FONT, STYLE, SIZE, OR COLOR.

NO CLAIM IS MADE TO THE EXCLUSIVE RIGHT TO USE "MMA", APART FROM THE MARK AS SHOWN.

SER. NO. 85-345,450, FILED 6-14-2011.

BERYL GARDNER, EXAMINING ATTORNEY



*David J. Kyffers*

Director of the United States Patent and Trademark Office

# United States of America

United States Patent and Trademark Office

## FAIRY BERRIES

**Reg. No. 4,124,697**

FORTUNE PRODUCTS, INC. (WASHINGTON CORPORATION)  
2824-A OLD HARTFORD ROAD  
LAKE STEVENS, WA 98258

**Registered Apr. 10, 2012**

**Int. Cl.: 11**

FOR: LIGHTING FIXTURES, IN CLASS 11 (U.S. CLS. 13, 21, 23, 31 AND 34).

**TRADEMARK**

FIRST USE 10-1-2010; IN COMMERCE 1-26-2011.

**PRINCIPAL REGISTER**

THE MARK CONSISTS OF STANDARD CHARACTERS WITHOUT CLAIM TO ANY PARTICULAR FONT, STYLE, SIZE, OR COLOR.

SER. NO. 85-345,518, FILED 6-14-2011.

CHRISTINA SOBRAL, EXAMINING ATTORNEY



*David J. Kybas*

Director of the United States Patent and Trademark Office

# United States of America

United States Patent and Trademark Office

## ALSKY SOCIAL MARKETING FIRM

**Reg. No. 4,124,698**

**Registered Apr. 10, 2012**

**Int. Cl.: 35**

**SERVICE MARK**

**PRINCIPAL REGISTER**

FATOLA, BENJAMIN (UNITED STATES INDIVIDUAL)  
21364 E. PUMMELOS RD  
QUEEN CREEK, AZ 85142

FOR: ON-LINE ADVERTISING AND MARKETING SERVICES; ADVERTISING AND MARKETING SERVICES PROVIDED BY MEANS OF INDIRECT METHODS OF MARKETING COMMUNICATIONS, NAMELY, SOCIAL MEDIA, SEARCH ENGINE MARKETING, INQUIRY MARKETING, INTERNET MARKETING, MOBILE MARKETING, BLOGGING AND OTHER FORMS OF PASSIVE, SHARABLE OR VIRAL COMMUNICATIONS CHANNELS; CONSULTING SERVICES IN THE FIELD OF INTERNET MARKETING; MARKETING CONSULTING; DEVELOPMENT OF MARKETING STRATEGIES AND CONCEPTS, IN CLASS 35 (U.S. CLS. 100, 101 AND 102).

FIRST USE 5-23-2011; IN COMMERCE 5-23-2011.

THE MARK CONSISTS OF STANDARD CHARACTERS WITHOUT CLAIM TO ANY PARTICULAR FONT, STYLE, SIZE, OR COLOR.

NO CLAIM IS MADE TO THE EXCLUSIVE RIGHT TO USE "SOCIAL MARKETING FIRM", APART FROM THE MARK AS SHOWN.

SER. NO. 85-345,799, FILED 6-14-2011.

WILLIAM BRECKENFELD, EXAMINING ATTORNEY



*David J. Kypos*

Director of the United States Patent and Trademark Office

United States of America  
United States Patent and Trademark Office

C-NavC<sup>1</sup>

**Reg. No. 4,124,699**

C&C TECHNOLOGIES, INC. (LOUISIANA CORPORATION)  
730 EAST KALISTE SALOOM ROAD  
LAFAYETTE, LA 70508

**Registered Apr. 10, 2012**

**Int. Cl.: 39**

FOR: GPS NAVIGATION SERVICES PROVIDED BY GEOSTATIONARY COMMUNICATION SATELLITES, IN CLASS 39 (U.S. CLS. 100 AND 105).

**SERVICE MARK**

FIRST USE 5-31-2011; IN COMMERCE 5-31-2011.

**PRINCIPAL REGISTER**

OWNER OF U.S. REG. NOS. 3,168,556, 3,989,042, AND 3,992,776.

THE COLOR(S) BLUE IS/ARE CLAIMED AS A FEATURE OF THE MARK.

THE MARK CONSISTS OF THE WORD "C-NAVC" WITH A SUPERScript "1" AFTER THE SECOND "C", ALL IN BLUE LETTERS.

SER. NO. 85-346,182, FILED 6-14-2011.

STEPHANIE ALI, EXAMINING ATTORNEY



*David J. Kyffers*

Director of the United States Patent and Trademark Office

# United States of America

United States Patent and Trademark Office

# C-NavC<sup>2</sup>

**Reg. No. 4,124,700**

C&C TECHNOLOGIES, INC. (LOUISIANA CORPORATION)  
730 EAST KALISTE SALOOM ROAD  
LAFAYETTE, LA 70508

**Registered Apr. 10, 2012**

**Int. Cl.: 39**

FOR: GPS NAVIGATION SERVICES PROVIDED BY GEOSTATIONARY COMMUNICATION SATELLITES, IN CLASS 39 (U.S. CLS. 100 AND 105).

**SERVICE MARK**

FIRST USE 5-31-2011; IN COMMERCE 5-31-2011.

**PRINCIPAL REGISTER**

OWNER OF U.S. REG. NOS. 3,168,556, 3,989,042, AND 3,992,776.

THE COLOR(S) BLUE IS/ARE CLAIMED AS A FEATURE OF THE MARK.

THE MARK CONSISTS OF THE WORD "C-NAVC" WITH A SUPERScript "2" AFTER THE SECOND "C", ALL IN BLUE LETTERS.

SER. NO. 85-346,191, FILED 6-14-2011.

STEPHANIE ALI, EXAMINING ATTORNEY



*David J. Kybas*

Director of the United States Patent and Trademark Office

# United States of America

United States Patent and Trademark Office

# 33

**Reg. No. 4,124,701**

33 BOOKS CO. (OREGON SOLE PROPRIETORSHIP)  
925 NE 70TH AVE.

**Registered Apr. 10, 2012**

PORTLAND, OR 97213

**Int. Cl.: 16**

FOR: PRINTED MATERIALS, NAMELY, A SERIES OF EDUCATIONAL FILL-IN-THE-BLANK, NON-FICTION JOURNALS INCLUDING INFORMATION, SYSTEMS AND FORMS FOR RATING AND EVALUATION, AND NOTES ABOUT FOOD, DRINK AND OTHER CONSUMABLES, INCLUDING BEER, WINE, COFFEE, CIGARS, AND CHEESE, IN CLASS 16 (U.S. CLS. 2, 5, 22, 23, 29, 37, 38 AND 50).

**TRADEMARK**

**PRINCIPAL REGISTER**

FIRST USE 11-24-2009; IN COMMERCE 11-24-2009.

THE MARK CONSISTS OF STANDARD CHARACTERS WITHOUT CLAIM TO ANY PARTICULAR FONT, STYLE, SIZE, OR COLOR.

SER. NO. 85-346,193, FILED 6-14-2011.

CHARLOTTE CORWIN, EXAMINING ATTORNEY



*David J. Kybas*

Director of the United States Patent and Trademark Office

# United States of America

United States Patent and Trademark Office

# Hollybyte

**Reg. No. 4,124,702**

**Registered Apr. 10, 2012**

**Int. Cl.: 42**

**SERVICE MARK**

**PRINCIPAL REGISTER**

DIGITAL NOVAE MEDIA, S.L. (SPAIN SOCIEDAD DE RESPONSABILIDAD LIMITADA (SL))  
ALFONSO GÓMEZ, 19 - PISO 3  
MADRID, SPAIN 28037

FOR: APPLICATION SERVICE PROVIDER (ASP), NAMELY, HOSTING COMPUTER SOFTWARE APPLICATIONS OF OTHERS; PROVIDING TEMPORARY USE OF NON-DOWNLOADABLE SOFTWARE FOR THE LOADING, DOWNLOADING, UPLOADING, CAPTURING, PRESENTATION, SHOWING, EDITING, REPRODUCTION, BROADCAST, VIEW, PREVIEW, EXHIBITION, MARKING, EXCHANGE, MANAGING, DELIVERING, EDITION, PLAY OR SUPPLY OF ELECTRONIC MEDIA, MULTIMEDIA CONTENTS, VIDEOS, MOVIES, TABLES, IMAGES, TEXTS, PHOTOGRAPHS, GAMES, CONTENTS GENERATED BY THE USERS, AUDIO CONTENTS AND AUDIO INFORMATION THROUGH THE INTERNET AND OTHER COMPUTER AND COMMUNICATION NETWORKS; PROVIDING ON-LINE, NON-DOWNLOADABLE SOFTWARE FOR ALLOWING THE EXCHANGE OF MULTIMEDIA CONTENTS AND COMMENTS BETWEEN USERS; PROVIDING ON-LINE, NON-DOWNLOADABLE SOFTWARE FOR ALLOWING THE PROVIDERS OF CONTENTS TO MAINTAIN A TRACKING DOWN OF THE MULTIMEDIA CONTENTS; HOSTING OF MULTIMEDIA CONTENT FOR OTHERS; HOSTING OF ENTERTAINMENT MULTIMEDIA AND EDUCATIONAL CONTENT FOR OTHERS, IN CLASS 42 (U.S. CLS. 100 AND 101).

OWNER OF SPAIN REG. NO. 2897241, DATED 2-9-2010, EXPIRES 10-22-2019.

THE COLOR(S) BLACK AND BLUE IS/ARE CLAIMED AS A FEATURE OF THE MARK.

THE MARK CONSISTS OF THE LETTERING "HOLLY" IN BLACK ADJACENT THE LETTER "BYTE" IN BLUE, ADJACENT THREE SOLID CIRCLES IN BLUE ARRANGED IN A TRIANGLE.

SER. NO. 85-346,566, FILED 6-15-2011.

ALEX KEAM, EXAMINING ATTORNEY



*David J. Keam*

Director of the United States Patent and Trademark Office

# United States of America

United States Patent and Trademark Office

## CEO EVENTS

**Reg. No. 4,124,703**

**Registered Apr. 10, 2012**

**Int. Cl.: 35**

**SERVICE MARK**

**PRINCIPAL REGISTER**

LANGE, LTD. (COLORADO CORPORATION)  
2050 W. HURON ST.  
CHICAGO, IL 60612

FOR: SPECIAL EVENT PLANNING FOR BUSINESS PURPOSES; ARRANGING AND CONDUCTING SPECIAL EVENTS FOR BUSINESS PURPOSES; BUSINESS MEETING PLANNING; PROVIDING BUSINESS AND COMMERCIAL INFORMATION IN THE FIELD OF BUSINESS TRAVEL MANAGEMENT AND THE BUSINESS TRAVEL INDUSTRY, IN CLASS 35 (U.S. CLS. 100, 101 AND 102).

FIRST USE 6-1-2011; IN COMMERCE 6-1-2011.

THE MARK CONSISTS OF STANDARD CHARACTERS WITHOUT CLAIM TO ANY PARTICULAR FONT, STYLE, SIZE, OR COLOR.

NO CLAIM IS MADE TO THE EXCLUSIVE RIGHT TO USE "EVENTS", APART FROM THE MARK AS SHOWN.

SER. NO. 85-346,925, FILED 6-15-2011.

MATTHEW MCDOWELL, EXAMINING ATTORNEY



*David J. Kybas*

Director of the United States Patent and Trademark Office



# United States of America

United States Patent and Trademark Office



**Reg. No. 4,124,704**

**Registered Apr. 10, 2012**

**Int. Cl.: 39**

**SERVICE MARK**

**PRINCIPAL REGISTER**

THE MISSING PIECE FOUNDATION (ARIZONA CORPORATION)  
SUITE 12-243  
2820 N. PINAL AVENUE  
CASA GRANDE, AZ 85122

FOR: CHARITABLE SERVICES, NAMELY, ORGANIZING TOURS IN A SUPERCAR TO PROMOTE PUBLIC AWARENESS OF THE NEED TO USE NONTRADITIONAL TOOLS TO AID THOSE IN NEED, IN CLASS 39 (U.S. CLS. 100 AND 105).

FIRST USE 7-7-2007; IN COMMERCE 7-7-2007.

NO CLAIM IS MADE TO THE EXCLUSIVE RIGHT TO USE "GOOD", APART FROM THE MARK AS SHOWN.

THE MARK CONSISTS OF THE WORDING "MACHINESEVEN" AND "DRIVEN. FOR GOOD." AND A DESIGN TO THE LEFT OF THE WORDING THAT CONSISTS OF A STYLIZED "7" ENCOMPASSED IN A PARTIALLY SHADED CIRCLE WITH THE TOP PORTION OF THE STYLIZED "7" FORMING A ROAD LEADING TO THE RIGHT.

SER. NO. 85-347,062, FILED 6-15-2011.

CHRISTOPHER BUONGIORNO, EXAMINING ATTORNEY



*David J. Kyros*

Director of the United States Patent and Trademark Office

# United States of America

United States Patent and Trademark Office



**Reg. No. 4,124,705**

SHERMAN, DANIEL A (UNITED STATES INDIVIDUAL)  
48290 VISTA CALICO  
LA QUINTA, CA 92253

**Registered Apr. 10, 2012**

**Int. Cls.: 6, 13 and 22**

FOR: WILD ANIMAL TRAPS, IN CLASS 6 (U.S. CLS. 2, 12, 13, 14, 23, 25 AND 50).

FIRST USE 5-12-2011; IN COMMERCE 6-7-2011.

**TRADEMARK**

FOR: NET GUNS, IN CLASS 13 (U.S. CLS. 2 AND 9).

**PRINCIPAL REGISTER**

FIRST USE 5-12-2011; IN COMMERCE 6-7-2011.

FOR: NETS USED BY POLICE OR SECURITY FORCES IN RESTRAINING PEOPLE, IN CLASS 22 (U.S. CLS. 1, 2, 7, 19, 22, 42 AND 50).

FIRST USE 5-12-2011; IN COMMERCE 6-7-2011.

THE MARK CONSISTS OF THE DESIGN OF A BIRD TALON IN RED AND BLACK WITH WHITE OUTLINING APPEARING OVER THE DESIGN OF A SPIDER WEB IN WHITE, ORANGE AND BROWN WITHIN A BORDER OF TWO CONCENTRIC CIRCLES WHERE THE INNER CIRCLE IS WHITE AND THE OUTER CIRCLE IS RED. ALL OF THE AFOREMENTIONED APPEARS TO THE LEFT OF THE STYLIZED WORDING "SUPER" IN ORANGE AND RED WITH BLACK OUTLINING APPEARING OVER THE STYLIZED WORDING "TALON" IN RED AND ORANGE WITH BLACK OUTLINING APPEARING OVER THE STYLIZED WORDING "ULTRA" IN GOLD AND ORANGE WITH BLACK OUTLINING.

THE COLOR(S) RED, ORANGE, BLACK, GOLD, WHITE AND BROWN IS/ARE CLAIMED AS A FEATURE OF THE MARK.

SER. NO. 85-347,477, FILED 6-15-2011.

AMY C. KEAN, EXAMINING ATTORNEY



*David J. Kappas*

Director of the United States Patent and Trademark Office

# United States of America

United States Patent and Trademark Office

# PEPE DISCOS

**Reg. No. 4,124,706**

**Registered Apr. 10, 2012**

**Int. Cl.: 30**

**TRADEMARK**

**PRINCIPAL REGISTER**

DISCOS PEPE CORPORATION (NEW JERSEY CORPORATION)  
415 63RD STREET  
WEST NEW YORK, NJ 07093

FOR: DOUGH, IN CLASS 30 (U.S. CL. 46).

FIRST USE 0-0-1986; IN COMMERCE 0-0-1986.

THE MARK CONSISTS OF STANDARD CHARACTERS WITHOUT CLAIM TO ANY PARTICULAR FONT, STYLE, SIZE, OR COLOR.

NO CLAIM IS MADE TO THE EXCLUSIVE RIGHT TO USE "DISCOS", APART FROM THE MARK AS SHOWN.

THE ENGLISH TRANSLATION OF "DISCOS" IN THE MARK IS "DISCS".

SER. NO. 85-347,698, FILED 6-16-2011.

MATTHEW MCDOWELL, EXAMINING ATTORNEY



*David J. Kybas*

Director of the United States Patent and Trademark Office

# United States of America

United States Patent and Trademark Office

## UHI Worldwide

**Reg. No. 4,124,707**

ULTRA HEAT INCORPORATED (INDIANA CORPORATION), AKA UHI WORLDWIDE  
1314 PERKINS AVENUE  
ELKHART, IN 46516

**Registered Apr. 10, 2012**

**Int. Cl.: 11**

FOR: HEATING ELEMENTS; HEATING PADS NOT FOR MEDICAL PURPOSES, IN CLASS 11 (U.S. CLS. 13, 21, 23, 31 AND 34).

**TRADEMARK**

FIRST USE 0-0-2009; IN COMMERCE 0-0-2009.

**PRINCIPAL REGISTER**

THE MARK CONSISTS OF STANDARD CHARACTERS WITHOUT CLAIM TO ANY PARTICULAR FONT, STYLE, SIZE, OR COLOR.

OWNER OF U.S. REG. NO. 3,371,733.

NO CLAIM IS MADE TO THE EXCLUSIVE RIGHT TO USE "WORLDWIDE", APART FROM THE MARK AS SHOWN.

SER. NO. 85-347,736, FILED 6-16-2011.

BARBARA RUTLAND, EXAMINING ATTORNEY



*David J. Kyffers*

Director of the United States Patent and Trademark Office

# United States of America

United States Patent and Trademark Office

# TEXT ME TIX

**Reg. No. 4,124,708**

TEXT ME TIX LLC (UTAH LIMITED LIABILITY COMPANY)  
1616 TOMAHAWK DRIVE  
SALT LAKE CITY, UT 84103

**Registered Apr. 10, 2012**

**Int. Cl.: 41**

FOR: TICKET AGENCY SERVICES RENDERED ONLINE AND THROUGH MOBILE DEVICES FOR ENTERTAINMENT EVENTS, IN CLASS 41 (U.S. CLS. 100, 101 AND 107).

**SERVICE MARK**

FIRST USE 11-30-2010; IN COMMERCE 11-30-2010.

**PRINCIPAL REGISTER**

THE MARK CONSISTS OF STANDARD CHARACTERS WITHOUT CLAIM TO ANY PARTICULAR FONT, STYLE, SIZE, OR COLOR.

SER. NO. 85-347,854, FILED 6-16-2011.

WILLIAM P. SHANAHAN, EXAMINING ATTORNEY



*David J. Kybas*

Director of the United States Patent and Trademark Office

# United States of America

## United States Patent and Trademark Office



**Reg. No. 4,124,709**

**Registered Apr. 10, 2012**

**Int. Cl.: 43**

**SERVICE MARK**

**PRINCIPAL REGISTER**

PIPER'S KILT OF EASTCHESTER, INC. (NEW YORK CORPORATION)  
433 WHITE PLAINS ROAD  
EASTCHESTER, NY 10707

FOR: RESTAURANT AND BAR SERVICES, IN CLASS 43 (U.S. CLS. 100 AND 101).

FIRST USE 0-0-1964; IN COMMERCE 0-0-1964.

THE MARK CONSISTS OF A DANCING PIPER WEARING A KILT WHILE HOLDING A BURGER IN ONE HAND AND A MUG OF BEER IN THE OTHER HAND; THE PIPER'S HAT APPEARS IN THE COLORS BLACK, RED, AND GREEN; THE PIPER'S FACE APPEARS IN THE COLORS PEACH, BLACK, AND WHITE, THE BODY OF THE PIPER'S JACKET APPEARS IN THE COLOR GREEN AND HIS KILT IN RED AND BLACK, WITH THE ADORNMENTS ON THE JACKET AND KILT APPEARING IN THE COLORS YELLOW, BLACK, PURPLE, ORANGE, AND WHITE; THE PIPER'S LEGGINGS, SOCKS, AND SHOES APPEAR IN THE COLORS RED, BLACK, GREEN, AND WHITE; THE PIPER'S GLOVES ARE ORANGE; THE MUG OF BEER IN THE PIPER'S HAND APPEARS IN THE COLORS YELLOW, BLACK, AND WHITE; THE BURGER DESIGN IN THE PIPER'S OTHER HAND APPEAR IN THE COLORS PEACH AND BLACK.

THE COLOR(S) WHITE, BLACK, GREEN, RED, YELLOW, ORANGE, PEACH AND PURPLE IS/ARE CLAIMED AS A FEATURE OF THE MARK.

SER. NO. 85-348,121, FILED 6-16-2011.

KEVIN CORWIN, EXAMINING ATTORNEY



*David J. Kybas*

Director of the United States Patent and Trademark Office

# United States of America

United States Patent and Trademark Office



**Reg. No. 4,124,710**

**Registered Apr. 10, 2012**

**Int. Cl.: 39**

**SERVICE MARK**

**PRINCIPAL REGISTER**

PHOENIX INTERNATIONAL FREIGHT SERVICES, LTD. (ILLINOIS CORPORATION)  
1501 N. MITTEL BLVD., SUITE B  
WOOD DALE, IL 601911263

FOR: TRANSPORTATION OF GOODS BY WATER, IN CLASS 39 (U.S. CLS. 100 AND 105).

FIRST USE 12-0-2008; IN COMMERCE 12-0-2008.

OWNER OF U.S. REG. NO. 2,573,241.

NO CLAIM IS MADE TO THE EXCLUSIVE RIGHT TO USE "LINE" OR "OCEAN CONSOLIDATION SERVICES", APART FROM THE MARK AS SHOWN.

THE MARK CONSISTS OF THE WORDS "PIX LINE" IN LARGE TYPE OVER THE SMALLER WORDS "OCEAN CONSOLIDATION SERVICES," ALL WITHIN A BANNER SUPERIMPOSED OVER A GLOBE.

SER. NO. 85-348,279, FILED 6-16-2011.

CHARLOTTE CORWIN, EXAMINING ATTORNEY



*David J. Kyffers*

Director of the United States Patent and Trademark Office

# United States of America

United States Patent and Trademark Office

## QUINTESS BEYOND

**Reg. No. 4,124,711**

**Registered Apr. 10, 2012**

**Int. Cl.: 39**

**SERVICE MARK**

**PRINCIPAL REGISTER**

CLUB HOLDINGS, LLC (DELAWARE LIMITED LIABILITY COMPANY)  
SUITE 300  
11101 WEST 120TH AVENUE  
BROOMFIELD, CO 80021

FOR: MEMBERSHIP CLUB SERVICES, NAMELY, ORGANIZATION OF THEME-BASED EXCURSIONS, SIGHTSEEING TOURS, HOLIDAYS, TOURS AND TRAVEL AS PART OF CLUB MEMBERSHIPS THAT OFFER TEMPORARY LODGING ACCOMMODATIONS IN CLUB OWNED, LEASED, LICENSED, OPERATED OR SPONSORED VACATION RESIDENCES OR DESTINATION PROPERTIES; PROVIDING INFORMATION OVER THE INTERNET ABOUT THEME-BASED EXCURSIONS, SIGHTSEEING TOURS, HOLIDAYS, TOURS AND TRAVEL AS PART OF CLUB MEMBERSHIPS THAT OFFER TEMPORARY LODGING ACCOMMODATIONS IN CLUB OWNED, LEASED, LICENSED, OPERATED OR SPONSORED VACATION RESIDENCES OR DESTINATION PROPERTIES, IN CLASS 39 (U.S. CLS. 100 AND 105).

FIRST USE 6-9-2011; IN COMMERCE 6-9-2011.

THE MARK CONSISTS OF STANDARD CHARACTERS WITHOUT CLAIM TO ANY PARTICULAR FONT, STYLE, SIZE, OR COLOR.

OWNER OF U.S. REG. NOS. 3,122,187 AND 3,972,038.

THE WORDING "QUINTESS" HAS NO MEANING IN A FOREIGN LANGUAGE.

SER. NO. 85-348,339, FILED 6-16-2011.

BRIAN PINO, EXAMINING ATTORNEY



*David J. Kyffers*

Director of the United States Patent and Trademark Office



# United States of America

United States Patent and Trademark Office

## SAVVYCONNECT

**Reg. No. 4,124,712**

LUTH RESEARCH LLC (DELAWARE LIMITED LIABILITY COMPANY)  
1365 FOURTH AVENUE  
SAN DIEGO, CA 92101

**Registered Apr. 10, 2012**

**Int. Cls.: 35, 38 and 42**

FOR: COLLECTING THE RESULTS, DATA AND STATISTICS FROM MARKET RESEARCH, CONSULTING SERVICES, ONLINE SOCIAL NETWORKING AND INTERNET NAVIGATION FOR MEASURING, ANALYZING, UNDERSTANDING, REPORTING AND PREDICTING CONSUMER BEHAVIOR, CONSUMER CONFIDENCE, BRAND INTERACTION AND BUYING DECISIONS, IN CLASS 35 (U.S. CLS. 100, 101 AND 102).

**SERVICE MARK**

**PRINCIPAL REGISTER**

FIRST USE 5-31-2007; IN COMMERCE 5-31-2009.

FOR: TRANSMISSION VIA TELECOMMUNICATIONS NETWORKS OF DATABASE INFORMATION IN THE NATURE OF INTERNET NAVIGATION ACTIVITIES, ONLINE SOCIAL NETWORKING ACTIVITY, MESSAGES, AND WEBLOGS BY AND AMONG COMMUNITY MEMBERS OF A SOCIAL NETWORK, IN CLASS 38 (U.S. CLS. 100, 101 AND 104).

FIRST USE 5-31-2007; IN COMMERCE 5-31-2009.

FOR: HOSTING SOCIAL NETWORKS, NAMELY, INTERACTIVE HOSTING SERVICES WHICH ALLOW THE USER TO PUBLISH AND SHARE THEIR OWN CONTENT AND IMAGES ONLINE, IN CLASS 42 (U.S. CLS. 100 AND 101).

FIRST USE 5-31-2007; IN COMMERCE 5-31-2009.

THE MARK CONSISTS OF STANDARD CHARACTERS WITHOUT CLAIM TO ANY PARTICULAR FONT, STYLE, SIZE, OR COLOR.

SER. NO. 85-348,853, FILED 6-17-2011.

AISHA CLARKE, EXAMINING ATTORNEY



*David J. Kybas*

Director of the United States Patent and Trademark Office

# United States of America

United States Patent and Trademark Office

# VSAVVY

**Reg. No. 4,124,713**

**Registered Apr. 10, 2012**

**Int. Cls.: 35 and 42**

**SERVICE MARK**

**PRINCIPAL REGISTER**

LUTH RESEARCH LLC (DELAWARE LIMITED LIABILITY COMPANY)  
1365 FOURTH AVENUE  
SAN DIEGO, CA 92101

FOR: MARKET RESEARCH AND CONSULTING SERVICES, CONDUCTING MARKET RESEARCH SURVEYS AND COLLECTING, ANALYZING AND REPORTING DATA AND STATISTICS USING METHODS DESIGNED TO REDUCE AND ELIMINATE FALSE AND INACCURATE SURVEY DATA AND REDUCE THE POTENTIAL FOR FRAUDULENT SURVEY RESPONSES AND ABUSE OF THE MARKET RESEARCH PROCESS, IN CLASS 35 (U.S. CLS. 100, 101 AND 102).

FIRST USE 1-31-2008; IN COMMERCE 1-31-2008.

FOR: DEVELOPMENT OF INFORMATION TECHNOLOGY SYSTEMS USED TO PERFORM MARKET RESEARCH AND CONSULTING SERVICES. DESIGN AND DEVELOPMENT OF HARDWARE, SOFTWARE AND COMPUTER NETWORKS FOR USE IN MARKET RESEARCH TO REDUCE AND ELIMINATE FALSE AND INACCURATE SURVEY DATA AND REDUCE THE POTENTIAL FOR FRAUDULENT SURVEY RESPONSES AND ABUSE OF THE MARKET RESEARCH PROCESS, IN CLASS 42 (U.S. CLS. 100 AND 101).

FIRST USE 1-31-2008; IN COMMERCE 1-31-2008.

THE MARK CONSISTS OF STANDARD CHARACTERS WITHOUT CLAIM TO ANY PARTICULAR FONT, STYLE, SIZE, OR COLOR.

SER. NO. 85-348,884, FILED 6-17-2011.

AISHA CLARKE, EXAMINING ATTORNEY



*David J. Kyjars*

Director of the United States Patent and Trademark Office

# United States of America

United States Patent and Trademark Office



**Reg. No. 4,124,714**

SWEET DESIGNS CHOCOLATIER, INC. (OHIO CORPORATION)  
16100 DETROIT AVENUE  
LAKWOOD, OH 44107

**Registered Apr. 10, 2012**

**Int. Cl.: 30**

FOR: CHOCOLATE CONFECTIONS, IN CLASS 30 (U.S. CL. 46).

**TRADEMARK**

FIRST USE 12-1-1995; IN COMMERCE 12-1-1995.

**PRINCIPAL REGISTER**

NO CLAIM IS MADE TO THE EXCLUSIVE RIGHT TO USE "DELICIOUS CHOCOLATES & CANDY," "SWEET" AND "CHOCOLATIER", APART FROM THE MARK AS SHOWN.

THE COLOR(S) RED, BLACK, MAROON, WHITE IS/ARE CLAIMED AS A FEATURE OF THE MARK.

THE MARK CONSISTS OF THE TEXT "SWEET DESIGNS CHOCOLATIER" AND "DELICIOUS CHOCOLATES & CANDY." THERE IS A SMALL HEART IN THE FIRST "E" IN "SWEET". THE WORD "SWEET" IS RED, THE REST OF THE WORDS ARE BLACK. THE HEART IS MAROON. THE BACKGROUND IS WHITE.

SER. NO. 85-348,995, FILED 6-17-2011.

AMY ALFIERI, EXAMINING ATTORNEY



*David J. Kybas*

Director of the United States Patent and Trademark Office

# United States of America

United States Patent and Trademark Office

# MIXXiL

**Reg. No. 4,124,715**

EDGORE L. MILBERG (MASSACHUSETTS SOLE PROPRIETORSHIP), DBA MIXXIL LLC  
101 FEDERAL STREET  
BOSTON, MA 02110

**Registered Apr. 10, 2012**

**Int. Cl.: 9**

FOR: COMPUTER SEARCH ENGINE SOFTWARE, IN CLASS 9 (U.S. CLS. 21, 23, 26, 36 AND 38).

**TRADEMARK**

FIRST USE 1-19-2009; IN COMMERCE 1-19-2009.

**PRINCIPAL REGISTER**

THE MARK CONSISTS OF STANDARD CHARACTERS WITHOUT CLAIM TO ANY PARTICULAR FONT, STYLE, SIZE, OR COLOR.

SER. NO. 85-349,017, FILED 6-17-2011.

AMY ALFIERI, EXAMINING ATTORNEY



*David J. Kybas*

Director of the United States Patent and Trademark Office

# United States of America

United States Patent and Trademark Office

Babies live because you  
give

**Reg. No. 4,124,716**

ALICE & KERI INC (CALIFORNIA CORPORATION), DBA MILKIN' MAMAS  
PO BOX 7439

**Registered Apr. 10, 2012**

HUNTINGTON BEACH, CA 92615

**Int. Cl.: 35**

FOR: PROMOTING PUBLIC AWARENESS OF THE NEED FOR THE DONATION OF HUMAN  
BREAST MILK, IN CLASS 35 (U.S. CLS. 100, 101 AND 102).

**SERVICE MARK**

FIRST USE 0-0-2008; IN COMMERCE 0-0-2010.

**PRINCIPAL REGISTER**

THE MARK CONSISTS OF STANDARD CHARACTERS WITHOUT CLAIM TO ANY PAR-  
TICULAR FONT, STYLE, SIZE, OR COLOR.

SER. NO. 85-349,186, FILED 6-17-2011.

JENNIFER WILLISTON, EXAMINING ATTORNEY



*David J. Kybas*

Director of the United States Patent and Trademark Office

# United States of America

United States Patent and Trademark Office

## QUERER ES PODER

**Reg. No. 4,124,717**

MEREDITH CORPORATION (IOWA CORPORATION)  
1716 LOCUST STREET  
DES MOINES, IA 50309

**Registered Apr. 10, 2012**

**Int. Cl.: 41**

FOR: ENTERTAINMENT SERVICES, NAMELY, THE PROVISION OF CONTINUING NEWS SEGMENTS SHOWCASING WOMEN AND THEIR ACCOMPLISHMENTS OR LIFESTYLE CHANGES DELIVERED BY TELEVISION BROADCASTS AND THE INTERNET, IN CLASS 41 (U.S. CLS. 100, 101 AND 107).

**SERVICE MARK**

**PRINCIPAL REGISTER**

FIRST USE 6-10-2011; IN COMMERCE 6-10-2011.

THE MARK CONSISTS OF STANDARD CHARACTERS WITHOUT CLAIM TO ANY PARTICULAR FONT, STYLE, SIZE, OR COLOR.

THE ENGLISH TRANSLATION OF "QUERER ES PODER" IN THE MARK IS "WHERE THERE IS A WILL THERE IS A WAY".

SER. NO. 85-349,202, FILED 6-17-2011.

LINDA M. KING, EXAMINING ATTORNEY



*David J. Kybas*

Director of the United States Patent and Trademark Office

# United States of America

United States Patent and Trademark Office



**Reg. No. 4,124,718**

**Registered Apr. 10, 2012**

**Int. Cls.: 29 and 30**

**TRADEMARK**

**PRINCIPAL REGISTER**

DIPPERS FOOD BRANDS, LLC. (CALIFORNIA LIMITED LIABILITY COMPANY)  
710 SANDOVAL WAY  
HAYWARD, CA 94544

FOR: HIGH PROTEIN APPETIZERS, NAMELY, BREADED AND FRIED MEATS (CHICKEN, BEEF, PORK), IN CLASS 29 (U.S. CL. 46).

FIRST USE 6-1-2011; IN COMMERCE 6-1-2011.

FOR: MEAL KITS CONSISTING PRIMARILY OF NOODLES; FROZEN PREPARED ENTREES CONSISTING PRIMARILY OF PASTA OR RICE, IN CLASS 30 (U.S. CL. 46).

FIRST USE 6-1-2011; IN COMMERCE 6-1-2011.

THE MARK CONSISTS OF OVAL IMAGE IS RED WITH YELLOW ARCHED IMAGES THAT OUTLINE AND EMBELLISH RED OVAL. WITHIN RED OVAL IS "MEAT DIPPERS" TEXT. "MEATY" FONT COLOR IS YELLOW, HIGHLIGHTED BY WHITE ASTERISK & HIGHLIGHTS ON LETTERS IN "MEATY"; "MEATY" TEXT HAS FONT STYLE THAT IS SHADOWED IN BLACK. "DIPPERS" TEXT IS IN WHITE. BELOW RED OVAL IMAGE IS A RED RIBBON BANNER IMAGE THAT IS CENTERED ALONG THE OVAL AND OUTLINED IN YELLOW. AT LEFT & RIGHT ENDS OF RED RIBBON BANNER ARE TWO TEAR DROP IMAGES IN RED THAT ARE MIRRORED OF EACH OTHER. BELOW RED RIBBON BANNER IMAGE OUTLINED IN YELLOW IS TEXT "IT'S ALL ABOUT THE DIPPIN" IN RED FONT COLOR; OUTLINED & EMBOSSED IN FONT STYLE YELLOW COLOR.

THE COLOR(S) RED; YELLOW; WHITE; BLACK IS/ARE CLAIMED AS A FEATURE OF THE MARK.

SER. NO. 85-349,469, FILED 6-17-2011.

JACQUELINE A. LAVINE, EXAMINING ATTORNEY



*David J. Kybas*

Director of the United States Patent and Trademark Office

# United States of America

United States Patent and Trademark Office

## Palatine Oil Co., Inc.

**Reg. No. 4,124,719**

**Registered Apr. 10, 2012**

**Int. Cls.: 36 and 39**

**SERVICE MARK**

**PRINCIPAL REGISTER**

PALATINE OIL CO., INC. (ILLINOIS CORPORATION)  
900 NATIONAL PARKWAY  
SUITE 260  
SCHAUMBURG, IL 60173

FOR: CREDIT CARD AND PAYMENT CARD SERVICES FOR THE PURCHASE OF GASOLINE AND OTHER PETROLEUM PRODUCTS, IN CLASS 36 (U.S. CLS. 100, 101 AND 102).

FIRST USE 3-1-2011; IN COMMERCE 3-1-2011.

FOR: TRANSPORTATION, STORAGE AND DISTRIBUTION OF OILS AND FUELS, IN CLASS 39 (U.S. CLS. 100 AND 105).

FIRST USE 3-1-1972; IN COMMERCE 3-1-1972.

THE MARK CONSISTS OF STANDARD CHARACTERS WITHOUT CLAIM TO ANY PARTICULAR FONT, STYLE, SIZE, OR COLOR.

NO CLAIM IS MADE TO THE EXCLUSIVE RIGHT TO USE "OIL CO., INC.", APART FROM THE MARK AS SHOWN.

SER. NO. 85-349,620, FILED 6-17-2011.

STEPHANIE ALI, EXAMINING ATTORNEY



*David J. Kyjars*

Director of the United States Patent and Trademark Office



# United States of America

United States Patent and Trademark Office

# Piano Safari

**Reg. No. 4,124,720**

KNERR, JULIE (UNITED STATES INDIVIDUAL)  
1211 CADDELL LANE  
NORMAN, OK 73069 AND

**Registered Apr. 10, 2012**

**Int. Cl.: 16**

FISHER, KATHERINE LEIGH (UNITED STATES INDIVIDUAL)  
6539 MEADOWBROOK ROAD  
ALBANY, OH 45710

**TRADEMARK**

**PRINCIPAL REGISTER**

FOR: PRINTED EDUCATIONAL PUBLICATIONS, NAMELY, BOOKS AND FLASHCARDS  
IN THE FIELD OF MUSIC EDUCATION AND, PRINTED MUSIC SCORES, NAMELY, MUSIC  
SHEETS, IN CLASS 16 (U.S. CLS. 2, 5, 22, 23, 29, 37, 38 AND 50).

FIRST USE 12-1-2007; IN COMMERCE 1-8-2008.

THE MARK CONSISTS OF STANDARD CHARACTERS WITHOUT CLAIM TO ANY PAR-  
TICULAR FONT, STYLE, SIZE, OR COLOR.

NO CLAIM IS MADE TO THE EXCLUSIVE RIGHT TO USE "PIANO", APART FROM THE  
MARK AS SHOWN.

SER. NO. 85-349,875, FILED 6-18-2011.

DEZMONA MIZELLE, EXAMINING ATTORNEY



*David J. Kyffers*

Director of the United States Patent and Trademark Office

# United States of America

United States Patent and Trademark Office

## JAKE'S BAR · GRILL

**Reg. No. 4,124,721**

SEARS, JONATHAN (UNITED STATES INDIVIDUAL)  
1826 GREENE ST APT C  
COLUMBIA, SC 29201

**Registered Apr. 10, 2012**

**Int. Cl.: 43**

FOR: BAR AND RESTAURANT SERVICES, IN CLASS 43 (U.S. CLS. 100 AND 101).

**SERVICE MARK**

FIRST USE 1-5-1999; IN COMMERCE 1-5-1999.

**PRINCIPAL REGISTER**

THE MARK CONSISTS OF STANDARD CHARACTERS WITHOUT CLAIM TO ANY PARTICULAR FONT, STYLE, SIZE, OR COLOR.

NO CLAIM IS MADE TO THE EXCLUSIVE RIGHT TO USE "BAR" AND "GRILL", APART FROM THE MARK AS SHOWN.

SER. NO. 85-350,025, FILED 6-19-2011.

COURTNEY ALVAREZ, EXAMINING ATTORNEY



*David J. Kyffers*

Director of the United States Patent and Trademark Office

# United States of America

United States Patent and Trademark Office

# Karmin

**Reg. No. 4,124,722**

HEIDEMANN, AMY (UNITED STATES INDIVIDUAL)  
33 WINSLOW ROAD, #1  
BROOKLINE, MA 02446 AND

**Registered Apr. 10, 2012**

**Int. Cl.: 41**

NOONAN, NICK (UNITED STATES INDIVIDUAL)  
33 WINSLOW ROAD, #1  
BROOKLINE, MA 02446

**SERVICE MARK**

**PRINCIPAL REGISTER**

FOR: ENTERTAINMENT, NAMELY, LIVE PERFORMANCES BY A MUSICAL BAND;  
PROVIDING A WEBSITE FEATURING INFORMATION IN THE FIELD OF MUSIC AND  
ENTERTAINMENT, IN CLASS 41 (U.S. CLS. 100, 101 AND 107).

FIRST USE 11-1-2009; IN COMMERCE 11-1-2009.

THE MARK CONSISTS OF THE WORDS "KARMIN" WITH A CIRCLE OVER THE LETTER  
"I" DEPICTING A SUN.

SER. NO. 85-350,271, FILED 6-20-2011.

JANICE L. MCMORROW, EXAMINING ATTORNEY



*David J. Kybas*

Director of the United States Patent and Trademark Office

# United States of America

United States Patent and Trademark Office

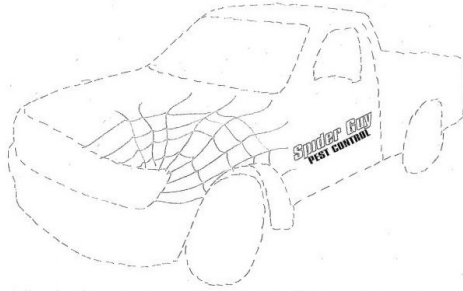

**Reg. No. 4,124,723**

**Registered Apr. 10, 2012**

**Int. Cl.: 37**

**SERVICE MARK**

**PRINCIPAL REGISTER**

SPIDER GUY, INC. (CALIFORNIA CORPORATION)  
4729 EAST OLIVE AVENUE  
FRESNO, CA 93702

FOR: PEST CONTROL SERVICES, IN CLASS 37 (U.S. CLS. 100, 103 AND 106).

FIRST USE 1-1-2000; IN COMMERCE 1-1-2000.

OWNER OF U.S. REG. NO. 3,893,937.

NO CLAIM IS MADE TO THE EXCLUSIVE RIGHT TO USE "PEST CONTROL", APART FROM THE MARK AS SHOWN.

THE MARK CONSISTS OF THE WORDS "SPIDER GUY PEST CONTROL" ALONG WITH SPIDER WEB DESIGNS ON AN AUTO VEHICLE WHICH MIMIC A FLAME DESIGN FOR AUTOMOBILE EXTERIORS. THE WORDS "SPIDER GUY PEST CONTROL" AND WEB DESIGNS ARE ON THE ON THE LEFT AND RIGHT FRONT OF THE AUTOMOBILE. THE AUTOMOBILE IS SHOWN IN DOTTED LINES FOR PLACEMENT AND NO CLAIM IS MADE THERETO.

SER. NO. 85-350,625, FILED 6-20-2011.

ALYSSA STEEL, EXAMINING ATTORNEY



*David J. Kyjars*

Director of the United States Patent and Trademark Office

# United States of America

United States Patent and Trademark Office

## YARDS BETTER. GARDENS BETTER.

**Reg. No. 4,124,724**

DALEN PRODUCTS, INC. (TENNESSEE CORPORATION)  
700 DALEN LANE  
KNOXVILLE, TN 37923

**Registered Apr. 10, 2012**

**Int. Cl.: 35**

FOR: CATALOG ORDERING SERVICE PROVIDED TO STORE OWNERS AND COMMERCIAL BUYERS AND FEATURING A WIDE VARIETY OF GARDEN, LANDSCAPING, AND TREE AND PLANT CARE PRODUCTS, IN CLASS 35 (U.S. CLS. 100, 101 AND 102).

**SERVICE MARK**

FIRST USE 3-1-2011; IN COMMERCE 3-1-2011.

**PRINCIPAL REGISTER**

THE MARK CONSISTS OF STANDARD CHARACTERS WITHOUT CLAIM TO ANY PARTICULAR FONT, STYLE, SIZE, OR COLOR.

SER. NO. 85-350,702, FILED 6-20-2011.

CHRIS WELLS, EXAMINING ATTORNEY



*David J. Kyffers*

Director of the United States Patent and Trademark Office

# United States of America

United States Patent and Trademark Office

## Aqua Terra Cultural Resource Consultants

**Reg. No. 4,124,725**

**Registered Apr. 10, 2012**

**Int. Cl.: 42**

**SERVICE MARK**

**PRINCIPAL REGISTER**

AQUA TERRA CULTURAL RESOURCE CONSULTANTS, LLC (WASHINGTON LIMITED LIABILITY COMPANY)  
5518 TROSPER LAKE STREET SW  
TUMWATER, WA 98512

FOR: ENVIRONMENTAL SERVICES, NAMELY, TECHNICAL CONSULTATION IN THE FIELD OF ENVIRONMENTAL SCIENCE; LAND SURVEYING; TECHNICAL SURVEYING; UNDERWATER EXPLORATION, IN CLASS 42 (U.S. CLS. 100 AND 101).

FIRST USE 6-9-2011; IN COMMERCE 6-9-2011.

THE MARK CONSISTS OF STANDARD CHARACTERS WITHOUT CLAIM TO ANY PARTICULAR FONT, STYLE, SIZE, OR COLOR.

NO CLAIM IS MADE TO THE EXCLUSIVE RIGHT TO USE "CULTURAL RESOURCE CONSULTANTS", APART FROM THE MARK AS SHOWN.

SER. NO. 85-350,807, FILED 6-20-2011.

STEVEN JACKSON, EXAMINING ATTORNEY



*David J. Kyffers*

Director of the United States Patent and Trademark Office

# United States of America

United States Patent and Trademark Office

# EarthMate

**Reg. No. 4,124,726**

BOYER, FRANKLIN C. (UNITED STATES INDIVIDUAL)  
25 POWERLINE ROAD  
BOYERTOWN, PA 19512

**Registered Apr. 10, 2012**

**Int. Cl.: 1**

FOR: COMPOST, IN CLASS 1 (U.S. CLS. 1, 5, 6, 10, 26 AND 46).

**TRADEMARK**

FIRST USE 2-20-1994; IN COMMERCE 2-20-1994.

**PRINCIPAL REGISTER**

THE MARK CONSISTS OF STANDARD CHARACTERS WITHOUT CLAIM TO ANY PARTICULAR FONT, STYLE, SIZE, OR COLOR.

SER. NO. 85-350,864, FILED 6-20-2011.

RONALD MCMORROW, EXAMINING ATTORNEY



*David J. Kybas*

Director of the United States Patent and Trademark Office

# United States of America

United States Patent and Trademark Office

# PowerLife

**Reg. No. 4,124,727**

HHC USA CORPORATION (DELAWARE CORPORATION)  
7210 DOMINION CIR.  
COMMERCE, CA 90040

**Registered Apr. 10, 2012**

**Int. Cl.: 20**

FOR: FURNITURE, NAMELY, MOTORIZED AND NON-MOTORIZED MOTION CHAIRS, TABLES AND BEDS, IN CLASS 20 (U.S. CLS. 2, 13, 22, 25, 32 AND 50).

**TRADEMARK**

FIRST USE 1-1-2008; IN COMMERCE 1-1-2008.

**PRINCIPAL REGISTER**

THE COLORS BLACK, WHITE, AND GRAY REPRESENT BACKGROUND, OUTLINING, SHADING AND/OR TRANSPARENT AREAS AND ARE NOT PART OF THE MARK

THE MARK CONSISTS OF THE LITERAL ELEMENT "POWERLIFE" WHERE ALL LETTERS ARE STYLIZED AND THE LETTER "P" AND "L" ARE IN CAPITAL CASE.

SER. NO. 85-350,885, FILED 6-20-2011.

DARRYL SPRUILL, EXAMINING ATTORNEY



*David J. Kybas*

Director of the United States Patent and Trademark Office



# United States of America

United States Patent and Trademark Office

# LACTORELIEF

**Reg. No. 4,124,728**

NATURE'S ONE, INC. (OHIO CORPORATION)  
8754 COTTER STREET  
LEWIS CENTER, OH 43035

**Registered Apr. 10, 2012**

**Int. Cl.: 5**

FOR: BABY FOOD; INFANT FORMULA, IN CLASS 5 (U.S. CLS. 6, 18, 44, 46, 51 AND 52).

**TRADEMARK**

FIRST USE 6-21-2011; IN COMMERCE 6-21-2011.

**PRINCIPAL REGISTER**

THE MARK CONSISTS OF STANDARD CHARACTERS WITHOUT CLAIM TO ANY PARTICULAR FONT, STYLE, SIZE, OR COLOR.

SER. NO. 85-351,509, FILED 6-21-2011.

TRACY CROSS, EXAMINING ATTORNEY



*David J. Kyffers*

Director of the United States Patent and Trademark Office

United States of America  
United States Patent and Trademark Office

# COMPREO

**Reg. No. 4,124,729**

TERUMO KABUSHIKI KAISHA (JAPAN CORPORATION), DBA TERUMO CORPORATION  
44-1, 2-CHOME, HATAGAYA  
SHIBUYA-KU, TOKYO, JAPAN

**Registered Apr. 10, 2012**

**Int. Cl.: 10**

FOR: MEDICAL APPARATUS AND INSTRUMENTS FOR INJECTING BONE CEMENT AND BONE FILLERS, AND PARTS AND FITTINGS THEREFOR; INJECTION INSTRUMENTS WITHOUT NEEDLES; INJECTION INSTRUMENTS WITH NEEDLES; INJECTION NEEDLES; NEEDLES FOR MEDICAL PURPOSES, IN CLASS 10 (U.S. CLS. 26, 39 AND 44).

**TRADEMARK**

**PRINCIPAL REGISTER**

THE MARK CONSISTS OF STANDARD CHARACTERS WITHOUT CLAIM TO ANY PARTICULAR FONT, STYLE, SIZE, OR COLOR.

OWNER OF JAPAN REG. NO. 5450395, DATED 11-11-2011, EXPIRES 11-11-2021.

THE WORDING "COMPREO" HAS NO MEANING IN A FOREIGN LANGUAGE.

SER. NO. 85-351,627, FILED 6-21-2011.

ELI HELLMAN, EXAMINING ATTORNEY



*David J. Kyros*

Director of the United States Patent and Trademark Office

# United States of America

United States Patent and Trademark Office

## DON SERVANDO

**Reg. No. 4,124,730**

**Registered Apr. 10, 2012**

**Int. Cl.: 33**

TEQUILERA ALZATI & MAGAÑA, S.A. DE C.V. (MEXICO SOCIEDAD ANONIMA DE CAPITAL VARIABLE (SA DE CV))  
NICOLAS PUGA 16, COL ARCOS SUR  
GUADALAJARA, JALISCO, MEXICO 44500

FOR: TEQUILA, IN CLASS 33 (U.S. CLS. 47 AND 49).

**TRADEMARK**

THE MARK CONSISTS OF STANDARD CHARACTERS WITHOUT CLAIM TO ANY PARTICULAR FONT, STYLE, SIZE, OR COLOR.

**PRINCIPAL REGISTER**

OWNER OF MEXICO REG. NO. 924124, DATED 3-13-2006, EXPIRES 2-10-2016.

THE NAME(S), PORTRAIT(S), AND/OR SIGNATURE(S) SHOWN IN THE MARK DOES NOT IDENTIFY A PARTICULAR LIVING INDIVIDUAL.

THE ENGLISH TRANSLATION OF "DON" IN THE MARK IS "MISTER".

SER. NO. 85-351,717, FILED 6-21-2011.

SHARON MEIER, EXAMINING ATTORNEY



*David J. Kyffers*

Director of the United States Patent and Trademark Office

# United States of America

United States Patent and Trademark Office



**Reg. No. 4,124,731**

**Registered Apr. 10, 2012**

**Int. Cl.: 34**

**TRADEMARK**

**PRINCIPAL REGISTER**

VINTAGE ROCKEFELLER CIGAR GROUP CORPORATION (NEW YORK CORPORATION)  
1010 NORTHERN BLVD, SUITE 240  
GREAT NECK, NY 11021

FOR: CIGARS, IN CLASS 34 (U.S. CLS. 2, 8, 9 AND 17).

FIRST USE 3-18-2011; IN COMMERCE 3-18-2011.

OWNER OF U.S. REG. NO. 4,007,416.

NO CLAIM IS MADE TO THE EXCLUSIVE RIGHT TO USE "CIGARS", "REPUBLICA" AND "DOMINICANA", APART FROM THE MARK AS SHOWN.

THE MARK CONSISTS OF A CIRCLE DESIGN WITH THE WORDS "ROCK-A-FELLER CIGARS" AROUND THE PERIMETER OF THE CIRCLE, AND LARGE "R" INSIDE THE CIRCLE, TWO REARING HORSES ON EITHER SIDE STANDING ON RIBBONS THAT SAY "REPUBLICA DOMINICANA" AND TOBACCO LEAVES AT THE BOTTOM OF THE CIRCLE.

THE ENGLISH TRANSLATION OF "REPUBLICA DOMINICANA" IN THE MARK IS "DOMINICAN REPUBLIC".

SER. NO. 85-351,850, FILED 6-21-2011.

ANTHONY RINKER, EXAMINING ATTORNEY



*David J. Kybas*

Director of the United States Patent and Trademark Office

# United States of America

United States Patent and Trademark Office

# NANOLOGIX

**Reg. No. 4,124,732**

NANOLOGIX, INC. (DELAWARE CORPORATION)  
843 NORTH MAIN STREET  
HUBBARD, OH 44425

**Registered Apr. 10, 2012**

**Int. Cl.: 10**

FOR: MEDICAL APPARATUS AND INSTRUMENT FOR DIAGNOSTIC USE, NAMELY, APPARATUS FOR MEDICAL DIAGNOSTIC TESTING IN THE FIELDS OF CANCER OR OTHER TISSUE-BASED DIAGNOSTIC TESTING, CYTOLOGY AND CELL-BASED TESTING, IN CLASS 10 (U.S. CLS. 26, 39 AND 44).

**TRADEMARK**

**PRINCIPAL REGISTER**

FIRST USE 4-7-2005; IN COMMERCE 4-7-2005.

THE MARK CONSISTS OF STANDARD CHARACTERS WITHOUT CLAIM TO ANY PARTICULAR FONT, STYLE, SIZE, OR COLOR.

SER. NO. 85-351,991, FILED 6-21-2011.

RENEE MCCRAY, EXAMINING ATTORNEY



*David J. Kyffers*

Director of the United States Patent and Trademark Office

# United States of America

United States Patent and Trademark Office

*Babette*

**Reg. No. 4,124,733**

**Registered Apr. 10, 2012**

**Int. Cl.: 25**

**TRADEMARK**

**PRINCIPAL REGISTER**

BABETTE, INC. (CALIFORNIA CORPORATION)  
867 ISABELLA STREET  
OAKLAND, CA 94607

FOR: WOMEN'S CLOTHING, NAMELY, BLOUSES, SHIRTS, TANK-TOPS, SWEATERS, TROUSERS, JEANS, PANTS, SKIRTS, DRESSES, SUITS, SCARVES, COATS, JACKETS, RAINCOATS, TEE SHIRTS, SOCKS; SHOES, IN CLASS 25 (U.S. CLS. 22 AND 39).

FIRST USE 12-31-2010; IN COMMERCE 12-31-2010.

OWNER OF U.S. REG. NOS. 2,740,006, 2,964,358, AND 3,728,287.

THE MARK CONSISTS OF THE LITERAL ELEMENT "BABETTE" IN A STYLIZED SCRIPT.

SER. NO. 85-352,075, FILED 6-21-2011.

TRACY CROSS, EXAMINING ATTORNEY



*David J. Kybas*

Director of the United States Patent and Trademark Office

# United States of America

United States Patent and Trademark Office

# Wendy Wild

**Reg. No. 4,124,734**

WENDY ZILBER (UNITED STATES INDIVIDUAL)  
PO BOX 150189

**Registered Apr. 10, 2012**

KEW GARDENS, NY 114150189

**Int. Cl.: 41**

FOR: ENTERTAINMENT IN THE NATURE OF LIVE RADIO PERSONALITY PERFORMANCES; RADIO ENTERTAINMENT SERVICES, NAMELY, RADIO PROGRAMS FEATURING PERFORMANCES BY A RADIO PERSONALITY; ON-LINE JOURNALS, NAMELY, BLOGS FEATURING STYLE AND LIFE, MAKEUP AND BEAUTY, FASHION, CELEBRITY GOSSIP, ENTERTAINMENT NEWS, AND ARTICLES ABOUT DIGITAL AND SOCIAL MEDIA; ENTERTAINMENT SERVICES, NAMELY, PERSONAL APPEARANCES BY A DIGITAL AND SOCIAL MEDIA ENTERTAINMENT PERSONALITY; ENTERTAINMENT SERVICES, NAMELY, PERSONAL APPEARANCES BY A RADIO PERSONALITY; ENTERTAINMENT SERVICES IN THE NATURE OF PRESENTING LIVE MUSICAL PERFORMANCES, IN CLASS 41 (U.S. CLS. 100, 101 AND 107).

**SERVICE MARK**

**PRINCIPAL REGISTER**

FIRST USE 11-1-1999; IN COMMERCE 5-25-2003.

THE MARK CONSISTS OF STANDARD CHARACTERS WITHOUT CLAIM TO ANY PARTICULAR FONT, STYLE, SIZE, OR COLOR.

THE NAME(S), PORTRAIT(S), AND/OR SIGNATURE(S) SHOWN IN THE MARK IDENTIFIES WENDY ZILBER, WHOSE CONSENT(S) TO REGISTER IS MADE OF RECORD.

SER. NO. 85-352,328, FILED 6-21-2011.

CYNTHIA TRIPI, EXAMINING ATTORNEY



*David J. Kyros*

Director of the United States Patent and Trademark Office

# United States of America

United States Patent and Trademark Office

## MARCUS SINGLETARY

**Reg. No. 4,124,735**

**Registered Apr. 10, 2012**

**Int. Cl.: 41**

**SERVICE MARK**

**PRINCIPAL REGISTER**

SINGLETARY, MARCUS R. (UNITED STATES INDIVIDUAL), DBA SINGLETARY, MARCUS R.  
12021 WILSHIRE BOULEVARD, SUITE 319  
LOS ANGELES, CA 90025

FOR: ENTERTAINMENT IN THE NATURE OF AUDIO AND VISUAL PERFORMANCES BY A LIVE MUSICAL PERFORMER, ACTOR, AND MUSICAL ARTIST; ENTERTAINMENT, NAMELY, LIVE MUSIC CONCERTS; ENTERTAINMENT, NAMELY, PERSONAL APPEARANCES BY AN ACTOR, CELEBRITY, MUSICIAN, AND PUBLIC FIGURE; ENTERTAINMENT SERVICES, NAMELY, PROVIDING A WEB SITE FEATURING MUSICAL PERFORMANCES, MUSICAL VIDEOS, RELATED FILM AND TELEVISION CLIPS, PHOTOGRAPHS, AND OTHER MULTIMEDIA MATERIALS FEATURING ENTERTAINMENT; ENTERTAINMENT SERVICES, NAMELY, PROVIDING NON-DOWNLOADABLE PRERECORDED MUSIC AND INFORMATION IN THE FIELDS OF MUSIC, POP CULTURE, SPORTS, AND ENTERTAINMENT; ENTERTAINMENT SERVICES, NAMELY, PROVIDING NON-DOWNLOADABLE PRERECORDED MUSIC, INFORMATION IN THE FIELD OF MUSIC ENTERTAINMENT, SPORTS, AND POP CULTURE, AND COMMENTARY AND ARTICLES ABOUT MUSIC, ALL ON-LINE VIA A GLOBAL COMPUTER NETWORK, IN CLASS 41 (U.S. CLS. 100, 101 AND 107).

FIRST USE 1-1-2004; IN COMMERCE 1-1-2006.

THE MARK CONSISTS OF STANDARD CHARACTERS WITHOUT CLAIM TO ANY PARTICULAR FONT, STYLE, SIZE, OR COLOR.

THE NAME "MARCUS SINGLETARY" IDENTIFIES A LIVING INDIVIDUAL WHOSE CONSENT IS OF RECORD.

SER. NO. 85-352,456, FILED 6-22-2011.

GEOFFREY FOSDICK, EXAMINING ATTORNEY



*David J. Kypos*

Director of the United States Patent and Trademark Office



# United States of America

United States Patent and Trademark Office

## YUCONNECTS

**Reg. No. 4,124,736**

**Registered Apr. 10, 2012**

**Int. Cls.: 41 and 45**

**SERVICE MARK**

**PRINCIPAL REGISTER**

YESHIVA UNIVERSITY (NEW YORK NOT-FOR-PROFIT CORPORATION)  
500 WEST 185TH STREET  
NEW YORK, NY 100333201

FOR: EDUCATION AND ENTERTAINMENT SERVICES, NAMELY, PROVIDING COURSES OF INSTRUCTION AT THE PROFESSIONAL LEVELS IN THE FIELDS OF RELATIONSHIPS, DATING AND MARRIAGE; TEACHING AND COMMUNITY EDUCATION PROGRAMS, NAMELY, CONDUCTING SEMINARS, WORKSHOPS, LECTURES, MENTORING, SPEAKER SERIES IN THE FIELDS OF RELATIONSHIPS, DATING AND MARRIAGE; SOCIAL CLUB FOR JEWISH SINGLE ADULTS, NAMELY, ARRANGING, ORGANIZING, AND HOSTING SOCIAL EVENTS, GET-TOGETHERS, AND PARTIES FOR CLUB MEMBERS, IN CLASS 41 (U.S. CLS. 100, 101 AND 107).

FIRST USE 1-31-2008; IN COMMERCE 1-31-2008.

FOR: ON-LINE SOCIAL NETWORKING SERVICES; JEWISH COMPUTER DATING SERVICES PROVIDED ONLINE THAT WILL ALLOW MATCHMAKERS TO SET-UP THEIR OWN PRIVATE NETWORK OF MEMBERS AND FACILITATE THE INTRODUCTION OF INDIVIDUALS; DATING CLUB SERVICES FOR JEWISH SINGLE ADULTS, IN CLASS 45 (U.S. CLS. 100 AND 101).

FIRST USE 1-31-2008; IN COMMERCE 1-31-2008.

THE MARK CONSISTS OF STANDARD CHARACTERS WITHOUT CLAIM TO ANY PARTICULAR FONT, STYLE, SIZE, OR COLOR.

OWNER OF U.S. REG. NOS. 2,930,309, 3,757,479 AND OTHERS.

SER. NO. 85-352,625, FILED 6-22-2011.

SIMON TENG, EXAMINING ATTORNEY



*David J. Kyjars*

Director of the United States Patent and Trademark Office

# United States of America

United States Patent and Trademark Office



**Reg. No. 4,124,737**

**Registered Apr. 10, 2012**

**Int. Cl.: 43**

**SERVICE MARK**

**PRINCIPAL REGISTER**

BANCHETTO CORPORATION (NEW YORK CORPORATION)  
145 NORTH AVENUE  
PARK RIDGE, NJ 07656

FOR: BAR AND RESTAURANT SERVICES; RESTAURANT; RESTAURANT AND BAR SERVICES; RESTAURANT AND BAR SERVICES, INCLUDING RESTAURANT CARRYOUT SERVICES; RESTAURANT SERVICES; RESTAURANT SERVICES FEATURING ITALIAN AND AMERICAN CUISINE; RESTAURANT SERVICES, INCLUDING SIT-DOWN SERVICE OF FOOD AND TAKE-OUT RESTAURANT SERVICES; RESTAURANT SERVICES, NAMELY, PROVIDING OF FOOD AND BEVERAGES FOR CONSUMPTION ON AND OFF THE PREMISES; RESTAURANT, BAR AND CATERING SERVICES; RESTAURANTS, IN CLASS 43 (U.S. CLS. 100 AND 101).

FIRST USE 3-11-2005; IN COMMERCE 3-11-2005.

NO CLAIM IS MADE TO THE EXCLUSIVE RIGHT TO USE "FEAST" OR "ITALIAN GOURMET", APART FROM THE MARK AS SHOWN.

THE MARK CONSISTS OF THE DESIGN OF A KNIFE AND FORK, SUPERIMPOSED BY THE STYLIZED LETTERS "BF", ALL INSIDE A CIRCLE THAT HAS AN OUTER FILLED BORDER CONTAINING THE STYLIZED WORDINGS "BANCHETTO FEAST" AND "ITALIAN GOURMET!".

THE ENGLISH TRANSLATION OF THE WORD "BANCHETTO" IN THE MARK IS "BANQUET" OR "FEAST".

SER. NO. 85-352,647, FILED 6-22-2011.

DAWN HAN, EXAMINING ATTORNEY



*David J. Kybas*

Director of the United States Patent and Trademark Office

# United States of America

United States Patent and Trademark Office

## Banchetto Feast

**Reg. No. 4,124,738**

**Registered Apr. 10, 2012**

**Int. Cl.: 43**

**SERVICE MARK**

**PRINCIPAL REGISTER**

BANCHETTO CORPORATION (NEW YORK CORPORATION)  
145 NORTH AVENUE  
PARK RIDGE, NJ 07656

FOR: BAR AND RESTAURANT SERVICES; RESTAURANT; RESTAURANT AND BAR SERVICES; RESTAURANT AND BAR SERVICES, INCLUDING RESTAURANT CARRYOUT SERVICES; RESTAURANT SERVICES; RESTAURANT SERVICES FEATURING ITALIAN AND AMERICAN CUISINE; RESTAURANT SERVICES, INCLUDING SIT-DOWN SERVICE OF FOOD AND TAKE-OUT RESTAURANT SERVICES; RESTAURANT SERVICES, NAMELY, PROVIDING OF FOOD AND BEVERAGES FOR CONSUMPTION ON AND OFF THE PREMISES; RESTAURANT, BAR AND CATERING SERVICES; RESTAURANTS, IN CLASS 43 (U.S. CLS. 100 AND 101).

FIRST USE 3-11-2005; IN COMMERCE 3-11-2005.

THE MARK CONSISTS OF STANDARD CHARACTERS WITHOUT CLAIM TO ANY PARTICULAR FONT, STYLE, SIZE, OR COLOR.

NO CLAIM IS MADE TO THE EXCLUSIVE RIGHT TO USE "FEAST", APART FROM THE MARK AS SHOWN.

THE ENGLISH TRANSLATION OF THE WORD "BANCHETTO" IN THE MARK IS "BANQUET" OR "FEAST".

SER. NO. 85-352,669, FILED 6-22-2011.

DAWN HAN, EXAMINING ATTORNEY



*David J. Kyffers*

Director of the United States Patent and Trademark Office

# United States of America

United States Patent and Trademark Office

## TRACKMYVEG

**Reg. No. 4,124,739**

RIVER RANCH FRESH FOODS, LLC (CALIFORNIA LIMITED LIABILITY COMPANY)  
1156 ABBOTT STREET  
SALINAS, CA 93901

**Registered Apr. 10, 2012**

**Int. Cl.: 43**

FOR: PROVIDING INFORMATION IN THE NATURE OF A DATABASE IN THE FIELD OF VEGETABLE RECIPES AND COOKING INFORMATION, IN CLASS 43 (U.S. CLS. 100 AND 101).

**SERVICE MARK**

FIRST USE 10-10-2011; IN COMMERCE 10-10-2011.

**PRINCIPAL REGISTER**

THE MARK CONSISTS OF STANDARD CHARACTERS WITHOUT CLAIM TO ANY PARTICULAR FONT, STYLE, SIZE, OR COLOR.

SER. NO. 85-352,831, FILED 6-22-2011.

JESSICA A. POWERS, EXAMINING ATTORNEY



*David J. Kybas*

Director of the United States Patent and Trademark Office

# United States of America

United States Patent and Trademark Office



**Reg. No. 4,124,740**

**Registered Apr. 10, 2012**

**Int. Cl.: 43**

**SERVICE MARK**

**PRINCIPAL REGISTER**

FILLMORE LC HOLDINGS I, LLC (DELAWARE LIMITED LIABILITY COMPANY)  
100 FILLMORE STREET, SUITE 600  
DENVER, CO 80206

FOR: PROVIDING COMMUNITY CENTERS FOR SOCIAL GATHERINGS AND MEETINGS; PROVIDING CONFERENCE ROOMS; PROVISION OF CONFERENCE FACILITIES; PROVISION OF CONFERENCE, EXHIBITION AND MEETING FACILITIES, IN CLASS 43 (U.S. CLS. 100 AND 101).

FIRST USE 3-1-2011; IN COMMERCE 4-1-2011.

OWNER OF U.S. REG. NOS. 2,606,707, 3,306,870 AND OTHERS.

NO CLAIM IS MADE TO THE EXCLUSIVE RIGHT TO USE "EVENTS CENTER", APART FROM THE MARK AS SHOWN.

THE MARK CONSISTS OF THE WORDING "LA COSTA COASTAL EVENTS CENTER" AND THE DESIGN OF A TRIANGLE.

THE ENGLISH TRANSLATION OF "LA COSTA" IN THE MARK IS "THE COAST".

SER. NO. 85-353,553, FILED 6-22-2011.

MARGARET POWER, EXAMINING ATTORNEY



*David J. Kyffers*

Director of the United States Patent and Trademark Office

# United States of America

United States Patent and Trademark Office

# SHE SAVED

**Reg. No. 4,124,741**

KERI LYN SHOSTED (UNITED STATES INDIVIDUAL)  
4000 N BROOKSIDE LN  
BOISE, ID 83714

**Registered Apr. 10, 2012**

**Int. Cl.: 41**

FOR: PROVIDING A LIFESTYLE BLOG RELATING TO COST SAVINGS IN THE FIELD OF FRUGAL LIVING, IN CLASS 41 (U.S. CLS. 100, 101 AND 107).

**SERVICE MARK**

FIRST USE 9-15-2008; IN COMMERCE 9-15-2008.

**PRINCIPAL REGISTER**

THE MARK CONSISTS OF STANDARD CHARACTERS WITHOUT CLAIM TO ANY PARTICULAR FONT, STYLE, SIZE, OR COLOR.

SER. NO. 85-353,566, FILED 6-22-2011.

MICHELE SWAIN, EXAMINING ATTORNEY



*David J. Kyffers*

Director of the United States Patent and Trademark Office

# United States of America

United States Patent and Trademark Office

## Grand Vin



**Reg. No. 4,124,742**

**Registered Apr. 10, 2012**

**Int. Cl.: 39**

**SERVICE MARK**

**PRINCIPAL REGISTER**

REPUBLIC NATIONAL DISTRIBUTING COMPANY, LLC (DELAWARE LIMITED LIABILITY COMPANY)  
ONE NATIONAL DRIVE, S.W.  
ATLANTA, GA 30336

FOR: WINE AND BEVERAGE DELIVERY AND DISTRIBUTION SERVICES, IN CLASS 39 (U.S. CLS. 100 AND 105).

FIRST USE 10-1-1985; IN COMMERCE 10-1-1985.

OWNER OF U.S. REG. NO. 3,048,766.

NO CLAIM IS MADE TO THE EXCLUSIVE RIGHT TO USE "GRAND VIN", APART FROM THE MARK AS SHOWN.

THE MARK CONSISTS OF A CLUSTER OF GRAPES WITH TWO LEAVES AND WITH THE WORDS "GRAND VIN" ABOVE THE CLUSTER OF GRAPES.

THE ENGLISH TRANSLATION OF "GRAND VIN" IN THE MARK IS BIG WINE.

SER. NO. 85-353,754, FILED 6-23-2011.

TEJBIR SINGH, EXAMINING ATTORNEY



*David J. Kybas*

Director of the United States Patent and Trademark Office

# United States of America

United States Patent and Trademark Office

ACCIDENTAL INVESTING. IT'S  
NOT ALWAYS THIS OBVIOUS.

**Reg. No. 4,124,743**

INVESCO HOLDING COMPANY LIMITED (UNITED KINGDOM COMPANY)  
1555 PEACHTREE STREET NE  
ATLANTA, GA 30309

**Registered Apr. 10, 2012**

**Int. Cl.: 36**

**SERVICE MARK**

**PRINCIPAL REGISTER**

FOR: FINANCIAL AND INVESTMENT SERVICES, NAMELY, MANAGEMENT AND BROKERAGE IN THE FIELDS OF STOCKS, BONDS, OPTIONS, COMMODITIES, FUTURES AND OTHER SECURITIES, AND INVESTMENT OF FUNDS OF OTHERS; TRANSFER AGENCY SERVICES RENDERED TO ISSUERS OF INVESTMENT SECURITIES; FINANCIAL ANALYSIS, MANAGEMENT, CONSULTING AND ADVISORY SERVICES; FUND INVESTMENT; FINANCIAL ACCOUNT REPORTING SERVICES RELATING TO INVESTMENT FUNDS; ELECTRONIC FUNDS TRANSFER; FINANCIAL INFORMATION AND EVALUATION SERVICES; SAVINGS AND LOAN SERVICES; INDIVIDUAL SAVINGS ACCOUNT SERVICES; CAPITAL INVESTMENT SERVICES; FINANCIAL TRANSACTION SERVICES, NAMELY, TRADING OF FINANCIAL INSTRUMENTS; INVESTMENT SERVICES, NAMELY, ASSET MANAGEMENT; FINANCIAL, SECURITIES AND COMMODITIES EXCHANGE SERVICES; INVESTMENT ANALYSIS; REAL ESTATE MANAGEMENT; RENTAL OF OFFICE SPACE; RETIREMENT PAYMENT SERVICES, NAMELY, INVESTMENT MANAGEMENT OF AND DISTRIBUTION OF ANNUITIES; AND TRUSTEESHIP REPRESENTATIVES, IN CLASS 36 (U.S. CLS. 100, 101 AND 102).

FIRST USE 4-9-2011; IN COMMERCE 4-9-2011.

THE MARK CONSISTS OF STANDARD CHARACTERS WITHOUT CLAIM TO ANY PARTICULAR FONT, STYLE, SIZE, OR COLOR.

SER. NO. 85-353,786, FILED 6-23-2011.

TINA BROWN, EXAMINING ATTORNEY



*David J. Kyjars*

Director of the United States Patent and Trademark Office



# United States of America

United States Patent and Trademark Office

## InsideOut: A SMART Recovery Correctional Program

**Reg. No. 4,124,744**

**Registered Apr. 10, 2012**

**Int. Cl.: 44**

**SERVICE MARK**

**PRINCIPAL REGISTER**

ALCOHOL & DRUG ABUSE SELF-HELP NETWORK, INC. (MARYLAND CORPORATION),  
DBA SMART RECOVERY  
7304 MENTOR AVE., SUITE F  
MENTOR, OH 44060

FOR: ADDICTION TREATMENT SERVICES; REHABILITATION OF ALCOHOL ADDICTED PATIENTS; REHABILITATION OF DRUG ADDICTED PATIENTS; REHABILITATION OF NARCOTIC ADDICTED PATIENTS, IN CLASS 44 (U.S. CLS. 100 AND 101).

FIRST USE 9-21-2000; IN COMMERCE 9-21-2000.

THE MARK CONSISTS OF STANDARD CHARACTERS WITHOUT CLAIM TO ANY PARTICULAR FONT, STYLE, SIZE, OR COLOR.

OWNER OF U.S. REG. NOS. 1,946,898 AND 3,244,295.

NO CLAIM IS MADE TO THE EXCLUSIVE RIGHT TO USE "CORRECTIONAL PROGRAM", APART FROM THE MARK AS SHOWN.

SER. NO. 85-353,962, FILED 6-23-2011.

GRETТА YAO, EXAMINING ATTORNEY



*David J. Kybas*

Director of the United States Patent and Trademark Office

# United States of America

United States Patent and Trademark Office

# SMUSH

**Reg. No. 4,124,745**

**Registered Apr. 10, 2012**

**Int. Cls.: 10 and 33**

**TRADEMARK**

**PRINCIPAL REGISTER**

GILI RITZ (UNITED STATES INDIVIDUAL)  
9461 CHARLEVILLE BLVD. #180  
BEVERLY HILLS, CA 90212

FOR: CONDOMS, IN CLASS 10 (U.S. CLS. 26, 39 AND 44).

FIRST USE 5-2-2011; IN COMMERCE 5-2-2011.

FOR: ALCOHOLIC BEVERAGES OF FRUIT; ALCOHOLIC PUNCH; PREPARED ALCOHOLIC COCKTAIL, IN CLASS 33 (U.S. CLS. 47 AND 49).

FIRST USE 6-23-2011; IN COMMERCE 6-23-2011.

THE MARK CONSISTS OF STANDARD CHARACTERS WITHOUT CLAIM TO ANY PARTICULAR FONT, STYLE, SIZE, OR COLOR.

OWNER OF U.S. REG. NOS. 3,159,499, 3,537,537, AND 3,591,042.

SER. NO. 85-354,160, FILED 6-23-2011.

STEVEN R. FINE, EXAMINING ATTORNEY



*David J. Kybas*

Director of the United States Patent and Trademark Office

# United States of America

United States Patent and Trademark Office

## VIRTUAL LEASH

**Reg. No. 4,124,746**

**Registered Apr. 10, 2012**

**Int. Cls.: 38 and 42**

**SERVICE MARK**

**PRINCIPAL REGISTER**

THE ETAG, LLC (NORTH CAROLINA LIMITED LIABILITY COMPANY)  
SUITE 2050  
1465 SANDHILL ROAD  
CANDLER, NC 28715

FOR: TRANSMITTING ELECTRONIC MESSAGES AND PHONE CALLS TO A USER UPON RECEIPT OF A COMMUNICATION INDICATING THE USER'S PET HAS BEEN FOUND , IN CLASS 38 (U.S. CLS. 100, 101 AND 104).

FIRST USE 7-0-2010; IN COMMERCE 7-0-2010.

FOR: PROVIDING A WEBSITE THAT ENABLES A USER TO CREATE A CUSTOMIZED WEB PAGE INCLUDING INFORMATION ABOUT THE USER'S PET THAT IS PERTINENT IF SUCH PET BECOMES LOST AND IS FOUND BY ANOTHER PARTY, IN CLASS 42 (U.S. CLS. 100 AND 101).

FIRST USE 7-0-2010; IN COMMERCE 7-0-2010.

THE MARK CONSISTS OF STANDARD CHARACTERS WITHOUT CLAIM TO ANY PARTICULAR FONT, STYLE, SIZE, OR COLOR.

NO CLAIM IS MADE TO THE EXCLUSIVE RIGHT TO USE "VIRTUAL", APART FROM THE MARK AS SHOWN.

SER. NO. 85-354,178, FILED 6-23-2011.

PAUL E. FAHRENKOPF, EXAMINING ATTORNEY



*David J. Kyffers*

Director of the United States Patent and Trademark Office

# United States of America

United States Patent and Trademark Office

# BLACKBURN

**Reg. No. 4,124,747**

**Registered Apr. 10, 2012**

**Int. Cl.: 13**

**TRADEMARK**

**PRINCIPAL REGISTER**

WILLIAM D. HOBER, INC. (KANSAS CORPORATION)  
ONE THOUSAND ONE SWIFT AVENUE  
P.O. BOX 27  
QUINTER, KS 67752

FOR: GUN PARTS, IN CLASS 13 (U.S. CLS. 2 AND 9).

FIRST USE 0-0-1988; IN COMMERCE 0-0-1988.

THE MARK CONSISTS OF STANDARD CHARACTERS WITHOUT CLAIM TO ANY PARTICULAR FONT, STYLE, SIZE, OR COLOR.

SEC. 2(F).

SER. NO. 85-355,092, FILED 6-24-2011.

TRACY CROSS, EXAMINING ATTORNEY



*David J. Kybas*

Director of the United States Patent and Trademark Office

# United States of America

United States Patent and Trademark Office

## Fertil-O-Base

**Reg. No. 4,124,748**

**Registered Apr. 10, 2012**

**Int. Cls.: 5 and 44**

**TRADEMARK**

**SERVICE MARK**

**PRINCIPAL REGISTER**

WENSKE, UDO (FED REP GERMANY INDIVIDUAL)  
BUSSARDSTR, 1  
CASTROP-RAUXEL, FED REP GERMANY 44577 AND

SCHMELZ, ULRICH (FED REP GERMANY INDIVIDUAL)  
GOSSLERSTR, 33A  
GÖTTINGEN, FED REP GERMANY 37075

FOR: PHARMACEUTICAL AND VETERINARY PREPARATIONS, NAMELY, MEDICINES FOR INCREASING FEMALE FERTILITY; PHARMACEUTICAL GELS FOR INTRAVAGINAL APPLICATION FOR INCREASING FEMALE FERTILITY, IN CLASS 5 (U.S. CLS. 6, 18, 44, 46, 51 AND 52).

FOR: MEDICAL SERVICES; VETERINARY SERVICES; HYGIENIC AND BEAUTY CARE FOR HUMAN BEINGS OR ANIMALS, IN CLASS 44 (U.S. CLS. 100 AND 101).

THE MARK CONSISTS OF STANDARD CHARACTERS WITHOUT CLAIM TO ANY PARTICULAR FONT, STYLE, SIZE, OR COLOR.

OWNER OF ERPN CMNTY TM OFC REG. NO. 009625641, DATED 5-20-2011, EXPIRES 12-24-2020.

SER. NO. 85-355,540, FILED 6-24-2011.

JOHN E. MICHOS, EXAMINING ATTORNEY



*David J. Kybas*

Director of the United States Patent and Trademark Office

# United States of America

United States Patent and Trademark Office

# GLASS H

**Reg. No. 4,124,749**

**Registered Apr. 10, 2012**

**Int. Cl.: 1**

**TRADEMARK**

**PRINCIPAL REGISTER**

ICL PERFORMANCE PRODUCTS LP (DELAWARE LIMITED PARTNERSHIP)  
SUITE 500  
622 EMERSON ROAD  
ST. LOUIS, MO 631411160

FOR: CHEMICAL ADDITIVES FOR USE IN THE MANUFACTURE OF FOOD, BEVERAGES  
AND DENTIFRICES, IN CLASS 1 (U.S. CLS. 1, 5, 6, 10, 26 AND 46).

FIRST USE 12-31-1999; IN COMMERCE 12-31-1999.

THE MARK CONSISTS OF STANDARD CHARACTERS WITHOUT CLAIM TO ANY PAR-  
TICULAR FONT, STYLE, SIZE, OR COLOR.

OWNER OF U.S. REG. NO. 812,366.

SER. NO. 85-355,593, FILED 6-24-2011.

CHARLOTTE CORWIN, EXAMINING ATTORNEY



*David J. Kyffers*

Director of the United States Patent and Trademark Office

# United States of America

United States Patent and Trademark Office

## FITNESS WITH A GOAL

**Reg. No. 4,124,750**

FIT LIVIN' LLC (INDIANA LIMITED LIABILITY COMPANY)  
14740 MACDUFF DRIVE  
NOBLESVILLE, IN 46062

**Registered Apr. 10, 2012**

**Int. Cl.: 41**

FOR: TRAINING SERVICES, NAMELY, PROVIDING WORKOUT PROGRAMS AND INSTRUCTION FOR HEALTHY DIETS, IN CLASS 41 (U.S. CLS. 100, 101 AND 107).

**SERVICE MARK**

FIRST USE 5-2-2011; IN COMMERCE 5-2-2011.

**PRINCIPAL REGISTER**

THE MARK CONSISTS OF STANDARD CHARACTERS WITHOUT CLAIM TO ANY PARTICULAR FONT, STYLE, SIZE, OR COLOR.

SER. NO. 85-355,873, FILED 6-24-2011.

MATTHEW KLINE, EXAMINING ATTORNEY



*David J. Kappas*

Director of the United States Patent and Trademark Office

# United States of America

United States Patent and Trademark Office

## Certified in National Threat Analysis, CNTA

**Reg. No. 4,124,751**

THE ROBERT L. O'BLOCK REVOCABLE TRUST (MISSOURI TRUST)  
2750 EAST SUNSHINE  
SPRINGFIELD, MO 65804

**Registered Apr. 10, 2012**

**CERTIFICATION MARK**

FOR: TRAINING AND EVALUATION IN THREAT ANALYSIS, IN CLASS B (U.S. CL. B).

**PRINCIPAL REGISTER**

FIRST USE 6-10-2011; IN COMMERCE 6-10-2011.

THE MARK CONSISTS OF STANDARD CHARACTERS WITHOUT CLAIM TO ANY PARTICULAR FONT, STYLE, SIZE, OR COLOR.

NO CLAIM IS MADE TO THE EXCLUSIVE RIGHT TO USE "CERTIFIED IN NATIONAL THREAT ANALYSIS", APART FROM THE MARK AS SHOWN.

THE CERTIFICATION MARK, AS USED OR INTENDED TO BE USED BY PERSONS AUTHORIZED BY THE CERTIFIER, CERTIFIES THAT THE PERSON CERTIFIED HAS ATTAINED THE REQUIRED EDUCATIONAL TRAINING AND HAS DEMONSTRATED COMPLIANCE WITH ETHICAL STANDARDS OF CONDUCT IN THE FIELD OF "THREAT ANALYSIS".

SER. NO. 85-355,994, FILED 6-24-2011.

JEFFREY LOOK, EXAMINING ATTORNEY



*David J. Kyffers*

Director of the United States Patent and Trademark Office



**United States of America**  
United States Patent and Trademark Office

# DEVOTION

**Reg. No. 4,124,752**

**Registered Apr. 10, 2012**

**Int. Cl.: 33**

**TRADEMARK**

**PRINCIPAL REGISTER**

O'BRIEN FAMILY VINEYARD, LLC (CALIFORNIA LIMITED LIABILITY COMPANY), DBA  
O'BRIEN ESTATE  
PO BOX 6020  
NAPA, CA 94581

FOR: RED WINE SOLD EXCLUSIVELY TO MEMBERS OF A WINE CLUB, IN CLASS 33  
(U.S. CLS. 47 AND 49).

FIRST USE 9-24-2010; IN COMMERCE 6-24-2011.

THE MARK CONSISTS OF STANDARD CHARACTERS WITHOUT CLAIM TO ANY PAR-  
TICULAR FONT, STYLE, SIZE, OR COLOR.

SER. NO. 85-356,317, FILED 6-25-2011.

ROBIN MITTLER, EXAMINING ATTORNEY



*David J. Kyffers*

Director of the United States Patent and Trademark Office

# United States of America

United States Patent and Trademark Office

**GROUP NIRE**  
Renewable Energy Solutions



**Reg. No. 4,124,753**

**Registered Apr. 10, 2012**

**Int. Cl.: 42**

**SERVICE MARK**

**PRINCIPAL REGISTER**

NIRE HOLDINGS CORP (TEXAS CORPORATION), DBA GROUP NIRE  
5219 CITY BANK PARKWAY  
SUITE 260  
LUBBOCK, TX 79407

FOR: TECHNOLOGICAL PLANNING AND CONSULTING SERVICES IN THE FIELD OF RENEWABLE ENERGY, IN CLASS 42 (U.S. CLS. 100 AND 101).

FIRST USE 5-22-2011; IN COMMERCE 5-22-2011.

NO CLAIM IS MADE TO THE EXCLUSIVE RIGHT TO USE "GROUP" AND "RENEWABLE ENERGY SOLUTIONS", APART FROM THE MARK AS SHOWN.

THE COLOR(S) BLACK, YELLOW, AND WHITE IS/ARE CLAIMED AS A FEATURE OF THE MARK.

THE MARK CONSISTS OF THE LITERAL TERM "GROUP NIRE RENEWABLE ENERGY SOLUTIONS" REPRESENTED IN STYLIZED FONT AND A DESIGN CONSISTING OF A CIRCLE APPEARING IN THE COLOR YELLOW LOCATED ON THE RIGHT SIDE OF THE LITERAL ELEMENT AND ENCOMPASSING A PORTION OF THE LETTER "E" IN "NIRE", WHEREIN THE TERM "GROUP" APPEARS SLIGHTLY CANTED IN AN ALMOST HORIZONTAL POSITION, RUNNING FROM BOTTOM TO TOP, AND LOCATED TO THE LEFT OF THE TERM "NIRE" WHICH IN TURN IS LOCATED ABOVE THE WORDS "RENEWABLE ENERGY SOLUTIONS", AND WHEREIN FURTHER THE LETTER "E" IN THE TERM "NIRE" OVERLAPS WITH THE YELLOW CIRCLE ON THE RIGHT SIDE SUCH THAT THE LETTER "E" APPEARS IN THE COLOR WHITE, WHILE ALL OTHER LITERAL ELEMENTS APPEAR IN THE COLOR BLACK.

SER. NO. 85-356,415, FILED 6-26-2011.

RONALD DELGIZZI, EXAMINING ATTORNEY



*David J. Kyjars*

Director of the United States Patent and Trademark Office

# United States of America

United States Patent and Trademark Office

# Simple Bills

**Reg. No. 4,124,754**

**Registered Apr. 10, 2012**

**Int. Cl.: 36**

**SERVICE MARK**

**PRINCIPAL REGISTER**

SIMPLE BILLS, INC. (TEXAS CORPORATION)  
SUITE 101  
900 AUSTIN AVENUE  
WACO, TX 76701

FOR: BILL CONSOLIDATION SERVICE FEATURING THE ABILITY TO ALLOCATE PORTIONS OF THE TOTAL BILL TO DIFFERENT PAYORS, IN CLASS 36 (U.S. CLS. 100, 101 AND 102).

FIRST USE 12-8-2008; IN COMMERCE 11-12-2010.

THE MARK CONSISTS OF STANDARD CHARACTERS WITHOUT CLAIM TO ANY PARTICULAR FONT, STYLE, SIZE, OR COLOR.

NO CLAIM IS MADE TO THE EXCLUSIVE RIGHT TO USE "BILLS", APART FROM THE MARK AS SHOWN.

SER. NO. 85-356,457, FILED 6-26-2011.

KYLE PEETE, EXAMINING ATTORNEY



*David J. Kyffers*

Director of the United States Patent and Trademark Office

# United States of America

United States Patent and Trademark Office

## diesel doctors

**Reg. No. 4,124,755**

**Registered Apr. 10, 2012**

**Int. Cl.: 37**

**SERVICE MARK**

**PRINCIPAL REGISTER**

MICHAEL TIMOTHY WARTHAN (UNITED STATES INDIVIDUAL), DBA DIESEL DOCTORS  
7333 EAST BUTHERUS DRIVE SUITE C300  
SCOTTSDALE, AZ 85260

FOR: VEHICLE MAINTENANCE AND REPAIR, IN CLASS 37 (U.S. CLS. 100, 103 AND 106).

FIRST USE 1-1-2009; IN COMMERCE 1-1-2009.

THE MARK CONSISTS OF STANDARD CHARACTERS WITHOUT CLAIM TO ANY PARTICULAR FONT, STYLE, SIZE, OR COLOR.

NO CLAIM IS MADE TO THE EXCLUSIVE RIGHT TO USE "DIESEL", APART FROM THE MARK AS SHOWN.

SER. NO. 85-356,847, FILED 6-27-2011.

LINDA M. KING, EXAMINING ATTORNEY



*David J. Kyffers*

Director of the United States Patent and Trademark Office

# United States of America

United States Patent and Trademark Office

## ROCK YOUR HAIR

**Reg. No. 4,124,756**

CHOP CHOP BANG BANG LTD (NEW JERSEY CORPORATION)  
1500 LAWRENCE AVENUE  
OCEAN, NJ 07712

**Registered Apr. 10, 2012**

**Int. Cl.: 44**

FOR: HAIRDRESSING AND HAIR SALON SERVICES, IN CLASS 44 (U.S. CLS. 100 AND 101).

**SERVICE MARK**

FIRST USE 5-1-2009; IN COMMERCE 5-1-2009.

**PRINCIPAL REGISTER**

THE MARK CONSISTS OF STANDARD CHARACTERS WITHOUT CLAIM TO ANY PARTICULAR FONT, STYLE, SIZE, OR COLOR.

NO CLAIM IS MADE TO THE EXCLUSIVE RIGHT TO USE "HAIR", APART FROM THE MARK AS SHOWN.

SER. NO. 85-357,017, FILED 6-27-2011.

JESSICA A. POWERS, EXAMINING ATTORNEY



*David J. Kybas*

Director of the United States Patent and Trademark Office

# United States of America

United States Patent and Trademark Office

## Trained In Detroit

**Reg. No. 4,124,757**

RYAN S. SPITERI (UNITED STATES INDIVIDUAL)  
26606 DELTON ST.

**Registered Apr. 10, 2012**

MADISON HEIGHTS, MI 48071

**Int. Cl.: 25**

FOR: ATHLETIC APPAREL, NAMELY, SHIRTS, PANTS, JACKETS, FOOTWEAR, HATS AND CAPS, ATHLETIC UNIFORMS, IN CLASS 25 (U.S. CLS. 22 AND 39).

**TRADEMARK**

FIRST USE 4-11-2011; IN COMMERCE 5-7-2011.

**PRINCIPAL REGISTER**

THE MARK CONSISTS OF STANDARD CHARACTERS WITHOUT CLAIM TO ANY PARTICULAR FONT, STYLE, SIZE, OR COLOR.

NO CLAIM IS MADE TO THE EXCLUSIVE RIGHT TO USE "DETROIT", APART FROM THE MARK AS SHOWN.

SER. NO. 85-357,041, FILED 6-27-2011.

HENRY S. ZAK, EXAMINING ATTORNEY



*David J. Kyffers*

Director of the United States Patent and Trademark Office

# United States of America

United States Patent and Trademark Office



**Reg. No. 4,124,758**

OLSON ALUMINUM CASTING, LTD (ILLINOIS CORPORATION)  
2135 15TH STREET  
ROCKFORD, IL 61104

**Registered Apr. 10, 2012**

**Int. Cl.: 6**

FOR: METAL BRACKETS FOR TRAFFIC SIGNALS, IN CLASS 6 (U.S. CLS. 2, 12, 13, 14, 23, 25 AND 50).

**TRADEMARK**

FIRST USE 7-23-2009; IN COMMERCE 4-1-2010.

**PRINCIPAL REGISTER**

OWNER OF U.S. REG. NO. 3,806,459.

NO CLAIM IS MADE TO THE EXCLUSIVE RIGHT TO USE "MAST ARM MOUNTING HARDWARE", APART FROM THE MARK AS SHOWN.

THE MARK CONSISTS OF THE STYLIZED WORDING "SKYBRACKET MAST ARM MOUNTING HARDWARE" WITH THE TERM "SKYBRACKET" IN LARGER TYPE WITH A CURVED LINE RUNNING THROUGH, AND THE WORDING "MAST ARM MOUNTING HARDWARE" APPEARING UNDERNEATH. BEHIND THE WORD "SKYBRACKET" APPEARS A HORIZONTAL POLE.

SER. NO. 85-357,780, FILED 6-28-2011.

JERI J. FICKES, EXAMINING ATTORNEY



*David J. Kyffers*

Director of the United States Patent and Trademark Office

# United States of America

United States Patent and Trademark Office

## Pippin Hill Farm

**Reg. No. 4,124,759**

**Registered Apr. 10, 2012**

**Int. Cl.: 33**

**TRADEMARK**

**PRINCIPAL REGISTER**

PIPPIN HILL FARM AND VINEYARDS LLC (VIRGINIA LIMITED LIABILITY COMPANY)  
119 ROTHERY ROAD  
CHARLOTTESVILLE, VA 22903

FOR: WINES, IN CLASS 33 (U.S. CLS. 47 AND 49).

FIRST USE 6-12-2011; IN COMMERCE 6-12-2011.

THE MARK CONSISTS OF STANDARD CHARACTERS WITHOUT CLAIM TO ANY PARTICULAR FONT, STYLE, SIZE, OR COLOR.

OWNER OF U.S. REG. NO. 4,013,703.

NO CLAIM IS MADE TO THE EXCLUSIVE RIGHT TO USE "FARM", APART FROM THE MARK AS SHOWN.

SER. NO. 85-357,787, FILED 6-28-2011.

FRED CARL, EXAMINING ATTORNEY



*David J. Kyfos*

Director of the United States Patent and Trademark Office



# United States of America

United States Patent and Trademark Office

## ACCELERATION EQUATION

**Reg. No. 4,124,760**

VANNOY GROUP, INC. (COLORADO CORPORATION), DBA VERUS GLOBAL, INC.  
10822 W. TOLLER DRIVE, SUITE #300

**Registered Apr. 10, 2012**

LITTLETON, CO 80127

**Int. Cl.: 41**

FOR: EDUCATIONAL SERVICES, NAMELY, CONDUCTING WORKSHOPS, COACHING SESSIONS, KEYNOTE SPEECHES, AND SEMINARS IN THE FIELD OF LEADERSHIP TRAINING AND DISTRIBUTING COURSE MATERIALS IN CONNECTION THEREWITH, IN CLASS 41 (U.S. CLS. 100, 101 AND 107).

**SERVICE MARK**

**PRINCIPAL REGISTER**

FIRST USE 5-3-2011; IN COMMERCE 5-3-2011.

THE MARK CONSISTS OF STANDARD CHARACTERS WITHOUT CLAIM TO ANY PARTICULAR FONT, STYLE, SIZE, OR COLOR.

SER. NO. 85-357,819, FILED 6-28-2011.

NATALIE POLZER, EXAMINING ATTORNEY



*David J. Kyffers*

Director of the United States Patent and Trademark Office

# United States of America

United States Patent and Trademark Office

## LIKE IT REAL

**Reg. No. 4,124,761**

**Registered Apr. 10, 2012**

**Int. Cl.: 35**

**SERVICE MARK**

**PRINCIPAL REGISTER**

LIKE IT IN THE REAL WORLD, INC. (DELAWARE CORPORATION)  
4012 230TH PLACE SE  
SAMMAMISH, WA 98075

FOR: ADVERTISING AND MARKETING SERVICES, NAMELY, PROMOTING THE GOODS AND SERVICES OF OTHERS USING ONLINE AND OUT-OF-HOME MARKETING FORMATS; ADVERTISING, MARKETING AND PROMOTION SERVICES, IN CLASS 35 (U.S. CLS. 100, 101 AND 102).

FIRST USE 6-25-2011; IN COMMERCE 6-25-2011.

THE MARK CONSISTS OF STANDARD CHARACTERS WITHOUT CLAIM TO ANY PARTICULAR FONT, STYLE, SIZE, OR COLOR.

SER. NO. 85-357,916, FILED 6-28-2011.

TRACY FLETCHER, EXAMINING ATTORNEY



*David J. Kybas*

Director of the United States Patent and Trademark Office

# United States of America

United States Patent and Trademark Office



**Reg. No. 4,124,762**

NPS USA, LLC (DELAWARE LIMITED LIABILITY COMPANY)  
597 E 51ST ST.  
BROOKLYN, NY 11203

**Registered Apr. 10, 2012**

**Int. Cl.: 25**

FOR: HEADBANDS, IN CLASS 25 (U.S. CLS. 22 AND 39).

**TRADEMARK**

FIRST USE 4-1-2010; IN COMMERCE 4-1-2010.

**PRINCIPAL REGISTER**

THE STIPPLING IS FOR SHADING PURPOSES ONLY.

THE MARK CONSISTS OF THE WORDING "FUN SPUNGE" IN STYLIZED LETTERING OVER THE DESIGN OF SEVEN DIFFERENT SIZED BUBBLES AND WITH THREE DROPS OF WATER.

SER. NO. 85-357,932, FILED 6-28-2011.

FRED CARL, EXAMINING ATTORNEY



*David J. Kyffers*

Director of the United States Patent and Trademark Office

# United States of America

United States Patent and Trademark Office

# VIVOLI

**Reg. No. 4,124,763**

VIVOLI FRANCHISING USA, INC. (CALIFORNIA CORPORATION)  
1520 HAYWORTH AVE #11  
LOS ANGELES, CA 90046

**Registered Apr. 10, 2012**

**Int. Cl.: 41**

FOR: EDUCATIONAL SERVICES, NAMELY, PROVIDING COURSES AND LECTURES IN THE FIELDS OF COOKING AND OENOLOGY, IN CLASS 41 (U.S. CLS. 100, 101 AND 107).

**SERVICE MARK**

FIRST USE 5-1-2011; IN COMMERCE 5-1-2011.

**PRINCIPAL REGISTER**

THE MARK CONSISTS OF STANDARD CHARACTERS WITHOUT CLAIM TO ANY PARTICULAR FONT, STYLE, SIZE, OR COLOR.

OWNER OF U.S. REG. NO. 3,297,698.

SEC. 2(F).

SER. NO. 85-358,374, FILED 6-28-2011.

KATINA MISTER, EXAMINING ATTORNEY



*David J. Kybas*

Director of the United States Patent and Trademark Office

# United States of America

United States Patent and Trademark Office

## Mission Communications

**Reg. No. 4,124,764**

**Registered Apr. 10, 2012**

**Int. Cl.: 45**

**SERVICE MARK**

**PRINCIPAL REGISTER**

MISSION COMMUNICATIONS, LLC (GEORGIA LIMITED LIABILITY COMPANY)  
3060-C BUSINESS PARK DRIVE  
NORCROSS, GA 30071

FOR: AUTOMATED ALARMING PROVIDED VIA SCADA (SUPERVISORY CONTROL AND DATA ACQUISITION) SERVICES FOR POTABLE WATER DISTRIBUTION AND WASTE WATER COLLECTION , IN CLASS 45 (U.S. CLS. 100 AND 101).

FIRST USE 6-1-2001; IN COMMERCE 6-1-2001.

THE MARK CONSISTS OF STANDARD CHARACTERS WITHOUT CLAIM TO ANY PARTICULAR FONT, STYLE, SIZE, OR COLOR.

NO CLAIM IS MADE TO THE EXCLUSIVE RIGHT TO USE "COMMUNICATIONS", APART FROM THE MARK AS SHOWN.

SER. NO. 85-358,566, FILED 6-28-2011.

MARK RADEMACHER, EXAMINING ATTORNEY



*David J. Kyffers*

Director of the United States Patent and Trademark Office

# United States of America

United States Patent and Trademark Office



**Reg. No. 4,124,765**

**Registered Apr. 10, 2012**

**Int. Cl.: 41**

**SERVICE MARK**

**PRINCIPAL REGISTER**

GRAND CANYON EDUCATION, INC. (DELAWARE CORPORATION)  
3300 WEST CAMELBACK ROAD  
PHOENIX, AZ 85017

FOR: EDUCATIONAL SERVICES, NAMELY, PROVIDING COURSES OF INSTRUCTION AND SEMINARS AT THE UNDERGRADUATE, GRADUATE, POST-GRADUATE, AND PROFESSIONAL LEVELS; ARRANGING AND CONDUCTING EDUCATIONAL CONFERENCES; EDUCATIONAL RESEARCH; LIBRARIES; PROVIDING COLLEGE, GRADUATE, POST-GRADUATE, AND PROFESSIONAL LEVEL COURSES OF INSTRUCTION AND SEMINARS VIA DISTANCE LEARNING COMMUNICATIONS MEDIA AND THE INTERNET, AND DISTRIBUTION OF COURSE MATERIALS IN CONNECTION THEREWITH; PROVIDING AN ON-LINE ELECTRONIC LIBRARY; ENTERTAINMENT SERVICES, NAMELY, PRESENTATION OF SPORTING AND ATHLETIC EVENTS, LECTURES, CONCERTS, FINE ART EXHIBITIONS, AND DRAMATIC PRODUCTIONS, IN CLASS 41 (U.S. CLS. 100, 101 AND 107).

FIRST USE 9-9-2004; IN COMMERCE 9-9-2004.

OWNER OF U.S. REG. NO. 3,039,105.

NO CLAIM IS MADE TO THE EXCLUSIVE RIGHT TO USE "UNIVERSITY, ARIZONA AND 1949", APART FROM THE MARK AS SHOWN.

THE MARK CONSISTS OF A CACTUS AND A CROSS IN THE CENTER OF DESERT DUNES ENCIRCLED WITH THE WORDS "GRAND CANYON UNIVERSITY ARIZONA 1949".

SEC. 2(F) AS TO "GRAND CANYON".

SER. NO. 85-358,583, FILED 6-28-2011.

LINDA ESTRADA, EXAMINING ATTORNEY



*David J. Kybas*

Director of the United States Patent and Trademark Office

# United States of America

United States Patent and Trademark Office

## FOUNDATIONS FOR PREACHING AND TEACHING

**Reg. No. 4,124,766**

CATHOLIC BISHOP OF CHICAGO (ILLINOIS NON-PROFIT CORPORATION)  
155 EAST SUPERIOR STREET  
CHICAGO, IL 60611

**Registered Apr. 10, 2012**

**Int. Cl.: 16**

FOR: PUBLICATIONS, NAMELY, BOOKS AND STUDY MATERIALS IN THE FIELDS OF RELIGIOUS EDUCATION, IN CLASS 16 (U.S. CLS. 2, 5, 22, 23, 29, 37, 38 AND 50).

**TRADEMARK**

FIRST USE 7-7-2010; IN COMMERCE 7-7-2010.

**PRINCIPAL REGISTER**

THE MARK CONSISTS OF STANDARD CHARACTERS WITHOUT CLAIM TO ANY PARTICULAR FONT, STYLE, SIZE, OR COLOR.

NO CLAIM IS MADE TO THE EXCLUSIVE RIGHT TO USE "PREACHING AND TEACHING", APART FROM THE MARK AS SHOWN.

SER. NO. 85-358,627, FILED 6-28-2011.

DORITT L. CARROLL, EXAMINING ATTORNEY



*David J. Kybas*

Director of the United States Patent and Trademark Office

# United States of America

United States Patent and Trademark Office

## CELEBRATING THE LECTIONARY

**Reg. No. 4,124,767**

CATHOLIC BISHOP OF CHICAGO (ILLINOIS NON-PROFIT CORPORATION)  
155 EAST SUPERIOR STREET  
CHICAGO, IL 60611

**Registered Apr. 10, 2012**

**Int. Cl.: 16**

FOR: PUBLICATIONS, NAMELY, BOOKS AND STUDY MATERIALS IN THE FIELDS OF RELIGIOUS EDUCATION, IN CLASS 16 (U.S. CLS. 2, 5, 22, 23, 29, 37, 38 AND 50).

**TRADEMARK**

FIRST USE 0-0-2007; IN COMMERCE 0-0-2007.

**PRINCIPAL REGISTER**

THE MARK CONSISTS OF STANDARD CHARACTERS WITHOUT CLAIM TO ANY PARTICULAR FONT, STYLE, SIZE, OR COLOR.

NO CLAIM IS MADE TO THE EXCLUSIVE RIGHT TO USE "LECTIONARY", APART FROM THE MARK AS SHOWN.

SER. NO. 85-358,636, FILED 6-28-2011.

DORITT L. CARROLL, EXAMINING ATTORNEY



*David J. Kybas*

Director of the United States Patent and Trademark Office



# United States of America

United States Patent and Trademark Office



**Reg. No. 4,124,768**

**Registered Apr. 10, 2012**

**Int. Cls.: 36 and 39**

**SERVICE MARK**

**PRINCIPAL REGISTER**

PALATINE OIL CO., INC. (ILLINOIS CORPORATION)  
900 NATIONAL PARKWAY  
SUITE 260  
SCHAUMBURG, IL 60173

FOR: CREDIT CARD AND PAYMENT CARD SERVICES FOR THE PURCHASE OF GASOLINE AND OTHER PETROLEUM PRODUCTS, IN CLASS 36 (U.S. CLS. 100, 101 AND 102).

FIRST USE 3-1-2011; IN COMMERCE 3-1-2011.

FOR: TRANSPORTATION, STORAGE AND DISTRIBUTION OF OILS AND FUELS, IN CLASS 39 (U.S. CLS. 100 AND 105).

FIRST USE 3-1-1972; IN COMMERCE 3-1-1972.

THE MARK CONSISTS OF THE WORDING "POC" IN LOWER-CASE LETTERING WITH A BLACK BAR RUNNING THROUGH THE MIDDLE OF THE LETTERS CREATING THREE CIRCULAR DESIGN ELEMENTS.

SER. NO. 85-358,696, FILED 6-28-2011.

STEPHANIE ALI, EXAMINING ATTORNEY



*David J. Kybas*

Director of the United States Patent and Trademark Office

# United States of America

United States Patent and Trademark Office

## SPEAK THE LANGUAGE OF FINANCE

**Reg. No. 4,124,769**

STRATEGIC FINANCIAL LITERACY, INC. (ARIZONA CORPORATION)  
5111 N. AVENIDA DE CASTILLA  
TUCSON, AZ 85718

**Registered Apr. 10, 2012**

**Int. Cls.: 9, 16 and 41**

FOR: ELECTRONIC PUBLICATIONS, NAMELY, BOOKS, WRITTEN ARTICLES, NEWSLETTERS, HANDOUTS AND WORKSHEETS IN THE FIELD OF FINANCE, FINANCIAL DECISION-MAKING, AND MANAGEMENT; AUDIO BOOKS IN THE FIELD OF FINANCE, FINANCIAL DECISION-MAKING AND MANAGEMENT, IN CLASS 9 (U.S. CLS. 21, 23, 26, 36 AND 38).

**TRADEMARK**

**SERVICE MARK**

FIRST USE 8-19-2010; IN COMMERCE 8-19-2010.

**PRINCIPAL REGISTER**

FOR: PRINTED EDUCATIONAL MATERIALS IN THE FIELD OF FINANCE, FINANCIAL DECISION-MAKING, AND FINANCIAL MANAGEMENT; PUBLICATIONS, NAMELY, BOOKS, WRITTEN ARTICLES, NEWSLETTERS, HANDOUTS, AND WORKSHEETS IN THE FIELD OF FINANCE, FINANCIAL-DECISION MAKING AND MANAGEMENT, IN CLASS 16 (U.S. CLS. 2, 5, 22, 23, 29, 37, 38 AND 50).

FIRST USE 11-1-2010; IN COMMERCE 11-1-2010.

FOR: EDUCATION SERVICES, NAMELY, PROVIDING CLASSES, SEMINARS, WORKSHOPS IN THE FIELD OF FINANCIAL DECISION-MAKING AND MANAGEMENT; PROFESSIONAL COACHING SERVICES IN THE FIELD OF FINANCIAL DECISION-MAKING AND MANAGEMENT, IN CLASS 41 (U.S. CLS. 100, 101 AND 107).

FIRST USE 11-1-2010; IN COMMERCE 11-1-2010.

THE MARK CONSISTS OF STANDARD CHARACTERS WITHOUT CLAIM TO ANY PARTICULAR FONT, STYLE, SIZE, OR COLOR.

NO CLAIM IS MADE TO THE EXCLUSIVE RIGHT TO USE "FINANCE", APART FROM THE MARK AS SHOWN.

SER. NO. 85-358,775, FILED 6-28-2011.

KELLEY WELLS, EXAMINING ATTORNEY



*David J. Kyffers*

Director of the United States Patent and Trademark Office

# United States of America

United States Patent and Trademark Office

# Z-Soft

**Reg. No. 4,124,770**

CISLAK MANUFACTURING INC. (ILLINOIS CORPORATION), DBA ZOLL-DENTAL  
7450 NORTH NATCHEZ AVENUE  
NILES, IL 60714

**Registered Apr. 10, 2012**

**Int. Cl.: 10**

FOR: DENTAL INSTRUMENTS FOR USE IN TEETH CLEANING AND DIAGNOSTIC PROCEDURES, IN CLASS 10 (U.S. CLS. 26, 39 AND 44).

**TRADEMARK**

FIRST USE 6-1-2011; IN COMMERCE 6-20-2011.

**PRINCIPAL REGISTER**

THE MARK CONSISTS OF STANDARD CHARACTERS WITHOUT CLAIM TO ANY PARTICULAR FONT, STYLE, SIZE, OR COLOR.

SER. NO. 85-359,266, FILED 6-29-2011.

MARK SPARACINO, EXAMINING ATTORNEY



*David J. Kyffers*

Director of the United States Patent and Trademark Office

# United States of America

United States Patent and Trademark Office

## BULLSEYE BEARINGS

**Reg. No. 4,124,771**

TGM DISTRIBUTION, INC. (MICHIGAN CORPORATION)  
183 S. MAIN

**Registered Apr. 10, 2012**

MT. CLEMENS, MI 48043

**Int. Cl.: 28**

FOR: SKATEBOARD ACCESSORIES, NAMELY, BEARINGS, IN CLASS 28 (U.S. CLS. 22, 23, 38 AND 50).

**TRADEMARK**

FIRST USE 12-31-2007; IN COMMERCE 12-31-2007.

**PRINCIPAL REGISTER**

THE MARK CONSISTS OF STANDARD CHARACTERS WITHOUT CLAIM TO ANY PARTICULAR FONT, STYLE, SIZE, OR COLOR.

NO CLAIM IS MADE TO THE EXCLUSIVE RIGHT TO USE "BEARINGS", APART FROM THE MARK AS SHOWN.

SER. NO. 85-359,388, FILED 6-29-2011.

HELENE LIWINSKI, EXAMINING ATTORNEY



*David J. Kyros*

Director of the United States Patent and Trademark Office

# United States of America

United States Patent and Trademark Office

# Femme Clean

**Reg. No. 4,124,772**

XTREME TOOLS INTERNATIONAL, INC. (FLORIDA CORPORATION)  
5535 N.W. 161ST STREET  
MIAMI GARDENS, FL 33014

**Registered Apr. 10, 2012**

**Int. Cl.: 3**

FOR: BODY WASH; COSMETIC SOAPS; NON-MEDICATED FEMININE HYGIENE WASH,  
IN CLASS 3 (U.S. CLS. 1, 4, 6, 50, 51 AND 52).

**TRADEMARK**

FIRST USE 1-1-2011; IN COMMERCE 1-1-2011.

**PRINCIPAL REGISTER**

THE MARK CONSISTS OF STANDARD CHARACTERS WITHOUT CLAIM TO ANY PARTICULAR FONT, STYLE, SIZE, OR COLOR.

NO CLAIM IS MADE TO THE EXCLUSIVE RIGHT TO USE "CLEAN", APART FROM THE MARK AS SHOWN.

THE ENGLISH TRANSLATION OF "FEMME" IN THE MARK IS "WOMAN".

SER. NO. 85-359,395, FILED 6-29-2011.

STEVEN R. FINE, EXAMINING ATTORNEY



*David J. Kyffers*

Director of the United States Patent and Trademark Office

# United States of America

United States Patent and Trademark Office

## AMPHETAMINE

**Reg. No. 4,124,773**

TGM DISTRIBUTION, INC. (MICHIGAN CORPORATION)  
183 S. MAIN

**Registered Apr. 10, 2012**

MT. CLEMENS, MI 48043

**Int. Cl.: 28**

FOR: SKATEBOARD ACCESSORIES, NAMELY, BALL BEARINGS FOR SKATEBOARDS,  
IN CLASS 28 (U.S. CLS. 22, 23, 38 AND 50).

**TRADEMARK**

FIRST USE 12-31-2006; IN COMMERCE 12-31-2006.

**PRINCIPAL REGISTER**

THE MARK CONSISTS OF STANDARD CHARACTERS WITHOUT CLAIM TO ANY PAR-  
TICULAR FONT, STYLE, SIZE, OR COLOR.

SER. NO. 85-359,432, FILED 6-29-2011.

HELENE LIWINSKI, EXAMINING ATTORNEY



*David J. Kybas*

Director of the United States Patent and Trademark Office

# United States of America

United States Patent and Trademark Office

# MYFORCE

**Reg. No. 4,124,774**

**Registered Apr. 10, 2012**

**Int. Cls.: 9, 38 and 45**

**TRADEMARK**

**SERVICE MARK**

**PRINCIPAL REGISTER**

SOTERIA SYSTEMS, LLC (COLORADO LIMITED LIABILITY COMPANY)  
1444 WAZEE ST., SUITE 125  
DENVER, CO 80202

FOR: PERSONAL EMERGENCY RESPONSE SYSTEMS COMPRISED OF COMPUTER HARDWARE AND SOFTWARE, ELECTRONIC TRANSMITTERS, ELECTRONIC RECEIVERS, CIRCUIT BOARDS, MICROPROCESSORS THAT LEVERAGE TELEPHONE, MOBILE PHONES, CELLULAR, DATA, WIRELESS, AND GLOBAL COMPUTER NETWORKS, NAMELY, SYSTEMS THAT TRANSMIT RECORDINGS OF AUDIO, IMAGES, PERSONAL DATA, AND LOCATION INFORMATION DERIVED FROM GLOBAL POSITIONING SYSTEMS (GPS), APPARATUS FOR WIRELESS COMMUNICATION AND CELLULAR TRIANGULATION FROM MOBILE DEVICE SOFTWARE TO A HOSTED COMPUTER SYSTEM USING CELLULAR, DATA, WIRELESS AND GLOBAL COMPUTER NETWORKS; SYSTEMS THAT ALLOW ACCESS BY REMOTE THIRD-PARTY MONITORING PROVIDERS TO DATA CONCERNING EMERGENCY INCIDENTS VIA CELLULAR, DATA, WIRELESS AND GLOBAL COMPUTER NETWORKS; AND SYSTEMS THAT IDENTIFY THE LOCATION AND CONTACT INFORMATION OF THE CLOSEST PUBLIC AND/OR PRIVATE EMERGENCY RESPONDERS BASED ON THE GPS LOCATION INFORMATION TRANSMITTED FROM THE MOBILE DEVICE, IN CLASS 9 (U.S. CLS. 21, 23, 26, 36 AND 38).

FIRST USE 5-21-2011; IN COMMERCE 5-21-2011.



*David J. Kyjars*

Director of the United States Patent and Trademark Office

FOR: EMERGENCY COMMUNICATION SERVICES ALLOWING AN INDIVIDUAL TO INITIATE AN ALERT TO AND COMMUNICATE WITH A REMOTE CENTRAL MONITORING STATION USING A MOBILE DEVICE THAT TRANSMITS RECORDED AUDIO, LOCATION INFORMATION AND OTHER DATA RELATED TO THE INDIVIDUAL OVER CELLULAR, DATA, WIRELESS OR OTHER GLOBAL COMPUTER NETWORKS; COMMUNICATION SERVICES VIA RADIO, TELEPHONE, TEXT, MOBILE PHONES, ELECTRONIC MAIL, COMPUTER TERMINALS, FIBRE-OPTIC NETWORKS, DIGITAL TRANSMISSION, WIRELESS BROADBAND AND SATELLITE, USED FOR THE PURPOSE OF VALIDATING THE EMERGENCY, IDENTIFYING THE CLOSEST PUBLIC AND/OR PRIVATE EMERGENCY RESPONDERS, AND NOTIFYING SUCH EMERGENCY RESPONDERS USING TELEPHONE LINES, CELLULAR, DATA, OR OTHER GLOBAL COMPUTER NETWORKS TO PROVIDE AID TO THE INDIVIDUAL UNDERGOING THE EMERGENCY, IN CLASS 38 (U.S. CLS. 100, 101 AND 104).

FIRST USE 5-21-2011; IN COMMERCE 5-21-2011.

**Reg. No. 4,124,774** FOR: CENTRAL DISPATCH SECURITY SERVICES PROVIDED FOR THE SAFETY OF INDIVIDUALS WHO INITIATE AN ALERT USING A MOBILE DEVICE THAT IS TRANSMITTED OVER CELLULAR, DATA, WIRELESS OR GLOBAL COMPUTER NETWORKS, NAMELY, ALARM MONITORING CONSISTING OF VALIDATING THE EMERGENCY BY LISTENING TO RECORDED AUDIO TRANSMITTED FROM THE MOBILE DEVICE, TRACKING THE SUBSCRIBER'S LOCATION DERIVED FROM GLOBAL POSITIONING SYSTEMS (GPS), AND SUMMONING AID FOR THE INDIVIDUAL BY NOTIFYING THE CLOSEST PUBLIC AND/OR PRIVATE EMERGENCY RESPONDERS, IN CLASS 45 (U.S. CLS. 100 AND 101).

FIRST USE 5-21-2011; IN COMMERCE 5-21-2011.

THE MARK CONSISTS OF STANDARD CHARACTERS WITHOUT CLAIM TO ANY PARTICULAR FONT, STYLE, SIZE, OR COLOR.

SER. NO. 85-359,478, FILED 6-29-2011.

JEAN IM, EXAMINING ATTORNEY



# United States of America

United States Patent and Trademark Office

## AO TEXTILE, INC.

**Reg. No. 4,124,775**

A.O. TEXTILE, INC. (NEW YORK CORPORATION)  
149 WEST 36TH STREET, 10TH FLOOR  
NEW YORK, NY 10018

**Registered Apr. 10, 2012**

**Int. Cl.: 35**

FOR: TEXTILE AND FABRIC IMPORT-EXPORT AGENCIES; WHOLESALE TEXTILE DISTRIBUTORSHIP SERVICES, IN CLASS 35 (U.S. CLS. 100, 101 AND 102).

**SERVICE MARK**

FIRST USE 7-28-1993; IN COMMERCE 7-28-1993.

**PRINCIPAL REGISTER**

THE MARK CONSISTS OF STANDARD CHARACTERS WITHOUT CLAIM TO ANY PARTICULAR FONT, STYLE, SIZE, OR COLOR.

NO CLAIM IS MADE TO THE EXCLUSIVE RIGHT TO USE "TEXTILE, INC.", APART FROM THE MARK AS SHOWN.

SER. NO. 85-359,510, FILED 6-29-2011.

KRISTIN DAHLING, EXAMINING ATTORNEY



*David J. Kybas*

Director of the United States Patent and Trademark Office

# United States of America

United States Patent and Trademark Office

## THE MAXIMUS SPARKLING WATER DECAFFEINATION METHOD

**Reg. No. 4,124,776**

MAXIMUS COFFEE GROUP, LP (TEXAS LIMITED PARTNERSHIP)  
3906 HARRISBURG BLVD.  
HOUSTON, TX 77003

**Registered Apr. 10, 2012**

**Int. Cl.: 40**

FOR: COFFEE ROASTING AND PROCESSING, IN CLASS 40 (U.S. CLS. 100, 103 AND 106).

**SERVICE MARK**

FIRST USE 6-14-2011; IN COMMERCE 6-14-2011.

**PRINCIPAL REGISTER**

THE MARK CONSISTS OF STANDARD CHARACTERS WITHOUT CLAIM TO ANY PARTICULAR FONT, STYLE, SIZE, OR COLOR.

OWNER OF U.S. REG. NOS. 3,544,140 AND 3,867,085.

NO CLAIM IS MADE TO THE EXCLUSIVE RIGHT TO USE "SPARKLING WATER DECAFFEINATION METHOD", APART FROM THE MARK AS SHOWN.

SER. NO. 85-359,618, FILED 6-29-2011.

CIMMERIAN COLEMAN, EXAMINING ATTORNEY



*David J. Kyfos*

Director of the United States Patent and Trademark Office

# United States of America

United States Patent and Trademark Office

## America My Home Team

**Reg. No. 4,124,777**

**Registered Apr. 10, 2012**

**Int. Cl.: 25**

**TRADEMARK**

**PRINCIPAL REGISTER**

MOORE, DANIEL B. (UNITED STATES INDIVIDUAL)  
305  
1290 GULF BLVD  
CLEARWATER, FL 33767

FOR: CLOTHING, NAMELY, T-SHIRTS, SHIRTS, KNIT SHIRTS, JERSEYS AND TANK TOPS, SHORTS, PANTS, SWEATERS, CAPS, HATS, SCARVES, VISORS, WARM-UP SUITS, SWEATSHIRTS, JACKETS, VESTS, UNIFORMS, NECKTIES, WRISTBANDS AND HEADBANDS, GLOVES, INFANT CLOTH BIBS, PAJAMAS, TODDLER AND INFANT PLAYSUITS, ROMPERS, OVERALLS AND CREEPERS, SOCKS AND HOSIERY, BELTS AND SUSPENDERS; FOOTWEAR, IN CLASS 25 (U.S. CLS. 22 AND 39).

FIRST USE 6-2-2011; IN COMMERCE 6-2-2011.

THE MARK CONSISTS OF STANDARD CHARACTERS WITHOUT CLAIM TO ANY PARTICULAR FONT, STYLE, SIZE, OR COLOR.

NO CLAIM IS MADE TO THE EXCLUSIVE RIGHT TO USE "AMERICA", APART FROM THE MARK AS SHOWN.

SER. NO. 85-359,929, FILED 6-29-2011.

DORITT L. CARROLL, EXAMINING ATTORNEY



*David J. Kyffers*

Director of the United States Patent and Trademark Office

# United States of America

United States Patent and Trademark Office

# **RAPID**Comfort

**Reg. No. 4,124,778**

**Registered Apr. 10, 2012**

**Int. Cls.: 5, 10 and 18**

**TRADEMARK**

**PRINCIPAL REGISTER**

GHC SPECIALTY BRANDS, LLC (WISCONSIN LIMITED LIABILITY COMPANY)  
401 SOUTH WRIGHT ROAD  
JANESVILLE, WI 535468729

FOR: ACETAMINOPHEN FOR RELIEF OF PAIN; ADHESIVE BANDAGES; FIRST AID KITS; FIRST AID KITS SPECIFICALLY FOR THE TREATMENT OF BURNS; IBUPROFEN FOR USE AS AN ORAL ANALGESIC; HYDROCORTISONE CREAM; TRIPLE ANTIBIOTIC CREAM; ASPIRIN; CARRYING CASES IN THE NATURE OF FIRST AID KITS SOLD EMPTY, IN CLASS 5 (U.S. CLS. 6, 18, 44, 46, 51 AND 52).

FIRST USE 1-0-2008; IN COMMERCE 1-0-2008.

FOR: CPR EMERGENCY KITS, COMPRISING GLOVES, DISPOSABLE MASK, ALCOHOL WIPES AND BIOHAZARD BAG ALL SOLD AS A UNIT, IN CLASS 10 (U.S. CLS. 26, 39 AND 44).

FIRST USE 1-0-2008; IN COMMERCE 1-0-2008.

FOR: FANNY PACKS , IN CLASS 18 (U.S. CLS. 1, 2, 3, 22 AND 41).

FIRST USE 1-0-2008; IN COMMERCE 1-0-2008.

THE MARK CONSISTS OF THE WORDS "RAPID COMFORT" WITH A TRIANGLE UNDERNEATH "RAPID".

SER. NO. 85-359,971, FILED 6-29-2011.

GENE MACIOL, EXAMINING ATTORNEY



*David J. Kyffers*

Director of the United States Patent and Trademark Office

# United States of America

United States Patent and Trademark Office



**Reg. No. 4,124,779**

**Registered Apr. 10, 2012**

**Int. Cl.: 41**

**SERVICE MARK**

**PRINCIPAL REGISTER**

NON-STOP MEDIA, INC. (NEW YORK CORPORATION)  
260 ROGERS AVE., #3  
BROOKLYN, NY 11225

FOR: PROVIDING CURRENT EVENT NEWS AND INFORMATION VIA A GLOBAL COMPUTER NETWORK, IN CLASS 41 (U.S. CLS. 100, 101 AND 107).

FIRST USE 12-1-2007, THE MARK WAS FIRST USED ANYWHERE IN A DIFFERENT FORM OTHER THAN THAT SOUGHT TO BE REGISTERED AT LEAST AS EARLY AS 12/01/2006; IN COMMERCE 12-1-2007, THE MARK WAS FIRST USED IN COMMERCE IN A DIFFERENT FORM OTHER THAN THAT SOUGHT TO BE REGISTERED AT LEAST AS EARLY AS 12/01/2006.

THE MARK CONSISTS OF FARSI CHARACTERS IN WHITE, THE TRANSLITERATION OF WHICH IS "IRAN DAR JAHAN" (THE TRANSLATION OF WHICH IS "IRAN IN THE WORLD") ON A RED RECTANGULAR BACKGROUND.

THE COLOR(S) RED AND WHITE IS/ARE CLAIMED AS A FEATURE OF THE MARK.

THE NON-LATIN CHARACTERS IN THE MARK TRANSLITERATE TO "IRAN DAR JAHAN" AND THIS MEANS "IRAN IN THE WORLD" IN ENGLISH.

THE ENGLISH TRANSLATION OF "IRAN DAR JAHAN" IN THE MARK IS "IRAN IN THE WORLD".

SER. NO. 85-360,261, FILED 6-30-2011.

BRIAN NEVILLE, EXAMINING ATTORNEY



*David J. Kybas*

Director of the United States Patent and Trademark Office

# United States of America

United States Patent and Trademark Office

## AT HOME IN THE D.

**Reg. No. 4,124,780**

**Registered Apr. 10, 2012**

**Int. Cl.: 36**

**SERVICE MARK**

**PRINCIPAL REGISTER**

BLUE CROSS BLUE SHIELD OF MICHIGAN (MICHIGAN CORPORATION)  
600 LAFAYETTE EAST  
DETROIT, MI 48226

FOR: INSURANCE SERVICES, NAMELY, UNDERWRITING, ISSUANCE AND ADMINISTRATION OF HEALTH AND DENTAL INSURANCE, IN CLASS 36 (U.S. CLS. 100, 101 AND 102).

FIRST USE 4-30-2011; IN COMMERCE 4-30-2011.

THE MARK CONSISTS OF STANDARD CHARACTERS WITHOUT CLAIM TO ANY PARTICULAR FONT, STYLE, SIZE, OR COLOR.

NO CLAIM IS MADE TO THE EXCLUSIVE RIGHT TO USE "THE D.", APART FROM THE MARK AS SHOWN.

SER. NO. 85-360,284, FILED 6-30-2011.

ALAIN LAPTER, EXAMINING ATTORNEY



*David J. Kyjars*

Director of the United States Patent and Trademark Office

# United States of America

United States Patent and Trademark Office



**Reg. No. 4,124,781**

SUNFRESH BEVERAGES, INC. (DELAWARE CORPORATION)  
111 OXMOOR ROAD  
BIRMINGHAM, AL 35209

**Registered Apr. 10, 2012**

**Int. Cl.: 32**

FOR: SOFT DRINKS, FRUIT FLAVORED DRINKS, AND SYRUPS FOR MAKING SAME, IN CLASS 32 (U.S. CLS. 45, 46 AND 48).

**TRADEMARK**

FIRST USE 1-1-2011; IN COMMERCE 1-1-2011.

**PRINCIPAL REGISTER**

OWNER OF U.S. REG. NOS. 381,562 AND 1,529,948.

NO CLAIM IS MADE TO THE EXCLUSIVE RIGHT TO USE "EST. 1914", APART FROM THE MARK AS SHOWN.

THE MARK CONSISTS OF THE WORDS "A SOUTHERN TRADITION" ON A RECTANGULAR BANNER WITH POINTED ENDS WHICH IS SUPERIMPOSED OVER A SQUARE WITH CURVED TOP AND BOTTOM BORDERS AND CONCAVE CORNERS. ON THE PORTION OF THE SQUARE ABOVE THE BANNER IS A BUNCH OF GRAPES DIRECTLY ABOVE THE WORD "GRAPICO" AND BELOW THE BANNER ARE THE WORDS "EST. 1914 NATURALLY GOOD".

SER. NO. 85-360,302, FILED 6-30-2011.

SEAN CROWLEY, EXAMINING ATTORNEY



*David J. Kyros*

Director of the United States Patent and Trademark Office

# United States of America

United States Patent and Trademark Office

# PressLabs

**Reg. No. 4,124,782**

PRESSLABS S.R.L. (ROMANIA LIMITED LIABILITY COMPANY)  
NELU ARISTIDE DRAGOMIR 22-24,BL.14,AP.5  
ARAD, ROMANIA

**Registered Apr. 10, 2012**

**Int. Cl.: 42**

FOR: WEB SITE HOSTING SERVICES, IN CLASS 42 (U.S. CLS. 100 AND 101).

**SERVICE MARK**

FIRST USE 1-20-2011; IN COMMERCE 3-11-2011.

**PRINCIPAL REGISTER**

THE MARK CONSISTS OF STANDARD CHARACTERS WITHOUT CLAIM TO ANY PARTICULAR FONT, STYLE, SIZE, OR COLOR.

SER. NO. 85-360,475, FILED 6-30-2011.

KIM SAITO, EXAMINING ATTORNEY



*David J. Kybas*

Director of the United States Patent and Trademark Office



# United States of America

United States Patent and Trademark Office

## STEAK HOUSE NO. 316

**Reg. No. 4,124,783**

BREXI, LLC (COLORADO LIMITED LIABILITY COMPANY)  
316 E. HOPKINS AVENUE  
ASPEN, CO 81611

**Registered Apr. 10, 2012**

**Int. Cl.: 43**

FOR: BAR AND RESTAURANT SERVICES, IN CLASS 43 (U.S. CLS. 100 AND 101).

**SERVICE MARK**

FIRST USE 7-19-2011; IN COMMERCE 7-19-2011.

**PRINCIPAL REGISTER**

THE MARK CONSISTS OF STANDARD CHARACTERS WITHOUT CLAIM TO ANY PARTICULAR FONT, STYLE, SIZE, OR COLOR.

NO CLAIM IS MADE TO THE EXCLUSIVE RIGHT TO USE "STEAK HOUSE", APART FROM THE MARK AS SHOWN.

SER. NO. 85-360,530, FILED 6-30-2011.

JOSETTE BEVERLY, EXAMINING ATTORNEY



*David J. Kyffers*

Director of the United States Patent and Trademark Office

# United States of America

United States Patent and Trademark Office

## LIGHT. RECREATED.

**Reg. No. 4,124,784**

GENESYS SYSTEMS LLC (NORTH CAROLINA LIMITED LIABILITY COMPANY)  
1300 TUNNEL ROAD  
ASHEVILLE, NC 28805

**Registered Apr. 10, 2012**

**Int. Cl.: 9**

FOR: BALLASTS FOR GAS DISCHARGE LAMPS, IN CLASS 9 (U.S. CLS. 21, 23, 26, 36 AND 38).

**TRADEMARK**

FIRST USE 4-1-2010; IN COMMERCE 4-1-2010.

**PRINCIPAL REGISTER**

THE MARK CONSISTS OF STANDARD CHARACTERS WITHOUT CLAIM TO ANY PARTICULAR FONT, STYLE, SIZE, OR COLOR.

NO CLAIM IS MADE TO THE EXCLUSIVE RIGHT TO USE "LIGHT", APART FROM THE MARK AS SHOWN.

SER. NO. 85-360,576, FILED 6-30-2011.

TINA L. SNAPP, EXAMINING ATTORNEY



*David J. Kyffers*

Director of the United States Patent and Trademark Office

# United States of America

United States Patent and Trademark Office

## Cooking Vacations

**Reg. No. 4,124,785**

**Registered Apr. 10, 2012**

**Int. Cls.: 39 and 41**

**SERVICE MARK**

**PRINCIPAL REGISTER**

COOKING VACATIONS (MASSACHUSETTS LIMITED LIABILITY COMPANY)  
SUITE 400  
20 PARK PLAZA  
BOSTON, MA 02116

FOR: ARRANGING TRAVEL TOURS OFFERED AS A FEATURE OF COOKING VACATION ADVENTURES CELEBRATING THE FOOD, ART AND MUSIC OF ITALY, IN CLASS 39 (U.S. CLS. 100 AND 105).

FIRST USE 1-0-2000; IN COMMERCE 1-0-2000.

FOR: ENTERTAINMENT SERVICES, NAMELY, ARRANGING AND CONDUCTING SPECIAL EVENTS FOR SOCIAL ENTERTAINMENT PURPOSES, NAMELY, THE CELEBRATION OF THE FOOD, ART, AND MUSIC OF ITALY OFFERED TO TRAVELERS ON ITALIAN VACATIONS; ENTERTAINMENT SERVICES, NAMELY, WINE AND FOOD TASTINGS; EDUCATION SERVICES, NAMELY, PROVIDING CLASSES IN THE FIELD OF COOKING; GUIDED TOURS OF WINERIES, IN CLASS 41 (U.S. CLS. 100, 101 AND 107).

FIRST USE 1-0-2000; IN COMMERCE 1-0-2000.

THE MARK CONSISTS OF STANDARD CHARACTERS WITHOUT CLAIM TO ANY PARTICULAR FONT, STYLE, SIZE, OR COLOR.

OWNER OF U.S. REG. NO. 3,306,029.

NO CLAIM IS MADE TO THE EXCLUSIVE RIGHT TO USE "VACATIONS", APART FROM THE MARK AS SHOWN.

SEC. 2(F).

SER. NO. 85-360,615, FILED 6-30-2011.

ERIN FALK, EXAMINING ATTORNEY



*David J. Kyffers*

Director of the United States Patent and Trademark Office

# United States of America

United States Patent and Trademark Office

# HELLO BAR

**Reg. No. 4,124,786**

LONGANECKER, CHARLES J. (UNITED STATES INDIVIDUAL)  
2970 5TH AVENUE, SUITE 340  
SAN DIEGO, CA 92103

**Registered Apr. 10, 2012**

**Int. Cl.: 42**

FOR: PROVIDING ON-LINE NON-DOWNLOADABLE EMBEDDABLE COMPUTER SOFTWARE FOR USE IN PROVIDING A WEBSITE TOOLBAR WHICH ALLOWS THE USER TO DELIVER MESSAGES AND PROVIDE WEB LINKS TO OTHER WEB PAGES THAT PROMOTE GOODS AND SERVICES, IN CLASS 42 (U.S. CLS. 100 AND 101).

**SERVICE MARK**

**PRINCIPAL REGISTER**

FIRST USE 9-24-2010; IN COMMERCE 9-24-2010.

THE MARK CONSISTS OF STANDARD CHARACTERS WITHOUT CLAIM TO ANY PARTICULAR FONT, STYLE, SIZE, OR COLOR.

NO CLAIM IS MADE TO THE EXCLUSIVE RIGHT TO USE "BAR", APART FROM THE MARK AS SHOWN.

SER. NO. 85-360,646, FILED 6-30-2011.

PRISCILLA MILTON, EXAMINING ATTORNEY



*David J. Kyjars*

Director of the United States Patent and Trademark Office

# United States of America

United States Patent and Trademark Office



**Reg. No. 4,124,787**

**Registered Apr. 10, 2012**

**Int. Cl.: 35**

MICHIGAN ASSOCIATION OF PUBLIC SCHOOL ACADEMIES (MICHIGAN CORPORATION), AKA MAPSA  
SUITE 135  
215 S. WASHINGTON SQUARE  
LANSING, MI 48933

**SERVICE MARK**

FOR: ASSOCIATION SERVICES, NAMELY, PROMOTING THE INTERESTS OF PUBLIC SCHOOL ACADEMIES, IN CLASS 35 (U.S. CLS. 100, 101 AND 102).

**PRINCIPAL REGISTER**

FIRST USE 9-1-2010; IN COMMERCE 9-1-2010.

NO CLAIM IS MADE TO THE EXCLUSIVE RIGHT TO USE "MICHIGAN ASSOCIATION OF PUBLIC SCHOOL ACADEMIES", APART FROM THE MARK AS SHOWN.

THE COLOR(S) BLUE AND GREY IS/ARE CLAIMED AS A FEATURE OF THE MARK.

THE COLOR BLUE APPEARS IN THE WORDING "MAPSA MICHIGAN ASSOCIATION OF PUBLIC SCHOOL ACADEMIES" AND IN THE LINE UNDERNEATH "MAPSA". THE COLOR GREY APPEARS IN THE DEPICTION OF THE TWO HAND PRINTS.

SER. NO. 85-360,930, FILED 6-30-2011.

EVELYN BRADLEY, EXAMINING ATTORNEY



*David J. Kyjars*

Director of the United States Patent and Trademark Office

United States of America  
United States Patent and Trademark Office



**Reg. No. 4,124,788**

**Registered Apr. 10, 2012**

**Int. Cl.: 35**

**SERVICE MARK**

**PRINCIPAL REGISTER**

BATTERIES AND THINGS, INC. (ILLINOIS CORPORATION)  
365 24TH STREET  
LASALLE, IL 61301

FOR: RETAIL STORE AND ON-LINE RETAIL STORE SERVICES FOR BATTERIES, BATTERY CHARGERS, FLASHLIGHTS, CELL PHONE CHARGERS AND OTHER SECURITY AND SAFETY PRODUCTS, IN CLASS 35 (U.S. CLS. 100, 101 AND 102).

FIRST USE 10-1-2010; IN COMMERCE 10-1-2010.

NO CLAIM IS MADE TO THE EXCLUSIVE RIGHT TO USE "BATTERIES", APART FROM THE MARK AS SHOWN.

THE COLOR(S) GRAY, ORANGE, BLACK AND WHITE IS/ARE CLAIMED AS A FEATURE OF THE MARK.

THE MARK CONSISTS OF THE WORDING "BATTERIES" IN ORANGE THAT SHADES TO LIGHT ORANGE CURVING FROM TOP TO BOTTOM WITH THE TOP PORTION OF THIS WORDING OUTLINED IN BLACK ALL OVER A BLACK BACKGROUND AND AN IMAGE OF A BATTERY IN ORANGE AND WHITE FEATURING THREE ELECTRICITY SYMBOLS IN WHITE AND GRAY TO THE LEFT OF THE WORDING "& THINGS" IN SHADED WHITE AND GRAY.

SER. NO. 85-361,096, FILED 6-30-2011.

DOMINIC J. FERRAIUOLO, EXAMINING ATTORNEY



*David J. Kybas*

Director of the United States Patent and Trademark Office

# United States of America

United States Patent and Trademark Office

## Medici Innovation Workshop

**Reg. No. 4,124,789**

THE MEDICI GROUP LLC (NEW YORK LIMITED LIABILITY COMPANY)  
1115 BROADWAY, 12TH FLOOR  
NEW YORK, NY 10010

**Registered Apr. 10, 2012**

**Int. Cl.: 41**

FOR: EDUCATIONAL SERVICES, NAMELY, A LEARNING AND INNOVATION CENTER FEATURING FULLY CUSTOMIZED LEADERSHIP, MOTIVATIONAL, EDUCATIONAL, AND BRAINSTORMING TRAINING; BUSINESS EDUCATION AND TRAINING SERVICES, NAMELY, DEVELOPING, AND FACILITATING CUSTOMIZED IN-COMPANY LEADERSHIP AND EXECUTIVE DEVELOPMENT PROGRAMS, PROVIDING EXECUTIVE COACHING SERVICES, AND PROVIDING PUBLIC AND IN-COMPANY KEYNOTE PRESENTATIONS TO BUSINESS LEADERS; BUSINESS EDUCATION AND TRAINING SERVICES, NAMELY, DEVELOPING AND FACILITATING CUSTOMIZED LEADERSHIP AND EXECUTIVE DEVELOPMENT PROGRAMS, PROVIDING EXECUTIVE COACHING SERVICES, AND PROVIDING BUSINESS EDUCATION PROGRAMS TO EMPLOYEES AND EXECUTIVES; EDUCATIONAL SERVICES, NAMELY, CONDUCTING SEMINARS AND WORKSHOPS IN THE FIELD OF BUSINESS STRATEGIES AND CREATIVE IDEATION, AND DISTRIBUTION OF TRAINING MATERIALS IN CONNECTION THEREWITH; PROVIDING GROUP COACHING AND LEARNING FORUMS IN THE FIELD OF LEADERSHIP DEVELOPMENT, BUSINESS STRATEGIES DEVELOPMENT AND CREATIVE IDEATION, IN CLASS 41 (U.S. CLS. 100, 101 AND 107).

**SERVICE MARK**

**PRINCIPAL REGISTER**

FIRST USE 2-27-2006; IN COMMERCE 2-27-2006.



THE MARK CONSISTS OF STANDARD CHARACTERS WITHOUT CLAIM TO ANY PARTICULAR FONT, STYLE, SIZE, OR COLOR.

NO CLAIM IS MADE TO THE EXCLUSIVE RIGHT TO USE "INNOVATION WORKSHOP", APART FROM THE MARK AS SHOWN.

SER. NO. 85-361,412, FILED 7-1-2011.

HENRY S. ZAK, EXAMINING ATTORNEY

*David J. Kybas*

Director of the United States Patent and Trademark Office

# United States of America

United States Patent and Trademark Office

## San Diego Property Pros

**Reg. No. 4,124,790**

HOFFMAN, WILLIAM (UNITED STATES INDIVIDUAL)  
1621 GLADE PLACE  
ESCONDIDO, CA 92029

**Registered Apr. 10, 2012**

**Int. Cl.: 36**

FOR: REAL ESTATE BROKERAGE, IN CLASS 36 (U.S. CLS. 100, 101 AND 102).

**SERVICE MARK**

FIRST USE 1-1-1964; IN COMMERCE 1-1-1964.

**PRINCIPAL REGISTER**

THE MARK CONSISTS OF STANDARD CHARACTERS WITHOUT CLAIM TO ANY PARTICULAR FONT, STYLE, SIZE, OR COLOR.

NO CLAIM IS MADE TO THE EXCLUSIVE RIGHT TO USE "PROPERTY", APART FROM THE MARK AS SHOWN.

SEC. 2(F).

SER. NO. 85-361,917, FILED 7-1-2011.

SAIMA MAKHDOOM, EXAMINING ATTORNEY



*David J. Kyffers*

Director of the United States Patent and Trademark Office



# United States of America

United States Patent and Trademark Office

## Innovation Experience

**Reg. No. 4,124,791**

THE MEDICI GROUP LLC (NEW YORK LIMITED LIABILITY COMPANY)  
1115 BROADWAY, 12TH FLOOR  
NEW YORK, NY 10010

**Registered Apr. 10, 2012**

**Int. Cl.: 41**

FOR: EDUCATIONAL SERVICES, NAMELY, A LEARNING AND INNOVATION CENTER FEATURING FULLY CUSTOMIZED LEADERSHIP, MOTIVATIONAL, EDUCATIONAL, AND BRAINSTORMING TRAINING; BUSINESS EDUCATION AND TRAINING SERVICES, NAMELY, DEVELOPING, AND FACILITATING CUSTOMIZED IN-COMPANY LEADERSHIP AND EXECUTIVE DEVELOPMENT PROGRAMS, PROVIDING EXECUTIVE COACHING SERVICES, AND PROVIDING PUBLIC AND IN-COMPANY KEYNOTE PRESENTATIONS TO BUSINESS LEADERS; BUSINESS EDUCATION AND TRAINING SERVICES, NAMELY, DEVELOPING AND FACILITATING CUSTOMIZED LEADERSHIP AND EXECUTIVE DEVELOPMENT PROGRAMS, PROVIDING EXECUTIVE COACHING SERVICES, AND PROVIDING BUSINESS EDUCATION PROGRAMS TO EMPLOYEES AND EXECUTIVES; EDUCATIONAL SERVICES, NAMELY, CONDUCTING SEMINARS AND WORKSHOPS IN THE FIELD OF BUSINESS STRATEGIES AND CREATIVE IDEATION, AND DISTRIBUTION OF TRAINING MATERIALS IN CONNECTION THEREWITH; PROVIDING GROUP COACHING AND LEARNING FORUMS IN THE FIELD OF LEADERSHIP DEVELOPMENT, BUSINESS STRATEGIES DEVELOPMENT AND CREATIVE IDEATION, IN CLASS 41 (U.S. CLS. 100, 101 AND 107).

**SERVICE MARK**

**PRINCIPAL REGISTER**

FIRST USE 2-27-2006; IN COMMERCE 2-27-2006.



THE MARK CONSISTS OF STANDARD CHARACTERS WITHOUT CLAIM TO ANY PARTICULAR FONT, STYLE, SIZE, OR COLOR.

NO CLAIM IS MADE TO THE EXCLUSIVE RIGHT TO USE "INNOVATION", APART FROM THE MARK AS SHOWN.

SER. NO. 85-362,014, FILED 7-1-2011.

HENRY S. ZAK, EXAMINING ATTORNEY

*David J. Kyffers*

Director of the United States Patent and Trademark Office

# United States of America

United States Patent and Trademark Office

# PermaVision

**Reg. No. 4,124,792**

CARL ZEISS VISION GMBH (FED REP GERMANY LIMITED LIABILITY COMPANY)  
TURNSTRASSE 27

**Registered Apr. 10, 2012**

AALEN, FED REP GERMANY 73430

**Int. Cl.: 9**

FOR: SPECTACLE LENSES AND PARTS THEREOF, IN CLASS 9 (U.S. CLS. 21, 23, 26, 36 AND 38).

**TRADEMARK**

THE MARK CONSISTS OF STANDARD CHARACTERS WITHOUT CLAIM TO ANY PARTICULAR FONT, STYLE, SIZE, OR COLOR.

**PRINCIPAL REGISTER**

PRIORITY CLAIMED UNDER SEC. 44(D) ON FED REP GERMANY APPLICATION NO. 302011025405, FILED 5-5-2011, REG. NO. 302011025405, DATED 5-25-2011, EXPIRES 5-31-2021.

SER. NO. 85-362,122, FILED 7-1-2011.

HENRY S. ZAK, EXAMINING ATTORNEY



*David J. Kyffers*

Director of the United States Patent and Trademark Office

# United States of America

United States Patent and Trademark Office

## SMOKING JACKET

**Reg. No. 4,124,793**

**Registered Apr. 10, 2012**

**Int. Cl.: 34**

**TRADEMARK**

**PRINCIPAL REGISTER**

KELNER BUTLER, HENDRIK, MONTT (DOMINICAN REP INDIVIDUAL)  
CALLE R, URB.CASILDA, RES MARIA JOSE 1A  
SANTIAGO, DOMINICAN REP

FOR: CIGARS, IN CLASS 34 (U.S. CLS. 2, 8, 9 AND 17).

FIRST USE 8-15-2011; IN COMMERCE 8-15-2011.

THE MARK CONSISTS OF STANDARD CHARACTERS WITHOUT CLAIM TO ANY PARTICULAR FONT, STYLE, SIZE, OR COLOR.

SER. NO. 85-362,227, FILED 7-1-2011.

ANDREA K. NADELMAN, EXAMINING ATTORNEY



*David J. Kyffers*

Director of the United States Patent and Trademark Office

United States of America  
United States Patent and Trademark Office

**PVentures**  
**GUIDING ENTREPRENEURSHIP**

**Reg. No. 4,124,794**

**Registered Apr. 10, 2012**

**Int. Cl.: 35**

**SERVICE MARK**

**PRINCIPAL REGISTER**

PEREIRA, ARMANDO N. (CALIFORNIA SOLE PROPRIETORSHIP), DBA PEREIRA VENTURES  
200 ERSELIA TRAIL  
ALAMO, CA 94507

FOR: ASSISTANCE AND ADVICE REGARDING BUSINESS ORGANIZATION AND MANAGEMENT; ASSISTANCE, ADVISORY SERVICES AND CONSULTANCY WITH REGARD TO BUSINESS PLANNING, BUSINESS ANALYSIS, BUSINESS MANAGEMENT, AND BUSINESS ORGANIZATION; BUSINESS CONSULTATION AND MANAGEMENT REGARDING MARKETING ACTIVITIES AND LAUNCHING OF NEW PRODUCTS; BUSINESS MANAGEMENT CONSULTATION IN THE FIELD OF EXECUTIVE AND LEADERSHIP DEVELOPMENT; BUSINESS MANAGEMENT CONSULTING IN THE FIELD OF TEAM DEVELOPMENT; CONSULTING SERVICES IN THE FIELD OF MANAGING INTELLECTUAL PROPERTIES; NEW BUSINESS VENTURE DEVELOPMENT AND FORMATION CONSULTING SERVICES, IN CLASS 35 (U.S. CLS. 100, 101 AND 102).

FIRST USE 1-18-2011; IN COMMERCE 1-18-2011.

NO CLAIM IS MADE TO THE EXCLUSIVE RIGHT TO USE "ENTREPRENEURSHIP", APART FROM THE MARK AS SHOWN.

THE MARK CONSISTS OF THREE WORDS ARRANGED IN TWO LINES. THE FIRST LINE IS "PVENTURES" IN LARGE FONT. THE SECOND LINE IS "GUIDING ENTREPRENEURSHIP" IN SMALLER FONT.

SER. NO. 85-362,338, FILED 7-2-2011.

WILLIAM P. SHANAHAN, EXAMINING ATTORNEY



*David J. Kybas*

Director of the United States Patent and Trademark Office

# United States of America

United States Patent and Trademark Office

## FAST TRACK CURRICULUM

**Reg. No. 4,124,795**

KIDS 'R' KIDS, INC. (GEORGIA CORPORATION)  
1625 EXECUTIVE DRIVE SOUTH  
DULUTH, GA 30096

**Registered Apr. 10, 2012**

**Int. Cl.: 41**

FOR: EDUCATION SERVICES IN THE NATURE OF EARLY CHILDHOOD INSTRUCTION,  
IN CLASS 41 (U.S. CLS. 100, 101 AND 107).

**SERVICE MARK**

FIRST USE 6-0-2011; IN COMMERCE 6-0-2011.

**PRINCIPAL REGISTER**

THE MARK CONSISTS OF STANDARD CHARACTERS WITHOUT CLAIM TO ANY PAR-  
TICULAR FONT, STYLE, SIZE, OR COLOR.

NO CLAIM IS MADE TO THE EXCLUSIVE RIGHT TO USE "CURRICULUM", APART FROM  
THE MARK AS SHOWN.

SER. NO. 85-362,357, FILED 7-2-2011.

ANDREW LEASER, EXAMINING ATTORNEY



*David J. Kyros*

Director of the United States Patent and Trademark Office

# United States of America

United States Patent and Trademark Office



**Reg. No. 4,124,796**

**Registered Apr. 10, 2012**

**Int. Cl.: 16**

**TRADEMARK**

**PRINCIPAL REGISTER**

IVY PUBLICATIONS, LLC (VIRGINIA LIMITED LIABILITY COMPANY), DBA  
ALBEMARLEFAMILY  
4282 IVY ROAD  
CHARLOTTESVILLE, VA 22903

FOR: TELEPHONE DIRECTORIES, IN CLASS 16 (U.S. CLS. 2, 5, 22, 23, 29, 37, 38 AND 50).

FIRST USE 1-15-2011; IN COMMERCE 6-14-2011.

NO CLAIM IS MADE TO THE EXCLUSIVE RIGHT TO USE "LOCALLY CHARLOTTESVILLE", APART FROM THE MARK AS SHOWN.

THE COLOR(S) BLACK, WHITE, YELLOW IS/ARE CLAIMED AS A FEATURE OF THE MARK.

THE MARK CONSISTS OF A BLACK ORNAMENTAL BORDER WITH A WHITE BACKGROUND THAT CONTAINS THE BLACK WORDING "LOCALLY CHARLOTTESVILLE" WITH THE "O" IN "LOCALLY" CONTAINING A WHITE DAISY WITH A YELLOW CENTER THAT IS OUTLINED IN BLACK.

SER. NO. 85-362,390, FILED 7-2-2011.

MEGHAN REINHART, EXAMINING ATTORNEY



*David J. Kyros*

Director of the United States Patent and Trademark Office

# United States of America

United States Patent and Trademark Office

# CUPCRAZED

**Reg. No. 4,124,797**

**Registered Apr. 10, 2012**

**Int. Cl.: 35**

**SERVICE MARK**

**PRINCIPAL REGISTER**

CUPCRAZED, INC. (SOUTH CAROLINA CORPORATION)  
936 MARKET STREET, SUITE 103  
FORT MILL, SC 29708

FOR: RETAIL BAKERY SHOP, IN CLASS 35 (U.S. CLS. 100, 101 AND 102).

FIRST USE 4-26-2010; IN COMMERCE 4-26-2010.

THE MARK CONSISTS OF STANDARD CHARACTERS WITHOUT CLAIM TO ANY PARTICULAR FONT, STYLE, SIZE, OR COLOR.

SER. NO. 85-362,857, FILED 7-5-2011.

SAMUEL E. SHARPER JR., EXAMINING ATTORNEY



*David J. Kybas*

Director of the United States Patent and Trademark Office

# United States of America

United States Patent and Trademark Office



**Reg. No. 4,124,798**

SHANNON HILL MUHAMMAD (UNITED STATES INDIVIDUAL)  
7218 S. ALBANY  
CHICAGO, IL 60629

**Registered Apr. 10, 2012**

**Int. Cl.: 25**

FOR: WEARABLE GARMENTS AND CLOTHING, NAMELY, SHIRTS, IN CLASS 25 (U.S. CLS. 22 AND 39).

**TRADEMARK**

FIRST USE 3-1-2009; IN COMMERCE 3-1-2009.

**PRINCIPAL REGISTER**

THE MARK CONSISTS OF A GIRL WITH A BROWN FACE AND BLACK EYES CONSISTING OF A MODIFIED CHECK MARK AND UPSIDE DOWN PARENTHESES, A BLACK SLIGHTLY CROOKED SMILE AND BLACK HAIR CONSISTING OF A BLACK FOOTBALL SHAPED BANG ON HER FOREHEAD AND SEVEN BLACK HALF CIRCLES OF HAIR AROUND HER HEAD.

THE COLOR(S) BLACK AND BROWN IS/ARE CLAIMED AS A FEATURE OF THE MARK.

SER. NO. 85-363,036, FILED 7-5-2011.

JERI J. FICKES, EXAMINING ATTORNEY



*David J. Kybas*

Director of the United States Patent and Trademark Office



# United States of America

United States Patent and Trademark Office



**Reg. No. 4,124,799**

**Registered Apr. 10, 2012**

**Int. Cls.: 41 and 43**

**SERVICE MARK**

**PRINCIPAL REGISTER**

SENECA GAMING CORPORATION (UNITED STATES TRIBALLY-CHARTERED CORPORATION OF THE SENECA NATION OF INDIANS, A FEDERALLY-RECOGNIZED AMERICAN INDIAN TRIBE)  
310 FOURTH STREET  
NIAGARA FALLS, NY 14303

FOR: CASINO SERVICES, IN CLASS 41 (U.S. CLS. 100, 101 AND 107).

FIRST USE 7-31-2007; IN COMMERCE 7-31-2007.

FOR: SNACK BAR SERVICES, IN CLASS 43 (U.S. CLS. 100 AND 101).

FIRST USE 7-31-2007; IN COMMERCE 7-31-2007.

OWNER OF U.S. REG. NO. 3,596,671.

NO CLAIM IS MADE TO THE EXCLUSIVE RIGHT TO USE "BUFFALO CREEK CASINO", APART FROM THE MARK AS SHOWN.

THE MARK CONSISTS OF AN ABSTRACT PROFILE OF A BUFFALO FACING RIGHT OVER THE WORD "SENECA". THE WORD "BUFFALO" APPEARS BELOW THE WORD "SENECA". THE WORD "CREEK" APPEARS BELOW THE WORD "BUFFALO". A HORIZONTAL LINE APPEARS BELOW THE WORD "CREEK". THE WORD "CASINO" APPEARS BELOW THE HORIZONTAL LINE.

SER. NO. 85-363,058, FILED 7-5-2011.

KATHLEEN M. VANSTON, EXAMINING ATTORNEY



*David J. Kybas*

Director of the United States Patent and Trademark Office

# United States of America

United States Patent and Trademark Office



# VENTAS

**Reg. No. 4,124,800**

**Registered Apr. 10, 2012**

**Int. Cl.: 36**

**SERVICE MARK**

**PRINCIPAL REGISTER**

VENTAS, INC. (DELAWARE CORPORATION)  
111 SOUTH WACKER DRIVE, SUITE 4800  
CHICAGO, IL 60606

FOR: REAL ESTATE SERVICES, NAMELY, REAL ESTATE INVESTMENT, ACQUISITION AND MANAGEMENT SERVICES, REAL ESTATE INVESTMENT TRUST SERVICES; REAL ESTATE ADMINISTRATION, NAMELY, REAL ESTATE FINANCING AND LEASING SERVICES; REAL ESTATE FUND MANAGEMENT SERVICES, IN CLASS 36 (U.S. CLS. 100, 101 AND 102).

FIRST USE 7-1-2011; IN COMMERCE 7-1-2011.

OWNER OF U.S. REG. NOS. 2,896,951 AND 3,893,965.

THE MARK CONSISTS OF THE STYLIZED WORD "VENTAS" WITH A FANCIFUL TRIANGLE DESIGN TO THE LEFT SIDE.

THE ENGLISH TRANSLATION OF "VENTAS" IN THE MARK IS "SALES".

SER. NO. 85-363,099, FILED 7-5-2011.

MATTHEW EINSTEIN, EXAMINING ATTORNEY



*David J. Kyros*

Director of the United States Patent and Trademark Office

# United States of America

United States Patent and Trademark Office

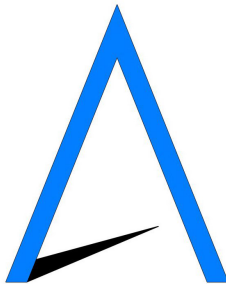

**Reg. No. 4,124,801**

**Registered Apr. 10, 2012**

**Int. Cl.: 36**

**SERVICE MARK**

**PRINCIPAL REGISTER**

VENTAS, INC. (DELAWARE CORPORATION)  
111 SOUTH WACKER DRIVE, SUITE 4800  
CHICAGO, IL 60606

FOR: REAL ESTATE SERVICES, NAMELY, REAL ESTATE INVESTMENT, ACQUISITION AND MANAGEMENT SERVICES, REAL ESTATE INVESTMENT TRUST SERVICES; REAL ESTATE ADMINISTRATION, NAMELY, REAL ESTATE FINANCING AND LEASING SERVICES; REAL ESTATE FUND MANAGEMENT SERVICES, IN CLASS 36 (U.S. CLS. 100, 101 AND 102).

FIRST USE 7-1-2011; IN COMMERCE 7-1-2011.

THE MARK CONSISTS OF A FANCIFUL TRIANGLE DESIGN WITH TWO BARS IN THE COLOR BLUE AND ONE BAR IN THE COLOR BLACK.

THE COLOR(S) BLUE AND BLACK IS/ARE CLAIMED AS A FEATURE OF THE MARK.

SER. NO. 85-363,169, FILED 7-5-2011.

MATTHEW EINSTEIN, EXAMINING ATTORNEY



*David J. Kybas*

Director of the United States Patent and Trademark Office

# United States of America

United States Patent and Trademark Office

# SOLAR X

**Reg. No. 4,124,802**

SOLARX EYEWEAR, LLC (OHIO LIMITED LIABILITY COMPANY)  
35490 LORAIN ROAD NORTH  
RIDGEVILLE, OH 44039

**Registered Apr. 10, 2012**

**Int. Cl.: 9**

FOR: SUNGLASSES AND SPECTACLES NOT INCLUDING OPHTHALMIC LENSES, IN CLASS 9 (U.S. CLS. 21, 23, 26, 36 AND 38).

**TRADEMARK**

FIRST USE 10-31-2007; IN COMMERCE 10-31-2007.

**PRINCIPAL REGISTER**

THE MARK CONSISTS OF STANDARD CHARACTERS WITHOUT CLAIM TO ANY PARTICULAR FONT, STYLE, SIZE, OR COLOR.

NO CLAIM IS MADE TO THE EXCLUSIVE RIGHT TO USE "SOLAR", APART FROM THE MARK AS SHOWN.

SER. NO. 85-363,668, FILED 7-5-2011.

TARA PATE, EXAMINING ATTORNEY



*David J. Kybas*

Director of the United States Patent and Trademark Office

# United States of America

United States Patent and Trademark Office



**Reg. No. 4,124,803**

**Registered Apr. 10, 2012**

**Int. Cls.: 35, 39 and 41**

**SERVICE MARK**

**PRINCIPAL REGISTER**

SEA WORLD LLC (DELAWARE LIMITED LIABILITY COMPANY)  
SUITE 400  
9205 SOUTH PARK CENTER LOOP  
ORLANDO, FL 32819

FOR: CHARITABLE SERVICES, NAMELY, ORGANIZING AND CONDUCTING VOLUNTEER PROGRAMS AND COMMUNITY SERVICE PROJECTS; CHARITABLE SERVICES, NAMELY, PROMOTING ENVIRONMENTAL AWARENESS TO CHILDREN, IN CLASS 35 (U.S. CLS. 100, 101 AND 102).

FIRST USE 2-0-2011; IN COMMERCE 2-0-2011.

FOR: ANIMAL RESCUE SERVICES; PROVIDING A WEBSITE FEATURING INFORMATION ON ANIMAL RESCUE SERVICES, IN CLASS 39 (U.S. CLS. 100 AND 105).

FIRST USE 2-0-2011; IN COMMERCE 2-0-2011.

FOR: EDUCATIONAL SERVICES, NAMELY, PROVIDING INSTRUCTIONAL SEMINARS, QUESTION AND ANSWER SESSIONS, WORKSHOPS AND CLASSES IN THE FIELDS OF NATURE, ANIMALS, WILDLIFE, ANIMAL HABITATS, BIOLOGY, BIOLOGICAL DIVERSITY, WILDLIFE PRESERVATION, HABITAT PRESERVATION, ECOLOGY, THE ENVIRONMENT, SUSTAINABILITY, REHABILITATION, ZOOLOGY AND BOTANY; ZOOLOGICAL PARKS AND EDUCATION IN RELATION TO ZOOLOGY AND ANIMAL LIFE, IN CLASS 41 (U.S. CLS. 100, 101 AND 107).

FIRST USE 2-0-2011; IN COMMERCE 2-0-2011.

OWNER OF U.S. REG. NOS. 1,780,901, 3,569,923 AND OTHERS.

THE MARK CONSISTS OF THE TERM "SEAWORLD CARES" BISECTED BY A PAIR OF OPEN HANDS CRADLING THE TAIL OF A WHALE.

SER. NO. 85-363,687, FILED 7-5-2011.

SUSAN LESLIE DUBOIS, EXAMINING ATTORNEY



*David J. Kyffers*

Director of the United States Patent and Trademark Office

# United States of America

United States Patent and Trademark Office



**Reg. No. 4,124,804**

**Registered Apr. 10, 2012**

**Int. Cl.: 18**

GUANGDONG SHUYE ENVIRONMENTAL TECHNOLOGY CO., LTD (CHINA LIMITED LIABILITY COMPANY)  
SIMAPU INDUSTRIAL PARK, HONGER ROAD  
YANHONG TOWN, CHENGHAI DISTRICT  
SHANTOU, GUANGDONG, CHINA

**TRADEMARK**

**PRINCIPAL REGISTER**

FOR: LEATHER, UNWORKED OR SEMI-WORKED; PURSES; BACKPACKS; LEATHER SHOPPING BAGS; HANDBAGS; VALISES; GARMENT BAGS FOR TRAVEL; MESH SHOPPING BAGS; IMITATION LEATHER; UMBRELLAS, IN CLASS 18 (U.S. CLS. 1, 2, 3, 22 AND 41).

FIRST USE 2-1-2009; IN COMMERCE 2-1-2009.

THE MARK CONSISTS OF YELLOW CURVED BAND AND A GREEN CURVED BAND FORMING A BROKEN CIRCLE. THE WORD "SHUYE" APPEARS WRITTEN ON THE BOTTOM RIGHT OF THE DESIGN, WITH THE FIRST HALF WRITTEN IN WHITE AND THE SECOND HALF WRITTEN IN GREEN.

THE COLOR(S) GREEN, YELLOW AND WHITE IS/ARE CLAIMED AS A FEATURE OF THE MARK.

SER. NO. 85-363,768, FILED 7-6-2011.

FRANK LATTUCA, EXAMINING ATTORNEY



*David J. Kyffers*

Director of the United States Patent and Trademark Office

# United States of America

United States Patent and Trademark Office

# GSKYER

**Reg. No. 4,124,805**

**Registered Apr. 10, 2012**

**Int. Cl.: 9**

**TRADEMARK**

**PRINCIPAL REGISTER**

YUYAO BOJING OPTICAL INSTRUMENT FACTORY (CHINA LIMITED LIABILITY COMPANY)  
WUMA INDUSTRIAL ZONE  
WUMA VILLAGE LUBU COUNTY  
YUYAO CITY, ZHEJIANG, CHINA

FOR: BINOCULARS; INSPECTION MIRRORS; LABORATORY EQUIPMENT, NAMELY, SPECTROSCOPES; MAGNIFYING GLASSES; MICROSCOPES; OPTICAL GLASSES; OPTICAL LENSES; PERISCOPES; STEREOSCOPES; TELESCOPES, IN CLASS 9 (U.S. CLS. 21, 23, 26, 36 AND 38).

FIRST USE 9-16-2005; IN COMMERCE 8-16-2009.

THE MARK CONSISTS OF THE LETTERS "GSKYER".

THE WORDING "GSKYER" HAS NO MEANING IN A FOREIGN LANGUAGE.

SER. NO. 85-363,775, FILED 7-6-2011.

FRANK LATTUCA, EXAMINING ATTORNEY



*David J. Kyffers*

Director of the United States Patent and Trademark Office

# United States of America

United States Patent and Trademark Office

## CFO SCOREBOARD FROM KEYS TO THE VAULT

**Reg. No. 4,124,806**

KEYS TO THE VAULT, INC. (TEXAS CORPORATION)  
4005 ENCLAVE MESA CIRCLE  
AUSTIN, TX 78731

**Registered Apr. 10, 2012**

**Int. Cl.: 9**

FOR: COMPUTER SOFTWARE PROGRAM UTILIZING A COMPANY'S BUSINESS PERFORMANCE INFORMATION TO PROVIDE A STATISTICAL ANALYSIS FOR THE EDUCATION OF A USER TO MAKE MORE INFORMED CURRENT AND FUTURE BUSINESS DECISIONS, IN CLASS 9 (U.S. CLS. 21, 23, 26, 36 AND 38).

**TRADEMARK**

**PRINCIPAL REGISTER**

FIRST USE 6-21-2011; IN COMMERCE 6-21-2011.

THE MARK CONSISTS OF STANDARD CHARACTERS WITHOUT CLAIM TO ANY PARTICULAR FONT, STYLE, SIZE, OR COLOR.

OWNER OF U.S. REG. NOS. 2,969,267 AND 3,217,587.

NO CLAIM IS MADE TO THE EXCLUSIVE RIGHT TO USE "CFO", APART FROM THE MARK AS SHOWN.

SER. NO. 85-363,908, FILED 7-6-2011.

DORITT L. CARROLL, EXAMINING ATTORNEY



*David J. Kyffers*

Director of the United States Patent and Trademark Office



# United States of America

United States Patent and Trademark Office

# Stabilis

**Reg. No. 4,124,807**

**Registered Apr. 10, 2012**

**Int. Cl.: 28**

**TRADEMARK**

**PRINCIPAL REGISTER**

THE PROPHET CORPORATION (MINNESOTA CORPORATION), DBA GOPHER SPORT  
2525 LEMOND ST. SW  
OWATONNA, MN 55060

FOR: WHEELED PLATFORM SCOOTER FOR GYMNASTICS AND EXERCISE USE, IN  
CLASS 28 (U.S. CLS. 22, 23, 38 AND 50).

FIRST USE 8-1-2010; IN COMMERCE 8-1-2010.

THE MARK CONSISTS OF STANDARD CHARACTERS WITHOUT CLAIM TO ANY PAR-  
TICULAR FONT, STYLE, SIZE, OR COLOR.

THE ENGLISH TRANSLATION OF "STABILIS" IN THE MARK IS "STABLE".

SER. NO. 85-363,916, FILED S.R. 7-6-2011 AM. P.R. 12-2-2011.

FRANK LATTUCA, EXAMINING ATTORNEY



*David J. Kybas*

Director of the United States Patent and Trademark Office

# United States of America

United States Patent and Trademark Office

CUI GLOBAL

**Reg. No. 4,124,808**

CUI GLOBAL, INC. (COLORADO CORPORATION)

**Registered Apr. 10, 2012**

546 19 AVENUE NE  
ST. PETERSBURG, FL 33704

**Int. Cl.: 9**

FOR: CONSUMER ELECTRONIC PRODUCTS, NAMELY, AUDIO SPEAKERS, ELECTRICAL AUDIO AND SPEAKER CABLES AND CONNECTORS, BUZZERS, ENCODERS, POWER TRANSFORMERS, LINEAR POWER SUPPLIES, MICROPHONES, ELECTRONIC SENSORS FOR SENSING RELATIVE PHYSICAL POSITIONING AND LOCATION; THERMAL MANAGEMENT DEVICES IN THE NATURE OF COMPUTER CHIP COOLING DEVICES; POWER CONVERTERS, POWER INVERTERS; AND ELECTRONIC NATURAL GAS PHYSICAL PROPERTIES AND QUALITY MEASUREMENT DEVICES IN THE NATURE OF A NATURAL GAS QUALITY METERING DEVICE, IN CLASS 9 (U.S. CLS. 21, 23, 26, 36 AND 38).

**TRADEMARK**

**PRINCIPAL REGISTER**

FIRST USE 1-4-2011; IN COMMERCE 7-1-2011.

NO CLAIM IS MADE TO THE EXCLUSIVE RIGHT TO USE "GLOBAL" , APART FROM THE MARK AS SHOWN.

THE COLOR(S) BLUE AND GRAY IS/ARE CLAIMED AS A FEATURE OF THE MARK.

THE MARK CONSISTS OF THE TERM "CUIGLOBAL", WITH THE LETTERS "CUI" AND THE "O" IN "GLOBAL" IN BLUE, AND THE REMAINING LETTERS IN "GLOBAL" IN GRAY. THE LOGO IS ON A WHITE BACKGROUND. THE "O" IN "GLOBAL" IS STYLIZED SLIGHTLY OBLONG ALONG THE HORIZONTAL PLANE AND SHADED TO APPEAR THREE DIMENSIONAL.



SER. NO. 85-364,045, FILED 7-6-2011.

WILLIAM P. SHANAHAN, EXAMINING ATTORNEY

*David J. Kyros*

Director of the United States Patent and Trademark Office

# United States of America

United States Patent and Trademark Office



**Reg. No. 4,124,809**

**Registered Apr. 10, 2012**

**Int. Cl.: 29**

**TRADEMARK**

**PRINCIPAL REGISTER**

MERCADO SAN FRANCISCO INC. (PUERTO RICO CORPORATION), DBA LA HACIENDA  
MEAT CENTER  
PMV 347 GARDEN HILLS PLAZA  
GUAYNABO, PUERTO RICO 009662700

FOR: FRESH MEAT; HAMBURGER; MARINATED MEAT; MEAT; MEAT; MEAT AND  
MEAT EXTRACTS; MEAT, FROZEN; PACKAGED MEATS; PROCESSED MEAT; SALTED  
MEAT; SEASONED MEAT; SLICED MEAT, IN CLASS 29 (U.S. CL. 46).

FIRST USE 6-1-2007; IN COMMERCE 6-1-2007.

NO CLAIM IS MADE TO THE EXCLUSIVE RIGHT TO USE "BBQ" AND "LA HACIENDA  
MEAT CENTER", APART FROM THE MARK AS SHOWN.

THE COLOR(S) RED, BLACK, WHITE IS/ARE CLAIMED AS A FEATURE OF THE MARK.

THE MARK CONSISTS OF A BLACK SQUARE WHICH IN THE MIDDLE HAVE THE WORDS  
"BBQ" AND UNDER IT THE WORD "FREAKS". THE WORDS ARE IN CAPITAL LETTERS  
AND IN WHITE. UNDER THE WORDS "BBQ FREAKS" THERE IS A RED CIRCLE WITH A  
BLACK BORDER. INSIDE THE CIRCLE THERE IS A LETTER "H". ONE OF THE LEGS OF  
THE "H" PULLS UP, WHILE THE OTHER ONE PULLS DOWN AND ARE UNITED IN THE  
MIDDLE BY A CIRCLE. THE "H" IS IN THE MIDDLE OF THE CIRCLE, THE TOP OF THE  
LEFT LEG AND THE BOTTOM OF THE RIGHT LEG TOUCHES THE BORDER OF THE  
CIRCLE. AFTER THE CIRCLE WITH THE "H" IT IS WRITTEN IN WHITE LETTERS "LA  
HACIENDA", CAPITAL "L" AND "H" AND THE REST OF THE LETTERS IN SMALL CAPS.  
UNDER "LA HACIENDA" IT IS WRITTEN IN RED THE WORDS "MEAT CENTER". TO THE  
RIGHT, OF THE WORD "BBQ", THERE IS A WHITE COW WEARING A RED APRON. THE  
RIGHT PAW OF THE COW IS SHAPED AS A SPATULA. THE COW IS HOLDING A WHITE  
BARBECUE. THE LID OF THE BARBECUE IS OPEN AND A FLAME IS COMING OUT  
FROM IT. THERE ARE TWO FLAMES ONE WHITE AND THE OTHER ONE RED.

THE ENGLISH TRANSLATION OF THE WORDS "LA HACIENDA" IN THE MARK IS "THE  
RANCH".

SER. NO. 85-364,146, FILED 7-6-2011.

JORDAN BAKER, EXAMINING ATTORNEY



*David J. Kyros*

Director of the United States Patent and Trademark Office

# United States of America

United States Patent and Trademark Office

## COMPLIANCE DEPOT

**Reg. No. 4,124,810**

**Registered Apr. 10, 2012**

**Int. Cl.: 35**

**SERVICE MARK**

**PRINCIPAL REGISTER**

REALPAGE, INC. (DELAWARE CORPORATION)  
4000 INTERNATIONAL PARKWAY  
CARROLLTON, TX 75007

FOR: BUSINESS SERVICES, NAMELY, REGISTERING, SCREENING, CREDENTIALING, AND ORGANIZING THIRD-PARTY VENDORS, SUPPLIERS, AND CONTRACTORS, AND DOCUMENTATION AND INFORMATION ON BEHALF OF OTHERS; BUSINESS SERVICES, NAMELY, VENDOR COMPLIANCE MANAGEMENT IN THE NATURE OF TRACKING AND MONITORING INSURANCE COMPLIANCE FOR THIRD-PARTY VENDORS, SUPPLIERS, AND CONTRACTORS, IN CLASS 35 (U.S. CLS. 100, 101 AND 102).

FIRST USE 3-0-2005; IN COMMERCE 3-0-2005.

THE MARK CONSISTS OF STANDARD CHARACTERS WITHOUT CLAIM TO ANY PARTICULAR FONT, STYLE, SIZE, OR COLOR.

NO CLAIM IS MADE TO THE EXCLUSIVE RIGHT TO USE "COMPLIANCE", APART FROM THE MARK AS SHOWN.

SER. NO. 85-364,461, FILED 7-6-2011.

APRIL ROACH, EXAMINING ATTORNEY



*David J. Kypos*

Director of the United States Patent and Trademark Office

# United States of America

United States Patent and Trademark Office



**Reg. No. 4,124,811**

**Registered Apr. 10, 2012**

**Int. Cls.: 35, 43 and 44**

**SERVICE MARK**

**PRINCIPAL REGISTER**

ECKERT'S, INC. (ILLINOIS CORPORATION)  
951 SOUTH GREENMOUNT ROAD  
BELLEVILLE, IL 62220

FOR: RETAIL STORE AND ONLINE RETAIL STORE SERVICES FEATURING FOOD AND BEVERAGE PRODUCTS; RETAIL GARDEN AND NURSERY STORE SERVICES, IN CLASS 35 (U.S. CLS. 100, 101 AND 102).

FIRST USE 0-0-1930; IN COMMERCE 0-0-1930.

FOR: RESTAURANT SERVICES, IN CLASS 43 (U.S. CLS. 100 AND 101).

FIRST USE 0-0-1930; IN COMMERCE 0-0-1930.

FOR: AGRICULTURAL SERVICES, NAMELY, GROWING APPLES, PEACHES, STRAWBERRIES, BLACKBERRIES, PUMPKINS, AND LIVE CHRISTMAS TREES FOR OTHERS, IN CLASS 44 (U.S. CLS. 100 AND 101).

FIRST USE 0-0-1930; IN COMMERCE 0-0-1930.

THE MARK CONSISTS OF THE LETTER "E" IMPRINTED ON AN APPLE DESIGN ALL SUPERIMPOSED ON AN OUTLINE OF A TRIANGLE.

SER. NO. 85-364,554, FILED 7-6-2011.

JOHN DALIER, EXAMINING ATTORNEY



*David J. Kybas*

Director of the United States Patent and Trademark Office

# United States of America

United States Patent and Trademark Office

*Villa*  
FATIMA

**Reg. No. 4,124,812**

**Registered Apr. 10, 2012**

**Int. Cl.: 44**

**SERVICE MARK**

**PRINCIPAL REGISTER**

VILLA FATIMA ORO VALLEY, LLC (ARIZONA LIMITED LIABILITY COMPANY)  
8810 E. TANQUE VERDE RD.  
TUCSON, AZ 85749

FOR: NURSING HOMES AND NURSING CARE, NAMELY, PROVIDING SKILLED NURSING CARE AT FACILITIES FOR ALZHEIMER'S DISEASE AND DEMENTIA, IN CLASS 44 (U.S. CLS. 100 AND 101).

FIRST USE 5-13-2009; IN COMMERCE 5-13-2009.

NO CLAIM IS MADE TO THE EXCLUSIVE RIGHT TO USE "VILLA", APART FROM THE MARK AS SHOWN.

THE MARK CONSISTS OF THE STYLIZED WORDING "VILLA" ABOVE THE STYLIZED WORDING "FATIMA", WITH THE DESIGN OF AN OUTLINE OF A DOVE WITH A BRANCH WITH TWO LEAVES IN ITS MOUTH.

SER. NO. 85-364,679, FILED 7-6-2011.

JAY BESCH, EXAMINING ATTORNEY



*David J. Kybas*

Director of the United States Patent and Trademark Office

# United States of America

United States Patent and Trademark Office



**Reg. No. 4,124,813**

ERIKA SHEPPARD (UNITED STATES INDIVIDUAL), DBA IAMERIKA  
PO BOX 461871  
ESCONDIDO, CA 920461871

**Registered Apr. 10, 2012**

**Int. Cls.: 35, 41 and 42**

FOR: CONSULTING SERVICES IN THE FIELD OF INTERNET MARKETING, IN CLASS 35 (U.S. CLS. 100, 101 AND 102).

**SERVICE MARK**

FIRST USE 2-28-2000; IN COMMERCE 2-28-2000.

**PRINCIPAL REGISTER**

FOR: PHOTOGRAPHY SERVICES, IN CLASS 41 (U.S. CLS. 100, 101 AND 107).

FIRST USE 2-28-2000; IN COMMERCE 2-28-2000.

FOR: CREATION, DESIGN, DEVELOPMENT AND MAINTENANCE OF WEB SITES FOR THIRD PARTIES, IN CLASS 42 (U.S. CLS. 100 AND 101).

FIRST USE 2-28-2000; IN COMMERCE 2-28-2000.

THE NAME(S), PORTRAIT(S), AND/OR SIGNATURE(S) SHOWN IN THE MARK IDENTIFIES "ERIKA" JEAN SHEPPARD, WHOSE CONSENT(S) TO REGISTER IS MADE OF RECORD.

THE COLOR(S) RED, BLUE IS/ARE CLAIMED AS A FEATURE OF THE MARK.

THE MARK CONSISTS OF THE NAME "IAMERIKA", IN UPPERCASE ACCID FONT, HAS FOUR WAVY LINES ATTACHED TO THE FIRST LETTER, "I". BOTH "I" CHARACTERS USE A STAR ABOVE IT, INSTEAD OF A DOT. THE WAVY LINES ARE BLUE, RED, BLUE, RED. THE "IAM" IS BLUE AND "ERIKA" IS RED. THE BLUE IS WEB COLOR 0066CC AND THE RED IS CC3300.

SER. NO. 85-364,778, FILED 7-6-2011.

INGA ERVIN, EXAMINING ATTORNEY



*David J. Kypos*

Director of the United States Patent and Trademark Office

# United States of America

## United States Patent and Trademark Office



**Reg. No. 4,124,814**

**Registered Apr. 10, 2012**

**Int. Cls.: 14 and 28**

**TRADEMARK**

**PRINCIPAL REGISTER**

DU BUISSON, KATHRYN FIONA MACKENZIE (UNITED KINGDOM INDIVIDUAL)  
27 OCEANIC DRIVE  
DAWESVILLE, WA, AUSTRALIA 6211

FOR: CLOCK DIALS; CLOCKS AND PARTS THEREFOR; CLOCKS AND WATCHES; DIALS FOR CLOCK-AND-WATCH-MAKING, IN CLASS 14 (U.S. CLS. 2, 27, 28 AND 50).

FOR: BOARD GAMES; CHILDREN'S EDUCATIONAL TOYS FOR DEVELOPING MATH SKILLS; TOY CLOCKS AND WATCHES, IN CLASS 28 (U.S. CLS. 22, 23, 38 AND 50).

PRIORITY CLAIMED UNDER SEC. 44(D) ON AUSTRALIA APPLICATION NO. 1417810, FILED 4-1-2011, REG. NO. 1417810, DATED 4-1-2011, EXPIRES 4-1-2021.

NO CLAIM IS MADE TO THE EXCLUSIVE RIGHT TO USE 1, 2, 3, 4, 5, 6, 7, 8, 9, 10, 11, 12, 12:00, 1:00, 2:00, 3:00, 4:00, 5:00, 6:00, 7:00, 8:00, 9:00, 10:00, 11:00, 13:00, 14:00, 15:00, 16:00, 17:00, 18:00, 19:00, 20:00, 21:00, 22:00, 23:00, 24:00, 5, 10, 15, 20, 25, 30, 35, 40, 45, 50, 55, 60, "AM", "PM", "NOON", AND "MIDNIGHT", APART FROM THE MARK AS SHOWN.

THE MARK CONSISTS OF A CLOCK DIAL WITH 5 CONCENTRIC CIRCLES. A CARTOON WOLF HEAD IS IN THE CENTER WITH THE WORDS DOIN' TIME. THE NUMERALS 1, 2, 3, 4, 5, 6, 7, 8, 9, 10, 11, 12 ARE ARRANGED IN A CIRCLE AROUND THE CENTRAL CIRCLE, EACH NUMBER SURMOUNTED ON A CIRCULAR DOT. THE NUMBERS 1:00, 2:00, 3:00, 4:00, 5:00, 6:00, 7:00, 8:00, 9:00, 10:00, 11:00, 12:00 ARE ARRANGED IN THE NEXT CIRCLE WITH THE LETTERS "AM" UNDER EACH NUMBER EXCEPT THAT "NOON" IS UNDER 12:00. THE NUMBERS 13:00, 14:00, 15:00, 16:00, 17:00, 18:00, 19:00, 20:00, 21:00, 22:00, 23:00, 24:00 ARE ARRANGED IN THE NEXT CIRCLE WITH THE LETTERS "PM" UNDER EACH NUMBER EXCEPT THE LETTERS "MIDNIGHT" IS UNDER THE 24:00. THE OUTER CIRCLE HAS THE NUMBERS 5, 10, 15, 20, 25, 30, 35, 40, 45, 50, 55 AND 60 ARRANGED EQUIDISTANT AROUND IT, SURMOUNTED ON A LIGHT SPOT. EACH OF THE NUMBERS IN THIS CIRCLE ARE INTERSPERSED WITH 4 DOTS.

SER. NO. 85-364,867, FILED 7-7-2011.

HELENE LIWINSKI, EXAMINING ATTORNEY



*David J. Kyros*

Director of the United States Patent and Trademark Office



# United States of America

United States Patent and Trademark Office

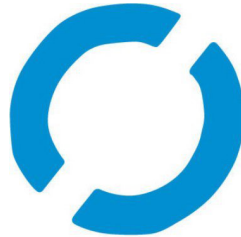

**GLOBAL  
ZERO**

**Reg. No. 4,124,815**

**Registered Apr. 10, 2012**

**Int. Cl.: 41**

**SERVICE MARK**

**PRINCIPAL REGISTER**

WORLD SECURITY INSTITUTE (D.C. CORPORATION)  
1779 MASSACHUSETTS AVENUE, N.W.  
WASHINGTON, DC 20036

FOR: EDUCATION SERVICES AND OUTREACH PROGRAMS, NAMELY, HOLDING SUMMITS, CONFERENCES, WORKSHOPS, MEETINGS, AND PRESENTATIONS IN THE FIELD OF INTERNATIONAL RELATIONS, INTERNATIONAL POLITICS, PUBLIC POLICY, AND THE REDUCTION AND ELIMINATION OF NUCLEAR WEAPONS; PROVIDING NEWS REPORTS BY MEANS OF NON-DOWNLOADABLE ELECTRONIC PUBLICATIONS, NAMELY, E-MAIL NEWSLETTERS IN THE FIELD OF INTERNATIONAL RELATIONS, INTERNATIONAL POLITICS, PUBLIC POLICY, AND THE REDUCTION AND ELIMINATION OF NUCLEAR WEAPONS; PROVIDING INFORMATION ABOUT SUMMITS, SYMPOSIA, CONFERENCES AND WORKSHOPS IN THE FIELD OF INTERNATIONAL RELATIONS, INTERNATIONAL POLITICS, PUBLIC POLICY, AND THE REDUCTION AND ELIMINATION OF NUCLEAR WEAPONS, IN CLASS 41 (U.S. CLS. 100, 101 AND 107).

FIRST USE 6-0-2008; IN COMMERCE 6-0-2008.

NO CLAIM IS MADE TO THE EXCLUSIVE RIGHT TO USE "GLOBAL", APART FROM THE MARK AS SHOWN.

THE COLOR(S) BLUE AND BLACK IS/ARE CLAIMED AS A FEATURE OF THE MARK.

THE MARK CONSISTS OF BLUE HALF CIRCLES ABOVE WORD "GLOBAL" IN BLACK ABOVE WORD "ZERO" IN BLACK.

SER. NO. 85-365,083, FILED 7-7-2011.

CHRISTINA SOBRAL, EXAMINING ATTORNEY



*David J. Kyjars*

Director of the United States Patent and Trademark Office

# United States of America

United States Patent and Trademark Office

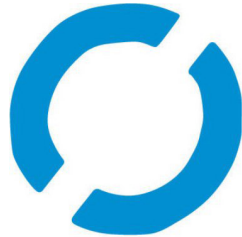

**GLOBAL  
ZERO**

A WORLD WITHOUT  
NUCLEAR WEAPONS

**Reg. No. 4,124,816**

**Registered Apr. 10, 2012**

**Int. Cl.: 41**

**SERVICE MARK**

**PRINCIPAL REGISTER**

WORLD SECURITY INSTITUTE (D.C. CORPORATION)  
1779 MASSACHUSETTS AVENUE, N.W.  
WASHINGTON, DC 20036

FOR: EDUCATION SERVICES AND OUTREACH PROGRAMS, NAMELY, HOLDING SUMMITS, CONFERENCES, WORKSHOPS, MEETINGS, AND PRESENTATIONS IN THE FIELD OF INTERNATIONAL RELATIONS, INTERNATIONAL POLITICS, PUBLIC POLICY, AND THE REDUCTION AND ELIMINATION OF NUCLEAR WEAPONS; PROVIDING NEWS REPORTS BY MEANS OF NON-DOWNLOADABLE ELECTRONIC PUBLICATIONS, NAMELY, E-MAIL NEWSLETTERS IN THE FIELD OF INTERNATIONAL RELATIONS, INTERNATIONAL POLITICS, PUBLIC POLICY, AND THE REDUCTION AND ELIMINATION OF NUCLEAR WEAPONS; PROVIDING INFORMATION ABOUT SUMMITS, SYMPOSIA, CONFERENCES AND WORKSHOPS IN THE FIELD OF INTERNATIONAL RELATIONS, INTERNATIONAL POLITICS, PUBLIC POLICY, AND THE REDUCTION AND ELIMINATION OF NUCLEAR WEAPONS, IN CLASS 41 (U.S. CLS. 100, 101 AND 107).

FIRST USE 6-0-2008; IN COMMERCE 6-0-2008.

NO CLAIM IS MADE TO THE EXCLUSIVE RIGHT TO USE "GLOBAL", APART FROM THE MARK AS SHOWN.

THE COLOR(S) BLUE AND BLACK IS/ARE CLAIMED AS A FEATURE OF THE MARK.

THE MARK CONSISTS OF BLUE HALF CIRCLES ABOVE WORD "GLOBAL" IN BLACK, ABOVE WORD "ZERO" IN BLACK, THEN VERTICAL BLACK LINE ACROSS FROM "GLOBAL ZERO" AND IN A SMALLER FONT THE WORDS "A WORLD WITHOUT" IN BLACK ABOVE WORDS "NUCLEAR WEAPONS" IN BLACK.

SER. NO. 85-365,085, FILED 7-7-2011.

CHRISTINA SOBRAL, EXAMINING ATTORNEY



*David J. Kybas*

Director of the United States Patent and Trademark Office

# United States of America

United States Patent and Trademark Office

## Purposeful Architecture

**Reg. No. 4,124,817**

**Registered Apr. 10, 2012**

**Int. Cl.: 42**

**SERVICE MARK**

**PRINCIPAL REGISTER**

CATHERINE PURPLE CHERRY ARCHITECTS, P.C. (MARYLAND CORPORATION), DBA  
PURPLE CHERRY ARCHITECTS  
ONE MELVIN AVENUE  
ANNAPOLIS, MD 21401

FOR: ARCHITECTURAL DESIGN SERVICES; ARCHITECTURAL CONSULTANCY; ARCHITECTURAL CONSULTATION; ARCHITECTURAL DESIGN; CONSULTING SERVICES IN THE FIELD OF ARCHITECTURAL DESIGN, IN CLASS 42 (U.S. CLS. 100 AND 101).

FIRST USE 10-1-2008; IN COMMERCE 10-1-2008.

THE MARK CONSISTS OF STANDARD CHARACTERS WITHOUT CLAIM TO ANY PARTICULAR FONT, STYLE, SIZE, OR COLOR.

NO CLAIM IS MADE TO THE EXCLUSIVE RIGHT TO USE "ARCHITECTURE", APART FROM THE MARK AS SHOWN.

SER. NO. 85-365,116, FILED 7-7-2011.

FRANK LATTUCA, EXAMINING ATTORNEY



*David J. Kyffers*

Director of the United States Patent and Trademark Office

# United States of America

United States Patent and Trademark Office



**Reg. No. 4,124,818**

**Registered Apr. 10, 2012**

**Int. Cl.: 41**

**SERVICE MARK**

**PRINCIPAL REGISTER**

SAINT MARY'S HALL (TEXAS NON-PROFIT CORPORATION)  
9401 STARCREST DRIVE  
SAN ANTONIO, TX 78217

FOR: EDUCATION SERVICES, NAMELY, PROVIDING MONTESSORI THROUGH 12TH GRADE CLASSROOM INSTRUCTION; EDUCATIONAL COUNSELING SERVICES TO ASSIST STUDENTS IN PLANNING AND PREPARING FOR FURTHER EDUCATION; EDUCATION SERVICES, NAMELY, PROVIDING CLASSES AND INSTRUCTION IN THE FIELD OF DANCE, IN CLASS 41 (U.S. CLS. 100, 101 AND 107).

FIRST USE 0-0-1996; IN COMMERCE 0-0-1996.

NO CLAIM IS MADE TO THE EXCLUSIVE RIGHT TO USE "HALL", "1879" AND "SAN ANTONIO, TEXAS", APART FROM THE MARK AS SHOWN.

THE MARK CONSISTS OF CIRCULAR SEAL COMPRISED OF FOUR CONCENTRIC RINGS, THE OUTER ONE BEING A THIN RING, THE NEXT RING BEING WIDE, FOLLOWED BY A THIN RING, THE CENTER OF THE SEAL BEING A CIRCLE; SCALING THE TOP HALF OF THE RING ARE THE WORDS "SAINT MARY'S HALL", AND THE WORDS "SAN ANTONIO, TEXAS" SCALING THE BOTTOM HALF OF THE RING. THE INTERIOR CIRCLE IS OVERLAID BY A SHIELD AND THE NUMBER "1879" ACROSS THE TOP, AND BELOW THE NUMBER, A BAR THAT EXTENDS THE LENGTH OF THE SHIELD, WITH A LARGE CROSS COVERING THE REST OF THE SHIELD FROM BELOW THE BAR TO THE BOTTOM AND EXTENDING TO EITHER EDGE OF THE SHIELD.

SER. NO. 85-365,125, FILED 7-7-2011.

DANNEAN HETZEL, EXAMINING ATTORNEY



*David J. Kyjars*

Director of the United States Patent and Trademark Office

# United States of America

United States Patent and Trademark Office

# SMH

**Reg. No. 4,124,819**

**Registered Apr. 10, 2012**

**Int. Cl.: 41**

**SERVICE MARK**

**PRINCIPAL REGISTER**

SAINT MARY'S HALL (TEXAS NON-PROFIT CORPORATION)  
9401 STARCREST DRIVE  
SAN ANTONIO, TX 78217

FOR: EDUCATION SERVICES, NAMELY, PROVIDING MONTESSORI THROUGH 12TH GRADE CLASSROOM INSTRUCTION; EDUCATIONAL COUNSELING SERVICES TO ASSIST STUDENTS IN PLANNING AND PREPARING FOR FURTHER EDUCATION; EDUCATION SERVICES, NAMELY, PROVIDING CLASSES AND INSTRUCTION IN THE FIELD OF DANCE, IN CLASS 41 (U.S. CLS. 100, 101 AND 107).

FIRST USE 0-0-1996; IN COMMERCE 0-0-1996.

THE MARK CONSISTS OF "SMH" IN ALL CAPS WITH THE CENTER OF THE "H" IN THE "SMH" BEING COVERED BY A SHIELD WITH A PLAIN CROSS COVERING THE SHIELD.

SER. NO. 85-365,130, FILED 7-7-2011.

DANNEAN HETZEL, EXAMINING ATTORNEY



*David J. Kybas*

Director of the United States Patent and Trademark Office

# United States of America

United States Patent and Trademark Office

# SMH

**Reg. No. 4,124,820**

SAINT MARY'S HALL (TEXAS NON-PROFIT CORPORATION)

**Registered Apr. 10, 2012**

9401 STARCREST DRIVE  
SAN ANTONIO, TX 78217

**Int. Cl.: 25**

FOR: ATHLETIC APPAREL, NAMELY, SHIRTS, HATS, CAPS, AND ATHLETIC UNIFORMS AS WELL AS CLOTHING, NAMELY, T-SHIRTS, SWEATSHIRTS, HOODED SWEATSHIRTS, JACKETS, SHIRTS, AND CAPS , IN CLASS 25 (U.S. CLS. 22 AND 39).

**TRADEMARK**

FIRST USE 0-0-1996; IN COMMERCE 0-0-1996.

**PRINCIPAL REGISTER**

THE MARK CONSISTS OF "SMH" IN ALL CAPS WITH THE CENTER OF THE "H" IN THE "SMH" BEING COVERED BY A SHIELD WITH A PLAIN CROSS COVERING THE SHIELD.

SER. NO. 85-365,131, FILED 7-7-2011.

DANNEAN HETZEL, EXAMINING ATTORNEY



*David J. Kybas*

Director of the United States Patent and Trademark Office

# United States of America

United States Patent and Trademark Office

# JACK JELLY

**Reg. No. 4,124,821**

EMPOWERED PRODUCTS, INC. (NEVADA CORPORATION)  
3367 W. OQUENDO RD.  
LAS VEGAS, NV 89118

**Registered Apr. 10, 2012**

**Int. Cl.: 5**

FOR: PERSONAL LUBRICANT, IN CLASS 5 (U.S. CLS. 6, 18, 44, 46, 51 AND 52).

**TRADEMARK**

FIRST USE 8-3-2003; IN COMMERCE 8-3-2003.

**PRINCIPAL REGISTER**

THE MARK CONSISTS OF STANDARD CHARACTERS WITHOUT CLAIM TO ANY PARTICULAR FONT, STYLE, SIZE, OR COLOR.

NO CLAIM IS MADE TO THE EXCLUSIVE RIGHT TO USE "JELLY", APART FROM THE MARK AS SHOWN.

SER. NO. 85-365,233, FILED 7-7-2011.

MARLENE BELL, EXAMINING ATTORNEY



*David J. Kyffers*

Director of the United States Patent and Trademark Office

# United States of America

United States Patent and Trademark Office

# GUN OIL

**Reg. No. 4,124,822**

EMPOWERED PRODUCTS, INC. (NEVADA CORPORATION)  
3367 W. OQUENDO RD.  
LAS VEGAS, NV 89118

**Registered Apr. 10, 2012**

**Int. Cl.: 5**

FOR: PERSONAL LUBRICANT, IN CLASS 5 (U.S. CLS. 6, 18, 44, 46, 51 AND 52).

**TRADEMARK**

FIRST USE 8-3-2003; IN COMMERCE 8-3-2003.

**PRINCIPAL REGISTER**

THE MARK CONSISTS OF STANDARD CHARACTERS WITHOUT CLAIM TO ANY PARTICULAR FONT, STYLE, SIZE, OR COLOR.

NO CLAIM IS MADE TO THE EXCLUSIVE RIGHT TO USE "OIL", APART FROM THE MARK AS SHOWN.

SER. NO. 85-365,235, FILED 7-7-2011.

MARLENE BELL, EXAMINING ATTORNEY



*David J. Kyffers*

Director of the United States Patent and Trademark Office



# United States of America

United States Patent and Trademark Office



**Reg. No. 4,124,823**

**Registered Apr. 10, 2012**

**Int. Cl.: 45**

**SERVICE MARK**

**PRINCIPAL REGISTER**

BINDER & BINDER - THE NATIONAL SOCIAL SECURITY DISABILITY ADVOCATES LLC  
(DELAWARE LIMITED LIABILITY COMPANY)  
300 RABRO DRIVE  
HAUPPAUGE, NY 11788

FOR: ADVOCACY SERVICES, NAMELY, LEGAL, PARALEGAL AND NON-ATTORNEY REPRESENTATIVE SERVICES FOR CLAIMANTS OF VETERANS BENEFITS, IN CLASS 45 (U.S. CLS. 100 AND 101).

FIRST USE 1-0-2010; IN COMMERCE 1-0-2010.

OWNER OF U.S. REG. NO. 3,875,150.

NO CLAIM IS MADE TO THE EXCLUSIVE RIGHT TO USE "THE REP FOR VETS", APART FROM THE MARK AS SHOWN.

THE MARK CONSISTS OF THE WORDS "THE REP FOR VETS" WITH THE WORD "THE" ABOVE THE "R" IN "REP" AND THE WORD "FOR" ABOVE THE "V" IN "VETS" AND WITH THE WORDS "REP" AND "VETS" SEPARATED BY A STAR, ALL OF WHICH IS IN A RECTANGULAR SHAPED BOX HAVING A RECTANGULAR BORDER AND ADJACENT TO A SQUARE BOX HAVING A STRIPED-BACKGROUND CONTAINING A HAND SHOWING THE PEACE SIGN.

SER. NO. 85-365,445, FILED 7-7-2011.

COURTNEY ALVAREZ, EXAMINING ATTORNEY



*David J. Kybas*

Director of the United States Patent and Trademark Office

# United States of America

United States Patent and Trademark Office



**BIAS**

Spot it. Talk about it.  
Open your mind. Prevent it.

**Reg. No. 4,124,824**

SYRACUSE UNIVERSITY (NEW YORK NON-PROFIT CORPORATION)  
303 UNIVERSITY PLACE  
SYRACUSE, NY 132442020

**Registered Apr. 10, 2012**

**Int. Cl.: 41**

FOR: PROVIDING A WEBSITE FEATURING EDUCATIONAL INFORMATION IN THE FIELD OF ELIMINATING BIAS IN A UNIVERSITY COMMUNITY, IN CLASS 41 (U.S. CLS. 100, 101 AND 107).

**SERVICE MARK**

FIRST USE 8-18-2010; IN COMMERCE 8-18-2010.

**PRINCIPAL REGISTER**

NO CLAIM IS MADE TO THE EXCLUSIVE RIGHT TO USE "BIAS", APART FROM THE MARK AS SHOWN.

THE MARK CONSISTS OF A LOGO OF A SERIES OF CURVED LINES FORMING A CYCLONIC IMAGE WITH THE WORD "STOP" WITHIN THE IMAGE AND THE WORDS "BIAS SPOT IT. TALK ABOUT IT." AND "OPEN YOUR MIND. PREVENT IT." POSITIONED IN RESPECTIVE LINES TO THE RIGHT OF THE IMAGE.

SER. NO. 85-365,516, FILED 7-7-2011.

NAAKWAMA ANKRAH, EXAMINING ATTORNEY



*David J. Kyffers*

Director of the United States Patent and Trademark Office

# United States of America

United States Patent and Trademark Office

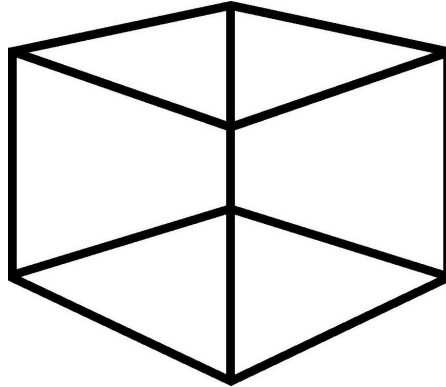

**Reg. No. 4,124,825**

**Registered Apr. 10, 2012**

**Int. Cl.: 36**

**SERVICE MARK**

**PRINCIPAL REGISTER**

BROWN & BROWN BENEFIT ADVISORS, INC. (NEW JERSEY CORPORATION)  
SUITE 400  
3101 W. MARTIN LUTHER KING, JR. BLVD.  
TAMPA, FL 33607

FOR: INSURANCE BROKERAGE; CONSULTING SERVICES, NAMELY, PROVIDING INFORMATION IN THE FIELD OF EMPLOYEE INSURANCE BENEFIT PLANS, IN CLASS 36 (U.S. CLS. 100, 101 AND 102).

FIRST USE 1-0-2011; IN COMMERCE 1-0-2011.

THE MARK CONSISTS OF A BOX DESIGN.

SER. NO. 85-365,585, FILED 7-7-2011.

STEVEN JACKSON, EXAMINING ATTORNEY



*David J. Kyffers*

Director of the United States Patent and Trademark Office

# United States of America

United States Patent and Trademark Office

## MIZUMI COLLEZIONI

**Reg. No. 4,124,826**

MONTERO INTERNATIONAL, INC. (NEW YORK CORPORATION)  
1 LINDEN PLACE, SUITE 300  
GREAT NECK, NY 11021

**Registered Apr. 10, 2012**

**Int. Cl.: 25**

FOR: CLOTHING, NAMELY, SHIRTS, T-SHIRTS, PANTS, JACKETS, AND COATS, IN CLASS 25 (U.S. CLS. 22 AND 39).

**TRADEMARK**

FIRST USE 6-1-2011; IN COMMERCE 6-1-2011.

**PRINCIPAL REGISTER**

THE MARK CONSISTS OF STANDARD CHARACTERS WITHOUT CLAIM TO ANY PARTICULAR FONT, STYLE, SIZE, OR COLOR.

NO CLAIM IS MADE TO THE EXCLUSIVE RIGHT TO USE "COLLEZIONI", APART FROM THE MARK AS SHOWN.

THE ENGLISH TRANSLATION OF THE WORD "COLLEZIONI" IN THE MARK IS "COLLECTION". THE WORDING "MIZUMI" HAS NO MEANING IN A FOREIGN LANGUAGE.

SER. NO. 85-365,621, FILED 7-7-2011.

VIVIAN MICZNIK FIRST, EXAMINING ATTORNEY



*David J. Kybas*

Director of the United States Patent and Trademark Office

# United States of America

United States Patent and Trademark Office



**Reg. No. 4,124,827**

ZING-A-DING, INC. (WISCONSIN CORPORATION)

**Registered Apr. 10, 2012**

P.O. BOX 168  
OREGON, WI 53575

**Int. Cl.: 37**

FOR: AUTOMOBILE BODY REPAIR AND FINISHING FOR OTHERS, IN CLASS 37 (U.S. CLS. 100, 103 AND 106).

**SERVICE MARK**

FIRST USE 3-9-1994; IN COMMERCE 3-9-1994.

**PRINCIPAL REGISTER**

NO CLAIM IS MADE TO THE EXCLUSIVE RIGHT TO USE "INC", APART FROM THE MARK AS SHOWN.

THE MARK CONSISTS OF THE WORDS "ZING-A-DING, INC." WITH A LARGE GRAPHIC "ZD" ABOVE.

SER. NO. 85-365,678, FILED 7-7-2011.

STEPHANIE ALI, EXAMINING ATTORNEY



*David J. Kyros*

Director of the United States Patent and Trademark Office

# United States of America

United States Patent and Trademark Office

## Hard Times for Men

**Reg. No. 4,124,828**

NATURAL WURKS LLC (FLORIDA LIMITED LIABILITY COMPANY)  
2172 10TH AVENUE NORTH  
LAKE WORTH, FL 33461

**Registered Apr. 10, 2012**

**Int. Cl.: 5**

FOR: DIETARY SUPPLEMENTS, IN CLASS 5 (U.S. CLS. 6, 18, 44, 46, 51 AND 52).

**TRADEMARK**

FIRST USE 9-17-2008; IN COMMERCE 9-17-2008.

**PRINCIPAL REGISTER**

THE MARK CONSISTS OF STANDARD CHARACTERS WITHOUT CLAIM TO ANY PARTICULAR FONT, STYLE, SIZE, OR COLOR.

NO CLAIM IS MADE TO THE EXCLUSIVE RIGHT TO USE "FOR MEN", APART FROM THE MARK AS SHOWN.

SER. NO. 85-365,695, FILED 7-7-2011.

ELI HELLMAN, EXAMINING ATTORNEY



*David J. Kyffers*

Director of the United States Patent and Trademark Office

# United States of America

United States Patent and Trademark Office

## Vacation Internationale

**Reg. No. 4,124,829**

**Registered Apr. 10, 2012**

**Int. Cl.: 36**

**SERVICE MARK**

**PRINCIPAL REGISTER**

VACATION INTERNATIONALE, INC. (WASHINGTON CORPORATION), FORMERLY VTS OPERATING FUND, INC.  
1417 - 116TH AVENUE NE  
BELLEVUE, WA 98004

FOR: VACATION REAL ESTATE TIMESHARE SERVICES, IN CLASS 36 (U.S. CLS. 100, 101 AND 102).

FIRST USE 3-1-1984; IN COMMERCE 3-1-1984.

THE MARK CONSISTS OF STANDARD CHARACTERS WITHOUT CLAIM TO ANY PARTICULAR FONT, STYLE, SIZE, OR COLOR.

NO CLAIM IS MADE TO THE EXCLUSIVE RIGHT TO USE "VACATION", APART FROM THE MARK AS SHOWN.

SEC. 2(F).

SER. NO. 85-365,758, FILED 7-7-2011.

CHRIS WELLS, EXAMINING ATTORNEY



*David J. Kyffers*

Director of the United States Patent and Trademark Office

# United States of America

United States Patent and Trademark Office

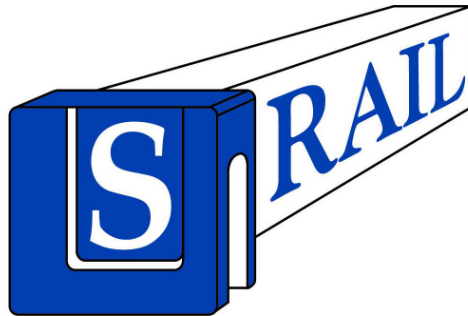

**Reg. No. 4,124,830**

**Registered Apr. 10, 2012**

**Int. Cl.: 6**

**TRADEMARK**

**PRINCIPAL REGISTER**

BERGER BUILDING PRODUCTS, INC. (PENNSYLVANIA CORPORATION)  
805 PENNSYLVANIA BOULEVARD  
FEASTERVILLE, PA 19053

FOR: METAL SNOW RETENTION APPARATUS, NAMELY, SNOW BARS, SNOW FENCES AND SNOW RAILS FOR ROOFS OF BUILDINGS, IN CLASS 6 (U.S. CLS. 2, 12, 13, 14, 23, 25 AND 50).

FIRST USE 9-4-2001; IN COMMERCE 9-4-2001.

OWNER OF U.S. REG. NO. 2,717,916.

THE COLOR(S) BLUE, WHITE AND BLACK IS/ARE CLAIMED AS A FEATURE OF THE MARK.

NO CLAIM IS MADE TO THE EXCLUSIVE RIGHT TO USE "RAIL", APART FROM THE MARK AS SHOWN.

THE MARK CONSISTS OF A DEPICTION OF A BLUE SNOW FENCE CASTING HAVE A WHITE CAPITAL LETTER "S" AND OTHER SMALL WHITE ELEMENTS ON THE CASTING ON THE FRONT AND HAVING A DEPICTION OF A WHITE RAIL EXTENDING REARWARDLY FROM THE CASTING AND BEARING THE BLUE CAPITAL LETTERS "RAIL". THE ENTIRE DESIGN IS OUTLINED IN BLACK.

SER. NO. 85-365,771, FILED 7-7-2011.

AMY HELLA, EXAMINING ATTORNEY

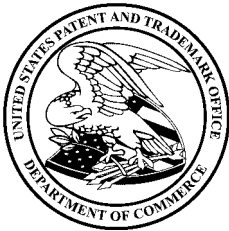

*David J. Kyjars*

Director of the United States Patent and Trademark Office



# United States of America

United States Patent and Trademark Office

## Vision All

**Reg. No. 4,124,831**

**Registered Apr. 10, 2012**

**Int. Cl.: 5**

**TRADEMARK**

**PRINCIPAL REGISTER**

GREENSIDE, S.A. DE C.V. (MEXICO SOCIEDAD ANONIMA (SA DE CV))  
INTERIOR 23  
LÁZARO CÁRDENAS NÚMERO 1007 PTE.  
SAN PEDRO G.G., N.L., MEXICO 66266

FOR: DIETARY AND NUTRITIONAL SUPPLEMENTS; HERBAL PILLS AND MIXES FOR THE PSYCHOLOGICAL BENEFIT OF CLEANSING ONE'S KARMA; HERBAL SUPPLEMENTS; HERBAL SUPPLEMENTS FOR SLEEPING PROBLEMS; HERBAL TEAS FOR MEDICINAL PURPOSES; HERBAL TOPICAL CREAMS, GELS, SALVES, SPRAYS, POWDER, BALMS, LINIMENT AND OINTMENTS FOR THE RELIEF OF ACHES AND PAIN; MEDICINAL HERBAL EXTRACTS FOR MEDICAL PURPOSES; MEDICINAL HERBAL PREPARATIONS; NATURAL HERBAL SUPPLEMENTS, IN CLASS 5 (U.S. CLS. 6, 18, 44, 46, 51 AND 52).

FIRST USE 7-1-2011; IN COMMERCE 7-1-2011.

NO CLAIM IS MADE TO THE EXCLUSIVE RIGHT TO USE "VISION" , APART FROM THE MARK AS SHOWN.

THE COLOR(S) PURPLE AND WHITE IS/ARE CLAIMED AS A FEATURE OF THE MARK.

THE MARK CONSISTS OF THE STYLIZED WORDING "VISION ALL" IN THE COLOR PURPLE WITH THE LETTERS "V" AND "A" CAPITALIZED, AND A CIRCULAR STYLIZED DESIGN OF AN EYE IN PURPLE AND WHITE NEXT TO THE WORDING.

SER. NO. 85-365,806, FILED 7-7-2011.

STEVEN R. FINE, EXAMINING ATTORNEY



*David J. Kyros*

Director of the United States Patent and Trademark Office

# United States of America

United States Patent and Trademark Office



**Reg. No. 4,124,832**

**Registered Apr. 10, 2012**

**Int. Cl.: 6**

**TRADEMARK**

**PRINCIPAL REGISTER**

BERGER BUILDING PRODUCTS, INC. (PENNSYLVANIA CORPORATION)  
805 PENNSYLVANIA BOULEVARD  
FEASTERVILLE, PA 19053

FOR: METAL SNOW RETENTION APPARATUS, NAMELY, SNOW BARS, SNOW FENCES AND SNOW RAILS FOR ROOFS OF BUILDINGS, IN CLASS 6 (U.S. CLS. 2, 12, 13, 14, 23, 25 AND 50).

FIRST USE 12-8-2004; IN COMMERCE 12-8-2004.

OWNER OF U.S. REG. NO. 3,026,237.

THE COLOR(S) BLUE, WHITE AND BLACK IS/ARE CLAIMED AS A FEATURE OF THE MARK.

NO CLAIM IS MADE TO THE EXCLUSIVE RIGHT TO USE "RAIL", APART FROM THE MARK AS SHOWN.

THE MARK CONSISTS OF A DEPICTION OF A BLUE SNOW FENCE CASTING HAVING WHITE LETTERS "E" AND "RAIL" ON THE FRONT. THE CASTING AND ANGLE SHAPE UNDER THE "E" ARE OUTLINED IN BLACK.

SER. NO. 85-365,834, FILED 7-7-2011.

AMY HELLA, EXAMINING ATTORNEY



*David J. Kybas*

Director of the United States Patent and Trademark Office

# United States of America

United States Patent and Trademark Office

## VI Resorts

**Reg. No. 4,124,833**

**Registered Apr. 10, 2012**

**Int. Cl.: 36**

**SERVICE MARK**

**PRINCIPAL REGISTER**

VACATION INTERNATIONALE, INC. (WASHINGTON CORPORATION), FORMERLY VTS OPERATING FUND, INC.  
1417 - 116TH AVENUE NE  
BELLEVUE, WA 98004

FOR: VACATION REAL ESTATE TIMESHARE SERVICES, IN CLASS 36 (U.S. CLS. 100, 101 AND 102).

FIRST USE 3-1-1984; IN COMMERCE 3-1-1984.

THE MARK CONSISTS OF STANDARD CHARACTERS WITHOUT CLAIM TO ANY PARTICULAR FONT, STYLE, SIZE, OR COLOR.

NO CLAIM IS MADE TO THE EXCLUSIVE RIGHT TO USE "RESORTS", APART FROM THE MARK AS SHOWN.

SER. NO. 85-365,864, FILED 7-7-2011.

CHRIS WELLS, EXAMINING ATTORNEY



*David J. Kyffers*

Director of the United States Patent and Trademark Office

# United States of America

United States Patent and Trademark Office

# VI Travel

**Reg. No. 4,124,834**

**Registered Apr. 10, 2012**

**Int. Cl.: 39**

**SERVICE MARK**

**PRINCIPAL REGISTER**

VACATION INTERNATIONALE, INC. (WASHINGTON CORPORATION), FORMERLY VTS  
OPERATING FUND, INC.  
1417 - 116TH AVENUE NE  
BELLEVUE, WA 98004

FOR: TRAVEL AGENCY SERVICES, NAMELY, MAKING RESERVATIONS AND BOOKINGS  
FOR TRANSPORTATION, IN CLASS 39 (U.S. CLS. 100 AND 105).

FIRST USE 7-1-2004; IN COMMERCE 7-1-2004.

THE MARK CONSISTS OF STANDARD CHARACTERS WITHOUT CLAIM TO ANY PAR-  
TICULAR FONT, STYLE, SIZE, OR COLOR.

NO CLAIM IS MADE TO THE EXCLUSIVE RIGHT TO USE "TRAVEL", APART FROM THE  
MARK AS SHOWN.

SER. NO. 85-365,906, FILED 7-7-2011.

CHRIS WELLS, EXAMINING ATTORNEY



*David J. Kybas*

Director of the United States Patent and Trademark Office

# United States of America

United States Patent and Trademark Office

## ECHATEPACA

**Reg. No. 4,124,835**

**Registered Apr. 10, 2012**

**Int. Cl.: 41**

**SERVICE MARK**

**PRINCIPAL REGISTER**

ECHATEPACA.LLC (FLORIDA LIMITED LIABILITY COMPANY), DBA ECHATTEPACA.LLC  
PO BOX 942502  
MIAMI, FLA 33194  
MIAMI, FL 33194

FOR: ENTERTAINMENT SERVICES, NAMELY, THE PROVISION OF A CONTINUING TELEVISION VARIETY SHOW FEATURING SEGMENTS ON GAMES, SPORTS, WEATHER, REAL ESTATE INFORMATION, COMMENTARY, FINANCE INFORMATION, PERSONALS, ACTORS, SINGERS, SONG WRITERS, MOVIES, BANDS, SHOPPING, BOOKS, HEALTH, TRANSPORTATION, TRAVEL, WEBSITES, SONGS, DATING, NIGHTCLUBS, RESTAURANTS, FASHION, SOAP OPERAS, NEWS, CELEBRITY NEWS, JOBS, FOOD, HOROSCOPES, MUSIC, POLITICS, AND CELEBRITY GOSSIP, IN CLASS 41 (U.S. CLS. 100, 101 AND 107).

FIRST USE 0-0-1988; IN COMMERCE 7-21-2006.

THE MARK CONSISTS OF STANDARD CHARACTERS WITHOUT CLAIM TO ANY PARTICULAR FONT, STYLE, SIZE, OR COLOR.

OWNER OF U.S. REG. NOS. 3,792,601 AND 3,935,387.

THE ENGLISH TRANSLATION OF "ECHATEPACA" IN THE MARK IS "COME OVER HERE".

SER. NO. 85-366,062, FILED 7-7-2011.

SUSAN LESLIE DUBOIS, EXAMINING ATTORNEY



*David J. Kyffers*

Director of the United States Patent and Trademark Office

# United States of America

United States Patent and Trademark Office

# iband

**Reg. No. 4,124,836**

ZIMMERMAN, AARON (INDIANA LIMITED LIABILITY COMPANY)  
716 GLENWAY DRIVE  
LOGANSPOET, IN 46947

**Registered Apr. 10, 2012**

**Int. Cl.: 45**

FOR: PROVIDING A SOCIAL NETWORKING WEBSITE FOR ENTERTAINMENT PURPOSES,  
IN CLASS 45 (U.S. CLS. 100 AND 101).

**SERVICE MARK**

FIRST USE 7-7-2011; IN COMMERCE 7-7-2011.

**PRINCIPAL REGISTER**

THE MARK CONSISTS OF STANDARD CHARACTERS WITHOUT CLAIM TO ANY PARTICULAR FONT, STYLE, SIZE, OR COLOR.

SER. NO. 85-366,089, FILED 7-7-2011.

ODESSA BIBBINS, EXAMINING ATTORNEY



*David J. Kyffers*

Director of the United States Patent and Trademark Office

# United States of America

United States Patent and Trademark Office

# CPAFlorida.com

**Reg. No. 4,124,837**

**Registered Apr. 10, 2012**

**Int. Cl.: 36**

**SERVICE MARK**

**PRINCIPAL REGISTER**

KANE, MONTE (UNITED STATES INDIVIDUAL)  
SUITE 800  
1221 BRICKELL AVENUE  
MIAMI, FL 33131

FOR: PROVIDING INFORMATION ON FINANCIAL PLANNING AND INVESTMENT MANAGEMENT FOR INDIVIDUALS AND BUSINESSES VIA A GLOBAL COMPUTER NETWORK, IN CLASS 36 (U.S. CLS. 100, 101 AND 102).

FIRST USE 4-29-1997; IN COMMERCE 4-29-1997.

THE MARK CONSISTS OF STANDARD CHARACTERS WITHOUT CLAIM TO ANY PARTICULAR FONT, STYLE, SIZE, OR COLOR.

OWNER OF U.S. REG. NO. 3,105,370.

SEC. 2(F).

SER. NO. 85-366,140, FILED 7-8-2011.

JULIE WATSON, EXAMINING ATTORNEY



*David J. Kybas*

Director of the United States Patent and Trademark Office

# United States of America

United States Patent and Trademark Office

## LEGISLATOR DIRECT

**Reg. No. 4,124,838**

**Registered Apr. 10, 2012**

**Int. Cl.: 9**

**TRADEMARK**

**PRINCIPAL REGISTER**

DEMOCRACY DATA & COMMUNICATIONS, LLC (VIRGINIA LIMITED LIABILITY COMPANY)  
174 WATERFRONT STREET, SUITE 500  
NATIONAL HARBOR, MD 20745

FOR: COMPUTER APPLICATION SOFTWARE FOR PERSONAL COMPUTERS, MOBILE PHONES AND HANDHELD COMPUTERS, NAMELY, SOFTWARE USED TO ORGANIZE, MANAGE AND TRACK LEGISLATIVE INFORMATION AND LOBBYING ACTIVITIES, IN CLASS 9 (U.S. CLS. 21, 23, 26, 36 AND 38).

FIRST USE 2-8-2007; IN COMMERCE 4-19-2007.

THE MARK CONSISTS OF STANDARD CHARACTERS WITHOUT CLAIM TO ANY PARTICULAR FONT, STYLE, SIZE, OR COLOR.

NO CLAIM IS MADE TO THE EXCLUSIVE RIGHT TO USE "LEGISLATOR", APART FROM THE MARK AS SHOWN.

SER. NO. 85-366,245, FILED 7-8-2011.

BILL DAWE, EXAMINING ATTORNEY



*David J. Kyffers*

Director of the United States Patent and Trademark Office



# United States of America

United States Patent and Trademark Office

# KIME

**Reg. No. 4,124,839**

HODGES, STEVEN R. (UNITED STATES INDIVIDUAL)  
1017 BRIDGESTONE PLACE  
KNOXVILLE, TN 37919

**Registered Apr. 10, 2012**

**Int. Cl.: 36**

FOR: CHARITABLE SERVICES, NAMELY, FUNDRAISING IN THE FIELD OF NEUROLOGICAL DISORDERS, IN CLASS 36 (U.S. CLS. 100, 101 AND 102).

**SERVICE MARK**

FIRST USE 3-0-2010; IN COMMERCE 1-0-2011.

**PRINCIPAL REGISTER**

THE MARK CONSISTS OF STANDARD CHARACTERS WITHOUT CLAIM TO ANY PARTICULAR FONT, STYLE, SIZE, OR COLOR.

SER. NO. 85-366,375, FILED 7-8-2011.

JUDITH HELFMAN, EXAMINING ATTORNEY



*David J. Kybas*

Director of the United States Patent and Trademark Office

# United States of America

United States Patent and Trademark Office



**Reg. No. 4,124,840**

ART STUDENTS LEAGUE OF DENVER (COLORADO NON-PROFIT CORPORATION)  
200 GRANT STREET  
DENVER, CO 80203

**Registered Apr. 10, 2012**

**Int. Cl.: 41**

FOR: EDUCATION SERVICES, NAMELY, PROVIDING LIVE AND ON-LINE CLASSES, SEMINARS, WORKSHOPS, MENTORING, TUTORING, AND TRAINING IN THE FIELD OF ART SPECIFICALLY, EXPOSURE TO TOXINS IN CREATING ART, THE NON-HAZARDOUS USE OF ART MATERIALS, AND ENVIRONMENTALLY CONSCIENTIOUS DISPOSAL METHODS, IN CLASS 41 (U.S. CLS. 100, 101 AND 107).

**SERVICE MARK**

**PRINCIPAL REGISTER**

FIRST USE 6-1-2009; IN COMMERCE 6-1-2009.

NO CLAIM IS MADE TO THE EXCLUSIVE RIGHT TO USE "SAFE ART", APART FROM THE MARK AS SHOWN.

THE COLOR(S) BLUE, GREEN AND BLACK IS/ARE CLAIMED AS A FEATURE OF THE MARK.

THE MARK CONSISTS OF THE WORD "SAFE" IN BLACK CAPITAL LETTERS WITH A BLACK BRACKET TO THE LEFT OF THE WORD AND A GREEN PAINT SPLASH TO THE LEFT OF THE LEFT BRACKET AND THE WORD "ART" IN GREEN CAPITAL LETTERS WITH A BLACK BRACKET TO THE RIGHT OF THE WORD AND A BLUE PAINT SPLASH TO THE RIGHT OF THE RIGHT BRACKET.

SER. NO. 85-366,385, FILED 7-8-2011.

LESLIE RICHARDS, EXAMINING ATTORNEY



*David J. Kyjars*

Director of the United States Patent and Trademark Office

# United States of America

United States Patent and Trademark Office

## SIMPLY SMOOTH

**Reg. No. 4,124,841**

ALL CULTURES, INC. (NEW YORK CORPORATION)  
12 GATES ST.

**Registered Apr. 10, 2012**

GREENLAWN, NY 11740

**Int. Cl.: 3**

FOR: HAIR CARE PRODUCTS, NAMELY, NON-MEDICATED KERATIN TREATMENT, SHAMPOO, CONDITIONERS, NON-MEDICATED HAIR BALMS, HAIR GLOSSES, HAIR SPRAY, HAIR VOLUMIZERS, IN CLASS 3 (U.S. CLS. 1, 4, 6, 50, 51 AND 52).

**TRADEMARK**

FIRST USE 4-0-2008; IN COMMERCE 4-0-2008.

**PRINCIPAL REGISTER**

THE MARK CONSISTS OF STANDARD CHARACTERS WITHOUT CLAIM TO ANY PARTICULAR FONT, STYLE, SIZE, OR COLOR.

NO CLAIM IS MADE TO THE EXCLUSIVE RIGHT TO USE "SMOOTH", APART FROM THE MARK AS SHOWN.

SER. NO. 85-366,431, FILED 7-8-2011.

FRED CARL, EXAMINING ATTORNEY



*David J. Kyffers*

Director of the United States Patent and Trademark Office

# United States of America

United States Patent and Trademark Office



**Reg. No. 4,124,842**

**Registered Apr. 10, 2012**

**Int. Cl.: 33**

**TRADEMARK**

**PRINCIPAL REGISTER**

LANNOM, TODD (UNITED STATES INDIVIDUAL)  
510 13TH ST.  
VIRGINIA BEACH, VA 23451

FOR: WINES, IN CLASS 33 (U.S. CLS. 47 AND 49).

FIRST USE 7-7-2011; IN COMMERCE 7-7-2011.

THE MARK CONSISTS OF A TOP HAT WITH VINES COMING OUT FROM THE OPENING OF THE HAT. THE WORDS "TOP HAT" ARE AT THE BOTTOM OF THE VINES.

SER. NO. 85-366,543, FILED 7-8-2011.

KATHERINE E. HALMEN, EXAMINING ATTORNEY



*David J. Kyjars*

Director of the United States Patent and Trademark Office

# United States of America

United States Patent and Trademark Office



**Reg. No. 4,124,843**

**Registered Apr. 10, 2012**

**Int. Cls.: 14, 25, 35, 36,  
41, 42 and 45**

**TRADEMARK**

**SERVICE MARK**

**PRINCIPAL REGISTER**

LIVE WORLD MEDIA, LLC (NEVADA LIMITED LIABILITY COMPANY)  
711 S. CARSON ST. STE. 4  
CARSON CITY, NV 89701

FOR: BRACELETS; JEWELLERY, INCLUDING IMITATION JEWELLERY AND PLASTIC JEWELLERY; JEWELRY; JEWELRY, NAMELY, DOG TAGS FOR WEAR BY HUMANS FOR DECORATIVE PURPOSES; KEY CHAINS AS JEWELLERY; KEY CHAINS OF PRECIOUS METAL; WATCHES, CLOCKS, IN CLASS 14 (U.S. CLS. 2, 27, 28 AND 50).

FIRST USE 3-9-2011; IN COMMERCE 3-9-2011.

FOR: ANKLE SOCKS; ATHLETIC APPAREL, NAMELY, SHIRTS, PANTS, JACKETS, FOOTWEAR, HATS AND CAPS, ATHLETIC UNIFORMS; BASEBALL CAPS AND HATS; HOODED SWEATSHIRTS; JACKETS; POLO SHIRTS; SHIRTS; SHIRTS AND SHORT-SLEEVED SHIRTS; SHOES; SHORT-SLEEVED OR LONG-SLEEVED T-SHIRTS; SWEATSHIRTS; T-SHIRTS, IN CLASS 25 (U.S. CLS. 22 AND 39).

FIRST USE 3-9-2011; IN COMMERCE 3-9-2011.

FOR: CHARITABLE SERVICES, NAMELY, ORGANIZING AND CONDUCTING VOLUNTEER PROGRAMS AND COMMUNITY SERVICE PROJECTS AIMED AT INCREASING SUPPORT AND MORALE OF FAMILIES OF DECEASED WAR VETERANS, WAR VETERANS, CURRENT MEMBERS AND FUTURE MEMBERS OF THE U.S. MILITARY; ON-LINE RETAIL STORE SERVICES FEATURING PROMOTIONAL MERCHANDISE, NAMELY, T-SHIRTS, CAPS, SWEATSHIRTS, FOOTWEAR, WATCHES, CLOCKS, JEWELRY, IMITATION JEWELRY, JACKETS, KEY CHAINS, DOG TAGS AND BRACELETS; PROVIDING A WEBSITE FOR CONNECTING SELLERS WITH BUYERS, IN CLASS 35 (U.S. CLS. 100, 101 AND 102).

FIRST USE 3-9-2011; IN COMMERCE 3-9-2011.

FOR: CHARITABLE FUNDRAISING, IN CLASS 36 (U.S. CLS. 100, 101 AND 102).

FIRST USE 3-9-2011; IN COMMERCE 3-9-2011.

FOR: ENTERTAINMENT SERVICES, NAMELY, PROVIDING VIRTUAL ENVIRONMENTS IN WHICH USERS CAN INTERACT FOR RECREATIONAL, LEISURE OR ENTERTAINMENT PURPOSES, IN CLASS 41 (U.S. CLS. 100, 101 AND 107).



*David J. Kyffers*

Director of the United States Patent and Trademark Office

**Reg. No. 4,124,843** FIRST USE 3-9-2011; IN COMMERCE 3-9-2011.

FOR: COMPUTER SERVICES, NAMELY, CREATING AN ON-LINE COMMUNITY FOR REGISTERED USERS TO PARTICIPATE IN DISCUSSIONS, GET FEEDBACK FROM THEIR PEERS, FORM VIRTUAL COMMUNITIES, AND ENGAGE IN SOCIAL NETWORKING SERVICES IN THE FIELD OF CONNECTING MILITARY PERSONNEL AND THEIR FAMILIES AND FRIENDS TO SERVICES, BENEFITS, RESOURCES AND EACH OTHER, IN CLASS 42 (U.S. CLS. 100 AND 101).

FIRST USE 3-9-2011; IN COMMERCE 3-9-2011.

FOR: ON-LINE SOCIAL NETWORKING SERVICES, IN CLASS 45 (U.S. CLS. 100 AND 101).

FIRST USE 3-9-2011; IN COMMERCE 3-9-2011.

NO CLAIM IS MADE TO THE EXCLUSIVE RIGHT TO USE "MILITARY", APART FROM THE MARK AS SHOWN.

THE COLOR(S) RED, BLACK AND BLUE IS/ARE CLAIMED AS A FEATURE OF THE MARK.

THE MARK CONSISTS OF A STYLIZED FLAG CONSISTING OF 3 STARS OUTLINED IN BLUE IN THE UPPER LEFT HAND CORNER, WITH 6 INDIVIDUAL RED STRIPES EMERGING FROM THE STARS AND BELOW THE STARS TO CREATE THE IMAGE OF A STYLIZED FLAG. BELOW THE FLAG IS THE BLACK WORD "MILITARY" ABOVE THE WORD "CONNECTONE", THE "CONNECT" IN BLUE AND "ONE" IN RED.

SER. NO. 85-366,567, FILED 7-8-2011.

LESLEY LAMOTHE, EXAMINING ATTORNEY

# United States of America

United States Patent and Trademark Office



**Reg. No. 4,124,844**

**Registered Apr. 10, 2012**

**Int. Cl.: 36**

**SERVICE MARK**

**PRINCIPAL REGISTER**

VACATION INTERNATIONALE, INC. (WASHINGTON CORPORATION), FORMERLY VTS OPERATING FUND, INC.  
1417 - 116TH AVENUE NE  
BELLEVUE, WA 98004

FOR: VACATION REAL ESTATE TIMESHARE SERVICES, IN CLASS 36 (U.S. CLS. 100, 101 AND 102).

FIRST USE 7-1-2004; IN COMMERCE 7-1-2004.

THE MARK CONSISTS OF A STYLIZED "V" WITHIN ANOTHER SIMILARLY STYLIZED "V" THAT TOGETHER HAVE THE APPEARANCE OF A PLANT. ONE HALF OF THIS "PLANT" APPEARS WITHIN A SHADED RECTANGLE.

SER. NO. 85-366,656, FILED 7-8-2011.

CHRIS WELLS, EXAMINING ATTORNEY



*David J. Kyjars*

Director of the United States Patent and Trademark Office

United States of America  
United States Patent and Trademark Office

HOUZZ

**Reg. No. 4,124,845**

**Registered Apr. 10, 2012**

**Int. Cls.: 35, 37 and 42**

**SERVICE MARK**

**PRINCIPAL REGISTER**

HOUZZ, INC. (DELAWARE CORPORATION)  
444 RAMONA STREET, 2ND FLOOR  
PALO ALTO, CA 94301

FOR: PROMOTING HOME DESIGN AND DECORATING PRODUCTS OF OTHERS BY PROVIDING HYPERTEXT LINKS TO THE WEB SITES OF OTHERS; PROMOTING HOME DESIGN, DECORATING, AND REMODELING SERVICES OF OTHERS BY PROVIDING CONTACT INFORMATION AND HYPERTEXT LINKS TO SERVICE PROVIDER'S WEBSITES, IN CLASS 35 (U.S. CLS. 100, 101 AND 102).

FIRST USE 8-0-2008; IN COMMERCE 8-0-2008.

FOR: PROVIDING A WEBSITE THAT FEATURES INFORMATION IN THE FIELD OF HOME RENOVATION AND REMODELING, IN CLASS 37 (U.S. CLS. 100, 103 AND 106).

FIRST USE 8-0-2008; IN COMMERCE 8-0-2008.

FOR: PROVIDING A WEBSITE FEATURING INFORMATION IN THE FIELD OF INTERIOR DESIGN AND ARCHITECTURE FOR USE BY INTERIOR DESIGNERS AND ARCHITECTS; PROVIDING A WEBSITE FEATURING INFORMATION IN THE FIELD OF HOME INTERIOR DESIGN AND INTERIOR DECORATING; PROVIDING AN WEBSITE THAT FEATURES TEMPORARY USE OF NON-DOWNLOADABLE SOFTWARE ALLOWING WEBSITE USERS TO UPLOAD, POST, SHARE AND DISPLAY ONLINE PHOTOS OF INTERIOR DESIGN AND DECORATING IDEAS AND WHICH ALSO ALLOWS USERS TO POST QUESTIONS AND COMMENTS IN THE FIELD OF INTERIOR DESIGN, DECORATING AND REMODELING; PROVIDING A WEBSITE FEATURING TEMPORARY USE OF NON-DOWNLOADABLE SOFTWARE FOR USE IN CREATING ONLINE, ELECTRONIC SCRAPBOOKS OF DESIGN AND DECORATING IDEAS, IN CLASS 42 (U.S. CLS. 100 AND 101).

FIRST USE 8-0-2008; IN COMMERCE 8-0-2008.

THE MARK CONSISTS OF STANDARD CHARACTERS WITHOUT CLAIM TO ANY PARTICULAR FONT, STYLE, SIZE, OR COLOR.

SER. NO. 85-366,717, FILED 7-8-2011.

MICHAEL TANNER, EXAMINING ATTORNEY



*David J. Kyffers*

Director of the United States Patent and Trademark Office



# United States of America

United States Patent and Trademark Office



**Reg. No. 4,124,846**

BUTTERFLY WINGS (PENNSYLVANIA CORPORATION)  
135 EAST MAIN ST  
NEW HOLLAND, PA 17557 AND

**Registered Apr. 10, 2012**

**Int. Cl.: 45**

BRACELIN, LAURIE L. (UNITED STATES INDIVIDUAL)  
135 EAST MAIN ST  
NEW HOLLAND, PA 17557

**SERVICE MARK**

**PRINCIPAL REGISTER**

FOR: COUNSELING IN THE FIELD OF PERSONAL DEVELOPMENT, NAMELY, SELF-IMPROVEMENT, SELF-FULFILLMENT, AND INTERPERSONAL COMMUNICATION; PROVIDING PERSONAL SUPPORT SERVICES FOR PATIENTS AND FAMILIES OF PATIENTS, NAMELY, EMOTIONAL COUNSELING AND EMOTIONAL SUPPORT, IN CLASS 45 (U.S. CLS. 100 AND 101).

FIRST USE 2-1-2011; IN COMMERCE 2-1-2011.

THE MARK CONSISTS OF A BUTTERFLY DESIGN OUTLINED IN BLACK WITH THE COLOR RED ON THE RIGHT WING WITH TWO BLACK DOTS REPRESENTING THE "B" IN THE SCRIPT WORDING "BUTTERFLY" WITH THE WORDING "UTTERFLY" IN BLACK THAT FORMS TO THE RIGHT ALL OVER THE COLOR GOLD ON THE LOWER BASE OF BOTH WINGS OF THE BUTTERFLY DESIGN REPRESENTING THE "W" IN THE SCRIPT WORDING "WINGS" WITH THE WORDING "INGS" IN BLACK; NO COLOR IS CLAIMED FOR INSIDE THE TOP LEFT PORTION OF THE WINGS.

THE COLOR(S) RED, GOLD, AND BLACK IS/ARE CLAIMED AS A FEATURE OF THE MARK.

SER. NO. 85-366,737, FILED 7-8-2011.

DOMINIC J. FERRAIUOLO, EXAMINING ATTORNEY



*David J. Kybas*

Director of the United States Patent and Trademark Office

# United States of America

United States Patent and Trademark Office

## OMNICATHEPSIN

**Reg. No. 4,124,847**

ENZO LIFE SCIENCES, INC. (NEW YORK CORPORATION)  
10 EXECUTIVE BLVD.

**Registered Apr. 10, 2012**

FARMINGDALE, NY 11735

**Int. Cl.: 1**

FOR: FLUOROGENIC PEPTIDE SUBSTRATE FOR SCIENTIFIC RESEARCH USE, IN CLASS 1 (U.S. CLS. 1, 5, 6, 10, 26 AND 46).

**TRADEMARK**

FIRST USE 6-15-1999; IN COMMERCE 6-15-1999.

**PRINCIPAL REGISTER**

THE MARK CONSISTS OF STANDARD CHARACTERS WITHOUT CLAIM TO ANY PARTICULAR FONT, STYLE, SIZE, OR COLOR.

SER. NO. 85-367,246, FILED 7-9-2011.

ELLEN B. AWRICH, EXAMINING ATTORNEY



*David J. Kybas*

Director of the United States Patent and Trademark Office

# United States of America

United States Patent and Trademark Office



**Reg. No. 4,124,848**

**Registered Apr. 10, 2012**

**Int. Cl.: 44**

**SERVICE MARK**

**PRINCIPAL REGISTER**

BLUE CROSS & BLUE SHIELD OF MISSISSIPPI, A MUTUAL INSURANCE COMPANY  
(MISSISSIPPI CORPORATION)  
3545 LAKELAND DRIVE  
JACKSON, MS 392151043

FOR: WELLNESS AND HEALTH-RELATED CONSULTING SERVICES, IN CLASS 44 (U.S. CLS. 100 AND 101).

FIRST USE 5-13-1997; IN COMMERCE 5-13-1997.

OWNER OF U.S. REG. NO. 2,060,782.

THE COLOR(S) GREEN IS/ARE CLAIMED AS A FEATURE OF THE MARK.

NO CLAIM IS MADE TO THE EXCLUSIVE RIGHT TO USE "HEALTHY", APART FROM THE MARK AS SHOWN.

THE MARK CONSISTS OF THE WORDS "HEALTHY YOU" WITH AN EXCLAMATION MARK AFTER THE WORDS AND A GREEN APPLE IN THE BACKGROUND. THE WORDING AND THE EXCLAMATION MARK ARE IN GREEN WHILE THE COLOR WHITE IS MERELY USED AS BACKGROUND.

SER. NO. 85-367,302, FILED 7-9-2011.

DOMINICK J. SALEMI, EXAMINING ATTORNEY



*David J. Kyffers*

Director of the United States Patent and Trademark Office

# United States of America

United States Patent and Trademark Office

## Laser Leftovers

**Reg. No. 4,124,849**

**Registered Apr. 10, 2012**

**Int. Cl.: 19**

**TRADEMARK**

**PRINCIPAL REGISTER**

KALLENSHAAN WOODS, INC. (NEVADA CORPORATION)  
940 CRAZYHORSE WAY  
LAS VEGAS, NV 89110

FOR: SEMI-WORKED WOOD IN THE FORM OF CYLINDERS WITH DIFFERENT LASER-CUT CUTOUTS SPECIFICALLY DESIGNED FOR USE BY PEN TURNERS FOR CREATING WOODEN PENS, IN CLASS 19 (U.S. CLS. 1, 12, 33 AND 50).

FIRST USE 8-24-2010; IN COMMERCE 8-24-2010.

THE MARK CONSISTS OF STANDARD CHARACTERS WITHOUT CLAIM TO ANY PARTICULAR FONT, STYLE, SIZE, OR COLOR.

NO CLAIM IS MADE TO THE EXCLUSIVE RIGHT TO USE "LASER", APART FROM THE MARK AS SHOWN.

SER. NO. 85-367,378, FILED 7-10-2011.

MICHAEL TANNER, EXAMINING ATTORNEY



*David J. Kyffers*

Director of the United States Patent and Trademark Office

# United States of America

United States Patent and Trademark Office



**Reg. No. 4,124,850**

**Registered Apr. 10, 2012**

**Int. Cl.: 35**

**SERVICE MARK**

**PRINCIPAL REGISTER**

MAJOR THRIFT FRANCHISE SYSTEM, INC. (KANSAS CORPORATION)  
11111 SOUTH GLENVIEW  
OLATHE, KS 66061

FOR: BUSINESS MANAGEMENT CONSULTING WITH RELATION TO STRATEGY, MARKETING, PRODUCTION, PERSONNEL AND RETAIL SALE MATTERS, IN CLASS 35 (U.S. CLS. 100, 101 AND 102).

FIRST USE 5-23-2011; IN COMMERCE 5-23-2011.

NO CLAIM IS MADE TO THE EXCLUSIVE RIGHT TO USE "THRIFT", APART FROM THE MARK AS SHOWN.

THE MARK CONSISTS OF A PULLOVER SHIRT ON TOP OF A PAIR OF PANTS, WITH THE WORDS "MAJOR THRIFT" TO THE LEFT SIDE OF THE SHIRT AND PANTS.

SER. NO. 85-367,552, FILED 7-11-2011.

SEAN CROWLEY, EXAMINING ATTORNEY



*David J. Kybas*

Director of the United States Patent and Trademark Office

# United States of America

United States Patent and Trademark Office

# DENTORIUM

**Reg. No. 4,124,851**

DENTORIUM PRODUCTS COMPANY, INC (NEW YORK CORPORATION)  
18 WEST 21ST STREET  
NEW YORK, NY 10010

**Registered Apr. 10, 2012**

**Int. Cls.: 5 and 10**

FOR: DENTAL MATERIALS, NAMELY, ABRASIVES, ALLOYS, ACRYLICS, DUPLICATING MATERIALS, IMPRESSION MATERIALS, WAXES, AND INVESTMENT MATERIALS, NAMELY, GYPSUM, IN CLASS 5 (U.S. CLS. 6, 18, 44, 46, 51 AND 52).

**TRADEMARK**

FIRST USE 1-2-1959; IN COMMERCE 1-2-1959.

**PRINCIPAL REGISTER**

FOR: DENTAL INSTRUMENTS, NAMELY, ACRYLICS IN THE NATURE OF HEAT CURE DENTAL ACRYLICS AND COLD CURE DENTAL ACRYLICS, MANDRELS AND ARTICULATORS; ARTIFICIAL TEETH, IN CLASS 10 (U.S. CLS. 26, 39 AND 44).

FIRST USE 1-2-1959; IN COMMERCE 1-2-1959.

THE MARK CONSISTS OF STANDARD CHARACTERS WITHOUT CLAIM TO ANY PARTICULAR FONT, STYLE, SIZE, OR COLOR.

OWNER OF U.S. REG. NO. 694,976.

SER. NO. 85-367,579, FILED 7-11-2011.

BRIAN NEVILLE, EXAMINING ATTORNEY



*David J. Kyros*

Director of the United States Patent and Trademark Office

# United States of America

United States Patent and Trademark Office

## Oxy Advantage

**Reg. No. 4,124,852**

LINDENBACH, JACKIE (UNITED STATES INDIVIDUAL)  
229 GYPSY BAY RD.  
SAGLE, ID 83860

**Registered Apr. 10, 2012**

**Int. Cl.: 5**

FOR: NUTRITIONAL SUPPLEMENTS EXCLUDING ACNE MEDICATIONS AND MEDICATED SKIN CARE PREPARATIONS, IN CLASS 5 (U.S. CLS. 6, 18, 44, 46, 51 AND 52).

**TRADEMARK**

FIRST USE 10-1-2008; IN COMMERCE 10-1-2008.

**PRINCIPAL REGISTER**

THE MARK CONSISTS OF STANDARD CHARACTERS WITHOUT CLAIM TO ANY PARTICULAR FONT, STYLE, SIZE, OR COLOR.

SER. NO. 85-367,603, FILED 7-11-2011.

LAURIE KAUFMAN, EXAMINING ATTORNEY



*David J. Kyffers*

Director of the United States Patent and Trademark Office

# United States of America

United States Patent and Trademark Office

re\*be

**Reg. No. 4,124,853**

**Registered Apr. 10, 2012**

**Int. Cl.: 44**

**SERVICE MARK**

**PRINCIPAL REGISTER**

DR. RONALD J. KOLEGRAFF (IOWA PARTNERSHIP), DBA MY SKIN CLINICS, PLC  
1008 EAST VIEW AVE., UNITS 6 & 8  
OKOBOJI, IA 51355

FOR: LASER HAIR REMOVAL SERVICES; LIPOSUCTION AND SURGICAL BODY SHAPING SERVICES; MEDICAL SKIN CARE SERVICES; MINIMALLY INVASIVE SURGICAL SERVICES; PERMANENT HAIR REMOVAL AND REDUCTION SERVICES; PROVIDING LASER THERAPY FOR TREATING MEDICAL CONDITIONS; SURGERY, IN CLASS 44 (U.S. CLS. 100 AND 101).

FIRST USE 4-1-2006; IN COMMERCE 4-1-2006.

THE MARK CONSISTS OF STANDARD CHARACTERS WITHOUT CLAIM TO ANY PARTICULAR FONT, STYLE, SIZE, OR COLOR.

SER. NO. 85-367,706, FILED 7-11-2011.

HOWARD SMIGA, EXAMINING ATTORNEY



*David J. Kyffers*

Director of the United States Patent and Trademark Office



# United States of America

United States Patent and Trademark Office

## JAVITS CENTER

**Reg. No. 4,124,854**

**Registered Apr. 10, 2012**

**Int. Cls.: 36 and 43**

**SERVICE MARK**

**PRINCIPAL REGISTER**

NEW YORK CONVENTION CENTER OPERATING CORPORATION (NEW YORK PUBLIC  
BENEFIT CORPORATION)  
655 WEST 34TH STREET  
NEW YORK, NY 10001

FOR: LEASING OF CONVENTION SPACE, IN CLASS 36 (U.S. CLS. 100, 101 AND 102).

FIRST USE 0-0-1997; IN COMMERCE 0-0-1997.

FOR: GENERAL PURPOSE CONVENTION AND EXHIBITION FACILITIES; PROVIDING  
CONVENTION FACILITIES, IN CLASS 43 (U.S. CLS. 100 AND 101).

FIRST USE 0-0-1997; IN COMMERCE 0-0-1997.

THE MARK CONSISTS OF STANDARD CHARACTERS WITHOUT CLAIM TO ANY PAR-  
TICULAR FONT, STYLE, SIZE, OR COLOR.

NO CLAIM IS MADE TO THE EXCLUSIVE RIGHT TO USE "CENTER", APART FROM THE  
MARK AS SHOWN.

SEC. 2(F).

SER. NO. 85-367,739, FILED 7-11-2011.

ANNE MADDEN, EXAMINING ATTORNEY



*David J. Kyros*

Director of the United States Patent and Trademark Office

# United States of America

United States Patent and Trademark Office



**Reg. No. 4,124,855**

ENVIRO-GREEN CLEANING, INC. (MONTANA CORPORATION)

**Registered Apr. 10, 2012**

P.O. BOX 17825  
MISSOULA, MT 59808

**Int. Cl.: 37**

FOR: ENVIRONMENTALLY FRIENDLY CLEANING OF COMMERCIAL PREMISES, IN CLASS 37 (U.S. CLS. 100, 103 AND 106).

**SERVICE MARK**

FIRST USE 5-15-2011; IN COMMERCE 5-15-2011.

**PRINCIPAL REGISTER**

NO CLAIM IS MADE TO THE EXCLUSIVE RIGHT TO USE "CLEANING", APART FROM THE MARK AS SHOWN.

THE COLOR(S) GREEN AND WHITE IS/ARE CLAIMED AS A FEATURE OF THE MARK.

THE MARK CONSISTS OF THE WORDS "ENVIRO-GREEN CLEANING" IN GREEN LETTERS IN THE LOWER FOREGROUND OF THE SQUARE-SHAPED LOGO, WITH A SPHERE IMAGE BEHIND CENTER WHICH IS MADE UP OF GEOMETRIC SHAPES GREEN AND WHITE PARTS FORMING THE SPHERE IMAGE.

SER. NO. 85-367,741, FILED 7-11-2011.

MARK SPARACINO, EXAMINING ATTORNEY



*David J. Kypos*

Director of the United States Patent and Trademark Office

# United States of America

United States Patent and Trademark Office



**Reg. No. 4,124,856**

FERRELL, WILLIE (UNITED STATES INDIVIDUAL)  
64 SKYVIEW TERRACE  
MANCHESTER, CT 06040

**Registered Apr. 10, 2012**

**Int. Cl.: 35**

FOR: ON-LINE RETAIL STORE SERVICES FEATURING BOOKS AND BIBLE STUDY MATERIALS, IN CLASS 35 (U.S. CLS. 100, 101 AND 102).

**SERVICE MARK**

FIRST USE 3-18-2000; IN COMMERCE 3-18-2000.

**PRINCIPAL REGISTER**

THE MARK CONSISTS OF THE STYLIZED WORDING "SHARING GOD'S WORD ON THE WEB" APPEARING IN AN ARCH AROUND THE STYLIZED DEPICTION OF A DOORWAY CONTAINING A CROSS IN THE UPPER LEFT PORTION OF THE DOORWAY AND THREE RAYS OF LIGHT EMANATING FROM THE CROSS. THE STYLIZED WORDING "JESUS IS ALL.COM" APPEARS BELOW THE DOORWAY.

SER. NO. 85-367,805, FILED 7-11-2011.

AMY KERTGATE, EXAMINING ATTORNEY



*David J. Kappas*

Director of the United States Patent and Trademark Office

# United States of America

United States Patent and Trademark Office

## HEALTH GRAPH

**Reg. No. 4,124,857**

**Registered Apr. 10, 2012**

**Int. Cl.: 42**

**SERVICE MARK**

**PRINCIPAL REGISTER**

FITNESSKEEPER, INC. (DELAWARE CORPORATION)  
4TH FLOOR  
580 HARRISON AVENUE  
BOSTON, MA 02118

FOR: APPLICATION SERVICE PROVIDER (ASP) FEATURING SOFTWARE FOR USE IN ORGANIZING, TRACKING AND ANALYZING THE USER'S HEALTH AND FITNESS DATA; APPLICATION SERVICE PROVIDER FEATURING APPLICATION PROGRAMMING INTERFACE (API) SOFTWARE FOR ORGANIZING, TRACKING AND ANALYZING THE USER'S HEALTH AND FITNESS DATA, AND FOR ALLOWING DATA RETRIEVAL, UPLOAD, ACCESS, AND MANAGEMENT, AND FOR USE IN BUILDING SOFTWARE APPLICATIONS; SOFTWARE AS A SERVICE (SAAS) SERVICES FEATURING SOFTWARE FOR ORGANIZING, TRACKING AND ANALYZING THE USER'S HEALTH AND FITNESS DATA; APPLICATION SERVICE PROVIDER, NAMELY, HOSTING, MANAGING, DEVELOPING, AND MAINTAINING APPLICATIONS, SOFTWARE, AND WEB SITES, IN THE FIELDS OF PERSONAL HEALTH AND FITNESS, AND REMOTE DATA MANAGEMENT FOR DELIVERY OF CONTENT TO COMPUTERS, LAPTOPS AND MOBILE ELECTRONIC DEVICES, IN CLASS 42 (U.S. CLS. 100 AND 101).

FIRST USE 7-7-2011; IN COMMERCE 7-7-2011.

THE MARK CONSISTS OF STANDARD CHARACTERS WITHOUT CLAIM TO ANY PARTICULAR FONT, STYLE, SIZE, OR COLOR.

SER. NO. 85-367,888, FILED 7-11-2011.

INGRID C. EULIN, EXAMINING ATTORNEY



*David J. Kyjars*

Director of the United States Patent and Trademark Office

United States of America  
United States Patent and Trademark Office

**HEMCO**  
**Laboratory Planning Solutions**

**Reg. No. 4,124,858**

**Registered Apr. 10, 2012**

**Int. Cl.: 11**

**TRADEMARK**

**PRINCIPAL REGISTER**

HILL, RONALD, E., HRD LLC (MISSOURI LIMITED LIABILITY COMPANY), DBA HEMCO CORPORATION  
711 SOUTH POWELL RD  
INDEPENDENCE, MO 64056

FOR: LABORATORY VENTILATION HOODS, IN CLASS 11 (U.S. CLS. 13, 21, 23, 31 AND 34).

FIRST USE 3-1-2008; IN COMMERCE 3-1-2008.

NO CLAIM IS MADE TO THE EXCLUSIVE RIGHT TO USE "LABORATORY", APART FROM THE MARK AS SHOWN.

THE MARK CONSISTS OF THE STYLIZED WORDING "HEMCO" IS IN ALL CAPS, WITH A HORIZONTAL LINE BELOW AND BELOW THE LINE IS THE WORDING "LABORATORY PLANNING SOLUTIONS" IN A SMALLER FONT.

SER. NO. 85-367,929, FILED 7-11-2011.

KATHERINE CONNOLLY, EXAMINING ATTORNEY



*David J. Kyffers*

Director of the United States Patent and Trademark Office

# United States of America

United States Patent and Trademark Office

# ROADKING

**Reg. No. 4,124,859**

BOSCH SECURITY SYSTEMS, INC. (DELAWARE CORPORATION)  
12000 PORTLAND AVENUE SOUTH  
MINNEAPOLIS, MN 53374

**Registered Apr. 10, 2012**

**Int. Cl.: 9**

FOR: MICROPHONES FOR LAND-MOBILE COMMUNICATION BY RADIO, IN CLASS 9  
(U.S. CLS. 21, 23, 26, 36 AND 38).

**TRADEMARK**

FIRST USE 10-31-1974; IN COMMERCE 10-31-1974.

**PRINCIPAL REGISTER**

THE MARK CONSISTS OF STANDARD CHARACTERS WITHOUT CLAIM TO ANY PARTICULAR FONT, STYLE, SIZE, OR COLOR.

SER. NO. 85-367,967, FILED 7-11-2011.

SANJEEV VOHRA, EXAMINING ATTORNEY



*David J. Kybas*

Director of the United States Patent and Trademark Office

# United States of America

United States Patent and Trademark Office

## SPARKLE CITY

**Reg. No. 4,124,860**

**Registered Apr. 10, 2012**

**Int. Cl.: 35**

NEAT STUFF COLLECTIBLES.COM, LLC (NEW JERSEY LIMITED LIABILITY COMPANY),  
DBA SPARKLE CITY, LLC  
P.O. BOX 7420  
704 76TH STREET  
NORTH BERGEN, NJ 07047

**SERVICE MARK**

**PRINCIPAL REGISTER**

FOR: ON-LINE WHOLESALE AND RETAIL STORE SERVICES FEATURING COLLECTIBLE COMIC BOOKS, COLLECTIBLE SPORTS AND NON-SPORTS TRADING CARDS, COLLECTIBLE MUSIC MEMORABILIA, COLLECTIBLE TOY MEMORABILIA, COLLECTIBLE ARTWORK AND COLLECTIBLE AUTOGRAPHS; RETAIL STORE SERVICES FEATURING COLLECTIBLE COMIC BOOKS, COLLECTIBLE SPORTS AND NON-SPORTS TRADING CARDS, COLLECTIBLE MUSIC MEMORABILIA, COLLECTIBLE TOY MEMORABILIA, COLLECTIBLE ARTWORK AND COLLECTIBLE AUTOGRAPHS; RETAIL STORE SERVICES FEATURING COLLECTIBLE COMIC BOOKS, COLLECTIBLE SPORTS AND NON-SPORTS TRADING CARDS, COLLECTIBLE MUSIC MEMORABILIA, COLLECTIBLE TOY MEMORABILIA, COLLECTIBLE ARTWORK AND COLLECTIBLE AUTOGRAPHS ACCESSIBLE ON-LINE AND BY TELEPHONE, FACSIMILE AND MAIL ORDER; WHOLESALE STORE SERVICES FEATURING COLLECTIBLE COMIC BOOKS, COLLECTIBLE SPORTS AND NON-SPORTS TRADING CARDS, COLLECTIBLE MUSIC MEMORABILIA, COLLECTIBLE TOY MEMORABILIA, COLLECTIBLE ARTWORK AND COLLECTIBLE AUTOGRAPHS, IN CLASS 35 (U.S. CLS. 100, 101 AND 102).

FIRST USE 7-1-2011; IN COMMERCE 7-1-2011.

THE MARK CONSISTS OF STANDARD CHARACTERS WITHOUT CLAIM TO ANY PARTICULAR FONT, STYLE, SIZE, OR COLOR.

SER. NO. 85-367,973, FILED S.R. 7-11-2011 AM. P.R. 7-14-2011.

KATHERINE CONNOLLY, EXAMINING ATTORNEY



*David J. Kyjars*

Director of the United States Patent and Trademark Office

# United States of America

United States Patent and Trademark Office

## Breakthrough Georgia

**Reg. No. 4,124,861**

**Registered Apr. 10, 2012**

**Int. Cl.: 36**

**SERVICE MARK**

**PRINCIPAL REGISTER**

GEORGIA FAMILY COUNCIL, INC. (GEORGIA CORPORATION)  
SUITE 460  
3500 PARKWAY LANE  
NORCROSS, GA 30092

FOR: CHARITABLE FUNDRAISING SERVICES, NAMELY, BY PROVIDING INDIVIDUALS WITH THE INFORMATION AND OPPORTUNITY TO MAKE MONETARY DONATIONS TO THEIR FAVORITE CHARITY, IN CLASS 36 (U.S. CLS. 100, 101 AND 102).

FIRST USE 6-12-2011; IN COMMERCE 7-11-2011.

THE MARK CONSISTS OF STANDARD CHARACTERS WITHOUT CLAIM TO ANY PARTICULAR FONT, STYLE, SIZE, OR COLOR.

NO CLAIM IS MADE TO THE EXCLUSIVE RIGHT TO USE "GEORGIA", APART FROM THE MARK AS SHOWN.

SER. NO. 85-368,076, FILED 7-11-2011.

RENEE MCCRAY, EXAMINING ATTORNEY



*David J. Kyffers*

Director of the United States Patent and Trademark Office



# United States of America

United States Patent and Trademark Office

# RGB

**Reg. No. 4,124,862**

RGB SODA LLC (WASHINGTON LIMITED LIABILITY COMPANY)  
1809 15TH AVE APT 302  
SEATTLE, WA 98122

**Registered Apr. 10, 2012**

**Int. Cl.: 32**

FOR: NON-ALCOHOLIC BEVERAGES, NAMELY, CARBONATED BEVERAGES; SOFT DRINKS, NAMELY, SODAS, IN CLASS 32 (U.S. CLS. 45, 46 AND 48).

**TRADEMARK**

FIRST USE 9-2-2010; IN COMMERCE 9-2-2010.

**PRINCIPAL REGISTER**

THE MARK CONSISTS OF STANDARD CHARACTERS WITHOUT CLAIM TO ANY PARTICULAR FONT, STYLE, SIZE, OR COLOR.

SER. NO. 85-368,315, FILED 7-11-2011.

BARBARA GAYNOR, EXAMINING ATTORNEY



*David J. Kybas*

Director of the United States Patent and Trademark Office

# United States of America

United States Patent and Trademark Office

# Flex+Matic

**Reg. No. 4,124,863**

**Registered Apr. 10, 2012**

**Int. Cl.: 7**

**TRADEMARK**

**PRINCIPAL REGISTER**

COMMERCIAL MAILING ACCESSORIES, INC. (MISSOURI CORPORATION), DBA  
DISPENSA-MATIC LABEL DISPENSERS  
28220 PLAYMOR BEACH ROAD  
ROCKY MOUNT, MO 65072

FOR: ELECTRIC SEMI-AUTOMATIC AND AUTOMATIC LABEL APPLICATORS FOR  
COMMERCIAL USE, IN CLASS 7 (U.S. CLS. 13, 19, 21, 23, 31, 34 AND 35).

FIRST USE 1-1-2011; IN COMMERCE 1-1-2011.

THE MARK CONSISTS OF STANDARD CHARACTERS WITHOUT CLAIM TO ANY PAR-  
TICULAR FONT, STYLE, SIZE, OR COLOR.

OWNER OF U.S. REG. NOS. 3,947,472 AND 3,947,473.

SER. NO. 85-368,420, FILED 7-11-2011.

SHAILA SETTLES, EXAMINING ATTORNEY



*David J. Kyffers*

Director of the United States Patent and Trademark Office

# United States of America

United States Patent and Trademark Office



**Reg. No. 4,124,864**

ZABOTTA, INC (GEORGIA CORPORATION)  
1830 ANGUS LEE DRIVE  
LAWRENCEVILLE, GA 30045

**Registered Apr. 10, 2012**

**Int. Cl.: 34**

FOR: ELECTRONIC CIGARETTES FOR USE AS AN ALTERNATIVE TO TRADITIONAL CIGARETTES, IN CLASS 34 (U.S. CLS. 2, 8, 9 AND 17).

**TRADEMARK**

FIRST USE 7-1-2011; IN COMMERCE 7-1-2011.

**PRINCIPAL REGISTER**

THE MARK CONSISTS OF A STYLIZED DESIGN CONSISTING OF LINES AND BANDS IN THE COLOR GOLD LOCATED ABOVE AND BELOW THE WORDING "ENCIG" IN STYLIZED UPPER CASE FONT IN THE COLOR GOLD. BOTH THE DESIGN AND WORDING ARE SET AGAINST A BLACK RECTANGULAR BACKGROUND.

THE COLOR(S) BLACK AND GOLD IS/ARE CLAIMED AS A FEATURE OF THE MARK.

SER. NO. 85-368,429, FILED 7-11-2011.

RUSS HERMAN, EXAMINING ATTORNEY



*David J. Kybas*

Director of the United States Patent and Trademark Office

# United States of America

United States Patent and Trademark Office



**Reg. No. 4,124,865**

**Registered Apr. 10, 2012**

**Int. Cl.: 31**

**TRADEMARK**

**PRINCIPAL REGISTER**

NATURIPE BRANDS, LLC (DELAWARE LIMITED LIABILITY COMPANY)  
P.O. BOX 4280  
SALINAS, CA 939124280

FOR: FRESH BERRIES, IN CLASS 31 (U.S. CLS. 1 AND 46).

FIRST USE 10-1-2008; IN COMMERCE 10-1-2008.

OWNER OF U.S. REG. NOS. 2,069,613, 3,942,005 AND OTHERS.

THE MARK CONSISTS OF THE TERM "NATURIPE" IN A CURVED AND OUTLINED BACKGROUND RECTANGLE.

SER. NO. 85-368,493, FILED 7-11-2011.

COLLEEN KEARNEY, EXAMINING ATTORNEY



*David J. Kyffers*

Director of the United States Patent and Trademark Office

# United States of America

United States Patent and Trademark Office



**Reg. No. 4,124,866**

JON FELDMAN (UNITED STATES INDIVIDUAL)  
18504 HERITAGE HILLS DRIVE  
OLNEY, MD 20832

**Registered Apr. 10, 2012**

**Int. Cls.: 16 and 25**

FOR: STICKERS, IN CLASS 16 (U.S. CLS. 2, 5, 22, 23, 29, 37, 38 AND 50).

**TRADEMARK**

FIRST USE 2-1-2011; IN COMMERCE 2-1-2011.

**PRINCIPAL REGISTER**

FOR: SHIRTS, IN CLASS 25 (U.S. CLS. 22 AND 39).

FIRST USE 2-1-2011; IN COMMERCE 2-11-2011.

THE MARK CONSISTS OF THE STYLIZED WORDING "SPKSMEN" INSIDE OF AN ARC SHAPED QUADRILATERAL WITH A LINE BORDER.

SER. NO. 85-368,549, FILED 7-11-2011.

COURTNEY ALVAREZ, EXAMINING ATTORNEY



*David J. Kybas*

Director of the United States Patent and Trademark Office

# United States of America

United States Patent and Trademark Office

# NEXTSPACE

**Reg. No. 4,124,867**

**Registered Apr. 10, 2012**

**Int. Cl.: 35**

**SERVICE MARK**

**PRINCIPAL REGISTER**

NEXTSPACE COWORKING & INNOVATION, INC. (CALIFORNIA CORPORATION)  
101 COOPER STREET  
SANTA CRUZ, CA 95060

FOR: ASSOCIATION SERVICES, NAMELY, PROMOTING THE INTERESTS OF IT PROFESSIONALS; BUSINESS NETWORKING; PROVIDING FACILITIES FOR BUSINESS MEETINGS; ARRANGING AND CONDUCTING SPECIAL EVENTS FOR BUSINESS PURPOSES; ALL OF THE FOREGOING SERVICES FOR CREATIVE CLASS PROFESSIONALS AND KNOWLEDGE WORKERS, IN CLASS 35 (U.S. CLS. 100, 101 AND 102).

FIRST USE 8-16-2008; IN COMMERCE 9-8-2010.

THE MARK CONSISTS OF STANDARD CHARACTERS WITHOUT CLAIM TO ANY PARTICULAR FONT, STYLE, SIZE, OR COLOR.

SER. NO. 85-368,574, FILED 7-12-2011.

WILLIAM BRECKENFELD, EXAMINING ATTORNEY



*David J. Kyfos*

Director of the United States Patent and Trademark Office

# United States of America

United States Patent and Trademark Office

LOVE, HOPE & PIZZA

**Reg. No. 4,124,868**

HUNGRY HOWIE'S PIZZA & SUBS, INC. (MICHIGAN CORPORATION)  
30300 STEPHENSON HWY., SUITE 200  
MADISON HEIGHTS, MI 48071

**Registered Apr. 10, 2012**

**Int. Cl.: 43**

FOR: RESTAURANT SERVICES, CARRY OUT RESTAURANT SERVICES, INCLUDING PIZZA, CHICKEN WINGS, SUBS, BREAD, FOR CONSUMPTION ON OR OFF THE PREMISES, IN CLASS 43 (U.S. CLS. 100 AND 101).

**SERVICE MARK**

FIRST USE 10-1-2009; IN COMMERCE 10-1-2009.

**PRINCIPAL REGISTER**

THE MARK CONSISTS OF THE WORD "LOVE" IN A SKINNY FONT, THE WORD "HOPE" IN A THICKER FONT WITH A RIBBON IN PLACE OF THE "P", THE "&" SYMBOL, AND THEN THE WORD "PIZZA" IN AN EVEN THICKER FONT.

SER. NO. 85-368,684, FILED 7-12-2011.

RAUL CORDOVA, EXAMINING ATTORNEY



*David J. Kybas*

Director of the United States Patent and Trademark Office

# United States of America

United States Patent and Trademark Office

# SAY SI BON!

**Reg. No. 4,124,869**

**Registered Apr. 10, 2012**

**Int. Cl.: 35**

**SERVICE MARK**

**PRINCIPAL REGISTER**

THE PARADIES SHOPS, LLC (GEORGIA LIMITED LIABILITY COMPANY)  
5950 FULTON INDUSTRIAL BOULEVARD, SW  
ATLANTA, GA 30336

FOR: RETAIL STORE SERVICES FEATURING GOURMET MARKET PRE-PACKAGED FOODS-TO-GO INCLUDING SANDWICHES, SALADS, PASTRIES, DESSERTS, FRESH FRUITS, BEVERAGES, SNACKS, CANDIES, JUICES, TEAS AND OTHER HOT AND COLD BEVERAGES LOCATED IN AIRPORTS AND RETAIL CENTERS, IN CLASS 35 (U.S. CLS. 100, 101 AND 102).

FIRST USE 8-21-2011; IN COMMERCE 8-21-2011.

THE MARK CONSISTS OF STANDARD CHARACTERS WITHOUT CLAIM TO ANY PARTICULAR FONT, STYLE, SIZE, OR COLOR.

THE ENGLISH TRANSLATION OF THE WORDS "SI BON!" IN THE MARK IS "SO GOOD!".

SER. NO. 85-368,804, FILED 7-12-2011.

KATHERINE CONNOLLY, EXAMINING ATTORNEY



*David J. Kybas*

Director of the United States Patent and Trademark Office



# United States of America

United States Patent and Trademark Office

## Miss Hispanidad International

**Reg. No. 4,124,870**

MISS HISPANIDAD INTERNATIONAL LLC (CALIFORNIA LIMITED LIABILITY COMPANY)  
1600 N HARVARD BLVD  
LOS ANGELES, CA 90027

**Registered Apr. 10, 2012**

**Int. Cl.: 41**

FOR: ENTERTAINMENT IN THE NATURE OF BEAUTY PAGEANTS, IN CLASS 41 (U.S. CLS. 100, 101 AND 107).

**SERVICE MARK**

FIRST USE 10-24-2010; IN COMMERCE 10-24-2010.

**PRINCIPAL REGISTER**

THE MARK CONSISTS OF STANDARD CHARACTERS WITHOUT CLAIM TO ANY PARTICULAR FONT, STYLE, SIZE, OR COLOR.

NO CLAIM IS MADE TO THE EXCLUSIVE RIGHT TO USE "HISPANIDAD INTERNATIONAL", APART FROM THE MARK AS SHOWN.

THE ENGLISH TRANSLATION OF "HISPANIDAD" IS "PERSON OF HISPANIC ORIGIN".

SER. NO. 85-368,862, FILED 7-12-2011.

DAWN FELDMAN, EXAMINING ATTORNEY



*David J. Kyffers*

Director of the United States Patent and Trademark Office

# United States of America

United States Patent and Trademark Office

## NFL AUDIO PASS

**Reg. No. 4,124,871**

NATIONAL FOOTBALL LEAGUE (NEW YORK UNINCORPORATED ASSOCIATION)  
345 PARK AVE

**Registered Apr. 10, 2012**

NEW YORK, NY 10154

**Int. Cl.: 41**

FOR: ENTERTAINMENT SERVICES, NAMELY, A CONTINUING SUBSCRIPTION AUDIO PROGRAM IN THE FIELD OF FOOTBALL BROADCAST OVER THE INTERNET, IN CLASS 41 (U.S. CLS. 100, 101 AND 107).

**SERVICE MARK**

FIRST USE 4-1-2010; IN COMMERCE 4-1-2010.

**PRINCIPAL REGISTER**

THE MARK CONSISTS OF STANDARD CHARACTERS WITHOUT CLAIM TO ANY PARTICULAR FONT, STYLE, SIZE, OR COLOR.

OWNER OF U.S. REG. NOS. 886,055, 2,919,270, AND 3,394,343.

NO CLAIM IS MADE TO THE EXCLUSIVE RIGHT TO USE "AUDIO PASS", APART FROM THE MARK AS SHOWN.

SER. NO. 85-368,930, FILED 7-12-2011.

TEJBIR SINGH, EXAMINING ATTORNEY



*David J. Kyffers*

Director of the United States Patent and Trademark Office

# United States of America

United States Patent and Trademark Office

# SIMPLUS

**Reg. No. 4,124,872**

**Registered Apr. 10, 2012**

**Int. Cl.: 10**

**TRADEMARK**

**PRINCIPAL REGISTER**

FISHER & PAYKEL HEALTHCARE LIMITED (NEW ZEALAND LIMITED LIABILITY COMPANY)  
15 MAURICE PAYKEL PLACE EAST TAMAKI  
AUCKLAND, NEW ZEALAND 2013

FOR: MEDICAL APPARATUS AND INSTRUMENTS, NAMELY, RESPIRATORS AND ARTIFICIAL RESPIRATION APPARATUS; HUMIDIFIERS FOR MEDICAL USE; MEDICAL APPARATUS FOR THE TREATMENT OF OBSTRUCTIVE SLEEP APNEA; MEDICAL APPARATUS, NAMELY, NON-INVASIVE VENTILATION APPARATUS AND INSTRUMENTS; MEDICAL RESPIRATORY MASKS FOR USE IN TREATING OBSTRUCTIVE SLEEP APNEA; FACIAL MASKS, ORAL MASKS, NASAL MASKS, NASAL CANNULA, MOUTHPIECES, HEADGEAR, ALL BEING FOR MEDICAL PURPOSES; PARTS AND FITTINGS FOR ALL THE AFOREMENTIONED GOODS, IN CLASS 10 (U.S. CLS. 26, 39 AND 44).

THE MARK CONSISTS OF STANDARD CHARACTERS WITHOUT CLAIM TO ANY PARTICULAR FONT, STYLE, SIZE, OR COLOR.

PRIORITY CLAIMED UNDER SEC. 44(D) ON NEW ZEALAND APPLICATION NO. 842721, FILED 5-26-2011, REG. NO. 842721, DATED 5-26-2011, EXPIRES 5-26-2021.

SER. NO. 85-368,967, FILED 7-12-2011.

JOHN WILKE, EXAMINING ATTORNEY



*David J. Kyros*

Director of the United States Patent and Trademark Office

# United States of America

United States Patent and Trademark Office



**Reg. No. 4,124,873**

**Registered Apr. 10, 2012**

**Int. Cls.: 35 and 37**

**SERVICE MARK**

**PRINCIPAL REGISTER**

WEST FALLS SERVICE CENTER, INC. (VIRGINIA CORPORATION), DBA AMERICAN  
MAJESTIC EAGLE FUEL AND AUTO REPAIRS  
7399 LEE HIGHWAY  
FALLS CHURCH, VA 22042

FOR: RETAIL CONVENIENCE STORE SERVICES, IN CLASS 35 (U.S. CLS. 100, 101 AND 102).

FIRST USE 11-0-2010; IN COMMERCE 11-0-2010.

FOR: AUTO REPAIR AND MAINTENANCE SERVICES; AUTOMOBILE SERVICE STATIONS;  
AUTOMOBILE REFUELING STATIONS, IN CLASS 37 (U.S. CLS. 100, 103 AND 106).

FIRST USE 11-0-2010; IN COMMERCE 11-0-2010.

THE MARK CONSISTS OF A STYLIZED CIRCULAR LOGO HAVING THE CIRCLE IN BLUE AND WHITE, WITH A STYLIZATION OF THE U.S. FLAG WITH RED AND WHITE STRIPES AND WHITE STARS AGAINST A BLUE BACKGROUND FIELD IN THE CENTER OF THE CIRCLE AND AN EAGLE'S HEAD IN WHITE WITH A YELLOW BEAK AND BLACK EYE SUPERIMPOSED OVER THE STYLIZED FLAG DESIGN. THE ENTIRE DESIGN IS SET AGAINST A RED BACKGROUND.

THE COLOR(S) RED, WHITE, BLUE, YELLOW AND BLACK IS/ARE CLAIMED AS A FEATURE OF THE MARK.

SER. NO. 85-369,049, FILED 7-12-2011.

JEFFREY LOOK, EXAMINING ATTORNEY



*David J. Kybas*

Director of the United States Patent and Trademark Office

# United States of America

United States Patent and Trademark Office

## Purity of Worship Experience

**Reg. No. 4,124,874**

CANNON, CARLTON L (UNITED STATES INDIVIDUAL)  
32 LORDSHIP LANE  
DOVER, DE 19901

**Registered Apr. 10, 2012**

**Int. Cl.: 41**

FOR: ENTERTAINMENT, NAMELY, LIVE PERFORMANCES BY A MUSICAL BAND, IN CLASS 41 (U.S. CLS. 100, 101 AND 107).

**SERVICE MARK**

FIRST USE 7-25-2009; IN COMMERCE 7-25-2009.

**PRINCIPAL REGISTER**

THE MARK CONSISTS OF STANDARD CHARACTERS WITHOUT CLAIM TO ANY PARTICULAR FONT, STYLE, SIZE, OR COLOR.

SER. NO. 85-369,054, FILED 7-12-2011.

JEFFREY LOOK, EXAMINING ATTORNEY



*David J. Kyffers*

Director of the United States Patent and Trademark Office

# United States of America

United States Patent and Trademark Office

## HOLDEN BEACH, NC TURTLE WATCH PROGRAM

**Reg. No. 4,124,875**

**Registered Apr. 10, 2012**

**Int. Cl.: 25**

**TRADEMARK**

**PRINCIPAL REGISTER**

HOLDEN BEACH TURTLE WATCH PROGRAM INCORPORATED (NORTH CAROLINA CORPORATION)  
118 FRIGATE DRIVE  
HOLDEN BEACH, NC 28462 AND

MARWITZ, CHARLES ANTHONY (UNITED STATES INDIVIDUAL), AKA TONY MARWITZATHBEACH@MINDSPRING.COM  
118 FRIGATE DRIVE  
HOLDEN BEACH, NC 28462

FOR: HEADGEAR, NAMELY, HATS; HOODED SWEAT SHIRTS; RAINCOATS; SHORT-SLEEVED OR LONG-SLEEVED T-SHIRTS; SWEAT SHIRTS; TANK TOPS; WIND-JACKETS, IN CLASS 25 (U.S. CLS. 22 AND 39).

FIRST USE 6-15-2011; IN COMMERCE 6-15-2011.

THE MARK CONSISTS OF STANDARD CHARACTERS WITHOUT CLAIM TO ANY PARTICULAR FONT, STYLE, SIZE, OR COLOR.

OWNER OF U.S. REG. NOS. 4,030,142 AND 4,032,929.

NO CLAIM IS MADE TO THE EXCLUSIVE RIGHT TO USE "HOLDEN BEACH, NC", APART FROM THE MARK AS SHOWN.

SER. NO. 85-369,056, FILED 7-12-2011.

SEAN CROWLEY, EXAMINING ATTORNEY



*David J. Kybas*

Director of the United States Patent and Trademark Office

# United States of America

United States Patent and Trademark Office



**Reg. No. 4,124,876**

ILLINOIS HORSE RESCUE OF WILL COUNTY, INC. (ILLINOIS CORPORATION)  
P.O. BOX 1019  
PEOTONE, IL 60468

**Registered Apr. 10, 2012**

**Int. Cl.: 39**

FOR: EQUINE RESCUE SERVICES, NAMELY, REMOVING SUCH ANIMALS FROM HARM AND TRANSPORTING THEM TO SHELTER, IN CLASS 39 (U.S. CLS. 100 AND 105).

**SERVICE MARK**

FIRST USE 6-16-2011; IN COMMERCE 6-16-2011.

**PRINCIPAL REGISTER**

NO CLAIM IS MADE TO THE EXCLUSIVE RIGHT TO USE "ILLINOIS HORSE RESCUE OF WILL COUNTY", APART FROM THE MARK AS SHOWN.

THE COLOR(S) BLUE, YELLOW AND BLACK IS/ARE CLAIMED AS A FEATURE OF THE MARK.

THE MARK CONSISTS OF BLUE HORSE HEAD PROFILE WITH A YELLOW HALF MOON OR SUN TO THE RIGHT OF THE HORSE HEAD AND THE WORDS "ILLINOIS HORSE RESCUE OF WILL COUNTY" IN BLACK LETTERING APPEARING BELOW THE HORSE HEAD AND HALF MOON OR SUN.

SER. NO. 85-369,061, FILED 7-12-2011.

JEFFREY LOOK, EXAMINING ATTORNEY



*David J. Kybas*

Director of the United States Patent and Trademark Office

# United States of America

United States Patent and Trademark Office

## Green and Grow

**Reg. No. 4,124,877**

GREENANDGROW.ORG, L.L.C. (ARIZONA LIMITED LIABILITY COMPANY)

**Registered Apr. 10, 2012**

13206 N. 18TH PL.  
PHOENIX, AZ 85022

**Int. Cl.: 35**

FOR: PROVIDING A WEBSITE FEATURING A COMMERCIAL INFORMATION DIRECTORY OF SUSTAINABLE, ECOLOGICALLY-FRIENDLY, AND ENVIRONMENTALLY-FRIENDLY PRODUCTS AND SERVICES OF OTHERS, IN CLASS 35 (U.S. CLS. 100, 101 AND 102).

**SERVICE MARK**

FIRST USE 8-23-2009; IN COMMERCE 8-23-2009.

**PRINCIPAL REGISTER**

THE MARK CONSISTS OF STANDARD CHARACTERS WITHOUT CLAIM TO ANY PARTICULAR FONT, STYLE, SIZE, OR COLOR.

NO CLAIM IS MADE TO THE EXCLUSIVE RIGHT TO USE "GREEN", APART FROM THE MARK AS SHOWN.

SER. NO. 85-369,139, FILED 7-12-2011.

MYRIAH HABEEB, EXAMINING ATTORNEY



*David J. Kyffers*

Director of the United States Patent and Trademark Office



# United States of America

United States Patent and Trademark Office

## OKTAY TECHNOLOGY

**Reg. No. 4,124,878**

**Registered Apr. 10, 2012**

**Int. Cl.: 42**

**SERVICE MARK**

**PRINCIPAL REGISTER**

YATKO, STEVEN (UNITED STATES INDIVIDUAL)  
350 MAIN STREET  
BEDMINSTER, NJ 07921

FOR: COMPUTER CONSULTATION SERVICES, NAMELY, PROVIDING ADVISORY SERVICES FOR IT BUYERS AND SELLERS IN THE FIELD OF COMPUTER HARDWARE AND SOFTWARE DESIGN; PROVIDING A LAB WHICH ALLOWS IT SUPPLIERS AND BUYERS TO PERFORM FUNCTIONAL AND PERFORMANCE TESTING OF INFRASTRUCTURE AND/OR APPLICATIONS IN A CONTROLLED ENTERPRISE-CLASS DATA CENTER LAB ENVIRONMENT; COMPUTER NETWORK DESIGN SERVICES FOR OTHERS; COMPUTER NETWORK CONFIGURATION SERVICES, IN CLASS 42 (U.S. CLS. 100 AND 101).

FIRST USE 8-0-2010; IN COMMERCE 8-0-2010.

THE MARK CONSISTS OF STANDARD CHARACTERS WITHOUT CLAIM TO ANY PARTICULAR FONT, STYLE, SIZE, OR COLOR.

NO CLAIM IS MADE TO THE EXCLUSIVE RIGHT TO USE "TECHNOLOGY", APART FROM THE MARK AS SHOWN.

THE WORDING "OKTAY" HAS NO MEANING IN A FOREIGN LANGUAGE.

SER. NO. 85-369,254, FILED 7-12-2011.

ELIZABETH KAJUBI, EXAMINING ATTORNEY



*David J. Kybas*

Director of the United States Patent and Trademark Office

# United States of America

United States Patent and Trademark Office

## BROWARD CENTER

**Reg. No. 4,124,879**

**Registered Apr. 10, 2012**

**Int. Cl.: 41**

**SERVICE MARK**

**PRINCIPAL REGISTER**

PERFORMING ARTS CENTER AUTHORITY (FLORIDA BODY POLITICAL AND CORPORATE)  
201 SW FIFTH AVENUE  
FT. LAUDERDALE, FL 33312

FOR: PERFORMING ARTS CENTER SERVICES, NAMELY, PROVIDING FACILITIES FOR MOVIES, SHOWS, PLAYS, MUSIC CONCERTS AND EDUCATIONAL, CULTURAL, MUSICAL AND THEATRICAL PRESENTATIONS, IN CLASS 41 (U.S. CLS. 100, 101 AND 107).

FIRST USE 12-31-1991; IN COMMERCE 12-31-1991.

THE MARK CONSISTS OF STANDARD CHARACTERS WITHOUT CLAIM TO ANY PARTICULAR FONT, STYLE, SIZE, OR COLOR.

NO CLAIM IS MADE TO THE EXCLUSIVE RIGHT TO USE "CENTER", APART FROM THE MARK AS SHOWN.

SEC. 2(F).

SER. NO. 85-369,275, FILED 7-12-2011.

ANDREW LEASER, EXAMINING ATTORNEY

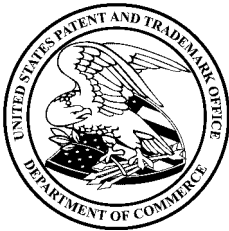

*David J. Kyffers*

Director of the United States Patent and Trademark Office

# United States of America

United States Patent and Trademark Office

## BROWARD CENTER FOR THE PERFORMING ARTS

**Reg. No. 4,124,880**

PERFORMING ARTS CENTER AUTHORITY (FLORIDA BODY POLITICAL AND CORPORATE)  
201 SW FIFTH AVENUE

**Registered Apr. 10, 2012**

FT. LAUDERDALE, FL 33312

**Int. Cl.: 41**

FOR: PERFORMING ARTS CENTER SERVICES, NAMELY, PROVIDING FACILITIES FOR MOVIES, SHOWS, PLAYS, MUSIC CONCERTS AND EDUCATIONAL, CULTURAL, MUSICAL AND THEATRICAL PRESENTATIONS, IN CLASS 41 (U.S. CLS. 100, 101 AND 107).

**SERVICE MARK**

FIRST USE 12-31-1991; IN COMMERCE 12-31-1991.

**PRINCIPAL REGISTER**

THE MARK CONSISTS OF STANDARD CHARACTERS WITHOUT CLAIM TO ANY PARTICULAR FONT, STYLE, SIZE, OR COLOR.

NO CLAIM IS MADE TO THE EXCLUSIVE RIGHT TO USE "CENTER FOR THE PERFORMING ARTS", APART FROM THE MARK AS SHOWN.

SEC. 2(F).

SER. NO. 85-369,277, FILED 7-12-2011.

ANDREW LEASER, EXAMINING ATTORNEY



*David J. Kyffers*

Director of the United States Patent and Trademark Office

United States of America  
United States Patent and Trademark Office

TRANSAIR

**Reg. No. 4,124,881**

**Registered Apr. 10, 2012**

**Int. Cl.: 9**

**TRADEMARK**

**PRINCIPAL REGISTER**

LILEE SYSTEMS, LTD. (CAYMAN ISLANDS CORPORATION)  
SUITE 78  
2905 STENDER WAY  
SANTA CLARA, CA 95054

FOR: BROADBAND WIRELESS EQUIPMENT, NAMELY, TELECOMMUNICATIONS BASE STATION EQUIPMENT FOR CELLULAR AND FIXED NETWORKING AND COMMUNICATIONS APPLICATIONS; DEVICES FOR WIRELESS RADIO TRANSMISSION; RADIO RECEIVERS AND TRANSMITTERS; RADIO TRANSCEIVERS; WIRELESS BROADBAND RADIOS, IN CLASS 9 (U.S. CLS. 21, 23, 26, 36 AND 38).

FIRST USE 10-1-2010; IN COMMERCE 2-1-2011.

THE MARK CONSISTS OF STANDARD CHARACTERS WITHOUT CLAIM TO ANY PARTICULAR FONT, STYLE, SIZE, OR COLOR.

SER. NO. 85-369,517, FILED 7-12-2011.

NAAKWAMA ANKRAH, EXAMINING ATTORNEY



*David J. Kyffers*

Director of the United States Patent and Trademark Office

# United States of America

United States Patent and Trademark Office

# GREENVOLTS

**Reg. No. 4,124,882**

GREENVOLTS, INC. (DELAWARE CORPORATION)  
46400 FREMONT BOULEVARD  
FREMONT, CA 94538

**Registered Apr. 10, 2012**

**Int. Cl.: 11**

FOR: PHOTOVOLTAIC-BASED POWER PLANTS, IN CLASS 11 (U.S. CLS. 13, 21, 23, 31 AND 34).

**TRADEMARK**

FIRST USE 11-8-2010; IN COMMERCE 11-8-2010.

**PRINCIPAL REGISTER**

THE MARK CONSISTS OF STANDARD CHARACTERS WITHOUT CLAIM TO ANY PARTICULAR FONT, STYLE, SIZE, OR COLOR.

OWNER OF U.S. REG. NO. 3,990,407.

SER. NO. 85-369,626, FILED 7-12-2011.

STEVEN PEREZ, EXAMINING ATTORNEY



*David J. Kyffers*

Director of the United States Patent and Trademark Office

# United States of America

United States Patent and Trademark Office



**Reg. No. 4,124,883**

GLENROCK DISTRIBUTING, LLC (COLORADO LIMITED LIABILITY COMPANY)  
2065 W. AMHERST  
ENGLEWOOD, CO 80110

**Registered Apr. 10, 2012**

**Int. Cl.: 28**

FOR: PROTECTIVE COVERING FOR TARGETS, IN CLASS 28 (U.S. CLS. 22, 23, 38 AND 50).

**TRADEMARK**

FIRST USE 3-0-2011; IN COMMERCE 3-2-2011.

**PRINCIPAL REGISTER**

NO CLAIM IS MADE TO THE EXCLUSIVE RIGHT TO USE "TARGET TARP", APART FROM THE MARK AS SHOWN.

THE COLOR(S) ORANGE, BROWN, WHITE IS/ARE CLAIMED AS A FEATURE OF THE MARK.

THE MARK CONSISTS OF THE WORDING "TARGET TARP" WITH "TARGET IN ORANGE AND "TARP" IN WHITE A BROWN SILHOUETTE OF A BUCK.

SER. NO. 85-369,639, FILED 7-12-2011.

CURTIS FRENCH, EXAMINING ATTORNEY



*David J. Kybas*

Director of the United States Patent and Trademark Office

# United States of America

United States Patent and Trademark Office

## WHERE SCIENCE WORKS NATURALLY

**Reg. No. 4,124,884**

NUTRITION RESOURCE, INC. (CALIFORNIA CORPORATION), DBA NUTRIBIOTIC  
P.O. BOX 238

**Registered Apr. 10, 2012**

LAKEPORT, CA 95453

**Int. Cl.: 3**

FOR: PERSONAL AND/OR BODY CARE PRODUCTS, NAMELY, SHAMPOO, CONDITIONER, SKIN CARE CLEANSERS, MOISTURIZERS, DEODORANT, TOOTHPASTE, AND MOUTH-WASH, IN CLASS 3 (U.S. CLS. 1, 4, 6, 50, 51 AND 52).

**TRADEMARK**

FIRST USE 5-6-2011; IN COMMERCE 5-6-2011.

**PRINCIPAL REGISTER**

THE MARK CONSISTS OF STANDARD CHARACTERS WITHOUT CLAIM TO ANY PARTICULAR FONT, STYLE, SIZE, OR COLOR.

OWNER OF U.S. REG. NO. 2,839,786.

SER. NO. 85-369,659, FILED 7-12-2011.

DORITT L. CARROLL, EXAMINING ATTORNEY



*David J. Kyros*

Director of the United States Patent and Trademark Office

# United States of America

United States Patent and Trademark Office

## WHERE SCIENCE WORKS NATURALLY

**Reg. No. 4,124,885**

**Registered Apr. 10, 2012**

**Int. Cl.: 5**

**TRADEMARK**

**PRINCIPAL REGISTER**

NUTRITION RESOURCE, INC. (CALIFORNIA CORPORATION), DBA NUTRIBIOTIC  
P.O. BOX 238  
LAKEPORT, CA 95453

FOR: PHARMACEUTICAL PRODUCTS, NAMELY, VITAMIN AND MINERAL SUPPLEMENTS, DIETARY SUPPLEMENTS CONTAINING GRAPEFRUIT SEED EXTRACT, OINTMENTS FOR PHARMACEUTICAL PURPOSES, NAMELY, ANTIBIOTIC AND ANTI-INFLAMMATORY OINTMENTS, DECONGESTANT NASAL SPRAYS, ANTIBACTERIAL THROAT SPRAYS, AND EAR DROPS, IN CLASS 5 (U.S. CLS. 6, 18, 44, 46, 51 AND 52).

FIRST USE 4-18-2011; IN COMMERCE 4-18-2011.

THE MARK CONSISTS OF STANDARD CHARACTERS WITHOUT CLAIM TO ANY PARTICULAR FONT, STYLE, SIZE, OR COLOR.

OWNER OF U.S. REG. NO. 2,839,786.

SER. NO. 85-369,678, FILED 7-12-2011.

DORITT L. CARROLL, EXAMINING ATTORNEY



*David J. Kyfos*

Director of the United States Patent and Trademark Office



# United States of America

United States Patent and Trademark Office

# Kypris

**Reg. No. 4,124,886**

**Registered Apr. 10, 2012**

**Int. Cl.: 3**

**TRADEMARK**

**PRINCIPAL REGISTER**

POLAN, CHASE M M (UNITED STATES INDIVIDUAL)  
7147 E RANCHO VISTA DR. #2009  
SCOTTSDALE, AZ 85251

FOR: BODY AND BEAUTY CARE COSMETICS; COSMETIC PREPARATIONS FOR BATH AND SHOWER; COSMETIC PREPARATIONS FOR BODY CARE; COSMETIC PREPARATIONS FOR PROTECTING THE SKIN FROM THE SUN'S RAYS; COSMETIC PREPARATIONS FOR SKIN CARE; AROMATIC SKIN CARE PREPARATIONS FOR FACE AND BODY, NAMELY, CLEANSERS, TONERS, SERUMS, MOISTURIZERS, BATH GELS AND SALTS USING ESSENTIAL OILS AND NATURAL EXTRACTS; NON-MEDICATED HERBAL BODY CARE PRODUCTS, NAMELY, CREME CLEANSERS, TONERS, SERUMS, MOISTURIZERS AND AFTER SUN LOTIONS AND GELS.; NON-MEDICATED SERUMS FOR USE ON FACE, BODY, HANDS, FEET; NON-MEDICATED SKIN CARE CREAMS AND LOTIONS; NON-MEDICATED SUN CARE PREPARATIONS FOR USE ON FACE AND BODY; PLANT AND HERB EXTRACTS SOLD AS COMPONENTS OF COSMETICS FOR FACE AND BODY; PRIVATE LABEL COSMETICS, IN CLASS 3 (U.S. CLS. 1, 4, 6, 50, 51 AND 52).

FIRST USE 8-13-2011; IN COMMERCE 8-13-2011.

THE MARK CONSISTS OF STANDARD CHARACTERS WITHOUT CLAIM TO ANY PARTICULAR FONT, STYLE, SIZE, OR COLOR.

SER. NO. 85-369,722, FILED 7-12-2011.

DOUGLAS LEE, EXAMINING ATTORNEY



*David J. Kypris*

Director of the United States Patent and Trademark Office

# United States of America

United States Patent and Trademark Office

## **GTEK LED**

**Reg. No. 4,124,887**

**Registered Apr. 10, 2012**

**Int. Cl.: 9**

**TRADEMARK**

**PRINCIPAL REGISTER**

GTEK GROUP LIMITED (CHINA LIMITED LIABILITY COMPANY)  
NO. 1001 ZHONGSHANYUAN ROAD  
SHENZHEN, GUANGDONG, CHINA 518055

FOR: SEMI-CONDUCTORS; PHOTOVOLTAIC CELLS; GLASS COVERED WITH AN ELECTRICAL CONDUCTOR; FLUORESCENT SCREENS; ELECTRONIC NOTICE BOARDS; NEON SIGNS; ELECTRO-DYNAMIC APPARATUS FOR THE REMOTE CONTROL OF SIGNALS; LED BOARD FOR DISPLAYING MESSAGES AUTOMATICALLY; TRAFFIC LIGHT APPARATUS, NAMELY, A SIGNALING DEVICE, IN CLASS 9 (U.S. CLS. 21, 23, 26, 36 AND 38).

FIRST USE 6-30-2005; IN COMMERCE 1-31-2006.

NO CLAIM IS MADE TO THE EXCLUSIVE RIGHT TO USE "LED", APART FROM THE MARK AS SHOWN.

THE MARK CONSISTS OF THE WORDS "GTEK" AND "LED".

SER. NO. 85-369,922, FILED 7-13-2011.

LESLEY LAMOTHE, EXAMINING ATTORNEY



*David J. Kybas*

Director of the United States Patent and Trademark Office

# United States of America

United States Patent and Trademark Office

## Science to span new business horizons

**Reg. No. 4,124,888**

THE SCIENCE COOPERATIVE, LLC (NEVADA LIMITED LIABILITY COMPANY)  
1007 W GOLF RD.

**Registered Apr. 10, 2012**

LIBERTYVILLE, IL 60048

**Int. Cl.: 42**

FOR: CONSULTING SERVICES FOR MEDICAL PRODUCT DEVELOPMENT, IN CLASS 42  
(U.S. CLS. 100 AND 101).

**SERVICE MARK**

FIRST USE 6-29-2011; IN COMMERCE 6-29-2011.

**PRINCIPAL REGISTER**

THE MARK CONSISTS OF STANDARD CHARACTERS WITHOUT CLAIM TO ANY PARTICULAR FONT, STYLE, SIZE, OR COLOR.

SER. NO. 85-370,076, FILED 7-13-2011.

DEBORAH LOBO, EXAMINING ATTORNEY



*David J. Kybas*

Director of the United States Patent and Trademark Office

# United States of America

United States Patent and Trademark Office



**Reg. No. 4,124,889**

**Registered Apr. 10, 2012**

**Int. Cl.: 25**

**TRADEMARK**

**PRINCIPAL REGISTER**

THE LEXINGTON COMPANY AB (SWEDEN AKTIEBOLAG (AB))  
SVARVARGATAN 11  
STOCKHOLM, SWEDEN SE-11249

FOR: CLOTHING, NAMELY, SHIRTS, RUGBY SHIRTS, T-SHIRTS, CARDIGANS, SWEATERS, POLO SHIRTS, POLO NECK SWEATERS, HOODS, FLEECE JACKETS, BLOUSES, TUNICS, PANTS, SLACKS, CHINOS, JEANS, BIKINIS, SHORTS; DRESSING GOWNS, PYJAMAS, BATHROBES, APRONS; FOOTWEAR; HEADGEAR, NAMELY, CAPS, IN CLASS 25 (U.S. CLS. 22 AND 39).

OWNER OF SWEDEN REG. NO. 368370, DATED 9-10-2004, EXPIRES 9-10-2014.

THE COLOR(S) WHITE, BLUE AND RED IS/ARE CLAIMED AS A FEATURE OF THE MARK.

OWNER OF U.S. REG. NOS. 3,220,226 AND 4,000,430.

THE MARK CONSISTS OF THE TERM "LEXINGTON" IN WHITE LETTERS, "LEX" SHOWN ABOVE THE LETTERS "ING" SHOWN ABOVE THE LETTERS "TON", ALL WITHIN A BLUE SQUARE, WITH A WHITE AND RED STRIPED SQUARE COUPLED THERETO AND TO THE RIGHT THEREOF.

SER. NO. 85-370,200, FILED 7-13-2011.

ELLEN PERKINS, EXAMINING ATTORNEY



*David J. Kyros*

Director of the United States Patent and Trademark Office

# United States of America

United States Patent and Trademark Office

# HIAC

**Reg. No. 4,124,890**

HACH COMPANY (DELAWARE CORPORATION)  
5600 LINDBERGH DRIVE  
LOVELAND, CO 80538

**Registered Apr. 10, 2012**

**Int. Cl.: 9**

FOR: MEASURING AND SCIENTIFIC APPARATUS, NAMELY, SENSORS AND METERS USED FOR QUANTIFICATION OF FLUID CONTAMINANTS, INCLUDING DETERMINING THE PRESENCE, SIZE AND OR AMOUNTS OF CONTAMINANTS IN FLUID, IN CLASS 9 (U.S. CLS. 21, 23, 26, 36 AND 38).

**TRADEMARK**

**PRINCIPAL REGISTER**

FIRST USE 6-30-1980; IN COMMERCE 6-30-1980.

THE MARK CONSISTS OF STANDARD CHARACTERS WITHOUT CLAIM TO ANY PARTICULAR FONT, STYLE, SIZE, OR COLOR.

SEC. 2(F).

SER. NO. 85-370,235, FILED 7-13-2011.

TRICIA SONNEBORN, EXAMINING ATTORNEY



*David J. Kybas*

Director of the United States Patent and Trademark Office

# United States of America

United States Patent and Trademark Office

# TVU

**Reg. No. 4,124,891**

**Registered Apr. 10, 2012**

**Int. Cl.: 38**

**SERVICE MARK**

**PRINCIPAL REGISTER**

TVU NETWORKS CORPORATION (DELAWARE CORPORATION)  
SUITE 100  
1225 PEAR AVENUE  
MOUNTAIN VIEW, CA 94043

FOR: STREAMING OF AUDIO AND VIDEO TELEVISION PROGRAMMING VIA A GLOBAL COMPUTER NETWORK OR THE INTERNET; COMMUNICATIONS SERVICES, NAMELY, THE TRANSMISSION OF AUDIO AND VIDEO DATA FROM A MOBILE DEVICE BY WIRED AND WIRELESS COMMUNICATIONS NETWORKS, THE INTERNET AND DATA NETWORKS, IN CLASS 38 (U.S. CLS. 100, 101 AND 104).

FIRST USE 12-31-2005; IN COMMERCE 12-31-2005.

THE MARK CONSISTS OF STANDARD CHARACTERS WITHOUT CLAIM TO ANY PARTICULAR FONT, STYLE, SIZE, OR COLOR.

SER. NO. 85-370,253, FILED 7-13-2011.

ANTHONY RINKER, EXAMINING ATTORNEY



*David J. Kybas*

Director of the United States Patent and Trademark Office

United States of America  
United States Patent and Trademark Office

MONNET

**Reg. No. 4,124,892**

THOMAS HINE & CO. (FRANCE CORPORATION)

**Registered Apr. 10, 2012**

16 QUAI DE L'ORANGERIE  
JARNAC, FRANCE 16200

**Int. Cl.: 33**

FOR: BRANDIES AND COGNACS, IN CLASS 33 (U.S. CLS. 47 AND 49).

**TRADEMARK**

FIRST USE 0-0-1838; IN COMMERCE 5-24-2011.

**PRINCIPAL REGISTER**

THE MARK CONSISTS OF STANDARD CHARACTERS WITHOUT CLAIM TO ANY PARTICULAR FONT, STYLE, SIZE, OR COLOR.

SER. NO. 85-370,514, FILED 7-13-2011.

KIMBERLY PERRY, EXAMINING ATTORNEY



*David J. Kybas*

Director of the United States Patent and Trademark Office

# United States of America

United States Patent and Trademark Office

# NOVISIMO

**Reg. No. 4,124,893**

JOSE CANEPA Y CIA. LTDA. (CHILE LIMITED LIABILITY COMPANY)

**Registered Apr. 10, 2012**

CAMINO LO SIERRA 1500  
CERRILLOS, SANTIAGO, CHILE

**Int. Cl.: 33**

FOR: WINES, IN CLASS 33 (U.S. CLS. 47 AND 49).

**TRADEMARK**

THE MARK CONSISTS OF STANDARD CHARACTERS WITHOUT CLAIM TO ANY PARTICULAR FONT, STYLE, SIZE, OR COLOR.

**PRINCIPAL REGISTER**

OWNER OF CHILE REG. NO. 584033, DATED 12-1-2000, RENEWED AS REG. NO. 924.244, DATED 12-1-2010, EXPIRES 12-1-2020.

THE ENGLISH TRANSLATION OF "NOVISIMO" IN THE MARK IS "NEWEST".

SER. NO. 85-370,613, FILED 7-13-2011.

KELLY BOULTON, EXAMINING ATTORNEY



*David J. Kyffers*

Director of the United States Patent and Trademark Office



# United States of America

United States Patent and Trademark Office

## 3D Earphone

**Reg. No. 4,124,894**

CYBER GROUP USA INC. (NEW YORK CORPORATION)

**Registered Apr. 10, 2012**

111-56 76TH DRIVE E6  
FOREST HILLS, NY 11375

**Int. Cl.: 9**

FOR: ELECTRONICS PRODUCTS, NAMELY, EARPHONES, EARPHONE IN-EAR, EARPHONE ON-EAR, EARPHONE AROUND-EAR, HEADPHONES, AUDIO HEADPHONES, WIRELESS EARPHONES, WIRELESS HEADPHONES, DIGITAL PHONES, MICROPHONES, MICROPHONE SPEAKERS, MICROPHONE ADAPTERS, WIRELESS MICROPHONES, TRANSMITTERS AND RECEIVERS FOR WIRELESS EARPHONES, TRANSMITTERS AND RECEIVERS FOR WIRELESS MICROPHONES, TRANSMITTERS AND RECEIVERS FOR CELLULAR PHONES; CELLULAR PHONES; CELLULAR PHONE ACCESSORIES, NAMELY, HAND-FREE AUDIO DEVICES FOR MOBILE PHONES; AUDIO DEVICES IN THE NATURE OF SPEAKERS FOR PDA AND NOTEBOOKS AND PC COMPUTERS; AUDIO SPEAKERS; AUDIO DEVICES, NAMELY, SPEAKERS, EARPHONES, HEADPHONES, MICROPHONES, AND MICROPHONE SPEAKERS; AUDIO DEVICES IN THE NATURE OF EARPHONES, HEADPHONES, MICROPHONES, AND MICROPHONE SPEAKERS FOR SPORTS HELMETS; WIRELESS AUDIO DEVICES IN THE NATURE OF SPEAKERS, MICROPHONES AND MICROPHONE SPEAKERS; DIGITAL AUDIO RECORDERS AND PLAYERS; AUDIO SPEAKER ENCLOSURES; SOUND AMPLIFIERS; TELEPHONE HEADSETS; WIRELESS TELEPHONE HEADSETS; PORTABLE LISTENING DEVICES, NAMELY, MP3 PLAYERS, MP4 PLAYERS, MULTIPLE PLAYERS, AND DIGITAL PLAYERS; DIGITAL AUDIO PLAYERS; MULTIPLE PLAYERS, NAMELY, DIGITAL AUDIO AND VIDEO PLAYERS; EARPHONE SLEEVES; EARPHONE CASES AND COVERS; EARPHONE AND HEADPHONE ADAPTERS; ELECTRONIC INSTRUMENTS FOR MONITORING AND CONTROLLING SOUND PRESSURE, AUDIO FREQUENCY AND SIGNAL LEVEL AND IMPEDANCES, IN CLASS 9 (U.S. CLS. 21, 23, 26, 36 AND 38).

**TRADEMARK**

**PRINCIPAL REGISTER**



FIRST USE 7-13-2011; IN COMMERCE 7-13-2011.

NO CLAIM IS MADE TO THE EXCLUSIVE RIGHT TO USE "3D EARPHONE", APART FROM THE MARK AS SHOWN.

THE COLOR(S) RED AND BLACK IS/ARE CLAIMED AS A FEATURE OF THE MARK.

*David J. Kybas*

THE MARK CONSISTS OF THE WORDS "I3D EARPHONE" IN BLACK, THE STYLIZED LETTER "I" WITHIN A BLACK PARTIAL CIRCLE, THE DOT ON THE "I" BEING THE COLOR RED.

Director of the United States Patent and Trademark Office

**Reg. No. 4,124,894** SER. NO. 85-370,765, FILED 7-13-2011.

KATHLEEN M. VANSTON, EXAMINING ATTORNEY

# United States of America

United States Patent and Trademark Office

## SURVIVOR MUD RUN

**Reg. No. 4,124,895**

ACTIVE LIFE EVENTS, INC. (CALIFORNIA CORPORATION)

**Registered Apr. 10, 2012**

1321 CAMPUS AVENUE  
REDLANDS, CA 92374

**Int. Cl.: 41**

FOR: ATHLETIC AND SPORTS EVENT SERVICES, NAMELY, ARRANGING, ORGANIZING, OPERATING AND CONDUCTING MARATHON RACES; ENCOURAGING AMATEUR SPORTS AND PHYSICAL EDUCATION BY ORGANIZING, SANCTIONING, CONDUCTING, REGULATING AND GOVERNING AMATEUR ATHLETIC PROGRAMS AND ACTIVITIES; ENTERTAINMENT IN THE NATURE OF COMPETITIONS IN THE FIELD OF RUNNING; ENTERTAINMENT SERVICES, NAMELY, ARRANGING AND CONDUCTING OF COMPETITIONS FOR RUNNING RACES; ORGANIZING, ARRANGING, AND CONDUCTING RUNNING RACES AND RELATED SOCIAL ENTERTAINMENT EVENTS, IN CLASS 41 (U.S. CLS. 100, 101 AND 107).

**SERVICE MARK**

**PRINCIPAL REGISTER**

FIRST USE 1-2-2011; IN COMMERCE 1-2-2011.

THE MARK CONSISTS OF STANDARD CHARACTERS WITHOUT CLAIM TO ANY PARTICULAR FONT, STYLE, SIZE, OR COLOR.

NO CLAIM IS MADE TO THE EXCLUSIVE RIGHT TO USE "MUD RUN", APART FROM THE MARK AS SHOWN.

SER. NO. 85-370,890, FILED 7-13-2011.

BARBARA RUTLAND, EXAMINING ATTORNEY



*David J. Kybas*

Director of the United States Patent and Trademark Office

# United States of America

United States Patent and Trademark Office

# HORSE 360

**Reg. No. 4,124,896**

ANIMAL 360 PTY LTD (AUSTRALIA PRIVATE LIMITED COMPANY)  
P.O. BOX 303

**Registered Apr. 10, 2012**

CALOUNDRA, QUEENSLAND, AUSTRALIA 4551

**Int. Cl.: 9**

FOR: DOWNLOADABLE SOFTWARE IN THE NATURE OF A MOBILE APPLICATION FOR USE IN IDENTIFYING, TEACHING AND UNDERSTANDING HORSE ANATOMY, IN CLASS 9 (U.S. CLS. 21, 23, 26, 36 AND 38).

**TRADEMARK**

FIRST USE 8-1-2010; IN COMMERCE 8-1-2010.

**PRINCIPAL REGISTER**

THE MARK CONSISTS OF STANDARD CHARACTERS WITHOUT CLAIM TO ANY PARTICULAR FONT, STYLE, SIZE, OR COLOR.

NO CLAIM IS MADE TO THE EXCLUSIVE RIGHT TO USE "HORSE", APART FROM THE MARK AS SHOWN.

SER. NO. 85-370,955, FILED 7-14-2011.

STEPHANIE ALI, EXAMINING ATTORNEY



*David J. Kybas*

Director of the United States Patent and Trademark Office

# United States of America

United States Patent and Trademark Office

# Life@Work

**Reg. No. 4,124,897**

**Registered Apr. 10, 2012**

**Int. Cl.: 35**

**SERVICE MARK**

**PRINCIPAL REGISTER**

ACS MARKETING, LP (DELAWARE LIMITED PARTNERSHIP)  
BUILDING 1, FLOOR 9  
2828 N. HASKELL AVE.  
DALLAS, TX 75204

FOR: ONLINE BUSINESS SERVICES, NAMELY, PROVIDING AN ONLINE HUMAN RESOURCES PORTAL FOR EMPLOYEES AND MANAGERS FOR USE IN THE FIELD OF EMPLOYEE HEALTH AND WELFARE BENEFITS, IN CLASS 35 (U.S. CLS. 100, 101 AND 102).

FIRST USE 6-23-2011; IN COMMERCE 6-23-2011.

THE MARK CONSISTS OF STANDARD CHARACTERS WITHOUT CLAIM TO ANY PARTICULAR FONT, STYLE, SIZE, OR COLOR.

SER. NO. 85-371,004, FILED 7-14-2011.

AMY C. KEAN, EXAMINING ATTORNEY



*David J. Kappas*

Director of the United States Patent and Trademark Office

United States of America  
United States Patent and Trademark Office

***Centaur***

**Reg. No. 4,124,898**

ALLIED BUYING CORPORATION (DELAWARE CORPORATION)  
200 W. 22ND STREET, SUITE 240  
LOMBARD, IL 60148

**Registered Apr. 10, 2012**

**Int. Cls.: 7, 11 and 20**

FOR: ELECTRIC FOOD BLENDERS; ELECTRIC MIXERS; ELECTRIC FOOD SLICERS, IN CLASS 7 (U.S. CLS. 13, 19, 21, 23, 31, 34 AND 35).

**TRADEMARK**

FIRST USE 10-1-2008; IN COMMERCE 10-1-2008.

**PRINCIPAL REGISTER**

FOR: REFRIGERATORS; FREEZERS; SINKS; REFRIGERATION EQUIPMENT, NAMELY, FOOD AND BEVERAGE CHILLING UNITS; DEEP FRYING MACHINES; ELECTRIC TOASTER OVENS; ELECTRIC FOOD STEAMER; ELECTRIC KETTLES, IN CLASS 11 (U.S. CLS. 13, 21, 23, 31 AND 34).

FIRST USE 3-1-2008; IN COMMERCE 3-1-2008.

FOR: SHELVING; INDUSTRIAL FOOD PREPARATION WORK TABLES; CHAIRS; FURNITURE; FURNITURE PARTS; FURNITURE PARTS, NAMELY, TABLE BASES; SEATING FURNITURE; TABLE TOPS, IN CLASS 20 (U.S. CLS. 2, 13, 22, 25, 32 AND 50).

FIRST USE 2-1-2008; IN COMMERCE 2-1-2008.

OWNER OF U.S. REG. NOS. 3,584,467, 4,031,865 AND OTHERS.

THE MARK CONSISTS OF THE WORD "CENTAUR" WITH STYLIZED UNDERLINING PARTIALLY CONNECTED TO THE LETTER "T".

SER. NO. 85-371,170, FILED 7-14-2011.

MICHAEL TANNER, EXAMINING ATTORNEY



*David J. Kyros*

Director of the United States Patent and Trademark Office

# United States of America

United States Patent and Trademark Office

# REBELSMOKE

**Reg. No. 4,124,899**

**Registered Apr. 10, 2012**

**Int. Cl.: 9**

**TRADEMARK**

**PRINCIPAL REGISTER**

REBELSMOKE RECORDS, LLC (NEW YORK LIMITED LIABILITY COMPANY)  
SUITE 4D  
120 WELLINGTON COURT  
STATEN ISLAND, NY 10314

FOR: AUDIO AND VIDEO RECORDINGS, INCLUDING DOWNLOADABLE AUDIO AND VIDEO RECORDINGS, FEATURING MUSICAL PERFORMANCES, IN CLASS 9 (U.S. CLS. 21, 23, 26, 36 AND 38).

FIRST USE 1-3-2011; IN COMMERCE 1-3-2011.

THE MARK CONSISTS OF STANDARD CHARACTERS WITHOUT CLAIM TO ANY PARTICULAR FONT, STYLE, SIZE, OR COLOR.

SER. NO. 85-371,175, FILED 7-14-2011.

STEVEN PEREZ, EXAMINING ATTORNEY



*David J. Kyffers*

Director of the United States Patent and Trademark Office

# United States of America

United States Patent and Trademark Office

## TIPHEALTH TAILORED INTERACTIVE PATIENT HEALTH

**Reg. No. 4,124,900**

SHREVE, MARILYN (UNITED STATES INDIVIDUAL)  
221 UPPER TOYON WAY  
KENTFIELD, CA 94904

**Registered Apr. 10, 2012**

**Int. Cl.: 44**

FOR: WELLNESS AND HEALTH-RELATED CONSULTING SERVICES, IN CLASS 44 (U.S. CLS. 100 AND 101).

**SERVICE MARK**

FIRST USE 5-3-2008; IN COMMERCE 5-3-2008.

**PRINCIPAL REGISTER**

THE MARK CONSISTS OF STANDARD CHARACTERS WITHOUT CLAIM TO ANY PARTICULAR FONT, STYLE, SIZE, OR COLOR.

NO CLAIM IS MADE TO THE EXCLUSIVE RIGHT TO USE "TAILORED INTERACTIVE PATIENT HEALTH", APART FROM THE MARK AS SHOWN.

SER. NO. 85-371,209, FILED 7-14-2011.

MICHAEL TANNER, EXAMINING ATTORNEY



*David J. Kyffers*

Director of the United States Patent and Trademark Office



# United States of America

United States Patent and Trademark Office

**WaterBlock**

**Reg. No. 4,124,901**

GILSTRAP, MARK A (UNITED STATES INDIVIDUAL)  
PO BOX 893  
MONROE, WA 98272

**Registered Apr. 10, 2012**

**Int. Cl.: 19**

FOR: NON-METAL BUILDING MATERIALS FOR WEATHERPROOFING, NAMELY, WOVEN AND NON WOVEN FABRICS USED FOR BUILDING WRAP, ROOFING UNDERLAYMENT, WINDOW AND DOOR FLASHING, IN CLASS 19 (U.S. CLS. 1, 12, 33 AND 50).

**TRADEMARK**

FIRST USE 11-15-2002; IN COMMERCE 2-19-2003.

**PRINCIPAL REGISTER**

THE MARK CONSISTS OF THE STYLIZED WORDING "WATERBLOCK" WITH AN UMBRELLA PLACED OVER THE LETTER "T" AND WITH RAINDROPS APPEARING ABOVE AND ON THE UMBRELLA.

SER. NO. 85-371,251, FILED 7-14-2011.

JENNIFER MARTIN, EXAMINING ATTORNEY



*David J. Kybas*

Director of the United States Patent and Trademark Office

# United States of America

United States Patent and Trademark Office

## ORANGE RUSH

**Reg. No. 4,124,902**

**Registered Apr. 10, 2012**

**Int. Cl.: 5**

**TRADEMARK**

**PRINCIPAL REGISTER**

SLVC,LLC (NEW JERSEY LIMITED LIABILITY COMPANY)  
700  
CENTRAL AVENUE  
FARMINGDALE, NJ 07727

FOR: DIETARY SUPPLEMENTAL DRINKS, IN CLASS 5 (U.S. CLS. 6, 18, 44, 46, 51 AND 52).

FIRST USE 5-10-1997; IN COMMERCE 5-10-1997.

THE MARK CONSISTS OF STANDARD CHARACTERS WITHOUT CLAIM TO ANY PARTICULAR FONT, STYLE, SIZE, OR COLOR.

NO CLAIM IS MADE TO THE EXCLUSIVE RIGHT TO USE "ORANGE", APART FROM THE MARK AS SHOWN.

SER. NO. 85-371,275, FILED 7-14-2011.

KATHERINE E. HALMEN, EXAMINING ATTORNEY



*David J. Kybas*

Director of the United States Patent and Trademark Office

# United States of America

United States Patent and Trademark Office

## AMERICAN MAJESTIC EAGLE

**Reg. No. 4,124,903**

**Registered Apr. 10, 2012**

**Int. Cls.: 35 and 37**

**SERVICE MARK**

**PRINCIPAL REGISTER**

WEST FALLS SERVICE CENTER, INC. (VIRGINIA CORPORATION), DBA AMERICAN MAJESTIC EAGLE FUEL AND AUTO REPAIRS  
7399 LEE HIGHWAY  
FALLS CHURCH, VA 22042

FOR: RETAIL CONVENIENCE STORE SERVICES, IN CLASS 35 (U.S. CLS. 100, 101 AND 102).

FIRST USE 8-0-2010; IN COMMERCE 8-0-2010.

FOR: AUTO REPAIR AND MAINTENANCE SERVICES; AUTOMOBILE SERVICE STATIONS; AUTOMOBILE REFUELING STATIONS, IN CLASS 37 (U.S. CLS. 100, 103 AND 106).

FIRST USE 8-0-2010; IN COMMERCE 8-0-2010.

THE MARK CONSISTS OF STANDARD CHARACTERS WITHOUT CLAIM TO ANY PARTICULAR FONT, STYLE, SIZE, OR COLOR.

SER. NO. 85-371,288, FILED 7-14-2011.

JEFFREY LOOK, EXAMINING ATTORNEY



*David J. Kyffers*

Director of the United States Patent and Trademark Office

# United States of America

United States Patent and Trademark Office

## PALMETTO HEALTH

**Reg. No. 4,124,904**

PALMETTO HEALTH (SOUTH CAROLINA NON-PROFIT CORPORATION)  
1301 TAYLOR STREET, SUITE 9-A  
COLUMBIA, SC 29201

**Registered Apr. 10, 2012**

**Int. Cl.: 44**

FOR: MEDICAL, SURGICAL, NURSING, AND COMPREHENSIVE ALLIED HEALTH CARE SERVICES, IN CLASS 44 (U.S. CLS. 100 AND 101).

**SERVICE MARK**

FIRST USE 10-1-2001; IN COMMERCE 10-1-2001.

**PRINCIPAL REGISTER**

THE MARK CONSISTS OF STANDARD CHARACTERS WITHOUT CLAIM TO ANY PARTICULAR FONT, STYLE, SIZE, OR COLOR.

NO CLAIM IS MADE TO THE EXCLUSIVE RIGHT TO USE "HEALTH", APART FROM THE MARK AS SHOWN.

SER. NO. 85-371,307, FILED 7-14-2011.

CAROLINE WOOD, EXAMINING ATTORNEY



*David J. Kybas*

Director of the United States Patent and Trademark Office

# United States of America

United States Patent and Trademark Office

# ULTRA GEL

**Reg. No. 4,124,905**

**Registered Apr. 10, 2012**

**Int. Cl.: 10**

**TRADEMARK**

**PRINCIPAL REGISTER**

PROFOOT, INC. (NEW YORK CORPORATION)  
74 20TH STREET  
BROOKLYN, NY 11232

FOR: ORTHOTIC INSOLES FOR FOOTWEAR, IN CLASS 10 (U.S. CLS. 26, 39 AND 44).

FIRST USE 2-0-2009; IN COMMERCE 2-0-2009.

THE MARK CONSISTS OF STANDARD CHARACTERS WITHOUT CLAIM TO ANY PARTICULAR FONT, STYLE, SIZE, OR COLOR.

NO CLAIM IS MADE TO THE EXCLUSIVE RIGHT TO USE "GEL", APART FROM THE MARK AS SHOWN.

SER. NO. 85-371,425, FILED 7-14-2011.

TRICIA SONNEBORN, EXAMINING ATTORNEY



*David J. Kyffers*

Director of the United States Patent and Trademark Office

# United States of America

United States Patent and Trademark Office

## MODERN CONCEPTS OUTDOORS

**Reg. No. 4,124,906**

MODERN CONCEPTS OUTDOORS LLC (ILLINOIS LIMITED LIABILITY COMPANY)  
RR2 BOX 150B  
TOWER HILL, IL 62571

**Registered Apr. 10, 2012**

**Int. Cl.: 28**

FOR: HUNTING STANDS; TREESTANDS FOR HUNTING; TREESTANDS FOR HUNTING HAVING A CONSTRUCTION THAT MECHANICALLY JOINS THE COMPONENTS OF THE STAND TOGETHER FOR A SECURED CONNECTION, IN CLASS 28 (U.S. CLS. 22, 23, 38 AND 50).

**TRADEMARK**

**PRINCIPAL REGISTER**

FIRST USE 3-11-2011; IN COMMERCE 3-11-2011.

THE MARK CONSISTS OF STANDARD CHARACTERS WITHOUT CLAIM TO ANY PARTICULAR FONT, STYLE, SIZE, OR COLOR.

NO CLAIM IS MADE TO THE EXCLUSIVE RIGHT TO USE THE WORD "OUTDOORS", APART FROM THE MARK AS SHOWN.

SER. NO. 85-371,613, FILED 7-14-2011.

ANNE MADDEN, EXAMINING ATTORNEY



*David J. Kyffers*

Director of the United States Patent and Trademark Office

# United States of America

United States Patent and Trademark Office

## CURVE BALL

**Reg. No. 4,124,907**

PACE'S PIZZA BALLS, INC. (NEVADA CORPORATION)  
13967 SOUTH VIRGINIA STREET, #910  
RENO, NV 89511

**Registered Apr. 10, 2012**

**Int. Cl.: 30**

FOR: DOUGH-ENROBED FOODS CONSISTING OF A DOUGH-BASED WRAPPER WITH FILLING CONSISTING PRIMARILY OF MEAT, CHEESE, SAUCE, SPICES, VEGETABLES, AND/OR FRUIT, IN CLASS 30 (U.S. CL. 46).

**TRADEMARK**

FIRST USE 9-25-2009; IN COMMERCE 9-25-2009.

**PRINCIPAL REGISTER**

THE MARK CONSISTS OF STANDARD CHARACTERS WITHOUT CLAIM TO ANY PARTICULAR FONT, STYLE, SIZE, OR COLOR.

NO CLAIM IS MADE TO THE EXCLUSIVE RIGHT TO USE "BALL", APART FROM THE MARK AS SHOWN.

SER. NO. 85-371,614, FILED 7-14-2011.

ANNE MADDEN, EXAMINING ATTORNEY



*David J. Kyffers*

Director of the United States Patent and Trademark Office

# United States of America

United States Patent and Trademark Office

## HEAVENLY VILLAGIO MARZANO

**Reg. No. 4,124,908**

**Registered Apr. 10, 2012**

**Int. Cl.: 31**

**TRADEMARK**

**PRINCIPAL REGISTER**

VILLAGE FARMS, L.P. (DELAWARE LIMITED PARTNERSHIP)  
7 CHRISTOPHER WAY  
EATONTOWN, NJ 07724

FOR: FRESH FRUIT AND VEGETABLES, IN CLASS 31 (U.S. CLS. 1 AND 46).

FIRST USE 10-15-2011; IN COMMERCE 10-15-2011.

THE MARK CONSISTS OF STANDARD CHARACTERS WITHOUT CLAIM TO ANY PARTICULAR FONT, STYLE, SIZE, OR COLOR.

THE ENGLISH TRANSLATION OF "VILLAGIO MARZANO" IN THE MARK IS VILLAGE "MARZANO".

SER. NO. 85-371,713, FILED 7-14-2011.

LAURA KOVALSKY, EXAMINING ATTORNEY



*David J. Kyffers*

Director of the United States Patent and Trademark Office



# United States of America

United States Patent and Trademark Office



**Reg. No. 4,124,909**

**Registered Apr. 10, 2012**

**Int. Cl.: 35**

**SERVICE MARK**

**PRINCIPAL REGISTER**

BROWN, PHILIP (UNITED STATES INDIVIDUAL)  
6657 SOUTH 1460 WEST  
TAYLORSVILLE, UT 84123

FOR: ASSOCIATION SERVICES, NAMELY, PROMOTING THE PUBLIC INTEREST AND AWARENESS IN CANCER RESEARCH AND EDUCATION, IN CLASS 35 (U.S. CLS. 100, 101 AND 102).

FIRST USE 1-1-2011; IN COMMERCE 1-1-2011.

NO CLAIM IS MADE TO THE EXCLUSIVE RIGHT TO USE "AWARENESS" "EDUCATION" "RELIEF", APART FROM THE MARK AS SHOWN.

THE COLOR(S) RED, GRAY AND WHITE IS/ARE CLAIMED AS A FEATURE OF THE MARK.

THE MARK CONSISTS OF A RED RIBBON WITH A WHITE BACKGROUND IS CENTERED WITHIN TWO RED CONCENTRIC CIRCLES, THE BACKGROUND WITHIN THE TWO CONCENTRIC CIRCLES IS RED. THE WORDS "AWARENESS" AND "EDUCATION" ARE GRAY IN COLOR AND ARE POSITIONED BETWEEN THE CONCENTRIC CIRCLES AND CENTERED AT THE TOP AND AROUND THE RIBBON ELEMENT. THE WORD "RELIEF" IS GRAY IN COLOR AND IS POSITIONED BETWEEN THE CONCENTRIC CIRCLES AND CENTERED BELOW THE RIBBON ELEMENT. FONT IS TWCENMT-REGULAR (EMBEDDED SUBSET).

SER. NO. 85-371,792, FILED 7-14-2011.

TIMOTHY FINNEGAN, EXAMINING ATTORNEY



*David J. Kybas*

Director of the United States Patent and Trademark Office

# United States of America

United States Patent and Trademark Office

## Hello! Housekeeping

**Reg. No. 4,124,910**

**Registered Apr. 10, 2012**

**Int. Cl.: 37**

**SERVICE MARK**

**PRINCIPAL REGISTER**

HELLO! HOUSEKEEPING, LLC (DELAWARE LIMITED LIABILITY COMPANY)

#4  
1426 GARDEN STREET  
SANTA BARBARA, CA 93101

FOR: CLEANING OF RESIDENTIAL HOUSES, IN CLASS 37 (U.S. CLS. 100, 103 AND 106).

FIRST USE 12-14-2010; IN COMMERCE 12-14-2010.

THE MARK CONSISTS OF STANDARD CHARACTERS WITHOUT CLAIM TO ANY PARTICULAR FONT, STYLE, SIZE, OR COLOR.

NO CLAIM IS MADE TO THE EXCLUSIVE RIGHT TO USE "HOUSEKEEPING", APART FROM THE MARK AS SHOWN.

SER. NO. 85-371,852, FILED 7-14-2011.

LINDA MICKLEBURGH, EXAMINING ATTORNEY



*David J. Kybas*

Director of the United States Patent and Trademark Office

# United States of America

United States Patent and Trademark Office

# EMAS

**Reg. No. 4,124,911**

**Registered Apr. 10, 2012**

**Int. Cl.: 9**

**TRADEMARK**

**PRINCIPAL REGISTER**

DR. RONALD LUCCHINO (UNITED STATES INDIVIDUAL)  
1211 GULF OF MEXICO DR., APT. 507  
LONGBOAT KEY, FL 34228

FOR: COMPUTER SOFTWARE AND HARDWARE FOR DETECTING ADVERSE REACTIONS TO MEDICATION IN PATIENTS; COMPUTER SOFTWARE FOR CONTROLLING AND MANAGING PATIENT MEDICAL INFORMATION; COMPUTER SOFTWARE FOR DETECTING ADVERSE REACTIONS TO MEDICATION IN PATIENTS; MEDICAL SOFTWARE FOR DETECTING ADVERSE REACTIONS TO MEDICATION IN PATIENTS, IN CLASS 9 (U.S. CLS. 21, 23, 26, 36 AND 38).

FIRST USE 7-1-2011; IN COMMERCE 7-1-2011.

THE MARK CONSISTS OF STANDARD CHARACTERS WITHOUT CLAIM TO ANY PARTICULAR FONT, STYLE, SIZE, OR COLOR.

SER. NO. 85-371,856, FILED 7-14-2011.

LINDA E. BLOHM, EXAMINING ATTORNEY



*David J. Kybas*

Director of the United States Patent and Trademark Office

# United States of America

United States Patent and Trademark Office

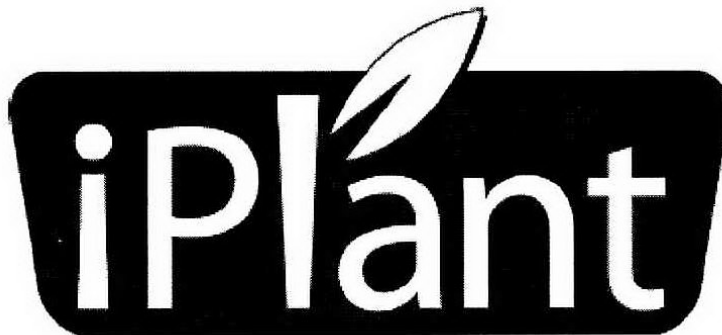

**Reg. No. 4,124,912**

FLOCANADA INC. (CANADA CORPORATION)  
177, MONTÉE RENAUD

**Registered Apr. 10, 2012**

SAINT-EUSTACHE (QUEBEC, CANADA J7R4K3)

**Int. Cl.: 31**

FOR: LIVE FLOWERING PLANTS; LIVE VEGETABLE PLANTS; LIVE FINE HERB PLANTS,  
IN CLASS 31 (U.S. CLS. 1 AND 46).

**TRADEMARK**

OWNER OF CANADA REG. NO. TMA791657, DATED 2-25-2011, EXPIRES 2-25-2026.

**PRINCIPAL REGISTER**

THE MARK CONSISTS OF THE STYLIZED WORD "IPLANT" WITH THE DEPICTION OF  
A LEAF ABOVE THE LETTER "A" AND TO THE RIGHT OF THE LETTER "L" ALL OF  
WHICH IS SURROUNDED BY A RECTANGLE WITH SLIGHTLY ANGLED VERTICAL  
SIDES.

SER. NO. 85-371,967, FILED 7-14-2011.

MICHAEL TANNER, EXAMINING ATTORNEY



*David J. Kyffers*

Director of the United States Patent and Trademark Office

# United States of America

United States Patent and Trademark Office

## ALL-STAR PULSE

**Reg. No. 4,124,913**

**Registered Apr. 10, 2012**

**Int. Cls.: 41 and 45**

**SERVICE MARK**

**PRINCIPAL REGISTER**

TURNER SPORTS, INC. (GEORGIA CORPORATION)  
C/O TURNER BROADCASTING SYSTEM, INC.  
ONE CNN CENTER, 10 NORTH  
ATLANTA, GA 30303

FOR: ENTERTAINMENT SERVICES, NAMELY, PROVIDING INFORMATION AND NEWS IN THE FIELDS OF SPORTS TEAMS AND PLAYERS, SPORTING EVENTS, CELEBRITIES, AND SPORTS NEWS VIA THE INTERNET, IN CLASS 41 (U.S. CLS. 100, 101 AND 107).

FIRST USE 2-19-2011; IN COMMERCE 2-19-2011.

FOR: ENTERTAINMENT SERVICES, NAMELY, PROVIDING INFORMATION AND NEWS IN THE FIELD OF SOCIAL NETWORKING TRENDS VIA THE INTERNET, IN CLASS 45 (U.S. CLS. 100 AND 101).

FIRST USE 2-19-2011; IN COMMERCE 2-19-2011.

THE MARK CONSISTS OF STANDARD CHARACTERS WITHOUT CLAIM TO ANY PARTICULAR FONT, STYLE, SIZE, OR COLOR.

NO CLAIM IS MADE TO THE EXCLUSIVE RIGHT TO USE "ALL-STAR", APART FROM THE MARK AS SHOWN.

SER. NO. 85-372,154, FILED 7-15-2011.

ASMAT KHAN, EXAMINING ATTORNEY



*David J. Kyros*

Director of the United States Patent and Trademark Office

# United States of America

United States Patent and Trademark Office



**Reg. No. 4,124,914**

**Registered Apr. 10, 2012**

**Int. Cls.: 35 and 41**

**SERVICE MARK**

**PRINCIPAL REGISTER**

NOVU LLC (MINNESOTA LIMITED LIABILITY COMPANY)  
SUITE 1400  
100 SOUTH 5TH STREET  
MINNEAPOLIS, MN 55402

FOR: BUSINESS MANAGEMENT AND BUSINESS CONSULTING IN THE FIELD OF HEALTH AND WELLNESS, IN CLASS 35 (U.S. CLS. 100, 101 AND 102).

FIRST USE 1-10-2011; IN COMMERCE 1-19-2011.

FOR: PROVIDING A WEB-BASED LOYALTY PROGRAM IN THE FIELD OF HEALTHY LIVING AND WELLNESS TO INSURERS AND EMPLOYERS DESIGNED TO REWARD PROGRAM PARTICIPANTS WHO EXERCISE, MAKE HEALTHY EATING CHOICES, AND ENGAGE IN OTHER HEALTH-PROMOTING ACTIVITIES, ISSUING AND TRACKING INCENTIVE AWARDS DESIGNED TO ENCOURAGE AND REWARD PARTICIPATION IN THE PROGRAM, AND MEASURING RESULTS OF AN INDIVIDUAL'S PARTICIPATION IN THE PROGRAM THROUGH HEALTH AND WELLNESS ASSESSMENTS AND MANAGEMENT TOOLS, IN CLASS 41 (U.S. CLS. 100, 101 AND 107).

FIRST USE 1-10-2011; IN COMMERCE 1-19-2011.

THE MARK CONSISTS OF THE LETTERS "N" IN BLUE, "O" IN BURGUNDY, "V" IN ORANGE, AND "U" IN GREEN, ALL IN A STYLIZED FONT.

THE COLOR(S) BLUE, BURGUNDY, ORANGE AND GREEN IS/ARE CLAIMED AS A FEATURE OF THE MARK.

SER. NO. 85-372,234, FILED 7-15-2011.

FONG HSU, EXAMINING ATTORNEY



*David J. Kybas*

Director of the United States Patent and Trademark Office

# United States of America

United States Patent and Trademark Office



**Reg. No. 4,124,915**

**Registered Apr. 10, 2012**

**Int. Cl.: 40**

**SERVICE MARK**

**PRINCIPAL REGISTER**

MAD SCIENTISTS BREWING PARTNERS LLC (NEW YORK LIMITED LIABILITY COMPANY), DBA SIXPOINT CRAFT ALES  
40 VAN DYKE STREET  
BROOKLYN, NY 11231

FOR: BREWERY SERVICES, IN CLASS 40 (U.S. CLS. 100, 103 AND 106).

FIRST USE 7-10-2011; IN COMMERCE 7-10-2011.

NO CLAIM IS MADE TO THE EXCLUSIVE RIGHT TO USE "SERIES", APART FROM THE MARK AS SHOWN.

THE MARK CONSISTS OF THE WORDS "SPICE OF LIFE SERIES" IN A CIRCLE WITH A HOPS LEAF AS A BACKGROUND.

SER. NO. 85-372,239, FILED 7-15-2011.

KEVIN CORWIN, EXAMINING ATTORNEY



*David J. Kybas*

Director of the United States Patent and Trademark Office

# United States of America

United States Patent and Trademark Office



**Reg. No. 4,124,916**

**Registered Apr. 10, 2012**

**Int. Cl.: 18**

**TRADEMARK**

**PRINCIPAL REGISTER**

KROMER HOLDING AG (SWITZERLAND CORPORATION)  
C/O TUCKER & LATIFI, LLP  
160 EAST 84TH STREET, SUITE 5-E  
NEW YORK, NY 10028

FOR: BAGS, NAMELY, HANDBAGS, SHOULDER BAGS, TOTE BAGS, BACK PACKS, GARMENT BAGS FOR TRAVEL, LEATHER KEY HOLDERS, WALLETS AND LUGGAGE, IN CLASS 18 (U.S. CLS. 1, 2, 3, 22 AND 41).

PRIORITY CLAIMED UNDER SEC. 44(D) ON ERPN CMNTY TM OFC APPLICATION NO. 10125301, FILED 7-15-2011, REG. NO. 010125301, DATED 11-16-2011, EXPIRES 7-15-2021.

OWNER OF U.S. REG. NO. 3,976,797.

THE NAME(S), PORTRAIT(S), AND/OR SIGNATURE(S) SHOWN IN THE MARK IDENTIFIES "MIA KROMER", WHOSE CONSENT(S) TO REGISTER IS MADE OF RECORD.

THE MARK CONSISTS OF THE WORDS "MIA KROMER" PLUS A STYLIZED FEATHER DESIGN THAT FORMS THE DOT ABOVE THE LETTER "I" IN "MIA" ON A THREE DIMENSIONAL NAME PLATE WITH FOUR BEVELED SIDES.

SER. NO. 85-372,299, FILED 7-15-2011.

JASON BLAIR, EXAMINING ATTORNEY



*David J. Kybas*

Director of the United States Patent and Trademark Office



# United States of America

United States Patent and Trademark Office

*iQ* <sup>+</sup>  
*plus*

**Reg. No. 4,124,917**

**Registered Apr. 10, 2012**

**Int. Cl.: 16**

**TRADEMARK**

**PRINCIPAL REGISTER**

ISCHOLAR, INC. (NEW YORK CORPORATION)  
301-A HENRY ST.  
LINDENHURST, NY 11757

FOR: NOTEBOOKS; PAPER NOTEBOOKS; SCHOOL SUPPLY KITS CONTAINING VARIOUS COMBINATIONS OF SELECTED SCHOOL SUPPLIES, NAMELY, WRITING INSTRUMENTS, PENS, PENCILS, MECHANICAL PENCILS, ERASERS, MARKERS, CRAYONS, HIGHLIGHTER PENS, FOLDERS, NOTEBOOKS, PAPER, PROTRACTORS, PAPER CLIPS, PENCIL SHARPENERS, WRITING GRIPS, GLUE AND BOOK MARKS; SPIRAL-BOUND NOTEBOOKS; WIRE-BOUND NOTEBOOKS, IN CLASS 16 (U.S. CLS. 2, 5, 22, 23, 29, 37, 38 AND 50).

FIRST USE 6-5-2011; IN COMMERCE 6-5-2011.

THE MARK CONSISTS OF THE LETTERS "IQ" WITH THE TEXT "PLUS" AND THE SIGN "+".

SER. NO. 85-372,566, FILED 7-15-2011.

ERNEST SHOSHO, EXAMINING ATTORNEY



*David J. Kyffers*

Director of the United States Patent and Trademark Office

# United States of America

United States Patent and Trademark Office

## AT THE DOOR

**Reg. No. 4,124,918**

**Registered Apr. 10, 2012**

**Int. Cls.: 35 and 42**

**SERVICE MARK**

**PRINCIPAL REGISTER**

EVENTBRITE, INC. (DELAWARE CORPORATION)  
SUITE 110  
651 BRANNAN STREET  
SAN FRANCISCO, CA 94107

FOR: BUSINESS SERVICES, NAMELY, RENTAL OF OFFICE MACHINERY AND EQUIPMENT TO ENABLE EVENT ORGANIZERS TO SELL TICKETS, PROCESS PAYMENT, PRINT TICKETS AND RECEIPTS, AND TRACK DAILY AND CURRENT EVENT SALES WHILE ONSITE, IN CLASS 35 (U.S. CLS. 100, 101 AND 102).

FIRST USE 6-11-2011; IN COMMERCE 7-1-2011.

FOR: PROVIDING TEMPORARY USE OF NON-DOWNLOADABLE SOFTWARE TO ENABLE EVENT ORGANIZERS TO SELL TICKETS, PROCESS PAYMENT, PRINT TICKETS AND RECEIPTS, AND TRACK DAILY AND CURRENT EVENT SALES WHILE ONSITE, IN CLASS 42 (U.S. CLS. 100 AND 101).

FIRST USE 6-11-2011; IN COMMERCE 7-1-2011.

THE MARK CONSISTS OF STANDARD CHARACTERS WITHOUT CLAIM TO ANY PARTICULAR FONT, STYLE, SIZE, OR COLOR.

SER. NO. 85-372,596, FILED 7-15-2011.

ANDREA HACK, EXAMINING ATTORNEY



*David J. Kybas*

Director of the United States Patent and Trademark Office

# United States of America

United States Patent and Trademark Office

# Verdetherm

**Reg. No. 4,124,919**

**Registered Apr. 10, 2012**

**Int. Cl.: 11**

**TRADEMARK**

**PRINCIPAL REGISTER**

COVALEN, INC. (INDIANA CORPORATION)  
6939 BROOKVILLE ROAD  
INDIANAPOLIS, IN 46239

FOR: HVAC UNIT AND PROCESS COOLING SYSTEMS APPARATUS COMPRISED OF HEATERS, COOLERS, CHILLERS, EXCHANGERS, PUMPS, VALVES, SENSORS, PIPING, WIRING AND CONTROLS SOLD AS A UNIT FOR THE PURPOSE OF RECOVERING HEAT GENERATED FROM FLUIDS IN HVAC AND PROCESS COOLING SYSTEMS, AS WELL AS GROUND, WELL, AND OPEN AND LOOP WATER AND FLUID SYSTEMS, IN CLASS 11 (U.S. CLS. 13, 21, 23, 31 AND 34).

FIRST USE 0-0-2007; IN COMMERCE 0-0-2007.

THE MARK CONSISTS OF STANDARD CHARACTERS WITHOUT CLAIM TO ANY PARTICULAR FONT, STYLE, SIZE, OR COLOR.

SER. NO. 85-372,662, FILED 7-15-2011.

DARRYL SPRUILL, EXAMINING ATTORNEY



*David J. Kyffers*

Director of the United States Patent and Trademark Office

# United States of America

United States Patent and Trademark Office

## LEGENDARY NAME! HOMEMADE TASTE

**Reg. No. 4,124,920**

GLIER'S MEATS, INC. (KENTUCKY CORPORATION)

**Registered Apr. 10, 2012**

533 GOETTA PLACE  
COVINGTON, KY 41011

**Int. Cl.: 29**

FOR: PROCESSED MEAT, NAMELY, GOETTA, A SAUSAGE-LIKE BLEND OF PORK, BEEF,  
STEEL-CUT OATS AND SEASONINGS, IN CLASS 29 (U.S. CL. 46).

**TRADEMARK**

FIRST USE 10-1-2002; IN COMMERCE 10-1-2002.

**PRINCIPAL REGISTER**

THE MARK CONSISTS OF STANDARD CHARACTERS WITHOUT CLAIM TO ANY PAR-  
TICULAR FONT, STYLE, SIZE, OR COLOR.

SER. NO. 85-372,663, FILED 7-15-2011.

DOMINIC J. FERRAIUOLO, EXAMINING ATTORNEY



*David J. Kybas*

Director of the United States Patent and Trademark Office

# United States of America

United States Patent and Trademark Office

## HENNESSEY CAPITAL

**Reg. No. 4,124,921**

HENNESSEY ENTERPRISES, INC. (MASSACHUSETTS CORPORATION)  
287 AUBURN ST.

**Registered Apr. 10, 2012**

NEWTON, MA 02466

**Int. Cl.: 36**

FOR: FINANCIAL SERVICES, NAMELY, FACTORING SERVICES, COMMERCIAL FINANCE LINE OF CREDIT SERVICES, PURCHASE ORDER FINANCING SERVICES, VENTURE CAPITAL FINANCING SERVICES, EQUIPMENT FINANCING SERVICES, REAL ESTATE FINANCING SERVICES, CREDIT APPROVAL SERVICES, INVOICE COLLECTION SERVICES, CASH MANAGEMENT ACCOUNT SERVICES, AND SUPPLIER DIRECTED PAYMENT SERVICES, NAMELY, PROCESSING THE PAYMENT OF INVOICES SUBMITTED BY SUPPLIERS OF GOODS AND SERVICES, IN CLASS 36 (U.S. CLS. 100, 101 AND 102).

**SERVICE MARK**

**PRINCIPAL REGISTER**

FIRST USE 4-26-2002; IN COMMERCE 4-26-2002.

THE MARK CONSISTS OF STANDARD CHARACTERS WITHOUT CLAIM TO ANY PARTICULAR FONT, STYLE, SIZE, OR COLOR.

OWNER OF U.S. REG. NO. 2,974,926.

NO CLAIM IS MADE TO THE EXCLUSIVE RIGHT TO USE "CAPITAL", APART FROM THE MARK AS SHOWN.

SEC. 2(F).

SER. NO. 85-372,716, FILED 7-15-2011.

DOMINIC J. FERRAIUOLO, EXAMINING ATTORNEY



*David J. Kyros*

Director of the United States Patent and Trademark Office

# United States of America

United States Patent and Trademark Office



**Reg. No. 4,124,922**

E & H GROUP, LLC (UTAH LIMITED LIABILITY COMPANY)  
3211 SOUTH ORCHARD DR.  
BOUNTIFUL, UT 84010

**Registered Apr. 10, 2012**

**Int. Cl.: 30**

FOR: BARBEQUE SAUCE, SPICE BLENDS AND DRY SPICE RUBS, IN CLASS 30 (U.S. CL. 46).

**TRADEMARK**

FIRST USE 8-14-2008; IN COMMERCE 6-19-2009.

**PRINCIPAL REGISTER**

NO CLAIM IS MADE TO THE EXCLUSIVE RIGHT TO USE "SPICE COMPANY", APART FROM THE MARK AS SHOWN.

THE MARK CONSISTS OF AN INNER CIRCLE CONTAINING THE OUTLINE IMAGE OF A ROOSTER AT THE VERY TOP, A BULL ON THE RIGHT SIDE, A PIG AT THE BOTTOM AND A FISH TO THE LEFT SIDE. ABOVE THE FISH IS A SMALL SHRIMP AND BELOW THE FISH IS A SMALL CRAB. BEHIND THE SIX ANIMALS IS A SWIRL DESIGN. SURROUNDING THIS INNER CIRCLE IS AN OUTER CIRCLE WHICH CONTAINS THE WORDS "THYME & SEASONS SPICE COMPANY" AND ALSO HAS A BORDER AROUND THE VERY OUTSIDE EDGE.

SER. NO. 85-372,718, FILED 7-15-2011.

DOMINIC J. FERRAIUOLO, EXAMINING ATTORNEY



*David J. Kyffers*

Director of the United States Patent and Trademark Office

# United States of America

United States Patent and Trademark Office

# PROFICIAN

**Reg. No. 4,124,923**

**Registered Apr. 10, 2012**

**Int. Cl.: 42**

**SERVICE MARK**

**PRINCIPAL REGISTER**

PROFICIAN CORPORATION (INDIANA CORPORATION)  
10929 LINCOLN HIGHWAY EAST  
NEW HAVEN, IN 46774

FOR: COMPUTER NETWORK CONFIGURATION SERVICES; COMPUTER NETWORK DESIGN FOR OTHERS; PROFESSIONAL COMPUTER SERVICES, NAMELY, NETWORK ANALYSIS, LAN/WAN DESIGN, WIRELESS ENGINEERING, CLOUD COMPUTING CONSULTING, DATA BACKUP, DATA RECOVERY, VIRTUALIZATION AND COMPUTER PROJECT MANAGEMENT; AND, ON SITE AND REMOTE COMPUTER NETWORK TECHNICAL MONITORING AND SOFTWARE MAINTENANCE SERVICES, IN CLASS 42 (U.S. CLS. 100 AND 101).

FIRST USE 0-0-1997; IN COMMERCE 0-0-1997.

THE MARK CONSISTS OF STANDARD CHARACTERS WITHOUT CLAIM TO ANY PARTICULAR FONT, STYLE, SIZE, OR COLOR.

SER. NO. 85-372,782, FILED 7-15-2011.

HAI-LY LAM, EXAMINING ATTORNEY



*David J. Kyffers*

Director of the United States Patent and Trademark Office

# United States of America

United States Patent and Trademark Office



**Reg. No. 4,124,924**

**Registered Apr. 10, 2012**

**Int. Cl.: 44**

**SERVICE MARK**

**PRINCIPAL REGISTER**

WELLNESS POSSIBILITIES, INCORPORATED (MARYLAND CORPORATION)  
2304 GUILFORD AVENUE  
BALTIMORE, MD 21218

FOR: NURSING HOME, IN CLASS 44 (U.S. CLS. 100 AND 101).

FIRST USE 7-1-2011; IN COMMERCE 7-1-2011.

NO CLAIM IS MADE TO THE EXCLUSIVE RIGHT TO USE "WELLNESS" , APART FROM THE MARK AS SHOWN.

THE MARK CONSISTS OF A HUMAN FORM CONSISTING OF A DOWNWARD FACING CRESCENT REPRESENTING A HUMAN HEAD, WITH AN UPWARD FACING CRESCENT UNDERNEATH THE HEAD REPRESENTING A HUMAN TORSO, AND A DOWNWARD FACING CRESCENT UNDERNEATH THE TORSO REPRESENTING A HUMAN LOWER BODY, AND WITH THE WORDS WELLNESS POSSIBILITIES TO THE RIGHT OF THE HUMAN FORM AND THE WORDS "WHERE LIVING COMES TO LIFE!" UNDERNEATH THE WORDS "WELLNESS POSSIBILITIES" AND ALSO TO THE RIGHT OF THE HUMAN FORM.

SER. NO. 85-372,805, FILED 7-15-2011.

LAURIE MAYES, EXAMINING ATTORNEY



*David J. Kybas*

Director of the United States Patent and Trademark Office



United States of America  
United States Patent and Trademark Office

***Centaur***  
***PLUS***

**Reg. No. 4,124,925**

ALLIED BUYING CORPORATION (DELAWARE CORPORATION)  
200 W. 22ND STREET, SUITE 240  
LOMBARD, IL 60148

**Registered Apr. 10, 2012**

**Int. Cls.: 11 and 20**

FOR: FREEZERS; REFRIGERATORS; SINKS, IN CLASS 11 (U.S. CLS. 13, 21, 23, 31 AND 34).

**TRADEMARK**

FIRST USE 4-0-2011; IN COMMERCE 4-0-2011.

**PRINCIPAL REGISTER**

FOR: INDUSTRIAL FOOD PREPARATION WORK TABLES, IN CLASS 20 (U.S. CLS. 2, 13, 22, 25, 32 AND 50).

FIRST USE 4-0-2011; IN COMMERCE 4-0-2011.

OWNER OF U.S. REG. NOS. 3,584,467, 4,031,865 AND OTHERS.

THE MARK CONSISTS OF THE WORDS "CENTAUR PLUS" WITH STYLIZED UNDERLINING PARTIALLY CONNECTED TO THE LETTER "T".

SER. NO. 85-372,815, FILED 7-15-2011.

MICHAEL TANNER, EXAMINING ATTORNEY



*David J. Kyfos*

Director of the United States Patent and Trademark Office

# United States of America

United States Patent and Trademark Office



美國華僑進出口商會

**Reg. No. 4,124,926**

**Registered Apr. 10, 2012**

**Int. Cl.: 35**

**SERVICE MARK**

**PRINCIPAL REGISTER**

AMERICA CHINESE IMPORT & EXPORT ASSOCIATES INC. (NEW YORK CORPORATION)  
81-45 UTOPIA PKWY  
JAMAICA, NY 11432

FOR: ASSOCIATION SERVICES, NAMELY, PROMOTING THE INTERESTS OF THE CHINESE AMERICAN BUSINESS ENTITIES AND THE CHINESE AMERICAN COMMUNITY, TO ENCOURAGE THE INTERESTS AND RIGHTS OF CHINESE AMERICAN AND MINORITIES, TO ENHANCE THE RESPECT AND COOPERATION OF AND AMONG CHINESE AMERICAN ASSOCIATIONS WITH THE AIM OF STRENGTHEN THE ECONOMIC, TRADE, CULTURE AND TECHNOLOGY EXCHANGES BETWEEN CHINA AND THE U.S., IN CLASS 35 (U.S. CLS. 100, 101 AND 102).

FIRST USE 6-1-1980; IN COMMERCE 6-1-1980.

NO CLAIM IS MADE TO THE EXCLUSIVE RIGHT TO USE "AMERICA CHINESE IMPORT & EXPORT ASSOCIATES, INC." AND THE NON-LATIN CHARACTERS THAT TRANSLITERATE TO "MEI GUO HUA QIAO JIN CHU KOU SHANG HUI", APART FROM THE MARK AS SHOWN.

THE COLOR(S) BLUE, RED, BLACK AND WHITE IS/ARE CLAIMED AS A FEATURE OF THE MARK.

THE NON-LATIN CHARACTERS IN THE MARK TRANSLITERATE TO "MEI GUO HUA QIAO JIN CHU KOU SHANG HUI" AND THIS MEANS "AMERICAN CHINESE IMPORT & EXPORT ASSOCIATION" IN ENGLISH.

THE MARK CONSISTS OF A SERIES OF CHINESE CHARACTERS BELOW A BLUE SINGLE LINE SQUARE WITH CURVED CORNERS. THE WORDING "AMERICA CHINESE IMPORT & EXPORT ASSOCIATES INC." IN BLACK IS SET INSIDE THE SQUARE AND SURROUNDING A RED SQUARE WITH FOUR ARROWS ADJACENT TO IT. ONE BLUE ARROW POINTING UP, ONE BLUE ARROW POINTING DOWN AND OTHER TWO WHITE ARROWS POINTING TO THE CENTER, ALL SET IN RED BACKGROUND.

SER. NO. 85-372,856, FILED 7-15-2011.

MICHAEL WEBSTER, EXAMINING ATTORNEY

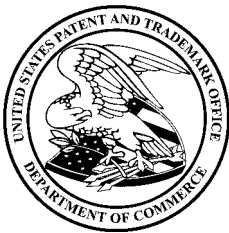

*David J. Kybas*

Director of the United States Patent and Trademark Office

# United States of America

United States Patent and Trademark Office

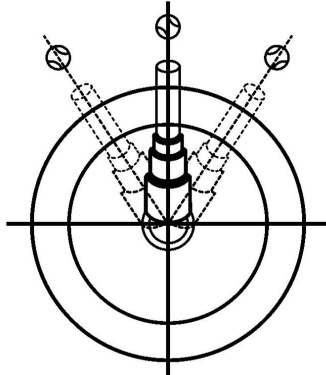

**Reg. No. 4,124,927**

**Registered Apr. 10, 2012**

**Int. Cl.: 28**

**TRADEMARK**

**PRINCIPAL REGISTER**

SAUMELL, JORGE E. (UNITED STATES INDIVIDUAL)  
8410 SW 36TH ST.  
MIAMI, FL 33155

FOR: BASEBALL AND SOFTBALL TRAINING APPARATUS USED TO IMPROVE THE HITTING ABILITIES AND MECHANICS OF A PLAYER'S SWING, IN CLASS 28 (U.S. CLS. 22, 23, 38 AND 50).

FIRST USE 2-22-2011; IN COMMERCE 2-22-2011.

THE MARK CONSISTS OF AN IMAGE OF THREE TUBES WITH THREE BASEBALLS IN THE AIR INSIDE TWO CIRCLES.

SER. NO. 85-372,922, FILED 7-15-2011.

JOHN DALIER, EXAMINING ATTORNEY



*David J. Kyffers*

Director of the United States Patent and Trademark Office

# United States of America

United States Patent and Trademark Office



**Reg. No. 4,124,928**

SCHNEIDER & ASSOCIATES CLAIM SERVICES (CALIFORNIA CORPORATION)  
2205 WEST OLIVE AVENUE  
BURBANK, CA 91506

**Registered Apr. 10, 2012**

**Int. Cl.: 36**

FOR: CLAIMS ADJUSTMENT IN THE FIELD OF INSURANCE, IN CLASS 36 (U.S. CLS. 100, 101 AND 102).

**SERVICE MARK**

FIRST USE 6-8-2011; IN COMMERCE 6-8-2011.

**PRINCIPAL REGISTER**

NO CLAIM IS MADE TO THE EXCLUSIVE RIGHT TO USE "REPORTING SYSTEM", APART FROM THE MARK AS SHOWN.

THE MARK CONSISTS OF THE STYLIZED TEXT "FIELDSTAR" ABOVE THE STYLIZED TEXT "REPORTING SYSTEM". THREE STARS SIT TO THE LOWER LEFT OF THE WORD "FIELDSTAR" AND ARE CONNECTED IN A CHECK MARK FORMATION. ANOTHER STAR SITS ABOVE THE LETTERS "TA" IN "FIELDSTAR". THIS STAR IS CONNECTED BY A LINE TO THE LARGEST OF THE OTHER THREE STARS. A SMALLER STAR IS INSIDE THE STAR ABOVE THE LETTERS "TA".

SER. NO. 85-372,938, FILED 7-15-2011.

KIM SAITO, EXAMINING ATTORNEY



*David J. Kyffers*

Director of the United States Patent and Trademark Office

# United States of America

United States Patent and Trademark Office

# iZoFlex

**Reg. No. 4,124,929**

**Registered Apr. 10, 2012**

**Int. Cl.: 10**

**TRADEMARK**

**PRINCIPAL REGISTER**

IZOLATION INC (CALIFORNIA CORPORATION)  
17151 NEWHOPE ST STE 201  
FOUNTAIN VALLEY, CA 92708

FOR: DENTAL DEVICE THAT EXPANDS THE MOUTH TO IMPROVE THE FIELD OF VIEW INSIDE THE MOUTH, AND EXTRACTS SALIVA FROM THE WORK AREA INSIDE THE MOUTH, IN CLASS 10 (U.S. CLS. 26, 39 AND 44).

FIRST USE 5-23-2010; IN COMMERCE 5-23-2010.

THE MARK CONSISTS OF STANDARD CHARACTERS WITHOUT CLAIM TO ANY PARTICULAR FONT, STYLE, SIZE, OR COLOR.

SER. NO. 85-373,008, FILED 7-15-2011.

JAMES STEIN, EXAMINING ATTORNEY



*David J. Kybas*

Director of the United States Patent and Trademark Office

# United States of America

United States Patent and Trademark Office

# SURFBOOK

**Reg. No. 4,124,930**

QIAN, JIN (CHINA INDIVIDUAL)  
GUOJIASHAN29

**Registered Apr. 10, 2012**

NANJING, CHINA 210037

**Int. Cl.: 9**

FOR: NOTEBOOK COMPUTERS; LAPTOP COMPUTERS; COMPUTER PERIPHERAL DEVICES; COMPUTERS; TABLET COMPUTERS; CAMERAS, IN CLASS 9 (U.S. CLS. 21, 23, 26, 36 AND 38).

**TRADEMARK**

FIRST USE 7-1-2011; IN COMMERCE 7-1-2011.

**PRINCIPAL REGISTER**

THE MARK CONSISTS OF STANDARD CHARACTERS WITHOUT CLAIM TO ANY PARTICULAR FONT, STYLE, SIZE, OR COLOR.

SER. NO. 85-373,077, FILED 7-16-2011.

JEFFREY LOOK, EXAMINING ATTORNEY



*David J. Kybas*

Director of the United States Patent and Trademark Office

# United States of America

United States Patent and Trademark Office

## LETICIA'S COCINA

**Reg. No. 4,124,931**

TU CASA INC. (NEVADA CORPORATION)  
8929 LOGGERS MILL AVE  
LAS VEGAS, NV 89143

**Registered Apr. 10, 2012**

**Int. Cl.: 43**

FOR: RESTAURANT, BAR AND CATERING SERVICES; TAKE-OUT RESTAURANT SERVICES; PROVIDING SOCIAL MEETINGS, BANQUET AND SOCIAL FUNCTION FACILITIES, IN CLASS 43 (U.S. CLS. 100 AND 101).

**SERVICE MARK**

FIRST USE 7-8-2009; IN COMMERCE 10-17-2009.

**PRINCIPAL REGISTER**

THE MARK CONSISTS OF STANDARD CHARACTERS WITHOUT CLAIM TO ANY PARTICULAR FONT, STYLE, SIZE, OR COLOR.

NO CLAIM IS MADE TO THE EXCLUSIVE RIGHT TO USE "CONCINA", APART FROM THE MARK AS SHOWN.

THE ENGLISH TRANSLATION OF THE WORD "CONCINA" IN THE MARK IS "KITCHEN".

SER. NO. 85-373,081, FILED 7-16-2011.

JEFFREY LOOK, EXAMINING ATTORNEY



*David J. Kyros*

Director of the United States Patent and Trademark Office

# United States of America

United States Patent and Trademark Office

# Mobileoke

**Reg. No. 4,124,932**

PLAYDATABASE.COM, LLC (CALIFORNIA LIMITED LIABILITY COMPANY)  
10256 SUNLAND BOULEVARD  
SUNLAND, CA 91040

**Registered Apr. 10, 2012**

**Int. Cls.: 35 and 41**

FOR: PROVIDING A SUBSCRIPTION TO A COMPUTER SERVICE, NAMELY, PROVIDING A WEB-BASED SUBSCRIPTION TO ALLOW ENTERTAINMENT VENUES TO PLACE LISTS OF KARAOKE SONGS INTO A DATABASE ACCESSIBLE TO CONSUMERS VIA THE INTERNET, IN CLASS 35 (U.S. CLS. 100, 101 AND 102).

**SERVICE MARK**

**PRINCIPAL REGISTER**

FIRST USE 3-5-2011; IN COMMERCE 3-5-2011.

FOR: PROVIDING A WEBSITE WHICH ALLOWS USERS TO ACCESS INFORMATION ABOUT SONGS AVAILABLE AT VENUES OPERATED BY THIRD PARTIES; PROVIDING A WEBSITE WHERE ENTERTAINMENT VENUES MAY SUBMIT INFORMATION ABOUT PARTICULAR SONGS AVAILABLE AT SUCH VENUES; PROVIDING AN INTERACTIVE WEBSITE FEATURING INFORMATION AND LINKS RELATING TO KARAOKE; PROVIDING INFORMATION TO OTHERS ABOUT AVAILABLE KARAOKE SONGS AT ENTERTAINMENT ESTABLISHMENTS; PROVIDING A WEBSITE FEATURING INFORMATION IN THE FIELD OF KARAOKE, IN CLASS 41 (U.S. CLS. 100, 101 AND 107).

FIRST USE 3-5-2011; IN COMMERCE 3-5-2011.

THE MARK CONSISTS OF STANDARD CHARACTERS WITHOUT CLAIM TO ANY PARTICULAR FONT, STYLE, SIZE, OR COLOR.

SER. NO. 85-373,134, FILED 7-16-2011.

ALLISON SCHRODY, EXAMINING ATTORNEY



*David J. Kyros*

Director of the United States Patent and Trademark Office



# United States of America

United States Patent and Trademark Office

# Frogury

**Reg. No. 4,124,933**

**Registered Apr. 10, 2012**

**Int. Cl.: 35**

**SERVICE MARK**

**PRINCIPAL REGISTER**

FROGURY LLC (FLORIDA LIMITED LIABILITY COMPANY)  
FROGURY  
TAMPA, FL 33647

FOR: SELF-SERVE YOGURT SHOP SERVICES, IN CLASS 35 (U.S. CLS. 100, 101 AND 102).

FIRST USE 7-15-2011; IN COMMERCE 7-15-2011.

THE MARK CONSISTS OF STANDARD CHARACTERS WITHOUT CLAIM TO ANY PARTICULAR FONT, STYLE, SIZE, OR COLOR.

SER. NO. 85-373,146, FILED 7-16-2011.

BARBARA A. GOLD, EXAMINING ATTORNEY



*David J. Kybas*

Director of the United States Patent and Trademark Office

# United States of America

United States Patent and Trademark Office

# Hyper-Flush

**Reg. No. 4,124,934**

HYPER-FLUSH, LLC (NORTH CAROLINA LIMITED LIABILITY COMPANY)  
1221 HERITAGE DRIVE  
WENDELL, NC 27591

**Registered Apr. 10, 2012**

**Int. Cl.: 37**

FOR: INTERNAL CLEANING OF POTABLE AND NON-POTABLE WATER TRANSFER AND DISTRIBUTION PIPES AND FITTINGS, IN CLASS 37 (U.S. CLS. 100, 103 AND 106).

**SERVICE MARK**

FIRST USE 6-5-2010; IN COMMERCE 6-5-2010.

**PRINCIPAL REGISTER**

THE MARK CONSISTS OF STANDARD CHARACTERS WITHOUT CLAIM TO ANY PARTICULAR FONT, STYLE, SIZE, OR COLOR.

SER. NO. 85-373,272, FILED 7-17-2011.

KIM MONINGHOFF, EXAMINING ATTORNEY



*David J. Kybas*

Director of the United States Patent and Trademark Office

# United States of America

United States Patent and Trademark Office

## Jane's Sweet Buns

**Reg. No. 4,124,935**

**Registered Apr. 10, 2012**

**Int. Cls.: 30 and 35**

**TRADEMARK**

**SERVICE MARK**

**PRINCIPAL REGISTER**

DEROSSİ CHELSEA, LLC (NEW YORK LIMITED LIABILITY COMPANY), DBA JANE'S SWEET BUNS  
102 ST. MARKS PLACE  
NEW YORK, NY 10009

FOR: BAKERY DESSERTS; BAKERY GOODS; BAKERY PRODUCTS; BROWNIES; CAKES; CHEESECAKE; COFFEE AND TEA; COOKIES; CUP CAKES; BUNS; DESSERT PUDDINGS; HOT CHOCOLATE; MUFFINS; PIES; DONUTS, IN CLASS 30 (U.S. CL. 46).

FIRST USE 7-15-2011; IN COMMERCE 7-15-2011.

FOR: RETAIL BAKERY SHOPS; WHOLESALE AND RETAIL STORE SERVICES AND ON-LINE RETAIL AND WHOLESALE STORE SERVICES FEATURING CONFECTIONERY, BAKERY DESSERTS, BAKERY GOODS, BAKERY PRODUCTS, CUPCAKES, PIES, CAKES, COOKIES, MUFFINS, BREAD, BUNS, CANDIES, DONUTS, COFFEE, TEA, BEVERAGES, CLOTHING, SHIRTS, T-SHIRTS, HATS, CAPS, FOOTWEAR, HEADWEAR, BEVERAGEWARE, MUGS, DRINKING GLASSES, JARS, KITCHEN UTENSILS AND COOKING UTENSILS, TEXTILES, APRONS, PACKAGING MATERIALS, BOXES AND BAGS OF PAPER OR CARDBOARD, PRINTED MATERIALS, COOKBOOKS, CATALOGS, IN CLASS 35 (U.S. CLS. 100, 101 AND 102).

FIRST USE 7-15-2011; IN COMMERCE 7-15-2011.

THE MARK CONSISTS OF STANDARD CHARACTERS WITHOUT CLAIM TO ANY PARTICULAR FONT, STYLE, SIZE, OR COLOR.

NO CLAIM IS MADE TO THE EXCLUSIVE RIGHT TO USE "SWEET BUNS", APART FROM THE MARK AS SHOWN.

THE NAME(S), PORTRAIT(S), AND/OR SIGNATURE(S) SHOWN IN THE MARK IDENTIFIES JANE KEENAN, WHOSE CONSENT(S) TO REGISTER IS MADE OF RECORD.

SER. NO. 85-373,316, FILED 7-17-2011.

NAAKWAMA ANKRAH, EXAMINING ATTORNEY



*David J. Kypos*

Director of the United States Patent and Trademark Office

# United States of America

United States Patent and Trademark Office

# Happy Camper

**Reg. No. 4,124,936**

TODD MEXICO (UNITED STATES INDIVIDUAL)  
630 BALDWINVILLE RD  
BALDWINVILLE, MA 01436

**Registered Apr. 10, 2012**

**Int. Cl.: 25**

FOR: T-SHIRTS; HATS; HOODED SWEAT SHIRTS; LONG-SLEEVED SHIRTS; SHIRTS;  
SWEATSHIRTS, IN CLASS 25 (U.S. CLS. 22 AND 39).

**TRADEMARK**

FIRST USE 11-7-2010; IN COMMERCE 11-7-2010.

**PRINCIPAL REGISTER**

THE MARK CONSISTS OF STANDARD CHARACTERS WITHOUT CLAIM TO ANY PARTICULAR FONT, STYLE, SIZE, OR COLOR.

NO CLAIM IS MADE TO THE EXCLUSIVE RIGHT TO USE "CAMPER", APART FROM THE MARK AS SHOWN.

SER. NO. 85-373,344, FILED 7-17-2011.

MARY CRAWFORD, EXAMINING ATTORNEY



*David J. Kybas*

Director of the United States Patent and Trademark Office

# United States of America

United States Patent and Trademark Office

# Happy Gamer

**Reg. No. 4,124,937**

TODD MEXICO (UNITED STATES INDIVIDUAL)  
630 BALDWINVILLE RD  
BALDWINVILLE, MA 01436

**Registered Apr. 10, 2012**

**Int. Cl.: 25**

FOR: T-SHIRTS; HATS; HOODED SWEAT SHIRTS; LONG-SLEEVED SHIRTS; SHIRTS;  
SWEATSHIRTS, IN CLASS 25 (U.S. CLS. 22 AND 39).

**TRADEMARK**

FIRST USE 11-7-2010; IN COMMERCE 11-7-2010.

**PRINCIPAL REGISTER**

THE MARK CONSISTS OF STANDARD CHARACTERS WITHOUT CLAIM TO ANY PARTICULAR FONT, STYLE, SIZE, OR COLOR.

NO CLAIM IS MADE TO THE EXCLUSIVE RIGHT TO USE "GAMER", APART FROM THE MARK AS SHOWN.

SER. NO. 85-373,346, FILED 7-17-2011.

MARY CRAWFORD, EXAMINING ATTORNEY



*David J. Kyffers*

Director of the United States Patent and Trademark Office

# United States of America

United States Patent and Trademark Office

# Happy Hunter

**Reg. No. 4,124,938**

TODD MEXICO (UNITED STATES INDIVIDUAL)  
630 BALDWINVILLE RD  
BALDWINVILLE, MA 01436

**Registered Apr. 10, 2012**

**Int. Cl.: 25**

FOR: T-SHIRTS; HATS; HOODED SWEAT SHIRTS; LONG-SLEEVED SHIRTS; SHIRTS;  
SWEATSHIRTS, IN CLASS 25 (U.S. CLS. 22 AND 39).

**TRADEMARK**

FIRST USE 11-7-2010; IN COMMERCE 11-7-2010.

**PRINCIPAL REGISTER**

THE MARK CONSISTS OF STANDARD CHARACTERS WITHOUT CLAIM TO ANY PARTICULAR FONT, STYLE, SIZE, OR COLOR.

NO CLAIM IS MADE TO THE EXCLUSIVE RIGHT TO USE "HUNTER", APART FROM THE MARK AS SHOWN.

SER. NO. 85-373,348, FILED 7-17-2011.

MARY CRAWFORD, EXAMINING ATTORNEY



*David J. Kyffers*

Director of the United States Patent and Trademark Office

# United States of America

United States Patent and Trademark Office

# Happy Golfer

**Reg. No. 4,124,939**

TODD MEXICO (UNITED STATES INDIVIDUAL)  
630 BALDWINVILLE RD  
BALDWINVILLE, MA 01436

**Registered Apr. 10, 2012**

**Int. Cl.: 25**

FOR: T-SHIRTS; HATS; HOODED SWEAT SHIRTS; LONG-SLEEVED SHIRTS; SHIRTS;  
SWEATSHIRTS, IN CLASS 25 (U.S. CLS. 22 AND 39).

**TRADEMARK**

FIRST USE 11-7-2010; IN COMMERCE 11-7-2010.

**PRINCIPAL REGISTER**

THE MARK CONSISTS OF STANDARD CHARACTERS WITHOUT CLAIM TO ANY PAR-  
TICULAR FONT, STYLE, SIZE, OR COLOR.

NO CLAIM IS MADE TO THE EXCLUSIVE RIGHT TO USE "GOLFER", APART FROM THE  
MARK AS SHOWN.

SER. NO. 85-373,350, FILED 7-17-2011.

MARY CRAWFORD, EXAMINING ATTORNEY



*David J. Kyffers*

Director of the United States Patent and Trademark Office

# United States of America

United States Patent and Trademark Office

# Happy Player

**Reg. No. 4,124,940**

TODD MEXICO (UNITED STATES INDIVIDUAL)  
630 BALDWINVILLE RD  
BALDWINVILLE, MA 01436

**Registered Apr. 10, 2012**

**Int. Cl.: 25**

FOR: T-SHIRTS; HATS; HOODED SWEAT SHIRTS; LONG-SLEEVED SHIRTS; SHIRTS;  
SWEATSHIRTS, IN CLASS 25 (U.S. CLS. 22 AND 39).

**TRADEMARK**

FIRST USE 11-7-2010; IN COMMERCE 11-7-2010.

**PRINCIPAL REGISTER**

THE MARK CONSISTS OF STANDARD CHARACTERS WITHOUT CLAIM TO ANY PAR-  
TICULAR FONT, STYLE, SIZE, OR COLOR.

NO CLAIM IS MADE TO THE EXCLUSIVE RIGHT TO USE "PLAYER", APART FROM THE  
MARK AS SHOWN.

SER. NO. 85-373,353, FILED 7-17-2011.

MARY CRAWFORD, EXAMINING ATTORNEY



*David J. Kyffers*

Director of the United States Patent and Trademark Office



# United States of America

United States Patent and Trademark Office

# Happy Runner

**Reg. No. 4,124,941**

TODD MEXICO (UNITED STATES INDIVIDUAL)  
630 BALDWINVILLE RD  
BALDWINVILLE, MA 01436

**Registered Apr. 10, 2012**

**Int. Cl.: 25**

FOR: T-SHIRTS; HATS; HOODED SWEAT SHIRTS; LONG-SLEEVED SHIRTS; SHIRTS;  
SWEATSHIRTS, IN CLASS 25 (U.S. CLS. 22 AND 39).

**TRADEMARK**

FIRST USE 11-7-2010; IN COMMERCE 11-7-2010.

**PRINCIPAL REGISTER**

THE MARK CONSISTS OF STANDARD CHARACTERS WITHOUT CLAIM TO ANY PARTICULAR FONT, STYLE, SIZE, OR COLOR.

NO CLAIM IS MADE TO THE EXCLUSIVE RIGHT TO USE "RUNNER", APART FROM THE MARK AS SHOWN.

SER. NO. 85-373,354, FILED S.R. 7-17-2011 AM. P.R. 11-16-2011.

MARY CRAWFORD, EXAMINING ATTORNEY



*David J. Kybas*

Director of the United States Patent and Trademark Office

# United States of America

United States Patent and Trademark Office



**Reg. No. 4,124,942**

FRANCES J. MULLA (UNITED STATES INDIVIDUAL)  
5076 PETAL PL # D  
DELRAY FEACH, FL 33484

**Registered Apr. 10, 2012**

**Int. Cl.: 9**

FOR: PRE RECORDED AUDIO TAPES FEATURING MUSIC, IN CLASS 9 (U.S. CLS. 21, 23, 26, 36 AND 38).

**TRADEMARK**

FIRST USE 2-14-1997; IN COMMERCE 2-14-1997.

**PRINCIPAL REGISTER**

NO CLAIM IS MADE TO THE EXCLUSIVE RIGHT TO USE "JAPAN", APART FROM THE MARK AS SHOWN.

THE COLOR(S) WHITE, BLACK, AND RED IS/ARE CLAIMED AS A FEATURE OF THE MARK.

THE MARK CONSISTS OF THE FOLLOWING: THE WORDING "I" AND "JAPAN" IN THE COLOR BLACK, THE DESIGN OF THE HEART IN THE COLOR RED, ALL ON A WHITE BACKGROUND.

SER. NO. 85-373,445, FILED 7-18-2011.

ANNE E. GUSTASON, EXAMINING ATTORNEY



*David J. Kybas*

Director of the United States Patent and Trademark Office

# United States of America

United States Patent and Trademark Office

## My ReCErt Tracker

**Reg. No. 4,124,943**

**Registered Apr. 10, 2012**

**Int. Cl.: 42**

**SERVICE MARK**

**PRINCIPAL REGISTER**

PEDIATRIC NURSING CERTIFICATION BOARD, INC. (MARYLAND CORPORATION)  
800 S. FREDERICK AVE., SUITE 204  
GAITHERSBURG, MD 20877

FOR: PROVIDING TEMPORARY USE OF NON-DOWNLOADABLE COMPUTER SOFTWARE FOR TRACKING DOCUMENTS OVER COMPUTER NETWORKS, INTRANETS AND THE INTERNET, IN CLASS 42 (U.S. CLS. 100 AND 101).

FIRST USE 6-1-2011; IN COMMERCE 6-1-2011.

THE MARK CONSISTS OF STANDARD CHARACTERS WITHOUT CLAIM TO ANY PARTICULAR FONT, STYLE, SIZE, OR COLOR.

NO CLAIM IS MADE TO THE EXCLUSIVE RIGHT TO USE "RECE RT TRACKER", APART FROM THE MARK AS SHOWN.

SER. NO. 85-373,480, FILED 7-18-2011.

INGRID C. EULIN, EXAMINING ATTORNEY



*David J. Kybas*

Director of the United States Patent and Trademark Office

# United States of America

United States Patent and Trademark Office

# PKard

**Reg. No. 4,124,944**

**Registered Apr. 10, 2012**

**Int. Cl.: 9**

**TRADEMARK**

**PRINCIPAL REGISTER**

THURSBY SOFTWARE SYSTEMS, INC. (TEXAS CORPORATION)  
4901 S COLLINS ST  
ARLINGTON, TX 76018

FOR: COMMUNICATIONS SOFTWARE FOR USE WITH SMART CARDS FOR CONNECTING COMPUTERS TO SECURE WEBSITES, WEB MAIL AND WEB VPN, IN CLASS 9 (U.S. CLS. 21, 23, 26, 36 AND 38).

FIRST USE 2-28-2011; IN COMMERCE 2-28-2011.

THE MARK CONSISTS OF STANDARD CHARACTERS WITHOUT CLAIM TO ANY PARTICULAR FONT, STYLE, SIZE, OR COLOR.

SER. NO. 85-373,535, FILED 7-18-2011.

AMY HELLA, EXAMINING ATTORNEY



*David J. Kyffers*

Director of the United States Patent and Trademark Office

# United States of America

United States Patent and Trademark Office

## TVU NETWORKS

**Reg. No. 4,124,945**

**Registered Apr. 10, 2012**

**Int. Cls.: 9 and 38**

**TRADEMARK**

**SERVICE MARK**

**PRINCIPAL REGISTER**

TVU NETWORKS CORPORATION (DELAWARE CORPORATION)  
SUITE 100  
1225 PEAR AVENUE  
MOUNTAIN VIEW, CA 94043

FOR: COMPUTER SOFTWARE ALLOWING FOR THE TRANSMISSION AND VIEWING OF GLOBAL TELEVISION CHANNEL PROGRAMMING CONTENT OVER THE INTERNET, INCLUDING THE INSERTION OF ADVERTISING WITHIN THE CHANNEL PROGRAMMING CONTENT; MOBILE VIDEO AND AUDIO CAPTURE AND TRANSMISSION SYSTEM, NAMELY, WIRED CABLE CONNECTORS, ASSOCIATED WIRED AND/OR WIRELESS TRANSMITTERS, AND INTEGRATED AUDIO PROCESSING, VIDEO PROCESSING AND VIDEO ENCODING SOFTWARE, ALL SOLD AS A UNIT, IN CLASS 9 (U.S. CLS. 21, 23, 26, 36 AND 38).

FIRST USE 3-1-2010; IN COMMERCE 3-1-2010.

FOR: STREAMING OF AUDIO AND VIDEO TELEVISION PROGRAMMING VIA A GLOBAL COMPUTER NETWORK OR THE INTERNET; COMMUNICATIONS SERVICES, NAMELY, THE TRANSMISSION OF AUDIO AND VIDEO DATA FROM A MOBILE DEVICE BY WIRED AND WIRELESS COMMUNICATIONS NETWORKS, THE INTERNET AND DATA NETWORKS, IN CLASS 38 (U.S. CLS. 100, 101 AND 104).

FIRST USE 12-31-2005; IN COMMERCE 12-31-2005.

THE MARK CONSISTS OF STANDARD CHARACTERS WITHOUT CLAIM TO ANY PARTICULAR FONT, STYLE, SIZE, OR COLOR.

NO CLAIM IS MADE TO THE EXCLUSIVE RIGHT TO USE "NETWORKS", APART FROM THE MARK AS SHOWN.

SER. NO. 85-373,582, FILED 7-18-2011.

ANTHONY RINKER, EXAMINING ATTORNEY



*David J. Kybas*

Director of the United States Patent and Trademark Office

# United States of America

United States Patent and Trademark Office

## ROBERT STOREY CELLARS

**Reg. No. 4,124,946**

**Registered Apr. 10, 2012**

**Int. Cl.: 33**

NEWMAN WINE AND SPIRITS, LP (PENNSYLVANIA LIMITED PARTNERSHIP)  
FOUR TOWER BRIDGE  
200 BARR HARBOR DRIVE - SUITE 400  
WEST CONSHOHOCKEN, PA 19428

FOR: WINE, IN CLASS 33 (U.S. CLS. 47 AND 49).

**TRADEMARK**

FIRST USE 1-1-2010; IN COMMERCE 1-1-2010.

**PRINCIPAL REGISTER**

THE MARK CONSISTS OF STANDARD CHARACTERS WITHOUT CLAIM TO ANY PARTICULAR FONT, STYLE, SIZE, OR COLOR.

NO CLAIM IS MADE TO THE EXCLUSIVE RIGHT TO USE "CELLARS", APART FROM THE MARK AS SHOWN.

THE NAME(S), PORTRAIT(S), AND/OR SIGNATURE(S) SHOWN IN THE MARK IDENTIFIES "ROBERT STOREY", WHOSE CONSENT(S) TO REGISTER IS MADE OF RECORD.

SER. NO. 85-373,608, FILED 7-18-2011.

STEPHANIE ALI, EXAMINING ATTORNEY



*David J. Kybas*

Director of the United States Patent and Trademark Office

# United States of America

United States Patent and Trademark Office

## Aspira The Spa

**Reg. No. 4,124,947**

OSTHOFF MANAGEMENT CORP. (WISCONSIN CORPORATION)

**Registered Apr. 10, 2012**

101 OSTHOFF AVENUE  
ELKHART LAKE, WI 53020

**Int. Cl.: 44**

FOR: HEALTH SPA SERVICES FOR HEALTH AND WELLNESS OF THE BODY AND SPIRIT, NAMELY, PROVIDING MASSAGE, FACIAL AND BODY TREATMENT SERVICES, COSMETIC BODY CARE SERVICES, IN CLASS 44 (U.S. CLS. 100 AND 101).

**SERVICE MARK**

FIRST USE 0-0-2005; IN COMMERCE 0-0-2005.

**PRINCIPAL REGISTER**

THE MARK CONSISTS OF STANDARD CHARACTERS WITHOUT CLAIM TO ANY PARTICULAR FONT, STYLE, SIZE, OR COLOR.

NO CLAIM IS MADE TO THE EXCLUSIVE RIGHT TO USE "THE SPA", APART FROM THE MARK AS SHOWN.

THE ENGLISH TRANSLATION OF THE WORD "ASPIRA" IN THE MARK IS "INFUSED WITH SPIRIT".

SER. NO. 85-373,639, FILED 7-18-2011.

LINDA POWELL, EXAMINING ATTORNEY



*David J. Kyjars*

Director of the United States Patent and Trademark Office

# United States of America

United States Patent and Trademark Office

# SoftSelect

**Reg. No. 4,124,948**

**Registered Apr. 10, 2012**

**Int. Cl.: 42**

**SERVICE MARK**

**PRINCIPAL REGISTER**

ENGLEMAN ASSOCIATES, INC. (WASHINGTON CORPORATION)  
WWW.SOFTSELECT.COM  
607 E. RESERVE STREET  
VANCOUVER, WA 98661

FOR: BUSINESS TECHNOLOGY SOFTWARE CONSULTATION SERVICES; COMPUTER HARDWARE AND SOFTWARE CONSULTING SERVICES; COMPUTER SOFTWARE CONSULTANCY; COMPUTER SOFTWARE CONSULTING, IN CLASS 42 (U.S. CLS. 100 AND 101).

FIRST USE 12-1-1996; IN COMMERCE 12-1-1996.

THE MARK CONSISTS OF STANDARD CHARACTERS WITHOUT CLAIM TO ANY PARTICULAR FONT, STYLE, SIZE, OR COLOR.

SEC. 2(F).

SER. NO. 85-373,642, FILED 7-18-2011.

H. M. FISHER, EXAMINING ATTORNEY



*David J. Kyfos*

Director of the United States Patent and Trademark Office



# United States of America

United States Patent and Trademark Office

## Lobby For The Silent Majority

**Reg. No. 4,124,949**

LOBBY FOR THE SILENT MAJORITY, INC (FLORIDA CORPORATION)  
9191 R G SKINNER PARKWAY  
SUITE 501, FL 32256

**Registered Apr. 10, 2012**

**Int. Cl.: 35**

FOR: LOBBYING SERVICES, NAMELY, PROMOTING THE INTERESTS OF THE ORGANIZATION'S MEMBERSHIP WHO RESIDE IN STATES WHERE THE ORGANIZATION OPERATES IN THE FIELDS OF ECONOMIC OR BUSINESS RELATED LEGISLATION, IN CLASS 35 (U.S. CLS. 100, 101 AND 102).

**SERVICE MARK**

**PRINCIPAL REGISTER**

FIRST USE 6-20-2011; IN COMMERCE 6-20-2011.

THE MARK CONSISTS OF STANDARD CHARACTERS WITHOUT CLAIM TO ANY PARTICULAR FONT, STYLE, SIZE, OR COLOR.

NO CLAIM IS MADE TO THE EXCLUSIVE RIGHT TO USE "LOBBY", APART FROM THE MARK AS SHOWN.

SER. NO. 85-373,681, FILED 7-18-2011.

DANNEAN HETZEL, EXAMINING ATTORNEY



*David J. Kyffers*

Director of the United States Patent and Trademark Office

# United States of America

United States Patent and Trademark Office

*L'école de la Maison*

**Reg. No. 4,124,950**

OSTHOFF MANAGEMENT CORP. (WISCONSIN CORPORATION)

**Registered Apr. 10, 2012**

101 OSTHOFF AVENUE  
ELKHART LAKE, WI 53020

**Int. Cl.: 41**

FOR: EDUCATION SERVICES, NAMELY, PROVIDING CLASSES, SEMINARS AND WORKSHOPS IN THE FIELD OF CULINARY ARTS, IN CLASS 41 (U.S. CLS. 100, 101 AND 107).

**SERVICE MARK**

FIRST USE 9-0-2008; IN COMMERCE 9-0-2008.

**PRINCIPAL REGISTER**

THE MARK CONSISTS OF THE WORDS "L'ECOLE DE LA MAISON" IN A SCRIPT FONT ON THE FIRST LINE; A FREE SCROLL DESIGN ON THE SECOND LINE.

SER. NO. 85-373,723, FILED 7-18-2011.

LINDA POWELL, EXAMINING ATTORNEY



*David J. Kybas*

Director of the United States Patent and Trademark Office

# United States of America

United States Patent and Trademark Office



**Reg. No. 4,124,951**

**Registered Apr. 10, 2012**

**Int. Cl.: 33**

**TRADEMARK**

**PRINCIPAL REGISTER**

DOUGLAS POLANER SELECTIONS (NEW YORK LIMITED LIABILITY COMPANY), DBA  
POLANER SELECTIONS  
19 N. MOGER AVE  
MT. KISCO, NY 10549

FOR: GRAPE WINE; RED WINE, IN CLASS 33 (U.S. CLS. 47 AND 49).

FIRST USE 7-18-2011; IN COMMERCE 7-18-2011.

THE MARK CONSISTS OF A SHEEP CENTERED AT THE TOP OF THE DESIGN. BELOW  
THE SHEEP IS THE WORD "LURRA" IN CAPITAL LETTERS.

THE ENGLISH TRANSLATION OF "LURRA" IN THE MARK IS "EARTH".

SER. NO. 85-373,801, FILED 7-18-2011.

SHAUNIA CARLYLE, EXAMINING ATTORNEY



*David J. Kyffers*

Director of the United States Patent and Trademark Office

# United States of America

United States Patent and Trademark Office

## HEARTLAND CO-OP

**Reg. No. 4,124,952**

**Registered Apr. 10, 2012**

**Int. Cl.: 39**

**SERVICE MARK**

**PRINCIPAL REGISTER**

HEARTLAND CO-OP (IOWA COOPERATIVE ASSOCIATION)  
SUITE 350  
2829 WESTOWN PKY  
WEST DES MOINES, IA 50266

FOR: GRAIN STORAGE AND HAULING SERVICES, IN CLASS 39 (U.S. CLS. 100 AND 105).

FIRST USE 12-31-1987; IN COMMERCE 12-31-1987.

THE MARK CONSISTS OF STANDARD CHARACTERS WITHOUT CLAIM TO ANY PARTICULAR FONT, STYLE, SIZE, OR COLOR.

NO CLAIM IS MADE TO THE EXCLUSIVE RIGHT TO USE "CO-OP", APART FROM THE MARK AS SHOWN.

SER. NO. 85-373,819, FILED 7-18-2011.

BARBARA RUTLAND, EXAMINING ATTORNEY



*David J. Kyffers*

Director of the United States Patent and Trademark Office

# United States of America

United States Patent and Trademark Office

## HIKE THE HILL

**Reg. No. 4,124,953**

AMERICAN HIKING SOCIETY (VIRGINIA CORPORATION)  
1422 FENWICK LANE  
SILVER SPRING, MD 20910

**Registered Apr. 10, 2012**

**Int. Cls.: 35, 41 and 42**

FOR: PROMOTING PUBLIC AWARENESS ABOUT HIKING AND RELATED OUTDOOR ACTIVITIES BY HOSTING A SERIES OF EVENTS RELATING TO THE OUTDOORS , IN CLASS 35 (U.S. CLS. 100, 101 AND 102).

**SERVICE MARK**

FIRST USE 6-0-1997; IN COMMERCE 6-0-1997.

**PRINCIPAL REGISTER**

FOR: CONDUCTING EDUCATIONAL WORKSHOPS AND EXHIBITIONS IN THE NATURE OF WEEK LONG SERIES OF EVENTS TO PROMOTE AND ENCOURAGE CIVIC, ELECTORAL, OR POLITICAL ENGAGEMENT AND PARTICIPATION RELATED TO TRAIL ADVOCACY AND OUR NATIONAL SYSTEM OF TRAILS; PROVIDING INFORMATION, NEWS AND COMMENTARY IN THE FIELD OF CURRENT EVENTS RELATING TO TRAIL ADVOCACY AND OUR NATIONAL SYSTEM OF TRAILS, IN CLASS 41 (U.S. CLS. 100, 101 AND 107).

FIRST USE 6-0-1997; IN COMMERCE 6-0-1997.

FOR: CREATING AN ON-LINE COMMUNITY FOR TRAIL ADVOCATES FOR THE PURPOSE OF PARTICIPATING, PROMOTING AND ENCOURAGING CIVIC, ELECTORAL, OR POLITICAL ENGAGEMENT AND PARTICIPATION RELATED TO TRAIL ADVOCACY AND OUR NATIONAL SYSTEM OF TRAILS, IN CLASS 42 (U.S. CLS. 100 AND 101).

FIRST USE 6-0-1997; IN COMMERCE 6-0-1997.

THE MARK CONSISTS OF STANDARD CHARACTERS WITHOUT CLAIM TO ANY PARTICULAR FONT, STYLE, SIZE, OR COLOR.

SER. NO. 85-373,829, FILED 7-18-2011.

MATTHEW EINSTEIN, EXAMINING ATTORNEY



*David J. Kyffers*

Director of the United States Patent and Trademark Office

# United States of America

United States Patent and Trademark Office



vergence

**Reg. No. 4,124,954**

**Registered Apr. 10, 2012**

**Int. Cl.: 9**

**TRADEMARK**

**PRINCIPAL REGISTER**

CUI GLOBAL, INC. (COLORADO CORPORATION)  
546 19 AVENUE NE  
ST. PETERSBURG, FL 33704

FOR: A DEVICE COMMONLY REFERRED TO AS AN ELECTRONIC NATURAL GAS INFERENTIAL METER THAT MEASURES NATURAL GAS PHYSICAL QUALITY PROPERTIES SUCH AS THERMAL CONDUCTIVITY, SPEED OF SOUND AND CARBON DIOXIDE CONTENT. FROM THESE MEASUREMENTS IT INFERS AN EFFECTIVE GAS MIXTURE COMPRISING FOUR COMPONENTS: METHANE, PROPANE, NITROGEN, AND MEASURED CARBON DIOXIDE, IN CLASS 9 (U.S. CLS. 21, 23, 26, 36 AND 38).

FIRST USE 7-1-2011; IN COMMERCE 7-5-2011.

THE MARK CONSISTS OF THE TERM "VERGENCE" IN GRAY, WITH THREE THICK VERTICAL STRAIGHT LINE ELEMENTS IN VARIOUS LENGTHS SPACED IN THE CENTER ABOVE; THE FIRST IS THE LONGEST IN BLUE, THE SECOND THE SHORTEST IN GRAY, AND THE THIRD MID-LENGTH IN LIGHT BLUE.

THE COLOR(S) BLUE, GRAY AND LIGHT BLUE IS/ARE CLAIMED AS A FEATURE OF THE MARK.

SER. NO. 85-373,927, FILED 7-18-2011.

WILLIAM P. SHANAHAN, EXAMINING ATTORNEY



*David J. Kyffers*

Director of the United States Patent and Trademark Office

# United States of America

United States Patent and Trademark Office



**Reg. No. 4,124,955**

**Registered Apr. 10, 2012**

**Int. Cls.: 41 and 42**

**SERVICE MARK**

**PRINCIPAL REGISTER**

INTERNATIONAL ELECTRICAL TESTING ASSOCIATION (WISCONSIN CORPORATION)  
SUITE 102  
3050 OLD CENTRE AVENUE  
PORTAGE, MI 49024

FOR: ARRANGING AND CONDUCTING EDUCATIONAL EXHIBITIONS, SEMINARS, AND CONFERENCES IN THE FIELD OF ELECTRICAL TESTING, IN CLASS 41 (U.S. CLS. 100, 101 AND 107).

FIRST USE 7-12-2011; IN COMMERCE 7-12-2011.

FOR: ACCREDITATION SERVICES, NAMELY, DEVELOPING, EVALUATING, AND TESTING STANDARDS FOR ELECTRICAL INDUSTRY FOR THE PURPOSE OF ACCREDITATION, IN CLASS 42 (U.S. CLS. 100 AND 101).

FIRST USE 7-12-2011; IN COMMERCE 7-12-2011.

OWNER OF U.S. REG. NOS. 3,434,851 AND 3,434,852.

THE MARK CONSISTS OF THE STYLIZED LETTERS, "NETA", SUPERIMPOSED ON TOP OF A CIRCULAR BORDER COMPRISED OF TWO LINES, ONE THICK AND ONE THIN. THE TOP HALF OF THE CIRCLE BEGINS ABOVE THE LETTER, "N", AND ENDS AT THE LETTER, "A"; THE BOTTOM HALF OF THE CIRCLE BEGINS UNDERNEATH THE LETTER, "A", AND ENDS UNDERNEATH THE LETTER, "N".

SER. NO. 85-373,981, FILED 7-18-2011.

HENRY S. ZAK, EXAMINING ATTORNEY



*David J. Kyjars*

Director of the United States Patent and Trademark Office

# United States of America

United States Patent and Trademark Office

# NETA

**Reg. No. 4,124,956**

**Registered Apr. 10, 2012**

**Int. Cls.: 41 and 42**

**SERVICE MARK**

**PRINCIPAL REGISTER**

INTERNATIONAL ELECTRICAL TESTING ASSOCIATION (WISCONSIN CORPORATION)  
SUITE 102  
3050 OLD CENTRE AVENUE  
PORTAGE, MI 49024

FOR: ARRANGING AND CONDUCTING EDUCATIONAL EXHIBITIONS, SEMINARS, AND CONFERENCES IN THE FIELD OF ELECTRICAL TESTING, IN CLASS 41 (U.S. CLS. 100, 101 AND 107).

FIRST USE 7-12-2011; IN COMMERCE 7-12-2011.

FOR: ACCREDITATION SERVICES, NAMELY, DEVELOPING, EVALUATING, AND TESTING STANDARDS FOR ELECTRICAL INDUSTRY FOR THE PURPOSE OF ACCREDITATION, IN CLASS 42 (U.S. CLS. 100 AND 101).

FIRST USE 7-12-2011; IN COMMERCE 7-12-2011.

OWNER OF U.S. REG. NOS. 3,434,851 AND 3,434,852.

THE MARK CONSISTS OF THE STYLIZED LETTERS, "NETA".

SER. NO. 85-374,020, FILED 7-18-2011.

HENRY S. ZAK, EXAMINING ATTORNEY



*David J. Kyjars*

Director of the United States Patent and Trademark Office



# United States of America

United States Patent and Trademark Office

# Hair Hookup's

**Reg. No. 4,124,957**

HAIR HOOKUP'S, LLC (CALIFORNIA LIMITED LIABILITY COMPANY)  
27 BOWER LANE

**Registered Apr. 10, 2012**

LADERA RANCH, CA 92694

**Int. Cl.: 35**

FOR: REFERRALS IN THE FIELD OF HAIR STYLISTS, NAMELY, AN ONLINE SERVICE WHEREIN HAIR PROFESSIONALS GET CONNECTED WITH EXISTING AND PROSPECTIVE CLIENTS IN NEED OF PROFESSIONAL SERVICE AND ADVICE ON A WEBSITE WHICH INCORPORATES A REFERRAL SYSTEM, SOCIAL NETWORKING, COUPONS AND SPECIALS, ONLINE RETAIL STORE SERVICES FEATURING HAIR PRODUCTS AND SUPPLIES, BLOGS, QUESTION AND ANSWER FORUMS AS WELL AS LEAD GENERATION FOR STYLISTS, IN CLASS 35 (U.S. CLS. 100, 101 AND 102).

**SERVICE MARK**

**PRINCIPAL REGISTER**

FIRST USE 5-25-2011; IN COMMERCE 7-16-2011.

THE MARK CONSISTS OF STANDARD CHARACTERS WITHOUT CLAIM TO ANY PARTICULAR FONT, STYLE, SIZE, OR COLOR.

NO CLAIM IS MADE TO THE EXCLUSIVE RIGHT TO USE "HAIR", APART FROM THE MARK AS SHOWN.

SER. NO. 85-374,021, FILED 7-18-2011.

JAMES A. RAUEN, EXAMINING ATTORNEY



*David J. Kybas*

Director of the United States Patent and Trademark Office

United States of America  
United States Patent and Trademark Office

**POWERTEST**  
CONFERENCE

**Reg. No. 4,124,958**

**Registered Apr. 10, 2012**

**Int. Cl.: 41**

**SERVICE MARK**

**PRINCIPAL REGISTER**

INTERNATIONAL ELECTRICAL TESTING ASSOCIATION (WISCONSIN CORPORATION)  
SUITE 102  
3050 OLD CENTRE AVENUE  
PORTAGE, MI 49024

FOR: ARRANGING AND CONDUCTING EDUCATIONAL EXHIBITIONS, SEMINARS, AND  
CONFERENCES IN THE FIELD OF ELECTRICAL TESTING, IN CLASS 41 (U.S. CLS. 100,  
101 AND 107).

FIRST USE 7-12-2011; IN COMMERCE 7-12-2011.

OWNER OF U.S. REG. NO. 3,172,589.

NO CLAIM IS MADE TO THE EXCLUSIVE RIGHT TO USE "CONFERENCE", APART FROM  
THE MARK AS SHOWN.

THE MARK CONSISTS OF THE WORD, "POWERTEST", WITH A STYLIZED LETTER "O"  
REPRESENTING AN ELECTRICAL ARC, ABOVE THE WORD, "CONFERENCE".

SER. NO. 85-374,069, FILED 7-18-2011.

HENRY S. ZAK, EXAMINING ATTORNEY



*David J. Kybas*

Director of the United States Patent and Trademark Office

# United States of America

United States Patent and Trademark Office

# GOVPAYNET

**Reg. No. 4,124,959**

**Registered Apr. 10, 2012**

**Int. Cl.: 36**

**SERVICE MARK**

**PRINCIPAL REGISTER**

GOVERNMENT PAYMENT SERVICE, INC. (DELAWARE CORPORATION)  
7102 LAKEVIEW PARKWAY DRIVE WEST  
INDIANAPOLIS, IN 46268

FOR: ELECTRONIC PAYMENT SERVICES, NAMELY, PROVIDING ELECTRONIC TRANSMISSION AND PROCESSING OF FINANCIAL TRANSACTIONS BETWEEN INDIVIDUALS AND GOVERNMENT ENTITIES, AND PROVIDING A SECURE, WEB-BASED SERVICE ENABLING USERS TO MAKE PAYMENTS TO GOVERNMENT ENTITIES, IN CLASS 36 (U.S. CLS. 100, 101 AND 102).

FIRST USE 6-1-2010; IN COMMERCE 6-1-2010.

THE MARK CONSISTS OF STANDARD CHARACTERS WITHOUT CLAIM TO ANY PARTICULAR FONT, STYLE, SIZE, OR COLOR.

OWNER OF U.S. REG. NOS. 3,955,981 AND 4,054,049.

SER. NO. 85-374,076, FILED 7-18-2011.

HENRY S. ZAK, EXAMINING ATTORNEY



*David J. Kybas*

Director of the United States Patent and Trademark Office

# United States of America

United States Patent and Trademark Office



**Reg. No. 4,124,960**

**Registered Apr. 10, 2012**

**Int. Cl.: 35**

**SERVICE MARK**

**PRINCIPAL REGISTER**

AMERICAN HOSPITAL ASSOCIATION (ILLINOIS NON-PROFIT CORPORATION)  
155 N. WACKER DR., SUITE 400  
CHICAGO, IL 60606

FOR: ASSOCIATION SERVICES, NAMELY, PROMOTING THE INTERESTS OF HEALTHCARE PROVIDERS AND HEALTHCARE SERVICE PROVIDERS AND FOSTERING THE OPERATIONS OF HOSPITALS, HEALTHCARE PROVIDERS AND HEALTHCARE SERVICE PROVIDERS THROUGH A VARIETY OF SERVICES, RESEARCH AND EDUCATION, IN CLASS 35 (U.S. CLS. 100, 101 AND 102).

FIRST USE 1-1-2004; IN COMMERCE 1-1-2004.

OWNER OF U.S. REG. NOS. 3,002,387 AND 3,032,690.

THE MARK CONSISTS OF SHADED SQUARE WITH BORDER AND CURVED SIDES. INSIDE SQUARE IS BLOCK "H". TWO SHADED WAVY BANDS AND ONE WAVY NON-SHADED BAND EXTEND FROM SQUARE TO THE RIGHT. ONE SHADED WAVY BAND AND ONE WAVY NON-SHADED BAND BELOW SQUARE EXTEND TO THE RIGHT.

SER. NO. 85-374,088, FILED 7-18-2011.

ROSELLE HERRERA, EXAMINING ATTORNEY



*David J. Kyffers*

Director of the United States Patent and Trademark Office

# United States of America

United States Patent and Trademark Office

## STATIC PULSE

**Reg. No. 4,124,961**

LG CORP. (REPUBLIC OF KOREA CORPORATION)  
20 YOIDO-DONG YOUNGDUNGPO-GU  
SEOUL, REPUBLIC OF KOREA

**Registered Apr. 10, 2012**

**Int. Cl.: 19**

FOR: VINYL TILE FOR FLOOR COVERINGS PREVENTING STATIC ELECTRICITY, IN CLASS 19 (U.S. CLS. 1, 12, 33 AND 50).

**TRADEMARK**

FIRST USE 1-1-2010; IN COMMERCE 1-1-2010.

**PRINCIPAL REGISTER**

THE MARK CONSISTS OF STANDARD CHARACTERS WITHOUT CLAIM TO ANY PARTICULAR FONT, STYLE, SIZE, OR COLOR.

OWNER OF U.S. REG. NO. 2,991,591.

NO CLAIM IS MADE TO THE EXCLUSIVE RIGHT TO USE "STATIC", APART FROM THE MARK AS SHOWN.

SER. NO. 85-374,147, FILED 7-18-2011.

RONALD AIKENS, EXAMINING ATTORNEY



*David J. Kyffers*

Director of the United States Patent and Trademark Office

# United States of America

United States Patent and Trademark Office



**Reg. No. 4,124,962**

**Registered Apr. 10, 2012**

**Int. Cl.: 41**

**SERVICE MARK**

**PRINCIPAL REGISTER**

LONGVIEW INDEPENDENT SCHOOL DISTRICT (TEXAS BODY POLITIC AND CORPORATE)  
1301 E. YOUNG ST.  
LONGVIEW, TX 75602

FOR: EDUCATIONAL SERVICES, NAMELY, PROVIDING COURSES OF INSTRUCTION AT THE HIGH SCHOOL LEVEL; ENTERTAINMENT IN THE NATURE OF COMPETITIONS IN THE FIELD OF HIGH SCHOOL ATHLETICS, LIVE BAND AND THEATER PERFORMANCES, IN CLASS 41 (U.S. CLS. 100, 101 AND 107).

FIRST USE 12-31-1996; IN COMMERCE 8-1-1997.

THE MARK CONSISTS OF AN UPPER CASE "L" STYLIZED IN THE GENERAL SHAPE OF A ROCKING CHAIR IN GREEN WITH AN INLAY OF YELLOW.

THE COLOR(S) GREEN AND YELLOW IS/ARE CLAIMED AS A FEATURE OF THE MARK.

SER. NO. 85-374,235, FILED 7-18-2011.

MIDGE BUTLER, EXAMINING ATTORNEY



*David J. Kyffers*

Director of the United States Patent and Trademark Office

# United States of America

United States Patent and Trademark Office

# Phoenix Hart

**Reg. No. 4,124,963**

WILLIAMS, JENNIFER (UNITED STATES INDIVIDUAL)  
134 NORTHSTAR CT.  
MURPHY, TX 75094

**Registered Apr. 10, 2012**

**Int. Cl.: 41**

FOR: ENTERTAINMENT SERVICES IN THE NATURE OF LIVE MUSICAL PERFORMANCES,  
IN CLASS 41 (U.S. CLS. 100, 101 AND 107).

**SERVICE MARK**

FIRST USE 12-1-2007; IN COMMERCE 6-1-2009.

**PRINCIPAL REGISTER**

THE MARK CONSISTS OF STANDARD CHARACTERS WITHOUT CLAIM TO ANY PARTICULAR FONT, STYLE, SIZE, OR COLOR.

THE NAME "PHOENIX HART" IDENTIFIES THE STAGE NAME OF JENNIFER WILLIAMS, A LIVING INDIVIDUAL, WHOSE CONSENT IS OF RECORD.

SER. NO. 85-374,279, FILED 7-18-2011.

MEGHAN REINHART, EXAMINING ATTORNEY



*David J. Kyjars*

Director of the United States Patent and Trademark Office

# United States of America

United States Patent and Trademark Office



**Reg. No. 4,124,964**

**Registered Apr. 10, 2012**

**Int. Cl.: 37**

**SERVICE MARK**

**PRINCIPAL REGISTER**

CURE-A-DENT, INC. (TEXAS CORPORATION)  
3905 POTOMAC AVE.  
FORT WORTH, TX 76107

FOR: AUTO HAIL REPAIR; VEHICLE HAIL REPAIR SERVICES; AUTOMOTIVE HAIL REPAIR SERVICES; PAINTLESS DENT REPAIR SERVICES FOR VEHICLES, IN CLASS 37 (U.S. CLS. 100, 103 AND 106).

FIRST USE 1-1-2010; IN COMMERCE 3-10-2010.

THE STIPLING IS FOR SHADING PURPOSES ONLY.

THE MARK CONSISTS OF AN OVAL GRADIENT WITH A BORDER, WITH A VEHICLE AND HAIL STONES FALLING IN THE MIDDLE OF THE GRADIENT, AND THE TEXT "CURE-A-DENT" BELOW THE VEHICLE.

SER. NO. 85-374,295, FILED 7-18-2011.

LINDA M. KING, EXAMINING ATTORNEY



*David J. Kyffers*

Director of the United States Patent and Trademark Office



# United States of America

United States Patent and Trademark Office



**Reg. No. 4,124,965**

MACOUZET DEL MORAL, RENE EDMUNDO (MEXICO INDIVIDUAL)  
CARR. A BARRETOS KM. 4.5  
LEON, MEXICO

**Registered Apr. 10, 2012**

**Int. Cl.: 31**

FOR: (BASED ON USE IN COMMERCE) FRESH FRUITS; FRESH VEGETABLES (BASED ON 44(E)) FRESH FRUITS; FRESH VEGETABLES, IN CLASS 31 (U.S. CLS. 1 AND 46).

**TRADEMARK**

FIRST USE 10-10-2003; IN COMMERCE 6-28-2010.

**PRINCIPAL REGISTER**

OWNER OF MEXICO REG. NO. 828170, DATED 3-31-2004, EXPIRES 2-6-2014.

THE MARK CONSISTS OF THE TEXT "MACU" IN STYLIZED LETTERS FOLLOWED BY A THREE-LEAFLET SILHOUETTE INSIDE AN OVAL. THE MARK INCLUDES THE SILHOUETTE OF A MOUNTAIN BEHIND THE TEXT.

THE WORDING "MACU" HAS NO MEANING IN A FOREIGN LANGUAGE.

SER. NO. 85-374,304, FILED 7-18-2011.

LINDA MICKLEBURGH, EXAMINING ATTORNEY



*David J. Kybas*

Director of the United States Patent and Trademark Office

# United States of America

United States Patent and Trademark Office



**Reg. No. 4,124,966**

**Registered Apr. 10, 2012**

**Int. Cl.: 41**

**SERVICE MARK**

**PRINCIPAL REGISTER**

COHEN, DEBORAH R (UNITED STATES INDIVIDUAL), DBA CORE YOGA  
71 WALDEN ST #2  
CAMBRIDGE, MA 02140

FOR: YOGA INSTRUCTION, IN CLASS 41 (U.S. CLS. 100, 101 AND 107).

FIRST USE 1-1-2002; IN COMMERCE 2-9-2002.

NO CLAIM IS MADE TO THE EXCLUSIVE RIGHT TO USE "YOGA", APART FROM THE MARK AS SHOWN.

THE COLOR(S) BLACK, DARK BLUE, LIGHT BLUE IS/ARE CLAIMED AS A FEATURE OF THE MARK.

THE MARK CONSISTS OF THE WORDS "CORE YOGA" IN THE COLOR BLACK ABOVE A BLACK SILHOUETTE IN PROFILE OF A HUMAN FIGURE BALANCED ON ONE LEG WITH THE OTHER LEG STRETCHED HORIZONTALLY TO THE LEFT AND THE HEAD AND ARMS OUTSTRETCHED TO THE RIGHT. THE WORDS AND FIGURE ARE SURROUNDED ON THE RIGHT SIDE BY A LIGHT BLUE SWIRL, AND OUTSIDE THAT ON THE LEFT, BY A DARK BLUE SWIRL.

SEC. 2(F).

SER. NO. 85-374,367, FILED 7-18-2011.

JAY FLOWERS, EXAMINING ATTORNEY



*David J. Kyros*

Director of the United States Patent and Trademark Office

# United States of America

United States Patent and Trademark Office

# POLEBILL

**Reg. No. 4,124,967**

**Registered Apr. 10, 2012**

**Int. Cl.: 41**

**SERVICE MARK**

**PRINCIPAL REGISTER**

POLE SPORT ENTERPRISE, INC. (NEW YORK CORPORATION)  
205 EAST 16TH STREET SUITE 3B  
NEW YORK, NY 10003

FOR: PROVIDING INFORMATION ON AERIAL ACTS, POLE DANCING AND POLE FITNESS EVENTS, ENTERTAINMENT, POLE DANCING AND POLE FITNESS PRODUCT AND SERVICE REVIEWS, NEWS AND INFORMATION ON OTHER AERIAL ACTS, POLE DANCING AND POLE FITNESS RELATED SUBJECTS VIA GLOBAL AND LOCAL COMMUNICATIONS NETWORKS; ENTERTAINMENT, NAMELY, PROVIDING AERIAL ACTS, POLE DANCING AND POLE FITNESS PERFORMANCES OF INDIVIDUALS OR GROUPS AND PERFORMANCES AND APPEARANCES BY AERIAL ACTS, POLE DANCING AND POLE FITNESS RELATED INDIVIDUALS AND GROUPS, DISTRIBUTED VIA GLOBAL AND LOCAL COMMUNICATIONS NETWORKS; PROVIDING ENTERTAINMENT SERVICES, IN THE NATURE OF AERIAL ACTS, POLE DANCING AND POLE FITNESS PRODUCTIONS AND PRODUCTIONS OF AUDIO AND VIDEO RECORDED PERFORMANCES BY AN INDIVIDUAL AND/OR GROUP VIA GLOBAL AND LOCAL COMMUNICATIONS NETWORKS, PRODUCTION OF PERSONAL APPEARANCES OF CELEBRITY INDIVIDUAL AND/OR GROUPS IN THE AERIAL ACTS, POLE DANCING AND POLE FITNESS RELATED FIELD; PROVIDING AERIAL ACTS, POLE DANCING AND POLE FITNESS EVENT LISTINGS; ARRANGING FOR TICKET RESERVATIONS FOR SHOWS AND OTHER ENTERTAINMENT EVENTS; ELECTRONIC PUBLISHING SERVICES, NAMELY, PUBLICATION OF TEXT, GRAPHIC, VIDEO, AUDIO AND MULTIMEDIA WORKS ON AERIAL ACTS, POLE DANCING AND POLE FITNESS-RELATED SUBJECTS VIA GLOBAL AND LOCAL COMMUNICATIONS NETWORKS; ARRANGING AND CONDUCTING AERIAL ACTS, POLE DANCING AND POLE FITNESS RELATED COMPETITIONS AND SWEEPSTAKES, IN CLASS 41 (U.S. CLS. 100, 101 AND 107).



FIRST USE 6-30-2011; IN COMMERCE 6-30-2011.

THE MARK CONSISTS OF STANDARD CHARACTERS WITHOUT CLAIM TO ANY PARTICULAR FONT, STYLE, SIZE, OR COLOR.

SER. NO. 85-374,478, FILED 7-18-2011.

JORDAN BAKER, EXAMINING ATTORNEY

*David J. Kypos*

Director of the United States Patent and Trademark Office

# United States of America

United States Patent and Trademark Office

## TCM TURNER CLASSIC MOVIES

**Reg. No. 4,124,968**

**Registered Apr. 10, 2012**

**Int. Cl.: 9**

**TRADEMARK**

**PRINCIPAL REGISTER**

TURNER CLASSIC MOVIES, INC. (DELAWARE CORPORATION)  
1050 TECHWOOD DRIVE, NW  
ATLANTA, GA 30318

FOR: DOWNLOADABLE SOFTWARE IN THE NATURE OF A MOBILE APPLICATION FOR DOWNLOADING CLASSIC FILMS TO MOBILE DEVICES, IN CLASS 9 (U.S. CLS. 21, 23, 26, 36 AND 38).

FIRST USE 12-8-2009; IN COMMERCE 12-8-2009.

THE MARK CONSISTS OF STANDARD CHARACTERS WITHOUT CLAIM TO ANY PARTICULAR FONT, STYLE, SIZE, OR COLOR.

OWNER OF U.S. REG. NOS. 2,555,350, 2,555,354 AND OTHERS.

NO CLAIM IS MADE TO THE EXCLUSIVE RIGHT TO USE "CLASSIC MOVIES", APART FROM THE MARK AS SHOWN.

SER. NO. 85-374,590, FILED 7-19-2011.

PATRICIA EVANKO, EXAMINING ATTORNEY



*David J. Kybas*

Director of the United States Patent and Trademark Office

# United States of America

United States Patent and Trademark Office



**Reg. No. 4,124,969**

**Registered Apr. 10, 2012**

**Int. Cl.: 41**

**SERVICE MARK**

**PRINCIPAL REGISTER**

PEDIATRIC NURSING CERTIFICATION BOARD, INC. (MARYLAND CORPORATION)  
800 S. FREDERICK RD., SUITE 204  
GAITHERSBURG, MD 20877

FOR: ORGANIZATION OF SEMINARS, WORKING GROUPS, RESEARCH GROUPS AND CONVENTIONS, IN THE FIELD OF MEDICINE, IN CLASS 41 (U.S. CLS. 100, 101 AND 107).

FIRST USE 9-1-2010; IN COMMERCE 9-1-2010.

NO CLAIM IS MADE TO THE EXCLUSIVE RIGHT TO USE "INSTITUTE OF PEDIATRIC NURSING", APART FROM THE MARK AS SHOWN.

THE COLOR(S) GREEN, LIGHT PURPLE, DARK PURPLE, BLACK AND WHITE IS/ARE CLAIMED AS A FEATURE OF THE MARK.

THE MARK CONSISTS OF 3 WHITE CAPITAL LETTERS (I, P AND N) STACKED VERTICALLY, EACH ENCLOSED IN A RECTANGULAR BLOCK OF COLOR (I IN GREEN, P IN DARK PURPLE AND N IN LIGHT PURPLE) WITH THE REMAINDER OF THE WORDS WHICH CORRESPOND TO EACH OF THESE LETTERS IN BLACK FREESTYLE (THAT IS, NSTITUTE, EDIATRIC AND URSING). THE "OF" OF "INSTITUTE" OF "PEDIATRIC" "NURSING" IS IN LIGHT PURPLE FREESTYLE AND IS ON THE SAME HORIZONTAL PLANT AS "INSTITUTE." THE BACKGROUND FOR THE WORDS AND COLOR BLOCKS IS WHITE.

SER. NO. 85-374,728, FILED 7-19-2011.

INGRID C. EULIN, EXAMINING ATTORNEY



*David J. Kyjars*

Director of the United States Patent and Trademark Office

United States of America  
United States Patent and Trademark Office

OMNIMMP

**Reg. No. 4,124,970**

ENZO LIFE SCIENCES, INC. (NEW YORK CORPORATION)  
10 EXECUTIVE BLVD  
FARMINGDALE, NY 11735

**Registered Apr. 10, 2012**

**Int. Cl.: 1**

FOR: FLUOROGENIC PEPTIDE SUBSTRATE FOR SCIENTIFIC RESEARCH USE, IN CLASS 1 (U.S. CLS. 1, 5, 6, 10, 26 AND 46).

**TRADEMARK**

FIRST USE 6-15-2008; IN COMMERCE 6-15-2008.

**PRINCIPAL REGISTER**

THE MARK CONSISTS OF STANDARD CHARACTERS WITHOUT CLAIM TO ANY PARTICULAR FONT, STYLE, SIZE, OR COLOR.

SER. NO. 85-374,739, FILED 7-19-2011.

ELLEN B. AWRICH, EXAMINING ATTORNEY



*David J. Kybas*

Director of the United States Patent and Trademark Office

# United States of America

United States Patent and Trademark Office

enjoy

**Reg. No. 4,124,971**

**Registered Apr. 10, 2012**

**Int. Cl.: 30**

**TRADEMARK**

**PRINCIPAL REGISTER**

ENJOY, INC. (NEW YORK CORPORATION)  
401 2ND AVENUE, #26-D  
NEW YORK, NY 10010

FOR: BAKERY GOODS, IN CLASS 30 (U.S. CL. 46).

FIRST USE 1-1-2010; IN COMMERCE 6-8-2010.

OWNER OF U.S. REG. NO. 4,023,620.

THE MARK CONSISTS OF THE WORD "ENJOY" IN LOWER CASE LETTERS IN GAR-  
MOND TYPE FACE.

SER. NO. 85-374,806, FILED 7-19-2011.

THOMAS MANOR, EXAMINING ATTORNEY



*David J. Kybas*

Director of the United States Patent and Trademark Office

# United States of America

United States Patent and Trademark Office



**Reg. No. 4,124,972**

FORMULA X2 CORP. (FLORIDA CORPORATION)  
1105 EMMETT STREET  
KISSIMMEE, FL 34741

**Registered Apr. 10, 2012**

**Int. Cl.: 1**

FOR: CHEMICAL ADDITIVES FOR FUEL TREATMENT, IN CLASS 1 (U.S. CLS. 1, 5, 6, 10, 26 AND 46).

**TRADEMARK**

FIRST USE 8-0-2010; IN COMMERCE 8-0-2010.

**PRINCIPAL REGISTER**

NO CLAIM IS MADE TO THE EXCLUSIVE RIGHT TO USE "FORMULA" AND "FUEL ADDITIVE", APART FROM THE MARK AS SHOWN.

THE COLOR(S) BLACK, WHITE, RED, GRAY, BLUE IS/ARE CLAIMED AS A FEATURE OF THE MARK.

THE MARK CONSISTS OF THE WORDS "FORMULA X2 FINALLY A FUEL ADDITIVE THAT REALLY WORKS WE CAN PROVE IT!" THE WORD "FORMULA" AND LETTER "X" ARE PRESENTED IN A STYLIZED BLACK FONT AND HAVE A WHITE AND GRAY OUTLINE. THE NUMBER "2" IS PRESENTED TO LEFT OF THE "X" AND IS IN A RED FONT AND IS OUTLINED IN WHITE AND GRAY. BELOW "FORMULA X2" ARE THE WORDS "FINALLY A FUEL ADDITIVE THAT REALLY WORKS". "FINALLY" IS PRESENTED IN A RED FONT AND IS OUTLINED IN GRAY. THE WORDS "A FUEL ADDITIVE THAT REALLY WORKS" ARE PRESENTED IN A BLUE AND WHITE FONT. BLUE IS ON THE OUTSIDE OF THE WORDS AND WHITE ON THE INSIDE. BELOW "A FUEL ADDITIVE THAT REALLY WORKS" IN ALL CAPITAL LETTERS ARE THE WORDS "WE CAN PROVE IT!" IN A STYLIZED RED FONT.



SER. NO. 85-374,809, FILED 7-19-2011.

PAUL MORENO, EXAMINING ATTORNEY

*David J. Kybas*

Director of the United States Patent and Trademark Office



# United States of America

United States Patent and Trademark Office

## MORELIA MEXICAN GRILL

**Reg. No. 4,124,973**

UNICO EN SABORES, INC. (TEXAS CORPORATION)  
920 PALM VILLEY BLVD.  
ROUND ROCK, TX 78664

**Registered Apr. 10, 2012**

**Int. Cl.: 43**

FOR: RESTAURANT AND BAR SERVICES FEATURING TEX-MEX CUISINE, IN CLASS 43 (U.S. CLS. 100 AND 101).

**SERVICE MARK**

FIRST USE 7-1-2009; IN COMMERCE 7-1-2009.

**PRINCIPAL REGISTER**

THE MARK CONSISTS OF STANDARD CHARACTERS WITHOUT CLAIM TO ANY PARTICULAR FONT, STYLE, SIZE, OR COLOR.

NO CLAIM IS MADE TO THE EXCLUSIVE RIGHT TO USE "MEXICAN GRILL", APART FROM THE MARK AS SHOWN.

SER. NO. 85-374,823, FILED 7-19-2011.

MICHAEL TANNER, EXAMINING ATTORNEY



*David J. Kybas*

Director of the United States Patent and Trademark Office

# United States of America

United States Patent and Trademark Office

## SWEET SLICE

**Reg. No. 4,124,974**

**Registered Apr. 10, 2012**

**Int. Cl.: 29**

**TRADEMARK**

**PRINCIPAL REGISTER**

FRANK BRUNCKHORST CO., L.L.C. (NEW YORK LIMITED LIABILITY COMPANY)  
24 ROCK STREET  
BROOKLYN, NY 11206

FOR: UNSLICED PROCESSED MEAT, IN CLASS 29 (U.S. CL. 46).

FIRST USE 11-18-1988; IN COMMERCE 11-18-1988.

THE MARK CONSISTS OF STANDARD CHARACTERS WITHOUT CLAIM TO ANY PARTICULAR FONT, STYLE, SIZE, OR COLOR.

OWNER OF U.S. REG. NO. 1,601,149.

NO CLAIM IS MADE TO THE EXCLUSIVE RIGHT TO USE "SWEET", APART FROM THE MARK AS SHOWN.

SER. NO. 85-374,826, FILED 7-19-2011.

MICHAEL TANNER, EXAMINING ATTORNEY



*David J. Kyffers*

Director of the United States Patent and Trademark Office

# United States of America

United States Patent and Trademark Office



**Reg. No. 4,124,975**

**Registered Apr. 10, 2012**

**Int. Cl.: 29**

**TRADEMARK**

**PRINCIPAL REGISTER**

UPSTATE NIAGARA COOPERATIVE, INC. (NEW YORK CORPORATION)  
25 ANDERSON ROAD  
BUFFALO, NY 14225

FOR: COTTAGE CHEESE; SOUR CREAM; YOGURT, IN CLASS 29 (U.S. CL. 46).

FIRST USE 8-0-2010; IN COMMERCE 8-0-2010.

OWNER OF U.S. REG. NOS. 2,108,530, 3,879,796 AND OTHERS.

THE COLOR(S) BLUE, LIGHT BLUE, AND WHITE IS/ARE CLAIMED AS A FEATURE OF THE MARK.

NO CLAIM IS MADE TO THE EXCLUSIVE RIGHT TO USE "FARMS", APART FROM THE MARK AS SHOWN.

THE MARK CONSISTS OF THE WORDS "UPSTATE FARMS", APPEARING ON TWO LINES IN UPPER CASE LETTERS IN WHITE, CENTERED WITHIN A FOUR-SIDED SHAPE IN THE COLOR BLUE, FEATURING STRAIGHT LINES ON THE TOP AND SIDES AND A CURVED LINE ON THE BOTTOM, REMINISCENT OF A TAG OR LABEL. LINING IN LIGHT BLUE APPEARS ON THE SIDES AND BOTTOM OF THE BLUE SHAPE. A LIGHT BLUE CRESCENT MOON SHAPE FACING DOWN APPEARS ABOVE THE WORD "UPSTATE".

SER. NO. 85-374,867, FILED 7-19-2011.

ANTHONY RINKER, EXAMINING ATTORNEY



*David J. Kybas*

Director of the United States Patent and Trademark Office

# United States of America

United States Patent and Trademark Office

# IRON-TONE

**Reg. No. 4,124,976**

THE ESPOMA COMPANY (NEW JERSEY CORPORATION)

**Registered Apr. 10, 2012**

6 ESPOMA ROAD  
MILLVILLE, NJ 08332

**Int. Cl.: 1**

FOR: PLANT FOOD AND FERTILIZERS CONTAINING IRON, IN CLASS 1 (U.S. CLS. 1, 5, 6, 10, 26 AND 46).

**TRADEMARK**

FIRST USE 11-17-2011; IN COMMERCE 11-17-2011.

**PRINCIPAL REGISTER**

THE MARK CONSISTS OF STANDARD CHARACTERS WITHOUT CLAIM TO ANY PARTICULAR FONT, STYLE, SIZE, OR COLOR.

OWNER OF U.S. REG. NOS. 690,753, 1,087,531 AND OTHERS.

SER. NO. 85-374,951, FILED 7-19-2011.

FONG HSU, EXAMINING ATTORNEY



*David J. Kyffers*

Director of the United States Patent and Trademark Office

# United States of America

United States Patent and Trademark Office



HOME TEAM MARKETING  
UNIVERSITY

**Reg. No. 4,124,977**

**Registered Apr. 10, 2012**

**Int. Cl.: 35**

**SERVICE MARK**

**PRINCIPAL REGISTER**

HOME TEAM MARKETING (OHIO LIMITED LIABILITY COMPANY)  
812 HURON ROAD, SUITE 205  
CLEVELAND, OH 44107

FOR: PROVIDING MARKETING SERVICES TO COLLEGES AND UNIVERSITIES BY MEANS OF SIGNAGE, PA ANNOUNCEMENTS, PROGRAM ADS AND THE LIKE PROVIDED AT HIGH SCHOOL EVENTS, IN CLASS 35 (U.S. CLS. 100, 101 AND 102).

FIRST USE 6-27-2011; IN COMMERCE 6-27-2011.

NO CLAIM IS MADE TO THE EXCLUSIVE RIGHT TO USE "HOME TEAM MARKETING UNIVERSITY", APART FROM THE MARK AS SHOWN.

THE MARK CONSISTS OF A LARGE STYLIZED LETTER "U" WITH A BANNER FLOWING ACROSS IT. IN THE CENTER OF THE BANNER ARE CONCENTRIC CIRCLES WITH THE STYLIZED LETTERS "HTM" IN THE CENTER; BELOW THIS SHAPE IS THE STYLIZED WORDING "HOME TEAM MARKETING", UNDERLINED, AND THEN THE WORDING "UNIVERSITY" BELOW THAT.

SER. NO. 85-374,958, FILED 7-19-2011.

BRIAN NEVILLE, EXAMINING ATTORNEY



*David J. Kybas*

Director of the United States Patent and Trademark Office

# United States of America

United States Patent and Trademark Office

## FUNTUAL

Life is a journey, we make  
it fun.

**Reg. No. 4,124,978**

**Registered Apr. 10, 2012**

**Int. Cl.: 35**

**SERVICE MARK**

**PRINCIPAL REGISTER**

VIRTUAL ENTERTAINMENT LLC (NEVADA LIMITED LIABILITY COMPANY), DBA  
FUNTUAL.COM  
2300 W SAHARA AVE SUITE 500  
LAS VEGAS, NV 891024353

FOR: ONLINE AUCTION, IN CLASS 35 (U.S. CLS. 100, 101 AND 102).

FIRST USE 12-1-2010; IN COMMERCE 12-1-2010.

THE MARK CONSISTS OF STANDARD CHARACTERS WITHOUT CLAIM TO ANY PARTICULAR FONT, STYLE, SIZE, OR COLOR.

SER. NO. 85-374,967, FILED 7-19-2011.

KIMBERLY FRYE, EXAMINING ATTORNEY



*David J. Kyros*

Director of the United States Patent and Trademark Office

# United States of America

United States Patent and Trademark Office

## Smarter Closings

**Reg. No. 4,124,979**

**Registered Apr. 10, 2012**

**Int. Cl.: 45**

**SERVICE MARK**

**PRINCIPAL REGISTER**

MCCAFFREE-SHORT TITLE COMPANY, INC. (KANSAS CORPORATION)  
SUITE 115  
4701 COLLEGE BLVD.  
LEAWOOD, KS 66211

FOR: CLOSING SERVICES FOR MORTGAGE LOANS; PREPARING AND ORGANIZING  
LOAN CLOSING DOCUMENTS; REAL ESTATE CLOSING SERVICES; TITLE SEARCHING  
, IN CLASS 45 (U.S. CLS. 100 AND 101).

FIRST USE 1-1-2010; IN COMMERCE 1-1-2010.

THE MARK CONSISTS OF STANDARD CHARACTERS WITHOUT CLAIM TO ANY PAR-  
TICULAR FONT, STYLE, SIZE, OR COLOR.

NO CLAIM IS MADE TO THE EXCLUSIVE RIGHT TO USE "CLOSINGS", APART FROM  
THE MARK AS SHOWN.

SER. NO. 85-374,969, FILED 7-19-2011.

PATRICIA EVANKO, EXAMINING ATTORNEY



*David J. Kyjars*

Director of the United States Patent and Trademark Office

# United States of America

United States Patent and Trademark Office

**CHROMACAST**

**Reg. No. 4,124,980**

INK AMERICA INTERNATIONAL, INC. (CALIFORNIA CORPORATION)  
13743 VENTURA BLVD. STE 330  
SHERMAN OAKS, CA 91423

**Registered Apr. 10, 2012**

**Int. Cl.: 2**

FOR: FILLED INK CARTRIDGES; INK CARTRIDGES FOR PRINTERS; INK JET CARTRIDGES; PHOTOCOPIER TONER IN CARTRIDGES; TONER CARTRIDGES, IN CLASS 2 (U.S. CLS. 6, 11 AND 16).

**TRADEMARK**

FIRST USE 9-24-2010; IN COMMERCE 9-24-2010.

**PRINCIPAL REGISTER**

THE MARK CONSISTS OF THE WORD "CHROMACAST" IN CAPITAL LETTERS AND STYLE ERAS BOLD A SNOW WAVE UNDERNEATH THE WORD "CHROMACAST" START UNDER THE LETTER "H" AND GOES UP TO THE FIRST "A".

THE WORDING "CHROMACAST" HAS NO MEANING IN A FOREIGN LANGUAGE.

SER. NO. 85-375,016, FILED 7-19-2011.

BILL DAWE, EXAMINING ATTORNEY



*David J. Kyros*

Director of the United States Patent and Trademark Office



# United States of America

United States Patent and Trademark Office



**Reg. No. 4,124,981**

**Registered Apr. 10, 2012**

**Int. Cl.: 31**

**TRADEMARK**

**PRINCIPAL REGISTER**

SUMMER LAKE TROUT FARM, INC. (OREGON CORPORATION), DBA DESERT SPRINGS TROUT FARM  
48320 DESERT SPRINGS RD  
SUMMER LAKE, OR 97640

FOR: LIVE FISH; LIVE FISH FOR FOOD PURPOSES, IN CLASS 31 (U.S. CLS. 1 AND 46).

FIRST USE 2-0-2010; IN COMMERCE 8-0-2010.

NO CLAIM IS MADE TO THE EXCLUSIVE RIGHT TO USE "TROUT FARM CLEAN WATER, CLEAN FISH A SUSTAINABLE GREEN HATCHERY", APART FROM THE MARK AS SHOWN.

THE COLOR(S) GREEN, BLUE, WHITE, GREY, BLACK, TAN, PINK, RED, YELLOW, ORANGE IS/ARE CLAIMED AS A FEATURE OF THE MARK.

THE MARK CONSISTS OF AN OVAL RING WITH AN INNER OVAL RING. THE RINGS ARE GREEN AND THE SPACE BETWEEN THEM IS TAN. IN THAT SPACE, ACROSS THE TOP, IN BLACK CAPITAL FONT IS THE WORDING "DESERT SPRINGS TROUT FARM" AND ACROSS THE BOTTOM IN BLACK CAPITALIZED AND LOWER CASE FONT IS "A SUSTAINABLE GREEN HATCHERY". THE CENTER BACKGROUND IS DEGREES OF BLUE AND HAS A RAINBOW TROUT (FISH) WITH SPLASHING WATER. THE BODY AND HEAD OF THE FISH IS STRIPED WITH GREENS, BLUE, PINK, RED, TAN, GREY, AND WHITE. THE FISH'S FINS ARE GREEN, ORANGE, YELLOW AND WHITE. THE SPLASHING WATER IS WHITE, BLUE, AND GREY AND IS NEAR THE BOTTOM RIGHT SIDE OF THE OVAL WHICH SPREADS ACROSS THE WORDS "GREEN" AND "HATCHERY". ON THE LEFT SIDE OF THE FISH IS THE WORDS, IN BLACK ITALIC CAPITALIZE AND LOWER CASE FONT, "CLEAN WATER, CLEAN FISH".

SER. NO. 85-375,035, FILED 7-19-2011.

MIDGE BUTLER, EXAMINING ATTORNEY



*David J. Kybas*

Director of the United States Patent and Trademark Office

# United States of America

United States Patent and Trademark Office

The logo for StelBolt features the word "StelBolt" in a bold, sans-serif font. The letter "S" is stylized to resemble a bolt head, and the letter "B" is stylized to resemble a bolt shaft with a hexagonal end. The background behind the text is a light gray gradient.

**Reg. No. 4,124,982**

**Registered Apr. 10, 2012**

**Int. Cl.: 20**

**TRADEMARK**

**PRINCIPAL REGISTER**

STELLAR CANADA INC. (CANADA CORPORATION)  
3385 HARVESTER ROAD, SUITE 240  
BURLINGTON, ONTARIO, CANADA L7N3N2

FOR: NON-METAL BOLTS, IN CLASS 20 (U.S. CLS. 2, 13, 22, 25, 32 AND 50).

FIRST USE 4-1-2011; IN COMMERCE 5-24-2011.

THE MARK CONSISTS OF THE STYLIZED WORDING "STELBOLT" OVER THE STYLIZED DESIGN OF A REPRESENTATION OF A THREADED BOLT.

THE WORDING "STEL" OR "STELBOLT" HAS NO MEANING IN A FOREIGN LANGUAGE.

SER. NO. 85-375,150, FILED 7-19-2011.

JAY BESCH, EXAMINING ATTORNEY



*David J. Kybas*

Director of the United States Patent and Trademark Office

# United States of America

United States Patent and Trademark Office



**Reg. No. 4,124,983**

BAKER-GOODWIN, BONNIE (UNITED STATES INDIVIDUAL)  
P.O. BOX 223  
ROCKSPRINGS, TX 78880

**Registered Apr. 10, 2012**

**Int. Cl.: 41**

FOR: HUNTING GUIDE SERVICES, IN CLASS 41 (U.S. CLS. 100, 101 AND 107).

**SERVICE MARK**

FIRST USE 1-1-1994; IN COMMERCE 1-1-1995.

**PRINCIPAL REGISTER**

NO CLAIM IS MADE TO THE EXCLUSIVE RIGHT TO USE "RANCH" , APART FROM THE MARK AS SHOWN.

THE MARK CONSISTS OF THE TEXT "BAKER3RANCH" WITH A BUCK ON THE LEFT SIDE, A DEER ON THE RIGHT, A HORIZONTAL LINE ABOVE WITH AN ARCH ABOVE THE "3", AND A HORIZONTAL LINE BELOW.

SER. NO. 85-375,453, FILED 7-19-2011.

ANDREW LEASER, EXAMINING ATTORNEY



*David J. Kyffers*

Director of the United States Patent and Trademark Office

# United States of America

United States Patent and Trademark Office

# CLR PRO

**Reg. No. 4,124,984**

**Registered Apr. 10, 2012**

**Int. Cl.: 3**

**TRADEMARK**

**PRINCIPAL REGISTER**

JELMAR, LLC (ILLINOIS LIMITED LIABILITY COMPANY)  
5550 W. TOUHY AVE.  
SKOKIE, IL 60077

FOR: CLEANING PREPARATIONS, NAMELY, ALL-PURPOSE CLEANING PREPARATIONS; SURFACE CLEANING PREPARATIONS, NAMELY, MULTI-SURFACE CLEANING PREPARATIONS FOR USE ON SURFACES MADE OF TILE, GLASS, CERAMIC, PORCELAIN, CEMENT, STUCCO, CHROME, GROUT, CAULK, FIBERGLASS, TILE, METAL SURFACES; GREASE AND TAR REMOVING PREPARATION FOR USE ON CONCRETE, TERRAZZO FLOORS, GRANITE, STONE FLOORS, ASPHALT, AND BARBECUE GRILLS, IN CLASS 3 (U.S. CLS. 1, 4, 6, 50, 51 AND 52).

FIRST USE 1-0-2011; IN COMMERCE 1-0-2011.

THE MARK CONSISTS OF STANDARD CHARACTERS WITHOUT CLAIM TO ANY PARTICULAR FONT, STYLE, SIZE, OR COLOR.

OWNER OF U.S. REG. NOS. 1,744,156, 1,922,799 AND OTHERS.

NO CLAIM IS MADE TO THE EXCLUSIVE RIGHT TO USE "PRO", APART FROM THE MARK AS SHOWN.

SER. NO. 85-375,717, FILED 7-20-2011.

COLLEEN DOMBROW, EXAMINING ATTORNEY



*David J. Kyros*

Director of the United States Patent and Trademark Office

# United States of America

United States Patent and Trademark Office



**Reg. No. 4,124,985**

JELMAR, LLC (ILLINOIS LIMITED LIABILITY COMPANY)  
5550 W. TOUHY AVE.  
SKOKIE, IL 60077

**Registered Apr. 10, 2012**

**Int. Cl.: 3**

FOR: CLEANING PREPARATIONS, NAMELY, ALL-PURPOSE CLEANING PREPARATIONS; SURFACE CLEANING PREPARATIONS, NAMELY, MULTI-SURFACE CLEANING PREPARATIONS FOR USE ON SURFACES MADE OF TILE, GLASS, CERAMIC, PORCELAIN, CEMENT, STUCCO, CHROME, GROUT, CAULK, FIBERGLASS, TILE, METAL SURFACES; GREASE AND TAR REMOVING PREPARATION FOR USE ON CONCRETE, TERRAZZO FLOORS, GRANITE, STONE FLOORS, ASPHALT, AND BARBECUE GRILLS, IN CLASS 3 (U.S. CLS. 1, 4, 6, 50, 51 AND 52).

**TRADEMARK**

**PRINCIPAL REGISTER**

FIRST USE 1-0-2011; IN COMMERCE 1-0-2011.

OWNER OF U.S. REG. NOS. 1,744,156, 1,922,799 AND OTHERS.

THE COLOR(S) WHITE, GREEN, ORANGE, YELLOW, AND BLACK IS/ARE CLAIMED AS A FEATURE OF THE MARK.

NO CLAIM IS MADE TO THE EXCLUSIVE RIGHT TO USE "PRO", APART FROM THE MARK AS SHOWN.

THE MARK CONSISTS OF THE LETTERS "CLR" IN BLACK AND THE WORD "PRO" IN BLACK; THE SQUARE BEHIND THE LETTER "C" IS WHITE AND OUTLINED IN BLACK, THE SQUARE BEHIND THE LETTER "L" IS GREEN AND OUTLINED IN BLACK, THE SQUARE BEHIND THE LETTER "R" IS ORANGE AND OUTLINED IN BLACK; AND THE SQUARE BEHIND THE WORD "PRO" IS YELLOW AND OUTLINED IN BLACK.

SER. NO. 85-375,722, FILED 7-20-2011.

COLLEEN DOMBROW, EXAMINING ATTORNEY



*David J. Kyjars*

Director of the United States Patent and Trademark Office

# United States of America

United States Patent and Trademark Office

# Tarn-X<sup>PRO</sup>

**Reg. No. 4,124,986**

JELMAR, LLC (ILLINOIS LIMITED LIABILITY COMPANY)  
5550 W. TOUHY AVE.  
SKOKIE, IL 60077

**Registered Apr. 10, 2012**

**Int. Cl.: 3**

FOR: TARNISH REMOVER FOR USE ON SURFACES MADE OF METALS, PRECIOUS METALS, PRECIOUS STONES AND SEMI-PRECIOUS STONES, IN CLASS 3 (U.S. CLS. 1, 4, 6, 50, 51 AND 52).

**TRADEMARK**

FIRST USE 1-0-2011; IN COMMERCE 1-0-2011.

**PRINCIPAL REGISTER**

OWNER OF U.S. REG. NO. 908,785.

NO CLAIM IS MADE TO THE EXCLUSIVE RIGHT TO USE "PRO", APART FROM THE MARK AS SHOWN.

THE MARK CONSISTS OF THE LETTERS "TARN" FOLLOWED BY A DASH AND THEN THE LETTER "X", ALL FOLLOWED BY THE WORD "PRO" IN A VERTICAL ORIENTATION AND PLACED IN A BOX.

SER. NO. 85-375,729, FILED 7-20-2011.

COLLEEN DOMBROW, EXAMINING ATTORNEY



*David J. Kyros*

Director of the United States Patent and Trademark Office

# United States of America

United States Patent and Trademark Office



**Reg. No. 4,124,987**

WALL STREET GREETINGS, LLC (KENTUCKY LIMITED LIABILITY COMPANY)  
3265 PINKARD PIKE  
VERSAILLES, KY 40383

**Registered Apr. 10, 2012**

**Int. Cl.: 45**

FOR: PROVIDING A SELECTION OF ON-LINE ELECTRONIC GREETING CARDS, IN CLASS 45 (U.S. CLS. 100 AND 101).

**SERVICE MARK**

FIRST USE 5-20-2011; IN COMMERCE 5-20-2011.

**PRINCIPAL REGISTER**

OWNER OF U.S. REG. NO. 3,614,855.

NO CLAIM IS MADE TO THE EXCLUSIVE RIGHT TO USE "WALL STREET E CARDS", APART FROM THE MARK AS SHOWN.

THE MARK CONSISTS OF AN OFFSET ENVELOPE WITH THE LETTER "E" EXITING THE ENVELOPE, THE WORD "CARDS" FOLLOWING THE "E" NEXT TO THE ENVELOPE, AND THE WORDS "WALL STREET" ABOVE THE ENVELOPE.

SER. NO. 85-375,731, FILED 7-20-2011.

JIM RINGLE, EXAMINING ATTORNEY



*David J. Kyffers*

Director of the United States Patent and Trademark Office

# United States of America

United States Patent and Trademark Office

# TARN-X PRO

**Reg. No. 4,124,988**

JELMAR, LLC (ILLINOIS LIMITED LIABILITY COMPANY)  
5550 W. TOUHY AVE.  
SKOKIE, IL 60077

**Registered Apr. 10, 2012**

**Int. Cl.: 3**

FOR: TARNISH REMOVER FOR USE ON SURFACES MADE OF METALS, PRECIOUS METALS, PRECIOUS STONES AND SEMI-PRECIOUS STONES, IN CLASS 3 (U.S. CLS. 1, 4, 6, 50, 51 AND 52).

**TRADEMARK**

FIRST USE 1-0-2011; IN COMMERCE 1-0-2011.

**PRINCIPAL REGISTER**

THE MARK CONSISTS OF STANDARD CHARACTERS WITHOUT CLAIM TO ANY PARTICULAR FONT, STYLE, SIZE, OR COLOR.

OWNER OF U.S. REG. NO. 908,785.

NO CLAIM IS MADE TO THE EXCLUSIVE RIGHT TO USE "PRO", APART FROM THE MARK AS SHOWN.

SER. NO. 85-375,732, FILED 7-20-2011.

COLLEEN DOMBROW, EXAMINING ATTORNEY



*David J. Kybas*

Director of the United States Patent and Trademark Office



# United States of America

United States Patent and Trademark Office

# TARNX PRO

**Reg. No. 4,124,989**

JELMAR, LLC (ILLINOIS LIMITED LIABILITY COMPANY)  
5550 W. TOUHY AVE.  
SKOKIE, IL 60077

**Registered Apr. 10, 2012**

**Int. Cl.: 3**

FOR: TARNISH REMOVER FOR USE ON SURFACES MADE OF METALS, PRECIOUS METALS, PRECIOUS STONES AND SEMI-PRECIOUS STONES, IN CLASS 3 (U.S. CLS. 1, 4, 6, 50, 51 AND 52).

**TRADEMARK**

FIRST USE 1-0-2011; IN COMMERCE 1-0-2011.

**PRINCIPAL REGISTER**

THE MARK CONSISTS OF STANDARD CHARACTERS WITHOUT CLAIM TO ANY PARTICULAR FONT, STYLE, SIZE, OR COLOR.

OWNER OF U.S. REG. NO. 908,785.

NO CLAIM IS MADE TO THE EXCLUSIVE RIGHT TO USE "PRO", APART FROM THE MARK AS SHOWN.

SER. NO. 85-375,735, FILED 7-20-2011.

COLLEEN DOMBROW, EXAMINING ATTORNEY



*David J. Kyffers*

Director of the United States Patent and Trademark Office

# United States of America

United States Patent and Trademark Office

# UBINSIGHT

**Reg. No. 4,124,990**

**Registered Apr. 10, 2012**

**Int. Cl.: 9**

**TRADEMARK**

**PRINCIPAL REGISTER**

PEERAPP LTD. (DELAWARE CORPORATION)  
ECHO BRIDGE OFFICE PARK  
375 ELLIOT STREET, SUITE 150K  
NEWTON UPPER FALLS, MA 02464

FOR: COMPUTER SOFTWARE FOR COMPUTER NETWORK ANALYSIS AND REPORTING,  
IN CLASS 9 (U.S. CLS. 21, 23, 26, 36 AND 38).

FIRST USE 1-0-2011; IN COMMERCE 1-0-2011.

THE MARK CONSISTS OF STANDARD CHARACTERS WITHOUT CLAIM TO ANY PAR-  
TICULAR FONT, STYLE, SIZE, OR COLOR.

SER. NO. 85-375,738, FILED 7-20-2011.

DEZMONA MIZELLE, EXAMINING ATTORNEY



*David J. Kybas*

Director of the United States Patent and Trademark Office

# United States of America

United States Patent and Trademark Office

**T  
a  
r  
n  
X  
PRO**

**Reg. No. 4,124,991**

JELMAR, LLC (ILLINOIS LIMITED LIABILITY COMPANY)  
5550 W. TOUHY AVE.  
SKOKIE, IL 60077

**Registered Apr. 10, 2012**

**Int. Cl.: 3**

FOR: TARNISH REMOVER FOR USE ON SURFACES MADE OF METALS, PRECIOUS METALS, PRECIOUS STONES AND SEMI-PRECIOUS STONES, IN CLASS 3 (U.S. CLS. 1, 4, 6, 50, 51 AND 52).

**TRADEMARK**

FIRST USE 1-0-2011; IN COMMERCE 1-0-2011.

**PRINCIPAL REGISTER**

OWNER OF U.S. REG. NO. 908,785.

NO CLAIM IS MADE TO THE EXCLUSIVE RIGHT TO USE "PRO", APART FROM THE MARK AS SHOWN.

THE MARK CONSISTS OF THE LETTERS "TARNX" POSITIONED VERTICALLY FOLLOWED BY THE WORD "PRO" IN A HORIZONTAL ORIENTATION AND PLACED IN A BOX.

SER. NO. 85-375,740, FILED 7-20-2011.

COLLEEN DOMBROW, EXAMINING ATTORNEY



*David J. Kybas*

Director of the United States Patent and Trademark Office

# United States of America

United States Patent and Trademark Office



**Reg. No. 4,124,992**

**Registered Apr. 10, 2012**

**Int. Cl.: 3**

**TRADEMARK**

**PRINCIPAL REGISTER**

JELMAR, LLC (ILLINOIS LIMITED LIABILITY COMPANY)  
5550 W. TOUHY AVE.  
SKOKIE, IL 60077

FOR: CLEANING PREPARATIONS, NAMELY, ALL-PURPOSE CLEANING PREPARATIONS; SURFACE CLEANING PREPARATIONS, NAMELY, MULTI-SURFACE CLEANING PREPARATIONS FOR USE ON SURFACES MADE OF TILE, GLASS, CERAMIC, PORCELAIN, CEMENT, STUCCO, CHROME, GROUT, CAULK, FIBERGLASS, TILE, METAL SURFACES; GREASE AND TAR REMOVING PREPARATION FOR USE ON CONCRETE, TERRAZZO FLOORS, GRANITE, STONE FLOORS, ASPHALT, AND BARBECUE GRILLS, IN CLASS 3 (U.S. CLS. 1, 4, 6, 50, 51 AND 52).

FIRST USE 3-0-2007; IN COMMERCE 3-0-2007.

OWNER OF U.S. REG. NOS. 1,744,156, 3,305,153 AND OTHERS.

THE COLOR(S) BLACK, WHITE, GREEN, ORANGE, AND YELLOW IS/ARE CLAIMED AS A FEATURE OF THE MARK.

THE MARK CONSISTS OF A QUADRILATERAL SHAPE IN THE COLOR YELLOW WITH WHITE LINES RADIALLY EXTENDING FROM A YELLOW CIRCLE; THE LETTERS "CLR" ARE IN BLACK, THE SQUARE BEHIND THE LETTER "C" IS WHITE AND OUTLINED IN BLACK, THE SQUARE BEHIND THE LETTER "L" IS GREEN AND OUTLINED IN BLACK, THE SQUARE BEHIND THE LETTER "R" IS ORANGE AND OUTLINED IN BLACK.

SER. NO. 85-375,751, FILED 7-20-2011.

COLLEEN DOMBROW, EXAMINING ATTORNEY



*David J. Kybas*

Director of the United States Patent and Trademark Office

# United States of America

United States Patent and Trademark Office



ROSS  
*Management Services*

**Reg. No. 4,124,993**

**Registered Apr. 10, 2012**

**Int. Cl.: 36**

S.J. ROSS ASSOCIATES, INC. (MARYLAND CORPORATION), TA ROSS MANAGEMENT SERVICES  
SUITE 350  
7910 WOODMONT AVENUE  
BETHESDA, MD 20814

**SERVICE MARK**

FOR: REAL ESTATE MANAGEMENT SERVICES, NAMELY, THE MANAGEMENT OF RESIDENTIAL, MULTI-FAMILY BUILDINGS, IN CLASS 36 (U.S. CLS. 100, 101 AND 102).

**PRINCIPAL REGISTER**

FIRST USE 1-1-2008; IN COMMERCE 1-1-2010.

OWNER OF U.S. REG. NO. 3,969,267.

THE COLOR(S) BLUE, WHITE AND SILVER IS/ARE CLAIMED AS A FEATURE OF THE MARK.

NO CLAIM IS MADE TO THE EXCLUSIVE RIGHT TO USE "MANAGEMENT SERVICES", APART FROM THE MARK AS SHOWN.

THE MARK CONSISTS OF A LOWER CASE WHITE STYLIZED LETTER "R" IN A BLUE CIRCLE, TO THE LEFT OF THE WORDS "ROSS MANAGEMENT SERVICES", WITH THE WORD "ROSS" APPEARING IN SILVER ABOVE THE ITALICIZED BLUE WORDING "MANAGEMENT SERVICES".

SER. NO. 85-375,856, FILED 7-20-2011.

NELSON SNYDER, EXAMINING ATTORNEY



*David J. Kyros*

Director of the United States Patent and Trademark Office

# United States of America

United States Patent and Trademark Office



ROSS  
*Renovation & Construction*

**Reg. No. 4,124,994**

**Registered Apr. 10, 2012**

**Int. Cl.: 37**

**SERVICE MARK**

**PRINCIPAL REGISTER**

S.J. ROSS ASSOCIATES, INC. (MARYLAND CORPORATION), TA ROSS RENOVATION & CONSTRUCTION  
SUIITE 350  
7910 WOODMONT AVENUE  
BETHESDA, MD 20814

FOR: REAL ESTATE DEVELOPMENT AND RENOVATION SERVICES, NAMELY, THE RENOVATION AND RESTORATION OF RESIDENTIAL, MULTI-FAMILY BUILDINGS, IN CLASS 37 (U.S. CLS. 100, 103 AND 106).

FIRST USE 1-1-2008; IN COMMERCE 1-1-2010.

OWNER OF U.S. REG. NO. 3,969,267.

THE COLOR(S) BROWN, WHITE AND SILVER IS/ARE CLAIMED AS A FEATURE OF THE MARK.

NO CLAIM IS MADE TO THE EXCLUSIVE RIGHT TO USE "RENOVATION & CONSTRUCTION", APART FROM THE MARK AS SHOWN.

THE MARK CONSISTS OF A WHITE, LOWER CASE STYLIZED LETTER "R" IN A BROWN CIRCLE, TO THE LEFT OF THE WORDS "ROSS RENOVATION & CONSTRUCTION", WITH "ROSS" APPEARING IN SILVER ABOVE THE BROWN ITALICIZED WORDING "RENOVATION & CONSTRUCTION".

SER. NO. 85-375,884, FILED 7-20-2011.

NELSON SNYDER, EXAMINING ATTORNEY



*David J. Kyros*

Director of the United States Patent and Trademark Office

# United States of America

United States Patent and Trademark Office

# TruServe

**Reg. No. 4,124,995**

**Registered Apr. 10, 2012**

**Int. Cl.: 42**

**SERVICE MARK**

**PRINCIPAL REGISTER**

UNIVERSITY OF NORTH DAKOTA (NORTH DAKOTA STATE UNIVERSITY)  
PO BOX 8378  
314 TWAMLEY  
GRAND FORKS, ND 582028378

FOR: PROVIDING TEMPORARY USE OF NON-DOWNLOADABLE COMPUTER DATABASE MANAGEMENT SOFTWARE FOR COLLECTING, TRACKING, AND ANALYZING INFORMATION ABOUT AN ORGANIZATION'S ACTIVITIES TO DEMONSTRATE THE ORGANIZATION'S LEVEL OF PERFORMANCE AND IMPACT ON A COMMUNITY, IN CLASS 42 (U.S. CLS. 100 AND 101).

FIRST USE 6-6-2011; IN COMMERCE 6-6-2011.

THE MARK CONSISTS OF STANDARD CHARACTERS WITHOUT CLAIM TO ANY PARTICULAR FONT, STYLE, SIZE, OR COLOR.

SER. NO. 85-375,923, FILED 7-20-2011.

DAVID TAYLOR, EXAMINING ATTORNEY



*David J. Kyfos*

Director of the United States Patent and Trademark Office

United States of America  
United States Patent and Trademark Office

*Elite Spas*

**Reg. No. 4,124,996**

MAAX SPAS INDUSTRIES CORP. (DELAWARE CORPORATION)  
25605 SOUTH ARIZONA AVENUE  
CHANDLER, AZ 85248

**Registered Apr. 10, 2012**

**Int. Cl.: 11**

FOR: HOT TUBS; SPAS IN THE NATURE OF HEATED POOLS, IN CLASS 11 (U.S. CLS. 13, 21, 23, 31 AND 34).

**TRADEMARK**

FIRST USE 3-3-2003; IN COMMERCE 3-3-2003.

**PRINCIPAL REGISTER**

NO CLAIM IS MADE TO THE EXCLUSIVE RIGHT TO USE "SPAS", APART FROM THE MARK AS SHOWN.

THE MARK CONSISTS OF THE WORDS "ELITE SPAS" IN STYLIZED TEXT PARTIALLY UNDERLINED WITH A CURVED LINE.

SER. NO. 85-376,040, FILED 7-20-2011.

JACLYN KIDWELL WALKER, EXAMINING ATTORNEY



*David J. Kyffers*

Director of the United States Patent and Trademark Office



# United States of America

United States Patent and Trademark Office

# ELITE SPAS

**Reg. No. 4,124,997**

MAAX SPAS INDUSTRIES CORP. (DELAWARE CORPORATION)  
25605 SOUTH ARIZONA AVENUE  
CHANDLER, AZ 85248

**Registered Apr. 10, 2012**

**Int. Cl.: 11**

FOR: HOT TUBS; SPAS IN THE NATURE OF HEATED POOLS, IN CLASS 11 (U.S. CLS. 13, 21, 23, 31 AND 34).

**TRADEMARK**

FIRST USE 3-3-2003; IN COMMERCE 3-3-2003.

**PRINCIPAL REGISTER**

THE MARK CONSISTS OF STANDARD CHARACTERS WITHOUT CLAIM TO ANY PARTICULAR FONT, STYLE, SIZE, OR COLOR.

NO CLAIM IS MADE TO THE EXCLUSIVE RIGHT TO USE "SPAS", APART FROM THE MARK AS SHOWN.

SER. NO. 85-376,063, FILED 7-20-2011.

JACLYN KIDWELL WALKER, EXAMINING ATTORNEY



*David J. Kyffers*

Director of the United States Patent and Trademark Office

# United States of America

United States Patent and Trademark Office



**Reg. No. 4,124,998**

**Registered Apr. 10, 2012**

**Int. Cl.: 9**

**TRADEMARK**

**PRINCIPAL REGISTER**

RED FUNNEL CONSULTING, LLC (INDIANA LIMITED LIABILITY COMPANY)  
5894 TALL TIMBER RUN  
CARMEL, IN 46033

FOR: COMPUTER APPLICATION SOFTWARE FOR HANDHELD COMPUTERS, NAMELY, SOFTWARE FOR COMPANIES' SALES TEAMS AND SUPPORT TEAMS TO PROVIDE CUSTOMERS WITH CURRENT PRODUCT INFORMATION TO CUSTOMERS AT THE POINT OF SALE, IN CLASS 9 (U.S. CLS. 21, 23, 26, 36 AND 38).

FIRST USE 9-27-2010; IN COMMERCE 9-27-2010.

THE MARK CONSISTS OF A BLUE WIDE V-SHAPED SYMBOL THAT IS POSITIONED ABOVE AN ORANGE WIDE V-SHAPED SYMBOL THAT IS POSITIONED ABOVE A GREEN WIDE V-SHAPED SYMBOL, ALL OF WHICH ARE CENTERED ABOVE THE WORD "FATSTAX" IN WHITE, ON A BLUE BACKGROUND.

THE COLOR(S) BLUE, ORANGE, GREEN AND WHITE IS/ARE CLAIMED AS A FEATURE OF THE MARK.

SER. NO. 85-376,089, FILED 7-20-2011.

EDWARD FENNESSY, EXAMINING ATTORNEY



*David J. Kyffers*

Director of the United States Patent and Trademark Office

# United States of America

United States Patent and Trademark Office



**Reg. No. 4,124,999**

MAAX SPAS INDUSTRIES CORP. (DELAWARE CORPORATION)  
25605 SOUTH ARIZONA AVENUE  
CHANDLER, AZ 85248

**Registered Apr. 10, 2012**

**Int. Cl.: 11**

FOR: HOT TUBS; SPAS IN THE NATURE OF HEATED POOLS, IN CLASS 11 (U.S. CLS. 13, 21, 23, 31 AND 34).

**TRADEMARK**

FIRST USE 11-30-2008; IN COMMERCE 11-30-2008.

**PRINCIPAL REGISTER**

OWNER OF U.S. REG. NO. 1,351,569.

NO CLAIM IS MADE TO THE EXCLUSIVE RIGHT TO USE "CALIFORNIA", "HOT TUBS" AND "ESTABLISHED 1972", APART FROM THE MARK AS SHOWN.

THE MARK CONSISTS OF A SOLID OVERALL OVAL SHAPED BACKGROUND WITHIN WHICH, AT THE TOP CENTER, IS A LANDSCAPE SCENE WITH A FIELD, A PARTIAL SUN, GRAPES AND LEAVES, BELOW THAT CENTERED IS THE WORD "CALIFORNIA", BELOW THAT CENTERED IN LARGER TYPE IS THE UNDERLINED WORD "COOPERAGE", WITH AN OVERSIZE "C", BELOW THAT IN SMALLER TYPE ARE THE WORDS "HOT TUBS", BELOW THAT IN A HALF-CIRCLE OUTLINE IS A FAN-LIKE IMAGE WITH NINE FAN BLADES EXTENDING FROM AN OPEN CIRCLE, AND BELOW THAT CENTERED AT THE BOTTOM INSIDE THE OVAL BACKGROUND ARE THE WORDS "ESTABLISHED 1972".

SER. NO. 85-376,095, FILED 7-20-2011.

JACLYN KIDWELL WALKER, EXAMINING ATTORNEY



*David J. Kyffers*

Director of the United States Patent and Trademark Office

# United States of America

United States Patent and Trademark Office

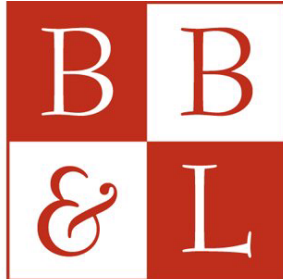

## Bennett Bigelow & Leedom, P.S.

**Reg. No. 4,125,000**

BENNETT BIGELOW & LEEDOM, P.S. (WASHINGTON CORPORATION)  
1700 SEVENTH AVENUE, SUITE 1900  
SEATTLE, WA 98101

**Registered Apr. 10, 2012**

**Int. Cl.: 45**

FOR: LEGAL SERVICES, IN CLASS 45 (U.S. CLS. 100 AND 101).

**SERVICE MARK**

FIRST USE 3-6-2000; IN COMMERCE 3-6-2000.

**PRINCIPAL REGISTER**

NO CLAIM IS MADE TO THE EXCLUSIVE RIGHT TO USE "P.S.", APART FROM THE MARK AS SHOWN.

THE COLOR(S) RED, WHITE, AND BLACK IS/ARE CLAIMED AS A FEATURE OF THE MARK.

THE MARK CONSISTS OF THE LETTERS "BB&L" ENCLOSED IN A SQUARE, DIVIDED INTO FOUR SQUARES, AND THE WORDS "BENNETT BIGELOW & LEEDOM, P.S." UNDERNEATH. THE FIRST LETTER "B" IS IN WHITE ON A RED SQUARE, WITH THE SECOND "B" IN RED ON A WHITE SQUARE. THE "&" SYMBOL IS IN RED ON A WHITE SQUARE, AND THE LETTER "L" IS IN WHITE ON A RED SQUARE. THE WORDING "BENNETT BIGELOW & LEEDOM, P.S. IS IN BLACK.

SER. NO. 85-376,178, FILED 7-20-2011.

CURTIS FRENCH, EXAMINING ATTORNEY



*David J. Kyjars*

Director of the United States Patent and Trademark Office

# United States of America

United States Patent and Trademark Office

## مصحف التجويد الناطق

**Reg. No. 4,125,001**

UFI, INC. (DELAWARE CORPORATION)  
7138 LITTLE RIVER TURNPIKE, SUITE 2005  
ANNANDALE, VA 22003

**Registered Apr. 10, 2012**

**Int. Cls.: 9, 16 and 41**

FOR: ELECTRONIC PENS; ELECTRONIC BOOK READER; ELECTRONIC PUBLICATIONS, NAMELY, BOOKS CONTAINING TEXT FROM RELIGIOUS SOURCES SUCH AS THE KORAN AND AN ACCOMPANYING ELECTRONIC READER ON WHICH AUDIO RECORDINGS OF THE TEXT AND INFORMATION RELATED TO THE TEXT ARE STORED, AND WHICH RECORDINGS ARE TRIGGERED BY PASSING THE ELECTRONIC READER OVER THE TEXT, IN CLASS 9 (U.S. CLS. 21, 23, 26, 36 AND 38).

**TRADEMARK**

**SERVICE MARK**

**PRINCIPAL REGISTER**

FIRST USE 9-1-2010; IN COMMERCE 9-1-2010.

FOR: EDUCATIONAL PUBLICATIONS, NAMELY, BOOKS IN THE FIELD OF RELIGION, IN CLASS 16 (U.S. CLS. 2, 5, 22, 23, 29, 37, 38 AND 50).

FIRST USE 9-1-2010; IN COMMERCE 9-1-2010.

FOR: PROVIDING RELIGIOUS EDUCATIONAL SERVICES, IN CLASS 41 (U.S. CLS. 100, 101 AND 107).

FIRST USE 9-1-2010; IN COMMERCE 9-1-2010.

NO CLAIM IS MADE TO THE EXCLUSIVE RIGHT TO USE "KORAN", APART FROM THE MARK AS SHOWN.

THE NON-LATIN CHARACTERS IN THE MARK TRANSLITERATE TO MOOS HAF ATTAJWEED ANNANTEEK AND THIS MEANS THE SPEAKING KORAN IN ENGLISH.

THE MARK CONSISTS OF THREE ARABIC WORDS, WHICH IN ENGLISH ARE PRONOUNCED AS FOLLOWS: MUS-HAF ATTAJWEED ANNANTIQ. THE MARK CONSISTS OF STANDARD ARABIC LETTERING, WITHOUT CLAIM TO ANY PARTICULAR FONT, STYLE, SIZE, OR COLOR.

THE ENGLISH TRANSLATION OF THE ENTIRETY OF THE MARK IS "THE SPEAKING KORAN".



*David J. Kyffers*

Director of the United States Patent and Trademark Office

**Reg. No. 4,125,001** SER. NO. 85-376,229, FILED 7-20-2011.

DOMINICK J. SALEMI, EXAMINING ATTORNEY

# United States of America

United States Patent and Trademark Office



**Reg. No. 4,125,002**

HARMONIX MUSIC SYSTEMS, INC. (DELAWARE CORPORATION)  
625 MASSACHUSETTS AVENUE  
CAMBRIDGE, MA 02139

**Registered Apr. 10, 2012**

**Int. Cl.: 9**

FOR: VIDEO GAME SOFTWARE; VIDEO GAME DISCS, IN CLASS 9 (U.S. CLS. 21, 23, 26, 36 AND 38).

**TRADEMARK**

FIRST USE 9-9-2009; IN COMMERCE 9-9-2009.

**PRINCIPAL REGISTER**

THE MARK CONSISTS OF THREE MICROPHONES INSIDE TWO CIRCLES.

SER. NO. 85-376,268, FILED 7-20-2011.

MIDGE BUTLER, EXAMINING ATTORNEY



*David J. Kybas*

Director of the United States Patent and Trademark Office

# United States of America

United States Patent and Trademark Office



**Reg. No. 4,125,003**

HARMONIX MUSIC SYSTEMS, INC. (DELAWARE CORPORATION)  
625 MASSACHUSETTS AVENUE  
CAMBRIDGE, MA 02139

**Registered Apr. 10, 2012**

**Int. Cl.: 9**

FOR: VIDEO GAME SOFTWARE; DOWNLOADABLE VIDEO GAME SOFTWARE; VIDEO GAME DISCS, IN CLASS 9 (U.S. CLS. 21, 23, 26, 36 AND 38).

**TRADEMARK**

FIRST USE 10-26-2010; IN COMMERCE 10-26-2010.

**PRINCIPAL REGISTER**

THE MARK CONSISTS OF PIANO KEYS INSIDE TWO CIRCLES.

SER. NO. 85-376,274, FILED 7-20-2011.

MIDGE BUTLER, EXAMINING ATTORNEY



*David J. Kyffers*

Director of the United States Patent and Trademark Office



# United States of America

United States Patent and Trademark Office



**Reg. No. 4,125,004**

**Registered Apr. 10, 2012**

**Int. Cl.: 41**

**SERVICE MARK**

**PRINCIPAL REGISTER**

VINTAGE PILATES INC. (CALIFORNIA CORPORATION)  
1950 SAWTELLE BOULEVARD, SUITE #185  
LOS ANGELES, CA 90025

FOR: PROVIDING FITNESS AND EXERCISE STUDIO SERVICES, NAMELY, PILATES INSTRUCTION AND TRAINING, IN CLASS 41 (U.S. CLS. 100, 101 AND 107).

FIRST USE 4-8-2010; IN COMMERCE 4-8-2010.

NO CLAIM IS MADE TO THE EXCLUSIVE RIGHT TO USE "PILATES", APART FROM THE MARK AS SHOWN.

THE COLOR(S) BLUE-GREEN, WHITE, BLACK, GREY AND YELLOW IS/ARE CLAIMED AS A FEATURE OF THE MARK.

THE MARK CONSISTS OF THE WORDS "VINTAGE" AND "PILATES" WRITTEN IN A CURVED PATTERN IN BLACK INK WITH WHITE SHADOWS OUTLINING THE WORDS. THE WORD "VINTAGE" IS PLACED IN A CURVED PATTERN ABOVE A MAN IN AN EXERCISE POSITION IN BLACK AND WHITE COLOR LOCATED WITHIN A YELLOW CIRCLE WITH A WHITE BORDER AND THAT IMAGE WITHIN A BLUE-GREEN SQUARE WITH A WHITE AND BLUE-GREEN BORDER. THE WORD "PILATES" IS PLACED IN A CURVED PATTERN BELOW A MAN IN AN EXERCISE POSITION LOCATED WITHIN A YELLOW CIRCLE WITH A WHITE BORDER AND THAT IMAGE WITHIN A BLUE-GREEN SQUARE WITH A WHITE AND BLUE-GREEN BORDER.

SER. NO. 85-376,334, FILED 7-20-2011.

ZACHARY BELLO, EXAMINING ATTORNEY



*David J. Kybas*

Director of the United States Patent and Trademark Office

# United States of America

United States Patent and Trademark Office



**AllWrestling**

**Reg. No. 4,125,005**

CM3 SOLUTIONS INC. (MARYLAND CORPORATION)  
905 W 7TH STREET SUITE 287  
FREDERICK, MD 21701

**Registered Apr. 10, 2012**

**Int. Cl.: 41**

FOR: ONLINE WEBSITE PROVIDING WRESTLING AND MIXED MARTIAL ARTS NEWS AND INFORMATION VIA A GLOBAL COMPUTER NETWORK; ONLINE BLOG PROVIDING WRESTLING AND MIXED MARTIAL ARTS NEWS AND INFORMATION, IN CLASS 41 (U.S. CLS. 100, 101 AND 107).

**SERVICE MARK**

**PRINCIPAL REGISTER**

FIRST USE 4-7-2011; IN COMMERCE 4-7-2011.

NO CLAIM IS MADE TO THE EXCLUSIVE RIGHT TO USE "ALL WRESTLING", APART FROM THE MARK AS SHOWN.

THE MARK CONSISTS OF A SQUARE WITH ONE EXTENDED SLANTED SIDE. THE LETTER "W" WITH A LETTER "A" SUPERIMPOSED ON TOP OF THE "W" APPEARS WITHIN THE SQUARE. BELOW IS THE STYLIZED WORDING "ALLWRESTLING".

SER. NO. 85-376,483, FILED S.R. 7-20-2011 AM. P.R. 11-10-2011.

JEAN IM, EXAMINING ATTORNEY



*David J. Kyros*

Director of the United States Patent and Trademark Office

# United States of America

United States Patent and Trademark Office

## Portraits of Valor

**Reg. No. 4,125,006**

**Registered Apr. 10, 2012**

**Int. Cl.: 41**

**SERVICE MARK**

**PRINCIPAL REGISTER**

NICK DEL CALZO (UNITED STATES INDIVIDUAL)  
5401 S. PARK TERRACE, UNIT A-301  
GREENWOOD VILLAGE, CO 80111

FOR: EDUCATIONAL AND ENTERTAINMENT SERVICES, NAMELY, ORGANIZING AND PROVIDING AN EXHIBITION OF PHOTOGRAPHS AND PORTRAITS; EDUCATIONAL AND ENTERTAINMENT SERVICES, NAMELY, ORGANIZING AND PROVIDING AN ONLINE EXHIBITION OF PHOTOGRAPHS AND PORTRAITS, IN CLASS 41 (U.S. CLS. 100, 101 AND 107).

FIRST USE 8-0-2008; IN COMMERCE 8-0-2008.

THE MARK CONSISTS OF STANDARD CHARACTERS WITHOUT CLAIM TO ANY PARTICULAR FONT, STYLE, SIZE, OR COLOR.

NO CLAIM IS MADE TO THE EXCLUSIVE RIGHT TO USE "PORTRAITS", APART FROM THE MARK AS SHOWN.

SER. NO. 85-376,688, FILED 7-20-2011.

ANDREA BUTLER, EXAMINING ATTORNEY



*David J. Kyffers*

Director of the United States Patent and Trademark Office

# United States of America

United States Patent and Trademark Office

## DART DASHBOARD

**Reg. No. 4,125,007**

**Registered Apr. 10, 2012**

**Int. Cl.: 42**

**SERVICE MARK**

**PRINCIPAL REGISTER**

DARTAPPRAISAL.COM, INC. (MICHIGAN CORPORATION)  
SUITE 125  
2701 TROY CENTER DRIVE  
TROY, MI 48084

FOR: WEB-BASED NON-DOWNLOADABLE SOFTWARE FOR ONLINE REAL ESTATE APPRAISAL DATA MANAGEMENT; PROVIDING ONLINE NON-DOWNLOADABLE SOFTWARE FOR USE IN CUSTOMIZED REPORTING FOR OPTIMAL REAL ESTATE APPRAISAL DATA MANAGEMENT, IN CLASS 42 (U.S. CLS. 100 AND 101).

FIRST USE 1-1-2010; IN COMMERCE 1-1-2010.

THE MARK CONSISTS OF STANDARD CHARACTERS WITHOUT CLAIM TO ANY PARTICULAR FONT, STYLE, SIZE, OR COLOR.

OWNER OF U.S. REG. NOS. 2,414,014, 3,739,441 AND OTHERS.

NO CLAIM IS MADE TO THE EXCLUSIVE RIGHT TO USE "DASHBOARD", APART FROM THE MARK AS SHOWN.

SER. NO. 85-376,766, FILED 7-20-2011.

JEFFREY LOOK, EXAMINING ATTORNEY



*David J. Kybas*

Director of the United States Patent and Trademark Office

# United States of America

United States Patent and Trademark Office

# DARTBOARD

**Reg. No. 4,125,008**

**Registered Apr. 10, 2012**

**Int. Cl.: 9**

**TRADEMARK**

**PRINCIPAL REGISTER**

DARTAPPRAISAL.COM, INC. (MICHIGAN CORPORATION)  
SUITE 125  
2701 TROY CENTER DRIVE  
TROY, MI 48084

FOR: ELECTRONIC PERIODIC PUBLICATIONS, NAMELY, A DOWNLOADABLE ELECTRONIC NEWSLETTER FEATURING A VARIETY OF ISSUES RELATING TO REAL ESTATE APPRAISAL SERVICES PRODUCED ON A QUARTERLY BASIS, IN CLASS 9 (U.S. CLS. 21, 23, 26, 36 AND 38).

FIRST USE 1-1-2010; IN COMMERCE 1-1-2010.

THE MARK CONSISTS OF STANDARD CHARACTERS WITHOUT CLAIM TO ANY PARTICULAR FONT, STYLE, SIZE, OR COLOR.

OWNER OF U.S. REG. NOS. 2,414,014, 3,739,441 AND OTHERS.

SER. NO. 85-376,769, FILED 7-20-2011.

JEFFREY LOOK, EXAMINING ATTORNEY



*David J. Kyffers*

Director of the United States Patent and Trademark Office

# United States of America

United States Patent and Trademark Office

## BivyPak System

**Reg. No. 4,125,009**

**Registered Apr. 10, 2012**

**Int. Cls.: 9 and 18**

**TRADEMARK**

**PRINCIPAL REGISTER**

DEVILLEZ, JEFFREY E. (UNITED STATES INDIVIDUAL)  
139 DESERT ROCK DRIVE  
LAS VEGAS, NV 89123

FOR: BIVOUC SACKS, NAMELY, WIND AND WATER RESISTANT BAGS INTO WHICH A PERSON CAN FIT TO PROTECT THEMSELVES FROM EXPOSURE TO THE ELEMENTS , IN CLASS 9 (U.S. CLS. 21, 23, 26, 36 AND 38).

FIRST USE 6-30-2011; IN COMMERCE 6-30-2011.

FOR: BACKPACKS, IN CLASS 18 (U.S. CLS. 1, 2, 3, 22 AND 41).

FIRST USE 6-30-2011; IN COMMERCE 6-30-2011.

THE MARK CONSISTS OF STANDARD CHARACTERS WITHOUT CLAIM TO ANY PARTICULAR FONT, STYLE, SIZE, OR COLOR.

NO CLAIM IS MADE TO THE EXCLUSIVE RIGHT TO USE "SYSTEM", APART FROM THE MARK AS SHOWN.

SER. NO. 85-376,807, FILED 7-20-2011.

JEFFREY LOOK, EXAMINING ATTORNEY



*David J. Kyfos*

Director of the United States Patent and Trademark Office

# United States of America

United States Patent and Trademark Office

# AlumiGuard

**Reg. No. 4,125,010**

SMARTSIGN LLC (DELAWARE LIMITED LIABILITY COMPANY)  
32 COURT ST.

**Registered Apr. 10, 2012**

BROOKLYN, NY 11201

**Int. Cl.: 6**

FOR: ASSET IDENTIFICATION TAGS MADE OF METAL, IN CLASS 6 (U.S. CLS. 2, 12, 13, 14, 23, 25 AND 50).

**TRADEMARK**

FIRST USE 7-0-2006; IN COMMERCE 7-0-2006.

**PRINCIPAL REGISTER**

THE MARK CONSISTS OF STANDARD CHARACTERS WITHOUT CLAIM TO ANY PARTICULAR FONT, STYLE, SIZE, OR COLOR.

SER. NO. 85-376,928, FILED 7-21-2011.

SANI KHOURI, EXAMINING ATTORNEY



*David J. Kybas*

Director of the United States Patent and Trademark Office

# United States of America

United States Patent and Trademark Office

# SCALETRON

**Reg. No. 4,125,011**

**Registered Apr. 10, 2012**

**Int. Cl.: 11**

**TRADEMARK**

**PRINCIPAL REGISTER**

FLUID DYNAMICS INTERNATIONAL LIMITED (UNITED KINGDOM LIMITED COMPANY)  
WHITE PLACE RIVER ROAD  
TAPLOW, UNITED KINGDOM SL60BG

FOR: WATER CONDITIONING UNITS; WATER SOFTENING APPARATUS AND INSTALLATIONS, IN CLASS 11 (U.S. CLS. 13, 21, 23, 31 AND 34).

FIRST USE 1-8-1986; IN COMMERCE 1-8-1986.

THE MARK CONSISTS OF STANDARD CHARACTERS WITHOUT CLAIM TO ANY PARTICULAR FONT, STYLE, SIZE, OR COLOR.

SER. NO. 85-376,986, FILED 7-21-2011.

SUSAN RICHARDS, EXAMINING ATTORNEY



*David J. Kybas*

Director of the United States Patent and Trademark Office



# United States of America

United States Patent and Trademark Office

## FINDERSCLUB

**Reg. No. 4,125,012**

GOTTESMAN BUSINESS BROKERS, INC (NEW YORK CORPORATION)  
200 EAST 71ST STREET  
NEW YORK, NY 10021

**Registered Apr. 10, 2012**

**Int. Cl.: 35**

FOR: BUSINESS NETWORKING SERVICES, SPECIFICALLY, CONNECTING PROSPECTIVE PARTICIPANTS FOR MERGERS, ACQUISITIONS AND THE SALE AND PURCHASE OF BUSINESSES, IN CLASS 35 (U.S. CLS. 100, 101 AND 102).

**SERVICE MARK**

FIRST USE 7-19-2011; IN COMMERCE 7-19-2011.

**PRINCIPAL REGISTER**

THE MARK CONSISTS OF STANDARD CHARACTERS WITHOUT CLAIM TO ANY PARTICULAR FONT, STYLE, SIZE, OR COLOR.

SER. NO. 85-376,990, FILED 7-21-2011.

WENDY JUN, EXAMINING ATTORNEY



*David J. Kyffers*

Director of the United States Patent and Trademark Office

# United States of America

United States Patent and Trademark Office

## SHORE STORE

**Reg. No. 4,125,013**

THE MERK, INC. (NEW JERSEY CORPORATION)  
1209 BOARDWALK  
SEASIDE HEIGHTS, NJ 08751

**Registered Apr. 10, 2012**

**Int. Cl.: 25**

FOR: BASEBALL CAPS AND HATS; HOODED SWEATSHIRTS; MUSCLE TOPS; PINNIES  
IN THE NATURE OF SCRIMMAGE VESTS FOR USE IN SPORTS; SHORTS; SWEATPANTS;  
T-SHIRTS; TANK-TOPS, IN CLASS 25 (U.S. CLS. 22 AND 39).

**TRADEMARK**

FIRST USE 3-1-2002; IN COMMERCE 3-1-2002.

**PRINCIPAL REGISTER**

THE MARK CONSISTS OF STANDARD CHARACTERS WITHOUT CLAIM TO ANY PAR-  
TICULAR FONT, STYLE, SIZE, OR COLOR.

SEC. 2(F).

SER. NO. 85-376,992, FILED 7-21-2011.

MATTHEW MCDOWELL, EXAMINING ATTORNEY



*David J. Kybas*

Director of the United States Patent and Trademark Office

# United States of America

United States Patent and Trademark Office

## FARMERS SMART CREDIT

**Reg. No. 4,125,014**

WAREHOUSE HOME FURNISHINGS DISTRIBUTORS, INC., (GEORGIA CORPORATION)  
1851 TELFAIR STREET  
DUBLIN, GA 31021

**Registered Apr. 10, 2012**

**Int. Cl.: 36**

FOR: FINANCIAL SERVICES RENDERED IN CONNECTION WITH THE ISSUANCE, RECEIPT AND TRANSFER OF LINES OF CREDIT, NAMELY, CREDIT PROCESSING SERVICES FOR THE PURCHASE OF FURNITURE, IN CLASS 36 (U.S. CLS. 100, 101 AND 102).

**SERVICE MARK**

FIRST USE 10-31-2009; IN COMMERCE 10-31-2009.

**PRINCIPAL REGISTER**

THE MARK CONSISTS OF STANDARD CHARACTERS WITHOUT CLAIM TO ANY PARTICULAR FONT, STYLE, SIZE, OR COLOR.

OWNER OF U.S. REG. NOS. 2,923,815, 3,828,196 AND OTHERS.

NO CLAIM IS MADE TO THE EXCLUSIVE RIGHT TO USE "CREDIT", APART FROM THE MARK AS SHOWN.

SER. NO. 85-377,120, FILED 7-21-2011.

STEVEN PEREZ, EXAMINING ATTORNEY



*David J. Kybas*

Director of the United States Patent and Trademark Office

# United States of America

United States Patent and Trademark Office

## WEYMAN'S BEST

**Reg. No. 4,125,015**

**Registered Apr. 10, 2012**

**Int. Cl.: 34**

**TRADEMARK**

**PRINCIPAL REGISTER**

U.S. SMOKELESS TOBACCO MANUFACTURING COMPANY LLC (VIRGINIA LIMITED LIABILITY COMPANY)  
6603 WEST BROAD STREET  
RICHMOND, VA 23230

FOR: TOBACCO PRODUCTS, NAMELY, CHEWING TOBACCO, IN CLASS 34 (U.S. CLS. 2, 8, 9 AND 17).

FIRST USE 2-21-2011; IN COMMERCE 2-21-2011.

THE MARK CONSISTS OF STANDARD CHARACTERS WITHOUT CLAIM TO ANY PARTICULAR FONT, STYLE, SIZE, OR COLOR.

OWNER OF U.S. REG. NO. 1,294,831.

NO CLAIM IS MADE TO THE EXCLUSIVE RIGHT TO USE "BEST", APART FROM THE MARK AS SHOWN.

SER. NO. 85-377,124, FILED 7-21-2011.

CURTIS FRENCH, EXAMINING ATTORNEY



*David J. Kyffers*

Director of the United States Patent and Trademark Office

# United States of America

United States Patent and Trademark Office

## BOOMER BASH

**Reg. No. 4,125,016**

**Registered Apr. 10, 2012**

**Int. Cl.: 41**

**SERVICE MARK**

**PRINCIPAL REGISTER**

THE UNIVERSITY OF OKLAHOMA ALUMNI ASSOCIATION (OKLAHOMA STATE UNIVERSITY)  
900 ASP AVENUE, SUITE 427  
NORMAN, OK 73019

FOR: ENTERTAINMENT EVENTS IN THE NATURE OF FOOTBALL GAME KICKOFF PARTIES, IN CLASS 41 (U.S. CLS. 100, 101 AND 107).

FIRST USE 8-25-2001; IN COMMERCE 8-25-2001.

THE MARK CONSISTS OF STANDARD CHARACTERS WITHOUT CLAIM TO ANY PARTICULAR FONT, STYLE, SIZE, OR COLOR.

OWNER OF U.S. REG. NOS. 3,093,031 AND 3,100,549.

NO CLAIM IS MADE TO THE EXCLUSIVE RIGHT TO USE "BASH", APART FROM THE MARK AS SHOWN.

SER. NO. 85-377,151, FILED 7-21-2011.

ELI HELLMAN, EXAMINING ATTORNEY



*David J. Kyffers*

Director of the United States Patent and Trademark Office

# United States of America

United States Patent and Trademark Office

## TRINI MIKE'S

**Reg. No. 4,125,017**

**Registered Apr. 10, 2012**

**Int. Cl.: 30**

**TRADEMARK**

**PRINCIPAL REGISTER**

TRINI MIKE'S, INC. (FLORIDA CORPORATION)  
6538 COLLINS AVE., # 373  
MIAMI BEACH, FL 33141

FOR: CONDIMENT, NAMELY, PEPPER SAUCE, IN CLASS 30 (U.S. CL. 46).

FIRST USE 4-20-2009; IN COMMERCE 4-20-2009.

THE MARK CONSISTS OF STANDARD CHARACTERS WITHOUT CLAIM TO ANY PARTICULAR FONT, STYLE, SIZE, OR COLOR.

OWNER OF U.S. REG. NO. 3,762,836.

SER. NO. 85-377,227, FILED 7-21-2011.

ZACHARY BELLO, EXAMINING ATTORNEY



*David J. Kyffers*

Director of the United States Patent and Trademark Office

# United States of America

United States Patent and Trademark Office

## Resonate Live Marketing

**Reg. No. 4,125,018**

**Registered Apr. 10, 2012**

**Int. Cl.: 35**

**SERVICE MARK**

**PRINCIPAL REGISTER**

RESONATE LIVE MARKETING, LLC (MINNESOTA LIMITED LIABILITY COMPANY)  
4800 SPRING CREEK DRIVE  
EXCELSIOR, MN 55331

FOR: ADVERTISING AND MARKETING; ADVERTISING AND MARKETING CONSULTANCY; ADVERTISING AND MARKETING SERVICES, NAMELY, PROMOTING THE GOODS AND SERVICES OF OTHERS; ADVERTISING SERVICES; ARRANGING AND CONDUCTING SPECIAL EVENTS FOR COMMERCIAL, PROMOTIONAL OR ADVERTISING PURPOSES; BUSINESS MARKETING SERVICES; EVENT PLANNING AND MANAGEMENT FOR MARKETING, BRANDING, PROMOTING OR ADVERTISING THE GOODS AND SERVICES OF OTHERS; MARKETING CONSULTING; ORGANISATION OF EXHIBITIONS AND EVENTS FOR COMMERCIAL OR ADVERTISING PURPOSES; ORGANIZATION OF EVENTS, EXHIBITIONS, FAIRS AND SHOWS FOR COMMERCIAL, PROMOTIONAL AND ADVERTISING PURPOSES; ORGANIZING, PROMOTING AND CONDUCTING EXHIBITIONS, TRADESHOWS AND EVENTS FOR BUSINESS PURPOSES; PUBLIC RELATIONS, IN CLASS 35 (U.S. CLS. 100, 101 AND 102).

FIRST USE 4-13-2010; IN COMMERCE 9-15-2010.

THE MARK CONSISTS OF STANDARD CHARACTERS WITHOUT CLAIM TO ANY PARTICULAR FONT, STYLE, SIZE, OR COLOR.

NO CLAIM IS MADE TO THE EXCLUSIVE RIGHT TO USE "LIVE MARKETING", APART FROM THE MARK AS SHOWN.

SER. NO. 85-377,270, FILED 7-21-2011.

SUSAN RICHARDS, EXAMINING ATTORNEY



*David J. Kyffers*

Director of the United States Patent and Trademark Office

# United States of America

United States Patent and Trademark Office

## IT'S YOUR SKIN

**Reg. No. 4,125,019**

**Registered Apr. 10, 2012**

**Int. Cl.: 44**

**SERVICE MARK**

**PRINCIPAL REGISTER**

JRY DERMA HEALTH INSTITUTE OF CHANDLER & TEMPE (ARIZONA LIMITED LIABILITY COMPANY)  
2905 W. WARNER RD. #17  
CHANDLER, AZ 85224

FOR: PROVIDING MEDICAL AND COSMETIC SKIN CARE SERVICES, IN CLASS 44 (U.S. CLS. 100 AND 101).

FIRST USE 7-1-2011; IN COMMERCE 7-1-2011.

THE MARK CONSISTS OF STANDARD CHARACTERS WITHOUT CLAIM TO ANY PARTICULAR FONT, STYLE, SIZE, OR COLOR.

NO CLAIM IS MADE TO THE EXCLUSIVE RIGHT TO USE "SKIN", APART FROM THE MARK AS SHOWN.

SER. NO. 85-377,272, FILED 7-21-2011.

SUSAN RICHARDS, EXAMINING ATTORNEY



*David J. Kyffers*

Director of the United States Patent and Trademark Office



# United States of America

United States Patent and Trademark Office



**Reg. No. 4,125,020**

**Registered Apr. 10, 2012**

**Int. Cl.: 25**

**TRADEMARK**

**PRINCIPAL REGISTER**

BAIK KWANG CORPORATION (NEW JERSEY CORPORATION), DBA CITY HUNTER,  
J-HEAD  
601 COMMERCIAL AVENUE  
CARLSTADT, NJ 07072

FOR: CLOTHING, NAMELY, CAPS, HATS, HEADBANDS, FOOTWEAR, PANTS, SHORTS,  
SWEATSHIRTS, SWEATPANTS, TIGHTS, JACKETS, TOPS, AND SHIRTS , IN CLASS 25  
(U.S. CLS. 22 AND 39).

FIRST USE 7-9-1998; IN COMMERCE 7-9-1998.

THE MARK CONSISTS OF THE "P" IS MADE UP OF A THICK, VERTICAL LINE AND A HORIZONTAL CURVE THAT OPENS UP TO THE LEFT. THE LINE OF THE "P" IS SLANTED AT A SLIGHT ANGLE AND LEANS TOWARD THE RIGHT. THE CURVATURE OF THE "P" CONNECTS WITH THE LINE OF THE "P" AT A SINGLE POINT, LOCATED AT THE UPPER-MID SECTION OF THE LINE. THE TOP OF THE CURVATURE BEGINS AS A THIN LINE AND THEN BEGINS TO THICKEN AS IT REACHES THE GREATEST POINT OF ITS CURVE AND THEN THINS OUT AGAIN AS IT REACHES THE BOTTOM OF THE CURVE AND ITS POINT OF CONNECTION TO THE LINE OF THE "P". THE TOP OF THE CURVATURE EXTENDS OUT TOWARD THE LEFT, BEYOND THE LOCATION OF THE LINE OF THE "P".

SER. NO. 85-377,305, FILED 7-21-2011.

LAURIE MAYES, EXAMINING ATTORNEY



*David J. Kyffers*

Director of the United States Patent and Trademark Office

# United States of America

United States Patent and Trademark Office



**Reg. No. 4,125,021**

HARMONIX MUSIC SYSTEMS, INC. (DELAWARE CORPORATION)  
625 MASSACHUSETTS AVENUE  
CAMBRIDGE, MA 02139

**Registered Apr. 10, 2012**

**Int. Cl.: 9**

FOR: VIDEO GAME SOFTWARE; DOWNLOADABLE VIDEO GAME SOFTWARE; VIDEO GAME DISCS, IN CLASS 9 (U.S. CLS. 21, 23, 26, 36 AND 38).

**TRADEMARK**

FIRST USE 11-20-2007; IN COMMERCE 11-20-2007.

**PRINCIPAL REGISTER**

THE MARK CONSISTS OF A DRUM SET WITH CYMBAL ON A STAND INSIDE TWO CIRCLES.

SER. NO. 85-377,468, FILED 7-21-2011.

MIDGE BUTLER, EXAMINING ATTORNEY



*David J. Kybas*

Director of the United States Patent and Trademark Office

United States of America  
United States Patent and Trademark Office

# RICELOOP

**Reg. No. 4,125,022**

RICELOOP LLC (FLORIDA LIMITED LIABILITY COMPANY)  
120 HARBOR VIEW LANE  
LARGO, FL 33770

**Registered Apr. 10, 2012**

**Int. Cls.: 38 and 44**

FOR: PROVIDING ELECTRONIC BULLETIN BOARD AND ONLINE CHAT ROOMS FOR TRANSMISSION BY AND AMONG USERS OF MESSAGES AND CONTENT RELATING TO RICE, IN CLASS 38 (U.S. CLS. 100, 101 AND 104).

**SERVICE MARK**

FIRST USE 7-10-2011; IN COMMERCE 7-10-2011.

**PRINCIPAL REGISTER**

FOR: INTERACTIVE WEBSITE PROVIDING AGRICULTURAL NEWS, INFORMATION, OPINION AND COMMENTS RELATING TO RICE, IN CLASS 44 (U.S. CLS. 100 AND 101).

FIRST USE 7-10-2011; IN COMMERCE 7-10-2011.

THE MARK CONSISTS OF STANDARD CHARACTERS WITHOUT CLAIM TO ANY PARTICULAR FONT, STYLE, SIZE, OR COLOR.

SER. NO. 85-377,511, FILED 7-21-2011.

WILLIAM BRECKENFELD, EXAMINING ATTORNEY



*David J. Kypos*

Director of the United States Patent and Trademark Office

# United States of America

## United States Patent and Trademark Office



**Reg. No. 4,125,023**

**Registered Apr. 10, 2012**

**Int. Cls.: 42 and 45**

**SERVICE MARK**

**PRINCIPAL REGISTER**

QUANTUM DISCOVERY, LLC (CONNECTICUT LIMITED LIABILITY COMPANY)  
501 OCEAN AVE.  
NEW LONDON, CT 06320

FOR: CONVERSION OF DATA OR DOCUMENTS FROM PHYSICAL TO ELECTRONIC MEDIA; DATA AUTOMATION AND COLLECTION SERVICE USING SOFTWARE TO EVALUATE, ANALYZE, SORT, COMPARE, MANAGE AND COLLECT DATA; PLATFORM AS A SERVICE (PAAS) FEATURING COMPUTER SOFTWARE PLATFORMS FOR DOCUMENT AND DATA MANAGEMENT AND INDEXING; PROVIDING AN ONLINE NETWORK SERVICE THAT ENABLES USERS TO SHARE DATA IN THE FIELD OF E-DISCOVERY FOR BUSINESS LEGAL DEPARTMENTS AND LAW FIRMS, IN CLASS 42 (U.S. CLS. 100 AND 101).

FIRST USE 5-16-2011; IN COMMERCE 5-16-2011.

FOR: LITIGATION SUPPORT SERVICES, NAMELY, CONDUCTING ELECTRONIC LEGAL DISCOVERY IN THE NATURE OF REVIEWING E-MAILS AND OTHER ELECTRONICALLY STORED INFORMATION THAT COULD BE RELEVANT EVIDENCE IN A LAWSUIT FOR BUSINESS LEGAL DEPARTMENTS AND LAW FIRMS; LITIGATION SUPPORT SERVICES, NAMELY, ELECTRONIC LEGAL DISCOVERY CONSULTING SERVICES, IN CLASS 45 (U.S. CLS. 100 AND 101).

FIRST USE 5-16-2011; IN COMMERCE 5-16-2011.



*David J. Kyffers*

Director of the United States Patent and Trademark Office

THE MARK CONSISTS OF THE LETTER "Q" COLORED IN LIGHT GREEN ON THE UPPER LEFT HAND SIDE, OLIVE GREEN ON THE LOWER LEFT HAND SIDE TO THE TAIL OF THE "Q", AND DARK TAN AFTER THE TAIL OF THE "Q", FADING TO LIGHT TAN ON THE RIGHT HAND SIDE OF THE "Q", WITH A VERTICAL LINE AND A HORIZONTAL LINE, BOTH OF WHICH ARE DARK GRAY INSIDE THE "Q" AND LIGHTER GRAY AS THEY CROSS THE "Q", WHICH LINES CROSS ONE ANOTHER AT THE CENTER OF THE "Q", WITH THE VERTICAL LINE APPEARING TO CROSS OVER THE TOP OF THE "Q" AND TO BE HIDDEN UNDER THE BOTTOM OF THE "Q", AND THE HORIZONTAL LINE APPEARING TO CROSS OVER THE LEFT HAND SIDE OF THE "Q" AND TO BE HIDDEN UNDER THE RIGHT HAND SIDE OF THE "Q".

THE COLOR(S) LIGHT GREEN, OLIVE GREEN, DARK TAN, LIGHT TAN, DARK GRAY AND LIGHT GRAY IS/ARE CLAIMED AS A FEATURE OF THE MARK.

**Reg. No. 4,125,023** SER. NO. 85-378,202, FILED 7-22-2011.

KEVON CHISOLM, EXAMINING ATTORNEY

# United States of America

United States Patent and Trademark Office

## PLAYOFF PULSE

**Reg. No. 4,125,024**

**Registered Apr. 10, 2012**

**Int. Cls.: 41 and 45**

**SERVICE MARK**

**PRINCIPAL REGISTER**

TURNER SPORTS, INC. (GEORGIA CORPORATION)  
C/O TURNER BROADCASTING SYSTEM, INC.  
ONE CNN CENTER, 10 NORTH  
ATLANTA, GA 30303

FOR: ENTERTAINMENT SERVICES, NAMELY, PROVIDING INFORMATION AND NEWS IN THE FIELDS OF SPORTS TEAMS AND PLAYERS, SPORTING EVENTS, CELEBRITIES, AND SPORTS NEWS VIA THE INTERNET, IN CLASS 41 (U.S. CLS. 100, 101 AND 107).

FIRST USE 4-16-2011; IN COMMERCE 4-16-2011.

FOR: ENTERTAINMENT SERVICES, NAMELY, PROVIDING INFORMATION AND NEWS IN THE FIELD OF SOCIAL NETWORKING TRENDS VIA THE INTERNET, IN CLASS 45 (U.S. CLS. 100 AND 101).

FIRST USE 4-16-2011; IN COMMERCE 4-16-2011.

THE MARK CONSISTS OF STANDARD CHARACTERS WITHOUT CLAIM TO ANY PARTICULAR FONT, STYLE, SIZE, OR COLOR.

NO CLAIM IS MADE TO THE EXCLUSIVE RIGHT TO USE "PLAYOFF", APART FROM THE MARK AS SHOWN.

SER. NO. 85-378,211, FILED 7-22-2011.

ASMAT KHAN, EXAMINING ATTORNEY



*David J. Kybas*

Director of the United States Patent and Trademark Office

# United States of America

United States Patent and Trademark Office

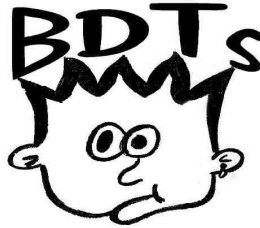

**Reg. No. 4,125,025**

BIG DUMMY TS LLC (FLORIDA LIMITED LIABILITY COMPANY)  
140 KAPOK CRESCENT  
ROYAL PALM BEACH, FL 33411

**Registered Apr. 10, 2012**

**Int. Cl.: 25**

FOR: SHIRTS, IN CLASS 25 (U.S. CLS. 22 AND 39).

**TRADEMARK**

FIRST USE 8-1-2010; IN COMMERCE 8-1-2010.

**PRINCIPAL REGISTER**

THE MARK CONSISTS OF THE STYLIZED TEXT "BDTS" WITH A CARTOON OF A HUMAN HEAD AT THE BOTTOM.

SER. NO. 85-378,217, FILED 7-22-2011.

ANDREA HACK, EXAMINING ATTORNEY



*David J. Kyffers*

Director of the United States Patent and Trademark Office

# United States of America

United States Patent and Trademark Office



CENTER FOR ULTRASOUND RESEARCH & EDUCATION

**Reg. No. 4,125,026**

NUSSBAUMER, KAREN (UNITED STATES INDIVIDUAL)  
5 ELM STREET

**Registered Apr. 10, 2012**

NEW ROCHELLE, NY 10805

**Int. Cl.: 41**

FOR: EDUCATION SERVICES, NAMELY, PROVIDING CLASSES IN THE FIELD OF ULTRASOUND TECHNOLOGY; TRAINING SERVICES IN THE FIELD OF ULTRASOUND TECHNOLOGY, IN CLASS 41 (U.S. CLS. 100, 101 AND 107).

**SERVICE MARK**

FIRST USE 9-1-2005; IN COMMERCE 10-10-2007.

**PRINCIPAL REGISTER**

NO CLAIM IS MADE TO THE EXCLUSIVE RIGHT TO USE "CENTER FOR ULTRASOUND RESEARCH & EDUCATION", APART FROM THE MARK AS SHOWN.

THE MARK CONSISTS OF A 'C' WITH THREE SWOOSHES THROUGH IT AND THREE BALLS AT THE END OF THE SWOOSHES, THE TEXT "CURE" BELOW THE IMAGE, AND THE TEXT "CENTER FOR ULTRASOUND RESEARCH & EDUCATION" BELOW "CURE".

SER. NO. 85-378,291, FILED 7-22-2011.

TEJBIR SINGH, EXAMINING ATTORNEY



*David J. Kybas*

Director of the United States Patent and Trademark Office



# United States of America

United States Patent and Trademark Office

# cashcall.com

**Reg. No. 4,125,027**

CASHCALL, INC. (CALIFORNIA CORPORATION)  
1600 SOUTH DOUGLASS ROAD  
ANAHEIM, CA 92660

**Registered Apr. 10, 2012**

**Int. Cl.: 36**

FOR: INSTALLMENT LOANS; MORTGAGE BANKING SERVICES, NAMELY, ORIGINATION, ACQUISITION, SERVICING, SECURITIZATION AND BROKERAGE OF MORTGAGE LOANS, IN CLASS 36 (U.S. CLS. 100, 101 AND 102).

**SERVICE MARK**

FIRST USE 3-1-2003; IN COMMERCE 3-1-2003.

**PRINCIPAL REGISTER**

THE MARK CONSISTS OF STANDARD CHARACTERS WITHOUT CLAIM TO ANY PARTICULAR FONT, STYLE, SIZE, OR COLOR.

SER. NO. 85-378,415, FILED 7-22-2011.

WILLIAM JACKSON, EXAMINING ATTORNEY



*David J. Kyffers*

Director of the United States Patent and Trademark Office

# United States of America

United States Patent and Trademark Office

# campestres

**Reg. No. 4,125,028**

CORONA, MARIO (UNITED STATES INDIVIDUAL)  
1227 HEAVENS PEAK  
SAN ANTONIO, TX 78258

**Registered Apr. 10, 2012**

**Int. Cl.: 37**

FOR: REAL ESTATE DEVELOPMENT, IN CLASS 37 (U.S. CLS. 100, 103 AND 106).

**SERVICE MARK**

FIRST USE 6-27-2011; IN COMMERCE 6-27-2011.

**PRINCIPAL REGISTER**

THE MARK CONSISTS OF THE WORD "CAMPESTRES" IN GREEN.

THE COLOR(S) GREEN IS/ARE CLAIMED AS A FEATURE OF THE MARK.

THE ENGLISH TRANSLATION OF "CAMPESTRES" IN THE MARK IS "COUNTRYSIDE".

SER. NO. 85-378,431, FILED 7-22-2011.

SEAN CROWLEY, EXAMINING ATTORNEY



*David J. Kybas*

Director of the United States Patent and Trademark Office

# United States of America

United States Patent and Trademark Office



**Reg. No. 4,125,029**

CORONA, MARIO (UNITED STATES INDIVIDUAL)  
1227 HEAVENS PEAK  
SAN ANTONIO, TX 78258

**Registered Apr. 10, 2012**

**Int. Cl.: 37**

FOR: REAL ESTATE DEVELOPMENT, IN CLASS 37 (U.S. CLS. 100, 103 AND 106).

**SERVICE MARK**

FIRST USE 6-27-2011; IN COMMERCE 6-27-2011.

**PRINCIPAL REGISTER**

THE MARK CONSISTS OF A GREEN TREE WITH A "C" SHAPE IN LIGHT BLUE ON THE LEFT SIDE AND A "P" SHAPE WITH THE "@" SYMBOL INSIDE IN LIGHT BLUE WITH A LEAF AT THE END OF THE "@" SYMBOL ON THE RIGHT SIDE, ALONG WITH WORD "CAMPESTRES" IN GREEN AND THE WORDING "CASCADA" IN BLUE.

THE COLOR(S) GREEN, LIGHT BLUE, AND BLUE IS/ARE CLAIMED AS A FEATURE OF THE MARK.

THE ENGLISH TRANSLATION OF "CAMPESTRES CASCADA" IN THE MARK IS "COUNTRYSIDE WATERFALL".

SER. NO. 85-378,474, FILED 7-22-2011.

SEAN CROWLEY, EXAMINING ATTORNEY



*David J. Kyros*

Director of the United States Patent and Trademark Office

# United States of America

United States Patent and Trademark Office

## CALUMET FARM

**Reg. No. 4,125,030**

KENNELOT STABLES, LTD. (BAHAMAS CORPORATION), DBA CALUMET FARM  
3301 VERSAILLES ROAD  
LEXINGTON, KY 40510

**Registered Apr. 10, 2012**

**Int. Cls.: 35, 41, 43 and  
44**

FOR: CONSIGNMENT SERVICES, NAMELY, PROMOTING AND MARKETING THE HORSES  
OF OTHERS, IN CLASS 35 (U.S. CLS. 100, 101 AND 102).

FIRST USE 12-31-1927; IN COMMERCE 12-31-1927.

**SERVICE MARK**

FOR: HORSE TRAINING, IN CLASS 41 (U.S. CLS. 100, 101 AND 107).

**PRINCIPAL REGISTER**

FIRST USE 12-31-1924; IN COMMERCE 12-31-1924.

FOR: BOARDING FOR HORSES; PROVIDING HORSE STABLE FACILITIES, IN CLASS 43  
(U.S. CLS. 100 AND 101).

FIRST USE 12-31-2000; IN COMMERCE 12-31-2000.

FOR: HORSE BREEDING AND STUD SERVICES; HORSE CARE, NAMELY, FEEDING THE  
HORSES OF ABSENT OWNERS; HORSE FARMS, IN CLASS 44 (U.S. CLS. 100 AND 101).

FIRST USE 12-31-1932; IN COMMERCE 12-31-1940.

THE MARK CONSISTS OF STANDARD CHARACTERS WITHOUT CLAIM TO ANY PAR-  
TICULAR FONT, STYLE, SIZE, OR COLOR.

OWNER OF U.S. REG. NO. 3,353,233.

NO CLAIM IS MADE TO THE EXCLUSIVE RIGHT TO USE "FARM", APART FROM THE  
MARK AS SHOWN.

SER. NO. 85-378,606, FILED 7-22-2011.

DOMINIC FATHY, EXAMINING ATTORNEY



*David J. Kyros*

Director of the United States Patent and Trademark Office

# United States of America

United States Patent and Trademark Office

# HB BMX

**Reg. No. 4,125,031**

GREEN, LONNIE (UNITED STATES INDIVIDUAL)  
328A MALBERT ST  
PERRIS, CA 92570

**Registered Apr. 10, 2012**

**Int. Cl.: 12**

FOR: BICYCLE GEARS; BICYCLE PARTS, NAMELY, BRAKE SHOES; BICYCLE PARTS, NAMELY, CHANGE-SPEED GEARS; BICYCLE PARTS, NAMELY, DISK WHEELS; BICYCLE PARTS, NAMELY, DRIVE CHAINS; BICYCLE PARTS, NAMELY, FORK CROWN COVERS; BICYCLE PARTS, NAMELY, FORKS; BICYCLE PARTS, NAMELY, FRONT FORK JOINTS; BICYCLE PARTS, NAMELY, GEAR WHEELS; BICYCLE PARTS, NAMELY, HANDLE BAR ENDS; BICYCLE PARTS, NAMELY, HANDLE BAR STEMS; BICYCLE PARTS, NAMELY, SPROCKETS; BICYCLE PARTS, NAMELY, TUBES AND CONNECTORS FOR BICYCLE FRAMES; BICYCLE PARTS, NAMELY, BRAKES, CHAINS, AND HANDLE BARS; BICYCLES, IN CLASS 12 (U.S. CLS. 19, 21, 23, 31, 35 AND 44).

**TRADEMARK**

**PRINCIPAL REGISTER**

FIRST USE 3-15-2011; IN COMMERCE 3-15-2011.

THE MARK CONSISTS OF STANDARD CHARACTERS WITHOUT CLAIM TO ANY PARTICULAR FONT, STYLE, SIZE, OR COLOR.

NO CLAIM IS MADE TO THE EXCLUSIVE RIGHT TO USE "BMX", APART FROM THE MARK AS SHOWN.

SER. NO. 85-378,638, FILED 7-22-2011.

SUSAN LESLIE DUBOIS, EXAMINING ATTORNEY



*David J. Kybas*

Director of the United States Patent and Trademark Office

# United States of America

United States Patent and Trademark Office

# PHBEAD

**Reg. No. 4,125,032**

**Registered Apr. 10, 2012**

**Int. Cl.: 14**

**TRADEMARK**

**PRINCIPAL REGISTER**

PHBEAD, LLC (KENTUCKY LIMITED LIABILITY COMPANY)  
327 CHESTNUT STREET, SUITE 4  
BEREA, KY 40403

FOR: JEWELRY, IN CLASS 14 (U.S. CLS. 2, 27, 28 AND 50).

FIRST USE 6-5-2007; IN COMMERCE 8-2-2007.

THE MARK CONSISTS OF STANDARD CHARACTERS WITHOUT CLAIM TO ANY PARTICULAR FONT, STYLE, SIZE, OR COLOR.

OWNER OF U.S. REG. NO. 3,426,145.

SER. NO. 85-378,662, FILED 7-22-2011.

AMY C. KEAN, EXAMINING ATTORNEY



*David J. Kyffers*

Director of the United States Patent and Trademark Office

# United States of America

United States Patent and Trademark Office



**Reg. No. 4,125,033**

**Registered Apr. 10, 2012**

**Int. Cl.: 14**

**TRADEMARK**

**PRINCIPAL REGISTER**

PHBEAD, LLC (KENTUCKY LIMITED LIABILITY COMPANY)  
327 CHESTNUT STREET, SUITE 4  
BEREA, KY 40403

FOR: JEWELRY, IN CLASS 14 (U.S. CLS. 2, 27, 28 AND 50).

FIRST USE 3-1-2010; IN COMMERCE 3-1-2010.

OWNER OF U.S. REG. NO. 3,426,145.

THE MARK CONSISTS OF A SHAPE OF A BUTTERFLY IMAGE WITH TRAILING CURVED LINES OVER THE WORD "PHBEAD" OVER THE WORDS "WHERE SCIENCE MEETS ART."

SER. NO. 85-378,727, FILED 7-22-2011.

AMY C. KEAN, EXAMINING ATTORNEY



*David J. Kappas*

Director of the United States Patent and Trademark Office

# United States of America

United States Patent and Trademark Office

 **WALL GUARDIAN** 

**Reg. No. 4,125,034**

SAF-T-SCREENS, INC. (TEXAS CORPORATION)  
347 HWY 289  
COMFORT, TX 78013

**Registered Apr. 10, 2012**

**Int. Cl.: 1**

FOR: WATERPROOFING CHEMICAL COMPOSITIONS FOR ARTICLES OF MASONRY, WOOD AND OTHER BUILDING AND/OR CONSTRUCTION SURFACES, IN CLASS 1 (U.S. CLS. 1, 5, 6, 10, 26 AND 46).

**TRADEMARK**

FIRST USE 7-5-2003; IN COMMERCE 7-5-2003.

**PRINCIPAL REGISTER**

NO CLAIM IS MADE TO THE EXCLUSIVE RIGHT TO USE "WALL", APART FROM THE MARK AS SHOWN.

THE MARK CONSISTS OF THE WORDS "WALL GUARDIAN" IN ALL CAPITAL LETTERS, THERE ARE TWO FIVE POINT STARS WITH CIRCLES AROUND THEM, ONE BEFORE "WALL" AND ONE AFTER "GUARDIAN."

SER. NO. 85-378,811, FILED 7-22-2011.

REBECCA EISINGER, EXAMINING ATTORNEY



*David J. Kyjars*

Director of the United States Patent and Trademark Office



# United States of America

United States Patent and Trademark Office

## EQUIVALENT

**Reg. No. 4,125,035**

**Registered Apr. 10, 2012**

**Int. Cl.: 32**

**TRADEMARK**

**PRINCIPAL REGISTER**

LEDERER, IRA S. (UNITED STATES INDIVIDUAL)  
EQUIVALENT  
27 OLD GLOUCESTER STREET  
LONDON, UNITED KINGDOM WC1N3AX

FOR: SOFT DRINKS, IN CLASS 32 (U.S. CLS. 45, 46 AND 48).

THE MARK CONSISTS OF STANDARD CHARACTERS WITHOUT CLAIM TO ANY PARTICULAR FONT, STYLE, SIZE, OR COLOR.

PRIORITY CLAIMED UNDER SEC. 44(D) ON UNITED KINGDOM APPLICATION NO. 2586190, FILED 6-29-2011, REG. NO. 2586190, DATED 9-30-2011, EXPIRES 9-30-2021.

SER. NO. 85-378,920, FILED 7-22-2011.

DAWN FELDMAN, EXAMINING ATTORNEY



*David J. Kybas*

Director of the United States Patent and Trademark Office

# United States of America

## United States Patent and Trademark Office

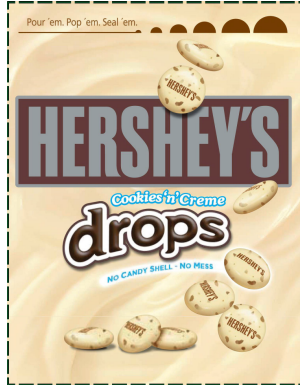

**Reg. No. 4,125,036**

**Registered Apr. 10, 2012**

**Int. Cl.: 30**

HERSHEY CHOCOLATE & CONFECTIONERY CORPORATION (DELAWARE CORPORATION)  
SUITE 204  
4860 ROBB STREET  
WHEAT RIDGE, CO 80033

**TRADEMARK**

**PRINCIPAL REGISTER**

FOR: CANDY, IN CLASS 30 (U.S. CL. 46).

FIRST USE 11-30-2010; IN COMMERCE 11-30-2010.

OWNER OF U.S. REG. NOS. 54,041, 3,321,536 AND OTHERS.

THE COLOR(S) BROWN, SILVER, BLUE, WHITE, TAN AND BEIGE IS/ARE CLAIMED AS A FEATURE OF THE MARK.

NO CLAIM IS MADE TO THE EXCLUSIVE RIGHT TO USE "COOKIES 'N CREME", "DROPS", "NO CANDY SHELL", AND PICTORIAL DEPICTION OF THE DROPS APART FROM THE MARK AS SHOWN., APART FROM THE MARK AS SHOWN.

THE COLOR(S) BROWN, SILVER, BLUE, WHITE, TAN AND BEIGE ARE CLAIMED AS A FEATURE OF THE MARK. THE MARK CONSISTS OF "HERSHEY'S" IN SILVER LETTERS WITHIN A BROWN RECTANGLE OUTLINED IN SILVER. BELOW ARE THE WORDS "COOKIES 'N CREME" IN WHITE LETTERS OUTLINED IN BLUE. "DROPS" APPEARS IN BROWN OUTLINED IN WHITE. "NO CANDY SHELL - NO MESS" APPEARS IN BLUE LETTERING WITHIN A WHITE BACKGROUND STRIP. THERE ARE NINE SPECKLED BROWN, TAN AND BEIGE CANDIES WITH "HERSHEY'S" IN BROWN APPEARING THEREON. AT THE TOP APPEARS A BROWN HORIZONTAL LINE AND TO THE RIGHT APPEAR INCREASING-SIZE PARTIAL CIRCLES IN BROWN BELOW THE WORDS "POUR 'EM. POP 'EM. SEAL 'EM" IN LIGHT BROWN LETTERS, ALL AGAINST A TAN AND BEIGE SWIRL BACKGROUND. THE DOTTED LINING SHOWN IN THE MARK IS NOT A FEATURE OF THE MARK BUT INTENDED TO SHOW PLACEMENT OF THE MARK ON THE PACKAGE.



*David J. Kybas*

SER. NO. 85-378,979, FILED 7-22-2011.

CHRISTOPHER SIDOTI, EXAMINING ATTORNEY

# United States of America

United States Patent and Trademark Office

## Making Our World a More Delicious Place

**Reg. No. 4,125,037**

DEBRA M. DAVIS (UNITED STATES INDIVIDUAL)

**Registered Apr. 10, 2012**

464 C.R. 2620  
MINEOLA, TX 75773

**Int. Cl.: 41**

FOR: ENTERTAINMENT AND EDUCATION SERVICES IN THE NATURE OF AN INSPIRATIONAL SERIES OF VIDEOS AND AUDIO MEDIA IN THE FIELDS OF PARENTING, MOTHERHOOD, MARRIAGE, MOTHERS AND DAUGHTER RELATIONSHIPS, FATHERS AND SON RELATIONSHIPS, GRANDPARENTING, FAMILY, SPIRITUALITY, CONFIDENCE BUILDING, CHRISTIANITY, DREAMS, AND COOKING, IN CLASS 41 (U.S. CLS. 100, 101 AND 107).

**SERVICE MARK**

**PRINCIPAL REGISTER**

FIRST USE 4-1-2009; IN COMMERCE 4-1-2011.

THE MARK CONSISTS OF STANDARD CHARACTERS WITHOUT CLAIM TO ANY PARTICULAR FONT, STYLE, SIZE, OR COLOR.

SER. NO. 85-378,989, FILED 7-22-2011.

KAELIE KUNG, EXAMINING ATTORNEY



*David J. Kyffers*

Director of the United States Patent and Trademark Office

# United States of America

United States Patent and Trademark Office

# TankMate

**Reg. No. 4,125,038**

CHRISTOPHER BIBOW (UNITED STATES INDIVIDUAL), DBA TORCHTOOLS  
47 N. WOODHULL ROAD  
HUNTINGTON, NY 11743

**Registered Apr. 10, 2012**

**Int. Cl.: 8**

FOR: TOOL HOLDERS FOR HOLDING TORCHES AND ACCESSORIES, NAMELY, HOSES, FLINT STRIKERS, AND VALVE KEYS, IN CLASS 8 (U.S. CLS. 23, 28 AND 44).

**TRADEMARK**

FIRST USE 9-3-2003; IN COMMERCE 11-3-2003.

**PRINCIPAL REGISTER**

THE MARK CONSISTS OF STANDARD CHARACTERS WITHOUT CLAIM TO ANY PARTICULAR FONT, STYLE, SIZE, OR COLOR.

SER. NO. 85-378,999, FILED 7-22-2011.

JORDAN BAKER, EXAMINING ATTORNEY



*David J. Kybas*

Director of the United States Patent and Trademark Office

# United States of America

United States Patent and Trademark Office

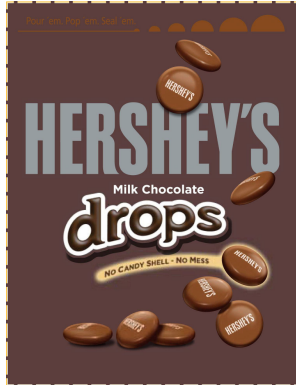

**Reg. No. 4,125,039**

**Registered Apr. 10, 2012**

**Int. Cl.: 30**

HERSHEY CHOCOLATE & CONFECTIONERY CORPORATION (DELAWARE CORPORATION)  
SUITE 204  
4860 ROBB STREET  
WHEAT RIDGE, CO 80033

**TRADEMARK**

**PRINCIPAL REGISTER**

FOR: CANDY, IN CLASS 30 (U.S. CL. 46).

FIRST USE 1-31-2010; IN COMMERCE 1-31-2010.

OWNER OF U.S. REG. NOS. 54,041, 3,321,536 AND OTHERS.

THE COLOR(S) BROWN, LIGHT BROWN, SILVER, WHITE, TAN AND BEIGE IS/ARE CLAIMED AS A FEATURE OF THE MARK.

NO CLAIM IS MADE TO THE EXCLUSIVE RIGHT TO USE THE WORDS "MILK CHOCOLATE", "DROPS", "NO CANDY SHELL" AND THE PICTORIAL DEPICTION OF THE DROPS APART FROM THE MARK AS SHOWN., APART FROM THE MARK AS SHOWN.

THE MARK CONSISTS OF "HERSHEY'S" IN SILVER LETTERS WITH THE WORDS "MILK CHOCOLATE" IN WHITE LETTERS. "DROPS" APPEARS IN BROWN LETTERS OUTLINED IN WHITE. "NO CANDY SHELL - NO MESS" APPEARS IN BROWN WITH A LIGHT BROWN OR TAN/BEIGE BACKGROUND STRIP. THERE ARE NINE ROUND CANDY PIECES IN BROWN WITH "HERSHEY'S" APPEARING IN WHITE LETTERS THEREON. AT THE TOP APPEARS A LIGHT BROWN HORIZONTAL LINE AND TO THE RIGHT APPEAR SIX INCREASING-SIZE PARTIAL CIRCLES IN LIGHT BROWN BELOW THE WORDS "POUR 'EM. POP 'EM. SEAL 'EM" IN LIGHT BROWN LETTERS, ALL AGAINST A BROWN BACKGROUND. THE DOTTED LINING SHOWN IN THE MARK IS NOT A FEATURE OF THE MARK BUT INTENDED TO SHOW PLACEMENT OF THE MARK ON THE PACKAGE.

SER. NO. 85-379,002, FILED 7-22-2011.

CHRISTOPHER SIDOTI, EXAMINING ATTORNEY



*David J. Kyffers*

Director of the United States Patent and Trademark Office

# United States of America

United States Patent and Trademark Office

## I Heart West Seattle

**Reg. No. 4,125,040**

STEINER, ROGER (UNITED STATES INDIVIDUAL)

**Registered Apr. 10, 2012**

5919 46TH AVE SW  
SEATTLE, WA 98136

**Int. Cl.: 36**

FOR: REAL ESTATE BROKERAGE, IN CLASS 36 (U.S. CLS. 100, 101 AND 102).

**SERVICE MARK**

FIRST USE 2-15-2007; IN COMMERCE 2-15-2007.

**PRINCIPAL REGISTER**

THE MARK CONSISTS OF STANDARD CHARACTERS WITHOUT CLAIM TO ANY PARTICULAR FONT, STYLE, SIZE, OR COLOR.

NO CLAIM IS MADE TO THE EXCLUSIVE RIGHT TO USE "WEST SEATTLE", APART FROM THE MARK AS SHOWN.

SER. NO. 85-379,088, FILED 7-22-2011.

FRED CARL, EXAMINING ATTORNEY



*David J. Kyffers*

Director of the United States Patent and Trademark Office

# United States of America

United States Patent and Trademark Office

## Outdoor Power

**Reg. No. 4,125,041**

ABSOLUTE EYEWEAR SOLUTIONS, INC. (NORTH CAROLINA CORPORATION)  
POST OFFICE BOX 828  
SENATOBIA, MS 38668

**Registered Apr. 10, 2012**

**Int. Cl.: 14**

FOR: BRACELETS, IN CLASS 14 (U.S. CLS. 2, 27, 28 AND 50).

**TRADEMARK**

FIRST USE 7-1-2011; IN COMMERCE 7-1-2011.

**PRINCIPAL REGISTER**

THE MARK CONSISTS OF STANDARD CHARACTERS WITHOUT CLAIM TO ANY PARTICULAR FONT, STYLE, SIZE, OR COLOR.

NO CLAIM IS MADE TO THE EXCLUSIVE RIGHT TO USE "OUTDOOR", APART FROM THE MARK AS SHOWN.

SER. NO. 85-379,231, FILED 7-23-2011.

CARYN GLASSER, EXAMINING ATTORNEY



*David J. Kyffers*

Director of the United States Patent and Trademark Office

# United States of America

United States Patent and Trademark Office

## Dallas Window Tint

**Reg. No. 4,125,042**

**Registered Apr. 10, 2012**

**Int. Cl.: 40**

**SERVICE MARK**

**PRINCIPAL REGISTER**

LEVERETT, ROBERT A. (UNITED STATES INDIVIDUAL)  
300-4  
2201 MAIN ST  
DALLAS, TX 75201

FOR: WINDOW TINTING SERVICES, IN CLASS 40 (U.S. CLS. 100, 103 AND 106).

FIRST USE 9-27-2004; IN COMMERCE 9-27-2004.

THE MARK CONSISTS OF STANDARD CHARACTERS WITHOUT CLAIM TO ANY PARTICULAR FONT, STYLE, SIZE, OR COLOR.

NO CLAIM IS MADE TO THE EXCLUSIVE RIGHT TO USE "WINDOW TINT", APART FROM THE MARK AS SHOWN.

SEC. 2(F).

SER. NO. 85-379,317, FILED 7-24-2011.

ZACHARY BELLO, EXAMINING ATTORNEY



*David J. Kyffers*

Director of the United States Patent and Trademark Office



# United States of America

United States Patent and Trademark Office

# Ninja Worm

**Reg. No. 4,125,043**

BITE IT! BAITS LLC (LOUISIANA LIMITED LIABILITY COMPANY)  
1734 GENDARME RD  
CARENCRO, LA 70520

**Registered Apr. 10, 2012**

**Int. Cl.: 28**

FOR: ARTIFICIAL FISHING WORMS; FISHING LURES; FISHING LURES, NAMELY, PLASTIC WORMS, IN CLASS 28 (U.S. CLS. 22, 23, 38 AND 50).

**TRADEMARK**

FIRST USE 7-1-2011; IN COMMERCE 7-10-2011.

**PRINCIPAL REGISTER**

THE MARK CONSISTS OF STANDARD CHARACTERS WITHOUT CLAIM TO ANY PARTICULAR FONT, STYLE, SIZE, OR COLOR.

NO CLAIM IS MADE TO THE EXCLUSIVE RIGHT TO USE "WORM", APART FROM THE MARK AS SHOWN.

SER. NO. 85-379,341, FILED 7-24-2011.

DOMINIC J. FERRAIUOLO, EXAMINING ATTORNEY



*David J. Kybas*

Director of the United States Patent and Trademark Office

# United States of America

United States Patent and Trademark Office

# Bella Vista

**Reg. No. 4,125,044**

**Registered Apr. 10, 2012**

**Int. Cl.: 41**

**SERVICE MARK**

**PRINCIPAL REGISTER**

BUSINESS WORLD RISING, INC. (CALIFORNIA CORPORATION), DBA BUSINESS WOMEN RISING, INC.  
3334 EAST COAST HIGHWAY, SUITE 417  
NEWPORT BEACH, CA 92625

FOR: BUSINESS EDUCATION AND TRAINING SERVICES, NAMELY, DEVELOPING AND FACILITATING CUSTOMIZED LEADERSHIP AND EXECUTIVE DEVELOPMENT PROGRAMS, PROVIDING EXECUTIVE COACHING SERVICES, AND PROVIDING BUSINESS EDUCATION PROGRAMS TO EMPLOYEES AND EXECUTIVES; EDUCATION SERVICES, NAMELY, MENTORING IN THE FIELD OF MANAGEMENT, LEADERSHIP AND EXECUTIVE DEVELOPMENT; PEER TO PEER COACHING SERVICES IN THE FIELD OF MANAGEMENT, LEADERSHIP AND EXECUTIVE DEVELOPMENT; PROVIDING EDUCATIONAL MENTORING SERVICES AND PROGRAMS IN THE FIELD OF MANAGEMENT, LEADERSHIP AND EXECUTIVE DEVELOPMENT; PROVIDING GROUP COACHING AND LEARNING FORUMS IN THE FIELD OF LEADERSHIP DEVELOPMENT, IN CLASS 41 (U.S. CLS. 100, 101 AND 107).

FIRST USE 6-24-2011; IN COMMERCE 7-14-2011.

THE MARK CONSISTS OF STANDARD CHARACTERS WITHOUT CLAIM TO ANY PARTICULAR FONT, STYLE, SIZE, OR COLOR.

THE ENGLISH TRANSLATION OF "BELLA VISTA" IN THE MARK IS "BEAUTIFUL VIEW".

SER. NO. 85-379,359, FILED 7-24-2011.

DOMINIC J. FERRAIUOLO, EXAMINING ATTORNEY



*David J. Kyffers*

Director of the United States Patent and Trademark Office

# United States of America

United States Patent and Trademark Office

# Magna Vista

**Reg. No. 4,125,045**

**Registered Apr. 10, 2012**

**Int. Cl.: 41**

**SERVICE MARK**

**PRINCIPAL REGISTER**

BUSINESS WORLD RISING, INC. (CALIFORNIA CORPORATION), DBA BUSINESS WOMEN RISING, INC.  
3334 EAST COAST HIGHWAY, SUITE 417  
NEWPORT BEACH, CA 92625

FOR: BUSINESS EDUCATION AND TRAINING SERVICES, NAMELY, DEVELOPING AND FACILITATING CUSTOMIZED LEADERSHIP AND EXECUTIVE DEVELOPMENT PROGRAMS, PROVIDING EXECUTIVE COACHING SERVICES, AND PROVIDING BUSINESS EDUCATION PROGRAMS TO EMPLOYEES AND EXECUTIVES; EDUCATION SERVICES, NAMELY, MENTORING IN THE FIELD OF MANAGEMENT, LEADERSHIP AND EXECUTIVE DEVELOPMENT; PEER TO PEER COACHING SERVICES IN THE FIELD OF MANAGEMENT, LEADERSHIP AND EXECUTIVE DEVELOPMENT; PROVIDING EDUCATIONAL MENTORING SERVICES AND PROGRAMS IN THE FIELD OF MANAGEMENT, LEADERSHIP AND EXECUTIVE DEVELOPMENT; PROVIDING GROUP COACHING AND LEARNING FORUMS IN THE FIELD OF LEADERSHIP DEVELOPMENT, IN CLASS 41 (U.S. CLS. 100, 101 AND 107).

FIRST USE 6-21-2011; IN COMMERCE 6-22-2011.

THE MARK CONSISTS OF STANDARD CHARACTERS WITHOUT CLAIM TO ANY PARTICULAR FONT, STYLE, SIZE, OR COLOR.

THE ENGLISH TRANSLATION OF "MAGNA VISTA" IN THE MARK IS "GREAT VIEW".

SER. NO. 85-379,368, FILED 7-24-2011.

DOMINIC J. FERRAIUOLO, EXAMINING ATTORNEY



*David J. Kyffers*

Director of the United States Patent and Trademark Office

# United States of America

United States Patent and Trademark Office



**Reg. No. 4,125,046**

**Registered Apr. 10, 2012**

**Int. Cl.: 43**

**SERVICE MARK**

**PRINCIPAL REGISTER**

MACRI'S DELI FRANCHISE, INC. (INDIANA CORPORATION)  
15575 VICTORIAN COURT  
GRANGER, IN 46530

FOR: RESTAURANT SERVICES, IN CLASS 43 (U.S. CLS. 100 AND 101).

FIRST USE 1-31-1981; IN COMMERCE 1-31-1981.

NO CLAIM IS MADE TO THE EXCLUSIVE RIGHT TO USE "DELI" , APART FROM THE MARK AS SHOWN.

THE COLOR(S) BLACK AND WHITE IS/ARE CLAIMED AS A FEATURE OF THE MARK.

THE MARK CONSISTS OF A FANCIFUL SHELL DESIGN IN SCALLOPED BLACK AND WHITE, WITH THE WORDS "MACRI'S DELI" IN A FANCY FONT, IN AN ARC, IN WHITE REVERSE ON BLACK, WITH WHITE TRIM, AND A REPRESENTATION OF A HOAGIE SANDWICH DEPICTED WITH WHITE BUNS AND BLACK FILLING, A GLASS OF WINE DEPICTED WITH WHITE GLASS AND BLACK DARK, A PITCHER OF BEER DEPICTED IN WHITE WITH BLACK LINING, AND MISCELLANEOUS DESIGNS WITH OVERALL QUADRILATERAL SHAPE IN WHITE AND BLACK.

SER. NO. 85-379,437, FILED 7-24-2011.

BRENDAN REGAN, EXAMINING ATTORNEY



*David J. Kyros*

Director of the United States Patent and Trademark Office

# United States of America

United States Patent and Trademark Office

## LISTEN TO LEAD

---

## CONSULTING

Know yourself. Hear others. Facilitate change.

**Reg. No. 4,125,047**

SCHONWALD, SARA WERNICK (UNITED STATES INDIVIDUAL)  
6415 CALIFORNIA STREET  
SAN FRANCISCO, CA 94121

**Registered Apr. 10, 2012**

**Int. Cl.: 45**

FOR: PERSONAL DEVELOPMENT CONSULTING SERVICES IN THE FIELDS OF SELF IMPROVEMENT AND INTERPERSONAL COMMUNICATIONS FOR INDIVIDUALS AND EMPLOYEES OF SCHOOLS, NONPROFITS, AND BUSINESSES, IN CLASS 45 (U.S. CLS. 100 AND 101).

**SERVICE MARK**

**PRINCIPAL REGISTER**

FIRST USE 7-12-2011; IN COMMERCE 7-12-2011.

NO CLAIM IS MADE TO THE EXCLUSIVE RIGHT TO USE "CONSULTING", APART FROM THE MARK AS SHOWN.

THE COLOR(S) BLACK, GREEN, AND GRAY IS/ARE CLAIMED AS A FEATURE OF THE MARK.

THE MARK CONSISTS OF A STYLIZED GREEN "LISTEN" WITH A SMALLER BLACK "TO" AND A STYLIZED GREEN "LEAD" ALL IN CAPITAL LETTERS WITH A BLACK HORIZONTAL LINE UNDERNEATH. UNDERNEATH THAT HORIZONTAL LINE IS THE WORD "CONSULTING" WRITTEN IN BLACK IN THE SAME STYLIZED TEXT AS "LISTEN TO LEAD". FINALLY, THE LOGO CONTAINS THE TAG LINE IN GRAY STYLIZED TEXT UNDERNEATH "CONSULTING" WHICH READS: "KNOW YOURSELF. HEAR OTHERS. FACILITATE CHANGE.". THE COLOR WHITE REPRESENTS BACKGROUND AREA AND IS NOT PART OF THE MARK.



SER. NO. 85-379,469, FILED 7-24-2011.

KATHLEEN M. VANSTON, EXAMINING ATTORNEY

*David J. Kyjars*

Director of the United States Patent and Trademark Office

# United States of America

United States Patent and Trademark Office

# WineWeaver

**Reg. No. 4,125,048**

**Registered Apr. 10, 2012**

**Int. Cl.: 21**

**TRADEMARK**

**PRINCIPAL REGISTER**

WESTPORT GLOBAL LIMITED (UNITED KINGDOM LIMITED LIABILITY COMPANY)  
LIONS HEAD, 5 THE SPAIN,  
PETERSFIELD,, UNITED KINGDOM GU323JZ

FOR: BAR, HOUSEHOLD AND KITCHEN UTENSILS RELATING TO WINE, NAMELY, HAND OPERATED WINE AERATORS FOR FACILITATING THE AERATION OF WINE PRIOR TO CONSUMPTION; BAR AND KITCHEN UTENSILS, NAMELY, WINE POURERS, DECANTERS, CORK EXTRACTORS, CORK SCREWS, BOTTLE OPENERS, BOTTLE STOPPERS SPECIALLY ADAPTED FOR USE WITH WINE BOTTLES, COOLERS FOR WINE; BEVERAGE GLASSWARE, IN CLASS 21 (U.S. CLS. 2, 13, 23, 29, 30, 33, 40 AND 50).

FIRST USE 11-25-2008; IN COMMERCE 12-15-2008.

THE MARK CONSISTS OF STANDARD CHARACTERS WITHOUT CLAIM TO ANY PARTICULAR FONT, STYLE, SIZE, OR COLOR.

OWNER OF U.S. REG. NO. 3,591,573.

SER. NO. 85-379,502, FILED 7-25-2011.

TRACY CROSS, EXAMINING ATTORNEY



*David J. Kypos*

Director of the United States Patent and Trademark Office

# United States of America

United States Patent and Trademark Office

# Elixir AP

**Reg. No. 4,125,049**

**Registered Apr. 10, 2012**

**Int. Cl.: 3**

**TRADEMARK**

**PRINCIPAL REGISTER**

GOLDEN GATE WORLDWIDE GROUP LLC (FLORIDA LIMITED LIABILITY COMPANY)  
PO BOX 255  
DEERFIELD BEACH, FL 33443

FOR: HAIR CARE KITS COMPRISING NON-MEDICATED HAIR CARE PREPARATIONS, NAMELY, CLEANSERS, SHAMPOO, CONDITIONER, TREATMENTS, HAIR MASK AND RECONSTRUCTOR; HAIR CLEANING PREPARATIONS; HAIR MASKS; HAIR SHAMPOOS AND CONDITIONERS; NON-MEDICATED HAIR TREATMENT PREPARATIONS FOR COSMETIC PURPOSES, IN CLASS 3 (U.S. CLS. 1, 4, 6, 50, 51 AND 52).

FIRST USE 7-3-2010; IN COMMERCE 11-30-2010.

THE MARK CONSISTS OF STANDARD CHARACTERS WITHOUT CLAIM TO ANY PARTICULAR FONT, STYLE, SIZE, OR COLOR.

NO CLAIM IS MADE TO THE EXCLUSIVE RIGHT TO USE "ELIXIR", APART FROM THE MARK AS SHOWN.

SER. NO. 85-379,516, FILED 7-25-2011.

MARTHA FROMM, EXAMINING ATTORNEY



*David J. Kypos*

Director of the United States Patent and Trademark Office

# United States of America

United States Patent and Trademark Office

# Grandpa Don

**Reg. No. 4,125,050**

**Registered Apr. 10, 2012**

**Int. Cl.: 16**

**TRADEMARK**

**PRINCIPAL REGISTER**

DONALD V. MCNAMARA (NEW YORK LIMITED LIABILITY COMPANY), DBA DVM  
CONSULTANTS LLC  
5857 STELLIUM DR.  
SYRACUSE, NY 13209

FOR: CHILDREN'S INTERACTIVE EDUCATIONAL BOOKS, IN CLASS 16 (U.S. CLS. 2, 5,  
22, 23, 29, 37, 38 AND 50).

FIRST USE 2-15-2010; IN COMMERCE 7-22-2011.

THE MARK CONSISTS OF STANDARD CHARACTERS WITHOUT CLAIM TO ANY PAR-  
TICULAR FONT, STYLE, SIZE, OR COLOR.

SER. NO. 85-379,562, FILED 7-25-2011.

JUDITH HELFMAN, EXAMINING ATTORNEY



*David J. Kyffers*

Director of the United States Patent and Trademark Office



# United States of America

United States Patent and Trademark Office

## WELDON COCONUT MILK

**Reg. No. 4,125,051**

**Registered Apr. 10, 2012**

**Int. Cl.: 32**

**TRADEMARK**

**PRINCIPAL REGISTER**

S.G.S. INTERNATIONAL RICE, INC. (NEW JERSEY CORPORATION)  
6 STONE TAVERN DRIVE  
CLARKSBURG, NJ 08510

FOR: COCONUT MILK, IN CLASS 32 (U.S. CLS. 45, 46 AND 48).

FIRST USE 0-0-2002; IN COMMERCE 2-18-2003.

THE MARK CONSISTS OF STANDARD CHARACTERS WITHOUT CLAIM TO ANY PARTICULAR FONT, STYLE, SIZE, OR COLOR.

NO CLAIM IS MADE TO THE EXCLUSIVE RIGHT TO USE "COCONUT MILK", APART FROM THE MARK AS SHOWN.

SER. NO. 85-379,631, FILED 7-25-2011.

LINDA M. KING, EXAMINING ATTORNEY



*David J. Kyffers*

Director of the United States Patent and Trademark Office

# United States of America

United States Patent and Trademark Office

## A Night At The Races

**Reg. No. 4,125,052**

**Registered Apr. 10, 2012**

**Int. Cl.: 41**

**SERVICE MARK**

**PRINCIPAL REGISTER**

A NITE AT THE RACES, INC. (FLORIDA CORPORATION), DBA A NITE AT THE RACES, INC.  
3043 JUPITER PARK CIRCLE  
JUPITEER, FL 334586012

FOR: ENTERTAINMENT SERVICES, NAMELY, EXHIBITION IN THE NATURE OF ORGANIZATION OF PRE-RECORDED HORSE RACES WITH SERVICES THAT INCLUDES THE RENTAL AND MANNED SERVICES FOR CONDUCTING A HORSE RACE SOCIAL EVENT THAT INCLUDES PRE-RECORDED HORSE RACES ALONG WITH RACE PROGRAMS, WAGERING TICKETS, DAILY DOUBLE TICKETS, FUNNY MONEY AND OTHER RELATED GAMING ITEMS; DISTRIBUTION OF PRERECORDED HORSE RACES IN THE NATURE OF A TELEVISION SHOW, IN CLASS 41 (U.S. CLS. 100, 101 AND 107).

FIRST USE 7-20-1977; IN COMMERCE 7-20-1977.

THE MARK CONSISTS OF STANDARD CHARACTERS WITHOUT CLAIM TO ANY PARTICULAR FONT, STYLE, SIZE, OR COLOR.

OWNER OF U.S. REG. NO. 2,281,241.

SER. NO. 85-379,633, FILED 7-25-2011.

WILLIAM ROSSMAN, EXAMINING ATTORNEY



*David J. Kypos*

Director of the United States Patent and Trademark Office

# United States of America

United States Patent and Trademark Office

## OMEGA 369 PLUS

**Reg. No. 4,125,053**

**Registered Apr. 10, 2012**

**Int. Cl.: 5**

**TRADEMARK**

**PRINCIPAL REGISTER**

EZEQUIEL M CANDELARIO (UNITED STATES INDIVIDUAL), DBA HEALTHY HORIZONS  
NATURAL SUPPLEMENTS  
1033 N WHITTIER ST  
ANAHEIM, CA 92806

FOR: DIETARY AND NUTRITIONAL SUPPLEMENTS CONTAINING OMEGA 3, 6 AND 9  
FATTY ACIDS, IN CLASS 5 (U.S. CLS. 6, 18, 44, 46, 51 AND 52).

FIRST USE 10-4-2010; IN COMMERCE 5-1-2011.

THE MARK CONSISTS OF STANDARD CHARACTERS WITHOUT CLAIM TO ANY PAR-  
TICULAR FONT, STYLE, SIZE, OR COLOR.

NO CLAIM IS MADE TO THE EXCLUSIVE RIGHT TO USE "OMEGA 639", APART FROM  
THE MARK AS SHOWN.

SER. NO. 85-379,636, FILED S.R. 7-25-2011 AM. P.R. 11-22-2011.

WILLIAM ROSSMAN, EXAMINING ATTORNEY



*David J. Kyffers*

Director of the United States Patent and Trademark Office

# United States of America

United States Patent and Trademark Office

## CONSOLIDATED RESOURCE IMAGING

**Reg. No. 4,125,054**

**Registered Apr. 10, 2012**

**Int. Cl.: 45**

**SERVICE MARK**

**PRINCIPAL REGISTER**

CONSOLIDATED RESOURCE IMAGING, LLC (MICHIGAN LIMITED LIABILITY COMPANY)  
2943 S. WILSON COURT NW  
GRAND RAPIDS, MI 49534

FOR: SURVEILLANCE SERVICES, IN CLASS 45 (U.S. CLS. 100 AND 101).

FIRST USE 1-18-2005; IN COMMERCE 1-18-2005.

THE MARK CONSISTS OF STANDARD CHARACTERS WITHOUT CLAIM TO ANY PARTICULAR FONT, STYLE, SIZE, OR COLOR.

NO CLAIM IS MADE TO THE EXCLUSIVE RIGHT TO USE "IMAGING", APART FROM THE MARK AS SHOWN.

SER. NO. 85-379,705, FILED 7-25-2011.

JEFF DEFORD, EXAMINING ATTORNEY



*David J. Kybas*

Director of the United States Patent and Trademark Office

# United States of America

United States Patent and Trademark Office



**Reg. No. 4,125,055**

**Registered Apr. 10, 2012**

**Int. Cl.: 9**

**TRADEMARK**

**PRINCIPAL REGISTER**

IWEBNET LIMITED LIABILITY COMPANY (NEW JERSEY LIMITED LIABILITY COMPANY)  
614 6TH AVENUE 2ND FLOOR  
LYNDHURST, NJ 07071

FOR: ACCESSORIES FOR CELLULAR TELEPHONES, LAPTOPS, TABLET COMPUTERS AND PERSONAL PORTABLE ELECTRONIC DEVICES, NAMELY, BATTERIES, CHARGERS FOR BATTERIES, ADAPTERS, HEADSETS, KEYBOARDS, MICE, PORTABLE AUDIO SPEAKERS, SCREEN PROTECTORS, FM TRANSMITTERS, MEMORY CARDS, USB CABLES, AUDIO AND VIDEO CABLES, CARRYING CASES AND PROTECTIVE SLEEVES FOR CELLULAR TELEPHONES, LAPTOPS, TABLET COMPUTERS AND PERSONAL PORTABLE ELECTRONIC DEVICES, ARM BANDS SPECIALLY DESIGNED FOR CARRYING CELLULAR TELEPHONES, LAPTOPS, TABLET COMPUTERS AND PERSONAL PORTABLE ELECTRONIC DEVICES, DESKTOP HOLDERS, STANDS AND DOCKING STATIONS SPECIALLY DESIGNED FOR CELLULAR TELEPHONES, AND CAR ACCESSORIES, NAMELY, STANDS AND MOUNTS SPECIALLY DESIGNED FOR HOLDING CELLULAR TELEPHONES, LAPTOPS, TABLET COMPUTERS AND PERSONAL PORTABLE ELECTRONIC DEVICES, IN CLASS 9 (U.S. CLS. 21, 23, 26, 36 AND 38).

FIRST USE 5-1-2011; IN COMMERCE 5-1-2011.

THE MARK CONSISTS OF A CIRCLE WITH GREEN, WHITE, AND BLACK LEAVES WITH THE BLACK WORD "FONUS" UNDERNEATH.

THE COLOR(S) GREEN, WHITE, BLACK IS/ARE CLAIMED AS A FEATURE OF THE MARK.

SER. NO. 85-379,787, FILED 7-25-2011.

JEFFERY COWARD, EXAMINING ATTORNEY



*David J. Kybas*

Director of the United States Patent and Trademark Office

# United States of America

United States Patent and Trademark Office

## SafeStor Endpoint Protection

**Reg. No. 4,125,056**

**Registered Apr. 10, 2012**

**Int. Cl.: 42**

**SERVICE MARK**

**PRINCIPAL REGISTER**

UBISTOR, INC. (ILLINOIS CORPORATION)  
SUITE 600  
1111 PLAZA DRIVE  
SCHAUMBURG, IL 60173

FOR: COMPUTER SERVICES, NAMELY, DATA ENCRYPTION, BACKUP AND RECOVERY,  
IN CLASS 42 (U.S. CLS. 100 AND 101).

FIRST USE 3-22-2011; IN COMMERCE 4-6-2011.

THE MARK CONSISTS OF STANDARD CHARACTERS WITHOUT CLAIM TO ANY PAR-  
TICULAR FONT, STYLE, SIZE, OR COLOR.

OWNER OF U.S. REG. NOS. 3,137,512, 3,662,189, AND 3,688,444.

NO CLAIM IS MADE TO THE EXCLUSIVE RIGHT TO USE "ENDPOINT PROTECTION",  
APART FROM THE MARK AS SHOWN.

SEC. 2(F) AS TO "SAFESTOR".

SER. NO. 85-379,789, FILED 7-25-2011.

FONG HSU, EXAMINING ATTORNEY



*David J. Kyros*

Director of the United States Patent and Trademark Office

# United States of America

United States Patent and Trademark Office

# TIMBERGATE

**Reg. No. 4,125,057**

**Registered Apr. 10, 2012**

**Int. Cl.: 19**

**TRADEMARK**

**PRINCIPAL REGISTER**

BERTCH CABINET MFG., INC. (IOWA CORPORATION)  
4747 CREDITWOOD DRIVE  
WATERLOO, IA 50704

FOR: WOODEN DOORS, IN CLASS 19 (U.S. CLS. 1, 12, 33 AND 50).

FIRST USE 2-1-2000; IN COMMERCE 2-1-2000.

THE MARK CONSISTS OF STANDARD CHARACTERS WITHOUT CLAIM TO ANY PARTICULAR FONT, STYLE, SIZE, OR COLOR.

OWNER OF U.S. REG. NO. 3,052,157.

SER. NO. 85-379,920, FILED 7-25-2011.

TINA L. SNAPP, EXAMINING ATTORNEY



*David J. Kyffers*

Director of the United States Patent and Trademark Office

# United States of America

United States Patent and Trademark Office

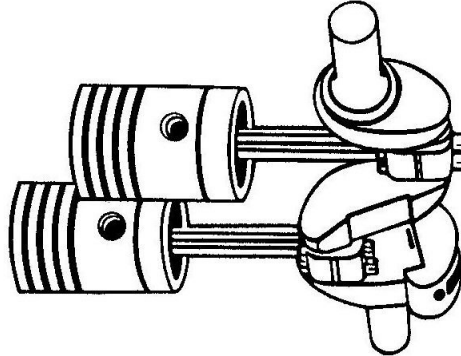

**Reg. No. 4,125,058**

**Registered Apr. 10, 2012**

**Int. Cl.: 41**

**SERVICE MARK**

**PRINCIPAL REGISTER**

TWO-CYLINDER, LTD. (IOWA CORPORATION)  
618 G AVENUE  
GRUNDY CENTER, IA 50638

FOR: PROVIDING INFORMATION IN THE FIELD OF AGRICULTURAL HISTORY DETAILING THE HISTORY OF A PARTICULAR PIECE OF AGRICULTURAL EQUIPMENT OR VEHICLE, FEATURING PRODUCTION RECORDS, REFERENCE MATERIALS AND HISTORICAL DOCUMENT EXCERPTS, IN CLASS 41 (U.S. CLS. 100, 101 AND 107).

FIRST USE 5-1-1986; IN COMMERCE 5-1-1986.

THE MARK CONSISTS OF A LINE DRAWING OF THE PISTONS AND CRANKSHAFT OF A TWO-CYLINDER ENGINE.

SER. NO. 85-379,923, FILED 7-25-2011.

DAVID H. STINE, EXAMINING ATTORNEY



*David J. Kyffers*

Director of the United States Patent and Trademark Office



# United States of America

United States Patent and Trademark Office

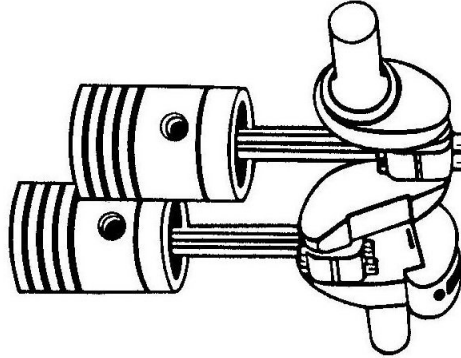

**Reg. No. 4,125,059**

**Registered Apr. 10, 2012**

**Int. Cls.: 9, 25 and 28**

**TRADEMARK**

**PRINCIPAL REGISTER**

TWO-CYLINDER, LTD. (IOWA CORPORATION)  
618 G AVENUE  
GRUNDY CENTER, IA 50638

FOR: DIGITAL MEDIA, NAMELY, PRERECORDED CDS AND DVDS FEATURING AGRICULTURAL VEHICLES, IN CLASS 9 (U.S. CLS. 21, 23, 26, 36 AND 38).

FIRST USE 1-1-2009; IN COMMERCE 1-1-2009.

FOR: BASEBALL CAPS AND HATS; T-SHIRTS, IN CLASS 25 (U.S. CLS. 22 AND 39).

FIRST USE 5-1-1988; IN COMMERCE 5-1-1988.

FOR: SCALE MODEL VEHICLES, IN CLASS 28 (U.S. CLS. 22, 23, 38 AND 50).

FIRST USE 1-1-1990; IN COMMERCE 1-1-1990.

THE MARK CONSISTS OF A LINE DRAWING OF THE PISTONS AND CRANKSHAFT OF A TWO-CYLINDER ENGINE.

SER. NO. 85-379,927, FILED 7-25-2011.

DAVID H. STINE, EXAMINING ATTORNEY



*David J. Kybas*

Director of the United States Patent and Trademark Office

# United States of America

United States Patent and Trademark Office

# FNDTV

**Reg. No. 4,125,060**

FRATERNITE NOTRE DAME, INC. (NEW YORK CORPORATION)  
502 N. CENTRAL AVENUE  
CHICAGO, IL 60644

**Registered Apr. 10, 2012**

**Int. Cl.: 9**

FOR: PRE-RECORDED ELECTRONIC DIGITAL AND NON-DIGITAL MEDIA FEATURING TV PROGRAMS, MUSIC, MUSICAL PERFORMANCES, FILM CLIPS, MOVIES AND DOCUMENTARIES FEATURING RELIGIOUS AND SECULAR FAMILY PROGRAMMING, IN CLASS 9 (U.S. CLS. 21, 23, 26, 36 AND 38).

**TRADEMARK**

**PRINCIPAL REGISTER**

FIRST USE 6-20-2006; IN COMMERCE 6-20-2006.

THE MARK CONSISTS OF STANDARD CHARACTERS WITHOUT CLAIM TO ANY PARTICULAR FONT, STYLE, SIZE, OR COLOR.

OWNER OF U.S. REG. NO. 3,907,504.

SER. NO. 85-379,972, FILED 7-25-2011.

AMY ALFIERI, EXAMINING ATTORNEY



*David J. Kyffers*

Director of the United States Patent and Trademark Office

# United States of America

United States Patent and Trademark Office

# NKOTBSB

**Reg. No. 4,125,061**

**Registered Apr. 10, 2012**

**Int. Cls.: 9, 25 and 41**

**TRADEMARK**

**SERVICE MARK**

**PRINCIPAL REGISTER**

NKOTBSB ENTERPRISES, LLC (DELAWARE LIMITED LIABILITY COMPANY)  
C/O KELLER TURNER RUTH ANDREWS GHANEM &  
700 12TH AVENUE SOUTH, SUITE 302  
NASHVILLE, TN 37203

FOR: MUSICAL SOUND RECORDINGS; MUSICAL VIDEO RECORDINGS, IN CLASS 9  
(U.S. CLS. 21, 23, 26, 36 AND 38).

FIRST USE 5-24-2011; IN COMMERCE 5-24-2011.

FOR: SHIRTS, IN CLASS 25 (U.S. CLS. 22 AND 39).

FIRST USE 0-0-2011; IN COMMERCE 0-0-2011.

FOR: ENTERTAINMENT, NAMELY, LIVE MUSIC CONCERTS, IN CLASS 41 (U.S. CLS.  
100, 101 AND 107).

FIRST USE 11-0-2010; IN COMMERCE 11-0-2010.

THE MARK CONSISTS OF STANDARD CHARACTERS WITHOUT CLAIM TO ANY PAR-  
TICULAR FONT, STYLE, SIZE, OR COLOR.

SER. NO. 85-379,980, FILED 7-25-2011.

HENRY S. ZAK, EXAMINING ATTORNEY



*David J. Kyros*

Director of the United States Patent and Trademark Office

# United States of America

United States Patent and Trademark Office

# BIG WOOD

**Reg. No. 4,125,062**

CORNICK, GARY, R (UNITED STATES INDIVIDUAL)  
1400 PAULLUS DRIVE  
HOLLISTER, CA 95023

**Registered Apr. 10, 2012**

**Int. Cl.: 9**

FOR: SERIES OF MUSICAL SOUND RECORDINGS, IN CLASS 9 (U.S. CLS. 21, 23, 26, 36 AND 38).

**TRADEMARK**

FIRST USE 6-5-2004; IN COMMERCE 6-21-2004.

**PRINCIPAL REGISTER**

THE MARK CONSISTS OF STANDARD CHARACTERS WITHOUT CLAIM TO ANY PARTICULAR FONT, STYLE, SIZE, OR COLOR.

SER. NO. 85-379,999, FILED 7-25-2011.

TARAH HARDY, EXAMINING ATTORNEY



*David J. Kyffers*

Director of the United States Patent and Trademark Office

# United States of America

United States Patent and Trademark Office

## Global Pedigree

**Reg. No. 4,125,063**

COWAN, JEREMY S. (UNITED STATES INDIVIDUAL)  
17021 JUNGQUIST RD

**Registered Apr. 10, 2012**

MOUNT VERNON, WA 98273

**Int. Cl.: 42**

FOR: COMPUTER SERVICES, NAMELY, CREATING AN ON-LINE VIRTUAL ENVIRONMENT FOR ANIMAL BREEDERS AND FANCIERS TO RECORD ANIMAL BREEDING HISTORY, ANIMAL ANCESTRY, MEDICAL DATA, AWARD RECORDS, REGISTRATION INFORMATION AND PHOTOGRAPHS, TO PRODUCE PRINTED PEDIGREES AND ELECTRONIC PEDIGREES FOR PUBLICATION AND EXCHANGE VIA A GLOBAL COMMUNICATIONS NETWORK, AND TO COLLABORATE TO MANAGE THE DATABASE; PROVIDING TEMPORARY USE OF A WEB-BASED SOFTWARE APPLICATION FOR ANIMAL BREEDERS AND FANCIERS TO RECORD ANIMAL BREEDING HISTORY, ANIMAL ANCESTRY, MEDICAL DATA, AWARD RECORDS, REGISTRATION INFORMATION AND PHOTOGRAPHS, TO PRODUCE PRINTED PEDIGREES AND ELECTRONIC PEDIGREES FOR PUBLICATION AND EXCHANGE VIA A GLOBAL COMMUNICATIONS NETWORK, AND TO COLLABORATE TO MANAGE THE DATABASE, IN CLASS 42 (U.S. CLS. 100 AND 101).

**SERVICE MARK**

**PRINCIPAL REGISTER**

FIRST USE 5-2-2010; IN COMMERCE 5-2-2010.

THE MARK CONSISTS OF STANDARD CHARACTERS WITHOUT CLAIM TO ANY PARTICULAR FONT, STYLE, SIZE, OR COLOR.

NO CLAIM IS MADE TO THE EXCLUSIVE RIGHT TO USE "PEDIGREE", APART FROM THE MARK AS SHOWN.

SER. NO. 85-380,018, FILED 7-25-2011.

DAVID HOFFMAN, EXAMINING ATTORNEY



*David J. Kybas*

Director of the United States Patent and Trademark Office

# United States of America

United States Patent and Trademark Office



**Reg. No. 4,125,064**

TAESEOB & YOUNG'S MISSION BEAUTY, INC. (CALIFORNIA CORPORATION)  
18346 VANOWEN ST.  
RESEDA, CA 91335

**Registered Apr. 10, 2012**

**Int. Cl.: 35**

FOR: RETAIL STORE AND ON-LINE RETAIL STORE SERVICES FEATURING BEAUTY SUPPLIES SUCH AS HAIR EXTENSIONS, WIGS, COSMETICS, HAIR CARE AND SKIN CARE , IN CLASS 35 (U.S. CLS. 100, 101 AND 102).

**SERVICE MARK**

FIRST USE 3-0-2010; IN COMMERCE 3-0-2010.

**PRINCIPAL REGISTER**

NO CLAIM IS MADE TO THE EXCLUSIVE RIGHT TO USE "BEAUTY SUPPLY", APART FROM THE MARK AS SHOWN.

THE COLOR(S) RED, WHITE AND BLACK IS/ARE CLAIMED AS A FEATURE OF THE MARK.

THE MARK CONSISTS OF "WOW" IN RED STYLIZED LETTERS OUTLINED IN BLACK WITH WHITE SHADING AND A BLACK EXCLAMATION POINT. BELOW THIS IS "BEAUTY SUPPLY" IN BLACK STYLIZED FONT.

SER. NO. 85-380,037, FILED 7-25-2011.

MICHELE SWAIN, EXAMINING ATTORNEY



*David J. Kybas*

Director of the United States Patent and Trademark Office

# United States of America

United States Patent and Trademark Office

# GNU

**Reg. No. 4,125,065**

**Registered Apr. 10, 2012**

**Int. Cls.: 9 and 16**

**TRADEMARK**

**PRINCIPAL REGISTER**

FREE SOFTWARE FOUNDATION (MASSACHUSETTS CORPORATION)  
SUITE 500  
51 FRANKLIN STREET  
BOSTON, MA 02110

FOR: COMPUTER OPERATING PROGRAMS AND COMPUTER OPERATING SYSTEMS; COMPUTER SOFTWARE DEVELOPMENT TOOLS; CHILDREN'S EDUCATIONAL SOFTWARE; COMPUTER AIDED DESIGN (CAD) SOFTWARE FOR DESIGNING INTEGRATED CIRCUITS; COMPUTER APPLICATION SOFTWARE FOR GENERAL PURPOSE COMPUTERS, NAMELY, SOFTWARE FOR USE IN DATABASE MANAGEMENT, FOR USE AS A SPREADSHEET, FOR WORD PROCESSING, FOR E-MAIL, AND FOR INTERNET BASED CHAT; COMPUTER DATABASE MANAGEMENT SOFTWARE FOR USE IN PERSONALIZING THE CONTENT OF E-MAIL COMMUNICATIONS; COMPUTER GAME SOFTWARE; COMPUTER GAME SOFTWARE FOR PERSONAL COMPUTERS AND HOME VIDEO GAME CONSOLES; COMPUTER GAME SOFTWARE FOR USE ON MOBILE AND CELLULAR PHONES; COMPUTER GAME SOFTWARE FOR USE WITH PERSONAL COMPUTERS, HOME VIDEO GAME CONSOLES USED WITH TELEVISIONS AND ARCADE-BASED VIDEO GAME CONSOLES; COMPUTER GRAPHICS SOFTWARE; COMPUTER SOFTWARE FOR SETTING UP AND CONFIGURING LOCAL AREA NETWORKS; COMPUTER SOFTWARE FOR SETTING UP AND CONFIGURING WIDE AREA NETWORKS; COMPUTER NETWORK SERVER; COMPUTER PROGRAMS FOR SEARCHING REMOTELY FOR CONTENT ON COMPUTERS AND COMPUTER NETWORKS; COMPUTER PROGRAMS FOR SEARCHING THE CONTENTS OF COMPUTERS AND COMPUTER NETWORKS BY REMOTE CONTROL; COMPUTER SOFTWARE FOR ACCESSING INFORMATION DIRECTORIES THAT MAY BE DOWNLOADED FROM THE GLOBAL COMPUTER NETWORK; COMPUTER SOFTWARE FOR ADMINISTRATION OF COMPUTER LOCAL AREA NETWORKS; COMPUTER SOFTWARE FOR ADMINISTRATION OF COMPUTER NETWORKS; COMPUTER SOFTWARE FOR APPLICATION AND DATABASE INTEGRATION; COMPUTER SOFTWARE FOR CONTROLLING AND MANAGING ACCESS SERVER APPLICATIONS; COMPUTER SOFTWARE FOR CREATING AND EDITING MUSIC AND SOUNDS; COMPUTER SOFTWARE FOR ENCRYPTION; COMPUTER SOFTWARE FOR USE IN THE ENCRYPTION AND DECRYPTION OF DIGITAL FILES, INCLUDING AUDIO, VIDEO, TEXT, BINARY, STILL IMAGES, GRAPHICS AND MULTIMEDIA FILES; COMPUTER SOFTWARE FOR USE IN THE SAFEGUARDING OF DIGITAL FILES, INCLUDING AUDIO, VIDEO, TEXT, BINARY, STILL IMAGES, GRAPHICS AND MULTIMEDIA FILES; COMPUTER SOFTWARE FOR USE IN DATABASE MANAGEMENT, FOR USE AS A SPREADSHEET, FOR WORD PROCESSING, FOR E-MAIL, AND FOR INTERNET BASED CHAT; COMPUTER SOFTWARE FOR USE AS

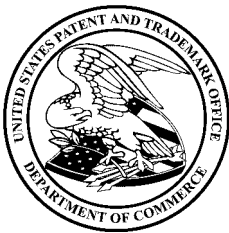

*David J. Kyjars*

Director of the United States Patent and Trademark Office

**Reg. No. 4,125,065** A CENTRALIZED SERVER FOR REMOTE USER AUTHENTICATION AND ACCOUNTING; COMPUTER SOFTWARE FOR USE IN SOCIAL NETWORKING; COMPUTER SOFTWARE FOR USE AS A CONFIGURATION ENGINE AND A HIGH LEVEL POLICY LANGUAGE FOR BUILDING EXPERT SYSTEMS TO ADMINISTRATE AND CONFIGURE LARGE COMPUTER NETWORKS; COMPUTER SOFTWARE FOR USE AS A SPELLING AND GRAMMAR CHECKER; COMPUTER SOFTWARE FOR THE BASIC DIRECTORY SEARCHING UTILITIES OF A COMPUTER OPERATING SYSTEM; COMPUTER SOFTWARE FOR THE DESIGN, CREATION, AND MANIPULATION OF TYPEFACE FONTS; COMPUTER SOFTWARE FOR USE AS A PRINT SPOOLING SYSTEM AND PRINTER INTERFACE; COMPUTER SOFTWARE FOR USE AS STAND-ALONE MULTIMEDIA PLAYBACK APPLICATION, OR AS A PLUGIN FOR WEB BROWSER MULTIMEDIA PLAYBACK; COMPUTER SOFTWARE FOR STATISTICAL ANALYSIS OF SAMPLED DATA; COMPUTER SOFTWARE FOR USE AS AN ADVANCED CALCULATOR AND MATHEMATICAL TOOL; COMPUTER SOFTWARE FOR USE AS A GRADE BOOK FOR TEACHERS TRACKING STUDENT GRADES; COMPUTER SOFTWARE FOR USE AS A PLATFORM TO RUN WEB-SERVICES THAT ALLOW COLLABORATION AND SIMULTANEOUS EDITING OF DATA BY MULTIPLE USERS BY INTEGRATING VARIOUS EXISTING COMMUNICATIONS TECHNOLOGIES; COMPUTER SOFTWARE FOR USE AS FINANCIAL PLANNING AND TRACKING, FINANCIAL MANAGEMENT, AND ACCOUNTING SOFTWARE; COMPUTER SOFTWARE FOR USE AS A SECURE, TRUST-BASED PEER-TO-PEER FRAMEWORK FOR THE TRANSMISSION AND SHARING OF DATA AND INFORMATION; COMPUTER SOFTWARE FOR USE AS A TEXT-TO-SPEECH SOFTWARE PACKAGE TO CONVERT TEXT STRINGS INTO PHONETIC DESCRIPTIONS, AIDED BY A PRONOUNCING DICTIONARY, LETTER-TO-SOUND RULES, AND RHYTHM AND INTONATION MODELS; COMPUTER SOFTWARE FOR USE AS A NUTRITION ANALYSIS SOFTWARE TO COMPUTE NUTRITIONAL CONTENT OF FOODS; COMPUTER SOFTWARE FOR USE AS A MASS SPECTROMETRIC FRAMEWORK FOR PREDICTING/ANALYZING MASS DATA FOR ANY POLYMER SEQUENCE OF ANY POLYMER TYPE; COMPUTER SOFTWARE FOR USE AS A SIMPLE MAIL TRANSFER PROTOCOL FOR ELECTRONIC MAIL TRANSMISSION; COMPUTER SOFTWARE FOR FILTERING UNSOLICITED, BULK COMMERCIAL ELECTRONIC MAIL MESSAGES; COMPUTER SOFTWARE FOR THE CREATION AND MANIPULATION OF ARCHIVES OF DATA AND INFORMATION; COMPUTER SOFTWARE THAT PROVIDES WEB-BASED ACCESS TO APPLICATIONS AND SERVICES THROUGH A WEB OPERATING SYSTEM OR PORTAL INTERFACE; COMPUTER SOFTWARE TO AUTOMATE DATA WAREHOUSING; COMPUTER SOFTWARE TO CONTROL AND IMPROVE COMPUTER AND AUDIO EQUIPMENT SOUND QUALITY; COMPUTER SOFTWARE TO ENHANCE THE AUDIO-VISUAL CAPABILITIES OF MULTIMEDIA APPLICATIONS, NAMELY, FOR THE INTEGRATION OF TEXT, AUDIO, GRAPHICS, STILL IMAGES AND MOVING PICTURES; COMPUTER TELEPHONY SOFTWARE; COMPUTER UTILITY PROGRAMS; DATA COMPRESSION SOFTWARE; DATABASE MANAGEMENT SOFTWARE FOR GENERAL USE; DESIGN LIBRARIES, NAMELY, DOWNLOADABLE ELECTRONIC DATA FILES FOR USE IN INTEGRATED CIRCUIT AND SEMICONDUCTOR DESIGN; DESKTOP PUBLISHING SOFTWARE; DOWNLOADABLE COMPUTER GAME PROGRAMS; DOWNLOADABLE PRINTING FONTS; ELECTRONIC GAME SOFTWARE; ELECTRONIC GAME SOFTWARE FOR CELLULAR TELEPHONES; ELECTRONIC GAME SOFTWARE FOR HANDHELD ELECTRONIC DEVICES; FACILITIES MANAGEMENT SOFTWARE, NAMELY, SOFTWARE TO CONTROL BUILDING ENVIRONMENT, ACCESS AND SECURITY SYSTEMS; GRAPHICAL USER INTERFACE SOFTWARE; HOME AND OFFICE AUTOMATION SYSTEMS COMPRISING WIRELESS AND WIRED CONTROLLERS, CONTROLLED DEVICES, AND SOFTWARE FOR LIGHTING, HVAC, SECURITY, SAFETY AND OTHER HOME AND OFFICE MONITORING AND CONTROL APPLICATIONS; INTERACTIVE GAME SOFTWARE; INTERACTIVE MULTIMEDIA COMPUTER GAME PROGRAM; INTERNET SERVERS; INTRANET SERVERS; LAN (LOCAL AREA NETWORK) OPERATING SOFTWARE; MUSIC-COMPOSITION SOFTWARE; NETWORK ACCESS SERVER OPERATING SOFTWARE; SOFTWARE FOR ENSURING THE SECURITY OF ELECTRONIC MAIL; SOFTWARE FOR OPTICAL CHARACTER RECOGNITION; TYPEFACE FONTS RECORDED ON MAGNETIC MEDIA; VIDEO GAME SOFTWARE; VPN (VIRTUAL PRIVATE NETWORK) OPERATING



**Reg. No. 4,125,065** SOFTWARE; WAN (WIDE AREA NETWORK) OPERATING SOFTWARE; WEB SITE DEVELOPMENT SOFTWARE, IN CLASS 9 (U.S. CLS. 21, 23, 26, 36 AND 38).

FIRST USE 9-27-1983; IN COMMERCE 12-31-1985.

FOR: COMPUTER MANUALS FOR ALL OF THE FOLLOWING SOFTWARE, NAMELY, COMPUTER OPERATING PROGRAMS AND COMPUTER OPERATING SYSTEMS, COMPUTER SOFTWARE DEVELOPMENT TOOLS, CHILDREN'S EDUCATIONAL SOFTWARE, COMPUTER AIDED DESIGN (CAD) SOFTWARE FOR DESIGNING INTEGRATED CIRCUITS, COMPUTER APPLICATION SOFTWARE FOR GENERAL PURPOSE COMPUTERS, NAMELY, SOFTWARE FOR USE IN DATABASE MANAGEMENT, FOR USE AS A SPREADSHEET, FOR WORD PROCESSING, FOR E-MAIL, AND FOR INTERNET BASED CHAT, COMPUTER DATABASE MANAGEMENT SOFTWARE FOR USE IN PERSONALIZING THE CONTENT OF E-MAIL COMMUNICATIONS, COMPUTER GAME SOFTWARE, COMPUTER GAME SOFTWARE FOR PERSONAL COMPUTERS AND HOME VIDEO GAME CONSOLES, COMPUTER GAME SOFTWARE FOR USE ON MOBILE AND CELLULAR PHONES, COMPUTER GAME SOFTWARE FOR USE WITH PERSONAL COMPUTERS, HOME VIDEO GAME CONSOLES USED WITH TELEVISIONS AND ARCADE-BASED VIDEO GAME CONSOLES, COMPUTER GRAPHICS SOFTWARE, COMPUTER SOFTWARE FOR SETTING UP AND CONFIGURING LOCAL AREA NETWORKS, COMPUTER SOFTWARE FOR SETTING UP AND CONFIGURING WIDE AREA NETWORKS, COMPUTER NETWORK SERVER, COMPUTER PROGRAMS FOR SEARCHING REMOTELY FOR CONTENT ON COMPUTERS AND COMPUTER NETWORKS, COMPUTER PROGRAMS FOR SEARCHING THE CONTENTS OF COMPUTERS AND COMPUTER NETWORKS BY REMOTE CONTROL, COMPUTER SOFTWARE FOR ACCESSING INFORMATION DIRECTORIES THAT MAY BE DOWNLOADED FROM THE GLOBAL COMPUTER NETWORK, COMPUTER SOFTWARE FOR ADMINISTRATION OF COMPUTER LOCAL AREA NETWORKS, COMPUTER SOFTWARE FOR ADMINISTRATION OF COMPUTER NETWORKS, COMPUTER SOFTWARE FOR APPLICATION AND DATABASE INTEGRATION, COMPUTER SOFTWARE FOR CONTROLLING AND MANAGING ACCESS SERVER APPLICATIONS, COMPUTER SOFTWARE FOR CREATING AND EDITING MUSIC AND SOUNDS, COMPUTER SOFTWARE FOR ENCRYPTION, COMPUTER SOFTWARE FOR USE IN THE ENCRYPTION AND DECRYPTION OF DIGITAL FILES, INCLUDING AUDIO, VIDEO, TEXT, BINARY, STILL IMAGES, GRAPHICS AND MULTIMEDIA FILES, COMPUTER SOFTWARE FOR USE IN THE SAFEGUARDING OF DIGITAL FILES, INCLUDING AUDIO, VIDEO, TEXT, BINARY, STILL IMAGES, GRAPHICS AND MULTIMEDIA FILES, COMPUTER SOFTWARE FOR USE IN DATABASE MANAGEMENT, FOR USE AS A SPREADSHEET, FOR WORD PROCESSING, FOR E-MAIL, AND FOR INTERNET BASED CHAT, COMPUTER SOFTWARE FOR USE AS A CENTRALIZED SERVER FOR REMOTE USER AUTHENTICATION AND ACCOUNTING, COMPUTER SOFTWARE FOR USE IN SOCIAL NETWORKING, COMPUTER SOFTWARE FOR USE AS A CONFIGURATION ENGINE AND A HIGH LEVEL POLICY LANGUAGE FOR BUILDING EXPERT SYSTEMS TO ADMINISTER AND CONFIGURE LARGE COMPUTER NETWORKS, COMPUTER SOFTWARE FOR USE AS A SPELLING AND GRAMMAR CHECKER, COMPUTER SOFTWARE FOR THE BASIC DIRECTORY SEARCHING UTILITIES OF A COMPUTER OPERATING SYSTEM, COMPUTER SOFTWARE FOR THE DESIGN, CREATION, AND MANIPULATION OF TYPEFACE FONTS, COMPUTER SOFTWARE FOR USE AS A PRINT SPOOLING SYSTEM AND PRINTER INTERFACE, COMPUTER SOFTWARE FOR USE AS STAND-ALONE MULTIMEDIA PLAYBACK APPLICATION, OR AS A PLUGIN FOR WEB BROWSER MULTIMEDIA PLAYBACK, COMPUTER SOFTWARE FOR STATISTICAL ANALYSIS OF SAMPLED DATA, COMPUTER SOFTWARE FOR USE AS AN ADVANCED CALCULATOR AND MATHEMATICAL TOOL, COMPUTER SOFTWARE FOR USE AS A GRADE BOOK FOR TEACHERS TRACKING STUDENT GRADES, COMPUTER SOFTWARE FOR USE AS A PLATFORM TO RUN WEB-SERVICES THAT ALLOW COLLABORATION AND SIMULTANEOUS EDITING OF DATA BY MULTIPLE USERS BY INTEGRATING VARIOUS EXISTING COMMUNICATIONS TECHNOLOGIES, COMPUTER SOFTWARE FOR USE AS FINANCIAL PLANNING AND TRACKING, FINANCIAL MANAGEMENT, AND ACCOUNTING SOFTWARE, COMPUTER SOFTWARE FOR USE AS A SECURE, TRUST-BASED PEER-TO-PEER FRAMEWORK FOR THE

**Reg. No. 4,125,065** TRANSMISSION AND SHARING OF DATA AND INFORMATION, COMPUTER SOFTWARE FOR USE AS A TEXT-TO-SPEECH SOFTWARE PACKAGE TO CONVERT TEXT STRINGS INTO PHONETIC DESCRIPTIONS, AIDED BY A PRONOUNCING DICTIONARY, LETTER-TO-SOUND RULES, AND RHYTHM AND INTONATION MODELS, COMPUTER SOFTWARE FOR USE AS A NUTRITION ANALYSIS SOFTWARE TO COMPUTE NUTRITIONAL CONTENT OF FOODS, COMPUTER SOFTWARE FOR USE AS A MASS SPECTROMETRIC FRAMEWORK FOR PREDICTING/ANALYZING MASS DATA FOR ANY POLYMER SEQUENCE OF ANY POLYMER TYPE, COMPUTER SOFTWARE FOR USE AS A SIMPLE MAIL TRANSFER PROTOCOL FOR ELECTRONIC MAIL TRANSMISSION, COMPUTER SOFTWARE FOR FILTERING UNSOLICITED, BULK COMMERCIAL ELECTRONIC MAIL MESSAGES, COMPUTER SOFTWARE FOR THE CREATION AND MANIPULATION OF ARCHIVES OF DATA AND INFORMATION, COMPUTER SOFTWARE THAT PROVIDES WEB-BASED ACCESS TO APPLICATIONS AND SERVICES THROUGH A WEB OPERATING SYSTEM OR PORTAL INTERFACE, COMPUTER SOFTWARE TO AUTOMATE DATA WAREHOUSING, COMPUTER SOFTWARE TO CONTROL AND IMPROVE COMPUTER AND AUDIO EQUIPMENT SOUND QUALITY, COMPUTER SOFTWARE TO ENHANCE THE AUDIO-VISUAL CAPABILITIES OF MULTIMEDIA APPLICATIONS, NAMELY, FOR THE INTEGRATION OF TEXT, AUDIO, GRAPHICS, STILL IMAGES AND MOVING PICTURES, COMPUTER TELEPHONY SOFTWARE, COMPUTER UTILITY PROGRAMS, DATA COMPRESSION SOFTWARE, DATABASE MANAGEMENT SOFTWARE FOR GENERAL USE, DESIGN LIBRARIES, NAMELY, DOWNLOADABLE ELECTRONIC DATA FILES FOR USE IN INTEGRATED CIRCUIT AND SEMICONDUCTOR DESIGN, DESKTOP PUBLISHING SOFTWARE, DOWNLOADABLE COMPUTER GAME PROGRAMS, DOWNLOADABLE PRINTING FONTS, ELECTRONIC GAME SOFTWARE, ELECTRONIC GAME SOFTWARE FOR CELLULAR TELEPHONES, ELECTRONIC GAME SOFTWARE FOR HANDHELD ELECTRONIC DEVICES, FACILITIES MANAGEMENT SOFTWARE, NAMELY, SOFTWARE TO CONTROL BUILDING ENVIRONMENT, ACCESS AND SECURITY SYSTEMS, GRAPHICAL USER INTERFACE SOFTWARE, HOME AND OFFICE AUTOMATION SYSTEMS COMPRISING WIRELESS AND WIRED CONTROLLERS, CONTROLLED DEVICES, AND SOFTWARE FOR LIGHTING, HVAC, SECURITY, SAFETY AND OTHER HOME AND OFFICE MONITORING AND CONTROL APPLICATIONS, INTERACTIVE GAME SOFTWARE, INTERACTIVE MULTIMEDIA COMPUTER GAME PROGRAM, INTERNET SERVERS, INTRANET SERVERS, LAN (LOCAL AREA NETWORK) OPERATING SOFTWARE, MUSIC-COMPOSITION SOFTWARE, NETWORK ACCESS SERVER OPERATING SOFTWARE, SOFTWARE FOR ENSURING THE SECURITY OF ELECTRONIC MAIL, SOFTWARE FOR OPTICAL CHARACTER RECOGNITION, TYPEFACE FONTS RECORDED ON MAGNETIC MEDIA, VIDEO GAME SOFTWARE, VPN (VIRTUAL PRIVATE NETWORK) OPERATING SOFTWARE, WAN (WIDE AREA NETWORK) OPERATING SOFTWARE, WEB SITE DEVELOPMENT SOFTWARE, IN CLASS 16 (U.S. CLS. 2, 5, 22, 23, 29, 37, 38 AND 50).

FIRST USE 9-27-1983; IN COMMERCE 12-31-1985.

THE MARK CONSISTS OF STANDARD CHARACTERS WITHOUT CLAIM TO ANY PARTICULAR FONT, STYLE, SIZE, OR COLOR.

OWNER OF U.S. REG. NO. 2,861,936.

SER. NO. 85-380,218, FILED 7-25-2011.

ELIZABETH KAJUBI, EXAMINING ATTORNEY

# United States of America

United States Patent and Trademark Office



**Reg. No. 4,125,066**

**Registered Apr. 10, 2012**

**Int. Cl.: 36**

**SERVICE MARK**

**PRINCIPAL REGISTER**

AMERICAN SPECIALTY INSURANCE & RISK SERVICES, INC. (INDIANA CORPORATION)  
SUITE 400  
3101 W. MARTIN LUTHER KING, JR. BLVD.  
TAMPA, FL 33607

FOR: INSURANCE BROKERAGE, INSURANCE ADMINISTRATION; INSURANCE CLAIMS  
ADMINISTRATION; FINANCIAL AND INSURANCE RISK MANAGEMENT IN THE SPORTS  
AND ENTERTAINMENT INDUSTRY, IN CLASS 36 (U.S. CLS. 100, 101 AND 102).

FIRST USE 6-0-2011; IN COMMERCE 6-0-2011.

THE MARK CONSISTS OF THE TERM "MIRROR" WITHIN TWO CONCENTRIC RECT-  
ANGLES WITH A REFLECTION IN THE FORM OF A CIRCULAR RAY OF LIGHT IN THE  
SPACE ABOVE AND BETWEEN THE "O" AND "R" OF THE TERM "MIRROR".

SER. NO. 85-380,236, FILED 7-25-2011.

BRIDGETT SMITH, EXAMINING ATTORNEY



*David J. Kyffers*

Director of the United States Patent and Trademark Office

# United States of America

United States Patent and Trademark Office

# MIRROR

**Reg. No. 4,125,067**

**Registered Apr. 10, 2012**

**Int. Cl.: 36**

**SERVICE MARK**

**PRINCIPAL REGISTER**

AMERICAN SPECIALTY INSURANCE & RISK SERVICES, INC. (INDIANA CORPORATION)  
SUITE 400  
3101 W. MARTIN LUTHER KING, JR. BLVD.  
TAMPA, FL 33607

FOR: INSURANCE BROKERAGE, INSURANCE ADMINISTRATION; INSURANCE CLAIMS  
ADMINISTRATION; FINANCIAL AND INSURANCE RISK MANAGEMENT IN THE SPORTS  
AND ENTERTAINMENT INDUSTRY, IN CLASS 36 (U.S. CLS. 100, 101 AND 102).

FIRST USE 6-0-2011; IN COMMERCE 6-0-2011.

THE MARK CONSISTS OF STANDARD CHARACTERS WITHOUT CLAIM TO ANY PAR-  
TICULAR FONT, STYLE, SIZE, OR COLOR.

SER. NO. 85-380,240, FILED 7-25-2011.

BRIDGETT SMITH, EXAMINING ATTORNEY



*David J. Kyffers*

Director of the United States Patent and Trademark Office

# United States of America

United States Patent and Trademark Office



**Reg. No. 4,125,068**

ST. JOSEPH'S ABBEY (LOUISIANA CORPORATION)  
75376 RIVER ROAD

**Registered Apr. 10, 2012**

ST. BENEDICT, LA 70457

**Int. Cl.: 45**

FOR: ORGANIZING RELIGIOUS RETREATS FOR YOUTHS IN THE FIELD OF RELIGION AND TO ASSIST OTHERS IN DEVELOPMENT AND ENHANCEMENT OF THEIR SPIRITUAL LIVES, IN CLASS 45 (U.S. CLS. 100 AND 101).

**SERVICE MARK**

FIRST USE 3-1-2001; IN COMMERCE 3-1-2001.

**PRINCIPAL REGISTER**

THE MARK CONSISTS OF THE LETTERS "A", "Y", & "F" IN A BLOCK FORMAT, WHEREBY THE Y FORMS A PORTION OF THE "A" AND "F".

SER. NO. 85-380,292, FILED 7-25-2011.

ELLEN PERKINS, EXAMINING ATTORNEY



*David J. Kyffers*

Director of the United States Patent and Trademark Office

# United States of America

United States Patent and Trademark Office

## ACG Research

**Reg. No. 4,125,069**

ACG RESEARCH LLC (NEVADA LIMITED LIABILITY COMPANY)  
2035 EAST CLIPPER LN.  
GILBERT, AZ 89234

**Registered Apr. 10, 2012**

**Int. Cl.: 35**

FOR: BUSINESS ADVICE AND INFORMATION; MARKET RESEARCH CONSULTATION;  
MARKET RESEARCH SERVICES, IN CLASS 35 (U.S. CLS. 100, 101 AND 102).

**SERVICE MARK**

FIRST USE 1-1-2010; IN COMMERCE 1-1-2010.

**PRINCIPAL REGISTER**

THE MARK CONSISTS OF STANDARD CHARACTERS WITHOUT CLAIM TO ANY PARTICULAR FONT, STYLE, SIZE, OR COLOR.

NO CLAIM IS MADE TO THE EXCLUSIVE RIGHT TO USE "RESEARCH", APART FROM THE MARK AS SHOWN.

SER. NO. 85-380,351, FILED 7-25-2011.

CHRISTINA SOBRAL, EXAMINING ATTORNEY



*David J. Kybas*

Director of the United States Patent and Trademark Office

# United States of America

United States Patent and Trademark Office

## Coordinator For A Day

**Reg. No. 4,125,070**

**Registered Apr. 10, 2012**

**Int. Cl.: 41**

**SERVICE MARK**

**PRINCIPAL REGISTER**

RUMPS, MYSTIQUE L. (UNITED STATES INDIVIDUAL)  
PO BOX 101269  
CHICAGO, IL 60610

FOR: PARTY AND WEDDING PLANNING, COORDINATION AND CONSULTATION SERVICES; PROVIDING INFORMATION IN THE FIELD OF WEDDING PARTY PLANNING, IN CLASS 41 (U.S. CLS. 100, 101 AND 107).

FIRST USE 8-1-2009; IN COMMERCE 9-1-2009.

THE MARK CONSISTS OF STANDARD CHARACTERS WITHOUT CLAIM TO ANY PARTICULAR FONT, STYLE, SIZE, OR COLOR.

NO CLAIM IS MADE TO THE EXCLUSIVE RIGHT TO USE "COORDINATOR", APART FROM THE MARK AS SHOWN.

SER. NO. 85-380,412, FILED 7-25-2011.

JAY BESCH, EXAMINING ATTORNEY



*David J. Kyffers*

Director of the United States Patent and Trademark Office

# United States of America

United States Patent and Trademark Office



**Reg. No. 4,125,071**

XIANGJUN LIN (CHINA INDIVIDUAL), AKA ANGIE LIN  
9108 HUNTINGTON DR. #D  
SAN GABRIEL, CA 91775

**Registered Apr. 10, 2012**

**Int. Cl.: 30**

FOR: BEVERAGES MADE OF TEA; COFFEE AND TEA; FRUIT TEAS; GREEN TEA; HERBAL TEA; OOLONG TEA; TEA; TEA-BASED BEVERAGES; TEA-BASED BEVERAGES WITH FRUIT FLAVORING, IN CLASS 30 (U.S. CL. 46).

**TRADEMARK**

FIRST USE 3-9-2009; IN COMMERCE 3-9-2009.

**PRINCIPAL REGISTER**

THE MARK CONSISTS OF A TAI CHI SYMBOL IN GREEN, DARK RED AND WHITE APPEARING TO THE LEFT OF THE WORDING "LAHAHA" IN GREEN.

THE COLOR(S) GREEN, DARK RED AND WHITE IS/ARE CLAIMED AS A FEATURE OF THE MARK.

THE ENGLISH TRANSLATION OF THE WORD "LAHAHA" IN THE MARK IS "HAPPY TASTING".

SER. NO. 85-380,589, FILED S.R. 7-26-2011 AM. P.R. 11-22-2011.

JOHN DWYER, EXAMINING ATTORNEY



*David J. Kybas*

Director of the United States Patent and Trademark Office



# United States of America

United States Patent and Trademark Office



**Reg. No. 4,125,072**

**Registered Apr. 10, 2012**

**Int. Cl.: 35**

**SERVICE MARK**

**PRINCIPAL REGISTER**

BENNETT AUTO SUPPLY, INC. (FLORIDA CORPORATION)  
3141 S.W. 10TH STREET POMPANO BEACH, FL  
3141 S.W. 10TH STREET  
POMPANO BEACH, FL 33069

FOR: ON-LINE WHOLESALE AND RETAIL STORE SERVICES FEATURING AUTO PARTS AND SUPPLIES; WHOLESALE AND RETAIL STORE SERVICES FEATURING AUTO PARTS AND SUPPLIES, IN CLASS 35 (U.S. CLS. 100, 101 AND 102).

FIRST USE 1-1-1995; IN COMMERCE 1-1-1995.

OWNER OF U.S. REG. NOS. 3,182,250 AND 3,969,566.

THE COLOR(S) BLACK, WHITE AND MUSTARD YELLOW IS/ARE CLAIMED AS A FEATURE OF THE MARK.

NO CLAIM IS MADE TO THE EXCLUSIVE RIGHT TO USE "AUTO SUPPLY", APART FROM THE MARK AS SHOWN.

THE MARK CONSISTS OF A RECTANGULAR ADVERTISING BANNER THE LITERAL ELEMENT "BENNETT AUTO SUPPLY" IN MUSTARD YELLOW ITALICIZED WITH LINES DEPICTING SPEED, PROPULSION, HEAT OR WIND. THE LITERAL MARK APPEARS ON A BLACK BACKGROUND WITH A CHECKERED FLAG DESIGN APPEARING AT THE TOP AND BOTTOM OF THE RECTANGULAR BANNER. THE CHECKERED FLAG DESIGN CONSISTS OF THE BLACK BACKGROUND AND WHITE.

SER. NO. 85-380,644, FILED 7-26-2011.

KAREN BRACEY, EXAMINING ATTORNEY



*David J. Kybas*

Director of the United States Patent and Trademark Office

# United States of America

United States Patent and Trademark Office

## Fresh Air Fido

**Reg. No. 4,125,073**

LOMASNEY, PAULA JEAN (UNITED STATES INDIVIDUAL), DBA FRESH AIR FIDO  
41 HOMESTEAD RD

**Registered Apr. 10, 2012**

SARATOGA SPRINGS, NY 12866

**Int. Cl.: 44**

FOR: DOG WALKING SERVICES, IN CLASS 44 (U.S. CLS. 100 AND 101).

**SERVICE MARK**

FIRST USE 7-25-2011; IN COMMERCE 7-25-2011.

**PRINCIPAL REGISTER**

THE MARK CONSISTS OF STANDARD CHARACTERS WITHOUT CLAIM TO ANY PARTICULAR FONT, STYLE, SIZE, OR COLOR.

SER. NO. 85-380,665, FILED 7-26-2011.

MARTHA FROMM, EXAMINING ATTORNEY



*David J. Kybas*

Director of the United States Patent and Trademark Office

# United States of America

United States Patent and Trademark Office

## Dog Park Comix

**Reg. No. 4,125,074**

DOG PARK COMIX, LLC (INDIANA LIMITED LIABILITY COMPANY)  
6028 ROSSLYN AVENUE  
INDIANAPOLIS, IN 46220

**Registered Apr. 10, 2012**

**Int. Cl.: 41**

FOR: PROVIDING ONLINE NON-DOWNLOADABLE COMIC STRIPS, IN CLASS 41 (U.S. CLS. 100, 101 AND 107).

**SERVICE MARK**

FIRST USE 6-28-2011; IN COMMERCE 6-28-2011.

**PRINCIPAL REGISTER**

THE MARK CONSISTS OF STANDARD CHARACTERS WITHOUT CLAIM TO ANY PARTICULAR FONT, STYLE, SIZE, OR COLOR.

NO CLAIM IS MADE TO THE EXCLUSIVE RIGHT TO USE "COMICS", APART FROM THE MARK AS SHOWN.

SER. NO. 85-380,679, FILED 7-26-2011.

ROBIN MITTLER, EXAMINING ATTORNEY



*David J. Kyffers*

Director of the United States Patent and Trademark Office

**United States of America**  
United States Patent and Trademark Office

# BIG ROCK

**Reg. No. 4,125,075**

CRYSTAL COAST TOURNAMENT INC. (NORTH CAROLINA CORPORATION)  
P. O. BOX 1673

**Registered Apr. 10, 2012**

MOREHEAD CITY, NC 28557

**Int. Cl.: 41**

FOR: ENTERTAINMENT IN THE NATURE OF FISHING TOURNAMENTS, IN CLASS 41  
(U.S. CLS. 100, 101 AND 107).

**SERVICE MARK**

FIRST USE 6-1-1959; IN COMMERCE 6-1-1959.

**PRINCIPAL REGISTER**

THE MARK CONSISTS OF STANDARD CHARACTERS WITHOUT CLAIM TO ANY PARTICULAR FONT, STYLE, SIZE, OR COLOR.

OWNER OF U.S. REG. NOS. 2,167,062, 2,233,237, AND 3,994,721.

SER. NO. 85-380,726, FILED 7-26-2011.

NATALIE POLZER, EXAMINING ATTORNEY



*David J. Kybas*

Director of the United States Patent and Trademark Office

# United States of America

United States Patent and Trademark Office

# JRD

**Reg. No. 4,125,076**

JANEL RUSSELL DESIGNS, INC. (DELAWARE CORPORATION)  
2866 MIDDLE STREET  
ST. PAUL, MN 55117

**Registered Apr. 10, 2012**

**Int. Cl.: 14**

FOR: JEWELRY, IN CLASS 14 (U.S. CLS. 2, 27, 28 AND 50).

**TRADEMARK**

FIRST USE 1-1-1999; IN COMMERCE 1-1-1999.

**PRINCIPAL REGISTER**

THE MARK CONSISTS OF STANDARD CHARACTERS WITHOUT CLAIM TO ANY PARTICULAR FONT, STYLE, SIZE, OR COLOR.

SER. NO. 85-380,794, FILED 7-26-2011.

DORITT L. CARROLL, EXAMINING ATTORNEY



*David J. Kybas*

Director of the United States Patent and Trademark Office

# United States of America

United States Patent and Trademark Office



**Reg. No. 4,125,077**

**Registered Apr. 10, 2012**

**Int. Cls.: 35 and 42**

**SERVICE MARK**

**PRINCIPAL REGISTER**

ERP ANALYSTS, INC (OHIO CORPORATION)  
425 METRO PL N STE 510  
DUBLIN, OH 43016

FOR: EMPLOYMENT AGENCY SERVICES, NAMELY, FILLING THE TEMPORARY AND PERMANENT STAFFING NEEDS OF BUSINESSES; EMPLOYMENT HIRING, RECRUITING, PLACEMENT, STAFFING AND CAREER NETWORKING SERVICES; BUSINESS MANAGEMENT CONSULTING AND ADVISORY SERVICES; COMMERCIAL ASSISTANCE RELATING TO SYSTEM IMPLEMENTATION AND SYSTEM INTEGRATION; BUSINESS CONSULTING, MANAGEMENT, PLANNING AND SUPERVISION; HUMAN RESOURCES CONSULTATION; INVENTORY MANAGEMENT; CUSTOMER RELATIONSHIP MANAGEMENT; BUSINESS PROCESS RE-ENGINEERING SERVICES; BUSINESS SERVICES, NAMELY, PROVIDING COMPUTER DATABASES REGARDING THE PURCHASE AND SALE OF A WIDE VARIETY OF PRODUCTS AND SERVICES OF OTHERS; OPERATION OF TELEPHONE CALL CENTERS FOR OTHERS, IN CLASS 35 (U.S. CLS. 100, 101 AND 102).

FIRST USE 9-1-2009; IN COMMERCE 9-1-2009.

FOR: COMPUTER HARDWARE AND SOFTWARE CONSULTING SERVICES; CONSULTING IN THE FIELD OF INFORMATION TECHNOLOGY; CONSULTING IN THE FIELD OF IT PROJECT MANAGEMENT; CONSULTING SERVICES IN THE FIELD OF DESIGN, SELECTION, IMPLEMENTATION AND USE OF COMPUTER HARDWARE AND SOFTWARE SYSTEMS FOR OTHERS; CONSULTING SERVICES IN THE FIELD OF IDENTIFICATION, SUPPORT, AND IMPLEMENTATION OF COMPUTER-BASED INFORMATION SYSTEMS FOR BUSINESSES; IT CONSULTING SERVICES; APPLICATION SERVICE PROVIDER (ASP), NAMELY, HOSTING COMPUTER SOFTWARE APPLICATIONS OF OTHERS; TECHNICAL SUPPORT SERVICES, NAMELY, TROUBLESHOOTING OF COMPUTER SOFTWARE PROBLEMS; UPDATING OF COMPUTER SOFTWARE FOR OTHERS; PERIODIC UPGRADING OF COMPUTER SOFTWARE FOR OTHERS; COMPUTER SOFTWARE CONSULTATION; COMPUTER SOFTWARE DESIGN FOR OTHERS; CONSULTANCY IN THE FIELD OF SOFTWARE DESIGN; INTEGRATION OF COMPUTER SYSTEMS AND NETWORKS; CONSULTING SERVICES IN THE FIELD OF DESIGN, SELECTION, IMPLEMENTATION AND USE OF COMPUTER HARDWARE AND SOFTWARE SYSTEMS FOR OTHERS; DESIGN, DEVELOPMENT AND IMPLEMENTATION OF SOFTWARE; COMPUTER NETWORK DESIGN FOR OTHERS; DATA WAREHOUSING; COMPUTER SYSTEMS INTEGRATION SERVICES; WEB SITE DEVELOPMENT FOR OTHERS; HOSTING THE WEB SITES



*David J. Kyffers*

Director of the United States Patent and Trademark Office

**Reg. No. 4,125,077** OF OTHERS ON A COMPUTER SERVER FOR A GLOBAL COMPUTER NETWORK, IN CLASS 42 (U.S. CLS. 100 AND 101).

FIRST USE 9-1-2009; IN COMMERCE 9-1-2009.

OWNER OF U.S. REG. NO. 3,697,327.

NO CLAIM IS MADE TO THE EXCLUSIVE RIGHT TO USE "ERP ANALYSTS", APART FROM THE MARK AS SHOWN.

THE MARK CONSISTS OF A GLOBE DESIGN WITH A CURVED BAND BENEATH IT EXTENDING UNDER THE WORDS "ERP ANALYSTS" AND THE WORDS "WE DO IT" BELOW.

SER. NO. 85-380,874, FILED 7-26-2011.

JOHN WILKE, EXAMINING ATTORNEY

# United States of America

United States Patent and Trademark Office

## JUST A FRAME

**Reg. No. 4,125,078**

**Registered Apr. 10, 2012**

**Int. Cl.: 20**

**TRADEMARK**

**PRINCIPAL REGISTER**

JANLYNN CORP. (MASSACHUSETTS CORPORATION)  
2070 WESTOVER ROAD  
CHICOPEE, MA 01022

FOR: FRAMES FOR EMBROIDERY, NEEDLEPOINT OR PHOTOGRAPHS, IN CLASS 20  
(U.S. CLS. 2, 13, 22, 25, 32 AND 50).

FIRST USE 6-1-1999; IN COMMERCE 6-1-1999.

THE MARK CONSISTS OF STANDARD CHARACTERS WITHOUT CLAIM TO ANY PARTICULAR FONT, STYLE, SIZE, OR COLOR.

NO CLAIM IS MADE TO THE EXCLUSIVE RIGHT TO USE "FRAME", APART FROM THE MARK AS SHOWN.

SER. NO. 85-380,893, FILED 7-26-2011.

INGA ERVIN, EXAMINING ATTORNEY



*David J. Kybas*

Director of the United States Patent and Trademark Office



# United States of America

United States Patent and Trademark Office

## CORN-N-TATER

**Reg. No. 4,125,079**

HOME COOKED SHORTCUTS (KANSAS SOLE PROPRIETORSHIP)  
2738 N RUSHWOOD CT  
WICHITA, KS 67226

**Registered Apr. 10, 2012**

**Int. Cl.: 16**

FOR: BAGS FOR MICROWAVE COOKING; MICROWAVE COOKING BAGS, IN CLASS 16  
(U.S. CLS. 2, 5, 22, 23, 29, 37, 38 AND 50).

**TRADEMARK**

FIRST USE 7-1-2011; IN COMMERCE 7-1-2011.

**PRINCIPAL REGISTER**

THE MARK CONSISTS OF STANDARD CHARACTERS WITHOUT CLAIM TO ANY PARTICULAR FONT, STYLE, SIZE, OR COLOR.

SER. NO. 85-380,967, FILED 7-26-2011.

DAVID ELTON, EXAMINING ATTORNEY



*David J. Kyfos*

Director of the United States Patent and Trademark Office

# United States of America

United States Patent and Trademark Office

## READY PART

**Reg. No. 4,125,080**

STRATASYS, INC. (DELAWARE CORPORATION)

**Registered Apr. 10, 2012**

7665 COMMERCE WAY  
EDEN PRAIRIE, MN 55344

**Int. Cl.: 40**

FOR: PARTS FINISHING SERVICES AND PARTS FABRICATION SERVICES, IN CLASS 40  
(U.S. CLS. 100, 103 AND 106).

**SERVICE MARK**

FIRST USE 5-8-2008; IN COMMERCE 5-8-2008.

**PRINCIPAL REGISTER**

THE MARK CONSISTS OF STANDARD CHARACTERS WITHOUT CLAIM TO ANY PARTICULAR FONT, STYLE, SIZE, OR COLOR.

NO CLAIM IS MADE TO THE EXCLUSIVE RIGHT TO USE "PART", APART FROM THE MARK AS SHOWN.

SER. NO. 85-380,968, FILED 7-26-2011.

SANI KHOURI, EXAMINING ATTORNEY

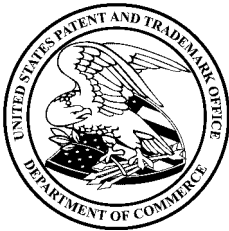

*David J. Kyffers*

Director of the United States Patent and Trademark Office

# United States of America

United States Patent and Trademark Office

## SEABOARD SOLAR

**Reg. No. 4,125,081**

SOLAIRE SOLUTIONS II, LLC (DELAWARE LIMITED LIABILITY COMPANY)  
51 SUGAR HOLLOW ROAD  
DANBURY, CT 06810

**Registered Apr. 10, 2012**

**Int. Cl.: 40**

FOR: GENERATION OF ELECTRICITY FROM SOLAR ENERGY, IN CLASS 40 (U.S. CLS. 100, 103 AND 106).

**SERVICE MARK**

FIRST USE 6-5-2011; IN COMMERCE 6-5-2011.

**PRINCIPAL REGISTER**

THE MARK CONSISTS OF STANDARD CHARACTERS WITHOUT CLAIM TO ANY PARTICULAR FONT, STYLE, SIZE, OR COLOR.

NO CLAIM IS MADE TO THE EXCLUSIVE RIGHT TO USE "SOLAR", APART FROM THE MARK AS SHOWN.

SER. NO. 85-381,059, FILED 7-26-2011.

DEBORAH LOBO, EXAMINING ATTORNEY



*David J. Kyffers*

Director of the United States Patent and Trademark Office

# United States of America

United States Patent and Trademark Office

## The Bastiat Society

**Reg. No. 4,125,082**

THE BASTIAT SOCIETY (SOUTH CAROLINA CORPORATION)  
175 KING STREET  
CHARLESTON, SC 29401

**Registered Apr. 10, 2012**

**Int. Cl.: 35**

FOR: CLUB SERVICES, NAMELY, PROMOTING THE INTERESTS OF BUSINESS PEOPLE SUPPORTING THE ECONOMIC THEORIES OF FRÉDÉRIC BASTIAT REGARDING A FREE SOCIETY, IN CLASS 35 (U.S. CLS. 100, 101 AND 102).

**SERVICE MARK**

FIRST USE 10-1-2004; IN COMMERCE 10-1-2004.

**PRINCIPAL REGISTER**

THE MARK CONSISTS OF STANDARD CHARACTERS WITHOUT CLAIM TO ANY PARTICULAR FONT, STYLE, SIZE, OR COLOR.

NO CLAIM IS MADE TO THE EXCLUSIVE RIGHT TO USE "SOCIETY", APART FROM THE MARK AS SHOWN.

THE NAME(S), PORTRAIT(S), AND/OR SIGNATURE(S) SHOWN IN THE MARK DOES NOT IDENTIFY A PARTICULAR LIVING INDIVIDUAL.

SER. NO. 85-381,072, FILED 7-26-2011.

GEOFFREY FOSDICK, EXAMINING ATTORNEY



*David J. Kyfos*

Director of the United States Patent and Trademark Office

# United States of America

United States Patent and Trademark Office

## THE WHITE CARPET

**Reg. No. 4,125,083**

THE WHITE CARPET (NEVADA LIMITED LIABILITY COMPANY)  
5398 EAST MOUNTAIN STREET  
STONE MOUNTAIN, GA 30083

**Registered Apr. 10, 2012**

**Int. Cl.: 36**

FOR: CHARITABLE FUND RAISING SERVICES BY MEANS OF ENTERTAINMENT EVENTS,  
IN CLASS 36 (U.S. CLS. 100, 101 AND 102).

**SERVICE MARK**

FIRST USE 3-1-2010; IN COMMERCE 3-1-2010.

**PRINCIPAL REGISTER**

THE MARK CONSISTS OF STANDARD CHARACTERS WITHOUT CLAIM TO ANY PARTICULAR FONT, STYLE, SIZE, OR COLOR.

SER. NO. 85-381,140, FILED 7-26-2011.

ANDREW LEASER, EXAMINING ATTORNEY



*David J. Kyros*

Director of the United States Patent and Trademark Office

# United States of America

United States Patent and Trademark Office

## MD THERAPEUTICALS

**Reg. No. 4,125,084**

MD THERAPEUTICALS, LLC (CALIFORNIA LIMITED LIABILITY COMPANY)  
445 30TH STREET  
OAKLAND, CA 94619

**Registered Apr. 10, 2012**

**Int. Cl.: 5**

FOR: NAIL FUNGUS TREATMENT PREPARATIONS, IN CLASS 5 (U.S. CLS. 6, 18, 44, 46, 51 AND 52).

**TRADEMARK**

FIRST USE 12-0-2005; IN COMMERCE 12-0-2005.

**PRINCIPAL REGISTER**

THE MARK CONSISTS OF STANDARD CHARACTERS WITHOUT CLAIM TO ANY PARTICULAR FONT, STYLE, SIZE, OR COLOR.

NO CLAIM IS MADE TO THE EXCLUSIVE RIGHT TO USE "THERAPEUTICALS", APART FROM THE MARK AS SHOWN.

SER. NO. 85-381,215, FILED 7-26-2011.

STEVEN R. FINE, EXAMINING ATTORNEY



*David J. Kybas*

Director of the United States Patent and Trademark Office

# United States of America

United States Patent and Trademark Office

# Bootleg Brew

**Reg. No. 4,125,085**

**Registered Apr. 10, 2012**

**Int. Cl.: 32**

**TRADEMARK**

**PRINCIPAL REGISTER**

MORGAN, JAY P (UNITED STATES INDIVIDUAL), DBA BOOTLEG BREW  
2629 FOOTHILL BLVD. #366  
LA CRESCENTA, CA 91214

FOR: POP, IN CLASS 32 (U.S. CLS. 45, 46 AND 48).

FIRST USE 9-1-2006; IN COMMERCE 10-3-2006.

THE MARK CONSISTS OF STANDARD CHARACTERS WITHOUT CLAIM TO ANY PARTICULAR FONT, STYLE, SIZE, OR COLOR.

NO CLAIM IS MADE TO THE EXCLUSIVE RIGHT TO USE "BREW", APART FROM THE MARK AS SHOWN.

SER. NO. 85-381,217, FILED S.R. 7-26-2011 AM. P.R. 11-22-2011.

STEVEN R. FINE, EXAMINING ATTORNEY



*David J. Kyffers*

Director of the United States Patent and Trademark Office

# United States of America

United States Patent and Trademark Office

## SCIENCE APPLIED

**Reg. No. 4,125,086**

**Registered Apr. 10, 2012**

**Int. Cls.: 37, 42 and 45**

**SERVICE MARK**

**PRINCIPAL REGISTER**

PROFESSIONAL ENGINEERING CONSULTANTS, P.A. (KANSAS PROFESSIONAL CORPORATION)  
303 S. TOPEKA ST.  
WICHITA, KS 67202

FOR: INSPECTION SERVICES IN THE COURSE OF CONSTRUCTION OF RESIDENTIAL, COMMERCIAL, INDUSTRIAL BUILDINGS; CONSULTING SERVICES FOR THE CONSTRUCTION OF WATER TREATMENT AND PURIFICATION PLANTS, SOLID WASTE TREATMENT PLANTS AND OTHER MUNICIPAL INFRASTRUCTURE FACILITIES; LAND DEVELOPMENT SERVICES, NAMELY, PLANNING AND LAYING OUT OF RESIDENTIAL AND/OR COMMERCIAL COMMUNITIES AND COMMERCIAL BUILDINGS; CONSULTING SERVICES IN THE FIELD OF RESIDENTIAL, COMMERCIAL, OR INDUSTRIAL REAL ESTATE SITE SELECTION; CONSTRUCTION MANAGEMENT, PLANNING, CONSULTATION AND SUPERVISION SERVICES, IN CLASS 37 (U.S. CLS. 100, 103 AND 106).

FIRST USE 1-7-2009; IN COMMERCE 1-7-2009.

FOR: ENGINEERING; DRAFTING OF PLANS AND ENGINEERING DRAWINGS FOR OTHERS; CIVIL ENGINEERING SERVICES; CUSTOM DESIGN SERVICES, TESTING SERVICES, INSPECTION SERVICES AND TECHNICAL CONSULTING SERVICES IN THE FIELD OF CIVIL ENGINEERING; ENGINEERING SERVICES FOR THE CONSTRUCTION OF WATER TREATMENT AND PURIFICATION PLANTS, SOLID WASTE TREATMENT PLANTS AND OTHER MUNICIPAL INFRASTRUCTURE FACILITIES; CUSTOM DESIGN OF DRAINAGE, EROSION, STORMWATER, WATERSHED AND FLOOD CONTROL AND MANAGEMENT SYSTEMS AND CONSULTING SERVICES IN CONNECTION THEREWITH; ENGINEERING SERVICES FOR THE DESIGN AND CONSTRUCTION OF AIRPORTS AND AIRFIELDS, AND CONSULTING SERVICES IN CONNECTION THEREWITH; FACILITIES DESIGN ENGINEERING SERVICES AND CONSULTING SERVICES IN CONNECTION THEREWITH; DESIGN PLANNING AND ENGINEERING OF BUILDINGS AND INFRASTRUCTURE SYSTEMS FOR BUILDINGS; ENGINEERING SERVICES FOR BUILDING AND PROPERTY CONDITION ASSESSMENT, FACILITY MANAGEMENT, REPAIR AND RESTORATION AND BUILDING INSTRUMENTATION; ELECTRICAL ENGINEERING; FOUNDATION ENGINEERING, FOUNDATION TESTING AND DESIGN SERVICES FOR OTHERS, AND CONSULTING SERVICES IN CONNECTION THEREWITH; ENGINEERING SERVICES IN THE FIELD OF ENERGY EFFICIENCY; ENGINEERING SERVICES IN THE FIELDS OF TRAFFIC AND TRANSPORTATION; DESIGN ENGINEERING SERVICES IN THE FIELD OF TRANSPORTATION SYSTEMS AND CONSULTING SERVICES IN CONNEC-



*David J. Kybas*

Director of the United States Patent and Trademark Office



**Reg. No. 4,125,086** TION THEREWITH; ENVIRONMENTAL ENGINEERING, TESTING AND INSPECTION SERVICES; GEOENVIRONMENTAL ENGINEERING; GEOTECHNICAL TESTING SERVICES AND CONSULTING SERVICES IN CONNECTION THEREWITH; HYDROLOGICAL AND HYDRAULIC ENGINEERING AND DESIGN ENGINEERING SERVICES; PROVIDING TESTING AND INSPECTION SERVICES IN THE FIELD OF HYDROLOGICAL AND HYDRAULIC SCIENCES AND CONSULTING SERVICES IN CONNECTION THEREWITH; MECHANICAL ENGINEERING; TESTING INSPECTION AND CONSULTING SERVICES IN THE FIELD OF MECHANICAL SYSTEMS; STRUCTURAL ENGINEERING DESIGN SERVICES; TESTING, INSPECTION AND CONSULTING SERVICES IN THE FIELD OF STRUCTURAL ENGINEERING; CONSTRUCTION ENGINEERING AND DESIGN SERVICES FOR OTHERS AND PROVIDING CONSULTING SERVICES IN CONNECTION THEREWITH; TRAFFIC AND TRANSPORTATION ENGINEERING; TRANSPORTATION AND TRAFFIC DESIGN PLANNING AND INTEGRATION SERVICES; MATERIALS ENGINEERING; MATERIALS TESTING, ANALYZING, EVALUATION, AND TESTING SERVICES AND CONSULTING SERVICES IN CONNECTION THEREWITH; ENGINEERING, TECHNICAL, ARCHITECTURAL, GEOLOGICAL, TOPOGRAPHIC, LAND, AND ROADWAY SURVEYING, IN CLASS 42 (U.S. CLS. 100 AND 101).

FIRST USE 1-7-2009; IN COMMERCE 1-7-2009.

FOR: CONSULTING SERVICES IN THE FIELD OF RESIDENTIAL, COMMERCIAL, OR INDUSTRIAL REAL ESTATE ZONING PERMITTING AND COMPLIANCE, IN CLASS 45 (U.S. CLS. 100 AND 101).

FIRST USE 1-7-2009; IN COMMERCE 1-7-2009.

THE MARK CONSISTS OF STANDARD CHARACTERS WITHOUT CLAIM TO ANY PARTICULAR FONT, STYLE, SIZE, OR COLOR.

NO CLAIM IS MADE TO THE EXCLUSIVE RIGHT TO USE "SCIENCE", APART FROM THE MARK AS SHOWN.

SER. NO. 85-381,223, FILED S.R. 7-26-2011 AM. P.R. 11-22-2011.

APRIL ROACH, EXAMINING ATTORNEY

# United States of America

United States Patent and Trademark Office

## Spencer Photography

**Reg. No. 4,125,087**

**Registered Apr. 10, 2012**

**Int. Cl.: 41**

**SERVICE MARK**

**PRINCIPAL REGISTER**

SPENCER PHOTOGRAPHY INC. (OHIO CORPORATION)  
9910 INDEPENDENCE BLVD  
CLEVELAND, OH 44130

FOR: DIGITAL IMAGING SERVICES; PHOTOGRAPHY; PHOTOGRAPHY SERVICES;  
PORTRAIT PHOTOGRAPHY; WEDDING PHOTOGRAPHY SERVICES, IN CLASS 41 (U.S.  
CLS. 100, 101 AND 107).

FIRST USE 1-1-2000; IN COMMERCE 1-1-2000.

THE MARK CONSISTS OF STANDARD CHARACTERS WITHOUT CLAIM TO ANY PAR-  
TICULAR FONT, STYLE, SIZE, OR COLOR.

NO CLAIM IS MADE TO THE EXCLUSIVE RIGHT TO USE "PHOTOGRAPHY", APART  
FROM THE MARK AS SHOWN.

SER. NO. 85-381,297, FILED 7-26-2011.

JULIE WATSON, EXAMINING ATTORNEY



*David J. Kybas*

Director of the United States Patent and Trademark Office

# United States of America

United States Patent and Trademark Office

## COLOR VISIONS

**Reg. No. 4,125,088**

**Registered Apr. 10, 2012**

**Int. Cl.: 24**

**TRADEMARK**

**PRINCIPAL REGISTER**

JMF SALES CORP (PENNSYLVANIA CORPORATION)  
7207 SHEFFIELD DR  
YARDLEY, PA 19067

FOR: TEXTILES AND FABRICS, NAMELY, BED SHEETS, PILLOW CASES, COMFORTERS, BEDSPREADS, QUILTS, PILLOW SHAMS, BED DUST RUFFLES, BED SKIRTS, DUVET COVERS, COMFORTER COVERS, MATTRESS PADS, BED BLANKETS, THROW BLANKETS, WATERBED SHEETS AND COMFORTERS, TOWELS, BATH TOWELS, BEACH TOWELS, KITCHEN TOWELS, BATH SHEETS, WASH CLOTHS, FABRIC SHOWER CURTAINS, TEXTILE WALL HANGINGS, ALL OF WHICH IS PRIMARILY MADE OF COTTON, IN CLASS 24 (U.S. CLS. 42 AND 50).

FIRST USE 7-1-2011; IN COMMERCE 7-15-2011.

THE MARK CONSISTS OF STANDARD CHARACTERS WITHOUT CLAIM TO ANY PARTICULAR FONT, STYLE, SIZE, OR COLOR.

NO CLAIM IS MADE TO THE EXCLUSIVE RIGHT TO USE "COLOR", APART FROM THE MARK AS SHOWN.

SER. NO. 85-381,353, FILED 7-26-2011.

JEFFREY LOOK, EXAMINING ATTORNEY



*David J. Kybas*

Director of the United States Patent and Trademark Office

# United States of America

United States Patent and Trademark Office



**Reg. No. 4,125,089**

**Registered Apr. 10, 2012**

**Int. Cls.: 9, 16, 35 and 42**

**TRADEMARK**

**SERVICE MARK**

**PRINCIPAL REGISTER**

SOLAR RATING & CERTIFICATION CORPORATION (SRCC) (FLORIDA NON-PROFIT CORPORATION)  
400 HIGH POINT DRIVE, SUITE 400  
COCOA, FL 32926

FOR: DOWNLOADABLE VIDEOS FEATURING SOLAR ENERGY EQUIPMENT, IN CLASS 9 (U.S. CLS. 21, 23, 26, 36 AND 38).

FIRST USE 12-21-2010; IN COMMERCE 5-2-2011.

FOR: PRINTED MATTER, NAMELY, NEWSLETTERS, BROCHURES, PERIODICALS, EDUCATIONAL MATERIALS, REPORTS, AND APPLICATION MATERIALS, NAMELY, CERTIFICATION APPLICATION FORMS, ALL IN THE FIELDS OF SOLAR ENERGY AND ENERGY EFFICIENCY; PRINTED CERTIFICATES AND PRINTED PAPER LABELS FOR SOLAR ENERGY PRODUCTS CERTIFIED BY THE MARK OWNER, IN CLASS 16 (U.S. CLS. 2, 5, 22, 23, 29, 37, 38 AND 50).

FIRST USE 12-21-2010; IN COMMERCE 5-2-2011.

FOR: PROVIDING CONSUMER INFORMATION IN THE FIELD OF SOLAR ENERGY AND ENERGY EFFICIENCY, NAMELY, PRODUCT RATINGS OF CONSUMER GOODS OF OTHERS CONCERNING THE PERFORMANCE OF SOLAR ENERGY EQUIPMENT; PROMOTING THE ECOLOGICAL BENEFITS OF SOLAR ENERGY; MAINTAINING A SEARCHABLE ON-LINE DIRECTORY OF SOLAR THERMAL PRODUCTS CERTIFIED BY THE MARK OWNER; AND, PROVIDING ON-LINE CONSUMER INFORMATION IN THE FIELD OF SOLAR ENERGY, IN CLASS 35 (U.S. CLS. 100, 101 AND 102).

FIRST USE 12-21-2010; IN COMMERCE 5-2-2011.

FOR: ANALYSIS AND EVALUATION OF SOLAR ENERGY EQUIPMENT FOR THE PURPOSE OF CERTIFICATION BASED ON PERFORMANCE AND DURABILITY REQUIREMENTS; AND, PROVIDING INFORMATION ON THE TESTING AND OPERATING REQUIREMENTS FOR THE CERTIFICATION OF SOLAR ENERGY EQUIPMENT, IN CLASS 42 (U.S. CLS. 100 AND 101).

FIRST USE 12-21-2010; IN COMMERCE 5-2-2011.



*David J. Kyjars*

Director of the United States Patent and Trademark Office

**Reg. No. 4,125,089** OWNER OF U.S. REG. NOS. 1,286,639 AND 3,599,538.

THE COLOR(S) BLUE AND WHITE IS/ARE CLAIMED AS A FEATURE OF THE MARK.

NO CLAIM IS MADE TO THE EXCLUSIVE RIGHT TO USE "SOLAR RATING" AND "CERTIFICATION CORPORATION ESTABLISHED 1980", APART FROM THE MARK AS SHOWN.

THE MARK CONSISTS OF THE WORDS "SOLAR RATING & CERTIFICATION CORPORATION ESTABLISHED 1980" FORMING A CIRCLE AND APPEARING IN WHITE LETTERS WITH TWO SMALL WHITE CIRCLES; THE LETTERS "SRCC" IN THE COLOR WHITE; WAVY BLUE LINES WHICH DEPICT WAVES OF WATER; AND, STRAIGHT BLUE LINES WHICH DEPICT RAYS OF THE SUN. THE BACKGROUND OF THE CIRCLES BEHIND THE WHITE LETTERS IS BLUE.

SER. NO. 85-381,406, FILED 7-26-2011.

NATALIE POLZER, EXAMINING ATTORNEY

# United States of America

United States Patent and Trademark Office



**Reg. No. 4,125,090**

**Registered Apr. 10, 2012**

**Int. Cl.: 35**

**SERVICE MARK**

**PRINCIPAL REGISTER**

SE10 LLP (UNITED KINGDOM LIMITED LIABILITY PARTNERSHIP)  
1 SEKFORDE STREET  
LONDON, UNITED KINGDOM EC1R0BE

FOR: (BASED ON USE IN COMMERCE) ADVERTISING AND PUBLICITY SERVICES; ADVERTISING, MARKETING AND PROMOTION SERVICES; PUBLIC RELATIONS (BASED ON 44(D) PRIORITY APPLICATION) ADVERTISING AND PUBLICITY SERVICES; ADVERTISING, MARKETING AND PROMOTION SERVICES; PUBLIC RELATIONS (BASED ON 44(E)) ADVERTISING AND PUBLICITY SERVICES; ADVERTISING, MARKETING AND PROMOTION SERVICES; PUBLIC RELATIONS, IN CLASS 35 (U.S. CLS. 100, 101 AND 102).

FIRST USE 12-0-2009; IN COMMERCE 12-0-2009.

PRIORITY CLAIMED UNDER SEC. 44(D) ON UNITED KINGDOM APPLICATION NO. 2571306, FILED 2-4-2011, REG. NO. 2571306, DATED 2-4-2011, EXPIRES 2-4-2021.

THE COLOR(S) BLUE, RED AND WHITE IS/ARE CLAIMED AS A FEATURE OF THE MARK.

NO CLAIM IS MADE TO THE EXCLUSIVE RIGHT TO USE "PR", APART FROM THE MARK AS SHOWN.

THE MARK CONSISTS OF A BLUE BOX CONTAINING THE WHITE LETTERS "SE" ADJACENT TO A RED BOX CONTAINING THE WHITE NUMBER "10" ABOVE THE WORD "INDUSTRIAL" IN WHITE ABOVE THE WORDS "STRENGTH PR" IN WHITE FONT.

SER. NO. 85-381,426, FILED 7-26-2011.

LINDA MICKLEBURGH, EXAMINING ATTORNEY



*David J. Kybas*

Director of the United States Patent and Trademark Office

# United States of America

United States Patent and Trademark Office

## All Societies United

**Reg. No. 4,125,091**

**Registered Apr. 10, 2012**

**Int. Cl.: 25**

**TRADEMARK**

**PRINCIPAL REGISTER**

SCOTT, JONATHAN (UNITED STATES INDIVIDUAL), DBA ALL SOCIETIES UNITED  
#138  
3104 E. CAMELBACK ROAD  
PHOENIX, AZ 85016

FOR: JACKETS; JEANS; LONG-SLEEVED SHIRTS; OVERCOATS; PANTS; SHIRTS; SHOES;  
SHORTS; SOCKS; SPORTS JERSEYS; SWEAT SHIRTS; T-SHIRTS; UNDERWEAR, IN CLASS  
25 (U.S. CLS. 22 AND 39).

FIRST USE 1-15-2010; IN COMMERCE 1-15-2010.

THE MARK CONSISTS OF STANDARD CHARACTERS WITHOUT CLAIM TO ANY PAR-  
TICULAR FONT, STYLE, SIZE, OR COLOR.

SER. NO. 85-381,486, FILED 7-26-2011.

DOMINICK J. SALEMI, EXAMINING ATTORNEY



*David J. Kyffers*

Director of the United States Patent and Trademark Office

# United States of America

United States Patent and Trademark Office



**Reg. No. 4,125,092**

**Registered Apr. 10, 2012**

**Int. Cl.: 9**

**TRADEMARK**

**PRINCIPAL REGISTER**

ALTOBELLI, LOUIS T. (UNITED STATES INDIVIDUAL), DBA PROFOX RACING INC.  
326  
10061 RIVERSIDE DR.  
TOLUCA LAKE, CA 91602

FOR: CLOTHING FOR PROTECTION AGAINST FIRE, IN CLASS 9 (U.S. CLS. 21, 23, 26, 36 AND 38).

FIRST USE 6-1-2010; IN COMMERCE 6-1-2010.

OWNER OF U.S. REG. NO. 3,153,486.

THE MARK CONSISTS OF ONE STYLIZED JUMPING FOX, ONE BLACK OBLONG WITH A WHITE CENTER SURROUNDING STANDARD CHARACTERS THAT READ: "PROFOX".

SER. NO. 85-381,494, FILED 7-26-2011.

DOMINICK J. SALEMI, EXAMINING ATTORNEY



*David J. Kybas*

Director of the United States Patent and Trademark Office



# United States of America

United States Patent and Trademark Office

## Dynamic Reports

**Reg. No. 4,125,093**

**Registered Apr. 10, 2012**

**Int. Cl.: 9**

**TRADEMARK**

**PRINCIPAL REGISTER**

EI DYNAMICS, INC. (IDAHO CORPORATION)  
110  
3943 IRVINE BLVD  
IRVINE, CA 92602

FOR: COMPUTER SOFTWARE THAT PROVIDES REAL-TIME, INTEGRATED BUSINESS MANAGEMENT INTELLIGENCE BY COMBINING INFORMATION FROM VARIOUS DATABASES AND PRESENTING IT IN AN EASY-TO-UNDERSTAND USER INTERFACE, IN CLASS 9 (U.S. CLS. 21, 23, 26, 36 AND 38).

FIRST USE 2-1-2008; IN COMMERCE 2-1-2008.

THE MARK CONSISTS OF STANDARD CHARACTERS WITHOUT CLAIM TO ANY PARTICULAR FONT, STYLE, SIZE, OR COLOR.

NO CLAIM IS MADE TO THE EXCLUSIVE RIGHT TO USE "REPORTS", APART FROM THE MARK AS SHOWN.

SER. NO. 85-381,496, FILED 7-26-2011.

ALICE BENMAMAN, EXAMINING ATTORNEY



*David J. Kyffers*

Director of the United States Patent and Trademark Office

# United States of America

United States Patent and Trademark Office

## DYNAMIC ALERTS

**Reg. No. 4,125,094**

**Registered Apr. 10, 2012**

**Int. Cl.: 9**

**TRADEMARK**

**PRINCIPAL REGISTER**

EI DYNAMICS, INC. (IDAHO CORPORATION)  
SUITE 110  
3943 IRVINE BLVD.  
IRVINE, CA 92602

FOR: COMPUTER SOFTWARE THAT PROVIDES REAL-TIME, INTEGRATED BUSINESS MANAGEMENT INTELLIGENCE BY COMBINING INFORMATION FROM VARIOUS DATABASES AND PRESENTING IT IN AN EASY-TO-UNDERSTAND USER INTERFACE, IN CLASS 9 (U.S. CLS. 21, 23, 26, 36 AND 38).

FIRST USE 2-1-2009; IN COMMERCE 2-1-2009.

THE MARK CONSISTS OF STANDARD CHARACTERS WITHOUT CLAIM TO ANY PARTICULAR FONT, STYLE, SIZE, OR COLOR.

NO CLAIM IS MADE TO THE EXCLUSIVE RIGHT TO USE "ALERTS", APART FROM THE MARK AS SHOWN.

SER. NO. 85-381,504, FILED 7-26-2011.

ALICE BENMAMAN, EXAMINING ATTORNEY



*David J. Kyffers*

Director of the United States Patent and Trademark Office

# United States of America

United States Patent and Trademark Office

## CGB FERTILIZER

**Reg. No. 4,125,095**

**Registered Apr. 10, 2012**

**Int. Cls.: 35 and 39**

**SERVICE MARK**

**PRINCIPAL REGISTER**

CGB ENTERPRISES, INC. (LOUISIANA CORPORATION)  
1001 SERVICE RD., E. HWY. 190  
COVINGTON, LA 70433

FOR: PRODUCT MERCHANDISING AND DISTRIBUTION OF BULK FERTILIZERS TO RETAIL OUTLETS AND FARM COOPERATIVES, IN CLASS 35 (U.S. CLS. 100, 101 AND 102).

FIRST USE 7-1-2011; IN COMMERCE 7-1-2011.

FOR: STORAGE AND TRANSPORTATION OF BULK FERTILIZERS TO RETAIL OUTLETS AND FARM COOPERATIVES, IN CLASS 39 (U.S. CLS. 100 AND 105).

FIRST USE 7-1-2011; IN COMMERCE 7-1-2011.

THE MARK CONSISTS OF STANDARD CHARACTERS WITHOUT CLAIM TO ANY PARTICULAR FONT, STYLE, SIZE, OR COLOR.

OWNER OF U.S. REG. NOS. 3,041,017, 3,164,626 AND OTHERS.

NO CLAIM IS MADE TO THE EXCLUSIVE RIGHT TO USE "FERTILIZER", APART FROM THE MARK AS SHOWN.

SER. NO. 85-381,563, FILED 7-26-2011.

RENEE MCCRAY, EXAMINING ATTORNEY

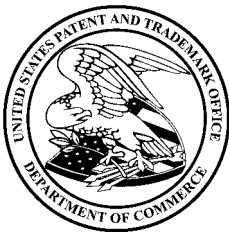

*David J. Kybas*

Director of the United States Patent and Trademark Office

# United States of America

United States Patent and Trademark Office



**Reg. No. 4,125,096**

**Registered Apr. 10, 2012**

**Int. Cl.: 28**

**TRADEMARK**

**PRINCIPAL REGISTER**

LAMARTEK, INC. (FLORIDA CORPORATION), DBA DIVE RITE  
175 NW WASHINGTON STREET  
LAKE CITY, FL 32055

FOR: SACKS AND BAGS IN THE NATURE OF SPORTSMEN'S DIVING BAGS FEATURING EQUIPMENT COVERS AND POCKETS, NAMELY, ZIP POCKETS, HOOK AND LOOP FASTENER POCKETS, QUICK RELEASE POCKETS, WEIGHT SYSTEM POCKETS, MASK POCKETS; SPORTING ARTICLES FOR SCUBA DIVING, NAMELY SLEEVES, ARROWS TO BE USED AS DIRECTIONAL MARKERS, RETAINING STRAPS, REELS AND LINES, AND SCUBA HARNESS INCLUDING SHOULDER PADS FOR THE SCUBA HARNESS, BAGS SPECIALLY ADAPTED FOR SPORTING EQUIPMENT NAMELY ANALYZER BAGS AND DRY SUIT BAGS, MAT IN THE NATURE OF SPORTSMEN'S MATT USED FOR GEARING UP PRE AND POST DIVE, DIVING FIN, IN CLASS 28 (U.S. CLS. 22, 23, 38 AND 50).

FIRST USE 6-15-2009; IN COMMERCE 1-12-2010.

OWNER OF U.S. REG. NOS. 2,291,852, 3,867,038 AND OTHERS.

THE COLOR(S) RED, YELLOW, WHITE AND BLACK IS/ARE CLAIMED AS A FEATURE OF THE MARK.

NO CLAIM IS MADE TO THE EXCLUSIVE RIGHT TO USE "DIVE", APART FROM THE MARK AS SHOWN.

THE MARK CONSISTS OF YELLOW TRIANGULAR SHAPE, RED TRIANGULAR SHAPE, WHITE LETTERS "DIVE RITE" WHICH ARE OUTLINED IN BLACK.

SER. NO. 85-381,607, FILED 7-26-2011.

KELLY TRUSILO, EXAMINING ATTORNEY



*David J. Kybas*

Director of the United States Patent and Trademark Office

# United States of America

United States Patent and Trademark Office

## PoliceOne Academy

**Reg. No. 4,125,097**

**Registered Apr. 10, 2012**

**Int. Cl.: 41**

**SERVICE MARK**

**PRINCIPAL REGISTER**

THE PRAETORIAN GROUP (CALIFORNIA CORPORATION)  
200 GREEN STREET, SUITE 200  
SAN FRANCISCO, CA 94111

FOR: PUBLISHING OF AN ELECTRONIC PUBLICATION FEATURING INFORMATION OF INTEREST TO THE LAW ENFORCEMENT COMMUNITY VIA THE INTERNET; ONLINE TRAINING IN THE NATURE OF COURSES, SEMINARS, WORKSHOPS, LECTURES AND VIDEO CONFERENCES FOR THE LAW ENFORCEMENT COMMUNITY VIA THE INTERNET, IN CLASS 41 (U.S. CLS. 100, 101 AND 107).

FIRST USE 11-1-2010; IN COMMERCE 11-1-2010.

THE MARK CONSISTS OF STANDARD CHARACTERS WITHOUT CLAIM TO ANY PARTICULAR FONT, STYLE, SIZE, OR COLOR.

OWNER OF U.S. REG. NO. 3,589,733.

NO CLAIM IS MADE TO THE EXCLUSIVE RIGHT TO USE "ACADEMY", APART FROM THE MARK AS SHOWN.

SER. NO. 85-381,652, FILED 7-26-2011.

SAMUEL E. SHARPER JR., EXAMINING ATTORNEY



*David J. Kyffers*

Director of the United States Patent and Trademark Office

# United States of America

United States Patent and Trademark Office

## SOAP QUEEN

**Reg. No. 4,125,098**

**Registered Apr. 10, 2012**

**Int. Cl.: 3**

**TRADEMARK**

**PRINCIPAL REGISTER**

BRAMBLE BERRY, INC. (WASHINGTON CORPORATION)  
2138 HUMBOLDT ST.  
BELLINGHAM, WA 98225

FOR: SOAP MAKING SUPPLY KITS CONSISTING OF FRAGRANCE OILS FOR SOAP, BULK SOAP BASE, SOAP COLORANTS, SOAP MOLDS, SOAP FRAGRANCE MATERIALS; SOAP MAKING SUPPLIES, NAMELY, FRAGRANCES CONSISTING OF ESSENTIAL OILS FOR USE IN THE MANUFACTURE OF SOAP, LOTION MAKING SUPPLIES, NAMELY, FRAGRANCES CONSISTING OF ESSENTIAL OILS; GENERAL TOILETRY MAKING SUPPLIES, NAMELY, FRAGRANCES CONSISTING OF ESSENTIAL OILS, IN CLASS 3 (U.S. CLS. 1, 4, 6, 50, 51 AND 52).

FIRST USE 2-28-2010; IN COMMERCE 2-28-2010.

THE MARK CONSISTS OF STANDARD CHARACTERS WITHOUT CLAIM TO ANY PARTICULAR FONT, STYLE, SIZE, OR COLOR.

NO CLAIM IS MADE TO THE EXCLUSIVE RIGHT TO USE "SOAP" , APART FROM THE MARK AS SHOWN.

SER. NO. 85-381,677, FILED 7-26-2011.

KARANENDRA S. CHHINA, EXAMINING ATTORNEY



*David J. Kyros*

Director of the United States Patent and Trademark Office

# United States of America

United States Patent and Trademark Office



**Reg. No. 4,125,099**

**Registered Apr. 10, 2012**

**Int. Cl.: 29**

**TRADEMARK**

**PRINCIPAL REGISTER**

QFCO, INC. (CALIFORNIA CORPORATION)  
1611 ADRIAN ROAD  
BURLINGAME, CA 94010

FOR: ANIMAL OILS AND FATS; BEEF BOUILLON; BEEF STOCK; BLENDED OIL; BONE OIL; BONELESS SKINLESS CHICKEN TENDERLOIN; BOUILLON; BOUILLON CONCENTRATES; CANDIED FRUIT; CANDIED FRUIT SNACKS; CANNED FRUITS; CANNED FRUITS AND VEGETABLES; CANNED OR BOTTLED FRUITS; CANNED PROCESSED OLIVES; CANOLA OIL; CHEESE POWDER; CHICKEN POWDER FOR HUMAN CONSUMPTION FOR USE AS A FOOD ADDITIVE; CHICKEN STOCK; COCONUT MILK POWDER; COCONUT OIL; COCONUT OIL AND FAT; COCONUT POWDER; COOKED FRUITS AND VEGETABLES; COOKING OIL; CORN OIL; CREAM POWDER; CRYSTALLISED, FROSTED, FROZEN, AND PRESERVED FRUIT; CRYSTALLIZED FRUIT; CRYSTALLIZED FRUITS; CUT FRUITS; DAIRY-BASED POWDERS FOR MAKING DAIRY-BASED FOOD BEVERAGES AND SHAKES; DEHYDRATED FRUIT SNACKS; DRIED DATES; DRIED FRUIT AND VEGETABLES; DRIED FRUIT MIXES; DRIED FRUIT-BASED SNACKS; DRIED FRUITS; DRIED FRUITS IN POWDER FORM; DRIED MILK POWDER; DRIED SEAFOOD IN POWDER FORM; DRIED VEGETABLES; DRIED VEGETABLES IN POWDER FORM; DRY OR AROMATIZED FRUIT; EDIBLE BONE OIL; EDIBLE OIL; EDIBLE OILS; EDIBLE OILS AND EDIBLE FATS; EDIBLE OILS AND FATS; EDIBLE OILS AND FATS, FISH AND MEAT PRESERVES; EDIBLE OILS AND FATS, PRESERVES; EDIBLE OILS AND FATS, PRESERVES AND PICKLES; EDIBLE OILS AND FATS, PRESERVES, PICKLES; FIG AND DATE ROLL CONSISTING OF DRIED FRUITS, NUTS, AND SPICES; FISH STOCK; FOOD ADDITIVES IN THE NATURE OF FAT ACIDS MADE FROM MEAT, FISH, FRUITS, VEGETABLES, EGGS, MILK AND EDIBLE OILS AND FATS; FOOD ADDITIVES, NAMELY, NATURAL FOOD EXTRACTS DERIVED FROM FISH, FISH OIL, FISH PROTEIN, ALGAE, SEAWEED, FISH OR SHARK CARTILAGE, OR SEASHELLS NOT FOR MEDICINAL PURPOSES AND FOR HUMAN CONSUMPTION; FOOD GLAZING PREPARATIONS COMPRISED PRIMARILY OF FRUIT AND/OR FRUIT PECTIN FOR USE IN COOKING AND BAKING; FOOD PACKAGE COMBINATIONS CONSISTING PRIMARILY OF CHEESE, MEAT AND/OR PROCESSED FRUIT; FROZEN, FROSTED, PRESERVED, PROCESSED, DRIED, COOKED OR CRYSTALLIZED FRUIT AND VEGETABLES EXTRACTS FOR USE IN PREPARED MEALS OR FOOD; FRUIT AND SOY BASED SNACK FOOD; FRUIT AND VEGETABLE GRANULES FOR USE IN PREPARED MEALS OR FOOD; FRUIT CHIPS; FRUIT CONCENTRATES AND PUREES USED AS INGREDIENTS OF FOODS; FRUIT CONSERVES; FRUIT PASTE; FRUIT PECTIN; FRUIT PEEL; FRUIT PEELS; FRUIT PRESERVES; FRUIT PULP; FRUIT PULPS; FRUIT PUREES; FRUIT-BASED FOOD BEVERAGE; FRUIT-BASED SNACK FOOD; FRUITS IN

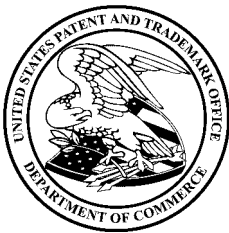

*David J. Kybas*

Director of the United States Patent and Trademark Office

**Reg. No. 4,125,099** PRESERVED FORM; GRAPSEED OIL; HARDENED OILS; INFUSED OILS FOR COOKING; MAIZE OIL; MARGARINE, EDIBLE OILS AND FATS; MEAT, FISH, FRUIT AND VEGETABLE PRESERVES; MEAT, FRUIT AND VEGETABLE JELLIES, JAMS; MEAT, FRUIT AND VEGETABLE JELLIES, JAMS, EGGS; MILK POWDER; MILK POWDER FOR FOOD PURPOSES; MILK POWDER FOR NUTRITIONAL PURPOSES; MUSHROOMS PUREE; NUTRITIONAL OILS FOR FOOD PURPOSES; OIL-BASED COOKING SPRAY; OILS AND FATS FOR FOOD; OLIVE OILS; OLIVE PASTES; PALM OIL; PALM OIL FOR FOOD; PEANUT OIL; PEPPER OIL; PICKLED FRUITS; POWDERED EGGS; POWDERED MILK; POWDERED MILK FOR FOOD PURPOSES; POWDERED OILS AND FATS; PREPARED ENTREES CONSISTING PRIMARILY OF VEGETABLES, SOUPS, FRUIT SALADS AND VEGETABLE SALADS; PRESERVED FRUIT AND VEGETABLES; PRESERVED FRUITS; PRESERVED FRUITS AND VEGETABLES; PRESERVED VEGETABLES (IN OIL); PRESERVED, DRIED AND COOKED FRUIT AND VEGETABLES; PRESERVED, DRIED AND COOKED OLIVES; PRESERVED, DRIED AND COOKED VEGETABLES; PRESERVED, DRIED, COOKED AND GRILLED VEGETABLES; PRESERVED, FROZEN, DRIED OR COOKED VEGETABLES; PROCESSED FRUIT- AND NUT-BASED FOOD BARS; PROCESSED MUSHROOMS; PROCESSED OILS AND FATS; PROCESSED OLIVE PUREE; PROCESSED OLIVES; PROCESSED OLIVES WITH PEPPERCORNS; PROCESSED STUFFED OLIVES; PROCESSED VEGETABLES, NAMELY, COOKED CUCUMBER, DAIKON, MUSHROOMS, BELLFLOWER ROOT, SPINACH, SOYBEAN SPROUTS AND BRACKEN FERN STEMS USED IN BIBIMBAP DISHES; PROTEIN POWDERS FOR HUMAN CONSUMPTION FOR USE AS A FOOD ADDITIVE; PUMPKIN SEED OIL; RAPE OIL; RICE BRAN OIL; SALAD OIL; SESAME OIL; SLICED FRUITS; SNACK MIX CONSISTING OF DEHYDRATED FRUIT AND PROCESSED NUTS; SNACK MIX CONSISTING OF PRIMARILY OF PROCESSED NUTS, SEEDS, DRIED FRUIT AND ALSO INCLUDING CHOCOLATE; SNACK MIX CONSISTING OF WASABI PEAS, PROCESSED NUTS, DEHYDRATED FRUIT AND/OR RAISINS; SNACK MIX CONSISTING PRIMARILY OF DEHYDRATED FRUITS, PROCESSED NUTS AND ALSO INCLUDING SESAME STICKS; SNACK MIX CONSISTING PRIMARILY OF PROCESSED FRUITS, PROCESSED NUTS AND/OR RAISINS; SOY BEAN OIL; SOYBEAN OIL; SOYBEAN OIL FOR COOKING; STEWED FRUIT; STUFFED OLIVES WITH FETA CHEESE IN SUNFLOWER OIL; STUFFED OLIVES WITH PESTO IN SUNFLOWER OIL; STUFFED OLIVES WITH RED PEPPER AND ALMOND; SUNFLOWER OIL; TRAIL MIX CONSISTING PRIMARILY OF PROCESSED NUTS, SEEDS, DRIED FRUIT AND ALSO INCLUDING CHOCOLATE; VEGETABLE OILS; VEGETABLE OILS AND FATS, IN CLASS 29 (U.S. CL. 46).

FIRST USE 1-1-2011; IN COMMERCE 1-1-2011.

NO CLAIM IS MADE TO THE EXCLUSIVE RIGHT TO USE THE NON-LATIN CHARACTERS THAT TRANSLITERATE TO "MEI PAI", APART FROM THE MARK AS SHOWN.

THE COLOR(S) RED, WHITE AND GOLD IS/ARE CLAIMED AS A FEATURE OF THE MARK.

THE NON-LATIN CHARACTERS IN THE MARK TRANSLITERATE TO "MEI PAI" AND THIS MEANS "U.S. BRAND" IN ENGLISH.

THE MARK CONSISTS OF A GOLD CROWN WITH A RED RIBBON WRAPPED AROUND IT AND THE WORDS "AMERICAN QUEEN", THE LETTER "A" AND TWO CHINESE CHARACTERS, ALL IN WHITE, WITHIN THE CROWN.

SER. NO. 85-381,745, FILED 7-26-2011.

DOUGLAS LEE, EXAMINING ATTORNEY



# United States of America

United States Patent and Trademark Office



**Reg. No. 4,125,100**

**Registered Apr. 10, 2012**

**Int. Cl.: 43**

**SERVICE MARK**

**PRINCIPAL REGISTER**

HARU HOLDING CORP. (DELAWARE CORPORATION)  
SUITE 201  
8685 NW 53RD TERRACE  
MIAMI, FL 33166

FOR: RESTAURANT, BAR, CARRY-OUT AND CATERING SERVICES, IN CLASS 43 (U.S. CLS. 100 AND 101).

FIRST USE 2-0-2005; IN COMMERCE 2-0-2005.

OWNER OF U.S. REG. NOS. 2,546,193 AND 2,709,147.

THE COLOR(S) GREEN AND BLUE IS/ARE CLAIMED AS A FEATURE OF THE MARK.

THE NON-LATIN CHARACTERS IN THE MARK TRANSLITERATE TO "HARU" AND THIS MEANS SPRING IN ENGLISH.

THE MARK CONSISTS OF THE WORD "HARU" APPEARS IN THE COLOR BLUE. TO THE RIGHT OF THE LITERARY ELEMENT APPEARS A JAPANESE CHARACTER SHADED IN BLUE. THE JAPANESE CHARACTER IS OVER A GREEN CIRCULAR DESIGN.

THE ENGLISH TRANSLATION OF THE WORD "HARU" IN THE MARK IS "SPRING".

SER. NO. 85-381,901, FILED 7-27-2011.

CURTIS FRENCH, EXAMINING ATTORNEY



*David J. Kyfos*

Director of the United States Patent and Trademark Office

# United States of America

United States Patent and Trademark Office

## Coupon for Hope

**Reg. No. 4,125,101**

**Registered Apr. 10, 2012**

**Int. Cl.: 35**

CATHOLIC CHARITIES OF THE ARCHDIOCESE OF MIAMI, INC. (FLORIDA CORPORATION)  
SECOND FLOOR  
1505 NE 26 STREET  
WILTON MANORS, FL 33305

**SERVICE MARK**

**PRINCIPAL REGISTER**

FOR: PROMOTING THE CHARITABLE SERVICES OF OTHERS, NAMELY, PROVIDING INDIVIDUALS WITH INFORMATION ABOUT VARIOUS CHARITIES FOR THE PURPOSE OF MAKING DONATIONS TO CHARITIES, IN CLASS 35 (U.S. CLS. 100, 101 AND 102).

FIRST USE 1-1-2011; IN COMMERCE 1-1-2011.

THE MARK CONSISTS OF STANDARD CHARACTERS WITHOUT CLAIM TO ANY PARTICULAR FONT, STYLE, SIZE, OR COLOR.

NO CLAIM IS MADE TO THE EXCLUSIVE RIGHT TO USE "COUPON", APART FROM THE MARK AS SHOWN.

SER. NO. 85-381,914, FILED 7-27-2011.

HOWARD B. LEVINE, EXAMINING ATTORNEY



*David J. Kyffers*

Director of the United States Patent and Trademark Office

# United States of America

United States Patent and Trademark Office

## FLORIDA'S SPACE COAST

**Reg. No. 4,125,102**

**Registered Apr. 10, 2012**

**Int. Cl.: 35**

**SERVICE MARK**

**PRINCIPAL REGISTER**

SPACE COAST OFFICE OF TOURISM (FLORIDA GOVERNMENTAL AGENCY)  
SUITE 150  
430 BREVARD AVENUE  
COCOA VILLAGE, FL 32922

FOR: CONVENTION AND VISITORS BUREAU SERVICES, NAMELY, PROMOTING BUSINESS, TOURISM AND THE HOLDING OF CONVENTIONS IN THE GREATER COCOA BEACH, CAPE CANAVERAL, AND BREVARD COUNTY, FLORIDA AREA, IN CLASS 35 (U.S. CLS. 100, 101 AND 102).

FIRST USE 1-1-1988; IN COMMERCE 1-1-1988.

THE MARK CONSISTS OF STANDARD CHARACTERS WITHOUT CLAIM TO ANY PARTICULAR FONT, STYLE, SIZE, OR COLOR.

OWNER OF U.S. REG. NO. 3,989,239.

SEC. 2(F).

SER. NO. 85-381,980, FILED 7-27-2011.

RAUL CORDOVA, EXAMINING ATTORNEY



*David J. Kybas*

Director of the United States Patent and Trademark Office

# United States of America

United States Patent and Trademark Office

## JOHNNY DANG

**Reg. No. 4,125,103**

**Registered Apr. 10, 2012**

**Int. Cl.: 42**

**SERVICE MARK**

**PRINCIPAL REGISTER**

JOHNNY DANG & CO., INC. (TEXAS CORPORATION), DBA JOHNNY DANG & CO  
253 SHARPSTOWN  
7500 BELLAIRE BLVD.  
HOUSTON, TX 77036

FOR: JEWELRY DESIGN, IN CLASS 42 (U.S. CLS. 100 AND 101).

FIRST USE 4-1-2011; IN COMMERCE 4-1-2011.

THE MARK CONSISTS OF STANDARD CHARACTERS WITHOUT CLAIM TO ANY PARTICULAR FONT, STYLE, SIZE, OR COLOR.

OWNER OF U.S. REG. NO. 3,985,687.

THE NAME(S), PORTRAIT(S), AND/OR SIGNATURE(S) SHOWN IN THE MARK IDENTIFIES "JOHNNY DANG", WHOSE CONSENT(S) TO REGISTER IS MADE OF RECORD.

SER. NO. 85-381,997, FILED 7-27-2011.

KELLY CHOE, EXAMINING ATTORNEY



*David J. Kybas*

Director of the United States Patent and Trademark Office

# United States of America

United States Patent and Trademark Office

# SPRIGGLES

**Reg. No. 4,125,104**

**Registered Apr. 10, 2012**

**Int. Cl.: 16**

**TRADEMARK**

**PRINCIPAL REGISTER**

GOTTLIEB, JEFFREY A. (UNITED STATES INDIVIDUAL)  
6170 RIDGE RD.  
OSCODA, MI 48750 AND

GOTTLIEB, MARTHA M. (UNITED STATES INDIVIDUAL)  
6170 RIDGE RD.  
OSCODA, MI 48750

FOR: PRINTED MATTER, NAMELY, PAPER SIGNS, BOOKS, MANUALS, CURRICULUM, NEWSLETTERS, INFORMATIONAL CARDS AND BROCHURES IN THE FIELD OF CHILDREN'S HEALTH AND WELLNESS, IN CLASS 16 (U.S. CLS. 2, 5, 22, 23, 29, 37, 38 AND 50).

FIRST USE 1-17-2000; IN COMMERCE 3-3-2000.

THE MARK CONSISTS OF STANDARD CHARACTERS WITHOUT CLAIM TO ANY PARTICULAR FONT, STYLE, SIZE, OR COLOR.

THE NAME(S), PORTRAIT(S), AND/OR SIGNATURE(S) SHOWN IN THE MARK DOES NOT IDENTIFY A PARTICULAR LIVING INDIVIDUAL.

THE WORDING "SPRIGGLES" HAS NO MEANING IN A FOREIGN LANGUAGE.

SER. NO. 85-382,012, FILED 7-27-2011.

BILL DAWE, EXAMINING ATTORNEY



*David J. Kyros*

Director of the United States Patent and Trademark Office

# United States of America

United States Patent and Trademark Office



**Reg. No. 4,125,105**

**Registered Apr. 10, 2012**

**Int. Cl.: 9**

**TRADEMARK**

**PRINCIPAL REGISTER**

CHEN, YUO SHYANG (UNITED STATES INDIVIDUAL)  
435 CORTEZ ROAD  
ARCADIA, CA 91007 AND

CHEN, ANGELL (UNITED STATES INDIVIDUAL)  
435 CORTEZ ROAD  
ARCADIA, CA 91007

FOR: HAND HELD UNITS FOR PLAYING VIDEO GAMES OTHER THAN THOSE ADAPTED FOR USE WITH AN EXTERNAL DISPLAY SCREEN OR MONITOR; VIDEO OUTPUT GAME MACHINES FOR USE WITH TELEVISIONS; VIDEO OUTPUT GAME MACHINES FOR USE WITH EXTERNAL DISPLAY SCREEN OR MONITOR; VIDEO GAME MACHINES FOR USE WITH EXTERNAL DISPLAY SCREEN OR MONITOR; VIDEO GAME MACHINES FOR USE WITH TELEVISIONS; VIDEO GAME JOYSTICKS; VIDEO GAME INTERACTIVE HAND HELD REMOTE CONTROLS FOR PLAYING ELECTRONIC GAMES; VIDEO GAME INTERACTIVE REMOTE CONTROL UNITS; VIDEO GAME INTERACTIVE CONTROL FLOOR PADS OR MATS; VIDEO GAME CONSOLES FOR USE WITH AN EXTERNAL DISPLAY SCREEN OR MONITOR; PLAYER-OPERATED ELECTRONIC CONTROLLERS FOR ELECTRONIC VIDEO GAME MACHINES; JOYSTICKS FOR VIDEO GAMES; HAND HELD JOY STICK UNITS FOR PLAYING VIDEO GAMES; GAMING HEADSETS FOR USE IN PLAYING VIDEO GAMES, IN CLASS 9 (U.S. CLS. 21, 23, 26, 36 AND 38).

FIRST USE 1-1-2001; IN COMMERCE 1-1-2001.

NO CLAIM IS MADE TO THE EXCLUSIVE RIGHT TO USE "GAMEWARE", APART FROM THE MARK AS SHOWN.

THE STIPPLING IS FOR SHADING PURPOSES ONLY.

THE MARK CONSISTS OF THE STYLIZED WORDS "YOBO GAMEWARE" WITH A SWOOSH ABOVE THE WORD "YOBO".

SER. NO. 85-382,023, FILED 7-27-2011.

DOUGLAS LEE, EXAMINING ATTORNEY



*David J. Kyros*

Director of the United States Patent and Trademark Office

# United States of America

United States Patent and Trademark Office



**Reg. No. 4,125,106**

**Registered Apr. 10, 2012**

**Int. Cl.: 11**

**TRADEMARK**

**PRINCIPAL REGISTER**

TIPSEE LIGHT COMPANY LLC (NEW YORK LIMITED LIABILITY COMPANY)  
P.O. BOX 18201  
ROCHESTER, NY 14618

FOR: FLASHLIGHTS, IN CLASS 11 (U.S. CLS. 13, 21, 23, 31 AND 34).

FIRST USE 1-8-2010; IN COMMERCE 1-8-2010.

NO CLAIM IS MADE TO THE EXCLUSIVE RIGHT TO USE "HANDS-FREE LIGHTS", APART FROM THE MARK AS SHOWN.

SER. NO. 85-382,053, FILED 7-27-2011.

MARY CRAWFORD, EXAMINING ATTORNEY



*David J. Kyffers*

Director of the United States Patent and Trademark Office

# United States of America

United States Patent and Trademark Office

## ORO DEL MAR

**Reg. No. 4,125,107**

VOODOO MANUFACTURING INC. (CALIFORNIA CORPORATION)

**Registered Apr. 10, 2012**

4215 GLENCOE AVE, SUITE 331  
MARINA DEL REY, CA 90292

**Int. Cl.: 25**

FOR: CLOTHING FOR MEN, WOMEN AND CHILDREN, NAMELY, PANTS, JEANS, TROUSERS, SHORTS, BELTS, TOPS, SHIRTS, JERSEYS, TURTLE-NECKS, GOLF SHIRTS, T-SHIRTS, SWEATSHIRTS, SWEATPANTS, WARM-UP SUITS, TANK TOPS, DRESSES, SKIRTS, BLOUSES, SUITS, TUXEDOS, BLAZERS, SPORT COATS, SWEATERS, KNITWEAR, OUTERWEAR, OVERALLS, JUMPERS, VESTS, HATS, SCARVES, COATS, JACKETS, OVERCOATS, PARKAS, SOCKS, FOOTWEAR, SHOES, BOOTS, SNEAKERS, BEACH SHOES, SANDALS, SLIPPERS, TIES, SUSPENDERS, UNDERWEAR, SWIMWEAR, BATHING SUITS, BIKINIS, MENS SHORTS FOR SWIMMING, HEADWEAR, BEANIES, GLOVES, MITTENS, PONCHOS, RAINCOATS, UMBRELLAS, WIND-RESISTANT JACKETS, SLEEPWEAR, ROBES, BATHROBES, PAJAMAS, LINGERIE, HOSIERY, BOXER SHORTS, CAPS, WOOL HATS, VISORS, HEADBANDS, EAR MUFFS, WRISTBANDS, AND CLOTH BIBS, IN CLASS 25 (U.S. CLS. 22 AND 39).

**TRADEMARK**

**PRINCIPAL REGISTER**

FIRST USE 3-1-2011; IN COMMERCE 5-2-2011.

THE MARK CONSISTS OF STANDARD CHARACTERS WITHOUT CLAIM TO ANY PARTICULAR FONT, STYLE, SIZE, OR COLOR.

THE ENGLISH TRANSLATION OF "ORO DEL MAR" IS "GOLD OF THE SEA".

SER. NO. 85-382,093, FILED 7-27-2011.

GISELLE AGOSTO, EXAMINING ATTORNEY



*David J. Kyffers*

Director of the United States Patent and Trademark Office



# United States of America

United States Patent and Trademark Office



**Reg. No. 4,125,108**

VETERAN FIRST ENERGY, LLC (VIRGINIA LIMITED LIABILITY COMPANY)  
11218 CROSS CORNER ROAD  
ASHLAND, VA 23005

**Registered Apr. 10, 2012**

**Int. Cl.: 37**

FOR: INSTALLATION AND MAINTENANCE OF RENEWABLE ENERGY SYSTEMS AND ALTERNATIVE ENERGY PRODUCTS FOR RESIDENTIAL AND COMMERCIAL USE , IN CLASS 37 (U.S. CLS. 100, 103 AND 106).

**SERVICE MARK**

FIRST USE 1-6-2011; IN COMMERCE 1-6-2011.

**PRINCIPAL REGISTER**

NO CLAIM IS MADE TO THE EXCLUSIVE RIGHT TO USE "ENERGY", APART FROM THE MARK AS SHOWN.

THE MARK CONSISTS OF 5 CONCENTRIC SWIRLS CREATING A CIRCLE WITH THE STYLIZED TEXT "VETERAN FIRST ENERGY".

SER. NO. 85-382,102, FILED 7-27-2011.

MARGERY A. TIERNEY, EXAMINING ATTORNEY



*David J. Kybas*

Director of the United States Patent and Trademark Office

# United States of America

United States Patent and Trademark Office

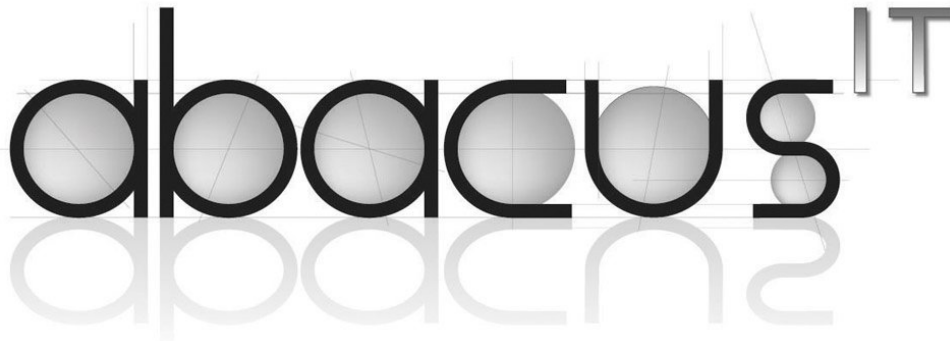

**Reg. No. 4,125,109**

ABACUS IT, INC (CALIFORNIA CORPORATION)  
9052 SANTA MONICA BLVD  
WEST HOLLYWOOD, CA 90069

**Registered Apr. 10, 2012**

**Int. Cl.: 42**

FOR: COMPUTER SERVICES, NAMELY, COMPUTER SYSTEM ADMINISTRATION FOR OTHERS, IN CLASS 42 (U.S. CLS. 100 AND 101).

**SERVICE MARK**

FIRST USE 5-17-2011; IN COMMERCE 5-17-2011.

**PRINCIPAL REGISTER**

NO CLAIM IS MADE TO THE EXCLUSIVE RIGHT TO USE "IT", APART FROM THE MARK AS SHOWN.

THE MARK CONSISTS OF THE STYLIZED WORDING "ABACUS IT" WITH THE LETTERS IN THE WORDING "ABACUS" SHADED IN AND ALSO INCORPORATING THE MIRROR IMAGE OF THE SAME WORDING UNDERNEATH.

SER. NO. 85-382,225, FILED 7-27-2011.

WON TEAK OH, EXAMINING ATTORNEY



*David J. Kybas*

Director of the United States Patent and Trademark Office

# United States of America

United States Patent and Trademark Office

## TEXT CONNECT

**Reg. No. 4,125,110**

**Registered Apr. 10, 2012**

**Int. Cl.: 36**

**SERVICE MARK**

**PRINCIPAL REGISTER**

HMY YACHT SALES, INC. (FLORIDA CORPORATION)  
817 NE 3RD STREET, #1  
DANIA, FL 33004

FOR: YACHT BROKERAGE SERVICES, NAMELY, PROVIDING YACHT LISTING INFORMATION TO WIRELESS ENABLED DEVICES VIA WIRELESS COMMUNICATION, IN CLASS 36 (U.S. CLS. 100, 101 AND 102).

FIRST USE 2-15-2011; IN COMMERCE 2-15-2011.

THE MARK CONSISTS OF STANDARD CHARACTERS WITHOUT CLAIM TO ANY PARTICULAR FONT, STYLE, SIZE, OR COLOR.

NO CLAIM IS MADE TO THE EXCLUSIVE RIGHT TO USE "TEXT", APART FROM THE MARK AS SHOWN.

SER. NO. 85-382,301, FILED 7-27-2011.

KAREN K. BUSH, EXAMINING ATTORNEY



*David J. Kyros*

Director of the United States Patent and Trademark Office

# United States of America

United States Patent and Trademark Office

# HDE

**Reg. No. 4,125,111**

HOTTESTDEALEVER CORP. (PENNSYLVANIA CORPORATION)  
620 N. ST. CLOUD STREET  
ALLENTOWN, PA 18104

**Registered Apr. 10, 2012**

**Int. Cl.: 35**

FOR: ON-LINE RETAIL STORE SERVICES FEATURING ELECTRONIC ACCESSORIES, NAMELY, CONSUMER ELECTRONICS, HOUSEHOLD ELECTRONICS, CAMERAS AND PHOTOGRAPHIC EQUIPMENT, COMPUTERS AND COMPUTER PERIPHERAL EQUIPMENT, HEALTH AND BEAUTY PRODUCTS AND NOVELTY ITEMS; ONLINE RETAIL STORE SERVICES FEATURING AUTOMOTIVE ACCESSORIES, HOME ACCESSORIES, OUTDOOR ACCESSORIES EXCLUDING PAINTBALL SUPPLIES AND EQUIPMENT, IN CLASS 35 (U.S. CLS. 100, 101 AND 102).

**SERVICE MARK**

**PRINCIPAL REGISTER**

FIRST USE 12-0-2008; IN COMMERCE 12-0-2008.

THE MARK CONSISTS OF STANDARD CHARACTERS WITHOUT CLAIM TO ANY PARTICULAR FONT, STYLE, SIZE, OR COLOR.

SER. NO. 85-382,379, FILED 7-27-2011.

JEFFREY LOOK, EXAMINING ATTORNEY



*David J. Kybas*

Director of the United States Patent and Trademark Office

# United States of America

United States Patent and Trademark Office

## TEMPLE CITY GATEWAY

**Reg. No. 4,125,112**

TEMPLE CITY GATEWAY LLC (CALIFORNIA LIMITED LIABILITY COMPANY)  
2566 WAGON TRAIN LANE  
DIAMOND BAR, CA 91765

**Registered Apr. 10, 2012**

**Int. Cl.: 37**

FOR: REAL ESTATE DEVELOPMENT SERVICES, IN CLASS 37 (U.S. CLS. 100, 103 AND 106).

**SERVICE MARK**

FIRST USE 5-0-2009; IN COMMERCE 5-0-2009.

**PRINCIPAL REGISTER**

THE MARK CONSISTS OF STANDARD CHARACTERS WITHOUT CLAIM TO ANY PARTICULAR FONT, STYLE, SIZE, OR COLOR.

NO CLAIM IS MADE TO THE EXCLUSIVE RIGHT TO USE "TEMPLE CITY", APART FROM THE MARK AS SHOWN.

SER. NO. 85-382,402, FILED 7-27-2011.

DAWN FELDMAN, EXAMINING ATTORNEY



*David J. Kybas*

Director of the United States Patent and Trademark Office

# United States of America

United States Patent and Trademark Office

## CareerFocus

**Reg. No. 4,125,113**

**Registered Apr. 10, 2012**

**Int. Cls.: 16, 35 and 41**

WASHTENAW COMMUNITY COLLEGE (MICHIGAN COMMUNITY COLLEGE,  
CHARTERED BY THE STATE OF MICHIGAN)  
MORRIS LAWRENCE 104R  
4800 E. HURON RIVER DRIVE  
ANN ARBOR, MI 48105

**TRADEMARK**

FOR: MAGAZINES IN THE FIELD OF CAREER DEVELOPMENT AND EDUCATIONAL GOALS, IN CLASS 16 (U.S. CLS. 2, 5, 22, 23, 29, 37, 38 AND 50).

**SERVICE MARK**

FIRST USE 11-1-1998; IN COMMERCE 11-1-1998.

**PRINCIPAL REGISTER**

FOR: PROVIDING ADVERTISING SPACE IN PERIODICALS, NEWSPAPERS AND MAGAZINES; PROVIDING ADVERTISING, MARKETING AND PROMOTIONAL SERVICES, NAMELY, DEVELOPMENT OF ADVERTISING CAMPAIGNS PROVIDED THROUGH CABLE TELEVISION BROADCAST, WEB CASTS, RADIO BROADCASTS, NEWSPAPERS, MAGAZINES, ONLINE BANNERS, OUTDOOR BILLBOARDS, WILD POSTINGS, BUS AND SUBWAY ADS , IN CLASS 35 (U.S. CLS. 100, 101 AND 102).

FIRST USE 11-1-1998; IN COMMERCE 11-1-1998.

FOR: ON-LINE LIBRARY SERVICES, NAMELY, PROVIDING ELECTRONIC LIBRARY SERVICES WHICH FEATURE NEWSPAPERS, MAGAZINES, PHOTOGRAPHS AND PICTURES VIA AN ON-LINE COMPUTER NETWORK; PROVIDING ON-LINE MAGAZINES IN THE FIELD OF CAREER DEVELOPMENT AND EDUCATIONAL GOALS, IN CLASS 41 (U.S. CLS. 100, 101 AND 107).

FIRST USE 11-1-1998; IN COMMERCE 11-1-1998.

THE MARK CONSISTS OF STANDARD CHARACTERS WITHOUT CLAIM TO ANY PARTICULAR FONT, STYLE, SIZE, OR COLOR.

SEC. 2(F).

SER. NO. 85-382,417, FILED 7-27-2011.

SHAILA SETTLES, EXAMINING ATTORNEY



*David J. Kyffers*

Director of the United States Patent and Trademark Office

# United States of America

United States Patent and Trademark Office

# COMPAS

**Reg. No. 4,125,114**

**Registered Apr. 10, 2012**

**Int. Cls.: 9 and 42**

**TRADEMARK**

**SERVICE MARK**

**PRINCIPAL REGISTER**

ROBERT HALF INTERNATIONAL INC. (DELAWARE CORPORATION)  
2884 SAND HILL ROAD  
MENLO PARK, CA 94025

FOR: DOWNLOADABLE SOFTWARE FOR MANAGEMENT OF BUSINESS OPERATIONS  
AUDITING AND COMPLIANCE, IN CLASS 9 (U.S. CLS. 21, 23, 26, 36 AND 38).

FIRST USE 11-13-2006; IN COMMERCE 11-13-2006.

FOR: PROVIDING TEMPORARY USE OF NON-DOWNLOADABLE SOFTWARE FOR  
MANAGEMENT OF BUSINESS OPERATIONS AUDITING AND COMPLIANCE, IN CLASS  
42 (U.S. CLS. 100 AND 101).

FIRST USE 11-13-2006; IN COMMERCE 11-13-2006.

THE MARK CONSISTS OF STANDARD CHARACTERS WITHOUT CLAIM TO ANY PAR-  
TICULAR FONT, STYLE, SIZE, OR COLOR.

SER. NO. 85-382,481, FILED 7-27-2011.

SANI KHOURI, EXAMINING ATTORNEY



*David J. Kybas*

Director of the United States Patent and Trademark Office

# United States of America

United States Patent and Trademark Office



**Reg. No. 4,125,115**

CPAMERICA INTERNATIONAL, INC. (GEORGIA CORPORATION)  
11801 RESEARCH DRIVE  
ALACHUA, FL 32615

**Registered Apr. 10, 2012**

**Int. Cl.: 35**

FOR: ASSOCIATION SERVICES, NAMELY, PROMOTING THE INTERESTS OF CERTIFIED PUBLIC ACCOUNTANTS AND PROVIDING USEFUL AND RELEVANT INDUSTRY INFORMATION TO CERTIFIED PUBLIC ACCOUNTANTS, IN CLASS 35 (U.S. CLS. 100, 101 AND 102).

**SERVICE MARK**

**PRINCIPAL REGISTER**

FIRST USE 12-31-2003; IN COMMERCE 12-31-2003.

OWNER OF U.S. REG. NO. 2,568,754.

NO CLAIM IS MADE TO THE EXCLUSIVE RIGHT TO USE "INTERNATIONAL", APART FROM THE MARK AS SHOWN.

THE MARK CONSISTS OF THE WORDING "INTERNATIONAL" UNDERNEATH THE WORDING "CPAMERICA" WITH A CIRCULAR DESIGN AND GLOBE OVERLAPPING THE WORDING "CPAMERICA".

SER. NO. 85-382,573, FILED 7-27-2011.

CHRISTINA SOBRAL, EXAMINING ATTORNEY



*David J. Kyffers*

Director of the United States Patent and Trademark Office



# United States of America

United States Patent and Trademark Office



**Reg. No. 4,125,116**

HOTTESTDEALEVER CORP. (PENNSYLVANIA CORPORATION)  
620 N. ST. CLOUD STREET  
ALLENTOWN, PA 18104

**Registered Apr. 10, 2012**

**Int. Cl.: 35**

FOR: ON-LINE RETAIL STORE SERVICES FEATURING ELECTRONIC ACCESSORIES, NAMELY, CONSUMER ELECTRONICS, HOUSEHOLD ELECTRONICS, CAMERAS AND PHOTOGRAPHIC EQUIPMENT, COMPUTERS AND COMPUTER PERIPHERAL EQUIPMENT, HEALTH AND BEAUTY PRODUCTS AND NOVELTY ITEMS; ONLINE RETAIL STORE SERVICES FEATURING AUTOMOTIVE ACCESSORIES, HOME ACCESSORIES, OUTDOOR ACCESSORIES EXCLUDING PAINTBALL SUPPLIES AND EQUIPMENT, IN CLASS 35 (U.S. CLS. 100, 101 AND 102).

**SERVICE MARK**

**PRINCIPAL REGISTER**

FIRST USE 12-0-2008; IN COMMERCE 12-0-2008.

THE MARK CONSISTS OF THE STYLIZED RED CAPITAL LETTERS "HDE" POSITIONED TO THE RIGHT OF A PAIR OF OVERLAPPING RED ORBIT RINGS AT RIGHT ANGLES TO EACH OTHER.

THE COLOR(S) RED IS/ARE CLAIMED AS A FEATURE OF THE MARK.

SER. NO. 85-382,597, FILED 7-27-2011.

JEFFREY LOOK, EXAMINING ATTORNEY



*David J. Kyffers*

Director of the United States Patent and Trademark Office

# United States of America

United States Patent and Trademark Office

## DEALER WEB WATCHER

**Reg. No. 4,125,117**

**Registered Apr. 10, 2012**

**Int. Cls.: 9 and 35**

**TRADEMARK**

**SERVICE MARK**

**PRINCIPAL REGISTER**

PLT TECHNOLOGY SOLUTIONS, LLC (TEXAS LIMITED LIABILITY COMPANY)  
3350 S. CENTRAL EXPRESSWAY  
MCKINNEY, TX 75070

FOR: DOWNLOADABLE COMPUTER SOFTWARE FOR COMMUNICATING IN REAL-TIME WITH POTENTIAL CUSTOMERS REGARDING PRICING AND AVAILABILITY OF AUTOMOBILES AND OTHER VEHICLES; DOWNLOADABLE COMPUTER COMMUNICATION SOFTWARE FOR MONITORING AND CONTROLLING REAL-TIME COMMUNICATIONS WITH POTENTIAL CUSTOMERS, IN CLASS 9 (U.S. CLS. 21, 23, 26, 36 AND 38).

FIRST USE 6-16-2010; IN COMMERCE 6-16-2010.

FOR: ONLINE BUSINESS CONSULTING SERVICES IN THE FIELD OF AUTOMOBILE SALES; ONLINE BUSINESS MONITORING AND TRACKING OF CUSTOMER SEARCH ACTIVITIES ON WEB SITES OF AUTOMOBILE DEALERS FOR PURPOSES OF PROVIDING DETAILS ABOUT USER CLICK TRAFFIC OR VISITS TO THE WEBSITE, IN CLASS 35 (U.S. CLS. 100, 101 AND 102).

FIRST USE 6-16-2010; IN COMMERCE 6-16-2010.

THE MARK CONSISTS OF STANDARD CHARACTERS WITHOUT CLAIM TO ANY PARTICULAR FONT, STYLE, SIZE, OR COLOR.

NO CLAIM IS MADE TO THE EXCLUSIVE RIGHT TO USE "DEALER WEB", APART FROM THE MARK AS SHOWN.

SER. NO. 85-382,611, FILED 7-27-2011.

JEFFREY LOOK, EXAMINING ATTORNEY



*David J. Kyffers*

Director of the United States Patent and Trademark Office

# United States of America

United States Patent and Trademark Office



**Reg. No. 4,125,118**

**Registered Apr. 10, 2012**

**Int. Cl.: 9**

**TRADEMARK**

**PRINCIPAL REGISTER**

RELIANCE INDUSTRIES, LLC (COLORADO LIMITED LIABILITY COMPANY)  
SUITE 1200  
10790 WEST 50TH AVENUE  
WHEAT RIDGE, CO 80033

FOR: FALL PROTECTION EQUIPMENT FOR FALL RESTRAINT AND FALL ARREST, NAMELY, ANCHORS, HARNESSSES, LANYARDS, CABLES, ANCHORAGE CONNECTORS, ARRESTORS, ENERGY ABSORBERS, CARABINEERS AND LIFELINES, IN CLASS 9 (U.S. CLS. 21, 23, 26, 36 AND 38).

FIRST USE 3-31-2011; IN COMMERCE 3-31-2011.

OWNER OF U.S. REG. NO. 4,026,824.

THE COLOR(S) RED, YELLOW, GREEN, BLACK AND WHITE IS/ARE CLAIMED AS A FEATURE OF THE MARK.

THE MARK CONSISTS OF THREE CIRCLES, ONE THAT IS RED WITH BLACK AND WHITE SHADING, ONE THAT IS YELLOW WITH BLACK AND WHITE SHADING AND ONE THAT IS GREEN WITH BLACK AND WHITE SHADING, ALL OF WHICH APPEAR ABOVE THE WORD "STOPLITE". IN THE WORD "STOPLITE", THE LETTERS "S", "T" AND "P" ARE BLACK, THE "O" IS RED, AND "LITE" IS WHITE WITH A BLACK OUTLINE.

SER. NO. 85-382,645, FILED 7-27-2011.

MEGHAN REINHART, EXAMINING ATTORNEY



*David J. Kyros*

Director of the United States Patent and Trademark Office

# United States of America

United States Patent and Trademark Office

## Set Yourself Free Divorce

**Reg. No. 4,125,119**

**Registered Apr. 10, 2012**

**Int. Cl.: 45**

**SERVICE MARK**

**PRINCIPAL REGISTER**

INFOTEL, INC. (NEW YORK CORPORATION), DBA WE THE PEOPLE OF NY  
219 W. 14TH ST.  
NEW YORK, NY 10011

FOR: PARALEGAL SERVICES, IN CLASS 45 (U.S. CLS. 100 AND 101).

FIRST USE 4-20-2011; IN COMMERCE 4-20-2011.

THE MARK CONSISTS OF STANDARD CHARACTERS WITHOUT CLAIM TO ANY PARTICULAR FONT, STYLE, SIZE, OR COLOR.

NO CLAIM IS MADE TO THE EXCLUSIVE RIGHT TO USE "DIVORCE", APART FROM THE MARK AS SHOWN.

SER. NO. 85-382,679, FILED 7-27-2011.

MEGHAN REINHART, EXAMINING ATTORNEY



*David J. Kyffers*

Director of the United States Patent and Trademark Office

# United States of America

United States Patent and Trademark Office



**Reg. No. 4,125,120**

AV WIRELESS, INC. (WYOMING CORPORATION)  
6117 RED WINERY RD.  
GEYSERVILLE, CA 95441

**Registered Apr. 10, 2012**

**Int. Cl.: 38**

FOR: INTERNET SERVICE PROVIDER (ISP), IN CLASS 38 (U.S. CLS. 100, 101 AND 104).

**SERVICE MARK**

FIRST USE 4-1-2002; IN COMMERCE 4-1-2002.

**PRINCIPAL REGISTER**

NO CLAIM IS MADE TO THE EXCLUSIVE RIGHT TO USE "INTERNET SERVICE PROVIDER", APART FROM THE MARK AS SHOWN.

THE COLOR(S) BLACK, ORANGE, GREY IS/ARE CLAIMED AS A FEATURE OF THE MARK.

THE MARK CONSISTS OF BLACK CAPITAL LETTERS "AV", OVERLAPPING ORANGE CAPITAL LETTERS "ISP", BELOW CAPITAL BLACK LETTERS "INTERNET SERVICE PROVIDER", TO THE RIGHT NEXT TO CAPITAL ORANGE LETTERS 4 GREY DOTS OF DIFFERENT SIZES CONNECTED WITH GREY LINES TO MAKE A GRAPE STEM, BELOW 13 ORANGE DOTS OF VARYING SIZES CONNECTED WITH ORANGE LINES TO MAKE A GRAPE CLUSTER.

SEC. 2(F).

SER. NO. 85-382,736, FILED 7-27-2011.

CHARLES L. JENKINS, EXAMINING ATTORNEY



*David J. Kyffers*

Director of the United States Patent and Trademark Office

# United States of America

United States Patent and Trademark Office

## SPORTS4HOPE

**Reg. No. 4,125,121**

SPORTS 4 HOPE INTERNATIONAL (CALIFORNIA CORPORATION)  
15820 PASEO DEL SUR  
SAN DIEGO, CA 92127

**Registered Apr. 10, 2012**

**Int. Cls.: 36 and 41**

FOR: CHARITABLE FUNDRAISING, IN CLASS 36 (U.S. CLS. 100, 101 AND 102).

**SERVICE MARK**

FIRST USE 7-1-2009; IN COMMERCE 7-1-2009.

**PRINCIPAL REGISTER**

FOR: EDUCATIONAL AND ENTERTAINMENT SERVICES FOR CHILDREN, NAMELY, PROVIDING INTERACTIVE PLAY AREAS, INSTRUCTIONAL CLASSES IN THE FIELD OF TEAMWORK, LEADERSHIP, AND PEACE EDUCATION, AND SOCIAL GATHERINGS FOR CHILDREN; ENCOURAGING AMATEUR SPORTS AND PHYSICAL EDUCATION BY ORGANIZING, SANCTIONING, CONDUCTING, REGULATING AND GOVERNING AMATEUR ATHLETIC PROGRAMS AND ACTIVITIES; ENTERTAINMENT IN THE NATURE OF SOCCER GAMES; OPERATION OF SPORTS CAMPS; ORGANISATION OF EXHIBITIONS FOR CULTURAL OR EDUCATIONAL PURPOSES; ORGANISATION OF SPORTS COMPETITIONS; ORGANIZING SPORTING EVENTS, NAMELY, ATHLETIC COMPETITIONS TO DEVELOP CHARACTER AND LEADERSHIP IN PARTICIPANTS AND TO PROMOTE PEACE; SPORTS INSTRUCTION SERVICES; SPORTS REFEREEING AND OFFICIATING; SPORTS TRAINING SERVICES, IN CLASS 41 (U.S. CLS. 100, 101 AND 107).

FIRST USE 7-1-2009; IN COMMERCE 7-1-2009.

THE MARK CONSISTS OF STANDARD CHARACTERS WITHOUT CLAIM TO ANY PARTICULAR FONT, STYLE, SIZE, OR COLOR.

SER. NO. 85-382,750, FILED 7-27-2011.

IRA J. GOODSID, EXAMINING ATTORNEY



*David J. Kyros*

Director of the United States Patent and Trademark Office

# United States of America

United States Patent and Trademark Office

## THE COLORADO KALEIDOSCOPE

**Reg. No. 4,125,122**

**Registered Apr. 10, 2012**

**Int. Cl.: 35**

**SERVICE MARK**

**PRINCIPAL REGISTER**

THE COLORADO HEALTH FOUNDATION (COLORADO NON-PROFIT CORPORATION)  
SUITE 1100  
501 S. CHERRY ST.  
DENVER, CO 80246

FOR: ASSOCIATION SERVICES, NAMELY, PROMOTING THE INTERESTS OF, PUBLIC AWARENESS OF, AND ADVOCACY IN THE FIELD OF HEALTH CARE, HEALTHCARE INFORMATION, EDUCATION, MEDICAL AND ASSISTED LIVING FACILITIES, HEALTH AND FITNESS, AND HEALTHY LIFESTYLES; PROMOTING PUBLIC AWARENESS OF HEALTH CARE SERVICES, HEALTHCARE INFORMATION, EDUCATION, MEDICAL AND ASSISTED LIVING FACILITIES, HEALTH AND FITNESS, AND HEALTHY LIFESTYLES VIA THE INTERNET, IN CLASS 35 (U.S. CLS. 100, 101 AND 102).

FIRST USE 6-7-2011; IN COMMERCE 6-7-2011.

THE MARK CONSISTS OF STANDARD CHARACTERS WITHOUT CLAIM TO ANY PARTICULAR FONT, STYLE, SIZE, OR COLOR.

NO CLAIM IS MADE TO THE EXCLUSIVE RIGHT TO USE "COLORADO", APART FROM THE MARK AS SHOWN.

SER. NO. 85-382,766, FILED 7-27-2011.

JOHN E. MICHOS, EXAMINING ATTORNEY



*David J. Kybas*

Director of the United States Patent and Trademark Office

# United States of America

United States Patent and Trademark Office

## DIRECTIONS INTERNATIONAL

**Reg. No. 4,125,123**

DIRECTIONS INTERNATIONAL, LLC (TENNESSEE LIMITED LIABILITY COMPANY)  
306 GAY STREET, SUITE 400  
NASHVILLE, TN 37201

**Registered Apr. 10, 2012**

**Int. Cl.: 41**

FOR: MUSIC PUBLISHING SERVICES; PRODUCTION OF SOUND AND MUSIC VIDEO RECORDINGS, IN CLASS 41 (U.S. CLS. 100, 101 AND 107).

**SERVICE MARK**

FIRST USE 4-28-2004; IN COMMERCE 4-28-2004.

**PRINCIPAL REGISTER**

THE MARK CONSISTS OF STANDARD CHARACTERS WITHOUT CLAIM TO ANY PARTICULAR FONT, STYLE, SIZE, OR COLOR.

NO CLAIM IS MADE TO THE EXCLUSIVE RIGHT TO USE "INTERNATIONAL", APART FROM THE MARK AS SHOWN.

SER. NO. 85-382,812, FILED 7-27-2011.

ELLEN PERKINS, EXAMINING ATTORNEY



*David J. Kybas*

Director of the United States Patent and Trademark Office



# United States of America

United States Patent and Trademark Office



**Reg. No. 4,125,124**

**Registered Apr. 10, 2012**

**Int. Cl.: 41**

**SERVICE MARK**

**PRINCIPAL REGISTER**

DIRECTIONS INTERNATIONAL, LLC (TENNESSEE LIMITED LIABILITY COMPANY)  
306 GAY STREET, SUITE 400  
NASHVILLE, TN 37201

FOR: MUSIC PUBLISHING SERVICES; PRODUCTION OF SOUND AND MUSIC VIDEO RECORDINGS, IN CLASS 41 (U.S. CLS. 100, 101 AND 107).

FIRST USE 2-5-2011; IN COMMERCE 2-5-2011.

NO CLAIM IS MADE TO THE EXCLUSIVE RIGHT TO USE "INTERNATIONAL", APART FROM THE MARK AS SHOWN.

THE MARK CONSISTS OF A STYLIZED DRAWING OF A RECORD ON A RECORD PLAYER, WHICH INCLUDES TWO DASHES REPRESENTING AN AIRPORT RUNWAY AND AN OUTLINE OF AN AIRPLANE IN THE CENTER OF THE RECORD, UNDER WHICH APPEARS THE LITERAL ELEMENT "DIRECTIONS INTERNATIONAL".

SER. NO. 85-382,839, FILED 7-27-2011.

ELLEN PERKINS, EXAMINING ATTORNEY



*David J. Kybas*

Director of the United States Patent and Trademark Office

# United States of America

United States Patent and Trademark Office

## BOSTON AF SYMPOSIUM

**Reg. No. 4,125,125**

**Registered Apr. 10, 2012**

**Int. Cl.: 41**

**SERVICE MARK**

**PRINCIPAL REGISTER**

CORCORAN, MURIEL (UNITED STATES INDIVIDUAL)  
25 SHATTUCK STEET  
NASHUA, NH 03064

FOR: ORGANIZATION OF CONFERENCES AND SYMPOSIA IN THE FIELD OF CARDIOLOGY AND RECENT DEVELOPMENTS IN THE TREATMENT OF ATRIAL FIBRILLATION AND PREVENTION OF ATRIAL FIBRILLATION RELATED STROKE AND OTHER SEQUELAE WITH AN EMPHASIS ON CURRENT AND EVOLVING PHARMACOLOGIC AND NONPHARMACOLOGIC THERAPIES, IN CLASS 41 (U.S. CLS. 100, 101 AND 107).

FIRST USE 1-15-1995; IN COMMERCE 1-15-1995.

THE MARK CONSISTS OF STANDARD CHARACTERS WITHOUT CLAIM TO ANY PARTICULAR FONT, STYLE, SIZE, OR COLOR.

NO CLAIM IS MADE TO THE EXCLUSIVE RIGHT TO USE "SYMPOSIUM", APART FROM THE MARK AS SHOWN.

SEC. 2(F).

SER. NO. 85-382,923, FILED 7-27-2011.

APRIL HESIK, EXAMINING ATTORNEY



*David J. Kyfos*

Director of the United States Patent and Trademark Office

# United States of America

United States Patent and Trademark Office

## COOKIE DOLL SWEET TREATS

**Reg. No. 4,125,126**

ROSS, REBECCA (UNITED STATES INDIVIDUAL)  
423 DON FERNANDO WAY  
SAN JOSE, CA 95123

**Registered Apr. 10, 2012**

**Int. Cl.: 30**

FOR: BAKERY DESSERTS; BAKERY GOODS, IN CLASS 30 (U.S. CL. 46).

**TRADEMARK**

FIRST USE 10-14-2010; IN COMMERCE 12-15-2010.

**PRINCIPAL REGISTER**

THE MARK CONSISTS OF STANDARD CHARACTERS WITHOUT CLAIM TO ANY PARTICULAR FONT, STYLE, SIZE, OR COLOR.

NO CLAIM IS MADE TO THE EXCLUSIVE RIGHT TO USE "COOKIE" AND "SWEET TREATS", APART FROM THE MARK AS SHOWN.

SER. NO. 85-382,957, FILED 7-27-2011.

WON TEAK OH, EXAMINING ATTORNEY



*David J. Kyffers*

Director of the United States Patent and Trademark Office

# United States of America

United States Patent and Trademark Office

## Wyndham Hall Press

**Reg. No. 4,125,127**

**Registered Apr. 10, 2012**

**Int. Cl.: 16**

**TRADEMARK**

**PRINCIPAL REGISTER**

MARK S. MCCULLOUGH (UNITED STATES INDIVIDUAL), DBA WYNDHAM HALL PRESS  
WWW.WYNDHAMHALLPRESS.COM  
5050 KERR RD.  
LIMA, OH 458069211

FOR: BOOKS IN THE FIELD OF LOGOTHERAPY; PRINTED PAMPHLETS, BROCHURES, MANUALS, BOOKS, BOOKLETS, LEAFLETS, FLYERS, INFORMATIONAL SHEETS AND NEWSLETTERS, ADHESIVE BACKED STICKERS, AND KITS COMPRISING ONE OR MORE OF THE FOREGOING MATERIALS IN THE FIELD OF PSYCHOLOGY; SCHOLARLY BOOKS ON VARIOUS TOPICS, NAMELY, RELIGION, EDUCATION AND PHILOSOPHY; SERIES OF FICTION AND NON-FICTION BOOKS ON A VARIETY OF TOPICS, IN CLASS 16 (U.S. CLS. 2, 5, 22, 23, 29, 37, 38 AND 50).

FIRST USE 2-12-1985; IN COMMERCE 2-12-1985.

THE MARK CONSISTS OF STANDARD CHARACTERS WITHOUT CLAIM TO ANY PARTICULAR FONT, STYLE, SIZE, OR COLOR.

NO CLAIM IS MADE TO THE EXCLUSIVE RIGHT TO USE "PRESS", APART FROM THE MARK AS SHOWN.

SER. NO. 85-383,093, FILED 7-28-2011.

KELLY CHOE, EXAMINING ATTORNEY



*David J. Kyjars*

Director of the United States Patent and Trademark Office

# United States of America

United States Patent and Trademark Office



**Reg. No. 4,125,128**

**Registered Apr. 10, 2012**

**Int. Cl.: 41**

**SERVICE MARK**

**PRINCIPAL REGISTER**

SIX FIGURE LLC (GEORGIA LIMITED LIABILITY COMPANY)  
1906 RIVERVIEW DR SE  
MARIETTA, GA 30067

FOR: EDUCATION SERVICES, NAMELY, PROVIDING SEMINARS AND MOTIVATIONAL SPEAKING IN THE FIELD OF MONEY MAKING STRATEGIES AND TEACHING PEOPLE HOW TO MAKE MORE MONEY, IN CLASS 41 (U.S. CLS. 100, 101 AND 107).

FIRST USE 12-15-2010; IN COMMERCE 12-15-2010.

NO CLAIM IS MADE TO THE EXCLUSIVE RIGHT TO USE "SIX FIGURE HAIRDRESSER", APART FROM THE MARK AS SHOWN.

THE MARK CONSISTS OF THE STYLIZED WORDS "SIX FIGURE HAIRDRESSER". AN IMAGE OF SCISSORS TO THE LEFT OF THE TEXT.

SER. NO. 85-383,102, FILED 7-28-2011.

JESSICA A. POWERS, EXAMINING ATTORNEY



*David J. Kyffers*

Director of the United States Patent and Trademark Office

# United States of America

United States Patent and Trademark Office

## Hotel Renovation Maximization

**Reg. No. 4,125,129**

**Registered Apr. 10, 2012**

**Int. Cl.: 35**

**SERVICE MARK**

**PRINCIPAL REGISTER**

MBOX COMMUNICATIONS LLC (D.C. LIMITED LIABILITY COMPANY)  
1325 1/2 WISCONSIN AVE NW  
WASHINGTON, DC 20007

FOR: ADVERTISING AND MARKETING CONSULTANCY FOR HOTEL MANAGEMENT AND HOTEL OWNERS PRIOR TO, DURING, AND IMMEDIATELY AFTER PHYSICAL PROPERTY RENOVATION FOR THE PURPOSE OF MAXIMIZING FINANCIAL RETURNS AND CUSTOMER SATISFACTION DURING SAID PERIOD, IN CLASS 35 (U.S. CLS. 100, 101 AND 102).

FIRST USE 1-1-2011; IN COMMERCE 1-1-2011.

THE MARK CONSISTS OF STANDARD CHARACTERS WITHOUT CLAIM TO ANY PARTICULAR FONT, STYLE, SIZE, OR COLOR.

NO CLAIM IS MADE TO THE EXCLUSIVE RIGHT TO USE "HOTEL RENOVATION", APART FROM THE MARK AS SHOWN.

SER. NO. 85-383,105, FILED 7-28-2011.

JESSICA A. POWERS, EXAMINING ATTORNEY



*David J. Kyros*

Director of the United States Patent and Trademark Office

# United States of America

United States Patent and Trademark Office

## ConnectSense

**Reg. No. 4,125,130**

GRID CONNECT INC. (ILLINOIS CORPORATION)  
1630 W. DIEHL RD.

**Registered Apr. 10, 2012**

NAPERVILLE, IL 60563

**Int. Cl.: 9**

FOR: COMPUTER HARDWARE; COMPUTER HARDWARE FOR PROCESSING DATA IN THE NATURE OF DATA ACQUISITION MODULES AND BOARDS, ANALOG AND DIGITAL INPUT/OUTPUT MODULES AND BOARDS AND SIGNAL CONDITIONING MODULES AND BOARDS, IN CLASS 9 (U.S. CLS. 21, 23, 26, 36 AND 38).

**TRADEMARK**

**PRINCIPAL REGISTER**

FIRST USE 5-26-2011; IN COMMERCE 5-26-2011.

THE MARK CONSISTS OF THE STYLIZED WORDS "CONNECTSENSE".

SER. NO. 85-383,124, FILED 7-28-2011.

COLLEEN KEARNEY, EXAMINING ATTORNEY



*David J. Kyffers*

Director of the United States Patent and Trademark Office

# United States of America

United States Patent and Trademark Office



**Reg. No. 4,125,131**

**Registered Apr. 10, 2012**

**Int. Cl.: 16**

**TRADEMARK**

**PRINCIPAL REGISTER**

COLDWELL, DR. LEONARD (UNITED STATES INDIVIDUAL)  
1150 HUNGRYNECK BLVD., SUITE #C 379  
MOUNT PLEASANT  
MOUNT PLEASANT, SC 29464

FOR: BOOKS IN THE FIELD OF SELF-HELP EDUCATION; NEWSLETTERS IN THE FIELD OF SELF-HELP EDUCATION, IN CLASS 16 (U.S. CLS. 2, 5, 22, 23, 29, 37, 38 AND 50).

FIRST USE 1-1-2009; IN COMMERCE 1-1-2009.

OWNER OF U.S. REG. NO. 3,634,374.

NO CLAIM IS MADE TO THE EXCLUSIVE RIGHT TO USE "MEDICINE SYSTEM", APART FROM THE MARK AS SHOWN.

THE STIPLING IS FOR SHADING PURPOSES.

THE MARK CONSISTS OF THE STYLIZED LETTERS AND WORDS "IBMS INSTINCT BASED MEDICINE SYSTEM" WRITTEN WITHIN A CIRCULAR SHAPE DESIGN.

SER. NO. 85-383,160, FILED 7-28-2011.

ANDREW LEASER, EXAMINING ATTORNEY



*David J. Kyffers*

Director of the United States Patent and Trademark Office



# United States of America

United States Patent and Trademark Office



## SpotMatch

**Reg. No. 4,125,132**

**Registered Apr. 10, 2012**

**Int. Cl.: 35**

**SERVICE MARK**

**PRINCIPAL REGISTER**

FITZGERALD, DONNA M. (UNITED STATES INDIVIDUAL)  
55 COURT STREET, STE. 330  
BOSTON, MA 02108

FOR: CONSULTANCY OF PERSONNEL RECRUITMENT; EMPLOYMENT COUNSELING AND RECRUITING; EMPLOYMENT HIRING, RECRUITING, PLACEMENT, STAFFING AND CAREER NETWORKING SERVICES; PERSONNEL PLACEMENT AND RECRUITMENT; PERSONNEL RECRUITMENT SERVICES AND EMPLOYMENT AGENCIES; PROFESSIONAL STAFFING AND RECRUITING SERVICES, IN CLASS 35 (U.S. CLS. 100, 101 AND 102).

FIRST USE 7-28-2011; IN COMMERCE 7-28-2011.

THE MARK CONSISTS OF THE FOLLOWING: A DESIGN OF AN OWL'S FACE IN BLACK AND BROWN WITH ORANGE AND BLACK EYES. TO THE RIGHT OF THIS DESIGN IS THE WORD "SPOTMATCH" IN AN ORANGE STYLIZED FONT ON A WHITE BACKGROUND.

THE COLOR(S) ORANGE, WHITE, BLACK AND BROWN IS/ARE CLAIMED AS A FEATURE OF THE MARK.

SER. NO. 85-383,230, FILED 7-28-2011.

ERNEST SHOSHO, EXAMINING ATTORNEY



*David J. Kybas*

Director of the United States Patent and Trademark Office

# United States of America

United States Patent and Trademark Office



**Reg. No. 4,125,133**

SSG FASHIONS LTD. (NEW YORK CORPORATION)  
27 EAST 37TH STREET  
NEW YORK, NY 10016

**Registered Apr. 10, 2012**

**Int. Cl.: 25**

FOR: WOMEN'S CLOTHING, NAMELY, BLOUSES, SKIRTS, PANTS, JUMPSUITS, DRESSES, COATS, SWEATERS, JACKETS, TIES AND DICKIES, IN CLASS 25 (U.S. CLS. 22 AND 39).

**TRADEMARK**

FIRST USE 1-1-2008; IN COMMERCE 1-1-2008.

**PRINCIPAL REGISTER**

THE SIGNATURE OF THE NAME "BYRON LARS" SHOWN IN THE MARK IDENTIFIES A LIVING INDIVIDUAL WHOSE CONSENT IS OF RECORD.

THE MARK CONSISTS OF THE WORDS "BYRON LARS" IN STYLIZED FORM.

SER. NO. 85-383,268, FILED 7-28-2011.

CAROL SPILS, EXAMINING ATTORNEY

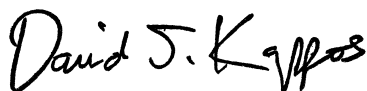

Director of the United States Patent and Trademark Office

# United States of America

United States Patent and Trademark Office



**Reg. No. 4,125,134**

**Registered Apr. 10, 2012**

**Int. Cl.: 43**

**SERVICE MARK**

**PRINCIPAL REGISTER**

NAF-NAF MANAGEMENT, INC. (ILLINOIS CORPORATION)  
739 FREEDOM DRIVE, #109  
NAPERVILLE, IL 60563

FOR: RESTAURANT SERVICES, IN CLASS 43 (U.S. CLS. 100 AND 101).

FIRST USE 9-3-2010; IN COMMERCE 9-3-2010.

THE MARK CONSISTS OF A WHITE TRIANGLE WITH RED BORDER CARRYING A BLACK CAMEL.

THE COLOR(S) RED, WHITE AND BLACK IS/ARE CLAIMED AS A FEATURE OF THE MARK.

SER. NO. 85-383,277, FILED 7-28-2011.

SANDRA BUJA, EXAMINING ATTORNEY



*David J. Kyffers*

Director of the United States Patent and Trademark Office

United States of America  
United States Patent and Trademark Office

**MACHETE**  
**TEQUILA TACOS**

**Reg. No. 4,125,135**

**Registered Apr. 10, 2012**

**Int. Cl.: 43**

**SERVICE MARK**

**PRINCIPAL REGISTER**

MACHETE, LLC (COLORADO LIMITED LIABILITY COMPANY)  
SUITE F  
2817 E 3RD AVE.  
DENVER, CO 80206

FOR: RESTAURANT AND BAR SERVICES, IN CLASS 43 (U.S. CLS. 100 AND 101).

FIRST USE 5-5-2011; IN COMMERCE 5-5-2011.

NO CLAIM IS MADE TO THE EXCLUSIVE RIGHT TO USE TEQUILA TACOS, APART FROM THE MARK AS SHOWN.

THE MARK CONSISTS OF THE WORDS "MACHETE TEQUILA TACOS" IN A FONT OF GOTHIC, THE "T" IN "MACHETE" IS A BLADE THAT COMPLETES THE "T", "MACHETE" IS UNDERLINED, "TEQUILA" AND "TACOS" ARE BELOW THE LINE AND RIGHT JUSTIFIED, WITH THE BLADE SEPARATING THEM, AND A STYLIZED CROSS TOWARDS THE END OF THE BLADE.

SER. NO. 85-383,281, FILED 7-28-2011.

CAROL SPILS, EXAMINING ATTORNEY



*David J. Kyffers*

Director of the United States Patent and Trademark Office

# United States of America

United States Patent and Trademark Office



**Reg. No. 4,125,136**

**Registered Apr. 10, 2012**

**Int. Cl.: 35**

**SERVICE MARK**

**PRINCIPAL REGISTER**

THE BASTIAT SOCIETY (SOUTH CAROLINA CORPORATION)  
175 KING STREET  
CHARLESTON, SC 29401

FOR: CLUB SERVICES, NAMELY, PROMOTING THE INTERESTS OF BUSINESS PEOPLE SUPPORTING THE ECONOMIC THEORIES OF FRÉDÉRIC BASTIAT REGARDING A FREE SOCIETY, IN CLASS 35 (U.S. CLS. 100, 101 AND 102).

FIRST USE 10-1-2004; IN COMMERCE 10-1-2004.

THE NAME(S), PORTRAIT(S), AND/OR SIGNATURE(S) SHOWN IN THE MARK DOES NOT IDENTIFY A PARTICULAR LIVING INDIVIDUAL.

THE COLOR(S) WHITE, OLIVE, BROWN, AND GREEN IS/ARE CLAIMED AS A FEATURE OF THE MARK.

THE MARK CONSISTS DEPICTION OF THE BUST OF FREDERIC BASTIAT APPEARING IN THE COLORS OLIVE, GREEN, AND BROWN WITH A WHITE SHIRT AND OLIVE JACKET. THE BUST APPEARS WITHIN A SEMI-CIRCULAR SEAL WHICH APPEARS IN THE COLORS OLIVE AND GREEN. THE WORDING "CE QU'ON VOIT ET CE QU'ON NE VOIT PAS" APPEARS WITHIN THE SEAL DESIGN IN THE COLOR OLIVE.

THE ENGLISH TRANSLATION OF "CE QU'ON VOIT ET CE QU'ON NE VOIT PAS" IN THE MARK IS "THAT WHICH IS SEEN, AND THAT WHICH IS UNSEEN".

SEC. 2(F).

SER. NO. 85-383,309, FILED 7-28-2011.

GEOFFREY FOSDICK, EXAMINING ATTORNEY



*David J. Kyjars*

Director of the United States Patent and Trademark Office

# United States of America

United States Patent and Trademark Office



**Reg. No. 4,125,137**

**Registered Apr. 10, 2012**

**Int. Cl.: 44**

**SERVICE MARK**

**PRINCIPAL REGISTER**

JARED H CONDIE DMD MS PLLC (WASHINGTON LIMITED LIABILITY COMPANY)  
1725 E. LINCOLN AVE.  
SUNNYSIDE, WA 98944

FOR: DENTIST SERVICES; ORTHODONTIC SERVICES, IN CLASS 44 (U.S. CLS. 100 AND 101).

FIRST USE 3-25-2010; IN COMMERCE 7-5-2010.

NO CLAIM IS MADE TO THE EXCLUSIVE RIGHT TO USE "ORTHODONTICS", APART FROM THE MARK AS SHOWN.

THE MARK CONSISTS OF A SUN WITH CURVY RAYS THAT ARE SEPARATED FROM THE BODY OF THE SUN. THE SUN HAS EYES THAT HAVE EYE CRINKLES ALONG THE EDGES. THE MIDDLE OF THE SUN HAS THE WORDING "SUNNY SMILE ORTHODONTICS", THEN BELOW THE SMILE THERE ARE A SET OF LIPS, BELOW THE TOP LIP IS A LINE OF TEETH WITH BRACES, THEN UNDER THE TEETH IS A MOUTH, AND BELOW THAT IS A LOWER LIP. LINED AROUND THE ENTIRE OUTSIDE ARE THE CURVY RAYS, AND EACH HAS A MID LINE IN IT.

SER. NO. 85-383,327, FILED 7-28-2011.

RUSS HERMAN, EXAMINING ATTORNEY



*David J. Kybas*

Director of the United States Patent and Trademark Office

# United States of America

United States Patent and Trademark Office

## SECO SELECT

**Reg. No. 4,125,138**

**Registered Apr. 10, 2012**

**Int. Cls.: 11 and 20**

**TRADEMARK**

**PRINCIPAL REGISTER**

MD HOLDINGS, LLC (INDIANA LIMITED LIABILITY COMPANY)  
451 EAST COUNTY LINE ROAD  
MOORESVILLE, IN 46158

FOR: BAKING OVENS; COMMERCIAL COOKING OVENS; CONVECTION OVENS; COOK-  
AND HOLD- OVENS; COOKING OVENS; INDUSTRIAL COOKING OVENS, IN CLASS 11  
(U.S. CLS. 13, 21, 23, 31 AND 34).

FIRST USE 5-16-2008; IN COMMERCE 5-16-2008.

FOR: BUFFETS; DISPLAY STANDS; DISPLAY TABLES; INDUSTRIAL WORK TABLES;  
METAL CABINETS; METAL DISPLAY STANDS; STORAGE RACKS, IN CLASS 20 (U.S.  
CLS. 2, 13, 22, 25, 32 AND 50).

FIRST USE 5-16-2008; IN COMMERCE 5-16-2008.

THE MARK CONSISTS OF STANDARD CHARACTERS WITHOUT CLAIM TO ANY PAR-  
TICULAR FONT, STYLE, SIZE, OR COLOR.

NO CLAIM IS MADE TO THE EXCLUSIVE RIGHT TO USE "SELECT" , APART FROM THE  
MARK AS SHOWN.

SER. NO. 85-383,354, FILED 7-28-2011.

JAY FLOWERS, EXAMINING ATTORNEY



*David J. Kybas*

Director of the United States Patent and Trademark Office

# United States of America

United States Patent and Trademark Office

## NIGHTLIFE EMPIRE

**Reg. No. 4,125,139**

**Registered Apr. 10, 2012**

**Int. Cl.: 35**

**SERVICE MARK**

**PRINCIPAL REGISTER**

NIGHTLIFE EMPIRE FRANCHISE LLC (NEVADA LIMITED LIABILITY COMPANY)  
SUITE 200-328  
8275 SOUTHEASTERN AVE.  
LAS VEGAS, NV 89123

FOR: BUSINESS MANAGEMENT, BUSINESS MARKETING AND BUSINESS CONSULTING SERVICES FOR BARS, RESTAURANTS, NIGHTCLUBS, LOUNGES AND HOTELS , IN CLASS 35 (U.S. CLS. 100, 101 AND 102).

FIRST USE 12-21-2010; IN COMMERCE 12-21-2010.

THE MARK CONSISTS OF STANDARD CHARACTERS WITHOUT CLAIM TO ANY PARTICULAR FONT, STYLE, SIZE, OR COLOR.

NO CLAIM IS MADE TO THE EXCLUSIVE RIGHT TO USE "NIGHTLIFE", APART FROM THE MARK AS SHOWN.

SER. NO. 85-383,405, FILED 7-28-2011.

MARTHA FROMM, EXAMINING ATTORNEY



*David J. Kyffers*

Director of the United States Patent and Trademark Office



# United States of America

United States Patent and Trademark Office



**Reg. No. 4,125,140**

**Registered Apr. 10, 2012**

**Int. Cl.: 39**

**SERVICE MARK**

**PRINCIPAL REGISTER**

FOURNIER, BONNIE (UNITED STATES INDIVIDUAL)  
PO BOX 580404  
MINNEAPOLIS, MN 55458

FOR: PROVIDING A WEBSITE FOR THE ELECTRONIC STORAGE OF DIGITAL PHOTOGRAPHS, NAMELY, AN ON-LINE ARCHIVE OF PHOTOGRAPHS, IN CLASS 39 (U.S. CLS. 100 AND 105).

FIRST USE 4-15-2006; IN COMMERCE 4-15-2006.

NO CLAIM IS MADE TO THE EXCLUSIVE RIGHT TO USE "PROJECT", APART FROM THE MARK AS SHOWN.

THE COLOR(S) RED, GREY AND BLACK IS/ARE CLAIMED AS A FEATURE OF THE MARK.

THE MARK CONSISTS OF THE WORD "THE" WHICH APPEARS IN BLACK OVER THE WORD "SMOOCH" AND AN EXCLAMATION POINT WHICH APPEAR IN RED, OVER THE WORD "PROJECT" WHICH APPEARS IN BLACK. THE WORD "SMOOCH" IS TRANSPOSED OVER THE SMUDGED OUTLINE OF A GREY HEART. THE COLOR WHITE REPRESENTS BACKGROUND AND IS NOT PART OF THE MARK.

SER. NO. 85-383,448, FILED 7-28-2011.

ROBIN MITTLER, EXAMINING ATTORNEY



*David J. Kybas*

Director of the United States Patent and Trademark Office

# United States of America

United States Patent and Trademark Office



**Reg. No. 4,125,141**

**Registered Apr. 10, 2012**

**Int. Cl.: 44**

CAROLINA CANINES FOR SERVICE INC. (NORTH CAROLINA CORPORATION), DBA  
CANINES FOR SERVICE  
STE 101  
1200 N. 23RD ST.  
WILMINGTON, NC 28405

**SERVICE MARK**

FOR: CHARITABLE SERVICES, NAMELY, PROVIDING TRAINED SERVICE DOGS TO  
DISABLED OR CHALLENGED PEOPLE, IN CLASS 44 (U.S. CLS. 100 AND 101).

**PRINCIPAL REGISTER**

FIRST USE 0-0-1997, THE MARK WAS FIRST USED ANYWHERE IN A DIFFERENT FORM  
OTHER THAN THAT SOUGHT TO BE REGISTERED AT LEAST AS EARLY AS 12/01/1996;  
IN COMMERCE 0-0-1997, THE MARK WAS FIRST USED IN COMMERCE IN A DIFFERENT  
FORM OTHER THAN THAT SOUGHT TO BE REGISTERED AT LEAST AS EARLY AS  
12/01/1996.

NO CLAIM IS MADE TO THE EXCLUSIVE RIGHT TO USE "CANINES FOR SERVICE" AND  
UNIVERSAL HANDICAP SYMBOL, APART FROM THE MARK AS SHOWN.

THE COLOR(S) BLUE, GOLD AND WHITE IS/ARE CLAIMED AS A FEATURE OF THE  
MARK.

THE MARK CONSISTS OF DIAMOND SHAPE OUTLINED IN BLUE WITH LIGHT BLUE  
INTERIOR SHADING CONTAINING A BLUE STICK FIGURE IN A BLUE WHEELCHAIR  
WITH A GOLD DOG STANDING BESIDE, BLUE BANNER BENEATH WITH CANINES IN  
WHITE UPPERCASE LETTERING AND FOR SERVICE IN BLUE UPPERCASE LETTERING  
BENEATH THE BANNER.



SER. NO. 85-383,460, FILED S.R. 7-28-2011 AM. P.R. 11-23-2011.

ANDREA BUTLER, EXAMINING ATTORNEY

*David J. Kyffers*

Director of the United States Patent and Trademark Office

# United States of America

United States Patent and Trademark Office



**Reg. No. 4,125,142**

THE PAYROLL SOURCE, INC. (TENNESSEE CORPORATION)  
11400 PARKSIDE DR., SUITE 508  
KNOXVILLE, TN 37934

**Registered Apr. 10, 2012**

**Int. Cl.: 35**

FOR: ADMINISTRATION AND MANAGEMENT OF BUSINESS PAYROLLS, IN CLASS 35  
(U.S. CLS. 100, 101 AND 102).

**SERVICE MARK**

FIRST USE 1-1-2010; IN COMMERCE 1-1-2010.

**PRINCIPAL REGISTER**

NO CLAIM IS MADE TO THE EXCLUSIVE RIGHT TO USE "PAYROLL", APART FROM  
THE MARK AS SHOWN.

THE MARK CONSISTS OF THE PHRASE "THE SHEPHERD'S PAYROLL" DEPICTED OVER  
THE LENGTH OF A HORIZONTAL CANE WITH THE TAGLINE "SERVING THOSE WHO  
SERVE" DEPICTED BELOW THE LENGTH OF THE CANE.

SER. NO. 85-383,508, FILED 7-28-2011.

PATRICIA EVANKO, EXAMINING ATTORNEY



*David J. Kybas*

Director of the United States Patent and Trademark Office

**United States of America**  
United States Patent and Trademark Office

# WRAPCLOT

**Reg. No. 4,125,143**

ST. TERESA MEDICAL, INC. (MINNESOTA CORPORATION)  
1371 DONEGAL DRIVE  
WOODBURY, MN 55125

**Registered Apr. 10, 2012**

**Int. Cl.: 5**

FOR: BANDAGES FOR WOUNDS, NAMELY, HEMOSTATIC BANDAGES AND GAUZE, IN CLASS 5 (U.S. CLS. 6, 18, 44, 46, 51 AND 52).

**TRADEMARK**

FIRST USE 1-0-2011; IN COMMERCE 1-0-2011.

**PRINCIPAL REGISTER**

THE MARK CONSISTS OF STANDARD CHARACTERS WITHOUT CLAIM TO ANY PARTICULAR FONT, STYLE, SIZE, OR COLOR.

SER. NO. 85-383,610, FILED 7-28-2011.

JAMES LOVELACE, EXAMINING ATTORNEY



*David J. Kybas*

Director of the United States Patent and Trademark Office

# United States of America

United States Patent and Trademark Office

# ANIMALCLOT

**Reg. No. 4,125,144**

ST. TERESA MEDICAL, INC. (MINNESOTA CORPORATION)  
1371 DONEGAL DRIVE  
WOODBURY, MN 55125

**Registered Apr. 10, 2012**

**Int. Cl.: 5**

FOR: BANDAGES FOR WOUNDS, NAMELY, HEMOSTATIC BANDAGES AND GAUZE, IN CLASS 5 (U.S. CLS. 6, 18, 44, 46, 51 AND 52).

**TRADEMARK**

FIRST USE 3-0-2011; IN COMMERCE 3-0-2011.

**PRINCIPAL REGISTER**

THE MARK CONSISTS OF STANDARD CHARACTERS WITHOUT CLAIM TO ANY PARTICULAR FONT, STYLE, SIZE, OR COLOR.

SER. NO. 85-383,618, FILED 7-28-2011.

JAMES LOVELACE, EXAMINING ATTORNEY



*David J. Kybas*

Director of the United States Patent and Trademark Office

# United States of America

United States Patent and Trademark Office



**Reg. No. 4,125,145**

**Registered Apr. 10, 2012**

**Int. Cl.: 41**

**SERVICE MARK**

**PRINCIPAL REGISTER**

MILES AHEAD MINISTRIES (CALIFORNIA NON-PROFIT CORPORATION)  
2277 ROSECRANS STREET  
SAN DIEGO, CA 92121

FOR: ORGANIZING AND CONDUCTING FOOT RACES, IN CLASS 41 (U.S. CLS. 100, 101 AND 107).

FIRST USE 7-20-2011; IN COMMERCE 7-20-2011.

NO CLAIM IS MADE TO THE EXCLUSIVE RIGHT TO USE "SAN DIEGO HALF MARATHON SD", APART FROM THE MARK AS SHOWN.

THE MARK CONSISTS OF THE WORDING "SAN DIEGO" ABOVE THE WORDING "HALF MARATHON" WHICH APPEARS ABOVE FOUR SILHOUETTES OF PEOPLE RUNNING AROUND A PATH WITH THE SAN DIEGO SKYLINE IN THE BACKGROUND INSIDE THE LETTERS "SD".

SER. NO. 85-383,640, FILED 7-28-2011.

JAMES LOVELACE, EXAMINING ATTORNEY



*David J. Kyffers*

Director of the United States Patent and Trademark Office

# United States of America

United States Patent and Trademark Office

# ONE STOP

**Reg. No. 4,125,146**

NEAL, INC. (TEXAS CORPORATION)

**Registered Apr. 10, 2012**

P.O. BOX 200427  
SAN ANTONIO, TX 78220

**Int. Cl.: 35**

FOR: RETAIL STORE SERVICES FEATURING CONVENIENCE STORE ITEMS, IN CLASS 35 (U.S. CLS. 100, 101 AND 102).

**SERVICE MARK**

FIRST USE 10-0-1972; IN COMMERCE 10-0-1972.

**PRINCIPAL REGISTER**

THE MARK CONSISTS OF STANDARD CHARACTERS WITHOUT CLAIM TO ANY PARTICULAR FONT, STYLE, SIZE, OR COLOR.

OWNER OF U.S. REG. NOS. 1,122,560 AND 1,149,157.

SER. NO. 85-383,655, FILED 7-28-2011.

HEATHER BIDDULPH, EXAMINING ATTORNEY



*David J. Kybas*

Director of the United States Patent and Trademark Office

# United States of America

United States Patent and Trademark Office

THE  
**Payroll**   
S O U R C E

**Reg. No. 4,125,147**

THE PAYROLL SOURCE, INC. (TENNESSEE CORPORATION)  
11400 PARKSIDE DR., SUITE 508  
KNOXVILLE, TN 37934

**Registered Apr. 10, 2012**

**Int. Cl.: 35**

FOR: ADMINISTRATION AND MANAGEMENT OF BUSINESS PAYROLLS, IN CLASS 35  
(U.S. CLS. 100, 101 AND 102).

**SERVICE MARK**

FIRST USE 3-1-2005; IN COMMERCE 3-1-2005.

**PRINCIPAL REGISTER**

NO CLAIM IS MADE TO THE EXCLUSIVE RIGHT TO USE "PAYROLL", APART FROM  
THE MARK AS SHOWN.

THE MARK CONSISTS OF THE PHRASE "THE PAYROLL SOURCE" WITH THE "O" IN  
THE TERM "PAYROLL" DEPICTED AS A QUARTER.

SER. NO. 85-383,717, FILED 7-28-2011.

PATRICIA EVANKO, EXAMINING ATTORNEY



*David J. Kybas*

Director of the United States Patent and Trademark Office



# United States of America

United States Patent and Trademark Office

## BEACH TWEETS

**Reg. No. 4,125,148**

**Registered Apr. 10, 2012**

**Int. Cl.: 24**

**TRADEMARK**

**PRINCIPAL REGISTER**

LOFTEX USA LLC (DELAWARE LIMITED LIABILITY COMPANY)  
58 WEST 40TH STREET  
NEW YORK, NY 10018

FOR: TOWELS, IN CLASS 24 (U.S. CLS. 42 AND 50).

FIRST USE 7-15-2011; IN COMMERCE 7-15-2011.

THE MARK CONSISTS OF STANDARD CHARACTERS WITHOUT CLAIM TO ANY PARTICULAR FONT, STYLE, SIZE, OR COLOR.

NO CLAIM IS MADE TO THE EXCLUSIVE RIGHT TO USE "BEACH", APART FROM THE MARK AS SHOWN.

SER. NO. 85-383,718, FILED 7-28-2011.

REBECCA SMITH, EXAMINING ATTORNEY



*David J. Kyffers*

Director of the United States Patent and Trademark Office

# United States of America

United States Patent and Trademark Office

## GLOBAL ADVENTURESS

**Reg. No. 4,125,149**

GLOBAL ADVENTURESS, LLC (WASHINGTON LIMITED LIABILITY COMPANY)  
80 VINE ST. #604  
SEATTLE, WA 98121

**Registered Apr. 10, 2012**

**Int. Cl.: 39**

FOR: PROVIDING INFORMATION FOR WOMEN ON THE SUBJECT OF WORLD TRAVEL EXPERIENCES VIA A WEBSITE, IN CLASS 39 (U.S. CLS. 100 AND 105).

**SERVICE MARK**

FIRST USE 9-10-2010; IN COMMERCE 9-10-2010.

**PRINCIPAL REGISTER**

THE MARK CONSISTS OF STANDARD CHARACTERS WITHOUT CLAIM TO ANY PARTICULAR FONT, STYLE, SIZE, OR COLOR.

NO CLAIM IS MADE TO THE EXCLUSIVE RIGHT TO USE "GLOBAL", APART FROM THE MARK AS SHOWN.

SER. NO. 85-383,743, FILED 7-28-2011.

CHRISTOPHER SIDOTI, EXAMINING ATTORNEY



*David J. Kyffers*

Director of the United States Patent and Trademark Office

# United States of America

## United States Patent and Trademark Office



**Reg. No. 4,125,150**

CHEMPLEX INDUSTRIES, INC. (FLORIDA CORPORATION)  
2820 S.W. 42ND AVE.  
PALM CITY, FL 34990

**Registered Apr. 10, 2012**

**Int. Cl.: 35**

FOR: GUIDING AND ASSISTING CUSTOMERS, NAMELY, PROVIDING ON-LINE BUYERS GUIDE SERVICES THAT PROVIDE PURCHASING INFORMATION IN THE FIELD OF GOODS USED FOR SPECTROCHEMICAL ANALYSIS, IN CLASS 35 (U.S. CLS. 100, 101 AND 102).

**SERVICE MARK**

**PRINCIPAL REGISTER**

FIRST USE 7-16-2011; IN COMMERCE 7-16-2011.

THE MARK CONSISTS OF A WIZARD WITH TAN SKIN AND TAN EYEBROWS, BLUE AND WHITE EYES, WHITE TEETH, A BLACK AND RED MOUTH, AND BLACK LINING AROUND THE FEATURES, WEARING A BLUE ROBE WITH A YELLOW BAND TIED AROUND THE WAIST, AND WEARING A POINTED BLUE HAT WITH YELLOW HALF-MOONS AND STARS, AND SHOD WITH BROWN SHOES, THE RIGHT ARM BEING RAISED AND THE RIGHT HAND HOLDING A BROWN WAND, THE LEFT ARM BEING BENT AT THE ELBOW WITH THE LEFT HAND ON THE HIP.

THE COLOR(S) BLUE, YELLOW, BROWN, WHITE, TAN, BLACK, AND RED IS/ARE CLAIMED AS A FEATURE OF THE MARK.

SER. NO. 85-383,757, FILED 7-28-2011.

LEIGH CAROLINE CASE, EXAMINING ATTORNEY



*David J. Kyffers*

Director of the United States Patent and Trademark Office

# United States of America

United States Patent and Trademark Office



**Reg. No. 4,125,151**

**Registered Apr. 10, 2012**

**Int. Cl.: 35**

**SERVICE MARK**

**PRINCIPAL REGISTER**

WILLIAM E SLOVE (TEXAS LIMITED LIABILITY COMPANY), AKA CIVIL LOGISTICS  
541 SPIKE BUCK RUN  
CANYON LAKE, TX 78133

FOR: CONSULTING IN THE FIELD OF PROCURING GOVERNMENT CONTRACTS FOR THE PURCHASE OF GOODS AND LABOR CONTRACTING SERVICES; ESTIMATING CONTRACTING WORK; PROVIDING ADVICE AND ASSISTANCE TO COMMERCIAL ENTITIES RELATING TO THE ESTABLISHMENT AND MAINTENANCE OF BUSINESS AND CONTRACTUAL RELATIONSHIPS WITH FEDERAL, STATE AND LOCAL GOVERNMENTS, IN CLASS 35 (U.S. CLS. 100, 101 AND 102).

FIRST USE 5-3-2011; IN COMMERCE 5-3-2011.

NO CLAIM IS MADE TO THE EXCLUSIVE RIGHT TO USE "CIVIL LOGISTICS", APART FROM THE MARK AS SHOWN.

THE COLOR(S) GREEN, YELLOW, BLUE IS/ARE CLAIMED AS A FEATURE OF THE MARK.

THE MARK CONSISTS OF 3 YELLOW LIGHTNING BOLTS ENCIRCLED BY 2 GREEN ARROWS ROTATING IN DIFFERENT DIRECTIONS AROUND THE LIGHTNING BOLTS, WITH BLUE LETTERING FOR THE WORD "CIVIL" AND GREEN LETTERING FOR THE WORD "LOGISTICS".

SER. NO. 85-383,815, FILED 7-28-2011.

KATHY DE JONGE, EXAMINING ATTORNEY



*David J. Kyjars*

Director of the United States Patent and Trademark Office

# United States of America

United States Patent and Trademark Office



**Reg. No. 4,125,152**

MICHEL ZWART (NETHERLANDS INDIVIDUAL)  
GRIJPENSTEINWEG 9  
HAARLEM, NETHERLANDS 2014KX

**Registered Apr. 10, 2012**

**Int. Cl.: 35**

FOR: ONLINE RETAIL STORE FEATURING GOLF PRODUCTS, NAMELY, DIVOT REPAIR TOOLS, STOCK AND CUSTOM GOLF BALL MARKERS, DISPLAY STANDS AND PROMOTIONAL MATERIALS FOR GOLF PRODUCTS, IN CLASS 35 (U.S. CLS. 100, 101 AND 102).

**SERVICE MARK**

FIRST USE 6-25-2008; IN COMMERCE 6-25-2008.

**PRINCIPAL REGISTER**

NO CLAIM IS MADE TO THE EXCLUSIVE RIGHT TO USE ".COM", APART FROM THE MARK AS SHOWN.

THE COLOR(S) BLACK WHITE AND ORANGE IS/ARE CLAIMED AS A FEATURE OF THE MARK.

THE MARK CONSISTS OF A BLACK BACKGROUND WITH THE WORD "PITCHFIX" IN THE CENTER AND ".COM" IN THE LOWER RIGHT CORNER. THE LETTERS "PITCH" AND ".COM" ARE IN WHITE, WITH THE DOT OF THE "I" AND THE LETTERS "FIX" IN ORANGE.

SER. NO. 85-383,896, FILED 7-28-2011.

KATHY DE JONGE, EXAMINING ATTORNEY



*David J. Kyjars*

Director of the United States Patent and Trademark Office

# United States of America

United States Patent and Trademark Office

## The Dines Letter

**Reg. No. 4,125,153**

**Registered Apr. 10, 2012**

**Int. Cls.: 16 and 41**

**TRADEMARK**

**SERVICE MARK**

**PRINCIPAL REGISTER**

JAMES DINES & CO., INC. (CALIFORNIA CORPORATION), AKA JAMES DINES & COMPANY, INC.  
P.O. BOX 22  
BELVEDERE, CA 94920

FOR: NEWSLETTERS IN THE FIELD OF FINANCIAL INFORMATION FOR TRADERS AND INVESTORS, IN CLASS 16 (U.S. CLS. 2, 5, 22, 23, 29, 37, 38 AND 50).

FIRST USE 0-0-1960; IN COMMERCE 0-0-1960.

FOR: PROVIDING NEWSLETTERS IN THE FIELD OF FINANCIAL INFORMATION FOR TRADERS AND INVESTORS VIA E-MAIL, IN CLASS 41 (U.S. CLS. 100, 101 AND 107).

FIRST USE 0-0-1996; IN COMMERCE 0-0-1996.

THE MARK CONSISTS OF STANDARD CHARACTERS WITHOUT CLAIM TO ANY PARTICULAR FONT, STYLE, SIZE, OR COLOR.

NO CLAIM IS MADE TO THE EXCLUSIVE RIGHT TO USE "LETTER", APART FROM THE MARK AS SHOWN.

SER. NO. 85-383,897, FILED 7-28-2011.

NELSON SNYDER, EXAMINING ATTORNEY



*David J. Kyjars*

Director of the United States Patent and Trademark Office

# United States of America

United States Patent and Trademark Office

# UltraHold

**Reg. No. 4,125,154**

**Registered Apr. 10, 2012**

**Int. Cl.: 17**

**TRADEMARK**

**PRINCIPAL REGISTER**

PHANTOM RESEARCH LABORATORIES, INC. (CALIFORNIA CORPORATION)  
TERRY CHIKA  
1957 FRIENDSHIP DRIVE, SUITE D  
EL CAJON, CA 92020

FOR: PLASTIC TAPE IN THE FORM OF ADHESIVE PADS FOR USE IN THE OPTICAL LENS GRINDING INDUSTRY, IN CLASS 17 (U.S. CLS. 1, 5, 12, 13, 35 AND 50).

FIRST USE 7-18-2011; IN COMMERCE 7-18-2011.

THE MARK CONSISTS OF STANDARD CHARACTERS WITHOUT CLAIM TO ANY PARTICULAR FONT, STYLE, SIZE, OR COLOR.

OWNER OF U.S. REG. NO. 4,048,639.

SER. NO. 85-384,013, FILED 7-28-2011.

ESTHER BELENKER, EXAMINING ATTORNEY



*David J. Kybas*

Director of the United States Patent and Trademark Office

# United States of America

United States Patent and Trademark Office



**Reg. No. 4,125,155**

BITEDOWNDEALS.COM, INC. (CALIFORNIA CORPORATION)  
16030 VENTURA BLVD, #695  
ENCINO, CA 91436

**Registered Apr. 10, 2012**

**Int. Cl.: 35**

FOR: ON-LINE RETAIL STORE SERVICES FEATURING DENTAL AND DENTISTRY PRODUCTS, IN CLASS 35 (U.S. CLS. 100, 101 AND 102).

**SERVICE MARK**

FIRST USE 4-19-2011; IN COMMERCE 4-19-2011.

**PRINCIPAL REGISTER**

THE MARK CONSISTS OF THE LITERAL ELEMENT "BITEDOWNDEALS" (ALL AS ONE WORD) WITH THE "B" IN "BITE", "D" IN "DOWN" AND "D" IN "DEALS" CAPITALIZED, ALL IN WHITE LETTERING, WITH AN IMAGE OF A CHATTERING TEETH WIND-UP TOY WITH RED GUMS, WHITE TEETH, BLACK FEET AND BLACK WINDING MECHANISM OPENING WIDE IMMEDIATELY TO THE LEFT OF THE LITERAL ELEMENT AND APPEARING POISED TO BITE DOWN ON THE "BITE" PORTION OF THE LITERAL ELEMENT. THE DESIGN ELEMENT OF THE MARK IS OUTLINED IN WHITE.

THE COLOR(S) RED, WHITE AND BLACK IS/ARE CLAIMED AS A FEATURE OF THE MARK.

SER. NO. 85-384,082, FILED 7-28-2011.

FLORENTINA BLANDU, EXAMINING ATTORNEY



*David J. Kybas*

Director of the United States Patent and Trademark Office



# United States of America

United States Patent and Trademark Office



**Reg. No. 4,125,156**

CANYON CREEK CONSULTING, INC. (CALIFORNIA CORPORATION)  
873 TARTAN COURT  
LINCOLN, CA 95648

**Registered Apr. 10, 2012**

**Int. Cls.: 37 and 42**

FOR: INSTALLATION AND MAINTENANCE OF TELECOMMUNICATION CABLING SYSTEMS, IN CLASS 37 (U.S. CLS. 100, 103 AND 106).

**SERVICE MARK**

FIRST USE 7-6-2010; IN COMMERCE 7-15-2010.

**PRINCIPAL REGISTER**

FOR: DESIGN, DEVELOPMENT, AND CONSULTING SERVICES RELATED THERETO IN THE FIELD OF TELECOMMUNICATION CABLING SYSTEMS, IN CLASS 42 (U.S. CLS. 100 AND 101).

FIRST USE 7-6-2010; IN COMMERCE 7-15-2010.

NO CLAIM IS MADE TO THE EXCLUSIVE RIGHT TO USE "TELECOMMUNICATIONS SYSTEM DESIGN AND TECHNICAL SERVICES" AND "CONSULTING, INC.", APART FROM THE MARK AS SHOWN.

THE STIPPLING IS FOR SHADING PURPOSES.

THE MARK CONSISTS OF AN OVAL SHAPE, BORDERED BY MANY FIBER CABLE LOOPS THAT TERMINATE IN BARE, ILLUMINATED FIBER OPTIC STRANDS ON ONE END. THIS END IS LOCATED INSIDE THE OVAL. ALSO INSIDE THE OVAL IS THE STYLIZED TEXT "CANYON CREEK". BELOW THIS TEXT, ALSO INSIDE THE OVAL, IS THE STYLIZED TEXT "CONSULTING, INC." IN SMALLER LETTERING. ARCHING ABOVE THE OVAL IS THE STYLIZED TEXT "TELECOMMUNICATIONS SYSTEM DESIGN AND TECHNICAL SERVICES".

SER. NO. 85-384,274, FILED 7-29-2011.

ELISSA GARBER KON, EXAMINING ATTORNEY



*David J. Kybas*

Director of the United States Patent and Trademark Office

# United States of America

United States Patent and Trademark Office

# AGENTWEB

**Reg. No. 4,125,157**

VANTIS LIFE INSURANCE COMPANY (CONNECTICUT CORPORATION)  
200 DAY HILL ROAD  
WINDSOR, CT 06095

**Registered Apr. 10, 2012**

**Int. Cls.: 36 and 42**

FOR: LIFE INSURANCE SERVICES, NAMELY, ISSUING ANNUITIES AND UNDERWRITING LIFE INSURANCE POLICIES; PROVIDING AN INTERNET WEBSITE PORTAL FOR INSURANCE AGENTS IN THE FIELD OF INSURANCE; PROVIDING INFORMATION IN THE FIELD OF INSURANCE, IN CLASS 36 (U.S. CLS. 100, 101 AND 102).

**SERVICE MARK**

**PRINCIPAL REGISTER**

FIRST USE 4-0-2004; IN COMMERCE 4-0-2004.

FOR: PROVIDING A WEBSITE FEATURING ONLINE NONDOWNLOADABLE SOFTWARE TOOLS IN THE FIELD OF INSURANCE, NAMELY, FOR PREPARING INSURANCE APPLICATIONS, OBTAINING PREMIUM QUOTATIONS, VIEWING ARCHIVED INSURANCE APPLICATIONS, REVIEWING INSURANCE POLICIES, VIEWING INSURANCE-RELATED FORMS AND MARKETING MATERIALS, GENERATING REPORTS, AND VIEWING INSURANCE-RELATED EDUCATIONAL MATERIALS, IN CLASS 42 (U.S. CLS. 100 AND 101).

FIRST USE 4-0-2004; IN COMMERCE 4-0-2004.

THE MARK CONSISTS OF STANDARD CHARACTERS WITHOUT CLAIM TO ANY PARTICULAR FONT, STYLE, SIZE, OR COLOR.

SEC. 2(F).

SER. NO. 85-384,279, FILED 7-29-2011.

REBECCA POVARCHUK, EXAMINING ATTORNEY



*David J. Kyjars*

Director of the United States Patent and Trademark Office

# United States of America

United States Patent and Trademark Office

## PINE RIVER MORTGAGE REIT INDEX

**Reg. No. 4,125,158**

PINE RIVER CAPITAL MANAGEMENT L.P. (DELAWARE LIMITED PARTNERSHIP)  
601 CARLSON PARKWAY, SUITE 330  
MINNETONKA, MN 55305

**Registered Apr. 10, 2012**

**Int. Cl.: 36**

FOR: PROVIDING A FINANCIAL INDEX OF SECURITIES VALUES FOR QUANTIFYING, MEASURING, ANALYZING, AND VALUING THE RESIDENTIAL MORTGAGE (REIT) SECTOR, IN CLASS 36 (U.S. CLS. 100, 101 AND 102).

**SERVICE MARK**

FIRST USE 6-21-2011; IN COMMERCE 6-21-2011.

**PRINCIPAL REGISTER**

THE MARK CONSISTS OF STANDARD CHARACTERS WITHOUT CLAIM TO ANY PARTICULAR FONT, STYLE, SIZE, OR COLOR.

OWNER OF U.S. REG. NO. 4,053,114.

NO CLAIM IS MADE TO THE EXCLUSIVE RIGHT TO USE "MORTGAGE REIT INDEX", APART FROM THE MARK AS SHOWN.

SER. NO. 85-384,282, FILED 7-29-2011.

REBECCA POVARCHUK, EXAMINING ATTORNEY



*David J. Kyffers*

Director of the United States Patent and Trademark Office

# United States of America

United States Patent and Trademark Office

## SENTRIFORCE

**Reg. No. 4,125,159**

**Registered Apr. 10, 2012**

**Int. Cl.: 9**

**TRADEMARK**

**PRINCIPAL REGISTER**

NETWORK OUTFITTERS, INC. (TEXAS CORPORATION), DBA SENTRIFORCE  
320 GARDEN OAKS BLVD.  
HOUSTON, TX 77018

FOR: CLOSED CIRCUIT TV SYSTEMS FOR SECURITY AND SURVEILLANCE, NAMELY, CAMERAS, VIDEO MONITORS, MICROPHONES, AND VIDEO AND AUDIO RECORDERS , IN CLASS 9 (U.S. CLS. 21, 23, 26, 36 AND 38).

FIRST USE 5-31-2011; IN COMMERCE 5-31-2011.

THE MARK CONSISTS OF STANDARD CHARACTERS WITHOUT CLAIM TO ANY PARTICULAR FONT, STYLE, SIZE, OR COLOR.

SER. NO. 85-384,283, FILED S.R. 7-29-2011 AM. P.R. 7-29-2011.

REBECCA POVARCHUK, EXAMINING ATTORNEY



*David J. Kyros*

Director of the United States Patent and Trademark Office

United States of America  
United States Patent and Trademark Office

FAIRY  
GODMOTHER  
CREATIONS LLC

**Reg. No. 4,125,160**

**Registered Apr. 10, 2012**

**Int. Cl.: 40**

**SERVICE MARK**

**PRINCIPAL REGISTER**

FAIRY GODMOTHER CREATIONS, LLC (OHIO LIMITED LIABILITY COMPANY), DBA  
FAIRY GODMOTHER CREATIONS, LLC  
3943 OLD TROY PIKE  
DAYTON, OH 45404

FOR: SEWING; SEWING SERVICES; SEWING SERVICES, NAMELY, CUSTOM CONSTRUCTION, STITCHING, TAILORING OF COSTUME CLOTHING AND COSTUME ITEMS, IN CLASS 40 (U.S. CLS. 100, 103 AND 106).

FIRST USE 5-1-2001; IN COMMERCE 5-1-2001.

THE MARK CONSISTS OF STANDARD CHARACTERS WITHOUT CLAIM TO ANY PARTICULAR FONT, STYLE, SIZE, OR COLOR.

NO CLAIM IS MADE TO THE EXCLUSIVE RIGHT TO USE "CREATIONS LLC", APART FROM THE MARK AS SHOWN.

SER. NO. 85-384,315, FILED 7-29-2011.

JENNY PARK, EXAMINING ATTORNEY



*David J. Kyffers*

Director of the United States Patent and Trademark Office

# United States of America

United States Patent and Trademark Office



**Reg. No. 4,125,161**

**Registered Apr. 10, 2012**

**Int. Cl.: 43**

**SERVICE MARK**

**PRINCIPAL REGISTER**

PACRIM U.S. LLC (DELAWARE LIMITED LIABILITY COMPANY), DBA CP HOMES  
716 S. CEDROS AVENUE  
SOLANA BEACH, CA 92075

FOR: PROVIDING ASSISTED LIVING FACILITIES, IN CLASS 43 (U.S. CLS. 100 AND 101).

FIRST USE 9-1-2010; IN COMMERCE 9-1-2010.

NO CLAIM IS MADE TO THE EXCLUSIVE RIGHT TO USE "HOMES LP", APART FROM THE MARK AS SHOWN.

THE COLOR(S) RED WHITE IS/ARE CLAIMED AS A FEATURE OF THE MARK.

THE MARK CONSISTS OF "CP HOMES LP" IN RED LETTERS WITH "CP" IN RED LETTERS WITH PARTIAL TRIANGLE IN RED ABOVE "CP" WITH WHITE BACKGROUND.

SER. NO. 85-384,360, FILED 7-29-2011.

ERIN FALK, EXAMINING ATTORNEY



*David J. Kyffers*

Director of the United States Patent and Trademark Office

# United States of America

United States Patent and Trademark Office



**Reg. No. 4,125,162**

STRONG RESULTS LLC (MARYLAND LIMITED LIABILITY COMPANY)  
605 COMMERCE DRIVE  
UPPER MARLBORO, MD 20774

**Registered Apr. 10, 2012**

**Int. Cl.: 41**

FOR: PERSONAL TRAINING PROVIDED IN CONNECTION WITH WEIGHT LOSS AND EXERCISE PROGRAMS, IN CLASS 41 (U.S. CLS. 100, 101 AND 107).

**SERVICE MARK**

FIRST USE 1-8-2008; IN COMMERCE 2-10-2008.

**PRINCIPAL REGISTER**

THE MARK CONSISTS OF THE STYLIZED WORDING "SR STRONG RESULTS" ACROSS SHADED CONCENTRIC CIRCLES, ALL IN BLUE

THE COLOR(S) BLUE IS/ARE CLAIMED AS A FEATURE OF THE MARK.

SER. NO. 85-384,377, FILED 7-29-2011.

HOWARD B. LEVINE, EXAMINING ATTORNEY



*David J. Kybas*

Director of the United States Patent and Trademark Office

# United States of America

United States Patent and Trademark Office

## Real Deal Sealcoating

**Reg. No. 4,125,163**

**Registered Apr. 10, 2012**

**Int. Cl.: 37**

**SERVICE MARK**

**PRINCIPAL REGISTER**

WEBSTER, RODNEY (PENNSYLVANIA SOLE PROPRIETORSHIP), DBA REAL DEAL  
SEALCOATING  
742 NORTH SECOND STREET  
LYKENS, PA 17048

FOR: CONSTRUCTION SERVICES, NAMELY, CONCRETE PAVING, SITE CLEARING,  
EXCAVATION, PAD PREPARATION, GRADING, AND ASPHALT PAVING SERVICES , IN  
CLASS 37 (U.S. CLS. 100, 103 AND 106).

FIRST USE 3-28-2011; IN COMMERCE 3-28-2011.

THE MARK CONSISTS OF STANDARD CHARACTERS WITHOUT CLAIM TO ANY PAR-  
TICULAR FONT, STYLE, SIZE, OR COLOR.

NO CLAIM IS MADE TO THE EXCLUSIVE RIGHT TO USE "SEALCOATING", APART  
FROM THE MARK AS SHOWN.

SER. NO. 85-384,417, FILED 7-29-2011.

MICHAEL SOUDERS, EXAMINING ATTORNEY



*David J. Kyffers*

Director of the United States Patent and Trademark Office



# United States of America

United States Patent and Trademark Office



**Reg. No. 4,125,164**

ABE'S MARKET, CO. (DELAWARE CORPORATION)  
424 LAMONT  
BUFFALO GROVE, IL 60089

**Registered Apr. 10, 2012**

**Int. Cl.: 35**

FOR: COMPUTERIZED ON-LINE RETAIL STORE SERVICES FEATURING NATURAL PRODUCTS IN THE FIELD OF GENERAL MERCHANDISE AND GENERAL CONSUMER GOODS; ON-LINE WHOLESALE AND RETAIL STORE SERVICES FEATURING NATURAL PRODUCTS IN THE FIELD OF GENERAL MERCHANDISE AND GENERAL CONSUMER GOODS; COMPUTERIZED ON-LINE ORDERING IN THE FIELD OF GENERAL MERCHANDISE AND GENERAL CONSUMER GOODS, IN CLASS 35 (U.S. CLS. 100, 101 AND 102).

**SERVICE MARK**

**PRINCIPAL REGISTER**

FIRST USE 7-31-2009; IN COMMERCE 7-31-2009.

THE MARK CONSISTS OF A BEAR PUSHING A SHOPPING CART.

SER. NO. 85-384,488, FILED 7-29-2011.

KIM SAITO, EXAMINING ATTORNEY



*David J. Kybas*

Director of the United States Patent and Trademark Office

# United States of America

United States Patent and Trademark Office

## APPLIED TRUST

**Reg. No. 4,125,165**

**Registered Apr. 10, 2012**

**Int. Cl.: 42**

**SERVICE MARK**

**PRINCIPAL REGISTER**

APPLIED TRUST ENGINEERING, INC. (COLORADO CORPORATION)  
SUITE 300  
1033 WALNUT STREET  
BOULDER, CO 80302

FOR: TECHNICAL SUPPORT SERVICES, NAMELY, TROUBLESHOOTING IN THE NATURE OF DIAGNOSING COMPUTER NETWORK, HARDWARE AND SOFTWARE PROBLEMS; COMPUTER NETWORK, HARDWARE AND SOFTWARE DESIGN AND COMPUTER NETWORK CONFIGURATION SERVICES FOR OTHERS, IN CLASS 42 (U.S. CLS. 100 AND 101).

FIRST USE 5-14-2010; IN COMMERCE 5-14-2010.

THE MARK CONSISTS OF STANDARD CHARACTERS WITHOUT CLAIM TO ANY PARTICULAR FONT, STYLE, SIZE, OR COLOR.

OWNER OF U.S. REG. NO. 3,011,291.

SER. NO. 85-384,511, FILED 7-29-2011.

TARAH HARDY, EXAMINING ATTORNEY



*David J. Kyffers*

Director of the United States Patent and Trademark Office

# United States of America

United States Patent and Trademark Office

# TANA-TAN

**Reg. No. 4,125,166**

**Registered Apr. 10, 2012**

**Int. Cl.: 12**

**TRADEMARK**

**PRINCIPAL REGISTER**

CLASSIC EXPORTS (INDIA PARTNERSHIP)  
212 CAPITAL PLAZA, PKT. D, INDER ENCLAVE  
PASCHIM VIHAR, DELHI, INDIA 110087

FOR: STEERING AND SUSPENSION SYSTEMS AND PARTS FOR STEERING AND SUSPENSION SYSTEMS FOR VEHICLES, NAMELY, UPPER BALL JOINTS, LOWER BALL JOINTS, BALL JOINTS WITH CONTROL ARMS, BUSHING KITS, INNER TIE ROD ENDS, OUTER TIE ROD ENDS, SLEEVES, IDLER ARMS, CENTER LINKS, STABILIZER KITS, INNER SOCKETS, PITMAN ARMS AND CONTROL ARM BUSHINGS, IN CLASS 12 (U.S. CLS. 19, 21, 23, 31, 35 AND 44).

FIRST USE 5-22-2011; IN COMMERCE 5-22-2011.

THE MARK CONSISTS OF STANDARD CHARACTERS WITHOUT CLAIM TO ANY PARTICULAR FONT, STYLE, SIZE, OR COLOR.

THE NAME(S), PORTRAIT(S), AND/OR SIGNATURE(S) SHOWN IN THE MARK DOES NOT IDENTIFY A PARTICULAR LIVING INDIVIDUAL.

SER. NO. 85-384,520, FILED 7-29-2011.

LINDA MICKLEBURGH, EXAMINING ATTORNEY



*David J. Kyffers*

Director of the United States Patent and Trademark Office

# United States of America

United States Patent and Trademark Office

# VETSPECS

**Reg. No. 4,125,167**

**Registered Apr. 10, 2012**

**Int. Cl.: 10**

**TRADEMARK**

**PRINCIPAL REGISTER**

VETSPECS, INC. (GEORGIA CORPORATION)  
SUITE 200  
111 MOUNTAIN BROOK DRIVE  
CANTON, GA 30115

FOR: MEDICAL AND VETERINARY DIAGNOSTIC, MONITORING, AND TREATMENT DEVICES AND EQUIPMENT, AND ACCOMPANYING ACCESSORIES AND ATTACHMENTS, NAMELY, PATIENT VITAL SIGNS MONITORING DEVICES, NAMELY, MULTI-PARAMETER VITAL SIGNS MONITORS, ANESTHESIA MONITORS, EKG MONITORS, BLOOD PRESSURE MONITORS, PULSE OXIMETERS, CAPNOGRAPHS, RESPIRATORY MONITORS, THERMOMETERS, BLOOD FLOW MONITORS, AND ESOPHAGEAL STETHOSCOPES; IMAGING SYSTEMS, NAMELY, ULTRASOUND APPARATUS; DIAGNOSTIC SYSTEMS, NAMELY, EKG MACHINES AND BLOOD PRESSURE DEVICES; TREATMENT AND REHABILITATION EQUIPMENT, NAMELY, PATIENT WARMING APPARATUS AND ACCOMPANYING ACCESSORIES AND ATTACHMENTS, NAMELY, SENSORS, PROBES, FUNCTION MODULES, CABLES AND SAMPLE LINES THAT WORK WITH THE ABOVE DESCRIBED DEVICES AND EQUIPMENT, IN CLASS 10 (U.S. CLS. 26, 39 AND 44).

FIRST USE 1-1-1997; IN COMMERCE 1-1-1997.

THE MARK CONSISTS OF STANDARD CHARACTERS WITHOUT CLAIM TO ANY PARTICULAR FONT, STYLE, SIZE, OR COLOR.

SER. NO. 85-384,558, FILED 7-29-2011.

KEVON CHISOLM, EXAMINING ATTORNEY



*David J. Kyffers*

Director of the United States Patent and Trademark Office

United States of America  
United States Patent and Trademark Office

# LightBreak

**Reg. No. 4,125,168**

IACONA, JAMES P (UNITED STATES INDIVIDUAL)  
5214 - F DIAMOND HTS. BLVD. #234  
SAN FRANCISCO, CA 94131

**Registered Apr. 10, 2012**

**Int. Cl.: 16**

FOR: PRINTED PATTERNS, IN CLASS 16 (U.S. CLS. 2, 5, 22, 23, 29, 37, 38 AND 50).

**TRADEMARK**

FIRST USE 5-17-2005; IN COMMERCE 5-17-2005.

**PRINCIPAL REGISTER**

THE MARK CONSISTS OF STANDARD CHARACTERS WITHOUT CLAIM TO ANY PARTICULAR FONT, STYLE, SIZE, OR COLOR.

SER. NO. 85-384,607, FILED 7-29-2011.

DANIEL CAPSHAW, EXAMINING ATTORNEY



*David J. Kyffers*

Director of the United States Patent and Trademark Office

# United States of America

United States Patent and Trademark Office

## Great Lakes Collection

**Reg. No. 4,125,169**

**Registered Apr. 10, 2012**

**Int. Cl.: 24**

**TRADEMARK**

**PRINCIPAL REGISTER**

VARA HOME USA, LLC (NEVADA LIMITED LIABILITY COMPANY)  
SUITE 100  
11301 CARMEL COMMONS BLVD., SUITE 100  
CHARLOTTE, NC 28226

FOR: BED COVERS; BED LINEN; BED SHEETS; BED SKIRTS; BED SPREADS; BEDSHEETS; COMFORTERS; COVERLETS; COVERS FOR CUSHIONS; CUSHION COVERS; DUST RUFFLES; DUVET COVERS; EIDERDOWN COVERS; FABRIC WINDOW COVERINGS AND TREATMENTS, NAMELY, CURTAINS, DRAPERIES, SHEERS, SWAGS AND VALANCES; FLANNEL; MATTRESS COVERS; MATTRESS PADS; PILLOW CASES; PILLOW COVERS; PILLOW SHAMS; PILLOWCASES; QUILTS; QUILTS OF TEXTILE; SHAMS; SHOWER CURTAINS; SHOWER ROOM CURTAINS, IN CLASS 24 (U.S. CLS. 42 AND 50).

FIRST USE 6-1-2011; IN COMMERCE 6-1-2011.

THE MARK CONSISTS OF STANDARD CHARACTERS WITHOUT CLAIM TO ANY PARTICULAR FONT, STYLE, SIZE, OR COLOR.

NO CLAIM IS MADE TO THE EXCLUSIVE RIGHT TO USE "COLLECTION", APART FROM THE MARK AS SHOWN.

SER. NO. 85-384,640, FILED 7-29-2011.

MICHAEL SOUDERS, EXAMINING ATTORNEY



*David J. Kyffers*

Director of the United States Patent and Trademark Office

# United States of America

United States Patent and Trademark Office

## North Shore Collection

**Reg. No. 4,125,170**

**Registered Apr. 10, 2012**

**Int. Cl.: 24**

**TRADEMARK**

**PRINCIPAL REGISTER**

VARA HOME USA, LLC (NEVADA LIMITED LIABILITY COMPANY)  
SUITE 100  
11301 CARMEL COMMONS BLVD., SUITE 100  
CHARLOTTE, NC 28226

FOR: BED COVERS; BED LINEN; BED SHEETS; BED SKIRTS; BED SPREADS; BEDSHEETS; COMFORTERS; COVERLETS; COVERS FOR CUSHIONS; CUSHION COVERS; DUST RUFFLES; DUVET COVERS; EIDERDOWN COVERS; FABRIC WINDOW COVERINGS AND TREATMENTS, NAMELY, CURTAINS, DRAPERIES, SHEERS, SWAGS AND VALANCES; FLANNEL; MATTRESS COVERS; MATTRESS PADS; PILLOW CASES; PILLOW COVERS; PILLOW SHAMS; PILLOWCASES; QUILTS; QUILTS OF TEXTILE; SHAMS; SHOWER CURTAINS; SHOWER ROOM CURTAINS, IN CLASS 24 (U.S. CLS. 42 AND 50).

FIRST USE 6-1-2011; IN COMMERCE 6-1-2011.

THE MARK CONSISTS OF STANDARD CHARACTERS WITHOUT CLAIM TO ANY PARTICULAR FONT, STYLE, SIZE, OR COLOR.

NO CLAIM IS MADE TO THE EXCLUSIVE RIGHT TO USE "COLLECTION", APART FROM THE MARK AS SHOWN.

SER. NO. 85-384,662, FILED 7-29-2011.

MICHAEL SOUDERS, EXAMINING ATTORNEY



*David J. Kyffers*

Director of the United States Patent and Trademark Office

# United States of America

United States Patent and Trademark Office



**Reg. No. 4,125,171**

WEHMEYER, JENNY (UNITED STATES INDIVIDUAL)  
17885 CR 467

**Registered Apr. 10, 2012**

ST. JAMES, MO 65559

**Int. Cl.: 35**

FOR: SELF-SERVE YOGURT SHOP SERVICES, IN CLASS 35 (U.S. CLS. 100, 101 AND 102).

**SERVICE MARK**

FIRST USE 6-0-2011; IN COMMERCE 6-0-2011.

**PRINCIPAL REGISTER**

NO CLAIM IS MADE TO THE EXCLUSIVE RIGHT TO USE "SELF SERVE FROZEN YOGURT", APART FROM THE MARK AS SHOWN.

THE MARK CONSISTS OF A SLICE OF KIWI AS THE FIRST "O" IN THE WORD "YOKIDOKI", AND THE SECOND "O" IS A BERRY. A SWIRL RESTS ABOVE AND BEHIND THE WORD "YOKIDOKI" TO PORTRAY A YOGURT SUNDAE. THE WORDS "SELF SERVE FROZEN YOGURT" ARE WRITTEN BELOW THE WORD "YOKIDOKI", ON A RIBBON.

SER. NO. 85-384,707, FILED 7-29-2011.

MICHAEL LITZAU, EXAMINING ATTORNEY



*David J. Kybas*

Director of the United States Patent and Trademark Office



# United States of America

United States Patent and Trademark Office

# STEP-UP

**Reg. No. 4,125,172**

**Registered Apr. 10, 2012**

**Int. Cl.: 41**

**SERVICE MARK**

**PRINCIPAL REGISTER**

THE SALISBURY FOUNDATION (ILLINOIS NON-PROFIT CORPORATION)  
1540 NORTH LAKE SHORE DRIVE  
CHICAGO, IL 60610

FOR: ORGANIZING AND CONDUCTING EDUCATIONAL CONFERENCES FOR YOUTH  
FEATURING YOUTH LEADERSHIP TRAINING, IN CLASS 41 (U.S. CLS. 100, 101 AND 107).

FIRST USE 7-0-2003; IN COMMERCE 7-0-2003.

THE MARK CONSISTS OF STANDARD CHARACTERS WITHOUT CLAIM TO ANY PAR-  
TICULAR FONT, STYLE, SIZE, OR COLOR.

SER. NO. 85-384,712, FILED 7-29-2011.

KATHERINE E. HALMEN, EXAMINING ATTORNEY



*David J. Kyros*

Director of the United States Patent and Trademark Office

# United States of America

United States Patent and Trademark Office

## EUROPEAN COPPER

**Reg. No. 4,125,173**

EUROPEAN COPPER, LLC (OKLAHOMA LIMITED LIABILITY COMPANY)  
7310 SOUTH YALE  
TULSA, OK 74136

**Registered Apr. 10, 2012**

**Int. Cl.: 6**

FOR: COPPER CHIMNEY CAPS AND VENTS, IN CLASS 6 (U.S. CLS. 2, 12, 13, 14, 23, 25 AND 50).

**TRADEMARK**

FIRST USE 3-1-2004; IN COMMERCE 3-1-2004.

**PRINCIPAL REGISTER**

THE MARK CONSISTS OF STANDARD CHARACTERS WITHOUT CLAIM TO ANY PARTICULAR FONT, STYLE, SIZE, OR COLOR.

OWNER OF U.S. REG. NO. 3,105,346.

NO CLAIM IS MADE TO THE EXCLUSIVE RIGHT TO USE "COPPER", APART FROM THE MARK AS SHOWN.

SER. NO. 85-384,717, FILED 7-29-2011.

JAMES GRIFFIN, EXAMINING ATTORNEY



*David J. Kyffers*

Director of the United States Patent and Trademark Office

# United States of America

United States Patent and Trademark Office



**Reg. No. 4,125,174**

**Registered Apr. 10, 2012**

**Int. Cls.: 41 and 44**

**SERVICE MARK**

**PRINCIPAL REGISTER**

LIV WITH AUTISM FOUNDATION, INC. (PENNSYLVANIA CORPORATION)  
PO BOX 436  
MOUNTAIN TOP, PA 18707

FOR: EDUCATION SERVICES, NAMELY, PROVIDING WORKSHOPS SKILL SHOPS, SYMPOSIUMS, TRAINING PROGRAMS, AND CONFERENCES, IN THE FIELD OF AUTISM; PROVIDING CLASSES, SEMINARS, WORKSHOPS, AND TRAINING FOR PARENTS, INSTRUCTORS, AND OTHER INDIVIDUALS IN THE FIELD OF EDUCATION FOR INDIVIDUALS WITH AUTISM; CONDUCTING WORKSHOPS AND SEMINARS IN AUTISM RELATED TOPICS; PROVIDING A WEB SITE THAT FEATURES INFORMAL INSTRUCTION ON AUTISM RELATED MATTERS; PROVIDING EDUCATIONAL MENTORING SERVICES AND PROGRAMS IN THE FIELD OF AUTISM MATTERS; EDUCATIONAL SERVICES, NAMELY, PROVIDING CLASSES, SEMINARS, WORKSHOPS, AND PRESENTATIONS DEALING WITH ISSUES OF CONCERN FOR CAREGIVERS, PARTNERS, WIVES AND HUSBANDS AND PARENTS OF INDIVIDUALS LIVING WITH AUTISM; CHARITABLE SERVICES, NAMELY, PROVIDING RESOURCE LIBRARY SERVICES TO THOSE IN NEED; ON-LINE LENDING LIBRARY SERVICES, NAMELY, PROVIDING ELECTRONIC LIBRARY SERVICES WHICH FEATURE REFERENCE WORKS, BOOKS, AND DOCUMENTS VIA AN ON-LINE COMPUTER NETWORK, PROVIDING BOOKS TO PARENTS OF AUTISTIC CHILDREN, IN CLASS 41 (U.S. CLS. 100, 101 AND 107).

FIRST USE 1-0-2011; IN COMMERCE 1-0-2011.



FOR: PROVIDING A DATABASE AND ONLINE RESOURCE CENTER, NAMELY, A WEBSITE FEATURING INFORMATION IN THE FIELD OF AUTISM; PROVIDING INFORMATION IN THE FIELD OF AUTISM; PROVIDING A WEBSITE FEATURING INFORMATION, DATA, NEWS AND RESOURCES IN THE FIELD OF AUTISM; BEHAVIORAL HEALTH CARE SERVICES IN THE FIELD OF AUTISM; HEALTH CARE SERVICES, NAMELY, BEHAVIORAL HEALTH AUTISM PROGRAMS; PROVIDING A WEBSITE FEATURING INFORMATION, RESOURCES AND COMPREHENSIVE CONTENT, NAMELY, INFORMATION RELATING TO DIAGNOSIS AND TREATMENT IN THE FIELD OF AUTISM, IN CLASS 44 (U.S. CLS. 100 AND 101).

FIRST USE 1-0-2011; IN COMMERCE 1-0-2011.

*David J. Kyjars*

Director of the United States Patent and Trademark Office

NO CLAIM IS MADE TO THE EXCLUSIVE RIGHT TO USE "AUTISM FOUNDATION", APART FROM THE MARK AS SHOWN.

**Reg. No. 4,125,174** THE STIPPLING IS FOR SHADING PURPOSES ONLY.

THE MARK CONSISTS OF THE WORDS "LIV WITH AUTISM FOUNDATION" WRITTEN IN A CIRCULAR FASHION WITH RIBBON DEVICES APPEARING ON THE LEFT AND THE RIGHT OF THE DESIGN. A STYLIZED DEPICTION OF A GIRL APPEARS IN THE MIDDLE OF THE DESIGN WITH THREE INTERLOCKING CIRCLES APPEARING BELOW THE GIRL DESIGN.

SER. NO. 85-384,720, FILED 7-29-2011.

ANDREW RHIM, EXAMINING ATTORNEY

# United States of America

United States Patent and Trademark Office

## ABE'S MARKET

**Reg. No. 4,125,175**

**Registered Apr. 10, 2012**

**Int. Cl.: 35**

**SERVICE MARK**

**PRINCIPAL REGISTER**

ABE'S MARKET, CO. (DELAWARE CORPORATION)  
424 LAMONT  
BUFFALO GROVE, IL 60089

FOR: COMPUTERIZED ON-LINE RETAIL STORE SERVICES FEATURING NATURAL PRODUCTS IN THE FIELD OF FOOD, BEAUTY PRODUCTS, VITAMINS AND DIETARY SUPPLEMENTS, NATURAL REMEDIES, SKIN CARE PRODUCTS, YOGA SUPPLIES, CLEANING PRODUCTS, HOUSEHOLD LINEN, TOYS, DIAPERS, PET CARE ITEMS, DISHES, AND BABY NURSING PRODUCTS; ON-LINE WHOLESALE AND RETAIL STORE SERVICES FEATURING NATURAL PRODUCTS IN THE FIELD OF FOOD, BEAUTY PRODUCTS, VITAMINS AND DIETARY SUPPLEMENTS, NATURAL REMEDIES, SKIN CARE PRODUCTS, YOGA SUPPLIES, CLEANING PRODUCTS, HOUSEHOLD LINEN, TOYS, DIAPERS, PET CARE ITEMS, DISHES, AND BABY NURSING PRODUCTS; COMPUTERIZED ON-LINE ORDERING IN THE FIELD OF FOOD, BEAUTY PRODUCTS, VITAMINS AND DIETARY SUPPLEMENTS, NATURAL REMEDIES, SKIN CARE PRODUCTS, YOGA SUPPLIES, CLEANING PRODUCTS, HOUSEHOLD LINEN, TOYS, DIAPERS, PET CARE ITEMS, DISHES, AND BABY NURSING PRODUCTS, IN CLASS 35 (U.S. CLS. 100, 101 AND 102).

FIRST USE 7-31-2009; IN COMMERCE 7-31-2009.

THE MARK CONSISTS OF STANDARD CHARACTERS WITHOUT CLAIM TO ANY PARTICULAR FONT, STYLE, SIZE, OR COLOR.

NO CLAIM IS MADE TO THE EXCLUSIVE RIGHT TO USE "MARKET", APART FROM THE MARK AS SHOWN.

SER. NO. 85-384,723, FILED 7-29-2011.

KIM SAITO, EXAMINING ATTORNEY



*David J. Kyjars*

Director of the United States Patent and Trademark Office

# United States of America

United States Patent and Trademark Office

# Angelino

**Reg. No. 4,125,176**

**Registered Apr. 10, 2012**

**Int. Cl.: 29**

**TRADEMARK**

**PRINCIPAL REGISTER**

DOLOUKHANIAN, SHELIA (UNITED STATES INDIVIDUAL)  
2300 CANADA BLVD.  
GLENDALE, CA 91208

FOR: GRAPE SEED OIL USED FOR COOKING, IN CLASS 29 (U.S. CL. 46).

FIRST USE 12-12-2005; IN COMMERCE 12-12-2005.

THE MARK CONSISTS OF STANDARD CHARACTERS WITHOUT CLAIM TO ANY PARTICULAR FONT, STYLE, SIZE, OR COLOR.

SER. NO. 85-384,757, FILED 7-29-2011.

AHSEN KHAN, EXAMINING ATTORNEY



*David J. Kybas*

Director of the United States Patent and Trademark Office

# United States of America

United States Patent and Trademark Office

## SUMMER TALENT EXPLORATION PROGRAM - UNLEASHING POTENTIAL

**Reg. No. 4,125,177**

THE SALISBURY FOUNDATION (ILLINOIS NON-PROFIT CORPORATION)  
1540 NORTH LAKE SHORE DRIVE  
CHICAGO, IL 60610

**Registered Apr. 10, 2012**

**Int. Cl.: 41**

FOR: ORGANIZING AND CONDUCTING EDUCATIONAL CONFERENCES FOR YOUTH  
FEATURING YOUTH LEADERSHIP TRAINING, IN CLASS 41 (U.S. CLS. 100, 101 AND 107).

**SERVICE MARK**

FIRST USE 7-0-2003; IN COMMERCE 7-0-2003.

**PRINCIPAL REGISTER**

THE MARK CONSISTS OF STANDARD CHARACTERS WITHOUT CLAIM TO ANY PAR-  
TICULAR FONT, STYLE, SIZE, OR COLOR.

SER. NO. 85-384,791, FILED 7-29-2011.

KATHERINE E. HALMEN, EXAMINING ATTORNEY



*David J. Kybas*

Director of the United States Patent and Trademark Office

# United States of America

United States Patent and Trademark Office

## NEUBERGER BERMAN LARGE CAP VALUE FUND

**Reg. No. 4,125,178**

NEUBERGER BERMAN MANAGEMENT LLC (NEW YORK LIMITED LIABILITY COMPANY)  
605 THIRD AVENUE

**Registered Apr. 10, 2012**

NEW YORK, NY 10158

**Int. Cl.: 36**

FOR: INVESTMENT ADVISORY AND MUTUAL FUND SERVICES, NAMELY, MUTUAL FUND ADVISORY AND INVESTMENT MANAGEMENT SERVICES, MUTUAL FUND UNDERWRITING AND ADMINISTRATION SERVICES, SPONSORING MUTUAL FUNDS, PROVIDING ADMINISTRATION AND SHAREHOLDER SERVICES TO MUTUAL FUNDS, DISTRIBUTING MUTUAL FUND SHARES AND MANAGING FUNDS AND BONDS AND OTHER INVESTMENTS FOR INSTITUTIONS AND THE GENERAL PUBLIC; CLEARANCE SERVICES, NAMELY, CLEARING AND SETTLING FINANCIAL TRANSACTIONS ON BEHALF OF OTHERS; MAINTAINING ASSETS AND SECURITIES FOR OTHERS, AND CONFIRMING AND TRACKING FINANCIAL TRANSACTIONS FOR OTHERS, IN CLASS 36 (U.S. CLS. 100, 101 AND 102).

**SERVICE MARK**

**PRINCIPAL REGISTER**

FIRST USE 4-19-2010; IN COMMERCE 4-19-2010.

THE MARK CONSISTS OF STANDARD CHARACTERS WITHOUT CLAIM TO ANY PARTICULAR FONT, STYLE, SIZE, OR COLOR.

OWNER OF U.S. REG. NOS. 2,877,175, 2,929,677 AND OTHERS.

NO CLAIM IS MADE TO THE EXCLUSIVE RIGHT TO USE "LARGE CAP VALUE FUND", APART FROM THE MARK AS SHOWN.

SER. NO. 85-384,851, FILED 7-29-2011.

JIM RINGLE, EXAMINING ATTORNEY



*David J. Kybas*

Director of the United States Patent and Trademark Office



# United States of America

United States Patent and Trademark Office

## NEUBERGER BERMAN GLOBAL EQUITY FUND

**Reg. No. 4,125,179**

NEUBERGER BERMAN MANAGEMENT LLC (NEW YORK LIMITED LIABILITY COMPANY)  
605 THIRD AVENUE  
NEW YORK, NY 10158

**Registered Apr. 10, 2012**

**Int. Cl.: 36**

FOR: INVESTMENT ADVISORY AND MUTUAL FUND SERVICES, NAMELY, MUTUAL FUND ADVISORY AND INVESTMENT MANAGEMENT SERVICES, MUTUAL FUND UNDERWRITING AND ADMINISTRATION SERVICES, SPONSORING MUTUAL FUNDS, PROVIDING ADMINISTRATION AND SHAREHOLDER SERVICES TO MUTUAL FUNDS, DISTRIBUTING MUTUAL FUND SHARES AND MANAGING FUNDS AND BONDS AND OTHER INVESTMENTS FOR INSTITUTIONS AND THE GENERAL PUBLIC; CLEARANCE SERVICES, NAMELY, CLEARING AND SETTLING FINANCIAL TRANSACTIONS ON BEHALF OF OTHERS; MAINTAINING ASSETS AND SECURITIES FOR OTHERS, AND CONFIRMING AND TRACKING FINANCIAL TRANSACTIONS FOR OTHERS, IN CLASS 36 (U.S. CLS. 100, 101 AND 102).

**SERVICE MARK**

**PRINCIPAL REGISTER**

FIRST USE 6-29-2011; IN COMMERCE 6-29-2011.

THE MARK CONSISTS OF STANDARD CHARACTERS WITHOUT CLAIM TO ANY PARTICULAR FONT, STYLE, SIZE, OR COLOR.

OWNER OF U.S. REG. NOS. 2,877,175, 2,929,677 AND OTHERS.

NO CLAIM IS MADE TO THE EXCLUSIVE RIGHT TO USE "GLOBAL EQUITY FUND", APART FROM THE MARK AS SHOWN.

SER. NO. 85-384,856, FILED 7-29-2011.

JIM RINGLE, EXAMINING ATTORNEY



*David J. Kypos*

Director of the United States Patent and Trademark Office

# United States of America

United States Patent and Trademark Office

## NEUBERGER BERMAN GLOBAL ALLOCATION FUND

**Reg. No. 4,125,180**

**Registered Apr. 10, 2012**

**Int. Cl.: 36**

**SERVICE MARK**

**PRINCIPAL REGISTER**

NEUBERGER BERMAN MANAGEMENT LLC (NEW YORK LIMITED LIABILITY COMPANY)  
605 THIRD AVENUE  
NEW YORK, NY 10158

FOR: INVESTMENT ADVISORY AND MUTUAL FUND SERVICES, NAMELY, MUTUAL FUND ADVISORY AND INVESTMENT MANAGEMENT SERVICES, MUTUAL FUND UNDERWRITING AND ADMINISTRATION SERVICES, SPONSORING MUTUAL FUNDS, PROVIDING ADMINISTRATION AND SHAREHOLDER SERVICES TO MUTUAL FUNDS, DISTRIBUTING MUTUAL FUND SHARES AND MANAGING FUNDS AND BONDS AND OTHER INVESTMENTS FOR INSTITUTIONS AND THE GENERAL PUBLIC; CLEARANCE SERVICES, NAMELY, CLEARING AND SETTLING FINANCIAL TRANSACTIONS ON BEHALF OF OTHERS; MAINTAINING ASSETS AND SECURITIES FOR OTHERS, AND CONFIRMING AND TRACKING FINANCIAL TRANSACTIONS FOR OTHERS, IN CLASS 36 (U.S. CLS. 100, 101 AND 102).

FIRST USE 6-29-2011; IN COMMERCE 6-29-2011.

THE MARK CONSISTS OF STANDARD CHARACTERS WITHOUT CLAIM TO ANY PARTICULAR FONT, STYLE, SIZE, OR COLOR.

OWNER OF U.S. REG. NOS. 2,877,175, 2,929,677 AND OTHERS.

NO CLAIM IS MADE TO THE EXCLUSIVE RIGHT TO USE "GLOBAL ALLOCATION FUND", APART FROM THE MARK AS SHOWN.

SER. NO. 85-384,867, FILED 7-29-2011.

JIM RINGLE, EXAMINING ATTORNEY



*David J. Kyjars*

Director of the United States Patent and Trademark Office

# United States of America

United States Patent and Trademark Office

## SUPER TOUGH

**Reg. No. 4,125,181**

ONLINE STORES, INC. (PENNSYLVANIA CORPORATION)  
1000 WESTINGHOUSE DRIVE, SUITE 1  
NEW STANTON, PA 15672

**Registered Apr. 10, 2012**

**Int. Cl.: 24**

FOR: CLOTH FLAGS; FABRIC FLAGS; NYLON FLAGS, IN CLASS 24 (U.S. CLS. 42 AND 50).

**TRADEMARK**

FIRST USE 6-30-2004; IN COMMERCE 6-30-2004.

**PRINCIPAL REGISTER**

THE MARK CONSISTS OF STANDARD CHARACTERS WITHOUT CLAIM TO ANY PARTICULAR FONT, STYLE, SIZE, OR COLOR.

NO CLAIM IS MADE TO THE EXCLUSIVE RIGHT TO USE "TOUGH", APART FROM THE MARK AS SHOWN.

SER. NO. 85-384,887, FILED 7-29-2011.

BRENDAN REGAN, EXAMINING ATTORNEY



*David J. Kyffers*

Director of the United States Patent and Trademark Office

# United States of America

United States Patent and Trademark Office

## FISH GONE WILD

**Reg. No. 4,125,182**

**Registered Apr. 10, 2012**

**Int. Cl.: 35**

**SERVICE MARK**

**PRINCIPAL REGISTER**

REEF MANAGEMENT SERVICES INC. (INDIANA CORPORATION)  
5613 N. KEYSTONE AVENUE  
INDIANAPOLIS, IN 46220

FOR: RETAIL PET STORES, IN CLASS 35 (U.S. CLS. 100, 101 AND 102).

FIRST USE 7-29-2011; IN COMMERCE 7-29-2011.

THE MARK CONSISTS OF STANDARD CHARACTERS WITHOUT CLAIM TO ANY PARTICULAR FONT, STYLE, SIZE, OR COLOR.

NO CLAIM IS MADE TO THE EXCLUSIVE RIGHT TO USE "FISH", APART FROM THE MARK AS SHOWN.

SER. NO. 85-384,895, FILED 7-29-2011.

ZACHARY BELLO, EXAMINING ATTORNEY



*David J. Kyffers*

Director of the United States Patent and Trademark Office

# United States of America

United States Patent and Trademark Office



**Reg. No. 4,125,183**

**Registered Apr. 10, 2012**

**Int. Cl.: 3**

**TRADEMARK**

**PRINCIPAL REGISTER**

LUCY LINDSEY BEAUTY (TEXAS SOLE PROPRIETORSHIP)  
3307 83RD ST.  
LUBBOCK, TX 79423

FOR: EXFOLIANTS FOR SKIN; FRAGRANCED SKIN CARE PREPARATIONS, NAMELY, SKIN LOTION; LOTIONS FOR SKIN; MOISTURIZING SOLUTIONS FOR THE SKIN; SKIN ABRASIVE PREPARATIONS; SKIN CLEANSERS; SKIN CLEANSING LOTION; SKIN CREAMS; SKIN LOTIONS; SKIN MOISTURIZER; SKIN SOAP, IN CLASS 3 (U.S. CLS. 1, 4, 6, 50, 51 AND 52).

FIRST USE 0-0-2009; IN COMMERCE 0-0-2009.

THE MARK CONSISTS OF TWO OVERLAPPING CAPITAL LETTER "L" S IN TWO DIFFERENT STYLIZED FONTS.

SER. NO. 85-384,903, FILED 7-29-2011.

ALYSSA STEEL, EXAMINING ATTORNEY



*David J. Kyffers*

Director of the United States Patent and Trademark Office

# United States of America

United States Patent and Trademark Office

# SUPER KNIT

**Reg. No. 4,125,184**

ONLINE STORES, INC. (PENNSYLVANIA CORPORATION)  
1000 WESTINGHOUSE DRIVE, SUITE 1  
NEW STANTON, PA 15672

**Registered Apr. 10, 2012**

**Int. Cl.: 24**

FOR: CLOTH FLAGS; FABRIC FLAGS; NYLON FLAGS, IN CLASS 24 (U.S. CLS. 42 AND 50).

**TRADEMARK**

FIRST USE 6-30-2004; IN COMMERCE 6-30-2004.

**PRINCIPAL REGISTER**

THE MARK CONSISTS OF STANDARD CHARACTERS WITHOUT CLAIM TO ANY PARTICULAR FONT, STYLE, SIZE, OR COLOR.

NO CLAIM IS MADE TO THE EXCLUSIVE RIGHT TO USE "KNIT", APART FROM THE MARK AS SHOWN.

SER. NO. 85-384,908, FILED 7-29-2011.

BRENDAN REGAN, EXAMINING ATTORNEY



*David J. Kyffers*

Director of the United States Patent and Trademark Office

# United States of America

United States Patent and Trademark Office

## DEAD BETTY'S GARAGE

**Reg. No. 4,125,185**

BRANDON KIMBALL (UNITED STATES INDIVIDUAL), DBA DEAD BETTY'S GARAGE  
236 BRISCOE ROAD  
CHUBBUCK, ID 83202 AND

**Registered Apr. 10, 2012**

**Int. Cl.: 25**

LINDSEY KIMBALL (UNITED STATES INDIVIDUAL)  
236 BRISCOE ROAD  
CHUBBUCK, ID 83202

**TRADEMARK**

**PRINCIPAL REGISTER**

FOR: WEARABLE GARMENTS AND CLOTHING, NAMELY, SHIRTS , IN CLASS 25 (U.S. CLS. 22 AND 39).

FIRST USE 5-1-2011; IN COMMERCE 6-11-2011.

THE MARK CONSISTS OF STANDARD CHARACTERS WITHOUT CLAIM TO ANY PARTICULAR FONT, STYLE, SIZE, OR COLOR.

SER. NO. 85-384,914, FILED 7-29-2011.

ESTHER A. BORSUK, EXAMINING ATTORNEY



*David J. Kyffers*

Director of the United States Patent and Trademark Office

# United States of America

United States Patent and Trademark Office

## Scribblers Crayons

**Reg. No. 4,125,186**

RANDI SHAPIRO (UNITED STATES INDIVIDUAL)  
62 STUART DRIVE  
SYOSSET, NY 11791

**Registered Apr. 10, 2012**

**Int. Cl.: 16**

FOR: HANDMADE RECYCLED CRAYONS, IN CLASS 16 (U.S. CLS. 2, 5, 22, 23, 29, 37, 38 AND 50).

**TRADEMARK**

FIRST USE 11-15-2010; IN COMMERCE 12-7-2010.

**PRINCIPAL REGISTER**

THE MARK CONSISTS OF STANDARD CHARACTERS WITHOUT CLAIM TO ANY PARTICULAR FONT, STYLE, SIZE, OR COLOR.

NO CLAIM IS MADE TO THE EXCLUSIVE RIGHT TO USE "CRAYONS", APART FROM THE MARK AS SHOWN.

SER. NO. 85-384,952, FILED 7-29-2011.

EDWARD NELSON, EXAMINING ATTORNEY



*David J. Kyffers*

Director of the United States Patent and Trademark Office



# United States of America

United States Patent and Trademark Office



**Reg. No. 4,125,187**

ZAD FASHION, INC. (CALIFORNIA CORPORATION), DBA ZAD  
6860 A CORTONA DR  
GOLETA, CA 93117

**Registered Apr. 10, 2012**

**Int. Cls.: 14 and 25**

FOR: CHARMS; COSTUME JEWELRY; HAIR JEWELRY IN THE NATURE OF JEWELRY FOR USE IN THE HAIR; INEXPENSIVE NON-JEWELRY WATCHES; JEWELRY; JEWELRY AND IMITATION JEWELRY; JEWELRY BROOCHES; JEWELRY CHAINS; JEWELRY WATCHES; JEWELRY, NAMELY, ANKLETS; JEWELRY, NAMELY, STONE PENDANTS; RINGS; WATCHES AND JEWELRY; WOMEN'S JEWELRY, IN CLASS 14 (U.S. CLS. 2, 27, 28 AND 50).

**TRADEMARK**

**PRINCIPAL REGISTER**

FIRST USE 10-1-1986; IN COMMERCE 10-1-1986.

FOR: WOMEN'S CLOTHING, NAMELY, SHIRTS, DRESSES, SKIRTS, BLOUSES, IN CLASS 25 (U.S. CLS. 22 AND 39).

FIRST USE 10-1-1986; IN COMMERCE 10-1-1986.

OWNER OF U.S. REG. NO. 3,070,217.

THE MARK CONSISTS OF THE CAPITAL LETTERS "ZAD" WITH A TRIANGLE SHAPE PRECEDING THE "Z" AND AN ATTACHED LINE FROM THE LOWER PART OF THE "Z" UNDERLINING THE "A" AND "D".

SER. NO. 85-384,964, FILED 7-29-2011.

AMY HELLA, EXAMINING ATTORNEY



*David J. Kybas*

Director of the United States Patent and Trademark Office

# United States of America

United States Patent and Trademark Office

## THE GLOBE AND MAIL

**Reg. No. 4,125,188**

**Registered Apr. 10, 2012**

**Int. Cls.: 9, 35, 38, 41  
and 42**

**TRADEMARK**

**SERVICE MARK**

**PRINCIPAL REGISTER**

THE GLOBE AND MAIL INC./PUBLICATIONS GLOBE AND MAIL INC. (CANADA CORPORATION)  
444 FRONT STREET WEST  
TORONTO, ONTARIO, CANADA M5V2S9

FOR: DOWNLOADABLE PUBLICATIONS, NAMELY, ELECTRONIC NEWSPAPERS AND MAGAZINE SUPPLEMENTS TO NEWSPAPERS IN THE FIELD OF CURRENT EVENTS RELATING TO BUSINESS, LOCAL, NATIONAL AND INTERNATIONAL NEWS, SPORTS, ARTS, ENTERTAINMENT, TECHNOLOGY, LIFE, TRAVEL, TELEVISION, WEATHER, VEHICLES, AND CLASSIFIED ADVERTISEMENTS; DOWNLOADABLE SOFTWARE IN THE NATURE OF A MOBILE APPLICATION FOR OBTAINING NEWS, INFORMATION, AND COMMENTARY OF THE TYPE FOUND IN GENERAL INTEREST NEWSPAPERS AND MAGAZINE SUPPLEMENTS TO NEWSPAPERS IN THE FIELD OF CURRENT EVENTS RELATING TO BUSINESS, LOCAL, NATIONAL AND INTERNATIONAL NEWS, SPORTS, ARTS, ENTERTAINMENT, TECHNOLOGY, LIFE, TRAVEL, TELEVISION, WEATHER, VEHICLES, AND CLASSIFIED ADVERTISEMENTS, IN CLASS 9 (U.S. CLS. 21, 23, 26, 36 AND 38).

FIRST USE 6-19-2009; IN COMMERCE 6-19-2009.

FOR: PROVIDING ADVERTISING SPACE IN PERIODICALS, NEWSPAPERS, AND MAGAZINES; INTERNET ADVERTISING SERVICES; DISSEMINATION OF ADVERTISING MATTER; CLASSIFIED ADVERTISING SERVICES; PROVIDING AN ON-LINE SEARCHABLE DATABASE FEATURING CLASSIFIED ADVERTISEMENT LISTINGS AND EMPLOYMENT OPPORTUNITIES, IN CLASS 35 (U.S. CLS. 100, 101 AND 102).

FIRST USE 11-23-1936; IN COMMERCE 11-23-1936.

FOR: PROVIDING ON-LINE FORUMS FOR TRANSMISSION OF MESSAGES AMONG COMPUTER USERS; AUDIO AND VIDEO BROADCASTING SERVICES OVER THE INTERNET; PROVIDING ON-LINE CHAT ROOMS FOR SOCIAL NETWORKING, IN CLASS 38 (U.S. CLS. 100, 101 AND 104).

FIRST USE 11-1-2001; IN COMMERCE 11-1-2001.

FOR: PROVIDING ONLINE NON-DOWNLOADABLE NEWSPAPERS AND MAGAZINE SUPPLEMENTS TO NEWSPAPERS IN THE FIELD OF CURRENT EVENTS RELATING TO



*David J. Kyjars*

Director of the United States Patent and Trademark Office

**Reg. No. 4,125,188** BUSINESS, LOCAL, NATIONAL AND INTERNATIONAL NEWS, SPORTS, ARTS, ENTERTAINMENT, TECHNOLOGY, LIFE, TRAVEL, TELEVISION, WEATHER, VEHICLES, AND CLASSIFIED ADVERTISEMENTS; PROVIDING INFORMATION, NEWS, AND COMMENTARY IN THE FIELD OF CURRENT EVENTS RELATING TO BUSINESS, LOCAL, NATIONAL AND INTERNATIONAL NEWS, SPORTS, ARTS, ENTERTAINMENT, TECHNOLOGY, LIFE, TRAVEL, TELEVISION, WEATHER, VEHICLES, AND CLASSIFIED ADVERTISEMENTS, IN CLASS 41 (U.S. CLS. 100, 101 AND 107).

FIRST USE 5-1-2008; IN COMMERCE 5-1-2008.

FOR: COMPUTER SERVICES, NAMELY, HOSTING ON-LINE WEB FACILITIES FOR OTHERS FOR ORGANIZING AND CONDUCTING ONLINE MEETINGS, GATHERINGS, AND INTERACTIVE DISCUSSIONS; COMPUTER SERVICES, NAMELY, CREATING AN ON-LINE COMMUNITY FOR REGISTERED USERS TO ORGANIZE GROUPS, EVENTS, PARTICIPATE IN DISCUSSIONS, AGGREGATE INFORMATION AND RESOURCES, AND ENGAGE IN SOCIAL, BUSINESS AND COMMUNITY NETWORKING; HOSTING OF DIGITAL CONTENT ON THE INTERNET; HOSTING AN ONLINE WEBSITE FOR THE PURPOSE OF UPLOADING, DOWNLOADING, POSTING, SHOWING, DISPLAYING, TAGGING, SHARING AND TRANSMITTING MESSAGES, COMMENTS, MULTIMEDIA CONTENT, VIDEOS, MOVIES, FILMS, PHOTOS, AUDIO CONTENT, ANIMATION, PICTURES, IMAGES, TEXT, INFORMATION, AND OTHER USER-GENERATED CONTENT, IN CLASS 42 (U.S. CLS. 100 AND 101).

FIRST USE 6-19-2000; IN COMMERCE 6-19-2000.

THE MARK CONSISTS OF STANDARD CHARACTERS WITHOUT CLAIM TO ANY PARTICULAR FONT, STYLE, SIZE, OR COLOR.

OWNER OF U.S. REG. NOS. 1,658,189, 3,539,512 AND OTHERS.

SER. NO. 85-384,996, FILED 7-29-2011.

KATHLEEN M. VANSTON, EXAMINING ATTORNEY

# United States of America

United States Patent and Trademark Office

## kW Engineering

**Reg. No. 4,125,189**

**Registered Apr. 10, 2012**

**Int. Cl.: 42**

**SERVICE MARK**

**PRINCIPAL REGISTER**

KILOWATT ENGINEERING, INC. (CALIFORNIA CORPORATION), DBA KW ENGINEERING, INC.  
287 17TH STREET, SUITE 300  
OAKLAND, CA 94612

FOR: ENERGY ENGINEERING SERVICES TO COMPANIES AND FACILITY OWNERS, IN CLASS 42 (U.S. CLS. 100 AND 101).

FIRST USE 3-1-1998; IN COMMERCE 3-1-1998.

THE MARK CONSISTS OF STANDARD CHARACTERS WITHOUT CLAIM TO ANY PARTICULAR FONT, STYLE, SIZE, OR COLOR.

NO CLAIM IS MADE TO THE EXCLUSIVE RIGHT TO USE "ENGINEERING", APART FROM THE MARK AS SHOWN.

SER. NO. 85-385,018, FILED 7-29-2011.

SAMUEL E. SHARPER JR., EXAMINING ATTORNEY



*David J. Kybas*

Director of the United States Patent and Trademark Office

# United States of America

United States Patent and Trademark Office

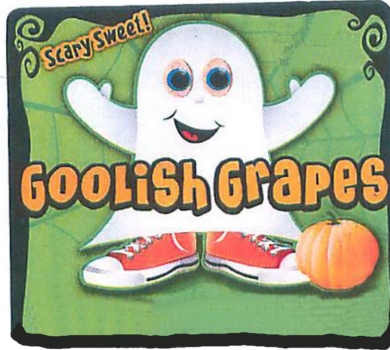

**Reg. No. 4,125,190**

**Registered Apr. 10, 2012**

**Int. Cl.: 31**

**TRADEMARK**

**PRINCIPAL REGISTER**

MJ VISALIA PRODUCE LLC (CALIFORNIA LIMITED LIABILITY COMPANY)  
15 AVENIDA ACAPONETA  
RIO RICO, AZ 85648

FOR: FRUITS, NAMELY, FRESH GRAPES, IN CLASS 31 (U.S. CLS. 1 AND 46).

FIRST USE 10-3-2008; IN COMMERCE 10-3-2008.

NO CLAIM IS MADE TO THE EXCLUSIVE RIGHT TO USE "GRAPES", APART FROM THE MARK AS SHOWN.

THE COLOR(S) BLACK, WHITE, GREEN, ORANGE, RED AND BLUE IS/ARE CLAIMED AS A FEATURE OF THE MARK.

THE MARK CONSISTS OF THE WORDS "GOOLISH GRAPES" WRITTEN IN ORANGE LETTERS OUTLINED IN BLACK ACROSS THE CENTER WITH THE WORDS "SCARY SWEET!" WRITTEN IN BLACK LETTERS OUTLINED IN ORANGE IN THE UPPER LEFT HAND CORNER. IN THE CENTER OF THE LOGO IS A SMILING WHITE GHOST WITH BLUE EYES, BLACK PUPILS AND LIGHT RED OUTLINING THE EYES; THE GHOST'S MOUTH IS REPRESENTED IN BLACK WITH A RED TONGUE SHOWING; AND THE GHOST IS WEARING RED SNEAKERS WITH WHITE SOLES BEARING A SINGLE BLACK LINE AND WHITE LACES. AN ORANGE PUMPKIN IS NEXT TO THE RIGHT SNEAKER. THE BACKGROUND IS GREEN WITH A DARKER GREEN SPIDERWEB DESIGN AND A BLACK BORDER.

SER. NO. 85-385,037, FILED 7-29-2011.

BENJAMIN OKEKE, EXAMINING ATTORNEY



*David J. Kybas*

Director of the United States Patent and Trademark Office

# United States of America

United States Patent and Trademark Office

WE MAKE LUXURY CRUISING  
AFFORDABLE

**Reg. No. 4,125,191**

KELLY CRUISES INC (ILLINOIS CORPORATION)  
1315 WEST 22ND STREET  
OAK LAWN, IL 60523

**Registered Apr. 10, 2012**

**Int. Cl.: 39**

FOR: ARRANGING OF TOURS AND CRUISES; TRAVEL, EXCURSION AND CRUISE ARRANGEMENT, IN CLASS 39 (U.S. CLS. 100 AND 105).

**SERVICE MARK**

FIRST USE 6-30-1995; IN COMMERCE 6-30-1995.

**PRINCIPAL REGISTER**

THE MARK CONSISTS OF STANDARD CHARACTERS WITHOUT CLAIM TO ANY PARTICULAR FONT, STYLE, SIZE, OR COLOR.

OWNER OF U.S. REG. NO. 2,048,489.

SER. NO. 85-385,125, FILED 7-29-2011.

BENJAMIN OKEKE, EXAMINING ATTORNEY



*David J. Kyffers*

Director of the United States Patent and Trademark Office

# United States of America

United States Patent and Trademark Office



**Reg. No. 4,125,192**

**Registered Apr. 10, 2012**

**Int. Cl.: 32**

**TRADEMARK**

**PRINCIPAL REGISTER**

HANSEN BEVERAGE COMPANY (DELAWARE CORPORATION)  
550 MONICA CIRCLE, SUITE 201  
CORONA, CA 92880

FOR: NON-ALCOHOLIC BEVERAGES, NAMELY, SOFT DRINKS; CARBONATED SOFT DRINKS; SODA WATER; FRUIT-FLAVORED SOFT DRINKS, IN CLASS 32 (U.S. CLS. 45, 46 AND 48).

FIRST USE 2-0-2010; IN COMMERCE 2-0-2010.

OWNER OF U.S. REG. NOS. 1,258,779, 4,030,269 AND OTHERS.

NO CLAIM IS MADE TO THE EXCLUSIVE RIGHT TO USE "NATURAL" AND "CANE SODA", APART FROM THE MARK AS SHOWN.

THE MARK CONSISTS OF THE LITERAL ELEMENT "HANSEN'S NATURAL CANE SODA" REPRESENTED IN STYLIZED FONT AND A DESIGN CONSISTING OF TWO CONCENTRIC CIRCLES WHEREIN THE TERM "HANSEN'S" IS SUPERIMPOSED HORIZONTALLY ACROSS THE CIRCLES WITH PORTIONS OF THE LETTERS "H" AND THE LAST LETTER "S" EXTENDING BEYOND THE CIRCLES, AND WHEREIN FURTHER THE WORD "NATURAL" APPEARS POSITIONED AS AN ARC IN THE UPPER HALF OF, AND ENCLOSED BY, THE CIRCLES, WHILE THE TERMS "CANE SODA" APPEAR IN AN ARC POSITION IN THE LOWER HALF OF, AND ENCLOSED BY, THE CIRCLES.

SER. NO. 85-385,212, FILED 7-29-2011.

RONALD DELGIZZI, EXAMINING ATTORNEY



*David J. Kyjars*

Director of the United States Patent and Trademark Office

# United States of America

United States Patent and Trademark Office



**Reg. No. 4,125,193**

KWONG, WEYMAN (UNITED STATES INDIVIDUAL)  
392 S ABBOTT AVE.  
MILPITAS, CA 95035

**Registered Apr. 10, 2012**

**Int. Cl.: 9**

FOR: COMPUTER KEYBOARDS, IN CLASS 9 (U.S. CLS. 21, 23, 26, 36 AND 38).

**TRADEMARK**

FIRST USE 2-1-2011; IN COMMERCE 2-1-2011.

**PRINCIPAL REGISTER**

NO CLAIM IS MADE TO THE EXCLUSIVE RIGHT TO USE "KEYBOARDS", APART FROM THE MARK AS SHOWN.

THE MARK CONSISTS OF AN OUTLINE OF THE "W", "A", "S", AND "D" KEYS ON A COMPUTER KEYBOARD IN THEIR NATURAL POSITIONS, VIEWED AT AN ANGLE, THE TEXT "WASD" ON THE RIGHT OF THE IMAGE, AND "KEYBOARDS" BELOW THE LETTERS "ASD" OF "WASD".

SER. NO. 85-385,337, FILED 7-30-2011.

TINA L. SNAPP, EXAMINING ATTORNEY



*David J. Kybas*

Director of the United States Patent and Trademark Office



# United States of America

United States Patent and Trademark Office

## THERAPY BEAT

**Reg. No. 4,125,194**

BRYSON, PENNY (UNITED STATES INDIVIDUAL)  
990 PONCE DE LEON BLVD.  
BROOKSVILLE, FL 34601

**Registered Apr. 10, 2012**

**Int. Cl.: 44**

FOR: SPEECH THERAPY SERVICES IN THE NATURE OF READING DEVELOPMENT USING RHYTHM AND DANCE, IN CLASS 44 (U.S. CLS. 100 AND 101).

**SERVICE MARK**

FIRST USE 5-30-2007; IN COMMERCE 7-1-2007.

**PRINCIPAL REGISTER**

THE MARK CONSISTS OF STANDARD CHARACTERS WITHOUT CLAIM TO ANY PARTICULAR FONT, STYLE, SIZE, OR COLOR.

NO CLAIM IS MADE TO THE EXCLUSIVE RIGHT TO USE "THERAPY", APART FROM THE MARK AS SHOWN.

SER. NO. 85-385,394, FILED 7-30-2011.

DOUGLAS LEE, EXAMINING ATTORNEY



*David J. Kybas*

Director of the United States Patent and Trademark Office

# United States of America

United States Patent and Trademark Office

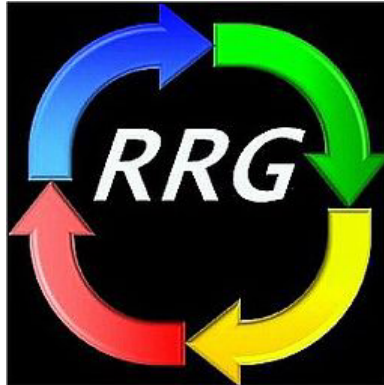

**Reg. No. 4,125,195**

**Registered Apr. 10, 2012**

**Int. Cl.: 36**

**SERVICE MARK**

**PRINCIPAL REGISTER**

RELATIVE ROTATION GRAPHS LTD (GIBRALTAR LIMITED LIABILITY COMPANY),  
DBA RELATIVE ROTATION GRAPHS LTD  
22/24 JOHN MACINTOSH SQUARE, PO BOX 758  
GIBRALTAR, GIBRALTAR

FOR: FINANCIAL AFFAIRS AND MONETARY AFFAIRS, NAMELY, FINANCIAL INFORMATION, MANAGEMENT AND ANALYSIS SERVICES; FINANCIAL CONSULTING SERVICES, NAMELY, EXPERT ANALYSIS IN FINANCE, IN CLASS 36 (U.S. CLS. 100, 101 AND 102).

PRIORITY CLAIMED UNDER SEC. 44(D) ON UNITED KINGDOM APPLICATION NO. 2588158, FILED 7-18-2011, REG. NO. 2588158, DATED 7-18-2011, EXPIRES 7-18-2021.

THE COLOR(S) BLACK, WHITE, GREEN, RED, YELLOW AND BLUE IS/ARE CLAIMED AS A FEATURE OF THE MARK.

THE MARK CONSISTS OF FOUR COLOURED CLOCKWISE ROTATING ARROWS FROM LIGHT TO DARK SHADE IN COLOURS DETAILED ON A SQUARE BLACK BACKGROUND, BLUE TOP LEFT, GREEN TOP RIGHT, RED BOTTOM LEFT AND YELLOW BOTTOM RIGHT. DARKER HUES OF EACH COLOUR ARE TO ARROW HEADS AND LIGHT TO TAILS. THE LETTER "RRG" IN ITALIC FORMAT IN WHITE CAPITALS IS PLACED WITHIN THE ROTATING ARROWS.

SER. NO. 85-385,395, FILED 7-30-2011.

DOUGLAS LEE, EXAMINING ATTORNEY



*David J. Kyros*

Director of the United States Patent and Trademark Office

# United States of America

United States Patent and Trademark Office

## JOCK TO DOC

**Reg. No. 4,125,196**

**Registered Apr. 10, 2012**

**Int. Cl.: 44**

**SERVICE MARK**

**PRINCIPAL REGISTER**

ADICKES, MARK (UNITED STATES INDIVIDUAL)  
6146 BORDLEY DRIVE  
HOUSTON, TX 77057 AND

ADICKES, JACKIE (UNITED STATES INDIVIDUAL)  
6146 BORDLEY DRIVE  
HOUSTON, TX 77057

FOR: PROVIDING INFORMATION, NEWS AND COMMENTARY IN THE FIELDS OF SPORTS MEDICINE AND SPORTS-RELATED HEALTH IN MULTIMEDIA FORMATS FOR USE IN PRINT, TELEVISION, RADIO AND/OR INTERNET MEDIA; PROVIDING A WEBSITE WITH MULTIMEDIA CONTENT IN THE FIELDS OF SPORTS MEDICINE AND SPORTS-RELATED HEALTH; PROVIDING A WEBSITE WITH MULTIMEDIA CONTENT FEATURING INFORMATION ABOUT HIP ANATOMY, SHOULDER ANATOMY, KNEE ANATOMY, HIP INJURIES, SHOULDER INJURIES, KNEE INJURIES, SPORTS MEDICINE ARTHROSCOPY, HIP SURGERY, KNEE SURGERY, SHOULDER SURGERY, PLATELET RICH PLASMA TREATMENT, PATIENT PROTOCOLS, AND RELATED REHABILITATION PROTOCOLS; ORTHOPEDIC SURGERY AND RELATED PHYSICAL REHABILITATION SERVICES PROVIDED AND OVERSEEN BY A PHYSICIAN WHO IS A FORMER PROFESSIONAL ATHLETE, IN CLASS 44 (U.S. CLS. 100 AND 101).

FIRST USE 5-7-2007; IN COMMERCE 5-7-2007.

THE MARK CONSISTS OF STANDARD CHARACTERS WITHOUT CLAIM TO ANY PARTICULAR FONT, STYLE, SIZE, OR COLOR.

OWNER OF U.S. REG. NO. 4,029,223.

SER. NO. 85-385,406, FILED 7-30-2011.

TRACY WHITTAKER-BROWN, EXAMINING ATTORNEY



*David J. Kyros*

Director of the United States Patent and Trademark Office

# United States of America

United States Patent and Trademark Office

h  
p  
o  
p  
e  
water

**Reg. No. 4,125,197**

THATE, JAMES (UNITED STATES INDIVIDUAL)  
P.O. BOX 2448  
PALM BEACH, FL 334802448

**Registered Apr. 10, 2012**

**Int. Cl.: 32**

FOR: BOTTLED WATER; SOFT DRINKS, IN CLASS 32 (U.S. CLS. 45, 46 AND 48).

**TRADEMARK**

FIRST USE 6-20-2011; IN COMMERCE 6-20-2011.

**PRINCIPAL REGISTER**

NO CLAIM IS MADE TO THE EXCLUSIVE RIGHT TO USE "WATER" , APART FROM THE MARK AS SHOWN.

THE MARK CONSISTS OF THE WORD "HOPE" TYPED VERTICALLY IN LOWERCASE LETTERS, WITH A STYLIZED LETTER "O" GRADATING VERTICALLY FROM LIGHT TO DARK. THE WORD "WATER" WRITTEN IN LOWERCASE LETTERS ROTATED 90 DEGREES TO THE LOWER RIGHT SIDE OF THE WORD "HOPE".

SER. NO. 85-385,418, FILED 7-30-2011.

DOMINICK J. SALEMI, EXAMINING ATTORNEY



*David J. Kybas*

Director of the United States Patent and Trademark Office

# United States of America

United States Patent and Trademark Office

# River Stones

**Reg. No. 4,125,198**

LESER ENTERPRISES LTD. (NEW YORK CORPORATION), DBA COLOR STORY  
18 EAST 48TH ST., # 1104  
NEW YORK, NY 10017

**Registered Apr. 10, 2012**

**Int. Cl.: 14**

FOR: JEWELRY, IN CLASS 14 (U.S. CLS. 2, 27, 28 AND 50).

**TRADEMARK**

FIRST USE 5-16-2011; IN COMMERCE 5-16-2011.

**PRINCIPAL REGISTER**

THE MARK CONSISTS OF STANDARD CHARACTERS WITHOUT CLAIM TO ANY PARTICULAR FONT, STYLE, SIZE, OR COLOR.

NO CLAIM IS MADE TO THE EXCLUSIVE RIGHT TO USE "STONES", APART FROM THE MARK AS SHOWN.

SER. NO. 85-385,426, FILED 7-30-2011.

DOMINICK J. SALEMI, EXAMINING ATTORNEY



*David J. Kybas*

Director of the United States Patent and Trademark Office

# United States of America

United States Patent and Trademark Office

## Boot Camp Life Coaching

**Reg. No. 4,125,199**

**Registered Apr. 10, 2012**

**Int. Cl.: 41**

**SERVICE MARK**

**PRINCIPAL REGISTER**

BOOT CAMP LIFE COACHING LLC (NEW YORK LIMITED LIABILITY COMPANY)  
SUITE 2456  
244 FIFTH AVENUE  
NEW YORK, NY 10001

FOR: LIFE COACHING SERVICES IN THE FIELD OF PERSONAL, PROFESSIONAL AND LIFE DEVELOPMENT, IN CLASS 41 (U.S. CLS. 100, 101 AND 107).

FIRST USE 3-25-2011; IN COMMERCE 7-22-2011.

THE MARK CONSISTS OF STANDARD CHARACTERS WITHOUT CLAIM TO ANY PARTICULAR FONT, STYLE, SIZE, OR COLOR.

NO CLAIM IS MADE TO THE EXCLUSIVE RIGHT TO USE "LIFE COACHING", APART FROM THE MARK AS SHOWN.

SER. NO. 85-385,544, FILED 7-31-2011.

FLORENTINA BLANDU, EXAMINING ATTORNEY



*David J. Kyjars*

Director of the United States Patent and Trademark Office

# United States of America

United States Patent and Trademark Office

## Hairs A Thought

**Reg. No. 4,125,200**

**Registered Apr. 10, 2012**

**Int. Cls.: 35 and 45**

**SERVICE MARK**

**PRINCIPAL REGISTER**

BETHANCOURT, BRISEIDA Y (UNITED STATES INDIVIDUAL)  
PO BOX 200721  
SAN ANTONIO, TX 78220

FOR: ADVERTISING AND COMMERCIAL INFORMATION SERVICES, VIA THE INTERNET; BUSINESS ADVICE AND INFORMATION; PROMOTING THE GOODS AND SERVICES OF OTHERS BY PROVIDING A COMMUNITY-DRIVEN WEB SITE FEATURING USER-SUBMITTED CONTENT IN THE NATURE OF COUPONS, REBATES, PRICE-COMPARISON INFORMATION, PRODUCT REVIEWS, LINKS TO THE RETAIL WEB SITES OF OTHERS, AND DISCOUNT INFORMATION; PROMOTING THE GOODS AND SERVICES OF OTHERS BY PROVIDING A WEBSITE FEATURING COUPONS, REBATES, PRICE-COMPARISON INFORMATION, PRODUCT REVIEWS, LINKS TO THE RETAIL WEBSITES OF OTHERS, AND DISCOUNT INFORMATION; PROVIDING CONSUMER INFORMATION IN THE FIELD OF HAIR; PROVIDING CONSUMER PRODUCT INFORMATION FOR THE PURPOSE OF SELECTING HAIR PRODUCTS TO MEET THE CONSUMER'S SPECIFICATIONS; PROVIDING INFORMATION IN THE FIELD OF THE BEAUTY INDUSTRY; PROVIDING ON-LINE BUSINESS INFORMATION OF OTHERS, NAMELY, ADVERTISEMENTS OR SOLICITATIONS; PROVIDING ON-LINE DIRECTORY INFORMATION SERVICES ALSO FEATURING HYPERLINKS TO OTHER WEB SITES; PROVISION OF A WEB SITE FEATURING COMMERCIAL INFORMATION ON SHOPPING, IN CLASS 35 (U.S. CLS. 100, 101 AND 102).

FIRST USE 7-22-2010; IN COMMERCE 7-22-2010.

FOR: PROVISION OF A WEB SITE FEATURING INFORMATION ON FASHION, IN CLASS 45 (U.S. CLS. 100 AND 101).

FIRST USE 7-22-2010; IN COMMERCE 7-22-2010.

THE MARK CONSISTS OF STANDARD CHARACTERS WITHOUT CLAIM TO ANY PARTICULAR FONT, STYLE, SIZE, OR COLOR.

SER. NO. 85-385,547, FILED 7-31-2011.

FLORENTINA BLANDU, EXAMINING ATTORNEY



*David J. Kypos*

Director of the United States Patent and Trademark Office

# United States of America

United States Patent and Trademark Office



**Reg. No. 4,125,201**

**Registered Apr. 10, 2012**

**Int. Cl.: 41**

**SERVICE MARK**

**PRINCIPAL REGISTER**

JONES, ZACHARY CHANNING (UNITED STATES INDIVIDUAL), DBA SUPREME COURT ATHLETICS  
7607 HAZARD CENTER DRIVE  
SAN DIEGO, CA 92108

FOR: COACHING AND INSTRUCTION SERVICES IN THE FIELD OF SPORTS, IN CLASS 41 (U.S. CLS. 100, 101 AND 107).

FIRST USE 1-1-1991; IN COMMERCE 1-1-1991.

THE MARK CONSISTS OF THE WORDING "SUPREME COURT" IN BLACK STYLIZED LETTERING WITH A RED 5 POINT CROWN DESIGN ABOVE THE WORDING. THE COLOR WHITE IS USED FOR BACKGROUND AND IS NOT CLAIMED AS A FEATURE OF THE MARK.

THE COLOR(S) RED AND BLACK IS/ARE CLAIMED AS A FEATURE OF THE MARK.

SER. NO. 85-385,592, FILED 7-31-2011.

MATTHEW MCDOWELL, EXAMINING ATTORNEY



*David J. Kybas*

Director of the United States Patent and Trademark Office



# United States of America

United States Patent and Trademark Office

## Drunken History

**Reg. No. 4,125,202**

AO MEDIA LLC (NEW MEXICO LIMITED LIABILITY COMPANY)  
2015 COTTON AVE.

**Registered Apr. 10, 2012**

LAS CRUCES, NM 88001

**Int. Cl.: 41**

FOR: PRODUCTION OF VIDEOS IN THE FIELD OF HISTORICAL AND/OR CULTURALLY SIGNIFICANT ESTABLISHMENTS THAT SERVE AND/OR PRODUCE ALCOHOL, IN CLASS 41 (U.S. CLS. 100, 101 AND 107).

**SERVICE MARK**

FIRST USE 4-0-2011; IN COMMERCE 4-0-2011.

**PRINCIPAL REGISTER**

THE MARK CONSISTS OF STANDARD CHARACTERS WITHOUT CLAIM TO ANY PARTICULAR FONT, STYLE, SIZE, OR COLOR.

NO CLAIM IS MADE TO THE EXCLUSIVE RIGHT TO USE "HISTORY", APART FROM THE MARK AS SHOWN.

SER. NO. 85-385,600, FILED 7-31-2011.

ROBIN CHOSID, EXAMINING ATTORNEY



*David J. Kybas*

Director of the United States Patent and Trademark Office

# United States of America

United States Patent and Trademark Office



**Reg. No. 4,125,203**

**Registered Apr. 10, 2012**

**Int. Cl.: 43**

**SERVICE MARK**

**PRINCIPAL REGISTER**

SHARK BITES AT THE SOUTHERNMOST POINT INC. (FLORIDA CORPORATION)  
SUITE A  
507 SOUTH STREET  
KEY WEST, FL 33040

FOR: CARRY-OUT RESTAURANTS; ICE CREAM SHOP SERVICES IN THE NATURE OF A RESTAURANT; RESTAURANT, IN CLASS 43 (U.S. CLS. 100 AND 101).

FIRST USE 5-1-2011; IN COMMERCE 5-1-2011.

NO CLAIM IS MADE TO THE EXCLUSIVE RIGHT TO USE "SOUTHERNMOST POINT", APART FROM THE MARK AS SHOWN.

THE COLOR(S) BLACK, WHITE, RED, LIGHT BLUE AND DARK BLUE IS/ARE CLAIMED AS A FEATURE OF THE MARK.

THE MARK CONSISTS OF A SMILING SHARK WEARING SUNGLASSES NEXT TO THE WORDS, "SHARK BITES AT THE SOUTHERNMOST POINT." THE SUNGLASSES HAVE BLACK RIMS AND BLUE LENSES. THE SHARK HAS A BLUE TOPSIDE AND DORSAL AREA AND A LIGHT BLUE BELLY. THE TEETH ARE WHITE. THE WORDS "SHARK BITES" ARE IN RED TO THE LEFT OF THE SHARK. THE WORDS "AT THE SOUTHERNMOST POINT" ARE IN BLACK UNDER THE WORDS "SHARK BITES".

SER. NO. 85-385,602, FILED 7-31-2011.

ROBIN CHOSID, EXAMINING ATTORNEY



*David J. Kybas*

Director of the United States Patent and Trademark Office

# United States of America

United States Patent and Trademark Office

# WeLeftWord

**Reg. No. 4,125,204**

**Registered Apr. 10, 2012**

**Int. Cl.: 45**

**SERVICE MARK**

**PRINCIPAL REGISTER**

KABIR SHUKLA (CALIFORNIA SOLE PROPRIETORSHIP)  
15 STEPHENS PATH  
PORT JEFFERSON, NY 11777

FOR: ON-LINE SOCIAL NETWORKING SERVICES; ONLINE SOCIAL NETWORKING SERVICES PROVIDED THROUGH A COMMUNITY WEBSITE; ONLINE SOCIAL NETWORKING SERVICES IN THE FIELD OF ENTERTAINMENT INDUSTRY PROVIDED VIA A WEBSITE; PROVIDING ON-LINE COMPUTER DATABASES AND ON-LINE SEARCHABLE DATABASES IN THE FIELD OF SOCIAL NETWORKING, IN CLASS 45 (U.S. CLS. 100 AND 101).

FIRST USE 7-29-2011; IN COMMERCE 7-29-2011.

THE MARK CONSISTS OF THE STYLIZED WORDING "WELEFTWORD", WITH THE WORD "WE" IN GRAY, THE WORD "LEFT" IN ORANGE, AND THE WORD "WORD" IN GRAY.

THE COLOR(S) GRAY AND ORANGE IS/ARE CLAIMED AS A FEATURE OF THE MARK.

SER. NO. 85-385,604, FILED 7-31-2011.

NICHOLAS ALTREE, EXAMINING ATTORNEY



*David J. Kybas*

Director of the United States Patent and Trademark Office

# United States of America

United States Patent and Trademark Office

## ADVANCED CUTTING TECHNOLOGY

**Reg. No. 4,125,205**

**Registered Apr. 10, 2012**

**Int. Cl.: 10**

**TRADEMARK**

**PRINCIPAL REGISTER**

BIOMET 3I, LLC (FLORIDA LIMITED LIABILITY COMPANY)  
4555 RIVERSIDE DRIVE  
PALM BEACH GARDENS, FL 33410

FOR: DENTAL DRILLS, MOTORIZED DRILL HEADS SPECIALLY DESIGNED FOR DENTAL PROCEDURES, AND COMPONENT PARTS FOR ALL THE AFORESAID GOODS, IN CLASS 10 (U.S. CLS. 26, 39 AND 44).

FIRST USE 6-9-2006; IN COMMERCE 6-9-2006.

THE MARK CONSISTS OF STANDARD CHARACTERS WITHOUT CLAIM TO ANY PARTICULAR FONT, STYLE, SIZE, OR COLOR.

OWNER OF U.S. REG. NO. 3,140,677.

NO CLAIM IS MADE TO THE EXCLUSIVE RIGHT TO USE "CUTTING TECHNOLOGY", APART FROM THE MARK AS SHOWN.

SEC. 2(F).

SER. NO. 85-385,647, FILED 8-1-2011.

AMY KERTGATE, EXAMINING ATTORNEY



*David J. Kybas*

Director of the United States Patent and Trademark Office

# United States of America

United States Patent and Trademark Office

## Seven Hills Construction, LLC

**Reg. No. 4,125,206**

**Registered Apr. 10, 2012**

**Int. Cl.: 37**

**SERVICE MARK**

**PRINCIPAL REGISTER**

SEVEN HILLS CONSTRUCTION, LLC (DELAWARE LIMITED LIABILITY COMPANY)  
313 ST. ANDREWS CIRCLE  
LYNCHBURG, VA 24503

FOR: BUILDING CONSTRUCTION, REMODELING AND REPAIR; CONSTRUCTION AND RENOVATION OF BUILDINGS; CONSTRUCTION AND REPAIR OF BUILDINGS; GENERAL CONSTRUCTION CONTRACTING, IN CLASS 37 (U.S. CLS. 100, 103 AND 106).

FIRST USE 6-12-2006; IN COMMERCE 6-12-2006.

THE MARK CONSISTS OF STANDARD CHARACTERS WITHOUT CLAIM TO ANY PARTICULAR FONT, STYLE, SIZE, OR COLOR.

NO CLAIM IS MADE TO THE EXCLUSIVE RIGHT TO USE "CONSTRUCTION, LLC", APART FROM THE MARK AS SHOWN.

SEC. 2(F).

SER. NO. 85-385,677, FILED 8-1-2011.

SUNG IN, EXAMINING ATTORNEY



*David J. Kyffers*

Director of the United States Patent and Trademark Office

# United States of America

United States Patent and Trademark Office

*Follow your star!*   
**Polaris**  
*.Productions.*

**Reg. No. 4,125,207**

**Registered Apr. 10, 2012**

**Int. Cl.: 41**

**SERVICE MARK**

**PRINCIPAL REGISTER**

POLARIS PRODUCTIONS, INC. (NEW YORK CORPORATION)  
#5-E  
458 W. 17TH ST.  
NEW YORK, NY 10011

FOR: ENTERTAINMENT IN THE NATURE OF THEATER PRODUCTIONS, IN CLASS 41  
(U.S. CLS. 100, 101 AND 107).

FIRST USE 7-4-2011; IN COMMERCE 7-4-2011.

NO CLAIM IS MADE TO THE EXCLUSIVE RIGHT TO USE "PRODUCTIONS", APART  
FROM THE MARK AS SHOWN.

THE MARK CONSISTS OF THE STYLIZED TEXT "POLARIS" ABOVE THE STYLIZED  
TEXT ".PRODUCTIONS.". THE LETTER "I" IN "POLARIS" IS DOTTED WITH A PARTIAL  
STAR, AND THE STYLIZED TEXT "FOLLOW YOUR STAR!" IS TO THE LEFT OF THE  
STAR AND PARTIALLY INSIDE IT.

SER. NO. 85-385,707, FILED 8-1-2011.

KRISTIN DAHLING, EXAMINING ATTORNEY



*David J. Kybas*

Director of the United States Patent and Trademark Office

# United States of America

United States Patent and Trademark Office



**Reg. No. 4,125,208**

WEBEYECARE INC. (PENNSYLVANIA CORPORATION)  
176 N. PINE ST.

**Registered Apr. 10, 2012**

LANGHORNE, PA 19047

**Int. Cl.: 35**

FOR: ON-LINE RETAIL STORE SERVICES FEATURING OPHTHALMIC PRODUCTS AND ACCESSORIES, CONTACT LENSES, EYEGLASSES, EYEWEAR ACCESSORIES, IN CLASS 35 (U.S. CLS. 100, 101 AND 102).

**SERVICE MARK**

FIRST USE 4-1-2009; IN COMMERCE 4-1-2009.

**PRINCIPAL REGISTER**

NO CLAIM IS MADE TO THE EXCLUSIVE RIGHT TO USE "WEB EYE CARE", APART FROM THE MARK AS SHOWN.

THE MARK CONSISTS OF THE WORDS "WEB EYE CARE" IN LOWERCASE LETTERS AND NO SPACES, IN WHICH THE WORD "EYE" IS IN A CIRCLE, AND THERE IS A CURVED LINE ABOVE THE WORDS "WEB EYE CARE" THAT IS THICKER NEAR THE "W" AND THINS OUT NEAR THE "E" IN "CARE," CREATING THE LOOK OF AN EYE.

SER. NO. 85-385,714, FILED 8-1-2011.

JEFFERY COWARD, EXAMINING ATTORNEY



*David J. Kyros*

Director of the United States Patent and Trademark Office

# United States of America

United States Patent and Trademark Office

## FLAVOR FUZE

**Reg. No. 4,125,209**

WING ENTERPRISES, INC. (FLORIDA CORPORATION)  
900 CIRCLE 75 PARKWAY, SUITE 930  
ATLANTA, GA 30339

**Registered Apr. 10, 2012**

**Int. Cl.: 43**

FOR: RESTAURANT SERVICES; RESTAURANTS FEATURING HOME DELIVERY; TAKE-OUT RESTAURANT SERVICES, IN CLASS 43 (U.S. CLS. 100 AND 101).

**SERVICE MARK**

FIRST USE 7-25-2011; IN COMMERCE 7-25-2011.

**PRINCIPAL REGISTER**

THE MARK CONSISTS OF STANDARD CHARACTERS WITHOUT CLAIM TO ANY PARTICULAR FONT, STYLE, SIZE, OR COLOR.

NO CLAIM IS MADE TO THE EXCLUSIVE RIGHT TO USE "FLAVOR", APART FROM THE MARK AS SHOWN.

SER. NO. 85-385,716, FILED 8-1-2011.

ALICIA COLLINS, EXAMINING ATTORNEY



*David J. Kybas*

Director of the United States Patent and Trademark Office



# United States of America

United States Patent and Trademark Office



**Reg. No. 4,125,210**

SNAKE RIVER FIREARMS INSTRUCTORS, LLC (IDAHO LIMITED LIABILITY COMPANY)  
330 W COMMONS RD.

**Registered Apr. 10, 2012**

IDAHO FALLS, ID 83401

**Int. Cl.: 41**

FOR: EDUCATIONAL SERVICES, NAMELY, CONDUCTING CLASSES IN THE FIELD OF FIREARM SAFETY AND TRAINING, IN CLASS 41 (U.S. CLS. 100, 101 AND 107).

**SERVICE MARK**

FIRST USE 2-1-2011; IN COMMERCE 2-1-2011.

**PRINCIPAL REGISTER**

THE MARK CONSISTS OF THE STYLIZED WORDING "SRFI" INSIDE A RECTANGLE. THE TITLE OF THE LETTER "I" IS IN THE SHAPE OF A BULLET HOLE.

SER. NO. 85-385,792, FILED 8-1-2011.

DAWN HAN, EXAMINING ATTORNEY



*David J. Kybas*

Director of the United States Patent and Trademark Office

# United States of America

United States Patent and Trademark Office



**Reg. No. 4,125,211**

**Registered Apr. 10, 2012**

**Int. Cl.: 37**

**SERVICE MARK**

**PRINCIPAL REGISTER**

FIREHOUSE ENTERPRISES, LLC (VIRGINIA LIMITED LIABILITY COMPANY), DBA  
FIREHOUSE WINDOWS AND SIDING  
210 N 21ST ST, SUITE C  
PURCELLVILLE, VA 20132

FOR: BUILDING CONSTRUCTION; BUILDING CONSTRUCTION AND REPAIR; BUILDING CONSTRUCTION SERVICES; BUILDING CONSTRUCTION, REMODELING AND REPAIR; BUILDING MAINTENANCE AND REPAIR; CONSTRUCTION AND REPAIR OF BUILDINGS; CONSTRUCTION, MAINTENANCE AND RENOVATION OF PROPERTY; CUSTOM CONSTRUCTION AND BUILDING RENOVATION; DOOR REPAIR SERVICES; HOUSE BUILDING AND REPAIR; HOUSING SERVICES, NAMELY, REPAIR, IMPROVEMENT, AND CONSTRUCTION OF RESIDENTIAL REAL PROPERTY; INSTALLATION, MAINTENANCE AND REPAIR OF DOORS; INSTALLATION, MAINTENANCE AND REPAIR OF WINDOWS, DOORS, AND SIDING FOR HOUSES AND BUILDINGS.; INSTALLATION, REPAIR AND REPLACEMENT OF WINDOWS, DOORS, AND SIDING FOR HOUSES AND BUILDINGS.; REMODELING OF WINDOWS, DOORS, AND SIDING FOR HOUSES AND BUILDINGS; RENOVATION IN THE FIELD OF WINDOWS, DOORS AND SIDING FOR HOUSES AND BUILDINGS; RESIDENTIAL AND COMMERCIAL BUILDING CONSTRUCTION, IN CLASS 37 (U.S. CLS. 100, 103 AND 106).

FIRST USE 1-27-2009; IN COMMERCE 1-27-2009.

NO CLAIM IS MADE TO THE EXCLUSIVE RIGHT TO USE "WINDOWS AND SIDING", APART FROM THE MARK AS SHOWN.

THE COLOR(S) BLACK, RED, WHITE, AND YELLOW IS/ARE CLAIMED AS A FEATURE OF THE MARK.

THE MARK CONSISTS OF A BLACK RECTANGLE THAT CONTAINS THE FOLLOWING: THE WORD "FIREHOUSE" IN RED LETTERING ABOVE A RED AND WHITE FIREMAN'S CREST THAT CONTAINS A WHITE FIREMAN'S HELMET AND "FH" IN WHITE LETTERING INSIDE A BLACK CIRCLE, WITH "WINDOWS AND SIDING" BELOW THE CREST IN YELLOW LETTERING.

SER. NO. 85-385,805, FILED 8-1-2011.

DORITT L. CARROLL, EXAMINING ATTORNEY



*David J. Kyppas*

Director of the United States Patent and Trademark Office

# United States of America

United States Patent and Trademark Office

Chubby Truckers

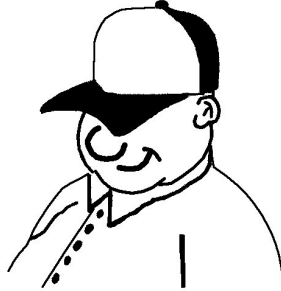

**Reg. No. 4,125,212**

**Registered Apr. 10, 2012**

**Int. Cl.: 39**

**SERVICE MARK**

**PRINCIPAL REGISTER**

CHUBBY TRUCKERS (NEW JERSEY LIMITED LIABILITY COMPANY)  
110-BLVD WEST  
KEYPORT, NJ 07735

FOR: TRANSPORT OF GOODS, IN CLASS 39 (U.S. CLS. 100 AND 105).

FIRST USE 2-0-2009; IN COMMERCE 2-0-2009.

NO CLAIM IS MADE TO THE EXCLUSIVE RIGHT TO USE "TRUCKERS" , APART FROM THE MARK AS SHOWN.

THE MARK CONSISTS OF AN IMAGE OF A MAN IN A TRUCKER HAT THAT COVERS HIS EYES. THE MAN IS SMILING. HE IS WEARING A SHIRT WITH BUTTONS DOWN THE FRONT, AND ONLY THE UPPER BODY IS VISIBLE. ABOVE THIS IMAGE IS THE STYLIZED TEXT "CHUBBY TRUCKERS".

SER. NO. 85-385,818, FILED 8-1-2011.

PATRICIA EVANKO, EXAMINING ATTORNEY



*David J. Kyffers*

Director of the United States Patent and Trademark Office

# United States of America

United States Patent and Trademark Office

## POTTER'S PASTIES & PIES

**Reg. No. 4,125,213**

**Registered Apr. 10, 2012**

**Int. Cl.: 30**

**TRADEMARK**

**PRINCIPAL REGISTER**

POTTER'S PASTIES LLC (MINNESOTA LIMITED LIABILITY COMPANY)  
7698 SOUTH BAY DRIVE  
BLOOMINGTON, MN 55438

FOR: PASTRIES; PASTRIES, NAMELY, PASTIES, IN CLASS 30 (U.S. CL. 46).

FIRST USE 5-25-2011; IN COMMERCE 5-25-2011.

THE MARK CONSISTS OF STANDARD CHARACTERS WITHOUT CLAIM TO ANY PARTICULAR FONT, STYLE, SIZE, OR COLOR.

NO CLAIM IS MADE TO THE EXCLUSIVE RIGHT TO USE "PASTIES & PIES", APART FROM THE MARK AS SHOWN.

SER. NO. 85-385,848, FILED 8-1-2011.

KATINA MISTER, EXAMINING ATTORNEY



*David J. Kybas*

Director of the United States Patent and Trademark Office

# United States of America

United States Patent and Trademark Office

## POTTER'S PASTIES & PIES

**Reg. No. 4,125,214**

POTTER'S PASTIES LLC (MINNESOTA LIMITED LIABILITY COMPANY)  
7698 SOUTH BAY DRIVE  
BLOOMINGTON, MN 55438

**Registered Apr. 10, 2012**

**Int. Cl.: 43**

FOR: PROVIDING OF FOOD AND DRINK; PROVIDING OF FOOD AND DRINK VIA A MOBILE TRUCK, IN CLASS 43 (U.S. CLS. 100 AND 101).

**SERVICE MARK**

FIRST USE 5-25-2011; IN COMMERCE 5-25-2011.

**PRINCIPAL REGISTER**

THE MARK CONSISTS OF STANDARD CHARACTERS WITHOUT CLAIM TO ANY PARTICULAR FONT, STYLE, SIZE, OR COLOR.

NO CLAIM IS MADE TO THE EXCLUSIVE RIGHT TO USE "PASTIES & PIES", APART FROM THE MARK AS SHOWN.

SER. NO. 85-385,851, FILED 8-1-2011.

KATINA MISTER, EXAMINING ATTORNEY



*David J. Kyffers*

Director of the United States Patent and Trademark Office

# United States of America

United States Patent and Trademark Office



**Reg. No. 4,125,215**

PUBLICBEAT, LLC (TEXAS LIMITED LIABILITY COMPANY)  
6338 N. NEW BRAUNFELS AVE. #201  
SAN ANTONIO, TX 78209

**Registered Apr. 10, 2012**

**Int. Cl.: 41**

FOR: PROVIDING AN ONLINE ENTERTAINMENT, RECREATION, LEISURE, AND CURRENT EVENT NEWS AND INFORMATION CALENDAR SPECIFIC TO A CITY SELECTED BY THE USER, IN CLASS 41 (U.S. CLS. 100, 101 AND 107).

**SERVICE MARK**

FIRST USE 10-0-2010; IN COMMERCE 10-0-2010.

**PRINCIPAL REGISTER**

THE MARK CONSISTS OF THE WORD "PUBLIC" IN BLACK FOLLOWED BY THE WORD "BEAT" IN BLUE WITH A STYLIZED DESIGN OF A MEGAPHONE IN BLACK POSITIONED OVER THE WORDS EXTENDING FROM AND FORMING THE DOT OVER THE LETTER "I".

THE COLOR(S) BLACK AND BLUE IS/ARE CLAIMED AS A FEATURE OF THE MARK.

SER. NO. 85-385,873, FILED 8-1-2011.

ODESSA BIBBINS, EXAMINING ATTORNEY



*David J. Kyffers*

Director of the United States Patent and Trademark Office

# United States of America

United States Patent and Trademark Office



**Reg. No. 4,125,216**

**Registered Apr. 10, 2012**

**Int. Cl.: 37**

**SERVICE MARK**

**PRINCIPAL REGISTER**

FIREHOUSE ENTERPRISES, LLC (VIRGINIA LIMITED LIABILITY COMPANY), DBA  
FIREHOUSE WINDOWS AND SIDING  
210 N 21ST ST, SUITE C  
PURCELLVILLE, VA 20132

FOR: BUILDING CONSTRUCTION; BUILDING CONSTRUCTION AND REPAIR; BUILDING CONSTRUCTION SERVICES; BUILDING CONSTRUCTION, REMODELING AND REPAIR; BUILDING MAINTENANCE AND REPAIR; CONSTRUCTION AND REPAIR OF BUILDINGS; CONSTRUCTION, MAINTENANCE AND RENOVATION OF PROPERTY; CUSTOM CONSTRUCTION AND BUILDING RENOVATION; DOOR REPAIR SERVICES; HOUSE BUILDING AND REPAIR; HOUSING SERVICES, NAMELY, REPAIR, IMPROVEMENT, AND CONSTRUCTION OF RESIDENTIAL REAL PROPERTY; INSTALLATION, MAINTENANCE AND REPAIR OF DOORS; INSTALLATION, MAINTENANCE AND REPAIR OF WINDOWS, DOORS, AND SIDING FOR HOUSES AND BUILDINGS.; INSTALLATION, REPAIR AND REPLACEMENT OF WINDOWS, DOORS, AND SIDING FOR HOUSES AND BUILDINGS.; REMODELING OF WINDOWS, DOORS, AND SIDING FOR HOUSES AND BUILDINGS; RENOVATION IN THE FIELD OF WINDOWS, DOORS AND SIDING FOR HOUSES AND BUILDINGS; RESIDENTIAL AND COMMERCIAL BUILDING CONSTRUCTION, IN CLASS 37 (U.S. CLS. 100, 103 AND 106).

FIRST USE 1-27-2009; IN COMMERCE 1-27-2009.

THE MARK CONSISTS OF A RED AND WHITE FIREMAN'S CREST, THAT CONTAINS "FH" IN WHITE LETTERING AND A WHITE FIREMAN'S HELMET SURROUNDED BY A BLACK CIRCLE. THE BACKGROUND BEHIND THE CREST ITSELF ALSO IS BLACK.

THE COLOR(S) BLACK, RED, AND WHITE IS/ARE CLAIMED AS A FEATURE OF THE MARK.

SER. NO. 85-385,879, FILED 8-1-2011.

DORITT L. CARROLL, EXAMINING ATTORNEY



*David J. Kyffers*

Director of the United States Patent and Trademark Office

**United States of America**  
United States Patent and Trademark Office

# TOODALOO

**Reg. No. 4,125,217**

TOODALOO LLC (FLORIDA LIMITED LIABILITY COMPANY)  
18323 CUTLASS DR.

**Registered Apr. 10, 2012**

FORT MYERS BEACH, FL 33931

**Int. Cl.: 25**

FOR: HATS; JACKETS; PANTS; SHIRTS, IN CLASS 25 (U.S. CLS. 22 AND 39).

**TRADEMARK**

FIRST USE 4-1-2011; IN COMMERCE 4-1-2011.

**PRINCIPAL REGISTER**

THE MARK CONSISTS OF STANDARD CHARACTERS WITHOUT CLAIM TO ANY PARTICULAR FONT, STYLE, SIZE, OR COLOR.

SER. NO. 85-385,922, FILED 8-1-2011.

JUSTINE D. PARKER, EXAMINING ATTORNEY



*David J. Kyffers*

Director of the United States Patent and Trademark Office



# United States of America

United States Patent and Trademark Office

## HICKORY HARDWARE PROJECT PACK

**Reg. No. 4,125,218**

**Registered Apr. 10, 2012**

**Int. Cl.: 6**

**TRADEMARK**

**PRINCIPAL REGISTER**

BELWITH PRODUCTS, LLC (DELAWARE LIMITED LIABILITY COMPANY), DBA HICKORY  
HARDWARE  
3100 BROADWAY SW  
GRANDVILLE, MI 49418

FOR: FURNITURE, DOOR, AND CABINET HARDWARE MADE OF METAL, NAMELY, KNOBS, PULLS, HINGES, DRAWER SLIDES AND CATCHES; HOME SECURITY AND SAFETY HARDWARE MADE OF METAL, NAMELY, PADLOCKS, WINDOW LOCKS, DRAWER LOCKS, MAIL BOX LOCKS, LUGGAGE LOCKS, REMOVABLE AUXILIARY DOOR LOCKING DEVICES AND REMOVABLE AUXILIARY DRAWER LOCKING DEVICES, IN CLASS 6 (U.S. CLS. 2, 12, 13, 14, 23, 25 AND 50).

FIRST USE 1-7-2011; IN COMMERCE 1-7-2011.

THE MARK CONSISTS OF STANDARD CHARACTERS WITHOUT CLAIM TO ANY PARTICULAR FONT, STYLE, SIZE, OR COLOR.

OWNER OF U.S. REG. NO. 3,529,212.

NO CLAIM IS MADE TO THE EXCLUSIVE RIGHT TO USE "HARDWARE" AND "PACK", APART FROM THE MARK AS SHOWN.

SER. NO. 85-385,923, FILED 8-1-2011.

EMILY CARLSEN, EXAMINING ATTORNEY



*David J. Kyffers*

Director of the United States Patent and Trademark Office

# United States of America

United States Patent and Trademark Office

# Kid's Weigh

**Reg. No. 4,125,219**

SUDHA SINGH, MD, PLLC (NEW YORK LIMITED LIABILITY COMPANY)  
30 GICK ROAD, PO BOX 616  
SARATOGA SPRINGS, NY 12866

**Registered Apr. 10, 2012**

**Int. Cl.: 44**

FOR: MEDICAL SERVICES, IN CLASS 44 (U.S. CLS. 100 AND 101).

**SERVICE MARK**

FIRST USE 7-14-2011; IN COMMERCE 7-14-2011.

**PRINCIPAL REGISTER**

THE MARK CONSISTS OF STANDARD CHARACTERS WITHOUT CLAIM TO ANY PARTICULAR FONT, STYLE, SIZE, OR COLOR.

NO CLAIM IS MADE TO THE EXCLUSIVE RIGHT TO USE "KID'S", APART FROM THE MARK AS SHOWN.

SER. NO. 85-385,931, FILED 8-1-2011.

ALICIA COLLINS, EXAMINING ATTORNEY



*David J. Kybas*

Director of the United States Patent and Trademark Office

# United States of America

United States Patent and Trademark Office

# ARASHIELD

**Reg. No. 4,125,220**

**Registered Apr. 10, 2012**

**Int. Cl.: 22**

**TRADEMARK**

**PRINCIPAL REGISTER**

NTR INCORPORATED (GEORGIA CORPORATION), DBA BLUEWATER ROPES  
209 LOVVORN ROAD  
CARROLLTON, GA 30117

FOR: ROPES AND SYNTHETIC ROPES, IN CLASS 22 (U.S. CLS. 1, 2, 7, 19, 22, 42 AND 50).

FIRST USE 1-3-2011; IN COMMERCE 1-14-2011.

THE MARK CONSISTS OF STANDARD CHARACTERS WITHOUT CLAIM TO ANY PARTICULAR FONT, STYLE, SIZE, OR COLOR.

SER. NO. 85-385,942, FILED 8-1-2011.

HOWARD B. LEVINE, EXAMINING ATTORNEY



*David J. Kybas*

Director of the United States Patent and Trademark Office

# United States of America

United States Patent and Trademark Office

## Lex's of Carytown

**Reg. No. 4,125,221**

**Registered Apr. 10, 2012**

**Int. Cl.: 35**

**SERVICE MARK**

**PRINCIPAL REGISTER**

LEX'S OF CARYTOWN, LTD. (VIRGINIA CORPORATION), AKA LEX'S OF CARYTOWN  
3020 W. CARY STREET  
RICHMOND, VA 23221

FOR: RETAIL CLOTHING BOUTIQUES; RETAIL STORE AND ON-LINE RETAIL STORE  
SERVICES FEATURING WOMEN'S CLOTHING, SHOES, JEWELRY, IN CLASS 35 (U.S.  
CLS. 100, 101 AND 102).

FIRST USE 10-0-1996; IN COMMERCE 8-0-1999.

THE MARK CONSISTS OF STANDARD CHARACTERS WITHOUT CLAIM TO ANY PAR-  
TICULAR FONT, STYLE, SIZE, OR COLOR.

NO CLAIM IS MADE TO THE EXCLUSIVE RIGHT TO USE "CARYTOWN", APART FROM  
THE MARK AS SHOWN.

SER. NO. 85-385,960, FILED 8-1-2011.

JUDITH HELFMAN, EXAMINING ATTORNEY



*David J. Kyffers*

Director of the United States Patent and Trademark Office

United States of America  
United States Patent and Trademark Office

**Ave**

**Reg. No. 4,125,222**

**Registered Apr. 10, 2012**

**Int. Cl.: 29**

**TRADEMARK**

**PRINCIPAL REGISTER**

RAGASA INDUSTRIAS, S.A. DE C.V. (MEXICO CORPORATION)  
AV. DR. JOSE ELEUTERIO GONZALEZ # 2815  
COL. MITRAS NORTE  
MONTERREY, N.L., MEXICO 64320

FOR: EDIBLE OILS AND FATS, IN CLASS 29 (U.S. CL. 46).

OWNER OF MEXICO REG. NO. 1060542, DATED 8-11-2008, EXPIRES 8-11-2018.

SER. NO. 85-385,977, FILED 8-1-2011.

JUDITH HELFMAN, EXAMINING ATTORNEY



*David J. Kyffers*

Director of the United States Patent and Trademark Office

United States of America  
United States Patent and Trademark Office

**i-Frame**  
**BUILDING SOLUTIONS**

**Reg. No. 4,125,223**

IFRAME BUILDING SOLUTIONS, LLC. (ARIZONA LIMITED LIABILITY COMPANY)  
8425 NORTH 90TH ST, SUITE 3  
SCOTTSDALE, AZ 85258

**Registered Apr. 10, 2012**

**Int. Cl.: 6**

FOR: COMMON METALS AND THEIR ALLOYS, NAMELY, METAL FRAMING SYSTEM COMPRISED OF METAL BUILDING CURTAIN WALLS WITH INSULATION; METAL BUILDING SYSTEM COMPRISED OF METAL BUILDING WALL PANELS; STEEL FRAMING SYSTEM WITH INSULATION, IN CLASS 6 (U.S. CLS. 2, 12, 13, 14, 23, 25 AND 50).

**TRADEMARK**

**PRINCIPAL REGISTER**

FIRST USE 3-31-2011; IN COMMERCE 3-31-2011.

NO CLAIM IS MADE TO THE EXCLUSIVE RIGHT TO USE "BUILDING SOLUTIONS", APART FROM THE MARK AS SHOWN.

THE MARK CONSISTS OF THE WORDING "I-FRAME" WITH THE WORDS "BUILDING SOLUTIONS" CENTERED BENEATH WITHIN A RECTANGULAR BOX.

SER. NO. 85-386,022, FILED 8-1-2011.

PATRICIA EVANKO, EXAMINING ATTORNEY



*David J. Kyffers*

Director of the United States Patent and Trademark Office

# United States of America

United States Patent and Trademark Office

# ZERO HEDGE

**Reg. No. 4,125,224**

ZERO HEDGE, LLC (DELAWARE LIMITED LIABILITY COMPANY)

**Registered Apr. 10, 2012**

220 E. 72ND STREET, APT 12G  
NEW YORK, NY 10021

**Int. Cl.: 35**

FOR: PROVIDING AN INTERNET WEBSITE FEATURING NEWS AND INFORMATION IN THE FIELD OF NATIONAL AND INTERNATIONAL POLITICS; PROVIDING CONSUMER NEWS AND INFORMATION IN THE FIELD OF EDUCATIONAL PRODUCTS AND SERVICES THAT HELP INDIVIDUALS AND BUSINESSES MAKE AND SAVE MONEY; PROVIDING INFORMATION AND NEWS IN THE FIELD OF BUSINESS; PROVIDING INFORMATION AND NEWS IN THE FIELD OF BUSINESS, NAMELY, INFORMATION AND NEWS ON CURRENT EVENTS AND ON ECONOMIC, LEGISLATIVE, AND REGULATORY DEVELOPMENTS AS IT RELATES TO AND CAN IMPACT BUSINESSES, IN CLASS 35 (U.S. CLS. 100, 101 AND 102).

**SERVICE MARK**

**PRINCIPAL REGISTER**

FIRST USE 1-9-2009; IN COMMERCE 1-9-2009.

THE MARK CONSISTS OF STANDARD CHARACTERS WITHOUT CLAIM TO ANY PARTICULAR FONT, STYLE, SIZE, OR COLOR.

SER. NO. 85-386,028, FILED 8-1-2011.

KELLY BOULTON, EXAMINING ATTORNEY



*David J. Kybas*

Director of the United States Patent and Trademark Office

# United States of America

United States Patent and Trademark Office



**Reg. No. 4,125,225**

**Registered Apr. 10, 2012**

**Int. Cl.: 41**

**SERVICE MARK**

**PRINCIPAL REGISTER**

CHAN SERVICES, LLC (PENNSYLVANIA LIMITED LIABILITY COMPANY), DBA VALLEY CREEK PRODUCTIONS  
1500 GROVE AVENUE  
WEST CHESTER, PA 19380

FOR: POST-PRODUCTION EDITING SERVICES IN THE FIELD OF MUSIC, VIDEOS AND FILM; VIDEO PRODUCTION SERVICES; VIDEO TAPE FILM PRODUCTION; VIDEOGRAPHY SERVICES, IN CLASS 41 (U.S. CLS. 100, 101 AND 107).

FIRST USE 7-25-2011; IN COMMERCE 8-1-2011.

NO CLAIM IS MADE TO THE EXCLUSIVE RIGHT TO USE "PRODUCTIONS", APART FROM THE MARK AS SHOWN.

THE COLOR(S) BLACK, ORANGE, YELLOW, GREEN, BLUE IS/ARE CLAIMED AS A FEATURE OF THE MARK.

THE MARK CONSISTS OF THE WORDING "VALLEY CREEK" IN ORANGE ON A PIECE OF LIGHT BLACK FILM WITH "PRODUCTIONS" IN ORANGE BELOW ON A BLACK BACKGROUND. ABOVE THE TEXT IS A SCENE DEPICTING A YELLOW SUN, GREEN MOUNTAINS, AND BLUE CREEK WITHIN A VALLEY ALL WITH A BLACK BACKGROUND. THE ENTIRE IMAGE IS SURROUNDED BY AN ORANGE OUTLINE INSIDE A LIGHT BLACK OUTLINE.

SER. NO. 85-386,031, FILED 8-1-2011.

KELLY BOULTON, EXAMINING ATTORNEY



*David J. Kypos*

Director of the United States Patent and Trademark Office



# United States of America

United States Patent and Trademark Office



**Reg. No. 4,125,226**

**Registered Apr. 10, 2012**

**Int. Cl.: 44**

CAROLINA CANINES FOR SERVICE INC. (NORTH CAROLINA CORPORATION), DBA  
CANINES FOR VETERANS  
STE 101  
1200 N. 23RD ST.  
WILMINGTON, NC 28405

**SERVICE MARK**

FOR: CHARITABLE SERVICES, NAMELY, LENDING TRAINED SERVICE DOGS TO  
VETERANS, IN CLASS 44 (U.S. CLS. 100 AND 101).

**PRINCIPAL REGISTER**

FIRST USE 1-0-2008; IN COMMERCE 4-0-2008.

NO CLAIM IS MADE TO THE EXCLUSIVE RIGHT TO USE "CANINES FOR VETERANS"  
AND "UNIVERSAL HANDICAPPED SYMBOL", APART FROM THE MARK AS SHOWN.

THE COLOR(S) RED, BLUE AND WHITE IS/ARE CLAIMED AS A FEATURE OF THE MARK.

THE MARK CONSISTS OF DIAMOND OUTLINED IN BLUE WITH A RED STICK FIGURE  
IN A WHEELCHAIR WITH A BLUE DOG STANDING BESIDE WITH THREE WHITE STARS  
ON IT'S SIDE AND RED HORIZONTAL LINES ABOVE A BLUE BANNER WITH WHITE  
WORD CANINES ABOVE RED WORDS FOR VETERANS.

SER. NO. 85-386,048, FILED 8-1-2011.

ANDREA BUTLER, EXAMINING ATTORNEY



*David J. Kybas*

Director of the United States Patent and Trademark Office

# United States of America

United States Patent and Trademark Office

# Gator Crunch

**Reg. No. 4,125,227**

WESTRONICS, INC. (MINNESOTA CORPORATION)  
7313 NORTH SHORE TRAIL  
FOREST LAKE, MN 55025

**Registered Apr. 10, 2012**

**Int. Cl.: 35**

FOR: ON-LINE WHOLESALE AND RETAIL STORE SERVICES FEATURING ELECTRONICS,  
IN CLASS 35 (U.S. CLS. 100, 101 AND 102).

**SERVICE MARK**

FIRST USE 7-8-2011; IN COMMERCE 7-8-2011.

**PRINCIPAL REGISTER**

THE MARK CONSISTS OF STANDARD CHARACTERS WITHOUT CLAIM TO ANY PARTICULAR FONT, STYLE, SIZE, OR COLOR.

SER. NO. 85-386,062, FILED S.R. 8-1-2011 AM. P.R. 11-30-2011.

MATTHEW PAPPAS, EXAMINING ATTORNEY



*David J. Kypas*

Director of the United States Patent and Trademark Office

# United States of America

United States Patent and Trademark Office

## ART + SCIENCE = UNDERSTANDING

**Reg. No. 4,125,228**

PALAY, BETSY ANN (UNITED STATES INDIVIDUAL)  
650 GERONA ROAD  
STANFORD, CA 94305

**Registered Apr. 10, 2012**

**Int. Cl.: 41**

FOR: EDUCATIONAL SERVICES, NAMELY, TEACHING, TRAINING OTHERS, AND PROVIDING PRESENTATIONS IN THE FIELD OF USING VISUAL THINKING SKILLS TO UNDERSTAND COMPLEX SCIENCE AND INFORMATION; CONSULTATION AND ADVICE REGARDING THE TEACHING OF VISUAL THINKING SKILLS TO EDUCATE ABOUT COMPLEX SCIENCE AND INFORMATION, IN CLASS 41 (U.S. CLS. 100, 101 AND 107).

**SERVICE MARK**

**PRINCIPAL REGISTER**

FIRST USE 7-28-2011; IN COMMERCE 7-28-2011.

THE MARK CONSISTS OF STANDARD CHARACTERS WITHOUT CLAIM TO ANY PARTICULAR FONT, STYLE, SIZE, OR COLOR.

SER. NO. 85-386,087, FILED 8-1-2011.

AMY KELLY, EXAMINING ATTORNEY



*David J. Kyffers*

Director of the United States Patent and Trademark Office

# United States of America

United States Patent and Trademark Office

## PANCAKE PALS

**Reg. No. 4,125,229**

SAVANNAH FOOD COMPANY, INC. (TENNESSEE CORPORATION)  
575 INDUSTRIAL ROAD  
SAVANNAH, TN 38372

**Registered Apr. 10, 2012**

**Int. Cl.: 30**

FOR: PREPARED AND PACKAGED FROZEN PANCAKES, IN CLASS 30 (U.S. CL. 46).

**TRADEMARK**

FIRST USE 8-26-2011; IN COMMERCE 8-26-2011.

**PRINCIPAL REGISTER**

THE MARK CONSISTS OF STANDARD CHARACTERS WITHOUT CLAIM TO ANY PARTICULAR FONT, STYLE, SIZE, OR COLOR.

NO CLAIM IS MADE TO THE EXCLUSIVE RIGHT TO USE "PANCAKE", APART FROM THE MARK AS SHOWN.

SER. NO. 85-386,098, FILED 8-1-2011.

LAURA HAMMEL, EXAMINING ATTORNEY



*David J. Kyffers*

Director of the United States Patent and Trademark Office

# United States of America

United States Patent and Trademark Office

## Cash Cow for Gold

**Reg. No. 4,125,230**

**Registered Apr. 10, 2012**

**Int. Cl.: 36**

**SERVICE MARK**

**PRINCIPAL REGISTER**

CASH COW FOR GOLD, LLC (TEXAS LIMITED LIABILITY COMPANY), AKA CASH COW SURPLUS AND CASH COW BROKERAGE  
7801 ALMA DRIVE, 105-277  
PLANO, TX 75025

FOR: FINANCIAL SERVICES, NAMELY, GOLD TRADING; PROVIDING MONETARY EXCHANGE SERVICES, NAMELY, EXCHANGING GOLD OF OTHERS FOR CASH, IN CLASS 36 (U.S. CLS. 100, 101 AND 102).

FIRST USE 12-14-2009; IN COMMERCE 12-14-2009.

THE MARK CONSISTS OF STANDARD CHARACTERS WITHOUT CLAIM TO ANY PARTICULAR FONT, STYLE, SIZE, OR COLOR.

NO CLAIM IS MADE TO THE EXCLUSIVE RIGHT TO USE "CASH" AND "FOR GOLD", APART FROM THE MARK AS SHOWN.

SER. NO. 85-386,143, FILED 8-1-2011.

REBECCA SMITH, EXAMINING ATTORNEY



*David J. Kyffers*

Director of the United States Patent and Trademark Office

# United States of America

United States Patent and Trademark Office

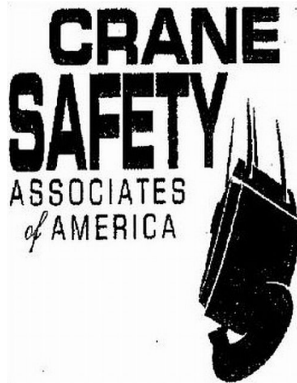

**Reg. No. 4,125,231**

**Registered Apr. 10, 2012**

**Int. Cls.: 37 and 41**

**SERVICE MARK**

**PRINCIPAL REGISTER**

CRANE SAFETY ASSOCIATES OF AMERICA, INC. (FLORIDA CORPORATION)  
730 OAK GROVE ROAD  
MCDONOUGH, GA 30253

FOR: INSPECTION AND MAINTENANCE OF CONSTRUCTION AND INDUSTRIAL CRANES,  
IN CLASS 37 (U.S. CLS. 100, 103 AND 106).

FIRST USE 10-10-2002; IN COMMERCE 10-10-2002.

FOR: TRAINING AND EVALUATION IN THE FIELD OF CONSTRUCTION AND INDUSTRIAL  
CRANES, IN CLASS 41 (U.S. CLS. 100, 101 AND 107).

FIRST USE 10-10-2002; IN COMMERCE 10-10-2002.

NO CLAIM IS MADE TO THE EXCLUSIVE RIGHT TO USE "CRANE SAFETY ASSOCIATES  
OF AMERICA", APART FROM THE MARK AS SHOWN.

THE MARK CONSISTS OF THE WORDING "CRANE SAFETY ASSOCIATES OF AMERICA"  
AND THE IMAGE OF A CRANE BLOCK WITH A CRANE HOOK.

SER. NO. 85-386,152, FILED 8-1-2011.

FLORENTINA BLANDU, EXAMINING ATTORNEY



*David J. Kybas*

Director of the United States Patent and Trademark Office

# United States of America

United States Patent and Trademark Office



## *The Bariatric Guru*

**Reg. No. 4,125,232**

AKEY, ERIN (UNITED STATES INDIVIDUAL)  
10773 RIGBY DRIVE  
MOBILE, AL 36695

**Registered Apr. 10, 2012**

**Int. Cl.: 41**

FOR: EDUCATION SERVICES, NAMELY, PROVIDING SEMINARS IN THE FIELD OF BARIATRICS, IN CLASS 41 (U.S. CLS. 100, 101 AND 107).

**SERVICE MARK**

FIRST USE 1-15-2011; IN COMMERCE 1-20-2011.

**PRINCIPAL REGISTER**

NO CLAIM IS MADE TO THE EXCLUSIVE RIGHT TO USE "BARIATRIC", APART FROM THE MARK AS SHOWN.

THE MARK CONSISTS OF A STICK FIGURE WITH HANDS RAISED IN A CIRCLE, AND THE WORDS "THE BARIATRIC GURU" BELOW THE IMAGE.

SER. NO. 85-386,155, FILED 8-1-2011.

PATRICIA EVANKO, EXAMINING ATTORNEY



*David J. Kybas*

Director of the United States Patent and Trademark Office

# United States of America

United States Patent and Trademark Office



**Reg. No. 4,125,233**

**Registered Apr. 10, 2012**

**Int. Cl.: 41**

**SERVICE MARK**

**PRINCIPAL REGISTER**

KAPIS, TONYA (UNITED STATES INDIVIDUAL)  
4294 WESTINGHOUSE AVE.  
TRAFFORD, PA 15085 AND

MILLIRON, TEMEA (ESTONIA INDIVIDUAL)  
4294 WESTINGHOUSE AVE.  
TRAFFORD, PA 15085

FOR: YOGA INSTRUCTION, IN CLASS 41 (U.S. CLS. 100, 101 AND 107).

FIRST USE 6-1-2011; IN COMMERCE 6-6-2011.

NO CLAIM IS MADE TO THE EXCLUSIVE RIGHT TO USE "YOGA", APART FROM THE MARK AS SHOWN.

THE MARK CONSISTS OF A CIRCLE SURROUNDING A SILHOUETTE OF A GIRL SITTING WITH HER LEGS CROSSED AND HER HANDS TOGETHER ABOVE HER HEAD WITH THE FINGERTIPS POINTING UP. THERE ARE 15 BUTTERFLIES AROUND HER. UNDER-NEATH HER IS THE STYLIZED TEXT "INFRA ~WAVE YOGA".

SER. NO. 85-386,156, FILED 8-1-2011.

CHRISTOPHER LAW, EXAMINING ATTORNEY



*David J. Kybas*

Director of the United States Patent and Trademark Office



# United States of America

United States Patent and Trademark Office

## Strategic Scrap

**Reg. No. 4,125,234**

**Registered Apr. 10, 2012**

**Int. Cl.: 35**

**SERVICE MARK**

**PRINCIPAL REGISTER**

STRATEGIC SCRAP CORP. (IOWA CORPORATION)  
P.O. BOX 641  
WATERLOO, IA 50704

FOR: PROMOTING THE GOODS AND SERVICES OF OTHERS BY PROVIDING A WEBSITE WHERE OTHERS CAN BUY AND SELL SCRAP METAL; PROVIDING A WEBSITE FEATURING AN ONLINE MARKETPLACE FOR EXCHANGING GOODS AND SERVICES WITH OTHER USERS; PROVIDING A WEBSITE FOR CONNECTING SELLERS WITH BUYERS, IN CLASS 35 (U.S. CLS. 100, 101 AND 102).

FIRST USE 10-1-2010; IN COMMERCE 10-1-2010.

THE MARK CONSISTS OF STANDARD CHARACTERS WITHOUT CLAIM TO ANY PARTICULAR FONT, STYLE, SIZE, OR COLOR.

NO CLAIM IS MADE TO THE EXCLUSIVE RIGHT TO USE "SCRAP", APART FROM THE MARK AS SHOWN.

SER. NO. 85-386,175, FILED 8-1-2011.

BARBARA GAYNOR, EXAMINING ATTORNEY



*David J. Kyffers*

Director of the United States Patent and Trademark Office

# United States of America

United States Patent and Trademark Office



**Reg. No. 4,125,235**

**Registered Apr. 10, 2012**

**Int. Cl.: 28**

**TRADEMARK**

**PRINCIPAL REGISTER**

BABCHINETSKAYA, LINA (UNITED STATES INDIVIDUAL)  
748 KENTWOOD STREET  
PHILADELPHIA, PA 19116 AND

BIRMAN, ROMAN (UNITED STATES INDIVIDUAL)  
748 KENTWOOD STREET  
PHILADELPHIA, PA 19116

FOR: MANUALLY-OPERATED EXERCISE EQUIPMENT FOR PHYSICAL FITNESS PURPOSES, IN CLASS 28 (U.S. CLS. 22, 23, 38 AND 50).

FIRST USE 1-1-2011; IN COMMERCE 6-1-2011.

NO CLAIM IS MADE TO THE EXCLUSIVE RIGHT TO USE "FITNESS", APART FROM THE MARK AS SHOWN.

THE MARK CONSISTS OF A LIGHTING BOLT IN THE CENTER, BETWEEN THE OUTLINED WORDS "BOLT" AND "FITNESS".

SER. NO. 85-386,178, FILED 8-1-2011.

CAROLINE WOOD, EXAMINING ATTORNEY



*David J. Kyros*

Director of the United States Patent and Trademark Office

# United States of America

United States Patent and Trademark Office



**Reg. No. 4,125,236**

**Registered Apr. 10, 2012**

**Int. Cl.: 41**

**SERVICE MARK**

**PRINCIPAL REGISTER**

BYRON KATIE INTERNATIONAL, INC. (CALIFORNIA CORPORATION)  
309 E ALISO STREET  
OJAI, CA 93023

FOR: EDUCATIONAL SERVICES, NAMELY, PROVIDING AND CONDUCTING EDUCATIONAL SEMINARS, WORKSHOPS, AND CLASSES IN THE FIELD OF STRESS MANAGEMENT AND DISSEMINATION OF WRITTEN AND AUDIO STUDY AND EXERCISE MATERIALS IN CONNECTION THEREWITH, IN CLASS 41 (U.S. CLS. 100, 101 AND 107).

FIRST USE 4-27-2011; IN COMMERCE 4-27-2011.

OWNER OF U.S. REG. NO. 4,003,988.

THE MARK CONSISTS OF TWO BRUSH STROKES FORMING AN IMAGE OF A PARTIAL HEART.

SER. NO. 85-386,216, FILED 8-1-2011.

SANI KHOURI, EXAMINING ATTORNEY



*David J. Kyffers*

Director of the United States Patent and Trademark Office

# United States of America

United States Patent and Trademark Office

## Local Elephant

**Reg. No. 4,125,237**

**Registered Apr. 10, 2012**

**Int. Cl.: 35**

**SERVICE MARK**

**PRINCIPAL REGISTER**

333APPLES LLC. (WASHINGTON LIMITED LIABILITY COMPANY), DBA LOCAL  
ELEPHANT  
11410 NE 124TH ST. #330  
KIRKLAND, WA 98034

FOR: BUSINESS ADVICE AND INFORMATION, IN CLASS 35 (U.S. CLS. 100, 101 AND 102).

FIRST USE 12-26-2010; IN COMMERCE 6-15-2011.

THE MARK CONSISTS OF STANDARD CHARACTERS WITHOUT CLAIM TO ANY PARTICULAR FONT, STYLE, SIZE, OR COLOR.

NO CLAIM IS MADE TO THE EXCLUSIVE RIGHT TO USE "LOCAL", APART FROM THE MARK AS SHOWN.

SER. NO. 85-386,242, FILED 8-1-2011.

CHRISTINA SOBRAL, EXAMINING ATTORNEY



*David J. Kyros*

Director of the United States Patent and Trademark Office

# United States of America

United States Patent and Trademark Office

## POWER FOR FUNDING

**Reg. No. 4,125,238**

**Registered Apr. 10, 2012**

**Int. Cl.: 36**

**SERVICE MARK**

**PRINCIPAL REGISTER**

KCM MARKETING INC. (CALIFORNIA CORPORATION), DBA MK BATTERY  
1631 S. SINCLAIR STREET  
ANAHEIM, CA 92806

FOR: CHARITABLE FUNDRAISING, IN CLASS 36 (U.S. CLS. 100, 101 AND 102).

FIRST USE 4-15-2010; IN COMMERCE 4-7-2011.

THE MARK CONSISTS OF STANDARD CHARACTERS WITHOUT CLAIM TO ANY PARTICULAR FONT, STYLE, SIZE, OR COLOR.

NO CLAIM IS MADE TO THE EXCLUSIVE RIGHT TO USE "FUNDING", APART FROM THE MARK AS SHOWN.

SER. NO. 85-386,310, FILED 8-1-2011.

CHARLES L. JENKINS, EXAMINING ATTORNEY



*David J. Kyffers*

Director of the United States Patent and Trademark Office

# United States of America

United States Patent and Trademark Office

## WEARABLE TOYS

**Reg. No. 4,125,239**

AMUQUANDOH, KWEKU E. (UNITED STATES INDIVIDUAL)  
275 PARK AVE., SUITE 2N  
BROOKLYN, NY 11205

**Registered Apr. 10, 2012**

**Int. Cl.: 25**

FOR: BOW TIES; BOWLING SHOES; CANVAS SHOES; COATS; COATS FOR MEN AND WOMEN; COATS MADE OF COTTON; COATS OF DENIM; DECK-SHOES; DENIM JACKETS; DENIMS; DOWN JACKETS; JACKETS; HATS; HEADGEAR, NAMELY, HATS; HEAVY JACKETS; SHOES; INFANTS' SHOES; JOGGING PANTS; JOGGING SUITS; LEATHER COATS; LEATHER JACKETS; COATS, TROUSERS, VESTS; PANTS; RAIN COATS; RAIN JACKETS; RAIN SUITS; RAINPROOF JACKETS; SKI JACKETS; SLEEVED OR SLEEVELESS JACKETS; SMALL HATS; SNOW BOARDING SUITS; SNOW PANTS; SNOW SUITS; SNOWBOARD GLOVES; SNOWBOARD PANTS; SPORT COATS; SPORTS JACKETS; STUFF JACKETS; SUEDE JACKETS; SWEAT PANTS; SWEAT SUITS; TENNIS SHOES; TIES; CAPS; TRACK PANTS; TRACK SUITS; WARM UP SUITS; WATERPROOF JACKETS AND PANTS; WIND COATS; WIND RESISTANT JACKETS; WIND-JACKETS; WOVEN OR KNITTED UNDERWEAR; WOOL AND LEATHER VARSITY JACKETS; WOOL JACKETS; SATIN JACKETS; T-SHIRTS, IN CLASS 25 (U.S. CLS. 22 AND 39).

**TRADEMARK**

**PRINCIPAL REGISTER**

FIRST USE 11-13-2006; IN COMMERCE 11-13-2006.

THE MARK CONSISTS OF STANDARD CHARACTERS WITHOUT CLAIM TO ANY PARTICULAR FONT, STYLE, SIZE, OR COLOR.

NO CLAIM IS MADE TO THE EXCLUSIVE RIGHT TO USE "WEARABLE", APART FROM THE MARK AS SHOWN.

SER. NO. 85-386,413, FILED 8-1-2011.

JEFFERY COWARD, EXAMINING ATTORNEY



*David J. Kyros*

Director of the United States Patent and Trademark Office

# United States of America

United States Patent and Trademark Office

# ARLINGTON

**Reg. No. 4,125,240**

ARLINGTON INDUSTRIES, INC. (NEW YORK CORPORATION)  
9051 NW 97TH TERRACE  
MIAMI, FL 33178

**Registered Apr. 10, 2012**

**Int. Cl.: 9**

FOR: ELECTRICAL CONNECTORS AND ELECTRICAL JUNCTION BOXES FOR ELECTRICAL WIRING, IN CLASS 9 (U.S. CLS. 21, 23, 26, 36 AND 38).

**TRADEMARK**

FIRST USE 12-1-1988; IN COMMERCE 12-1-1988.

**PRINCIPAL REGISTER**

THE MARK CONSISTS OF STANDARD CHARACTERS WITHOUT CLAIM TO ANY PARTICULAR FONT, STYLE, SIZE, OR COLOR.

SER. NO. 85-386,589, FILED 8-2-2011.

DARRYL SPRUILL, EXAMINING ATTORNEY



*David J. Kybas*

Director of the United States Patent and Trademark Office

# United States of America

United States Patent and Trademark Office

# iBOLT.co

**Reg. No. 4,125,241**

**Registered Apr. 10, 2012**

**Int. Cl.: 9**

**TRADEMARK**

**PRINCIPAL REGISTER**

IGRIP GLOBAL, LLC (UTAH LIMITED LIABILITY COMPANY), DBA WIRELESS  
ACCESSORIES SOLUTIONS  
1173 S 250 W STE 2-504  
ST. GEORGE, UT 84770

FOR: DEVICE USED TO HOLD AND ELECTRONICALLY CHARGE PORTABLE SMART-  
PHONES AND TABLET PCS; DEVICES FOR HOLDING AND MOUNTING PORTABLE  
SMARTPHONES AND TABLET PCS, IN CLASS 9 (U.S. CLS. 21, 23, 26, 36 AND 38).

FIRST USE 8-1-2011; IN COMMERCE 8-1-2011.

THE MARK CONSISTS OF STANDARD CHARACTERS WITHOUT CLAIM TO ANY PAR-  
TICULAR FONT, STYLE, SIZE, OR COLOR.

NO CLAIM IS MADE TO THE EXCLUSIVE RIGHT TO USE "BOLT", APART FROM THE  
MARK AS SHOWN.

SER. NO. 85-386,696, FILED 8-2-2011.

KELLEY WELLS, EXAMINING ATTORNEY



*David J. Kyffers*

Director of the United States Patent and Trademark Office



# United States of America

United States Patent and Trademark Office

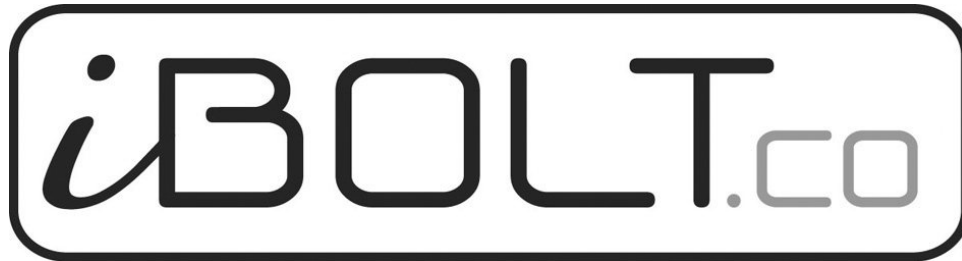

**Reg. No. 4,125,242**

**Registered Apr. 10, 2012**

**Int. Cl.: 9**

IGRIP GLOBAL, LLC (UTAH LIMITED LIABILITY COMPANY), DBA WIRELESS  
ACCESSORIES SOLUTIONS  
1173 S 250 W  
STE 2-504  
ST. GEORGE, UT 84770

**TRADEMARK**

**PRINCIPAL REGISTER**

FOR: DEVICE USED TO HOLD AND ELECTRONICALLY CHARGE PORTABLE SMART-  
PHONES AND TABLET PCS; DEVICES FOR HOLDING AND MOUNTING PORTABLE  
SMARTPHONES AND TABLET PCS, IN CLASS 9 (U.S. CLS. 21, 23, 26, 36 AND 38).

FIRST USE 8-1-2011; IN COMMERCE 8-1-2011.

NO CLAIM IS MADE TO THE EXCLUSIVE RIGHT TO USE "BOLT", APART FROM THE  
MARK AS SHOWN.

THE MARK CONSISTS OF A CARRIER SINGLE-LINE RECTANGLE WITH ROUNDED  
CORNERS, CONTAINING THE LETTERS "iBOLT.CO", WHERE "I" IS IN A LARGE STYLIZED  
FONT, "BOLT" IS IN LARGE SIMPLE LINE FONT, AND ".CO" IS IN SMALL SIMPLE LINE  
FONT.

SER. NO. 85-386,707, FILED 8-2-2011.

KELLEY WELLS, EXAMINING ATTORNEY



*David J. Kybas*

Director of the United States Patent and Trademark Office

# United States of America

United States Patent and Trademark Office

## GENERATION DEBT FREE

**Reg. No. 4,125,243**

**Registered Apr. 10, 2012**

**Int. Cl.: 36**

**SERVICE MARK**

**PRINCIPAL REGISTER**

GENERATION DEBT FREE, INC. (FLORIDA CORPORATION)  
4341 SW 73 TERRACE  
DAVIE, FL 33314

FOR: DEBT COUNSELING SERVICES, IN CLASS 36 (U.S. CLS. 100, 101 AND 102).

FIRST USE 11-18-2006; IN COMMERCE 11-18-2006.

THE MARK CONSISTS OF STANDARD CHARACTERS WITHOUT CLAIM TO ANY PARTICULAR FONT, STYLE, SIZE, OR COLOR.

NO CLAIM IS MADE TO THE EXCLUSIVE RIGHT TO USE "DEBT FREE", APART FROM THE MARK AS SHOWN.

SER. NO. 85-386,717, FILED 8-2-2011.

PATRICIA EVANKO, EXAMINING ATTORNEY



*David J. Kyffers*

Director of the United States Patent and Trademark Office

# United States of America

United States Patent and Trademark Office

**Fictiondist**  
ART/CLOTHING

**Reg. No. 4,125,244**

BERRIOS ORTIZ, GABRIEL F. (UNITED STATES INDIVIDUAL)  
46 ALTAVILLA ENCANTADA  
TRUJILLO ALTO, PUERTO RICO 00976

**Registered Apr. 10, 2012**

**Int. Cl.: 25**

FOR: BUTTON DOWN SHIRTS; CAPS; HATS; JACKETS; PANTS; SHOES; SNEAKERS; T-SHIRTS, IN CLASS 25 (U.S. CLS. 22 AND 39).

**TRADEMARK**

FIRST USE 10-0-2009; IN COMMERCE 10-0-2009.

**PRINCIPAL REGISTER**

NO CLAIM IS MADE TO THE EXCLUSIVE RIGHT TO USE "ART/CLOTHING", APART FROM THE MARK AS SHOWN.

THE MARK CONSISTS OF THE WORDS "FICTIONDIST" IN HIGHLY STYLIZED LETTERING FOLLOWED BY A PERIOD IN THE FORM OF A BOMB, WITH THE WORDS "ART/CLOTHING" BELOW.

SER. NO. 85-386,721, FILED 8-2-2011.

JOHN WILKE, EXAMINING ATTORNEY



*David J. Kyros*

Director of the United States Patent and Trademark Office

# United States of America

United States Patent and Trademark Office

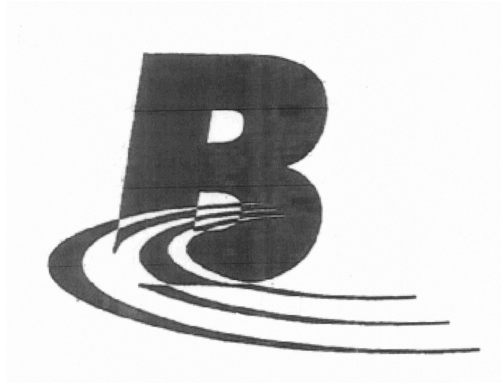

**Reg. No. 4,125,245**

**Registered Apr. 10, 2012**

**Int. Cls.: 37 and 42**

**SERVICE MARK**

**PRINCIPAL REGISTER**

BIOCHEM TECHNOLOGY, INC. (PENNSYLVANIA CORPORATION)  
3620 HORIZON DRIVE, SUITE 200  
KING OF PRUSSIA, PA 19406

FOR: INSTALLATION AND MAINTENANCE OF ELECTRONIC AND OPTICAL EQUIPMENT FOR DETECTING, ANALYZING, AND MONITORING INDUSTRIAL AND MUNICIPAL WASTEWATER INFLUENT, EFFLUENT AND PROCESS PARAMETERS, IN CLASS 37 (U.S. CLS. 100, 103 AND 106).

FIRST USE 7-1-1999; IN COMMERCE 7-1-1999.

FOR: INSTALLATION AND MAINTENANCE OF COMPUTER SOFTWARE FOR DETECTING, ANALYZING AND MONITORING INDUSTRIAL AND MUNICIPAL WASTEWATER INFLUENT, EFFLUENT AND PROCESS PARAMETERS; AND COLLECTION, MONITORING AND ANALYSIS OF INDUSTRIAL AND MUNICIPAL WASTEWATER INFLUENT, EFFLUENT AND PROCESS PARAMETERS DATA COLLECTED BY ELECTRONIC AND OPTICAL EQUIPMENT, AND CONSULTATION SERVICES BASED ON SUCH DATA COLLECTION, MONITORING AND ANALYSIS; AND ENGINEERING CONSULTING SERVICES IN THE FIELD OF INDUSTRIAL AND MUNICIPAL WASTEWATER, IN CLASS 42 (U.S. CLS. 100 AND 101).

FIRST USE 7-1-1999; IN COMMERCE 7-1-1999.

OWNER OF U.S. REG. NOS. 2,496,872 AND 2,496,873.

THE MARK CONSISTS OF THE LETTER "B" WITH THREE CURVED LINES COMING OUT OF THE LOWER HALF OF THE "B".

SER. NO. 85-386,794, FILED 8-2-2011.

TARAH HARDY, EXAMINING ATTORNEY



*David J. Kybas*

Director of the United States Patent and Trademark Office

# United States of America

United States Patent and Trademark Office



**BERRY**  
Insurance Group

**Reg. No. 4,125,246**

BERRY INSURANCE GROUP, INC. (OHIO CORPORATION)  
706 INDIAN HILL ROAD  
TERRACE PARK, OH 45174

**Registered Apr. 10, 2012**

**Int. Cl.: 36**

FOR: INSURANCE AGENCIES IN THE FIELDS OF PROPERTY, CASUALTY, LIFE, HEALTH AND SURPLUS INSURANCE, IN CLASS 36 (U.S. CLS. 100, 101 AND 102).

**SERVICE MARK**

FIRST USE 7-19-2011; IN COMMERCE 7-19-2011.

**PRINCIPAL REGISTER**

NO CLAIM IS MADE TO THE EXCLUSIVE RIGHT TO USE "INSURANCE GROUP", APART FROM THE MARK AS SHOWN.

THE MARK CONSISTS OF THE LETTER "B" INSIDE A SHADED CIRCLE DESIGN, TO THE LEFT OF THE WORDING "BERRY INSURANCE GROUP", IN STYLIZED FORM.

SER. NO. 85-386,846, FILED 8-2-2011.

BARBARA A. GOLD, EXAMINING ATTORNEY



*David J. Kybas*

Director of the United States Patent and Trademark Office

# United States of America

United States Patent and Trademark Office



**Reg. No. 4,125,247**

**Registered Apr. 10, 2012**

**Int. Cl.: 9**

**TRADEMARK**

**PRINCIPAL REGISTER**

DE JESUS, ANTONIO (UNITED STATES INDIVIDUAL)  
6H  
245 EAST 124TH STREET  
NEW YORK, NY 10035

FOR: PROTECTIVE CARRYING CASES FOR MOBILE PHONES, HANDHELD DIGITAL ELECTRONIC DEVICES, PERSONAL DIGITAL ASSISTANTS (PDA), HANDHELD PERSONAL COMPUTERS, AND COMPUTER PERIPHERAL DEVICES, IN CLASS 9 (U.S. CLS. 21, 23, 26, 36 AND 38).

FIRST USE 2-21-2010; IN COMMERCE 2-21-2010.

NO CLAIM IS MADE TO THE EXCLUSIVE RIGHT TO USE "LABS", APART FROM THE MARK AS SHOWN.

THE MARK CONSISTS OF THE TERMS, "NUGO LABS", IN STYLIZED FORM WITH A SMALL CIRCLE TO THE UPPER RIGHT OF "NUGO", ALL WITHIN A ROUND-EDGED SHADED RECTANGLE DESIGN.

SER. NO. 85-386,847, FILED 8-2-2011.

BARBARA A. GOLD, EXAMINING ATTORNEY



*David J. Kybas*

Director of the United States Patent and Trademark Office

# United States of America

United States Patent and Trademark Office

# Road Rhino

**Reg. No. 4,125,248**

TANDEM METALS (ILLINOIS LIMITED LIABILITY COMPANY)  
1149 S CENTRAL AVE  
UNIVERSITY PARK, IL 60484

**Registered Apr. 10, 2012**

**Int. Cl.: 40**

FOR: CUSTOM MANUFACTURE OF AFTER MARKET WINCH BUMPERS FOR OFF ROAD VEHICLES AND HEAVY-DUTY TRUCKS, IN CLASS 40 (U.S. CLS. 100, 103 AND 106).

**SERVICE MARK**

FIRST USE 7-21-2010; IN COMMERCE 7-21-2010.

**PRINCIPAL REGISTER**

THE MARK CONSISTS OF STANDARD CHARACTERS WITHOUT CLAIM TO ANY PARTICULAR FONT, STYLE, SIZE, OR COLOR.

SER. NO. 85-386,879, FILED 8-2-2011.

HOWARD B. LEVINE, EXAMINING ATTORNEY



*David J. Kyfos*

Director of the United States Patent and Trademark Office

# United States of America

United States Patent and Trademark Office

## GOOD FOOD HONEST DRINK

**Reg. No. 4,125,249**

**Registered Apr. 10, 2012**

**Int. Cl.: 43**

**SERVICE MARK**

**PRINCIPAL REGISTER**

O'NIELL'S INTELLECTUAL PROPERTY, LLC. (NEW MEXICO LIMITED LIABILITY COMPANY)  
4310 CENTRAL AVENUE, S.E., SUITE B  
ALBUQUERQUE, NM 87108

FOR: RESTAURANT SERVICES, IN CLASS 43 (U.S. CLS. 100 AND 101).

FIRST USE 1-1-1995; IN COMMERCE 1-1-1995.

THE MARK CONSISTS OF STANDARD CHARACTERS WITHOUT CLAIM TO ANY PARTICULAR FONT, STYLE, SIZE, OR COLOR.

NO CLAIM IS MADE TO THE EXCLUSIVE RIGHT TO USE "GOOD FOOD" AND "DRINK", APART FROM THE MARK AS SHOWN.

SER. NO. 85-386,919, FILED 8-2-2011.

JASON TURNER, EXAMINING ATTORNEY



*David J. Kyfos*

Director of the United States Patent and Trademark Office



# United States of America

United States Patent and Trademark Office

## TRIBRIDGE CONCERTO CLOUD SERVICES

**Reg. No. 4,125,250**

TRIBRIDGE HOLDINGS, LLC (DELAWARE LIMITED LIABILITY COMPANY)  
4830 W. KENNEDY BOULEVARD, SUITE 890  
TAMPA, FL 33609

**Registered Apr. 10, 2012**

**Int. Cl.: 42**

FOR: PROVIDING INTEGRATED PUBLIC AND PRIVATE CLOUD COMPUTING SERVICES  
TO BUSINESSES, IN CLASS 42 (U.S. CLS. 100 AND 101).

**SERVICE MARK**

FIRST USE 6-9-2011; IN COMMERCE 6-9-2011.

**PRINCIPAL REGISTER**

THE MARK CONSISTS OF STANDARD CHARACTERS WITHOUT CLAIM TO ANY PAR-  
TICULAR FONT, STYLE, SIZE, OR COLOR.

OWNER OF U.S. REG. NO. 2,690,039.

NO CLAIM IS MADE TO THE EXCLUSIVE RIGHT TO USE "CLOUD SERVICES", APART  
FROM THE MARK AS SHOWN.

SER. NO. 85-386,938, FILED 8-2-2011.

CHRISTOPHER BUONGIORNO, EXAMINING ATTORNEY



*David J. Kyffers*

Director of the United States Patent and Trademark Office

# United States of America

United States Patent and Trademark Office

## BANANA BUNKER

**Reg. No. 4,125,251**

STREMPLE, PAUL R. (UNITED STATES INDIVIDUAL)  
87 SUMMER STREET

**Registered Apr. 10, 2012**

MANCHESTER BY THE SEA, MA 01944

**Int. Cl.: 21**

FOR: PLASTIC STORAGE CONTAINERS FOR HOUSEHOLD OR DOMESTIC USE, IN CLASS 21 (U.S. CLS. 2, 13, 23, 29, 30, 33, 40 AND 50).

**TRADEMARK**

FIRST USE 2-16-2004; IN COMMERCE 2-16-2004.

**PRINCIPAL REGISTER**

THE MARK CONSISTS OF STANDARD CHARACTERS WITHOUT CLAIM TO ANY PARTICULAR FONT, STYLE, SIZE, OR COLOR.

NO CLAIM IS MADE TO THE EXCLUSIVE RIGHT TO USE "BANANA", APART FROM THE MARK AS SHOWN.

SER. NO. 85-386,963, FILED 8-2-2011.

ALLISON SCHRODY, EXAMINING ATTORNEY



*David J. Kybas*

Director of the United States Patent and Trademark Office

# United States of America

United States Patent and Trademark Office

## OHIO OMNI

**Reg. No. 4,125,252**

**Registered Apr. 10, 2012**

**Int. Cl.: 42**

**SERVICE MARK**

**PRINCIPAL REGISTER**

TECHSOLVE, INC. (OHIO CORPORATION)  
6705 STEGER DRIVE  
CINCINNATI, OH 45237

FOR: PROVIDING AN INTERACTIVE WEBSITE FOR PRODUCT INNOVATION AND DEVELOPMENT BETWEEN BUSINESS AND MANUFACTURING THROUGH COLLABORATION IN TECHNICAL KNOWLEDGE, LABORATORY FACILITIES, TEST EQUIPMENT AND PHYSICAL ASSETS FOR PRODUCT TESTING AND DEVELOPMENT, IN CLASS 42 (U.S. CLS. 100 AND 101).

FIRST USE 3-5-2010; IN COMMERCE 3-5-2010.

THE MARK CONSISTS OF STANDARD CHARACTERS WITHOUT CLAIM TO ANY PARTICULAR FONT, STYLE, SIZE, OR COLOR.

NO CLAIM IS MADE TO THE EXCLUSIVE RIGHT TO USE "OHIO", APART FROM THE MARK AS SHOWN.

SER. NO. 85-386,969, FILED 8-2-2011.

CHRISTOPHER BUONGIORNO, EXAMINING ATTORNEY



*David J. Kyjars*

Director of the United States Patent and Trademark Office

# United States of America

United States Patent and Trademark Office



**Reg. No. 4,125,253**

**Registered Apr. 10, 2012**

**Int. Cls.: 18 and 25**

**TRADEMARK**

**PRINCIPAL REGISTER**

CHRISTIAAN KEMPES (BELGIUM INDIVIDUAL)  
3830 MARIETTA WAY  
ST. CLOUD, FL 34772

FOR: UMBRELLAS FOR CHILDREN, IN CLASS 18 (U.S. CLS. 1, 2, 3, 22 AND 41).

FIRST USE 7-4-2011; IN COMMERCE 7-4-2011.

FOR: RAIN BOOTS; RAINCOATS, IN CLASS 25 (U.S. CLS. 22 AND 39).

FIRST USE 7-4-2011; IN COMMERCE 7-4-2011.

THE MARK CONSISTS OF THE STYLIZED TERM "KIDDIDOO" WITH A DESIGN OF A PAIR OF EYES ABOVE THE LETTER "K"; THE LETTER "K" IS RED, THE LETTER "I" IS ORANGE, THE LETTER "D" IS GREEN, THE SECOND LETTER "D" IS BLUE, THE LETTER "I" IS ORANGE, THE LETTER "D" IS RED, THE LETTER "O" IS BLUE AND THE LAST LETTER "O" IS GREEN. THE TERM IS OUTLINED WITH WHITE AND A SINGLE BLACK LINE. THE EYES ABOVE THE LETTER "K" ARE IN THE COLORS BLACK AND WHITE. .

THE COLOR(S) WHITE, BLACK, RED, ORANGE, GREEN AND BLUE ARE CLAIMED AS A FEATURE OF THE MARK. IS/ARE CLAIMED AS A FEATURE OF THE MARK.

SER. NO. 85-386,981, FILED 8-2-2011.

CHRISTOPHER BUONGIORNO, EXAMINING ATTORNEY



*David J. Kybas*

Director of the United States Patent and Trademark Office

# United States of America

United States Patent and Trademark Office



**SPRING LOTUS**  
Satisfy Your Needs

**Reg. No. 4,125,254**

**Registered Apr. 10, 2012**

**Int. Cl.: 35**

**SERVICE MARK**

**PRINCIPAL REGISTER**

SPRING LOTUS LTD. (TAIWAN CORPORATION)  
16F., NO. 38-1, SEC. 5  
NANJING E. RD., SONGSHAN DISTRICT  
TAIPEI CITY, TAIWAN

FOR: ADMINISTRATIVE PROCESSING OF PURCHASE ORDERS; BUSINESS ADVICE AND COMMERCIAL INFORMATION; BUSINESS ADVISORY SERVICES, CONSULTANCY AND INFORMATION; COMMERCIAL ADMINISTRATION OF THE LICENSING OF THE GOODS AND SERVICES OF OTHERS; COMMERCIAL INFORMATION AND ADVICE FOR CONSUMERS; CONSUMER ADVICE SHOP; COMMERCIAL INFORMATION AND DIRECTORY AGENCY; COST PRICE ANALYSIS; DISTRIBUTION OF SAMPLES FOR PUBLICITY PURPOSES; IMPORT AND EXPORT AGENCIES; OUTSOURCING SERVICES; BUSINESS ASSISTANCE; PROCUREMENT, NAMELY, PURCHASING STEMWARE, DINNERWARE AND GLASS ORNAMENTS FOR OTHERS; PURCHASING AGENTS, IN CLASS 35 (U.S. CLS. 100, 101 AND 102).

FIRST USE 3-31-2011; IN COMMERCE 3-31-2011.

THE MARK CONSISTS OF A DESIGN OF A LOTUS FLOWER FOLLOWED BY THE WORDS "SPRING LOTUS" ABOVE THE WORDS "SATISFY YOUR NEEDS".

SER. NO. 85-386,988, FILED 8-2-2011.

DARRYL SPRUILL, EXAMINING ATTORNEY



*David J. Kybas*

Director of the United States Patent and Trademark Office

# United States of America

United States Patent and Trademark Office

## IDECLAIR IT!

**Reg. No. 4,125,255**

IDECLAIR MEDIA CO. (TEXAS CORPORATION)

**Registered Apr. 10, 2012**

P.O. BOX 1803  
LEAGUE CITY, TX 775741803

**Int. Cl.: 41**

FOR: ENTERTAINMENT SERVICES, NAMELY, AN ON-GOING SERIES FEATURING A TALK SHOW PROVIDED THROUGH RADIO BROADCAST, IN CLASS 41 (U.S. CLS. 100, 101 AND 107).

**SERVICE MARK**

FIRST USE 2-14-2011; IN COMMERCE 2-14-2011.

**PRINCIPAL REGISTER**

THE MARK CONSISTS OF STANDARD CHARACTERS WITHOUT CLAIM TO ANY PARTICULAR FONT, STYLE, SIZE, OR COLOR.

OWNER OF U.S. REG. NOS. 3,977,395, 3,977,396 AND OTHERS.

SER. NO. 85-386,995, FILED 8-2-2011.

SANDRA BUJA, EXAMINING ATTORNEY



*David J. Kyffers*

Director of the United States Patent and Trademark Office

# United States of America

United States Patent and Trademark Office



**Reg. No. 4,125,256**

**Registered Apr. 10, 2012**

**Int. Cl.: 38**

**SERVICE MARK**

**PRINCIPAL REGISTER**

ICUETV, INC. (DELAWARE CORPORATION)  
210 LAKE DRIVE EAST, THIRD FLOOR  
CHERRY HILL, NJ 08002

FOR: ELECTRONIC, ELECTRIC, AND DIGITAL TRANSMISSION OF VOICE, DATA, IMAGES, SIGNALS, AND MESSAGES, IN CLASS 38 (U.S. CLS. 100, 101 AND 104).

FIRST USE 4-1-2010; IN COMMERCE 4-1-2010.

THE MARK CONSISTS OF A WHITE SPHERE, SHADED IN GRAY, WITH A RED BALL ON THE TOP LEFT PORTION OF THE SPHERE ABOVE A RED CONTRAIL INDICATING MOTION ORIGINATING FROM BELOW THE CENTER OF THE SPHERE, AND MOVING UPWARDS ON THE LEFT SIDE OF THE SPHERE. THE WHITE IN THE BACKGROUND REPRESENTS BACKGROUND OR TRANSPARENT AREAS AND IS NOT CLAIMED AS A FEATURE OF THE MARK.

THE COLOR(S) RED, WHITE AND GRAY IS/ARE CLAIMED AS A FEATURE OF THE MARK.

SER. NO. 85-387,006, FILED 8-2-2011.

JAMES LOVELACE, EXAMINING ATTORNEY



*David J. Kyjars*

Director of the United States Patent and Trademark Office

# United States of America

United States Patent and Trademark Office

## MILLROSE GAMES

**Reg. No. 4,125,257**

THE ARMORY FOUNDATION (NEW YORK CORPORATION)  
216 FORT WASHINGTON AVENUE  
NEW YORK, NY 10032

**Registered Apr. 10, 2012**

**Int. Cl.: 41**

FOR: ORGANIZING, OPERATING, AND CONDUCTING TRACK AND FIELD ATHLETIC EVENTS, IN CLASS 41 (U.S. CLS. 100, 101 AND 107).

**SERVICE MARK**

FIRST USE 0-0-1906; IN COMMERCE 0-0-1906.

**PRINCIPAL REGISTER**

THE MARK CONSISTS OF STANDARD CHARACTERS WITHOUT CLAIM TO ANY PARTICULAR FONT, STYLE, SIZE, OR COLOR.

NO CLAIM IS MADE TO THE EXCLUSIVE RIGHT TO USE "GAMES", APART FROM THE MARK AS SHOWN.

SER. NO. 85-387,047, FILED 8-2-2011.

KATHERINE CONNOLLY, EXAMINING ATTORNEY



*David J. Kybas*

Director of the United States Patent and Trademark Office



# United States of America

United States Patent and Trademark Office

## Urban Oasis

**Reg. No. 4,125,258**

**Registered Apr. 10, 2012**

**Int. Cl.: 35**

**SERVICE MARK**

**PRINCIPAL REGISTER**

DIAMOND, STANLEY (NEW MEXICO SOLE PROPRIETORSHIP), DBA URBAN OASIS  
21 VISTA VALLE CIRCLE  
LAMY, NM 87540

FOR: ADMINISTRATION OF A PROGRAM FOR ENABLING PARTICIPANTS TO OBTAIN DISCOUNTS ON PRODUCT AND SERVICES IN THE FIELDS OF TRANSPORTATION, ENTERTAINMENT, ORIGINAL MUSIC AND PROGRAMMING, HEALTH SERVICES, ENVIRONMENTAL EDUCATION, RECYCLING, ALTERNATIVE FUELS, HOME AND GARDENING, SOLAR ENERGY, SAFETY AND ENERGY TIPS, ELECTRONICS, APPLIANCES, AND PAINTS AND PAINTING MATERIALS; PROMOTING THE GOODS AND SERVICES OF OTHERS, NAMELY, PROVIDING INFORMATION REGARDING DISCOUNTS AND SPECIAL OFFERS FOR THE GOODS AND SERVICES OF OTHERS IN THE FIELD OF TRANSPORTATION, ENTERTAINMENT, ORIGINAL MUSIC AND PROGRAMMING, HEALTH SERVICES, ENVIRONMENTAL EDUCATION, RECYCLING, ALTERNATIVE FUELS, HOME AND GARDENING, SOLAR ENERGY, SAFETY AND ENERGY TIPS, ELECTRONICS, APPLIANCES, AND PAINTS AND PAINTING MATERIALS, IN CLASS 35 (U.S. CLS. 100, 101 AND 102).

FIRST USE 6-30-2010; IN COMMERCE 1-19-2011.

THE MARK CONSISTS OF STANDARD CHARACTERS WITHOUT CLAIM TO ANY PARTICULAR FONT, STYLE, SIZE, OR COLOR.

SER. NO. 85-387,129, FILED 8-2-2011.

INGRID C. EULIN, EXAMINING ATTORNEY



*David J. Kybas*

Director of the United States Patent and Trademark Office

# United States of America

United States Patent and Trademark Office

## Supergreen Solutions

**Reg. No. 4,125,259**

**Registered Apr. 10, 2012**

**Int. Cl.: 35**

**SERVICE MARK**

**PRINCIPAL REGISTER**

GREENER ENERGY,LLC (FLORIDA LIMITED LIABILITY COMPANY)  
2121 VISTA PARKWAY  
WEST PALM BEACH, FL 33411

FOR: WHOLESALE AND RETAIL STORE SERVICES FEATURING GOODS AND SERVICES IN THE FIELD OF SOLAR HOT WATER DEVICES, SOLAR POWER DEVICES, WIND POWER GENERATORS, ENERGY MANAGEMENT SYSTEMS, SKYLIGHTS FOR BUILDINGS, BUILDING VENTILATION SYSTEMS, BUILDING INSULATION, IN CLASS 35 (U.S. CLS. 100, 101 AND 102).

FIRST USE 7-5-2011; IN COMMERCE 7-5-2011.

THE MARK CONSISTS OF STANDARD CHARACTERS WITHOUT CLAIM TO ANY PARTICULAR FONT, STYLE, SIZE, OR COLOR.

NO CLAIM IS MADE TO THE EXCLUSIVE RIGHT TO USE "SOLUTIONS", APART FROM THE MARK AS SHOWN.

SER. NO. 85-387,130, FILED 8-2-2011.

PATRICIA EVANKO, EXAMINING ATTORNEY



*David J. Kyfos*

Director of the United States Patent and Trademark Office

# United States of America

United States Patent and Trademark Office



**Reg. No. 4,125,260**

GREENER ENERGY, LLC (FLORIDA LIMITED LIABILITY COMPANY)  
2121 VISTA PARKWAY  
WEST PALM BEACH, FL 33411

**Registered Apr. 10, 2012**

**Int. Cl.: 35**

FOR: WHOLESALE AND RETAIL STORE SERVICES FEATURING GOODS AND SERVICES IN THE FIELD OF SOLAR HOT WATER DEVICES, SOLAR POWER DEVICES, WIND POWER GENERATORS, ENERGY MANAGEMENT SYSTEMS, SKYLIGHTS FOR BUILDINGS, BUILDING VENTILATION SYSTEMS, BUILDING INSULATION, IN CLASS 35 (U.S. CLS. 100, 101 AND 102).

**SERVICE MARK**

**PRINCIPAL REGISTER**

FIRST USE 7-5-2011; IN COMMERCE 7-5-2011.

NO CLAIM IS MADE TO THE EXCLUSIVE RIGHT TO USE "SOLUTIONS" AND "ENERGY EFFICIENT PRODUCTS", APART FROM THE MARK AS SHOWN.

THE COLOR(S) RED, BLUE, GREEN, AND BLACK IS/ARE CLAIMED AS A FEATURE OF THE MARK.

THE MARK CONSISTS OF A STYLISTIC GREEN WIRE FRAME GLOBE, WITH RED, BLUE, AND GREEN ARCS SUPERIMPOSED UPON IT; ALL CENTERED ABOVE THE WORD, "SUPERGREEN", IN LARGE GREEN BLOCK LETTERS NEXT TO THE WORD, "SOLUTIONS", IN LARGE BLACK BLOCK LETTERS; ALL CENTERED ABOVE THE WORDS, "ENERGY EFFICIENT SOLUTIONS", IN SMALL BLACK ITALICIZED LETTERS.

SER. NO. 85-387,160, FILED 8-2-2011.

PATRICIA EVANKO, EXAMINING ATTORNEY



*David J. Kybas*

Director of the United States Patent and Trademark Office

# United States of America

United States Patent and Trademark Office



**Reg. No. 4,125,261**

**Registered Apr. 10, 2012**

**Int. Cl.: 44**

**SERVICE MARK**

**PRINCIPAL REGISTER**

CAROLINA CANINES FOR SERVICE INC. (NORTH CAROLINA CORPORATION), DBA  
CANINES FOR THERAPY  
STE 101  
1200 N. 23RD ST.  
WILMINGTON, NC 28405

FOR: ANIMAL-ASSISTED THERAPY SERVICES, NAMELY, PROVIDING TRAINED THERAPY DOGS TO PROVIDE PHYSICAL AND EMOTIONAL THERAPY TO INDIVIDUALS IN HEALTH CARE SETTINGS AND SCHOOLS, IN CLASS 44 (U.S. CLS. 100 AND 101).

FIRST USE 2-0-2002; IN COMMERCE 2-0-2002.

NO CLAIM IS MADE TO THE EXCLUSIVE RIGHT TO USE "CANINES FOR THERAPY", APART FROM THE MARK AS SHOWN.

THE COLOR(S) GOLD, BLACK BLUE, RED AND WHITE IS/ARE CLAIMED AS A FEATURE OF THE MARK.

THE MARK CONSISTS OF DIAMOND FILLED WITH GOLD OUTLINED IN BLACK WITH A BLUE KNEELING STICK PERSON HUGGING A BLACK DOG STANDING PROFILE HANDS HOLDING A RED HEART OVER A BLACK BANNER WITH WHITE CANINES AND BLACK FOR THERAPY BENEATH.

SER. NO. 85-387,163, FILED 8-2-2011.

ANDREA BUTLER, EXAMINING ATTORNEY



*David J. Kyffers*

Director of the United States Patent and Trademark Office

# United States of America

United States Patent and Trademark Office



**Reg. No. 4,125,262**

**Registered Apr. 10, 2012**

**Int. Cl.: 11**

**TRADEMARK**

**PRINCIPAL REGISTER**

SHERDEN ENERGY (MICHIGAN LIMITED LIABILITY COMPANY)  
1305 STEPKE COURT  
TRAVERSE CITY, MI 49685

FOR: HEAT EXCHANGE VENTILATOR FOR ENERGY RECOVERY FOR USE IN CLASSROOMS, IN CLASS 11 (U.S. CLS. 13, 21, 23, 31 AND 34).

FIRST USE 10-14-2010; IN COMMERCE 10-14-2010.

NO CLAIM IS MADE TO THE EXCLUSIVE RIGHT TO USE "AIR", APART FROM THE MARK AS SHOWN.

THE COLOR(S) BLACK, WHITE, RED, BLUE IS/ARE CLAIMED AS A FEATURE OF THE MARK.

THE MARK CONSISTS OF THE WORDING "A ARISTOTLE AIR" IN A STYLIZED FONT IN WHITE WITH A DESIGN THAT CONSISTS OF AN UPPER STRIPE OF RED AND LOWER STRIPE OF BLUE ACROSS THE LETTER "A" AND DEPICTED WITHIN A TRUNCATED TRIANGLE IN BLACK AND WHITE WITH A WHITE BORDER.

SER. NO. 85-387,170, FILED 8-2-2011.

RENEE MCCRAY, EXAMINING ATTORNEY



*David J. Kyros*

Director of the United States Patent and Trademark Office

# United States of America

United States Patent and Trademark Office

# Pit Boss

**Reg. No. 4,125,263**

**Registered Apr. 10, 2012**

**Int. Cl.: 41**

**SERVICE MARK**

**PRINCIPAL REGISTER**

BROWN, JAMELYN TYREECE (UNITED STATES INDIVIDUAL)  
1029 HWY. 6 N., SUITE 650-203  
HOUSTON, TX 77079

FOR: ENTERTAINMENT IN THE NATURE OF VISUAL AND AUDIO PERFORMANCES BY MUSIC ARTIST, MUSIC PERFORMER; ENTERTAINMENT IN THE NATURE OF VISUAL AND AUDIO PERFORMANCES, AND MUSICAL, VARIETY, NEWS AND COMEDY SHOWS; ENTERTAINMENT IN THE NATURE OF VISUAL AND AUDIO PERFORMANCES, NAMELY, MUSICAL BAND, ROCK GROUP, GYMNASTIC, DANCE, AND BALLET PERFORMANCES, IN CLASS 41 (U.S. CLS. 100, 101 AND 107).

FIRST USE 7-28-2011; IN COMMERCE 7-28-2011.

THE MARK CONSISTS OF STANDARD CHARACTERS WITHOUT CLAIM TO ANY PARTICULAR FONT, STYLE, SIZE, OR COLOR.

SER. NO. 85-387,198, FILED 8-2-2011.

JANICE L. MCMORROW, EXAMINING ATTORNEY



*David J. Kyffers*

Director of the United States Patent and Trademark Office

# United States of America

United States Patent and Trademark Office



**Reg. No. 4,125,264**

**Registered Apr. 10, 2012**

**Int. Cl.: 36**

**SERVICE MARK**

**PRINCIPAL REGISTER**

CHRISTINA-TAYLOR GREEN MEMORIAL FOUNDATION (ARIZONA NON-PROFIT CORPORATION)  
P.O. BOX 65000  
TUCSON, AZ 85728

FOR: ACCEPTING AND ADMINISTERING MONETARY CHARITABLE CONTRIBUTIONS; CHARITABLE FUNDRAISING SERVICES, IN CLASS 36 (U.S. CLS. 100, 101 AND 102).

FIRST USE 5-31-2011; IN COMMERCE 5-31-2011.

THE NAME(S), PORTRAIT(S), AND/OR SIGNATURE(S) SHOWN IN THE MARK DOES NOT IDENTIFY A PARTICULAR LIVING INDIVIDUAL.

THE MARK CONSISTS OF A PHOTOGRAPH FEATURING A FRONT VIEW FROM THE SHOULDERS UP OF CHRISTINA-TAYLOR GREEN.

SER. NO. 85-387,252, FILED 8-2-2011.

NAPOLEON SHARMA, EXAMINING ATTORNEY



*David J. Kybas*

Director of the United States Patent and Trademark Office

# United States of America

United States Patent and Trademark Office

## CHRISTINA-TAYLOR GREEN MEMORIAL FOUNDATION

**Reg. No. 4,125,265**

**Registered Apr. 10, 2012**

**Int. Cl.: 36**

**SERVICE MARK**

**PRINCIPAL REGISTER**

CHRISTINA-TAYLOR GREEN MEMORIAL FOUNDATION (ARIZONA NON-PROFIT CORPORATION)  
P.O. BOX 65000  
TUCSON, AZ 85728

FOR: ACCEPTING AND ADMINISTERING MONETARY CHARITABLE CONTRIBUTIONS; CHARITABLE FUNDRAISING SERVICES, IN CLASS 36 (U.S. CLS. 100, 101 AND 102).

FIRST USE 5-31-2011; IN COMMERCE 5-31-2011.

THE MARK CONSISTS OF STANDARD CHARACTERS WITHOUT CLAIM TO ANY PARTICULAR FONT, STYLE, SIZE, OR COLOR.

NO CLAIM IS MADE TO THE EXCLUSIVE RIGHT TO USE "MEMORIAL FOUNDATION", APART FROM THE MARK AS SHOWN.

THE NAME(S), PORTRAIT(S), AND/OR SIGNATURE(S) SHOWN IN THE MARK DOES NOT IDENTIFY A PARTICULAR LIVING INDIVIDUAL.

SER. NO. 85-387,262, FILED 8-2-2011.

NAPOLEON SHARMA, EXAMINING ATTORNEY



*David J. Kyffers*

Director of the United States Patent and Trademark Office



# United States of America

United States Patent and Trademark Office



**Reg. No. 4,125,266**

**Registered Apr. 10, 2012**

**Int. Cl.: 41**

**SERVICE MARK**

**PRINCIPAL REGISTER**

VIP TICKETS, INC. (NEVADA CORPORATION)  
14515 VENTURA BLVD.  
SUITE 210  
SHERMAN OAKS, CA 91403

FOR: ON-LINE AND TELEPHONE BASED TICKET AGENCY SERVICES FOR ENTERTAINMENT AND SPORTING EVENTS, IN CLASS 41 (U.S. CLS. 100, 101 AND 107).

FIRST USE 6-20-2011; IN COMMERCE 6-20-2011.

NO CLAIM IS MADE TO THE EXCLUSIVE RIGHT TO USE ".COM", APART FROM THE MARK AS SHOWN.

THE MARK CONSISTS OF THE STYLIZED WORDING "VIPTICKETS" AND THE STYLIZED WORDING ".COM" BELOW THE WORDING "VIPTICKETS" ON THE LOWER RIGHT OF THE MARK. THE MARK ALSO CONTAINS THE DESIGN OF AN OUTLINE OF THREE TICKETS BEHIND THE WORDING IN THE MARK.

SER. NO. 85-387,376, FILED 8-2-2011.

JAY BESCH, EXAMINING ATTORNEY



*David J. Kyros*

Director of the United States Patent and Trademark Office

# United States of America

United States Patent and Trademark Office

# medxproductions

**Reg. No. 4,125,267**

MERALI, MEHDI (UNITED STATES INDIVIDUAL)

**Registered Apr. 10, 2012**

P.O. BOX 46366  
WEST HOLLYWOOD, CA 90046

**Int. Cl.: 41**

FOR: ENTERTAINMENT SERVICES, NAMELY, PRODUCTION AND DISTRIBUTION OF MOTION PICTURES, MUSIC, FEATURE FILMS, SHORT FILMS, DOCUMENTARY FILMS, TELEVISION SHOWS, RADIO PROGRAMS, AND DIGITAL VIDEOS, NAMELY, MUSIC VIDEOS, WEB VIDEOS IN THE FIELD OF EDUCATION, ENTERTAINMENT, NEWS; PRESENTATION OF MUSICAL PERFORMANCES, STAGE PERFORMANCES, AND THEATRICAL PERFORMANCES, IN CLASS 41 (U.S. CLS. 100, 101 AND 107).

**SERVICE MARK**

**PRINCIPAL REGISTER**

FIRST USE 3-0-2004; IN COMMERCE 7-11-2011.

THE MARK CONSISTS OF STANDARD CHARACTERS WITHOUT CLAIM TO ANY PARTICULAR FONT, STYLE, SIZE, OR COLOR.

SER. NO. 85-387,389, FILED 8-2-2011.

B. PARADEWELAI, EXAMINING ATTORNEY



*David J. Kyffers*

Director of the United States Patent and Trademark Office

# United States of America

United States Patent and Trademark Office

# CLF

**Reg. No. 4,125,268**

**Registered Apr. 10, 2012**

**Int. Cls.: 35 and 36**

**SERVICE MARK**

**PRINCIPAL REGISTER**

CONSERVATION LAW FOUNDATION, INC. (MASSACHUSETTS NON-PROFIT CORPORATION)  
62 SUMMER STREET  
BOSTON, MA 021101016

FOR: PROMOTING PUBLIC AWARENESS OF ENVIRONMENTAL MATTERS, IN CLASS 35 (U.S. CLS. 100, 101 AND 102).

FIRST USE 11-0-1966; IN COMMERCE 11-0-1966.

FOR: CHARITABLE FUNDRAISING; CHARITABLE FUNDRAISING SERVICES; ON-LINE BUSINESS FUNDRAISING SERVICES, IN CLASS 36 (U.S. CLS. 100, 101 AND 102).

FIRST USE 11-0-1966; IN COMMERCE 11-0-1966.

THE MARK CONSISTS OF STANDARD CHARACTERS WITHOUT CLAIM TO ANY PARTICULAR FONT, STYLE, SIZE, OR COLOR.

SER. NO. 85-387,438, FILED 8-2-2011.

DANNEAN HETZEL, EXAMINING ATTORNEY



*David J. Kypos*

Director of the United States Patent and Trademark Office

# United States of America

United States Patent and Trademark Office

# Hiring Scale

**Reg. No. 4,125,269**

**Registered Apr. 10, 2012**

**Int. Cl.: 42**

**SERVICE MARK**

**PRINCIPAL REGISTER**

WANTED TECHNOLOGIES CORPORATION (CANADA CORPORATION)  
#500 EAST HALL  
400 JEAN-LESAGE BOULEVARD  
QUEBEC CITY, CANADA

FOR: SOFTWARE AS A SERVICE (SAAS) SERVICES FEATURING SOFTWARE FOR ANALYTICAL TOOLS FOR DATABASE RESEARCH ON EMPLOYMENT MARKET DATA INCLUDING ONLINE JOB ADS AND CANDIDATE SUPPLY DATA, IN CLASS 42 (U.S. CLS. 100 AND 101).

FIRST USE 3-24-2011; IN COMMERCE 3-24-2011.

THE MARK CONSISTS OF STANDARD CHARACTERS WITHOUT CLAIM TO ANY PARTICULAR FONT, STYLE, SIZE, OR COLOR.

NO CLAIM IS MADE TO THE EXCLUSIVE RIGHT TO USE "SCALE", APART FROM THE MARK AS SHOWN.

SER. NO. 85-387,473, FILED 8-2-2011.

DAVID MURRAY, EXAMINING ATTORNEY



*David J. Kyros*

Director of the United States Patent and Trademark Office

United States of America  
United States Patent and Trademark Office

brandboom

**Reg. No. 4,125,270**

**Registered Apr. 10, 2012**

**Int. Cl.: 42**

**SERVICE MARK**

**PRINCIPAL REGISTER**

BLACKCLOSET INC. (CALIFORNIA CORPORATION)  
UNIT 1705  
1100 S. HOPE ST.  
LOS ANGELES, CA 90015

FOR: SOFTWARE AS A SERVICE (SAAS) SERVICES, NAMELY, HOSTING SOFTWARE FOR USE BY OTHERS IN THE FIELD OF SALES, MORE SPECIFICALLY STORING AND PRESENTING PRODUCT INFORMATION AND CAPTURING OR CREATING SALES ORDERS, IN CLASS 42 (U.S. CLS. 100 AND 101).

FIRST USE 4-1-2011; IN COMMERCE 4-1-2011.

THE MARK CONSISTS OF STANDARD CHARACTERS WITHOUT CLAIM TO ANY PARTICULAR FONT, STYLE, SIZE, OR COLOR.

SER. NO. 85-387,489, FILED 8-2-2011.

LESLIE RICHARDS, EXAMINING ATTORNEY



*David J. Kyffers*

Director of the United States Patent and Trademark Office

# United States of America

United States Patent and Trademark Office

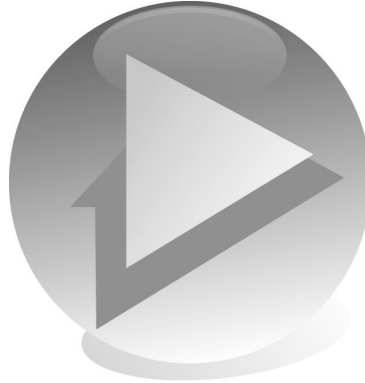

**Reg. No. 4,125,271**

**Registered Apr. 10, 2012**

**Int. Cl.: 9**

**TRADEMARK**

**PRINCIPAL REGISTER**

VISUALON, INC. (DELAWARE CORPORATION)  
4675 STEVENS CREEK BLVD., SUITE 200  
SANTA CLARA, CA 95051

FOR: COMPUTER APPLICATION SOFTWARE TO ALLOW ELECTRONIC MEDIA, MULTI-MEDIA CONTENT, VIDEOS, MOVIES, PICTURES, IMAGES, TEXT, PHOTOS, USER-GENERATED CONTENT, AUDIO CONTENT AND DATA TO RUN ON MOBILE DEVICES, IN CLASS 9 (U.S. CLS. 21, 23, 26, 36 AND 38).

FIRST USE 0-0-2006; IN COMMERCE 0-0-2006.

THE MARK CONSISTS OF A TRIANGLE OVERLAPPING A POLYGON SHAPE APPEARING IN FRONT OF A SHADOWED SPHERE WITH A SHADED CIRCLE ON TOP AND A PORTION OF A SHADED CIRCLE ON BOTTOM.

SER. NO. 85-387,491, FILED 8-2-2011.

LESLIE RICHARDS, EXAMINING ATTORNEY



*David J. Kyffers*

Director of the United States Patent and Trademark Office

# United States of America

United States Patent and Trademark Office

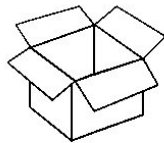

**MyShippingPartner.com**

**Reg. No. 4,125,272**

WILD WEB STUDIOS, INC. (TEXAS CORPORATION)  
912 MERRIMAN CT  
FRIENDSWOOD, TX 77546

**Registered Apr. 10, 2012**

**Int. Cl.: 40**

FOR: PRINTING OF POSTAGE LABELS FOR E-COMMERCE, IN CLASS 40 (U.S. CLS. 100, 103 AND 106).

**SERVICE MARK**

FIRST USE 2-1-2010; IN COMMERCE 2-1-2010.

**PRINCIPAL REGISTER**

THE MARK CONSISTS OF A BOX WITH THE STYLIZED TEXT "MYSHIPPINGPARTNER.COM".

SER. NO. 85-387,496, FILED 8-2-2011.

MEGHAN REINHART, EXAMINING ATTORNEY



*David J. Kybas*

Director of the United States Patent and Trademark Office

# United States of America

United States Patent and Trademark Office

## HAVE A BALL

**Reg. No. 4,125,273**

**Registered Apr. 10, 2012**

**Int. Cls.: 30 and 43**

**TRADEMARK**

**SERVICE MARK**

**PRINCIPAL REGISTER**

PACE'S PIZZA BALLS, INC. (NEVADA CORPORATION)  
13967 SOUTH VIRGINIA STREET, #910  
RENO, NV 89511

FOR: DOUGH-ENROBED FOODS CONSISTING OF A DOUGH-BASED WRAPPER WITH FILLING CONSISTING PRIMARILY OF MEAT, CHEESE, SAUCE, SPICES, EGGS, VEGETABLES, AND/OR FRUIT; DOUGH-ENROBED FOODS CONSISTING OF A DOUGH-BASED WRAPPER WITH FILLING CONSISTING PRIMARILY OF FRUIT, CANDY, COOKIES, AND/OR PEANUT BUTTER, IN CLASS 30 (U.S. CL. 46).

FIRST USE 9-25-2009; IN COMMERCE 9-25-2009.

FOR: RESTAURANT SERVICES, IN CLASS 43 (U.S. CLS. 100 AND 101).

FIRST USE 9-25-2009; IN COMMERCE 9-25-2009.

THE MARK CONSISTS OF STANDARD CHARACTERS WITHOUT CLAIM TO ANY PARTICULAR FONT, STYLE, SIZE, OR COLOR.

NO CLAIM IS MADE TO THE EXCLUSIVE RIGHT TO USE "BALL", APART FROM THE MARK AS SHOWN.

SER. NO. 85-387,503, FILED 8-2-2011.

ANNE MADDEN, EXAMINING ATTORNEY



*David J. Kyros*

Director of the United States Patent and Trademark Office



# United States of America

United States Patent and Trademark Office

# Bridal U

**Reg. No. 4,125,274**

**Registered Apr. 10, 2012**

**Int. Cl.: 41**

**SERVICE MARK**

**PRINCIPAL REGISTER**

PERRY CONSULTING (ARIZONA LIMITED LIABILITY COMPANY)  
PMB 185  
5130 W. BASELINE ROAD #117  
LAVEEN, AZ 85339

FOR: EDUCATIONAL SERVICES, NAMELY, PROVIDING CONFERENCES AND WORKSHOPS, WHERE PEOPLE CAN ALSO FACILITATE ONE-ON-ONE MEETINGS WITH EXPERTS, IN THE FIELD OF WEDDING PLANNING AND PREPARING, IN CLASS 41 (U.S. CLS. 100, 101 AND 107).

FIRST USE 6-0-2009; IN COMMERCE 6-0-2009.

THE MARK CONSISTS OF STANDARD CHARACTERS WITHOUT CLAIM TO ANY PARTICULAR FONT, STYLE, SIZE, OR COLOR.

NO CLAIM IS MADE TO THE EXCLUSIVE RIGHT TO USE "BRIDAL", APART FROM THE MARK AS SHOWN.

SER. NO. 85-387,521, FILED 8-2-2011.

ANDREW LEASER, EXAMINING ATTORNEY



*David J. Kypos*

Director of the United States Patent and Trademark Office

# United States of America

United States Patent and Trademark Office

## PIZZA THAT GETS AROUND

**Reg. No. 4,125,275**

**Registered Apr. 10, 2012**

**Int. Cls.: 30 and 43**

**TRADEMARK**

**SERVICE MARK**

**PRINCIPAL REGISTER**

PACE'S PIZZA BALLS, INC. (NEVADA CORPORATION)  
13967 SOUTH VIRGINIA STREET, #910  
RENO, NJ 89511

FOR: DOUGH-ENROBED FOODS CONSISTING OF A DOUGH-BASED WRAPPER WITH FILLING CONSISTING PRIMARILY OF MEAT, CHEESE, SAUCE, SPICES, EGGS, VEGETABLES, AND/OR FRUIT; DOUGH-ENROBED FOODS CONSISTING OF A DOUGH-BASED WRAPPER WITH FILLING CONSISTING PRIMARILY OF FRUIT, CANDY, COOKIES, AND/OR PEANUT BUTTER, IN CLASS 30 (U.S. CL. 46).

FIRST USE 9-25-2009; IN COMMERCE 9-25-2009.

FOR: RESTAURANT SERVICES, IN CLASS 43 (U.S. CLS. 100 AND 101).

FIRST USE 9-25-2009; IN COMMERCE 9-25-2009.

THE MARK CONSISTS OF STANDARD CHARACTERS WITHOUT CLAIM TO ANY PARTICULAR FONT, STYLE, SIZE, OR COLOR.

NO CLAIM IS MADE TO THE EXCLUSIVE RIGHT TO USE "PIZZA", APART FROM THE MARK AS SHOWN.

SER. NO. 85-387,542, FILED 8-2-2011.

ANNE MADDEN, EXAMINING ATTORNEY

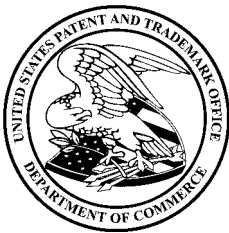

*David J. Kybas*

Director of the United States Patent and Trademark Office

United States of America  
United States Patent and Trademark Office

MAHANA

**Reg. No. 4,125,276**

**Registered Apr. 10, 2012**

**Int. Cl.: 36**

**SERVICE MARK**

**PRINCIPAL REGISTER**

ASSOCIATION OF APARTMENT OWNERS OF THE MAHANA AT KAA NAPALI (HAWAII  
UNINCORPORATED ASSOCIATION)  
110 KAA NAPALI SHORES PLACE  
LAHAINA, HI 96761

FOR: REAL ESTATE SERVICES, NAMELY, CONDOMINIUM MANAGEMENT SERVICES,  
IN CLASS 36 (U.S. CLS. 100, 101 AND 102).

FIRST USE 6-24-1975; IN COMMERCE 6-24-1975.

THE MARK CONSISTS OF STANDARD CHARACTERS WITHOUT CLAIM TO ANY PAR-  
TICULAR FONT, STYLE, SIZE, OR COLOR.

THE ENGLISH TRANSLATION OF "MAHANA" IN THE MARK IS "TWINNS."

SER. NO. 85-387,572, FILED 8-2-2011.

KATHERINE CHANG, EXAMINING ATTORNEY



*David J. Kyros*

Director of the United States Patent and Trademark Office

# United States of America

United States Patent and Trademark Office



**Reg. No. 4,125,277**

**Registered Apr. 10, 2012**

**Int. Cl.: 42**

**SERVICE MARK**

**PRINCIPAL REGISTER**

CARDIAC ACCREDITATION SERVICES (TEXAS LIMITED LIABILITY COMPANY)  
3820 CRESTHILL ROAD  
FORT WORTH, TX 76116

FOR: CONSULTING IN THE FIELD OF THE TESTING, ANALYSIS AND EVALUATION OF THE SERVICES OF OTHERS FOR THE PURPOSE OF CERTIFICATION ; PROVIDING TEMPORARY USE OF ON-LINE NONDOWNLOADABLE SOFTWARE AND APPLICATIONS FOR USE IN THE ACCREDITATION OF MEDICAL LABS, IN CLASS 42 (U.S. CLS. 100 AND 101).

FIRST USE 10-20-2010; IN COMMERCE 10-20-2010.

NO CLAIM IS MADE TO THE EXCLUSIVE RIGHT TO USE "CARDIAC ACCREDITATION SERVICES", APART FROM THE MARK AS SHOWN.

THE MARK CONSISTS OF THE STYLIZED TEXT "CAS" IN WHICH THE LETTER "A" IS REPRESENTED BY AN EKG SYMBOL THAT IS CONNECTED TO THE LETTER "C" AND UNDERLINES THE LETTER "S". A DOT SERVES AS THE CROSSBAR IN THE LETTER "A". THE LETTER "C" IS UNDERLINED. TO THE RIGHT OF THIS TEXT IS THE STYLIZED TEXT "CARDIAC" ABOVE THE STYLIZED TEXT "ACCREDITATION" ABOVE THE STYLIZED TEXT "SERVICES".

SER. NO. 85-387,579, FILED 8-2-2011.

LINDA MICKLEBURGH, EXAMINING ATTORNEY



*David J. Kyjars*

Director of the United States Patent and Trademark Office

# United States of America

United States Patent and Trademark Office



**Reg. No. 4,125,278**

**Registered Apr. 10, 2012**

**Int. Cl.: 40**

**SERVICE MARK**

**PRINCIPAL REGISTER**

IRONCO ENTERPRISES, LLC (ARIZONA LIMITED LIABILITY COMPANY)  
1025 EAST BROADWAY ROAD  
PHOENIX, AZ 85040

FOR: CUSTOM STEEL ROLLING AND FABRICATION TO THE ORDER AND SPECIFICATION OF OTHERS, IN CLASS 40 (U.S. CLS. 100, 103 AND 106).

FIRST USE 11-1-1999; IN COMMERCE 11-1-1999.

THE MARK CONSISTS OF A BLACK CHAIN THAT SPLITS OFF INTO TWO SECTIONS WITH BLACK OUTLINED AND WHITE INTERIOR HOOKS AT EACH END. THE HOOKS ARE BLACK OUTLINED WITH WHITE INTERIOR HOLDERS WHICH ARE ATTACHED TO AN IRON BEAM. THE IRON BEAM IS OUTLINED IN BLACK WITH A WHITE INTERIOR AND ALSO FORMS THE LETTER "I" IN THE WORD "IRON". THE LETTER "I" IS IN THE COLOR RED. THE WORD "IRONCO" IS IN THE COLOR RED FOR THE WORD "IRON" AND THE COLOR BLACK FOR THE ACRONYM "CO".

THE COLOR(S) RED, BLACK AND WHITE IS/ARE CLAIMED AS A FEATURE OF THE MARK.

SER. NO. 85-387,611, FILED 8-2-2011.

DAVID MURRAY, EXAMINING ATTORNEY



*David J. Kyffers*

Director of the United States Patent and Trademark Office

# United States of America

United States Patent and Trademark Office

## Bangers & Lace

**Reg. No. 4,125,279**

1670 DIVISION LLC (ILLINOIS LIMITED LIABILITY COMPANY)

**Registered Apr. 10, 2012**

1670 W. DIVISION  
CHICAGO, IL 60622

**Int. Cl.: 43**

FOR: RESTAURANT AND BAR SERVICES, IN CLASS 43 (U.S. CLS. 100 AND 101).

**SERVICE MARK**

FIRST USE 11-20-2010; IN COMMERCE 11-20-2010.

**PRINCIPAL REGISTER**

THE MARK CONSISTS OF STANDARD CHARACTERS WITHOUT CLAIM TO ANY PARTICULAR FONT, STYLE, SIZE, OR COLOR.

NO CLAIM IS MADE TO THE EXCLUSIVE RIGHT TO USE "BANGERS", APART FROM THE MARK AS SHOWN.

SER. NO. 85-387,613, FILED 8-2-2011.

DAVID I, EXAMINING ATTORNEY

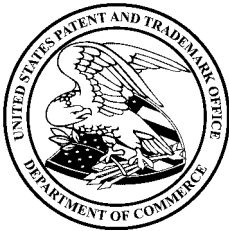

*David J. Kyffers*

Director of the United States Patent and Trademark Office

# United States of America

United States Patent and Trademark Office

# Made by Moos

**Reg. No. 4,125,280**

**Registered Apr. 10, 2012**

**Int. Cl.: 29**

**TRADEMARK**

**PRINCIPAL REGISTER**

SWISS-AMERICAN, INC. (MISSOURI CORPORATION)  
4200 PAPIN STREET  
SAINT LOUIS, MO 63110

FOR: CHEESE, IN CLASS 29 (U.S. CL. 46).

FIRST USE 10-1-2011; IN COMMERCE 10-1-2011.

THE MARK CONSISTS OF STANDARD CHARACTERS WITHOUT CLAIM TO ANY PARTICULAR FONT, STYLE, SIZE, OR COLOR.

SER. NO. 85-387,637, FILED 8-2-2011.

ALAIN LAPTER, EXAMINING ATTORNEY



*David J. Kyffers*

Director of the United States Patent and Trademark Office

# United States of America

United States Patent and Trademark Office

# Pizza Babe

**Reg. No. 4,125,281**

PUNJANI, NADIR (UNITED STATES INDIVIDUAL)  
PO BOX 341526  
TAMPA, FL 33694

**Registered Apr. 10, 2012**

**Int. Cl.: 39**

FOR: DELIVERY OF FOOD BY RESTAURANTS; PIZZA DELIVERY, IN CLASS 39 (U.S. CLS. 100 AND 105).

**SERVICE MARK**

FIRST USE 4-1-2011; IN COMMERCE 5-15-2011.

**PRINCIPAL REGISTER**

THE MARK CONSISTS OF STANDARD CHARACTERS WITHOUT CLAIM TO ANY PARTICULAR FONT, STYLE, SIZE, OR COLOR.

NO CLAIM IS MADE TO THE EXCLUSIVE RIGHT TO USE "PIZZA", APART FROM THE MARK AS SHOWN.

SER. NO. 85-387,649, FILED 8-2-2011.

CHRIS WELLS, EXAMINING ATTORNEY



*David J. Kyffers*

Director of the United States Patent and Trademark Office



# United States of America

United States Patent and Trademark Office

## Maximum Evolution in Lubrication Technology

**Reg. No. 4,125,282**

VEXTROM CORPORARTION (FLORIDA CORPORATION)

**Registered Apr. 10, 2012**

15751 SHERIDAN ST. SUITE 144  
DAVIE, FL 33331

**Int. Cl.: 4**

**TRADEMARK**

**PRINCIPAL REGISTER**

FOR: ALL PURPOSE LUBRICANTS; ALL PURPOSE PENETRATING OIL; AUTOMOBILE LUBRICANTS; AUTOMOTIVE ENGINE OILS; AUTOMOTIVE LUBRICANTS; BASE OILS; CRANKCASE OILS; CUTTING OIL FOR INDUSTRIAL METAL WORKING; CUTTING OILS; DRILLING LUBRICANTS; ENGINE OILS; GEAR OILS; GUN BARREL OIL; HEAT TRANSFER OILS; HEAVY OILS; HYDRAULIC OILS; INDUSTRIAL AND VEHICULAR LUBRICANTS; INDUSTRIAL LUBRICANTS; INDUSTRIAL OILS; LIGHT OILS; LUBRICANTS FOR AIR-CRAFT ENGINES; LUBRICANTS FOR DENTAL INSTRUMENTS; LUBRICANTS FOR INDUSTRIAL MACHINERY; LUBRICANTS FOR USE ON HOUSEHOLD ITEMS; LUBRICANTS, NAMELY, GRINDING FLUIDS; LUBRICATING GREASES; LUBRICATING OIL FOR MOTOR VEHICLE ENGINES; LUBRICATING OILS; LUBRICATING OILS; LUBRICATING OILS AND GREASES; LUBRICATION GREASE FOR VEHICLES; MARINE LUBRICANTS; MINERAL LUBRICATING OILS; MINERAL OIL FOR USE IN THE MANUFACTURE OF METAL CUTTING FLUIDS; MINERAL OILS AND GREASES FOR INDUSTRIAL PURPOSES; MOTOR OIL; MOTOR OILS; MOTOR VEHICLE LUBRICANTS; NON-CHEMICAL ADDITIVES FOR ENGINE OILS; NON-CHEMICAL ADDITIVES FOR FUELS, LUBRICANTS AND GREASES; NON-CHEMICAL ADDITIVES FOR OILS AND FUELS; NON-CHEMICAL ENGINE TREATMENTS AND ADDITIVES FOR ENGINE OILS, GASOLINE AND DIESEL FUELS, TRANSMISSION FLUIDS AND COOLING SYSTEMS; NON-CHEMICAL MOTOR OIL ADDITIVES; NON-MINERAL OILS AND GREASES FOR INDUSTRIAL PURPOSES; PENETRATING OIL; PREMIUM SPECIALTY INDUSTRIAL LUBRICANTS; RACING OIL; SOLID FILM LUBRICANTS; SYNTHETIC GEAR OIL; TEXTILE OILS; TRANSMISSION OILS; TWO CYCLE ENGINE OIL, IN CLASS 4 (U.S. CLS. 1, 6 AND 15).

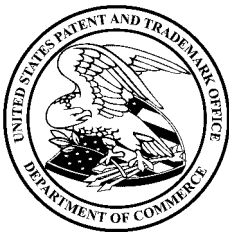

FIRST USE 2-5-2010; IN COMMERCE 5-27-2010.

THE MARK CONSISTS OF STANDARD CHARACTERS WITHOUT CLAIM TO ANY PARTICULAR FONT, STYLE, SIZE, OR COLOR.

NO CLAIM IS MADE TO THE EXCLUSIVE RIGHT TO USE "LUBRICATION TECHNOLOGY", APART FROM THE MARK AS SHOWN.

SER. NO. 85-387,665, FILED 8-2-2011.

*David J. Kyros*

Director of the United States Patent and Trademark Office

**Reg. No. 4,125,282** CHRIS WELLS, EXAMINING ATTORNEY

# United States of America

United States Patent and Trademark Office

## PAN JIU-JITSU CHAMPIONSHIP

**Reg. No. 4,125,283**

**Registered Apr. 10, 2012**

**Int. Cl.: 41**

**SERVICE MARK**

**PRINCIPAL REGISTER**

UNITED STATES BRAZILIAN JIU-JITSU FEDERATION, INC. (CALIFORNIA CORPORATION)  
SUITE F  
17845 SKY PARK CIRCLE  
IRVINE, CA 92614

FOR: ENTERTAINMENT IN THE NATURE OF COMPETITIONS IN THE FIELD OF JIU-JITSU; ORGANIZING SPORTING EVENTS, NAMELY, JIU-JITSU TOURNAMENTS , IN CLASS 41 (U.S. CLS. 100, 101 AND 107).

FIRST USE 0-0-2007; IN COMMERCE 0-0-2007.

THE MARK CONSISTS OF STANDARD CHARACTERS WITHOUT CLAIM TO ANY PARTICULAR FONT, STYLE, SIZE, OR COLOR.

OWNER OF U.S. REG. NOS. 3,469,942, 3,469,944 AND OTHERS.

NO CLAIM IS MADE TO THE EXCLUSIVE RIGHT TO USE "JIU-JITSU CHAMPIONSHIP", APART FROM THE MARK AS SHOWN.

SER. NO. 85-387,682, FILED 8-2-2011.

TASHIA BUNCH, EXAMINING ATTORNEY



*David J. Kyffers*

Director of the United States Patent and Trademark Office

# United States of America

United States Patent and Trademark Office

# BLACKBLUE

**Reg. No. 4,125,284**

ZHEJIANG MUSTANG BATTERY CO., LTD. (CHINA LIMITED LIABILITY COMPANY)  
NO.818 RONGJI ROAD, LUOTUO  
NINGBO, CHINA

**Registered Apr. 10, 2012**

**Int. Cl.: 9**

FOR: ANODE BATTERIES; BATTERIES; BATTERIES FOR LIGHTING; BATTERIES FOR POCKETLAMPS; BATTERY CHARGERS; GALVANIC BATTERIES; RECHARGEABLE ELECTRIC BATTERIES; SOLAR BATTERIES, IN CLASS 9 (U.S. CLS. 21, 23, 26, 36 AND 38).

**TRADEMARK**

**PRINCIPAL REGISTER**

FIRST USE 3-5-2011; IN COMMERCE 6-16-2011.

SER. NO. 85-387,706, FILED 8-2-2011.

REBECCA EISINGER, EXAMINING ATTORNEY



*David J. Kybas*

Director of the United States Patent and Trademark Office

# United States of America

United States Patent and Trademark Office

# **BiGVM**

**Reg. No. 4,125,285**

ZHEJIANG MUSTANG BATTERY CO., LTD. (CHINA LIMITED LIABILITY COMPANY)  
NO.818 RONGJI ROAD, LUOTUO  
NINGBO, CHINA

**Registered Apr. 10, 2012**

**Int. Cl.: 9**

FOR: ANODE BATTERIES; BATTERIES; BATTERIES FOR LIGHTING; BATTERIES FOR  
POCKETLAMPS; BATTERY CHARGERS; GALVANIC BATTERIES; RECHARGEABLE  
ELECTRIC BATTERIES; SOLAR BATTERIES, IN CLASS 9 (U.S. CLS. 21, 23, 26, 36 AND  
38).

**TRADEMARK**

**PRINCIPAL REGISTER**

FIRST USE 5-3-2011; IN COMMERCE 6-16-2011.

SER. NO. 85-387,711, FILED 8-2-2011.

REBECCA EISINGER, EXAMINING ATTORNEY

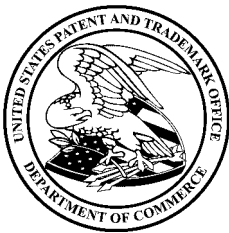

*David J. Kybas*

Director of the United States Patent and Trademark Office

# United States of America

United States Patent and Trademark Office



**Reg. No. 4,125,286**

ALERT SERVICES CORPORATION (DELAWARE CORPORATION)  
5181 STAVERLY LANE, SUITE 100  
NORCROSS, GA 30092

**Registered Apr. 10, 2012**

**Int. Cl.: 35**

FOR: BUSINESS PROCESS OUTSOURCING SERVICES IN THE FIELD OF TRACKING THE RECRUITMENT AND PLACEMENT OF PHYSICIANS AND HEALTHCARE PROFESSIONALS , IN CLASS 35 (U.S. CLS. 100, 101 AND 102).

**SERVICE MARK**

FIRST USE 7-1-2009; IN COMMERCE 7-1-2009.

**PRINCIPAL REGISTER**

NO CLAIM IS MADE TO THE EXCLUSIVE RIGHT TO USE "RECRUITING MANAGEMENT SYSTEM", APART FROM THE MARK AS SHOWN.

THE COLOR(S) BLACK, WHITE, BLUE AND GRAY IS/ARE CLAIMED AS A FEATURE OF THE MARK.

THE MARK CONSISTS OF THE LETTERS "R", "M", "S" PROGRESSING FROM LIGHT BLUE ON THE BOTTOM TO DARKER BLUE ON TOP ALONG WITH FAINT LIGHT BLUE SHADOWING APPEARING BELOW SAID WORDING, POSITIONED TO THE RIGHT OF AN IMAGE OF A COMPUTER, WITH WHITE AND BLACK KEYBOARD AND MONITOR, CENTERED ON BACKGROUND CONSISTING OF ONE OUTER BLUE CIRCLE AND ONE INNER CIRCLE WITH BLACK ON BOTTOM AND GRAY ON TOP SEPARATED BY A WAVY HORIZONTAL CENTER LINE, ALONG WITH FAINT LIGHT BLUE SHADOWING APPEARING BELOW SAID DESIGN; AND THE WORDS "RECRUITING MANAGEMENT SYSTEM" IN BLACK POSITIONED TO THE RIGHT OF THE "RMS" LETTERS.



SER. NO. 85-387,715, FILED 8-2-2011.

REBECCA EISINGER, EXAMINING ATTORNEY

*David J. Kyjars*

Director of the United States Patent and Trademark Office

# United States of America

United States Patent and Trademark Office

## Golden Glow Medical Spa

**Reg. No. 4,125,287**

GOLDENGLOWMEDICALSPA, LLC (FLORIDA LIMITED LIABILITY COMPANY)  
150 CLEARWATER LARGO ROAD N.

**Registered Apr. 10, 2012**

LARGO, FL 33770

**Int. Cl.: 44**

FOR: MEDICAL SPA SERVICES, NAMELY, MINIMALLY AND NON-INVASIVE COSMETIC AND BODY FITNESS THERAPIES, IN CLASS 44 (U.S. CLS. 100 AND 101).

**SERVICE MARK**

FIRST USE 3-1-2011; IN COMMERCE 4-13-2011.

**PRINCIPAL REGISTER**

THE MARK CONSISTS OF STANDARD CHARACTERS WITHOUT CLAIM TO ANY PARTICULAR FONT, STYLE, SIZE, OR COLOR.

NO CLAIM IS MADE TO THE EXCLUSIVE RIGHT TO USE "MEDICAL SPA", APART FROM THE MARK AS SHOWN.

SER. NO. 85-387,767, FILED 8-3-2011.

SETH A. RAPPAPORT, EXAMINING ATTORNEY



*David J. Kyffers*

Director of the United States Patent and Trademark Office

# United States of America

United States Patent and Trademark Office

# fruii

**Reg. No. 4,125,288**

**Registered Apr. 10, 2012**

**Int. Cl.: 32**

**TRADEMARK**

**PRINCIPAL REGISTER**

KAO, PETER (UNITED STATES INDIVIDUAL)  
2040 W. VALLEY BLVD.  
ALHAMBRA, CA 91803

FOR: FRUIT BEVERAGES; FRUIT CONCENTRATES AND PUREES USED AS INGREDIENTS OF BEVERAGES; FRUIT DRINKS AND FRUIT JUICES; FRUIT DRINKS AND JUICES; FRUIT JUICE; FRUIT JUICE BASES; FRUIT JUICES; FRUIT JUICES AND FRUIT DRINKS; FRUIT JUICES, NAMELY, MULBERRY, PASSION FRUIT, LYCHEE, POMEGRANATE, COCONUT AND LIME, AND GREEN MANGO JUICES; FRUIT-BASED BEVERAGES; FRUIT-FLAVORED BEVERAGES; FRUIT-FLAVOURED BEVERAGES; HERBAL JUICES; MIXED FRUIT JUICE; NON-ALCOHOLIC BEVERAGES CONTAINING FRUIT JUICES; NON-ALCOHOLIC BEVERAGES WITH TEA FLAVOR; NON-ALCOHOLIC FRUIT EXTRACTS USED IN THE PREPARATION OF BEVERAGES; NON-ALCOHOLIC FRUIT JUICE BEVERAGES, IN CLASS 32 (U.S. CLS. 45, 46 AND 48).

FIRST USE 6-1-2011; IN COMMERCE 8-1-2011.

THE MARK CONSISTS OF TERM "FRUII" APPEARING IN LOWER-CASE LETTERS AND WRITTEN IN A STYLIZED FONT

THE WORDING "FRUII" HAS NO MEANING IN A FOREIGN LANGUAGE.

SER. NO. 85-387,775, FILED 8-3-2011.

RICHARD WHITE, EXAMINING ATTORNEY



*David J. Kybas*

Director of the United States Patent and Trademark Office



# United States of America

United States Patent and Trademark Office

I LIVE A ROMANS 1:16 LIFE!

**Reg. No. 4,125,289**

**Registered Apr. 10, 2012**

**Int. Cl.: 45**

**SERVICE MARK**

**PRINCIPAL REGISTER**

TZEDAKAH MINISTRIES (TEXAS CORPORATION)  
1000 BUTCHER ROAD  
WAXAHACHIE, TX 75165

FOR: CHRISTIAN MINISTRY SERVICES, IN CLASS 45 (U.S. CLS. 100 AND 101).

FIRST USE 7-0-2011; IN COMMERCE 7-0-2011.

THE MARK CONSISTS OF STANDARD CHARACTERS WITHOUT CLAIM TO ANY PARTICULAR FONT, STYLE, SIZE, OR COLOR.

SER. NO. 85-387,846, FILED 8-3-2011.

REBECCA POVARCHUK, EXAMINING ATTORNEY



*David J. Kybas*

Director of the United States Patent and Trademark Office

# United States of America

United States Patent and Trademark Office

# SPEED BOLT

**Reg. No. 4,125,290**

**Registered Apr. 10, 2012**

**Int. Cl.: 13**

**TRADEMARK**

**PRINCIPAL REGISTER**

BENELLI U.S.A. CORPORATION (MARYLAND CORPORATION)  
17603 INDIAN HEAD HIGHWAY  
ACCOKEEK, MD 20607

FOR: FIREARMS AND PARTS THEREOF, IN CLASS 13 (U.S. CLS. 2 AND 9).

FIRST USE 1-31-2011; IN COMMERCE 1-31-2011.

THE MARK CONSISTS OF STANDARD CHARACTERS WITHOUT CLAIM TO ANY PARTICULAR FONT, STYLE, SIZE, OR COLOR.

NO CLAIM IS MADE TO THE EXCLUSIVE RIGHT TO USE "BOLT", APART FROM THE MARK AS SHOWN.

SER. NO. 85-387,851, FILED 8-3-2011.

RICHARD WHITE, EXAMINING ATTORNEY



*David J. Kyffers*

Director of the United States Patent and Trademark Office

# United States of America

United States Patent and Trademark Office

# ICIO

**Reg. No. 4,125,291**

VAN LANG, ALEX T.S. (UNITED STATES INDIVIDUAL)  
935 WESTBOURNE DR., UNIT #205  
LOS ANGELES, CA 90069

**Registered Apr. 10, 2012**

**Int. Cl.: 32**

FOR: BEVERAGES, NAMELY, BOTTLED AND FLAVORED WATER, IN CLASS 32 (U.S. CLS. 45, 46 AND 48).

**TRADEMARK**

FIRST USE 4-1-2007; IN COMMERCE 12-1-2007.

**PRINCIPAL REGISTER**

THE MARK CONSISTS OF STANDARD CHARACTERS WITHOUT CLAIM TO ANY PARTICULAR FONT, STYLE, SIZE, OR COLOR.

OWNER OF U.S. REG. NO. 3,604,441.

SER. NO. 85-387,853, FILED 8-3-2011.

APRIL ROACH, EXAMINING ATTORNEY



*David J. Kyffers*

Director of the United States Patent and Trademark Office

# United States of America

United States Patent and Trademark Office



**Reg. No. 4,125,292**

**Registered Apr. 10, 2012**

**Int. Cl.: 24**

**TRADEMARK**

**PRINCIPAL REGISTER**

ONLINE STORES, INC. (PENNSYLVANIA CORPORATION)  
1000 WESTINGHOUSE DRIVE, SUITE 1  
NEW STANTON, PA 15672

FOR: CLOTH FLAGS; FABRIC FLAGS; NYLON FLAGS, IN CLASS 24 (U.S. CLS. 42 AND 50).

FIRST USE 6-30-2004; IN COMMERCE 6-30-2004.

NO CLAIM IS MADE TO THE EXCLUSIVE RIGHT TO USE "KNIT", APART FROM THE MARK AS SHOWN.

THE MARK CONSISTS OF THE MARK IS COMPRISED OF A FLAG THAT BEARS THE WORD "SUPER" ABOVE THE WORD "KNIT", THAT IS STRETCHED BETWEEN A POLE AND A FIST, AND THAT TAPERS FROM WIDER BY THE POLE TO NARROWER BY THE FIST.

SER. NO. 85-387,889, FILED 8-3-2011.

BRENDAN REGAN, EXAMINING ATTORNEY



*David J. Kyffers*

Director of the United States Patent and Trademark Office

# United States of America

United States Patent and Trademark Office

## PASSION FOR LIGHT

**Reg. No. 4,125,293**

ZUMTOBEL AG (AUSTRIA AKTIENGESELLSCHAFT)  
HÖCHSTER STRASSE 8  
DORNBIRN, AUSTRIA 6850

**Registered Apr. 10, 2012**

**Int. Cls.: 9, 11, 35 and 42**

FOR: SOFTWARE, NAMELY, PROGRAMS FOR THE DESIGN AND PLANNING OF INSTALLATIONS FOR LIGHTING, AND PROGRAMS FOR CONTROLLING LIGHTING INSTALLATIONS AND SHADING DEVICES; REGULATING AND CONTROL DEVICES AND EQUIPMENT FOR LIGHTING INSTALLATIONS AND LIGHTS, LIGHT EMITTING DIODES OR ELECTROLUMINESCENT FOILS; LIGHT EMITTING DIODES, IN CLASS 9 (U.S. CLS. 21, 23, 26, 36 AND 38).

**TRADEMARK**

**SERVICE MARK**

**PRINCIPAL REGISTER**

FOR: LIGHTING INSTALLATIONS, DEVICES AND EQUIPMENT AND LIGHTS, NAMELY, ELECTRIC LAMPS; FIBER OPTIC LIGHTING INSTALLATIONS; LIGHT MODULES AND LIGHTS WITH LIGHT EMITTING DIODES AS THE MEANS OF LIGHTING, NAMELY, LIGHT FIXTURES; LIGHT SOURCES, NAMELY, LIGHT FIXTURES CONTAINING LIGHT-EMITTING DIODES; HEATING AND AIR CONDITIONING INSTALLATIONS COMPRISED OF VENTILATING INSTALLATIONS, DEVICES AND EQUIPMENT, DEVICES FOR DIRECTING AND GUIDING AIR, VENTILATION GRILLES FOR DIRECTING AIR, AND ROLLERS FOR DIRECTING AIR, IN CLASS 11 (U.S. CLS. 13, 21, 23, 31 AND 34).

FOR: ADVERTISING; PERSONNEL RECRUITMENT; ORGANIZATION OF EXHIBITIONS FOR COMMERCIAL OR ADVERTISING PURPOSES; DISTRIBUTION OF FLYERS, PROSPECTUS, PRINTED PAPERS AND SAMPLES FOR ADVERTISING PURPOSES FOR OTHERS, IN CLASS 35 (U.S. CLS. 100, 101 AND 102).

FOR: DESIGN AND TECHNICAL PLANNING OF INSTALLATIONS FOR LIGHTING, AIR CONDITIONING, VENTILATION AND HEATING; PROGRAMMING OF COMPUTING ROUTINES FOR ELECTRONIC DATA PROCESSING EQUIPMENT, IN CLASS 42 (U.S. CLS. 100 AND 101).

THE MARK CONSISTS OF STANDARD CHARACTERS WITHOUT CLAIM TO ANY PARTICULAR FONT, STYLE, SIZE, OR COLOR.

PRIORITY CLAIMED UNDER SEC. 44(D) ON AUSTRIA APPLICATION NO. AM772/2011, FILED 2-11-2011, REG. NO. 262141, DATED 4-28-2011, EXPIRES 4-30-2021.

SER. NO. 85-387,891, FILED 8-3-2011.



*David J. Kyjars*

Director of the United States Patent and Trademark Office

**Reg. No. 4,125,293** KRISTIN DAHLING, EXAMINING ATTORNEY

# United States of America

United States Patent and Trademark Office

**ROOF GUARDIAN** *Technologies*



**Reg. No. 4,125,294**

SAF-T-SCREENS, INC. (TEXAS CORPORATION)  
347 HWY 289  
COMFORT, TX 78013

**Registered Apr. 10, 2012**

**Int. Cl.: 2**

FOR: ELASTOMERIC-BASED COATINGS FOR USE ON ROOFS, WALLS AND BUILDING FOUNDATIONS, IN CLASS 2 (U.S. CLS. 6, 11 AND 16).

**TRADEMARK**

FIRST USE 4-1-2003; IN COMMERCE 4-1-2003.

**PRINCIPAL REGISTER**

NO CLAIM IS MADE TO THE EXCLUSIVE RIGHT TO USE "ROOF" AND "TECHNOLOGIES", APART FROM THE MARK AS SHOWN.

THE COLOR(S) ROYAL BLUE IS/ARE CLAIMED AS A FEATURE OF THE MARK.

THE MARK CONSISTS OF THE WORDS "ROOF GUARDIAN" IN CAPITAL LETTERS FOLLOWED BY "TECHNOLOGIES", ALL THE LETTERS ARE IN QUICK TYPE II FONT, ITALICIZED AND IN BOLD. UNDERNEATH THE WORDS IS AN ARROW THAT RUNS THE LENGTH OF THE WORDING, ALL LETTERS AND THE ARROW ARE ROYAL BLUE IN COLOR.

SER. NO. 85-387,911, FILED 8-3-2011.

REBECCA EISINGER, EXAMINING ATTORNEY



*David J. Kybas*

Director of the United States Patent and Trademark Office

# United States of America

United States Patent and Trademark Office



**Reg. No. 4,125,295**

**Registered Apr. 10, 2012**

**Int. Cl.: 44**

**SERVICE MARK**

**PRINCIPAL REGISTER**

HOOTMAN, THOMAS (UNITED STATES INDIVIDUAL)  
SUITE 101  
278 TOWN CENTER PRKY  
SANTEE, CA 92071

FOR: HEALTH SPA SERVICES FOR HEALTH AND WELLNESS OF THE BODY AND SPIRIT, IN CLASS 44 (U.S. CLS. 100 AND 101).

FIRST USE 11-1-2007; IN COMMERCE 1-11-2008.

NO CLAIM IS MADE TO THE EXCLUSIVE RIGHT TO USE "SPA", APART FROM THE MARK AS SHOWN.

THE MARK CONSISTS OF A CIRCLE WITH THE STYLIZED TEXT "SIMPLY SPA" AND A LINE IN THE MIDDLE. BELOW THERE IS THE STYLIZED TEXT "RELAX, REJUVENATE.....THE SIMPLE WAY".

SER. NO. 85-387,970, FILED 8-3-2011.

KIMBERLY PERRY, EXAMINING ATTORNEY



*David J. Kyros*

Director of the United States Patent and Trademark Office



# United States of America

United States Patent and Trademark Office



**Reg. No. 4,125,296**

**Registered Apr. 10, 2012**

**Int. Cl.: 41**

**SERVICE MARK**

**PRINCIPAL REGISTER**

CHILDREN'S MUSEUM OF JACKSONVILLE, INC. (NORTH CAROLINA CORPORATION)  
103 WINTHROPE WAY  
JACKSONVILLE, NC 28546

FOR: MUSEUMS, IN CLASS 41 (U.S. CLS. 100, 101 AND 107).

FIRST USE 5-15-2011; IN COMMERCE 5-15-2011.

NO CLAIM IS MADE TO THE EXCLUSIVE RIGHT TO USE "MUSEUM", APART FROM THE MARK AS SHOWN.

THE COLOR(S) TURQUOISE, ROSE, YELLOW, ORANGE, GREEN, PURPLE AND BLACK IS/ARE CLAIMED AS A FEATURE OF THE MARK.

THE MARK CONSISTS OF THE STYLIZED WORDS "ZING ZUMM" WRITTEN IN LARGE LETTERS WITH THE WORDING "AMAZING MUSEUM" IN BLOCK LETTERS POSITIONED ABOVE AND TO THE RIGHT OF "ZING ZUMM". FOUR CHILDLIKE FIGURES ARE UNDERNEATH "ZING" AND FOUR CHILDLIKE FIGURES ARE ABOVE THE WORD "ZUMM". THE COLOR TURQUOISE IS IN THE LETTERS "Z" AND "G" IN "ZING" AND THE FIRST "M" IN "ZUMM". THE COLOR ROSE IS IN THE LETTERS "I" IN "ZING" AND THE LETTERS "Z" AND THE SECOND "M" IN "ZUMM". THE COLOR YELLOW IS IN THE LETTERS "N" IN "ZING" AND "U" IN "ZUMM". THE COLOR ORANGE IS IN THE BODIES/CLOTHING OF THE FIGURES HOLDING THE TURQUOISE "Z" OF "ZING" AND ON TOP OF THE ROSE "Z" OF "ZUMM". THE COLOR GREEN IS IN THE BODIES/CLOTHING OF THE FIGURES HOLDING THE "I" AND "N" OF "ZING", TO THE LEFT OF THE "Z" IN "ZUMM", AND ON TOP OF THE FIRST "M" OF "ZUMM". THE COLOR PURPLE IS IN THE BODIES/CLOTHING OF THE FIGURES UNDER THE "G" OF "ZING", RESTING IN THE CURVE OF THE "U" OF "ZUMM", AND ON TOP OF THE LAST "M" IN "ZUMM". THE COLOR BLACK IS USED FOR THE WORDS "AMAZING MUSEUM" AND TO OUTLINE THE LETTERS OF "ZING ZUMM" AS WELL AS IN THE DRAWINGS OF ALL OF THE CHILDLIKE FIGURES.



SER. NO. 85-387,984, FILED 8-3-2011.

*David J. Kyros*

MICHAEL LITZAU, EXAMINING ATTORNEY

# United States of America

United States Patent and Trademark Office

## The Perfect Game Foundation

**Reg. No. 4,125,297**

**Registered Apr. 10, 2012**

**Int. Cls.: 36 and 41**

**SERVICE MARK**

**PRINCIPAL REGISTER**

THE PERFECT GAME FOUNDATION, INC. (VIRGINIA CORPORATION)  
C/O DQW HOLDINGS, LLC  
1012 NORTHWOODS TRAIL  
MCLEAN, VA 22102

FOR: CHARITABLE FOUNDATION SERVICES, NAMELY, PROVIDING FINANCIAL ASSISTANCE FOR PROGRAMS AND SERVICES OF OTHERS, IN CLASS 36 (U.S. CLS. 100, 101 AND 102).

FIRST USE 4-30-2011; IN COMMERCE 4-30-2011.

FOR: EDUCATION SERVICES, NAMELY, MENTORING IN THE FIELD OF THE BUSINESS OF SPORTS, IN CLASS 41 (U.S. CLS. 100, 101 AND 107).

FIRST USE 4-30-2011; IN COMMERCE 4-30-2011.

THE MARK CONSISTS OF STANDARD CHARACTERS WITHOUT CLAIM TO ANY PARTICULAR FONT, STYLE, SIZE, OR COLOR.

NO CLAIM IS MADE TO THE EXCLUSIVE RIGHT TO USE "FOUNDATION", APART FROM THE MARK AS SHOWN.

SER. NO. 85-388,014, FILED 8-3-2011.

JENNIFER DIXON, EXAMINING ATTORNEY



*David J. Kybas*

Director of the United States Patent and Trademark Office

# United States of America

United States Patent and Trademark Office

## Round Up Red

**Reg. No. 4,125,298**

**Registered Apr. 10, 2012**

**Int. Cl.: 33**

**TRADEMARK**

**PRINCIPAL REGISTER**

HELWIG TASTING ROOM, LLC (CALIFORNIA LIMITED LIABILITY COMPANY)  
188 COLT LN  
THOUSAND OAKS, CA 91361

FOR: WINE, IN CLASS 33 (U.S. CLS. 47 AND 49).

FIRST USE 4-14-2011; IN COMMERCE 5-1-2011.

THE MARK CONSISTS OF STANDARD CHARACTERS WITHOUT CLAIM TO ANY PARTICULAR FONT, STYLE, SIZE, OR COLOR.

NO CLAIM IS MADE TO THE EXCLUSIVE RIGHT TO USE "RED", APART FROM THE MARK AS SHOWN.

SER. NO. 85-388,028, FILED 8-3-2011.

KAREN K. BUSH, EXAMINING ATTORNEY



*David J. Kyffers*

Director of the United States Patent and Trademark Office

# United States of America

United States Patent and Trademark Office

**BROADWAY**  
*Blast*

**Reg. No. 4,125,299**

FRANCESCHINA, AMANDA (UNITED STATES INDIVIDUAL)  
3433 STATEWOOD DRIVE  
CINCINNATI, OH 45251

**Registered Apr. 10, 2012**

**Int. Cl.: 41**

FOR: PROVIDING DANCE FITNESS CLASSES AND INSTRUCTION USING SHOWTUNES, SONGS AND MOVEMENT INSPIRED BY MUSICAL THEATRE, AND SONGS AND MOVEMENT INSPIRED BY MUSICAL MOVIE PRODUCTIONS, IN CLASS 41 (U.S. CLS. 100, 101 AND 107).

**SERVICE MARK**

**PRINCIPAL REGISTER**

FIRST USE 8-2-2011; IN COMMERCE 8-2-2011.

NO CLAIM IS MADE TO THE EXCLUSIVE RIGHT TO USE "BROADWAY", APART FROM THE MARK AS SHOWN.

THE MARK CONSISTS OF THE STYLIZED TEXT "BROADWAY BLAST".

SER. NO. 85-388,046, FILED 8-3-2011.

EMILY CARLSEN, EXAMINING ATTORNEY



*David J. Kyffers*

Director of the United States Patent and Trademark Office

# United States of America

United States Patent and Trademark Office

## PRAIRIE HILLS

**Reg. No. 4,125,300**

**Registered Apr. 10, 2012**

**Int. Cl.: 43**

**SERVICE MARK**

**PRINCIPAL REGISTER**

HILDEBRANDT & ASSOCIATES, LTD (IOWA CORPORATION), DBA PRAIRIE HILLS  
ASSISTED LIVING  
300 SOUTHGATE BLVD  
FAIRFIELD, IA 52556

FOR: PROVIDING ASSISTED LIVING FACILITIES, IN CLASS 43 (U.S. CLS. 100 AND 101).

FIRST USE 10-30-2003; IN COMMERCE 10-30-2003.

THE MARK CONSISTS OF STANDARD CHARACTERS WITHOUT CLAIM TO ANY PARTICULAR FONT, STYLE, SIZE, OR COLOR.

SER. NO. 85-388,073, FILED 8-3-2011.

TEJBIR SINGH, EXAMINING ATTORNEY



*David J. Kybas*

Director of the United States Patent and Trademark Office

# United States of America

United States Patent and Trademark Office



# ARMOR

## PEST CONTROL

**Reg. No. 4,125,301**

ARMOR PEST CONTROL, INC. (FLORIDA CORPORATION)  
6614 ATLANTIC BLVD.  
JACKSONVILLE, FL 32211

**Registered Apr. 10, 2012**

**Int. Cl.: 37**

FOR: TERMITE AND PEST CONTROL, IN CLASS 37 (U.S. CLS. 100, 103 AND 106).

**SERVICE MARK**

FIRST USE 4-1-2011; IN COMMERCE 4-1-2011.

**PRINCIPAL REGISTER**

NO CLAIM IS MADE TO THE EXCLUSIVE RIGHT TO USE "PEST CONTROL", APART FROM THE MARK AS SHOWN.

THE MARK CONSISTS OF A SHIELD WITH THE LETTERS "APC" WITHIN THE SHIELD AND WITH THE WORD "ARMOR" TO THE RIGHT OF THE SHIELD AND WITH THE WORDS "PEST CONTROL" BENEATH THE WORD "ARMOR", AND WITH A SHADOW APPEARING BENEATH THE SHIELD.

SER. NO. 85-388,083, FILED 8-3-2011.

B. PARADEWELAI, EXAMINING ATTORNEY



*David J. Kyros*

Director of the United States Patent and Trademark Office

**United States of America**  
United States Patent and Trademark Office

# Kavanojo

**Reg. No. 4,125,302**

KAVANAUGH, JOHN (UNITED STATES INDIVIDUAL)  
985 EAST BELMONT AVE  
SALT LAKE CITY, UT 84105

**Registered Apr. 10, 2012**

**Int. Cl.: 9**

FOR: ELECTRICAL PICKUPS USED IN THE AMPLIFICATION OF MUSICAL INSTRUMENTS,  
NAMELY, BANJOS, IN CLASS 9 (U.S. CLS. 21, 23, 26, 36 AND 38).

**TRADEMARK**

FIRST USE 12-6-2002; IN COMMERCE 6-15-2008.

**PRINCIPAL REGISTER**

THE MARK CONSISTS OF STANDARD CHARACTERS WITHOUT CLAIM TO ANY PAR-  
TICULAR FONT, STYLE, SIZE, OR COLOR.

SER. NO. 85-388,089, FILED 8-3-2011.

KELLY BOULTON, EXAMINING ATTORNEY



*David J. Kyffers*

Director of the United States Patent and Trademark Office

# United States of America

United States Patent and Trademark Office



**Reg. No. 4,125,303**

**Registered Apr. 10, 2012**

**Int. Cl.: 9**

**TRADEMARK**

**PRINCIPAL REGISTER**

SYNPLICITY, LLC (CALIFORNIA LIMITED LIABILITY COMPANY)  
1136 EDDY STREET, SUITE C  
SAN FRANCISCO, CA 94109

FOR: COMPUTER SOFTWARE FOR CREATING SEARCHABLE DATABASES OF INFORMATION AND DATA; COMPUTER SOFTWARE FOR THE COLLECTION, EDITING, ORGANIZING, MODIFYING, BOOK MARKING, TRANSMISSION, STORAGE AND SHARING OF DATA AND INFORMATION, SAFEGUARDING OF DIGITAL FILES, INCLUDING AUDIO, VIDEO, TEXT, BINARY, STILL IMAGES, GRAPHICS AND MULTIMEDIA FILES, AND FOR PROVIDING MANAGEMENT OF USER DATA THAT MAY BE DOWNLOADED FROM A GLOBAL COMPUTER NETWORK, IN CLASS 9 (U.S. CLS. 21, 23, 26, 36 AND 38).

FIRST USE 4-14-2008; IN COMMERCE 4-14-2008.

THE MARK CONSISTS OF A PINWHEEL WITH FOUR CURVED SYMMETRICAL BLADES, IN (CLOCKWISE FROM TOP) GREEN, RED, ORANGE AND BLUE, EACH OUTLINED IN BLACK AND HAVING TWO BLACK RADIAL HASHES NEAR THE HUB.

THE COLOR(S) GREEN, RED, ORANGE, BLUE AND BLACK IS/ARE CLAIMED AS A FEATURE OF THE MARK.

SER. NO. 85-388,090, FILED 8-3-2011.

EDWARD FENNESSY, EXAMINING ATTORNEY



*David J. Kybas*

Director of the United States Patent and Trademark Office



# United States of America

United States Patent and Trademark Office

# AIS

**Reg. No. 4,125,304**

ADVANCED IMAGING STUDIO, INC. (ILLINOIS CORPORATION)  
4307 N CENTRAL AVE.  
CHICAGO, IL 60634

**Registered Apr. 10, 2012**

**Int. Cl.: 44**

FOR: MEDICAL IMAGING SERVICES, IN CLASS 44 (U.S. CLS. 100 AND 101).

**SERVICE MARK**

FIRST USE 11-5-2009; IN COMMERCE 11-9-2009.

**PRINCIPAL REGISTER**

THE MARK CONSISTS OF STANDARD CHARACTERS WITHOUT CLAIM TO ANY PARTICULAR FONT, STYLE, SIZE, OR COLOR.

OWNER OF U.S. REG. NO. 3,907,710.

SER. NO. 85-388,138, FILED 8-3-2011.

DANIEL CAPSHAW, EXAMINING ATTORNEY



*David J. Kyffers*

Director of the United States Patent and Trademark Office

# United States of America

United States Patent and Trademark Office



**Reg. No. 4,125,305**

**Registered Apr. 10, 2012**

**Int. Cl.: 43**

**SERVICE MARK**

**PRINCIPAL REGISTER**

RETAIL RESTAURANT DEVELOPMENT, L.L.C. (WASHINGTON LIMITED LIABILITY COMPANY)  
6615 LINWOOD LN SW  
LAKEWOOD, WA 98499

FOR: CAFE AND RESTAURANT SERVICES; CAFE-RESTAURANTS; CARRY-OUT RESTAURANTS; FAST-FOOD RESTAURANT SERVICES; FAST-FOOD RESTAURANTS; RESTAURANT; RESTAURANT AND BAR SERVICES, INCLUDING RESTAURANT CARRYOUT SERVICES; RESTAURANT AND CAFE SERVICES; RESTAURANT AND CATERING SERVICES; RESTAURANT SERVICES; RESTAURANTS; TAKE-OUT RESTAURANT SERVICES, IN CLASS 43 (U.S. CLS. 100 AND 101).

FIRST USE 12-1-1999; IN COMMERCE 12-1-1999.

OWNER OF U.S. REG. NOS. 2,421,145 AND 4,052,796.

NO CLAIM IS MADE TO THE EXCLUSIVE RIGHT TO USE "CHINATOWN CAFÉ", APART FROM THE MARK AS SHOWN.

THE MARK CONSISTS OF THE TERMS "RRD'S CHINATOWN CAFE", A DESIGN OF A PAGODA, AND A DESIGN OF A TREE, ALL ATOP A CIRCULAR BACKGROUND.

SER. NO. 85-388,239, FILED 8-3-2011.

REBECCA GILBERT, EXAMINING ATTORNEY



*David J. Kybas*

Director of the United States Patent and Trademark Office

# United States of America

United States Patent and Trademark Office

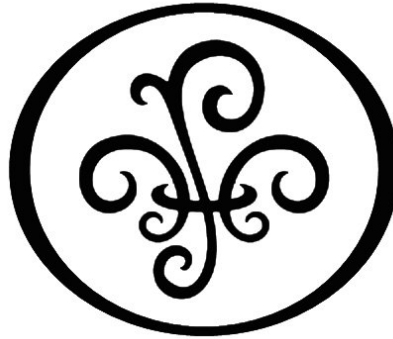

**Reg. No. 4,125,306**

GRAYMEIREN HOLDINGS, L.L.C. (TEXAS LIMITED LIABILITY COMPANY)  
1122 SPRING CYPRESS  
SPRING, TX 77373

**Registered Apr. 10, 2012**

**Int. Cl.: 36**

FOR: PROVIDING MONETARY EXCHANGE SERVICES, NAMELY, EXCHANGING PRE-  
CIOUS METALS OF OTHERS FOR MONEY, IN CLASS 36 (U.S. CLS. 100, 101 AND 102).

**SERVICE MARK**

FIRST USE 7-0-2008; IN COMMERCE 7-0-2008.

**PRINCIPAL REGISTER**

THE MARK CONSISTS OF A STYLIZED FLEUR-DE-LIS DESIGN IN AN OVAL.

SER. NO. 85-388,271, FILED 8-3-2011.

SIMON TENG, EXAMINING ATTORNEY



*David J. Kybas*

Director of the United States Patent and Trademark Office

# United States of America

United States Patent and Trademark Office

# Drain Dudes

**Reg. No. 4,125,307**

**Registered Apr. 10, 2012**

**Int. Cl.: 37**

**SERVICE MARK**

**PRINCIPAL REGISTER**

CHECKERED FLAG PLUMBING (CALIFORNIA SOLE PROPRIETORSHIP)  
39130 3RD ST EAST  
PALMDALE, CA 93550

FOR: PLUMBING, IN CLASS 37 (U.S. CLS. 100, 103 AND 106).

FIRST USE 4-1-2006; IN COMMERCE 4-1-2006.

THE MARK CONSISTS OF STANDARD CHARACTERS WITHOUT CLAIM TO ANY PARTICULAR FONT, STYLE, SIZE, OR COLOR.

NO CLAIM IS MADE TO THE EXCLUSIVE RIGHT TO USE "DRAIN", APART FROM THE MARK AS SHOWN.

SER. NO. 85-388,283, FILED 8-3-2011.

JOHN WILKE, EXAMINING ATTORNEY



*David J. Kyffers*

Director of the United States Patent and Trademark Office

# United States of America

United States Patent and Trademark Office

# APPCAT

**Reg. No. 4,125,308**

PREMIER APP SHOP, LLC (NEVADA LIMITED LIABILITY COMPANY)  
7500 W LAKE MEAD BLVD. STE. 9-478

**Registered Apr. 10, 2012**

LAS VEGAS, NV 89128

**Int. Cl.: 9**

FOR: COMPUTER SOFTWARE, NAMELY, SOFTWARE FOR DEVELOPING MOBILE SOFTWARE APPLICATIONS AND FOR DELIVERING DIGITAL CONTENT TO MOBILE DEVICES, PERSONAL COMPUTERS, CONSOLES, AND TABLET COMPUTERS, IN CLASS 9 (U.S. CLS. 21, 23, 26, 36 AND 38).

**TRADEMARK**

**PRINCIPAL REGISTER**

FIRST USE 11-1-2010; IN COMMERCE 11-1-2010.

THE MARK CONSISTS OF STANDARD CHARACTERS WITHOUT CLAIM TO ANY PARTICULAR FONT, STYLE, SIZE, OR COLOR.

SER. NO. 85-388,344, FILED 8-3-2011.

ADA HAN, EXAMINING ATTORNEY



*David J. Kyffers*

Director of the United States Patent and Trademark Office

# United States of America

United States Patent and Trademark Office

## AIRO Athletics

**Reg. No. 4,125,309**

**Registered Apr. 10, 2012**

**Int. Cl.: 41**

**SERVICE MARK**

**PRINCIPAL REGISTER**

MENARD, DAVID (UNITED STATES INDIVIDUAL)  
1112 WESTON ROAD  
WESTON, FL 33326

FOR: ATHLETIC TRAINING SERVICES, IN CLASS 41 (U.S. CLS. 100, 101 AND 107).

FIRST USE 4-20-2010; IN COMMERCE 4-20-2010.

THE MARK CONSISTS OF STANDARD CHARACTERS WITHOUT CLAIM TO ANY PARTICULAR FONT, STYLE, SIZE, OR COLOR.

NO CLAIM IS MADE TO THE EXCLUSIVE RIGHT TO USE "ATHLETICS", APART FROM THE MARK AS SHOWN.

SER. NO. 85-388,362, FILED 8-3-2011.

LOURDES AYALA, EXAMINING ATTORNEY



*David J. Kyffers*

Director of the United States Patent and Trademark Office

# United States of America

United States Patent and Trademark Office



**Reg. No. 4,125,310**

**Registered Apr. 10, 2012**

**Int. Cl.: 10**

**TRADEMARK**

**PRINCIPAL REGISTER**

NANCY LYN KETOLA (UNITED STATES INDIVIDUAL)  
780 FAIRWAY PARK DRIVE  
ANN ARBOR, MI 48103 AND

REBECCA NOEL SMITH (UNITED STATES INDIVIDUAL)  
780 FAIRWAY PARK DRIVE  
ANN ARBOR, MI 48103

FOR: ADULT SEXUAL STIMULATION AIDS, NAMELY, VIBRATORS , IN CLASS 10 (U.S. CLS. 26, 39 AND 44).

FIRST USE 8-21-2010; IN COMMERCE 9-15-2010.

THE MARK CONSISTS OF A SHIELD WHICH IS IN THE SHAPE OF AN UPSIDE DOWN TRIANGLE WITH THE LETTER "S" CENTERED IN THE MIDDLE. THERE ARE THREE PARALLEL LINES CENTERED ABOVE THE SHIELD AND NEXT TO THE LEFT AND RIGHT BOTTOM PORTIONS OF THE SHIELD. THE WORDING "SPORTYVIBE" APPEARS TO THE RIGHT OF THE SHIELD WITH THE LETTERS "BE" AND IN THE WORD "VIBE" UNDERLINED BY A LINE WHICH SLANTS UPWARD TO THE RIGHT. THE WORDING "SERIOUS FUN FOR THE SERIOUS FAN" APPEARS CENTERED BELOW THE LETTERS "SPORTYVI" IN THE WORDING "SPORTYVIBE".

SER. NO. 85-388,416, FILED 8-3-2011.

TINA BROWN, EXAMINING ATTORNEY



*David J. Kyjars*

Director of the United States Patent and Trademark Office

# United States of America

United States Patent and Trademark Office

## GET YOUR MACA ON!

**Reg. No. 4,125,311**

GOLDEN ISLES MEDICAL, INC. (GEORGIA CORPORATION)  
12 PLANTATION WAY

**Registered Apr. 10, 2012**

ST. SIMONS ISLAND, GA 31522

**Int. Cl.: 5**

FOR: CALCIUM SUPPLEMENTS; DIETARY AND NUTRITIONAL SUPPLEMENTS; DIETARY BEVERAGE SUPPLEMENTS FOR HUMAN CONSUMPTION IN LIQUID AND DRY MIX FORM FOR THERAPEUTIC PURPOSES; DIETARY FOOD SUPPLEMENTS; DIETARY SUPPLEMENTAL DRINKS; DIETARY SUPPLEMENTS; DIETARY SUPPLEMENTS FOR CONTROLLING CHOLESTEROL; DIETARY SUPPLEMENTS FOR HUMAN CONSUMPTION; FOOD SUPPLEMENTS; HERBAL SUPPLEMENTS; MEAL REPLACEMENT AND DIETARY SUPPLEMENT DRINK MIXES; MINERAL FOOD SUPPLEMENTS; MINERAL NUTRITIONAL SUPPLEMENTS; MINERAL SUPPLEMENTS; NATURAL HERBAL SUPPLEMENTS; NATURAL SUPPLEMENTS FOR TREATING CANDIDA; NATURAL SUPPLEMENTS FOR TREATING DEPRESSION AND ANXIETY; NUTRACEUTICALS FOR USE AS A DIETARY SUPPLEMENT; NUTRITIONAL SUPPLEMENT IN THE NATURE OF A NUTRIENT-DENSE, PROTEIN-BASED DRINK MIX; NUTRITIONAL SUPPLEMENTS; POWDERED FRUIT-FLAVORED DIETARY SUPPLEMENT DRINK MIX; POWDERED NUTRITIONAL SUPPLEMENT DRINK MIX; PROTEIN SUPPLEMENTS; ALL OF THE AFOREMENTIONED GOODS CONTAINING MACA ROOT, IN CLASS 5 (U.S. CLS. 6, 18, 44, 46, 51 AND 52).

**TRADEMARK**

**PRINCIPAL REGISTER**

FIRST USE 11-15-2010; IN COMMERCE 11-15-2010.

THE MARK CONSISTS OF STANDARD CHARACTERS WITHOUT CLAIM TO ANY PARTICULAR FONT, STYLE, SIZE, OR COLOR.

SER. NO. 85-388,454, FILED 8-3-2011.

ROBIN CHOSID, EXAMINING ATTORNEY



*David J. Kyros*

Director of the United States Patent and Trademark Office



**United States of America**  
United States Patent and Trademark Office

# BNBQUEST

**Reg. No. 4,125,312**

VENSOF, INC. (ARIZONA CORPORATION)  
13934 N. 59TH AVE, SUITE 140  
GLENDALE, AZ 85306

**Registered Apr. 10, 2012**

**Int. Cl.: 43**

FOR: PROVIDING A WEB SITE FEATURING INFORMATION ON BED AND BREAKFAST  
INN SERVICES WORLDWIDE, IN CLASS 43 (U.S. CLS. 100 AND 101).

**SERVICE MARK**

FIRST USE 5-0-2011; IN COMMERCE 5-0-2011.

**PRINCIPAL REGISTER**

THE MARK CONSISTS OF STANDARD CHARACTERS WITHOUT CLAIM TO ANY PAR-  
TICULAR FONT, STYLE, SIZE, OR COLOR.

SER. NO. 85-388,488, FILED 8-3-2011.

PAUL MORENO, EXAMINING ATTORNEY



*David J. Kyffers*

Director of the United States Patent and Trademark Office

# United States of America

United States Patent and Trademark Office

## I&M JEANS U.S.A.

**Reg. No. 4,125,313**

ITSME JEAN, INC. (CALIFORNIA CORPORATION)  
1100 SOUTH SAN PEDRO STREET, L-01  
LOS ANGELES, CA 90015

**Registered Apr. 10, 2012**

**Int. Cl.: 25**

FOR: JEANS; DENIM PANTS; PANTS; CLOTHING, NAMELY, JEANS, DENIM PANTS, PANTS, IN CLASS 25 (U.S. CLS. 22 AND 39).

**TRADEMARK**

FIRST USE 6-1-2011; IN COMMERCE 6-1-2011.

**PRINCIPAL REGISTER**

THE MARK CONSISTS OF STANDARD CHARACTERS WITHOUT CLAIM TO ANY PARTICULAR FONT, STYLE, SIZE, OR COLOR.

NO CLAIM IS MADE TO THE EXCLUSIVE RIGHT TO USE "JEANS U.S.A.", APART FROM THE MARK AS SHOWN.

SER. NO. 85-388,496, FILED 8-3-2011.

TINA BROWN, EXAMINING ATTORNEY



*David J. Kyffers*

Director of the United States Patent and Trademark Office

# United States of America

United States Patent and Trademark Office

# STUDYLOGIC

**Reg. No. 4,125,314**

**Registered Apr. 10, 2012**

**Int. Cl.: 35**

**SERVICE MARK**

**PRINCIPAL REGISTER**

STUDY LOGIC LLC (NEW YORK LIMITED LIABILITY COMPANY)  
SUITE 206  
445 CENTRAL AVENUE  
CEDARHURST, NY 11516

FOR: ADVICE ON THE ANALYSIS OF CONSUMER BUYING HABITS AND NEEDS PROVIDED WITH THE HELP OF SENSORY, QUALITY AND QUANTITY-RELATED DATA; ANALYSIS OF MARKET RESEARCH DATA AND STATISTICS; BUSINESS SERVICES, NAMELY, CONSUMER RESEARCH AND CONSULTING RELATED THERETO; CONDUCTING BUSINESS AND MARKET RESEARCH SURVEYS; MARKET RESEARCH AND BUSINESS ANALYSES; MARKET RESEARCH BY MEANS OF A COMPUTER DATABASE; MARKETING SERVICES, NAMELY, CONDUCTING CONSUMER TRACKING BEHAVIOR RESEARCH AND CONSUMER TREND ANALYSIS, IN CLASS 35 (U.S. CLS. 100, 101 AND 102).

FIRST USE 1-14-2005; IN COMMERCE 4-7-2005.

THE MARK CONSISTS OF STANDARD CHARACTERS WITHOUT CLAIM TO ANY PARTICULAR FONT, STYLE, SIZE, OR COLOR.

SER. NO. 85-388,535, FILED 8-3-2011.

PAUL MORENO, EXAMINING ATTORNEY



*David J. Kyffers*

Director of the United States Patent and Trademark Office

# United States of America

United States Patent and Trademark Office

## COMMONWEALTH FINANCIAL GROUP

**Reg. No. 4,125,315**

**Registered Apr. 10, 2012**

**Int. Cl.: 36**

**SERVICE MARK**

**PRINCIPAL REGISTER**

COMMONWEALTH FINANCIAL GROUP, INC. (SOUTH CAROLINA CORPORATION)  
SUITE 106  
225 SEVEN FARMS DRIVE  
CHARLESTON, SC 29492

FOR: FINANCIAL CONSULTING AND FINANCIAL PLANNING SERVICES PROVIDED TO  
INDIVIDUALS ON A FEE BASIS, IN CLASS 36 (U.S. CLS. 100, 101 AND 102).

FIRST USE 1-1-2001; IN COMMERCE 1-1-2001.

THE MARK CONSISTS OF STANDARD CHARACTERS WITHOUT CLAIM TO ANY PAR-  
TICULAR FONT, STYLE, SIZE, OR COLOR.

NO CLAIM IS MADE TO THE EXCLUSIVE RIGHT TO USE "FINANCIAL GROUP", APART  
FROM THE MARK AS SHOWN.

SER. NO. 85-388,548, FILED 8-3-2011.

JAY FLOWERS, EXAMINING ATTORNEY



*David J. Kyffers*

Director of the United States Patent and Trademark Office

# United States of America

United States Patent and Trademark Office

## Multiplied Rewards

**Reg. No. 4,125,316**

QUANTUMCASH, LLC (NEW JERSEY LIMITED LIABILITY COMPANY)  
476 DELAWARE AVENUE

**Registered Apr. 10, 2012**

EGG HARBOR TOWNSHIP, NJ 08234

**Int. Cl.: 35**

FOR: ADMINISTRATION OF A CUSTOMER LOYALTY PROGRAM WHICH PROVIDES CASH REWARDS AND INCENTIVES FOR THE SALE AND USAGE OF TRANSACTION CARDS, ELECTRONIC ACCOUNTS, AND OTHER PAYMENT DEVICES OR LOYALTY PROGRAMS, IN CLASS 35 (U.S. CLS. 100, 101 AND 102).

**SERVICE MARK**

**PRINCIPAL REGISTER**

FIRST USE 3-24-1999; IN COMMERCE 1-1-2001.

THE MARK CONSISTS OF STANDARD CHARACTERS WITHOUT CLAIM TO ANY PARTICULAR FONT, STYLE, SIZE, OR COLOR.

NO CLAIM IS MADE TO THE EXCLUSIVE RIGHT TO USE "REWARDS", APART FROM THE MARK AS SHOWN.

SER. NO. 85-388,549, FILED 8-3-2011.

JAY FLOWERS, EXAMINING ATTORNEY



*David J. Kyffers*

Director of the United States Patent and Trademark Office

# United States of America

United States Patent and Trademark Office

## The Success Stick

**Reg. No. 4,125,317**

**Registered Apr. 10, 2012**

**Int. Cl.: 9**

**TRADEMARK**

**PRINCIPAL REGISTER**

POLARIS GLOBAL (ARIZONA LIMITED LIABILITY COMPANY), AKA POLARIS GLOBAL MARKETING  
14835 E SHEA BLVD STE 103-618  
FOUNTAIN HILLS, AZ 85268

FOR: PRE-RECORDED FLASH DRIVES FEATURING EDUCATIONAL MATERIAL IN THE FIELDS OF PERSONAL SUCCESS, PERSONAL DEVELOPMENT, SELF-HELP, AND GENERAL BUSINESS DEVELOPMENT, IN CLASS 9 (U.S. CLS. 21, 23, 26, 36 AND 38).

FIRST USE 7-15-2011; IN COMMERCE 7-15-2011.

THE MARK CONSISTS OF STANDARD CHARACTERS WITHOUT CLAIM TO ANY PARTICULAR FONT, STYLE, SIZE, OR COLOR.

NO CLAIM IS MADE TO THE EXCLUSIVE RIGHT TO USE "STICK", APART FROM THE MARK AS SHOWN.

SER. NO. 85-388,554, FILED 8-3-2011.

CARRIE GENOVESE, EXAMINING ATTORNEY



*David J. Kyffers*

Director of the United States Patent and Trademark Office

# United States of America

United States Patent and Trademark Office

## THE NEUROLOGIST

**Reg. No. 4,125,318**

**Registered Apr. 10, 2012**

**Int. Cl.: 9**

**TRADEMARK**

**PRINCIPAL REGISTER**

WOLTERS KLUWER HEALTH, INC. (DELAWARE CORPORATION)  
TWO COMMERCE SQUARE  
2001 MARKET STREET  
PHILADELPHIA, PA 19103

FOR: ELECTRONIC PUBLICATIONS, NAMELY, PERIODICALS, MAGAZINES, JOURNALS, AND ARTICLES IN THE FIELD OF HEALTH, ON PRE-RECORDED ELECTRONIC AND DIGITAL MEDIA; DOWNLOADABLE ELECTRONIC PUBLICATIONS, NAMELY, PERIODICALS, MAGAZINES, JOURNALS, AND ARTICLES IN THE FIELD OF HEALTH, IN CLASS 9 (U.S. CLS. 21, 23, 26, 36 AND 38).

FIRST USE 3-5-2002; IN COMMERCE 3-5-2002.

THE MARK CONSISTS OF STANDARD CHARACTERS WITHOUT CLAIM TO ANY PARTICULAR FONT, STYLE, SIZE, OR COLOR.

OWNER OF U.S. REG. NO. 2,473,737.

SEC. 2(F).

SER. NO. 85-388,557, FILED 8-3-2011.

JORDAN BAKER, EXAMINING ATTORNEY



*David J. Kyffers*

Director of the United States Patent and Trademark Office

# United States of America

United States Patent and Trademark Office



**Reg. No. 4,125,319**

SILENT HEROES MOTORCYCLE CLUB (NORTH CAROLINA CORPORATION)  
5147 FRONT ST  
STEDMAN, NC 28391

**Registered Apr. 10, 2012**

**Int. Cl.: 35**

FOR: CLUB SERVICES, NAMELY, PROMOTING THE INTERESTS OF MOTORCYCLISTS,  
IN CLASS 35 (U.S. CLS. 100, 101 AND 102).

**SERVICE MARK**

FIRST USE 3-17-2005; IN COMMERCE 3-17-2005.

**PRINCIPAL REGISTER**

NO CLAIM IS MADE TO THE EXCLUSIVE RIGHT TO USE "MC", APART FROM THE  
MARK AS SHOWN.

THE MARK CONSISTS OF A GRAPHIC OF A MALTESE CROSS WITH A PHOENIX LOCATED IN THE CENTER OF IT. ABOVE THE GRAPHIC IS A CURVED BANNER CONTAINING THE STYLIZED WORDING "SILENT HEROES" WITH A GRAPHIC OF TWO CROSSED AXES SEPARATING THE TERMS. BELOW THE RIGHT SIDE OF THE BANNER IS A SQUARE CONTAINING THE STYLIZED TEXT "MC".

SER. NO. 85-388,576, FILED 8-3-2011.

ALYSSA STEEL, EXAMINING ATTORNEY



*David J. Kybas*

Director of the United States Patent and Trademark Office



# United States of America

United States Patent and Trademark Office

## BLUE POOL OYSTERS

**Reg. No. 4,125,320**

HAMA HAMA COMPANY (WASHINGTON CORPORATION)  
35846 N US HIGHWAY 101  
LILLIWAUP, WA 98555

**Registered Apr. 10, 2012**

**Int. Cl.: 29**

FOR: SHELLFISH, NAMELY, OYSTERS, IN CLASS 29 (U.S. CL. 46).

**TRADEMARK**

FIRST USE 12-30-2010; IN COMMERCE 12-30-2010.

**PRINCIPAL REGISTER**

THE MARK CONSISTS OF STANDARD CHARACTERS WITHOUT CLAIM TO ANY PARTICULAR FONT, STYLE, SIZE, OR COLOR.

OWNER OF U.S. REG. NO. 4,025,865.

NO CLAIM IS MADE TO THE EXCLUSIVE RIGHT TO USE "OYSTERS", APART FROM THE MARK AS SHOWN.

SER. NO. 85-388,673, FILED 8-3-2011.

REBECCA EISINGER, EXAMINING ATTORNEY



*David J. Kyffers*

Director of the United States Patent and Trademark Office

# United States of America

United States Patent and Trademark Office



**Reg. No. 4,125,321**

**Registered Apr. 10, 2012**

**Int. Cl.: 41**

**SERVICE MARK**

**PRINCIPAL REGISTER**

THE BIG PICTURE COMPANY (RHODE ISLAND NON-PROFIT CORPORATION)  
325 PUBLIC STREET  
PROVIDENCE, RI 02905

FOR: EDUCATIONAL SERVICES, NAMELY, DEVELOPING AND DISSEMINATING EDUCATIONAL MATERIALS AND DEVELOPING AND CONDUCTING MENTORING, TUTORING, CLASSES, SEMINARS AND WORKSHOPS, ALL IN THE FIELD OF STUDENT LEARNING-SKILLS DEVELOPMENT, SPECIFICALLY FOR SMALL, SPECIALIZED SCHOOLS THAT OFFER COURSES OF INSTRUCTION AS WELL AS STUDENT-MENTORING PROGRAMS, INTERN PROGRAMS, LEARNING SKILLS DEVELOPMENT PROGRAMS, AND TUTORING PROGRAMS AT THE ELEMENTARY, MIDDLE AND SECONDARY SCHOOL LEVELS; PROVIDING EDUCATIONAL SUPPORT, NAMELY, DEVELOPING EDUCATIONAL CURRICULA, CONDUCTING LEADERSHIP TRAINING AND ONE-ON-ONE COACHING FOR TEACHERS AND PRINCIPALS, AND CONDUCTING ONE-ON-ONE AND SMALL GROUP TEACHER TRAINING, AND DISTRIBUTING COURSE MATERIALS THEREWITH, ALL IN THE FIELD OF STUDENT LEARNING-SKILLS DEVELOPMENT, SPECIFICALLY FOR SMALL, SPECIALIZED SCHOOLS THAT OFFER COURSES OF INSTRUCTION AS WELL AS STUDENT-MENTORING PROGRAMS, INTERN PROGRAMS, LEARNING SKILLS DEVELOPMENT PROGRAMS, AND TUTORING PROGRAMS AT THE ELEMENTARY, MIDDLE AND SECONDARY SCHOOL LEVELS, IN CLASS 41 (U.S. CLS. 100, 101 AND 107).

FIRST USE 6-1-2008; IN COMMERCE 6-1-2008.

NO CLAIM IS MADE TO THE EXCLUSIVE RIGHT TO USE "LEARNING", APART FROM THE MARK AS SHOWN.

THE COLOR(S) GREEN, BLACK, WHITE IS/ARE CLAIMED AS A FEATURE OF THE MARK.

THE MARK CONSISTS OF THE WORDS "BIG PICTURE LEARNING" INSIDE A GREEN SQUARE. THE WORDS "BIG" AND "PICTURE" ARE BLACK, WHILE THE WORD "LEARNING" IS WHITE. THE EDGES OF THE WORD "BIG" ARE CROPPED OFF BY THE EDGES OF THE SQUARE.



*David J. Kyros*

Director of the United States Patent and Trademark Office

SER. NO. 85-388,680, FILED 8-3-2011.

REBECCA EISINGER, EXAMINING ATTORNEY

# United States of America

United States Patent and Trademark Office



**Reg. No. 4,125,322**

**Registered Apr. 10, 2012**

**Int. Cl.: 41**

**SERVICE MARK**

**PRINCIPAL REGISTER**

LIFESTYLE PROMOTIONS, LLC (CALIFORNIA LIMITED LIABILITY COMPANY)  
16541 GOTHARD ST., SUITE 210  
HUNTINGTON BEACH, CA 92647

FOR: ORGANIZING COMMUNITY FESTIVALS FEATURING PRIMARILY LIVE MUSICAL PERFORMANCES AND EDUCATIONAL DEMONSTRATIONS AND RELATED EDUCATIONAL DISCUSSIONS ABOUT BEER AND ALSO PROVIDING FOOD, SNACK AND BEER TASTINGS, IN CLASS 41 (U.S. CLS. 100, 101 AND 107).

FIRST USE 5-1-2010; IN COMMERCE 5-1-2011.

THE MARK CONSISTS OF THE WORDS "TASTE OF BREWS" IN STYLIZED FONT, TWO STYLIZED BEER MUGS WITH FOAM AT THE TOPS AND A STYLIZED SCROLL DESIGN CONNECTING THE TWO BEER MUGS.

SER. NO. 85-388,704, FILED 8-3-2011.

DAVID YONTEF, EXAMINING ATTORNEY



*David J. Kyffers*

Director of the United States Patent and Trademark Office

# United States of America

United States Patent and Trademark Office



**Reg. No. 4,125,323**

**Registered Apr. 10, 2012**

**Int. Cl.: 25**

**TRADEMARK**

**PRINCIPAL REGISTER**

JESSE MOYA (CALIFORNIA SOLE PROPRIETORSHIP), DBA MOYABRAND  
14330 CARNELL ST  
WHITTIER, CA 90603

FOR: MARTIAL ARTS UNIFORMS; MARTIAL ARTS BELTS; T-SHIRTS, SWEATPANTS,  
SHORTS, PANTS, AND SHIRTS, IN CLASS 25 (U.S. CLS. 22 AND 39).

FIRST USE 6-15-2010; IN COMMERCE 7-1-2010.

OWNER OF U.S. REG. NO. 3,935,054.

THE MARK CONSISTS OF THE WORDING "MOYABRAND", INCLUDED IS A MARK/LOGO  
THAT FORMS A STYLIZED LETTER "M". THE LETTER "M" IS CUSTOM DESIGNED TO  
A SHAPE SIMILAR TO AN ANCIENT WARRIOR MASK, WITH SLITS IN THE MARK THAT  
FORM AND OR SHAPE SIMILAR TO A PAIR OF EYES WITHIN A MASK.

SER. NO. 85-388,805, FILED 8-3-2011.

KAPIL BHANOT, EXAMINING ATTORNEY



*David J. Kybas*

Director of the United States Patent and Trademark Office

# United States of America

United States Patent and Trademark Office

## Database SuperStar

**Reg. No. 4,125,324**

**Registered Apr. 10, 2012**

**Int. Cl.: 41**

**SERVICE MARK**

**PRINCIPAL REGISTER**

PASK, ADRIAN (UNITED STATES INDIVIDUAL)  
11TH FLOOR  
304 PARK AVE. S  
NEW YORK, NY 10010

FOR: EDUCATION SERVICES, NAMELY, PROVIDING IN PERSON AND ON-LINE VIDEO TRAINING IN THE FIELD OF USING COMPUTER SOFTWARE; TRAINING SERVICES IN THE FIELD OF USING COMPUTER SOFTWARE FOR BUSINESS, IN CLASS 41 (U.S. CLS. 100, 101 AND 107).

FIRST USE 7-1-2010; IN COMMERCE 7-13-2011.

THE MARK CONSISTS OF STANDARD CHARACTERS WITHOUT CLAIM TO ANY PARTICULAR FONT, STYLE, SIZE, OR COLOR.

NO CLAIM IS MADE TO THE EXCLUSIVE RIGHT TO USE "DATABASE", APART FROM THE MARK AS SHOWN.

SER. NO. 85-388,834, FILED 8-3-2011.

RONALD MCMORROW, EXAMINING ATTORNEY



*David J. Kyffers*

Director of the United States Patent and Trademark Office

# United States of America

United States Patent and Trademark Office

## Infinity Energy

**Reg. No. 4,125,325**

**Registered Apr. 10, 2012**

**Int. Cl.: 35**

**SERVICE MARK**

**PRINCIPAL REGISTER**

INFINITY ENERGY (WYOMING CORPORATION)  
1740 DELL RANGE BLVD., STE H  
CHEYENNE, WY 82009

FOR: DISTRIBUTORSHIP SERVICES IN THE FIELD OF ALTERNATIVE ENERGY AND ENERGY SAVING PRODUCTS INCLUDING WIND MILLS, SOLAR PANELS, LOW ENERGY WATER DE-SALINATION FILTERS, AND LOW ENERGY HEATING AND COOLING SYSTEMS, FOR BOTH HOME AND COMMERCIAL USE, IN CLASS 35 (U.S. CLS. 100, 101 AND 102).

FIRST USE 1-1-2011; IN COMMERCE 1-1-2011.

THE MARK CONSISTS OF STANDARD CHARACTERS WITHOUT CLAIM TO ANY PARTICULAR FONT, STYLE, SIZE, OR COLOR.

NO CLAIM IS MADE TO THE EXCLUSIVE RIGHT TO USE "ENERGY", APART FROM THE MARK AS SHOWN.

SER. NO. 85-388,837, FILED 8-3-2011.

RONALD MCMORROW, EXAMINING ATTORNEY



*David J. Kyros*

Director of the United States Patent and Trademark Office

# United States of America

United States Patent and Trademark Office



**Reg. No. 4,125,326**

JAMIK CORP. (WASHINGTON CORPORATION)

**Registered Apr. 10, 2012**

536 DAISY LN.  
LYNDEN, WA 98264

**Int. Cl.: 37**

FOR: CAR WASHING, IN CLASS 37 (U.S. CLS. 100, 103 AND 106).

**SERVICE MARK**

FIRST USE 5-1-2011; IN COMMERCE 6-1-2011.

**PRINCIPAL REGISTER**

NO CLAIM IS MADE TO THE EXCLUSIVE RIGHT TO USE "DE WAGEN WASSERIJ", APART FROM THE MARK AS SHOWN.

THE MARK CONSISTS OF THE STYLIZED WORDING "DE WAGEN WASSERIJ" APPEARING ADJACENT TO A DUTCH WOMAN WHO IS WASHING A SMALL CAR WITH HUMAN FEATURES, THE CAR'S HEADLIGHTS ARE EYES AND ITS GRILL IS A MOUTH, SEVERAL SMALL STARS APPEAR ABOVE THE CAR.

THE ENGLISH TRANSLATION OF "DE WAGEN WASSERIJ" IN THE MARK IS "THE CAR WASH".

SER. NO. 85-388,839, FILED 8-3-2011.

RONALD MCMORROW, EXAMINING ATTORNEY



*David J. Kyffers*

Director of the United States Patent and Trademark Office

# United States of America

United States Patent and Trademark Office

# GINGI MED

**Reg. No. 4,125,327**

**Registered Apr. 10, 2012**

**Int. Cl.: 5**

**TRADEMARK**

**PRINCIPAL REGISTER**

DUNAGIN PHARMACEUTICAL, INC. (ARKANSAS CORPORATION), AKA MASSCO  
DENTAL F/K/A DUNAGIN & COMPANY CORPORATION  
1593 HIGHWAY 72 SOUTHEAST  
GRAVETTE, AR 72736

FOR: MEDICATED DENTAL RINSES, IN CLASS 5 (U.S. CLS. 6, 18, 44, 46, 51 AND 52).

FIRST USE 4-1-1999; IN COMMERCE 4-1-1999.

THE MARK CONSISTS OF STANDARD CHARACTERS WITHOUT CLAIM TO ANY PARTICULAR FONT, STYLE, SIZE, OR COLOR.

SER. NO. 85-388,843, FILED 8-3-2011.

ESTHER A. BORSUK, EXAMINING ATTORNEY



*David J. Kyffers*

Director of the United States Patent and Trademark Office



# United States of America

United States Patent and Trademark Office

# NEMAHR

**Reg. No. 4,125,328**

**Registered Apr. 10, 2012**

**Int. Cl.: 44**

**SERVICE MARK**

**PRINCIPAL REGISTER**

COPHEC, LLC (NEW JERSEY LIMITED LIABILITY COMPANY)  
SUITE 211  
253 MAIN STREET  
MATAWAN, NJ 07747

FOR: PROVIDING HEALTH INFORMATION TECHNOLOGY SOLUTIONS FOR PHYSICIANS AND OTHER HEALTH CARE SERVICE PROVIDERS, IN CLASS 44 (U.S. CLS. 100 AND 101).

FIRST USE 7-23-2011; IN COMMERCE 7-23-2011.

THE MARK CONSISTS OF STANDARD CHARACTERS WITHOUT CLAIM TO ANY PARTICULAR FONT, STYLE, SIZE, OR COLOR.

SER. NO. 85-388,845, FILED 8-3-2011.

NAAKWAMA ANKRAH, EXAMINING ATTORNEY



*David J. Kyffers*

Director of the United States Patent and Trademark Office

# United States of America

United States Patent and Trademark Office

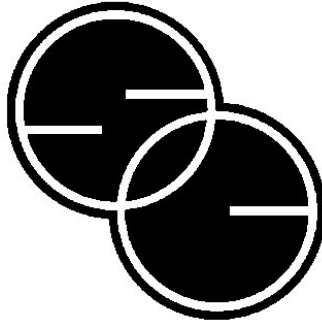

**Reg. No. 4,125,329**

**Registered Apr. 10, 2012**

**Int. Cl.: 42**

**SERVICE MARK**

**PRINCIPAL REGISTER**

THE SCIENCE COOPERATIVE, LLC (NEVADA LIMITED LIABILITY COMPANY)  
1007 W GOLF RD.  
LIBERTYVILLE, IL 60048

FOR: CONSULTING SERVICES FOR MEDICAL PRODUCT DEVELOPMENT, IN CLASS 42  
(U.S. CLS. 100 AND 101).

FIRST USE 6-22-2011; IN COMMERCE 6-22-2011.

THE MARK CONSISTS OF THE STYLIZED LETTERS "SC". THE TWO LETTERS ARE  
SHAPED AS CIRCLES.

SER. NO. 85-388,850, FILED 8-3-2011.

DEBORAH LOBO, EXAMINING ATTORNEY



*David J. Kyffers*

Director of the United States Patent and Trademark Office

# United States of America

United States Patent and Trademark Office



**Reg. No. 4,125,330**

**Registered Apr. 10, 2012**

**Int. Cl.: 35**

**SERVICE MARK**

**PRINCIPAL REGISTER**

KIWI DISTRIBUTING, INC. (CALIFORNIA CORPORATION)  
8457 A. SOUTH EASTERN AVENUE  
BELL GARDENS, CA 90201

FOR: DISTRIBUTORSHIP SERVICES IN THE FIELDS OF RED WINE, WHITE WINE, SPARKLING WINE, BEER, VODKA, RUM, TEQUILA, GIN, WHISKEY, BOTTLED WATER, SPARKLING WATER, SODA WATER, FRUIT JUICE, FRUIT BAR SNACKS, MULTI-GRAIN SNACKS, CHEESE AND OLIVE OIL, IN CLASS 35 (U.S. CLS. 100, 101 AND 102).

FIRST USE 6-11-2011; IN COMMERCE 7-25-2011.

NO CLAIM IS MADE TO THE EXCLUSIVE RIGHT TO USE "DISTRIBUTING, INC.", APART FROM THE MARK AS SHOWN.

THE MARK CONSISTS OF STYLIZED BIRD (ON LEFT) WITH "KIWI DISTRIBUTING, INC." (ON RIGHT). "KIWI" IS ON THE TOP AND "DISTRIBUTING, INC." IS BELOW "KIWI".

SER. NO. 85-388,880, FILED 8-3-2011.

CAROLINE WOOD, EXAMINING ATTORNEY



*David J. Kyffers*

Director of the United States Patent and Trademark Office

# United States of America

United States Patent and Trademark Office

## CASABLANCA DEL PALMAR

**Reg. No. 4,125,331**

JOSE CASTRO MEJIA (UNITED STATES INDIVIDUAL)

**Registered Apr. 10, 2012**

P.O. BOX 1626  
INDIO, CA 92202

**Int. Cl.: 31**

FOR: FRESH DATES; RAW DATES, IN CLASS 31 (U.S. CLS. 1 AND 46).

**TRADEMARK**

FIRST USE 9-1-2010; IN COMMERCE 9-1-2010.

**PRINCIPAL REGISTER**

THE MARK CONSISTS OF STANDARD CHARACTERS WITHOUT CLAIM TO ANY PARTICULAR FONT, STYLE, SIZE, OR COLOR.

THE ENGLISH TRANSLATION OF "CASABLANCA DEL PALMAR" IN THE MARK IS "WHITE HOUSE OF THE PALM GROVE".

SER. NO. 85-388,885, FILED 8-3-2011.

APRIL HESIK, EXAMINING ATTORNEY



*David J. Kyffers*

Director of the United States Patent and Trademark Office

# United States of America

United States Patent and Trademark Office

## SANDWICHES UNLIMITED

**Reg. No. 4,125,332**

SANDWICHES UNLIMITED OF ORANGE, INC. (NEW JERSEY CORPORATION)  
23 NORTH CENTER STREET  
ORANGE, NJ 07050

**Registered Apr. 10, 2012**

**Int. Cl.: 43**

FOR: CATERING SERVICES; RESTAURANT SERVICES, IN CLASS 43 (U.S. CLS. 100 AND 101).

**SERVICE MARK**

FIRST USE 12-31-1974; IN COMMERCE 12-31-1974.

**PRINCIPAL REGISTER**

THE MARK CONSISTS OF STANDARD CHARACTERS WITHOUT CLAIM TO ANY PARTICULAR FONT, STYLE, SIZE, OR COLOR.

NO CLAIM IS MADE TO THE EXCLUSIVE RIGHT TO USE "SANDWICHES", APART FROM THE MARK AS SHOWN.

SER. NO. 85-388,890, FILED 8-3-2011.

APRIL HESIK, EXAMINING ATTORNEY



*David J. Kybas*

Director of the United States Patent and Trademark Office

# United States of America

United States Patent and Trademark Office



**Reg. No. 4,125,333**

**Registered Apr. 10, 2012**

**Int. Cl.: 41**

**SERVICE MARK**

**PRINCIPAL REGISTER**

BRIERE'S GOALIE SCHOOL, INC. (ALABAMA CORPORATION)  
329 JASMINE DRIVE  
MADISON, AL 35757

FOR: PROVIDING TRAINING SERVICES IN THE FIELD OF ICE HOCKEY, IN CLASS 41 (U.S. CLS. 100, 101 AND 107).

FIRST USE 5-1-2011; IN COMMERCE 5-1-2011.

NO CLAIM IS MADE TO THE EXCLUSIVE RIGHT TO USE "CANADIAN PROFESSIONAL GOALIE SCHOOLS", APART FROM THE MARK AS SHOWN.

THE COLOR(S) RED, WHITE AND BLACK IS/ARE CLAIMED AS A FEATURE OF THE MARK.

THE MARK CONSISTS OF A RED AND WHITE DISC DESIGN FEATURING THE WORDING "CANADIAN PROFESSIONAL GOALIE SCHOOLS" IN WHITE ALONG THE RED PERIMETER WITH TWO MORTARBOARD CAPS IN WHITE, AND SUPERIMPOSED IN THE CENTER IS A SILHOUETTE OF A HOCKEY PLAYER HOLDING A HOCKEY STICK IN BLACK; THE BLACK RECTANGLE IS NOT PART OF THE MARK BUT REPRESENTS TRANSPARENT BACKGROUND.

SER. NO. 85-388,897, FILED 8-3-2011.

KELLY CHOE, EXAMINING ATTORNEY



*David J. Kyjars*

Director of the United States Patent and Trademark Office

# United States of America

United States Patent and Trademark Office

## BUILD YOUR OWN DIAMOND JEWELRY

**Reg. No. 4,125,334**

BLUE NILE, INC. (DELAWARE CORPORATION)  
411 FIRST AVENUE SOUTH, SUITE 700  
SEATTLE, WA 98104

**Registered Apr. 10, 2012**

**Int. Cl.: 35**

FOR: ONLINE RETAIL STORE SERVICES IN THE FIELD OF DIAMOND JEWELRY, IN CLASS 35 (U.S. CLS. 100, 101 AND 102).

**SERVICE MARK**

FIRST USE 1-24-2002; IN COMMERCE 1-24-2002.

**PRINCIPAL REGISTER**

THE MARK CONSISTS OF STANDARD CHARACTERS WITHOUT CLAIM TO ANY PARTICULAR FONT, STYLE, SIZE, OR COLOR.

OWNER OF U.S. REG. NOS. 3,336,051, 3,398,442 AND OTHERS.

NO CLAIM IS MADE TO THE EXCLUSIVE RIGHT TO USE "DIAMOND JEWELRY", APART FROM THE MARK AS SHOWN.

SEC. 2(F).

SER. NO. 85-388,918, FILED 8-3-2011.

TRACY FLETCHER, EXAMINING ATTORNEY

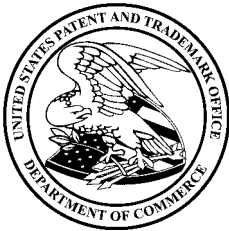

*David J. Kyfos*

Director of the United States Patent and Trademark Office

# United States of America

United States Patent and Trademark Office

## BUILD YOUR OWN FIVE-STONE RING

**Reg. No. 4,125,335**

BLUE NILE, INC. (DELAWARE CORPORATION)  
411 FIRST AVENUE SOUTH, SUITE 700  
SEATTLE, WA 98104

**Registered Apr. 10, 2012**

**Int. Cl.: 35**

FOR: ONLINE RETAIL STORE SERVICES IN THE FIELD OF JEWELRY, IN CLASS 35 (U.S. CLS. 100, 101 AND 102).

**SERVICE MARK**

FIRST USE 9-1-2005; IN COMMERCE 9-1-2005.

**PRINCIPAL REGISTER**

THE MARK CONSISTS OF STANDARD CHARACTERS WITHOUT CLAIM TO ANY PARTICULAR FONT, STYLE, SIZE, OR COLOR.

OWNER OF U.S. REG. NOS. 3,336,051, 3,394,853 AND OTHERS.

NO CLAIM IS MADE TO THE EXCLUSIVE RIGHT TO USE "FIVE-STONE RING", APART FROM THE MARK AS SHOWN.

SEC. 2(F).

SER. NO. 85-388,930, FILED 8-3-2011.

TRACY FLETCHER, EXAMINING ATTORNEY

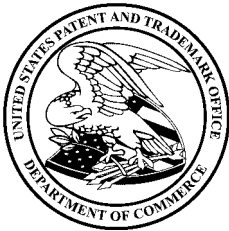

*David J. Kybas*

Director of the United States Patent and Trademark Office



# United States of America

United States Patent and Trademark Office

# TRS

**Reg. No. 4,125,336**

**Registered Apr. 10, 2012**

**Int. Cl.: 35**

**SERVICE MARK**

**PRINCIPAL REGISTER**

DANERICA ENTERPRISES, INC. (CALIFORNIA CORPORATION), DBA TAX RESOLUTION SERVICES, CO.  
ENCINO OFFICE PARK, BUILDING IV  
6345 BALBOA BOULEVARD, SUITE 285  
ENCINO, CA 91316

FOR: TAX ADVISORY SERVICES; TAX AND TAXATION PLANNING, ADVICE, INFORMATION AND CONSULTANCY SERVICES; TAX CONSULTATION, IN CLASS 35 (U.S. CLS. 100, 101 AND 102).

FIRST USE 6-0-1998; IN COMMERCE 6-0-1998.

THE MARK CONSISTS OF STANDARD CHARACTERS WITHOUT CLAIM TO ANY PARTICULAR FONT, STYLE, SIZE, OR COLOR.

OWNER OF U.S. REG. NO. 3,813,220.

SER. NO. 85-388,951, FILED 8-3-2011.

CAROLINE WOOD, EXAMINING ATTORNEY



*David J. Kyffers*

Director of the United States Patent and Trademark Office

# United States of America

United States Patent and Trademark Office



**Reg. No. 4,125,337**

**Registered Apr. 10, 2012**

**Int. Cl.: 41**

**SERVICE MARK**

**PRINCIPAL REGISTER**

CAPITAL ONE FINANCIAL CORPORATION (DELAWARE CORPORATION)  
12077-0270 / BECKY DIMMETT  
15000 CAPITAL ONE DRIVE  
RICHMOND, VA 23238

FOR: PROVIDING RECOGNITION AND INCENTIVES BY WAY OF AWARDS TO DEMONSTRATE EXCELLENCE IN THE FIELD OF COLLEGE ATHLETICS AND ACADEMICS, IN CLASS 41 (U.S. CLS. 100, 101 AND 107).

FIRST USE 9-1-2010; IN COMMERCE 9-1-2010.

OWNER OF U.S. REG. NOS. 2,975,852, 3,926,997 AND OTHERS.

NO CLAIM IS MADE TO THE EXCLUSIVE RIGHT TO USE "CUP" OR "ATHLETIC EXCELLENCE", APART FROM THE MARK AS SHOWN.

THE MARK CONSISTS OF THE WORDS "CAPITAL" AND "ONE" SUPERIMPOSED OVER A SOLID BOOMERANG SHAPE THAT OPENS TO THE LEFT, IS THICK IN THE MIDDLE, IS TAPERED ON EITHER END AND BEGINS UNDER THE WORDS "CAPITAL" AND "ONE" AND ARCHES UP OVER THEM ABOVE THE WORD "CUP", ALL ENCIRCLED WITH LAUREL LEAVES ABOVE A CAPSULE SHAPED BASE WITH THE WORDS "ATHLETIC EXCELLENCE" WITHIN THE CAPSULE SHAPE.

SER. NO. 85-388,975, FILED 8-3-2011.

DOUGLAS LEE, EXAMINING ATTORNEY



*David J. Kyros*

Director of the United States Patent and Trademark Office

# United States of America

United States Patent and Trademark Office

## i3 Health

**Reg. No. 4,125,338**

**Registered Apr. 10, 2012**

**Int. Cl.: 41**

**SERVICE MARK**

**PRINCIPAL REGISTER**

BRAMWELL, MICHAEL (UNITED STATES INDIVIDUAL), DBA I3 HEALTH  
SUITE 9-268  
184 S. LIVINGSTON AVENUE  
LIVINGSTON, NJ 07039 AND

CUTRONA, MELISSA L. (UNITED STATES INDIVIDUAL), DBA I3 HEALTH  
SUITE 9-268  
184 S. LIVINGSTON AVENUE  
LIVINGSTON, NJ 07039

FOR: ARRANGING AND CONDUCTING EDUCATIONAL CONFERENCES; CONTINUING EDUCATION SERVICES, NAMELY, PROVIDING LIVE AND ON-LINE CONTINUING PROFESSIONAL EDUCATION SEMINARS IN THE LEGAL, MEDICAL, ACCOUNTING, AND REAL ESTATE FIELDS; EDUCATIONAL SERVICES, NAMELY, PROVIDING CONTINUING PROFESSIONAL EDUCATION COURSES IN THE FIELD OF MEDICINE; PROVIDING CONTINUING BUSINESS EDUCATION COURSES; PROVIDING CONTINUING MEDICAL EDUCATION COURSES, IN CLASS 41 (U.S. CLS. 100, 101 AND 107).

FIRST USE 5-29-2010; IN COMMERCE 2-16-2011.

THE MARK CONSISTS OF STANDARD CHARACTERS WITHOUT CLAIM TO ANY PARTICULAR FONT, STYLE, SIZE, OR COLOR.

NO CLAIM IS MADE TO THE EXCLUSIVE RIGHT TO USE "HEALTH", APART FROM THE MARK AS SHOWN.

SER. NO. 85-389,022, FILED 8-3-2011.

JOHN WILKE, EXAMINING ATTORNEY



*David J. Kybas*

Director of the United States Patent and Trademark Office

# United States of America

United States Patent and Trademark Office

## TALENTDESK

**Reg. No. 4,125,339**

**Registered Apr. 10, 2012**

**Int. Cl.: 42**

**SERVICE MARK**

**PRINCIPAL REGISTER**

TALENT VENTURES, INC. (DELAWARE CORPORATION)  
SUITE #600  
ONE COMMERCE CENTER - 1201 ORANGE ST.  
WILMINGTON, DE 19899

FOR: SOFTWARE AS A SERVICE (SAAS) SERVICES, NAMELY, HOSTING SOFTWARE ON A WEBSITE FOR USE BY OTHERS IN THE FIELD OF EMPLOYMENT RECRUITING FOR VIEWING AND SEARCHING EMPLOYMENT CANDIDATE RESUMES, LISTING JOB OPPORTUNITIES, TRACKING AND SCREENING JOB APPLICANTS, INTERVIEWING JOB APPLICANTS ONLINE AND THROUGH VIDEO, AUDIO AND TEXTUAL APPLICATIONS AND TRANSMITTING AND SHARING DATA AND INFORMATION WITH JOB APPLICANTS FOR COMMUNICATION PURPOSES, IN CLASS 42 (U.S. CLS. 100 AND 101).

FIRST USE 6-28-2011; IN COMMERCE 7-26-2011.

THE MARK CONSISTS OF STANDARD CHARACTERS WITHOUT CLAIM TO ANY PARTICULAR FONT, STYLE, SIZE, OR COLOR.

SER. NO. 85-389,078, FILED 8-4-2011.

DAVID YONTEF, EXAMINING ATTORNEY



*David J. Kyffers*

Director of the United States Patent and Trademark Office

# United States of America

United States Patent and Trademark Office



**Reg. No. 4,125,340**

**Registered Apr. 10, 2012**

**Int. Cl.: 35**

**SERVICE MARK**

**PRINCIPAL REGISTER**

MEDICAL CONTRACTING SERVICES, INC. (TEXAS CORPORATION)  
SUITE 470  
10300 N. CENTRAL EXPRESSWAY  
DALLAS, TX 75231

FOR: PLACEMENT OF TEMPORARY MEDICAL PERSONNEL, IN CLASS 35 (U.S. CLS. 100, 101 AND 102).

FIRST USE 1-1-2001; IN COMMERCE 1-1-2001.

THE MARK CONSISTS OF AN OVAL SURROUNDED BY TWO CURVED LINES SHOWN IN A SLIGHTLY TILTED POSITION.

SER. NO. 85-389,082, FILED 8-4-2011.

DAVID YONTEF, EXAMINING ATTORNEY



*David J. Kybas*

Director of the United States Patent and Trademark Office

# United States of America

United States Patent and Trademark Office

# HAUL BOYS

**Reg. No. 4,125,341**

HALL, MARIE (UNITED STATES INDIVIDUAL)  
3518 WELLSLEY DRIVE  
POWDER SPRINGS, GA 30127

**Registered Apr. 10, 2012**

**Int. Cl.: 39**

FOR: TRUCK HAULING; TRUCKING SERVICES, NAMELY, HAULING OF JUNK, TRASH AND DEBRIS; JUNK, TRASH AND DEBRIS REMOVAL, IN CLASS 39 (U.S. CLS. 100 AND 105).

**SERVICE MARK**

FIRST USE 6-11-2008; IN COMMERCE 6-11-2008.

**PRINCIPAL REGISTER**

THE MARK CONSISTS OF STANDARD CHARACTERS WITHOUT CLAIM TO ANY PARTICULAR FONT, STYLE, SIZE, OR COLOR.

NO CLAIM IS MADE TO THE EXCLUSIVE RIGHT TO USE "HAUL", APART FROM THE MARK AS SHOWN.

SER. NO. 85-389,086, FILED 8-4-2011.

JENNIFER VASQUEZ, EXAMINING ATTORNEY



*David J. Kyffers*

Director of the United States Patent and Trademark Office

# United States of America

United States Patent and Trademark Office

## one heck of a blot

**Reg. No. 4,125,342**

SOAP & GLORY LIMITED (UNITED KINGDOM LIMITED COMPANY (LTD.))  
3 LOGAN PLACE

**Registered Apr. 10, 2012**

LONDON, UNITED KINGDOM W86QN

**Int. Cl.: 3**

FOR: COSMETICS, NAMELY, FACE POWDER, MATTIFYING FACE POWDER, TRANSLUCENT FACE POWDER, IN CLASS 3 (U.S. CLS. 1, 4, 6, 50, 51 AND 52).

**TRADEMARK**

THE MARK CONSISTS OF STANDARD CHARACTERS WITHOUT CLAIM TO ANY PARTICULAR FONT, STYLE, SIZE, OR COLOR.

**PRINCIPAL REGISTER**

OWNER OF UNITED KINGDOM REG. NO. 2571910, DATED 11-4-2011, EXPIRES 11-4-2021.

SER. NO. 85-389,124, FILED 8-4-2011.

STEVEN JACKSON, EXAMINING ATTORNEY



*David J. Kyffers*

Director of the United States Patent and Trademark Office

# United States of America

United States Patent and Trademark Office

## FASHION FOR PAWS

**Reg. No. 4,125,343**

**Registered Apr. 10, 2012**

**Int. Cl.: 16**

**TRADEMARK**

**PRINCIPAL REGISTER**

WASHINGTON HUMANE SOCIETY/SPCA (D.C. CONGRESSIONALLY CHARTERED  
NONPROFIT ORGANIZATION)  
7319 GEORGIA AVENUE, N.W.  
WASHINGTON, DC 20012

FOR: CALENDARS; GREETING CARDS; NOTE CARDS; POSTERS; STICKERS, IN CLASS  
16 (U.S. CLS. 2, 5, 22, 23, 29, 37, 38 AND 50).

FIRST USE 1-19-2011; IN COMMERCE 6-3-2011.

THE MARK CONSISTS OF STANDARD CHARACTERS WITHOUT CLAIM TO ANY PAR-  
TICULAR FONT, STYLE, SIZE, OR COLOR.

OWNER OF U.S. REG. NO. 4,018,158.

SER. NO. 85-389,153, FILED 8-4-2011.

SANDRA BUJA, EXAMINING ATTORNEY



*David J. Kyffers*

Director of the United States Patent and Trademark Office



# United States of America

United States Patent and Trademark Office



**Reg. No. 4,125,344**

**Registered Apr. 10, 2012**

**Int. Cl.: 36**

**SERVICE MARK**

**PRINCIPAL REGISTER**

BANCO SANTANDER S.A (SPAIN CORPORATION)  
PASEO DE PEREDA, 9-12, 39004 SANTANDER  
CANTABRIA ESPAÑA, SPAIN

FOR: BROKERAGE SERVICES FOR STOCKS AND BONDS; BUSINESS, STOCK OPTION AND PENSION VALUATION SERVICES; CORPORATE FINANCE SERVICES, NAMELY, CONSULTATION IN THE FIELD OF ASSET SALES; CORPORATE FINANCE SERVICES, NAMELY, CONSULTATION IN THE FIELD OF CAPITAL STRUCTURE; FINANCIAL ADVICE AND CONSULTANCY SERVICES; FINANCIAL AND INVESTMENT SERVICES, NAMELY, MANAGEMENT AND BROKERAGE IN THE FIELDS OF STOCKS, BONDS, OPTIONS, COMMODITIES, FUTURES AND OTHER SECURITIES, AND THE INVESTMENT OF FUNDS OF OTHERS; FINANCIAL CONSULTANCY AND INSURANCE CONSULTANCY; FINANCIAL CONSULTING SERVICES, NAMELY, EXPERT ANALYSIS IN FINANCE; FINANCIAL SERVICES, NAMELY, ADMINISTRATION OF TRANSACTIONS INVOLVING FUNDS DRAWN FROM SECURITIES, STOCKS, FUNDS, EQUITIES, BONDS, CASH, OR OTHER TYPES OF FINANCIAL INVESTMENTS IN RETIREMENT PLANS USING A CHECK OR NEGOTIABLE ORDER OF WITHDRAWAL OVER A GLOBAL DATA NETWORK; INSURANCE AGENCIES; INSURANCE AGENCY AND BROKERAGE; INSURANCE AND FINANCIAL INFORMATION AND CONSULTANCY SERVICES; INSURANCE SERVICES, NAMELY, UNDERWRITING, ISSUING AND ADMINISTRATION OF LIFE INSURANCE; MONETARY EXCHANGE; REAL ESTATE FINANCING SERVICES; REAL ESTATE INVESTMENT SERVICES, IN CLASS 36 (U.S. CLS. 100, 101 AND 102).

OWNER OF SPAIN REG. NO. 2858066, DATED 5-6-2009, EXPIRES 5-6-2019.

THE COLOR(S) RED AND BLACK IS/ARE CLAIMED AS A FEATURE OF THE MARK.

OWNER OF U.S. REG. NOS. 1,324,983, 3,918,644 AND OTHERS.

THE MARK CONSISTS OF A DESIGN OF A RED FLAME OVER A RED OVAL, TO THE LEFT OF THE STYLIZED WORD "SANTANDER" IN RED, TO THE LEFT OF THE WORD "SELECT" IN BLACK.

SEC. 2(F) AS TO "SANTANDER".

SER. NO. 85-389,155, FILED 8-4-2011.



*David J. Kyjars*

Director of the United States Patent and Trademark Office

**Reg. No. 4,125,344** LAURA KOVALSKY, EXAMINING ATTORNEY

# United States of America

United States Patent and Trademark Office



**Reg. No. 4,125,345**

**Registered Apr. 10, 2012**

**Int. Cl.: 35**

**SERVICE MARK**

**PRINCIPAL REGISTER**

GREEN SPORTS NJ INC (NEW JERSEY CORPORATION)  
100 NORTH UNION AVENUE  
CRANFORD, NJ 07016

FOR: RETAIL STORE SERVICES FEATURING NEW AND GENTLY USED SPORTS EQUIPMENT, CLOTHING AND MEMORABILIA, IN CLASS 35 (U.S. CLS. 100, 101 AND 102).

FIRST USE 10-1-2010; IN COMMERCE 10-1-2010.

NO CLAIM IS MADE TO THE EXCLUSIVE RIGHT TO USE "GREEN" "SPORTS" OR "NJ", APART FROM THE MARK AS SHOWN.

THE MARK CONSISTS OF A CIRCULAR DESIGN CONSISTING OF THREE ARROWS GOING IN A CLOCKWISE DIRECTION. INSIDE THE CIRCLE IS THE STYLIZED TEXT "GREEN" ABOVE THE STYLIZED TEXT "SPORTS" ABOVE THE STYLIZED TEXT "NJ". NEXT TO "NJ" ARE SMALL GRAPHICS OF A BASKETBALL AND A FOOTBALL.

SER. NO. 85-389,160, FILED 8-4-2011.

KATHERINE CONNOLLY, EXAMINING ATTORNEY



*David J. Kyffers*

Director of the United States Patent and Trademark Office

# United States of America

United States Patent and Trademark Office

# CANARIA

**Reg. No. 4,125,346**

ROSARIO, RAYMOND (UNITED STATES INDIVIDUAL)  
372 WILSON AVENUE  
LYNDHURST, NJ 07071

**Registered Apr. 10, 2012**

**Int. Cl.: 15**

FOR: MUSICAL INSTRUMENTS; STRING INSTRUMENTS; VIOLINS, IN CLASS 15 (U.S. CLS. 2, 21 AND 36).

**TRADEMARK**

FIRST USE 4-1-2011; IN COMMERCE 4-1-2011.

**PRINCIPAL REGISTER**

THE MARK CONSISTS OF STANDARD CHARACTERS WITHOUT CLAIM TO ANY PARTICULAR FONT, STYLE, SIZE, OR COLOR.

OWNER OF U.S. REG. NO. 4,005,764.

THE ENGLISH TRANSLATION OF THE WORD "CANARIA" IN THE MARK IS "OF OR FROM THE CANARY ISLANDS".

SER. NO. 85-389,165, FILED 8-4-2011.

COLLEEN KEARNEY, EXAMINING ATTORNEY



*David J. Kybas*

Director of the United States Patent and Trademark Office

**United States of America**  
United States Patent and Trademark Office

# WART-HOG

**Reg. No. 4,125,347**

**Registered Apr. 10, 2012**

**Int. Cl.: 28**

**TRADEMARK**

**PRINCIPAL REGISTER**

LUCK "E" STRIKE CORPORATION (MISSOURI CORPORATION)  
P.O. BOX 587  
#1 INDUSTRIAL PARK  
CASSVILLE, MO 65625

FOR: FISHING LURES AND ARTIFICIAL FISHING BAITS, IN CLASS 28 (U.S. CLS. 22, 23, 38 AND 50).

FIRST USE 7-21-2011; IN COMMERCE 7-21-2011.

THE MARK CONSISTS OF STANDARD CHARACTERS WITHOUT CLAIM TO ANY PARTICULAR FONT, STYLE, SIZE, OR COLOR.

SER. NO. 85-389,193, FILED 8-4-2011.

ADA HAN, EXAMINING ATTORNEY



*David J. Kyffers*

Director of the United States Patent and Trademark Office

# United States of America

United States Patent and Trademark Office



**Reg. No. 4,125,348**

SUSAN J. MENDELSON (UNITED STATES INDIVIDUAL)  
5002 KUGLER MILL ROAD  
CINCINNATI, OH 45236

**Registered Apr. 10, 2012**

**Int. Cl.: 44**

FOR: CLINICAL MENTAL HEALTH COUNSELING SERVICES, IN CLASS 44 (U.S. CLS. 100 AND 101).

**SERVICE MARK**

FIRST USE 5-1-2005; IN COMMERCE 5-1-2005.

**PRINCIPAL REGISTER**

OWNER OF U.S. REG. NO. 3,103,599.

THE NAME "DR. SUSIE" IDENTIFIES A LIVING INDIVIDUAL WHOSE CONSENT IS OF RECORD.

THE MARK CONSISTS OF THE WORDING "DR. SUSIE" ACROSS THE TOP, AND "TRANSFORM EMPOWER SOAR" ACROSS THE BOTTOM OF A CIRCLE DESIGN, ALL SURROUNDING AN ABSTRACT DEPICTION OF A BUTTERFLY IN FLIGHT.

SER. NO. 85-389,202, FILED 8-4-2011.

LAURA KOVALSKY, EXAMINING ATTORNEY



*David J. Kybas*

Director of the United States Patent and Trademark Office

# United States of America

United States Patent and Trademark Office

# VaxForm

**Reg. No. 4,125,349**

VAXFORM, LLC (PENNSYLVANIA LIMITED LIABILITY COMPANY)  
9700 GREAT SENECA HIGHWAY #174  
ROCKVILLE, MD 20850

**Registered Apr. 10, 2012**

**Int. Cl.: 42**

FOR: CONSULTING SERVICES IN THE FIELD OF VACCINE AND BIOLOGICS FORMULATION AND DEVELOPMENT, IN CLASS 42 (U.S. CLS. 100 AND 101).

**SERVICE MARK**

FIRST USE 9-29-2010; IN COMMERCE 2-7-2011.

**PRINCIPAL REGISTER**

THE MARK CONSISTS OF STANDARD CHARACTERS WITHOUT CLAIM TO ANY PARTICULAR FONT, STYLE, SIZE, OR COLOR.

SER. NO. 85-389,210, FILED 8-4-2011.

LINDA ORNDORFF, EXAMINING ATTORNEY



*David J. Kyffers*

Director of the United States Patent and Trademark Office

# United States of America

United States Patent and Trademark Office

# HeyGov!

**Reg. No. 4,125,350**

**Registered Apr. 10, 2012**

**Int. Cl.: 9**

**TRADEMARK**

**PRINCIPAL REGISTER**

IMAGER SOFTWARE, INC. (FLORIDA CORPORATION), DBA ISC  
2932 WELLINGTON CIR  
TALLAHASSEE, FL 32309

FOR: COMPUTER APPLICATION SOFTWARE FOR MOBILE PHONES, TABLET COMPUTERS AND COMPUTERS, NAMELY, SOFTWARE FOR CITIZENS TO SUBMIT DATA TO THE GOVERNMENT AND FOR A CITIZEN TO DISCOVER GOVERNMENT DATA, IN CLASS 9 (U.S. CLS. 21, 23, 26, 36 AND 38).

FIRST USE 6-1-2010; IN COMMERCE 11-1-2010.

THE MARK CONSISTS OF STANDARD CHARACTERS WITHOUT CLAIM TO ANY PARTICULAR FONT, STYLE, SIZE, OR COLOR.

SER. NO. 85-389,222, FILED 8-4-2011.

MARC LEIPZIG, EXAMINING ATTORNEY



*David J. Kyffers*

Director of the United States Patent and Trademark Office



# United States of America

United States Patent and Trademark Office

## KID'S CHOICE

**Reg. No. 4,125,351**

**Registered Apr. 10, 2012**

**Int. Cl.: 5**

**TRADEMARK**

**PRINCIPAL REGISTER**

DUNAGIN PHARMACEUTICAL, INC. (ARKANSAS CORPORATION), AKA MASSCO  
DENTAL  
1593 WEST HIGHWAY 72  
GRAVETTE, AR 72736

FOR: ANTI-CAVITY DENTAL COATING PREPARATIONS CONTAINING FLUORIDE, IN CLASS 5 (U.S. CLS. 6, 18, 44, 46, 51 AND 52).

FIRST USE 4-1-1999; IN COMMERCE 4-1-1999.

THE MARK CONSISTS OF STANDARD CHARACTERS WITHOUT CLAIM TO ANY PARTICULAR FONT, STYLE, SIZE, OR COLOR.

NO CLAIM IS MADE TO THE EXCLUSIVE RIGHT TO USE "KID'S", APART FROM THE MARK AS SHOWN.

SER. NO. 85-389,232, FILED 8-4-2011.

ESTHER A. BORSUK, EXAMINING ATTORNEY



*David J. Kyffers*

Director of the United States Patent and Trademark Office

# United States of America

United States Patent and Trademark Office

## BURRELLESLUCE MEDIA OUTREACH

**Reg. No. 4,125,352**

**Registered Apr. 10, 2012**

**Int. Cl.: 35**

**SERVICE MARK**

**PRINCIPAL REGISTER**

BURRELLE'S INFORMATION SERVICES, LLC (DELAWARE LIMITED LIABILITY COMPANY)  
75 EAST NORTHFIELD ROAD  
LIVINGSTON, NJ 07039

FOR: MEDIA MONITORING SERVICES, NAMELY, MONITORING PRINT MEDIA, TELEVISION, RADIO, AND OTHER MEDIA FOR CUSTOMER-SPECIFIED TOPICS, GATHERING RELEVANT CONTENT ON THOSE TOPICS, AND PROVIDING DOCUMENTATION AND ANALYSIS OF THAT MEDIA CONTENT TO OTHERS FOR BUSINESS PURPOSES; BUSINESS INFORMATION SERVICES, NAMELY, DISTRIBUTION OF CLIPPINGS AND BROADCAST SUMMARIES FROM MEDIA AND ELECTRONIC BROADCAST MEDIA, INCLUDING NEWS SERVICES, TELEVISION, RADIO, ELECTRONIC PUBLICATIONS AND COMMUNICATIONS VIA A GLOBAL COMPUTER NETWORK, AND ANALYSES OF CLIPPINGS AND BROADCAST TRANSCRIPTS RELATING TO ADVERTISING, EDITORIAL SLANT, NUMBER OF MESSAGE MENTIONS, CIRCULATION AND CONTENT, IN CLASS 35 (U.S. CLS. 100, 101 AND 102).

FIRST USE 8-28-2010; IN COMMERCE 8-28-2010.

THE MARK CONSISTS OF STANDARD CHARACTERS WITHOUT CLAIM TO ANY PARTICULAR FONT, STYLE, SIZE, OR COLOR.

OWNER OF U.S. REG. NOS. 3,070,359, 3,223,822, AND 3,614,982.

NO CLAIM IS MADE TO THE EXCLUSIVE RIGHT TO USE "MEDIA OUTREACH", APART FROM THE MARK AS SHOWN.

SER. NO. 85-389,260, FILED 8-4-2011.

Alice Benmaman, Examining Attorney



*David J. Kyffers*

Director of the United States Patent and Trademark Office

# United States of America

United States Patent and Trademark Office

# Ticket Platform

**Reg. No. 4,125,353**

TICKET PLATFORM LLC (CALIFORNIA LIMITED LIABILITY COMPANY)  
10 UNIVERSAL CITY PLAZA, #1950  
UNIVERSAL CITY, CA 91608

**Registered Apr. 10, 2012**

**Int. Cl.: 42**

FOR: WEBSITE DESIGN AND DEVELOPMENT FOR OTHERS, IN CLASS 42 (U.S. CLS. 100 AND 101).

**SERVICE MARK**

FIRST USE 1-13-2007; IN COMMERCE 1-13-2007.

**PRINCIPAL REGISTER**

NO CLAIM IS MADE TO THE EXCLUSIVE RIGHT TO USE "TICKET PLATFORM", APART FROM THE MARK AS SHOWN.

THE MARK CONSISTS OF THE STYLIZED WORDS "TICKET PLATFORM". AN IMAGE OF A PUZZLE PIECE DISPLAYED IN BETWEEN THE TWO WORDS.

SER. NO. 85-389,271, FILED 8-4-2011.

CHRISTINA SOBRAL, EXAMINING ATTORNEY



*David J. Kybas*

Director of the United States Patent and Trademark Office

# United States of America

United States Patent and Trademark Office

# 72Lux

**Reg. No. 4,125,354**

**Registered Apr. 10, 2012**

**Int. Cl.: 35**

**SERVICE MARK**

**PRINCIPAL REGISTER**

COMBINE COUTURE INC. (DELAWARE CORPORATION), DBA 72LUX  
145 EAST 72ND ST STE 5F  
NEW YORK, NY 10021

FOR: ON-LINE RETAIL STORE SERVICES FEATURING A WIDE VARIETY OF CONSUMER GOODS OF OTHERS; ON-LINE RETAIL STORE SERVICES FEATURING LUXURY CLOTHING, SHOES AND ACCESSORIES; ON-LINE RETAIL GIFT SHOPS; PROMOTING AND SHOWCASING THE GOODS OF OTHERS IN THE FIELD OF LUXURY CLOTHING, SHOES AND ACCESSORIES BY MEANS OF AN ON-LINE SHOPPING SITE WITH LINKS TO THE RETAIL ADVERTISEMENTS OF OTHERS; RETAIL CLOTHING STORES, IN CLASS 35 (U.S. CLS. 100, 101 AND 102).

FIRST USE 2-1-2011; IN COMMERCE 2-3-2011.

THE MARK CONSISTS OF STANDARD CHARACTERS WITHOUT CLAIM TO ANY PARTICULAR FONT, STYLE, SIZE, OR COLOR.

SER. NO. 85-389,375, FILED 8-4-2011.

ANDREA BUTLER, EXAMINING ATTORNEY



*David J. Kybas*

Director of the United States Patent and Trademark Office

# United States of America

United States Patent and Trademark Office

## BEYOND CELL

**Reg. No. 4,125,355**

**Registered Apr. 10, 2012**

**Int. Cl.: 9**

**TRADEMARK**

**PRINCIPAL REGISTER**

MAJOR COMMUNICATIONS, INC. (CALIFORNIA CORPORATION)  
12718 SCHABARUM AVENUE  
IRWINDALE, CA 91706

FOR: CELL PHONE ACCESSORIES, NAMELY, FACEPLATES, BATTERIES, BATTERY COVERS, BATTERY CHARGERS, ANTENNAE, ANTENNA TESTERS, HEADSETS, KEYPADS, DATA CABLES, SCREEN PROTECTORS, CARRYING CASES AND STRAPS, IN CLASS 9 (U.S. CLS. 21, 23, 26, 36 AND 38).

FIRST USE 8-0-2003; IN COMMERCE 8-0-2003.

THE MARK CONSISTS OF STANDARD CHARACTERS WITHOUT CLAIM TO ANY PARTICULAR FONT, STYLE, SIZE, OR COLOR.

NO CLAIM IS MADE TO THE EXCLUSIVE RIGHT TO USE "CELL", APART FROM THE MARK AS SHOWN.

SER. NO. 85-389,414, FILED 8-4-2011.

IRA J. GOODSaid, EXAMINING ATTORNEY



*David J. Kyffers*

Director of the United States Patent and Trademark Office

# United States of America

United States Patent and Trademark Office



**Reg. No. 4,125,356**

WEND-EN-EDEN L.L.C. (ARIZONA LIMITED LIABILITY COMPANY)

**Registered Apr. 10, 2012**

P. O. BOX 294  
CAVE CREEK, AZ 85327

**Int. Cl.: 41**

FOR: EDUCATIONAL SERVICES, NAMELY, CONDUCTING CONFERENCES, SEMINARS AND WORKSHOPS TO TEACH OTHERS TO ENGAGE WITH ANIMALS OR PETS SO AS TO HEAL THEM, AND PRINTABLE MATERIALS DISTRIBUTED THEREWITH, IN CLASS 41 (U.S. CLS. 100, 101 AND 107).

**SERVICE MARK**

**PRINCIPAL REGISTER**

FIRST USE 12-31-2005; IN COMMERCE 12-31-2005.

THE MARK CONSISTS OF A HAND WITH EXTENDED FINGER AND A PAW COMING TOGETHER

SER. NO. 85-389,416, FILED 8-4-2011.

IRA J. GOODSaid, EXAMINING ATTORNEY



*David J. Kyffers*

Director of the United States Patent and Trademark Office

# United States of America

United States Patent and Trademark Office



## Napoleon's Choice

**Reg. No. 4,125,357**

**Registered Apr. 10, 2012**

**Int. Cl.: 5**

**TRADEMARK**

**PRINCIPAL REGISTER**

ECUADORIAN RAINFOREST, LLC (NEW JERSEY LIMITED LIABILITY COMPANY)  
25 MAIN ST.  
BLDG. 6  
BELLEVILLE, NJ 07109

FOR: DIETARY AND NUTRITIONAL SUPPLEMENTS; DIETARY FOOD SUPPLEMENTS;  
DIETARY SUPPLEMENTAL DRINKS; DIETARY SUPPLEMENTAL DRINKS IN THE NATURE  
OF VITAMIN AND MINERAL BEVERAGES; DIETARY SUPPLEMENTS; DIETARY SUPPLE-  
MENTS FOR DOMESTIC ANIMAL CONSUMPTION, IN CLASS 5 (U.S. CLS. 6, 18, 44, 46, 51  
AND 52).

FIRST USE 1-1-2011; IN COMMERCE 1-1-2011.

THE MARK CONSISTS OF FRUITS IN A PILE SURROUNDING A MINIATURE POODLE  
INSIDE A BORDERED CIRCLE, AND THE TEXT "NAPOLEON'S CHOICE" BELOW.

SER. NO. 85-389,419, FILED 8-4-2011.

MELISSA VALLILLO, EXAMINING ATTORNEY



*David J. Kyjars*

Director of the United States Patent and Trademark Office

# United States of America

United States Patent and Trademark Office

## MANYWORLDS

**Reg. No. 4,125,358**

**Registered Apr. 10, 2012**

**Int. Cls.: 35 and 41**

**SERVICE MARK**

**PRINCIPAL REGISTER**

MANYWORLDS, INC. (TEXAS CORPORATION)  
510 BERING DRIVE, SUITE 470  
HOUSTON, TX 77057

FOR: ADVISORY SERVICES RELATING TO BUSINESS MANAGEMENT AND BUSINESS OPERATIONS, IN CLASS 35 (U.S. CLS. 100, 101 AND 102).

FIRST USE 11-1-1998; IN COMMERCE 12-1-1998.

FOR: EDUCATIONAL SERVICES, NAMELY, CONDUCTING SEMINARS AND CONFERENCES IN THE FIELD OF INFORMATION TECHNOLOGY TRENDS, IN CLASS 41 (U.S. CLS. 100, 101 AND 107).

FIRST USE 11-1-1998; IN COMMERCE 12-1-1998.

THE MARK CONSISTS OF STANDARD CHARACTERS WITHOUT CLAIM TO ANY PARTICULAR FONT, STYLE, SIZE, OR COLOR.

OWNER OF U.S. REG. NO. 3,100,268.

SER. NO. 85-389,420, FILED 8-4-2011.

KATHERINE CHANG, EXAMINING ATTORNEY



*David J. Kybas*

Director of the United States Patent and Trademark Office



# United States of America

United States Patent and Trademark Office



**Reg. No. 4,125,359**

PLENTY LEFT, LLC (MICHIGAN LIMITED LIABILITY COMPANY)  
3893 ZYGMUNT

**Registered Apr. 10, 2012**

JACKSON, MI 49201

**Int. Cl.: 35**

FOR: PROVIDING A WEB SITE WHERE USERS CAN POST ITEMS FOR SALE THROUGH ON-LINE CLASSIFIED ADVERTISEMENTS, IN CLASS 35 (U.S. CLS. 100, 101 AND 102).

**SERVICE MARK**

FIRST USE 7-25-2011; IN COMMERCE 7-25-2011.

**PRINCIPAL REGISTER**

THE MARK CONSISTS OF THE WORDING "PLENTY LEFT" IN GREEN STYLIZED LETTERING WITH AN IMAGE OF A BROWN BOWL WITH 6 RED SPHERES REPRESENTING THE SIX FOOD GROUPS, THE IMAGE OF THE BOWL AND SPHERES FOUND ON A SHADED GREEN CIRCLE.

THE COLOR(S) GREEN, RED AND BROWN IS/ARE CLAIMED AS A FEATURE OF THE MARK.

SER. NO. 85-389,426, FILED 8-4-2011.

HELENE LIWINSKI, EXAMINING ATTORNEY



*David J. Kybas*

Director of the United States Patent and Trademark Office

# United States of America

United States Patent and Trademark Office

# scrub•all

**Reg. No. 4,125,360**

ALPINE MARKETING INTL., INC. (UTAH CORPORATION)  
2263 SEGO LILY DRIVE  
SANDY, UT 84092

**Registered Apr. 10, 2012**

**Int. Cl.: 21**

FOR: ABRASIVE SPONGES FOR SCRUBBING THE SKIN; BATH PRODUCTS, NAMELY, BODY SPONGES; BATH SPONGES; CLEANING SPONGES; FACIAL CLEANSING SPONGES; SCRUB SPONGES; SPONGES FOR HOUSEHOLD PURPOSES, IN CLASS 21 (U.S. CLS. 2, 13, 23, 29, 30, 33, 40 AND 50).

**TRADEMARK**

**PRINCIPAL REGISTER**

FIRST USE 6-27-2006; IN COMMERCE 6-27-2006.

THE MARK CONSISTS OF THE WORDS "SCRUB ALL" AND THE DESIGN OF BUBBLES FORMING IN PART A RAISED PERIOD IN THE SPACE BETWEEN THE WORDING.

SER. NO. 85-389,456, FILED 8-4-2011.

HANNO RITTNER, EXAMINING ATTORNEY



*David J. Kyffers*

Director of the United States Patent and Trademark Office

# United States of America

United States Patent and Trademark Office

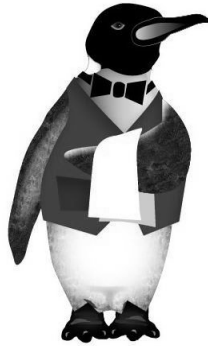

**Reg. No. 4,125,361**

**Registered Apr. 10, 2012**

**Int. Cl.: 35**

**SERVICE MARK**

**PRINCIPAL REGISTER**

UNIVERSITY DELIVERY SERVICES LLC (COLORADO LIMITED LIABILITY COMPANY),  
DBA UNIVERSITY STUDENT SERVICES; RALPHIE'S ROOM SERVICE  
2704-02(B)  
3800 BARR COURT  
BOULDER, CO 80305

FOR: ON-LINE RETAIL STORE SERVICES FEATURING GIFT BASKETS AND CARE  
PACKAGES WITH SELECTED ITEMS REGARDING A PARTICULAR THEME OR OCCASION,  
IN CLASS 35 (U.S. CLS. 100, 101 AND 102).

FIRST USE 1-25-2011; IN COMMERCE 1-25-2011.

THE MARK CONSISTS OF A STYLIZED PENGUIN WEARING A BOW TIE AND VEST AND  
WITH A TOWEL DRAPED OVER THE FOLDED LEFT WING.

SER. NO. 85-389,499, FILED 8-4-2011.

LAURIE MAYES, EXAMINING ATTORNEY



*David J. Kybas*

Director of the United States Patent and Trademark Office

# United States of America

United States Patent and Trademark Office

# SYNXI

**Reg. No. 4,125,362**

**Registered Apr. 10, 2012**

**Int. Cl.: 42**

**SERVICE MARK**

**PRINCIPAL REGISTER**

MANYWORLDS, INC. (TEXAS CORPORATION)  
510 BERING DRIVE, SUITE 470  
HOUSTON, TX 77057

FOR: PROVIDING TEMPORARY USE OF ONLINE NON-DOWNLOADABLE COMPUTER SOFTWARE FOR AUTO-LEARNING TO GENERATE PERSONALIZED RECOMMENDATIONS FOR COMPUTER USERS BASED ON THEIR BEHAVIORAL INFORMATION, IN CLASS 42 (U.S. CLS. 100 AND 101).

FIRST USE 1-2-2011; IN COMMERCE 1-4-2011.

THE MARK CONSISTS OF STANDARD CHARACTERS WITHOUT CLAIM TO ANY PARTICULAR FONT, STYLE, SIZE, OR COLOR.

SER. NO. 85-389,530, FILED 8-4-2011.

KATHERINE CHANG, EXAMINING ATTORNEY



*David J. Kybas*

Director of the United States Patent and Trademark Office

# United States of America

United States Patent and Trademark Office

# Yogurt Mart

**Reg. No. 4,125,363**

**Registered Apr. 10, 2012**

**Int. Cl.: 30**

**TRADEMARK**

**PRINCIPAL REGISTER**

HNT ENTERPRISES LLC (ARIZONA LIMITED LIABILITY COMPANY), DBA YOGURT  
MART  
3232 E SHEA BLVD  
PHOENIX, AZ 85028

FOR: FROZEN YOGURT, IN CLASS 30 (U.S. CL. 46).

FIRST USE 6-1-2011; IN COMMERCE 6-3-2011.

THE MARK CONSISTS OF STANDARD CHARACTERS WITHOUT CLAIM TO ANY PARTICULAR FONT, STYLE, SIZE, OR COLOR.

NO CLAIM IS MADE TO THE EXCLUSIVE RIGHT TO USE "YOGURT", APART FROM THE MARK AS SHOWN.

SER. NO. 85-389,538, FILED 8-4-2011.

AMY KELLY, EXAMINING ATTORNEY



*David J. Kyffers*

Director of the United States Patent and Trademark Office

# United States of America

United States Patent and Trademark Office

# WIGIG

**Reg. No. 4,125,364**

**Registered Apr. 10, 2012**

**Int. Cls.: 35 and 42**

**SERVICE MARK**

**PRINCIPAL REGISTER**

WIRELESS GIGABIT ALLIANCE, INC. (DELAWARE CORPORATION)  
3855 SW 153RD DRIVE  
BEAVERTON, OR 97006

FOR: ASSOCIATION SERVICES, NAMELY, PROMOTING THE INTERESTS OF THE WIRELESS INDUSTRY; ASSOCIATION SERVICES, NAMELY, PROMOTING THE INTERESTS OF THE WIRELESS INDUSTRY BY PROMOTING THE ADOPTION OF SPECIFICATIONS THAT DEFINE TRANSMISSION OF AUDIO, VIDEO, AND DATA IN THE MILLIMETER WAVE FREQUENCY BAND OPERATING WITHIN A LINE OF SIGHT AND NON-LINE OF SIGHT ENVIRONMENT; ASSOCIATION SERVICES, NAMELY, PROMOTING THE INTERESTS OF THE WIRELESS INDUSTRY BY PROMOTING THE ADOPTION AND UTILIZATION OF STANDARDS AND SPECIFICATIONS THAT DEFINE TRANSMISSION OF AUDIO, VIDEO, AND DATA IN THE MILLIMETER WAVE FREQUENCY BAND OPERATING WITHIN A LINE OF SIGHT AND NON-LINE OF SIGHT ENVIRONMENT, IN CLASS 35 (U.S. CLS. 100, 101 AND 102).

FIRST USE 5-6-2009; IN COMMERCE 5-6-2009.

FOR: DEVELOPMENT OF VOLUNTARY STANDARDS THAT DEFINE TRANSMISSION OF AUDIO, VIDEO, AND DATA IN THE MILLIMETER WAVE FREQUENCY BAND OPERATING WITHIN A LINE OF SIGHT AND NON-LINE OF SIGHT ENVIRONMENT; DESIGN AND DEVELOPMENT OF WIRELESS COMPUTER NETWORKS, NAMELY, DESIGN AND DEVELOPMENT OF A NETWORK OF INTEROPERABLE PRODUCTS FOR THE TRANSMISSION OF AUDIO, VIDEO, AND DATA IN THE MILLIMETER WAVE FREQUENCY BAND OPERATING WITHIN A LINE OF SIGHT AND NON-LINE OF SIGHT ENVIRONMENT, IN CLASS 42 (U.S. CLS. 100 AND 101).

FIRST USE 5-6-2009; IN COMMERCE 5-6-2009.

THE MARK CONSISTS OF STANDARD CHARACTERS WITHOUT CLAIM TO ANY PARTICULAR FONT, STYLE, SIZE, OR COLOR.

OWNER OF U.S. REG. NO. 4,054,774.

SER. NO. 85-389,584, FILED 8-4-2011.

REBECCA SMITH, EXAMINING ATTORNEY



*David J. Kyffers*

Director of the United States Patent and Trademark Office

# United States of America

United States Patent and Trademark Office

## THE LAMP SAFE

**Reg. No. 4,125,365**

**Registered Apr. 10, 2012**

**Int. Cls.: 21 and 37**

**TRADEMARK**

**SERVICE MARK**

**PRINCIPAL REGISTER**

THE LAMP SAFE LIMITED LIABILITY COMPANY (NEW JERSEY LIMITED LIABILITY COMPANY)  
829 BEECHWOOD AVENUE  
CHERRY HILL, NJ 08002

FOR: CLEAN-UP KITS COMPRISED OF A PLASTIC BUCKET, RUBBER GLOVES, AND FLAT CARDS FOR PICKING UP AND STORING BROKEN COMPACT FLUORESCENT LAMPS AND OTHER UNIVERSAL WASTE, IN CLASS 21 (U.S. CLS. 2, 13, 23, 29, 30, 33, 40 AND 50).

FIRST USE 2-28-2011; IN COMMERCE 2-28-2011.

FOR: ENVIRONMENTAL REMEDIATION SERVICES, NAMELY, COLLECTION OF LAMPS, BALLASTS AND BATTERIES FOR RECYCLING, AND DISPOSAL OF UNIVERSAL WASTES, NAMELY, LAMPS, BALLASTS AND BATTERIES, IN CLASS 37 (U.S. CLS. 100, 103 AND 106).

FIRST USE 1-31-2010; IN COMMERCE 1-31-2010.

THE MARK CONSISTS OF STANDARD CHARACTERS WITHOUT CLAIM TO ANY PARTICULAR FONT, STYLE, SIZE, OR COLOR.

NO CLAIM IS MADE TO THE EXCLUSIVE RIGHT TO USE "LAMP", APART FROM THE MARK AS SHOWN.

SER. NO. 85-389,686, FILED 8-4-2011.

CARRIE GENOVESE, EXAMINING ATTORNEY



*David J. Kybas*

Director of the United States Patent and Trademark Office

# United States of America

United States Patent and Trademark Office



**Reg. No. 4,125,366**

**Registered Apr. 10, 2012**

**Int. Cl.: 30**

**TRADEMARK**

**PRINCIPAL REGISTER**

CADBURY IRELAND LIMITED (IRELAND CORPORATION)  
MALAHIDE ROAD COOLOCK  
DUBLIN, IRELAND 5

FOR: CANDY, IN CLASS 30 (U.S. CL. 46).

FIRST USE 5-31-2005; IN COMMERCE 5-31-2005.

OWNER OF U.S. REG. NOS. 443,802, 3,689,023 AND OTHERS.

THE COLOR(S) MEDIUM BLUE, LIGHTER BLUE, BROWN, WHITE, RED, GREEN AND TAN IS/ARE CLAIMED AS A FEATURE OF THE MARK.

NO CLAIM IS MADE TO THE EXCLUSIVE RIGHT TO USE "ALMOND" AND "MILK CHOCOLATE COCONUT & ALMONDS" AND "THE PICTORIAL REPRESENTATION OF ALMONDS", APART FROM THE MARK AS SHOWN.

THE NAME "PETER PAUL" DOES NOT IDENTIFY A LIVING INDIVIDUAL.

THE MARK CONSISTS OF THE WORDING "PETER PAUL" IN WHITE INSIDE A RED OVAL. THIS IS ABOVE THE WORDING "ALMOND JOY" IN BROWN LETTERING WITH WHITE OUTLINING. THE LETTER "O" IN "JOY" IS REPLACED BY A BROWN AND WHITE HALF COCONUT. THE WORDING "MILK CHOCOLATE COCONUT & ALMONDS" APPEARS IN BROWN ON A TAN BANNER. THE BANNER IS BELOW THE WORDING "ALMOND JOY". A DESIGN OF TWO BROWN ALMONDS AND GREEN PALM LEAVES APPEARS TO THE RIGHT OF THE BANNER. THE BACKGROUND CONTAINS A WHITE AND BROWN HALF OPEN COCONUT, LIGHTER BLUE SHADING, AND MEDIUM BLUE PALM TREES. THE DOTTED LINES INDICATE THE POSITIONING OF THE MARK AND ARE NOT PART OF THE MARK.

SER. NO. 85-389,699, FILED 8-4-2011.

SETH A. RAPPAPORT, EXAMINING ATTORNEY



*David J. Kyffers*

Director of the United States Patent and Trademark Office



# United States of America

United States Patent and Trademark Office

# POOL PARTY

**Reg. No. 4,125,367**

**Registered Apr. 10, 2012**

**Int. Cl.: 35**

**SERVICE MARK**

**PRINCIPAL REGISTER**

DWAYNE E. HUNT (UNITED STATES INDIVIDUAL)  
3401 RUCKRIEGEL PARKWAY  
LOUISVILLE, KY 40299

FOR: RETAIL STORES FEATURING HOT TUBS, SPAS, SAUNAS AND ACCESSORIES THEREFOR, SWIMMING POOLS AND ACCESSORIES THEREFOR, FIREPLACES, FIREPLACE INSERTS, WOOD BURNING STOVES, GAS LOGS, POOL TABLES AND ACCESSORIES THEREFOR, TANNING SYSTEMS, GAS GRILLS, OUTDOOR KITCHENS, CASUAL INDOOR AND OUTDOOR FURNITURE, PERGOLAS, GAZEBOS, BARS, BAR STOOLS, GAME TABLES, BASKETBALL GOALS AND BACKBOARDS, CLOCKS, EXERCISE EQUIPMENT, NAMELY, TREADMILLS, STATIONARY BIKES, ELLIPTICAL MACHINES, AND HOME GYM EQUIPMENT, CABINETS FOR STORING WINE AND SPIRITS, JUNGLE GYMS, CHAIRS, HOME THEATER SEATING, ELECTRONICS, JUKE BOXES, GAMING EQUIPMENT, NAMELY, SLOT MACHINES AND POKER CHIPS, DART BOARDS, ARCADE GAMES, FOOSBALL TABLES, TABLES FOR TABLE TENNIS, AND SHUFFLE BOARD TABLES, IN CLASS 35 (U.S. CLS. 100, 101 AND 102).

FIRST USE 0-0-2010; IN COMMERCE 0-0-2010.

THE MARK CONSISTS OF STANDARD CHARACTERS WITHOUT CLAIM TO ANY PARTICULAR FONT, STYLE, SIZE, OR COLOR.

NO CLAIM IS MADE TO THE EXCLUSIVE RIGHT TO USE "POOL", APART FROM THE MARK AS SHOWN.

SER. NO. 85-389,701, FILED 8-4-2011.

JENNIFER DIXON, EXAMINING ATTORNEY



*David J. Kybas*

Director of the United States Patent and Trademark Office

# United States of America

United States Patent and Trademark Office

# AMBIO5

**Reg. No. 4,125,368**

**Registered Apr. 10, 2012**

**Int. Cl.: 5**

**TRADEMARK**

**PRINCIPAL REGISTER**

OKTOS SURGICAL CORPORATION (CALIFORNIA CORPORATION)  
SUITE B  
3184 AIRWAY AVENUE  
COSTA MESA, CA 92626

FOR: BIOLOGICAL TISSUE FOR USE IN SURGERY, IN CLASS 5 (U.S. CLS. 6, 18, 44, 46, 51 AND 52).

FIRST USE 6-0-2008; IN COMMERCE 6-0-2008.

THE MARK CONSISTS OF STANDARD CHARACTERS WITHOUT CLAIM TO ANY PARTICULAR FONT, STYLE, SIZE, OR COLOR.

SER. NO. 85-389,704, FILED 8-4-2011.

SANJEEV VOHRA, EXAMINING ATTORNEY



*David J. Kybas*

Director of the United States Patent and Trademark Office

# United States of America

United States Patent and Trademark Office

## WASTE LOCK

**Reg. No. 4,125,369**

M2 POLYMER TECHNOLOGIES, INC. (ILLINOIS CORPORATION)  
1315 CHADWICK  
WEST DUNDEE, IL 60118

**Registered Apr. 10, 2012**

**Int. Cl.: 17**

FOR: GRANULAR SUPERABSORBENT POLYMER FOR LARGE-SCALE OR BULK  
AQUEOUS ENVIRONMENTAL WASTE SOLIDIFICATION, IN CLASS 17 (U.S. CLS. 1, 5,  
12, 13, 35 AND 50).

**TRADEMARK**

FIRST USE 2-27-2000; IN COMMERCE 4-20-2000.

**PRINCIPAL REGISTER**

THE MARK CONSISTS OF STANDARD CHARACTERS WITHOUT CLAIM TO ANY PAR-  
TICULAR FONT, STYLE, SIZE, OR COLOR.

NO CLAIM IS MADE TO THE EXCLUSIVE RIGHT TO USE "WASTE", APART FROM THE  
MARK AS SHOWN.

SER. NO. 85-389,738, FILED 8-4-2011.

HENRY S. ZAK, EXAMINING ATTORNEY



*David J. Kybas*

Director of the United States Patent and Trademark Office

United States of America  
United States Patent and Trademark Office

prizeKing

**Reg. No. 4,125,370**

**Registered Apr. 10, 2012**

**Int. Cl.: 42**

**SERVICE MARK**

**PRINCIPAL REGISTER**

PRIZEKING PTY LTD (AUSTRALIA CORPORATION)  
LEVEL 11 269 WICKHAM STREET  
FORTITUDE VALLEY, AUSTRALIA QLD4006

FOR: HOSTING AN ON-LINE COMMUNITY WEB SITE FEATURING ONLINE COMPETITIONS, DOWNLOADABLE RINGTONES AND MP3S, IN CLASS 42 (U.S. CLS. 100 AND 101).

FIRST USE 12-1-2010; IN COMMERCE 12-1-2010.

THE MARK CONSISTS OF STANDARD CHARACTERS WITHOUT CLAIM TO ANY PARTICULAR FONT, STYLE, SIZE, OR COLOR.

OWNER OF U.S. REG. NO. 4,042,526.

SER. NO. 85-389,791, FILED 8-4-2011.

THOMAS MANOR, EXAMINING ATTORNEY



*David J. Kyfos*

Director of the United States Patent and Trademark Office

# United States of America

United States Patent and Trademark Office

## Beyond Freedom Evolution University

**Reg. No. 4,125,371**

**Registered Apr. 10, 2012**

**Int. Cl.: 9**

**TRADEMARK**

**PRINCIPAL REGISTER**

POLARIS GLOBAL (ARIZONA LIMITED LIABILITY COMPANY), AKA POLARIS GLOBAL  
MARKETING  
14835 E SHEA BLVD STE 103-618  
FOUNTAIN HILLS, AZ 85268

FOR: PRE-RECORDED FLASH DRIVES FEATURING EDUCATIONAL MATERIAL IN THE  
FIELDS OF PERSONAL SUCCESS AND DEVELOPMENT, SELF-HELP, AND GENERAL  
BUSINESS DEVELOPMENT, IN CLASS 9 (U.S. CLS. 21, 23, 26, 36 AND 38).

FIRST USE 8-1-2011; IN COMMERCE 8-1-2011.

THE MARK CONSISTS OF STANDARD CHARACTERS WITHOUT CLAIM TO ANY PAR-  
TICULAR FONT, STYLE, SIZE, OR COLOR.

OWNER OF U.S. REG. NO. 2,946,678.

NO CLAIM IS MADE TO THE EXCLUSIVE RIGHT TO USE "UNIVERSITY", APART FROM  
THE MARK AS SHOWN.

SER. NO. 85-389,801, FILED 8-4-2011.

CARRIE GENOVESE, EXAMINING ATTORNEY



*David J. Kyffers*

Director of the United States Patent and Trademark Office

# United States of America

United States Patent and Trademark Office



**Reg. No. 4,125,372**

**Registered Apr. 10, 2012**

**Int. Cl.: 39**

**SERVICE MARK**

**PRINCIPAL REGISTER**

SCOOT 2 YOU, LLC (PENNSYLVANIA LIMITED LIABILITY COMPANY)  
1917 MONTROSE STREET  
PHILADELPHIA, PA 19146

FOR: RENTAL OF SCOOTERS FOR TRANSPORTATION PURPOSES, IN CLASS 39 (U.S. CLS. 100 AND 105).

FIRST USE 2-18-2011; IN COMMERCE 2-18-2011.

THE MARK CONSISTS OF THE WORDS "SCOOT2YOU" CENTERED IN A CIRCLE WITH A CONCENTRIC CIRCLE FORMED BY THREE LINES AND THREE LEAF DESIGNS OUTSIDE OF THE CIRCLE WITH A BREAK BETWEEN EACH OF THE THREE LINES. THE COLOR BLACK APPEARS IN THE WORDS "SCOOT" AND "YOU". THE COLOR GREEN APPEARS IN THE THREE LINES AND LEAF DESIGNS FORMING THE OUTER CIRCLE, THE NUMBER "2" AND THE LEFT SIDE OF THE LETTER "T" IN THE WORD "SCOOT" WHICH IS FORMED BY A LEAF DESIGN. THE COLOR GRAY APPEARS IN THE BORDER OF THE INNER CIRCLE. THE COLOR WHITE APPEARS INSIDE OF THE CIRCLES.

THE COLOR(S) GREEN, BLACK, GRAY AND WHITE IS/ARE CLAIMED AS A FEATURE OF THE MARK.

SER. NO. 85-389,843, FILED 8-4-2011.

TINA BROWN, EXAMINING ATTORNEY



*David J. Kybas*

Director of the United States Patent and Trademark Office

# United States of America

United States Patent and Trademark Office

## Polaris Global Media

**Reg. No. 4,125,373**

**Registered Apr. 10, 2012**

**Int. Cl.: 9**

**TRADEMARK**

**PRINCIPAL REGISTER**

POLARIS GLOBAL (ARIZONA LIMITED LIABILITY COMPANY), AKA POLARIS GLOBAL MARKETING  
14835 E SHEA BLVD STE 103-618  
FOUNTAIN HILLS, AZ 85268

FOR: MOTION PICTURE FILMS ABOUT HUMAN INTEREST DOCUMENTARIES; PRE-RECORDED CDS FEATURING EDUCATIONAL MATERIAL IN THE FIELDS OF PERSONAL DEVELOPMENT, SELF-HELP, AND GENERAL BUSINESS DEVELOPMENT; PRE-RECORDED DVDS FEATURING EDUCATIONAL MATERIAL IN THE FIELDS OF PERSONAL DEVELOPMENT, SELF-HELP, AND GENERAL BUSINESS DEVELOPMENT; PRE-RECORDED FLASH DRIVES FEATURING EDUCATIONAL MATERIAL IN THE FIELDS OF PERSONAL DEVELOPMENT, SELF-HELP, AND GENERAL BUSINESS DEVELOPMENT, IN CLASS 9 (U.S. CLS. 21, 23, 26, 36 AND 38).

FIRST USE 9-9-2009; IN COMMERCE 9-9-2009.

THE MARK CONSISTS OF STANDARD CHARACTERS WITHOUT CLAIM TO ANY PARTICULAR FONT, STYLE, SIZE, OR COLOR.

OWNER OF U.S. REG. NOS. 3,874,617, 4,014,729, AND 4,040,475.

NO CLAIM IS MADE TO THE EXCLUSIVE RIGHT TO USE "GLOBAL MEDIA", APART FROM THE MARK AS SHOWN.

SER. NO. 85-389,874, FILED 8-4-2011.

CARRIE GENOVESE, EXAMINING ATTORNEY



*David J. Kyffers*

Director of the United States Patent and Trademark Office

# United States of America

United States Patent and Trademark Office

# Sirona Springs

**Reg. No. 4,125,374**

SIRONA SPRINGS (CALIFORNIA PARTNERSHIP)  
6925 FAIRVIEW DRIVE  
EL CERRITO, CA 94530

**Registered Apr. 10, 2012**

**Int. Cl.: 3**

FOR: COSMETICS; PERFUMES; AND HANDMADE SOAP BARS, IN CLASS 3 (U.S. CLS. 1, 4, 6, 50, 51 AND 52).

**TRADEMARK**

FIRST USE 12-20-2008; IN COMMERCE 2-2-2009.

**PRINCIPAL REGISTER**

THE MARK CONSISTS OF STANDARD CHARACTERS WITHOUT CLAIM TO ANY PARTICULAR FONT, STYLE, SIZE, OR COLOR.

SER. NO. 85-389,947, FILED 8-4-2011.

ALEXANDER L. POWERS, EXAMINING ATTORNEY



*David J. Kyros*

Director of the United States Patent and Trademark Office



# United States of America

United States Patent and Trademark Office

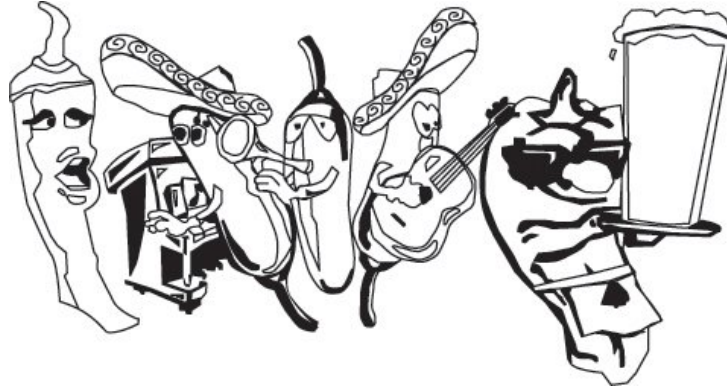

**Reg. No. 4,125,375**

**Registered Apr. 10, 2012**

**Int. Cl.: 43**

**SERVICE MARK**

**PRINCIPAL REGISTER**

JALAPENO TREE HOLDINGS, LLC (TEXAS LIMITED LIABILITY COMPANY), DBA THE  
JALAPENO TREE MEXICAN RESTAURANT  
SUITE 250  
1131 ROCKINGHAM DRIVE  
RICHARDSON, TX 75063

FOR: BAR AND RESTAURANT SERVICES, IN CLASS 43 (U.S. CLS. 100 AND 101).

FIRST USE 4-1-2005; IN COMMERCE 2-15-2007.

OWNER OF U.S. REG. NO. 3,368,466.

THE MARK CONSISTS OF FANCIFUL CHARACTERIZATIONS OF 5 HOT PEPPERS, ONE OF WHICH IS SINGING, THE SECOND OF WHICH IS PLAYING THE PIANO AND WEARING A SOMBRERO, THE THIRD IS PLAYING A HORN, THE FOURTH IS PLAYING A GUITAR WHILE WEARING A SOMBRERO AND THE 5TH IS CARRYING A BEVERAGE ON A TRAY.

SER. NO. 85-389,970, FILED 8-4-2011.

TRACY CROSS, EXAMINING ATTORNEY



*David J. Kyros*

Director of the United States Patent and Trademark Office

# United States of America

United States Patent and Trademark Office

# MINTA

**Reg. No. 4,125,376**

BEV MARKETING GROUP COMPANY, INC. (CALIFORNIA CORPORATION)  
1304 N. HIGHLAND AVE. SUITE 290  
HOLLYWOOD, CA 90028

**Registered Apr. 10, 2012**

**Int. Cl.: 32**

FOR: NON-ALCOHOLIC BEVERAGES, NAMELY, CARBONATED BEVERAGES, IN CLASS 32 (U.S. CLS. 45, 46 AND 48).

**TRADEMARK**

FIRST USE 8-3-2011; IN COMMERCE 8-3-2011.

**PRINCIPAL REGISTER**

THE MARK CONSISTS OF STANDARD CHARACTERS WITHOUT CLAIM TO ANY PARTICULAR FONT, STYLE, SIZE, OR COLOR.

THE WORDING "MINTA" HAS NO MEANING IN A FOREIGN LANGUAGE.

SER. NO. 85-390,018, FILED 8-4-2011.

JAMES LOVELACE, EXAMINING ATTORNEY



*David J. Kybas*

Director of the United States Patent and Trademark Office

# United States of America

United States Patent and Trademark Office

## Old Bastards Clan

**Reg. No. 4,125,377**

FUNKWERKES LLC (ALABAMA LIMITED LIABILITY COMPANY)

**Registered Apr. 10, 2012**

P.O. BOX 2468  
MUSCLE SHOALS, AL 35660

**Int. Cl.: 41**

FOR: ENTERTAINMENT SERVICES, NAMELY, PROVIDING ONLINE ELECTRONIC GAMES,  
IN CLASS 41 (U.S. CLS. 100, 101 AND 107).

**SERVICE MARK**

FIRST USE 12-31-2003; IN COMMERCE 12-31-2003.

**PRINCIPAL REGISTER**

THE MARK CONSISTS OF STANDARD CHARACTERS WITHOUT CLAIM TO ANY PAR-  
TICULAR FONT, STYLE, SIZE, OR COLOR.

SER. NO. 85-390,029, FILED 8-4-2011.

JAMES LOVELACE, EXAMINING ATTORNEY



*David J. Kyffers*

Director of the United States Patent and Trademark Office

# United States of America

United States Patent and Trademark Office

## REVIEW RIGHT

**Reg. No. 4,125,378**

**Registered Apr. 10, 2012**

**Int. Cl.: 35**

**SERVICE MARK**

**PRINCIPAL REGISTER**

SCHIENEMAN, KARL (UNITED STATES INDIVIDUAL)  
4685 MIDDLE ROAD  
ALLISON PARK, PA 15101

FOR: TESTING TO DETERMINE THE PROFESSIONAL COMPETENCY OF LEGAL DOCUMENT REVIEW PROFESSIONALS BY PROVIDING A COMPUTERIZED TEST TO EVALUATE HOW THE DOCUMENT REVIEW PROFESSIONAL EVALUATES INFORMATION IN A TIMED SETTING IN ORDER TO GAIN AN ASSESSMENT OF THE PROFESSIONAL'S ACCURACY, THINKING, AND SPEED OF REVIEWING DOCUMENTS BEFORE PLACING THE PERSON ON A LEGAL DOCUMENT REVIEW PROJECT, IN CLASS 35 (U.S. CLS. 100, 101 AND 102).

FIRST USE 7-1-2011; IN COMMERCE 7-1-2011.

THE MARK CONSISTS OF STANDARD CHARACTERS WITHOUT CLAIM TO ANY PARTICULAR FONT, STYLE, SIZE, OR COLOR.

NO CLAIM IS MADE TO THE EXCLUSIVE RIGHT TO USE "REVIEW", APART FROM THE MARK AS SHOWN.

SER. NO. 85-390,047, FILED 8-4-2011.

APRIL HESIK, EXAMINING ATTORNEY



*David J. Kybas*

Director of the United States Patent and Trademark Office

# United States of America

United States Patent and Trademark Office

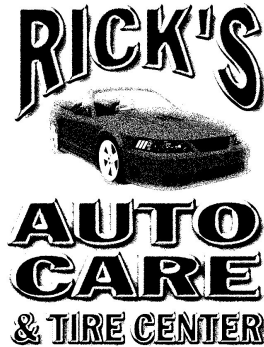

**Reg. No. 4,125,379**

RICK'S AUTO CARE & TIRE CENTER INC. (VIRGINIA CORPORATION)  
232 S. ROYAL AVE.  
FRONT ROYAL, VA 22630

**Registered Apr. 10, 2012**

**Int. Cl.: 37**

FOR: VEHICLE MAINTENANCE AND REPAIR, IN CLASS 37 (U.S. CLS. 100, 103 AND 106).

**SERVICE MARK**

FIRST USE 3-28-2008; IN COMMERCE 6-20-2008.

**PRINCIPAL REGISTER**

NO CLAIM IS MADE TO THE EXCLUSIVE RIGHT TO USE "AUTO CARE & TIRE CENTER",  
APART FROM THE MARK AS SHOWN.

THE STIPPLING IS FOR SHADING PURPOSES ONLY.

THE MARK CONSISTS OF THE FRONT END VIEW OF A SPORTS CAR, THE TEXT "RICK'S"  
ARCHED ABOVE THE CAR, AND THE TEXT "AUTO CARE & TIRE CENTER" BELOW  
THE CAR, TAKING UP THREE LINES.

SER. NO. 85-390,074, FILED 8-4-2011.

TASHIA BUNCH, EXAMINING ATTORNEY



*David J. Kyffers*

Director of the United States Patent and Trademark Office

# United States of America

United States Patent and Trademark Office

## Perfect Paws Pet Ministry

**Reg. No. 4,125,380**

**Registered Apr. 10, 2012**

**Int. Cl.: 45**

**SERVICE MARK**

**PRINCIPAL REGISTER**

CALVARY EPISCOPAL CHURCH (MASSACHUSETTS NON-PROFIT ORGANIZATION)  
CORNER OF HOLTEN AND CHERRY STREETS  
P.O. BOX 393  
DANVERS, MA 01923

FOR: CHRISTIAN MINISTRY SERVICES FOR PEOPLE WITH ANIMAL COMPANIONS, PET FUNERAL SERVICES, ORGANIZING AND CONDUCTING SUPPORT GROUPS FOR PEOPLE WITH PETS AND ANIMALS GOING THROUGH MEDICAL AND PHYSICAL ISSUES AND ANIMAL EUTHANASIA, AND PEOPLE GOING THROUGH PET LOSS BEREAVEMENT, IN CLASS 45 (U.S. CLS. 100 AND 101).

FIRST USE 2-8-2010; IN COMMERCE 2-22-2010.

THE MARK CONSISTS OF STANDARD CHARACTERS WITHOUT CLAIM TO ANY PARTICULAR FONT, STYLE, SIZE, OR COLOR.

NO CLAIM IS MADE TO THE EXCLUSIVE RIGHT TO USE "PET MINISTRY", APART FROM THE MARK AS SHOWN.

SER. NO. 85-390,129, FILED 8-4-2011.

LINDA POWELL, EXAMINING ATTORNEY



*David J. Kybas*

Director of the United States Patent and Trademark Office

# United States of America

United States Patent and Trademark Office



**Reg. No. 4,125,381**

FLEXEDGE GAMING, LLC (NEVADA LIMITED LIABILITY COMPANY)  
19744 BEACH BLVD. # 117  
HUNTINGTON BEACH, CA 92648

**Registered Apr. 10, 2012**

**Int. Cl.: 41**

FOR: ENTERTAINMENT IN THE NATURE OF CARD GAMES; ENTERTAINMENT SERVICES, NAMELY, CASINO GAMING; GAMING SERVICES IN THE NATURE OF CASINO GAMING, IN CLASS 41 (U.S. CLS. 100, 101 AND 107).

**SERVICE MARK**

FIRST USE 7-31-2010; IN COMMERCE 7-31-2010.

**PRINCIPAL REGISTER**

NO CLAIM IS MADE TO THE EXCLUSIVE RIGHT TO USE "BET", APART FROM THE MARK AS SHOWN.

THE MARK CONSISTS OF A CIRCLE WITH A CURVED BANNER OVERLYING A PORTION OF THE CIRCLE AND THE STACKED WORDS "RED FLEX BET" WHEREIN THE WORDS "RED" AND "BET" APPEAR IN BLOCK STYLE LETTERING AND THE WORD "FLEX" APPEARS IN SCRIPT STYLE LETTERING.

SER. NO. 85-390,135, FILED 8-4-2011.

LINDA POWELL, EXAMINING ATTORNEY



*David J. Kyros*

Director of the United States Patent and Trademark Office

# United States of America

United States Patent and Trademark Office

## SUNDAY NITE SLOW JAMS

**Reg. No. 4,125,382**

FUSION RADIO NETWORKS (ARIZONA LIMITED LIABILITY COMPANY)  
P O BOX 36731  
TUCSON, AZ 85740

**Registered Apr. 10, 2012**

**Int. Cl.: 9**

FOR: COMPACT DISCS FEATURING MUSIC, IN CLASS 9 (U.S. CLS. 21, 23, 26, 36 AND 38).

**TRADEMARK**

FIRST USE 1-0-2002; IN COMMERCE 1-0-2002.

**PRINCIPAL REGISTER**

THE MARK CONSISTS OF STANDARD CHARACTERS WITHOUT CLAIM TO ANY PARTICULAR FONT, STYLE, SIZE, OR COLOR.

OWNER OF U.S. REG. NO. 3,266,876.

NO CLAIM IS MADE TO THE EXCLUSIVE RIGHT TO USE "SLOW JAMS", APART FROM THE MARK AS SHOWN.

SER. NO. 85-390,148, FILED 8-4-2011.

MARTHA FROMM, EXAMINING ATTORNEY



*David J. Kybas*

Director of the United States Patent and Trademark Office



# United States of America

United States Patent and Trademark Office

## APPLIED ON SERVICE

**Reg. No. 4,125,383**

**Registered Apr. 10, 2012**

**Int. Cl.: 42**

**SERVICE MARK**

**PRINCIPAL REGISTER**

APPLIED MATERIALS, INC. (DELAWARE CORPORATION)  
M/S 1241  
3050 BOWERS AVENUE  
SANTA CLARA, CA 95054

FOR: PROVIDING ONLINE TECHNICAL OPERATING INFORMATION IN THE FIELD OF SOLAR ENERGY TECHNOLOGY, IN CLASS 42 (U.S. CLS. 100 AND 101).

FIRST USE 6-30-2011; IN COMMERCE 6-30-2011.

THE MARK CONSISTS OF STANDARD CHARACTERS WITHOUT CLAIM TO ANY PARTICULAR FONT, STYLE, SIZE, OR COLOR.

OWNER OF U.S. REG. NO. 3,481,062.

NO CLAIM IS MADE TO THE EXCLUSIVE RIGHT TO USE "SERVICE", APART FROM THE MARK AS SHOWN.

SER. NO. 85-390,226, FILED 8-4-2011.

MICHAEL WIENER, EXAMINING ATTORNEY



*David J. Kyffers*

Director of the United States Patent and Trademark Office

# United States of America

United States Patent and Trademark Office



**Reg. No. 4,125,384**

**Registered Apr. 10, 2012**

**Int. Cl.: 10**

**TRADEMARK**

**PRINCIPAL REGISTER**

HEALTHMATE INTERNATIONAL, LLC (MISSOURI LIMITED LIABILITY COMPANY)  
709 EAST 97TH STREET  
KANSAS CITY, MO 64131

FOR: ELECTRIC MASSAGE APPARATUS FOR HOUSEHOLD USE; ELECTRIC MASSAGE APPLIANCES, NAMELY, ELECTRIC VIBRATING MASSAGER; MASSAGE APPARATUS; MASSAGE APPARATUS AND INSTRUMENTS; MASSAGING APPARATUS FOR PERSONAL USE, IN CLASS 10 (U.S. CLS. 26, 39 AND 44).

FIRST USE 8-1-2010; IN COMMERCE 9-1-2010.

OWNER OF U.S. REG. NO. 4,035,888.

THE MARK CONSISTS OF THE YIN YANG LOGO SURROUNDED BY A CIRCLE CONTAINING THE WORDS "HEALTHMATE FOREVER".

SER. NO. 85-390,227, FILED 8-4-2011.

DORITT L. CARROLL, EXAMINING ATTORNEY



*David J. Kyfos*

Director of the United States Patent and Trademark Office

# United States of America

United States Patent and Trademark Office

## COTES DU ROGUE

**Reg. No. 4,125,385**

**Registered Apr. 10, 2012**

**Int. Cl.: 33**

**TRADEMARK**

**PRINCIPAL REGISTER**

MERRILL CELLARS, LLC (OREGON LIMITED LIABILITY COMPANY)  
P.O. BOX 157  
JACKSONVILLE, OR 97530

FOR: WINES, IN CLASS 33 (U.S. CLS. 47 AND 49).

FIRST USE 2-6-2008; IN COMMERCE 3-10-2010.

THE MARK CONSISTS OF STANDARD CHARACTERS WITHOUT CLAIM TO ANY PARTICULAR FONT, STYLE, SIZE, OR COLOR.

THE ENGLISH TRANSLATION OF "COTES DU" IS "COASTS OF".

SER. NO. 85-390,281, FILED 8-5-2011.

CARRIE GENOVESE, EXAMINING ATTORNEY



*David J. Kyffers*

Director of the United States Patent and Trademark Office

# United States of America

United States Patent and Trademark Office

## HI-VISION HI-YIELDS

**Reg. No. 4,125,386**

ECOOMART CO. (CALIFORNIA CORPORATION)

**Registered Apr. 10, 2012**

18351 COLIMA ROAD, #83  
ROWLAND HEIGHTS, CA 91748

**Int. Cl.: 2**

FOR: PHOTOCOPIER TONER; PHOTOCOPIER TONER IN CARTRIDGES; PRINTING TONER; TONER; TONER CARTRIDGES; XEROGRAPHIC TONERS, IN CLASS 2 (U.S. CLS. 6, 11 AND 16).

**TRADEMARK**

FIRST USE 7-1-2011; IN COMMERCE 7-1-2011.

**PRINCIPAL REGISTER**

THE MARK CONSISTS OF STANDARD CHARACTERS WITHOUT CLAIM TO ANY PARTICULAR FONT, STYLE, SIZE, OR COLOR.

NO CLAIM IS MADE TO THE EXCLUSIVE RIGHT TO USE "HIGH YIELDS", APART FROM THE MARK AS SHOWN.

SER. NO. 85-390,284, FILED 8-5-2011.

CARRIE GENOVESE, EXAMINING ATTORNEY



*David J. Kybas*

Director of the United States Patent and Trademark Office

# United States of America

United States Patent and Trademark Office

## I HAVE WINGS SPRING BLING

**Reg. No. 4,125,387**

**Registered Apr. 10, 2012**

**Int. Cl.: 36**

**SERVICE MARK**

**PRINCIPAL REGISTER**

WOMEN WITH WINGS, INC. (KENTUCKY CORPORATION), DBA I HAVE WINGS BREAST  
CANCER FOUNDATION  
1289 BRIGHTLEAF BOULEVARD  
ERLANGER, KY 41018

FOR: CHARITABLE FUND RAISING SERVICES, IN CLASS 36 (U.S. CLS. 100, 101 AND  
102).

FIRST USE 5-21-2005; IN COMMERCE 5-21-2005.

THE MARK CONSISTS OF STANDARD CHARACTERS WITHOUT CLAIM TO ANY PAR-  
TICULAR FONT, STYLE, SIZE, OR COLOR.

OWNER OF U.S. REG. NO. 3,743,941.

SER. NO. 85-390,321, FILED 8-5-2011.

INGRID C. EULIN, EXAMINING ATTORNEY



*David J. Kyffers*

Director of the United States Patent and Trademark Office

# United States of America

United States Patent and Trademark Office



**Reg. No. 4,125,388**

**Registered Apr. 10, 2012**

**Int. Cls.: 35 and 42**

**SERVICE MARK**

**PRINCIPAL REGISTER**

CARETECH SOLUTIONS, INC. (MICHIGAN CORPORATION)  
901 WILSHIRE DRIVE, SUITE 100  
TROY, MI 48084

FOR: BUSINESS CONSULTING SERVICES IN THE FIELD OF INFORMATION TECHNOLOGY; OUTSOURCING IN THE FIELD OF INFORMATION TECHNOLOGY, IN CLASS 35 (U.S. CLS. 100, 101 AND 102).

FIRST USE 1-26-2011; IN COMMERCE 1-26-2011.

FOR: CONSULTING SERVICES IN THE FIELD OF DESIGN, SELECTION, IMPLEMENTATION AND USE OF COMPUTER HARDWARE AND SOFTWARE SYSTEMS FOR OTHERS; DESIGN, CREATION, HOSTING, MAINTENANCE OF WEBSITES FOR OTHERS, IN CLASS 42 (U.S. CLS. 100 AND 101).

FIRST USE 1-26-2011; IN COMMERCE 1-26-2011.

OWNER OF U.S. REG. NO. 3,139,011.

THE MARK CONSISTS OF THE WORDING "CARETECHSOLUTIONS" APPEARING TO THE RIGHT OF A DESIGN FEATURE CONSISTING OF FOUR OVERLAPPING SPHERES, WITH ONE SPHERE SLIGHTLY PROTRUDING ON THE LEFT, ONE SPHERE SLIGHTLY PROTRUDING ON THE RIGHT, ONE SPHERE SLIGHTLY PROTRUDING ABOVE THE REST, AND ONE SPHERE SLIGHTLY PROTRUDING BELOW THE OTHERS.

SER. NO. 85-390,357, FILED 8-5-2011.

TARAH HARDY, EXAMINING ATTORNEY



*David J. Kybas*

Director of the United States Patent and Trademark Office

# United States of America

United States Patent and Trademark Office

# Primer

**Reg. No. 4,125,389**

**Registered Apr. 10, 2012**

**Int. Cl.: 45**

**SERVICE MARK**

**PRINCIPAL REGISTER**

SNAVELY, ANDREW (UNITED STATES INDIVIDUAL)  
#311  
1409 N. ALTA VISTA BLVD  
LOS ANGELES, CA 90046

FOR: ENTERTAINMENT SERVICES, NAMELY, PROVIDING A WEB SITE FEATURING PHOTOGRAPHIC, VIDEO AND PROSE PRESENTATIONS FEATURING MEN'S LIFESTYLE INTERESTS, IN CLASS 45 (U.S. CLS. 100 AND 101).

FIRST USE 3-20-2008; IN COMMERCE 5-1-2008.

THE MARK CONSISTS OF STANDARD CHARACTERS WITHOUT CLAIM TO ANY PARTICULAR FONT, STYLE, SIZE, OR COLOR.

SER. NO. 85-390,398, FILED 8-5-2011.

KRISTINA MORRIS, EXAMINING ATTORNEY



*David J. Kyffers*

Director of the United States Patent and Trademark Office

# United States of America

United States Patent and Trademark Office

## Discover Bulk Foods

**Reg. No. 4,125,390**

DUTCH VALLEY FOOD DISTRIBUTORS INC. (PENNSYLVANIA CORPORATION)  
7615 LANCASTER AVENUE, P.O. BOX 465  
MYERSTOWN, PA 17067

**Registered Apr. 10, 2012**

**Int. Cl.: 35**

FOR: PROMOTING PUBLIC AWARENESS OF BULK FOODS, IN CLASS 35 (U.S. CLS. 100, 101 AND 102).

**SERVICE MARK**

FIRST USE 6-4-2009; IN COMMERCE 6-4-2009.

**PRINCIPAL REGISTER**

THE MARK CONSISTS OF STANDARD CHARACTERS WITHOUT CLAIM TO ANY PARTICULAR FONT, STYLE, SIZE, OR COLOR.

OWNER OF U.S. REG. NO. 3,734,017.

NO CLAIM IS MADE TO THE EXCLUSIVE RIGHT TO USE "BULK FOODS", APART FROM THE MARK AS SHOWN.

SER. NO. 85-390,475, FILED 8-5-2011.

SANDRA BUJA, EXAMINING ATTORNEY



*David J. Kyffers*

Director of the United States Patent and Trademark Office



# United States of America

United States Patent and Trademark Office

# RISE

Research, Innovation & Science for Engineered Fabrics

**Reg. No. 4,125,391**

**Registered Apr. 10, 2012**

**Int. Cl.: 35**

INDA, ASSOCIATION OF THE NONWOVEN FABRICS INDUSTRY (DELAWARE CORPORATION)

SUITE 115

1100 CRESCENT GREEN

CARY, NC 27518

**SERVICE MARK**

**PRINCIPAL REGISTER**

FOR: ARRANGING AND CONDUCTING BUSINESS CONFERENCES; TRADE ASSOCIATION SERVICES, NAMELY, PROMOTING THE INTERESTS OF THE NONWOVEN FABRICS INDUSTRY, IN CLASS 35 (U.S. CLS. 100, 101 AND 102).

FIRST USE 4-16-2010; IN COMMERCE 4-16-2010.

NO CLAIM IS MADE TO THE EXCLUSIVE RIGHT TO USE "RESEARCH, INNOVATION & SCIENCE FOR ENGINEERED FABRICS", APART FROM THE MARK AS SHOWN.

THE MARK CONSISTS OF THE STYLIZED WORD "RISE" WITH THE WORDS "RESEARCH, INNOVATION & SCIENCE FOR ENGINEERED FABRICS" BELOW IT.

SER. NO. 85-390,535, FILED 8-5-2011.

REBECCA SMITH, EXAMINING ATTORNEY



*David J. Kyffers*

Director of the United States Patent and Trademark Office

# United States of America

United States Patent and Trademark Office



**Reg. No. 4,125,392**

GODWIN MANUFACTURING CO., INC. (NORTH CAROLINA CORPORATION)  
17665 US HIGHWAY 421 SOUTH  
DUNN, NC 28334

**Registered Apr. 10, 2012**

**Int. Cl.: 7**

FOR: MECHANICAL SPREADERS; SNOW PLOWS, IN CLASS 7 (U.S. CLS. 13, 19, 21, 23, 31, 34 AND 35).

**TRADEMARK**

FIRST USE 1-1-1992; IN COMMERCE 1-1-1992.

**PRINCIPAL REGISTER**

NO CLAIM IS MADE TO THE EXCLUSIVE RIGHT TO USE "ROADS", APART FROM THE MARK AS SHOWN.

THE MARK CONSISTS OF THE FIRST WORD "GOOD" LOCATED AND CENTERED ABOVE THE SECOND WORD "ROADS". THE "A" IN "ROADS" IS AN IMAGE OF A DIVIDED HIGHWAY WITH HASH MARKS RUNNING DOWN THE CENTER OF A ROAD. THE "A" IS ANGLED WITH THE TOP BEING ROUGHLY HALF THE WIDTH OF THE BOTTOM. THERE IS A BAR RUNNING HORIZONTALLY THROUGH BOTH "GOOD" AND "ROADS", WITH THE EXCEPTION OF THE "A". ALL LETTERS ARE UPPERCASE.

SER. NO. 85-390,568, FILED 8-5-2011.

APRIL ROACH, EXAMINING ATTORNEY



*David J. Kyffers*

Director of the United States Patent and Trademark Office

# United States of America

United States Patent and Trademark Office

# Dollar Station

**Reg. No. 4,125,393**

**Registered Apr. 10, 2012**

**Int. Cl.: 35**

**SERVICE MARK**

**PRINCIPAL REGISTER**

AXIS SOURCING GROUP INC. (CALIFORNIA CORPORATION)  
797 HUTCHINSON ROAD  
WALNUT CREEK, CA 94598

FOR: RETAIL DEPARTMENT STORE SERVICES, IN CLASS 35 (U.S. CLS. 100, 101 AND 102).

FIRST USE 10-14-2010; IN COMMERCE 3-7-2011.

THE MARK CONSISTS OF STANDARD CHARACTERS WITHOUT CLAIM TO ANY PARTICULAR FONT, STYLE, SIZE, OR COLOR.

NO CLAIM IS MADE TO THE EXCLUSIVE RIGHT TO USE "DOLLAR", APART FROM THE MARK AS SHOWN.

SER. NO. 85-390,612, FILED 8-5-2011.

HAI-LY LAM, EXAMINING ATTORNEY



*David J. Kyffers*

Director of the United States Patent and Trademark Office

# United States of America

United States Patent and Trademark Office

## GERRY WEBER

**Reg. No. 4,125,394**

**Registered Apr. 10, 2012**

**Int. Cl.: 25**

**TRADEMARK**

**PRINCIPAL REGISTER**

GERRY WEBER INTERNATIONAL AG (FED REP GERMANY CORPORATION)  
NEULEHENSTRASSE 8  
33790 HALLE/WESTFALEN, FED REP GERMANY

FOR: CLOTHING, NAMELY, WOMEN'S BLOUSES, SKIRTS, JACKETS, TROUSERS, COATS, DRESSES, WOMEN'S SUITS, T-SHIRTS, POLO-SHIRTS, PULLOVERS, CARDIGANS, BLAZERS, CLOAKS, VESTS, JEANS, LEGGINGS, BELTS, SCARVES, SHOES, IN CLASS 25 (U.S. CLS. 22 AND 39).

FIRST USE 0-0-1997; IN COMMERCE 0-0-1997.

THE MARK CONSISTS OF STANDARD CHARACTERS WITHOUT CLAIM TO ANY PARTICULAR FONT, STYLE, SIZE, OR COLOR.

OWNER OF U.S. REG. NOS. 1,982,160 AND 2,413,774.

THE NAME "GERRY WEBER" IDENTIFIES A LIVING INDIVIDUAL WHOSE CONSENT IS OF RECORD.

SER. NO. 85-390,623, FILED 8-5-2011.

MATTHEW EINSTEIN, EXAMINING ATTORNEY



*David J. Kyjars*

Director of the United States Patent and Trademark Office

# United States of America

United States Patent and Trademark Office

## SUGAR QUEEN CUPCAKES

**Reg. No. 4,125,395**

SIX BRITTENS, LLC (TEXAS LIMITED LIABILITY COMPANY)  
211 MAIN STREET, SUITE 100  
LAKE DALLAS, TX 75065

**Registered Apr. 10, 2012**

**Int. Cl.: 30**

FOR: BROWNIES; CAKES; COOKIES; CUP CAKES, IN CLASS 30 (U.S. CL. 46).

FIRST USE 11-1-2009; IN COMMERCE 11-1-2009.

**TRADEMARK**

THE MARK CONSISTS OF STANDARD CHARACTERS WITHOUT CLAIM TO ANY PARTICULAR FONT, STYLE, SIZE, OR COLOR.

**PRINCIPAL REGISTER**

NO CLAIM IS MADE TO THE EXCLUSIVE RIGHT TO USE "CUPCAKES", APART FROM THE MARK AS SHOWN.

SER. NO. 85-390,643, FILED 8-5-2011.

YAT SYE, LEE, EXAMINING ATTORNEY



*David J. Kyffers*

Director of the United States Patent and Trademark Office

# United States of America

United States Patent and Trademark Office

# InnerCompass

**Reg. No. 4,125,396**

MARSHALL, KIMBERLEY A. (UNITED STATES INDIVIDUAL)  
PO BOX 667  
SANDPOINT, ID 83864

**Registered Apr. 10, 2012**

**Int. Cl.: 41**

FOR: BUSINESS EDUCATION AND TRAINING SERVICES, NAMELY, DEVELOPING AND FACILITATING CUSTOMIZED LEADERSHIP AND EXECUTIVE DEVELOPMENT PROGRAMS, PROVIDING EXECUTIVE COACHING SERVICES, AND PROVIDING BUSINESS EDUCATION PROGRAMS TO EMPLOYEES AND EXECUTIVES; PERSONAL COACHING SERVICES IN THE FIELD OF VALUES CLARIFICATION, GOAL SETTING, LIFE RENEWAL, AND CAREER MANAGEMENT FOR ADULTS.; PROFESSIONAL COACHING SERVICES IN THE FIELD OF LEADERSHIP, TEAMWORK, VALUES CLARIFICATION, GOAL SETTING, PERFORMANCE ENHANCEMENT, LIFE RENEWAL, AND CAREER MANAGEMENT FOR ADULTS.; PROVIDING GROUP COACHING AND LEARNING FORUMS IN THE FIELD OF LEADERSHIP DEVELOPMENT, IN CLASS 41 (U.S. CLS. 100, 101 AND 107).

**SERVICE MARK**

**PRINCIPAL REGISTER**

FIRST USE 1-5-1999; IN COMMERCE 4-10-1999.

THE MARK CONSISTS OF STANDARD CHARACTERS WITHOUT CLAIM TO ANY PARTICULAR FONT, STYLE, SIZE, OR COLOR.

SER. NO. 85-390,677, FILED 8-5-2011.

RONALD MCMORROW, EXAMINING ATTORNEY



*David J. Kybas*

Director of the United States Patent and Trademark Office

# United States of America

United States Patent and Trademark Office

## PIANO EMT

**Reg. No. 4,125,397**

PIANO EMT, LLC (GEORGIA LIMITED LIABILITY COMPANY)  
4990 MEADOW OVERLOOK DRIVE  
CUMMING, GA 30040

**Registered Apr. 10, 2012**

**Int. Cl.: 37**

FOR: TUNING, MAINTENANCE, REPAIR, REBUILDING, AND RESTORATION OF VINTAGE PLAYER PIANOS, IN CLASS 37 (U.S. CLS. 100, 103 AND 106).

**SERVICE MARK**

FIRST USE 8-1-2011; IN COMMERCE 8-1-2011.

**PRINCIPAL REGISTER**

THE MARK CONSISTS OF STANDARD CHARACTERS WITHOUT CLAIM TO ANY PARTICULAR FONT, STYLE, SIZE, OR COLOR.

NO CLAIM IS MADE TO THE EXCLUSIVE RIGHT TO USE "PIANO", APART FROM THE MARK AS SHOWN.

SER. NO. 85-390,683, FILED 8-5-2011.

RONALD MCMORROW, EXAMINING ATTORNEY



*David J. Kyffers*

Director of the United States Patent and Trademark Office

# United States of America

United States Patent and Trademark Office

## Piano EMT

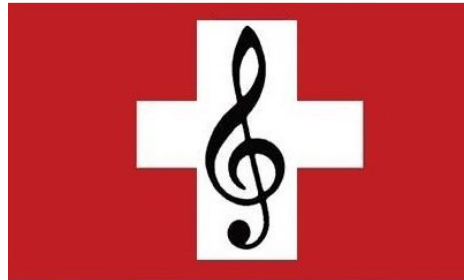

**Emergency Maintenance Technician**

**Reg. No. 4,125,398**

**Registered Apr. 10, 2012**

**Int. Cl.: 37**

**SERVICE MARK**

**PRINCIPAL REGISTER**

PIANO EMT, LLC (GEORGIA LIMITED LIABILITY COMPANY)  
4990 MEADOW OVERLOOK DRIVE  
CUMMING, GA 30040

FOR: TUNING, MAINTENANCE, REPAIR, REBUILDING, AND RESTORATION OF VINTAGE PLAYER PIANOS, IN CLASS 37 (U.S. CLS. 100, 103 AND 106).

FIRST USE 8-1-2011; IN COMMERCE 8-1-2011.

NO CLAIM IS MADE TO THE EXCLUSIVE RIGHT TO USE "PIANO" AND "MAINTENANCE TECHNICIAN", APART FROM THE MARK AS SHOWN.

THE COLOR(S) RED, BLACK AND WHITE IS/ARE CLAIMED AS A FEATURE OF THE MARK.

THE MARK CONSISTS OF A WHITE CROSS ON A RED RECTANGLE, LOCATED WITHIN THE WHITE CROSS IS A BLACK TREBLE CLEF, THE WORDS "PIANO EMT" APPEAR IN BLACK LETTERS ABOVE THE RECTANGLE AND THE WORDS "EMERGENCY MAINTENANCE TECHNICIAN" APPEAR IN BLACK LETTERS BELOW THE RECTANGLE.

SER. NO. 85-390,693, FILED 8-5-2011.

RONALD MCMORROW, EXAMINING ATTORNEY



*David J. Kybas*

Director of the United States Patent and Trademark Office



**United States of America**  
United States Patent and Trademark Office

# ArthroPet

**Reg. No. 4,125,399**

**Registered Apr. 10, 2012**

**Int. Cl.: 5**

**TRADEMARK**

**PRINCIPAL REGISTER**

NEOCELL (CALIFORNIA CORPORATION)  
1911 SOUTH SUSAN STREET  
SANTA ANA, CA 92704

FOR: DIETARY PET SUPPLEMENTS IN THE FORM OF PET TREATS, IN CLASS 5 (U.S. CLS. 6, 18, 44, 46, 51 AND 52).

FIRST USE 1-1-1996; IN COMMERCE 1-1-1996.

THE MARK CONSISTS OF STANDARD CHARACTERS WITHOUT CLAIM TO ANY PARTICULAR FONT, STYLE, SIZE, OR COLOR.

OWNER OF U.S. REG. NO. 3,873,244.

SER. NO. 85-390,698, FILED 8-5-2011.

JOHN GARTNER, EXAMINING ATTORNEY



*David J. Kyffers*

Director of the United States Patent and Trademark Office

# United States of America

United States Patent and Trademark Office



**Reg. No. 4,125,400**

**Registered Apr. 10, 2012**

**Int. Cl.: 37**

**SERVICE MARK**

**PRINCIPAL REGISTER**

MCGLOTHLIN, SUSANNE (UNITED STATES INDIVIDUAL)  
345 UPPER SAMSONVILLE RD  
OLIVEBRIDGE, NY 12461

FOR: CARPET AND RUG CLEANING; CLEANING OF BUILDINGS; CLEANING OF COMMERCIAL PREMISES; CLEANING OF INDUSTRIAL PREMISES; CLEANING OF RESIDENTIAL HOUSES; CRIME SCENE CLEAN-UP SERVICES; DEGREASING AND CLEANING SERVICES USING SOLVENT AND VAPOR TECHNOLOGY; DISINFECTING, IN CLASS 37 (U.S. CLS. 100, 103 AND 106).

FIRST USE 4-1-2011; IN COMMERCE 4-1-2011.

THE MARK CONSISTS OF A BLUE WATER DROP WITH A SMILEY FACE WITH A BLACK OUTLINE AND BLACK FEATURES, WHITE GLOVED HANDS AND SHOES WHICH ARE WHITE AND LIGHT BLUE HOLDING A STEAM CLEANING MACHINE WITH A BLACK HOSE AND GRAY END WITH A WHITE THOUGHT BUBBLE OUTLINED IN LIGHT BLUE, WITH THE WORDING "WE FOG IT, YOU FOGETABOUTIT" ALSO IN BLUE.

THE COLOR(S) BLUE, WHITE, BLACK AND GRAY IS/ARE CLAIMED AS A FEATURE OF THE MARK.

SER. NO. 85-390,735, FILED 8-5-2011.

NORA BUCHANAN WILL, EXAMINING ATTORNEY



*David J. Kypos*

Director of the United States Patent and Trademark Office

# United States of America

United States Patent and Trademark Office



**Reg. No. 4,125,401**

**Registered Apr. 10, 2012**

**Int. Cl.: 9**

**TRADEMARK**

**PRINCIPAL REGISTER**

WOMBAT SECURITY TECHNOLOGIES, INC. (DELAWARE CORPORATION)  
4620 HENRY STREET, THIRD FLOOR  
PITTSBURGH, PA 15213

FOR: DOWNLOADABLE COMPUTER SOFTWARE AND COMPUTER PROGRAMS FOR CYBER SECURITY TRAINING PURPOSES, NAMELY, TO TRAIN EMPLOYEES AND CUSTOMERS OF BUSINESSES HOW TO AVOID CYBER SECURITY THREATS AND FOR FILTERING EMAILS, WEB CONTENT OR SHORT MESSAGES, IN CLASS 9 (U.S. CLS. 21, 23, 26, 36 AND 38).

FIRST USE 7-23-2008; IN COMMERCE 10-3-2008.

NO CLAIM IS MADE TO THE EXCLUSIVE RIGHT TO USE "SECURITY TECHNOLOGIES", APART FROM THE MARK AS SHOWN.

THE MARK CONSISTS OF THE WORDS "WOMBAT SECURITY TECHNOLOGIES" AND A SKETCH OF A "WOMBAT" SURROUNDED BY A CIRCLE.

SER. NO. 85-390,829, FILED 8-5-2011.

CAROLINE WOOD, EXAMINING ATTORNEY



*David J. Kybas*

Director of the United States Patent and Trademark Office

# United States of America

United States Patent and Trademark Office



**Reg. No. 4,125,402**

**Registered Apr. 10, 2012**

**Int. Cl.: 42**

**SERVICE MARK**

**PRINCIPAL REGISTER**

WOMBAT SECURITY TECHNOLOGIES, INC. (DELAWARE CORPORATION)  
4620 HENRY STREET, THIRD FLOOR  
PITTSBURGH, PA 15213

FOR: CLOUD-BASED SOFTWARE AS A SERVICE (SAAS) SERVICES FEATURING SOFTWARE FOR CYBER SECURITY TRAINING PURPOSES, NAMELY, TO TRAIN EMPLOYEES AND CUSTOMERS OF BUSINESSES HOW TO AVOID CYBER SECURITY THREATS AND FOR FILTERING EMAILS, WEB CONTENT OR SHORT MESSAGES, IN CLASS 42 (U.S. CLS. 100 AND 101).

FIRST USE 7-23-2008; IN COMMERCE 10-3-2008.

NO CLAIM IS MADE TO THE EXCLUSIVE RIGHT TO USE "SECURITY TECHNOLOGIES", APART FROM THE MARK AS SHOWN.

THE MARK CONSISTS OF THE WORDS "WOMBAT SECURITY TECHNOLOGIES" AND A SKETCH OF A WOMBAT SURROUNDED BY A CIRCLE.

SER. NO. 85-390,846, FILED 8-5-2011.

CAROLINE WOOD, EXAMINING ATTORNEY



*David J. Kybas*

Director of the United States Patent and Trademark Office

# United States of America

United States Patent and Trademark Office

# SPRING STRUTTIN FALL RUTTIN

**Reg. No. 4,125,403**

**Registered Apr. 10, 2012**

**Int. Cl.: 16**

**TRADEMARK**

**PRINCIPAL REGISTER**

WRIGHT, HENRY (UNITED STATES INDIVIDUAL)  
499 SCARBOROUGH DRIVE  
VERSAILLES, KY 40383

FOR: BLANK OR PARTIALLY PRINTED POSTCARDS; BUMPER STICKERS; DECALS; DECORATIVE DECALS FOR VEHICLE WINDOWS; GREETINGS CARDS AND POSTCARDS; MAGNETIC BUMPER STICKERS; MOUNTED POSTERS; PICTURE POSTCARDS; POSTCARDS; POSTCARDS AND GREETING CARDS; POSTCARDS AND PICTURE POSTCARDS; POSTERS; POSTERS MADE OF PAPER; UNMOUNTED POSTERS, IN CLASS 16 (U.S. CLS. 2, 5, 22, 23, 29, 37, 38 AND 50).

FIRST USE 8-2-2011; IN COMMERCE 8-2-2011.

THE MARK CONSISTS OF STANDARD CHARACTERS WITHOUT CLAIM TO ANY PARTICULAR FONT, STYLE, SIZE, OR COLOR.

SER. NO. 85-390,868, FILED 8-5-2011.

C. DIONNE CLYBURN, EXAMINING ATTORNEY



*David J. Kyffers*

Director of the United States Patent and Trademark Office

# United States of America

United States Patent and Trademark Office

## SOCIAL MEDIA ASSIST

**Reg. No. 4,125,404**

NOVELLA, CHRISTEL (UNITED STATES INDIVIDUAL)  
608 HEATHERCREST COURT  
SIMPSONVILLE, SC 29681

**Registered Apr. 10, 2012**

**Int. Cl.: 35**

FOR: CREATIVE MARKETING DESIGN SERVICES; PROMOTION AND MARKETING SERVICES AND RELATED CONSULTING, IN CLASS 35 (U.S. CLS. 100, 101 AND 102).

**SERVICE MARK**

FIRST USE 6-14-2010; IN COMMERCE 6-14-2010.

**PRINCIPAL REGISTER**

THE MARK CONSISTS OF STANDARD CHARACTERS WITHOUT CLAIM TO ANY PARTICULAR FONT, STYLE, SIZE, OR COLOR.

NO CLAIM IS MADE TO THE EXCLUSIVE RIGHT TO USE "SOCIAL MEDIA", APART FROM THE MARK AS SHOWN.

SER. NO. 85-390,898, FILED 8-5-2011.

ANGELA M. MICHELI, EXAMINING ATTORNEY



*David J. Kybas*

Director of the United States Patent and Trademark Office

# United States of America

United States Patent and Trademark Office

## It's Up to Us

**Reg. No. 4,125,405**

**Registered Apr. 10, 2012**

**Int. Cl.: 35**

**SERVICE MARK**

**PRINCIPAL REGISTER**

COUNTY OF SAN DIEGO (CALIFORNIA POLITICAL SUBDIVISION OF THE STATE OF CALIFORNIA)  
1600 PACIFIC HIGHWAY  
SAN DIEGO, CA 92101

FOR: PROMOTING PUBLIC AWARENESS OF MENTAL ILLNESS, STIGMA REDUCTION, SUICIDE PREVENTION, AND AVAILABLE RESOURCES IN THOSE FIELDS , IN CLASS 35 (U.S. CLS. 100, 101 AND 102).

FIRST USE 9-13-2010; IN COMMERCE 9-13-2010.

THE MARK CONSISTS OF STANDARD CHARACTERS WITHOUT CLAIM TO ANY PARTICULAR FONT, STYLE, SIZE, OR COLOR.

SER. NO. 85-390,919, FILED 8-5-2011.

ROBIN MITTLER, EXAMINING ATTORNEY



*David J. Kyffers*

Director of the United States Patent and Trademark Office

# United States of America

United States Patent and Trademark Office



**Reg. No. 4,125,406**

**Registered Apr. 10, 2012**

**Int. Cl.: 35**

**SERVICE MARK**

**PRINCIPAL REGISTER**

COUNTY OF SAN DIEGO (CALIFORNIA POLITICAL SUBDIVISION OF THE STATE OF CALIFORNIA)  
1600 PACIFIC HIGHWAY  
SAN DIEGO, CA 92101

FOR: PROMOTING PUBLIC AWARENESS OF MENTAL ILLNESS, STIGMA REDUCTION, SUICIDE PREVENTION, AND AVAILABLE RESOURCES IN THOSE FIELDS, IN CLASS 35 (U.S. CLS. 100, 101 AND 102).

FIRST USE 9-13-2010; IN COMMERCE 9-13-2010.

THE MARK CONSISTS OF A VERTICAL RECTANGLE SURROUNDED BY A LIGHTER BORDER, WITH THE WORDS "IT'S UP TO US" PRINTED INSIDE. THE SPACE INSIDE THE "U" CONSISTS OF TWO HANDS ENGAGED IN A HANDSHAKE.

SER. NO. 85-390,933, FILED 8-5-2011.

ROBIN MITTLER, EXAMINING ATTORNEY



*David J. Kyjars*

Director of the United States Patent and Trademark Office



# United States of America

United States Patent and Trademark Office

# Up2SD

**Reg. No. 4,125,407**

**Registered Apr. 10, 2012**

**Int. Cl.: 35**

**SERVICE MARK**

**PRINCIPAL REGISTER**

COUNTY OF SAN DIEGO (CALIFORNIA POLITICAL SUBDIVISION OF THE STATE OF CALIFORNIA)  
1600 PACIFIC HIGHWAY  
SAN DIEGO, CA 92101

FOR: PROMOTING PUBLIC AWARENESS OF MENTAL ILLNESS, STIGMA REDUCTION, SUICIDE PREVENTION, AND AVAILABLE RESOURCES IN THOSE FIELDS , IN CLASS 35 (U.S. CLS. 100, 101 AND 102).

FIRST USE 9-13-2010; IN COMMERCE 9-13-2010.

THE MARK CONSISTS OF STANDARD CHARACTERS WITHOUT CLAIM TO ANY PARTICULAR FONT, STYLE, SIZE, OR COLOR.

SER. NO. 85-390,946, FILED 8-5-2011.

ROBIN MITTLER, EXAMINING ATTORNEY



*David J. Kybas*

Director of the United States Patent and Trademark Office

# United States of America

United States Patent and Trademark Office

## NATURE'S GURU

**Reg. No. 4,125,408**

SAGAR SHAH (UNITED STATES INDIVIDUAL), DBA NATURE'S GURU  
19416 AMHURST COURT  
CERRITOS, CA 90703

**Registered Apr. 10, 2012**

**Int. Cl.: 32**

FOR: POWDER AND CONCENTRATES USED IN THE PREPARATION OF SPORTS BEVERAGES, FRUIT-FLAVORED BEVERAGES AND TEA-FLAVORED BEVERAGES, IN CLASS 32 (U.S. CLS. 45, 46 AND 48).

**TRADEMARK**

FIRST USE 10-9-2009; IN COMMERCE 9-30-2010.

**PRINCIPAL REGISTER**

THE MARK CONSISTS OF STANDARD CHARACTERS WITHOUT CLAIM TO ANY PARTICULAR FONT, STYLE, SIZE, OR COLOR.

SER. NO. 85-390,971, FILED 8-5-2011.

JENNY PARK, EXAMINING ATTORNEY



*David J. Kyffers*

Director of the United States Patent and Trademark Office

# United States of America

United States Patent and Trademark Office

## SCREAM ACRES HAUNTED HOUSE

**Reg. No. 4,125,409**

**Registered Apr. 10, 2012**

**Int. Cl.: 41**

**SERVICE MARK**

**PRINCIPAL REGISTER**

SCREAM ACRES HAUNTED HOUSE AND HAYRIDE, LLC (SOUTH CAROLINA LIMITED LIABILITY COMPANY), DBA SCREAM ACRES  
1283 OLD CAMDEN RD.  
BISHOPVILLE, SC 29010

FOR: PROVIDING AMUSEMENT FACILITIES, IN CLASS 41 (U.S. CLS. 100, 101 AND 107).

FIRST USE 10-31-2005; IN COMMERCE 10-31-2005.

THE MARK CONSISTS OF STANDARD CHARACTERS WITHOUT CLAIM TO ANY PARTICULAR FONT, STYLE, SIZE, OR COLOR.

NO CLAIM IS MADE TO THE EXCLUSIVE RIGHT TO USE "HAUNTED HOUSE", APART FROM THE MARK AS SHOWN.

SER. NO. 85-391,020, FILED 8-5-2011.

SANDRA BUJA, EXAMINING ATTORNEY



*David J. Kybas*

Director of the United States Patent and Trademark Office

# United States of America

United States Patent and Trademark Office

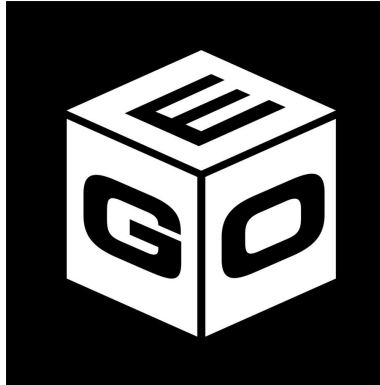

**Reg. No. 4,125,410**

**Registered Apr. 10, 2012**

**Int. Cl.: 9**

**TRADEMARK**

**PRINCIPAL REGISTER**

GEO SEMICONDUCTOR INC. (DELAWARE CORPORATION)  
SUITE 1050  
2350 MISSION COLLEGE BLVD.  
SANTA CLARA, CA 95054

FOR: ELECTRONIC COMPONENTS, NAMELY, ELECTRONIC IMAGE PROCESSING COMPONENTS; INTEGRATED CIRCUITS; INTEGRATED CIRCUIT COMPONENTS FOR GRAPHIC, IMAGE GENERATION, VIDEO, AND OPTICAL DEVICES AND SYSTEMS; SEMICONDUCTOR DEVICES; SOFTWARE AND HARDWARE SOLD AS A UNIT, NAMELY, FOR IMAGE PROCESSING, IN CLASS 9 (U.S. CLS. 21, 23, 26, 36 AND 38).

FIRST USE 10-0-2006; IN COMMERCE 10-0-2006.

THE MARK CONSISTS OF THE WORD "GEO," WHICH IS DISPLAYED ON THREE-SIDED CUBE. THE LEFT SIDE OF THE CUBE DISPLAYS THE LETTER "G." THE MIDDLE SIDE OF THE CUBE DISPLAYS THE LETTER "E." THE RIGHT SIDE OF THE CUBE DISPLAYS THE LETTER "O"; THE FOREGOING APPEARING ON A CONTRASTING BACKGROUND.

SER. NO. 85-391,040, FILED 8-5-2011.

HELENE LIWINSKI, EXAMINING ATTORNEY



*David J. Kyffers*

Director of the United States Patent and Trademark Office

# United States of America

United States Patent and Trademark Office

# TDL

**Reg. No. 4,125,411**

**Registered Apr. 10, 2012**

**Int. Cls.: 16 and 41**

**TRADEMARK**

**SERVICE MARK**

**PRINCIPAL REGISTER**

JAMES DINES & CO., INC. (CALIFORNIA CORPORATION), AKA JAMES DINES & COMPANY, INC.  
P.O. BOX 22  
BELVEDERE, CA 94920

FOR: NEWSLETTERS IN THE FIELD OF FINANCIAL INFORMATION FOR TRADERS AND INVESTORS, IN CLASS 16 (U.S. CLS. 2, 5, 22, 23, 29, 37, 38 AND 50).

FIRST USE 0-0-1960; IN COMMERCE 0-0-1960.

FOR: PROVIDING NEWSLETTERS IN THE FIELD OF FINANCIAL INFORMATION FOR TRADERS AND INVESTORS VIA E-MAIL, IN CLASS 41 (U.S. CLS. 100, 101 AND 107).

FIRST USE 0-0-1996; IN COMMERCE 0-0-1996.

THE MARK CONSISTS OF STANDARD CHARACTERS WITHOUT CLAIM TO ANY PARTICULAR FONT, STYLE, SIZE, OR COLOR.

SER. NO. 85-391,058, FILED 8-5-2011.

NELSON SNYDER, EXAMINING ATTORNEY



*David J. Kypos*

Director of the United States Patent and Trademark Office

# United States of America

United States Patent and Trademark Office



**Reg. No. 4,125,412**

STRANDS OF BEAUTY (GEORGIA LIMITED LIABILITY COMPANY)  
1279 WINESAP  
AUSTELL, GA 30106

**Registered Apr. 10, 2012**

**Int. Cl.: 44**

FOR: HAIR SALON SERVICES, IN CLASS 44 (U.S. CLS. 100 AND 101).

**SERVICE MARK**

FIRST USE 1-1-2009; IN COMMERCE 1-1-2009.

**PRINCIPAL REGISTER**

THE MARK CONSISTS OF THE STYLIZED WORDING "STRANDS OF BEAUTY", WITH THE WORDING "STRANDS OF" IN TAN WITH BROWN SHADING AND THE WORDING "BEAUTY" IN BROWN, WITH A DEPICTION OF THE HEAD AND TORSO OF A WOMAN EXTENDING UP FROM THE LETTER Y, WITH THE WOMAN HAVING A WHITE FACE, A WHITE NECK, BROWN FACIAL FEATURES, BROWN HAIR, AND A SHIRT IN SHADES OF TAN AND BROWN.

THE COLOR(S) TAN, BROWN, AND WHITE IS/ARE CLAIMED AS A FEATURE OF THE MARK.

SER. NO. 85-391,073, FILED 8-5-2011.

CYNTHIA TRIPI, EXAMINING ATTORNEY



*David J. Kyffers*

Director of the United States Patent and Trademark Office

# United States of America

United States Patent and Trademark Office



**Reg. No. 4,125,413**

**Registered Apr. 10, 2012**

**Int. Cl.: 35**

**SERVICE MARK**

**PRINCIPAL REGISTER**

THE ODD LUMINARY, LLC (NEW YORK LIMITED LIABILITY COMPANY)  
APT #2  
1693 11TH AVE.  
BROOKLYN, NY 11218

FOR: ON-LINE ART GALLERIES; ON-LINE RETAIL STORE SERVICES FEATURING AP-  
PAREL, BAGS, JEWELRY, SCULPTURES, CURIOS, FINE ART PRINTS AND PLUSH TOYS  
, IN CLASS 35 (U.S. CLS. 100, 101 AND 102).

FIRST USE 10-4-2010; IN COMMERCE 2-28-2011.

THE MARK CONSISTS OF AN ILLUSTRATED BEARDED CHARACTER SITTING ON A  
BENCH WITH AN OWL ON HIS SHOULDER AND A CANDLE ATTACHED TO HIS HEAD.  
REPTILIAN ARMS AND LEGS FORM THE EDGES OF THE BENCH. GRASS IS UNDER  
THE BENCH.

SER. NO. 85-391,120, FILED 8-5-2011.

MICHAEL WEBSTER, EXAMINING ATTORNEY



*David J. Kyffers*

Director of the United States Patent and Trademark Office

# United States of America

United States Patent and Trademark Office

# emPath

**Reg. No. 4,125,414**

**Registered Apr. 10, 2012**

**Int. Cl.: 9**

**TRADEMARK**

**PRINCIPAL REGISTER**

NOW SOLUTIONS, INC. (DELAWARE CORPORATION)  
SUITE 300  
101 W. RENNER ROAD  
RICHARDSON, TX 75082

FOR: COMPUTER SOFTWARE, NAMELY, CLIENT/SERVER ARCHITECTURE, DATABASE MANAGEMENT, DATA ACCESS, DATA CONTROL, AND GRAPHIC USER INTERFACE FOR INTEGRATED HUMAN RESOURCES AND PAYROLL APPLICATIONS, IN CLASS 9 (U.S. CLS. 21, 23, 26, 36 AND 38).

FIRST USE 4-13-2001; IN COMMERCE 11-26-2001.

THE MARK CONSISTS OF STANDARD CHARACTERS WITHOUT CLAIM TO ANY PARTICULAR FONT, STYLE, SIZE, OR COLOR.

SER. NO. 85-391,134, FILED 8-5-2011.

JANET LEE, EXAMINING ATTORNEY



*David J. Kyffers*

Director of the United States Patent and Trademark Office



# United States of America

United States Patent and Trademark Office



**Reg. No. 4,125,415**

**Registered Apr. 10, 2012**

**Int. Cl.: 9**

**TRADEMARK**

**PRINCIPAL REGISTER**

GEO SEMICONDUCTOR INC. (DELAWARE CORPORATION)  
SUITE 1050  
2350 MISSION COLLEGE BLVD.  
SANTA CLARA, CA 95054

FOR: ELECTRONIC COMPONENTS, NAMELY, ELECTRONIC IMAGE PROCESSING COMPONENTS; INTEGRATED CIRCUITS; INTEGRATED CIRCUIT COMPONENTS FOR GRAPHIC, IMAGE GENERATION, VIDEO, AND OPTICAL DEVICES AND SYSTEMS; SEMICONDUCTOR DEVICES; SOFTWARE AND HARDWARE SOLD AS A UNIT, NAMELY, FOR IMAGE PROCESSING, IN CLASS 9 (U.S. CLS. 21, 23, 26, 36 AND 38).

FIRST USE 0-0-2006; IN COMMERCE 0-0-2006.

THE MARK CONSISTS OF THE WORD "GEO," WHICH IS DISPLAYED IN THE COLOR WHITE ON A THREE-SIDED CUBE. THE LEFT SIDE OF THE CUBE DISPLAYS THE LETTER "G" AND IS RED IN COLOR. THE MIDDLE SIDE OF THE CUBE DISPLAYS THE LETTER "E" AND IS BLUE IN COLOR. THE RIGHT SIDE OF THE CUBE DISPLAYS THE LETTER "O" AND IS GREEN IN COLOR. A GRAY SHADOW APPEARS UNDERNEATH THE CUBE.

THE COLOR(S) RED, BLUE, GREEN, GRAY AND WHITE IS/ARE CLAIMED AS A FEATURE OF THE MARK.

SER. NO. 85-391,156, FILED 8-5-2011.

HELENE LIWINSKI, EXAMINING ATTORNEY



*David J. Kyffers*

Director of the United States Patent and Trademark Office

# United States of America

United States Patent and Trademark Office



# APSD

ASSOCIATION OF PROPERTY  
SCENE DESIGNERS

**Reg. No. 4,125,416**

**Registered Apr. 10, 2012**

**Int. Cl.: 41**

**SERVICE MARK**

**PRINCIPAL REGISTER**

ASSOCIATION OF PROPERTY SCENE DESIGNERS (COLORADO LIMITED LIABILITY COMPANY)  
UNIT 79D  
79 CRYSTAL PARK RD  
MANITOU SPRINGS, CO 80829

FOR: TRAINING SERVICES IN THE FIELD OF THE HOME STAGING INDUSTRY, IN CLASS 41 (U.S. CLS. 100, 101 AND 107).

FIRST USE 2-18-2008; IN COMMERCE 5-15-2008.

NO CLAIM IS MADE TO THE EXCLUSIVE RIGHT TO USE "APSD" AND "ASSOCIATION OF PROPERTY SCENE DESIGNERS", APART FROM THE MARK AS SHOWN.

THE STIPPLING IS FOR SHADING PURPOSES ONLY.

THE MARK CONSISTS OF A GLOBE ENCIRCLED BY TWO ARROWS WITH EACH ARROWHEAD CONTAINING FOUR WINDOWS REPRESENTING A HOUSE WITH A CHIMNEY AND WINDOWS. THE STIPPLING IS FOR SHADING PURPOSES. THE WORDING, "APSD" IN ALL CAPS IS TO THE RIGHT OF THE GLOBE, WITH THE WORDING, "ASSOCIATION OF PROPERTY" IN ALL CAPS BELOW, AND WITH THE WORDING, "SCENE DESIGNERS" IN ALL CAPS BELOW "ASSOCIATION OF PROPERTY".

SER. NO. 85-391,182, FILED 8-5-2011.

ODESSA BIBBINS, EXAMINING ATTORNEY



*David J. Kybas*

Director of the United States Patent and Trademark Office

# United States of America

United States Patent and Trademark Office

## VACLEEN AUTOMATIC FILTRATION

**Reg. No. 4,125,417**

**Registered Apr. 10, 2012**

**Int. Cl.: 11**

**TRADEMARK**

**PRINCIPAL REGISTER**

OLSON IRRIGATION SYSTEMS (CALIFORNIA CORPORATION)  
10910 WHEATLANDS AVENUE  
SANTEE, CA 92072

FOR: IRRIGATION AND INDUSTRIAL FILTRATION SYSTEMS, COMPRISED OF TANKS, NOZZLES, VALVES, CLEANING MECHANISMS, MOVABLE NOZZLES, AND FILTER SCREENS, IN CLASS 11 (U.S. CLS. 13, 21, 23, 31 AND 34).

FIRST USE 6-29-2011; IN COMMERCE 6-29-2011.

THE MARK CONSISTS OF STANDARD CHARACTERS WITHOUT CLAIM TO ANY PARTICULAR FONT, STYLE, SIZE, OR COLOR.

OWNER OF U.S. REG. NO. 2,886,468.

NO CLAIM IS MADE TO THE EXCLUSIVE RIGHT TO USE "AUTOMATIC FILTRATION", APART FROM THE MARK AS SHOWN.

SER. NO. 85-391,240, FILED 8-5-2011.

RICHARD WHITE, EXAMINING ATTORNEY



*David J. Kybas*

Director of the United States Patent and Trademark Office

# United States of America

United States Patent and Trademark Office

## ENDORETURN

**Reg. No. 4,125,418**

EDWARDS LIFESCIENCES CORPORATION (DELAWARE CORPORATION)  
ONE EDWARDS WAY  
IRVINE, CA 92614

**Registered Apr. 10, 2012**

**Int. Cl.: 10**

FOR: CATHETERS FOR USE IN CARDIOVASCULAR SURGERY PROCEDURES, IN CLASS 10 (U.S. CLS. 26, 39 AND 44).

**TRADEMARK**

FIRST USE 8-11-1998; IN COMMERCE 8-11-1998.

**PRINCIPAL REGISTER**

THE MARK CONSISTS OF STANDARD CHARACTERS WITHOUT CLAIM TO ANY PARTICULAR FONT, STYLE, SIZE, OR COLOR.

SER. NO. 85-391,271, FILED 8-5-2011.

ANGELA DUONG, EXAMINING ATTORNEY



*David J. Kybas*

Director of the United States Patent and Trademark Office

# United States of America

United States Patent and Trademark Office

# TATTOO FX

**Reg. No. 4,125,419**

TINSLEY TRANSFERS, INC. (CALIFORNIA CORPORATION)  
11684 PENDLETON STREET  
SUN VALLEY, CA 91352

**Registered Apr. 10, 2012**

**Int. Cl.: 25**

FOR: SHIRTS, TANK TOPS, UNDERWEAR, SLEEVES, WORN SEPARATE AND APART FROM SHIRTS AND OTHER TOPS, IN CLASS 25 (U.S. CLS. 22 AND 39).

**TRADEMARK**

FIRST USE 1-5-2006; IN COMMERCE 1-5-2006.

**PRINCIPAL REGISTER**

THE MARK CONSISTS OF STANDARD CHARACTERS WITHOUT CLAIM TO ANY PARTICULAR FONT, STYLE, SIZE, OR COLOR.

NO CLAIM IS MADE TO THE EXCLUSIVE RIGHT TO USE "TATTOO", APART FROM THE MARK AS SHOWN.

SER. NO. 85-391,293, FILED 8-5-2011.

SUSAN LESLIE DUBOIS, EXAMINING ATTORNEY



*David J. Kyffers*

Director of the United States Patent and Trademark Office

# United States of America

United States Patent and Trademark Office

## Pest Rx

**Reg. No. 4,125,420**

**Registered Apr. 10, 2012**

**Int. Cl.: 37**

**SERVICE MARK**

**PRINCIPAL REGISTER**

TIMOTHY ARTHUR PALMATIER (CALIFORNIA SOLE PROPRIETORSHIP), DBA PEST  
RX  
PO BOX 2204  
RIVERSIDE, CA 92516

FOR: PEST CONTROL, IN CLASS 37 (U.S. CLS. 100, 103 AND 106).

FIRST USE 6-1-2007; IN COMMERCE 6-1-2007.

THE MARK CONSISTS OF STANDARD CHARACTERS WITHOUT CLAIM TO ANY PARTICULAR FONT, STYLE, SIZE, OR COLOR.

OWNER OF U.S. REG. NO. 3,715,194.

NO CLAIM IS MADE TO THE EXCLUSIVE RIGHT TO USE "PEST", APART FROM THE MARK AS SHOWN.

SER. NO. 85-391,345, FILED 8-6-2011.

WILLIAM BRECKENFELD, EXAMINING ATTORNEY



*David J. Kyfos*

Director of the United States Patent and Trademark Office

# United States of America

United States Patent and Trademark Office



**Reg. No. 4,125,421**

SECURELY YOURS LLC (MICHIGAN LIMITED LIABILITY COMPANY)  
131 GUILFORD ROAD

**Registered Apr. 10, 2012**

BLOOMFIELD HILLS, MI 48304

**Int. Cl.: 45**

**SERVICE MARK**

**PRINCIPAL REGISTER**

FOR: COMPUTER SECURITY SERVICES IN THE NATURE OF PROVIDING AN INTERNET TRUST CENTER, NAMELY, COMPUTER SECURITY ASSURANCE AND ADMINISTRATION OF DIGITAL KEYS AND DIGITAL CERTIFICATES; COMPUTERIZED SECURITY SERVICES, NAMELY, ELECTRONICALLY MONITORING, DETECTING AND REPORTING ON SUSPICIOUS AND ABNORMAL PATTERNS OF POINT OF SALE ACTIVITY WHICH TYPICALLY INDICATE PROBLEMS SUCH AS THEFT, WRONGDOING, TRAINING ISSUES, OR CUSTOMER SERVICE ISSUES; CONSULTATION IN THE FIELD OF DATA THEFT AND IDENTITY THEFT; CONSULTATION SERVICES CONCERNING HOMELAND SAFETY AND SECURITY ISSUES; CONSULTATION SERVICES IN THE FIELD OF THE SAFETY NEEDS OF COMMERCIAL AND INDUSTRIAL COMPANIES; CONSULTING AND LEGAL SERVICES IN THE FIELD OF PRIVACY AND SECURITY LAWS, REGULATIONS, AND REQUIREMENTS; CONSULTING SERVICES IN THE FIELD OF HOMELAND SECURITY; CONSULTING SERVICES IN THE FIELD OF MAINTAINING THE SECURITY AND INTEGRITY OF DATABASES; CONSULTING SERVICES IN THE FIELD OF NATIONAL SECURITY, IN CLASS 45 (U.S. CLS. 100 AND 101).

FIRST USE 6-1-2011; IN COMMERCE 6-1-2011.

NO CLAIM IS MADE TO THE EXCLUSIVE RIGHT TO USE "MOBILE", APART FROM THE MARK AS SHOWN.

THE MARK CONSISTS OF A DESIGN OF A LOCK WITH 4 VERTICAL BARS OF INCREASING LENGTH WITHIN THE LOCK. TO THE RIGHT OF THIS DESIGN APPEARS THE STYLIZED WORDING "SECURELY MOBILE", AND THE STYLIZED WORDING "SECURITY IN THE PALM OF YOUR HAND" APPEARS AT THE BOTTOM OF THE MARK.

SER. NO. 85-391,550, FILED 8-6-2011.

ANDREW LEASER, EXAMINING ATTORNEY



*David J. Kyjars*

Director of the United States Patent and Trademark Office

# United States of America

United States Patent and Trademark Office

## Universal CRASH! Toolbox

**Reg. No. 4,125,422**

SAFETY THROUGH EDUCATION, INC. (FLORIDA CORPORATION)  
6650 W INDIANTOWN ROAD, SUITE 200  
JUPITER, FL 33458

**Registered Apr. 10, 2012**

**Int. Cls.: 9 and 16**

FOR: DIGITAL MEDIA, NAMELY, PRE-RECORDED DVDS, DOWNLOADABLE AUDIO AND VIDEO RECORDINGS, AND CDS FEATURING AND PROMOTING SCIENCE, MATH, PHYSICS, BIOLOGY AND HEALTH; EDUCATIONAL SOFTWARE FEATURING INSTRUCTION IN SCIENCE, MATH, PHYSICS, BIOLOGY AND HEALTH, IN CLASS 9 (U.S. CLS. 21, 23, 26, 36 AND 38).

**TRADEMARK**

**PRINCIPAL REGISTER**

FIRST USE 4-29-2011; IN COMMERCE 4-29-2011.

FOR: EDUCATIONAL KITS SOLD AS A UNIT IN THE FIELD OF SCIENCE, MATH, PHYSICS, BIOLOGY AND HEALTH CONSISTING PRIMARILY OF PRINTED INSTRUCTIONAL MATERIALS, PHOTOGRAPHS, TRAINING MANUALS, WORKBOOKS, ACTIVITY BOOKS, EDUCATIONAL BOOKS, FLASH CARDS, WORKSHEETS, TEACHER GUIDES AND ALSO INCLUDING DVDS, IN CLASS 16 (U.S. CLS. 2, 5, 22, 23, 29, 37, 38 AND 50).

FIRST USE 4-29-2011; IN COMMERCE 4-29-2011.

THE MARK CONSISTS OF STANDARD CHARACTERS WITHOUT CLAIM TO ANY PARTICULAR FONT, STYLE, SIZE, OR COLOR.

NO CLAIM IS MADE TO THE EXCLUSIVE RIGHT TO USE "TOOLBOX", APART FROM THE MARK AS SHOWN.

SER. NO. 85-391,664, FILED 8-7-2011.

KATINA MISTER, EXAMINING ATTORNEY



*David J. Kybas*

Director of the United States Patent and Trademark Office



# United States of America

United States Patent and Trademark Office

## Box Play for Kids

**Reg. No. 4,125,423**

**Registered Apr. 10, 2012**

**Int. Cl.: 16**

**TRADEMARK**

**PRINCIPAL REGISTER**

HARWELL, JANETTE EUSEBIO (ARIZONA LIMITED LIABILITY COMPANY), DBA BOX  
PLAY FOR KIDS, LLC  
66 W. CAMBRIDGE AVENUE  
PHOENIX, AZ 85003

FOR: STICKERS, IN CLASS 16 (U.S. CLS. 2, 5, 22, 23, 29, 37, 38 AND 50).

FIRST USE 7-21-2011; IN COMMERCE 7-21-2011.

THE MARK CONSISTS OF STANDARD CHARACTERS WITHOUT CLAIM TO ANY PARTICULAR FONT, STYLE, SIZE, OR COLOR.

SER. NO. 85-391,665, FILED 8-7-2011.

KATINA MISTER, EXAMINING ATTORNEY



*David J. Kybas*

Director of the United States Patent and Trademark Office

# United States of America

United States Patent and Trademark Office

## LEARN, TOGETHER

**Reg. No. 4,125,424**

SIMVERSITY, LLC (DELAWARE LIMITED LIABILITY COMPANY)  
801 W. 5TH ST., STE. 312  
AUSTIN, TX 78703

**Registered Apr. 10, 2012**

**Int. Cl.: 41**

FOR: EDUCATION SERVICES, NAMELY, PROVIDING ON-LINE CLASSES, COURSES AND WORKSHOPS IN THE FIELD OF SELF-IMPROVEMENT, IN CLASS 41 (U.S. CLS. 100, 101 AND 107).

**SERVICE MARK**

FIRST USE 7-15-2011; IN COMMERCE 8-6-2011.

**PRINCIPAL REGISTER**

THE MARK CONSISTS OF STANDARD CHARACTERS WITHOUT CLAIM TO ANY PARTICULAR FONT, STYLE, SIZE, OR COLOR.

NO CLAIM IS MADE TO THE EXCLUSIVE RIGHT TO USE "LEARN", APART FROM THE MARK AS SHOWN.

SER. NO. 85-391,710, FILED 8-7-2011.

KATINA MISTER, EXAMINING ATTORNEY



*David J. Kyffers*

Director of the United States Patent and Trademark Office

# United States of America

United States Patent and Trademark Office

## REAL DAUGHTER!

**Reg. No. 4,125,425**

**Registered Apr. 10, 2012**

**Int. Cl.: 25**

**TRADEMARK**

**PRINCIPAL REGISTER**

TIMOTHY L WILKS (UNITED STATES INDIVIDUAL), DBA REAL DAD! INC.  
APT 2B  
621 EAST 105TH STREET  
BROOKLYN, NY 11236

FOR: APPAREL FOR DANCERS, NAMELY, TEE SHIRTS, SWEATSHIRTS, PANTS, LEGGINGS, SHORTS AND JACKETS; ATHLETIC APPAREL, NAMELY, SHIRTS, PANTS, JACKETS, FOOTWEAR, HATS AND CAPS, ATHLETIC UNIFORMS; BASEBALL CAPS AND HATS, IN CLASS 25 (U.S. CLS. 22 AND 39).

FIRST USE 1-24-2007; IN COMMERCE 1-24-2007.

THE MARK CONSISTS OF STANDARD CHARACTERS WITHOUT CLAIM TO ANY PARTICULAR FONT, STYLE, SIZE, OR COLOR.

SER. NO. 85-391,716, FILED 8-8-2011.

EMILY CHUO, EXAMINING ATTORNEY



*David J. Kybas*

Director of the United States Patent and Trademark Office

# United States of America

United States Patent and Trademark Office

# REAL SON!

**Reg. No. 4,125,426**

**Registered Apr. 10, 2012**

**Int. Cl.: 25**

**TRADEMARK**

**PRINCIPAL REGISTER**

TIMOTHY L WILKS (UNITED STATES INDIVIDUAL), DBA REAL DAD! INC.  
APT 2B  
621 EAST 105TH STREET  
BROOKLYN, NY 11236

FOR: APPAREL FOR DANCERS, NAMELY, TEE SHIRTS, SWEATSHIRTS, PANTS, LEGGINGS, SHORTS AND JACKETS; ATHLETIC APPAREL, NAMELY, SHIRTS, PANTS, JACKETS, FOOTWEAR, HATS AND CAPS, ATHLETIC UNIFORMS; BASEBALL CAPS AND HATS; T-SHIRTS, IN CLASS 25 (U.S. CLS. 22 AND 39).

FIRST USE 1-24-2007; IN COMMERCE 1-24-2007.

THE MARK CONSISTS OF STANDARD CHARACTERS WITHOUT CLAIM TO ANY PARTICULAR FONT, STYLE, SIZE, OR COLOR.

SER. NO. 85-391,718, FILED 8-8-2011.

EMILY CHUO, EXAMINING ATTORNEY



*David J. Kybas*

Director of the United States Patent and Trademark Office

# United States of America

United States Patent and Trademark Office

# REAL WIFE!

**Reg. No. 4,125,427**

**Registered Apr. 10, 2012**

**Int. Cl.: 25**

**TRADEMARK**

**PRINCIPAL REGISTER**

TIMOTHY L WILKS (UNITED STATES INDIVIDUAL), DBA REAL DAD! INC.  
APT 2B  
621 EAST 105TH STREET  
BROOKLYN, NY 11236

FOR: APPAREL FOR DANCERS, NAMELY, TEE SHIRTS, SWEATSHIRTS, PANTS, LEGGINGS, SHORTS AND JACKETS; ATHLETIC APPAREL, NAMELY, SHIRTS, PANTS, JACKETS, FOOTWEAR, HATS AND CAPS, ATHLETIC UNIFORMS, IN CLASS 25 (U.S. CLS. 22 AND 39).

FIRST USE 1-24-2007; IN COMMERCE 1-24-2007.

THE MARK CONSISTS OF STANDARD CHARACTERS WITHOUT CLAIM TO ANY PARTICULAR FONT, STYLE, SIZE, OR COLOR.

SER. NO. 85-391,719, FILED 8-8-2011.

EMILY CHUO, EXAMINING ATTORNEY



*David J. Kybas*

Director of the United States Patent and Trademark Office

# United States of America

United States Patent and Trademark Office

## REAL GIRLFRIEND!

**Reg. No. 4,125,428**

**Registered Apr. 10, 2012**

**Int. Cl.: 25**

**TRADEMARK**

**PRINCIPAL REGISTER**

TIMOTHY L WILKS (UNITED STATES INDIVIDUAL), DBA REAL DAD! INC.  
APT 2B  
621 EAST 105TH STREET  
BROOKLYN, NY 11236

FOR: APPAREL FOR DANCERS, NAMELY, TEE SHIRTS, SWEATSHIRTS, PANTS, LEGGINGS, SHORTS AND JACKETS; ATHLETIC APPAREL, NAMELY, SHIRTS, PANTS, JACKETS, FOOTWEAR, HATS AND CAPS, ATHLETIC UNIFORMS, IN CLASS 25 (U.S. CLS. 22 AND 39).

FIRST USE 1-24-2007; IN COMMERCE 1-24-2007.

THE MARK CONSISTS OF STANDARD CHARACTERS WITHOUT CLAIM TO ANY PARTICULAR FONT, STYLE, SIZE, OR COLOR.

SER. NO. 85-391,721, FILED 8-8-2011.

EMILY CHUO, EXAMINING ATTORNEY



*David J. Kyffers*

Director of the United States Patent and Trademark Office

# United States of America

United States Patent and Trademark Office



**Reg. No. 4,125,429**

ETAILINSIGHTS, INC. (NORTH CAROLINA CORPORATION)  
106 HIDDEN ROCK COURT  
CARY, NC 27513

**Registered Apr. 10, 2012**

**Int. Cl.: 42**

FOR: PROVIDING TEMPORARY USE OF ON-LINE NON-DOWNLOADABLE SOFTWARE FOR CONDUCTING RESEARCH IN THE FIELD OF THE RETAIL AND WHOLESALE DISTRIBUTION INDUSTRY, IN CLASS 42 (U.S. CLS. 100 AND 101).

**SERVICE MARK**

FIRST USE 1-26-2011; IN COMMERCE 4-6-2011.

**PRINCIPAL REGISTER**

THE MARK CONSISTS OF A STYLIZED SHOPPING CART IN PROFILE AND THE WORD "ETAILINSIGHTS", WHERE THE 'E' IS IN THE SHOPPING CART, THE LETTERS "TAIL" RENDERED IN GREY ARE ADJACENT TO THE "E" BUT NOT IN THE SHOPPING CART, AND THE LETTERS "INSIGHTS" RENDERED IN ORANGE ARE ADJACENT TO THE LETTERS "TAIL".

THE COLOR(S) ORANGE AND GRAY IS/ARE CLAIMED AS A FEATURE OF THE MARK.

SER. NO. 85-391,804, FILED 8-8-2011.

DOMINIC J. FERRAIUOLO, EXAMINING ATTORNEY



*David J. Kybas*

Director of the United States Patent and Trademark Office

# United States of America

United States Patent and Trademark Office

## PINE COBBLE

**Reg. No. 4,125,430**

EQUUSTOCK, LLC (ILLINOIS LIMITED LIABILITY COMPANY)  
8179 STARWOOD DRIVE, SUITE 1  
LOVES PARK, IL 61111

**Registered Apr. 10, 2012**

**Int. Cl.: 31**

FOR: ANIMAL LITTER; LITTER FOR DOMESTIC ANIMALS; WOOD SHAVINGS FOR ANIMAL BEDDING, IN CLASS 31 (U.S. CLS. 1 AND 46).

**TRADEMARK**

FIRST USE 1-4-2011; IN COMMERCE 1-4-2011.

**PRINCIPAL REGISTER**

THE MARK CONSISTS OF STANDARD CHARACTERS WITHOUT CLAIM TO ANY PARTICULAR FONT, STYLE, SIZE, OR COLOR.

NO CLAIM IS MADE TO THE EXCLUSIVE RIGHT TO USE "PINE", APART FROM THE MARK AS SHOWN.

SER. NO. 85-391,889, FILED 8-8-2011.

STEVEN JACKSON, EXAMINING ATTORNEY



*David J. Kyffers*

Director of the United States Patent and Trademark Office



# United States of America

United States Patent and Trademark Office

# Startracs

**Reg. No. 4,125,431**

**Registered Apr. 10, 2012**

**Int. Cl.: 45**

**SERVICE MARK**

**PRINCIPAL REGISTER**

STARTRACS ENTERPRISES, INC. (NEW HAMPSHIRE CORPORATION)  
47 CONSTITUTION DRIVE  
BEDFORD, NH 03110

FOR: EMERGENCY RESPONSE ALARM MONITORING SERVICES, NAMELY, MONITORING OF ALERT DEVICES BY A REMOTE MONITORING CENTER FOR THE DISPATCH OF EMERGENCY PUBLIC HEALTH AND SECURITY SERVICES AND NOTIFICATION TO THIRD PARTIES, INCLUDING COMMUNICATING WITH THIRD PARTIES AND PROVIDING DATA AND AUDIO TO THIRD PARTIES TO ASSIST DISPATCH, IN CLASS 45 (U.S. CLS. 100 AND 101).

FIRST USE 10-13-1999; IN COMMERCE 10-13-1999.

THE MARK CONSISTS OF STANDARD CHARACTERS WITHOUT CLAIM TO ANY PARTICULAR FONT, STYLE, SIZE, OR COLOR.

OWNER OF U.S. REG. NO. 2,450,165.

SER. NO. 85-391,913, FILED 8-8-2011.

SAMUEL E. SHARPER JR., EXAMINING ATTORNEY



*David J. Kyffers*

Director of the United States Patent and Trademark Office

# United States of America

United States Patent and Trademark Office

# emPath

**Reg. No. 4,125,432**

**Registered Apr. 10, 2012**

**Int. Cl.: 42**

**SERVICE MARK**

**PRINCIPAL REGISTER**

NOW SOLUTIONS, INC. (DELAWARE CORPORATION)  
SUITE 300  
101 W. RENNER ROAD  
RICHARDSON, TX 75082

FOR: SOFTWARE AS A SERVICE (SAAS) SERVICES FEATURING SOFTWARE IN THE FIELD OF HUMAN RESOURCES MANAGEMENT, IN CLASS 42 (U.S. CLS. 100 AND 101).

FIRST USE 12-15-2006; IN COMMERCE 12-15-2006.

THE MARK CONSISTS OF STANDARD CHARACTERS WITHOUT CLAIM TO ANY PARTICULAR FONT, STYLE, SIZE, OR COLOR.

SER. NO. 85-391,958, FILED 8-8-2011.

JANET LEE, EXAMINING ATTORNEY



*David J. Kybas*

Director of the United States Patent and Trademark Office

United States of America  
United States Patent and Trademark Office

MENZEGO

**Reg. No. 4,125,433**

**Registered Apr. 10, 2012**

**Int. Cl.: 14**

**TRADEMARK**

**PRINCIPAL REGISTER**

XOVIVO LLC (VIRGINIA LIMITED LIABILITY COMPANY), DBA XOVIVO FASHION  
ACCESSORIES  
5979 JAN MAR DRIVE  
FALLS CHURCH, VA 22041

FOR: JEWELRY, IN CLASS 14 (U.S. CLS. 2, 27, 28 AND 50).

FIRST USE 8-5-2011; IN COMMERCE 8-5-2011.

THE MARK CONSISTS OF STANDARD CHARACTERS WITHOUT CLAIM TO ANY PARTICULAR FONT, STYLE, SIZE, OR COLOR.

SER. NO. 85-391,981, FILED 8-8-2011.

KARANENDRA S. CHHINA, EXAMINING ATTORNEY



*David J. Kybas*

Director of the United States Patent and Trademark Office

# United States of America

United States Patent and Trademark Office

# Eagle Grip

**Reg. No. 4,125,434**

ANCHOR MANAGEMENT TEAM (MICHIGAN LIMITED LIABILITY COMPANY)  
5390 SKELTON ROAD  
COLUMBIAVILLE, MI 48421

**Registered Apr. 10, 2012**

**Int. Cl.: 28**

FOR: GOLF GLOVES; WEIGHT LIFTING GLOVES; WORK-OUT GLOVES, IN CLASS 28  
(U.S. CLS. 22, 23, 38 AND 50).

**TRADEMARK**

FIRST USE 8-8-2011; IN COMMERCE 8-8-2011.

**PRINCIPAL REGISTER**

THE MARK CONSISTS OF STANDARD CHARACTERS WITHOUT CLAIM TO ANY PARTICULAR FONT, STYLE, SIZE, OR COLOR.

NO CLAIM IS MADE TO THE EXCLUSIVE RIGHT TO USE "GRIP", APART FROM THE MARK AS SHOWN.

SER. NO. 85-392,027, FILED 8-8-2011.

APRIL HESIK, EXAMINING ATTORNEY



*David J. Kyffers*

Director of the United States Patent and Trademark Office

# United States of America

United States Patent and Trademark Office



**Reg. No. 4,125,435**

**Registered Apr. 10, 2012**

**Int. Cl.: 9**

**TRADEMARK**

**PRINCIPAL REGISTER**

BAREFOOT ATLAS LLC (VIRGINIA LIMITED LIABILITY COMPANY)  
851 N GLEBE RD APT 1921  
ARLINGTON, VA 22203

FOR: DOWNLOADABLE ELECTRONIC PUBLICATIONS IN THE NATURE OF E-BOOKS AND PAMPHLETS IN THE FIELD OF TRAVEL AND VOLUNTEERING, IN CLASS 9 (U.S. CLS. 21, 23, 26, 36 AND 38).

FIRST USE 2-1-2010; IN COMMERCE 8-6-2011.

NO CLAIM IS MADE TO THE EXCLUSIVE RIGHT TO USE "ATLAS", APART FROM THE MARK AS SHOWN.

THE MARK CONSISTS OF THE WORDS "BAREFOOT ATLAS" AND TWO FOOTPRINTS POINTED IN OPPOSITE DIRECTIONS WITHIN A CIRCLE WITH A DECORATIVE EIGHT-POINT BORDER.

SER. NO. 85-392,043, FILED 8-8-2011.

CHRISTOPHER BUONGIORNO, EXAMINING ATTORNEY



*David J. Kybas*

Director of the United States Patent and Trademark Office

# United States of America

United States Patent and Trademark Office

# ARCTREE

**Reg. No. 4,125,436**

ARCHANGEL ANCIENT TREE ARCHIVE (MICHIGAN CORPORATION)  
400 CASS STREET  
TRAVERSE CITY, MI 49684

**Registered Apr. 10, 2012**

**Int. Cl.: 31**

FOR: LIVING TREES, IN CLASS 31 (U.S. CLS. 1 AND 46).

**TRADEMARK**

FIRST USE 8-1-2011; IN COMMERCE 8-1-2011.

**PRINCIPAL REGISTER**

THE MARK CONSISTS OF STANDARD CHARACTERS WITHOUT CLAIM TO ANY PARTICULAR FONT, STYLE, SIZE, OR COLOR.

SER. NO. 85-392,075, FILED 8-8-2011.

TRICIA SONNEBORN, EXAMINING ATTORNEY



*David J. Kyffers*

Director of the United States Patent and Trademark Office

# United States of America

United States Patent and Trademark Office

## SMART Collaboration

**Reg. No. 4,125,437**

**Registered Apr. 10, 2012**

**Int. Cl.: 35**

**SERVICE MARK**

**PRINCIPAL REGISTER**

COMMUNITY HEALTH SOLUTIONS INC. (VIRGINIA CORPORATION)  
STE. 201  
9603 GAYTON RD.  
RICHMOND, VA 23238

FOR: CONSULTING SERVICES, NAMELY, TO EMPLOYERS, COMMUNITY ORGANIZATIONS, BROKERS AND BENEFICIARIES, RELATED TO CONSUMER INFORMATION REGARDING HEALTH CARE PLAN OPTIONS, PRODUCTS AND PROGRAMS IN THE FIELD OF MANAGED CARE AND STATE AND FEDERAL MEDICAL CARE PROGRAMS, IN CLASS 35 (U.S. CLS. 100, 101 AND 102).

FIRST USE 1-4-2010; IN COMMERCE 1-4-2010.

THE MARK CONSISTS OF STANDARD CHARACTERS WITHOUT CLAIM TO ANY PARTICULAR FONT, STYLE, SIZE, OR COLOR.

NO CLAIM IS MADE TO THE EXCLUSIVE RIGHT TO USE "COLLABORATION", APART FROM THE MARK AS SHOWN.

SER. NO. 85-392,115, FILED 8-8-2011.

JESSICA A. POWERS, EXAMINING ATTORNEY



*David J. Kyros*

Director of the United States Patent and Trademark Office

# United States of America

United States Patent and Trademark Office

## BUILDING BRANDS THROUGH PACKAGING

**Reg. No. 4,125,438**

**Registered Apr. 10, 2012**

**Int. Cl.: 40**

**SERVICE MARK**

**PRINCIPAL REGISTER**

CL&D GRAPHICS, INC. (WISCONSIN CORPORATION)  
1101 W. SECOND STREET  
OCONOMOWOC, WI 53066

FOR: PRINTING SERVICES, IN CLASS 40 (U.S. CLS. 100, 103 AND 106).

FIRST USE 8-1-2010; IN COMMERCE 8-1-2010.

THE MARK CONSISTS OF STANDARD CHARACTERS WITHOUT CLAIM TO ANY PARTICULAR FONT, STYLE, SIZE, OR COLOR.

SER. NO. 85-392,123, FILED 8-8-2011.

NANCY CLARKE, EXAMINING ATTORNEY



*David J. Kybas*

Director of the United States Patent and Trademark Office



# United States of America

United States Patent and Trademark Office

## Valley Vixens

**Reg. No. 4,125,439**

**Registered Apr. 10, 2012**

**COLLECTIVE  
MEMBERSHIP**

**PRINCIPAL REGISTER**

CRUZ, AISHA (UNITED STATES INDIVIDUAL)  
820 WILLOW ST. #182  
SAN JOSE, CA 95125 AND

GARCIA, RHONDA (UNITED STATES INDIVIDUAL)  
820 WILLOW ST. #182  
SAN JOSE, CA 95125 AND

GOMEZ, CRYSTAL (UNITED STATES INDIVIDUAL)  
820 WILLOW ST. #182  
SAN JOSE, CA 95125

FOR: INDICATING MEMBERSHIP TO INDICATE MEMBERSHIP IN A MOTORCYCLE CLUB, IN CLASS 200 (U.S. CL. 200).

FIRST USE 7-4-2009; IN COMMERCE 7-4-2009.

THE MARK CONSISTS OF STANDARD CHARACTERS WITHOUT CLAIM TO ANY PARTICULAR FONT, STYLE, SIZE, OR COLOR.

SER. NO. 85-392,166, FILED 8-8-2011.

THOMAS MANOR, EXAMINING ATTORNEY



*David J. Kypos*

Director of the United States Patent and Trademark Office

# United States of America

United States Patent and Trademark Office

# Goldie knots

**Reg. No. 4,125,440**

**Registered Apr. 10, 2012**

**Int. Cl.: 14**

ELLINGSON, LINDSAY (UNITED STATES INDIVIDUAL)  
APT 9M  
205 3RD AVE  
NEW YORK, NY 10003

FOR: JEWELRY, IN CLASS 14 (U.S. CLS. 2, 27, 28 AND 50).

**TRADEMARK**

FIRST USE 8-0-2009; IN COMMERCE 1-0-2010.

**PRINCIPAL REGISTER**

THE MARK CONSISTS OF STANDARD CHARACTERS WITHOUT CLAIM TO ANY PARTICULAR FONT, STYLE, SIZE, OR COLOR.

NO CLAIM IS MADE TO THE EXCLUSIVE RIGHT TO USE "KNOTS", APART FROM THE MARK AS SHOWN.

SER. NO. 85-392,194, FILED 8-8-2011.

COLLEEN KEARNEY, EXAMINING ATTORNEY



*David J. Kybas*

Director of the United States Patent and Trademark Office

# United States of America

United States Patent and Trademark Office

## Laraia's Cheese Shop

**Reg. No. 4,125,441**

DD DUMPLINGS LLC (NEW YORK LIMITED LIABILITY COMPANY)  
5 SEEGER DRIVE  
NANUET, NY 10954

**Registered Apr. 10, 2012**

**Int. Cl.: 35**

FOR: RETAIL STORE SERVICES FEATURING CHEESE, IN CLASS 35 (U.S. CLS. 100, 101 AND 102).

**SERVICE MARK**

FIRST USE 10-18-2010; IN COMMERCE 10-18-2010.

**PRINCIPAL REGISTER**

THE MARK CONSISTS OF STANDARD CHARACTERS WITHOUT CLAIM TO ANY PARTICULAR FONT, STYLE, SIZE, OR COLOR.

NO CLAIM IS MADE TO THE EXCLUSIVE RIGHT TO USE "CHEESE SHOP", APART FROM THE MARK AS SHOWN.

SER. NO. 85-392,250, FILED 8-8-2011.

WILLIAM P. SHANAHAN, EXAMINING ATTORNEY



*David J. Kybas*

Director of the United States Patent and Trademark Office

# United States of America

United States Patent and Trademark Office

## We secure your vision

**Reg. No. 4,125,442**

**Registered Apr. 10, 2012**

**Int. Cl.: 42**

**SERVICE MARK**

**PRINCIPAL REGISTER**

WASHINGTON SOFTWARE, INC. (MARYLAND CORPORATION)  
20410 CENTURY BLVD, SUITE 220  
GERMANTOWN, MD 20874

FOR: APPLICATION SERVICE PROVIDER (ASP), NAMELY, HOSTING COMPUTER SOFTWARE APPLICATIONS OF OTHERS; APPLICATION SERVICE PROVIDER, NAMELY, HOSTING, MANAGING, DEVELOPING, ANALYZING, AND MAINTAINING APPLICATIONS, SOFTWARE, AND WEB SITES, OF OTHERS IN THE FIELDS OF ADVERTISING AND MARKETING; APPLICATION SERVICE PROVIDER, NAMELY, HOSTING, MANAGING, DEVELOPING, ANALYZING, AND MAINTAINING APPLICATIONS, SOFTWARE, AND WEB SITES, OF OTHERS IN THE FIELDS OF HEALTHCARE, BENEFITS PROGRAMS, EMPLOYEE PRODUCTIVITY, RISK MANAGEMENT; BUSINESS TECHNOLOGY SOFTWARE CONSULTATION SERVICES; COMPUTER AIDED GRAPHIC DESIGN; COMPUTER CONSULTATION; COMPUTER CONSULTATION IN THE FIELD OF COMPUTER SECURITY; COMPUTER GRAPHICS DESIGN SERVICES; COMPUTER HARDWARE AND SOFTWARE CONSULTING SERVICES; COMPUTER HARDWARE AND SOFTWARE DESIGN; COMPUTER HARDWARE DEVELOPMENT; COMPUTER MONITORING SERVICE WHICH TRACKS APPLICATION SOFTWARE PERFORMANCE, PERFORMS PERIODIC MAINTENANCE AND PROVIDES REPORTS AND ALERTS CONCERNING SUCH PERFORMANCE; COMPUTER MONITORING SERVICE WHICH TRACKS HARDWARE PERFORMANCE AND PROCESSES AND SENDS OUT HISTORICAL REPORTS AND ALERTS; COMPUTER NETWORK CONFIGURATION SERVICES; COMPUTER PROGRAMMING AND COMPUTER SYSTEM ANALYSIS; COMPUTER PROGRAMMING AND MAINTENANCE OF COMPUTER PROGRAMS; COMPUTER PROGRAMMING AND SOFTWARE DESIGN; COMPUTER PROGRAMMING CONSULTANCY; COMPUTER PROGRAMMING SERVICES, NAMELY, CONTENT CREATION FOR VIRTUAL WORLDS AND THREE DIMENSIONAL PLATFORMS; COMPUTER SECURITY CONSULTANCY; COMPUTER SECURITY CONSULTANCY IN THE FIELD OF SCANNING AND PENETRATION TESTING OF COMPUTERS AND NETWORKS TO ASSESS INFORMATION SECURITY VULNERABILITY; COMPUTER SECURITY SERVICE, NAMELY, RESTRICTING ACCESS TO AND BY COMPUTER NETWORKS TO AND OF UNDESIRE WEB SITES, MEDIA AND INDIVIDUALS AND FACILITIES; COMPUTER SERVICES, NAMELY, COMPUTER SYSTEM ADMINISTRATION FOR OTHERS; COMPUTER SERVICES, NAMELY, CREATING COMPUTER NETWORK-BASED INDEXES OF INFORMATION, WEBSITES AND RESOURCES; COMPUTER SERVICES, NAMELY, CREATING, MAINTAINING, DESIGNING AND IMPLEMENTING WEB SITES FOR OTHERS; COMPUTER SERVICES, NAMELY, DESIGNING AND IMPLEMENTING WEB PAGES FOR OTHERS; COMPUTER SERVICES, NAMELY, DESIGNING AND IMPLEMENTING WEB



*David J. Kybas*

Director of the United States Patent and Trademark Office



**Reg. No. 4,125,442** OPMENT OF COMPUTERS AND PROGRAMS FOR COMPUTERS; DESIGN AND DEVELOPMENT OF ON-LINE COMPUTER SOFTWARE SYSTEMS; DESIGN AND DEVELOPMENT OF WIRELESS COMPUTER NETWORKS; DESIGN AND MAINTENANCE OF COMPUTER SITES FOR THIRD PARTIES; DESIGN AND MAINTENANCE OF WEB SITES FOR OTHERS; DESIGN AND WRITING OF COMPUTER SOFTWARE; DESIGN OF HOME PAGES AND WEB SITES; DESIGN OF HOME PAGES, COMPUTER SOFTWARE AND WEB SITES; DESIGN OF HOMEPAGES AND WEBSITES; DESIGN, CREATION, HOSTING, MAINTENANCE OF WEBSITES FOR OTHERS; DESIGN, DEPLOYMENT AND MANAGEMENT OF WIRELESS NETWORKS FOR OTHERS; DESIGN, DEVELOPMENT AND IMPLEMENTATION OF SOFTWARE; DESIGN, DEVELOPMENT, AND CONSULTING SERVICES RELATED THERETO IN THE FIELD OF GRAPHIC DESIGN; DESIGN, DEVELOPMENT, INSTALLATION AND MAINTENANCE OF COMPUTER SOFTWARE; DESIGN, INSTALLATION, UPDATING AND MAINTENANCE OF COMPUTER SOFTWARE; DESIGN, MAINTENANCE, DEVELOPMENT AND UPDATING OF COMPUTER SOFTWARE; DESIGNING AND DEVELOPING WEBPAGES ON THE INTERNET; DESIGNING WEB PAGES FOR OTHERS; DESIGNING WEBSITES FOR ADVERTISING PURPOSES; DESIGNING WEBSITES FOR OTHERS; DESIGNING, CREATING, MAINTAINING, AND HOSTING ELECTRONIC COMMERCE WEBSITES FOR OTHERS; DEVELOPING AND UPDATING COMPUTER SOFTWARE; DEVELOPING COMPUTER SOFTWARE; DEVELOPMENT AND CREATION OF COMPUTER PROGRAMMES FOR DATA PROCESSING; DEVELOPMENT OF CUSTOMIZED SOFTWARE FOR OTHERS FOR USE IN RISK ASSESSMENT, INFORMATION SECURITY, BUSINESS ANALYSIS, AUDIT AND AUDIT PLANNING, AND SALES MANAGEMENT; DEVELOPMENT OF DATA PROCESSING PROGRAMS BY ORDER OF THIRD PARTIES; DEVELOPMENT OF SECURITY SYSTEMS AND CONTINGENCY PLANNING FOR INFORMATION SYSTEMS; DEVELOPMENT OF SOFTWARE FOR SECURE NETWORK OPERATIONS; DEVELOPMENT, DESIGN AND UPDATING OF HOME PAGES; DEVELOPMENT, UPDATING AND MAINTENANCE OF SOFTWARE AND DATA BASES; ELABORATION AND MAINTENANCE OF WEB SITES FOR THIRD PARTIES; GRAPHIC ART DESIGN; GRAPHIC ARTS DESIGNING; GRAPHIC DESIGN; GRAPHIC DESIGN SERVICES; GRAPHIC DESIGN SERVICES FOR CREATING GRAPHIC ELEMENTS OF CORPORATE LOGOS AND MARKETING MATERIALS; HOMEPAGE AND WEBPAGE DESIGN; HOSTING THE SOFTWARE, WEBSITES AND OTHER COMPUTER APPLICATIONS OF OTHERS ON A VIRTUAL PRIVATE SERVER; INDUSTRIAL AND GRAPHIC ART DESIGN; INFORMATION TECHNOLOGY CONSULTATION; INSTALLATION AND MAINTENANCE OF COMPUTER SOFTWARE; INSTALLATION, MAINTENANCE AND REPAIR OF COMPUTER SOFTWARE; INSTALLATION, MAINTENANCE AND REPAIR OF SOFTWARE FOR COMPUTER SYSTEMS; INSTALLATION, REPAIR AND MAINTENANCE OF COMPUTER SOFTWARE; INTEGRATION OF COMPUTER SYSTEMS AND NETWORKS; IT CONSULTING SERVICES; IT INTEGRATION SERVICES; MAINTENANCE AND UPDATING OF COMPUTER SOFTWARE; MAINTENANCE AND UPGRADING OF COMPUTER SOFTWARE; MAINTENANCE OF COMPUTER SOFTWARE RELATING TO COMPUTER SECURITY AND PREVENTION OF COMPUTER RISKS; MAINTENANCE OF WEBSITES AND HOSTING ON-LINE WEB FACILITIES FOR OTHERS; MONITORING THE COMPUTER SYSTEMS OF OTHERS FOR TECHNICAL PURPOSES AND PROVIDING BACK-UP COMPUTER PROGRAMS AND FACILITIES; PLANNING, DESIGN AND IMPLEMENTATION OF COMPUTER TECHNOLOGIES FOR OTHERS; PLANNING, DESIGN AND MANAGEMENT OF INFORMATION TECHNOLOGY SYSTEMS; PLANNING, DESIGN, DEVELOPMENT, MAINTENANCE AND OPTIMIZATION OF ONLINE WEBSITES FOR THIRD PARTIES; PREPARATION, UPDATE, INSTALLATION AND MAINTENANCE OF COMPUTER SOFTWARE; PROCESSING OF VIDEO DATA, NAMELY, INTERPRETING VIDEO CONTENT AND IDENTIFYING SEGMENTS THAT CONTAIN PREDEFINED KEY EVENTS; PROFESSIONAL COMPUTER SERVICES, NAMELY, NETWORK ANALYSIS, LAN/WAN DESIGN, WIRELESS ENGINEERING, VIRTUALIZATION AND COMPUTER PROJECT MANAGEMENT; PROVIDING A WEB SITE THAT FEATURES INFORMATION ON COMPUTER TECHNOLOGY AND PROGRAMMING; REMOTE COMPUTER NETWORK TECHNICAL MONITORING AND SOFTWARE MAINTENANCE SERVICES; RESEARCH AND DEVELOPMENT OF COMPUTER SOFTWARE; RESEARCH IN THE FIELD OF INTELLIGENCE AND SECURITY TECHNOLOGY; RESEARCH, DEVELOPMENT, DESIGN AND UPGRADING OF COMPUTER SOFTWARE; SEARCHING AND RE-

**Reg. No. 4,125,442** TRIEVING INFORMATION, SITES, AND OTHER RESOURCES AVAILABLE ON COMPUTER NETWORKS FOR OTHERS; SOFTWARE DESIGN AND DEVELOPMENT; SOFTWARE DEVELOPMENT CONSULTING IN THE FIELD OF INFORMATION TECHNOLOGY (IT); SOFTWARE DEVELOPMENT FOR OTHERS IN THE FIELD OF SOFTWARE CONFIGURATION MANAGEMENT; TECHNICAL ADVICE RELATING TO OPERATION OF COMPUTERS; TECHNICAL SUPPORT SERVICES, NAMELY, 24X7 MONITORING OF NETWORK SYSTEMS, SERVERS AND WEB AND DATABASE APPLICATIONS AND NOTIFICATION OF RELATED EVENTS AND ALERTS; TECHNICAL SUPPORT SERVICES, NAMELY, INSTALLATION, ADMINISTRATION, AND TROUBLESHOOTING OF WEB AND DATABASE APPLICATIONS; TECHNICAL SUPPORT SERVICES, NAMELY, MIGRATION OF DATA CENTER, SERVER AND DATABASE APPLICATIONS; TECHNICAL SUPPORT SERVICES, NAMELY, REMOTE ADMINISTRATION AND MANAGEMENT OF IN-HOUSE AND HOSTED DATA CENTER DEVICES, DATABASES AND SOFTWARE APPLICATIONS; TECHNICAL SUPPORT SERVICES, NAMELY, REMOTE AND ON-SITE INFRASTRUCTURE MANAGEMENT SERVICES FOR MONITORING, ADMINISTRATION AND MANAGEMENT OF PUBLIC AND PRIVATE CLOUD COMPUTING IT AND APPLICATION SYSTEMS; TECHNICAL SUPPORT SERVICES, NAMELY, TECHNICAL ADMINISTRATION OF SERVERS FOR OTHERS AND TROUBLESHOOTING IN THE NATURE OF DIAGNOSING SERVER PROBLEMS; TECHNICAL SUPPORT SERVICES, NAMELY, TROUBLESHOOTING IN THE NATURE OF DIAGNOSING COMPUTER HARDWARE AND SOFTWARE PROBLEMS; TECHNICAL SUPPORT SERVICES, NAMELY, TROUBLESHOOTING OF COMPUTER SOFTWARE PROBLEMS; TECHNICAL SUPPORT, NAMELY, MONITORING OF NETWORK SYSTEMS; TESTING OF SECURITY SYSTEMS; TRACKING AND REPORTING OF ONLINE WEBSITE PERFORMANCE TO DETERMINE THE TECHNOLOGICAL EFFECTIVENESS OF THE WEBSITES FOR NON-BUSINESS PURPOSES; UPDATING AND DESIGN OF COMPUTER SOFTWARE; UPDATING AND MAINTENANCE OF COMPUTER SOFTWARE; UPDATING OF COMPUTER SOFTWARE RELATING TO COMPUTER SECURITY AND PREVENTION OF COMPUTER RISKS; WEB PUBLISHING, NAMELY, CREATING A WEBSITE AND UPLOADING IT ONTO AN INTERNET SERVER; WEB SITE DESIGN; WEB SITE DEVELOPMENT FOR OTHERS; WEBSITE DESIGN AND DEVELOPMENT FOR OTHERS; WEBSITE DEVELOPMENT FOR OTHERS; WEBSITE USABILITY TESTING SERVICES, IN CLASS 42 (U.S. CLS. 100 AND 101).

FIRST USE 8-2-2011; IN COMMERCE 8-2-2011.

THE MARK CONSISTS OF STANDARD CHARACTERS WITHOUT CLAIM TO ANY PARTICULAR FONT, STYLE, SIZE, OR COLOR.

SER. NO. 85-392,288, FILED 8-8-2011.

JIM RINGLE, EXAMINING ATTORNEY

# United States of America

United States Patent and Trademark Office

## MASTERSLIDE

**Reg. No. 4,125,443**

**Registered Apr. 10, 2012**

**Int. Cls.: 6 and 40**

**TRADEMARK**

**SERVICE MARK**

**PRINCIPAL REGISTER**

QUANEX BUILDING PRODUCTS CORPORATION (DELAWARE CORPORATION)  
SUITE 1500  
1900 WEST LOOP SOUTH  
HOUSTON, SC 77027

FOR: METAL FRAMES FOR SCREEN DOORS; BUILDING PRODUCTS, NAMELY, METAL SCREEN DOORS, IN CLASS 6 (U.S. CLS. 2, 12, 13, 14, 23, 25 AND 50).

FIRST USE 4-12-2011; IN COMMERCE 4-12-2011.

FOR: CUSTOM MANUFACTURE OF BUILDING PRODUCTS, NAMELY, SCREEN DOORS, IN CLASS 40 (U.S. CLS. 100, 103 AND 106).

FIRST USE 4-12-2011; IN COMMERCE 4-12-2011.

THE MARK CONSISTS OF STANDARD CHARACTERS WITHOUT CLAIM TO ANY PARTICULAR FONT, STYLE, SIZE, OR COLOR.

SER. NO. 85-392,385, FILED 8-8-2011.

MATTHEW PAPPAS, EXAMINING ATTORNEY



*David J. Kyppas*

Director of the United States Patent and Trademark Office



# United States of America

United States Patent and Trademark Office



**Reg. No. 4,125,444**

**Registered Apr. 10, 2012**

**Int. Cl.: 10**

**TRADEMARK**

**PRINCIPAL REGISTER**

PREWITT, DR. MARY JULIA WIESS (UNITED STATES INDIVIDUAL)  
1604 TWIN OAK DRIVE  
FAYETTEVILLE, NC 28305 AND

PREWITT, DR. JAMES ROBINSON (UNITED STATES INDIVIDUAL)  
1604 TWIN OAK DRIVE  
FAYETTEVILLE, NC 28305

FOR: ORTHODONTIC MACHINES AND INSTRUMENTS, IN CLASS 10 (U.S. CLS. 26, 39 AND 44).

FIRST USE 12-11-1989; IN COMMERCE 12-11-1989.

OWNER OF U.S. REG. NO. 4,044,583.

THE MARK CONSISTS OF THE DESIGN OF A CARICATURE OF THE HEAD OF A ZEBRA HAVING GLASSES AND A WIDE SMILE SHOWING ITS TEETH.

SER. NO. 85-392,407, FILED 8-8-2011.

JAY BESCH, EXAMINING ATTORNEY



*David J. Kybas*

Director of the United States Patent and Trademark Office

# United States of America

United States Patent and Trademark Office

# SagePresence

**Reg. No. 4,125,445**

SAGEPRESENCE, LLC (MINNESOTA LIMITED LIABILITY COMPANY)  
6201 134TH STREET WEST  
ST. PAUL, MN 55124

**Registered Apr. 10, 2012**

**Int. Cl.: 41**

FOR: CONDUCTING WORKSHOPS AND SEMINARS IN PUBLIC SPEAKING, SELLING, LEADERSHIP, NETWORKING, PROMOTIONAL PITCHING AND INTERVIEWING; FILM AND VIDEO PRODUCTION CONSULTING SERVICES; PERSONAL COACHING SERVICES IN THE FIELD OF PUBLIC SPEAKING, SELLING, LEADERSHIP, NETWORKING, PROMOTIONAL PITCHING AND INTERVIEWING; PROFESSIONAL COACHING SERVICES IN THE FIELD OF PUBLIC SPEAKING, SELLING, LEADERSHIP, NETWORKING, PROMOTIONAL PITCHING AND INTERVIEWING, IN CLASS 41 (U.S. CLS. 100, 101 AND 107).

**SERVICE MARK**

**PRINCIPAL REGISTER**

FIRST USE 3-30-2007; IN COMMERCE 12-30-2007.

THE MARK CONSISTS OF STANDARD CHARACTERS WITHOUT CLAIM TO ANY PARTICULAR FONT, STYLE, SIZE, OR COLOR.

SER. NO. 85-392,443, FILED 8-8-2011.

HANNO RITTNER, EXAMINING ATTORNEY



*David J. Kyffers*

Director of the United States Patent and Trademark Office

# United States of America

United States Patent and Trademark Office

## INTERNET CONNECT

**Reg. No. 4,125,446**

MERRITT-MUNSON, CAROLANN (UNITED STATES INDIVIDUAL)  
7855 CANYON LAKE CIRCLE  
ORLANDO, FL 32835 AND

**Registered Apr. 10, 2012**

**Int. Cl.: 45**

MUNSON, CHRISTOPHER MERRITT (UNITED STATES INDIVIDUAL)  
7855 CANYON LAKE CIRCLE  
ORLANDO, FL 32835

**SERVICE MARK**

**PRINCIPAL REGISTER**

FOR: DATING SERVICES; INTERNET-BASED DATING, SOCIAL INTRODUCTION AND SOCIAL NETWORKING SERVICES; WEB SITE SERVICES FEATURING ON-LINE DATING CLUB, IN CLASS 45 (U.S. CLS. 100 AND 101).

FIRST USE 7-14-2011; IN COMMERCE 7-14-2011.

THE MARK CONSISTS OF STANDARD CHARACTERS WITHOUT CLAIM TO ANY PARTICULAR FONT, STYLE, SIZE, OR COLOR.

NO CLAIM IS MADE TO THE EXCLUSIVE RIGHT TO USE "INTERNET", APART FROM THE MARK AS SHOWN.

SER. NO. 85-392,472, FILED 8-8-2011.

HANNO RITTNER, EXAMINING ATTORNEY



*David J. Kyffers*

Director of the United States Patent and Trademark Office

# United States of America

United States Patent and Trademark Office

## HS Fiber

**Reg. No. 4,125,447**

**Registered Apr. 10, 2012**

**Int. Cl.: 10**

**TRADEMARK**

**PRINCIPAL REGISTER**

RIVERPOINT MEDICAL, LLC (OREGON LIMITED LIABILITY COMPANY)  
825 NE 25TH AVENUE  
PORTLAND, OR 97232

FOR: SURGICAL SUTURES, IN CLASS 10 (U.S. CLS. 26, 39 AND 44).

FIRST USE 3-1-2011; IN COMMERCE 5-8-2011.

THE MARK CONSISTS OF STANDARD CHARACTERS WITHOUT CLAIM TO ANY PARTICULAR FONT, STYLE, SIZE, OR COLOR.

NO CLAIM IS MADE TO THE EXCLUSIVE RIGHT TO USE "FIBER", APART FROM THE MARK AS SHOWN.

SER. NO. 85-392,505, FILED 8-8-2011.

IRA J. GOODSaid, EXAMINING ATTORNEY



*David J. Kyffers*

Director of the United States Patent and Trademark Office

# United States of America

United States Patent and Trademark Office

## FILMCONVERT

**Reg. No. 4,125,448**

**Registered Apr. 10, 2012**

**Int. Cls.: 9 and 42**

**TRADEMARK**

**SERVICE MARK**

**PRINCIPAL REGISTER**

RUBBER MONKEY SOFTWARE LTD. (NEW ZEALAND LIMITED COMPANY (LTD.))  
80 ADELAIDE ROAD, LEVEL 1  
WELLINGTON, WELLINGTON, NEW ZEALAND

FOR: COMPUTER SOFTWARE, COMPUTER PROGRAMS AND COMPUTER SOFTWARE THAT PROVIDES WEB-BASED ACCESS TO APPLICATIONS AND SERVICES THROUGH A WEB OPERATING SYSTEM OR PORTAL INTERFACE USED FOR DIGITAL VIDEO PROCESSING, DIGITAL VIDEO COLOR ANALYSIS, AND FILM STOCK EMULATION, IN CLASS 9 (U.S. CLS. 21, 23, 26, 36 AND 38).

FIRST USE 4-17-2009; IN COMMERCE 3-30-2011.

FOR: COMPUTER AND TECHNOLOGICAL PROFESSIONAL SERVICES, NAMELY, DIGITAL VIDEO PROCESSING AND VIDEO ANALYSIS; SOFTWARE AS A SERVICE (SAAS) SERVICES FEATURING SOFTWARE FOR DIGITAL VIDEO PROCESSING, DIGITAL VIDEO COLOR ANALYSIS, AND FILM STOCK EMULATION, IN CLASS 42 (U.S. CLS. 100 AND 101).

FIRST USE 4-17-2009; IN COMMERCE 3-30-2011.

THE MARK CONSISTS OF STANDARD CHARACTERS WITHOUT CLAIM TO ANY PARTICULAR FONT, STYLE, SIZE, OR COLOR.

SER. NO. 85-392,543, FILED 8-8-2011.

ODESSA BIBBINS, EXAMINING ATTORNEY



*David J. Kybas*

Director of the United States Patent and Trademark Office

# United States of America

United States Patent and Trademark Office



**Reg. No. 4,125,449**

**Registered Apr. 10, 2012**

**Int. Cls.: 41 and 45**

**SERVICE MARK**

**PRINCIPAL REGISTER**

BE IN HEALTH, INC. (GEORGIA CORPORATION)  
4178 CREST HIGHWAY  
THOMASTON, GA 30286

FOR: PROVIDING ON-LINE RELIGIOUS INSTRUCTION PROMOTING CHRISTIAN AND FAMILY VALUES; RELIGIOUS INSTRUCTION SERVICES, IN CLASS 41 (U.S. CLS. 100, 101 AND 107).

FIRST USE 3-1-2004; IN COMMERCE 3-1-2004.

FOR: CHARITABLE OUTREACH SERVICES, NAMELY, PROVIDING COUNSELING SERVICES IN THE FIELD OF RELIGION; COUNSELING IN THE FIELD OF DEVELOPING, STRENGTHENING AND SUSTAINING WELL-BALANCED FAMILIES AND FAMILY RELATIONSHIPS; COUNSELING IN THE FIELD OF PERSONAL DEVELOPMENT, NAMELY, SELF-IMPROVEMENT, SELF-FULFILLMENT, AND INTERPERSONAL COMMUNICATION; COUNSELING SERVICES IN THE FIELD OF CHRISTIAN CONDUCT IN PERSONAL RELATIONSHIPS; PROVIDING EMOTIONAL COUNSELING AND EMOTIONAL SUPPORT SERVICES FOR TROUBLED AND AT-RISK YOUTH AND THEIR FAMILIES; SPIRITUAL COUNSELING, IN CLASS 45 (U.S. CLS. 100 AND 101).

FIRST USE 3-1-2004; IN COMMERCE 3-1-2004.

OWNER OF U.S. REG. NO. 3,091,105.

NO CLAIM IS MADE TO THE EXCLUSIVE RIGHT TO USE "SPIRITUAL", APART FROM THE MARK AS SHOWN.

THE MARK CONSISTS OF TWO LINES OF WRITING, THE FIRST LINE BEING THE STYLIZED WORD, "SPIRITUAL" WITH AN OVER-SIZED LETTER "S" AND, AT THE END OF THE LETTER, "L" DISPLAYING THE FIGURES OF TWO ICONS REPRESENTING A MAN AND A WOMAN HOLDING HANDS, FURTHER, ON THE SECOND LINE, THERE IS DISPLAYED THE WORD "LIFELINE" IN ALL CAPITAL LETTERS, AND THE ENTIRETY OF THE MARK HAVING A RECTANGULAR BORDER ENCLOSING BOTH LINES OF WRITING.

SER. NO. 85-392,578, FILED 8-8-2011.



*David J. Kybas*

Director of the United States Patent and Trademark Office

**Reg. No. 4,125,449** JAMES GRIFFIN, EXAMINING ATTORNEY

# United States of America

United States Patent and Trademark Office

## Sign Jewelry.com

**Reg. No. 4,125,450**

**Registered Apr. 10, 2012**

**Int. Cl.: 14**

MONTANA JEWELRY (NEW YORK CORPORATION)  
GALLERY 600  
76 WEST 47 STREET  
NEW YORK, NY 10036

FOR: JEWELRY, IN CLASS 14 (U.S. CLS. 2, 27, 28 AND 50).

**TRADEMARK**

FIRST USE 10-1-2010; IN COMMERCE 10-1-2010.

**PRINCIPAL REGISTER**

THE MARK CONSISTS OF STANDARD CHARACTERS WITHOUT CLAIM TO ANY PARTICULAR FONT, STYLE, SIZE, OR COLOR.

NO CLAIM IS MADE TO THE EXCLUSIVE RIGHT TO USE "JEWELRY.COM", APART FROM THE MARK AS SHOWN.

SER. NO. 85-392,608, FILED 8-8-2011.

REBECCA SMITH, EXAMINING ATTORNEY



*David J. Kyffers*

Director of the United States Patent and Trademark Office



# United States of America

United States Patent and Trademark Office

## Visual Storage Intelligence

**Reg. No. 4,125,451**

CLEAR TECHNOLOGIES, INC, (TEXAS CORPORATION)  
1199 S. BELT LINE RD, SUITE 120  
COPPELL, TX 75019

**Registered Apr. 10, 2012**

**Int. Cl.: 9**

FOR: COMPUTER SOFTWARE FOR ANALYZING IT STORAGE UTILIZATION AND CAPACITY, IN CLASS 9 (U.S. CLS. 21, 23, 26, 36 AND 38).

**TRADEMARK**

FIRST USE 3-1-2010; IN COMMERCE 3-1-2010.

**PRINCIPAL REGISTER**

THE MARK CONSISTS OF STANDARD CHARACTERS WITHOUT CLAIM TO ANY PARTICULAR FONT, STYLE, SIZE, OR COLOR.

NO CLAIM IS MADE TO THE EXCLUSIVE RIGHT TO USE "VISUAL STORAGE", APART FROM THE MARK AS SHOWN.

SER. NO. 85-392,647, FILED 8-8-2011.

MICHAEL SOUDERS, EXAMINING ATTORNEY



*David J. Kybas*

Director of the United States Patent and Trademark Office

# United States of America

United States Patent and Trademark Office

SNAP@DISCOUNT<sup>TM</sup>

**Reg. No. 4,125,452**

FARRIS, TONY (UNITED STATES INDIVIDUAL)  
18431 MAHOGANY RCH RD  
RAMONA, CA 92065

**Registered Apr. 10, 2012**

**Int. Cl.: 35**

FOR: PROMOTIONAL SERVICES, NAMELY, PROMOTING THE GOODS OF OTHERS BY MEANS OF PROVIDING ONLINE COUPONS, IN CLASS 35 (U.S. CLS. 100, 101 AND 102).

**SERVICE MARK**

FIRST USE 6-1-2011; IN COMMERCE 6-1-2011.

**PRINCIPAL REGISTER**

NO CLAIM IS MADE TO THE EXCLUSIVE RIGHT TO USE "DISCOUNT" AND ".COM", APART FROM THE MARK AS SHOWN.

THE MARK CONSISTS OF THE WORDING "SNAP@DISCOUNT" WITH THE WORD ".COM" APPEARING VERTICALLY GOING UPWARD TO THE RIGHT OF THE LETTER "T" IN THE WORD "DISCOUNT". THE "@" SYMBOL APPEARS IN THE CENTER OF A SQUARE. THERE ARE FOUR SLANTED LINES EXTENDING FROM THE TOP OF THE SQUARE IN DIFFERENT DIRECTIONS. THERE IS DOTTED HORIZONTAL LINE EXTENDING FROM THE BOTTOM OF THE "@" SYMBOL, UNDERLINING THE WORDS "DISCOUNT" AND ".COM" AND EXTENDING OUTWARD TO THE RIGHT OF THE WORDING.

SER. NO. 85-392,658, FILED 8-8-2011.

TINA BROWN, EXAMINING ATTORNEY



*David J. Kyffers*

Director of the United States Patent and Trademark Office

# United States of America

United States Patent and Trademark Office



**Reg. No. 4,125,453**

**Registered Apr. 10, 2012**

**Int. Cl.: 7**

**TRADEMARK**

**PRINCIPAL REGISTER**

DL WHOLESALE INC. (CALIFORNIA CORPORATION)  
SUITE D  
6764 PRESTON AVE.  
LIVERMORE, CA 94551

FOR: HERBAL AND PLANT EXTRACTION WASHING MACHINES, BAGS, AND ACCESSORIES THEREFORE USED IN THE HYDROPONIC INDUSTRY SOLD AS A UNIT, IN CLASS 7 (U.S. CLS. 13, 19, 21, 23, 31, 34 AND 35).

FIRST USE 11-22-2010; IN COMMERCE 1-26-2011.

THE MARK CONSISTS OF A CLOUD OF BLUE SMOKE WITH BLUE BUBBLES AND WHITE LIGHT ORBS INSIDE, THE WORDING "BUBBLE MAGIC" IN BLACK SUPERIMPOSED ON THE FRONT RIGHT WITH AN ILLUSTRATION OF A BLACK, WHITE, AND GRAY MAGICIAN'S WAND BELOW THE WORDING.

THE COLOR(S) BLUE, WHITE, BLACK, AND GRAY IS/ARE CLAIMED AS A FEATURE OF THE MARK.

THE WORD(S) "BUBBLE MAGIC" HAS NO MEANING IN A FOREIGN LANGUAGE.

SER. NO. 85-392,679, FILED 8-8-2011.

JEFF DEFORD, EXAMINING ATTORNEY



*David J. Kybas*

Director of the United States Patent and Trademark Office

# United States of America

United States Patent and Trademark Office

## The Networking Queen

**Reg. No. 4,125,454**

**Registered Apr. 10, 2012**

**Int. Cl.: 41**

**SERVICE MARK**

**PRINCIPAL REGISTER**

DENAI VAUGHN (UNITED STATES INDIVIDUAL), AKA THE NETWORKING QUEEN  
2655 CO RD 3  
GROOM, TX 79039

FOR: BUSINESS EDUCATION AND TRAINING SERVICES, NAMELY, DEVELOPING AND FACILITATING CUSTOMIZED LEADERSHIP AND EXECUTIVE DEVELOPMENT PROGRAMS, PROVIDING EXECUTIVE COACHING SERVICES, AND PROVIDING BUSINESS EDUCATION PROGRAMS TO EMPLOYEES AND EXECUTIVES; BUSINESS EDUCATION AND TRAINING SERVICES, NAMELY, DEVELOPING, AND FACILITATING CUSTOMIZED IN-COMPANY LEADERSHIP AND EXECUTIVE DEVELOPMENT PROGRAMS, PROVIDING EXECUTIVE COACHING SERVICES, AND PROVIDING PUBLIC AND IN-COMPANY KEYNOTE PRESENTATIONS TO BUSINESS LEADERS; EDUCATIONAL AND ENTERTAINMENT SERVICES, NAMELY, PROVIDING MOTIVATIONAL AND EDUCATIONAL SPEAKERS; EDUCATIONAL AND ENTERTAINMENT SERVICES, NAMELY, PROVIDING MOTIVATIONAL AND EDUCATIONAL SPEAKERS IN THE FIELD OF SELF- AND PERSONAL IMPROVEMENT; PROVIDING GROUP COACHING AND LEARNING FORUMS IN THE FIELD OF LEADERSHIP DEVELOPMENT; PROVIDING GROUP COACHING IN THE FIELD OF BUSINESS TO CONSUMER NETWORKING, IN CLASS 41 (U.S. CLS. 100, 101 AND 107).

FIRST USE 0-0-2008; IN COMMERCE 0-0-2008.

THE MARK CONSISTS OF STANDARD CHARACTERS WITHOUT CLAIM TO ANY PARTICULAR FONT, STYLE, SIZE, OR COLOR.

NO CLAIM IS MADE TO THE EXCLUSIVE RIGHT TO USE "NETWORKING", APART FROM THE MARK AS SHOWN.

SER. NO. 85-392,713, FILED 8-8-2011.

AMY KELLY, EXAMINING ATTORNEY



*David J. Kyffers*

Director of the United States Patent and Trademark Office

# United States of America

United States Patent and Trademark Office

PEOPLE DON'T LEAVE HERE  
HUNGRY OR THIRSTY!

**Reg. No. 4,125,455**

**Registered Apr. 10, 2012**

**Int. Cl.: 43**

**SERVICE MARK**

**PRINCIPAL REGISTER**

STATE STREET PALAZZIO TRATTORIA ITALIANA, INC. (CALIFORNIA CORPORATION)  
1026 STATE STREET  
SANTA BARBARA, CA 93101

FOR: RESTAURANT AND BAR SERVICES, IN CLASS 43 (U.S. CLS. 100 AND 101).

FIRST USE 8-4-2011; IN COMMERCE 8-4-2011.

THE MARK CONSISTS OF STANDARD CHARACTERS WITHOUT CLAIM TO ANY PARTICULAR FONT, STYLE, SIZE, OR COLOR.

OWNER OF U.S. REG. NO. 3,512,067.

SER. NO. 85-392,720, FILED 8-8-2011.

KAREN K. BUSH, EXAMINING ATTORNEY



*David J. Kyffers*

Director of the United States Patent and Trademark Office

# United States of America

United States Patent and Trademark Office



cooknation.com

**Reg. No. 4,125,456**

**Registered Apr. 10, 2012**

**Int. Cl.: 35**

**SERVICE MARK**

**PRINCIPAL REGISTER**

LANE, MICHAEL (UNITED STATES INDIVIDUAL)  
SUITE 112  
8409 PICKWICK  
DALLAS, TX 75225

FOR: BUYING CLUB SERVICES IN THE FIELD OF FOOD, BEVERAGES AND RELATED ITEMS TO EATING ESTABLISHMENTS, IN CLASS 35 (U.S. CLS. 100, 101 AND 102).

FIRST USE 7-27-2011; IN COMMERCE 7-27-2011.

THE MARK CONSISTS OF A DESIGN HAVING THE LETTERS "C" AND "N" THAT BREAK THE CIRCUMFERENCE OF A SHADED CIRCLE MOSTLY CONTAINING THE LETTERS WHICH ARE UNSHADED. DIRECTLY UNDERNEATH THE DESIGN IS THE WORD, "COOKNATION.COM".

SER. NO. 85-392,776, FILED 8-8-2011.

AHSEN KHAN, EXAMINING ATTORNEY



*David J. Kybas*

Director of the United States Patent and Trademark Office

# United States of America

United States Patent and Trademark Office



**Reg. No. 4,125,457**

**Registered Apr. 10, 2012**

**Int. Cl.: 35**

**SERVICE MARK**

**PRINCIPAL REGISTER**

STAR PEAK, LLC (COLORADO LIMITED LIABILITY COMPANY), DBA STAR PEAK  
PO BOX 1127  
CONIFER, CO 80433

FOR: BUSINESS CONSULTING AND INFORMATION SERVICES, IN CLASS 35 (U.S. CLS. 100, 101 AND 102).

FIRST USE 3-19-1996; IN COMMERCE 11-21-2000.

NO CLAIM IS MADE TO THE EXCLUSIVE RIGHT TO USE "LLC", APART FROM THE MARK AS SHOWN.

THE COLOR(S) BLUE, GREEN, BLACK, AND WHITE IS/ARE CLAIMED AS A FEATURE OF THE MARK.

THE MARK CONSISTS OF A GREEN MOUNTAIN WITH WHITE SNOWCAP LANDSCAPE, A BLACK AND WHITE MULTIPLE STAR WITH TEN POINTS TO LEFT OF MOUNTAIN, UNDER THE MOUNTAIN ARE STYLIZED BLACK LETTERS SPELLING "STAR PEAK, LLC", BACKGROUND AROUND OBJECTS IS BLUE, AND ENTIRE DESIGN HAS A BLACK SURROUNDING BORDER.

SER. NO. 85-392,812, FILED 8-9-2011.

HOWARD SMIGA, EXAMINING ATTORNEY



*David J. Kyffers*

Director of the United States Patent and Trademark Office

# United States of America

United States Patent and Trademark Office



**Reg. No. 4,125,458**

**Registered Apr. 10, 2012**

**Int. Cl.: 31**

**TRADEMARK**

**PRINCIPAL REGISTER**

DOW AGROSCIENCES LLC (DELAWARE LIMITED LIABILITY COMPANY)  
9330 ZIONSVILLE ROAD  
INDIANAPOLIS, IN 46268

FOR: AGRICULTURAL SEED, IN CLASS 31 (U.S. CLS. 1 AND 46).

FIRST USE 12-31-2009; IN COMMERCE 12-31-2009.

OWNER OF U.S. REG. NOS. 3,907,231 AND 3,925,231.

NO CLAIM IS MADE TO THE EXCLUSIVE RIGHT TO USE "CORN", APART FROM THE MARK AS SHOWN.

THE MARK CONSISTS OF THE WORDS "PRAIRIE SHIELD CORN" WITH A KERNEL INSIDE A SHIELD.

SER. NO. 85-392,869, FILED 8-9-2011.

NAKIA HENRY, EXAMINING ATTORNEY



*David J. Kybas*

Director of the United States Patent and Trademark Office



# United States of America

United States Patent and Trademark Office



**Reg. No. 4,125,459**

**Registered Apr. 10, 2012**

**Int. Cl.: 31**

**TRADEMARK**

**PRINCIPAL REGISTER**

DOW AGROSCIENCES LLC (DELAWARE LIMITED LIABILITY COMPANY)  
9330 ZIONSVILLE ROAD  
INDIANAPOLIS, IN 46268

FOR: AGRICULTURAL SEED, IN CLASS 31 (U.S. CLS. 1 AND 46).

FIRST USE 12-31-2009; IN COMMERCE 12-31-2009.

OWNER OF U.S. REG. NOS. 3,907,231 AND 3,925,231.

NO CLAIM IS MADE TO THE EXCLUSIVE RIGHT TO USE "SOYBEAN", APART FROM THE MARK AS SHOWN.

THE MARK CONSISTS OF WORDS "PRAIRIE SHIELD SOYBEAN XTRA" INSIDE SHIELD DESIGN.

SER. NO. 85-392,874, FILED 8-9-2011.

NAKIA HENRY, EXAMINING ATTORNEY



*David J. Kybas*

Director of the United States Patent and Trademark Office

# United States of America

United States Patent and Trademark Office

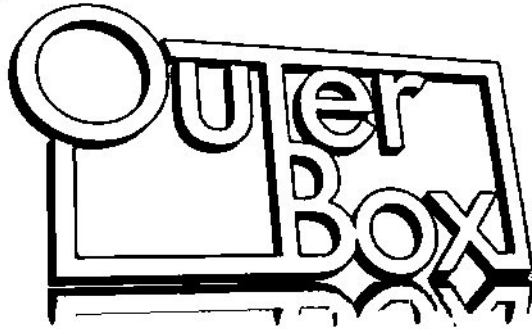

**Reg. No. 4,125,460**

**Registered Apr. 10, 2012**

**Int. Cls.: 35 and 42**

**SERVICE MARK**

**PRINCIPAL REGISTER**

OUTERBOX SOLUTIONS, INC. (OHIO CORPORATION)  
SUITE 103  
453 S HIGH ST.  
AKRON, OH 44311

FOR: ADVERTISING AND MARKETING, IN CLASS 35 (U.S. CLS. 100, 101 AND 102).

FIRST USE 1-1-2004; IN COMMERCE 1-1-2004.

FOR: COMPUTER SERVICES, NAMELY, SEARCH ENGINE OPTIMIZATION; WEB SITE DESIGN, IN CLASS 42 (U.S. CLS. 100 AND 101).

FIRST USE 1-1-2004; IN COMMERCE 1-1-2004.

THE MARK CONSISTS OF THE WORDING "OUTER BOX" IN A STYLIZED FORM. THE LETTERS "T", "B", AND "X" ARE EXTENDED SUCH THAT "T" AND "B" ARE CONNECTED AND THE WORDING IS CONTAINED WITHIN A RECTANGULAR BORDER FORMED BY THE EXTENSIONS. AT THE BOTTOM OF THE MARK, THE BOTTOM PORTION OF THE RECTANGLE AND WORDING ARE ALSO REFLECTED AS IF RESTING ON A MIRROR.

SER. NO. 85-392,979, FILED 8-9-2011.

CORY BOONE, EXAMINING ATTORNEY



*David J. Kybas*

Director of the United States Patent and Trademark Office

**United States of America**  
United States Patent and Trademark Office

**PYZIQUE**

**Reg. No. 4,125,461**

PYZIQUE WALL SYSTEMS INC. (MISSOURI CORPORATION)  
520 DIX ROAD

**Registered Apr. 10, 2012**

JEFFERSON CITY, MO 65109

**Int. Cl.: 19**

FOR: MULTI-USE STONE RETAINING WALL BLOCKS, IN CLASS 19 (U.S. CLS. 1, 12, 33 AND 50).

**TRADEMARK**

FIRST USE 0-0-1994; IN COMMERCE 0-0-1994.

**PRINCIPAL REGISTER**

THE MARK CONSISTS OF STANDARD CHARACTERS WITHOUT CLAIM TO ANY PARTICULAR FONT, STYLE, SIZE, OR COLOR.

SER. NO. 85-393,139, FILED 8-9-2011.

RONALD AIKENS, EXAMINING ATTORNEY



*David J. Kyffers*

Director of the United States Patent and Trademark Office

# United States of America

United States Patent and Trademark Office

## Deep Space Technology Company

**Reg. No. 4,125,462**

PUTZ, GREGORY (UNITED STATES INDIVIDUAL)  
188 SOUTH 1225 EAST  
BOUNTIFUL, UT 84010

**Registered Apr. 10, 2012**

**Int. Cl.: 35**

FOR: BUSINESS CONSULTING SERVICES, NAMELY, PROVIDING ASSISTANCE IN DEVELOPMENT OF BUSINESS STRATEGIES AND CREATIVE IDEATION, IN CLASS 35 (U.S. CLS. 100, 101 AND 102).

**SERVICE MARK**

FIRST USE 3-8-1994; IN COMMERCE 6-1-2002.

**PRINCIPAL REGISTER**

THE MARK CONSISTS OF STANDARD CHARACTERS WITHOUT CLAIM TO ANY PARTICULAR FONT, STYLE, SIZE, OR COLOR.

NO CLAIM IS MADE TO THE EXCLUSIVE RIGHT TO USE "COMPANY", APART FROM THE MARK AS SHOWN.

SER. NO. 85-393,145, FILED 8-9-2011.

LINDA MICKLEBURGH, EXAMINING ATTORNEY



*David J. Kybas*

Director of the United States Patent and Trademark Office

# United States of America

United States Patent and Trademark Office



**Reg. No. 4,125,463**

HALL, BRUCE A. (UNITED STATES INDIVIDUAL)  
24048 SUGAR CANE LANE  
GAITHERSBURG, MD 208824028

**Registered Apr. 10, 2012**

**Int. Cl.: 9**

FOR: DISTANCE MEASURING APPARATUS, IN CLASS 9 (U.S. CLS. 21, 23, 26, 36 AND 38).

**TRADEMARK**

FIRST USE 8-9-2011; IN COMMERCE 8-9-2011.

**PRINCIPAL REGISTER**

THE MARK CONSISTS A HIGHLY STYLIZED RUNNING FIGURE INSIDE A BOX, WITH ARROW-TIPPED LINES RUNNING OUTWARD TO THE RIGHT UNDERLINING THE FIGURE AND ANOTHER LINE AT A 90 DEGREE ANGLE TO THE LONGER LINE. THE STYLIZED WORDING "SAQPAQ" APPEARS TO THE RIGHT OF THE RUNNING FIGURE ABOVE THE LINE RUNNING TO THE RIGHT

SER. NO. 85-393,217, FILED 8-9-2011.

GEOFFREY FOSDICK, EXAMINING ATTORNEY



*David J. Kybas*

Director of the United States Patent and Trademark Office

# United States of America

United States Patent and Trademark Office

# Facilis

**Reg. No. 4,125,464**

**Registered Apr. 10, 2012**

**Int. Cl.: 9**

**TRADEMARK**

**PRINCIPAL REGISTER**

FACILIS TECHNOLOGY INC. (MASSACHUSETTS CORPORATION)  
577 MAIN STREET, SUITE 120  
HUDSON, MA 01749

FOR: COMPUTER STORAGE DEVICES, NAMELY, HIGH-SPEED STORAGE SUBSYSTEMS FOR STORAGE AND BACKUP OF ELECTRONIC DATA EITHER LOCALLY OR VIA A TELECOMMUNICATIONS NETWORK, IN CLASS 9 (U.S. CLS. 21, 23, 26, 36 AND 38).

FIRST USE 11-1-2003; IN COMMERCE 6-1-2004.

THE MARK CONSISTS OF STANDARD CHARACTERS WITHOUT CLAIM TO ANY PARTICULAR FONT, STYLE, SIZE, OR COLOR.

SER. NO. 85-393,222, FILED 8-9-2011.

DANIEL CAPSHAW, EXAMINING ATTORNEY



*David J. Kybas*

Director of the United States Patent and Trademark Office

# United States of America

United States Patent and Trademark Office

# MOBIUS

**Reg. No. 4,125,465**

KATZ, CLIFFORD E. (UNITED STATES INDIVIDUAL)  
35 N CHATSWORTH AVE APT 1P  
LARCHMONT, NY 105381954

**Registered Apr. 10, 2012**

**Int. Cl.: 36**

FOR: REAL ESTATE BROKERAGE, IN CLASS 36 (U.S. CLS. 100, 101 AND 102).

**SERVICE MARK**

FIRST USE 6-30-1998; IN COMMERCE 6-30-1998.

**PRINCIPAL REGISTER**

THE MARK CONSISTS OF STANDARD CHARACTERS WITHOUT CLAIM TO ANY PARTICULAR FONT, STYLE, SIZE, OR COLOR.

SER. NO. 85-393,318, FILED 8-9-2011.

COURTNEY ALVAREZ, EXAMINING ATTORNEY



*David J. Kybas*

Director of the United States Patent and Trademark Office

# United States of America

United States Patent and Trademark Office



**Reg. No. 4,125,466**

**Registered Apr. 10, 2012**

**Int. Cl.: 41**

**SERVICE MARK**

**PRINCIPAL REGISTER**

JOHNSON & WALES UNIVERSITY (RHODE ISLAND CORPORATION)  
8 ABBOTT PARK PLACE  
PROVIDENCE, RI 02903

FOR: EDUCATIONAL SERVICES, NAMELY, PROVIDING COURSES OF INSTRUCTION AND TRAINING AT THE UNDERGRADUATE, GRADUATE, POST-GRADUATE, AND PROFESSIONAL LEVELS; ENTERTAINMENT SERVICES, NAMELY, ORGANIZING, PROMOTING, AND CONDUCTING ATHLETIC EVENTS, LECTURES AND CONCERTS; PROVIDING SOCIAL EVENTS IN THE NATURE OF PARTIES FOR UNDERGRADUATE AND ALUMNI FOR THE PURPOSES OF ENCOURAGING COLLEGE ATHLETIC AND EDUCATIONAL PROGRAMS, IN CLASS 41 (U.S. CLS. 100, 101 AND 107).

FIRST USE 12-31-2007; IN COMMERCE 12-31-2007.

NO CLAIM IS MADE TO THE EXCLUSIVE RIGHT TO USE "1914", APART FROM THE MARK AS SHOWN.

THE MARK CONSISTS OF A SHIELD OR CREST FEATURING TWO SECTIONS. THE TOP SECTION FEATURES A GRIFFIN, AND THE BOTTOM SECTION FEATURES AN "X". A BANNER CONTAINING THE NUMERALS "1914" SITS ON TOP OF THE SHIELD OR CREST.

SER. NO. 85-393,362, FILED 8-9-2011.

BRIAN NEVILLE, EXAMINING ATTORNEY



*David J. Kybas*

Director of the United States Patent and Trademark Office



# United States of America

## United States Patent and Trademark Office

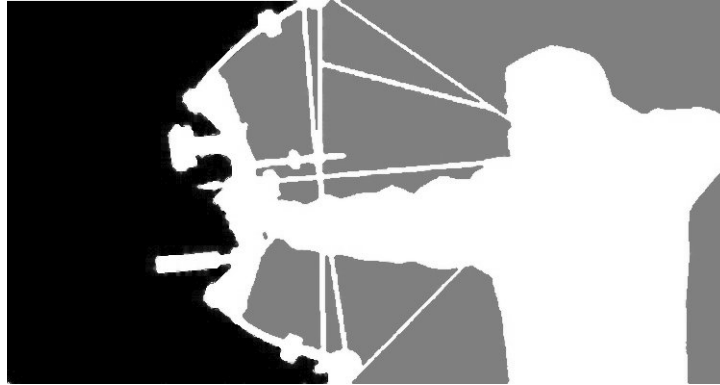

**Reg. No. 4,125,467**

**Registered Apr. 10, 2012**

**Int. Cl.: 35**

**SERVICE MARK**

**PRINCIPAL REGISTER**

EDER INC. (NEW YORK CORPORATION)  
320 EAST 46TH ST., SUITE 20A  
NEW YORK, NY 10017

FOR: ONLINE RETAIL STORE SERVICES FEATURING EQUIPMENT AND GIFTS IN THE FIELD OF ARCHERY, HUNTING, AND GAME PROCESSING, INCLUDING BOWS, CROSSBOWS, ARROWS, ARROW RESTS, BOWSTRING RELEASES, GUNS, SLINGSHOTS, HUNTING BLINDS, TREESTANDS, ARTIFICIAL SCENTS, GAME CAMERAS, RANGEFINDERS, FOOD STORAGE AND PRESERVATION EQUIPMENT, AND HUNTING AND CASUAL CLOTHING; BUYERS' CLUB SERVICES; ADMINISTRATION OF A DISCOUNT PROGRAM ALLOWING PARTICIPANTS TO OBTAIN DISCOUNTS ON EQUIPMENT AND GIFTS IN THE FIELD OF ARCHERY, HUNTING, AND GAME PROCESSING THROUGH USE OF MEMBERSHIP IN THE PROGRAM, IN CLASS 35 (U.S. CLS. 100, 101 AND 102).

FIRST USE 7-0-2006; IN COMMERCE 7-0-2006.

THE MARK CONSISTS OF A STYLIZED IMAGE OF A SILHOUETTE OF A BOWHUNTER, WITH OPPOSITE SIDES OF THE SILHOUETTE BEING SHADED DIFFERENTLY.

SER. NO. 85-393,368, FILED 8-9-2011.

BRIAN NEVILLE, EXAMINING ATTORNEY



*David J. Kybas*

Director of the United States Patent and Trademark Office

# United States of America

United States Patent and Trademark Office



**Reg. No. 4,125,468**

DL DESIGN STUDIO, INC. (ILLINOIS CORPORATION)  
254 OTIS ROAD  
BARRINGTON HILLS, IL 60010

**Registered Apr. 10, 2012**

**Int. Cl.: 35**

FOR: RETAIL STORE AND ON-LINE RETAIL STORE SERVICES FEATURING GENERAL MERCHANDISE, INCLUDING BUT NOT LIMITED TO GLASSWARE, HOUSEWARES, TOOLS, TOYS, STATIONERY, CLOTHING, SPECIALTY FOOD PRODUCTS, CLEANING PRODUCTS, COOKWARE, PET SUPPLIES, HARDWARE, BEAUTY SUPPLIES, HOMEGOODS, IN CLASS 35 (U.S. CLS. 100, 101 AND 102).

**SERVICE MARK**

**PRINCIPAL REGISTER**

FIRST USE 10-15-2009; IN COMMERCE 10-15-2009.

NO CLAIM IS MADE TO THE EXCLUSIVE RIGHT TO USE "U.S.A." AND "AMERICAN GENERAL STORE", APART FROM THE MARK AS SHOWN.

THE MARK CONSISTS OF THE WORDS "NORTON'S U.S.A." APPEARING OVER THE PHRASE "A UNIQUELY AMERICAN GENERAL STORE". THE WORDS APPEAR IN A LONG HORIZONTAL RECTANGULAR SHAPE WITH A GRAPHIC ELEMENT RESEMBLING A STAR APPEARING AT THE BEGINNING AND END OF EACH OF THE TWO ROWS OF WORDS. A HORIZONTAL LINE APPEARS ABOVE AND BELOW THE TWO ROWS OF WORDS. TO THE RIGHT OF THE WORDS APPEARS AN ARTIST'S RENDERING OF THE ACTUAL BARN THAT THE CORPORATION OWNS AND THE RETAIL STORE OPERATES IN WITH THE SKY APPEARING ABOVE. IN THE CENTER OF THE BARN IS A LARGE OVERHEAD DOOR WITH THREE ROWS OF GLASS PANELS, EXPOSING THE INSIDE OF THE STORE. THERE IS A WINDOW TO THE RIGHT OF THE OVERHEAD DOOR AND A LARGE SIXTEEN-PANED FIXED WINDOW ABOVE. ABOVE THE SIXTEEN-PANED WINDOW IS A HAY DOOR WITH GLASS IN THE UPPER HALF. THERE IS A DOOR APPEARING AT THE BOTTOM LEFT OF THE BARN AND A SIGN INDICATING "NORTON'S U.S.A. A UNIQUELY AMERICAN GENERAL STORE" HANGING ABOVE AND TO THE RIGHT OF THE DOOR OVER A WOODEN PIECE OF LATTICE THAT HOLDS A CHALKBOARD SIGN WITH THE WORDS "AIR CONDITIONED". BEHIND THE OVERHEAD DOOR IS AN AMERICAN FLAG. THE BARN'S CHIMNEY IS SHOWN IN THE DEPICTION BETWEEN SEVERAL TREES WHICH APPEAR BEHIND THE BARN. LOW SHRUBS APPEAR IN FRONT OF THE BARN.

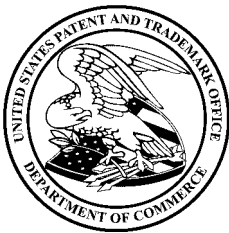

*David J. Kappas*

SER. NO. 85-393,673, FILED 8-9-2011.

**Reg. No. 4,125,468** LINDA MICKLEBURGH, EXAMINING ATTORNEY

United States of America  
United States Patent and Trademark Office

GOGOMIX

**Reg. No. 4,125,469**

SILVA, G. TODD (UNITED STATES INDIVIDUAL)  
1206 SE 7TH STREET  
FORT LAUDERDALE, FL 33301

**Registered Apr. 10, 2012**

**Int. Cl.: 35**

FOR: ADVERTISING AND PUBLICITY SERVICES, NAMELY, PROMOTING THE GOODS, SERVICES, BRAND IDENTITY AND COMMERCIAL INFORMATION AND NEWS OF THIRD PARTIES THROUGH PRINT, AUDIO, VIDEO, DIGITAL AND ON-LINE MEDIUM, IN CLASS 35 (U.S. CLS. 100, 101 AND 102).

**SERVICE MARK**

**PRINCIPAL REGISTER**

FIRST USE 11-11-2011; IN COMMERCE 11-11-2011.

THE MARK CONSISTS OF STANDARD CHARACTERS WITHOUT CLAIM TO ANY PARTICULAR FONT, STYLE, SIZE, OR COLOR.

SER. NO. 85-393,852, FILED 8-9-2011.

FRANK LATTUCA, EXAMINING ATTORNEY



*David J. Kyffers*

Director of the United States Patent and Trademark Office

# United States of America

United States Patent and Trademark Office



**Reg. No. 4,125,470**

KUTCHINSKY, CHARLES (UNITED STATES INDIVIDUAL)  
23 MOONEY LANE  
CHESTER SPRINGS, PA 19425

**Registered Apr. 10, 2012**

**Int. Cl.: 41**

FOR: ENTERTAINMENT SERVICES, NAMELY, AN ON-GOING SERIES FEATURING CRAFT BREWERS AND BREWERIES PROVIDED THROUGH CABLE TELEVISION, INTERNET AND WEBCASTS, IN CLASS 41 (U.S. CLS. 100, 101 AND 107).

**SERVICE MARK**

FIRST USE 4-1-2011; IN COMMERCE 4-1-2011.

**PRINCIPAL REGISTER**

NO CLAIM IS MADE TO THE EXCLUSIVE RIGHT TO USE "BEER", APART FROM THE MARK AS SHOWN.

THE COLOR(S) ORANGE, YELLOW, BLACK AND GRAY IS/ARE CLAIMED AS A FEATURE OF THE MARK.

THE MARK CONSISTS OF THE DESIGN OF A COASTER IN BLACK AND GRAY WITH THE STYLIZED WORDING "BEER" IN ORANGE LETTERING WITH CARBONATION BUBBLES WITHIN THE LETTERS, A HORIZONTAL YELLOW LINE BELOW "BEER" AND ABOVE THE STYLIZED WORDING "APPÉTIT" WITH A SLIGHTLY INCLINED ACCENT MARK ABOVE THE "E" IN "APPÉTIT", AND WITH A CONDENSATION RING, ALL WITHIN THE CENTER OF THREE CONCENTRIC CIRCLES, WITH THE FIRST TWO CONCENTRIC CIRCLES SHARING A CIRCULAR YELLOW BORDER AND WITH THE SECOND AND THIRD CONCENTRIC CIRCLES SHARING A BLACK BORDER.

THE ENGLISH TRANSLATION OF THE WORD "APPÉTIT" IN THE MARK IS "APPETITE".

SER. NO. 85-394,036, FILED 8-10-2011.

NANCY CLARKE, EXAMINING ATTORNEY



*David J. Kybas*

Director of the United States Patent and Trademark Office

# United States of America

United States Patent and Trademark Office

## Influence Live

**Reg. No. 4,125,471**

**Registered Apr. 10, 2012**

**Int. Cl.: 41**

**SERVICE MARK**

**PRINCIPAL REGISTER**

POLARIS GLOBAL (ARIZONA LIMITED LIABILITY COMPANY), AKA POLARIS GLOBAL  
MARKETING  
14835 E SHEA BLVD  
FOUNTAIN HILLS, AZ 85268

FOR: CONDUCTING WORKSHOPS AND SEMINARS IN PERSONAL AWARENESS; CONDUCTING WORKSHOPS AND SEMINARS IN SELF AWARENESS; EDUCATIONAL SERVICES, NAMELY, CONDUCTING LIVE SEMINARS, CONFERENCES, WORKSHOPS IN THE FIELD OF BUSINESS DEVELOPMENT AND DISTRIBUTION OF EDUCATIONAL MATERIALS IN CONNECTION THEREWITH, IN CLASS 41 (U.S. CLS. 100, 101 AND 107).

FIRST USE 9-9-2009; IN COMMERCE 4-20-2010.

THE MARK CONSISTS OF STANDARD CHARACTERS WITHOUT CLAIM TO ANY PARTICULAR FONT, STYLE, SIZE, OR COLOR.

NO CLAIM IS MADE TO THE EXCLUSIVE RIGHT TO USE "LIVE", APART FROM THE MARK AS SHOWN.

SER. NO. 85-394,118, FILED 8-10-2011.

CARRIE GENOVESE, EXAMINING ATTORNEY



*David J. Kybas*

Director of the United States Patent and Trademark Office

# United States of America

United States Patent and Trademark Office

## Sovereignty Live

**Reg. No. 4,125,472**

**Registered Apr. 10, 2012**

**Int. Cl.: 41**

**SERVICE MARK**

**PRINCIPAL REGISTER**

POLARIS GLOBAL (ARIZONA LIMITED LIABILITY COMPANY), AKA POLARIS GLOBAL  
MARKETING  
14835 E SHEA BLVD STE 103-618  
FOUNTAIN HILLS, AZ 85268

FOR: CONDUCTING WORKSHOPS AND SEMINARS IN PERSONAL AWARENESS; CONDUCTING WORKSHOPS AND SEMINARS IN SELF AWARENESS; EDUCATIONAL SERVICES, NAMELY, CONDUCTING LIVE SEMINARS, WORKSHOPS, CONFERENCES IN THE FIELD OF BUSINESS DEVELOPMENT AND DISTRIBUTION OF COURSE AND EDUCATIONAL MATERIALS IN CONNECTION THEREWITH, IN CLASS 41 (U.S. CLS. 100, 101 AND 107).

FIRST USE 9-9-2009; IN COMMERCE 4-20-2010.

THE MARK CONSISTS OF STANDARD CHARACTERS WITHOUT CLAIM TO ANY PARTICULAR FONT, STYLE, SIZE, OR COLOR.

NO CLAIM IS MADE TO THE EXCLUSIVE RIGHT TO USE "LIVE", APART FROM THE MARK AS SHOWN.

SER. NO. 85-394,140, FILED 8-10-2011.

CARRIE GENOVESE, EXAMINING ATTORNEY



*David J. Kybas*

Director of the United States Patent and Trademark Office

# United States of America

United States Patent and Trademark Office



**Reg. No. 4,125,473**

**Registered Apr. 10, 2012**

**Int. Cl.: 41**

**SERVICE MARK**

**PRINCIPAL REGISTER**

GET MOTIVATED SEMINARS, INC. (FLORIDA CORPORATION)  
SUITE C4  
4710 EISENHOWER BLVD.  
TAMPA, FL 33634

FOR: EDUCATION SERVICES, NAMELY, PROVIDING MOTIVATIONAL SPEECHES, SEMINARS, WORKSHOPS, AND TRAINING PROGRAMS IN THE FIELDS OF BUSINESS AND PERSONAL IMPROVEMENT, IN CLASS 41 (U.S. CLS. 100, 101 AND 107).

FIRST USE 1-1-2005; IN COMMERCE 1-1-2005.

OWNER OF U.S. REG. NOS. 3,267,850, 3,535,473 AND OTHERS.

THE COLOR(S) BLUE, RED, GRAY AND BLACK IS/ARE CLAIMED AS A FEATURE OF THE MARK.

NO CLAIM IS MADE TO THE EXCLUSIVE RIGHT TO USE "BUSINESS SEMINAR", APART FROM THE MARK AS SHOWN.

THE MARK CONSISTS OF A BLACK RECTANGLE WITH GRAY SPECS IN THE LEFT CORNER AS THE BACKGROUND TO THE WORDS "GET MOTIVATED! BUSINESS SEMINAR" IN THE COLOR GRAY WITH A DRAWING OF A MAN, STYLIZED, IN BLUE COLOR DEPICTED RUNNING ACROSS A FINISH LINE IN RED COLOR.

SER. NO. 85-394,152, FILED 8-10-2011.

LINDA ESTRADA, EXAMINING ATTORNEY



*David J. Kybas*

Director of the United States Patent and Trademark Office



# United States of America

United States Patent and Trademark Office

## Foundation Live

**Reg. No. 4,125,474**

**Registered Apr. 10, 2012**

**Int. Cl.: 41**

**SERVICE MARK**

**PRINCIPAL REGISTER**

POLARIS GLOBAL (ARIZONA LIMITED LIABILITY COMPANY), AKA POLARIS GLOBAL MARKETING  
14835 E SHEA BLVD STE 103-618  
FOUNTAIN HILL, AZ 85268

FOR: CONDUCTING WORKSHOPS AND SEMINARS IN PERSONAL AWARENESS; CONDUCTING WORKSHOPS AND SEMINARS IN SELF AWARENESS; EDUCATIONAL SERVICES, NAMELY, CONDUCTING LIVE SEMINARS, WORKSHOPS AND CONFERENCES IN THE FIELD OF BUSINESS DEVELOPMENT AND DISTRIBUTION OF COURSE AND EDUCATIONAL MATERIALS IN CONNECTION THEREWITH, IN CLASS 41 (U.S. CLS. 100, 101 AND 107).

FIRST USE 9-9-2009; IN COMMERCE 4-20-2010.

THE MARK CONSISTS OF STANDARD CHARACTERS WITHOUT CLAIM TO ANY PARTICULAR FONT, STYLE, SIZE, OR COLOR.

NO CLAIM IS MADE TO THE EXCLUSIVE RIGHT TO USE "LIVE", APART FROM THE MARK AS SHOWN.

SER. NO. 85-394,247, FILED 8-10-2011.

CARRIE GENOVESE, EXAMINING ATTORNEY



*David J. Kybas*

Director of the United States Patent and Trademark Office

# United States of America

United States Patent and Trademark Office

## Equine Myotherapy by Art Trickey

**Reg. No. 4,125,475**

ARTHUR M. TRICKEY (UNITED STATES INDIVIDUAL)  
3401 PATTONS MILL LANE  
GALAX, VA 24333

**Registered Apr. 10, 2012**

**Int. Cl.: 44**

FOR: ANIMAL HUSBANDRY, IN CLASS 44 (U.S. CLS. 100 AND 101).

**SERVICE MARK**

FIRST USE 1-1-2000; IN COMMERCE 7-18-2011.

**PRINCIPAL REGISTER**

THE MARK CONSISTS OF STANDARD CHARACTERS WITHOUT CLAIM TO ANY PARTICULAR FONT, STYLE, SIZE, OR COLOR.

NO CLAIM IS MADE TO THE EXCLUSIVE RIGHT TO USE "EQUINE MYOTHERAPY", APART FROM THE MARK AS SHOWN.

SER. NO. 85-394,447, FILED 8-10-2011.

PAUL MORENO, EXAMINING ATTORNEY



*David J. Kyffers*

Director of the United States Patent and Trademark Office

# United States of America

United States Patent and Trademark Office

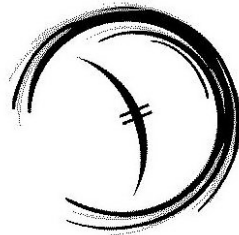

**CLASQUIN**  
OVERSEAS FORWARDING AND LOGISTICS

**Reg. No. 4,125,476**

CLASQUIN SA (FRANCE SOCIÉTÉ ANONYME (SA))  
235 COURS LAFAYETTE, LE RHONE ALPES  
F-69451 LYON CEDEX 06, FRANCE

**Registered Apr. 10, 2012**

**Int. Cl.: 39**

FOR: FREIGHT TRANSPORTATION BY RIVER, MARITIME, AIR, ROAD AND RAIL TRANSPORT OF PERSONS AND GOODS; FREIGHT TRAIN TRANSPORT; FREIGHT SHIP TRANSPORT; MERCHANDISE PACKAGING FOR OTHERS; STORAGE AND DELIVERY OF GOODS; TRANSPORT BROKERAGE; AND FREIGHT FORWARDING, IN CLASS 39 (U.S. CLS. 100 AND 105).

**SERVICE MARK**

**PRINCIPAL REGISTER**

OWNER OF FRANCE REG. NO. 063419269, DATED 3-28-2006, EXPIRES 3-28-2016.

NO CLAIM IS MADE TO THE EXCLUSIVE RIGHT TO USE "OVERSEAS FORWARDING AND LOGISTICS", APART FROM THE MARK AS SHOWN.

THE MARK CONSISTS OF AN ABSTRACT DEPICTION OF THE SUN REPRESENTED BY SEVERAL OVERLAPPING, PAINT BRUSH-LIKE STROKES PRESENTED IN A CIRCUMFERENTIAL PATTERN AROUND THREE-QUARTERS OF A FULL CIRCLE, AND IN THE CENTER OF WHICH APPEARS AN ABSTRACT DEPICTION OF A BIRD-LIKE CREATURE CROSSING AT AN ANGLE FROM SOUTHWEST TO NORTHEAST. THE ABSTRACT DEPICTION OF THE BIRD-LIKE CREATURE CONSISTS OF TWO SHORT PARALLEL LINES REPRESENTING THE BIRD'S BODY AND A TAPERED SEMI-CIRCULAR LINE PERPENDICULAR TO THE BIRD'S BODY WHICH REPRESENTS THE WINGS. THE LITERAL ELEMENTS "CLASQUIN OVERSEAS FORWARDING AND LOGISTICS" ARE WRITTEN BELOW THE ABSTRACT SUN AND BIRD.



SER. NO. 85-394,492, FILED 8-10-2011.

CAROL SPILS, EXAMINING ATTORNEY

*David J. Kybas*

Director of the United States Patent and Trademark Office

# United States of America

United States Patent and Trademark Office



**Reg. No. 4,125,477**

AIC AMERICA (NEVADA CORPORATION)  
5685 SPRING MOUNTAIN ROAD  
LAS VEGAS, NV 89146

**Registered Apr. 10, 2012**

**Int. Cl.: 36**

FOR: UNDERWRITING, AGENCY AND BROKERAGE OF AUTO INSURANCE POLICIES; SERVICING OF AUTO INSURANCE POLICIES, NAMELY, INSURANCE PAYMENT PROCESSING AND INSURANCE INFORMATION AND CONSULTATION, IN CLASS 36 (U.S. CLS. 100, 101 AND 102).

**SERVICE MARK**

**PRINCIPAL REGISTER**

FIRST USE 2-0-2010; IN COMMERCE 2-0-2010.

THE MARK CONSISTS OF A CARTOON IMAGE OF A BLUE CAR WITH A SMILEY FACE. ON THE SMILEY FACE THERE ARE BLACK AND WHITE HEADLIGHTS APPEARING AS EYES, RED LIPS AND WHITE TEETH. THE CAR HAS WHITE TIRES WITH RED IN THE MIDDLE, AND A BLUE, RED, WHITE AND BLACK UNITED STATES FLAG ATTACHED TO THE REAR END.

THE COLOR(S) RED, WHITE, BLACK AND BLUE IS/ARE CLAIMED AS A FEATURE OF THE MARK.

SER. NO. 85-394,570, FILED 8-10-2011.

DEZMONA MIZELLE, EXAMINING ATTORNEY



*David J. Kybas*

Director of the United States Patent and Trademark Office

# United States of America

United States Patent and Trademark Office

# MagicCloser

**Reg. No. 4,125,478**

JCV ENTERPRISES, INC (COLORADO CORPORATION)  
1490 E. MINERAL PL.  
CENTENNIAL, CO 80122

**Registered Apr. 10, 2012**

**Int. Cl.: 9**

FOR: ELECTRIC DOOR OPENERS AND CLOSERS, IN CLASS 9 (U.S. CLS. 21, 23, 26, 36 AND 38).

**TRADEMARK**

FIRST USE 9-1-2010; IN COMMERCE 9-1-2010.

**PRINCIPAL REGISTER**

THE MARK CONSISTS OF STANDARD CHARACTERS WITHOUT CLAIM TO ANY PARTICULAR FONT, STYLE, SIZE, OR COLOR.

SER. NO. 85-394,829, FILED 8-10-2011.

JORDAN BAKER, EXAMINING ATTORNEY



*David J. Kyffers*

Director of the United States Patent and Trademark Office

# United States of America

United States Patent and Trademark Office

## NAFCU Today

**Reg. No. 4,125,479**

NATIONAL ASSOCIATION OF FEDERAL CREDIT UNIONS (CALIFORNIA CORPORATION)  
3138 NORTH 10TH STREET  
ARLINGTON, VA 22201

**Registered Apr. 10, 2012**

**Int. Cl.: 9**

FOR: DOWNLOADABLE ELECTRONIC NEWSLETTERS DELIVERED BY E-MAIL IN THE  
FIELD OF CREDIT UNIONS, IN CLASS 9 (U.S. CLS. 21, 23, 26, 36 AND 38).

**TRADEMARK**

FIRST USE 1-1-2011; IN COMMERCE 1-1-2011.

**PRINCIPAL REGISTER**

THE MARK CONSISTS OF STANDARD CHARACTERS WITHOUT CLAIM TO ANY PAR-  
TICULAR FONT, STYLE, SIZE, OR COLOR.

OWNER OF U.S. REG. NOS. 1,973,005 AND 2,549,858.

SER. NO. 85-395,189, FILED 8-11-2011.

PRISCILLA MILTON, EXAMINING ATTORNEY



*David J. Kybas*

Director of the United States Patent and Trademark Office

# United States of America

United States Patent and Trademark Office

# REDI[2]

**Reg. No. 4,125,480**

**Registered Apr. 10, 2012**

**Int. Cl.: 42**

**SERVICE MARK**

**PRINCIPAL REGISTER**

REDI2 TECHNOLOGIES, INC. (DELAWARE CORPORATION)  
1771 BROADWAY  
OAKLAND, CA 94612

FOR: PROVIDING TEMPORARY USE OF ON-LINE NON-DOWNLOADABLE SOFTWARE IN THE FIELD OF FINANCIAL SERVICES, NAMELY, FOR USE IN THE MANAGEMENT OF BILLING, INVOICING, ACCOUNTS RECEIVABLE, REVENUE ACCOUNTING AND REPORTING, RECONCILIATION, REVENUE ANALYTICS, AND REVENUE FORECASTING, IN CLASS 42 (U.S. CLS. 100 AND 101).

FIRST USE 1-1-2011; IN COMMERCE 1-1-2011.

THE MARK CONSISTS OF STANDARD CHARACTERS WITHOUT CLAIM TO ANY PARTICULAR FONT, STYLE, SIZE, OR COLOR.

OWNER OF U.S. REG. NO. 2,997,745.

SER. NO. 85-395,726, FILED 8-11-2011.

LESLIE RICHARDS, EXAMINING ATTORNEY



*David J. Kyffers*

Director of the United States Patent and Trademark Office

# United States of America

United States Patent and Trademark Office



**Reg. No. 4,125,481**

**Registered Apr. 10, 2012**

**Int. Cl.: 13**

**TRADEMARK**

**PRINCIPAL REGISTER**

NOVAK, WAYNE F. (UNITED STATES INDIVIDUAL)  
1206 30TH STREET  
PARKERSBURG, WV 26101

FOR: FIREARM SIGHTS; NON-TELESCOPIC GUN SIGHTS FOR FIREARMS; PISTOL GRIPS;  
PISTOL HOLSTERS; SIGHTS, NAMELY, OPEN SIGHTS FOR USE ON FIREARMS, IN CLASS  
13 (U.S. CLS. 2 AND 9).

FIRST USE 2-3-1987; IN COMMERCE 2-3-1987.

OWNER OF U.S. REG. NOS. 2,472,719 AND 3,395,479.

THE MARK CONSISTS OF THE WORDING "NOVAK'S" WITHIN A STYLIZED REPRESENT-  
ATION OF A REAR PISTOL SIGHT.

SEC. 2(F).

SER. NO. 85-395,772, FILED 8-11-2011.

ZACHARY BELLO, EXAMINING ATTORNEY



*David J. Kyffers*

Director of the United States Patent and Trademark Office



# United States of America

United States Patent and Trademark Office

# C-KIT

**Reg. No. 4,125,482**

STACK, EDWARD (UNITED STATES INDIVIDUAL)  
4318 SUNNY LAKE DRIVE  
HARTLAND, MI 48353

**Registered Apr. 10, 2012**

**Int. Cl.: 5**

FOR: CATARACT EYE CARE KITS COMPRISED PRIMARILY OF PHARMACEUTICAL EYE DROPS AND ALSO CONTAINING EYE SHIELDS AND PROTECTIVE GLASSES, IN CLASS 5 (U.S. CLS. 6, 18, 44, 46, 51 AND 52).

**TRADEMARK**

FIRST USE 5-31-2011; IN COMMERCE 5-31-2011.

**PRINCIPAL REGISTER**

THE MARK CONSISTS OF STANDARD CHARACTERS WITHOUT CLAIM TO ANY PARTICULAR FONT, STYLE, SIZE, OR COLOR.

SER. NO. 85-395,867, FILED 8-11-2011.

CAROL SPILS, EXAMINING ATTORNEY



*David J. Kyffers*

Director of the United States Patent and Trademark Office

# United States of America

United States Patent and Trademark Office

## NATURALLY NAKED PET PRODUCTS

**Reg. No. 4,125,483**

**Registered Apr. 10, 2012**

**Int. Cl.: 31**

**TRADEMARK**

**PRINCIPAL REGISTER**

DOUBLE SHOT RANCH, LLC (CALIFORNIA LIMITED LIABILITY COMPANY), DBA THE HEALTHY MUTT  
28611 MARKUSON ROAD  
SILVERADO, CA 92676

FOR: PET FOOD, IN CLASS 31 (U.S. CLS. 1 AND 46).

FIRST USE 6-0-2011; IN COMMERCE 6-0-2011.

THE MARK CONSISTS OF STANDARD CHARACTERS WITHOUT CLAIM TO ANY PARTICULAR FONT, STYLE, SIZE, OR COLOR.

NO CLAIM IS MADE TO THE EXCLUSIVE RIGHT TO USE "PET PRODUCTS", APART FROM THE MARK AS SHOWN.

SER. NO. 85-395,871, FILED 8-11-2011.

CAROL SPILS, EXAMINING ATTORNEY



*David J. Kyffers*

Director of the United States Patent and Trademark Office

# United States of America

United States Patent and Trademark Office



**Reg. No. 4,125,484**

**Registered Apr. 10, 2012**

**Int. Cl.: 14**

**TRADEMARK**

**PRINCIPAL REGISTER**

COLUCCI, MELISSA (UNITED STATES INDIVIDUAL)  
1 COUNTRY CLUB PLACE WEST  
CAMP HILL, PA 17011

FOR: BRACELETS; EARRINGS; JEWELRY; PENDANTS; RINGS, IN CLASS 14 (U.S. CLS. 2, 27, 28 AND 50).

FIRST USE 1-1-2009; IN COMMERCE 1-1-2009.

NO CLAIM IS MADE TO THE EXCLUSIVE RIGHT TO USE "ORAFO", APART FROM THE MARK AS SHOWN.

THE MARK CONSISTS OF AN ABSTRACT DESIGN OF TWO WAVY HORIZONTAL LINES ABOVE THE TEXT "C'ORAFO".

THE ENGLISH TRANSLATION OF "ORAFO "IN THE MARK IS "GOLDSMITH".

SER. NO. 85-395,889, FILED 8-11-2011.

CAROL SPILS, EXAMINING ATTORNEY



*David J. Kyffers*

Director of the United States Patent and Trademark Office

# United States of America

United States Patent and Trademark Office

## The New Realty Group

**Reg. No. 4,125,485**

**Registered Apr. 10, 2012**

**Int. Cl.: 36**

**SERVICE MARK**

**PRINCIPAL REGISTER**

THE NEW REALTY GROUP, LLC (NORTH CAROLINA LIMITED LIABILITY COMPANY),  
DBA THE NEW REALTY GROUP  
702 MIDYETTE ST  
ORIENTAL, NC 28571

FOR: PROVIDING A DATABASE OF INFORMATION ABOUT RESIDENTIAL REAL ESTATE LISTINGS IN DIFFERENT NEIGHBORHOODS AND COMMUNITIES; PROVIDING INFORMATION IN THE FIELD OF REAL ESTATE BY MEANS OF LINKING THE WEB SITE TO OTHER WEB SITES FEATURING REAL ESTATE INFORMATION; PROVIDING INFORMATION IN THE FIELD OF REAL ESTATE VIA THE INTERNET; REAL ESTATE AGENCIES; REAL ESTATE BROKERAGE, IN CLASS 36 (U.S. CLS. 100, 101 AND 102).

FIRST USE 7-11-2011; IN COMMERCE 7-11-2011.

THE MARK CONSISTS OF STANDARD CHARACTERS WITHOUT CLAIM TO ANY PARTICULAR FONT, STYLE, SIZE, OR COLOR.

NO CLAIM IS MADE TO THE EXCLUSIVE RIGHT TO USE "REALTY GROUP", APART FROM THE MARK AS SHOWN.

SER. NO. 85-395,915, FILED 8-11-2011.

CAROL SPILS, EXAMINING ATTORNEY



*David J. Kyffers*

Director of the United States Patent and Trademark Office

# United States of America

United States Patent and Trademark Office



**Reg. No. 4,125,486**

KM SIMON LLC (ARIZONA LIMITED LIABILITY COMPANY)  
5800 N YUCCA RD

**Registered Apr. 10, 2012**

PARADISE VALLEY, AZ 85253

**Int. Cl.: 45**

FOR: PROVIDING A WEBSITE ON THE INTERNET FOR THE PURPOSE OF SOCIAL NETWORKING, IN CLASS 45 (U.S. CLS. 100 AND 101).

**SERVICE MARK**

FIRST USE 7-29-2011; IN COMMERCE 7-29-2011.

**PRINCIPAL REGISTER**

THE MARK CONSISTS OF THE WORD "DORMTALES" IN BLUE, WITH A RED GRADUATION HAT ON THE LETTER "D", AND RED AND WHITE AND BLUE AND WHITE BOOKS STACKED BENEATH THE WORD "DORMTALES".

THE COLOR(S) RED, WHITE, AND BLUE IS/ARE CLAIMED AS A FEATURE OF THE MARK.

SER. NO. 85-396,013, FILED 8-11-2011.

SANJEEV VOHRA, EXAMINING ATTORNEY



*David J. Kyffers*

Director of the United States Patent and Trademark Office

# United States of America

United States Patent and Trademark Office

# InSourcing

**Reg. No. 4,125,487**

**Registered Apr. 10, 2012**

**Int. Cl.: 37**

**SERVICE MARK**

**PRINCIPAL REGISTER**

QUALITY SYSTEMS, INC. (TENNESSEE CORPORATION)  
1101 MENZLER ROAD  
NASHVILLE, TN 37210

FOR: APPLICATION OF COATINGS AND SEALERS; APPLICATION OF CONCRETE COATINGS FOR BEAUTIFICATION PURPOSES; APPLICATION OF EPOXY COATINGS TO FLOORS; BUILDING CONSTRUCTION AND REPAIR; CONSTRUCTION AND REPAIR OF BUILDINGS; CONSTRUCTION, MAINTENANCE AND RENOVATION OF PROPERTY; INSTALLATION, MAINTENANCE AND REPAIR OF PROTECTIVE COATINGS FOR FLOORS; MASONRY SERVICES; PAINTING AND APPLYING COATINGS TO BUILDING INTERIORS AND BUILDING EXTERIORS; REPAIR OF BUILDINGS, IN CLASS 37 (U.S. CLS. 100, 103 AND 106).

FIRST USE 8-1-2011; IN COMMERCE 8-1-2011.

THE MARK CONSISTS OF STANDARD CHARACTERS WITHOUT CLAIM TO ANY PARTICULAR FONT, STYLE, SIZE, OR COLOR.

SER. NO. 85-396,233, FILED 8-12-2011.

AISHA CLARKE, EXAMINING ATTORNEY



*David J. Kyros*

Director of the United States Patent and Trademark Office

# United States of America

United States Patent and Trademark Office

# Wumpa

**Reg. No. 4,125,488**

WUMPA, LLC (ARIZONA LIMITED LIABILITY COMPANY)  
18635 N. 35TH AVE. STE. 110-94  
PHOENIX, AZ 85027

**Registered Apr. 10, 2012**

**Int. Cl.: 41**

FOR: ARRANGING, ORGANIZING, CONDUCTING, AND HOSTING SOCIAL ENTERTAINMENT EVENTS, IN CLASS 41 (U.S. CLS. 100, 101 AND 107).

**SERVICE MARK**

FIRST USE 8-1-2011; IN COMMERCE 8-1-2011.

**PRINCIPAL REGISTER**

THE MARK CONSISTS OF STANDARD CHARACTERS WITHOUT CLAIM TO ANY PARTICULAR FONT, STYLE, SIZE, OR COLOR.

THE WORDING "WUMPA" HAS NO MEANING IN A FOREIGN LANGUAGE.

SER. NO. 85-396,530, FILED 8-12-2011.

EDWARD NELSON, EXAMINING ATTORNEY



*David J. Kybas*

Director of the United States Patent and Trademark Office

# United States of America

United States Patent and Trademark Office

## OFF THE BUS

**Reg. No. 4,125,489**

**Registered Apr. 10, 2012**

**Int. Cls.: 35 and 41**

**SERVICE MARK**

**PRINCIPAL REGISTER**

THEHUFFINGTONPOST.COM, INC. (DELAWARE CORPORATION)  
22000 AOL WAY  
DULLES, VA 20166

FOR: PROVIDING A WEBSITE FEATURING INFORMATION AND COMMENTARY IN THE FIELD OF POLITICS, POLITICAL CAMPAIGNS, ELECTIONS, AND GOVERNMENT AFFAIRS-, IN CLASS 35 (U.S. CLS. 100, 101 AND 102).

FIRST USE 7-0-2007; IN COMMERCE 7-0-2007.

FOR: ON-LINE JOURNALS, NAMELY, BLOGS IN THE FIELD OF POLITICS, POLITICAL CAMPAIGNS, ELECTIONS, AND GOVERNMENT AFFAIRS, IN CLASS 41 (U.S. CLS. 100, 101 AND 107).

FIRST USE 7-0-2007; IN COMMERCE 7-0-2007.

THE MARK CONSISTS OF STANDARD CHARACTERS WITHOUT CLAIM TO ANY PARTICULAR FONT, STYLE, SIZE, OR COLOR.

SER. NO. 85-396,549, FILED 8-12-2011.

EDWARD NELSON, EXAMINING ATTORNEY



*David J. Kybas*

Director of the United States Patent and Trademark Office



# United States of America

United States Patent and Trademark Office

## Embrace Cancer Survivorship Program Sanford

**Reg. No. 4,125,490**

SANFORD NORTH (NORTH DAKOTA NON-PROFIT CORPORATION)  
801 BROADWAY N.  
FARGO, ND 58122

**Registered Apr. 10, 2012**

**Int. Cls.: 41 and 45**

FOR: EDUCATION SERVICES, NAMELY, ONE-ON-ONE MENTORING IN THE FIELD OF  
CANCER SURVIVORSHIP, IN CLASS 41 (U.S. CLS. 100, 101 AND 107).

**SERVICE MARK**

FIRST USE 3-0-2011; IN COMMERCE 3-0-2011.

**PRINCIPAL REGISTER**

FOR: PROVIDING PERSONAL SUPPORT SERVICES FOR PATIENTS AND FAMILIES OF  
PATIENTS WITH CANCER, NAMELY, PROVIDING SUPPORT GROUPS AND PERSONAL  
SUPPORT INFORMATION, IN CLASS 45 (U.S. CLS. 100 AND 101).

FIRST USE 3-0-2011; IN COMMERCE 3-0-2011.

THE MARK CONSISTS OF STANDARD CHARACTERS WITHOUT CLAIM TO ANY PAR-  
TICULAR FONT, STYLE, SIZE, OR COLOR.

OWNER OF U.S. REG. NOS. 3,810,415, 3,810,421, AND 3,932,807.

NO CLAIM IS MADE TO THE EXCLUSIVE RIGHT TO USE "CANCER SURVIVORSHIP  
PROGRAM", APART FROM THE MARK AS SHOWN.

SER. NO. 85-396,576, FILED 8-12-2011.

CHRISIE B. KING, EXAMINING ATTORNEY



*David J. Kybas*

Director of the United States Patent and Trademark Office

# United States of America

United States Patent and Trademark Office

embrace  
Cancer Survivorship Program

SANFORD

**Reg. No. 4,125,491**

SANFORD NORTH (NORTH DAKOTA NON-PROFIT CORPORATION)  
801 BROADWAY N.  
FARGO, ND 58122

**Registered Apr. 10, 2012**

**Int. Cls.: 41 and 45**

FOR: EDUCATION SERVICES, NAMELY, ONE-ON-ONE MENTORING IN THE FIELD OF CANCER SURVIVORSHIP, IN CLASS 41 (U.S. CLS. 100, 101 AND 107).

**SERVICE MARK**

FIRST USE 3-0-2011; IN COMMERCE 3-0-2011.

**PRINCIPAL REGISTER**

FOR: PROVIDING PERSONAL SUPPORT SERVICES FOR PATIENTS AND FAMILIES OF PATIENTS WITH CANCER, NAMELY, PROVIDING SUPPORT GROUPS AND PERSONAL SUPPORT INFORMATION, IN CLASS 45 (U.S. CLS. 100 AND 101).

FIRST USE 3-0-2011; IN COMMERCE 3-0-2011.

OWNER OF U.S. REG. NOS. 3,810,415, 3,810,421, AND 3,932,807.

NO CLAIM IS MADE TO THE EXCLUSIVE RIGHT TO USE "CANCER SURVIVORSHIP PROGRAM", APART FROM THE MARK AS SHOWN.

THE MARK CONSISTS OF THE WORD "EMBRACE", BETWEEN SLIGHTLY OFFSET PARENTHESES, ABOVE THE WORDS "CANCER SURVIVORSHIP PROGRAM". BELOW, OFFSET TO THE RIGHT, IS THE WORD "SANFORD". THE "O" IN "SANFORD" HAS AN INSET CROSS OF LORRAINE, OFFSET TO THE LEFT.

SER. NO. 85-396,653, FILED 8-12-2011.

CHRISIE B. KING, EXAMINING ATTORNEY



*David J. Kybas*

Director of the United States Patent and Trademark Office

# United States of America

United States Patent and Trademark Office

## SEVENTH GENERATION

**Reg. No. 4,125,492**

SEVENTH GENERATION, INC. (VERMONT CORPORATION)

**Registered Apr. 10, 2012**

60 LAKE STREET  
BURLINGTON, VT 05401

**Int. Cls.: 3, 9, 35 and 38**

FOR: FABRIC SOFTENER FOR LAUNDRY USE; DISHWASHER RINSE AID, IN CLASS 3 (U.S. CLS. 1, 4, 6, 50, 51 AND 52).

**TRADEMARK**

FIRST USE 12-31-2003; IN COMMERCE 12-31-2003.

**SERVICE MARK**

FOR: ON-LINE DOWNLOADABLE ELECTRONIC NEWSLETTERS IN THE FIELD OF ENVIRONMENTAL AND SOCIAL INITIATIVES, IMPLICATIONS OF USE OF ENVIRONMENTALLY SENSITIVE PRODUCTS, EARTH-FRIENDLY CONSUMER STRATEGIES AND INITIATIVES AND ENVIRONMENTAL RESOURCES, IN CLASS 9 (U.S. CLS. 21, 23, 26, 36 AND 38).

**PRINCIPAL REGISTER**

FIRST USE 3-31-2008; IN COMMERCE 3-31-2008.

FOR: PROVIDING ON-LINE EDUCATIONAL INFORMATION CONCERNING ENVIRONMENTAL AND SOCIAL INITIATIVES, NAMELY, PROMOTING ENVIRONMENTAL AWARENESS BY DETAILING IMPLICATIONS OF USE OF ENVIRONMENTALLY SENSITIVE PRODUCTS, EARTH-FRIENDLY CONSUMER STRATEGIES AND INITIATIVES AND ENVIRONMENTAL RESOURCES USED FOR POVERTY RELIEF, SOCIAL RESPONSIBILITY AND CONSERVATION; CHARITABLE SERVICES, NAMELY, PROVIDING ONLINE INFORMATION CONCERNING CHARITABLE PROGRAMS, NAMELY, ORGANIZING AND CONDUCTING VOLUNTEER PROGRAM AND COMMUNITY SERVICE PROJECTS, IN CLASS 35 (U.S. CLS. 100, 101 AND 102).

FIRST USE 3-31-2008; IN COMMERCE 3-31-2008.

FOR: PROVIDING ON-LINE FORUMS, CHAT-ROOMS AND MESSAGE BOARDS FOR TRANSMISSION OF MESSAGES AMONG COMPUTER USERS IN THE FIELD OF ENVIRONMENTAL AND SOCIAL INITIATIVES, IMPLICATIONS OF USE OF ENVIRONMENTALLY SENSITIVE PRODUCTS, EARTH-FRIENDLY CONSUMER STRATEGIES AND INITIATIVES AND ENVIRONMENTAL RESOURCES, IN CLASS 38 (U.S. CLS. 100, 101 AND 104).

FIRST USE 3-31-2008; IN COMMERCE 3-31-2008.



*David J. Kyros*

Director of the United States Patent and Trademark Office

**Reg. No. 4,125,492** THE MARK CONSISTS OF STANDARD CHARACTERS WITHOUT CLAIM TO ANY PARTICULAR FONT, STYLE, SIZE, OR COLOR.

OWNER OF U.S. REG. NOS. 1,847,543 AND 3,917,862.

SER. NO. 85-397,024, FILED 8-12-2011.

ESTHER BELENKER, EXAMINING ATTORNEY

# United States of America

United States Patent and Trademark Office

## PRESENTABLE OVENWARE

**Reg. No. 4,125,493**

**Registered Apr. 10, 2012**

**Int. Cl.: 21**

**TRADEMARK**

**PRINCIPAL REGISTER**

TEMP-TATIONS LLC (DELAWARE LIMITED LIABILITY COMPANY)  
180 GORDON DRIVE  
SUITE 102  
EXTON, PA 19341

FOR: NON-ELECTRIC KITCHEN CONTAINERS NOT MADE OF PRECIOUS METALS AND BAKEWARE; THERMAL INSULATED CONTAINERS FOR FOOD, IN CLASS 21 (U.S. CLS. 2, 13, 23, 29, 30, 33, 40 AND 50).

FIRST USE 1-1-2006; IN COMMERCE 1-1-2006.

THE MARK CONSISTS OF STANDARD CHARACTERS WITHOUT CLAIM TO ANY PARTICULAR FONT, STYLE, SIZE, OR COLOR.

NO CLAIM IS MADE TO THE EXCLUSIVE RIGHT TO USE "OVENWARE", APART FROM THE MARK AS SHOWN.

SER. NO. 85-397,089, FILED 8-12-2011.

MATTHEW EINSTEIN, EXAMINING ATTORNEY



*David J. Kyffers*

Director of the United States Patent and Trademark Office

# United States of America

United States Patent and Trademark Office

# Candypress

**Reg. No. 4,125,494**

**Registered Apr. 10, 2012**

**Int. Cl.: 9**

**TRADEMARK**

**PRINCIPAL REGISTER**

CAVALLO COMMUNICATIONS LLC (NEW JERSEY LIMITED LIABILITY COMPANY),  
DBA CANDYPRESS  
681 HADDON AVENUE  
COLLINGSWOOD, NJ 08108

FOR: DOWNLOADABLE COMPUTER SOFTWARE TO ALLOW CONSUMERS AND MERCHANTS TO PERFORM ELECTRONIC BUSINESS TRANSACTIONS, IN CLASS 9 (U.S. CLS. 21, 23, 26, 36 AND 38).

FIRST USE 5-8-2002; IN COMMERCE 5-8-2002.

THE MARK CONSISTS OF STANDARD CHARACTERS WITHOUT CLAIM TO ANY PARTICULAR FONT, STYLE, SIZE, OR COLOR.

SER. NO. 85-397,782, FILED 8-15-2011.

LUCY ARANT, EXAMINING ATTORNEY



*David J. Kybas*

Director of the United States Patent and Trademark Office

# United States of America

United States Patent and Trademark Office



**Reg. No. 4,125,495**

**Registered Apr. 10, 2012**

**Int. Cl.: 27**

**TRADEMARK**

**PRINCIPAL REGISTER**

JAMES ODABASHIAN (UNITED STATES INDIVIDUAL)  
6199 N. FEDERAL HIGHWAY  
BOCA RATON, FL 33487 AND

JAIME ODABASHIAN (UNITED STATES INDIVIDUAL)  
6199 N. FEDERAL HIGHWAY  
BOCA RATON, FL 33487

FOR: CARPETS AND RUGS, IN CLASS 27 (U.S. CLS. 19, 20, 37, 42 AND 50).

FIRST USE 1-1-1980; IN COMMERCE 1-1-1980.

THE MARK CONSISTS OF THE LETTER "O" WITH A LION HOLDING A SWORD IN ITS PAW COMPLETELY CONTAINED WITHIN THE LETTER.

SER. NO. 85-397,812, FILED 8-15-2011.

REGINA DRUMMOND, EXAMINING ATTORNEY



*David J. Kybas*

Director of the United States Patent and Trademark Office

# United States of America

United States Patent and Trademark Office

## CURB\_CUISINE

**Reg. No. 4,125,496**

**Registered Apr. 10, 2012**

**Int. Cl.: 43**

**SERVICE MARK**

**PRINCIPAL REGISTER**

MARINATION LLC (WASHINGTON LIMITED LIABILITY COMPANY)  
PO BOX 28324  
SEATTLE, WA 98118

FOR: CARRY-OUT RESTAURANTS; PROVIDING OF FOOD AND DRINK VIA A MOBILE TRUCK; RESTAURANT AND BAR SERVICES; RESTAURANT AND CATERING SERVICES, IN CLASS 43 (U.S. CLS. 100 AND 101).

FIRST USE 6-30-2009; IN COMMERCE 6-30-2009.

THE MARK CONSISTS OF STANDARD CHARACTERS WITHOUT CLAIM TO ANY PARTICULAR FONT, STYLE, SIZE, OR COLOR.

NO CLAIM IS MADE TO THE EXCLUSIVE RIGHT TO USE "CUISINE", APART FROM THE MARK AS SHOWN.

SER. NO. 85-398,262, FILED 8-15-2011.

JEFFREY LOOK, EXAMINING ATTORNEY



*David J. Kyffers*

Director of the United States Patent and Trademark Office



# United States of America

United States Patent and Trademark Office

## One Touch Teapot

**Reg. No. 4,125,497**

SCULATTI, SUZAN MARIE (UNITED STATES INDIVIDUAL)  
1335 MAIN STREET, STE. 106  
ST. HELENA, CA 94574

**Registered Apr. 10, 2012**

**Int. Cl.: 21**

FOR: TEA POTS, IN CLASS 21 (U.S. CLS. 2, 13, 23, 29, 30, 33, 40 AND 50).

**TRADEMARK**

FIRST USE 3-4-2011; IN COMMERCE 3-5-2011.

**PRINCIPAL REGISTER**

THE MARK CONSISTS OF STANDARD CHARACTERS WITHOUT CLAIM TO ANY PARTICULAR FONT, STYLE, SIZE, OR COLOR.

NO CLAIM IS MADE TO THE EXCLUSIVE RIGHT TO USE "TEAPOT", APART FROM THE MARK AS SHOWN.

SER. NO. 85-398,478, FILED 8-15-2011.

RAUL CORDOVA, EXAMINING ATTORNEY



*David J. Kyffers*

Director of the United States Patent and Trademark Office

# United States of America

United States Patent and Trademark Office

NABICA  
NATIONAL  
ASSOCIATION  
OF BLACK  
INVENTORS,  
COMPOSERS, &  
ARTIST

**Reg. No. 4,125,498**

**Registered Apr. 10, 2012**

**Int. Cl.: 35**

**SERVICE MARK**

**PRINCIPAL REGISTER**

WALKER, TROY A (UNITED STATES INDIVIDUAL), DBA NABICA  
P.O. BOX 2712  
SUISUN CITY, CA 94585

FOR: ASSOCIATION SERVICES, NAMELY, PROMOTING THE INTERESTS OF AFRICAN AMERICANS, E.G. AUTHORS, MUSICIANS, POETS, INVENTORS, ARTIST, IN CLASS 35 (U.S. CLS. 100, 101 AND 102).

FIRST USE 1-27-2010; IN COMMERCE 1-27-2010.

THE MARK CONSISTS OF STANDARD CHARACTERS WITHOUT CLAIM TO ANY PARTICULAR FONT, STYLE, SIZE, OR COLOR.

NO CLAIM IS MADE TO THE EXCLUSIVE RIGHT TO USE "NATIONAL ASSOCIATION OF BLACK INVENTORS, COMPOSERS, & ARTIST", APART FROM THE MARK AS SHOWN.

SER. NO. 85-398,546, FILED 8-15-2011.

LEIGH CAROLINE CASE, EXAMINING ATTORNEY



*David J. Kyros*

Director of the United States Patent and Trademark Office

# United States of America

United States Patent and Trademark Office

## CHATSWORTH

**Reg. No. 4,125,499**

**Registered Apr. 10, 2012**

**Int. Cl.: 30**

**TRADEMARK**

**PRINCIPAL REGISTER**

H. J. HEINZ COMPANY, L.P. (DELAWARE LIMITED PARTNERSHIP)  
357 SIXTH AVENUE  
PITTSBURGH, PA 15222

FOR: SALAD DRESSINGS, IN CLASS 30 (U.S. CL. 46).

FIRST USE 1-14-2010; IN COMMERCE 1-14-2010.

THE MARK CONSISTS OF STANDARD CHARACTERS WITHOUT CLAIM TO ANY PARTICULAR FONT, STYLE, SIZE, OR COLOR.

OWNER OF U.S. REG. NO. 1,707,006.

SER. NO. 85-398,679, FILED 8-16-2011.

INGRID C. EULIN, EXAMINING ATTORNEY



*David J. Kybas*

Director of the United States Patent and Trademark Office

# United States of America

United States Patent and Trademark Office

HOTCAM

**Reg. No. 4,125,500**

**Registered Apr. 10, 2012**

**Int. Cl.: 41**

**SERVICE MARK**

**PRINCIPAL REGISTER**

HOTCAM, INC. (NEW YORK CORPORATION)  
SUITE 740 & 750  
336 WEST 37TH STREET  
NEW YORK, NY 10018

FOR: FILM AND VIDEO PRODUCTION CONSULTING SERVICES; MEDIA PRODUCTION SERVICES, NAMELY, VIDEO AND FILM PRODUCTION; MOTION PICTURE AND VIDEO RENTAL SERVICES; MOTION PICTURE CAMERA RENTAL SERVICES; RENTAL OF AUDIO EQUIPMENT; RENTAL OF CAMERAS; RENTAL OF FACILITIES AND EQUIPMENT FOR THE PRODUCTION OF TELEVISION PROGRAMS; RENTAL OF STAGE AND MOVIE EQUIPMENT, NAMELY, CAMERA EQUIPMENT, LIGHTING EQUIPMENT AND GRIP EQUIPMENT; RENTAL OF VIDEO CAMERAS; RENTAL SERVICES FOR AUDIO AND VIDEO EQUIPMENT; TELEVISION, VIDEO AND MOVIE FILMING SERVICES, IN CLASS 41 (U.S. CLS. 100, 101 AND 107).

FIRST USE 7-2-1999; IN COMMERCE 4-3-2000.

THE MARK CONSISTS OF THE FIRST THREE LETTERS "H", "O", AND "T" ARE IN HOT PINK AND THE LAST THREE LETTERS "C", "A", AND "M" ARE IN NEON ORANGE.

THE COLOR(S) HOT PINK AND NEON ORANGE IS/ARE CLAIMED AS A FEATURE OF THE MARK.

SER. NO. 85-398,878, FILED 8-16-2011.

JEFFREY LOOK, EXAMINING ATTORNEY



*David J. Kyros*

Director of the United States Patent and Trademark Office

# United States of America

United States Patent and Trademark Office

## WISDOM IN FLIGHT

**Reg. No. 4,125,501**

**Registered Apr. 10, 2012**

**Int. Cl.: 45**

**SERVICE MARK**

**PRINCIPAL REGISTER**

SAPIENTIA LAW GROUP PLLC (MINNESOTA LIMITED LIABILITY COMPANY)  
SUITE 1242  
12 S. 6TH STREET  
MINNEAPOLIS, MN 55402

FOR: LEGAL SERVICES, IN CLASS 45 (U.S. CLS. 100 AND 101).

FIRST USE 3-15-2011; IN COMMERCE 3-15-2011.

THE MARK CONSISTS OF STANDARD CHARACTERS WITHOUT CLAIM TO ANY PARTICULAR FONT, STYLE, SIZE, OR COLOR.

SER. NO. 85-399,116, FILED 8-16-2011.

MARC LEIPZIG, EXAMINING ATTORNEY



*David J. Kybas*

Director of the United States Patent and Trademark Office

# United States of America

United States Patent and Trademark Office

SAPIENTIA  
LAW GROUP



**Reg. No. 4,125,502**

**Registered Apr. 10, 2012**

**Int. Cl.: 45**

**SERVICE MARK**

**PRINCIPAL REGISTER**

SAPIENTIA LAW GROUP PLLC (MINNESOTA LIMITED LIABILITY COMPANY)  
SUITE 1242  
12 S. 6TH STREET  
MINNEAPOLIS, MN 55402

FOR: LEGAL SERVICES, IN CLASS 45 (U.S. CLS. 100 AND 101).

FIRST USE 3-15-2011; IN COMMERCE 3-15-2011.

NO CLAIM IS MADE TO THE EXCLUSIVE RIGHT TO USE "LAW GROUP", APART FROM THE MARK AS SHOWN.

THE MARK CONSISTS OF A STYLIZED SPELLING OF "SAPIENTIA" FOLLOWED BY THE PHRASE "LAW GROUP" ALONG WITH A STYLIZED OWL IN FLIGHT.

THE ENGLISH TRANSLATION OF "SAPIENTIA" IN THE MARK IS "WISDOM".

SER. NO. 85-399,172, FILED 8-16-2011.

MARC LEIPZIG, EXAMINING ATTORNEY



*David J. Kyffers*

Director of the United States Patent and Trademark Office

# United States of America

United States Patent and Trademark Office



## SAPIENTIA LAW GROUP

**Reg. No. 4,125,503**

**Registered Apr. 10, 2012**

**Int. Cl.: 45**

**SERVICE MARK**

**PRINCIPAL REGISTER**

SAPIENTIA LAW GROUP PLLC (MINNESOTA LIMITED LIABILITY COMPANY)  
SUITE 1242  
12 S. 6TH STREET  
MINNEAPOLIS, MN 55402

FOR: LEGAL SERVICES, IN CLASS 45 (U.S. CLS. 100 AND 101).

FIRST USE 4-15-2011; IN COMMERCE 4-15-2011.

NO CLAIM IS MADE TO THE EXCLUSIVE RIGHT TO USE "LAW GROUP", APART FROM THE MARK AS SHOWN.

THE MARK CONSISTS OF A STYLIZED SPELLING OF "SAPIENTIA" OVER THE PHRASE "LAW GROUP" ALONG WITH A STYLIZED OWL IN FLIGHT.

THE ENGLISH TRANSLATION OF "SAPIENTIA" IN THE MARK IS "WISDOM".

SER. NO. 85-399,240, FILED 8-16-2011.

MARC LEIPZIG, EXAMINING ATTORNEY



*David J. Kybas*

Director of the United States Patent and Trademark Office

# United States of America

United States Patent and Trademark Office

## THIRSTY SQUARES

**Reg. No. 4,125,504**

EUROMARKET DESIGNS, INC. (ILLINOIS CORPORATION)  
1250 TECHNY ROAD  
NORTHBROOK, IL 60062

**Registered Apr. 10, 2012**

**Int. Cl.: 27**

FOR: FLOOR COVERINGS, NAMELY, DOORMATS, FLOOR RUNNERS, AND FLOOR MATS, NAMELY, STAIR TREAD MATS, IN CLASS 27 (U.S. CLS. 19, 20, 37, 42 AND 50).

**TRADEMARK**

FIRST USE 4-18-2011; IN COMMERCE 4-18-2011.

**PRINCIPAL REGISTER**

THE MARK CONSISTS OF STANDARD CHARACTERS WITHOUT CLAIM TO ANY PARTICULAR FONT, STYLE, SIZE, OR COLOR.

NO CLAIM IS MADE TO THE EXCLUSIVE RIGHT TO USE "SQUARES", APART FROM THE MARK AS SHOWN.

SER. NO. 85-399,501, FILED 8-16-2011.

LESLIE RICHARDS, EXAMINING ATTORNEY



*David J. Kyffers*

Director of the United States Patent and Trademark Office



# United States of America

United States Patent and Trademark Office

# RenuvaSkin

**Reg. No. 4,125,505**

HENKEMANS, TOM (UNITED STATES INDIVIDUAL)  
2442 23RD STREET NORTH  
ST. PETERSBURG, FL 33713

**Registered Apr. 10, 2012**

**Int. Cl.: 10**

FOR: ELECTRONIC LIGHT THERAPY APPARATUS FOR THE SKIN; LIGHT-BASED MEDICAL DEVICES, NAMELY, A LIGHT EMITTING DIODE (LED) DEVICE FOR INCREASING THE HUMAN BODY'S OWN PRODUCTION OF COLLAGEN, IN CLASS 10 (U.S. CLS. 26, 39 AND 44).

**TRADEMARK**

**PRINCIPAL REGISTER**

FIRST USE 3-1-2011; IN COMMERCE 3-1-2011.

THE MARK CONSISTS OF THE STYLIZED WORD "RENUVASKIN".

SER. NO. 85-399,608, FILED 8-16-2011.

JENNIFER DIXON, EXAMINING ATTORNEY



*David J. Kyffers*

Director of the United States Patent and Trademark Office

# United States of America

United States Patent and Trademark Office

## WE KEEP YOU COOKING!

**Reg. No. 4,125,506**

**Registered Apr. 10, 2012**

**Int. Cl.: 45**

**SERVICE MARK**

**PRINCIPAL REGISTER**

SAMIRO SERVICES, INC. (NEW YORK CORPORATION)  
2ND FLOOR  
47-25 34TH STREET  
LONG ISLAND CITY, NY 11101

FOR: FIRE PREVENTION CONSULTING SERVICES, IN CLASS 45 (U.S. CLS. 100 AND 101).

FIRST USE 12-0-1989; IN COMMERCE 12-0-1989.

THE MARK CONSISTS OF STANDARD CHARACTERS WITHOUT CLAIM TO ANY PARTICULAR FONT, STYLE, SIZE, OR COLOR.

SER. NO. 85-399,618, FILED 8-16-2011.

BRIAN NEVILLE, EXAMINING ATTORNEY



*David J. Kybas*

Director of the United States Patent and Trademark Office

# United States of America

United States Patent and Trademark Office

*Renuva Med*

**Reg. No. 4,125,507**

HENKEMANS, TOM (UNITED STATES INDIVIDUAL)  
2442 23RD STREET NORTH  
ST. PETERSBURG, FL 33713

**Registered Apr. 10, 2012**

**Int. Cl.: 10**

FOR: MASSAGE APPARATUS, IN CLASS 10 (U.S. CLS. 26, 39 AND 44).

**TRADEMARK**

FIRST USE 3-1-2011; IN COMMERCE 3-1-2011.

**PRINCIPAL REGISTER**

NO CLAIM IS MADE TO THE EXCLUSIVE RIGHT TO USE "MED" , APART FROM THE MARK AS SHOWN.

THE MARK CONSISTS OF THE STYLIZED WORDS "RENUVA MED" BELOW A SOLID WAVY LINE.

SER. NO. 85-399,635, FILED 8-16-2011.

JENNIFER DIXON, EXAMINING ATTORNEY



*David J. Kyffers*

Director of the United States Patent and Trademark Office

# United States of America

United States Patent and Trademark Office

## RL RADIANT-LITE

**Reg. No. 4,125,508**

TIBA INTERNATIONAL, INC. (FLORIDA CORPORATION)  
1550 N. CONGRESS AVE  
WEST PALM BEACH, FL 33409

**Registered Apr. 10, 2012**

**Int. Cl.: 11**

FOR: LIGHT BULBS; LIGHTING FIXTURES, IN CLASS 11 (U.S. CLS. 13, 21, 23, 31 AND 34).

**TRADEMARK**

FIRST USE 7-1-2011; IN COMMERCE 7-1-2011.

**PRINCIPAL REGISTER**

THE MARK CONSISTS OF STANDARD CHARACTERS WITHOUT CLAIM TO ANY PARTICULAR FONT, STYLE, SIZE, OR COLOR.

NO CLAIM IS MADE TO THE EXCLUSIVE RIGHT TO USE "RADIANT LIGHT", APART FROM THE MARK AS SHOWN.

SER. NO. 85-400,487, FILED 8-17-2011.

CHRISIE B. KING, EXAMINING ATTORNEY



*David J. Kybas*

Director of the United States Patent and Trademark Office

# United States of America

United States Patent and Trademark Office

## SOBIESKI CYNAMON

**Reg. No. 4,125,509**

**Registered Apr. 10, 2012**

**Int. Cl.: 33**

**TRADEMARK**

**PRINCIPAL REGISTER**

BELVEDERE S.A. (FRANCE CORPORATION)  
10 AVENUE CHARLES JAFFELIN  
21200 BEAUNE, FRANCE

FOR: CINNAMON FLAVORED VODKA, IN CLASS 33 (U.S. CLS. 47 AND 49).

FIRST USE 6-27-2011; IN COMMERCE 6-27-2011.

THE MARK CONSISTS OF STANDARD CHARACTERS WITHOUT CLAIM TO ANY PARTICULAR FONT, STYLE, SIZE, OR COLOR.

OWNER OF U.S. REG. NOS. 2,378,523, 3,576,360 AND OTHERS.

NO CLAIM IS MADE TO THE EXCLUSIVE RIGHT TO USE "CINNAMON", APART FROM THE MARK AS SHOWN.

THE ENGLISH TRANSLATION OF THE WORD "CYNAMON" IN THE MARK IS "CINNAMON".

SER. NO. 85-400,522, FILED 8-17-2011.

JAY BESCH, EXAMINING ATTORNEY



*David J. Kyros*

Director of the United States Patent and Trademark Office

# United States of America

United States Patent and Trademark Office

## SOBIESKI ORANGE

**Reg. No. 4,125,510**

BELVEDERE S.A. (FRANCE CORPORATION)  
10 AVENUE CHARLES JAFFELIN  
21200 BEAUNE, FRANCE

**Registered Apr. 10, 2012**

**Int. Cl.: 33**

FOR: ORANGE FLAVORED VODKA, IN CLASS 33 (U.S. CLS. 47 AND 49).

**TRADEMARK**

FIRST USE 7-7-2010; IN COMMERCE 7-7-2010.

**PRINCIPAL REGISTER**

THE MARK CONSISTS OF STANDARD CHARACTERS WITHOUT CLAIM TO ANY PARTICULAR FONT, STYLE, SIZE, OR COLOR.

OWNER OF U.S. REG. NOS. 2,378,523, 3,576,360 AND OTHERS.

NO CLAIM IS MADE TO THE EXCLUSIVE RIGHT TO USE "ORANGE", APART FROM THE MARK AS SHOWN.

SER. NO. 85-400,531, FILED 8-17-2011.

JAY BESCH, EXAMINING ATTORNEY



*David J. Kyffers*

Director of the United States Patent and Trademark Office

# United States of America

United States Patent and Trademark Office

## SOBIESKI RASPBERRY

**Reg. No. 4,125,511**

**Registered Apr. 10, 2012**

**Int. Cl.: 33**

**TRADEMARK**

**PRINCIPAL REGISTER**

BELVEDERE S.A. (FRANCE CORPORATION)  
10 AVENUE CHARLES JAFFELIN  
21200 BEAUNE, FRANCE

FOR: RASPBERRY FLAVORED VODKA, IN CLASS 33 (U.S. CLS. 47 AND 49).

FIRST USE 8-23-2010; IN COMMERCE 8-23-2010.

THE MARK CONSISTS OF STANDARD CHARACTERS WITHOUT CLAIM TO ANY PARTICULAR FONT, STYLE, SIZE, OR COLOR.

OWNER OF U.S. REG. NOS. 2,378,523, 3,576,360 AND OTHERS.

NO CLAIM IS MADE TO THE EXCLUSIVE RIGHT TO USE "RASPBERRY", APART FROM THE MARK AS SHOWN.

SER. NO. 85-400,539, FILED 8-17-2011.

JAY BESCH, EXAMINING ATTORNEY



*David J. Kybas*

Director of the United States Patent and Trademark Office

# United States of America

United States Patent and Trademark Office



**Reg. No. 4,125,512**

**Registered Apr. 10, 2012**

**Int. Cl.: 45**

**SERVICE MARK**

**PRINCIPAL REGISTER**

SAN DIEGO HOSPICE AND THE INSTITUTE FOR PALLIATIVE MEDICINE, CORPORATION  
(CALIFORNIA CORPORATION)  
4311 THIRD AVENUE  
SAN DIEGO, CA 92103

FOR: GRIEF COUNSELING; BEREAVEMENT CONSULTING; PROVIDING PERSONAL SUPPORT SERVICES FOR FAMILIES OF PATIENTS WITH LIFE THREATENING DISORDERS, NAMELY, COMPANIONSHIP, HELP WITH MEDICAL FORMS, EMOTIONAL COUNSELING AND EMOTIONAL SUPPORT, IN CLASS 45 (U.S. CLS. 100 AND 101).

FIRST USE 6-1-2011; IN COMMERCE 6-1-2011.

OWNER OF U.S. REG. NO. 4,048,710.

NO CLAIM IS MADE TO THE EXCLUSIVE RIGHT TO USE "GRIEF" AND "A FAMILY BEREAVEMENT PROGRAM", APART FROM THE MARK AS SHOWN.

THE MARK CONSISTS OF THE STYLIZED WORDS "GRIEF STREET" TO THE LEFT OF A STYLIZED DRAWING OF A STREET LIGHT ABOVE THE WORDS "A FAMILY BEREAVEMENT PROGRAM".

SER. NO. 85-400,788, FILED 8-17-2011.

LINDA MICKLEBURGH, EXAMINING ATTORNEY



*David J. Kybas*

Director of the United States Patent and Trademark Office



# United States of America

United States Patent and Trademark Office



**Reg. No. 4,125,513**

**Registered Apr. 10, 2012**

**Int. Cl.: 36**

**SERVICE MARK**

**PRINCIPAL REGISTER**

KUAPAY LLC (CALIFORNIA LIMITED LIABILITY COMPANY)  
201 WILSHIRE BLVD., 2ND FLOOR  
SANTA MONICA, CA 90401

FOR: FACILITATING POINT OF SALE FINANCIAL TRANSACTIONS VIA MOBILE PHONE AND A GLOBAL COMPUTER NETWORK, NAMELY, PROVIDING SECURE COMMERCIAL TRANSACTIONS AND PAYMENT OPTIONS USING A MOBILE DEVICE AT A POINT OF SALE; PROVIDING PAYMENT SERVICES TO CONSUMERS AND RETAILERS VIA MOBILE PHONE AND A GLOBAL COMPUTER NETWORK, NAMELY, BILL PAYMENT SERVICES, CREDIT CARD PAYMENT SERVICES AND DEBIT CARD PAYMENT SERVICES; TRANSMISSION OF BILLS, INVOICES AND PAYMENTS INVOLVING CREDIT CARDS, BANK CARDS, AND BANK ACCOUNTS VIA MOBILE PHONE AND A GLOBAL COMPUTER NETWORK, NAMELY, THE ELECTRONIC PROCESSING AND TRANSMISSION OF BILLS AND BILL PAYMENT DATA; PAYMENT PROCESSING SERVICES, NAMELY, CREDIT CARD AND DEBIT CARD TRANSACTION PROCESSING SERVICES, IN CLASS 36 (U.S. CLS. 100, 101 AND 102).

FIRST USE 9-9-2011; IN COMMERCE 9-9-2011.

THE MARK CONSISTS OF THE STYLIZED WORD "KUAPAY" AND A DESIGN OF A ROUNDED CORNER SQUARE WITH THE INITIAL "K" INSIDE. THE ROUNDED CORNER SQUARE APPEARS TO THE LEFT OF THE WORDING, AND CONSISTS OF THREE TRIANGULAR LIKE SHAPES IN BLUE, GIVING THE ILLUSION OF A LETTER "K" ON A BLUE BACKGROUND. TO THE RIGHT OF THE DESIGN, THE WORDING "KUAPAY" APPEARS IN LOWERCASE LETTERS, WITH "KUA" IN BLUE AND "PAY" IN BLACK.

THE COLOR(S) BLUE AND BLACK IS/ARE CLAIMED AS A FEATURE OF THE MARK.

THE ENGLISH TRANSLATION OF "KUA" IN THE MARK IS "MY".

SER. NO. 85-401,000, FILED 8-18-2011.

JERI J. FICKES, EXAMINING ATTORNEY



*David J. Kyffers*

Director of the United States Patent and Trademark Office

# United States of America

United States Patent and Trademark Office

## MCCOY'S BUILDING SUPPLY

**Reg. No. 4,125,514**

**Registered Apr. 10, 2012**

**Int. Cl.: 17**

**TRADEMARK**

**PRINCIPAL REGISTER**

MCCOY CORPORATION (TEXAS CORPORATION)  
P.O. BOX 1028  
SAN MARCOS, TX 78667

FOR: FILLING MATERIALS, NAMELY, ELASTOMERIC SILICONE AND LATEX GELS AND PASTES USED AS FILLING MATERIAL; INSULATING MATERIALS; SEALANTS FOR HOMES, BUILDINGS AND OTHER STRUCTURES; ACRYLIC BASED OR SILICONE BASED ADHESIVES, NAMELY, ADHESIVE TAPES, GELS, PASTES, SPRAYS AND LIQUIDS FOR COMMERCIAL AND INDUSTRIAL USE; CAULKING; CAULKING COMPOUNDS; ACRYLIC BASED SEALANTS AND ADHESIVES; WEATHER STRIPPING SEALANTS IN THE NATURE OF CAULK, IN CLASS 17 (U.S. CLS. 1, 5, 12, 13, 35 AND 50).

FIRST USE 5-1-1996; IN COMMERCE 5-1-1996.

THE MARK CONSISTS OF STANDARD CHARACTERS WITHOUT CLAIM TO ANY PARTICULAR FONT, STYLE, SIZE, OR COLOR.

OWNER OF U.S. REG. NOS. 2,078,503 AND 2,844,624.

NO CLAIM IS MADE TO THE EXCLUSIVE RIGHT TO USE "BUILDING SUPPLY", APART FROM THE MARK AS SHOWN.

SEC. 2(F).

SER. NO. 85-401,079, FILED 8-18-2011.

BERNICE MIDDLETON, EXAMINING ATTORNEY



*David J. Kyffers*

Director of the United States Patent and Trademark Office

# United States of America

United States Patent and Trademark Office

## MCCOY'S BUILDING SUPPLY

**Reg. No. 4,125,515**

**Registered Apr. 10, 2012**

**Int. Cl.: 21**

**TRADEMARK**

**PRINCIPAL REGISTER**

MCCOY CORPORATION (TEXAS CORPORATION)  
P.O. BOX 1028  
SAN MARCOS, TX 78667

FOR: BUCKETS; PLASTIC BUCKETS; PLASTIC PAINT BUCKETS; ALL-PURPOSE PORTABLE UTILITY BUCKETS; CONTAINERS FOR HOUSEHOLD USE, IN CLASS 21 (U.S. CLS. 2, 13, 23, 29, 30, 33, 40 AND 50).

FIRST USE 12-15-2002; IN COMMERCE 12-15-2002.

THE MARK CONSISTS OF STANDARD CHARACTERS WITHOUT CLAIM TO ANY PARTICULAR FONT, STYLE, SIZE, OR COLOR.

OWNER OF U.S. REG. NOS. 2,078,503 AND 2,844,624.

NO CLAIM IS MADE TO THE EXCLUSIVE RIGHT TO USE "BUILDING SUPPLY", APART FROM THE MARK AS SHOWN.

SEC. 2(F).

SER. NO. 85-401,109, FILED 8-18-2011.

BERNICE MIDDLETON, EXAMINING ATTORNEY



*David J. Kybas*

Director of the United States Patent and Trademark Office

# United States of America

United States Patent and Trademark Office

## MCCOY'S BUILDING SUPPLY

**Reg. No. 4,125,516**

MCCOY CORPORATION (TEXAS CORPORATION)

**Registered Apr. 10, 2012**

P.O. BOX 1028  
SAN MARCOS, TX 78667

**Int. Cl.: 31**

FOR: WOOD CHIPS FOR USE AS GROUND COVER; WOOD SHAVINGS FOR ANIMAL BEDDING, IN CLASS 31 (U.S. CLS. 1 AND 46).

**TRADEMARK**

FIRST USE 8-1-2008; IN COMMERCE 8-1-2008.

**PRINCIPAL REGISTER**

THE MARK CONSISTS OF STANDARD CHARACTERS WITHOUT CLAIM TO ANY PARTICULAR FONT, STYLE, SIZE, OR COLOR.

OWNER OF U.S. REG. NOS. 2,078,503 AND 2,844,624.

SEC. 2(F).

SER. NO. 85-401,159, FILED 8-18-2011.

BERNICE MIDDLETON, EXAMINING ATTORNEY



*David J. Kyffers*

Director of the United States Patent and Trademark Office

# United States of America

United States Patent and Trademark Office

## COMPETITIVE EDGE PROTECTION

**Reg. No. 4,125,517**

**Registered Apr. 10, 2012**

**Int. Cl.: 36**

PCH INSURANCE SERVICES, INC. (CALIFORNIA CORPORATION), DBA COMPETITIVE  
EDGE PROTECTION

D-8  
245 FISCHER AVE.  
COSTA MESA, CA 92626

**SERVICE MARK**

**PRINCIPAL REGISTER**

FOR: INSURANCE AGENCIES; INSURANCE AGENCIES IN THE FIELD OF AUTOMOBILE  
DAMAGE COVERAGE FOR HMSA MEMBERS WHILE IN THE ACT OF RACING HISTORIC  
OR CLASSIC CARS AT HMSA SANCTIONED EVENTS; DESIGN AND DEVELOPMENT OF  
INSURANCE POLICIES FOR OTHERS; INSURANCE SERVICES, NAMELY, WRITING  
PROPERTY AND CASUALTY INSURANCE, IN CLASS 36 (U.S. CLS. 100, 101 AND 102).

FIRST USE 2-28-2011; IN COMMERCE 2-28-2011.

THE MARK CONSISTS OF STANDARD CHARACTERS WITHOUT CLAIM TO ANY PAR-  
TICULAR FONT, STYLE, SIZE, OR COLOR.

NO CLAIM IS MADE TO THE EXCLUSIVE RIGHT TO USE "PROTECTION", APART FROM  
THE MARK AS SHOWN.

SER. NO. 85-401,213, FILED 8-18-2011.

KELLY CHOE, EXAMINING ATTORNEY



*David J. Kyffers*

Director of the United States Patent and Trademark Office

# United States of America

United States Patent and Trademark Office

# The Ruckus

**Reg. No. 4,125,518**

**Registered Apr. 10, 2012**

**Int. Cl.: 42**

**SERVICE MARK**

**PRINCIPAL REGISTER**

RUCKUS REVOLUTION, LLC (NEW YORK LIMITED LIABILITY COMPANY)  
C/O ROGER A. PLIAKAS, ESQ., APC  
9720 WILSHIRE BLVD., STE. 700  
BEVERLY HILLS, CA 90212

FOR: PROVIDING A WEBSITE FEATURING TECHNOLOGY THAT ENABLES USERS TO UPLOAD AND SHARE USER-GENERATED COMEDY VIDEOS, PHOTOS AND TEXT FOR THE PURPOSE OF ENTERTAINMENT, AND TO CONNECT WITH LIKE-MINDED USERS, IN CLASS 42 (U.S. CLS. 100 AND 101).

FIRST USE 8-8-2011; IN COMMERCE 8-8-2011.

THE MARK CONSISTS OF STANDARD CHARACTERS WITHOUT CLAIM TO ANY PARTICULAR FONT, STYLE, SIZE, OR COLOR.

SER. NO. 85-401,649, FILED 8-18-2011.

NICHOLAS ALTREE, EXAMINING ATTORNEY



*David J. Kybas*

Director of the United States Patent and Trademark Office

United States of America  
United States Patent and Trademark Office

潔宮寶  
Female One

**Reg. No. 4,125,519**

USA FAR OCEAN GROUP, INC. (CALIFORNIA CORPORATION)  
1069 W. VALLEY BLVD., SUITE 338  
ALHAMBRA, CA 91803

**Registered Apr. 10, 2012**

**Int. Cl.: 5**

FOR: HERBAL SUPPLEMENTS, IN CLASS 5 (U.S. CLS. 6, 18, 44, 46, 51 AND 52).

**TRADEMARK**

FIRST USE 0-0-2005; IN COMMERCE 0-0-2005.

**PRINCIPAL REGISTER**

NO CLAIM IS MADE TO THE EXCLUSIVE RIGHT TO USE "FEMALE" AND THE NON-LATIN CHARACTERS THAT TRANSLITERATE TO "JIE GONG", APART FROM THE MARK AS SHOWN.

THE NON-LATIN CHARACTERS IN THE MARK TRANSLITERATE TO "JIE GONG BAO", AND THIS MEANS "UTERUS TREASURE" IN ENGLISH.

THE MARK CONSISTS OF THE STYLIZED WORDINGS "FEMALE ONE" AND THREE STYLIZED CHINESE CHARACTERS.

SER. NO. 85-401,952, FILED 8-19-2011.

WENDY JUN, EXAMINING ATTORNEY



David J. Kyros

Director of the United States Patent and Trademark Office

# United States of America

United States Patent and Trademark Office

# 前列神通

**Reg. No. 4,125,520**

USA FAR OCEAN GROUP, INC. (CALIFORNIA CORPORATION)  
1069 W. VALLEY BLVD., SUITE 338  
ALHAMBRA, CA 91803

**Registered Apr. 10, 2012**

**Int. Cl.: 5**

FOR: HERBAL SUPPLEMENTS, IN CLASS 5 (U.S. CLS. 6, 18, 44, 46, 51 AND 52).

**TRADEMARK**

FIRST USE 6-0-2008; IN COMMERCE 6-0-2008.

**PRINCIPAL REGISTER**

THE MARK CONSISTS OF FOUR CHINESE CHARACTERS.

THE NON-LATIN CHARACTERS IN THE MARK TRANSLITERATE TO "QIAN LIE SHEN TONG", AND THIS MEANS "FOREFRONT SUPERNATURAL" IN ENGLISH.

SER. NO. 85-402,005, FILED 8-19-2011.

WENDY JUN, EXAMINING ATTORNEY



*David J. Kybas*

Director of the United States Patent and Trademark Office



# United States of America

United States Patent and Trademark Office

**XTREME NETWORKING. XPECT THE UNEXPECTED.**

**Reg. No. 4,125,521**

CONSULTNETWORK, LLC (NEW JERSEY LIMITED LIABILITY COMPANY)  
5 OVERLOOK TERRACE  
CHESTER, NJ 07930

**Registered Apr. 10, 2012**

**Int. Cl.: 35**

FOR: ARRANGING AND CONDUCTING BUSINESS CONFERENCES; ARRANGING AND CONDUCTING SPECIAL EVENTS FOR BUSINESS PURPOSES; BUSINESS MEETING PLANNING, IN CLASS 35 (U.S. CLS. 100, 101 AND 102).

**SERVICE MARK**

FIRST USE 5-1-2008; IN COMMERCE 5-1-2008.

**PRINCIPAL REGISTER**

THE MARK CONSISTS OF THE WORDS "XTREME NETWORKING" WITH THE "X" IN THE COLOR RED AND ALL OTHER LETTERS IN THE COLOR BLACK FOLLOWED BY A PERIOD IN THE COLOR BLACK, AND THE WORDS "XPECT THE UNEXPECTED" WITH THE "X"S IN THE COLOR RED AND ALL OTHER LETTERS IN THE COLOR BLACK FOLLOWED BY A PERIOD IN THE COLOR BLACK.

THE COLOR(S) RED AND BLACK IS/ARE CLAIMED AS A FEATURE OF THE MARK.

SER. NO. 85-402,382, FILED 8-19-2011.

GRETTA YAO, EXAMINING ATTORNEY



*David J. Kyffers*

Director of the United States Patent and Trademark Office

# United States of America

United States Patent and Trademark Office



**Reg. No. 4,125,522**

**Registered Apr. 10, 2012**

**Int. Cl.: 9**

**TRADEMARK**

**PRINCIPAL REGISTER**

FINNIS, RICARDO (UNITED STATES INDIVIDUAL)  
4280 REFLECTIONS BLVD  
SUITE 202  
SUNRISE, FL 33351

FOR: DIGITAL MATERIALS, NAMELY, DVDS AND CDS FEATURING A REALITY DJ TELEVISION SHOW; DIGITAL MEDIA, NAMELY, PRE-RECORDED DVDS, DOWNLOADABLE AUDIO AND VIDEO RECORDINGS, AND CDS FEATURING A REALITY DJ TELEVISION SHOW; DIGITAL MEDIA, NAMELY, PRE-RECORDED VIDEO CASSETTES, DIGITAL VIDEO DISCS, DIGITAL VERSATILE DISCS, DOWNLOADABLE AUDIO AND VIDEO RECORDINGS, DVDS, AND HIGH DEFINITION DIGITAL DISCS FEATURING A REALITY DJ TELEVISION SHOW; DIGITAL MEDIA, NAMELY, PRE-RECORDED AUDIO RECORDINGS FEATURING MUSIC, IN CLASS 9 (U.S. CLS. 21, 23, 26, 36 AND 38).

FIRST USE 2-15-2009; IN COMMERCE 2-15-2009.

THE MARK CONSISTS OF THE WORDING "PARTY ROCKA". THE WORD "PARTY" IS IN RED OUTLINED IN BLUE WITH YELLOW AND ORANGE SPECKS THROUGHOUT. UNDERNEATH "PARTY" IS THE WORD "ROCKA" IN GRAY OUTLINED IN BLUE, WITH WHITE AND PURPLE SPECKS. TO THE LEFT OF THE WORDING IS THE BLACK AND WHITE SILHOUETTE OF A DJ WITH HIS HAND ON TOP OF A BLUE AND BLACK RECORD.

THE COLOR(S) RED, WHITE, BLUE, BLACK, ORANGE, YELLOW, PURPLE, IS/ARE CLAIMED AS A FEATURE OF THE MARK.

SER. NO. 85-403,040, FILED 8-20-2011.

TARAH HARDY, EXAMINING ATTORNEY



*David J. Kybas*

Director of the United States Patent and Trademark Office

# United States of America

United States Patent and Trademark Office

## Recycling On The Go!

**Reg. No. 4,125,523**

**Registered Apr. 10, 2012**

**Int. Cl.: 35**

GREEN RECYCLING ENTERPIRSES, LLC (NEBRASKA LIMITED LIABILITY COMPANY),  
DBA SECOND NATURE MEDIA  
SUITE 400  
13505 A STREET  
OMAHA, NE 68144

**SERVICE MARK**

**PRINCIPAL REGISTER**

FOR: ADVERTISING AGENCIES; ADVERTISING AGENCIES, NAMELY, PROMOTING THE GOODS AND SERVICES OF OTHERS; ADVERTISING AND MARKETING; ADVERTISING AND MARKETING SERVICES, NAMELY, PROMOTING THE GOODS AND SERVICES OF OTHERS; ADVERTISING AND PROMOTIONAL SERVICES; ADVERTISING AND PUBLICITY SERVICES; ADVERTISING AND PUBLICITY SERVICES, NAMELY, PROMOTING THE GOODS, SERVICES, BRAND IDENTITY AND COMMERCIAL INFORMATION AND NEWS OF THIRD PARTIES THROUGH PRINT, AUDIO, VIDEO, DIGITAL AND ON-LINE MEDIUM; ADVERTISING SERVICES, NAMELY, PROMOTING AND MARKETING THE GOODS AND SERVICES OF OTHERS IN THE FIELD OF PUBLIC RECYCLING VIA PRINT AND ELECTRONIC MEDIA; ADVERTISING, INCLUDING PROMOTION OF PRODUCTS AND SERVICES OF THIRD PARTIES THROUGH SPONSORING ARRANGEMENTS AND LICENCE AGREEMENTS RELATING TO INTERNATIONAL SPORTS' EVENTS; ADVERTISING, MARKETING AND PROMOTION SERVICES; ARRANGING AND CONDUCTING OF FAIRS AND EXHIBITIONS FOR BUSINESS AND ADVERTISING PURPOSES; ARRANGING AND CONDUCTING SPECIAL EVENTS FOR COMMERCIAL, PROMOTIONAL OR ADVERTISING PURPOSES; BANNER ADVERTISING, IN CLASS 35 (U.S. CLS. 100, 101 AND 102).

FIRST USE 8-1-2010; IN COMMERCE 8-1-2010.

THE MARK CONSISTS OF STANDARD CHARACTERS WITHOUT CLAIM TO ANY PARTICULAR FONT, STYLE, SIZE, OR COLOR.

NO CLAIM IS MADE TO THE EXCLUSIVE RIGHT TO USE "RECYCLING", APART FROM THE MARK AS SHOWN.

SER. NO. 85-403,076, FILED 8-20-2011.

DAVID MURRAY, EXAMINING ATTORNEY



*David J. Kyffers*

Director of the United States Patent and Trademark Office

# United States of America

United States Patent and Trademark Office

# Flower Flops

**Reg. No. 4,125,524**

RUTH SPECTOR (UNITED STATES INDIVIDUAL)  
21 FOX HUNT LANE  
LAKE SUCCESS, NY 11020

**Registered Apr. 10, 2012**

**Int. Cl.: 25**

FOR: FLIP FLOPS, IN CLASS 25 (U.S. CLS. 22 AND 39).

**TRADEMARK**

FIRST USE 3-11-2011; IN COMMERCE 3-11-2011.

**PRINCIPAL REGISTER**

THE MARK CONSISTS OF STANDARD CHARACTERS WITHOUT CLAIM TO ANY PARTICULAR FONT, STYLE, SIZE, OR COLOR.

NO CLAIM IS MADE TO THE EXCLUSIVE RIGHT TO USE "FLOPS", APART FROM THE MARK AS SHOWN.

SER. NO. 85-403,177, FILED 8-21-2011.

ARETHA SOMERVILLE, EXAMINING ATTORNEY



*David J. Kyffers*

Director of the United States Patent and Trademark Office

# United States of America

United States Patent and Trademark Office



**Reg. No. 4,125,525**

SELECT ONION (OREGON LIMITED LIABILITY COMPANY)  
602 STANTON BLVD.  
ONTARIO, OR 97914

**Registered Apr. 10, 2012**

**Int. Cl.: 29**

FOR: APPETIZERS, NAMELY, BREADED ONION RINGS, BREADED VEGETABLES AND BREADED CHEESE, IN CLASS 29 (U.S. CL. 46).

**TRADEMARK**

FIRST USE 7-20-2011; IN COMMERCE 7-25-2011.

**PRINCIPAL REGISTER**

NO CLAIM IS MADE TO THE EXCLUSIVE RIGHT TO USE "APPETIZERS", APART FROM THE MARK AS SHOWN.

THE MARK CONSISTS OF THE STYLIZED TEXT "SELECT" ABOVE THE STYLIZED TEXT "APPETIZERS" WHICH APPEARS DIAGONALLY. UNDER "APPETIZERS" IS A BOX CONTAINING THE STYLIZED TEXT "THE TASTE OF QUALITY".

SER. NO. 85-403,343, FILED 8-22-2011.

ALEXANDER L. POWERS, EXAMINING ATTORNEY



*David J. Kyffers*

Director of the United States Patent and Trademark Office

# United States of America

United States Patent and Trademark Office

# VTCloud

**Reg. No. 4,125,526**

**Registered Apr. 10, 2012**

**Int. Cls.: 38 and 42**

**SERVICE MARK**

**PRINCIPAL REGISTER**

GKR SYSTEMS, INC. (MISSISSIPPI CORPORATION), DBA VENTURE TECHNOLOGIES  
860 CENTRE STREET  
RIDGELAND, MS 39157

FOR: PROVIDING CO-LOCATION SERVICES FOR VOICE, VIDEO AND DATA COMMUNICATIONS APPLICATIONS; TELEPHONY COMMUNICATION SERVICES; VOICE OVER INTERNET PROTOCOL (VOIP) SERVICES, IN CLASS 38 (U.S. CLS. 100, 101 AND 104).

FIRST USE 11-2-2011; IN COMMERCE 11-2-2011.

FOR: COMPUTER CO-LOCATION SERVICES, NAMELY, PROVIDING FACILITIES FOR THE LOCATION OF COMPUTER SERVERS WITH THE EQUIPMENT OF OTHERS; COMPUTER SECURITY CONSULTANCY IN THE FIELD OF SCANNING AND PENETRATION TESTING OF COMPUTERS AND NETWORKS TO ASSESS INFORMATION SECURITY VULNERABILITY; COMPUTER SECURITY SERVICE, NAMELY, RESTRICTING ACCESS TO AND BY COMPUTER NETWORKS TO AND OF UNDESIRE WEB SITES, MEDIA AND INDIVIDUALS AND FACILITIES; COMPUTER SERVICES, NAMELY, CLOUD HOSTING PROVIDER SERVICES; COMPUTER SERVICES, NAMELY, INTEGRATION OF PRIVATE AND PUBLIC CLOUD COMPUTING ENVIRONMENTS; COMPUTER SERVICES, NAMELY, PROVIDING VIRTUAL AND NON VIRTUAL SERVERS TO OTHERS; CONSULTING SERVICES IN THE FIELD OF HOSTING COMPUTER SOFTWARE APPLICATIONS; DEVELOPING AND IMPLEMENTING CUSTOMIZED PLANS FOR IMPROVING COMPUTER SECURITY AND PREVENTING CRIMINAL ACTIVITY FOR BUSINESSES AND GOVERNMENTAL AGENCIES; DEVELOPMENT OF SECURITY SYSTEMS AND CONTINGENCY PLANNING FOR INFORMATION SYSTEMS; HOSTING THE SOFTWARE, WEBSITES AND OTHER COMPUTER APPLICATIONS OF OTHERS ON A VIRTUAL PRIVATE SERVER; PROVIDING VIRTUAL COMPUTER SYSTEMS AND VIRTUAL COMPUTER ENVIRONMENTS THROUGH CLOUD COMPUTING; REMOTE COMPUTER BACKUP SERVICES; REMOTE ONLINE BACKUP OF COMPUTER DATA; TECHNICAL CONSULTING SERVICES IN THE FIELDS OF DATACENTER ARCHITECTURE, PUBLIC AND PRIVATE CLOUD COMPUTING SOLUTIONS, AND EVALUATION AND IMPLEMENTATION OF INTERNET TECHNOLOGY AND SERVICES; TECHNICAL SUPPORT SERVICES, NAMELY, REMOTE AND ON-SITE INFRASTRUCTURE MANAGEMENT SERVICES FOR MONITORING, ADMINISTRATION AND MANAGEMENT OF PUBLIC AND PRIVATE CLOUD COMPUTING IT AND APPLICATION SYSTEMS, IN CLASS 42 (U.S. CLS. 100 AND 101).



*David J. Kyffers*

Director of the United States Patent and Trademark Office

FIRST USE 11-2-2011; IN COMMERCE 11-2-2011.

**Reg. No. 4,125,526** THE MARK CONSISTS OF STANDARD CHARACTERS WITHOUT CLAIM TO ANY PARTICULAR FONT, STYLE, SIZE, OR COLOR.

SER. NO. 85-403,832, FILED 8-22-2011.

SHAILA SETTLES, EXAMINING ATTORNEY

# United States of America

United States Patent and Trademark Office



**Reg. No. 4,125,527**

**Registered Apr. 10, 2012**

**Int. Cls.: 29 and 30**

**TRADEMARK**

**PRINCIPAL REGISTER**

CALIFORNIA CUSTOM FRUITS AND FLAVORS, INC. (CALIFORNIA CORPORATION),  
DBA CALIFORNIA CUSTOM FRUITS AND FLAVORS, INC.  
15800 TAPIA STREET  
IRWINDALE, CA 91706

FOR: PROCESSED FRUITS, IN CLASS 29 (U.S. CL. 46).

FIRST USE 3-19-2007; IN COMMERCE 3-1-2010.

FOR: FLAVOR ENHANCERS USED IN FOOD AND BEVERAGE PRODUCTS, IN CLASS 30  
(U.S. CL. 46).

FIRST USE 3-17-2007; IN COMMERCE 3-1-2010.

OWNER OF U.S. REG. NO. 3,439,133.

THE COLOR(S) RED, BLUE, GREEN, BLACK, SILVER(GRAY) IS/ARE CLAIMED AS A  
FEATURE OF THE MARK.

NO CLAIM IS MADE TO THE EXCLUSIVE RIGHT TO USE "CALIFORNIA CUSTOM FRUITS  
& FLAVORS", APART FROM THE MARK AS SHOWN.

THE MARK CONSISTS OF A SMILING RED STRAWBERRY OUTLINED IN BLACK WITH  
GREEN LEAVES ON TOP AND GREEN ARMS HOLDING A BLUE FLASK IN ONE HAND  
AND A SILVER (GRAY) SPOON IN THE OTHER HAND, ALSO OUTLINED IN BLACK. THE  
WORDING "CALIFORNIA CUSTOM" IN BLACK OVER THE WORDING "FRUITS & FLA-  
VORS" IN BLUE, ALL TO THE LEFT OF THE DESIGN. THE WHITE IN THE EYES IS NOT  
BEING CLAIMED AS A COLOR IN MARK AS IT REPRESENTS BACKGROUND.

SER. NO. 85-403,862, FILED 8-22-2011.

CHERYL CLAYTON, EXAMINING ATTORNEY



*David J. Kyjars*

Director of the United States Patent and Trademark Office



# United States of America

United States Patent and Trademark Office



**Reg. No. 4,125,528**

**Registered Apr. 10, 2012**

**Int. Cl.: 36**

**SERVICE MARK**

**PRINCIPAL REGISTER**

JAMES RIVER GROUP, INC. (DELAWARE CORPORATION)  
SUITE #33  
300 MEADOWMONT VILLAGE CIRCLE  
CHAPEL HILL, NC 27517

FOR: INSURANCE UNDERWRITING IN THE FIELDS OF PROPERTY, CASUALTY, HEALTHCARE AND PROFESSIONAL LIABILITY INSURANCE, IN CLASS 36 (U.S. CLS. 100, 101 AND 102).

FIRST USE 7-1-2003; IN COMMERCE 7-1-2003.

THE MARK CONSISTS OF A BLUE CURVED LINE ABOVE A GREY CURVED LINE.

THE COLOR(S) BLUE AND GREY IS/ARE CLAIMED AS A FEATURE OF THE MARK.

SER. NO. 85-403,883, FILED 8-22-2011.

KELLY BOULTON, EXAMINING ATTORNEY



*David J. Kybas*

Director of the United States Patent and Trademark Office

# United States of America

United States Patent and Trademark Office

## WALLABY ORGANIC

**Reg. No. 4,125,529**

**Registered Apr. 10, 2012**

**Int. Cl.: 29**

**TRADEMARK**

**PRINCIPAL REGISTER**

WALLABY YOGURT COMPANY, INC. (CALIFORNIA CORPORATION)  
110 B MEZZETTA COURT  
AMERICAN CANYON, CA 94503

FOR: ORGANIC SOUR CREAM; AND ORGANIC YOGURTS, IN CLASS 29 (U.S. CL. 46).

FIRST USE 1-1-2004; IN COMMERCE 1-1-2004.

THE MARK CONSISTS OF STANDARD CHARACTERS WITHOUT CLAIM TO ANY PARTICULAR FONT, STYLE, SIZE, OR COLOR.

OWNER OF U.S. REG. NOS. 2,509,712, 3,381,589, AND 4,039,861.

NO CLAIM IS MADE TO THE EXCLUSIVE RIGHT TO USE "ORGANIC", APART FROM THE MARK AS SHOWN.

SER. NO. 85-404,160, FILED 8-22-2011.

ALEXANDER L. POWERS, EXAMINING ATTORNEY



*David J. Kyffers*

Director of the United States Patent and Trademark Office

# United States of America

United States Patent and Trademark Office

## P.O. & FRIENDS BOWLING LEAGUE

**Reg. No. 4,125,530**

PFAFF, RICHARD (UNITED STATES INDIVIDUAL)  
735 N NORA AVE  
WEST COVINA, CA 91790

**Registered Apr. 10, 2012**

**Int. Cl.: 41**

FOR: ENTERTAINMENT SERVICES, NAMELY, THE ORGANIZING AND CONDUCTING OF A BOWLING LEAGUE, IN CLASS 41 (U.S. CLS. 100, 101 AND 107).

**SERVICE MARK**

FIRST USE 5-0-1965; IN COMMERCE 5-0-1965.

**PRINCIPAL REGISTER**

THE MARK CONSISTS OF STANDARD CHARACTERS WITHOUT CLAIM TO ANY PARTICULAR FONT, STYLE, SIZE, OR COLOR.

NO CLAIM IS MADE TO THE EXCLUSIVE RIGHT TO USE "BOWLING LEAGUE", APART FROM THE MARK AS SHOWN.

SER. NO. 85-404,249, FILED 8-22-2011.

LINDA POWELL, EXAMINING ATTORNEY



*David J. Kyffers*

Director of the United States Patent and Trademark Office

United States of America  
United States Patent and Trademark Office

novatech  
INTERNATIONAL

**Reg. No. 4,125,531**

**Registered Apr. 10, 2012**

**Int. Cl.: 1**

**TRADEMARK**

**PRINCIPAL REGISTER**

NOVA-TECH INTERNATIONAL, INC (TEXAS CORPORATION)  
800 ROCKMEAD DR STE 102  
KINGWOOD, TX 773392496

FOR: CHEMICAL TEST KITS FOR USE IN ANALYZING WATER QUALITY, NAMELY, REAGENTS, VISUAL COLOR STANDARDS, COLORMETRIC INSTRUMENTS, CALIBRATED SAMPLE CONTAINERS, CALCULATION DEVICES FOR DETERMINING WATER BALANCE AND TREATMENT CHEMICAL DOSAGES, CHEMICALS FOR THE CALIBRATION OF WATER TESTING INSTRUMENTS FOR LABORATORY OR RESEARCH USE, IN CLASS 1 (U.S. CLS. 1, 5, 6, 10, 26 AND 46).

FIRST USE 2-12-2010; IN COMMERCE 5-12-2010.

NO CLAIM IS MADE TO THE EXCLUSIVE RIGHT TO USE "INTERNATIONAL", APART FROM THE MARK AS SHOWN.

THE MARK CONSISTS OF A STYLIZED TEXT "NOVATECH" WITH CIRCUIT BOARD SYMBOLS AND TEXT "INTERNATIONAL".

SER. NO. 85-404,611, FILED 8-23-2011.

SAMUEL E. SHARPER JR., EXAMINING ATTORNEY



*David J. Kyffers*

Director of the United States Patent and Trademark Office

# United States of America

United States Patent and Trademark Office

Restoring Hope. Renewing  
Lives.

**Reg. No. 4,125,532**

HAVEN HOUSE (PENNSYLVANIA CORPORATION)  
1530 HANOVER AVENUE  
ALLENTOWN, PA 18109

**Registered Apr. 10, 2012**

**Int. Cl.: 44**

FOR: CLINICAL MENTAL HEALTH COUNSELING SERVICES, IN CLASS 44 (U.S. CLS. 100 AND 101).

**SERVICE MARK**

FIRST USE 8-25-2011; IN COMMERCE 8-25-2011.

**PRINCIPAL REGISTER**

THE MARK CONSISTS OF STANDARD CHARACTERS WITHOUT CLAIM TO ANY PARTICULAR FONT, STYLE, SIZE, OR COLOR.

SER. NO. 85-404,696, FILED 8-23-2011.

ZHALEH DELANEY, EXAMINING ATTORNEY



*David J. Kybas*

Director of the United States Patent and Trademark Office

# United States of America

United States Patent and Trademark Office

# XMOUNT

**Reg. No. 4,125,533**

**Registered Apr. 10, 2012**

**Int. Cl.: 6**

**TRADEMARK**

**PRINCIPAL REGISTER**

FITNESS ANYWHERE LLC (DELAWARE LIMITED LIABILITY COMPANY), DBA FITNESS ANYWHERE LLC  
755 SANSOME ST, STE 600  
SAN FRANCISCO, CA 94111

FOR: HARDWARE MOUNTING SYSTEMS FOR USE WITH EXERCISE TRAINING EQUIPMENT COMPRISED OF A STEEL PLATE, LAG SCREWS AND ANCHORS FOR ATTACHMENT TO WALLS, VERTICAL STUDS AND SECURE OVERHEAD BEAMS, IN CLASS 6 (U.S. CLS. 2, 12, 13, 14, 23, 25 AND 50).

FIRST USE 12-8-2008; IN COMMERCE 12-8-2008.

THE MARK CONSISTS OF STANDARD CHARACTERS WITHOUT CLAIM TO ANY PARTICULAR FONT, STYLE, SIZE, OR COLOR.

SER. NO. 85-404,701, FILED 8-23-2011.

ALEXANDER L. POWERS, EXAMINING ATTORNEY



*David J. Kyffers*

Director of the United States Patent and Trademark Office

# United States of America

United States Patent and Trademark Office

# RAN3

**Reg. No. 4,125,534**

SAFE TV SHOP, LLC (NORTH CAROLINA LIMITED LIABILITY COMPANY)  
520 ELLIOT STREET  
CHARLOTTE, NC 28202

**Registered Apr. 10, 2012**

**Int. Cl.: 9**

FOR: ADHESIVE SHIELD THAT NEUTRALIZES UNWANTED MOBILE PHONE RADIATION,  
IN CLASS 9 (U.S. CLS. 21, 23, 26, 36 AND 38).

**TRADEMARK**

FIRST USE 8-22-2011; IN COMMERCE 8-22-2011.

**PRINCIPAL REGISTER**

THE MARK CONSISTS OF STANDARD CHARACTERS WITHOUT CLAIM TO ANY PARTICULAR FONT, STYLE, SIZE, OR COLOR.

SER. NO. 85-404,744, FILED 8-23-2011.

MICHELLE DUBOIS, EXAMINING ATTORNEY



*David J. Kybas*

Director of the United States Patent and Trademark Office

# United States of America

United States Patent and Trademark Office

## YOUTHLAND ACADEMY

**Reg. No. 4,125,535**

**Registered Apr. 10, 2012**

**Int. Cl.: 43**

**SERVICE MARK**

**PRINCIPAL REGISTER**

YOUTHLAND ACADEMY, INC. (OHIO CORPORATION)  
9352 MAIN STREET  
CINCINNATI, OH 45242

FOR: DAY CARE CENTERS; DAY-CARE CENTRES; NURSERIES AND DAY CARE CENTERS; PRESCHOOLER AND INFANT CARE AT DAYCARE CENTERS, IN CLASS 43 (U.S. CLS. 100 AND 101).

FIRST USE 7-31-1986; IN COMMERCE 7-31-1986.

THE MARK CONSISTS OF STANDARD CHARACTERS WITHOUT CLAIM TO ANY PARTICULAR FONT, STYLE, SIZE, OR COLOR.

OWNER OF U.S. REG. NO. 1,572,333.

NO CLAIM IS MADE TO THE EXCLUSIVE RIGHT TO USE "ACADEMY", APART FROM THE MARK AS SHOWN.

SER. NO. 85-404,863, FILED 8-23-2011.

LUCY ARANT, EXAMINING ATTORNEY



*David J. Kyfos*

Director of the United States Patent and Trademark Office



# United States of America

United States Patent and Trademark Office



**Reg. No. 4,125,536**

**Registered Apr. 10, 2012**

**Int. Cl.: 12**

**TRADEMARK**

**PRINCIPAL REGISTER**

METAL FORMS CORPORATION (WISCONSIN CORPORATION)  
3334 N. BOOTH STREET  
MILWAUKEE, WI 53212

FOR: HAND-DRIVEN VEHICLES, NAMELY, WHEELBARROWS, CONSTRUCTION CARTS, AND WHEELED MORTAR TUBS IN THE NATURE OF CARTS FOR HAULING MORTAR, IN CLASS 12 (U.S. CLS. 19, 21, 23, 31, 35 AND 44).

FIRST USE 3-7-2011; IN COMMERCE 3-7-2011.

OWNER OF U.S. REG. NO. 2,618,050.

NO CLAIM IS MADE TO THE EXCLUSIVE RIGHT TO USE "CONCRETE & MASONRY WHEELBARROWS", APART FROM THE MARK AS SHOWN.

THE MARK CONSISTS OF A STYLIZED MAN WITH THE WORDS "TOUGH GUY" ACROSS HIS UPPER BODY AND THE WORD "STERLING" BELOW THE FIGURE IN UPPERCASE LETTERS, WITH THE WORDS "CONCRETE & MASONRY WHEELBARROWS" FOUND BELOW THE WORD "STERLING" IN SMALLER UPPERCASE LETTERS.

SER. NO. 85-404,926, FILED 8-23-2011.

KATHERINE E. HALMEN, EXAMINING ATTORNEY



*David J. Kybas*

Director of the United States Patent and Trademark Office

# United States of America

United States Patent and Trademark Office



**Reg. No. 4,125,537**

**Registered Apr. 10, 2012**

**Int. Cl.: 44**

**SERVICE MARK**

**PRINCIPAL REGISTER**

DURHAM NEPHROLOGY ASSOCIATES, P.A. (NORTH CAROLINA PROFESSIONAL CORPORATION)  
4419 BEN FRANKLIN BLVD.  
DURHAM, NC 27704

FOR: MEDICAL SERVICES IN THE FIELD OF NEPHROLOGY, IN CLASS 44 (U.S. CLS. 100 AND 101).

FIRST USE 4-0-2008; IN COMMERCE 4-0-2008.

NO CLAIM IS MADE TO THE EXCLUSIVE RIGHT TO USE "NEPHROLOGY", APART FROM THE MARK AS SHOWN.

THE COLOR(S) RED AND BLUE IS/ARE CLAIMED AS A FEATURE OF THE MARK.

THE MARK CONSISTS OF A RED KIDNEY DESIGN WITH A BLUE SEMI CIRCLE ABOVE AND BELOW THE DESIGN AND THE WORDS "DURHAM NEPHROLOGY" IN BLUE UNDER THE DESIGN.

SEC. 2(F) AS TO "DURHAM NEPHROLOGY".

SER. NO. 85-405,626, FILED 8-24-2011.

MICHAEL WEBSTER, EXAMINING ATTORNEY



*David J. Kyjars*

Director of the United States Patent and Trademark Office

# United States of America

United States Patent and Trademark Office

*Reflecting  
the quality difference.*

**Reg. No. 4,125,538**

**Registered Apr. 10, 2012**

**Int. Cl.: 12**

**TRADEMARK**

**PRINCIPAL REGISTER**

POLY WAY INDUSTRY CO., LTD. (TAIWAN CORPORATION)  
NO. 12, HWAN GONG RD.  
YUNGKANG DIST.  
TAINAN, TAIWAN R.O.C.

FOR: AUTOMOBILE SIDEVIEW MIRRORS, MOTORCYCLE SIDEVIEW MIRRORS,  
REARVIEW MIRRORS, VEHICLE PARTS, NAMELY, BLIND-SPOT MIRRORS, IN CLASS  
12 (U.S. CLS. 19, 21, 23, 31, 35 AND 44).

FIRST USE 1-2-2003; IN COMMERCE 1-2-2003.

THE MARK CONSISTS OF THE WORDS "REFLECTING THE QUALITY DIFFERENCE." IN  
STYLIZED FONT.

SER. NO. 85-405,634, FILED 8-24-2011.

JERI J. FICKES, EXAMINING ATTORNEY



*David J. Kyffers*

Director of the United States Patent and Trademark Office

# United States of America

United States Patent and Trademark Office



**Reg. No. 4,125,539**

**Registered Apr. 10, 2012**

**Int. Cls.: 9 and 42**

**TRADEMARK**

**SERVICE MARK**

**PRINCIPAL REGISTER**

XTRANORMAL TECHNOLOGY INC. / XTRANORMAL TECHNOLOGIE INC. (CANADA CORPORATION)  
5555 CASGRAIN AVENUE, 2ND FLOOR  
MONTREAL, QUEBEC, CANADA H2T-1Y1

FOR: MULTIMEDIA COMPUTER SOFTWARE APPLICATION WHICH IS DOWNLOADABLE TO DESKTOP AND MOBILE DEVICES AND USED FOR THE CREATION OF SHORT OR LONG FORM ANIMATED OR MOVING PICTURES, NAMELY, THE CONCEPTION, REFINEMENT, PRODUCTION AND FINISHING OF MESSAGES, PROFILES, PRESENTATIONS, NEWSCASTS, ADS, AND SHORT AND LONG FORM CLIPS, IN CLASS 9 (U.S. CLS. 21, 23, 26, 36 AND 38).

FIRST USE 6-6-2010; IN COMMERCE 6-6-2010.

FOR: PROVIDING A WEB SITE FEATURING TEMPORARY USE OF NON-DOWNLOADABLE MULTIMEDIA COMPUTER SOFTWARE USED FOR THE CREATION OF SHORT OR LONG FORM ANIMATED OR MOVING PICTURES, NAMELY, THE CONCEPTION, REFINEMENT, PRODUCTION AND FINISHING OF MESSAGES, PROFILES, PRESENTATIONS, NEWSCASTS, ADS, AND SHORT AND LONG FORM CLIPS, IN CLASS 42 (U.S. CLS. 100 AND 101).

FIRST USE 6-6-2010; IN COMMERCE 6-6-2010.

OWNER OF U.S. REG. NO. 3,983,049.

THE MARK CONSISTS OF THE LETTERS "X" AND "N" IN A STYLIZED FORMAT PLACED OVER THE WORD "XTRANORMAL".

SER. NO. 85-405,855, FILED 8-24-2011.

KATHERINE E. HALMEN, EXAMINING ATTORNEY



*David J. Kybas*

Director of the United States Patent and Trademark Office

# United States of America

United States Patent and Trademark Office



**Reg. No. 4,125,540**

**Registered Apr. 10, 2012**

**Int. Cl.: 28**

**TRADEMARK**

**PRINCIPAL REGISTER**

CHAD VOSS (UNITED STATES INDIVIDUAL)  
2040 EASTRIDGE AVE, SUITE A-10  
RIVERSIDE, CA 92507

FOR: FISHING LURE PARTS; FISHING SINKERS; FISHING SPINNERS; FISHING WEIGHTS;  
LURES FOR FISHING, IN CLASS 28 (U.S. CLS. 22, 23, 38 AND 50).

FIRST USE 8-1-2011; IN COMMERCE 8-1-2011.

NO CLAIM IS MADE TO THE EXCLUSIVE RIGHT TO USE "WEIGHTS", APART FROM  
THE MARK AS SHOWN.

THE COLOR(S) BLACK AND RED IS/ARE CLAIMED AS A FEATURE OF THE MARK.

THE MARK CONSISTS OF A BLACK "V" OUTLINED IN RED FORMING THE INSIDE OF  
A FIRST PART OF A RED "W" PLACED ABOVE THE RED WORDS "VOSS WEIGHTS".

SER. NO. 85-405,969, FILED 8-24-2011.

DEBORAH LOBO, EXAMINING ATTORNEY



*David J. Kyffers*

Director of the United States Patent and Trademark Office

# United States of America

United States Patent and Trademark Office

## CANVAS USA

**Reg. No. 4,125,541**

CANVAS U.S.A., INC. (TEXAS CORPORATION)  
1010 HIGHWAY 35 SOUTH  
ROCKPORT, TX 78382

**Registered Apr. 10, 2012**

**Int. Cl.: 12**

FOR: FITTED AND SEMI-FITTED CANVAS COVERS FOR BOATS, CARS AND TRUCKS,  
IN CLASS 12 (U.S. CLS. 19, 21, 23, 31, 35 AND 44).

**TRADEMARK**

FIRST USE 1-1-1986; IN COMMERCE 1-1-1986.

**PRINCIPAL REGISTER**

THE MARK CONSISTS OF STANDARD CHARACTERS WITHOUT CLAIM TO ANY PAR-  
TICULAR FONT, STYLE, SIZE, OR COLOR.

NO CLAIM IS MADE TO THE EXCLUSIVE RIGHT TO USE "CANVAS", APART FROM THE  
MARK AS SHOWN.

SEC. 2(F).

SER. NO. 85-406,003, FILED 8-24-2011.

HEATHER BIDDULPH, EXAMINING ATTORNEY

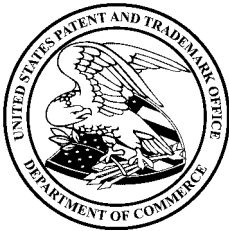

*David J. Kyffers*

Director of the United States Patent and Trademark Office

United States of America  
United States Patent and Trademark Office

netTALK<sup>®</sup>)

**Reg. No. 4,125,542**

NETTALK.COM, INC. (FLORIDA CORPORATION)  
1100 NW 163RD DRIVE, SUITE B-4  
NORTH MIAMI BEACH, FL 33169

**Registered Apr. 10, 2012**

**Int. Cls.: 9 and 38**

FOR: VOICE OVER INTERNET PROTOCOL (VOIP) PHONE ADAPTER, IN CLASS 9 (U.S. CLS. 21, 23, 26, 36 AND 38).

**TRADEMARK**

FIRST USE 7-1-2010; IN COMMERCE 7-1-2010.

**SERVICE MARK**

FOR: VOICE OVER INTERNET PROTOCOL (VOIP) SERVICES, IN CLASS 38 (U.S. CLS. 100, 101 AND 104).

**PRINCIPAL REGISTER**

FIRST USE 7-1-2010; IN COMMERCE 7-1-2010.

OWNER OF U.S. REG. NOS. 3,617,846 AND 3,995,352.

THE MARK CONSISTS OF THE WORDING "NETTALK" WITH A DESIGN ELEMENT CONSISTING OF A CIRCLE AND TWO CURVED LINES DIRECTLY ADJACENT TO THE RIGHT OF THE WORDING.

SER. NO. 85-406,177, FILED 8-24-2011.

ZACHARY BELLO, EXAMINING ATTORNEY



*David J. Kyffers*

Director of the United States Patent and Trademark Office

# United States of America

United States Patent and Trademark Office

## San Diego Merchant Services

**Reg. No. 4,125,543**

**Registered Apr. 10, 2012**

**Int. Cl.: 36**

**SERVICE MARK**

**PRINCIPAL REGISTER**

SAN DIEGO MERCHANT SERVICES, INC. (CALIFORNIA CORPORATION), DBA SAN DIEGO MERCHANT SERVICES  
8865 SPECTRUM CENTER BLVD STE 9103  
SAN DIEGO, CA 92123

FOR: MERCHANT SERVICES, NAMELY, PAYMENT TRANSACTION PROCESSING SERVICES, IN CLASS 36 (U.S. CLS. 100, 101 AND 102).

FIRST USE 3-1-2008; IN COMMERCE 3-1-2008.

THE MARK CONSISTS OF STANDARD CHARACTERS WITHOUT CLAIM TO ANY PARTICULAR FONT, STYLE, SIZE, OR COLOR.

NO CLAIM IS MADE TO THE EXCLUSIVE RIGHT TO USE "MERCHANT SERVICES", APART FROM THE MARK AS SHOWN.

SEC. 2(F).

SER. NO. 85-406,238, FILED 8-24-2011.

LINDA E. BLOHM, EXAMINING ATTORNEY



*David J. Kyffers*

Director of the United States Patent and Trademark Office



# United States of America

United States Patent and Trademark Office

## Friends of Sheba Medical Center

**Reg. No. 4,125,544**

**Registered Apr. 10, 2012**

**Int. Cl.: 36**

**SERVICE MARK**

**PRINCIPAL REGISTER**

FRIENDS OF SHEBA MEDICAL CENTER, INC. (CALIFORNIA CORPORATION)  
SUITE #670  
2566 OVERLAND AVE.  
LOS ANGELES, CA 90064

FOR: CHARITABLE FUNDRAISING SERVICES, IN CLASS 36 (U.S. CLS. 100, 101 AND 102).

FIRST USE 2-5-1993; IN COMMERCE 2-5-1993.

THE MARK CONSISTS OF STANDARD CHARACTERS WITHOUT CLAIM TO ANY PARTICULAR FONT, STYLE, SIZE, OR COLOR.

NO CLAIM IS MADE TO THE EXCLUSIVE RIGHT TO USE "MEDICAL CENTER", APART FROM THE MARK AS SHOWN.

THE NAME(S), PORTRAIT(S), AND/OR SIGNATURE(S) SHOWN IN THE MARK DOES NOT IDENTIFY A PARTICULAR LIVING INDIVIDUAL.

SER. NO. 85-406,328, FILED 8-24-2011.

REBECCA SMITH, EXAMINING ATTORNEY



*David J. Kyffers*

Director of the United States Patent and Trademark Office

# United States of America

United States Patent and Trademark Office

## JDM CAPITAL

**Reg. No. 4,125,545**

**Registered Apr. 10, 2012**

**Int. Cls.: 35 and 36**

**SERVICE MARK**

**PRINCIPAL REGISTER**

JDM CAPITAL CORPORATION (NEW YORK CORPORATION)  
641 LEXINGTON AVENUE  
NEW YORK, NY 10022

FOR: BUSINESS MARKETING CONSULTATION SERVICES FOR OTHERS, IN THE FIELD OF THE MORTGAGE BANKING INDUSTRY; MERGER AND ACQUISITION CONSULTATION IN THE FIELD OF BUSINESS; AND MORTGAGE BANKING AFFINITY MARKETING SERVICES, NAMELY, PROMOTING THE SERVICES OF COMPANIES PROVIDING SERVICES AND PRODUCTS TO THE MORTGAGORS THROUGH THE DISTRIBUTION OF PRINTED AND ELECTRONIC PROMOTIONAL MATERIALS, IN CLASS 35 (U.S. CLS. 100, 101 AND 102).

FIRST USE 7-15-2004; IN COMMERCE 7-15-2004.

FOR: MORTGAGE ACQUISITION AND SECURITIZATION; MORTGAGE BROKERAGE SERVICES; HEDGING ADVISORY SERVICES AND FINANCIAL PORTFOLIO MANAGEMENT, IN CLASS 36 (U.S. CLS. 100, 101 AND 102).

FIRST USE 7-15-2004; IN COMMERCE 7-15-2004.

THE MARK CONSISTS OF STANDARD CHARACTERS WITHOUT CLAIM TO ANY PARTICULAR FONT, STYLE, SIZE, OR COLOR.

NO CLAIM IS MADE TO THE EXCLUSIVE RIGHT TO USE "CAPITAL", APART FROM THE MARK AS SHOWN.

SER. NO. 85-406,373, FILED 8-24-2011.

REBECCA POVARCHUK, EXAMINING ATTORNEY



*David J. Kyros*

Director of the United States Patent and Trademark Office

# United States of America

United States Patent and Trademark Office

## DRENCHED FITNESS

**Reg. No. 4,125,546**

DRENCHED FITNESS, LLC (CALIFORNIA LIMITED LIABILITY COMPANY)  
4201 HARTFIELD CT.

**Registered Apr. 10, 2012**

WESTLAKE VILLAGE, CA 91361

**Int. Cls.: 25 and 41**

FOR: WEARABLE GARMENTS AND CLOTHING, NAMELY, SHIRTS, IN CLASS 25 (U.S. CLS. 22 AND 39).

**TRADEMARK**

FIRST USE 12-21-2010; IN COMMERCE 12-22-2010.

**SERVICE MARK**

FOR: PHYSICAL FITNESS STUDIO SERVICES, NAMELY, PROVIDING EXERCISE CLASSES, BODY SCULPTING CLASSES, AND GROUP FITNESS CLASSES, IN CLASS 41 (U.S. CLS. 100, 101 AND 107).

**PRINCIPAL REGISTER**

FIRST USE 12-21-2010; IN COMMERCE 12-22-2010.

THE MARK CONSISTS OF STANDARD CHARACTERS WITHOUT CLAIM TO ANY PARTICULAR FONT, STYLE, SIZE, OR COLOR.

NO CLAIM IS MADE TO THE EXCLUSIVE RIGHT TO USE "FITNESS", APART FROM THE MARK AS SHOWN.

SER. NO. 85-406,583, FILED 8-24-2011.

ALEXANDER L. POWERS, EXAMINING ATTORNEY



*David J. Kyros*

Director of the United States Patent and Trademark Office

# United States of America

United States Patent and Trademark Office

## Teens Gone Clean

**Reg. No. 4,125,547**

LEVINE, ASHER (UNITED STATES INDIVIDUAL)  
1102 MONTROSE AVENUE  
NASHVILLE, TN 37204

**Registered Apr. 10, 2012**

**Int. Cl.: 25**

FOR: CLOTHING, NAMELY, T-SHIRTS AND HOODED SWEATSHIRTS, IN CLASS 25 (U.S. CLS. 22 AND 39).

**TRADEMARK**

FIRST USE 7-1-2011; IN COMMERCE 7-1-2011.

**PRINCIPAL REGISTER**

THE MARK CONSISTS OF STANDARD CHARACTERS WITHOUT CLAIM TO ANY PARTICULAR FONT, STYLE, SIZE, OR COLOR.

SER. NO. 85-406,608, FILED 8-24-2011.

CHRISTINA SOBRAL, EXAMINING ATTORNEY



*David J. Kyffers*

Director of the United States Patent and Trademark Office

# United States of America

United States Patent and Trademark Office

**Sibertecture**  
Architecture + Technology

**Reg. No. 4,125,548**

**Registered Apr. 10, 2012**

**Int. Cl.: 42**

**SERVICE MARK**

**PRINCIPAL REGISTER**

SIBERTEKTURE ARCHITECT, PLLC (NEW YORK LIMITED LIABILITY COMPANY)  
SUITE 801  
262 W. 38TH STREET  
NEW YORK, NY 10018

FOR: ARCHITECTURAL SERVICES; CONSTRUCTION DRAFTING; INTERIOR DESIGN SERVICES; RESEARCH ON BUILDING CONSTRUCTION OR CITY PLANNING, IN CLASS 42 (U.S. CLS. 100 AND 101).

FIRST USE 9-23-2010; IN COMMERCE 9-23-2010.

NO CLAIM IS MADE TO THE EXCLUSIVE RIGHT TO USE "ARCHITECTURE" AND "TECHNOLOGY", APART FROM THE MARK AS SHOWN.

THE MARK CONSISTS OF 4 RECTANGLES IN DIFFERENT SHAPES AND ON EACH SIDE OF THE STYLIZED TEXT "SIBERTEKTURE". BELOW THERE IS THE STYLIZED TEXT "ARCHITECTURE + TECHNOLOGY".

SER. NO. 85-406,655, FILED 8-24-2011.

DEBORAH LOBO, EXAMINING ATTORNEY



*David J. Kybas*

Director of the United States Patent and Trademark Office

# United States of America

United States Patent and Trademark Office

## BLOOM TRUE

**Reg. No. 4,125,549**

**Registered Apr. 10, 2012**

**Int. Cl.: 41**

**SERVICE MARK**

**PRINCIPAL REGISTER**

BOWLEY, FLORA S. (OREGON CORPORATION), DBA FLORA BOWLEY DESIGNS  
1625 NE BRYANT STREET  
PORTLAND, OR 97211

FOR: EDUCATION SERVICES, NAMELY, PROVIDING MENTORING, TUTORING, CLASSES, SEMINARS AND WORKSHOPS IN THE FIELD OF PAINTING AND ART; EDUCATION SERVICES, NAMELY, PROVIDING ON-LINE INTERACTIVE COURSES AND INSTRUCTION IN THE FIELD OF PAINTING AND ART; EDUCATIONAL SERVICES, NAMELY, CONDUCTING LIVE, IN-PERSON INTERACTIVE COURSES AND INSTRUCTION IN THE FIELDS OF PAINTING AND ART AND DISTRIBUTION OF TRAINING MATERIALS IN CONNECTION THEREWITH, IN CLASS 41 (U.S. CLS. 100, 101 AND 107).

FIRST USE 9-15-2010; IN COMMERCE 9-15-2010.

THE MARK CONSISTS OF STANDARD CHARACTERS WITHOUT CLAIM TO ANY PARTICULAR FONT, STYLE, SIZE, OR COLOR.

SER. NO. 85-406,670, FILED 8-24-2011.

REBECCA SMITH, EXAMINING ATTORNEY



*David J. Kyffers*

Director of the United States Patent and Trademark Office

# United States of America

United States Patent and Trademark Office

# IDEELI

**Reg. No. 4,125,550**

**Registered Apr. 10, 2012**

**Int. Cl.: 35**

**SERVICE MARK**

**PRINCIPAL REGISTER**

IDEELI INC. (DELAWARE CORPORATION)  
148 LAFAYETTE, 10TH FLOOR  
NEW YORK, NY 10013

FOR: PROMOTING THE GOODS AND SERVICES OF OTHERS VIA THE INTERNET AND WIRELESS DEVICES; PROMOTING THE GOODS AND SERVICES OF OTHERS BY PROVIDING A WEBSITE FEATURING PRODUCT INFORMATION, PRODUCT REVIEWS, SPECIAL OFFERS, DISCOUNT VOUCHERS AND LINKS TO THE RETAIL AND SERVICE WEBSITES OF OTHERS; PROMOTING, ADVERTISING, AND MARKETING THE GOODS AND SERVICES OF OTHERS IN THE FIELDS OF CLOTHING, SHOES, JEWELRY, HANDBAGS, HOME DÉCOR, ELECTRONICS, TRAVEL, ENTERTAINMENT, MOVIES, MUSIC, BOOKS, HEALTH, AND BEAUTY; ONLINE-RETAIL-STORE SERVICES IN THE FIELDS OF CLOTHING, SHOES, JEWELRY, HANDBAGS, HOME DÉCOR, ELECTRONICS, TRAVEL, ENTERTAINMENT, MOVIES, MUSIC, BOOKS, HEALTH, AND BEAUTY , IN CLASS 35 (U.S. CLS. 100, 101 AND 102).

FIRST USE 6-1-2007; IN COMMERCE 6-1-2007.

THE MARK CONSISTS OF STANDARD CHARACTERS WITHOUT CLAIM TO ANY PARTICULAR FONT, STYLE, SIZE, OR COLOR.

OWNER OF U.S. REG. NO. 3,915,685.

SER. NO. 85-407,030, FILED 8-25-2011.

SUE LAWRENCE, EXAMINING ATTORNEY



*David J. Kyros*

Director of the United States Patent and Trademark Office

# United States of America

United States Patent and Trademark Office



**Reg. No. 4,125,551**

**Registered Apr. 10, 2012**

**Int. Cl.: 3**

**TRADEMARK**

**PRINCIPAL REGISTER**

CONCEPT II COSMETICS, LLC (FLORIDA LIMITED LIABILITY COMPANY)  
2200 NW 92 AVE.  
MIAMI, FL 33172

FOR: AROMATIC PREPARATIONS, NAMELY, BODY LOTIONS, BODY SPRAY, BODY CREAMS; COLOGNES, PERFUMES AND COSMETICS, IN CLASS 3 (U.S. CLS. 1, 4, 6, 50, 51 AND 52).

FIRST USE 8-10-2001; IN COMMERCE 8-10-2001.

THE MARK CONSISTS OF A CIRCLE WITH THE LETTER "C" AND THE ROMAN NUMERAL II OVERLAPPING INSIDE OF THE CIRCLE.

SER. NO. 85-407,348, FILED 8-25-2011.

CAROL SPILS, EXAMINING ATTORNEY



*David J. Kyffers*

Director of the United States Patent and Trademark Office



# United States of America

United States Patent and Trademark Office

# WOW! Ed

**Reg. No. 4,125,552**

**Registered Apr. 10, 2012**

**Int. Cl.: 41**

**SERVICE MARK**

**PRINCIPAL REGISTER**

CENTER FOR EDUCATIONAL IMPROVEMENT, INC. (VIRGINIA NON-PROFIT CORPORATION)  
402 COUNCIL DRIVE, N.E.  
VIENNA, VA 22180

FOR: PROVIDING ONLINE NEWSLETTERS IN THE FIELD OF EDUCATION INNOVATION, IN CLASS 41 (U.S. CLS. 100, 101 AND 107).

FIRST USE 11-0-2010; IN COMMERCE 11-0-2010.

THE MARK CONSISTS OF STANDARD CHARACTERS WITHOUT CLAIM TO ANY PARTICULAR FONT, STYLE, SIZE, OR COLOR.

NO CLAIM IS MADE TO THE EXCLUSIVE RIGHT TO USE "ED", APART FROM THE MARK AS SHOWN.

SER. NO. 85-407,425, FILED 8-25-2011.

KATHRYN COWARD, EXAMINING ATTORNEY



*David J. Kyffers*

Director of the United States Patent and Trademark Office

# United States of America

United States Patent and Trademark Office

# MaxID

**Reg. No. 4,125,553**

**Registered Apr. 10, 2012**

**Int. Cl.: 42**

**SERVICE MARK**

**PRINCIPAL REGISTER**

MAXID CORP. (DELAWARE CORPORATION)  
1775 WIEHHLE AVE SUITE 104  
RESTON, VA 20190

FOR: DEVELOPMENT OF NEW TECHNOLOGY FOR OTHERS IN THE FIELDS OF AUTOMATIC ELECTRONIC IDENTIFICATION VERIFICATION SYSTEMS AND BIOMETRICS; TECHNOLOGY CONSULTATION AND RESEARCH IN THE FIELDS OF AUTOMATIC ELECTRONIC IDENTIFICATION VERIFICATION SYSTEMS AND BIOMETRICS, IN CLASS 42 (U.S. CLS. 100 AND 101).

FIRST USE 6-0-2007; IN COMMERCE 6-0-2007.

THE MARK CONSISTS OF STANDARD CHARACTERS WITHOUT CLAIM TO ANY PARTICULAR FONT, STYLE, SIZE, OR COLOR.

SER. NO. 85-407,457, FILED 8-25-2011.

DAVID YONTEF, EXAMINING ATTORNEY



*David J. Kyffers*

Director of the United States Patent and Trademark Office

# United States of America

United States Patent and Trademark Office

## Heart Centered Education

**Reg. No. 4,125,554**

**Registered Apr. 10, 2012**

**Int. Cl.: 41**

**SERVICE MARK**

**PRINCIPAL REGISTER**

CENTER FOR EDUCATIONAL IMPROVEMENT, INC. (VIRGINIA NON-PROFIT CORPORATION)  
402 COUNCIL DRIVE, N.E.  
VIENNA, VA 22180

FOR: CONSULTING SERVICES IN THE FIELD OF EDUCATION INNOVATION AND SCHOOL IMPROVEMENT; EDUCATION SERVICES, NAMELY, PROVIDING INSTRUCTION IN THE FIELD OF EDUCATION DESIGNED TO IMPROVE EDUCATORS' TEACHING SKILLS; EDUCATIONAL SERVICES, NAMELY, DEVELOPING CURRICULUM AND RELATED INSTRUCTIONAL STRATEGIES FOR OTHERS IN THE FIELD OF EDUCATION INNOVATION AND SCHOOL IMPROVEMENT, IN CLASS 41 (U.S. CLS. 100, 101 AND 107).

FIRST USE 8-18-2011; IN COMMERCE 8-18-2011.

THE MARK CONSISTS OF STANDARD CHARACTERS WITHOUT CLAIM TO ANY PARTICULAR FONT, STYLE, SIZE, OR COLOR.

NO CLAIM IS MADE TO THE EXCLUSIVE RIGHT TO USE "EDUCATION" , APART FROM THE MARK AS SHOWN.

SER. NO. 85-407,541, FILED 8-25-2011.

KATHRYN COWARD, EXAMINING ATTORNEY



*David J. Kyros*

Director of the United States Patent and Trademark Office

# United States of America

United States Patent and Trademark Office

# EFY

**Reg. No. 4,125,555**

**Registered Apr. 10, 2012**

**Int. Cl.: 25**

**TRADEMARK**

**PRINCIPAL REGISTER**

BRIGHAM YOUNG UNIVERSITY (UTAH CORPORATION)  
OFFICE OF THE GENERAL COUNSEL  
A-357 ASB  
PROVO, UT 84602

FOR: WEARABLE GARMENTS AND CLOTHING, NAMELY, SHIRTS, IN CLASS 25 (U.S. CLS. 22 AND 39).

FIRST USE 1-6-1976; IN COMMERCE 1-6-1976.

THE MARK CONSISTS OF STANDARD CHARACTERS WITHOUT CLAIM TO ANY PARTICULAR FONT, STYLE, SIZE, OR COLOR.

SER. NO. 85-407,732, FILED 8-25-2011.

ERNEST SHOSHO, EXAMINING ATTORNEY



*David J. Kybas*

Director of the United States Patent and Trademark Office

# United States of America

United States Patent and Trademark Office

## NATIVEVISION

**Reg. No. 4,125,556**

**Registered Apr. 10, 2012**

**Int. Cls.: 41, 44 and 45**

**SERVICE MARK**

**PRINCIPAL REGISTER**

THE JOHNS HOPKINS UNIVERSITY (MARYLAND CORPORATION)  
113 GARLAND HALL  
3400 NORTH CHARLES STREET  
BALTIMORE, MD 21218

FOR: SUMMER CAMP/DAY CAMP SERVICES; AFTER SCHOOL EDUCATIONAL PROGRAMS IN THE FIELDS OF HEALTHY LIFESTYLES AND YOUTH DEVELOPMENT; PROVIDING GROUP COACHING AND LEARNING FORUMS IN THE FIELD OF LEADERSHIP DEVELOPMENT; AND COUNSELING SERVICES IN THE FIELD OF PHYSICAL FITNESS, ALL OF THE FOREGOING SERVICES PROVIDED TO AMERICAN INDIAN YOUTH AND THEIR FAMILIES, IN CLASS 41 (U.S. CLS. 100, 101 AND 107).

FIRST USE 1-0-1997; IN COMMERCE 1-0-1997.

FOR: COUNSELING SERVICES IN THE FIELDS OF HEALTH, NUTRITION AND LIFESTYLE WELLNESS, PROVIDED TO AMERICAN INDIAN YOUTH AND THEIR FAMILIES, IN CLASS 44 (U.S. CLS. 100 AND 101).

FIRST USE 1-0-1997; IN COMMERCE 1-0-1997.

FOR: COUNSELING IN THE FIELD OF PERSONAL DEVELOPMENT, NAMELY, SELF IMPROVEMENT, SELF FULFILLMENT AND INTERPERSONAL COMMUNICATION; AND COUNSELING IN THE FIELD OF DEVELOPING, STRENGTHENING AND SUSTAINING WELL-BALANCED FAMILIES AND FAMILY RELATIONSHIPS, ALL OF THE FOREGOING SERVICES PROVIDED TO AMERICAN INDIAN YOUTH AND THEIR FAMILIES, IN CLASS 45 (U.S. CLS. 100 AND 101).

FIRST USE 1-0-1997; IN COMMERCE 1-0-1997.

THE MARK CONSISTS OF STANDARD CHARACTERS WITHOUT CLAIM TO ANY PARTICULAR FONT, STYLE, SIZE, OR COLOR.

SER. NO. 85-408,170, FILED 8-26-2011.

DAVID H. STINE, EXAMINING ATTORNEY



*David J. Kyffers*

Director of the United States Patent and Trademark Office

# United States of America

United States Patent and Trademark Office

# ALTSTÄDTER

**Reg. No. 4,125,557**

LIDL STIFTUNG & CO. KG (FED REP GERMANY KOMMANDITGESELLSCHAFT (KG))  
STIFTSBERGSTR. 1

**Registered Apr. 10, 2012**

NECKARSULM, FED REP GERMANY 74167

**Int. Cl.: 33**

FOR: ALCOHOLIC BEVERAGES EXCEPT BEERS, NAMELY, CORN BRANDY, FRUIT BRANDY, DISTILLED SPIRITS, LIQUEURS, WINES, SPARKLING WINES, IN CLASS 33 (U.S. CLS. 47 AND 49).

**TRADEMARK**

THE MARK CONSISTS OF STANDARD CHARACTERS WITHOUT CLAIM TO ANY PARTICULAR FONT, STYLE, SIZE, OR COLOR.

**PRINCIPAL REGISTER**

OWNER OF ERPN CMNTY TM OFC REG. NO. 004868337, DATED 1-8-2007, EXPIRES 1-24-2016.

THE ENGLISH TRANSLATION OF THE WORD "ALTSTÄDTER" IN THE MARK IS "OLD-TOWN DWELLER".

SER. NO. 85-408,183, FILED 8-26-2011.

MARILYN IZZI, EXAMINING ATTORNEY



*David J. Kybas*

Director of the United States Patent and Trademark Office

# United States of America

United States Patent and Trademark Office

# *NativeVision*

**Reg. No. 4,125,558**

**Registered Apr. 10, 2012**

**Int. Cls.: 41, 44 and 45**

**SERVICE MARK**

**PRINCIPAL REGISTER**

THE JOHNS HOPKINS UNIVERSITY (MARYLAND CORPORATION)  
113 GARLAND HALL  
3400 NORTH CHARLES STREET  
BALTIMORE, MD 21218

FOR: SUMMER CAMP/DAY CAMP SERVICES; AFTER SCHOOL EDUCATIONAL PROGRAMS IN THE FIELDS OF HEALTHY LIFESTYLES AND YOUTH DEVELOPMENT; PROVIDING GROUP COACHING AND LEARNING FORUMS IN THE FIELD OF LEADERSHIP DEVELOPMENT; AND COUNSELING SERVICES IN THE FIELD OF PHYSICAL FITNESS, ALL OF THE FOREGOING SERVICES PROVIDED TO AMERICAN INDIAN YOUTH AND THEIR FAMILIES, IN CLASS 41 (U.S. CLS. 100, 101 AND 107).

FIRST USE 1-0-1997; IN COMMERCE 1-0-1997.

FOR: COUNSELING SERVICES IN THE FIELDS OF HEALTH, NUTRITION AND LIFESTYLE WELLNESS, PROVIDED TO AMERICAN INDIAN YOUTH AND THEIR FAMILIES, IN CLASS 44 (U.S. CLS. 100 AND 101).

FIRST USE 1-0-1997; IN COMMERCE 1-0-1997.

FOR: COUNSELING IN THE FIELD OF PERSONAL DEVELOPMENT, NAMELY, SELF IMPROVEMENT, SELF FULFILLMENT AND INTERPERSONAL COMMUNICATION; AND COUNSELING IN THE FIELD OF DEVELOPING, STRENGTHENING AND SUSTAINING WELL-BALANCED FAMILIES AND FAMILY RELATIONSHIPS, ALL OF THE FOREGOING SERVICES PROVIDED TO AMERICAN INDIAN YOUTH AND THEIR FAMILIES, IN CLASS 45 (U.S. CLS. 100 AND 101).

FIRST USE 1-0-1997; IN COMMERCE 1-0-1997.

THE MARK CONSISTS OF THE WORD "NATIVEVISION" IN STYLIZED LETTERS WITH THE DESIGN OF A SUN ABOVE THE WORD "VISION".

SER. NO. 85-408,186, FILED 8-26-2011.

DAVID H. STINE, EXAMINING ATTORNEY



*David J. Kyros*

Director of the United States Patent and Trademark Office

# United States of America

United States Patent and Trademark Office



Fresh Air Lodging  
Green Today, Better Tomorrow.

**Reg. No. 4,125,559**

**Registered Apr. 10, 2012**

**Int. Cl.: 35**

**SERVICE MARK**

**PRINCIPAL REGISTER**

WILMES HOSPITALITY LLC (MINNESOTA LIMITED LIABILITY COMPANY)  
4301 EAST SUPERIOR STREET  
DULUTH, MN 55804

FOR: ADVERTISING AND MARKETING SERVICES PROVIDED BY MEANS OF INDIRECT METHODS OF MARKETING COMMUNICATIONS, NAMELY, SOCIAL MEDIA, SEARCH ENGINE MARKETING, INQUIRY MARKETING, INTERNET MARKETING, MOBILE MARKETING, BLOGGING AND OTHER FORMS OF PASSIVE, SHARABLE OR VIRAL COMMUNICATIONS CHANNELS, IN CLASS 35 (U.S. CLS. 100, 101 AND 102).

FIRST USE 5-6-2011; IN COMMERCE 5-6-2011.

NO CLAIM IS MADE TO THE EXCLUSIVE RIGHT TO USE "LODGING", APART FROM THE MARK AS SHOWN.

THE COLOR(S) GREEN, BROWN, AND BLUE IS/ARE CLAIMED AS A FEATURE OF THE MARK.

THE MARK CONSISTS OF A GREEN AND BROWN TREE WITH THE WORDING "FRESH AIR LODGING" IN BLUE AND THE WORDING "GREEN TODAY, BETTER TOMORROW." IN GREEN.

SER. NO. 85-408,299, FILED 8-26-2011.

CHRISTINA SOBRAL, EXAMINING ATTORNEY



*David J. Kybas*

Director of the United States Patent and Trademark Office



# United States of America

United States Patent and Trademark Office

LIVING HEALTHIER TOGETHER

**Reg. No. 4,125,560**

**Registered Apr. 10, 2012**

**Int. Cl.: 44**

**SERVICE MARK**

**PRINCIPAL REGISTER**

ANNE ARUNDEL HEALTH SYSTEM, INC. (MARYLAND CORPORATION)  
2001 MEDICAL PARKWAY  
ANNAPOLIS, MD 21401

FOR: HEALTH CARE, IN CLASS 44 (U.S. CLS. 100 AND 101).

FIRST USE 2-25-2010; IN COMMERCE 5-1-2010.

THE MARK CONSISTS OF STANDARD CHARACTERS WITHOUT CLAIM TO ANY PARTICULAR FONT, STYLE, SIZE, OR COLOR.

SER. NO. 85-408,608, FILED 8-26-2011.

SUNG IN, EXAMINING ATTORNEY



*David J. Kyffers*

Director of the United States Patent and Trademark Office

# United States of America

United States Patent and Trademark Office



## DIVE RITE

**Reg. No. 4,125,561**

**Registered Apr. 10, 2012**

**Int. Cl.: 9**

**TRADEMARK**

**PRINCIPAL REGISTER**

LAMARTEK, INC. (FLORIDA CORPORATION), DBA DIVE RITE  
175 NW WASHINGTON STREET  
LAKE CITY, FL 32055

FOR: PLASTIC PROTECTIVE LENSES FOR ATTACHMENT TO DIVE COMPUTERS, DIVING COMPUTERS, COMPUTER SOFTWARE, NAMELY, COMPUTERIZED LOGBOOK FOR SCUBA DIVING, COMPUTER SOFTWARE USED TO COMPUTE DECOMPRESSION TABLES, COMPUTER INTERFACE BOARDS, COMPUTER HARDWARE, VIDEO CAMERA ARMS, GAS FLOW METER, DIVING HELMETS, DIVING EQUIPMENT, NAMELY, BREATHING GAS REGULATORS, FIRST AND SECOND STAGE REGULATORS FOR BREATHING GAS, DIVING SUITS FEATURING DRY SUIT, GAITERS, DIVING SUIT UNDERGARMENTS, NAMELY, SHORT AND LONG JUMPSUITS, AND UNDERWATER URINATORS, SPORTING ARTICLES FOR SCUBA DIVING, NAMELY, BUOYANCY COMPENSATOR MODULES, BUOYANCY CONTROL DEVICES AND BUOYANCY COMPENSATORS; PRESSURE GAUGES, DEPTH GAUGES, COMPASSES, CLOSED CIRCUIT REBREATHERS, DIVING MASKS, SNORKELS, LIFT BAGS TO DEPLOY TO THE SURFACE OF THE WATER DURING SCUBA DIVING ACTIVITY FOR BUOYANCY AND SIGNALING, AUDIO AND VIDEO RECORDINGS FEATURING SCUBA TRAINING FILMS AND SCUBA DIVING FILMS, IN CLASS 9 (U.S. CLS. 21, 23, 26, 36 AND 38).

FIRST USE 11-1-2009; IN COMMERCE 11-1-2009.

OWNER OF U.S. REG. NOS. 2,291,852, 3,867,038 AND OTHERS.

THE COLOR(S) RED, YELLOW, WHITE AND BLACK IS/ARE CLAIMED AS A FEATURE OF THE MARK.

NO CLAIM IS MADE TO THE EXCLUSIVE RIGHT TO USE "DIVE", APART FROM THE MARK AS SHOWN.

THE MARK CONSISTS OF A RED TRIANGLE, A YELLOW TRIANGLE WITH Q-TIP SHAPE CUT OUTS, THE WORDS "DIVE RITE" IN WHITE WITH BLACK OUTLINE.

SER. NO. 85-408,792, FILED 8-26-2011.

KELLY TRUSILO, EXAMINING ATTORNEY

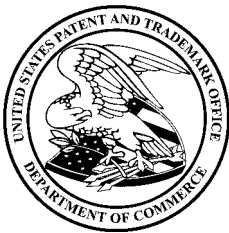

*David J. Kyros*

Director of the United States Patent and Trademark Office

# United States of America

United States Patent and Trademark Office

## PMA Media Group

**Reg. No. 4,125,562**

**Registered Apr. 10, 2012**

**Int. Cl.: 35**

**SERVICE MARK**

**PRINCIPAL REGISTER**

PMA MEDIA GROUP, INC. (UTAH CORPORATION)  
5255 N EDGEWOOD DR, STE 225  
PROVO, UT 84604

FOR: ADVERTISING AND MARKETING SERVICES PROVIDED BY MEANS OF INDIRECT METHODS OF MARKETING COMMUNICATIONS, NAMELY, SOCIAL MEDIA, SEARCH ENGINE MARKETING, INQUIRY MARKETING, INTERNET MARKETING, MOBILE MARKETING, BLOGGING AND OTHER FORMS OF PASSIVE, SHARABLE OR VIRAL COMMUNICATIONS CHANNELS; ON-LINE ADVERTISING SERVICES FOR OTHERS, IN CLASS 35 (U.S. CLS. 100, 101 AND 102).

FIRST USE 1-12-2005; IN COMMERCE 7-20-2005.

THE MARK CONSISTS OF STANDARD CHARACTERS WITHOUT CLAIM TO ANY PARTICULAR FONT, STYLE, SIZE, OR COLOR.

NO CLAIM IS MADE TO THE EXCLUSIVE RIGHT TO USE "MEDIA GROUP", APART FROM THE MARK AS SHOWN.

SER. NO. 85-409,388, FILED 8-29-2011.

CHRISTINA SOBRAL, EXAMINING ATTORNEY



*David J. Kybas*

Director of the United States Patent and Trademark Office

# United States of America

United States Patent and Trademark Office

YOUTHLAND  
**ACADEMY**

**Reg. No. 4,125,563**

**Registered Apr. 10, 2012**

**Int. Cls.: 35 and 43**

**SERVICE MARK**

**PRINCIPAL REGISTER**

YOUTHLAND ACADEMY, INC. (OHIO CORPORATION)  
9352 MAIN STREET  
CINCINNATI, OH 45242

FOR: FRANCHISING, NAMELY, OFFERING BUSINESS MANAGEMENT ASSISTANCE IN THE ESTABLISHMENT AND/OR OPERATION OF NURSERY AND PRESCHOOLER DAY CARE CENTERS, IN CLASS 35 (U.S. CLS. 100, 101 AND 102).

FIRST USE 7-31-1986; IN COMMERCE 7-31-1986.

FOR: DAY CARE CENTERS; NURSERIES AND DAY CARE CENTERS; PRESCHOOLER AND INFANT CARE AT DAYCARE CENTERS, IN CLASS 43 (U.S. CLS. 100 AND 101).

FIRST USE 7-31-1986; IN COMMERCE 7-31-1986.

OWNER OF U.S. REG. NO. 1,572,333.

THE MARK CONSISTS OF THE WORD "YOUTHLAND" WITH AN UPPERCASE "Y", INTENDED TO APPEAR AS IF HAND WRITTEN IN CRAYON, WITH THE STIPPLING SHOWN BEING AN ELEMENT OF THE MARK, NAMELY, NON-SPECIFIC DIFFERENT COLORS, WITH THE WORD "ACADEMY", RIGHT JUSTIFIED, IN SMALLER BOLD LETTERS BELOW.

SER. NO. 85-409,615, FILED 8-29-2011.

LUCY ARANT, EXAMINING ATTORNEY



*David J. Kybas*

Director of the United States Patent and Trademark Office

# United States of America

United States Patent and Trademark Office

## THE GRUNT NETWORK

**Reg. No. 4,125,564**

**Registered Apr. 10, 2012**

**Int. Cl.: 38**

**SERVICE MARK**

**PRINCIPAL REGISTER**

GRIDIRON VENTURES, LLC (NORTH CAROLINA LIMITED LIABILITY COMPANY)  
SUITE A  
2 BOLIN HEIGHTS  
CHAPEL HILL, NC 27514

FOR: ELECTRONIC TRANSMISSION OF SPORTS AND ENTERTAINMENT MEDIA CONTENT, IN CLASS 38 (U.S. CLS. 100, 101 AND 104).

FIRST USE 4-28-2011; IN COMMERCE 4-28-2011.

THE MARK CONSISTS OF STANDARD CHARACTERS WITHOUT CLAIM TO ANY PARTICULAR FONT, STYLE, SIZE, OR COLOR.

OWNER OF U.S. REG. NOS. 4,029,847 AND 4,046,691.

NO CLAIM IS MADE TO THE EXCLUSIVE RIGHT TO USE "NETWORK", APART FROM THE MARK AS SHOWN.

SER. NO. 85-409,640, FILED 8-29-2011.

ALEXANDER L. POWERS, EXAMINING ATTORNEY



*David J. Kyfos*

Director of the United States Patent and Trademark Office

# United States of America

United States Patent and Trademark Office

# RisCloud

**Reg. No. 4,125,565**

AON ESOLUTIONS, INC. (CALIFORNIA CORPORATION)  
200 E. RANDOLPH STREET  
CHICAGO, IL 60601

**Registered Apr. 10, 2012**

**Int. Cl.: 42**

FOR: CLOUD COMPUTING FEATURING SOFTWARE FOR USE IN PROVIDING REGULATED DATA, OPERATIONAL PERFORMANCE, ENHANCED SECURITY AND FLEXIBILITY IN THE FIELD OF INSURANCE AND RISK MANAGEMENT, IN CLASS 42 (U.S. CLS. 100 AND 101).

**SERVICE MARK**

**PRINCIPAL REGISTER**

FIRST USE 10-3-2011; IN COMMERCE 10-31-2011.

THE MARK CONSISTS OF STANDARD CHARACTERS WITHOUT CLAIM TO ANY PARTICULAR FONT, STYLE, SIZE, OR COLOR.

SER. NO. 85-409,750, FILED 8-29-2011.

JOHN GARTNER, EXAMINING ATTORNEY



*David J. Kybas*

Director of the United States Patent and Trademark Office

# United States of America

United States Patent and Trademark Office



**Reg. No. 4,125,566**

ABITIBOWATER INC. (DELAWARE CORPORATION)  
BUREAU 800 RUE METCALFE  
MONTREAL, CANADA H3B5H2

**Registered Apr. 10, 2012**

**Int. Cls.: 37 and 40**

FOR: PAPER, CARDBOARD, PLASTIC, ALUMINUM AND GLASS COLLECTION FOR RECYCLING, IN CLASS 37 (U.S. CLS. 100, 103 AND 106).

**SERVICE MARK**

FIRST USE 11-15-2008; IN COMMERCE 11-15-2008.

**PRINCIPAL REGISTER**

FOR: RECYCLING OF PAPER, CARDBOARD, PLASTIC, ALUMINUM AND GLASS, IN CLASS 40 (U.S. CLS. 100, 103 AND 106).

FIRST USE 11-15-2008; IN COMMERCE 11-15-2008.

NO CLAIM IS MADE TO THE EXCLUSIVE RIGHT TO USE "RECYCLING", APART FROM THE MARK AS SHOWN.

THE MARK CONSISTS OF THE WORD "ECOREWARDS" ABOVE THE WORD "RECYCLING" AND IN WHICH A TREE PROJECTS UPWARDLY FROM THE "O".

SER. NO. 85-410,025, FILED 8-29-2011.

MICHAEL LEVY, EXAMINING ATTORNEY



*David J. Kybas*

Director of the United States Patent and Trademark Office

# United States of America

United States Patent and Trademark Office

## APPLIED SMARTFACTORY

**Reg. No. 4,125,567**

**Registered Apr. 10, 2012**

**Int. Cl.: 9**

**TRADEMARK**

**PRINCIPAL REGISTER**

APPLIED MATERIALS, INC. (DELAWARE CORPORATION)  
3050 BOWERS AVENUE  
M/S 1241  
SANTA CLARA, CA 95054

FOR: OPERATIONAL SOFTWARE FOR THE INSPECTION, REVIEW, MEASUREMENT, AND MONITORING OF THE MANUFACTURE OF SEMICONDUCTOR AND/OR PHOTO-VOLTAIC ELEMENTS IN THE NATURE OF WAFERS, RETICLES, SOLAR FILMS, AND FLAT PANEL DISPLAYS, IN CLASS 9 (U.S. CLS. 21, 23, 26, 36 AND 38).

FIRST USE 7-31-2010; IN COMMERCE 7-31-2010.

THE MARK CONSISTS OF STANDARD CHARACTERS WITHOUT CLAIM TO ANY PARTICULAR FONT, STYLE, SIZE, OR COLOR.

OWNER OF U.S. REG. NOS. 1,943,850, 4,002,846 AND OTHERS.

SER. NO. 85-410,085, FILED 8-29-2011.

MICHAEL WIENER, EXAMINING ATTORNEY



*David J. Kyffers*

Director of the United States Patent and Trademark Office



# United States of America

United States Patent and Trademark Office

## PISTOLS & PUMPS

**Reg. No. 4,125,568**

PISTOLS AND PUMPS, LLC (MISSOURI LIMITED LIABILITY COMPANY)

**Registered Apr. 10, 2012**

41 ARROWHEAD BEACH CLUB  
LAKE OZARK, MO 65049

**Int. Cl.: 35**

FOR: ONLINE RETAIL STORE SERVICES FEATURING CLOTHING, BAGS, SHOOTING ACCESSORIES, GLASSES, HEARING PROTECTION, FLASHLIGHTS, KNIVES, DECALS AND STICKERS; AND PROMOTING THE GOODS AND SERVICES OF OTHERS BY ARRANGING FOR SPONSORS TO AFFILIATE THEIR GOODS AND SERVICES WITH MEMBERSHIP CARD, IN CLASS 35 (U.S. CLS. 100, 101 AND 102).

**SERVICE MARK**

**PRINCIPAL REGISTER**

FIRST USE 8-22-2011; IN COMMERCE 8-22-2011.

THE MARK CONSISTS OF STANDARD CHARACTERS WITHOUT CLAIM TO ANY PARTICULAR FONT, STYLE, SIZE, OR COLOR.

NO CLAIM IS MADE TO THE EXCLUSIVE RIGHT TO USE "PISTOLS", APART FROM THE MARK AS SHOWN.

SER. NO. 85-410,276, FILED 8-30-2011.

JENNY PARK, EXAMINING ATTORNEY



*David J. Kybas*

Director of the United States Patent and Trademark Office

# United States of America

United States Patent and Trademark Office

# PROXTEE

**Reg. No. 4,125,569**

ATHLETIC INNOVATIONS, LLC (UTAH LIMITED LIABILITY COMPANY)  
125 E SUNSET CIR.  
ALPINE, UT 84004

**Registered Apr. 10, 2012**

**Int. Cl.: 28**

FOR: BASEBALL BATTING TEES, IN CLASS 28 (U.S. CLS. 22, 23, 38 AND 50).

**TRADEMARK**

FIRST USE 7-1-2010; IN COMMERCE 7-1-2010.

**PRINCIPAL REGISTER**

THE MARK CONSISTS OF STANDARD CHARACTERS WITHOUT CLAIM TO ANY PARTICULAR FONT, STYLE, SIZE, OR COLOR.

SER. NO. 85-410,443, FILED 8-30-2011.

ALEX KEAM, EXAMINING ATTORNEY



*David J. Kybas*

Director of the United States Patent and Trademark Office

# United States of America

United States Patent and Trademark Office

## Q DISCOVERY

**Reg. No. 4,125,570**

**Registered Apr. 10, 2012**

**Int. Cls.: 42 and 45**

**SERVICE MARK**

**PRINCIPAL REGISTER**

QUANTUM DISCOVERY, LLC (CONNECTICUT LIMITED LIABILITY COMPANY)  
501 OCEAN AVE  
NEW LONDON, CT 06320

FOR: CONVERSION OF DATA OR DOCUMENTS FROM PHYSICAL TO ELECTRONIC MEDIA; DATA AUTOMATION AND COLLECTION SERVICE USING SOFTWARE TO EVALUATE, ANALYZE, SORT, COMPARE, MANAGE AND COLLECT DATA; PLATFORM AS A SERVICE (PAAS) FEATURING COMPUTER SOFTWARE PLATFORMS FOR DOCUMENT AND DATA MANAGEMENT AND INDEXING; PROVIDING AN ONLINE NETWORK SERVICE THAT ENABLES USERS TO SHARE DATA IN THE FIELD OF E-DISCOVERY FOR BUSINESS LEGAL DEPARTMENTS AND LAW FIRMS, IN CLASS 42 (U.S. CLS. 100 AND 101).

FIRST USE 7-25-2011; IN COMMERCE 7-25-2011.

FOR: LITIGATION SUPPORT SERVICES, NAMELY, CONDUCTING ELECTRONIC LEGAL DISCOVERY IN THE NATURE OF REVIEWING E-MAILS AND OTHER ELECTRONICALLY STORED INFORMATION THAT COULD BE RELEVANT EVIDENCE IN A LAWSUIT FOR BUSINESS LEGAL DEPARTMENTS AND LAW FIRMS; LITIGATION SUPPORT SERVICES, NAMELY, ELECTRONIC LEGAL DISCOVERY CONSULTING SERVICES, IN CLASS 45 (U.S. CLS. 100 AND 101).

FIRST USE 7-25-2011; IN COMMERCE 7-25-2011.

THE MARK CONSISTS OF STANDARD CHARACTERS WITHOUT CLAIM TO ANY PARTICULAR FONT, STYLE, SIZE, OR COLOR.

NO CLAIM IS MADE TO THE EXCLUSIVE RIGHT TO USE "DISCOVERY", APART FROM THE MARK AS SHOWN.

SER. NO. 85-411,185, FILED 8-30-2011.

KEVON CHISOLM, EXAMINING ATTORNEY



*David J. Kyffers*

Director of the United States Patent and Trademark Office

# United States of America

United States Patent and Trademark Office

# SEASIDERS

**Reg. No. 4,125,571**

**Registered Apr. 10, 2012**

**Int. Cl.: 25**

**TRADEMARK**

**PRINCIPAL REGISTER**

BRIGHAM YOUNG UNIVERSITY (UTAH CORPORATION)  
OFFICE OF THE GENERAL COUNSEL  
A-357 ASB  
PROVO, UT 84602

FOR: WEARABLE GARMENTS AND CLOTHING, NAMELY, SHIRTS, IN CLASS 25 (U.S. CLS. 22 AND 39).

FIRST USE 10-1-1984; IN COMMERCE 10-1-1984.

THE MARK CONSISTS OF STANDARD CHARACTERS WITHOUT CLAIM TO ANY PARTICULAR FONT, STYLE, SIZE, OR COLOR.

SER. NO. 85-411,597, FILED 8-31-2011.

ERNEST SHOSHO, EXAMINING ATTORNEY



*David J. Kyffers*

Director of the United States Patent and Trademark Office

# United States of America

United States Patent and Trademark Office

## BABYSITTER BOOT CAMP

**Reg. No. 4,125,572**

**Registered Apr. 10, 2012**

**Int. Cl.: 41**

**SERVICE MARK**

**PRINCIPAL REGISTER**

NEALY, CHRISTINE (UNITED STATES INDIVIDUAL)  
450 BROWN THRASHER COURT  
ALPHARETTA, GA 30009

FOR: EDUCATIONAL SERVICES, NAMELY, CONDUCTING WORKSHOPS IN THE FIELDS OF INFANT AND CHILD SAFETY, BASIC LIFE SAVING SKILLS INCLUDING ADULT/CHILD CPR, FIRSTAID, SIGNS OF CHOKING AND HOW TO HELP A CHOKING VICTIM, HOW TO PHONE EMS, 911 EMERGENCY RESPONSE NUMBER, AS WELL AS AGE APPROPRIATE TOYS AND GAMES FOR PERSONS PROVIDING CHILD CARE SERVICES AND DISTRIBUTION OF TRAINING MATERIALS IN CONNECTION THEREWITH, IN CLASS 41 (U.S. CLS. 100, 101 AND 107).

FIRST USE 5-1-2011; IN COMMERCE 5-1-2011.

THE MARK CONSISTS OF STANDARD CHARACTERS WITHOUT CLAIM TO ANY PARTICULAR FONT, STYLE, SIZE, OR COLOR.

NO CLAIM IS MADE TO THE EXCLUSIVE RIGHT TO USE "BABYSITTER", APART FROM THE MARK AS SHOWN.

SER. NO. 85-411,620, FILED 8-31-2011.

CHRISTINA SOBRAL, EXAMINING ATTORNEY



*David J. Kyros*

Director of the United States Patent and Trademark Office

# United States of America

United States Patent and Trademark Office

## Brigham Young University-Hawaii

**Reg. No. 4,125,573**

**Registered Apr. 10, 2012**

**Int. Cls.: 25 and 41**

**TRADEMARK**

**SERVICE MARK**

**PRINCIPAL REGISTER**

BRIGHAM YOUNG UNIVERSITY (UTAH CORPORATION)  
OFFICE OF THE GENERAL COUNSEL  
A-357 ASB  
PROVO, UT 84602

FOR: WEARABLE GARMENTS AND CLOTHING, NAMELY, SHIRTS, IN CLASS 25 (U.S. CLS. 22 AND 39).

FIRST USE 9-1-1974; IN COMMERCE 9-1-1974.

FOR: EDUCATING AT UNIVERSITY OR COLLEGES, IN CLASS 41 (U.S. CLS. 100, 101 AND 107).

FIRST USE 9-1-1974; IN COMMERCE 9-1-1974.

THE MARK CONSISTS OF STANDARD CHARACTERS WITHOUT CLAIM TO ANY PARTICULAR FONT, STYLE, SIZE, OR COLOR.

OWNER OF U.S. REG. NOS. 1,647,398, 2,992,152, AND 3,065,131.

NO CLAIM IS MADE TO THE EXCLUSIVE RIGHT TO USE "UNIVERSITY HAWAII", APART FROM THE MARK AS SHOWN.

SER. NO. 85-411,645, FILED 8-31-2011.

ERNEST SHOSHO, EXAMINING ATTORNEY



*David J. Kyjars*

Director of the United States Patent and Trademark Office

# United States of America

United States Patent and Trademark Office

# BYU-Hawaii

**Reg. No. 4,125,574**

**Registered Apr. 10, 2012**

**Int. Cls.: 25 and 41**

**TRADEMARK**

**SERVICE MARK**

**PRINCIPAL REGISTER**

BRIGHAM YOUNG UNIVERSITY (UTAH CORPORATION)  
OFFICE OF THE GENERAL COUNSEL  
A-357 ASB  
PROVO, UT 84602

FOR: WEARABLE GARMENTS AND CLOTHING, NAMELY, SHIRTS, IN CLASS 25 (U.S. CLS. 22 AND 39).

FIRST USE 9-1-1974; IN COMMERCE 9-1-1974.

FOR: EDUCATING AT UNIVERSITY OR COLLEGES, IN CLASS 41 (U.S. CLS. 100, 101 AND 107).

FIRST USE 9-1-1974; IN COMMERCE 9-1-1974.

THE MARK CONSISTS OF STANDARD CHARACTERS WITHOUT CLAIM TO ANY PARTICULAR FONT, STYLE, SIZE, OR COLOR.

OWNER OF U.S. REG. NOS. 1,581,409, 3,355,053, AND 3,529,756.

SER. NO. 85-411,665, FILED 8-31-2011.

ERNEST SHOSHO, EXAMINING ATTORNEY



*David J. Kyjars*

Director of the United States Patent and Trademark Office

# United States of America

United States Patent and Trademark Office

# bellwood

**Reg. No. 4,125,575**

**Registered Apr. 10, 2012**

**Int. Cl.: 25**

**TRADEMARK**

**PRINCIPAL REGISTER**

S.E.A. S.R.L. (ITALY LIMITED LIABILITY COMPANY)  
VIA DEI BARROCCIALI, 13  
41012 CARPI (MO), ITALY

FOR: CLOTHING, NAMELY, SKIRTS, TROUSERS, SHIRTS, BLOUSES, JERSEYS, SWEATERS, T-SHIRTS, SINGLETs, OVERALLS, JACKETS, BLOUSONS, BELTS, BATH-ROBES, SWIMMING COSTUMES, TIES, HEADSCARVES, DRESSING GOWNS, UNDERWEAR, COATS, RAINCOATS, HATS, SCARVES, GLOVES, JEANS, BODYSUITS; BATHING WRAPS, NAMELY, BEACH COVER-UPS; SHOES, BOOTS AND SLIPPERS, IN CLASS 25 (U.S. CLS. 22 AND 39).

OWNER OF ERPN CMNTY TM OFC REG. NO. 006040811, DATED 6-5-2010, EXPIRES 6-26-2017.

THE MARK CONSISTS OF THE WORD "BELLWOOD" IN LOWER CASE LETTERS.

SER. NO. 85-411,764, FILED 8-31-2011.

TINA BROWN, EXAMINING ATTORNEY



*David J. Kyffers*

Director of the United States Patent and Trademark Office



# United States of America

United States Patent and Trademark Office

## Lord Talbott's

**Reg. No. 4,125,576**

CARIBBEAN DISTILLERS LLC (FLORIDA LIMITED LIABILITY COMPANY)  
350 DAKOTA AVENUE  
LAKE ALFRED, FL 33850

**Registered Apr. 10, 2012**

**Int. Cl.: 33**

FOR: GIN, IN CLASS 33 (U.S. CLS. 47 AND 49).

**TRADEMARK**

FIRST USE 7-16-2009; IN COMMERCE 7-16-2009.

**PRINCIPAL REGISTER**

THE MARK CONSISTS OF STANDARD CHARACTERS WITHOUT CLAIM TO ANY PARTICULAR FONT, STYLE, SIZE, OR COLOR.

THE NAME "LORD TALBOTT" DOES NOT IDENTIFY A LIVING INDIVIDUAL.

SER. NO. 85-411,859, FILED 8-31-2011.

DAVID COLLIER, EXAMINING ATTORNEY



*David J. Kyffers*

Director of the United States Patent and Trademark Office

# United States of America

United States Patent and Trademark Office

# SOFTSTAR

**Reg. No. 4,125,577**

**Registered Apr. 10, 2012**

**Int. Cl.: 9**

**TRADEMARK**

**PRINCIPAL REGISTER**

SOFTSTAR ENTERTAINMENT INC. (TAIWAN CORPORATION)  
16F, 16F-3 NO. 166, CHENGYI ROAD  
ZHONGHE DIST.  
NEW TAIPEI CITY 235, TAIWAN

FOR: COMPUTER GAME SOFTWARE; COMPUTER GAME SOFTWARE DOWNLOADABLE FROM A GLOBAL COMPUTER NETWORK; COMPUTER GAME SOFTWARE FOR USE ON MOBILE AND CELLULAR PHONES; ELECTRONIC GAME SOFTWARE FOR WIRELESS DEVICES; ELECTRONIC GAME SOFTWARE; INTERACTIVE GAME SOFTWARE; MOTION PICTURE FILMS FEATURING CHILDREN'S ENTERTAINMENT, IN CLASS 9 (U.S. CLS. 21, 23, 26, 36 AND 38).

FIRST USE 12-1-1989; IN COMMERCE 12-1-1998.

THE MARK CONSISTS OF STANDARD CHARACTERS WITHOUT CLAIM TO ANY PARTICULAR FONT, STYLE, SIZE, OR COLOR.

OWNER OF U.S. REG. NOS. 1,742,352 AND 1,859,799.

SER. NO. 85-412,035, FILED 8-31-2011.

SHAUNIA CARLYLE, EXAMINING ATTORNEY



*David J. Kyffers*

Director of the United States Patent and Trademark Office

# United States of America

United States Patent and Trademark Office



**Reg. No. 4,125,578**

**Registered Apr. 10, 2012**

**Int. Cl.: 9**

**TRADEMARK**

**PRINCIPAL REGISTER**

SOFTSTAR ENTERTAINMENT INC. (TAIWAN CORPORATION)  
16F, 16F-3 NO. 166, CHENGYI ROAD  
ZHONGHE DIST.  
NEW TAIPEI CITY 235, TAIWAN

FOR: COMPUTER GAME SOFTWARE; COMPUTER GAME SOFTWARE DOWNLOADABLE FROM A GLOBAL COMPUTER NETWORK; COMPUTER GAME SOFTWARE FOR USE ON MOBILE AND CELLULAR PHONES; ELECTRONIC GAME SOFTWARE FOR WIRELESS DEVICES; ELECTRONIC GAME SOFTWARE; INTERACTIVE GAME SOFTWARE; MOTION PICTURE FILMS FEATURING CHILDREN'S ENTERTAINMENT, IN CLASS 9 (U.S. CLS. 21, 23, 26, 36 AND 38).

FIRST USE 12-1-1989; IN COMMERCE 12-1-1998.

THE MARK CONSISTS OF THE STYLIZED LETTERS "SS". THE FIRST IS BLUE AND THE SECOND IS WHITE WITH A BLUE OUTLINE. IN THE UPPER RIGHT CORNER IS A BLUE STAR.

THE COLOR(S) BLUE AND WHITE IS/ARE CLAIMED AS A FEATURE OF THE MARK.

SER. NO. 85-412,062, FILED 8-31-2011.

SHAUNIA CARLYLE, EXAMINING ATTORNEY



*David J. Kyffers*

Director of the United States Patent and Trademark Office

# United States of America

United States Patent and Trademark Office



**Reg. No. 4,125,579**

**Registered Apr. 10, 2012**

**Int. Cl.: 35**

**SERVICE MARK**

**PRINCIPAL REGISTER**

BOSLEY TIRE AND WHEEL SUPERSTORE (KANSAS CORPORATION)  
3948 SOUTH BORADWAY  
WICHITA, KS 67217

FOR: RETAIL TIRE STORES, IN CLASS 35 (U.S. CLS. 100, 101 AND 102).

FIRST USE 11-1-2010; IN COMMERCE 11-1-2010.

THE MARK CONSISTS OF AN AUTOMOTIVE TIRE WITH ARMS, LEGS, MOUTH AND EYES.

SER. NO. 85-412,195, FILED 8-31-2011.

WENDY JUN, EXAMINING ATTORNEY



*David J. Kyffers*

Director of the United States Patent and Trademark Office

# United States of America

United States Patent and Trademark Office

## Certified Migration Professional (CMP)

**Reg. No. 4,125,580**

MIGRATIONX CORP (ILLINOIS CORPORATION)

**Registered Apr. 10, 2012**

9301 AVONDALE RD NE # C2013  
REDMOND, WA 98052

**Int. Cl.: 35**

FOR: BUSINESS SERVICES, NAMELY, DESIGN, DEVELOPMENT AND ANALYSIS OF TESTS FOR TESTING PROFESSIONAL COMPETENCY, IN CLASS 35 (U.S. CLS. 100, 101 AND 102).

**SERVICE MARK**

FIRST USE 5-1-2007; IN COMMERCE 5-1-2010.

**PRINCIPAL REGISTER**

THE MARK CONSISTS OF STANDARD CHARACTERS WITHOUT CLAIM TO ANY PARTICULAR FONT, STYLE, SIZE, OR COLOR.

NO CLAIM IS MADE TO THE EXCLUSIVE RIGHT TO USE "CERTIFIED MIGRATION PROFESSIONAL", APART FROM THE MARK AS SHOWN.

SER. NO. 85-412,760, FILED 9-1-2011.

ANDREA K. NADELMAN, EXAMINING ATTORNEY



*David J. Kybas*

Director of the United States Patent and Trademark Office

# United States of America

United States Patent and Trademark Office

# SLOPMMASTER

**Reg. No. 4,125,581**

**Registered Apr. 10, 2012**

**Int. Cl.: 28**

**TRADEMARK**

**PRINCIPAL REGISTER**

JOE BUCHER (UNITED STATES INDIVIDUAL), DBA JOE BUCHER OUTDOORS  
P.O. BOX 1105  
3359 HIGHWAY 70 EAST  
EAGLE RIVER, WI 54521

FOR: FISHING LURES; FISHING TACKLE, IN CLASS 28 (U.S. CLS. 22, 23, 38 AND 50).

FIRST USE 6-1-1993; IN COMMERCE 6-1-1993.

THE MARK CONSISTS OF STANDARD CHARACTERS WITHOUT CLAIM TO ANY PARTICULAR FONT, STYLE, SIZE, OR COLOR.

SER. NO. 85-412,811, FILED 9-1-2011.

ANDREA K. NADELMAN, EXAMINING ATTORNEY



*David J. Kybas*

Director of the United States Patent and Trademark Office

# United States of America

United States Patent and Trademark Office

## COATS COTTON

**Reg. No. 4,125,582**

**Registered Apr. 10, 2012**

**Int. Cl.: 23**

**TRADEMARK**

**PRINCIPAL REGISTER**

J. & P. COATS, LIMITED (UNITED KINGDOM COMPANY)  
1 GEORGE SQUARE  
GLASGOW, UNITED KINGDOM G21AL

FOR: THREAD, IN CLASS 23 (U.S. CL. 43).

FIRST USE 8-17-2007; IN COMMERCE 8-17-2007.

THE MARK CONSISTS OF STANDARD CHARACTERS WITHOUT CLAIM TO ANY PARTICULAR FONT, STYLE, SIZE, OR COLOR.

OWNER OF U.S. REG. NOS. 295,659, 3,516,726 AND OTHERS.

NO CLAIM IS MADE TO THE EXCLUSIVE RIGHT TO USE "COTTON", APART FROM THE MARK AS SHOWN.

SER. NO. 85-412,972, FILED 9-1-2011.

KATHY DE JONGE, EXAMINING ATTORNEY



*David J. Kyffers*

Director of the United States Patent and Trademark Office

# United States of America

United States Patent and Trademark Office

## COATS BOBBIN

**Reg. No. 4,125,583**

**Registered Apr. 10, 2012**

**Int. Cl.: 23**

**TRADEMARK**

**PRINCIPAL REGISTER**

J. & P. COATS, LIMITED (UNITED KINGDOM COMPANY)  
1 GEORGE SQUARE  
GLASGOW, UNITED KINGDOM G21AL

FOR: THREAD, IN CLASS 23 (U.S. CL. 43).

FIRST USE 4-2-2008; IN COMMERCE 4-2-2008.

THE MARK CONSISTS OF STANDARD CHARACTERS WITHOUT CLAIM TO ANY PARTICULAR FONT, STYLE, SIZE, OR COLOR.

OWNER OF U.S. REG. NOS. 295,659, 3,516,726 AND OTHERS.

NO CLAIM IS MADE TO THE EXCLUSIVE RIGHT TO USE "BOBBIN", APART FROM THE MARK AS SHOWN.

SER. NO. 85-412,981, FILED 9-1-2011.

KATHY DE JONGE, EXAMINING ATTORNEY



*David J. Kyffers*

Director of the United States Patent and Trademark Office



# United States of America

United States Patent and Trademark Office

## COATS RAYON

**Reg. No. 4,125,584**

**Registered Apr. 10, 2012**

**Int. Cl.: 23**

**TRADEMARK**

**PRINCIPAL REGISTER**

J. & P. COATS, LIMITED (UNITED KINGDOM COMPANY)  
1 GEORGE SQUARE  
GLASGOW, UNITED KINGDOM G21AL

FOR: THREAD, IN CLASS 23 (U.S. CL. 43).

FIRST USE 4-2-2008; IN COMMERCE 4-2-2008.

THE MARK CONSISTS OF STANDARD CHARACTERS WITHOUT CLAIM TO ANY PARTICULAR FONT, STYLE, SIZE, OR COLOR.

OWNER OF U.S. REG. NOS. 295,659, 3,516,726 AND OTHERS.

NO CLAIM IS MADE TO THE EXCLUSIVE RIGHT TO USE "RAYON", APART FROM THE MARK AS SHOWN.

SER. NO. 85-412,998, FILED 9-1-2011.

KATHY DE JONGE, EXAMINING ATTORNEY



*David J. Kyffers*

Director of the United States Patent and Trademark Office

# United States of America

United States Patent and Trademark Office

## COATS EXTRA STRONG

**Reg. No. 4,125,585**

**Registered Apr. 10, 2012**

**Int. Cl.: 23**

**TRADEMARK**

**PRINCIPAL REGISTER**

J. & P. COATS, LIMITED (UNITED KINGDOM COMPANY)  
1 GEORGE SQUARE  
GLASGOW, UNITED KINGDOM G21AL

FOR: THREAD, IN CLASS 23 (U.S. CL. 43).

FIRST USE 3-28-2008; IN COMMERCE 3-28-2008.

THE MARK CONSISTS OF STANDARD CHARACTERS WITHOUT CLAIM TO ANY PARTICULAR FONT, STYLE, SIZE, OR COLOR.

OWNER OF U.S. REG. NOS. 295,659, 3,516,726 AND OTHERS.

NO CLAIM IS MADE TO THE EXCLUSIVE RIGHT TO USE "EXTRA STRONG", APART FROM THE MARK AS SHOWN.

SER. NO. 85-413,010, FILED 9-1-2011.

KATHY DE JONGE, EXAMINING ATTORNEY



*David J. Kyffers*

Director of the United States Patent and Trademark Office

# United States of America

United States Patent and Trademark Office

## COATS METALLIC

**Reg. No. 4,125,586**

**Registered Apr. 10, 2012**

**Int. Cl.: 23**

**TRADEMARK**

**PRINCIPAL REGISTER**

J. & P. COATS, LIMITED (UNITED KINGDOM COMPANY)  
1 GEORGE SQUARE  
GLASGOW, UNITED KINGDOM G21AL

FOR: THREAD, IN CLASS 23 (U.S. CL. 43).

FIRST USE 8-17-2007; IN COMMERCE 8-17-2007.

THE MARK CONSISTS OF STANDARD CHARACTERS WITHOUT CLAIM TO ANY PARTICULAR FONT, STYLE, SIZE, OR COLOR.

OWNER OF U.S. REG. NOS. 295,659, 3,516,726 AND OTHERS.

NO CLAIM IS MADE TO THE EXCLUSIVE RIGHT TO USE "METALLIC", APART FROM THE MARK AS SHOWN.

SER. NO. 85-413,024, FILED 9-1-2011.

KATHY DE JONGE, EXAMINING ATTORNEY



*David J. Kybas*

Director of the United States Patent and Trademark Office

# United States of America

United States Patent and Trademark Office

## COATS TRANSPARENT

**Reg. No. 4,125,587**

**Registered Apr. 10, 2012**

**Int. Cl.: 23**

**TRADEMARK**

**PRINCIPAL REGISTER**

J. & P. COATS, LIMITED (UNITED KINGDOM COMPANY)  
1 GEORGE SQUARE  
GLASGOW, UNITED KINGDOM G21AL

FOR: THREAD, IN CLASS 23 (U.S. CL. 43).

FIRST USE 8-17-2007; IN COMMERCE 8-17-2007.

THE MARK CONSISTS OF STANDARD CHARACTERS WITHOUT CLAIM TO ANY PARTICULAR FONT, STYLE, SIZE, OR COLOR.

OWNER OF U.S. REG. NOS. 295,659, 3,516,726 AND OTHERS.

NO CLAIM IS MADE TO THE EXCLUSIVE RIGHT TO USE "TRANSPARENT", APART FROM THE MARK AS SHOWN.

SER. NO. 85-413,035, FILED 9-1-2011.

KATHY DE JONGE, EXAMINING ATTORNEY



*David J. Kyffers*

Director of the United States Patent and Trademark Office

# United States of America

United States Patent and Trademark Office

## COATS COTTON COVERED

**Reg. No. 4,125,588**

**Registered Apr. 10, 2012**

**Int. Cl.: 23**

**TRADEMARK**

**PRINCIPAL REGISTER**

J. & P. COATS, LIMITED (UNITED KINGDOM COMPANY)  
1 GEORGE SQUARE  
GLASGOW, UNITED KINGDOM G21AL

FOR: THREAD, IN CLASS 23 (U.S. CL. 43).

FIRST USE 3-10-2010; IN COMMERCE 3-10-2010.

THE MARK CONSISTS OF STANDARD CHARACTERS WITHOUT CLAIM TO ANY PARTICULAR FONT, STYLE, SIZE, OR COLOR.

OWNER OF U.S. REG. NOS. 295,659, 3,516,726 AND OTHERS.

NO CLAIM IS MADE TO THE EXCLUSIVE RIGHT TO USE "COTTON COVERED", APART FROM THE MARK AS SHOWN.

SER. NO. 85-413,064, FILED 9-1-2011.

KATHY DE JONGE, EXAMINING ATTORNEY



*David J. Kyffers*

Director of the United States Patent and Trademark Office

# United States of America

United States Patent and Trademark Office



**idapa**  
*Engineered Motion*

**Reg. No. 4,125,589**

**Registered Apr. 10, 2012**

**Int. Cl.: 35**

**SERVICE MARK**

**PRINCIPAL REGISTER**

INTEGRATED DENTAL APPLIANCE PROCESS APPLICATIONS (FLORIDA SOLE PROPRIETORSHIP), DBA INTEGRATED DENTAL APPLIANCE PROCESS APPLICATIONS  
8146 SILVER MIST PL  
TRINITY, FL 34655

FOR: BUSINESS CONSULTING SERVICES RELATING TO THE INTEGRATION OF THE AREAS OF BUSINESS PROCESS TECHNOLOGY, ORGANIZATIONAL LEARNING, CHANGE MANAGEMENT, AND OPERATIONAL SUSTAINABILITY, IN CLASS 35 (U.S. CLS. 100, 101 AND 102).

FIRST USE 8-30-2011; IN COMMERCE 8-30-2011.

THE MARK CONSISTS OF A PICTURE ON THE LEFT OF A ROUND GEAR FOLLOWED BY "IDAPA" UNDER THIS IS; "ENGINEERED MOTION".

SER. NO. 85-413,286, FILED 9-1-2011.

JOHN HWANG, EXAMINING ATTORNEY



*David J. Kybas*

Director of the United States Patent and Trademark Office

# United States of America

United States Patent and Trademark Office



**Reg. No. 4,125,590**

**Registered Apr. 10, 2012**

**Int. Cl.: 41**

**SERVICE MARK**

**PRINCIPAL REGISTER**

THE WICKFORD GROUP, LLC (VIRGINIA LIMITED LIABILITY COMPANY)  
13TH FLOOR  
11951 FREEDOM DRIVE  
RESTON, VA 20190

FOR: BUSINESS EDUCATION AND TRAINING SERVICES, NAMELY, PROVIDING CUSTOMIZED SEMINARS IN THE FIELD OF DEVELOPING AND FACILITATING ATTORNEY MANAGEMENT AND CLIENT RETENTION TECHNIQUES; PROVIDING ATTORNEY COACHING SERVICES, PROVIDING TRAINING IN BUSINESS DEVELOPMENT; PROVIDING CONTINUING LEGAL EDUCATION (CLE) PROGRAMS, IN CLASS 41 (U.S. CLS. 100, 101 AND 107).

FIRST USE 7-15-2011; IN COMMERCE 7-15-2011.

OWNER OF U.S. REG. NOS. 4,059,087, 4,059,088 AND OTHERS.

THE COLOR(S) BLUE IS/ARE CLAIMED AS A FEATURE OF THE MARK.

NO CLAIM IS MADE TO THE EXCLUSIVE RIGHT TO USE "GROUP", APART FROM THE MARK AS SHOWN.

THE MARK CONSISTS OF THE LETTER "W" IN A CIRCLE, NEXT TO A VERTICAL LINE, NEXT TO "THE WICKFORD GROUP" WITH A HORIZONTAL LINE RUNNING UNDER THE WORD "WICKFORD" ALL IN THE COLOR BLUE VARYING FROM MEDIUM BLUE AT THE TOP OF THE IMAGE TO DARK BLUE AT THE BOTTOM.

SER. NO. 85-413,294, FILED 9-1-2011.

JACQUELINE A. LAVINE, EXAMINING ATTORNEY



*David J. Kybas*

Director of the United States Patent and Trademark Office

# United States of America

United States Patent and Trademark Office



**Reg. No. 4,125,591**

RAMP UP, LLC (FLORIDA LIMITED LIABILITY COMPANY), DBA THE RAMP  
1004 ALDTON ROAD  
MIAMI BEACH, FL 33139

**Registered Apr. 10, 2012**

**Int. Cl.: 35**

FOR: ON-LINE RETAIL STORE SERVICES FEATURING ATHLETIC TRAINING ORTHOTICS  
FOR THE JAW, IN CLASS 35 (U.S. CLS. 100, 101 AND 102).

**SERVICE MARK**

FIRST USE 7-1-2011; IN COMMERCE 8-9-2011.

**PRINCIPAL REGISTER**

NO CLAIM IS MADE TO THE EXCLUSIVE RIGHT TO USE "LLC" AND "ORTHOTICS",  
APART FROM THE MARK AS SHOWN.

THE MARK CONSISTS OF "RAMP UP" ASCENDING A TRIANGULAR SHAPE AND "LLC"  
DESCENDING A TRIANGULAR SHAPE. THERE IS A CURVED LINE UNDER THE WORDS  
"RAMP UP" AND A TRIANGULAR SHAPE WITH AN IMAGE OF A BRAIN INSIDE. BELOW  
THE TRIANGULAR SHAPE ARE THE WORDS "POWER AND PROTECTION THRU OR-  
THOTICS".

SER. NO. 85-413,317, FILED 9-1-2011.

BARBARA RUTLAND, EXAMINING ATTORNEY



*David J. Kybas*

Director of the United States Patent and Trademark Office



# United States of America

United States Patent and Trademark Office

## ST. PETER'S HEALTH PARTNERS

**Reg. No. 4,125,592**

**Registered Apr. 10, 2012**

**Int. Cl.: 44**

**SERVICE MARK**

**PRINCIPAL REGISTER**

ST. PETER'S HEALTH PARTNERS (NEW YORK NON-PROFIT CORPORATION)  
315 S. MANNING BOULEVARD  
ALBANY, NY 12208

FOR: HOSPITAL AND HEALTHCARE SERVICES, IN CLASS 44 (U.S. CLS. 100 AND 101).

FIRST USE 6-2-2011; IN COMMERCE 10-3-2011.

THE MARK CONSISTS OF STANDARD CHARACTERS WITHOUT CLAIM TO ANY PARTICULAR FONT, STYLE, SIZE, OR COLOR.

NO CLAIM IS MADE TO THE EXCLUSIVE RIGHT TO USE "HEALTH PARTNERS", APART FROM THE MARK AS SHOWN.

SER. NO. 85-413,326, FILED 9-1-2011.

MARIA-VICTORIA SUAREZ, EXAMINING ATTORNEY



*David J. Kybas*

Director of the United States Patent and Trademark Office

# United States of America

United States Patent and Trademark Office

## ACCESS MEXICO

**Reg. No. 4,125,593**

CSX INTELLECTUAL PROPERTIES CORPORATION (DELAWARE CORPORATION)  
500 WATER STREET, J150  
JACKSONVILLE, FL 32202

**Registered Apr. 10, 2012**

**Int. Cl.: 39**

FOR: WAREHOUSE TRANSLOADING AND STORAGE SERVICES, IN CLASS 39 (U.S. CLS. 100 AND 105).

**SERVICE MARK**

FIRST USE 9-18-2003; IN COMMERCE 9-18-2003.

**PRINCIPAL REGISTER**

THE MARK CONSISTS OF STANDARD CHARACTERS WITHOUT CLAIM TO ANY PARTICULAR FONT, STYLE, SIZE, OR COLOR.

OWNER OF U.S. REG. NOS. 2,907,434 AND 2,963,192.

SEC. 2(F).

SER. NO. 85-413,330, FILED 9-1-2011.

JOHN HWANG, EXAMINING ATTORNEY



*David J. Kybas*

Director of the United States Patent and Trademark Office

# United States of America

United States Patent and Trademark Office

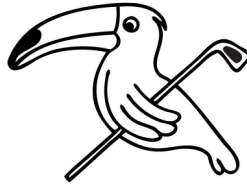

**Reg. No. 4,125,594**

SIEGFRIED & PARZIFAL, INC. (CALIFORNIA CORPORATION)  
18701 ARENTH AVE.  
CITY OF INDUSTRY, CA 91748

**Registered Apr. 10, 2012**

**Int. Cl.: 25**

FOR: DENIM JACKETS; JACKETS; JEANS; KNIT SHIRTS; PANTS; SHIRTS; SHORTS;  
SWEATERS; WOVEN TOPS, IN CLASS 25 (U.S. CLS. 22 AND 39).

**TRADEMARK**

FIRST USE 7-18-2011; IN COMMERCE 7-18-2011.

**PRINCIPAL REGISTER**

THE MARK CONSISTS OF A TOUCAN BIRD HOLDING A GOLF CLUB UNDER ITS WING.

SER. NO. 85-413,383, FILED 9-1-2011.

BRIAN NEVILLE, EXAMINING ATTORNEY



*David J. Kybas*

Director of the United States Patent and Trademark Office

# United States of America

United States Patent and Trademark Office



**Reg. No. 4,125,595**

**Registered Apr. 10, 2012**

**Int. Cl.: 9**

**TRADEMARK**

**PRINCIPAL REGISTER**

SONY ERICSSON MOBILE COMMUNICATIONS AB (SWEDEN CORPORATION)  
NYA VATTENTORNET  
LUND, SWEDEN SE-22188

FOR: DOWNLOADABLE COMPUTER SOFTWARE FOR STORING, USING, PLAYING, VIEWING, AND TRANSFERRING DIGITAL AND MEDIA CONTENT ON OR BETWEEN MOBILE PHONES, MOBILE DEVICES, PERSONAL COMPUTERS, AND ELECTRONIC GAME DEVICES, IN CLASS 9 (U.S. CLS. 21, 23, 26, 36 AND 38).

FIRST USE 7-0-2010; IN COMMERCE 7-0-2010.

THE MARK CONSISTS OF A CURVED MISCELLANEOUS DESIGN FEATURING SHADED PORTIONS. MOST OF THE SHADED PORTIONS ARE VARIOUS SHADES OF GRAY, BUT ONE IS ORANGE, ONE IS YELLOW, AND ONE IS RED. THE DESIGN HAS A GRAY SHADOW BENEATH IT.

THE COLOR(S) GRAY, ORANGE, YELLOW, AND RED IS/ARE CLAIMED AS A FEATURE OF THE MARK.

SER. NO. 85-413,440, FILED 9-1-2011.

LEIGH LOWRY, EXAMINING ATTORNEY



*David J. Kyjars*

Director of the United States Patent and Trademark Office

# United States of America

United States Patent and Trademark Office

## LIFE'S SHORT, TRAVEL WELL

**Reg. No. 4,125,596**

DESIGNER LIMOUSINES, INC. (NEW YORK CORPORATION)  
16 DAVIS AVENUE  
PORT WASHINGTON, NY 11050

**Registered Apr. 10, 2012**

**Int. Cl.: 39**

FOR: LIMOUSINE SERVICES; CAR RENTAL SERVICES; BUS CHARTERING SERVICES,  
IN CLASS 39 (U.S. CLS. 100 AND 105).

**SERVICE MARK**

FIRST USE 1-1-1990; IN COMMERCE 1-1-1990.

**PRINCIPAL REGISTER**

THE MARK CONSISTS OF STANDARD CHARACTERS WITHOUT CLAIM TO ANY PAR-  
TICULAR FONT, STYLE, SIZE, OR COLOR.

SER. NO. 85-413,503, FILED 9-1-2011.

ELLEN PERKINS, EXAMINING ATTORNEY



*David J. Kybas*

Director of the United States Patent and Trademark Office

# United States of America

United States Patent and Trademark Office

# La Merika

**Reg. No. 4,125,597**

DELICATO VINEYARDS (CALIFORNIA CORPORATION)  
12001 S HIGHWAY 99  
MANTECA, CA 95336

**Registered Apr. 10, 2012**

**Int. Cl.: 33**

FOR: APERITIF WINES; APERITIFS WITH A WINE BASE; COOKING WINE; FORTIFIED WINES; FRUIT WINE; GRAPE WINE; HONEY WINE; KITS FOR MAKING WINE; NATURAL SPARKLING WINES; PORT WINES; PREPARED WINE COCKTAILS; RED WINE; RED WINES; ROSE WINE; SPARKLING FRUIT WINE; SPARKLING GRAPE WINE; SPARKLING WINES; STILL WINES; STRAWBERRY WINE; SWEET WINES; TABLE WINES; TONIC SWEET GRAPE WINE CONTAINING EXTRACTS FROM GINSENG AND CONCHONA BARK (NINJIN-KINATETSU WINE); WHITE WINE; WINE; WINE COOLERS; WINE PUNCH; WINE PUNCHES; WINE-BASED BEVERAGE, NAMELY, PIQUETTE; WINE-BASED DRINKS; WINES; WINES AND FORTIFIED WINES; WINES AND LIQUEURS; WINES AND SPARKLING WINES; WINES DERIVED FROM GRAPES GROWN IN CA, LABELED AND ADVERTISED IN COMPLIANCE WITH CA LAWS FOR WINES, IN CLASS 33 (U.S. CLS. 47 AND 49).

**TRADEMARK**

**PRINCIPAL REGISTER**

FIRST USE 1-27-2010; IN COMMERCE 1-0-2011.

THE MARK CONSISTS OF STANDARD CHARACTERS WITHOUT CLAIM TO ANY PARTICULAR FONT, STYLE, SIZE, OR COLOR.

SER. NO. 85-413,598, FILED 9-1-2011.

MARC LEIPZIG, EXAMINING ATTORNEY



*David J. Kypos*

Director of the United States Patent and Trademark Office

# United States of America

United States Patent and Trademark Office

## EVERYDAY SANTA

**Reg. No. 4,125,598**

WOOD INNOVATIONS, LLC (GEORGIA LIMITED LIABILITY COMPANY)  
204 CALUSA LAKE COURT  
BALL GROUND, GA 30107

**Registered Apr. 10, 2012**

**Int. Cl.: 28**

FOR: DOLL ACCESSORIES; DOLL CLOTHING; DOLLS, IN CLASS 28 (U.S. CLS. 22, 23, 38 AND 50).

**TRADEMARK**

FIRST USE 12-1-1992; IN COMMERCE 12-1-1992.

**PRINCIPAL REGISTER**

THE MARK CONSISTS OF STANDARD CHARACTERS WITHOUT CLAIM TO ANY PARTICULAR FONT, STYLE, SIZE, OR COLOR.

NO CLAIM IS MADE TO THE EXCLUSIVE RIGHT TO USE "SANTA", APART FROM THE MARK AS SHOWN.

SER. NO. 85-413,632, FILED 9-1-2011.

HELENE LIWINSKI, EXAMINING ATTORNEY



*David J. Kyffers*

Director of the United States Patent and Trademark Office

# United States of America

United States Patent and Trademark Office

## Photos and Facets

**Reg. No. 4,125,599**

DEBBI ROBERTSON (UNITED STATES INDIVIDUAL)  
9204 LIBERTY CROSSING DRIVE  
FORT WORTH, TX 76131

**Registered Apr. 10, 2012**

**Int. Cl.: 41**

FOR: ON-LINE JOURNALS, NAMELY, BLOGS FEATURING PHOTOGRAPHY, NATURE AND RELATED MATTERS, IN CLASS 41 (U.S. CLS. 100, 101 AND 107).

**SERVICE MARK**

FIRST USE 8-25-2011; IN COMMERCE 8-25-2011.

**PRINCIPAL REGISTER**

THE MARK CONSISTS OF STANDARD CHARACTERS WITHOUT CLAIM TO ANY PARTICULAR FONT, STYLE, SIZE, OR COLOR.

NO CLAIM IS MADE TO THE EXCLUSIVE RIGHT TO USE "PHOTOS", APART FROM THE MARK AS SHOWN.

SER. NO. 85-413,858, FILED 9-2-2011.

LUCY ARANT, EXAMINING ATTORNEY



*David J. Kybas*

Director of the United States Patent and Trademark Office



# United States of America

United States Patent and Trademark Office

# COVERAGE

**Reg. No. 4,125,600**

**Registered Apr. 10, 2012**

**Int. Cl.: 16**

**TRADEMARK**

**PRINCIPAL REGISTER**

MEDICAL PROFESSIONAL MUTUAL INSURANCE COMPANY (MASSACHUSETTS CORPORATION)  
101 ARCH STREET  
BOSTON, MA 02110

FOR: MAGAZINES IN THE FIELD OF PROFESSIONAL LIABILITY INSURANCE AND RISK MANAGEMENT, IN CLASS 16 (U.S. CLS. 2, 5, 22, 23, 29, 37, 38 AND 50).

FIRST USE 0-0-1995; IN COMMERCE 0-0-1995.

THE MARK CONSISTS OF STANDARD CHARACTERS WITHOUT CLAIM TO ANY PARTICULAR FONT, STYLE, SIZE, OR COLOR.

SEC. 2(F).

SER. NO. 85-416,720, FILED 9-7-2011.

JULIE WATSON, EXAMINING ATTORNEY



*David J. Kyffers*

Director of the United States Patent and Trademark Office

# United States of America

United States Patent and Trademark Office

## RACE TIRES AMERICA

**Reg. No. 4,125,601**

**Registered Apr. 10, 2012**

**Int. Cl.: 12**

**TRADEMARK**

**PRINCIPAL REGISTER**

POLYMER ENTERPRISES CORP. (DELAWARE CORPORATION)  
SUITE 1300  
1105 N. MARKET STREET  
WILMINGTON, DE 19801

FOR: TIRES, NAMELY, TIRES FOR RACING VEHICLES, IN CLASS 12 (U.S. CLS. 19, 21, 23, 31, 35 AND 44).

FIRST USE 2-8-2000; IN COMMERCE 2-8-2000.

THE MARK CONSISTS OF STANDARD CHARACTERS WITHOUT CLAIM TO ANY PARTICULAR FONT, STYLE, SIZE, OR COLOR.

OWNER OF U.S. REG. NO. 2,596,245.

NO CLAIM IS MADE TO THE EXCLUSIVE RIGHT TO USE "RACE TIRES", APART FROM THE MARK AS SHOWN.

SEC. 2(F).

SER. NO. 85-417,464, FILED 9-8-2011.

ELISSA GARBER KON, EXAMINING ATTORNEY



*David J. Kyffers*

Director of the United States Patent and Trademark Office

# United States of America

United States Patent and Trademark Office

## SMARTKNITKIDS

**Reg. No. 4,125,602**

KNIT-RITE, INC. (DELAWARE CORPORATION)  
120 OSAGE AVENUE  
KANSAS CITY, KS 66105

**Registered Apr. 10, 2012**

**Int. Cls.: 10 and 25**

FOR: CLOTHING FOR MEDICAL PURPOSES, NAMELY, UNDERWEAR USED FOR PERSONS HAVING TACTILE DEFENSIVENESS, IN CLASS 10 (U.S. CLS. 26, 39 AND 44).

**TRADEMARK**

FIRST USE 12-6-2010; IN COMMERCE 12-6-2010.

**PRINCIPAL REGISTER**

FOR: UNDERWEAR, IN CLASS 25 (U.S. CLS. 22 AND 39).

FIRST USE 12-6-2010; IN COMMERCE 12-6-2010.

THE MARK CONSISTS OF STANDARD CHARACTERS WITHOUT CLAIM TO ANY PARTICULAR FONT, STYLE, SIZE, OR COLOR.

OWNER OF U.S. REG. NOS. 3,366,927 AND 3,539,745.

SER. NO. 85-418,893, FILED 9-9-2011.

REGINA DRUMMOND, EXAMINING ATTORNEY



*David J. Kyffers*

Director of the United States Patent and Trademark Office

# United States of America

United States Patent and Trademark Office

# Healthfuls

**Reg. No. 4,125,603**

**Registered Apr. 10, 2012**

**Int. Cl.: 31**

**TRADEMARK**

**PRINCIPAL REGISTER**

RHODE ISLAND TEXTILE COMPANY (RHODE ISLAND CORPORATION)  
211 COLUMBUS AVE. PO BOX 999  
PAWTUCKET, RI 02862

FOR: DOG TREATS, IN CLASS 31 (U.S. CLS. 1 AND 46).

FIRST USE 8-30-2011; IN COMMERCE 8-30-2011.

THE MARK CONSISTS OF STANDARD CHARACTERS WITHOUT CLAIM TO ANY PARTICULAR FONT, STYLE, SIZE, OR COLOR.

SER. NO. 85-419,841, FILED 9-12-2011.

SOPHIA S. KIM, EXAMINING ATTORNEY



*David J. Kybas*

Director of the United States Patent and Trademark Office

# United States of America

United States Patent and Trademark Office

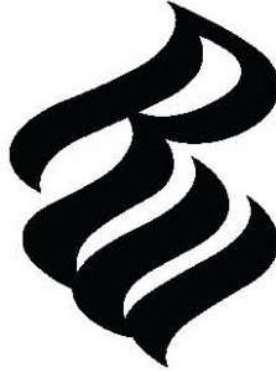

**Reg. No. 4,125,604**

**Registered Apr. 10, 2012**

**Int. Cl.: 9**

**TRADEMARK**

**PRINCIPAL REGISTER**

STUDIO IP HOLDINGS LLC (DELAWARE LIMITED LIABILITY COMPANY)  
103 FOULK ROAD  
WILMINGTON, DE 19803

FOR: EYEWEAR, NAMELY, SUNGLASSES, EYEGLASSES, AND THEIR CASES, IN CLASS  
9 (U.S. CLS. 21, 23, 26, 36 AND 38).

FIRST USE 2-29-2004; IN COMMERCE 2-29-2004.

OWNER OF U.S. REG. NOS. 2,781,618, 3,537,673 AND OTHERS.

THE MARK CONSISTS OF STYLIZED LETTERS "R" AND "W".

SER. NO. 85-423,383, FILED 9-15-2011.

GEORGE LORENZO, EXAMINING ATTORNEY



*David J. Kyffers*

Director of the United States Patent and Trademark Office

# United States of America

United States Patent and Trademark Office



**Reg. No. 4,125,605**

**Registered Apr. 10, 2012**

**Int. Cl.: 35**

**SERVICE MARK**

**PRINCIPAL REGISTER**

U.S. DEPARTMENT OF HEALTH AND HUMAN SERVICES (UNITED STATES AGENCY  
OF THE UNITED STATES GOVERNMENT)  
BLDG 31 RM 2B 50  
31 CENTER DRIVE  
BETHESDA, MD 20892

FOR: PUBLIC ADVOCACY TO PROMOTE AWARENESS ABOUT MINORITY HEALTH IS-  
SUES AND OVERCOMING HEALTH DISPARITIES IN MINORITY POPULATIONS, IN  
CLASS 35 (U.S. CLS. 100, 101 AND 102).

FIRST USE 4-8-2011; IN COMMERCE 4-8-2011.

NO CLAIM IS MADE TO THE EXCLUSIVE RIGHT TO USE "U.S. DEPARTMENT OF HEALTH  
AND HUMAN SERVICES OFFICE OF MINORITY HEALTH", APART FROM THE MARK  
AS SHOWN.

THE COLOR(S) BLUE, GREEN, GRAY, ORANGE, VIOLET AND BLACK IS/ARE CLAIMED  
AS A FEATURE OF THE MARK.

THE MARK CONSISTS OF THE DESIGN OF FIVE STYLIZED SWOOSHES IN A HALF-  
CIRCULAR PATTERN THAT GOES BLUE, GREEN, GRAY, ORANGE, AND VIOLET FROM  
TOP TO BOTTOM. THE SWOOSHES SURROUND THE LEFT SIDE OF THE LETTER "O"  
IN THE LETTERS "OMH" THAT ALL APPEAR IN BLACK. STACKED VERTICALLY BELOW  
THE LETTERS "OMH" IS THE TEXT "U.S. DEPARTMENT OF HEALTH AND HUMAN  
SERVICES OFFICE OF MINORITY HEALTH" IN BLACK.

SER. NO. 85-423,396, FILED 9-15-2011.

JASON BLAIR, EXAMINING ATTORNEY



*David J. Kyjars*

Director of the United States Patent and Trademark Office

# United States of America

United States Patent and Trademark Office

## YOUR AT&T NEWSLETTER

**Reg. No. 4,125,606**

**Registered Apr. 10, 2012**

**Int. Cl.: 41**

**SERVICE MARK**

**PRINCIPAL REGISTER**

AT&T INTELLECTUAL PROPERTY II, L.P. (NEVADA LIMITED PARTNERSHIP)  
645 EAST PLUMB LANE  
RENO, NV 89502

FOR: PROVIDING NEWSLETTERS IN THE FIELD OF TELECOMMUNICATIONS AND TELEPHONY PRODUCTS AND SERVICES, MESSAGING SERVICES, HIGH-SPEED ACCESS TO THE INTERNET AND GLOBAL COMPUTER NETWORKS, WIRELESS ELECTRONIC, DIGITAL OR IP TRANSMISSION OF VOICE, AUDIO, MUSIC, MESSAGES, GRAPHICS, IMAGES, DATA AND INFORMATION, TELEVISION AND VIDEO TRANSMISSION PRODUCTS AND SERVICES, IP TELEVISION AND IP VIDEO TRANSMISSION PRODUCTS AND SERVICES, AND MOBILE INTERNET APPLICATIONS VIA E-MAIL, IN CLASS 41 (U.S. CLS. 100, 101 AND 107).

FIRST USE 8-24-2011; IN COMMERCE 8-24-2011.

THE MARK CONSISTS OF STANDARD CHARACTERS WITHOUT CLAIM TO ANY PARTICULAR FONT, STYLE, SIZE, OR COLOR.

NO CLAIM IS MADE TO THE EXCLUSIVE RIGHT TO USE "YOUR" AND "NEWSLETTER", APART FROM THE MARK AS SHOWN.

SER. NO. 85-423,476, FILED 9-15-2011.

ALEX KEAM, EXAMINING ATTORNEY



*David J. Kybas*

Director of the United States Patent and Trademark Office

# United States of America

United States Patent and Trademark Office

## PNC WEALTH INSIGHT

**Reg. No. 4,125,607**

**Registered Apr. 10, 2012**

**Int. Cl.: 36**

**SERVICE MARK**

**PRINCIPAL REGISTER**

THE PNC FINANCIAL SERVICES GROUP, INC. (PENNSYLVANIA CORPORATION)  
249 FIFTH AVENUE  
PITTSBURGH, PA 15222

FOR: ONLINE WEALTH MANAGEMENT SERVICES; WEALTH MANAGEMENT SERVICES  
AND INVESTMENT INFORMATION PROVIDED THROUGH A WEBSITE, IN CLASS 36  
(U.S. CLS. 100, 101 AND 102).

FIRST USE 5-31-2011; IN COMMERCE 5-31-2011.

THE MARK CONSISTS OF STANDARD CHARACTERS WITHOUT CLAIM TO ANY PAR-  
TICULAR FONT, STYLE, SIZE, OR COLOR.

OWNER OF U.S. REG. NOS. 1,416,898, 2,675,555 AND OTHERS.

NO CLAIM IS MADE TO THE EXCLUSIVE RIGHT TO USE "WEALTH", APART FROM THE  
MARK AS SHOWN.

SER. NO. 85-423,745, FILED 9-15-2011.

JOHN WILKE, EXAMINING ATTORNEY



*David J. Kybas*

Director of the United States Patent and Trademark Office



# United States of America

United States Patent and Trademark Office

## CORESAFETY

**Reg. No. 4,125,608**

**Registered Apr. 10, 2012**

**Int. Cl.: 45**

**SERVICE MARK**

**PRINCIPAL REGISTER**

NATIONAL MINING ASSOCIATION (DELAWARE CORPORATION)  
SUITE 500 EAST  
101 CONSTITUTION AVENUE NW  
WASHINGTON, DC 20001

FOR: PROVIDING INFORMATION CONCERNING MINING SAFETY, IN CLASS 45 (U.S. CLS. 100 AND 101).

FIRST USE 9-16-2011; IN COMMERCE 9-16-2011.

THE MARK CONSISTS OF STANDARD CHARACTERS WITHOUT CLAIM TO ANY PARTICULAR FONT, STYLE, SIZE, OR COLOR.

SER. NO. 85-424,994, FILED 9-16-2011.

INGA ERVIN, EXAMINING ATTORNEY



*David J. Kyffers*

Director of the United States Patent and Trademark Office

# United States of America

United States Patent and Trademark Office

*Samuel Loyd*

**Reg. No. 4,125,609**

**Registered Apr. 10, 2012**

**Int. Cl.: 28**

**TRADEMARK**

**PRINCIPAL REGISTER**

TONY FATSEAS (AUSTRALIA INDIVIDUAL)  
77 BREAM STREET  
COOGEE, AUSTRALIA 2034

FOR: PUZZLES, IN CLASS 28 (U.S. CLS. 22, 23, 38 AND 50).

FIRST USE 3-11-2006; IN COMMERCE 7-14-2006.

OWNER OF U.S. REG. NOS. 3,323,706, 3,996,839, AND 3,996,899.

THE NAME(S), PORTRAIT(S), AND/OR SIGNATURE(S) SHOWN IN THE MARK DOES NOT IDENTIFY A PARTICULAR LIVING INDIVIDUAL.

THE MARK CONSISTS OF THE SIGNATURE OF THE NAME "SAMUEL LOYD".

SEC. 2(F).

SER. NO. 85-425,465, FILED 9-18-2011.

BARNEY CHARLON, EXAMINING ATTORNEY



*David J. Kybas*

Director of the United States Patent and Trademark Office

# United States of America

United States Patent and Trademark Office

## STUDENT LPI

**Reg. No. 4,125,610**

**Registered Apr. 10, 2012**

**Int. Cls.: 9, 16 and 41**

**TRADEMARK**

**SERVICE MARK**

**PRINCIPAL REGISTER**

JOHN WILEY & SONS, INC. (NEW YORK CORPORATION)  
111 RIVER STREET  
HOBOKEN, NJ 07030

FOR: DOWNLOADABLE EDUCATION SOFTWARE FEATURING INSTRUCTION IN THE FIELD OF LEADERSHIP, EDUCATIONAL SOFTWARE RECORDED ON CD-ROM AND DVD-ROM FEATURING INSTRUCTION IN THE FIELD OF LEADERSHIP; DOWNLOADABLE EDUCATIONAL PUBLICATIONS IN THE NATURE OF BOOKS, NEWSLETTERS, MAGAZINES, JOURNALS, AND CATALOGUES IN THE FIELD OF LEADERSHIP, IN CLASS 9 (U.S. CLS. 21, 23, 26, 36 AND 38).

FIRST USE 1-1-1997; IN COMMERCE 1-1-1997.

FOR: INSTRUCTIONAL BOOKS AND OTHER PRINTED TRAINING MATERIALS, NAMELY, TRAINING MANUALS, GUIDES AND SEMINAR MATERIALS IN THE NATURE OF NEWSLETTERS, FOR USE IN CONNECTION WITH A CONTINUING SERIES OF CLASSES, SEMINARS, CONFERENCES, AND WORKSHOPS IN THE FIELD OF LEADERSHIP DEVELOPMENT, IN CLASS 16 (U.S. CLS. 2, 5, 22, 23, 29, 37, 38 AND 50).

FIRST USE 1-1-1997; IN COMMERCE 1-1-1997.

FOR: EDUCATIONAL SERVICES, NAMELY, CONDUCTING A CONTINUING SERIES OF CLASSES, SEMINARS, CONFERENCES, AND WORKSHOPS IN THE FIELD OF LEADERSHIP DEVELOPMENT AND DISTRIBUTING COURSE MATERIALS IN CONNECTION THEREWITH; WORKSHOPS AND SEMINARS IN THE FIELD OF LEADERSHIP, IN CLASS 41 (U.S. CLS. 100, 101 AND 107).

FIRST USE 1-1-1997; IN COMMERCE 1-1-1997.

THE MARK CONSISTS OF STANDARD CHARACTERS WITHOUT CLAIM TO ANY PARTICULAR FONT, STYLE, SIZE, OR COLOR.

OWNER OF U.S. REG. NOS. 3,368,505 AND 3,369,123.

NO CLAIM IS MADE TO THE EXCLUSIVE RIGHT TO USE "STUDENT", APART FROM THE MARK AS SHOWN.



*David J. Kyjars*

Director of the United States Patent and Trademark Office

**Reg. No. 4,125,610** SER. NO. 85-426,028, FILED 9-19-2011.

B. PARADEWELAI, EXAMINING ATTORNEY

# United States of America

United States Patent and Trademark Office



**Reg. No. 4,125,611**

**Registered Apr. 10, 2012**

**Int. Cls.: 36 and 44**

**SERVICE MARK**

**PRINCIPAL REGISTER**

AMERICAN BRAIN TUMOR ASSOCIATION (ILLINOIS NON-PROFIT CORPORATION)  
8550 W. BRYN MAWR AVENUE, SUITE 550  
CHICAGO, IL 606313225

FOR: CHARITABLE FUNDRAISING SERVICES, NAMELY, ORGANIZING AND CONDUCTING FUNDRAISING EVENTS AND FUNDRAISING PROJECTS TO SUPPORT BRAIN TUMOR RESEARCH, TO PROMOTE AWARENESS OF BRAIN TUMOR TREATMENT AND TO SUPPORT BRAIN TUMOR PATIENTS AND THEIR FAMILIES, IN CLASS 36 (U.S. CLS. 100, 101 AND 102).

FIRST USE 5-2-2011; IN COMMERCE 5-2-2011.

FOR: CHARITABLE SERVICES, NAMELY, PROVIDING A FREE ONLINE RESOURCE IN THE NATURE OF A WEBSITE PROVIDING BRAIN TUMOR MEDICAL TREATMENT INFORMATION FOR BRAIN TUMOR PATIENTS; CHARITABLE OUTREACH PROGRAMS, NAMELY, PROVIDING INFORMATION AND COUNSELING PROGRAMS IN THE FIELD OF HEALTH, MEDICAL SERVICES AND MEDICAL TREATMENT OPTIONS FOR BRAIN TUMOR PATIENTS, IN CLASS 44 (U.S. CLS. 100 AND 101).

FIRST USE 5-2-2011; IN COMMERCE 5-2-2011.

OWNER OF U.S. REG. NO. 3,507,573.

THE MARK CONSISTS OF A FRAGMENTED CIRCLE WITH A SOLID DOT IN THE CENTRAL PORTION OF THE CIRCLE AND TWO INTERSECTING CONVEX LINES EXTENDING FROM WITHIN THE CIRCLE TO AN AREA BELOW THE CIRCLE FORMING THE SHAPE OF A PERSON.

SER. NO. 85-426,350, FILED 9-19-2011.

CAROL SPILS, EXAMINING ATTORNEY



*David J. Kybas*

Director of the United States Patent and Trademark Office

# United States of America

United States Patent and Trademark Office



**Reg. No. 4,125,612**

**Registered Apr. 10, 2012**

**Int. Cls.: 1, 7, 9 and 40**

**TRADEMARK**

**SERVICE MARK**

**PRINCIPAL REGISTER**

3D SYSTEMS, INC. (CALIFORNIA CORPORATION)  
333 THREE D SYSTEMS CIRCLE  
ROCK HILL, SC 29730

FOR: SOLID IMAGING MATERIALS, NAMELY, PLASTIC, METAL, WAX, SILICONE, UR-ETHANE, CERAMIC OR COMPOSITE MATERIALS, USED TO CREATE THREE-DIMEN-SIONAL EMBODIMENTS OF COMPUTER GENERATED DESIGNS, IN CLASS 1 (U.S. CLS. 1, 5, 6, 10, 26 AND 46).

FIRST USE 5-26-2011; IN COMMERCE 8-1-2011.

FOR: COMPUTER DRIVEN MACHINE FOR MAKING THREE-DIMENSIONAL EMBODI-MENTS OF COMPUTER GENERATED DESIGNS, IN CLASS 7 (U.S. CLS. 13, 19, 21, 23, 31, 34 AND 35).

FIRST USE 5-26-2011; IN COMMERCE 8-1-2011.

FOR: COMPUTER SOFTWARE FOR USE IN DESIGNING THREE-DIMENSIONAL OBJECTS AND CONTROLLING MACHINES FOR MAKING THREE-DIMENSIONAL EMBODIMENTS OF THE OBJECTS, IN CLASS 9 (U.S. CLS. 21, 23, 26, 36 AND 38).

FIRST USE 5-26-2011; IN COMMERCE 8-1-2011.

FOR: MANUFACTURE OF THREE-DIMENSIONAL OBJECTS, NAMELY, PROTOTYPES, MODELS, PATTERNS, MOLDS, MEDICAL DEVICES OR FINISHED GOODS, TO THE ORDER AND SPECIFICATION OF OTHERS, IN CLASS 40 (U.S. CLS. 100, 103 AND 106).

FIRST USE 5-26-2011; IN COMMERCE 8-1-2011.

NO CLAIM IS MADE TO THE EXCLUSIVE RIGHT TO USE "3D", APART FROM THE MARK AS SHOWN.

THE MARK CONSISTS OF A CUBE WITH THE NUMBER "3" ON ONE SIDE, THE LETTER "D" ON ANOTHER SIDE, AND THE LETTER "S" ON THE BOTTOM SIDE.

SER. NO. 85-427,976, FILED 9-21-2011.



*David J. Kyjars*

Director of the United States Patent and Trademark Office

**Reg. No. 4,125,612** DAVID MURRAY, EXAMINING ATTORNEY

# United States of America

United States Patent and Trademark Office



**Reg. No. 4,125,613**

**Registered Apr. 10, 2012**

**Int. Cl.: 36**

**SERVICE MARK**

**PRINCIPAL REGISTER**

CHARTWAY FEDERAL CREDIT UNION (UNITED STATES FEDERALLY CHARTERED CREDIT UNION)  
160 NEWTOWN ROAD  
VIRGINIA BEACH, VA 234622415

FOR: CREDIT UNION AND BANKING SERVICES; SAVINGS ACCOUNT SERVICES; CHECKING ACCOUNT SERVICES; BANKING AND CREDIT UNION SERVICES FEATURING THE PROVISION OF CERTIFICATES OF DEPOSIT; BANKING AND CREDIT UNION SERVICES FEATURING MONEY MARKET ACCOUNTS; INDIVIDUAL RETIREMENT ACCOUNT SERVICES; CONSUMER LENDING SERVICES; CREDIT CARD, CHARGE CARD AND DEBIT CARD SERVICES; CREDIT AND LOAN SERVICES; FINANCING OF AUTO LOANS; AUTO DEALER LOAN FINANCING; MORTGAGE LENDING; HOME EQUITY LOANS AND LINES OF CREDIT; STUDENT LOANS; PROVIDING BUSINESS SAVINGS AND CHECKING ACCOUNT SERVICES; FINANCING BUSINESS LOANS; FINANCING CONSTRUCTION LOANS; COMMERCIAL LENDING SERVICES; ONLINE BANKING SERVICES; ELECTRONIC BANKING VIA A GLOBAL COMPUTER NETWORK; ATM BANKING SERVICES; INSURANCE AND FINANCIAL INFORMATION AND CONSULTANCY SERVICES; INVESTMENT ADVICE; FINANCIAL PLANNING FOR RETIREMENT, IN CLASS 36 (U.S. CLS. 100, 101 AND 102).

FIRST USE 1-1-2010; IN COMMERCE 1-1-2010.

NO CLAIM IS MADE TO THE EXCLUSIVE RIGHT TO USE "CREDIT UNION", APART FROM THE MARK AS SHOWN.

THE MARK CONSISTS OF A STYLIZED DESIGN OF THE WORDS "HERITAGEWEST" IN INITIAL CAPS WITH THE WORDS "CREDIT UNION" IN ALL CAPS BELOW THOSE WORDS; AND A DESIGN ELEMENT COMPOSED OF ELONGATED SHAPES OF THREE PEOPLE (TWO LARGE AND ONE SMALLER IN CENTER) LOCATED TO THE LEFT OF THE WORDS "HERITAGEWEST CREDIT UNION".

SER. NO. 85-428,903, FILED 9-22-2011.

TARAH HARDY, EXAMINING ATTORNEY



*David J. Kyros*

Director of the United States Patent and Trademark Office



# United States of America

United States Patent and Trademark Office



**Reg. No. 4,125,614**

ZUFFA, LLC (NEVADA LIMITED LIABILITY COMPANY)  
2960 W. SAHARA AVENUE  
LAS VEGAS, NV 89102

**Registered Apr. 10, 2012**

**Int. Cl.: 38**

FOR: AUDIO AND VIDEO BROADCASTING SERVICES OVER THE INTERNET; PAY-PER-VIEW TELEVISION TRANSMISSION SERVICES; STREAMING OF AUDIO, VISUAL AND AUDIOVISUAL MATERIAL VIA A GLOBAL COMPUTER NETWORK; VIDEO ON DEMAND TRANSMISSIONS, IN CLASS 38 (U.S. CLS. 100, 101 AND 104).

**SERVICE MARK**

**PRINCIPAL REGISTER**

FIRST USE 1-30-2011; IN COMMERCE 1-30-2011.

OWNER OF U.S. REG. NOS. 2,645,312, 3,004,864 AND OTHERS.

NO CLAIM IS MADE TO THE EXCLUSIVE RIGHT TO USE "TV", APART FROM THE MARK AS SHOWN.

THE MARK CONSISTS OF THE STYLIZED TEXT "UFC TV" IN WHICH TV APPEARS AGAINST A PARALLELOGRAM.

SER. NO. 85-432,172, FILED 9-26-2011.

JOHN WILKE, EXAMINING ATTORNEY



*David J. Kybas*

Director of the United States Patent and Trademark Office

# United States of America

United States Patent and Trademark Office

## DENTURES & DENTAL SERVICES

**Reg. No. 4,125,615**

BENCHMARK CONSULTING GROUP, LLC (OKLAHOMA LIMITED LIABILITY COMPANY)  
200 NORTH BROADWAY STREET  
CHECOTAH, OK 74426

**Registered Apr. 10, 2012**

**Int. Cl.: 44**

FOR: DENTIST SERVICES, IN CLASS 44 (U.S. CLS. 100 AND 101).

**SERVICE MARK**

FIRST USE 12-31-1987; IN COMMERCE 12-31-1987.

**PRINCIPAL REGISTER**

THE MARK CONSISTS OF STANDARD CHARACTERS WITHOUT CLAIM TO ANY PARTICULAR FONT, STYLE, SIZE, OR COLOR.

OWNER OF U.S. REG. NO. 3,635,872.

NO CLAIM IS MADE TO THE EXCLUSIVE RIGHT TO USE "DENTAL SERVICES", APART FROM THE MARK AS SHOWN.

SEC. 2(F).

SER. NO. 85-433,226, FILED 9-27-2011.

BERYL GARDNER, EXAMINING ATTORNEY



*David J. Kyffers*

Director of the United States Patent and Trademark Office

# United States of America

United States Patent and Trademark Office

## APPLIED CHARGER

**Reg. No. 4,125,616**

**Registered Apr. 10, 2012**

**Int. Cl.: 7**

**TRADEMARK**

**PRINCIPAL REGISTER**

APPLIED MATERIALS, INC. (DELAWARE CORPORATION)  
3050 BOWERS AVENUE  
M/S 1241  
SANTA CLARA, CA 95054

FOR: MACHINES FOR THE PROCESSING AND PRODUCTION OF SEMICONDUCTOR SUBSTRATES, THIN FILMS, SILICON DISCS AND WAFERS; MACHINES FOR THE POLISHING, CLEANING, PROCESS MONITORING, AND MEASURING OF SEMICONDUCTOR SUBSTRATES, THIN FILMS, SILICON DISCS AND WAFERS, IN CLASS 7 (U.S. CLS. 13, 19, 21, 23, 31, 34 AND 35).

FIRST USE 7-31-2010; IN COMMERCE 7-31-2010.

THE MARK CONSISTS OF STANDARD CHARACTERS WITHOUT CLAIM TO ANY PARTICULAR FONT, STYLE, SIZE, OR COLOR.

OWNER OF U.S. REG. NOS. 4,002,845, 4,044,528 AND OTHERS.

SER. NO. 85-433,537, FILED 9-27-2011.

MICHAEL WIENER, EXAMINING ATTORNEY



*David J. Kyros*

Director of the United States Patent and Trademark Office

# United States of America

United States Patent and Trademark Office

## LANDYVISION

**Reg. No. 4,125,617**

**Registered Apr. 10, 2012**

**Int. Cl.: 9**

**TRADEMARK**

**PRINCIPAL REGISTER**

LANDYVISION, INC. (NEW YORK CORPORATION)  
218 GOAT HILL ROAD  
WOODSTOCK, NY 12498

FOR: DIGITAL MEDIA, NAMELY, VIDEO CASSETTES, CDS, DVDS, DOWNLOADABLE AUDIO AND VIDEO FILES, AND HIGH DEFINITION DIGITAL VIDEO RECORDINGS FEATURING MUSIC AND AUDIO/VISUAL ENTERTAINMENT, NAMELY, MUSIC, DOCUMENTARIES, AND MUSICAL ENTERTAINMENT, IN CLASS 9 (U.S. CLS. 21, 23, 26, 36 AND 38).

FIRST USE 9-19-1990; IN COMMERCE 6-1-1997.

THE MARK CONSISTS OF STANDARD CHARACTERS WITHOUT CLAIM TO ANY PARTICULAR FONT, STYLE, SIZE, OR COLOR.

SEC. 2(F).

SER. NO. 85-435,927, FILED 9-29-2011.

DAVID TOOLEY, EXAMINING ATTORNEY



*David J. Kyffers*

Director of the United States Patent and Trademark Office

# United States of America

United States Patent and Trademark Office

# SNACK UP

**Reg. No. 4,125,618**

AFN BROKER LLC (NEW JERSEY LIMITED LIABILITY COMPANY)  
1092 ST. GEORGE AVE. UNIT 166  
RAHWAY, NJ 07065

**Registered Apr. 10, 2012**

**Int. Cl.: 30**

FOR: BISCUITS; CANDIES; COOKIES; CRACKERS; SAUCES, IN CLASS 30 (U.S. CL. 46).

FIRST USE 3-0-2009; IN COMMERCE 3-0-2009.

**TRADEMARK**

THE MARK CONSISTS OF STANDARD CHARACTERS WITHOUT CLAIM TO ANY PARTICULAR FONT, STYLE, SIZE, OR COLOR.

**PRINCIPAL REGISTER**

NO CLAIM IS MADE TO THE EXCLUSIVE RIGHT TO USE "SNACK", APART FROM THE MARK AS SHOWN.

SER. NO. 85-436,013, FILED 9-30-2011.

CURTIS FRENCH, EXAMINING ATTORNEY



*David J. Kybas*

Director of the United States Patent and Trademark Office

# United States of America

United States Patent and Trademark Office

# BIZZY DIET

**Reg. No. 4,125,619**

**Registered Apr. 10, 2012**

**Int. Cl.: 41**

**SERVICE MARK**

**PRINCIPAL REGISTER**

MUSCLEPHARM CORPORATION (NEVADA CORPORATION)  
4721 IRONTON STREET; UNIT A  
DENVER, CO 80239

FOR: EDUCATIONAL SERVICES, NAMELY, CONDUCTING INFORMAL ON-LINE PROGRAMS IN THE FIELDS OF FITNESS TRAINING AND NUTRITION, AND PRINTABLE MATERIALS DISTRIBUTED THEREWITH, IN CLASS 41 (U.S. CLS. 100, 101 AND 107).

FIRST USE 7-1-2011; IN COMMERCE 7-1-2011.

THE MARK CONSISTS OF STANDARD CHARACTERS WITHOUT CLAIM TO ANY PARTICULAR FONT, STYLE, SIZE, OR COLOR.

NO CLAIM IS MADE TO THE EXCLUSIVE RIGHT TO USE "DIET", APART FROM THE MARK AS SHOWN.

SER. NO. 85-437,820, FILED 10-3-2011.

HOWARD SMIGA, EXAMINING ATTORNEY



*David J. Kyffers*

Director of the United States Patent and Trademark Office

# United States of America

United States Patent and Trademark Office

## DO MASSAGE

**Reg. No. 4,125,620**

**Registered Apr. 10, 2012**

**Int. Cl.: 25**

**TRADEMARK**

**PRINCIPAL REGISTER**

TOODALOO LLC (FLORIDA LIMITED LIABILITY COMPANY)  
18323 CUTLASS DR.  
FORT MYERS BEACH, FL 33931

FOR: HATS; JACKETS; PANTS; SHIRTS, IN CLASS 25 (U.S. CLS. 22 AND 39).

FIRST USE 7-1-2011; IN COMMERCE 7-1-2011.

THE MARK CONSISTS OF STANDARD CHARACTERS WITHOUT CLAIM TO ANY PARTICULAR FONT, STYLE, SIZE, OR COLOR.

SER. NO. 85-438,232, FILED 10-3-2011.

JUSTINE D. PARKER, EXAMINING ATTORNEY



*David J. Kyffers*

Director of the United States Patent and Trademark Office

# United States of America

United States Patent and Trademark Office

## I DO MASSAGE

**Reg. No. 4,125,621**

TOODALOO LLC (FLORIDA LIMITED LIABILITY COMPANY)  
18323 CUTLASS DR.

**Registered Apr. 10, 2012**

FORT MYERS BEACH, FL 33931

**Int. Cl.: 25**

FOR: HATS; JACKETS; PANTS; SHIRTS, IN CLASS 25 (U.S. CLS. 22 AND 39).

**TRADEMARK**

FIRST USE 7-1-2011; IN COMMERCE 7-1-2011.

**PRINCIPAL REGISTER**

THE MARK CONSISTS OF STANDARD CHARACTERS WITHOUT CLAIM TO ANY PARTICULAR FONT, STYLE, SIZE, OR COLOR.

SER. NO. 85-438,239, FILED 10-3-2011.

JUSTINE D. PARKER, EXAMINING ATTORNEY



*David J. Kyffers*

Director of the United States Patent and Trademark Office



# United States of America

United States Patent and Trademark Office

# Kidsiderate

**Reg. No. 4,125,622**

**Registered Apr. 10, 2012**

**Int. Cl.: 41**

**SERVICE MARK**

**PRINCIPAL REGISTER**

SEAWORLD PARKS & ENTERTAINMENT LLC (DELAWARE LIMITED LIABILITY COMPANY)  
SUITE 400  
9205 SOUTH PARK CENTER LOOP  
ORLANDO, FL 32819

FOR: ENTERTAINMENT SERVICES IN THE NATURE OF AMUSEMENT PARK RIDES, AMUSEMENT PARK SHOWS AND AMUSEMENT PARK ATTRACTIONS, IN CLASS 41 (U.S. CLS. 100, 101 AND 107).

FIRST USE 12-0-2008; IN COMMERCE 6-0-2009.

THE MARK CONSISTS OF THE STYLIZED TERM "KIDSIDERATE" WITH THE "K" STYLIZED AS A STICK FIGURE PERSON.

SER. NO. 85-439,164, FILED 10-4-2011.

WILLIAM ROSSMAN, EXAMINING ATTORNEY



*David J. Kyffers*

Director of the United States Patent and Trademark Office

# United States of America

United States Patent and Trademark Office



**Reg. No. 4,125,623**

HICKORY FARMS, INC. (DELAWARE CORPORATION)  
1505 HOLLAND ROAD  
MAUMEE, OH 43537

**Registered Apr. 10, 2012**

**Int. Cl.: 35**

FOR: ONLINE RETAIL STORE SERVICES FEATURING FOOD AND GIFTS, IN CLASS 35  
(U.S. CLS. 100, 101 AND 102).

**SERVICE MARK**

FIRST USE 7-1-2008; IN COMMERCE 7-1-2008.

**PRINCIPAL REGISTER**

OWNER OF U.S. REG. NOS. 1,413,521, 3,016,141, AND 3,291,924.

NO CLAIM IS MADE TO THE EXCLUSIVE RIGHT TO USE "EST. 1951", APART FROM  
THE MARK AS SHOWN.

THE MARK CONSISTS OF THE WORDS "HICKORY FARMS" OVER THE LETTERS AND  
NUMERALS "EST. 1951". A DRAWING OF A BARN AND SILO IS CENTERED BETWEEN  
THE WORDS "HICKORY" AND "FARMS".

SER. NO. 85-440,066, FILED 10-5-2011.

ANDREA BUTLER, EXAMINING ATTORNEY



*David J. Kypos*

Director of the United States Patent and Trademark Office

# United States of America

United States Patent and Trademark Office

## YOGA GYPSY

**Reg. No. 4,125,624**

**Registered Apr. 10, 2012**

**Int. Cl.: 25**

**TRADEMARK**

**PRINCIPAL REGISTER**

40 DAYS, LLC (ARKANSAS LIMITED LIABILITY COMPANY), DBA 40 DAYS OUTFITTERS  
SUITE 100  
2530 PINNACLE HILLS PARKWAY  
ROGERS, AR 72758

FOR: PANTS; SHIRTS, IN CLASS 25 (U.S. CLS. 22 AND 39).

FIRST USE 3-1-2010; IN COMMERCE 7-19-2011.

THE MARK CONSISTS OF STANDARD CHARACTERS WITHOUT CLAIM TO ANY PARTICULAR FONT, STYLE, SIZE, OR COLOR.

NO CLAIM IS MADE TO THE EXCLUSIVE RIGHT TO USE "YOGA", APART FROM THE MARK AS SHOWN.

SER. NO. 85-440,167, FILED 10-5-2011.

CHARLOTTE CORWIN, EXAMINING ATTORNEY



*David J. Kybas*

Director of the United States Patent and Trademark Office

# United States of America

United States Patent and Trademark Office

## ACNECEUTICALS

**Reg. No. 4,125,625**

SHELLING, CHRISTIANNE E (UNITED STATES INDIVIDUAL)  
PO BOX 58  
THREE RIVERS, CA 93271

**Registered Apr. 10, 2012**

**Int. Cl.: 3**

FOR: NON-MEDICATED ACNE TREATMENT PREPARATIONS, IN CLASS 3 (U.S. CLS. 1, 4, 6, 50, 51 AND 52).

**TRADEMARK**

FIRST USE 12-1-2003; IN COMMERCE 12-1-2003.

**PRINCIPAL REGISTER**

THE MARK CONSISTS OF STANDARD CHARACTERS WITHOUT CLAIM TO ANY PARTICULAR FONT, STYLE, SIZE, OR COLOR.

OWNER OF U.S. REG. NO. 2,914,657.

SER. NO. 85-442,927, FILED 10-9-2011.

GIANCARLO CASTRO, EXAMINING ATTORNEY



*David J. Kybas*

Director of the United States Patent and Trademark Office

# United States of America

United States Patent and Trademark Office

## WHERE COMPASSION MEETS COMMITMENT

**Reg. No. 4,125,626**

AMERICAN BRAIN TUMOR ASSOCIATION (ILLINOIS NON-PROFIT CORPORATION)  
8550 W. BRYN MAWR AVENUE, SUITE 550  
CHICAGO, IL 606313225

**Registered Apr. 10, 2012**

**Int. Cls.: 36 and 44**

FOR: CHARITABLE FUNDRAISING SERVICES, NAMELY, ORGANIZING AND CONDUCTING FUNDRAISING EVENTS AND PROJECTS TO SUPPORT BRAIN TUMOR RESEARCH, TO PROMOTE AWARENESS OF BRAIN TUMOR TREATMENT AND TO SUPPORT BRAIN TUMOR PATIENTS AND THEIR FAMILIES, IN CLASS 36 (U.S. CLS. 100, 101 AND 102).

**SERVICE MARK**

**PRINCIPAL REGISTER**

FIRST USE 5-2-2011; IN COMMERCE 5-2-2011.

FOR: CHARITABLE SERVICES, NAMELY, PROVIDING A FREE ONLINE RESOURCE IN THE NATURE OF A WEBSITE PROVIDING BRAIN TUMOR MEDICAL TREATMENT INFORMATION FOR BRAIN TUMOR PATIENTS; CHARITABLE OUTREACH PROGRAMS, NAMELY, PROVIDING INFORMATION AND COUNSELING PROGRAMS IN THE FIELD OF HEALTH, MEDICAL SERVICES AND MEDICAL TREATMENT OPTIONS FOR BRAIN TUMOR PATIENTS, IN CLASS 44 (U.S. CLS. 100 AND 101).

FIRST USE 5-2-2011; IN COMMERCE 5-2-2011.

THE MARK CONSISTS OF STANDARD CHARACTERS WITHOUT CLAIM TO ANY PARTICULAR FONT, STYLE, SIZE, OR COLOR.

SER. NO. 85-443,342, FILED 10-10-2011.

CAROL SPILS, EXAMINING ATTORNEY



*David J. Kyjars*

Director of the United States Patent and Trademark Office

# United States of America

United States Patent and Trademark Office



**Reg. No. 4,125,627**

**Registered Apr. 10, 2012**

**Int. Cl.: 9**

**TRADEMARK**

**PRINCIPAL REGISTER**

SCHLUMBERGER TECHNOLOGY CORPORATION (TEXAS CORPORATION)  
SUITE 100  
5599 SAN FELIPE  
HOUSTON, TX 77056

FOR: COMPUTER SOFTWARE, NAMELY, FOR USE IN THE OIL AND GAS EXPLORATION AND PRODUCTION INDUSTRY FOR DATA COLLECTION, DATA MANAGEMENT AND DATA ANALYSIS AND INSTRUCTIONAL MANUALS SOLD AS A UNIT THEREWITH, IN CLASS 9 (U.S. CLS. 21, 23, 26, 36 AND 38).

FIRST USE 9-30-2011; IN COMMERCE 9-30-2011.

THE MARK CONSISTS OF A STYLIZED "A" IN A BOX WITH ROUNDED CORNERS.

SER. NO. 85-443,447, FILED 10-10-2011.

FLORENTINA BLANDU, EXAMINING ATTORNEY



*David J. Kyffers*

Director of the United States Patent and Trademark Office

# United States of America

United States Patent and Trademark Office

# Cutter

**Reg. No. 4,125,628**

**Registered Apr. 10, 2012**

**Int. Cl.: 4**

**TRADEMARK**

**PRINCIPAL REGISTER**

UNITED INDUSTRIES CORPORATION (DELAWARE CORPORATION)  
1 RIDER TRAIL PLAZA DRIVE  
EARTH CITY, MO 63045

FOR: CANDLES, IN CLASS 4 (U.S. CLS. 1, 6 AND 15).

FIRST USE 1-30-2011; IN COMMERCE 1-30-2011.

THE MARK CONSISTS OF STANDARD CHARACTERS WITHOUT CLAIM TO ANY PARTICULAR FONT, STYLE, SIZE, OR COLOR.

OWNER OF U.S. REG. NOS. 1,341,985, 1,757,957, AND 3,397,604.

SER. NO. 85-443,512, FILED 10-10-2011.

AMY ALFIERI, EXAMINING ATTORNEY



*David J. Kybas*

Director of the United States Patent and Trademark Office

# United States of America

United States Patent and Trademark Office

THERE'S NO PLACE LIKE HOME

**Reg. No. 4,125,629**

**Registered Apr. 10, 2012**

**Int. Cl.: 21**

**TRADEMARK**

**PRINCIPAL REGISTER**

TURNER ENTERTAINMENT CO. (DELAWARE CORPORATION)  
BLDG 156  
4000 WARNER BLVD.  
BURBANK, CA 91522

FOR: GLASS, CERAMIC AND EARTHENWARE GOODS, NAMELY, BOWLS, PLATES, COFFEE CUPS, AND CUPS; BEVERAGE GLASSWARE, NAMELY, JUGS, MUGS AND DRINKING GLASSES; INFANT CUPS; THERMAL INSULATED CONTAINERS FOR FOOD OR BEVERAGES; WATER BOTTLES SOLD EMPTY; AND DINNERWARE, NAMELY, PAPER PLATES AND PAPER CUPS, IN CLASS 21 (U.S. CLS. 2, 13, 23, 29, 30, 33, 40 AND 50).

FIRST USE 6-15-2009; IN COMMERCE 6-15-2009.

THE MARK CONSISTS OF STANDARD CHARACTERS WITHOUT CLAIM TO ANY PARTICULAR FONT, STYLE, SIZE, OR COLOR.

OWNER OF U.S. REG. NOS. 2,522,947 AND 2,540,752.

SER. NO. 85-444,895, FILED 10-11-2011.

KAREN SEVERSON, EXAMINING ATTORNEY



*David J. Kyffers*

Director of the United States Patent and Trademark Office



# United States of America

United States Patent and Trademark Office

# myBYU

**Reg. No. 4,125,630**

**Registered Apr. 10, 2012**

**Int. Cl.: 41**

**SERVICE MARK**

**PRINCIPAL REGISTER**

BRIGHAM YOUNG UNIVERSITY (UTAH CORPORATION)  
OFFICE OF THE GENERAL COUNSEL  
A-357 ASB  
PROVO, UT 84602

FOR: EDUCATING AT UNIVERSITY OR COLLEGES, IN CLASS 41 (U.S. CLS. 100, 101 AND 107).

FIRST USE 9-22-2011; IN COMMERCE 9-22-2011.

THE MARK CONSISTS OF STANDARD CHARACTERS WITHOUT CLAIM TO ANY PARTICULAR FONT, STYLE, SIZE, OR COLOR.

OWNER OF U.S. REG. NOS. 1,581,409, 3,355,053, AND 3,529,756.

SER. NO. 85-447,021, FILED 10-13-2011.

ERNEST SHOSHO, EXAMINING ATTORNEY



*David J. Kyffers*

Director of the United States Patent and Trademark Office

# United States of America

United States Patent and Trademark Office

## THE HUFFINGTON POST GAME CHANGERS

**Reg. No. 4,125,631**

**Registered Apr. 10, 2012**

**Int. Cl.: 41**

**SERVICE MARK**

**PRINCIPAL REGISTER**

THEHUFFINGTONPOST.COM, INC. (DELAWARE CORPORATION)  
22000 AOL WAY  
DULLES, VA 20166

FOR: PROVIDING RECOGNITION AND INCENTIVES BY THE WAY OF AWARDS TO DEMONSTRATE EXCELLENCE IN THE FIELDS OF EDUCATION, ENTERTAINMENT, HEALTH, CULTURE, TECHNOLOGY, POLITICS, MEDIA, SPORTS, STYLE, GREEN LIVING, FOOD, AND TRAVEL; ONLINE JOURNALS, NAMELY, BLOGS FEATURING EDUCATION, ENTERTAINMENT, HEALTH, CULTURE, TECHNOLOGY, POLITICS, MEDIA, SPORTS, STYLE, GREEN LIVING, FOOD, AND TRAVEL, IN CLASS 41 (U.S. CLS. 100, 101 AND 107).

FIRST USE 10-1-2009; IN COMMERCE 10-1-2009.

THE MARK CONSISTS OF STANDARD CHARACTERS WITHOUT CLAIM TO ANY PARTICULAR FONT, STYLE, SIZE, OR COLOR.

OWNER OF U.S. REG. NOS. 3,095,331, 4,011,546 AND OTHERS.

NO CLAIM IS MADE TO THE EXCLUSIVE RIGHT TO USE "GAME CHANGERS", APART FROM THE MARK AS SHOWN.

SER. NO. 85-448,917, FILED 10-17-2011.

EDWARD NELSON, EXAMINING ATTORNEY



*David J. Kybas*

Director of the United States Patent and Trademark Office

# United States of America

United States Patent and Trademark Office

# JE GEM

**Reg. No. 4,125,632**

**Registered Apr. 10, 2012**

**Int. Cl.: 35**

**SERVICE MARK**

**PRINCIPAL REGISTER**

SU, JE GEM (MALAYSIA INDIVIDUAL)  
EMPORIO PLACE, 93/141 SOI SUKHUMVIT 24,  
SUKHUMVIT RD, KLONG TON, KLONG TOEI,  
BANGKOK, THAILAND 10110

FOR: ELECTRONIC RETAIL STORE AND WHOLESALE STORE SERVICES VIA COMPUTER  
FEATURING GEMSTONES, JEWELRY, BEAD AND GEMSTONE CARVINGS, ART, AN-  
TIQUES, ARTIFACTS AND STATUES, IN CLASS 35 (U.S. CLS. 100, 101 AND 102).

FIRST USE 1-1-2002; IN COMMERCE 1-1-2002.

THE MARK CONSISTS OF STANDARD CHARACTERS WITHOUT CLAIM TO ANY PAR-  
TICULAR FONT, STYLE, SIZE, OR COLOR.

NO CLAIM IS MADE TO THE EXCLUSIVE RIGHT TO USE "GEM", APART FROM THE  
MARK AS SHOWN.

SER. NO. 85-449,059, FILED 10-17-2011.

LAURA HAMMEL, EXAMINING ATTORNEY



*David J. Kyffers*

Director of the United States Patent and Trademark Office

# United States of America

United States Patent and Trademark Office

## ADVISOR DIRECTED TRUST

**Reg. No. 4,125,633**

**Registered Apr. 10, 2012**

**Int. Cl.: 36**

**SERVICE MARK**

**PRINCIPAL REGISTER**

FRANKLIN RESOURCES, INC. (DELAWARE CORPORATION), DBA FRANKLIN  
TEMPLETON INVESTMENTS  
ONE FRANKLIN PARKWAY  
SAN MATEO, CA 94066

FOR: BANKING SERVICES; ELECTRONIC BANKING VIA A GLOBAL COMPUTER NETWORK; FINANCIAL TRUST OPERATIONS; FINANCIAL TRUST PLANNING; TRUST MANAGEMENT ACCOUNTS; TRUST SERVICES, NAMELY, INVESTMENT AND TRUST COMPANY SERVICES, IN CLASS 36 (U.S. CLS. 100, 101 AND 102).

FIRST USE 11-0-2003; IN COMMERCE 11-0-2003.

THE MARK CONSISTS OF STANDARD CHARACTERS WITHOUT CLAIM TO ANY PARTICULAR FONT, STYLE, SIZE, OR COLOR.

OWNER OF U.S. REG. NO. 3,161,195.

NO CLAIM IS MADE TO THE EXCLUSIVE RIGHT TO USE "TRUST", APART FROM THE MARK AS SHOWN.

SEC. 2(F).

SER. NO. 85-449,737, FILED 10-18-2011.

FLORENTINA BLANDU, EXAMINING ATTORNEY



*David J. Kybas*

Director of the United States Patent and Trademark Office

# United States of America

United States Patent and Trademark Office

## SOBIESKI ESPRESSO

**Reg. No. 4,125,634**

BELVEDERE S.A. (FRANCE CORPORATION)  
10 AVENUE CHARLES JAFFELIN  
BEAUNE, FRANCE 21200

**Registered Apr. 10, 2012**

**Int. Cl.: 33**

FOR: ESPRESSO FLAVORED VODKA, IN CLASS 33 (U.S. CLS. 47 AND 49).

**TRADEMARK**

FIRST USE 10-12-2011; IN COMMERCE 10-12-2011.

**PRINCIPAL REGISTER**

THE MARK CONSISTS OF STANDARD CHARACTERS WITHOUT CLAIM TO ANY PARTICULAR FONT, STYLE, SIZE, OR COLOR.

OWNER OF U.S. REG. NOS. 2,378,523, 3,576,360 AND OTHERS.

NO CLAIM IS MADE TO THE EXCLUSIVE RIGHT TO USE "ESPRESSO", APART FROM THE MARK AS SHOWN.

SER. NO. 85-450,233, FILED 10-18-2011.

JAY BESCH, EXAMINING ATTORNEY



*David J. Kyffers*

Director of the United States Patent and Trademark Office

# United States of America

United States Patent and Trademark Office

# SANÜK

**Reg. No. 4,125,635**

**Registered Apr. 10, 2012**

**Int. Cl.: 25**

**TRADEMARK**

**PRINCIPAL REGISTER**

DECKERS OUTDOOR CORPORATION (DELAWARE CORPORATION)  
495-A SOUTH FAIRVIEW AVENUE  
GOLETA, CA 93117

FOR: FOOTWEAR; HEADWEAR; T-SHIRTS, IN CLASS 25 (U.S. CLS. 22 AND 39).

FIRST USE 1-7-1997; IN COMMERCE 1-7-1997.

THE MARK CONSISTS OF STANDARD CHARACTERS WITHOUT CLAIM TO ANY PARTICULAR FONT, STYLE, SIZE, OR COLOR.

OWNER OF U.S. REG. NOS. 2,150,576 AND 3,787,465.

THE ENGLISH TRANSLATION OF THE WORD "SANÜK" IN THE MARK IS "FUN".

SER. NO. 85-450,943, FILED 10-19-2011.

THEODORE MCBRIDE, EXAMINING ATTORNEY

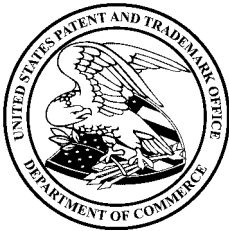

*David J. Kyffers*

Director of the United States Patent and Trademark Office

# United States of America

United States Patent and Trademark Office



**Reg. No. 4,125,636**

**Registered Apr. 10, 2012**

**Int. Cl.: 9**

PRAGMATIC WORKS SOFTWARE, INC (FLORIDA CORPORATION), DBA PRAGMATIC WORKS  
SUI TE 216  
400 COLLEGE DRIVE  
MIDDLEBURG, FL 32068

**TRADEMARK**

FOR: COMPUTER SOFTWARE FOR APPLICATION AND DATABASE INTEGRATION, IN CLASS 9 (U.S. CLS. 21, 23, 26, 36 AND 38).

**PRINCIPAL REGISTER**

FIRST USE 11-1-2008; IN COMMERCE 4-22-2009.

THE MARK CONSISTS OF BLACK BOLD ITALIC LETTERS FOR "BI XPRESS" FOLLOWING FOUR RED PARALLELOGRAMS, GREY UNCLOSED OVAL STARTING AT THE "P" CONTINUING THROUGH THE "E" IN "XPRESS" AND STOPPING BEFORE REACHING THE BOTTOM OF THE "P", A RED ARCH THAT FOLLOWS ALONG THE INSIDE OF THE GREY OVAL AND STOPS BEFORE IT REACHES THE LETTER "E", TRIANGULAR GREY SHAPE POINTING THROUGH THE LETTER "P" AND "R" EXTENDING THROUGH THE RED ARCH IN THE GREY OVAL.

THE COLOR(S) BLACK, RED AND GREY IS/ARE CLAIMED AS A FEATURE OF THE MARK.

SER. NO. 85-451,984, FILED 10-20-2011.

HENRY S. ZAK, EXAMINING ATTORNEY



*David J. Kyjars*

Director of the United States Patent and Trademark Office

# United States of America

United States Patent and Trademark Office

# LRN

**Reg. No. 4,125,637**

**Registered Apr. 10, 2012**

**Int. Cl.: 41**

**SERVICE MARK**

**PRINCIPAL REGISTER**

LRN CORPORATION (DELAWARE CORPORATION)  
1100 GLENDON AVENUE, SUITE 700  
LOS ANGELES, CA 90024

FOR: EDUCATIONAL SERVICES, NAMELY, PROVIDING GROUP COACHING AND IN-PERSON LEARNING FORUMS AND PROVIDING ONLINE AND LIVE CLASSES AND TUTORING, ALL IN THE FIELDS OF BUSINESS ORAL AND WRITTEN COMMUNICATIONS, BUSINESS AND PROFESSIONAL CONDUCT BY BUSINESSES, INSTITUTIONS, AND GOVERNMENT AGENCIES, LEADERSHIP DEVELOPMENT, CORPORATE AND SOCIAL VALUES, INSTITUTIONAL BEHAVIOR AND CULTURE, CORPORATE GOVERNANCE, VALUES-DRIVEN AND VALUES-BASED BUSINESS LEADERSHIP, INSPIRATIONAL LEADERSHIP DEVELOPMENT, ETHICAL LEADERSHIP DEVELOPMENT, ENVIRONMENTAL INITIATIVES, BUSINESS ORGANIZATIONAL DEVELOPMENT, CORPORATE CULTURE AND BUSINESS, CULTURAL, SOCIAL AND ENVIRONMENTAL RESPONSIBILITY FOR BUSINESS, BUSINESS ENTERPRISE OPERATIONAL SUSTAINABILITY, ENVIRONMENTAL SUSTAINABILITY ISSUES, ANTI-BRIBERY AND CORRUPTION IN BUSINESS, ETHICAL BUSINESS CONDUCT AND COMMUNICATIONS, CONFLICTS OF INTEREST IN BUSINESS, ETHICS AND REGULATORY COMPLIANCE PROGRAM EFFECTIVENESS IN THE FIELD OF BUSINESS AND CORPORATE MANAGEMENT AND OPERATION, EXPORT REGULATIONS, PERFORMANCE AND PROCUREMENT OF GOVERNMENT CONTRACTS AND BUSINESS RELATIONSHIPS BETWEEN GOVERNMENT AND GOVERNMENT CONTRACTORS, INSIDER TRADING AND DEALING RELATED TO THE RECORDING AND REGISTERING OF THE TRANSFER OF SECURITIES, MANAGING INTELLECTUAL PROPERTY, BUSINESS INVESTIGATIONS, PRIVACY LAWS AND PROTECTION OF BUSINESS AND PERSONAL INFORMATION, BUSINESS RECORDS MANAGEMENT AND RETENTION, AND ENVIRONMENTAL ISSUES; EDUCATIONAL AND ENTERTAINMENT SERVICES, NAMELY, PROVIDING MOTIVATIONAL AND EDUCATIONAL SPEAKING SERVICES IN THE FIELDS OF LAW, BUSINESS ETHICS, BUSINESS ORAL AND WRITTEN COMMUNICATIONS, BUSINESS AND PROFESSIONAL CONDUCT BY BUSINESSES, INSTITUTIONS, AND GOVERNMENT AGENCIES, LEADERSHIP DEVELOPMENT, CORPORATE AND SOCIAL VALUES, INSTITUTIONAL BEHAVIOR AND CULTURE, CORPORATE GOVERNANCE, VALUES-DRIVEN AND VALUES-BASED BUSINESS LEADERSHIP DEVELOPMENT, INSPIRATIONAL LEADERSHIP DEVELOPMENT, ETHICAL LEADERSHIP DEVELOPMENT, ENVIRONMENTAL INITIATIVES, BUSINESS ORGANIZATIONAL DEVELOPMENT, CORPORATE CULTURE AND BUSINESS, CULTURAL, SOCIAL AND ENVIRONMENTAL RESPONSIBILITY FOR BUSINESS, BUSINESS ENTERPRISE OPERATIONAL SUSTAINABILITY, ENVIRONMENTAL SUSTAINABILITY ISSUES, ANTI-BRIBERY AND CORRUPTION



*David J. Kybas*

Director of the United States Patent and Trademark Office



**Reg. No. 4,125,637** IN BUSINESS, BUSINESS CONDUCT AND COMMUNICATIONS, CONFLICTS OF INTEREST IN BUSINESS, ETHICS AND COMPLIANCE PROGRAM EFFECTIVENESS IN THE FIELD OF BUSINESS AND CORPORATE MANAGEMENT AND OPERATION, EXPORT REGULATIONS, PERFORMANCE AND PROCUREMENT OF GOVERNMENT CONTRACTS AND GOVERNMENT CONTRACTOR BUSINESS RELATIONSHIPS, INSIDER TRADING AND DEALING RELATED TO THE RECORDING AND REGISTERING OF THE TRANSFER OF SECURITIES, MANAGING INTELLECTUAL PROPERTY, BUSINESS INVESTIGATIONS, PRIVACY LAWS AND PROTECTION OF BUSINESS AND PERSONAL INFORMATION, BUSINESS RECORDS MANAGEMENT AND RETENTION, AND ENVIRONMENTAL ISSUES, IN CLASS 41 (U.S. CLS. 100, 101 AND 107).

FIRST USE 5-0-2000; IN COMMERCE 5-0-2000.

THE MARK CONSISTS OF STANDARD CHARACTERS WITHOUT CLAIM TO ANY PARTICULAR FONT, STYLE, SIZE, OR COLOR.

OWNER OF U.S. REG. NOS. 1,975,636 AND 3,795,027.

SER. NO. 85-452,690, FILED 10-20-2011.

JERI J. FICKES, EXAMINING ATTORNEY

# United States of America

United States Patent and Trademark Office

# TRUSLATE

**Reg. No. 4,125,638**

BUILDING MATERIALS INVESTMENT CORP. (DELAWARE CORPORATION)  
2600 SINGLETON BLVD.  
DALLAS, TX 75212

**Registered Apr. 10, 2012**

**Int. Cl.: 19**

FOR: ROOFING SLATES; NON-METAL ROOF VENTS FOR VENTILATION IN RESIDENTIAL OR COMMERCIAL BUILDINGS, IN CLASS 19 (U.S. CLS. 1, 12, 33 AND 50).

**TRADEMARK**

FIRST USE 9-30-2008; IN COMMERCE 9-30-2008.

**PRINCIPAL REGISTER**

THE MARK CONSISTS OF STANDARD CHARACTERS WITHOUT CLAIM TO ANY PARTICULAR FONT, STYLE, SIZE, OR COLOR.

SER. NO. 85-454,470, FILED 10-24-2011.

MEGHAN REINHART, EXAMINING ATTORNEY



*David J. Kyffers*

Director of the United States Patent and Trademark Office

# United States of America

United States Patent and Trademark Office

## HP A HUFFINGTON POST MEDIA GROUP PUBLICATION

**Reg. No. 4,125,639**

THEHUFFINGTONPOST.COM, INC. (DELAWARE CORPORATION)  
22000 AOL WAY  
DULLES, VA 20166

**Registered Apr. 10, 2012**

**Int. Cl.: 41**

FOR: ONLINE ELECTRONIC PUBLISHING OF BOOKS, IN CLASS 41 (U.S. CLS. 100, 101 AND 107).

**SERVICE MARK**

FIRST USE 9-7-2011; IN COMMERCE 9-7-2011.

**PRINCIPAL REGISTER**

THE MARK CONSISTS OF STANDARD CHARACTERS WITHOUT CLAIM TO ANY PARTICULAR FONT, STYLE, SIZE, OR COLOR.

OWNER OF U.S. REG. NOS. 3,095,331, 4,011,546 AND OTHERS.

NO CLAIM IS MADE TO THE EXCLUSIVE RIGHT TO USE "MEDIA GROUP PUBLICATION", APART FROM THE MARK AS SHOWN.

SER. NO. 85-454,697, FILED 10-24-2011.

EDWARD NELSON, EXAMINING ATTORNEY



*David J. Kybas*

Director of the United States Patent and Trademark Office

# United States of America

United States Patent and Trademark Office

# APPLIED E3

**Reg. No. 4,125,640**

**Registered Apr. 10, 2012**

**Int. Cl.: 9**

**TRADEMARK**

**PRINCIPAL REGISTER**

APPLIED MATERIALS, INC. (DELAWARE CORPORATION)  
3050 BOWERS AVENUE  
M/S 1241  
SANTA CLARA, CA 95054

FOR: COMPUTER SOFTWARE FOR THE OPERATION OF SEMICONDUCTOR OR SOLAR CELL PROCESSING AND PRODUCTION EQUIPMENT INCLUDING METROLOGY, POLISHING, AND CLEANING EQUIPMENT, IN CLASS 9 (U.S. CLS. 21, 23, 26, 36 AND 38).

FIRST USE 7-31-2011; IN COMMERCE 7-31-2011.

THE MARK CONSISTS OF STANDARD CHARACTERS WITHOUT CLAIM TO ANY PARTICULAR FONT, STYLE, SIZE, OR COLOR.

OWNER OF U.S. REG. NOS. 1,943,850, 4,002,846 AND OTHERS.

SER. NO. 85-457,286, FILED 10-26-2011.

MICHAEL WIENER, EXAMINING ATTORNEY



*David J. Kybas*

Director of the United States Patent and Trademark Office

# United States of America

United States Patent and Trademark Office

# ASSURANCE

**Reg. No. 4,125,641**

**Registered Apr. 10, 2012**

**Int. Cl.: 42**

**SERVICE MARK**

**PRINCIPAL REGISTER**

CHAMPION COLLEGE SERVICES, INC. (ARIZONA CORPORATION)  
4600 SOUTH MILL AVENUE, SUITE 180  
TEMPE, AZ 85285

FOR: CLOUD COMPUTING FEATURING SOFTWARE FOR LOAN MANAGEMENT SERVICES; CLOUD COMPUTING FEATURING SOFTWARE FOR FINANCIAL SERVICES, NAMELY, LOAN DEFAULT MITIGATION SERVICES; PROVIDING A WEBSITE FEATURING NON-DOWNLOADABLE SOFTWARE FOR LOAN MANAGEMENT SERVICES; AND PROVIDING TEMPORARY USE OF ON-LINE NON-DOWNLOADABLE SOFTWARE FOR LOAN SERVICES, NAMELY, LOAN MANAGEMENT SERVICES, IN CLASS 42 (U.S. CLS. 100 AND 101).

FIRST USE 10-10-2011; IN COMMERCE 10-10-2011.

THE MARK CONSISTS OF STANDARD CHARACTERS WITHOUT CLAIM TO ANY PARTICULAR FONT, STYLE, SIZE, OR COLOR.

SER. NO. 85-458,256, FILED 10-27-2011.

TOBY BULLOFF, EXAMINING ATTORNEY



*David J. Kyjars*

Director of the United States Patent and Trademark Office

# United States of America

United States Patent and Trademark Office

## RALPH LAUREN

**Reg. No. 4,125,642**

PRL USA HOLDINGS, INC. (DELAWARE CORPORATION)  
550 SEVENTH AVENUE  
NEW YORK, NY 10018

**Registered Apr. 10, 2012**

**Int. Cl.: 18**

FOR: DOG APPAREL, IN CLASS 18 (U.S. CLS. 1, 2, 3, 22 AND 41).

**TRADEMARK**

FIRST USE 9-0-2004; IN COMMERCE 9-0-2004.

**PRINCIPAL REGISTER**

THE MARK CONSISTS OF STANDARD CHARACTERS WITHOUT CLAIM TO ANY PARTICULAR FONT, STYLE, SIZE, OR COLOR.

OWNER OF U.S. REG. NOS. 1,976,324, 3,877,439 AND OTHERS.

THE NAME "RALPH LAUREN" IDENTIFIES A LIVING INDIVIDUAL WHOSE CONSENT IS OF RECORD.

SER. NO. 85-459,386, FILED 10-28-2011.

NANCY CLARKE, EXAMINING ATTORNEY



*David J. Kyffers*

Director of the United States Patent and Trademark Office

# United States of America

United States Patent and Trademark Office

## Acquiring Response

**Reg. No. 4,125,643**

**Registered Apr. 10, 2012**

**Int. Cl.: 35**

**SERVICE MARK**

**PRINCIPAL REGISTER**

PRINT MANAGEMENT PARTNERS, INC. (ILLINOIS CORPORATION), DBA CABLE QUEST  
SUITE 1050  
701 LEE STREET  
DES PLAINES, IL 60016

FOR: CUSTOMER RELATIONSHIP MANAGEMENT, IN CLASS 35 (U.S. CLS. 100, 101 AND 102).

FIRST USE 12-1-2009; IN COMMERCE 12-1-2009.

THE MARK CONSISTS OF STANDARD CHARACTERS WITHOUT CLAIM TO ANY PARTICULAR FONT, STYLE, SIZE, OR COLOR.

SER. NO. 85-461,092, FILED 11-1-2011.

DORITT L. CARROLL, EXAMINING ATTORNEY



*David J. Kyffers*

Director of the United States Patent and Trademark Office

# United States of America

United States Patent and Trademark Office



KeraCell

**Reg. No. 4,125,644**

SUSAN RAFFY (UNITED STATES INDIVIDUAL), DBA SUSAN RAFFY  
1010 VIA REATA  
VISTA, CA 920816844

**Registered Apr. 10, 2012**

**Int. Cl.: 3**

FOR: NON-MEDICATED PREPARATIONS ALL FOR THE CARE OF SKIN, HAIR AND SCALP, IN CLASS 3 (U.S. CLS. 1, 4, 6, 50, 51 AND 52).

**TRADEMARK**

FIRST USE 9-10-2010; IN COMMERCE 9-10-2010.

**PRINCIPAL REGISTER**

THE MARK CONSISTS OF THE UNDERLINED TERM, "KERACELL", BELOW THE DESIGN OF A SPHERE SPLIT IN HALF VERTICALLY.

SER. NO. 85-461,710, FILED 11-1-2011.

BARBARA A. GOLD, EXAMINING ATTORNEY



*David J. Kyffers*

Director of the United States Patent and Trademark Office



# United States of America

United States Patent and Trademark Office

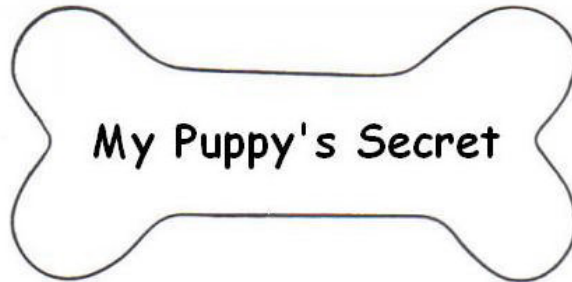

**Reg. No. 4,125,645**

JOHN TORIS (UNITED STATES INDIVIDUAL)  
5015 N. 19TH PLACE  
MILWAUKEE, WI 53209 AND

**Registered Apr. 10, 2012**

**Int. Cl.: 35**

CAROL TORIS (UNITED STATES INDIVIDUAL)  
5015 N. 19TH PLACE  
MILWAUKEE, WI 53209

**SERVICE MARK**

**PRINCIPAL REGISTER**

FOR: RESELLER SERVICES, NAMELY, DISTRIBUTORSHIP SERVICES IN THE FIELD OF PET PRODUCTS BAKED TREATS, RUBBER TOYS, RAWHIDE SNACKS, CHEW TOYS, RUBBER TOYS, JERKY TREATS CHEWS, DOG BISCUITS, RUBBER BONES AND BALLS FOR DOGS, IN CLASS 35 (U.S. CLS. 100, 101 AND 102).

FIRST USE 9-17-2010; IN COMMERCE 1-16-2011.

SER. NO. 85-462,030, FILED 11-1-2011.

JUDITH HELFMAN, EXAMINING ATTORNEY



*David J. Kybas*

Director of the United States Patent and Trademark Office

# United States of America

United States Patent and Trademark Office



**Reg. No. 4,125,646**

**Registered Apr. 10, 2012**

**Int. Cl.: 9**

**TRADEMARK**

**PRINCIPAL REGISTER**

IFLASH INC. (CALIFORNIA CORPORATION)  
1330 44TH AVE.  
SAN FRANCISCO, CA 94122

FOR: CELL PHONE BATTERY CHARGERS; DISPLAY PROTECTOR TO PROVIDE SHADE AND PRIVACY FOR ELECTRONIC DEVICES HAVING SCREENS; MEMORY CARDS; USB CABLES, IN CLASS 9 (U.S. CLS. 21, 23, 26, 36 AND 38).

FIRST USE 1-1-2009; IN COMMERCE 1-1-2009.

NO CLAIM IS MADE TO THE EXCLUSIVE RIGHT TO USE "FLASH", APART FROM THE MARK AS SHOWN.

THE MARK CONSISTS OF A STYLIZED LETTER "I" IN A DESIGN OF A LIGHT TOWER; ADJACENT TO THE LETTER "I", TO THE RIGHT, IS THE STYLIZED WORDING "FLASH". A SERIES OF HORIZONTAL LINES EMANATES AS SHADING TO THE "FLASH" WORDING.

SER. NO. 85-465,764, FILED 11-7-2011.

JORDAN BAKER, EXAMINING ATTORNEY



*David J. Kyros*

Director of the United States Patent and Trademark Office

# United States of America

United States Patent and Trademark Office

## LIVING MEDICINE

**Reg. No. 4,125,647**

**Registered Apr. 10, 2012**

**Int. Cls.: 41 and 44**

**SERVICE MARK**

**PRINCIPAL REGISTER**

FABRICIUS ENTERPRISES, LLC (NEVADA LIMITED LIABILITY COMPANY)  
15306 N.E. 12TH WAY  
VANCOUVER, WA 98684

FOR: EDUCATIONAL SERVICES, NAMELY, TEACHING AND CONDUCTING SEMINARS AND WORKSHOPS IN THE FIELD OF NATUROPATHIC MEDICINE, IN CLASS 41 (U.S. CLS. 100, 101 AND 107).

FIRST USE 9-1-1997; IN COMMERCE 9-1-1997.

FOR: MEDICAL SERVICES; MEDICAL CLINICS; MEDICAL TESTING AND EVALUATION; AND MEDICAL AND NUTRITIONAL COUNSELING IN THE FIELD OF HOMEOPATHIC AND BOTANICAL REMEDIES, IN CLASS 44 (U.S. CLS. 100 AND 101).

FIRST USE 9-1-1997; IN COMMERCE 9-1-1997.

THE MARK CONSISTS OF STANDARD CHARACTERS WITHOUT CLAIM TO ANY PARTICULAR FONT, STYLE, SIZE, OR COLOR.

NO CLAIM IS MADE TO THE EXCLUSIVE RIGHT TO USE "MEDICINE" , APART FROM THE MARK AS SHOWN.

SER. NO. 85-476,873, FILED 11-18-2011.

CHRISIE B. KING, EXAMINING ATTORNEY



*David J. Kybas*

Director of the United States Patent and Trademark Office

# United States of America

United States Patent and Trademark Office

 **Perfect365**

**Reg. No. 4,125,648**

ARCSOFT, INC. (CALIFORNIA CORPORATION)  
46601 FREMONT BLVD.  
FREMONT, CA 94538

**Registered Apr. 10, 2012**

**Int. Cls.: 9 and 42**

FOR: COMPUTER SOFTWARE FOR CREATING, MANIPULATING AND PROCESSING DIGITAL CONTENT, IN CLASS 9 (U.S. CLS. 21, 23, 26, 36 AND 38).

**TRADEMARK**

FIRST USE 11-2-2011; IN COMMERCE 11-2-2011.

**SERVICE MARK**

FOR: HOSTING OF DIGITAL CONTENT ON THE INTERNET; PROVIDING ONLINE NON-DOWNLOADABLE SOFTWARE FOR CREATING, MANIPULATING, PROCESSING, TRANSFERRING, UPLOADING, AND DOWNLOADING DIGITAL CONTENT, IN CLASS 42 (U.S. CLS. 100 AND 101).

**PRINCIPAL REGISTER**

FIRST USE 11-2-2011; IN COMMERCE 11-2-2011.

THE MARK CONSISTS OF THE WORD "PERFECT365" TO THE RIGHT OF A DRAWING OF A STYLIZED WOMAN'S FACE. THE FACE DESIGN INCLUDES THE RIGHT EYE AND AN OUTLINE OF THE NOSE STARTING FROM THE RIGHT EYEBROW.

SER. NO. 85-490,010, FILED 12-7-2011.

JENNIFER WILLISTON, EXAMINING ATTORNEY



*David J. Kybas*

Director of the United States Patent and Trademark Office

# United States of America

United States Patent and Trademark Office

# FV

**Reg. No. 4,125,649**

**Registered Apr. 10, 2012**

**Int. Cls.: 9 and 41**

**TRADEMARK**

**SERVICE MARK**

**PRINCIPAL REGISTER**

ZYNGA INC. (DELAWARE CORPORATION)  
365 VERMONT STREET  
SAN FRANCISCO, CA 94103

FOR: COMPUTER GAME SOFTWARE; VIDEO GAME PROGRAMS; AND COMPUTER SOFTWARE PLATFORMS FOR SOCIAL NETWORKING; INTERACTIVE VIDEO GAME PROGRAMS; DOWNLOADABLE ELECTRONIC GAME PROGRAMS AND COMPUTER SOFTWARE PLATFORMS FOR SOCIAL NETWORKING THAT MAY BE ACCESSED VIA THE INTERNET, COMPUTERS AND WIRELESS DEVICES; COMPUTER SOFTWARE TO ENABLE UPLOADING, POSTING, SHOWING, DISPLAYING, TAGGING, BLOGGING, SHARING OR OTHERWISE PROVIDING ELECTRONIC MEDIA OR INFORMATION IN THE FIELDS OF VIRTUAL COMMUNITIES, ELECTRONIC GAMING, ENTERTAINMENT, AND GENERAL INTEREST VIA THE INTERNET OR OTHER COMMUNICATIONS NETWORKS WITH THIRD PARTIES; DOWNLOADABLE VIRTUAL GOODS, NAMELY, COMPUTER PROGRAMS FEATURING ARTICLES OF CLOTHING, FURNITURE, DECORATIONS, VEHICLES, FARM EQUIPMENT, TOOLS, TREES AND SHRUBS, PLANTS, FISH SUPPLIES AND EQUIPMENT, BATHROOM FIXTURES, KITCHEN FIXTURES, AND OTHER CONSUMER GOODS FOR USE IN ONLINE VIRTUAL WORLDS, IN CLASS 9 (U.S. CLS. 21, 23, 26, 36 AND 38).

FIRST USE 6-16-2010; IN COMMERCE 6-16-2010.



FOR: ENTERTAINMENT SERVICES, NAMELY, PROVIDING ONLINE COMPUTER AND ELECTRONIC GAMES; ENTERTAINMENT SERVICES, NAMELY, PROVIDING ONLINE COMPUTER GAMES, ENHANCEMENTS WITHIN ONLINE COMPUTER GAMES, AND GAME APPLICATIONS WITHIN ONLINE COMPUTER GAMES; PROVIDING ONLINE REVIEWS OF COMPUTER GAMES, AND PROVIDING OF INFORMATION RELATING TO COMPUTER GAMES; PROVIDING AN INTERNET WEBSITE PORTAL IN THE FIELD OF COMPUTER GAMES AND GAMING; ENTERTAINMENT SERVICES, NAMELY, PROVIDING VIRTUAL ENVIRONMENTS IN WHICH USERS CAN INTERACT THROUGH SOCIAL GAMES FOR RECREATIONAL, LEISURE OR ENTERTAINMENT PURPOSES, IN CLASS 41 (U.S. CLS. 100, 101 AND 107).

FIRST USE 6-16-2010; IN COMMERCE 6-16-2010.

*David J. Kyros*

Director of the United States Patent and Trademark Office

THE MARK CONSISTS OF STANDARD CHARACTERS WITHOUT CLAIM TO ANY PARTICULAR FONT, STYLE, SIZE, OR COLOR.

**Reg. No. 4,125,649** SER. NO. 85-976,015, FILED 8-19-2010.

ANDREA HACK, EXAMINING ATTORNEY

# United States of America

United States Patent and Trademark Office

## CANDY GIRL

**Reg. No. 4,125,650**

PS BRANDS, LLC. (NEW YORK LIMITED LIABILITY COMPANY)  
100 WEST 33RD STREET, SUITE 1105  
NEW YORK, NY 10001

**Registered Apr. 10, 2012**

**Int. Cls.: 9 and 25**

FOR: SUNGLASSES, IN CLASS 9 (U.S. CLS. 21, 23, 26, 36 AND 38).

**TRADEMARK**

FIRST USE 12-1-2011; IN COMMERCE 12-1-2011.

**PRINCIPAL REGISTER**

FOR: CHILDREN'S APPAREL, NAMELY, T-SHIRTS AND SWIMWEAR, IN CLASS 25 (U.S. CLS. 22 AND 39).

FIRST USE 10-24-2011; IN COMMERCE 10-24-2011.

THE MARK CONSISTS OF STANDARD CHARACTERS WITHOUT CLAIM TO ANY PARTICULAR FONT, STYLE, SIZE, OR COLOR.

OWNER OF U.S. REG. NO. 2,689,276.

SN 76-698,286, FILED 7-7-2009.

JOHN DALIER, EXAMINING ATTORNEY

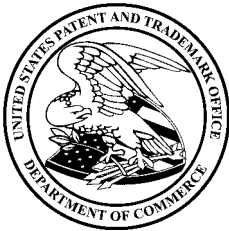

*David J. Kyffers*

Director of the United States Patent and Trademark Office

# United States of America

United States Patent and Trademark Office

## SHELBYFEST

**Reg. No. 4,125,651**

CARROLL HALL SHELBY TRUST (TEXAS REVOCABLE TRUST)  
11150 WEST OLYMPIC BLVD., SUITE 1050  
LOS ANGELES, CA 90064

**Registered Apr. 10, 2012**

**Int. Cls.: 25 and 41**

FOR: CLOTHING, NAMELY, T-SHIRTS, JACKETS, SHIRTS, HATS, CAPS, AND WIND RESISTANT JACKETS, IN CLASS 25 (U.S. CLS. 22 AND 39).

**TRADEMARK**

FIRST USE 3-1-2006; IN COMMERCE 2-1-2007.

**SERVICE MARK**

FOR: ORGANIZING AND CONDUCTING EXHIBITIONS AND FAIRS FEATURING THE DISPLAY OF AUTOMOBILES AND RACE CARS FOR EDUCATIONAL PURPOSES, IN CLASS 41 (U.S. CLS. 100, 101 AND 107).

**PRINCIPAL REGISTER**

FIRST USE 3-1-2006; IN COMMERCE 2-1-2007.

THE MARK CONSISTS OF STANDARD CHARACTERS WITHOUT CLAIM TO ANY PARTICULAR FONT, STYLE, SIZE, OR COLOR.

OWNER OF U.S. REG. NOS. 1,768,020, 2,357,468, AND OTHERS.

SN 76-699,515, FILED 9-18-2009.

CHRISTOPHER BUONGIORNO, EXAMINING ATTORNEY



*David J. Kybas*

Director of the United States Patent and Trademark Office



# United States of America

United States Patent and Trademark Office

## GOURMET

**Reg. No. 4,125,652**

**Registered Apr. 10, 2012**

**Int. Cl.: 24**

**TRADEMARK**

**PRINCIPAL REGISTER**

ADVANCE MAGAZINE PUBLISHERS INC. (NEW YORK CORPORATION)  
4 TIMES SQUARE  
NEW YORK, NY 10036

FOR: BEACH TOWELS, IN CLASS 24 (U.S. CLS. 42 AND 50).

FIRST USE 12-31-2010; IN COMMERCE 12-31-2010.

THE MARK CONSISTS OF STANDARD CHARACTERS WITHOUT CLAIM TO ANY PARTICULAR FONT, STYLE, SIZE, OR COLOR.

SN 76-701,879, FILED 3-3-2010.

DEZMONA MIZELLE, EXAMINING ATTORNEY



*David J. Kybas*

Director of the United States Patent and Trademark Office

# United States of America

United States Patent and Trademark Office

## FIT FOR WORK

**Reg. No. 4,125,653**

UNITED MARKETING GROUP, L.L.C. (ILLINOIS LIMITED LIABILITY COMPANY)  
929 NORTH PLUM GROVE ROAD  
SCHAUMBURG, IL 60173

**Registered Apr. 10, 2012**

**Int. Cl.: 35**

FOR: MEMBERSHIP CLUB SERVICES PROVIDING DISCOUNTS FOR HEALTH-RELATED SERVICES OF OTHERS, NAMELY, DENTAL SERVICES, VISION SERVICES, HEARING SERVICES, CHIROPRACTOR SERVICES, ALTERNATIVE MEDICINE SERVICES, MEDICAL LABORATORY AND IMAGING SERVICES AND RETAIL PHARMACY SERVICES, IN CLASS 35 (U.S. CLS. 100, 101 AND 102).

**SERVICE MARK**

**PRINCIPAL REGISTER**

FIRST USE 9-19-2011; IN COMMERCE 9-19-2011.

THE MARK CONSISTS OF STANDARD CHARACTERS WITHOUT CLAIM TO ANY PARTICULAR FONT, STYLE, SIZE, OR COLOR.

SN 76-701,956, FILED 3-8-2010.

WENDY GOODMAN, EXAMINING ATTORNEY



*David J. Kybas*

Director of the United States Patent and Trademark Office

# United States of America

United States Patent and Trademark Office

## CHALLENGER

**Reg. No. 4,125,654**

IR, NEIL (UNITED STATES INDIVIDUAL)  
2956 ALLON STREET  
OCEANSIDE, NY 11572

**Registered Apr. 10, 2012**

**Int. Cl.: 12**

FOR: BICYCLES, BICYCLE PADS, NAMELY, BRAKES, CHAINS, HANDLEBARS, WHEELS AND FRAMES, IN CLASS 12 (U.S. CLS. 19, 21, 23, 31, 35 AND 44).

**TRADEMARK**

FIRST USE 3-1-2010; IN COMMERCE 3-1-2010.

**PRINCIPAL REGISTER**

THE MARK CONSISTS OF STANDARD CHARACTERS WITHOUT CLAIM TO ANY PARTICULAR FONT, STYLE, SIZE, OR COLOR.

SN 76-702,582, FILED 4-22-2010.

FLORENTINA BLANDU, EXAMINING ATTORNEY



*David J. Kyfos*

Director of the United States Patent and Trademark Office

United States of America  
United States Patent and Trademark Office

**HECMEE**

**Reg. No. 4,125,655**

SANKEI KOGYO CO., LTD (JAPAN CORPORATION)  
48, AZASUKEMACHI, SUKEMACHI, UENO-CHO  
SUZUKI-SHI, MIE-KEN, JAPAN

**Registered Apr. 10, 2012**

**Int. Cl.: 20**

FOR: CHAIRS, IN CLASS 20 (U.S. CLS. 2, 13, 22, 25, 32 AND 50).

**TRADEMARK**

FIRST USE 8-1-2009; IN COMMERCE 2-9-2011.

**PRINCIPAL REGISTER**

OWNER OF JAPAN REG. NO. 5292882, DATED 1-8-2010, EXPIRES 1-8-2020.

THE MARK CONSISTS OF THE WORDING "HECMEE" IN STYLIZED LETTERING, WITH PIPE SEGMENTS FORMING THE TWO LETTER "C"'S.

SN 76-702,855, FILED 5-7-2010.

JULIE VEPPUMTHARA, EXAMINING ATTORNEY



*David J. Kyros*

Director of the United States Patent and Trademark Office

# United States of America

United States Patent and Trademark Office

## AFTERMASTER

**Reg. No. 4,125,656**

MYSTUDIO, INC. (ARIZONA CORPORATION)

**Registered Apr. 10, 2012**

7650 EAST EVANS DRIVE  
SCOTTSDALE, AZ 85260

**Int. Cl.: 41**

FOR: SOUND PROCESSING SERVICES IN THE NATURE OF AUDIO PRODUCTION SERVICES, NAMELY, CREATING AND PRODUCING AMBIENT SOUNDSCAPES AND SOUND STORIES OF MUSEUMS, GALLERIES, ATTRACTIONS, PODCASTS, BROADCASTS, WEBSITES AND GAMES, IN CLASS 41 (U.S. CLS. 100, 101 AND 107).

**SERVICE MARK**

**PRINCIPAL REGISTER**

FIRST USE 1-31-2011; IN COMMERCE 1-31-2011.

THE MARK CONSISTS OF STANDARD CHARACTERS WITHOUT CLAIM TO ANY PARTICULAR FONT, STYLE, SIZE, OR COLOR.

SN 76-703,426, FILED 6-18-2010.

GRETCHEN ULRICH, EXAMINING ATTORNEY



*David J. Kybas*

Director of the United States Patent and Trademark Office

# United States of America

United States Patent and Trademark Office

# ILT

**Reg. No. 4,125,657**

ABBOTT & COBB, INC. (PENNSYLVANIA CORPORATION)  
4151 STREET ROAD  
TREVOSE, PA 19053

**Registered Apr. 10, 2012**

**Int. Cl.: 31**

FOR: FRUITED MELON SEEDS FOR PLANTING AND UNPROCESSED FRESH FRUITED MELONS, IN CLASS 31 (U.S. CLS. 1 AND 46).

**TRADEMARK**

FIRST USE 3-1-2010; IN COMMERCE 3-1-2010.

**PRINCIPAL REGISTER**

THE MARK CONSISTS OF STANDARD CHARACTERS WITHOUT CLAIM TO ANY PARTICULAR FONT, STYLE, SIZE, OR COLOR.

OWNER OF U.S. REG. NO. 3,185,195.

SN 76-703,628, FILED 7-2-2010.

KHANH LE, EXAMINING ATTORNEY



*David J. Kybas*

Director of the United States Patent and Trademark Office

# United States of America

United States Patent and Trademark Office

## CHILD'S PLAY

**Reg. No. 4,125,658**

CHILD'S PLAY (INTERNATIONAL) LTD. (UNITED KINGDOM CORPORATION)  
ASHWORTH ROAD, BRIDGEMEAD  
SWINDON SN5 7YD, GREAT BRITAIN

**Registered Apr. 10, 2012**

**Int. Cl.: 9**

FOR: PRERECORDED AUDIO TAPES, VIDEO TAPES, CDS AND DVDS FEATURING  
CHILDREN'S STORIES, IN CLASS 9 (U.S. CLS. 21, 23, 26, 36 AND 38).

**TRADEMARK**

FIRST USE 12-6-1988; IN COMMERCE 12-6-1988.

**PRINCIPAL REGISTER**

THE MARK CONSISTS OF STANDARD CHARACTERS WITHOUT CLAIM TO ANY PAR-  
TICULAR FONT, STYLE, SIZE, OR COLOR.

OWNER OF U.S. REG. NOS. 1,091,403 AND 1,638,928.

SN 76-703,635, FILED 7-2-2010.

KHANH LE, EXAMINING ATTORNEY



*David J. Kyffers*

Director of the United States Patent and Trademark Office

# United States of America

United States Patent and Trademark Office



**Reg. No. 4,125,659**

E C GROW INCORPORATED (WISCONSIN CORPORATION)  
4970 KANE ROAD  
EAU CLAIRE, WI 54702

**Registered Apr. 10, 2012**

**Int. Cl.: 1**

FOR: CHEMICAL COMPOUNDS FOR USE IN MELTING ICE AND SNOW, IN CLASS 1 (U.S. CLS. 1, 5, 6, 10, 26 AND 46).

**TRADEMARK**

FIRST USE 11-1-2010; IN COMMERCE 11-1-2010.

**PRINCIPAL REGISTER**

NO CLAIM IS MADE TO THE EXCLUSIVE RIGHT TO USE "PET FRIENDLY ICE MELT", APART FROM THE MARK AS SHOWN.

THE MARK CONSISTS OF A PUPPY AND SNOWFLAKE DESIGN ABOVE THE WORDING "WINTER PAW", WHICH IS IN TURN ABOVE A TRIANGLE CONTAINING THE WORDING "PET FRIENDLY ICEMELT". NEXT TO THE WORDING "WINTER PAW" IS A PAW PRINT EXTENDING OUT OF THE TRIANGLE.

SN 76-703,725, FILED 7-9-2010.

STEVEN R. FINE, EXAMINING ATTORNEY



*David J. Kybas*

Director of the United States Patent and Trademark Office



# United States of America

United States Patent and Trademark Office

# SAYSPEL

**Reg. No. 4,125,660**

BLAIN, ROY W. (UNITED KINGDOM INDIVIDUAL)  
BOELLINGER HOEFE

**Registered Apr. 10, 2012**

HEILBRONN, FED REP GERMANY 74078

**Int. Cl.: 16**

FOR: BOOKS IN THE FIELD OF PHONETIC SPELLING AND PRONUNCIATION OF ENGLISH WORDS, IN CLASS 16 (U.S. CLS. 2, 5, 22, 23, 29, 37, 38 AND 50).

**TRADEMARK**

FIRST USE 2-1-2011; IN COMMERCE 2-1-2011.

**PRINCIPAL REGISTER**

THE MARK CONSISTS OF STANDARD CHARACTERS WITHOUT CLAIM TO ANY PARTICULAR FONT, STYLE, SIZE, OR COLOR.

OWNER OF U.S. REG. NO. 3,562,913.

SN 76-706,482, FILED 2-22-2011.

LEIGH CAROLINE CASE, EXAMINING ATTORNEY



*David J. Kybas*

Director of the United States Patent and Trademark Office

# United States of America

United States Patent and Trademark Office

## BITES OF BLISS

**Reg. No. 4,125,661**

RHONDA SNYDER (UNITED STATES INDIVIDUAL), DBA BITES OF BLISS,  
5832 HILLTOP ROAD  
HIDDEN HILLS, CA 91302

**Registered Apr. 10, 2012**

**Int. Cl.: 29**

FOR: ORGANIC, RAW, VEGAN, GLUTEN-FREE, DAIRY-FREE, SOY-FREE AND NO-SUGAR-ADDED NUT AND FRUIT-BASED SNACK FOODS, IN CLASS 29 (U.S. CL. 46).

**TRADEMARK**

FIRST USE 1-31-2011; IN COMMERCE 1-31-2011.

**PRINCIPAL REGISTER**

THE MARK CONSISTS OF STANDARD CHARACTERS WITHOUT CLAIM TO ANY PARTICULAR FONT, STYLE, SIZE, OR COLOR.

SN 76-706,538, FILED 2-24-2011.

KHANH LE, EXAMINING ATTORNEY



*David J. Kyffers*

Director of the United States Patent and Trademark Office

# United States of America

United States Patent and Trademark Office

# EVERLINE

**Reg. No. 4,125,662**

UNIVERSAL LIGHTING TECHNOLOGIES, INC. (DELAWARE CORPORATION)  
26 CENTURY BOULEVARD, SUITE 500  
NASHVILLE, TN 372143683

**Registered Apr. 10, 2012**

**Int. Cl.: 9**

FOR: LED LAMPS, LED CONTROLLERS, LED BALLASTS, AND LED MODULE, IN CLASS 9 (U.S. CLS. 21, 23, 26, 36 AND 38).

**TRADEMARK**

FIRST USE 12-22-2011; IN COMMERCE 12-22-2011.

**PRINCIPAL REGISTER**

COLOR IS NOT CLAIMED AS A PART OF THE DESIGN. THE DESIGN CONSISTS OF THE STYLIZED WORD "EVERLINE" WITH THE "E", "E" AND "R" IN "EVER" BEING IN A MATCHING THICK UPPERCASE DARK STYLIZED FONT AND WITH THE "V" HAVING A STYLIZED THIN LEFT LINE STARTING AT THE TOP AND BECOMING THICK AT THE BOTTOM AND CONTINUING WITH THE THICK LINE UP THE RIGHT LINE TO COMPLETE THE "V". THE WORD "LINE" IS IN A THIN UPPERCASE FONT.

SN 76-706,992, FILED 3-29-2011.

DAWN FELDMAN, EXAMINING ATTORNEY



*David J. Kyros*

Director of the United States Patent and Trademark Office

# United States of America

United States Patent and Trademark Office

## IT'S 5 O'CLOCK SOMEWHERE

**Reg. No. 4,125,663**

**Registered Apr. 10, 2012**

**Int. Cl.: 43**

**SERVICE MARK**

**PRINCIPAL REGISTER**

MARGARITAVILLE ENTERPRISES, LLC (DELAWARE LIMITED LIABILITY COMPANY)  
256 WORTH AVENUE, SUITE Q-R  
PALM BEACH, FL 33480

FOR: RESTAURANT AND BAR SERVICES, IN CLASS 43 (U.S. CLS. 100 AND 101).

FIRST USE 7-12-2004; IN COMMERCE 7-12-2004.

THE MARK CONSISTS OF STANDARD CHARACTERS WITHOUT CLAIM TO ANY PARTICULAR FONT, STYLE, SIZE, OR COLOR.

SN 77-005,179, FILED 9-22-2006.

BARBARA BROWN, EXAMINING ATTORNEY



*David J. Kybas*

Director of the United States Patent and Trademark Office

# United States of America

United States Patent and Trademark Office

# ODYSSEY

**Reg. No. 4,125,664**

**Registered Apr. 10, 2012**

**Int. Cl.: 9**

**TRADEMARK**

**PRINCIPAL REGISTER**

STEREOTAXIS, INC. (DELAWARE CORPORATION)  
4320 FOREST PARK AVENUE  
SUITE 100  
ST. LOUIS, MO 63108

FOR: CONSOLIDATED GRAPHICAL USER INTERFACE AND NETWORKING SYSTEMS INCORPORATING COMPUTER HARDWARE, SOFTWARE, AND NETWORKING INFRASTRUCTURE FOR INTERFACING WITH MEDICAL DEVICES, IN CLASS 9 (U.S. CLS. 21, 23, 26, 36 AND 38).

FIRST USE 12-31-2007; IN COMMERCE 12-31-2007.

THE MARK CONSISTS OF STANDARD CHARACTERS WITHOUT CLAIM TO ANY PARTICULAR FONT, STYLE, SIZE, OR COLOR.

SN 77-107,579, FILED 2-14-2007.

PAULA MAHONEY, EXAMINING ATTORNEY



*David J. Kybas*

Director of the United States Patent and Trademark Office

# United States of America

United States Patent and Trademark Office

## Consent MD

**Reg. No. 4,125,665**

APPLIED SURGICAL DATA, INC. (NEW YORK CORPORATION)  
666 OLD COUNTRY ROAD, SUITE 509  
GARDEN CITY, NY 11530

**Registered Apr. 10, 2012**

**Int. Cls.: 35 and 42**

FOR: COMPUTERIZED DATABASE MANAGEMENT, IN CLASS 35 (U.S. CLS. 100, 101 AND 102).

**SERVICE MARK**

FIRST USE 7-1-2006; IN COMMERCE 7-15-2010.

**PRINCIPAL REGISTER**

FOR: APPLICATION SERVICE PROVIDER (ASP) FEATURING SOFTWARE IN THE FIELD OF MEDICINE AND INFORMED CONSENT, IN CLASS 42 (U.S. CLS. 100 AND 101).

FIRST USE 7-1-2006; IN COMMERCE 7-15-2010.

THE MARK CONSISTS OF STANDARD CHARACTERS WITHOUT CLAIM TO ANY PARTICULAR FONT, STYLE, SIZE, OR COLOR.

NO CLAIM IS MADE TO THE EXCLUSIVE RIGHT TO USE "CONSENT", APART FROM THE MARK AS SHOWN.

SN 77-134,671, FILED 3-19-2007.

JULIE GUTTADAURO, EXAMINING ATTORNEY



*David J. Kyffers*

Director of the United States Patent and Trademark Office

# United States of America

United States Patent and Trademark Office

## SENSIBLE SWEETS

**Reg. No. 4,125,666**

CONAGRA FOODS RDM, INC. (DELAWARE CORPORATION)  
ONE CONAGRA DRIVE  
OMAHA, NE 68102

**Registered Apr. 10, 2012**

**Int. Cl.: 30**

FOR: COCOA MIXES, IN CLASS 30 (U.S. CL. 46).

FIRST USE 11-5-2007; IN COMMERCE 11-5-2007.

**TRADEMARK**

THE MARK CONSISTS OF STANDARD CHARACTERS WITHOUT CLAIM TO ANY PARTICULAR FONT, STYLE, SIZE, OR COLOR.

**PRINCIPAL REGISTER**

NO CLAIM IS MADE TO THE EXCLUSIVE RIGHT TO USE "SWEETS", APART FROM THE MARK AS SHOWN.

SN 77-143,334, FILED 3-29-2007.

LEIGH CAROLINE CASE, EXAMINING ATTORNEY



*David J. Kyffers*

Director of the United States Patent and Trademark Office

# United States of America

United States Patent and Trademark Office

## DISNEY RESORT COLLECTION

**Reg. No. 4,125,667**

**Registered Apr. 10, 2012**

**Int. Cl.: 35**

**SERVICE MARK**

**PRINCIPAL REGISTER**

DISNEY ENTERPRISES, INC. (DELAWARE CORPORATION)  
500 SOUTH BUENA VISTA STREET  
BURBANK, CA 91521

FOR: ON-LINE RETAIL STORE SERVICES FEATURING SOAP, SHAMPOO, CONDITIONER, SUNSCREEN, LOTION, BEDDING, LINENS, APPAREL, HEADWEAR, FOOTWEAR, BAGS, TEA, COFFEE, CANDLES, FURNITURE, LAMPS, RUGS, DECORATIVE ACCESSORIES, PAINT, WALLPAPER, GAMES, TOYS AND CLOCKS; MAIL ORDER CATALOG SERVICES FEATURING SOAP, SHAMPOO, CONDITIONER, SUNSCREEN, LOTION, BEDDING, LINENS, APPAREL, HEADWEAR, FOOTWEAR, BAGS, TEA, COFFEE, CANDLES, FURNITURE, LAMPS, RUGS, DECORATIVE ACCESSORIES, PAINT, WALLPAPER, GAMES, TOYS AND CLOCKS, IN CLASS 35 (U.S. CLS. 100, 101 AND 102).

FIRST USE 2-28-2009; IN COMMERCE 2-28-2009.

THE MARK CONSISTS OF STANDARD CHARACTERS WITHOUT CLAIM TO ANY PARTICULAR FONT, STYLE, SIZE, OR COLOR.

OWNER OF U.S. REG. NOS. 2,573,544, 3,242,910, AND OTHERS.

NO CLAIM IS MADE TO THE EXCLUSIVE RIGHT TO USE "RESORT COLLECTION", APART FROM THE MARK AS SHOWN.

SN 77-154,414, FILED 4-11-2007.

BRIDGETT SMITH, EXAMINING ATTORNEY



*David J. Kyros*

Director of the United States Patent and Trademark Office



# United States of America

United States Patent and Trademark Office



**Reg. No. 4,125,668**

**Registered Apr. 10, 2012**

**Int. Cl.: 24**

**TRADEMARK**

**PRINCIPAL REGISTER**

IMG HOME TEXTILE INC. (CALIFORNIA CORPORATION)  
1798 19TH AVE  
SAN FRANCISCO, CA 94122

FOR: BED BLANKETS; BED CANOPIES; BED LINEN; BED PADS; BED SHEETS; BED SKIRTS; BED SPREADS; FEATHER BEDS; SILK BED BLANKETS; HAND TOWELS OF TEXTILE; PLACE MATS OF TEXTILE MATERIAL; QUILTS OF TEXTILE; TAPESTRIES OF TEXTILE; TEXTILE FABRICS FOR HOME AND COMMERCIAL INTERIORS; TEXTILE NAPKINS; TEXTILE PLACE MATS; TEXTILE PRINTERS' BLANKETS; TEXTILE SERVIETTES; TEXTILE SUBSTITUTE MATERIALS MADE FROM SYNTHETIC MATERIALS; TEXTILE TABLECLOTHS; CURTAIN LOOPS OF TEXTILE MATERIAL; CURTAINS; CURTAINS MADE OF TEXTILE FABRICS; SHOWER ROOM CURTAINS; WINDOW CURTAINS; FELT AND NON-WOVEN TEXTILE FABRICS; PILLOW CASES; PILLOW COVERS; PILLOW SHAMS; PILLOWCASES; FABRIC WINDOW COVERINGS AND TREATMENTS, NAMELY, CURTAINS, DRAPERIES, SHEERS, SWAGS AND VALANCES; POUFS; PUFFS, IN CLASS 24 (U.S. CLS. 42 AND 50).

FIRST USE 7-1-2011; IN COMMERCE 7-1-2011.

NO CLAIM IS MADE TO THE EXCLUSIVE RIGHT TO USE "HOME COLLECTIONS", APART FROM THE MARK AS SHOWN.

THE COLOR(S) GOLD IS/ARE CLAIMED AS A FEATURE OF THE MARK.

THE MARK CONSISTS OF GOLD OVAL SHAPE WITH CROWN ON THE TOP, LEAVES AT THE SIDES, AND AN ANGEL WITH STARS IN THE MIDDLE. WORDS "IMG" ABOVE THE ANGEL. "IMAGINE HOME COLLECTIONS" ON THE BOTTOM.

SN 77-155,253, FILED 4-12-2007.

MATTHEW MCDOWELL, EXAMINING ATTORNEY



*David J. Kyros*

Director of the United States Patent and Trademark Office

# United States of America

United States Patent and Trademark Office



**Reg. No. 4,125,669**

**Registered Apr. 10, 2012**

**Int. Cl.: 9**

**TRADEMARK**

**PRINCIPAL REGISTER**

RENESAS ELECTRONICS CORPORATION (JAPAN CORPORATION)  
1753, SHIMONUMABE, NAKAHARA-KU  
KAWASAKI-SHI, KANAGAWA, JAPAN

FOR: COMPUTER MEMORIES; ELECTRICITY CONTROL PANELS; MAGNETIC DATA MEDIA, NAMELY, BLANK MAGNETIC DATA CARRIERS, MAGNETIC TAPE DRIVES, MAGNETIC DISCS, COMPACT DISCS, DIGITAL VERSATILE DISCS, OPTICAL MEMORIES AND INTEGRATED CIRCUIT MEMORIES SUCH AS ROMS, PROMS, AND EPROMS; OPTICAL DATA MEDIA, NAMELY, BLANK DVDS, BLANK CDS AND BLANK TAPES FOR USE IN CONNECTION WITH SEMICONDUCTORS AND SEMICONDUCTOR TECHNOLOGY; BLANK OPTICAL DISCS; INTEGRATED CIRCUIT CARDS; INTERFACES FOR COMPUTERS; LASERS, NOT FOR MEDICAL PURPOSES; ELECTRIC METERING EQUIPMENT DETECTORS; TELEPHONE SWITCHES; PARTS AND ACCESSORIES IN THE NATURE OF INTEGRATED CIRCUIT CHIPS FOR GAMES; ELECTRONIC CIRCUITS, BLANK MAGNETO-OPTICAL DISCS PARTS FOR ELECTRIC COMMUNICATION APPARATUS AND INSTRUMENTS, SWITCHES; DIODES; TRANSISTORS; INTEGRATED CIRCUITS; LARGE SCALE INTEGRATED CIRCUITS; RECORDED OR DOWNLOADABLE COMPUTER PROGRAMS FOR USE IN CONNECTION WITH THE DESIGN AND TESTING OF INTEGRATED CIRCUITS, LARGE SCALE INTEGRATED CIRCUITS, SEMI-CONDUCTOR DEVICES, CPUS, ELECTRONIC CIRCUITS, AND MEMORY; COMPUTER PERIPHERALS AND COMPUTER PROGRAMS TO RUN COMPUTER PERIPHERALS; SEMICONDUCTORS; SEMI-CONDUCTOR DEVICES; CPU; ELECTRONIC CIRCUITS; SEMI-CONDUCTOR DEVICES, INTEGRATED CIRCUITS INCLUDING CPUS, ELECTRONIC CIRCUITS; ENCODED INTEGRATED CIRCUIT CARD CONTAINING PROGRAMMING FOR DEVELOPING AND DESIGNING OF SEMI-CONDUCTOR DEVICES, INTEGRATED CIRCUITS INCLUDING CPU AND ELECTRONIC CIRCUITS; SEMI-CONDUCTOR MEMORY; MICROPROCESSORS; MICROCONTROLLERS; MICROCOMPUTERS; PROGRAMS FOR MICROCOMPUTERS, NAMELY, SOFTWARE FOR USE IN DATABASE MANAGEMENT, USE IN ELECTRONIC STORAGE OF DATA, FOR USING THE INTERNET, PROCESSING DIGITAL MUSIC FILES, COMPUTER OPERATING PROGRAMS; ENCODED INTEGRATED CIRCUIT CARDS CONTAINING PROGRAMMING FOR TESTING AND EVALUATING OF MICROCOMPUTERS, MICROCONTROLLERS, MICROPROCESSORS AND SEMI-CONDUCTOR INTEGRATED CIRCUITS; SEMI-CONDUCTOR INTEGRATED CIRCUITS; SEMI-CONDUCTOR SENSOR; SEMI-CONDUCTOR COMMUTATORS; SILICON WAFER FOR SEMI-CONDUCTORS; LIGHT EMITTING DIODE (LED); PRINTED CIRCUIT BOARD; CENTRAL PROCESSING UNITS FOR PROCESSING INFORMATION, DATA, SOUND OR IMAGES; CARDS, NAMELY, BLANK SMART CARDS, BLANK INTEGRATED CIRCUIT CARDS FOR RECORDING, TRANSMITTING, AND REPRODUCING



*David J. Kappas*

Director of the United States Patent and Trademark Office

**Reg. No. 4,125,669** SOUND AND IMAGES IN MOBILE TELEPHONE SERVICES, BLANK ELECTRONIC CHIP CARDS, GRAPHICS CARDS, LAN COMPUTER CARDS FOR CONNECTING PORTABLE COMPUTER DEVICES TO COMPUTER NETWORKS, MAGNETICALLY ENCODED DEBIT OR CREDIT CARDS, MEMORY CARDS, PCMCIA CARDS, SOUND CARDS, SYSTEM BOARDS (MOTHER CARDS) AND PROCESSORS; SEMI-CONDUCTOR CHECKING MACHINES; SEMI-CONDUCTOR TESTING MACHINES, IN CLASS 9 (U.S. CLS. 21, 23, 26, 36 AND 38).

FIRST USE 6-25-2007; IN COMMERCE 6-25-2007.

OWNER OF U.S. REG. NO. 3,075,072.

THE MARK CONSISTS OF THE STYLIZED WORD "RENESAS" WITH A HOOK-LIKE DEVICE.

THE MARK "RENESAS" HAS NO MEANING IN A FOREIGN LANGUAGE.

SN 77-214,622, FILED 6-25-2007.

KATHERINE STOIDES, EXAMINING ATTORNEY

# United States of America

United States Patent and Trademark Office

# MOCHILATO

**Reg. No. 4,125,670**

MIKAWAYA, INC. (CALIFORNIA CORPORATION)  
400 E. 4TH STREET  
LOS ANGELES, CA 90013

**Registered Apr. 10, 2012**

**Int. Cls.: 29, 30, and 43**

FOR: FRUIT TOPPINGS, IN CLASS 29 (U.S. CL. 46).

FIRST USE 8-30-2007; IN COMMERCE 2-28-2009.

**TRADEMARK**

FOR: BAKERY DESSERTS; ICE CREAM AND GELATO DESSERTS , IN CLASS 30 (U.S. CL. 46).

**SERVICE MARK**

**PRINCIPAL REGISTER**

FIRST USE 8-30-2007; IN COMMERCE 2-28-2009.

FOR: RESTAURANT SERVICES; CAFES; CARRYOUT RESTAURANTS; SNACK BARS; ICE CREAM PARLORS, IN CLASS 43 (U.S. CLS. 100 AND 101).

FIRST USE 8-30-2007; IN COMMERCE 2-28-2009.

THE MARK CONSISTS OF STANDARD CHARACTERS WITHOUT CLAIM TO ANY PARTICULAR FONT, STYLE, SIZE, OR COLOR.

SN 77-218,631, FILED 6-29-2007.

NICHOLAS ALTREE, EXAMINING ATTORNEY



*David J. Kyros*

Director of the United States Patent and Trademark Office

# United States of America

United States Patent and Trademark Office

# E(Z)RF

**Reg. No. 4,125,671**

MERU NETWORKS, INC. (DELAWARE CORPORATION)  
894 ROSS DRIVE  
SUNNYVALE, CA 94089

**Registered Apr. 10, 2012**

**Int. Cl.: 9**

FOR: SOFTWARE FOR OPERATING AND MANAGING WIRELESS NETWORKS AND COMMUNICATIONS SYSTEMS, NAMELY, SOFTWARE FOR IMPLEMENTING AND MANAGING SECURITY POLICIES FOR WIRELESS ACCESS, EXCLUDING RFID CONTROL SYSTEMS, IN CLASS 9 (U.S. CLS. 21, 23, 26, 36 AND 38).

**TRADEMARK**

**PRINCIPAL REGISTER**

FIRST USE 1-31-2012; IN COMMERCE 1-31-2012.

THE MARK CONSISTS OF STANDARD CHARACTERS WITHOUT CLAIM TO ANY PARTICULAR FONT, STYLE, SIZE, OR COLOR.

SN 77-236,653, FILED 7-23-2007.

LOURDES AYALA, EXAMINING ATTORNEY



*David J. Kyjars*

Director of the United States Patent and Trademark Office

# United States of America

United States Patent and Trademark Office



**Reg. No. 4,125,672**

AUTOMOTIVE DATA SOLUTIONS INC. (CANADA CORPORATION)  
8400 BOUGAINVILLE

**Registered Apr. 10, 2012**

MONTREAL, QUEBEC, CANADA H4P 2G1

**Int. Cls.: 7 and 9**

FOR: REMOTE STARTERS FOR MOTORS AND ENGINES, IN CLASS 7 (U.S. CLS. 13, 19, 21, 23, 31, 34 AND 35).

**TRADEMARK**

FIRST USE 7-29-2011; IN COMMERCE 8-23-2011.

**PRINCIPAL REGISTER**

FOR: ELECTRONIC INTERFACE DEVICES USED IN THE INSTALLATION OF REMOTE STARTERS AND SECURITY SYSTEMS, NAMELY, TRANSPONDERS, DATABUS INTERFACES FOR USE IN VEHICLE DOOR LOCK/UNLOCK, CAR ALARMS, TRUNK RELEASE, AND ENGINE START/DISABLE, IN CLASS 9 (U.S. CLS. 21, 23, 26, 36 AND 38).

FIRST USE 7-29-2011; IN COMMERCE 8-23-2011.

SN 77-245,872, FILED 8-2-2007.

DEIRDRE ROBERTSON, EXAMINING ATTORNEY



*David J. Kybas*

Director of the United States Patent and Trademark Office

# United States of America

United States Patent and Trademark Office

## RICARDO ARJONA

**Reg. No. 4,125,673**

**Registered Apr. 10, 2012**

**Int. Cl.: 41**

**SERVICE MARK**

**PRINCIPAL REGISTER**

ARJONA, RICARDO (GUATEMALA INDIVIDUAL)  
C/O PRYOR CASHMAN LLP, 7 TIMES SQUARE  
NEW YORK, NY 10036

FOR: RECORD PRODUCTION; MUSIC PRODUCTION; AUDIO RECORDING AND PRODUCTION; MOTION PICTURE SONG PRODUCTION; RECORDING STUDIOS; ENTERTAINMENT SERVICES, NAMELY, PRODUCTION AND DISTRIBUTION OF MUSICAL AUDIO AND VIDEO RECORDINGS FOR BROADCAST; MUSIC PUBLISHING SERVICES; ENTERTAINMENT IN THE NATURE OF A LIVE MUSICAL PERFORMER, MUSICAL BAND OR MUSICAL GROUP; ENTERTAINMENT IN THE NATURE OF LIVE PERFORMANCES BY A MUSICAL ARTIST, MUSICAL GROUP OR MUSICAL BAND; ENTERTAINMENT IN THE NATURE OF VISUAL AND AUDIO PERFORMANCES BY A MUSICAL ARTIST, MUSICAL GROUP AND MUSICAL BAND; ENTERTAINMENT, NAMELY, LIVE MUSIC CONCERTS; LIVE PERFORMANCES FEATURING PRERECORDED VOCAL AND INSTRUMENTAL PERFORMANCES VIEWED ON A BIG SCREEN; PLANNING ARRANGEMENT OF SHOWING MOVIES, SHOWS, PLAYS OR MUSICAL PERFORMANCES; ENTERTAINMENT, NAMELY, PERSONAL APPEARANCES BY A MUSICIAN, MUSICAL GROUP OR MUSICAL BAND; ENTERTAINMENT, NAMELY, PERSONAL APPEARANCES BY A TELEVISION STAR, ENTERTAINMENT SERVICES, NAMELY, PROVIDING A WEB SITE FEATURING MUSICAL PERFORMANCES, MUSICAL VIDEOS, RELATED FILM CLIPS, PHOTOGRAPHS, AND OTHER MULTIMEDIA MATERIALS; ENTERTAINMENT SERVICES, NAMELY, PROVIDING PRERECORDED MUSIC, INFORMATION IN THE FIELD OF MUSIC, ALL ONLINE VIA A GLOBAL COMPUTER NETWORK; MOTION PICTURE FILM PRODUCTION; ENTERTAINMENT IN THE NATURE OF LIVE TRAVELING TOURS BY A PROFESSIONAL ENTERTAINER FEATURING MUSIC, IN CLASS 41 (U.S. CLS. 100, 101 AND 107).



FIRST USE 2-0-2010; IN COMMERCE 2-0-2010.

THE MARK CONSISTS OF STANDARD CHARACTERS WITHOUT CLAIM TO ANY PARTICULAR FONT, STYLE, SIZE, OR COLOR.

SN 77-247,104, FILED 8-3-2007.

YAT SYE, LEE, EXAMINING ATTORNEY

*David J. Kyros*

Director of the United States Patent and Trademark Office

# United States of America

United States Patent and Trademark Office

## QUANTUMDIGITAL

**Reg. No. 4,125,674**

**Registered Apr. 10, 2012**

**Int. Cl.: 42**

**SERVICE MARK**

**PRINCIPAL REGISTER**

QUANTUMDIGITAL, INC. (TEXAS CORPORATION)  
8702 CROSS PARK DRIVE  
AUSTIN, TX 78754

FOR: WEBSITE DEVELOPMENT SERVICES FOR OTHERS, NAMELY, DEVELOPMENT OF WEB-TO-PRINT PORTALS FOR USE BY THIRD PARTIES TO PERMIT EMPLOYEES AND AUTHORIZED PARTIES OF SUCH THIRD PARTIES TO ORDER, OBTAIN, DEPLOY AND TRACK CUSTOMIZED MARKETING AND RELATED MATERIALS, IN CLASS 42 (U.S. CLS. 100 AND 101).

FIRST USE 12-20-2007; IN COMMERCE 1-2-2008.

THE MARK CONSISTS OF STANDARD CHARACTERS WITHOUT CLAIM TO ANY PARTICULAR FONT, STYLE, SIZE, OR COLOR.

OWNER OF U.S. REG. NOS. 3,274,933, 3,274,938, AND 3,322,884.

SN 77-247,616, FILED 8-6-2007.

DEBRA LEE, EXAMINING ATTORNEY



*David J. Kyros*

Director of the United States Patent and Trademark Office



# United States of America

United States Patent and Trademark Office



**Reg. No. 4,125,675**

QUANTUMDIGITAL, INC. (TEXAS CORPORATION)

**Registered Apr. 10, 2012**

8702 CROSS PARK DRIVE  
AUSTIN, TX 78754

**Int. Cl.: 42**

FOR: WEBSITE DEVELOPMENT SERVICES FOR OTHERS, NAMELY, DEVELOPMENT OF WEB-TO-PRINT PORTALS FOR USE BY THIRD PARTIES TO PERMIT EMPLOYEES AND AUTHORIZED PARTIES OF SUCH THIRD PARTIES TO ORDER, OBTAIN, DEPLOY AND TRACK CUSTOMIZED MARKETING AND RELATED MATERIALS, IN CLASS 42 (U.S. CLS. 100 AND 101).

**SERVICE MARK**

**PRINCIPAL REGISTER**

FIRST USE 12-20-2007; IN COMMERCE 1-2-2008.

OWNER OF U.S. REG. NOS. 3,274,933, 3,274,938, AND 3,322,884.

NO CLAIM IS MADE TO THE EXCLUSIVE RIGHT TO USE "DIGITAL", APART FROM THE MARK AS SHOWN.

SN 77-247,649, FILED 8-6-2007.

DEBRA LEE, EXAMINING ATTORNEY



*David J. Kybas*

Director of the United States Patent and Trademark Office

# United States of America

United States Patent and Trademark Office

## THE FIVE ELEMENTS

**Reg. No. 4,125,676**

DITTERICH-SHILAKES, KIRSTEN (UNITED STATES INDIVIDUAL)

**Registered Apr. 10, 2012**

39 MESA ST., SUITE 101  
SAN FRANCISCO, CA 94129

**Int. Cl.: 41**

FOR: EDUCATIONAL AND ENTERTAINMENT SERVICES, NAMELY, ARRANGING AND CONDUCTING EDUCATIONAL AND ENTERTAINMENT DEMONSTRATIONS, MULTIMEDIA PRESENTATIONS, AND LECTURES IN THE FIELDS OF ART, FOOD, WINE, THE HUMANITIES, AND THEMATIC LECTURES ON LOVE AT PARTIES, CONFERENCES, CORPORATE EVENTS AND OTHER SPECIAL EVENTS, IN CLASS 41 (U.S. CLS. 100, 101 AND 107).

**SERVICE MARK**

**PRINCIPAL REGISTER**

FIRST USE 1-13-2012; IN COMMERCE 1-13-2012.

THE MARK CONSISTS OF STANDARD CHARACTERS WITHOUT CLAIM TO ANY PARTICULAR FONT, STYLE, SIZE, OR COLOR.

SN 77-249,089, FILED 8-7-2007.

DEBRA LEE, EXAMINING ATTORNEY



*David J. Kyffers*

Director of the United States Patent and Trademark Office

# United States of America

United States Patent and Trademark Office

## STREET SURFING

**Reg. No. 4,125,677**

STREET SURFING LLC (NEVADA LIMITED LIABILITY COMPANY)  
101 CONVENTION CENTER DRIVE, SUITE 700  
LAS VEGAS, NV 89109

**Registered Apr. 10, 2012**

**Int. Cl.: 9**

FOR: PROTECTIVE HELMETS, IN CLASS 9 (U.S. CLS. 21, 23, 26, 36 AND 38).

**TRADEMARK**

FIRST USE 10-17-2007; IN COMMERCE 10-17-2007.

**PRINCIPAL REGISTER**

THE MARK CONSISTS OF STANDARD CHARACTERS WITHOUT CLAIM TO ANY PARTICULAR FONT, STYLE, SIZE, OR COLOR.

SN 77-249,485, FILED 8-7-2007.

STEVEN JACKSON, EXAMINING ATTORNEY



*David J. Kyffers*

Director of the United States Patent and Trademark Office

# United States of America

United States Patent and Trademark Office

## Wishes & Dreams

**Reg. No. 4,125,678**

HANCOCK FABRICS, INC. (DELAWARE CORPORATION)  
ONE FASHION WAY  
BALDWYN, MS 38824

**Registered Apr. 10, 2012**

**Int. Cls.: 25 and 28**

FOR: MASQUERADE COSTUMES FOR CHILDREN, IN CLASS 25 (U.S. CLS. 22 AND 39).

FIRST USE 8-20-2009; IN COMMERCE 8-20-2009.

**TRADEMARK**

FOR: COSTUME ACCESSORIES FOR CHILDREN, NAMELY, CROWNS, TOY HEADPIECES, WINGS, AND WANDS, IN CLASS 28 (U.S. CLS. 22, 23, 38 AND 50).

**PRINCIPAL REGISTER**

FIRST USE 8-20-2009; IN COMMERCE 8-20-2009.

THE MARK CONSISTS OF STANDARD CHARACTERS WITHOUT CLAIM TO ANY PARTICULAR FONT, STYLE, SIZE, OR COLOR.

SN 77-251,959, FILED 8-10-2007.

MICHAEL ENGEL, EXAMINING ATTORNEY



*David J. Kyffers*

Director of the United States Patent and Trademark Office

**United States of America**  
United States Patent and Trademark Office

# AQUARAY

**Reg. No. 4,125,679**

HAYWARD INDUSTRIES, INC. (NEW JERSEY CORPORATION)  
620 DIVISION STREET  
ELIZABETH, NJ 07207

**Registered Apr. 10, 2012**

**Int. Cl.: 7**

FOR: UNDERWATER SWIMMING POOL CLEANING MACHINES FOR CLEANING THE SURFACE OF A RESIDENTIAL SWIMMING POOL, IN CLASS 7 (U.S. CLS. 13, 19, 21, 23, 31, 34 AND 35).

**TRADEMARK**

FIRST USE 10-0-2010; IN COMMERCE 3-0-2011.

**PRINCIPAL REGISTER**

THE MARK CONSISTS OF STANDARD CHARACTERS WITHOUT CLAIM TO ANY PARTICULAR FONT, STYLE, SIZE, OR COLOR.

OWNER OF U.S. REG. NOS. 1,383,031, 2,184,852, AND 2,234,984.

SN 77-260,652, FILED 8-21-2007.

DEBRA LEE, EXAMINING ATTORNEY



*David J. Kybas*

Director of the United States Patent and Trademark Office

# United States of America

United States Patent and Trademark Office

## A GIRLS NIGHT MUSICAL

**Reg. No. 4,125,680**

**Registered Apr. 10, 2012**

**Int. Cl.: 41**

**SERVICE MARK**

**PRINCIPAL REGISTER**

ENTERTAINMENT EVENTS, INC. (NEW YORK CORPORATION)  
8TH FLOOR  
320 WEST 37TH STREET  
NEW YORK, NY 10018

FOR: A SERIES OF FEMALE-THEMED, FEMALE-CAST, BOOK MUSICAL COMEDIES, IN CLASS 41 (U.S. CLS. 100, 101 AND 107).

FIRST USE 6-29-2010; IN COMMERCE 11-3-2010.

THE MARK CONSISTS OF STANDARD CHARACTERS WITHOUT CLAIM TO ANY PARTICULAR FONT, STYLE, SIZE, OR COLOR.

NO CLAIM IS MADE TO THE EXCLUSIVE RIGHT TO USE "MUSICAL", APART FROM THE MARK AS SHOWN.

SN 77-308,780, FILED 10-19-2007.

YAT SYE, LEE, EXAMINING ATTORNEY



*David J. Kybas*

Director of the United States Patent and Trademark Office

# United States of America

United States Patent and Trademark Office

## RANDY BACHMAN IMPRESSIONS

**Reg. No. 4,125,681**

**Registered Apr. 10, 2012**

**Int. Cl.: 25**

**TRADEMARK**

**PRINCIPAL REGISTER**

RANBACH MUSIC LTD. (CANADA CORPORATION)  
442 BRANT STREET, SUITE 203  
C/O DANYLIW & MANN CHARTERED ACCOUNTANTS  
BURLINGTON, ONTARIO, CANADA L7R2G4

FOR: MEN'S AND WOMEN'S CLOTHING, NAMELY, T-SHIRTS, TOPS, IN CLASS 25 (U.S. CLS. 22 AND 39).

FIRST USE 11-25-2011; IN COMMERCE 1-10-2012.

THE MARK CONSISTS OF STANDARD CHARACTERS WITHOUT CLAIM TO ANY PARTICULAR FONT, STYLE, SIZE, OR COLOR.

PRIORITY CLAIMED UNDER SEC. 44(D) ON CANADA APPLICATION NO. 1370517, FILED 11-2-2007.

THE NAME(S), PORTRAIT(S), AND/OR SIGNATURE(S) SHOWN IN THE MARK IDENTIFIES "RANDY BACHMAN", WHOSE CONSENT(S) TO REGISTER IS SUBMITTED.

SN 77-323,661, FILED 11-7-2007.

MELISSA VALLILLO, EXAMINING ATTORNEY



*David J. Kybas*

Director of the United States Patent and Trademark Office

# United States of America

United States Patent and Trademark Office



**Reg. No. 4,125,682**

**Registered Apr. 10, 2012**

**Int. Cl.: 36**

**SERVICE MARK**

**PRINCIPAL REGISTER**

MERCANTIL SERVICIOS FINANCIEROS, C.A. (VENEZUELA CORPORATION)  
EDIFICIO MERCANTIL, GERENCIA LEGAL DE  
AVENIDA ANDRES BELLO CRUCE CON AVENIDA  
CARACAS, VENEZUELA

FOR: BANKING; CAPITAL INVESTMENT SERVICES; CHARITABLE FUND RAISING; CHECK VERIFICATION; FINANCIAL CLEARING HOUSES; FINANCIAL CONSULTANCY; INSURANCE CONSULTANCY; CREDIT BUREAU; CREDIT CARD SERVICES; ISSUANCE OF CREDIT CARDS; DEBIT CARD SERVICES; SAFE DEPOSIT BOX SERVICES FOR THE DEPOSIT OF VALUABLES; EXCHANGING MONEY; FINANCIAL EVALUATION FOR BANKING, REAL ESTATE, AND INSURANCE PURPOSES; PROVIDING FINANCIAL INFORMATION; FINANCIAL MANAGEMENT; FINANCIAL SPONSORSHIP OF ATHLETIC EVENTS; FINANCING SERVICES, NAMELY, MONEY LENDING, INVESTMENT FUND TRANSFER AND TRANSACTION SERVICES, MORTGAGE PLANNING; FUNDS INVESTMENT; ELECTRONIC FUNDS TRANSFER; FINANCIAL GUARANTEE AND SURETY; HEALTH INSURANCE UNDERWRITING; INSURANCE INFORMATION; INSTALLMENT LOANS; INSURANCE BROKERAGE; INSURANCE CONSULTANCY; INSURANCE INFORMATION; INSURANCE UNDERWRITING; ISSUE OF TOKENS OF VALUE; ISSUING OF TRAVELLERS' CHECKS; LEASE-PURCHASE FINANCING; LIFE INSURANCE UNDERWRITING; LOAN FINANCING; FINANCIAL MANAGEMENT; MORTGAGE BANKING; MUTUAL FUND BROKERAGE; SAFE DEPOSIT BOX SERVICES; SAVINGS BANKS; SECURITIES BROKERAGE; SURETY SERVICES; TRUSTEESHIP REPRESENTATIVES; LAND AND REAL ESTATE VALUATIONS, IN CLASS 36 (U.S. CLS. 100, 101 AND 102).

FIRST USE 11-0-2007; IN COMMERCE 11-0-2007.

NO CLAIM IS MADE TO THE EXCLUSIVE RIGHT TO USE "MERCANTIL COMMERCE BANK INVESTMENT SERVICES", APART FROM THE MARK AS SHOWN.

THE COLOR(S) BLUE, ORANGE AND GRAY IS/ARE CLAIMED AS A FEATURE OF THE MARK.

THE MARK CONSISTS OF THE COLOR BLUE FOR THE WORDS "MERCANTIL COMMERCEBANK", THE COLOR GRAY FOR THE WORDS "INVESTMENT SERVICES", BLUE ON THE INTERIOR OF THE CURVED DESIGN AND DARK ORANGE ON THE OUTSIDE WITH LIGHT ORANGE SHADING AROUND THE EDGES OF THE OUTSIDE OF THE CURVED DESIGN.



*David J. Kypos*

Director of the United States Patent and Trademark Office



**Reg. No. 4,125,682** THE ENGLISH TRANSLATION OF THE WORD "MERCANTIL" IN THE MARK IS "MERCANTILE".

SN 77-333,172, FILED 11-19-2007.

GRETTA YAO, EXAMINING ATTORNEY

# United States of America

United States Patent and Trademark Office

## LIVING GOODS

**Reg. No. 4,125,683**

ORE ORIGINALS, INC. (CALIFORNIA CORPORATION)  
1357 CORONADO AVE.  
LONG BEACH, CA 90804

**Registered Apr. 10, 2012**

**Int. Cls.: 16, 20, 35, and 40**

FOR: MAGNETIC BOARDS, CHALK BOARDS AND PHOTO BOARDS FOR HOME USE, IN CLASS 16 (U.S. CLS. 2, 5, 22, 23, 29, 37, 38 AND 50).

FIRST USE 1-29-1999; IN COMMERCE 1-29-1999.

**TRADEMARK**

FOR: BULLETIN BOARDS, IN CLASS 20 (U.S. CLS. 2, 13, 22, 25, 32 AND 50).

**SERVICE MARK**

FIRST USE 1-29-1999; IN COMMERCE 1-29-1999.

**PRINCIPAL REGISTER**

FOR: RETAIL/WHOLESALE MAIL ORDER CATALOG SERVICES FEATURING HOUSEHOLD PRODUCTS SUCH AS BULLETIN BOARDS, MAGNETIC BOARDS, CHALK BOARDS, PHOTO BOARDS, IN CLASS 35 (U.S. CLS. 100, 101 AND 102).

FIRST USE 1-29-1999; IN COMMERCE 1-29-1999.

FOR: MANUFACTURE OF HOUSEHOLD AND KITCHEN PRODUCTS TO THE ORDER AND SPECIFICATIONS OF OTHERS AND CUSTOM MANUFACTURE OF HOUSEHOLD AND KITCHEN PRODUCTS, IN CLASS 40 (U.S. CLS. 100, 103 AND 106).

FIRST USE 1-29-1999; IN COMMERCE 1-29-1999.

THE MARK CONSISTS OF STANDARD CHARACTERS WITHOUT CLAIM TO ANY PARTICULAR FONT, STYLE, SIZE, OR COLOR.

OWNER OF U.S. REG. NO. 2,463,331.

NO CLAIM IS MADE TO THE EXCLUSIVE RIGHT TO USE "GOODS", APART FROM THE MARK AS SHOWN.

SN 77-344,059, FILED 12-4-2007.

JANICE L. MCMORROW, EXAMINING ATTORNEY



*David J. Kyros*

Director of the United States Patent and Trademark Office

# United States of America

United States Patent and Trademark Office

## Giving Beauty

**Reg. No. 4,125,684**

L'HEUREUX, KATHARINE (UNITED STATES INDIVIDUAL)  
325 W. 16TH ST., #6E  
NEW YORK, NY 10011

**Registered Apr. 10, 2012**

**Int. Cl.: 3**

FOR: BODY LOTION; BEAUTY CREAMS FOR BODY CARE; BODY AND BEAUTY CARE COSMETICS; COSMETIC CREAMS FOR SKIN CARE; COSMETIC PREPARATIONS FOR BODY CARE, IN CLASS 3 (U.S. CLS. 1, 4, 6, 50, 51 AND 52).

**TRADEMARK**

FIRST USE 2-13-2009; IN COMMERCE 2-13-2009.

**PRINCIPAL REGISTER**

THE MARK CONSISTS OF STANDARD CHARACTERS WITHOUT CLAIM TO ANY PARTICULAR FONT, STYLE, SIZE, OR COLOR.

NO CLAIM IS MADE TO THE EXCLUSIVE RIGHT TO USE "BEAUTY", APART FROM THE MARK AS SHOWN.

SN 77-344,569, FILED 12-5-2007.

MARTHA SANTOMARTINO, EXAMINING ATTORNEY



*David J. Kybas*

Director of the United States Patent and Trademark Office

# United States of America

United States Patent and Trademark Office

## CAREMETRICS

**Reg. No. 4,125,685**

**Registered Apr. 10, 2012**

**Int. Cls.: 35 and 44**

**SERVICE MARK**

**PRINCIPAL REGISTER**

COMMONWEALTH ENTERPRISE GROUP LLC (MASSACHUSETTS LIMITED LIABILITY COMPANY)  
14 RESERVIOR ROAD  
WAYLAND, MA 01778

FOR: HEALTH CARE COST REVIEW AND MANAGEMENT FOR THE HEALTH BENEFIT PLANS OF OTHERS, NAMELY, ANALYSIS OF PATIENT DATA TO LOWER COST; PROVIDING BUSINESS SERVICES IN THE NATURE OF HEALTH CARE COST CONTAINMENT TO LOWER COST; BUSINESS SERVICES IN THE FIELD OF HEALTHCARE DATA, NAMELY, COMPILING PATIENT AND HEALTHCARE DATA FOR OTHERS, PREPARING BUSINESS REPORTS, MARKET STUDIES, AND MARKET STUDY ANALYSIS FOR OTHERS IN THE FIELD OF HEALTH CARE; PROVIDING BUSINESS INTELLIGENCE SERVICES, IN CLASS 35 (U.S. CLS. 100, 101 AND 102).

FIRST USE 6-0-2011; IN COMMERCE 6-0-2011.

FOR: PROVIDING CLINICAL INFORMATION IN THE FIELD OF HEALTHCARE VIA TELEPHONE AND INTERNET TO EMPLOYERS, GOVERNMENT, PAYERS, PROVIDERS, PATIENTS, PHARMACEUTICAL COMPANIES, FINANCIAL SERVICES COMPANIES AND MANAGED CARE ORGANIZATIONS, IN CLASS 44 (U.S. CLS. 100 AND 101).

FIRST USE 6-0-2011; IN COMMERCE 6-0-2011.

THE MARK CONSISTS OF STANDARD CHARACTERS WITHOUT CLAIM TO ANY PARTICULAR FONT, STYLE, SIZE, OR COLOR.

SN 77-345,031, FILED 12-5-2007.

KRISTIN CARLSON, EXAMINING ATTORNEY



*David J. Kyros*

Director of the United States Patent and Trademark Office

# United States of America

United States Patent and Trademark Office

## GENERATION HUMANITY

**Reg. No. 4,125,686**

SANDRA EUGENIA BORGONOVO (UNITED STATES INDIVIDUAL)  
150 OCEAN LANE DRIVE  
KEY BISCAYNE, FL 33149

**Registered Apr. 10, 2012**

**Int. Cl.: 36**

FOR: CHARITABLE SERVICES, NAMELY, RAISING, MANAGING, AND DISBURSING FUNDS IN CONNECTION WITH PROGRAMS TO IMPROVE THE WELFARE OF CHILDREN , IN CLASS 36 (U.S. CLS. 100, 101 AND 102).

**SERVICE MARK**

FIRST USE 10-0-2009; IN COMMERCE 10-0-2009.

**PRINCIPAL REGISTER**

THE MARK CONSISTS OF STANDARD CHARACTERS WITHOUT CLAIM TO ANY PARTICULAR FONT, STYLE, SIZE, OR COLOR.

SN 77-345,877, FILED 12-6-2007.

TRACY CROSS, EXAMINING ATTORNEY



*David J. Kyffers*

Director of the United States Patent and Trademark Office

# United States of America

United States Patent and Trademark Office

# PACNET

**Reg. No. 4,125,687**

**Registered Apr. 10, 2012**

**Int. Cls.: 39, 42, and 45**

**SERVICE MARK**

**PRINCIPAL REGISTER**

PACNET LIMITED (BERMUDA CORPORATION)  
CLARENDON HOUSE, 2 CHURCH STREET  
HAMILTON HM 11, BERMUDA

FOR: CO-LOCATION SERVICES, NAMELY, PROVIDING A SECURE FACILITY FOR THE STORAGE OF VOICE, VIDEO AND DATA TELECOMMUNICATIONS EQUIPMENT OF OTHERS; STORAGE OF WEBSITES, WEB CENTERS, ELECTRONIC MAIL, NEWSGROUPS, LIST SERVERS AND THE DIGITAL CONTENT AND DATA OF OTHERS, IN CLASS 39 (U.S. CLS. 100 AND 105).

FIRST USE 1-0-2008; IN COMMERCE 1-0-2008.

FOR: DATA CENTER MANAGEMENT SERVICES; INTERNET BACKUP SERVICES, NAMELY, NETWORK BACKUP SERVICE TO A PRIVATE NETWORK VIA THE INTERNET, IN CLASS 42 (U.S. CLS. 100 AND 101).

FIRST USE 2-0-2011; IN COMMERCE 2-0-2011.

FOR: AUTHENTICATION OF PERSONAL IDENTIFICATION INFORMATION AND DIGITAL SIGNATURES IN THE FIELDS OF TELECOMMUNICATIONS AND NETWORK SERVICES; PROVIDING USER AUTHENTICATION SERVICES IN THE FIELDS OF TELECOMMUNICATIONS AND NETWORK SERVICES; PROVIDING USER AUTHENTICATION SERVICES TO OTHERS IN THE FIELD OF VOICE AND DATA COMMUNICATION NETWORK SERVICES; ELECTRONIC MONITORING SERVICES FOR SECURITY PURPOSES IN THE FIELD OF ELECTRONIC DATA NETWORKS, IN CLASS 45 (U.S. CLS. 100 AND 101).

FIRST USE 11-0-2011; IN COMMERCE 11-0-2011.

THE MARK CONSISTS OF STANDARD CHARACTERS WITHOUT CLAIM TO ANY PARTICULAR FONT, STYLE, SIZE, OR COLOR.

SN 77-347,643, FILED 12-10-2007.

FRANK LATTUCA, EXAMINING ATTORNEY



*David J. Kyffers*

Director of the United States Patent and Trademark Office

# United States of America

United States Patent and Trademark Office

# ELEVATION

**Reg. No. 4,125,688**

**Registered Apr. 10, 2012**

**Int. Cl.: 5**

**TRADEMARK**

**PRINCIPAL REGISTER**

ELEVATION PHARMACEUTICALS, INC. (DELAWARE CORPORATION)  
2711 CENTERVILLE ROAD, SUITE 400  
WILMINGTON, DE 19808

FOR: INHALED PHARMACEUTICAL PREPARATIONS FOR THE TREATMENT OF RESPIRATORY DISEASES, NAMELY, ASTHMA, EMPHYSEMA, BRONCHITIS, COPD, LOWER RESPIRATORY INFECTIONS, PNEUMONIA, TUBERCULOSIS, CYSTIC FIBROSIS, LUNG CANCER, PULMONARY FIBROSIS, BRONCHIECTASIS, BYSSINOSIS, BRONCHIOLITIS, ASBESTOSIS, FIBROSIS, SARCOIDOSIS PLEURAL EFFUSION, HYPERSENSITIVITY, PNEUMONITIS, ASBESTOSIS, PLEURISY, INFANT RESPIRATORY DISTRESS SYNDROME, ACUTE RESPIRATORY DISTRESS SYNDROME, SEVERE ACUTE RESPIRATORY SYNDROME, PULMONARY OEDEMA, PULMONARY EMBOLISM, PULMONARY HYPERTENSION, AND ALL UPPER RESPIRATORY INFECTIONS, SOLD AS A UNIT WITH PULMONARY AND INTRANASAL DRUG DELIVERY DEVICES, IN CLASS 5 (U.S. CLS. 6, 18, 44, 46, 51 AND 52).

FIRST USE 6-1-2011; IN COMMERCE 6-1-2011.

THE MARK CONSISTS OF STANDARD CHARACTERS WITHOUT CLAIM TO ANY PARTICULAR FONT, STYLE, SIZE, OR COLOR.

SN 77-349,437, FILED 12-11-2007.

CHRIS DONINGER, EXAMINING ATTORNEY



*David J. Kyros*

Director of the United States Patent and Trademark Office

# United States of America

United States Patent and Trademark Office

## LONDONLOCK

**Reg. No. 4,125,689**

ARTISTIC PAVER MANUFACTURING, INC. (FLORIDA CORPORATION)  
120 N.E. 179 STREET  
N. MIAMI, FL 33162

**Registered Apr. 10, 2012**

**Int. Cl.: 19**

FOR: PAVERS, PAVING BLOCKS, DRIVEWAY PAVERS, PAVERS FOR PEDESTRIAN AREAS, PAVERS FOR POOL AREAS, IN CLASS 19 (U.S. CLS. 1, 12, 33 AND 50).

**TRADEMARK**

FIRST USE 11-12-2007; IN COMMERCE 5-19-2011.

**PRINCIPAL REGISTER**

THE MARK CONSISTS OF STANDARD CHARACTERS WITHOUT CLAIM TO ANY PARTICULAR FONT, STYLE, SIZE, OR COLOR.

SN 77-356,809, FILED 12-20-2007.

CHARISMA HAMPTON, EXAMINING ATTORNEY



*David J. Kybas*

Director of the United States Patent and Trademark Office



# United States of America

United States Patent and Trademark Office

## ARAYA FINE ART REVEALED

**Reg. No. 4,125,690**

HERST VENTURES, INC. (CALIFORNIA CORPORATION)  
2027 FOURTH ST.  
BERKELEY, CA 94710

**Registered Apr. 10, 2012**

**Int. Cl.: 11**

FOR: LED LIGHTING FIXTURES, IN CLASS 11 (U.S. CLS. 13, 21, 23, 31 AND 34).

**TRADEMARK**

FIRST USE 1-11-2012; IN COMMERCE 1-11-2012.

**PRINCIPAL REGISTER**

THE MARK CONSISTS OF STANDARD CHARACTERS WITHOUT CLAIM TO ANY PARTICULAR FONT, STYLE, SIZE, OR COLOR.

NO CLAIM IS MADE TO THE EXCLUSIVE RIGHT TO USE "FINE ART", APART FROM THE MARK AS SHOWN.

SN 77-356,876, FILED 12-20-2007.

LESLIE RICHARDS, EXAMINING ATTORNEY



*David J. Kyffers*

Director of the United States Patent and Trademark Office

# United States of America

United States Patent and Trademark Office



**Reg. No. 4,125,691**

**Registered Apr. 10, 2012**

**Int. Cl.: 30**

**TRADEMARK**

**PRINCIPAL REGISTER**

NEW WORLD PASTA COMPANY (DELAWARE CORPORATION)  
85 SHANNON ROAD  
HARRISBURG, PA 17112

FOR: PASTA, IN CLASS 30 (U.S. CL. 46).

FIRST USE 10-0-2007; IN COMMERCE 10-0-2007.

OWNER OF U.S. REG. NOS. 2,026,782, 2,722,075, AND OTHERS.

THE MARK CONSISTS OF A STYLIZED RECTANGULAR BANNER WITH A STYLIZED BUILDING AND TOWER.

SN 77-361,970, FILED 12-31-2007.

BRIAN NEVILLE, EXAMINING ATTORNEY



*David J. Kyffers*

Director of the United States Patent and Trademark Office

# United States of America

United States Patent and Trademark Office



**Reg. No. 4,125,692**

**Registered Apr. 10, 2012**

**Int. Cls.: 29 and 30**

**TRADEMARK**

**PRINCIPAL REGISTER**

NEW WORLD PASTA COMPANY (DELAWARE CORPORATION)  
85 SHANNON ROAD  
HARRISBURG, PA 17112

FOR: CHEESE, IN CLASS 29 (U.S. CL. 46).

FIRST USE 10-0-2010; IN COMMERCE 10-0-2010.

FOR: PASTA; BREADCRUMBS, IN CLASS 30 (U.S. CL. 46).

FIRST USE 10-0-2010; IN COMMERCE 10-0-2010.

OWNER OF U.S. REG. NOS. 518,709, 2,004,806, AND OTHERS.

THE MARK CONSISTS OF A STYLIZED RECTANGULAR BANNER WITH A WHEAT STALK BORDERING THE BOTTOM EDGE.

SN 77-361,987, FILED 12-31-2007.

BRIAN NEVILLE, EXAMINING ATTORNEY



*David J. Kybas*

Director of the United States Patent and Trademark Office

# United States of America

United States Patent and Trademark Office

## MIDDLE-EARTH

**Reg. No. 4,125,693**

**Registered Apr. 10, 2012**

**Int. Cl.: 29**

**TRADEMARK**

**PRINCIPAL REGISTER**

THE SAUL ZAENTZ COMPANY (DELAWARE CORPORATION)  
2600 TENTH STREET  
BERKELEY, CA 94710

FOR: VEGETABLE SALADS, IN CLASS 29 (U.S. CL. 46).

FIRST USE 6-0-2011; IN COMMERCE 6-0-2011.

THE MARK CONSISTS OF STANDARD CHARACTERS WITHOUT CLAIM TO ANY PARTICULAR FONT, STYLE, SIZE, OR COLOR.

OWNER OF U.S. REG. NOS. 1,109,520, 2,897,943, AND OTHERS.

SN 77-366,785, FILED 1-8-2008.

MICHAEL LITZAU, EXAMINING ATTORNEY



*David J. Kyffers*

Director of the United States Patent and Trademark Office

# United States of America

United States Patent and Trademark Office



**Reg. No. 4,125,694**

**Registered Apr. 10, 2012**

**Int. Cls.: 29 and 41**

**TRADEMARK**

**SERVICE MARK**

**PRINCIPAL REGISTER**

BEN & JERRY'S HOMEMADE INC. (VERMONT CORPORATION)  
30 COMMUNITY DRIVE, SUITE 1  
SOUTH BURLINGTON, VT 054036828

FOR: COTTAGE CHEESE, CHEESES, IN CLASS 29 (U.S. CL. 46).

FIRST USE 0-0-2008; IN COMMERCE 0-0-2008.

FOR: EDUCATIONAL SERVICES, NAMELY, PROVIDING CLASSES, SEMINARS, WORKSHOPS IN THE FIELD OF SUSTAINABLE DAIRY FARMING, PROVIDING TRAINING IN THE FIELD OF SUSTAINABLE DAIRY FARMING; ENTERTAINMENT SERVICES, NAMELY, ARRANGING AND CONDUCTING SPECIAL EVENTS CENTERED AROUND THE THEME OF SUSTAINABLE DAIRY FARMING, IN CLASS 41 (U.S. CLS. 100, 101 AND 107).

FIRST USE 0-0-2008; IN COMMERCE 0-0-2008.

SN 77-367,931, FILED 1-9-2008.

KIMBERLY FRYE, EXAMINING ATTORNEY



*David J. Kybas*

Director of the United States Patent and Trademark Office

# United States of America

United States Patent and Trademark Office



**Reg. No. 4,125,695**

**Registered Apr. 10, 2012**

**Int. Cl.: 25**

**TRADEMARK**

**PRINCIPAL REGISTER**

BACK BEAT, INC. (CALIFORNIA CORPORATION)  
901 WEST 9TH ST., #606  
AUSTIN, TX 78703

FOR: PANTS, JEANS, T-SHIRTS AND SWEATSHIRTS, IN CLASS 25 (U.S. CLS. 22 AND 39).

FIRST USE 1-0-2012; IN COMMERCE 1-0-2012.

OWNER OF U.S. REG. NOS. 2,256,563 AND 2,867,283.

THE MARK CONSISTS OF A STYLIZED REPRESENTATION OF THE TERM "SUGAR" POSITIONED BENEATH THE DESIGN OF A VISAGE OF A WINKING GIRL WEARING A NECKLACE.

SN 77-372,471, FILED 1-15-2008.

BRENDAN REGAN, EXAMINING ATTORNEY



*David J. Kybas*

Director of the United States Patent and Trademark Office

# United States of America

United States Patent and Trademark Office

## SUPER STICKS

**Reg. No. 4,125,696**

AMERICAN PIONEER POWDER, INC. (DELAWARE CORPORATION)  
24007 SEVENTH HEAVEN  
KATY, FL 77494

**Registered Apr. 10, 2012**

**Int. Cl.: 13**

FOR: COMPRESSED POWDER CHARGES FOR USE IN MODERN AND PRIMITIVE FIREARMS; PRE-MEASURED POWDER CHARGES FOR USE IN MODERN AND PRIMITIVE FIREARMS AND GUNPOWDER FOR USE IN MODERN AND PRIMITIVE FIREARMS, AND FOR USE IN RELATED GOODS, IN CLASS 13 (U.S. CLS. 2 AND 9).

**TRADEMARK**

**PRINCIPAL REGISTER**

FIRST USE 4-25-2008; IN COMMERCE 4-25-2008.

THE MARK CONSISTS OF STANDARD CHARACTERS WITHOUT CLAIM TO ANY PARTICULAR FONT, STYLE, SIZE, OR COLOR.

SEC. 2(F) AS TO "STICKS".

OWNER OF U.S. REG. NO. 2,865,486.

SN 77-375,051, FILED 1-18-2008.

SUE LAWRENCE, EXAMINING ATTORNEY



*David J. Kyffers*

Director of the United States Patent and Trademark Office

# United States of America

United States Patent and Trademark Office

## PINK DOING GREEN

**Reg. No. 4,125,697**

**Registered Apr. 10, 2012**

**Int. Cl.: 36**

**SERVICE MARK**

**PRINCIPAL REGISTER**

MARY KAY INC. (DELAWARE CORPORATION)  
11.300 TMKB  
16251 DALLAS PARKWAY  
ADDISON, TX 75001

FOR: CHARITABLE FUNDRAISING SERVICES, IN CLASS 36 (U.S. CLS. 100, 101 AND 102).

FIRST USE 2-16-2008; IN COMMERCE 2-16-2008.

THE MARK CONSISTS OF STANDARD CHARACTERS WITHOUT CLAIM TO ANY PARTICULAR FONT, STYLE, SIZE, OR COLOR.

NO CLAIM IS MADE TO THE EXCLUSIVE RIGHT TO USE "GREEN", APART FROM THE MARK AS SHOWN.

SN 77-391,935, FILED 2-8-2008.

TEJBIR SINGH, EXAMINING ATTORNEY



*David J. Kybas*

Director of the United States Patent and Trademark Office



# United States of America

United States Patent and Trademark Office

# REDRAY

**Reg. No. 4,125,698**

**Registered Apr. 10, 2012**

**Int. Cl.: 9**

**TRADEMARK**

**PRINCIPAL REGISTER**

RED.COM, INC. (WASHINGTON CORPORATION)  
34 PARKER  
IRVINE, CA 92618

FOR: DIGITAL CINEMA PLAYERS; DIGITAL IMAGE CONTROLLER FOR CINEMA, MOVIE, TELEVISION, VIDEO, AUDIO, AND PHOTOGRAPH PRODUCTION AND PRESENTATION APPLICATIONS; DIGITAL IMAGE PLAYER FOR CINEMA, MOVIE, TELEVISION, VIDEO, AUDIO, AND PHOTOGRAPH PRODUCTION AND PRESENTATION APPLICATIONS; OPTICAL AND MAGNETO-OPTICAL DISC PLAYERS AND RECORDERS FOR AUDIO, VIDEO AND COMPUTER DATA; BLANK OPTICAL AND MAGNETO-OPTICAL DISCS, PRE-RECORDED OPTICAL AND MAGNETO-OPTICAL DISCS FEATURING MUSIC, TEXT DATA, STILL IMAGES AND MOTION PICTURES; DIGITAL SATELLITE BROADCASTING SYSTEMS, NAMELY, RECEIVERS, TRANSMITTERS AND ANTENNAS FOR SATELLITE BROADCASTING; CINEMATOGRAPHIC MACHINES AND APPARATUS WITH DIGITAL VERSATILE DISC FUNCTIONS, NAMELY, CAMCORDERS WITH DIGITAL VERSATILE DISC FUNCTIONS; DIGITAL VERSATILE DISC PLAYERS; DIGITAL VERSATILE DISC RECORDERS, IN CLASS 9 (U.S. CLS. 21, 23, 26, 36 AND 38).

FIRST USE 1-9-2012; IN COMMERCE 1-9-2012.

THE MARK CONSISTS OF STANDARD CHARACTERS WITHOUT CLAIM TO ANY PARTICULAR FONT, STYLE, SIZE, OR COLOR.

SN 77-392,293, FILED 2-8-2008.

ELLEN B. AWRICH, EXAMINING ATTORNEY



*David J. Kypos*

Director of the United States Patent and Trademark Office

# United States of America

United States Patent and Trademark Office

# Playbies

**Reg. No. 4,125,699**

COLEMAN, SHIRA (UNITED STATES INDIVIDUAL)  
118 CALABASAS ROAD  
WATSONVILLE, CA 95076

**Registered Apr. 10, 2012**

**Int. Cl.: 9**

FOR: EDUCATIONAL AND DEVELOPMENTAL DVD'S FOR CHILD CAREGIVER TRAINING,  
IN CLASS 9 (U.S. CLS. 21, 23, 26, 36 AND 38).

**TRADEMARK**

FIRST USE 12-26-2007; IN COMMERCE 9-5-2011.

**PRINCIPAL REGISTER**

THE MARK CONSISTS OF STANDARD CHARACTERS WITHOUT CLAIM TO ANY PARTICULAR FONT, STYLE, SIZE, OR COLOR.

SN 77-396,521, FILED 2-13-2008.

TARAH HARDY, EXAMINING ATTORNEY



*David J. Kybas*

Director of the United States Patent and Trademark Office

# United States of America

United States Patent and Trademark Office

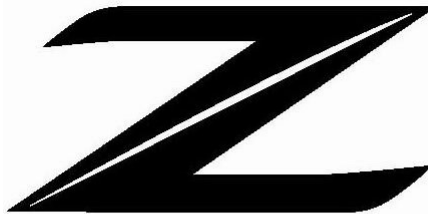

**Reg. No. 4,125,700**

**Registered Apr. 10, 2012**

**Int. Cl.: 28**

**TRADEMARK**

**PRINCIPAL REGISTER**

NISSAN JIDOSHA KABUSHIKI KAISHA (JAPAN CORPORATION), DBA NISSAN MOTOR CO., LTD.,  
NO. 2 TAKARACHO, KANAGAWA-KU  
YOKOHAMA-SHI, KANAGAWA, JAPAN 2208623

FOR: TOYS AND PLAYTHINGS, NAMELY, DIE CAST TOY VEHICLES, BATTERY OPERATED REMOTE CONTROL TOY VEHICLES, PLASTIC MODEL HOBBY CRAFT KITS FOR CONSTRUCTING TOY AND SCALE MOTOR VEHICLES, IN CLASS 28 (U.S. CLS. 22, 23, 38 AND 50).

FIRST USE 2-0-2010; IN COMMERCE 2-0-2010.

THE MARK CONSISTS OF STYLIZED LETTER "Z".

SN 77-401,052, FILED 2-20-2008.

GEOFFREY FOSDICK, EXAMINING ATTORNEY



*David J. Kybas*

Director of the United States Patent and Trademark Office

United States of America  
United States Patent and Trademark Office

LAYLAJOY

**Reg. No. 4,125,701**

**Registered Apr. 10, 2012**

**Int. Cl.: 25**

**TRADEMARK**

**PRINCIPAL REGISTER**

WILLIAMS, LAYLA JOY (UNITED STATES INDIVIDUAL)  
229 WEST 60TH STREET  
APT. 3U  
NEW YORK, NY 10023

FOR: FOOTWEAR, IN CLASS 25 (U.S. CLS. 22 AND 39).

FIRST USE 5-19-2011; IN COMMERCE 5-19-2011.

THE MARK CONSISTS OF STANDARD CHARACTERS WITHOUT CLAIM TO ANY PARTICULAR FONT, STYLE, SIZE, OR COLOR.

THE NAME(S), PORTRAIT(S), AND/OR SIGNATURE(S) SHOWN IN THE MARK IDENTIFIES LAYLA JOY WILLIAMS, WHOSE CONSENT(S) TO REGISTER IS SUBMITTED.

SN 77-405,874, FILED 2-26-2008.

KYLE PEETE, EXAMINING ATTORNEY



*David J. Kybas*

Director of the United States Patent and Trademark Office

United States of America  
United States Patent and Trademark Office

utique

**Reg. No. 4,125,702**

**Registered Apr. 10, 2012**

**Int. Cl.: 35**

**SERVICE MARK**

**PRINCIPAL REGISTER**

UTIQUE, INC. (DELAWARE CORPORATION)  
456 GEARY STREET  
SAN FRANCISCO, CA 94102

FOR: RETAIL STORE SERVICES FEATURING COSMETICS, BEAUTY SUPPLIES, CLOTHING AND ACCESSORIES; ONLINE RETAIL STORE SERVICES FEATURING COSMETICS, BEAUTY SUPPLIES, CLOTHING AND ACCESSORIES; KIOSK RETAIL STORE SERVICES FEATURING CLOTHING; ISSUING GIFT CERTIFICATES WHICH MAY THEN BE REDEEMED FOR GOODS OR SERVICES, IN CLASS 35 (U.S. CLS. 100, 101 AND 102).

FIRST USE 3-13-2009; IN COMMERCE 3-13-2009.

THE MARK CONSISTS OF A STYLIZED DIAMOND OR FOUR POINTED STAR ABOVE AND BETWEEN THE LETTERS "U" AND "T" IN THE WORD "UTIQUE".

SN 77-411,449, FILED 3-3-2008.

DEZMONA MIZELLE, EXAMINING ATTORNEY



*David J. Kybas*

Director of the United States Patent and Trademark Office

# United States of America

United States Patent and Trademark Office

## COMPLETE SWEEP

**Reg. No. 4,125,703**

**Registered Apr. 10, 2012**

**Int. Cl.: 21**

**TRADEMARK**

**PRINCIPAL REGISTER**

QUICKIE MANUFACTURING CORPORATION (NEW JERSEY CORPORATION)  
1150 TAYLORS LANE P.O. BOX 156  
CINNAMINSON, NJ 08077

FOR: BROOMS, IN CLASS 21 (U.S. CLS. 2, 13, 23, 29, 30, 33, 40 AND 50).

FIRST USE 10-0-2009; IN COMMERCE 10-0-2009.

THE MARK CONSISTS OF STANDARD CHARACTERS WITHOUT CLAIM TO ANY PARTICULAR FONT, STYLE, SIZE, OR COLOR.

NO CLAIM IS MADE TO THE EXCLUSIVE RIGHT TO USE "SWEEP", APART FROM THE MARK AS SHOWN.

SN 77-419,039, FILED 3-11-2008.

JENNIFER MARTIN, EXAMINING ATTORNEY



*David J. Kyffers*

Director of the United States Patent and Trademark Office

# United States of America

United States Patent and Trademark Office

# RiskShield

**Reg. No. 4,125,704**

**Registered Apr. 10, 2012**

**Int. Cl.: 9**

**TRADEMARK**

**PRINCIPAL REGISTER**

VIDSYS, INC. (DELAWARE CORPORATION)  
SUITE 310  
293 BOSTON POST ROAD WEST  
MARLBOROUGH, MA 01752

FOR: SOFTWARE WHICH COLLECTS AND CORRELATES ALARMS AND OTHER DATA ACROSS AN ORGANIZATION TO IDENTIFY, ASSESS, MANAGE AND RESOLVE PHYSICAL SECURITY RISKS SOLD TOGETHER WITH SECURITY ALARM SYSTEMS, IN CLASS 9 (U.S. CLS. 21, 23, 26, 36 AND 38).

FIRST USE 4-1-2008; IN COMMERCE 4-1-2008.

THE MARK CONSISTS OF STANDARD CHARACTERS WITHOUT CLAIM TO ANY PARTICULAR FONT, STYLE, SIZE, OR COLOR.

SN 77-430,820, FILED 3-25-2008.

TRACY FLETCHER, EXAMINING ATTORNEY



*David J. Kyffers*

Director of the United States Patent and Trademark Office

# United States of America

United States Patent and Trademark Office

## REPRIORMENT

**Reg. No. 4,125,705**

**Registered Apr. 10, 2012**

**Int. Cls.: 41 and 45**

**SERVICE MARK**

**PRINCIPAL REGISTER**

MATHER LIFEWAYS (ILLINOIS CORPORATION)  
1603 ORRINGTON AVENUE  
EVANSTON, IL 60201

FOR: PROVIDING SERVICES FOR SENIOR ADULTS, NAMELY, PHYSICAL FITNESS TRAINING SERVICES AND EDUCATIONAL PROGRAMS, NAMELY, CLASSES IN THE FIELDS OF YOGA, STRENGTH TRAINING, STRETCHING, PAINTING, POETRY, COMPUTERS, ART, DANCE AND MENTAL EXERCISES; PROVIDING SERVICES FOR SENIOR ADULTS, NAMELY, CONDUCTING SOCIAL PROGRAMS IN THE NATURE OF DINNER THEATRES AND CURRENT EVENT ROUNDTABLE DISCUSSIONS AND ORGANIZING SOCIAL OUTINGS TO DINNER THEATRES, CURRENT EVENT ROUNDTABLE DISCUSSIONS AND SPORTING EVENTS, IN CLASS 41 (U.S. CLS. 100, 101 AND 107).

FIRST USE 9-21-2011; IN COMMERCE 9-21-2011.

FOR: PROVIDING SERVICES FOR SENIOR ADULTS, NAMELY, CONDUCTING SOCIAL PROGRAMS IN THE NATURE OF SOCIAL INTRODUCTION EVENTS AND ORGANIZING SOCIAL OUTINGS TO SOCIAL INTRODUCTION EVENTS, IN CLASS 45 (U.S. CLS. 100 AND 101).

FIRST USE 9-21-2011; IN COMMERCE 9-21-2011.

THE MARK CONSISTS OF STANDARD CHARACTERS WITHOUT CLAIM TO ANY PARTICULAR FONT, STYLE, SIZE, OR COLOR.

SN 77-432,509, FILED 3-26-2008.

EUGENIA MARTIN, EXAMINING ATTORNEY



*David J. Kyffers*

Director of the United States Patent and Trademark Office



# United States of America

United States Patent and Trademark Office

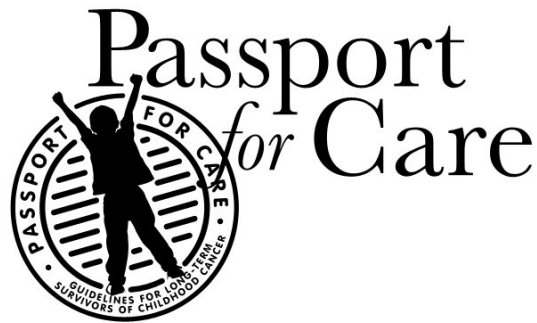

**Reg. No. 4,125,706**

**Registered Apr. 10, 2012**

**Int. Cls.: 38 and 44**

**SERVICE MARK**

**PRINCIPAL REGISTER**

BAYLOR COLLEGE OF MEDICINE (TEXAS NON-PROFIT CORPORATION)  
ONE BAYLOR PLAZA  
MD-600D  
HOUSTON, TX 77030

FOR: PROVIDING ACCESS TO DATABASES TO PATIENTS AND SURVIVORS OF CHRONIC ILLNESSES, SUCH DATABASES CONTAINING THEIR MEDICAL INFORMATION AND HEALTHCARE GUIDELINES INDIVIDUALIZED TO THEIR MEDICAL HISTORY, IN CLASS 38 (U.S. CLS. 100, 101 AND 104).

FIRST USE 12-8-2010; IN COMMERCE 12-8-2010.

FOR: PROVIDING MEDICAL INFORMATION, CONSULTANCY AND ADVISORY SERVICES, IN THE NATURE OF PROVIDING PATIENTS AND SURVIVORS OF CHRONIC ILLNESSES WITH THEIR PERSONAL MEDICAL INFORMATION, AND OFFERING HEALTHCARE GUIDELINES INDIVIDUALIZED TO THEIR MEDICAL HISTORY, IN CLASS 44 (U.S. CLS. 100 AND 101).

FIRST USE 12-8-2010; IN COMMERCE 12-8-2010.

NO CLAIM IS MADE TO THE EXCLUSIVE RIGHT TO USE "CARE", "CARE", OR "GUIDELINES FOR LONG-TERM SURVIVORS OF CHILDHOOD CANCER", APART FROM THE MARK AS SHOWN.

THE MARK CONSISTS OF TWO CONCENTRIC CIRCLES OVERLAID WITH A SILHOUETTE OF A CHILD WITH ITS ARMS STRETCHED UPWARDS, AND OVERLAID WITH SPACED-APART LINES THAT ARE PERPENDICULAR TO THE LONG AXIS OF THE SILHOUETTE; BETWEEN THE TWO CIRCLES ARE THE WORDS "PASSPORT FOR CARE -- GUIDELINES FOR LONG-TERM SURVIVORS OF CHILDHOOD CANCER". THE PHRASE "PASSPORT FOR CARE" ALSO APPEARS ABOVE AND THE TO THE RIGHT OF THE CIRCLES.

SN 77-441,270, FILED 4-7-2008.

ANDREA HACK, EXAMINING ATTORNEY



*David J. Kyffers*

Director of the United States Patent and Trademark Office

# United States of America

United States Patent and Trademark Office

## SOCAL CONNECTED

**Reg. No. 4,125,707**

**Registered Apr. 10, 2012**

**Int. Cls.: 9, 38, and 41**

**TRADEMARK**

**SERVICE MARK**

**PRINCIPAL REGISTER**

COMMUNITY TELEVISION OF SOUTHERN CALIFORNIA (CALIFORNIA CORPORATION)  
4401 SUNSET BOULEVARD  
LOS ANGELES, CA 90027

FOR: DOWNLOADABLE PODCASTS FEATURING ARTICLES, REVIEWS, INTERVIEWS, EDITORIALS, AUDIO CLIPS, VIDEO CLIPS, PHOTOGRAPHS AND OTHER MULTIMEDIA MATERIALS IN THE FIELDS OF CURRENT EVENTS, REGIONAL AND NATIONAL GOVERNMENT, REGIONAL AND NATIONAL NEWS, WORLD AFFAIRS, POLITICS, CULTURAL ISSUES AND EVENTS, HISTORY, ARTS, PROFILES OF INDIVIDUALS, ENVIRONMENT, HEALTH CARE, SCIENCE AND TECHNOLOGY, AND RELIGION, IN CLASS 9 (U.S. CLS. 21, 23, 26, 36 AND 38).

FIRST USE 2-7-2012; IN COMMERCE 2-7-2012.

FOR: ONLINE JOURNALS, NAMELY, CHAT ROOMS FEATURING DISCUSSION ON CURRENT EVENTS, REGIONAL AND NATIONAL GOVERNMENT, REGIONAL AND NATIONAL NEWS, WORLD AFFAIRS, POLITICS, CULTURAL ISSUES AND EVENTS, HISTORY, ARTS, PROFILES OF INDIVIDUALS, ENVIRONMENT, HEALTH CARE, SCIENCE AND TECHNOLOGY, AND RELIGION, IN CLASS 38 (U.S. CLS. 100, 101 AND 104).

FIRST USE 1-25-2011; IN COMMERCE 1-25-2011.

FOR: NEWS AND ENTERTAINMENT SERVICES, NAMELY, A CONTINUING PROGRAM SERIES PROVIDING NEWS AND INFORMATION IN A WIDE RANGE OF FIELDS OF CURRENT EVENTS, REGIONAL AND NATIONAL GOVERNMENT, REGIONAL AND NATIONAL NEWS, POLITICS, CULTURAL ISSUES AND EVENTS, HISTORY, ARTS, PROFILES OF INDIVIDUALS, ENVIRONMENT, HEALTH CARE, SCIENCE AND TECHNOLOGY, AND RELIGION PROVIDED THROUGH PODCAST; ENTERTAINMENT SERVICES, NAMELY, PROVIDING PODCASTS FEATURING INTERVIEWS, AUDIO CLIPS AND VIDEO CLIPS, AND LIVE VIDEO IN THE FIELDS OF CURRENT EVENTS, REGIONAL AND NATIONAL GOVERNMENT, REGIONAL AND NATIONAL NEWS, WORLD AFFAIRS, POLITICS, CULTURAL ISSUES AND EVENTS, HISTORY, ARTS, PROFILES OF INDIVIDUALS, ENVIRONMENT, HEALTH CARE, SCIENCE AND TECHNOLOGY, AND RELIGION, IN CLASS 41 (U.S. CLS. 100, 101 AND 107).

FIRST USE 2-7-2012; IN COMMERCE 2-7-2012.



*David J. Kyjars*

Director of the United States Patent and Trademark Office

**Reg. No. 4,125,707** THE MARK CONSISTS OF STANDARD CHARACTERS WITHOUT CLAIM TO ANY PARTICULAR FONT, STYLE, SIZE, OR COLOR.

NO CLAIM IS MADE TO THE EXCLUSIVE RIGHT TO USE "SOCAL", APART FROM THE MARK AS SHOWN.

SN 77-446,588, FILED 4-11-2008.

MICHAEL KEATING, EXAMINING ATTORNEY

# United States of America

United States Patent and Trademark Office

## START LOSING. START WINNING. START!

**Reg. No. 4,125,708**

**Registered Apr. 10, 2012**

**Int. Cls.: 38, 41, and 44**

**SERVICE MARK**

**PRINCIPAL REGISTER**

LOSS LEADERS, LLC (MICHIGAN LIMITED LIABILITY COMPANY)  
2093 HEALTH DRIVE  
SUITE 302  
WYOMING, MI 49519

FOR: PROVIDING ON-LINE CHAT ROOMS FOR TRANSMISSION OF MESSAGES AMONG COMPUTER USERS AND WEIGHT MANAGEMENT PROFESSIONALS CONCERNING WEIGHT MANAGEMENT, DIET PLANNING AND NUTRITION, IN CLASS 38 (U.S. CLS. 100, 101 AND 104).

FIRST USE 8-12-2010; IN COMMERCE 8-12-2010.

FOR: EDUCATIONAL AND ENTERTAINMENT SERVICES, NAMELY, PROVIDING A SYNDICATED RADIO PROGRAM IN THE FIELDS OF WEIGHT LOSS AND NUTRITION; ENTERTAINMENT SERVICES, NAMELY, PROVIDING CONTINUING RADIO PROGRAMS, WEB EPISODES, PODCASTS, AND PROGRAMS ACCESSIBLE VIA THE INTERNET, ALL IN THE FIELD OF WEIGHT LOSS, NUTRITION, WEIGHT MANAGEMENT, AND HEALTH; EDUCATIONAL AND ENTERTAINMENT SERVICES, NAMELY, A CONTINUING PROGRAM FEATURING INSTRUCTION IN THE FIELDS OF EXERCISE AND FITNESS ACCESSIBLE VIA THE INTERNET; EDUCATIONAL AND ENTERTAINMENT SERVICES, NAMELY, PROVIDING A CONTINUING PROGRAM ABOUT WEIGHT MANAGEMENT, ACCESSIBLE VIA THE INTERNET, IN CLASS 41 (U.S. CLS. 100, 101 AND 107).

FIRST USE 4-0-2010; IN COMMERCE 4-0-2010.

FOR: WEIGHT REDUCTION DIET PLANNING AND SUPERVISION; PROVIDING WEIGHT MANAGEMENT DIET PLANNING AND SUPERVISION SERVICES VIA THE INTERNET; COUNSELING IN THE FIELDS OF WEIGHT MANAGEMENT, DIET PLANNING AND NUTRITION; PROVIDING INFORMATION AND CONSULTATION IN THE FIELD OF WEIGHT MANAGEMENT DIET PLANNING VIA E-MAIL RESPONSES TO INDIVIDUAL DIETERS' QUESTIONS POSED TO WEIGHT MANAGEMENT PROFESSIONALS, IN CLASS 44 (U.S. CLS. 100 AND 101).

FIRST USE 4-0-2010; IN COMMERCE 4-0-2010.

THE MARK CONSISTS OF STANDARD CHARACTERS WITHOUT CLAIM TO ANY PARTICULAR FONT, STYLE, SIZE, OR COLOR.



*David J. Kyjars*

Director of the United States Patent and Trademark Office

**Reg. No. 4,125,708** SN 77-472,882, FILED 5-13-2008.

CYNTHIA TRIPI, EXAMINING ATTORNEY

# United States of America

United States Patent and Trademark Office

## STONEHENGE VINEYARD AND WINERY

**Reg. No. 4,125,709**

**Registered Apr. 10, 2012**

**Int. Cl.: 33**

**TRADEMARK**

**PRINCIPAL REGISTER**

STONEHENGE WINERY AND VINEYARD, LLC (PENNSYLVANIA LIMITED LIABILITY COMPANY)  
487 STONE CHURCH DR  
MT. BETHEL, PA 18343

FOR: WINE; APERITIF WINES; FRUIT WINE; COOKING WINE; RED WINE; TABLE WINE; SPARKLING WINES; WHITE WINE, IN CLASS 33 (U.S. CLS. 47 AND 49).

FIRST USE 7-0-2011; IN COMMERCE 7-0-2011.

THE MARK CONSISTS OF STANDARD CHARACTERS WITHOUT CLAIM TO ANY PARTICULAR FONT, STYLE, SIZE, OR COLOR.

NO CLAIM IS MADE TO THE EXCLUSIVE RIGHT TO USE "VINEYARD AND WINERY", APART FROM THE MARK AS SHOWN.

SN 77-473,319, FILED 5-13-2008.

CHARLES L. JENKINS, EXAMINING ATTORNEY



*David J. Kybas*

Director of the United States Patent and Trademark Office

# United States of America

United States Patent and Trademark Office

# ECOLOGIC

**Reg. No. 4,125,710**

**Registered Apr. 10, 2012**

**Int. Cl.: 11**

**TRADEMARK**

**PRINCIPAL REGISTER**

NORDYNE INC. (DELAWARE CORPORATION)  
8000 PHOENIX PARKWAY  
O'FALLON, MO 63366

FOR: AIR CONDITIONERS, FURNACES AND HEAT PUMPS SOLD EXCLUSIVELY THROUGH LICENSED HVAC CONTRACTORS, IN CLASS 11 (U.S. CLS. 13, 21, 23, 31 AND 34).

FIRST USE 12-31-2007; IN COMMERCE 12-31-2007.

THE MARK CONSISTS OF STANDARD CHARACTERS WITHOUT CLAIM TO ANY PARTICULAR FONT, STYLE, SIZE, OR COLOR.

SN 77-474,898, FILED 5-15-2008.

PAUL E. FAHRENKOPF, EXAMINING ATTORNEY



*David J. Kyffers*

Director of the United States Patent and Trademark Office

# United States of America

United States Patent and Trademark Office

## NINJAI THE LITTLE NINJA

**Reg. No. 4,125,711**

NINJAI GANG, LLC (HAWAII LIMITED LIABILITY COMPANY)  
P.O. BOX 1916  
KAILUA, HI 96734

**Registered Apr. 10, 2012**

**Int. Cl.: 16**

FOR: STICKERS, IN CLASS 16 (U.S. CLS. 2, 5, 22, 23, 29, 37, 38 AND 50).

**TRADEMARK**

FIRST USE 5-20-2010; IN COMMERCE 5-20-2010.

**PRINCIPAL REGISTER**

THE MARK CONSISTS OF STANDARD CHARACTERS WITHOUT CLAIM TO ANY PARTICULAR FONT, STYLE, SIZE, OR COLOR.

OWNER OF U.S. REG. NOS. 2,872,444 AND 3,042,123.

SN 77-476,109, FILED 5-15-2008.

LEIGH CAROLINE CASE, EXAMINING ATTORNEY



*David J. Kyffers*

Director of the United States Patent and Trademark Office



# United States of America

United States Patent and Trademark Office

## NINJAI THE LITTLE NINJA

**Reg. No. 4,125,712**

NINJAI GANG, LLC (HAWAII LIMITED LIABILITY COMPANY)  
P.O. BOX 1916  
KAILUA, HI 96734

**Registered Apr. 10, 2012**

**Int. Cl.: 41**

FOR: ENTERTAINMENT SERVICES, NAMELY, ENTERTAINMENT IN THE NATURE OF ON-GOING TELEVISION PROGRAMS FEATURING ANIMATION, IN CLASS 41 (U.S. CLS. 100, 101 AND 107).

**SERVICE MARK**

FIRST USE 5-20-2010; IN COMMERCE 5-20-2010.

**PRINCIPAL REGISTER**

THE MARK CONSISTS OF STANDARD CHARACTERS WITHOUT CLAIM TO ANY PARTICULAR FONT, STYLE, SIZE, OR COLOR.

OWNER OF U.S. REG. NOS. 2,872,444 AND 3,042,123.

SN 77-476,121, FILED 5-15-2008.

LEIGH CAROLINE CASE, EXAMINING ATTORNEY



*David J. Kyffers*

Director of the United States Patent and Trademark Office

# United States of America

United States Patent and Trademark Office

# SLUSCIOUS

**Reg. No. 4,125,713**

SERAFINI, MONICA (UNITED STATES INDIVIDUAL)  
1203 WYOMING ST.

**Registered Apr. 10, 2012**

BOULDER CITY, NV 89005

**Int. Cl.: 35**

**SERVICE MARK**

**PRINCIPAL REGISTER**

FOR: MAIL ORDER SERVICES FEATURING CLOTHING, BATH AND BODY PRODUCTS, SEXUAL AIDS AND NOVELTIES, PUBLICATIONS, LINGERIE, JEWELRY, CDS AND VIDEOS, ADULT TOYS AND GAMES, LEATHER GOODS AND FETISH EQUIPMENT; MAIL ORDER CATALOG SERVICES FEATURING CLOTHING, BATH AND BODY PRODUCTS, SEXUAL AIDS AND NOVELTIES, PUBLICATIONS, LINGERIE, JEWELRY, CDS AND VIDEOS, ADULT TOYS AND GAMES, LEATHER GOODS AND FETISH EQUIPMENT; CATALOG ORDERING SERVICES FEATURING CLOTHING, BATH AND BODY PRODUCTS, SEXUAL AIDS AND NOVELTIES, PUBLICATIONS, LINGERIE, JEWELRY, CDS AND VIDEOS, ADULT TOYS AND GAMES, LEATHER GOODS AND FETISH EQUIPMENT; ELECTRONIC CATALOG SERVICES FEATURING CLOTHING, BATH AND BODY PRODUCTS, SEXUAL AIDS AND NOVELTIES, PUBLICATIONS, LINGERIE, JEWELRY, CDS AND VIDEOS, ADULT TOYS AND GAMES, LEATHER GOODS AND FETISH EQUIPMENT; DISTRIBUTORSHIP SERVICES AND SHOP AT HOME PARTIES FEATURING CLOTHING, BATH AND BODY PRODUCTS, SEXUAL AIDS AND NOVELTIES, PUBLICATIONS, LINGERIE, JEWELRY, CDS AND VIDEOS, ADULT TOYS AND GAMES, LEATHER GOODS AND FETISH EQUIPMENT; DEMONSTRATION OF PRODUCTS FEATURING CLOTHING, BATH AND BODY PRODUCTS, SEXUAL AIDS AND NOVELTIES, PUBLICATIONS, LINGERIE, JEWELRY, CDS AND VIDEOS, ADULT TOYS AND GAMES, LEATHER GOODS AND FETISH EQUIPMENT; SALES DEMONSTRATION FOR OTHERS FEATURING CLOTHING, BATH AND BODY PRODUCTS, SEXUAL AIDS AND NOVELTIES, PUBLICATIONS, LINGERIE, JEWELRY, CDS AND VIDEOS, ADULT TOYS AND GAMES, LEATHER GOODS AND FETISH EQUIPMENT, IN CLASS 35 (U.S. CLS. 100, 101 AND 102).



FIRST USE 1-16-2012; IN COMMERCE 1-16-2012.

THE MARK CONSISTS OF STANDARD CHARACTERS WITHOUT CLAIM TO ANY PARTICULAR FONT, STYLE, SIZE, OR COLOR.

SN 77-478,550, FILED 5-19-2008.

ERIN FALK, EXAMINING ATTORNEY

*David J. Kyros*

Director of the United States Patent and Trademark Office

# United States of America

United States Patent and Trademark Office

## FLY FOR THE CURE

**Reg. No. 4,125,714**

**Registered Apr. 10, 2012**

**Int. Cl.: 36**

THE SUSAN G. KOMEN BREAST CANCER FOUNDATION, INC. (TEXAS NON-PROFIT CORPORATION)  
SUITE 250  
5005 LBJ FREEWAY  
DALLAS, TX 75244

**SERVICE MARK**

**PRINCIPAL REGISTER**

FOR: CHARITABLE FUNDRAISING SERVICES, NAMELY, RAISING MONEY FOR BREAST CANCER RESEARCH AND RAISING MONEY FOR LOCAL COMMUNITY BREAST HEALTH AWARENESS PROGRAMS, IN CLASS 36 (U.S. CLS. 100, 101 AND 102).

FIRST USE 10-3-2011; IN COMMERCE 10-3-2011.

THE MARK CONSISTS OF STANDARD CHARACTERS WITHOUT CLAIM TO ANY PARTICULAR FONT, STYLE, SIZE, OR COLOR.

NO CLAIM IS MADE TO THE EXCLUSIVE RIGHT TO USE "FLY", APART FROM THE MARK AS SHOWN.

SN 77-479,480, FILED 5-20-2008.

PAUL MORENO, EXAMINING ATTORNEY



*David J. Kyffers*

Director of the United States Patent and Trademark Office

# United States of America

United States Patent and Trademark Office

## ALABAMA-COUSHATTA

**Reg. No. 4,125,715**

**Registered Apr. 10, 2012**

**Int. Cl.: 34**

**TRADEMARK**

**PRINCIPAL REGISTER**

ALABAMA-COUSHATTA TRIBE OF TEXAS (UNITED STATES FEDERALLY-RECOGNIZED INDIAN TRIBE)  
571 STATE PARK ROAD 56  
LIVINGSTON, TX 77351

FOR: CIGARETTES; CIGARETTE LIGHTERS NOT FOR LAND VEHICLES, IN CLASS 34 (U.S. CLS. 2, 8, 9 AND 17).

FIRST USE 11-25-2009; IN COMMERCE 11-25-2009.

THE MARK CONSISTS OF STANDARD CHARACTERS WITHOUT CLAIM TO ANY PARTICULAR FONT, STYLE, SIZE, OR COLOR.

SN 77-480,226, FILED 5-21-2008.

KATHLEEN M. VANSTON, EXAMINING ATTORNEY



*David J. Kybas*

Director of the United States Patent and Trademark Office

# United States of America

United States Patent and Trademark Office



**Reg. No. 4,125,716**

**Registered Apr. 10, 2012**

**Int. Cl.: 34**

**TRADEMARK**

**PRINCIPAL REGISTER**

ALABAMA-COUSHATTA TRIBE OF TEXAS (UNITED STATES FEDERALLY-RECOGNIZED INDIAN TRIBE)  
571 STATE PARK ROAD 56  
LIVINGSTON, TX 77351

FOR: CIGARETTE LIGHTERS NOT FOR LAND VEHICLES, IN CLASS 34 (U.S. CLS. 2, 8, 9 AND 17).

FIRST USE 11-25-2009; IN COMMERCE 11-25-2009.

THE MARK CONSISTS OF STYLIZED DOUBLE-HEADED WOODPECKER WITHIN A CIRCLE.

SN 77-480,436, FILED 5-21-2008.

KATHLEEN M. VANSTON, EXAMINING ATTORNEY



*David J. Kyjars*

Director of the United States Patent and Trademark Office

# United States of America

United States Patent and Trademark Office



**Reg. No. 4,125,717**

**Registered Apr. 10, 2012**

**Int. Cl.: 25**

**TRADEMARK**

**PRINCIPAL REGISTER**

PUSSYCAT DOLLS, LLC (DELAWARE LIMITED LIABILITY COMPANY)  
UNIVERSAL MUSIC GROUP  
2220 COLORADO AVENUE  
SANTA MONICA, CA 90404

FOR: UNDERWEAR; UNDERGARMENTS; GLOVES; HATS; CAPS; HOSIERY; JACKETS; LINGERIE; PAJAMAS; PANTS; SHORTS; SHIRTS; SWEAT SHIRTS; SWEAT PANTS; SWEAT JACKETS; SWEATERS; T-SHIRTS; TANK TOPS; SOCKS; TOPS, IN CLASS 25 (U.S. CLS. 22 AND 39).

FIRST USE 9-1-2005; IN COMMERCE 9-1-2005.

THE MARK CONSISTS OF THE WORDS "PUSSYCAT DOLLS" WITHIN A HEART, WITH THE WORD "PUSSYCAT" PLACED ON A BANNER DISPLAYED ACROSS THE UPPER PART OF THE HEART, THE WORD "DOLLS" DISPLAYED ON THE HEART UNDER THE BANNER AND AN ORNAMENTAL DESIGN ON THE TOP OF THE HEART.

SN 77-480,543, FILED 5-21-2008.

BRETT J. GOLDEN, EXAMINING ATTORNEY



*David J. Kybas*

Director of the United States Patent and Trademark Office

# United States of America

United States Patent and Trademark Office

# ALTIUS

**Reg. No. 4,125,718**

ALTIUS ASSOCIATES LIMITED (UNITED KINGDOM LIMITED LIABILITY COMPANY)  
20 GROSVENOR PLACE

**Registered Apr. 10, 2012**

LONDON, UNITED KINGDOM SW1X7HN

**Int. Cls.: 35 and 36**

FOR: MARKET RESEARCH IN THE FINANCIAL SECTOR, IN CLASS 35 (U.S. CLS. 100, 101 AND 102).

**SERVICE MARK**

FIRST USE 4-21-1998; IN COMMERCE 4-21-1998.

**PRINCIPAL REGISTER**

FOR: FINANCIAL SERVICES, IN PARTICULAR PORTFOLIO MANAGEMENT AND INVESTMENT SERVICES RELATING TO INVESTMENT IN PRIVATE CAPITAL, PRIVATE EQUITY, PRIVATE EQUITY FUNDS, AND PRIVATE MARKETS INVESTMENTS; INVESTMENT MANAGEMENT, NAMELY, MANAGEMENT OF INVESTMENT IN PRIVATE CAPITAL, PRIVATE EQUITY, PRIVATE EQUITY FUNDS, AND PRIVATE MARKETS INVESTMENTS; ADVISORY SERVICES RELATING TO INVESTMENT IN PRIVATE CAPITAL, PRIVATE EQUITY, PRIVATE EQUITY FUNDS, AND PRIVATE MARKETS INVESTMENTS; CONSULTATION SERVICES WITH REGARD TO THE AFOREMENTIONED SERVICES, IN CLASS 36 (U.S. CLS. 100, 101 AND 102).

FIRST USE 4-21-1998; IN COMMERCE 4-21-1998.

THE MARK CONSISTS OF STANDARD CHARACTERS WITHOUT CLAIM TO ANY PARTICULAR FONT, STYLE, SIZE, OR COLOR.

SN 77-484,218, FILED 5-27-2008.

CHRISIE B. KING, EXAMINING ATTORNEY



*David J. Kyffers*

Director of the United States Patent and Trademark Office

# United States of America

United States Patent and Trademark Office

# SKINMINUTE

**Reg. No. 4,125,719**

NEOCUTIS SA (SWITZERLAND SOCIEDAD ANONIMA (SA))  
CHEMIN DU STAND 6  
PULLY 1009, SWITZERLAND

**Registered Apr. 10, 2012**

**Int. Cl.: 41**

FOR: ENTERTAINMENT SERVICES, NAMELY, PROVIDING PODCASTS IN THE FIELD OF DERMATOLOGY, IN CLASS 41 (U.S. CLS. 100, 101 AND 107).

**SERVICE MARK**

FIRST USE 1-20-2012; IN COMMERCE 1-20-2012.

**PRINCIPAL REGISTER**

THE MARK CONSISTS OF STANDARD CHARACTERS WITHOUT CLAIM TO ANY PARTICULAR FONT, STYLE, SIZE, OR COLOR.

SN 77-486,381, FILED 5-29-2008.

JOSETTE BEVERLY, EXAMINING ATTORNEY



*David J. Kybas*

Director of the United States Patent and Trademark Office



# United States of America

United States Patent and Trademark Office

# PHILLY.COM

**Reg. No. 4,125,720**

**Registered Apr. 10, 2012**

**Int. Cls.: 35 and 42**

**SERVICE MARK**

**PRINCIPAL REGISTER**

PHILADELPHIA MEDIA NETWORK (DIGITAL) LLC (DELAWARE LIMITED LIABILITY COMPANY)  
400 NORTH BROAD STREET  
PHILADELPHIA, PA 19130

FOR: ADVERTISING AND PROMOTIONAL SERVICES; ADVERTISING AND PROMOTING THE GOODS AND SERVICES OF OTHERS THROUGH PRINT MEDIA IN NEWSPAPERS AND MAGAZINE AND THROUGH ELECTRONIC MEDIA IN AN ELECTRONIC WEBSITE ON THE INTERNET; COMPUTERIZED ON-LINE ORDERING FEATURING GENERAL MERCHANDISE AND GENERAL CONSUMER GOODS; PROVIDING AN ON-LINE DIRECTORY INFORMATION SERVICE FEATURING INFORMATION REGARDING INFORMATION TO LOCATE PEOPLE, PLACES, ORGANIZATIONS, PHONE NUMBERS, HOME PAGES, AND ELECTRONIC MAIL ADDRESSES AND WEBSITES; PROVIDING ONLINE DIRECTORY INFORMATION SERVICES FEATURING HYPERLINKS TO OTHER WEBSITES; PROVIDING ONLINE WEBSITES FEATURING NEWS AND INFORMATION IN A WIDE VARIETY OF FIELDS GENERALLY FOUND IN DAILY NEWSPAPERS, NAMELY, POLITICS, PUBLIC POLICY, BUSINESS INFORMATION, CONSUMER INFORMATION REGARDING GENERAL CONSUMER MERCHANDISE, CLASSIFIED ADVERTISING FOR OTHERS, PROVIDING INFORMATION ABOUT AUTOMOBILES FOR SALE BY MEANS OF THE INTERNET, AND ADVERTISING OF COMMERCIAL OR RESIDENTIAL REAL ESTATE, IN CLASS 35 (U.S. CLS. 100, 101 AND 102).

FIRST USE 3-31-1999; IN COMMERCE 3-31-1999.



FOR: ONLINE COMPUTER SERVICES, NAMELY, CREATING INDEXES OF INFORMATION, SITES AND OTHER RESOURCES AVAILABLE ON COMPUTER NETWORKS; SEARCHING AND RETRIEVING INFORMATION, WEBSITES AND OTHER RESOURCES AVAILABLE ON COMPUTER NETWORKS FOR OTHERS; COMPUTER SERVICES, NAMELY, CREATING AND MAINTAINING WEB SITES FOR OTHERS; SEARCHING AND RETRIEVING INFORMATION, WEBSITES AND OTHER RESOURCES AVAILABLE ON COMPUTER NETWORKS FOR OTHERS; PROVIDING SPECIFIC INFORMATION AS REQUESTED BY INTERNET USERS VIA THE INTERNET, IN CLASS 42 (U.S. CLS. 100 AND 101).

FIRST USE 3-31-1999; IN COMMERCE 3-31-1999.

*David J. Kyffers*

Director of the United States Patent and Trademark Office

THE MARK CONSISTS OF STANDARD CHARACTERS WITHOUT CLAIM TO ANY PARTICULAR FONT, STYLE, SIZE, OR COLOR.

**Reg. No. 4,125,720** SEC. 2(F).

OWNER OF U.S. REG. NO. 2,722,761.

SN 77-486,489, FILED 5-29-2008.

LOURDES AYALA, EXAMINING ATTORNEY

# United States of America

United States Patent and Trademark Office

# Vincero Sport

**Reg. No. 4,125,721**

FRANK, MELINDA (UNITED STATES INDIVIDUAL)  
485 EDGEWOOD RD.

**Registered Apr. 10, 2012**

SAN MATEO, CA 94402

**Int. Cl.: 25**

FOR: SPORTS BRAS, IN CLASS 25 (U.S. CLS. 22 AND 39).

**TRADEMARK**

FIRST USE 1-6-2012; IN COMMERCE 1-16-2012.

**PRINCIPAL REGISTER**

THE MARK CONSISTS OF STANDARD CHARACTERS WITHOUT CLAIM TO ANY PARTICULAR FONT, STYLE, SIZE, OR COLOR.

NO CLAIM IS MADE TO THE EXCLUSIVE RIGHT TO USE "SPORT", APART FROM THE MARK AS SHOWN.

THE FOREIGN WORDING IN THE MARK, "VINCERO", TRANSLATES INTO ENGLISH AS "I SHALL WIN".

SN 77-487,210, FILED 5-30-2008.

ODESSA BIBBINS, EXAMINING ATTORNEY

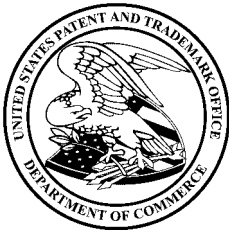

*David J. Kyffers*

Director of the United States Patent and Trademark Office

# United States of America

United States Patent and Trademark Office

## Black Opal True Color

**Reg. No. 4,125,722**

MANA PRODUCTS, INC. (NEW YORK CORPORATION)  
32-02 QUEENS BOULEVARD  
LONG ISLAND CITY, NY 11101

**Registered Apr. 10, 2012**

**Int. Cl.: 3**

FOR: COSMETICS, AND NON-MEDICATED SKINCARE PREPARATIONS, IN CLASS 3  
(U.S. CLS. 1, 4, 6, 50, 51 AND 52).

**TRADEMARK**

FIRST USE 1-16-2012; IN COMMERCE 1-16-2012.

**PRINCIPAL REGISTER**

THE MARK CONSISTS OF STANDARD CHARACTERS WITHOUT CLAIM TO ANY PARTICULAR FONT, STYLE, SIZE, OR COLOR.

OWNER OF U.S. REG. NOS. 1,825,722, 1,949,678, AND 2,024,917.

SN 77-488,212, FILED 6-1-2008.

MARK T. MULLEN, EXAMINING ATTORNEY



*David J. Kyffers*

Director of the United States Patent and Trademark Office

# United States of America

United States Patent and Trademark Office



**Reg. No. 4,125,723**

**Registered Apr. 10, 2012**

**Int. Cls.: 29 and 30**

**TRADEMARK**

**PRINCIPAL REGISTER**

SOCIETE DES PRODUITS NESTLE S.A. (SWITZERLAND SOCIÉTÉ ANONYME (SA))  
INTELLECTUAL PROPERTY DEPARTMENT  
CASE POSTALE 353  
VEVEY 1800, SWITZERLAND

FOR: PRE-PACKAGED MEALS CONSISTING PRIMARILY OF MEAT, POULTRY, VEGETABLES, AND CHEESE; FRUIT BASED SNACK FOOD; FRUIT AND YOGURT BASED SNACK FOOD, IN CLASS 29 (U.S. CL. 46).

FIRST USE 12-31-2008; IN COMMERCE 12-31-2008.

FOR: PRE-PACKAGED MEALS CONSISTING PRIMARILY OF PASTA WITH MEAT SAUCE, PASTA AND SAUCE; BAKERY PRODUCTS, WHOLE GRAIN SNACKS, IN CLASS 30 (U.S. CL. 46).

FIRST USE 12-31-2008; IN COMMERCE 12-31-2008.

THE MARK CONSISTS OF THE IMAGE OF A RUNNING CHILD HOLDING A BALL CONTAINED WITHIN A RECTANGLE.

SN 77-488,970, FILED 6-3-2008.

WENDY GOODMAN, EXAMINING ATTORNEY



*David J. Kybas*

Director of the United States Patent and Trademark Office

# United States of America

United States Patent and Trademark Office

## LATIN LATTE

**Reg. No. 4,125,724**

**Registered Apr. 10, 2012**

**Int. Cl.: 30**

**TRADEMARK**

**PRINCIPAL REGISTER**

STEGMAN, DEBORAH (UNITED STATES INDIVIDUAL)  
201 - 3RD STREET, #202  
OAKLAND, CA 94607

FOR: COOKIES, IN CLASS 30 (U.S. CL. 46).

FIRST USE 2-9-2012; IN COMMERCE 2-9-2012.

THE MARK CONSISTS OF STANDARD CHARACTERS WITHOUT CLAIM TO ANY PARTICULAR FONT, STYLE, SIZE, OR COLOR.

NO CLAIM IS MADE TO THE EXCLUSIVE RIGHT TO USE "LATIN", APART FROM THE MARK AS SHOWN.

SN 77-489,186, FILED 6-2-2008.

PAULA MAHONEY, EXAMINING ATTORNEY



*David J. Kyffers*

Director of the United States Patent and Trademark Office

# United States of America

United States Patent and Trademark Office



**Reg. No. 4,125,725**

**Registered Apr. 10, 2012**

**Int. Cls.: 9 and 28**

**TRADEMARK**

**PRINCIPAL REGISTER**

NIPPON DENKI KABUSHIKI KAISHA (JAPAN CORPORATION), DBA NEC CORPORATION,  
7-1, SHIBA 5-CHOME, MINATO-KU  
TOKYO, JAPAN

FOR: ROBOTS FOR PERSONAL OR HOBBY USE; ROBOTS FOR ENTERTAINMENT USE;  
COMPUTERS; COMPUTER SOFTWARE FOR USE IN COMPUTER GRAPHICS, INTERACT-  
IVE VIDEO AND VIRTUAL REALITY; GRAPHIC USER INTERFACE SOFTWARE; ELEC-  
TRONIC APPARATUS FOR RECORDING, TRANSMITTING AND REPRODUCING SOUND  
AND IMAGES; PERSONAL DIGITAL ASSISTANTS (PDAS); INFORMATION APPLIANCES,  
NAMELY, COMPUTERIZED INFORMATION APPARATUSES FOR MANAGING INFORM-  
ATION AND RECEIVING AND SENDING MESSAGES; CAR NAVIGATION COMPUTERS;  
MOBILE PHONE, IN CLASS 9 (U.S. CLS. 21, 23, 26, 36 AND 38).

FIRST USE 1-10-2012; IN COMMERCE 1-10-2012.

FOR: TOY ROBOTS; PROMOTIONAL REPLICAS OF TOY ROBOTS, IN CLASS 28 (U.S.  
CLS. 22, 23, 38 AND 50).

FIRST USE 1-10-2012; IN COMMERCE 1-10-2012.

THE MARK CONSISTS OF THE STYLIZED WORD "PAPER0" WITH TWO DOTS INSIDE  
THE STYLIZED LETTER "R".

SN 77-490,457, FILED 6-4-2008.

TINA MAI, EXAMINING ATTORNEY



*David J. Kybas*

Director of the United States Patent and Trademark Office

# United States of America

United States Patent and Trademark Office



**Reg. No. 4,125,726**

**Registered Apr. 10, 2012**

**Int. Cl.: 28**

**TRADEMARK**

**PRINCIPAL REGISTER**

SPORTS BINGO, INC. (VIRGINIA CORPORATION)  
SUITE 201  
225 SEVEN FARMS DRIVE  
CHARLESTON, SC 29492

FOR: BINGO CARDS USED IN A BINGO STYLE GAME PLAYED IN ACCORDANCE WITH EVENTS THAT TAKE PLACE IN AN AUTO RACING EVENT, IN CLASS 28 (U.S. CLS. 22, 23, 38 AND 50).

FIRST USE 10-15-2008; IN COMMERCE 2-20-2012.

NO CLAIM IS MADE TO THE EXCLUSIVE RIGHT TO USE "AUTO RACING BINGO", APART FROM THE MARK AS SHOWN.

THE COLOR(S) RED, WHITE, DARK BLUE, LIGHT BLUE IS/ARE CLAIMED AS A FEATURE OF THE MARK.

THE MARK CONSISTS OF STYLIZED SANS SERIF CAPITALIZED LETTERS SPELLING "RACING" IN DARK BLUE COLOR WITH FIVE UNEVENLY SPACED THICK LINES PRECEDING IT IN SHADES OF BLUE FROM LIGHT BLUE TO DARK BLUE WITH THICK RED LINES ABOVE AND BELOW STRETCHING THE LENGTH OF THE MARK WITH CAPITALIZED LETTERS SPELLING "AUTO" IN WHITE WITH RED BACKDROP SHADING ABOVE TO THE LEFT OVER THE UPPER RED LINE AND FIVE RED COLOR CIRCLES EACH CONTAINING SINGLE ITALICIZED WHITE COLOR LETTERS SPELLING "BINGO" IN COMBINATION OVER THE LOWER RED LINE.

SN 77-490,843, FILED 6-4-2008.

CORY BOONE, EXAMINING ATTORNEY



*David J. Kybas*

Director of the United States Patent and Trademark Office



# United States of America

United States Patent and Trademark Office

## WASHINGTON KASTLES

**Reg. No. 4,125,727**

WASHINGTON TEAM TENNIS LLC (DELAWARE LIMITED LIABILITY COMPANY)  
509 7TH STREET, N.W.  
WASHINGTON, DC 20004

**Registered Apr. 10, 2012**

**Int. Cl.: 18**

FOR: ATHLETIC BAGS, IN CLASS 18 (U.S. CLS. 1, 2, 3, 22 AND 41).

**TRADEMARK**

FIRST USE 7-0-2008; IN COMMERCE 7-0-2008.

**PRINCIPAL REGISTER**

THE MARK CONSISTS OF STANDARD CHARACTERS WITHOUT CLAIM TO ANY PARTICULAR FONT, STYLE, SIZE, OR COLOR.

NO CLAIM IS MADE TO THE EXCLUSIVE RIGHT TO USE "WASHINGTON", APART FROM THE MARK AS SHOWN.

SN 77-494,701, FILED 6-9-2008.

THEODORE MCBRIDE, EXAMINING ATTORNEY



*David J. Kyffers*

Director of the United States Patent and Trademark Office

# United States of America

United States Patent and Trademark Office

# OKAVANGO

**Reg. No. 4,125,728**

SAVVANAH CREATIONS USA, LTD. (NEW YORK CORPORATION)  
96 E. 7TH ST.

**Registered Apr. 10, 2012**

NEW YORK, NY 10009

**Int. Cl.: 25**

FOR: CLOTHING FOR WOMEN, NAMELY, BLOUSES; BLOUSONS; BOLEROS; CAMISOLES; CARDIGANS; CHEMISES; SUIT COATS; TOP COATS; CORSELETS; DRESSES; HALTER TOPS; HATS; JACKETS; JEANS; LEGGINGS; PEIGNOIRS; PULLOVERS; SCARVES; SHAWLS; SHIRTS; SHORTS; SKIRTS; SLACKS; SWEATERS; T-SHIRTS, IN CLASS 25 (U.S. CLS. 22 AND 39).

**TRADEMARK**

**PRINCIPAL REGISTER**

FIRST USE 12-27-2011; IN COMMERCE 12-27-2011.

THE MARK CONSISTS OF STANDARD CHARACTERS WITHOUT CLAIM TO ANY PARTICULAR FONT, STYLE, SIZE, OR COLOR.

THE WORDING "OKAVANGO" HAS NO MEANING IN A FOREIGN LANGUAGE.

SN 77-495,560, FILED 6-10-2008.

EVELYN BRADLEY, EXAMINING ATTORNEY



*David J. Kybas*

Director of the United States Patent and Trademark Office

**United States of America**  
United States Patent and Trademark Office

# ELECTRAK

**Reg. No. 4,125,729**

METER DEVICES COMPANY, INC. (OHIO CORPORATION)  
3359 BRUENING AVE. S.W.  
CANTON, OH 44706

**Registered Apr. 10, 2012**

**Int. Cl.: 9**

FOR: PRIMARY ELECTRIC POWER METERING ENCLOSURES, IN CLASS 9 (U.S. CLS. 21, 23, 26, 36 AND 38).

**TRADEMARK**

FIRST USE 8-16-2011; IN COMMERCE 8-16-2011.

**PRINCIPAL REGISTER**

THE MARK CONSISTS OF STANDARD CHARACTERS WITHOUT CLAIM TO ANY PARTICULAR FONT, STYLE, SIZE, OR COLOR.

SN 77-497,388, FILED 6-12-2008.

MICHAEL WIENER, EXAMINING ATTORNEY



*David J. Kyffers*

Director of the United States Patent and Trademark Office

# United States of America

United States Patent and Trademark Office

# ORIGAMI

**Reg. No. 4,125,730**

THORLEY INDUSTRIES (PENNSYLVANIA LIMITED LIABILITY COMPANY), DBA 4MOMS,  
40 24TH STREET, 3RD FLOOR  
PITTSBURGH, PA 15222

**Registered Apr. 10, 2012**

**Int. Cl.: 12**

FOR: STROLLERS; STRUCTURAL PARTS AND ACCESSORIES SPECIFICALLY ADAPTED  
FOR USE ON STROLLERS, IN CLASS 12 (U.S. CLS. 19, 21, 23, 31, 35 AND 44).

**TRADEMARK**

FIRST USE 8-26-2011; IN COMMERCE 8-26-2011.

**PRINCIPAL REGISTER**

THE MARK CONSISTS OF STANDARD CHARACTERS WITHOUT CLAIM TO ANY PAR-  
TICULAR FONT, STYLE, SIZE, OR COLOR.

THE FOREIGN WORDING IN THE MARK TRANSLATES INTO ENGLISH AS THE ART OF  
FOLDING PAPER.

SN 77-502,209, FILED 6-18-2008.

BILL DAWE, EXAMINING ATTORNEY



*David J. Kybas*

Director of the United States Patent and Trademark Office

# United States of America

United States Patent and Trademark Office

## ODOR GUARD

**Reg. No. 4,125,731**

FIRST QUALITY RETAIL SERVICES, LLC (DELAWARE LIMITED LIABILITY COMPANY)  
80 CUTTERMILL ROAD, SUITE 500  
GREAT NECK, NY 11021

**Registered Apr. 10, 2012**

**Int. Cl.: 5**

FOR: ABSORBANT INCONTINENCE PRODUCTS, NAMELY, BRIEFS, PADS AND UNDERWEAR, IN CLASS 5 (U.S. CLS. 6, 18, 44, 46, 51 AND 52).

**TRADEMARK**

FIRST USE 5-23-2011; IN COMMERCE 5-23-2011.

**PRINCIPAL REGISTER**

THE MARK CONSISTS OF STANDARD CHARACTERS WITHOUT CLAIM TO ANY PARTICULAR FONT, STYLE, SIZE, OR COLOR.

OWNER OF U.S. REG. NO. 1,867,961.

NO CLAIM IS MADE TO THE EXCLUSIVE RIGHT TO USE "ODOR", APART FROM THE MARK AS SHOWN.

SN 77-502,599, FILED 6-19-2008.

WILLIAM P. SHANAHAN, EXAMINING ATTORNEY



*David J. Kybas*

Director of the United States Patent and Trademark Office

# United States of America

United States Patent and Trademark Office

## PRAMUKH SWAMI MAHARAJ

**Reg. No. 4,125,732**

**Registered Apr. 10, 2012**

**Int. Cl.: 36**

**SERVICE MARK**

**PRINCIPAL REGISTER**

BOCHASANWASI SHRI AKSHAR PURUSHOTTAM SWAMINARAYAN SANSTHA, INC.  
(DELAWARE NON-PROFIT CORPORATION)  
81 SUTTONS LANE  
PISCATAWAY, NJ 088545723

FOR: PROVIDING EDUCATIONAL SCHOLARSHIPS, IN CLASS 36 (U.S. CLS. 100, 101 AND 102).

FIRST USE 1-24-2012; IN COMMERCE 1-24-2012.

THE MARK CONSISTS OF STANDARD CHARACTERS WITHOUT CLAIM TO ANY PARTICULAR FONT, STYLE, SIZE, OR COLOR.

THE NAME(S), PORTRAIT(S), AND/OR SIGNATURE(S) SHOWN IN THE MARK IDENTIFIES "PRAMUKH SWAMI MAHARAJ", WHOSE CONSENT(S) TO REGISTER IS MADE OF RECORD.

SN 77-504,107, FILED 6-20-2008.

KELLY TRUSILO, EXAMINING ATTORNEY



*David J. Kybas*

Director of the United States Patent and Trademark Office

# United States of America

United States Patent and Trademark Office

## COMFORTCLEAT

**Reg. No. 4,125,733**

MACNEILL ENGINEERING COMPANY, INC. (MASSACHUSETTS CORPORATION)  
140 LOCKE DRIVE, P.O. BOX 735  
MARLBOROUGH, MA 01752

**Registered Apr. 10, 2012**

**Int. Cl.: 25**

FOR: CLEATS FOR GOLF SHOES, IN CLASS 25 (U.S. CLS. 22 AND 39).

**TRADEMARK**

FIRST USE 2-17-2012; IN COMMERCE 2-17-2012.

**PRINCIPAL REGISTER**

THE MARK CONSISTS OF STANDARD CHARACTERS WITHOUT CLAIM TO ANY PARTICULAR FONT, STYLE, SIZE, OR COLOR.

SN 77-505,250, FILED 6-23-2008.

HANNO RITTNER, EXAMINING ATTORNEY



*David J. Kybas*

Director of the United States Patent and Trademark Office

# United States of America

United States Patent and Trademark Office

# FD

**Reg. No. 4,125,734**

**Registered Apr. 10, 2012**

**Int. Cl.: 5**

**TRADEMARK**

**PRINCIPAL REGISTER**

STB LIFESAVING TECHNOLOGIES INC. (WASHINGTON CORPORATION)  
13212 NE 16TH ST. SUITE #312  
BELLEVUE, WA 98005

FOR: ADHESIVE BANDAGES; ADHESIVE FOR BANDAGES FOR SKIN WOUNDS;  
BANDAGES FOR DRESSINGS; BANDAGES FOR SKIN WOUNDS; SURGICAL BANDAGES  
, IN CLASS 5 (U.S. CLS. 6, 18, 44, 46, 51 AND 52).

FIRST USE 2-9-2012; IN COMMERCE 2-9-2012.

THE MARK CONSISTS OF STANDARD CHARACTERS WITHOUT CLAIM TO ANY PAR-  
TICULAR FONT, STYLE, SIZE, OR COLOR.

SN 77-507,833, FILED 6-25-2008.

NATALIE POLZER, EXAMINING ATTORNEY



*David J. Kyffers*

Director of the United States Patent and Trademark Office



# United States of America

United States Patent and Trademark Office

## FIBRIN ADHESIVE STAT

**Reg. No. 4,125,735**

STB LIFESAVING TECHNOLOGIES INC. (WASHINGTON CORPORATION)  
13212 NE 16TH ST. SUITE #312  
BELLEVUE, WA 98005

**Registered Apr. 10, 2012**

**Int. Cl.: 5**

FOR: ADHESIVE BANDAGES; ADHESIVE FOR BANDAGES FOR SKIN WOUNDS;  
BANDAGES FOR DRESSINGS; BANDAGES FOR SKIN WOUNDS; SURGICAL BANDAGES  
, IN CLASS 5 (U.S. CLS. 6, 18, 44, 46, 51 AND 52).

**TRADEMARK**

FIRST USE 2-9-2012; IN COMMERCE 2-9-2012.

**PRINCIPAL REGISTER**

THE MARK CONSISTS OF STANDARD CHARACTERS WITHOUT CLAIM TO ANY PAR-  
TICULAR FONT, STYLE, SIZE, OR COLOR.

NO CLAIM IS MADE TO THE EXCLUSIVE RIGHT TO USE "FIBRIN ADHESIVE", APART  
FROM THE MARK AS SHOWN.

SN 77-507,945, FILED 6-25-2008.

NATALIE POLZER, EXAMINING ATTORNEY



*David J. Kyros*

Director of the United States Patent and Trademark Office

# United States of America

United States Patent and Trademark Office

# LIFEMOVES

**Reg. No. 4,125,736**

THINKING MOVES, LLC (WISCONSIN LIMITED LIABILITY COMPANY)  
243 PLAINVIEW DRIVE  
RIVER FALLS, WI 54022

**Registered Apr. 10, 2012**

**Int. Cl.: 9**

FOR: DVD AND CD-ROM FEATURING INTERACTIVE MOVEMENTS AND MUSIC DESIGNED TO STIMULATE THE BRAIN AND TO ENHANCE LEARNING, PHYSICAL BALANCE AND FOCUS, PROPRIOCEPTION AND TEMPORAL-SPATIAL ABILITIES, IN CLASS 9 (U.S. CLS. 21, 23, 26, 36 AND 38).

**TRADEMARK**

**PRINCIPAL REGISTER**

FIRST USE 10-12-2011; IN COMMERCE 10-12-2011.

THE MARK CONSISTS OF STANDARD CHARACTERS WITHOUT CLAIM TO ANY PARTICULAR FONT, STYLE, SIZE, OR COLOR.

SN 77-509,579, FILED 6-27-2008.

REBECCA GILBERT, EXAMINING ATTORNEY



*David J. Kybas*

Director of the United States Patent and Trademark Office

# United States of America

United States Patent and Trademark Office

# Curiosityville

**Reg. No. 4,125,737**

CURIOSITYVILLE LLC (MARYLAND LIMITED LIABILITY COMPANY)  
912 WESTERN RUN ROAD  
COCKEYSVILLE, MD 21030

**Registered Apr. 10, 2012**

**Int. Cls.: 16, 28, 38, and 41**

FOR: CHILDREN'S ACTIVITY BOOKS, IN CLASS 16 (U.S. CLS. 2, 5, 22, 23, 29, 37, 38 AND 50).

FIRST USE 1-15-2012; IN COMMERCE 1-15-2012.

**TRADEMARK**

FOR: PLUSH TOYS, IN CLASS 28 (U.S. CLS. 22, 23, 38 AND 50).

**SERVICE MARK**

FIRST USE 12-31-2010; IN COMMERCE 12-31-2010.

**PRINCIPAL REGISTER**

FOR: PROVIDING ON-LINE CHAT ROOMS AND ELECTRONIC BULLETIN BOARDS FOR TRANSMISSION OF MESSAGES AMONG USERS IN THE FIELD OF GENERAL INTEREST, IN CLASS 38 (U.S. CLS. 100, 101 AND 104).

FIRST USE 6-30-2011; IN COMMERCE 6-30-2011.

FOR: ENTERTAINMENT SERVICES, NAMELY, PROVIDING ON-LINE COMPUTER GAMES, IN CLASS 41 (U.S. CLS. 100, 101 AND 107).

FIRST USE 6-30-2011; IN COMMERCE 6-30-2011.

THE MARK CONSISTS OF STANDARD CHARACTERS WITHOUT CLAIM TO ANY PARTICULAR FONT, STYLE, SIZE, OR COLOR.

SN 77-509,732, FILED 6-27-2008.

LINDA POWELL, EXAMINING ATTORNEY



*David J. Kybas*

Director of the United States Patent and Trademark Office

# United States of America

United States Patent and Trademark Office

## HEALTH IN A NETWORKED LIFE

**Reg. No. 4,125,738**

**Registered Apr. 10, 2012**

**Int. Cls.: 9 and 35**

**TRADEMARK**

**SERVICE MARK**

**PRINCIPAL REGISTER**

THE JOHN AND MARY R. MARKLE FOUNDATION (NEW YORK NOT-FOR-PROFIT CORPORATION)  
10 ROCKEFELLER PLAZA, 16TH FLOOR  
NEW YORK, NY 10020

FOR: DOWNLOADABLE ELECTRONIC PUBLICATIONS IN THE NATURE OF WHITE PAPERS AND RESEARCH REPORTS CONCERNING USES OF NEW INFORMATION AND COMMUNICATION TECHNOLOGIES IN THE FIELDS OF PRIVACY, DATA SECURITY, HEALTH, HEALTHCARE, PERSONAL HEALTHCARE, INFORMATION TECHNOLOGY, AND INFORMATION TECHNOLOGY INFRASTRUCTURE, IN CLASS 9 (U.S. CLS. 21, 23, 26, 36 AND 38).

FIRST USE 2-3-2012; IN COMMERCE 2-3-2012.

FOR: PROMOTING INTEREST IN AND PUBLIC AWARENESS OF ISSUES RELATED TO ELECTRONIC CONNECTIVITY IN HEALTHCARE AND IMPROVEMENTS AND ACCESS TO SECURE, INTERCONNECTED HEALTH INFORMATION INFRASTRUCTURE TO IMPROVE THE QUALITY OF MEDICAL CARE AND RESEARCH, TO ALLOW PATIENTS TO BECOME MORE ACTIVE PARTICIPANTS IN THEIR TREATMENT, TO REDUCE MEDICAL ERRORS, AND TO HELP STABILIZE THE RAPIDLY GROWING COSTS OF HEALTHCARE; AND PROMOTING PUBLIC AWARENESS OF THE NEED FOR DISCUSSION AND POLICY DEVELOPMENT IN THE FIELDS OF PRIVACY, DATA SECURITY, HEALTH, HEALTHCARE, PERSONAL HEALTHCARE, INFORMATION TECHNOLOGY, AND INFORMATION TECHNOLOGY INFRASTRUCTURE, IN CLASS 35 (U.S. CLS. 100, 101 AND 102).

FIRST USE 1-31-2011; IN COMMERCE 1-31-2011.

THE MARK CONSISTS OF STANDARD CHARACTERS WITHOUT CLAIM TO ANY PARTICULAR FONT, STYLE, SIZE, OR COLOR.

NO CLAIM IS MADE TO THE EXCLUSIVE RIGHT TO USE "HEALTH", APART FROM THE MARK AS SHOWN.

SN 77-511,295, FILED 6-30-2008.

DAVID MILLER, EXAMINING ATTORNEY



*David J. Kyros*

Director of the United States Patent and Trademark Office

# United States of America

United States Patent and Trademark Office

# ELIMA WEED

**Reg. No. 4,125,739**

GREENSTAR PLANT PRODUCTS INC. (CANADA CORPORATION)  
9430 198TH STREET  
LANGLEY, BC, CANADA V1M3C8

**Registered Apr. 10, 2012**

**Int. Cl.: 5**

FOR: HERBICIDES, IN CLASS 5 (U.S. CLS. 6, 18, 44, 46, 51 AND 52).

**TRADEMARK**

FIRST USE 3-3-2008; IN COMMERCE 1-19-2012.

**PRINCIPAL REGISTER**

THE MARK CONSISTS OF STANDARD CHARACTERS WITHOUT CLAIM TO ANY PARTICULAR FONT, STYLE, SIZE, OR COLOR.

SN 77-513,857, FILED 7-2-2008.

SUSAN STIGLITZ, EXAMINING ATTORNEY



*David J. Kyffers*

Director of the United States Patent and Trademark Office

# United States of America

United States Patent and Trademark Office

NOVA<sup>3</sup>

**Reg. No. 4,125,740**

RPB, LTD. (NEW ZEALAND CORPORATION), DBA RESPIRATORY,  
5450 WEST 83RD STREET  
LOS ANGELES, CA 90045

**Registered Apr. 10, 2012**

**Int. Cl.: 9**

FOR: RESPIRATORS FOR NON-MEDICAL USE, IN CLASS 9 (U.S. CLS. 21, 23, 26, 36 AND 38).

**TRADEMARK**

FIRST USE 1-5-2012; IN COMMERCE 1-5-2012.

**PRINCIPAL REGISTER**

THE MARK CONSISTS OF "NOVA" WITH A SUPERScript 3.

SN 77-514,013, FILED 7-2-2008.

KATHRYN COWARD, EXAMINING ATTORNEY



*David J. Kyffers*

Director of the United States Patent and Trademark Office

# United States of America

United States Patent and Trademark Office

# EFFECTILAX

**Reg. No. 4,125,741**

**Registered Apr. 10, 2012**

**Int. Cl.: 5**

**TRADEMARK**

**PRINCIPAL REGISTER**

LABORATORIOS GARDEN HOUSE INTERNACIONAL S.A. (CHILE CORPORATION)  
AVENIDA PRESIDENTE ALESSANDRI RODRIGUEZ  
12.310  
SAN BERNARDO, SANTIAGO, CHILE

FOR: LAXATIVE TABLETS; HERBAL TEA FOR MEDICINAL PURPOSE, NAMELY, LAXATIVE TEA FOR THE TREATMENT OF INTESTINAL IRREGULARITY, IN CLASS 5 (U.S. CLS. 6, 18, 44, 46, 51 AND 52).

FIRST USE 7-24-2011; IN COMMERCE 7-24-2011.

THE MARK CONSISTS OF STANDARD CHARACTERS WITHOUT CLAIM TO ANY PARTICULAR FONT, STYLE, SIZE, OR COLOR.

SN 77-517,188, FILED 7-8-2008.

JUDITH HELFMAN, EXAMINING ATTORNEY



*David J. Kyffers*

Director of the United States Patent and Trademark Office

# United States of America

United States Patent and Trademark Office

## VISIBLESUITE

**Reg. No. 4,125,742**

**Registered Apr. 10, 2012**

**Int. Cl.: 42**

**SERVICE MARK**

**PRINCIPAL REGISTER**

VISIBLE MEASURES CORP. (DELAWARE CORPORATION)  
5TH FLOOR  
143 SOUTH STREET  
BOSTON, MA 02111

FOR: PROVIDING ON-LINE NON-DOWNLOADABLE SOFTWARE FOR ENABLING USERS TO QUANTIFY AND ANALYZE AUDIENCE ENGAGEMENT AND EXPERIENCE WITH INTERNET VIDEO AND INTERACTIVE ADVERTISING, IN CLASS 42 (U.S. CLS. 100 AND 101).

FIRST USE 12-31-2008; IN COMMERCE 12-31-2008.

THE MARK CONSISTS OF STANDARD CHARACTERS WITHOUT CLAIM TO ANY PARTICULAR FONT, STYLE, SIZE, OR COLOR.

SN 77-518,370, FILED 7-9-2008.

SETH A. RAPPAPORT, EXAMINING ATTORNEY



*David J. Kyros*

Director of the United States Patent and Trademark Office



# United States of America

United States Patent and Trademark Office

## VISIBLECAMPAIGN

**Reg. No. 4,125,743**

**Registered Apr. 10, 2012**

**Int. Cl.: 42**

**SERVICE MARK**

**PRINCIPAL REGISTER**

VISIBLE MEASURES CORP. (DELAWARE CORPORATION)  
5TH FLOOR  
143 SOUTH STREET  
BOSTON, MA 02111

FOR: PROVIDING ON-LINE NON-DOWNLOADABLE SOFTWARE FOR ENABLING USERS TO QUANTIFY AND ANALYZE AUDIENCE ENGAGEMENT AND EXPERIENCE WITH INTERNET VIDEO AND INTERACTIVE ADVERTISING, IN CLASS 42 (U.S. CLS. 100 AND 101).

FIRST USE 12-31-2008; IN COMMERCE 12-31-2008.

THE MARK CONSISTS OF STANDARD CHARACTERS WITHOUT CLAIM TO ANY PARTICULAR FONT, STYLE, SIZE, OR COLOR.

SN 77-518,372, FILED 7-9-2008.

SETH A. RAPPAPORT, EXAMINING ATTORNEY



*David J. Kyffers*

Director of the United States Patent and Trademark Office

# United States of America

United States Patent and Trademark Office

# DROORS

**Reg. No. 4,125,744**

**Registered Apr. 10, 2012**

**Int. Cl.: 25**

**TRADEMARK**

**PRINCIPAL REGISTER**

DC SHOES, INC. (CALIFORNIA CORPORATION)  
15202 GRAHAM STREET  
HUNTINGTON BEACH, CA 92649

FOR: T-SHIRTS, IN CLASS 25 (U.S. CLS. 22 AND 39).

FIRST USE 12-14-2011; IN COMMERCE 12-14-2011.

THE MARK CONSISTS OF STANDARD CHARACTERS WITHOUT CLAIM TO ANY PARTICULAR FONT, STYLE, SIZE, OR COLOR.

OWNER OF U.S. REG. NOS. 1,795,090 AND 2,662,530.

SN 77-520,481, FILED 7-11-2008.

HENRY S. ZAK, EXAMINING ATTORNEY



*David J. Kyffers*

Director of the United States Patent and Trademark Office

United States of America  
United States Patent and Trademark Office

# ICEBERGS

**Reg. No. 4,125,745**

SORENSEN, CASEY (CANADA INDIVIDUAL)  
35 LINDMAN CLOSE

**Registered Apr. 10, 2012**

SYLVAN LAKE, ALBERTA, CANADA T4S2M5

**Int. Cl.: 21**

FOR: REFRIGERANT PACKS FOR USE BY ORDINARY CONSUMERS TO KEEP FOOD AND DRINK COLD; RE-USABLE, RE-FREEZABLE ICE PACKS, COLD PACKS AND ICE GEL PACKS TO KEEP FOOD AND DRINK COLD; AND NON-TOXIC, REUSABLE ICE SUBSTITUTES IN PACKS USED BY ORDINARY CONSUMERS IN INSULATED COOLERS FOR PERSONAL USE TO KEEP FOOD AND DRINK COLD, IN CLASS 21 (U.S. CLS. 2, 13, 23, 29, 30, 33, 40 AND 50).

**TRADEMARK**

**PRINCIPAL REGISTER**

FIRST USE 1-20-2012; IN COMMERCE 1-25-2012.

THE MARK CONSISTS OF STANDARD CHARACTERS WITHOUT CLAIM TO ANY PARTICULAR FONT, STYLE, SIZE, OR COLOR.

SN 77-521,408, FILED 7-14-2008.

JENNY PARK, EXAMINING ATTORNEY



*David J. Kyros*

Director of the United States Patent and Trademark Office

# United States of America

United States Patent and Trademark Office

# ATTRITION

**Reg. No. 4,125,746**

HITER, CHUCK (UNITED STATES INDIVIDUAL)  
5013 HANGING MOSS LANE  
SARASOTA, FL 34238 AND

**Registered Apr. 10, 2012**

**Int. Cl.: 25**

HITER, TERI (UNITED STATES INDIVIDUAL)  
5013 HANGING MOSS LANE  
SARASOTA, FL 34238

**TRADEMARK**

**PRINCIPAL REGISTER**

FOR: CLOTHING, NAMELY, SHIRTS, T-SHIRTS, LONG-SLEEVED SHIRTS, SHORT-SLEEVED SHIRTS, SWEATSHIRTS, JACKETS, PULL OVERS, RAIN GEAR, NAMELY, RAIN COATS, HEADWEAR, NAMELY, HATS, IN CLASS 25 (U.S. CLS. 22 AND 39).

FIRST USE 1-27-2012; IN COMMERCE 1-27-2012.

THE MARK CONSISTS OF STANDARD CHARACTERS WITHOUT CLAIM TO ANY PARTICULAR FONT, STYLE, SIZE, OR COLOR.

SN 77-524,307, FILED 7-17-2008.

KATHY DE JONGE, EXAMINING ATTORNEY



*David J. Kyffers*

Director of the United States Patent and Trademark Office

**United States of America**  
United States Patent and Trademark Office

**NUTRAJAVA**

**Reg. No. 4,125,747**

ICON GROUP, LLC (VERMONT LIMITED LIABILITY COMPANY)  
167 MAIN STREET, #208  
BRATTLEBORO, VT 05301

**Registered Apr. 10, 2012**

**Int. Cl.: 32**

FOR: NON-ALCOHOLIC COFFEE-FLAVORED BEVERAGES, IN CLASS 32 (U.S. CLS. 45, 46 AND 48).

**TRADEMARK**

FIRST USE 8-19-2011; IN COMMERCE 8-19-2011.

**PRINCIPAL REGISTER**

THE MARK CONSISTS OF STANDARD CHARACTERS WITHOUT CLAIM TO ANY PARTICULAR FONT, STYLE, SIZE, OR COLOR.

SN 77-526,263, FILED 7-18-2008.

JOHN HWANG, EXAMINING ATTORNEY



*David J. Kyffers*

Director of the United States Patent and Trademark Office

# United States of America

United States Patent and Trademark Office

## Organic Hair Design "Be Good To Yourself, Be Good To Our Planet"

**Reg. No. 4,125,748**

**Registered Apr. 10, 2012**

**Int. Cl.: 3**

**TRADEMARK**

**PRINCIPAL REGISTER**

ELLIOTT, SUZANNE VESTA (UNITED STATES INDIVIDUAL), DBA ORGANIC HAIR DESIGN,  
358 SHAWNEEHAW AVENUE  
BANNER ELK, NC 28604

FOR: BODY AND BEAUTY CARE COSMETICS PRIMARILY PRODUCED USING AND COMPOSED OF NATURAL, ORGANIC MATERIALS, IN CLASS 3 (U.S. CLS. 1, 4, 6, 50, 51 AND 52).

FIRST USE 1-24-2012; IN COMMERCE 1-24-2012.

THE MARK CONSISTS OF STANDARD CHARACTERS WITHOUT CLAIM TO ANY PARTICULAR FONT, STYLE, SIZE, OR COLOR.

NO CLAIM IS MADE TO THE EXCLUSIVE RIGHT TO USE "ORGANIC HAIR DESIGN", APART FROM THE MARK AS SHOWN.

SN 77-526,461, FILED 7-18-2008.

CORY BOONE, EXAMINING ATTORNEY



*David J. Kyffers*

Director of the United States Patent and Trademark Office

# United States of America

United States Patent and Trademark Office

# GPS ANGEL

**Reg. No. 4,125,749**

**Registered Apr. 10, 2012**

**Int. Cls.: 9, 38, and 42**

**TRADEMARK**

**SERVICE MARK**

**PRINCIPAL REGISTER**

INFORAD LIMITED (IRELAND CORPORATION)  
SMITHSTOWN INDUSTRIAL ESTATE, SHAUNIT L6  
COUNTY CLARE, IRELAND

FOR: ELECTRONIC GPS-BASED TRAFFIC AND SPEED CAMERA WARNING DEVICES,  
IN CLASS 9 (U.S. CLS. 21, 23, 26, 36 AND 38).

FIRST USE 10-15-2008; IN COMMERCE 11-22-2008.

FOR: TRANSMISSION OF DATABASE INFORMATION VIA TELECOMMUNICATIONS  
NETWORKS, IN CLASS 38 (U.S. CLS. 100, 101 AND 104).

FIRST USE 10-15-2008; IN COMMERCE 11-22-2008.

FOR: UPDATING AND MAINTENANCE OF GPS COMPUTER SOFTWARE, IN CLASS 42  
(U.S. CLS. 100 AND 101).

FIRST USE 10-15-2008; IN COMMERCE 11-22-2008.

THE MARK CONSISTS OF STANDARD CHARACTERS WITHOUT CLAIM TO ANY PAR-  
TICULAR FONT, STYLE, SIZE, OR COLOR.

NO CLAIM IS MADE TO THE EXCLUSIVE RIGHT TO USE "GPS", APART FROM THE  
MARK AS SHOWN.

SN 77-526,842, FILED 7-21-2008.

NATALIE POLZER, EXAMINING ATTORNEY



*David J. Kyffers*

Director of the United States Patent and Trademark Office

# United States of America

United States Patent and Trademark Office



**Reg. No. 4,125,750**

CONOPCO, INC. (NEW YORK CORPORATION)  
700 SYLVAN AVENUE  
ENGLEWOOD CLIFFS, NJ 07632

**Registered Apr. 10, 2012**

**Int. Cls.: 3 and 5**

FOR: PETROLEUM JELLY FOR COSMETIC PURPOSES, IN CLASS 3 (U.S. CLS. 1, 4, 6, 50, 51 AND 52).

**TRADEMARK**

FIRST USE 7-0-2010; IN COMMERCE 7-0-2010.

**PRINCIPAL REGISTER**

FOR: PHARMACEUTICAL PREPARATIONS, NAMELY, PREPARATIONS FOR ALLEVIATING SKIN CONDITIONS, PREPARATIONS FOR THE TREATMENT AND/OR ALLEVIATION OF SUNBURN; PETROLEUM JELLY FOR MEDICAL PURPOSES, IN CLASS 5 (U.S. CLS. 6, 18, 44, 46, 51 AND 52).

FIRST USE 7-0-2010; IN COMMERCE 7-0-2010.

NO CLAIM IS MADE TO THE EXCLUSIVE RIGHT TO USE "PURITY GUARANTEED", APART FROM THE MARK AS SHOWN.

THE MARK CONSISTS OF THE A DESIGN WITH THREE DROPS AT THE CENTER OF TWO CONCENTRIC CIRCLES; TWO HORIZONTAL LINES SEPARATE THE DROPS FROM ONE ANOTHER; THE WORDING "TRIPLE PURIFICATION" IS POSITIONED ABOVE THE CENTRAL DESIGN AND THE WORDING "PURITY GUARANTEED" IS LOCATED BELOW THE DROP DESIGN.

SN 77-528,339, FILED 7-22-2008.

COLLEEN KEARNEY, EXAMINING ATTORNEY



*David J. Kybas*

Director of the United States Patent and Trademark Office



# United States of America

United States Patent and Trademark Office

# HMI TO GO

**Reg. No. 4,125,751**

THE HETRICK-MARTIN INSTITUTE, INC. (NEW YORK NON-PROFIT CORPORATION)  
2 ASTOR PLACE

**Registered Apr. 10, 2012**

NEW YORK, NY 10003

**Int. Cls.: 41 and 44**

FOR: EDUCATIONAL SERVICES, NAMELY, PROVIDING CLASSES, SEMINARS, COURSES AND WORKSHOPS AND DISTRIBUTING RELATED COURSE MATERIAL THEREWITH IN THE FIELDS OF ACADEMIC MENTORING AND EMOTIONAL COUNSELING FOR LESBIAN, GAY, BISEXUAL, TRANSGENDER AND QUESTIONING YOUTH, AND IN THE FIELD OF HIGH SCHOOL CURRICULUM; AFTER SCHOOL RECREATION PROGRAMS FOR CHILDREN IN GRADES 9 THROUGH 12 IN THE FIELDS OF ARTS AND CRAFTS AND PHOTOGRAPHY; PROVIDING EDUCATION INFORMATION FOR HOMELESS YOUTH VIA A WEBSITE; PROVIDING EDUCATION INFORMATION ON YOUTH SERVICES VIA A WEBSITE, IN CLASS 41 (U.S. CLS. 100, 101 AND 107).

**SERVICE MARK**

**PRINCIPAL REGISTER**

FIRST USE 6-0-2009; IN COMMERCE 6-0-2009.

FOR: CHARITABLE SERVICES, NAMELY, PROVIDING MEDICAL SERVICES, MEDICAL CONSULTATION, AND PSYCHOLOGICAL COUNSELING IN THE FIELDS OF HEALTH MEDICINE, HIV AWARENESS AND PREVENTION, REPRODUCTIVE HEALTH CARE AND VIOLENCE PREVENTION; PROVIDING INFORMATION ON MEDICAL SERVICES, MEDICAL CONSULTATION AND PSYCHOLOGICAL COUNSELING FOR AT-RISK YOUTH VIA A WEB SITE, IN CLASS 44 (U.S. CLS. 100 AND 101).

FIRST USE 6-0-2009; IN COMMERCE 6-0-2009.

THE MARK CONSISTS OF STANDARD CHARACTERS WITHOUT CLAIM TO ANY PARTICULAR FONT, STYLE, SIZE, OR COLOR.

SN 77-529,470, FILED 7-23-2008.

LIEF MARTIN, EXAMINING ATTORNEY



*David J. Kybas*

Director of the United States Patent and Trademark Office

# United States of America

United States Patent and Trademark Office

# RIPTIDE

**Reg. No. 4,125,752**

NATIONAL TOBACCO COMPANY, L.P. (DELAWARE LIMITED PARTNERSHIP)  
5201 INTERCHANGE WAY  
LOUISVILLE, KY 40229

**Registered Apr. 10, 2012**

**Int. Cl.: 34**

FOR: TOBACCO, IN CLASS 34 (U.S. CLS. 2, 8, 9 AND 17).

**TRADEMARK**

FIRST USE 1-27-2012; IN COMMERCE 1-27-2012.

**PRINCIPAL REGISTER**

THE MARK CONSISTS OF STANDARD CHARACTERS WITHOUT CLAIM TO ANY PARTICULAR FONT, STYLE, SIZE, OR COLOR.

SN 77-531,407, FILED 7-25-2008.

LESLIE RICHARDS, EXAMINING ATTORNEY



*David J. Kyffers*

Director of the United States Patent and Trademark Office

# United States of America

United States Patent and Trademark Office

## ATLANTIC SPORTS HEALTH

**Reg. No. 4,125,753**

**Registered Apr. 10, 2012**

**Int. Cl.: 42**

**SERVICE MARK**

**PRINCIPAL REGISTER**

ATLANTIC HEALTH SYSTEM, INC. (NEW JERSEY NON-PROFIT CORPORATION)  
475 SOUTH STREET  
MORRISTOWN, NJ 07960

FOR: MEDICAL RESEARCH, IN CLASS 42 (U.S. CLS. 100 AND 101).

FIRST USE 5-1-2011; IN COMMERCE 5-1-2011.

THE MARK CONSISTS OF STANDARD CHARACTERS WITHOUT CLAIM TO ANY PARTICULAR FONT, STYLE, SIZE, OR COLOR.

NO CLAIM IS MADE TO THE EXCLUSIVE RIGHT TO USE "SPORTS HEALTH", APART FROM THE MARK AS SHOWN.

SN 77-533,614, FILED 7-29-2008.

LINDA LAVACHE, EXAMINING ATTORNEY



*David J. Kyffers*

Director of the United States Patent and Trademark Office

# United States of America

United States Patent and Trademark Office

## SENSIBLY INDULGENT

**Reg. No. 4,125,754**

**Registered Apr. 10, 2012**

**Int. Cl.: 30**

**TRADEMARK**

**PRINCIPAL REGISTER**

CSM BAKERY PRODUCTS NA, INC. (DELAWARE CORPORATION)  
1912 MONTREAL ROAD  
TUCKER, GA 30084

FOR: BAKERY GOODS, IN CLASS 30 (U.S. CL. 46).

FIRST USE 3-0-2010; IN COMMERCE 3-0-2010.

THE MARK CONSISTS OF STANDARD CHARACTERS WITHOUT CLAIM TO ANY PARTICULAR FONT, STYLE, SIZE, OR COLOR.

SN 77-534,821, FILED 7-30-2008.

TRACY WHITTAKER-BROWN, EXAMINING ATTORNEY



*David J. Kyffers*

Director of the United States Patent and Trademark Office

# United States of America

United States Patent and Trademark Office

## FOREST FRESH

**Reg. No. 4,125,755**

SPITFIRE GLOBAL, INC. (FLORIDA CORPORATION)  
8000 SAILBOAT KEY BLVD.#406  
ST. PETE BEACH, FL 33707

**Registered Apr. 10, 2012**

**Int. Cl.: 31**

FOR: CAT AND DOG LITTER COMPRISING ORGANIC WOOD PARTICLES, EITHER ALONE OR COMBINED WITH OTHER SUBSTRATES, IN CLASS 31 (U.S. CLS. 1 AND 46).

**TRADEMARK**

FIRST USE 7-10-2008; IN COMMERCE 12-13-2011.

**PRINCIPAL REGISTER**

THE MARK CONSISTS OF STANDARD CHARACTERS WITHOUT CLAIM TO ANY PARTICULAR FONT, STYLE, SIZE, OR COLOR.

SN 77-539,216, FILED 8-5-2008.

STEVEN PEREZ, EXAMINING ATTORNEY



*David J. Kybas*

Director of the United States Patent and Trademark Office

# United States of America

United States Patent and Trademark Office

## KIRIN KYOWA FOODS COMPANY, LIMITED

**Reg. No. 4,125,756**

**Registered Apr. 10, 2012**

**Int. Cls.: 1, 29, and 30**

**TRADEMARK**

**PRINCIPAL REGISTER**

KIRIN HOLDINGS KABUSHIKI KAISHA (JAPAN CORPORATION), TA KIRIN HOLDINGS CO., LTD.,  
10-1, SHINKAWA 2-CHOME  
CHUO-KU, TOKYO, JAPAN

FOR: CURDLAN CHEMICAL FOR THE FOOD INDUSTRY, NAMELY, CHEMICALS USED IN FOOD INDUSTRY, CHEMICAL ADDITIVES FOR USE IN THE MANUFACTURE OF FOODS; CHEMICAL PRODUCTS IN THE NATURE OF HYDROLYZED PROTEINS, NAMELY, CHEMICAL PREPARATIONS IN THE NATURE OF HYDROLYZED PROTEINS FOR USE IN THE MANUFACTURE OF FOODS, IN CLASS 1 (U.S. CLS. 1, 5, 6, 10, 26 AND 46).

FIRST USE 4-24-2009; IN COMMERCE 6-16-2009.

FOR: HYDROLYZED PROTEIN USED AS A FOOD ADDITIVE AND FOOD FILLER, IN CLASS 29 (U.S. CL. 46).

FIRST USE 4-24-2009; IN COMMERCE 6-16-2009.

FOR: FOOD ADDITIVES FOR NON-NUTRITIONAL PURPOSES FOR USE AS A FLAVORING; THICKENING AGENT USED FOR COOKING; FLAVOR ENHANCERS USED IN FOOD PRODUCTS; SEASONINGS AND CONDIMENTS, NAMELY, CHEMICAL SEASONINGS, SEASONINGS CONTAINING HYDROLYZED PROTEINS, IN CLASS 30 (U.S. CL. 46).

FIRST USE 4-24-2009; IN COMMERCE 6-16-2009.

THE MARK CONSISTS OF STANDARD CHARACTERS WITHOUT CLAIM TO ANY PARTICULAR FONT, STYLE, SIZE, OR COLOR.

OWNER OF U.S. REG. NOS. 2,701,995, 3,145,747, AND OTHERS.

NO CLAIM IS MADE TO THE EXCLUSIVE RIGHT TO USE "FOODS COMPANY LIMITED", APART FROM THE MARK AS SHOWN.

THE ENGLISH TRANSLATION OF "KYOWA" IN THE MARK IS HARMONY.

SN 77-551,728, FILED 8-20-2008.



*David J. Kypos*

Director of the United States Patent and Trademark Office

**Reg. No. 4,125,756** JAY BESCH, EXAMINING ATTORNEY

# United States of America

United States Patent and Trademark Office

# SWAN LAKE

**Reg. No. 4,125,757**

IGT (NEVADA CORPORATION)  
9295 PROTOTYPE DRIVE  
RENO, NV 895218986

**Registered Apr. 10, 2012**

**Int. Cl.: 9**

FOR: GAMING DEVICES, NAMELY, GAMING MACHINES; MACHINES FOR PLAYING GAMES OF CHANCE, IN CLASS 9 (U.S. CLS. 21, 23, 26, 36 AND 38).

**TRADEMARK**

FIRST USE 11-15-2011; IN COMMERCE 11-15-2011.

**PRINCIPAL REGISTER**

THE MARK CONSISTS OF STANDARD CHARACTERS WITHOUT CLAIM TO ANY PARTICULAR FONT, STYLE, SIZE, OR COLOR.

SN 77-552,675, FILED 8-21-2008.

DAVID YONTEF, EXAMINING ATTORNEY



*David J. Kyffers*

Director of the United States Patent and Trademark Office



# United States of America

United States Patent and Trademark Office

# FLICK FOOTBALL

MORE THAN A GAME MORE THAN A SPORT

**Reg. No. 4,125,758**

FLICKSPORTSGAMES.COM (CALIFORNIA LIMITED LIABILITY PARTNERSHIP)  
8643 HAYDEN PLACE  
CULVER CITY, CA 90232

**Registered Apr. 10, 2012**

**Int. Cl.: 28**

FOR: BOARD GAMES, NAMELY, FOOTBALL BOARD GAMES, IN CLASS 28 (U.S. CLS. 22, 23, 38 AND 50).

**TRADEMARK**

FIRST USE 11-1-2008; IN COMMERCE 11-1-2008.

**PRINCIPAL REGISTER**

NO CLAIM IS MADE TO THE EXCLUSIVE RIGHT TO USE "FLICK FOOTBALL", APART FROM THE MARK AS SHOWN.

THE COLOR(S) GREEN, YELLOW, AND GRAY IS/ARE CLAIMED AS A FEATURE OF THE MARK.

THE MARK CONSISTS OF THE STYLIZED WORDS "FLICK FOOTBALL", WITH EACH LETTER OUTLINED IN YELLOW AND HAVING SHADES OF GREEN ON THE INSIDE, WITH DARK GREEN AT THE TOPS AND BOTTOMS WITHIN THE WORDS AND LIGHT GREEN IN THE MIDDLE, AND THE WORDS "MORE THAN A GAME MORE THAN A SPORT" BELOW "FLICK FOOTBALL", WHEREIN THE WORDS "MORE THAN A GAME MORE THAN A SPORT" ARE COMPRISING SHADES OF GRAY, ON AND SURROUNDED BY A GRAY RECTANGULAR BACKGROUND.

SN 77-557,440, FILED 8-27-2008.

ANDREW LEASER, EXAMINING ATTORNEY



*David J. Kyros*

Director of the United States Patent and Trademark Office

# United States of America

United States Patent and Trademark Office

## ecosteps

**Reg. No. 4,125,759**

**Registered Apr. 10, 2012**

**Int. Cl.: 40**

**SERVICE MARK**

**PRINCIPAL REGISTER**

JOHNSON CONTROLS TECHNOLOGY COMPANY (MICHIGAN CORPORATION)  
915 EAST 32ND STREET  
HOLLAND, MI 49423

FOR: RECYCLING OF BATTERIES, IN CLASS 40 (U.S. CLS. 100, 103 AND 106).

FIRST USE 1-0-2012; IN COMMERCE 1-0-2012.

THE MARK CONSISTS OF THE WORD "ECOSTEPS" WITH THE ARROWS FORMING THE LETTER "O".

SN 77-559,063, FILED 8-29-2008.

MARIA-VICTORIA SUAREZ, EXAMINING ATTORNEY



*David J. Kybas*

Director of the United States Patent and Trademark Office

# United States of America

United States Patent and Trademark Office

# CHORUS

**Reg. No. 4,125,760**

ELI LILLY AND COMPANY (INDIANA CORPORATION)  
LILLY CORPORATE CENTER  
INDIANAPOLIS, IN 46285

**Registered Apr. 10, 2012**

**Int. Cl.: 42**

FOR: PROVIDING PHARMACEUTICAL RESEARCH AND DEVELOPMENT SERVICES, IN CLASS 42 (U.S. CLS. 100 AND 101).

**SERVICE MARK**

FIRST USE 12-27-2007; IN COMMERCE 12-27-2007.

**PRINCIPAL REGISTER**

THE MARK CONSISTS OF STANDARD CHARACTERS WITHOUT CLAIM TO ANY PARTICULAR FONT, STYLE, SIZE, OR COLOR.

SN 77-559,075, FILED 8-29-2008.

KRISTINA MORRIS, EXAMINING ATTORNEY



*David J. Kybas*

Director of the United States Patent and Trademark Office

# United States of America

United States Patent and Trademark Office



**Reg. No. 4,125,761**

**Registered Apr. 10, 2012**

**Int. Cl.: 43**

**SERVICE MARK**

**PRINCIPAL REGISTER**

CREATIVE ATTRACTIONS, LLC (MINNESOTA LIMITED LIABILITY COMPANY)  
858 DECATUR AVENUE N.  
GOLDEN VALLEY, MN 55427

FOR: RESTAURANT AND BAR SERVICES, IN CLASS 43 (U.S. CLS. 100 AND 101).

FIRST USE 12-0-2011; IN COMMERCE 12-0-2011.

NO CLAIM IS MADE TO THE EXCLUSIVE RIGHT TO USE "KITCHEN" AND "CULINARY ART", APART FROM THE MARK AS SHOWN.

THE MARK CONSISTS OF THE WORD "ZI" IN THE CENTER OF A CIRCLE WITH A WAVY LINE TO THE RIGHT OF THE WORD "ZI", ABOVE A SERIES OF CONCENTRIC BARS. BELOW IS THE WORDS "IMPERIAL KITCHEN", A HORIZONTAL LINE, THE WORDS "ASIAN ANTIQUITIES & CULINARY ART", AND A HORIZONTAL LINE.

THE ENGLISH TRANSLATION OF THE WORD "ZI" IN THE MARK IS PURPLE.

SN 77-568,645, FILED 9-12-2008.

JILL C. ALT, EXAMINING ATTORNEY



*David J. Kyffers*

Director of the United States Patent and Trademark Office

# United States of America

United States Patent and Trademark Office

## Managed Realities

**Reg. No. 4,125,762**

EMAT CAPITAL MANAGEMENT, LLC (CALIFORNIA LIMITED LIABILITY COMPANY)  
7474 NORTH FIGUEROA ST., SUITE A  
LOS ANGELES, CA 90041

**Registered Apr. 10, 2012**

**Int. Cl.: 35**

FOR: BUSINESS MANAGEMENT SERVICES FOR OTHERS; BUSINESS CONSULTATION SERVICES, IN CLASS 35 (U.S. CLS. 100, 101 AND 102).

**SERVICE MARK**

FIRST USE 2-23-2012; IN COMMERCE 2-23-2012.

**PRINCIPAL REGISTER**

THE MARK CONSISTS OF STANDARD CHARACTERS WITHOUT CLAIM TO ANY PARTICULAR FONT, STYLE, SIZE, OR COLOR.

SN 77-568,791, FILED 9-12-2008.

DAVID H. STINE, EXAMINING ATTORNEY



*David J. Kybas*

Director of the United States Patent and Trademark Office

# United States of America

United States Patent and Trademark Office

## Basement Strategies

**Reg. No. 4,125,763**

EMAT CAPITAL MANAGEMENT, LLC (CALIFORNIA LIMITED LIABILITY COMPANY)  
7474 N. FIGUEROA, SUITE A  
LOS ANGELES, CA 90041

**Registered Apr. 10, 2012**

**Int. Cl.: 35**

FOR: BUSINESS DEVELOPMENT SERVICES, NAMELY, PROVIDING START-UP ACTIVITIES FOR BUSINESSES OF OTHERS, IN CLASS 35 (U.S. CLS. 100, 101 AND 102).

**SERVICE MARK**

FIRST USE 2-23-2012; IN COMMERCE 2-23-2012.

**PRINCIPAL REGISTER**

THE MARK CONSISTS OF STANDARD CHARACTERS WITHOUT CLAIM TO ANY PARTICULAR FONT, STYLE, SIZE, OR COLOR.

SN 77-568,802, FILED 9-12-2008.

DAVID H. STINE, EXAMINING ATTORNEY



*David J. Kyffers*

Director of the United States Patent and Trademark Office

# United States of America

United States Patent and Trademark Office

## LOLA CAFE & BAKERY

**Reg. No. 4,125,764**

**Registered Apr. 10, 2012**

**Int. Cl.: 30**

**TRADEMARK**

**PRINCIPAL REGISTER**

JACQUELINE BORRO (UNITED STATES INDIVIDUAL)  
12 N. WASHINGTON ST.  
14-G  
ROCKVILLE, MD 20850

FOR: TEA, MATE, BAKERY GOODS, ENGLISH TEA SANDWICHES, EMPANADAS, CHIMICHURRI SAUCE, DULCE DE LECHE, GELATO, ICE CREAM, CHURROS, IN CLASS 30 (U.S. CL. 46).

FIRST USE 0-0-2008; IN COMMERCE 0-0-2008.

THE MARK CONSISTS OF STANDARD CHARACTERS WITHOUT CLAIM TO ANY PARTICULAR FONT, STYLE, SIZE, OR COLOR.

NO CLAIM IS MADE TO THE EXCLUSIVE RIGHT TO USE "CAFE & BAKERY", APART FROM THE MARK AS SHOWN.

SN 77-574,155, FILED 9-19-2008.

HOWARD B. LEVINE, EXAMINING ATTORNEY



*David J. Kybas*

Director of the United States Patent and Trademark Office

# United States of America

United States Patent and Trademark Office

# DVF

**Reg. No. 4,125,765**

**Registered Apr. 10, 2012**

**Int. Cl.: 35**

**SERVICE MARK**

**PRINCIPAL REGISTER**

DIANE VON FURSTENBERG STUDIO (CONNECTICUT PARTNERSHIP)  
CLOUDWALK FARM ASPETUCK ROAD  
NEW MILFORD, CT 06776

FOR: RETAIL STORE SERVICES FEATURING APPAREL, LUGGAGE, HANDBAGS, WATCHES, JEWELRY, EYEWEAR AND BODY AND BEAUTY CARE COSMETICS, IN CLASS 35 (U.S. CLS. 100, 101 AND 102).

FIRST USE 4-12-2002; IN COMMERCE 4-12-2002.

THE MARK CONSISTS OF STANDARD CHARACTERS WITHOUT CLAIM TO ANY PARTICULAR FONT, STYLE, SIZE, OR COLOR.

OWNER OF U.S. REG. NOS. 2,877,398, 3,066,869, AND OTHERS.

THE NAME(S), PORTRAIT(S), AND/OR SIGNATURE(S) SHOWN IN THE MARK IDENTIFIES AN INDIVIDUAL, WHOSE CONSENT(S) TO REGISTER IS MADE OF RECORD.

SN 77-574,618, FILED 9-19-2008.

AMY C. KEAN, EXAMINING ATTORNEY



*David J. Kyffers*

Director of the United States Patent and Trademark Office



# United States of America

United States Patent and Trademark Office

## DIANE VON FURSTENBERG

**Reg. No. 4,125,766**

**Registered Apr. 10, 2012**

**Int. Cl.: 35**

**SERVICE MARK**

**PRINCIPAL REGISTER**

DIANE VON FURSTENBERG STUDIO (CONNECTICUT PARTNERSHIP)  
CLOUDWALK FARM ASPETUCK ROAD  
NEW MILFORD, CT 06776

FOR: RETAIL STORE SERVICES FEATURING APPAREL, LUGGAGE, HANDBAGS, WATCHES, JEWELRY, EYEWEAR AND BODY AND BEAUTY CARE COSMETICS, IN CLASS 35 (U.S. CLS. 100, 101 AND 102).

FIRST USE 4-12-2002; IN COMMERCE 4-12-2002.

THE MARK CONSISTS OF STANDARD CHARACTERS WITHOUT CLAIM TO ANY PARTICULAR FONT, STYLE, SIZE, OR COLOR.

OWNER OF U.S. REG. NOS. 2,276,188, 2,877,401, AND OTHERS.

THE NAME(S), PORTRAIT(S), AND/OR SIGNATURE(S) SHOWN IN THE MARK IDENTIFIES AN INDIVIDUAL, WHOSE CONSENT(S) TO REGISTER IS MADE OF RECORD.

SN 77-574,907, FILED 9-19-2008.

AMY C. KEAN, EXAMINING ATTORNEY



*David J. Kyfos*

Director of the United States Patent and Trademark Office

# United States of America

United States Patent and Trademark Office

## Midnight Swimming Music

**Reg. No. 4,125,767**

**Registered Apr. 10, 2012**

**Int. Cls.: 9, 35, and 41**

AMATO, PAULA (UNITED STATES INDIVIDUAL), DBA MIDNIGHT SWIMMING MUSIC, INC.,  
SUITE #415  
9 DESBROSSES STREET  
NEW YORK, NY 10013

**TRADEMARK**

**SERVICE MARK**

**PRINCIPAL REGISTER**

FOR: DIGITAL MEDIA, NAMELY, VISUAL AND AUDIO RECORDINGS IN THE FORMAT OF DVDS, DOWNLOADABLE WAV, MP3 FILES, PODCASTS, BLOGS, AND RING TONES FEATURING MUSICAL ARTISTS; ELECTRONIC PUBLICATIONS RECORDED ON COMPUTER MEDIA, NAMELY, PRESS RELEASES, BROCHURES, AND NEWSLETTERS FEATURING NEW AND PRE-EXISTING MUSICAL RECORDING ARTISTS; PRE-RECORDED DIGITAL MEDIA FEATURING MUSICAL RECORDING ARTISTS; PRE-RECORDED ELECTRONIC MEDIA, NAMELY, PRE-RECORDED CDS, DVDS, DVRS FEATURING MUSICAL RECORDING ARTISTS; VIDEO MAGAZINES RECORDED ON ELECTRONIC MEDIA FEATURING NEW AND PRE-EXISTING MUSICAL RECORDING ARTISTS, IN CLASS 9 (U.S. CLS. 21, 23, 26, 36 AND 38).

FIRST USE 4-28-2008; IN COMMERCE 6-16-2008.

FOR: PROMOTIONAL AND COMMERCIAL ADVERTISING SERVICES, NAMELY, ONLINE WHOLESALE AND RETAIL STORE SERVICES FEATURING DOWNLOADABLE SOUND, MUSIC, IMAGE AND VIDEO FILES FOR PROMOTIONAL PURPOSES; MUSIC PROMOTION SERVICES; ADVERTISING SERVICES, NAMELY, PREPARING AND PLACING ADVERTISEMENTS FOR OTHERS, FEATURING MUSICAL RECORDING ARTISTS; PROMOTING THE PRODUCTS AND SERVICES OF OTHERS BY DISTRIBUTION OF PRINTED, AUDIO, VIDEO AND INTERNET-RELATED PROMOTIONAL MATERIAL; PROVIDING AN INTERNET WEBSITE PORTAL FEATURING LINKS TO MUSIC-RELATED MERCHANDISE FOR RETAIL PURPOSES; ARRANGING PERSONAL APPEARANCES BY PERSONS WORKING IN THE FIELD OF MUSIC AND ENTERTAINMENT; MUSIC SELECTION SERVICES FOR USE IN ADVERTISING; ADVERTISING AGENCY SERVICES; DISSEMINATION OF ADVERTISING MATERIALS AND DEVELOPING PROMOTIONAL CAMPAIGNS FOR BUSINESSES; PROMOTIONAL AND COMMERCIAL ADVERTISING SERVICES, NAMELY, PROMOTING AUDIO RECORDINGS FEATURING MUSICAL RECORDING ARTISTS; ADVERTISING AND PROMOTION OF LIVE MUSIC CONCERTS, IN CLASS 35 (U.S. CLS. 100, 101 AND 102).



*David J. Kyffers*

Director of the United States Patent and Trademark Office

FIRST USE 4-28-2008; IN COMMERCE 6-16-2008.

**Reg. No. 4,125,767** FOR: MUSIC PRODUCTION SERVICES, NAMELY, PROVIDING MULTIMEDIA ENTERTAINMENT SERVICES IN THE NATURE OF RECORDING, PRODUCTION AND POST-PRODUCTION SERVICES IN THE FIELDS OF MUSIC, VIDEO, AND FILMS, FEATURING MUSICAL RECORDING ARTISTS; ENTERTAINMENT IN THE NATURE OF AN ON-GOING SPECIAL VARIETY NEWS AND MUSIC BROADCAST FEATURING MUSICAL RECORDING ARTISTS AND NEWS ABOUT THE MUSIC INDUSTRY, BROADCAST OVER AUDIO AND VIDEO MEDIA; ENTERTAINMENT SERVICES, NAMELY, PROVIDING PRE-RECORDED MUSIC AND INFORMATION IN THE FIELD OF MUSIC AND COMMENTARY AND ARTICLES ABOUT MUSIC, AVAILABLE ON-LINE ACCESSIBLE THROUGH A GLOBAL COMPUTER NETWORK; ENTERTAINMENT SERVICES, NAMELY, PRODUCTION OF LIVE MUSIC CONCERTS; MUSIC AND MUSIC VIDEO PRODUCTION AND PUBLISHING SERVICES; MUSIC SELECTION SERVICES FOR USE IN TELEVISION, FILM, RADIO AND VIDEO; POST-PRODUCTION EDITING SERVICES IN THE FIELD OF MUSIC, VIDEOS AND FILMS; PRODUCTION OF SOUND AND MUSIC VIDEO RECORDINGS; PROVIDING AN INTERNET WEBSITE PORTAL FEATURING LINKS TO MUSICAL ARTIST WEBSITES AND MUSIC PERFORMANCE INFORMATION; ONLINE JOURNALS, NAMELY, BLOGS FEATURING MUSICAL RECORDING ARTISTS, PROMOTIONAL AND COMMERCIAL ADVERTISING FOR THE MUSIC INDUSTRY; PROVIDING ONLINE NON-DOWNLOADABLE DIGITAL MUSIC FROM THE INTERNET, IN CLASS 41 (U.S. CLS. 100, 101 AND 107).

FIRST USE 4-28-2008; IN COMMERCE 6-16-2008.

THE MARK CONSISTS OF STANDARD CHARACTERS WITHOUT CLAIM TO ANY PARTICULAR FONT, STYLE, SIZE, OR COLOR.

NO CLAIM IS MADE TO THE EXCLUSIVE RIGHT TO USE "MUSIC", APART FROM THE MARK AS SHOWN.

SN 77-575,116, FILED 9-21-2008.

SUZANNE BLANE, EXAMINING ATTORNEY

# United States of America

United States Patent and Trademark Office



**Reg. No. 4,125,768**

**Registered Apr. 10, 2012**

**Int. Cl.: 32**

**TRADEMARK**

**PRINCIPAL REGISTER**

TEQUILA CUERVO LA ROJENA, S.A. DE C.V. (MEXICO CORPORATION)  
CIRCUNVALACION SUR #44A, FRACCIONAMIENTO  
LAS FUENTES, ZAPOPAN  
JALISCO, CODIGO, MEXICO 45070

FOR: NON-ALCOHOLIC COCKTAIL MIX, IN CLASS 32 (U.S. CLS. 45, 46 AND 48).

FIRST USE 12-14-2010; IN COMMERCE 12-14-2010.

OWNER OF U.S. REG. NOS. 711,630, 3,181,045, AND OTHERS.

THE COLOR(S) BLACK, GOLD, WHITE, RED, CAUCASIAN SKIN TONES, BROWN, GREEN, ORANGE, YELLOW, BLUE, AND PINK AND PURPLE IS/ARE CLAIMED AS A FEATURE OF THE MARK.

NO CLAIM IS MADE TO THE EXCLUSIVE RIGHT TO USE "CLASSIC LIME" AND "THE ORIGINAL MARGARITA MIX", APART FROM THE MARK AS SHOWN.

THE MARK "JOSE CUERVO" DOES NOT IDENTIFY A LIVING INDIVIDUAL.

THE MARK CONSISTS OF THE WORDS "JOSE CUERVO" IN BLACK WITH A GOLD BORDER IN SPECIAL SCRIPT, THE WORDS "THE ORIGINAL MARGARITA MIX" IN WHITE ON A RED RIBBON WITH GOLD LINING, THE WORDS "CLASSIC LIME" IN WHITE ON A RED RIBBON WITH GOLD BORDER, A REPRESENTATION OF A BUST OF A WOMAN HAVING CAUCASIAN SKIN TONE, RED LIPS, BROWN EYES AND EYEBROWS AND BROWN AND BLACK HAIR WITH ORANGE FLOWERS HAVING YELLOW BUDS AND GREEN LEAVES, A MARGARITA GLASS IN YELLOW WITH A WHITE RIM, WITH TWO WHOLE LIMES IN GREEN, TWO SLICED LIMES IN GREEN AND WHITE REPRESENTATION ALL ON A GREEN BACKGROUND WITH A REPRESENTATION OF SCENERY CONSISTING OF A SUNSET IN ORANGE, YELLOW AND GOLD, GREEN GROUND, BLUE, PINK AND PURPLE SKY ALL WITHIN A BLACK AND GOLD RECTANGULAR BLOCK.

THE ENGLISH TRANSLATION OF "CUERVO" IS CROW OR RAVEN.

SN 77-585,600, FILED 10-3-2008.

JULIE GUTTADAURO, EXAMINING ATTORNEY



*David J. Kyffers*

Director of the United States Patent and Trademark Office

# United States of America

United States Patent and Trademark Office

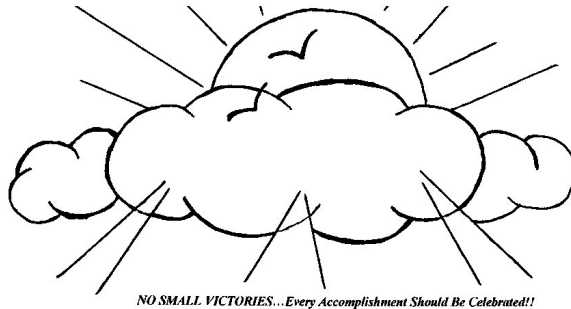

**Reg. No. 4,125,769**

**Registered Apr. 10, 2012**

**Int. Cl.: 25**

**TRADEMARK**

**PRINCIPAL REGISTER**

WILLIAMS-HINES, JACQUELINE (UNITED STATES INDIVIDUAL)  
34 HUTCHINSON STREET  
SPRINGFIELD, MA 01119

FOR: JACKETS; SWEAT SHIRTS; T-SHIRTS, IN CLASS 25 (U.S. CLS. 22 AND 39).

FIRST USE 4-30-2011; IN COMMERCE 4-30-2011.

THE MARK CONSISTS OF THE WORDING "NO SMALL VICTORIES .EVERY ACCOMPLISHMENT SHOULD BE CELEBRATED!!" ABOVE WHICH APPEARS A DESIGN OF CLOUDS, THE SUN AND TWO FLYING BIRDS.

SN 77-586,220, FILED 10-6-2008.

ERIN FALK, EXAMINING ATTORNEY



*David J. Kybas*

Director of the United States Patent and Trademark Office

# United States of America

United States Patent and Trademark Office

# SHURTECH

**Reg. No. 4,125,770**

SHURTAPE TECHNOLOGIES, LLC (NORTH CAROLINA LIMITED LIABILITY COMPANY)  
1712 EIGHTH STREET DRIVE, SE  
HICKORY, NC 28602

**Registered Apr. 10, 2012**

**Int. Cls.: 1, 16, 17, 20, 21,  
26, and 27**

FOR: PRODUCTS FOR USE IN HOME AND BUILDING RENOVATION, MAINTENANCE AND REPAIR, NAMELY, PADS IMPREGNATED WITH AN ADHESIVE HARDENING AGENT WHICH CAN BE MOLDED AND THEN HARDENED TO SECURE PLASTIC AND METAL SCREWS AND ANCHORS; PLIABLE GUM-LIKE COMPOUND FOR USE AS AN INDUSTRIAL ADHESIVE, IN CLASS 1 (U.S. CLS. 1, 5, 6, 10, 26 AND 46).

**TRADEMARK**

**PRINCIPAL REGISTER**

FIRST USE 12-0-2010; IN COMMERCE 12-0-2010.



*David J. Kyjars*

Director of the United States Patent and Trademark Office

FOR: ADHESIVES FOR STATIONERY OR HOUSEHOLD PURPOSES AND DISPENSERS AND APPLICATORS THEREFOR; ADHESIVE TAPES FOR STATIONERY OR HOUSEHOLD PURPOSES AND DISPENSERS THEREFOR; ADHESIVE MOUNTING TAPES AND TABS FOR STATIONERY OR HOUSEHOLD PURPOSES; CORRECTION TAPE AND APPLICATORS THEREFOR; ADHESIVE TAPES FOR HOBBIES AND CRAFTS AND DISPENSERS THEREFOR; ARTISTS' MATERIALS, NAMELY, ARTS AND CRAFTS PAINT KITS; PLIABLE GUM-LIKE COMPOUND USED AS AN ADHESIVE FOR STATIONERY AND HOUSEHOLD USE; OFFICE REQUISITES, NAMELY, OFFICE ORGANIZERS FOR STATIONERY USE, FILE FOLDERS, LABELS, NOTE PADS, HIGHLIGHTING PENS, SELF-STICK LABELS, POSTER PAPER, MOUNTING TAPES; HOLDERS FOR DESK ACCESSORIES, ORGANIZERS FOR STATIONERY USE, PERSONAL ORGANIZERS; MATERIALS FOR PACKAGING, MOVING AND STORAGE SUPPLIES, NAMELY, MAILING, PACKAGING, STRAPPING AND MASKING TAPES, TAPE DISPENSERS FOR HOME AND OFFICE USE; PLASTIC STRETCH WRAP; PACKING KITS FOR GLASSWARE AND DISHES COMPRISED OF CARDBOARD BOXES AND DIVIDERS AND PLASTIC POUCHES; CARTON SEALING TAPE, CARDBOARD BOXES; PAPER AND CARDBOARD PADDED BOXES; PAPER CONTAINERS, ENVELOPES, CUSHIONED ENVELOPES, CUSHIONS AND PADDING FOR PACKING PURPOSES; CARDBOARD MAILING AND SHIPPING BOXES AND CONTAINERS; PLASTIC AND PAPER CUSHIONED ENVELOPES FOR PACKAGING AND MAILING PURPOSES; PLASTIC CELLULAR WRAP WITH AIR CUSHIONED POCKETS FOR WRAPPING AND PACKAGING; PAPER MAIL POUCHES, PACKING PAPER, WRAPPING PAPER, CUSHIONED WRAPPING AND PACKING PAPER, TISSUE PAPER, PAPER LABELS; PLASTIC SHEETS FOR COVERING SHELVES AND DRAWERS; PAINTING TAPE AND DISPENSERS FOR THEREFOR; PLASTIC MOVING AND STORAGE SUPPLIES, NAMELY, STORAGE BAGS, FURNITURE BAGS AND COVERS; LAMINATING MACHINES FOR HOME AND OFFICE USE; PRINTED

**Reg. No. 4,125,770** NEWSLETTERS ON THE SUBJECT OF ENTREPRENEURSHIP, MARKETING, BUSINESS RELATIONS, AND MANAGEMENT; PLASTIC SHELF LINING MATERIAL, IN CLASS 16 (U.S. CLS. 2, 5, 22, 23, 29, 37, 38 AND 50).

FIRST USE 12-0-2010; IN COMMERCE 12-0-2010.

FOR: ELONGATED TAPE HAVING A PRESSURE ADHESIVE ON ONE SIDE; DUCT TAPE, MASKING TAPE; TAPES FOR USE IN ELECTRICAL INSTALLATION, NAMELY, ELECTRICAL TAPE; ELONGATED VINYL FIRE-RESISTANT TAPE HAVING A PRESSURE SENSITIVE ADHESIVE ON ONE SIDE; WEATHERSTRIPPING FOR THE HOME; AIR CONDITIONER PLASTIC FOAM SEALS FOR INSULATION, INSULATING FOAM TAPE, INSULATING SOCKET SEALS AND INSULATING TAPE; RUG TAPES; NON-PERMANENT ADHESIVE PUTTY, IN CLASS 17 (U.S. CLS. 1, 5, 12, 13, 35 AND 50).

FIRST USE 12-0-2010; IN COMMERCE 12-0-2010.

FOR: KITCHEN, BATH, HOME STORAGE AND ORGANIZATION PRODUCTS, NAMELY, SHELVING; PLASTIC SHELF LINING MATERIAL, IN CLASS 20 (U.S. CLS. 2, 13, 22, 25, 32 AND 50).

FIRST USE 12-0-2010; IN COMMERCE 12-0-2010.

FOR: TOILET BRUSHES, IN CLASS 21 (U.S. CLS. 2, 13, 23, 29, 30, 33, 40 AND 50).

FIRST USE 12-0-2010; IN COMMERCE 12-0-2010.

FOR: HOOK AND LOOP FASTENERS FOR CONSUMER USE; ADHESIVE-BACKED HOOK AND LOOP MATERIAL FOR MOUNTING PURPOSES, IN CLASS 26 (U.S. CLS. 37, 39, 40, 42 AND 50).

FIRST USE 12-0-2010; IN COMMERCE 12-0-2010.

FOR: RUBBER OR PLASTIC MATS, NAMELY, BATH MATS, SHOWER MATS, KITCHEN MATS AND FLOOR MATS , IN CLASS 27 (U.S. CLS. 19, 20, 37, 42 AND 50).

FIRST USE 12-0-2010; IN COMMERCE 12-0-2010.

THE MARK CONSISTS OF STANDARD CHARACTERS WITHOUT CLAIM TO ANY PARTICULAR FONT, STYLE, SIZE, OR COLOR.

SN 77-588,009, FILED 10-8-2008.

JANICE L. MCMORROW, EXAMINING ATTORNEY

# United States of America

United States Patent and Trademark Office

# PERQUAT

**Reg. No. 4,125,771**

**Registered Apr. 10, 2012**

**Int. Cl.: 5**

**TRADEMARK**

**PRINCIPAL REGISTER**

STERILEX CORPORATION (MARYLAND CORPORATION)  
111 LAKE FRONT DRIVE  
HUNT VALLEY, MD 21030

FOR: DISINFECTANTS, ANTIMICROBIAL CLEANERS, DISINFECTANT CLEANERS, SANITIZING PREPARATIONS, DISINFECTING PREPARATIONS USED FOR BIOFILM REMOVAL, DISINFECTING PREPARATIONS USED TO KILL MICROORGANISMS IN BIOFILM, ANTIMICROBIAL PREPARATIONS AND SANITIZING PREPARATIONS USED TO SANITIZE, DISINFECT, STERILIZE, AND REMOVE BIOFILM, ALL FOR USE ON HEALTH CARE AND MEDICAL EQUIPMENT, SURFACES, AND DEVICES, DENTAL EQUIPMENT, SURFACES, AND DEVICES, DENTAL UNIT WATERLINES AND EVACUATION LINES, HARD SURFACES, DRAINS, UTENSILS, HOUSEHOLD SURFACES, HOUSEHOLD EQUIPMENT, PIPES, TANKS AND PROCESSING EQUIPMENT, COP SYSTEMS AND CIP SYSTEMS IN THE FOOD, BEVERAGE, AND DAIRY INDUSTRY, WINE AND BEER TRANSFER LINES, EGGS, EGG HATCHERS AND OTHER EQUIPMENT USED IN THE PRODUCTION OF EGGS, ANIMAL HEALTH FACILITIES AND EQUIPMENT; BIOCIDES USED IN THE MANUFACTURE OF ALKALINE PAPER; ANTIMICROBIAL PREPARATIONS USED TO TREAT ANIMAL AND HUMAN DERMAL MALADIES, FOOT BATHS, WHIRLPOOL BATHS AND SPAS, SWIMMING POOLS, INDUSTRIAL WATER TREATMENT SYSTEMS, COOLING WATER SYSTEMS, MOLD REMOVAL ON SURFACES, FOOD SERVICE SURFACES, EQUIPMENT AND UTENSILS, RETAIL FOOD SURFACES, EQUIPMENT AND UTENSILS, REFRIGERATION EQUIPMENT, REFRIGERATION COILS, ICE MACHINES, DECORATIVE FOUNTAINS, WATER PIPING AND HOSES, HEATING, VENTILATING, AND AIR CONDITIONING (HVAC) SYSTEMS, GYMNASIUM EQUIPMENT AND SURFACES; HAND SANITIZING GELS; CHEMICALS IN THE NATURE OF MOLD INHIBITORS USED TO TREAT EDIBLE PRODUCTS TO KILL OR REMOVE SPOILAGE ORGANISMS; WATER TREATMENT BIOCIDES FOR INDUSTRIAL USE; SANITIZING, DISINFECTING AND DECONTAMINATING PREPARATIONS FOR HOUSEHOLD AND INDUSTRIAL USE ON HARD SURFACES, EQUIPMENT, UTENSILS, CIP SYSTEMS, COP SYSTEMS, TANKS, PIPING SYSTEMS, DRAINS, CONVEYANCE SYSTEMS, DEVICES, CONTAINERS, HOUSEHOLD ITEMS AND SURFACES; DENTAL RINSING LIQUIDS; MEDICATED DENTAL AND MOUTH RINSING LIQUIDS; ANTI-CAVITY MOUTH RINSES, IN CLASS 5 (U.S. CLS. 6, 18, 44, 46, 51 AND 52).



*David J. Kyros*

FIRST USE 11-23-2011; IN COMMERCE 11-23-2011.



**Reg. No. 4,125,771** THE MARK CONSISTS OF STANDARD CHARACTERS WITHOUT CLAIM TO ANY PARTICULAR FONT, STYLE, SIZE, OR COLOR.

SN 77-592,241, FILED 10-14-2008.

KEVIN DINALLO, EXAMINING ATTORNEY

# United States of America

United States Patent and Trademark Office

## BABCOCK WANSON

**Reg. No. 4,125,772**

BABCOCK WANSON HOLDING (FRANCE SOCIÉTÉ PAR ACTIONS SIMPLIFIÉE (SAS))  
80 RUE EMILE ZOLA

**Registered Apr. 10, 2012**

LA COURNEUVE, FRANCE 93123

**Int. Cls.: 6, 7, 11, 35, 37,  
40, 41, and 42**

FOR: (BASED ON 44(E)) COMMON METALS AND THEIR ALLOYS; METAL BUILDING MATERIALS, NAMELY, STEEL; TRANSPORTABLE METAL BUILDINGS; MATERIALS FOR RAILWAY TRACKS MADE OF METAL; NON ELECTRIC CABLES AND WIRES OF COMMON METAL; HARDWARE MADE OF METAL, NAMELY, BOILER INCINERATOR CASINGS; METAL TUBES AND PIPES; METAL SAFES; STEEL IN THE FORM OF COILS, IN CLASS 6 (U.S. CLS. 2, 12, 13, 14, 23, 25 AND 50).

**TRADEMARK**

**SERVICE MARK**

**PRINCIPAL REGISTER**

FOR: (BASED ON 44(E)) MOTORS AND ENGINES, EXCEPT FOR LAND VEHICLES; NON ELECTRIC MACHINE TRANSMISSION COUPLINGS AND TRANSMISSION COMPONENTS, EXCEPT FOR LAND VEHICLES; INCUBATORS FOR EGGS; FEEDING APPARATUS FOR ENGINE BOILERS, NAMELY, PUMPS AS PART OF A MACHINE; ANTI-POLLUTION DEVICES FOR MOTORS AND ENGINES; ELECTRIC PUMPS FOR HEATING INSTALLATIONS; HYDRAULIC CONTROLS FOR MACHINES, ENGINES AND MOTORS; AERATOR MACHINES, NAMELY, DE-AERATORS FOR FEEDWATER; FEEDWATER REGULATORS BEING PARTS OF MACHINES; HEAT EXCHANGERS BEING PARTS OF MACHINES AND COMPONENT PARTS THEREOF; ELECTRIC PUMPS; PUMPS FOR HEATING INSTALLATIONS; STEAM ENGINES , IN CLASS 7 (U.S. CLS. 13, 19, 21, 23, 31, 34 AND 35).



*David J. Kyjars*

Director of the United States Patent and Trademark Office

FOR: (BASED ON 44(E)) APPARATUS FOR HEATING, STEAM GENERATING, AND DRYING PURPOSES, NAMELY, GASEOUS EFFLUENT INCINERATOR BURNERS; HEATING INSTALLATIONS, NAMELY, BURNERS; HEAT ACCUMULATORS; STEAM ACCUMULATORS; WATER SOFTENING APPARATUS AND INSTALLATIONS; HEATING INSTALLATIONS, NAMELY, HOT AIR APPARATUS, AIR REHEATERS, AIR DRIERS, FEEDING APPARATUS FOR HEATING BOILERS, FLUES FOR HEATING BOILERS, CHIMNEY FLUES, HEAT REGENERATORS AND HEATING BOILERS; HEATING INSTALLATIONS, NAMELY, HEATING APPARATUS FOR SOLID, LIQUID AND GASEOUS FUELS; REGULATING AND SAFETY ACCESSORIES FOR GAS PIPES, NAMELY, METERED VALVES; REGULATING AND SAFETY ACCESSORIES FOR WATER APPARATUS, NAMELY, METERED VALVES; WATER FILTERING APPARATUS; WATER SOFTENING APPARATUS AND INSTALLATIONS; WATER PURIFYING APPARATUS; WATER HEATERS; PRESSURE WATER HOT WATER TANKS; HEAT EXCHANGERS, NOT BEING PARTS OF MACHINES; FLUE GAS ECONOMIZERS AND FUEL ECONOMIZERS; GAS BURNERS; GAS BOILERS; HEATING INSTALLATIONS, NAMELY, STEAM BOILERS, OTHER THAN PARTS OF A MACHINE; INCINER-

**Reg. No. 4,125,772** ATORS; WATER HEATERS; REGULATING ACCESSORIES FOR WATER OR GAS APPARATUS AND PIPES, NAMELY, METERED VALVES; STEAM GENERATING HEATING INSTALLATIONS; AIR COOLING APPARATUS; EVAPORATOR; HEAT PUMP; HEATING SYSTEM, NAMELY, HEATING INSTALLATIONS; HEATING INSTALLATIONS, NAMELY, A RADIANT TUBE; SUPER STEAM HEATERS; PIPES FOR HEATING BOILERS; EXPANSION TANKS, NAMELY, HOT WATER TANKS , IN CLASS 11 (U.S. CLS. 13, 21, 23, 31 AND 34).

FOR: (BASED ON 44(E)) BUSINESS CONSULTANCY SERVICES, IN CLASS 35 (U.S. CLS. 100, 101 AND 102).

FOR: (BASED ON USE IN COMMERCE) (BASED ON 44(E)) INSTALLATION, REPAIR AND MAINTENANCE OF COMPLETE INDUSTRIAL BOILERS AND BURNERS, INDUSTRIAL HEATING APPARATUS, INCINERATORS AND COMPONENT PARTS THEREOF; INSTALLATION, REPAIR AND MAINTENANCE OF A COMPLETE PROCESS HEATING SYSTEM AND COMPONENT PARTS THEREOF; INSTALLATION, REPAIR, AND MAINTENANCE OF FLUE GAS TREATMENT DEVICES; CLEANING AND REPAIR OF BOILERS, INDUSTRIAL HEATING APPARATUS, BURNERS, AND INCINERATORS; INSTALLATION, MAINTENANCE AND REPAIR OF HEATING EQUIPMENT; REBUILDING OF MACHINERY THAT HAS BEEN WORN OR PARTIALLY DESTROYED; INSTALLATION, REPAIR AND MAINTENANCE OF COMPONENT PARTS AND DEVICES FOR GAS AND WATER TREATMENTS, IN CLASS 37 (U.S. CLS. 100, 103 AND 106).

FIRST USE 1-1-2012; IN COMMERCE 1-1-2012.

FOR: (BASED ON USE IN COMMERCE) (BASED ON 44(E)) WATER TREATMENT, NAMELY, CLARIFICATION, FILTERING, DECARBONIZATION, AND DEMINERALIZATION BY RESINS; WASTE TREATMENT, NAMELY, TRANSFORMATION, RECYCLING AND INCINERATION OF ALL WASTE AND TRASH; AIR PURIFICATION; AIR DEODORIZING; ODOR NEUTRALIZATION SERVICES; ASSEMBLY AND DISASSEMBLY OF INDUSTRIAL BOILERS; RENTAL OF INDUSTRIAL BOILERS, IN CLASS 40 (U.S. CLS. 100, 103 AND 106).

FIRST USE 1-1-2012; IN COMMERCE 1-1-2012.

FOR: (BASED ON USE IN COMMERCE) (BASED ON 44(E)) PROVIDING TRAINING SERVICES FOR OTHERS IN THE FIELDS OF FLUE GAS, INDUSTRIAL HEATING, INDUSTRIAL WATER, THE TREATMENT OF ODOR, WASTE INCINERATION AND TRASH INCINERATION, AND IN THE FIELD OF WASTE TRANSFORMATION AND TRASH TRANSFORMATION, IN CLASS 41 (U.S. CLS. 100, 101 AND 107).

FIRST USE 1-1-2012; IN COMMERCE 1-1-2012.

FOR: (BASED ON 44(E)) TECHNICAL MONITORING SCIENTIFIC RESEARCH SERVICES FOR OTHERS IN THE FIELDS OF COMPONENTS AND COMPLETE INDUSTRIAL BOILERS, OFF GAS TREATMENTS, INDUSTRIAL WATER TREATMENTS, WASTE AND TRASH INCINERATION, BURNERS, INCINERATORS, COMPONENTS AND COMPLETE PROCESS HEATING SYSTEMS, FLUE GAS TREATMENT DEVICES, ODOR TREATMENT DEVICES AND IN THE FIELD OF RENDERING DEVICES; PROVIDING TECHNICAL SCIENTIFIC RESEARCH ADVICE IN THE NATURE OF TECHNICAL MONITORING SCIENTIFIC RESEARCH SERVICES AND SCIENTIFIC RESEARCH CONSULTING; PREPARATION OF TECHNICAL EXPERT SCIENTIFIC RESEARCH REPORTS, CONDUCTING ENGINEERING SURVEYS, PREPARING TECHNICAL SCIENTIFIC RESEARCH PROJECT STUDIES, PROVIDING ENGINEERING SERVICES, SCIENTIFIC RESEARCH SERVICES AND TECHNOLOGY SCIENTIFIC RESEARCH SERVICES AND SCIENTIFIC RESEARCH ANALYSIS SERVICES ALL IN THE FIELDS OF FLUE GAS, INDUSTRIAL HEATING, INDUSTRIAL WATER, THE TREATMENT OF ODOR, WASTE INCINERATION OR TRASH INCINERATION, IN THE FIELD OF WASTE TRANSFORMATION AND TRASH TRANSFORMATION, IN CLASS 42 (U.S. CLS. 100 AND 101).

**Reg. No. 4,125,772** THE MARK CONSISTS OF STANDARD CHARACTERS WITHOUT CLAIM TO ANY PARTICULAR FONT, STYLE, SIZE, OR COLOR.

PRIORITY CLAIMED UNDER SEC. 44(D) ON FRANCE APPLICATION NO. 083570356, FILED 4-17-2008, REG. NO. 083570356, DATED 9-19-2008, EXPIRES 4-17-2018.

OWNER OF FRANCE REG. NO. 96616747, DATED 8-30-1996, EXPIRES 3-20-2016.

THE NAME "BABCOCK WANSON" DOES NOT IDENTIFY A LIVING INDIVIDUAL.

SN 77-593,874, FILED 10-16-2008.

LEIGH CAROLINE CASE, EXAMINING ATTORNEY

# United States of America

United States Patent and Trademark Office

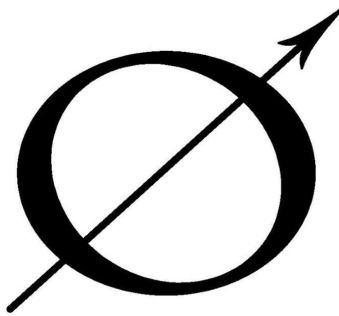

**Reg. No. 4,125,773**

**Registered Apr. 10, 2012**

**Int. Cl.: 39**

**SERVICE MARK**

**PRINCIPAL REGISTER**

FILLMORE PEARL HOLDING, LTD. (CAYMAN ISLANDS CORPORATION)  
UGLAND HOUSE, SOUTH CHURCH STREET  
GEORGE TOWN, CAYMAN ISLANDS KY11104

FOR: TRAVEL SERVICES, NAMELY, CRUISE SHIP SERVICES, TRAVEL, EXCURSION  
AND CRUISE ARRANGEMENT, ARRANGING CRUISES AND TOURS, CONDUCTING  
BOAT CHARTERS, IN CLASS 39 (U.S. CLS. 100 AND 105).

FIRST USE 12-31-2010; IN COMMERCE 12-31-2010.

THE MARK CONSISTS OF THE LETTER "O" WITH AN ARROW RUNNING THROUGH  
THE LETTER "O" POINTING UP AND DIAGONALLY TO THE RIGHT.

SN 77-595,380, FILED 10-17-2008.

STEVEN PEREZ, EXAMINING ATTORNEY



*David J. Kyffers*

Director of the United States Patent and Trademark Office

# United States of America

United States Patent and Trademark Office

## EAU MONUMENTALE

**Reg. No. 4,125,774**

THIRD MAN, INC. (NEW YORK CORPORATION)

**Registered Apr. 10, 2012**

54 W. 10TH ST., NO. 9  
NEW YORK, NY 10011

**Int. Cl.: 3**

FOR: COLOGNE; EAU DE TOILETTE; EAU DE COLOGNE; FRAGRANCES FOR PERSONAL USE; PERFUMES; TOILET WATER, IN CLASS 3 (U.S. CLS. 1, 4, 6, 50, 51 AND 52).

**TRADEMARK**

FIRST USE 11-0-2011; IN COMMERCE 11-0-2011.

**PRINCIPAL REGISTER**

THE MARK CONSISTS OF STANDARD CHARACTERS WITHOUT CLAIM TO ANY PARTICULAR FONT, STYLE, SIZE, OR COLOR.

THE ENGLISH TRANSLATION OF THE WORD "MONUMENTALE" IN THE MARK IS MONUMENTAL.

SN 77-599,542, FILED 10-23-2008.

ERNEST SHOSHO, EXAMINING ATTORNEY



*David J. Kybas*

Director of the United States Patent and Trademark Office

# United States of America

United States Patent and Trademark Office

## SCARLET SPIDER

**Reg. No. 4,125,775**

MARVEL CHARACTERS, INC. (DELAWARE CORPORATION)  
1600 ROSECRANS AVENUE  
MANHATTAN BEACH, CA 90266

**Registered Apr. 10, 2012**

**Int. Cl.: 16**

FOR: COMIC BOOKS; MAGAZINES FEATURING PRINTED STORIES IN ILLUSTRATED FORM AND COMIC BOOK STORIES AND ARTWORK; PRINTED PERIODICALS IN THE FIELD OF COMIC BOOK STORIES AND ARTWORK, IN CLASS 16 (U.S. CLS. 2, 5, 22, 23, 29, 37, 38 AND 50).

**TRADEMARK**

**PRINCIPAL REGISTER**

FIRST USE 1-11-2012; IN COMMERCE 1-11-2012.

THE MARK CONSISTS OF STANDARD CHARACTERS WITHOUT CLAIM TO ANY PARTICULAR FONT, STYLE, SIZE, OR COLOR.

OWNER OF U.S. REG. NOS. 885,910, 2,276,140, AND OTHERS.

SN 77-600,142, FILED 10-24-2008.

GIANCARLO CASTRO, EXAMINING ATTORNEY



*David J. Kyros*

Director of the United States Patent and Trademark Office

# United States of America

United States Patent and Trademark Office

Harumika

**Reg. No. 4,125,776**

SUNRISE INC. (JAPAN CORPORATION)

**Registered Apr. 10, 2012**

2-44-10 KAMIIGUSA

SUGINAMI-KU, TOKYO, JAPAN 167-0023

**Int. Cl.: 28**

FOR: DOLL CASES; DOLL CLOTHING; DOLLS AND ACCESSORIES THEREFOR; DOLLS AND PLAYSETS THEREFOR; DOLLS' CLOTHES; PLAYSETS FOR DOLLS; PLAYSETS FOR DOLLS COMPRISED OF DOLL FURNITURE, INCLUDING BEDS, CLOSET, WARDROBES, RUNWAYS; PHOTOGRAPHY STUDIO PLAYSETS FOR DOLLS INCLUDING TOY ACCESSORIES THEREFOR, IN CLASS 28 (U.S. CLS. 22, 23, 38 AND 50).

**TRADEMARK**

**PRINCIPAL REGISTER**

FIRST USE 7-1-2009; IN COMMERCE 7-1-2009.

THE MARK CONSISTS OF THE LETTERS "H A R U M" IN STYLIZED SCRIPT, THEN DESIGN OF A DRESS FORM, FOLLOWED BY THE LETTERS "K A" IN STYLIZED SCRIPT.

THE WORDING "HARUM KA" HAS NO MEANING IN A FOREIGN LANGUAGE.

SN 77-612,653, FILED 11-12-2008.

WARREN L. OLANDRIA, EXAMINING ATTORNEY



*David J. Kyffers*

Director of the United States Patent and Trademark Office



# United States of America

United States Patent and Trademark Office

# BEYONCÉ

**Reg. No. 4,125,777**

**Registered Apr. 10, 2012**

**Int. Cl.: 3**

**TRADEMARK**

**PRINCIPAL REGISTER**

KNOWLES, BEYONCÉ (UNITED STATES INDIVIDUAL)  
599 LEXINGTON AVENUE  
C/O REED SMITH LLP  
NEW YORK, NY 10022

FOR: FRAGRANCES AND PERFUMERY; BODY SPRAYS USED AS A PERSONAL DEODORANT AND AS FRAGRANCE; BATH AND SHOWER GELS, OILS, FOAMS AND SALTS NOT FOR MEDICAL PURPOSES; BATH BEADS; BATH CREAMS; BATH CRYSTALS; BATH FIZZIES; BATH FLAKES; BATH HERBS; BATH LOTIONS; BATH MILKS; BATH PEARLS; BATH POWDERS; BATH SOAPS IN LIQUID, SOLID OR GEL FORM; BUBBLE BATH; HAND, BODY AND FOOT LOTIONS, SOAPS AND POWDERS, BUTTERS AND CREAMS; SKIN AND BODY TOPICAL LOTIONS, CREAMS AND OILS FOR COSMETIC USE; EYE PILLOWS CONTAINING FRAGRANCES; MAKEUP, NAMELY, FOUNDATION, EYE SHADOW, LIP GLOSS, LIPSTICK, MASCARA, EYE LINER, BLUSH, EYE MAKEUP REMOVER, EYE PENCILS, EYE SHADOW, EYEBROW PENCILS, EYELINERS, FACE POWDER; COSMETIC COMPACTS; HAIR AND SKIN PREPARATIONS, NAMELY, HAIR SPRAY, SHAMPOO, CONDITIONER, SHAVING CREAM, SKIN CLEANSERS, ASTRINGENTS FOR COSMETIC PURPOSES, BEAUTY MASKS, FACIAL SCRUBS, NIGHT CREAM, SKIN CREAM, EYE CREAM, MOISTURIZERS, CLARIFIERS, SKIN EMOLLIENTS, SKIN TONERS, AND BODY SPLASH, IN CLASS 3 (U.S. CLS. 1, 4, 6, 50, 51 AND 52).

FIRST USE 1-31-2010; IN COMMERCE 1-31-2010.

THE MARK CONSISTS OF STANDARD CHARACTERS WITHOUT CLAIM TO ANY PARTICULAR FONT, STYLE, SIZE, OR COLOR.

OWNER OF U.S. REG. NO. 2,879,852.

THE NAME(S), PORTRAIT(S), AND/OR SIGNATURE(S) SHOWN IN THE MARK IDENTIFIES "BEYONCE" KNOWLES, WHOSE CONSENT(S) TO REGISTER IS MADE OF RECORD.

SN 77-613,638, FILED 11-13-2008.

JANICE L. MCMORROW, EXAMINING ATTORNEY



*David J. Kyros*

Director of the United States Patent and Trademark Office

# United States of America

United States Patent and Trademark Office



**Reg. No. 4,125,778**

INTERNATIONAL DB2 USERS GROUP (ILLINOIS CORPORATION)  
401 NORTH MICHIGAN AVENUE  
CHICAGO, IL 60611

**Registered Apr. 10, 2012**

**Int. Cl.: 35**

FOR: ARRANGING AND CONDUCTING TRADE SHOWS IN THE FIELD OF DATABASE MANAGEMENT SYSTEMS AND RELATED FIELDS, NAMELY, COMPUTER OPERATING SYSTEMS; PROVIDING INFORMATION VIA A WEBSITE IN THE FIELD OF DATABASE MANAGEMENT; ASSOCIATION SERVICES NAMELY, PROMOTING THE INTERESTS OF DATABASE MANAGEMENT SYSTEM USERS AND SUPPLIERS, IN CLASS 35 (U.S. CLS. 100, 101 AND 102).

**SERVICE MARK**

**PRINCIPAL REGISTER**

FIRST USE 8-3-2007; IN COMMERCE 8-3-2007.

OWNER OF U.S. REG. NOS. 1,875,254 AND 2,433,568.

THE MARK CONSISTS OF THE WORDS "IDUG" IN CAPITAL LETTERS NEXT TO CIRCLE WITH SPIRAL DESIGN.

SN 77-619,277, FILED 11-21-2008.

SUE LAWRENCE, EXAMINING ATTORNEY



*David J. Kyros*

Director of the United States Patent and Trademark Office

# United States of America

United States Patent and Trademark Office

# CASEDATA

**Reg. No. 4,125,779**

OCE BUSINESS SERVICES, INC. (DELAWARE CORPORATION)  
460 WEST 34TH STREET  
NEW YORK, NY 10001

**Registered Apr. 10, 2012**

**Int. Cl.: 9**

FOR: COMPUTER SOFTWARE USED TO PROVIDE WEB-BASED DOCUMENT REVIEW APPLICATIONS, COLLABORATION, CALENDARING, CASE MANAGEMENT, DOCUMENT REDACTION AND DOCUMENT SEARCHING, IN CLASS 9 (U.S. CLS. 21, 23, 26, 36 AND 38).

**TRADEMARK**

**PRINCIPAL REGISTER**

FIRST USE 1-13-1999; IN COMMERCE 1-13-1999.

THE MARK CONSISTS OF STANDARD CHARACTERS WITHOUT CLAIM TO ANY PARTICULAR FONT, STYLE, SIZE, OR COLOR.

OWNER OF U.S. REG. NO. 2,806,397.

SN 77-624,459, FILED 12-2-2008.

KAPIL BHANOT, EXAMINING ATTORNEY



*David J. Kybas*

Director of the United States Patent and Trademark Office

# United States of America

United States Patent and Trademark Office

## ENTREPRENEURS WITHOUT BORDERS

**Reg. No. 4,125,780**

**Registered Apr. 10, 2012**

**Int. Cl.: 41**

**SERVICE MARK**

**PRINCIPAL REGISTER**

BOARD OF TRUSTEES OF THE UNIVERSITY OF ILLINOIS, THE (ILLINOIS BODY POLITIC  
AND CORPORATE)  
506 SOUTH WRIGHT STREET  
352 HENRY ADMINISTRATION BUILDING  
URBANA, IL 61801

FOR: EDUCATIONAL SERVICES, NAMELY, PROVIDING COURSES, PROGRAMS, SEM-  
INARS, WORKSHOPS, ONLINE TRAINING, CERTIFICATE PROGRAMS IN THE FIELDS  
OF ECONOMICS, FINANCE AND BUSINESS, IN CLASS 41 (U.S. CLS. 100, 101 AND 107).

FIRST USE 11-28-2007; IN COMMERCE 11-28-2007.

THE MARK CONSISTS OF STANDARD CHARACTERS WITHOUT CLAIM TO ANY PAR-  
TICULAR FONT, STYLE, SIZE, OR COLOR.

NO CLAIM IS MADE TO THE EXCLUSIVE RIGHT TO USE "ENTREPRENEURS", APART  
FROM THE MARK AS SHOWN.

SN 77-627,938, FILED 12-6-2008.

YAT SYE, LEE, EXAMINING ATTORNEY



*David J. Kyffers*

Director of the United States Patent and Trademark Office

# United States of America

United States Patent and Trademark Office



**Reg. No. 4,125,781**

**Registered Apr. 10, 2012**

**Int. Cl.: 33**

**TRADEMARK**

**PRINCIPAL REGISTER**

SUTTER HOME WINERY, INC. (CALIFORNIA CORPORATION)  
100 ST. HELENA HWY SOUTH, P.O. BOX 248  
ST. HELENA, CA 94574

FOR: WINE, IN CLASS 33 (U.S. CLS. 47 AND 49).

FIRST USE 1-12-2009; IN COMMERCE 1-12-2009.

NO CLAIM IS MADE TO THE EXCLUSIVE RIGHT TO USE "PAK" AND "PACKAGING" AND "MINIMUM OF 40% POST-CONSUMER WASTE", APART FROM THE MARK AS SHOWN.

THE MARK CONSISTS OF THE IMAGE OF GLOBE ENCIRCLED WITH A BANNER READING "MINIMUM OF 40% POST-CONSUMER WASTE" ABOVE WHICH ARE THE WORDS "PLANET WISE PAK" AND BENEATH WHICH ARE THE WORDS "PACKAGING WITH A CONSCIENCE", ALL OF WHICH IS ENCLOSED IN A LARGER EXTERNAL CIRCLE.

SN 77-630,075, FILED 12-10-2008.

DAVID HOFFMAN, EXAMINING ATTORNEY



*David J. Kyffers*

Director of the United States Patent and Trademark Office

# United States of America

United States Patent and Trademark Office



**Reg. No. 4,125,782**

**Registered Apr. 10, 2012**

**Int. Cl.: 32**

**TRADEMARK**

**PRINCIPAL REGISTER**

HANSEN PRE, LLC (DELAWARE LIMITED LIABILITY COMPANY)  
550 MONICA CIRCLE, SUITE 201  
CORONA, CA 92880

FOR: SPORTS DRINKS, IN CLASS 32 (U.S. CLS. 45, 46 AND 48).

FIRST USE 8-1-2008; IN COMMERCE 5-1-2009.

THE MARK CONSISTS OF THE WORD "PRE" WHICH HAS ABOVE IT A SERIES OF LINES THAT RADIATE OUT IN THE FORM OF A SEMI-CIRCLE .

THE WORDING "PRE" HAS NO MEANING IN A FOREIGN LANGUAGE.

SN 77-633,180, FILED 12-15-2008.

ANDREW RHIM, EXAMINING ATTORNEY



*David J. Kyffers*

Director of the United States Patent and Trademark Office

# United States of America

United States Patent and Trademark Office

# Stile Tech

**Reg. No. 4,125,783**

**Registered Apr. 10, 2012**

**Int. Cl.: 3**

**TRADEMARK**

**PRINCIPAL REGISTER**

GINA L. TAGLIENTE (UNITED STATES INDIVIDUAL), AKA GINA STILE,  
1467 BALDWIN BLVD.  
1467 BALDWIN BLVD.  
BAYSHORE, NY 11706

FOR: AFTER-SUN GELS; AFTER-SUN MILKS; AFTER-SUN OILS; ALOE VERA GEL FOR COSMETIC PURPOSES; ASTRINGENTS FOR COSMETIC PURPOSES; BATH OILS FOR COSMETIC PURPOSES; BATH POWDER; BLEACHING PREPARATIONS FOR COSMETIC PURPOSES; BODY AND BEAUTY CARE COSMETICS; CLEANSING CREAMS; COLOGNES, PERFUMES AND COSMETICS; COLORING PREPARATIONS FOR COSMETIC PURPOSES; CONCEALERS; COSMETIC CREAMS; COSMETIC CREAMS FOR SKIN CARE; COSMETIC FACIAL BLOTTING PAPERS; COSMETIC HAIR DRESSING PREPARATIONS; COSMETIC HAIR REGROWTH INHIBITING PREPARATIONS; COSMETIC MILKS; COSMETIC OILS; COSMETIC OILS FOR THE EPIDERMIS; COSMETIC OLIVE OIL FOR THE FACE AND BODY; COSMETIC PENCILS; COSMETIC PREPARATIONS; COSMETIC PREPARATIONS AGAINST SUNBURN; COSMETIC PREPARATIONS FOR BODY CARE; COSMETIC PREPARATIONS FOR EYE LASHES; COSMETIC PREPARATIONS FOR SKIN RENEWAL; COSMETIC PRODUCTS IN THE FORM OF AEROSOLS FOR SKIN CARE; COSMETIC PRODUCTS IN THE FORM OF AEROSOLS FOR SKINCARE; COSMETIC ROUGES; COSMETIC SOAPS; COSMETIC SUN-PROTECTING PREPARATIONS; COSMETIC SUN-TANNING PREPARATIONS; COSMETIC SUNTAN LOTIONS; COSMETICS; COSMETICS AND COSMETIC PREPARATIONS; COSMETICS AND MAKE-UP; COSMETICS FOR ANIMALS; COSMETICS IN GENERAL, INCLUDING PERFUMES; COSMETICS, NAMELY, LIP PRIMER; COSMETICS, NAMELY, COMPACTS; COSMETICS, NAMELY, LIP REPAIRERS; DECORATIVE TRANSFERS AND SKIN JEWELS FOR COSMETIC PURPOSES; EYE COMPRESSES FOR COSMETIC PURPOSES; EYEBROW COSMETICS; FACE CREAMS FOR COSMETIC USE; FOAMS CONTAINING COSMETICS AND SUNSCREENS; GLITTER FOR COSMETIC PURPOSES; HENNA FOR COSMETIC PURPOSES; LOTIONS FOR COSMETIC PURPOSES; MAKE-UP KITS COMPRISED OF SKIN CARE, HAIR CARE, MAKE-UP ETC.; MILK FOR COSMETIC PURPOSES; NAIL VARNISH FOR COSMETIC PURPOSES; NON-MEDICATED COSMETIC SKIN CARE PREPARATIONS CONSISTING OF ORGANIC COCONUT VIRGIN OIL AND COCONUT VIRGIN OIL; NON-MEDICATED HAIR TREATMENT PREPARATIONS FOR COSMETIC PURPOSES; OILS FOR COSMETIC PURPOSES; PENCILS FOR COSMETIC PURPOSES; PERFUME OILS FOR THE MANUFACTURE OF COSMETIC PREPARATIONS; PRE-MOISTENED COSMETIC TISSUES; PRE-MOISTENED COSMETIC TOWELETTES; PRE-MOISTENED COSMETIC WIPES; PRIVATE LABEL COSMETICS; RETINOL CREAM FOR COSMETIC PURPOSES; SHEA BUTTER FOR COSMETIC PURPOSES; SKIN AND

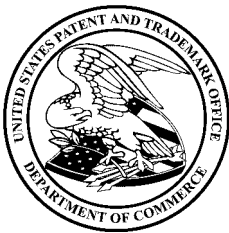

*David J. Kyros*

Director of the United States Patent and Trademark Office

**Reg. No. 4,125,783** BODY TOPICAL LOTIONS, CREAMS AND OILS FOR COSMETIC USE; SKIN FRESHENERS; SOAPS; SOLID POWDER FOR COMPACTS; SUNTAN OILS FOR COSMETIC PURPOSES; TISSUES IMPREGNATED WITH COSMETIC LOTIONS; TONERS; TOPICAL SKIN SPRAYS FOR COSMETIC PURPOSES; WRINKLE-MINIMIZING COSMETIC PREPARATIONS FOR TOPICAL FACIAL USE, IN CLASS 3 (U.S. CLS. 1, 4, 6, 50, 51 AND 52).

FIRST USE 1-16-2012; IN COMMERCE 1-16-2012.

THE MARK CONSISTS OF "STILETECH".

SN 77-636,445, FILED 12-18-2008.

BRIAN NEVILLE, EXAMINING ATTORNEY



# United States of America

United States Patent and Trademark Office

# KNEWTON

**Reg. No. 4,125,784**

KNEWTON, INC. (DELAWARE CORPORATION)  
19 UNION SQUARE WEST  
NEW YORK, NY 10003

**Registered Apr. 10, 2012**

**Int. Cl.: 42**

FOR: APPLICATION SERVICE PROVIDER (ASP) FEATURING SOFTWARE THAT ENABLES THE DISTRIBUTION OF ON-LINE EDUCATIONAL COURSES AND ON-LINE COURSE MATERIAL USED IN CONNECTION THEREWITH AT ALL LEVELS OF INSTRUCTION VIA THE INTERNET, IN CLASS 42 (U.S. CLS. 100 AND 101).

**SERVICE MARK**

**PRINCIPAL REGISTER**

FIRST USE 11-0-2008; IN COMMERCE 11-0-2008.

THE MARK CONSISTS OF STANDARD CHARACTERS WITHOUT CLAIM TO ANY PARTICULAR FONT, STYLE, SIZE, OR COLOR.

SN 77-636,665, FILED 12-19-2008.

GINA FINK, EXAMINING ATTORNEY



*David J. Kybas*

Director of the United States Patent and Trademark Office

# United States of America

United States Patent and Trademark Office

## ENVIROCYCLE

**Reg. No. 4,125,785**

ENVIROCYCLE SYSTEMS INC. (CANADA CORPORATION)  
101 RUE DU MOULIN, BUREAU 116  
MAGOG, QUEBEC, CANADA J1X4A1

**Registered Apr. 10, 2012**

**Int. Cls.: 7 and 21**

FOR: MACHINES, NAMELY, RECYCLING COMPOSTER, IN CLASS 7 (U.S. CLS. 13, 19, 21, 23, 31, 34 AND 35).

**TRADEMARK**

FIRST USE 12-31-1991; IN COMMERCE 12-31-1991.

**PRINCIPAL REGISTER**

FOR: GARBAGE CANS; WASTE CONTAINERS FOR HOUSEHOLD USE, NAMELY, CONTAINERS IN WHICH FOOD WASTE IS THROWN AWAY FOR MAKING COMPOST; POTS, WATERING CANS, IN CLASS 21 (U.S. CLS. 2, 13, 23, 29, 30, 33, 40 AND 50).

FIRST USE 8-31-2009; IN COMMERCE 8-31-2009.

THE MARK CONSISTS OF STANDARD CHARACTERS WITHOUT CLAIM TO ANY PARTICULAR FONT, STYLE, SIZE, OR COLOR.

SN 77-636,881, FILED 12-19-2008.

KARANENDRA S. CHHINA, EXAMINING ATTORNEY



*David J. Kyffers*

Director of the United States Patent and Trademark Office

# United States of America

United States Patent and Trademark Office

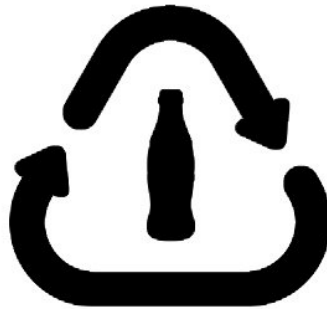

**Reg. No. 4,125,786**

**Registered Apr. 10, 2012**

**Int. Cl.: 32**

**TRADEMARK**

**PRINCIPAL REGISTER**

THE COCA-COLA COMPANY (DELAWARE CORPORATION)  
ONE COCA-COLA PLAZA  
ATLANTA, GA 30313

FOR: NON-ALCOHOLIC BEVERAGES, NAMELY, DRINKING WATERS, SOFT DRINKS, SPORTS DRINKS, FRUIT DRINKS AND FRUIT JUICES, IN CLASS 32 (U.S. CLS. 45, 46 AND 48).

FIRST USE 2-0-2009; IN COMMERCE 2-0-2009.

OWNER OF U.S. REG. NOS. 1,057,884, 3,939,081, AND OTHERS.

THE MARK CONSISTS OF TWO ARROWS FORMING THE SHAPE OF A TRIANGLE DESIGN WITH THE CONTOUR BOTTLE DESIGN ON THE INSIDE OF THE TRIANGLE.

SN 77-640,774, FILED 12-29-2008.

HENRY S. ZAK, EXAMINING ATTORNEY



*David J. Kyffers*

Director of the United States Patent and Trademark Office

# United States of America

United States Patent and Trademark Office

# MAHAMOSA

**Reg. No. 4,125,787**

MAHAMOSA, LLC (GEORGIA LIMITED LIABILITY COMPANY)

**Registered Apr. 10, 2012**

P.O. BOX 12372  
ATLANTA, GA 30355

**Int. Cl.: 43**

FOR: PREPARATION OF FOOD AND BEVERAGES; SERVING FOOD AND BEVERAGES; RESTAURANT SERVICES; CAFÉ SERVICES; BISTRO SERVICES; BAR SERVICES; CARRY-OUT RESTAURANT SERVICES; CATERING SERVICES; PROVIDING INFORMATION VIA GLOBAL COMMUNICATIONS NETWORKS ABOUT FOOD AND BEVERAGE SERVICES, NAMELY, FOOD AND DRINK COOKING AND PREPARATION, RESTAURANT SERVICES, RESTAURANTS, CAFES, BISTROS, BARS, AND CATERING, IN CLASS 43 (U.S. CLS. 100 AND 101).

**SERVICE MARK**

**PRINCIPAL REGISTER**

FIRST USE 10-15-2011; IN COMMERCE 10-15-2011.

THE MARK CONSISTS OF STANDARD CHARACTERS WITHOUT CLAIM TO ANY PARTICULAR FONT, STYLE, SIZE, OR COLOR.

THE WORDING "MAHAMOSA" HAS NO MEANING IN A FOREIGN LANGUAGE.

SN 77-642,464, FILED 1-1-2009.

CORY BOONE, EXAMINING ATTORNEY



*David J. Kyffers*

Director of the United States Patent and Trademark Office

# United States of America

United States Patent and Trademark Office

# MAX & CO.

**Reg. No. 4,125,788**

MAX MARA INTERNATIONAL S.A. (LUXEMBOURG CORPORATION)  
17, BOULEVARD ROYAL  
L-2449 LUXEMBOURG, LUXEMBOURG

**Registered Apr. 10, 2012**

**Int. Cl.: 9**

FOR: SUNGLASSES; LENSES, FRAMES AND CASES FOR SUNGLASSES, IN CLASS 9 (U.S. CLS. 21, 23, 26, 36 AND 38).

**TRADEMARK**

FIRST USE 9-0-2007; IN COMMERCE 2-0-2010.

**PRINCIPAL REGISTER**

THE MARK CONSISTS OF STANDARD CHARACTERS WITHOUT CLAIM TO ANY PARTICULAR FONT, STYLE, SIZE, OR COLOR.

OWNER OF U.S. REG. NO. 2,231,279.

SN 77-645,443, FILED 1-8-2009.

SANJEEV VOHRA, EXAMINING ATTORNEY



*David J. Kybas*

Director of the United States Patent and Trademark Office

# United States of America

United States Patent and Trademark Office

# Gee

**Reg. No. 4,125,789**

BRATISLAV ROZENFELD (UNITED STATES INDIVIDUAL)  
22 RIVER TERRACE 16M  
NEW YORK, NY 10282

**Registered Apr. 10, 2012**

**Int. Cl.: 25**

FOR: CLOTHING, NAMELY, SHIRTS, PANTS, AND HATS, IN CLASS 25 (U.S. CLS. 22 AND 39).

**TRADEMARK**

FIRST USE 0-0-2011; IN COMMERCE 0-0-2011.

**PRINCIPAL REGISTER**

THE MARK CONSISTS OF STANDARD CHARACTERS WITHOUT CLAIM TO ANY PARTICULAR FONT, STYLE, SIZE, OR COLOR.

SN 77-646,740, FILED 1-9-2009.

SHAUNIA CARLYLE, EXAMINING ATTORNEY



*David J. Kybas*

Director of the United States Patent and Trademark Office

# United States of America

United States Patent and Trademark Office

## TRADIN' WITH THE GREATS

**Reg. No. 4,125,790**

ESPINA, JODY (UNITED STATES INDIVIDUAL), DBA JODY JAZZ,  
223 W. BOLTON ST.  
SAVANNAH, GA 31401

**Registered Apr. 10, 2012**

**Int. Cl.: 9**

FOR: PRE-RECORDED CDS, DVDS, MP3S AND INSTRUCTIONAL MATERIALS, SOLD AS  
A UNIT, FEATURING MUSIC, IN CLASS 9 (U.S. CLS. 21, 23, 26, 36 AND 38).

**TRADEMARK**

FIRST USE 11-28-2011; IN COMMERCE 11-28-2011.

**PRINCIPAL REGISTER**

THE MARK CONSISTS OF STANDARD CHARACTERS WITHOUT CLAIM TO ANY PAR-  
TICULAR FONT, STYLE, SIZE, OR COLOR.

SN 77-646,885, FILED 1-9-2009.

ODESSA BIBBINS, EXAMINING ATTORNEY



*David J. Kyffers*

Director of the United States Patent and Trademark Office

# United States of America

United States Patent and Trademark Office

# NEXSIM

**Reg. No. 4,125,791**

COMPUTER SCIENCES CORPORATION (NEVADA CORPORATION)  
3170 FAIRVIEW PARK DRIVE  
FALLS CHURCH, VA 22042

**Registered Apr. 10, 2012**

**Int. Cl.: 9**

FOR: AIR TRAFFIC CONTROL SIMULATORS, IN CLASS 9 (U.S. CLS. 21, 23, 26, 36 AND 38).

**TRADEMARK**

FIRST USE 4-9-2009; IN COMMERCE 4-9-2009.

**PRINCIPAL REGISTER**

THE MARK CONSISTS OF STANDARD CHARACTERS WITHOUT CLAIM TO ANY PARTICULAR FONT, STYLE, SIZE, OR COLOR.

SN 77-648,634, FILED 1-13-2009.

PAUL E. FAHRENKOPF, EXAMINING ATTORNEY



*David J. Kybas*

Director of the United States Patent and Trademark Office



# United States of America

United States Patent and Trademark Office

## TRYDOR ESOONIUX SCOPE

**Reg. No. 4,125,792**

**Registered Apr. 10, 2012**

**Int. Cl.: 28**

**TRADEMARK**

**PRINCIPAL REGISTER**

MATTEL, INC. (DELAWARE CORPORATION)  
M1-1518  
333 CONTINENTAL BLVD.  
EL SEGUNDO, CA 90245

FOR: TOYS, GAMES AND PLAYTHINGS, NAMELY, TOY ACTION FIGURES AND ACCESSORIES THEREFOR, IN CLASS 28 (U.S. CLS. 22, 23, 38 AND 50).

FIRST USE 11-25-2011; IN COMMERCE 11-25-2011.

THE MARK CONSISTS OF STANDARD CHARACTERS WITHOUT CLAIM TO ANY PARTICULAR FONT, STYLE, SIZE, OR COLOR.

SN 77-654,766, FILED 1-22-2009.

AMY KERTGATE, EXAMINING ATTORNEY



*David J. Kybas*

Director of the United States Patent and Trademark Office

# United States of America

United States Patent and Trademark Office



**Reg. No. 4,125,793**

M/S. TRI-STAR PRODUCTS PVT. LTD. (INDIA LIMITED COMPANY (LTD.))  
B-43, SECTOR 80

**Registered Apr. 10, 2012**

NOIDA - 201 305, U.P., INDIA

**Int. Cl.: 26**

FOR: BUTTONS, HOOKS AND EYES, PINS, NAMELY, KNITTING PINS, CROCHET PINS, NEEDLES, IN CLASS 26 (U.S. CLS. 37, 39, 40, 42 AND 50).

**TRADEMARK**

FIRST USE 9-2-2011; IN COMMERCE 9-2-2011.

**PRINCIPAL REGISTER**

NO CLAIM IS MADE TO THE EXCLUSIVE RIGHT TO USE "KNITTER'S", APART FROM THE MARK AS SHOWN.

THE MARK CONSISTS OF THE WORDS "KNITTER'S PRIDE" WITHIN AN OVAL SHAPE.

SN 77-660,164, FILED 1-30-2009.

LINDSEY RUBIN, EXAMINING ATTORNEY



*David J. Kybas*

Director of the United States Patent and Trademark Office

# United States of America

United States Patent and Trademark Office

## WALK OF SHAME

**Reg. No. 4,125,794**

URBAN DECAY COSMETICS LLC (DELAWARE LIMITED LIABILITY COMPANY)  
833 WEST 16TH STREET  
NEWPORT BEACH, CA 92663

**Registered Apr. 10, 2012**

**Int. Cl.: 3**

FOR: COSMETICS, IN CLASS 3 (U.S. CLS. 1, 4, 6, 50, 51 AND 52).

**TRADEMARK**

FIRST USE 1-26-2012; IN COMMERCE 1-26-2012.

**PRINCIPAL REGISTER**

THE MARK CONSISTS OF STANDARD CHARACTERS WITHOUT CLAIM TO ANY PARTICULAR FONT, STYLE, SIZE, OR COLOR.

SN 77-661,222, FILED 2-2-2009.

LINDA E. BLOHM, EXAMINING ATTORNEY



*David J. Kyffers*

Director of the United States Patent and Trademark Office

# United States of America

United States Patent and Trademark Office

# TRUSCULPT

**Reg. No. 4,125,795**

CUTERA, INC. (DELAWARE CORPORATION)  
3240 BAYSHORE BLVD.  
BRISBANE, CA 94005

**Registered Apr. 10, 2012**

**Int. Cl.: 10**

FOR: MEDICAL DEVICE, NAMELY, A RADIO FREQUENCY DEVICE FOR THE TREATMENT OF CELLULITE AND FAT, IN CLASS 10 (U.S. CLS. 26, 39 AND 44).

**TRADEMARK**

FIRST USE 11-0-2009; IN COMMERCE 11-0-2009.

**PRINCIPAL REGISTER**

THE MARK CONSISTS OF STANDARD CHARACTERS WITHOUT CLAIM TO ANY PARTICULAR FONT, STYLE, SIZE, OR COLOR.

SN 77-662,751, FILED 2-3-2009.

MARY CRAWFORD, EXAMINING ATTORNEY



*David J. Kybas*

Director of the United States Patent and Trademark Office

# United States of America

United States Patent and Trademark Office

## MR. FABLES

**Reg. No. 4,125,796**

LEWIS, WILLIAM R. (UNITED STATES INDIVIDUAL)  
1144 IDEMA, S.E.  
GRAND RAPIDS, MI 49506

**Registered Apr. 10, 2012**

**Int. Cl.: 43**

FOR: RESTAURANT SERVICES, IN CLASS 43 (U.S. CLS. 100 AND 101).

**SERVICE MARK**

FIRST USE 2-27-2012; IN COMMERCE 2-27-2012.

**PRINCIPAL REGISTER**

THE MARK CONSISTS OF STANDARD CHARACTERS WITHOUT CLAIM TO ANY PARTICULAR FONT, STYLE, SIZE, OR COLOR.

SN 77-665,119, FILED 2-6-2009.

KATHERINE CHANG, EXAMINING ATTORNEY



*David J. Kybas*

Director of the United States Patent and Trademark Office

# United States of America

United States Patent and Trademark Office



**Reg. No. 4,125,797**

**Registered Apr. 10, 2012**

**Int. Cl.: 25**

**TRADEMARK**

**PRINCIPAL REGISTER**

HITER, CHUCK (UNITED STATES INDIVIDUAL)  
5013 HANGING MOSS LANE  
SARASOTA, FL 34238 AND

HITER, TERI (UNITED STATES INDIVIDUAL)  
5013 HANGING MOSS LANE  
SARASOTA, FL 34238

FOR: CLOTHING, NAMELY, SHIRTS, T-SHIRTS, LONG-SLEEVED SHIRTS, SHORT-SLEEVED SHIRTS, SWEATSHIRTS, JACKETS, PULL OVERS, RAIN GEAR, NAMELY, RAIN COATS, HEADWEAR, NAMELY, STOCKING HATS, HATS, IN CLASS 25 (U.S. CLS. 22 AND 39).

FIRST USE 1-27-2012; IN COMMERCE 1-27-2012.

NO CLAIM IS MADE TO THE EXCLUSIVE RIGHT TO USE "GOLF", APART FROM THE MARK AS SHOWN.

THE MARK CONSISTS OF THE WORDS "ATTRITION GOLF" BETWEEN TWO CROSSED GOLF CLUBS, THE HANDLES OF THE GOLF CLUBS DEPICTED AS WINGS.

SN 77-669,234, FILED 2-12-2009.

BRIDGETT SMITH, EXAMINING ATTORNEY



*David J. Kybas*

Director of the United States Patent and Trademark Office

# United States of America

United States Patent and Trademark Office

## VINYLMATION

**Reg. No. 4,125,798**

DISNEY ENTERPRISES, INC. (DELAWARE CORPORATION)  
500 SOUTH BUENA VISTA STREET  
BURBANK, CA 91521

**Registered Apr. 10, 2012**

**Int. Cl.: 25**

FOR: HEADWEAR; JACKETS; SHIRTS, IN CLASS 25 (U.S. CLS. 22 AND 39).

**TRADEMARK**

FIRST USE 12-22-2009; IN COMMERCE 12-22-2009.

**PRINCIPAL REGISTER**

THE MARK CONSISTS OF STANDARD CHARACTERS WITHOUT CLAIM TO ANY PARTICULAR FONT, STYLE, SIZE, OR COLOR.

SN 77-678,511, FILED 2-25-2009.

MICHAEL SOUDERS, EXAMINING ATTORNEY



*David J. Kyffers*

Director of the United States Patent and Trademark Office

# United States of America

## United States Patent and Trademark Office

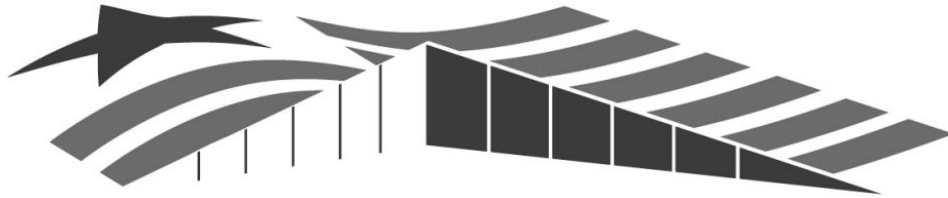

**Reg. No. 4,125,799**

**Registered Apr. 10, 2012**

**Int. Cls.: 16, 35, 36, 41,  
and 45**

**TRADEMARK**

**SERVICE MARK**

**PRINCIPAL REGISTER**

VIETNAM VETERANS MEMORIAL FUND (D.C. NON-PROFIT CORPORATION)  
2600 VIRGINIA AVENUE, NW, SUITE 104  
WASHINGTON, DC 20037

FOR: PRINTED MATERIALS AND PUBLICATIONS, NAMELY, BROCHURES, BOOKLETS, AND HANDOUTS ABOUT VIETNAM, THE VIETNAM WAR, THE VIETNAM VETERANS MEMORIAL, OTHER WARS AND MILITARY ENGAGEMENTS, MILITARY SERVICE, AND ISSUES THAT IMPACT VETERANS, IN CLASS 16 (U.S. CLS. 2, 5, 22, 23, 29, 37, 38 AND 50).

FIRST USE 5-25-1998; IN COMMERCE 5-25-1998.

FOR: PROMOTING PUBLIC AWARENESS OF VIETNAM, THE VIETNAM WAR, THE VIETNAM VETERANS MEMORIAL, OTHER WARS AND MILITARY ENGAGEMENTS, MILITARY SERVICE, AND ISSUES THAT IMPACT VETERANS, IN CLASS 35 (U.S. CLS. 100, 101 AND 102).

FIRST USE 5-25-1998; IN COMMERCE 5-25-1998.

FOR: CHARITABLE AND MEMORIAL FUND RAISING SERVICES, IN CLASS 36 (U.S. CLS. 100, 101 AND 102).

FIRST USE 5-25-1998; IN COMMERCE 5-25-1998.

FOR: MUSEUM AND MUSEUM SERVICES; PREPARING, ORGANIZING, AND DISPLAYING EXHIBITIONS ON VIETNAM, THE VIETNAM WAR, OTHER WARS AND MILITARY ENGAGEMENTS, MILITARY SERVICE, AND ISSUES THAT IMPACT VETERANS FOR EDUCATIONAL AND ENTERTAINMENT PURPOSES; EDUCATIONAL SERVICES, NAMELY, CONDUCTING CLASSES, SEMINARS, EXHIBITIONS, PRESENTATIONS AND SEMINARS RELATED TO VIETNAM, THE VIETNAM WAR, OTHER WARS AND MILITARY ENGAGEMENTS, MILITARY SERVICE, AND ISSUES THAT IMPACT VETERANS; MINE AWARENESS EDUCATION; DEVELOPMENT AND DISSEMINATION OF EDUCATIONAL MATERIALS FOR OTHERS ABOUT VIETNAM, THE VIETNAM WAR, THE VIETNAM VETERANS MEMORIAL, OTHER WARS AND MILITARY ENGAGEMENTS, MILITARY SERVICE, AND ISSUES THAT IMPACT VETERANS; PROVIDING AN ONLINE WEBSITE CONTAINING HISTORICAL AND CULTURAL INFORMATION ABOUT VIETNAM, THE VIETNAM WAR,



*David J. Kappas*

Director of the United States Patent and Trademark Office



**Reg. No. 4,125,799** THE VIETNAM VETERANS MEMORIAL, OTHER WARS AND MILITARY ENGAGEMENTS, AND THE HISTORY OF MILITARY SERVICE, IN CLASS 41 (U.S. CLS. 100, 101 AND 107).

FIRST USE 5-25-1998; IN COMMERCE 5-25-1998.

FOR: PROVIDING A WEBSITE FEATURING AN ELECTRONIC SCRAPBOOK FOR THE POSTING OF NOTES, PHOTOGRAPHS AND OTHER DIGITAL CONTENT AS REMEMBRANCES OF VETERANS OF THE VIETNAM WAR AND OTHER WARS AND MILITARY ENGAGEMENTS; PROVIDING AN ONLINE WEBSITE CONTAINING INFORMATION ABOUT THE PERSONAL AND FAMILY LIFESTYLE ISSUES THAT IMPACT VETERANS AND ABOUT PERSONAL MEMORIES OF MILITARY SERVICE, IN CLASS 45 (U.S. CLS. 100 AND 101).

FIRST USE 5-25-1998; IN COMMERCE 5-25-1998.

THE MARK CONSISTS OF A STYLIZED DEPICTION OF THE AMERICAN FLAG AND A THREE-DIMENSIONAL IMAGE OF A WALL.

SN 77-685,734, FILED 3-6-2009.

JEAN IM, EXAMINING ATTORNEY

# United States of America

United States Patent and Trademark Office

## Cook's Delight

**Reg. No. 4,125,800**

**Registered Apr. 10, 2012**

**Int. Cls.: 29 and 30**

**TRADEMARK**

**PRINCIPAL REGISTER**

WILLIAMS WEST & WITT'S PRODUCTS COMPANY (ILLINOIS CORPORATION), DBA  
INTEGRATIVE FLAVORS,  
3501 W. DUNES HIGHWAY  
MICHIGAN CITY, IN 46360

FOR: FOOD AND FOOD ITEMS FOR CONSUMPTION, NAMELY, SOUP MIXES, PREPARATIONS FOR MAKING SOUPS, SOUP PASTES, SOUP BASES, FOOD BASES, MEAT PASTES, VEGETABLE PASTES, SEAFOOD PASTES, BOUILLON CONCENTRATES, IN CLASS 29 (U.S. CL. 46).

FIRST USE 2-0-1939; IN COMMERCE 2-0-1939.

FOR: FOOD ITEMS FOR THE IMPROVEMENT OF THE FLAVOR OF FOOD, NAMELY, GRAVY MIXES, SAUCE MIXES, FLAVORINGS, SEASONINGS, FLAVOR ENHANCERS USED IN FOOD AND BEVERAGE PRODUCTS, SEASONING MIXES FOR SOUPS, CONCENTRATES USED FOR SEASONING, SEASONING PASTES, IN CLASS 30 (U.S. CL. 46).

FIRST USE 2-0-1939; IN COMMERCE 2-0-1939.

THE MARK CONSISTS OF STANDARD CHARACTERS WITHOUT CLAIM TO ANY PARTICULAR FONT, STYLE, SIZE, OR COLOR.

NO CLAIM IS MADE TO THE EXCLUSIVE RIGHT TO USE "COOK'S", APART FROM THE MARK AS SHOWN.

SN 77-687,711, FILED 3-10-2009.

RICHARD WHITE, EXAMINING ATTORNEY



*David J. Kyffers*

Director of the United States Patent and Trademark Office

United States of America  
United States Patent and Trademark Office

COOK'S  
Delight

**Reg. No. 4,125,801**

**Registered Apr. 10, 2012**

**Int. Cls.: 29 and 30**

**TRADEMARK**

**PRINCIPAL REGISTER**

WILLIAMS WEST & WITT'S PRODUCTS COMPANY D/B/A INTEGRATIVE FLAVORS  
(ILLINOIS CORPORATION), DBA INTEGRATIVE FLAVORS,  
3501 W. DUNES HIGHWAY  
MICHIGAN CITY, IN 46360

FOR: FOOD AND FOOD ITEMS FOR CONSUMPTION, NAMELY, SOUP MIXES, PREPARATIONS FOR MAKING SOUPS, SOUP PASTES, SOUP BASES, FOOD BASES, MEAT PASTES, VEGETABLE PASTES, SEAFOOD PASTES, BOUILLON CONCENTRATES, IN CLASS 29 (U.S. CL. 46).

FIRST USE 3-3-2008; IN COMMERCE 3-3-2008.

FOR: FOOD ITEMS FOR THE IMPROVEMENT OF THE FLAVOR OF FOOD, NAMELY, GRAVY MIXES, SAUCE MIXES, FLAVORINGS, SEASONINGS, FLAVOR ENHANCERS USED IN FOOD AND BEVERAGE PRODUCTS, SEASONING MIXES FOR SOUPS, CONCENTRATES USED FOR SEASONING, SEASONING PASTES, IN CLASS 30 (U.S. CL. 46).

FIRST USE 3-3-2008; IN COMMERCE 3-3-2008.

NO CLAIM IS MADE TO THE EXCLUSIVE RIGHT TO USE "COOK'S", APART FROM THE MARK AS SHOWN.

THE MARK CONSISTS OF THE WORD "COOK'S" ABOVE THE WORD "DELIGHT", INCLUDING STARS, ONE OF WHICH IS THE DOT ON THE "I" IN "DELIGHT" AND WITH A CURVED LINE BELOW.

SN 77-687,718, FILED 3-10-2009.

RICHARD WHITE, EXAMINING ATTORNEY



*David J. Kybas*

Director of the United States Patent and Trademark Office

# United States of America

United States Patent and Trademark Office

## EMPOWERING YOUR LIVING SPACE

**Reg. No. 4,125,802**

**Registered Apr. 10, 2012**

**Int. Cl.: 9**

**TRADEMARK**

**PRINCIPAL REGISTER**

SYNERGY ELEMENTS, INC. (WASHINGTON CORPORATION)  
1111 THIRD AVENUE  
SUITE 3400  
SEATTLE, WA 98101

FOR: COMPUTER SOFTWARE AND HARDWARE FOR DIGITAL MEDIA MANAGEMENT AND DISTRIBUTION; COMPUTER SOFTWARE FOR MANIPULATING DIGITAL AUDIO INFORMATION FOR USE IN AUDIO MEDIA APPLICATIONS; COMPUTER SOFTWARE FOR ORGANIZING AND VIEWING DIGITAL IMAGES AND PHOTOGRAPHS; WIRELESS AND WIRED CONTROLLERS, ELECTRICAL CONTROLLING DEVICES, AND SOFTWARE FOR DIGITAL MEDIA MANAGEMENT, IN CLASS 9 (U.S. CLS. 21, 23, 26, 36 AND 38).

FIRST USE 7-1-2009; IN COMMERCE 7-1-2009.

THE MARK CONSISTS OF STANDARD CHARACTERS WITHOUT CLAIM TO ANY PARTICULAR FONT, STYLE, SIZE, OR COLOR.

SN 77-688,979, FILED 3-11-2009.

ANGELA M. MICHELI, EXAMINING ATTORNEY



*David J. Kybas*

Director of the United States Patent and Trademark Office

# United States of America

United States Patent and Trademark Office

## BE WHO YOU ARE

**Reg. No. 4,125,803**

**Registered Apr. 10, 2012**

**Int. Cl.: 44**

**SERVICE MARK**

**PRINCIPAL REGISTER**

BOBBI BROWN PROFESSIONAL COSMETICS INC. (DELAWARE CORPORATION)  
767 FIFTH AVENUE  
TRADEMARK DEPARTMENT  
NEW YORK, NY 10153

FOR: CONSULTATION SERVICES IN THE FIELD OF MAKEUP, NAMELY, ON-LINE MAKEUP CONSULTATION SERVICES AND IN-PERSON MAKEUP CONSULTATION AND APPLICATION SERVICES, IN CLASS 44 (U.S. CLS. 100 AND 101).

FIRST USE 9-1-2011; IN COMMERCE 9-1-2011.

THE MARK CONSISTS OF STANDARD CHARACTERS WITHOUT CLAIM TO ANY PARTICULAR FONT, STYLE, SIZE, OR COLOR.

SN 77-690,579, FILED 3-13-2009.

REBECCA POVARCHUK, EXAMINING ATTORNEY



*David J. Kybas*

Director of the United States Patent and Trademark Office

# United States of America

United States Patent and Trademark Office



**Reg. No. 4,125,804**

**Registered Apr. 10, 2012**

**Int. Cl.: 32**

JUS WATER INCORPORATED (GUYANA CORPORATION)  
KINGSTON  
1+2 COWAN ST  
GEORGETOWN, GUYANA

FOR: BOTTLED WATER, IN CLASS 32 (U.S. CLS. 45, 46 AND 48).

**TRADEMARK**

FIRST USE 6-0-2009; IN COMMERCE 6-0-2009.

**PRINCIPAL REGISTER**

NO CLAIM IS MADE TO THE EXCLUSIVE RIGHT TO USE "WATER", APART FROM THE MARK AS SHOWN.

THE MARK CONSISTS OF A WATER DROPLET AND SPLASH TO THE LEFT OF THE WORD "JUS" WHICH IS FOLLOWED BY A WATER DROP TO THE RIGHT AND ALL ABOVE THE WORD "WATER".

SN 77-695,364, FILED 3-20-2009.

BRIAN NEVILLE, EXAMINING ATTORNEY



*David J. Kybas*

Director of the United States Patent and Trademark Office

# United States of America

United States Patent and Trademark Office

# A2T

**Reg. No. 4,125,805**

HILL-ROM SERVICES, INC. (DELAWARE CORPORATION)  
1069 STATE ROUTE 46 EAST  
BATESVILLE, IN 470068835

**Registered Apr. 10, 2012**

**Int. Cl.: 9**

FOR: COMPUTER SOFTWARE FOR USE IN HEALTHCARE FACILITIES TO COLLECT, MONITOR, TRANSMIT AND DISPLAY INFORMATION RELATED TO MEDICAL EQUIPMENT AND MEDICAL FACILITY RESOURCE ALLOCATION, UTILIZATION AND STATUS, IN CLASS 9 (U.S. CLS. 21, 23, 26, 36 AND 38).

**TRADEMARK**

**PRINCIPAL REGISTER**

FIRST USE 0-0-2003; IN COMMERCE 0-0-2003.

THE MARK CONSISTS OF STANDARD CHARACTERS WITHOUT CLAIM TO ANY PARTICULAR FONT, STYLE, SIZE, OR COLOR.

SN 77-695,837, FILED 3-20-2009.

ANDREA K. NADELMAN, EXAMINING ATTORNEY



*David J. Kyffers*

Director of the United States Patent and Trademark Office

# United States of America

United States Patent and Trademark Office

# RACE TEC

**Reg. No. 4,125,806**

REUSCH GMBH (FED REP GERMANY CORPORATION)  
EICHENDORFFSTRASSE 5  
72666 NECKARTAILFINGEN, FED REP GERMANY

**Registered Apr. 10, 2012**

**Int. Cl.: 28**

FOR: GLOVES ADAPTED FOR SPECIAL SPORTS NOT INCLUDED IN OTHER CLASSES,  
NAMESLY, GOALKEEPER GLOVES, IN CLASS 28 (U.S. CLS. 22, 23, 38 AND 50).

**TRADEMARK**

FIRST USE 10-1-2010; IN COMMERCE 10-1-2010.

**PRINCIPAL REGISTER**

PRIORITY CLAIMED UNDER SEC. 44(D) ON SWITZERLAND APPLICATION NO. 00165/2009,  
FILED 3-19-2009, REG. NO. 588217, DATED 7-1-2009, EXPIRES 3-19-2019.

THE MARK CONSISTS OF THE WORD "RACE" IN LARGE BOLD STYLIZED PRINT, WITH  
THE WORD "TEC" UNDERNEATH IT IN STYLIZED SMALLER BOLD PRINT.

SN 77-696,246, FILED 3-20-2009.

ELLEN B. AWRICH, EXAMINING ATTORNEY



*David J. Kybas*

Director of the United States Patent and Trademark Office



# United States of America

United States Patent and Trademark Office

## MANCO & MANCO PIZZA

**Reg. No. 4,125,807**

MANCO PIZZA, INC. (NEW JERSEY CORPORATION)  
1302 HARBOUR COVE SOUTH  
SOMERS POINT, NJ 08244

**Registered Apr. 10, 2012**

**Int. Cl.: 43**

FOR: RESTAURANT SERVICES, IN CLASS 43 (U.S. CLS. 100 AND 101).

**SERVICE MARK**

FIRST USE 1-1-2012; IN COMMERCE 1-1-2012.

**PRINCIPAL REGISTER**

THE MARK CONSISTS OF STANDARD CHARACTERS WITHOUT CLAIM TO ANY PARTICULAR FONT, STYLE, SIZE, OR COLOR.

NO CLAIM IS MADE TO THE EXCLUSIVE RIGHT TO USE "PIZZA", APART FROM THE MARK AS SHOWN.

SN 77-698,922, FILED 3-25-2009.

HOWARD B. LEVINE, EXAMINING ATTORNEY



*David J. Kybas*

Director of the United States Patent and Trademark Office

# United States of America

United States Patent and Trademark Office

## THE MOVEMENT IN HIP RESTORATION

**Reg. No. 4,125,808**

PIVOT MEDICAL, INC. (DELAWARE CORPORATION)  
247 HUMBOLDT CT.  
SUNNYVALE, CA 94089

**Registered Apr. 10, 2012**

**Int. Cl.: 10**

FOR: MEDICAL DEVICES, NAMELY, INSTRUMENTS FOR USE IN ARTHROSCOPIC SURGERY, NAMELY, ORTHOPEDIC FIXATION DEVICES, IN CLASS 10 (U.S. CLS. 26, 39 AND 44).

**TRADEMARK**

FIRST USE 3-2-2011; IN COMMERCE 3-2-2011.

**PRINCIPAL REGISTER**

THE MARK CONSISTS OF STANDARD CHARACTERS WITHOUT CLAIM TO ANY PARTICULAR FONT, STYLE, SIZE, OR COLOR.

SN 77-701,293, FILED 3-27-2009.

ASMAT KHAN, EXAMINING ATTORNEY



*David J. Kybas*

Director of the United States Patent and Trademark Office

# United States of America

United States Patent and Trademark Office

## REPOTTINGAMERICA

**Reg. No. 4,125,809**

**Registered Apr. 10, 2012**

**Int. Cls.: 41 and 45**

**SERVICE MARK**

**PRINCIPAL REGISTER**

REPOTTING, LLC (DELAWARE CORPORATION)  
2950 CHAIN BRIDGE ROAD, N.W.  
WASHINGTON, DC 20016

FOR: EDUCATIONAL AND ENTERTAINMENT SERVICES IN THE NATURE OF LECTURES, SEMINARS, AND WORKSHOPS IN THE FIELD OF PERSONAL AND PROFESSIONAL LIFE STRATEGIES, GOALS AND FULFILLMENT, IN CLASS 41 (U.S. CLS. 100, 101 AND 107).

FIRST USE 6-30-2009; IN COMMERCE 6-30-2009.

FOR: PROVIDING INFORMATION AND ADVICE REGARDING PERSONAL LIFE STRATEGIES, GOALS AND FULFILLMENT; PROVIDING A WEBSITE FEATURING INFORMATION ABOUT PERSONAL LIFE STRATEGIES, GOALS AND FULFILLMENT, IN CLASS 45 (U.S. CLS. 100 AND 101).

FIRST USE 6-30-2009; IN COMMERCE 6-30-2009.

THE MARK CONSISTS OF STANDARD CHARACTERS WITHOUT CLAIM TO ANY PARTICULAR FONT, STYLE, SIZE, OR COLOR.

OWNER OF U.S. REG. NO. 3,217,943.

SN 77-703,410, FILED 3-31-2009.

DOMINIC J. FERRAIUOLO, EXAMINING ATTORNEY



*David J. Kyffers*

Director of the United States Patent and Trademark Office

# United States of America

United States Patent and Trademark Office

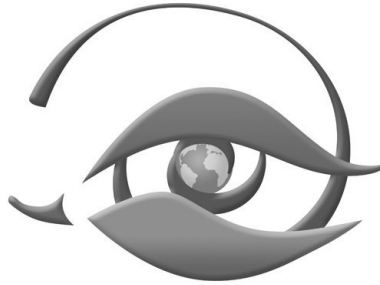

**Reg. No. 4,125,810**

**Registered Apr. 10, 2012**

**Int. Cl.: 41**

**SERVICE MARK**

**PRINCIPAL REGISTER**

GGG CONSCIOUS PRODUCTIONS, LLC (FLORIDA LIMITED LIABILITY COMPANY)  
SUITE 1004  
2627 S. BAYSHORE DRIVE  
COCONUT GROVE, FL 33133

FOR: DIRECTION, PRODUCTION, PROVIDING RATINGS OF CONTENT AND SYNDICATION FOR OTHERS OF AUDIO OR VIDEO SHOWS, INTERVIEWS, LIVE OR PRE-RECORDED, WEBSITE ENTERTAINMENT CONTENT, SUITABLE FOR BROADCAST OVER TELEVISION, RADIO, SATELLITE, CABLE, INTERNET; DISTRIBUTION FOR OTHERS, OF AUDIO OR VIDEO SHOWS, LIVE OR PRE-RECORDED INTERVIEWS VIA TELEVISION, RADIO, SATELLITE, CABLE, INTERNET; EDUCATION SERVICES, NAMELY, PROVIDING CONTINUING EDUCATIONAL SHOWS SUITABLE FOR BROADCAST OVER ALL ELECTRONIC MEDIA, TELEVISION, RADIO, SATELLITE, CABLE, INTERNET IN THE FIELDS OF THE ARTS, MOVIES, MUSIC, BOOKS AND OTHER WRITINGS, NUTRITION, NEW TECHNOLOGY, ENVIRONMENT, SOCIAL AWARENESS, SOCIAL MOVEMENT, SPIRITUAL AWARENESS, BUSINESS ETHICS, PHILANTHROPY, VOLUNTEERING, LOCAL ENTREPRENEURS, GOVERNMENT, SPIRITUALITY, MEDIATION, CULTURE, HEALTH, PHYSICAL FITNESS, MENTAL FITNESS, HOLISTIC LIVING, CONSERVATION, HORTICULTURE, POSITIVE LIFESTYLES, IN CLASS 41 (U.S. CLS. 100, 101 AND 107).

FIRST USE 5-1-2010; IN COMMERCE 5-1-2010.



*David J. Kyros*

Director of the United States Patent and Trademark Office

THE MARK CONSISTS OF A DESIGN, SAID DESIGN COMPRISING THE IMAGE OF A UNIQUE DESIGN OF AN EYE, WHEREIN THE OUTER PERIPHERY OR "EYE SOCKET" IS DEPICTED BY A SPIRALING OUTWARD CIRCULAR-LIKE LINE EXTENDING ALMOST 360 DEGREES AROUND; IN ADDITION, THERE IS DEPICTED AN UPPER EYE LID DEPICTED BY A HORIZONTALLY POSITIONED WAVE-LIKE FORM MORE PARTICULARLY DESCRIBED BY STARTING AT THE INNERMOST POINT OF THE AFOREMENTIONED "EYE-SOCKET" SPIRALING LINE, THEN PROCEEDING HORIZONTALLY TO THE RIGHT AND IN A SINUSOIDAL-LIKE WAVE FORM WITH AN EVER INCREASING CROSS SECTION UNTIL ONE REACHES THE APPROXIMATE CENTER OF THE "EYE" OR DESIGN, WHEREUPON THE CROSS SECTION BEGINS TO RE-NARROW, UNTIL THE "UPPER EYE-LID" TERMINATES ON THE RIGHT SIDE; IN ADDITION, THERE IS DEPICTED A LOWER EYE LID DEPICTED BY A HORIZONTALLY POSITIONED WAVE-LIKE FORM MORE PARTICULARLY DESCRIBED BY STARTING AT THE INNERMOST POINT OF THE AFOREMENTIONED "EYE-SOCKET" SPIRALING LINE, THEN PROCEEDING HORIZONTALLY TO THE RIGHT AND IN A SINUSOIDAL-LIKE WAVE FORM WITH AN EVER IN-

**Reg. No. 4,125,810** CREAMING CROSS SECTION UNTIL ONE REACHES JUST TO THE LEFT OF THE APPROXIMATE CENTER OF THE "EYE" OR DESIGN, WHEREUPON THE CROSS SECTION BEGINS TO RE-NARROW, UNTIL THE "LOWER EYE-LID" TERMINATES ON THE RIGHT SIDE; IN ADDITION, THE EYE'S CENTER OR IRIS IS DEPICTED BY A SPIRALING OUTWARD CIRCULAR-LIKE LINE, OF A SMALLER DIAMETER AND ALMOST CONCENTRIC WITH THE AFOREMENTIONED "EYE-SOCKET" SPIRALING OUTWARD LINE, SAID "IRIS" CIRCULAR-LIKE SPIRALING OUTWARD LINE EXTENDING ALMOST 360 DEGREES AROUND AND TERMINATING ON THE RIGHT SIDE OF THE AFOREMENTIONED "UPPER EYE-LID"; IN ADDITION, THE CENTER CORE OF THE MARK'S EYE DESIGN OR "EYE-PUPIL" CONSISTS OF AN IMAGE OF THE EARTH SHOWING THE NORTH AND SOUTH AMERICAN CONTINENTS; IN ADDITION, THERE IS DEPICTED IN THE LOWER LEFT CORNER OF THE MARK, AN "EYE-DUCT", ILLUSTRATED STARTING AT THE EXTREME LEFT-MOST POINT OF THE MARK AND LOCATED HORIZONTALLY SLIGHTLY LOWER THAN THE CENTER OF THE "EYE-PUPIL", THEN PROCEEDING HORIZONTALLY TO THE RIGHT AND IN A SINUSOIDAL-LIKE WAVE FORM WITH AN EVER INCREASING CROSS SECTION UNTIL ONE REACHES JUST TO THE LEFT OF THE LEFT-MOST POINT OF THE "UPPER-EYE-LID" AND "LOWER-EYE-LID".

SN 77-713,981, FILED 4-14-2009.

EUGENIA MARTIN, EXAMINING ATTORNEY

# United States of America

United States Patent and Trademark Office

# CloudTracks

**Reg. No. 4,125,811**

**Registered Apr. 10, 2012**

**Int. Cl.: 9**

**TRADEMARK**

**PRINCIPAL REGISTER**

PG MUSIC INC. (CANADA CORPORATION)  
29 CADILLAC AVENUE  
VICTORIA, CANADA V8Z1T3

FOR: COMPUTER SOFTWARE FOR THE DELIVERY OF MUSICAL TRACKS CREATED FROM AUDIO SAMPLES OF LIVE PERFORMANCES OF MUSICAL INSTRUMENTS, IN CLASS 9 (U.S. CLS. 21, 23, 26, 36 AND 38).

FIRST USE 1-1-2010; IN COMMERCE 2-1-2012.

THE MARK CONSISTS OF STANDARD CHARACTERS WITHOUT CLAIM TO ANY PARTICULAR FONT, STYLE, SIZE, OR COLOR.

SN 77-715,598, FILED 4-16-2009.

BRENDAN MCCAULEY, EXAMINING ATTORNEY



*David J. Kyffers*

Director of the United States Patent and Trademark Office

# United States of America

United States Patent and Trademark Office

# SYMPHONIX

**Reg. No. 4,125,812**

**Registered Apr. 10, 2012**

**Int. Cl.: 9**

**TRADEMARK**

**PRINCIPAL REGISTER**

GLOUCESTER ENGINEERING CO., INC. (DELAWARE CORPORATION)  
BLACKBURN INDUSTRIAL PARK  
11 DORY ROAD, P.O. BOX 900  
GLOUCESTER, MA 01930

FOR: AUTOMATED PROCESS CONTROL SYSTEM, NAMELY, MICRO-PROCESSOR BASED HARDWARE AND SOFTWARE USED TO MONITOR AND CONTROL INDUSTRIAL MACHINERY USED FOR THE MANUFACTURE OF EXTRUDED PLASTIC FILM; COMPUTER HARDWARE MODULES CONTAINING SOFTWARE FOR PROCESS CONTROL FOR USE IN THE FIELD OF EXTRUDED PLASTIC FILM, IN CLASS 9 (U.S. CLS. 21, 23, 26, 36 AND 38).

FIRST USE 7-29-2011; IN COMMERCE 7-29-2011.

THE MARK CONSISTS OF STANDARD CHARACTERS WITHOUT CLAIM TO ANY PARTICULAR FONT, STYLE, SIZE, OR COLOR.

SN 77-718,469, FILED 4-21-2009.

MICHELLE DUBOIS, EXAMINING ATTORNEY



*David J. Kyros*

Director of the United States Patent and Trademark Office

# United States of America

United States Patent and Trademark Office

## FOUR GREAT CHINESE BEAUTIES

**Reg. No. 4,125,813**

IGT (NEVADA CORPORATION)  
9295 PROTOTYPE DRIVE  
RENO, NV 895218986

**Registered Apr. 10, 2012**

**Int. Cl.: 9**

FOR: GAMING MACHINES, NAMELY, DEVICES WHICH ACCEPT A WAGER, IN CLASS 9 (U.S. CLS. 21, 23, 26, 36 AND 38).

**TRADEMARK**

FIRST USE 11-29-2011; IN COMMERCE 11-29-2011.

**PRINCIPAL REGISTER**

THE MARK CONSISTS OF STANDARD CHARACTERS WITHOUT CLAIM TO ANY PARTICULAR FONT, STYLE, SIZE, OR COLOR.

SN 77-727,562, FILED 5-1-2009.

BERYL GARDNER, EXAMINING ATTORNEY



*David J. Kybas*

Director of the United States Patent and Trademark Office



# United States of America

United States Patent and Trademark Office

# M&K

**Reg. No. 4,125,814**

**Registered Apr. 10, 2012**

**Int. Cls.: 8 and 21**

**TRADEMARK**

**PRINCIPAL REGISTER**

MIKE & KREMMEL LTD. (HONG KONG CORPORATION)  
ROOM 609-616, NEW T&T CENTRE  
HARBOUR CITY, 7 CANTON ROAD, TSIMSHATSUI  
KOWLOON, HONG KONG

FOR: NON-ELECTRIC CAN OPENERS; CUTLERY, NAMELY, KITCHEN KNIVES AND SPOONS; NON-ELECTRIC FOOD SLICERS, PIZZA CUTTERS, NON-ELECTRIC VEGETABLE AND FRUIT PEELERS FOR HOUSEHOLD USE, IN CLASS 8 (U.S. CLS. 23, 28 AND 44).

FIRST USE 3-0-2010; IN COMMERCE 3-0-2010.

FOR: HOUSEHOLD AND KITCHEN UTENSILS, NAMELY, GARLIC PRESSES, JAR OPENERS, MIXING SPOONS, SPATULAS AND KITCHEN TONGS, IN CLASS 21 (U.S. CLS. 2, 13, 23, 29, 30, 33, 40 AND 50).

FIRST USE 3-0-2010; IN COMMERCE 3-0-2010.

THE MARK CONSISTS OF STANDARD CHARACTERS WITHOUT CLAIM TO ANY PARTICULAR FONT, STYLE, SIZE, OR COLOR.

SN 77-739,912, FILED 5-19-2009.

BRIAN CALLAGHAN, EXAMINING ATTORNEY



*David J. Kybas*

Director of the United States Patent and Trademark Office

# United States of America

United States Patent and Trademark Office

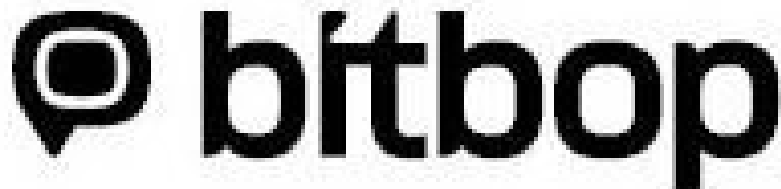
The logo for bitbop features a stylized speech bubble icon on the left, containing a small circle. To the right of the icon, the word "bitbop" is written in a bold, lowercase, sans-serif font.

**Reg. No. 4,125,815**

JESTA DIGITAL, LLC (DELAWARE LIMITED LIABILITY COMPANY)  
6420 WILSHIRE BLVD., SUITE 600  
LOS ANGELES, CA 90048

**Registered Apr. 10, 2012**

**Int. Cl.: 41**

FOR: ENTERTAINMENT SERVICES IN THE NATURE OF PRODUCTION AND DISTRIBUTION TELEVISION PROGRAMS; PROVIDING ON-LINE INFORMATION IN THE FIELD OF TELEVISION AND VIDEO ENTERTAINMENT VIA THE INTERNET, IN CLASS 41 (U.S. CLS. 100, 101 AND 107).

**SERVICE MARK**

**PRINCIPAL REGISTER**

FIRST USE 6-24-2010; IN COMMERCE 6-24-2010.

THE MARK CONSISTS OF AN EMPTY TALK BUBBLE WITH AN INTERIOR RING TO THE LEFT OF THE TERM "BITBOP".

SN 77-745,463, FILED 5-27-2009.

DAWN FELDMAN, EXAMINING ATTORNEY



*David J. Kyffers*

Director of the United States Patent and Trademark Office

# United States of America

United States Patent and Trademark Office



**Reg. No. 4,125,816**

**Registered Apr. 10, 2012**

**Int. Cl.: 25**

**TRADEMARK**

**PRINCIPAL REGISTER**

BONNIE ZOLL (UNITED STATES INDIVIDUAL)  
PO BOX 3485  
CLEARWATER BEACH, FL 33767 AND

RANDY ZOLL (UNITED STATES INDIVIDUAL)  
PO BOX 3485  
CLEARWATER BEACH, FL 33767

FOR: A-SHIRTS; ATHLETIC APPAREL, NAMELY, SHIRTS, PANTS, JACKETS, FOOTWEAR, HATS AND CAPS, ATHLETIC UNIFORMS; ATHLETIC SHOES; BABY TOPS; BALLOON PANTS; BASELAYER TOPS; BASKETBALL SNEAKERS; BATHING COSTUMES FOR WOMEN; BATHING SUITS FOR MEN; BELTS; BELTS FOR CLOTHING; BODY SHIRTS; BRAS; BUTTON-FRONT ALOHA SHIRTS; CAMP SHIRTS; CANVAS SHOES; CAPRI PANTS; CAPS; CARGO PANTS; CHILDREN'S AND INFANT'S APPAREL, NAMELY, JUMPERS, OVERALL SLEEPWEAR, PAJAMAS, ROMPERS AND ONE-PIECE GARMENTS; CHILDREN'S HEADWEAR; CLOTHING FOR ATHLETIC USE, NAMELY, PADDED ELBOW COMPRESSION SLEEVES; CLOTHING FOR ATHLETIC USE, NAMELY, PADDED PANTS; CLOTHING FOR ATHLETIC USE, NAMELY, PADDED SHIRTS; CLOTHING FOR ATHLETIC USE, NAMELY, PADDED SHORTS; CLOTHING FOR WEAR IN JUDO PRACTICES; CLOTHING FOR WEAR IN WRESTLING GAMES; CLOTHING, NAMELY, ARM WARMERS; CLOTHING, NAMELY, BASE LAYERS; CLOTHING, NAMELY, FOLK COSTUMES; CLOTHING, NAMELY, HAND-WARMERS; CLOTHING, NAMELY, KHAKIS; CLOTHING, NAMELY, KNEE WARMERS; CLOTHING, NAMELY, MATERNITY BANDS; CLOTHING, NAMELY, NECK TUBES; CLOTHING, NAMELY, THOBES; CLOTHING, NAMELY, WRAP-AROUNDS; COATS FOR MEN AND WOMEN; CROP TOPS; DENIMS; DRESS SHIRTS; FLEECE SHORTS; FOOTWEAR FOR MEN; FOOTWEAR FOR MEN AND WOMEN; FOOTWEAR FOR WOMEN; GYM PANTS; GYM SHORTS; HALTER TOPS; HEADBANDS AGAINST SWEATING; HOODED PULLOVERS; HOODED SWEAT SHIRTS; HOODS; HOODS; INFANT AND TODDLER ONE PIECE CLOTHING; INFANTS' SHOES AND BOOTS; JERSEYS; JOGGING PANTS; KNIT SHIRTS; LEATHER BELTS; LEATHER SHOES; LONG-SLEEVED SHIRTS; MEN'S AND WOMEN'S JACKETS, COATS, TROUSERS, VESTS; MEN'S SOCKS; MEN'S SUITS; MEN'S SUITS, WOMEN'S SUITS; MEN'S UNDERWEAR; MOISTURE-WICKING SPORTS BRAS; MOISTURE-WICKING SPORTS SHIRTS; MUSCLE TOPS; NIGHT SHIRTS; OPEN-NECKED SHIRTS; OVER SHIRTS; PANTIES, SHORTS AND BRIEFS; PANTS; PETTI-PANTS; PIQUE SHIRTS; POLO SHIRTS; RUGBY SHIRTS; RUGBY SHORTS; RUGBY TOPS; SHIRTS; SHIRTS FOR SUITS; SHOES; SHORT SETS; SHORT TROUSERS; SHORT-SLEEVED OR LONG-SLEEVED T-SHIRTS; SHORT-SLEEVED SHIRTS; SHORTS; SHOULDER WRAPS; SLEEP



*David J. Kybas*

Director of the United States Patent and Trademark Office

**Reg. No. 4,125,816** SHIRTS; SLIDING SHORTS; SNEAKERS; SPORT SHIRTS; SPORTS BRA; SPORTS BRAS; SPORTS PANTS; SPORTS SHIRTS; SPORTS SHIRTS WITH SHORT SLEEVES; STRETCH PANTS; SUSPENDER BELTS FOR MEN; SUSPENDER BELTS FOR WOMEN; SWEAT BANDS; SWEAT JACKETS; SWEAT PANTS; SWEAT SHIRTS; SWEAT SHORTS; SWEAT SUITS; T-SHIRTS; TANK TOPS; TANK-TOPS; TEE SHIRTS; TIES; TOP COATS; TOPS; TRACK PANTS; TRAINING SHOES; TRAVEL CLOTHING CONTAINED IN A PACKAGE COMPRISING REVERSIBLE JACKETS, PANTS, SKIRTS, TOPS AND A BELT OR SCARF; TRIATHLON CLOTHING, NAMELY, TRIATHLON TIGHTS, TRIATHLON SHORTS, TRIATHLON SINGLET, TRIATHLON SHIRTS, TRIATHLON SUITS; TUBE TOPS; TURTLE NECK SHIRTS; UNDER GARMENTS; UNDERWEAR, NAMELY, BOY SHORTS; WALKING SHORTS; WATERPROOF JACKETS AND PANTS; WEARABLE GARMENTS AND CLOTHING, NAMELY, SHIRTS; WIND PANTS; WIND SHIRTS; WOMEN'S SHOES; WOMEN'S UNDERWEAR; WRAPS, IN CLASS 25 (U.S. CLS. 22 AND 39).

FIRST USE 12-14-2010; IN COMMERCE 1-22-2011.

OWNER OF U.S. REG. NO. 3,655,339.

THE COLOR(S) BLACK, WHITE, GRAY AND ORANGE IS/ARE CLAIMED AS A FEATURE OF THE MARK.

THE NAME(S), PORTRAIT(S), AND/OR SIGNATURE(S) SHOWN IN THE MARK DOES NOT IDENTIFY A PARTICULAR LIVING INDIVIDUAL.

THE MARK CONSISTS OF A MAN, OUTLINED IN ORANGE, STANDING ON A BLACK BACKGROUND. THE MAN WEARS A SLEEVELESS T-SHIRT AND SHORTS. THE COLORS BLACK, GRAY AND WHITE APPEAR IN THE SLEEVELESS T-SHIRT AND SHORTS. THE MAN WEARS SHOES AND SOCKS, THE COLOR BLACK AND WHITE APPEAR IN THE SHOES AND SOCKS. THE COLORS WHITE, BLACK AND GRAY APPEAR ON THE MAN'S EXPOSED SKIN. THE MAN HOLDS IN HIS LEFT HAND A BASKETBALL, THE COLORS ORANGE AND BLACK APPEAR ON THE BASKETBALL, THE BASKETBALL IS LOCATED NEAR HIS LEFT HIP. THE MAN'S LOWER LEFT ARM HAS A BLACK AND GRAY ARM BAND. THE MAN'S RIGHT HAND IS EXTENDED WITH THREE FINGERS HELD OUT. THE NUMBER "3", IN WHITE, WITH A HAND, IN WHITE, HOLDING UP THREE FINGERS APPEARS ON THE LOWER RIGHT CUFF OF THE MAN'S SHORTS. THE WORDS "TREY MAN", IN ORANGE, APPEAR IN A WHITE BOX JUST UNDER THE MAN'S LEFT KNEE.

SN 77-745,489, FILED 5-27-2009.

STEVEN PEREZ, EXAMINING ATTORNEY

# United States of America

United States Patent and Trademark Office

A Q U A  C H E M

**Reg. No. 4,125,817**

**Registered Apr. 10, 2012**

**Int. Cls.: 1 and 11**

**TRADEMARK**

**PRINCIPAL REGISTER**

AQUA-CHEM, INC. (DELAWARE CORPORATION)  
3001 E. JOHN SEVIER HWY  
KNOXVILLE, TN 37914

FOR: CHEMICAL PRODUCTS FOR USE IN SEPARATION, CONCENTRATION, DEMINERALIZATION AND PURIFICATION OF FLUIDS, IN CLASS 1 (U.S. CLS. 1, 5, 6, 10, 26 AND 46).

FIRST USE 4-4-2010; IN COMMERCE 4-4-2010.

FOR: FLUID PURIFICATION, SEPARATION AND CONCENTRATION UNITS UTILIZING EVAPORATION, DISTILLATION AND/OR MEMBRANE PROCESSES AND STRUCTURAL PARTS THEREOF, IN CLASS 11 (U.S. CLS. 13, 21, 23, 31 AND 34).

FIRST USE 4-4-2010; IN COMMERCE 4-4-2010.

OWNER OF U.S. REG. NOS. 766,376 AND 1,307,927.

THE MARK CONSISTS OF THREE CIRCLES BETWEEN THE WORDS "AQUA CHEM".

SN 77-750,206, FILED 6-2-2009.

ALICIA COLLINS, EXAMINING ATTORNEY



*David J. Kyjars*

Director of the United States Patent and Trademark Office

# United States of America

United States Patent and Trademark Office

## Noches de Tropicana

**Reg. No. 4,125,818**

**Registered Apr. 10, 2012**

**Int. Cl.: 38**

**SERVICE MARK**

**PRINCIPAL REGISTER**

GLR SERVICES, INC. (DELAWARE CORPORATION)  
SUITE 700  
4770 BISCAYNE BLVD.  
MIAMI, FL 33137

FOR: BROADCASTING OF RADIO PROGRAMMES; RADIO PROGRAM BROADCASTING,  
IN CLASS 38 (U.S. CLS. 100, 101 AND 104).

FIRST USE 2-2-2009; IN COMMERCE 2-2-2009.

THE MARK CONSISTS OF STANDARD CHARACTERS WITHOUT CLAIM TO ANY PAR-  
TICULAR FONT, STYLE, SIZE, OR COLOR.

NO CLAIM IS MADE TO THE EXCLUSIVE RIGHT TO USE "NOCHES", APART FROM THE  
MARK AS SHOWN.

THE ENGLISH TRANSLATION OF "NOCHES DE TROPICANA" IN THE MARK IS "TROP-  
ICANA NIGHTS".

SN 77-752,147, FILED 6-4-2009.

KHANH LE, EXAMINING ATTORNEY



*David J. Kybas*

Director of the United States Patent and Trademark Office

# United States of America

United States Patent and Trademark Office

# V-GO

**Reg. No. 4,125,819**

**Registered Apr. 10, 2012**

**Int. Cl.: 10**

**TRADEMARK**

**PRINCIPAL REGISTER**

VALERITAS, INC. (DELAWARE CORPORATION)  
SUITE 100  
750 ROUTE 202 SOUTH  
BRIDGEWATER, NJ 08807

FOR: MEDICAL APPARATUS, NAMELY, INFUSION AND INJECTION DEVICES FOR ADMINISTERING DRUGS, IN CLASS 10 (U.S. CLS. 26, 39 AND 44).

FIRST USE 1-3-2012; IN COMMERCE 1-3-2012.

THE MARK CONSISTS OF STANDARD CHARACTERS WITHOUT CLAIM TO ANY PARTICULAR FONT, STYLE, SIZE, OR COLOR.

SN 77-752,694, FILED 6-4-2009.

ELLEN B. AWRICH, EXAMINING ATTORNEY



*David J. Kyffers*

Director of the United States Patent and Trademark Office

# United States of America

United States Patent and Trademark Office

# GhostRunner

**Reg. No. 4,125,820**

GUSTAFSON, JIM (UNITED STATES INDIVIDUAL)  
4177 CHARLESTON TRAIL  
SMYRNA, GA 30080

**Registered Apr. 10, 2012**

**Int. Cl.: 9**

FOR: COMPUTER GAME SOFTWARE, IN CLASS 9 (U.S. CLS. 21, 23, 26, 36 AND 38).

**TRADEMARK**

FIRST USE 1-8-2011; IN COMMERCE 1-8-2011.

**PRINCIPAL REGISTER**

THE MARK CONSISTS OF STANDARD CHARACTERS WITHOUT CLAIM TO ANY PARTICULAR FONT, STYLE, SIZE, OR COLOR.

SN 77-753,012, FILED 6-5-2009.

ROBIN CHOSID, EXAMINING ATTORNEY



*David J. Kyffers*

Director of the United States Patent and Trademark Office



# United States of America

United States Patent and Trademark Office

# SIBICS

**Reg. No. 4,125,821**

**Registered Apr. 10, 2012**

**Int. Cl.: 9**

**TRADEMARK**

**PRINCIPAL REGISTER**

NOL-TEC SYSTEMS SOUTHEAST (NORTH CAROLINA CORPORATION)  
901 BLAIRHILL ROAD, SUITE 500  
CHARLOTTE, NC 28217

FOR: INDUSTRIAL CRANE AND POSITIONING SOLUTION, NAMELY, POSITION LOOP  
CONTROLLER SOFTWARE, IN CLASS 9 (U.S. CLS. 21, 23, 26, 36 AND 38).

FIRST USE 7-1-2009; IN COMMERCE 7-1-2009.

THE MARK CONSISTS OF STANDARD CHARACTERS WITHOUT CLAIM TO ANY PAR-  
TICULAR FONT, STYLE, SIZE, OR COLOR.

SN 77-756,082, FILED 6-10-2009.

IRA J. GOODSaid, EXAMINING ATTORNEY



*David J. Kyffers*

Director of the United States Patent and Trademark Office

# United States of America

United States Patent and Trademark Office

## SUPER FUSION 7S

**Reg. No. 4,125,822**

IGT (NEVADA CORPORATION)  
9295 PROTOTYPE DRIVE  
RENO, NV 895218986

**Registered Apr. 10, 2012**

**Int. Cl.: 9**

FOR: GAMING MACHINES, NAMELY, DEVICES WHICH ACCEPT A WAGER, IN CLASS 9 (U.S. CLS. 21, 23, 26, 36 AND 38).

**TRADEMARK**

FIRST USE 1-6-2012; IN COMMERCE 1-6-2012.

**PRINCIPAL REGISTER**

THE MARK CONSISTS OF STANDARD CHARACTERS WITHOUT CLAIM TO ANY PARTICULAR FONT, STYLE, SIZE, OR COLOR.

NO CLAIM IS MADE TO THE EXCLUSIVE RIGHT TO USE "7S", APART FROM THE MARK AS SHOWN.

SN 77-758,127, FILED 6-12-2009.

KHANH LE, EXAMINING ATTORNEY



*David J. Kybas*

Director of the United States Patent and Trademark Office

# United States of America

United States Patent and Trademark Office



**Reg. No. 4,125,823**

**Registered Apr. 10, 2012**

**Int. Cls.: 7 and 9**

**TRADEMARK**

**PRINCIPAL REGISTER**

SERVICIOS CONDUMEX, S.A. DE C.V. (MEXICO CORPORATION)  
MIGUEL DE CERVANTES SAAVEDRA NO. 255  
COL. GRANADA  
MEXICO CITY, MEXICO 11520

FOR: MACHINES PARTS, NAMELY, BUSHINGS; FANS FOR MOTORS AND ENGINES; MOTORS AND ENGINES EXCEPT FOR LAND VEHICLES; MACHINE COUPLINGS AND TRANSMISSION COMPONENTS EXCEPT FOR LAND VEHICLES; INCUBATORS FOR EGGS, IN CLASS 7 (U.S. CLS. 13, 19, 21, 23, 31, 34 AND 35).

FIRST USE 8-25-2003; IN COMMERCE 8-25-2003.

FOR: SCIENTIFIC, NAUTICAL, SURVEYING, PHOTOGRAPHIC, CINEMATOGRAPHIC, OPTICAL, WEIGHING, MEASURING, SIGNALING, CHECKING (SUPERVISION), LIFE-SAVING AND TEACHING APPARATUS AND INSTRUMENTS, NAMELY, CAMERAS; APPARATUS AND INSTRUMENTS FOR CONDUCTING, SWITCHING, TRANSFORMING, ACCUMULATING, REGULATING OR CONTROLLING ELECTRICITY, NAMELY, CONDUITS, SWITCHES, REGULATORS AND CIRCUIT BREAKERS; APPARATUS FOR RECORDING, TRANSMISSION OR REPRODUCTION OF SOUND OR IMAGES, NAMELY, BLANK MAGNETIC DATA CARRIERS; BLANK RECORDING DISCS; AUTOMATIC VENDING MACHINES AND MECHANISMS FOR COIN-OPERATED APPARATUS; CASH REGISTERS, CALCULATING MACHINES, DATA PROCESSING EQUIPMENT AND COMPUTERS; FIRE-EXTINGUISHING APPARATUS; AND TRANSFORMERS; ELECTRICAL REACTORS AND MOBILE POWER SUBSTATIONS; PRESSURE GAUGES, SHUNT PHASE SHIFTERS; GAS DETECTORS FOR DETECTING THE PRESENCE OF GAS, IN CLASS 9 (U.S. CLS. 21, 23, 26, 36 AND 38).

FIRST USE 8-25-2003; IN COMMERCE 8-25-2003.

THE MARK CONSISTS OF THE LETTERS "IEM" OVER A DESIGN BLOCK.

SN 77-762,139, FILED 6-17-2009.

KIMBERLY PERRY, EXAMINING ATTORNEY



*David J. Kyffers*

Director of the United States Patent and Trademark Office

# United States of America

United States Patent and Trademark Office

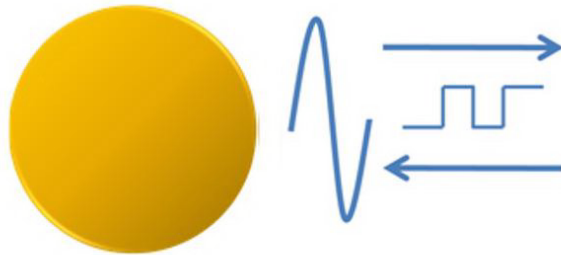

**Reg. No. 4,125,824**

**Registered Apr. 10, 2012**

**Int. Cl.: 9**

**TRADEMARK**

**PRINCIPAL REGISTER**

DIRECT GRID TECHNOLOGIES LLC (NEW YORK LIMITED LIABILITY COMPANY)  
131 HEARTLAND BLVD.  
EDGEWOOD, NY 11717

FOR: POWER INVERTERS, WITH POWER LINE PHASE SENSING DETECTING AND POWER OUTPUT PHASE SYNCHRONIZATION CIRCUITRY, FOR USE IN LIGHT INDUSTRIAL AND RESIDENTIAL APPLICATIONS, IN CLASS 9 (U.S. CLS. 21, 23, 26, 36 AND 38).

FIRST USE 7-1-2009; IN COMMERCE 7-1-2009.

THE MARK CONSISTS OF A REPRESENTATION OF THE SUN IN GOLD, FOLLOWED TO THE RIGHT BY A SINE WAVE PATTERN IN BLUE, LASTLY FOLLOWED BY A SQUARE WAVE PATTERN, IN BLUE, WITH ARROWS, ALSO IN BLUE, PARALLEL TO AND SITUATED ABOVE AND BELOW THE SQUARE WAVE PATTERN AND POINTING IN OPPOSITE DIRECTIONS.

THE COLOR(S) GOLD AND BLUE IS/ARE CLAIMED AS A FEATURE OF THE MARK.

SN 77-763,133, FILED 6-18-2009.

SALLY SHIH, EXAMINING ATTORNEY



*David J. Kyffers*

Director of the United States Patent and Trademark Office

# United States of America

United States Patent and Trademark Office

# BLOOMSPOT

**Reg. No. 4,125,825**

**Registered Apr. 10, 2012**

**Int. Cls.: 35 and 38**

**SERVICE MARK**

**PRINCIPAL REGISTER**

BLOOMSPOT, INC. (DELAWARE CORPORATION)  
345 RITCH STREET  
SAN FRANCISCO, CA 94107

FOR: PROVIDING AN INTERNET WEBSITE TO THE PUBLIC THAT PROVIDES ACCESS TO INFORMATION, NAMELY, PROVIDING CONSUMER INFORMATION ON PRODUCTS AND SERVICES OF OTHERS AND RECOMMENDATIONS ON PRODUCTS AND SERVICES OF OTHERS, IN CLASS 35 (U.S. CLS. 100, 101 AND 102).

FIRST USE 1-31-2010; IN COMMERCE 1-31-2010.

FOR: PROVIDING A TELECOMMUNICATIONS SERVICE, NAMELY, PROVIDING TELECOMMUNICATIONS ACCESS TO THE PUBLIC THROUGH AN INTERNET WEBSITE TO HOSTED BLOGS AND A SOURCE FOR EMAIL MESSAGES THAT ARE TRANSMITTED TO THE PUBLIC AND PROVIDING TELECOMMUNICATIONS ACCESS TO LISTINGS OF INTERNET WEBSITE HYPERLINKS TO OTHER INTERNET WEBSITES OFFERING PRODUCTS AND SERVICES, IN CLASS 38 (U.S. CLS. 100, 101 AND 104).

FIRST USE 1-31-2010; IN COMMERCE 1-31-2010.

THE MARK CONSISTS OF STANDARD CHARACTERS WITHOUT CLAIM TO ANY PARTICULAR FONT, STYLE, SIZE, OR COLOR.

SN 77-763,945, FILED 6-19-2009.

ADA HAN, EXAMINING ATTORNEY



*David J. Kybas*

Director of the United States Patent and Trademark Office

# United States of America

United States Patent and Trademark Office

## PUSS IN BOOTS

**Reg. No. 4,125,826**

DREAMWORKS ANIMATION L.L.C. (DELAWARE LIMITED LIABILITY COMPANY)  
1000 FLOWER STREET  
GLENDALE, CA 91201

**Registered Apr. 10, 2012**

**Int. Cls.: 9, 16, and 25**

FOR: VIDEO GAME CARTRIDGES AND PRERECORDED CDS FEATURING MUSIC AND MOTION PICTURE SOUND TRACKS , IN CLASS 9 (U.S. CLS. 21, 23, 26, 36 AND 38).

**TRADEMARK**

FIRST USE 10-28-2011; IN COMMERCE 10-28-2011.

**PRINCIPAL REGISTER**

FOR: CHILDREN'S ACTIVITY BOOKS, CHILDREN'S STORYBOOKS, COLORING BOOKS, WIRE-BOUND NOTEBOOKS, CALENDARS, STICKERS, TEMPORARY TATTOOS AND GREETING CARDS, IN CLASS 16 (U.S. CLS. 2, 5, 22, 23, 29, 37, 38 AND 50).

FIRST USE 10-28-2011; IN COMMERCE 10-28-2011.

FOR: SHIRTS AND PAJAMAS, IN CLASS 25 (U.S. CLS. 22 AND 39).

FIRST USE 10-28-2011; IN COMMERCE 10-28-2011.

THE MARK CONSISTS OF STANDARD CHARACTERS WITHOUT CLAIM TO ANY PARTICULAR FONT, STYLE, SIZE, OR COLOR.

OWNER OF U.S. REG. NO. 2,965,384.

SN 77-765,548, FILED 6-22-2009.

GISELLE AGOSTO, EXAMINING ATTORNEY



*David J. Kybas*

Director of the United States Patent and Trademark Office

# United States of America

United States Patent and Trademark Office



**Reg. No. 4,125,827**

PHILADELPHIA 76ERS L.P. (DELAWARE LIMITED PARTNERSHIP)

**Registered Apr. 10, 2012**

3601 S. BROAD STREET  
PHILADELPHIA, PA 19148

**Int. Cl.: 41**

**SERVICE MARK**

**PRINCIPAL REGISTER**

FOR: ENTERTAINMENT AND EDUCATIONAL SERVICES IN THE NATURE OF ONGOING TELEVISION AND RADIO PROGRAMS IN THE FIELD OF BASKETBALL AND RENDERING LIVE BASKETBALL GAMES AND BASKETBALL EXHIBITIONS; THE PRODUCTION AND DISTRIBUTION OF RADIO AND TELEVISION SHOWS FEATURING BASKETBALL GAMES, BASKETBALL EVENTS AND PROGRAMS IN THE FIELD OF BASKETBALL; CONDUCTING AND ARRANGING BASKETBALL CLINICS AND CAMPS, COACHES CLINICS AND CAMPS, DANCE TEAM CLINICS AND CAMPS AND BASKETBALL GAMES; ENTERTAINMENT SERVICES IN THE NATURE OF PERSONAL APPEARANCES BY A COSTUMED MASCOT OR DANCE TEAM AT BASKETBALL GAMES AND EXHIBITIONS, CLINICS, CAMPS, PROMOTIONS, AND OTHER BASKETBALL-RELATED EVENTS, SPECIAL EVENTS AND PARTIES; FAN CLUB SERVICES; ENTERTAINMENT SERVICES, NAMELY, PROVIDING A WEBSITE FEATURING NON-DOWNLOADABLE MULTIMEDIA MATERIAL IN THE NATURE OF TELEVISION HIGHLIGHTS, INTERACTIVE TELEVISION HIGHLIGHTS, VIDEO RECORDINGS, VIDEO STREAM RECORDINGS, INTERACTIVE VIDEO HIGHLIGHT SELECTIONS, RADIO PROGRAMS, RADIO HIGHLIGHTS, AND AUDIO RECORDINGS IN THE FIELD OF BASKETBALL; PROVIDING NEWS AND INFORMATION IN THE NATURE OF STATISTICS AND TRIVIA IN THE FIELD OF BASKETBALL; ON-LINE NON-DOWNLOADABLE GAMES, NAMELY, COMPUTER GAMES, VIDEO GAMES, INTERACTIVE VIDEO GAMES, ACTION SKILL GAMES, ARCADE GAMES, ADULTS' AND CHILDREN'S PARTY GAMES, BOARD GAMES, PUZZLES, AND TRIVIA GAMES; ELECTRONIC PUBLISHING SERVICES, NAMELY, PUBLICATION OF MAGAZINES, GUIDES, NEWSLETTERS, COLORING BOOKS, AND GAME SCHEDULES OF OTHERS ON-LINE THROUGH THE INTERNET, ALL IN THE FIELD OF BASKETBALL; PROVIDING AN ONLINE COMPUTER DATABASE IN THE FIELD OF BASKETBALL; ENTERTAINMENT SERVICES, NAMELY, PROVIDING INTERACTIVE VIDEO GAMES AND TRIVIA GAME SOFTWARE PROVIDED OVER THE INTERNET, IN CLASS 41 (U.S. CLS. 100, 101 AND 107).



FIRST USE 10-6-2009; IN COMMERCE 10-6-2009.

*David J. Kappas*

OWNER OF U.S. REG. NOS. 1,152,695, 1,987,275, AND OTHERS.

SEC. 2(F) AS TO "PHILADELPHIA".

**Reg. No. 4,125,827** THE MARK CONSISTS OF A DEPICTION OF A BASKETBALL AND A RING OF STARS WITH THE WORDS "76ERS" SURROUNDED BY A SQUARE BORDER AND ABOVE A BAND WITH THE WORD "PHILADELPHIA".

SN 77-767,002, FILED 6-24-2009.

JOHN WILKE, EXAMINING ATTORNEY



# United States of America

United States Patent and Trademark Office

## I've got the cooler!

**Reg. No. 4,125,828**

**Registered Apr. 10, 2012**

**Int. Cl.: 25**

**TRADEMARK**

**PRINCIPAL REGISTER**

STEVENS, VIRGINIA L. (UNITED STATES INDIVIDUAL)  
26 MANNING STREET  
IPSWICH, MA 01938 AND

DANIELSON JR., LELAND G. (UNITED STATES INDIVIDUAL)  
26 MANNING STREET  
IPSWICH, MA 01938

FOR: T-SHIRTS, IN CLASS 25 (U.S. CLS. 22 AND 39).

FIRST USE 6-1-2010; IN COMMERCE 6-1-2010.

THE MARK CONSISTS OF STANDARD CHARACTERS WITHOUT CLAIM TO ANY PARTICULAR FONT, STYLE, SIZE, OR COLOR.

SN 77-767,521, FILED 6-24-2009.

LEIGH CAROLINE CASE, EXAMINING ATTORNEY



*David J. Kybas*

Director of the United States Patent and Trademark Office

# United States of America

United States Patent and Trademark Office



## Fit4All Families

**Reg. No. 4,125,829**

**Registered Apr. 10, 2012**

**Int. Cls.: 41 and 44**

**SERVICE MARK**

**PRINCIPAL REGISTER**

ALL CHILDREN'S HOSPITAL, INC. (FLORIDA NON-PROFIT CORPORATION)  
801 SIXTH STREET SOUTH  
ST. PETERSBURG, FL 33701

FOR: COUNSELING SERVICES IN THE FIELD OF PHYSICAL FITNESS; PHYSICAL FITNESS INSTRUCTION, IN CLASS 41 (U.S. CLS. 100, 101 AND 107).

FIRST USE 2-21-2011; IN COMMERCE 2-21-2011.

FOR: HEALTH CARE RELATED SERVICES FOR CHILDREN AND FAMILIES IN THE FIELD OF WEIGHT MANAGEMENT; PREVENTION SERVICES FOR THE HEALTH AND WELLNESS OF FAMILIES, NAMELY, MEDICAL COUNSELING SERVICES IN THE FIELD OF FITNESS AND WEIGHT MANAGEMENT, IN CLASS 44 (U.S. CLS. 100 AND 101).

FIRST USE 2-21-2011; IN COMMERCE 2-21-2011.

OWNER OF U.S. REG. NOS. 1,908,977, 1,972,375, AND 3,474,889.

THE COLOR(S) BLUE, PURPLE, ORANGE, YELLOW, RED, AND PINK IS/ARE CLAIMED AS A FEATURE OF THE MARK.

NO CLAIM IS MADE TO THE EXCLUSIVE RIGHT TO USE "CHILDREN'S HOSPITAL", APART FROM THE MARK AS SHOWN.

THE MARK CONSISTS OF THE STYLIZED TERM "ALL CHILDREN'S HOSPITAL" AND A FANCIFUL REPRESENTATION OF THREE "CHILDREN" IN BLUE; SEVEN SQUARES UNDERNEATH IN PURPLE, ORANGE, BLUE, YELLOW, RED, PINK, AND BLUE; AND THE STYLIZED TERM "FIT4ALLFAMILIES" IN BLUE.

SN 77-769,035, FILED 6-26-2009.

JIM RINGLE, EXAMINING ATTORNEY



*David J. Kybas*

Director of the United States Patent and Trademark Office

# United States of America

United States Patent and Trademark Office

# ABBA

**Reg. No. 4,125,830**

**Registered Apr. 10, 2012**

**Int. Cl.: 16**

**TRADEMARK**

**PRINCIPAL REGISTER**

POLAR MUSIC INTERNATIONAL A.B. (SWEDEN CORPORATION)  
BANERGATEN 16  
STOCKHOLM, SWEDEN 11483

FOR: BOOKS AND MAGAZINES IN THE FIELDS OF MUSIC, ENTERTAINMENT, ART AND/OR CULTURE; ADDRESS BOOKS; APPOINTMENT BOOKS; CALENDARS; GREETING CARDS; POST CARDS; PEN AND PENCIL CASES; PENCIL SHARPENERS; PENS; PENCILS; DATE BOOKS; BUMPER STICKERS; DECALS; NOTE PADS; STICKERS; POSTERS; TRADING CARDS; STATIONERY, IN CLASS 16 (U.S. CLS. 2, 5, 22, 23, 29, 37, 38 AND 50).

FIRST USE 8-17-1974; IN COMMERCE 8-17-1974.

THE MARK CONSISTS OF STANDARD CHARACTERS WITHOUT CLAIM TO ANY PARTICULAR FONT, STYLE, SIZE, OR COLOR.

OWNER OF U.S. REG. NOS. 1,072,394, 1,072,398, AND 3,389,319.

SN 77-770,150, FILED 6-29-2009.

JOHN DALIER, EXAMINING ATTORNEY



*David J. Kybas*

Director of the United States Patent and Trademark Office

# United States of America

United States Patent and Trademark Office

# EVALUES

**Reg. No. 4,125,831**

WAL-MART STORES, INC. (DELAWARE CORPORATION)  
702 SW 8TH STREET  
BENTONVILLE, AR 727160520

**Registered Apr. 10, 2012**

**Int. Cl.: 35**

FOR: PROMOTING THE GOODS OF OTHERS, NAMELY, PROVIDING INFORMATION REGARDING DISCOUNTS, COUPONS, REBATES, VOUCHERS AND SPECIAL OFFERS FOR THE GOODS OF OTHERS; RETAIL STORE SERVICES FEATURING A WIDE VARIETY OF CONSUMER GOODS OF OTHERS, IN CLASS 35 (U.S. CLS. 100, 101 AND 102).

**SERVICE MARK**

**PRINCIPAL REGISTER**

FIRST USE 6-30-2009; IN COMMERCE 6-30-2009.

THE MARK CONSISTS OF STANDARD CHARACTERS WITHOUT CLAIM TO ANY PARTICULAR FONT, STYLE, SIZE, OR COLOR.

SN 77-770,673, FILED 6-29-2009.

VERNA BETH RIRIE, EXAMINING ATTORNEY



*David J. Kyffers*

Director of the United States Patent and Trademark Office

United States of America  
United States Patent and Trademark Office

# REZOLVE

**Reg. No. 4,125,832**

REVA MEDICAL, INC. (CALIFORNIA CORPORATION)  
5751 COPLEY DRIVE, SUITE B  
SAN DIEGO, CA 92111

**Registered Apr. 10, 2012**

**Int. Cl.: 10**

FOR: STENTS, IN CLASS 10 (U.S. CLS. 26, 39 AND 44).

**TRADEMARK**

FIRST USE 12-21-2011; IN COMMERCE 12-21-2011.

**PRINCIPAL REGISTER**

THE MARK CONSISTS OF STANDARD CHARACTERS WITHOUT CLAIM TO ANY PARTICULAR FONT, STYLE, SIZE, OR COLOR.

SN 77-771,645, FILED 6-30-2009.

EUGENIA MARTIN, EXAMINING ATTORNEY



*David J. Kybas*

Director of the United States Patent and Trademark Office

# United States of America

United States Patent and Trademark Office

The logo for UltraGuard Filtration Systems. The word "UltraGuard" is written in a large, bold, sans-serif font. Below it, the words "FILTRATION SYSTEMS" are written in a smaller, all-caps, sans-serif font. The entire logo is enclosed in a thin rectangular border.

**Reg. No. 4,125,833**

**Registered Apr. 10, 2012**

**Int. Cl.: 11**

**TRADEMARK**

**PRINCIPAL REGISTER**

TST WATER LLC (CALIFORNIA LIMITED LIABILITY COMPANY)  
42188 RIO NEDO  
UNIT B  
TEMECULA, CA 92590

FOR: MEMBRANE FILTERS FOR SALE TO, AND USE BY, THE DRINKING WATER TREATMENT INDUSTRY, IN CLASS 11 (U.S. CLS. 13, 21, 23, 31 AND 34).

FIRST USE 6-27-2009; IN COMMERCE 9-21-2010.

NO CLAIM IS MADE TO THE EXCLUSIVE RIGHT TO USE "FILTRATION SYSTEMS", APART FROM THE MARK AS SHOWN.

THE MARK CONSISTS OF THE STYLIZED WORD "ULTRAGUARD" ALONG WITH THE WORDS "FILTRATION SYSTEMS".

SN 77-772,404, FILED 7-1-2009.

RAUL CORDOVA, EXAMINING ATTORNEY



*David J. Kyros*

Director of the United States Patent and Trademark Office

# United States of America

United States Patent and Trademark Office

# BED SOK

**Reg. No. 4,125,834**

MORGAN COLLECTION, INC. (NEW YORK CORPORATION)  
31 SOUTH STREET  
MOUNT VERNON, NY 10550

**Registered Apr. 10, 2012**

**Int. Cl.: 24**

FOR: BED SKIRTS; PILLOW-TOP, LOW-PROFILE BED SKIRTS, IN CLASS 24 (U.S. CLS. 42 AND 50).

**TRADEMARK**

FIRST USE 3-11-2011; IN COMMERCE 3-11-2011.

**PRINCIPAL REGISTER**

THE MARK CONSISTS OF STANDARD CHARACTERS WITHOUT CLAIM TO ANY PARTICULAR FONT, STYLE, SIZE, OR COLOR.

NO CLAIM IS MADE TO THE EXCLUSIVE RIGHT TO USE "BED", APART FROM THE MARK AS SHOWN.

SN 77-775,347, FILED 7-7-2009.

MIDGE BUTLER, EXAMINING ATTORNEY



*David J. Kybas*

Director of the United States Patent and Trademark Office

# United States of America

United States Patent and Trademark Office

## STATUS NOW

**Reg. No. 4,125,835**

VELOCITY FULFILLMENT SERVICES, INC. (ARIZONA CORPORATION)  
4936 SOUTH ASH AVENUE  
TEMPE, AZ 85282

**Registered Apr. 10, 2012**

**Int. Cl.: 35**

FOR: PROCESSING MANUFACTURER'S REBATES; PROMOTING THE GOODS OF OTHERS, NAMELY, PROVIDING COUPONS, REBATES AND VOUCHERS FOR THE GOODS OF OTHERS; PROMOTING THE GOODS OF OTHERS, NAMELY, PROVIDING INFORMATION REGARDING DISCOUNTS, COUPONS, REBATES, VOUCHERS AND SPECIAL OFFERS FOR THE GOODS OF OTHERS, IN CLASS 35 (U.S. CLS. 100, 101 AND 102).

**SERVICE MARK**

**PRINCIPAL REGISTER**

FIRST USE 8-1-2005; IN COMMERCE 8-1-2005.

THE MARK CONSISTS OF STANDARD CHARACTERS WITHOUT CLAIM TO ANY PARTICULAR FONT, STYLE, SIZE, OR COLOR.

NO CLAIM IS MADE TO THE EXCLUSIVE RIGHT TO USE "STATUS", APART FROM THE MARK AS SHOWN.

SN 77-777,678, FILED 7-9-2009.

KRISTIN DAHLING, EXAMINING ATTORNEY



*David J. Kybas*

Director of the United States Patent and Trademark Office



# United States of America

United States Patent and Trademark Office

## INSTANT SHINE

**Reg. No. 4,125,836**

TURTLE WAX, INC. (ILLINOIS CORPORATION)  
625 WILLOWBROOK CENTRE PARKWAY  
WILLOWBROOK, IL 60527

**Registered Apr. 10, 2012**

**Int. Cl.: 3**

FOR: CLEANING, WASHING, WAXING, POLISHING, RESTORING, SHINING, AND PROTECTING PREPARATIONS FOR VEHICLES, IN CLASS 3 (U.S. CLS. 1, 4, 6, 50, 51 AND 52).

**TRADEMARK**

FIRST USE 12-0-2009; IN COMMERCE 12-0-2009.

**PRINCIPAL REGISTER**

THE MARK CONSISTS OF STANDARD CHARACTERS WITHOUT CLAIM TO ANY PARTICULAR FONT, STYLE, SIZE, OR COLOR.

NO CLAIM IS MADE TO THE EXCLUSIVE RIGHT TO USE "SHINE", APART FROM THE MARK AS SHOWN.

SN 77-777,751, FILED 7-9-2009.

KATHERINE CHANG, EXAMINING ATTORNEY



*David J. Kybas*

Director of the United States Patent and Trademark Office

# United States of America

United States Patent and Trademark Office



**Reg. No. 4,125,837**

**Registered Apr. 10, 2012**

**Int. Cls.: 29 and 30**

**TRADEMARK**

**PRINCIPAL REGISTER**

OCEAN DIRECT, LLC (CALIFORNIA LIMITED LIABILITY COMPANY)  
12624 DAPHNE AVENUE  
HAWTHORNE, CA 90250

FOR: FRUIT-BASED FILLING FOR CAKES AND PIES, IN CLASS 29 (U.S. CL. 46).

FIRST USE 4-3-2009; IN COMMERCE 4-3-2009.

FOR: CUSTARD-BASED FILLINGS FOR CAKES AND PIES; CHOCOLATE-BASED FILLINGS FOR CAKES AND PIES; PIE SHELLS; STUFFING MIXES CONTAINING BREAD; BREAD CRUMB; BAKERY GOODS, IN CLASS 30 (U.S. CL. 46).

FIRST USE 4-3-2009; IN COMMERCE 4-3-2009.

NO CLAIM IS MADE TO THE EXCLUSIVE RIGHT TO USE "BAKERY", APART FROM THE MARK AS SHOWN.

THE STIPPLING IS FOR SHADING PURPOSES ONLY.

THE MARK CONSISTS OF THE TEXT "LIBERTY BAKERY" IN A STYLIZED FONT WITH A WHEAT STALK GRAPHIC IN UPPER LEFT OF TEXT, AND STARS IN LOWER RIGHT OF THE TEXT; TEXT AND DESIGNS ARE IN A STYLIZED BOX WITH 3 ROUNDED CORNERS.

SN 77-780,118, FILED 7-13-2009.

AMY ALFIERI, EXAMINING ATTORNEY

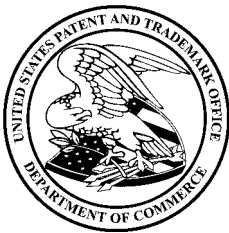

*David J. Kybas*

Director of the United States Patent and Trademark Office

# United States of America

United States Patent and Trademark Office

# SAVVYSHE

**Reg. No. 4,125,838**

HARBORMOON PUBLISHING, LLC (CALIFORNIA LIMITED LIABILITY COMPANY)  
20601 LOMITA AVENUE  
SARATOGA, CA 95070

**Registered Apr. 10, 2012**

**Int. Cls.: 16, 25, and 35**

FOR: BOOKS IN THE FIELDS OF SELF HELP, MENTAL WELL BEING, HUMOR AND BUSINESS; STATIONERY, POSTCARDS, GREETING CARDS, INVITATION CARDS, NOTE CARDS, NOTEPADS, CALENDARS, AND STICKERS, IN CLASS 16 (U.S. CLS. 2, 5, 22, 23, 29, 37, 38 AND 50).

**TRADEMARK**

**SERVICE MARK**

FIRST USE 1-15-2012; IN COMMERCE 1-15-2012.

**PRINCIPAL REGISTER**

FOR: CLOTHING FOR WOMEN AND GIRLS, NAMELY, T-SHIRTS, TOPS, SWEATSHIRTS, SWEAT PANTS, TANK TOPS, SOCKS, HATS, SLEEPWEAR, BEACHWEAR, FOOTWEAR, SLIPPERS, AND APRONS; CHILDREN'S AND INFANT'S APPAREL, NAMELY, JUMPERS, OVERALL SLEEPWEAR, PAJAMAS, ROMPERS, ONE PIECE GARMENTS, TOPS, BOTTOMS, CLOTH BIBS, HEADWEAR, AND SOCKS, IN CLASS 25 (U.S. CLS. 22 AND 39).

FIRST USE 1-15-2012; IN COMMERCE 1-15-2012.

FOR: ONLINE RETAIL STORE SERVICES FEATURING CLOTHING, BOOKS, STATIONERY, POSTCARDS, GREETING CARDS, INVITATION CARDS, NOTE CARDS, NOTEPADS, CALENDARS, AND STICKERS, IN CLASS 35 (U.S. CLS. 100, 101 AND 102).

FIRST USE 1-15-2012; IN COMMERCE 1-15-2012.

THE MARK CONSISTS OF STANDARD CHARACTERS WITHOUT CLAIM TO ANY PARTICULAR FONT, STYLE, SIZE, OR COLOR.

SN 77-780,139, FILED 7-13-2009.

JOHN DWYER, EXAMINING ATTORNEY



*David J. Kyros*

Director of the United States Patent and Trademark Office

# United States of America

United States Patent and Trademark Office

## OPENCOLLATERAL

**Reg. No. 4,125,839**

**Registered Apr. 10, 2012**

**Int. Cl.: 36**

**SERVICE MARK**

**PRINCIPAL REGISTER**

CITIGROUP GLOBAL MARKETS INC. (NEW YORK CORPORATION)  
388 GREENWICH STREET  
NEW YORK, NY 10013

FOR: HEDGE FUND CONSULTING AND MANAGEMENT SERVICES; CONSULTING ON FINANCIAL SECURITIES TRADING AND EXECUTION STRATEGY; PROVIDING SERVICES AS SECURITY AGENT, ADMINISTRATIVE AGENT AND STOCK TRANSFER AGENT FOR OTHERS, NAMELY, AGENCIES FOR TRADING OF SECURITIES, SECURITIES INDEX FUTURES, SECURITIES OPTIONS, OVERSEAS MARKET SECURITIES FUTURES, IN CLASS 36 (U.S. CLS. 100, 101 AND 102).

FIRST USE 10-1-2010; IN COMMERCE 10-1-2010.

THE MARK CONSISTS OF STANDARD CHARACTERS WITHOUT CLAIM TO ANY PARTICULAR FONT, STYLE, SIZE, OR COLOR.

SN 77-780,669, FILED 7-14-2009.

BARBARA BROWN, EXAMINING ATTORNEY



*David J. Kyffers*

Director of the United States Patent and Trademark Office

# United States of America

United States Patent and Trademark Office

# TAKE OFF

**Reg. No. 4,125,840**

BIAGRO WESTERN SALES, INC. (CALIFORNIA CORPORATION)  
35801 ROAD 132  
VISALIA, CA 93792

**Registered Apr. 10, 2012**

**Int. Cl.: 1**

FOR: METABOLIC PLANT FERTILIZERS AND GROWTH REGULATORS FOR AGRICULTURAL USE, IN CLASS 1 (U.S. CLS. 1, 5, 6, 10, 26 AND 46).

**TRADEMARK**

FIRST USE 5-31-2011; IN COMMERCE 5-31-2011.

**PRINCIPAL REGISTER**

THE MARK CONSISTS OF STANDARD CHARACTERS WITHOUT CLAIM TO ANY PARTICULAR FONT, STYLE, SIZE, OR COLOR.

SN 77-782,156, FILED 7-15-2009.

LAURIE MAYES, EXAMINING ATTORNEY



*David J. Kyffers*

Director of the United States Patent and Trademark Office

# United States of America

United States Patent and Trademark Office

# ACHATES

**Reg. No. 4,125,841**

**Registered Apr. 10, 2012**

**Int. Cl.: 42**

**SERVICE MARK**

**PRINCIPAL REGISTER**

ACHATES POWER, INC. (DELAWARE CORPORATION)  
4060 SORENTO VALLEY BLVD.  
SUITE A  
SAN DIEGO, CA 92121

FOR: CONSULTING IN THE FIELD OF ENGINEERING, IN CLASS 42 (U.S. CLS. 100 AND 101).

FIRST USE 8-5-2010; IN COMMERCE 8-5-2010.

THE MARK CONSISTS OF STANDARD CHARACTERS WITHOUT CLAIM TO ANY PARTICULAR FONT, STYLE, SIZE, OR COLOR.

SN 77-790,028, FILED 7-27-2009.

GISELLE AGOSTO, EXAMINING ATTORNEY



*David J. Kybas*

Director of the United States Patent and Trademark Office

# United States of America

United States Patent and Trademark Office

## SPIRAL SOFTWARE

**Reg. No. 4,125,842**

**Registered Apr. 10, 2012**

**Int. Cls.: 9, 35, and 42**

**TRADEMARK**

**SERVICE MARK**

**PRINCIPAL REGISTER**

SPIRAL SOFTWARE LIMITED (UNITED KINGDOM CORPORATION)  
ST. ANDREW'S HOUSE  
ST. ANDREW'S ROAD  
CAMBRIDGE, UNITED KINGDOM CB41DL

FOR: COMPUTER SOFTWARE FOR DATA MODELLING; COMPUTER SOFTWARE FOR THE VALIDATION OF MODEL PREDICTIONS; COMPUTER SOFTWARE FOR SCIENTIFIC DATA ANALYSIS; DATA, NAMELY, ASSAY DATA IN THE FIELD OF THE PETROLEUM AND PETROCHEMICAL INDUSTRIES, RECORDED ON ELECTRONIC, OPTICAL OR MAGNETIC MEDIA; MAGNETIC DATA CARRIERS THAT ARE PRE-RECORDED WITH ELECTRONIC DATA AND ASSAY DATA AND COMPUTER SOFTWARE FOR DATA PROCESSING AND DATA ANALYSIS; RECORDING COMPACT DISCS, AND DVDS THAT ARE PRE-RECORDED WITH ELECTRONIC DATA AND ASSAY DATA AND COMPUTER SOFTWARE FOR DATA PROCESSING AND DATA ANALYSIS; DOWNLOADABLE ELECTRONIC PUBLICATIONS IN THE NATURE OF MANUALS, BROCHURES AND PRODUCT INFORMATION SHEETS IN THE FIELD OF THE PETROLEUM AND PETROCHEMICAL INDUSTRIES; CD-ROMS, DVD-ROMS AND COMPUTER DISCS BEARING SOFTWARE FOR THE EXPLORATION, PRODUCTIONS, REFINING AND TRADING OF CRUDE OIL AND CRUDE OIL PRODUCTS, AND PROCESS MANUFACTURING INDUSTRIES AND LOGISTICS RELATING TO THESE INDUSTRIES AND ELECTRONIC DATA, NAMELY, DATA RELATING TO CRUDE OIL IN THE FIELD OF OIL REFINING, PETROCHEMICAL ENGINEERING AND GAS AND OIL PROSPECTING, EXTRACTION AND RECOVERY, AND ASSAY DATA, IN CLASS 9 (U.S. CLS. 21, 23, 26, 36 AND 38).

FIRST USE 6-0-1998; IN COMMERCE 3-0-1999.

FOR: COMPILATION, ANALYSIS, RETRIEVAL AND PROVISION OF BUSINESS DATA AND STATISTICAL INFORMATION FOR BUSINESS AND COMMERCIAL PURPOSES; MARKET ANALYSIS AND RESEARCH; MANAGEMENT OF COMMUNICATION NETWORKS; THE COMPILATION, ANALYSIS, RETRIEVAL AND PROVISION OF BUSINESS DATA AND STATISTICAL INFORMATION FOR BUSINESS AND COMMERCIAL PURPOSES, MARKET ANALYSIS AND RESEARCH AND MANAGEMENT OF COMMUNICATION NETWORKS, AND THAT ARE ALSO PROVIDED VIA THE INTERNET; PROVIDING INFORMATION ABOUT THE COST ASSESSMENT OF OIL FIELDS, IN CLASS 35 (U.S. CLS. 100, 101 AND 102).

FIRST USE 6-0-1998; IN COMMERCE 3-0-1999.



*David J. Kyffers*

Director of the United States Patent and Trademark Office

**Reg. No. 4,125,842** FOR: INSTALLATION OF COMPUTER SOFTWARE, RELATING ONLY TO MODELING, DETERMINING AND PREDICTING MATERIALS, MODELLING, SCHEDULING AND OPTIMIZING PROCESSES, ALL SUCH DATA, INFORMATION, MATERIALS AND PROCESSES RELATING TO AND/OR USED IN THE EXPLORATION, PRODUCTION, REFINING AND TRADING OF CRUDE OIL AND CRUDE OIL PRODUCTS, AND PROCESS MANUFACTURING INDUSTRIES AND LOGISTICS RELATING TO THESE INDUSTRIES; MAINTENANCE AND TECHNICAL SUPPORT SERVICES, NAMELY, TROUBLESHOOTING OF COMPUTER SOFTWARE PROBLEMS; INSTALLATION, MAINTENANCE AND TECHNICAL SUPPORT SERVICES, NAMELY, IDENTIFYING, DIAGNOSING, ADVISING ON, CORRECTING, WORKING AROUND, REPAIRING COMPUTER SOFTWARE FAILURES, DEFECTS, BUGS AND ERRORS; PROVIDING INFORMATION ABOUT THE TECHNICAL ANALYSIS OF OIL FIELDS; PROVISION OF CONSULTANCY AND ADVISORY SERVICES IN THE FIELDS OF OIL PROSPECTING, PETROCHEMICAL ENGINEERING, AND GAS AND OIL LOCATION AND SURVEYING ALL BASED UPON ASSAYS FEATURING DETAILED ANALYSES AND EVALUATION, IN CLASS 42 (U.S. CLS. 100 AND 101).

FIRST USE 6-0-1998; IN COMMERCE 3-0-1999.

THE MARK CONSISTS OF STANDARD CHARACTERS WITHOUT CLAIM TO ANY PARTICULAR FONT, STYLE, SIZE, OR COLOR.

OWNER OF ERPNTM CMNTY TM OFC REG. NO. 008455289, DATED 4-26-2010, EXPIRES 7-28-2019.

NO CLAIM IS MADE TO THE EXCLUSIVE RIGHT TO USE "SOFTWARE" IN CLASSES 9 AND 42 ONLY, APART FROM THE MARK AS SHOWN.

SN 77-791,507, FILED 7-28-2009.

RON FAIRBANKS, EXAMINING ATTORNEY



# United States of America

United States Patent and Trademark Office

## CRUDESUITE

**Reg. No. 4,125,843**

**Registered Apr. 10, 2012**

**Int. Cls.: 9, 35, 39, and  
42**

**TRADEMARK**

**SERVICE MARK**

**PRINCIPAL REGISTER**

SPIRAL SOFTWARE LIMITED (UNITED KINGDOM CORPORATION)  
ST. ANDREW'S HOUSE  
ST. ANDREW'S ROAD  
CAMBRIDGE, UNITED KINGDOM CB41DL

FOR: COMPUTER SOFTWARE FOR DATA PROCESSING AND DATA ANALYSIS; COMPUTER PROGRAMS FOR DATA PROCESSING AND DATA ANALYSIS; COMPUTER SOFTWARE FOR USE IN SIMULATING, MODELLING, DESIGNING, OPTIMIZING, OPERATING AND MANAGING INFORMATION AND DATA RELATING TO CRUDE OIL AND TO THE PREDICTION OF CRUDE OIL PROPERTIES; COMPUTER SOFTWARE FOR ELECTRONIC DATABASES IN THE FIELD OF THE PETROLEUM AND PETROCHEMICAL INDUSTRIES RECORDED ON COMPUTER MEDIA; COMPUTER SOFTWARE FOR DATA PROCESSING AND DATA ANALYSIS FOR USE OVER COMPUTER NETWORKS AND BY REMOTE COMPUTER ACCESS; COMPUTER SOFTWARE FOR THE EXTRACTION, ANALYSIS, MANAGEMENT AND MANIPULATION OF INFORMATION FROM SMALL AND LARGE DATA SETS BY THE APPLICATION OF MATHEMATICAL AND DATA VISUALIZATION TECHNIQUES; COMPUTER SOFTWARE FOR THE VALIDATION AND RECONCILIATION OF DATA IN THE FIELD OF THE PETROLEUM AND PETROCHEMICAL INDUSTRIES; COMPUTER SOFTWARE FOR DATA MODELLING; COMPUTER SOFTWARE FOR THE VALIDATION OF MODEL PREDICTIONS; COMPUTER SOFTWARE TO ENABLE SEARCHING OF DATA AND DETAILED VIEWING AND REPORTING OF DATA; COMPUTER SOFTWARE FOR SCIENTIFIC DATA ANALYSIS; DATA, NAMELY, ASSAY DATA IN THE FIELD OF THE PETROLEUM AND PETROCHEMICAL INDUSTRIES, RECORDED ON ELECTRONIC, OPTICAL OR MAGNETIC MEDIA; MAGNETIC DATA CARRIERS THAT ARE PRE-RECORDED WITH ELECTRONIC DATA AND ASSAY DATA AND COMPUTER SOFTWARE FOR DATA PROCESSING AND DATA ANALYSIS; RECORDING COMPACT DISCS, AND DVDS THAT ARE PRE-RECORDED WITH ELECTRONIC DATA AND ASSAY DATA AND COMPUTER SOFTWARE FOR DATA PROCESSING AND DATA ANALYSIS; DOWNLOADABLE ELECTRONIC PUBLICATIONS IN THE NATURE OF MANUALS, BROCHURES AND PRODUCT INFORMATION SHEETS IN THE FIELD OF THE PETROLEUM AND PETROCHEMICAL INDUSTRIES; CD-ROMS, DVD-ROMS AND COMPUTER DISCS BEARING SOFTWARE FOR THE EXPLORATION, PRODUCTION, REFINING AND TRADING OF CRUDE OIL AND CRUDE OIL PRODUCTS, AND PROCESS MANUFACTURING INDUSTRIES AND LOGISTICS RELATING TO THESE INDUSTRIES AND ELECTRONIC DATA, NAMELY, DATA RELATING TO CRUDE OIL IN THE FIELD OF OIL REFINING, PETROCHEMICAL ENGINEERING AND GAS AND OIL PROSPECTING, EXTRACTION AND RECOVERY, AND ASSAY DATA, IN CLASS 9 (U.S. CLS. 21, 23, 26, 36 AND 38).

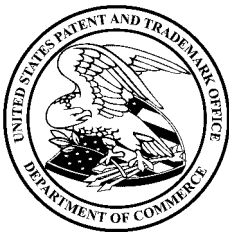

*David J. Kyffers*

Director of the United States Patent and Trademark Office

**Reg. No. 4,125,843** FIRST USE 4-0-2004; IN COMMERCE 4-0-2004.

FOR: COMPILATION, ANALYSIS, RETRIEVAL AND PROVISION OF BUSINESS DATA AND STATISTICAL INFORMATION FOR BUSINESS AND COMMERCIAL PURPOSES; DATA PROCESSING SERVICES; DATA MANAGEMENT SERVICES; MARKET ANALYSIS AND RESEARCH; MANAGEMENT OF COMMUNICATION NETWORKS; CONSULTING AND ADVISORY SERVICES RELATING TO THE COMPILATION, ANALYSIS, RETRIEVAL AND PROVISION OF BUSINESS DATA AND STATISTICAL INFORMATION FOR BUSINESS AND COMMERCIAL PURPOSES, DATA PROCESSING SERVICES, DATA MANAGEMENT SERVICES, MARKET ANALYSIS AND RESEARCH AND MANAGEMENT OF COMMUNICATION NETWORKS, AND THAT ARE ALSO PROVIDED VIA THE INTERNET; PROVIDING INFORMATION ABOUT THE COST ASSESSMENT OF OIL FIELDS; DATABASE MANAGEMENT SERVICES FOR OTHERS FEATURING INFORMATION RELATING TO CRUDE OIL IN THE FIELD OF OIL REFINING, PETROCHEMICAL ENGINEERING AND GAS AND OIL PROSPECTING, EXTRACTION AND RECOVERY , IN CLASS 35 (U.S. CLS. 100, 101 AND 102).

FIRST USE 4-0-2004; IN COMMERCE 4-0-2004.

FOR: ELECTRONIC STORAGE OF DATA AND STATISTICAL INFORMATION, IN CLASS 39 (U.S. CLS. 100 AND 105).

FIRST USE 4-0-2004; IN COMMERCE 4-0-2004.

FOR: INSTALLATION OF COMPUTER SOFTWARE, RELATING ONLY TO MODELING, DETERMINING AND PREDICTING MATERIALS, MODELLING, SCHEDULING AND OPTIMISING PROCESSES, ALL SUCH DATA, INFORMATION, MATERIALS AND PROCESSES RELATING TO AND/OR USED IN THE EXPLORATION, PRODUCTION, REFINING AND TRADING OF CRUDE OIL AND CRUDE OIL PRODUCTS, AND PROCESS MANUFACTURING INDUSTRIES AND LOGISTICS RELATING TO THESE INDUSTRIES; MAINTENANCE AND TECHNICAL SUPPORT SERVICES, NAMELY, TROUBLESHOOTING OF COMPUTER SOFTWARE PROBLEMS; INSTALLATION, MAINTENANCE AND TECHNICAL SUPPORT SERVICES, NAMELY, IDENTIFYING, DIAGNOSING, ADVISING ON, CORRECTING, WORKING AROUND, REPAIRING COMPUTER SOFTWARE FAILURES, DEFECTS, BUGS AND ERRORS; PROVIDING INFORMATION ABOUT THE TECHNICAL ANALYSIS OF OIL FIELDS; PROVISION OF CONSULTANCY AND ADVISORY SERVICES IN THE FIELDS OF OIL PROSPECTING, PETROCHEMICAL ENGINEERING, AND GAS AND OIL LOCATION AND SURVEYING ALL BASED UPON ASSAYS FEATURING DETAILED ANALYSES AND EVALUATION, IN CLASS 42 (U.S. CLS. 100 AND 101).

FIRST USE 4-0-2004; IN COMMERCE 4-0-2004.

THE MARK CONSISTS OF STANDARD CHARACTERS WITHOUT CLAIM TO ANY PARTICULAR FONT, STYLE, SIZE, OR COLOR.

PRIORITY CLAIMED UNDER SEC. 44(D) ON ERPN CMNTY TM OFC APPLICATION NO. 008455611, FILED 7-28-2009, REG. NO. 8455611, DATED 4-26-2010, EXPIRES 7-28-2019.

SN 77-791,514, FILED 7-28-2009.

RON FAIRBANKS, EXAMINING ATTORNEY

# United States of America

United States Patent and Trademark Office

## TIMBERSTRONG

**Reg. No. 4,125,844**

**Registered Apr. 10, 2012**

**Int. Cl.: 19**

**TRADEMARK**

**PRINCIPAL REGISTER**

TIMBERSTRONG (PENNSYLVANIA PARTNERSHIP)  
100 S. MAPLE STREET  
KUTZTOWN, PA 19530

FOR: CONSTRUCTION MATERIALS, NAMELY, NON-METAL FASTENERS SPECIALLY ADAPTED FOR NON-METAL COMPOSITE DECKING AND LUMBER; COMPOSITE BUILDING MATERIALS, NAMELY, NON-METAL COMPOSITE DECKING; COMPOSITE DECKING PANELS COMPOSED PRIMARILY OF NON-METAL MATERIALS; PREASSEMBLED NON-METAL DECKING PANELS; NON-METAL FLOATING DOCKS, IN CLASS 19 (U.S. CLS. 1, 12, 33 AND 50).

FIRST USE 1-30-2012; IN COMMERCE 1-30-2012.

THE MARK CONSISTS OF STANDARD CHARACTERS WITHOUT CLAIM TO ANY PARTICULAR FONT, STYLE, SIZE, OR COLOR.

SN 77-794,484, FILED 7-31-2009.

SIMON TENG, EXAMINING ATTORNEY



*David J. Kyfos*

Director of the United States Patent and Trademark Office

# United States of America

United States Patent and Trademark Office

# TRUE

**Reg. No. 4,125,845**

**Registered Apr. 10, 2012**

**Int. Cl.: 19**

**TRADEMARK**

**PRINCIPAL REGISTER**

USG INTERIORS, LLC (DELAWARE LIMITED LIABILITY COMPANY)  
550 WEST ADAMS STREET, DEPT. 189  
CHICAGO, IL 606613676

FOR: CEILING PANELS, NOT OF METAL, IN CLASS 19 (U.S. CLS. 1, 12, 33 AND 50).

FIRST USE 10-1-2010; IN COMMERCE 10-1-2010.

THE MARK CONSISTS OF STANDARD CHARACTERS WITHOUT CLAIM TO ANY PARTICULAR FONT, STYLE, SIZE, OR COLOR.

SN 77-795,733, FILED 8-3-2009.

ELLEN B. AWRICH, EXAMINING ATTORNEY



*David J. Kybas*

Director of the United States Patent and Trademark Office

# United States of America

United States Patent and Trademark Office



**Reg. No. 4,125,846**

SHAWNEE STATE UNIVERSITY (OHIO STATE UNIVERSITY)  
940 SECOND STREET  
PORTSMOUTH, OH 456624344

**Registered Apr. 10, 2012**

**Int. Cl.: 25**

FOR: APPAREL, NAMELY, T-SHIRTS, TIES, SCARVES, SWEATSHIRTS, SHORTS, HATS, JOGGING SUITS AND SWEATERS, IN CLASS 25 (U.S. CLS. 22 AND 39).

**TRADEMARK**

FIRST USE 9-1-2009; IN COMMERCE 9-1-2009.

**PRINCIPAL REGISTER**

THE MARK CONSISTS OF THE WORDS "SHAWNEE STATE BEARS" ON AN ARCHED BANNER.

SN 77-797,297, FILED 8-5-2009.

KEVIN DINALLO, EXAMINING ATTORNEY



*David J. Kyjars*

Director of the United States Patent and Trademark Office

# United States of America

United States Patent and Trademark Office



**Reg. No. 4,125,847**

**Registered Apr. 10, 2012**

**Int. Cl.: 25**

**TRADEMARK**

**PRINCIPAL REGISTER**

WURTH, GASTON (CHILE INDIVIDUAL)  
10408 LIMERICK AVE.  
CHATSWORTH, CA 91311

FOR: BEANIES; HATS; JACKETS; PANTS; SHIRTS; SHORTS; SWEAT PANTS; SWEAT SHIRTS; T-SHIRTS; TANK TOPS, IN CLASS 25 (U.S. CLS. 22 AND 39).

FIRST USE 4-8-2001; IN COMMERCE 4-8-2010.

NO CLAIM IS MADE TO THE EXCLUSIVE RIGHT TO USE "CLOTHING", APART FROM THE MARK AS SHOWN.

THE MARK CONSISTS OF A FIST WITH "DROP U" WRITTEN ON FINGERS.

SN 77-797,369, FILED 8-5-2009.

WILLIAM P. SHANAHAN, EXAMINING ATTORNEY



*David J. Kyffers*

Director of the United States Patent and Trademark Office

# United States of America

United States Patent and Trademark Office

## 4 SEASONS FOR LIFE

**Reg. No. 4,125,848**

1 2 8 WORLDWIDE, INC. (FLORIDA CORPORATION)  
110 PORTOFINO DRIVE  
NORTH VENICE, FL 34275

**Registered Apr. 10, 2012**

**Int. Cl.: 44**

FOR: PROVIDING DIETARY AND NUTRITION PLANNING, TREATMENT AND SUPERVISION THROUGH WEIGHT REDUCTION PROGRAMS, COUNSELING, CREATING DIETARY AND NUTRITIONAL REGIMES AND DISCUSSIONS; PROVIDING ADVICE, CONSULTATION AND INFORMATION IN THE FIELD OF WEIGHT CONTROL AND NUTRITION, IN CLASS 44 (U.S. CLS. 100 AND 101).

**SERVICE MARK**

**PRINCIPAL REGISTER**

FIRST USE 10-11-2008; IN COMMERCE 10-11-2008.

THE MARK CONSISTS OF STANDARD CHARACTERS WITHOUT CLAIM TO ANY PARTICULAR FONT, STYLE, SIZE, OR COLOR.

SN 77-801,577, FILED 8-11-2009.

JAMES A. RAUEN, EXAMINING ATTORNEY



*David J. Kyffers*

Director of the United States Patent and Trademark Office

# United States of America

United States Patent and Trademark Office

## LifeGuard Mobile

**Reg. No. 4,125,849**

**Registered Apr. 10, 2012**

**Int. Cl.: 9**

**TRADEMARK**

**PRINCIPAL REGISTER**

LIFEGUARD HEALTH NETWORKS, INC. (DELAWARE CORPORATION)  
1055 WESTLAKES DRIVE, 3RD FLOOR  
BERWYN, PA 19312

FOR: COMPUTER SOFTWARE, NAMELY, AN ADVANCED MOBILE APPLICATION PROVIDING LOCATION BASED SERVICES (CELLULAR TRIANGULATION AND EMBEDDED GPS) AND ESCALATION ENGINE(S) TO 1ST LEVEL RESPONDERS (POLICE/FIRE/RESCUE) ON CELL PHONES AND SMART MOBILE DEVICES, IN CLASS 9 (U.S. CLS. 21, 23, 26, 36 AND 38).

FIRST USE 11-5-2011; IN COMMERCE 12-13-2011.

THE MARK CONSISTS OF STANDARD CHARACTERS WITHOUT CLAIM TO ANY PARTICULAR FONT, STYLE, SIZE, OR COLOR.

NO CLAIM IS MADE TO THE EXCLUSIVE RIGHT TO USE "MOBILE", APART FROM THE MARK AS SHOWN.

SN 77-803,109, FILED 8-12-2009.

HENRY S. ZAK, EXAMINING ATTORNEY



*David J. Kyffers*

Director of the United States Patent and Trademark Office



# United States of America

United States Patent and Trademark Office

# SPRINGLOFT

**Reg. No. 4,125,850**

LOUISVILLE BEDDING COMPANY (DELAWARE CORPORATION)  
10400 BUNSEN WAY  
LOUISVILLE, KY 40299

**Registered Apr. 10, 2012**

**Int. Cl.: 20**

FOR: PILLOWS, BED PILLOWS, IN CLASS 20 (U.S. CLS. 2, 13, 22, 25, 32 AND 50).

**TRADEMARK**

FIRST USE 3-4-2008; IN COMMERCE 3-4-2008.

**PRINCIPAL REGISTER**

THE MARK CONSISTS OF STANDARD CHARACTERS WITHOUT CLAIM TO ANY PARTICULAR FONT, STYLE, SIZE, OR COLOR.

SN 77-803,659, FILED 8-13-2009.

SALLY SHIH, EXAMINING ATTORNEY



*David J. Kyffers*

Director of the United States Patent and Trademark Office

# United States of America

United States Patent and Trademark Office

# CUJOC

**Reg. No. 4,125,851**

**Registered Apr. 10, 2012**

**Int. Cl.: 25**

**TRADEMARK**

**PRINCIPAL REGISTER**

CARTER, TASHA (UNITED STATES INDIVIDUAL)  
8120 LAUREL RUN DRIVE  
MEMPHIS, TN 38125 AND

CARTER JR., JOE (UNITED STATES INDIVIDUAL)  
8120 LAUREL RUN DRIVE  
MEMPHIS, TN 38125

FOR: CLOTHING, NAMELY, T-SHIRTS, NECKTIES, BOW TIES, VESTS, TURTLENECKS, DRESS AND CASUAL SLACKS, DRESS AND CASUAL SHIRTS, JEANS, SWEATSHIRTS, SWEAT PANTS, JOGGING SUITS, SKULL CAPS, GLOVES, SCARVES, BASEBALL CAPS, LINGERIE, UNDERWEAR, BELTS, SHOES, SANDALS, AND TENNIS SHOES, IN CLASS 25 (U.S. CLS. 22 AND 39).

FIRST USE 4-1-2010; IN COMMERCE 4-1-2010.

THE MARK CONSISTS OF STANDARD CHARACTERS WITHOUT CLAIM TO ANY PARTICULAR FONT, STYLE, SIZE, OR COLOR.

SN 77-807,887, FILED 8-19-2009.

KATHRYN COWARD, EXAMINING ATTORNEY



*David J. Kybas*

Director of the United States Patent and Trademark Office

# United States of America

United States Patent and Trademark Office

# INNOVEL

**Reg. No. 4,125,852**

PPG INDUSTRIES OHIO, INC. (DELAWARE CORPORATION)  
3800 WEST 143RD STREET  
CLEVELAND, OH 44111

**Registered Apr. 10, 2012**

**Int. Cl.: 2**

FOR: COATING COMPOSITIONS IN THE NATURE OF PAINT FOR PACKAGING APPLICATIONS, IN CLASS 2 (U.S. CLS. 6, 11 AND 16).

**TRADEMARK**

FIRST USE 10-31-2011; IN COMMERCE 10-31-2011.

**PRINCIPAL REGISTER**

THE MARK CONSISTS OF STANDARD CHARACTERS WITHOUT CLAIM TO ANY PARTICULAR FONT, STYLE, SIZE, OR COLOR.

SN 77-808,151, FILED 8-19-2009.

NAAKWAMA ANKRAH, EXAMINING ATTORNEY



*David J. Kyfos*

Director of the United States Patent and Trademark Office

# United States of America

United States Patent and Trademark Office

## LORDS HOTELS

**Reg. No. 4,125,853**

**Registered Apr. 10, 2012**

**Int. Cl.: 43**

**SERVICE MARK**

**PRINCIPAL REGISTER**

LORDS HOTELS LLC (DELAWARE LIMITED LIABILITY COMPANY)  
C/O FROSS ZELNICK LEHRMAN & ZISSU, P.C.  
NEW YORK  
NEW YORK, NY 10017

FOR: HOTEL SERVICES, IN CLASS 43 (U.S. CLS. 100 AND 101).

FIRST USE 2-6-2012; IN COMMERCE 2-6-2012.

THE MARK CONSISTS OF STANDARD CHARACTERS WITHOUT CLAIM TO ANY PARTICULAR FONT, STYLE, SIZE, OR COLOR.

NO CLAIM IS MADE TO THE EXCLUSIVE RIGHT TO USE "HOTELS", APART FROM THE MARK AS SHOWN.

SN 77-808,495, FILED 8-19-2009.

KEVON CHISOLM, EXAMINING ATTORNEY



*David J. Kybas*

Director of the United States Patent and Trademark Office

# United States of America

United States Patent and Trademark Office

# MOD.

**Reg. No. 4,125,854**

**Registered Apr. 10, 2012**

**Int. Cl.: 9**

**TRADEMARK**

**PRINCIPAL REGISTER**

C. DECOR, INC. (TEXAS CORPORATION)  
320 S. STATE HIGHWAY 121 N. SUITE 208  
COPPELL, TX 75019

FOR: BAGS FOR CAMERAS AND PHOTOGRAPHIC EQUIPMENT; CAMERA STRAPS;  
LENS CAP KEEPERS, NAMELY, A LEASH THAT ATTACHES A LENS CAP TO A CAMERA  
TO PREVENT LOSS OF THE LENS CAP , IN CLASS 9 (U.S. CLS. 21, 23, 26, 36 AND 38).

FIRST USE 9-1-2009; IN COMMERCE 9-1-2009.

THE MARK CONSISTS OF STANDARD CHARACTERS WITHOUT CLAIM TO ANY PAR-  
TICULAR FONT, STYLE, SIZE, OR COLOR.

SN 77-808,520, FILED 8-19-2009.

RUDY R. SINGLETON, EXAMINING ATTORNEY



*David J. Kyfos*

Director of the United States Patent and Trademark Office

# United States of America

United States Patent and Trademark Office

# GOLFworthy

**Reg. No. 4,125,855**

**Registered Apr. 10, 2012**

**Int. Cl.: 27**

**TRADEMARK**

**PRINCIPAL REGISTER**

TURFWORTHY LLC (NORTH CAROLINA LIMITED LIABILITY COMPANY)  
7109 CESSNA DRIVE  
GREENSBORO, NC 27409

FOR: ARTIFICIAL TURF, IN CLASS 27 (U.S. CLS. 19, 20, 37, 42 AND 50).

FIRST USE 4-26-2011; IN COMMERCE 4-26-2011.

THE MARK CONSISTS OF STANDARD CHARACTERS WITHOUT CLAIM TO ANY PARTICULAR FONT, STYLE, SIZE, OR COLOR.

SN 77-810,997, FILED 8-24-2009.

RAUL CORDOVA, EXAMINING ATTORNEY



*David J. Kyffers*

Director of the United States Patent and Trademark Office

# United States of America

United States Patent and Trademark Office

# SPORTworthy

**Reg. No. 4,125,856**

**Registered Apr. 10, 2012**

**Int. Cl.: 27**

**TRADEMARK**

**PRINCIPAL REGISTER**

TURFWORTHY LLC (NORTH CAROLINA LIMITED LIABILITY COMPANY)  
7109 CESSNA DRIVE  
GREENSBORO, NC 27409

FOR: ARTIFICIAL TURF, IN CLASS 27 (U.S. CLS. 19, 20, 37, 42 AND 50).

FIRST USE 8-23-2011; IN COMMERCE 8-23-2011.

THE MARK CONSISTS OF STANDARD CHARACTERS WITHOUT CLAIM TO ANY PARTICULAR FONT, STYLE, SIZE, OR COLOR.

SN 77-810,998, FILED 8-24-2009.

RAUL CORDOVA, EXAMINING ATTORNEY



*David J. Kybas*

Director of the United States Patent and Trademark Office

# United States of America

United States Patent and Trademark Office

# PLAYworthy

**Reg. No. 4,125,857**

**Registered Apr. 10, 2012**

**Int. Cl.: 27**

**TRADEMARK**

**PRINCIPAL REGISTER**

TURFWORTHY LLC (NORTH CAROLINA LIMITED LIABILITY COMPANY)  
7109 CESSNA DRIVE  
GREENSBORO, NC 27409

FOR: ARTIFICIAL TURF, IN CLASS 27 (U.S. CLS. 19, 20, 37, 42 AND 50).

FIRST USE 8-12-2011; IN COMMERCE 8-12-2011.

THE MARK CONSISTS OF STANDARD CHARACTERS WITHOUT CLAIM TO ANY PARTICULAR FONT, STYLE, SIZE, OR COLOR.

SN 77-811,007, FILED 8-24-2009.

RAUL CORDOVA, EXAMINING ATTORNEY



*David J. Kyffers*

Director of the United States Patent and Trademark Office



# United States of America

United States Patent and Trademark Office

# PUTTworthy

**Reg. No. 4,125,858**

**Registered Apr. 10, 2012**

**Int. Cl.: 27**

**TRADEMARK**

**PRINCIPAL REGISTER**

TURFWORTHY LLC (NORTH CAROLINA LIMITED LIABILITY COMPANY)  
7109 CESSNA DRIVE  
GREENSBORO, NC 27409

FOR: ARTIFICIAL TURF, IN CLASS 27 (U.S. CLS. 19, 20, 37, 42 AND 50).

FIRST USE 11-30-2011; IN COMMERCE 11-30-2011.

THE MARK CONSISTS OF STANDARD CHARACTERS WITHOUT CLAIM TO ANY PARTICULAR FONT, STYLE, SIZE, OR COLOR.

SN 77-811,013, FILED 8-24-2009.

RAUL CORDOVA, EXAMINING ATTORNEY



*David J. Kyffers*

Director of the United States Patent and Trademark Office

# United States of America

United States Patent and Trademark Office

# LAWNworthy

**Reg. No. 4,125,859**

**Registered Apr. 10, 2012**

**Int. Cl.: 27**

**TRADEMARK**

**PRINCIPAL REGISTER**

TURFWORTHY LLC (NORTH CAROLINA LIMITED LIABILITY COMPANY)  
7109 CESSNA DRIVE  
GREENSBORO, NC 27409

FOR: ARTIFICIAL TURF, IN CLASS 27 (U.S. CLS. 19, 20, 37, 42 AND 50).

FIRST USE 4-30-2011; IN COMMERCE 4-30-2011.

THE MARK CONSISTS OF STANDARD CHARACTERS WITHOUT CLAIM TO ANY PARTICULAR FONT, STYLE, SIZE, OR COLOR.

SN 77-811,017, FILED 8-24-2009.

RAUL CORDOVA, EXAMINING ATTORNEY



*David J. Kyffers*

Director of the United States Patent and Trademark Office

# United States of America

United States Patent and Trademark Office

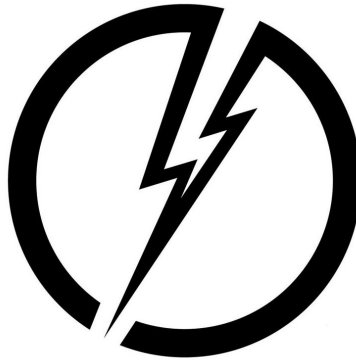

**Reg. No. 4,125,860**

TASER INTERNATIONAL, INC. (DELAWARE CORPORATION)  
17800 N. 85TH ST.  
SCOTTSDALE, AZ 85255

**Registered Apr. 10, 2012**

**Int. Cl.: 26**

FOR: BELT BUCKLES HAVING COMPARTMENTS FOR HOLDING ELECTRONIC EQUIPMENT, IN CLASS 26 (U.S. CLS. 37, 39, 40, 42 AND 50).

**TRADEMARK**

FIRST USE 5-25-2010; IN COMMERCE 5-25-2010.

**PRINCIPAL REGISTER**

THE MARK CONSISTS OF AN IMAGE OF A STYLIZED LIGHTNING BOLT WITHIN A CIRCLE.

SN 77-813,126, FILED 8-26-2009.

TASNEEM HUSSAIN, EXAMINING ATTORNEY



*David J. Kybas*

Director of the United States Patent and Trademark Office

# United States of America

United States Patent and Trademark Office

## BACK TO CHURCH SUNDAY

**Reg. No. 4,125,861**

**Registered Apr. 10, 2012**

**Int. Cls.: 16 and 20**

**TRADEMARK**

**PRINCIPAL REGISTER**

OUTREACH, INC. (CALIFORNIA CORPORATION)  
2230 OAK RIDGE WAY  
VISTA, CA 92081

FOR: PRINTED ADVERTISING FOR USE BY OTHERS, NAMELY, ADVERTISING PAMPHLETS AND POSTCARDS; PAPER MAILERS IN THE NATURE OF POSTCARDS AND BULLETINS FEATURING RELIGIOUS INFORMATION; PAPER BANNERS; INVITATION CARDS; GREETING CARDS HAVING A CHRISTIAN MESSAGE; STATIONERY; BROCHURES IN THE FIELD OF RELIGION; DOOR HANGERS, NAMELY, PLACARDS OF PAPER OR CARDBOARD; PRINTED GUIDES FOR RELIGIOUS CAMPAIGNS, IN CLASS 16 (U.S. CLS. 2, 5, 22, 23, 29, 37, 38 AND 50).

FIRST USE 12-0-2008; IN COMMERCE 8-0-2009.

FOR: PLASTIC BANNERS; BANNER STANDS, NAMELY, DISPLAY STANDS, IN CLASS 20 (U.S. CLS. 2, 13, 22, 25, 32 AND 50).

FIRST USE 12-0-2008; IN COMMERCE 8-0-2009.

THE MARK CONSISTS OF STANDARD CHARACTERS WITHOUT CLAIM TO ANY PARTICULAR FONT, STYLE, SIZE, OR COLOR.

SN 77-817,877, FILED 9-1-2009.

ROBERT STRUCK, EXAMINING ATTORNEY



*David J. Kybas*

Director of the United States Patent and Trademark Office

# United States of America

United States Patent and Trademark Office

## INNOVATION IN MOTION

**Reg. No. 4,125,862**

**Registered Apr. 10, 2012**

**Int. Cls.: 35 and 44**

**SERVICE MARK**

**PRINCIPAL REGISTER**

MICRO BEEF TECHNOLOGIES, LTD. (TEXAS LIMITED PARTNERSHIP)  
P.O. BOX 9262  
AMARILLO, TX 79105

FOR: LIVESTOCK MANAGEMENT SERVICES, NAMELY, PROVIDING CUSTOMIZED BUSINESS MANAGEMENT PROGRAMS FOR INDIVIDUAL ANIMAL INFORMATION COLLECTION AND BUSINESS MANAGEMENT; PROVIDING INFORMATION ON MARKETING IN THE FIELD OF ANIMAL MANAGEMENT, IN CLASS 35 (U.S. CLS. 100, 101 AND 102).

FIRST USE 1-0-2008; IN COMMERCE 1-0-2008.

FOR: PROVIDING INFORMATION ON HEALTH AND NUTRITION IN THE FIELD OF ANIMAL MANAGEMENT; CONSULTING SERVICES IN THE FIELD OF ANIMAL MANAGEMENT, NAMELY, RESEARCH, DEVELOPMENT, ANALYSIS AND IDENTIFICATION OF PROCESSES TO EFFICIENTLY RAISE INDIVIDUAL ANIMALS, IN CLASS 44 (U.S. CLS. 100 AND 101).

FIRST USE 1-0-2008; IN COMMERCE 1-0-2008.

THE MARK CONSISTS OF STANDARD CHARACTERS WITHOUT CLAIM TO ANY PARTICULAR FONT, STYLE, SIZE, OR COLOR.

SN 77-817,915, FILED 9-1-2009.

EUGENIA MARTIN, EXAMINING ATTORNEY



*David J. Kyros*

Director of the United States Patent and Trademark Office

# United States of America

## United States Patent and Trademark Office

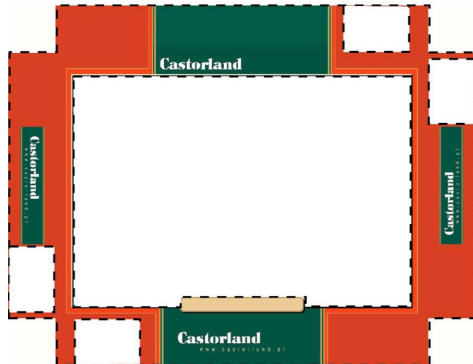

**Reg. No. 4,125,863**

**Registered Apr. 10, 2012**

**Int. Cl.: 28**

**TRADEMARK**

**PRINCIPAL REGISTER**

CASTOR DRUKARNIA I WYDAWNICTWO MAREK BRYLA, WOJCIECH LIPINSKI SP.J.  
(POLAND REGISTERED PARTNERSHIP)  
UL. LOKIETKA 119  
31-263 KRAKOW, POLAND

FOR: PUZZLES AND BOARD GAMES, IN CLASS 28 (U.S. CLS. 22, 23, 38 AND 50).

FIRST USE 6-27-2005; IN COMMERCE 10-31-2005.

OWNER OF U.S. REG. NO. 3,046,420.

THE COLOR(S) GREEN, RED, WHITE, CREAM, YELLOW AND BLACK IS/ARE CLAIMED AS A FEATURE OF THE MARK.

THE MARK CONSISTS OF A THREE-DIMENSIONAL CONFIGURATION OF THE GOODS, A CARDBOARD BOX, AND CONSISTS OF THE COLORS GREEN, RED, WHITE, CREAM, YELLOW AND BLACK AS FEATURES OF THE MARK. THE MARK CONSISTS OF A RECTANGLE OUTLINED IN BLACK IN THE MIDDLE, EACH SIDE OF THE RECTANGLE CONTAINING A RECTANGLE BORDER, THE RECTANGLE ABOVE THE TOP SIDE OF THE WHITE RECTANGLE IS RED WITH WHITE SMALLER RECTANGLE TO THE LEFT AND A GREEN RECTANGLE IN THE MIDDLE AND OUTLINED IN YELLOW WITH THE WHITE WORDING "CASTORLAND WWW.CASTORLAND.PL", THE LEFT SIDE OF THE MIDDLE RECTANGLE CONTAINS A RED RECTANGLE WITH GREEN MIDDLE RECTANGLE WITH YELLOW LINES ON EACH SHORTER SIDES WITH THE WHITE WORDING "CASTORLAND" IN THE MIDDLE AND WHITE RECTANGLE IS RED RECTANGLE WITH GREEN SMALLER RECTANGLE IN THE MIDDLE AND OUTLINED IN YELLOW WITH THE WHITE WORDING "CASTORLAND WWW.CASTORLAND.PL" IN THE MIDDLE AND A WHITE RECTANGLE APPEARING TO THE RIGHT OF THE GREEN RECTANGLE, TO THE RIGHT SIDE OF THE WHITE RECTANGLE AND THE WHITE MIDDLE RECTANGLE IS A CREAM COLOR RECTANGLE BAR IN THE MIDDLE OVERLAPPING THE WHITE RECTANGLE AND THE GREEN RECTANGLE WITH YELLOW LINES ON THE SHORTER SIDES OF THE RECTANGLE AND THE WHITE WORDING "CASTORLAND WWW.CASTORLAND.PL" IN THE MIDDLE, AND A WHITE RECTANGLE AT THE BOTTOM OF THE RED RECTANGLE, AND A YELLOW LINE BORDERING THE WHITE RECTANGLE ON TOP SIDE AND THE SIDES ABOVE THE GREEN RECTANGLES ON BOTH RIGHT AND LEFT SIDES ON TOP AND THE RIGHT AND LEFT SIDES ON THE BOTTOM SIDE BELOW THE GREEN RECTANGLE AND AROUND THE GREEN RECTANGLES ON THE RIGHT



*David J. Kybas*

Director of the United States Patent and Trademark Office

**Reg. No. 4,125,863** AND LEFT SIDE OF THE WHITE RECTANGLE. THE BROKEN LINE AROUND THE BORDER OF THE MARK IS TO SHOW POSITION AND IS NOT A PART OF THE MARK.

SN 77-819,284, FILED 9-3-2009.

JENNY PARK, EXAMINING ATTORNEY

# United States of America

## United States Patent and Trademark Office

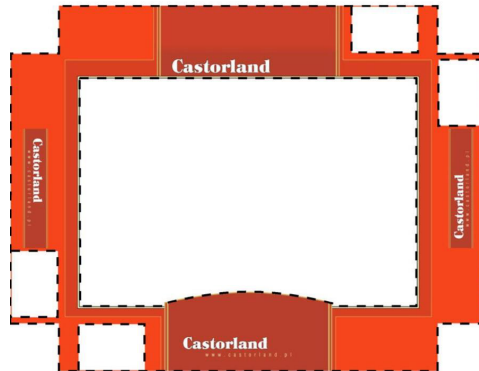

**Reg. No. 4,125,864**

**Registered Apr. 10, 2012**

**Int. Cl.: 28**

**TRADEMARK**

**PRINCIPAL REGISTER**

CASTOR DRUKARNIA I WYDAWNICTWO MAREK BRYLA, WOJCIECH LIPINSKI SP.J.  
(POLAND REGISTERED PARTNERSHIP)  
UL. LOKIETKA 119  
31-263 KRAKOW, POLAND

FOR: PUZZLES AND BOARD GAMES, IN CLASS 28 (U.S. CLS. 22, 23, 38 AND 50).

FIRST USE 6-27-2005; IN COMMERCE 10-31-2005.

OWNER OF U.S. REG. NO. 3,046,420.

THE COLOR(S) RED, DARK RED, WHITE, YELLOW AND BLACK IS/ARE CLAIMED AS A FEATURE OF THE MARK.

THE MARK CONSISTS OF A THREE-DIMENSIONAL CONFIGURATION OF THE CARDBOARD BOX PACKAGING OF THE GOODS. THE MARK CONSISTS OF THE FOLLOWING, ALL OF WHICH ARE ELEMENTS OF THE MARK UNLESS OTHERWISE SO STATED, WITH THE DRAWING ORIENTED IN THE LANDSCAPE FORMAT: A CENTRAL, LARGE WHITE RECTANGLE AND FOUR SMALLER RECTANGLES AT, RESPECTIVELY THE BOTTOM LEFT, LOWER LEFT, TOP RIGHT AND UPPER RIGHT; NONE OF THOSE FIVE RECTANGLES IS AN ELEMENT OF THE MARK; A RED BORDER IN THE CONFIGURATION OF THE OUTLINED OF THE PRODUCT BOX TOP, AS FLATTENED; THE CENTER WHITE RECTANGLE IS FRAMED BY A BORDER THAT IS BLACK, YELLOW, DARK RED, THEN YELLOW; INTERPOSED INTO THAT BORDER IN THE MIDDLE ON TOP AND BOTTOM, FROM THE WHITE CENTER RECTANGLE TO THE RESPECTIVE EDGE OF THE MARK, IS A DARK RED BOX BORDERED IN YELLOW, THEN DARK RED AND THEN YELLOW; THE TOP OF SUCH BOX IS RECTANGULAR AND CONTAINS THE WORD "CASTORLAND" IN WHITE; THE BOTTOM SUCH BOX IS RECTANGULAR EXCEPT FOR AN ARCHING TOP, BORDERED IN YELLOW, THAT INTRUDES INTO THE WHITE CENTRAL RECTANGLE, AND IT CONTAINS THE WORDING "CASTORLAND" IN WHITE, "WWW.CASTORLAND.PL" IN YELLOW; ON EITHER SIDE OF THE CENTER WHITE RECTANGLE IS A DARK RED RECTANGLE RUNNING VERTICALLY, BORDERED BY VERTICAL YELLOW LINES AND CONTAINING THE WORDS "CASTORLAND" IN WHITE "WWW.CASTORLAND.PL" IN YELLOW. THE BROKEN LINE AROUND THE BORDER OF THE MARK IS TO SHOW POSITION AND IS NOT A PART OF THE MARK.



*David J. Kybas*

Director of the United States Patent and Trademark Office

SN 77-819,288, FILED 9-3-2009.



**Reg. No. 4,125,864** JENNY PARK, EXAMINING ATTORNEY

# United States of America

United States Patent and Trademark Office

## THE BIG PONY COLLECTION

**Reg. No. 4,125,865**

PRL USA HOLDINGS, INC. (DELAWARE CORPORATION)  
550 SEVENTH AVENUE  
NEW YORK, NY 10018

**Registered Apr. 10, 2012**

**Int. Cl.: 3**

FOR: SHOWER GEL; PERSONAL DEODORANT; AND BODY SPRAY, IN CLASS 3 (U.S. CLS. 1, 4, 6, 50, 51 AND 52).

**TRADEMARK**

FIRST USE 8-0-2011; IN COMMERCE 8-0-2011.

**PRINCIPAL REGISTER**

THE MARK CONSISTS OF STANDARD CHARACTERS WITHOUT CLAIM TO ANY PARTICULAR FONT, STYLE, SIZE, OR COLOR.

NO CLAIM IS MADE TO THE EXCLUSIVE RIGHT TO USE "COLLECTION", APART FROM THE MARK AS SHOWN.

SN 77-819,745, FILED 9-3-2009.

WENDY GOODMAN, EXAMINING ATTORNEY



*David J. Kyffers*

Director of the United States Patent and Trademark Office

# United States of America

United States Patent and Trademark Office



**Reg. No. 4,125,866**

**Registered Apr. 10, 2012**

**Int. Cl.: 33**

**TRADEMARK**

**PRINCIPAL REGISTER**

TEQUILA CUERVO LA ROJENA, S.A. DE C.V. (MEXICO CORPORATION)  
CIRCUNVALACION SUR #44A  
FRACCIONAMIENTO LAS FUENTES  
ZAPOPAN JALISCO, MEXICO 45070

FOR: TEQUILA LIQUOR, FLAVORED TEQUILAS, IN CLASS 33 (U.S. CLS. 47 AND 49).

FIRST USE 12-16-2002; IN COMMERCE 12-16-2002.

OWNER OF U.S. REG. NO. 2,691,815.

SEC. 2(F).

"L. GALLARDO" DOES NOT IDENTIFY A LIVING INDIVIDUAL.

THE MARK CONSISTS OF "L. GALLARDO" SIGNATURE.

THE ENGLISH TRANSLATION OF "GALLARDO" IN THE MARK IS "GALLANT".

SN 77-821,048, FILED 9-5-2009.

TARAH HARDY, EXAMINING ATTORNEY

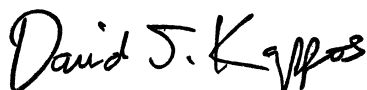
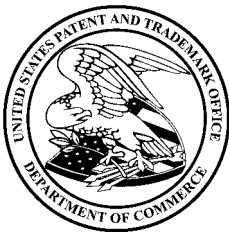

Director of the United States Patent and Trademark Office

**United States of America**  
United States Patent and Trademark Office

# ECO-FLO

**Reg. No. 4,125,867**

GARDNER DENVER NASH, LLC (DELAWARE LIMITED LIABILITY COMPANY)  
9 TREFOIL DRIVE  
TRUMBULL, CT 066111330

**Registered Apr. 10, 2012**

**Int. Cls.: 7 and 37**

FOR: LIQUID RING PUMPS, IN CLASS 7 (U.S. CLS. 13, 19, 21, 23, 31, 34 AND 35).

**TRADEMARK**

FIRST USE 8-31-2009; IN COMMERCE 8-31-2009.

**SERVICE MARK**

FOR: RETROFITTING LIQUID RING PUMPS, IN CLASS 37 (U.S. CLS. 100, 103 AND 106).

**PRINCIPAL REGISTER**

FIRST USE 8-31-2009; IN COMMERCE 8-31-2009.

THE MARK CONSISTS OF STANDARD CHARACTERS WITHOUT CLAIM TO ANY PARTICULAR FONT, STYLE, SIZE, OR COLOR.

SN 77-826,902, FILED 9-15-2009.

HOWARD B. LEVINE, EXAMINING ATTORNEY



*David J. Kybas*

Director of the United States Patent and Trademark Office

# United States of America

United States Patent and Trademark Office

## QUARTET GREAT IDEAS START HERE

**Reg. No. 4,125,868**

**Registered Apr. 10, 2012**

**Int. Cls.: 6, 9, and 16**

**TRADEMARK**

**PRINCIPAL REGISTER**

GENERAL BINDING CORPORATION (DELAWARE CORPORATION)  
300 TOWER PARKWAY  
LINCOLNSHIRE, IL 60031

FOR: NON-LUMINOUS AND NON-MECHANICAL METAL SIGNS, IN CLASS 6 (U.S. CLS. 2, 12, 13, 14, 23, 25 AND 50).

FIRST USE 1-31-2009; IN COMMERCE 1-31-2009.

FOR: ELECTRONIC SCANNING AND PRINTING APPARATUS, NAMELY, ELECTRONIC COPY BOARDS WITH AND WITHOUT CONNECTIONS TO COMPUTERS; PROJECTION SCREENS; BLACK MARKER BOARD WITH AN EXTERNAL LIGHT SOURCE INTEGRATE INTO SAME; MAGNETS; APPARATUS FOR RECORDING, TRANSMITTING, RECEIVING AND REPRODUCING IMAGES; DISPLAY BOARDS INCORPORATING SCANNERS; LUMINOUS SIGNS, ELECTRONIC OUTLETS; COMPONENT PARTS THEREOF, IN CLASS 9 (U.S. CLS. 21, 23, 26, 36 AND 38).

FIRST USE 1-31-2009; IN COMMERCE 1-31-2009.

FOR: DRAWING BOARDS; CHART BOARDS; NOTICE BOARDS; DRY WIPE BOARDS; BULLETIN BOARDS; MESSAGE BOARDS; CORK BOARDS; DIRECTORY BOARDS; MAGNETIC BOARDS; COPY BOARDS; BLACK MARKER BOARDS; STANDS AND EASELS FOR ALL THE AFORESAID GOODS; STANDS, NAMELY, TABLE-TOP EASEL STANDS WHICH PROP AN EASEL; EASELS; PENS; MARKERS; WRITING AND DRAWING INSTRUMENTS; CHALKS; CRAYONS; PAPER CUTTERS AND TRIMMERS; STAPLES AND STAPLE PRESSES; ERASERS; CHALK HOLDERS; PASTELS; DRAWING CHARCOAL; PLASTIC LETTERS, NUMBERS AND CHARACTERS, ARTISTS' MATERIALS, NAMELY, WATER SOLUBLE TEMPERA CRAYONS, CAKES OF TEMPERA PAINT, MARKERS, PLASTIC PAINT TRAY, AND EASEL CLIPS; PAINT BRUSHES; ALL FOR USE ON BOARDS; PARTS AND FITTINGS FOR THE AFORESAID GOODS, IN CLASS 16 (U.S. CLS. 2, 5, 22, 23, 29, 37, 38 AND 50).

FIRST USE 1-31-2009; IN COMMERCE 1-31-2009.

THE MARK CONSISTS OF STANDARD CHARACTERS WITHOUT CLAIM TO ANY PARTICULAR FONT, STYLE, SIZE, OR COLOR.



*David J. Kyffers*

Director of the United States Patent and Trademark Office

**Reg. No. 4,125,868** OWNER OF U.S. REG. NOS. 3,099,451, 3,254,326, AND OTHERS.

SN 77-827,880, FILED 9-16-2009.

JILL C. ALT, EXAMINING ATTORNEY

# United States of America

United States Patent and Trademark Office



**Reg. No. 4,125,869**

PETROLEUM NEWSPAPERS OF ALASKA, LLC (ALASKA LIMITED LIABILITY COMPANY)  
5441 OLD SEWARD HWY., SUITE #3  
ANCHORAGE, AK 99518

**Registered Apr. 10, 2012**

**Int. Cl.: 9**

FOR: DOWNLOADABLE ELECTRONIC MAGAZINE IN THE FIELD OF ENERGY AND OIL,  
IN CLASS 9 (U.S. CLS. 21, 23, 26, 36 AND 38).

**TRADEMARK**

FIRST USE 7-15-2009; IN COMMERCE 7-21-2009.

**PRINCIPAL REGISTER**

NO CLAIM IS MADE TO THE EXCLUSIVE RIGHT TO USE "GREENING OF OIL", APART  
FROM THE MARK AS SHOWN.

THE MARK CONSISTS OF AN ORGANIC LOOKING TREE WITH A TEARDROP BELOW  
IT. TO THE RIGHT OF THE DESIGN IS THE STYLIZED PHRASE "GREENINGOFOIL".

SN 77-830,338, FILED 9-18-2009.

KIM SAITO, EXAMINING ATTORNEY



*David J. Kybas*

Director of the United States Patent and Trademark Office

# United States of America

United States Patent and Trademark Office

## WOOD-WORM

**Reg. No. 4,125,870**

POWERS FASTENERS, INC. (NEW YORK CORPORATION)  
2 POWERS LANE  
BREWSTER, NY 10509

**Registered Apr. 10, 2012**

**Int. Cl.: 6**

FOR: METAL FASTENERS, NAMELY, SCREWS; METAL THREADED FASTENERS, IN CLASS 6 (U.S. CLS. 2, 12, 13, 14, 23, 25 AND 50).

**TRADEMARK**

FIRST USE 7-15-2010; IN COMMERCE 7-15-2010.

**PRINCIPAL REGISTER**

THE MARK CONSISTS OF STANDARD CHARACTERS WITHOUT CLAIM TO ANY PARTICULAR FONT, STYLE, SIZE, OR COLOR.

SN 77-832,124, FILED 9-22-2009.

ANNE FARRELL, EXAMINING ATTORNEY



*David J. Kybas*

Director of the United States Patent and Trademark Office



# United States of America

United States Patent and Trademark Office

# ConsistBIS

**Reg. No. 4,125,871**

**Registered Apr. 10, 2012**

**Int. Cl.: 9**

**TRADEMARK**

**PRINCIPAL REGISTER**

CONSIST SOFTWARE SOLUTIONS, INC. (DELAWARE CORPORATION)  
SUITE C  
874 WALKER ROAD  
DOVER, DE 199042778

FOR: COMPUTER SOFTWARE FOR MANAGING BUSINESS INFORMATION FOR BUSINESS APPLICATIONS, IN CLASS 9 (U.S. CLS. 21, 23, 26, 36 AND 38).

FIRST USE 12-31-2009; IN COMMERCE 12-31-2009.

THE MARK CONSISTS OF STANDARD CHARACTERS WITHOUT CLAIM TO ANY PARTICULAR FONT, STYLE, SIZE, OR COLOR.

SN 77-833,322, FILED 9-23-2009.

WENDY JUN, EXAMINING ATTORNEY



*David J. Kybas*

Director of the United States Patent and Trademark Office

# United States of America

United States Patent and Trademark Office

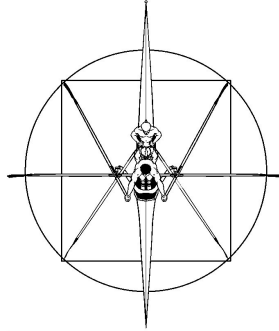

The Rowing Store

**Reg. No. 4,125,872**

THOMAS, JAMIESON (UNITED STATES INDIVIDUAL)  
922 GOLFSIDE DRIVE  
WINTER PARK, FL 32792

**Registered Apr. 10, 2012**

**Int. Cl.: 35**

FOR: ON-LINE RETAIL STORE SERVICES FEATURING ROWING PRODUCTS, IN CLASS 35 (U.S. CLS. 100, 101 AND 102).

**SERVICE MARK**

FIRST USE 1-1-2009; IN COMMERCE 1-1-2010.

**PRINCIPAL REGISTER**

NO CLAIM IS MADE TO THE EXCLUSIVE RIGHT TO USE "THE ROWING STORE", APART FROM THE MARK AS SHOWN.

THE MARK CONSISTS OF A CIRCLE, WITHIN WHICH IS A SQUARE, WITHIN THE SQUARE IS A ROWING SHELL THAT EXTENDS VERTICALLY BEYOND THE SQUARE AND CIRCLE, IN THE ROWING SHELL IS A DEPICTION OF AN INDIVIDUAL ROWER IN THREE DIFFERENT POSITIONS WHERE THE ROWER GETS FAINTER AS THE POSITION MOVES BACK TO SHOW MOVEMENT, THE ROWER HAS AN OAR IN EACH OF ITS HANDS AND EACH DEPICTION SHOWS THE OARS IN DIFFERENT POSITIONS OF A SINGLE STROKE, BELOW THE DESIGN IS THE WORDING "THE ROWING STORE" BETWEEN TWO SOLID LINES.

SN 77-835,644, FILED 9-25-2009.

CHRISTINA SOBRAL, EXAMINING ATTORNEY



*David J. Kyros*

Director of the United States Patent and Trademark Office

# United States of America

United States Patent and Trademark Office

# 360°

**Reg. No. 4,125,873**

THE CLEVELAND CLINIC FOUNDATION (OHIO CORPORATION)  
9500 EUCLID AVENUE  
CLEVELAND, OH 44195

**Registered Apr. 10, 2012**

**Int. Cls.: 9, 35, 41, 43, 44,  
and 45**

FOR: DIGITAL MEDIA, NAMELY, DOWNLOADABLE AUDIO FILES, DOWNLOADABLE PODCASTS, DOWNLOADABLE WEBCASTS, ALL IN THE FIELDS OF NUTRITION, COOKING, EXERCISE, STRESS MANAGEMENT, AND HEALTH- AND WELLNESS-RELATED TOPICS; DOWNLOADABLE ELECTRONIC NEWSLETTERS IN THE FIELDS OF NUTRITION, COOKING, EXERCISE, STRESS MANAGEMENT, AND HEALTH- AND WELLNESS-RELATED TOPICS; ELECTRONIC DAY PLANNERS, ELECTRONIC CALENDARS, ELECTRONIC COOKBOOKS AND ELECTRONIC RECIPE CARDS, RECORDED ON COMPUTER MEDIA OR DOWNLOADABLE; COMPUTER PROGRAMS FOR STRESS MANAGEMENT PROGRAMS, AND HEALTH- AND WELLNESS-MANAGEMENT PROGRAMS, IN CLASS 9 (U.S. CLS. 21, 23, 26, 36 AND 38).

**TRADEMARK**

**SERVICE MARK**

**PRINCIPAL REGISTER**

FIRST USE 9-9-2009; IN COMMERCE 9-9-2009.

FOR: ON-LINE RETAIL STORE SERVICES FEATURING HEALTH AND WELLNESS PRODUCTS, VITAMINS AND SUPPLEMENTS FOR HUMAN CONSUMPTION, PERSONAL CARE AND BEAUTY PRODUCTS, NUTRITIONAL PRODUCTS, PERSONAL CARE APPLIANCES, FITNESS EQUIPMENT, MASSAGE CHAIRS, BED LINENS, BOOKS, MAGAZINES, AND PRE-RECORDED AUDIO AND VIDEO DISCS; PROVIDING A WEBSITE FEATURING CONSUMER INFORMATION ABOUT FITNESS AND WELLNESS PRODUCTS AND SERVICES; RATING OF CONSUMER PRODUCTS AND SERVICES FOR OTHERS IN THE FIELDS OF PHYSICAL AND MENTAL HEALTH, COOKING, WELLNESS, EXERCISE, NUTRITION, FITNESS, DISEASE PREVENTION AND MANAGEMENT, STRESS MANAGEMENT, PHARMACOLOGY, HOMEOPATHY, DIETARY SUPPLEMENTS, IN CLASS 35 (U.S. CLS. 100, 101 AND 102).

FIRST USE 9-1-2009; IN COMMERCE 9-1-2009.

FOR: WEBSITE PROVIDING INFORMATION, NEWS AND COUNSELING IN THE FIELD OF EXERCISE AND FITNESS TO CONSUMERS, PROVIDERS, ADMINISTRATORS AND OTHER PARTICIPANTS IN THE HEALTHCARE INDUSTRY; ON-LINE INTERACTIVE COURSES OF INSTRUCTION IN THE FIELDS OF PHYSICAL AND MENTAL HEALTH, COOKING, WELLNESS, EXERCISE, NUTRITION, FITNESS, DISEASE PREVENTION AND MANAGEMENT, STRESS MANAGEMENT, DIETARY SUPPLEMENTS, AGING, DIETING,



*David J. Kyjars*

Director of the United States Patent and Trademark Office

**Reg. No. 4,125,873** PERSONAL MOTIVATION, GOAL ATTAINMENT, WEIGHT LOSS, AND LIFESTYLE PROVIDED TO CONSUMERS, PROVIDERS, ADMINISTRATORS AND OTHER PARTICIPANTS IN THE HEALTHCARE INDUSTRY; PROVIDING INFORMATION ABOUT FITNESS, EXERCISE, AND PHYSICAL FITNESS; LIFE COACHING SERVICES IN THE FIELDS OF STRESS MANAGEMENT, DIETING, AND WEIGHT LOSS; ON-LINE JOURNALS, NAMELY, BLOGS FEATURING INFORMATION IN THE FIELDS OF PHYSICAL AND MENTAL HEALTH, COOKING, WELLNESS, EXERCISE, NUTRITION, FITNESS, DISEASE PREVENTION AND MANAGEMENT, AND DIETARY SUPPLEMENTS, IN CLASS 41 (U.S. CLS. 100, 101 AND 107).

FIRST USE 9-1-2009; IN COMMERCE 9-1-2009.

FOR: PROVIDING A DATABASE IN THE FIELD OF RECIPES AND COOKING INFORMATION; WEBSITE PROVIDING INFORMATION, NEWS AND ADVICE IN THE FIELD OF COOKING, IN CLASS 43 (U.S. CLS. 100 AND 101).

FIRST USE 4-1-2010; IN COMMERCE 4-1-2010.

FOR: PROVIDING INFORMATION ABOUT HEALTH AND BEAUTY; WELLNESS SERVICES, NAMELY, HEALTH CARE COUNSELING, NUTRITIONAL CONSULTATION; PROVIDING GENERAL HEALTH, WELLNESS AND MEDICAL INFORMATION TO THE PUBLIC; PROVIDING AN INTERACTIVE WEBSITE IN THE FIELD OF HEALTH THAT GUIDES CONSUMERS TO BETTER HEALTH, AND HEALTH COMPLIANCE; PROVIDING ADVICE, CONSULTATION AND INFORMATION IN THE FIELDS OF PHYSICAL AND MENTAL HEALTH, WELLNESS, NUTRITION, DISEASE PREVENTION AND MANAGEMENT, STRESS MANAGEMENT, DIETING, AND WEIGHT LOSS; ON-LINE WELLNESS SERVICES, NAMELY, PERSONAL ASSESSMENTS, PERSONALIZED ROUTINES, MAINTENANCE SCHEDULES AND COUNSELING; WEBSITE PROVIDING INFORMATION, NEWS AND COUNSELING IN THE FIELDS OF PHYSICAL AND MENTAL HEALTH, WELLNESS, NUTRITION, DISEASE PREVENTION AND MANAGEMENT, STRESS MANAGEMENT, AND DIETARY SUPPLEMENTS, IN CLASS 44 (U.S. CLS. 100 AND 101).

FIRST USE 9-1-2009; IN COMMERCE 9-1-2009.

FOR: PROVIDING ADVICE, CONSULTATION, COUNSELING AND INFORMATION IN THE FIELDS OF PERSONAL MOTIVATION, PERSONAL GOAL ATTAINMENT, AND PERSONAL LIFESTYLES; WEBSITE PROVIDING INFORMATION, NEWS AND COUNSELING IN THE FIELDS PERSONAL MOTIVATION, PERSONAL GOAL ATTAINMENT, AND PERSONAL LIFESTYLES TO CONSUMERS, PROVIDERS, ADMINISTRATORS AND OTHER PARTICIPANTS IN THE HEALTHCARE INDUSTRY, IN CLASS 45 (U.S. CLS. 100 AND 101).

FIRST USE 9-1-2009; IN COMMERCE 9-1-2009.

THE MARK CONSISTS OF THE NUMBERS "3605" WITH THE NUMBER "5" REDUCED IN SIZE INSIDE THE NUMBER ZERO ALONG WITH A DEGREE SYMBOL TO THE UPPER RIGHT SIDE OF THE ZERO.

SN 77-837,237, FILED 9-29-2009.

ELLEN PERKINS, EXAMINING ATTORNEY

# United States of America

United States Patent and Trademark Office

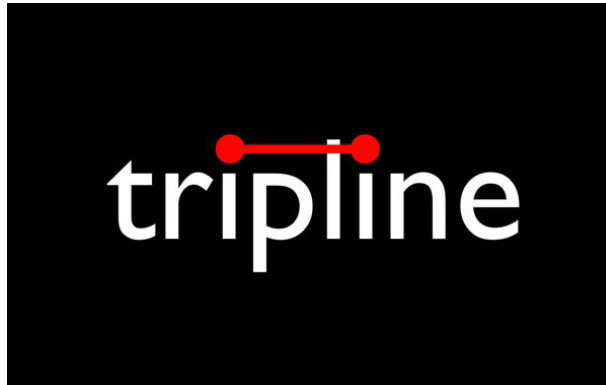

**Reg. No. 4,125,874**

**Registered Apr. 10, 2012**

**Int. Cl.: 39**

**SERVICE MARK**

**PRINCIPAL REGISTER**

TRIPLINE, INC (CALIFORNIA CORPORATION)  
1307 N FAIRFAX AVE.  
WEST HOLLYWOOD, CA 90046

FOR: ONLINE CREATION AND COORDINATION OF TRAVEL PLANS, TRAVEL STATUS UPDATES AND SHARING OF TRAVEL STORIES FOR INDIVIDUALS AND GROUPS; TRAVEL INFORMATION SERVICES; PROVIDING LINKS TO WEBSITES OF OTHERS FEATURING TRAVEL INFORMATION AND SERVICES, IN CLASS 39 (U.S. CLS. 100 AND 105).

FIRST USE 1-1-2010; IN COMMERCE 8-5-2010.

THE MARK CONSISTS OF THE WORD "TRIPLINE" ACCOMPANIED BY A RED LINE WITH DOTS AT EACH END REPRESENTING TRAVEL BETWEEN POINTS.

THE COLOR(S) RED IS/ARE CLAIMED AS A FEATURE OF THE MARK.

SN 77-839,178, FILED 10-1-2009.

SHAUNIA CARLYLE, EXAMINING ATTORNEY



*David J. Kybas*

Director of the United States Patent and Trademark Office

# United States of America

United States Patent and Trademark Office



**Reg. No. 4,125,875**

**Registered Apr. 10, 2012**

**Int. Cl.: 29**

**TRADEMARK**

**PRINCIPAL REGISTER**

WESTERN FISHBOAT OWNER'S ASSOCIATION (CALIFORNIA CORPORATION)  
740 NORTH HARBOR DRIVE  
SAN DIEGO, CA 921015806

FOR: TUNA FISH, NAMELY, WILD CAUGHT ALBACORE, IN CLASS 29 (U.S. CL. 46).

FIRST USE 1-1-2009; IN COMMERCE 1-1-2011.

NO CLAIM IS MADE TO THE EXCLUSIVE RIGHT TO USE "WILD PACIFIC ALBACORE",  
APART FROM THE MARK AS SHOWN.

THE COLOR(S) WHITE, LIGHT BLUE, MIDDLE BLUE, DARK BLUE, GRAY SHADOW  
IS/ARE CLAIMED AS A FEATURE OF THE MARK.

THE MARK CONSISTS OF A CIRCLE WITH A BLUE EXTERIOR BORDER AND AS YOU  
MOVE INWARD FROM THE EDGE OF THE BLUE CIRCLE BORDER THERE IS A WHITE  
CONCENTRIC CIRCLE BORDER. IN THE UPPER ONE HALF OF THE MARK IS A WHITE  
STYLIZED ALBACORE TUNA IN THREE PARTS WITH ITS HEAD FACING TO THE RIGHT  
-- THE THREE PARTS ARE TAIL, THE LONG DORSAL FIN, AND THE BODY AND HEAD,  
WITH A ROUND WHITE EYE WITH BACKGROUND SHADOW. STARTING FROM THE  
BOTTOM RIGHT OF THE MARK ENDING ON THE LEFT UPPER SIDE IS A BLUE WAVE,  
ABOVE AND BELOW WHICH ARE TWO LIGHT BLUE WAVE LINES, ONE STARTING AT  
THE BOTTOM RIGHT AND ENDING ON THE MIDDLE LEFT, THE OTHER STARTING IN  
THE MIDDLE RIGHT AND ENDING IN THE UPPER LEFT SIDE. MOVING FROM THE  
BOTTOM OF THE MARK TO THE TOP, ABOVE THE LAST LIGHT BLUE WAVE IS ANOTH-  
ER DARK BLUE WAVE, STARTING IN THE UPPER RIGHT OF THE CIRCLE AND ENDING  
ON THE TOP JUST LEFT OF CENTER OF THE CIRCLE.

SN 77-840,564, FILED 10-2-2009.

MARILYN IZZI, EXAMINING ATTORNEY



*David J. Kyffers*

Director of the United States Patent and Trademark Office

# United States of America

United States Patent and Trademark Office



**Reg. No. 4,125,876**

YTG BRANDS CORP. (CANADA CORPORATION)  
2000 APPLEBY LINE, SUITE 408  
BURLINGTON, ONTARIO, CANADA L7L7H7

**Registered Apr. 10, 2012**

**Int. Cl.: 30**

FOR: POPCORN, IN CLASS 30 (U.S. CL. 46).

**TRADEMARK**

FIRST USE 1-20-2012; IN COMMERCE 1-20-2012.

**PRINCIPAL REGISTER**

THE MARK CONSISTS OF THE WORD "AMAIZE" WITH A STYLIZED "M" AND STYLIZED DOTS OVER THE "I" WITH THE WORDS "CRUNCH YOUR CRAVINGS" UNDERNEATH "AMAIZE".

SN 77-845,079, FILED 10-9-2009.

DAVID COLLIER, EXAMINING ATTORNEY



*David J. Kyros*

Director of the United States Patent and Trademark Office

# United States of America

United States Patent and Trademark Office

## WHAT DOES IT MEAN TO BE

**Reg. No. 4,125,877**

**Registered Apr. 10, 2012**

**Int. Cls.: 9 and 16**

**TRADEMARK**

**PRINCIPAL REGISTER**

LITTLE PICKLE PRESS LLC (CALIFORNIA LIMITED LIABILITY COMPANY)  
P.O. BOX 983  
BELVEDERE, CA 94920

FOR: DOWNLOADABLE ELECTRONIC PUBLICATIONS, NAMELY, A SERIES OF E-BOOKS, TALKING E-BOOKS AND INTERACTIVE E-BOOKS IN THE FIELD OF CHILDREN'S TOPICS AND STORIES, IN CLASS 9 (U.S. CLS. 21, 23, 26, 36 AND 38).

FIRST USE 10-0-2010; IN COMMERCE 10-0-2010.

FOR: A SERIES OF CHILDREN'S BOOKS, IN CLASS 16 (U.S. CLS. 2, 5, 22, 23, 29, 37, 38 AND 50).

FIRST USE 3-15-2010; IN COMMERCE 3-15-2010.

THE MARK CONSISTS OF STANDARD CHARACTERS WITHOUT CLAIM TO ANY PARTICULAR FONT, STYLE, SIZE, OR COLOR.

SN 77-845,596, FILED 10-9-2009.

AMEEN IMAM, EXAMINING ATTORNEY



*David J. Kyjars*

Director of the United States Patent and Trademark Office



# United States of America

United States Patent and Trademark Office



**Reg. No. 4,125,878**

**Registered Apr. 10, 2012**

**Int. Cl.: 29**

**TRADEMARK**

**PRINCIPAL REGISTER**

BLACK TIGER LLC (CALIFORNIA LIMITED LIABILITY COMPANY)  
13837 MONTEREY LANE  
LA MIRADA, CA 90638

FOR: BEEF JERKY, IN CLASS 29 (U.S. CL. 46).

FIRST USE 3-1-2010; IN COMMERCE 3-1-2010.

THE MARK CONSISTS OF A DESIGN COMPRISED OF ONE SIDE OF A TIGER'S FACE.

SN 77-847,135, FILED 10-12-2009.

MARTHA FROMM, EXAMINING ATTORNEY



*David J. Kybas*

Director of the United States Patent and Trademark Office

# United States of America

United States Patent and Trademark Office

## Smarter Video

**Reg. No. 4,125,879**

**Registered Apr. 10, 2012**

**Int. Cl.: 9**

**TRADEMARK**

**PRINCIPAL REGISTER**

APELLIS, INC. (MARYLAND CORPORATION)  
1300 19TH STREET NW SUITE 100  
WASHINGTON, DC 20036

FOR: COMPUTER HARDWARE FOR COMMUNICATING AUDIO, VIDEO AND DATA BETWEEN COMPUTERS VIA A GLOBAL COMPUTER NETWORK, WIDE-AREA COMPUTER NETWORKS, AND PEER-TO-PEER COMPUTER NETWORKS; IP VIDEO SERVERS; PC DIGITAL VIDEO RECORDERS; SOUND AND VIDEO RECORDING AND PLAYBACK MACHINES, IN CLASS 9 (U.S. CLS. 21, 23, 26, 36 AND 38).

FIRST USE 8-18-2011; IN COMMERCE 8-18-2011.

THE MARK CONSISTS OF STANDARD CHARACTERS WITHOUT CLAIM TO ANY PARTICULAR FONT, STYLE, SIZE, OR COLOR.

NO CLAIM IS MADE TO THE EXCLUSIVE RIGHT TO USE "VIDEO", APART FROM THE MARK AS SHOWN.

SN 77-847,525, FILED 10-13-2009.

KELLEY WELLS, EXAMINING ATTORNEY



*David J. Kyffers*

Director of the United States Patent and Trademark Office

# United States of America

United States Patent and Trademark Office

# MediFone

**Reg. No. 4,125,880**

RAO, BINDU RAMA (UNITED STATES INDIVIDUAL)  
21 HENLEY DRIVE

**Registered Apr. 10, 2012**

LAGUNA NIGUEL, CA 92677

**Int. Cl.: 38**

FOR: TRANSMISSION OF VOICE, DATA AND IMAGES RELATING TO PATIENT MEDICAL RECORDS BY MEANS OF TELECOMMUNICATIONS NETWORKS, IN CLASS 38 (U.S. CLS. 100, 101 AND 104).

**SERVICE MARK**

FIRST USE 6-1-2010; IN COMMERCE 9-1-2010.

**PRINCIPAL REGISTER**

THE MARK CONSISTS OF STANDARD CHARACTERS WITHOUT CLAIM TO ANY PARTICULAR FONT, STYLE, SIZE, OR COLOR.

SN 77-850,641, FILED 10-16-2009.

MARIAM MAHMOUDI, EXAMINING ATTORNEY



*David J. Kybas*

Director of the United States Patent and Trademark Office

# United States of America

United States Patent and Trademark Office

# FIRST STEP

**Reg. No. 4,125,881**

**Registered Apr. 10, 2012**

**Int. Cls.: 35 and 36**

**SERVICE MARK**

**PRINCIPAL REGISTER**

FIRST STEP ECONOMIC OPPORTUNITY ZONE, INC. (DELAWARE CORPORATION)  
625 SLATERS LANE, SUITE 200  
ALEXANDRIA, VA 223141176

FOR: BUSINESS MANAGEMENT SERVICES; BUSINESS CONSULTING SERVICES; PROMOTING PUBLIC AWARENESS OF THE NEED FOR THE ECONOMIC DEVELOPMENT IN FOREIGN COUNTRIES; RECRUITMENT OF FIRMS TO SOURCE PRODUCTION, NAMELY, PROMOTING SPECIAL ECONOMIC ZONES IN FOREIGN COUNTRIES TO BUSINESSES, IN CLASS 35 (U.S. CLS. 100, 101 AND 102).

FIRST USE 11-18-2009; IN COMMERCE 11-18-2009.

FOR: RAISING CAPITAL, NAMELY, RAISING DEBT AND EQUITY CAPITAL FOR SPECIAL ECONOMIC ZONE IN FOREIGN COUNTRIES, IN CLASS 36 (U.S. CLS. 100, 101 AND 102).

FIRST USE 11-0-2009; IN COMMERCE 11-0-2009.

THE MARK CONSISTS OF STANDARD CHARACTERS WITHOUT CLAIM TO ANY PARTICULAR FONT, STYLE, SIZE, OR COLOR.

SN 77-851,031, FILED 10-16-2009.

KATHRYN COWARD, EXAMINING ATTORNEY



*David J. Kyros*

Director of the United States Patent and Trademark Office

# United States of America

United States Patent and Trademark Office



**Reg. No. 4,125,882**

HOOPER, DOUGLAS (UNITED STATES INDIVIDUAL)  
3308 WHITE PINE DRIVE  
NASHVILLE, TN 37214

**Registered Apr. 10, 2012**

**Int. Cl.: 35**

FOR: RETAIL STORE SERVICES FEATURING NEW AND USED GOLF EQUIPMENT, IN CLASS 35 (U.S. CLS. 100, 101 AND 102).

**SERVICE MARK**

FIRST USE 1-4-2012; IN COMMERCE 1-4-2012.

**PRINCIPAL REGISTER**

NO CLAIM IS MADE TO THE EXCLUSIVE RIGHT TO USE "GOLF", APART FROM THE MARK AS SHOWN.

THE COLOR(S) GREEN, BLACK AND WHITE IS/ARE CLAIMED AS A FEATURE OF THE MARK.

THE MARK CONSISTS OF THE WORDS "CLUB HOUSE GOLF" IN BLACK WITH A GREEN ARROW ON THE LETTER "H" AND A GOLF CLUB ATTACHED TO THE LETTER "L" ALL ON A WHITE BACKGROUND.

SN 77-853,770, FILED 10-21-2009.

AISHA CLARKE, EXAMINING ATTORNEY



*David J. Kybas*

Director of the United States Patent and Trademark Office

# United States of America

United States Patent and Trademark Office

# WISH

**Reg. No. 4,125,883**

**Registered Apr. 10, 2012**

**Int. Cl.: 33**

**TRADEMARK**

**PRINCIPAL REGISTER**

WISH WINE CO., LLC (WASHINGTON LIMITED LIABILITY COMPANY)  
10015 LAKE CITY WAY NE PMB #101  
SEATTLE, WA 98125

FOR: WINES, IN CLASS 33 (U.S. CLS. 47 AND 49).

FIRST USE 1-25-2012; IN COMMERCE 1-25-2012.

THE MARK CONSISTS OF STANDARD CHARACTERS WITHOUT CLAIM TO ANY PARTICULAR FONT, STYLE, SIZE, OR COLOR.

SN 77-854,880, FILED 10-22-2009.

MARTHA FROMM, EXAMINING ATTORNEY



*David J. Kybas*

Director of the United States Patent and Trademark Office

# United States of America

United States Patent and Trademark Office



**Reg. No. 4,125,884**

HOOPER, DOUGLAS (UNITED STATES INDIVIDUAL)  
3308 WHITE PINE DRIVE  
NASHVILLE, TN 37214

**Registered Apr. 10, 2012**

**Int. Cl.: 35**

FOR: RETAIL STORE SERVICES FEATURING NEW AND USED GOLF EQUIPMENT, IN CLASS 35 (U.S. CLS. 100, 101 AND 102).

**SERVICE MARK**

FIRST USE 1-4-2012; IN COMMERCE 1-4-2012.

**PRINCIPAL REGISTER**

THE MARK CONSISTS OF THE LETTERS "CHG" IN BLACK WITH A GREEN ARROW ON THE LETTER "H" AND A GOLF CLUB AND BALL BELOW THE LETTER "H" IN BLACK.

THE COLOR(S) BLACK AND GREEN IS/ARE CLAIMED AS A FEATURE OF THE MARK.

SN 77-856,336, FILED 10-23-2009.

AISHA CLARKE, EXAMINING ATTORNEY



*David J. Kybas*

Director of the United States Patent and Trademark Office

# United States of America

United States Patent and Trademark Office

# in:ciite

**Reg. No. 4,125,885**

**Registered Apr. 10, 2012**

**Int. Cl.: 41**

**SERVICE MARK**

**PRINCIPAL REGISTER**

INDELIBLE CREATIVE GROUP, LLC (TENNESSEE LIMITED LIABILITY COMPANY)  
FOUR CORPORATE CENTRE SUITE 501  
810 CRESCENT CENTRE DRIVE  
FRANKLIN, TN 37067

FOR: PRODUCTION OF ANIMATION, VIDEO, FILM, AND MOTION PICTURES; MULTI-MEDIA PUBLISHING OF BOOKS AND VIDEO; MUSIC PRODUCTION SERVICES, IN CLASS 41 (U.S. CLS. 100, 101 AND 107).

FIRST USE 1-22-2011; IN COMMERCE 1-30-2011.

THE MARK CONSISTS OF A SMALL LETTER "I", APPEARING WITH THE BOTTOM PORTION OF THE LETTER ENCLOSED IN AN OPEN ENDED CIRCLE, FOLLOWED BY THE SMALL LETTERS "IN:CIITE".

SN 77-857,475, FILED 10-26-2009.

ANDREA HACK, EXAMINING ATTORNEY



*David J. Kybas*

Director of the United States Patent and Trademark Office



# United States of America

United States Patent and Trademark Office

# LOOPIT

**Reg. No. 4,125,886**

**Registered Apr. 10, 2012**

**Int. Cl.: 28**

**TRADEMARK**

**PRINCIPAL REGISTER**

GOLAD, ADAR (NETHERLANDS INDIVIDUAL)  
SCHERENENKWEG 16  
HATTEM, NETHERLANDS 8051KH

FOR: APPARATUS FOR ELECTRONIC GAMES OTHER THAN THOSE ADAPTED FOR USE WITH AN EXTERNAL DISPLAY SCREEN OR MONITOR; BOARD GAMES; CARD GAMES; EDUCATIONAL CARD GAMES; HAND HELD UNITS FOR PLAYING ELECTRONIC GAMES OTHER THAN THOSE ADAPTED FOR USE WITH AN EXTERNAL DISPLAY SCREEN OR MONITOR; PARLOR GAMES; PLAYING CARDS, IN CLASS 28 (U.S. CLS. 22, 23, 38 AND 50).

FIRST USE 2-18-2007; IN COMMERCE 2-22-2008.

THE MARK CONSISTS OF STANDARD CHARACTERS WITHOUT CLAIM TO ANY PARTICULAR FONT, STYLE, SIZE, OR COLOR.

OWNER OF BENELUX REG. NO. 0822433, DATED 7-5-2007, EXPIRES 4-16-2017.

SN 77-860,102, FILED 10-29-2009.

SHARON MEIER, EXAMINING ATTORNEY



*David J. Kyfos*

Director of the United States Patent and Trademark Office

# United States of America

United States Patent and Trademark Office

## GIVE GOD THE PRAISE

**Reg. No. 4,125,887**

CLEMENT BROWN JR. (UNITED STATES INDIVIDUAL)

**Registered Apr. 10, 2012**

16580 KENTFIELD  
DETROIT, MI 48219

**Int. Cl.: 25**

FOR: CLOTHING AND WEARING APPAREL IN THE NATURE OF FOOTWEAR, HEADGEAR, NAMELY, HATS, CAPS; SKULL CAPS, HOODED SWEATSHIRTS, ASCOTS, ARTICLES OF OUTER CLOTHING, NAMELY, COATS, OVERCOATS, RAIN COATS, PONCHOS; ARTICLES OF UNDERCLOTHING, NAMELY, UNDERSHIRTS, BRAS, CAMISOLES, UNDERCLOTHES, PANTIES; SHIRTS, WOVEN SHIRTS, DRESS SHIRTS, POLO SHIRTS, SUITS, TIES, SWEATSHIRTS, JACKETS, SNOWSUITS, PANTS, TROUSERS, SHORTS, TANK TOPS, RAINWEAR, CLOTH BIBS, SKIRTS, BLOUSES, DRESSES, SUSPENDERS, SWEATERS, ATHLETIC UNIFORMS, WARM-UP SUITS, JOGGING SUITS, SHOES, BOOTS, SNEAKERS, SANDALS, BOOTIES, SLIPPER SOCKS, SWIMWEAR, SCARVES, DRESSING GOWNS, BOXER SHORTS, SOCKS, T-SHIRTS; SUN VISORS, SLEEPWEAR, PAJAMAS, SLIPPERS, UNDERWEAR, LINGERIE, WRIST BANDS, HEAD BANDS, ROBES; FOOTWEAR AND HEADWEAR FOR BABIES AND TODDLERS; ARTICLES OF CLOTHING FOR BABIES AND TODDLERS, NAMELY, ROMPER SUITS, CLOTH DIAPERS, SHAWLS, BIBS NOT OF PAPER AND BOOTIES, IN CLASS 25 (U.S. CLS. 22 AND 39).

**TRADEMARK**

**PRINCIPAL REGISTER**

FIRST USE 12-31-2009; IN COMMERCE 12-31-2009.

THE MARK CONSISTS OF STANDARD CHARACTERS WITHOUT CLAIM TO ANY PARTICULAR FONT, STYLE, SIZE, OR COLOR.

SN 77-860,417, FILED 10-29-2009.

KATHERINE CONNOLLY, EXAMINING ATTORNEY



*David J. Kyffers*

Director of the United States Patent and Trademark Office

**United States of America**  
United States Patent and Trademark Office

# TANGIER

**Reg. No. 4,125,888**

**Registered Apr. 10, 2012**

**Int. Cl.: 19**

**TRADEMARK**

**PRINCIPAL REGISTER**

MASONITE INTERNATIONAL CORPORATION (CANADA CORPORATION)  
1820 MATHESON BOULEVARD, UNIT B4  
MISSISSAUGA, CANADA L4W0B3

FOR: DOOR LITES, SIDE LITES AND TRANSOM LITES, ALL IN THE NATURE OF GLASS AND PLASTIC PANELS FOR ENTRANCEWAYS, IN CLASS 19 (U.S. CLS. 1, 12, 33 AND 50).

FIRST USE 1-10-2012; IN COMMERCE 1-10-2012.

THE MARK CONSISTS OF STANDARD CHARACTERS WITHOUT CLAIM TO ANY PARTICULAR FONT, STYLE, SIZE, OR COLOR.

SN 77-861,086, FILED 10-30-2009.

MATTHEW KLINE, EXAMINING ATTORNEY



*David J. Kyffers*

Director of the United States Patent and Trademark Office

# United States of America

United States Patent and Trademark Office



**Reg. No. 4,125,889**

AFAM CONCEPT, INC. (ILLINOIS CORPORATION)  
7401 SOUTH PULASKI ROAD  
CHICAGO, IL 60629

**Registered Apr. 10, 2012**

**Int. Cl.: 3**

FOR: FACE AND BODY LOTIONS; SKIN TONERS; SKIN CLEANSERS; AND SKIN MOIS-  
TURIZERS, IN CLASS 3 (U.S. CLS. 1, 4, 6, 50, 51 AND 52).

**TRADEMARK**

FIRST USE 6-0-2011; IN COMMERCE 6-0-2011.

**PRINCIPAL REGISTER**

THE NAME "MAX FAIR" DOES NOT IDENTIFY A LIVING INDIVIDUAL.

THE MARK CONSISTS OF THE WORDS "MAX FAIR" IN A STYLIZED FORM.

SN 77-864,902, FILED 11-4-2009.

JAY BESCH, EXAMINING ATTORNEY



*David J. Kybas*

Director of the United States Patent and Trademark Office

# United States of America

United States Patent and Trademark Office

## BALLY ASSURANCE

**Reg. No. 4,125,890**

BALLY TOTAL FITNESS HOLDING CORPORATION (DELAWARE CORPORATION)  
8700 WEST BRYN MAWR  
CHICAGO, IL 60631

**Registered Apr. 10, 2012**

**Int. Cl.: 35**

FOR: PRICE COMPARISON SERVICES AND PROVIDING CONSUMER PROTECTION INFORMATION IN CONNECTION WITH HEALTH CLUB SERVICES, IN CLASS 35 (U.S. CLS. 100, 101 AND 102).

**SERVICE MARK**

FIRST USE 1-1-2010; IN COMMERCE 1-1-2010.

**PRINCIPAL REGISTER**

THE MARK CONSISTS OF STANDARD CHARACTERS WITHOUT CLAIM TO ANY PARTICULAR FONT, STYLE, SIZE, OR COLOR.

OWNER OF U.S. REG. NOS. 1,973,721, 3,219,807, AND OTHERS.

NO CLAIM IS MADE TO THE EXCLUSIVE RIGHT TO USE "ASSURANCE", APART FROM THE MARK AS SHOWN.

SN 77-866,132, FILED 11-5-2009.

DAWN HAN, EXAMINING ATTORNEY



*David J. Kyffers*

Director of the United States Patent and Trademark Office

# United States of America

United States Patent and Trademark Office



**Reg. No. 4,125,891**

**Registered Apr. 10, 2012**

**Int. Cl.: 5**

**TRADEMARK**

**PRINCIPAL REGISTER**

JOHNSON & JOHNSON (NEW JERSEY CORPORATION)  
ONE JOHNSON & JOHNSON PLAZA  
NEW BRUNSWICK, NJ 089337001

FOR: ANTIHISTAMINES; DECONGESTANTS, IN CLASS 5 (U.S. CLS. 6, 18, 44, 46, 51 AND 52).

FIRST USE 2-8-2010; IN COMMERCE 2-8-2010.

THE MARK CONSISTS OF AN ABSTRACT DESIGN ON A GREEN SQUARE WITH A YELLOW BAR ACROSS THE TOP OF THE SQUARE THAT INTERSECT WITH A GREEN, RED AND ORANGE SEMI-CIRCLE, A WHITE STAR APPEARS ON THE SEMI-CIRCLE, AND A BLUE BAR EXTENDS FROM THE BOTTOM OF THE SEMI-CIRCLE, A FAINT YELLOW CIRCLE APPEARS BELOW THE BLUE BAR AND A WHITE AND SILVER LINE EXTENDS ACROSS THE SQUARE BENEATH THE CIRCLE.

THE COLOR(S) RED, GREEN, BLUE, YELLOW, SILVER, ORANGE AND WHITE IS/ARE CLAIMED AS A FEATURE OF THE MARK.

SN 77-866,674, FILED 11-6-2009.

RONALD MCMORROW, EXAMINING ATTORNEY



*David J. Kybas*

Director of the United States Patent and Trademark Office

United States of America  
United States Patent and Trademark Office

ShāToBu

**Reg. No. 4,125,892**

MAYFAIR TECH INC. (CANADA CORPORATION)  
3701 JARRY ST. EAST

**Registered Apr. 10, 2012**

MONTREAL, QUEBEC, CANADA H1Z2G1

**Int. Cl.: 25**

FOR: CLOTHING, NAMELY, TOPS AND BOTTOMS, INTIMATE APPAREL IN THE NATURE OF UNDERGARMENTS, UNDERWEAR, LINGERIE, ACTIVEWEAR, NAMELY, TOPS AND BOTTOMS, CASUAL WEAR, NAMELY, TOPS AND BOTTOMS, HOSIERY; FOOTWEAR, IN CLASS 25 (U.S. CLS. 22 AND 39).

**TRADEMARK**

**PRINCIPAL REGISTER**

FIRST USE 2-28-2010; IN COMMERCE 10-31-2011.

THE MARK CONSISTS OF STYLIZED VERSION OF THE WORD "SHATOBU".

THE WORDING "SHATOBU" HAS NO MEANING IN A FOREIGN LANGUAGE.

SN 77-868,621, FILED 11-9-2009.

ERNEST SHOSHO, EXAMINING ATTORNEY



*David J. Kyffers*

Director of the United States Patent and Trademark Office

United States of America  
United States Patent and Trademark Office

ShāToBu  
THE WORKOUT YOU WEAR

**Reg. No. 4,125,893**

MAYFAIR TECH INC. (CANADA CORPORATION)  
3701 JARRY ST. EAST

**Registered Apr. 10, 2012**

MONTREAL, QUEBEC, CANADA H1Z2G1

**Int. Cl.: 25**

FOR: CLOTHING, NAMELY, TOPS AND BOTTOMS, INTIMATE APPAREL IN THE NATURE OF UNDERGARMENTS, UNDERWEAR, LINGERIE, ACTIVEWEAR, NAMELY, TOPS AND BOTTOMS, CASUAL WEAR, NAMELY, TOPS AND BOTTOMS, HOSIERY; FOOTWEAR, IN CLASS 25 (U.S. CLS. 22 AND 39).

**TRADEMARK**

**PRINCIPAL REGISTER**

FIRST USE 2-28-2010; IN COMMERCE 10-31-2011.

PRIORITY CLAIMED UNDER SEC. 44(D) ON CANADA APPLICATION NO. 1454295, FILED 10-6-2009.

THE MARK CONSISTS OF A STYLIZED VERSION OF THE WORD "SHATOBU" AND THE PHRASE "THE WORKOUT YOU WEAR" IN PLAIN BLOCK LETTERS.

THE WORDING "SHATOBU" HAS NO MEANING IN A FOREIGN LANGUAGE.

SN 77-868,631, FILED 11-9-2009.

ERNEST SHOSHO, EXAMINING ATTORNEY

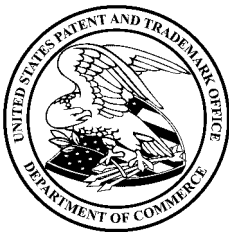

*David J. Kyffers*

Director of the United States Patent and Trademark Office



# United States of America

United States Patent and Trademark Office

# SHATOBU

**Reg. No. 4,125,894**

MAYFAIR TECH INC. (CANADA CORPORATION)  
3701 JARRY ST. EAST

**Registered Apr. 10, 2012**

MONTREAL, QUEBEC, CANADA H1Z2G1

**Int. Cl.: 25**

FOR: CLOTHING, NAMELY, TOPS AND BOTTOMS, INTIMATE APPAREL IN THE NATURE OF UNDERGARMENTS, UNDERWEAR, LINGERIE, ACTIVEWEAR, NAMELY, TOPS AND BOTTOMS, CASUAL WEAR, NAMELY, TOPS AND BOTTOMS, HOSIERY; FOOTWEAR, IN CLASS 25 (U.S. CLS. 22 AND 39).

**TRADEMARK**

**PRINCIPAL REGISTER**

FIRST USE 2-28-2010; IN COMMERCE 10-31-2011.

THE MARK CONSISTS OF STANDARD CHARACTERS WITHOUT CLAIM TO ANY PARTICULAR FONT, STYLE, SIZE, OR COLOR.

PRIORITY CLAIMED UNDER SEC. 44(D) ON CANADA APPLICATION NO. 1453319, FILED 9-28-2009.

THE WORDING "SHATOBU" HAS NO MEANING IN A FOREIGN LANGUAGE.

SN 77-868,643, FILED 11-9-2009.

ERNEST SHOSHO, EXAMINING ATTORNEY



*David J. Kyfos*

Director of the United States Patent and Trademark Office

# United States of America

United States Patent and Trademark Office

# Aleees Ark

**Reg. No. 4,125,895**

ADVANCED LITHIUM ELECTROCHEMISTRY CO., LTD. (TAIWAN CORPORATION)  
NO. 2-1, SINGHUA RD., TAOYUAN CITY  
TAOYUAN COUNTY, TAIWAN 330

**Registered Apr. 10, 2012**

**Int. Cls.: 1, 9, 12, 39, and 40**

FOR: INDUSTRIAL CHEMICALS, ACIDULATED WATER FOR RECHARGING ACCUMULATORS, SALTS FOR GALVANIC CELLS, CHEMICALS FOR USE IN INDUSTRY; ION CONDUCTIVE CHEMICAL COMPOUNDS FOR USE IN LITHIUM ION BATTERIES AND LITHIUM ION ACCUMULATORS, IN CLASS 1 (U.S. CLS. 1, 5, 6, 10, 26 AND 46).

**TRADEMARK**

FIRST USE 1-12-2010; IN COMMERCE 3-1-2010.

**SERVICE MARK**

**PRINCIPAL REGISTER**

FOR: ACCUMULATOR BOXES; ACCUMULATOR JARS; ACCUMULATORS; BATTERIES FOR VEHICLES; BATTERY CASES; BATTERY CHARGE DEVICES; BATTERY CHARGERS; BATTERY PACKS; ELECTRIC ACCUMULATORS; ELECTRIC ACCUMULATORS FOR VEHICLES; ELECTRIC STORAGE BATTERIES; ELECTRICAL STORAGE BATTERIES; CELL PACK, NAMELY, ELECTRICAL CELLS AND BATTERIES, IN CLASS 9 (U.S. CLS. 21, 23, 26, 36 AND 38).

FIRST USE 1-12-2010; IN COMMERCE 3-1-2010.

FOR: AUTOMOBILES, LAND VEHICLES, NAMELY, CARS, BICYCLES, MOTORCYCLES, AND BUS; ELECTRIC LAND VEHICLES, NAMELY, CARS, BICYCLES, MOTORCYCLES, AND BUS, IN CLASS 12 (U.S. CLS. 19, 21, 23, 31, 35 AND 44).

FIRST USE 1-12-2010; IN COMMERCE 3-1-2010.

FOR: STORAGE OF WASTED BATTERIES; ELECTRICITY DISTRIBUTION; FREIGHT TRANSPORTATION OF GOODS AND PASSENGER TRANSPORTATION BY TRUCK, TRAIN, BUS, AIR AND MARINE VEHICLES, IN CLASS 39 (U.S. CLS. 100 AND 105).

FIRST USE 1-12-2010; IN COMMERCE 3-1-2010.

FOR: RECYCLING OF WASTED BATTERIES; SORTING WASTE AND RECYCLABLE MATERIAL; PRODUCTION OF ELECTRICAL ENERGY, IN CLASS 40 (U.S. CLS. 100, 103 AND 106).

FIRST USE 1-12-2010; IN COMMERCE 3-1-2010.



*David J. Kyffers*

Director of the United States Patent and Trademark Office

**Reg. No. 4,125,895** THE MARK CONSISTS OF STANDARD CHARACTERS WITHOUT CLAIM TO ANY PARTICULAR FONT, STYLE, SIZE, OR COLOR.

OWNER OF U.S. REG. NOS. 3,278,654 AND 3,456,495.

SN 77-871,946, FILED 11-13-2009.

KAELIE KUNG, EXAMINING ATTORNEY

# United States of America

United States Patent and Trademark Office

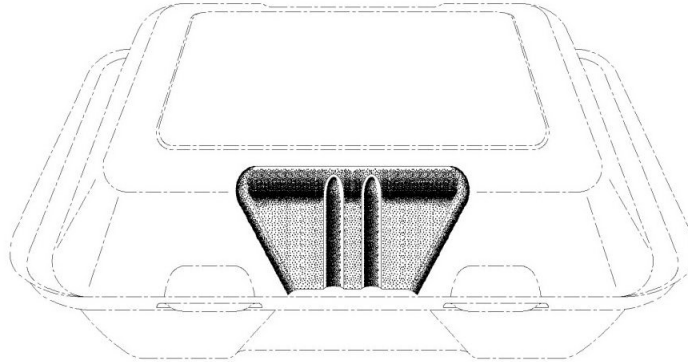

**Reg. No. 4,125,896**

**Registered Apr. 10, 2012**

**Int. Cl.: 16**

**TRADEMARK**

**PRINCIPAL REGISTER**

HUHTAMAKI, INC. (KANSAS CORPORATION)  
9201 PACKAGING DRIVE  
DESOTO, KS 66018

FOR: BIODEGRADABLE PAPER PULP-BASED TO-GO CONTAINERS FOR FOOD, IN CLASS 16 (U.S. CLS. 2, 5, 22, 23, 29, 37, 38 AND 50).

FIRST USE 4-13-2009; IN COMMERCE 6-1-2009.

THE MARK CONSISTS OF A RECESSED AREA IN THE LID OF A DISPOSABLE FOOD CONTAINER, THE RECESSED AREA HAVING TWO VERTICALLY-ORIENTED INDENTATIONS THEREIN. THE MATTER SHOWN IN BROKEN LINES IS NOT PART OF THE MARK AND SERVES ONLY TO SHOW THE POSITION OR PLACEMENT OF THE MARK.

SN 77-872,452, FILED 11-13-2009.

TINA L. SNAPP, EXAMINING ATTORNEY



*David J. Kybas*

Director of the United States Patent and Trademark Office

# United States of America

United States Patent and Trademark Office

## Olly Oogleberry

**Reg. No. 4,125,897**

TICKLE ME SILLY, LLC (FLORIDA LIMITED LIABILITY COMPANY)  
12 HAMMOCK BEACH PARKWAY  
PALM COAST, FL 32137

**Registered Apr. 10, 2012**

**Int. Cls.: 16, 25, and 28**

FOR: BABY BOOKS, CHILDREN'S BOOKS, CHILDREN'S STORYBOOKS, COMIC BOOKS, STORY BOOKS, IN CLASS 16 (U.S. CLS. 2, 5, 22, 23, 29, 37, 38 AND 50).

**TRADEMARK**

FIRST USE 11-12-2011; IN COMMERCE 11-12-2011.

**PRINCIPAL REGISTER**

FOR: T-SHIRTS, IN CLASS 25 (U.S. CLS. 22 AND 39).

FIRST USE 10-22-2010; IN COMMERCE 10-22-2010.

FOR: PLUSH DOLLS; PLUSH TOYS; SOFT SCULPTURE PLUSH TOYS; STUFFED AND PLUSH TOYS, IN CLASS 28 (U.S. CLS. 22, 23, 38 AND 50).

FIRST USE 1-11-2012; IN COMMERCE 1-11-2012.

THE MARK CONSISTS OF STANDARD CHARACTERS WITHOUT CLAIM TO ANY PARTICULAR FONT, STYLE, SIZE, OR COLOR.

THE NAME "OLLY OOGLEBERRY" DOES NOT IDENTIFY A LIVING INDIVIDUAL.

SN 77-872,717, FILED 11-14-2009.

MICHAEL SOUDERS, EXAMINING ATTORNEY



*David J. Kybas*

Director of the United States Patent and Trademark Office

# United States of America

United States Patent and Trademark Office

## KIYOKO LINDEN

**Reg. No. 4,125,898**

**Registered Apr. 10, 2012**

**Int. Cl.: 25**

**TRADEMARK**

**PRINCIPAL REGISTER**

BUCKNER, SHEMEKA T. (UNITED STATES INDIVIDUAL)  
1634 NORTH LINDER AVE.  
CHICAGO, IL 60639

FOR: BELTS; BLOUSES; CAPRI PANTS; CARGO PANTS; COATS; DENIMS; DRESS SHIRTS; DRESS SUITS; DRESSES; EVENING DRESSES; GLOVES; GLOVES AS CLOTHING; HATS; HEAD SCARVES; JACKETS; JEANS; JUMPSUITS; KNIT SHIRTS; KNITTED GLOVES; LEATHER JACKETS; LEATHER PANTS; LONG-SLEEVED SHIRTS; OPEN-NECKED SHIRTS; OUTDOOR GLOVES; POLO SHIRTS; RAIN JACKETS; REVERSIBLE JACKETS; SCARVES; SHIRTS; SHIRTS AND SHORT-SLEEVED SHIRTS; SHIRTS FOR SUITS; SHOULDER SCARVES; SILK SCARVES; SKIRT SUITS; SKIRTS; SKIRTS AND DRESSES; STRETCH PANTS; SUEDE JACKETS; T-SHIRTS; TRENCH COATS; TURTLE NECK SHIRTS; WEDDING DRESSES; WOMEN'S SHOES, IN CLASS 25 (U.S. CLS. 22 AND 39).

FIRST USE 1-7-2009; IN COMMERCE 12-10-2010.

THE MARK CONSISTS OF STANDARD CHARACTERS WITHOUT CLAIM TO ANY PARTICULAR FONT, STYLE, SIZE, OR COLOR.

"KIYOKO LINDEN" DOES NOT IDENTIFY A LIVING INDIVIDUAL.

THE WORDING "KIYOKO LINDEN" HAS NO MEANING IN A FOREIGN LANGUAGE

SN 77-873,460, FILED 11-16-2009.

BILL DAWE, EXAMINING ATTORNEY



*David J. Kyffers*

Director of the United States Patent and Trademark Office

# United States of America

United States Patent and Trademark Office

# SURETRACK

**Reg. No. 4,125,899**

**Registered Apr. 10, 2012**

**Int. Cl.: 20**

**TRADEMARK**

**PRINCIPAL REGISTER**

J.R. CLANCY, INC. (NEW YORK CORPORATION)  
7041 INTERSTATE ISLAND ROAD  
SYRACUSE, NY 132099713

FOR: CURTAIN RAILS, IN CLASS 20 (U.S. CLS. 2, 13, 22, 25, 32 AND 50).

FIRST USE 2-1-2012; IN COMMERCE 2-1-2012.

THE MARK CONSISTS OF STANDARD CHARACTERS WITHOUT CLAIM TO ANY PARTICULAR FONT, STYLE, SIZE, OR COLOR.

SN 77-873,644, FILED 11-16-2009.

AMEEN IMAM, EXAMINING ATTORNEY



*David J. Kybas*

Director of the United States Patent and Trademark Office

# United States of America

United States Patent and Trademark Office

## DECORIVETS

**Reg. No. 4,125,900**

VINTAJ NATURAL BRASS CO. (ILLINOIS CORPORATION)  
8933 WEST STAGECOACH TRAIL  
GALENA, IL 61036

**Registered Apr. 10, 2012**

**Int. Cl.: 14**

FOR: JEWELRY FINDINGS; BEADING ACCESSORIES, NAMELY, BEADS FOR MAKING JEWELRY; EMBELLISHMENTS, NAMELY, METAL CHARMS FOR MAKING JEWELRY; EMBELLISHMENTS, NAMELY, METAL JEWELRY CHARMS FOR USE IN CRAFTING, IN CLASS 14 (U.S. CLS. 2, 27, 28 AND 50).

**TRADEMARK**

**PRINCIPAL REGISTER**

FIRST USE 1-31-2009; IN COMMERCE 1-31-2009.

THE MARK CONSISTS OF STANDARD CHARACTERS WITHOUT CLAIM TO ANY PARTICULAR FONT, STYLE, SIZE, OR COLOR.

SN 77-873,754, FILED 11-16-2009.

MARK SPARACINO, EXAMINING ATTORNEY



*David J. Kyffers*

Director of the United States Patent and Trademark Office



**United States of America**  
United States Patent and Trademark Office

**FLEXTEC**

**Reg. No. 4,125,901**

LINCOLN GLOBAL, INC. (DELAWARE CORPORATION)  
17721 RAILROAD STREET  
CITY OF INDUSTRY, CA 91748

**Registered Apr. 10, 2012**

**Int. Cl.: 9**

FOR: ELECTRIC ARC WELDERS, IN CLASS 9 (U.S. CLS. 21, 23, 26, 36 AND 38).

**TRADEMARK**

FIRST USE 12-31-2010; IN COMMERCE 12-31-2010.

**PRINCIPAL REGISTER**

THE MARK CONSISTS OF STANDARD CHARACTERS WITHOUT CLAIM TO ANY PARTICULAR FONT, STYLE, SIZE, OR COLOR.

SN 77-873,771, FILED 11-16-2009.

KATHERINE CONNOLLY, EXAMINING ATTORNEY



*David J. Kybas*

Director of the United States Patent and Trademark Office

# United States of America

United States Patent and Trademark Office



**Reg. No. 4,125,902**

QUIJADA, FRANCIS (UNITED STATES INDIVIDUAL)  
4770 E. 48TH STREET  
LOS ANGELES, CA 90058

**Registered Apr. 10, 2012**

**Int. Cl.: 25**

FOR: CLOTHING, NAMELY, SHIRTS, T-SHIRTS, DRESSES AND SHORTS; SHOES;  
FOOTWEAR, IN CLASS 25 (U.S. CLS. 22 AND 39).

**TRADEMARK**

FIRST USE 6-14-2010; IN COMMERCE 6-14-2010.

**PRINCIPAL REGISTER**

THE MARK CONSISTS OF BOTTOM EYELASHES WITH THE WORD "EYELID" APPEARING  
ABOVE THE IMAGE IN SCRIPT FONT.

SN 77-876,987, FILED 11-19-2009.

MARLENE BELL, EXAMINING ATTORNEY



*David J. Kybas*

Director of the United States Patent and Trademark Office

# United States of America

United States Patent and Trademark Office



**Reg. No. 4,125,903**

**Registered Apr. 10, 2012**

**Int. Cl.: 21**

**TRADEMARK**

**PRINCIPAL REGISTER**

ILIA, NIMEROVSKIY (CANADA INDIVIDUAL)  
4934 CHATEAU PIERREFONDS  
PIERREFONDS, QUEBEC, CANADA H9K1H8

FOR: COOKING SKEWERS, IN CLASS 21 (U.S. CLS. 2, 13, 23, 29, 30, 33, 40 AND 50).

FIRST USE 1-10-2009; IN COMMERCE 2-15-2010.

NO CLAIM IS MADE TO THE EXCLUSIVE RIGHT TO USE "SHASHLIK SERVICE INTERNATIONAL", APART FROM THE MARK AS SHOWN.

THE COLOR(S) YELLOW, RED, BLACK, WHITE IS/ARE CLAIMED AS A FEATURE OF THE MARK.

THE MARK CONSISTS OF A BLACK AND WHITE STYLIZED GLOBE WITH A BLACK AND WHITE STYLIZED SKEWER VERTICALLY RUNNING UP ITS CENTER AND THE STYLIZED WORD "SHASHLIK" IN YELLOW, THE STYLIZED WORD "SERVICE" IN RED AND THE STYLIZED WORD "INTERNATIONAL" IN BLACK WRITTEN ACROSS THE SURFACE OF THE GLOBE, STATING AT ITS CENTER AND EXTENDING TO THE RIGHT BEYOND THE EDGE OF THE GLOBE. THE FIRST LETTER "S" OF "SHASHLIK" APPEARS AS A LARGE RED "S" CENTERED ON TOP OF THE FIRST LETTER "I" OF "INTERNATIONAL", WHICH APPEARS AS A LARGE BLACK "I" FORMING THE BODY OF THE SKEWER AND RESTING ON TOP OF THE FIRST LETTER "S" OF "SERVICE", WHICH APPEARS AS A LARGE YELLOW "S".

SN 77-877,194, FILED 11-20-2009.

SUZANNE BLANE, EXAMINING ATTORNEY



*David J. Kyros*

Director of the United States Patent and Trademark Office

United States of America  
United States Patent and Trademark Office

# WOLFGRIP

**Reg. No. 4,125,904**

**Registered Apr. 10, 2012**

**Int. Cl.: 5**

**TRADEMARK**

**PRINCIPAL REGISTER**

SHARPE, BECKY C. (UNITED STATES INDIVIDUAL), DBA SHARPESHOTS,  
78 SUMMIT ROAD  
MEDFORD, MA 02155

FOR: INCONTINENCE PADS, IN CLASS 5 (U.S. CLS. 6, 18, 44, 46, 51 AND 52).

FIRST USE 1-0-2010; IN COMMERCE 4-0-2011.

THE MARK CONSISTS OF STANDARD CHARACTERS WITHOUT CLAIM TO ANY PARTICULAR FONT, STYLE, SIZE, OR COLOR.

SN 77-879,726, FILED 11-24-2009.

KYLE PEETE, EXAMINING ATTORNEY



*David J. Kyfos*

Director of the United States Patent and Trademark Office

# United States of America

United States Patent and Trademark Office

# BESSA

**Reg. No. 4,125,905**

**Registered Apr. 10, 2012**

**Int. Cl.: 14**

**TRADEMARK**

**PRINCIPAL REGISTER**

COMEX INTERNATIONAL TRADING, INC. (CALIFORNIA CORPORATION)  
650 SOUTH HILL STREET, SUITE 629  
LOS ANGELES, CA 90014

FOR: JEWELRY, IN CLASS 14 (U.S. CLS. 2, 27, 28 AND 50).

FIRST USE 11-1-2011; IN COMMERCE 11-1-2011.

THE MARK CONSISTS OF THE STYLIZED WORD "BESSA", THE LETTER "A" IN "BESSA" IS STYLIZED IN THAT THE CENTER HORIZONTAL LINE OF THE LETTER IS MISSING.

SN 77-880,364, FILED 11-24-2009.

LINDA E. BLOHM, EXAMINING ATTORNEY



*David J. Kybas*

Director of the United States Patent and Trademark Office

# United States of America

United States Patent and Trademark Office



**Reg. No. 4,125,906**

**Registered Apr. 10, 2012**

**Int. Cls.: 9, 16, 35, 36, 41,  
42, and 45**

**TRADEMARK**

**SERVICE MARK**

**PRINCIPAL REGISTER**

TOWERS PERRIN CAPITAL CORPORATION (DELAWARE CORPORATION)  
SUITE 325  
1011 CENTRE ROAD  
WILMINGTON, DE 19805

FOR: COMPUTER SOFTWARE FOR FINANCIAL MODELING AND BENCHMARKING, STOCHASTIC MODELING, EVALUATING JOBS AND BENEFIT PLANS, CREATING AND MAINTAINING EMPLOYEE PAY STRUCTURES, EVALUATING EMPLOYEE PERFORMANCE, ASSET ALLOCATION, CATASTROPHE MODELING, QUALITY ASSURANCE, AND FOR MODELING, RECORDING, ORGANIZING, CALCULATING, REPORTING, DISPLAYING, ANALYZING, EVALUATING, COMPARING, PREDICTING, AND UPDATING ACTUARIAL DATA, FINANCIAL DATA, BUSINESS DATA, AND HUMAN RESOURCES DATA, ALL FOR USE IN THE FIELDS OF HUMAN RESOURCES, EMPLOYEE COMPENSATION AND BENEFITS, RETIREMENT PLANNING, PENSION AND RETIREMENT PLANS, INVESTMENTS, PROFIT-SHARING PLANS, STOCK PURCHASE PLANS, HEALTH CARE, HEALTH CARE PLANS, DENTAL PLANS, PRESCRIPTION PLANS, PERSONNEL MANAGEMENT, WORKFORCE EFFECTIVENESS, REWARDS MANAGEMENT, EMPLOYEE JOB EVALUATION, EMPLOYER-EMPLOYEE COMMUNICATIONS, EMPLOYEE SAFETY, EMPLOYEE RELOCATION, OUTSOURCING, BUSINESS AND ORGANIZATIONAL MANAGEMENT AND OPERATIONS, ORGANIZATIONAL STRUCTURE AND REORGANIZATION, PRODUCT DEVELOPMENT AND MARKETING, MERGERS AND ACQUISITIONS, STRATEGIC PLANNING, CONTINGENCY PLANNING, CHANGE MANAGEMENT, INFORMATION TECHNOLOGY, RISK MANAGEMENT, RISK EVALUATION, ACTUARIAL MATTERS, FINANCIAL SERVICES, INVESTMENTS, FINANCIAL PLANNING, FINANCIAL MODELING, ASSET ALLOCATION, CATASTROPHE MODELING, AND/OR QUALITY ASSURANCE; DOWNLOADABLE ELECTRONIC PUBLICATIONS IN THE NATURE OF PERIODICALS, BOOKS, NEWSLETTERS, REPORTS, SURVEYS, ARTICLE REPRINTS, MEMORANDA, GUIDES, MANUALS, AND DIRECTORIES, DOWNLOADABLE PODCASTS, AND DOWNLOADABLE VIDEO RECORDINGS, ALL IN THE FIELDS OF HUMAN RESOURCES, EMPLOYEE COMPENSATION AND BENEFITS, RETIREMENT PLANNING, PENSION AND RETIREMENT PLANS, INVESTMENTS, PROFIT-SHARING PLANS, STOCK PURCHASE PLANS, HEALTH CARE, HEALTH CARE PLANS, DENTAL PLANS, PRESCRIPTION PLANS, PERSONNEL MANAGEMENT, WORKFORCE EFFECTIVENESS, REWARDS MANAGEMENT, EMPLOYEE JOB EVALUATION, EMPLOYER-EMPLOYEE COMMUNICATIONS, EMPLOYEE SAFETY, EMPLOYEE RELOCATION, OUTSOURCING, BUSINESS AND ORGANIZATIONAL MANAGEMENT AND OPERATIONS, ORGANIZATIONAL STRUCTURE AND REORGANIZATION, PRODUCT DEVELOPMENT AND MARKETING, MERGERS AND ACQUISITIONS,



*David J. Kyjars*

Director of the United States Patent and Trademark Office

**Reg. No. 4,125,906** STRATEGIC PLANNING, CONTINGENCY PLANNING, CHANGE MANAGEMENT, INFORMATION TECHNOLOGY, RISK MANAGEMENT, RISK EVALUATION, ACTUARIAL MATTERS, FINANCIAL SERVICES, INVESTMENTS, FINANCIAL PLANNING, FINANCIAL MODELING, ASSET ALLOCATION, CATASTROPHE MODELING, AND/OR QUALITY ASSURANCE; COMPUTER SOFTWARE FOR INTERNAL BUSINESS USE BY INSURERS, NAMELY, SOFTWARE FOR FINANCIAL MODELING AND BENCHMARKING, STOCHASTIC MODELING, ASSET ALLOCATION, CATASTROPHE MODELING, AND FOR MODELING, RECORDING, ORGANIZING, CALCULATING, REPORTING, DISPLAYING, ANALYZING, EVALUATING, COMPARING, PREDICTING, AND UPDATING ACTUARIAL DATA AND FINANCIAL DATA; DOWNLOADABLE ELECTRONIC PUBLICATIONS, DOWNLOADABLE PODCASTS, AND DOWNLOADABLE VIDEO RECORDINGS FOR USE IN BUSINESS MANAGEMENT BY INSURERS, ALL IN THE FIELDS OF ENTERPRISE RISK MANAGEMENT, FINANCIAL AND REGULATORY REPORTING, MERGERS AND ACQUISITIONS, CORPORATE RESTRUCTURING, MARKETING, FINANCIAL MODELING, PRICING, AND LOSS RESERVE REQUIREMENTS, IN CLASS 9 (U.S. CLS. 21, 23, 26, 36 AND 38).

FIRST USE 1-4-2010; IN COMMERCE 1-4-2010.

FOR: PRINTED MATTER AND PUBLICATIONS, NAMELY, PERIODICALS, BOOKS, NEWSLETTERS, REPORTS, SURVEYS, ARTICLE REPRINTS, MEMORANDA, GUIDES, MANUALS, AND DIRECTORIES IN THE FIELDS OF HUMAN RESOURCES, EMPLOYEE COMPENSATION AND BENEFITS, RETIREMENT PLANNING, PENSION AND RETIREMENT PLANS, INVESTMENTS, PROFIT-SHARING PLANS, STOCK PURCHASE PLANS, HEALTH CARE, HEALTH CARE PLANS, DENTAL PLANS, PRESCRIPTION PLANS, PERSONNEL MANAGEMENT, WORKFORCE EFFECTIVENESS, REWARDS MANAGEMENT, EMPLOYEE JOB EVALUATION, PERSONNEL POLICIES, EMPLOYER-EMPLOYEE COMMUNICATIONS, EMPLOYEE SAFETY, EMPLOYEE RELOCATION, OUTSOURCING, BUSINESS AND ORGANIZATIONAL MANAGEMENT AND OPERATIONS, ORGANIZATIONAL STRUCTURE AND REORGANIZATION, PRODUCT DEVELOPMENT AND MARKETING, MERGERS AND ACQUISITIONS, STRATEGIC PLANNING, CONTINGENCY PLANNING, CHANGE MANAGEMENT, INFORMATION TECHNOLOGY, RISK MANAGEMENT, RISK EVALUATION, ACTUARIAL MATTERS, FINANCIAL SERVICES, INVESTMENTS, FINANCIAL PLANNING, FINANCIAL MODELING, ASSET ALLOCATION, CATASTROPHE MODELING, AND/OR QUALITY ASSURANCE; PRINTED MATTER AND PUBLICATIONS FOR USE IN BUSINESS MANAGEMENT BY INSURERS, NAMELY, PERIODICALS, BOOKS, NEWSLETTERS, REPORTS, SURVEYS, ARTICLE REPRINTS, MEMORANDA, GUIDE, MANUALS AND DIRECTORIES IN THE FIELDS OF ENTERPRISE RISK MANAGEMENT, FINANCIAL AND REGULATORY REPORTING, MERGERS AND ACQUISITIONS, CORPORATE RESTRUCTURING, MARKETING, FINANCIAL MODELING, PRICING, AND LOSS RESERVE REQUIREMENTS, IN CLASS 16 (U.S. CLS. 2, 5, 22, 23, 29, 37, 38 AND 50).

FIRST USE 3-1-2010; IN COMMERCE 3-1-2010.

FOR: BUSINESS CONSULTATION SERVICES; CONSULTING SERVICES IN THE FIELD OF BUSINESS RISK MANAGEMENT; BUSINESS CONSULTING SERVICES IN THE FIELDS OF PERSONNEL AND HUMAN RESOURCE MANAGEMENT, WORKFORCE EFFECTIVENESS, EMPLOYEE JOB EVALUATION, EMPLOYER-EMPLOYEE COMMUNICATIONS, EMPLOYEE RELOCATION, BUSINESS AND ORGANIZATIONAL MANAGEMENT AND OPERATIONS, CONTINGENCY PLANNING, STRATEGIC PLANNING, OPERATIONS, MERGERS AND ACQUISITIONS, ORGANIZATIONAL STRUCTURE AND REORGANIZATION, AND MARKETING; INFORMATION IN BUSINESS MATTERS; ASSISTANCE IN MANAGEMENT OF BUSINESS ACTIVITIES; OUTSOURCING SERVICES; MANAGEMENT AND COMPILATION OF COMPUTERIZED DATABASES; MARKET ANALYSIS AND RESEARCH SERVICES; MARKET REPORTS AND STUDIES; CONDUCTING BUSINESS RESEARCH AND SURVEYS; PREPARING BUSINESS REPORTS; CUSTOM PREPARATION OF EMPLOYER-EMPLOYEE COMMUNICATIONS MATERIALS IN THE NATURE OF PRINTED AND ELECTRONIC ANNOUNCEMENTS, MEMORANDA, BOOKS, REPORTS, NEWSLETTERS, GUIDES, MANUALS, PERIODICALS, AND AUDIO-VISUAL PRESENTA-

**Reg. No. 4,125,906** TIONS FOR OTHERS; BUSINESS CONSULTING SERVICES FOR INSURERS IN THE FIELDS OF BUSINESS RISK MANAGEMENT, REGULATORY REPORTING, MERGERS AND ACQUISITIONS, CORPORATE RESTRUCTURING, AND MARKETING, IN CLASS 35 (U.S. CLS. 100, 101 AND 102).

FIRST USE 1-4-2010; IN COMMERCE 1-4-2010.

FOR: FINANCIAL CONSULTING SERVICES IN THE FIELDS OF FINANCIAL RISK MANAGEMENT, FINANCIAL SERVICES, INVESTMENTS, EMPLOYEE COMPENSATION AND BENEFITS, PROFIT-SHARING PLANS, STOCK PURCHASE PLANS, SAVINGS, PENSION AND RETIREMENT PLANS, AND IN THE ADMINISTRATION OF HEALTH CARE, DENTAL, AND PRESCRIPTION DRUG PLANS; ADMINISTRATION OF EMPLOYEE COMPENSATION AND BENEFIT PLANS, PROFIT-SHARING PLANS, STOCK PURCHASE PLANS, SAVINGS, PENSION, AND RETIREMENT PLANS, AND HEALTH CARE, DENTAL, AND PRESCRIPTION PLANS; FINANCIAL RESEARCH AND INFORMATION SERVICES; ACTUARIAL CONSULTING AND SERVICES; REINSURANCE BROKERAGE SERVICES; FINANCIAL CONSULTING SERVICES FOR INSURERS IN THE FIELDS OF FINANCIAL RISK MANAGEMENT, FINANCIAL REPORTING, FINANCIAL MODELING, PRICING, AND LOSS RESERVE REQUIREMENTS, IN CLASS 36 (U.S. CLS. 100, 101 AND 102).

FIRST USE 1-4-2010; IN COMMERCE 1-4-2010.

FOR: EDUCATIONAL SERVICES, NAMELY, CONDUCTING WORKSHOPS, SEMINARS, AND EDUCATIONAL PROGRAMS IN THE FIELDS OF HUMAN RESOURCES, EMPLOYEE COMPENSATION AND BENEFITS, RETIREMENT PLANNING, PENSION AND RETIREMENT PLANS, INVESTMENTS, PROFIT-SHARING PLANS, STOCK PURCHASE PLANS, HEALTH CARE, HEALTH CARE PLANS, DENTAL PLANS, PRESCRIPTION PLANS, PERSONNEL MANAGEMENT, WORKFORCE EFFECTIVENESS, REWARDS MANAGEMENT, EMPLOYEE JOB EVALUATION, PERSONNEL POLICIES, EMPLOYER-EMPLOYEE COMMUNICATIONS, EMPLOYEE SAFETY, EMPLOYEE RELOCATION, OUTSOURCING, BUSINESS AND ORGANIZATIONAL MANAGEMENT AND OPERATIONS, ORGANIZATIONAL STRUCTURE AND REORGANIZATION, PRODUCT DEVELOPMENT AND MARKETING, MERGERS AND ACQUISITIONS, STRATEGIC PLANNING, CONTINGENCY PLANNING, CHANGE MANAGEMENT, INFORMATION TECHNOLOGY, RISK MANAGEMENT, RISK EVALUATION, ACTUARIAL MATTERS, FINANCIAL SERVICES, INVESTMENTS, FINANCIAL PLANNING, FINANCIAL MODELING, ASSET ALLOCATION, CATASTROPHE MODELING, AND/OR QUALITY ASSURANCE; ELECTRONIC NON-DOWNLOADABLE PUBLICATIONS, NAMELY, PERIODICALS, BOOKS, NEWSLETTERS, REPORTS, SURVEYS, ARTICLE REPRINTS, MEMORANDA, GUIDES, MANUALS, AND DIRECTORIES, NON-DOWNLOADABLE PODCASTS, AND NON-DOWNLOADABLE VIDEO RECORDINGS, ALL IN THE FIELDS OF HUMAN RESOURCES, EMPLOYEE COMPENSATION AND BENEFITS, RETIREMENT PLANNING, PENSION AND RETIREMENT PLANS, INVESTMENTS, PROFIT-SHARING PLANS, STOCK PURCHASE PLANS, HEALTH CARE, HEALTH CARE PLANS, DENTAL PLANS, PRESCRIPTION PLANS, PERSONNEL MANAGEMENT, WORKFORCE EFFECTIVENESS, REWARDS MANAGEMENT, EMPLOYEE JOB EVALUATION, PERSONNEL POLICIES, EMPLOYER-EMPLOYEE COMMUNICATIONS, EMPLOYEE SAFETY, EMPLOYEE RELOCATION, OUTSOURCING, BUSINESS AND ORGANIZATIONAL MANAGEMENT AND OPERATIONS, ORGANIZATIONAL STRUCTURE AND REORGANIZATION, PRODUCT DEVELOPMENT AND MARKETING, MERGERS AND ACQUISITIONS, STRATEGIC PLANNING, CONTINGENCY PLANNING, CHANGE MANAGEMENT, INFORMATION TECHNOLOGY, RISK MANAGEMENT, RISK EVALUATION, ACTUARIAL MATTERS, FINANCIAL SERVICES, INVESTMENTS, FINANCIAL PLANNING, FINANCIAL MODELING, ASSET ALLOCATION, CATASTROPHE MODELING, AND/OR QUALITY ASSURANCE; EDUCATIONAL SERVICES FOR INSURERS, NAMELY, PROVIDING WORKSHOPS, SEMINARS AND EDUCATIONAL PROGRAMS IN THE FIELDS OF ENTERPRISE RISK MANAGEMENT, FINANCIAL AND REGULATORY REPORTING, MERGERS AND ACQUISITIONS, CORPORATE RESTRUCTURING, MARKETING, FINANCIAL MODELING, PRICING, AND LOSS RESERVE REQUIREMENTS; ELECTRONIC NON-DOWNLOADABLE ELECTRONIC



**Reg. No. 4,125,906** PUBLICATIONS, ELECTRONIC NON-DOWNLOADABLE PODCASTS, AND ELECTRONIC NON-DOWNLOADABLE VIDEO RECORDINGS FOR INSURERS, ALL IN THE FIELDS OF ENTERPRISE RISK MANAGEMENT, FINANCIAL AND REGULATORY REPORTING, MERGERS AND ACQUISITIONS, CORPORATE RESTRUCTURING, MARKETING, FINANCIAL MODELING, PRICING, AND LOSS RESERVE REQUIREMENTS, IN CLASS 41 (U.S. CLS. 100, 101 AND 107).

FIRST USE 1-12-2010; IN COMMERCE 1-12-2010.

FOR: COMPUTER AND INFORMATION TECHNOLOGY CONSULTATION; DESIGN, DEVELOPMENT, AND IMPLEMENTATION OF COMPUTER HARDWARE AND SOFTWARE, DATABASES, WEBSITES, AND INTRANETS; COMPUTER SYSTEMS INTEGRATION SERVICES; COMPUTER PROGRAMMING AND COMPUTER MODELING SERVICES, NAMELY, COMPUTER SIMULATION FROM COMPUTER PROGRAMS FOR OTHERS; COMPUTER PROJECT MANAGEMENT SERVICES; APPLICATION SERVICE PROVIDER (ASP) SERVICES, NAMELY, PROVIDING, HOSTING, MANAGING, DEVELOPING, AND MAINTAINING APPLICATIONS, SOFTWARE, WEB SITES, AND DATABASES OF OTHERS IN THE FIELDS OF HUMAN RESOURCES, EMPLOYEE COMPENSATION AND BENEFITS, RETIREMENT PLANNING, PENSION AND RETIREMENT PLANS, INVESTMENTS, PROFIT-SHARING PLANS, STOCK PURCHASE PLANS, HEALTH CARE, HEALTH CARE PLANS, DENTAL PLANS, PRESCRIPTION PLANS, PERSONNEL MANAGEMENT, WORKFORCE EFFECTIVENESS, REWARDS MANAGEMENT, EMPLOYEE JOB EVALUATION, PERSONNEL POLICIES, EMPLOYER-EMPLOYEE COMMUNICATIONS, EMPLOYEE SAFETY, EMPLOYEE RELOCATION, OUTSOURCING, BUSINESS AND ORGANIZATIONAL MANAGEMENT AND OPERATIONS, ORGANIZATIONAL STRUCTURE AND REORGANIZATION, PRODUCT DEVELOPMENT AND MARKETING, MERGERS AND ACQUISITIONS, STRATEGIC PLANNING, CONTINGENCY PLANNING, CHANGE MANAGEMENT, INFORMATION TECHNOLOGY, RISK MANAGEMENT, RISK EVALUATION, ACTUARIAL MATTERS, FINANCIAL SERVICES, INVESTMENTS, FINANCIAL PLANNING, FINANCIAL MODELING, ASSET ALLOCATION, CATASTROPHE MODELING, AND/OR QUALITY ASSURANCE; PRODUCT DEVELOPMENT CONSULTATION; APPLICATION SERVICE PROVIDER (ASP) SERVICES FOR INTERNAL BUSINESS USE BY INSURERS, NAMELY, PROVIDING, HOSTING, MANAGING, DEVELOPING, AND MAINTAINING APPLICATIONS, SOFTWARE, WEB SITES, AND DATABASES OF OTHERS IN FIELDS OF ENTERPRISE RISK MANAGEMENT, FINANCIAL AND REGULATORY REPORTING, MERGERS AND ACQUISITIONS, CORPORATE RESTRUCTURING, MARKETING, FINANCIAL MODELING, PRICING, AND LOSS RESERVE REQUIREMENTS, IN CLASS 42 (U.S. CLS. 100 AND 101).

FIRST USE 1-4-2010; IN COMMERCE 1-4-2010.

FOR: CONSULTING IN THE FIELD OF WORKPLACE SAFETY, IN CLASS 45 (U.S. CLS. 100 AND 101).

FIRST USE 1-4-2010; IN COMMERCE 1-4-2010.

THE MARK CONSISTS OF THE LETTERS "TW" IN THE FORM OF A STYLIZED SIGNATURE IN THE COLOR RED-ORANGE.

THE COLOR(S) RED-ORANGE IS/ARE CLAIMED AS A FEATURE OF THE MARK.

SN 77-882,671, FILED 11-30-2009.

ELISSA GARBER KON, EXAMINING ATTORNEY

# United States of America

United States Patent and Trademark Office



**Reg. No. 4,125,907**

**Registered Apr. 10, 2012**

**Int. Cls.: 9, 16, 35, 36, 41,  
42, and 45**

**TRADEMARK**

**SERVICE MARK**

**PRINCIPAL REGISTER**

TOWERS PERRIN CAPITAL CORPORATION (DELAWARE CORPORATION)  
1011 CENTRE ROAD  
1011 CENTRE ROAD  
WILMINGTON, DE 19805

FOR: COMPUTER SOFTWARE FOR FINANCIAL MODELING AND BENCHMARKING, STOCHASTIC MODELING, EVALUATING JOBS AND BENEFIT PLANS, CREATING AND MAINTAINING EMPLOYEE PAY STRUCTURES, EVALUATING EMPLOYEE PERFORMANCE, ASSET ALLOCATION, CATASTROPHE MODELING, QUALITY ASSURANCE, AND FOR MODELING, RECORDING, ORGANIZING, CALCULATING, REPORTING, DISPLAYING, ANALYZING, EVALUATING, COMPARING, PREDICTING, AND UPDATING ACTUARIAL DATA, FINANCIAL DATA, BUSINESS DATA, AND HUMAN RESOURCES DATA, ALL FOR USE IN THE FIELDS OF HUMAN RESOURCES, EMPLOYEE COMPENSATION AND BENEFITS, RETIREMENT PLANNING, PENSION AND RETIREMENT PLANS, INVESTMENTS, PROFIT-SHARING PLANS, STOCK PURCHASE PLANS, HEALTH CARE, HEALTH CARE PLANS, DENTAL PLANS, PRESCRIPTION PLANS, PERSONNEL MANAGEMENT, WORKFORCE EFFECTIVENESS, REWARDS MANAGEMENT, EMPLOYEE JOB EVALUATION, EMPLOYER-EMPLOYEE COMMUNICATIONS, EMPLOYEE SAFETY, EMPLOYEE RELOCATION, OUTSOURCING, BUSINESS AND ORGANIZATIONAL MANAGEMENT AND OPERATIONS, ORGANIZATIONAL STRUCTURE AND REORGANIZATION, PRODUCT DEVELOPMENT AND MARKETING, MERGERS AND ACQUISITIONS, STRATEGIC PLANNING, CONTINGENCY PLANNING, CHANGE MANAGEMENT, INFORMATION TECHNOLOGY, RISK MANAGEMENT, RISK EVALUATION, ACTUARIAL MATTERS, FINANCIAL SERVICES, INVESTMENTS, FINANCIAL PLANNING, FINANCIAL MODELING, ASSET ALLOCATION, CATASTROPHE MODELING, AND/OR QUALITY ASSURANCE; DOWNLOADABLE ELECTRONIC PUBLICATIONS IN THE NATURE OF PERIODICALS, BOOKS, NEWSLETTERS, REPORTS, SURVEYS, ARTICLE REPRINTS, MEMORANDA, GUIDES, MANUALS, AND DIRECTORIES, DOWNLOADABLE PODCASTS, AND DOWNLOADABLE VIDEO RECORDINGS, ALL IN THE FIELDS OF HUMAN RESOURCES, EMPLOYEE COMPENSATION AND BENEFITS, RETIREMENT PLANNING, PENSION AND RETIREMENT PLANS, INVESTMENTS, PROFIT-SHARING PLANS, STOCK PURCHASE PLANS, HEALTH CARE, HEALTH CARE PLANS, DENTAL PLANS, PRESCRIPTION PLANS, PERSONNEL MANAGEMENT, WORKFORCE EFFECTIVENESS, REWARDS MANAGEMENT, EMPLOYEE JOB EVALUATION, EMPLOYER-EMPLOYEE COMMUNICATIONS, EMPLOYEE SAFETY, EMPLOYEE RELOCATION, OUTSOURCING, BUSINESS AND ORGANIZATIONAL MANAGEMENT AND OPERATIONS, ORGANIZATIONAL STRUCTURE AND REORGANIZATION, PRODUCT DEVELOPMENT AND MARKETING, MERGERS AND ACQUISITIONS,



*David J. Kybas*

Director of the United States Patent and Trademark Office

**Reg. No. 4,125,907** STRATEGIC PLANNING, CONTINGENCY PLANNING, CHANGE MANAGEMENT, INFORMATION TECHNOLOGY, RISK MANAGEMENT, RISK EVALUATION, ACTUARIAL MATTERS, FINANCIAL SERVICES, INVESTMENTS, FINANCIAL PLANNING, FINANCIAL MODELING, ASSET ALLOCATION, CATASTROPHE MODELING, AND/OR QUALITY ASSURANCE; COMPUTER SOFTWARE FOR INTERNAL BUSINESS USE BY INSURERS, NAMELY, SOFTWARE FOR FINANCIAL MODELING AND BENCHMARKING, STOCHASTIC MODELING, ASSET ALLOCATION, CATASTROPHE MODELING, AND FOR MODELING, RECORDING, ORGANIZING, CALCULATING, REPORTING, DISPLAYING, ANALYZING, EVALUATING, COMPARING, PREDICTING, AND UPDATING ACTUARIAL DATA AND FINANCIAL DATA; DOWNLOADABLE ELECTRONIC PUBLICATIONS, DOWNLOADABLE PODCASTS, AND DOWNLOADABLE VIDEO RECORDINGS FOR USE IN BUSINESS MANAGEMENT BY INSURERS, ALL IN THE FIELDS OF ENTERPRISE RISK MANAGEMENT, FINANCIAL AND REGULATORY REPORTING, MERGERS AND ACQUISITIONS, CORPORATE RESTRUCTURING, MARKETING, FINANCIAL MODELING, PRICING, AND LOSS RESERVE REQUIREMENTS, IN CLASS 9 (U.S. CLS. 21, 23, 26, 36 AND 38).

FIRST USE 1-4-2010; IN COMMERCE 1-4-2010.

FOR: PRINTED MATTER AND PUBLICATIONS, NAMELY, PERIODICALS, BOOKS, NEWSLETTERS, REPORTS, SURVEYS, ARTICLE REPRINTS, MEMORANDA, GUIDES, MANUALS, AND DIRECTORIES IN THE FIELDS OF HUMAN RESOURCES, EMPLOYEE COMPENSATION AND BENEFITS, RETIREMENT PLANNING, PENSION AND RETIREMENT PLANS, INVESTMENTS, PROFIT-SHARING PLANS, STOCK PURCHASE PLANS, HEALTH CARE, HEALTH CARE PLANS, DENTAL PLANS, PRESCRIPTION PLANS, PERSONNEL MANAGEMENT, WORKFORCE EFFECTIVENESS, REWARDS MANAGEMENT, EMPLOYEE JOB EVALUATION, PERSONNEL POLICIES, EMPLOYER-EMPLOYEE COMMUNICATIONS, EMPLOYEE SAFETY, EMPLOYEE RELOCATION, OUTSOURCING, BUSINESS AND ORGANIZATIONAL MANAGEMENT AND OPERATIONS, ORGANIZATIONAL STRUCTURE AND REORGANIZATION, PRODUCT DEVELOPMENT AND MARKETING, MERGERS AND ACQUISITIONS, STRATEGIC PLANNING, CONTINGENCY PLANNING, CHANGE MANAGEMENT, INFORMATION TECHNOLOGY, RISK MANAGEMENT, RISK EVALUATION, ACTUARIAL MATTERS, FINANCIAL SERVICES, INVESTMENTS, FINANCIAL PLANNING, FINANCIAL MODELING, ASSET ALLOCATION, CATASTROPHE MODELING, AND/OR QUALITY ASSURANCE; PRINTED MATTER AND PUBLICATIONS FOR USE IN BUSINESS MANAGEMENT BY INSURERS, NAMELY, PERIODICALS, BOOKS, NEWSLETTERS, REPORTS, SURVEYS, ARTICLE REPRINTS, MEMORANDA, GUIDE, MANUALS AND DIRECTORIES IN THE FIELDS OF ENTERPRISE RISK MANAGEMENT, FINANCIAL AND REGULATORY REPORTING, MERGERS AND ACQUISITIONS, CORPORATE RESTRUCTURING, MARKETING, FINANCIAL MODELING, PRICING, AND LOSS RESERVE REQUIREMENTS, IN CLASS 16 (U.S. CLS. 2, 5, 22, 23, 29, 37, 38 AND 50).

FIRST USE 3-1-2010; IN COMMERCE 3-1-2010.

FOR: BUSINESS CONSULTATION SERVICES; CONSULTING SERVICES IN THE FIELD OF BUSINESS RISK MANAGEMENT; BUSINESS CONSULTING SERVICES IN THE FIELDS OF PERSONNEL AND HUMAN RESOURCE MANAGEMENT, WORKFORCE EFFECTIVENESS, EMPLOYEE JOB EVALUATION, EMPLOYER-EMPLOYEE COMMUNICATIONS, EMPLOYEE RELOCATION, BUSINESS AND ORGANIZATIONAL MANAGEMENT AND OPERATIONS, CONTINGENCY PLANNING, STRATEGIC PLANNING, OPERATIONS, MERGERS AND ACQUISITIONS, ORGANIZATIONAL STRUCTURE AND REORGANIZATION, AND MARKETING; INFORMATION IN BUSINESS MATTERS; ASSISTANCE IN MANAGEMENT OF BUSINESS ACTIVITIES; OUTSOURCING SERVICES; MANAGEMENT AND COMPILATION OF COMPUTERIZED DATABASES; MARKET ANALYSIS AND RESEARCH SERVICES; MARKET REPORTS AND STUDIES; CONDUCTING BUSINESS RESEARCH AND SURVEYS; PREPARING BUSINESS REPORTS; CUSTOM PREPARATION OF EMPLOYER-EMPLOYEE COMMUNICATIONS MATERIALS IN THE NATURE OF PRINTED AND ELECTRONIC ANNOUNCEMENTS, MEMORANDA, BOOKS, REPORTS, NEWSLETTERS, GUIDES, MANUALS, PERIODICALS, AND AUDIO-VISUAL PRESENTA-

**Reg. No. 4,125,907** TIONS FOR OTHERS; BUSINESS CONSULTING SERVICES FOR INSURERS IN THE FIELDS OF BUSINESS RISK MANAGEMENT, REGULATORY REPORTING, MERGERS AND ACQUISITIONS, CORPORATE RESTRUCTURING, AND MARKETING, IN CLASS 35 (U.S. CLS. 100, 101 AND 102).

FIRST USE 1-4-2010; IN COMMERCE 1-4-2010.

FOR: FINANCIAL CONSULTING SERVICES IN THE FIELDS OF FINANCIAL RISK MANAGEMENT, FINANCIAL SERVICES, INVESTMENTS, EMPLOYEE COMPENSATION AND BENEFITS, PROFIT-SHARING PLANS, STOCK PURCHASE PLANS, SAVINGS, PENSION AND RETIREMENT PLANS, AND IN THE ADMINISTRATION OF HEALTH CARE, DENTAL, AND PRESCRIPTION DRUG PLANS; ADMINISTRATION OF EMPLOYEE COMPENSATION AND BENEFIT PLANS, PROFIT-SHARING PLANS, STOCK PURCHASE PLANS, SAVINGS, PENSION, AND RETIREMENT PLANS, AND HEALTH CARE, DENTAL, AND PRESCRIPTION PLANS; FINANCIAL RESEARCH AND INFORMATION SERVICES; ACTUARIAL CONSULTING AND SERVICES; REINSURANCE BROKERAGE SERVICES; FINANCIAL CONSULTING SERVICES FOR INSURERS IN THE FIELDS OF FINANCIAL RISK MANAGEMENT, FINANCIAL REPORTING, FINANCIAL MODELING, PRICING, AND LOSS RESERVE REQUIREMENTS, IN CLASS 36 (U.S. CLS. 100, 101 AND 102).

FIRST USE 1-4-2010; IN COMMERCE 1-4-2010.

FOR: EDUCATIONAL SERVICES, NAMELY, CONDUCTING WORKSHOPS, SEMINARS, AND EDUCATIONAL PROGRAMS IN THE FIELDS OF HUMAN RESOURCES, EMPLOYEE COMPENSATION AND BENEFITS, RETIREMENT PLANNING, PENSION AND RETIREMENT PLANS, INVESTMENTS, PROFIT-SHARING PLANS, STOCK PURCHASE PLANS, HEALTH CARE, HEALTH CARE PLANS, DENTAL PLANS, PRESCRIPTION PLANS, PERSONNEL MANAGEMENT, WORKFORCE EFFECTIVENESS, REWARDS MANAGEMENT, EMPLOYEE JOB EVALUATION, PERSONNEL POLICIES, EMPLOYER-EMPLOYEE COMMUNICATIONS, EMPLOYEE SAFETY, EMPLOYEE RELOCATION, OUTSOURCING, BUSINESS AND ORGANIZATIONAL MANAGEMENT AND OPERATIONS, ORGANIZATIONAL STRUCTURE AND REORGANIZATION, PRODUCT DEVELOPMENT AND MARKETING, MERGERS AND ACQUISITIONS, STRATEGIC PLANNING, CONTINGENCY PLANNING, CHANGE MANAGEMENT, INFORMATION TECHNOLOGY, RISK MANAGEMENT, RISK EVALUATION, ACTUARIAL MATTERS, FINANCIAL SERVICES, INVESTMENTS, FINANCIAL PLANNING, FINANCIAL MODELING, ASSET ALLOCATION, CATASTROPHE MODELING, AND/OR QUALITY ASSURANCE; ELECTRONIC NON-DOWNLOADABLE PUBLICATIONS, NAMELY, PERIODICALS, BOOKS, NEWSLETTERS, REPORTS, SURVEYS, ARTICLE REPRINTS, MEMORANDA, GUIDES, MANUALS, AND DIRECTORIES, NON-DOWNLOADABLE PODCASTS, AND NON-DOWNLOADABLE VIDEO RECORDINGS, ALL IN THE FIELDS OF HUMAN RESOURCES, EMPLOYEE COMPENSATION AND BENEFITS, RETIREMENT PLANNING, PENSION AND RETIREMENT PLANS, INVESTMENTS, PROFIT-SHARING PLANS, STOCK PURCHASE PLANS, HEALTH CARE, HEALTH CARE PLANS, DENTAL PLANS, PRESCRIPTION PLANS, PERSONNEL MANAGEMENT, WORKFORCE EFFECTIVENESS, REWARDS MANAGEMENT, EMPLOYEE JOB EVALUATION, PERSONNEL POLICIES, EMPLOYER-EMPLOYEE COMMUNICATIONS, EMPLOYEE SAFETY, EMPLOYEE RELOCATION, OUTSOURCING, BUSINESS AND ORGANIZATIONAL MANAGEMENT AND OPERATIONS, ORGANIZATIONAL STRUCTURE AND REORGANIZATION, PRODUCT DEVELOPMENT AND MARKETING, MERGERS AND ACQUISITIONS, STRATEGIC PLANNING, CONTINGENCY PLANNING, CHANGE MANAGEMENT, INFORMATION TECHNOLOGY, RISK MANAGEMENT, RISK EVALUATION, ACTUARIAL MATTERS, FINANCIAL SERVICES, INVESTMENTS, FINANCIAL PLANNING, FINANCIAL MODELING, ASSET ALLOCATION, CATASTROPHE MODELING, AND/OR QUALITY ASSURANCE; EDUCATIONAL SERVICES FOR INSURERS, NAMELY, PROVIDING WORKSHOPS, SEMINARS AND EDUCATIONAL PROGRAMS IN THE FIELDS OF ENTERPRISE RISK MANAGEMENT, FINANCIAL AND REGULATORY REPORTING, MERGERS AND ACQUISITIONS, CORPORATE RESTRUCTURING, MARKETING, FINANCIAL MODELING, PRICING, AND LOSS RESERVE REQUIREMENTS; ELECTRONIC NON-DOWNLOADABLE ELECTRONIC

**Reg. No. 4,125,907** PUBLICATIONS, ELECTRONIC NON-DOWNLOADABLE PODCASTS, AND ELECTRONIC NON-DOWNLOADABLE VIDEO RECORDINGS FOR INSURERS, ALL IN THE FIELDS OF ENTERPRISE RISK MANAGEMENT, FINANCIAL AND REGULATORY REPORTING, MERGERS AND ACQUISITIONS, CORPORATE RESTRUCTURING, MARKETING, FINANCIAL MODELING, PRICING, AND LOSS RESERVE REQUIREMENTS, IN CLASS 41 (U.S. CLS. 100, 101 AND 107).

FIRST USE 1-12-2010; IN COMMERCE 1-12-2010.

FOR: COMPUTER AND INFORMATION TECHNOLOGY CONSULTATION; DESIGN, DEVELOPMENT, AND IMPLEMENTATION OF COMPUTER HARDWARE AND SOFTWARE, DATABASES, WEBSITES, AND INTRANETS; COMPUTER SYSTEMS INTEGRATION SERVICES; COMPUTER PROGRAMMING AND COMPUTER MODELING SERVICES, NAMELY, COMPUTER SIMULATION FROM COMPUTER PROGRAMS FOR OTHERS; COMPUTER PROJECT MANAGEMENT SERVICES; APPLICATION SERVICE PROVIDER (ASP) SERVICES, NAMELY, PROVIDING, HOSTING, MANAGING, DEVELOPING, AND MAINTAINING APPLICATIONS, SOFTWARE, WEB SITES, AND DATABASES OF OTHERS IN THE FIELDS OF HUMAN RESOURCES, EMPLOYEE COMPENSATION AND BENEFITS, RETIREMENT PLANNING, PENSION AND RETIREMENT PLANS, INVESTMENTS, PROFIT-SHARING PLANS, STOCK PURCHASE PLANS, HEALTH CARE, HEALTH CARE PLANS, DENTAL PLANS, PRESCRIPTION PLANS, PERSONNEL MANAGEMENT, WORKFORCE EFFECTIVENESS, REWARDS MANAGEMENT, EMPLOYEE JOB EVALUATION, PERSONNEL POLICIES, EMPLOYER-EMPLOYEE COMMUNICATIONS, EMPLOYEE SAFETY, EMPLOYEE RELOCATION, OUTSOURCING, BUSINESS AND ORGANIZATIONAL MANAGEMENT AND OPERATIONS, ORGANIZATIONAL STRUCTURE AND REORGANIZATION, PRODUCT DEVELOPMENT AND MARKETING, MERGERS AND ACQUISITIONS, STRATEGIC PLANNING, CONTINGENCY PLANNING, CHANGE MANAGEMENT, INFORMATION TECHNOLOGY, RISK MANAGEMENT, RISK EVALUATION, ACTUARIAL MATTERS, FINANCIAL SERVICES, INVESTMENTS, FINANCIAL PLANNING, FINANCIAL MODELING, ASSET ALLOCATION, CATASTROPHE MODELING, AND/OR QUALITY ASSURANCE; PRODUCT DEVELOPMENT CONSULTATION; APPLICATION SERVICE PROVIDER (ASP) SERVICES FOR INTERNAL BUSINESS USE BY INSURERS, NAMELY, PROVIDING, HOSTING, MANAGING, DEVELOPING, AND MAINTAINING APPLICATIONS, SOFTWARE, WEB SITES, AND DATABASES OF OTHERS IN FIELDS OF ENTERPRISE RISK MANAGEMENT, FINANCIAL AND REGULATORY REPORTING, MERGERS AND ACQUISITIONS, CORPORATE RESTRUCTURING, MARKETING, FINANCIAL MODELING, PRICING, AND LOSS RESERVE REQUIREMENTS, IN CLASS 42 (U.S. CLS. 100 AND 101).

FIRST USE 1-4-2010; IN COMMERCE 1-4-2010.

FOR: CONSULTING IN THE FIELD OF WORKPLACE SAFETY, IN CLASS 45 (U.S. CLS. 100 AND 101).

FIRST USE 1-4-2010; IN COMMERCE 1-4-2010.

THE MARK CONSISTS OF THE LETTERS "TW" IN THE FORM OF A STYLIZED SIGNATURE.

SN 77-882,675, FILED 11-30-2009.

ELISSA GARBER KON, EXAMINING ATTORNEY

# United States of America

United States Patent and Trademark Office

## SHAREPORTS.COM

**Reg. No. 4,125,908**

SHAREPORTS.COM LLC (NEW YORK LIMITED LIABILITY COMPANY)  
415 E 37TH ST STE 38D  
NEW YORK, NY 10016

**Registered Apr. 10, 2012**

**Int. Cl.: 36**

FOR: FINANCIAL RESEARCH AND EQUITY RESEARCH BROKERAGE SERVICES; FINANCIAL RESEARCH AND INFORMATION SERVICES; PROVIDING INFORMATION AND RESEARCH IN THE FIELD OF FINANCE AND FINANCIAL INVESTMENTS, IN CLASS 36 (U.S. CLS. 100, 101 AND 102).

**SERVICE MARK**

**PRINCIPAL REGISTER**

FIRST USE 11-0-2010; IN COMMERCE 11-0-2010.

THE MARK CONSISTS OF STANDARD CHARACTERS WITHOUT CLAIM TO ANY PARTICULAR FONT, STYLE, SIZE, OR COLOR.

SN 77-883,828, FILED 12-1-2009.

JANICE L. MCMORROW, EXAMINING ATTORNEY



*David J. Kyffers*

Director of the United States Patent and Trademark Office

# United States of America

United States Patent and Trademark Office

# JUST PLAY

**Reg. No. 4,125,909**

JUST PLAY, LLC (DELAWARE LIMITED LIABILITY COMPANY)  
401 FAIRWAY DRIVE  
DEERFIELD BEACH, FL 33441

**Registered Apr. 10, 2012**

**Int. Cls.: 3 and 5**

FOR: HAND SOAPS AND BATH SOAPS IN THE NATURE OF LIQUID SOAPS, GEL SOAPS, FOAMING SOAPS, IN CLASS 3 (U.S. CLS. 1, 4, 6, 50, 51 AND 52).

**TRADEMARK**

FIRST USE 6-1-2011; IN COMMERCE 6-1-2011.

**PRINCIPAL REGISTER**

FOR: SANITIZING PREPARATIONS, NAMELY, HAND SANITIZERS HAVING ANTI-MICROBIAL AND ANTI-BACTERIAL PROPERTIES; GERMICIDES, IN CLASS 5 (U.S. CLS. 6, 18, 44, 46, 51 AND 52).

FIRST USE 10-1-2011; IN COMMERCE 10-1-2011.

THE MARK CONSISTS OF STANDARD CHARACTERS WITHOUT CLAIM TO ANY PARTICULAR FONT, STYLE, SIZE, OR COLOR.

SN 77-883,954, FILED 12-2-2009.

SAIMA MAKHDOOM, EXAMINING ATTORNEY



*David J. Kyros*

Director of the United States Patent and Trademark Office

# United States of America

United States Patent and Trademark Office

# STRONGSUIT

**Reg. No. 4,125,910**

**Registered Apr. 10, 2012**

**Int. Cls.: 21 and 25**

**TRADEMARK**

**PRINCIPAL REGISTER**

STRONG SUIT, INC. (SOUTH CAROLINA CORPORATION)  
150 EXECUTIVE CENTER DR.  
SUITE 2100 #283  
GREENVILLE, SC 29615

FOR: GLOVES, NAMELY, WORK GLOVES, IN CLASS 21 (U.S. CLS. 2, 13, 23, 29, 30, 33, 40 AND 50).

FIRST USE 12-20-2011; IN COMMERCE 12-20-2011.

FOR: GLOVES, NAMELY, MOTORCYCLE GLOVES, IN CLASS 25 (U.S. CLS. 22 AND 39).

FIRST USE 12-20-2011; IN COMMERCE 12-20-2011.

THE MARK CONSISTS OF STANDARD CHARACTERS WITHOUT CLAIM TO ANY PARTICULAR FONT, STYLE, SIZE, OR COLOR.

SN 77-886,416, FILED 12-4-2009.

PAUL E. FAHRENKOPF, EXAMINING ATTORNEY



*David J. Kyfos*

Director of the United States Patent and Trademark Office



# United States of America

United States Patent and Trademark Office

## REAL BEAUTY

**Reg. No. 4,125,911**

ENDLESSBEAUTY.COM, LLC (TEXAS LIMITED LIABILITY COMPANY)  
600 W. 28TH STREET, SUITE 210  
AUSTIN, TX 78705

**Registered Apr. 10, 2012**

**Int. Cls.: 35, 44, and 45**

FOR: PROVIDING A WEBSITE WHERE USERS CAN POST RATINGS, REVIEWS AND RECOMMENDATIONS ON BEAUTY AND HEALTH PRODUCTS FOR COMMERCIAL PURPOSES, IN CLASS 35 (U.S. CLS. 100, 101 AND 102).

**SERVICE MARK**

FIRST USE 3-1-2011; IN COMMERCE 3-1-2011.

**PRINCIPAL REGISTER**

FOR: PROVIDING AN INTERACTIVE WEBSITE FEATURING INFORMATION ABOUT HEALTH AND BEAUTY TRENDS; PROVIDING NEWS AND INFORMATION IN THE FIELD OF PERSONAL HEALTH AND BEAUTY, IN CLASS 44 (U.S. CLS. 100 AND 101).

FIRST USE 10-1-2011; IN COMMERCE 10-1-2011.

FOR: ONLINE SOCIAL NETWORKING IN THE FIELD OF BEAUTY AND HEALTH, IN CLASS 45 (U.S. CLS. 100 AND 101).

FIRST USE 10-1-2010; IN COMMERCE 10-1-2010.

THE MARK CONSISTS OF STANDARD CHARACTERS WITHOUT CLAIM TO ANY PARTICULAR FONT, STYLE, SIZE, OR COLOR.

NO CLAIM IS MADE TO THE EXCLUSIVE RIGHT TO USE "BEAUTY", APART FROM THE MARK AS SHOWN.

SN 77-889,700, FILED 12-9-2009.

WENDY GOODMAN, EXAMINING ATTORNEY



*David J. Kybas*

Director of the United States Patent and Trademark Office

# United States of America

United States Patent and Trademark Office

## SUSURROS DE ÃNGEL

**Reg. No. 4,125,912**

**Registered Apr. 10, 2012**

**Int. Cl.: 4**

**TRADEMARK**

**PRINCIPAL REGISTER**

INTERNATIONAL FLAVORS & FRAGRANCES INC. (NEW YORK CORPORATION)  
10TH FLOOR - LAW DEPARTMENT  
521 WEST 57TH STREET  
NEW YORK, NY 10019

FOR: CANDLES, IN CLASS 4 (U.S. CLS. 1, 6 AND 15).

FIRST USE 7-27-2011; IN COMMERCE 7-27-2011.

THE MARK CONSISTS OF STANDARD CHARACTERS WITHOUT CLAIM TO ANY PARTICULAR FONT, STYLE, SIZE, OR COLOR.

OWNER OF U.S. REG. NO. 2,664,558.

THE ENGLISH TRANSLATION OF "SUSURROS DE ANGEL" IN THE MARK IS WHISPERS OF AN ANGEL.

SN 77-890,678, FILED 12-10-2009.

ADA HAN, EXAMINING ATTORNEY



*David J. Kybas*

Director of the United States Patent and Trademark Office

# United States of America

United States Patent and Trademark Office

## RIVIERA TRAVELER

**Reg. No. 4,125,913**

JACK VICTOR LIMITED (CANADA CORPORATION)  
1250 ST. ALEXANDRE STREET  
MONTREAL, CANADA H3B3H6

**Registered Apr. 10, 2012**

**Int. Cl.: 25**

FOR: DRESS SUITS; JACKETS; PANTS; SPORT COATS, IN CLASS 25 (U.S. CLS. 22 AND 39).

**TRADEMARK**

FIRST USE 8-1-2011; IN COMMERCE 8-1-2011.

**PRINCIPAL REGISTER**

THE MARK CONSISTS OF STANDARD CHARACTERS WITHOUT CLAIM TO ANY PARTICULAR FONT, STYLE, SIZE, OR COLOR.

OWNER OF U.S. REG. NOS. 229,285, 2,103,661, AND 2,815,714.

SN 77-891,721, FILED 12-11-2009.

STEPHANIE ALI, EXAMINING ATTORNEY



*David J. Kyffers*

Director of the United States Patent and Trademark Office

# United States of America

United States Patent and Trademark Office



**Reg. No. 4,125,914**

**Registered Apr. 10, 2012**

**Int. Cl.: 4**

CAROTHERS, JOSHUA C (UNITED STATES INDIVIDUAL)  
2L  
254 IRVING AVE  
BROOKLYN, NY 11237

FOR: CANDLES FOR LIGHTING, IN CLASS 4 (U.S. CLS. 1, 6 AND 15).

**TRADEMARK**

FIRST USE 8-16-2010; IN COMMERCE 8-16-2010.

**PRINCIPAL REGISTER**

NO CLAIM IS MADE TO THE EXCLUSIVE RIGHT TO USE "CANDLE" , APART FROM THE MARK AS SHOWN.

THE NON-LATIN CHARACTERS IN THE MARK TRANSLITERATE TO TSAI AND THIS MEANS "WEALTH" IN ENGLISH.

THE MARK CONSISTS OF THE WORDING "WEALTH" AND "CANDLE" WITH THE WORD ELEMENTS SEPARATED BY THE CHINESE SYMBOL FOR WEALTH, THE FLAME APPEARS DIRECTLY ABOVE THE SYMBO.

SN 77-892,272, FILED 12-13-2009.

JEFF DEFORD, EXAMINING ATTORNEY



*David J. Kybas*

Director of the United States Patent and Trademark Office

# United States of America

United States Patent and Trademark Office



**Reg. No. 4,125,915**

**Registered Apr. 10, 2012**

**Int. Cl.: 25**

**TRADEMARK**

**PRINCIPAL REGISTER**

HUGHES, ANDREANITA (UNITED STATES INDIVIDUAL)  
P.O. BOX 2702  
COUNTRY CLUB HILLS, IL 60478

FOR: ATHLETIC APPAREL, NAMELY, SHIRTS, PANTS, JACKETS, FOOTWEAR, HATS AND CAPS, ATHLETIC UNIFORMS; BODY SHIRTS; CAPRI PANTS; CARGO PANTS; CLOTHING FOR ATHLETIC USE, NAMELY, PADDED SHIRTS; DENIM JACKETS; DENIMS; DOWN JACKETS; DRESS SHIRTS; FUR COATS AND JACKETS; FUR HATS; FUR JACKETS; HATS; HATS FOR INFANTS, BABIES, TODDLERS AND CHILDREN; HEAVY JACKETS; JACKETS; JACKETS AND SOCKS; LEATHER JACKETS; LEATHER PANTS; LONG JACKETS; LOUNGE PANTS; MEN'S AND WOMEN'S JACKETS, COATS, TROUSERS, VESTS; NIGHT SHIRTS; OPEN-NECKED SHIRTS; OVER SHIRTS; PADDED JACKETS; PANTS; PARTY HATS; REVERSIBLE JACKETS; SCIENTIFIC AND TECHNOLOGICAL APPAREL, NAMELY, SHIRTS, PANTS, JACKETS, FOOTWEAR, HATS AND CAPS, UNIFORMS; SHIRT FRONTS; SHIRTS; SHIRTS AND SHORT-SLEEVED SHIRTS; SHIRTS FOR INFANTS, BABIES, TODDLERS AND CHILDREN; SHORT-SLEEVED OR LONG-SLEEVED T-SHIRTS; SHORT-SLEEVED SHIRTS; SKI JACKETS; SKIRTS; SKIRTS AND DRESSES; SLEEP SHIRTS; SMALL HATS; SPORT SHIRTS; SPORTS JACKETS; SPORTS PANTS; SPORTS SHIRTS; SPORTS SHIRTS WITH SHORT SLEEVES; STRETCH PANTS; SUEDE JACKETS; SWEAT JACKETS; SWEAT PANTS; SWEAT SHIRTS; T-SHIRTS; TEE SHIRTS; TRAVEL CLOTHING CONTAINED IN A PACKAGE COMPRISING REVERSIBLE JACKETS, PANTS, SKIRTS, TOPS AND A BELT OR SCARF; TURTLE NECK SHIRTS; WEARABLE GARMENTS AND CLOTHING, NAMELY, SHIRTS; WIND RESISTANT JACKETS; WIND-JACKETS; WOMEN'S HATS AND HOODS, IN CLASS 25 (U.S. CLS. 22 AND 39).

FIRST USE 12-4-2009; IN COMMERCE 12-4-2009.

NO CLAIM IS MADE TO THE EXCLUSIVE RIGHT TO USE "DESIGNS", APART FROM THE MARK AS SHOWN.

THE MARK CONSISTS OF FOUR CARDS SPREAD EAGLE WITH THE WORDING "DECK PLAYER DESIGNS" BELOW THE FOUR CARDS.

SN 77-892,368, FILED 12-14-2009.

SEAN CROWLEY, EXAMINING ATTORNEY



*David J. Kypos*

Director of the United States Patent and Trademark Office

# United States of America

United States Patent and Trademark Office

# I-LIGHT

**Reg. No. 4,125,916**

**Registered Apr. 10, 2012**

**Int. Cl.: 8**

**TRADEMARK**

**PRINCIPAL REGISTER**

SPECTRUM BRANDS, INC. (DELAWARE CORPORATION)  
601 RAYOVAC DRIVE, LAW DEPT.  
MADISON, WI 53711

FOR: ELECTRIC INTENSE PULSED LIGHT HAIR REMOVAL OR REDUCTION APPLIANCE FOR CONSUMER USE; AND INTENSE PULSED LIGHT EMITTING DEVICE FOR HAIR REMOVAL OR REDUCTION, IN CLASS 8 (U.S. CLS. 23, 28 AND 44).

FIRST USE 11-30-2011; IN COMMERCE 11-30-2011.

THE MARK CONSISTS OF STANDARD CHARACTERS WITHOUT CLAIM TO ANY PARTICULAR FONT, STYLE, SIZE, OR COLOR.

SN 77-894,883, FILED 12-16-2009.

DOMINICK J. SALEMI, EXAMINING ATTORNEY



*David J. Kybas*

Director of the United States Patent and Trademark Office

# United States of America

United States Patent and Trademark Office

## SHADOW OF THE PANTHER

**Reg. No. 4,125,917**

IGT (NEVADA CORPORATION)  
9295 PROTOTYPE DRIVE  
RENO, NV 895218986

**Registered Apr. 10, 2012**

**Int. Cl.: 9**

FOR: GAMING MACHINES, NAMELY, DEVICES WHICH ACCEPT A WAGER, IN CLASS 9 (U.S. CLS. 21, 23, 26, 36 AND 38).

**TRADEMARK**

FIRST USE 11-15-2011; IN COMMERCE 11-15-2011.

**PRINCIPAL REGISTER**

THE MARK CONSISTS OF STANDARD CHARACTERS WITHOUT CLAIM TO ANY PARTICULAR FONT, STYLE, SIZE, OR COLOR.

SN 77-895,212, FILED 12-16-2009.

LINDA ESTRADA, EXAMINING ATTORNEY



*David J. Kybas*

Director of the United States Patent and Trademark Office

# United States of America

United States Patent and Trademark Office

## POP ART PIXIES

**Reg. No. 4,125,918**

CRAYOLA PROPERTIES, INC. (DELAWARE CORPORATION)  
1100 CHURCH LANE  
EASTON, PA 18042

**Registered Apr. 10, 2012**

**Int. Cl.: 21**

FOR: KITS FOR MAKING SUN CATCHERS, VASES AND PLATES; HYDROPONIC GARDEN KIT FOR HOME USE COMPRISING GROWING CONTAINERS WITH DRAIN COMPONENTS AND ALSO INCLUDING HYDROPONIC SEEDS AND SUBSTRATE, IN CLASS 21 (U.S. CLS. 2, 13, 23, 29, 30, 33, 40 AND 50).

**TRADEMARK**

**PRINCIPAL REGISTER**

FIRST USE 6-30-2010; IN COMMERCE 6-30-2010.

THE MARK CONSISTS OF STANDARD CHARACTERS WITHOUT CLAIM TO ANY PARTICULAR FONT, STYLE, SIZE, OR COLOR.

SN 77-895,787, FILED 12-17-2009.

NORA BUCHANAN WILL, EXAMINING ATTORNEY



*David J. Kyffers*

Director of the United States Patent and Trademark Office



# United States of America

United States Patent and Trademark Office

## POP ART PIXIES

**Reg. No. 4,125,919**

CRAYOLA PROPERTIES, INC. (DELAWARE CORPORATION)  
1100 CHURCH LANE  
EASTON, PA 18042

**Registered Apr. 10, 2012**

**Int. Cl.: 20**

FOR: KITS FOR MAKING WIND CHIMES, THREE DIMENSIONAL SHADOWBOX WALL ART AND PICTURE FRAMES, IN CLASS 20 (U.S. CLS. 2, 13, 22, 25, 32 AND 50).

**TRADEMARK**

FIRST USE 6-30-2010; IN COMMERCE 6-30-2010.

**PRINCIPAL REGISTER**

THE MARK CONSISTS OF STANDARD CHARACTERS WITHOUT CLAIM TO ANY PARTICULAR FONT, STYLE, SIZE, OR COLOR.

SN 77-895,887, FILED 12-17-2009.

NORA BUCHANAN WILL, EXAMINING ATTORNEY



*David J. Kyros*

Director of the United States Patent and Trademark Office

United States of America  
United States Patent and Trademark Office

# HARCRYL

**Reg. No. 4,125,920**

HARCROS CHEMICALS INC. (KANSAS CORPORATION)  
5200 SPEAKER ROAD  
KANSAS CITY, KS 66106

**Registered Apr. 10, 2012**

**Int. Cl.: 1**

FOR: CHEMICALS, NAMELY, ACRYLIC MONOMERS AND POLYMERS FOR USE IN INDUSTRY, IN CLASS 1 (U.S. CLS. 1, 5, 6, 10, 26 AND 46).

**TRADEMARK**

FIRST USE 2-4-2011; IN COMMERCE 2-4-2011.

**PRINCIPAL REGISTER**

THE MARK CONSISTS OF STANDARD CHARACTERS WITHOUT CLAIM TO ANY PARTICULAR FONT, STYLE, SIZE, OR COLOR.

SN 77-896,520, FILED 12-18-2009.

DEBRA LEE, EXAMINING ATTORNEY



*David J. Kybas*

Director of the United States Patent and Trademark Office

# United States of America

United States Patent and Trademark Office



**Reg. No. 4,125,921**

**Registered Apr. 10, 2012**

**Int. Cl.: 29**

**TRADEMARK**

**PRINCIPAL REGISTER**

GOLDMAN, JUDE (UNITED STATES INDIVIDUAL), DBA PUCKERS GOURMET,  
3322 COUNTY RT 30  
SALEM, NY 12865

FOR: PICKLED VEGETABLES; PICKLES; SPICY PICKLES, IN CLASS 29 (U.S. CL. 46).

FIRST USE 11-1-2009; IN COMMERCE 5-1-2010.

NO CLAIM IS MADE TO THE EXCLUSIVE RIGHT TO USE "GOURMET", "100% NATURAL", "NEW YORK SOUR", AND "SUPERIOR PICKLED", APART FROM THE MARK AS SHOWN.

THE COLOR(S) GRAY, BLACK, WHITE, RED AND GREEN IS/ARE CLAIMED AS A FEATURE OF THE MARK.

THE MARK CONSISTS OF BLACK OVAL, LIGHT GREEN, LOW OPACITY-FADED IMAGE OF PICKLES, ROSEWOOD STD FONT IN GREEN, RED AND WHITE READING "PUCKERS GOURMET" LUCIDA GRANDE FONT IN GREEN, RED AND WHITE READING "100% NATURAL", "NEW YORK SOUR POWER" AND "SUPERIOR PICKLED DELECTABLES" RETRO 1920'S CIRCUS, ANNOUNCER, CLOWN FACE, WITH BLACK HAIR PARTED IN THE MIDDLE, RED HAIR HIGHLIGHTS, GREEN EYES, BLACK HANDLE BAR MOUSTAGE, BLACK GOATEE, RED LIPS IN A PUCKERED OR SOUR FACED EXPRESSION, WHITE SKIN WITH LIGHT GRAY SHADING FOUR RED STARS, STROKED IN GREEN TWO FINIAL SCROLLS IN GREEN RED AND WHITE ON EITHER END OF "SUPERIOR PICKLED DELECTABLES".

SN 77-896,659, FILED 12-18-2009.

TRACY CROSS, EXAMINING ATTORNEY



*David J. Kybas*

Director of the United States Patent and Trademark Office

# United States of America

United States Patent and Trademark Office

# PODSIBLE

**Reg. No. 4,125,922**

**Registered Apr. 10, 2012**

**Int. Cl.: 42**

**SERVICE MARK**

**PRINCIPAL REGISTER**

TOP HOST TECH, LLC (MICHIGAN LIMITED LIABILITY COMPANY)  
SUITE 600  
39555 ORCHARD HILL PLACE  
NOVI, MI 48375

FOR: WEB SITE HOSTING SERVICES, IN CLASS 42 (U.S. CLS. 100 AND 101).

FIRST USE 12-1-2010; IN COMMERCE 12-1-2010.

THE MARK CONSISTS OF STANDARD CHARACTERS WITHOUT CLAIM TO ANY PARTICULAR FONT, STYLE, SIZE, OR COLOR.

SN 77-897,593, FILED 12-19-2009.

TINA MAI, EXAMINING ATTORNEY



*David J. Kyffers*

Director of the United States Patent and Trademark Office

# United States of America

United States Patent and Trademark Office

## SIR BENNI MILES

**Reg. No. 4,125,923**

DIRTY JERZ TRADEMARKS, GMBH (FED REP GERMANY LIMITED LIABILITY COMPANY)  
WILHELM-WAGENFELD-STRASSE 22  
MUNCHEN, FED REP GERMANY 80807

**Registered Apr. 10, 2012**

**Int. Cl.: 25**

FOR: CLOTHING, NAMELY, SHIRTS, SWEATSHIRTS, PANTS, JEANS, BELTS, JACKETS,  
COATS, IN CLASS 25 (U.S. CLS. 22 AND 39).

**TRADEMARK**

FIRST USE 12-0-1995; IN COMMERCE 12-20-2011.

**PRINCIPAL REGISTER**

THE MARK CONSISTS OF STANDARD CHARACTERS WITHOUT CLAIM TO ANY PAR-  
TICULAR FONT, STYLE, SIZE, OR COLOR.

OWNER OF U.S. REG. NOS. 1,999,992, 2,769,783, AND 2,778,307.

"SIR BENNI MILES" IS NOT THE NAME OF A SPECIFIC LIVING INDIVIDUAL.

SN 77-898,976, FILED 12-22-2009.

HEATHER THOMPSON, EXAMINING ATTORNEY



*David J. Kybas*

Director of the United States Patent and Trademark Office

# United States of America

United States Patent and Trademark Office



**Reg. No. 4,125,924**

**Registered Apr. 10, 2012**

**Int. Cl.: 1**

**TRADEMARK**

**PRINCIPAL REGISTER**

STET ACQUISITION, INC. (TEXAS CORPORATION), DBA WISEARTH AND WISEARTH ORGANICS,  
P.O. BOX 797426  
DALLAS, TX 75379

FOR: FERTILIZERS, IN CLASS 1 (U.S. CLS. 1, 5, 6, 10, 26 AND 46).

FIRST USE 8-30-2010; IN COMMERCE 10-31-2011.

THE MARK CONSISTS OF THE WORD "WISEARTH" WITH A SUN AND GRAIN ABOVE THE LETTERS "AR".

SN 77-900,158, FILED 12-23-2009.

EUGENIA MARTIN, EXAMINING ATTORNEY



*David J. Kyffers*

Director of the United States Patent and Trademark Office

# United States of America

United States Patent and Trademark Office

# BONDLEND

**Reg. No. 4,125,925**

EQUILEND HOLDINGS LLC (DELAWARE LIMITED LIABILITY COMPANY)  
17 STATE STREET 9TH FLOOR  
NEW YORK, NY 10004

**Registered Apr. 10, 2012**

**Int. Cl.: 36**

FOR: FINANCIAL SERVICES, NAMELY, PROVIDING SERVICES IN THE NATURE OF AUTOMATED SECURITIES FINANCE RELATING TO SECURITIES LENDING AND BORROWING TRANSACTIONS VIA A GLOBAL COMPUTER NETWORK, IN CLASS 36 (U.S. CLS. 100, 101 AND 102).

**SERVICE MARK**

**PRINCIPAL REGISTER**

FIRST USE 5-17-2010; IN COMMERCE 5-17-2010.

THE MARK CONSISTS OF STANDARD CHARACTERS WITHOUT CLAIM TO ANY PARTICULAR FONT, STYLE, SIZE, OR COLOR.

SN 77-900,200, FILED 12-23-2009.

MARGERY A. TIERNEY, EXAMINING ATTORNEY



*David J. Kyffers*

Director of the United States Patent and Trademark Office

# United States of America

United States Patent and Trademark Office

# SKY SUITES

**Reg. No. 4,125,926**

**Registered Apr. 10, 2012**

**Int. Cl.: 36**

**SERVICE MARK**

**PRINCIPAL REGISTER**

NEVINS LEWBEL PROPERTY MANAGEMENT, INC. (CALIFORNIA CORPORATION)  
920 GARDEN STREET, SUITE A  
SANTA BARBARA, CA 93101

FOR: LEASING OF APARTMENTS; REAL ESTATE SERVICES, NAMELY, RENTAL OF SHORT-TERM FURNISHED APARTMENTS; RENTING OF APARTMENTS, IN CLASS 36 (U.S. CLS. 100, 101 AND 102).

FIRST USE 2-1-2012; IN COMMERCE 2-1-2012.

THE MARK CONSISTS OF STANDARD CHARACTERS WITHOUT CLAIM TO ANY PARTICULAR FONT, STYLE, SIZE, OR COLOR.

NO CLAIM IS MADE TO THE EXCLUSIVE RIGHT TO USE "SUITES", APART FROM THE MARK AS SHOWN.

SN 77-900,498, FILED 12-23-2009.

JAMES GRIFFIN, EXAMINING ATTORNEY



*David J. Kyffers*

Director of the United States Patent and Trademark Office



# United States of America

United States Patent and Trademark Office

# ByUs NEWS

**Reg. No. 4,125,927**

1383491 ALBERTA LTD. (CANADA CORPORATION)

**Registered Apr. 10, 2012**

200-5970 CENTRE STREET SE  
CALGARY, ALBERTA, CANADA T2H0C1

**Int. Cls.: 9 and 41**

FOR: DOWNLOADABLE MULTIMEDIA NEWS PODCASTS, IN CLASS 9 (U.S. CLS. 21, 23, 26, 36 AND 38).

**TRADEMARK**

FIRST USE 1-24-2012; IN COMMERCE 1-24-2012.

**SERVICE MARK**

FOR: PROVIDING ONLINE NON-DOWNLOADABLE NEWSPAPERS; PROVIDING ONLINE NON-DOWNLOADABLE NEWSLETTERS AND MAGAZINES IN THE FIELD OF CURRENT NEWSWORTHY EVENTS; OPERATION OF AN ONLINE NEWS NETWORK NAMELY, PROVIDING AN INTERNET NEWS PORTAL FEATURING LINKS TO NEWS STORIES AND ARTICLES IN THE FIELD OF CURRENT EVENTS; AND PROVIDING ONLINE NON-DOWNLOADABLE SOFTWARE USED TO COMPILE, COLLECT, PUBLISH, PRODUCE AND BROADCAST ONLINE NEWS PROGRAMS, NEWSPAPERS, NEWSLETTERS, MAGAZINES AND MULTIMEDIA NEWS PODCASTS, IN CLASS 41 (U.S. CLS. 100, 101 AND 107).

**PRINCIPAL REGISTER**

FIRST USE 1-24-2012; IN COMMERCE 1-24-2012.

THE MARK CONSISTS OF STANDARD CHARACTERS WITHOUT CLAIM TO ANY PARTICULAR FONT, STYLE, SIZE, OR COLOR.

NO CLAIM IS MADE TO THE EXCLUSIVE RIGHT TO USE "NEWS", APART FROM THE MARK AS SHOWN.

SN 77-900,502, FILED 12-23-2009.

JAMES GRIFFIN, EXAMINING ATTORNEY



*David J. Kybas*

Director of the United States Patent and Trademark Office

# United States of America

United States Patent and Trademark Office

# TUFFRAIL

**Reg. No. 4,125,928**

**Registered Apr. 10, 2012**

**Int. Cl.: 12**

**TRADEMARK**

**PRINCIPAL REGISTER**

TBD PRODUCTS, INC. (WISCONSIN CORPORATION), AKA TUFFRAIL.COM,  
N116W18515 MORSE DRIVE  
GERMANTOWN, WI 53022

FOR: GENERAL PURPOSE CARGO MANAGEMENT SYSTEM FOR ATTACHMENT TO AUTOMOBILES, TRUCKS, OFF-ROAD VEHICLES, TRAILERS AND BOATS AND FOR GENERAL PURPOSE SECUREMENT COMPRISED PRIMARILY OF SINGULAR OR PLURAL EXTRUDED ALUMINUM ALLOY RAILS AND CARGO-SECURING ACCESSORIES, NAMELY, LOCKING PINS, NONE OF THE ABOVE BEING USED WITH RAILROAD CARS, IN CLASS 12 (U.S. CLS. 19, 21, 23, 31, 35 AND 44).

FIRST USE 2-28-2010; IN COMMERCE 2-28-2010.

THE MARK CONSISTS OF THE WORD TOUGH SPELLED PHONETICALLY AS "TUFF" COMBINED WITH THE WORD "RAIL", UNDERLINED THE FULL LENGTH OF THE WORD ALONG WITH THE HORIZONTAL BAR OF THE LETTER "T" EXTENDED AT BEYOND THE LENGTH OF THE ENTIRE WORD COMBINATION.

SN 77-900,990, FILED 12-25-2009.

RUDY R. SINGLETON, EXAMINING ATTORNEY



*David J. Kyffers*

Director of the United States Patent and Trademark Office

# United States of America

United States Patent and Trademark Office

# MAXMEM

**Reg. No. 4,125,929**

**Registered Apr. 10, 2012**

**Int. Cl.: 9**

**TRADEMARK**

**PRINCIPAL REGISTER**

NEW CONCEPTS DEVELOPMENT CORPORATION (ILLINOIS CORPORATION)  
2650 BRIDGE LANE  
WOODSTOCK, IL 60098

FOR: COMPUTER MEMORY UPGRADE KIT COMPRISING ONE OR MORE COMPUTER MEMORY MODULES, HAND TOOL FOR INSTALLING COMPUTER MEMORY MODULE, AND INSTRUCTION MANUAL , IN CLASS 9 (U.S. CLS. 21, 23, 26, 36 AND 38).

FIRST USE 2-14-2012; IN COMMERCE 2-14-2012.

THE MARK CONSISTS OF STANDARD CHARACTERS WITHOUT CLAIM TO ANY PARTICULAR FONT, STYLE, SIZE, OR COLOR.

OWNER OF U.S. REG. NO. 2,331,974.

SN 77-901,909, FILED 12-29-2009.

MICHAEL LITZAU, EXAMINING ATTORNEY



*David J. Kybas*

Director of the United States Patent and Trademark Office

United States of America  
United States Patent and Trademark Office

# MAXRAM

**Reg. No. 4,125,930**

**Registered Apr. 10, 2012**

**Int. Cl.: 9**

**TRADEMARK**

**PRINCIPAL REGISTER**

NEW CONCEPTS DEVELOPMENT CORPORATION (ILLINOIS CORPORATION)  
2650 BRIDGE LANE  
WOODSTOCK, IL 60098

FOR: COMPUTER MEMORY UPGRADE KIT COMPRISING ONE OR MORE COMPUTER MEMORY MODULES, HAND TOOL FOR INSTALLING COMPUTER MEMORY MODULE, AND INSTRUCTION MANUAL , IN CLASS 9 (U.S. CLS. 21, 23, 26, 36 AND 38).

FIRST USE 2-14-2012; IN COMMERCE 2-14-2012.

THE MARK CONSISTS OF STANDARD CHARACTERS WITHOUT CLAIM TO ANY PARTICULAR FONT, STYLE, SIZE, OR COLOR.

OWNER OF U.S. REG. NO. 2,331,974.

SN 77-901,939, FILED 12-29-2009.

MICHAEL LITZAU, EXAMINING ATTORNEY



*David J. Kybas*

Director of the United States Patent and Trademark Office

# United States of America

United States Patent and Trademark Office

# BIOCLOSURE

**Reg. No. 4,125,931**

NEWAGE INDUSTRIES, INC. (PENNSYLVANIA CORPORATION)  
145 JAMES WAY  
SOUTHAMPTON, PA 18966

**Registered Apr. 10, 2012**

**Int. Cl.: 9**

FOR: LABORATORY EQUIPMENT, NAMELY, CLOSURES, SEALS, AND STOPPERS MADE OF PLASTIC, RUBBER OR THERMOPLASTIC ELASTOMERS FOR USE WITH LABORATORY BOTTLES, CONTAINERS, HOSES, TUBING AND MOLDED ASSEMBLIES; LABORATORY EQUIPMENT, NAMELY, SINGLE-USE SYSTEMS PRIMARILY COMPRISED OF A COMBINATION OF TUBING, HOSES, MOLDED COMPONENTS, CLOSURES, SEALS, AND/OR STOPPERS MADE PRIMARILY OF PLASTIC, RUBBER OR THERMOPLASTIC ELASTOMERS, IN CLASS 9 (U.S. CLS. 21, 23, 26, 36 AND 38).

**TRADEMARK**

**PRINCIPAL REGISTER**

FIRST USE 1-27-2010; IN COMMERCE 2-26-2010.

THE MARK CONSISTS OF STANDARD CHARACTERS WITHOUT CLAIM TO ANY PARTICULAR FONT, STYLE, SIZE, OR COLOR.

SN 77-902,192, FILED 12-29-2009.

MICHAEL WEBSTER, EXAMINING ATTORNEY



*David J. Kyros*

Director of the United States Patent and Trademark Office

# United States of America

United States Patent and Trademark Office

## PALMPERFECT SPLASH

**Reg. No. 4,125,932**

CLIO DESIGNS INCORPORATED (MASSACHUSETTS CORPORATION)  
80 COOLIDGE HILL ROAD  
WATERTOWN, MA 02472

**Registered Apr. 10, 2012**

**Int. Cl.: 8**

FOR: ELECTRIC HAIR TRIMMERS; BATTERY-OPERATED HAIR TRIMMERS AND SHAVERS, IN CLASS 8 (U.S. CLS. 23, 28 AND 44).

**TRADEMARK**

FIRST USE 4-0-2010; IN COMMERCE 4-0-2010.

**PRINCIPAL REGISTER**

THE MARK CONSISTS OF STANDARD CHARACTERS WITHOUT CLAIM TO ANY PARTICULAR FONT, STYLE, SIZE, OR COLOR.

OWNER OF U.S. REG. NO. 3,112,735.

SN 77-902,863, FILED 12-30-2009.

SUZANNE BLANE, EXAMINING ATTORNEY



*David J. Kyffers*

Director of the United States Patent and Trademark Office

# United States of America

United States Patent and Trademark Office

# Cannagen

**Reg. No. 4,125,933**

**Registered Apr. 10, 2012**

**Int. Cl.: 35**

**SERVICE MARK**

**PRINCIPAL REGISTER**

DAVID HOLMES (UNITED STATES INDIVIDUAL), DBA CANNAGEN,  
1843 NORTH VERDUGO ROAD  
GLENDALE, CA 91208

FOR: PROVIDING A SEARCHABLE ON-LINE ADVERTISING WEBSITE AND GUIDE  
FEATURING THE GOODS AND SERVICES OF OTHER VENDORS VIA THE INTERNET;  
PROVIDING A WEBSITE FOR CONNECTING SELLERS WITH BUYERS, IN CLASS 35 (U.S.  
CLS. 100, 101 AND 102).

FIRST USE 7-9-2010; IN COMMERCE 7-9-2010.

THE MARK CONSISTS OF STANDARD CHARACTERS WITHOUT CLAIM TO ANY PAR-  
TICULAR FONT, STYLE, SIZE, OR COLOR.

SN 77-903,279, FILED 12-31-2009.

LINDSEY RUBIN, EXAMINING ATTORNEY



*David J. Kybas*

Director of the United States Patent and Trademark Office

# United States of America

United States Patent and Trademark Office

# SPRIG

**Reg. No. 4,125,934**

**Registered Apr. 10, 2012**

**Int. Cl.: 4**

**TRADEMARK**

**PRINCIPAL REGISTER**

NEST FRAGRANCES, LLC (NEW YORK LIMITED LIABILITY COMPANY)  
601 WEST 26TH STREET, NO. 1500  
NEW YORK, NY 10001

FOR: CANDLES, IN CLASS 4 (U.S. CLS. 1, 6 AND 15).

FIRST USE 8-1-2011; IN COMMERCE 8-1-2011.

THE MARK CONSISTS OF STANDARD CHARACTERS WITHOUT CLAIM TO ANY PARTICULAR FONT, STYLE, SIZE, OR COLOR.

SN 77-904,004, FILED 1-3-2010.

DAVID TOOLEY, EXAMINING ATTORNEY



*David J. Kyffers*

Director of the United States Patent and Trademark Office



# United States of America

United States Patent and Trademark Office

## ALDEN LEATHER DEFENDER

**Reg. No. 4,125,935**

ALDEN SHOE COMPANY, INC. (MASSACHUSETTS CORPORATION)  
1 TAUNTON STREET  
MIDDLEBOROUGH, MA 02346

**Registered Apr. 10, 2012**

**Int. Cl.: 1**

FOR: WATERPROOFING AND STAIN REPELLING COMPOUND FOR LEATHER AND SUEDE, IN CLASS 1 (U.S. CLS. 1, 5, 6, 10, 26 AND 46).

**TRADEMARK**

FIRST USE 9-20-2011; IN COMMERCE 9-20-2011.

**PRINCIPAL REGISTER**

THE MARK CONSISTS OF STANDARD CHARACTERS WITHOUT CLAIM TO ANY PARTICULAR FONT, STYLE, SIZE, OR COLOR.

OWNER OF U.S. REG. NOS. 1,530,928, 1,656,326, AND 1,719,475.

NO CLAIM IS MADE TO THE EXCLUSIVE RIGHT TO USE "LEATHER", APART FROM THE MARK AS SHOWN.

SN 77-904,675, FILED 1-4-2010.

PAM WILLIS, EXAMINING ATTORNEY



*David J. Kybas*

Director of the United States Patent and Trademark Office

# United States of America

United States Patent and Trademark Office

# BULLRUSH

**Reg. No. 4,125,936**

LIFE LESSONS, LLC (INDIANA LIMITED LIABILITY COMPANY)  
9230 CONSERVATION WAY  
FORT WAYNE, IN 46809

**Registered Apr. 10, 2012**

**Int. Cl.: 25**

FOR: SHIRTS, SWEATSHIRTS, SWEATPANTS, IN CLASS 25 (U.S. CLS. 22 AND 39).

**TRADEMARK**

FIRST USE 5-13-2011; IN COMMERCE 5-13-2011.

**PRINCIPAL REGISTER**

THE MARK CONSISTS OF STANDARD CHARACTERS WITHOUT CLAIM TO ANY PARTICULAR FONT, STYLE, SIZE, OR COLOR.

SN 77-905,041, FILED 1-5-2010.

STEVEN PEREZ, EXAMINING ATTORNEY



*David J. Kybas*

Director of the United States Patent and Trademark Office

# United States of America

United States Patent and Trademark Office

# DAVINCH

**Reg. No. 4,125,937**

**Registered Apr. 10, 2012**

**Int. Cl.: 6**

**TRADEMARK**

**PRINCIPAL REGISTER**

KABUSHIKI KAISHA KOBE SEIKO SHO (JAPAN CORPORATION), TA KOBE STEEL, LTD.,  
10-26, WAKINOHAMA-CHO 2-CHOME, CHUO-KU  
KOBE-SHI, HYOGO, JAPAN 651-8585

FOR: IRONS AND STEELS; NONFERROUS METALS AND THEIR ALLOYS; METAL MATERIALS FOR BUILDING OR CONSTRUCTION, NAMELY, REINFORCING MATERIALS OF METAL FOR BUILDING PURPOSES; PREFABRICATED BUILDING ASSEMBLY KITS OF METAL COMPRISED OF COMPOSITE PANELS COMPRISED PRIMARILY OF METAL; ARTIFICIAL FISH REEFS OF METAL; POULTRY CAGES OF METAL; METAL MOULDS FOR FORMING CEMENT PRODUCTS; METAL JUNCTIONS FOR PIPES; METAL FLANGES; KEYS, NAMELY, METAL KEYS FOR LOCKS; COTTER PINS; RAILWAY POINTS; ROAD SIGNS OF METAL; INDUSTRIAL PACKAGING CONTAINERS OF METAL, NAMELY, CONTAINERS OF METAL AND PACKAGING CONTAINERS OF METAL, IN CLASS 6 (U.S. CLS. 2, 12, 13, 14, 23, 25 AND 50).

FIRST USE 10-12-2010; IN COMMERCE 10-12-2010.

THE MARK CONSISTS OF STANDARD CHARACTERS WITHOUT CLAIM TO ANY PARTICULAR FONT, STYLE, SIZE, OR COLOR.

OWNER OF JAPAN REG. NO. 4911714, DATED 12-2-2005, EXPIRES 12-2-2015.

SN 77-905,301, FILED 1-5-2010.

ANGELA DUONG, EXAMINING ATTORNEY



*David J. Kyros*

Director of the United States Patent and Trademark Office

# United States of America

United States Patent and Trademark Office

## GRAB AND GLOW

**Reg. No. 4,125,938**

**Registered Apr. 10, 2012**

**Int. Cl.: 5**

**TRADEMARK**

**PRINCIPAL REGISTER**

PREPARESMART LLC (WASHINGTON LIMITED LIABILITY COMPANY)  
17725 NE 65TH STREET, SUITE B-200  
REDMOND, WA 98052

FOR: EMERGENCY PREPAREDNESS AND RESPONSE KITS CONTAINING VARIOUS COMBINATIONS OF FIRST AID KITS, FIRST AID SUPPLIES, EMERGENCY FOOD AND WATER, FLASHLIGHTS, LIGHT STICKS, PONCHOS, BLANKETS, HAND WARMERS, GLOVES, MASKS, MATCHES, RADIOS, HYGIENE SUPPLIES, EMERGENCY TOOLS, SAFETY SUPPLIES, SHELTER AND WARMTH SUPPLIES, BACKPACKS, BUCKETS, COOLER BAGS AND FANNY PACKS, IN CLASS 5 (U.S. CLS. 6, 18, 44, 46, 51 AND 52).

FIRST USE 8-12-2009; IN COMMERCE 2-8-2010.

THE MARK CONSISTS OF STANDARD CHARACTERS WITHOUT CLAIM TO ANY PARTICULAR FONT, STYLE, SIZE, OR COLOR.

SN 77-905,443, FILED 1-5-2010.

MARY ROSSMAN, EXAMINING ATTORNEY



*David J. Kyros*

Director of the United States Patent and Trademark Office

# United States of America

United States Patent and Trademark Office

# APPUP

**Reg. No. 4,125,939**

**Registered Apr. 10, 2012**

**Int. Cls.: 9, 35, and 42**

**TRADEMARK**

**SERVICE MARK**

**PRINCIPAL REGISTER**

INTEL CORPORATION (DELAWARE CORPORATION)  
2200 MISSION COLLEGE BOULEVARD  
SANTA CLARA, CA 95052

FOR: COMPUTER SOFTWARE AND DOWNLOADABLE COMPUTER SOFTWARE FOR USE IN SEARCHING FOR, BROWSING, AND PURCHASING SOFTWARE ON AN ELECTRONIC DATABASE, IN CLASS 9 (U.S. CLS. 21, 23, 26, 36 AND 38).

FIRST USE 1-7-2010; IN COMMERCE 1-7-2010.

FOR: RETAIL STORE SERVICES FEATURING COMPUTER SOFTWARE; PROVIDING CONSUMER INFORMATION IN THE FIELDS OF COMPUTER SOFTWARE AND CONSUMER REVIEWS OF COMPUTER SOFTWARE, IN CLASS 35 (U.S. CLS. 100, 101 AND 102).

FIRST USE 1-7-2010; IN COMMERCE 1-7-2010.

FOR: PROVIDING A WEBSITE FEATURING TECHNICAL INFORMATION RELATING TO COMPUTER SOFTWARE; UPDATING OF COMPUTER SOFTWARE, IN CLASS 42 (U.S. CLS. 100 AND 101).

FIRST USE 1-7-2010; IN COMMERCE 1-7-2010.

THE MARK CONSISTS OF STANDARD CHARACTERS WITHOUT CLAIM TO ANY PARTICULAR FONT, STYLE, SIZE, OR COLOR.

PRIORITY CLAIMED UNDER SEC. 44(D) ON ITALY APPLICATION NO. RM2009C00646, FILED 11-12-2009.

THE WORDING "APPUP" HAS NO MEANING IN A FOREIGN LANGUAGE.

SN 77-906,832, FILED 1-7-2010.

CHARISMA HAMPTON, EXAMINING ATTORNEY



*David J. Kyffers*

Director of the United States Patent and Trademark Office

# United States of America

United States Patent and Trademark Office

## INTEL APPUP

**Reg. No. 4,125,940**

**Registered Apr. 10, 2012**

**Int. Cls.: 9, 35, and 42**

**TRADEMARK**

**SERVICE MARK**

**PRINCIPAL REGISTER**

INTEL CORPORATION (DELAWARE CORPORATION)  
2200 MISSION COLLEGE BOULEVARD  
SANTA CLARA, CA 95052

FOR: COMPUTER SOFTWARE AND DOWNLOADABLE COMPUTER SOFTWARE FOR USE IN SEARCHING FOR, BROWSING, AND PURCHASING SOFTWARE ON AN ELECTRONIC DATABASE, IN CLASS 9 (U.S. CLS. 21, 23, 26, 36 AND 38).

FIRST USE 1-7-2010; IN COMMERCE 1-7-2010.

FOR: RETAIL STORE SERVICES FEATURING COMPUTER SOFTWARE; PROVIDING CONSUMER INFORMATION IN THE FIELDS OF COMPUTER SOFTWARE AND CONSUMER REVIEWS OF COMPUTER SOFTWARE, IN CLASS 35 (U.S. CLS. 100, 101 AND 102).

FIRST USE 1-7-2010; IN COMMERCE 1-7-2010.

FOR: PROVIDING A WEBSITE FEATURING TECHNICAL INFORMATION RELATING TO COMPUTER SOFTWARE; UPDATING OF COMPUTER SOFTWARE, IN CLASS 42 (U.S. CLS. 100 AND 101).

FIRST USE 1-7-2010; IN COMMERCE 1-7-2010.

THE MARK CONSISTS OF STANDARD CHARACTERS WITHOUT CLAIM TO ANY PARTICULAR FONT, STYLE, SIZE, OR COLOR.

PRIORITY CLAIMED UNDER SEC. 44(D) ON ITALY APPLICATION NO. RM2009C00646, FILED 11-12-2009.

OWNER OF U.S. REG. NOS. 2,446,693, 3,029,954, AND OTHERS.

THE WORDING "APPUP" HAS NO MEANING IN A FOREIGN LANGUAGE.

SN 77-906,836, FILED 1-7-2010.

CHARISMA HAMPTON, EXAMINING ATTORNEY



*David J. Kyffers*

Director of the United States Patent and Trademark Office

# United States of America

United States Patent and Trademark Office

# Bourriquot

**Reg. No. 4,125,941**

**Registered Apr. 10, 2012**

**Int. Cl.: 33**

**TRADEMARK**

**PRINCIPAL REGISTER**

CONFIDENTIAL VINTNERS LLC (CALIFORNIA LIMITED LIABILITY COMPANY)  
1250 CHURCH ST., STE. F  
ST. HELENA, CA 94574

FOR: WINE, IN CLASS 33 (U.S. CLS. 47 AND 49).

FIRST USE 9-13-2011; IN COMMERCE 2-3-2012.

THE MARK CONSISTS OF STANDARD CHARACTERS WITHOUT CLAIM TO ANY PARTICULAR FONT, STYLE, SIZE, OR COLOR.

THE WORDING "BOURRIQUOT" HAS NO MEANING IN A FOREIGN LANGUAGE.

SN 77-908,051, FILED 1-8-2010.

DEBRA LEE, EXAMINING ATTORNEY



*David J. Kyffers*

Director of the United States Patent and Trademark Office

# United States of America

United States Patent and Trademark Office

# GAMEHOUSE

**Reg. No. 4,125,942**

**Registered Apr. 10, 2012**

**Int. Cl.: 36**

**SERVICE MARK**

**PRINCIPAL REGISTER**

REALNETWORKS, INC. (WASHINGTON CORPORATION)  
SUITE 1000  
2601 ELLIOTT AVENUE  
SEATTLE, WA 98121

FOR: DIGITAL CURRENCY EXCHANGE SERVICES, NAMELY, PROVIDING VIRTUAL ELECTRONIC TOKENS UTILIZED TO PLAY ONLINE OR DOWNLOADABLE GAMES AND ACQUIRE VIRTUAL PRIZES AND ACCESSORIES WITHIN THE GAMES, IN CLASS 36 (U.S. CLS. 100, 101 AND 102).

FIRST USE 6-15-2011; IN COMMERCE 6-15-2011.

THE MARK CONSISTS OF STANDARD CHARACTERS WITHOUT CLAIM TO ANY PARTICULAR FONT, STYLE, SIZE, OR COLOR.

OWNER OF U.S. REG. NO. 2,784,290.

SN 77-908,234, FILED 1-8-2010.

MEGHAN REINHART, EXAMINING ATTORNEY



*David J. Kyffers*

Director of the United States Patent and Trademark Office



# United States of America

United States Patent and Trademark Office

## THE ABSTER

**Reg. No. 4,125,943**

**Registered Apr. 10, 2012**

**Int. Cl.: 28**

**TRADEMARK**

**PRINCIPAL REGISTER**

THE ABSTER INC (NEW YORK CORPORATION)  
70-15 AUSTIN ST. 3RD. FL.  
FOREST HILLS, NY 11375

FOR: ACCESSORY FOR MANUALLY-OPERATED EXERCISE EQUIPMENT, NAMELY, ACCESSORY ATTACHMENT TO INCREASE MUSCLE RESISTANCE; EXERCISE EQUIPMENT, NAMELY, ABDOMINAL BOARDS; EXERCISE EQUIPMENT, NAMELY, CHEST EXPANDERS; EXERCISE EQUIPMENT, NAMELY, CHEST PULLS; EXERCISE EQUIPMENT, NAMELY, ROTARY ABDOMINAL BOARDS; EXERCISE EQUIPMENT, NAMELY, SHOULDER STRETCHER USING A CABLE; EXERCISE MACHINES; MANUAL LEG EXERCISERS; MANUALLY-OPERATED EXERCISE EQUIPMENT; MANUALLY-OPERATED EXERCISE EQUIPMENT FOR PHYSICAL FITNESS PURPOSES, IN CLASS 28 (U.S. CLS. 22, 23, 38 AND 50).

FIRST USE 12-23-2011; IN COMMERCE 2-2-2012.

THE MARK CONSISTS OF STANDARD CHARACTERS WITHOUT CLAIM TO ANY PARTICULAR FONT, STYLE, SIZE, OR COLOR.

SN 77-909,132, FILED 1-11-2010.

MICHELLE DUBOIS, EXAMINING ATTORNEY



*David J. Kyros*

Director of the United States Patent and Trademark Office

# United States of America

United States Patent and Trademark Office

## TIMELESS COOL

**Reg. No. 4,125,944**

SHERYL D. GREEN (UNITED STATES INDIVIDUAL)  
17 SCHUYLER LANE  
BLOOMFIELD, CT 06002

**Registered Apr. 10, 2012**

**Int. Cls.: 14, 41, 42, and  
45**

FOR: JEWELRY, IN CLASS 14 (U.S. CLS. 2, 27, 28 AND 50).

FIRST USE 1-30-2012; IN COMMERCE 1-30-2012.

**TRADEMARK**

FOR: ON-LINE JOURNALS, NAMELY, BLOGS FEATURING JEWELRY, DESIGN, FASHION, AND LIFESTYLE TRENDS, IN CLASS 41 (U.S. CLS. 100, 101 AND 107).

**SERVICE MARK**

FIRST USE 3-1-2008; IN COMMERCE 3-1-2008.

**PRINCIPAL REGISTER**

FOR: PROVIDING INFORMATION IN THE FIELD OF CLOTHING DESIGN, JEWELRY DESIGN, AND ARTISTIC DESIGN OF PRODUCTS, IN CLASS 42 (U.S. CLS. 100 AND 101).

FIRST USE 3-1-2008; IN COMMERCE 3-1-2008.

FOR: PROVIDING INFORMATION IN THE FIELD OF JEWELRY FASHION, FASHION, AND LIFESTYLE TRENDS, IN CLASS 45 (U.S. CLS. 100 AND 101).

FIRST USE 3-1-2008; IN COMMERCE 3-1-2008.

THE MARK CONSISTS OF STANDARD CHARACTERS WITHOUT CLAIM TO ANY PARTICULAR FONT, STYLE, SIZE, OR COLOR.

SN 77-912,203, FILED 1-14-2010.

KRISTINA MORRIS, EXAMINING ATTORNEY



*David J. Kybas*

Director of the United States Patent and Trademark Office

# United States of America

United States Patent and Trademark Office

cuide-se  
bem

**Reg. No. 4,125,945**

**Registered Apr. 10, 2012**

**Int. Cl.: 3**

**TRADEMARK**

**PRINCIPAL REGISTER**

BOTICA COMERCIAL FARMACEUTICA LTDA. (BRAZIL LIMITED LIABILITY COMPANY)  
AV. RUI BARBOSA, 3450  
AFONSO PENA  
SAO JOSE DOS PINHAIS, PARANA, BRAZIL 83065260

FOR: MOISTURIZERS AND CLEANSERS FOR THE FACE, SKIN MOISTURIZERS, SOAP FOR PERSONAL USE; OILS FOR TOILETRY PURPOSES, IN CLASS 3 (U.S. CLS. 1, 4, 6, 50, 51 AND 52).

FIRST USE 4-0-2010; IN COMMERCE 4-0-2010.

THE MARK CONSISTS OF THE STYLIZED WORDS "CUIDE SE BEM" WITH THE "I" DOTTED WITH A DROP OF WATER.

THE ENGLISH TRANSLATION OF "CUIDE SE BEM" IN THE MARK IS "TAKE GOOD CARE OF YOURSELF".

SN 77-913,844, FILED 1-18-2010.

GINA FINK, EXAMINING ATTORNEY



*David J. Kyffers*

Director of the United States Patent and Trademark Office

# United States of America

United States Patent and Trademark Office

## JUMPING BEANS

**Reg. No. 4,125,946**

**Registered Apr. 10, 2012**

**Int. Cl.: 21**

**TRADEMARK**

**PRINCIPAL REGISTER**

KOHL'S ILLINOIS, INC. (NEVADA CORPORATION)  
4340 FOX VALLEY CENTER DRIVE  
NEW YORK SQUARE  
AURORA, IL 60504

FOR: BEVERAGeware; SERVINGWARE FOR SERVING FOOD, IN CLASS 21 (U.S. CLS. 2, 13, 23, 29, 30, 33, 40 AND 50).

FIRST USE 2-13-2012; IN COMMERCE 2-13-2012.

THE MARK CONSISTS OF STANDARD CHARACTERS WITHOUT CLAIM TO ANY PARTICULAR FONT, STYLE, SIZE, OR COLOR.

OWNER OF U.S. REG. NOS. 3,427,962, 3,654,709, AND OTHERS.

SN 77-918,120, FILED 1-22-2010.

DAVID C. REIHNER, EXAMINING ATTORNEY



*David J. Kybas*

Director of the United States Patent and Trademark Office

# United States of America

United States Patent and Trademark Office

## Powered By Protein

**Reg. No. 4,125,947**

**Registered Apr. 10, 2012**

**Int. Cl.: 30**

**TRADEMARK**

**PRINCIPAL REGISTER**

FIGO BRANDS INC (DELAWARE CORPORATION)  
15 TURKEY HILL CIRCLE  
WESTPORT, CT 06880

FOR: CHOCOLATE; CHOCOLATE BARS; CHOCOLATE AND CHOCOLATES; CHOCOLATE CANDIES; CHOCOLATE MOUSSE; CHOCOLATE POWDER; CHOCOLATES AND CHOCOLATE BASED READY TO EAT CANDIES AND SNACKS; COCOA BEVERAGES WITH MILK; COCOA MIXES; COCOA POWDER; COCOA-BASED BEVERAGES; COFFEE-BASED BEVERAGE CONTAINING MILK; COFFEE-BASED BEVERAGES; COOKIE DOUGH; COOKIE MIXES; COOKIES; COOKIES AND CRACKERS; EDIBLE FRUIT ICES; EDIBLE ICES; FLAVORED ICE BLOCKS; FLAVORED ICES; FROZEN CONFECTIONERY; FROZEN CONFECTIONS; FROZEN CONFECTIONS, NAMELY, FREEZER POPS; FROZEN COOKIE DOUGH; FROZEN CUSTARDS; FROZEN DESSERT CONSISTING OF FRUIT AND CREAM OR CREAM SUBSTITUTES; FROZEN YOGHURT; FROZEN YOGURT; GRAIN-BASED SNACK FOODS; GRANOLA; GRANOLA SNACKS; GRANOLA-BASED SNACK BARS; HOT CHOCOLATE; ICE CREAM; ICE CREAM DESSERTS; ICE CREAM DRINKS; ICE CREAM FLOATS; ICE CREAM MIXES; ICE CREAM POWDER; ICE CREAM SANDWICHES; ICE CREAM SUBSTITUTE; ICE CREAMS; ICE MILK; ICE MILK BARS; ICES AND ICE CREAMS; ICE-CREAM; INSTANT PANCAKE MIXES; INSTANT PUDDING MIXES; ITALIAN ICE; MILK CHOCOLATE; MILK SHAKES; MIXES FOR BAKERY GOODS; OAT FLAKES; OAT-MEAL; PANCAKE MIXES; PARFAITS; SHAKES; SHERBET; SHERBETS; SNACK CAKES; SNACK FOODS, NAMELY, CHOCOLATE-BASED SNACK FOODS; SORBETS; TAPIOCA, IN CLASS 30 (U.S. CL. 46).

FIRST USE 1-2-2010; IN COMMERCE 1-15-2011.

THE MARK CONSISTS OF STANDARD CHARACTERS WITHOUT CLAIM TO ANY PARTICULAR FONT, STYLE, SIZE, OR COLOR.

SN 77-918,484, FILED 1-22-2010.

EDWARD FENNESSY, EXAMINING ATTORNEY



*David J. Kyros*

Director of the United States Patent and Trademark Office

# United States of America

United States Patent and Trademark Office

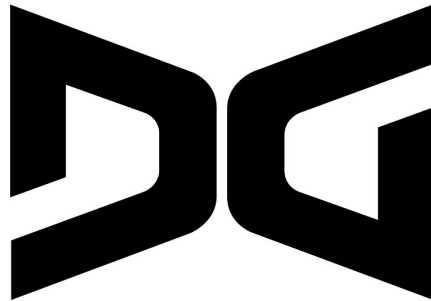

**Reg. No. 4,125,948**

**Registered Apr. 10, 2012**

**Int. Cl.: 28**

**TRADEMARK**

**PRINCIPAL REGISTER**

DYNAMIC BRANDS, LLC (VIRGINIA LIMITED LIABILITY COMPANY)  
8575 MAGELLAN PARKWAY, SUITE 1000  
RICHMOND, VA 23227

FOR: GOLF BAGS AND TRAVEL COVERS FOR GOLF CLUBS, IN CLASS 28 (U.S. CLS. 22, 23, 38 AND 50).

FIRST USE 5-1-2010; IN COMMERCE 5-1-2010.

THE MARK CONSISTS OF THE STYLIZED LETTERS "DG".

SN 77-920,130, FILED 1-26-2010.

LAURA KOVALSKY, EXAMINING ATTORNEY



*David J. Kyffers*

Director of the United States Patent and Trademark Office

# United States of America

United States Patent and Trademark Office

# A.R.C.A.D

**Reg. No. 4,125,949**

**Registered Apr. 10, 2012**

**Int. Cls.: 35 and 42**

**SERVICE MARK**

**PRINCIPAL REGISTER**

FONDATION A.R.C.A.D AIDE ET RECHERCHE EN CANCEROLOGIE DIGESTIVE (FRANCE  
FOUNDATION)  
22 RUE MALHER  
PARIS, FRANCE 75004

FOR: PROMOTING AWARENESS AMONG RESEARCHERS AND THE MEDICAL INDUSTRY  
OF ISSUES RELATED TO CLINICAL TRIALS AND CLINICAL RESEARCH IN THE MEDICAL  
FIELD, IN CLASS 35 (U.S. CLS. 100, 101 AND 102).

FIRST USE 6-27-2007; IN COMMERCE 1-24-2008.

FOR: PROVIDING MEDICAL AND SCIENTIFIC RESEARCH INFORMATION IN THE FIELD  
OF CLINICAL TRIALS, IN CLASS 42 (U.S. CLS. 100 AND 101).

FIRST USE 6-27-2007; IN COMMERCE 1-24-2008.

THE MARK CONSISTS OF STANDARD CHARACTERS WITHOUT CLAIM TO ANY PAR-  
TICULAR FONT, STYLE, SIZE, OR COLOR.

SN 77-920,157, FILED 1-26-2010.

NATALIE POLZER, EXAMINING ATTORNEY



*David J. Kybas*

Director of the United States Patent and Trademark Office

# United States of America

United States Patent and Trademark Office

## SERIE N

**Reg. No. 4,125,950**

**Registered Apr. 10, 2012**

**Int. Cl.: 34**

INTERMATCH SWEDEN AB (SWEDEN CORPORATION)  
C/O MOLL WENDÉN ADVOKATBYRÅ  
STORTORGET 8  
SE-211 34 MALMÖ, SWEDEN 11885

FOR: CIGARS, IN CLASS 34 (U.S. CLS. 2, 8, 9 AND 17).

**TRADEMARK**

FIRST USE 10-0-2010; IN COMMERCE 10-0-2010.

**PRINCIPAL REGISTER**

THE MARK CONSISTS OF STANDARD CHARACTERS WITHOUT CLAIM TO ANY PARTICULAR FONT, STYLE, SIZE, OR COLOR.

OWNER OF U.S. REG. NO. 2,780,299.

NO CLAIM IS MADE TO THE EXCLUSIVE RIGHT TO USE "SERIE", APART FROM THE MARK AS SHOWN.

THE ENGLISH TRANSLATION OF "SERIE" IN THE MARK IS "SERIES".

SN 77-921,236, FILED 1-27-2010.

LOURDES AYALA, EXAMINING ATTORNEY



*David J. Kybas*

Director of the United States Patent and Trademark Office



# United States of America

United States Patent and Trademark Office



**Reg. No. 4,125,951**

**Registered Apr. 10, 2012**

**Int. Cl.: 32**

**TRADEMARK**

**PRINCIPAL REGISTER**

ENEGREN, CHRISTOPHER R. (UNITED STATES INDIVIDUAL)  
11253 BENTCREEK RD  
MOORPARK, CA 93021

FOR: BEER, IN CLASS 32 (U.S. CLS. 45, 46 AND 48).

FIRST USE 12-1-2009; IN COMMERCE 1-23-2012.

NO CLAIM IS MADE TO THE EXCLUSIVE RIGHT TO USE "BREWING CO.", APART FROM THE MARK AS SHOWN.

THE COLOR(S) BLACK, WHITE, BURGUNDY, YELLOW AND GREEN IS/ARE CLAIMED AS A FEATURE OF THE MARK.

THE MARK CONSISTS OF AN OVAL DESIGN APPEARING IN BURGUNDY WITH A WHITE BORDER AND A BLACK OUTLINE, WITH TWO HERALDIC LION INSIGNIAS IN YELLOW, BOTH HOLDING YELLOW BEER STEINS, WITH GREEN LEAVES APPEARING TO THE LEFT AND RIGHT OF THE LION DESIGNS, AND THE WORD "ENEGREN" APPEARING IN BLACK WITHIN A WHITE BANNER ABOVE THE LIONS AND THE WORDS "BREWING CO." APPEARING IN WHITE BELOW THE LION DESIGNS.

SN 77-922,456, FILED 1-28-2010.

DAVID COLLIER, EXAMINING ATTORNEY



*David J. Kybas*

Director of the United States Patent and Trademark Office

# United States of America

United States Patent and Trademark Office

## TEAM ARIN

**Reg. No. 4,125,952**

**Registered Apr. 10, 2012**

**Int. Cl.: 42**

**SERVICE MARK**

**PRINCIPAL REGISTER**

AMERICAN REGISTRY FOR INTERNET NUMBERS, LTD. (VIRGINIA CORPORATION)  
3635 CONCORDE PARKWAY, SUITE 200  
CHANTILLY, VA 20151

FOR: PROVIDING TECHNICAL INFORMATION REGARDING THE OPERATION OF COMPUTER-BASED INFORMATION SYSTEMS AND COMPONENTS DESIGNED FOR USE IN THE FIELD OF INTERNET GOVERNANCE, INTERNET OPERATION AND TECHNICAL COORDINATION OF INTERNET NUMBER RESOURCES; PROVIDING AN INTERNET WEBSITE PORTAL OFFERING TECHNICAL INFORMATION REGARDING THE OPERATION OF COMPUTER-BASED INFORMATION SYSTEMS AND COMPONENTS THAT ARE SPECIFICALLY DESIGNED FOR USE IN THE FIELD OF INTERNET GOVERNANCE, INTERNET OPERATION AND TECHNICAL COORDINATION OF INTERNET NUMBER RESOURCES, IN CLASS 42 (U.S. CLS. 100 AND 101).

FIRST USE 10-0-2006; IN COMMERCE 10-0-2006.

THE MARK CONSISTS OF STANDARD CHARACTERS WITHOUT CLAIM TO ANY PARTICULAR FONT, STYLE, SIZE, OR COLOR.

OWNER OF U.S. REG. NOS. 3,043,320 AND 3,047,439.

SN 77-923,257, FILED 1-29-2010.

JULIE WATSON, EXAMINING ATTORNEY



*David J. Kybas*

Director of the United States Patent and Trademark Office

# United States of America

United States Patent and Trademark Office



**Reg. No. 4,125,953**

**Registered Apr. 10, 2012**

**Int. Cl.: 41**

**SERVICE MARK**

**PRINCIPAL REGISTER**

CEO STYLE CONSULTING, LLC (OHIO LIMITED LIABILITY COMPANY)  
P.O. BOX 385  
BEREA, OH 44017

FOR: BUSINESS EDUCATION AND TRAINING SERVICES, NAMELY, DEVELOPING, AND FACILITATING CUSTOMIZED IN-COMPANY LEADERSHIP AND EXECUTIVE DEVELOPMENT PROGRAMS, PROVIDING EXECUTIVE COACHING SERVICES, AND PROVIDING PUBLIC AND IN-COMPANY KEYNOTE PRESENTATIONS TO BUSINESS LEADERS, IN CLASS 41 (U.S. CLS. 100, 101 AND 107).

FIRST USE 5-1-2010; IN COMMERCE 5-1-2010.

NO CLAIM IS MADE TO THE EXCLUSIVE RIGHT TO USE "CONSULTING, LLC", APART FROM THE MARK AS SHOWN.

THE COLOR(S) BLACK, WHITE, AND RED IS/ARE CLAIMED AS A FEATURE OF THE MARK.

THE MARK CONSISTS OF THE SILHOUETTE OF A BUSINESSMAN IN BLACK WITH A WHITE SHIRT STANDING SHOWING HIS FULL BODY (AT AN ANGLE) TO THE LEFT OF "CEO" IN RED AND THE SILHOUETTE OF A BUSINESSWOMAN IN BLACK WITH A WHITE BLOUSE STANDING SHOWING HER FULL BODY (AT AN ANGLE) IS TO THE RIGHT OF "CEO". BOTH THE MAN AND WOMAN ARE ADJACENT TO "CEO". THE WORD "STYLE" COLORED BLACK IS INSIDE OF THE UPPER PORTION OF THE "O" IN "CEO" AND IT HAS A DESIGNED UNDERLINE BELOW THE WORD "STYLE". THERE ARE 3 HORIZONTAL RED LINES: ONE IS ABOVE THE WORD "CEO", ONE IS BELOW THE WORD "CEO", AND ONE IS ADJACENT TO THE INNER FOOT OF THE MAN AND WOMAN. BELOW THE SECOND LINE IS "CONSULTING, LLC." COLORED BLACK AND WITH AN UPWARD CURVED ANGLE, THE PHRASE "CREATOR OF EXCELLENT OPPORTUNITIES" COLORED BLACK IS RIGHT ABOVE THE THIRD RED HORIZONTAL LINE.

SN 77-923,673, FILED 1-29-2010.

RUDY R. SINGLETON, EXAMINING ATTORNEY



*David J. Kappas*

Director of the United States Patent and Trademark Office

# United States of America

United States Patent and Trademark Office



**Reg. No. 4,125,954**

**Registered Apr. 10, 2012**

**Int. Cl.: 41**

**SERVICE MARK**

**PRINCIPAL REGISTER**

ALLEN FLOYD PERRY (MARYLAND LIMITED LIABILITY COMPANY), TA RISE & GRIND ENTERTAINMENT LLC.,  
1030 16TH STREET APT.2  
MIAMI BEACH, FL 33139

FOR: EDUCATIONAL SERVICES IN THE NATURE OF MUSIC BUSINESS SCHOOLS, IN CLASS 41 (U.S. CLS. 100, 101 AND 107).

FIRST USE 10-5-2011; IN COMMERCE 1-2-2012.

NO CLAIM IS MADE TO THE EXCLUSIVE RIGHT TO USE "ACADEMY", "FOUNDED 2007", "ESTABLISHED 2009", "MUSIC", "EDUCATION" OR "BUSINESS", APART FROM THE MARK AS SHOWN.

THE COLOR(S) GOLD, BLACK, WHITE, BLUE, BROWN, AND GRAY IS/ARE CLAIMED AS A FEATURE OF THE MARK.

THE MARK CONSISTS OF A SHIELD WITH WINGS AND A CROWN, AND A BANNER UNFURLED BELOW IT. THE BANNER, SHIELD, WINGS AND CROWN ARE SHOWN IN THE COLOR GOLD, WITH HIGHLIGHTS AND SHADING IN WHITE AND BROWN. THE BANNER AT THE BOTTOM OF THE EMBLEM SHOWS THE WORDING "HIP-HOP ACADEMY, WHERE ASPIRING ARTISTS BEGIN, FOUNDED 2007, ESTABLISHED 2009" IN BROWN. THE TOP OF THE BANNER HOLDS A BROWN SILHOUETTE OF A CROWD RAISING THEIR HANDS TOWARDS THE SHIELD EMBLEM. THE SHIELD CONTAINS FOUR CHAMBERS WITH A SHADED GOLD AND BROWN BACKGROUND. THE SHIELD IS DIVIDED INTO FOUR QUADRANTS BY GOLD LINES. THE UPPER LEFT QUADRANT SHOWS THE TERM "MUSIC" IN GOLD COLORING ABOVE A WHITE HIGHLIGHTED IMAGE OF A BROWN MICROPHONE. THE TOP RIGHT QUADRANT SHOWS THE TERM "EDUCATION" IN GOLD COLORING ABOVE A WHITE HIGHLIGHTED IMAGE OF A STACK OF GRAY BOOKS. THE BOTTOM LEFT QUADRANT SHOWS THE TERM "UNITY", IN GOLD WITH A WHITE HIGHLIGHTED IMAGE OF A BROWN GLOBE WITH A BROWN SILHOUETTE OF PEOPLE HOLDING HANDS CIRCLING THE GLOBE. THE BOTTOM RIGHT QUADRANT SHOWS THE TERM "BUSINESS" IN GOLD COLORING WITH A BROWN SILHOUETTE OF TWO MEN HOLDING WHITE PAPERWORK AND ONE FEMALE HOLDING A BROWN BRIEFCASE AND WHITE PAPERS AGAINST A BACKGROUND CONTAINING A BLUE MAP. THE ENTIRE MARK IS SHOWN ON A BLACK BACKGROUND WITH WHITE SEMI-TRANSPARENT SHADING AND WITH GOLD SEMI-TRANSPARENT



*David J. Kyros*

Director of the United States Patent and Trademark Office

**Reg. No. 4,125,954** MUSIC NOTES EXTENDING FROM THE LEFT AND RIGHT SIDE OF THE EMBLEM, AND  
ACROSS THE BACKGROUND OF THE SHIELD.

SN 77-924,717, FILED 2-1-2010.

SUSAN LESLIE DUBOIS, EXAMINING ATTORNEY

# United States of America

United States Patent and Trademark Office

# FLEX360

**Reg. No. 4,125,955**

**Registered Apr. 10, 2012**

**Int. Cl.: 5**

**TRADEMARK**

**PRINCIPAL REGISTER**

VITACOST.COM INC. (DELAWARE CORPORATION)  
SUITE 500  
5400 BROKEN SOUND BLVD. N.W.  
BOCA RATON, FL 33487

FOR: DIETARY AND NUTRITIONAL SUPPLEMENTS, IN CLASS 5 (U.S. CLS. 6, 18, 44, 46, 51 AND 52).

FIRST USE 9-21-2011; IN COMMERCE 9-21-2011.

THE MARK CONSISTS OF STANDARD CHARACTERS WITHOUT CLAIM TO ANY PARTICULAR FONT, STYLE, SIZE, OR COLOR.

SN 77-925,609, FILED 2-2-2010.

STEVEN JACKSON, EXAMINING ATTORNEY



*David J. Kyros*

Director of the United States Patent and Trademark Office

# United States of America

United States Patent and Trademark Office

## SIN CITY DIABLOS

**Reg. No. 4,125,956**

**Registered Apr. 10, 2012**

**Int. Cl.: 9**

**TRADEMARK**

**PRINCIPAL REGISTER**

BALLY GAMING, INC. (NEVADA CORPORATION), DBA BALLY TECHNOLOGIES,  
ATTN: PAMELA BOWSHER, LAW DEPT.  
6601 SOUTH BERMUDA ROAD  
LAS VEGAS, NV 89119

FOR: GAMING DEVICES, NAMELY, SLOT MACHINES WITH OR WITHOUT VIDEO  
OUTPUT, IN CLASS 9 (U.S. CLS. 21, 23, 26, 36 AND 38).

FIRST USE 2-1-2006; IN COMMERCE 2-1-2006.

THE MARK CONSISTS OF STANDARD CHARACTERS WITHOUT CLAIM TO ANY PAR-  
TICULAR FONT, STYLE, SIZE, OR COLOR.

NO CLAIM IS MADE TO THE EXCLUSIVE RIGHT TO USE "SIN CITY", APART FROM THE  
MARK AS SHOWN.

THE ENGLISH TRANSLATION OF THE WORD "DIABLOS" IN THE MARK IS DEVILS.

SN 77-926,373, FILED 2-2-2010.

THEODORE MCBRIDE, EXAMINING ATTORNEY



*David J. Kybas*

Director of the United States Patent and Trademark Office

# United States of America

United States Patent and Trademark Office

## FIREBIRD STUDIOS

**Reg. No. 4,125,957**

**Registered Apr. 10, 2012**

**Int. Cl.: 9**

**TRADEMARK**

**PRINCIPAL REGISTER**

BALLY GAMING, INC. (NEVADA CORPORATION), DBA BALLY TECHNOLOGIES,  
ATTN: PAMELA BOWSHER, LAW DEPT.  
6601 SOUTH BERMUDA ROAD  
LAS VEGAS, NV 89119

FOR: GAMING DEVICES, NAMELY, SLOT MACHINES WITH OR WITHOUT VIDEO  
OUTPUT, IN CLASS 9 (U.S. CLS. 21, 23, 26, 36 AND 38).

FIRST USE 2-1-2009; IN COMMERCE 2-1-2009.

THE MARK CONSISTS OF STANDARD CHARACTERS WITHOUT CLAIM TO ANY PAR-  
TICULAR FONT, STYLE, SIZE, OR COLOR.

OWNER OF U.S. REG. NO. 3,716,667.

SN 77-926,391, FILED 2-2-2010.

THEODORE MCBRIDE, EXAMINING ATTORNEY



*David J. Kybas*

Director of the United States Patent and Trademark Office



# United States of America

United States Patent and Trademark Office



**Reg. No. 4,125,958**

CRYSTAL ROCK LLC (DELAWARE LIMITED LIABILITY COMPANY)  
1050 BUCKINGHAM STREET  
WATERTOWN, CT 06795

**Registered Apr. 10, 2012**

**Int. Cls.: 37, 40, and 43**

FOR: MAINTENANCE OF WATER FILTRATION SYSTEMS FOR HOMES AND OFFICES, IN CLASS 37 (U.S. CLS. 100, 103 AND 106).

**SERVICE MARK**

FIRST USE 5-1-2010; IN COMMERCE 5-1-2010.

**PRINCIPAL REGISTER**

FOR: RENTAL OF WATER FILTRATION SYSTEMS FOR HOMES AND OFFICES, IN CLASS 40 (U.S. CLS. 100, 103 AND 106).

FIRST USE 5-1-2010; IN COMMERCE 5-1-2010.

FOR: RENTAL OF FOOD SERVICE EQUIPMENT, NAMELY, HOT AND COLD WATER DISPENSERS, COFFEE MAKERS, REFRIGERATORS, MICROWAVE OVENS AND VENDING MACHINES, IN CLASS 43 (U.S. CLS. 100 AND 101).

FIRST USE 5-1-2010; IN COMMERCE 5-1-2010.

OWNER OF U.S. REG. NOS. 2,423,046, 2,450,626, AND 2,786,852.

THE MARK CONSISTS OF A DEPICTION OF MOUNTAINS TO THE LEFT OF THE WORDS "CRYSTAL ROCK".

SN 77-926,846, FILED 2-3-2010.

TOBY BULLOFF, EXAMINING ATTORNEY



*David J. Kyros*

Director of the United States Patent and Trademark Office

# United States of America

United States Patent and Trademark Office

# USA PRO 8

**Reg. No. 4,125,959**

LEE BROS. FOODSERVICE, INC. (CALIFORNIA CORPORATION)  
660 E. GISH RD.

**Registered Apr. 10, 2012**

SAN JOSE, CA 95112

**Int. Cl.: 7**

FOR: ELECTRIC FOOD BLENDERS; ELECTRIC FOOD PROCESSORS; ELECTRIC JUICE EXTRACTORS; JUICE EXTRACTORS; JUICE MACHINES, IN CLASS 7 (U.S. CLS. 13, 19, 21, 23, 31, 34 AND 35).

**TRADEMARK**

FIRST USE 12-9-2009; IN COMMERCE 12-9-2009.

**PRINCIPAL REGISTER**

THE MARK CONSISTS OF STANDARD CHARACTERS WITHOUT CLAIM TO ANY PARTICULAR FONT, STYLE, SIZE, OR COLOR.

NO CLAIM IS MADE TO THE EXCLUSIVE RIGHT TO USE "USA PRO", APART FROM THE MARK AS SHOWN.

SN 77-927,435, FILED 2-3-2010.

NANCY CLARKE, EXAMINING ATTORNEY



*David J. Kybas*

Director of the United States Patent and Trademark Office

# United States of America

United States Patent and Trademark Office

The logo for Focalin XR, featuring a stylized eye icon to the left of the text "Focalin XR" in a bold, italicized sans-serif font.

**Reg. No. 4,125,960**

NOVARTIS AG (SWITZERLAND CORPORATION)  
CH - 4002

**Registered Apr. 10, 2012**

BASEL, SWITZERLAND

**Int. Cl.: 44**

FOR: MEDICAL SERVICES, NAMELY, PROVIDING MEDICAL INFORMATION TO PATIENTS; PROVIDING HEALTH INFORMATION, IN CLASS 44 (U.S. CLS. 100 AND 101).

**SERVICE MARK**

FIRST USE 5-31-2005; IN COMMERCE 5-31-2005.

**PRINCIPAL REGISTER**

OWNER OF U.S. REG. NOS. 2,978,115 AND 3,178,358.

NO CLAIM IS MADE TO THE EXCLUSIVE RIGHT TO USE "XR", APART FROM THE MARK AS SHOWN.

THE MARK CONSISTS OF THE WORDING "FOCALIN XR" PRECEDED BY AN ARC AND A SPHERE.

SN 77-928,011, FILED 2-4-2010.

EVELYN BRADLEY, EXAMINING ATTORNEY



*David J. Kybas*

Director of the United States Patent and Trademark Office

# United States of America

United States Patent and Trademark Office

# CHEAPSHOT

**Reg. No. 4,125,961**

SHAKEN, STIRRED, AND STRAIGHT LLC (COLORADO LIMITED LIABILITY COMPANY)  
11703 FENWICK CIRCLE  
PARKER, CO 80134

**Registered Apr. 10, 2012**

**Int. Cl.: 33**

FOR: SPIRITS, IN CLASS 33 (U.S. CLS. 47 AND 49).

**TRADEMARK**

FIRST USE 10-1-2011; IN COMMERCE 10-1-2011.

**PRINCIPAL REGISTER**

THE MARK CONSISTS OF STANDARD CHARACTERS WITHOUT CLAIM TO ANY PARTICULAR FONT, STYLE, SIZE, OR COLOR.

SN 77-928,364, FILED 2-4-2010.

TRICIA SONNEBORN, EXAMINING ATTORNEY



*David J. Kyffers*

Director of the United States Patent and Trademark Office

# United States of America

United States Patent and Trademark Office

## SMALL POTATOES

**Reg. No. 4,125,962**

LITTLE AIRPLANE PRODUCTIONS, INC. (NEW YORK CORPORATION)  
207 FRONT STREET  
NEW YORK, NY 10038

**Registered Apr. 10, 2012**

**Int. Cl.: 41**

FOR: ENTERTAINMENT SERVICES IN THE NATURE OF A CHILDREN'S TELEVISION SERIES, IN CLASS 41 (U.S. CLS. 100, 101 AND 107).

**SERVICE MARK**

FIRST USE 9-6-2011; IN COMMERCE 9-6-2011.

**PRINCIPAL REGISTER**

THE MARK CONSISTS OF STANDARD CHARACTERS WITHOUT CLAIM TO ANY PARTICULAR FONT, STYLE, SIZE, OR COLOR.

SN 77-928,813, FILED 2-5-2010.

KEVIN DINALLO, EXAMINING ATTORNEY



*David J. Kybas*

Director of the United States Patent and Trademark Office

# United States of America

United States Patent and Trademark Office

## GLOBE WHIZ

**Reg. No. 4,125,963**

ETIQUETTE & PROTOCOL INTERNATIONAL, INC. (NEW YORK CORPORATION)  
202 HOLBROOK RD.

**Registered Apr. 10, 2012**

HOLBROOK, NY 11741

**Int. Cl.: 28**

FOR: BOARD GAMES AND GAME COMPONENT PIECES SOLD AS A UNIT THEREWITH,  
IN CLASS 28 (U.S. CLS. 22, 23, 38 AND 50).

**TRADEMARK**

FIRST USE 9-23-2011; IN COMMERCE 9-23-2011.

**PRINCIPAL REGISTER**

THE MARK CONSISTS OF STANDARD CHARACTERS WITHOUT CLAIM TO ANY PAR-  
TICULAR FONT, STYLE, SIZE, OR COLOR.

SN 77-928,845, FILED 2-5-2010.

KEVIN DINALLO, EXAMINING ATTORNEY



*David J. Kybas*

Director of the United States Patent and Trademark Office

# United States of America

United States Patent and Trademark Office

## YOUR SPARK MAKES US WALMART

**Reg. No. 4,125,964**

**Registered Apr. 10, 2012**

**Int. Cl.: 35**

**SERVICE MARK**

**PRINCIPAL REGISTER**

WAL-MART STORES, INC. (DELAWARE CORPORATION)  
702 SW 8TH STREET  
BENTONVILLE, AR 727160520

FOR: ON-LINE RETAIL STORE SERVICES FEATURING A WIDE VARIETY OF CONSUMER GOODS OF OTHERS; RETAIL DEPARTMENT STORES; RETAIL GROCERY STORES, IN CLASS 35 (U.S. CLS. 100, 101 AND 102).

FIRST USE 6-0-2010; IN COMMERCE 6-0-2010.

THE MARK CONSISTS OF STANDARD CHARACTERS WITHOUT CLAIM TO ANY PARTICULAR FONT, STYLE, SIZE, OR COLOR.

OWNER OF U.S. REG. NOS. 1,783,039, 3,612,345, AND OTHERS.

SN 77-929,841, FILED 2-6-2010.

VERNA BETH RIRIE, EXAMINING ATTORNEY



*David J. Kyffers*

Director of the United States Patent and Trademark Office

# United States of America

United States Patent and Trademark Office



**Reg. No. 4,125,965**

**Registered Apr. 10, 2012**

**Int. Cl.: 45**

**SERVICE MARK**

**PRINCIPAL REGISTER**

TIMOTHY L. NESSEL/TERRIBLETIMMY (UNITED STATES INDIVIDUAL), DBA  
THETERRIBLETIMMY.COM/THETERRIBLETIMMY,  
1401 WALNUT AVE.  
ESCALON, CA 95320

FOR: PROVIDING A SOCIAL NETWORKING WEBSITE RELATED TO EXPOSING REALITIES IN WORLD AND LOCAL NEWS; PROVIDING A COMMUNITY WEBSITE FEATURING CRIME; PROVIDING INFORMATION RELATING TO LEGAL AFFAIRS NAMELY, INFORMATION AND LINKS REGARDING CONSTITUTIONAL RIGHTS, FREEDOM OF SPEECH RIGHTS AND OTHER RIGHTS PERTAINING TO PROFESSIONAL FREELANCE NEWS REPORTING, AND CAPTURING OF PRERECORDED PHOTOGRAPHIC AND LIVE VIDEO WITH AUDIO IN PUBLIC PLACES; ALL OF THE ABOVE SERVICES PROVIDED BY MEANS OF LOCAL AND GLOBAL COMMUNICATIONS NETWORKS, VIA A COMPUTER DATA BASE, TELECOMMUNICATIONS, AND HAND HELD MOBILE DEVICES, IN CLASS 45 (U.S. CLS. 100 AND 101).

FIRST USE 3-22-2011; IN COMMERCE 3-22-2011.

THE MARK CONSISTS OF THE STYLIZED WORDING IN WHITE "REALITY EXPOSED!" APPEARING ATOP A RED OUTLINE DESIGN RESEMBLING A TELEVISION WITH ANTENNA. A DESIGN OF A PAIR OF BLACK EYES WITH EYEBROWS APPEARS THE RIGHT OF THE TELEVISION AND ANTENNA DESIGN. THE EYES, EYEBROWS, TELEVISION AND ANTENNA DESIGNS HAVE GREY SHADOWS. BELOW THE TELEVISION AND ANTENNA DESIGN APPEARS THE BLACK STYLIZED WORDING "THETERRIBLETIMMY", WHICH APPEARS ABOVE THE BLACK STYLIZED WORDING "NEWS & EVENTS".

THE COLOR(S) RED, BLACK, GREY AND WHITE IS/ARE CLAIMED AS A FEATURE OF THE MARK.

SN 77-929,862, FILED 2-6-2010.

KALIE KUNG, EXAMINING ATTORNEY



*David J. Kappas*

Director of the United States Patent and Trademark Office



# United States of America

United States Patent and Trademark Office

## Green HOPE

**Reg. No. 4,125,966**

**Registered Apr. 10, 2012**

**Int. Cls.: 16, 41, and 42**

**TRADEMARK**

**SERVICE MARK**

**PRINCIPAL REGISTER**

SUSTAINABLE DEVELOPMENT INTERNATIONAL CORPORATION (MARYLAND CORPORATION)  
PO BOX 218  
MORGANTON, NC 28680

FOR: EDUCATIONAL PUBLICATIONS, NAMELY, EDUCATIONAL LEARNING CARDS, FLASH CARDS, ACTIVITY CARDS, WORKBOOKS, TEXTBOOKS, ACTIVITY BOOKS, STORY BOOKS, PUZZLE BOOKS, PRINTED PUZZLES, TEACHER GUIDES, MANUALS, POSTERS AND EDUCATIONAL BOOKLETS ALL IN THE FIELD OF GREEN BUSINESS PRACTICES, ECOLOGICAL LITERACY, SYSTEMS THINKING TO PROMOTE GREEN BUSINESS PRACTICES, AND ECOLOGICAL SUSTAINABILITY, IN CLASS 16 (U.S. CLS. 2, 5, 22, 23, 29, 37, 38 AND 50).

FIRST USE 2-25-2010; IN COMMERCE 5-25-2011.

FOR: PROVIDING A WEB SITE THAT FEATURES INFORMAL INSTRUCTION ON GREEN BUSINESS PRACTICES, ECOLOGICAL LITERACY, SYSTEMS THINKING TO PROMOTE GREEN BUSINESS PRACTICES, AND ECOLOGICAL SUSTAINABILITY, IN CLASS 41 (U.S. CLS. 100, 101 AND 107).

FIRST USE 2-25-2010; IN COMMERCE 5-25-2011.

FOR: TESTING, ANALYSIS AND EVALUATION OF THE GOODS AND SERVICES OF OTHERS FOR THE PURPOSE OF CERTIFICATION; TESTING, ANALYSIS AND EVALUATION OF THE GOODS OF OTHERS FOR THE PURPOSE OF CERTIFICATION; TESTING, ANALYSIS AND EVALUATION OF THE SERVICES OF OTHERS FOR THE PURPOSE OF CERTIFICATION; WORKPLACE CERTIFICATION SERVICES, NAMELY, CONDUCTING SURVEYS AND TESTING FOR WORKPLACE EXCELLENCE, IN CLASS 42 (U.S. CLS. 100 AND 101).

FIRST USE 2-25-2010; IN COMMERCE 9-1-2011.

THE MARK CONSISTS OF STANDARD CHARACTERS WITHOUT CLAIM TO ANY PARTICULAR FONT, STYLE, SIZE, OR COLOR.

NO CLAIM IS MADE TO THE EXCLUSIVE RIGHT TO USE "GREEN", APART FROM THE MARK AS SHOWN.

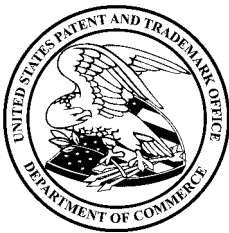

*David J. Kyros*

Director of the United States Patent and Trademark Office

**Reg. No. 4,125,966** SN 77-930,293, FILED 2-8-2010.

MARY CRAWFORD, EXAMINING ATTORNEY

# United States of America

United States Patent and Trademark Office

## BIG ACTION

**Reg. No. 4,125,967**

**Registered Apr. 10, 2012**

**Int. Cl.: 28**

**TRADEMARK**

**PRINCIPAL REGISTER**

MATTEL, INC. (DELAWARE CORPORATION)  
M1-1518  
333 CONTINENTAL BOULEVARD  
EL SEGUNDO, CA 90245

FOR: TOYS, GAMES AND PLAYTHINGS, NAMELY, REMOTE CONTROLLED TOY VEHICLES AND ACCESSORIES THEREFOR, IN CLASS 28 (U.S. CLS. 22, 23, 38 AND 50).

FIRST USE 1-30-2012; IN COMMERCE 1-30-2012.

THE MARK CONSISTS OF STANDARD CHARACTERS WITHOUT CLAIM TO ANY PARTICULAR FONT, STYLE, SIZE, OR COLOR.

SN 77-931,256, FILED 2-9-2010.

ANNE MADDEN, EXAMINING ATTORNEY



*David J. Kybas*

Director of the United States Patent and Trademark Office

# United States of America

United States Patent and Trademark Office

# CoNeck-Tie

**Reg. No. 4,125,968**

PIONESSA, WILLIAM M. (UNITED STATES INDIVIDUAL)  
331 MUTTON HILL ROAD  
ADDISON, NY 14801

**Registered Apr. 10, 2012**

**Int. Cl.: 25**

FOR: NECKTIES, IN CLASS 25 (U.S. CLS. 22 AND 39).

**TRADEMARK**

FIRST USE 1-5-2012; IN COMMERCE 1-15-2012.

**PRINCIPAL REGISTER**

THE MARK CONSISTS OF STANDARD CHARACTERS WITHOUT CLAIM TO ANY PARTICULAR FONT, STYLE, SIZE, OR COLOR.

SN 77-932,778, FILED 2-10-2010.

JOHN WILKE, EXAMINING ATTORNEY



*David J. Kyffers*

Director of the United States Patent and Trademark Office

# United States of America

United States Patent and Trademark Office

# QUICKSERVE

**Reg. No. 4,125,969**

**Registered Apr. 10, 2012**

**Int. Cls.: 35, 37, and 41**

**SERVICE MARK**

**PRINCIPAL REGISTER**

CUMMINS INC. (INDIANA CORPORATION)  
500 JACKSON STREET  
COLUMBUS, IN 47201

FOR: ON-LINE RETAIL STORE SERVICES FEATURING SERVICE PUBLICATIONS FOR ENGINE REPAIR AND MAINTENANCE, HAND OPERATED AND ELECTRICAL TOOLS USED IN VEHICLE AND ENGINE REPAIR, SOFTWARE FOR USE IN CONNECTION WITH ENGINE REPAIR, DIAGNOSTICS AND MAINTENANCE, SOFTWARE USED IN CONNECTION WITH TRAINING IN THE FIELD OF ENGINE DIAGNOSTICS, REPAIR AND MAINTENANCE AND REPLACEMENT ENGINE PARTS, IN CLASS 35 (U.S. CLS. 100, 101 AND 102).

FIRST USE 4-0-2001; IN COMMERCE 4-0-2001.

FOR: PROVIDING A SEARCHABLE ONLINE DATABASE OF INFORMATION IN THE FIELD OF ENGINE AND VEHICLE MAINTENANCE AND REPAIR, IN CLASS 37 (U.S. CLS. 100, 103 AND 106).

FIRST USE 4-0-2001; IN COMMERCE 4-0-2001.

FOR: EDUCATIONAL SERVICES, NAMELY, PROVIDING A WEBSITE FEATURING ON-LINE TRAINING IN THE FIELD OF VEHICLE AND ENGINE DIAGNOSTICS, REPAIR AND MAINTENANCE, IN CLASS 41 (U.S. CLS. 100, 101 AND 107).

FIRST USE 4-0-2001; IN COMMERCE 4-0-2001.

THE MARK CONSISTS OF STANDARD CHARACTERS WITHOUT CLAIM TO ANY PARTICULAR FONT, STYLE, SIZE, OR COLOR.

OWNER OF U.S. REG. NO. 1,494,539.

SN 77-933,117, FILED 2-10-2010.

BRIAN CALLAGHAN, EXAMINING ATTORNEY



*David J. Kyffers*

Director of the United States Patent and Trademark Office

# United States of America

United States Patent and Trademark Office

# NEPTUNE

**Reg. No. 4,125,970**

ADVANCED BIONICS, LLC (DELAWARE LIMITED LIABILITY COMPANY)  
28515 WESTINGHOUSE PLACE  
VALENCIA, CA 91355

**Registered Apr. 10, 2012**

**Int. Cl.: 10**

FOR: SOUND PROCESSORS FOR USE WITH COCHLEAR IMPLANTS AND ACCESSORIES  
USED THEREWITH, IN CLASS 10 (U.S. CLS. 26, 39 AND 44).

**TRADEMARK**

FIRST USE 12-20-2011; IN COMMERCE 12-20-2011.

**PRINCIPAL REGISTER**

THE MARK CONSISTS OF STANDARD CHARACTERS WITHOUT CLAIM TO ANY PARTICULAR FONT, STYLE, SIZE, OR COLOR.

SN 77-934,566, FILED 2-12-2010.

KELLEY WELLS, EXAMINING ATTORNEY



*David J. Kybas*

Director of the United States Patent and Trademark Office

# United States of America

United States Patent and Trademark Office

## AQUA RESCUE

**Reg. No. 4,125,971**

OCCY LABORATOIRE INC. (CANADA CORPORATION)  
2929 JOSEPH-ARMAND BOMBARDIER

**Registered Apr. 10, 2012**

LAVAL (QUEBEC), CANADA H7P6C4

**Int. Cl.: 3**

FOR: NON-MEDICATED SKIN CARE PREPARATIONS, NAMELY, ANTI-WRINKLE PREPARATIONS, IN CLASS 3 (U.S. CLS. 1, 4, 6, 50, 51 AND 52).

**TRADEMARK**

FIRST USE 11-13-2009; IN COMMERCE 3-31-2011.

**PRINCIPAL REGISTER**

THE MARK CONSISTS OF STANDARD CHARACTERS WITHOUT CLAIM TO ANY PARTICULAR FONT, STYLE, SIZE, OR COLOR.

SN 77-934,593, FILED 2-12-2010.

HEATHER THOMPSON, EXAMINING ATTORNEY



*David J. Kybas*

Director of the United States Patent and Trademark Office

# United States of America

United States Patent and Trademark Office

# WannaWear

**Reg. No. 4,125,972**

TINA M.HILLSTROM (UNITED STATES INDIVIDUAL), AKA TINA O,  
9646 HEATHER ROAD  
BEVERLY HILLS, CA 90210

**Registered Apr. 10, 2012**

**Int. Cl.: 35**

FOR: ONLINE RETAIL STORE SERVICES FEATURING CLOTHING, IN CLASS 35 (U.S. CLS. 100, 101 AND 102).

**SERVICE MARK**

FIRST USE 4-30-2010; IN COMMERCE 4-30-2010.

**PRINCIPAL REGISTER**

THE MARK CONSISTS OF STANDARD CHARACTERS WITHOUT CLAIM TO ANY PARTICULAR FONT, STYLE, SIZE, OR COLOR.

SN 77-934,893, FILED 2-12-2010.

KRISTIN DAHLING, EXAMINING ATTORNEY



*David J. Kybas*

Director of the United States Patent and Trademark Office



# United States of America

United States Patent and Trademark Office

## SHOWER GLU

**Reg. No. 4,125,973**

**Registered Apr. 10, 2012**

**Int. Cl.: 3**

**TRADEMARK**

**PRINCIPAL REGISTER**

CLIO DESIGNS INCORPORATED (MASSACHUSETTS CORPORATION)  
80 COOLIDGE HILL ROAD  
WATERTOWN, MA 02472

FOR: BODY WASH, IN CLASS 3 (U.S. CLS. 1, 4, 6, 50, 51 AND 52).

FIRST USE 12-0-2011; IN COMMERCE 12-0-2011.

THE MARK CONSISTS OF STANDARD CHARACTERS WITHOUT CLAIM TO ANY PARTICULAR FONT, STYLE, SIZE, OR COLOR.

NO CLAIM IS MADE TO THE EXCLUSIVE RIGHT TO USE "SHOWER", APART FROM THE MARK AS SHOWN.

SN 77-935,076, FILED 2-12-2010.

SUZANNE BLANE, EXAMINING ATTORNEY



*David J. Kyffers*

Director of the United States Patent and Trademark Office

# United States of America

United States Patent and Trademark Office

## ACUVUE ASSURED

**Reg. No. 4,125,974**

JOHNSON & JOHNSON (NEW JERSEY CORPORATION)  
ONE JOHNSON & JOHNSON PLAZA  
NEW BRUNSWICK, NJ 089337001

**Registered Apr. 10, 2012**

**Int. Cl.: 9**

FOR: CONTACT LENSES, IN CLASS 9 (U.S. CLS. 21, 23, 26, 36 AND 38).

**TRADEMARK**

FIRST USE 3-26-2010; IN COMMERCE 3-26-2010.

**PRINCIPAL REGISTER**

THE MARK CONSISTS OF STANDARD CHARACTERS WITHOUT CLAIM TO ANY PARTICULAR FONT, STYLE, SIZE, OR COLOR.

OWNER OF U.S. REG. NOS. 1,458,177, 2,547,208, AND 3,014,623.

SN 77-937,492, FILED 2-17-2010.

TIMOTHY FINNEGAN, EXAMINING ATTORNEY



*David J. Kybas*

Director of the United States Patent and Trademark Office

# United States of America

United States Patent and Trademark Office



**Reg. No. 4,125,975**

**Registered Apr. 10, 2012**

**Int. Cl.: 40**

**SERVICE MARK**

**PRINCIPAL REGISTER**

MADRIL, ERIC M. (UNITED STATES INDIVIDUAL)  
81-244 IRIS COURT  
INDIO, CA 92201 AND

MADRIL, JULIE A (UNITED STATES INDIVIDUAL)  
81-244 IRIS COURT  
INDIO, CA 92201

FOR: CUSTOMIZED PRINTING OF COMPANY NAMES AND LOGOS FOR PROMOTIONAL AND ADVERTISING PURPOSES ON THE GOODS OF OTHERS, IN CLASS 40 (U.S. CLS. 100, 103 AND 106).

FIRST USE 2-18-2010; IN COMMERCE 2-18-2010.

THE MARK CONSISTS OF A CROSS AND MAN WITHIN A CIRCLE, THE CROSS BEING IN BROWN, THE MAN IN BLUE, THE PERIMETER OF THE CIRCLE IN BLUE, AND BOTH MAN AND CROSS BEING AGAINST A YELLOW AND WHITE BACKGROUND; THE LETTERS "BTB", EACH LETTER BEING IN YELLOW AND WHITE AGAINST A BLUE OVAL BACKGROUND; AND THE WORDING BACK TO THE BASICS IN BLUE.

THE COLOR(S) BLUE, YELLOW, WHITE AND BROWN IS/ARE CLAIMED AS A FEATURE OF THE MARK.

SN 77-938,798, FILED 2-18-2010.

STEVEN R. FINE, EXAMINING ATTORNEY



*David J. Kybas*

Director of the United States Patent and Trademark Office

# United States of America

United States Patent and Trademark Office

# AJIPHASE

**Reg. No. 4,125,976**

**Registered Apr. 10, 2012**

**Int. Cls.: 1 and 40**

**TRADEMARK**

**SERVICE MARK**

**PRINCIPAL REGISTER**

AJINOMOTO CO., INC. (JAPAN CORPORATION)  
15-1, KYOBASHI 1-CHOME  
CHUO-KU, TOKYO, JAPAN

FOR: CHEMICALS USED IN THE MANUFACTURE OF PHARMACEUTICALS AND FOR USE IN PHARMACEUTICAL SCIENCE; CHEMICAL PREPARATIONS USED IN THE MANUFACTURE OF PHARMACEUTICALS AND FOR USE IN PHARMACEUTICAL SCIENCE; CHEMICALS USED IN INDUSTRY AND SCIENCE, NAMELY, PEPTIDES; PEPTIDE PREPARATIONS, NAMELY, PEPTIDE SUBSTRATES FOR USE IN THE MANUFACTURE OF PHARMACEUTICALS AND FOR USE IN PHARMACEUTICAL SCIENCE; PEPTIDE PREPARATIONS, NAMELY, PEPTIDE SUBSTRATES FOR USE IN THE MANUFACTURE OF PHARMACEUTICALS, FOR USE IN PHARMACEUTICAL SCIENCE, FOR USE IN ANALYSIS, CLINICAL TESTING AND CLINICAL EXAMINATION FOR MEDICAL, CHEMICAL, OR BIOCHEMICAL LABORATORY USE, AND FOR INDUSTRIAL USE, IN CLASS 1 (U.S. CLS. 1, 5, 6, 10, 26 AND 46).

FIRST USE 4-30-2010; IN COMMERCE 4-30-2010.

FOR: CONSULTATION IN THE FIELD OF CUSTOM SYNTHESIS OF PEPTIDES; CUSTOM SYNTHESIS OF PEPTIDES; CUSTOM MANUFACTURE OF PEPTIDES, IN CLASS 40 (U.S. CLS. 100, 103 AND 106).

FIRST USE 1-29-2010; IN COMMERCE 1-29-2010.

THE MARK CONSISTS OF STANDARD CHARACTERS WITHOUT CLAIM TO ANY PARTICULAR FONT, STYLE, SIZE, OR COLOR.

SN 77-939,821, FILED 2-19-2010.

SUNG IN, EXAMINING ATTORNEY



*David J. Kypos*

Director of the United States Patent and Trademark Office

# United States of America

United States Patent and Trademark Office

# SUDAFED

**Reg. No. 4,125,977**

JOHNSON & JOHNSON (NEW JERSEY CORPORATION)  
ONE JOHNSON & JOHNSON PLAZA  
NEW BRUNSWICK, NJ 089337001

**Registered Apr. 10, 2012**

**Int. Cl.: 5**

FOR: PHARMACEUTICAL PREPARATION FOR THE RELIEF AND PREVENTION OF UPPER RESPIRATORY SYMPTOMS; NASAL DECONGESTANT, IN CLASS 5 (U.S. CLS. 6, 18, 44, 46, 51 AND 52).

**TRADEMARK**

FIRST USE 2-25-2010; IN COMMERCE 2-25-2010.

**PRINCIPAL REGISTER**

OWNER OF U.S. REG. NOS. 565,723, 2,741,719, AND OTHERS.

THE MARK CONSISTS OF STYLIZED WORD "SUDAFED".

SN 77-939,929, FILED 2-19-2010.

KELLY BOULTON, EXAMINING ATTORNEY



*David J. Kyjars*

Director of the United States Patent and Trademark Office

# United States of America

United States Patent and Trademark Office



**Reg. No. 4,125,978**

**Registered Apr. 10, 2012**

**Int. Cl.: 5**

**TRADEMARK**

**PRINCIPAL REGISTER**

JOHNSON & JOHNSON (NEW JERSEY CORPORATION)  
ONE JOHNSON & JOHNSON PLAZA  
NEW BRUNSWICK, NJ 089337001

FOR: PHARMACEUTICAL PREPARATION FOR THE RELIEF AND PREVENTION OF UPPER RESPIRATORY SYMPTOMS; NASAL DECONGESTANT, IN CLASS 5 (U.S. CLS. 6, 18, 44, 46, 51 AND 52).

FIRST USE 2-25-2010; IN COMMERCE 2-25-2010.

THE MARK CONSISTS OF A SHIELD DESIGN.

SN 77-939,947, FILED 2-19-2010.

KELLY BOULTON, EXAMINING ATTORNEY



*David J. Kyffers*

Director of the United States Patent and Trademark Office

# United States of America

United States Patent and Trademark Office

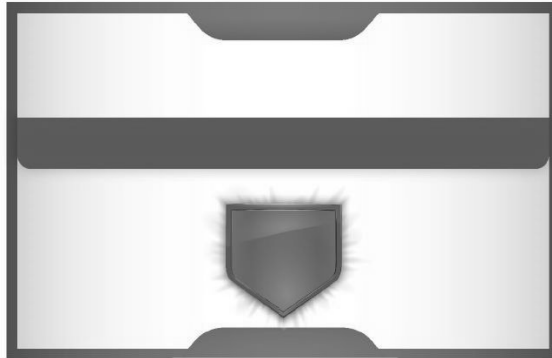

**Reg. No. 4,125,979**

**Registered Apr. 10, 2012**

**Int. Cl.: 5**

**TRADEMARK**

**PRINCIPAL REGISTER**

JOHNSON & JOHNSON (NEW JERSEY CORPORATION)  
ONE JOHNSON & JOHNSON PLAZA  
NEW BRUNSWICK, NJ 089337001

FOR: PHARMACEUTICAL PREPARATION FOR THE RELIEF AND PREVENTION OF UPPER RESPIRATORY SYMPTOMS; NASAL DECONGESTANT, IN CLASS 5 (U.S. CLS. 6, 18, 44, 46, 51 AND 52).

FIRST USE 2-25-2010; IN COMMERCE 2-25-2010.

THE MARK CONSISTS OF A RECTANGLE FEATURING QUADRILATERAL INDENTATIONS AT THE TOP AND BOTTOM WITH A RECTANGULAR BAR AT THE TOP AND A SHIELD DESIGN AT THE BOTTOM PORTION.

SN 77-939,958, FILED 2-19-2010.

KELLY BOULTON, EXAMINING ATTORNEY



*David J. Kybas*

Director of the United States Patent and Trademark Office

# United States of America

United States Patent and Trademark Office

# FLIGHTSTER

**Reg. No. 4,125,980**

AMERICAN TRAVEL SOLUTIONS, INC. (CALIFORNIA CORPORATION)  
26707 WEST AGOURA RD. #204  
CALABASAS, CA 91302

**Registered Apr. 10, 2012**

**Int. Cl.: 39**

FOR: TRAVEL AGENCY SERVICES, NAMELY, MAKING RESERVATIONS AND BOOKINGS FOR AIRLINE TRANSPORTATION, IN CLASS 39 (U.S. CLS. 100 AND 105).

**SERVICE MARK**

FIRST USE 12-2-2011; IN COMMERCE 12-1-2011.

**PRINCIPAL REGISTER**

THE MARK CONSISTS OF STANDARD CHARACTERS WITHOUT CLAIM TO ANY PARTICULAR FONT, STYLE, SIZE, OR COLOR.

SN 77-940,337, FILED 2-19-2010.

JAMES A. RAUEN, EXAMINING ATTORNEY



*David J. Kybas*

Director of the United States Patent and Trademark Office



# United States of America

United States Patent and Trademark Office

## NEWTEK SITECENTER

**Reg. No. 4,125,981**

NEWTEK BUSINESS SERVICES, INC. (NEW YORK CORPORATION)

**Registered Apr. 10, 2012**

1440 BROADWAY  
NEW YORK, NY 10018

**Int. Cl.: 42**

FOR: COMPUTER AND BUSINESS SERVICES, NAMELY, HOSTING OF THE WEB SITES OF OTHERS ON A COMPUTER SERVER FOR A GLOBAL COMPUTER NETWORK; PROVIDING INFORMATION ABOUT WEB SITE DEVELOPMENT; WEB SITE HOSTING SERVICES; DESIGNING, DEVELOPING, AND HOSTING WEB SITES FOR OTHERS; DATA ENCRYPTION SERVICES; PROVIDING TEMPORARY USE OF ONLINE, NON-DOWNLOADABLE SOFTWARE TO ENABLE USERS TO RESERVE, MANAGE AND SECURE DOMAIN NAMES FOR USE ON A GLOBAL COMPUTER NETWORK AND TO ACCESS, ADD, MODIFY, OR DELETE THEIR DOMAIN NAME INFORMATION, IN CLASS 42 (U.S. CLS. 100 AND 101).

**SERVICE MARK**

**PRINCIPAL REGISTER**

FIRST USE 3-24-2010; IN COMMERCE 3-24-2010.

THE MARK CONSISTS OF STANDARD CHARACTERS WITHOUT CLAIM TO ANY PARTICULAR FONT, STYLE, SIZE, OR COLOR.

OWNER OF U.S. REG. NOS. 3,312,445, 3,344,122, AND OTHERS.

SN 77-940,407, FILED 2-19-2010.

JOHN GARTNER, EXAMINING ATTORNEY



*David J. Kybas*

Director of the United States Patent and Trademark Office

# United States of America

United States Patent and Trademark Office

## BIG FASHION, LITTLE PRICES

**Reg. No. 4,125,982**

**Registered Apr. 10, 2012**

**Int. Cls.: 25 and 35**

**TRADEMARK**

**SERVICE MARK**

**PRINCIPAL REGISTER**

THE CHILDREN'S PLACE SERVICES COMPANY, LLC (DELAWARE LIMITED LIABILITY COMPANY)  
500 PLAZA DRIVE  
SECAUCUS, NJ 07094

FOR: CLOTHING, NAMELY, SHIRTS, SWEATERS, PANTS, BODYSUITS, COVERALLS, SLEEPWEAR, SWIMWEAR, TANK TOPS, SHORTS, VESTS, UNDERWEAR, DRESSES, SKIRTS, COATS, BLAZERS, GLOVES, HATS, SCARVES, FOOTWEAR, HEADWEAR, IN CLASS 25 (U.S. CLS. 22 AND 39).

FIRST USE 1-1-2012; IN COMMERCE 1-1-2012.

FOR: RETAIL STORE SERVICES FEATURING CHILDREN'S CLOTHING AND ACCESSORIES, IN CLASS 35 (U.S. CLS. 100, 101 AND 102).

FIRST USE 3-0-2010; IN COMMERCE 3-0-2010.

THE MARK CONSISTS OF STANDARD CHARACTERS WITHOUT CLAIM TO ANY PARTICULAR FONT, STYLE, SIZE, OR COLOR.

SN 77-941,471, FILED 2-22-2010.

ODESSA BIBBINS, EXAMINING ATTORNEY



*David J. Kybas*

Director of the United States Patent and Trademark Office

# United States of America

United States Patent and Trademark Office

# RAW

**Reg. No. 4,125,983**

**Registered Apr. 10, 2012**

**Int. Cl.: 25**

**TRADEMARK**

**PRINCIPAL REGISTER**

WORLD WRESTLING ENTERTAINMENT, INC. (DELAWARE CORPORATION)  
1241 EAST MAIN STREET  
STAMFORD, CT 06902

FOR: CLOTHING, NAMELY, TANK TOPS, T-SHIRTS, SHIRTS, SPORT SHIRTS, DRESS SHIRTS, POLO SHIRTS, UNDERSHIRTS, SWEATSHIRTS, SWEATERS, PULLOVERS, JACKETS, RAINCOATS, OVERCOATS, TOPCOATS, TROUSERS, PANTS, JEAN PANTS, JOGGING SUITS, EXERCISE PANTS, EXERCISE SUITS, SWEATPANTS, SHORTS, UNDERWEAR, BOXER SHORTS, SOCKS, CLOTHING TIES, PAJAMAS, BELTS, GLOVES, HALLOWEEN AND MASQUERADE COSTUMES, WRIST BANDS, BANDANNAS; FOOTWEAR, NAMELY, SHOES, SNEAKERS, BOOTS, SLIPPERS; HEADWEAR, NAMELY, HATS, CAPS, IN CLASS 25 (U.S. CLS. 22 AND 39).

FIRST USE 1-31-1993; IN COMMERCE 1-31-1993.

THE MARK CONSISTS OF STANDARD CHARACTERS WITHOUT CLAIM TO ANY PARTICULAR FONT, STYLE, SIZE, OR COLOR.

SN 77-942,095, FILED 2-23-2010.

JOHN HWANG, EXAMINING ATTORNEY



*David J. Kypos*

Director of the United States Patent and Trademark Office

# United States of America

United States Patent and Trademark Office



**Reg. No. 4,125,984**

**Registered Apr. 10, 2012**

**Int. Cl.: 9**

**TRADEMARK**

**PRINCIPAL REGISTER**

EARTHWORKS SYSTEM, LLC (OHIO LIMITED LIABILITY COMPANY)  
33200 BAINBRIDGE ROAD  
SUITE D  
SOLON, OH 44139

FOR: MAGNETICALLY ENCODED PLASTIC TRANSACTION, INFORMATION AND IDENTIFICATION CARDS, IN CLASS 9 (U.S. CLS. 21, 23, 26, 36 AND 38).

FIRST USE 1-0-2008; IN COMMERCE 1-0-2008.

OWNER OF U.S. REG. NO. 3,462,902.

NO CLAIM IS MADE TO THE EXCLUSIVE RIGHT TO USE "RECYCLED" AND THE RECYCLING SYMBOL, APART FROM THE MARK AS SHOWN.

THE MARK CONSISTS OF THE DESIGN OF TWO CONCENTRIC CIRCLES CONTAINING THE WORDING "EARTHWORKS RECYCLED" AND A RECYCLING SYMBOL IN THE CENTER.

SN 77-942,270, FILED 2-23-2010.

DAWN HAN, EXAMINING ATTORNEY



*David J. Kyjars*

Director of the United States Patent and Trademark Office

# United States of America

United States Patent and Trademark Office

**EARN YOUR STRIPES**  
FISHING TEAM

**Reg. No. 4,125,985**

**Registered Apr. 10, 2012**

**Int. Cl.: 25**

**TRADEMARK**

**PRINCIPAL REGISTER**

ERIC REMIG (NEW JERSEY LIMITED LIABILITY COMPANY), DBA EARN YOUR STRIPES  
FISHING TEAM,  
406 GREENWOOD LANE  
BRICK, NJ 08723

FOR: FISHING SHIRTS; SKULL CAPS; SPORTS CAPS AND HATS, IN CLASS 25 (U.S. CLS.  
22 AND 39).

FIRST USE 1-1-2011; IN COMMERCE 2-1-2011.

THE MARK CONSISTS OF THE PHRASE "EARN YOUR STRIPES" ARRANGED IN A FISH-  
LIKE SHAPE. THE WORDS "FISHING TEAM" UNDERNEATH THE WORD "STRIPES".

SN 77-943,162, FILED 2-24-2010.

REGINA DRUMMOND, EXAMINING ATTORNEY



*David J. Kyffers*

Director of the United States Patent and Trademark Office

# United States of America

United States Patent and Trademark Office

## SECUREBYNATURE

**Reg. No. 4,125,986**

STELLA & CHEWY'S LLC (WISCONSIN LIMITED LIABILITY COMPANY)  
W145 S6550 TESS CORNERS DRIVE  
MUSKEGO, WI 53150

**Registered Apr. 10, 2012**

**Int. Cl.: 45**

FOR: FOOD SAFETY PROCESS SERVICES FOR THE PREVENTION OF HEALTH RISK, NAMELY, ELIMINATING PATHOGENS FROM RAW MEAT PRODUCTS VIA HYDROSTATIC HIGH PRESSURE PROCESSING, USE OF PHOTOHYDROIONIZATION, AND ANTIMICROBIAL EQUIPMENT AND PROCESSES, IN CLASS 45 (U.S. CLS. 100 AND 101).

**SERVICE MARK**

**PRINCIPAL REGISTER**

FIRST USE 9-15-2010; IN COMMERCE 11-15-2010.

THE MARK CONSISTS OF STANDARD CHARACTERS WITHOUT CLAIM TO ANY PARTICULAR FONT, STYLE, SIZE, OR COLOR.

SN 77-945,331, FILED 2-25-2010.

ANDREA HACK, EXAMINING ATTORNEY



*David J. Kybas*

Director of the United States Patent and Trademark Office

# United States of America

United States Patent and Trademark Office

# NAVIA.COM

**Reg. No. 4,125,987**

**Registered Apr. 10, 2012**

**Int. Cl.: 36**

**SERVICE MARK**

**PRINCIPAL REGISTER**

VIP REALTY GROUP, INC. (FLORIDA CORPORATION)  
13131 UNIVERSITY DRIVE  
FORT MYERS, FL 33907

FOR: REAL ESTATE SERVICES, NAMELY, REAL ESTATE ACQUISITION SERVICES, REAL ESTATE CONSULTATION, REAL ESTATE LISTING, REAL ESTATE MULTIPLE LISTING SERVICES; INFORMATION SERVICES, NAMELY, PROVIDING INFORMATION IN THE FIELD OF REAL ESTATE VIA THE INTERNET, PROVIDING REAL ESTATE LISTINGS AND REAL ESTATE INFORMATION VIA THE INTERNET, PROVIDING INFORMATION IN THE FIELD OF REAL ESTATE BY MEANS OF LINKING THE WEB SITE TO OTHER WEB SITES FEATURING REAL ESTATE INFORMATION, IN CLASS 36 (U.S. CLS. 100, 101 AND 102).

FIRST USE 3-8-2011; IN COMMERCE 3-8-2011.

THE MARK CONSISTS OF STANDARD CHARACTERS WITHOUT CLAIM TO ANY PARTICULAR FONT, STYLE, SIZE, OR COLOR.

THE WORDING "NAVIA" HAS NO MEANING IN A FOREIGN LANGUAGE.

SN 77-945,722, FILED 2-26-2010.

JAMES LOVELACE, EXAMINING ATTORNEY



*David J. Kyffers*

Director of the United States Patent and Trademark Office

# United States of America

United States Patent and Trademark Office

## Thunder On The Comstock

**Reg. No. 4,125,988**

**Registered Apr. 10, 2012**

**Int. Cl.: 25**

**TRADEMARK**

**PRINCIPAL REGISTER**

ZULIM, MARK, W (UNITED STATES INDIVIDUAL)  
P.O. BOX 352  
1620 COMBINATION ROAD  
VIRGINIA CITY, NV 89440

FOR: T-SHIRTS, IN CLASS 25 (U.S. CLS. 22 AND 39).

FIRST USE 8-9-2004; IN COMMERCE 8-12-2005.

THE MARK CONSISTS OF STANDARD CHARACTERS WITHOUT CLAIM TO ANY PARTICULAR FONT, STYLE, SIZE, OR COLOR.

SN 77-947,701, FILED 3-1-2010.

MATTHEW KLINE, EXAMINING ATTORNEY



*David J. Kappas*

Director of the United States Patent and Trademark Office



# United States of America

United States Patent and Trademark Office

# MACARON

**Reg. No. 4,125,989**

THE WINE GROUP LLC (DELAWARE LIMITED LIABILITY COMPANY)  
4596 S. TRACY BLVD.  
TRACY, CA 95377

**Registered Apr. 10, 2012**

**Int. Cl.: 33**

FOR: WINE, IN CLASS 33 (U.S. CLS. 47 AND 49).

**TRADEMARK**

FIRST USE 2-20-2012; IN COMMERCE 2-20-2012.

**PRINCIPAL REGISTER**

THE MARK CONSISTS OF STANDARD CHARACTERS WITHOUT CLAIM TO ANY PARTICULAR FONT, STYLE, SIZE, OR COLOR.

THE ENGLISH TRANSLATION OF "MACARON" IN THE MARK IS "MACAROON".

SN 77-949,065, FILED 3-3-2010.

TRACY FLETCHER, EXAMINING ATTORNEY



*David J. Kyffers*

Director of the United States Patent and Trademark Office

# United States of America

## United States Patent and Trademark Office



**Reg. No. 4,125,990**

**Registered Apr. 10, 2012**

**Int. Cls.: 9, 35, 36, 38, 42,  
and 45**

**TRADEMARK**

**SERVICE MARK**

**PRINCIPAL REGISTER**

FREELANCER TECHNOLOGY PTY LIMITED (AUSTRALIA LIMITED LIABILITY COMPANY)  
5/36 BAYSWATER ROAD  
POTTS POINT NSW, AUSTRALIA 2011

FOR: DOWNLOADABLE COMPUTER SOFTWARE FOR USE IN WEBSITE AUTHORIZING, DOWNLOADING, TRANSMITTING, RECEIVING, EDITING, EXTRACTING, ENCODING, DECODING, PLAYING, STORING AND ORGANIZING TEXT, DATA, IMAGES, AUDIO FILES, AND VIDEO FILES; COMPUTER SOFTWARE FOR PERSONAL INFORMATION MANAGEMENT; COMPUTER SOFTWARE FOR USE IN RECORDING, ORGANIZING, TRANSMITTING, MANIPULATING, AND REVIEWING TEXT, DATA, AUDIO FILES, AND VIDEO FILES IN CONNECTION WITH COMPUTERS, TELEVISION SET-TOP BOXES, MUSIC PLAYERS, VIDEO PLAYERS, MEDIA PLAYERS, CELLULAR PHONES, AND PORTABLE AND HANDHELD DIGITAL ELECTRONIC DEVICES; COMPUTER SOFTWARE FOR ACCESSING, BROWSING AND SEARCHING ONLINE DATABASES; COMPUTER SOFTWARE TO ENABLE USERS TO PROGRAM AND DISTRIBUTE AUDIO, VIDEO, TEXT AND OTHER MULTIMEDIA CONTENT, INCLUDING MUSIC, CONCERTS, VIDEOS, RADIO, TELEVISION, NEWS, SPORTS, CULTURAL EVENTS, AND ENTERTAINMENT-RELATED AND EDUCATIONAL PROGRAMS VIA COMMUNICATIONS NETWORKS; COMPUTER SOFTWARE FOR IDENTIFYING, LOCATING, GROUPING, DISTRIBUTING, AND MANAGING DATA AND LINKS BETWEEN COMPUTER SERVERS AND USERS CONNECTED TO ELECTRONIC COMMUNICATIONS NETWORKS, IN CLASS 9 (U.S. CLS. 21, 23, 26, 36 AND 38).

FIRST USE 12-7-2009; IN COMMERCE 12-7-2009.

FOR: ONLINE RETAIL STORE SERVICES FEATURING COMPUTER SOFTWARE; ONLINE BUSINESS DIRECTORIES IN THE FIELD OF EMPLOYMENT; PROVIDING A WEBSITE ALLOWING USERS TO POST MESSAGES OFFERING OR SEEKING JOB OPPORTUNITIES; PROVIDING ONLINE PROJECT MANAGEMENT SERVICES FOR OTHERS FOR BUSINESS PURPOSES IN THE FIELD OF SCHEDULING, ACCOUNTING, BUSINESS PROJECT MANAGEMENT AND BUSINESS DEVELOPMENT, PROVIDING AN ON-LINE SEARCHABLE DATABASE FEATURING CLASSIFIED AD LISTINGS AND EMPLOYMENT OPPORTUNITIES, IN CLASS 35 (U.S. CLS. 100, 101 AND 102).

FIRST USE 12-7-2009; IN COMMERCE 12-7-2009.



*David J. Kyjars*

Director of the United States Patent and Trademark Office

**Reg. No. 4,125,990** FOR: ELECTRONIC PAYMENT SERVICES, NAMELY, PROCESSING ELECTRONIC FUNDS TRANSFER, CREDIT CARD, DEBIT CARD, ELECTRONIC CHECK AND ELECTRONIC PAYMENTS VIA AN ELECTRONIC COMMUNICATIONS NETWORK; ELECTRONIC FUNDS TRANSFER SERVICES; ONLINE ESCROW SERVICE FOR PAYMENT OF SERVICES , IN CLASS 36 (U.S. CLS. 100, 101 AND 102).

FIRST USE 12-7-2009; IN COMMERCE 12-7-2009.

FOR: PROVIDING ON-LINE ELECTRONIC BULLETIN BOARDS FOR TRANSMISSION OF MESSAGES AMONG COMPUTER USERS CONCERNING JOB OPPORTUNITIES, IN CLASS 38 (U.S. CLS. 100, 101 AND 104).

FIRST USE 12-7-2009; IN COMMERCE 12-7-2009.

FOR: COMPUTER SERVICES, NAMELY, CREATING AN ON-LINE COMMUNITY FOR REGISTERED USERS TO PARTICIPATE IN DISCUSSIONS, GET FEEDBACK FROM THEIR PEERS, FORM VIRTUAL COMMUNITIES, AND ENGAGE IN BUSINESS NETWORKING; COMPUTER SERVICES, NAMELY, PROVIDING A WEB-BASED SYSTEM AND ONLINE PORTAL FEATURING ON-LINE NON-DOWNLOADABLE SOFTWARE THAT ENABLES USERS TO ACCESS RECRUITMENT, PROJECT MANAGEMENT, DISPUTE RESOLUTION, EMPLOYMENT, EMPLOYMENT DIRECTORY, BUSINESS DIRECTORY, AND JOB POSTING RESOURCES; APPLICATION SERVICE PROVIDER FEATURING APPLICATION PROGRAMMING INTERFACE (API) SOFTWARE FOR USE IN BUILDING SOFTWARE APPLICATIONS FOR ADVERTISING, PROJECT MANAGEMENT, USER FEEDBACK AND EMPLOYMENT SERVICES; COMPUTER SERVICES, NAMELY, DESIGNING AND IMPLEMENTING ON DEMAND WEB SITES IN THE NATURE OF TURNKEY PACKAGES ALLOWING CUSTOMERS TO CREATE ECOMMERCE WEB SITES FOR THE PURPOSE OF UPLOADING PHOTOS AND CREATING GIFTS; TESTING, ANALYSIS AND EVALUATION OF THE GOODS AND SERVICES OF OTHERS FOR THE PURPOSE OF CERTIFICATION; CREATING AN ON-LINE COMMUNITY FOR REGISTERED USERS TO EVALUATE THE REPUTATION, RELIABILITY, AND INTEGRITY OF INDIVIDUAL SERVICES PROVIDERS AND CUSTOMERS, SHOWCASE THEIR SKILLS, GET FEEDBACK FROM THEIR PEERS, FORM VIRTUAL COMMUNITIES, ENGAGE IN SOCIAL NETWORKING AND IMPROVE THEIR TALENT; DESIGN, CREATION, HOSTING, MAINTENANCE OF WEBSITES FOR OTHERS, IN CLASS 42 (U.S. CLS. 100 AND 101).

FIRST USE 12-7-2009; IN COMMERCE 12-7-2009.

FOR: DISPUTE RESOLUTION SERVICES; IDENTIFICATION VERIFICATION SERVICES, NAMELY, PROVIDING AUTHENTICATION OF PERSONAL IDENTIFICATION INFORMATION; ONLINE SOCIAL NETWORKING SERVICES, IN CLASS 45 (U.S. CLS. 100 AND 101).

FIRST USE 12-7-2009; IN COMMERCE 12-7-2009.

THE MARK CONSISTS OF A BIRD IN AN ORIGAMI STYLE. THE BEAK, TAIL, AND WINGS ARE BLUE. THE BODY IS LIGHT BLUE. THE HEAD IS PALE BLUE.

THE COLOR(S) BLUE, LIGHT BLUE, AND PALE BLUE IS/ARE CLAIMED AS A FEATURE OF THE MARK.

SN 77-949,232, FILED 3-3-2010.

SANJEEV VOHRA, EXAMINING ATTORNEY

# United States of America

United States Patent and Trademark Office



**Reg. No. 4,125,991**

JACKCO TRANSNATIONAL INC. (CALIFORNIA CORPORATION)  
2127 EDWARDS AVENUE  
SOUTH EL MONTE, CA 91733

**Registered Apr. 10, 2012**

**Int. Cl.: 7**

FOR: ELECTRIC SANDERS; ELECTRIC SCREWDRIVERS; ELECTRIC WELDING MACHINES; ELECTRICAL DRILLS, IN CLASS 7 (U.S. CLS. 13, 19, 21, 23, 31, 34 AND 35).

**TRADEMARK**

FIRST USE 8-1-2010; IN COMMERCE 8-1-2010.

**PRINCIPAL REGISTER**

OWNER OF U.S. REG. NO. 3,081,942.

NO CLAIM IS MADE TO THE EXCLUSIVE RIGHT TO USE "POWER SWITCH", APART FROM THE MARK AS SHOWN.

THE MARK CONSISTS OF THE STYLIZED WORDING "POWER SWITCH" WITH A DESIGN OF LIGHTNING TO THE RIGHT AND THE STYLIZED WORDING "BY JACKCO" UNDERNEATH WITH A HORIZONTAL LINE.

SN 77-950,872, FILED 3-4-2010.

HOWARD FRIEDMAN, EXAMINING ATTORNEY



*David J. Kybas*

Director of the United States Patent and Trademark Office

# United States of America

United States Patent and Trademark Office

# HP OMNI

**Reg. No. 4,125,992**

HEWLETT-PACKARD DEVELOPMENT COMPANY, L.P. (TEXAS LIMITED PARTNERSHIP)  
11445 COMPAQ CENTER DRIVE WEST  
HOUSTON, TX 77070

**Registered Apr. 10, 2012**

**Int. Cl.: 9**

FOR: COMPUTERS; COMPUTER HARDWARE; COMPUTER PERIPHERALS, IN CLASS 9  
(U.S. CLS. 21, 23, 26, 36 AND 38).

**TRADEMARK**

FIRST USE 9-0-2010; IN COMMERCE 9-0-2010.

**PRINCIPAL REGISTER**

THE MARK CONSISTS OF STANDARD CHARACTERS WITHOUT CLAIM TO ANY PARTICULAR FONT, STYLE, SIZE, OR COLOR.

OWNER OF U.S. REG. NOS. 1,733,457, 3,412,631, AND OTHERS.

SN 77-952,138, FILED 3-5-2010.

JAY BESCH, EXAMINING ATTORNEY



*David J. Kybas*

Director of the United States Patent and Trademark Office

# United States of America

United States Patent and Trademark Office

# CannaSense

**Reg. No. 4,125,993**

**Registered Apr. 10, 2012**

**Int. Cls.: 3 and 5**

**TRADEMARK**

**PRINCIPAL REGISTER**

SWAIM, PATTI T (UNITED STATES INDIVIDUAL)  
711 BLOSSOM CT.  
REDDING, CA 96003

FOR: COSMETIC CREAMS FOR SKIN CARE; COSMETIC PREPARATIONS FOR BODY CARE; COSMETIC PREPARATIONS FOR SKIN RENEWAL; COSMETIC PREPARATIONS FOR THE CARE OF MOUTH AND TEETH; COSMETIC PREPARATIONS, NAMELY, SKIN BALSAMS; COSMETIC PRODUCTS IN THE FORM OF AEROSOLS FOR SKIN CARE; COSMETIC PRODUCTS IN THE FORM OF AEROSOLS FOR SKINCARE; COSMETIC PRODUCTS TAKEN ORALLY, NAMELY, PILLS THAT INDUCE BRONZING OF THE SKIN; ESSENTIAL OILS FOR USE IN THE MANUFACTURE OF SCENTED PRODUCTS; HAIR CARE CREAMS; HAIR CARE LOTIONS; HAIR CARE PREPARATIONS; HAIR CARE PREPARATIONS CONSISTING OF ORGANIC COCONUT VIRGIN OIL AND COCONUT VIRGIN OIL; HAIR PRODUCTS, NAMELY, THICKENING CONTROL CREAMS; NAIL CARE PREPARATIONS; NAIL CARE PREPARATIONS, NAMELY, NAIL SOFTENERS; NAIL GROOMING PRODUCTS, NAMELY, TIPS, GLUE, LACQUER AND GLITTER; NAIL REPAIR PRODUCTS, NAMELY, LINEN NAIL WRAPS; NAIL REPAIR PRODUCTS, NAMELY, NAIL WRAPS; NAIL REPAIR PRODUCTS, NAMELY, SILK NAIL WRAPS; NATURAL COCOA BUTTER BASED PERSONAL CARE PRODUCTS, NAMELY, BODY LOTION, SHOWER GEL, SOAP, BODY POLISH, BODY AND FOOT SCRUB AND NON-MEDICATED SKIN CREAMS; NON-MEDICATED COSMETIC SKIN CARE PREPARATIONS CONSISTING OF ORGANIC COCONUT VIRGIN OIL AND COCONUT VIRGIN OIL; NON-MEDICATED HERBAL BODY CARE PRODUCTS, NAMELY, BODY OILS, SALVES, AND LIP BALMS; NON-MEDICATED LIP CARE PREPARATIONS; NON-MEDICATED PREPARATIONS ALL FOR THE CARE OF SKIN, HAIR AND SCALP; NON-MEDICATED SKIN CARE PREPARATION, NAMELY, BODY MIST; NON-MEDICATED SKIN CARE PREPARATIONS; NON-MEDICATED SKIN CARE PREPARATIONS, NAMELY, CREAMS, LOTIONS, GELS, TONERS, CLEANERS AND PEELS; NON-MEDICATED SKIN CREAM FOR GENERAL SKIN RASH AND IRRITATION RESULTING FROM SKIN SHINGLES; NON-MEDICATED SKIN CREAMS; NON-MEDICATED STIMULATING LOTIONS FOR THE SKIN; NON-MEDICATED SUN CARE PREPARATIONS; OIL BATHS FOR HAIR CARE; PATCHES CONTAINING SUN SCREEN AND SUN BLOCK FOR USE ON THE SKIN; PET CARE KITS COMPRISING SHAMPOO, CONDITIONER, BODY SPRAY; SKIN ABRASIVE PREPARATIONS; SKIN AND BODY TOPICAL LOTIONS, CREAMS AND OILS FOR COSMETIC USE; SKIN BRONZER; SKIN BRONZING CREAMS; SKIN CARE PREPARATION, NAMELY, BODY POLISH; SKIN CARE PREPARATIONS, NAMELY, BODY BALM; SKIN CARE PREPARATIONS, NAMELY, CHEMICAL PEELS FOR SKIN; SKIN CARE PREPARATIONS, NAMELY, FRUIT ACID PEELS



*David J. Kyros*

Director of the United States Patent and Trademark Office

**Reg. No. 4,125,993** FOR SKIN; SKIN CARE PREPARATIONS, NAMELY, SKIN PEELS; SKIN CARE PRODUCTS, NAMELY, NON-MEDICATED SKIN SERUM; SKIN CLARIFIERS; SKIN CLEANSERS; SKIN CLEANSING CREAM; SKIN CLEANSING LOTION; SKIN CONDITIONERS; SKIN CONDITIONING CREAMS FOR COSMETIC PURPOSES; SKIN CREAM; SKIN CREAMS; SKIN CREAMS IN LIQUID AND IN SOLID FORM; SKIN CREAMS IN LIQUID AND SOLID; SKIN CREAMS IN LIQUID AND SOLID FORM; SKIN EMOLLIENTS; SKIN FRESHENERS; SKIN GELS FOR ACCELERATING, ENHANCING OR EXTENDING TANS; SKIN LIGHTENERS; SKIN LIGHTENING CREAMS; SKIN LOTION; SKIN LOTIONS; SKIN MASKS; SKIN MOISTURIZER; SKIN MOISTURIZER MASKS; SKIN POLISHING RICE BRAN (ARAINUKA); SKIN SOAP; SKIN TEXTURIZERS; SKIN TONERS; SKIN WHITENING CREAMS; SKIN WHITENING PREPARATIONS; SOAPS FOR BODY CARE; SUN CARE LOTIONS; TOPICAL SKIN SPRAYS FOR COSMETIC PURPOSES; WIPES IMPREGNATED WITH A SKIN CLEANSER; WRINKLE REMOVING SKIN CARE PREPARATIONS; WRINKLE-MINIMIZING COSMETIC PREPARATIONS FOR TOPICAL FACIAL USE, IN CLASS 3 (U.S. CLS. 1, 4, 6, 50, 51 AND 52).

FIRST USE 5-15-2011; IN COMMERCE 5-15-2011.

FOR: BANDAGES FOR SKIN WOUNDS; HERBAL TOPICAL CREAMS, GELS, SALVES, SPRAYS, POWDER, BALMS, LINIMENT AND OINTMENTS FOR THE RELIEF OF ACHES AND PAIN; MEDICATED SKIN CARE PREPARATIONS; MEDICATED SKIN CARE PREPARATIONS, NAMELY, CREAMS, LOTIONS, GELS, TONERS, CLEANERS AND PEELS; MEDICINAL CREAMS FOR SKIN CARE, IN CLASS 5 (U.S. CLS. 6, 18, 44, 46, 51 AND 52).

FIRST USE 5-15-2011; IN COMMERCE 5-15-2011.

THE MARK CONSISTS OF STANDARD CHARACTERS WITHOUT CLAIM TO ANY PARTICULAR FONT, STYLE, SIZE, OR COLOR.

SN 77-952,440, FILED 3-6-2010.

ROBERT STRUCK, EXAMINING ATTORNEY

# United States of America

United States Patent and Trademark Office

# RAIN KISSED

**Reg. No. 4,125,994**

**Registered Apr. 10, 2012**

**Int. Cl.: 3**

**TRADEMARK**

**PRINCIPAL REGISTER**

BATH & BODY WORKS BRAND MANAGEMENT, INC. (DELAWARE CORPORATION)  
5 LIMITED PARKWAY EAST  
REYNOLDSBURG, OH 43068

FOR: PERSONAL CARE PRODUCTS, NAMELY, ANTIBACTERIAL SKIN SOAPS, BATH FOAMS, BATH GELS, BATH SOAPS IN LIQUID, SOLID OR GEL FORM, BODY CREAMS, BODY LOTIONS, BODY SCRUB, BODY SPRAY USED AS A PERSONAL DEODORANT AND AS FRAGRANCE, BODY WASH FOR HUMANS, BUBBLE BATH, COLOGNE, CREAM SOAPS, EAU DE PARFUM, EAU DE TOILETTE, FACE AND BODY LOTIONS, HAND CLEANSERS, HAND CLEANING PREPARATIONS, HAND CREAMS, HAND LOTIONS, HAND SOAPS, LIQUID BATH SOAPS, LIQUID SOAPS FOR HANDS, FACE AND BODY, LOTIONS FOR FACE AND BODY CARE, LOTIONS FOR FACE AND BODY, SHOWER AND BATH GEL, SHOWER CREAMS, SHOWER GELS, IN CLASS 3 (U.S. CLS. 1, 4, 6, 50, 51 AND 52).

FIRST USE 7-5-2010; IN COMMERCE 7-5-2010.

THE MARK CONSISTS OF STANDARD CHARACTERS WITHOUT CLAIM TO ANY PARTICULAR FONT, STYLE, SIZE, OR COLOR.

OWNER OF U.S. REG. NO. 3,620,095.

SN 77-954,606, FILED 3-9-2010.

JAY BESCH, EXAMINING ATTORNEY



*David J. Kypos*

Director of the United States Patent and Trademark Office



# United States of America

United States Patent and Trademark Office

# CYGNET

**Reg. No. 4,125,995**

**Registered Apr. 10, 2012**

**Int. Cls.: 41 and 42**

**SERVICE MARK**

**PRINCIPAL REGISTER**

VISUAL SYSTEMS, INC. (CALIFORNIA CORPORATION)  
P.O. BOX 14160  
994 MILL STREET, SUITE 201  
SAN LUIS OBISPO, CA 93406

FOR: TRAINING SERVICES IN THE FIELD OF THE DEVELOPMENT, IMPLEMENTATION, INTEGRATION AND USE OF COMPUTER SOFTWARE AND SOFTWARE DEVELOPMENT TOOLS, IN CLASS 41 (U.S. CLS. 100, 101 AND 107).

FIRST USE 0-0-1995; IN COMMERCE 0-0-1995.

FOR: COMPUTER CONSULTATION SERVICES; DESIGN AND DEVELOPMENT OF COMPUTER SOFTWARE IN THE NATURE OF COMPUTER SOFTWARE APPLICATIONS AND COMPUTER SOFTWARE APPLICATION DEVELOPMENT TOOLS; DESIGN, DEVELOPMENT AND IMPLEMENTATION OF SOFTWARE; SOFTWARE INTEGRATION SERVICES, NAMELY, INTEGRATING SOFTWARE APPLICATIONS IN AN EXISTING COMPUTER NETWORK COMPOSED OF COMPUTER HARDWARE AND COMPUTER SOFTWARE; TECHNICAL SUPPORT SERVICES, NAMELY, TROUBLESHOOTING OF COMPUTER SOFTWARE PROBLEMS, IN CLASS 42 (U.S. CLS. 100 AND 101).

FIRST USE 0-0-1995; IN COMMERCE 0-0-1995.

THE MARK CONSISTS OF STANDARD CHARACTERS WITHOUT CLAIM TO ANY PARTICULAR FONT, STYLE, SIZE, OR COLOR.

SN 77-955,627, FILED 3-10-2010.

DAVID ELTON, EXAMINING ATTORNEY



*David J. Kyffers*

Director of the United States Patent and Trademark Office

# United States of America

United States Patent and Trademark Office



**Reg. No. 4,125,996**

**Registered Apr. 10, 2012**

**Int. Cl.: 44**

**SERVICE MARK**

**PRINCIPAL REGISTER**

ASPEN DENTAL MANAGEMENT, INC. (DELAWARE CORPORATION)  
281 SANDERS CREEK PARKWAY  
EAST SYRACUSE, NY 13057

FOR: PROVIDING A WEBSITE FEATURING NON-DOWNLOADABLE INFORMATIONAL VIDEOS IN THE FIELD OF DENTAL HEALTH CARE, IN CLASS 44 (U.S. CLS. 100 AND 101).

FIRST USE 2-3-2010; IN COMMERCE 2-3-2010.

NO CLAIM IS MADE TO THE EXCLUSIVE RIGHT TO USE "GUIDES", APART FROM THE MARK AS SHOWN.

THE MARK CONSISTS OF THE WORDS "SMILE GUIDES" POSITIONED NEXT TO A SQUARE BOX WITH AN ARC POSITIONED IN THE CENTRAL PORTION THEREOF AND BOUNDED BY DIFFERENTLY SHADED REGIONS AND THE WORDS "SIMPLE STEPS TO FINDING YOUR SMILE." POSITIONED BELOW THE SQUARE.

SN 77-956,239, FILED 3-11-2010.

KAELIE KUNG, EXAMINING ATTORNEY



*David J. Kappas*

Director of the United States Patent and Trademark Office

# United States of America

United States Patent and Trademark Office

## The Adventures of Raa and J

**Reg. No. 4,125,997**

LOWE, MARSHA (UNITED STATES INDIVIDUAL), DBA LOWE, MARSHA ANDERSON,  
PO BOX 8111  
KANSAS CITY, MO 64112

**Registered Apr. 10, 2012**

**Int. Cl.: 16**

FOR: CHILDREN'S BOOKS, IN CLASS 16 (U.S. CLS. 2, 5, 22, 23, 29, 37, 38 AND 50).

**TRADEMARK**

FIRST USE 4-4-2010; IN COMMERCE 9-7-2010.

**PRINCIPAL REGISTER**

THE MARK CONSISTS OF STANDARD CHARACTERS WITHOUT CLAIM TO ANY PARTICULAR FONT, STYLE, SIZE, OR COLOR.

SN 77-956,848, FILED 3-11-2010.

BARBARA GAYNOR, EXAMINING ATTORNEY



*David J. Kyffers*

Director of the United States Patent and Trademark Office

# United States of America

United States Patent and Trademark Office



nurturing life.

**Reg. No. 4,125,998**

**Registered Apr. 10, 2012**

**Int. Cl.: 3**

**TRADEMARK**

**PRINCIPAL REGISTER**

MANNA PRO PRODUCTS, LLC (MISSOURI LIMITED LIABILITY COMPANY)  
707 SPIRIT 40 PARK DRIVE, SUITE 150  
ST. LOUIS, MO 63005

FOR: NON-MEDICATED GROOMING PREPARATIONS FOR PETS AND LIVESTOCK,  
NAMESLY, SHAMPOOS, CONDITIONERS AND DETANGLERS, IN CLASS 3 (U.S. CLS. 1,  
4, 6, 50, 51 AND 52).

FIRST USE 4-0-2010; IN COMMERCE 4-0-2010.

OWNER OF U.S. REG. NOS. 1,406,988 AND 2,645,871.

THE MARK CONSISTS OF A DEPICTION OF A BARN ABOVE THE WORDING "MANNA  
PRO", WHICH IS ABOVE THE WORDING "NURTURING LIFE".

SN 77-960,061, FILED 3-16-2010.

MARTHA FROMM, EXAMINING ATTORNEY



*David J. Kyffers*

Director of the United States Patent and Trademark Office

# United States of America

United States Patent and Trademark Office



**Reg. No. 4,125,999**

**Registered Apr. 10, 2012**

**Int. Cls.: 25 and 35**

**TRADEMARK**

**SERVICE MARK**

**PRINCIPAL REGISTER**

LETHAL ATHLETE LLC (DELAWARE LIMITED LIABILITY COMPANY)  
4D  
328 EAST 74TH  
NEW YORK, NY 10021

FOR: ATHLETIC APPAREL, NAMELY, SHIRTS, PANTS, JACKETS, FOOTWEAR, HATS AND CAPS, ATHLETIC UNIFORMS, IN CLASS 25 (U.S. CLS. 22 AND 39).

FIRST USE 11-11-2011; IN COMMERCE 11-11-2011.

FOR: PROVIDING AN ON-LINE DIRECTORY INFORMATION SERVICE FEATURING INFORMATION ON ATHLETIC LIFE, ON-LINE ATHLETIC TRAINING, CLASSIFIED ADS, VIRTUAL COMMUNITY, SOCIAL NETWORKING, PHOTO AND VIDEO SHARING; ADVERTISING, MARKETING AND INFORMATION DISTRIBUTION SERVICES, NAMELY, PROVIDING CLASSIFIED ADVERTISING SERVICES FOR OTHERS VIA THE GLOBAL COMPUTER NETWORK, AND PROMOTING THE GOODS AND SERVICES OF OTHERS OVER THE INTERNET, IN CLASS 35 (U.S. CLS. 100, 101 AND 102).

FIRST USE 11-11-2011; IN COMMERCE 11-11-2011.

THE MARK CONSISTS OF A STYLIZED LETTER "X" PLACED ON TOP OF ANOTHER STYLIZED LETTER "X" SO THAT THE CENTER CROSSING OF FIRST LETTER "X" LIES ABOVE THE CENTER CROSSING OF THE SECOND LETTER "X".

SN 77-961,551, FILED 3-17-2010.

SUSAN LESLIE DUBOIS, EXAMINING ATTORNEY



*David J. Kybas*

Director of the United States Patent and Trademark Office

# United States of America

United States Patent and Trademark Office

## FRIGHTENING ENTERTAINMENT

**Reg. No. 4,126,000**

FRIGHTENING ENTERTAINMENT LLC (DELAWARE LIMITED LIABILITY COMPANY)  
444 N. FARING ROAD  
LOS ANGELES, CA 90077

**Registered Apr. 10, 2012**

**Int. Cl.: 41**

FOR: PRODUCTION AND DISTRIBUTION OF FILM AND VIDEO, MUSIC VIDEOS, MOTION PICTURES, AND RADIO PROGRAMS; MULTIMEDIA ENTERTAINMENT SOFTWARE PRODUCTION SERVICES; PRODUCTION OF AUDIO RECORDS, VIDEO GAMES, PHOTOGRAPHY, AND STAGE PRODUCTIONS, IN CLASS 41 (U.S. CLS. 100, 101 AND 107).

**SERVICE MARK**

**PRINCIPAL REGISTER**

FIRST USE 5-1-2010; IN COMMERCE 5-1-2010.

THE MARK CONSISTS OF STANDARD CHARACTERS WITHOUT CLAIM TO ANY PARTICULAR FONT, STYLE, SIZE, OR COLOR.

NO CLAIM IS MADE TO THE EXCLUSIVE RIGHT TO USE "ENTERTAINMENT", APART FROM THE MARK AS SHOWN.

SN 77-962,575, FILED 3-18-2010.

REBECCA POVARCHUK, EXAMINING ATTORNEY



*David J. Kybas*

Director of the United States Patent and Trademark Office

# United States of America

United States Patent and Trademark Office

## LITTLE BELLA

**Reg. No. 4,126,001**

**Registered Apr. 10, 2012**

**Int. Cl.: 25**

**TRADEMARK**

**PRINCIPAL REGISTER**

COLOR IMAGE APPAREL, INC. (CALIFORNIA CORPORATION)  
6670 FLOTILLA STREET  
COMMERCE, CA 90040

FOR: WOMEN'S CLOTHING, NAMELY, TEE SHIRTS, SHORT SLEEVE SHIRTS, LONG SLEEVE SHIRTS, TANK TOPS, FLEECE TOPS, FLEECE PANTS, SHIRTS, PANTS, YOGA PANTS, CAPRI PANTS, SHORTS, BRAS, UNDERWEAR, CAMISOLES, SWEATSHIRTS, POLO SHIRTS, AND JACKETS, IN CLASS 25 (U.S. CLS. 22 AND 39).

FIRST USE 6-1-2011; IN COMMERCE 6-1-2011.

THE MARK CONSISTS OF STANDARD CHARACTERS WITHOUT CLAIM TO ANY PARTICULAR FONT, STYLE, SIZE, OR COLOR.

OWNER OF U.S. REG. NOS. 3,158,111, 3,519,794, AND OTHERS.

THE ENGLISH TRANSLATION OF "BELLA" IN THE MARK IS "BEAUTIFUL".

SN 77-962,652, FILED 3-18-2010.

DANNEAN HETZEL, EXAMINING ATTORNEY



*David J. Kyffers*

Director of the United States Patent and Trademark Office

# United States of America

United States Patent and Trademark Office

# baby eden

**Reg. No. 4,126,002**

BABY EDEN, INC. (FLORIDA CORPORATION), DBA BABY EDEN,  
2101 SW 76 AVE  
MIAMI, FL 33155

**Registered Apr. 10, 2012**

**Int. Cl.: 35**

FOR: ONLINE RETAIL STORE FEATURING BABY PRODUCTS, IN CLASS 35 (U.S. CLS. 100, 101 AND 102).

**SERVICE MARK**

FIRST USE 1-2-2012; IN COMMERCE 1-2-2012.

**PRINCIPAL REGISTER**

THE MARK CONSISTS OF STANDARD CHARACTERS WITHOUT CLAIM TO ANY PARTICULAR FONT, STYLE, SIZE, OR COLOR.

SN 77-962,845, FILED 3-18-2010.

MATTHEW KLINE, EXAMINING ATTORNEY



*David J. Kappas*

Director of the United States Patent and Trademark Office



# United States of America

United States Patent and Trademark Office

# RÖHM

**Reg. No. 4,126,003**

**Registered Apr. 10, 2012**

**Int. Cl.: 13**

**TRADEMARK**

**PRINCIPAL REGISTER**

UMAREX SPORTWAFFEN GMBH & CO KG (FED REP GERMANY LIMITED LIABILITY COMPANY)  
DONNERFELD 2  
ARNSBERG, FED REP GERMANY 59757

FOR: BLANK CARTRIDGE FIRING GUNS; AIR GUNS; NON-LETHAL GUNS WHICH FLASH A LASER LIGHT TO ALLOW USER TO PRACTICE ACCURATE TARGETING, NAMELY, MARKSMANSHIP, IN CLASS 13 (U.S. CLS. 2 AND 9).

FIRST USE 2-2-2010; IN COMMERCE 11-0-2010.

THE MARK CONSISTS OF THE STYLIZED WORD "RÖHM" IN THE COLOR BLUE, THE LETTERS IN BLOCK-STYLE FORM, A BULLS-EYE APPEARS INSIDE THE LETTER "O", AN UMLAUT APPEARS ABOVE THE LETTER "O".

THE COLOR(S) BLUE IS/ARE CLAIMED AS A FEATURE OF THE MARK.

THE TERM "RÖHM" HAS NO MEANING IN A FOREIGN LANGUAGE.

SN 77-965,650, FILED 3-23-2010.

LEIGH CAROLINE CASE, EXAMINING ATTORNEY



*David J. Kyfos*

Director of the United States Patent and Trademark Office

# United States of America

United States Patent and Trademark Office

# RÖHM

**Reg. No. 4,126,004**

**Registered Apr. 10, 2012**

**Int. Cl.: 13**

**TRADEMARK**

**PRINCIPAL REGISTER**

UMAREX SPORTWAFFEN GMBH & CO KG (FED REP GERMANY LIMITED LIABILITY COMPANY)  
DONNERFELD 2  
ARNSBERG, FED REP GERMANY 59757

FOR: BLANK CARTRIDGE FIRING GUNS; AIR GUNS; NON-LETHAL GUNS WHICH FLASH A LASER LIGHT TO ALLOW USER TO PRACTICE ACCURATE TARGETING, NAMELY, MARKSMANSHIP, IN CLASS 13 (U.S. CLS. 2 AND 9).

FIRST USE 0-0-1963; IN COMMERCE 11-0-2010.

THE MARK CONSISTS OF STANDARD CHARACTERS WITHOUT CLAIM TO ANY PARTICULAR FONT, STYLE, SIZE, OR COLOR.

THE TERM "RÖHM" HAS NO MEANING IN A FOREIGN LANGUAGE.

SN 77-965,654, FILED 3-23-2010.

LEIGH CAROLINE CASE, EXAMINING ATTORNEY



*David J. Kyffers*

Director of the United States Patent and Trademark Office

# United States of America

United States Patent and Trademark Office

## ACTIVE NATURALS INSTITUTE

**Reg. No. 4,126,005**

**Registered Apr. 10, 2012**

**Int. Cls.: 41 and 42**

**SERVICE MARK**

**PRINCIPAL REGISTER**

JOHNSON & JOHNSON (NEW JERSEY CORPORATION)  
ONE JOHNSON & JOHNSON PLAZA  
NEW BRUNSWICK, NJ 089337001

FOR: PROVIDING ONLINE INFORMATION, NAMELY, NON-DOWNLOADABLE PUBLICATIONS, REGARDING INGREDIENTS IN SKIN CARE PREPARATIONS; EDUCATIONAL SERVICES, NAMELY, CONDUCTING SEMINARS, WEBINARS, FORUMS, CONFERENCES, AND WORKSHOPS IN THE FIELD OF DERMATOLOGY, IN CLASS 41 (U.S. CLS. 100, 101 AND 107).

FIRST USE 3-0-2008; IN COMMERCE 3-0-2008.

FOR: MEDICAL RESEARCH IN THE FIELD OF SKIN CARE PREPARATIONS; RESEARCH AND SCIENTIFIC STUDIES IN THE FIELD OF INGREDIENTS IN SKIN CARE PREPARATIONS, IN CLASS 42 (U.S. CLS. 100 AND 101).

FIRST USE 3-0-2008; IN COMMERCE 3-0-2008.

THE MARK CONSISTS OF STANDARD CHARACTERS WITHOUT CLAIM TO ANY PARTICULAR FONT, STYLE, SIZE, OR COLOR.

OWNER OF U.S. REG. NO. 3,032,656.

NO CLAIM IS MADE TO THE EXCLUSIVE RIGHT TO USE "INSTITUTE", APART FROM THE MARK AS SHOWN.

SN 77-966,804, FILED 3-24-2010.

FRANK LATTUCA, EXAMINING ATTORNEY



*David J. Kybas*

Director of the United States Patent and Trademark Office

# United States of America

United States Patent and Trademark Office

# cls

**Reg. No. 4,126,006**

**Registered Apr. 10, 2012**

**Int. Cl.: 39**

**SERVICE MARK**

**PRINCIPAL REGISTER**

CAROLINA LOGISTICS SERVICES, L.L.C. (NORTH CAROLINA LIMITED LIABILITY COMPANY)  
2601 PILGRIM COURT  
WINSTON-SALEM, NC 27106

FOR: SUPPLY CHAIN LOGISTICS AND REVERSE LOGISTICS SERVICES, NAMELY, STORAGE, TRANSPORTATION AND DELIVERY OF GOODS FOR OTHERS BY AIR, RAIL, SHIP OR TRUCK, IN CLASS 39 (U.S. CLS. 100 AND 105).

FIRST USE 2-28-1998; IN COMMERCE 2-28-1998.

THE MARK CONSISTS OF STANDARD CHARACTERS WITHOUT CLAIM TO ANY PARTICULAR FONT, STYLE, SIZE, OR COLOR.

OWNER OF U.S. REG. NOS. 3,148,094, 3,692,582, AND OTHERS.

SN 77-977,295, FILED 9-5-2008.

SUZANNE BLANE, EXAMINING ATTORNEY



*David J. Kybas*

Director of the United States Patent and Trademark Office

# United States of America

United States Patent and Trademark Office

## MAI COUTURE

**Reg. No. 4,126,007**

HML & CO. LLC (CALIFORNIA LIMITED LIABILITY COMPANY)  
15091 BEACH BOULEVARD  
WESTMINSTER, CA 92683

**Registered Apr. 10, 2012**

**Int. Cl.: 3**

FOR: POWDER BLUSH; COSMETIC FACIAL BLOTTING PAPER; SKIN BRONZER, NAMELY, BODY LIQUID BRONZERS; LOOSE AND PRESS POWDERS, NAMELY, FACE POWDER , IN CLASS 3 (U.S. CLS. 1, 4, 6, 50, 51 AND 52).

**TRADEMARK**

FIRST USE 8-29-2009; IN COMMERCE 8-29-2009.

**PRINCIPAL REGISTER**

THE MARK CONSISTS OF STANDARD CHARACTERS WITHOUT CLAIM TO ANY PARTICULAR FONT, STYLE, SIZE, OR COLOR.

THE ENGLISH TRANSLATION OF "MAI" IN THE MARK IS TURTLE SHELL.

SN 77-981,519, FILED 1-15-2009.

NELSON SNYDER, EXAMINING ATTORNEY



*David J. Kybas*

Director of the United States Patent and Trademark Office

# United States of America

United States Patent and Trademark Office

**CEL**  
**SCAN**

**Reg. No. 4,126,008**

GLOBAL ENERGY INNOVATIONS, LLC (CALIFORNIA LIMITED LIABILITY COMPANY)  
254 EAST GISH ROAD  
SAN JOSE, CA 95112

**Registered Apr. 10, 2012**

**Int. Cl.: 9**

FOR: BATTERY MONITORING EQUIPMENT THAT IS HAND HELD, NAMELY, A BATTERY FUEL GAUGE FOR DETERMINING THE STATE OF HEALTH AND/OR STATE OF CHARGE OF BATTERIES, IN CLASS 9 (U.S. CLS. 21, 23, 26, 36 AND 38).

**TRADEMARK**

FIRST USE 1-3-2011; IN COMMERCE 1-3-2011.

**PRINCIPAL REGISTER**

NO CLAIM IS MADE TO THE EXCLUSIVE RIGHT TO USE "CELL SCAN", APART FROM THE MARK AS SHOWN.

THE MARK CONSISTS OF A STYLIZED CAPITAL LETTER "C", A STYLIZED CAPITAL LETTER "E", A STYLIZED CAPITAL LETTER "L", AND THE WORD "SCAN" IN CAPITAL LETTERS, WHERE THE LINE OF THE LETTER "A" IS EXTENDED TO THE LEFT INTO THE LETTER "C"; THE WORD "SCAN" IS ALLOCATED BELOW THE LETTERS "CEL" AND LIMITED BY A LINE AT THE TOP AND AT THE BOTTOM.

SN 77-982,459, FILED 10-1-2009.

LYDIA BELZER, EXAMINING ATTORNEY



*David J. Kyros*

Director of the United States Patent and Trademark Office

# United States of America

United States Patent and Trademark Office

# CAL FIRE

**Reg. No. 4,126,009**

CDF FIREFIGHTERS CORPORATION (CALIFORNIA CORPORATION)  
1731 J STREET  
SACRAMENTO, CA 95814

**Registered Apr. 10, 2012**

**Int. Cls.: 8, 14, 16, 18, 21,  
and 26**

FOR: HAND TOOLS, NAMELY, KNIVES, IN CLASS 8 (U.S. CLS. 23, 28 AND 44).

FIRST USE 1-25-2011; IN COMMERCE 1-25-2011.

**TRADEMARK**

FOR: LAPEL PINS, RINGS, TIE PINS, TIE TACKS, TIE CLASPS, COLLECTABLE COINS, COMMEMORATIVE COINS, CHALLENGE COINS, IN CLASS 14 (U.S. CLS. 2, 27, 28 AND 50).

**PRINCIPAL REGISTER**

FIRST USE 8-28-2011; IN COMMERCE 8-28-2011.

FOR: DECALS, IN CLASS 16 (U.S. CLS. 2, 5, 22, 23, 29, 37, 38 AND 50).

FIRST USE 9-14-2009; IN COMMERCE 9-14-2009.

FOR: BACKPACKS; TRAVEL BAGS; GEAR BAGS BEING DUFFLE BAGS OR BACK PACKS FOR CLOTHES USED BY FIREFIGHTERS, NAMELY, TURNOUT PANTS, TURNOUT COATS, RUBBER BOOTS, GLOVES; UTILITY BAGS BEING DUFFLE BAGS OR BACK PACKS FOR CLOTHES USED BY FIREFIGHTERS, NAMELY, TURNOUT PANTS, TURNOUT COATS, RUBBER BOOTS, GLOVES AND FIREFIGHTING EQUIPMENT, NAMELY, AXES, HATCHETS, SCREWDRIVERS, KNIVES, CAN OPENERS, PLIERS, FILES, SCISSORS, AWLS; TURNOUT COATS, RUBBER BOOTS, GLOVES, FIRST AID KITS, GOGGLES, KNIVES, LENSES, FLASHLIGHTS, BATTERIES, IN CLASS 18 (U.S. CLS. 1, 2, 3, 22 AND 41).

FIRST USE 1-25-2011; IN COMMERCE 1-25-2011.

FOR: MUGS, CUPS, IN CLASS 21 (U.S. CLS. 2, 13, 23, 29, 30, 33, 40 AND 50).

FIRST USE 1-25-2011; IN COMMERCE 1-25-2011.

FOR: BELT BUCKLES, IN CLASS 26 (U.S. CLS. 37, 39, 40, 42 AND 50).

FIRST USE 1-25-2011; IN COMMERCE 1-25-2011.



*David J. Kyros*

Director of the United States Patent and Trademark Office

**Reg. No. 4,126,009** THE MARK CONSISTS OF STANDARD CHARACTERS WITHOUT CLAIM TO ANY PARTICULAR FONT, STYLE, SIZE, OR COLOR.

NO CLAIM IS MADE TO THE EXCLUSIVE RIGHT TO USE "CAL", APART FROM THE MARK AS SHOWN.

SN 77-982,871, FILED 7-30-2009.

RAUL CORDOVA, EXAMINING ATTORNEY



**United States of America**  
United States Patent and Trademark Office

**CAL FIRE**

**Reg. No. 4,126,010**

CDF FIREFIGHTERS CORPORATION (CALIFORNIA CORPORATION)  
1731 J STREET  
SACRAMENTO, CA 95814

**Registered Apr. 10, 2012**

**Int. Cls.: 22 and 24**

FOR: LAUNDRY BAGS, IN CLASS 22 (U.S. CLS. 1, 2, 7, 19, 22, 42 AND 50).

**TRADEMARK**

FIRST USE 9-14-2009; IN COMMERCE 9-14-2009.

**PRINCIPAL REGISTER**

FOR: TOWELS , IN CLASS 24 (U.S. CLS. 42 AND 50).

FIRST USE 9-14-2009; IN COMMERCE 9-14-2009.

THE MARK CONSISTS OF STANDARD CHARACTERS WITHOUT CLAIM TO ANY PARTICULAR FONT, STYLE, SIZE, OR COLOR.

NO CLAIM IS MADE TO THE EXCLUSIVE RIGHT TO USE "CAL", APART FROM THE MARK AS SHOWN.

SN 77-982,872, FILED 7-30-2009.

RAUL CORDOVA, EXAMINING ATTORNEY



*David J. Kybas*

Director of the United States Patent and Trademark Office

# United States of America

United States Patent and Trademark Office

## ANDREW MARC

**Reg. No. 4,126,011**

**Registered Apr. 10, 2012**

**Int. Cl.: 25**

**TRADEMARK**

**PRINCIPAL REGISTER**

G-III LEATHER FASHIONS, INC. (NEW YORK CORPORATION)  
35TH FLOOR  
512 SEVENTH AVENUE  
NEW YORK, NY 100184202

FOR: FOOTWEAR, SHOES AND BOOTS, IN CLASS 25 (U.S. CLS. 22 AND 39).

FIRST USE 11-0-2011; IN COMMERCE 11-0-2011.

THE MARK CONSISTS OF STANDARD CHARACTERS WITHOUT CLAIM TO ANY PARTICULAR FONT, STYLE, SIZE, OR COLOR.

OWNER OF U.S. REG. NOS. 2,647,906, 3,614,832, AND OTHERS.

THE NAME(S), PORTRAIT(S), AND/OR SIGNATURE(S) SHOWN IN THE MARK IDENTIFIES "ANDREW MARC", WHOSE CONSENT(S) TO REGISTER IS MADE OF RECORD.

SN 77-982,876, FILED 12-5-2008.

WARREN L. OLANDRIA, EXAMINING ATTORNEY



*David J. Kybas*

Director of the United States Patent and Trademark Office

# United States of America

United States Patent and Trademark Office

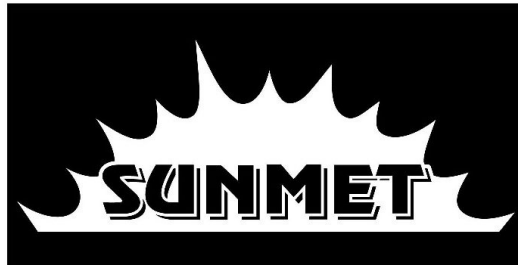

**Reg. No. 4,126,012**

ETCHEGARAY FARMS, LLC (CALIFORNIA LIMITED LIABILITY COMPANY)  
P.O. BOX 964  
VISALIA, CA 93279

**Registered Apr. 10, 2012**

**Int. Cl.: 29**

FOR: PROCESSED FRUITS, NAMELY, FROZEN, DEHYDRATED, VACUUM-PACKED, ASEPTICALLY-PACKAGED, SLICED AND DICED, CHERRIES, KIWI FRUIT, ORANGES, AND POMEGRANATES(EXCLUDING DEHYDRATED GRAPES, APPLES, CHERRIES, NECTARINES, PLUMS AND PEACHES), IN CLASS 29 (U.S. CL. 46).

**TRADEMARK**

**PRINCIPAL REGISTER**

FIRST USE 12-2-2011; IN COMMERCE 12-2-2011.

THE MARK CONSISTS OF THE WORD "SUNMET", STYLIZED TO CREATE A SHADOW EFFECT, PLACED WITHIN A SEMI-CIRCLE STYLIZED SO AS TO APPEAR TO BE A SUNBURST.

SN 77-982,894, FILED 9-23-2006.

AISHA CLARKE, EXAMINING ATTORNEY



*David J. Kybas*

Director of the United States Patent and Trademark Office

# United States of America

United States Patent and Trademark Office

# SUNMET



**Reg. No. 4,126,013**

**Registered Apr. 10, 2012**

**Int. Cl.: 29**

**TRADEMARK**

**PRINCIPAL REGISTER**

ETCHEGARAY FARMS, LLC (CALIFORNIA LIMITED LIABILITY COMPANY)  
P.O. BOX 964  
VISALIA, CA 93279

FOR: PROCESSED FRUITS, NAMELY, FROZEN, DEHYDRATED, VACUUM-PACKED, ASEPTICALLY-PACKAGED, SLICED AND DICED, CHERRIES, KIWI FRUIT, ORANGES, AND POMEGRANATES(EXCLUDING DEHYDRATED GRAPES, APPLES, CHERRIES, NECTARINES, PLUMS AND PEACHES), IN CLASS 29 (U.S. CL. 46).

FIRST USE 12-2-2011; IN COMMERCE 12-2-2011.

THE MARK CONSISTS OF THE WORD SUNMET, STYLIZED TO CREATE A SHADOW EFFECT, PLACED ABOVE A SEMI-CIRCLE STYLIZED SO AS TO APPEAR TO BE A SUNBURST.

SN 77-982,895, FILED 9-23-2006.

AISHA CLARKE, EXAMINING ATTORNEY



*David J. Kyffers*

Director of the United States Patent and Trademark Office

# United States of America

United States Patent and Trademark Office

## HAZELDEN LIFELINES

**Reg. No. 4,126,014**

**Registered Apr. 10, 2012**

**Int. Cl.: 41**

**SERVICE MARK**

**PRINCIPAL REGISTER**

HAZELDEN FOUNDATION (MINNESOTA CORPORATION)  
15251 PLEASANT VALLEY ROAD  
CENTER CITY, MN 55012

FOR: EDUCATIONAL SERVICES, NAMELY, PROVIDING CURRICULUM AND WORKSHOPS IN THE FIELD OF ADDICTION PREVENTION, TREATMENT, AND SUICIDE AWARENESS AND PREVENTION, AND TRAINING MATERIALS AND EDUCATIONAL MATERIALS FOR THE BENEFIT OF OTHERS FOR THE FURTHERING OF THE GROWTH AND DEVELOPMENT OF ADDICTION PREVENTION, TREATMENT, AND SUICIDE AWARENESS AND PREVENTION DISTRIBUTED THEREWITH, IN CLASS 41 (U.S. CLS. 100, 101 AND 107).

FIRST USE 12-7-2011; IN COMMERCE 12-7-2011.

THE MARK CONSISTS OF STANDARD CHARACTERS WITHOUT CLAIM TO ANY PARTICULAR FONT, STYLE, SIZE, OR COLOR.

OWNER OF U.S. REG. NOS. 3,497,294, 3,497,297, AND OTHERS.

SN 77-982,943, FILED 10-5-2009.

MIDGE BUTLER, EXAMINING ATTORNEY



*David J. Kyffers*

Director of the United States Patent and Trademark Office

# United States of America

United States Patent and Trademark Office

# ECHOSTAR

**Reg. No. 4,126,015**

**Registered Apr. 10, 2012**

**Int. Cl.: 9**

**TRADEMARK**

**PRINCIPAL REGISTER**

ECHOSTAR TECHNOLOGIES L.L.C. (TEXAS LIMITED LIABILITY COMPANY)  
100 INVERNESS TERRACE EAST  
ENGLEWOOD, CO 80112

FOR: COMMUNICATIONS EQUIPMENT, NAMELY, DIGITAL VIDEO RECORDERS, AUDIO-VIDEO RECEIVERS, SIGNAL FREQUENCY RECEIVERS AND ANTENNAE FOR RECEIVING SIGNAL FREQUENCIES; COMMUNICATIONS SOFTWARE, NAMELY, SYSTEM APPLICATION AND OPERATING SOFTWARE FOR RESIDENTIAL AND COMMERCIAL TELEVISION RECEIVER SYSTEMS AND PLACE SHIFTING DEVICES; SOFTWARE REFLECTING THE ON-SCREEN LISTING OF AVAILABLE PROGRAMMING; RECEIVERS FOR RECEIVING AUDIO, VIDEO AND DATA SIGNALS DISTRIBUTED VIA SATELLITE; SATELLITE TELEVISION RECEIVERS; TERRESTRIAL TELEVISION RECEIVERS; INTERNET TELEVISION RECEIVERS; PROGRAMMABLE DIGITAL TELEVISION RECORDERS; PLACE SHIFTING DEVICES; HOME AUDIO AND VIDEO SERVERS; DIGITAL MEDIA ADAPTERS; VIDEO TRANSMITTERS; STORAGE DEVICES FOR STORING AUDIO, VIDEO, IMAGE AND DATA INFORMATION; ELECTRONIC APPARATUS AND DEVICES FOR CONTROLLING ACCESS TO PAY-TELEVISION SERVICES; COMMUNICATIONS SOFTWARE, NAMELY, NETWORKING SOFTWARE FOR AUDIO, VIDEO AND DATA DISTRIBUTION SYSTEMS; COMPUTER HARDWARE AND SOFTWARE FOR CONTROLLING THE OPERATION OF AUDIO AND VIDEO DEVICES AND FOR VIEWING, SEARCHING AND PLAYING AUDIO, VIDEO, TELEVISION, MOVIES, PHOTOGRAPHS AND OTHER DIGITAL IMAGES; COMPUTER SOFTWARE FOR USE IN ORGANIZING, TRANSMITTING, RECEIVING, MANIPULATING, PLAYING AND REVIEWING TEXT, DATA, IMAGE, AUDIO, AND VIDEO FILES; DISTRIBUTION SYSTEMS FOR TRANSMITTING AUDIO, VIDEO AND DATA SIGNALS FROM A RECEIVER TO PRESENTATION CLIENT DEVICES; COMPUTER HARDWARE AND SOFTWARE FOR STREAMING AUDIO, VIDEO, IMAGE AND DATA INFORMATION TO A VARIETY OF CLIENT DEVICES, NAMELY, TELEVISIONS, PERSONAL COMPUTERS, MOBILE PHONES, PERSONAL DIGITAL ASSISTANTS (PDA) AND STAND-ALONE HARDWARE DECODERS; PARTS AND FITTINGS OF THE AFOREMENTIONED GOODS; OPERATOR MAINTENANCE AND INSTRUCTIONAL MANUALS DISTRIBUTED THEREWITH, IN CLASS 9 (U.S. CLS. 21, 23, 26, 36 AND 38).



*David J. Kybas*

Director of the United States Patent and Trademark Office

FIRST USE 3-31-1988; IN COMMERCE 3-31-1988.

THE MARK CONSISTS OF STANDARD CHARACTERS WITHOUT CLAIM TO ANY PARTICULAR FONT, STYLE, SIZE, OR COLOR.

**Reg. No. 4,126,015** SN 77-982,953, FILED 2-12-2009.

JOHN WILKE, EXAMINING ATTORNEY

# United States of America

United States Patent and Trademark Office

## JACKSON GUTHY

**Reg. No. 4,126,016**

JACKSON GUTHY (UNITED STATES INDIVIDUAL)  
9663 SANTA MONICA BOULEVARD, #700  
BEVERLY HILLS, CA 90210

**Registered Apr. 10, 2012**

**Int. Cl.: 41**

FOR: ENTERTAINMENT, NAMELY, LIVE MUSICAL AND THEATRICAL PERFORMANCES,  
IN CLASS 41 (U.S. CLS. 100, 101 AND 107).

**SERVICE MARK**

FIRST USE 4-30-2011; IN COMMERCE 4-30-2011.

**PRINCIPAL REGISTER**

THE MARK CONSISTS OF STANDARD CHARACTERS WITHOUT CLAIM TO ANY PAR-  
TICULAR FONT, STYLE, SIZE, OR COLOR.

THE NAME "JACKSON GUTHY" IDENTIFIES A LIVING INDIVIDUAL WHOSE CONSENT  
IS OF RECORD.

SN 77-982,974, FILED 8-5-2009.

MARK PILARO, EXAMINING ATTORNEY



*David J. Kybas*

Director of the United States Patent and Trademark Office



# United States of America

United States Patent and Trademark Office

# ASANA

**Reg. No. 4,126,017**

**Registered Apr. 10, 2012**

**Int. Cl.: 9**

**TRADEMARK**

**PRINCIPAL REGISTER**

ASANA, INC. (DELAWARE CORPORATION)  
1550 BRYANT STREET, SUITE 100  
SAN FRANCISCO, CA 94103

FOR: SOFTWARE FOR USE IN TASK AND PROJECT MANAGEMENT; SOFTWARE FOR ELECTRONIC COMMUNICATIONS, INCLUDING CHATS, EMAIL AND DISCUSSIONS; SOFTWARE FOR FACILITATING THE EXCHANGE OF INFORMATION VIA THE INTERNET FEATURING COLLABORATION TOOLS; SOFTWARE FOR USE IN SHARING INFORMATION FOR THE FACILITATION OF COLLABORATIVE WORKING AND INTERACTIVE DISCUSSIONS; SOFTWARE FOR PROVIDING TOOLS USED IN AND FOR CUSTOMER RELATIONSHIP MANAGEMENT; SOFTWARE FOR ENTERPRISE RESOURCE PLANNING; SOFTWARE FOR PROVIDING TOOLS USED IN AND FOR HUMAN RESOURCES MANAGEMENT; SOFTWARE FOR PROVIDING TOOLS USED IN AND FOR RECRUITING; SOFTWARE FOR PROVIDING TOOLS THAT ALLOW USERS TO CONDUCT PERFORMANCE REVIEWS; SOFTWARE PLATFORM FOR CREATING, STORING, MANAGING, AND RETRIEVING STRUCTURED DATA; SOFTWARE FOR PROVIDING MEANS FOR UTILIZING ABSTRACTED FUNCTIONALITY FOR IDENTITY, ACCESS CONTROL, SUBSCRIPTIONS, NOTIFICATIONS, AND EDITING OF DATA, IN CLASS 9 (U.S. CLS. 21, 23, 26, 36 AND 38).

FIRST USE 11-24-2009; IN COMMERCE 11-24-2009.

THE MARK CONSISTS OF STANDARD CHARACTERS WITHOUT CLAIM TO ANY PARTICULAR FONT, STYLE, SIZE, OR COLOR.

SN 77-982,976, FILED 7-28-2009.

JESSICA A. POWERS, EXAMINING ATTORNEY



*David J. Kyjars*

Director of the United States Patent and Trademark Office

# United States of America

United States Patent and Trademark Office

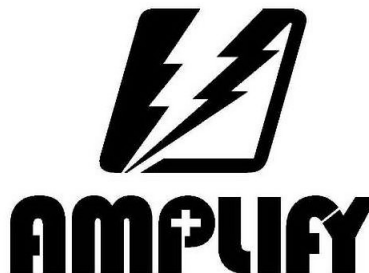

**Reg. No. 4,126,018**

SEARS BRANDS, LLC (ILLINOIS LIMITED LIABILITY COMPANY)  
3333 BEVERLY ROAD  
HOFFMAN ESTATES, IL 60179

**Registered Apr. 10, 2012**

**Int. Cl.: 25**

FOR: APPAREL, NAMELY, TOPS, BOTTOMS, SHIRTS, SWEATERS, PANTS, JEANS, SHORTS, JACKETS, COATS, SWIMWEAR; CLOTHING ACCESSORIES, NAMELY, SOCKS, HATS, BELTS, IN CLASS 25 (U.S. CLS. 22 AND 39).

**TRADEMARK**

FIRST USE 7-0-2010; IN COMMERCE 7-0-2010.

**PRINCIPAL REGISTER**

THE MARK CONSISTS OF A STYLIZED LIGHTNING BOLT APPEARING ABOVE THE WORD "AMPLIFY" WITH A DESIGN OF A CROSS APPEARING IN THE CENTER OF THE LETTER "P".

SN 77-983,024, FILED 2-9-2010.

BRIAN PINO, EXAMINING ATTORNEY



*David J. Kybas*

Director of the United States Patent and Trademark Office

# United States of America

United States Patent and Trademark Office

## Hollywood Life

**Reg. No. 4,126,019**

**Registered Apr. 10, 2012**

**Int. Cl.: 41**

**SERVICE MARK**

**PRINCIPAL REGISTER**

HOLLYWOODLIFE.COM, LLC (CALIFORNIA LIMITED LIABILITY COMPANY)  
14TH FLOOR  
9800 SOUTH LA CIENEGA BLVD.  
INGLEWOOD, CA 90301

FOR: CONTESTS AND INCENTIVE AWARD PROGRAMS TO ENCOURAGE STUDENTS AND ORGANIZATION MEMBERS TO SET UP AND ACHIEVE GOALS IN ACADEMICS, ATTENDANCE, CITIZENSHIP AND CONDUCT; PROVIDING RECOGNITION AND INCENTIVES BY THE WAY OF AWARDS AND CONTESTS TO DEMONSTRATE EXCELLENCE IN THE FIELD OF POP CULTURE, ACTING, MOVIES, THEATER, TELEVISION SHOWS, FASHION, LIFESTYLE AND SPORTS; ENTERTAINMENT SERVICES, NAMELY, THE PROVISION OF CONTINUING PROGRAMS FEATURING TOPICS ON POP CULTURE, ACTING, MOVIES, THEATER, TELEVISION SHOWS, FASHION, LIFESTYLE AND SPORTS FIGURES DELIVERED BY RADIO, TELEVISION, SATELLITE AND COMPUTER NETWORKS; ON-LINE JOURNALS, NAMELY, BLOGS FEATURING POP CULTURE, ACTING, MOVIES, THEATER, TELEVISION SHOWS, FASHION, LIFESTYLE AND SPORTS TOPICS; PRODUCTION OF DVDS, VIDEOTAPES AND TELEVISION PROGRAMS FEATURING POP CULTURE, ACTING, MOVIES, THEATER, TELEVISION SHOWS, FASHION, LIFESTYLE, AND SPORTS TOPICS; PROVIDING RATINGS FOR TELEVISION, MOVIE, MUSIC, VIDEO AND VIDEO GAME CONTENT; TELEVISION SHOW PRODUCTION; ENTERTAINMENT SERVICES, NAMELY, PROVIDING A WEBSITE THAT DISPLAYS REVIEWS, RECOMMENDATIONS, RANKINGS, TRACKINGS, VOTES AND INFORMATION RELATING TO UNCREATED, UNRELEASED, NEW, SPECIAL, POPULAR, AND RARE PRODUCTS, SERVICES, AND EVENTS IN THE FIELDS OF POP CULTURE, ACTING, MOVIES, THEATER, TELEVISION SHOWS, FASHION, LIFESTYLE, AND SPORTS, ALL EXCLUSIVELY FOR NON-BUSINESS AND NON-COMMERCIAL TRANSACTIONS AND PURPOSES; PROVIDING ON-LINE ENTERTAINMENT INFORMATION; ELECTRONIC PUBLISHING SERVICES, NAMELY, PUBLICATION OF TEXT AND GRAPHIC WORKS OF OTHERS ON CDS, DVDS AND ON-LINE DIGITAL FORMATS FEATURING POP CULTURE, ACTING, MOVIES, THEATER, TELEVISION SHOWS, FASHION, LIFESTYLE AND SPORTS; ENTERTAINMENT SERVICES, NAMELY, PROVIDING ON-LINE REVIEWS OF ACTING, MOVIES, THEATER AND TELEVISION SHOWS; PROVISION OF A WEB SITE FEATURING INFORMATION ON POP CULTURE, ENTERTAINMENT AND SPORTS, IN CLASS 41 (U.S. CLS. 100, 101 AND 107).



*David J. Kyjars*

FIRST USE 12-1-2011; IN COMMERCE 12-1-2011.

**Reg. No. 4,126,019** THE MARK CONSISTS OF STANDARD CHARACTERS WITHOUT CLAIM TO ANY PARTICULAR FONT, STYLE, SIZE, OR COLOR.

NO CLAIM IS MADE TO THE EXCLUSIVE RIGHT TO USE "HOLLYWOOD", APART FROM THE MARK AS SHOWN.

SN 77-983,036, FILED 7-15-2009.

IRA J. GOODSaid, EXAMINING ATTORNEY

# United States of America

United States Patent and Trademark Office

# ABCDNA

**Reg. No. 4,126,020**

A.B.C. HOME FURNISHINGS, INC. (NEW YORK CORPORATION)  
888 BROADWAY  
NEW YORK, NY 10003

**Registered Apr. 10, 2012**

**Int. Cl.: 35**

FOR: RETAIL STORE SERVICES FEATURING FURNITURE, HOME FURNISHINGS, BEDDING, LINENS, HOME ACCESSORIES, ACCESSORIES, AND JEWELRY, IN CLASS 35 (U.S. CLS. 100, 101 AND 102).

**SERVICE MARK**

FIRST USE 9-0-2011; IN COMMERCE 9-0-2011.

**PRINCIPAL REGISTER**

THE MARK CONSISTS OF STANDARD CHARACTERS WITHOUT CLAIM TO ANY PARTICULAR FONT, STYLE, SIZE, OR COLOR.

OWNER OF U.S. REG. NOS. 2,384,468, 2,394,540, AND OTHERS.

SN 77-983,037, FILED 6-4-2009.

GINA FINK, EXAMINING ATTORNEY



*David J. Kybas*

Director of the United States Patent and Trademark Office

# United States of America

## United States Patent and Trademark Office



**Reg. No. 4,126,021**

FACEBOOK, INC. (DELAWARE CORPORATION)  
1601 WILLOW ROAD  
MENLO PARK, CA 94025

**Registered Apr. 10, 2012**

**Int. Cls.: 35, 36, and 41**

FOR: INCENTIVE AWARD PROGRAMS TO PROMOTE THE SALE OF SERVICES AND PRODUCTS OF THIRD PARTIES; ADVERTISING, NAMELY, PROMOTING THE GOODS AND SERVICES OF THIRD PARTIES VIA COMPUTER AND COMMUNICATION NETWORKS, IN CLASS 35 (U.S. CLS. 100, 101 AND 102).

**SERVICE MARK**

**PRINCIPAL REGISTER**

FIRST USE 2-0-2010; IN COMMERCE 2-0-2010.

FOR: FINANCIAL EXCHANGE SERVICES, NAMELY, PROVIDING A VIRTUAL CURRENCY FOR USE BY MEMBERS OF AN ONLINE COMMUNITY VIA COMPUTER AND COMMUNICATION NETWORKS; INCENTIVE AWARD PROGRAMS FOR THE PURPOSE OF RAISING MONEY FOR A WIDE VARIETY OF CHARITABLE CAUSES, IN CLASS 36 (U.S. CLS. 100, 101 AND 102).

FIRST USE 2-0-2010; IN COMMERCE 2-0-2010.

FOR: PROVIDING INFORMATION RELATING TO INTERACTIVE, MULTIPLAYER AND SINGLE PLAYER GAMES VIA COMPUTER AND COMMUNICATIONS NETWORKS, IN CLASS 41 (U.S. CLS. 100, 101 AND 107).

FIRST USE 2-0-2010; IN COMMERCE 2-0-2010.

THE MARK CONSISTS OF AN IMAGE OF A GOLD AND WHITE COIN, OUTLINED IN BROWN WITH A GLOBE FEATURING TWO ARROWS DEPICTED INSIDE, WITH THE LETTER "F" FEATURED IN A BLUE SQUARE WITH A LIGHTER BLUE LINE ALONG THE BOTTOM.

THE COLOR(S) GOLD, WHITE, BROWN, BLUE AND LIGHT BLUE IS/ARE CLAIMED AS A FEATURE OF THE MARK.

SN 77-983,039, FILED 2-11-2010.

JAY FLOWERS, EXAMINING ATTORNEY



*David J. Kyffers*

Director of the United States Patent and Trademark Office

# United States of America

United States Patent and Trademark Office



**Reg. No. 4,126,022**

DUANE READE INTERNATIONAL, LLC (DELAWARE LIMITED LIABILITY COMPANY)  
440 9TH AVENUE, 6TH FLOOR  
NEW YORK, NY 10001

**Registered Apr. 10, 2012**

**Int. Cl.: 18**

FOR: COSMETIC BAGS SOLD EMPTY, IN CLASS 18 (U.S. CLS. 1, 2, 3, 22 AND 41).

**TRADEMARK**

FIRST USE 10-31-2009; IN COMMERCE 10-31-2009.

**PRINCIPAL REGISTER**

THE MARK CONSISTS OF THE WORD "LOOK" IN CAPITAL BLOCK LETTERS FOLLOWED BY THE LOWER CASE LETTERS "NY" ALL IN STYLIZED LETTERING FOLLOWED BY A HEART DESIGN ENCLOSED WITHIN AN INCOMPLETE CIRCLE.

SN 77-983,042, FILED 7-29-2009.

KIM MONINGHOFF, EXAMINING ATTORNEY



*David J. Kyffers*

Director of the United States Patent and Trademark Office

# United States of America

United States Patent and Trademark Office

# ULTRATECH

**Reg. No. 4,126,023**

VOLM COMPANIES, INC. (WISCONSIN CORPORATION)  
1804 N. EDISON ST.  
ANTIGO, WI 55409

**Registered Apr. 10, 2012**

**Int. Cl.: 16**

FOR: SYNTHETIC RESIN MESH, PRIMARILY PLASTIC, BAGS FOR PACKAGING FRESH PRODUCE, IN CLASS 16 (U.S. CLS. 2, 5, 22, 23, 29, 37, 38 AND 50).

**TRADEMARK**

FIRST USE 2-1-2012; IN COMMERCE 2-1-2012.

**PRINCIPAL REGISTER**

THE MARK CONSISTS OF STANDARD CHARACTERS WITHOUT CLAIM TO ANY PARTICULAR FONT, STYLE, SIZE, OR COLOR.

SN 77-983,044, FILED 1-12-2010.

MATTHEW PAPPAS, EXAMINING ATTORNEY



*David J. Kypas*

Director of the United States Patent and Trademark Office



# United States of America

United States Patent and Trademark Office

## WHAT'S IT WORTH

**Reg. No. 4,126,024**

**Registered Apr. 10, 2012**

**Int. Cl.: 41**

**SERVICE MARK**

**PRINCIPAL REGISTER**

YANKEES ENTERTAINMENT AND SPORTS NETWORK, LLC (DELAWARE LIMITED LIABILITY COMPANY)  
405 LEXINGTON AVENUE, 36TH FLOOR  
NEW YORK, NY 101743699

FOR: ENTERTAINMENT IN THE NATURE OF ONGOING TELEVISION PROGRAMS IN THE FIELD OF ENTERTAINMENT PROGRAMMING FEATURING THE EVALUATION OF SPORTS MEMORABILIA, IN CLASS 41 (U.S. CLS. 100, 101 AND 107).

FIRST USE 11-2-2002; IN COMMERCE 11-2-2002.

THE MARK CONSISTS OF STANDARD CHARACTERS WITHOUT CLAIM TO ANY PARTICULAR FONT, STYLE, SIZE, OR COLOR.

SN 78-096,820, FILED 12-5-2001.

CHARLOTTE CORWIN, EXAMINING ATTORNEY



*David J. Kyffers*

Director of the United States Patent and Trademark Office

# United States of America

United States Patent and Trademark Office

## TAKE CARE HEALTH CENTER

**Reg. No. 4,126,025**

**Registered Apr. 10, 2012**

**Int. Cl.: 44**

**SERVICE MARK**

**PRINCIPAL REGISTER**

TAKE CARE HEALTH SYSTEMS, LLC (DELAWARE LIMITED LIABILITY COMPANY)  
161 WASHINGTON ST.  
EIGHT TOWER BRIDGE, SUITE 1400  
CONSHOHOCKEN, PA 19428

FOR: MANAGED HEALTH CARE SERVICES, NAMELY, PROVIDING MEDICAL AND PHARMACEUTICAL CONSULTATION, PERFORMING DIAGNOSIS AND TREATMENT OF DISEASES, MEDICAL TESTING, AND PROVIDING HEALTH CARE INFORMATION BY PHONE AND THE INTERNET; MEDICAL CLINICS; AND MOBILE HEALTHCARE CENTERS, IN CLASS 44 (U.S. CLS. 100 AND 101).

FIRST USE 6-0-2006; IN COMMERCE 6-0-2006.

THE MARK CONSISTS OF STANDARD CHARACTERS WITHOUT CLAIM TO ANY PARTICULAR FONT, STYLE, SIZE, OR COLOR.

NO CLAIM IS MADE TO THE EXCLUSIVE RIGHT TO USE "HEALTH CENTER", APART FROM THE MARK AS SHOWN.

SN 78-537,747, FILED 12-23-2004.

DAVID MURRAY, EXAMINING ATTORNEY



*David J. Kyros*

Director of the United States Patent and Trademark Office

# United States of America

United States Patent and Trademark Office

## FEDEX CUSTOM CRITICAL AIR EXPEDITE NETWORK

**Reg. No. 4,126,026**

FEDERAL EXPRESS CORPORATION (DELAWARE CORPORATION)  
3620 HACKS CROSS ROAD, BLDG B, 3RD FL  
MEMPHIS, TN 38125

**Registered Apr. 10, 2012**

**Int. Cl.: 39**

FOR: PICK-UP, TRANSPORTATION, STORAGE AND DELIVERY OF DOCUMENTS,  
PACKAGES AND FREIGHT BY LAND AND AIR, IN CLASS 39 (U.S. CLS. 100 AND 105).

**SERVICE MARK**

FIRST USE 10-1-2011; IN COMMERCE 10-1-2011.

**PRINCIPAL REGISTER**

THE MARK CONSISTS OF STANDARD CHARACTERS WITHOUT CLAIM TO ANY PAR-  
TICULAR FONT, STYLE, SIZE, OR COLOR.

OWNER OF U.S. REG. NOS. 971,628, 3,057,886, AND OTHERS.

NO CLAIM IS MADE TO THE EXCLUSIVE RIGHT TO USE "AIR", "EXPEDITE" AND  
"NETWORK", APART FROM THE MARK AS SHOWN.

SN 78-726,303, FILED 10-4-2005.

MARK RADEMACHER, EXAMINING ATTORNEY



*David J. Kyjars*

Director of the United States Patent and Trademark Office

# United States of America

United States Patent and Trademark Office

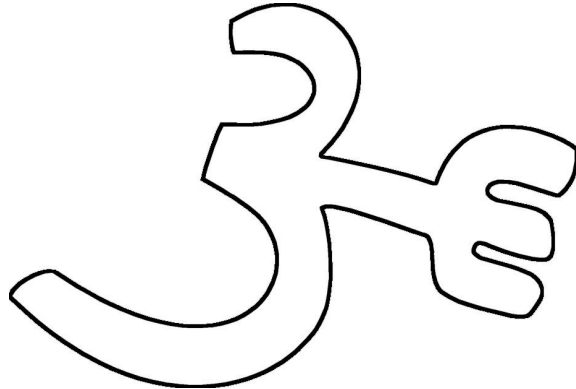

**Reg. No. 4,126,027**

THREE FORKS RANCH CORP. (WYOMING CORPORATION)  
7701 FORSYTH  
ST. LOUIS, MO 63105

**Registered Apr. 10, 2012**

**Int. Cls.: 13, 25, and 28**

FOR: FIREARMS, NAMELY, SPORTING RIFLES, IN CLASS 13 (U.S. CLS. 2 AND 9).

**TRADEMARK**

FIRST USE 8-0-2007; IN COMMERCE 8-0-2007.

**PRINCIPAL REGISTER**

FOR: JACKETS, PANTS, SHIRTS, VESTS, RAINWEAR, IN CLASS 25 (U.S. CLS. 22 AND 39).

FIRST USE 1-0-2008; IN COMMERCE 1-0-2008.

FOR: FISHING GEAR, NAMELY, FISHING REELS AND HAND-HELD NETS, IN CLASS 28 (U.S. CLS. 22, 23, 38 AND 50).

FIRST USE 5-0-2006; IN COMMERCE 5-0-2006.

THE MARK CONSISTS OF STYLIZED NUMBER 3 WITH A HORIZONTAL, THREE-PRONGED FORK JUTTING OUT TO THE RIGHT FROM THE MIDDLE OF THE NUMBER 3.

SN 78-859,670, FILED 4-12-2006.

MYRIAH HABEEB, EXAMINING ATTORNEY



*David J. Kybas*

Director of the United States Patent and Trademark Office

# United States of America

United States Patent and Trademark Office



**Reg. No. 4,126,028**

THREE FORKS RANCH CORP. (WYOMING CORPORATION)  
7701 FORSYTH  
ST. LOUIS, MO 63105

**Registered Apr. 10, 2012**

**Int. Cls.: 13 and 25**

FOR: FIREARMS, NAMELY, SPORTING RIFLES, IN CLASS 13 (U.S. CLS. 2 AND 9).

**TRADEMARK**

FIRST USE 8-0-2007; IN COMMERCE 8-0-2007.

**PRINCIPAL REGISTER**

FOR: JACKETS, PANTS, SHIRTS, RAINWEAR, IN CLASS 25 (U.S. CLS. 22 AND 39).

FIRST USE 1-0-2008; IN COMMERCE 1-0-2008.

THE MARK CONSISTS OF A STYLIZED NUMBER 3 WITH A HORIZONTAL, THREE-PRONGED FORK JUTTING OUT TO THE RIGHT FROM THE MIDDLE OF THE NUMBER 3; BENEATH THAT IS THE PHRASE "THREE FORKS", WHICH IS OVER LINED AND UNDERLINED WITH HORIZONTAL LINES; THE OVER LINE ALSO HAS A HORSE-SHOE SHAPED SEMI-CIRCLE THAT ARCS AROUND THE STYLIZED NUMBER 3; THE TOPS OF THE LETTERS "T" AND "H" IN "THREE" AND "K" IN "FORKS" FUNCTION AS THE OVER LINE ABOVE THE PHRASE "THREE FORKS"; BENEATH THE UNDERLINE IS THE WORD "RANCH", WITH A BREAK IN THE UNDERLINE FOR THE TOP OF THE LETTERS "R" AND "H" IN "RANCH".

SN 78-859,691, FILED 4-12-2006.

MYRIAH HABEEB, EXAMINING ATTORNEY



*David J. Kyros*

Director of the United States Patent and Trademark Office

# United States of America

United States Patent and Trademark Office



**Reg. No. 4,126,029**

**Registered Apr. 10, 2012**

**Int. Cl.: 21**

**TRADEMARK**

**PRINCIPAL REGISTER**

HEB GROCERY COMPANY, LP (TEXAS LIMITED PARTNERSHIP)  
CORPORATE LAW DEPARTMENT  
646 SOUTH MAIN  
SAN ANTONIO, TX 78204

FOR: DINNERWARE; SCRUBBING BRUSHES; CLEANING BRUSHES FOR HOUSEHOLD USE; DISPOSABLE DINNERWARE, NAMELY, PLATES, BOWLS, AND CUPS; POTTIES FOR CHILDREN AND POTTY TRAINING SEATS; PLASTIC STORAGE CONTAINERS FOR HOUSEHOLD OR DOMESTIC USE; PLASTIC STORAGE CONTAINERS FOR HOUSEHOLD OR DOMESTIC USE, NAMELY, INFANT FORMULA STORAGE CONTAINERS AND DISPENSERS AND SNACK STORAGE CONTAINERS AND DISPENSERS, IN CLASS 21 (U.S. CLS. 2, 13, 23, 29, 30, 33, 40 AND 50).

FIRST USE 5-31-2011; IN COMMERCE 5-31-2011.

OWNER OF U.S. REG. NOS. 3,710,082, 3,710,083, AND 3,710,084.

THE MARK CONSISTS OF THE WORDING "WEE" AND DESIGNS WITHIN AN OVAL BORDER. THE WORDING APPEARS IN A STYLIZED FONT, AND LINES AROUND THE LETTERS SUGGEST MOVEMENT.

SN 85-001,759, FILED 3-30-2010.

CORY BOONE, EXAMINING ATTORNEY



*David J. Kybas*

Director of the United States Patent and Trademark Office

# United States of America

United States Patent and Trademark Office

# WOMANSMART

**Reg. No. 4,126,030**

**Registered Apr. 10, 2012**

**Int. Cl.: 35**

**SERVICE MARK**

**PRINCIPAL REGISTER**

COMMUNICATIONS STRATEGIES, INC. (NEW JERSEY CORPORATION)  
135-137 MAIN STREET  
MADISON, NJ 07940

FOR: ADVERTISING SERVICES, PUBLIC RELATIONS AND MARKETING SERVICES, NAMELY, PROMOTING AND MARKETING THE GOODS AND SERVICES OF OTHERS THROUGH ALL PUBLIC COMMUNICATION MEANS; MARKETING AND CONSULTING SERVICES IN THE FIELD OF PROMOTING AND TRACKING THE GOODS, SERVICES, AND BRANDS OF OTHERS THROUGH ALL PUBLIC COMMUNICATION MEANS, PARTICULARLY SPECIALIZING IN THE USE OF MOBILE, SOCIAL, AND PRINT MEDIA TO DRIVE CONSUMER INTEREST, ENGAGEMENT AND ACTION; PROMOTION AND MARKETING SERVICES AND RELATED CONSULTING; PUBLIC RELATIONS, IN CLASS 35 (U.S. CLS. 100, 101 AND 102).

FIRST USE 1-29-2001; IN COMMERCE 7-25-2001.

THE MARK CONSISTS OF THE WORD "WOMANSMART" WITH THE LETTER "O" REPRESENTED BY A SUN WITH RAYS.

SN 85-001,990, FILED 3-30-2010.

HOWARD B. LEVINE, EXAMINING ATTORNEY



*David J. Kybas*

Director of the United States Patent and Trademark Office

# United States of America

United States Patent and Trademark Office

## CHIEF KAHAI

**Reg. No. 4,126,031**

**Registered Apr. 10, 2012**

**Int. Cl.: 30**

**TRADEMARK**

**PRINCIPAL REGISTER**

LEWIS BROTHERS BAKERIES, INCORPORATED (MISSOURI CORPORATION), DBA  
LEWIS BAKERIES, INC.,  
500 N. FULTON AVENUE  
EVANSVILLE, IN 47710

FOR: BREAD; ROLLS, IN CLASS 30 (U.S. CL. 46).

FIRST USE 3-7-2011; IN COMMERCE 3-7-2011.

THE MARK CONSISTS OF STANDARD CHARACTERS WITHOUT CLAIM TO ANY PARTICULAR FONT, STYLE, SIZE, OR COLOR.

SN 85-002,235, FILED 3-30-2010.

ALLISON SCHRODY, EXAMINING ATTORNEY



*David J. Kybas*

Director of the United States Patent and Trademark Office



# United States of America

United States Patent and Trademark Office

## SPIILLED MILK

**Reg. No. 4,126,032**

THE RABBIT HOLE BAKESHOP, LLC (NEW JERSEY LIMITED LIABILITY COMPANY)  
8 TUXEDO PLACE  
MORRISTOWN, NJ 07960

**Registered Apr. 10, 2012**

**Int. Cl.: 30**

FOR: BAKERY PRODUCTS, NAMELY, COOKIES, IN CLASS 30 (U.S. CL. 46).

**TRADEMARK**

FIRST USE 9-0-2009; IN COMMERCE 9-0-2009.

**PRINCIPAL REGISTER**

THE MARK CONSISTS OF STANDARD CHARACTERS WITHOUT CLAIM TO ANY PARTICULAR FONT, STYLE, SIZE, OR COLOR.

SN 85-003,859, FILED 4-2-2010.

FONG HSU, EXAMINING ATTORNEY



*David J. Kyffers*

Director of the United States Patent and Trademark Office

# United States of America

United States Patent and Trademark Office



**Reg. No. 4,126,033**

**Registered Apr. 10, 2012**

**Int. Cl.: 18**

**TRADEMARK**

**PRINCIPAL REGISTER**

JILL MILAN LLC (CALIFORNIA LIMITED LIABILITY COMPANY)  
80 EDDYSTONE COURT  
REDWOOD CITY, CA 94065

FOR: ALL-PURPOSE CARRYING BAGS; BRIEFCASES; HANDBAGS; OVERNIGHT BAGS;  
PURSES; TOTE BAGS; WALLETS, IN CLASS 18 (U.S. CLS. 1, 2, 3, 22 AND 41).

FIRST USE 4-0-2011; IN COMMERCE 4-0-2011.

THE MARK CONSISTS OF A STYLIZED "JM" INSIDE A BLACK SQUARE, FRAMED BY  
A WHITE AND BLACK BORDER.

SN 85-004,436, FILED 4-1-2010.

JIM RINGLE, EXAMINING ATTORNEY



*David J. Kybas*

Director of the United States Patent and Trademark Office

# United States of America

United States Patent and Trademark Office

# OLE

**Reg. No. 4,126,034**

MIRATEC SYSTEMS, INC. (MINNESOTA CORPORATION)  
640 OLIVE STREET  
SAINT PAUL, MN 55401

**Registered Apr. 10, 2012**

**Int. Cl.: 35**

FOR: ONLINE SERVICES FEATURING VISUAL COMMUNICATIONS PRODUCTS, SERVICES AND SUPPLIES IN THE NATURE OF PROVIDING ONLINE BUSINESS INFORMATION CONCERNING THE PURCHASE OF VISUAL COMMUNICATIONS PRODUCTS, NAMELY, PROVIDING ONLINE PRICE ESTIMATES, PROVIDING CUSTOMER ORDER STATUS INFORMATION, PROVIDING AUTOMATIC PRICE QUOTATIONS, PROVIDING PRODUCT AVAILABILITY INFORMATION AND PROVIDING PRODUCT DELIVERY AND PURCHASE ORDER TRACKING INFORMATION; PROVIDING AN ONLINE COMPUTER DATABASE FEATURING CONSUMER PRODUCT INFORMATION IN THE FIELD OF VISUAL COMMUNICATIONS PRODUCTS; PROVIDING ONLINE ORDERING SERVICES FEATURING VISUAL COMMUNICATIONS PRODUCTS; PROVIDING AN ONLINE COMPUTER DATABASE FEATURING CUSTOMER SERVICES IN THE FIELD OF VISUAL COMMUNICATIONS PRODUCTS, NAMELY, PROVIDING AN ON-LINE COMPUTER DATABASE IN THE FIELD OF LOCATING PRODUCTS, DESCRIBING PRODUCTS, AND PRICING PRODUCTS, IN CLASS 35 (U.S. CLS. 100, 101 AND 102).

**SERVICE MARK**

**PRINCIPAL REGISTER**

FIRST USE 4-8-2010; IN COMMERCE 4-8-2010.

THE MARK CONSISTS OF STANDARD CHARACTERS WITHOUT CLAIM TO ANY PARTICULAR FONT, STYLE, SIZE, OR COLOR.

SN 85-004,530, FILED 4-1-2010.

LEIGH LOWRY, EXAMINING ATTORNEY



*David J. Kyffers*

Director of the United States Patent and Trademark Office

# United States of America

United States Patent and Trademark Office

## Baseball Gameplan

**Reg. No. 4,126,035**

SHOTZOOM LLC (ARIZONA LIMITED LIABILITY COMPANY)  
8283 N HAYDEN SUITE 258  
SCOTTSDALE, AZ 85258

**Registered Apr. 10, 2012**

**Int. Cl.: 9**

FOR: DOWNLOADABLE SOFTWARE IN THE NATURE OF A MOBILE APPLICATION FOR USE IN BASEBALL TRAINING TECHNIQUES, BASEBALL INSTRUCTIONAL STRATEGIES, AND BASEBALL FUNDAMENTALS, IN CLASS 9 (U.S. CLS. 21, 23, 26, 36 AND 38).

**TRADEMARK**

FIRST USE 4-1-2010; IN COMMERCE 4-1-2010.

**PRINCIPAL REGISTER**

THE MARK CONSISTS OF STANDARD CHARACTERS WITHOUT CLAIM TO ANY PARTICULAR FONT, STYLE, SIZE, OR COLOR.

NO CLAIM IS MADE TO THE EXCLUSIVE RIGHT TO USE "BASEBALL", APART FROM THE MARK AS SHOWN.

SN 85-004,538, FILED 4-1-2010.

BERNICE MIDDLETON, EXAMINING ATTORNEY



*David J. Kyfos*

Director of the United States Patent and Trademark Office

# United States of America

United States Patent and Trademark Office

# LUCK

**Reg. No. 4,126,036**

**Registered Apr. 10, 2012**

**Int. Cl.: 41**

**SERVICE MARK**

**PRINCIPAL REGISTER**

HOME BOX OFFICE, INC. (DELAWARE CORPORATION)  
1100 AVENUE OF THE AMERICAS  
NEW YORK, NY 10036

FOR: ENTERTAINMENT SERVICES IN THE NATURE OF AN ONGOING DRAMATIC TELEVISION PROGRAM; INTERACTIVE ONLINE ENTERTAINMENT IN THE NATURE OF A WEBSITE CONTAINING PHOTOGRAPHIC, VIDEO AND PROSE PRESENTATIONS, RELATED FILM CLIPS AND OTHER MULTIMEDIA MATERIALS FEATURING AN ONGOING DRAMATIC TELEVISION SERIES, IN CLASS 41 (U.S. CLS. 100, 101 AND 107).

FIRST USE 1-29-2012; IN COMMERCE 1-29-2012.

THE MARK CONSISTS OF STANDARD CHARACTERS WITHOUT CLAIM TO ANY PARTICULAR FONT, STYLE, SIZE, OR COLOR.

SN 85-005,052, FILED 4-2-2010.

JEAN IM, EXAMINING ATTORNEY



*David J. Kybas*

Director of the United States Patent and Trademark Office

# United States of America

United States Patent and Trademark Office

# MASKARE

**Reg. No. 4,126,037**

SUN SHINE GLOBAL (ARIZONA LIMITED LIABILITY COMPANY)  
POB 90884

**Registered Apr. 10, 2012**

PHOENIX, AZ 85066

**Int. Cl.: 9**

FOR: PROTECTION MASKS, IN CLASS 9 (U.S. CLS. 21, 23, 26, 36 AND 38).

**TRADEMARK**

FIRST USE 10-26-2010; IN COMMERCE 10-26-2010.

**PRINCIPAL REGISTER**

THE MARK CONSISTS OF STANDARD CHARACTERS WITHOUT CLAIM TO ANY PARTICULAR FONT, STYLE, SIZE, OR COLOR.

SN 85-008,369, FILED 4-7-2010.

DAVID HOFFMAN, EXAMINING ATTORNEY



*David J. Kyffers*

Director of the United States Patent and Trademark Office

# United States of America

United States Patent and Trademark Office

# MOLDGEAR

**Reg. No. 4,126,038**

MIDWEST INNOVATION, INC. (ILLINOIS CORPORATION)  
23 PALISADES LANE  
OAKWOOD HILLS, IL 60013

**Registered Apr. 10, 2012**

**Int. Cl.: 9**

FOR: ELECTRIC CABLES, WIRES, CONDUCTORS AND CONNECTION FITTINGS THEREFOR, IN CLASS 9 (U.S. CLS. 21, 23, 26, 36 AND 38).

**TRADEMARK**

FIRST USE 1-2-2008; IN COMMERCE 1-2-2008.

**PRINCIPAL REGISTER**

THE MARK CONSISTS OF STANDARD CHARACTERS WITHOUT CLAIM TO ANY PARTICULAR FONT, STYLE, SIZE, OR COLOR.

SN 85-008,880, FILED 4-7-2010.

DEBRA LEE, EXAMINING ATTORNEY



*David J. Kyffers*

Director of the United States Patent and Trademark Office

# United States of America

United States Patent and Trademark Office

## MONEY BY DESIGN

**Reg. No. 4,126,039**

JOHN MURATORI MINISTRIES (CONNECTICUT CORPORATION)  
1486 HIGHLAND AVENUE  
CHESHIRE, CT 06410

**Registered Apr. 10, 2012**

**Int. Cl.: 16**

FOR: PUBLICATIONS, NAMELY, TEACHERS BOOKS, WORKBOOKS, TEXT BOOKS IN THE FIELD OF BIBLICAL ECONOMICS. PRODUCTS HAVE A BIBLICAL AND SCRIPTURAL BASIS THAT ARE DIRECTLY CORRELATED WITH SUCH TOPICS AS FINANCES AND LEADERSHIP DEVELOPMENT, IN CLASS 16 (U.S. CLS. 2, 5, 22, 23, 29, 37, 38 AND 50).

**TRADEMARK**

**PRINCIPAL REGISTER**

FIRST USE 1-1-2010; IN COMMERCE 5-10-2010.

THE MARK CONSISTS OF STANDARD CHARACTERS WITHOUT CLAIM TO ANY PARTICULAR FONT, STYLE, SIZE, OR COLOR.

NO CLAIM IS MADE TO THE EXCLUSIVE RIGHT TO USE "MONEY", APART FROM THE MARK AS SHOWN.

SN 85-009,451, FILED 4-8-2010.

CURTIS FRENCH, EXAMINING ATTORNEY



*David J. Kyffers*

Director of the United States Patent and Trademark Office



# United States of America

United States Patent and Trademark Office

# LangXpert

**Reg. No. 4,126,040**

**Registered Apr. 10, 2012**

**Int. Cls.: 35 and 42**

**SERVICE MARK**

**PRINCIPAL REGISTER**

GLOBALDOC, INC. (GEORGIA CORPORATION)  
1800 PEACHTREE STREET  
SUITE 525  
ATLANTA, GA 30309

FOR: BUSINESS PROJECT MANAGEMENT FOR OTHERS IN THE FIELDS OF LANGUAGE TRANSLATION, CUSTOM WRITING, TEXT ADAPTATION, INTERPRETING, PROOFREADING, LAYOUT OTHER THAN FOR ADVERTISING PURPOSES, AND PROCESSING OF LANGUAGE FILES, FOR MULTI-LANGUAGE TECHNICAL, MARKETING, AND FINANCIAL DOCUMENTS AND MULTI-LANGUAGE MULTIMEDIA PRESENTATIONS, IN CLASS 35 (U.S. CLS. 100, 101 AND 102).

FIRST USE 5-6-2010; IN COMMERCE 5-6-2010.

FOR: COMPUTER SERVICES, NAMELY, PROVIDING A WEB-BASED SYSTEM AND ON-LINE PORTAL FOR OTHERS TO COMMUNICATE WITH THE SERVICE-PROVIDER'S EMPLOYEES, SUBMIT PROJECT-RELATED REQUESTS, UPLOAD AND DOWNLOAD FILES AND DOCUMENTS, VIEW THE STATUS OF PROJECTS, AND VIEW AND APPROVE TRANSLATIONS AND OTHER WORK PRODUCT IN PROGRESS, FOR END-TO-END AUTOMATION AND MANAGEMENT OF PROJECTS; PROJECT MANAGEMENT FOR THE DEVELOPMENT OF MULTI-LANGUAGE WEBSITES AND COMPUTER SOFTWARE INTERFACES FOR OTHERS IN THE FIELDS OF LANGUAGE TRANSLATION, CUSTOM WRITING, TEXT ADAPTATION, INTERPRETING, PROOFREADING, LAYOUT OTHER THAN FOR ADVERTISING PURPOSES, AND PROCESSING OF LANGUAGE FILES, FOR SUCH WEBSITES AND COMPUTER SOFTWARE INTERFACES, IN CLASS 42 (U.S. CLS. 100 AND 101).

FIRST USE 5-6-2010; IN COMMERCE 5-6-2010.

THE MARK CONSISTS OF STANDARD CHARACTERS WITHOUT CLAIM TO ANY PARTICULAR FONT, STYLE, SIZE, OR COLOR.

SN 85-009,652, FILED 4-8-2010.

RONALD AIKENS, EXAMINING ATTORNEY



*David J. Kyros*

Director of the United States Patent and Trademark Office

# United States of America

United States Patent and Trademark Office



## The Gideons International

**Reg. No. 4,126,041**

**Registered Apr. 10, 2012**

**Int. Cls.: 16 and 41**

**TRADEMARK**

**SERVICE MARK**

**PRINCIPAL REGISTER**

THE GIDEONS INTERNATIONAL (ILLINOIS NOT-FOR-PROFIT CORPORATION)  
50 CENTURY BOULEVARD  
NASHVILLE, TN 37214

FOR: BIBLES, TESTAMENTS AND MAGAZINES, NAMELY, MAGAZINES DEVOTED TO RELIGIOUS AND INSPIRATIONAL ISSUES, IN CLASS 16 (U.S. CLS. 2, 5, 22, 23, 29, 37, 38 AND 50).

FIRST USE 9-0-2011; IN COMMERCE 9-0-2011.

FOR: DISSEMINATION OF RELIGIOUS INSTRUCTIONAL MATERIAL IN THE NATURE OF BIBLES, TESTAMENTS, AND EDUCATIONAL LITERATURE DEVOTED TO RELIGIOUS AND INSPIRATIONAL TOPICS TO INDIVIDUALS, HOTELS, SCHOOLS, UNIVERSITIES, COLLEGES, HOSPITALS, PENAL INSTITUTIONS, ARMED FORCES, MEDICAL PERSONNEL, MOTELS, AIRPLANES, TRAINS, STEAMSHIPS, ATTORNEY OFFICES, RETIREMENT HOMES, ASSISTED LIVING FACILITIES, AND NURSING HOMES, IN CLASS 41 (U.S. CLS. 100, 101 AND 107).

FIRST USE 9-0-2011; IN COMMERCE 9-0-2011.

OWNER OF U.S. REG. NOS. 631,355, 635,619, AND 677,829.

NO CLAIM IS MADE TO THE EXCLUSIVE RIGHT TO USE "INTERNATIONAL", APART FROM THE MARK AS SHOWN.

THE MARK CONSISTS OF THE WORDS "THE GIDEONS INTERNATIONAL" WITH A LANTERN DESIGN.

SN 85-009,853, FILED 4-8-2010.

HENRY S. ZAK, EXAMINING ATTORNEY



*David J. Kybas*

Director of the United States Patent and Trademark Office

# United States of America

United States Patent and Trademark Office

## WACKO MARIA

**Reg. No. 4,126,042**

YUGEN KAISHA WACKO MARIA (JAPAN CORPORATION)  
3-17-7 AOBADAI, MEGURO-KU  
TOKYO, JAPAN

**Registered Apr. 10, 2012**

**Int. Cls.: 14, 18, and 25**

FOR: KEY RINGS OF PRECIOUS METAL, JEWEL CASES OF PRECIOUS METAL, PERSONAL ORNAMENTS OF PRECIOUS METAL, UNWROUGHT AND SEMI-WROUGHT PRECIOUS STONES AND THEIR IMITATIONS, SHOE ORNAMENTS OF PRECIOUS METAL, CLOCKS AND WATCHES, IN CLASS 14 (U.S. CLS. 2, 27, 28 AND 50).

**TRADEMARK**

**PRINCIPAL REGISTER**

FIRST USE 2-9-2004; IN COMMERCE 11-21-2011.

FOR: HANDBAG FRAMES, PURSE FRAMES, BAGS AND POUCHES, NAMELY, SHOULDER BAGS, BRIEFCASES, CARRY-ON BAGS, TRUNKS, HANDBAGS, BOSTON BAGS, BACK-PACKS, KEY CASES, PURSES, WALLETS, BUSINESS CARD CASES, VANITY CASES SOLD EMPTY, UMBRELLAS AND THEIR PARTS, WALKING STICKS, LEATHER, FUR, IN CLASS 18 (U.S. CLS. 1, 2, 3, 22 AND 41).

FIRST USE 2-9-2004; IN COMMERCE 11-21-2011.

FOR: CLOTHING, NAMELY, CHILDREN'S HEADWEAR, CHILDREN'S SHIRTS, CHILDREN'S TROUSERS; JACKETS, JOGGING PANTS, SWEAT PANTS, SUITS, SKIRTS, TROUSERS, OVERCOATS, MANTLES, RAIN COATS, CARDIGANS, SWEATERS, VESTS, WAISTCOATS, OPEN-NECKED SHIRTS, CUFFS, COLLARS, SPORT SHIRTS, POLO SHIRTS, SHIRTS FOR SUITS, NIGHTGOWNS, PAJAMAS, BATH ROBES, UNDERSHIRTS, PANTIES, SHORTS AND BRIEFS, PETTICOATS, SLEEP MASKS, SOCKS, STOCKINGS, FUR STOLEs, SHAWLS, SCARVES, GLOVES, MITTENS, NECK TIES, NECKERCHIEFS, BANDANAS, MUFFLERS; CLOTHES FOR SPORTS, NAMELY, SPORTS OVER UNIFORMS, SKI SUITS FOR COMPETITION, HEADBANDS, WIND JACKETS, UNIFORMS, STOCKINGS, WRISTBANDS; GARTERS, SOCK SUSPENDERS, SUSPENDERS, WAISTBANDS, BELTS FOR CLOTHING, FOOTWEAR, MASQUERADE COSTUMES, BOOTS FOR SPORT, IN CLASS 25 (U.S. CLS. 22 AND 39).

FIRST USE 2-9-2004; IN COMMERCE 11-21-2011.

THE MARK CONSISTS OF STANDARD CHARACTERS WITHOUT CLAIM TO ANY PARTICULAR FONT, STYLE, SIZE, OR COLOR.



*David J. Kybas*

Director of the United States Patent and Trademark Office

**Reg. No. 4,126,042** SN 85-011,851, FILED 4-12-2010.

EDWARD FENNESSY, EXAMINING ATTORNEY

# United States of America

United States Patent and Trademark Office

## GUILTY PARTIES

**Reg. No. 4,126,043**

YUGEN KAISHA WACKO MARIA (JAPAN CORPORATION)  
3-17-7 AOBADAI, MEGURO-KU  
TOKYO, JAPAN

**Registered Apr. 10, 2012**

**Int. Cls.: 14, 18, and 25**

FOR: KEY RINGS OF PRECIOUS METAL, JEWEL CASES OF PRECIOUS METAL, PERSONAL ORNAMENTS OF PRECIOUS METAL, UNWROUGHT AND SEMI-WROUGHT PRECIOUS STONES AND THEIR IMITATIONS, SHOE ORNAMENTS OF PRECIOUS METAL, CLOCKS AND WATCHES, IN CLASS 14 (U.S. CLS. 2, 27, 28 AND 50).

**TRADEMARK**

**PRINCIPAL REGISTER**

FIRST USE 9-3-2007; IN COMMERCE 11-21-2011.

FOR: HANDBAG FRAMES, PURSE FRAMES, BAGS AND POUCHES, NAMELY, SHOULDER BAGS, BRIEFCASES, CARRY-ON BAGS, TRUNKS, HANDBAGS, BOSTON BAGS, BACK-PACKS, KEY CASES, PURSES, WALLETS, BUSINESS CARD CASES, VANITY CASES SOLD EMPTY, UMBRELLAS AND THEIR PARTS, WALKING STICKS, LEATHER, FUR, IN CLASS 18 (U.S. CLS. 1, 2, 3, 22 AND 41).

FIRST USE 9-3-2007; IN COMMERCE 11-21-2011.

FOR: CLOTHING, NAMELY, CHILDREN'S HEADWEAR, CHILDREN'S SHIRTS, CHILDREN'S TROUSERS; JACKETS, JOGGING PANTS, SWEAT PANTS, SUITS, SKIRTS, TROUSERS, OVERCOATS, MANTLES, RAIN COATS, CARDIGANS, SWEATERS, VESTS, WAISTCOATS, OPEN-NECKED SHIRTS, CUFFS, COLLARS, SPORT SHIRTS, POLO SHIRTS, SHIRTS FOR SUITS, NIGHTGOWNS, PAJAMAS, BATH ROBES, UNDERSHIRTS, PANTIES, SHORTS AND BRIEFS, PETTICOATS, SLEEP MASKS, SOCKS, STOCKINGS, FUR STOLES, SHAWLS, SCARVES, GLOVES, MITTENS, NECK TIES, NECKERCHIEFS, BANDANAS, MUFFLERS; CLOTHES FOR SPORTS, NAMELY, SPORTS OVER UNIFORMS, SKI SUITS FOR COMPETITION, HEADBANDS, WIND JACKETS, UNIFORMS, STOCKINGS, WRISTBANDS; GARTERS, SOCK SUSPENDERS, SUSPENDERS, WAISTBANDS, BELTS FOR CLOTHING, FOOTWEAR, MASQUERADE COSTUMES, BOOTS FOR SPORT, IN CLASS 25 (U.S. CLS. 22 AND 39).

FIRST USE 9-3-2007; IN COMMERCE 11-21-2011.

THE MARK CONSISTS OF STANDARD CHARACTERS WITHOUT CLAIM TO ANY PARTICULAR FONT, STYLE, SIZE, OR COLOR.



*David J. Kybas*

Director of the United States Patent and Trademark Office

**Reg. No. 4,126,043** SN 85-011,853, FILED 4-12-2010.

EDWARD FENNESSY, EXAMINING ATTORNEY

# United States of America

United States Patent and Trademark Office

## The Language Express

**Reg. No. 4,126,044**

**Registered Apr. 10, 2012**

**Int. Cl.: 9**

**TRADEMARK**

**PRINCIPAL REGISTER**

ZIMMERMAN, MARC H. (UNITED STATES INDIVIDUAL), DBA THE LANGUAGE EXPRESS,  
1543 JUNIPERHILL DRIVE  
ENCINITAS, CA 92024

FOR: APPARATUS FOR SPEECH RECORDING AND REPLAYING; CHILDREN'S EDUCATIONAL SOFTWARE; COMPUTER GAME CARTRIDGES; COMPUTER GAME CARTRIDGES AND DISCS; COMPUTER GAME CASSETTES; COMPUTER GAME CONSOLES FOR USE WITH AN EXTERNAL DISPLAY SCREEN OR MONITOR; COMPUTER GAME DISCS; COMPUTER GAME EQUIPMENT, NAMELY, DISCS; COMPUTER GAME JOYSTICKS; COMPUTER GAME PROGRAMS; COMPUTER GAME PROGRAMS DOWNLOADABLE VIA THE INTERNET; COMPUTER GAME PROGRAMS; COMPUTER GAME PROGRAMS, CARTRIDGES, AND CASSETTES; COMPUTER GAME SOFTWARE; COMPUTER GAME SOFTWARE DOWNLOADABLE FROM A GLOBAL COMPUTER NETWORK; COMPUTER GAME SOFTWARE FOCUSING ON ACHIEVING A SET OF GOALS, POSITIONS, OWNERSHIP, AND CREDENTIALS, AND PROFESSIONAL AND SOCIAL STATUS, AND GOOD FORTUNE NECESSARY TO SUCCEED PROFESSIONALLY AND PERSONALLY, AND NOT REFERRING EITHER TO A GROUP OF SOFTWARE FOR USE IN COMMERCE OR TO A GROUP OF OFFICES; COMPUTER GAME SOFTWARE FOR PERSONAL COMPUTERS AND HOME VIDEO GAME CONSOLES; COMPUTER GAME SOFTWARE FOR USE ON MOBILE AND CELLULAR PHONES; COMPUTER GAME SOFTWARE FOR USE WITH PERSONAL COMPUTERS, HOME VIDEO GAME CONSOLES USED WITH TELEVISIONS, AND FOR ARCADE-BASED VIDEO GAME CONSOLES; COMPUTER HARDWARE AND COMPUTER PERIPHERAL DEVICES; COMPUTER HARDWARE AND COMPUTER SOFTWARE PROGRAMS FOR THE INTEGRATION OF TEXT, AUDIO, GRAPHICS, STILL IMAGES AND MOVING PICTURES INTO AN INTERACTIVE DELIVERY FOR MULTIMEDIA APPLICATIONS; COMPUTER HARDWARE AND SOFTWARE USED FOR THE CONTROL OF VOICE CONTROLLED INFORMATION AND COMMUNICATION DEVICES; COMPUTER PROGRAMS FOR VIDEO AND COMPUTER GAMES; COMPUTER SOFTWARE FEATURING TRAINING IN THE FIELD OF TREATMENT FOR ADULT AND CHILDREN'S SOCIAL DELAY, SPEECH DELAY, AUTISM, DEVELOPMENTAL DELAY, SPEECH THERAPY, PERVASIVE DEVELOPMENTAL DISORDER (PDD), PERVASIVE DEVELOPMENTAL DISORDER NOT OTHERWISE SPECIFIED (PDD-NOS), ASBERGER SYNDROME, ATTENTION DEFICIT DISORDER, (ADD), ATTENTION DEFICIT HYPERACTIVITY DISORDER (ADHD), SOCIAL IMPAIRMENT, STROKE, BRAIN DAMAGE AND PHYSICAL REHABILITATION; COMPUTER SOFTWARE AND COMPUTER HARDWARE FOR USE IN LANGUAGE LOCALIZATION, BY MEANS OF LANGUAGE TRANSLATION, SUBTITLING, DUBBING, CLOSED CAPTIONING AND TELETEXT FOR FEATURE FILMS, TELEVISION



*David J. Kybas*

Director of the United States Patent and Trademark Office

**Reg. No. 4,126,044** PROGRAMS, VIDEOS AND DIGITAL MEDIA IN GENERAL; COMPUTER-GAMING SOFTWARE; DOWNLOADABLE COMPUTER GAME PROGRAMS; DOWNLOADABLE COMPUTER GAME SOFTWARE VIA A GLOBAL COMPUTER NETWORK AND WIRELESS DEVICES; DOWNLOADABLE COMPUTER PROGRAMS FEATURING POSITIONABLE GAME PIECE FIGURES FOR USE IN THE FIELD OF COMPUTER GAMES; GAME CONTROLLERS FOR COMPUTER GAMES; INTERACTIVE GAME PROGRAMS; INTERACTIVE GAME SOFTWARE; INTERACTIVE MULTIMEDIA COMPUTER GAME PROGRAM; COMPUTER SOFTWARE FOR HEALTH CARE PROFESSIONALS FOR USE IN LANGUAGE AND SOCIAL SKILLS REHABILITATION FOR PATIENTS WITH ADULT AND CHILDREN'S SOCIAL DELAY, SPEECH DELAY, AUTISM, DEVELOPMENTAL DELAY, SPEECH THERAPY, PERVASIVE DEVELOPMENTAL DISORDER (PDD), PERVASIVE DEVELOPMENTAL DISORDER NOT OTHERWISE SPECIFIED (PDD-NOS), ASBERGER SYNDROME, ATTENTION DEFICIT DISORDER, (ADD), ATTENTION DEFICIT HYPERACTIVITY DISORDER (ADHD), SOCIAL IMPAIRMENT, STROKE, AND BRAIN DAMAGE; INTERACTIVE VIDEO GAMES OF VIRTUAL REALITY COMPRISED OF COMPUTER HARDWARE FOR USE WITH AN EXTERNAL MONITOR AND SOFTWARE; RECORDED COMPUTER GAME PROGRAMS; VIDEO AND COMPUTER GAME PROGRAMS; WIRELESS COMMUNICATION DEVICE FEATURING VOICE, DATA AND IMAGE TRANSMISSION INCLUDING VOICE, TEXT AND PICTURE MESSAGING, A VIDEO AND STILL IMAGE CAMERA, ALSO FUNCTIONAL TO PURCHASE MUSIC, GAMES, VIDEO AND SOFTWARE APPLICATIONS OVER THE AIR FOR DOWNLOADING TO THE DEVICE, IN CLASS 9 (U.S. CLS. 21, 23, 26, 36 AND 38).

FIRST USE 5-1-2011; IN COMMERCE 11-16-2011.

THE MARK CONSISTS OF STANDARD CHARACTERS WITHOUT CLAIM TO ANY PARTICULAR FONT, STYLE, SIZE, OR COLOR.

NO CLAIM IS MADE TO THE EXCLUSIVE RIGHT TO USE "LANGUAGE", APART FROM THE MARK AS SHOWN.

SN 85-012,100, FILED 4-12-2010.

EDWARD FENNESSY, EXAMINING ATTORNEY



# United States of America

United States Patent and Trademark Office

# GOHOW

**Reg. No. 4,126,045**

**Registered Apr. 10, 2012**

**Int. Cls.: 9 and 35**

**TRADEMARK**

**SERVICE MARK**

**PRINCIPAL REGISTER**

SAPIENT CORPORATION (DELAWARE CORPORATION)  
131 DARTMOUTH STREET  
BOSTON, MA 02116

FOR: COMPUTER SOFTWARE FOR USE WITH PERSONAL MOBILE WIRELESS INTERNET DIGITAL ELECTRONIC DEVICES FOR RECEIPT, TRANSMISSION AND DISPLAY OF AUDIO, AUDIO/VISUAL, MULTIMEDIA CONTENT, TEXTUAL CONTENT AND OTHER DIGITAL DATA, IN CLASS 9 (U.S. CLS. 21, 23, 26, 36 AND 38).

FIRST USE 5-5-2010; IN COMMERCE 5-5-2010.

FOR: PROVIDING ON LINE CONSUMER INFORMATION THROUGH MOBILE DEVICES OR OTHER ELECTRONIC MEDIA, CONCERNING THE LOCATION OF RETAILERS, CONCESSIONAIRES, SERVICE PROVIDERS AND POINTS OF INTEREST WITHIN AND RELEVANT TO VENUES AND DEFINED GEOGRAPHIC LOCATIONS, IN CLASS 35 (U.S. CLS. 100, 101 AND 102).

FIRST USE 5-5-2010; IN COMMERCE 5-5-2010.

THE MARK CONSISTS OF STANDARD CHARACTERS WITHOUT CLAIM TO ANY PARTICULAR FONT, STYLE, SIZE, OR COLOR.

SN 85-013,827, FILED 4-14-2010.

ESTHER BELENKER, EXAMINING ATTORNEY



*David J. Kyffers*

Director of the United States Patent and Trademark Office

# United States of America

United States Patent and Trademark Office

S&A | stawiarski  
& associates p.c.

**Reg. No. 4,126,046**

LEO STAWIARSKI (UNITED STATES INDIVIDUAL)  
6560 GREENWOOD PLAZA, SUITE 325  
ENGLWOOD, CO 80111

**Registered Apr. 10, 2012**

**Int. Cls.: 36 and 45**

FOR: POST JUDGMENT DEBT RECOVERY AND DEBT COLLECTION, IN CLASS 36 (U.S. CLS. 100, 101 AND 102).

**SERVICE MARK**

FIRST USE 10-31-2011; IN COMMERCE 10-31-2011.

**PRINCIPAL REGISTER**

FOR: LEGAL SERVICES, NAMELY, COORDINATION OF LOCAL COUNSEL FOR OTHERS, IN CLASS 45 (U.S. CLS. 100 AND 101).

FIRST USE 10-31-2011; IN COMMERCE 10-31-2011.

NO CLAIM IS MADE TO THE EXCLUSIVE RIGHT TO USE "& ASSOCIATES P.C.", APART FROM THE MARK AS SHOWN.

THE MARK CONSISTS OF THE LETTERS "S&A" IN COMBINATION WITH "STAWIARSKI & ASSOCIATES P.C".

SN 85-016,288, FILED 4-16-2010.

JAMES GRIFFIN, EXAMINING ATTORNEY



*David J. Kyffers*

Director of the United States Patent and Trademark Office

# United States of America

United States Patent and Trademark Office

MAIDTRON The definition of  
MAIDTRON is 1) A person who  
was a good friend when you  
were single and is not married.  
2) A person who culminates  
your single and married life.

**Reg. No. 4,126,047**

**Registered Apr. 10, 2012**

**Int. Cl.: 25**

**TRADEMARK**

**PRINCIPAL REGISTER**

NASH, LASHAWN (UNITED STATES INDIVIDUAL)  
#221  
5800 TECHNI CENTER  
AUSTIN, TX 78721

FOR: HATS; SHIRTS; SHORTS, IN CLASS 25 (U.S. CLS. 22 AND 39).

FIRST USE 12-12-2010; IN COMMERCE 12-12-2010.

THE MARK CONSISTS OF STANDARD CHARACTERS WITHOUT CLAIM TO ANY PARTICULAR FONT, STYLE, SIZE, OR COLOR.

SEC. 2(F).

SN 85-016,301, FILED 4-16-2010.

WILLIAM ROSSMAN, EXAMINING ATTORNEY



*David J. Kybas*

Director of the United States Patent and Trademark Office

# United States of America

United States Patent and Trademark Office



## The Institutes

Proven Knowledge. Powerful Results.

**Reg. No. 4,126,048**

**Registered Apr. 10, 2012**

**Int. Cls.: 16, 35, and 41**

**TRADEMARK**

**SERVICE MARK**

**PRINCIPAL REGISTER**

AMERICAN INSTITUTE FOR CHARTERED PROPERTY CASUALTY UNDERWRITERS  
(PENNSYLVANIA CORPORATION)  
720 PROVIDENCE ROAD  
MALVERN, PA 19355

FOR: PRINTED EDUCATIONAL MATERIALS, NAMELY, NEWSLETTERS, PAMPHLETS AND BROCHURES IN THE FIELD OF INSURANCE, IN CLASS 16 (U.S. CLS. 2, 5, 22, 23, 29, 37, 38 AND 50).

FIRST USE 7-1-2010; IN COMMERCE 7-1-2010.

FOR: ASSOCIATION SERVICES, NAMELY, PROMOTING THE INTERESTS OF PROFESSIONALS IN THE PROPERTY-CASUALTY INSURANCE AND RISK MANAGEMENT INDUSTRY, IN CLASS 35 (U.S. CLS. 100, 101 AND 102).

FIRST USE 7-1-2010; IN COMMERCE 7-1-2010.

FOR: EDUCATIONAL SERVICES, NAMELY, PROVIDING COURSES OF INSTRUCTION IN THE FIELD OF INSURANCE, IN CLASS 41 (U.S. CLS. 100, 101 AND 107).

FIRST USE 7-1-2010; IN COMMERCE 7-1-2010.

THE MARK CONSISTS OF THE WORDING "THE INSTITUTES" AND "PROVEN KNOWLEDGE. POWERFUL RESULTS." IN A STYLIZED FONT AND A DESIGN THAT CONSISTS OF THREE INTERSECTING TRIANGLES.

SEC. 2(F) AS TO "THE INSTITUTES".

SN 85-016,875, FILED 4-19-2010.

RENEE MCCRAY, EXAMINING ATTORNEY



*David J. Kyjars*

Director of the United States Patent and Trademark Office

# United States of America

United States Patent and Trademark Office

## WESTERN REWARDS

**Reg. No. 4,126,049**

**Registered Apr. 10, 2012**

**Int. Cls.: 9 and 28**

**TRADEMARK**

**PRINCIPAL REGISTER**

TOCCATA GAMING INTERNATIONAL, LLC (WISCONSIN LIMITED LIABILITY COMPANY)  
2414 INDUSTRIAL DRIVE #D  
NEENAH, WI 54956

FOR: AMUSEMENT GAMES, NAMELY, ELECTRONIC WAGERING AND NON-WAGERING MACHINES FOR PLAYING GAMES OF CHANCE; ELECTRONIC GAMES OF SKILL, NAMELY, GAMING MACHINES; DOWNLOADABLE COMPUTER GAME SOFTWARE; AND INTERACTIVE VIDEO GAME PROGRAMS, IN CLASS 9 (U.S. CLS. 21, 23, 26, 36 AND 38).

FIRST USE 1-17-2012; IN COMMERCE 1-17-2012.

FOR: AMUSEMENT GAME MACHINES, IN CLASS 28 (U.S. CLS. 22, 23, 38 AND 50).

FIRST USE 1-17-2012; IN COMMERCE 1-17-2012.

THE MARK CONSISTS OF STANDARD CHARACTERS WITHOUT CLAIM TO ANY PARTICULAR FONT, STYLE, SIZE, OR COLOR.

NO CLAIM IS MADE TO THE EXCLUSIVE RIGHT TO USE "REWARDS" , APART FROM THE MARK AS SHOWN.

SN 85-019,070, FILED 4-21-2010.

JESSICA FATHY, EXAMINING ATTORNEY



*David J. Kybas*

Director of the United States Patent and Trademark Office

# United States of America

United States Patent and Trademark Office

## PREHISTORIC PAYS

**Reg. No. 4,126,050**

TOCCATA GAMING INTERNATIONAL, LLC (WISCONSIN LIMITED LIABILITY COMPANY)  
2414 INDUSTRIAL DRIVE #D  
NEENAH, WI 54956

**Registered Apr. 10, 2012**

**Int. Cls.: 9 and 28**

FOR: AMUSEMENT GAMES, NAMELY, ELECTRONIC WAGERING AND NON-WAGERING MACHINES FOR PLAYING GAMES OF CHANCE; ELECTRONIC GAMES OF SKILL, NAMELY, GAMING MACHINES; DOWNLOADABLE COMPUTER GAME SOFTWARE; AND INTERACTIVE VIDEO GAME PROGRAMS, IN CLASS 9 (U.S. CLS. 21, 23, 26, 36 AND 38).

**TRADEMARK**

**PRINCIPAL REGISTER**

FIRST USE 12-30-2011; IN COMMERCE 12-30-2011.

FOR: AMUSEMENT GAME MACHINES, IN CLASS 28 (U.S. CLS. 22, 23, 38 AND 50).

FIRST USE 12-30-2011; IN COMMERCE 12-30-2011.

THE MARK CONSISTS OF STANDARD CHARACTERS WITHOUT CLAIM TO ANY PARTICULAR FONT, STYLE, SIZE, OR COLOR.

NO CLAIM IS MADE TO THE EXCLUSIVE RIGHT TO USE "PAYS" , APART FROM THE MARK AS SHOWN.

SN 85-019,433, FILED 4-21-2010.

JESSICA FATHY, EXAMINING ATTORNEY



*David J. Kybas*

Director of the United States Patent and Trademark Office

# United States of America

United States Patent and Trademark Office

## FLASH SHIELD

**Reg. No. 4,126,051**

**Registered Apr. 10, 2012**

**Int. Cl.: 6**

**TRADEMARK**

**PRINCIPAL REGISTER**

TITFLEX CORPORATION (CONNECTICUT CORPORATION)  
603 HENDEE STREET  
SPRINGFIELD, MA 011390054

FOR: ENERGY DISSIPATIVE GAS PIPING SYSTEM MADE PRIMARILY OF METAL AND PRIMARILY COMPRISED OF PIPING MADE PRIMARILY OF METAL AND METAL PIPE FITTINGS, ALL SOLD AS A UNIT WITH ACCESSORIES FOR THE FOREGOING IN THE NATURE OF STUB NAILS AND OUTLET BOXES, WHICH PROTECT AGAINST POTENTIAL ARCING DURING LIGHTNING STRIKES BY MITIGATING THE POTENTIAL DAMAGE TO SUCH SYSTEM CAUSED BY ELECTRICAL ARCING; TUBES OF STAINLESS STEEL, IN CLASS 6 (U.S. CLS. 2, 12, 13, 14, 23, 25 AND 50).

FIRST USE 8-0-2010; IN COMMERCE 8-0-2010.

THE MARK CONSISTS OF STANDARD CHARACTERS WITHOUT CLAIM TO ANY PARTICULAR FONT, STYLE, SIZE, OR COLOR.

SN 85-019,794, FILED 4-21-2010.

MAUREEN DALL, EXAMINING ATTORNEY



*David J. Kyjars*

Director of the United States Patent and Trademark Office

# United States of America

United States Patent and Trademark Office

# DIGITWHIZ

**Reg. No. 4,126,052**

BROWN, KAREN S. (UNITED STATES INDIVIDUAL)  
48 SERENO CIRCLE  
OAKLAND, CA 94619

**Registered Apr. 10, 2012**

**Int. Cl.: 41**

FOR: CHILDREN'S EDUCATIONAL SERVICES, NAMELY, PROVIDING ACADEMIC PERFORMANCE EVALUATION, GUIDANCE AND MONITORING FOR CHILDREN PRE-KINDERGARTEN THROUGH GRADE 12 VIA THE INTERNET , IN CLASS 41 (U.S. CLS. 100, 101 AND 107).

**SERVICE MARK**

**PRINCIPAL REGISTER**

FIRST USE 10-20-2010; IN COMMERCE 10-20-2010.

THE MARK CONSISTS OF STANDARD CHARACTERS WITHOUT CLAIM TO ANY PARTICULAR FONT, STYLE, SIZE, OR COLOR.

SN 85-022,349, FILED 4-24-2010.

JANICE KIM, EXAMINING ATTORNEY



*David J. Kyffers*

Director of the United States Patent and Trademark Office



# United States of America

United States Patent and Trademark Office

*Miss Pearl*

**Reg. No. 4,126,053**

**Registered Apr. 10, 2012**

**Int. Cls.: 40 and 42**

**SERVICE MARK**

**PRINCIPAL REGISTER**

ELIZABETH & PARTNERS, LTD. (OHIO LIMITED LIABILITY COMPANY)  
UNIT 7  
621 VIRGINIA STREET  
MARIETTA, OH 45750

FOR: CUSTOM MANUFACTURE AND FABRICATION OF PEARL JEWELRY FOR OTHERS,  
IN CLASS 40 (U.S. CLS. 100, 103 AND 106).

FIRST USE 9-1-2011; IN COMMERCE 9-1-2011.

FOR: CUSTOM DESIGN FOR OTHERS IN THE FIELD OF PEARL JEWELRY, IN CLASS 42  
(U.S. CLS. 100 AND 101).

FIRST USE 9-1-2011; IN COMMERCE 9-1-2011.

NO CLAIM IS MADE TO THE EXCLUSIVE RIGHT TO USE "PEARL", APART FROM THE  
MARK AS SHOWN.

THE NAME "MISS PEARL" DOES NOT IDENTIFY A LIVING INDIVIDUAL.

SN 85-023,773, FILED 4-27-2010.

MARIA-VICTORIA SUAREZ, EXAMINING ATTORNEY



*David J. Kybas*

Director of the United States Patent and Trademark Office

# United States of America

United States Patent and Trademark Office

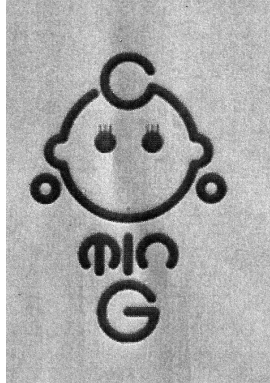

**Reg. No. 4,126,054**

**Registered Apr. 10, 2012**

**Int. Cls.: 40 and 42**

**SERVICE MARK**

**PRINCIPAL REGISTER**

ELIZABETH & PARTNERS, LTD. (OHIO LIMITED LIABILITY COMPANY)  
UNIT 7  
621 VIRGINIA STREET  
MARIETTA, OH 45750

FOR: CUSTOM MANUFACTURE AND FABRICATION OF JEWELRY FOR OTHERS, IN CLASS 40 (U.S. CLS. 100, 103 AND 106).

FIRST USE 9-1-2011; IN COMMERCE 9-1-2011.

FOR: CUSTOM DESIGN FOR OTHERS IN THE FIELD OF JEWELRY, IN CLASS 42 (U.S. CLS. 100 AND 101).

FIRST USE 9-1-2011; IN COMMERCE 9-1-2011.

THE MARK CONSISTS OF A CARTOON FIGURE OF A WOMAN WITH EARRINGS ABOVE THE LETTER "G".

SN 85-025,324, FILED 4-28-2010.

MARIA-VICTORIA SUAREZ, EXAMINING ATTORNEY



*David J. Kybas*

Director of the United States Patent and Trademark Office

# United States of America

United States Patent and Trademark Office

## DREAM PRACTICE

**Reg. No. 4,126,055**

MEEKS MARKETING SYSTEMS, INC. (MONTANA CORPORATION)  
13915 MOON DRIVE  
BIG FORK, MT 59911

**Registered Apr. 10, 2012**

**Int. Cl.: 16**

FOR: INSTRUCTIONAL KITS, SOLD AS A UNIT, CONSISTING OF MANUALS AND CDS  
IN THE FIELD OF PRACTICE MANAGEMENT OF CHIROPRACTIC PRACTICES, IN CLASS  
16 (U.S. CLS. 2, 5, 22, 23, 29, 37, 38 AND 50).

**TRADEMARK**

FIRST USE 11-30-2010; IN COMMERCE 11-30-2010.

**PRINCIPAL REGISTER**

THE MARK CONSISTS OF STANDARD CHARACTERS WITHOUT CLAIM TO ANY PAR-  
TICULAR FONT, STYLE, SIZE, OR COLOR.

NO CLAIM IS MADE TO THE EXCLUSIVE RIGHT TO USE "PRACTICE", APART FROM  
THE MARK AS SHOWN.

SN 85-025,754, FILED 4-28-2010.

KELLY TRUSILO, EXAMINING ATTORNEY



*David J. Kybas*

Director of the United States Patent and Trademark Office

# United States of America

United States Patent and Trademark Office



**Reg. No. 4,126,056**

**Registered Apr. 10, 2012**

**Int. Cl.: 42**

**SERVICE MARK**

**PRINCIPAL REGISTER**

ARKIPELAGO INTERNATIONAL, INC. (NORTH CAROLINA CORPORATION)  
3301 BURNT MILL DRIVE  
WILMINGTON, NC 28403

FOR: COMPUTER SERVICES, NAMELY, PROVIDING USERS REMOTE MONITORING OF USE OF AND AN INVENTORY OF CONSUMABLE PRODUCTS, NAMELY, GAS AND FUEL SUPPLIES, THROUGH COMPUTER NETWORKS, IN CLASS 42 (U.S. CLS. 100 AND 101).

FIRST USE 9-1-2011; IN COMMERCE 9-1-2011.

THE MARK CONSISTS OF THE WORD "GOENERGIES" WITH "GO" IN THE COLOR GREEN AND "ENERGIES" IS THE COLOR BLACK, WITH A SWIRL COMPRISED OF GRAY AND GREEN CIRCLES ABOVE "ENERGIES", WITH A SHADOW OF THE WORDING, "GOENERGIES" IN GRAY, BELOW "GOENERGIES" IN GREEN AND BLACK.

THE COLOR(S) GREEN, BLACK, AND GRAY IS/ARE CLAIMED AS A FEATURE OF THE MARK.

SN 85-025,979, FILED 4-29-2010.

ODESSA BIBBINS, EXAMINING ATTORNEY



*David J. Kyros*

Director of the United States Patent and Trademark Office

# United States of America

United States Patent and Trademark Office

# ALPIXTLE

**Reg. No. 4,126,057**

ARGO NATURAL HEALTH LABS, INC (CALIFORNIA CORPORATION)  
1418 BROADWAY AVE.  
CHULA VISTA, CA 91911

**Registered Apr. 10, 2012**

**Int. Cl.: 5**

FOR: PHARMACEUTICAL PRODUCTS, NAMELY, NATURAL SUPPLEMENTS, IN CLASS 5 (U.S. CLS. 6, 18, 44, 46, 51 AND 52).

**TRADEMARK**

FIRST USE 12-1-2008; IN COMMERCE 12-1-2008.

**PRINCIPAL REGISTER**

THE MARK CONSISTS OF STANDARD CHARACTERS WITHOUT CLAIM TO ANY PARTICULAR FONT, STYLE, SIZE, OR COLOR.

SN 85-026,936, FILED 4-30-2010.

MARY ROSSMAN, EXAMINING ATTORNEY



*David J. Kyros*

Director of the United States Patent and Trademark Office

# United States of America

United States Patent and Trademark Office

# GlobalDoc

**Reg. No. 4,126,058**

**Registered Apr. 10, 2012**

**Int. Cls.: 35, 41, and 42**

**SERVICE MARK**

**PRINCIPAL REGISTER**

GLOBALDOC, INC. (GEORGIA CORPORATION)  
SUITE 525  
1800 PEACHTREE STREET  
ATLANTA, GA 30309

FOR: PROVIDING BUSINESS CONSULTING AND BUSINESS ADMINISTRATIVE SUPPORT FOR CLIENTS IN CONNECTION WITH THE PRODUCTION OF CLIENTS MULTI-LANGUAGE TECHNICAL, MARKETING, AND FINANCIAL DOCUMENTS, MULTIMEDIA PRESENTATIONS, WEBSITES, AND COMPUTER SOFTWARE INTERFACES IN THE NATURE OF HELP SCREENS, ONLINE PROMPTS, PULL-DOWN MENUS AND CELLULAR PHONE DISPLAYS, IN CLASS 35 (U.S. CLS. 100, 101 AND 102).

FIRST USE 5-6-2010; IN COMMERCE 5-6-2010.

FOR: PROVIDING LANGUAGE-TRANSLATION SERVICES FOR CLIENTS, NAMELY, TRANSLATION TO AND FROM ALL LANGUAGES, IN CONNECTION WITH THE PRODUCTION OF CLIENTS MULTI-LANGUAGE TECHNICAL, MARKETING, AND FINANCIAL DOCUMENTS, MULTIMEDIA PRESENTATIONS, WEBSITES, AND COMPUTER SOFTWARE INTERFACES IN THE NATURE OF HELP SCREENS, ONLINE PROMPTS, PULL-DOWN MENUS AND CELLULAR PHONE DISPLAYS; LAYOUT, DESIGN, AND FORMATTING IN THE NATURE OF LAYOUT OF MULTI-LANGUAGE TECHNICAL, MARKETING, AND FINANCIAL DOCUMENTS, MULTIMEDIA PRESENTATIONS, WEBSITES, AND COMPUTER SOFTWARE INTERFACES IN THE NATURE OF HELP SCREENS, ONLINE PROMPTS, PULL-DOWN MENUS AND CELLULAR PHONE DISPLAYS, ALL OTHER THAN FOR ADVERTISING PURPOSES; DESKTOP PUBLISHING FOR OTHERS; PROCESSING IN THE NATURE OF TRANSLATING FOR OTHERS OF LANGUAGE FILES USED FOR WEBSITES AND DESKTOP PUBLISHING; TRANSLATING ORALLY FOR PERSONS CONVERSING IN DIFFERENT LANGUAGES; WRITING AND EDITING OF THE TEXT OF OTHERS IN CONNECTION WITH THE PRODUCTION OF CLIENTS MULTI-LANGUAGE MARKETING AND FINANCIAL DOCUMENTS, MULTIMEDIA PRESENTATIONS, WEBSITES, AND COMPUTER SOFTWARE INTERFACES IN THE NATURE OF HELP SCREENS, ONLINE PROMPTS, PULL-DOWN MENUS AND CELLULAR PHONE DISPLAYS, OTHER THAN FOR ADVERTISING OR PUBLICITY; EDITING OF THE TEXT OF OTHERS IN CONNECTION WITH THE PRODUCTION OF CLIENTS MULTI-LANGUAGE TECHNICAL DOCUMENTS, IN CLASS 41 (U.S. CLS. 100, 101 AND 107).



*David J. Kyros*

Director of the United States Patent and Trademark Office

FIRST USE 5-6-2010; IN COMMERCE 5-6-2010.

**Reg. No. 4,126,058** FOR: TECHNICAL WRITING SERVICES FOR OTHERS IN CONNECTION WITH THE PRODUCTION OF CLIENTS MULTILANGUAGE TECHNICAL DOCUMENTS; DESIGN AND INTEGRATION OF GRAPHICS INTO MULTI-LANGUAGE TECHNICAL, MARKETING, AND FINANCIAL DOCUMENTS, MULTIMEDIA PRESENTATIONS, WEBSITES, AND COMPUTER SOFTWARE INTERFACES IN THE NATURE OF HELP SCREENS, ONLINE PROMPTS, PULL-DOWN MENUS AND CELLULAR PHONE DISPLAYS, ALL OTHER THAN FOR ADVERTISING PURPOSES, IN CLASS 42 (U.S. CLS. 100 AND 101).

FIRST USE 5-6-2010; IN COMMERCE 5-6-2010.

OWNER OF U.S. REG. NOS. 2,172,733 AND 2,172,734.

THE MARK CONSISTS OF THE WORD "GLOBALDOC" IN STYLIZED SCRIPT AND A DESIGN INCORPORATING A SQUARE (DIVIDED INTO FOUR PARTS BY WHITE-SPACE VERTICAL AND HORIZONTAL BARS) AND A WHITE-SPACE GLOBE INSIDE THE SQUARE.

SN 85-029,355, FILED 5-4-2010.

RONALD AIKENS, EXAMINING ATTORNEY

# United States of America

United States Patent and Trademark Office

## Xcessive Force

**Reg. No. 4,126,059**

ASSANTE, SALVATORE (UNITED STATES INDIVIDUAL)  
174 GENESEE AVENUE  
STATEN ISLAND, NY 10308

**Registered Apr. 10, 2012**

**Int. Cl.: 25**

FOR: HATS; JACKETS; PANTS; SHIRTS; SHOES, IN CLASS 25 (U.S. CLS. 22 AND 39).

**TRADEMARK**

FIRST USE 4-13-2010; IN COMMERCE 2-9-2012.

**PRINCIPAL REGISTER**

THE MARK CONSISTS OF STANDARD CHARACTERS WITHOUT CLAIM TO ANY PARTICULAR FONT, STYLE, SIZE, OR COLOR.

SN 85-029,480, FILED 5-4-2010.

GINA FINK, EXAMINING ATTORNEY



*David J. Kyffers*

Director of the United States Patent and Trademark Office



# United States of America

United States Patent and Trademark Office

## The Diapering Doula

**Reg. No. 4,126,060**

**Registered Apr. 10, 2012**

**Int. Cl.: 37**

**SERVICE MARK**

**PRINCIPAL REGISTER**

THE TRIANGLE DIAPER COMPANY, LLC (NORTH CAROLINA LIMITED LIABILITY COMPANY), DBA THE DIAPERING DOULA,  
4109 GRACE PARK DRIVE  
MORRISVILLE, NC 27560

FOR: LAUNDERING OF BABIES' DIAPERS, IN CLASS 37 (U.S. CLS. 100, 103 AND 106).

FIRST USE 2-1-2009; IN COMMERCE 5-1-2009.

THE MARK CONSISTS OF STANDARD CHARACTERS WITHOUT CLAIM TO ANY PARTICULAR FONT, STYLE, SIZE, OR COLOR.

NO CLAIM IS MADE TO THE EXCLUSIVE RIGHT TO USE "DOULA", APART FROM THE MARK AS SHOWN.

SN 85-030,322, FILED 5-5-2010.

MARK SPARACINO, EXAMINING ATTORNEY



*David J. Kyffers*

Director of the United States Patent and Trademark Office

# United States of America

United States Patent and Trademark Office



**Reg. No. 4,126,061**

**Registered Apr. 10, 2012**

**Int. Cl.: 28**

**TRADEMARK**

**PRINCIPAL REGISTER**

MO CHI FITNESS, INC. (CALIFORNIA CORPORATION)  
6400 JOE ED WAY  
BAKERSFIELD, CA 93308

FOR: PORTABLE FLOOR EXERCISE DEVICES HAVING AN UPPER ROTATABLE PLATFORM THAT A USER STANDS ON TO PERFORM TWISTING EXERCISE MOVEMENTS, IN CLASS 28 (U.S. CLS. 22, 23, 38 AND 50).

FIRST USE 6-30-2011; IN COMMERCE 6-30-2011.

THE NAME(S), PORTRAIT(S), AND/OR SIGNATURE(S) SHOWN IN THE MARK DOES NOT IDENTIFY A PARTICULAR LIVING INDIVIDUAL.

THE MARK CONSISTS OF THE FOLLOWING: A DARK CIRCLE CONTAINING THE STYLIZED WORD "MO" WITH THE LETTER "M" FEATURING A LONG TAIL THAT UNDERLINES THE STYLIZED WORD "CHI" WITH A HEART ACTING AS A DOT OVER THE LETTER "I" IN "CHI".

THE WORDING "MO CHI" HAS NO MEANING IN A FOREIGN LANGUAGE.

SN 85-030,892, FILED 5-5-2010.

DAVID C. REIHNER, EXAMINING ATTORNEY



*David J. Kybas*

Director of the United States Patent and Trademark Office

# United States of America

United States Patent and Trademark Office

## MO CHI FITNESS

**Reg. No. 4,126,062**

**Registered Apr. 10, 2012**

**Int. Cl.: 28**

**TRADEMARK**

**PRINCIPAL REGISTER**

MO CHI FITNESS, INC. (CALIFORNIA CORPORATION)  
6400 JOE ED WAY  
BAKERSFIELD, CA 93308

FOR: PORTABLE FLOOR EXERCISE DEVICES HAVING AN UPPER ROTATABLE PLATFORM THAT A USER STANDS ON TO PERFORM TWISTING EXERCISE MOVEMENTS, IN CLASS 28 (U.S. CLS. 22, 23, 38 AND 50).

FIRST USE 6-30-2011; IN COMMERCE 6-30-2011.

THE MARK CONSISTS OF STANDARD CHARACTERS WITHOUT CLAIM TO ANY PARTICULAR FONT, STYLE, SIZE, OR COLOR.

NO CLAIM IS MADE TO THE EXCLUSIVE RIGHT TO USE "FITNESS", APART FROM THE MARK AS SHOWN.

THE NAME(S), PORTRAIT(S), AND/OR SIGNATURE(S) SHOWN IN THE MARK DOES NOT IDENTIFY A PARTICULAR LIVING INDIVIDUAL.

THE WORDING "MO CHI" HAS NO MEANING IN A FOREIGN LANGUAGE.

SN 85-030,900, FILED 5-5-2010.

DAVID C. REIHNER, EXAMINING ATTORNEY



*David J. Kyffers*

Director of the United States Patent and Trademark Office

# United States of America

United States Patent and Trademark Office

## WHITECLOUD PERFORMANCE ANALYTICS

**Reg. No. 4,126,063**

**Registered Apr. 10, 2012**

**Int. Cl.: 35**

**SERVICE MARK**

**PRINCIPAL REGISTER**

WHITECLOUD ANALYTICS INC. (DELAWARE CORPORATION)  
SUITE 200  
225 N. 9TH STREET  
BOISE, ID 83702

FOR: BUSINESS MANAGEMENT CONSULTING WITH RELATION TO OPERATION, STRATEGY, AND APPLICATION, PARTICULARLY SPECIALIZING IN THE USE OF ANALYTIC MODELS TO IMPROVE AND REACH A DESIRED CLINICAL AND OPERATIONAL BUSINESS PERFORMANCE IN THE FIELD OF HEALTHCARE, IN CLASS 35 (U.S. CLS. 100, 101 AND 102).

FIRST USE 10-31-2009; IN COMMERCE 10-31-2009.

THE MARK CONSISTS OF STANDARD CHARACTERS WITHOUT CLAIM TO ANY PARTICULAR FONT, STYLE, SIZE, OR COLOR.

NO CLAIM IS MADE TO THE EXCLUSIVE RIGHT TO USE "PERFORMANCE ANALYTICS", APART FROM THE MARK AS SHOWN.

SN 85-032,791, FILED 5-7-2010.

SIMON TENG, EXAMINING ATTORNEY



*David J. Kyffers*

Director of the United States Patent and Trademark Office

# United States of America

United States Patent and Trademark Office

## Knowledge Refinery

**Reg. No. 4,126,064**

**Registered Apr. 10, 2012**

**Int. Cls.: 9 and 42**

**TRADEMARK**

**SERVICE MARK**

**PRINCIPAL REGISTER**

HATHA SYSTEMS LLC (MARYLAND LIMITED LIABILITY COMPANY)  
10 LIGHT STREET  
BALTIMORE, MD 21202

FOR: COMPUTER PROGRAM FOR USE IN KNOWLEDGE MANAGEMENT, NAMELY, DELIVERING KNOWLEDGE IN THE NATURE OF DIAGRAMS, REPORTS, TAGGING AND ANNOTATION OF RELEVANT DATA, AS WELL AS RESPONSES TO COMPUTER-BASED QUERIES, THROUGH THE EXTRACTION FROM AND ANALYSIS OF SOFTWARE SYSTEMS AND THEIR ASSOCIATED PROCESSES, IN CLASS 9 (U.S. CLS. 21, 23, 26, 36 AND 38).

FIRST USE 5-1-2010; IN COMMERCE 9-30-2011.

FOR: COMPUTER SERVICES, NAMELY, ACTING AS AN APPLICATION SERVICE PROVIDER IN THE FIELD OF KNOWLEDGE MANAGEMENT TO HOST COMPUTER APPLICATION SOFTWARE FOR DELIVERING KNOWLEDGE IN THE NATURE OF DIAGRAMS, REPORTS, TAGGING AND ANNOTATION OF RELEVANT DATA, AS WELL AS RESPONSES TO COMPUTER-BASED QUERIES, THROUGH THE EXTRACTION FROM AND ANALYSIS OF SOFTWARE SYSTEMS AND THEIR ASSOCIATED PROCESSES, IN CLASS 42 (U.S. CLS. 100 AND 101).

FIRST USE 5-1-2010; IN COMMERCE 9-30-2011.

THE MARK CONSISTS OF STANDARD CHARACTERS WITHOUT CLAIM TO ANY PARTICULAR FONT, STYLE, SIZE, OR COLOR.

NO CLAIM IS MADE TO THE EXCLUSIVE RIGHT TO USE "KNOWLEDGE", APART FROM THE MARK AS SHOWN.

SN 85-032,812, FILED 5-7-2010.

SALLY SHIH, EXAMINING ATTORNEY



*David J. Kypos*

Director of the United States Patent and Trademark Office

# United States of America

United States Patent and Trademark Office

## REAL MEN SWING PINK

**Reg. No. 4,126,065**

HILLERICH & BRADSBY CO. (KENTUCKY CORPORATION)  
800 WEST MAIN STREET  
LOUISVILLE, KY 40202

**Registered Apr. 10, 2012**

**Int. Cls.: 35 and 36**

FOR: PROMOTING PUBLIC AWARENESS OF BREAST CANCER, IN CLASS 35 (U.S. CLS. 100, 101 AND 102).

**SERVICE MARK**

FIRST USE 5-0-2010; IN COMMERCE 5-0-2010.

**PRINCIPAL REGISTER**

FOR: CHARITABLE FUNDRAISING SERVICES BY MEANS OF SELLING PINK BASEBALL BATS TO RAISE FUNDS FOR BREAST CANCER RESEARCH; CHARITABLE FUNDRAISING SERVICES BY MEANS OF PROVIDING PINK BASEBALL BATS TO OTHERS FOR FUTURE SALE TO RAISE FUNDS FOR BREAST CANCER RESEARCH, IN CLASS 36 (U.S. CLS. 100, 101 AND 102).

FIRST USE 5-0-2010; IN COMMERCE 5-0-2010.

THE MARK CONSISTS OF STANDARD CHARACTERS WITHOUT CLAIM TO ANY PARTICULAR FONT, STYLE, SIZE, OR COLOR.

SN 85-033,240, FILED 5-7-2010.

TRICIA SONNEBORN, EXAMINING ATTORNEY



*David J. Kyffers*

Director of the United States Patent and Trademark Office

# United States of America

United States Patent and Trademark Office

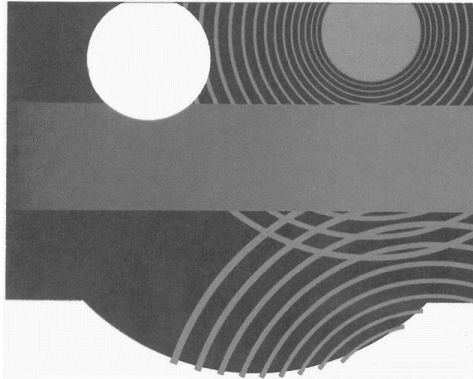

**Reg. No. 4,126,066**

**Registered Apr. 10, 2012**

**Int. Cl.: 25**

**TRADEMARK**

**PRINCIPAL REGISTER**

SLANE HOSIERY MILLS, INC. (NORTH CAROLINA CORPORATION)  
PO BOX 2486 313 S. CENTENNIAL STREET  
HIGH POINT, NC 27260

FOR: SOCKS AND STOCKINGS, IN CLASS 25 (U.S. CLS. 22 AND 39).

FIRST USE 7-15-2011; IN COMMERCE 7-15-2011.

THE MARK CONSISTS OF AN INCOMPLETE SPHERE WITH A SERIES OF INCOMPLETE CIRCLES WHICH PARTIALLY INTERSECT AND OVERLAP WITH A SERIES OF CONCENTRIC RADIATING INCOMPLETE CIRCLES, INTERRUPTED IN PART BY A STRAIGHT RECTANGULAR CARRIER BLOCK WHICH IS SHADED ON THE LEFT SIDE; TO THE LEFT OF THE INCOMPLETE SPHERE IS A LARGER INCOMPLETE CARRIER SPHERE, ALL OF THE FOREGOING APPEARING ON A SHADED BACKGROUND.

SN 85-033,339, FILED 5-7-2010.

HEATHER THOMPSON, EXAMINING ATTORNEY



*David J. Kybas*

Director of the United States Patent and Trademark Office

# United States of America

United States Patent and Trademark Office

# Hexbgone

**Reg. No. 4,126,067**

**Registered Apr. 10, 2012**

**Int. Cl.: 25**

**TRADEMARK**

**PRINCIPAL REGISTER**

SANDERSON, THOMAS ALLEN (UNITED STATES INDIVIDUAL)  
4220 N KENMORE AVENUE  
APT 1  
CHICAGO, IL 60613

FOR: ATHLETIC APPAREL, NAMELY, SHIRTS, PANTS, JACKETS, FOOTWEAR, HATS  
AND CAPS, ATHLETIC UNIFORMS, IN CLASS 25 (U.S. CLS. 22 AND 39).

FIRST USE 4-28-2011; IN COMMERCE 5-20-2011.

THE MARK CONSISTS OF STANDARD CHARACTERS WITHOUT CLAIM TO ANY PAR-  
TICULAR FONT, STYLE, SIZE, OR COLOR.

SN 85-033,742, FILED 5-9-2010.

RENEE MCCRAY, EXAMINING ATTORNEY



*David J. Kyros*

Director of the United States Patent and Trademark Office



# United States of America

United States Patent and Trademark Office

# FRESHBIKES

**Reg. No. 4,126,068**

**Registered Apr. 10, 2012**

**Int. Cl.: 35**

**SERVICE MARK**

**PRINCIPAL REGISTER**

FRESHBIKES FRANCHISING, LLC (VIRGINIA LIMITED LIABILITY COMPANY)  
3924 WILSON BLVD  
ARLINGTON, VA 22203

FOR: RETAIL SPORTING GOODS STORES; RETAIL STORE SERVICES FEATURING BICYCLES, BICYCLE ACCESSORIES AND EXERCISE EQUIPMENT; RETAIL STORES FEATURING BICYCLES, BICYCLE ACCESSORIES AND EXERCISE EQUIPMENT; FRANCHISE SERVICES, NAMELY, OFFERING TECHNICAL AND BUSINESS MANAGEMENT ASSISTANCE IN THE ESTABLISHMENT AND OPERATION OF RETAIL STORES FOR THE SALE OF BICYCLES, BICYCLE ACCESSORIES AND EXERCISE EQUIPMENT; FRANCHISING, NAMELY, OFFERING TECHNICAL ASSISTANCE IN THE ESTABLISHMENT AND/OR OPERATION OF RETAIL STORES FOR THE SALE OF BICYCLES, BICYCLE ACCESSORIES AND EXERCISE EQUIPMENT, IN CLASS 35 (U.S. CLS. 100, 101 AND 102).

FIRST USE 9-20-2009; IN COMMERCE 9-20-2009.

THE MARK CONSISTS OF STANDARD CHARACTERS WITHOUT CLAIM TO ANY PARTICULAR FONT, STYLE, SIZE, OR COLOR.

SN 85-034,270, FILED 5-10-2010.

TRACY FLETCHER, EXAMINING ATTORNEY



*David J. Kybas*

Director of the United States Patent and Trademark Office

# United States of America

United States Patent and Trademark Office

## CALICO SKIES VINEYARD AND WINERY

**Reg. No. 4,126,069**

**Registered Apr. 10, 2012**

**Int. Cl.: 33**

**TRADEMARK**

**PRINCIPAL REGISTER**

KIMBERLEY, WILLIAM (UNITED STATES INDIVIDUAL)  
P.O. BOX 335, 201 NORTH MAIN ST  
INWOOD, IA 51240

FOR: WINES, IN CLASS 33 (U.S. CLS. 47 AND 49).

FIRST USE 3-1-2010; IN COMMERCE 5-1-2011.

THE MARK CONSISTS OF STANDARD CHARACTERS WITHOUT CLAIM TO ANY PARTICULAR FONT, STYLE, SIZE, OR COLOR.

NO CLAIM IS MADE TO THE EXCLUSIVE RIGHT TO USE "VINEYARD AND WINERY", APART FROM THE MARK AS SHOWN.

SN 85-037,070, FILED 5-12-2010.

JOHN DWYER, EXAMINING ATTORNEY



*David J. Kybas*

Director of the United States Patent and Trademark Office

# United States of America

United States Patent and Trademark Office



**Reg. No. 4,126,070**

**Registered Apr. 10, 2012**

**Int. Cls.: 10 and 21**

**TRADEMARK**

**PRINCIPAL REGISTER**

INTERGANIC (UNITED ARAB EMIR. CORPORATION)  
P.O. BOX 263232  
DUBAI, UNITED ARAB EMIR.

FOR: BABY GOODS AND ACCESSORIES, NAMELY, BABY BOTTLE NIPPLES; BABY BOTTLES; NIPPLES FOR BABY BOTTLES; NURSING BOTTLES; PACIFIER CLIPS; PACIFIERS FOR BABIES; BREAST PUMPS; BREAST PUMP EQUIPMENT, NAMELY, BREAST PUMPS; TEETHING RINGS; TEETHING RINGS INCORPORATING BABY RATTLES; TEETHING TOYS, NAMELY, TEETHING RINGS; DISHES ADAPTED TO FEED BABIES AND CHILDREN; CUPS SOLD EMPTY ADAPTED TO FEED BABIES AND CHILDREN, IN CLASS 10 (U.S. CLS. 26, 39 AND 44).

FIRST USE 6-1-2011; IN COMMERCE 9-1-2011.

FOR: INFANT'S AND CHILDREN'S DRINKING CUPS; DISHES FOR BABIES AND INFANTS; TOOTHBRUSHES; PLASTIC OR GLASS DRINKING CONTAINERS SOLD EMPTY, NAMELY, CUPS FOR BABIES, IN CLASS 21 (U.S. CLS. 2, 13, 23, 29, 30, 33, 40 AND 50).

FIRST USE 6-1-2011; IN COMMERCE 9-1-2011.

THE MARK CONSISTS OF "MII" IN LARGE TYPEFACE APPEARING ABOVE THE WORDS "MY", ARABIC WORDING THAT MEANS "MY" IN ENGLISH, "MON", AN ASIAN CHARACTER THAT MEANS "MY" IN ENGLISH, "MI", AND AN ASIAN CHARACTER THAT MEANS "MY" IN ENGLISH.

THE ENGLISH TRANSLATION OF "MII", "MON" AND "MI" IN THE MARK IS "MY". THE NON-LATIN CHARACTERS IN THE MARK TRANSLITERATE TO "MY", AND THIS MEANS "MY" IN ENGLISH.

SN 85-037,550, FILED 5-13-2010.

DEBRA LEE, EXAMINING ATTORNEY



*David J. Kyffers*

Director of the United States Patent and Trademark Office

# United States of America

United States Patent and Trademark Office

## INSIGHT. ACTION. RESULTS.

**Reg. No. 4,126,071**

ECOLAB USA INC. (DELAWARE CORPORATION)

**Registered Apr. 10, 2012**

370 WABASHA STREET NORTH  
SAINT PAUL, MN 55102

**Int. Cls.: 35 and 41**

FOR: BUSINESS AUDITING; BUSINESS CONSULTING AND INFORMATION SERVICES; BUSINESS DATA ANALYSIS; INFORMATION AND DATA COMPILING AND ANALYZING RELATING TO BUSINESS MANAGEMENT; PREPARATION OF BUSINESS REPORTS, IN CLASS 35 (U.S. CLS. 100, 101 AND 102).

**SERVICE MARK**

**PRINCIPAL REGISTER**

FIRST USE 12-1-2010; IN COMMERCE 12-1-2010.

FOR: BUSINESS TRAINING; EDUCATIONAL SERVICES, NAMELY, DEVELOPING AND CONDUCTING TRAINING COURSES AND DISTRIBUTION OF TRAINING MATERIALS IN CONNECTION THEREWITH FOR SUBJECT MATTERS AS REQUESTED BY CUSTOMERS; TRAINING SERVICES IN THE FIELD OF CLEANING, SANITIZING AND FOOD SAFETY, IN CLASS 41 (U.S. CLS. 100, 101 AND 107).

FIRST USE 12-1-2010; IN COMMERCE 12-1-2010.

THE MARK CONSISTS OF STANDARD CHARACTERS WITHOUT CLAIM TO ANY PARTICULAR FONT, STYLE, SIZE, OR COLOR.

SN 85-037,833, FILED 5-13-2010.

KATHERINE CHANG, EXAMINING ATTORNEY



*David J. Kyjars*

Director of the United States Patent and Trademark Office

# United States of America

United States Patent and Trademark Office

# INTERSTAK

**Reg. No. 4,126,072**

INTERPACK, INC. (ARKANSAS CORPORATION)  
1102 INDUSTRIAL PARK  
BERRYVILLE, AR 72616

**Registered Apr. 10, 2012**

**Int. Cl.: 16**

FOR: PAPER GOODS, NAMELY, PAPER AND CARDBOARD; CORRUGATED PAPER PARTITIONS, CONTAINERS, BOXES, AND BOARDS, IN CLASS 16 (U.S. CLS. 2, 5, 22, 23, 29, 37, 38 AND 50).

**TRADEMARK**

FIRST USE 9-13-2011; IN COMMERCE 9-13-2011.

**PRINCIPAL REGISTER**

THE MARK CONSISTS OF STANDARD CHARACTERS WITHOUT CLAIM TO ANY PARTICULAR FONT, STYLE, SIZE, OR COLOR.

SN 85-038,417, FILED 5-14-2010.

ARETHA SOMERVILLE, EXAMINING ATTORNEY



*David J. Kyfos*

Director of the United States Patent and Trademark Office

# United States of America

United States Patent and Trademark Office

# Captain Morgan

**Reg. No. 4,126,073**

**Registered Apr. 10, 2012**

**Int. Cl.: 33**

**TRADEMARK**

**PRINCIPAL REGISTER**

DIAGEO NORTH AMERICA, INC. (CONNECTICUT CORPORATION)  
801 MAIN AVENUE  
NORWALK, CT 06851

FOR: ALCOHOLIC BEVERAGES EXCEPT BEERS, IN CLASS 33 (U.S. CLS. 47 AND 49).

FIRST USE 11-30-2011; IN COMMERCE 11-30-2011.

OWNER OF U.S. REG. NOS. 972,985, 3,509,465, AND OTHERS.

THE NAME(S), PORTRAIT(S), AND/OR SIGNATURE(S) SHOWN IN THE MARK DOES NOT IDENTIFY A PARTICULAR LIVING INDIVIDUAL.

THE MARK CONSISTS OF THE WORDS "CAPTAIN" AND "MORGAN" IN A STYLIZED FONT.

SN 85-039,011, FILED 5-14-2010.

HEATHER THOMPSON, EXAMINING ATTORNEY



*David J. Kyffers*

Director of the United States Patent and Trademark Office

# United States of America

United States Patent and Trademark Office

## BIOSAN P MAX

**Reg. No. 4,126,074**

**Registered Apr. 10, 2012**

**Int. Cls.: 1, 3, and 5**

**TRADEMARK**

**PRINCIPAL REGISTER**

CKM HOLDINGS INC. (DELAWARE CORPORATION)  
696 WINER INDUSTRIAL WAY  
LAWRENCEVILLE, GA 30046

FOR: CHEMICALS, CHEMICAL SUBSTANCES AND NATURAL BIOLOGICAL PREPARATIONS AND SUBSTANCES IN THE NATURE OF BIOLOGICALLY ACTIVE ENZYMES AND MICROORGANISMS FOR THE TREATMENT OF WASTE AND FOR USE IN THE MANUFACTURE OF SUBSTANCES FOR THE TREATMENT OF WASTE, INDUSTRIAL, AND INSTITUTIONAL PRODUCTS, BUT NOT FOR THE DETECTION OF MICROORGANISMS; MICROBIAL PREPARATIONS FOR THE TREATMENT OF WASTE; MICROBIAL PREPARATIONS FOR THE TREATMENT OF WASTEWATER PIPES; NATURAL BIOLOGICAL PREPARATIONS AND SUBSTANCES, NAMELY, BIOLOGICALLY ACTIVE ENZYMES AND MICROORGANISMS FOR THE TREATMENT OF WASTE; NATURAL BIOLOGICAL PREPARATIONS AND SUBSTANCES, NAMELY, PLANT EXTRACTS FOR USE IN MANUFACTURE OF PERFUMERY, ESSENTIAL OILS, CHEMICAL PREPARATIONS FOR CLEANING PURPOSES; MICROBIAL PREPARATIONS FOR THE TREATMENT OF WASTE; MICROBIAL PREPARATIONS FOR USE IN PERFUMERY, ESSENTIAL OILS, CHEMICAL PREPARATIONS FOR CLEANING PURPOSES; MICROBIAL PREPARATIONS FOR THE TREATMENT OF WASTEWATER PIPES; NATURAL BIOLOGICAL PREPARATIONS AND SUBSTANCES, NAMELY, PLANT AND HERB EXTRACTS FOR THE TREATMENT OF WASTE AND FOR USE IN THE MANUFACTURE OF CLEANING COMPOUNDS AND INDUSTRIAL AND INSTITUTIONAL PRODUCTS; NATURAL BIOLOGICAL PREPARATIONS AND SUBSTANCES, NAMELY, PLANT AND HERB EXTRACTS FOR THE TREATMENT OF WASTE; MICROBIAL PREPARATIONS FOR THE TREATMENT OF WASTE; CHEMICAL PREPARATIONS FOR THE TREATMENT OF WASTEWATER PIPES; NATURAL BIOLOGICAL PREPARATIONS AND SUBSTANCES, NAMELY, BOTANICAL EXTRACTS FOR THE TREATMENT OF WASTE AND FOR USE IN THE MANUFACTURE OF CLEANING COMPOUNDS AND INDUSTRIAL AND INSTITUTIONAL PRODUCTS, IN CLASS 1 (U.S. CLS. 1, 5, 6, 10, 26 AND 46).



FIRST USE 6-1-2009; IN COMMERCE 6-1-2009.

*David J. Kybas*

Director of the United States Patent and Trademark Office

FOR: CLEANING PREPARATIONS AND AGENTS FOR THE TREATMENT OF SANITARY WASTE; CLEANING PRODUCTS, NAMELY, IMPREGNATED ITEMS, NAMELY, GRANULES, MICRO-GRANULES, POWDERS, NON-WOVEN SHEATHS, CARDS, STRIPS, SACHETS, TOWELETTES, WIPES AND TISSUES FOR THE TREATMENT OF SANITARY WASTE, IN CLASS 3 (U.S. CLS. 1, 4, 6, 50, 51 AND 52).

**Reg. No. 4,126,074** FIRST USE 6-1-2009; IN COMMERCE 6-1-2009.

FOR: BIOCIDAL AND ODOR CONTROL TREATMENTS, NAMELY, DISINFECTANTS FOR SANITARY PURPOSES, ODOR ELIMINATORS NOT FOR PERSONAL USE AND ODOR NEUTRALIZING PREPARATIONS FOR USE ON SANITARY WARE, SANITARY BINS, DIAPER BINS, ADULT DIAPER BINS AND WASTE BINS, IN CLASS 5 (U.S. CLS. 6, 18, 44, 46, 51 AND 52).

FIRST USE 6-1-2009; IN COMMERCE 6-1-2009.

THE MARK CONSISTS OF STANDARD CHARACTERS WITHOUT CLAIM TO ANY PARTICULAR FONT, STYLE, SIZE, OR COLOR.

SN 85-040,729, FILED 5-17-2010.

NATALIE POLZER, EXAMINING ATTORNEY



# United States of America

United States Patent and Trademark Office

## BIOSAN NATURALS

**Reg. No. 4,126,075**

**Registered Apr. 10, 2012**

**Int. Cls.: 1, 3, and 5**

**TRADEMARK**

**PRINCIPAL REGISTER**

CKM HOLDINGS INC. (DELAWARE CORPORATION)  
696 WINER INDUSTRIAL WAY  
LAWRENCEVILLE, GA 30046

FOR: CHEMICALS, CHEMICAL SUBSTANCES AND NATURAL BIOLOGICAL PREPARATIONS AND SUBSTANCES IN THE NATURE OF BIOLOGICALLY ACTIVE ENZYMES AND MICROORGANISMS FOR THE TREATMENT OF WASTE AND FOR USE IN THE MANUFACTURE OF SUBSTANCES FOR THE TREATMENT OF WASTE, INDUSTRIAL, AND INSTITUTIONAL PRODUCTS, BUT NOT FOR THE DETECTION OF MICROORGANISMS; MICROBIAL PREPARATIONS FOR THE TREATMENT OF WASTE; MICROBIAL PREPARATIONS FOR THE TREATMENT OF WASTEWATER PIPES; NATURAL BIOLOGICAL PREPARATIONS AND SUBSTANCES, NAMELY, BIOLOGICALLY ACTIVE ENZYMES AND MICROORGANISMS FOR THE TREATMENT OF WASTE; NATURAL BIOLOGICAL PREPARATIONS AND SUBSTANCES, NAMELY, PLANT EXTRACTS FOR USE IN MANUFACTURE OF PERFUMERY, ESSENTIAL OILS, CHEMICAL PREPARATIONS FOR CLEANING PURPOSES; MICROBIAL PREPARATIONS FOR THE TREATMENT OF WASTE; MICROBIAL PREPARATIONS FOR USE IN PERFUMERY, ESSENTIAL OILS, CHEMICAL PREPARATIONS FOR CLEANING PURPOSES; MICROBIAL PREPARATIONS FOR THE TREATMENT OF WASTEWATER PIPES; NATURAL BIOLOGICAL PREPARATIONS AND SUBSTANCES, NAMELY, PLANT AND HERB EXTRACTS FOR THE TREATMENT OF WASTE AND FOR USE IN THE MANUFACTURE OF CLEANING COMPOUNDS AND INDUSTRIAL AND INSTITUTIONAL PRODUCTS; NATURAL BIOLOGICAL PREPARATIONS AND SUBSTANCES, NAMELY, PLANT AND HERB EXTRACTS FOR THE TREATMENT OF WASTE; MICROBIAL PREPARATIONS FOR THE TREATMENT OF WASTE; CHEMICAL PREPARATIONS FOR THE TREATMENT OF WASTEWATER PIPES; NATURAL BIOLOGICAL PREPARATIONS AND SUBSTANCES, NAMELY, BOTANICAL EXTRACTS FOR THE TREATMENT OF WASTE AND FOR USE IN THE MANUFACTURE OF CLEANING COMPOUNDS AND INDUSTRIAL AND INSTITUTIONAL PRODUCTS, IN CLASS 1 (U.S. CLS. 1, 5, 6, 10, 26 AND 46).



FIRST USE 9-1-2009; IN COMMERCE 9-1-2009.

*David J. Kyffers*

Director of the United States Patent and Trademark Office

FOR: CLEANING PREPARATIONS AND AGENTS FOR THE TREATMENT OF SANITARY WASTE; CLEANING PRODUCTS, NAMELY, IMPREGNATED ITEMS, NAMELY, GRANULES, MICRO-GRANULES, POWDERS, NON-WOVEN SHEATHS, CARDS, STRIPS, SACHETS, TOWELETTES, WIPES AND TISSUES FOR THE TREATMENT OF SANITARY WASTE, IN CLASS 3 (U.S. CLS. 1, 4, 6, 50, 51 AND 52).

**Reg. No. 4,126,075** FIRST USE 9-1-2009; IN COMMERCE 9-1-2009.

FOR: BIOCIDAL AND ODOR CONTROL TREATMENTS, NAMELY, DISINFECTANTS FOR SANITARY PURPOSES, ODOR ELIMINATORS NOT FOR PERSONAL USE AND ODOR NEUTRALIZING PREPARATIONS FOR USE ON SANITARY WARE, SANITARY BINS, DIAPER BINS, ADULT DIAPER BINS AND WASTE BINS, IN CLASS 5 (U.S. CLS. 6, 18, 44, 46, 51 AND 52).

FIRST USE 9-1-2009; IN COMMERCE 9-1-2009.

THE MARK CONSISTS OF STANDARD CHARACTERS WITHOUT CLAIM TO ANY PARTICULAR FONT, STYLE, SIZE, OR COLOR.

NO CLAIM IS MADE TO THE EXCLUSIVE RIGHT TO USE "NATURALS" AS TO CLASS 1, APART FROM THE MARK AS SHOWN.

SN 85-040,734, FILED 5-17-2010.

NATALIE POLZER, EXAMINING ATTORNEY

# United States of America

United States Patent and Trademark Office

## Cone Drive Solar

**Reg. No. 4,126,076**

CONE DRIVE OPERATIONS, INC. (DELAWARE CORPORATION)  
240 E. 12TH ST.

**Registered Apr. 10, 2012**

TRAVERSE CITY, MI 49685

**Int. Cl.: 7**

FOR: MOTORS, GEARS AND DRIVES FOR ORIENTATING SOLAR PANELS, IN CLASS 7  
(U.S. CLS. 13, 19, 21, 23, 31, 34 AND 35).

**TRADEMARK**

FIRST USE 7-1-2010; IN COMMERCE 7-1-2010.

**PRINCIPAL REGISTER**

THE MARK CONSISTS OF STANDARD CHARACTERS WITHOUT CLAIM TO ANY PARTICULAR FONT, STYLE, SIZE, OR COLOR.

OWNER OF U.S. REG. NOS. 642,562 AND 3,192,467.

NO CLAIM IS MADE TO THE EXCLUSIVE RIGHT TO USE "DRIVE SOLAR", APART FROM THE MARK AS SHOWN.

SN 85-041,569, FILED 5-18-2010.

SARA BENJAMIN, EXAMINING ATTORNEY

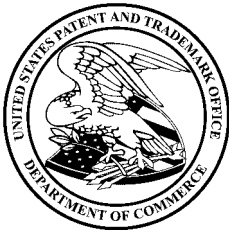

*David J. Kybas*

Director of the United States Patent and Trademark Office

# United States of America

United States Patent and Trademark Office

# APPLIQUES

**Reg. No. 4,126,077**

**Registered Apr. 10, 2012**

**Int. Cl.: 35**

**SERVICE MARK**

**PRINCIPAL REGISTER**

GUN LAKE TRIBAL GAMING AUTHORITY (UNITED STATES FEDERALLY-RECOGNIZED INDIAN TRIBE)  
1743 142ND AVENUE, SUITE 3  
DORR, MI 49323

FOR: RETAIL GIFT SHOP SERVICES, IN CLASS 35 (U.S. CLS. 100, 101 AND 102).

FIRST USE 2-26-2011; IN COMMERCE 2-26-2011.

THE MARK CONSISTS OF STANDARD CHARACTERS WITHOUT CLAIM TO ANY PARTICULAR FONT, STYLE, SIZE, OR COLOR.

SN 85-042,107, FILED 5-18-2010.

KATHY DE JONGE, EXAMINING ATTORNEY



*David J. Kyffers*

Director of the United States Patent and Trademark Office

United States of America  
United States Patent and Trademark Office

HUMMINGBIRK

**Reg. No. 4,126,078**

FIELDS, JOE (UNITED STATES INDIVIDUAL)  
3926 LOGANS LANDING  
LOUISVILLE, TN 37777

**Registered Apr. 10, 2012**

**Int. Cl.: 12**

FOR: VEHICLES, NAMELY, ELECTRIC POWERED BICYCLES AND OTHER ELECTRIC POWERED VEHICLES; ELECTRIC POWERED BICYCLES AND OTHER ELECTRIC POWERED VEHICLES, NAMELY, TRICYCLES AND FOUR WHEELED ELECTRIC POWERED CARTS; PARTS AND ACCESSORIES FOR ELECTRIC POWERED BICYCLES AND OTHER ELECTRIC POWERED VEHICLES, NAMELY, TRICYCLES AND FOUR WHEELED ELECTRIC POWERED CARTS, IN CLASS 12 (U.S. CLS. 19, 21, 23, 31, 35 AND 44).

**TRADEMARK**

**PRINCIPAL REGISTER**

FIRST USE 4-15-2010; IN COMMERCE 9-15-2010.

THE MARK CONSISTS OF ALL CAPITAL LETTERS WITH THE EXCEPTION OF THE "B" WHICH IS IN THE FORM OF THE OUTLINE OF A HUMMINGBIRD.

SN 85-042,132, FILED 5-19-2010.

AISHA CLARKE, EXAMINING ATTORNEY



*David J. Kybas*

Director of the United States Patent and Trademark Office

# United States of America

United States Patent and Trademark Office

## TOP O' THE MORNIN'

**Reg. No. 4,126,079**

**Registered Apr. 10, 2012**

**Int. Cl.: 9**

**TRADEMARK**

**PRINCIPAL REGISTER**

WMS GAMING INC. (DELAWARE CORPORATION)  
800 SOUTH NORTHPOINT BOULEVARD  
WAUKEGAN, IL 60085

FOR: COMPONENTS FOR GAMING MACHINES THAT GENERATE OR DISPLAY WAGER OUTCOMES, NAMELY, CONTROLLERS, DISPLAYS, BUTTON PANELS, BOLSTERS, ELECTRICAL WIRING, AND COMPUTER HARDWARE AND SOFTWARE ASSOCIATED THEREWITH; GAMING MACHINES, NAMELY, DEVICES WHICH ACCEPT A WAGER; GAMING SOFTWARE THAT GENERATES OR DISPLAYS WAGER OUTCOMES OF GAMING MACHINES, IN CLASS 9 (U.S. CLS. 21, 23, 26, 36 AND 38).

FIRST USE 5-19-2011; IN COMMERCE 5-19-2011.

THE MARK CONSISTS OF STANDARD CHARACTERS WITHOUT CLAIM TO ANY PARTICULAR FONT, STYLE, SIZE, OR COLOR.

SN 85-042,379, FILED 5-19-2010.

NICHOLAS COLEMAN, EXAMINING ATTORNEY



*David J. Kyffers*

Director of the United States Patent and Trademark Office

# United States of America

United States Patent and Trademark Office

# Green Wonk

**Reg. No. 4,126,080**

AMERICAN UNIVERSITY (D.C. CORPORATION)  
4400 MASSACHUSETTS AVENUE, NW  
WASHINGTON, DC 20016

**Registered Apr. 10, 2012**

**Int. Cl.: 41**

FOR: EDUCATIONAL SERVICES, NAMELY, PROVIDING EDUCATIONAL PROGRAMS, COURSES OF INSTRUCTION AT THE COLLEGE AND GRADUATE LEVEL, SEMINARS, LECTURES, AND WORKSHOPS IN THE FIELD OF ENVIRONMENTAL STUDIES, IN CLASS 41 (U.S. CLS. 100, 101 AND 107).

**SERVICE MARK**

**PRINCIPAL REGISTER**

FIRST USE 6-17-2011; IN COMMERCE 6-17-2011.

THE MARK CONSISTS OF STANDARD CHARACTERS WITHOUT CLAIM TO ANY PARTICULAR FONT, STYLE, SIZE, OR COLOR.

NO CLAIM IS MADE TO THE EXCLUSIVE RIGHT TO USE "GREEN", APART FROM THE MARK AS SHOWN.

SN 85-043,817, FILED 5-20-2010.

DAVID HOFFMAN, EXAMINING ATTORNEY



*David J. Kyffers*

Director of the United States Patent and Trademark Office

United States of America  
United States Patent and Trademark Office

# KELOIL

**Reg. No. 4,126,081**

CANAAN L. HARRIS (UNITED STATES INDIVIDUAL)  
1315 ST. JOSEPH'S PARKWAY, SUITE 1001  
HOUSTON, TX 77002

**Registered Apr. 10, 2012**

**Int. Cl.: 5**

FOR: PHARMACEUTICAL SOLUTION FOR THE TREATMENT OF SKIN DISORDERS,  
NAMELY, ADVANCED SCAR TISSUE, IN CLASS 5 (U.S. CLS. 6, 18, 44, 46, 51 AND 52).

**TRADEMARK**

FIRST USE 1-16-2012; IN COMMERCE 1-16-2012.

**PRINCIPAL REGISTER**

THE MARK CONSISTS OF STANDARD CHARACTERS WITHOUT CLAIM TO ANY PAR-  
TICULAR FONT, STYLE, SIZE, OR COLOR.

SN 85-044,842, FILED 5-21-2010.

MARTHA SANTOMARTINO, EXAMINING ATTORNEY



*David J. Kybas*

Director of the United States Patent and Trademark Office



# United States of America

United States Patent and Trademark Office

# SLEEP-N-GO

**Reg. No. 4,126,082**

SLEEP-N-GO INN, LLC (ARIZONA LIMITED LIABILITY COMPANY)  
16009 N. 81ST STREET, SUITE 200  
SCOTTSDALE, AZ 85260

**Registered Apr. 10, 2012**

**Int. Cl.: 43**

FOR: HOTELS, HOTEL SERVICES, IN CLASS 43 (U.S. CLS. 100 AND 101).

**SERVICE MARK**

FIRST USE 6-0-2011; IN COMMERCE 6-0-2011.

**PRINCIPAL REGISTER**

THE MARK CONSISTS OF STANDARD CHARACTERS WITHOUT CLAIM TO ANY PARTICULAR FONT, STYLE, SIZE, OR COLOR.

SN 85-045,309, FILED 5-21-2010.

AISHA CLARKE, EXAMINING ATTORNEY



*David J. Kyffers*

Director of the United States Patent and Trademark Office

# United States of America

United States Patent and Trademark Office

## American Funds Tax-Exempt Fund of New York

**Reg. No. 4,126,083**

**Registered Apr. 10, 2012**

**Int. Cl.: 36**

**SERVICE MARK**

**PRINCIPAL REGISTER**

AMERICAN FUNDS DISTRIBUTORS INC. (DELAWARE TRUST)  
ATTN: DAVID M. GIVNER (DMG)  
333 S. HOPE STREET, 55TH FLOOR  
LOS ANGELES, CA 90071

FOR: FINANCIAL SERVICES, NAMELY, FINANCIAL ANALYSIS, EVALUATION AND CONSULTATION; INVESTMENT MANAGEMENT AND ADVICE; MUTUAL FUND INVESTMENT MANAGEMENT AND DISTRIBUTION; ANNUITY SERVICES, NAMELY, INVESTMENT MANAGEMENT AND DISTRIBUTION OF VARIABLE ANNUITIES; FIDUCIARY SERVICES, NAMELY, SERVING AS TRUSTEE FOR DIRECTED AND DISCRETIONARY TRUST ACCOUNTS; ESTATE PLANNING; AND FINANCIAL ADMINISTRATION OF EMPLOYEE BENEFIT, PENSION AND RETIREMENT PLANS IN CONNECTION THEREWITH, IN CLASS 36 (U.S. CLS. 100, 101 AND 102).

FIRST USE 11-1-2010; IN COMMERCE 11-1-2010.

THE MARK CONSISTS OF STANDARD CHARACTERS WITHOUT CLAIM TO ANY PARTICULAR FONT, STYLE, SIZE, OR COLOR.

SEC. 2(F) AS TO "AMERICAN FUNDS" HAS BECOME DISTINCTIVE OF THE GOODS/SERVICES AS EVIDENCED BY THE OWNERSHIP ON THE PRINCIPAL REGISTER FOR THE SAME MARK FOR RELATED GOODS OR SERVICES OF U.S. REGISTRATION NO(S). 2627929, 3183222, 3563152, 3774096 AND OTHERS. .

OWNER OF U.S. REG. NOS. 2,627,929, 3,774,096, AND OTHERS.

NO CLAIM IS MADE TO THE EXCLUSIVE RIGHT TO USE "TAX-EXEMPT FUND" OR "NEW YORK", APART FROM THE MARK AS SHOWN.

SN 85-045,518, FILED 5-21-2010.

RICHARD WHITE, EXAMINING ATTORNEY



*David J. Kypos*

Director of the United States Patent and Trademark Office

# United States of America

United States Patent and Trademark Office

## PROTEIN SQUARED

**Reg. No. 4,126,084**

**Registered Apr. 10, 2012**

**Int. Cl.: 29**

**TRADEMARK**

**PRINCIPAL REGISTER**

TSUDIS CHOCOLATE COMPANY (DELAWARE CORPORATION)  
610 ALPHA DRIVE  
PITTSBURGH, PA 15238

FOR: PROTEIN-BASED NUTRIENT DENSE SNACK BARS, IN CLASS 29 (U.S. CL. 46).

FIRST USE 3-31-2011; IN COMMERCE 3-31-2011.

THE MARK CONSISTS OF STANDARD CHARACTERS WITHOUT CLAIM TO ANY PARTICULAR FONT, STYLE, SIZE, OR COLOR.

NO CLAIM IS MADE TO THE EXCLUSIVE RIGHT TO USE "PROTEIN", APART FROM THE MARK AS SHOWN.

SN 85-046,696, FILED 5-24-2010.

KATHERINE CHANG, EXAMINING ATTORNEY



*David J. Kybas*

Director of the United States Patent and Trademark Office

# United States of America

United States Patent and Trademark Office

# POWERPILL

**Reg. No. 4,126,085**

HEALTHPRIZE TECHNOLOGIES, LLC (DELAWARE LIMITED LIABILITY COMPANY)  
40 RICHARDS AVENUE, 3RD FLOOR  
NORWALK, CT 06854

**Registered Apr. 10, 2012**

**Int. Cl.: 41**

FOR: SWEEPSTAKE SERVICES; SWEEPSTAKE SERVICES PROVIDED OVER A GLOBAL  
COMPUTER NETWORK, IN CLASS 41 (U.S. CLS. 100, 101 AND 107).

**SERVICE MARK**

FIRST USE 11-23-2009; IN COMMERCE 5-27-2010.

**PRINCIPAL REGISTER**

THE MARK CONSISTS OF STANDARD CHARACTERS WITHOUT CLAIM TO ANY PAR-  
TICULAR FONT, STYLE, SIZE, OR COLOR.

SN 85-047,375, FILED 5-25-2010.

HANNO RITTNER, EXAMINING ATTORNEY



*David J. Kyffers*

Director of the United States Patent and Trademark Office

# United States of America

United States Patent and Trademark Office

## PARADISE SHORES

**Reg. No. 4,126,086**

**Registered Apr. 10, 2012**

**Int. Cl.: 18**

**TRADEMARK**

**PRINCIPAL REGISTER**

BDSRCO, INC. (DELAWARE CORPORATION)  
103 FOULK ROAD  
SUITE 202  
WILMINGTON, DE 19803

FOR: WALLET'S, SPORTS BAGS, DUFFLE BAGS, WHEELED BAGS AND TOTE BAGS, IN CLASS 18 (U.S. CLS. 1, 2, 3, 22 AND 41).

FIRST USE 2-1-2012; IN COMMERCE 2-1-2012.

THE MARK CONSISTS OF STANDARD CHARACTERS WITHOUT CLAIM TO ANY PARTICULAR FONT, STYLE, SIZE, OR COLOR.

OWNER OF U.S. REG. NOS. 2,182,259 AND 3,004,216.

SN 85-049,443, FILED 5-27-2010.

MYRIAH HABEEB, EXAMINING ATTORNEY



*David J. Kyffers*

Director of the United States Patent and Trademark Office

# United States of America

United States Patent and Trademark Office

# CAP

**Reg. No. 4,126,087**

MSC SERVICES CORP. (NEW YORK CORPORATION)  
75 MAXESS ROAD  
MELVILLE, NY 11747

**Registered Apr. 10, 2012**

**Int. Cl.: 9**

FOR: AUTOMATED DISPENSING MACHINES FOR TOOLS AND MACHINE SUPPLIES, NAMELY, AUTOMATED TOOL AND MACHINE SHOP SUPPLY DISPENSING SYSTEMS COMPRISING A CABINET THAT DISPENSES SELECTED TOOLS OR SUPPLIES TO A USER, IN CLASS 9 (U.S. CLS. 21, 23, 26, 36 AND 38).

**TRADEMARK**

**PRINCIPAL REGISTER**

FIRST USE 8-31-2009; IN COMMERCE 8-31-2009.

THE MARK CONSISTS OF STANDARD CHARACTERS WITHOUT CLAIM TO ANY PARTICULAR FONT, STYLE, SIZE, OR COLOR.

SN 85-049,542, FILED 5-27-2010.

BENJAMIN OKEKE, EXAMINING ATTORNEY



*David J. Kyffers*

Director of the United States Patent and Trademark Office

# United States of America

United States Patent and Trademark Office

# Slanger1

**Reg. No. 4,126,088**

**Registered Apr. 10, 2012**

**Int. Cl.: 25**

**TRADEMARK**

**PRINCIPAL REGISTER**

KBS GROUP, INC. (TEXAS CORPORATION)  
16055 SPACE CENTER BLVD., SUITE 235  
HOUSTON, TX 77062

FOR: SHIRTS AND SHORT-SLEEVED SHIRTS, IN CLASS 25 (U.S. CLS. 22 AND 39).

FIRST USE 10-28-2011; IN COMMERCE 10-28-2011.

THE MARK CONSISTS OF STANDARD CHARACTERS WITHOUT CLAIM TO ANY PARTICULAR FONT, STYLE, SIZE, OR COLOR.

SN 85-050,767, FILED 5-28-2010.

RICHARD WHITE, EXAMINING ATTORNEY



*David J. Kyffers*

Director of the United States Patent and Trademark Office

# United States of America

United States Patent and Trademark Office

## ENVY ORGANICS

**Reg. No. 4,126,089**

FORTUNE HI-TECH MARKETING, INC. (KENTUCKY CORPORATION)  
880 CORPORATE DRIVE, SITE300  
LEXINGTON, KY 40503

**Registered Apr. 10, 2012**

**Int. Cl.: 3**

FOR: ORGANIC NON-MEDICATED SKIN CARE PREPARATIONS, IN CLASS 3 (U.S. CLS. 1, 4, 6, 50, 51 AND 52).

**TRADEMARK**

FIRST USE 9-5-2010; IN COMMERCE 9-5-2010.

**PRINCIPAL REGISTER**

THE MARK CONSISTS OF STANDARD CHARACTERS WITHOUT CLAIM TO ANY PARTICULAR FONT, STYLE, SIZE, OR COLOR.

NO CLAIM IS MADE TO THE EXCLUSIVE RIGHT TO USE "ORGANICS", APART FROM THE MARK AS SHOWN.

SN 85-052,368, FILED 6-2-2010.

LINDA M. KING, EXAMINING ATTORNEY



*David J. Kyffers*

Director of the United States Patent and Trademark Office



# United States of America

United States Patent and Trademark Office

# R PAK

**Reg. No. 4,126,090**

**Registered Apr. 10, 2012**

**Int. Cl.: 9**

**TRADEMARK**

**PRINCIPAL REGISTER**

RJR POLYMERS, INC. (CALIFORNIA CORPORATION)  
7875 EDGEWATER DRIVE  
OAKLAND, CA 94621

FOR: THERMALLY ENHANCED PLASTIC BASE CAVITY PACKAGE USED FOR HIGH-FREQUENCY ELECTRONIC COMPONENTS, NAMELY, AIR CAVITY HOUSINGS FOR POWER DEVICES TYPICALLY USING GALLIUMARSENITE DYE GENERATING OVER ONE (1) WATT OF POWER, IN CLASS 9 (U.S. CLS. 21, 23, 26, 36 AND 38).

FIRST USE 4-1-1999; IN COMMERCE 4-1-1999.

THE MARK CONSISTS OF STANDARD CHARACTERS WITHOUT CLAIM TO ANY PARTICULAR FONT, STYLE, SIZE, OR COLOR.

SN 85-052,811, FILED 6-2-2010.

BARBARA BROWN, EXAMINING ATTORNEY



*David J. Kybas*

Director of the United States Patent and Trademark Office

# United States of America

United States Patent and Trademark Office

# LEAN CAFÉ

**Reg. No. 4,126,091**

WAL-MART STORES, INC. (DELAWARE CORPORATION)  
702 SW 8TH STREET  
BENTONVILLE, AR 727160520

**Registered Apr. 10, 2012**

**Int. Cls.: 29 and 30**

FOR: PRE-PACKAGED DINNERS CONSISTING OF MEAT OR POULTRY SERVED WITH PASTA, AND VEGETABLES; PREPARED FOOD KITS COMPOSED OF MEAT, POULTRY, AND/OR VEGETABLES AND ALSO INCLUDING SAUCES OR SEASONINGS, READY FOR COOKING AND ASSEMBLY AS A MEAL, IN CLASS 29 (U.S. CL. 46).

**TRADEMARK**

**PRINCIPAL REGISTER**

FIRST USE 8-23-2010; IN COMMERCE 8-23-2010.

FOR: PIZZAS; PREPARED PASTA; RAVIOLI, IN CLASS 30 (U.S. CL. 46).

FIRST USE 8-23-2010; IN COMMERCE 8-23-2010.

THE MARK CONSISTS OF STANDARD CHARACTERS WITHOUT CLAIM TO ANY PARTICULAR FONT, STYLE, SIZE, OR COLOR.

NO CLAIM IS MADE TO THE EXCLUSIVE RIGHT TO USE "LEAN", APART FROM THE MARK AS SHOWN.

SN 85-053,249, FILED 6-2-2010.

CAROLYN CATALDO, EXAMINING ATTORNEY



*David J. Kybas*

Director of the United States Patent and Trademark Office

# United States of America

United States Patent and Trademark Office



**Reg. No. 4,126,092**

**Registered Apr. 10, 2012**

**Int. Cls.: 9 and 25**

**TRADEMARK**

**PRINCIPAL REGISTER**

RAK'D UP TECHNOLOGIES, LLC (PENNSYLVANIA LIMITED LIABILITY COMPANY)  
4700 WESTPORT DRIVE  
MECHANICSBURG, PA 17055

FOR: BAGS AND BACKPACKS ESPECIALLY ADAPTED FOR HOLDING LAPTOPS, IN CLASS 9 (U.S. CLS. 21, 23, 26, 36 AND 38).

FIRST USE 8-1-2010; IN COMMERCE 8-1-2010.

FOR: CLOTHING, NAMELY, TOPS, JACKETS, ALL FOR USE BY SPORTSMEN AND HUNTING ENTHUSIASTS; HEADWEAR, FOR USE BY SPORTSMEN AND HUNTING ENTHUSIASTS, IN CLASS 25 (U.S. CLS. 22 AND 39).

FIRST USE 8-1-2010; IN COMMERCE 8-1-2010.

THE MARK CONSISTS OF THE WORDING "RAK'D UP" ACROSS THE CENTER OF A BULLS EYE TARGET WITH THREE BULLET HOLES IN THE TARGET AND SIX DEER SKULLS ENCIRCLING THE TARGET.

SN 85-053,805, FILED 6-3-2010.

SIMON TENG, EXAMINING ATTORNEY



*David J. Kybas*

Director of the United States Patent and Trademark Office

# United States of America

United States Patent and Trademark Office

# IVANKA

**Reg. No. 4,126,093**

**Registered Apr. 10, 2012**

**Int. Cl.: 18**

**TRADEMARK**

**PRINCIPAL REGISTER**

IVANKA TRUMP MARKS LLC (DELAWARE LIMITED LIABILITY COMPANY)  
502 PARK AVENUE  
NEW YORK, NY 10022

FOR: HANDBAGS, WALLETS, IN CLASS 18 (U.S. CLS. 1, 2, 3, 22 AND 41).

FIRST USE 7-0-2011; IN COMMERCE 7-0-2011.

THE MARK CONSISTS OF STANDARD CHARACTERS WITHOUT CLAIM TO ANY PARTICULAR FONT, STYLE, SIZE, OR COLOR.

OWNER OF U.S. REG. NOS. 3,589,236, 3,593,246, AND 3,620,026.

THE NAME IN THE MARK IDENTIFIES "IVANKA" TRUMP, WHOSE CONSENT TO REGISTER IS MADE OF RECORD.

SN 85-054,940, FILED 6-4-2010.

HEATHER BIDDULPH, EXAMINING ATTORNEY



*David J. Kybas*

Director of the United States Patent and Trademark Office

# United States of America

United States Patent and Trademark Office

# In the Light

**Reg. No. 4,126,094**

**Registered Apr. 10, 2012**

**Int. Cls.: 9 and 41**

**TRADEMARK**

**SERVICE MARK**

**PRINCIPAL REGISTER**

FAITH TO VISION FILMS LLC (NEW YORK LIMITED LIABILITY COMPANY)  
PO BOX 553  
NEW YORK, NY 10116

FOR: DIGITAL MEDIA, NAMELY, PRE-RECORDED VIDEO CASSETTES, DIGITAL VIDEO DISCS, DIGITAL VERSATILE DISCS, DOWNLOADABLE AUDIO AND VIDEO RECORDINGS, DVDS, AND HIGH DEFINITION DIGITAL DISCS FEATURING TALK SHOWS; DOWNLOADABLE MULTIMEDIA FILE CONTAINING ARTWORK, TEXT, AUDIO, VIDEO, GAMES, AND INTERNET WEB LINKS RELATING TO TELEVISION TALK SHOWS; DOWNLOADABLE TELEVISION SHOWS VIA THE INTERNET AND WIRELESS DEVICES; DVDS FEATURING A TELEVISION SERIES; PRE-RECORDED CDS, VIDEO TAPES, LASER DISKS AND DVDS FEATURING A TELEVISION SERIES, IN CLASS 9 (U.S. CLS. 21, 23, 26, 36 AND 38).

FIRST USE 1-1-2010; IN COMMERCE 4-1-2010.

FOR: DIRECTION OF MAKING RADIO OR TELEVISION PROGRAMS; EDUCATIONAL AND ENTERTAINMENT SERVICES, NAMELY, A CONTINUING PROGRAM ABOUT TALK SHOWS ACCESSIBLE BY RADIO, TELEVISION, SATELLITE, AUDIO, VIDEO AND COMPUTER NETWORKS; ENTERTAINMENT AND EDUCATION SERVICES IN THE NATURE OF A SERIES OF SHORT SHOWS FEATURING TELEVISED TALK SHOWS DISTRIBUTED TO MOBILE HANDSETS, WHICH MAY INCLUDE VIDEO, TEXT, PHOTOS, ILLUSTRATIONS OR HYPERTEXT; ENTERTAINMENT AND EDUCATIONAL SERVICES, NAMELY, THE PRESENTATION OF SEMINARS, LECTURES, WORKSHOPS AND PANEL DISCUSSIONS, AND ONGOING TELEVISION AND RADIO TALK SHOWS ALL IN THE FIELD OF PUBLIC INTEREST CONCERNING RELIGIONS, CULTURES, AND ETHNICITY; ENTERTAINMENT IN THE NATURE OF AN ON-GOING SPECIAL VARIETY, NEWS, MUSIC OR COMEDY SHOW FEATURING A TALK SHOW TELEVISION SERIES BROADCAST OVER TELEVISION, SATELLITE, AUDIO, AND VIDEO MEDIA; ENTERTAINMENT IN THE NATURE OF ONGOING TELEVISION PROGRAMS IN THE FIELD OF TALK SHOWS; ENTERTAINMENT IN THE NATURE OF A TELEVISION TALK DRAMA SERIES; ENTERTAINMENT SERVICES, NAMELY, A MULTIMEDIA PROGRAM SERIES FEATURING COMEDY, ACTION AND ADVENTURE DISTRIBUTED VIA VARIOUS PLATFORMS ACROSS MULTIPLE FORMS OF TRANSMISSION MEDIA; ENTERTAINMENT SERVICES, NAMELY, AN ON-GOING SERIES FEATURING A TELEVISION DRAMA SERIES PROVIDED THROUGH BROADCAST, CABLE TELEVISION, WEBCASTS, AND DIGITAL TRANSMISSION; ENTERTAINMENT SERVICES, NAMELY, PROVIDING ON-GOING TELEVISION PROGRAMS IN THE FIELD

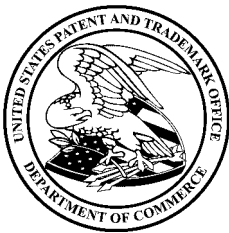

*David J. Kyjars*

Director of the United States Patent and Trademark Office

**Reg. No. 4,126,094** OF TALK SHOWS VIA A GLOBAL COMPUTER NETWORK; ENTERTAINMENT SERVICES, NAMELY, THE PROVISION OF CONTINUING A TELEVISION SERIES FEATURING TALK SHOWS DELIVERED BY TRADITIONAL BROADCAST, CABLE, AND DIGITAL TRANSMISSION; ENTERTAINMENT, NAMELY, A CONTINUING TELEVISION TALK SHOW SERIES BROADCAST OVER TELEVISION, SATELLITE, AUDIO, AND VIDEO MEDIA; ENTERTAINMENT, NAMELY, A CONTINUING A TELEVISION DRAMA SERIES SHOW BROADCAST OVER TRADITIONAL BROADCAST, CABLE, AND THE INTERNET, IN CLASS 41 (U.S. CLS. 100, 101 AND 107).

FIRST USE 1-1-2010; IN COMMERCE 4-1-2010.

THE MARK CONSISTS OF STANDARD CHARACTERS WITHOUT CLAIM TO ANY PARTICULAR FONT, STYLE, SIZE, OR COLOR.

SN 85-055,078, FILED 6-4-2010.

VIVIAN MICZNIK FIRST, EXAMINING ATTORNEY

# United States of America

United States Patent and Trademark Office



**Reg. No. 4,126,095**

**Registered Apr. 10, 2012**

**Int. Cl.: 25**

**TRADEMARK**

**PRINCIPAL REGISTER**

PEDRO RUBIO TAILORED (CALIFORNIA SOLE PROPRIETORSHIP)  
1065 N. FAIRFAX AVENUE  
WEST HOLLYWOOD, CA 90046

FOR: DENIM JACKETS; DENIMS; DRESS SHIRTS; DRESS SUITS; GYM PANTS; HOODED SWEAT SHIRTS; JACKETS; JERSEYS; KNIT SHIRTS; LEATHER BELTS; LEATHER JACKETS; LEATHER PANTS; LEATHER SHIRTS; LONG JACKETS; MEN'S SUITS; PANTS; POCKET SQUARES; POLO SHIRTS; SHIRTS; SHORT-SLEEVED OR LONG-SLEEVED T-SHIRTS; SHORT-SLEEVED SHIRTS; SPORTS JACKETS; SPORTS PANTS; SPORTS SHIRTS; SPORTS SHIRTS WITH SHORT SLEEVES; SUIT COATS; SUITS; SWEAT JACKETS; SWEAT PANTS; SWEAT SHIRTS; SWEAT SUITS; SWIMWEAR; T-SHIRTS; TEE SHIRTS; TIES; TOPS; VESTED SUITS, IN CLASS 25 (U.S. CLS. 22 AND 39).

FIRST USE 5-13-2011; IN COMMERCE 5-13-2011.

THE MARK CONSISTS OF A REVERSE UPPERCASE "P" (MIRROR-IMAGE) FOLLOWED BY AN UPPERCASE "R", WITH BOTH LETTERS INSIDE A CIRCLE.

SN 85-055,108, FILED 6-4-2010.

ELLEN PERKINS, EXAMINING ATTORNEY



*David J. Kyros*

Director of the United States Patent and Trademark Office

# United States of America

United States Patent and Trademark Office



**Reg. No. 4,126,096**

**Registered Apr. 10, 2012**

**Int. Cl.: 28**

**TRADEMARK**

**PRINCIPAL REGISTER**

DOLLAMUR, LP (DELAWARE PARTNERSHIP)  
SUITE 1225  
3100 WEST END AVENUE  
NASHVILLE, TN 37203

FOR: PERSONAL EXERCISE MATS, IN CLASS 28 (U.S. CLS. 22, 23, 38 AND 50).

FIRST USE 6-0-2009; IN COMMERCE 6-0-2009.

THE MARK CONSISTS OF A SPIRAL COMPOSED OF INTERCONNECTED RECTANGLES  
EXTENDING INTO A SOLID STRAIGHT LINE.

SN 85-055,957, FILED 6-7-2010.

MARY ROSSMAN, EXAMINING ATTORNEY



*David J. Kybas*

Director of the United States Patent and Trademark Office



# United States of America

United States Patent and Trademark Office

## SEED YOUR SOUL

**Reg. No. 4,126,097**

MAMMA CHIA, LLC (CALIFORNIA LIMITED LIABILITY COMPANY)  
1209 CLOS DUVAL  
BONSALL, CA 92003

**Registered Apr. 10, 2012**

**Int. Cl.: 32**

FOR: FRUIT-FLAVORED BEVERAGES, IN CLASS 32 (U.S. CLS. 45, 46 AND 48).

**TRADEMARK**

FIRST USE 10-15-2010; IN COMMERCE 10-15-2010.

**PRINCIPAL REGISTER**

THE MARK CONSISTS OF STANDARD CHARACTERS WITHOUT CLAIM TO ANY PARTICULAR FONT, STYLE, SIZE, OR COLOR.

OWNER OF U.S. REG. NOS. 3,844,648 AND 3,845,269.

SN 85-056,285, FILED 6-7-2010.

TARA PATE, EXAMINING ATTORNEY



*David J. Kyffers*

Director of the United States Patent and Trademark Office

# United States of America

United States Patent and Trademark Office

# iFrastructure

**Reg. No. 4,126,098**

**Registered Apr. 10, 2012**

**Int. Cls.: 35 and 42**

**SERVICE MARK**

**PRINCIPAL REGISTER**

AMEC ENVIRONMENT & INFRASTRUCTURE, INC. (NEVADA CORPORATION)  
1105 LAKEWOOD PARKWAY  
SUITE 300  
ALPHARETTA, GA 30009

FOR: DATABASE MANAGEMENT; DATABASE MANAGEMENT IN THE FIELDS OF CONSTRUCTION, ENVIRONMENTAL, MANAGEMENT AND REMEDIATION, ARCHITECTURE, ENGINEERING AND FACILITIES MANAGEMENT; PROVIDING AN ON-LINE COMPUTER DATABASE FOR THE REPORTING AND TRACKING OF DATA IN THE FIELDS OF CONSTRUCTION, ENVIRONMENTAL, MANAGEMENT AND REMEDIATION, ARCHITECTURE, ENGINEERING AND FACILITIES MANAGEMENT FOR BUSINESS PURPOSES; PROJECT MANAGEMENT SERVICES FOR OTHERS FOR BUSINESS PURPOSES IN THE FIELDS OF CONSTRUCTION, ENVIRONMENTAL, MANAGEMENT AND REMEDIATION, ARCHITECTURE, ENGINEERING AND FACILITIES MANAGEMENT; BUSINESS RECORDS MANAGEMENT SERVICES; BUSINESS MANAGEMENT CONSULTATION SERVICES IN THE FIELD OF CRISIS MANAGEMENT IN CONNECTION WITH HEALTH, SAFETY OR ENVIRONMENTAL PROBLEMS, INCIDENTS AND HAZARDS, IN CLASS 35 (U.S. CLS. 100, 101 AND 102).

FIRST USE 10-8-2007; IN COMMERCE 10-8-2007.



*David J. Kyffers*

Director of the United States Patent and Trademark Office

FOR: APPLICATION SERVICE PROVIDER, NAMELY, HOSTING COMPUTER SOFTWARE APPLICATIONS OF OTHERS; ASP SERVICES FEATURING SOFTWARE FOR USE IN THE FIELD OF CONSTRUCTION MANAGEMENT; ASP SERVICES FEATURING SOFTWARE FOR USE IN THE FIELD OF LEGAL COMPLIANCE FOR THE CONSTRUCTION, ENVIRONMENTAL AND ENGINEERING AND DESIGN INDUSTRIES; ASP SERVICES FEATURING SOFTWARE FOR USE IN THE FIELD OF ENVIRONMENTAL COMPLIANCE, MANAGEMENT, AND REMEDIATION; ASP SERVICES FEATURING SOFTWARE FOR USE IN THE FIELDS OF ARCHITECTURE, ENGINEERING, AND FACILITIES-MANAGEMENT; APPLICATION SERVICE PROVIDER, NAMELY, PROVIDING, HOSTING, MANAGING, DEVELOPING, RESEARCHING, ANALYZING, REPORTING, AND MAINTAINING APPLICATIONS, SOFTWARE, WEB SITES, AND DATABASES OF OTHERS IN THE FIELDS OF CONSTRUCTION, ENVIRONMENTAL, MANAGEMENT AND REMEDIATION, ARCHITECTURE, ENGINEERING AND FACILITIES MANAGEMENT; DESIGN, DEVELOPMENT AND CONSULTING SERVICES IN THE FIELDS OF CONSTRUCTION, ENVIRONMENTAL, MANAGEMENT AND REMEDIATION, ARCHITECTURE, ENGINEERING AND FACILITIES MANAGEMENT; WEB-BASED DESIGN FOR OTHERS IN THE FIELDS OF CONSTRUCTION, ENVIRONMENT-

**Reg. No. 4,126,098** AL, MANAGEMENT AND REMEDIATION, ARCHITECTURE, ENGINEERING AND FACILITIES MANAGEMENT; INSTALLATION OF COMPUTER SOFTWARE; DATA WAREHOUSING, IN CLASS 42 (U.S. CLS. 100 AND 101).

FIRST USE 10-8-2007; IN COMMERCE 10-8-2007.

THE MARK CONSISTS OF STANDARD CHARACTERS WITHOUT CLAIM TO ANY PARTICULAR FONT, STYLE, SIZE, OR COLOR.

SN 85-056,308, FILED 6-7-2010.

VIVIAN MICZNIK FIRST, EXAMINING ATTORNEY

# United States of America

United States Patent and Trademark Office

## KNOWMOLOGY

**Reg. No. 4,126,099**

CHARLES F. REIDELBACH, JR. (UNITED STATES INDIVIDUAL)  
645 FRONT STREET #804  
SAN DIEGO, CA 92101

**Registered Apr. 10, 2012**

**Int. Cl.: 45**

FOR: PROVIDING ON-LINE INFORMATION AND NEWS IN THE FIELD OF LAW, IN CLASS 45 (U.S. CLS. 100 AND 101).

**SERVICE MARK**

FIRST USE 5-11-2010; IN COMMERCE 5-11-2010.

**PRINCIPAL REGISTER**

THE MARK CONSISTS OF STANDARD CHARACTERS WITHOUT CLAIM TO ANY PARTICULAR FONT, STYLE, SIZE, OR COLOR.

SN 85-057,370, FILED 6-8-2010.

TRACY WHITTAKER-BROWN, EXAMINING ATTORNEY



*David J. Kybas*

Director of the United States Patent and Trademark Office

# United States of America

United States Patent and Trademark Office

# TOPSECRET

**Reg. No. 4,126,100**

**Registered Apr. 10, 2012**

**Int. Cl.: 25**

**TRADEMARK**

**PRINCIPAL REGISTER**

LEADING LADY, INC. (OHIO CORPORATION)  
24050 COMMERCE PARK, SUITE 101  
BEACHWOOD, OH 44122

FOR: BODY SHAPERS; CAMISOLES; FOUNDATION GARMENTS; HALTER TOPS; KNIT SHIRTS; LINGERIE; NIGHT SHIRTS; SHIRTS; SHORTS; SLEEPWEAR; SWEATERS; TANK TOPS; UNDERGARMENTS; HALTER TOPS IN THE NATURE OF PONCHO-STYLE LOUNGEWEAR; KNIT SHIRTS IN THE NATURE OF LOUNGEWEAR; SHIRTS IN THE NATURE OF LOUNGEWEAR; SWEATERS IN THE NATURE OF LOUNGEWEAR; UNDERGARMENTS IN THE NATURE OF LOUNGEWEAR AND CHEMISES, IN CLASS 25 (U.S. CLS. 22 AND 39).

FIRST USE 6-15-2011; IN COMMERCE 6-15-2011.

THE MARK CONSISTS OF STANDARD CHARACTERS WITHOUT CLAIM TO ANY PARTICULAR FONT, STYLE, SIZE, OR COLOR.

OWNER OF U.S. REG. NOS. 1,055,635 AND 1,913,392.

SN 85-057,738, FILED 6-8-2010.

WARREN L. OLANDRIA, EXAMINING ATTORNEY



*David J. Kyffers*

Director of the United States Patent and Trademark Office

# United States of America

United States Patent and Trademark Office

# PayAdTV

**Reg. No. 4,126,101**

**Registered Apr. 10, 2012**

**Int. Cl.: 9**

**TRADEMARK**

**PRINCIPAL REGISTER**

GUINANE GEORGE THOMAS (UNITED STATES INDIVIDUAL)  
4 WOODHOLM LN.  
MANCHESTER, MA 01944

FOR: COMPUTER CONTROLLED TELEVISIONS OPERATED OVER TELEPHONE LINES, OR CABLE LINES, OR WIRELESS DEVICES. PRINCIPALLY ADVERTISING DIFFERENT PRODUCTS FOR PAY, IN CLASS 9 (U.S. CLS. 21, 23, 26, 36 AND 38).

FIRST USE 2-20-2007; IN COMMERCE 2-20-2007.

THE MARK CONSISTS OF STANDARD CHARACTERS WITHOUT CLAIM TO ANY PARTICULAR FONT, STYLE, SIZE, OR COLOR.

SN 85-057,884, FILED 6-8-2010.

KYLE PEETE, EXAMINING ATTORNEY



*David J. Kybas*

Director of the United States Patent and Trademark Office

# United States of America

United States Patent and Trademark Office

# My Scent

**Reg. No. 4,126,102**

JORDAN DREW CORPORATION (NEW YORK CORPORATION)  
C/O SAS GROUP INC., 220 WHITE PLAINS RD  
TARRYTOWN, NY 10591

**Registered Apr. 10, 2012**

**Int. Cl.: 21**

FOR: PERFUME ATOMIZER SOLD EMPTY, IN CLASS 21 (U.S. CLS. 2, 13, 23, 29, 30, 33, 40 AND 50).

**TRADEMARK**

FIRST USE 9-6-2010; IN COMMERCE 9-6-2010.

**PRINCIPAL REGISTER**

THE MARK CONSISTS OF STANDARD CHARACTERS WITHOUT CLAIM TO ANY PARTICULAR FONT, STYLE, SIZE, OR COLOR.

NO CLAIM IS MADE TO THE EXCLUSIVE RIGHT TO USE "SCENT", APART FROM THE MARK AS SHOWN.

SN 85-058,166, FILED 6-9-2010.

PAM WILLIS, EXAMINING ATTORNEY



*David J. Kyffers*

Director of the United States Patent and Trademark Office

# United States of America

United States Patent and Trademark Office

## BUBBLY VEE

**Reg. No. 4,126,103**

**Registered Apr. 10, 2012**

**Int. Cl.: 41**

**SERVICE MARK**

**PRINCIPAL REGISTER**

BROWN, VIVIAN (UNITED STATES INDIVIDUAL)  
16 GILFFORD PLACE  
IRVINGTON, NJ 07111

FOR: ENTERTAINMENT SERVICES IN THE NATURE OF LIVE MUSIC CONCERTS, AND VISUAL AND AUDIO MUSICAL PERFORMANCES PERTAINING TO EARLY CHILDHOOD EDUCATION; ENTERTAINMENT, NAMELY, STAGE PERFORMANCES IN THE NATURE OF LECTURE FOR HIRE IN THE FIELD OF EARLY CHILDHOOD EDUCATION BY AN INDIVIDUAL; PROVIDING A WEBSITE FEATURING ENTERTAINMENT INFORMATION PERTAINING TO UPCOMING LIVE MUSICAL CONCERTS, LIVE MUSICAL PERFORMANCES, AND STAGE PERFORMANCES IN THE FIELD OF EARLY CHILDHOOD EDUCATION BY AN INDIVIDUAL, WHERE THE USERS MAY VIEW NON-DOWNLOADABLE VIDEOS FEATURING STAGE PERFORMANCES IN THE FIELD OF EARLY CHILDHOOD EDUCATION BY AN INDIVIDUAL, IN CLASS 41 (U.S. CLS. 100, 101 AND 107).

FIRST USE 8-30-2011; IN COMMERCE 2-13-2012.

THE MARK CONSISTS OF STANDARD CHARACTERS WITHOUT CLAIM TO ANY PARTICULAR FONT, STYLE, SIZE, OR COLOR.

THE NAME "BUBBLY VEE" DOES NOT IDENTIFY A LIVING INDIVIDUAL.

SN 85-058,811, FILED 6-9-2010.

AMY ALFIERI, EXAMINING ATTORNEY



*David J. Kyffers*

Director of the United States Patent and Trademark Office



# United States of America

United States Patent and Trademark Office

# SIGNUM

**Reg. No. 4,126,104**

**Registered Apr. 10, 2012**

**Int. Cl.: 1**

**TRADEMARK**

**PRINCIPAL REGISTER**

RIZOBACTER ARGENTINA S.A. (ARGENTINA CORPORATION)  
AVENIDA PRESIDENTE ARTURO FRONDIZI 1150  
PERGAMINO, ARGENTINA B2702HDA

FOR: FERTILIZERS; INOCULANTS, NAMELY, BIOLOGICAL MICROORGANISMS USED  
IN FERMENTATION OF SILAGE; NATURAL FERTILIZERS; NON-CHEMICAL BIO-FER-  
TILIZERS, IN CLASS 1 (U.S. CLS. 1, 5, 6, 10, 26 AND 46).

FIRST USE 1-1-2009; IN COMMERCE 12-1-2011.

THE MARK CONSISTS OF STANDARD CHARACTERS WITHOUT CLAIM TO ANY PAR-  
TICULAR FONT, STYLE, SIZE, OR COLOR.

SN 85-059,452, FILED 6-10-2010.

PAM WILLIS, EXAMINING ATTORNEY



*David J. Kybas*

Director of the United States Patent and Trademark Office

# United States of America

United States Patent and Trademark Office

# IDM

**Reg. No. 4,126,105**

INTELLICYT CORPORATION (NEW MEXICO CORPORATION)  
317 COMMERCIAL NE, SUITE G-100  
ALBUQUERQUE, NM 87102

**Registered Apr. 10, 2012**

**Int. Cl.: 9**

FOR: SOFTWARE FOR STORING AND MANAGING EXPERIMENTS COMPRISING TIME SEGMENTED FLOW CYTOMETRY DATA, IN CLASS 9 (U.S. CLS. 21, 23, 26, 36 AND 38).

**TRADEMARK**

FIRST USE 11-1-2009; IN COMMERCE 4-1-2010.

**PRINCIPAL REGISTER**

THE MARK CONSISTS OF STANDARD CHARACTERS WITHOUT CLAIM TO ANY PARTICULAR FONT, STYLE, SIZE, OR COLOR.

SN 85-059,872, FILED 6-10-2010.

DEBRA LEE, EXAMINING ATTORNEY



*David J. Kybas*

Director of the United States Patent and Trademark Office

# United States of America

United States Patent and Trademark Office

## THE DRIVER SCIENCE COMPANY

**Reg. No. 4,126,106**

**Registered Apr. 10, 2012**

**Int. Cls.: 9 and 36**

**TRADEMARK**

**SERVICE MARK**

**PRINCIPAL REGISTER**

DRIVECAM, INC. (CALIFORNIA CORPORATION)  
8911 BALBOA AVENUE  
SAN DIEGO, CA 92123

FOR: VIDEO EVENT RECORDERS; COMPUTER SOFTWARE FOR ANALYZING DATA FROM VIDEO EVENT RECORDERS FOR USE IN THE FIELD OF DRIVER RISK MANAGEMENT, IMPROVING DRIVER SAFETY AND REDUCING RISKY DRIVING BEHAVIOR; DRIVING PERFORMANCE MANAGEMENT SOFTWARE, IN CLASS 9 (U.S. CLS. 21, 23, 26, 36 AND 38).

FIRST USE 6-1-2010; IN COMMERCE 8-1-2010.

FOR: FINANCIAL RISK MANAGEMENT CONSULTING SERVICES RELATED TO DRIVER BEHAVIOR, NAMELY, MANAGEMENT AND REDUCTION OF THE FINANCIAL RISK CREATED BY DRIVERS BY REDUCING RISKY DRIVING BEHAVIOR, IN CLASS 36 (U.S. CLS. 100, 101 AND 102).

FIRST USE 6-1-2010; IN COMMERCE 8-1-2010.

THE MARK CONSISTS OF STANDARD CHARACTERS WITHOUT CLAIM TO ANY PARTICULAR FONT, STYLE, SIZE, OR COLOR.

NO CLAIM IS MADE TO THE EXCLUSIVE RIGHT TO USE "DRIVER" AND "COMPANY", APART FROM THE MARK AS SHOWN.

SN 85-059,971, FILED 6-10-2010.

MICHAEL ENGEL, EXAMINING ATTORNEY



*David J. Kyffers*

Director of the United States Patent and Trademark Office

# United States of America

United States Patent and Trademark Office

## REINVENTING GEOSPATIAL

**Reg. No. 4,126,107**

REINVENTING GEOSPATIAL, INC. (VIRGINIA CORPORATION)  
12020 SUNRISE VALLEY DRIVE, SUITE 100  
RESTON, VA 20191

**Registered Apr. 10, 2012**

**Int. Cl.: 35**

FOR: BUSINESS MANAGEMENT AND OPERATION ASSISTANCE FOR BUSINESSES AND GOVERNMENT; COMMERCIAL ASSISTANCE RELATING TO SYSTEM IMPLEMENTATION AND SYSTEM INTEGRATION; BUSINESS CONSULTING SERVICES AND BUSINESS STRATEGIC PLANNING OF INFORMATION MANAGEMENT AND INFORMATION TECHNOLOGY; BUSINESS CONSULTING SERVICES RELATING TO ELECTRONIC COMMERCE AND ELECTRONIC BUSINESS OPERATIONS; DATA PROCESSING SERVICES BY MEANS OF A COMPUTER; BUSINESS CONSULTING SERVICES RELATING TO PRODUCT DISTRIBUTION, OPERATIONS MANAGEMENT SERVICES, LOGISTICS, REVERSE LOGISTICS, SUPPLY CHAIN, AND PRODUCTION SYSTEMS AND DISTRIBUTION SOLUTIONS; ADVISORY SERVICES RELATING TO BUSINESS MANAGEMENT AND BUSINESS OPERATIONS AND FINANCIAL RECORDS MANAGEMENT, IN CLASS 35 (U.S. CLS. 100, 101 AND 102).

**SERVICE MARK**

**PRINCIPAL REGISTER**

FIRST USE 9-10-2009; IN COMMERCE 9-10-2009.

THE MARK CONSISTS OF STANDARD CHARACTERS WITHOUT CLAIM TO ANY PARTICULAR FONT, STYLE, SIZE, OR COLOR.

SN 85-060,311, FILED 6-11-2010.

MAYUR VAGHANI, EXAMINING ATTORNEY



*David J. Kybas*

Director of the United States Patent and Trademark Office

# United States of America

United States Patent and Trademark Office

## CURTAIN OF COLD

**Reg. No. 4,126,108**

**Registered Apr. 10, 2012**

**Int. Cl.: 21**

**TRADEMARK**

**PRINCIPAL REGISTER**

POLAR TECH INDUSTRIES, INC. (ILLINOIS CORPORATION)  
415 E. RAILROAD AVENUE  
GENOA, IL 60135

FOR: COLD PACKS FILLED WITH GEL OR FOAM REFRIGERANT USED TO KEEP FOOD, DRINK, PHARMACEUTICAL PRODUCTS AND PERISHABLES COLD, IN CLASS 21 (U.S. CLS. 2, 13, 23, 29, 30, 33, 40 AND 50).

FIRST USE 7-15-2011; IN COMMERCE 7-15-2011.

THE MARK CONSISTS OF STANDARD CHARACTERS WITHOUT CLAIM TO ANY PARTICULAR FONT, STYLE, SIZE, OR COLOR.

NO CLAIM IS MADE TO THE EXCLUSIVE RIGHT TO USE "COLD", APART FROM THE MARK AS SHOWN.

SN 85-060,393, FILED 6-11-2010.

STEVEN PEREZ, EXAMINING ATTORNEY



*David J. Kybas*

Director of the United States Patent and Trademark Office

# United States of America

United States Patent and Trademark Office

# DISHTRICK

**Reg. No. 4,126,109**

**Registered Apr. 10, 2012**

**Int. Cl.: 7**

**TRADEMARK**

**PRINCIPAL REGISTER**

WHIRLPOOL PROPERTIES, INC. (MICHIGAN CORPORATION)  
500 RENAISSANCE DRIVE  
SUITE 101  
ST. JOSEPH, MI 49085

FOR: DISHWASHER ACCESSORIES, NAMELY, SILVERWARE BASKETS, UTENSIL CLIPS AND SMALL ITEM BASKETS FOR SECURING DISHES AND GLASSES ON THE RACK OF A DISHWASHER ALL SOLD SEPARATELY FROM A DISHWASHER, IN CLASS 7 (U.S. CLS. 13, 19, 21, 23, 31, 34 AND 35).

FIRST USE 11-1-2010; IN COMMERCE 11-1-2010.

THE MARK CONSISTS OF STANDARD CHARACTERS WITHOUT CLAIM TO ANY PARTICULAR FONT, STYLE, SIZE, OR COLOR.

SN 85-061,740, FILED 6-14-2010.

JENNIFER MARTIN, EXAMINING ATTORNEY



*David J. Kyffers*

Director of the United States Patent and Trademark Office

# United States of America

United States Patent and Trademark Office



**Reg. No. 4,126,110**

**Registered Apr. 10, 2012**

**Int. Cl.: 7**

**TRADEMARK**

**PRINCIPAL REGISTER**

WHIRLPOOL PROPERTIES, INC. (MICHIGAN CORPORATION)  
SUITE 101  
500 RENAISSANCE DRIVE  
ST. JOSEPH, MI 49085

FOR: DISHWASHING ACCESSORIES, NAMELY, SILVERWARE BASKETS, UTENSIL CLIPS AND SMALL ITEM BASKETS FOR SECURING DISHES AND GLASSES ON THE RACK OF A DISHWASHER ALL SOLD SEPARATELY FROM A DISHWASHER, IN CLASS 7 (U.S. CLS. 13, 19, 21, 23, 31, 34 AND 35).

FIRST USE 11-1-2010; IN COMMERCE 11-1-2010.

THE MARK CONSISTS OF A DESIGN OF A PLATE, FORK AND KNIFE WITH THE STYLIZED WORDING "DISHTRICK" APPEARING ACROSS THE PLATE.

SN 85-061,775, FILED 6-14-2010.

JENNIFER MARTIN, EXAMINING ATTORNEY



*David J. Kybas*

Director of the United States Patent and Trademark Office

# United States of America

United States Patent and Trademark Office



**Reg. No. 4,126,111**

**Registered Apr. 10, 2012**

**Int. Cl.: 11**

**TRADEMARK**

**PRINCIPAL REGISTER**

EVOLUTION LIGHTING, LLC (DELAWARE LIMITED LIABILITY COMPANY)  
SUITE 101  
16200 NW 59TH AVENUE  
MIAMI LAKES, FL 33014

FOR: ELECTRIC LAMPS, IN CLASS 11 (U.S. CLS. 13, 21, 23, 31 AND 34).

FIRST USE 10-12-2010; IN COMMERCE 10-12-2010.

THE MARK CONSISTS OF THE LETTERS "V" AND "M" SEPARATED BY A LINE ALL CONTAINED IN A CIRCLE.

SN 85-061,869, FILED 6-14-2010.

CHARLES L. JENKINS, EXAMINING ATTORNEY



*David J. Kybas*

Director of the United States Patent and Trademark Office



# United States of America

United States Patent and Trademark Office

## DAVEY BICKFORD

**Reg. No. 4,126,112**

**Registered Apr. 10, 2012**

**Int. Cls.: 9, 13, and 42**

**TRADEMARK**

**SERVICE MARK**

**PRINCIPAL REGISTER**

DAVEY INC. (DELAWARE CORPORATION)  
CORPORATION TRUST CENTER  
1209 ORANGE STREET  
WILMINGTON, DE 19801

FOR: ELECTRIC CONDUCTOR WIRES FOR DETONATING EXPLOSIVES; COMPUTER SOFTWARE FOR THE DETONATION OF EXPLOSIVES, IN CLASS 9 (U.S. CLS. 21, 23, 26, 36 AND 38).

FIRST USE 6-2-1987; IN COMMERCE 6-2-1987.

FOR: IGNITERS FOR USE WITH EXPLOSIVES; DETONATORS; DETONATING CORDS AND FUSES; BLASTING CAPS; BOOSTERS AND SQUIBS; CONNECTORS FOR DETONATION PURPOSES; DETONATION DEVICES FOR BLASTING OPEN-PIT MINES, UNDERGROUND MINES, UNDERWATER MINES, OPEN-PIT CIVIL ENGINEERING, UNDERGROUND CIVIL ENGINEERING, AND UNDERWATER CIVIL ENGINEERING; SHOCK TUBE; FUSEHEADS, IN CLASS 13 (U.S. CLS. 2 AND 9).

FIRST USE 6-2-1987; IN COMMERCE 6-2-1987.

FOR: ENGINEERING CONSULTING SERVICES TO THE MINING, QUARRY AND CONSTRUCTION INDUSTRIES IN THE FIELD OF DETONATION OF EXPLOSIVES; ENGINEERING SERVICES, NAMELY, ENGINEERING FOR THE MINING, QUARRY AND CONSTRUCTION INDUSTRIES IN THE FIELD OF DETONATION OF EXPLOSIVES; ENGINEERING SERVICES, NAMELY, ENGINEERING FOR THE DETONATION OF EXPLOSIVES, IN CLASS 42 (U.S. CLS. 100 AND 101).

FIRST USE 10-31-2002; IN COMMERCE 10-31-2002.

THE MARK CONSISTS OF STANDARD CHARACTERS WITHOUT CLAIM TO ANY PARTICULAR FONT, STYLE, SIZE, OR COLOR.

THE NAME(S), PORTRAIT(S), AND/OR SIGNATURE(S) SHOWN IN THE MARK DOES NOT IDENTIFY A PARTICULAR LIVING INDIVIDUAL.

SN 85-061,939, FILED 6-14-2010.



*David J. Kyjars*

Director of the United States Patent and Trademark Office

**Reg. No. 4,126,112** KATHRYN COWARD, EXAMINING ATTORNEY

# United States of America

United States Patent and Trademark Office



**Reg. No. 4,126,113**

**Registered Apr. 10, 2012**

**Int. Cl.: 35**

**SERVICE MARK**

**PRINCIPAL REGISTER**

CROSSMARK, INC. (DELAWARE CORPORATION)  
5100 LEGACY DRIVE  
PLANO, TX 75024

FOR: MANUFACTURER REPRESENTATIVES IN THE FIELD OF FOODS AND CONSUMER GOODS, NAMELY, HEALTH AND BEAUTY AIDS, CONFECTIONS, DRY GROCERY GOODS, FROZEN FOODS, DINNER ENTREES, ICE CREAM, PAPER PLATES AND CUPS, PAPER TOWELS, TOILET AND FACIAL TISSUE, JUICES AND DRINKS, SMALL APPLIANCES, SPORTING GOODS, BABY FORMULA, PHOTOGRAPHIC SUPPLIES, PHOTOGRAPHIC EQUIPMENT AND PHOTOGRAPHIC FILM, TRADING CARDS, PET FOOD, AUTOMOTIVE SUPPLIES, PHARMACEUTICALS, TOYS, AND GAMES; INVENTORY AND SHELF ARRANGEMENT SERVICES, NAMELY, REPLENISHING AND RESETTING ITEMS FOR SALE BY OTHERS; SALES VOLUME TRACKING FOR OTHERS; ACCOUNT AUDITING, NAMELY, AUDITING SALES FOR OTHERS; CONDUCTING MARKET RESEARCH AND MARKET RESEARCH FOR OTHERS; PRODUCT DISPLAY AND BUSINESS MERCHANDISING SERVICES FOR OTHERS, IN CLASS 35 (U.S. CLS. 100, 101 AND 102).

FIRST USE 2-28-2010; IN COMMERCE 2-28-2010.

THE MARK CONSISTS OF AN ARCH OF INCREASING WIDTH FROM LEFT TO RIGHT.

SN 85-062,372, FILED 6-14-2010.

ERIN FALK, EXAMINING ATTORNEY



*David J. Kyjars*

Director of the United States Patent and Trademark Office

# United States of America

United States Patent and Trademark Office

## ANNIE-MELS

**Reg. No. 4,126,114**

LANZENDORF, DEANNA M. (UNITED STATES INDIVIDUAL)  
7812 CLOVER LAKE COURT  
CEDAR HILL, MO 63016

**Registered Apr. 10, 2012**

**Int. Cl.: 18**

FOR: PET HARNESES, IN CLASS 18 (U.S. CLS. 1, 2, 3, 22 AND 41).

**TRADEMARK**

FIRST USE 10-14-2011; IN COMMERCE 10-14-2011.

**PRINCIPAL REGISTER**

THE MARK CONSISTS OF STANDARD CHARACTERS WITHOUT CLAIM TO ANY PARTICULAR FONT, STYLE, SIZE, OR COLOR.

SN 85-062,913, FILED 6-15-2010.

RONALD AIKENS, EXAMINING ATTORNEY



*David J. Kyffers*

Director of the United States Patent and Trademark Office

# United States of America

United States Patent and Trademark Office

# CELLIES

**Reg. No. 4,126,115**

BEHAR, ANDREA (UNITED STATES INDIVIDUAL)  
11 FARVIEW RD  
TENAFLY, NJ 07670

**Registered Apr. 10, 2012**

**Int. Cl.: 9**

FOR: SPECIALTY HOLSTER FOR CARRYING CELLULAR PHONE IN A DECORATIVE WRISTBAND FOR CONSUMERS, IN CLASS 9 (U.S. CLS. 21, 23, 26, 36 AND 38).

**TRADEMARK**

FIRST USE 7-6-2010; IN COMMERCE 7-6-2010.

**PRINCIPAL REGISTER**

THE MARK CONSISTS OF STANDARD CHARACTERS WITHOUT CLAIM TO ANY PARTICULAR FONT, STYLE, SIZE, OR COLOR.

SN 85-063,901, FILED 6-16-2010.

GINA FINK, EXAMINING ATTORNEY



*David J. Kybas*

Director of the United States Patent and Trademark Office

# United States of America

United States Patent and Trademark Office

## RAW FRICTION

**Reg. No. 4,126,116**

**Registered Apr. 10, 2012**

**Int. Cl.: 28**

**TRADEMARK**

**PRINCIPAL REGISTER**

RAW FRICTION EXTREME R.C. TOY, LLC (PENNSYLVANIA LIMITED LIABILITY COMPANY)

131 BELLA VISTA COURT  
MURRAYSVILLE, PA 15668

FOR: TOYS, NAMELY, REMOTE CONTROL HELICOPTERS, IN CLASS 28 (U.S. CLS. 22, 23, 38 AND 50).

FIRST USE 12-15-2009; IN COMMERCE 12-15-2009.

THE MARK CONSISTS OF STANDARD CHARACTERS WITHOUT CLAIM TO ANY PARTICULAR FONT, STYLE, SIZE, OR COLOR.

SN 85-063,993, FILED 6-16-2010.

ANNE E. GUSTASON, EXAMINING ATTORNEY



*David J. Kybas*

Director of the United States Patent and Trademark Office

# United States of America

United States Patent and Trademark Office

## LASSEN INNOVATION

**Reg. No. 4,126,117**

NICHOLAS J. WEBB (UNITED STATES INDIVIDUAL)  
16314 TEXAS SPRINGS ROAD  
REDDING, TX 96001

**Registered Apr. 10, 2012**

**Int. Cl.: 35**

FOR: MANAGEMENT CONSULTING AND ADVISORY SERVICES IN THE FIELD OF INNOVATION MANAGEMENT, IN CLASS 35 (U.S. CLS. 100, 101 AND 102).

**SERVICE MARK**

FIRST USE 7-1-2010; IN COMMERCE 7-1-2010.

**PRINCIPAL REGISTER**

THE MARK CONSISTS OF STANDARD CHARACTERS WITHOUT CLAIM TO ANY PARTICULAR FONT, STYLE, SIZE, OR COLOR.

NO CLAIM IS MADE TO THE EXCLUSIVE RIGHT TO USE "INNOVATION", APART FROM THE MARK AS SHOWN.

SN 85-064,163, FILED 6-16-2010.

MICHAEL W. BAIRD, EXAMINING ATTORNEY



*David J. Kybas*

Director of the United States Patent and Trademark Office

# United States of America

United States Patent and Trademark Office



**Reg. No. 4,126,118**

**Registered Apr. 10, 2012**

**Int. Cl.: 29**

**TRADEMARK**

**PRINCIPAL REGISTER**

MIDWEST MEAT PACKING FACILITY, LLC (DELAWARE LIMITED LIABILITY COMPANY)  
P.O. BOX 580  
GIBBON, NE 68840

FOR: MEAT, FISH, POULTRY AND GAME, IN CLASS 29 (U.S. CL. 46).

FIRST USE 9-23-2010; IN COMMERCE 9-23-2010.

THE MARK CONSISTS OF THE STYLIZED WORDING "MOTHER'S CHOICE" IN CAPITALIZED, DARK BROWN BLOCK LETTERS. A GREEN AND LIGHT GREEN LEAF IS POSITIONED AS AN APOSTROPHE BETWEEN THE LETTERS "R" AND "S" IN THE WORD "MOTHER'S". UNDERNEATH THE WORD "CHOICE" IS A WAVY RED, DARK RED, AND ORANGE BANNER WITH A GOLD AND DARK GOLD LINE BORDER EMBELLISHMENT ON THE TOP AND BOTTOM OF THE BANNER.

THE COLOR(S) GREEN, LIGHT GREEN, DARK BROWN, RED, DARK RED, ORANGE, GOLD, AND DARK GOLD IS/ARE CLAIMED AS A FEATURE OF THE MARK.

SN 85-064,664, FILED 6-16-2010.

DAVID TOOLEY, EXAMINING ATTORNEY



*David J. Kybas*

Director of the United States Patent and Trademark Office



# United States of America

United States Patent and Trademark Office

# GENUSTECH

**Reg. No. 4,126,119**

**Registered Apr. 10, 2012**

**Int. Cl.: 9**

**TRADEMARK**

**PRINCIPAL REGISTER**

GENUS LIMITED (HONG KONG LIMITED COMPANY (LTD.))  
111 QUEEN'S RD WEST  
HUA FU COMMERCIAL BUILDING, STE. 1801-03 18/F 18/F  
SHEUNG WAN, HONG KONG

FOR: FILM AND VIDEO PRODUCTION PARTS AND FITTINGS AND ACCESSORIES, NAMELY,, RAY SHADE, SUN-SHADE, MOUNTING DEVICES FOR MOTION-PICTURE AND COMMERCIAL VIDEO PRODUCTION EQUIPMENT; ALL THE AFORESAID FUNCTIONING TO ASSIST WITH LIGHTING REQUIREMENTS FOR A PROFESSIONAL USER IN THE FORM OF SPECIALITY ATTACHMENTS FOR PROFESSIONAL MOTION-PICTURE AND COMMERCIAL PRODUCTION EQUIPMENT FOR PROVIDING SHADING AND REDUCING GLARE AND PARTS AND ACCESSORIES THEREFOR, IN CLASS 9 (U.S. CLS. 21, 23, 26, 36 AND 38).

FIRST USE 11-2-2011; IN COMMERCE 11-8-2011.

THE MARK CONSISTS OF STANDARD CHARACTERS WITHOUT CLAIM TO ANY PARTICULAR FONT, STYLE, SIZE, OR COLOR.

OWNER OF U.S. REG. NO. 3,835,704.

SN 85-065,504, FILED 6-17-2010.

EUGENIA MARTIN, EXAMINING ATTORNEY



*David J. Kyros*

Director of the United States Patent and Trademark Office

# United States of America

United States Patent and Trademark Office

PRACTICE **Mojo**

**Reg. No. 4,126,120**

**Registered Apr. 10, 2012**

**Int. Cls.: 35, 38, and 42**

**SERVICE MARK**

**PRINCIPAL REGISTER**

SMARTHEALTH, INC. (ARIZONA CORPORATION)  
3400 EAST MCDOWELL  
PHOENIX, AZ 85008

FOR: MARKETING SERVICES FOR MEDICAL AND DENTAL PRACTICES; PROVIDING A WEBSITE FOR PATIENT CUSTOMER SERVICE, NAMELY, FOR PROVIDING CUSTOMER SERVICE AND PRODUCT INQUIRY SERVICES ONLINE; PROVIDING A WEBSITE FOR ONLINE MARKETING OF MEDICAL AND DENTAL PRACTICES, IN CLASS 35 (U.S. CLS. 100, 101 AND 102).

FIRST USE 4-4-2011; IN COMMERCE 4-4-2011.

FOR: PROVIDING AUTOMATED PATIENT MESSAGING SERVICES, NAMELY, PROVIDING E-MAIL AND TEXT MESSAGES TO PATIENTS; AUTOMATED RECURRING AND PERIODIC DENTAL AND MEDICAL PATIENT COMMUNICATIONS VIA EMAIL AND TEXT MESSAGES, IN CLASS 38 (U.S. CLS. 100, 101 AND 104).

FIRST USE 6-25-2010; IN COMMERCE 6-25-2010.

FOR: PROVIDING TEMPORARY USE OF ONLINE-NON-DOWNLOADABLE SOFTWARE FOR DENTAL AND MEDICAL PRACTICE MANAGEMENT; PROVIDING ON-LINE, NON-DOWNLOADABLE, INTERNET-BASED SOFTWARE APPLICATION FOR MEDICAL AND DENTAL BILLING; PROVIDING TEMPORARY USE OF ONLINE, NON-DOWNLOADABLE SOFTWARE FOR SCHEDULING PATIENTS IN MEDICAL AND DENTAL PRACTICES, IN CLASS 42 (U.S. CLS. 100 AND 101).

FIRST USE 4-4-2011; IN COMMERCE 4-4-2011.

THE MARK CONSISTS OF THE LETTERS "PRACTICEMOJO" STYLIZED, WITH A SWOOSH UNDERLINE APPEARING UNDER THE "MOJO" PORTION OF THE MARK.

SN 85-065,680, FILED 6-17-2010.

JULIE VEPPUMTHARA, EXAMINING ATTORNEY



*David J. Kyros*

Director of the United States Patent and Trademark Office

# United States of America

United States Patent and Trademark Office

## SIMONIS 4000

**Reg. No. 4,126,121**

IWAN SIMONIS (ILLINOIS CORPORATION)  
1931 INDUSTRIAL DRIVE  
LIBERTYVILLE, IL 60654

**Registered Apr. 10, 2012**

**Int. Cl.: 24**

FOR: BILLIARD CLOTH; BILLIARD CLOTH; WOOLEN CLOTH, IN CLASS 24 (U.S. CLS. 42 AND 50).

**TRADEMARK**

FIRST USE 6-19-2000; IN COMMERCE 6-19-2000.

**PRINCIPAL REGISTER**

THE MARK CONSISTS OF STANDARD CHARACTERS WITHOUT CLAIM TO ANY PARTICULAR FONT, STYLE, SIZE, OR COLOR.

OWNER OF U.S. REG. NOS. 1,395,774 AND 2,876,663.

SN 85-065,864, FILED 6-17-2010.

TAMARA FRAZIER, EXAMINING ATTORNEY



*David J. Kyffers*

Director of the United States Patent and Trademark Office

# United States of America

United States Patent and Trademark Office

## MAPCONNECT

**Reg. No. 4,126,122**

**Registered Apr. 10, 2012**

**Int. Cls.: 9, 38, and 42**

**TRADEMARK**

**SERVICE MARK**

**PRINCIPAL REGISTER**

BROADMAP, LLC (VIRGINIA LIMITED LIABILITY COMPANY)  
SUITE 305 11543-A NUCKOLS ROAD  
GLEN ALLEN, VA 23059

FOR: ELECTRONIC DATABASE FEATURING ENCODED GEOGRAPHIC COORDINATE INFORMATION, GEOGRAPHIC POINT ATTRIBUTION, GEOGRAPHIC BOUNDARIES AND TELECOMMUNICATIONS DATA TO SUPPORT LOCATION INTELLIGENCE IN THE FIELDS OF BROADBAND SERVICE MANAGEMENT, RISK MANAGEMENT, REAL ESTATE AND PROPERTY MANAGEMENT, TARGET MARKETING MANAGEMENT, EMERGENCY SERVICES MANAGEMENT, RETAIL SITE SELECTION MANAGEMENT, GEOGRAPHIC INFORMATION SOFTWARE APPLICATION DEVELOPMENT RECORDED ON COMPUTER MEDIA; COMPUTER SOFTWARE FOR USE IN CREATING MAPS IN THE FIELDS OF GEOGRAPHIC INFORMATION SYSTEMS AND TELECOMMUNICATIONS, IN CLASS 9 (U.S. CLS. 21, 23, 26, 36 AND 38).

FIRST USE 9-15-2009; IN COMMERCE 9-15-2009.

FOR: TELECOMMUNICATION CONSULTATION IN THE NATURE OF TECHNICAL CONSULTING IN THE FIELDS OF TELECOMMUNICATION ASSET MANAGEMENT ATTRIBUTION AND VISUAL MAPPING OF DATA TRANSMISSION AND COMMUNICATIONS, IN CLASS 38 (U.S. CLS. 100, 101 AND 104).

FIRST USE 8-31-2009; IN COMMERCE 8-31-2009.

FOR: DATA AUTOMATION SERVICES USING PROPRIETARY SOFTWARE TO COMPILE, COLLECT, STANDARDIZE, INTEGRATE, MAINTAIN, AND IMPROVE DATA, NAMELY, BASE MAP DATA, BROADBAND SERVICEABILITY DATA, GEOGRAPHIC IMAGES, AND GEOGRAPHIC INFORMATION SYSTEM DATA; APPLICATION SERVICE PROVIDER FEATURING SOFTWARE FOR USE IN CREATING MAP DATABASES, IN THE FIELDS OF GEOGRAPHIC INFORMATION SYSTEMS AND TELECOMMUNICATIONS, IN CLASS 42 (U.S. CLS. 100 AND 101).

FIRST USE 8-31-2009; IN COMMERCE 8-31-2009.

THE MARK CONSISTS OF STANDARD CHARACTERS WITHOUT CLAIM TO ANY PARTICULAR FONT, STYLE, SIZE, OR COLOR.



*David J. Kyffers*

Director of the United States Patent and Trademark Office

**Reg. No. 4,126,122** SN 85-066,037, FILED 6-18-2010.

AISHA CLARKE, EXAMINING ATTORNEY

# United States of America

United States Patent and Trademark Office

## vive la vida yoga

**Reg. No. 4,126,123**

**Registered Apr. 10, 2012**

**Int. Cl.: 41**

**SERVICE MARK**

**PRINCIPAL REGISTER**

LOPEZ, BETTY (UNITED STATES INDIVIDUAL), DBA VIVE LA VIDA YOGA,  
4 PEAR TREE LANE  
FRANKLIN PARK., NJ 08823

FOR: YOGA INSTRUCTION, IN CLASS 41 (U.S. CLS. 100, 101 AND 107).

FIRST USE 9-1-2009; IN COMMERCE 9-1-2009.

THE MARK CONSISTS OF STANDARD CHARACTERS WITHOUT CLAIM TO ANY PARTICULAR FONT, STYLE, SIZE, OR COLOR.

NO CLAIM IS MADE TO THE EXCLUSIVE RIGHT TO USE "YOGA", APART FROM THE MARK AS SHOWN.

THE ENGLISH TRANSLATION OF THE WORDS "VIVE LA VIDA" IS LIVE THE LIFE.

SN 85-067,005, FILED 6-19-2010.

MATTHEW EINSTEIN, EXAMINING ATTORNEY



*David J. Kybas*

Director of the United States Patent and Trademark Office

United States of America  
United States Patent and Trademark Office

PASCHÓN

**Reg. No. 4,126,124**

FARRELL, CHARLES E. (UNITED STATES INDIVIDUAL)  
221 LINCREEK DRIVE  
COLUMBIA, SC 29212

**Registered Apr. 10, 2012**

**Int. Cl.: 16**

FOR: ART PRINTS, IN CLASS 16 (U.S. CLS. 2, 5, 22, 23, 29, 37, 38 AND 50).

**TRADEMARK**

FIRST USE 1-30-2012; IN COMMERCE 1-30-2012.

**PRINCIPAL REGISTER**

THE MARK CONSISTS OF STANDARD CHARACTERS WITHOUT CLAIM TO ANY PARTICULAR FONT, STYLE, SIZE, OR COLOR.

SN 85-067,094, FILED 6-19-2010.

BARBARA A. GOLD, EXAMINING ATTORNEY



*David J. Kybas*

Director of the United States Patent and Trademark Office

# United States of America

United States Patent and Trademark Office



**Reg. No. 4,126,125**

**Registered Apr. 10, 2012**

**Int. Cl.: 25**

**TRADEMARK**

**PRINCIPAL REGISTER**

FARRELL, CHARLES E. (UNITED STATES INDIVIDUAL)  
221 LINCREEK DRIVE  
COLUMBIA, SC 29212

FOR: CLOTHING, NAMELY, T-SHIRTS, SHIRTS, TOPS, BOTTOMS, BELTS AND HEADWEAR, IN CLASS 25 (U.S. CLS. 22 AND 39).

FIRST USE 1-30-2012; IN COMMERCE 1-30-2012.

THE MARK CONSISTS OF AN IMAGE OF AN OIL PAINTING RESEMBLING ROUGHLY CONCENTRIC CIRCLES BEGINNING WITH A BLACK DOT IN THE CENTER WITH CIRCLES RADIATING OUT FROM THE CENTER DOT APPEARING IN YELLOW, GREEN, RED, WHITE, AND BLACK.

THE COLOR(S) BLACK, WHITE, RED, GREEN AND YELLOW IS/ARE CLAIMED AS A FEATURE OF THE MARK.

SN 85-067,103, FILED 6-19-2010.

BARBARA A. GOLD, EXAMINING ATTORNEY



*David J. Kybas*

Director of the United States Patent and Trademark Office



# United States of America

United States Patent and Trademark Office

# WASTE NOT

**Reg. No. 4,126,126**

WISCONSIN FILM & BAG, INC. (WISCONSIN CORPORATION)  
3100 EAST RICHMOND STREET  
SHAWANO, WI 54166

**Registered Apr. 10, 2012**

**Int. Cl.: 40**

FOR: RECYCLING PROGRAM TO ENCOURAGE THE RECYCLING OF POLYETHYLENE FILMS AND BAGS, IN CLASS 40 (U.S. CLS. 100, 103 AND 106).

**SERVICE MARK**

FIRST USE 11-1-2011; IN COMMERCE 11-1-2011.

**PRINCIPAL REGISTER**

THE MARK CONSISTS OF STANDARD CHARACTERS WITHOUT CLAIM TO ANY PARTICULAR FONT, STYLE, SIZE, OR COLOR.

SN 85-067,343, FILED 6-21-2010.

NAKIA HENRY, EXAMINING ATTORNEY



*David J. Kybas*

Director of the United States Patent and Trademark Office

# United States of America

United States Patent and Trademark Office

## TRESTLE LUXE

**Reg. No. 4,126,127**

**Registered Apr. 10, 2012**

**Int. Cl.: 10**

**TRADEMARK**

**PRINCIPAL REGISTER**

ALPHATEC SPINE, INC. (CALIFORNIA CORPORATION)  
5818 EL CAMINO REAL  
ALPHATEC SPINE, INC.  
CARLSBAD, CA 92008

FOR: SPINAL IMPLANT PLATE, SCREWS AND ASSOCIATED SURGICAL APPARATUS  
AND INSTRUMENTS, IN CLASS 10 (U.S. CLS. 26, 39 AND 44).

FIRST USE 1-1-2012; IN COMMERCE 1-1-2012.

THE MARK CONSISTS OF STANDARD CHARACTERS WITHOUT CLAIM TO ANY PAR-  
TICULAR FONT, STYLE, SIZE, OR COLOR.

OWNER OF U.S. REG. NO. 3,471,451.

SN 85-068,010, FILED 6-21-2010.

MARTHA SANTOMARTINO, EXAMINING ATTORNEY



*David J. Kybas*

Director of the United States Patent and Trademark Office

# United States of America

United States Patent and Trademark Office

# GO 4 FREE

**Reg. No. 4,126,128**

ESTUDILLO, ROBERTO (UNITED STATES INDIVIDUAL)

**Registered Apr. 10, 2012**

P.O. BOX 434026  
SAN YSIDRO, CA 92143

**Int. Cl.: 39**

FOR: TRANSPORT OF PERSONS, IN CLASS 39 (U.S. CLS. 100 AND 105).

**SERVICE MARK**

FIRST USE 6-4-2010; IN COMMERCE 6-4-2010.

**PRINCIPAL REGISTER**

THE MARK CONSISTS OF STANDARD CHARACTERS WITHOUT CLAIM TO ANY PARTICULAR FONT, STYLE, SIZE, OR COLOR.

NO CLAIM IS MADE TO THE EXCLUSIVE RIGHT TO USE "FOR FREE", APART FROM THE MARK AS SHOWN.

SN 85-068,092, FILED 6-21-2010.

DEBRA LEE, EXAMINING ATTORNEY



*David J. Kyffers*

Director of the United States Patent and Trademark Office

# United States of America

United States Patent and Trademark Office

## PACIFIC FESTIVAL: OC

**Reg. No. 4,126,129**

COLLABORATIVE MEDIA, LLC (CALIFORNIA LIMITED LIABILITY COMPANY)  
729 W. 16TH SUITE A-4  
COSTA MESA, CA 92627

**Registered Apr. 10, 2012**

**Int. Cls.: 25 and 41**

FOR: HATS; SHIRTS; SWEAT SHIRTS; T-SHIRTS, IN CLASS 25 (U.S. CLS. 22 AND 39).

FIRST USE 3-0-2010; IN COMMERCE 3-0-2010.

**TRADEMARK**

FOR: ENTERTAINMENT IN THE NATURE OF ORGANIZING AND PRODUCING LIVE MUSICAL EVENTS, IN CLASS 41 (U.S. CLS. 100, 101 AND 107).

**SERVICE MARK**

**PRINCIPAL REGISTER**

FIRST USE 3-0-2010; IN COMMERCE 3-0-2010.

THE MARK CONSISTS OF STANDARD CHARACTERS WITHOUT CLAIM TO ANY PARTICULAR FONT, STYLE, SIZE, OR COLOR.

NO CLAIM IS MADE TO THE EXCLUSIVE RIGHT TO USE "FESTIVAL: OC", APART FROM THE MARK AS SHOWN.

SN 85-068,174, FILED 6-21-2010.

CHARLES L. JENKINS, EXAMINING ATTORNEY



*David J. Kybas*

Director of the United States Patent and Trademark Office

# United States of America

United States Patent and Trademark Office

## TSHIRTYOURGAME

**Reg. No. 4,126,130**

**Registered Apr. 10, 2012**

**Int. Cl.: 25**

**TRADEMARK**

**PRINCIPAL REGISTER**

T-SHIRT YOUR GAME (NEVADA LIMITED LIABILITY COMPANY)  
2635 ROSE MIST COURT  
RENO, NV 89521

FOR: SWEAT SHIRTS; T-SHIRTS, IN CLASS 25 (U.S. CLS. 22 AND 39).

FIRST USE 11-26-2011; IN COMMERCE 11-26-2011.

THE MARK CONSISTS OF STANDARD CHARACTERS WITHOUT CLAIM TO ANY PARTICULAR FONT, STYLE, SIZE, OR COLOR.

NO CLAIM IS MADE TO THE EXCLUSIVE RIGHT TO USE "T-SHIRT", APART FROM THE MARK AS SHOWN.

SN 85-069,797, FILED 6-23-2010.

MATTHEW MCDOWELL, EXAMINING ATTORNEY



*David J. Kyffers*

Director of the United States Patent and Trademark Office

United States of America  
United States Patent and Trademark Office

TINAK

**Reg. No. 4,126,131**

TINA KESHISHIAN (UNITED STATES INDIVIDUAL)  
13207 VENTURA BLVD  
STUDIO CTY, CA 91604

**Registered Apr. 10, 2012**

**Int. Cl.: 3**

FOR: COSMETICS, IN CLASS 3 (U.S. CLS. 1, 4, 6, 50, 51 AND 52).

**TRADEMARK**

FIRST USE 1-1-2012; IN COMMERCE 1-1-2012.

**PRINCIPAL REGISTER**

THE MARK CONSISTS OF STANDARD CHARACTERS WITHOUT CLAIM TO ANY PARTICULAR FONT, STYLE, SIZE, OR COLOR.

THE NAME(S), PORTRAIT(S), AND/OR SIGNATURE(S) SHOWN IN THE MARK IDENTIFIES "TINA KESHISHIAN", WHOSE CONSENT(S) TO REGISTER IS MADE OF RECORD.

SN 85-069,887, FILED 6-23-2010.

DAVID TOOLEY, EXAMINING ATTORNEY



*David J. Kyffers*

Director of the United States Patent and Trademark Office

# United States of America

United States Patent and Trademark Office

# MDG&E

**Reg. No. 4,126,132**

**Registered Apr. 10, 2012**

**Int. Cl.: 35**

**SERVICE MARK**

**PRINCIPAL REGISTER**

US GAS & ELECTRIC, INC. (DELAWARE CORPORATION)  
290 N.W. 165TH STREET  
PH5  
NORTH MIAMI BEACH, FL 33169

FOR: ENERGY MANAGEMENT SERVICES, NAMELY, PROVIDING A SERVICE THAT  
ALLOWS CUSTOMERS TO PURCHASE ENERGY, NAMELY, ELECTRICITY AND NATURAL  
GAS, AT VARIABLE PRICES, IN CLASS 35 (U.S. CLS. 100, 101 AND 102).

FIRST USE 11-30-2011; IN COMMERCE 11-30-2011.

THE MARK CONSISTS OF STANDARD CHARACTERS WITHOUT CLAIM TO ANY PAR-  
TICULAR FONT, STYLE, SIZE, OR COLOR.

OWNER OF U.S. REG. NO. 3,800,175.

SN 85-070,102, FILED 6-23-2010.

KATHERINE STOIDES, EXAMINING ATTORNEY



*David J. Kyros*

Director of the United States Patent and Trademark Office

# United States of America

United States Patent and Trademark Office

## MOTHER GOOSE

**Reg. No. 4,126,133**

**Registered Apr. 10, 2012**

**Int. Cl.: 21**

**TRADEMARK**

**PRINCIPAL REGISTER**

PATRICK HUANG (CANADA INDIVIDUAL)  
7728 JENSEN PLACE  
BURNABY, BC, CANADA V5A2A8

FOR: CANDLE HOLDERS; VASES; COOKIE CUTTERS; BAKING DISHES; BAKEWARE; COOKWARE, NAMELY, POTS AND PANS; TEA AND COFFEE SETS; BEVERAGEWARE; NON-ELECTRIC KETTLES; NON-ELECTRIC TEAPOTS; NON-ELECTRIC JUICERS; CUTTING BOARDS; KNIFE BLOCKS; KITCHEN UTENSILS, NAMELY, LADLES, TONGS, SKIMMERS, TURNERS, PEELERS, GRATERS, AND BOTTLE OPENERS; CLEANING BRUSHES FOR HOUSEHOLD USE; CLOTHES DRYING HANGERS; HOUSEHOLD GLOVES FOR GENERAL USE; COOKIE JARS AND CANDY JARS; CANDY BOXES; NON-METAL PIGGY BANKS; FIGURINES OF CHINA, CRYSTAL, GLASS AND PORCELAIN; ORNAMENTS OF CHINA, CRYSTAL, GLASS AND PORCELAIN; PLASTIC CONTAINERS, NAMELY, PLASTIC PARTY FAVOR BOXES SOLD EMPTY; FABRIC AND TEXTILE PARTY FAVOR BOXES SOLD EMPTY; BASKETS OF WICKER, STRAW, WOOD, AND CLOTH, IN CLASS 21 (U.S. CLS. 2, 13, 23, 29, 30, 33, 40 AND 50).

FIRST USE 11-30-2011; IN COMMERCE 11-30-2011.

THE MARK CONSISTS OF STANDARD CHARACTERS WITHOUT CLAIM TO ANY PARTICULAR FONT, STYLE, SIZE, OR COLOR.

OWNER OF U.S. REG. NOS. 2,845,451, 2,870,422, AND OTHERS.

SN 85-070,118, FILED 6-23-2010.

KATHERINE STOIDES, EXAMINING ATTORNEY



*David J. Kyjars*

Director of the United States Patent and Trademark Office



# United States of America

United States Patent and Trademark Office

# SmartRack

**Reg. No. 4,126,134**

**Registered Apr. 10, 2012**

**Int. Cl.: 9**

**TRADEMARK**

**PRINCIPAL REGISTER**

TRIPPE MANUFACTURING COMPANY (ILLINOIS CORPORATION)  
1111 35TH STREET  
CHICAGO, IL 60609

FOR: MOUNTING RACKS AND ENCLOSURES FOR COMPUTER HARDWARE, IN CLASS  
9 (U.S. CLS. 21, 23, 26, 36 AND 38).

FIRST USE 7-0-1999; IN COMMERCE 7-0-1999.

THE MARK CONSISTS OF STANDARD CHARACTERS WITHOUT CLAIM TO ANY PAR-  
TICULAR FONT, STYLE, SIZE, OR COLOR.

SN 85-070,154, FILED 6-23-2010.

VERNA BETH RIRIE, EXAMINING ATTORNEY



*David J. Kybas*

Director of the United States Patent and Trademark Office

# United States of America

United States Patent and Trademark Office

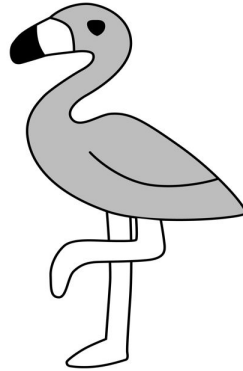

**Reg. No. 4,126,135**

MORGENSTERN, LUKE LESLIE (CANADA INDIVIDUAL)  
21432 WARDEN AVE  
QUEENSVILLE, ONTARIO, CANADA L0G1R0

**Registered Apr. 10, 2012**

**Int. Cl.: 25**

FOR: ATHLETIC APPAREL, NAMELY, SHIRTS, PANTS, JACKETS, FOOTWEAR, HATS  
AND CAPS, ATHLETIC UNIFORMS, IN CLASS 25 (U.S. CLS. 22 AND 39).

**TRADEMARK**

FIRST USE 3-27-2011; IN COMMERCE 6-21-2011.

**PRINCIPAL REGISTER**

THE MARK CONSISTS OF A FLAMINGO STANDING ON ONE LEG.

SN 85-070,235, FILED 6-23-2010.

COLLEEN DOMBROW, EXAMINING ATTORNEY



*David J. Kybas*

Director of the United States Patent and Trademark Office

# United States of America

United States Patent and Trademark Office

# SELKO

**Reg. No. 4,126,136**

**Registered Apr. 10, 2012**

**Int. Cl.: 31**

**TRADEMARK**

**PRINCIPAL REGISTER**

SELKO B.V. (NETHERLANDS LIMITED LIABILITY COMPANY)  
JELLINGHAUSSTRAAT 22  
5048 AZ TILBURG, NETHERLANDS

FOR: NON-MEDICATED ADDITIVES FOR USE IN MANUFACTURE OF ANIMAL FEED, FEED PREMIXES AND FEED CONCENTRATES AS NUTRITIONAL SUPPLEMENTS, IN CLASS 31 (U.S. CLS. 1 AND 46).

FIRST USE 5-7-2007; IN COMMERCE 5-7-2007.

THE MARK CONSISTS OF STANDARD CHARACTERS WITHOUT CLAIM TO ANY PARTICULAR FONT, STYLE, SIZE, OR COLOR.

OWNER OF U.S. REG. NO. 3,657,625.

SN 85-070,494, FILED 6-24-2010.

SKYE YOUNG, EXAMINING ATTORNEY



*David J. Kyjars*

Director of the United States Patent and Trademark Office

# United States of America

United States Patent and Trademark Office

## REB'L FLEUR

**Reg. No. 4,126,137**

RORAJ TRADE, LLC (NEW YORK LIMITED LIABILITY COMPANY)  
400 SOUTH HOPE STREET  
LOS ANGELES, CA 90071

**Registered Apr. 10, 2012**

**Int. Cl.: 3**

FOR: BATH GELS, BODY LOTIONS, SHOWER GELS, PERFUME, IN CLASS 3 (U.S. CLS. 1, 4, 6, 50, 51 AND 52).

**TRADEMARK**

FIRST USE 12-6-2010; IN COMMERCE 12-6-2010.

**PRINCIPAL REGISTER**

THE MARK CONSISTS OF STANDARD CHARACTERS WITHOUT CLAIM TO ANY PARTICULAR FONT, STYLE, SIZE, OR COLOR.

THE ENGLISH TRANSLATION OF THE WORD "FLEUR" IN THE MARK IS "FLOWER".

SN 85-070,576, FILED 6-24-2010.

WILLIAM ROSSMAN, EXAMINING ATTORNEY



*David J. Kybas*

Director of the United States Patent and Trademark Office

# United States of America

United States Patent and Trademark Office

## REB'L FLEUR

**Reg. No. 4,126,138**

**Registered Apr. 10, 2012**

**Int. Cl.: 18**

**TRADEMARK**

**PRINCIPAL REGISTER**

RORAJ TRADE, LLC (NEW YORK LIMITED LIABILITY COMPANY)  
400 SOUTH HOPE STREET  
C/O HOLLAND & KNIGHT, 8TH FLOOR  
LOS ANGELES, CA 90071

FOR: PURSES; COSMETIC CASES, IN CLASS 18 (U.S. CLS. 1, 2, 3, 22 AND 41).

FIRST USE 12-12-2010; IN COMMERCE 12-12-2010.

THE MARK CONSISTS OF STANDARD CHARACTERS WITHOUT CLAIM TO ANY PARTICULAR FONT, STYLE, SIZE, OR COLOR.

THE ENGLISH TRANSLATION OF THE WORD "FLEUR" IN THE MARK IS FLOWER.

SN 85-070,583, FILED 6-24-2010.

WILLIAM ROSSMAN, EXAMINING ATTORNEY



*David J. Kybas*

Director of the United States Patent and Trademark Office

# United States of America

United States Patent and Trademark Office

## WALKABILITY

**Reg. No. 4,126,139**

**Registered Apr. 10, 2012**

**Int. Cl.: 25**

**TRADEMARK**

**PRINCIPAL REGISTER**

THE ROCKPORT COMPANY, LLC (DELAWARE LIMITED LIABILITY COMPANY)  
1895 J.W. FOSTER BOULEVARD  
CANTON, MA 02021

FOR: FOOTWEAR, IN CLASS 25 (U.S. CLS. 22 AND 39).

FIRST USE 12-29-2011; IN COMMERCE 12-29-2011.

THE MARK CONSISTS OF STANDARD CHARACTERS WITHOUT CLAIM TO ANY PARTICULAR FONT, STYLE, SIZE, OR COLOR.

SN 85-070,611, FILED 6-24-2010.

SUZANNE BLANE, EXAMINING ATTORNEY



*David J. Kybas*

Director of the United States Patent and Trademark Office

# United States of America

United States Patent and Trademark Office

*Charity*  
**Donor**

**Reg. No. 4,126,140**

ESTUDILLO, ROBERTO (UNITED STATES INDIVIDUAL)  
P.O. BOX 434026  
SAN YSIDRO, CA 92143

**Registered Apr. 10, 2012**

**Int. Cl.: 36**

FOR: CHARITABLE FUND RAISING SERVICES, IN CLASS 36 (U.S. CLS. 100, 101 AND 102).

**SERVICE MARK**

FIRST USE 1-21-2011; IN COMMERCE 1-21-2011.

**PRINCIPAL REGISTER**

NO CLAIM IS MADE TO THE EXCLUSIVE RIGHT TO USE "CHARITY DONOR", APART FROM THE MARK AS SHOWN.

THE MARK CONSISTS OF THE WORD "CHARITY" WITH AN IMAGE OF A RIBBON FORMING THE DOT ABOVE THE "I" AND THE LINE CROSSING THE "T", THE WORD "DONOR" APPEARS BELOW THE WORD "CHARITY".

SN 85-071,168, FILED 6-24-2010.

DEBRA LEE, EXAMINING ATTORNEY



*David J. Kybas*

Director of the United States Patent and Trademark Office

# United States of America

United States Patent and Trademark Office



**metacritic**

Keeping score of entertainment.

**Reg. No. 4,126,141**

**Registered Apr. 10, 2012**

**Int. Cl.: 41**

**SERVICE MARK**

**PRINCIPAL REGISTER**

CBS INTERACTIVE INC. (DELAWARE CORPORATION)  
51 WEST 52ND STREET  
NEW YORK, NY 10019

FOR: ENTERTAINMENT SERVICES, NAMELY, PROVIDING ONLINE REVIEWS AND INFORMATION ON THE REVIEWS OF MOVIES, MUSIC, TELEVISION SHOWS, COMPUTER GAMES, AND VIDEO GAMES, IN CLASS 41 (U.S. CLS. 100, 101 AND 107).

FIRST USE 8-11-2010; IN COMMERCE 8-11-2010.

OWNER OF U.S. REG. NOS. 2,625,905, 2,640,363, AND 2,813,999.

THE MARK CONSISTS OF FANCIFUL "M" IN A DOUBLE CIRCLE. THE WORDING "METACRITIC KEEPING SCORE OF ENTERTAINMENT" IS TO THE RIGHT OF THE DESIGN.

SN 85-071,173, FILED 6-24-2010.

KAREN SEVERSON, EXAMINING ATTORNEY



*David J. Kyffers*

Director of the United States Patent and Trademark Office



# United States of America

United States Patent and Trademark Office



**Reg. No. 4,126,142**

ESTUDILLO, ROBERTO (UNITED STATES INDIVIDUAL)  
P.O. BOX 434026  
SAN YSIDRO, CA 92143

**Registered Apr. 10, 2012**

**Int. Cl.: 39**

FOR: TRANSPORT OF PERSONS, IN CLASS 39 (U.S. CLS. 100 AND 105).

**SERVICE MARK**

FIRST USE 6-4-2010; IN COMMERCE 6-4-2010.

**PRINCIPAL REGISTER**

NO CLAIM IS MADE TO THE EXCLUSIVE RIGHT TO USE "FOR FREE" , APART FROM THE MARK AS SHOWN.

THE COLOR(S) BLUE AND ORANGE IS/ARE CLAIMED AS A FEATURE OF THE MARK.

THE MARK CONSISTS OF THE WORD "GO" IN THE COLOR BLUE WITH THE NUMBER "4" IN THE COLOR ORANGE APPEARING JUST BELOW AND SLIGHTLY OVERLAPPING THE BOTTOM SIDE OF THE LETTER "O" IN THE WORD "GO", AND THE WORD "FREE" IN THE COLOR BLUE APPEARING BELOW THE NUMBER "4" WITH THE LETTERS "R" AND "E" IN THE WORD "FREE" SLIGHTLY OVERLAPPING THE BOTTOM OF THE NUMBER "4".

SN 85-071,186, FILED 6-24-2010.

DEBRA LEE, EXAMINING ATTORNEY



*David J. Kyros*

Director of the United States Patent and Trademark Office

# United States of America

United States Patent and Trademark Office

## BLACKBIRD TECHNOLOGIES

**Reg. No. 4,126,143**

**Registered Apr. 10, 2012**

**Int. Cl.: 9**

**TRADEMARK**

**PRINCIPAL REGISTER**

BLACKBIRD TECHNOLOGIES, INC. (VIRGINIA CORPORATION)  
13900 LINCOLN PARK DRIVE, SUITE 400  
HERNDON, VA 20171

FOR: COMPUTER SOFTWARE FOR COMMUNICATION AND VISUALIZATION FUNCTIONS BETWEEN MOBILE COMMUNICATIONS DEVICES FOR USE IN SURVEILLANCE, MILITARY AND GOVERNMENT OPERATIONS; COMPUTER SOFTWARE FOR LOCATING, MAPPING, NAVIGATING, AND MONITORING THE POSITION AND STATUS OF PERSONS OR GOODS FOR USE IN SURVEILLANCE, MILITARY AND GOVERNMENT OPERATIONS; PERSONAL DIGITAL ASSISTANTS, NAMELY, PDAS FOR USE IN SURVEILLANCE, MILITARY AND GOVERNMENT OPERATIONS; MOBILE COMMUNICATION DEVICES AND CELLULAR COMMUNICATION DEVICES, NAMELY, COMMUNICATION TRANSMITTERS FOR USE IN SURVEILLANCE, MILITARY AND GOVERNMENT OPERATIONS; RADIO FREQUENCY IDENTIFICATION (RFID) TAGS AND READERS; DEVICES FOR MAPPING, NAVIGATING, AND MONITORING THE POSITION AND STATUS OF PERSONS OR GOODS, NAMELY, AUTOMATED SELF CONTAINED ELECTRONIC SURVEILLANCE DEVICES THAT CAN BE DEPLOYED TO SUPPORT GOVERNMENT OPERATIONS IN REMOTE LOCATIONS, AND SENSORS FOR USE IN MILITARY, LAW ENFORCEMENT, CIVIL, SCIENTIFIC AND INDUSTRIAL APPLICATIONS; PORTABLE ELECTRONIC SURVEILLANCE TAGS AND TAGGING EQUIPMENT INCORPORATING GLOBAL POSITIONING SYSTEM TRANSMITTERS AND RECEIVER, IN CLASS 9 (U.S. CLS. 21, 23, 26, 36 AND 38).

FIRST USE 10-0-2006; IN COMMERCE 10-0-2006.

THE MARK CONSISTS OF STANDARD CHARACTERS WITHOUT CLAIM TO ANY PARTICULAR FONT, STYLE, SIZE, OR COLOR.

OWNER OF U.S. REG. NOS. 2,348,587 AND 2,389,589.

NO CLAIM IS MADE TO THE EXCLUSIVE RIGHT TO USE "TECHNOLOGIES", APART FROM THE MARK AS SHOWN.

SN 85-072,666, FILED 6-28-2010.

HANNO RITTNER, EXAMINING ATTORNEY



*David J. Kyffers*

Director of the United States Patent and Trademark Office

# United States of America

United States Patent and Trademark Office

# BLACKBIRD

**Reg. No. 4,126,144**

BLACKBIRD TECHNOLOGIES, INC. (VIRGINIA CORPORATION)  
13900 LINCOLN PARK DRIVE, SUITE 400  
HERNDON, VA 20171

**Registered Apr. 10, 2012**

**Int. Cls.: 37, 41, 42, and  
45**

FOR: INSTALLATION AND MAINTENANCE OF COMPUTER AND COMMUNICATIONS NETWORK HARDWARE USED IN THE WIRELESS TELECOMMUNICATIONS FIELD, IN CLASS 37 (U.S. CLS. 100, 103 AND 106).

**SERVICE MARK**

FIRST USE 4-0-1999; IN COMMERCE 4-0-1999.

**PRINCIPAL REGISTER**

FOR: LANGUAGE TRANSLATION AND INTERPRETATION SERVICES; SECURITY TRAINING SERVICES IN THE FIELD OF GOVERNMENT AND HOMELAND SECURITY INFORMATION; SECURITY TRAINING OTHERS IN THE LOCATING, MAPPING, NAVIGATING AND MONITORING THE POSITION OR STATUS OF PERSONS OR GOODS FOR SECURITY AND INVESTIGATORY PURPOSES, IN CLASS 41 (U.S. CLS. 100, 101 AND 107).

FIRST USE 8-0-2000; IN COMMERCE 8-0-2000.

FOR: CUSTOM DEVELOPMENT OF COMPUTER SOFTWARE AND HARDWARE FOR OTHERS; RESEARCH AND DEVELOPMENT FOR OTHERS IN THE FIELDS OF SOFTWARE, HARDWARE, OPERATING SYSTEMS, AND WIRELESS COMMUNICATIONS USED IN LOCATING, MAPPING, NAVIGATING AND MONITORING THE POSITION OR STATUS OF PERSONS OR GOODS INSTALLATION, MAINTENANCE, AND SUPPORT SERVICES FOR COMPUTER SOFTWARE AND COMMUNICATIONS NETWORK SOFTWARE USED IN THE WIRELESS TELECOMMUNICATIONS FIELD; COMMUNICATIONS SERVICES, NAMELY, DEVELOPING, IMPLEMENTING, INTEGRATING AND MONITORING SECURE COMMUNICATION NETWORKS FOR OTHERS, NAMELY, DESIGN AND DEVELOPMENT OF SECURITY SYSTEMS AND CONTINGENCY PLANNING FOR INFORMATION SYSTEMS, DEVELOPING AND IMPLEMENTING CUSTOMIZED PLANS FOR IMPROVING SECURITY AND PREVENTING CRIMINAL ACTIVITY FOR BUSINESSES AND GOVERNMENTAL AGENCIES, INTEGRATION OF COMPUTER COMMUNICATION SYSTEMS AND NETWORKS, COMPUTER MONITORING TRACKING HARDWARE PERFORMANCE AND PROCESSES WHICH SENDS OUT HISTORICAL REPORTS AND ALERTS; CONSULTING SERVICES IN THE FIELD OF COMPUTER SECURITY; CONSULTATION IN THE FIELD OF SECURE COMPUTER NETWORKING, INFORMATION ASSURANCE AND IDENTITY AND ACCESS MANAGEMENT, NAMELY, CONSULTING IN THE FIELD OF SECURE COMPUTER NETWORK INTEGRATION, IN CLASS 42 (U.S. CLS. 100 AND 101).



*David J. Kyffers*

Director of the United States Patent and Trademark Office

**Reg. No. 4,126,144** FIRST USE 4-0-1999; IN COMMERCE 4-0-1999.

FOR: CONSULTING SERVICES IN THE FIELD OF NATIONAL SECURITY; CONSULTATION IN THE FIELD OF SECURE INFORMATION ASSURANCE AND IDENTITY AND ACCESS MANAGEMENT, NAMELY, ON-LINE MONITORING TO PREVENT ILLEGAL FILE SHARING AND PROVIDING ELECTRONIC REPORTS REGARDING ATTEMPTS AT ILLEGAL FILE SHARING IN CONNECTION THEREWITH ON NETWORKS WORLDWIDE, IN CLASS 45 (U.S. CLS. 100 AND 101).

FIRST USE 8-0-2000; IN COMMERCE 8-0-2000.

THE MARK CONSISTS OF STANDARD CHARACTERS WITHOUT CLAIM TO ANY PARTICULAR FONT, STYLE, SIZE, OR COLOR.

OWNER OF U.S. REG. NOS. 2,348,587 AND 2,389,589.

SN 85-072,671, FILED 6-28-2010.

HANNO RITTNER, EXAMINING ATTORNEY

# United States of America

United States Patent and Trademark Office

## BROUN OF COLSTOUN

**Reg. No. 4,126,145**

**Registered Apr. 10, 2012**

**Int. Cl.: 26**

**TRADEMARK**

**PRINCIPAL REGISTER**

BROUN, WAYNE H. (AUSTRALIA INDIVIDUAL)  
MPUMALANGA, 112 NARRABEEN PARK PARADE  
WARRIEWOOD BEACH NSW, AUSTRALIA 2102

FOR: BELT BUCKLES NOT OF PRECIOUS METAL; BELT CLASPS; BROOCHES; EMBROIDERED EMBLEMS; AND ORNAMENTAL NOVELTY PINS, IN CLASS 26 (U.S. CLS. 37, 39, 40, 42 AND 50).

FIRST USE 12-1-2011; IN COMMERCE 12-1-2011.

THE MARK CONSISTS OF STANDARD CHARACTERS WITHOUT CLAIM TO ANY PARTICULAR FONT, STYLE, SIZE, OR COLOR.

THE NAME(S), PORTRAIT(S), AND/OR SIGNATURE(S) SHOWN IN THE MARK DOES NOT IDENTIFY A PARTICULAR LIVING INDIVIDUAL.

SN 85-073,262, FILED 6-28-2010.

KYLE PEETE, EXAMINING ATTORNEY



*David J. Kyffers*

Director of the United States Patent and Trademark Office

# United States of America

United States Patent and Trademark Office

## Caring Hands

**Reg. No. 4,126,146**

**Registered Apr. 10, 2012**

**Int. Cls.: 43, 44, and 45**

**SERVICE MARK**

**PRINCIPAL REGISTER**

LUTHERAN LIFE COMMUNITIES (ILLINOIS CORPORATION)  
3150 SALT CREEK LANE  
ARLINGTON HEIGHTS, IL 60005

FOR: PROVIDING MEALS TO HOSPICE RESIDENTS AND THEIR FAMILY MEMBERS;  
PROVIDING ROOM AND BOARD TO HOSPICE RESIDENTS, IN CLASS 43 (U.S. CLS. 100  
AND 101).

FIRST USE 5-19-2009; IN COMMERCE 4-1-2010.

FOR: PROVIDING HEALTHCARE SERVICES TO HOSPICE RESIDENTS; PROVIDING  
NURSING SERVICES TO HOSPICE RESIDENTS, IN CLASS 44 (U.S. CLS. 100 AND 101).

FIRST USE 5-19-2009; IN COMMERCE 4-1-2010.

FOR: PROVIDING COUNSELING IN THE FIELD OF GRIEF COUNSELING FOR HOSPICE  
RESIDENTS AND THEIR FAMILIES; COUNSELING IN THE FIELD OF SUPPORTING INDI-  
VIDUALS AND FAMILIES DEALING WITH TERMINAL ILLNESS; RELIGIOUS SERVICES  
PROVIDED TO HOSPICE RESIDENTS, IN CLASS 45 (U.S. CLS. 100 AND 101).

FIRST USE 5-19-2009; IN COMMERCE 4-1-2010.

THE MARK CONSISTS OF STANDARD CHARACTERS WITHOUT CLAIM TO ANY PAR-  
TICULAR FONT, STYLE, SIZE, OR COLOR.

SN 85-073,779, FILED 6-29-2010.

JAMES A. RAUEN, EXAMINING ATTORNEY



*David J. Kyros*

Director of the United States Patent and Trademark Office

# United States of America

United States Patent and Trademark Office

## WILKINSON CHUTES

**Reg. No. 4,126,147**

**Registered Apr. 10, 2012**

**Int. Cls.: 6 and 7**

**TRADEMARK**

**PRINCIPAL REGISTER**

WHR HOLDINGS, LLC (FLORIDA LIMITED LIABILITY COMPANY)  
3001 GREENE STREET  
HOLLYWOOD, FL 33020

FOR: METAL DOORS FOR LAUNDRY CHUTES, NAMELY, INTAKE DOORS AND DISCHARGE DOORS; METAL DOORS FOR TRASH CHUTES, NAMELY, INTAKE DOORS AND DISCHARGE DOORS; TRASH CHUTES, NAMELY, METAL TRASH CHUTES IN THE NATURE OF BUILDING MATERIALS; AND LAUNDRY CHUTES, NAMELY, METAL LAUNDRY CHUTES IN THE NATURE OF BUILDING MATERIALS, IN CLASS 6 (U.S. CLS. 2, 12, 13, 14, 23, 25 AND 50).

FIRST USE 1-18-2012; IN COMMERCE 1-18-2012.

FOR: GARBAGE DISPOSALS FOR RUBBISH, GARBAGE, PAPER, SOILED LINEN AND/OR CONSTRUCTION MATERIALS, AND REPLACEMENT PARTS THEREFOR, IN CLASS 7 (U.S. CLS. 13, 19, 21, 23, 31, 34 AND 35).

FIRST USE 1-21-2012; IN COMMERCE 1-21-2012.

THE MARK CONSISTS OF STANDARD CHARACTERS WITHOUT CLAIM TO ANY PARTICULAR FONT, STYLE, SIZE, OR COLOR.

SEC. 2(F).

OWNER OF U.S. REG. NO. 2,797,205.

NO CLAIM IS MADE TO THE EXCLUSIVE RIGHT TO USE "CHUTES", APART FROM THE MARK AS SHOWN.

SN 85-074,143, FILED 6-29-2010.

CHRISTINE COOPER, EXAMINING ATTORNEY



*David J. Kyffers*

Director of the United States Patent and Trademark Office

# United States of America

United States Patent and Trademark Office

## WIDGEON SNUGAROO

**Reg. No. 4,126,148**

**Registered Apr. 10, 2012**

**Int. Cl.: 12**

**TRADEMARK**

**PRINCIPAL REGISTER**

S.I.T., INC. (CALIFORNIA CORPORATION)  
2401 MERCED STREET  
SUITE #200  
SAN LEANDRO, CA 94577

FOR: CONTOURED SEAT-COVER FOR USE WITH HARD-SHELLED-PORTABLE CHILDREN'S CARRIERS AND CAR-SEATS WHICH ENVELOPES THE CHILD WITHIN THE CARRIER OR CAR-SEAT AND PROTECTS THE CHILD FROM WEATHER ELEMENTS, IN CLASS 12 (U.S. CLS. 19, 21, 23, 31, 35 AND 44).

FIRST USE 8-0-2011; IN COMMERCE 8-0-2011.

THE MARK CONSISTS OF STANDARD CHARACTERS WITHOUT CLAIM TO ANY PARTICULAR FONT, STYLE, SIZE, OR COLOR.

OWNER OF U.S. REG. NO. 1,412,418.

SN 85-074,192, FILED 6-29-2010.

GENE MACIOL, EXAMINING ATTORNEY



*David J. Kyffers*

Director of the United States Patent and Trademark Office



# United States of America

United States Patent and Trademark Office



**Reg. No. 4,126,149**

**Registered Apr. 10, 2012**

**Int. Cls.: 9 and 35**

**TRADEMARK**

**SERVICE MARK**

**PRINCIPAL REGISTER**

MSD CONSUMER CARE, INC. (DELAWARE CORPORATION)  
3030 JACKSON AVENUE  
MEMPHIS, TN 38151

FOR: COMPUTER APPLICATION SOFTWARE FOR MOBILE PHONES, NAMELY, SOFTWARE FOR PROVIDING CONSUMER INFORMATION ON SUN SAFETY AND SAFE SUN EXPOSURE PRACTICES, AND SUN CARE PRODUCT RECOMMENDATIONS, VIA A MOBILE PHONE APPLICATION, IN CLASS 9 (U.S. CLS. 21, 23, 26, 36 AND 38).

FIRST USE 6-30-2010; IN COMMERCE 6-30-2010.

FOR: INFORMATION AND ADVICE FOR CONSUMERS, NAMELY, PROVIDING CONSUMER INFORMATION ON SUN SAFETY AND SAFE SUN EXPOSURE PRACTICES, AND SUN CARE PRODUCT RECOMMENDATIONS, VIA A MOBILE PHONE APPLICATION, IN CLASS 35 (U.S. CLS. 100, 101 AND 102).

FIRST USE 6-30-2010; IN COMMERCE 6-30-2010.

OWNER OF U.S. REG. NOS. 917,825, 1,490,740, AND OTHERS.

NO CLAIM IS MADE TO THE EXCLUSIVE RIGHT TO USE "ALERT", APART FROM THE MARK AS SHOWN.

THE MARK CONSISTS OF THE STYLIZED WORD "COPPERTONE" WITHIN A BALLOON-SHAPED BACKGROUND, ABOVE THE STYLIZED WORDING "MYUV ALERT" CONTAINED WITHIN AN OBLONG SHAPE.

SN 85-074,498, FILED 6-30-2010.

ESTHER BELENKER, EXAMINING ATTORNEY



*David J. Kyros*

Director of the United States Patent and Trademark Office

# United States of America

United States Patent and Trademark Office

READ. WRITE. REMEMBER.

**Reg. No. 4,126,150**

DAVID W. KEEFE, JR. (UNITED STATES INDIVIDUAL)  
183 RANGE RD  
WILTON, CT 06897

**Registered Apr. 10, 2012**

**Int. Cl.: 28**

FOR: DRAWING TOYS; SKETCHING TOYS, IN CLASS 28 (U.S. CLS. 22, 23, 38 AND 50).

**TRADEMARK**

FIRST USE 12-3-2010; IN COMMERCE 12-3-2010.

**PRINCIPAL REGISTER**

THE MARK CONSISTS OF STANDARD CHARACTERS WITHOUT CLAIM TO ANY PARTICULAR FONT, STYLE, SIZE, OR COLOR.

SN 85-074,538, FILED 6-30-2010.

MATTHEW MCDOWELL, EXAMINING ATTORNEY



*David J. Kyffers*

Director of the United States Patent and Trademark Office

# United States of America

United States Patent and Trademark Office

## THE WORLD'S ONLY BOOKMARK AND DRAWING PAD!

**Reg. No. 4,126,151**

DAVID W. KEEFE, JR. (UNITED STATES INDIVIDUAL)  
183 RANGE RD  
WILTON, CT 06897

**Registered Apr. 10, 2012**

**Int. Cl.: 28**

FOR: DRAWING TOYS; SKETCHING TOYS, IN CLASS 28 (U.S. CLS. 22, 23, 38 AND 50).

**TRADEMARK**

FIRST USE 12-3-2010; IN COMMERCE 12-3-2010.

**PRINCIPAL REGISTER**

THE MARK CONSISTS OF STANDARD CHARACTERS WITHOUT CLAIM TO ANY PARTICULAR FONT, STYLE, SIZE, OR COLOR.

NO CLAIM IS MADE TO THE EXCLUSIVE RIGHT TO USE "BOOKMARK AND DRAWING PAD", APART FROM THE MARK AS SHOWN.

SN 85-074,551, FILED 6-30-2010.

MATTHEW MCDOWELL, EXAMINING ATTORNEY



*David J. Kyffers*

Director of the United States Patent and Trademark Office

# United States of America

United States Patent and Trademark Office

# HYDROSPORT

**Reg. No. 4,126,152**

JOHNSON & JOHNSON (NEW JERSEY CORPORATION)  
ONE JOHNSON & JOHNSON PLAZA  
NEW BRUNSWICK, NJ 089337001

**Registered Apr. 10, 2012**

**Int. Cl.: 3**

FOR: SUNCARE PREPARATIONS, NAMELY, SUNSCREEN, IN CLASS 3 (U.S. CLS. 1, 4, 6, 50, 51 AND 52).

**TRADEMARK**

FIRST USE 4-6-2011; IN COMMERCE 4-6-2011.

**PRINCIPAL REGISTER**

THE MARK CONSISTS OF STANDARD CHARACTERS WITHOUT CLAIM TO ANY PARTICULAR FONT, STYLE, SIZE, OR COLOR.

SN 85-074,612, FILED 6-30-2010.

ROSELLE HERRERA, EXAMINING ATTORNEY



*David J. Kyffers*

Director of the United States Patent and Trademark Office

# United States of America

United States Patent and Trademark Office

## THE GREAT PYRAMIDS

**Reg. No. 4,126,153**

KONAMI GAMING, INC. (NEVADA CORPORATION)  
585 TRADE CENTER DRIVE  
LAS VEGAS, NV 89119

**Registered Apr. 10, 2012**

**Int. Cl.: 9**

FOR: ELECTRONIC GAME PROGRAMS; GAMING EQUIPMENT, NAMELY, SLOT MACHINES WITH OR WITHOUT VIDEO OUTPUT; GAMING MACHINES; MACHINES FOR PLAYING GAMES OF CHANCE; SLOT MACHINES, IN CLASS 9 (U.S. CLS. 21, 23, 26, 36 AND 38).

**TRADEMARK**

**PRINCIPAL REGISTER**

FIRST USE 10-4-2011; IN COMMERCE 10-4-2011.

THE MARK CONSISTS OF STANDARD CHARACTERS WITHOUT CLAIM TO ANY PARTICULAR FONT, STYLE, SIZE, OR COLOR.

OWNER OF U.S. REG. NOS. 2,854,992 AND 3,636,331.

SN 85-075,550, FILED 6-30-2010.

MAUREEN DALL, EXAMINING ATTORNEY



*David J. Kyros*

Director of the United States Patent and Trademark Office

# United States of America

United States Patent and Trademark Office

## Exponential Living - The P.O.W.E.R. to stop spending 100% of your time on 10% of who you are

**Reg. No. 4,126,154**

RILEY, SHERI (UNITED STATES INDIVIDUAL)  
2625 PIEDMONT RD, SUITE 56-497  
ATLANTA, GA 30324

**Registered Apr. 10, 2012**

**Int. Cl.: 41**

FOR: CONDUCTING WORKSHOPS AND SEMINARS IN PERSONAL AWARENESS; CONDUCTING WORKSHOPS AND SEMINARS IN SELF AWARENESS; CONDUCTING WORKSHOPS AND SEMINARS IN SELF EVALUATION; EDUCATION SERVICES, NAMELY, PROVIDING SEMINARS, LECTURES, TELESEMINARS, TELECLASSES, AND WORKSHOPS IN THE FIELDS OF SELF EVALUATION; EDUCATIONAL SERVICES, NAMELY, CONDUCTING SEMINARS, LECTURES, TELESEMINARS, TELECLASSES, AND WORKSHOPS IN PERSONAL AWARENESS, IN CLASS 41 (U.S. CLS. 100, 101 AND 107).

**SERVICE MARK**

**PRINCIPAL REGISTER**

FIRST USE 7-29-2011; IN COMMERCE 7-29-2011.

THE MARK CONSISTS OF STANDARD CHARACTERS WITHOUT CLAIM TO ANY PARTICULAR FONT, STYLE, SIZE, OR COLOR.

SN 85-075,641, FILED 7-1-2010.

ANNE FARRELL, EXAMINING ATTORNEY



*David J. Kyros*

Director of the United States Patent and Trademark Office

# United States of America

United States Patent and Trademark Office

## P.O.W.E.R - Perspective, Ownership, Wisdom, Engagement, Reward

**Reg. No. 4,126,155**

RILEY, SHERI (UNITED STATES INDIVIDUAL)  
2625 PIEDMONT RD, SUITE 56-497  
ATLANTA, GA 30324

**Registered Apr. 10, 2012**

**Int. Cl.: 41**

FOR: CONDUCTING WORKSHOPS AND SEMINARS IN PERSONAL AWARENESS; CONDUCTING WORKSHOPS AND SEMINARS IN SELF AWARENESS; CONDUCTING WORKSHOPS AND SEMINARS IN SELF EVALUATION; EDUCATION SERVICES, NAMELY, PROVIDING SEMINARS, LECTURES, TELESEMINARS, TELECLASSES, AND WORKSHOPS IN THE FIELD OF SELF EVALUATION; EDUCATIONAL SERVICES, NAMELY, CONDUCTING SEMINARS, LECTURES, TELESEMINARS, TELECLASSES, AND WORKSHOPS IN PERSONAL AWARENESS, IN CLASS 41 (U.S. CLS. 100, 101 AND 107).

**SERVICE MARK**

**PRINCIPAL REGISTER**

FIRST USE 7-29-2011; IN COMMERCE 7-29-2011.

THE MARK CONSISTS OF STANDARD CHARACTERS WITHOUT CLAIM TO ANY PARTICULAR FONT, STYLE, SIZE, OR COLOR.

SN 85-075,643, FILED 7-1-2010.

ANNE FARRELL, EXAMINING ATTORNEY



*David J. Kyros*

Director of the United States Patent and Trademark Office

# United States of America

United States Patent and Trademark Office



**Reg. No. 4,126,156**

**Registered Apr. 10, 2012**

**Int. Cl.: 16**

**TRADEMARK**

**PRINCIPAL REGISTER**

GOLDEN STATE WARRIORS, LLC (CALIFORNIA LIMITED LIABILITY COMPANY)  
1011 BROADWAY  
OAKLAND, CA 94607

FOR: PUBLICATIONS AND PRINTED MATTER, NAMELY, BASKETBALL TRADING CARDS, TRADING CARDS, STICKERS, DECALS, COMMEMORATIVE BASKETBALL STAMPS, COLLECTIBLE CARDBOARD TRADING DISCS, MEMO BOARDS, CLIPBOARDS, PAPER COASTERS, POST CARDS, PLACE MATS OF PAPER, FACIAL TISSUES, NOTE CARDS, MEMO PADS, NOTE PADS, BALL POINT PENS, CRAYONS, FELT TIP MARKERS, RUBBER BANDS, PENCILS, PEN AND PAPER HOLDERS, DESKTOP DOCUMENT STANDS, SCRAP BOOKS, RUBBER STAMPS, DRAFTING RULERS, PAPER BANNERS AND FLAGS, 3-RING BINDERS, STATIONERY FOLDERS, WIREBOUND NOTEBOOKS, PORTFOLIO NOTEBOOKS, UNMOUNTED AND MOUNTED PHOTOGRAPHS, POSTERS, CALENDARS, BUMPER STICKERS, BOOK COVERS, BOOKMARKS, WRAPPING PAPER, CHILDREN'S ACTIVITY BOOKS, CHILDREN'S COLORING BOOKS; STATISTICAL BOOKS, GUIDE BOOKS, AND REFERENCE BOOKS, ALL IN THE FIELD OF BASKETBALL; MAGAZINES IN THE FIELD OF BASKETBALL, CATALOGS IN THE FIELD OF BASKETBALL, COMMEMORATIVE GAME AND SOUVENIR PROGRAMS RELATED TO BASKETBALL, PAPER PENNANTS, STATIONERY, STATIONERY-TYPE PORTFOLIOS, POST CARDS, INVITATION CARDS, PRINTED CERTIFICATES, GREETING CARDS, CHRISTMAS CARDS, HOLIDAY CARDS, INFORMATIONAL STATISTICAL SHEETS FOR BASKETBALL TOPICS; NEWSLETTERS, BROCHURES, PAMPHLETS, AND GAME SCHEDULES IN THE FIELD OF BASKETBALL; BANK CHECKS, CHECK BOOK COVERS, CHECK BOOK HOLDERS, COMIC BOOKS; NON-MAGNETIC CREDIT CARDS AND TELEPHONE CALLING CARDS NOT MAGNETICALLY ENCODED, IN CLASS 16 (U.S. CLS. 2, 5, 22, 23, 29, 37, 38 AND 50).



FIRST USE 6-17-2010; IN COMMERCE 6-24-2010.

THE MARK CONSISTS OF STYLIZED LETTER "W" OVER A DESIGN OF THE OUTLINE OF CALIFORNIA.

SEC. 2(F) AS TO "REPRESENTATION OF THE STATE OF CALIFORNIA" .

SN 85-075,817, FILED 7-1-2010.

MATTHEW MCDOWELL, EXAMINING ATTORNEY

*David J. Kyros*

Director of the United States Patent and Trademark Office



# United States of America

United States Patent and Trademark Office

# TRILENIUM

**Reg. No. 4,126,157**

EQUITY IP HOLDINGS, LLC (NEVADA LIMITED LIABILITY COMPANY)  
23945 CALABASAS ROAD, SUITE 201  
CALABASAS, CA 91302

**Registered Apr. 10, 2012**

**Int. Cl.: 9**

FOR: EYEGLASS LENSES; EYEGLASSES; SUNGLASS LENSES; SUNGLASSES, IN CLASS 9 (U.S. CLS. 21, 23, 26, 36 AND 38).

**TRADEMARK**

FIRST USE 0-0-2006; IN COMMERCE 0-0-2006.

**PRINCIPAL REGISTER**

THE MARK CONSISTS OF STANDARD CHARACTERS WITHOUT CLAIM TO ANY PARTICULAR FONT, STYLE, SIZE, OR COLOR.

SN 85-076,075, FILED 7-1-2010.

REBECCA GILBERT, EXAMINING ATTORNEY



*David J. Kybas*

Director of the United States Patent and Trademark Office

# United States of America

United States Patent and Trademark Office

# Chill Son

**Reg. No. 4,126,158**

**Registered Apr. 10, 2012**

**Int. Cls.: 25 and 28**

**TRADEMARK**

**PRINCIPAL REGISTER**

PRE-GAME ENTERPRISES LLC (WEST VIRGINIA LIMITED LIABILITY COMPANY)  
1539 FARNSWORTH DRIVE  
CHARLESTON, WV 25311

FOR: T-SHIRTS; HATS, IN CLASS 25 (U.S. CLS. 22 AND 39).

FIRST USE 8-1-2010; IN COMMERCE 8-1-2010.

FOR: ATHLETIC EQUIPMENT, NAMELY, MOUTH GUARDS, IN CLASS 28 (U.S. CLS. 22, 23, 38 AND 50).

FIRST USE 8-1-2010; IN COMMERCE 8-1-2010.

THE MARK CONSISTS OF STANDARD CHARACTERS WITHOUT CLAIM TO ANY PARTICULAR FONT, STYLE, SIZE, OR COLOR.

SN 85-076,232, FILED 7-1-2010.

ANDREW LEASER, EXAMINING ATTORNEY

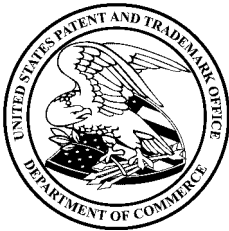

*David J. Kyffers*

Director of the United States Patent and Trademark Office

# United States of America

United States Patent and Trademark Office



**Reg. No. 4,126,159**

**Registered Apr. 10, 2012**

**Int. Cls.: 25 and 28**

**TRADEMARK**

**PRINCIPAL REGISTER**

PRE-GAME ENTERPRISES LLC (WEST VIRGINIA LIMITED LIABILITY COMPANY)  
1539 FARNSWORTH DRIVE  
CHARLESTON, WV 25311

FOR: T-SHIRTS; HATS, IN CLASS 25 (U.S. CLS. 22 AND 39).

FIRST USE 8-1-2010; IN COMMERCE 8-1-2010.

FOR: ATHLETIC EQUIPMENT, NAMELY, MOUTH GUARDS, IN CLASS 28 (U.S. CLS. 22, 23, 38 AND 50).

FIRST USE 8-1-2010; IN COMMERCE 8-1-2010.

THE MARK CONSISTS OF THE WORDS "CHILL SON" IN A STYLIZED FONT INSIDE THE DRAWING OF A FOOTBALL.

SN 85-076,259, FILED 7-1-2010.

ANDREW LEASER, EXAMINING ATTORNEY



*David J. Kybas*

Director of the United States Patent and Trademark Office

# United States of America

United States Patent and Trademark Office

## YOUR BOTTLE FOR LIFE

**Reg. No. 4,126,160**

NALGE NUNC INTERNATIONAL CORPORATION (DELAWARE CORPORATION)  
75 PANORAMA CREEK DRIVE  
ROCHESTER, NY 14625

**Registered Apr. 10, 2012**

**Int. Cl.: 21**

FOR: PLASTIC WATER BOTTLES SOLD EMPTY, IN CLASS 21 (U.S. CLS. 2, 13, 23, 29, 30, 33, 40 AND 50).

**TRADEMARK**

FIRST USE 0-0-2011; IN COMMERCE 0-0-2011.

**PRINCIPAL REGISTER**

THE MARK CONSISTS OF STANDARD CHARACTERS WITHOUT CLAIM TO ANY PARTICULAR FONT, STYLE, SIZE, OR COLOR.

SN 85-076,269, FILED 7-1-2010.

MELISSA VALLILLO, EXAMINING ATTORNEY



*David J. Kybas*

Director of the United States Patent and Trademark Office

# United States of America

United States Patent and Trademark Office

# UWF

**Reg. No. 4,126,161**

**Registered Apr. 10, 2012**

**Int. Cl.: 41**

**SERVICE MARK**

**PRINCIPAL REGISTER**

URBAN WRESTLING INC. (NEW YORK CORPORATION)  
201 EAST 87TH STREET  
SUITE 24R  
NEW YORK, NY 10128

FOR: ENTERTAINMENT SERVICES, NAMELY, PRODUCTION AND DISTRIBUTION OF TELEVISION, SATELLITE TELEVISION AND PAY-PER-VIEW PROGRAMS FEATURING WRESTLING EXHIBITIONS; AND PRODUCTION OF LIVE WRESTLING EXHIBITIONS, IN CLASS 41 (U.S. CLS. 100, 101 AND 107).

FIRST USE 6-26-2011; IN COMMERCE 6-26-2011.

THE MARK CONSISTS OF STANDARD CHARACTERS WITHOUT CLAIM TO ANY PARTICULAR FONT, STYLE, SIZE, OR COLOR.

SN 85-076,694, FILED 7-2-2010.

APRIL ROACH, EXAMINING ATTORNEY



*David J. Kyffers*

Director of the United States Patent and Trademark Office

# United States of America

United States Patent and Trademark Office

## URBAN WRESTLING FEDERATION

**Reg. No. 4,126,162**

**Registered Apr. 10, 2012**

**Int. Cl.: 41**

**SERVICE MARK**

**PRINCIPAL REGISTER**

URBAN WRESTLING INC. (NEW YORK CORPORATION)  
201 EAST 87TH STREET  
SUITE 24R  
NEW YORK, NY 10128

FOR: ENTERTAINMENT SERVICES, NAMELY, PRODUCTION AND DISTRIBUTION OF TELEVISION, SATELLITE TELEVISION AND PAY-PER-VIEW PROGRAMS FEATURING WRESTLING EXHIBITIONS; AND PRODUCTION OF LIVE WRESTLING EXHIBITIONS, IN CLASS 41 (U.S. CLS. 100, 101 AND 107).

FIRST USE 6-26-2011; IN COMMERCE 6-26-2011.

THE MARK CONSISTS OF STANDARD CHARACTERS WITHOUT CLAIM TO ANY PARTICULAR FONT, STYLE, SIZE, OR COLOR.

NO CLAIM IS MADE TO THE EXCLUSIVE RIGHT TO USE "WRESTLING FEDERATION", APART FROM THE MARK AS SHOWN.

SN 85-076,698, FILED 7-2-2010.

APRIL ROACH, EXAMINING ATTORNEY



*David J. Kyffers*

Director of the United States Patent and Trademark Office

# United States of America

United States Patent and Trademark Office

## DONE FOR YOU

**Reg. No. 4,126,163**

DONNA KOZIK & ASSOCIATES, INC. (CALIFORNIA CORPORATION)  
3780 ARNOLD AVE.

**Registered Apr. 10, 2012**

SAN DIEGO, CA 92104

**Int. Cl.: 16**

FOR: BOOKS FEATURING BUSINESS AND PERSONAL SUCCESS STORIES, TIPS AND STRATEGIES FROM BUSINESS OWNERS AND PERSONAL STORIES AND HOW-TO STRATEGIES FOR BUSINESS AND COPING WITH INTERPERSONAL RELATIONS, IN CLASS 16 (U.S. CLS. 2, 5, 22, 23, 29, 37, 38 AND 50).

**TRADEMARK**

**PRINCIPAL REGISTER**

FIRST USE 9-1-2011; IN COMMERCE 9-1-2011.

THE MARK CONSISTS OF STANDARD CHARACTERS WITHOUT CLAIM TO ANY PARTICULAR FONT, STYLE, SIZE, OR COLOR.

SN 85-077,948, FILED 7-5-2010.

KATHERINE STOIDES, EXAMINING ATTORNEY



*David J. Kybas*

Director of the United States Patent and Trademark Office

# United States of America

United States Patent and Trademark Office

onbiz

**Reg. No. 4,126,164**

**Registered Apr. 10, 2012**

**Int. Cl.: 39**

**SERVICE MARK**

**PRINCIPAL REGISTER**

SOUTH AFRICAN AIRWAYS (PROPRIETARY) LIMITED (SOUTH AFRICA COMPANY)  
ROOM 504 E BLOCK, AIRWAYS PARK  
JONES ROAD, OR TAMBO INTL. AIRPORT  
GAUTENG, SOUTH AFRICA

FOR: AIR TRANSPORT; MERCHANDISE PACKAGING FOR OTHERS; STORAGE OF GOODS;  
ORGANIZATION OF TRAVEL , IN CLASS 39 (U.S. CLS. 100 AND 105).

FIRST USE 7-1-2007; IN COMMERCE 7-1-2007.

SN 85-078,181, FILED 7-6-2010.

KIM MONINGHOFF, EXAMINING ATTORNEY



*David J. Kyffers*

Director of the United States Patent and Trademark Office



# United States of America

United States Patent and Trademark Office

## LIFE IS MOTION

**Reg. No. 4,126,165**

**Registered Apr. 10, 2012**

**Int. Cl.: 25**

**TRADEMARK**

**PRINCIPAL REGISTER**

TUREK, CHARLES (UNITED STATES INDIVIDUAL)  
6 PONDEROSA LN  
ROLLING HILLS ESTATES, CA 90274 AND

TUREK, CAROLYN (UNITED STATES INDIVIDUAL)  
6 PONDEROSA LN  
ROLLING HILLS ESTATES, CA 90274 AND

TUREK, LISA (UNITED STATES INDIVIDUAL)  
6 PONDEROSA LN  
ROLLING HILLS ESTATES, CA 90274 AND

TUREK, JEFF (UNITED STATES INDIVIDUAL)  
6 PONDEROSA LN  
ROLLING HILLS ESTATES, CA 90274

FOR: HATS; JACKETS; PANTS; SHIRTS; SWEAT SHIRTS, IN CLASS 25 (U.S. CLS. 22 AND 39).

FIRST USE 8-1-2011; IN COMMERCE 8-1-2011.

THE MARK CONSISTS OF STANDARD CHARACTERS WITHOUT CLAIM TO ANY PARTICULAR FONT, STYLE, SIZE, OR COLOR.

SN 85-078,795, FILED 7-6-2010.

FONG HSU, EXAMINING ATTORNEY



*David J. Kybas*

Director of the United States Patent and Trademark Office

# United States of America

United States Patent and Trademark Office

# SPORTSTER

**Reg. No. 4,126,166**

**Registered Apr. 10, 2012**

**Int. Cl.: 13**

**TRADEMARK**

**PRINCIPAL REGISTER**

ALLIANT TECHSYSTEMS INC. (DELAWARE CORPORATION)  
7480 FLYING CLOUD DRIVE  
MINNEAPOLIS, MN 55344

FOR: AMMUNITION POUCHES, IN CLASS 13 (U.S. CLS. 2 AND 9).

FIRST USE 1-1-2011; IN COMMERCE 1-1-2011.

THE MARK CONSISTS OF STANDARD CHARACTERS WITHOUT CLAIM TO ANY PARTICULAR FONT, STYLE, SIZE, OR COLOR.

SN 85-079,171, FILED 7-7-2010.

LOURDES AYALA, EXAMINING ATTORNEY



*David J. Kybas*

Director of the United States Patent and Trademark Office

# United States of America

United States Patent and Trademark Office

## CHOCOLATE SHREDDER

**Reg. No. 4,126,167**

**Registered Apr. 10, 2012**

**Int. Cl.: 32**

**TRADEMARK**

**PRINCIPAL REGISTER**

SMOOTHIE KING FRANCHISES, INC. (LOUISIANA CORPORATION)  
121 PARK PLACE  
COVINGTON, LA 70433

FOR: SMOOTHIES, IN CLASS 32 (U.S. CLS. 45, 46 AND 48).

FIRST USE 7-1-2011; IN COMMERCE 7-1-2011.

THE MARK CONSISTS OF STANDARD CHARACTERS WITHOUT CLAIM TO ANY PARTICULAR FONT, STYLE, SIZE, OR COLOR.

OWNER OF U.S. REG. NO. 3,325,939.

NO CLAIM IS MADE TO THE EXCLUSIVE RIGHT TO USE "CHOCOLATE", APART FROM THE MARK AS SHOWN.

SN 85-079,468, FILED 7-7-2010.

ADA HAN, EXAMINING ATTORNEY



*David J. Kyffers*

Director of the United States Patent and Trademark Office

# United States of America

United States Patent and Trademark Office

## VANILLA SHREDDER

**Reg. No. 4,126,168**

**Registered Apr. 10, 2012**

**Int. Cl.: 32**

**TRADEMARK**

**PRINCIPAL REGISTER**

SMOOTHIE KING FRANCHISES, INC. (LOUISIANA CORPORATION)  
121 PARK PLACE  
COVINGTON, LA 70433

FOR: SMOOTHIE, IN CLASS 32 (U.S. CLS. 45, 46 AND 48).

FIRST USE 7-1-2011; IN COMMERCE 7-1-2011.

THE MARK CONSISTS OF STANDARD CHARACTERS WITHOUT CLAIM TO ANY PARTICULAR FONT, STYLE, SIZE, OR COLOR.

OWNER OF U.S. REG. NO. 3,325,939.

NO CLAIM IS MADE TO THE EXCLUSIVE RIGHT TO USE "VANILLA", APART FROM THE MARK AS SHOWN.

SN 85-079,484, FILED 7-7-2010.

ADA HAN, EXAMINING ATTORNEY



*David J. Kyffers*

Director of the United States Patent and Trademark Office

# United States of America

United States Patent and Trademark Office

## INFLUENCE RESOURCES

**Reg. No. 4,126,169**

THE GENERAL COUNCIL OF THE ASSEMBLIES OF GOD (MISSOURI CORPORATION)  
1445 NORTH BOONVILLE AVENUE  
SPRINGFIELD, MO 65802

**Registered Apr. 10, 2012**

**Int. Cl.: 16**

FOR: PRINTED MATERIALS, NAMELY, BOOKS, MAGAZINES, JOURNALS, EDUCATIONAL MATERIALS AND PRINTED EDUCATIONAL RESOURCES, ALL IN THE FIELD OF RELIGION AND SPECIFICALLY EXCLUDING THE LEGAL AND BUSINESS FIELDS, IN CLASS 16 (U.S. CLS. 2, 5, 22, 23, 29, 37, 38 AND 50).

**TRADEMARK**

**PRINCIPAL REGISTER**

FIRST USE 7-7-2011; IN COMMERCE 7-7-2011.

THE MARK CONSISTS OF STANDARD CHARACTERS WITHOUT CLAIM TO ANY PARTICULAR FONT, STYLE, SIZE, OR COLOR.

NO CLAIM IS MADE TO THE EXCLUSIVE RIGHT TO USE "RESOURCES", APART FROM THE MARK AS SHOWN.

SN 85-080,013, FILED 7-8-2010.

LINDA POWELL, EXAMINING ATTORNEY



*David J. Kyffers*

Director of the United States Patent and Trademark Office

# United States of America

United States Patent and Trademark Office

## INTEGRATED PRODUCTS

**Reg. No. 4,126,170**

**Registered Apr. 10, 2012**

**Int. Cl.: 35**

**SERVICE MARK**

**PRINCIPAL REGISTER**

INTEGRATED PRODUCTS, INC. (DELAWARE CORPORATION)  
PO BOX 907  
21320 HAMBURG AVENUE WEST  
LAKEVILLE, MN 55044

FOR: OUTSOURCING OF MANUFACTURING SERVICES FOR OTHERS, IN CLASS 35 (U.S. CLS. 100, 101 AND 102).

FIRST USE 3-22-2011; IN COMMERCE 3-22-2011.

THE MARK CONSISTS OF STANDARD CHARACTERS WITHOUT CLAIM TO ANY PARTICULAR FONT, STYLE, SIZE, OR COLOR.

NO CLAIM IS MADE TO THE EXCLUSIVE RIGHT TO USE "PRODUCTS", APART FROM THE MARK AS SHOWN.

SN 85-080,240, FILED 7-8-2010.

REBECCA EISINGER, EXAMINING ATTORNEY



*David J. Kyffers*

Director of the United States Patent and Trademark Office

# United States of America

United States Patent and Trademark Office



**Reg. No. 4,126,171**

**Registered Apr. 10, 2012**

**Int. Cl.: 25**

**TRADEMARK**

**PRINCIPAL REGISTER**

FOOD CIRCUS SUPERMARKETS, INC. (NEW JERSEY CORPORATION)  
1500 LAWRENCE AVENUE  
OCEAN, NJ 07712

FOR: APPAREL, NAMELY, CAPS; HATS; HEADBANDS; HEADWEAR; FOOTWEAR; JACKETS; JOGGING SUITS; PAJAMAS; POLO SHIRTS; PULLOVERS; SHORT-SLEEVED OR LONG-SLEEVED T-SHIRTS; SHORTS; SWEAT PANTS; SWEAT SHIRTS; SWIMSUITS; T-SHIRTS; TANK TOPS; TIES; TRUNKS; UNDERWEAR; WRISTBANDS; INFANT CLOTHING; SLEEPERS; JUMPSUITS; BIBS; ROMPERS AND OTHER ONE-PIECE GARMENTS; DRESSES; JUMPERS; SWEATERS; DIAPER COVERS; OVERALLS; SOCKS; BOOTIES; TIGHTS; GLOVES, IN CLASS 25 (U.S. CLS. 22 AND 39).

FIRST USE 4-19-2011; IN COMMERCE 4-19-2011.

THE MARK CONSISTS OF CLOWN FIGURE DESIGN CONSISTING OF SINGLE CLOWN, WHITE FACE WITH BLACK EYES AND EYEBROWS, ROUND RED NOSE, SINGLE RED DIAMOND ABOVE EACH EYE, A RED DOT ON EACH CHEEK, RED MOUTH AND RED OUTLINE AROUND MOUTH, FLESH-COLORED EARS, GOLD TUFT OF HAIR ABOVE EACH EAR, WEARING A POINTED HAT, BLUE WITH YELLOW TRIM AROUND BASE AND YELLOW POM-POM ON TOP, RED BOW TIE WITH RED HEART IN THE MIDDLE OUTLINED IN WHITE, CLOWN SUIT WITH YELLOW AND BLUE DIAMOND PATTERN, ROW OF FOUR WHITE POM-POMS GOING VERTICALLY DOWN CENTER OF SUIT, CUFFS OF SUIT OUTLINED IN BLACK WITH BLACK S-SHAPED DESIGN ON EACH CUFF, WHITE GLOVES, BLACK SHOES WITH A RED POM-POM ON TOP OF EACH SHOE, IN A STANDING POSITION WITH RIGHT HAND RAISED AND POINTING INDEX FINGER UPWARDS, INDEX FINGER TIPPED IN RED, LEFT HAND HOLDING WHITE BALLOON WITH WORD "SAVE" ON IT IN RED BLOCK LETTERS, ENTIRE FIGURE OUTLINED IN BLACK, ARMS OF CLOWN OUTLINED IN WHITE.

THE COLOR(S) WHITE, RED, BLUE, YELLOW, GOLD, FLESH AND BLACK IS/ARE CLAIMED AS A FEATURE OF THE MARK.

SN 85-080,254, FILED 7-8-2010.

REBECCA EISINGER, EXAMINING ATTORNEY



*David J. Kyros*

Director of the United States Patent and Trademark Office

United States of America  
United States Patent and Trademark Office

A<sup>2</sup>D<sup>3</sup>

**Reg. No. 4,126,172**

EVERBRITE LLC (WISCONSIN LIMITED LIABILITY COMPANY)  
4949 SOUTH 100TH STREET  
GREENFIELD, WI 532200020 AND

**Registered Apr. 10, 2012**

**Int. Cl.: 9**

D3 LED, LLC (DELAWARE LIMITED LIABILITY COMPANY)  
11492 SUNRISE GOLD CIRCLE  
RANCHO CORDOVA, CA 95742

**TRADEMARK**

**PRINCIPAL REGISTER**

FOR: ELECTRONIC DISPLAYS, NAMELY, ELECTRONIC SCOREBOARDS AND ELECTRIC LUMINESCENT DISPLAY PANELS, IN CLASS 9 (U.S. CLS. 21, 23, 26, 36 AND 38).

FIRST USE 6-3-2010; IN COMMERCE 9-1-2010.

THE MARK CONSISTS OF THE LETTERS "AD" WHERE A SUPERSRIPT NUMBER "2" IS OVERLAPPING THE LETTER "A" AND A SUPERSRIPT NUMBER "3" IS OVERLAPPING THE LETTER "D".

SN 85-080,419, FILED 7-8-2010.

HENRY S. ZAK, EXAMINING ATTORNEY



*David J. Kyros*

Director of the United States Patent and Trademark Office



# United States of America

United States Patent and Trademark Office

# MEDPODIUM

**Reg. No. 4,126,173**

CARDIUM THERAPEUTICS, INC. (DELAWARE CORPORATION)  
12255 EL CAMINO REAL, SUITE 250  
SAN DIEGO, CA 92130

**Registered Apr. 10, 2012**

**Int. Cl.: 5**

FOR: GOODS FOR PERSONAL CARE, NAMELY, NUTRACEUTICALS FOR USE AS DIETARY SUPPLEMENTS, VITAMINS, DIETARY SUPPLEMENTS, HERBAL PREPARATIONS USED AS DIETARY SUPPLEMENTS, COMBINATION NUTRACEUTICALS, VITAMINS AND HERBAL PREPARATIONS USED AS DIETARY SUPPLEMENTS, IN CLASS 5 (U.S. CLS. 6, 18, 44, 46, 51 AND 52).

**TRADEMARK**

**PRINCIPAL REGISTER**

FIRST USE 12-31-2010; IN COMMERCE 12-31-2010.

THE MARK CONSISTS OF STANDARD CHARACTERS WITHOUT CLAIM TO ANY PARTICULAR FONT, STYLE, SIZE, OR COLOR.

SN 85-080,428, FILED 7-8-2010.

COURTNEY ALVAREZ, EXAMINING ATTORNEY



*David J. Kyffers*

Director of the United States Patent and Trademark Office

# United States of America

United States Patent and Trademark Office

## SAMSUNG CHRONO

**Reg. No. 4,126,174**

**Registered Apr. 10, 2012**

**Int. Cl.: 9**

**TRADEMARK**

**PRINCIPAL REGISTER**

SAMSUNG ELECTRONICS CO., LTD. (REPUBLIC OF KOREA CORPORATION)  
416, MAETAN-DONG, YEONGTONG-GU  
SUWON-SI, GYEONGGI-DO, REPUBLIC OF KOREA

FOR: MOBILE PHONES; SMARTPHONES, IN CLASS 9 (U.S. CLS. 21, 23, 26, 36 AND 38).

FIRST USE 6-10-2011; IN COMMERCE 6-10-2011.

THE MARK CONSISTS OF STANDARD CHARACTERS WITHOUT CLAIM TO ANY PARTICULAR FONT, STYLE, SIZE, OR COLOR.

OWNER OF U.S. REG. NOS. 2,882,774, 3,713,355, AND OTHERS.

THE ENGLISH TRANSLATION OF "SAMSUNG" IN THE MARK IS "THREE STARS".

SN 85-080,743, FILED 7-8-2010.

WILLIAM ROSSMAN, EXAMINING ATTORNEY



*David J. Kyros*

Director of the United States Patent and Trademark Office

# United States of America

United States Patent and Trademark Office

# STANCHART

**Reg. No. 4,126,175**

**Registered Apr. 10, 2012**

**Int. Cls.: 9 and 16**

**TRADEMARK**

**PRINCIPAL REGISTER**

STANDARD CHARTERED PLC (UNITED KINGDOM PUBLIC LIMITED COMPANY (PLC))  
1 ALDERMANBURY SQUARE  
LONDON, EC2V 7SB, UNITED KINGDOM

FOR: AUTOMATIC TELLER MACHINES, MAGNETIC AND/OR ELECTRONIC CARD READERS AND ASSOCIATED COMPUTER HARDWARE FOR PROCESSING AND FACILITATING ACCESS TO CARD TRANSACTIONS AND DATA RELATING THERETO AND FOR PAYMENT AND TRANSACTION PROCESSING; COMPUTERS FOR VERIFYING DATA ON MAGNETICALLY ENCODED CARDS OR CARDS BEARING ELECTRONIC INFORMATION; CARTRIDGES, DISCS, TAPES, CARDS AND OTHER RECORDING MATERIALS IN THE NATURE OF EITHER BLANK OR PRE-RECORDED, AND IF PRE-RECORDED, CONTAINING SOFTWARE FOR COLLECTING, PROCESSING AND/OR STORING TRANSACTIONS AND/OR DATA RELATED THERETO AND/OR SOFTWARE FACILITATING AND MANAGING SAME; VIDEO RECORDINGS CONTAINING MATERIAL IN THE FIELD OF BANKING, PROVISION OF CREDIT AND FINANCE; CASH REGISTERS, CALCULATING MACHINES, CARD READING MACHINES, COMPUTERS, PRINTERS, COMPUTER NETWORKS CONSISTING OF HUBS, SWITCHES, ROUTERS, AND ADAPTERS AND/OR COMPUTER SOFTWARE, ALL FOR INPUT, OUTPUT, STORAGE, ARRANGING, TAGGING, CATALOGUING, PROCESSING, RETRIEVING, REPORTING ON, PROVIDING SECURITY AND RESTRICTED ACCESS TO DATA, INFORMATION, COMPUTER PROGRAMS AND COMPUTER SYSTEMS RELATING TO BANKING, PROVISION OF CREDIT AND FINANCIAL TRANSACTIONS, SERVICES AND PRODUCTS; MAGNETIC CARDS, MAGNETICALLY ENCODED AND PROGRAMMABLE SMART CARDS BEING EITHER BLANK OR CONTAINING DATA RELATING TO CARD HOLDERS, SECURITY CODES AND INFORMATION TO FACILITATE ACCESS TO BANKING, PROVISION OF CREDIT AND FINANCIAL SERVICES; BLANK MAGNETIC DATA CARRIERS FOR RECORDATION OF COMPUTER PROGRAMS, MOUSE PADS, COMPUTER CHIPS USED FOR THE ACQUISITION, RECORDING, PROCESSING, TRANSMISSION, STORAGE OR OUTPUT OF DATA, COMPUTER MOUSE, TELECOMMUNICATION WIRES AND MODEMS, COMPUTERS AND COMPUTER NETWORKS CONSISTING OF HUBS, SWITCHES, ROUTERS, AND ADAPTERS, WIRELESS COMMUNICATION SYSTEMS CONSISTING OF AMPLIFIERS AND ANTENNAS FOR WIRELESS COMMUNICATION, APPARATUS FOR WIRELESS TRANSMISSION OF ACOUSTIC INFORMATION, COMPUTER SOFTWARE FOR WIRELESS CONTENT DELIVERY, DEVICES FOR WIRELESS RADIO TRANSMISSION, WIRELESS COMPUTER PERIPHERALS, WIRELESS TELEPHONES, WIRELESS TELEPHONY APPARATUS AND INTERFACES, TELEPHONES AND INSTALLATIONS FOR TELEPHONES, NAMELY, TELEPHONE TERMINALS; PAGERS; TELEPHONE ANSWERING MACHINES; MAGNETICALLY RECOR-



*David J. Kyjars*

Director of the United States Patent and Trademark Office

**Reg. No. 4,126,175** DED AND MACHINE-READABLE CREDIT CARD, CHARGE CARD, CASH CARD, CHECK GUARANTEED CARDS, IN CLASS 9 (U.S. CLS. 21, 23, 26, 36 AND 38).

FIRST USE 11-8-1978; IN COMMERCE 7-26-2007.

FOR: BOOKS, BOOKLETS, CATALOGUES, MAGAZINES, PERIODICAL PUBLICATIONS, NAMELY, NEWSLETTERS, BROCHURES, PAMPHLETS, POSTERS, CHECKBOOKS, NOTEPADS, NOTEPAPER, PAPER, BLANK BANK DEPOSIT AND WITHDRAWAL SLIPS, PAPER FOR USE IN PRINT ADS FOR MAGAZINES AND NEWSPAPERS, BLANK INVOICE FORMS, BLANK BANK STATEMENT FORMS, PAPER NAME TAGS, TENT CARDS, STICKERS, ENVELOPES, PAPER FOLDERS, PAPER FILE JACKETS, BILLBOARDS, NAMELY, ADVERTISING SIGNS OF PAPER OR CARDBOARD, TABLE CALENDARS, CALENDAR CARDS, DIARIES, PAPER NAME CARDS, PRINTED ANNUAL REPORTS, GREETING CARDS AND MANUALS MADE FROM PAPER, ALL RELATING TO BANKING, CORPORATE AND PERSONAL FINANCE, CREDIT PRODUCTS AND PROVISION, REAL ESTATE, PERSONAL FINANCIAL AND TAX PLANNING, INVESTMENTS, CORPORATE FINANCE, CURRENCY AND ALL TYPES OF INSURANCE; TRAVELLERS' CHECKS, POSTAL MONEY ORDERS, MONEY DRAFTS AND BANK CHECKS; CARDBOARD AND PLASTIC BUSINESS OR ADVERTISING CARDS; BOOK BINDINGS, BOOKBINDING CLOTH AND TAPE; STATIONERY; PENS AND PENCILS; DOCUMENT FILES AND FOLDERS; CHECKBOOK AND PASSBOOK WALLETS; TYPEWRITERS, OFFICE STATIONERY, DESK PADS, PAPER, NAMELY, COPIER PAPER, PRINTER PAPER, LETTER PAPER, WRITING PAPER, NOTEPADS, NOTEPAPER, NOTE PAPER WITH ADHESIVE STRIP, PRINTED CALENDARS, DRAWING RULERS; PRINTED INSTRUCTIONAL AND TEACHING MATERIAL IN THE FIELD OF BANKING, CORPORATE AND PERSONAL FINANCE, CREDIT PRODUCTS AND PROVISION, REAL ESTATE, PERSONAL FINANCIAL AND TAX PLANNING, INVESTMENTS, CORPORATE FINANCE, CURRENCY AND ALL TYPES OF INSURANCE; GENERAL PURPOSE PLASTIC BAGS, ENVELOPES AND PLASTIC BUBBLE PACKS FOR MERCHANDISE PACKAGING, IN CLASS 16 (U.S. CLS. 2, 5, 22, 23, 29, 37, 38 AND 50).

FIRST USE 11-8-1978; IN COMMERCE 7-26-2007.

THE MARK CONSISTS OF STANDARD CHARACTERS WITHOUT CLAIM TO ANY PARTICULAR FONT, STYLE, SIZE, OR COLOR.

OWNER OF U.S. REG. NOS. 2,667,489, 3,621,088, AND 3,791,934.

SN 85-081,093, FILED 7-9-2010.

BARBARA RUTLAND, EXAMINING ATTORNEY

# United States of America

United States Patent and Trademark Office

# TUF-CAN

**Reg. No. 4,126,176**

FINZER ROLLER LLC (ILLINOIS LIMITED LIABILITY COMPANY)  
129 RAWLS ROAD

**Registered Apr. 10, 2012**

DES PLAINES, IL 600181328

**Int. Cl.: 7**

FOR: INDUSTRIAL ROLLERS AND PARTS THEREFOR FOR COATING AND PRINTING MACHINES, IN CLASS 7 (U.S. CLS. 13, 19, 21, 23, 31, 34 AND 35).

**TRADEMARK**

FIRST USE 6-1-2010; IN COMMERCE 6-1-2010.

**PRINCIPAL REGISTER**

THE MARK CONSISTS OF STANDARD CHARACTERS WITHOUT CLAIM TO ANY PARTICULAR FONT, STYLE, SIZE, OR COLOR.

SN 85-081,140, FILED 7-9-2010.

AISHA CLARKE, EXAMINING ATTORNEY



*David J. Kybas*

Director of the United States Patent and Trademark Office

# United States of America

United States Patent and Trademark Office

# SUPER-CAN

**Reg. No. 4,126,177**

FINZER ROLLER LLC (ILLINOIS LIMITED LIABILITY COMPANY)  
129 RAWLS ROAD

**Registered Apr. 10, 2012**

DESPAINES, IL 600181328

**Int. Cl.: 7**

FOR: INDUSTRIAL ROLLERS AND PARTS THEREFOR FOR COATING AND PRINTING MACHINES, IN CLASS 7 (U.S. CLS. 13, 19, 21, 23, 31, 34 AND 35).

**TRADEMARK**

FIRST USE 6-1-2010; IN COMMERCE 6-1-2010.

**PRINCIPAL REGISTER**

THE MARK CONSISTS OF STANDARD CHARACTERS WITHOUT CLAIM TO ANY PARTICULAR FONT, STYLE, SIZE, OR COLOR.

SN 85-081,168, FILED 7-9-2010.

AISHA CLARKE, EXAMINING ATTORNEY



*David J. Kybas*

Director of the United States Patent and Trademark Office

# United States of America

United States Patent and Trademark Office

# ULTRA-CAN

**Reg. No. 4,126,178**

FINZER ROLLER LLC (ILLINOIS LIMITED LIABILITY COMPANY)  
129 RAWLS ROAD

**Registered Apr. 10, 2012**

DESPAINES, IL 600181328

**Int. Cl.: 7**

FOR: INDUSTRIAL ROLLERS AND PARTS THEREFOR FOR COATING AND PRINTING MACHINES, IN CLASS 7 (U.S. CLS. 13, 19, 21, 23, 31, 34 AND 35).

**TRADEMARK**

FIRST USE 6-1-2010; IN COMMERCE 6-1-2010.

**PRINCIPAL REGISTER**

THE MARK CONSISTS OF STANDARD CHARACTERS WITHOUT CLAIM TO ANY PARTICULAR FONT, STYLE, SIZE, OR COLOR.

SN 85-081,198, FILED 7-9-2010.

AISHA CLARKE, EXAMINING ATTORNEY



*David J. Kyjars*

Director of the United States Patent and Trademark Office

# United States of America

United States Patent and Trademark Office



**Reg. No. 4,126,179**

**Registered Apr. 10, 2012**

**Int. Cl.: 9**

**TRADEMARK**

**PRINCIPAL REGISTER**

PCT INTERNATIONAL, INC. (NEVADA CORPORATION)  
2260 WEST BROADWAY ROAD  
MESA, AZ 852021898

FOR: CABLE, SATELLITE, FIBER OPTIC AND TELECOMMUNICATIONS PRODUCTS AND COMPONENTS, NAMELY, TELECOMMUNICATIONS CABLE, COAXIAL CONNECTORS, TELECOMMUNICATIONS CONNECTIVITY MODULES IN THE NATURE OF ELECTRIC PLUG CONNECTORS, INTERCONNECT CABLES FOR CONNECTING TWO OR MORE TELECOMMUNICATIONS OR AUDIO/VISUAL DEVICES, SIGNAL SPLITTERS FOR ELECTRONIC TELECOMMUNICATIONS APPARATUS, ELECTRICAL TERMINAL BLOCKS FOR TELECOMMUNICATIONS CONNECTIONS, POWER ADAPTERS FOR TELECOMMUNICATIONS CONNECTIONS AND ENCLOSURES SPECIFICALLY DESIGNED FOR TELECOMMUNICATIONS ELECTRICAL CONNECTION CABLES; COAXIAL CABLE CONNECTORS; PLUG ADAPTORS; ELECTRICAL POWER DEVICES IN THE NATURE OF TAPS; FIBER OPTIC CABLES; TRANSCEIVERS; ELECTRICAL POWER SUPPLIES AND ELECTRICAL POWER DISTRIBUTION UNITS, IN CLASS 9 (U.S. CLS. 21, 23, 26, 36 AND 38).

FIRST USE 12-1-2005; IN COMMERCE 12-1-2005.

OWNER OF U.S. REG. NOS. 2,605,652, 2,640,581, AND 2,868,286.

THE MARK CONSISTS OF THE LETTERING "PCT" ON A BACKGROUND OF A LINED RECTANGLE WHICH HAS BROKEN LINES WHERE THE LETTERS APPEAR AND THREE INCOMPLETE OVAL RINGS SEPARATING EACH LETTER.

SN 85-081,458, FILED 7-9-2010.

COLLEEN KEARNEY, EXAMINING ATTORNEY



*David J. Kyjars*

Director of the United States Patent and Trademark Office



# United States of America

United States Patent and Trademark Office

# eBx

**Reg. No. 4,126,180**

**Registered Apr. 10, 2012**

**Int. Cl.: 10**

**TRADEMARK**

**PRINCIPAL REGISTER**

XOFT, INC. (DELAWARE CORPORATION)  
345 POTRERO AVENUE  
SUNNYVALE, CA 94085

FOR: RADIATION THERAPY APPARATUS, NAMELY, A MINIATURE ELECTRONIC X-RAY TUBE, A BALLOON APPLICATOR AND CATHETER FOR RECEIVING THE MINIATURE X-RAY TUBE TO ADMINISTER RADIATION TO A PATIENT, AN ELECTRONIC CONTROLLER FOR THE X-RAY TUBE AND FOR THE BALLOON APPLICATOR, AND A FLEXIBLE X-RAY SHIELD FOR USE ON A PATIENT TO CONTAIN RADIATION, ALL SOLD AS A UNIT, IN CLASS 10 (U.S. CLS. 26, 39 AND 44).

FIRST USE 8-31-2010; IN COMMERCE 8-31-2010.

THE MARK CONSISTS OF THE STYLIZED LETTERS "EBX" WITH THE "E" AND "X" IN LOWER CASE LETTERS AND THE "B" IN UPPER CASE.

SN 85-081,466, FILED 7-9-2010.

DANIEL CAPSHAW, EXAMINING ATTORNEY



*David J. Kyffers*

Director of the United States Patent and Trademark Office

# United States of America

United States Patent and Trademark Office

## Destinee & Paris

**Reg. No. 4,126,181**

MONROE, DESTINEE (UNITED STATES INDIVIDUAL)  
10061 RIVERSIDE DR  
TALUCA LAKES, CA 91602 AND

**Registered Apr. 10, 2012**

**Int. Cl.: 41**

MONROE, PARIS (UNITED STATES INDIVIDUAL)  
10061 RIVERSIDE DR.  
TALUCA LAKES, CA 91602

**SERVICE MARK**

**PRINCIPAL REGISTER**

FOR: ENTERTAINMENT IN THE NATURE OF LIVE PERFORMANCES BY MUSICAL GROUP, IN CLASS 41 (U.S. CLS. 100, 101 AND 107).

FIRST USE 8-17-2011; IN COMMERCE 8-17-2011.

THE MARK CONSISTS OF STANDARD CHARACTERS WITHOUT CLAIM TO ANY PARTICULAR FONT, STYLE, SIZE, OR COLOR.

SN 85-082,248, FILED 7-12-2010.

WILLIAM VERHOSEK, EXAMINING ATTORNEY



*David J. Kyros*

Director of the United States Patent and Trademark Office

# United States of America

United States Patent and Trademark Office

## THE SMALL BUSINESS AUTHORITY INDEX

**Reg. No. 4,126,182**

NEWTEK BUSINESS SERVICES, INC. (NEW YORK CORPORATION)

**Registered Apr. 10, 2012**

1440 BROADWAY  
NEW YORK, NY 10018

**Int. Cls.: 35 and 42**

**SERVICE MARK**

**PRINCIPAL REGISTER**

FOR: ACCOUNTING SERVICES; ONLINE ACCOUNTING SERVICES; COMPUTERIZED ACCOUNTING SERVICES; ACCOUNTING SERVICES FOR ELECTRONIC FUNDS SERVICES; ADMINISTRATION OF BUSINESS PAYROLL FOR OTHERS; PAYROLL PREPARATION; FINANCIAL STATEMENT PREPARATION AND ANALYSIS FOR BUSINESS; INTEGRATED TRACKING AND MANAGEMENT OF COMMERCIAL TRANSACTIONS ON A GLOBAL COMPUTER NETWORK; NOTIFICATION SERVICES TO BUSINESSES IN THE NATURE OF PROVIDING INFORMATION REGARDING BUSINESS FILING REQUIREMENTS AND FILING DATES VIA THE INTERNET AND EMAIL; INCOME TAX CONSULTATION AND PREPARATION SERVICES; BUSINESS ACQUISITION AND MERGER CONSULTATION; BUSINESS APPRAISALS; BUSINESS AUDITING; BUSINESS CONSULTATION; BUSINESS DEVELOPMENT SERVICES, NAMELY, PROVIDING START-UP SUPPORT FOR BUSINESSES OF OTHERS; BUSINESS INVOICING SERVICES; CONDUCTING BUSINESS AND MARKET RESEARCH SURVEYS; BUSINESS MANAGEMENT PLANNING; BUSINESS MANAGEMENT INFORMATION ON A WIDE VARIETY OF TOPICS TO BUSINESS PROFESSIONALS; BUSINESS MARKETING; BUSINESS MARKETING CONSULTING SERVICES; BUSINESS ORGANIZATIONAL CONSULTATION; BUSINESS PLANNING; BUSINESS RESEARCH AND SURVEYS; BUSINESS SUCCESSION PLANNING; BUSINESS SUPERVISION; PREPARING BUSINESS REPORTS; PROVIDING STATISTICAL INFORMATION FOR BUSINESSES; BUSINESS MANAGEMENT CONSULTATION AND MANAGEMENT CONSULTATION SERVICES; CONSULTING SERVICES IN THE FIELD OF BUSINESS MANAGEMENT, MANAGEMENT, AND HUMAN RESOURCES, IN CLASS 35 (U.S. CLS. 100, 101 AND 102).

FIRST USE 12-0-2007; IN COMMERCE 12-0-2007.

FOR: PROVIDING TEMPORARY USE OF ON-LINE NON-DOWNLOADABLE SOFTWARE FOR USE IN PROVIDING REFERRAL, FINANCIAL, SALES, PLANNING, FORECASTING, AND BUDGETING MODULES; PROVIDING TEMPORARY USE OF ON-LINE NON-DOWNLOADABLE SOFTWARE TO ALLOW CUSTOMERS TO ACCESS ACCOUNT INFORMATION, REVIEW REFERRAL INFORMATION, AND INITIATE CONTACT REQUESTS, IN CLASS 42 (U.S. CLS. 100 AND 101).

FIRST USE 12-0-2007; IN COMMERCE 12-0-2007.



*David J. Kyjars*

Director of the United States Patent and Trademark Office

**Reg. No. 4,126,182** THE MARK CONSISTS OF STANDARD CHARACTERS WITHOUT CLAIM TO ANY PARTICULAR FONT, STYLE, SIZE, OR COLOR.

NO CLAIM IS MADE TO THE EXCLUSIVE RIGHT TO USE "SMALL BUSINESS" AND "INDEX", APART FROM THE MARK AS SHOWN.

SN 85-082,518, FILED 7-12-2010.

BRIAN NEVILLE, EXAMINING ATTORNEY

# United States of America

United States Patent and Trademark Office

## GUESSWORKS

**Reg. No. 4,126,183**

**Registered Apr. 10, 2012**

**Int. Cl.: 41**

**SERVICE MARK**

**PRINCIPAL REGISTER**

PENNY PUBLICATIONS, LLC (CONNECTICUT LIMITED LIABILITY COMPANY)  
6 PROWITT STREET  
NORWALK, CT 06855

FOR: ENTERTAINMENT SERVICES IN THE NATURE OF AN ON-LINE INTERACTIVE GAME PROVIDED BY MEANS OF A GLOBAL COMPUTER NETWORK, IN CLASS 41 (U.S. CLS. 100, 101 AND 107).

FIRST USE 10-10-2011; IN COMMERCE 10-10-2011.

THE MARK CONSISTS OF STANDARD CHARACTERS WITHOUT CLAIM TO ANY PARTICULAR FONT, STYLE, SIZE, OR COLOR.

SN 85-083,092, FILED 7-13-2010.

REBECCA EISINGER, EXAMINING ATTORNEY



*David J. Kyffers*

Director of the United States Patent and Trademark Office

# United States of America

United States Patent and Trademark Office



**Reg. No. 4,126,184**

**Registered Apr. 10, 2012**

**Int. Cl.: 25**

**TRADEMARK**

**PRINCIPAL REGISTER**

BYG OUTDOORS, LLC (NORTH CAROLINA LIMITED LIABILITY COMPANY)  
770 FOX CREEK ROAD  
MARS HILL, NC 28754

FOR: CLOTHING, NAMELY, SHIRTS, HATS, AND OUTERWEAR IN THE NATURE OF COATS, JACKETS AND PARKAS, IN CLASS 25 (U.S. CLS. 22 AND 39).

FIRST USE 8-0-2010; IN COMMERCE 8-0-2010.

THE MARK CONSISTS OF A DEER SKULL, HORNS ATTACHED TO THE DEER SKULL, AND A HUMAN SKULL CENTERED ABOVE THE DEER SKULL AND HAVING EYEBALLS.

SN 85-083,408, FILED 7-13-2010.

MELISSA VALLILLO, EXAMINING ATTORNEY



*David J. Kyffers*

Director of the United States Patent and Trademark Office

# United States of America

United States Patent and Trademark Office

# ILG&E

**Reg. No. 4,126,185**

**Registered Apr. 10, 2012**

**Int. Cl.: 35**

**SERVICE MARK**

**PRINCIPAL REGISTER**

U.S. GAS & ELECTRIC, INC. (DELAWARE CORPORATION)  
PH5  
290 N.W. 165TH STREET  
NORTH MIAMI BEACH, FL 33169

FOR: ENERGY MANAGEMENT SERVICES, NAMELY, PROVIDING A SERVICE THAT  
ALLOWS CUSTOMERS TO PURCHASE ENERGY, NAMELY, ELECTRICITY AND NATURAL  
GAS, AT VARIABLE PRICES, IN CLASS 35 (U.S. CLS. 100, 101 AND 102).

FIRST USE 4-28-2011; IN COMMERCE 4-28-2011.

THE MARK CONSISTS OF STANDARD CHARACTERS WITHOUT CLAIM TO ANY PAR-  
TICULAR FONT, STYLE, SIZE, OR COLOR.

OWNER OF U.S. REG. NO. 3,800,175.

SN 85-083,677, FILED 7-13-2010.

KATHERINE STOIDES, EXAMINING ATTORNEY



*David J. Kyffers*

Director of the United States Patent and Trademark Office

# United States of America

United States Patent and Trademark Office

## Maury the Mouse

**Reg. No. 4,126,186**

O'CONNOR, SUZANNE M. (UNITED STATES INDIVIDUAL)  
29 WASHINGTON RIDGE ROAD  
EAST GRANBY, CT 06026

**Registered Apr. 10, 2012**

**Int. Cl.: 16**

FOR: CHILDREN'S BOOKS, IN CLASS 16 (U.S. CLS. 2, 5, 22, 23, 29, 37, 38 AND 50).

**TRADEMARK**

FIRST USE 7-14-2010; IN COMMERCE 7-14-2010.

**PRINCIPAL REGISTER**

THE MARK CONSISTS OF STANDARD CHARACTERS WITHOUT CLAIM TO ANY PARTICULAR FONT, STYLE, SIZE, OR COLOR.

SN 85-084,046, FILED 7-14-2010.

WILLIAM VERHOSEK, EXAMINING ATTORNEY



*David J. Kybas*

Director of the United States Patent and Trademark Office



# United States of America

United States Patent and Trademark Office

## BORDER BATTLES

**Reg. No. 4,126,187**

**Registered Apr. 10, 2012**

**Int. Cl.: 41**

**SERVICE MARK**

**PRINCIPAL REGISTER**

THE OUTDOOR CHANNEL, INC. (NEVADA CORPORATION)  
SUITE 103  
4335 BUSINESS PARK DRIVE  
TEMECULA, CA 92950

FOR: ENTERTAINMENT, NAMELY, A CONTINUING REALITY BASED SHOW BROADCAST OVER TELEVISION, SATELLITE, AUDIO, AND VIDEO MEDIA, IN CLASS 41 (U.S. CLS. 100, 101 AND 107).

FIRST USE 12-28-2011; IN COMMERCE 12-28-2011.

THE MARK CONSISTS OF STANDARD CHARACTERS WITHOUT CLAIM TO ANY PARTICULAR FONT, STYLE, SIZE, OR COLOR.

SN 85-084,562, FILED 7-14-2010.

STEVEN R. FINE, EXAMINING ATTORNEY



*David J. Kyros*

Director of the United States Patent and Trademark Office

# United States of America

United States Patent and Trademark Office

Mixto

**Reg. No. 4,126,188**

VELOSO, PEDRO M (PORTUGAL INDIVIDUAL)  
242 CLINTON ROAD  
WEST CALDWELL, NJ 07006

**Registered Apr. 10, 2012**

**Int. Cl.: 33**

FOR: RED WINE; STILL WINES; WHITE WINE; WINE; WINES, IN CLASS 33 (U.S. CLS. 47 AND 49).

**TRADEMARK**

FIRST USE 8-11-2011; IN COMMERCE 1-15-2012.

**PRINCIPAL REGISTER**

THE MARK CONSISTS OF BRUSH LETTERING DEPICTING THE TERM "MIXTO".

SN 85-084,714, FILED 7-14-2010.

BRIDGETT SMITH, EXAMINING ATTORNEY



*David J. Kybas*

Director of the United States Patent and Trademark Office

# United States of America

United States Patent and Trademark Office



**Reg. No. 4,126,189**

**Registered Apr. 10, 2012**

**Int. Cls.: 35 and 42**

**SERVICE MARK**

**PRINCIPAL REGISTER**

EPROVENANCE LLC (DELAWARE LIMITED LIABILITY COMPANY)  
9 LIVERMORE ROAD  
BELMONT, MA 02478

FOR: MONITORING, TRACKING AND REPORTING ON THE LOCATION OF BOTTLES, CASES AND PALLETS OF WINE AND CHAMPAGNE THROUGHOUT TRANSPORT AND STORAGE; MONITORING, TRACKING AND REPORTING ON THE LOCATION OF BOTTLES, CASES AND PALLETS OF WINE AND CHAMPAGNE THROUGHOUT THE DISTRIBUTION CHAIN AND AT END CONSUMER LOCATIONS; BUSINESS MARKETING CONSULTING SERVICES; PROVIDING AN ONLINE DATABASE FOR TRACKING AND REPORTING THE LOCATION, TRANSPORT AND STORAGE HISTORY OF BOTTLES, CASES AND PALLETS OF WINE AND CHAMPAGNE; ISSUING CERTIFICATES VALIDATING DATA ON ENVIRONMENTAL CONDITIONS OF WINE AND CHAMPAGNE BEING SHIPPED AND STORED BY OTHERS, IN CLASS 35 (U.S. CLS. 100, 101 AND 102).

FIRST USE 2-0-2011; IN COMMERCE 2-0-2011.

FOR: TECHNICAL MONITORING, MEASURING AND REPORTING THE ENVIRONMENTAL CONDITIONS OF BOTTLES, CASES AND PALLETS OF WINE AND CHAMPAGNE THROUGHOUT TRANSPORT AND STORAGE THROUGH THE USE OF A SYSTEM COMPRISED OF RFID SENSORS, TAGS, READERS, AND AN ONLINE DATABASE; TECHNICAL MONITORING, MEASURING AND REPORTING THE ENVIRONMENTAL CONDITIONS OF BOTTLES, CASES AND PALLETS OF WINE AND CHAMPAGNE THROUGHOUT THE DISTRIBUTION CHAIN AND AT END CONSUMER LOCATIONS THROUGH THE USE OF A SYSTEM COMPRISED OF RFID SENSORS, TAGS, READERS, AND AN ONLINE DATABASE; TECHNICAL CONSULTING SERVICES RELATED TO ENVIRONMENTAL CONDITIONS FOR TRANSPORT AND STORAGE OF WINE AND CHAMPAGNE AND RELATING TO CORRECTIVE ACTIONS FOR IMPROPER ENVIRONMENTAL CONDITIONS; PROVIDING AN ONLINE DATABASE FOR TRACKING AND REPORTING THE ENVIRONMENTAL CONDITIONS OF BOTTLES, CASES AND PALLETS OF WINE AND CHAMPAGNE, IN CLASS 42 (U.S. CLS. 100 AND 101).

FIRST USE 3-10-2007; IN COMMERCE 3-10-2007.

THE MARK CONSISTS OF A BUNCH OF GRAPES (THE STEM OF WHICH IS MADE UP OF A STYLIZED "E" AND "P") ABOVE THE WORD "EPROVENANCE" WITH A STYLIZED, LOWER-CASE "E".



*David J. Kybas*

Director of the United States Patent and Trademark Office

**Reg. No. 4,126,189** SN 85-085,720, FILED 7-15-2010.

BRIAN PINO, EXAMINING ATTORNEY

# United States of America

United States Patent and Trademark Office

# DIRTY PURE

**Reg. No. 4,126,190**

**Registered Apr. 10, 2012**

**Int. Cl.: 33**

**TRADEMARK**

**PRINCIPAL REGISTER**

OLD VINE WINE PARTNERS LLC (CALIFORNIA CORPORATION)  
5584 SILVERADO TRAIL  
NAPA, CA 94558

FOR: WINE, IN CLASS 33 (U.S. CLS. 47 AND 49).

FIRST USE 2-22-2012; IN COMMERCE 2-22-2012.

THE MARK CONSISTS OF STANDARD CHARACTERS WITHOUT CLAIM TO ANY PARTICULAR FONT, STYLE, SIZE, OR COLOR.

SN 85-085,896, FILED 7-15-2010.

BRIDGETT SMITH, EXAMINING ATTORNEY



*David J. Kyffers*

Director of the United States Patent and Trademark Office

# United States of America

United States Patent and Trademark Office

## STICK WITH IT

**Reg. No. 4,126,191**

PLASSMEYER, MONETTA (UNITED STATES INDIVIDUAL)  
10559 CAMINITO BASSWOOD  
SAN DIEGO, CA 92131

**Registered Apr. 10, 2012**

**Int. Cl.: 18**

FOR: COSMETIC CARRYING CASES SOLD EMPTY; COSMETIC CASES SOLD EMPTY,  
IN CLASS 18 (U.S. CLS. 1, 2, 3, 22 AND 41).

**TRADEMARK**

FIRST USE 10-11-2011; IN COMMERCE 10-11-2011.

**PRINCIPAL REGISTER**

THE MARK CONSISTS OF STANDARD CHARACTERS WITHOUT CLAIM TO ANY PAR-  
TICULAR FONT, STYLE, SIZE, OR COLOR.

SN 85-086,345, FILED 7-16-2010.

LOURDES AYALA, EXAMINING ATTORNEY



*David J. Kybas*

Director of the United States Patent and Trademark Office

# United States of America

United States Patent and Trademark Office



**Reg. No. 4,126,192**

ZAGG INC (NEVADA CORPORATION)

**Registered Apr. 10, 2012**

3855 SOUTH 500 WEST, STE. C  
SALT LAKE CITY, UT 84115

**Int. Cl.: 9**

**TRADEMARK**

**PRINCIPAL REGISTER**

FOR: EARPHONES AND HEADPHONES; AUDIO SPEAKERS; CHARGERS FOR BATTERIES AND POWER ACCESSORIES FOR PERSONAL ELECTRONIC DEVICES, NAMELY, CELL PHONES, PERSONAL MUSIC PLAYERS, TABLET-STYLE COMPUTERS, HANDHELD COMPUTERS, HANDHELD GAMING DEVICES, LAPTOPS, AND MEDIA PLAYERS; PROTECTIVE CASES FOR ELECTRONIC DEVICES, NAMELY, CELL PHONES, PERSONAL MUSIC PLAYERS, TABLET-STYLE COMPUTERS, HANDHELD COMPUTERS, HANDHELD GAMING DEVICES, LAPTOPS, AND MEDIA PLAYERS, CLEAR PROTECTIVE COVER FILM FOR PERSONAL ELECTRONIC DEVICES; CLEAR PROTECTIVE COVER FILM FOR ELECTRONIC SCREENS ON PERSONAL ELECTRONIC DEVICES; BAGS AND POUCHES SPECIFICALLY ADAPTED FOR HOLDING OR CARRYING ELECTRONIC DEVICES, NAMELY, CELL PHONES, PERSONAL MUSIC PLAYERS, TABLET-STYLE COMPUTERS, HANDHELD COMPUTERS, HANDHELD GAMING DEVICES, LAPTOPS, AND MEDIA PLAYERS; CASES AND CONTAINERS SPECIFICALLY ADAPTED FOR HOLDING, CARRYING, AND PROTECTING ELECTRONIC DEVICES, NAMELY, CELL PHONES, PERSONAL MUSIC PLAYERS, TABLET-STYLE COMPUTERS, HANDHELD COMPUTERS, HANDHELD GAMING DEVICES, LAPTOPS, AND MEDIA PLAYERS; PROTECTIVE CARRYING SLEEVES AND ARMBANDS FOR ELECTRONIC DEVICES, NAMELY, CELL PHONES, PERSONAL MUSIC PLAYERS, TABLET-STYLE COMPUTERS, HANDHELD COMPUTERS, HANDHELD GAMING DEVICES, LAPTOPS, AND MEDIA PLAYERS; MEDIA PLAYERS; ELECTRONIC CABLES; DIGITAL AUDIO COMPONENTS, NAMELY, PERSONAL RADIO AND VIDEO TUNERS AND TRANSMITTERS; ELECTRICAL AND ELECTRONIC CONNECTORS; MOBILE MEDIA DEVICE SOFTWARE AND APPLICATIONS, NAMELY, SOFTWARE APPLICATIONS FOR CREATING AND BUYING PROTECTIVE CASES FOR ELECTRONIC DEVICES, BAGS AND POUCHES SPECIFICALLY ADAPTED FOR HOLDING OR CARRYING ELECTRONIC DEVICES, CASES AND CONTAINERS SPECIFICALLY ADAPTED FOR HOLDING, CARRYING, AND PROTECTING ELECTRONIC DEVICES, AND PROTECTIVE CARRYING SLEEVES AND ARMBANDS FOR ELECTRONIC DEVICES, IN CLASS 9 (U.S. CLS. 21, 23, 26, 36 AND 38).



*David J. Kyffers*

FIRST USE 3-0-2006; IN COMMERCE 3-0-2006.

OWNER OF U.S. REG. NO. 3,309,320.

**Reg. No. 4,126,192** THE MARK CONSISTS OF A STYLIZED DRAWING OF A FROG WITH THE WORD "IFROGZ" NEXT TO IT WRITTEN IN A STYLIZED MANNER.

SN 85-087,013, FILED 7-16-2010.

FRANK LATTUCA, EXAMINING ATTORNEY



# United States of America

United States Patent and Trademark Office

# Genble

**Reg. No. 4,126,193**

**Registered Apr. 10, 2012**

**Int. Cl.: 42**

**SERVICE MARK**

**PRINCIPAL REGISTER**

GENOVATIVE CORP (DELAWARE CORPORATION)  
3511 SILVERSIDE ROAD, SUITE 105  
WILMINGTON, DE 19810

FOR: RESEARCH AND DEVELOPMENT SERVICES IN THE BIOTECHNOLOGY, DENTAL,  
MEDICAL AND PHARMACEUTICAL FIELDS, IN CLASS 42 (U.S. CLS. 100 AND 101).

FIRST USE 5-1-2011; IN COMMERCE 5-1-2011.

THE MARK CONSISTS OF STANDARD CHARACTERS WITHOUT CLAIM TO ANY PAR-  
TICULAR FONT, STYLE, SIZE, OR COLOR.

SN 85-087,095, FILED 7-17-2010.

ALLISON HOLTZ, EXAMINING ATTORNEY



*David J. Kybas*

Director of the United States Patent and Trademark Office

# United States of America

United States Patent and Trademark Office

# MagicFlips

**Reg. No. 4,126,194**

**Registered Apr. 10, 2012**

**Int. Cl.: 25**

**TRADEMARK**

**PRINCIPAL REGISTER**

THEMAGICTOUCH GMBH (FED REP GERMANY GESELLSCHAFT MIT BESCHRÄNKTER  
HAFTUNG (GMBH))  
INDUSTRIEGEBIET NORD  
BENZSTRASSE 17  
DIEBURG, FED REP GERMANY 64807

FOR: FOOTWEAR, SANDALS AND BATHING SANDALS, EXCLUDING SWIM WEAR, IN  
CLASS 25 (U.S. CLS. 22 AND 39).

FIRST USE 9-0-2009; IN COMMERCE 9-0-2009.

THE MARK CONSISTS OF STANDARD CHARACTERS WITHOUT CLAIM TO ANY PAR-  
TICULAR FONT, STYLE, SIZE, OR COLOR.

SN 85-087,295, FILED 7-19-2010.

BARBARA BROWN, EXAMINING ATTORNEY



*David J. Kybas*

Director of the United States Patent and Trademark Office

# United States of America

United States Patent and Trademark Office

## SAMY TWISTED

**Reg. No. 4,126,195**

**Registered Apr. 10, 2012**

**Int. Cl.: 3**

**TRADEMARK**

**PRINCIPAL REGISTER**

SAMY MARK, INC. (FLORIDA CORPORATION)  
700 BROOKER CREEK BLVD.  
OLDSMAR, FL 34677

FOR: HAIR CARE PREPARATIONS, IN CLASS 3 (U.S. CLS. 1, 4, 6, 50, 51 AND 52).

FIRST USE 1-1-2011; IN COMMERCE 1-1-2011.

THE MARK CONSISTS OF STANDARD CHARACTERS WITHOUT CLAIM TO ANY PARTICULAR FONT, STYLE, SIZE, OR COLOR.

OWNER OF U.S. REG. NOS. 3,087,282 AND 3,909,303.

NO CLAIM IS MADE TO THE EXCLUSIVE RIGHT TO USE "TWISTED", APART FROM THE MARK AS SHOWN.

THE NAME "SAMY" IDENTIFIES A LIVING INDIVIDUAL WHOSE CONSENT IS OF RECORD.

SN 85-087,429, FILED 7-19-2010.

ROBERT C. CLARK JR., EXAMINING ATTORNEY



*David J. Kybas*

Director of the United States Patent and Trademark Office

# United States of America

United States Patent and Trademark Office

## GET RELIEF RESPONSIBLY

**Reg. No. 4,126,196**

JOHNSON & JOHNSON (NEW JERSEY CORPORATION)  
ONE JOHNSON & JOHNSON PLAZA  
NEW BRUNSWICK, NJ 089337001

**Registered Apr. 10, 2012**

**Int. Cl.: 44**

FOR: PROVIDING MEDICAL INFORMATION RELATING TO APPROPRIATE USE OF OVER  
THE COUNTER PAIN RELIEVERS, IN CLASS 44 (U.S. CLS. 100 AND 101).

**SERVICE MARK**

FIRST USE 4-19-2011; IN COMMERCE 4-19-2011.

**PRINCIPAL REGISTER**

THE MARK CONSISTS OF STANDARD CHARACTERS WITHOUT CLAIM TO ANY PAR-  
TICULAR FONT, STYLE, SIZE, OR COLOR.

SN 85-087,595, FILED 7-19-2010.

JAY BESCH, EXAMINING ATTORNEY



*David J. Kyffers*

Director of the United States Patent and Trademark Office

# United States of America

United States Patent and Trademark Office

## CITRUS SPICE GLOW

**Reg. No. 4,126,197**

**Registered Apr. 10, 2012**

**Int. Cl.: 3**

**TRADEMARK**

**PRINCIPAL REGISTER**

THE PROCTER & GAMBLE COMPANY (OHIO CORPORATION)  
ONE PROCTER & GAMBLE PLAZA  
CINCINNATI, OH 45202

FOR: FABRIC SOFTENERS, IN CLASS 3 (U.S. CLS. 1, 4, 6, 50, 51 AND 52).

FIRST USE 2-7-2011; IN COMMERCE 2-7-2011.

THE MARK CONSISTS OF STANDARD CHARACTERS WITHOUT CLAIM TO ANY PARTICULAR FONT, STYLE, SIZE, OR COLOR.

NO CLAIM IS MADE TO THE EXCLUSIVE RIGHT TO USE "CITRUS SPICE", APART FROM THE MARK AS SHOWN.

SN 85-087,682, FILED 7-19-2010.

ANGELA M. MICHELI, EXAMINING ATTORNEY



*David J. Kybas*

Director of the United States Patent and Trademark Office

# United States of America

United States Patent and Trademark Office

# FISHLIPS

**Reg. No. 4,126,198**

JEFFERS, JAMES (UNITED STATES INDIVIDUAL)  
10423 S.W. 16TH MANOR  
DAVIE, FL 333247458

**Registered Apr. 10, 2012**

**Int. Cls.: 25 and 41**

FOR: FISHING T-SHIRTS, IN CLASS 25 (U.S. CLS. 22 AND 39).

**TRADEMARK**

FIRST USE 1-11-1983; IN COMMERCE 3-4-1986.

**SERVICE MARK**

FOR: FISHING GUIDE AND PLEASURE BOAT CRUISE SERVICES, IN CLASS 41 (U.S. CLS. 100, 101 AND 107).

**PRINCIPAL REGISTER**

FIRST USE 1-11-1983; IN COMMERCE 3-4-1986.

THE MARK CONSISTS OF STANDARD CHARACTERS WITHOUT CLAIM TO ANY PARTICULAR FONT, STYLE, SIZE, OR COLOR.

SN 85-087,953, FILED 7-19-2010.

JULIE WATSON, EXAMINING ATTORNEY



*David J. Kybas*

Director of the United States Patent and Trademark Office

# United States of America

United States Patent and Trademark Office

# NUCLEUS

**Reg. No. 4,126,199**

**Registered Apr. 10, 2012**

**Int. Cl.: 9**

**TRADEMARK**

**PRINCIPAL REGISTER**

GENERAL ELECTRIC COMPANY (NEW YORK CORPORATION)  
1 RIVER ROAD  
SCHENECTADY, NY 12345

FOR: ELECTRIC CONTROL DEVICES FOR HOUSEHOLD ENERGY MANAGEMENT; COMPUTER SOFTWARE AND HARDWARE FOR USE WITH SMART GRID APPLICATIONS, NAMELY, SOFTWARE WITH ENERGY LOAD MANAGEMENT AND CONTROL APPLICATIONS AND A WIRELESS HOME ENERGY MONITOR THAT COLLECTS AND STORES DATA ON HOUSEHOLD ELECTRICITY CONSUMPTION; WIRELESS ACCESS POINT (WAP) DEVICES, IN CLASS 9 (U.S. CLS. 21, 23, 26, 36 AND 38).

FIRST USE 2-15-2011; IN COMMERCE 2-15-2011.

THE MARK CONSISTS OF STANDARD CHARACTERS WITHOUT CLAIM TO ANY PARTICULAR FONT, STYLE, SIZE, OR COLOR.

SN 85-088,241, FILED 7-20-2010.

ANDREA HACK, EXAMINING ATTORNEY



*David J. Kyffers*

Director of the United States Patent and Trademark Office

# United States of America

United States Patent and Trademark Office

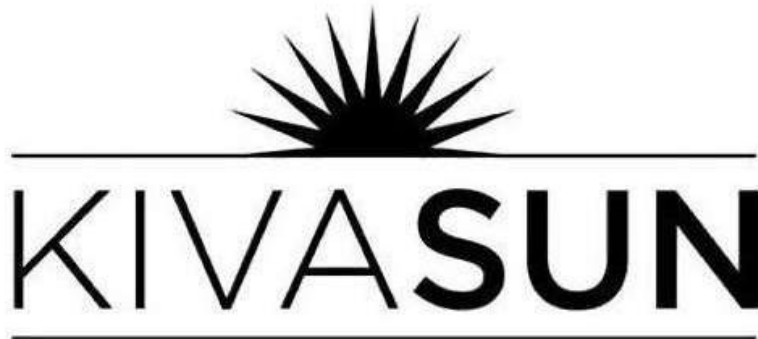

**Reg. No. 4,126,200**

**Registered Apr. 10, 2012**

**Int. Cl.: 29**

**TRADEMARK**

**PRINCIPAL REGISTER**

NB3 FOODS, LLC (NEW MEXICO LIMITED LIABILITY COMPANY)  
SUITE 100A  
51 JEMEZ CANYON DAM ROAD  
BERNALILLO, NM 87004

FOR: FISH, NAMELY, SALMON; MEAT; MEAT, FROZEN; SMOKED FISH, IN CLASS 29  
(U.S. CL. 46).

FIRST USE 1-1-2010; IN COMMERCE 1-1-2010.

THE MARK CONSISTS OF THE COMPOUND LITERAL ELEMENT "KIVASUN" IN STYLIZED LETTERING WITH ASSOCIATED DESIGN ELEMENTS. THE DESIGN ELEMENTS ARE TWO HORIZONTAL LINES, ABOVE AND BELOW THE LITERAL ELEMENT, WITH THE TOP HORIZONTAL LINE INTEGRATED WITH THE DESIGN OF A PARTIAL SUN WITH RAYS.

SN 85-088,792, FILED 7-20-2010.

JUDITH HELFMAN, EXAMINING ATTORNEY



*David J. Kybas*

Director of the United States Patent and Trademark Office



# United States of America

United States Patent and Trademark Office

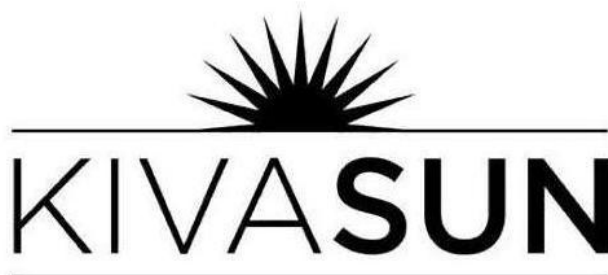

*Respect the land. Revere the food.*

**Reg. No. 4,126,201**

**Registered Apr. 10, 2012**

**Int. Cl.: 29**

**TRADEMARK**

**PRINCIPAL REGISTER**

NB3 FOODS, LLC (NEW MEXICO LIMITED LIABILITY COMPANY)  
SUITE 100A  
51 JEMEZ CANYON DAM ROAD  
BERNALILLO, NM 87004

FOR: FISH, NAMELY, SALMON; MEAT; MEAT, FROZEN; SMOKED FISH, IN CLASS 29  
(U.S. CL. 46).

FIRST USE 1-1-2010; IN COMMERCE 1-1-2010.

THE MARK CONSISTS OF THE LITERAL ELEMENTS "KIVASUN" AND "RESPECT THE LAND. REVERE THE FOOD." IN STYLIZED LETTERING WITH ASSOCIATED DESIGN ELEMENTS. THE DESIGN ELEMENTS ARE TWO HORIZONTAL LINES, ABOVE AND BELOW THE LITERAL ELEMENT "KIVASUN", WITH THE TOP HORIZONTAL LINE INTEGRATED WITH THE DESIGN OF A PARTIAL SUN WITH RAYS.

SN 85-088,823, FILED 7-20-2010.

JUDITH HELFMAN, EXAMINING ATTORNEY



*David J. Kybas*

Director of the United States Patent and Trademark Office

# United States of America

United States Patent and Trademark Office

# OneReach

**Reg. No. 4,126,202**

NEXANS (FRANCE SOCIÉTÉ ANONYME (SA))  
8 RUE DU GENERAL FOY  
PARIS, FRANCE 75008

**Registered Apr. 10, 2012**

**Int. Cl.: 9**

FOR: CABLING SYSTEM COMPRISING ELECTRICAL CABLES AND WIRES, DATA CABLES, POWER PORT MODULES, PATCH PANELS, PORT MEDIA MODULES, POWER SUPPLY MODULES, TERMINAL CABLES, REMOTE CONVERTERS, REMOTE MODULES, AND REMOTE PORT MODULES, IN CLASS 9 (U.S. CLS. 21, 23, 26, 36 AND 38).

**TRADEMARK**

**PRINCIPAL REGISTER**

FIRST USE 9-13-2010; IN COMMERCE 9-13-2010.

THE MARK CONSISTS OF STANDARD CHARACTERS WITHOUT CLAIM TO ANY PARTICULAR FONT, STYLE, SIZE, OR COLOR.

SN 85-090,025, FILED 7-21-2010.

JOSETTE BEVERLY, EXAMINING ATTORNEY



*David J. Kyros*

Director of the United States Patent and Trademark Office

# United States of America

United States Patent and Trademark Office

## START SOMETHING GOOD

**Reg. No. 4,126,203**

DURAFLAME, INC. (CALIFORNIA CORPORATION)  
2894 MONTE DIABLO AVENUE  
STOCKTON, CA 95203

**Registered Apr. 10, 2012**

**Int. Cl.: 4**

FOR: ARTIFICIAL FIRELOGS; SOLID FIRE STARTERS; CHARCOAL BRIQUETTES;  
LIGHTER FLUID, IN CLASS 4 (U.S. CLS. 1, 6 AND 15).

**TRADEMARK**

FIRST USE 9-0-2011; IN COMMERCE 9-0-2011.

**PRINCIPAL REGISTER**

THE MARK CONSISTS OF STANDARD CHARACTERS WITHOUT CLAIM TO ANY PARTICULAR FONT, STYLE, SIZE, OR COLOR.

SN 85-090,044, FILED 7-21-2010.

ROSELLE HERRERA, EXAMINING ATTORNEY



*David J. Kybas*

Director of the United States Patent and Trademark Office

# United States of America

United States Patent and Trademark Office



**Reg. No. 4,126,204**

**Registered Apr. 10, 2012**

**Int. Cl.: 9**

**TRADEMARK**

**PRINCIPAL REGISTER**

INOLECT, LLC (LOUISIANA LIMITED LIABILITY COMPANY)  
17474 OPPORTUNITY AVENUE  
BATON ROUGE, LA 70817

FOR: ELECTRONIC APPARATUS AND INSTRUMENTS FOR CONTROLLING OTHER ELECTRICAL APPARATUSES, NAMELY, REMOTE RACKING MACHINES FOR ENGAGING AND DISENGAGING ELECTRICAL POWER CIRCUIT BREAKERS; CUSTOMIZED ENCLOSURES OR WORK AREAS CONSISTING PRIMARILY OF ELECTRICAL EQUIPMENT, NAMELY, ELECTRICAL SWITCHING GEAR, MOTOR CONTROL EQUIPMENT, AND, CONTROL PANELS, NAMELY, MODULAR UNITS CONTAINING THAT EQUIPMENT, IN CLASS 9 (U.S. CLS. 21, 23, 26, 36 AND 38).

FIRST USE 11-0-2010; IN COMMERCE 11-0-2010.

THE MARK CONSISTS OF A CIRCLE WHICH IS INCOMPLETE AT THE TOP WITH A LIGHTNING BOLT SITUATED IN THE OPEN PORTION OF THE CIRCLE.

SN 85-090,646, FILED 7-22-2010.

DEBRA LEE, EXAMINING ATTORNEY



*David J. Kyffers*

Director of the United States Patent and Trademark Office

# United States of America

United States Patent and Trademark Office



**Reg. No. 4,126,205**

INOLECT, LLC (LOUISIANA LIMITED LIABILITY COMPANY)  
17474 OPPORTUNITY AVENUE  
BATON ROUGE, LA 70817

**Registered Apr. 10, 2012**

**Int. Cl.: 42**

FOR: ENGINEERING SERVICES IN THE FIELD OF ELECTRICAL ENERGY PRODUCTION AND DISTRIBUTION, IN CLASS 42 (U.S. CLS. 100 AND 101).

**SERVICE MARK**

FIRST USE 11-0-2010; IN COMMERCE 11-0-2010.

**PRINCIPAL REGISTER**

THE MARK CONSISTS OF A CIRCLE WHICH IS INCOMPLETE AT THE TOP WITH A LIGHTNING BOLT SITUATED IN THE OPEN PORTION OF THE CIRCLE.

SN 85-090,710, FILED 7-22-2010.

DEBRA LEE, EXAMINING ATTORNEY



*David J. Kybas*

Director of the United States Patent and Trademark Office

# United States of America

United States Patent and Trademark Office

# CROSSGEN

**Reg. No. 4,126,206**

**Registered Apr. 10, 2012**

**Int. Cl.: 16**

**TRADEMARK**

**PRINCIPAL REGISTER**

DISNEY ENTERPRISES, INC. (DELAWARE CORPORATION)  
500 SOUTH BUENA VISTA STREET  
BURBANK, CA 91521

FOR: COMIC BOOKS, IN CLASS 16 (U.S. CLS. 2, 5, 22, 23, 29, 37, 38 AND 50).

FIRST USE 3-31-2011; IN COMMERCE 3-31-2011.

THE MARK CONSISTS OF STANDARD CHARACTERS WITHOUT CLAIM TO ANY PARTICULAR FONT, STYLE, SIZE, OR COLOR.

SN 85-091,063, FILED 7-22-2010.

JOHN DWYER, EXAMINING ATTORNEY



*David J. Kyffers*

Director of the United States Patent and Trademark Office

# United States of America

United States Patent and Trademark Office

## THE 101

**Reg. No. 4,126,207**

**Registered Apr. 10, 2012**

**Int. Cls.: 9 and 16**

**TRADEMARK**

**PRINCIPAL REGISTER**

PREMIER AGENDAS, INC. (WASHINGTON CORPORATION)  
2000 KENTUCKY STREET  
BELLINGHAM, WA 98229

FOR: ONLINE, DOWNLOADABLE MATERIALS, NAMELY, NEWSLETTERS, VIDEOS, ARTICLES THAT PROVIDE RESOURCE MATERIALS, NAMELY, NEWSLETTERS, VIDEOS, ARTICLES TO HELP STUDENTS PLAN AND SCHEDULE THEIR TIME, HELP TEACHERS HELP STUDENTS PLAN AND SCHEDULE THEIR TIME, AND HELP PARENTS HELP THEIR STUDENTS PLAN AND SCHEDULE THEIR TIME; PRE-RECORDED ELECTRONIC VIDEOS THAT PROVIDE RESOURCE MATERIALS, NAMELY, EXECUTIVE FUNCTION SKILLS, JOURNALING INFORMATION AND SKILLS, TO HELP STUDENTS PLAN AND SCHEDULE THEIR TIME, HELP TEACHERS HELP STUDENTS PLAN AND SCHEDULE THEIR TIME, AND HELP PARENTS HELP THEIR STUDENTS PLAN AND SCHEDULE THEIR TIME, IN CLASS 9 (U.S. CLS. 21, 23, 26, 36 AND 38).

FIRST USE 12-0-2010; IN COMMERCE 12-0-2010.

FOR: PRINTED MATERIALS, NAMELY, STUDENT PLANNERS AND WORKBOOKS THAT HELP STUDENTS PLAN AND SCHEDULE THEIR TIME; TEACHER MATERIALS, NAMELY, PLANNERS, CALENDARS, NOTEBOOKS, PRESENTATIONS, POSTERS AND NEWSLETTERS THAT HELP TEACHERS HELP STUDENTS PLAN AND SCHEDULE THEIR TIME; AND PARENT MATERIALS, NAMELY, PLANNERS, CALENDARS, NOTEBOOKS, NEWSLETTERS, AND PRESENTATIONS SENT BY TEACHERS TO PARENTS TO HELP THEIR STUDENTS PLAN AND SCHEDULE THEIR TIME; PAPER BANNERS THAT PROMOTE STUDENT PLANNING; PLASTIC PAGE FINDERS IN THE NATURE OF BOOKMARKS THAT HELP STUDENTS PLAN AND SCHEDULE THEIR TIME, IN CLASS 16 (U.S. CLS. 2, 5, 22, 23, 29, 37, 38 AND 50).

FIRST USE 6-0-2010; IN COMMERCE 6-0-2010.

THE MARK CONSISTS OF STANDARD CHARACTERS WITHOUT CLAIM TO ANY PARTICULAR FONT, STYLE, SIZE, OR COLOR.

SN 85-091,113, FILED 7-22-2010.

DAVID COLLIER, EXAMINING ATTORNEY



*David J. Kyffers*

Director of the United States Patent and Trademark Office

# United States of America

United States Patent and Trademark Office

## UNPLUGGING AND RECONNECTING

**Reg. No. 4,126,208**

**Registered Apr. 10, 2012**

**Int. Cls.: 9 and 41**

**TRADEMARK**

**SERVICE MARK**

**PRINCIPAL REGISTER**

MIND OVER BODY, INC. (NEW YORK CORPORATION)  
1663 EAST 17TH STREET  
BROOKLYN, NY 11229

FOR: PRE-RECORDED DVDS FEATURING SEMINARS IN THE FIELD OF PERSONAL RELATIONSHIPS AND SELF AWARENESS, IN CLASS 9 (U.S. CLS. 21, 23, 26, 36 AND 38).

FIRST USE 8-19-2011; IN COMMERCE 8-19-2011.

FOR: CONDUCTING WORKSHOPS AND SEMINARS IN THE FIELD OF PERSONAL RELATIONSHIPS AND SELF AWARENESS; ON-LINE JOURNALS, NAMELY, BLOGS FEATURING INFORMATION IN THE FIELD OF PERSONAL RELATIONSHIPS AND SELF AWARENESS, IN CLASS 41 (U.S. CLS. 100, 101 AND 107).

FIRST USE 5-10-2011; IN COMMERCE 5-10-2011.

THE MARK CONSISTS OF STANDARD CHARACTERS WITHOUT CLAIM TO ANY PARTICULAR FONT, STYLE, SIZE, OR COLOR.

SN 85-091,469, FILED 7-23-2010.

DAWN FELDMAN, EXAMINING ATTORNEY

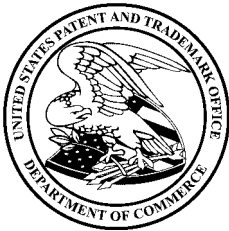

*David J. Kyffers*

Director of the United States Patent and Trademark Office



# United States of America

United States Patent and Trademark Office

## WHIP IT GOOD

**Reg. No. 4,126,209**

**Registered Apr. 10, 2012**

**Int. Cl.: 33**

**TRADEMARK**

**PRINCIPAL REGISTER**

WHITE ROCK DISTILLERIES, INC. (MAINE CORPORATION)  
21 SARATOGA STREET  
LEWISTON, ME 04241

FOR: VODKA, IN CLASS 33 (U.S. CLS. 47 AND 49).

FIRST USE 7-31-2011; IN COMMERCE 7-31-2011.

THE MARK CONSISTS OF STANDARD CHARACTERS WITHOUT CLAIM TO ANY PARTICULAR FONT, STYLE, SIZE, OR COLOR.

SN 85-092,415, FILED 7-26-2010.

ALEX KEAM, EXAMINING ATTORNEY



*David J. Kybas*

Director of the United States Patent and Trademark Office

# United States of America

United States Patent and Trademark Office



**Reg. No. 4,126,210**

**Registered Apr. 10, 2012**

**Int. Cl.: 43**

**SERVICE MARK**

**PRINCIPAL REGISTER**

DD IP HOLDER LLC (DELAWARE LIMITED LIABILITY COMPANY)  
130 ROYALL ST.  
CANTON, MA 02021

FOR: RESTAURANT SERVICES, IN CLASS 43 (U.S. CLS. 100 AND 101).

FIRST USE 8-31-2010; IN COMMERCE 8-31-2010.

OWNER OF U.S. REG. NOS. 1,148,165, 3,282,278, AND OTHERS.

THE COLOR(S) ORANGE, PINK, WHITE AND BROWN IS/ARE CLAIMED AS A FEATURE OF THE MARK.

NO CLAIM IS MADE TO THE EXCLUSIVE RIGHT TO USE "DONUTS" AND "COFFEE" AND "EXPRESS", APART FROM THE MARK AS SHOWN.

THE MARK CONSISTS OF THE WORD "DUNKIN'" IN ORANGE OVER THE WORD "DONUTS" IN PINK OVER THE WORD "EXPRESS" IN ORANGE. TO THE LEFT OF THE WORDS IS A DESIGN OF A CUP BEARING THE LETTERS "DD" FROM WHICH STEAM IS RISING, SUPERIMPOSED ON A RECTANGLE WITH ROUNDED EDGES. THE COLOR ORANGE APPEARS IN THE LEFT SIDE OF THE RECTANGLE AND IN THE FIRST OCCURRENCE OF THE LETTER "D" IN "DD". THE COLOR PINK APPEARS IN THE RIGHT SIDE OF THE RECTANGLE AND IN THE SECOND OCCURRENCE OF THE LETTER "D" IN "DD". THE COLOR BROWN APPEARS IN THE OUTLINE OF THE CUP, INSIDE THE TOP OF THE CUP AND IN THE RISING STEAM. THE COLOR WHITE APPEARS INSIDE THE CUP, IN THE OUTLINE OF THE CUP AND IN THE BACKGROUND OF THE MARK.

SN 85-093,622, FILED 7-27-2010.

LINDA E. BLOHM, EXAMINING ATTORNEY



*David J. Kybas*

Director of the United States Patent and Trademark Office

# United States of America

United States Patent and Trademark Office

# IDLK

**Reg. No. 4,126,211**

**Registered Apr. 10, 2012**

**Int. Cl.: 9**

**TRADEMARK**

**PRINCIPAL REGISTER**

MIN, YU (CHINA INDIVIDUAL)  
UNIT 2006-07A, FUTURA PLAZA  
111-113 HOW MING ST.  
KWUN TONG, HONG KONG

FOR: COMPUTER PERIPHERAL DEVICES; ELECTRONIC LOCKS; SMART CARD READERS;  
BIOMETRIC FINGERPRINT SCANNERS; BIOMETRIC FINGERPRINT DOOR LOCKS; AC-  
CESS CONTROL AND ALARM MONITORING SYSTEMS; ELECTRONIC DOOR OPENERS,  
IN CLASS 9 (U.S. CLS. 21, 23, 26, 36 AND 38).

FIRST USE 3-0-2011; IN COMMERCE 3-0-2011.

THE MARK CONSISTS OF STANDARD CHARACTERS WITHOUT CLAIM TO ANY PAR-  
TICULAR FONT, STYLE, SIZE, OR COLOR.

SN 85-094,107, FILED 7-27-2010.

TARAH HARDY, EXAMINING ATTORNEY



*David J. Kybas*

Director of the United States Patent and Trademark Office

# United States of America

United States Patent and Trademark Office

# PivotRed

**Reg. No. 4,126,212**

**Registered Apr. 10, 2012**

**Int. Cl.: 35**

**SERVICE MARK**

**PRINCIPAL REGISTER**

WPP PROPERTIES (DELAWARE PARTNERSHIP)  
4TH FLOOR  
100 PARK AVENUE  
NEW YORK, NY 10017

FOR: ADVERTISING AGENCY SERVICES; PUBLIC RELATIONS SERVICES; MEDIA RELATIONS SERVICES, NAMELY, SECURING AIRTIME ON ALL FORMS OF MEDIA COMMUNICATIONS STATIONS, SYSTEMS, NETWORKS, AND SERVICES FOR THE PURPOSE OF PROMOTING THE GOODS AND SERVICES OF OTHERS; MARKETING RESEARCH SERVICES; CONDUCTING AND ANALYZING PUBLIC OPINION SURVEYS; DEVELOPING ADVERTISING AND PROMOTIONAL CAMPAIGNS FOR BUSINESSES TO GENERATE AWARENESS, DISSEMINATE INFORMATION, MANAGE PERCEPTIONS AND ENHANCE THE REPUTATION OF OTHERS IN ORDER TO MOTIVATE BEHAVIORS THAT CREATE POSITIVE BUSINESS RESULTS, IN CLASS 35 (U.S. CLS. 100, 101 AND 102).

FIRST USE 8-1-2010; IN COMMERCE 8-1-2010.

THE MARK CONSISTS OF STANDARD CHARACTERS WITHOUT CLAIM TO ANY PARTICULAR FONT, STYLE, SIZE, OR COLOR.

SN 85-094,789, FILED 7-28-2010.

RICHARD WHITE, EXAMINING ATTORNEY



*David J. Kyros*

Director of the United States Patent and Trademark Office

# United States of America

United States Patent and Trademark Office

## Light Practitioner

**Reg. No. 4,126,213**

SALLY RISCH (UNITED STATES INDIVIDUAL)  
1914 ALBERT STREET  
RACINE, WI 53404

**Registered Apr. 10, 2012**

**Int. Cl.: 45**

FOR: COUNSELING IN THE FIELD OF PERSONAL DEVELOPMENT, NAMELY, SELF-IMPROVEMENT, SELF-FULFILLMENT, AND INTERPERSONAL COMMUNICATION, IN CLASS 45 (U.S. CLS. 100 AND 101).

**SERVICE MARK**

FIRST USE 12-7-2011; IN COMMERCE 12-7-2011.

**PRINCIPAL REGISTER**

THE MARK CONSISTS OF STANDARD CHARACTERS WITHOUT CLAIM TO ANY PARTICULAR FONT, STYLE, SIZE, OR COLOR.

NO CLAIM IS MADE TO THE EXCLUSIVE RIGHT TO USE "PRACTITIONER", APART FROM THE MARK AS SHOWN.

SN 85-095,009, FILED 7-28-2010.

MICHAEL ENGEL, EXAMINING ATTORNEY



*David J. Kybas*

Director of the United States Patent and Trademark Office

# United States of America

United States Patent and Trademark Office

# dorm bunkie

**Reg. No. 4,126,214**

**Registered Apr. 10, 2012**

**Int. Cls.: 38 and 42**

**SERVICE MARK**

**PRINCIPAL REGISTER**

DORMBUNKIE.COM, LLC (PENNSYLVANIA LIMITED LIABILITY COMPANY)  
520 PINETOWN ROAD  
FORT WASHINGTON, PA 19034

FOR: PROVIDING ONLINE INSTANT MESSAGING SERVICES AND E-MAILING SERVICES, NAMELY, FOR STUDENTS TO FIND COLLEGE ROOMMATES AND FRIENDS WITH SIMILAR INTERESTS, IN CLASS 38 (U.S. CLS. 100, 101 AND 104).

FIRST USE 1-5-2012; IN COMMERCE 1-5-2012.

FOR: COMPUTER SERVICES, NAMELY, HOSTING ONLINE WEB FACILITIES FOR FINDING COLLEGE ROOMMATES AND FRIENDS WITH SIMILAR INTERESTS FOR THE PURPOSE OF ORGANIZING AND CONDUCTING ONLINE MEETINGS, GATHERINGS, AND INTERACTIVE DISCUSSIONS; COMPUTER SERVICES IN THE NATURE OF CUSTOMIZED WEB PAGES FEATURING USER-DEFINED INFORMATION, PERSONAL PROFILES, PHOTOS AND INFORMATION, IN CLASS 42 (U.S. CLS. 100 AND 101).

FIRST USE 1-5-2012; IN COMMERCE 1-5-2012.

THE MARK CONSISTS OF THE WORD "DORM" WHICH APPEARS IN LOWERCASE LETTERS ABOVE THE WORD "BUNKIE", WHICH ALSO APPEARS IN LOWERCASE LETTERS. THE WORD "DORM" IS LINED UP TO APPEAR ABOVE THE "UNKIE" PART OF THE WORD "BUNKIE", SO THAT THE "R" IN "DORM" IS CONNECTED IN A STRAIGHT LINE WITH THE "K" IN "BUNKIE". THE LETTER "E" AT THE END OF THE WORD "BUNKIE" IS ON AN ANGLE.

SN 85-095,363, FILED 7-28-2010.

CHARLES L. JENKINS, EXAMINING ATTORNEY



*David J. Kybas*

Director of the United States Patent and Trademark Office

# United States of America

United States Patent and Trademark Office



**Reg. No. 4,126,215**

**Registered Apr. 10, 2012**

**Int. Cl.: 35**

APARTMENT OWNERS ASSOCIATION OF CALIFORNIA, INC. (CALIFORNIA CORPORATION)  
SUITE 300  
6445 SEPULVEDA BLVD.  
VAN NUYS, CA 91411

**SERVICE MARK**

FOR: ASSOCIATION SERVICES, MAINLY, PROMOTING THE INTERESTS OF LANDLORDS AND RENTAL HOUSING PROVIDERS, IN CLASS 35 (U.S. CLS. 100, 101 AND 102).

**PRINCIPAL REGISTER**

FIRST USE 1-1-1982; IN COMMERCE 1-1-1982.

NO CLAIM IS MADE TO THE EXCLUSIVE RIGHT TO USE "APARTMENT OWNERS ASSOCIATION OF CALIFORNIA, INC", APART FROM THE MARK AS SHOWN.

THE COLOR(S) BLUE, RED, BLACK & WHITE IS/ARE CLAIMED AS A FEATURE OF THE MARK.

THE MARK CONSISTS OF THE LITERAL ELEMENT "AOA APARTMENT OWNERS ASSOCIATION OF CALIFORNIA, INC." AND DESIGN ELEMENTS CONSISTING OF A SINGLE OVAL BORDER AND A HORIZONTAL QUADRILATERAL, WHEREIN THE LETTERS "AOA" ARE LOCATED ABOVE THE RED-COLORED HORIZONTAL QUADRILATERAL, THE LETTERS APPEARING IN UPPERCASE BLOCK LETTERS IN THE COLOR WHITE AND OUTLINED IN THE COLOR BLUE WITH BLUE COLOR SHADOWING, AND WHEREIN FURTHER THE TERMS "APARTMENT OWNERS ASSOCIATION OF CALIFORNIA, INC." ARE LOCATED BELOW THE RED-COLORED HORIZONTAL QUADRILATERAL AND APPEAR IN UPPER- AND LOWERCASE LETTERS IN THE COLOR BLACK. THE LITERAL ELEMENT AND THE HORIZONTAL QUADRILATERAL DESIGN ELEMENT ARE SUPERIMPOSED UPON A WHITE BACKGROUND AND CIRCUMSCRIBED BY THE SINGLE OVAL BORDER WHICH APPEARS IN THE COLOR RED.



SN 85-096,270, FILED 7-29-2010.

RONALD DELGIZZI, EXAMINING ATTORNEY

*David J. Kyffers*

Director of the United States Patent and Trademark Office

# United States of America

United States Patent and Trademark Office



**Reg. No. 4,126,216**

ANGEL, LUZ (UNITED STATES INDIVIDUAL)  
6550 SW 7TH COURT  
NORTH LAUDERDALE, FL 33068

**Registered Apr. 10, 2012**

**Int. Cl.: 42**

FOR: CUSTOM DESIGN OF WEARABLE APPAREL, SKATEBOARDS, SCHOOL SUPPLIES,  
AND BOOKBAGS BASED ON PERSONAL SELECTIONS MADE BY THE CUSTOMER, IN  
CLASS 42 (U.S. CLS. 100 AND 101).

**SERVICE MARK**

FIRST USE 7-10-2010; IN COMMERCE 6-4-2011.

**PRINCIPAL REGISTER**

THE MARK CONSISTS OF THE STYLIZED TEXT "PLA".

SN 85-096,680, FILED 7-30-2010.

JULIE GUTTADAURO, EXAMINING ATTORNEY



*David J. Kybas*

Director of the United States Patent and Trademark Office



# United States of America

United States Patent and Trademark Office

# UNICORN

**Reg. No. 4,126,217**

GE HEALTHCARE BIO-SCIENCES AB (SWEDEN LIMITED LIABILITY COMPANY)  
30 BJORKGATAN

**Registered Apr. 10, 2012**

UPPSALA, SWEDEN SE-75184

**Int. Cl.: 9**

FOR: COMPUTER SOFTWARE FOR CONTROLLING AUTOMATED LIQUID HANDLING SYSTEMS, NAMELY, CHROMATOGRAPHY SYSTEMS, FILTRATION SYSTEMS, BIO REACTORS AND OLIGONUCLEOTIDE SYNTHESIZERS, IN CLASS 9 (U.S. CLS. 21, 23, 26, 36 AND 38).

**TRADEMARK**

**PRINCIPAL REGISTER**

FIRST USE 6-14-2011; IN COMMERCE 6-14-2011.

THE MARK CONSISTS OF STANDARD CHARACTERS WITHOUT CLAIM TO ANY PARTICULAR FONT, STYLE, SIZE, OR COLOR.

OWNER OF U.S. REG. NO. 1,930,850.

SN 85-096,874, FILED 7-30-2010.

EVELYN BRADLEY, EXAMINING ATTORNEY



*David J. Kyjars*

Director of the United States Patent and Trademark Office

# United States of America

United States Patent and Trademark Office

# ZIMA

**Reg. No. 4,126,218**

**Registered Apr. 10, 2012**

**Int. Cl.: 31**

**TRADEMARK**

**PRINCIPAL REGISTER**

MASTRONARDI PRODUCE LTD. (CANADA CORPORATION)  
C/O KOENIG & ASSOCIATES  
920 GARDEN STREET, SUITE A  
SANTA BARBARA, CA 93101

FOR: FRESH TOMATOES; RAW TOMATOES; UNPROCESSED TOMATOES, IN CLASS 31  
(U.S. CLS. 1 AND 46).

FIRST USE 11-30-2010; IN COMMERCE 11-30-2010.

THE MARK CONSISTS OF STANDARD CHARACTERS WITHOUT CLAIM TO ANY PARTICULAR FONT, STYLE, SIZE, OR COLOR.

PRIORITY CLAIMED UNDER SEC. 44(D) ON CANADA APPLICATION NO. 1478361, FILED 4-26-2010, REG. NO. TMA798116, DATED 5-20-2011, EXPIRES 5-20-2026.

SN 85-097,165, FILED 7-30-2010.

HANNO RITTNER, EXAMINING ATTORNEY



*David J. Kyffers*

Director of the United States Patent and Trademark Office

# United States of America

United States Patent and Trademark Office



**Reg. No. 4,126,219**

**Registered Apr. 10, 2012**

**Int. Cl.: 33**

**TRADEMARK**

**PRINCIPAL REGISTER**

PROXIMO SPIRITS, INC. (DELAWARE CORPORATION)  
333 WASHINGTON STREET  
JERSEY CITY, NJ 07302

FOR: ALCOHOLIC BEVERAGES, EXCEPT BEERS, IN CLASS 33 (U.S. CLS. 47 AND 49).

FIRST USE 1-24-2007; IN COMMERCE 1-24-2007.

OWNER OF U.S. REG. NO. 3,295,856.

THE COLOR(S) SILVER, BLACK, AND LIGHT BROWN IS/ARE CLAIMED AS A FEATURE OF THE MARK.

NO CLAIM IS MADE TO THE EXCLUSIVE RIGHT TO USE "COLORADO WHISKEY" AND THE COLOR DARK BROWN FOUND INSIDE THE BOTTLE, APART FROM THE MARK AS SHOWN.

WHILE THE MARK CONTAINS THE COLORS DARK BROWN, SILVER, BLACK AND LIGHT BROWN, ONLY THE COLORS SILVER, BLACK, AND LIGHT BROWN ARE CLAIMED AS FEATURES OF THE MARK. THE MARK CONSISTS OF A CONFIGURATION OF PACKAGING OF THE GOODS, NAMELY, A BOTTLE WITH THE TERM "STRANAHAN'S" IN SCRIPT APPEARING IN BLACK ON A SILVER CAP, AND ACROSS THE BODY OF THE BOTTLE APPEARS A LIGHT BROWN LABEL POSITIONED DIAGONALLY CONTAINING THE TERM "STRANAHAN'S" IN SCRIPT IN BLACK, THE WORDS "COLORADO WHISKEY" IN BLACK, THE WORDS "COLORADO'S ORIGINAL" IN BLACK AND A DEPICTION OF A BARREL IN BLACK. A DARK BROWN LIQUID IS SHOWN INSIDE THE BOTTLE TO INDICATE LOCATION OF THE GOODS BUT NEITHER THE DARK BROWN COLOR OF THE LIQUID NOR THE OVERALL BOTTLE AND CAP SHAPE ARE CLAIMED AS FEATURES OF THE MARK.

SN 85-097,252, FILED 7-30-2010.

MAYUR VAGHANI, EXAMINING ATTORNEY



*David J. Kyffers*

Director of the United States Patent and Trademark Office

# United States of America

United States Patent and Trademark Office

# Blue Sky MD

**Reg. No. 4,126,220**

**Registered Apr. 10, 2012**

**Int. Cl.: 44**

**SERVICE MARK**

**PRINCIPAL REGISTER**

BLUE SKY MD, LLC (TENNESSEE LIMITED LIABILITY COMPANY)  
7105 CROSSROADS BLVD. SUITE 105  
BRENTWOOD, TN 37027

FOR: MEDICAL CLINIC PROVIDING WEIGHT LOSS SOLUTIONS, SERVICES AND PROGRAMS, NUTRITION COUNSELING, HORMONE THERAPY, INCLUDING, BIOIDENTICAL HORMONE REPLACEMENT, ANTI AGING THERAPY, AND NATURAL HORMONE THERAPY, MEDICAL AESTHETIC PROCEDURES, INCLUDING, LASERHAIR REMOVAL, LASER PEELS, BOTULINUM TOXIN TREATMENTS, MICRODERMABRASION, LIPOSUCTION, VEIN TREATMENTS, VEIN THERAPY, CELLULITE TREATMENTS, BODY CONTOURING TREATMENTS, INJECTABLE FILLER TREATMENTS, FACIALS, AND SKIN CARE, IN CLASS 44 (U.S. CLS. 100 AND 101).

FIRST USE 8-0-2010; IN COMMERCE 8-0-2010.

THE MARK CONSISTS OF STANDARD CHARACTERS WITHOUT CLAIM TO ANY PARTICULAR FONT, STYLE, SIZE, OR COLOR.

NO CLAIM IS MADE TO THE EXCLUSIVE RIGHT TO USE "MD", APART FROM THE MARK AS SHOWN.

SN 85-097,780, FILED 8-2-2010.

JESSICA A. POWERS, EXAMINING ATTORNEY



*David J. Kyros*

Director of the United States Patent and Trademark Office

# United States of America

United States Patent and Trademark Office

# TouchPoint

**Reg. No. 4,126,221**

**Registered Apr. 10, 2012**

**Int. Cl.: 9**

**TRADEMARK**

**PRINCIPAL REGISTER**

CRESTRON ELECTRONICS INC. (NEW JERSEY CORPORATION)  
15 VOLVO DRIVE  
ROCKLEIGH, NJ 07647

FOR: COMPUTER OPERATING SOFTWARE FOR NAVIGATING SYSTEMS, NAMELY, AUDIO, VIDEO, LIGHTING, SECURITY, POWER AND UTILITIES MANAGEMENT SYSTEMS ALL IN AN INTEGRATED COMPUTER AND TOUCH PANEL ENVIRONMENT VIA A GRAPHICAL USER INTERFACE INCLUDING A VIRTUAL MOUSE AND VIRTUAL KEYBOARD, IN CLASS 9 (U.S. CLS. 21, 23, 26, 36 AND 38).

FIRST USE 8-1-2010; IN COMMERCE 8-6-2010.

THE MARK CONSISTS OF STANDARD CHARACTERS WITHOUT CLAIM TO ANY PARTICULAR FONT, STYLE, SIZE, OR COLOR.

SN 85-098,187, FILED 8-2-2010.

BERYL GARDNER, EXAMINING ATTORNEY



*David J. Kyffers*

Director of the United States Patent and Trademark Office

# United States of America

United States Patent and Trademark Office



**Reg. No. 4,126,222**

**Registered Apr. 10, 2012**

**Int. Cl.: 25**

**TRADEMARK**

**PRINCIPAL REGISTER**

COMERCIAL DEXIM LTDA (CHILE SOCIEDADE POR QUOTAS DE RESPONSABILIDADE LIMITADA (LTDA))  
MONJITAS 887 COMUNA DE SANTIAGO  
SANTIAGO, CHILE

FOR: FOOTWEAR, IN CLASS 25 (U.S. CLS. 22 AND 39).

FIRST USE 1-15-2012; IN COMMERCE 1-15-2012.

THE MARK CONSISTS OF A "B" APPEARING IN WHITE AND OUTLINED IN BLACK, WITH THE CENTER OF THE "B" FILLED IN WITH BLACK. THE LETTER "B" IS SURROUNDED BY A BLACK CIRCLE WITH A WHITE INTERIOR, ABOVE THE STYLIZED WORD "BAMERS", WITH THE "B" APPEARING IN BLUE, THE "A" APPEARING IN PINK, THE "M" APPEARING IN GREEN, THE "E" APPEARING IN YELLOW, THE "R" APPEARING IN ORANGE AND THE "S" APPEARING IN RED. THE WHITE INSIDE THE CIRCLE AND THE LETTER "B" ARE PART OF THE MARK, BUT THE REST OF THE WHITE IS NOT PART OF THE MARK AND REPRESENTS BACKGROUND AREA.

THE COLOR(S) BLACK, WHITE, BLUE, PINK, GREEN, YELLOW, ORANGE, AND RED IS/ARE CLAIMED AS A FEATURE OF THE MARK.

SN 85-098,324, FILED 8-2-2010.

ELLEN B. AWRICH, EXAMINING ATTORNEY



*David J. Kybas*

Director of the United States Patent and Trademark Office

# United States of America

United States Patent and Trademark Office

*Earth Green*   
Carpet Clean

**Reg. No. 4,126,223**

ROYAL SERVICES OF THE TRIAD, INC (NORTH CAROLINA CORPORATION)  
4033 BANOAK ST  
HIGH POINT, NC 27265

**Registered Apr. 10, 2012**

**Int. Cl.: 37**

FOR: ENVIRONMENTALLY FRIENDLY CARPET CLEANING, IN CLASS 37 (U.S. CLS. 100, 103 AND 106).

**SERVICE MARK**

FIRST USE 8-0-2011; IN COMMERCE 8-0-2011.

**PRINCIPAL REGISTER**

NO CLAIM IS MADE TO THE EXCLUSIVE RIGHT TO USE "GREEN CARPET CLEAN", APART FROM THE MARK AS SHOWN.

THE MARK CONSISTS OF A FROG WITH HIS ARMS WRAPPED AROUND THE EARTH. TO THE LEFT THERE IS THE STYLIZED TEXT "EARTH GREEN CARPET CLEAN".

SN 85-098,486, FILED 8-2-2010.

ROBERT STRUCK, EXAMINING ATTORNEY



*David J. Kybas*

Director of the United States Patent and Trademark Office

# United States of America

United States Patent and Trademark Office

# LLI

**Reg. No. 4,126,224**

**Registered Apr. 10, 2012**

**Int. Cl.: 1**

**TRADEMARK**

**PRINCIPAL REGISTER**

RIZOBACTER ARGENTINA S.A. (ARGENTINA CORPORATION)  
AVENIDA DR. ARTURO FRONDIZI 1150  
PERGAMINO, ARGENTINA B2702HDA

FOR: INOCULANTS, NAMELY, BIOLOGICAL MICROORGANISMS USED IN FERMENTATION OF SILAGE; NATURAL FERTILIZERS; NON-CHEMICAL BIO-FERTILIZERS , IN CLASS 1 (U.S. CLS. 1, 5, 6, 10, 26 AND 46).

FIRST USE 12-1-2008; IN COMMERCE 12-1-2011.

THE MARK CONSISTS OF STANDARD CHARACTERS WITHOUT CLAIM TO ANY PARTICULAR FONT, STYLE, SIZE, OR COLOR.

SN 85-098,604, FILED 8-3-2010.

PAM WILLIS, EXAMINING ATTORNEY



*David J. Kyffers*

Director of the United States Patent and Trademark Office



# United States of America

United States Patent and Trademark Office



## KRIEG AG

**Reg. No. 4,126,225**

**Registered Apr. 10, 2012**

**Int. Cl.: 9**

**TRADEMARK**

**PRINCIPAL REGISTER**

CRAKE, WILLIAM M. (UNITED STATES INDIVIDUAL)  
911 DEBOLL  
HOUSTON, TX 77022

FOR: ELECTRIC METERS; GAS METERS; WATER METERS; ELECTRIC FUSE BOXES; CIRCUIT BREAKERS; ELECTRIC WIRES AND CABLES, IN CLASS 9 (U.S. CLS. 21, 23, 26, 36 AND 38).

FIRST USE 1-12-2012; IN COMMERCE 1-12-2012.

THE MARK CONSISTS OF AN ABSTRACT TOWER DESIGN IN BLACK WITH TWO WINDOWS IN THE MIDDLE AND A GATE AT THE BOTTOM OF THE DESIGN. AT THE TOP OF THE TOWER ARE REDDISH ORANGE FLAMES. DIRECTLY BENEATH THE DESIGN IS THE PHRASE "KRIEG AG" IN STYLIZED BLACK LETTERING. THE COLOR WHITE IS USED TO INDICATE BACKGROUND OR TRANSPARENT PORTIONS AND IS NOT PART OF THE MARK.

THE COLOR(S) REDDISH ORANGE AND BLACK IS/ARE CLAIMED AS A FEATURE OF THE MARK.

THE ENGLISH TRANSLATION OF "KRIEG" IN THE MARK IS "WAR".

SN 85-099,263, FILED 8-3-2010.

DAVID HOFFMAN, EXAMINING ATTORNEY



*David J. Kybas*

Director of the United States Patent and Trademark Office

# United States of America

United States Patent and Trademark Office

# ACTIFRESH

**Reg. No. 4,126,226**

**Registered Apr. 10, 2012**

**Int. Cl.: 3**

**TRADEMARK**

**PRINCIPAL REGISTER**

PURE & NATURAL COMPANY (ARIZONA CORPORATION)  
MS 04.50  
19001 NORTH SCOTTSDALE ROAD  
SCOTTSDALE, AZ 85255

FOR: FABRIC SOFTENERS, IN CLASS 3 (U.S. CLS. 1, 4, 6, 50, 51 AND 52).

FIRST USE 10-2-2011; IN COMMERCE 10-2-2011.

THE MARK CONSISTS OF STANDARD CHARACTERS WITHOUT CLAIM TO ANY PARTICULAR FONT, STYLE, SIZE, OR COLOR.

SN 85-099,729, FILED 8-4-2010.

VIVIAN MICZNIK FIRST, EXAMINING ATTORNEY



*David J. Kybas*

Director of the United States Patent and Trademark Office

# United States of America

United States Patent and Trademark Office

## Presenting a Losing Proposition

**Reg. No. 4,126,227**

PURE INVENTIONS, LLC (NEW JERSEY LIMITED LIABILITY COMPANY)  
64 B GRANT PLACE  
LITTLE SILVER, NJ 07739

**Registered Apr. 10, 2012**

**Int. Cl.: 32**

FOR: ALL NATURAL FRUIT JUICES, BOTTLED DRINKING WATER, SPRING WATER AND MINERAL WATER, NON-ALCOHOLIC BEVERAGES FLAVORED BY TEA, SPORTS DRINKS AND POWDER MIXES FOR USE IN THE PREPARATION OF ENERGY SOFT DRINKS, IN CLASS 32 (U.S. CLS. 45, 46 AND 48).

**TRADEMARK**

**PRINCIPAL REGISTER**

FIRST USE 1-1-2011; IN COMMERCE 1-1-2011.

THE MARK CONSISTS OF STANDARD CHARACTERS WITHOUT CLAIM TO ANY PARTICULAR FONT, STYLE, SIZE, OR COLOR.

SN 85-099,793, FILED 8-4-2010.

EDWARD NELSON, EXAMINING ATTORNEY



*David J. Kyffers*

Director of the United States Patent and Trademark Office

# United States of America

United States Patent and Trademark Office

# AC SMART

**Reg. No. 4,126,228**

LG ELECTRONICS INC. (REPUBLIC OF KOREA CORPORATION)  
20 YEOUIDO-DONG YEONGDEUNGPO-GU  
SEOUL, REPUBLIC OF KOREA 150-721

**Registered Apr. 10, 2012**

**Int. Cl.: 11**

FOR: AIR PURIFYING APPARATUS; AIR CONDITIONERS; HOT AIR BLOWERS, IN CLASS 11 (U.S. CLS. 13, 21, 23, 31 AND 34).

**TRADEMARK**

FIRST USE 1-2-2012; IN COMMERCE 1-2-2012.

**PRINCIPAL REGISTER**

THE MARK CONSISTS OF STANDARD CHARACTERS WITHOUT CLAIM TO ANY PARTICULAR FONT, STYLE, SIZE, OR COLOR.

NO CLAIM IS MADE TO THE EXCLUSIVE RIGHT TO USE "AC", APART FROM THE MARK AS SHOWN.

SN 85-100,154, FILED 8-4-2010.

IRA J. GOODSaid, EXAMINING ATTORNEY



*David J. Kyffers*

Director of the United States Patent and Trademark Office

# United States of America

United States Patent and Trademark Office

## Multi V SPACE

**Reg. No. 4,126,229**

LG ELECTRONICS INC. (REPUBLIC OF KOREA CORPORATION)  
20 YEUIDO-DONG YEONGDEUNGPO-GU  
SEOUL, REPUBLIC OF KOREA 150-721

**Registered Apr. 10, 2012**

**Int. Cl.: 11**

FOR: AIR PURIFYING APPARATUS; AIR CONDITIONERS; HOT AIR BLOWERS, IN CLASS  
11 (U.S. CLS. 13, 21, 23, 31 AND 34).

**TRADEMARK**

FIRST USE 1-2-2012; IN COMMERCE 1-2-2012.

**PRINCIPAL REGISTER**

THE MARK CONSISTS OF STANDARD CHARACTERS WITHOUT CLAIM TO ANY PAR-  
TICULAR FONT, STYLE, SIZE, OR COLOR.

SN 85-100,182, FILED 8-4-2010.

IRA J. GOODSaid, EXAMINING ATTORNEY



*David J. Kyros*

Director of the United States Patent and Trademark Office

# United States of America

United States Patent and Trademark Office



**Reg. No. 4,126,230**

**Registered Apr. 10, 2012**

**Int. Cl.: 30**

**TRADEMARK**

**PRINCIPAL REGISTER**

VISION'S SOWN, AN ANCIENT BAKING COMPANY (MASSACHUSETTS CORPORATION)  
40 PETERBOROUGH STREET, APT. 44  
BOSTON, MA 02215

FOR: COOKIES, IN CLASS 30 (U.S. CL. 46).

FIRST USE 1-18-2011; IN COMMERCE 1-18-2011.

NO CLAIM IS MADE TO THE EXCLUSIVE RIGHT TO USE "AN ANCIENT BAKING COMPANY", APART FROM THE MARK AS SHOWN.

THE COLOR(S) BROWN, RED, LIGHT BLUE, TAN, YELLOW, AND GREEN IS/ARE CLAIMED AS A FEATURE OF THE MARK.

THE NON-LATIN CHARACTERS IN THE MARK transliterate to "ANKH WEDJA SENEB" AND THIS MEANS "LIFE, PROSPERITY, HEALTH" IN ENGLISH.

THE NAME(S), PORTRAIT(S), AND/OR SIGNATURE(S) SHOWN IN THE MARK DOES NOT IDENTIFY A PARTICULAR LIVING INDIVIDUAL.

THE MARK CONSISTS OF THE WORDS "LIFE, PROSPERITY, HEALTH" IN BROWN AT THE TOP CENTER IN SMALL SIZE; IN LARGE RED LETTERS THE WORDS "VISION'S SOWN" WITH THE "O"'S BEING REPRESENTED BY LIGHT BLUE FLOWERS WITH YELLOW CENTERS AND GREEN STEMS; ON EITHER SIDE A KNEELING HUMAN FIGURE WITH TAN SKIN AND BROWN FACIAL FEATURES AND LIGHT BLUE CLOTHES DEPICTED AS WORKING WITH TAN AND BROWN BAKING TOOLS, THE FIGURE ON THE RIGHT WITH BROWN HAIR, UNDERNEATH EACH FIGURE A BROWN OVAL WITH THREE BROWN HIEROGLYPHS; BETWEEN THE HIEROGLYPHS A LIGHT BLUE BANNER WITH BROWN BORDER WITH THE WORDS "AN ANCIENT BAKING COMPANY" WRITTEN OVER IT IN BROWN; UNDERNEATH THE BANNER THE WORDS "ANKH WEDJA SENEB" IN BROWN.

THE ENGLISH TRANSLATION OF "ANKH WEDJA SENEB" IN THE MARK IS "LIFE, PROSPERITY, HEALTH".

SN 85-100,841, FILED 8-5-2010.



*David J. Kyffers*

Director of the United States Patent and Trademark Office

**Reg. No. 4,126,230** RENEE MCCRAY, EXAMINING ATTORNEY

# United States of America

United States Patent and Trademark Office

# LAKER

**Reg. No. 4,126,231**

**Registered Apr. 10, 2012**

**Int. Cl.: 9**

**TRADEMARK**

**PRINCIPAL REGISTER**

SPRINGSOFT INC. (TAIWAN CORPORATION)  
25, INDUSTRY EAST ROAD IV  
SCIENCE BASED INDUSTRIAL PARK  
HSINCHU, TAIWAN 300 AND

SPRINGSOFT USA, INC. (CALIFORNIA CORPORATION)  
1732 NORTH FIRST STREET, STE #200  
SAN JOSE, CA 95112

FOR: ELECTRONIC DESIGN AUTOMATION COMPUTER PROGRAMS ON COMPACT DISCS, DVDS, AND FLASH MEMORY CARDS, AND INSTRUCTION MANUALS SOLD AS A UNIT, IN CLASS 9 (U.S. CLS. 21, 23, 26, 36 AND 38).

FIRST USE 11-15-2001; IN COMMERCE 12-29-2003.

THE MARK CONSISTS OF STANDARD CHARACTERS WITHOUT CLAIM TO ANY PARTICULAR FONT, STYLE, SIZE, OR COLOR.

SN 85-101,626, FILED 8-6-2010.

CURTIS FRENCH, EXAMINING ATTORNEY



*David J. Kypos*

Director of the United States Patent and Trademark Office



# United States of America

United States Patent and Trademark Office

# CALL-HEAR

**Reg. No. 4,126,232**

STEP-HEAR (ISRAEL CORPORATION)  
153 YIGAL ALON ST.  
TEL AVIV 67443, ISRAEL

**Registered Apr. 10, 2012**

**Int. Cl.: 9**

FOR: TELEPHONE SETS, TELEPHONE APPARATUS AND RECEIVERS, TELEPHONE TRANSMITTERS, INTERCOMS, PAGING EQUIPMENT, PERIPHERAL COMPONENT INTERFACE PCI HARDWARE, MICROPHONES FOR COMMUNICATION DEVICES AND GPS/GSM TRACKING DEVICES, AND INTERCOMS, IN CLASS 9 (U.S. CLS. 21, 23, 26, 36 AND 38).

**TRADEMARK**

**PRINCIPAL REGISTER**

FIRST USE 8-10-2010; IN COMMERCE 2-2-2012.

THE MARK CONSISTS OF STANDARD CHARACTERS WITHOUT CLAIM TO ANY PARTICULAR FONT, STYLE, SIZE, OR COLOR.

SN 85-101,879, FILED 8-6-2010.

LINDA POWELL, EXAMINING ATTORNEY



*David J. Kyffers*

Director of the United States Patent and Trademark Office

# United States of America

United States Patent and Trademark Office

# Road Rash

**Reg. No. 4,126,233**

DR. COLORCHIP CORPORATION (FLORIDA CORPORATION)  
1339 SOUTH KILLIAN DRIVE, SUITE #1  
LAKE PARK, FL 33403

**Registered Apr. 10, 2012**

**Int. Cl.: 2**

FOR: PAINT CHIP REPAIR KIT FOR USE IN REPAIRING SCRATCHES AND CHIPS ON VEHICLES COMPRISING PAINT, BRUSH APPLICATOR, BLENDING AGENT, NITRILE GLOVE, WIPING CLOTH AND INSTRUCTION MANUALS SOLD AS A UNIT THEREWITH, IN CLASS 2 (U.S. CLS. 6, 11 AND 16).

**TRADEMARK**

**PRINCIPAL REGISTER**

FIRST USE 11-1-2011; IN COMMERCE 1-15-2012.

THE MARK CONSISTS OF STANDARD CHARACTERS WITHOUT CLAIM TO ANY PARTICULAR FONT, STYLE, SIZE, OR COLOR.

SN 85-102,710, FILED 8-8-2010.

HOWARD SMIGA, EXAMINING ATTORNEY



*David J. Kyffers*

Director of the United States Patent and Trademark Office

# United States of America

United States Patent and Trademark Office

ONLY YOU KNOW YOU'RE THERE

**Reg. No. 4,126,234**

GHOST SCENT CO. (NORTH CAROLINA CORPORATION)  
239 SOUTH MAIN STREET  
MARION, NC 28752

**Registered Apr. 10, 2012**

**Int. Cl.: 28**

FOR: HUNTING AND OUTDOOR RECREATION PRODUCTS, NAMELY, HUNTING GAME CALLS AND SCENT CAMOUFLAGE PRODUCTS, NAMELY, HUNTERS' SCENT CAMOUFLAGE AND ANIMAL URINES, IN CLASS 28 (U.S. CLS. 22, 23, 38 AND 50).

**TRADEMARK**

FIRST USE 10-0-2009; IN COMMERCE 10-0-2009.

**PRINCIPAL REGISTER**

THE MARK CONSISTS OF STANDARD CHARACTERS WITHOUT CLAIM TO ANY PARTICULAR FONT, STYLE, SIZE, OR COLOR.

SN 85-103,053, FILED 8-9-2010.

BARBARA GAYNOR, EXAMINING ATTORNEY



*David J. Kybas*

Director of the United States Patent and Trademark Office

# United States of America

United States Patent and Trademark Office

## AMERICAN GIRL

**Reg. No. 4,126,235**

**Registered Apr. 10, 2012**

**Int. Cl.: 35**

**SERVICE MARK**

**PRINCIPAL REGISTER**

AMERICAN GIRL, LLC (DELAWARE LIMITED LIABILITY COMPANY)  
M1-1518  
333 CONTINENTAL BOULEVARD  
EL SEGUNDO, CA 90245

FOR: COMPUTERIZED ONLINE ORDERING SERVICES IN THE FIELD OF TOYS, GAMES AND PLAYTHINGS; ELECTRONIC COMMERCE SERVICES, NAMELY, PROVIDING INFORMATION ABOUT PRODUCTS VIA TELECOMMUNICATION NETWORKS FOR ADVERTISING AND SALES PURPOSES, IN CLASS 35 (U.S. CLS. 100, 101 AND 102).

FIRST USE 8-12-1999; IN COMMERCE 8-12-1999.

THE MARK CONSISTS OF STANDARD CHARACTERS WITHOUT CLAIM TO ANY PARTICULAR FONT, STYLE, SIZE, OR COLOR.

OWNER OF U.S. REG. NOS. 1,269,348, 1,966,430, AND OTHERS.

SN 85-104,532, FILED 8-10-2010.

DANNEAN HETZEL, EXAMINING ATTORNEY



*David J. Kyffers*

Director of the United States Patent and Trademark Office

# United States of America

United States Patent and Trademark Office

## AMERICAN GIRL

**Reg. No. 4,126,236**

**Registered Apr. 10, 2012**

**Int. Cl.: 42**

**SERVICE MARK**

**PRINCIPAL REGISTER**

AMERICAN GIRL, LLC (DELAWARE LIMITED LIABILITY COMPANY)  
M1-1518  
333 CONTINENTAL BOULEVARD  
EL SEGUNDO, CA 90245

FOR: COMPUTER SERVICES, NAMELY, CREATING AN ONLINE COMMUNITY FOR REGISTERED USERS TO PARTICIPATE IN DISCUSSIONS, GET FEEDBACK FROM PEERS AND ENGAGE IN SOCIAL NETWORKING, IN CLASS 42 (U.S. CLS. 100 AND 101).

FIRST USE 7-25-2011; IN COMMERCE 7-25-2011.

THE MARK CONSISTS OF STANDARD CHARACTERS WITHOUT CLAIM TO ANY PARTICULAR FONT, STYLE, SIZE, OR COLOR.

OWNER OF U.S. REG. NOS. 1,269,348, 1,966,430, AND OTHERS.

SN 85-104,535, FILED 8-10-2010.

DANNEAN HETZEL, EXAMINING ATTORNEY



*David J. Kybas*

Director of the United States Patent and Trademark Office

# United States of America

United States Patent and Trademark Office

## GLIDE & SHINE

**Reg. No. 4,126,237**

BISELL HOMECARE, INC. (MICHIGAN CORPORATION)  
2345 WALKER AVENUE NW  
GRAND RAPIDS, MI 49544

**Registered Apr. 10, 2012**

**Int. Cl.: 21**

FOR: MOPS, IN CLASS 21 (U.S. CLS. 2, 13, 23, 29, 30, 33, 40 AND 50).

**TRADEMARK**

FIRST USE 9-30-2011; IN COMMERCE 9-30-2011.

**PRINCIPAL REGISTER**

THE MARK CONSISTS OF STANDARD CHARACTERS WITHOUT CLAIM TO ANY PARTICULAR FONT, STYLE, SIZE, OR COLOR.

SN 85-104,908, FILED 8-11-2010.

AMY KERTGATE, EXAMINING ATTORNEY



*David J. Kybas*

Director of the United States Patent and Trademark Office

# United States of America

United States Patent and Trademark Office

## STOP YOUR WORLD

**Reg. No. 4,126,238**

**Registered Apr. 10, 2012**

**Int. Cl.: 30**

**TRADEMARK**

**PRINCIPAL REGISTER**

KRAFT FOODS GLOBAL BRANDS LLC (DELAWARE LIMITED LIABILITY COMPANY)  
THREE LAKES DRIVE  
NORTHFIELD, IL 60093

FOR: COFFEE AND TEA, IN CLASS 30 (U.S. CL. 46).

FIRST USE 11-30-2011; IN COMMERCE 11-30-2011.

THE MARK CONSISTS OF STANDARD CHARACTERS WITHOUT CLAIM TO ANY PARTICULAR FONT, STYLE, SIZE, OR COLOR.

SN 85-105,797, FILED 8-12-2010.

ANNE MADDEN, EXAMINING ATTORNEY



*David J. Kyffers*

Director of the United States Patent and Trademark Office

# United States of America

United States Patent and Trademark Office

## WHO, WHAT, WHERE, WHEN AND WHY IN THE WORLD OF STYLE

**Reg. No. 4,126,239**

ADVANCE MAGAZINE PUBLISHERS INC. (NEW YORK CORPORATION)  
4 TIMES SQUARE  
NEW YORK, NY 10036

**Registered Apr. 10, 2012**

**Int. Cls.: 9 and 16**

FOR: DOWNLOADABLE MAGAZINES IN THE FIELD OF WOMEN'S FASHION AND LIFESTYLE, IN CLASS 9 (U.S. CLS. 21, 23, 26, 36 AND 38).

**TRADEMARK**

FIRST USE 11-30-2011; IN COMMERCE 11-30-2011.

**PRINCIPAL REGISTER**

FOR: MAGAZINES IN THE FIELD OF WOMEN'S FASHION AND LIFESTYLE, IN CLASS 16 (U.S. CLS. 2, 5, 22, 23, 29, 37, 38 AND 50).

FIRST USE 9-30-2010; IN COMMERCE 9-30-2010.

THE MARK CONSISTS OF STANDARD CHARACTERS WITHOUT CLAIM TO ANY PARTICULAR FONT, STYLE, SIZE, OR COLOR.

SN 85-106,266, FILED 8-12-2010.

ELISSA GARBER KON, EXAMINING ATTORNEY



*David J. Kybas*

Director of the United States Patent and Trademark Office



# United States of America

United States Patent and Trademark Office

# Ilusión

**Reg. No. 4,126,240**

**Registered Apr. 10, 2012**

**Int. Cl.: 35**

**SERVICE MARK**

**PRINCIPAL REGISTER**

DILTEX, S.A. DE C.V. (MEXICO CORPORATION)  
AV PRIMERO DE MAYO NO. 125 A. COL.  
SAN ANDRES ATOTO C.P. 53510 NAUCALPAN  
DE JUAREZ, EDO. DE, MEXICO

FOR: ONLINE RETAIL STORE SERVICES FEATURING, LINGERIE, UNDERWEAR, BRAS, BODYSUITS, CHEMISES, CAMISOLES, SLIPS, CORSETS, BODICES, SLEEPWEAR, HOODED SWEATSHIRTS, SHIRTS, JACKETS, SWIMWEAR, SHORTS, BLOUSES, T-SHIRTS, TANK TOPS, JEANS, PANTS, DRESSES, SWEAT PANTS, LEGGINGS, IN CLASS 35 (U.S. CLS. 100, 101 AND 102).

FIRST USE 1-0-2010; IN COMMERCE 1-0-2010.

OWNER OF U.S. REG. NO. 2,249,819.

THE COLOR(S) PURPLE AND PINK IS/ARE CLAIMED AS A FEATURE OF THE MARK.

THE MARK CONSISTS OF THE LITERAL ELEMENT "ILUSION" AND A FIGURATIVE DESIGN OF A ROSE.

THE ENGLISH TRANSLATION OF "ILUSION" IN THE MARK IS ILLUSION.

SN 85-106,482, FILED 8-12-2010.

GINA FINK, EXAMINING ATTORNEY



*David J. Kybas*

Director of the United States Patent and Trademark Office

# United States of America

United States Patent and Trademark Office

# CAIPIONE

**Reg. No. 4,126,241**

**Registered Apr. 10, 2012**

**Int. Cls.: 30, 32, and 33**

**TRADEMARK**

**PRINCIPAL REGISTER**

NATURAL DRINKS S/A (BRAZIL CORPORATION)  
NO. 1726, CONJUNTO 91, SALA B  
AVE. PRESIDENTE JUSCELINO KUBITSCHEK  
SAO PAULO, BRAZIL

FOR: FROZEN DESSERT CONSISTING OF FRUIT AND CREAM OR CREAM SUBSTITUTES,  
IN CLASS 30 (U.S. CL. 46).

FIRST USE 5-2-2007; IN COMMERCE 1-19-2010.

FOR: CONCENTRATES, SYRUPS OR POWDERS USED IN THE PREPARATION OF SOFT  
DRINKS; FRUIT DRINKS AND FRUIT JUICES; NON-ALCOHOLIC BEVERAGES CONTAIN-  
ING FRUIT JUICES; NON-ALCOHOLIC BEVERAGES, NAMELY, CARBONATED BEVER-  
AGES; POWDERS USED IN THE PREPARATION OF FRUIT-BASED BEVERAGES; SYRUPS  
FOR BEVERAGES; SYRUPS FOR MAKING BEVERAGES; SYRUPS FOR MAKING FRUIT-  
FLAVORED DRINKS; SYRUPS FOR MAKING SOFT DRINKS, IN CLASS 32 (U.S. CLS. 45,  
46 AND 48).

FIRST USE 5-2-2007; IN COMMERCE 1-19-2010.

FOR: ALCOHOLIC BEVERAGES EXCEPT BEERS; DISTILLED SPIRITS, IN CLASS 33 (U.S.  
CLS. 47 AND 49).

FIRST USE 5-2-2007; IN COMMERCE 1-19-2010.

THE MARK CONSISTS OF STANDARD CHARACTERS WITHOUT CLAIM TO ANY PAR-  
TICULAR FONT, STYLE, SIZE, OR COLOR.

OWNER OF U.S. REG. NOS. 3,917,642 AND 3,917,643.

THE WORDING "CAIPIONE" HAS NO MEANING IN A FOREIGN LANGUAGE.

SN 85-107,472, FILED 8-13-2010.

CHRIS DONINGER, EXAMINING ATTORNEY



*David J. Kyros*

Director of the United States Patent and Trademark Office

# United States of America

United States Patent and Trademark Office

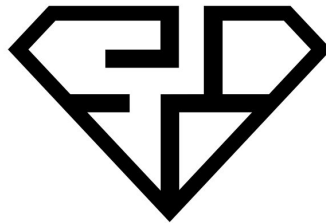

## SUPABEATZ

**Reg. No. 4,126,242**

GUZMAN, CHRISTIAN N (UNITED STATES INDIVIDUAL)  
15 ROXTON ST. APT. 2  
DORCHESTER, MA 02121 AND

**Registered Apr. 10, 2012**

**Int. Cl.: 41**

MONTAS, OMAR D (UNITED STATES INDIVIDUAL)  
APT. 1L  
64 ROSSETER ST.  
BOSTON, MA 02121

**SERVICE MARK**

**PRINCIPAL REGISTER**

FOR: MUSIC PRODUCTION SERVICES, IN CLASS 41 (U.S. CLS. 100, 101 AND 107).

FIRST USE 9-12-2010; IN COMMERCE 10-27-2010.

THE MARK CONSISTS OF THE LETTERS "S" AND "B" WITHIN A DIAMOND SHAPE, AND THE TERM "SUPABEATZ".

SN 85-107,742, FILED 8-14-2010.

BRIAN NEVILLE, EXAMINING ATTORNEY



*David J. Kybas*

Director of the United States Patent and Trademark Office

# United States of America

United States Patent and Trademark Office

## SIERRA WEST

**Reg. No. 4,126,243**

**Registered Apr. 10, 2012**

**Int. Cl.: 25**

**TRADEMARK**

**PRINCIPAL REGISTER**

THE WALKING COMPANY HOLDINGS, INC. (CALIFORNIA CORPORATION)  
25 W. ANAPAMU  
LEGAL DEPT.  
SANTA BARBARA, CA 93101

FOR: CLOTHING, FOOTWEAR, AND HEADWEAR, NAMELY, HATS, HEADGEAR, NAMELY, CAPS, SHOES, AND SOCKS, IN CLASS 25 (U.S. CLS. 22 AND 39).

FIRST USE 11-7-2010; IN COMMERCE 11-7-2010.

THE MARK CONSISTS OF STANDARD CHARACTERS WITHOUT CLAIM TO ANY PARTICULAR FONT, STYLE, SIZE, OR COLOR.

OWNER OF U.S. REG. NOS. 1,495,161 AND 1,986,750.

SN 85-107,888, FILED 8-16-2010.

CHRISTINE COOPER, EXAMINING ATTORNEY



*David J. Kybas*

Director of the United States Patent and Trademark Office

# United States of America

United States Patent and Trademark Office

# FEED

**Reg. No. 4,126,244**

FEED PROJECTS LLC (NEW YORK LIMITED LIABILITY COMPANY)  
420 WEST 14TH STREET, SUITE 6NE  
NEW YORK, NY 10014

**Registered Apr. 10, 2012**

**Int. Cls.: 8 and 21**

FOR: FLATWARE, NAMELY, FORKS, KNIVES, SPOONS, AND SPORKS, IN CLASS 8 (U.S. CLS. 23, 28 AND 44).

**TRADEMARK**

FIRST USE 3-1-2011; IN COMMERCE 3-1-2011.

**PRINCIPAL REGISTER**

FOR: HOUSEHOLD CONTAINERS FOR FOODS; STAINLESS STEEL WATER BOTTLES SOLD EMPTY, IN CLASS 21 (U.S. CLS. 2, 13, 23, 29, 30, 33, 40 AND 50).

FIRST USE 3-1-2011; IN COMMERCE 3-1-2011.

THE MARK CONSISTS OF STANDARD CHARACTERS WITHOUT CLAIM TO ANY PARTICULAR FONT, STYLE, SIZE, OR COLOR.

OWNER OF U.S. REG. NO. 3,526,344.

SN 85-108,019, FILED 8-16-2010.

JEFF DEFORD, EXAMINING ATTORNEY



*David J. Kybas*

Director of the United States Patent and Trademark Office

# United States of America

United States Patent and Trademark Office

## SNOMIST FAMILY VALUE

**Reg. No. 4,126,245**

**Registered Apr. 10, 2012**

**Int. Cl.: 29**

**TRADEMARK**

**PRINCIPAL REGISTER**

DULCICH, INC. (OREGON CORPORATION)  
16797 SE 130TH  
CLACKAMAS, OR 97015

FOR: FROZEN FISH AND SEAFOOD, IN CLASS 29 (U.S. CL. 46).

FIRST USE 10-31-2010; IN COMMERCE 10-31-2010.

THE MARK CONSISTS OF STANDARD CHARACTERS WITHOUT CLAIM TO ANY PARTICULAR FONT, STYLE, SIZE, OR COLOR.

NO CLAIM IS MADE TO THE EXCLUSIVE RIGHT TO USE "FAMILY VALUE", APART FROM THE MARK AS SHOWN.

SN 85-108,367, FILED 8-16-2010.

DEBRA LEE, EXAMINING ATTORNEY



*David J. Kyffers*

Director of the United States Patent and Trademark Office

# United States of America

United States Patent and Trademark Office

# POLE-SORB

**Reg. No. 4,126,246**

**Registered Apr. 10, 2012**

**Int. Cl.: 1**

**TRADEMARK**

**PRINCIPAL REGISTER**

VITAPAC (HK) INDUSTRIAL LIMITED (HONG KONG LIMITED LIABILITY COMPANY)  
58-76 TA CHUEN PING STREET, KWAI CHUNG  
UNIT 1107A, WELL FUNG INDUSTRIAL CENTER  
NEW TERRITORIES, HONG KONG

FOR: CALCIUM SALTS; CHLORINE; CONDENSATION PREVENTING CHEMICALS; DEHYDRATING PREPARATIONS FOR INDUSTRIAL PURPOSES, NAMELY, CALCIUM CHLORIDE FOR INDUSTRIAL PURPOSES; MOISTURE ABSORBING CHEMICAL SUBSTANCES; MOISTURE INDICATING DESICCANTS; MOISTURE ABSORBING DESICCANTS; SALT FOR PRESERVING, OTHER THAN FOR FOODSTUFFS, NAMELY, SALT FOR PACKING GOODS, IN CLASS 1 (U.S. CLS. 1, 5, 6, 10, 26 AND 46).

FIRST USE 10-19-2010; IN COMMERCE 4-1-2011.

THE MARK CONSISTS OF STANDARD CHARACTERS WITHOUT CLAIM TO ANY PARTICULAR FONT, STYLE, SIZE, OR COLOR.

SN 85-108,395, FILED 8-16-2010.

MICHAEL KEATING, EXAMINING ATTORNEY



*David J. Kybas*

Director of the United States Patent and Trademark Office

# United States of America

United States Patent and Trademark Office

## HERE SNOWBOARDS

**Reg. No. 4,126,247**

**Registered Apr. 10, 2012**

**Int. Cl.: 28**

**TRADEMARK**

**PRINCIPAL REGISTER**

DECUSATIS, STEVEN (UNITED STATES INDIVIDUAL)  
7829 DEVON STREET  
PHILADELPHIA, PA 19118

FOR: SNOWBOARDS, IN CLASS 28 (U.S. CLS. 22, 23, 38 AND 50).

FIRST USE 11-11-2011; IN COMMERCE 11-11-2011.

THE MARK CONSISTS OF STANDARD CHARACTERS WITHOUT CLAIM TO ANY PARTICULAR FONT, STYLE, SIZE, OR COLOR.

NO CLAIM IS MADE TO THE EXCLUSIVE RIGHT TO USE "SNOWBOARDS", APART FROM THE MARK AS SHOWN.

SN 85-108,777, FILED 8-16-2010.

WARREN L. OLANDRIA, EXAMINING ATTORNEY



*David J. Kyffers*

Director of the United States Patent and Trademark Office



# United States of America

United States Patent and Trademark Office

## Perfect Warm

**Reg. No. 4,126,248**

TACONY CORPORATION (MISSOURI CORPORATION)  
1760 GILSINN LANE  
FENTON, MO 63026

**Registered Apr. 10, 2012**

**Int. Cl.: 11**

FOR: PORTABLE ELECTRIC ZONE HEATERS, IN CLASS 11 (U.S. CLS. 13, 21, 23, 31 AND 34).

**TRADEMARK**

FIRST USE 10-23-2010; IN COMMERCE 10-23-2010.

**PRINCIPAL REGISTER**

THE MARK CONSISTS OF STANDARD CHARACTERS WITHOUT CLAIM TO ANY PARTICULAR FONT, STYLE, SIZE, OR COLOR.

NO CLAIM IS MADE TO THE EXCLUSIVE RIGHT TO USE "WARM", APART FROM THE MARK AS SHOWN.

SN 85-109,132, FILED 8-17-2010.

MICHAEL LITZAU, EXAMINING ATTORNEY



*David J. Kyffers*

Director of the United States Patent and Trademark Office

# United States of America

United States Patent and Trademark Office

## MANAGE YOUR CLEAVAGE IN COMFORT

**Reg. No. 4,126,249**

UPTON, JULIE (UNITED STATES INDIVIDUAL)  
9517 MEADOW RIDGE LANE  
LAYTONSVILLE, MD 20882

**Registered Apr. 10, 2012**

**Int. Cl.: 25**

FOR: CLOTHING, NAMELY, LADIES' UNDERGARMENTS, CAMISOLES AND TANK TOPS,  
IN CLASS 25 (U.S. CLS. 22 AND 39).

**TRADEMARK**

FIRST USE 9-22-2010; IN COMMERCE 9-22-2010.

**PRINCIPAL REGISTER**

THE MARK CONSISTS OF STANDARD CHARACTERS WITHOUT CLAIM TO ANY PAR-  
TICULAR FONT, STYLE, SIZE, OR COLOR.

SN 85-109,576, FILED 8-17-2010.

BRIAN NEVILLE, EXAMINING ATTORNEY



*David J. Kybas*

Director of the United States Patent and Trademark Office

# United States of America

United States Patent and Trademark Office

## FACTORY SERIES

**Reg. No. 4,126,250**

FOX FACTORY, INC. (CALIFORNIA CORPORATION)

**Registered Apr. 10, 2012**

130 HANGAR WAY  
WATSONVILLE, CA 95076

**Int. Cl.: 12**

FOR: SUSPENSION SYSTEMS AND SHOCK ABSORBERS FOR BICYCLES, IN CLASS 12  
(U.S. CLS. 19, 21, 23, 31, 35 AND 44).

**TRADEMARK**

FIRST USE 11-15-2010; IN COMMERCE 11-15-2010.

**PRINCIPAL REGISTER**

THE MARK CONSISTS OF STANDARD CHARACTERS WITHOUT CLAIM TO ANY PARTICULAR FONT, STYLE, SIZE, OR COLOR.

NO CLAIM IS MADE TO THE EXCLUSIVE RIGHT TO USE "SERIES", APART FROM THE MARK AS SHOWN.

SN 85-111,850, FILED 8-19-2010.

KEVIN CORWIN, EXAMINING ATTORNEY



*David J. Kybas*

Director of the United States Patent and Trademark Office

# United States of America

United States Patent and Trademark Office

# ECO-FLEX

**Reg. No. 4,126,251**

**Registered Apr. 10, 2012**

**Int. Cl.: 3**

**TRADEMARK**

**PRINCIPAL REGISTER**

BEL AIR FINISHING SUPPLY CORP. (RHODE ISLAND CORPORATION)  
QUONSET INDUSTRIAL PARK  
101 CIRCUIT DRIVE  
NORTH KINGSTOWN, RI 02852

FOR: FINISHING MEDIA IN THE NATURE OF SHINING AND DEBURRING PREPARATIONS FOR USE IN FINISHING MACHINES FOR FINISHING SURFACES OF WORKPIECES, IN CLASS 3 (U.S. CLS. 1, 4, 6, 50, 51 AND 52).

FIRST USE 9-3-2010; IN COMMERCE 10-6-2010.

THE MARK CONSISTS OF STANDARD CHARACTERS WITHOUT CLAIM TO ANY PARTICULAR FONT, STYLE, SIZE, OR COLOR.

SN 85-112,215, FILED 8-20-2010.

LAURIE MAYES, EXAMINING ATTORNEY



*David J. Kyfos*

Director of the United States Patent and Trademark Office

# United States of America

United States Patent and Trademark Office

## CANVAS OFFICE LANDSCAPE

**Reg. No. 4,126,252**

HERMAN MILLER, INC. (MICHIGAN CORPORATION)  
855 EAST MAIN AVEUE  
ZEELAND, MI 49464

**Registered Apr. 10, 2012**

**Int. Cl.: 20**

FOR: OFFICE FURNITURE, IN CLASS 20 (U.S. CLS. 2, 13, 22, 25, 32 AND 50).

FIRST USE 9-17-2010; IN COMMERCE 9-17-2010.

**TRADEMARK**

THE MARK CONSISTS OF STANDARD CHARACTERS WITHOUT CLAIM TO ANY PARTICULAR FONT, STYLE, SIZE, OR COLOR.

**PRINCIPAL REGISTER**

NO CLAIM IS MADE TO THE EXCLUSIVE RIGHT TO USE "OFFICE", APART FROM THE MARK AS SHOWN.

SN 85-113,537, FILED 8-23-2010.

JOHN GARTNER, EXAMINING ATTORNEY



*David J. Kyffers*

Director of the United States Patent and Trademark Office

# United States of America

United States Patent and Trademark Office

## AVANT WELLNESS

**Reg. No. 4,126,253**

HEWITSON, ANDREW (AUSTRALIA INDIVIDUAL)  
33004 CHRISTINA DR.  
DANA POINT, CA 92629

**Registered Apr. 10, 2012**

**Int. Cl.: 35**

FOR: DISTRIBUTORSHIP SERVICES IN THE FIELD OF WELLNESS PRODUCTS, IN CLASS 35 (U.S. CLS. 100, 101 AND 102).

**SERVICE MARK**

FIRST USE 7-1-2009; IN COMMERCE 1-1-2010.

**PRINCIPAL REGISTER**

THE MARK CONSISTS OF STANDARD CHARACTERS WITHOUT CLAIM TO ANY PARTICULAR FONT, STYLE, SIZE, OR COLOR.

NO CLAIM IS MADE TO THE EXCLUSIVE RIGHT TO USE "WELLNESS", APART FROM THE MARK AS SHOWN.

SN 85-114,316, FILED 8-24-2010.

CHRISTINA SOBRAL, EXAMINING ATTORNEY



*David J. Kybas*

Director of the United States Patent and Trademark Office

# United States of America

United States Patent and Trademark Office



## Spiral Solutions

eGaming. Delivered

**Reg. No. 4,126,254**

**Registered Apr. 10, 2012**

**Int. Cl.: 41**

**SERVICE MARK**

**PRINCIPAL REGISTER**

SPIRAL SOLUTIONS LTD (ISRAEL LIMITED LIABILITY COMPANY)  
P.O. BOX 10, BAR LEV INDUSTRIAL PARK  
MISGAV, ISRAEL 10079

FOR: PROVIDING ONLINE, NON-DOWNLOADABLE COMPUTER GAMES MADE AVAILABLE FROM A COMPUTER DATABASE VIA THE INTERNET COMPUTER NETWORK OR OTHER ELECTRONIC MEDIA; PROVIDING ONLINE, NON-DOWNLOADABLE COMPUTER GAMES ON A GLOBAL COMPUTER NETWORK OR VIA WIRELESS ELECTRONIC COMMUNICATION DEVICES, NAMELY, MOBILE HANDSETS, PDAS, CELLULAR TELEPHONES, HANDHELD COMPUTERS; PROVIDING A COMPUTER GAME THAT MAY BE ACCESSED NETWORK-WIDE BY NETWORK USERS EITHER BY MEANS OF A GLOBAL COMPUTER NETWORK OR BY WIRELESS ELECTRONIC COMMUNICATION DEVICES, NAMELY, MOBILE HANDSETS, PDAS, CELLULAR TELEPHONES, HANDHELD COMPUTERS; PROVIDING INFORMATION CONCERNING ENTERTAINMENT MADE AVAILABLE FROM A COMPUTER DATABASE OR A GLOBAL COMPUTER NETWORK OR BY WIRELESS ELECTRONIC COMMUNICATION DEVICES, NAMELY, MOBILE HANDSETS, PDAS, CELLULAR TELEPHONES, HANDHELD COMPUTERS; GAME SERVICES, NAMELY, PROVIDING ONLINE, NON-DOWNLOADABLE MULTI-PLAYER COMPUTER GAMES, IN CLASS 41 (U.S. CLS. 100, 101 AND 107).

FIRST USE 1-1-2011; IN COMMERCE 1-1-2011.

OWNER OF U.S. REG. NO. 2,587,471.

NO CLAIM IS MADE TO THE EXCLUSIVE RIGHT TO USE "EGAMING", APART FROM THE MARK AS SHOWN.

THE MARK CONSISTS OF A STYLIZED LETTER "S" WITH TWO ARROWS IN A CIRCLE APPEARING TO THE LEFT OF THE WORDING "SPIRAL SOLUTIONS", WITH THE WORDING "EGAMING.DELIVERED" APPEARING BENEATH "SOLUTIONS".

SN 85-114,397, FILED 8-24-2010.

NELSON SNYDER, EXAMINING ATTORNEY



*David J. Kyjars*

Director of the United States Patent and Trademark Office

# United States of America

United States Patent and Trademark Office

# RecDirect

**Reg. No. 4,126,255**

LEISURE PRODUCTS INC. (TENNESSEE CORPORATION)  
1044 FORDTOWN RD.  
KINGSPORT, TN 37663

**Registered Apr. 10, 2012**

**Int. Cl.: 11**

FOR: SPAS IN THE NATURE OF HEATED POOLS, IN CLASS 11 (U.S. CLS. 13, 21, 23, 31 AND 34).

**TRADEMARK**

FIRST USE 3-1-2009; IN COMMERCE 3-1-2009.

**PRINCIPAL REGISTER**

THE MARK CONSISTS OF STANDARD CHARACTERS WITHOUT CLAIM TO ANY PARTICULAR FONT, STYLE, SIZE, OR COLOR.

SN 85-114,460, FILED 8-24-2010.

CYNTHIA TRIPI, EXAMINING ATTORNEY



*David J. Kybas*

Director of the United States Patent and Trademark Office



# United States of America

United States Patent and Trademark Office

# NICOBOCO

**Reg. No. 4,126,256**

**Registered Apr. 10, 2012**

**Int. Cl.: 25**

**TRADEMARK**

**PRINCIPAL REGISTER**

YOURIDE FRANQUIAS E LICENCIAMENTO LTDA. (BRAZIL CORPORATION)  
ALAMEDA ARAGUAIA, 933, CF. 84, ALPHAVILL  
8330 SW 171 ST., PALMETTO BAY, FL 33157.  
SAO PABLO, BRAZIL

FOR: CLOTHING, NAMELY, SHIRTS, SHORTS, BLOUSES, BIKINIS, CAPS, PANTS, SWEATPANTS, UNDERWEAR, JACKETS, STOCKINGS, SOCKS, FOOTWEAR, NAMELY, BOOTS, SLIPPERS, IN CLASS 25 (U.S. CLS. 22 AND 39).

FIRST USE 1-26-2012; IN COMMERCE 1-26-2012.

THE MARK CONSISTS OF STANDARD CHARACTERS WITHOUT CLAIM TO ANY PARTICULAR FONT, STYLE, SIZE, OR COLOR.

THE NAME "NICOBOCO" DOES NOT IDENTIFY A LIVING INDIVIDUAL.

THE WORDING "NICOBOCO" HAS NO MEANING IN A FOREIGN LANGUAGE.

SN 85-115,880, FILED 8-25-2010.

KATHLEEN LORENZO, EXAMINING ATTORNEY



*David J. Kyffers*

Director of the United States Patent and Trademark Office

# United States of America

United States Patent and Trademark Office

## BROADWAY'S J2

**Reg. No. 4,126,257**

MY GOLDIE FOODS, INC. (NEW YORK CORPORATION)  
915 E. 17TH STREET  
BROOKLYN, NY 11230

**Registered Apr. 10, 2012**

**Int. Cl.: 30**

FOR: PREPARED FOODS, NAMELY, PIZZA, BLINTZES, FOCACCIA BREAD, GARLIC BREAD KNOTS AND PASTA, IN CLASS 30 (U.S. CL. 46).

**TRADEMARK**

FIRST USE 9-20-2010; IN COMMERCE 9-20-2010.

**PRINCIPAL REGISTER**

THE MARK CONSISTS OF STANDARD CHARACTERS WITHOUT CLAIM TO ANY PARTICULAR FONT, STYLE, SIZE, OR COLOR.

SN 85-116,408, FILED 8-26-2010.

FRANK LATTUCA, EXAMINING ATTORNEY



*David J. Kyros*

Director of the United States Patent and Trademark Office

# United States of America

United States Patent and Trademark Office

## BRILLIANCE COLLECTION

**Reg. No. 4,126,258**

**Registered Apr. 10, 2012**

**Int. Cl.: 2**

**TRADEMARK**

**PRINCIPAL REGISTER**

AKZO NOBEL COATINGS INTERNATIONAL B.V. (NETHERLANDS LIMITED LIABILITY COMPANY)  
VELPERWEG 76  
ARNHEM, NETHERLANDS 6824BM

FOR: COATING COMPOSITIONS AND PAINTERS' MATERIALS, NAMELY, PAINT, ALL FOR INTERIOR AND EXTERIOR DECORATIVE PURPOSES, IN CLASS 2 (U.S. CLS. 6, 11 AND 16).

FIRST USE 1-31-2011; IN COMMERCE 1-31-2011.

THE MARK CONSISTS OF STANDARD CHARACTERS WITHOUT CLAIM TO ANY PARTICULAR FONT, STYLE, SIZE, OR COLOR.

OWNER OF U.S. REG. NO. 3,166,126.

NO CLAIM IS MADE TO THE EXCLUSIVE RIGHT TO USE "COLLECTION", APART FROM THE MARK AS SHOWN.

SN 85-116,718, FILED 8-26-2010.

DOMINIC FATHY, EXAMINING ATTORNEY



*David J. Kybas*

Director of the United States Patent and Trademark Office

# United States of America

United States Patent and Trademark Office

## MYCEUTICALS

**Reg. No. 4,126,259**

KANDU ENTERPRISES, LLC (COLORADO LIMITED LIABILITY COMPANY)  
PO BOX 44  
FRISCO, CO 80443

**Registered Apr. 10, 2012**

**Int. Cl.: 5**

FOR: DIETARY AND NUTRITIONAL SUPPLEMENTS, IN CLASS 5 (U.S. CLS. 6, 18, 44, 46, 51 AND 52).

**TRADEMARK**

FIRST USE 7-7-2009; IN COMMERCE 10-6-2010.

**PRINCIPAL REGISTER**

THE MARK CONSISTS OF STANDARD CHARACTERS WITHOUT CLAIM TO ANY PARTICULAR FONT, STYLE, SIZE, OR COLOR.

SN 85-116,972, FILED 8-26-2010.

ASMAT KHAN, EXAMINING ATTORNEY



*David J. Kybas*

Director of the United States Patent and Trademark Office

# United States of America

United States Patent and Trademark Office

# LUXCODE

**Reg. No. 4,126,260**

**Registered Apr. 10, 2012**

**Int. Cl.: 36**

**SERVICE MARK**

**PRINCIPAL REGISTER**

PAYMENT TRANSACTION SERVICES, INC. (DELAWARE CORPORATION)  
SUITE 4000  
1000 WINTER STREET  
WALTHAM, MA 02451

FOR: PREPAID PURCHASE CARD SERVICES, NAMELY, ISSUING PREPAID PURCHASE CARDS AND PROCESSING ELECTRONIC PAYMENTS MADE THROUGH PREPAID CARDS, IN CLASS 36 (U.S. CLS. 100, 101 AND 102).

FIRST USE 6-1-2011; IN COMMERCE 6-1-2011.

THE MARK CONSISTS OF STANDARD CHARACTERS WITHOUT CLAIM TO ANY PARTICULAR FONT, STYLE, SIZE, OR COLOR.

SN 85-117,260, FILED 8-27-2010.

WILLIAM JACKSON, EXAMINING ATTORNEY



*David J. Kybas*

Director of the United States Patent and Trademark Office

# United States of America

United States Patent and Trademark Office



**Reg. No. 4,126,261**

**Registered Apr. 10, 2012**

**Int. Cl.: 41**

**SERVICE MARK**

**PRINCIPAL REGISTER**

CARTER, DEBORRAH D. (UNITED STATES INDIVIDUAL)  
#352  
1249 S. DIAMOND BAR BLVD.  
DIAMOND BAR, CA 91765

FOR: PROVIDING ON-LINE NEWSLETTERS IN THE FIELD OF BREAST CANCER, BREAST CANCER HEALTH AND NUTRITION, AND FEATURING BREAST CANCER SURVIVOR STORIES , IN CLASS 41 (U.S. CLS. 100, 101 AND 107).

FIRST USE 4-1-2001; IN COMMERCE 10-1-2010.

NO CLAIM IS MADE TO THE EXCLUSIVE RIGHT TO USE "SURVIVOR", APART FROM THE MARK AS SHOWN.

THE MARK CONSISTS OF DESIGN OF AN ELEGANT FEMALE STANDING IN A POSED POSITION WEARING AN EVENING GOWN. ACROSS THE UPPER MID SECTION APPEARS THE WORDING "SASSY SURVIVOR", AND AT THE BOTTOM OF THE GOWN IS THE WORDING "MAKING AWARENESS A PRIORITY".

SN 85-118,647, FILED 8-30-2010.

MATTHEW MCDOWELL, EXAMINING ATTORNEY



*David J. Kyros*

Director of the United States Patent and Trademark Office

# United States of America

United States Patent and Trademark Office

## EXCLUSIVO GOLDEN CERTIFICATE

**Reg. No. 4,126,262**

MARTINEZ, JOSE L. (UNITED STATES INDIVIDUAL)  
41 LAKE LOUISE DRIVE  
CARMEL, NY 10512

**Registered Apr. 10, 2012**

**Int. Cl.: 16**

FOR: PRINTED DISCOUNT CERTIFICATES, IN CLASS 16 (U.S. CLS. 2, 5, 22, 23, 29, 37, 38 AND 50).

**TRADEMARK**

FIRST USE 2-12-2011; IN COMMERCE 2-12-2011.

**PRINCIPAL REGISTER**

THE MARK CONSISTS OF STANDARD CHARACTERS WITHOUT CLAIM TO ANY PARTICULAR FONT, STYLE, SIZE, OR COLOR.

NO CLAIM IS MADE TO THE EXCLUSIVE RIGHT TO USE "GOLDEN CERTIFICATE", APART FROM THE MARK AS SHOWN.

THE ENGLISH TRANSLATION OF "EXCLUSIVO" IN THE MARK IS "EXCLUSIVE".

SN 85-118,896, FILED 8-30-2010.

BRIAN CALLAGHAN, EXAMINING ATTORNEY



*David J. Kyffers*

Director of the United States Patent and Trademark Office

# United States of America

United States Patent and Trademark Office

# PROMIDIAN



**Reg. No. 4,126,263**

**Registered Apr. 10, 2012**

**Int. Cl.: 35**

**SERVICE MARK**

**PRINCIPAL REGISTER**

ACCESS COMMUNICATIONS, LLC (DELAWARE LIMITED LIABILITY COMPANY)  
400 CONNELL DRIVE  
BERKELEY HEIGHTS, NJ 07922

FOR: STRATEGIC AND MANAGEMENT BUSINESS CONSULTING IN THE PHARMACEUTICAL, BIOTECHNOLOGY AND HEALTHCARE FIELDS; MARKETING AND SALES CONSULTING SERVICES IN THE FIELD OF PHARMACEUTICAL, BIOTECHNOLOGY AND HEALTHCARE PRODUCTS AND SERVICES, NAMELY, BRAND MANAGEMENT, MARKET ASSESSMENT, RESEARCH AND DEVELOPMENT AND IMPLEMENTATION OF PRODUCT LAUNCH, SALES AND DISTRIBUTION STRATEGIES, PRICING AND CONTRACTING STRATEGIES AND MODELING, ACCOUNT SEGMENTATION AND PRIORITIZATION, MANAGED MARKETS LAUNCH PLANNING, CHANNEL STRATEGY AND VALUE PROPOSITION, IN CLASS 35 (U.S. CLS. 100, 101 AND 102).

FIRST USE 3-18-2011; IN COMMERCE 3-18-2011.

THE MARK CONSISTS OF THE WORD "PROMIDIAN" IN STYLIZED LETTERING WITH A STYLIZED ARROWHEAD TO THE RIGHT OF THE LETTERING. THE COLOR GRAY IN THE STYLIZED ARROWHEAD IS FOR SHADING PURPOSES ONLY.

SN 85-119,848, FILED 8-31-2010.

NICHOLAS ALTREE, EXAMINING ATTORNEY



*David J. Kybas*

Director of the United States Patent and Trademark Office



# United States of America

United States Patent and Trademark Office



**Reg. No. 4,126,264**

REDD ZONE, LLC (OREGON LIMITED LIABILITY CORPORATION)  
300 WEST IRVING AVE  
ASTORIA, OR 97103

**Registered Apr. 10, 2012**

**Int. Cl.: 35**

FOR: BUSINESS CONSULTING SERVICES IN THE FISH HATCHING INDUSTRY, IN CLASS 35 (U.S. CLS. 100, 101 AND 102).

**SERVICE MARK**

FIRST USE 1-1-2010; IN COMMERCE 3-21-2010.

**PRINCIPAL REGISTER**

THE MARK CONSISTS OF A RECTANGLE HORIZONTALLY BISECTED INTO TWO SMALLER RECTANGLES. THE WORD "REDD" APPEARS IN STYLIZED TEXT IN THE UPPER PORTION, AND THE WORD "ZONE" APPEARS IN STYLIZED TEXT IN THE LOWER PORTION.

SN 85-120,307, FILED 8-31-2010.

ANDREA HACK, EXAMINING ATTORNEY



*David J. Kyros*

Director of the United States Patent and Trademark Office

# United States of America

United States Patent and Trademark Office

## LIFE IS FANTASTIC

**Reg. No. 4,126,265**

KURT E CHANA (UNITED STATES INDIVIDUAL)

**Registered Apr. 10, 2012**

865 N STATE RD 434, SUITE 1000  
ALTAMONTE SPRINGS, FL 327147059

**Int. Cl.: 25**

FOR: ATHLETIC APPAREL, NAMELY, SHIRTS, PANTS, JACKETS, FOOTWEAR, HATS AND CAPS, ATHLETIC UNIFORMS; CHILDREN'S AND INFANT'S APPAREL, NAMELY, JUMPERS, OVERALL SLEEPWEAR, PAJAMAS, ROMPERS AND ONE-PIECE GARMENTS, IN CLASS 25 (U.S. CLS. 22 AND 39).

**TRADEMARK**

**PRINCIPAL REGISTER**

FIRST USE 6-1-2011; IN COMMERCE 6-1-2011.

THE MARK CONSISTS OF STANDARD CHARACTERS WITHOUT CLAIM TO ANY PARTICULAR FONT, STYLE, SIZE, OR COLOR.

SN 85-121,544, FILED 9-2-2010.

BRIAN NEVILLE, EXAMINING ATTORNEY



*David J. Kybas*

Director of the United States Patent and Trademark Office

# United States of America

United States Patent and Trademark Office

## ZIMMER CURV

**Reg. No. 4,126,266**

**Registered Apr. 10, 2012**

**Int. Cl.: 5**

**TRADEMARK**

**PRINCIPAL REGISTER**

ZIMMER, INC. (DELAWARE CORPORATION)  
345 EAST MAIN STREET  
WARSAW, IN 46580

FOR: IMPLANTABLE BIOMATERIAL IN THE NATURE OF COLLAGEN MEMBRANES FOR THE HEALING, PROTECTION AND REPAIR OF BIOLOGICAL TISSUE, IN CLASS 5 (U.S. CLS. 6, 18, 44, 46, 51 AND 52).

FIRST USE 7-31-2011; IN COMMERCE 7-31-2011.

THE MARK CONSISTS OF STANDARD CHARACTERS WITHOUT CLAIM TO ANY PARTICULAR FONT, STYLE, SIZE, OR COLOR.

OWNER OF U.S. REG. NOS. 647,921, 3,531,019, AND OTHERS.

NO CLAIM IS MADE TO THE EXCLUSIVE RIGHT TO USE "CURVE", APART FROM THE MARK AS SHOWN.

SN 85-122,646, FILED 9-3-2010.

SUSAN STIGLITZ, EXAMINING ATTORNEY



*David J. Kybas*

Director of the United States Patent and Trademark Office

# United States of America

United States Patent and Trademark Office

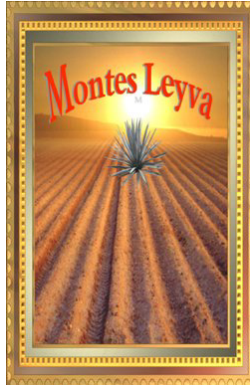

**Reg. No. 4,126,267**

**Registered Apr. 10, 2012**

**Int. Cl.: 33**

**TRADEMARK**

**PRINCIPAL REGISTER**

MONTES LEYVA, S.A. DE C.V. (MEXICO CORPORATION)  
GENERAL ANAYA # 36  
AUTLAN, JALISCO, MEXICO 48900

FOR: TEQUILA, IN CLASS 33 (U.S. CLS. 47 AND 49).

FIRST USE 7-1-2011; IN COMMERCE 7-1-2011.

THE MARK CONSISTS OF THE WORDING "MONTES LEYVA" IN RED ON A BACKGROUND OF YELLOW AND GOLD SUNSHINE THAT IS WHITE AT THE CENTER AND IS ABOVE A BROWN MOUNTAIN. THE DITCHES ARE BROWN AND GOLD AND IN THE MIDDLE IS A GREEN AGAVE PLANT WITH BLACK SHADOWS. THE SCENE IS OUTLINED BY FRAMES FIRST OF GRAY ON THE INNER LAYER, THEN YELLOW AND BROWN, THEN BROWN AND FINALLY YELLOW AND GOLD ON THE OUTER LAYER.

THE COLOR(S) RED, BLACK, WHITE, GREEN, GRAY, YELLOW, BROWN AND GOLD IS/ARE CLAIMED AS A FEATURE OF THE MARK.

THE ENGLISH TRANSLATION OF "MONTES LEYVA" IN THE MARK IS "MOUNT LEYVA".

SN 85-123,174, FILED 9-3-2010.

JESSICA A. POWERS, EXAMINING ATTORNEY



*David J. Kybas*

Director of the United States Patent and Trademark Office

# United States of America

United States Patent and Trademark Office



**Reg. No. 4,126,268**

AMG PET SUPPLY LLC (ILLINOIS LIMITED LIABILITY COMPANY)  
5441-1/2 N LINCOLN AVE.  
CHICAGO, IL 60625

**Registered Apr. 10, 2012**

**Int. Cl.: 35**

FOR: RETAIL STORE SERVICES FEATURING DOG AND CAT SUPPLIES, NAMELY, FOOD, COLLARS, TOYS, IN CLASS 35 (U.S. CLS. 100, 101 AND 102).

**SERVICE MARK**

FIRST USE 6-15-2010; IN COMMERCE 8-15-2010.

**PRINCIPAL REGISTER**

NO CLAIM IS MADE TO THE EXCLUSIVE RIGHT TO USE "CHICAGO", APART FROM THE MARK AS SHOWN.

THE MARK CONSISTS OF AN INCOMPLETE RECTANGLE WITHIN AN INCOMPLETE RECTANGLE ON WHICH ARE THE WORDS "THE ACTIVE PET" AND "CHICAGO" WITHIN TWO STARS; A DOG RIDING A SKATEBOARD; AND A CAT ROLLER SKATING.

SN 85-124,196, FILED 9-7-2010.

DAVID C. REIHNER, EXAMINING ATTORNEY



*David J. Kybas*

Director of the United States Patent and Trademark Office

# United States of America

United States Patent and Trademark Office



# AsiaUSA

**Reg. No. 4,126,269**

**Registered Apr. 10, 2012**

**Int. Cl.: 35**

**SERVICE MARK**

**PRINCIPAL REGISTER**

CLSA B.V. (NETHERLANDS CORPORATION)  
ATRIUM BUILDING 5TH FLOOR  
STRAWINSKYLAAN 3501  
1077ZX AMSTERDAM, NETHERLANDS

FOR: ARRANGING AND CONDUCTING BUSINESS CONFERENCES AND FORUMS, IN CLASS 35 (U.S. CLS. 100, 101 AND 102).

FIRST USE 9-24-2009; IN COMMERCE 9-24-2009.

NO CLAIM IS MADE TO THE EXCLUSIVE RIGHT TO USE "ASIA USA", APART FROM THE MARK AS SHOWN.

THE MARK CONSISTS OF A FANCIFUL DEPICTION OF A GLOBE WITH THE WORDS "ASIAUSA" IMMEDIATELY TO THE RIGHT OF THE GLOBE.

SN 85-124,672, FILED 9-8-2010.

VIVIAN MICZNIK FIRST, EXAMINING ATTORNEY



*David J. Kyros*

Director of the United States Patent and Trademark Office

# United States of America

United States Patent and Trademark Office

## SOLAR SERPENT

**Reg. No. 4,126,270**

**Registered Apr. 10, 2012**

**Int. Cl.: 28**

**TRADEMARK**

**PRINCIPAL REGISTER**

MATTEL, INC. (DELAWARE CORPORATION)  
M1-1518  
333 CONTINENTAL BOULEVARD  
EL SEGUNDO, CA 90245

FOR: TOY ACTION FIGURES AND ACCESSORIES THEREFOR, IN CLASS 28 (U.S. CLS. 22, 23, 38 AND 50).

FIRST USE 9-1-2011; IN COMMERCE 9-1-2011.

THE MARK CONSISTS OF STANDARD CHARACTERS WITHOUT CLAIM TO ANY PARTICULAR FONT, STYLE, SIZE, OR COLOR.

NO CLAIM IS MADE TO THE EXCLUSIVE RIGHT TO USE "SERPENT", APART FROM THE MARK AS SHOWN.

SN 85-124,883, FILED 9-8-2010.

JACQUELINE A. LAVINE, EXAMINING ATTORNEY



*David J. Kyffers*

Director of the United States Patent and Trademark Office

# United States of America

United States Patent and Trademark Office

# VIPER

**Reg. No. 4,126,271**

**Registered Apr. 10, 2012**

**Int. Cl.: 8**

**TRADEMARK**

**PRINCIPAL REGISTER**

MARIANNA INDUSTRIES, INC. (NEBRASKA CORPORATION)  
11222 "I" STREET  
OMAHA, NE 68137

FOR: SCISSORS FOR CUTTING HUMAN HAIR, IN CLASS 8 (U.S. CLS. 23, 28 AND 44).

FIRST USE 1-11-2012; IN COMMERCE 1-11-2012.

THE MARK CONSISTS OF STANDARD CHARACTERS WITHOUT CLAIM TO ANY PARTICULAR FONT, STYLE, SIZE, OR COLOR.

SN 85-125,214, FILED 9-8-2010.

SANI KHOURI, EXAMINING ATTORNEY



*David J. Kybas*

Director of the United States Patent and Trademark Office



# United States of America

United States Patent and Trademark Office

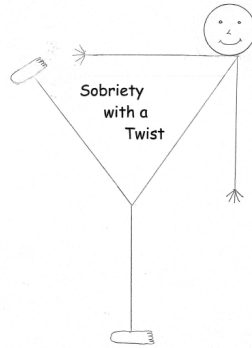

**Reg. No. 4,126,272**

**Registered Apr. 10, 2012**

**Int. Cl.: 41**

**SERVICE MARK**

**PRINCIPAL REGISTER**

LICHTCSIEN, SHARON J. (UNITED STATES INDIVIDUAL)  
1914 ATLANTIC AVENUE  
SANDUSKY, OH 44870

FOR: YOGA INSTRUCTION, IN CLASS 41 (U.S. CLS. 100, 101 AND 107).

FIRST USE 11-1-2010; IN COMMERCE 11-1-2010.

THE MARK CONSISTS OF A STICK FIGURE YOGA PERSON STRETCHING IN THE SHAPE OF A MARTINI GLASS AND THE WORDING "SOBRIETY WITH A TWIST".

SN 85-125,515, FILED 9-9-2010.

HEATHER BIDDULPH, EXAMINING ATTORNEY



*David J. Kyffers*

Director of the United States Patent and Trademark Office

# United States of America

United States Patent and Trademark Office



**Reg. No. 4,126,273**

**Registered Apr. 10, 2012**

**Int. Cl.: 17**

**TRADEMARK**

**PRINCIPAL REGISTER**

INTERFACE SOLUTIONS, INC. (DELAWARE CORPORATION)  
216 WOHLSEN WAY  
LANCASTER, PA 17603

FOR: FIBER-REINFORCED COMPOSITE MATERIALS IN SHEET AND ROLL FORM MADE PRIMARILY FROM RECYCLED WOOD, COTTON, LEATHER AND OTHER NATURAL AND SYNTHETIC PRODUCTS FOR USE IN THE MANUFACTURE OF COVERINGS FOR BOOKS, PHOTO ALBUMS, ORGANIZERS, NOTEBOOKS, PORTFOLIOS, SUNDRY OFFICE AND PUBLISHING PRODUCTS, LUXURY BOX COVERS, DESK ACCESSORIES, WALLETS, BELTS, HANDBAGS, SHOES, FURNITURE, UPHOLSTERY, LABELS AND TAGS, IN CLASS 17 (U.S. CLS. 1, 5, 12, 13, 35 AND 50).

FIRST USE 6-15-2011; IN COMMERCE 6-15-2011.

NO CLAIM IS MADE TO THE EXCLUSIVE RIGHT TO USE "SUSTAINABLE MATERIALS TECHNOLOGY", APART FROM THE MARK AS SHOWN.

THE MARK CONSISTS OF AN INNER CIRCLE SURROUNDED BY A CONCENTRIC OUTER CIRCLE FORMED BY A PARTIAL DIAMOND DESIGN. THE STYLIZED WORD "EMERGE" IN LOWER CASE APPEARS TO THE RIGHT OF THE GEOMETRIC DESIGN AND THE STYLIZED WORDS "SUSTAINABLE MATERIALS TECHNOLOGY" IN LOWER CASE APPEAR BELOW THE WORD "EMERGE". A SOLID HORIZONTAL LINE APPEARS ABOVE THE WORDS "SUSTAINABLE MATERIALS TECHNOLOGY". THE STIPPLING IS FOR SHADING PURPOSES ONLY.

SN 85-125,760, FILED 9-9-2010.

DAVID TAYLOR, EXAMINING ATTORNEY



*David J. Kyros*

Director of the United States Patent and Trademark Office

# United States of America

United States Patent and Trademark Office

## CONTELLIGENCE

**Reg. No. 4,126,274**

**Registered Apr. 10, 2012**

**Int. Cls.: 35 and 42**

**SERVICE MARK**

**PRINCIPAL REGISTER**

POINT-TO-POINT MARKETING INC. (COLORADO CORPORATION)  
11562 N COUNTY RD 17  
FORT COLLINS, CO 80524

FOR: PROVIDING ADVERTISING LEAD AND ADVERTISER RELATIONSHIP MANAGEMENT SERVICES AND PROVIDING DATABASES FOR MANAGING, TRACKING AND ANALYZING LEADS, CONTACTS AND ADVERTISER RELATIONS IN THE ADVERTISING FIELD, AND FOR LEAD AND ADVERTISER RELATIONSHIP MANAGEMENT SERVICES, IN CLASS 35 (U.S. CLS. 100, 101 AND 102).

FIRST USE 2-0-2011; IN COMMERCE 5-0-2011.

FOR: PROVIDING ONLINE NON-DOWNLOADABLE SOFTWARE FOR STORING, MANAGING, TRACKING AND ANALYZING MANAGING LEADS, CONTACTS AND ADVERTISER RELATIONSHIPS IN THE ADVERTISING FIELD, PROVIDING ONLINE NON-DOWNLOADABLE COMPUTER DATABASE SOFTWARE FOR USE IN THE MANAGEMENT OF LEADS, CONTACTS AND ADVERTISER RELATIONSHIPS, AND FOR USE IN THE MARKETING AND DISTRIBUTION OF ADVERTISEMENTS AND PROMOTIONS FOR OTHERS, IN CLASS 42 (U.S. CLS. 100 AND 101).

FIRST USE 2-0-2011; IN COMMERCE 5-0-2011.

THE MARK CONSISTS OF STANDARD CHARACTERS WITHOUT CLAIM TO ANY PARTICULAR FONT, STYLE, SIZE, OR COLOR.

SN 85-125,763, FILED 9-9-2010.

PAM WILLIS, EXAMINING ATTORNEY



*David J. Kyffers*

Director of the United States Patent and Trademark Office

# United States of America

United States Patent and Trademark Office

# JERI LEE

**Reg. No. 4,126,275**

**Registered Apr. 10, 2012**

**Int. Cl.: 9**

**TRADEMARK**

**PRINCIPAL REGISTER**

ASK US MEDIA LLC (WASHINGTON LIMITED LIABILITY COMPANY)  
11251 120TH AVE. NE, SUITE 202  
KIRKLAND, WA 98033

FOR: COMPUTER SOFTWARE FOR UPLOAD, STORAGE, RETRIEVAL, DOWNLOAD, STREAMING, TRANSMISSION AND DELIVERY OF DIGITAL CONTENT; DOWNLOADABLE AND STREAMABLE AUDIO FILES, MULTIMEDIA FILES, AUDIO MATERIAL, AND VIDEO MATERIAL FEATURING HIGH PROFILE ENTERTAINERS, EXTREME ACTION SPORTS, TOP MODELS FROM AROUND THE WORLD, INDEPENDENT MUSIC AND ARTISTS, INFORMATION ON THE ENVIRONMENT, ENVIRONMENTAL BRANDS, FAITH, MOTIVATION AND INSPIRATION PRAYERS, WOMEN'S AND MEN'S LIFESTYLE; DOWNLOADABLE AND STREAMABLE FILMS AND MOVIES FEATURING HIGH PROFILE ENTERTAINERS, EXTREME ACTION SPORTS, TOP MODELS FROM AROUND THE WORLD, INDEPENDENT MUSIC AND ARTISTS, INFORMATION ON THE ENVIRONMENT, ENVIRONMENTAL BRANDS, FAITH, MOTIVATION AND INSPIRATION PRAYERS, WOMEN'S AND MEN'S LIFESTYLE, ALL PROVIDED VIA A VIDEO-ON-DEMAND SERVICE, IN CLASS 9 (U.S. CLS. 21, 23, 26, 36 AND 38).

FIRST USE 12-9-2010; IN COMMERCE 12-9-2010.

THE MARK CONSISTS OF STANDARD CHARACTERS WITHOUT CLAIM TO ANY PARTICULAR FONT, STYLE, SIZE, OR COLOR.

THE NAME(S), PORTRAIT(S), AND/OR SIGNATURE(S) SHOWN IN THE MARK IDENTIFIES "JERRI LEE", WHOSE CONSENT(S) TO REGISTER IS MADE OF RECORD.

SN 85-126,387, FILED 9-9-2010.

ALEXANDER L. POWERS, EXAMINING ATTORNEY



*David J. Kypos*

Director of the United States Patent and Trademark Office

# United States of America

United States Patent and Trademark Office

# G-STYLE

**Reg. No. 4,126,276**

**Registered Apr. 10, 2012**

**Int. Cl.: 9**

**TRADEMARK**

**PRINCIPAL REGISTER**

ASK US MEDIA LLC (WASHINGTON LIMITED LIABILITY COMPANY)  
11251 120TH AVE. NE, SUITE 202  
KIRKLAND, WA 98033

FOR: COMPUTER SOFTWARE FOR UPLOAD, STORAGE, RETRIEVAL, DOWNLOAD, STREAMING, TRANSMISSION AND DELIVERY OF DIGITAL CONTENT; DOWNLOADABLE AND STREAMABLE AUDIO FILES, MULTIMEDIA FILES, AUDIO MATERIAL, AND VIDEO MATERIAL FEATURING HIGH PROFILE ENTERTAINERS, EXTREME ACTION SPORTS, TOP MODELS FROM AROUND THE WORLD, INDEPENDENT MUSIC AND ARTISTS, INFORMATION ON THE ENVIRONMENT, ENVIRONMENTAL BRANDS, FAITH, MOTIVATION AND INSPIRATION PRAYERS, WOMEN'S AND MEN'S LIFESTYLE; DOWNLOADABLE AND STREAMABLE FILMS AND MOVIES FEATURING HIGH PROFILE ENTERTAINERS, EXTREME ACTION SPORTS, TOP MODELS FROM AROUND THE WORLD, INDEPENDENT MUSIC AND ARTISTS, INFORMATION ON THE ENVIRONMENT, ENVIRONMENTAL BRANDS, FAITH, MOTIVATION AND INSPIRATION PRAYERS, WOMEN'S AND MEN'S LIFESTYLE, ALL PROVIDED VIA A VIDEO-ON-DEMAND SERVICE, IN CLASS 9 (U.S. CLS. 21, 23, 26, 36 AND 38).

FIRST USE 12-9-2010; IN COMMERCE 12-9-2010.

THE MARK CONSISTS OF STANDARD CHARACTERS WITHOUT CLAIM TO ANY PARTICULAR FONT, STYLE, SIZE, OR COLOR.

SN 85-126,391, FILED 9-9-2010.

ALEXANDER L. POWERS, EXAMINING ATTORNEY



*David J. Kyros*

Director of the United States Patent and Trademark Office

# United States of America

United States Patent and Trademark Office

# SLICK DOGG

**Reg. No. 4,126,277**

**Registered Apr. 10, 2012**

**Int. Cl.: 9**

**TRADEMARK**

**PRINCIPAL REGISTER**

ASK US MEDIA LLC (WASHINGTON LIMITED LIABILITY COMPANY)  
11251 120TH AVE. NE, SUITE 202  
KIRKLAND, WA 98033

FOR: COMPUTER SOFTWARE FOR UPLOAD, STORAGE, RETRIEVAL, DOWNLOAD, STREAMING, TRANSMISSION AND DELIVERY OF DIGITAL CONTENT; DOWNLOADABLE AND STREAMABLE AUDIO FILES, MULTIMEDIA FILES, AUDIO MATERIAL, AND VIDEO MATERIAL FEATURING HIGH PROFILE ENTERTAINERS, EXTREME ACTION SPORTS, TOP MODELS FROM AROUND THE WORLD, INDEPENDENT MUSIC AND ARTISTS, INFORMATION ON THE ENVIRONMENT, ENVIRONMENTAL BRANDS, FAITH, MOTIVATION AND INSPIRATION PRAYERS, WOMEN'S AND MEN'S LIFESTYLE; DOWNLOADABLE AND STREAMABLE FILMS AND MOVIES FEATURING HIGH PROFILE ENTERTAINERS, EXTREME ACTION SPORTS, TOP MODELS FROM AROUND THE WORLD, INDEPENDENT MUSIC AND ARTISTS, INFORMATION ON THE ENVIRONMENT, ENVIRONMENTAL BRANDS, FAITH, MOTIVATION AND INSPIRATION PRAYERS, WOMEN'S AND MEN'S LIFESTYLE, ALL PROVIDED VIA A VIDEO-ON-DEMAND SERVICE, IN CLASS 9 (U.S. CLS. 21, 23, 26, 36 AND 38).

FIRST USE 12-9-2010; IN COMMERCE 12-9-2010.

THE MARK CONSISTS OF STANDARD CHARACTERS WITHOUT CLAIM TO ANY PARTICULAR FONT, STYLE, SIZE, OR COLOR.

SN 85-126,394, FILED 9-9-2010.

ALEXANDER L. POWERS, EXAMINING ATTORNEY



*David J. Kyros*

Director of the United States Patent and Trademark Office

# United States of America

United States Patent and Trademark Office

## STARRY O PHONIC SOUND

**Reg. No. 4,126,278**

**Registered Apr. 10, 2012**

**Int. Cl.: 41**

**SERVICE MARK**

**PRINCIPAL REGISTER**

DISNEY ENTERPRISES, INC. (DELAWARE CORPORATION)  
500 SOUTH BUENA VISTA STREET  
BURBANK, CA 91521

FOR: THEME PARK SERVICES, IN CLASS 41 (U.S. CLS. 100, 101 AND 107).

FIRST USE 8-30-2010; IN COMMERCE 8-30-2010.

THE MARK CONSISTS OF STANDARD CHARACTERS WITHOUT CLAIM TO ANY PARTICULAR FONT, STYLE, SIZE, OR COLOR.

NO CLAIM IS MADE TO THE EXCLUSIVE RIGHT TO USE "SOUND", APART FROM THE MARK AS SHOWN.

SN 85-126,977, FILED 9-10-2010.

MARK T. MULLEN, EXAMINING ATTORNEY



*David J. Kybas*

Director of the United States Patent and Trademark Office

# United States of America

United States Patent and Trademark Office



**Reg. No. 4,126,279**

**Registered Apr. 10, 2012**

**Int. Cl.: 5**

**TRADEMARK**

**PRINCIPAL REGISTER**

SABINSA CORPORATION (NEW JERSEY CORPORATION)  
20 LAKE DRIVE  
EAST WINDSOR, NJ 08520

FOR: DIETARY SUPPLEMENTS CONTAINING POTASSIUM, IN CLASS 5 (U.S. CLS. 6, 18, 44, 46, 51 AND 52).

FIRST USE 10-1-2010; IN COMMERCE 10-1-2010.

OWNER OF U.S. REG. NO. 3,435,381.

THE COLOR(S) TEAL AND YELLOW IS/ARE CLAIMED AS A FEATURE OF THE MARK.

NO CLAIM IS MADE TO THE EXCLUSIVE RIGHT TO USE "CITRIN K", APART FROM THE MARK AS SHOWN.

THE MARK CONSISTS OF STYLIZED STICK FIGURE WITH A HEAD APPEARING IN THE COLOR "TEAL" AND THE BODY APPEARING IN THE COLOR "YELLOW" PARTIALLY ENCASING THE TEXT, WHICH IS DISPLAYED AS A STYLIZED UPPER CASE "C" AND LOWER CASE LETTERS "ITRIN" APPEARING IN THE COLOR TEAL, TO THE RIGHT OF WHICH APPEARS THE UPPER CASE LETTER "K" IN THE COLOR "YELLOW" WITH "TEAL" SHADOW HIGHLIGHTS.

SN 85-127,981, FILED 9-13-2010.

RONALD AIKENS, EXAMINING ATTORNEY



*David J. Kybas*

Director of the United States Patent and Trademark Office



# United States of America

United States Patent and Trademark Office

# ZOENASA

**Reg. No. 4,126,280**

**Registered Apr. 10, 2012**

**Int. Cl.: 5**

**TRADEMARK**

**PRINCIPAL REGISTER**

ALTHEUS THERAPEUTICS, INC. (OKLAHOMA CORPORATION)  
SUITE 435  
755 RESEARCH PARKWAY  
OKLAHOMA CITY, OK 73104

FOR: PHARMACEUTICAL PREPARATIONS AND SUBSTANCES FOR THE TREATMENT OF GASTRO-INTESTINAL DISEASES, IN CLASS 5 (U.S. CLS. 6, 18, 44, 46, 51 AND 52).

FIRST USE 12-21-2011; IN COMMERCE 12-21-2011.

THE MARK CONSISTS OF STANDARD CHARACTERS WITHOUT CLAIM TO ANY PARTICULAR FONT, STYLE, SIZE, OR COLOR.

SN 85-129,827, FILED 9-15-2010.

LINDA ORNDORFF, EXAMINING ATTORNEY



*David J. Kybas*

Director of the United States Patent and Trademark Office

# United States of America

United States Patent and Trademark Office

## EAT YOUR GREENS

**Reg. No. 4,126,281**

DUFF, KIMBERLY A. (UNITED STATES INDIVIDUAL)  
11530 SEABECK HIGHWAY NW  
SEABECK, WA 98380

**Registered Apr. 10, 2012**

**Int. Cl.: 35**

FOR: RETAIL STORE SERVICES FEATURING FOOD AND BEVERAGE CONTAINERS, CARRYING BAGS, UTENSILS, LINENS, AND CLOTHING ALL OF THE FOREGOING ARE ENVIRONMENTALLY-FRIENDLY, IN CLASS 35 (U.S. CLS. 100, 101 AND 102).

**SERVICE MARK**

FIRST USE 9-16-2010; IN COMMERCE 1-19-2011.

**PRINCIPAL REGISTER**

THE MARK CONSISTS OF STANDARD CHARACTERS WITHOUT CLAIM TO ANY PARTICULAR FONT, STYLE, SIZE, OR COLOR.

SN 85-130,562, FILED 9-15-2010.

BERYL GARDNER, EXAMINING ATTORNEY



*David J. Kyjars*

Director of the United States Patent and Trademark Office

# United States of America

United States Patent and Trademark Office

# WINDSERT

**Reg. No. 4,126,282**

DLP INDUSTRIES, INC. (FLORIDA CORPORATION)  
2125 SOUTHWEST 60TH WAY  
MIRAMAR, FL 33023

**Registered Apr. 10, 2012**

**Int. Cl.: 6**

FOR: METAL WINDOW FRAME MOUNTING SYSTEM, COMPRISING, NAMELY, A SERIES OF ALUMINUM CHANNEL BRACKETS ATTACHED TO THE OPENING OF A DOOR CONTAINING A FUNCTIONING WINDOW CAPABLE OF BEING OPENED AND CLOSED, FOR THE MOUNTING OF METAL-FRAMED WINDOWS INTO DOORS, IN CLASS 6 (U.S. CLS. 2, 12, 13, 14, 23, 25 AND 50).

**TRADEMARK**

**PRINCIPAL REGISTER**

FIRST USE 11-16-2011; IN COMMERCE 11-16-2011.

THE MARK CONSISTS OF STANDARD CHARACTERS WITHOUT CLAIM TO ANY PARTICULAR FONT, STYLE, SIZE, OR COLOR.

SN 85-131,342, FILED 9-16-2010.

NAPOLEON SHARMA, EXAMINING ATTORNEY



*David J. Kybas*

Director of the United States Patent and Trademark Office

# United States of America

United States Patent and Trademark Office



**Reg. No. 4,126,283**

COREMO OCMEA SPA (ITALY CORPORATION)  
VIA G. GALILEI 12, ASSAGO  
MILAN, ITALY 20090

**Registered Apr. 10, 2012**

**Int. Cl.: 7**

FOR: INDUSTRIAL BRAKES AND CLUTCHES FOR MACHINES, IN CLASS 7 (U.S. CLS. 13, 19, 21, 23, 31, 34 AND 35).

**TRADEMARK**

FIRST USE 5-0-1960; IN COMMERCE 0-0-1995.

**PRINCIPAL REGISTER**

THE MARK CONSISTS OF "COREMO OCMEA" IN STYLIZED LETTERS WITH A FANCIFUL LETTER "C".

SN 85-131,584, FILED 9-16-2010.

APRIL ROACH, EXAMINING ATTORNEY



*David J. Kybas*

Director of the United States Patent and Trademark Office

# United States of America

United States Patent and Trademark Office

# LIFEWELL

**Reg. No. 4,126,284**

**Registered Apr. 10, 2012**

**Int. Cls.: 35, 41, 42, 44,  
and 45**

**SERVICE MARK**

**PRINCIPAL REGISTER**

LIFEWELL LTD. (GEORGIA LIMITED LIABILITY COMPANY), DBA LIFEWELL HEALTH PLANS,  
1701 BARRETT LAKES BLVD., SUITE 240  
KENNESAW, GA 30144

FOR: ORGANIZING AND ADMINISTERING NETWORKS OF HEALTH CARE PROVIDERS AND HEALTH CARE SPECIALISTS , IN CLASS 35 (U.S. CLS. 100, 101 AND 102).

FIRST USE 7-1-2003; IN COMMERCE 7-1-2003.

FOR: PROVIDING INFORMATION TO INDIVIDUALS, EMPLOYERS, AND MEMBER-CREATED GROUPS VIA A GLOBAL COMPUTER NETWORK IN THE FIELD OF PERSONAL AND PROFESSIONAL COACHING SERVICES IN THE FIELD OF BEHAVIOR CHANGE; PERSONAL AND PROFESSIONAL COACHING SERVICES FOR INDIVIDUALS, EMPLOYERS, AND MEMBER-CREATED GROUPS IN THE FIELDS OF GOAL-SETTING AND ACHIEVEMENT; AND PROVIDING EDUCATIONAL MENTORING SERVICES AND PROGRAMS VIA A GLOBAL COMPUTER NETWORK IN THE FIELDS OF GOAL-SETTING AND ACHIEVEMENT, IN CLASS 41 (U.S. CLS. 100, 101 AND 107).

FIRST USE 12-13-2007; IN COMMERCE 12-13-2007.

FOR: COMPUTER SERVICES, NAMELY, HOSTING ONLINE WEB FACILITIES FOR OTHERS FOR ORGANIZING AND CONDUCTING ONLINE MEETINGS, GATHERINGS, AND INTERACTIVE DISCUSSIONS; COMPUTER SERVICES, NAMELY, HOSTING ON-LINE INTERACTIVE PUBLIC CALENDARS THAT ALLOW MULTIPLE PARTICIPANTS TO SHARE EVENT SCHEDULES; PROVIDING AND MAINTAINING A WEBSITE THAT FEATURES TECHNOLOGY THAT ENABLES THE SECURE EXCHANGE OF HEALTH INFORMATION ONLINE BY USERS; PROVIDING A WEBSITE FEATURING TECHNOLOGY THAT ENABLES USERS TO SHARE INFORMATION ONLINE AMONG HEALTHCARE PRACTITIONERS AND BETWEEN PATIENTS AND PRACTITIONERS, IN CLASS 42 (U.S. CLS. 100 AND 101).

FIRST USE 5-6-2009; IN COMMERCE 5-6-2009.

FOR: PROVIDING ON-LINE INFORMATION IN THE FIELD OF HEALTH; PROVIDING MEDICAL INFORMATION, IN CLASS 44 (U.S. CLS. 100 AND 101).

FIRST USE 5-6-2009; IN COMMERCE 5-6-2009.



*David J. Kyjars*

Director of the United States Patent and Trademark Office

**Reg. No. 4,126,284** FOR: PROVIDING ON-LINE INFORMATION IN THE FIELDS OF SELF-HELP, PERSONAL INTEREST LIFESTYLES, AND PERSONAL EMPOWERMENT SUBJECT MATTERS; ORGANIZING AND CONDUCTING SUPPORT GROUPS IN THE FIELDS OF SELF-HELP, HEALTH, PERSONAL INTEREST LIFESTYLES, AND PERSONAL EMPOWERMENT SUBJECT MATTERS, IN CLASS 45 (U.S. CLS. 100 AND 101).

FIRST USE 5-6-2009; IN COMMERCE 5-6-2009.

THE MARK CONSISTS OF STANDARD CHARACTERS WITHOUT CLAIM TO ANY PARTICULAR FONT, STYLE, SIZE, OR COLOR.

OWNER OF U.S. REG. NO. 2,916,892.

SN 85-133,570, FILED 9-20-2010.

LAURIE KAUFMAN, EXAMINING ATTORNEY

# United States of America

United States Patent and Trademark Office

# LEAD ANGEL

**Reg. No. 4,126,285**

CUSTOMER FOCUSED MARKETING, INC (TEXAS CORPORATION)  
511 E. CARPENTER FRWY., SUITE #575  
IRVING, TX 75062

**Registered Apr. 10, 2012**

**Int. Cl.: 35**

FOR: CUSTOMER RELATIONSHIP MANAGEMENT, IN CLASS 35 (U.S. CLS. 100, 101 AND 102).

**SERVICE MARK**

FIRST USE 9-1-2010; IN COMMERCE 9-20-2010.

**PRINCIPAL REGISTER**

THE MARK CONSISTS OF THE STYLIZED TEXT "LEAD ANGEL".

SN 85-134,436, FILED 9-21-2010.

NICHOLAS ALTREE, EXAMINING ATTORNEY



*David J. Kybas*

Director of the United States Patent and Trademark Office

# United States of America

United States Patent and Trademark Office

## A NIGHT OF MYSTERY

**Reg. No. 4,126,286**

IGT (NEVADA CORPORATION)  
9295 PROTOTYPE DRIVE  
RENO, NV 895218986

**Registered Apr. 10, 2012**

**Int. Cl.: 9**

FOR: GAMING MACHINES, NAMELY, DEVICES WHICH ACCEPT A WAGER, IN CLASS 9 (U.S. CLS. 21, 23, 26, 36 AND 38).

**TRADEMARK**

FIRST USE 1-11-2012; IN COMMERCE 1-11-2012.

**PRINCIPAL REGISTER**

THE MARK CONSISTS OF STANDARD CHARACTERS WITHOUT CLAIM TO ANY PARTICULAR FONT, STYLE, SIZE, OR COLOR.

SN 85-134,750, FILED 9-21-2010.

JIM RINGLE, EXAMINING ATTORNEY



*David J. Kybas*

Director of the United States Patent and Trademark Office



# United States of America

United States Patent and Trademark Office

## GRAND ILLUSIONS VINYL WOODBOND

**Reg. No. 4,126,287**

EASTERN WHOLESALE FENCE CO., INC. (NEW YORK CORPORATION)  
274 MIDDLE ISLAND ROAD  
MEDFORD, NY 11763

**Registered Apr. 10, 2012**

**Int. Cl.: 19**

FOR: NON-METAL FENCE PANELS, POSTS AND CAPS; NON-METAL FENCES AND GATES; PVC RAILINGS, IN CLASS 19 (U.S. CLS. 1, 12, 33 AND 50).

**TRADEMARK**

FIRST USE 1-0-2011; IN COMMERCE 1-0-2011.

**PRINCIPAL REGISTER**

THE MARK CONSISTS OF STANDARD CHARACTERS WITHOUT CLAIM TO ANY PARTICULAR FONT, STYLE, SIZE, OR COLOR.

OWNER OF U.S. REG. NOS. 3,426,306, 3,426,307, AND 3,483,652.

NO CLAIM IS MADE TO THE EXCLUSIVE RIGHT TO USE "VINYL", APART FROM THE MARK AS SHOWN.

SN 85-134,768, FILED 9-21-2010.

EUGENIA MARTIN, EXAMINING ATTORNEY



*David J. Kybas*

Director of the United States Patent and Trademark Office

# United States of America

United States Patent and Trademark Office

# CABANA

**Reg. No. 4,126,288**

**Registered Apr. 10, 2012**

**Int. Cl.: 9**

**TRADEMARK**

**PRINCIPAL REGISTER**

DEPARTMENT OF BEHAVIOR AND LOGIC, INC. (DELAWARE CORPORATION)  
383 WEST PORTAL AVENUE  
SAN FRANCISCO, CA 94127

FOR: COMPUTER PROGRAMS USED IN THE DESIGN AND CREATION OF COMPUTER APPLICATION SOFTWARE FOR MOBILE ELECTRONIC DEVICES, IN CLASS 9 (U.S. CLS. 21, 23, 26, 36 AND 38).

FIRST USE 2-23-2011; IN COMMERCE 2-23-2011.

THE MARK CONSISTS OF STANDARD CHARACTERS WITHOUT CLAIM TO ANY PARTICULAR FONT, STYLE, SIZE, OR COLOR.

SN 85-136,134, FILED 9-23-2010.

JOHN SCHUYLER YARD, EXAMINING ATTORNEY



*David J. Kyffers*

Director of the United States Patent and Trademark Office

United States of America  
United States Patent and Trademark Office

# PreviLEAN

**Reg. No. 4,126,289**

CELL SCIENCE SYSTEMS CORPORATION (FLORIDA CORPORATION)  
852 SOUTH MILITARY TRAIL  
DEERFIELD BEACH, FL 33442

**Registered Apr. 10, 2012**

**Int. Cl.: 44**

FOR: MEDICAL TESTING FOR DIAGNOSTIC OR TREATMENT PURPOSES; PROVIDING WEIGHT LOSS PROGRAM SERVICES, IN CLASS 44 (U.S. CLS. 100 AND 101).

**SERVICE MARK**

FIRST USE 12-1-2011; IN COMMERCE 12-1-2011.

**PRINCIPAL REGISTER**

THE MARK CONSISTS OF STANDARD CHARACTERS WITHOUT CLAIM TO ANY PARTICULAR FONT, STYLE, SIZE, OR COLOR.

SN 85-136,245, FILED 9-23-2010.

KEVIN DINALLO, EXAMINING ATTORNEY



*David J. Kybas*

Director of the United States Patent and Trademark Office

# United States of America

United States Patent and Trademark Office

# MAXEON

**Reg. No. 4,126,290**

**Registered Apr. 10, 2012**

**Int. Cl.: 9**

**TRADEMARK**

**PRINCIPAL REGISTER**

SUNPOWER CORPORATION (DELAWARE CORPORATION)  
TRADEMARK DEPT.  
77 RIO ROBLES  
SAN JOSE, CA 95134

FOR: APPARATUS FOR CONVERTING SOLAR RADIATION TO ELECTRICAL ENERGY, NAMELY, PHOTOVOLTAIC SOLAR MODULES; ELECTRONIC SENSORS FOR MEASURING SOLAR RADIATION; APPARATUS FOR CONVERTING ELECTRONIC RADIATION TO ELECTRICAL ENERGY, NAMELY, PHOTOVOLTAIC ROOFING MEMBERS AND PHOTOVOLTAIC CLADDING PANELS, IN CLASS 9 (U.S. CLS. 21, 23, 26, 36 AND 38).

FIRST USE 3-28-2011; IN COMMERCE 3-28-2011.

THE MARK CONSISTS OF STANDARD CHARACTERS WITHOUT CLAIM TO ANY PARTICULAR FONT, STYLE, SIZE, OR COLOR.

SN 85-136,990, FILED 9-23-2010.

JIM RINGLE, EXAMINING ATTORNEY



*David J. Kyfos*

Director of the United States Patent and Trademark Office

# United States of America

United States Patent and Trademark Office

## ROYAL JOE

**Reg. No. 4,126,291**

**Registered Apr. 10, 2012**

**Int. Cl.: 25**

**TRADEMARK**

**PRINCIPAL REGISTER**

FANG, HUNG (UNITED STATES INDIVIDUAL)  
#401B  
2500 E. FOOTHILL BLVD.  
PASADENA, CA 91107

FOR: CLOTHING, NAMELY, JACKETS, HOODED SWEATSHIRTS, LONG SLEEVE AND SHORT SLEEVE POLO SHIRTS, LONG SLEEVE AND SHORT SLEEVE SHIRTS, LONG SLEEVE AND SHORT SLEEVE TEE SHIRTS, OUTERWEAR, NAMELY, CAUSAL COATS AND JACKETS, SWEATERS, TROUSERS, PANTS, UNDERWEAR, BRAS, DRESSES, JEANS, T-SHIRTS, WIND COATS, BIKINIS, SPORTSWEAR, NAMELY, SWEAT RESISTANT, LIGHT-WEIGHT SHIRTS AND PANTS FOR EXERCISING AND GOLF HATS, BASEBALL HATS AND VISORS, SKIRTS, HATS, SOCKS, SCARVES, IN CLASS 25 (U.S. CLS. 22 AND 39).

FIRST USE 9-15-2011; IN COMMERCE 9-15-2011.

THE MARK CONSISTS OF STANDARD CHARACTERS WITHOUT CLAIM TO ANY PARTICULAR FONT, STYLE, SIZE, OR COLOR.

THE NAME(S), PORTRAIT(S), AND/OR SIGNATURE(S) SHOWN IN THE MARK DOES NOT IDENTIFY A PARTICULAR LIVING INDIVIDUAL.

SN 85-137,184, FILED 9-24-2010.

HEATHER THOMPSON, EXAMINING ATTORNEY



*David J. Kyros*

Director of the United States Patent and Trademark Office

# United States of America

United States Patent and Trademark Office

Thai  1st

**Reg. No. 4,126,292**

**Registered Apr. 10, 2012**

**Int. Cl.: 43**

**SERVICE MARK**

**PRINCIPAL REGISTER**

BLUE BASIL, INC. (NORTH CAROLINA CORPORATION)  
9824 RAE ROAD  
SUITE B  
CHARLOTTE, NC 28277

FOR: RESTAURANT SERVICES, IN CLASS 43 (U.S. CLS. 100 AND 101).

FIRST USE 10-10-2011; IN COMMERCE 10-10-2011.

NO CLAIM IS MADE TO THE EXCLUSIVE RIGHT TO USE "THAI" , APART FROM THE MARK AS SHOWN.

THE COLOR(S) PURPLE, GREEN , BLUE AND WHITE IS/ARE CLAIMED AS A FEATURE OF THE MARK.

THE MARK CONSISTS OF THE STYLIZED WORD "THAI" IN WHITE AND PURPLE OUTLINING FOLLOWED BY THE GRAPHIC REPRESENTATION OF GREEN LEAVES WITH BLUE OUTLINING FOLLOWED BY THE STYLIZED WORD "1ST" IN WHITE AND PURPLE OUTLINING.

SN 85-137,734, FILED 9-24-2010.

WILLIAM VERHOSEK, EXAMINING ATTORNEY



*David J. Kyffers*

Director of the United States Patent and Trademark Office

# United States of America

United States Patent and Trademark Office

# LUCROS

**Reg. No. 4,126,293**

**Registered Apr. 10, 2012**

**Int. Cl.: 1**

**TRADEMARK**

**PRINCIPAL REGISTER**

FBSCIENCES, INC. (DELAWARE CORPORATION)  
SUITE 100  
153 N. MAIN ST.  
COLLIERVILLE, TN 38017

FOR: FOLIAR-APPLIED NUTRIENT SOLUTION FOR AGRICULTURAL AND HORTICULTURAL USE; AGRICULTURAL PRODUCTS, NAMELY, FOLIAR-APPLIED MICRONUTRIENT COMBINATION OF SUCROSE AND LUCRATIVE; AGRICULTURAL PRODUCTS, NAMELY, FOLIAR-APPLIED MICRONUTRIENT COMBINATION OF SUCROSE AND BORON FOR INCREASING EXTRACTABLE SUGARS, IN CLASS 1 (U.S. CLS. 1, 5, 6, 10, 26 AND 46).

FIRST USE 7-14-2010; IN COMMERCE 7-14-2010.

THE MARK CONSISTS OF STANDARD CHARACTERS WITHOUT CLAIM TO ANY PARTICULAR FONT, STYLE, SIZE, OR COLOR.

THE ENGLISH TRANSLATION OF THE WORD "LUCROS" IN THE MARK IS "PROFITS".

SN 85-137,863, FILED 9-24-2010.

REBECCA POVARCHUK, EXAMINING ATTORNEY



*David J. Kyffers*

Director of the United States Patent and Trademark Office

# United States of America

United States Patent and Trademark Office

# OmniList

**Reg. No. 4,126,294**

**Registered Apr. 10, 2012**

**Int. Cl.: 9**

**TRADEMARK**

**PRINCIPAL REGISTER**

POOCH, INC. (NORTH CAROLINA CORPORATION)  
868 JORDAN HILLS DRIVE  
CHAPEL HILL, NC 27517

FOR: COMPUTER APPLICATION SOFTWARE FOR MOBILE PHONES, NAMELY, SOFTWARE FOR CREATING AND MAINTAINING TO DO LISTS AND NOTES; COMPUTER APPLICATION SOFTWARE FOR DESKTOP, LAPTOP, AND NETBOOK COMPUTERS, NAMELY, SOFTWARE FOR CREATING AND MAINTAINING TO DO LISTS AND NOTES; COMPUTER SOFTWARE FOR THE COLLECTION, EDITING, ORGANIZING, MODIFYING, BOOK MARKING, TRANSMISSION, STORAGE AND SHARING OF DATA AND INFORMATION; COMPUTER SOFTWARE THAT PROVIDES WEB-BASED ACCESS TO APPLICATIONS AND SERVICES THROUGH A WEB OPERATING SYSTEM OR PORTAL INTERFACE, IN CLASS 9 (U.S. CLS. 21, 23, 26, 36 AND 38).

FIRST USE 5-26-2011; IN COMMERCE 5-26-2011.

THE MARK CONSISTS OF STANDARD CHARACTERS WITHOUT CLAIM TO ANY PARTICULAR FONT, STYLE, SIZE, OR COLOR.

SN 85-138,253, FILED 9-25-2010.

BRIAN NEVILLE, EXAMINING ATTORNEY



*David J. Kybas*

Director of the United States Patent and Trademark Office



# United States of America

United States Patent and Trademark Office

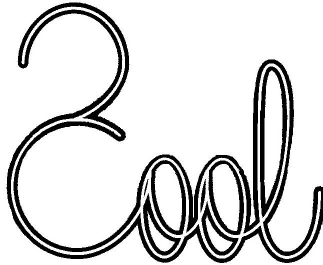

**Reg. No. 4,126,295**

CROULET, ODILE (UNITED STATES INDIVIDUAL)  
9603 SAVANNAH ESTATES DRIVE  
LAKE WORTH, FL 33467

**Registered Apr. 10, 2012**

**Int. Cl.: 25**

FOR: BLOUSES; DRESSES; PANTS; SHIRTS; SHOES; SHORTS, IN CLASS 25 (U.S. CLS. 22 AND 39).

**TRADEMARK**

FIRST USE 6-1-2011; IN COMMERCE 6-1-2011.

**PRINCIPAL REGISTER**

THE MARK CONSISTS OF THE STYLIZED TEXT "C COOL" WITH THE "C" PRESENTED BACKWARDS AND ATTACHED TO THE TOP OF THE LETTER "C" OF "COOL".

SN 85-138,670, FILED 9-27-2010.

ANTHONY RINKER, EXAMINING ATTORNEY



*David J. Kybas*

Director of the United States Patent and Trademark Office

# United States of America

United States Patent and Trademark Office



The Chemical Free Cleaning Network

**Reg. No. 4,126,296**

THE CHEMICAL FREE CLEANING NETWORK (DELAWARE CORPORATION)  
522 EPSOM ROAD  
BALTIMORE, MD 21286

**Registered Apr. 10, 2012**

**Int. Cl.: 41**

FOR: EDUCATIONAL SERVICES, NAMELY, CLASSES AND SEMINARS IN THE FIELDS OF CHEMICAL FREE CLEANING, IN CLASS 41 (U.S. CLS. 100, 101 AND 107).

**SERVICE MARK**

FIRST USE 6-1-2009; IN COMMERCE 6-1-2009.

**PRINCIPAL REGISTER**

NO CLAIM IS MADE TO THE EXCLUSIVE RIGHT TO USE "THE CHEMICAL FREE CLEANING NETWORK", APART FROM THE MARK AS SHOWN.

THE COLOR(S) GREEN, DARK GREEN, BLACK, RED AND BLUE IS/ARE CLAIMED AS A FEATURE OF THE MARK.

THE MARK CONSISTS OF THE LETTERS "CFCN" IN GREEN, THE PHRASE "THE CHEMICAL FREE CLEANING NETWORK" BELOW IN BLACK, A BEAKER IN BLUE AND BLACK WITH A RED CANCEL CIRCLE ON TOP OF THE BEAKER, AND THE DESIGN OF A LEAF IN GREEN AND DARK GREEN.

SN 85-139,663, FILED 9-28-2010.

AISHA SALEM, EXAMINING ATTORNEY



*David J. Kappas*

Director of the United States Patent and Trademark Office

# United States of America

United States Patent and Trademark Office

# POP BOOM

**Reg. No. 4,126,297**

**Registered Apr. 10, 2012**

**Int. Cl.: 41**

**SERVICE MARK**

**PRINCIPAL REGISTER**

CROWDSTAR INTERNATIONAL LIMITED (IRELAND PRIVATE LIMITED COMPANY)  
ANGLESEA HOUSE CARYSFORT AVENUE, SUITE 4  
BLACKROCK, CO. DUBLIN, IRELAND

FOR: ENTERTAINMENT SERVICES, NAMELY, PROVIDING TEMPORARY USE OF NON-DOWNLOADABLE ELECTRONIC GAMES BY MEANS OF THE INTERNET OR OTHER WIRED OR WIRELESS NETWORKS, IN CLASS 41 (U.S. CLS. 100, 101 AND 107).

FIRST USE 9-0-2010; IN COMMERCE 9-0-2010.

THE MARK CONSISTS OF STANDARD CHARACTERS WITHOUT CLAIM TO ANY PARTICULAR FONT, STYLE, SIZE, OR COLOR.

SN 85-139,947, FILED 9-28-2010.

KEVIN DINALLO, EXAMINING ATTORNEY



*David J. Kyffers*

Director of the United States Patent and Trademark Office

# United States of America

United States Patent and Trademark Office



**Reg. No. 4,126,298**

**Registered Apr. 10, 2012**

**Int. Cl.: 9**

**TRADEMARK**

**PRINCIPAL REGISTER**

DEPARTMENT OF BEHAVIOR AND LOGIC, INC. (DELAWARE CORPORATION)  
383 WEST PORTAL AVENUE  
SAN FRANCISCO, CA 94127

FOR: COMPUTER PROGRAMS USED IN THE DESIGN AND CREATION OF COMPUTER APPLICATION SOFTWARE FOR MOBILE ELECTRONIC DEVICES, IN CLASS 9 (U.S. CLS. 21, 23, 26, 36 AND 38).

FIRST USE 2-23-2011; IN COMMERCE 2-23-2011.

THE MARK CONSISTS OF A BIRD IN FRONT OF A CIRCLE.

SN 85-140,482, FILED 9-28-2010.

JOHN SCHUYLER YARD, EXAMINING ATTORNEY



*David J. Kybas*

Director of the United States Patent and Trademark Office

# United States of America

United States Patent and Trademark Office

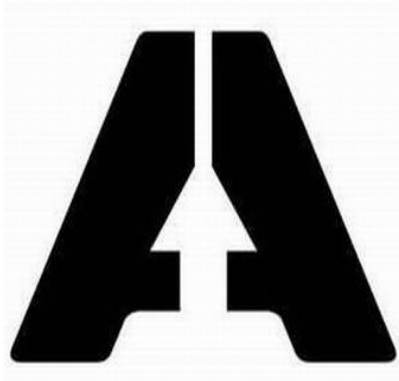

**Reg. No. 4,126,299**

**Registered Apr. 10, 2012**

**Int. Cls.: 18 and 25**

**TRADEMARK**

**PRINCIPAL REGISTER**

JOHN B. SANFILIPPO & SON, INC. (DELAWARE CORPORATION)  
1703 N. RANDALL ROAD  
ELGIN, IL 601237820

FOR: TOTE BAGS, LUGGAGE, BACKPACKS AND UMBRELLAS, IN CLASS 18 (U.S. CLS. 1, 2, 3, 22 AND 41).

FIRST USE 7-29-2010; IN COMMERCE 7-29-2010.

FOR: CLOTHING, NAMELY, SHIRTS, HATS, PANTS, BOXER BRIEFS, BOXER SHORTS AND FOOTWEAR, IN CLASS 25 (U.S. CLS. 22 AND 39).

FIRST USE 2-0-2010; IN COMMERCE 4-16-2010.

THE MARK CONSISTS OF A STYLIZED CAPITAL LETTER "A" WITH THE INTERIOR THEREOF FORMING THE OUTLINE OF AN ARROWHEAD WITH THE TOP AND MIDDLE CONNECTING PORTIONS OF THE "A" BEING DIVIDED BY WHITE SPACE.

SN 85-141,918, FILED 9-30-2010.

JOHN E. MICHOS, EXAMINING ATTORNEY



*David J. Kybas*

Director of the United States Patent and Trademark Office

# United States of America

United States Patent and Trademark Office

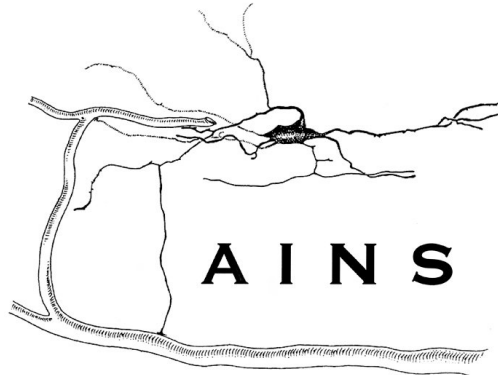

**Reg. No. 4,126,300**

**Registered Apr. 10, 2012**

**Int. Cl.: 16**

**TRADEMARK**

**PRINCIPAL REGISTER**

FILIANO, JAMES JOSEPH (UNITED STATES INDIVIDUAL), DBA ANCORA IMPARO  
NEURO SCIENCE,  
P.O. BOX 1452  
LEBANON, NH 03766

FOR: BOOKS IN THE FIELD OF THE FUNCTION AND DEVELOPMENT OF THE NERVOUS SYSTEM, NEUROLOGICAL DISEASES, NEUROLOGICAL, COGNITIVE AND BEHAVIORAL HEALTH, MENTAL AND PSYCHOLOGICAL DEVELOPMENT, AND NUTRITIONAL, ENVIRONMENTAL AND TOXIC FACTORS THAT AFFECT THE NERVOUS SYSTEM, IN CLASS 16 (U.S. CLS. 2, 5, 22, 23, 29, 37, 38 AND 50).

FIRST USE 9-5-2011; IN COMMERCE 9-5-2011.

THE MARK CONSISTS OF A DRAWING OF A NEURON IN CONTACT WITH A BLOOD VESSEL AND THE INITIALS "AINS".

SN 85-142,319, FILED 9-30-2010.

TAMARA FRAZIER, EXAMINING ATTORNEY



*David J. Kyffers*

Director of the United States Patent and Trademark Office

# United States of America

United States Patent and Trademark Office

## CREATORPRENEUR

**Reg. No. 4,126,301**

**Registered Apr. 10, 2012**

**Int. Cl.: 41**

**SERVICE MARK**

**PRINCIPAL REGISTER**

DR. JULIA D. ROSS (UNITED STATES INDIVIDUAL)  
1113 W. ADDITION STREET  
MARTINSBURG, WV 25401

FOR: BUSINESS EDUCATION AND TRAINING SERVICES, NAMELY, CONDUCTING TRAINING IN THE FIELDS OF BUSINESS MANAGEMENT AND PERSONAL DEVELOPMENT TO HELP OTHERS INTEGRATE 19TH CENTURY SKILLS OF ENTERPRISE, MASTERY, SELF-RELIANCE, AND RESOLUTENESS INTO THE 21ST CENTURY ECONOMY AND DISTRIBUTION OF COURSE MATERIALS IN CONNECTION THEREWITH; PROVIDING A WEBSITE FEATURING BUSINESS EDUCATION AND TRAINING SERVICES, NAMELY, CONDUCTING TRAINING IN THE FIELDS OF BUSINESS MANAGEMENT AND PERSONAL DEVELOPMENT TO HELP OTHERS INTEGRATE 19TH CENTURY SKILLS OF ENTERPRISE, MASTERY, SELF-RELIANCE, AND RESOLUTENESS INTO THE 21ST CENTURY ECONOMY AND DISTRIBUTION OF COURSE MATERIALS IN CONNECTION THEREWITH, IN CLASS 41 (U.S. CLS. 100, 101 AND 107).

FIRST USE 10-12-2010; IN COMMERCE 10-12-2010.

THE MARK CONSISTS OF STANDARD CHARACTERS WITHOUT CLAIM TO ANY PARTICULAR FONT, STYLE, SIZE, OR COLOR.

SN 85-142,674, FILED 9-30-2010.

KAPIL BHANOT, EXAMINING ATTORNEY



*David J. Kyros*

Director of the United States Patent and Trademark Office

# United States of America

United States Patent and Trademark Office

## MAKING FRIENDS FROM ALL AROUND

**Reg. No. 4,126,302**

**Registered Apr. 10, 2012**

**Int. Cl.: 9**

**TRADEMARK**

**PRINCIPAL REGISTER**

THE LANGUAGE EXPRESS, INC (CALIFORNIA CORPORATION)  
1543 JUNIPERHILL DRIVE  
ENCINITAS, CA 92024

FOR: APPARATUS FOR SPEECH RECORDING AND REPLAYING; CHILDREN'S EDUCATIONAL SOFTWARE; COMPUTER GAME CARTRIDGES; COMPUTER GAME CARTRIDGES AND DISCS; COMPUTER GAME CASSETTES; COMPUTER GAME CONSOLES FOR USE WITH AN EXTERNAL DISPLAY SCREEN OR MONITOR; COMPUTER GAME DISCS; COMPUTER GAME EQUIPMENT, NAMELY, DISCS; COMPUTER GAME JOYSTICKS; COMPUTER GAME PROGRAMS; COMPUTER GAME PROGRAMS DOWNLOADABLE VIA THE INTERNET; COMPUTER GAME PROGRAMS, CARTRIDGES, AND CASSETTES; COMPUTER GAME SOFTWARE; COMPUTER GAME SOFTWARE DOWNLOADABLE FROM A GLOBAL COMPUTER NETWORK; COMPUTER GAME SOFTWARE FOCUSING ON ACHIEVING A SET OF GOALS, POSITIONS, OWNERSHIP, AND CREDENTIALS, AND PROFESSIONAL AND SOCIAL STATUS, AND GOOD FORTUNE NECESSARY TO SUCCEED PROFESSIONALLY AND PERSONALLY, AND NOT REFERRING EITHER TO A GROUP OF SOFTWARE FOR USE IN COMMERCE OR TO A GROUP OF OFFICES; COMPUTER GAME SOFTWARE FOR PERSONAL COMPUTERS AND HOME VIDEO GAME CONSOLES; COMPUTER GAME SOFTWARE FOR USE ON MOBILE AND CELLULAR PHONES; COMPUTER GAME SOFTWARE FOR USE WITH PERSONAL COMPUTERS, HOME VIDEO GAME CONSOLES USED WITH TELEVISIONS, AND FOR ARCADE-BASED VIDEO GAME CONSOLES; COMPUTER HARDWARE AND COMPUTER PERIPHERAL DEVICES; COMPUTER HARDWARE AND COMPUTER SOFTWARE PROGRAMS FOR THE INTEGRATION OF TEXT, AUDIO, GRAPHICS, STILL IMAGES AND MOVING PICTURES INTO AN INTERACTIVE DELIVERY FOR MULTIMEDIA APPLICATIONS; COMPUTER HARDWARE AND SOFTWARE USED FOR THE CONTROL OF VOICE CONTROLLED INFORMATION AND COMMUNICATION DEVICES; COMPUTER PROGRAMS FOR VIDEO AND COMPUTER GAMES; COMPUTER SOFTWARE FEATURING TRAINING IN THE FIELD OF TREATMENT FOR ADULT AND CHILDREN'S SOCIAL DELAY, SPEECH DELAY, AUTISM, DEVELOPMENTAL DELAY, SPEECH THERAPY, PERSVASIVE DEVELOPMENTAL DISORDER (PDD), PERSVASIVE DEVELOPMENTAL DISORDER NOT OTHERWISE SPECIFIED (PDD-NOS), ASPERGER'S SYNDROME, ATTENTION DEFICIT DISORDER, (ADD), ATTENTION DEFICIT HYPERACTIVITY DISORDER (ADHD), SOCIAL IMPAIRMENT, STROKE, BRAIN DAMAGE AND PHYSICAL REHABILITATION; COMPUTER SOFTWARE AND COMPUTER HARDWARE FOR USE IN LANGUAGE LOCALIZATION, BY MEANS OF LANGUAGE TRANSLATION, SUBTITLING, DUBBING, CLOSED CAPTIONING AND TELETEXT FOR FEATURE FILMS, TELEVISION PROGRAMS, VIDEOS AND DIGITAL MEDIA IN GENERAL; COM-



*David J. Kybas*

Director of the United States Patent and Trademark Office



**Reg. No. 4,126,302** PUTER-GAMING SOFTWARE; DOWNLOADABLE COMPUTER GAME PROGRAMS; DOWNLOADABLE COMPUTER GAME SOFTWARE VIA A GLOBAL COMPUTER NETWORK AND WIRELESS DEVICES; DOWNLOADABLE COMPUTER PROGRAMS FEATURING POSITIONABLE GAME PIECE FIGURES FOR USE IN THE FIELD OF COMPUTER GAMES; GAME CONTROLLERS FOR COMPUTER GAMES; INTERACTIVE GAME PROGRAMS; INTERACTIVE GAME SOFTWARE; INTERACTIVE MULTIMEDIA COMPUTER GAME PROGRAM; COMPUTER SOFTWARE FOR HEALTH CARE PROFESSIONALS FOR USE IN LANGUAGE AND SOCIAL SKILLS REHABILITATION FOR PATIENTS WITH ADULT AND CHILDREN'S SOCIAL DELAY, SPEECH DELAY, AUTISM, DEVELOPMENTAL DELAY, SPEECH THERAPY, PERVASIVE DEVELOPMENTAL DISORDER (PDD), PERVASIVE DEVELOPMENTAL DISORDER NOT OTHERWISE SPECIFIED (PDD-NOS), ASPERGER'S SYNDROME, ATTENTION DEFICIT DISORDER, (ADD), ATTENTION DEFICIT HYPERACTIVITY DISORDER (ADHD), SOCIAL IMPAIRMENT, STROKE, AND BRAIN DAMAGE; INTERACTIVE VIDEO GAMES OF VIRTUAL REALITY COMPRISED OF COMPUTER HARDWARE FOR USE WITH AN EXTERNAL MONITOR AND SOFTWARE; RECORDED COMPUTER GAME PROGRAMS; VIDEO AND COMPUTER GAME PROGRAMS; WIRELESS COMMUNICATION DEVICE FEATURING VOICE, DATA AND IMAGE TRANSMISSION INCLUDING VOICE, TEXT AND PICTURE MESSAGING, A VIDEO AND STILL IMAGE CAMERA, ALSO FUNCTIONAL TO PURCHASE MUSIC, GAMES, VIDEO AND SOFTWARE APPLICATIONS OVER THE AIR FOR DOWNLOADING TO THE DEVICE, IN CLASS 9 (U.S. CLS. 21, 23, 26, 36 AND 38).

FIRST USE 5-1-2011; IN COMMERCE 11-16-2011.

THE MARK CONSISTS OF STANDARD CHARACTERS WITHOUT CLAIM TO ANY PARTICULAR FONT, STYLE, SIZE, OR COLOR.

SN 85-142,715, FILED 10-1-2010.

MARLENE BELL, EXAMINING ATTORNEY

# United States of America

United States Patent and Trademark Office

# TEAMSIGHT

**Reg. No. 4,126,303**

MCCARTHY HOLDINGS, INC. (DELAWARE CORPORATION)

**Registered Apr. 10, 2012**

1341 N. ROCK HILL ROAD  
ST. LOUIS, MO 631241498

**Int. Cls.: 37 and 38**

FOR: CONSTRUCTION PROJECT MANAGEMENT SERVICES, NAMELY, PROVIDING PROJECT UPDATES, INFORMATION AND COLLABORATION ON DECISIONS, ALL PROVIDED ONLINE, IN CLASS 37 (U.S. CLS. 100, 103 AND 106).

**SERVICE MARK**

FIRST USE 4-30-2011; IN COMMERCE 4-30-2011.

**PRINCIPAL REGISTER**

FOR: TELECOMMUNICATIONS SERVICES, NAMELY, PROVIDING AN ONLINE PROJECT MANAGEMENT FORUM DESIGNED TO ALLOW ALL PARTIES INVOLVED TO POST PROJECT UPDATES, SHARE INFORMATION AND COLLABORATE ON DECISIONS, IN CLASS 38 (U.S. CLS. 100, 101 AND 104).

FIRST USE 4-30-2011; IN COMMERCE 4-30-2011.

THE MARK CONSISTS OF STANDARD CHARACTERS WITHOUT CLAIM TO ANY PARTICULAR FONT, STYLE, SIZE, OR COLOR.

SN 85-142,895, FILED 10-1-2010.

APRIL ROACH, EXAMINING ATTORNEY



*David J. Kyffers*

Director of the United States Patent and Trademark Office

# United States of America

United States Patent and Trademark Office

# DermaKinetics

**Reg. No. 4,126,304**

PHOTOKINETIX INC. (NEW YORK CORPORATION)  
1435 FIRST AVENUE #2FS  
NEW YORK, NY 10021

**Registered Apr. 10, 2012**

**Int. Cls.: 3 and 10**

FOR: SKIN AND BODY TOPICAL LOTIONS, CREAMS AND OILS FOR COSMETIC USE,  
IN CLASS 3 (U.S. CLS. 1, 4, 6, 50, 51 AND 52).

**TRADEMARK**

FIRST USE 1-0-2011; IN COMMERCE 1-0-2011.

**PRINCIPAL REGISTER**

FOR: COSMETIC APPARATUS, NAMELY, LIGHT BASED DEVICES PROVIDING MAINLY  
PULSED LIGHT FOR PERFORMING NON-ABLATIVE AESTHETIC SKIN TREATMENT  
PROCEDURES, IN CLASS 10 (U.S. CLS. 26, 39 AND 44).

FIRST USE 1-0-2011; IN COMMERCE 1-0-2011.

THE MARK CONSISTS OF STANDARD CHARACTERS WITHOUT CLAIM TO ANY PAR-  
TICULAR FONT, STYLE, SIZE, OR COLOR.

SN 85-143,851, FILED 10-3-2010.

JOHN DALIER, EXAMINING ATTORNEY



*David J. Kybas*

Director of the United States Patent and Trademark Office

# United States of America

United States Patent and Trademark Office

# TURNTABLE

**Reg. No. 4,126,305**

SOTTO LLC (CALIFORNIA LIMITED LIABILITY COMPANY)  
250 ROBIN MEADOW LANE  
WATSONVILLE, CA 95076

**Registered Apr. 10, 2012**

**Int. Cl.: 12**

FOR: BICYCLES; BICYCLE PARTS, NAMELY, FRAMES AND FRAME PARTS, STEMS, HANDLEBARS, DERAILLEURS, SHIFTERS, CRANKS, PEDALS, HUBS, WHEEL RIMS AND TIRES , IN CLASS 12 (U.S. CLS. 19, 21, 23, 31, 35 AND 44).

**TRADEMARK**

FIRST USE 3-15-2011; IN COMMERCE 12-1-2011.

**PRINCIPAL REGISTER**

THE MARK CONSISTS OF STANDARD CHARACTERS WITHOUT CLAIM TO ANY PARTICULAR FONT, STYLE, SIZE, OR COLOR.

SN 85-144,399, FILED 10-4-2010.

ROBERT STRUCK, EXAMINING ATTORNEY



*David J. Kyffers*

Director of the United States Patent and Trademark Office

# United States of America

United States Patent and Trademark Office

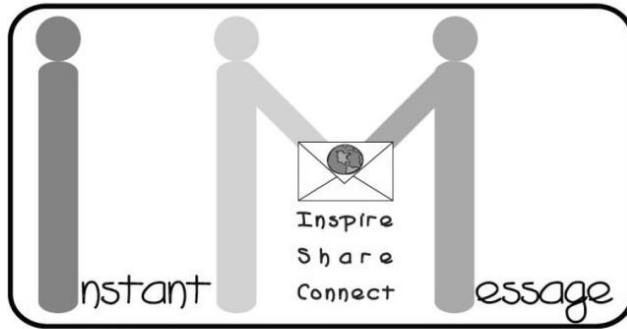

IM - "The Message & The Messenger"

**Reg. No. 4,126,306**

**Registered Apr. 10, 2012**

**Int. Cl.: 16**

**TRADEMARK**

**PRINCIPAL REGISTER**

THE CURECHIEF FOUNDATION, INC. (CONNECTICUT NON-PROFIT CORPORATION)  
P.O. BOX 1337  
286 MAPLE AVENUE, SUITE 301  
CHESHIRE, CT 064105337

FOR: GREETING CARDS HAVING INSPIRATIONAL MESSAGES, IN CLASS 16 (U.S. CLS. 2, 5, 22, 23, 29, 37, 38 AND 50).

FIRST USE 8-31-2010; IN COMMERCE 8-31-2010.

NO CLAIM IS MADE TO THE EXCLUSIVE RIGHT TO USE "INSTANT MESSAGE INSPIRE SHARE CONNECT", APART FROM THE MARK AS SHOWN.

THE MARK CONSISTS OF "INSTANT MESSAGE INSPIRE SHARE CONNECT IM - "THE MESSAGE & THE MESSENGER"" AND STYLIZED DESIGN OF FIGURES FORMING THE "I" AND "M" IN "INSTANT MESSAGE", WITH FIGURES IN LETTER "M" HOLDING AN ENVELOPE FEATURING A GLOBE ON TOP FLAP.

SN 85-144,415, FILED 10-4-2010.

BERYL GARDNER, EXAMINING ATTORNEY



*David J. Kyffers*

Director of the United States Patent and Trademark Office

# United States of America

United States Patent and Trademark Office

## SWEDEN WITH LOVE

**Reg. No. 4,126,307**

**Registered Apr. 10, 2012**

**Int. Cl.: 41**

**SERVICE MARK**

**PRINCIPAL REGISTER**

ULRICA WIHLBORG (UNITED STATES INDIVIDUAL)  
1124 CHELSEA AVENUE  
SANTA MONICA, CA 90403

FOR: ON-LINE JOURNALS, NAMELY, BLOGS FEATURING LIFESTYLE ARTICLES, INTERIOR DESIGN, FOOD AND TRAVEL WITH A PRIMARY FOCUS ON SWEDEN; PROVIDING A WEBSITE FEATURING RESOURCES, NAMELY, NON-DOWNLOADABLE PUBLICATIONS IN THE NATURE OF MAGAZINES AND BOOKS IN THE FIELD OF LIFESTYLE, INTERIOR DESIGN, FOOD AND TRAVEL WITH A PRIMARY FOCUS ON SWEDEN, IN CLASS 41 (U.S. CLS. 100, 101 AND 107).

FIRST USE 1-17-2012; IN COMMERCE 1-17-2012.

THE MARK CONSISTS OF STANDARD CHARACTERS WITHOUT CLAIM TO ANY PARTICULAR FONT, STYLE, SIZE, OR COLOR.

NO CLAIM IS MADE TO THE EXCLUSIVE RIGHT TO USE "SWEDEN", APART FROM THE MARK AS SHOWN.

SN 85-144,752, FILED 10-4-2010.

RUSS HERMAN, EXAMINING ATTORNEY



*David J. Kyfos*

Director of the United States Patent and Trademark Office

# United States of America

United States Patent and Trademark Office

# THE EDGE

**Reg. No. 4,126,308**

PERFORMANCE FILMWORKS, INC. (CALIFORNIA CORPORATION)  
3763 BARRY AVE.

**Registered Apr. 10, 2012**

LOS ANGELES, CA 90066

**Int. Cls.: 7, 9, 39, and 41**

FOR: CRANES, NAMELY, CAMERA CRANES, GYRO STABILIZED REMOTE CONTROLLED CAMERA CRANES, AND NON-GYRO STABILIZED REMOTE CONTROLLED CAMERA CRANES, IN CLASS 7 (U.S. CLS. 13, 19, 21, 23, 31, 34 AND 35).

**TRADEMARK**

FIRST USE 10-10-2010; IN COMMERCE 10-10-2010.

**SERVICE MARK**

**PRINCIPAL REGISTER**

FOR: TILTING HEADS FOR CAMERAS; MOUNTING DEVICES FOR CAMERAS AND MONITORS; GYRO STABILIZED REMOTE CONTROLLED CAMERA HEADS; NON-GYRO STABILIZED REMOTE CONTROLLED CAMERA HEADS; CAMERA MOUNTING ACCESSORIES, NAMELY, LEVELING HEADS, SUSPENSION MOUNTS AND SPRING MOUNTS; CRANES SPECIALLY DESIGNED TO WORK WITH CAMERAS AS ACCESSORIES, NAMELY, CRANES FOR CAMERAS, GYRO STABILIZED REMOTE CONTROLLED CAMERA CRANES, AND NON-GYRO STABILIZED REMOTE CONTROLLED CAMERA CRANES, IN CLASS 9 (U.S. CLS. 21, 23, 26, 36 AND 38).

FIRST USE 10-10-2010; IN COMMERCE 10-10-2010.

FOR: RENTAL OF VEHICLES, IN CLASS 39 (U.S. CLS. 100 AND 105).

FIRST USE 10-10-2010; IN COMMERCE 10-10-2010.

FOR: RENTAL OF CINEMATOGRAPHIC MACHINES AND APPARATUS, IN CLASS 41 (U.S. CLS. 100, 101 AND 107).

FIRST USE 10-10-2010; IN COMMERCE 10-10-2010.

THE MARK CONSISTS OF STANDARD CHARACTERS WITHOUT CLAIM TO ANY PARTICULAR FONT, STYLE, SIZE, OR COLOR.

SN 85-145,564, FILED 10-5-2010.

JENNY PARK, EXAMINING ATTORNEY

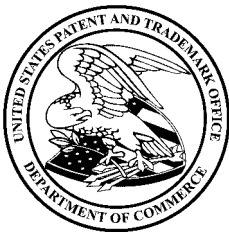

*David J. Kyffers*

Director of the United States Patent and Trademark Office

# United States of America

United States Patent and Trademark Office

# USM

**Reg. No. 4,126,309**

**Registered Apr. 10, 2012**

**Int. Cl.: 9**

**TRADEMARK**

**PRINCIPAL REGISTER**

SEAGATE TECHNOLOGY LLC (DELAWARE LIMITED LIABILITY COMPANY)  
10200 SOUTH DEANZA BOULEVARD  
CUPERTINO, CA 95014

FOR: COMPUTER STORAGE DEVICES, NAMELY, COMPUTER MEMORY HARDWARE AND HARD DRIVES FOR COMPUTERS; DATA STORAGE DEVICES, NAMELY, HARD DISK DRIVES, SOLID STATE DRIVES, BLANK DIGITAL STORAGE MEDIA, HARD DRIVES WITH SOLID STATE MEMORY, AND HYBRID DRIVES; DATA STORAGE DEVICE ACCESSORIES, NAMELY, ELECTRICAL CONNECTORS, WIRES, CABLES, ADAPTORS; COMPUTER CONNECTION CABLES AND ADAPTORS; DOCKING STATIONS FOR DATA STORAGE DEVICES; INTERFACES FOR COMPUTERS; HIGH DEFINITION MULTIMEDIA INTERFACE CABLES; PERIPHERAL COMPONENT INTERFACE (PCI) HARDWARE; CONNECTORS AND ADAPTORS FOR USE WITH PORTABLE ELECTRONIC DEVICES; COMPUTER HARDWARE FOR UPLOAD, STORAGE, RETRIEVAL, DOWNLOAD, TRANSMISSION AND DELIVERY OF DIGITAL CONTENT; DIGITAL DISK DRIVES, COMPUTER PERIPHERAL DEVICES; REMOVABLE HARD DRIVE BASED COMPUTER BACKUP SYSTEMS, IN CLASS 9 (U.S. CLS. 21, 23, 26, 36 AND 38).

FIRST USE 11-1-2011; IN COMMERCE 11-1-2011.

THE MARK CONSISTS OF STANDARD CHARACTERS WITHOUT CLAIM TO ANY PARTICULAR FONT, STYLE, SIZE, OR COLOR.

SN 85-146,605, FILED 10-6-2010.

ERNEST SHOSHO, EXAMINING ATTORNEY



*David J. Kyfos*

Director of the United States Patent and Trademark Office



# United States of America

United States Patent and Trademark Office



**Reg. No. 4,126,310**

**Registered Apr. 10, 2012**

**Int. Cls.: 35 and 40**

**SERVICE MARK**

**PRINCIPAL REGISTER**

SUNTOPIA, INC. (CALIFORNIA CORPORATION)  
SUITE D  
442 HOUSER STREET  
COTATI, CA 94931

FOR: DISTRIBUTORSHIPS IN THE FIELD OF SOLAR THERMAL HEATING SOLUTIONS FOR SWIMMING POOLS, NAMELY, SOLAR THERMAL COLLECTORS, SOLAR HEAT COLLECTION PANELS, IN CLASS 35 (U.S. CLS. 100, 101 AND 102).

FIRST USE 9-1-2010; IN COMMERCE 9-1-2010.

FOR: CUSTOM MANUFACTURING OF SOLAR THERMAL HEATING SOLUTIONS FOR SWIMMING POOLS, NAMELY, SOLAR THERMAL COLLECTORS, SOLAR HEAT COLLECTION PANELS, IN CLASS 40 (U.S. CLS. 100, 103 AND 106).

FIRST USE 9-1-2010; IN COMMERCE 9-1-2010.

THE MARK CONSISTS OF THE WORDS "SUNTOPIA" WRITTEN IN BLUE COLOR ABOVE WHICH AN IMAGE REPRESENTING THE RISING SUN IN YELLOW APPEARS.

THE COLOR(S) BLUE AND YELLOW IS/ARE CLAIMED AS A FEATURE OF THE MARK.

SN 85-148,082, FILED 10-8-2010.

LINDSEY RUBIN, EXAMINING ATTORNEY



*David J. Kybas*

Director of the United States Patent and Trademark Office

# United States of America

United States Patent and Trademark Office

# DYNACONE

**Reg. No. 4,126,311**

MEGUIAR'S, INC. (CALIFORNIA CORPORATION)  
17991 MITCHELL SOUTH  
IRVINE, CA 92614

**Registered Apr. 10, 2012**

**Int. Cl.: 7**

FOR: POWER OPERATED VEHICLE POLISHING AND CLEANING TOOLS, NAMELY, BUFFERS AND POLISHERS, IN CLASS 7 (U.S. CLS. 13, 19, 21, 23, 31, 34 AND 35).

**TRADEMARK**

FIRST USE 2-0-2011; IN COMMERCE 2-0-2011.

**PRINCIPAL REGISTER**

THE MARK CONSISTS OF STANDARD CHARACTERS WITHOUT CLAIM TO ANY PARTICULAR FONT, STYLE, SIZE, OR COLOR.

SN 85-148,100, FILED 10-8-2010.

GEOFFREY FOSDICK, EXAMINING ATTORNEY



*David J. Kyffers*

Director of the United States Patent and Trademark Office

United States of America  
United States Patent and Trademark Office

GANXY

**Reg. No. 4,126,312**

**Registered Apr. 10, 2012**

**Int. Cl.: 35**

**SERVICE MARK**

**PRINCIPAL REGISTER**

GANXY, INC. (DELAWARE CORPORATION)  
3015 FORT HAMILTON PARKWAY  
SUITE 2R  
BROOKLYN, NY 11218

FOR: COMPUTERIZED ON-LINE RETAIL STORE SERVICES IN THE FIELD OF DIGITAL INFORMATION AND CONTENT FEATURING DOWNLOADABLE SOUND, MUSIC, IMAGE, VIDEO AND GAME FILES; MARKETING, ADVERTISING, AND PROMOTING THE RETAIL GOODS AND SERVICES OF OTHERS TO WIRELESS ELECTRONIC DEVICES; MOBILE RETAIL STORE SERVICES FEATURING DIGITAL INFORMATION AND CONTENT, NAMELY, DOWNLOADABLE SOUND, MUSIC, IMAGE, VIDEO AND GAME FILES; ON-LINE RETAIL CONSIGNMENT STORES FEATURING DIGITAL INFORMATION AND CONTENT, NAMELY, DOWNLOADABLE SOUND, MUSIC, IMAGE, VIDEO AND GAME FILES; ON-LINE RETAIL STORE SERVICES FEATURING DOWNLOADABLE PRE-RECORDED MUSIC AND VIDEO FILES; ON-LINE RETAIL STORE SERVICES FEATURING PHYSICAL AND VIRTUAL MERCHANDISE FOR USE BY MEMBERS OF AN ONLINE COMMUNITY IN CONNECTION WITH A DESIGNATED WEBSITE FEATURING FICTIONAL CHARACTERS; ON-LINE RETAIL STORE SERVICES FEATURING DIGITAL INFORMATION AND CONTENT, NAMELY, DOWNLOADABLE SOUND, MUSIC, IMAGE, VIDEO AND GAME FILES; ON-LINE WHOLESALE AND RETAIL STORE SERVICES FEATURING DOWNLOADABLE SOUND, MUSIC, IMAGE, VIDEO AND GAME FILES; ON-LINE WHOLESALE AND RETAIL STORE SERVICES FEATURING DIGITAL INFORMATION AND CONTENT, NAMELY, DOWNLOADABLE SOUND, MUSIC, IMAGE, VIDEO AND GAME FILES; RETAIL STORE AND ON-LINE RETAIL STORE SERVICES FEATURING DIGITAL INFORMATION AND CONTENT, NAMELY, DOWNLOADABLE SOUND, MUSIC, IMAGE, VIDEO AND GAME FILES; WHOLESALE AND RETAIL STORE SERVICES AND ON-LINE RETAIL AND WHOLESALE STORE SERVICES FEATURING DIGITAL INFORMATION AND CONTENT, NAMELY, DOWNLOADABLE SOUND, MUSIC, IMAGE, VIDEO AND GAME FILES, IN CLASS 35 (U.S. CLS. 100, 101 AND 102).



FIRST USE 10-13-2009; IN COMMERCE 9-20-2010.

THE MARK CONSISTS OF STANDARD CHARACTERS WITHOUT CLAIM TO ANY PARTICULAR FONT, STYLE, SIZE, OR COLOR.

SN 85-148,222, FILED 10-8-2010.

*David J. Kyffers*

Director of the United States Patent and Trademark Office

**Reg. No. 4,126,312** RICHARD WHITE, EXAMINING ATTORNEY

# United States of America

United States Patent and Trademark Office

## Cheatin' Heart

**Reg. No. 4,126,313**

DIAMOND GAME ENTERPRISES (CALIFORNIA CORPORATION)  
9340 PENFIELD AVE  
CHATSWORTH, CA 91311

**Registered Apr. 10, 2012**

**Int. Cl.: 9**

FOR: GAMING EQUIPMENT, NAMELY, ELECTRONIC GAMING MACHINES AND GAMING MACHINES WITH VIDEO OUTPUT, IN CLASS 9 (U.S. CLS. 21, 23, 26, 36 AND 38).

**TRADEMARK**

FIRST USE 11-11-2011; IN COMMERCE 12-9-2011.

**PRINCIPAL REGISTER**

THE MARK CONSISTS OF STANDARD CHARACTERS WITHOUT CLAIM TO ANY PARTICULAR FONT, STYLE, SIZE, OR COLOR.

SN 85-148,351, FILED 10-8-2010.

AMEEN IMAM, EXAMINING ATTORNEY



*David J. Kyffers*

Director of the United States Patent and Trademark Office

# United States of America

United States Patent and Trademark Office



GroupLocker

**Reg. No. 4,126,314**

**Registered Apr. 10, 2012**

**Int. Cl.: 9**

**TRADEMARK**

**PRINCIPAL REGISTER**

ZEVA INCORPORATED (VIRGINIA CORPORATION)  
4805 AUTUMN GLORY WAY  
CHANTILLY, VA 20151

FOR: COMPUTER SOFTWARE THAT CONVERTS ACTIVE DIRECTORY GROUPS IN DIGITAL IDENTITIES TO DYNAMIC GROUPS ENFORCED BY CRITERIA OR BUSINESS RULES, IN CLASS 9 (U.S. CLS. 21, 23, 26, 36 AND 38).

FIRST USE 4-1-2011; IN COMMERCE 4-1-2011.

THE MARK CONSISTS OF A GRAY PYRAMID WITH AN INCOMPLETE WHITE LINE SEPARATING THE SPHERES OF THE PYRAMID, WITHIN THE PYRAMID ARE TWO CIRCLES, THERE IS A FINGERPRINT WITHIN THE PYRAMID IN GRAY AND WHITE, A SQUARE IN LIGHT BLUE AND WHITE, A SECOND SQUARE IN BLUE AND THE REMAINDER OF THE CIRCLE TO THE RIGHT HAS A BLUE GEOMETRIC SHAPE AND A BLACK BACKGROUND. THE THREE HUMAN FIGURES ARE IN GREEN, WHITE, BROWN AND BLACK; YELLOW, WHITE, BROWN AND BLACK AND BLACK, BROWN, WHITE AND LIGHT BLUE. THE WORD "GROUPLOCKER" IS IN WHITE WITH A GRAY OUTLINE.

THE COLOR(S) WHITE, GRAY, LIGHT BLUE, BLACK, BLUE, GREEN, BROWN AND YELLOW IS/ARE CLAIMED AS A FEATURE OF THE MARK.

SN 85-149,203, FILED 10-10-2010.

EDWARD NELSON, EXAMINING ATTORNEY



*David J. Kyffers*

Director of the United States Patent and Trademark Office

# United States of America

United States Patent and Trademark Office

## TURBOCHARGED

**Reg. No. 4,126,315**

**Registered Apr. 10, 2012**

**Int. Cls.: 16 and 41**

**TRADEMARK**

**SERVICE MARK**

**PRINCIPAL REGISTER**

THE BUSINESS SCHOOL OF HAPPINESS, INC. (CONNECTICUT CORPORATION)  
231 ROMFORD ROAD  
WASHINGTON DEPOT, CT 06794

FOR: PRINTED PUBLICATIONS, NAMELY, BOOKS, PERIODICALS, PAMPHLETS, BROCHURES, MAGAZINES AND NEWSLETTERS IN THE FIELD OF PROTOCOLS FOR DIET, HEALTH, WEIGHT LOSS, WEIGHT CONTROL, NUTRITION, EXERCISE AND FITNESS WITHOUT THE USE OF VITAMIN AND NUTRITIONAL SUPPLEMENTS; PRINTED TRAINING MATERIALS AND COOKBOOKS ALL FEATURING RECIPES, INFORMATION AND ADVICE ON DIET, HEALTH, WEIGHT LOSS, WEIGHT CONTROL, NUTRITION, EXERCISE AND FITNESS WITHOUT THE USE OF VITAMIN AND NUTRITIONAL SUPPLEMENTS, IN CLASS 16 (U.S. CLS. 2, 5, 22, 23, 29, 37, 38 AND 50).

FIRST USE 3-1-2010; IN COMMERCE 3-1-2010.

FOR: CONDUCTING SEMINARS, LECTURES AND WORKSHOPS IN THE FIELDS OF DIET, HEALTH, WEIGHT LOSS, WEIGHT CONTROL, NUTRITION, EXERCISE AND FITNESS WITHOUT THE USE OF VITAMIN AND NUTRITIONAL SUPPLEMENTS; PROVIDING A WEBSITE FEATURING INSTRUCTION IN THE FIELD OF DIET, HEALTH, WEIGHT LOSS, WEIGHT CONTROL, NUTRITION, EXERCISE AND FITNESS WITHOUT THE USE OF VITAMIN AND NUTRITIONAL SUPPLEMENTS, IN CLASS 41 (U.S. CLS. 100, 101 AND 107).

FIRST USE 3-1-2010; IN COMMERCE 3-1-2010.

THE MARK CONSISTS OF STANDARD CHARACTERS WITHOUT CLAIM TO ANY PARTICULAR FONT, STYLE, SIZE, OR COLOR.

SN 85-149,385, FILED 10-11-2010.

NANCY CLARKE, EXAMINING ATTORNEY



*David J. Kyjars*

Director of the United States Patent and Trademark Office

# United States of America

United States Patent and Trademark Office

# StudentSmart

**Reg. No. 4,126,316**

WORLDGATE, LLC (VIRGINIA LIMITED LIABILITY COMPANY)  
1760 RESTON PARKWAY, SUITE 504  
RESTON, VA 20190

**Registered Apr. 10, 2012**

**Int. Cl.: 9**

FOR: COMPUTER SOFTWARE THAT PROVIDES REAL-TIME, INTEGRATED BUSINESS MANAGEMENT INTELLIGENCE BY COMBINING INFORMATION FROM VARIOUS DATABASES AND PRESENTING IT IN AN EASY-TO-UNDERSTAND USER INTERFACE, IN CLASS 9 (U.S. CLS. 21, 23, 26, 36 AND 38).

**TRADEMARK**

**PRINCIPAL REGISTER**

FIRST USE 5-1-2010; IN COMMERCE 7-12-2010.

THE MARK CONSISTS OF STANDARD CHARACTERS WITHOUT CLAIM TO ANY PARTICULAR FONT, STYLE, SIZE, OR COLOR.

SN 85-149,586, FILED 10-11-2010.

MARK SPARACINO, EXAMINING ATTORNEY



*David J. Kyffers*

Director of the United States Patent and Trademark Office



# United States of America

United States Patent and Trademark Office

## IT CLINGS TO THINGS

**Reg. No. 4,126,317**

PC TREASURES, INC. (MICHIGAN CORPORATION)

**Registered Apr. 10, 2012**

1795 N. LAPEER ROAD  
OXFORD, MI 48371

**Int. Cl.: 9**

FOR: PHOTOGRAPHIC ACCESSORIES, NAMELY, FLEXIBLE TRIPODS, IN CLASS 9 (U.S. CLS. 21, 23, 26, 36 AND 38).

**TRADEMARK**

FIRST USE 11-17-2010; IN COMMERCE 11-17-2010.

**PRINCIPAL REGISTER**

THE MARK CONSISTS OF STANDARD CHARACTERS WITHOUT CLAIM TO ANY PARTICULAR FONT, STYLE, SIZE, OR COLOR.

SN 85-149,724, FILED 10-11-2010.

STEVEN R. FINE, EXAMINING ATTORNEY



*David J. Kybas*

Director of the United States Patent and Trademark Office

# United States of America

United States Patent and Trademark Office

## HAZELNUT HEAVEN

**Reg. No. 4,126,318**

CHOCOLADEFABRIKEN LINDT & SPRÜNGLI AG (SWITZERLAND CORPORATION)  
SEESTRAßE 204

**Registered Apr. 10, 2012**

CH-8802 KILCHBERG, SWITZERLAND

**Int. Cl.: 30**

FOR: CHOCOLATE CONTAINING HAZELNUTS, IN CLASS 30 (U.S. CL. 46).

FIRST USE 6-30-2011; IN COMMERCE 6-30-2011.

**TRADEMARK**

THE MARK CONSISTS OF STANDARD CHARACTERS WITHOUT CLAIM TO ANY PARTICULAR FONT, STYLE, SIZE, OR COLOR.

**PRINCIPAL REGISTER**

NO CLAIM IS MADE TO THE EXCLUSIVE RIGHT TO USE "HAZELNUT", APART FROM THE MARK AS SHOWN.

SN 85-150,329, FILED 10-12-2010.

ANDREW RHIM, EXAMINING ATTORNEY



*David J. Kybas*

Director of the United States Patent and Trademark Office

# United States of America

United States Patent and Trademark Office

## PREPARE FOR EXCEPTIONAL

**Reg. No. 4,126,319**

**Registered Apr. 10, 2012**

**Int. Cl.: 41**

**SERVICE MARK**

**PRINCIPAL REGISTER**

FULLBRIDGE INCORPORATED (DELAWARE CORPORATION)  
25 MT. AUBURN, SUITE 410  
CAMBRIDGE, MA 02138

FOR: EDUCATIONAL SERVICES, NAMELY, PROVIDING LIVE AND ONLINE COURSES OF INSTRUCTION AND TRAINING AT THE UNIVERSITY, POST-GRADUATE AND PROFESSIONAL LEVEL IN THE FIELD OF BUSINESS AND SUBJECTS RELATING TO BUSINESS, NAMELY, CONTINUING BUSINESS EDUCATION, FINANCE, BUSINESS STRATEGY, BUSINESS INNOVATION, BUSINESS PLANNING, PROJECT MANAGEMENT, AND PROFESSIONAL DEVELOPMENT, IN CLASS 41 (U.S. CLS. 100, 101 AND 107).

FIRST USE 8-19-2010; IN COMMERCE 8-19-2010.

THE MARK CONSISTS OF STANDARD CHARACTERS WITHOUT CLAIM TO ANY PARTICULAR FONT, STYLE, SIZE, OR COLOR.

SN 85-150,813, FILED 10-12-2010.

MARY CRAWFORD, EXAMINING ATTORNEY



*David J. Kybas*

Director of the United States Patent and Trademark Office

# United States of America

United States Patent and Trademark Office

## STUC PIERRE

**Reg. No. 4,126,320**

**Registered Apr. 10, 2012**

**Int. Cl.: 19**

**TRADEMARK**

**PRINCIPAL REGISTER**

PLATRE.COM LTD (UNITED KINGDOM CORPORATION)  
SUITE 23, PARK ROYAL HOUSE  
23 PARK ROYAL ROAD  
LONDRES, UNITED KINGDOM NW107JH

FOR: NON METALLIC BUILDING MATERIALS, NAMELY, SOFFITS; NON-METALLIC RIGID PIPES FOR BUILDING; ASPHALT, PITCH AND BITUMEN; NON-METALLIC TRANSPORTABLE BUILDINGS; MONUMENTS, NOT OF METAL; NON-METALLIC BUILDING MATERIALS, NAMELY, CERAMIC TILES; NON-METAL SCAFFOLDING; GLASS FOR BUILDING; INSULATING GLASS FOR WINDOWS FOR BUILDING PURPOSES; CONCRETE; CEMENT MIXES; ROOFING CEMENT; WORKS OF ART OF STONE, CONCRETE OR MARBLE; STATUES OF STONE, CONCRETE OR MARBLE; FIGURINES OF STONE, CONCRETE OR MARBLE; NON-METAL STAINED-GLASS WINDOWS; BUILDING TIMBER; TOMBSTONES NOT OF METAL, NAMELY, TOMBSTONES OF STONE, CONCRETE OR MARBLE, IN CLASS 19 (U.S. CLS. 1, 12, 33 AND 50).

FIRST USE 5-18-2011; IN COMMERCE 5-18-2011.

THE MARK CONSISTS OF STANDARD CHARACTERS WITHOUT CLAIM TO ANY PARTICULAR FONT, STYLE, SIZE, OR COLOR.

NO CLAIM IS MADE TO THE EXCLUSIVE RIGHT TO USE "STUC", APART FROM THE MARK AS SHOWN.

THE ENGLISH TRANSLATION OF "STUC" IN THE MARK IS STUCCO.

SN 85-151,435, FILED 10-13-2010.

EVELYN BRADLEY, EXAMINING ATTORNEY



*David J. Kybas*

Director of the United States Patent and Trademark Office

# United States of America

United States Patent and Trademark Office

# DON DANIEL

**Reg. No. 4,126,321**

**Registered Apr. 10, 2012**

**Int. Cl.: 33**

**TRADEMARK**

**PRINCIPAL REGISTER**

REGNOSO, DANIEL (UNITED STATES INDIVIDUAL)  
800 WEST 220TH STREET  
TORRANCE, CA 90502

FOR: TEQUILA, IN CLASS 33 (U.S. CLS. 47 AND 49).

FIRST USE 10-13-2010; IN COMMERCE 10-13-2010.

THE MARK CONSISTS OF STANDARD CHARACTERS WITHOUT CLAIM TO ANY PARTICULAR FONT, STYLE, SIZE, OR COLOR.

THE ENGLISH TRANSLATION OF "DON" IN THE MARK IS "SIR".

SN 85-152,040, FILED 10-13-2010.

TINA MAI, EXAMINING ATTORNEY



*David J. Kyffers*

Director of the United States Patent and Trademark Office

# United States of America

United States Patent and Trademark Office

## Highway Guardian

**Reg. No. 4,126,322**

CORBY, LLC (OHIO LIMITED LIABILITY COMPANY)  
P.O. BOX 127

**Registered Apr. 10, 2012**

HAYESVILLE, OH 44838

**Int. Cl.: 9**

FOR: SPEED LIMITERS FOR LIMITING VEHICLE ENGINE SPEED, NAMELY, AFTERMARKET, ADD-ON DEVICES FOR VEHICLES IN ORDER TO LIMIT THE MAXIMUM SPEED OUTPUT OF AN AUTOMOBILE, IN CLASS 9 (U.S. CLS. 21, 23, 26, 36 AND 38).

**TRADEMARK**

FIRST USE 1-13-2012; IN COMMERCE 1-13-2012.

**PRINCIPAL REGISTER**

THE MARK CONSISTS OF STANDARD CHARACTERS WITHOUT CLAIM TO ANY PARTICULAR FONT, STYLE, SIZE, OR COLOR.

SN 85-152,516, FILED 10-14-2010.

JAMES A. RAUEN, EXAMINING ATTORNEY



*David J. Kyffers*

Director of the United States Patent and Trademark Office

# United States of America

United States Patent and Trademark Office

simiessentials

**Reg. No. 4,126,323**

**Registered Apr. 10, 2012**

**Int. Cl.: 3**

**TRADEMARK**

**PRINCIPAL REGISTER**

ALBO, SIMI C. (VENEZUELA INDIVIDUAL), TA SIMI ESSENTIALS,  
21205 YACHT CLUB DRIVE #2101  
AVENTURA, FL 33180

FOR: FACIAL CLEANSERS CONTAINING BENZOYL PEROXIDE FOR COSMETIC PURPOSES; TONERS; ASTRINGENTS FOR COSMETIC PURPOSES; COSMETIC CREAMS, NAMELY, FACE CREAMS, BODY CREAM, EYE CREAM AND SKIN CREAM; COSMETIC MASKS; BODY MILK FOR COSMETIC PURPOSES; TANNING, AFTER-SUN AND ALOE VERA GEL FOR COSMETIC PURPOSES AND COSMETIC OILS, IN CLASS 3 (U.S. CLS. 1, 4, 6, 50, 51 AND 52).

FIRST USE 3-29-2011; IN COMMERCE 3-29-2011.

THE MARK CONSISTS OF THE TERM "SIMIESSENTIALS" IN LIGHT GREEN WITH THE TERM "SIMI" IN BOLD PRINT.

THE COLOR(S) LIGHT GREEN IS/ARE CLAIMED AS A FEATURE OF THE MARK.

SN 85-153,767, FILED 10-15-2010.

TARA PATE, EXAMINING ATTORNEY



*David J. Kybas*

Director of the United States Patent and Trademark Office

# United States of America

United States Patent and Trademark Office



**Reg. No. 4,126,324**

**Registered Apr. 10, 2012**

**Int. Cl.: 3**

**TRADEMARK**

**PRINCIPAL REGISTER**

L'OREAL USA CREATIVE, INC. (DELAWARE CORPORATION)  
575 FIFTH AVENUE  
NEW YORK, NY 10017

FOR: A COMBINATION OF INGREDIENTS SOLD AS AN INTEGRAL COMPONENT OF HAIR CARE, HAIR STYLING AND NON-MEDICATED HAIR TREATMENT PREPARATIONS, IN CLASS 3 (U.S. CLS. 1, 4, 6, 50, 51 AND 52).

FIRST USE 9-0-2011; IN COMMERCE 9-0-2011.

NO CLAIM IS MADE TO THE EXCLUSIVE RIGHT TO USE "PROTEIN", APART FROM THE MARK AS SHOWN.

THE MARK CONSISTS OF THE WORDS INTERLOCK PROTEIN NETWORK AND INITIALS "I", "P", "N" WITHIN AN OVAL WITH A CIRCLE REPRESENTING A MOLECULE ABOVE THE LETTER "N".

SN 85-155,053, FILED 10-18-2010.

JOHN HWANG, EXAMINING ATTORNEY



*David J. Kybas*

Director of the United States Patent and Trademark Office



# United States of America

United States Patent and Trademark Office

## TRANSFORMING RUMBLE RIG

**Reg. No. 4,126,325**

**Registered Apr. 10, 2012**

**Int. Cl.: 28**

**TRADEMARK**

**PRINCIPAL REGISTER**

MATTEL, INC. (DELAWARE CORPORATION)  
M1-1518  
333 CONTINENTAL BOULEVARD  
EL SEGUNDO, CA 90245

FOR: TOY VEHICLES AND ACCESSORIES THEREFOR; TOY ACTION FIGURES AND ACCESSORIES THEREFOR AND TOY ACTION FIGURES PLAYSETS AND ACCESSORIES THEREFOR, IN CLASS 28 (U.S. CLS. 22, 23, 38 AND 50).

FIRST USE 6-22-2011; IN COMMERCE 6-22-2011.

THE MARK CONSISTS OF STANDARD CHARACTERS WITHOUT CLAIM TO ANY PARTICULAR FONT, STYLE, SIZE, OR COLOR.

NO CLAIM IS MADE TO THE EXCLUSIVE RIGHT TO USE "RIG", APART FROM THE MARK AS SHOWN.

SN 85-155,383, FILED 10-18-2010.

MATTHEW PAPPAS, EXAMINING ATTORNEY



*David J. Kypas*

Director of the United States Patent and Trademark Office

# United States of America

United States Patent and Trademark Office

## COLOSSAL CRASHDOWN ARENA

**Reg. No. 4,126,326**

**Registered Apr. 10, 2012**

**Int. Cl.: 28**

**TRADEMARK**

**PRINCIPAL REGISTER**

MATTEL, INC. (DELAWARE CORPORATION)  
M1-1518  
333 CONTINENTAL BOULEVARD  
EL SEGUNDO, CA 90245

FOR: TOY ACTION FIGURE PLAYSETS AND ACCESSORIES THEREFOR, IN CLASS 28  
(U.S. CLS. 22, 23, 38 AND 50).

FIRST USE 5-18-2011; IN COMMERCE 5-18-2011.

THE MARK CONSISTS OF STANDARD CHARACTERS WITHOUT CLAIM TO ANY PARTICULAR FONT, STYLE, SIZE, OR COLOR.

OWNER OF U.S. REG. NO. 3,341,982.

SN 85-155,396, FILED 10-18-2010.

MATTHEW PAPPAS, EXAMINING ATTORNEY



*David J. Kyffers*

Director of the United States Patent and Trademark Office

# United States of America

United States Patent and Trademark Office

## SOURCE FOUR XT

**Reg. No. 4,126,327**

ELECTRONIC THEATRE CONTROLS, INC. (WISCONSIN CORPORATION)  
3031 PLEASANT VIEW ROAD  
MIDDLETON, WI 535620979

**Registered Apr. 10, 2012**

**Int. Cl.: 11**

FOR: LIGHTING FIXTURES, PARTICULARLY OUTDOOR LIGHTING FIXTURES, IN CLASS 11 (U.S. CLS. 13, 21, 23, 31 AND 34).

**TRADEMARK**

FIRST USE 5-24-2011; IN COMMERCE 5-24-2011.

**PRINCIPAL REGISTER**

THE MARK CONSISTS OF STANDARD CHARACTERS WITHOUT CLAIM TO ANY PARTICULAR FONT, STYLE, SIZE, OR COLOR.

OWNER OF U.S. REG. NOS. 2,349,369 AND 2,850,621.

SN 85-156,780, FILED 10-20-2010.

JAY FLOWERS, EXAMINING ATTORNEY



*David J. Kybas*

Director of the United States Patent and Trademark Office

# United States of America

United States Patent and Trademark Office

## BrightCurePDQ

**Reg. No. 4,126,328**

SEABRIGHT HOLDINGS, INC. (DELAWARE CORPORATION)  
1501 4TH AVENUE, SUITE 2600  
SEATTLE, WA 98101

**Registered Apr. 10, 2012**

**Int. Cl.: 35**

FOR: MEDICAL CLAIMS MANAGEMENT SERVICES, NAMELY, REVIEW, MANAGEMENT AND AUTHORIZATION OF MEDICAL TREATMENTS AND MEDICATIONS PRESCRIBED FOR PERSONS INJURED AT WORK, THE MEDICAL MANAGEMENT SERVICES PROVIDED BY DOCTORS AND OTHER MEDICAL CARE PROVIDERS WORKING WITH CLAIM EXAMINERS ON BEHALF OF WORKERS COMPENSATION INSURANCE CARRIERS, IN CLASS 35 (U.S. CLS. 100, 101 AND 102).

**SERVICE MARK**

**PRINCIPAL REGISTER**

FIRST USE 6-23-2010; IN COMMERCE 6-23-2010.

THE MARK CONSISTS OF STANDARD CHARACTERS WITHOUT CLAIM TO ANY PARTICULAR FONT, STYLE, SIZE, OR COLOR.

OWNER OF U.S. REG. NOS. 3,264,706 AND 3,264,707.

SN 85-156,999, FILED 10-20-2010.

DEZMONA MIZELLE, EXAMINING ATTORNEY



*David J. Kypos*

Director of the United States Patent and Trademark Office

# United States of America

United States Patent and Trademark Office

# FLIPCHART

**Reg. No. 4,126,329**

**Registered Apr. 10, 2012**

**Int. Cl.: 9**

**TRADEMARK**

**PRINCIPAL REGISTER**

HOWMEDICA OSTEONICS CORP. (NEW JERSEY CORPORATION)  
325 CORPORATE DRIVE  
MAHWAH, NJ 07430

FOR: COMPUTER SOFTWARE USED FOR EDUCATION, INSTRUCTION, COUNSELING AND LEARNING IN THE MEDICAL AND HEALTHCARE FIELDS; COMPUTER SOFTWARE FOR USE IN STORING, DISPLAYING, MANAGING, ORGANIZING, RETRIEVING, AND BROWSING IMAGES, AND INFORMATION IN THE MEDICAL AND HEALTHCARE FIELDS; COMPUTER SOFTWARE FOR STORING, DISPLAYING, MANAGING, RETRIEVING, ANNOTATING, MARKING AND BROWSING MEDICAL IMAGES, AND USER MANUALS IN ELECTRONIC FORM, SOLD TOGETHER AS A UNIT, IN CLASS 9 (U.S. CLS. 21, 23, 26, 36 AND 38).

FIRST USE 2-11-2011; IN COMMERCE 2-11-2011.

THE MARK CONSISTS OF STANDARD CHARACTERS WITHOUT CLAIM TO ANY PARTICULAR FONT, STYLE, SIZE, OR COLOR.

SN 85-157,221, FILED 10-20-2010.

FLORENTINA BLANDU, EXAMINING ATTORNEY



*David J. Kyffers*

Director of the United States Patent and Trademark Office

# United States of America

United States Patent and Trademark Office

## DRAKE YOUNG GUNS HUNT CLUB

**Reg. No. 4,126,330**

**Registered Apr. 10, 2012**

**Int. Cl.: 41**

**SERVICE MARK**

**PRINCIPAL REGISTER**

ICON OUTDOORS, INC. (MARYLAND CORPORATION)  
3451 ELLICOTT CENTER DRIVE  
ELLICOTT CITY, MD 210434191

FOR: EDUCATIONAL SERVICES, NAMELY, PROVIDING LIVE AND ON-LINE EDUCATIONAL CLASSES, SEMINARS AND WORKSHOPS, TO KIDS AND PARENTS IN THE FIELD OF OUTDOORS ACTIVITIES, NAMELY, HUNTING AND DISTRIBUTION OF COURSE MATERIALS IN CONNECTION THEREWITH; AND PROVIDING ON-LINE EDUCATIONAL INFORMATION TO KIDS AND PARENTS IN THE FIELD OF HUNTING, IN CLASS 41 (U.S. CLS. 100, 101 AND 107).

FIRST USE 12-0-2008; IN COMMERCE 1-0-2009.

THE MARK CONSISTS OF STANDARD CHARACTERS WITHOUT CLAIM TO ANY PARTICULAR FONT, STYLE, SIZE, OR COLOR.

NO CLAIM IS MADE TO THE EXCLUSIVE RIGHT TO USE "HUNT CLUB", APART FROM THE MARK AS SHOWN.

SN 85-158,123, FILED 10-21-2010.

LINDA ORNDORFF, EXAMINING ATTORNEY



*David J. Kybas*

Director of the United States Patent and Trademark Office

# United States of America

United States Patent and Trademark Office

# GenieMD

**Reg. No. 4,126,331**

GENIEMD, LLC (CALIFORNIA LIMITED LIABILITY COMPANY)  
939 EAGLE RIDGE DR.  
DANVILLE, CA 94506

**Registered Apr. 10, 2012**

**Int. Cl.: 9**

FOR: COMPUTER APPLICATION SOFTWARE FOR MOBILE PHONES AND HANDHELD COMPUTERS, NAMELY, SOFTWARE FOR RECORDING AND TRACKING MEDICAL, VITALS, DIET AND EXERCISE INFORMATION, IN CLASS 9 (U.S. CLS. 21, 23, 26, 36 AND 38).

**TRADEMARK**

**PRINCIPAL REGISTER**

FIRST USE 4-4-2011; IN COMMERCE 9-30-2011.

THE MARK CONSISTS OF STANDARD CHARACTERS WITHOUT CLAIM TO ANY PARTICULAR FONT, STYLE, SIZE, OR COLOR.

SN 85-159,337, FILED 10-22-2010.

BRETT J. GOLDEN, EXAMINING ATTORNEY



*David J. Kybas*

Director of the United States Patent and Trademark Office

# United States of America

United States Patent and Trademark Office

## THE WAY TO GROW

**Reg. No. 4,126,332**

INSIGHT COMMUNICATIONS COMPANY, INC. (DELAWARE CORPORATION)  
810 SEVENTH AVENUE  
NEW YORK, NY 10019

**Registered Apr. 10, 2012**

**Int. Cl.: 35**

FOR: ADVERTISING SERVICES, NAMELY, PROMOTING THE GOODS AND SERVICES OF OTHERS BY PLACING THE ADVERTISEMENTS OF OTHERS ON CABLE TELEVISION SYSTEMS, THE INTERNET AND OTHER ELECTRONIC COMMUNICATIONS NETWORKS, ARRANGING, SCHEDULING, SELLING AND PROVIDING SIMULTANEOUS, MULTI-CHANNEL ADVERTISING FOR OTHERS, AND PLANNING AND IMPLEMENTING TARGETED ADVERTISING CAMPAIGNS FOR OTHERS, IN CLASS 35 (U.S. CLS. 100, 101 AND 102).

**SERVICE MARK**

**PRINCIPAL REGISTER**

FIRST USE 12-16-2010; IN COMMERCE 12-16-2010.

THE MARK CONSISTS OF STANDARD CHARACTERS WITHOUT CLAIM TO ANY PARTICULAR FONT, STYLE, SIZE, OR COLOR.

SN 85-159,362, FILED 10-22-2010.

RONALD AIKENS, EXAMINING ATTORNEY



*David J. Kyffers*

Director of the United States Patent and Trademark Office



# United States of America

United States Patent and Trademark Office

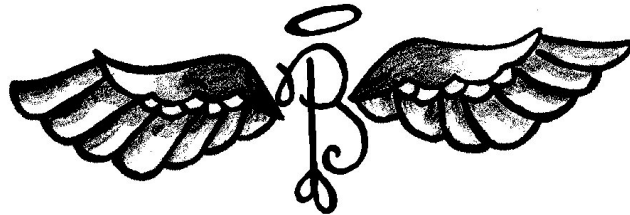

**Reg. No. 4,126,333**

BRILLIANCE BY BRITONI B CORPORATION (FLORIDA CORPORATION)  
4081 CRYSTAL LAKE DRIVE  
POMPANO BEACH, FL 33064

**Registered Apr. 10, 2012**

**Int. Cl.: 21**

FOR: BEVERAGE GLASSWARE; PILSNER DRINKING GLASSES; VASES; WINE GLASSES,  
IN CLASS 21 (U.S. CLS. 2, 13, 23, 29, 30, 33, 40 AND 50).

**TRADEMARK**

FIRST USE 10-10-2010; IN COMMERCE 2-1-2011.

**PRINCIPAL REGISTER**

THE STIPLING IS FOR SHADING PURPOSES ONLY.

THE MARK CONSISTS OF THE LETTER "B" IN BETWEEN ANGEL WINGS AND A HALO  
ABOVE THE "B". THE "B" AND HALO ARE IN CURSIVE WRITING.

SN 85-160,371, FILED 10-25-2010.

CURTIS FRENCH, EXAMINING ATTORNEY



*David J. Kybas*

Director of the United States Patent and Trademark Office

# United States of America

United States Patent and Trademark Office

## OPTILED

**Reg. No. 4,126,334**

**Registered Apr. 10, 2012**

**Int. Cls.: 9 and 11**

**TRADEMARK**

**PRINCIPAL REGISTER**

HUIZHOU LIGHT ENGINE LTD (CHINA LIMITED LIABILITY COMPANY)  
NO. 7 BUILDING, NO. 21 JIANG BEI YUN  
SHAN, EAST ROAD  
HUIZHOU CITY, GUANGDONG, CHINA

FOR: ELECTRIC SIGNS; ELECTRIC AND ELECTRONIC EQUIPMENT FOR USE WITH LED LIGHTING STRIPS AND LED ROPE LIGHTING, NAMELY, TIMERS, REMOTE CONTROLS, THERMAL MOTION SENSORS, DIMMERS, PHOTOCCELL SENSORS, AND LIGHTING CONTROLLERS; APPARATUS AND INSTRUMENTS FOR CONDUCTING, SWITCHING AND TRANSFORMING ELECTRICITY, NAMELY, ELECTRICITY CONNECTORS, ELECTRIC COLLECTORS, ELECTRIC RELAYS, ELECTRIC CONDUCTORS, ELECTRIC REGULATORS, ELECTRICITY TRANSFORMERS, AND ELECTRICITY REDUCERS, IN CLASS 9 (U.S. CLS. 21, 23, 26, 36 AND 38).

FIRST USE 1-1-2011; IN COMMERCE 9-1-2011.

FOR: LIGHTING APPARATUS, NAMELY, LIGHTING INSTALLATIONS; ELECTRIC LIGHTING FIXTURES FOR USE IN COMMERCIAL, INDUSTRIAL, AND RESIDENTIAL APPLICATIONS; LUMINARIES; LED LIGHTING SYSTEMS, NAMELY, LED MODULES AND POWER SUPPLIES; FLUORESCENT LIGHTING TUBES; LIGHTING TRACKS AND LED LIGHTING TRACKS; ROPE LIGHTING AND LED ROPE LIGHTING; CONNECTORS AND MOUNTINGS COMPONENTS FOR LIGHTING UNITS; LIGHT-EMITTING DIODES FOR USE IN LIGHTING PANEL; AND STRUCTURAL PARTS AND FITTINGS FOR THE AFORESAID GOODS, ALL FOR INDOOR AND OUTDOOR USE, IN CLASS 11 (U.S. CLS. 13, 21, 23, 31 AND 34).

FIRST USE 1-1-2011; IN COMMERCE 9-1-2011.

OWNER OF U.S. REG. NOS. 2,861,422 AND 3,397,675.

THE MARK CONSISTS OF THE MARK "OPTILED" IN STYLIZED LETTERS IN WHICH THE LETTER "O" IS ELONGATED TO POINTS IN THE UPPER LEFT AND LOWER RIGHT SIDES.

SN 85-160,505, FILED 10-25-2010.

RAUL CORDOVA, EXAMINING ATTORNEY



*David J. Kypos*

Director of the United States Patent and Trademark Office

# United States of America

United States Patent and Trademark Office

# CLOUDPLEX

**Reg. No. 4,126,335**

BROCADE COMMUNICATIONS SYSTEMS, INC. (DELAWARE CORPORATION)  
130 HOLGER WAY  
SAN JOSE, CA 95134

**Registered Apr. 10, 2012**

**Int. Cl.: 9**

FOR: COMPUTER SOFTWARE AND HARDWARE, NAMELY, SERVERS AND ROUTERS, USED TO CREATE AND MANAGE VIRTUALIZED DATA CENTERS AND COMPUTING INFRASTRUCTURES, IN CLASS 9 (U.S. CLS. 21, 23, 26, 36 AND 38).

**TRADEMARK**

FIRST USE 5-3-2011; IN COMMERCE 12-31-2011.

**PRINCIPAL REGISTER**

THE MARK CONSISTS OF STANDARD CHARACTERS WITHOUT CLAIM TO ANY PARTICULAR FONT, STYLE, SIZE, OR COLOR.

SN 85-160,757, FILED 10-25-2010.

ERIN FALK, EXAMINING ATTORNEY



*David J. Kyros*

Director of the United States Patent and Trademark Office

# United States of America

United States Patent and Trademark Office



**Reg. No. 4,126,336**

**Registered Apr. 10, 2012**

**Int. Cl.: 17**

**TRADEMARK**

**PRINCIPAL REGISTER**

SHG PUR-PROFILE GMBH (FED REP GERMANY LIMITED LIABILITY COMPANY)  
WECOSTRASSE 3  
EITORF, FED REP GERMANY 53783

FOR: EXTRUDED PROFILES OF FLEXIBLE, SHOCK-ABSORBING POLYURETHANE FOAM, NAMELY, WARNING AND PROTECTIVE SAFETY BUMPERS AND BUMPER GUARDS FOR PROTECTING INDUSTRIAL MACHINERY, WALLS AND PASSAGeways INDOORS OR OUTDOORS AGAINST IMPACT; FLEXIBLE PROTECTIVE, SHOCK-ABSORBING, SAFETY POLYURETHANE FOAM BUMPERS FOR ANGLES, NOOKS AND SURFACES FOR COVERING OR WARNING OF HAZARD SOURCES INDOORS OR OUTDOORS, IN CLASS 17 (U.S. CLS. 1, 5, 12, 13, 35 AND 50).

FIRST USE 11-30-2009; IN COMMERCE 11-30-2009.

OWNER OF ERPN CMNTY TM OFC REG. NO. 004294633, DATED 2-16-2006, EXPIRES 2-17-2015.

THE MARK CONSISTS OF THE UPPER CASE LETTERS "SHG" WHICH ARE CONNECTED; THE TOP RIGHT CURVE OF THE LETTER "S" IS CONNECTED TO THE LEFT LEG OF THE LETTER "H"; THE RIGHT LEG OF THE LETTER "H" IS CONNECTED TO THE BACK/LEFT SIDE CURVE OF THE LETTER "G".

SN 85-161,096, FILED 10-26-2010.

KELLY TRUSILO, EXAMINING ATTORNEY



*David J. Kybas*

Director of the United States Patent and Trademark Office

# United States of America

United States Patent and Trademark Office

# OPALITE

**Reg. No. 4,126,337**

AURUM CERAMIC DENTAL LABORATORIES LTD. (CANADA CORPORATION)  
115-17TH AVENUE SW

**Registered Apr. 10, 2012**

CALGARY, ALBERTA, CANADA T2S0A1

**Int. Cl.: 10**

FOR: DENTAL CROWNS AND DENTAL BRIDGES, IN CLASS 10 (U.S. CLS. 26, 39 AND 44).

FIRST USE 1-0-2010; IN COMMERCE 1-0-2010.

**TRADEMARK**

THE MARK CONSISTS OF STANDARD CHARACTERS WITHOUT CLAIM TO ANY PARTICULAR FONT, STYLE, SIZE, OR COLOR.

**PRINCIPAL REGISTER**

SN 85-161,252, FILED 10-26-2010.

JESSICA FATHY, EXAMINING ATTORNEY



*David J. Kybas*

Director of the United States Patent and Trademark Office

# United States of America

United States Patent and Trademark Office

## SMOKEY'S FIREHOUSE ADVENTURE

**Reg. No. 4,126,338**

**Registered Apr. 10, 2012**

**Int. Cl.: 28**

**TRADEMARK**

**PRINCIPAL REGISTER**

MATTEL, INC. (DELAWARE CORPORATION)  
M1-1518  
333 CONTINENTAL BOULEVARD  
EL SEGUNDO, CA 90245

FOR: TOY VEHICLES AND ACCESSORIES THEREFOR; TOY VEHICLE PLAYSETS AND ACCESSORIES THEREFOR, IN CLASS 28 (U.S. CLS. 22, 23, 38 AND 50).

FIRST USE 7-20-2011; IN COMMERCE 7-20-2011.

THE MARK CONSISTS OF STANDARD CHARACTERS WITHOUT CLAIM TO ANY PARTICULAR FONT, STYLE, SIZE, OR COLOR.

OWNER OF U.S. REG. NO. 3,400,101.

NO CLAIM IS MADE TO THE EXCLUSIVE RIGHT TO USE "FIREHOUSE", APART FROM THE MARK AS SHOWN.

SN 85-161,803, FILED 10-26-2010.

MATTHEW PAPPAS, EXAMINING ATTORNEY



*David J. Kyffers*

Director of the United States Patent and Trademark Office

# United States of America

United States Patent and Trademark Office

## POWER ALMANAC

**Reg. No. 4,126,339**

**Registered Apr. 10, 2012**

**Int. Cl.: 35**

**SERVICE MARK**

**PRINCIPAL REGISTER**

LTBL, LLC (CALIFORNIA LIMITED LIABILITY COMPANY)  
38 LAKEWOOD CIRCLE  
SAN MATEO, CA 94402

FOR: PROVIDING AN ONLINE DIRECTORY INFORMATION SERVICE FEATURING DATA AND RESEARCH INFORMATION RELATED TO PUBLIC OFFICIALS, IN CLASS 35 (U.S. CLS. 100, 101 AND 102).

FIRST USE 2-6-2011; IN COMMERCE 6-28-2011.

THE MARK CONSISTS OF STANDARD CHARACTERS WITHOUT CLAIM TO ANY PARTICULAR FONT, STYLE, SIZE, OR COLOR.

NO CLAIM IS MADE TO THE EXCLUSIVE RIGHT TO USE "ALMANAC", APART FROM THE MARK AS SHOWN.

SN 85-161,820, FILED 10-26-2010.

WILLIAM P. SHANAHAN, EXAMINING ATTORNEY



*David J. Kyjars*

Director of the United States Patent and Trademark Office

# United States of America

United States Patent and Trademark Office

# NIGHTWASH

**Reg. No. 4,126,340**

SAMSUNG ELECTRONICS CO., LTD. (REPUBLIC OF KOREA CORPORATION)  
416, MAETAN-DONG, YEONGTONG-GU  
SUWON-SI, GYEONGGI-DO, REPUBLIC OF KOREA

**Registered Apr. 10, 2012**

**Int. Cl.: 7**

FOR: ELECTRIC WASHING MACHINES FOR CLOTHING; ELECTRIC WASHING MACHINES  
FOR HOUSEHOLD PURPOSES , IN CLASS 7 (U.S. CLS. 13, 19, 21, 23, 31, 34 AND 35).

**TRADEMARK**

FIRST USE 4-1-2010; IN COMMERCE 4-1-2010.

**PRINCIPAL REGISTER**

THE MARK CONSISTS OF STANDARD CHARACTERS WITHOUT CLAIM TO ANY PAR-  
TICULAR FONT, STYLE, SIZE, OR COLOR.

SN 85-162,693, FILED 10-27-2010.

KRISTINA MORRIS, EXAMINING ATTORNEY



*David J. Kyffers*

Director of the United States Patent and Trademark Office



# United States of America

United States Patent and Trademark Office

# TOAS-TITE

**Reg. No. 4,126,341**

**Registered Apr. 10, 2012**

**Int. Cl.: 21**

**TRADEMARK**

**PRINCIPAL REGISTER**

TOAS-TITE, LLC (ILLINOIS LIMITED LIABILITY COMPANY)  
881 N DOVINGTON DRIVE  
HOFFMAN ESTATES, IL 60169

FOR: SMALL COOKING APPLIANCE, NAMELY, NON-ELECTRIC SANDWICH MAKER FOR MAKING SANDWICH-TYPE MEALS, PASTRIES AND SNACKS, IN CLASS 21 (U.S. CLS. 2, 13, 23, 29, 30, 33, 40 AND 50).

FIRST USE 10-31-2011; IN COMMERCE 10-31-2011.

THE MARK CONSISTS OF STANDARD CHARACTERS WITHOUT CLAIM TO ANY PARTICULAR FONT, STYLE, SIZE, OR COLOR.

SN 85-162,733, FILED 10-27-2010.

DAVID TOOLEY, EXAMINING ATTORNEY



*David J. Kyffers*

Director of the United States Patent and Trademark Office

# United States of America

United States Patent and Trademark Office



**Reg. No. 4,126,342**

**Registered Apr. 10, 2012**

**Int. Cls.: 10 and 21**

**TRADEMARK**

**PRINCIPAL REGISTER**

INTERGANIC (UNITED ARAB EMIR. CORPORATION)  
P.O. BOX 263232  
DUBAI, UNITED ARAB EMIR.

FOR: BABY GOODS AND ACCESSORIES, NAMELY, BABY BOTTLE NIPPLES; BABY BOTTLES; NIPPLES FOR BABY BOTTLES; NURSING BOTTLES; PACIFIER CLIPS; PACIFIERS FOR BABIES; TEETHING RINGS; TEETHING RINGS INCORPORATING BABY RATTLES; DISHES ADAPTED TO FEED BABIES AND CHILDREN; CUPS SOLD EMPTY ADAPTED TO FEED BABIES AND CHILDREN, IN CLASS 10 (U.S. CLS. 26, 39 AND 44).

FIRST USE 7-1-2011; IN COMMERCE 7-1-2011.

FOR: INFANT'S AND CHILDREN'S DRINKING CUPS; DISHES FOR BABIES AND INFANTS; TOOTHBRUSHES; PLASTIC OR GLASS DRINKING CONTAINERS SOLD EMPTY, NAMELY, PLASTIC AND GLASS CUPS AND PLASTIC AND GLASS BOTTLES, IN CLASS 21 (U.S. CLS. 2, 13, 23, 29, 30, 33, 40 AND 50).

FIRST USE 7-1-2011; IN COMMERCE 7-1-2011.

NO CLAIM IS MADE TO THE EXCLUSIVE RIGHT TO USE "VENT", APART FROM THE MARK AS SHOWN.

THE MARK CONSISTS OF A BUTTERFLY WITH THE WORDS "FLUTTER FLEX VENT" CURVING AROUND THE BUTTERFLY.

SN 85-162,974, FILED 10-27-2010.

SETH A. RAPPAPORT, EXAMINING ATTORNEY



*David J. Kybas*

Director of the United States Patent and Trademark Office

# United States of America

United States Patent and Trademark Office

# WHO BRAIN

**Reg. No. 4,126,343**

**Registered Apr. 10, 2012**

**Int. Cl.: 35**

**SERVICE MARK**

**PRINCIPAL REGISTER**

WHOBRAIN, INC. (DELAWARE CORPORATION)  
5052 TIERRA BAJA WAY  
SAN DIEGO, CA 92115

FOR: ADVERTISING AND MARKETING; ON-LINE ADVERTISING AND MARKETING SERVICES; CONSUMER RESEARCH SERVICES, IN CLASS 35 (U.S. CLS. 100, 101 AND 102).

FIRST USE 8-10-2010; IN COMMERCE 11-30-2011.

THE MARK CONSISTS OF STANDARD CHARACTERS WITHOUT CLAIM TO ANY PARTICULAR FONT, STYLE, SIZE, OR COLOR.

SN 85-163,809, FILED 10-28-2010.

EDWARD FENNESSY, EXAMINING ATTORNEY



*David J. Kyffers*

Director of the United States Patent and Trademark Office

# United States of America

United States Patent and Trademark Office

## Red Dog Fishing

**Reg. No. 4,126,344**

**Registered Apr. 10, 2012**

**Int. Cl.: 41**

**SERVICE MARK**

**PRINCIPAL REGISTER**

DE JONG, PETER CORNELIUS (UNITED STATES INDIVIDUAL), DBA RED DOG FISHING,  
2803 SANTA LAURA  
MISSION, TX 78572

FOR: FISHING GUIDE SERVICES, IN CLASS 41 (U.S. CLS. 100, 101 AND 107).

FIRST USE 9-15-2009; IN COMMERCE 1-15-2012.

THE MARK CONSISTS OF STANDARD CHARACTERS WITHOUT CLAIM TO ANY PARTICULAR FONT, STYLE, SIZE, OR COLOR.

NO CLAIM IS MADE TO THE EXCLUSIVE RIGHT TO USE "FISHING", APART FROM THE MARK AS SHOWN.

SN 85-163,911, FILED 10-28-2010.

ELI HELLMAN, EXAMINING ATTORNEY



*David J. Kyffers*

Director of the United States Patent and Trademark Office

# United States of America

United States Patent and Trademark Office

# THERAHEEL

**Reg. No. 4,126,345**

NATIONAL CONSOLIDATED INC. (TEXAS CORPORATION)  
1743 ASPEN RIDGE  
SAN ANTONIO, TX 78248

**Registered Apr. 10, 2012**

**Int. Cl.: 10**

FOR: A FLEXIBLE SHEATH DESIGNED TO COVER THE FOOT TO AID IN SOFTENING THE HEEL AND FOOT, NAMELY, DISPOSABLE THERAPEUTIC FOOT WRAP, IN CLASS 10 (U.S. CLS. 26, 39 AND 44).

**TRADEMARK**

FIRST USE 4-1-2010; IN COMMERCE 1-1-2012.

**PRINCIPAL REGISTER**

THE MARK CONSISTS OF STANDARD CHARACTERS WITHOUT CLAIM TO ANY PARTICULAR FONT, STYLE, SIZE, OR COLOR.

SN 85-165,623, FILED 10-31-2010.

DANNEAN HETZEL, EXAMINING ATTORNEY



*David J. Kyffers*

Director of the United States Patent and Trademark Office

# United States of America

United States Patent and Trademark Office

# CLOUDPOD

**Reg. No. 4,126,346**

**Registered Apr. 10, 2012**

**Int. Cl.: 42**

**SERVICE MARK**

**PRINCIPAL REGISTER**

CANVAS SYSTEMS, LLC (GEORGIA LIMITED LIABILITY COMPANY)  
3025 NORTHWOODS PARKWAY  
NORCROSS, GA 30071

FOR: RENTAL OF COMPUTER HARDWARE AND COMPUTER PERIPHERALS; INSTALLATION, REPAIR AND MAINTENANCE OF COMPUTER SOFTWARE; NONE OF THE FOREGOING RELATED TO PORTABLE AND HANDHELD DIGITAL ELECTRONIC DEVICES AND SOFTWARE THEREFOR FOR RECORDING, ORGANIZING, TRANSMITTING, MANIPULATING, AND REVIEWING TEXT, DATA, AUDIO, IMAGE AND VIDEO FILES, IN CLASS 42 (U.S. CLS. 100 AND 101).

FIRST USE 7-27-2010; IN COMMERCE 7-27-2010.

THE MARK CONSISTS OF STANDARD CHARACTERS WITHOUT CLAIM TO ANY PARTICULAR FONT, STYLE, SIZE, OR COLOR.

SN 85-165,811, FILED 11-1-2010.

LINDSEY RUBIN, EXAMINING ATTORNEY



*David J. Kybas*

Director of the United States Patent and Trademark Office

# United States of America

United States Patent and Trademark Office

## SIGNATURE DNA

**Reg. No. 4,126,347**

**Registered Apr. 10, 2012**

**Int. Cls.: 40 and 42**

**SERVICE MARK**

**PRINCIPAL REGISTER**

SIGNATURE DNA, LLC (MISSOURI LIMITED LIABILITY COMPANY)  
3215 NE CARNEGIE DRIVE  
LEE'S SUMMIT, MO 64064

FOR: CREATION OF CUSTOM ARTWORK CONTAINING GENETIC INFORMATION, IN CLASS 40 (U.S. CLS. 100, 103 AND 106).

FIRST USE 12-0-2010; IN COMMERCE 9-0-2011.

FOR: DESIGN OF CUSTOM ARTWORK CONTAINING GENETIC INFORMATION, IN CLASS 42 (U.S. CLS. 100 AND 101).

FIRST USE 12-0-2010; IN COMMERCE 9-0-2011.

THE MARK CONSISTS OF STANDARD CHARACTERS WITHOUT CLAIM TO ANY PARTICULAR FONT, STYLE, SIZE, OR COLOR.

NO CLAIM IS MADE TO THE EXCLUSIVE RIGHT TO USE "DNA", APART FROM THE MARK AS SHOWN.

SN 85-166,416, FILED 11-1-2010.

ROBERT STRUCK, EXAMINING ATTORNEY



*David J. Kybas*

Director of the United States Patent and Trademark Office

# United States of America

United States Patent and Trademark Office

## CAPTIVATE OFFICE PULSE

**Reg. No. 4,126,348**

**Registered Apr. 10, 2012**

**Int. Cl.: 35**

**SERVICE MARK**

**PRINCIPAL REGISTER**

GANNETT SATELLITE INFORMATION NETWORK, INC. (DELAWARE CORPORATION)  
7950 JONES BRANCH DRIVE  
MCLEAN, VA 22107

FOR: CONDUCTING SURVEYS, POLLING AND MARKET RESEARCH; PROVIDING INFORMATION ABOUT SURVEYS, POLLING AND MARKET RESEARCH; REPORTING THE RESULTS OF SURVEYS, POLLING AND MARKET RESEARCH, IN CLASS 35 (U.S. CLS. 100, 101 AND 102).

FIRST USE 7-21-2011; IN COMMERCE 7-21-2011.

THE MARK CONSISTS OF STANDARD CHARACTERS WITHOUT CLAIM TO ANY PARTICULAR FONT, STYLE, SIZE, OR COLOR.

OWNER OF U.S. REG. NOS. 2,357,757 AND 3,719,060.

SN 85-166,450, FILED 11-1-2010.

RON FAIRBANKS, EXAMINING ATTORNEY



*David J. Kyffers*

Director of the United States Patent and Trademark Office



# United States of America

United States Patent and Trademark Office

# ReadyReturn

**Reg. No. 4,126,349**

SEABRIGHT HOLDINGS, INC. (DELAWARE CORPORATION)  
1501 4TH AVENUE, SUITE 2600  
SEATTLE, WA 98101

**Registered Apr. 10, 2012**

**Int. Cl.: 35**

FOR: PROVIDING WORK PLACEMENT AND REFERRAL SERVICES; PROVIDING INFORMATION SERVICES TO ASSIST EMPLOYERS IN PROVIDING RETURN-TO-WORK EMPLOYMENT OPPORTUNITIES FOR WORKERS RECOVERING FROM ON-THE-JOB INJURIES, IN CLASS 35 (U.S. CLS. 100, 101 AND 102).

**SERVICE MARK**

**PRINCIPAL REGISTER**

FIRST USE 7-1-2010; IN COMMERCE 10-12-2010.

THE MARK CONSISTS OF STANDARD CHARACTERS WITHOUT CLAIM TO ANY PARTICULAR FONT, STYLE, SIZE, OR COLOR.

SN 85-167,360, FILED 11-2-2010.

DEZMONA MIZELLE, EXAMINING ATTORNEY



*David J. Kybas*

Director of the United States Patent and Trademark Office

# United States of America

United States Patent and Trademark Office

## Undercover Motorcycle

**Reg. No. 4,126,350**

**Registered Apr. 10, 2012**

**Int. Cl.: 12**

**TRADEMARK**

**PRINCIPAL REGISTER**

RICKETTS, WAYNE M (CANADA SOLE PROPRIETORSHIP), DBA WXM WADIFF XTREME MOTORSPORTS,  
#401-8892 MONTCALM ST  
VANCOUVER, BC, CANADA V6P4R3

FOR: MOTORCYCLES, IN CLASS 12 (U.S. CLS. 19, 21, 23, 31, 35 AND 44).

FIRST USE 8-30-2011; IN COMMERCE 8-30-2011.

THE MARK CONSISTS OF STANDARD CHARACTERS WITHOUT CLAIM TO ANY PARTICULAR FONT, STYLE, SIZE, OR COLOR.

NO CLAIM IS MADE TO THE EXCLUSIVE RIGHT TO USE "MOTORCYCLE", APART FROM THE MARK AS SHOWN.

SN 85-168,103, FILED 11-3-2010.

CHERYL CLAYTON, EXAMINING ATTORNEY



*David J. Kyffers*

Director of the United States Patent and Trademark Office

# United States of America

United States Patent and Trademark Office

## ODORLESS PETS

**Reg. No. 4,126,351**

**Registered Apr. 10, 2012**

**Int. Cl.: 5**

**TRADEMARK**

**PRINCIPAL REGISTER**

SPARTAN ENTERPRISES & TECHNOLOGIES INC. (MICHIGAN CORPORATION), DBA  
WATERSHED WELLNESS CENTER,  
6439 W. SAGINAW HIGHWAY  
LANSING, MI 48917

FOR: ANIMAL FEED ADDITIVES, NAMELY, ANIMAL FEED SUPPLEMENTS, FOR USE  
IN REDUCING FECAL ODOR , IN CLASS 5 (U.S. CLS. 6, 18, 44, 46, 51 AND 52).

FIRST USE 8-26-2011; IN COMMERCE 8-26-2011.

THE MARK CONSISTS OF STANDARD CHARACTERS WITHOUT CLAIM TO ANY PAR-  
TICULAR FONT, STYLE, SIZE, OR COLOR.

SN 85-168,278, FILED 11-3-2010.

JAMES MACFARLANE, EXAMINING ATTORNEY



*David J. Kyffers*

Director of the United States Patent and Trademark Office

# United States of America

United States Patent and Trademark Office

## ARMORED SPON

**Reg. No. 4,126,352**

**Registered Apr. 10, 2012**

**Int. Cls.: 6, 9, and 38**

**TRADEMARK**

**SERVICE MARK**

**PRINCIPAL REGISTER**

CABLE MANUFACTURING BUSINESS, INC. (CALIFORNIA CORPORATION)  
SUITE A  
16462 GOTHARD STREET  
HUNTINGTON BEACH, CA 92647

FOR: CABLE CLAMPS OF METAL; CABLE JUNCTION SLEEVES OF METAL , IN CLASS 6 (U.S. CLS. 2, 12, 13, 14, 23, 25 AND 50).

FIRST USE 1-5-2010; IN COMMERCE 2-1-2010.

FOR: CABLES AND FIBRES FOR THE TRANSMISSION OF SOUNDS AND IMAGES; CABLES FOR ELECTRICAL OR OPTICAL SIGNAL TRANSMISSION; COMMUNICATIONS SOFTWARE FOR CONNECTING SECURE NETWORK USERS; COMPUTER CABLES; COMPUTER HARDWARE AND SOFTWARE FOR SETTING UP AND CONFIGURING LOCAL AREA NETWORKS; COMPUTER HARDWARE AND SOFTWARE FOR SETTING UP AND CONFIGURING WIDE AREA NETWORKS; COMPUTER HARDWARE FOR COMMUNICATING AUDIO, VIDEO AND DATA BETWEEN COMPUTERS VIA A GLOBAL COMPUTER NETWORK, WIDE-AREA COMPUTER NETWORKS, AND PEER-TO-PEER COMPUTER NETWORKS; COMPUTER NETWORK INTERFACE DEVICES; COMPUTER NETWORKING HARDWARE; COMPUTER SOFTWARE AND HARDWARE FOR SECURE NETWORK USERS, NAMELY, TAMPER DETECTION HARDWARE AND SOFTWARE TO MONITOR AND DETECT TAMPERING WITH THE HARDWARE AND SECURITY INTRUSIONS; COMPUTER SOFTWARE AND HARDWARE FOR SECURE NETWORK USERS; COMPUTER SOFTWARE FOR ADMINISTRATION OF COMPUTER LOCAL AREA NETWORKS; COMPUTER SOFTWARE FOR ADMINISTRATION OF COMPUTER NETWORKS; COMPUTERS FOR NETWORK MANAGEMENT; ELECTRICAL AND OPTICAL CABLES; ELECTRONIC AND OPTICAL COMMUNICATIONS INSTRUMENTS AND COMPONENTS, NAMELY, OPTICAL DATA LINKS; FIBER OPTIC CABLES; FIBER OPTICS; FIBRE OPTIC COUPLINGS; FIBRE-OPTIC CABLES; LAN (LOCAL AREA NETWORK) ACCESS POINTS FOR CONNECTING NETWORK COMPUTER USERS; LAN (LOCAL AREA NETWORK) HARDWARE; LAN (LOCAL AREA NETWORK) OPERATING SOFTWARE; METAL CABINETS SPECIALLY ADAPTED TO PROTECT TELECOMMUNICATIONS EQUIPMENT IN THE NATURE OF FIBER OPTIC CABLES.; OPTICAL CABLES; OPTICAL COMMUNICATIONS SYSTEMS COMPRISED OF OPTICAL AND ELECTRONIC HARDWARE AND COMPUTER SOFTWARE FOR THE TRANSMISSION OF DATA BETWEEN TWO POINTS; OPTICAL FIBER CABLES; OPTICAL FIBERS; OPTICAL FIBERS SOLD AS A COMPONENT OF FIBER OPTICAL CABLES; OPTICAL FIBRES; OPTICAL FIBRES, TELEPHONE RECEIVERS, SWITCHBOARDS,



*David J. Kyffers*

Director of the United States Patent and Trademark Office

**Reg. No. 4,126,352** TELEPHONE AND TELEGRAPH WIRES, VIDEO TELEPHONES; PROTECTIVE SHEATHS FOR FIBER OPTICAL CABLES; TELECOMMUNICATION CABLES; TELECOMMUNICATIONS AND DATA NETWORKING HARDWARE, NAMELY, DEVICES FOR TRANSPORTING AND AGGREGATING VOICE, DATA, AND VIDEO COMMUNICATIONS ACROSS MULTIPLE NETWORK INFRASTRUCTURES AND COMMUNICATIONS PROTOCOLS; WAN (WIDE AREA NETWORK) HARDWARE, IN CLASS 9 (U.S. CLS. 21, 23, 26, 36 AND 38).

FIRST USE 1-5-2010; IN COMMERCE 2-1-2010.

FOR: COMMUNICATION VIA FIBRE OPTICAL NETWORKS; COMMUNICATION VIA FIBRE-OPTIC NETWORKS; COMMUNICATION VIA OPTICAL FIBRE NETWORKS; COMMUNICATIONS VIA FIBER-OPTIC NETWORKS; COMMUNICATIONS VIA FIBRE-OPTIC NETWORKS; TELECOMMUNICATION SERVICES, NAMELY, LOCAL AND LONG DISTANCE TRANSMISSION OF VOICE, DATA, GRAPHICS AND VIDEO BY MEANS OF BROADBAND OPTICAL OR WIRELESS NETWORKS; TELECOMMUNICATION SERVICES, NAMELY, LOCAL AND LONG DISTANCE TRANSMISSION OF VOICE, DATA, GRAPHICS AND VIDEO BY MEANS OF BROADBAND, COPPER AND OPTICAL OR WIRELESS NETWORKS; TELECOMMUNICATION SERVICES, NAMELY, PROVIDING INTERNET ACCESS VIA BROADBAND OPTICAL OR WIRELESS NETWORKS; TELECOMMUNICATIONS SERVICES, NAMELY, PROVIDING FIBER OPTIC NETWORK SERVICES; TRANSMISSION OF INFORMATION ON OPTICAL TELECOMMUNICATION NETWORKS; TRANSMISSION OF SDI-FORMATTED TELEVISION AND AUDIO SIGNALS OVER FIBER OPTIC CABLES, IN CLASS 38 (U.S. CLS. 100, 101 AND 104).

FIRST USE 1-5-2010; IN COMMERCE 2-1-2010.

THE MARK CONSISTS OF STANDARD CHARACTERS WITHOUT CLAIM TO ANY PARTICULAR FONT, STYLE, SIZE, OR COLOR.

NO CLAIM IS MADE TO THE EXCLUSIVE RIGHT TO USE "SPON" , APART FROM THE MARK AS SHOWN.

SN 85-168,363, FILED 11-3-2010.

MARILYN IZZI, EXAMINING ATTORNEY

# United States of America

United States Patent and Trademark Office

# YUM

**Reg. No. 4,126,353**

**Registered Apr. 10, 2012**

**Int. Cls.: 5 and 29**

**TRADEMARK**

**PRINCIPAL REGISTER**

THE NEST COLLECTIVE, INC. (DELAWARE CORPORATION)  
1485 PARK AVENUE, SUITE 200  
EMERYVILLE, CA 94608

FOR: BABY FOODS, IN CLASS 5 (U.S. CLS. 6, 18, 44, 46, 51 AND 52).

FIRST USE 5-31-2010; IN COMMERCE 5-31-2010.

FOR: PREPARED MEALS FOR TODDLERS CONSISTING PRIMARILY OF MEAT AND  
POULTRY, IN CLASS 29 (U.S. CL. 46).

FIRST USE 4-30-2010; IN COMMERCE 4-30-2010.

THE MARK CONSISTS OF STANDARD CHARACTERS WITHOUT CLAIM TO ANY PAR-  
TICULAR FONT, STYLE, SIZE, OR COLOR.

SN 85-169,388, FILED 11-4-2010.

PAM WILLIS, EXAMINING ATTORNEY



*David J. Kybas*

Director of the United States Patent and Trademark Office

# United States of America

United States Patent and Trademark Office

## WINE ENTRE FEMMES

**Reg. No. 4,126,354**

HARRIS, SHARON (UNITED STATES INDIVIDUAL)

**Registered Apr. 10, 2012**

PO BOX 801  
RUTHERFORD, CA 94573

**Int. Cl.: 35**

FOR: ADVERTISING, PROMOTION, AND MARKETING SERVICES IN THE NATURE OF VIRAL MARKETING PROGRAM, ON-LINE BUSINESS NETWORKING AND ARRANGING FAMILIARIZATION TOURS IN WINE INDUSTRY FOR WHOLESALERS, RETAILERS, TRAVEL MEDIA, AND WINE INDUSTRY BUYERS; PROVIDING BUSINESS INFORMATION IN THE FIELD OF THE WINE INDUSTRY, IN CLASS 35 (U.S. CLS. 100, 101 AND 102).

**SERVICE MARK**

**PRINCIPAL REGISTER**

FIRST USE 1-30-2012; IN COMMERCE 1-30-2012.

THE MARK CONSISTS OF STANDARD CHARACTERS WITHOUT CLAIM TO ANY PARTICULAR FONT, STYLE, SIZE, OR COLOR.

THE ENGLISH TRANSLATION OF "WINE ENTRE FEMMES" IN THE MARK IS WINE BETWEEN WOMEN.

SN 85-169,754, FILED 11-4-2010.

MARK SHINER, EXAMINING ATTORNEY



*David J. Kyros*

Director of the United States Patent and Trademark Office

# United States of America

United States Patent and Trademark Office

# PANYL

**Reg. No. 4,126,355**

**Registered Apr. 10, 2012**

**Int. Cl.: 20**

**TRADEMARK**

**PRINCIPAL REGISTER**

PANYL, INC (DELAWARE CORPORATION)  
455 9TH ST  
BROOKLYN, NY 11215

FOR: LAMINATED VINYL TO BE AFFIXED TO THE SURFACE OF FURNITURE; VINYL APPLIQUES FOR ATTACHMENT TO WINDOWS, MIRRORS, AND OTHER SOLID SURFACES, IN CLASS 20 (U.S. CLS. 2, 13, 22, 25, 32 AND 50).

FIRST USE 7-1-2011; IN COMMERCE 12-1-2011.

THE MARK CONSISTS OF STANDARD CHARACTERS WITHOUT CLAIM TO ANY PARTICULAR FONT, STYLE, SIZE, OR COLOR.

THE WORDING "PANYL" HAS NO MEANING IN A FOREIGN LANGUAGE.

SN 85-170,022, FILED 11-5-2010.

GILBERT SWIFT, EXAMINING ATTORNEY



*David J. Kyfos*

Director of the United States Patent and Trademark Office



# United States of America

United States Patent and Trademark Office

## CLEAN HANDS MATTER

**Reg. No. 4,126,356**

**Registered Apr. 10, 2012**

**Int. Cls.: 9, 35, and 37**

**TRADEMARK**

**SERVICE MARK**

**PRINCIPAL REGISTER**

PROVENTIX SYSTEMS, INC. (DELAWARE CORPORATION)  
4518 VALLEYDALE ROAD, SUITE 201  
BIRMINGHAM, AL 35242

FOR: SENSORS AND INFORMATION DELIVERY, DISPLAY AND MANAGEMENT DEVICES, NAMELY, REMOTE ELECTRONIC MONITORING STATIONS CONTAINING NON-CONTACT IDENTIFICATION SENSORS AND DISPLAY SCREENS FOR DETECTING SPECIFIC USERS AND DISPLAYING CONTEXT-SPECIFIC INFORMATION; WIRED AND WIRELESS NETWORK DEVICES, NAMELY, REMOTE ELECTRONIC MONITORING STATIONS CONTAINING NON-CONTACT IDENTIFICATION SENSORS, DISPLAY SCREENS, AND COMMUNICATION CIRCUITRY FOR PROVIDING TWO-WAY COMMUNICATION OF DATA INCLUDING USER IDENTITY INFORMATION AND CONTEXT-SPECIFIC INFORMATION, IN CLASS 9 (U.S. CLS. 21, 23, 26, 36 AND 38).

FIRST USE 8-23-2011; IN COMMERCE 8-23-2011.

FOR: BUSINESS SERVICES, NAMELY, OPERATION AND ADMINISTRATION OF INFORMATION DELIVERY, DISPLAY AND MANAGEMENT DEVICES, NAMELY, MONITORING STATIONS CONTAINING NON-CONTACT IDENTIFICATION SENSORS AND DISPLAY SCREENS FOR DETECTING SPECIFIC USERS AND DISPLAYING CONTEXT-SPECIFIC INFORMATION AND NETWORKS FOR OTHERS; BUSINESS CONSULTING SERVICES FOR OTHERS IN THE DEVELOPMENT, SOURCING AND IMPLEMENTATION OF INFORMATION DELIVERY, DISPLAY AND MANAGEMENT SYSTEMS, NAMELY, SYSTEMS COMPOSED OF MULTIPLE MONITORING STATIONS CONTAINING NON-CONTACT IDENTIFICATION SENSORS AND DISPLAY SCREENS FOR DETECTING SPECIFIC USERS AND DISPLAYING CONTEXT-SPECIFIC INFORMATION AND NETWORKS, IN CLASS 35 (U.S. CLS. 100, 101 AND 102).

FIRST USE 2-2-2012; IN COMMERCE 2-2-2012.

FOR: MAINTENANCE OF INFORMATION DELIVERY, DISPLAY AND MANAGEMENT DEVICES, NAMELY, MONITORING STATIONS CONTAINING NON-CONTACT IDENTIFICATION SENSORS AND DISPLAY SCREENS FOR DETECTING SPECIFIC USERS AND DISPLAYING CONTEXT-SPECIFIC INFORMATION AND NETWORKS FOR OTHERS, IN CLASS 37 (U.S. CLS. 100, 103 AND 106).

FIRST USE 2-2-2012; IN COMMERCE 2-2-2012.



*David J. Kyffers*

Director of the United States Patent and Trademark Office

**Reg. No. 4,126,356** THE MARK CONSISTS OF STANDARD CHARACTERS WITHOUT CLAIM TO ANY PARTICULAR FONT, STYLE, SIZE, OR COLOR.

SN 85-170,132, FILED 11-5-2010.

WILLIAM VERHOSEK, EXAMINING ATTORNEY

# United States of America

United States Patent and Trademark Office

## Where Architecture & Construction Converge

**Reg. No. 4,126,357**

DOUGLASS, KEVIN (UNITED STATES INDIVIDUAL)  
1933 COVENTRY CT  
THOUSAND OAKS, CA 91362

**Registered Apr. 10, 2012**

**Int. Cl.: 37**

FOR: BUILDING CONSTRUCTION SERVICES, IN CLASS 37 (U.S. CLS. 100, 103 AND 106).

**SERVICE MARK**

FIRST USE 1-20-2011; IN COMMERCE 1-20-2011.

**PRINCIPAL REGISTER**

THE MARK CONSISTS OF STANDARD CHARACTERS WITHOUT CLAIM TO ANY PARTICULAR FONT, STYLE, SIZE, OR COLOR.

SN 85-171,268, FILED 11-8-2010.

SETH A. RAPPAPORT, EXAMINING ATTORNEY



*David J. Kyffers*

Director of the United States Patent and Trademark Office

# United States of America

United States Patent and Trademark Office

# WeCare<sup>+</sup>

**Reg. No. 4,126,358**

LONG TERM SOLUTIONS, INC. (MASSACHUSETTS CORPORATION)  
235 WEST CENTRAL STREET  
NATICK, MA 01760

**Registered Apr. 10, 2012**

**Int. Cl.: 44**

FOR: PROVIDING MEDICAL CARE PLANNING FOR ELDERS WHO CAN NO LONGER FUNCTION INDEPENDENTLY, IN CLASS 44 (U.S. CLS. 100 AND 101).

**SERVICE MARK**

FIRST USE 2-1-2011; IN COMMERCE 3-1-2011.

**PRINCIPAL REGISTER**

THE MARK CONSISTS OF THE STYLIZED WORDING "WECARE+" AND A PLUS SIGN IN DARK AND LIGHT BLUE.

THE COLOR(S) BLUE IN DARK AND LIGHT SHADES IS/ARE CLAIMED AS A FEATURE OF THE MARK.

SN 85-172,560, FILED 11-9-2010.

IRA J. GOODSaid, EXAMINING ATTORNEY



*David J. Kyffers*

Director of the United States Patent and Trademark Office

United States of America  
United States Patent and Trademark Office

# ECOBLOX

**Reg. No. 4,126,359**

OVIVO LUXEMBOURG S.A.R.L. (LUXEMBOURG CORPORATION)  
6C, RUE GABRIEL LIPPMAN  
MUNSBACH, LUXEMBOURG L-5365

**Registered Apr. 10, 2012**

**Int. Cl.: 11**

FOR: WASTEWATER TREATMENT UNITS, NAMELY, MEMBRANE BIOREACTORS, IN CLASS 11 (U.S. CLS. 13, 21, 23, 31 AND 34).

**TRADEMARK**

FIRST USE 11-8-2008; IN COMMERCE 11-29-2011.

**PRINCIPAL REGISTER**

THE MARK CONSISTS OF STANDARD CHARACTERS WITHOUT CLAIM TO ANY PARTICULAR FONT, STYLE, SIZE, OR COLOR.

SN 85-172,660, FILED 11-9-2010.

NAPOLEON SHARMA, EXAMINING ATTORNEY



*David J. Kybas*

Director of the United States Patent and Trademark Office

# United States of America

United States Patent and Trademark Office

## FEDTRANSACTION ANALYZER

**Reg. No. 4,126,360**

**Registered Apr. 10, 2012**

**Int. Cl.: 36**

**SERVICE MARK**

**PRINCIPAL REGISTER**

FEDERAL RESERVE BANKS COMPOSED OF FEDERAL RESERVE BANK OF ATLANTA, FEDERAL RESERVE BANK OF NEW YORK, FEDERAL RESERVE BANK OF BOSTON, FEDERAL RESERVE BANK OF CHICAGO, FEDERAL RESERVE BANK OF CLEVELAND, FEDERAL RESERVE BANK OF DALLAS, FEDERAL RESERVE BANK OF KANSAS CITY, FEDERAL RESERVE BANK OF MINNEAPOLIS, FEDERAL RESERVE BANK OF PHILADELPHIA, FEDERAL RESERVE BANK OF RICHMOND, FEDERAL RESERVE BANK OF ST. LOUIS, FEDERAL RESERVE BANK OF SAN FRANCISCO (UNITED STATES UNITED STATES JOINT VENTURE OF FEDERALLY CHARTERED CORPORATIONS) FEDERAL RESERVE BANK OF CHICAGO  
230 SOUTH LASALLE STREET  
CHICAGO, IL 606041413

FOR: FINANCIAL SERVICES, NAMELY, A BANKING INFORMATION SERVICE THAT OFFERS DATA REPORTING FEATURES AND HELPS AUTOMATE MANUAL REPORTING PROCESSES; FINANCIAL INFORMATION SERVICES, IN CLASS 36 (U.S. CLS. 100, 101 AND 102).

FIRST USE 7-31-2010; IN COMMERCE 7-31-2010.

THE MARK CONSISTS OF STANDARD CHARACTERS WITHOUT CLAIM TO ANY PARTICULAR FONT, STYLE, SIZE, OR COLOR.

NO CLAIM IS MADE TO THE EXCLUSIVE RIGHT TO USE "ANALYZER", APART FROM THE MARK AS SHOWN.

SN 85-173,764, FILED 11-10-2010.

KAELIE KUNG, EXAMINING ATTORNEY



*David J. Kybas*

Director of the United States Patent and Trademark Office

# United States of America

United States Patent and Trademark Office

## YOUR HIM EDGE

**Reg. No. 4,126,361**

**Registered Apr. 10, 2012**

**Int. Cls.: 9, 35, and 42**

**TRADEMARK**

**SERVICE MARK**

**PRINCIPAL REGISTER**

IOD INCORPORATED (WISCONSIN CORPORATION)  
1030 ONTARIO ROAD  
GREEN BAY, WI 54311

FOR: SOFTWARE FOR TRACKING, RECORDING AND MANAGING THE RELEASE OF MEDICAL RECORDS; SOFTWARE TO MANAGE THE PROCESS OF SCANNING AND DIGITALLY CONVERTING PAPER MEDICAL RECORDS TO ELECTRONIC MEDIA, IN CLASS 9 (U.S. CLS. 21, 23, 26, 36 AND 38).

FIRST USE 2-6-2012; IN COMMERCE 2-6-2012.

FOR: FILE AND DOCUMENT MANAGEMENT SERVICES, NAMELY, FILE AND DOCUMENT INDEXING FOR OTHERS; RECORD RELEASE MANAGEMENT SERVICES, NAMELY, MANAGING THE STORAGE, INDEXING, RETRIEVAL AND RELEASE OF INFORMATION AND RECORDS FOR OTHERS; MEDICAL BILLING SUPPORT SERVICES, NAMELY, CODING MEDICAL RECORDS FOR BILLING PURPOSES; ACCOUNT AUDITING, NAMELY, AUDITING OF CODING OF RECORDS FOR COMPLIANCE PURPOSES; CONSULTING SERVICES IN THE PAYMENT MANAGEMENT OF HEALTH CARE, NAMELY, THE PAYMENT OF FEES FOR MEDICAL SERVICES PERFORMED, IN CLASS 35 (U.S. CLS. 100, 101 AND 102).

FIRST USE 2-6-2012; IN COMMERCE 2-6-2012.

FOR: ELECTRONIC SCANNING OF MEDICAL RECORDS, IN CLASS 42 (U.S. CLS. 100 AND 101).

FIRST USE 2-6-2012; IN COMMERCE 2-6-2012.

THE MARK CONSISTS OF STANDARD CHARACTERS WITHOUT CLAIM TO ANY PARTICULAR FONT, STYLE, SIZE, OR COLOR.

SN 85-173,777, FILED 11-10-2010.

COURTNEY ALVAREZ, EXAMINING ATTORNEY



*David J. Kyffers*

Director of the United States Patent and Trademark Office

# United States of America

United States Patent and Trademark Office

## WICKED CLONE

**Reg. No. 4,126,362**

MODORCEA MIHAELA (ROMANIA INDIVIDUAL)  
447 EAST 78TH STREET APT. 4B  
NEW YORK, NY 10075

**Registered Apr. 10, 2012**

**Int. Cl.: 41**

FOR: ENTERTAINMENT IN THE NATURE OF VISUAL AND AUDIO PERFORMANCES BY MUSICAL BANDS, ACTORS, WRITERS, AND DANCERS; ENTERTAINMENT IN THE NATURE OF FASHION SHOWS; MUSIC PRODUCTION SERVICES, IN CLASS 41 (U.S. CLS. 100, 101 AND 107).

**SERVICE MARK**

**PRINCIPAL REGISTER**

FIRST USE 10-7-2009; IN COMMERCE 6-21-2011.

THE MARK CONSISTS OF STANDARD CHARACTERS WITHOUT CLAIM TO ANY PARTICULAR FONT, STYLE, SIZE, OR COLOR.

SN 85-174,012, FILED 11-10-2010.

BARBARA A. GOLD, EXAMINING ATTORNEY



*David J. Kyffers*

Director of the United States Patent and Trademark Office



# United States of America

United States Patent and Trademark Office

## MAGIKIMONO

**Reg. No. 4,126,363**

HAUETER, CHRISTOPHER (UNITED STATES INDIVIDUAL)  
1041 AVENUE D

**Registered Apr. 10, 2012**

REDONDO BEACH, CA 90277

**Int. Cl.: 25**

FOR: CAPS; HOODED SWEAT SHIRTS; JACKETS; PANTS; SHOES; T-SHIRTS, IN CLASS 25 (U.S. CLS. 22 AND 39).

**TRADEMARK**

FIRST USE 9-1-2011; IN COMMERCE 11-20-2011.

**PRINCIPAL REGISTER**

THE MARK CONSISTS OF STANDARD CHARACTERS WITHOUT CLAIM TO ANY PARTICULAR FONT, STYLE, SIZE, OR COLOR.

SN 85-174,050, FILED 11-10-2010.

FRED CARL, EXAMINING ATTORNEY



*David J. Kybas*

Director of the United States Patent and Trademark Office

# United States of America

United States Patent and Trademark Office

# BRITE STIX

**Reg. No. 4,126,364**

ARCH CHEMICALS, INC. (VIRGINIA CORPORATION)  
501 MERRITT 7, P.O. BOX 5204  
NORWALK, CT 068565204

**Registered Apr. 10, 2012**

**Int. Cl.: 1**

FOR: CHEMICALS USED TO SANITIZE AND TO TREAT SWIMMING POOL, SPA AND HOT TUB WATER, IN CLASS 1 (U.S. CLS. 1, 5, 6, 10, 26 AND 46).

**TRADEMARK**

FIRST USE 10-25-2011; IN COMMERCE 10-25-2011.

**PRINCIPAL REGISTER**

THE MARK CONSISTS OF STANDARD CHARACTERS WITHOUT CLAIM TO ANY PARTICULAR FONT, STYLE, SIZE, OR COLOR.

NO CLAIM IS MADE TO THE EXCLUSIVE RIGHT TO USE "STICKS", APART FROM THE MARK AS SHOWN.

SN 85-175,264, FILED 11-12-2010.

ANDREW LEASER, EXAMINING ATTORNEY



*David J. Kyffers*

Director of the United States Patent and Trademark Office

# United States of America

United States Patent and Trademark Office

# there there

**Reg. No. 4,126,365**

HOLDSWORTH LLC (CALIFORNIA LIMITED LIABILITY COMPANY), DBA THERE THERE,  
1440 BROADWAY STE 210  
OAKLAND, CA 94612

**Registered Apr. 10, 2012**

**Int. Cl.: 25**

FOR: HATS; JACKETS; JERSEYS; SWEATSHIRTS; T-SHIRTS; TEE SHIRTS; TOPS;  
WEARABLE GARMENTS AND CLOTHING, NAMELY, SHIRTS; WRAPS, IN CLASS 25 (U.S.  
CLS. 22 AND 39).

**TRADEMARK**

FIRST USE 12-17-2010; IN COMMERCE 12-22-2010.

**PRINCIPAL REGISTER**

THE MARK CONSISTS OF STANDARD CHARACTERS WITHOUT CLAIM TO ANY PAR-  
TICULAR FONT, STYLE, SIZE, OR COLOR.

SN 85-176,075, FILED 11-12-2010.

ANTHONY RINKER, EXAMINING ATTORNEY



*David J. Kyffers*

Director of the United States Patent and Trademark Office

# United States of America

United States Patent and Trademark Office

## ILLEGAL LENGTH

**Reg. No. 4,126,366**

**Registered Apr. 10, 2012**

**Int. Cl.: 3**

**TRADEMARK**

**PRINCIPAL REGISTER**

L'OREAL USA CREATIVE, INC. (DELAWARE CORPORATION)  
575 FIFTH AVENUE  
NEW YORK, NY 10017

FOR: MASCARA, IN CLASS 3 (U.S. CLS. 1, 4, 6, 50, 51 AND 52).

FIRST USE 1-0-2012; IN COMMERCE 1-0-2012.

THE MARK CONSISTS OF STANDARD CHARACTERS WITHOUT CLAIM TO ANY PARTICULAR FONT, STYLE, SIZE, OR COLOR.

OWNER OF U.S. REG. NO. 1,590,438.

SN 85-176,441, FILED 11-15-2010.

JOHN HWANG, EXAMINING ATTORNEY



*David J. Kyffers*

Director of the United States Patent and Trademark Office

# United States of America

United States Patent and Trademark Office

# SEATPAK

**Reg. No. 4,126,367**

FRAWLEY, SANDRA (UNITED STATES INDIVIDUAL)  
P.O. BOX 858

**Registered Apr. 10, 2012**

GREENWOOD LAKE, NY 10925

**Int. Cl.: 18**

FOR: BAGS FOR CARRYING BABIES' ACCESSORIES, IN CLASS 18 (U.S. CLS. 1, 2, 3, 22 AND 41).

**TRADEMARK**

FIRST USE 12-1-2010; IN COMMERCE 12-1-2010.

**PRINCIPAL REGISTER**

THE MARK CONSISTS OF STANDARD CHARACTERS WITHOUT CLAIM TO ANY PARTICULAR FONT, STYLE, SIZE, OR COLOR.

SN 85-176,580, FILED 11-15-2010.

TASNEEM HUSSAIN, EXAMINING ATTORNEY



*David J. Kybas*

Director of the United States Patent and Trademark Office

# United States of America

United States Patent and Trademark Office

## YOUR LOCAL ROOTS

**Reg. No. 4,126,368**

UNITED NATURAL FOODS, INC. (DELAWARE CORPORATION)  
313 IRON HORSE WAY  
PROVIDENCE, RI 02908

**Registered Apr. 10, 2012**

**Int. Cl.: 35**

FOR: MARKETING SERVICES, NAMELY, PROVIDING AN INFORMATIONAL MARKETING PROGRAM TO PROMOTE THE SALE OF LOCAL PRODUCTS WITHIN NATURAL AND ORGANIC RETAIL GROCERY STORES FOR PARTICIPATING SUPPLIERS, IN CLASS 35 (U.S. CLS. 100, 101 AND 102).

**SERVICE MARK**

**PRINCIPAL REGISTER**

FIRST USE 6-12-2011; IN COMMERCE 6-12-2011.

THE MARK CONSISTS OF STANDARD CHARACTERS WITHOUT CLAIM TO ANY PARTICULAR FONT, STYLE, SIZE, OR COLOR.

NO CLAIM IS MADE TO THE EXCLUSIVE RIGHT TO USE "LOCAL", APART FROM THE MARK AS SHOWN.

SN 85-176,597, FILED 11-15-2010.

TINA MAI, EXAMINING ATTORNEY



*David J. Kyros*

Director of the United States Patent and Trademark Office

# United States of America

United States Patent and Trademark Office

# TAGG

**Reg. No. 4,126,369**

**Registered Apr. 10, 2012**

**Int. Cl.: 9**

**TRADEMARK**

**PRINCIPAL REGISTER**

SNAPTRACS, INC. (CALIFORNIA CORPORATION)  
5775 MOREHOUSE DRIVE  
SAN DIEGO, CA 921211714

FOR: ELECTRONIC DEVICES FOR ANIMAL LOCATING AND TRACKING PROGRAMMED TO USE GLOBAL POSITIONING SYSTEMS (GPS) OR CELLULAR COMMUNICATIONS, IN CLASS 9 (U.S. CLS. 21, 23, 26, 36 AND 38).

FIRST USE 9-30-2011; IN COMMERCE 9-30-2011.

THE MARK CONSISTS OF STANDARD CHARACTERS WITHOUT CLAIM TO ANY PARTICULAR FONT, STYLE, SIZE, OR COLOR.

SN 85-176,826, FILED 11-15-2010.

SUE LAWRENCE, EXAMINING ATTORNEY



*David J. Kybas*

Director of the United States Patent and Trademark Office

# United States of America

United States Patent and Trademark Office

## CAIS CAPITAL LLC

**Reg. No. 4,126,370**

CAPITAL INTEGRATION SYSTEMS LLC (DELAWARE LIMITED LIABILITY COMPANY)  
590 MADISON AVENUE  
NEW YORK, NY 10022

**Registered Apr. 10, 2012**

**Int. Cl.: 36**

FOR: FINANCIAL SERVICES, NAMELY, BROKER/DEALER SERVICES AND BROKERAGE SERVICES FOR CAPITAL INVESTMENT, IN CLASS 36 (U.S. CLS. 100, 101 AND 102).

**SERVICE MARK**

FIRST USE 3-11-2011; IN COMMERCE 3-11-2011.

**PRINCIPAL REGISTER**

THE MARK CONSISTS OF STANDARD CHARACTERS WITHOUT CLAIM TO ANY PARTICULAR FONT, STYLE, SIZE, OR COLOR.

OWNER OF U.S. REG. NO. 3,912,207.

NO CLAIM IS MADE TO THE EXCLUSIVE RIGHT TO USE "CAPITAL LLC", APART FROM THE MARK AS SHOWN.

SN 85-177,993, FILED 11-16-2010.

JAY BESCH, EXAMINING ATTORNEY



*David J. Kybas*

Director of the United States Patent and Trademark Office



# United States of America

United States Patent and Trademark Office



**Reg. No. 4,126,371**

**Registered Apr. 10, 2012**

**Int. Cls.: 9, 12, and 45**

**TRADEMARK**

**SERVICE MARK**

**PRINCIPAL REGISTER**

ARGOPOWER, LLC (FLORIDA LIMITED LIABILITY COMPANY)  
SUITE 8  
1 OLEANDER COURT  
COCOA, FL 32922

FOR: WATERPROOF SELF CONTAINED ELECTRONIC SURVEILLANCE INSTALLATIONS THAT CAN BE DEPLOYED TO GATHER EVIDENCE OR INTELLIGENCE IN MARITIME AND HARBOR LOCATIONS; WATERPROOF CLOSED CIRCUIT TV SYSTEMS FOR SECURITY AND SURVEILLANCE, NAMELY, CAMERAS, SWITCHERS, MONITORS, MICROPHONES, SPECIAL SENSORS AND RECORDERS FOR USE IN MARITIME AND HARBOR LOCATIONS; WATERPROOF COMPUTER HARDWARE FOR IP VIDEO SURVEILLANCE IN MARITIME AND HARBOR LOCATIONS; WATERPROOF ELECTRIC AND ELECTRONIC VIDEO SURVEILLANCE INSTALLATIONS FOR USE IN MARITIME AND HARBOR LOCATIONS; WATERPROOF VEHICLE SAFETY EQUIPMENT, NAMELY, AN AUTONOMOUS ON-BOARD VESSEL SURVEILLANCE SYSTEM COMPRISED OF CAMERAS, MONITORS AND SPECIAL SENSORS FOR IDENTIFYING, MEASURING, RECORDING, AND EXPOSING THREATS AND POTENTIAL THREATS IN MARITIME AND HARBOR LOCATIONS, IN CLASS 9 (U.S. CLS. 21, 23, 26, 36 AND 38).

FIRST USE 10-25-2010; IN COMMERCE 11-4-2010.

FOR: BOATS AND STRUCTURAL PARTS THEREFOR; JON BOATS, KAYAK-LIKE BOATS; SELF-PROPELLED, AUTONOMOUS ELECTRIC WATERCRAFT IN THE NATURE OF BOATS AND VESSELS, IN CLASS 12 (U.S. CLS. 19, 21, 23, 31, 35 AND 44).

FIRST USE 10-25-2010; IN COMMERCE 11-4-2010.

FOR: PROVIDING RECONNAISSANCE AND SURVEILLANCE SERVICES IN MARITIME AND HARBOR LOCATIONS; MARITIME AND HARBOR SURVEILLANCE SERVICES, IN CLASS 45 (U.S. CLS. 100 AND 101).

FIRST USE 10-25-2010; IN COMMERCE 11-4-2010.

NO CLAIM IS MADE TO THE EXCLUSIVE RIGHT TO USE "SILENT PATROL" IN CLASSES 12 AND 45, APART FROM THE MARK AS SHOWN.



*David J. Kyffers*

Director of the United States Patent and Trademark Office

**Reg. No. 4,126,371** THE COLOR(S) DARK RED, MEDIUM RED, LIGHT BLUE, MEDIUM BLUE, DARK BLUE, WHITE, GRAY, PURPLE, AND BLACK IS/ARE CLAIMED AS A FEATURE OF THE MARK.

THE MARK CONSISTS OF THE WORDS "SILENT PATROL" SLANTING BACK, A STYLIZED SONAR DISPLAY SCREEN, AND THREE STYLIZED SPEARS WITH SPLASHES AT THE LOWER POINTS. THE WORD "PATROL" IS IN THE FOREGROUND IN MEDIUM BLUE WITH WHITE OUTLINING; THE WORD "SILENT" IS IN THE BACKGROUND IN DARK BLUE WITH GRAY OUTLINING; THE SONAR DISPLAY SCREEN HAS A DARK RED CENTER SURROUNDED BY MEDIUM RED WITH A BLACK OUTLINE, BLACK CROSSHAIRS OVER THE RED PORTIONS, ONE CONCENTRIC CIRCLE IN LIGHT BLUE FADING TO DARK BLUE WITH A BLACK OUTLINE, AND A SECOND CONCENTRIC CIRCLE IN MEDIUM BLUE FADING TO PURPLE WITH A BLACK OUTLINE; THE THREE STYLIZED SPEARS ARE LIGHT BLUE AT THE LOWER POINTS FADING TO BLACK AT THE TOPS HAVING A PARTIAL WHITE OUTLINE, WITH A BLACK BAND ON THE LEFT SIDE OF THE LOWER PORTIONS AND A LIGHT BLUE BAND ON THE LEFT SIDE OF THE UPPER PORTIONS; THE SPLASHES ARE MEDIUM BLUE AT THE POINTS OF THE SPEARS FADING TO LIGHT BLUE WITH WHITE AND BLACK OUTLINING.

SN 85-178,657, FILED 11-17-2010.

DOUGLAS LEE, EXAMINING ATTORNEY

# United States of America

United States Patent and Trademark Office

## GLADE EXPRESSIONS

**Reg. No. 4,126,372**

S. C. JOHNSON & SON, INC. (WISCONSIN CORPORATION)  
1525 HOWE STREET  
RACINE, WI 53403

**Registered Apr. 10, 2012**

**Int. Cl.: 5**

FOR: AIR FRESHENERS, IN CLASS 5 (U.S. CLS. 6, 18, 44, 46, 51 AND 52).

**TRADEMARK**

FIRST USE 12-10-2011; IN COMMERCE 12-10-2011.

**PRINCIPAL REGISTER**

THE MARK CONSISTS OF STANDARD CHARACTERS WITHOUT CLAIM TO ANY PARTICULAR FONT, STYLE, SIZE, OR COLOR.

OWNER OF U.S. REG. NOS. 2,918,091, 2,986,070, AND OTHERS.

SN 85-178,912, FILED 11-17-2010.

DAVID I, EXAMINING ATTORNEY



*David J. Kyffers*

Director of the United States Patent and Trademark Office

# United States of America

United States Patent and Trademark Office

# NINHO

**Reg. No. 4,126,373**

**Registered Apr. 10, 2012**

**Int. Cl.: 29**

**TRADEMARK**

**PRINCIPAL REGISTER**

SOCIETE DES PRODUITS NESTLE S.A. (SWITZERLAND CORPORATION)  
CASE POSTALE 353  
1800 VEVEY, SWITZERLAND

FOR: POWDERED MILK, IN CLASS 29 (U.S. CL. 46).

FIRST USE 1-31-2011; IN COMMERCE 1-31-2011.

THE MARK CONSISTS OF STANDARD CHARACTERS WITHOUT CLAIM TO ANY PARTICULAR FONT, STYLE, SIZE, OR COLOR.

THE ENGLISH TRANSLATION OF "NINHO" IN THE MARK IS "NEST".

SN 85-179,816, FILED 11-18-2010.

DAVID TOOLEY, EXAMINING ATTORNEY



*David J. Kybas*

Director of the United States Patent and Trademark Office

# United States of America

United States Patent and Trademark Office

# TWYNERGY

**Reg. No. 4,126,374**

**Registered Apr. 10, 2012**

**Int. Cl.: 9**

**TRADEMARK**

**PRINCIPAL REGISTER**

HEWLETT-PACKARD DEVELOPMENT COMPANY, L.P. (TEXAS LIMITED PARTNERSHIP)  
11445 COMPAQ CENTER DRIVE WEST  
HOUSTON, TX 77070

FOR: DOWNLOADABLE SOFTWARE IN THE FIELD OF SOCIAL NETWORKING; DOWNLOADABLE SOFTWARE IN THE NATURE OF A MOBILE APPLICATION THAT MANAGES DATA IN SOCIAL MEDIA WEBSITES; SOFTWARE AND SOFTWARE APPLICATIONS TO ENABLE TRANSMISSION, ACCESS, ORGANIZATION, AND MANAGEMENT OF SOCIAL NETWORKING ONLINE SERVICES, TEXT, WEBLINKS, AND IMAGES VIA THE INTERNET AND OTHER COMMUNICATIONS NETWORKS; COMPUTER SOFTWARE USED TO ENHANCE THE CAPABILITIES AND FEATURES OF OTHER SOFTWARE AND NON-DOWNLOADABLE ONLINE SOFTWARE; SOFTWARE FOR ACCESSING INFORMATION ON A GLOBAL COMPUTER NETWORK; DOWNLOADABLE SOFTWARE THAT MANAGES DATA IN SOCIAL MEDIA WEBSITES AVAILABLE VIA THE INTERNET AND WIRELESS DEVICES, IN CLASS 9 (U.S. CLS. 21, 23, 26, 36 AND 38).

FIRST USE 10-21-2011; IN COMMERCE 10-21-2011.

THE MARK CONSISTS OF STANDARD CHARACTERS WITHOUT CLAIM TO ANY PARTICULAR FONT, STYLE, SIZE, OR COLOR.

SN 85-179,850, FILED 11-18-2010.

ELISSA GARBER KON, EXAMINING ATTORNEY



*David J. Kyros*

Director of the United States Patent and Trademark Office

# United States of America

United States Patent and Trademark Office



**Reg. No. 4,126,375**

**Registered Apr. 10, 2012**

**Int. Cl.: 30**

**TRADEMARK**

**PRINCIPAL REGISTER**

NELSON, OCTAVIUS (UNITED STATES INDIVIDUAL)  
PO BOX 17202  
GREENVILLE, SC 29606

FOR: SEASONINGS, IN CLASS 30 (U.S. CL. 46).

FIRST USE 10-9-2010; IN COMMERCE 10-9-2010.

NO CLAIM IS MADE TO THE EXCLUSIVE RIGHT TO USE "ALL PURPOSE SEASONING",  
APART FROM THE MARK AS SHOWN.

THE MARK CONSISTS OF TWO CIRCLES WITH THE STYLIZED TEXT "BOBBY'S ALL  
PURPOSE SEASONING" ON THE OUTER CIRCLE. IN THE MIDDLE THERE IS THE  
STYLIZED TEXT "MAKE IT GOOD!".

SN 85-180,961, FILED 11-19-2010.

JULIE WATSON, EXAMINING ATTORNEY



*David J. Kybas*

Director of the United States Patent and Trademark Office

# United States of America

United States Patent and Trademark Office

## The Lash Factory

**Reg. No. 4,126,376**

**Registered Apr. 10, 2012**

**Int. Cl.: 44**

**SERVICE MARK**

**PRINCIPAL REGISTER**

MONICA I. DEPTULA (UNITED STATES INDIVIDUAL), DBA THE LASH FACTORY,  
10925 BLUFFSIDE DR  
#214  
STUDIO CITY, CA 91604 AND

TERESA M. SHERAN (MEXICO INDIVIDUAL), DBA THE LASH FACTORY,  
10925 BLUFFSIDE DR  
#214  
STUDIO CITY, CA 91604

FOR: PROVIDING ON-SITE BEAUTY SERVICES, NAMELY, APPLICATION OF EYELASH  
EXTENSIONS, IN CLASS 44 (U.S. CLS. 100 AND 101).

FIRST USE 10-1-2010; IN COMMERCE 12-4-2010.

THE MARK CONSISTS OF STANDARD CHARACTERS WITHOUT CLAIM TO ANY PAR-  
TICULAR FONT, STYLE, SIZE, OR COLOR.

NO CLAIM IS MADE TO THE EXCLUSIVE RIGHT TO USE "LASH", APART FROM THE  
MARK AS SHOWN.

SN 85-181,186, FILED 11-19-2010.

PAM WILLIS, EXAMINING ATTORNEY



*David J. Kyffers*

Director of the United States Patent and Trademark Office

# United States of America

United States Patent and Trademark Office



**Reg. No. 4,126,377**

**Registered Apr. 10, 2012**

**Int. Cls.: 37 and 38**

**SERVICE MARK**

**PRINCIPAL REGISTER**

SPX CORPORATION (DELAWARE CORPORATION)  
13515 BALLANTYNE CORPORATE PLACE  
CHARLOTTE, NC 28277

FOR: PROVIDING AN ONLINE COMPUTER DATA BASE FEATURING INFORMATION ABOUT VEHICLE REPAIR AND MAINTENANCE; TECHNICAL SUPPORT SERVICES, NAMELY, PROVIDING TECHNICAL ADVICE IN THE FIELD OF VEHICLE REPAIR AND MAINTENANCE; TECHNICAL SUPPORT SERVICES, NAMELY, TROUBLESHOOTING IN THE NATURE OF DIAGNOSING PROBLEMS WITH VEHICLES, IN CLASS 37 (U.S. CLS. 100, 103 AND 106).

FIRST USE 4-29-2011; IN COMMERCE 4-29-2011.

FOR: PROVIDING ON-LINE CHAT ROOMS FOR THE TRANSMISSION OF MESSAGES AMONG VEHICLE REPAIR AND MAINTENANCE TECHNICIANS AND CUSTOMERS IN THE FIELD OF TECHNICAL VEHICLE REPAIR, IN CLASS 38 (U.S. CLS. 100, 101 AND 104).

FIRST USE 4-29-2011; IN COMMERCE 4-29-2011.

NO CLAIM IS MADE TO THE EXCLUSIVE RIGHT TO USE "TECH", APART FROM THE MARK AS SHOWN.

THE COLOR(S) BLUE AND WHITE IS/ARE CLAIMED AS A FEATURE OF THE MARK.

THE NAME JOHN ZAK IDENTIFIES A LIVING INDIVIDUAL WHOSE CONSENT IS OF RECORD.

THE MARK CONSISTS OF A DARK BLUE RECTANGULAR OUTLINE WITH A LIGHT BLUE AND BLUE INTERIOR, AND A WHITE CAR ABOVE THE WHITE WORDS "TECH 4 TECHS".

SN 85-182,251, FILED 11-22-2010.

VIVIAN MICZNIK FIRST, EXAMINING ATTORNEY



*David J. Kyffers*

Director of the United States Patent and Trademark Office



# United States of America

United States Patent and Trademark Office

## TECH 4 TECHS

**Reg. No. 4,126,378**

**Registered Apr. 10, 2012**

**Int. Cls.: 37 and 38**

**SERVICE MARK**

**PRINCIPAL REGISTER**

SPX CORPORATION (DELAWARE CORPORATION)  
13515 BALLANTYNE CORPORATE PLACE  
CHARLOTTE, NC 28277

FOR: PROVIDING AN ONLINE COMPUTER DATA BASE FEATURING TECHNICAL INFORMATION ABOUT VEHICLE REPAIR AND MAINTENANCE; TECHNICAL SUPPORT SERVICES, NAMELY, PROVIDING TECHNICAL ADVICE IN THE FIELD OF VEHICLE REPAIR AND MAINTENANCE; TECHNICAL SUPPORT SERVICES; NAMELY, TROUBLESHOOTING IN THE NATURE OF DIAGNOSING PROBLEMS WITH VEHICLES, IN CLASS 37 (U.S. CLS. 100, 103 AND 106).

FIRST USE 4-29-2011; IN COMMERCE 4-29-2011.

FOR: PROVIDING ON-LINE CHAT ROOMS FOR THE TRANSMISSION OF MESSAGES AMONG VEHICLE REPAIR AND MAINTENANCE TECHNICIANS AND CUSTOMERS IN THE FIELD OF TECHNICAL VEHICLE REPAIR, IN CLASS 38 (U.S. CLS. 100, 101 AND 104).

FIRST USE 4-29-2011; IN COMMERCE 4-29-2011.

THE MARK CONSISTS OF STANDARD CHARACTERS WITHOUT CLAIM TO ANY PARTICULAR FONT, STYLE, SIZE, OR COLOR.

NO CLAIM IS MADE TO THE EXCLUSIVE RIGHT TO USE "TECH", APART FROM THE MARK AS SHOWN.

SN 85-182,298, FILED 11-22-2010.

VIVIAN MICZNIK FIRST, EXAMINING ATTORNEY



*David J. Kyffers*

Director of the United States Patent and Trademark Office

# United States of America

United States Patent and Trademark Office

## NEW ENGLAND EXPLORER

**Reg. No. 4,126,379**

**Registered Apr. 10, 2012**

**Int. Cl.: 41**

**SERVICE MARK**

**PRINCIPAL REGISTER**

ENGLISH LANGUAGE CENTER, INC. (MASSACHUSETTS CORPORATION)  
10850 WILSHIRE BOULEVARD  
LOS ANGELES, CA 90024

FOR: LANGUAGE INSTRUCTION SERVICES, NAMELY, INTENSIVE PROGRAMS TEACHING AMERICAN ENGLISH BY PROVIDING LANGUAGE STUDENTS WITH OPPORTUNITIES TO UNDERSTAND LOCAL CUSTOMS AND LANGUAGE USAGE, AND TO PRACTICE THEIR ENGLISH OUTSIDE OF THE CLASSROOM, BY PROVIDING GUIDED TOURS AND INSTRUCTION AT SITES OF LOCAL INTEREST, IN CLASS 41 (U.S. CLS. 100, 101 AND 107).

FIRST USE 11-22-2010; IN COMMERCE 11-22-2010.

THE MARK CONSISTS OF STANDARD CHARACTERS WITHOUT CLAIM TO ANY PARTICULAR FONT, STYLE, SIZE, OR COLOR.

NO CLAIM IS MADE TO THE EXCLUSIVE RIGHT TO USE "NEW ENGLAND", APART FROM THE MARK AS SHOWN.

SN 85-182,367, FILED 11-22-2010.

ROBIN CHOSID, EXAMINING ATTORNEY



*David J. Kybas*

Director of the United States Patent and Trademark Office

# United States of America

United States Patent and Trademark Office

## CALIFORNIA CRUISER

**Reg. No. 4,126,380**

**Registered Apr. 10, 2012**

**Int. Cl.: 41**

**SERVICE MARK**

**PRINCIPAL REGISTER**

ENGLISH LANGUAGE CENTER, INC. (MASSACHUSETTS CORPORATION)  
10850 WILSHIRE BOULEVARD  
LOS ANGELES, CA 90024

FOR: LANGUAGE INSTRUCTION SERVICES, NAMELY, INTENSIVE PROGRAMS TEACHING AMERICAN ENGLISH BY PROVIDING LANGUAGE STUDENTS WITH OPPORTUNITIES TO UNDERSTAND LOCAL CUSTOMS AND LANGUAGE USAGE, AND TO PRACTICE THEIR ENGLISH OUTSIDE OF THE CLASSROOM, BY PROVIDING GUIDED TOURS AND INSTRUCTION AT SITES OF LOCAL INTEREST, IN CLASS 41 (U.S. CLS. 100, 101 AND 107).

FIRST USE 11-22-2010; IN COMMERCE 11-22-2010.

THE MARK CONSISTS OF STANDARD CHARACTERS WITHOUT CLAIM TO ANY PARTICULAR FONT, STYLE, SIZE, OR COLOR.

NO CLAIM IS MADE TO THE EXCLUSIVE RIGHT TO USE "CALIFORNIA", APART FROM THE MARK AS SHOWN.

SN 85-182,376, FILED 11-22-2010.

ROBIN CHOSID, EXAMINING ATTORNEY



*David J. Kyffers*

Director of the United States Patent and Trademark Office

# United States of America

United States Patent and Trademark Office

## LIHONG CHEM

**Reg. No. 4,126,381**

**Registered Apr. 10, 2012**

**Int. Cl.: 1**

**TRADEMARK**

**PRINCIPAL REGISTER**

CHONGQING LIHONG FINE CHEMICALS CO., LTD. (CHINA LIMITED COMPANY (LTD.))  
NO.6, JIANGXIA ROAD, NAN'AN DISTRICT  
CHONGQING, CHINA

FOR: ADHESIVES FOR CERAMICS, PAPERMAKING, MINING EXTRACTION, SYNTHETIC RESINS; ADHESIVES FOR USE IN THE MANUFACTURE OF PAINTS; ADHESIVES FOR USE IN THE MANUFACTURE OF PHARMACEUTICAL PREPARATIONS; ADHESIVES FOR USE IN THE MANUFACTURE OF TEXTILES; ADHESIVES FOR THE BUILDING INDUSTRY; ADHESIVES FOR USE IN FOOD PRESERVING, FOR THE FOOD PROCESSING INDUSTRY, FOR USE IN THE MANUFACTURE OF FOOD; CELLULOSE; CHEMICAL ADDITIVES FOR DRILLING MUDS; CHEMICAL ADDITIVES FOR OIL WELL DRILLING FLUID; CHEMICAL ADDITIVES FOR USE AS BINDING AGENTS IN FEED PELLETS; CHEMICAL ADDITIVES FOR USE IN THE MANUFACTURE OF FOOD, PHARMACEUTICALS, COSMETICS; CHEMICALS USED IN THE TEXTILE INDUSTRY, NAMELY, PRINTING PASTE AND COLOR ENHANCER FOR PRINTING TEXTILES; INDUSTRIAL ADHESIVES; POLYMER COATING AGENTS FOR PAPER; PRODUCE STABILIZER USED FOR PRESERVING FOODS, IN CLASS 1 (U.S. CLS. 1, 5, 6, 10, 26 AND 46).

FIRST USE 7-3-2005; IN COMMERCE 7-3-2005.

NO CLAIM IS MADE TO THE EXCLUSIVE RIGHT TO USE "CHEM", APART FROM THE MARK AS SHOWN.

THE COLOR(S) BLUE, LIGHT BLUE AND BLACK IS/ARE CLAIMED AS A FEATURE OF THE MARK.

THE MARK CONSISTS OF THE WORDS "LIHONG CHEM" WITH STYLIZED DESIGN. THE FACES OF THE TEN LETTERS ARE BLUE IN COLOR AND THE SIDES OF THE TEN LETTERS ARE LIGHT BLUE AND BLACK IN COLOR.

THE WORDING "LIHONG" HAS NO MEANING IN A FOREIGN LANGUAGE.

SN 85-183,057, FILED 11-23-2010.

GISELLE AGOSTO, EXAMINING ATTORNEY



*David J. Kyjars*

Director of the United States Patent and Trademark Office

# United States of America

United States Patent and Trademark Office

## HOLIDAYS & SEASONAL CELEBRATIONS

**Reg. No. 4,126,382**

THE EDUCATION CENTER, INC. (NORTH CAROLINA CORPORATION)  
3515 WEST MARKET STREET  
GREENSBORO, NC 27403

**Registered Apr. 10, 2012**

**Int. Cl.: 41**

FOR: COMPUTER SERVICES, NAMELY, PROVIDING INFORMATION IN THE FIELD OF CHILDHOOD EDUCATION, IN CLASS 41 (U.S. CLS. 100, 101 AND 107).

**SERVICE MARK**

FIRST USE 11-14-2002; IN COMMERCE 11-14-2002.

**PRINCIPAL REGISTER**

THE MARK CONSISTS OF STANDARD CHARACTERS WITHOUT CLAIM TO ANY PARTICULAR FONT, STYLE, SIZE, OR COLOR.

SEC. 2(F).

OWNER OF U.S. REG. NO. 2,902,547.

SN 85-183,843, FILED 11-23-2010.

BRIAN NEVILLE, EXAMINING ATTORNEY



*David J. Kybas*

Director of the United States Patent and Trademark Office

# United States of America

United States Patent and Trademark Office

## MAXWELL HOUSE INTERNATIONAL

**Reg. No. 4,126,383**

**Registered Apr. 10, 2012**

**Int. Cl.: 30**

**TRADEMARK**

**PRINCIPAL REGISTER**

KRAFT FOODS GLOBAL BRANDS LLC (DELAWARE LIMITED LIABILITY COMPANY)  
THREE LAKES DRIVE  
NORTHFIELD, IL 60093

FOR: COFFEE AND TEA, IN CLASS 30 (U.S. CL. 46).

FIRST USE 7-25-2011; IN COMMERCE 7-25-2011.

THE MARK CONSISTS OF STANDARD CHARACTERS WITHOUT CLAIM TO ANY PARTICULAR FONT, STYLE, SIZE, OR COLOR.

OWNER OF U.S. REG. NOS. 599,153 AND 1,750,312.

NO CLAIM IS MADE TO THE EXCLUSIVE RIGHT TO USE "INTERNATIONAL", APART FROM THE MARK AS SHOWN.

SN 85-183,884, FILED 11-23-2010.

RONALD MCMORROW, EXAMINING ATTORNEY



*David J. Kyffers*

Director of the United States Patent and Trademark Office

# United States of America

United States Patent and Trademark Office

## ELSA GLORIA

**Reg. No. 4,126,384**

**Registered Apr. 10, 2012**

**Int. Cl.: 9**

**TRADEMARK**

**PRINCIPAL REGISTER**

ELSA INVESTMENT CORP., LTD. (TAIWAN CORPORATION)  
7F.-2, NO.268, SEC. 1, WENHUA RD.  
BANQIA CITY, TAIPEI COUNTY, TAIWAN 220

FOR: COMPUTER GRAPHICS SOFTWARE; COMPUTER PROGRAMS FOR EDITING IMAGES, SOUND AND VIDEO; COMPUTER PROGRAMS FOR USER INTERFACE DESIGN; COMPUTER PROGRAMS RECORDED ON DATA MEDIA (SOFTWARE) DESIGNED FOR USE IN CONSTRUCTION AND AUTOMATED MANUFACTURING (CAD/CAM); GRAPHICS CARDS; VIEWING DEVICES, NAMELY, DIGITAL PHOTOGRAPH VIEWERS, 3D DIGITAL PHOTOGRAPH VIEWERS, UNDERWATER DIGITAL PHOTOGRAPH VIEWERS, UNDERWATER 3D DIGITAL PHOTOGRAPHS VIEWERS, UNDERWATER LCD DISPLAYS, UNDERWATER ENCLOSURES FOR LCD DISPLAYS AND UNDERWATER ENCLOSURES FOR VIDEO PLAYERS, IN CLASS 9 (U.S. CLS. 21, 23, 26, 36 AND 38).

FIRST USE 1-1-1995; IN COMMERCE 1-1-1995.

THE MARK CONSISTS OF STANDARD CHARACTERS WITHOUT CLAIM TO ANY PARTICULAR FONT, STYLE, SIZE, OR COLOR.

SN 85-184,256, FILED 11-24-2010.

BARBARA RUTLAND, EXAMINING ATTORNEY



*David J. Kyffers*

Director of the United States Patent and Trademark Office

# United States of America

United States Patent and Trademark Office

## VIVA COFFEE

**Reg. No. 4,126,385**

FRANGES, MIKE (UNITED STATES INDIVIDUAL)  
1671 JUANITA AVE.  
SAN JOSE, CA 95125

**Registered Apr. 10, 2012**

**Int. Cl.: 43**

FOR: COFFEE SHOPS, IN CLASS 43 (U.S. CLS. 100 AND 101).

**SERVICE MARK**

FIRST USE 11-15-2000; IN COMMERCE 11-15-2008.

**PRINCIPAL REGISTER**

THE MARK CONSISTS OF STANDARD CHARACTERS WITHOUT CLAIM TO ANY PARTICULAR FONT, STYLE, SIZE, OR COLOR.

NO CLAIM IS MADE TO THE EXCLUSIVE RIGHT TO USE "COFFEE", APART FROM THE MARK AS SHOWN.

SN 85-184,269, FILED 11-24-2010.

MARK SPARACINO, EXAMINING ATTORNEY



*David J. Kyffers*

Director of the United States Patent and Trademark Office



# United States of America

United States Patent and Trademark Office

## OLIOS HEALTH

**Reg. No. 4,126,386**

OLIOS HEALTH INC. (DELAWARE CORPORATION)  
224 N. FAIR OAKS AVENUE, SUITE 300  
PASADENA, CA 91103

**Registered Apr. 10, 2012**

**Int. Cl.: 35**

FOR: MEDICAL BILLING SERVICES; BUSINESS CONSULTING SERVICES IN THE FIELD OF MEDICAL OFFICE OPERATION; OFFICE ADMINISTRATION SERVICES, NAMELY, MANAGEMENT OF MEDICAL OFFICES FOR OTHERS, IN CLASS 35 (U.S. CLS. 100, 101 AND 102).

**SERVICE MARK**

**PRINCIPAL REGISTER**

FIRST USE 12-0-2010; IN COMMERCE 12-0-2010.

THE MARK CONSISTS OF STANDARD CHARACTERS WITHOUT CLAIM TO ANY PARTICULAR FONT, STYLE, SIZE, OR COLOR.

NO CLAIM IS MADE TO THE EXCLUSIVE RIGHT TO USE "HEALTH", APART FROM THE MARK AS SHOWN.

SN 85-184,364, FILED 11-24-2010.

TARA PATE, EXAMINING ATTORNEY



*David J. Kybas*

Director of the United States Patent and Trademark Office

# United States of America

United States Patent and Trademark Office

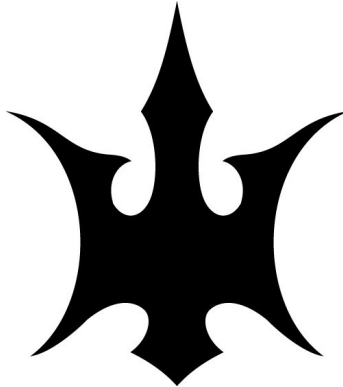

**Reg. No. 4,126,387**

**Registered Apr. 10, 2012**

**Int. Cls.: 16 and 25**

**TRADEMARK**

**PRINCIPAL REGISTER**

DIOSY BROTHERS, LLC (FLORIDA LIMITED LIABILITY COMPANY)  
3740 20TH STREET, SUITE A  
VERO BEACH, FL 32960

FOR: DECALS, DECALS FOR CARS AND BOATS, IN CLASS 16 (U.S. CLS. 2, 5, 22, 23, 29, 37, 38 AND 50).

FIRST USE 9-3-2009; IN COMMERCE 9-3-2009.

FOR: SHIRTS AND HATS, IN CLASS 25 (U.S. CLS. 22 AND 39).

FIRST USE 9-3-2009; IN COMMERCE 12-12-2011.

THE MARK CONSISTS OF A TRIDENT DESIGN.

SN 85-184,720, FILED 11-24-2010.

REGINA DRUMMOND, EXAMINING ATTORNEY



*David J. Kybas*

Director of the United States Patent and Trademark Office

# United States of America

United States Patent and Trademark Office

## AMERICAN HAIRLINES

**Reg. No. 4,126,388**

**Registered Apr. 10, 2012**

**Int. Cls.: 3, 26, and 44**

**TRADEMARK**

**SERVICE MARK**

**PRINCIPAL REGISTER**

EVA GABOR INTERNATIONAL, LTD. (DELAWARE CORPORATION)  
5900 EQUITABLE ROAD  
KANSAS CITY, MO 64120

FOR: HAIR CARE PREPARATIONS, NAMELY, SHAMPOOS, CONDITIONERS, MOISTURIZERS, RINSES, MISTS, THERMAL PROTECTIVE SPRAYS, SPRAY CONDITIONERS, HAIR GELS, SPRAY GELS, SCULPTING FOAM, LOTIONS, STYLING SERUM, STYLING SPRAYS, STYLING GELS, STYLING LOTIONS, STRAIGHTENING CREAMS, HAIR SPRAYS, POMADES, STYLING PREPARATIONS, SHINE SPRAYS, SHINE DROPS, HAIR WAXES, AND NON-MEDICATED TREATMENTS, NAMELY, HAIR STRENGTHENING PREPARATIONS, AND HAIR STRAIGHTENING PREPARATIONS, IN CLASS 3 (U.S. CLS. 1, 4, 6, 50, 51 AND 52).

FIRST USE 1-4-2012; IN COMMERCE 1-4-2012.

FOR: WIGS, HAIRPIECES, AND ADD-IN AND ADD-ON HAIR EXTENSIONS CONSTRUCTED PRIMARILY OF SYNTHETIC AND/OR HUMAN HAIR, IN CLASS 26 (U.S. CLS. 37, 39, 40, 42 AND 50).

FIRST USE 1-0-1980; IN COMMERCE 1-0-1980.

FOR: HAIR REPLACEMENT, HAIR ADDITION AND HAIR EXTENSION SERVICES, IN CLASS 44 (U.S. CLS. 100 AND 101).

FIRST USE 0-0-2003; IN COMMERCE 0-0-2003.

THE MARK CONSISTS OF STANDARD CHARACTERS WITHOUT CLAIM TO ANY PARTICULAR FONT, STYLE, SIZE, OR COLOR.

NO CLAIM IS MADE TO THE EXCLUSIVE RIGHT TO USE "AMERICAN", APART FROM THE MARK AS SHOWN.

SN 85-185,164, FILED 11-24-2010.

CARYN GLASSER, EXAMINING ATTORNEY

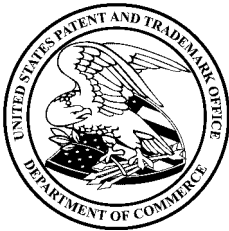

*David J. Kyros*

Director of the United States Patent and Trademark Office

# United States of America

United States Patent and Trademark Office

# Agency 720

**Reg. No. 4,126,389**

**Registered Apr. 10, 2012**

**Int. Cl.: 35**

**SERVICE MARK**

**PRINCIPAL REGISTER**

GOODBY, SILVERSTEIN & PARTNERS INC. (CALIFORNIA CORPORATION)  
720 CALIFORNIA STREET  
SAN FRANCISCO, CA 94108

FOR: ADVERTISING AGENCY SERVICES; PUBLIC RELATIONS SERVICES; MARKET RESEARCH AND ANALYSIS; MEDIA BUYING SERVICES IN THE NATURE OF FACILITATING THE PLANNING, BUYING AND SELLING OF MEDIA; MEDIA MARKET RESEARCH AND CONSULTATION SERVICES; PLANNING, NEGOTIATING AND ARRANGING THE BUYING OF ADVERTISING AND MEDIA SPACE AND MEDIA TIME FOR THIRD PARTIES; ADVERTISING AND PROMOTIONAL SERVICES, NAMELY, PREPARING AND PLACING ADVERTISEMENT FOR OTHERS; DIGITAL AND ONLINE ADVERTISING; E-MAIL MARKETING AND ADVERTISING; INTERACTIVE AND WIRELESS ADVERTISING AND MARKETING; CUSTOMER RELATIONSHIP MARKETING AND ADVERTISING; DIRECT MARKETING ADVERTISING FOR OTHERS; BUSINESS MARKETING CONSULTING IN THE FIELDS OF BRAND DEVELOPMENT AND BRAND MARKETING, IN CLASS 35 (U.S. CLS. 100, 101 AND 102).

FIRST USE 11-29-2010; IN COMMERCE 3-1-2011.

THE MARK CONSISTS OF STANDARD CHARACTERS WITHOUT CLAIM TO ANY PARTICULAR FONT, STYLE, SIZE, OR COLOR.

NO CLAIM IS MADE TO THE EXCLUSIVE RIGHT TO USE "AGENCY", APART FROM THE MARK AS SHOWN.

SN 85-186,418, FILED 11-29-2010.

Laurie Mayes, Examining Attorney



*David J. Kyffers*

Director of the United States Patent and Trademark Office

# United States of America

United States Patent and Trademark Office



**Reg. No. 4,126,390**

**Registered Apr. 10, 2012**

**Int. Cl.: 43**

**SERVICE MARK**

**PRINCIPAL REGISTER**

YO-BURGER, INC. (NEW YORK CORPORATION)  
#10E  
3515 HENRY HUDSON PARKWAY  
RIVERDALE, NY 10463

FOR: BAR AND RESTAURANT SERVICES, IN CLASS 43 (U.S. CLS. 100 AND 101).

FIRST USE 10-19-2010; IN COMMERCE 10-19-2010.

SN 85-186,546, FILED 11-29-2010.

HEATHER BIDDULPH, EXAMINING ATTORNEY



*David J. Kyffers*

Director of the United States Patent and Trademark Office

# United States of America

United States Patent and Trademark Office

# KYSOR

**Reg. No. 4,126,391**

**Registered Apr. 10, 2012**

**Int. Cl.: 11**

**TRADEMARK**

**PRINCIPAL REGISTER**

KYSOR INDUSTRIAL CORPORATION (MICHIGAN CORPORATION)  
ONE MADISON AVENUE  
CADILLAC, MI 49601

FOR: FOOD SERVICE EQUIPMENT, NAMELY, REFRIGERATORS, FREEZERS AND REFRIGERATED SYSTEMS COMPOSED OF INSULATED PANELS, INSULATED DOORS, WINDOWS, EVAPORATORS AND CONDENSERS OR THERMO-TRANSFER DEVICES THAT CREATE A TEMPERATURE CONTROLLED PACKAGE; REFRIGERATED DISPLAY AND STORAGE CASES; REFRIGERATED SELF-SERVICE CASES; REFRIGERATED SERVICE DELI CASES; REFRIGERATED BOXES; DEEP FREEZING DEVICES; PORTABLE REFRIGERATING BOXES; REFRIGERATING ROOMS; WALK-IN COOLERS; WALK-IN FREEZERS; BEVERAGE COOLING UNITS; CUSTOM FABRICATED REFRIGERATORS AND FREEZERS USED BY SUPERMARKETS, CONVENIENCE STORES AND RESTAURANTS; MODULAR INSULATED COLD STORAGE WAREHOUSES; MODULAR INSULATED PANELS AND DOORS FOR WALK-IN REFRIGERATED AND FREEZER ENCLOSURES; ENVIRONMENTAL COOLING ROOMS AND FREEZERS; REFRIGERATORS AND FREEZERS FEATURING BUILT-IN ALARM SYSTEMS, LIGHTING CONTROLS AND EVAPORATORS; AND STRUCTURAL PARTS AND FITTINGS FOR ALL THE AFORESAID GOODS, IN CLASS 11 (U.S. CLS. 13, 21, 23, 31 AND 34).

FIRST USE 3-1-1987; IN COMMERCE 3-1-1987.

THE MARK CONSISTS OF STANDARD CHARACTERS WITHOUT CLAIM TO ANY PARTICULAR FONT, STYLE, SIZE, OR COLOR.

OWNER OF U.S. REG. NO. 1,590,738.

SN 85-186,562, FILED 11-29-2010.

MICHAEL ENGEL, EXAMINING ATTORNEY



*David J. Kyros*

Director of the United States Patent and Trademark Office

# United States of America

United States Patent and Trademark Office

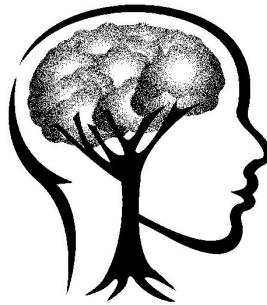

**Reg. No. 4,126,392**

**Registered Apr. 10, 2012**

**Int. Cl.: 35**

**SERVICE MARK**

**PRINCIPAL REGISTER**

WHOBRAIN, INC. (DELAWARE CORPORATION)  
5052 TIERRA BAJA WAY  
SAN DIEGO, CA 92115

FOR: ADVERTISING AND MARKETING; ON-LINE ADVERTISING AND MARKETING SERVICES; CONSUMER RESEARCH SERVICES, IN CLASS 35 (U.S. CLS. 100, 101 AND 102).

FIRST USE 8-10-2010; IN COMMERCE 11-30-2011.

THE STIPLING IS FOR SHADING PURPOSES ONLY.

THE MARK CONSISTS OF TWO ELEMENTS: 1. AN OUTLINED SILHOUETTE OF THE RIGHT SIDE OF A HUMAN HEAD; 2. A TREE WITH MANY LEAVES, BRANCHES, A TRUNK, AND ROOTS. THE LEAVES OF THE TREE ARE POSITIONED WHERE THE HUMAN BRAIN WOULD BE, AND THE ROOTS OF THE TREE END WHERE THE HUMAN NECK ENDS.

SN 85-186,666, FILED 11-29-2010.

EDWARD FENNESSY, EXAMINING ATTORNEY



*David J. Kyffers*

Director of the United States Patent and Trademark Office

# United States of America

United States Patent and Trademark Office



**Reg. No. 4,126,393**

**Registered Apr. 10, 2012**

**Int. Cl.: 9**

**TRADEMARK**

**PRINCIPAL REGISTER**

SEAGATE TECHNOLOGY LLC (DELAWARE LIMITED LIABILITY COMPANY)  
10200 SOUTH DEANZA BOULEVARD  
CUPERTINO, CA 95014

FOR: COMPUTER STORAGE DEVICES, NAMELY, COMPUTER MEMORY HARDWARE AND HARD DRIVES FOR COMPUTERS; DATA STORAGE DEVICES, NAMELY, HARD DISK DRIVES, SOLID STATE DRIVES, BLANK DIGITAL STORAGE MEDIA, HARD DRIVES WITH SOLID STATE MEMORY, AND HYBRID DRIVES; DATA STORAGE DEVICE ACCESSORIES, NAMELY, ELECTRICAL CONNECTORS, WIRES, CABLES, ADAPTORS; COMPUTER CONNECTION CABLES AND ADAPTORS; DOCKING STATIONS FOR DATA STORAGE DEVICES; INTERFACES FOR COMPUTERS; HIGH DEFINITION MULTIMEDIA INTERFACE CABLES; PERIPHERAL COMPONENT INTERFACE (PCI) HARDWARE; CONNECTORS AND ADAPTORS FOR USE WITH PORTABLE ELECTRONIC DEVICES; COMPUTER HARDWARE FOR UPLOAD, STORAGE, RETRIEVAL, DOWNLOAD, TRANSMISSION AND DELIVERY OF DIGITAL CONTENT; DIGITAL DISK DRIVES, COMPUTER PERIPHERAL DEVICES; REMOVABLE HARD DRIVE BASED COMPUTER BACKUP SYSTEMS, IN CLASS 9 (U.S. CLS. 21, 23, 26, 36 AND 38).

FIRST USE 11-1-2011; IN COMMERCE 11-1-2011.

THE MARK CONSISTS OF THE LETTERS "USM" ABOVE THE DESIGN OF FOUR PARALLELOGRAMS.

SN 85-186,690, FILED 11-29-2010.

ERNEST SHOSHO, EXAMINING ATTORNEY



*David J. Kybas*

Director of the United States Patent and Trademark Office



# United States of America

United States Patent and Trademark Office

## FREAK SHOW

**Reg. No. 4,126,394**

**Registered Apr. 10, 2012**

**Int. Cl.: 33**

**TRADEMARK**

**PRINCIPAL REGISTER**

MICHAEL-DAVID, LLC (CALIFORNIA LIMITED LIABILITY COMPANY)  
4580 WEST HIGHWAY 12  
LODI, CA 95242

FOR: WINE, IN CLASS 33 (U.S. CLS. 47 AND 49).

FIRST USE 12-15-2011; IN COMMERCE 12-15-2011.

THE MARK CONSISTS OF STANDARD CHARACTERS WITHOUT CLAIM TO ANY PARTICULAR FONT, STYLE, SIZE, OR COLOR.

SN 85-187,133, FILED 11-30-2010.

MARK T. MULLEN, EXAMINING ATTORNEY



*David J. Kyffers*

Director of the United States Patent and Trademark Office

# United States of America

United States Patent and Trademark Office

## COOK'S CARVED FROM THE BONE

**Reg. No. 4,126,395**

**Registered Apr. 10, 2012**

**Int. Cl.: 29**

**TRADEMARK**

**PRINCIPAL REGISTER**

SF INVESTMENTS, INC. (DELAWARE CORPORATION)  
BAYNARD BUILDING, SUITE 103  
3411 SILVERSIDE ROAD  
WILMINGTON, DE 19810

FOR: PORK, HAM, IN CLASS 29 (U.S. CL. 46).

FIRST USE 1-3-2011; IN COMMERCE 1-3-2011.

THE MARK CONSISTS OF STANDARD CHARACTERS WITHOUT CLAIM TO ANY PARTICULAR FONT, STYLE, SIZE, OR COLOR.

OWNER OF U.S. REG. NOS. 2,386,413, 2,727,078, AND 3,671,652.

NO CLAIM IS MADE TO THE EXCLUSIVE RIGHT TO USE "CARVED FROM THE BONE", APART FROM THE MARK AS SHOWN.

SN 85-187,142, FILED 11-30-2010.

VIVIAN MICZNIK FIRST, EXAMINING ATTORNEY



*David J. Kybas*

Director of the United States Patent and Trademark Office

# United States of America

United States Patent and Trademark Office

## DIAMOND SOLITAIRE

**Reg. No. 4,126,396**

BRULIN & COMPANY INC. (INDIANA CORPORATION)

**Registered Apr. 10, 2012**

P.O. BOX 270  
INDIANAPOLIS, IN 462060270

**Int. Cl.: 3**

FOR: CLEANING PREPARATIONS, NAMELY, A CONCRETE FLOOR REVITALIZER INTENDED FOR DAILY USE IN THE BURNISHING PROCESS, IN CLASS 3 (U.S. CLS. 1, 4, 6, 50, 51 AND 52).

**TRADEMARK**

FIRST USE 12-9-2010; IN COMMERCE 3-1-2011.

**PRINCIPAL REGISTER**

THE MARK CONSISTS OF STANDARD CHARACTERS WITHOUT CLAIM TO ANY PARTICULAR FONT, STYLE, SIZE, OR COLOR.

SN 85-187,343, FILED 11-30-2010.

HOWARD B. LEVINE, EXAMINING ATTORNEY



*David J. Kyfos*

Director of the United States Patent and Trademark Office

# United States of America

United States Patent and Trademark Office

# CM CORE

**Reg. No. 4,126,397**

ORTHO MOLECULAR PRODUCTS, INC. (WISCONSIN CORPORATION)  
P.O. BOX 1060, 3017 BUSINESS PARK DRIVE  
STEVENS POINT, WI 54481

**Registered Apr. 10, 2012**

**Int. Cl.: 5**

FOR: NUTRACEUTICAL DIETARY SUPPLEMENTS, IN CLASS 5 (U.S. CLS. 6, 18, 44, 46, 51 AND 52).

**TRADEMARK**

FIRST USE 1-4-2012; IN COMMERCE 1-4-2012.

**PRINCIPAL REGISTER**

THE MARK CONSISTS OF STANDARD CHARACTERS WITHOUT CLAIM TO ANY PARTICULAR FONT, STYLE, SIZE, OR COLOR.

SN 85-188,212, FILED 12-1-2010.

RAUL CORDOVA, EXAMINING ATTORNEY



*David J. Kybas*

Director of the United States Patent and Trademark Office

# United States of America

United States Patent and Trademark Office

## Mending Hearts One Card at a time

**Reg. No. 4,126,398**

**Registered Apr. 10, 2012**

**Int. Cl.: 16**

**TRADEMARK**

**PRINCIPAL REGISTER**

TRUE EMOTIONS (FLORIDA LIMITED LIABILITY COMPANY)  
167 WEDGE STREET  
HUMACAO, PUERTO RICO 00791

FOR: GREETING CARDS; BOOKS IN THE FIELD OF SELF HELP, MOTIVATION, MEDITATION, AND COUNSELING; BOOKS IN THE FIELD OF RELATIONSHIPS AND FEATURING DEVOTIONALS; JOURNALS FEATURING ART AND TEXT INFORMATION ABOUT RELATIONSHIPS; GREETING CARDS, DEVOTIONAL PRAYER CARDS, AND PAPER STATIONERY WITH INSPIRATIONAL MESSAGES IMPRINTED THEREON AND POSTERS, THAT EXPRESS PICTORIAL OR IN ART FORM ALONG WITH LITERARY TEXT INFORMATION RELATING TO RELATIONSHIPS; POSTERS, IN CLASS 16 (U.S. CLS. 2, 5, 22, 23, 29, 37, 38 AND 50).

FIRST USE 11-30-2011; IN COMMERCE 1-1-2012.

THE MARK CONSISTS OF STANDARD CHARACTERS WITHOUT CLAIM TO ANY PARTICULAR FONT, STYLE, SIZE, OR COLOR.

SN 85-188,637, FILED 12-1-2010.

GISELLE AGOSTO, EXAMINING ATTORNEY



*David J. Kyffers*

Director of the United States Patent and Trademark Office

# United States of America

United States Patent and Trademark Office



**Reg. No. 4,126,399**

**Registered Apr. 10, 2012**

**Int. Cl.: 3**

**TRADEMARK**

**PRINCIPAL REGISTER**

FIVE STAR FRAGRANCE COMPANY, INC. (NEW YORK CORPORATION)  
SUITE 1  
35 SAWGRASS DRIVE  
BELLPORT, NY 11713

FOR: COLOGNE SPRAY; BODY WASH, SHAVE CREAM; AND GIFT SETS CONSISTING OF COLOGNE SPRAY, BODY WASH AND SHAVE CREAM, IN CLASS 3 (U.S. CLS. 1, 4, 6, 50, 51 AND 52).

FIRST USE 6-29-2011; IN COMMERCE 6-29-2011.

OWNER OF U.S. REG. NOS. 3,319,857, 3,555,987, AND OTHERS.

THE NAME(S), PORTRAIT(S), AND/OR SIGNATURE(S) SHOWN IN THE MARK IDENTIFIES "MICHAEL JORDAN", WHOSE CONSENT(S) TO REGISTER IS MADE OF RECORD.

THE MARK CONSISTS OF A RECTANGULAR BOX WITH THE CONTOUR OF THE FRONT OF A MAN'S HEAD AND SHOULDERS; THE TERM "FLIGHT" IN CAPITAL LETTERS APPEARS IN A VERTICAL POSITION FROM THE TOP OF THE BOX THE TERM "FLIGHT" IS UNDERLINED AND THE UNDERLINE ENDS IN AN ARROW POINT. THE NAME "MICHAEL JORDAN" POSITIONED BELOW THE UNDERLINE.

SN 85-188,902, FILED 12-2-2010.

ELLEN PERKINS, EXAMINING ATTORNEY



*David J. Kybas*

Director of the United States Patent and Trademark Office

# United States of America

United States Patent and Trademark Office



**Reg. No. 4,126,400**

**Registered Apr. 10, 2012**

**Int. Cls.: 7 and 12**

**TRADEMARK**

**PRINCIPAL REGISTER**

ZHEJIANG UN FORKLIFT CO., LTD (CHINA CORPORATION)  
NO.1, ROAD ONE, XINDENG NEW DISTRICT,  
FUYANG, HANGZHOU, ZHEJIANG, CHINA 311404

FOR: ROAD CONSTRUCTION MACHINES, NAMELY, ROAD ROLLERS, STEAMROLLERS; EARTH MOVING MACHINES, NAMELY, EARTH-SCRAPERS, EXCAVATORS; LOADERS; SHOVEL MACHINES; DIGGER MACHINES; BULLDOZERS; ROOTDOZERS; DITCH DIGGERS; PULVERIZER MACHINES, NAMELY, SOIL PULVERIZERS, IN CLASS 7 (U.S. CLS. 13, 19, 21, 23, 31, 34 AND 35).

FIRST USE 9-1-2008; IN COMMERCE 3-31-2011.

FOR: VEHICLES FOR LIFTING AND TRANSPORTING MATERIALS, NAMELY, FORK LIFT TRUCKS; MOTOR VEHICLES FOR LAND USE, NAMELY, TRUCKS, TRAILER VEHICLES, ELECTRIC VEHICLES, AUTOMOBILES, CYCLE CARS, VAN VEHICLES, MOTOR HOMES, TANK CARS, STORAGE BATTERY CONVEY CARS, IN CLASS 12 (U.S. CLS. 19, 21, 23, 31, 35 AND 44).

FIRST USE 9-1-2008; IN COMMERCE 3-31-2011.

THE MARK CONSISTS OF A WORD AND A DESIGN. THE WORD "UN" CONSISTS OF TWO LETTERS OF " U, N" FROM LEFT TO RIGHT, WITH THE RIGHT PART OF THE LETTER "U" SHARED WITH THE LEFT PART OF THE LETTER "N". THE DESIGN CONSISTS OF FIVE OVALS NESTED ONE AFTER ANOTHER, THREE SHADED, TWO UNSHADED WITH THE MOST INNER SHADED OVAL CONTAINING THE WORD "UN", WITH THE "U" PARTIALLY UNSHADED, AND THE "N" PARTIALLY SHADED.

SN 85-189,333, FILED 12-2-2010.

ODESSA BIBBINS, EXAMINING ATTORNEY



*David J. Kyros*

Director of the United States Patent and Trademark Office

# United States of America

United States Patent and Trademark Office

## LIVE THE GOLD LIFE

**Reg. No. 4,126,401**

AUSTRALIAN GOLD, LLC (INDIANA LIMITED LIABILITY COMPANY)  
6270 CORPORATE DR.

**Registered Apr. 10, 2012**

INDIANAPOLIS, IN 46278

**Int. Cl.: 3**

FOR: INDOOR AND OUTDOOR NON-MEDICATED SKIN TANNING PREPARATIONS, IN CLASS 3 (U.S. CLS. 1, 4, 6, 50, 51 AND 52).

**TRADEMARK**

FIRST USE 11-1-2011; IN COMMERCE 11-1-2011.

**PRINCIPAL REGISTER**

THE MARK CONSISTS OF STANDARD CHARACTERS WITHOUT CLAIM TO ANY PARTICULAR FONT, STYLE, SIZE, OR COLOR.

SN 85-189,377, FILED 12-2-2010.

FRANK LATTUCA, EXAMINING ATTORNEY



*David J. Kybas*

Director of the United States Patent and Trademark Office



# United States of America

United States Patent and Trademark Office



**Reg. No. 4,126,402**

**Registered Apr. 10, 2012**

**Int. Cl.: 41**

**SERVICE MARK**

**PRINCIPAL REGISTER**

NATIONAL REAL ESTATE INVESTORS ASSOCIATION (TEXAS CORPORATION)  
525 WEST FIFTH STREET  
COVINGTON, KY 41011

FOR: EDUCATIONAL SERVICES IN THE NATURE OF OFFERING WEB BASED AND CLASSROOM TRAINING FOR TEACHING AND CERTIFICATION OF REAL ESTATE INVESTORS AND OFFERING CONTINUING EDUCATION THEREFOR, IN CLASS 41 (U.S. CLS. 100, 101 AND 107).

FIRST USE 12-1-2010; IN COMMERCE 12-1-2010.

THE MARK CONSISTS OF AN OUTLINE OF A HOUSE WITH THE LETTERS "CARI" INSIDE AND A CURVILINEAR LINE DESIGN ALONG THE BOTTOM.

SN 85-189,471, FILED 12-2-2010.

NATALIE POLZER, EXAMINING ATTORNEY



*David J. Kybas*

Director of the United States Patent and Trademark Office

# United States of America

United States Patent and Trademark Office

# DrainFlash

**Reg. No. 4,126,403**

PUFAHL, JOSEPH (UNITED STATES INDIVIDUAL)  
980 DEPOT LANE  
CUTCHOGUE, NY 11935

**Registered Apr. 10, 2012**

**Int. Cl.: 19**

FOR: SELF ADHESIVE NON-METAL BUILDING FLASHING FOR USE IN CONSTRUCTION,  
IN CLASS 19 (U.S. CLS. 1, 12, 33 AND 50).

**TRADEMARK**

FIRST USE 4-0-2011; IN COMMERCE 4-0-2011.

**PRINCIPAL REGISTER**

THE MARK CONSISTS OF STANDARD CHARACTERS WITHOUT CLAIM TO ANY PARTICULAR FONT, STYLE, SIZE, OR COLOR.

SN 85-190,200, FILED 12-3-2010.

ALYSSA STEEL, EXAMINING ATTORNEY



*David J. Kybas*

Director of the United States Patent and Trademark Office

# United States of America

United States Patent and Trademark Office

## Chase BusinessEconomy Checking

**Reg. No. 4,126,404**

JPMORGAN CHASE & CO. (DELAWARE CORPORATION)  
270 PARK AVENUE  
NEW YORK, NY 10017

**Registered Apr. 10, 2012**

**Int. Cl.: 36**

FOR: BANKING AND FINANCIAL SERVICES, NAMELY, CHECKING ACCOUNT SERVICES,  
IN CLASS 36 (U.S. CLS. 100, 101 AND 102).

**SERVICE MARK**

FIRST USE 2-1-2011; IN COMMERCE 2-1-2011.

**PRINCIPAL REGISTER**

THE MARK CONSISTS OF STANDARD CHARACTERS WITHOUT CLAIM TO ANY PARTICULAR FONT, STYLE, SIZE, OR COLOR.

OWNER OF U.S. REG. NOS. 1,521,765, 3,324,462, AND OTHERS.

NO CLAIM IS MADE TO THE EXCLUSIVE RIGHT TO USE "CHECKING", APART FROM THE MARK AS SHOWN.

SN 85-191,069, FILED 12-6-2010.

DANNEAN HETZEL, EXAMINING ATTORNEY



*David J. Kyros*

Director of the United States Patent and Trademark Office

# United States of America

United States Patent and Trademark Office

## CHASE TOTAL CHECKING

**Reg. No. 4,126,405**

JPMORGAN CHASE & CO. (DELAWARE CORPORATION)  
270 PARK AVENUE  
NEW YORK, NY 10017

**Registered Apr. 10, 2012**

**Int. Cl.: 36**

FOR: BANKING AND FINANCIAL SERVICES, NAMELY, CHECKING ACCOUNT SERVICES,  
IN CLASS 36 (U.S. CLS. 100, 101 AND 102).

**SERVICE MARK**

FIRST USE 11-0-2011; IN COMMERCE 11-0-2011.

**PRINCIPAL REGISTER**

THE MARK CONSISTS OF STANDARD CHARACTERS WITHOUT CLAIM TO ANY PARTICULAR FONT, STYLE, SIZE, OR COLOR.

OWNER OF U.S. REG. NOS. 1,521,765, 3,324,462, AND OTHERS.

NO CLAIM IS MADE TO THE EXCLUSIVE RIGHT TO USE "CHECKING", APART FROM THE MARK AS SHOWN.

SN 85-191,077, FILED 12-6-2010.

DANNEAN HETZEL, EXAMINING ATTORNEY



*David J. Kybas*

Director of the United States Patent and Trademark Office

# United States of America

United States Patent and Trademark Office



**Reg. No. 4,126,406**

**Registered Apr. 10, 2012**

**Int. Cl.: 35**

**SERVICE MARK**

**PRINCIPAL REGISTER**

MIXLINX INC. (CANADA CORPORATION)  
229 MAVRINAC BOULEVARD  
AURONA, CANADA L4G7T6

FOR: PROMOTING, ADVERTISING AND MARKETING THE GOODS AND SERVICES OF OTHERS THROUGH ON-LINE ORDERING AND CATALOGING OF THOSE GOODS AND SERVICES; PROMOTING THE GOODS AND SERVICES OF OTHERS BY PROVIDING A WEB SITE FEATURING COUPONS, LOYALTY PROGRAMS, REBATES, PRICE-COMPARISON INFORMATION, PRODUCT REVIEWS, LINKS TO THE RETAIL WEB SITES OF OTHERS, AND DISCOUNT INFORMATION; ON-LINE ADVERTISING AND MARKETING SERVICES; SALES VOLUME TRACKING FOR OTHERS, NAMELY, FOR THE EXPENDITURE OF MONIES MADE THROUGH THE USE OF WEBSITES FOR MEMBERS; ON-LINE RETAIL STORE SERVICES AND RETAIL DISCOUNT STORE SERVICES IN THE FIELDS OF APPAREL AND ACCESSORIES, AUTOMOTIVE PARTS AND ACCESSORIES, TOYS, BOOKS, MUSIC, VIDEO, COMPUTER AND ELECTRONICS, AND SPORTING GOODS; RETAIL DEPARTMENT STORES; ON-LINE RETAIL STORE SERVICES AND RETAIL DISCOUNT STORE SERVICES FEATURING TICKETS FOR ENTERTAINMENT, NAMELY, AMUSEMENT PARKS, MOVIES, THEATERS AND SHOWS; ON-LINE RETAIL STORE SERVICES AND RETAIL DISCOUNT STORE SERVICES FEATURING FLOWERS AND GIFTS, FOOD AND DRUG, HEALTH AND BEAUTY, HOME FURNISHING AND IMPROVEMENT, JEWELRY, AND OFFICE SUPPLIES; ON-LINE NON-APPAREL SPECIALTY RETAIL STORE SERVICES FEATURING PET SUPPLIES; ON-LINE RETAIL STORE SERVICES AND RETAIL DISCOUNT STORE SERVICES FEATURING MUSIC RELATED MERCHANDISE AND MUSICAL INSTRUMENTS; ON-LINE RETAIL STORE SERVICES AND RETAIL DISCOUNT STORE SERVICES FEATURING HOBBY CRAFT SUPPLIES; ON-LINE RETAIL STORE SERVICES AND RETAIL DISCOUNT STORE SERVICES FEATURING TELECOMMUNICATIONS PRODUCTS INCLUDING WIRELESS PRODUCTS AND SERVICES INCLUDING WIRELESS HANDHELD DEVICES AND SERVICE PLANS, HOME TELEPHONE PRODUCTS AND SERVICES PLANS, AND CABLE ACCESS PRODUCTS AND SERVICE PLANS, IN CLASS 35 (U.S. CLS. 100, 101 AND 102).



FIRST USE 8-1-2011; IN COMMERCE 8-1-2011.

*David J. Kybas*

Director of the United States Patent and Trademark Office

THE MARK CONSISTS OF THE LETTERS "MIXLINX" WITH THE SECOND "X" BEING IN THE FORM OF A GEOMETRIC FIGURE OF TWO CIRCLES INTERSECTING TO FORM THE LETTER "X" IN A PERSPECTIVE ORIENTATION WITH THE FRONT OF THE CIRCLES BEING A SOLID GREEN COLOR AND THE REAR OF THE CIRCLES BEING STRIPED IN

**Reg. No. 4,126,406** ALTERNATING GREEN AND WHITE STRIPES. THE WORD "MIXLINX" IS WRITTEN IN GREY.

THE COLOR(S) WHITE, GREEN AND GREY IS/ARE CLAIMED AS A FEATURE OF THE MARK.

SN 85-191,543, FILED 12-6-2010.

INGA ERVIN, EXAMINING ATTORNEY

# United States of America

United States Patent and Trademark Office

## TOTALBANNERNOW

**Reg. No. 4,126,407**

**Registered Apr. 10, 2012**

**Int. Cl.: 35**

**SERVICE MARK**

**PRINCIPAL REGISTER**

REACHLOCAL, INC. (DELAWARE CORPORATION)  
SUITE 1600  
21700 OXNARD STREET  
WOODLAND HILLS, CA 91367

FOR: ADVERTISING SERVICES, NAMELY, CREATION OF CONTENT FOR ONLINE ADVERTISING, BANNER ADVERTISING SERVICES, INTERNET ADVERTISING SERVICES, DISSEMINATION OF ADVERTISING FOR OTHERS VIA A GLOBAL COMPUTER NETWORK, DISSEMINATION OF ADVERTISING FOR OTHERS VIA PUBLIC AND PRIVATE WIRELESS NETWORKS FOR DISPLAY ON MOBILE DEVICES; ADVERTISING THE GOODS AND SERVICES OF OTHERS VIA WEB PAGES OPTIMIZED FOR ONLINE SEARCH ENGINES; ADVERTISING ON THE INTERNET FOR OTHERS; ADVERTISING AND MARKETING SERVICES PROVIDED BY MEANS OF INDIRECT METHODS OF MARKETING COMMUNICATIONS, NAMELY, SOCIAL MEDIA, SEARCH ENGINE MARKETING, SEARCH ENGINE OPTIMIZATION, INQUIRY MARKETING, INTERNET MARKETING, MOBILE MARKETING, BLOGGING AND OTHER FORMS OF PASSIVE, SHARABLE, OR VIRAL COMMUNICATIONS CHANNELS; COMPUTER SERVICES, NAMELY, SEARCH ENGINE MARKETING; CONSULTATION SERVICES IN THE FIELDS OF SEARCH ENGINE MARKETING, IN CLASS 35 (U.S. CLS. 100, 101 AND 102).

FIRST USE 6-0-2010; IN COMMERCE 6-0-2010.

THE MARK CONSISTS OF STANDARD CHARACTERS WITHOUT CLAIM TO ANY PARTICULAR FONT, STYLE, SIZE, OR COLOR.

SN 85-191,869, FILED 12-7-2010.

ARETHA SOMERVILLE, EXAMINING ATTORNEY



*David J. Kyffers*

Director of the United States Patent and Trademark Office

# United States of America

United States Patent and Trademark Office

## MEMORY MATTERS

**Reg. No. 4,126,408**

MARKET2CUSTOMER LLC (DELAWARE LIMITED LIABILITY COMPANY)  
TWO CANAL PARK  
CAMBRIDGE, MA 02141

**Registered Apr. 10, 2012**

**Int. Cl.: 35**

FOR: PROVISION OF STRATEGIC MARKETING CONSULTING SERVICES FOR OTHERS,  
IN CLASS 35 (U.S. CLS. 100, 101 AND 102).

**SERVICE MARK**

FIRST USE 11-16-2011; IN COMMERCE 11-16-2011.

**PRINCIPAL REGISTER**

THE MARK CONSISTS OF STANDARD CHARACTERS WITHOUT CLAIM TO ANY PARTICULAR FONT, STYLE, SIZE, OR COLOR.

SN 85-191,891, FILED 12-7-2010.

ARETHA SOMERVILLE, EXAMINING ATTORNEY



*David J. Kybas*

Director of the United States Patent and Trademark Office



# United States of America

United States Patent and Trademark Office

# REGPEDIA

**Reg. No. 4,126,409**

**Registered Apr. 10, 2012**

**Int. Cl.: 42**

**SERVICE MARK**

**PRINCIPAL REGISTER**

ARGENT CONSULTING SERVICES, INC. (TEXAS CORPORATION)  
16225 PARK TEN PLACE  
SUITE 110  
HOUSTON, TX 77084

FOR: PROVIDING SUBSCRIPTION-BASED USE OF ON-LINE, NON-DOWNLOADABLE SOFTWARE FEATURING REGULATIONS, PERMITS AND OTHER COMPLIANCE-RELATED DATA FORMATTED WITH TASKS, FREQUENCIES AND OTHER PERTINENT DETAILS TO ALLOW USERS ACCESS TO CURRENT DATA AND ONGOING UPDATES TO THE DATA, IN CLASS 42 (U.S. CLS. 100 AND 101).

FIRST USE 6-30-2010; IN COMMERCE 6-30-2010.

THE MARK CONSISTS OF STANDARD CHARACTERS WITHOUT CLAIM TO ANY PARTICULAR FONT, STYLE, SIZE, OR COLOR.

SN 85-192,447, FILED 12-7-2010.

KYLE PEETE, EXAMINING ATTORNEY



*David J. Kybas*

Director of the United States Patent and Trademark Office

# United States of America

United States Patent and Trademark Office

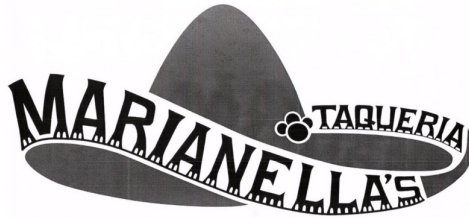

**Reg. No. 4,126,410**

**Registered Apr. 10, 2012**

**Int. Cl.: 43**

**SERVICE MARK**

**PRINCIPAL REGISTER**

STARVO HOLDINGS, LLC (NEW YORK LIMITED LIABILITY COMPANY)  
4175 PARK AVE  
BRONX, NY 10457

FOR: RESTAURANT SERVICES AND TAKE-OUT RESTAURANT SERVICES, IN CLASS 43  
(U.S. CLS. 100 AND 101).

FIRST USE 4-1-2011; IN COMMERCE 4-1-2011.

NO CLAIM IS MADE TO THE EXCLUSIVE RIGHT TO USE "TAQUERIA", APART FROM  
THE MARK AS SHOWN.

THE MARK CONSISTS OF A HAT WITH THE WORDS "MARIANELLA'S TAQUERIA".

SN 85-192,999, FILED 12-8-2010.

SAIMA MAKHDOOM, EXAMINING ATTORNEY



*David J. Kybas*

Director of the United States Patent and Trademark Office

# United States of America

United States Patent and Trademark Office

## TRUE NATURE GROUP

**Reg. No. 4,126,411**

**Registered Apr. 10, 2012**

**Int. Cl.: 35**

**SERVICE MARK**

**PRINCIPAL REGISTER**

TRUE NATURE GROUP, INC. (DELAWARE CORPORATION)  
101 10TH STREET S., STE 101  
KIRKLAND, WA 98033

FOR: MAIL ORDER CATALOG SERVICES FEATURING COSMETIC, BEAUTY CARE, SKIN CARE, BODY CARE, PERSONAL CARE, HAIR CARE, AND AROMATHERAPY PRODUCTS; WHOLESALE AND RETAIL STORE SERVICES AND ON-LINE RETAIL AND WHOLESALE STORE SERVICES FEATURING COSMETIC, BEAUTY CARE, SKIN CARE, BODY CARE, PERSONAL CARE, HAIR CARE, AND AROMATHERAPY PRODUCTS, IN CLASS 35 (U.S. CLS. 100, 101 AND 102).

FIRST USE 1-0-2011; IN COMMERCE 1-0-2011.

THE MARK CONSISTS OF STANDARD CHARACTERS WITHOUT CLAIM TO ANY PARTICULAR FONT, STYLE, SIZE, OR COLOR.

NO CLAIM IS MADE TO THE EXCLUSIVE RIGHT TO USE "GROUP", APART FROM THE MARK AS SHOWN.

SN 85-193,316, FILED 12-8-2010.

MARTHA SANTOMARTINO, EXAMINING ATTORNEY



*David J. Kyros*

Director of the United States Patent and Trademark Office

# United States of America

United States Patent and Trademark Office

# PRIMO27

**Reg. No. 4,126,412**

**Registered Apr. 10, 2012**

**Int. Cl.: 30**

**TRADEMARK**

**PRINCIPAL REGISTER**

SPICE CRAFTERS INC. (FLORIDA CORPORATION)  
5451 MILLENIA LAKES BLVD  
#310  
ORLANDO, FL 32839

FOR: SPICE BLENDS; TEA; SEASONINGS; SALT; FLAVORINGS, IN CLASS 30 (U.S. CL. 46).

FIRST USE 6-1-2010; IN COMMERCE 8-12-2010.

THE MARK CONSISTS OF STANDARD CHARACTERS WITHOUT CLAIM TO ANY PARTICULAR FONT, STYLE, SIZE, OR COLOR.

SN 85-193,461, FILED 12-8-2010.

KYLE PEETE, EXAMINING ATTORNEY



*David J. Kyffers*

Director of the United States Patent and Trademark Office

# United States of America

United States Patent and Trademark Office

## ARISTA MOLECULAR

**Reg. No. 4,126,413**

IRIS INTERNATIONAL, INC. (DELAWARE CORPORATION)  
9172 EATON AVENUE  
CHATSWORTH, CA 91311

**Registered Apr. 10, 2012**

**Int. Cls.: 42 and 44**

FOR: MEDICAL LABORATORY SERVICES; MEDICAL TESTING SERVICES FOR SCIENTIFIC RESEARCH PURPOSES, IN CLASS 42 (U.S. CLS. 100 AND 101).

**SERVICE MARK**

FIRST USE 1-4-2011; IN COMMERCE 1-4-2011.

**PRINCIPAL REGISTER**

FOR: MEDICAL TESTING FOR DIAGNOSTIC OR TREATMENT PURPOSES, IN CLASS 44 (U.S. CLS. 100 AND 101).

FIRST USE 1-4-2011; IN COMMERCE 1-4-2011.

THE MARK CONSISTS OF STANDARD CHARACTERS WITHOUT CLAIM TO ANY PARTICULAR FONT, STYLE, SIZE, OR COLOR.

NO CLAIM IS MADE TO THE EXCLUSIVE RIGHT TO USE "MOLECULAR", APART FROM THE MARK AS SHOWN.

SN 85-193,670, FILED 12-8-2010.

EVELYN BRADLEY, EXAMINING ATTORNEY



*David J. Kybas*

Director of the United States Patent and Trademark Office

# United States of America

United States Patent and Trademark Office

# FAT SHACK

**Reg. No. 4,126,414**

FAT SHACK LATE NIGHT DELIVERY, LLC (NEW JERSEY LIMITED LIABILITY COMPANY)  
45 MAPLE STREET  
RAMSEY, NJ 07446

**Registered Apr. 10, 2012**

**Int. Cl.: 43**

FOR: CAFE AND RESTAURANT SERVICES, IN CLASS 43 (U.S. CLS. 100 AND 101).

**SERVICE MARK**

FIRST USE 12-13-2011; IN COMMERCE 12-13-2011.

**PRINCIPAL REGISTER**

THE MARK CONSISTS OF STANDARD CHARACTERS WITHOUT CLAIM TO ANY PARTICULAR FONT, STYLE, SIZE, OR COLOR.

SN 85-193,727, FILED 12-8-2010.

EVELYN BRADLEY, EXAMINING ATTORNEY



*David J. Kyffers*

Director of the United States Patent and Trademark Office

# United States of America

United States Patent and Trademark Office

## ACID SOOTHE

**Reg. No. 4,126,415**

BOHAGER HOLDINGS, LLC (FLORIDA LIMITED LIABILITY COMPANY)  
1341 RAZORBILL LANE  
PUNTA GORDA, FL 33983

**Registered Apr. 10, 2012**

**Int. Cl.: 5**

FOR: ENZYME FOOD SUPPLEMENTS; ENZYMES FOR MEDICAL PURPOSES; NUTRITIONAL SUPPLEMENTS, IN CLASS 5 (U.S. CLS. 6, 18, 44, 46, 51 AND 52).

**TRADEMARK**

FIRST USE 12-13-2004; IN COMMERCE 12-13-2004.

**PRINCIPAL REGISTER**

THE MARK CONSISTS OF STANDARD CHARACTERS WITHOUT CLAIM TO ANY PARTICULAR FONT, STYLE, SIZE, OR COLOR.

NO CLAIM IS MADE TO THE EXCLUSIVE RIGHT TO USE "ACID", APART FROM THE MARK AS SHOWN.

SN 85-194,053, FILED 12-9-2010.

JAMES GRIFFIN, EXAMINING ATTORNEY



*David J. Kyffers*

Director of the United States Patent and Trademark Office

# United States of America

United States Patent and Trademark Office

## VAPORSTREAM

**Reg. No. 4,126,416**

SAGE MANUFACTURING CORPORATION (WASHINGTON CORPORATION)  
8500 NORTHEAST DAY ROAD  
BAINBRIDGE ISLAND, WA 98110

**Registered Apr. 10, 2012**

**Int. Cl.: 25**

FOR: FABRICS, NAMELY, TWO LAYER FABRICS HAVING AN INNER LAYER FOR WICKING MOISTURE FROM THE SKIN AND AN OUTER LAYER TO REPEL WATER AND PROVIDES INSULATION SOLD AS AN INTEGRAL COMPONENT OF BASE LAYER GARMENTS, IN CLASS 25 (U.S. CLS. 22 AND 39).

**TRADEMARK**

**PRINCIPAL REGISTER**

FIRST USE 9-30-2011; IN COMMERCE 9-30-2011.

THE MARK CONSISTS OF STANDARD CHARACTERS WITHOUT CLAIM TO ANY PARTICULAR FONT, STYLE, SIZE, OR COLOR.

SN 85-194,251, FILED 12-9-2010.

DEIRDRE ROBERTSON, EXAMINING ATTORNEY



*David J. Kyffers*

Director of the United States Patent and Trademark Office



# United States of America

United States Patent and Trademark Office

## CLIMASTREAM

**Reg. No. 4,126,417**

**Registered Apr. 10, 2012**

**Int. Cl.: 25**

**TRADEMARK**

**PRINCIPAL REGISTER**

SAGE MANUFACTURING CORPORATION (WASHINGTON CORPORATION)  
8500 NORTHEAST DAY ROAD  
BAINBRIDGE ISLAND, WA 98110

FOR: FABRICS, NAMELY, A BLEND OF WOOL AND SYNTHETIC FIBERS SOLD AS AN INTEGRAL COMPONENT OF BASE LAYER GARMENTS, IN CLASS 25 (U.S. CLS. 22 AND 39).

FIRST USE 9-30-2011; IN COMMERCE 9-30-2011.

THE MARK CONSISTS OF STANDARD CHARACTERS WITHOUT CLAIM TO ANY PARTICULAR FONT, STYLE, SIZE, OR COLOR.

SN 85-194,256, FILED 12-9-2010.

DEIRDRE ROBERTSON, EXAMINING ATTORNEY



*David J. Kybas*

Director of the United States Patent and Trademark Office

# United States of America

United States Patent and Trademark Office

# TERN

**Reg. No. 4,126,418**

**Registered Apr. 10, 2012**

**Int. Cl.: 12**

**TRADEMARK**

**PRINCIPAL REGISTER**

MOBILITY HOLDINGS, LIMITED (HONG KONG CORPORATION)  
ROOM 1201, 12TH FLOOR  
CONNAUGHT COMMERCIAL BLDG, 185 WANCHAI RD  
WANCHAI, HONG KONG

FOR: BICYCLE, BICYCLE SADDLES, COVERS FOR BICYCLE SADDLES, BICYCLE SEAT POSTS, AIR PUMPS FOR BICYCLES FOR THE INFLATION OF TYRES, BICYCLE TRAILERS, BICYCLE STANDS, BASKETS ADAPTED FOR BICYCLES, PEDALS FOR BICYCLES, COVERS FOR FOOT PEDALS ON CYCLES, BICYCLE HUBS, FITTED BICYCLE COVERS, PANNIER BAGS FOR BICYCLES, WATER BOTTLE HOLDERS FOR BICYCLES, IN CLASS 12 (U.S. CLS. 19, 21, 23, 31, 35 AND 44).

FIRST USE 7-25-2011; IN COMMERCE 7-25-2011.

THE MARK CONSISTS OF STANDARD CHARACTERS WITHOUT CLAIM TO ANY PARTICULAR FONT, STYLE, SIZE, OR COLOR.

SN 85-194,283, FILED 12-9-2010.

ANNE MADDEN, EXAMINING ATTORNEY



*David J. Kyjars*

Director of the United States Patent and Trademark Office

# United States of America

United States Patent and Trademark Office

## SOLAR DE URBEZO

**Reg. No. 4,126,419**

BODEGAS SOLAR DE URBEZO, S. L. (SPAIN LIMITED LIABILITY COMPANY)  
SAN VALERO, 14

**Registered Apr. 10, 2012**

CARINENA, SPAIN 50400

**Int. Cl.: 33**

FOR: WINES, IN CLASS 33 (U.S. CLS. 47 AND 49).

**TRADEMARK**

FIRST USE 1-1-2000; IN COMMERCE 10-1-2011.

**PRINCIPAL REGISTER**

THE MARK CONSISTS OF STANDARD CHARACTERS WITHOUT CLAIM TO ANY PARTICULAR FONT, STYLE, SIZE, OR COLOR.

THE ENGLISH TRANSLATION OF "SOLAR DE URBEZO" IN THE MARK IS URBEZO ESTATE.

SN 85-194,789, FILED 12-10-2010.

AISHA CLARKE, EXAMINING ATTORNEY



*David J. Kybas*

Director of the United States Patent and Trademark Office

United States of America  
United States Patent and Trademark Office

C.  . R. E.  
Construction and Remodeling Experts For  Cure

**Reg. No. 4,126,420**

DAVID B. MCGARREY (UNITED STATES INDIVIDUAL)  
4395 QUICK LANE  
CODY, WY 82414

**Registered Apr. 10, 2012**

**Int. Cl.: 16**

FOR: CHILDREN'S BOOKS; COLORING BOOKS, IN CLASS 16 (U.S. CLS. 2, 5, 22, 23, 29, 37, 38 AND 50).

**TRADEMARK**

FIRST USE 12-1-2011; IN COMMERCE 12-1-2011.

**PRINCIPAL REGISTER**

OWNER OF U.S. REG. NO. 3,729,721.

THE COLOR(S) PINK, PURPLE, AND BLACK IS/ARE CLAIMED AS A FEATURE OF THE MARK.

THE MARK CONSISTS OF THE TERM "C.A.R.E." IN BLACK EXCEPT THE LETTER "A" WHICH IS DEPICTED AS A STYLIZED RIBBON IN PINK AND PURPLE; BENEATH APPEARS THE WORDING "CONSTRUCTION AND REMODELING EXPERTS" IN BLACK, FOLLOWED BY THE WORDING "FOR A CURE" IN BLACK, WITH THE LETTER "A" BEING DEPICTED AS A PINK AND PURPLE RIBBON DESIGN BETWEEN THE TERMS "FOR" AND "CURE".

SN 85-194,938, FILED 12-10-2010.

LAURA KOVALSKY, EXAMINING ATTORNEY



*David J. Kyffers*

Director of the United States Patent and Trademark Office

# United States of America

United States Patent and Trademark Office

# TriEst

**Reg. No. 4,126,421**

**Registered Apr. 10, 2012**

**Int. Cl.: 5**

**TRADEMARK**

**PRINCIPAL REGISTER**

TRiest AG GROUP, INC. (DELAWARE CORPORATION)  
1101 INDUSTRIAL BLVD  
GREENVILLE, NC 27834

FOR: FUMIGANTS, IN CLASS 5 (U.S. CLS. 6, 18, 44, 46, 51 AND 52).

FIRST USE 1-1-2011; IN COMMERCE 1-1-2011.

THE MARK CONSISTS OF STANDARD CHARACTERS WITHOUT CLAIM TO ANY PARTICULAR FONT, STYLE, SIZE, OR COLOR.

SN 85-195,264, FILED 12-10-2010.

GIANCARLO CASTRO, EXAMINING ATTORNEY



*David J. Kybas*

Director of the United States Patent and Trademark Office

# United States of America

United States Patent and Trademark Office

## THE LOVE JAM

**Reg. No. 4,126,422**

THE LOVE JAM, LLC (TEXAS LIMITED LIABILITY COMPANY)

**Registered Apr. 10, 2012**

P.O. BOX 790227  
SAN ANTONIO, TX 78279

**Int. Cl.: 41**

FOR: EDUCATIONAL SERVICES, NAMELY, SEMINARS, CONFERENCES, AND RETREATS IN THE FIELDS OF PSYCHOLOGY, SELF IMPROVEMENT, AND PERSONAL MOTIVATION; ENTERTAINMENT SERVICES, NAMELY, ARRANGING, ORGANIZING, CONDUCTING, AND HOSTING MUSICAL EVENTS, NAMELY, LIVE MUSIC CONCERTS AND FESTIVALS; ENTERTAINMENT SERVICES, NAMELY, ARRANGING, ORGANIZING, CONDUCTING, AND HOSTING CULTURAL EVENTS; SPECIAL EVENT PLANNING FOR SOCIAL ENTERTAINMENT PURPOSES, IN CLASS 41 (U.S. CLS. 100, 101 AND 107).

**SERVICE MARK**

**PRINCIPAL REGISTER**

FIRST USE 9-4-2009; IN COMMERCE 10-31-2009.

THE MARK CONSISTS OF STANDARD CHARACTERS WITHOUT CLAIM TO ANY PARTICULAR FONT, STYLE, SIZE, OR COLOR.

NO CLAIM IS MADE TO THE EXCLUSIVE RIGHT TO USE "JAM" AS TO ENTERTAINMENT SERVICES, NAMELY, ARRANGING, ORGANIZING, CONDUCTING, AND HOSTING MUSICAL EVENTS, NAMELY, LIVE MUSIC CONCERTS AND FESTIVALS, APART FROM THE MARK AS SHOWN.

SN 85-195,344, FILED 12-10-2010.

TRACY WHITTAKER-BROWN, EXAMINING ATTORNEY



*David J. Kypos*

Director of the United States Patent and Trademark Office

United States of America  
United States Patent and Trademark Office

# HELLCAT

**Reg. No. 4,126,423**

BARNETT OUTDOORS, LLC (FLORIDA LIMITED LIABILITY COMPANY)  
955 LIVE OAK

**Registered Apr. 10, 2012**

TARPON SPRINGS, FL 34689

**Int. Cl.: 28**

FOR: CROSSBOWS, IN CLASS 28 (U.S. CLS. 22, 23, 38 AND 50).

**TRADEMARK**

FIRST USE 2-22-2011; IN COMMERCE 2-22-2011.

**PRINCIPAL REGISTER**

THE MARK CONSISTS OF STANDARD CHARACTERS WITHOUT CLAIM TO ANY PARTICULAR FONT, STYLE, SIZE, OR COLOR.

SN 85-195,409, FILED 12-10-2010.

DAVID HOFFMAN, EXAMINING ATTORNEY



*David J. Kyfos*

Director of the United States Patent and Trademark Office

# United States of America

United States Patent and Trademark Office

## Washington Family Ranch Creekside

**Reg. No. 4,126,424**

**Registered Apr. 10, 2012**

**Int. Cls.: 41 and 45**

**SERVICE MARK**

**PRINCIPAL REGISTER**

YOUNG LIFE (TEXAS CORPORATION)  
LEGAL DEPARTMENT  
420 N. CASCADE AVENUE  
COLORADO SPRINGS, CO 80903

FOR: RECREATIONAL SERVICES IN THE NATURE OF PROVIDING CAMPS OF A CHRISTIAN AND EVANGELISTIC NATURE FOR MIDDLE SCHOOL, HIGH SCHOOL AND COLLEGE STUDENTS, IN CLASS 41 (U.S. CLS. 100, 101 AND 107).

FIRST USE 5-14-2011; IN COMMERCE 5-14-2011.

FOR: EVANGELISTIC AND MINISTERIAL SERVICES, IN CLASS 45 (U.S. CLS. 100 AND 101).

FIRST USE 5-14-2011; IN COMMERCE 5-14-2011.

THE MARK CONSISTS OF STANDARD CHARACTERS WITHOUT CLAIM TO ANY PARTICULAR FONT, STYLE, SIZE, OR COLOR.

OWNER OF U.S. REG. NOS. 2,414,744, 2,414,745, AND 3,760,262.

NO CLAIM IS MADE TO THE EXCLUSIVE RIGHT TO USE "RANCH CREEKSIDE", APART FROM THE MARK AS SHOWN.

SN 85-196,013, FILED 12-12-2010.

CHARLOTTE CORWIN, EXAMINING ATTORNEY



*David J. Kybas*

Director of the United States Patent and Trademark Office



# United States of America

United States Patent and Trademark Office

# FlushNSav

**Reg. No. 4,126,425**

KANAR, MELVIN I (UNITED STATES INDIVIDUAL)  
4549 SNOWY EGRET DR  
NAPLES, FL 34119

**Registered Apr. 10, 2012**

**Int. Cl.: 11**

FOR: TOILET CONVERSION KITS FOR CONVERTING A SINGLE-FLUSH TOILET INTO A DUAL-FLUSH TOILET, IN CLASS 11 (U.S. CLS. 13, 21, 23, 31 AND 34).

**TRADEMARK**

FIRST USE 11-0-2011; IN COMMERCE 11-0-2011.

**PRINCIPAL REGISTER**

THE MARK CONSISTS OF STANDARD CHARACTERS WITHOUT CLAIM TO ANY PARTICULAR FONT, STYLE, SIZE, OR COLOR.

SN 85-196,020, FILED 12-12-2010.

REBECCA SMITH, EXAMINING ATTORNEY



*David J. Kybas*

Director of the United States Patent and Trademark Office

# United States of America

United States Patent and Trademark Office

## KEEP THE CONNECTION

**Reg. No. 4,126,426**

**Registered Apr. 10, 2012**

**Int. Cl.: 10**

**TRADEMARK**

**PRINCIPAL REGISTER**

MEDELA HOLDING AG (SWITZERLAND CORPORATION)  
LATTICHSTRASSE 4B  
BAAR, SWITZERLAND 6340

FOR: BREAST PUMPS; BREAST SHIELDS; FEEDING BOTTLES; MEDICAL POUCHES AND CONTAINERS SPECIALLY DESIGNED FOR THE COLLECTION, DEEP-FREEZING, STORING, TRANSPORT, AND REHEATING BREAST MILK FOR MEDICAL PURPOSES; FEEDING BOTTLES FOR MEDICAL PURPOSES; BREAST NIPPLE SHIELDS FOR MEDICAL PURPOSES; NIPPLE FORMERS FOR BREASTFEEDING, NAMELY, MEDICAL DEVICE WHICH APPLIES PRESSURE ON THE NIPPLE MUSCLE AND HELPS IT TO EXTEND OR PREPARE FLAT OR INVERTED NIPPLES FOR BREASTFEEDING, IN CLASS 10 (U.S. CLS. 26, 39 AND 44).

FIRST USE 1-0-2011; IN COMMERCE 1-0-2011.

THE MARK CONSISTS OF STANDARD CHARACTERS WITHOUT CLAIM TO ANY PARTICULAR FONT, STYLE, SIZE, OR COLOR.

SN 85-196,877, FILED 12-13-2010.

DAVID TAYLOR, EXAMINING ATTORNEY



*David J. Kyfos*

Director of the United States Patent and Trademark Office

# United States of America

United States Patent and Trademark Office

## FASCO AMERICA

**Reg. No. 4,126,427**

FASCO AMERICA, INC (ALABAMA CORPORATION)  
105 INDUSTRIAL PARK DR  
MUSCLE SHOALS, AL 35661

**Registered Apr. 10, 2012**

**Int. Cls.: 6, 7, and 8**

FOR: WIRES, SCREWS, NAILS AND CLAMPS OF METAL, IN CLASS 6 (U.S. CLS. 2, 12, 13, 14, 23, 25 AND 50).

**TRADEMARK**

FIRST USE 12-31-2010; IN COMMERCE 12-31-2010.

**PRINCIPAL REGISTER**

FOR: POWER-DRIVEN, AIR-DRIVEN AND EXPLOSIVE-ACTIVATED TOOLS, NAMELY, NAILERS, BRADDERS, STAPLERS, PINNERS AND PLIERS AND MACHINES FOR DRIVING IN FASTENERS SUCH AS NAILS, SCREWS, CLAMPS AND WIRES INTO MATERIALS LIKE WOOD, METAL, AND PLASTICS, IN CLASS 7 (U.S. CLS. 13, 19, 21, 23, 31, 34 AND 35).

FIRST USE 12-31-2010; IN COMMERCE 12-31-2010.

FOR: HAND-OPERATED TOOLS, NAMELY, NAILERS, BRADDERS, STAPLERS, PINNERS AND PLIERS, FOR DRIVING IN FASTENERS SUCH AS NAILS, SCREWS, CLAMPS AND WIRES INTO MATERIALS LIKE WOOD, METAL, AND PLASTICS, IN CLASS 8 (U.S. CLS. 23, 28 AND 44).

FIRST USE 12-31-2010; IN COMMERCE 12-31-2010.

THE MARK CONSISTS OF STANDARD CHARACTERS WITHOUT CLAIM TO ANY PARTICULAR FONT, STYLE, SIZE, OR COLOR.

NO CLAIM IS MADE TO THE EXCLUSIVE RIGHT TO USE "AMERICA", APART FROM THE MARK AS SHOWN.

SN 85-197,224, FILED 12-14-2010.

TRACY FLETCHER, EXAMINING ATTORNEY



*David J. Kypos*

Director of the United States Patent and Trademark Office

# United States of America

United States Patent and Trademark Office

## NEVER LEAVE IT SHORT

**Reg. No. 4,126,428**

**Registered Apr. 10, 2012**

**Int. Cl.: 25**

**TRADEMARK**

**PRINCIPAL REGISTER**

STEINHOFF, PATRICIA (UNITED STATES INDIVIDUAL)  
4 PLANTATION ROAD  
MANSFIELD, MA 02048

FOR: APPAREL FOR DANCERS, NAMELY, TEE SHIRTS, SWEATSHIRTS, PANTS, LEGGINGS, SHORTS AND JACKETS; BASEBALL CAPS; BASEBALL CAPS AND HATS; BEACH FOOTWEAR; BEACHWEAR; BELTS FOR CLOTHING; BERMUDA SHORTS; BOARD SHORTS; BOXER SHORTS; CAPS; CAPS WITH VISORS; CHILDREN'S HEADWEAR; CLOTHING, NAMELY, NECK TUBES; COVERUPS; EAR BANDS; EAR MUFFS; EAR WARMERS; EARBANDS; FLEECE BOTTOMS; FLEECE PULLOVERS; FLEECE SHORTS; FLEECE TOPS; FLEECE VESTS; FLIP FLOPS; GYM SHORTS; HATS; HEAD SCARVES; HEAD SWEATBANDS; HEAD WEAR; HEADBANDS; HEADBANDS AGAINST SWEATING; HEADWEAR; HOODED PULLOVERS; HOODED SWEAT SHIRTS; HOODED SWEATSHIRTS; INFANT AND TODDLER ONE PIECE CLOTHING; INFANT WEAR; INFANTWEAR; JOGGING OUTFITS; JOGGING PANTS; JOGGING SUITS; LONG SLEEVE PULLOVERS; LONG SLEEVED VESTS; LONG UNDERWEAR; LONG-SLEEVED SHIRTS; LOUNGE PANTS; LOUNGEWEAR; MITTENS; NECK BANDS; NIGHTWEAR; ONE PIECE GARMENT FOR INFANTS AND TODDLERS; ONE-PIECE GARMENTS FOR CHILDREN; OUTDOOR GLOVES; OUTDOOR MITTENS; OUTER JACKETS; PAJAMA BOTTOMS; PAJAMAS; PONCHOS; PULLOVERS; REVERSIBLE JACKETS; SCARFS; SCARVES; SHIRTS; SHORTS; SINGLETS; SLEEP PANTS; SLEEP SHIRTS; SLEEPING GARMENTS; SLEEPWEAR; SLEEVED OR SLEEVELESS JACKETS; SLEEVELESS JERSEYS; SPORTS JERSEYS; SUN VISORS; SURF WEAR; SWEAT BANDS; SWEAT PANTS; SWEAT SHIRTS; SWEAT SHORTS; SWEAT SUITS; SWEATBANDS; SWEATPANTS; SWEATSHIRTS; SWEATSOCKS; SWEATSUITS; SWIM CAPS; T-SHIRTS; TANK TOPS; TANK-TOPS; TANKINIS; TEE SHIRTS; TOPS; VISORS; WARM UP OUTFITS; WIND COATS; WIND PANTS; WIND RESISTANT JACKETS; WIND-JACKETS; WOMEN'S ATHLETIC TOPS WITH BUILT-IN BRAS; WRIST BANDS; WRIST-BANDS; YOGA PANTS; YOGA SHIRTS, IN CLASS 25 (U.S. CLS. 22 AND 39).



FIRST USE 12-30-2011; IN COMMERCE 12-30-2011.

THE MARK CONSISTS OF STANDARD CHARACTERS WITHOUT CLAIM TO ANY PARTICULAR FONT, STYLE, SIZE, OR COLOR.

SN 85-197,911, FILED 12-14-2010.

CAROL SPILS, EXAMINING ATTORNEY

*David J. Kyros*

Director of the United States Patent and Trademark Office

# United States of America

United States Patent and Trademark Office

# NLIS

**Reg. No. 4,126,429**

**Registered Apr. 10, 2012**

**Int. Cl.: 25**

**TRADEMARK**

**PRINCIPAL REGISTER**

STEINHOFF, PATRICIA (UNITED STATES INDIVIDUAL)  
4 PLANTATION ROAD  
MANSFIELD, MA 02048

FOR: APPAREL FOR DANCERS, NAMELY, TEE SHIRTS, SWEATSHIRTS, PANTS, LEGGINGS, SHORTS AND JACKETS; BASEBALL CAPS; BASEBALL CAPS AND HATS; BEACH FOOTWEAR; BEACHWEAR; BELTS FOR CLOTHING; BERMUDA SHORTS; BOARD SHORTS; BOXER SHORTS; CAPS; CAPS WITH VISORS; CHILDREN'S HEADWEAR; CLOTHING, NAMELY, NECK TUBES; COVERUPS; EAR BANDS; EAR MUFFS; EAR WARMERS; EARBANDS; FLEECE BOTTOMS; FLEECE PULLOVERS; FLEECE SHORTS; FLEECE TOPS; FLEECE VESTS; FLIP FLOPS; GYM SHORTS; HATS; HEAD SCARVES; HEAD SWEATBANDS; HEAD WEAR; HEADBANDS; HEADBANDS AGAINST SWEATING; HEADWEAR; HOODED PULLOVERS; HOODED SWEAT SHIRTS; HOODED SWEATSHIRTS; INFANT AND TODDLER ONE PIECE CLOTHING; INFANT WEAR; INFANTWEAR; JOGGING OUTFITS; JOGGING PANTS; JOGGING SUITS; LONG SLEEVE PULLOVERS; LONG SLEEVED VESTS; LONG UNDERWEAR; LONG-SLEEVED SHIRTS; LOUNGE PANTS; LOUNGEWEAR; MITTENS; NECK BANDS; NIGHTWEAR; ONE PIECE GARMENT FOR INFANTS AND TODDLERS; ONE-PIECE GARMENTS FOR CHILDREN; OUTDOOR GLOVES; OUTDOOR MITTENS; OUTER JACKETS; PAJAMA BOTTOMS; PAJAMAS; PONCHOS; PULLOVERS; REVERSIBLE JACKETS; SCARFS; SCARVES; SHIRTS; SHORTS; SINGLETS; SLEEP PANTS; SLEEP SHIRTS; SLEEPING GARMENTS; SLEEPWEAR; SLEEVED OR SLEEVELESS JACKETS; SLEEVELESS JERSEYS; SPORTS JERSEYS; SUN VISORS; SURF WEAR; SWEAT BANDS; SWEAT PANTS; SWEAT SHIRTS; SWEAT SHORTS; SWEAT SUITS; SWEATBANDS; SWEATPANTS; SWEATSHIRTS; SWEATSOCKS; SWEATSUITS; SWIM CAPS; T-SHIRTS; TANK TOPS; TANK-TOPS; TANKINIS; TEE SHIRTS; TOPS; VISORS; WARM UP OUTFITS; WIND COATS; WIND PANTS; WIND RESISTANT JACKETS; WIND-JACKETS; WOMEN'S ATHLETIC TOPS WITH BUILT-IN BRAS; WRIST BANDS; WRIST-BANDS; YOGA PANTS; YOGA SHIRTS, IN CLASS 25 (U.S. CLS. 22 AND 39).



FIRST USE 12-31-2011; IN COMMERCE 12-31-2011.

THE MARK CONSISTS OF STANDARD CHARACTERS WITHOUT CLAIM TO ANY PARTICULAR FONT, STYLE, SIZE, OR COLOR.

*David J. Kypas*

SN 85-197,912, FILED 12-14-2010.

CAROL SPILS, EXAMINING ATTORNEY

# United States of America

United States Patent and Trademark Office



**Reg. No. 4,126,430**

**Registered Apr. 10, 2012**

**Int. Cl.: 28**

**TRADEMARK**

**PRINCIPAL REGISTER**

FIN-S TECH LLC (FLORIDA LIMITED LIABILITY COMPANY)  
919 FOXPOINTE CIRCLE  
DELRAY BEACH, FL 33445

FOR: SURFBOARD FINS, IN CLASS 28 (U.S. CLS. 22, 23, 38 AND 50).

FIRST USE 9-1-2010; IN COMMERCE 9-27-2011.

NO CLAIM IS MADE TO THE EXCLUSIVE RIGHT TO USE "FINS", APART FROM THE MARK AS SHOWN.

THE MARK CONSISTS OF "FIN-S" IN STYLIZED FORM. THE TWO ENDS OF THE LETTER "S" ARE SHAPED LIKE FINS WHILE THE MIDDLE PORTION IS FORMED WITH ZIGZAG LINES. THE SHADED RECTANGLE IS FOR BACKGROUND PURPOSES ONLY.

SN 85-198,090, FILED 12-15-2010.

EVELYN BRADLEY, EXAMINING ATTORNEY



*David J. Kybas*

Director of the United States Patent and Trademark Office

# United States of America

United States Patent and Trademark Office

## Who Wants to Date a Comedian

**Reg. No. 4,126,431**

ENTERTAINMENT CONTENT, INC. (CALIFORNIA CORPORATION)  
1925 CENTURY PARK EAST, SUITE 1025  
LOS ANGELES, CA 90067

**Registered Apr. 10, 2012**

**Int. Cl.: 41**

FOR: ENTERTAINMENT SERVICES, NAMELY, ONGOING TELEVISION PROGRAMS IN THE FIELDS OF DATING AND COMEDY; ONGOING ENTERTAINMENT PROGRAMS IN THE FIELDS OF DATING AND COMEDY PRESENTED OVER THE INTERNET; ONGOING ENTERTAINMENT PROGRAMS IN THE FIELDS OF DATING AND COMEDY ACCESSIBLE BY CABLE, SATELLITE, TELEVISION, INTERNET, WIRELESS NETWORKS, AND THROUGH TRANSMISSION OF AUDIO AND/OR VIDEO SIGNALS TO ANY TYPE OF VISUAL DISPLAY DEVICE OR ANY DELIVERY MECHANISM; PRODUCTION AND DISTRIBUTION OF TELEVISION SHOWS, IN CLASS 41 (U.S. CLS. 100, 101 AND 107).

**SERVICE MARK**

**PRINCIPAL REGISTER**

FIRST USE 9-0-2011; IN COMMERCE 9-0-2011.

THE MARK CONSISTS OF STANDARD CHARACTERS WITHOUT CLAIM TO ANY PARTICULAR FONT, STYLE, SIZE, OR COLOR.

SN 85-198,967, FILED 12-15-2010.

ARETHA SOMERVILLE, EXAMINING ATTORNEY



*David J. Kyros*

Director of the United States Patent and Trademark Office

# United States of America

United States Patent and Trademark Office

# moMEntfree

**Reg. No. 4,126,432**

**Registered Apr. 10, 2012**

**Int. Cl.: 35**

**SERVICE MARK**

**PRINCIPAL REGISTER**

MOMENTFREE (NEW YORK PARTNERSHIP)  
APT E5  
2728 KINGS HIGHWAY  
BROOKLYN, NY 11229

FOR: OPERATING OF GLOBAL ONLINE MARKETPLACE FOR BUYERS AND SELLERS OF GOODS AND/OR SERVICES, IN CLASS 35 (U.S. CLS. 100, 101 AND 102).

FIRST USE 1-1-2012; IN COMMERCE 1-1-2012.

THE MARK CONSISTS OF STANDARD CHARACTERS WITHOUT CLAIM TO ANY PARTICULAR FONT, STYLE, SIZE, OR COLOR.

SN 85-198,973, FILED 12-15-2010.

WENDY GOODMAN, EXAMINING ATTORNEY



*David J. Kyros*

Director of the United States Patent and Trademark Office



# United States of America

United States Patent and Trademark Office



**Reg. No. 4,126,433**

LOVELOSTENT, LLC (ARIZONA LIMITED LIABILITY COMPANY)  
519 W EUCLID  
PHOENIX, AZ 85041

**Registered Apr. 10, 2012**

**Int. Cl.: 25**

FOR: CLOTHING, NAMELY, TOPS, BOTTOMS, SHIRTS, AND PANTS, IN CLASS 25 (U.S. CLS. 22 AND 39).

**TRADEMARK**

FIRST USE 8-31-2011; IN COMMERCE 12-12-2011.

**PRINCIPAL REGISTER**

THE MARK CONSISTS OF A HEART AND SURROUNDED BY SEVERAL CLOUDS WHICH ARE ALL SHARPLY OUTLINED. THE WORDS "LOVE", "ENT." AND "LOST" ARE WRITTEN ON THE CLOUD AS SHOWN IN THE MARK. .

SN 85-199,149, FILED 12-16-2010.

JAMES GRIFFIN, EXAMINING ATTORNEY



*David J. Kyffers*

Director of the United States Patent and Trademark Office

# United States of America

United States Patent and Trademark Office

# SNS

**Reg. No. 4,126,434**

**Registered Apr. 10, 2012**

**Int. Cl.: 5**

**TRADEMARK**

**PRINCIPAL REGISTER**

SERIOUS NUTRITION SOLUTIONS, LLC (VIRGINIA LIMITED LIABILITY COMPANY)  
SUITE A  
3801 US HIGHWAY 29  
DANVILLE, VA 24540

FOR: DIETARY AND NUTRITIONAL SUPPLEMENTS, IN CLASS 5 (U.S. CLS. 6, 18, 44, 46, 51 AND 52).

FIRST USE 12-1-2011; IN COMMERCE 12-1-2011.

THE MARK CONSISTS OF STANDARD CHARACTERS WITHOUT CLAIM TO ANY PARTICULAR FONT, STYLE, SIZE, OR COLOR.

SN 85-199,218, FILED 12-16-2010.

KYLE PEETE, EXAMINING ATTORNEY



*David J. Kyffers*

Director of the United States Patent and Trademark Office

# United States of America

United States Patent and Trademark Office

## Promoting Human Dignity through Civility and Respect for Conscience

**Reg. No. 4,126,435**

**Registered Apr. 10, 2012**

**Int. Cls.: 35 and 41**

**SERVICE MARK**

**PRINCIPAL REGISTER**

COMMON GOOD (VIRGINIA CORPORATION), DBA GOOD OF ALL,  
1718 M STREET, SUITE 187  
WASHINGTON, DC 20036

FOR: PROMOTING PUBLIC AWARENESS OF POLITICS, CULTURE, EDUCATION, RELI-  
GION, TECHNOLOGY AND EMPLOYMENT TO ENCOURAGE PUBLIC DISCOURSE AND  
CONVERSATION , IN CLASS 35 (U.S. CLS. 100, 101 AND 102).

FIRST USE 9-30-2010; IN COMMERCE 9-30-2010.

FOR: PROVIDING CURRENT EVENT NEWS AND INFORMATION VIA GLOBAL COMPUTER  
NETWORK IN THE FIELD OF NATIONAL AND INTERNATIONAL ISSUES; ONLINE  
NEWSLETTER FEATURING NEWS AND INFORMATION ON NATIONAL AND INTERNA-  
TIONAL ISSUES, IN CLASS 41 (U.S. CLS. 100, 101 AND 107).

FIRST USE 9-30-2010; IN COMMERCE 9-30-2010.

THE MARK CONSISTS OF STANDARD CHARACTERS WITHOUT CLAIM TO ANY PAR-  
TICULAR FONT, STYLE, SIZE, OR COLOR.

SN 85-199,249, FILED 12-16-2010.

DEZMONA MIZELLE, EXAMINING ATTORNEY



*David J. Kyros*

Director of the United States Patent and Trademark Office

# United States of America

United States Patent and Trademark Office



**Reg. No. 4,126,436**

**Registered Apr. 10, 2012**

**Int. Cls.: 35 and 41**

**SERVICE MARK**

**PRINCIPAL REGISTER**

COMMON GOOD (VIRGINIA CORPORATION), DBA GOOD OF ALL,  
1718 M STREET, SUITE 187  
WASHINGTON, DC 20036

FOR: PROMOTING PUBLIC AWARENESS OF POLITICS, CULTURE, EDUCATION, RELIGION, TECHNOLOGY AND EMPLOYMENT TO ENCOURAGE PUBLIC DISCOURSE AND CONVERSATION, IN CLASS 35 (U.S. CLS. 100, 101 AND 102).

FIRST USE 9-30-2010; IN COMMERCE 9-30-2010.

FOR: PROVIDING CURRENT EVENT NEWS AND INFORMATION VIA GLOBAL COMPUTER NETWORK IN THE FIELD OF NATIONAL AND INTERNATIONAL ISSUES; ONLINE NEWSLETTER FEATURING NEWS AND INFORMATION ON NATIONAL AND INTERNATIONAL ISSUES, IN CLASS 41 (U.S. CLS. 100, 101 AND 107).

FIRST USE 9-30-2010; IN COMMERCE 9-30-2010.

THE MARK CONSISTS OF A BLACK CANDLE WITH A RED FLAME IN A CUPPED BLACK HAND. THE WHITE IN THE MARK REPRESENTS BACKGROUND AND IS NOT PART OF THE MARK.

THE COLOR(S) BLACK AND RED IS/ARE CLAIMED AS A FEATURE OF THE MARK.

SN 85-199,254, FILED 12-16-2010.

DEZMONA MIZELLE, EXAMINING ATTORNEY



*David J. Kyjars*

Director of the United States Patent and Trademark Office

# United States of America

United States Patent and Trademark Office



**Reg. No. 4,126,437**

**Registered Apr. 10, 2012**

**Int. Cl.: 29**

**TRADEMARK**

**PRINCIPAL REGISTER**

MARIO CAMACHO FOODS, LLC (DELAWARE LIMITED LIABILITY COMPANY)  
2502 WALDEN WOODS DRIVE  
PLANT CITY, FL 33566

FOR: PROCESSED OLIVES, IN CLASS 29 (U.S. CL. 46).

FIRST USE 8-30-2011; IN COMMERCE 8-30-2011.

OWNER OF U.S. REG. NOS. 1,481,725, 1,791,772, AND 1,886,210.

THE COLOR(S) GREEN, WHITE, RED-ORANGE AND YELLOW IS/ARE CLAIMED AS A FEATURE OF THE MARK.

THE MARK CONSISTS OF THE NAME "MARIO" IN STYLIZED WHITE LETTERS, EACH WITH A GREEN SHADED BORDER. THE INTERIOR OF THE "O" IN "MARIO" CONTAINS A FANCIFUL REPRESENTATION OF A GREEN OLIVE WITH A SMALLER RED-ORANGE CIRCLE NEAR THE TOP OF THE OLIVE. BELOW THE TERM "MARIO" IS THE TERM "D'OLIVIO", IN GRADIENT GREEN WITH A YELLOW BORDER FOR EACH LETTER.

THE ENGLISH TRANSLATION OF "D'OLIVIO" IN THE MARK IS "OF THE OLIVE TREE".

SN 85-199,256, FILED 12-16-2010.

PAULA MAHONEY, EXAMINING ATTORNEY



*David J. Kybas*

Director of the United States Patent and Trademark Office

# United States of America

United States Patent and Trademark Office

## Heaven for your skin.

**Reg. No. 4,126,438**

MICHAEL STEPIE (UNITED STATES INDIVIDUAL)  
10808 EMERALD CHASE DRIVE  
ORLANDO, FL 32836

**Registered Apr. 10, 2012**

**Int. Cl.: 3**

FOR: NON-MEDICATED SKIN CARE PREPARATIONS, IN CLASS 3 (U.S. CLS. 1, 4, 6, 50, 51 AND 52).

**TRADEMARK**

FIRST USE 12-20-2011; IN COMMERCE 12-20-2011.

**PRINCIPAL REGISTER**

THE MARK CONSISTS OF STANDARD CHARACTERS WITHOUT CLAIM TO ANY PARTICULAR FONT, STYLE, SIZE, OR COLOR.

SN 85-200,250, FILED 12-17-2010.

ARETHA SOMERVILLE, EXAMINING ATTORNEY



*David J. Kyfos*

Director of the United States Patent and Trademark Office

# United States of America

United States Patent and Trademark Office

# GOMBEY

**Reg. No. 4,126,439**

**Registered Apr. 10, 2012**

**Int. Cl.: 34**

**TRADEMARK**

**PRINCIPAL REGISTER**

PRESIDENT TOBACCO, LLC. (FLORIDA LIMITED LIABILITY COMPANY)  
#1406  
7000 ISLAND BLVD.  
AVENTURA, FL 33160

FOR: CIGARETTES; CIGARS, IN CLASS 34 (U.S. CLS. 2, 8, 9 AND 17).

FIRST USE 5-23-2011; IN COMMERCE 5-23-2011.

THE MARK CONSISTS OF STANDARD CHARACTERS WITHOUT CLAIM TO ANY PARTICULAR FONT, STYLE, SIZE, OR COLOR.

SN 85-200,258, FILED 12-17-2010.

ARETHA SOMERVILLE, EXAMINING ATTORNEY



*David J. Kyffers*

Director of the United States Patent and Trademark Office

# United States of America

United States Patent and Trademark Office

## YOU'RE WELCOME

**Reg. No. 4,126,440**

CHRIS EVANS (UNITED STATES INDIVIDUAL)

**Registered Apr. 10, 2012**

434 EAST 73RD STREET  
KANSAS CITY, MO 64131

**Int. Cl.: 35**

FOR: BUSINESS CONSULTING AND ADVISORY SERVICES IN THE FIELDS OF PRODUCT DESIGN, PRODUCT DEVELOPMENT, PRODUCT BRANDING, AND PRODUCT MARKETING, IN CLASS 35 (U.S. CLS. 100, 101 AND 102).

**SERVICE MARK**

FIRST USE 12-8-2011; IN COMMERCE 12-8-2011.

**PRINCIPAL REGISTER**

THE MARK CONSISTS OF STANDARD CHARACTERS WITHOUT CLAIM TO ANY PARTICULAR FONT, STYLE, SIZE, OR COLOR.

SN 85-200,506, FILED 12-17-2010.

NAPOLEON SHARMA, EXAMINING ATTORNEY



*David J. Kybas*

Director of the United States Patent and Trademark Office



# United States of America

United States Patent and Trademark Office

# IPEACE

**Reg. No. 4,126,441**

**Registered Apr. 10, 2012**

**Int. Cl.: 45**

**SERVICE MARK**

**PRINCIPAL REGISTER**

MCKEOWN, JAMES F. (UNITED STATES INDIVIDUAL)  
730 24TH STREET, NW, SUITE ONE  
WASHINGTON, DC 20037

FOR: MEDIATION, IN CLASS 45 (U.S. CLS. 100 AND 101).

FIRST USE 10-31-2011; IN COMMERCE 10-31-2011.

THE MARK CONSISTS OF STANDARD CHARACTERS WITHOUT CLAIM TO ANY PARTICULAR FONT, STYLE, SIZE, OR COLOR.

SN 85-200,583, FILED 12-17-2010.

STEVEN PEREZ, EXAMINING ATTORNEY



*David J. Kybas*

Director of the United States Patent and Trademark Office

# United States of America

United States Patent and Trademark Office

## DO YOU KNOW WHO I AM?

**Reg. No. 4,126,442**

DO YOU KNOW WHO I AM, INC. (MINNESOTA CORPORATION)  
4820 WESTMINSTER ROAD  
MINNETONKA, MN 55345

**Registered Apr. 10, 2012**

**Int. Cl.: 41**

FOR: ENTERTAINMENT SERVICES, NAMELY, TELEVISION, CABLE AND INTERNET PROGRAMMING, IN CLASS 41 (U.S. CLS. 100, 101 AND 107).

**SERVICE MARK**

FIRST USE 4-30-2006; IN COMMERCE 4-30-2006.

**PRINCIPAL REGISTER**

THE MARK CONSISTS OF STANDARD CHARACTERS WITHOUT CLAIM TO ANY PARTICULAR FONT, STYLE, SIZE, OR COLOR.

SN 85-200,786, FILED 12-17-2010.

CAROL SPILS, EXAMINING ATTORNEY



*David J. Kybas*

Director of the United States Patent and Trademark Office

# United States of America

United States Patent and Trademark Office

## RELATIONSHIPS FOR LIFE

**Reg. No. 4,126,443**

**Registered Apr. 10, 2012**

**Int. Cls.: 9 and 42**

**TRADEMARK**

**SERVICE MARK**

**PRINCIPAL REGISTER**

MOTIVITY SOLUTIONS, INC. (COLORADO CORPORATION)  
5555 DTC PARKWAY, SUITE B2500  
GREENWOOD VILLAGE, CO 80111

FOR: COMPUTER SOFTWARE FOR MARKETING MANAGEMENT, NAMELY, FOR IDENTIFICATION OF NEW BUSINESS OPPORTUNITIES, CLIENT ACQUISITION, AND CLIENT RELATIONSHIP OPTIMIZATION; COMPUTER SOFTWARE FOR SALES MANAGEMENT, NAMELY, FOR IDENTIFICATION OF NEW BUSINESS OPPORTUNITIES, CLIENT ACQUISITION, AND CLIENT RELATIONSHIP OPTIMIZATION; COMPUTER SOFTWARE FOR RELATIONSHIP MANAGEMENT, NAMELY, FOR CLIENT RELATIONSHIP OPTIMIZATION AND MANAGEMENT; AND COMPUTER SOFTWARE FOR TASK MANAGEMENT, NAMELY, FOR IDENTIFICATION OF NEW BUSINESS OPPORTUNITIES, CLIENT ACQUISITION, AND CLIENT RELATIONSHIP OPTIMIZATION, IN CLASS 9 (U.S. CLS. 21, 23, 26, 36 AND 38).

FIRST USE 6-23-2011; IN COMMERCE 6-23-2011.

FOR: COMPUTER SOFTWARE CONSULTING; PROVIDING TEMPORARY USE OF ON-LINE NON-DOWNLOADABLE COMPUTER SOFTWARE FOR MARKETING MANAGEMENT, NAMELY, FOR IDENTIFICATION OF NEW BUSINESS OPPORTUNITIES, CLIENT ACQUISITION, AND CLIENT RELATIONSHIP OPTIMIZATION; COMPUTER SOFTWARE FOR SALES MANAGEMENT, NAMELY, FOR IDENTIFICATION OF NEW BUSINESS OPPORTUNITIES, CLIENT ACQUISITION, AND CLIENT RELATIONSHIP OPTIMIZATION; COMPUTER SOFTWARE FOR RELATIONSHIP MANAGEMENT, NAMELY, FOR CLIENT RELATIONSHIP OPTIMIZATION AND MANAGEMENT; AND COMPUTER SOFTWARE FOR TASK MANAGEMENT, NAMELY, FOR IDENTIFICATION OF NEW BUSINESS OPPORTUNITIES, CLIENT ACQUISITION, AND CLIENT RELATIONSHIP OPTIMIZATION, IN CLASS 42 (U.S. CLS. 100 AND 101).

FIRST USE 6-23-2011; IN COMMERCE 6-23-2011.

THE MARK CONSISTS OF STANDARD CHARACTERS WITHOUT CLAIM TO ANY PARTICULAR FONT, STYLE, SIZE, OR COLOR.

SN 85-202,343, FILED 12-20-2010.

KELLEY WELLS, EXAMINING ATTORNEY



*David J. Kypas*

Director of the United States Patent and Trademark Office

# United States of America

United States Patent and Trademark Office



**Reg. No. 4,126,444**

THORNLEY, TRISTAN GERARD (UNITED STATES INDIVIDUAL)  
42781 W. WILD HORSE TRAIL  
MARICOPA, AZ 85138

**Registered Apr. 10, 2012**

**Int. Cl.: 25**

FOR: HOODED SWEATSHIRTS; LONG-SLEEVED SHIRTS; SHIRTS AND SHORT-SLEEVED SHIRTS; SHORT-SLEEVED OR LONG-SLEEVED T-SHIRTS; SWEATSHIRTS; T-SHIRTS, IN CLASS 25 (U.S. CLS. 22 AND 39).

**TRADEMARK**

FIRST USE 10-1-2010; IN COMMERCE 10-1-2011.

**PRINCIPAL REGISTER**

THE MARK CONSISTS OF A STANDARD "P", A "CLUB SYMBOL" USED AS "O", A STYLIZED "K", "E" AND "R"; A STYLIZED "R" CONTAINING A LONG CURVING TAILING WITH AN ANIMATED "SPADE SYMBOL" WITH GLOVES, HANGING ON WITH ONE GLOVE TO THE TAIL END OF THE "R", A ROTATED "DIAMOND SYMBOL" AS "O", A STANDARD "L" AND "L", A STYLIZED "E" AND "R"; A STANDARD "C", A ROTATED "HEART SYMBOL" AS "O", A STANDARD "A", A STYLIZED "S", "T", "E", AND "R".

SN 85-202,686, FILED 12-21-2010.

WILLIAM BRECKENFELD, EXAMINING ATTORNEY



*David J. Kybas*

Director of the United States Patent and Trademark Office

# United States of America

United States Patent and Trademark Office

# RIP-ART

**Reg. No. 4,126,445**

RIP ART, LLC (HAWAII LIMITED LIABILITY COMPANY)  
2314 TORBAY DR  
ORANGE PARK, FL 32073

**Registered Apr. 10, 2012**

**Int. Cl.: 26**

FOR: CLOTH PATCHES FOR CLOTHING; PATCHES FOR CLOTHING MADE OF RUBBER, PLASTIC AND VINYL, IN CLASS 26 (U.S. CLS. 37, 39, 40, 42 AND 50).

**TRADEMARK**

FIRST USE 4-17-2011; IN COMMERCE 4-17-2011.

**PRINCIPAL REGISTER**

THE MARK CONSISTS OF STANDARD CHARACTERS WITHOUT CLAIM TO ANY PARTICULAR FONT, STYLE, SIZE, OR COLOR.

SN 85-202,881, FILED 12-21-2010.

DAVID TAYLOR, EXAMINING ATTORNEY



*David J. Kyffers*

Director of the United States Patent and Trademark Office

# United States of America

United States Patent and Trademark Office

WITH LOVE FROM CALIFORNIA

**Reg. No. 4,126,446**

PACIFIC SUNWEAR OF CALIFORNIA, INC. (CALIFORNIA CORPORATION)  
3450 EAST MIRALOMA AVENUE  
ANAHEIM, CA 92806

**Registered Apr. 10, 2012**

**Int. Cl.: 9**

FOR: EYEWEAR, NAMELY, SUNGLASSES, IN CLASS 9 (U.S. CLS. 21, 23, 26, 36 AND 38).

FIRST USE 6-1-2011; IN COMMERCE 6-1-2011.

**TRADEMARK**

THE MARK CONSISTS OF STANDARD CHARACTERS WITHOUT CLAIM TO ANY PARTICULAR FONT, STYLE, SIZE, OR COLOR.

**PRINCIPAL REGISTER**

NO CLAIM IS MADE TO THE EXCLUSIVE RIGHT TO USE "FROM CALIFORNIA", APART FROM THE MARK AS SHOWN.

SN 85-202,998, FILED 12-21-2010.

NAPOLEON SHARMA, EXAMINING ATTORNEY



*David J. Kyffers*

Director of the United States Patent and Trademark Office

# United States of America

United States Patent and Trademark Office

## NUTRI-GRAIN FRUIT FUSION

**Reg. No. 4,126,447**

KELLOGG NORTH AMERICA COMPANY (DELAWARE CORPORATION)  
ONE KELLOGG SQUARE, PO BOX 3599  
BATTLE CREEK, MI 490163599

**Registered Apr. 10, 2012**

**Int. Cl.: 30**

FOR: GRAIN-BASED SNACK FOOD BAR; GRAIN-BASED SNACK FOOD BAR ALSO  
CONTAINING FRUIT; CEREAL-BASED SNACK FOOD BAR, IN CLASS 30 (U.S. CL. 46).

**TRADEMARK**

FIRST USE 4-0-2011; IN COMMERCE 4-0-2011.

**PRINCIPAL REGISTER**

THE MARK CONSISTS OF STANDARD CHARACTERS WITHOUT CLAIM TO ANY PAR-  
TICULAR FONT, STYLE, SIZE, OR COLOR.

OWNER OF U.S. REG. NOS. 1,255,456, 3,389,446, AND OTHERS.

NO CLAIM IS MADE TO THE EXCLUSIVE RIGHT TO USE "FRUIT", APART FROM THE  
MARK AS SHOWN.

SN 85-203,009, FILED 12-21-2010.

BARBARA A. GOLD, EXAMINING ATTORNEY



*David J. Kybas*

Director of the United States Patent and Trademark Office

# United States of America

United States Patent and Trademark Office

## REACTION FACTION

**Reg. No. 4,126,448**

**Registered Apr. 10, 2012**

**Int. Cl.: 42**

**SERVICE MARK**

**PRINCIPAL REGISTER**

MICHAEL COSTARAS (UNITED STATES INDIVIDUAL)  
161 BAYVIEW ROAD  
MANHASSET, NY 11030

FOR: PROVIDING AN INTERACTIVE WEBSITE FEATURING TECHNOLOGY THAT EN-  
ABLES COMPUTER USERS THE ABILITY TO UPLOAD, POST, DISPLAY, EXCHANGE  
AND SHARE USER-GENERATED VIDEOS; PROVIDING A WEBSITE FEATURING TECH-  
NOLOGY THAT ENABLES USERS TO UPLOAD, POST, DISPLAY, EXCHANGE AND SHARE  
USER-GENERATED VIDEOS; PROVIDING A WEBSITE FEATURING TECHNOLOGY THAT  
ENABLES USERS TO VOTE FOR THEIR FAVORITE VIDEO(S), IN CLASS 42 (U.S. CLS.  
100 AND 101).

FIRST USE 8-15-2011; IN COMMERCE 8-15-2011.

THE MARK CONSISTS OF STANDARD CHARACTERS WITHOUT CLAIM TO ANY PAR-  
TICULAR FONT, STYLE, SIZE, OR COLOR.

SN 85-203,042, FILED 12-21-2010.

SANDRA BUJA, EXAMINING ATTORNEY



*David J. Kyffers*

Director of the United States Patent and Trademark Office



# United States of America

United States Patent and Trademark Office

**First**  **Tech**  
federal credit union

**Reg. No. 4,126,449**

**Registered Apr. 10, 2012**

**Int. Cl.: 36**

**SERVICE MARK**

**PRINCIPAL REGISTER**

FIRST TECHNOLOGY FEDERAL CREDIT UNION (UNITED STATES FEDERAL CREDIT UNION)  
C/O 121 SW MORRISON #600  
PORTLAND, OR 97204

FOR: ATM BANKING SERVICES; BANKING SERVICES; CHECKING ACCOUNT SERVICES; CREDIT AND LOAN SERVICES; CREDIT CARD AND DEBIT CARD SERVICES; CREDIT UNION SERVICES; CREDIT UNION SERVICES PROVIDED BY MOBILE TELEPHONE CONNECTIONS; CREDIT UNIONS; DEBIT CARD SERVICES; ELECTRONIC BANKING VIA A GLOBAL COMPUTER NETWORK; ELECTRONIC DEBIT TRANSACTIONS; FINANCIAL CONSULTING SERVICES, NAMELY, EXPERT ANALYSIS IN FINANCE; FINANCIAL SERVICES, NAMELY, SAVINGS PROGRAMS FOR YOUTHS; FINANCING AND LOAN SERVICES; FINANCING OF PURCHASES; FINANCING RELATING TO AUTOMOBILES; FINANCING SERVICES; HOME BANKING; HOME EQUITY LOANS; INSTALLMENT LOANS; ISSUANCE OF CREDIT CARDS; LOAN FINANCING; MORTGAGE BANKING SERVICES, NAMELY, ORIGINATION, ACQUISITION, SERVICING, SECURITIZATION AND BROKERAGE OF MORTGAGE LOANS; ON-LINE BANKING SERVICES; PROVIDING BANK ACCOUNT INFORMATION BY TELEPHONE; PROVIDING ELECTRONIC PROCESSING OF ACH AND CREDIT CARD TRANSACTIONS AND ELECTRONIC PAYMENTS VIA A GLOBAL COMPUTER NETWORK; PROVIDING ELECTRONIC PROCESSING OF ELECTRONIC FUNDS TRANSFER, ACH, CREDIT CARD, DEBIT CARD, ELECTRONIC CHECK AND ELECTRONIC PAYMENTS; PROVIDING INFORMATION AND ADVICE IN THE FIELD OF FINANCE, FINANCIAL INVESTMENTS, FINANCIAL VALUATIONS, AND THE FINANCIAL ASPECTS OF RETIREMENT; PROVIDING STUDENT LOAN INFORMATION; PROVIDING STUDENT LOANS; PROVIDING TEMPORARY LOANS; REVOLVING LOANS; SAFE DEPOSIT BOX SERVICES; SAVINGS ACCOUNT SERVICES; STUDENT LOAN SERVICES; TEMPORARY LOANS, IN CLASS 36 (U.S. CLS. 100, 101 AND 102).

FIRST USE 1-1-2011; IN COMMERCE 1-1-2011.

OWNER OF U.S. REG. NOS. 3,163,172, 3,888,198, AND OTHERS.

NO CLAIM IS MADE TO THE EXCLUSIVE RIGHT TO USE "FIRST" AND "FEDERAL CREDIT UNION", APART FROM THE MARK AS SHOWN.



*David J. Kappas*

Director of the United States Patent and Trademark Office

**Reg. No. 4,126,449** THE MARK CONSISTS OF "FIRST 1 TECH FEDERAL CREDIT UNION" WITH A STYLIZED NUMERAL "1" CREATED AS A SILHOUETTE BETWEEN OPPOSING BASES OF TRIANGLES ALIGNED VERTICALLY.

SN 85-203,248, FILED 12-21-2010.

DAVID I, EXAMINING ATTORNEY

# United States of America

United States Patent and Trademark Office

Addison  Avenue  
investment services

**Reg. No. 4,126,450**

**Registered Apr. 10, 2012**

**Int. Cl.: 36**

**SERVICE MARK**

**PRINCIPAL REGISTER**

FIRST TECHNOLOGY FEDERAL CREDIT UNION (UNITED STATES FEDERAL CREDIT UNION)  
C/O 121 SW MORRISON #600  
PORTLAND, OR 97204

FOR: FINANCIAL AND INVESTMENT SERVICES, NAMELY, MANAGEMENT AND BROKERAGE IN THE FIELDS OF STOCKS, BONDS, OPTIONS, COMMODITIES, FUTURES AND OTHER SECURITIES, AND THE INVESTMENT OF FUNDS OF OTHERS; FINANCIAL INVESTMENT ANALYSIS AND STOCK RESEARCH; FINANCIAL INVESTMENT BROKERAGE SERVICES; FINANCIAL PLANNING AND INVESTMENT ADVISORY SERVICES; FINANCIAL SERVICES, NAMELY, ADMINISTRATION OF TRANSACTIONS INVOLVING FUNDS DRAWN FROM SECURITIES, STOCKS, FUNDS, EQUITIES, BONDS, CASH, OR OTHER TYPES OF FINANCIAL INVESTMENTS IN RETIREMENT PLANS USING A CHECK OR NEGOTIABLE ORDER OF WITHDRAWAL OVER A GLOBAL DATA NETWORK; FINANCIAL SERVICES, NAMELY, ADMINISTRATION OF TRANSACTIONS INVOLVING FUNDS DRAWN FROM SECURITIES, STOCKS, FUNDS, EQUITIES, BONDS, CASH, OR OTHER TYPES OF FINANCIAL INVESTMENTS IN RETIREMENT PLANS USING A CREDIT OR DEBIT CARD OVER A GLOBAL DATA NETWORK; FINANCIAL SERVICES, NAMELY, COORDINATION, WITHIN A SINGLE ACCOUNT, OF AN INVESTMENT PORTFOLIO'S MAINTENANCE, TRADING, REBALANCING, AND TAX MANAGEMENT NEEDS; FINANCIAL SERVICES, NAMELY, INVESTMENT ADVICE, INVESTMENT MANAGEMENT, INVESTMENT CONSULTATION AND INVESTMENT OF FUNDS FOR OTHERS, INCLUDING PRIVATE AND PUBLIC EQUITY AND DEBT INVESTMENT SERVICES; INVESTMENT ADVISORY SERVICES; INVESTMENT BY ELECTRONIC MEANS; INVESTMENT MANAGEMENT OF AND DISTRIBUTION OF ANNUITIES; MUTUAL FUND INVESTMENT; MUTUAL FUNDS AND CAPITAL INVESTMENT; PROVIDING FINANCIAL SERVICES WITH RESPECT TO SECURITIES AND OTHER FINANCIAL INSTRUMENTS AND PRODUCTS, NAMELY, TRADING OF AND INVESTMENTS IN SECURITIES AND FINANCIAL INSTRUMENTS AND PRODUCTS FOR OTHERS; PROVIDING INFORMATION AND ADVICE IN THE FIELD OF FINANCE, FINANCIAL INVESTMENTS, FINANCIAL VALUATIONS, AND THE FINANCIAL ASPECTS OF RETIREMENT; PROVIDING INFORMATION AND RESEARCH IN THE FIELD OF FINANCE AND FINANCIAL INVESTMENTS, IN CLASS 36 (U.S. CLS. 100, 101 AND 102).



*David J. Kyjars*

Director of the United States Patent and Trademark Office

FIRST USE 1-1-2011; IN COMMERCE 1-1-2011.

OWNER OF U.S. REG. NOS. 2,608,032, 3,423,442, AND 3,425,023.

**Reg. No. 4,126,450** NO CLAIM IS MADE TO THE EXCLUSIVE RIGHT TO USE "INVESTMENT SERVICES",  
APART FROM THE MARK AS SHOWN.

THE MARK CONSISTS OF "ADDISON 1 AVENUE INVESTMENT SERVICES" WITH A  
STYLIZED NUMERAL "1" CREATED AS A SILHOUETTE BETWEEN OPPOSING BASES  
OF TRIANGLE ALIGNED VERTICALLY.

SN 85-203,362, FILED 12-21-2010.

DAVID I, EXAMINING ATTORNEY

# United States of America

United States Patent and Trademark Office

## WHITE & YELLOW

**Reg. No. 4,126,451**

AVANTAR, LLC (UTAH LIMITED LIABILITY COMPANY)  
5152 NORTH EDGEWOOD DRIVE, SUITE 350  
PROVO, UT 84604

**Registered Apr. 10, 2012**

**Int. Cl.: 9**

FOR: COMPUTER APPLICATION SOFTWARE FOR MOBILE DEVICES, NAMELY, DOWNLOADABLE SOFTWARE TO SEARCH FOR LOCAL BUSINESS ORGANIZATIONS, SERVICE PROVIDERS AND OTHER BUSINESS RESOURCES, IN CLASS 9 (U.S. CLS. 21, 23, 26, 36 AND 38).

**TRADEMARK**

**PRINCIPAL REGISTER**

FIRST USE 4-5-2010; IN COMMERCE 4-5-2010.

THE MARK CONSISTS OF STANDARD CHARACTERS WITHOUT CLAIM TO ANY PARTICULAR FONT, STYLE, SIZE, OR COLOR.

SN 85-203,386, FILED 12-21-2010.

KATHRYN COWARD, EXAMINING ATTORNEY



*David J. Kybas*

Director of the United States Patent and Trademark Office

United States of America  
United States Patent and Trademark Office

RIP N LIP  
OUTFITTERS

**Reg. No. 4,126,452**

PIGOTT, WILLIAM C. III (UNITED STATES INDIVIDUAL), DBA RIPNLIP OUTFITTERS,  
35 OAK STREET  
N. FORT MYERS, FL 33903

**Registered Apr. 10, 2012**

**Int. Cl.: 16**

FOR: DECALS; DECORATIVE DECALS FOR VEHICLE WINDOWS; BUMPER STICKERS,  
IN CLASS 16 (U.S. CLS. 2, 5, 22, 23, 29, 37, 38 AND 50).

**TRADEMARK**

FIRST USE 0-0-2011; IN COMMERCE 0-0-2011.

**PRINCIPAL REGISTER**

NO CLAIM IS MADE TO THE EXCLUSIVE RIGHT TO USE "OUTFITTERS", APART FROM  
THE MARK AS SHOWN.

THE COLOR(S) GOLD, NAVY BLUE IS/ARE CLAIMED AS A FEATURE OF THE MARK.

SEC. 2(F).

THE NAME(S), PORTRAIT(S), AND/OR SIGNATURE(S) SHOWN IN THE MARK DOES NOT  
IDENTIFY A PARTICULAR LIVING INDIVIDUAL.

THE MARK CONSISTS OF "RIP N LIP" HAS THREE SMALL LINES UNDERNEATH  
"RIPNLIP" AND THEY ARE GOLD, "RIPNLIP" TEXT IS NAVY BLUE, "OUTFITTERS" IS  
ALSO NAVY BLUE.

THE ENGLISH TRANSLATION OF "RIPNLIP" IN THE MARK IS "RIPNLIP". THE WORDING  
"RIPNLIP" HAS NO MEANING IN A FOREIGN LANGUAGE.

SN 85-203,923, FILED 12-22-2010.

JILL PRATER, EXAMINING ATTORNEY



*David J. Kyffers*

Director of the United States Patent and Trademark Office

# United States of America

United States Patent and Trademark Office

## AMERICAN CAMPUS

**Reg. No. 4,126,453**

IDEA NUOVA, INC. (NEW YORK CORPORATION)  
302 FIFTH AVENUE  
NEW YORK, NY 10001

**Registered Apr. 10, 2012**

**Int. Cls.: 20 and 24**

FOR: PILLOWS, IN CLASS 20 (U.S. CLS. 2, 13, 22, 25, 32 AND 50).

FIRST USE 11-1-2010; IN COMMERCE 6-20-2010.

**TRADEMARK**

FOR: BED BLANKETS; BED SHEETS; BLANKET THROWS; COMFORTERS; PILLOW CASES; PILLOW SHAMS, IN CLASS 24 (U.S. CLS. 42 AND 50).

**PRINCIPAL REGISTER**

FIRST USE 11-1-2010; IN COMMERCE 6-20-2010.

THE MARK CONSISTS OF STANDARD CHARACTERS WITHOUT CLAIM TO ANY PARTICULAR FONT, STYLE, SIZE, OR COLOR.

NO CLAIM IS MADE TO THE EXCLUSIVE RIGHT TO USE "AMERICAN", APART FROM THE MARK AS SHOWN.

SN 85-204,321, FILED 12-22-2010.

ODESSA BIBBINS, EXAMINING ATTORNEY



*David J. Kyffers*

Director of the United States Patent and Trademark Office

# United States of America

United States Patent and Trademark Office

# Gastra Girl

**Reg. No. 4,126,454**

REBECCA J. HARDER (UNITED STATES INDIVIDUAL)

**Registered Apr. 10, 2012**

#230  
1750 SW HARBOR WAY  
PORTLAND, OR 97201

**Int. Cl.: 41**

FOR: ON-LINE JOURNALS, NAMELY, BLOGS FEATURING DIGESTIVE HEALTH AND NATURAL RESOURCES FOR DIGESTIVE HEALTH, IN CLASS 41 (U.S. CLS. 100, 101 AND 107).

**SERVICE MARK**

**PRINCIPAL REGISTER**

FIRST USE 7-1-2011; IN COMMERCE 10-1-2011.

THE MARK CONSISTS OF STANDARD CHARACTERS WITHOUT CLAIM TO ANY PARTICULAR FONT, STYLE, SIZE, OR COLOR.

SN 85-204,459, FILED 12-22-2010.

THEODORE MCBRIDE, EXAMINING ATTORNEY



*David J. Kybas*

Director of the United States Patent and Trademark Office



**United States of America**  
United States Patent and Trademark Office

# QUANTUM

**Reg. No. 4,126,455**

**Registered Apr. 10, 2012**

**Int. Cl.: 10**

**TRADEMARK**

**PRINCIPAL REGISTER**

SONOVA HOLDING AG (SWITZERLAND CORPORATION)  
LAUBISRÜTISTRASSE 28  
8712 STÄFA, SWITZERLAND

FOR: HEARING AIDS, IN CLASS 10 (U.S. CLS. 26, 39 AND 44).

FIRST USE 5-0-2011; IN COMMERCE 6-0-2011.

THE MARK CONSISTS OF STANDARD CHARACTERS WITHOUT CLAIM TO ANY PARTICULAR FONT, STYLE, SIZE, OR COLOR.

SN 85-204,738, FILED 12-23-2010.

DAWN HAN, EXAMINING ATTORNEY



*David J. Kybas*

Director of the United States Patent and Trademark Office

# United States of America

United States Patent and Trademark Office

## WATERBOTICS

**Reg. No. 4,126,456**

**Registered Apr. 10, 2012**

**Int. Cls.: 16 and 41**

**TRADEMARK**

**SERVICE MARK**

**PRINCIPAL REGISTER**

THE TRUSTEES OF THE STEVENS INSTITUTE OF TECHNOLOGY (NEW JERSEY  
NON-PROFIT CORPORATION)  
CASTLE POINT ON HUDSON  
HOBOKEN, NJ 07030

FOR: EDUCATION PUBLICATIONS, NAMELY, PRINTED EDUCATIONAL MATERIALS, GUIDES, BOOKS, BROCHURES, AND HAND-OUTS IN THE FIELDS OF SCIENCE, TECHNOLOGY, ENGINEERING, AND MATHEMATICS, IN CLASS 16 (U.S. CLS. 2, 5, 22, 23, 29, 37, 38 AND 50).

FIRST USE 4-1-2010; IN COMMERCE 4-1-2010.

FOR: EDUCATION SERVICES, NAMELY, PROVIDING CLASSES, SEMINARS, WORKSHOPS, AND CAMPS IN THE FIELDS OF SCIENCE, TECHNOLOGY, ENGINEERING, AND MATHEMATICS; EDUCATION SERVICES, NAMELY, PROVIDING HANDS-ON OPPORTUNITIES FOR CHILDREN IN THE FIELDS OF SCIENCE, TECHNOLOGY, ENGINEERING, AND MATHEMATICS THROUGH CLASSES, SEMINARS, WORKSHOPS, CAMPS, TRAINING AND CURRICULUM DEVELOPMENT FOR CHILDREN, PARENTS AND EDUCATORS; PROVIDING ONLINE PUBLICATIONS IN THE NATURE OF EDUCATIONAL MATERIALS, GUIDES, BOOKS, BROCHURES, AND HAND-OUTS IN THE FIELDS OF SCIENCE, TECHNOLOGY, ENGINEERING, AND MATHEMATICS, IN CLASS 41 (U.S. CLS. 100, 101 AND 107).

FIRST USE 4-1-2010; IN COMMERCE 4-1-2010.

THE MARK CONSISTS OF STANDARD CHARACTERS WITHOUT CLAIM TO ANY PARTICULAR FONT, STYLE, SIZE, OR COLOR.

SN 85-204,960, FILED 12-23-2010.

JAMES GRIFFIN, EXAMINING ATTORNEY



*David J. Kyros*

Director of the United States Patent and Trademark Office

# United States of America

United States Patent and Trademark Office

# TIMARK

**Reg. No. 4,126,457**

**Registered Apr. 10, 2012**

**Int. Cl.: 33**

**TRADEMARK**

**PRINCIPAL REGISTER**

SMASHING GRAPES, LLC (CALIFORNIA LIMITED LIABILITY COMPANY)  
274 REDWOOD SHORES PARKWAY #136  
REDWOOD CITY, CA 94065

FOR: ALCOHOLIC BEVERAGES EXCEPT BEERS, IN CLASS 33 (U.S. CLS. 47 AND 49).

FIRST USE 2-11-2011; IN COMMERCE 2-11-2011.

THE MARK CONSISTS OF STANDARD CHARACTERS WITHOUT CLAIM TO ANY PARTICULAR FONT, STYLE, SIZE, OR COLOR.

SN 85-205,282, FILED 12-23-2010.

GIANCARLO CASTRO, EXAMINING ATTORNEY



*David J. Kybas*

Director of the United States Patent and Trademark Office

# United States of America

United States Patent and Trademark Office

## TOUCH TUNNEL

**Reg. No. 4,126,458**

**Registered Apr. 10, 2012**

**Int. Cl.: 41**

**SERVICE MARK**

**PRINCIPAL REGISTER**

LIBERTY SCIENCE CENTER (NEW JERSEY CORPORATION)  
COMMUNICATIONS DEPARTMENT  
251 PHILLIP STREET  
JERSEY CITY, NJ 07305

FOR: INTERACTIVE MUSEUM EXHIBITION FOR SENSORY ENHANCEMENT, IN CLASS 41 (U.S. CLS. 100, 101 AND 107).

FIRST USE 1-23-1993; IN COMMERCE 1-23-1993.

THE MARK CONSISTS OF STANDARD CHARACTERS WITHOUT CLAIM TO ANY PARTICULAR FONT, STYLE, SIZE, OR COLOR.

SN 85-205,425, FILED 12-23-2010.

GIANCARLO CASTRO, EXAMINING ATTORNEY



*David J. Kybas*

Director of the United States Patent and Trademark Office

# United States of America

United States Patent and Trademark Office

## versatile to the core

**Reg. No. 4,126,459**

**Registered Apr. 10, 2012**

**Int. Cl.: 20**

**TRADEMARK**

**PRINCIPAL REGISTER**

VERSIA, INC. (ARIZONA CORPORATION)  
5739 N. 7TH STREET  
PHOENIX, AZ 85014

FOR: FURNITURE; RESIDENTIAL AND COMMERCIAL FURNITURE; CUSTOM FURNITURE; CABINETS; FURNITURE PARTS; FURNITURE, NAMELY, WALL UNITS; OFFICE FURNITURE; FILING CABINETS; OFFICE TABLES; HIGH DENSITY MOBILE FILING AND STORAGE SHELVING; TABLES; COMPACTABLE ROLLING SHELVING FOR FILING AND STORAGE; SHELVING; SHELVING FOR LOCKERS, IN CLASS 20 (U.S. CLS. 2, 13, 22, 25, 32 AND 50).

FIRST USE 1-20-2012; IN COMMERCE 1-20-2012.

THE MARK CONSISTS OF STANDARD CHARACTERS WITHOUT CLAIM TO ANY PARTICULAR FONT, STYLE, SIZE, OR COLOR.

SN 85-205,556, FILED 12-24-2010.

JACQUELINE A. LAVINE, EXAMINING ATTORNEY



*David J. Kybas*

Director of the United States Patent and Trademark Office

# United States of America

United States Patent and Trademark Office



**Reg. No. 4,126,460**

**Registered Apr. 10, 2012**

**Int. Cl.: 20**

**TRADEMARK**

**PRINCIPAL REGISTER**

VERSIA, INC. (ARIZONA CORPORATION)  
5739 N. 7TH STREET  
PHOENIX, AZ 85014

FOR: FURNITURE; RESIDENTIAL AND COMMERCIAL FURNITURE; CUSTOM FURNITURE; CABINETS; FURNITURE PARTS; FURNITURE, NAMELY, WALL UNITS; OFFICE FURNITURE; FILING CABINETS; OFFICE TABLES; HIGH DENSITY MOBILE FILING AND STORAGE SHELVING; TABLES; COMPACTABLE ROLLING SHELVING FOR FILING AND STORAGE; SHELVING; SHELVING FOR LOCKERS, IN CLASS 20 (U.S. CLS. 2, 13, 22, 25, 32 AND 50).

FIRST USE 1-20-2012; IN COMMERCE 1-20-2012.

THE MARK CONSISTS OF A GREEN AND WHITE PIXELATED APPLE WITH A BLACK STEM AND A GRAY SHADOW BELOW THE APPLE.

THE COLOR(S) GREEN, WHITE, BLACK AND GRAY IS/ARE CLAIMED AS A FEATURE OF THE MARK.

SN 85-205,563, FILED 12-24-2010.

JACQUELINE A. LAVINE, EXAMINING ATTORNEY



*David J. Kyffers*

Director of the United States Patent and Trademark Office

# United States of America

United States Patent and Trademark Office



**Reg. No. 4,126,461**

**Registered Apr. 10, 2012**

**Int. Cl.: 20**

**TRADEMARK**

**PRINCIPAL REGISTER**

VERSIA, INC. (ARIZONA CORPORATION)  
5739 N. 7TH STREET  
PHOENIX, AZ 85014

FOR: FURNITURE; RESIDENTIAL AND COMMERCIAL FURNITURE; CUSTOM FURNITURE; CABINETS; FURNITURE PARTS; FURNITURE, NAMELY, WALL UNITS; OFFICE FURNITURE; FILING CABINETS; OFFICE TABLES; HIGH DENSITY MOBILE FILING AND STORAGE SHELVING; TABLES; COMPACTABLE ROLLING SHELVING FOR FILING AND STORAGE; SHELVING; SHELVING FOR LOCKERS, IN CLASS 20 (U.S. CLS. 2, 13, 22, 25, 32 AND 50).

FIRST USE 1-20-2012; IN COMMERCE 1-20-2012.

THE MARK CONSISTS OF A WHITE LETTER "V" ON A PIXELATED GREEN SUBSTANTIALLY-TRAPEZOIDAL BACKGROUND WITH A GRAY SHADOW AT THE BOTTOM.

THE COLOR(S) GREEN, WHITE AND GRAY IS/ARE CLAIMED AS A FEATURE OF THE MARK.

SN 85-205,567, FILED 12-24-2010.

JACQUELINE A. LAVINE, EXAMINING ATTORNEY



*David J. Kybas*

Director of the United States Patent and Trademark Office

# United States of America

United States Patent and Trademark Office

## THE WINNING DIFFERENCE

**Reg. No. 4,126,462**

SERVANTHOOD, INC. (NEW YORK CORPORATION)

**Registered Apr. 10, 2012**

229-19 MERRICK BLVD  
LAURELTON, NY 11413

**Int. Cl.: 32**

FOR: NON ALCOHOLIC BEVERAGES, NAMELY, DRINKING WATER AND FLAVORED DRINKING WATER ENHANCED WITH VITAMINS, IN CLASS 32 (U.S. CLS. 45, 46 AND 48).

**TRADEMARK**

FIRST USE 1-25-2011; IN COMMERCE 1-25-2011.

**PRINCIPAL REGISTER**

THE MARK CONSISTS OF STANDARD CHARACTERS WITHOUT CLAIM TO ANY PARTICULAR FONT, STYLE, SIZE, OR COLOR.

SN 85-205,694, FILED 12-26-2010.

DANNEAN HETZEL, EXAMINING ATTORNEY



*David J. Kyffers*

Director of the United States Patent and Trademark Office



# United States of America

United States Patent and Trademark Office



**Reg. No. 4,126,463**

**Registered Apr. 10, 2012**

**Int. Cl.: 9**

**TRADEMARK**

**PRINCIPAL REGISTER**

RIPPLE MOBILE LLC (OHIO LIMITED LIABILITY COMPANY)  
7003 POST ROAD, SUITE 408  
DUBLIN, OH 43016

FOR: COMPUTER SOFTWARE FOR TIME AND LOCATION MANAGEMENT; MOBILE PRODUCTIVITY APPLICATIONS; SOFTWARE FOR MOBILE PHONES AND OTHER MOBILE DEVICES, NAMELY, SOFTWARE FOR TIME AND LOCATION MANAGEMENT; DOWNLOADABLE SOFTWARE IN THE NATURE OF A MOBILE APPLICATION FOR TIME AND LOCATION MANAGEMENT, IN CLASS 9 (U.S. CLS. 21, 23, 26, 36 AND 38).

FIRST USE 12-22-2010; IN COMMERCE 12-22-2010.

THE MARK CONSISTS OF A DESIGN FEATURING A STYLIZED CLOCK FACE ENCIRCLED BY A MARKER HAVING A DOWNWARD ORIENTED TRIANGULAR TAIL INDICATING A LOCATION ON A MAP.

SN 85-206,374, FILED 12-28-2010.

ALLISON HOLTZ, EXAMINING ATTORNEY



*David J. Kyros*

Director of the United States Patent and Trademark Office

# United States of America

United States Patent and Trademark Office

# StoneWood

**Reg. No. 4,126,464**

LIEFKE, NORMAN WILLIAM (CANADA INDIVIDUAL)  
800 153255-24 AVE

**Registered Apr. 10, 2012**

SURREY, B.C., CANADA V4A2H9

**Int. Cl.: 28**

FOR: MODULAR PLAY CENTERS CONSISTING OF PANELS, DECKS, PLATFORMS, HANDRAILS, SLIDES, AND STEPS ALL SOLD SEPARATELY OR IN SELECTED COMBINATIONS, IN CLASS 28 (U.S. CLS. 22, 23, 38 AND 50).

**TRADEMARK**

FIRST USE 9-30-2011; IN COMMERCE 9-30-2011.

**PRINCIPAL REGISTER**

THE MARK CONSISTS OF STANDARD CHARACTERS WITHOUT CLAIM TO ANY PARTICULAR FONT, STYLE, SIZE, OR COLOR.

SN 85-207,216, FILED 12-29-2010.

CHARLOTTE CORWIN, EXAMINING ATTORNEY



*David J. Kybas*

Director of the United States Patent and Trademark Office

# United States of America

United States Patent and Trademark Office

# DeckTile

**Reg. No. 4,126,465**

**Registered Apr. 10, 2012**

**Int. Cl.: 28**

**TRADEMARK**

**PRINCIPAL REGISTER**

LIEFKE, NORMAN WILLIAM (CANADA INDIVIDUAL)  
800 153255-24 AVE  
SURREY, B.C., CANADA V4A2H9

FOR: MODULAR PLAY CENTERS CONSISTING OF PANELS, DECKS, PLATFORMS, HANDRAILS, SLIDES, AND STEPS ALL SOLD SEPARATELY OR IN SELECTED COMBINATIONS, IN CLASS 28 (U.S. CLS. 22, 23, 38 AND 50).

FIRST USE 9-30-2011; IN COMMERCE 9-30-2011.

THE MARK CONSISTS OF STANDARD CHARACTERS WITHOUT CLAIM TO ANY PARTICULAR FONT, STYLE, SIZE, OR COLOR.

SN 85-207,254, FILED 12-29-2010.

CHARLOTTE CORWIN, EXAMINING ATTORNEY



*David J. Kyffers*

Director of the United States Patent and Trademark Office

# United States of America

United States Patent and Trademark Office

## LARK BEAUTY & WELLNESS

**Reg. No. 4,126,466**

**Registered Apr. 10, 2012**

**Int. Cl.: 3**

**TRADEMARK**

**PRINCIPAL REGISTER**

LARK BEAUTY & WELLNESS, LLC (NEW HAMPSHIRE LIMITED LIABILITY COMPANY)  
34 HIGH BRIDGE HILL  
NASHUA, NH 03063

FOR: AFTER SHAVE LOTIONS; AFTER-SHAVE; AFTER-SHAVE CREAMS; AFTER-SHAVE GEL; AFTER-SHAVE LOTIONS; AFTER-SUN GELS; AFTER-SUN MILKS; AFTER-SUN OILS; ALOE VERA GEL FOR COSMETIC PURPOSES; ASTRINGENTS FOR COSMETIC PURPOSES; BATH GEL; BATH OILS FOR COSMETIC PURPOSES; BATH POWDER; BEAUTY CREAMS; BEAUTY CREAMS FOR BODY CARE; BEAUTY GELS; BEAUTY LOTIONS; BEAUTY SOAP; BODY AND BEAUTY CARE COSMETICS; BODY LOTION; BODY SPRAYS; CLEANSING CREAMS; COLOGNES, PERFUMES AND COSMETICS; COLORING PREPARATIONS FOR COSMETIC PURPOSES; CONCEALERS; COSMETIC BALLS; COSMETIC BATH SALTS; COSMETIC CREAMS; COSMETIC CREAMS FOR SKIN CARE; COSMETIC HAIR REGROWTH INHIBITING PREPARATIONS; COSMETIC HAND CREAMS; COSMETIC MASKS; COSMETIC MASSAGE CREAMS; COSMETIC MILKS; COSMETIC NOURISHING CREAMS; COSMETIC OILS; COSMETIC OILS FOR THE EPIDERMIS; COSMETIC PADS; COSMETIC PREPARATIONS; COSMETIC PREPARATIONS AGAINST SUNBURN; COSMETIC PREPARATIONS FOR BODY CARE; COSMETIC PREPARATIONS FOR EYE LASHES; COSMETIC PREPARATIONS FOR PROTECTING THE SKIN FROM THE SUN'S RAYS; COSMETIC PREPARATIONS FOR SKIN CARE; COSMETIC PREPARATIONS FOR SKIN RENEWAL; COSMETIC PREPARATIONS FOR SLIMMING PURPOSES; COSMETIC PREPARATIONS FOR THE CARE OF MOUTH AND TEETH; COSMETIC PREPARATIONS FOR THE HAIR AND SCALP; COSMETIC PREPARATIONS, NAMELY, FIRMING CREAMS; COSMETIC PREPARATIONS, NAMELY, FIRMING LOTIONS; COSMETIC SUN MILK LOTIONS; COSMETIC SUN-PROTECTING PREPARATIONS; COSMETIC SUN-TANNING PREPARATIONS; COSMETIC SUNSCREEN PREPARATIONS; COSMETIC SUNTAN LOTIONS; COSMETIC SUNTAN PREPARATIONS; COSMETICS; COSMETICS AND COSMETIC PREPARATIONS; COSMETICS AND MAKE-UP; COSMETICS IN GENERAL, INCLUDING PERFUMES; FACE AND BODY BEAUTY CREAMS; FACIAL BEAUTY MASKS; FACIAL WASHES; HAIR GEL AND HAIR MOUSSE; HAIR GELS; MASSAGE CREAMS; MASSAGE LOTIONS; MASSAGE OIL; NON-MEDICATED ACNE TREATMENT PREPARATIONS; NON-MEDICATED HAIR TREATMENT PREPARATIONS FOR COSMETIC PURPOSES; NON-MEDICATED OINTMENTS FOR THE PREVENTION AND TREATMENT OF SUNBURN; SUNSCREEN CREAMS, IN CLASS 3 (U.S. CLS. 1, 4, 6, 50, 51 AND 52).



*David J. Kappas*

FIRST USE 5-20-2010; IN COMMERCE 5-20-2010.

**Reg. No. 4,126,466** THE MARK CONSISTS OF STANDARD CHARACTERS WITHOUT CLAIM TO ANY PARTICULAR FONT, STYLE, SIZE, OR COLOR.

NO CLAIM IS MADE TO THE EXCLUSIVE RIGHT TO USE "BEAUTY & WELLNESS", APART FROM THE MARK AS SHOWN.

SN 85-207,368, FILED 12-29-2010.

RICHARD WHITE, EXAMINING ATTORNEY

# United States of America

United States Patent and Trademark Office

creative  
**STUDIO** Ink

**Reg. No. 4,126,467**

CITY ELECTRIC SUPPLY CO. (FLORIDA CORPORATION)  
6827 N. ORANGE BLOSSOM TRAIL, SUITE 2  
ORLANDO, FL 328609521

**Registered Apr. 10, 2012**

**Int. Cl.: 42**

FOR: DESIGN SERVICES, NAMELY, DESIGN OF GRAPHIC PACKAGING AND DATA VISUALIZATION MATERIALS FOR OTHERS, IN CLASS 42 (U.S. CLS. 100 AND 101).

**SERVICE MARK**

FIRST USE 6-1-2010; IN COMMERCE 6-1-2010.

**PRINCIPAL REGISTER**

NO CLAIM IS MADE TO THE EXCLUSIVE RIGHT TO USE "CREATIVE STUDIO", APART FROM THE MARK AS SHOWN.

THE MARK CONSISTS OF THE WORDS "CREATIVE STUDIO INK" IN STYLIZED LETTERS WITH THE LETTER "O" BROKEN AND AN UNDERLINE ENDING IN A DOT.

SN 85-207,378, FILED 12-29-2010.

SETH A. RAPPAPORT, EXAMINING ATTORNEY



*David J. Kybas*

Director of the United States Patent and Trademark Office

# United States of America

United States Patent and Trademark Office

# CYGUSA

**Reg. No. 4,126,468**

DAVID LEVY COMPANY, INC. (CALIFORNIA CORPORATION)  
12753 MOORE ST  
CERRITOS, CA 90703

**Registered Apr. 10, 2012**

**Int. Cl.: 17**

FOR: HEAT SHRINK NYLON TUBING FOR COVERING ELECTRICAL WIRE AND NYLON GROMMETS, IN CLASS 17 (U.S. CLS. 1, 5, 12, 13, 35 AND 50).

**TRADEMARK**

FIRST USE 11-11-2011; IN COMMERCE 11-11-2011.

**PRINCIPAL REGISTER**

THE MARK CONSISTS OF STANDARD CHARACTERS WITHOUT CLAIM TO ANY PARTICULAR FONT, STYLE, SIZE, OR COLOR.

SN 85-207,408, FILED 12-29-2010.

PAM WILLIS, EXAMINING ATTORNEY



*David J. Kyffers*

Director of the United States Patent and Trademark Office

# United States of America

United States Patent and Trademark Office

## SOCIALLY YOURS

**Reg. No. 4,126,469**

**Registered Apr. 10, 2012**

**Int. Cl.: 35**

**SERVICE MARK**

**PRINCIPAL REGISTER**

BLUE CALYPSO, LLC (TEXAS LIMITED LIABILITY COMPANY)  
19111 NORTH DALLAS PKWY  
SUITE 200  
DALLAS, TX 75287

FOR: DIGITAL ADVERTISING DISTRIBUTED TO MOBILE DEVICES AND INTERNET  
USERS, IN CLASS 35 (U.S. CLS. 100, 101 AND 102).

FIRST USE 10-0-2010; IN COMMERCE 10-0-2010.

THE MARK CONSISTS OF STANDARD CHARACTERS WITHOUT CLAIM TO ANY PAR-  
TICULAR FONT, STYLE, SIZE, OR COLOR.

SN 85-207,795, FILED 12-30-2010.

ALLISON HOLTZ, EXAMINING ATTORNEY



*David J. Kyjars*

Director of the United States Patent and Trademark Office



# United States of America

United States Patent and Trademark Office

## BE GOOD TO YOUR EARS

**Reg. No. 4,126,470**

MWM MOBILE PRODUCTS, LLC (INDIANA LIMITED LIABILITY COMPANY)  
6602 E. 75TH STREET, SUITE 520  
INDIANAPOLIS, IN 46250

**Registered Apr. 10, 2012**

**Int. Cl.: 9**

FOR: ACOUSTIC COMPONENTS, NAMELY, HEADPHONES, EARPHONES, SOUND PRESSURE LIMITERS AND SOUND PRESSURE LEVEL METERS, IN CLASS 9 (U.S. CLS. 21, 23, 26, 36 AND 38).

**TRADEMARK**

FIRST USE 1-5-2011; IN COMMERCE 1-5-2011.

**PRINCIPAL REGISTER**

THE MARK CONSISTS OF STANDARD CHARACTERS WITHOUT CLAIM TO ANY PARTICULAR FONT, STYLE, SIZE, OR COLOR.

SN 85-207,829, FILED 12-30-2010.

RUDY R. SINGLETON, EXAMINING ATTORNEY



*David J. Kyffers*

Director of the United States Patent and Trademark Office

# United States of America

United States Patent and Trademark Office



**Reg. No. 4,126,471**

**Registered Apr. 10, 2012**

**Int. Cl.: 41**

**SERVICE MARK**

**PRINCIPAL REGISTER**

SPECIALTYCARE, INC. (DELAWARE CORPORATION)  
ONE AMERICAN CENTER, SUITE 800  
3100 WEST END AVENUE  
NASHVILLE, TN 37203

FOR: EDUCATIONAL SERVICES, NAMELY, FIELD TRAINING AND CONDUCTING CLASSES AND DISTANCE LEARNING INSTRUCTION FOR CURRENT HEALTHCARE PROFESSIONALS THROUGH THEIR AFFILIATED INSTITUTIONS AND NOT INCLUDING COLLEGIATE OR UNIVERSITY INSTRUCTION, ALL IN THE FIELD OF HEALTHCARE, IN CLASS 41 (U.S. CLS. 100, 101 AND 107).

FIRST USE 1-1-2011; IN COMMERCE 1-1-2011.

OWNER OF U.S. REG. NO. 3,905,642.

NO CLAIM IS MADE TO THE EXCLUSIVE RIGHT TO USE "SPECIALTYCARE UNIVERSITY", "2010" AND "CLINICAL EXCELLENCE", APART FROM THE MARK AS SHOWN.

THE MARK CONSISTS OF A RIBBON-LIKE DESIGN INCORPORATING THE LETTERS "S", "C" ABOVE A DASH, "2010" AND A DASH AND ABOVE TWO BRANCHES WITH LEAVES FRAMING THE BOTTOM, ALL OF WHICH IS SURROUNDED BY A DOTTED CIRCULAR LINE; AND ENCIRCLED WITH THE PHRASE "SPECIALTYCARE UNIVERSITY" AT THE TOP AND THE PHRASES "INTEGRITY", SMALL CIRCLE SHAPE, "RESPECT", SMALL CIRCLE SHAPE, "TEAMWORK"; ABOVE THE PHRASES "CLINICAL EXCELLENCE", SMALL CIRCLE SHAPE, "LEADERSHIP", SMALL CIRCLE SHAPE, "STEWARDSHIP"; ALL OF WHICH IS SURROUNDED BY A DOTTED CIRCULAR LINE.

SN 85-208,066, FILED 12-30-2010.

SANI KHOURI, EXAMINING ATTORNEY



*David J. Kyffers*

Director of the United States Patent and Trademark Office

# United States of America

United States Patent and Trademark Office

## WHAT A JERK

**Reg. No. 4,126,472**

**Registered Apr. 10, 2012**

**Int. Cl.: 29**

**TRADEMARK**

**PRINCIPAL REGISTER**

MILLER, JOHN C. (UNITED STATES INDIVIDUAL)  
38467 N LOYOLA AVE  
BEACH PARK, IL 60087

FOR: BEEF JERKY; LOX, IN CLASS 29 (U.S. CL. 46).

FIRST USE 6-1-2005; IN COMMERCE 6-1-2005.

THE MARK CONSISTS OF STANDARD CHARACTERS WITHOUT CLAIM TO ANY PARTICULAR FONT, STYLE, SIZE, OR COLOR.

SN 85-208,082, FILED 12-30-2010.

SOPHIA S. KIM, EXAMINING ATTORNEY



*David J. Kybas*

Director of the United States Patent and Trademark Office

**United States of America**  
United States Patent and Trademark Office

# SALESFORCE

**Reg. No. 4,126,473**

SALESFORCE.COM, INC. (DELAWARE CORPORATION)  
THE LANDMARK @ ONE MARKET ST., STE. 300  
SAN FRANCISCO, CA 94105

**Registered Apr. 10, 2012**

**Int. Cl.: 45**

FOR: ON-LINE SOCIAL NETWORKING SERVICES, IN CLASS 45 (U.S. CLS. 100 AND 101).

**SERVICE MARK**

FIRST USE 11-18-2009; IN COMMERCE 11-18-2009.

**PRINCIPAL REGISTER**

THE MARK CONSISTS OF STANDARD CHARACTERS WITHOUT CLAIM TO ANY PARTICULAR FONT, STYLE, SIZE, OR COLOR.

SN 85-208,281, FILED 12-30-2010.

AMY KERTGATE, EXAMINING ATTORNEY



*David J. Kybas*

Director of the United States Patent and Trademark Office

# United States of America

United States Patent and Trademark Office

## SALESFORCE.COM

**Reg. No. 4,126,474**

SALESFORCE.COM, INC. (DELAWARE CORPORATION)  
THE LANDMARK @ ONE MARKET ST., STE. 300  
SAN FRANCISCO, CA 94105

**Registered Apr. 10, 2012**

**Int. Cl.: 45**

FOR: ON-LINE SOCIAL NETWORKING SERVICES, IN CLASS 45 (U.S. CLS. 100 AND 101).

**SERVICE MARK**

FIRST USE 11-18-2009; IN COMMERCE 11-18-2009.

**PRINCIPAL REGISTER**

THE MARK CONSISTS OF STANDARD CHARACTERS WITHOUT CLAIM TO ANY PARTICULAR FONT, STYLE, SIZE, OR COLOR.

SN 85-208,296, FILED 12-30-2010.

AMY KERTGATE, EXAMINING ATTORNEY



*David J. Kybas*

Director of the United States Patent and Trademark Office

# United States of America

United States Patent and Trademark Office

# Bykaholic

**Reg. No. 4,126,475**

**Registered Apr. 10, 2012**

**Int. Cl.: 25**

**TRADEMARK**

**PRINCIPAL REGISTER**

MANAGES, SAMUELA EUDORA (UNITED STATES INDIVIDUAL)  
656 MAIN STREET  
VAN BUREN, ME 04785

FOR: ADULT NOVELTY GAG CLOTHING ITEM, NAMELY, SOCKS; BABY LAYETTES FOR CLOTHING; BELTS; BELTS FOR CLOTHING; BELTS MADE OUT OF CLOTH; BIBS NOT OF CLOTH OR PAPER; BOTTOMS; CHILDREN'S AND INFANTS' CLOTH BIBS; CHILDREN'S CLOTH EATING BIBS; CLOTH BIBS; CLOTH BIBS FOR ADULT DINERS; CLOTH BIBS FOR USE BY SENIOR CITIZENS OR PHYSICALLY- OR MENTALLY-CHALLENGED PERSONS; CLOTH DIAPERS; CLOTHING EXTENSION USED TO EXTEND THE NORMAL SIZE RANGE OF CLOTHING ITEMS TO ACCOMMODATE PREGNANCY SIZE CHANGES; CLOTHING FOR ATHLETIC USE, NAMELY, PADDED ELBOW COMPRESSION SLEEVES BEING PART OF AN ATHLETIC GARMENT; CLOTHING FOR ATHLETIC USE, NAMELY, PADDED PANTS; CLOTHING FOR ATHLETIC USE, NAMELY, PADDED SHIRTS; CLOTHING FOR ATHLETIC USE, NAMELY, PADDED SHORTS; CLOTHING FOR BABIES, TODDLERS AND CHILDREN, TREATED WITH FIRE AND HEAT RETARDANTS, NAMELY, PAJAMAS, JACKETS, SHIRTS, PANTS, JUMPERS; CLOTHING FOR WEAR IN JUDO PRACTICES; CLOTHING FOR WEAR IN WRESTLING GAMES; CLOTHING ITEMS, NAMELY, ADHESIVE POCKETS THAT MAY BE AFFIXED DIRECTLY TO THE BODY AS A DECORATIVE PIECE OF CLOTHING WITH UTILITY; CLOTHING ITEMS, NAMELY, ADHESIVE POCKETS THAT MAY BE AFFIXED DIRECTLY TO THE INSIDE OF CLOTHING FOR STORAGE AND SAFEKEEPING OF PERSONAL ITEMS; CLOTHING SHIELDS, NAMELY, PADS APPLIED TO THE UNDERARMS OF SHIRTS, BLOUSES AND SWEATERS; CLOTHING, NAMELY, ARM WARMERS; CLOTHING, NAMELY, ATHLETIC SLEEVES; CLOTHING, NAMELY, BASE LAYERS; CLOTHING, NAMELY, FOLK COSTUMES; CLOTHING, NAMELY, HAND-WARMERS; CLOTHING, NAMELY, KHAKIS; CLOTHING, NAMELY, KNEE WARMERS; CLOTHING, NAMELY, MATERNITY BANDS; CLOTHING, NAMELY, NECK TUBES; CLOTHING, NAMELY, THOBES; CLOTHING, NAMELY, WRAP-AROUNDS; CORSETS; DUSTERS; EYESHADES; FABRIC SOLD AS AN INTEGRAL COMPONENT OF FINISHED CLOTHING ITEMS, NAMELY, SHORTS, SOCKS, UNDERGARMENT, SUITS, PANTS, SHIRTS, TIGHTS, JACKET, TANK TOPS, LEGGINGS AND SKIRTS; FIGURE SKATING CLOTHING, NAMELY, DRESS, LEGGINGS, SHIRTS AND PANTS; FOULARDS; GLOVES AS CLOTHING; HEADBANDS FOR CLOTHING; HOODS; INFANT AND TODDLER ONE PIECE CLOTHING; INFANT CLOTH DIAPERS; INSERTS SPECIALLY ADAPTED FOR CLOTH DIAPERS MADE OF BAMBOO; INSERTS SPECIALLY ADAPTED FOR CLOTH DIAPERS MADE OF HEMP; INSERTS SPECIALLY ADAPTED FOR CLOTH DIAPERS MADE OF MICROFIBER; JACKETS; JERSEYS; LEATHER BELTS; MANTLES; MUFFLERS; NON-



*David J. Kybas*

Director of the United States Patent and Trademark Office

**Reg. No. 4,126,475** DISPOSABLE CLOTH TRAINING PANTS; PAPER HATS FOR USE AS CLOTHING ITEMS; PARTS OF CLOTHING, NAMELY, GUSSETS FOR TIGHTS, GUSSETS FOR STOCKINGS, GUSSETS FOR BATHING SUITS, GUSSETS FOR UNDERWEAR, GUSSETS FOR LEOTARDS AND GUSSETS FOR FOOTLETS; PARTS OF CLOTHING, NAMELY, UNDERARM GUSSETS; PARTY HATS; PERSPIRATION ABSORBENT UNDERWEAR CLOTHING; POCKET SQUARES; SHIFTS; SHORT SETS; SHOULDER WRAPS; SHOULDER WRAPS FOR CLOTHING; SWADDLING CLOTHES; TIES; TOPS; TRAVEL CLOTHING CONTAINED IN A PACKAGE COMPRISING REVERSIBLE JACKETS, PANTS, SKIRTS, TOPS AND A BELT OR SCARF; TRIATHLON CLOTHING, NAMELY, TRIATHLON TIGHTS, TRIATHLON SHORTS, TRIATHLON SINGLET, TRIATHLON SHIRT, TRIATHLON SUIT; UNDERARM CLOTHING SHIELDS; WEARABLE GARMENTS AND CLOTHING, NAMELY, SHIRTS; WRAPS, IN CLASS 25 (U.S. CLS. 22 AND 39).

FIRST USE 12-30-2010; IN COMMERCE 1-11-2011.

THE MARK CONSISTS OF STANDARD CHARACTERS WITHOUT CLAIM TO ANY PARTICULAR FONT, STYLE, SIZE, OR COLOR.

SN 85-208,394, FILED 12-30-2010.

KARANENDRA S. CHHINA, EXAMINING ATTORNEY

# United States of America

United States Patent and Trademark Office

# Cyklaholic

**Reg. No. 4,126,476**

**Registered Apr. 10, 2012**

**Int. Cl.: 25**

**TRADEMARK**

**PRINCIPAL REGISTER**

MANAGES, SAMUELA EUDORA (UNITED STATES INDIVIDUAL)  
656 MAIN STREET  
VAN BUREN, ME 04785

FOR: ADULT NOVELTY GAG CLOTHING ITEM, NAMELY, SOCKS; BABY LAYETTES FOR CLOTHING; BELTS; BELTS FOR CLOTHING; BELTS MADE OUT OF CLOTH; BIBS NOT OF CLOTH OR PAPER; BOTTOMS; CHILDREN'S AND INFANTS' CLOTH BIBS; CHILDREN'S CLOTH EATING BIBS; CLOTH BIBS; CLOTH BIBS FOR ADULT DINERS; CLOTH BIBS FOR USE BY SENIOR CITIZENS OR PHYSICALLY- OR MENTALLY-CHALLENGED PERSONS; CLOTH DIAPERS; CLOTHING EXTENSION USED TO EXTEND THE NORMAL SIZE RANGE OF CLOTHING ITEMS TO ACCOMMODATE PREGNANCY SIZE CHANGES; CLOTHING FOR ATHLETIC USE, NAMELY, PADDED ELBOW COMPRESSION SLEEVES BEING PART OF AN ATHLETIC GARMENT; CLOTHING FOR ATHLETIC USE, NAMELY, PADDED PANTS; CLOTHING FOR ATHLETIC USE, NAMELY, PADDED SHIRTS; CLOTHING FOR ATHLETIC USE, NAMELY, PADDED SHORTS; CLOTHING FOR BABIES, TODDLERS AND CHILDREN, TREATED WITH FIRE AND HEAT RETARDANTS, NAMELY, PAJAMAS, JACKETS, SHIRTS, PANTS, JUMPERS; CLOTHING FOR WEAR IN JUDO PRACTICES; CLOTHING FOR WEAR IN WRESTLING GAMES; CLOTHING ITEMS, NAMELY, ADHESIVE POCKETS THAT MAY BE AFFIXED DIRECTLY TO THE BODY AS A DECORATIVE PIECE OF CLOTHING WITH UTILITY; CLOTHING ITEMS, NAMELY, ADHESIVE POCKETS THAT MAY BE AFFIXED DIRECTLY TO THE INSIDE OF CLOTHING FOR STORAGE AND SAFEKEEPING OF PERSONAL ITEMS; CLOTHING SHIELDS, NAMELY, PADS APPLIED TO THE UNDERARMS OF SHIRTS, BLOUSES AND SWEATERS; CLOTHING, NAMELY, ARM WARMERS; CLOTHING, NAMELY, ATHLETIC SLEEVES; CLOTHING, NAMELY, BASE LAYERS; CLOTHING, NAMELY, FOLK COSTUMES; CLOTHING, NAMELY, HAND-WARMERS; CLOTHING, NAMELY, KHAKIS; CLOTHING, NAMELY, KNEE WARMERS; CLOTHING, NAMELY, MATERNITY BANDS; CLOTHING, NAMELY, NECK TUBES; CLOTHING, NAMELY, THOBES; CLOTHING, NAMELY, WRAP-AROUNDS; CORSETS; DUSTERS; EYESHADES; FABRIC SOLD AS AN INTEGRAL COMPONENT OF FINISHED CLOTHING ITEMS, NAMELY, SHORTS, SOCKS, UNDERGARMENT, SUITS, PANTS, SHIRTS, TIGHTS, JACKET, TANK TOPS, LEGGINGS AND SKIRTS; FIGURE SKATING CLOTHING, NAMELY, DRESS, LEGGINGS, SHIRTS AND PANTS; FOULARDS; GLOVES AS CLOTHING; HEADBANDS FOR CLOTHING; HOODS; INFANT AND TODDLER ONE PIECE CLOTHING; INFANT CLOTH DIAPERS; INSERTS SPECIALLY ADAPTED FOR CLOTH DIAPERS MADE OF BAMBOO; INSERTS SPECIALLY ADAPTED FOR CLOTH DIAPERS MADE OF HEMP; INSERTS SPECIALLY ADAPTED FOR CLOTH DIAPERS MADE OF MICROFIBER; JACKETS; JERSEYS; LEATHER BELTS; MANTLES; MUFFLERS; NON-



*David J. Kybas*

Director of the United States Patent and Trademark Office



**Reg. No. 4,126,476** DISPOSABLE CLOTH TRAINING PANTS; PAPER HATS FOR USE AS CLOTHING ITEMS; PARTS OF CLOTHING, NAMELY, GUSSETS FOR TIGHTS, GUSSETS FOR STOCKINGS, GUSSETS FOR BATHING SUITS, GUSSETS FOR UNDERWEAR, GUSSETS FOR LEOTARDS AND GUSSETS FOR FOOTLETS; PARTS OF CLOTHING, NAMELY, UNDERARM GUSSETS; PARTY HATS; PERSPIRATION ABSORBENT UNDERWEAR CLOTHING; POCKET SQUARES; SHIFTS; SHORT SETS; SHOULDER WRAPS; SHOULDER WRAPS FOR CLOTHING; SWADDLING CLOTHES; TIES; TOPS; TRAVEL CLOTHING CONTAINED IN A PACKAGE COMPRISING REVERSIBLE JACKETS, PANTS, SKIRTS, TOPS AND A BELT OR SCARF; TRIATHLON CLOTHING, NAMELY, TRIATHLON TIGHTS, TRIATHLON SHORTS, TRIATHLON SINGLET, TRIATHLON SHIRT, TRIATHLON SUIT; UNDERARM CLOTHING SHIELDS; WEARABLE GARMENTS AND CLOTHING, NAMELY, SHIRTS; WRAPS, IN CLASS 25 (U.S. CLS. 22 AND 39).

FIRST USE 12-30-2010; IN COMMERCE 1-11-2011.

THE MARK CONSISTS OF STANDARD CHARACTERS WITHOUT CLAIM TO ANY PARTICULAR FONT, STYLE, SIZE, OR COLOR.

SN 85-208,399, FILED 12-30-2010.

KARANENDRA S. CHHINA, EXAMINING ATTORNEY

# United States of America

United States Patent and Trademark Office

## MULTIHOUSING DIRECT

**Reg. No. 4,126,477**

DHI CORP. (WISCONSIN CORPORATION)  
5205 W. DONGES BAY ROAD  
MEQUON, WI 53092

**Registered Apr. 10, 2012**

**Int. Cls.: 6, 11, and 21**

FOR: METAL DOOR HARDWARE, NAMELY, DOORKNOBS, LOCKSETS, HANDLESETS, LOCKS, KEYS AND LATCHES, BATHROBE HOOK HANGERS IN THE NATURE OF METAL GARMENT HOOKS; METAL ESCUTCHEON PLATES, IN CLASS 6 (U.S. CLS. 2, 12, 13, 14, 23, 25 AND 50).

**TRADEMARK**

**PRINCIPAL REGISTER**

FIRST USE 1-0-2011; IN COMMERCE 1-0-2011.

FOR: INDOOR AND OUTDOOR ELECTRIC LIGHTING FIXTURES, FAUCETS, CEILING FANS, IN CLASS 11 (U.S. CLS. 13, 21, 23, 31 AND 34).

FIRST USE 1-0-2011; IN COMMERCE 1-0-2011.

FOR: BATH ACCESSORIES, NAMELY, TOWEL RINGS, TOWEL BARS, TOILET PAPER HOLDERS, IN CLASS 21 (U.S. CLS. 2, 13, 23, 29, 30, 33, 40 AND 50).

FIRST USE 1-0-2011; IN COMMERCE 1-0-2011.

THE MARK CONSISTS OF STANDARD CHARACTERS WITHOUT CLAIM TO ANY PARTICULAR FONT, STYLE, SIZE, OR COLOR.

NO CLAIM IS MADE TO THE EXCLUSIVE RIGHT TO USE "DIRECT", APART FROM THE MARK AS SHOWN.

SN 85-209,001, FILED 1-3-2011.

SUSAN RICHARDS, EXAMINING ATTORNEY



*David J. Kyffers*

Director of the United States Patent and Trademark Office

**United States of America**  
United States Patent and Trademark Office

# ACCU1ST

**Reg. No. 4,126,478**

ACCU1ST INC (CALIFORNIA CORPORATION)  
13337 SOUTH STREET, #328  
CERRITOS, CA 90703

**Registered Apr. 10, 2012**

**Int. Cl.: 9**

FOR: PEDOMETERS; TIMERS, IN CLASS 9 (U.S. CLS. 21, 23, 26, 36 AND 38).

**TRADEMARK**

FIRST USE 1-21-2011; IN COMMERCE 1-21-2011.

**PRINCIPAL REGISTER**

THE MARK CONSISTS OF STANDARD CHARACTERS WITHOUT CLAIM TO ANY PARTICULAR FONT, STYLE, SIZE, OR COLOR.

SN 85-209,026, FILED 1-3-2011.

SUZANNE BLANE, EXAMINING ATTORNEY



*David J. Kyffers*

Director of the United States Patent and Trademark Office

# United States of America

United States Patent and Trademark Office

# Thankster

**Reg. No. 4,126,479**

BLUE LINK VENTURES, LLC (NEW YORK LIMITED LIABILITY COMPANY)  
188 EAST 64TH STREET, #2501  
NEW YORK, NY 10005

**Registered Apr. 10, 2012**

**Int. Cl.: 16**

FOR: ANNOUNCEMENT CARDS; ENVELOPES; GREETING CARDS; NOTE CARDS; PLACE CARDS, IN CLASS 16 (U.S. CLS. 2, 5, 22, 23, 29, 37, 38 AND 50).

**TRADEMARK**

FIRST USE 12-22-2011; IN COMMERCE 12-22-2011.

**PRINCIPAL REGISTER**

THE MARK CONSISTS OF STANDARD CHARACTERS WITHOUT CLAIM TO ANY PARTICULAR FONT, STYLE, SIZE, OR COLOR.

SN 85-209,072, FILED 1-3-2011.

TINA L. SNAPP, EXAMINING ATTORNEY



*David J. Kybas*

Director of the United States Patent and Trademark Office

# United States of America

United States Patent and Trademark Office

# CertAlert

**Reg. No. 4,126,480**

**Registered Apr. 10, 2012**

**Int. Cl.: 9**

**TRADEMARK**

**PRINCIPAL REGISTER**

PRODICO TECHNOLOGIES, LLC. (ILLINOIS LIMITED LIABILITY COMPANY)  
7364 S KING DR. #1  
CHICAGO, IL 606191728

FOR: MACHINES FOR DISPENSING PRE-DETERMINED DOSAGES OF MEDICATION WHICH ALSO INCORPORATE TIMERS FOR REMINDING PERSONS TO TAKE MEDICINE , IN CLASS 9 (U.S. CLS. 21, 23, 26, 36 AND 38).

FIRST USE 7-15-2011; IN COMMERCE 12-15-2011.

THE MARK CONSISTS OF STANDARD CHARACTERS WITHOUT CLAIM TO ANY PARTICULAR FONT, STYLE, SIZE, OR COLOR.

SN 85-209,087, FILED 1-3-2011.

STEVEN PEREZ, EXAMINING ATTORNEY



*David J. Kyffers*

Director of the United States Patent and Trademark Office

# United States of America

United States Patent and Trademark Office

# WIGS

**Reg. No. 4,126,481**

**Registered Apr. 10, 2012**

**Int. Cl.: 35**

**SERVICE MARK**

**PRINCIPAL REGISTER**

WIGS, WOMEN IN GOD'S SERVICE (ALABAMA CORPORATION)  
1271 ROCHESTER ROAD  
JACKSONVILLE, AL 36265

FOR: ASSOCIATION SERVICES, NAMELY, PROMOTING THE INTERESTS OF WOMEN IN FOSTERING FAITH-BASED COMMUNITY SERVICE AND MISSION PROJECTS; CHARITABLE SERVICES, NAMELY, ORGANIZING AND CONDUCTING FAITH-BASED VOLUNTEER PROGRAMS AND COMMUNITY SERVICE PROJECTS, IN CLASS 35 (U.S. CLS. 100, 101 AND 102).

FIRST USE 12-19-2011; IN COMMERCE 12-19-2011.

THE MARK CONSISTS OF STANDARD CHARACTERS WITHOUT CLAIM TO ANY PARTICULAR FONT, STYLE, SIZE, OR COLOR.

SN 85-209,104, FILED 1-3-2011.

ANNE E. GUSTASON, EXAMINING ATTORNEY



*David J. Kybas*

Director of the United States Patent and Trademark Office

# United States of America

United States Patent and Trademark Office



**Reg. No. 4,126,482**

**Registered Apr. 10, 2012**

**Int. Cl.: 35**

**SERVICE MARK**

**PRINCIPAL REGISTER**

WIGS, WOMEN IN GOD'S SERVICE (ALABAMA CORPORATION)  
1271 ROCHESTER ROAD  
JACKSONVILLE, AL 36265

FOR: ASSOCIATION SERVICES, NAMELY, PROMOTING THE INTERESTS OF WOMEN IN FOSTERING FAITH-BASED COMMUNITY SERVICE AND MISSION PROJECTS; CHARITABLE SERVICES, NAMELY, ORGANIZING AND CONDUCTING FAITH-BASED VOLUNTEER PROGRAMS AND COMMUNITY SERVICE PROJECTS, IN CLASS 35 (U.S. CLS. 100, 101 AND 102).

FIRST USE 12-19-2011; IN COMMERCE 12-19-2011.

THE MARK CONSISTS OF THE WORD "WIGS" IN A STYLIZED FONT LOCATED IN A FIRST OVAL WITH THE WORDS "WOMEN IN GOD'S SERVICE" IN A STYLIZED FONT LOCATED IN THE LOWER RIGHT PERIPHERY OF A LARGER OVAL ENCOMPASSING THE FIRST OVAL.

SN 85-209,220, FILED 1-3-2011.

ANNE E. GUSTASON, EXAMINING ATTORNEY



*David J. Kybas*

Director of the United States Patent and Trademark Office

# United States of America

United States Patent and Trademark Office

# TANKSHIELD

**Reg. No. 4,126,483**

BURLINGAME INDUSTRIES, INC. (MICHIGAN CORPORATION)  
6749 E. FULTON ST., STE. B-407  
ADA, MI 49301

**Registered Apr. 10, 2012**

**Int. Cl.: 6**

FOR: LOCKABLE SECURITY DEVICES, NAMELY, METAL SHROUDS THAT AFFIX TO BULK STORAGE CONTAINERS AND ARE LOCKABLE AGAINST UNAUTHORIZED ACCESS, IN CLASS 6 (U.S. CLS. 2, 12, 13, 14, 23, 25 AND 50).

**TRADEMARK**

FIRST USE 5-12-2011; IN COMMERCE 1-18-2012.

**PRINCIPAL REGISTER**

THE MARK CONSISTS OF STANDARD CHARACTERS WITHOUT CLAIM TO ANY PARTICULAR FONT, STYLE, SIZE, OR COLOR.

SN 85-209,222, FILED 1-3-2011.

FRANK LATTUCA, EXAMINING ATTORNEY



*David J. Kybas*

Director of the United States Patent and Trademark Office



# United States of America

United States Patent and Trademark Office

## EUGENE STOLTZFUS

**Reg. No. 4,126,484**

**Registered Apr. 10, 2012**

**Int. Cl.: 20**

**TRADEMARK**

**PRINCIPAL REGISTER**

EUGENE STOLTZFUS ARCHITECTS, PLC (VIRGINIA LIMITED LIABILITY COMPANY)  
SUITE 300  
61 S. MAIN STREET  
HARRISONBURG, VA 22801

FOR: FURNITURE, IN CLASS 20 (U.S. CLS. 2, 13, 22, 25, 32 AND 50).

FIRST USE 6-1-2011; IN COMMERCE 6-1-2011.

THE MARK CONSISTS OF STANDARD CHARACTERS WITHOUT CLAIM TO ANY PARTICULAR FONT, STYLE, SIZE, OR COLOR.

THE NAME "EUGENE STOLTZFUS" IDENTIFIES A LIVING INDIVIDUAL WHOSE CONSENT IS OF RECORD.

SN 85-209,232, FILED 1-3-2011.

STEVEN PEREZ, EXAMINING ATTORNEY



*David J. Kyffers*

Director of the United States Patent and Trademark Office

# United States of America

United States Patent and Trademark Office

# INTRU

**Reg. No. 4,126,485**

**Registered Apr. 10, 2012**

**Int. Cl.: 9**

**TRADEMARK**

**PRINCIPAL REGISTER**

INTEL CORPORATION (DELAWARE CORPORATION)  
2200 MISSION COLLEGE BOULEVARD  
SANTA CLARA, CA 950528119

FOR: COMPUTER HARDWARE; INTEGRATED CIRCUITS; COMPUTER CHIPSETS;  
GRAPHICS CARDS; HD GRAPHIC CHIPSETS, IN CLASS 9 (U.S. CLS. 21, 23, 26, 36 AND  
38).

FIRST USE 1-5-2011; IN COMMERCE 1-5-2011.

THE MARK CONSISTS OF STANDARD CHARACTERS WITHOUT CLAIM TO ANY PAR-  
TICULAR FONT, STYLE, SIZE, OR COLOR.

OWNER OF U.S. REG. NO. 3,886,801.

SN 85-209,504, FILED 1-3-2011.

JASON BLAIR, EXAMINING ATTORNEY



*David J. Kyffers*

Director of the United States Patent and Trademark Office

# United States of America

United States Patent and Trademark Office

LIFE • CAST  
SPAS

**Reg. No. 4,126,486**

STRONG INDUSTRIES, INC. (PENNSYLVANIA CORPORATION)  
P.O. BOX 108  
NORTHUMBERLAND, PA 17857

**Registered Apr. 10, 2012**

**Int. Cl.: 11**

FOR: SELF CONTAINED SPAS IN THE NATURE OF FREESTANDING HEATED POOLS AND WHIRLPOOLS, FILTERS, HEATERS AND PUMPS ALL SOLD AS A UNIT, IN CLASS 11 (U.S. CLS. 13, 21, 23, 31 AND 34).

**TRADEMARK**

FIRST USE 9-13-2011; IN COMMERCE 9-13-2011.

**PRINCIPAL REGISTER**

NO CLAIM IS MADE TO THE EXCLUSIVE RIGHT TO USE "SPAS", APART FROM THE MARK AS SHOWN.

THE MARK CONSISTS OF THE STYLIZED WORDS "LIFE" AND "CAST" SEPARATED BY A STYLIZED HYPHEN.

SN 85-209,510, FILED 1-3-2011.

DAVID TAYLOR, EXAMINING ATTORNEY



*David J. Kyros*

Director of the United States Patent and Trademark Office

# United States of America

United States Patent and Trademark Office

## BUFFALO JACKS

**Reg. No. 4,126,487**

McFARLAND, KIRT (UNITED STATES INDIVIDUAL)  
1465 S. CRESTON CIRCLE  
MESA, AZ 85204

**Registered Apr. 10, 2012**

**Int. Cl.: 29**

FOR: BEEF JERKY; DRIED MEAT; MEAT AND MEAT EXTRACTS, IN CLASS 29 (U.S. CL. 46).

**TRADEMARK**

FIRST USE 10-1-2011; IN COMMERCE 10-1-2011.

**PRINCIPAL REGISTER**

THE MARK CONSISTS OF STANDARD CHARACTERS WITHOUT CLAIM TO ANY PARTICULAR FONT, STYLE, SIZE, OR COLOR.

NO CLAIM IS MADE TO THE EXCLUSIVE RIGHT TO USE "BUFFALO", APART FROM THE MARK AS SHOWN.

SN 85-209,602, FILED 1-3-2011.

MATTHEW MCDOWELL, EXAMINING ATTORNEY



*David J. Kybas*

Director of the United States Patent and Trademark Office

# United States of America

United States Patent and Trademark Office

WORK  
Well NC

**Reg. No. 4,126,488**

**Registered Apr. 10, 2012**

**Int. Cl.: 44**

**SERVICE MARK**

**PRINCIPAL REGISTER**

THE NORTH CAROLINA PUBLIC HEALTH FOUNDATION (NORTH CAROLINA CORPORATION)  
P.O. BOX 18763  
RALEIGH, NC 27619

FOR: PROVIDING ASSISTANCE, FITNESS EVALUATION AND CONSULTATION TO CORPORATE CLIENTS TO HELP THEIR EMPLOYEES MAKE HEALTH, WELLNESS AND NUTRITIONAL CHANGES IN THEIR DAILY LIVING TO IMPROVE HEALTH; WELLNESS AND HEALTH-RELATED CONSULTING SERVICES, IN CLASS 44 (U.S. CLS. 100 AND 101).

FIRST USE 6-1-2011; IN COMMERCE 6-1-2011.

NO CLAIM IS MADE TO THE EXCLUSIVE RIGHT TO USE "NC", APART FROM THE MARK AS SHOWN.

THE MARK CONSISTS OF "WORK" POSITIONED ABOVE "WELL NC" IN STYLIZED FONT.

SN 85-210,050, FILED 1-4-2011.

NANCY CLARKE, EXAMINING ATTORNEY



*David J. Kybas*

Director of the United States Patent and Trademark Office

# United States of America

United States Patent and Trademark Office

# FINDINGS

**Reg. No. 4,126,489**

**Registered Apr. 10, 2012**

**Int. Cl.: 42**

**SERVICE MARK**

**PRINCIPAL REGISTER**

FINDINGS, INC. (DELAWARE CORPORATION)  
416 WEST 13TH STREET, SUITE 203  
NEW YORK, NY 10014

FOR: APPLICATION SERVICE PROVIDER (ASP) FEATURING SOFTWARE FOR UPLOADING, DOWNLOADING, STREAMING, POSTING, DISPLAYING, EDITING, TAGGING, BLOGGING, LINKING, ORGANIZING, STORING, SHARING OR OTHERWISE PROVIDING ELECTRONIC MEDIA OR INFORMATION OVER COMMUNICATION NETWORKS; APPLICATION SERVICE PROVIDER (ASP) FEATURING SOFTWARE FOR CREATING INDEXES OF INFORMATION, SITES AND OTHER RESOURCES AVAILABLE ON COMPUTER NETWORKS; APPLICATION SERVICE PROVIDER (ASP) FEATURING SOFTWARE FOR SOCIAL NETWORKING AND TRANSMISSION OF ELECTRONIC MEDIA OR INFORMATION OVER COMMUNICATION NETWORKS, IN CLASS 42 (U.S. CLS. 100 AND 101).

FIRST USE 11-1-2010; IN COMMERCE 11-1-2010.

THE MARK CONSISTS OF STANDARD CHARACTERS WITHOUT CLAIM TO ANY PARTICULAR FONT, STYLE, SIZE, OR COLOR.

SN 85-210,169, FILED 1-4-2011.

ANTHONY RINKER, EXAMINING ATTORNEY



*David J. Kybas*

Director of the United States Patent and Trademark Office

# United States of America

United States Patent and Trademark Office

# NexSite

**Reg. No. 4,126,490**

**Registered Apr. 10, 2012**

**Int. Cl.: 10**

**TRADEMARK**

**PRINCIPAL REGISTER**

MARVAO MEDICAL DEVICES LTD (IRELAND LIMITED LIABILITY COMPANY)  
IIBC, GMIT, DUBLIN ROAD  
GALWAY, IRELAND

FOR: CATHETERS AND PARTS AND FITTINGS THEREFOR, IN CLASS 10 (U.S. CLS. 26, 39 AND 44).

FIRST USE 4-1-2011; IN COMMERCE 4-1-2011.

THE MARK CONSISTS OF STANDARD CHARACTERS WITHOUT CLAIM TO ANY PARTICULAR FONT, STYLE, SIZE, OR COLOR.

SN 85-210,558, FILED 1-5-2011.

APRIL HESIK, EXAMINING ATTORNEY



*David J. Kyffers*

Director of the United States Patent and Trademark Office

# United States of America

United States Patent and Trademark Office

## Invest Your Conscience

**Reg. No. 4,126,491**

EVERETT, CRAIG R (UNITED STATES INDIVIDUAL)  
4327 VIA CERRITOS

**Registered Apr. 10, 2012**

NEWBURY PARK, CA 91320

**Int. Cl.: 36**

FOR: ADVICE RELATING TO INVESTMENTS; FINANCIAL INVESTMENT ANALYSIS AND STOCK RESEARCH; INVESTMENT MANAGEMENT, IN CLASS 36 (U.S. CLS. 100, 101 AND 102).

**SERVICE MARK**

FIRST USE 9-13-2011; IN COMMERCE 9-13-2011.

**PRINCIPAL REGISTER**

THE MARK CONSISTS OF STANDARD CHARACTERS WITHOUT CLAIM TO ANY PARTICULAR FONT, STYLE, SIZE, OR COLOR.

SN 85-210,598, FILED 1-5-2011.

REGINA DRUMMOND, EXAMINING ATTORNEY



*David J. Kyffers*

Director of the United States Patent and Trademark Office



# United States of America

United States Patent and Trademark Office

## KNOWLEDGE UNIVERSE

**Reg. No. 4,126,492**

**Registered Apr. 10, 2012**

**Int. Cls.: 41, 42, and 43**

**SERVICE MARK**

**PRINCIPAL REGISTER**

KNOWLEDGE UNIVERSE LLC (CALIFORNIA LIMITED LIABILITY COMPANY)  
1250 FOURTH STREET  
SANTA MONICA, CA 90401

FOR: EDUCATION SERVICES IN THE NATURE OF EARLY CHILDHOOD INSTRUCTION AND PROVIDING KINDERGARTEN CLASSROOM INSTRUCTION; EDUCATIONAL PROGRAMS, NAMELY, PRE-SCHOOLS; PROVIDING AFTER SCHOOL EDUCATIONAL PROGRAMS FOR CHILDREN IN GRADES ONE THROUGH SIX; DAY CAMP SERVICES; ACADEMIC ENRICHMENT PROGRAMS IN THE FIELDS OF MATH, READING, HEALTH AND FITNESS AND FOREIGN LANGUAGES, IN CLASS 41 (U.S. CLS. 100, 101 AND 107).

FIRST USE 1-0-2008; IN COMMERCE 1-0-2008.

FOR: COMPUTER SERVICE, NAMELY, ACTING AS AN APPLICATION SERVICE PROVIDER IN THE FIELD OF KNOWLEDGE MANAGEMENT TO HOST COMPUTER APPLICATION SOFTWARE FOR CREATING SEARCHABLE DATABASES OF INFORMATION AND DATA; APPLICATION SERVICE PROVIDER (ASP), NAMELY, HOSTING COMPUTER SOFTWARE APPLICATIONS OF OTHERS AND HOSTING, MANAGING, DEVELOPING, ANALYZING AND MAINTAINING WEB SITES OF OTHERS IN THE FIELDS OF EDUCATION AND CHILD CARE; COMPUTER SOFTWARE DESIGNING AND UPDATING; COMPUTER SOFTWARE CONSULTING; COMPUTER CONSULTATION; COMPUTER PROJECT MANAGEMENT SERVICES; IT CONSULTING SERVICES; INFORMATION TECHNOLOGY (IT) INTEGRATION SERVICES; COMPUTER SERVICES, NAMELY, REMOTE MANAGEMENT OF THE INFORMATION TECHNOLOGY (IT) SYSTEMS OF OTHERS; CONSULTING IN THE FIELD OF TELECOMMUNICATIONS TECHNOLOGY, IN CLASS 42 (U.S. CLS. 100 AND 101).

FIRST USE 0-0-2009; IN COMMERCE 0-0-2009.

FOR: CHILDCARE CENTERS; CHILD CARE SERVICES; PRESCHOOLER AND INFANT CARE AT DAYCARE CENTERS, IN CLASS 43 (U.S. CLS. 100 AND 101).

FIRST USE 1-0-2008; IN COMMERCE 1-0-2008.

THE MARK CONSISTS OF STANDARD CHARACTERS WITHOUT CLAIM TO ANY PARTICULAR FONT, STYLE, SIZE, OR COLOR.

OWNER OF U.S. REG. NO. 2,832,193.



*David J. Kyffers*

Director of the United States Patent and Trademark Office

**Reg. No. 4,126,492** SN 85-210,695, FILED 1-5-2011.

STEVEN JACKSON, EXAMINING ATTORNEY

# United States of America

United States Patent and Trademark Office

# Knowledge UNIVERSE

**Reg. No. 4,126,493**

KNOWLEDGE UNIVERSE LLC (CALIFORNIA LIMITED LIABILITY COMPANY)  
1250 FOURTH STREET  
SANTA MONICA, CA 90401

**Registered Apr. 10, 2012**

**Int. Cls.: 41, 42, and 43**

FOR: EDUCATION SERVICES IN THE NATURE OF EARLY CHILDHOOD INSTRUCTION AND PROVIDING KINDERGARTEN CLASSROOM INSTRUCTION; EDUCATIONAL PROGRAMS, NAMELY, PRE-SCHOOLS; PROVIDING AFTER SCHOOL EDUCATIONAL PROGRAMS FOR CHILDREN IN GRADES ONE THROUGH SIX; DAY CAMP SERVICES; ACADEMIC ENRICHMENT PROGRAMS IN THE FIELDS OF MATH, READING, HEALTH AND FITNESS AND FOREIGN LANGUAGES, IN CLASS 41 (U.S. CLS. 100, 101 AND 107).

**SERVICE MARK**

**PRINCIPAL REGISTER**

FIRST USE 1-0-2008; IN COMMERCE 1-0-2008.

FOR: COMPUTER SERVICE, NAMELY, ACTING AS AN APPLICATION SERVICE PROVIDER IN THE FIELD OF KNOWLEDGE MANAGEMENT TO HOST COMPUTER APPLICATION SOFTWARE FOR CREATING SEARCHABLE DATABASES OF INFORMATION AND DATA; APPLICATION SERVICE PROVIDER (ASP), NAMELY, HOSTING COMPUTER SOFTWARE APPLICATIONS OF OTHERS AND HOSTING, MANAGING, DEVELOPING, ANALYZING AND MAINTAINING WEB SITES OF OTHERS IN THE FIELDS OF EDUCATION AND CHILD CARE; COMPUTER SOFTWARE DESIGNING AND UPDATING; COMPUTER SOFTWARE CONSULTING; COMPUTER CONSULTATION; COMPUTER PROJECT MANAGEMENT SERVICES; IT CONSULTING SERVICES; INFORMATION TECHNOLOGY (IT) INTEGRATION SERVICES; COMPUTER SERVICES, NAMELY, REMOTE MANAGEMENT OF THE INFORMATION TECHNOLOGY (IT) SYSTEMS OF OTHERS; CONSULTING IN THE FIELD OF TELECOMMUNICATIONS TECHNOLOGY, IN CLASS 42 (U.S. CLS. 100 AND 101).

FIRST USE 0-0-2009; IN COMMERCE 0-0-2009.

FOR: CHILDCARE CENTERS; CHILD CARE SERVICES; PRESCHOOLER AND INFANT CARE AT DAYCARE CENTERS, IN CLASS 43 (U.S. CLS. 100 AND 101).

FIRST USE 1-0-2008; IN COMMERCE 1-0-2008.

OWNER OF U.S. REG. NO. 2,832,193.

THE MARK CONSISTS OF "KNOWLEDGE" IN STYLIZED PRINT, WITH A STYLIZED GLOBE IN PLACE OF THE LETTER "O" ABOVE "UNIVERSE" IN STYLIZED PRINT.



*David J. Kybas*

Director of the United States Patent and Trademark Office

**Reg. No. 4,126,493** SN 85-211,148, FILED 1-5-2011.

STEVEN JACKSON, EXAMINING ATTORNEY

# United States of America

United States Patent and Trademark Office

## COMMIT TO THE LIFESTYLE

**Reg. No. 4,126,494**

CLEARY, KEVIN P (UNITED STATES INDIVIDUAL)  
815 1ST ST

**Registered Apr. 10, 2012**

MANHATTAN BEACH, CA 90266

**Int. Cl.: 25**

FOR: BATHING SUITS; BOTTOMS; HATS; HEADWEAR; PANTS; SHIRTS; SHORTS; SWEAT SHIRTS; SWIMWEAR; TOPS, IN CLASS 25 (U.S. CLS. 22 AND 39).

**TRADEMARK**

FIRST USE 5-0-2011; IN COMMERCE 5-0-2011.

**PRINCIPAL REGISTER**

THE MARK CONSISTS OF STANDARD CHARACTERS WITHOUT CLAIM TO ANY PARTICULAR FONT, STYLE, SIZE, OR COLOR.

SN 85-211,365, FILED 1-5-2011.

SANI KHOURI, EXAMINING ATTORNEY



*David J. Kybas*

Director of the United States Patent and Trademark Office

# United States of America

United States Patent and Trademark Office

# Ironbound

**Reg. No. 4,126,495**

**Registered Apr. 10, 2012**

**Int. Cl.: 9**

**TRADEMARK**

**PRINCIPAL REGISTER**

RED LANTERN GAME STUDIOS LLC (NEW JERSEY LIMITED LIABILITY COMPANY)  
549 ROBINSON TER  
UNION, NJ 07083

FOR: COMPUTER GAME CARTRIDGES; COMPUTER GAME CARTRIDGES AND DISCS; COMPUTER GAME DISCS; COMPUTER GAME EQUIPMENT, NAMELY, DISCS; COMPUTER GAME PROGRAMMES; COMPUTER GAME PROGRAMMES DOWNLOADABLE VIA THE INTERNET; COMPUTER GAME PROGRAMS; COMPUTER GAME SOFTWARE; COMPUTER GAME SOFTWARE DOWNLOADABLE FROM A GLOBAL COMPUTER NETWORK; COMPUTER GAME SOFTWARE FOR PERSONAL COMPUTERS AND HOME VIDEO GAME CONSOLES; COMPUTER GAME SOFTWARE FOR USE ON MOBILE AND CELLULAR PHONES; COMPUTER GAME SOFTWARE FOR USE WITH PERSONAL COMPUTERS, HOME VIDEO GAME CONSOLES USED WITH TELEVISIONS AND ARCADE-BASED VIDEO GAME CONSOLES; DOWNLOADABLE COMPUTER GAME PROGRAMS; DOWNLOADABLE COMPUTER GAME SOFTWARE VIA A GLOBAL COMPUTER NETWORK AND WIRELESS DEVICES; DOWNLOADABLE ELECTRONIC GAME PROGRAMS; GAME SOFTWARE; INTERACTIVE GAME PROGRAMS; INTERACTIVE GAME SOFTWARE; VIDEO AND COMPUTER GAME PROGRAMS; VIDEO GAME CARTRIDGES AND DISCS; VIDEO GAME DISCS; VIDEO GAME SOFTWARE, IN CLASS 9 (U.S. CLS. 21, 23, 26, 36 AND 38).

FIRST USE 10-12-2011; IN COMMERCE 10-12-2011.

THE MARK CONSISTS OF STANDARD CHARACTERS WITHOUT CLAIM TO ANY PARTICULAR FONT, STYLE, SIZE, OR COLOR.

SN 85-211,486, FILED 1-5-2011.

CHERYL CLAYTON, EXAMINING ATTORNEY



*David J. Kyros*

Director of the United States Patent and Trademark Office

# United States of America

United States Patent and Trademark Office

# TULUM

**Reg. No. 4,126,496**

**Registered Apr. 10, 2012**

**Int. Cl.: 6**

**TRADEMARK**

**PRINCIPAL REGISTER**

THE DELANEY CO. (GEORGIA CORPORATION)  
265 CASTLEBERRY INDUSTRIAL DRIVE  
CUMMING, GA 30040

FOR: DOOR HANDLE SETS MADE PRINCIPALLY OF METAL, IN CLASS 6 (U.S. CLS. 2, 12, 13, 14, 23, 25 AND 50).

FIRST USE 9-23-2011; IN COMMERCE 9-23-2011.

THE MARK CONSISTS OF STANDARD CHARACTERS WITHOUT CLAIM TO ANY PARTICULAR FONT, STYLE, SIZE, OR COLOR.

SN 85-211,591, FILED 1-6-2011.

BRIAN NEVILLE, EXAMINING ATTORNEY



*David J. Kybas*

Director of the United States Patent and Trademark Office

# United States of America

United States Patent and Trademark Office

## Intervention Point

**Reg. No. 4,126,497**

MORRIS, ROBERT (UNITED STATES INDIVIDUAL)  
5 CATON CIRCLE  
NEWTOWN, PA 18940

**Registered Apr. 10, 2012**

**Int. Cl.: 41**

FOR: PROVIDING ON-LINE PUBLICATIONS IN THE NATURE OF BOOKS, JOURNALS, MAGAZINES IN THE FIELD OF HEALTHCARE, EDUCATION AND FINANCE, IN CLASS 41 (U.S. CLS. 100, 101 AND 107).

**SERVICE MARK**

FIRST USE 8-31-2010; IN COMMERCE 8-1-2011.

**PRINCIPAL REGISTER**

THE MARK CONSISTS OF STANDARD CHARACTERS WITHOUT CLAIM TO ANY PARTICULAR FONT, STYLE, SIZE, OR COLOR.

SN 85-211,688, FILED 1-6-2011.

REGINA DRUMMOND, EXAMINING ATTORNEY



*David J. Kybas*

Director of the United States Patent and Trademark Office



# United States of America

United States Patent and Trademark Office



**Reg. No. 4,126,498**

**Registered Apr. 10, 2012**

**Int. Cl.: 37**

**SERVICE MARK**

**PRINCIPAL REGISTER**

SIGNATURE FLIGHT SUPPORT UK REGIONS (UNITED KINGDOM CORPORATION)  
LONDON LUTON AIRPORT  
HANGER 63 PERCIVAL WAY  
LUTON, BEDFORDSHIRE, UNITED KINGDOM LU29NT

FOR: MAINTENANCE AND REPAIR OF AIRCRAFT, IN CLASS 37 (U.S. CLS. 100, 103 AND 106).

FIRST USE 3-1-2011; IN COMMERCE 3-1-2011.

OWNER OF U.S. REG. NOS. 1,998,482 AND 2,032,400.

NO CLAIM IS MADE TO THE EXCLUSIVE RIGHT TO USE "AIRCRAFT MAINTENANCE", APART FROM THE MARK AS SHOWN.

THE MARK CONSISTS OF A PARTIAL CIRCLE WITH AN X IN THE MIDDLE SHOWN ON THE LEFT HAND SIDE OF THE WORDS "SIGNATURE TECHNICAIR AIRCRAFT MAINTENANCE".

SN 85-212,572, FILED 1-7-2011.

ALEXANDER L. POWERS, EXAMINING ATTORNEY



*David J. Kypos*

Director of the United States Patent and Trademark Office

# United States of America

United States Patent and Trademark Office

# BIOLIGHTER

**Reg. No. 4,126,499**

**Registered Apr. 10, 2012**

**Int. Cl.: 4**

**TRADEMARK**

**PRINCIPAL REGISTER**

THE MISSING LINK TOURS (NEVADA CORPORATION), DBA DOGPATCH BIOFUELS,  
765 PENNSYLVANIA AVE.  
SAN FRANCISCO, CA 94107

FOR: LIGHTER FLUID, IN CLASS 4 (U.S. CLS. 1, 6 AND 15).

FIRST USE 1-6-2011; IN COMMERCE 1-6-2011.

THE MARK CONSISTS OF THE WORD "BIOLIGHTER" IN BLACK TEXTURED TO APPEAR AS THOUGH MADE OF CHARCOAL FOLLOWED BY A FLAME DESIGN WHEN THE CENTER OF THE FLAME IS YELLOW SURROUNDED BY CONCENTRIC SHAPES OF DARKENING SHADES OF GREEN.

THE COLOR(S) BLACK, GREEN AND YELLOW IS/ARE CLAIMED AS A FEATURE OF THE MARK.

SN 85-213,020, FILED 1-7-2011.

EUGENIA MARTIN, EXAMINING ATTORNEY



*David J. Kybas*

Director of the United States Patent and Trademark Office

# United States of America

United States Patent and Trademark Office

# MANDRILL

**Reg. No. 4,126,500**

**Registered Apr. 10, 2012**

**Int. Cl.: 42**

**SERVICE MARK**

**PRINCIPAL REGISTER**

THE ROCKET SCIENCE GROUP LLC (GEORGIA LIMITED LIABILITY COMPANY), DBA  
MAILCHIMP,  
512 MEANS ST. #404  
ATLANTA, GA 30318

FOR: PROVIDING ON-LINE NON-DOWNLOADABLE SOFTWARE FOR SUPPORTING AND  
MANAGING THE CREATION AND SENDING OF ELECTRONIC MAIL, IN CLASS 42 (U.S.  
CLS. 100 AND 101).

FIRST USE 10-27-2011; IN COMMERCE 10-27-2011.

THE MARK CONSISTS OF STANDARD CHARACTERS WITHOUT CLAIM TO ANY PAR-  
TICULAR FONT, STYLE, SIZE, OR COLOR.

SN 85-213,066, FILED 1-7-2011.

JANICE KIM, EXAMINING ATTORNEY



*David J. Kybas*

Director of the United States Patent and Trademark Office

# United States of America

United States Patent and Trademark Office

## PRIVATE CLIENT SAVINGS SELECT PLUS

**Reg. No. 4,126,501**

JPMORGAN CHASE & CO. (DELAWARE CORPORATION)  
270 PARK AVENUE  
NEW YORK, NY 10017

**Registered Apr. 10, 2012**

**Int. Cl.: 36**

FOR: BANKING AND FINANCIAL SERVICES, NAMELY, PRIVATE BANK DEPOSIT ACCOUNTS, IN CLASS 36 (U.S. CLS. 100, 101 AND 102).

**SERVICE MARK**

FIRST USE 8-0-2011; IN COMMERCE 8-0-2011.

**PRINCIPAL REGISTER**

THE MARK CONSISTS OF STANDARD CHARACTERS WITHOUT CLAIM TO ANY PARTICULAR FONT, STYLE, SIZE, OR COLOR.

NO CLAIM IS MADE TO THE EXCLUSIVE RIGHT TO USE "PRIVATE CLIENT SAVINGS", APART FROM THE MARK AS SHOWN.

SN 85-213,136, FILED 1-7-2011.

DANNEAN HETZEL, EXAMINING ATTORNEY



*David J. Kybas*

Director of the United States Patent and Trademark Office

# United States of America

United States Patent and Trademark Office

## Chase BusinessSelect Checking

**Reg. No. 4,126,502**

JPMORGAN CHASE & CO. (DELAWARE CORPORATION)  
270 PARK AVENUE  
NEW YORK, NY 10017

**Registered Apr. 10, 2012**

**Int. Cl.: 36**

FOR: BANKING AND FINANCIAL SERVICES, NAMELY, CHECKING ACCOUNT SERVICES,  
IN CLASS 36 (U.S. CLS. 100, 101 AND 102).

**SERVICE MARK**

FIRST USE 2-1-2011; IN COMMERCE 2-1-2011.

**PRINCIPAL REGISTER**

THE MARK CONSISTS OF STANDARD CHARACTERS WITHOUT CLAIM TO ANY PAR-  
TICULAR FONT, STYLE, SIZE, OR COLOR.

OWNER OF U.S. REG. NOS. 1,521,765, 3,324,462, AND OTHERS.

NO CLAIM IS MADE TO THE EXCLUSIVE RIGHT TO USE "CHECKING", APART FROM  
THE MARK AS SHOWN.

SN 85-213,201, FILED 1-7-2011.

DANNEAN HETZEL, EXAMINING ATTORNEY



*David J. Kybas*

Director of the United States Patent and Trademark Office

# United States of America

United States Patent and Trademark Office

## Chase BusinessSelect Checking With Interest

**Reg. No. 4,126,503**

JPMORGAN CHASE & CO. (DELAWARE CORPORATION)  
270 PARK AVENUE  
NEW YORK, NY 10017

**Registered Apr. 10, 2012**

**Int. Cl.: 36**

FOR: BANKING AND FINANCIAL SERVICES, NAMELY, CHECKING ACCOUNT SERVICES,  
IN CLASS 36 (U.S. CLS. 100, 101 AND 102).

**SERVICE MARK**

FIRST USE 2-1-2011; IN COMMERCE 2-1-2011.

**PRINCIPAL REGISTER**

THE MARK CONSISTS OF STANDARD CHARACTERS WITHOUT CLAIM TO ANY PAR-  
TICULAR FONT, STYLE, SIZE, OR COLOR.

OWNER OF U.S. REG. NOS. 1,521,765, 3,324,462, AND OTHERS.

NO CLAIM IS MADE TO THE EXCLUSIVE RIGHT TO USE "CHECKING WITH INTEREST",  
APART FROM THE MARK AS SHOWN.

SN 85-213,206, FILED 1-7-2011.

DANNEAN HETZEL, EXAMINING ATTORNEY



*David J. Kybas*

Director of the United States Patent and Trademark Office

# United States of America

United States Patent and Trademark Office



**Reg. No. 4,126,504**

FERRIS, C. WILLIAM (UNITED STATES INDIVIDUAL), DBA SUNBREAK THERAPY,  
13906 CRESCENT VALLEY DR. NW  
GIG HARBOR, WA 98332

**Registered Apr. 10, 2012**

**Int. Cl.: 44**

FOR: MASSAGE THERAPY SERVICES; MENTAL HEALTH SERVICES, IN CLASS 44 (U.S. CLS. 100 AND 101).

**SERVICE MARK**

FIRST USE 10-1-2011; IN COMMERCE 10-1-2011.

**PRINCIPAL REGISTER**

NO CLAIM IS MADE TO THE EXCLUSIVE RIGHT TO USE "THERAPY", APART FROM THE MARK AS SHOWN.

THE COLOR(S) YELLOW, WHITE, AND BLACK IS/ARE CLAIMED AS A FEATURE OF THE MARK.

THE MARK CONSISTS OF A SUN OUTLINED IN YELLOW WITH WHITE INTERIOR WITH YELLOW RAYS BEHIND CLOUDS OUTLINED IN YELLOW AND THE WORDING "SUN-BREAK THERAPY" WRITTEN UNDER THE SUN IN BLACK.

SN 85-213,237, FILED 1-7-2011.

BARBARA BROWN, EXAMINING ATTORNEY



*David J. Kyffers*

Director of the United States Patent and Trademark Office

# United States of America

United States Patent and Trademark Office

# ENCORE

**Reg. No. 4,126,505**

**Registered Apr. 10, 2012**

**Int. Cl.: 41**

**SERVICE MARK**

**PRINCIPAL REGISTER**

CONSOLIDATED GRAPHICS, INC. (TEXAS CORPORATION)  
5858 WESTHEIMER RD., STE. 200  
HOUSTON, TX 77057

FOR: PROVIDING RECOGNITION BY THE WAY OF AWARDS TO DEMONSTRATE EXCELLENCE IN THE FIELD OF PRINTING TECHNOLOGY AND GRAPHIC PROCUREMENT, IN CLASS 41 (U.S. CLS. 100, 101 AND 107).

FIRST USE 11-1-2010; IN COMMERCE 11-1-2010.

THE MARK CONSISTS OF STANDARD CHARACTERS WITHOUT CLAIM TO ANY PARTICULAR FONT, STYLE, SIZE, OR COLOR.

SN 85-213,287, FILED 1-7-2011.

ANGELA M. MICHELI, EXAMINING ATTORNEY



*David J. Kyffers*

Director of the United States Patent and Trademark Office



# United States of America

United States Patent and Trademark Office

## PRESSURE SAFE

**Reg. No. 4,126,506**

MORASCH, STEVEN J. (UNITED STATES INDIVIDUAL)  
4050 NE 158TH  
PORTLAND, OR 97230 AND

**Registered Apr. 10, 2012**

**Int. Cl.: 40**

MORASCH, MICHAEL N. (UNITED STATES INDIVIDUAL)  
4050 NE 158TH  
PORTLAND, OR 97230

**SERVICE MARK**

**PRINCIPAL REGISTER**

FOR: FOOD PRESERVATION SERVICES; FOOD PROCESSING; PROVIDING TECHNICAL INFORMATION IN THE FIELD OF FOOD PROCESSING, IN CLASS 40 (U.S. CLS. 100, 103 AND 106).

FIRST USE 12-21-2011; IN COMMERCE 12-21-2011.

THE MARK CONSISTS OF STANDARD CHARACTERS WITHOUT CLAIM TO ANY PARTICULAR FONT, STYLE, SIZE, OR COLOR.

SN 85-213,599, FILED 1-9-2011.

DAVID TAYLOR, EXAMINING ATTORNEY



*David J. Kyros*

Director of the United States Patent and Trademark Office

# United States of America

United States Patent and Trademark Office

# NOVAGRAFT

**Reg. No. 4,126,507**

HUMPHREY, BRUCE (UNITED STATES INDIVIDUAL)  
8 OLD FORGE ROAD  
ANDOVER, NJ 07821

**Registered Apr. 10, 2012**

**Int. Cl.: 5**

FOR: HUMAN ALLOGRAFT BONE AND TISSUE, IN CLASS 5 (U.S. CLS. 6, 18, 44, 46, 51 AND 52).

**TRADEMARK**

FIRST USE 7-11-2010; IN COMMERCE 11-8-2010.

**PRINCIPAL REGISTER**

THE MARK CONSISTS OF STANDARD CHARACTERS WITHOUT CLAIM TO ANY PARTICULAR FONT, STYLE, SIZE, OR COLOR.

SN 85-213,735, FILED 1-10-2011.

GINA HAYES, EXAMINING ATTORNEY



*David J. Kybas*

Director of the United States Patent and Trademark Office

# United States of America

United States Patent and Trademark Office



**Reg. No. 4,126,508**

PREMIER 3D ANIMATION LLC (MICHIGAN LIMITED LIABILITY COMPANY)  
25853 MULBERRY LANE  
NOVI, MI 48202

**Registered Apr. 10, 2012**

**Int. Cl.: 9**

FOR: VIDEO GAME SOFTWARE, IN CLASS 9 (U.S. CLS. 21, 23, 26, 36 AND 38).

**TRADEMARK**

FIRST USE 5-1-2010; IN COMMERCE 5-1-2010.

**PRINCIPAL REGISTER**

THE MARK CONSISTS OF THE STYLIZED WORDS "THE GREAT BIBLE RACE" IN A STACKED FORMATION.

SN 85-213,989, FILED 1-10-2011.

WILLIAM ROSSMAN, EXAMINING ATTORNEY



*David J. Kyffers*

Director of the United States Patent and Trademark Office

# United States of America

United States Patent and Trademark Office

# HALSEY

**Reg. No. 4,126,509**

JOHNSON III, WILLIAM H. (UNITED STATES INDIVIDUAL)  
28961 PALOS VERDES DRIVE EAST  
RANCHO PALOS VERDES, CA 90275

**Registered Apr. 10, 2012**

**Int. Cl.: 25**

FOR: CLOTHING, NAMELY, PANTS, SHORTS, JACKETS, SHIRTS, SWEATSHIRTS, VESTS, HEADWEAR, IN CLASS 25 (U.S. CLS. 22 AND 39).

**TRADEMARK**

FIRST USE 9-0-2011; IN COMMERCE 9-0-2011.

**PRINCIPAL REGISTER**

THE MARK CONSISTS OF STANDARD CHARACTERS WITHOUT CLAIM TO ANY PARTICULAR FONT, STYLE, SIZE, OR COLOR.

SN 85-213,992, FILED 1-10-2011.

H. M. FISHER, EXAMINING ATTORNEY



*David J. Kybas*

Director of the United States Patent and Trademark Office

# United States of America

United States Patent and Trademark Office

## THE HERO COMES FROM WITHIN

**Reg. No. 4,126,510**

**Registered Apr. 10, 2012**

**Int. Cl.: 25**

**TRADEMARK**

**PRINCIPAL REGISTER**

CAGE HERO, LLC (FLORIDA LIMITED LIABILITY COMPANY)  
9050 PINES BLVD., SUITE 301  
PEMBROKE PINES, FL 330246442

FOR: CLOTHING AND ATHLETIC APPAREL, NAMELY, SHIRTS, PANTS, JACKETS, FOOTWEAR, HATS AND CAPS, ATHLETIC UNIFORMS, PANTIES, SHORTS, BRIEFS, SHORT-SLEEVED OR LONG-SLEEVED T-SHIRTS, SPORT SHIRTS, SWEATSHIRTS; HATS, NAMELY, BASEBALL CAPS, WOOLLY HATS; RASHGUARDS; FOOTWEAR, IN CLASS 25 (U.S. CLS. 22 AND 39).

FIRST USE 6-1-2010; IN COMMERCE 1-18-2012.

THE MARK CONSISTS OF STANDARD CHARACTERS WITHOUT CLAIM TO ANY PARTICULAR FONT, STYLE, SIZE, OR COLOR.

SN 85-214,079, FILED 1-10-2011.

ALLISON SCHRODY, EXAMINING ATTORNEY



*David J. Kybas*

Director of the United States Patent and Trademark Office

# United States of America

United States Patent and Trademark Office

## RUNWAY BY ECHODESIGN

**Reg. No. 4,126,511**

THE ECHO DESIGN GROUP, INC. (NEW YORK CORPORATION)  
10 EAST 40TH STREET  
NEW YORK, NY 10016

**Registered Apr. 10, 2012**

**Int. Cl.: 25**

FOR: GLOVES, IN CLASS 25 (U.S. CLS. 22 AND 39).

**TRADEMARK**

FIRST USE 3-7-2011; IN COMMERCE 3-7-2011.

**PRINCIPAL REGISTER**

THE MARK CONSISTS OF STANDARD CHARACTERS WITHOUT CLAIM TO ANY PARTICULAR FONT, STYLE, SIZE, OR COLOR.

SN 85-214,964, FILED 1-11-2011.

DAVID H. STINE, EXAMINING ATTORNEY



*David J. Kybas*

Director of the United States Patent and Trademark Office

# United States of America

United States Patent and Trademark Office

## TECHDEFENDER

**Reg. No. 4,126,512**

**Registered Apr. 10, 2012**

**Int. Cl.: 36**

**SERVICE MARK**

**PRINCIPAL REGISTER**

IRONSHORE INC. (CAYMAN ISLANDS CORPORATION)  
CENTURY YARD, CRICKET SQUARE  
HUTCHINS DRIVE, P.O. BOX 2681 GT  
GEORGE TOWN, CAYMAN ISLANDS

FOR: INSURANCE UNDERWRITING SERVICES IN THE FIELD OF PROFESSIONAL LIABILITY, IN CLASS 36 (U.S. CLS. 100, 101 AND 102).

FIRST USE 5-24-2011; IN COMMERCE 5-24-2011.

THE MARK CONSISTS OF STANDARD CHARACTERS WITHOUT CLAIM TO ANY PARTICULAR FONT, STYLE, SIZE, OR COLOR.

SN 85-215,085, FILED 1-11-2011.

DAVID TAYLOR, EXAMINING ATTORNEY



*David J. Kyffers*

Director of the United States Patent and Trademark Office

# United States of America

United States Patent and Trademark Office

## COLD STEEL

**Reg. No. 4,126,513**

**Registered Apr. 10, 2012**

**Int. Cl.: 33**

**TRADEMARK**

**PRINCIPAL REGISTER**

LENAHAN, CHRIS (UNITED STATES INDIVIDUAL)  
35 NW 3RD AVENUE  
PORTLAND, OR 97209

FOR: VODKA, IN CLASS 33 (U.S. CLS. 47 AND 49).

FIRST USE 11-20-2011; IN COMMERCE 11-20-2011.

THE MARK CONSISTS OF STANDARD CHARACTERS WITHOUT CLAIM TO ANY PARTICULAR FONT, STYLE, SIZE, OR COLOR.

SN 85-215,412, FILED 1-11-2011.

AISHA CLARKE, EXAMINING ATTORNEY



*David J. Kybas*

Director of the United States Patent and Trademark Office



# United States of America

United States Patent and Trademark Office

# THE BEAST

**Reg. No. 4,126,514**

MORALES, FELIPE E. (UNITED STATES INDIVIDUAL)  
323 E. NAKOMA  
SAN ANTONIO, TX 78216

**Registered Apr. 10, 2012**

**Int. Cl.: 11**

FOR: BARBECUE GRILLS; BARBECUE SMOKERS, IN CLASS 11 (U.S. CLS. 13, 21, 23, 31 AND 34).

**TRADEMARK**

FIRST USE 11-30-2011; IN COMMERCE 11-30-2011.

**PRINCIPAL REGISTER**

THE MARK CONSISTS OF STANDARD CHARACTERS WITHOUT CLAIM TO ANY PARTICULAR FONT, STYLE, SIZE, OR COLOR.

SN 85-215,729, FILED 1-12-2011.

KATHERINE STOIDES, EXAMINING ATTORNEY



*David J. Kyffers*

Director of the United States Patent and Trademark Office

# United States of America

United States Patent and Trademark Office

# SCORECHECK

**Reg. No. 4,126,515**

INTERSECTIONS INC. (DELAWARE CORPORATION)  
3901 STONECROFT BLVD.  
CHANTILLY, VA 20151

**Registered Apr. 10, 2012**

**Int. Cls.: 35, 36, and 45**

FOR: MONITORING CONSUMER CREDIT REPORTS AND CREDIT SCORES; PROVIDING AN ALERT AS TO CERTAIN CHANGES IN CREDIT REPORTS, IN CLASS 35 (U.S. CLS. 100, 101 AND 102).

**SERVICE MARK**

FIRST USE 5-25-2011; IN COMMERCE 5-25-2011.

**PRINCIPAL REGISTER**

FOR: PROVIDING CREDIT REPORTING DATA MAINTAINED BY OTHERS; PROVIDING IDENTITY THEFT INSURANCE UNDERWRITTEN BY OTHERS; PROVIDING CONSULTATION REGARDING CREDIT REPORTS AND CREDIT SCORES; FRAUD RESOLUTION ASSISTANCE, NAMELY, ASSISTANCE WITH DISPUTING FRAUDULENT ACTIVITY ON CREDIT REPORTS AND RESTORING CREDIT DAMAGED BY IDENTITY THEFT; PROVIDING FINANCIAL CALCULATORS, IN CLASS 36 (U.S. CLS. 100, 101 AND 102).

FIRST USE 5-25-2011; IN COMMERCE 5-25-2011.

FOR: PROVIDING ADVICE AND CONSULTATION IN THE FIELD OF IDENTITY THEFT; IDENTITY THEFT PROTECTION SERVICES, NAMELY, MONITORING PERSONAL IDENTITY INFORMATION AND FINANCIAL IDENTITY FOR PREVENTION OF IDENTITY THEFT AND FRAUD; IDENTITY MANAGEMENT SERVICES, NAMELY, OBTAINING CREDIT INFORMATION AND OTHER PUBLIC AND PERSONAL IDENTITY INFORMATION FOR USE IN PROVIDING REPORTS ON IMPACT OF ACTIVITIES ON CREDIT SCORES, IN CLASS 45 (U.S. CLS. 100 AND 101).

FIRST USE 5-25-2011; IN COMMERCE 5-25-2011.

THE MARK CONSISTS OF STANDARD CHARACTERS WITHOUT CLAIM TO ANY PARTICULAR FONT, STYLE, SIZE, OR COLOR.

SN 85-215,737, FILED 1-12-2011.

MAYUR VAGHANI, EXAMINING ATTORNEY



*David J. Kyros*

Director of the United States Patent and Trademark Office

# United States of America

United States Patent and Trademark Office

## ZERONET MODULAR HOMES

**Reg. No. 4,126,516**

**Registered Apr. 10, 2012**

**Int. Cl.: 19**

**TRADEMARK**

**PRINCIPAL REGISTER**

KRZYWICKI, VAN B. (UNITED STATES INDIVIDUAL), DBA ZERONET MODULAR HOMES,  
122 FISH CABIN RD  
GLEN SPEY, NY 12737

FOR: MODULAR HOMES, IN CLASS 19 (U.S. CLS. 1, 12, 33 AND 50).

FIRST USE 1-4-2011; IN COMMERCE 9-22-2011.

THE MARK CONSISTS OF STANDARD CHARACTERS WITHOUT CLAIM TO ANY PARTICULAR FONT, STYLE, SIZE, OR COLOR.

NO CLAIM IS MADE TO THE EXCLUSIVE RIGHT TO USE "MODULAR HOMES", APART FROM THE MARK AS SHOWN.

SN 85-215,740, FILED 1-12-2011.

FRANK LATTUCA, EXAMINING ATTORNEY



*David J. Kyffers*

Director of the United States Patent and Trademark Office

# United States of America

United States Patent and Trademark Office

## ONE NATION. ONE SPIRIT.

**Reg. No. 4,126,517**

**Registered Apr. 10, 2012**

**Int. Cl.: 33**

SIDNEY FRANK IMPORTING CO., INC. (NEW YORK CORPORATION)  
SUITE 203  
20 CEDAR STREET  
NEW ROCHELLE, NY 10801

FOR: DISTILLED SPIRITS, IN CLASS 33 (U.S. CLS. 47 AND 49).

**TRADEMARK**

FIRST USE 4-21-2011; IN COMMERCE 4-21-2011.

**PRINCIPAL REGISTER**

THE MARK CONSISTS OF STANDARD CHARACTERS WITHOUT CLAIM TO ANY PARTICULAR FONT, STYLE, SIZE, OR COLOR.

NO CLAIM IS MADE TO THE EXCLUSIVE RIGHT TO USE "SPIRIT", APART FROM THE MARK AS SHOWN.

SN 85-215,869, FILED 1-12-2011.

SHAUNIA CARLYLE, EXAMINING ATTORNEY



*David J. Kyffers*

Director of the United States Patent and Trademark Office

# United States of America

United States Patent and Trademark Office

# SWITCHLAB

**Reg. No. 4,126,518**

**Registered Apr. 10, 2012**

**Int. Cl.: 9**

**TRADEMARK**

**PRINCIPAL REGISTER**

SWITCHLAB INC. (TAIWAN CORPORATION)  
8FL., NO. 66, CHUNG CHENG RD.  
HSIN CHUANG CITY  
TAIPEI HSIEN, TAIWAN

FOR: AUTOMATIC ELECTRICAL DISTRIBUTION APPARATUS; AUTOMATIC SWITCH-BOARDS; CIRCUIT BREAKERS; CONNECTORS FOR ELECTRONIC CIRCUITS; CONVERTERS FOR ELECTRIC PLUGS; CURRENT CONVERTERS; CUT-OUT SWITCHES; ELECTRIC CAPACITORS; ELECTRIC CONTROL PANELS; ELECTRIC CONVERTERS; ELECTRIC FUSE BOXES; ELECTRIC PLUGS; ELECTRIC RELAYS; ELECTRIC RESISTORS; ELECTRIC SOCKETS; ELECTRIC SWITCH PLATES; ELECTRIC SWITCHES; ELECTRIC TRANSFORMERS; ELECTRICAL AND ELECTRONIC CONNECTORS; ELECTRICAL DISTRIBUTION BOXES; ELECTRODES; ELECTROMAGNETIC COILS; HEAT SINKS FOR USE IN ELECTRONIC COMPONENTS; HIGH FREQUENCY SWITCHES; HIGH-FREQUENCY SWITCHING POWER SUPPLIES; POWER SUPPLIES; POWER SWITCHES; RECTIFIERS; REMOTE CIRCUIT BREAKER CONTROL SWITCH OPERATORS; SOLENOID VALVES; SWITCH BOXES; VOLTAGE REGULATORS; VOLTAGE REGULATORS FOR ELECTRIC POWER; VOLTAGE STABILIZING POWER SUPPLY, IN CLASS 9 (U.S. CLS. 21, 23, 26, 36 AND 38).

FIRST USE 3-1-2011; IN COMMERCE 3-1-2011.

THE MARK CONSISTS OF STANDARD CHARACTERS WITHOUT CLAIM TO ANY PARTICULAR FONT, STYLE, SIZE, OR COLOR.

SN 85-215,914, FILED 1-12-2011.

AISHA CLARKE, EXAMINING ATTORNEY



*David J. Kybas*

Director of the United States Patent and Trademark Office

# United States of America

United States Patent and Trademark Office

## VICTOR MOON

**Reg. No. 4,126,519**

MELTZER, MELANIE (UNITED STATES INDIVIDUAL)  
502 1/2 POINSETTIA  
CORONA DEL MAR, CA 92625

**Registered Apr. 10, 2012**

**Int. Cl.: 25**

FOR: CLOTHING, NAMELY, T-SHIRTS, AND HEADWEAR, IN CLASS 25 (U.S. CLS. 22 AND 39).

**TRADEMARK**

FIRST USE 1-24-2012; IN COMMERCE 1-24-2012.

**PRINCIPAL REGISTER**

THE MARK CONSISTS OF STANDARD CHARACTERS WITHOUT CLAIM TO ANY PARTICULAR FONT, STYLE, SIZE, OR COLOR.

THE NAME(S), PORTRAIT(S), AND/OR SIGNATURE(S) SHOWN IN THE MARK DOES NOT IDENTIFY A PARTICULAR LIVING INDIVIDUAL.

SN 85-216,008, FILED 1-12-2011.

MEGHAN REINHART, EXAMINING ATTORNEY



*David J. Kybas*

Director of the United States Patent and Trademark Office

# United States of America

United States Patent and Trademark Office



**Reg. No. 4,126,520**

MELTZER, MELANIE (UNITED STATES INDIVIDUAL)  
502 1/2 POINSETTIA  
CORONA DEL MAR, CA 92625

**Registered Apr. 10, 2012**

**Int. Cl.: 25**

FOR: CLOTHING, NAMELY, T-SHIRTS, AND HEADWEAR, IN CLASS 25 (U.S. CLS. 22 AND 39).

**TRADEMARK**

FIRST USE 1-24-2012; IN COMMERCE 1-24-2012.

**PRINCIPAL REGISTER**

THE MARK CONSISTS OF AN INCOMPLETE, INVERSE TRIANGLE THAT RESEMBLES THE LETTER "V" FOLLOWED BY A VERTICALLY ANGLED BAR AND A VERTICALLY ANGLED INCOMPLETE BAR.

SN 85-216,025, FILED 1-12-2011.

MEGHAN REINHART, EXAMINING ATTORNEY



*David J. Kybas*

Director of the United States Patent and Trademark Office

# United States of America

United States Patent and Trademark Office

# Heyoka

**Reg. No. 4,126,521**

URBAN INDIAN LLC (PENNSYLVANIA LIMITED LIABILITY COMPANY)  
8845 BROCKLEHURST ST.  
PHILADELPHIA, PA 19152

**Registered Apr. 10, 2012**

**Int. Cl.: 25**

FOR: DRESSES; PONCHOS; SCARVES; SHIRTS; SWEATERS; SWEATSHIRTS; VESTS, IN CLASS 25 (U.S. CLS. 22 AND 39).

**TRADEMARK**

FIRST USE 7-1-2011; IN COMMERCE 7-1-2011.

**PRINCIPAL REGISTER**

THE MARK CONSISTS OF STANDARD CHARACTERS WITHOUT CLAIM TO ANY PARTICULAR FONT, STYLE, SIZE, OR COLOR.

SN 85-216,436, FILED 1-12-2011.

JENNIFER MARTIN, EXAMINING ATTORNEY



*David J. Kybas*

Director of the United States Patent and Trademark Office



# United States of America

United States Patent and Trademark Office

# MyLVAD

**Reg. No. 4,126,522**

MYLVAD LLC (D.C. LIMITED LIABILITY COMPANY)  
110 IRVING STREET NW, SUITE 1E3  
WASHINGTON, DC 20010

**Registered Apr. 10, 2012**

**Int. Cl.: 45**

FOR: ONLINE SOCIAL NETWORKING SERVICES PROVIDED THROUGH A COMMUNITY WEBSITE THAT CONNECTS PATIENTS WITH COMMON MEDICAL ISSUES, IN CLASS 45 (U.S. CLS. 100 AND 101).

**SERVICE MARK**

FIRST USE 1-9-2012; IN COMMERCE 1-9-2012.

**PRINCIPAL REGISTER**

THE MARK CONSISTS OF STANDARD CHARACTERS WITHOUT CLAIM TO ANY PARTICULAR FONT, STYLE, SIZE, OR COLOR.

SN 85-216,437, FILED 1-12-2011.

CHARLES L. JENKINS, EXAMINING ATTORNEY



*David J. Kyffers*

Director of the United States Patent and Trademark Office

# United States of America

United States Patent and Trademark Office

MAKES GOOD COFFEE GREAT

**Reg. No. 4,126,523**

VITA PERK, LLC (MICHIGAN LIMITED LIABILITY COMPANY)  
621 GRAEFIELD COURT  
BIRMINGHAM, MI 48009

**Registered Apr. 10, 2012**

**Int. Cl.: 5**

FOR: NATURAL VITAMIN AND MINERAL SUPPLEMENT ADDITIVE FOR BEVERAGES INCLUDING COFFEE, IN CLASS 5 (U.S. CLS. 6, 18, 44, 46, 51 AND 52).

**TRADEMARK**

FIRST USE 4-15-2011; IN COMMERCE 4-15-2011.

**PRINCIPAL REGISTER**

THE MARK CONSISTS OF STANDARD CHARACTERS WITHOUT CLAIM TO ANY PARTICULAR FONT, STYLE, SIZE, OR COLOR.

SN 85-216,993, FILED 1-13-2011.

MATTHEW PAPPAS, EXAMINING ATTORNEY



*David J. Kypas*

Director of the United States Patent and Trademark Office

# United States of America

United States Patent and Trademark Office



**Reg. No. 4,126,524**

BARNIE'S II, INC. (FLORIDA CORPORATION)  
2126 W. LANDSTREET ROAD, SUITE 300  
ORLANDO, FL 32809

**Registered Apr. 10, 2012**

**Int. Cl.: 43**

FOR: RESTAURANT SERVICES, IN CLASS 43 (U.S. CLS. 100 AND 101).

**SERVICE MARK**

FIRST USE 2-10-2011; IN COMMERCE 2-10-2011.

**PRINCIPAL REGISTER**

OWNER OF U.S. REG. NOS. 3,255,590, 3,425,962, AND OTHERS.

THE COLOR(S) GREEN AND BROWN IS/ARE CLAIMED AS A FEATURE OF THE MARK.

THE MARK CONSISTS OF THE WORDING "BARNIE'S ESPRESSO" WITH WORD "BARNIE'S" APPEARING IN GREEN ABOVE A BANNER WITH BROWN EDGES AND THE WORDING "ESPRESSO" APPEARING IN BROWN WITHIN.

SN 85-217,095, FILED 1-13-2011.

JACLYN KIDWELL WALKER, EXAMINING ATTORNEY



*David J. Kyros*

Director of the United States Patent and Trademark Office

# United States of America

United States Patent and Trademark Office

## The Imitation of Christ

**Reg. No. 4,126,525**

JOHN AUGUST MEDIA, LLC (WASHINGTON LIMITED LIABILITY COMPANY)  
832 MADISON AVE., N.

**Registered Apr. 10, 2012**

BAINBRIDGE ISLAND, WA 98110

**Int. Cl.: 41**

FOR: MULTIMEDIA PUBLISHING OF BOOKS, MAGAZINES, JOURNALS, SOFTWARE, GAMES, MUSIC, AND ELECTRONIC PUBLICATIONS, IN CLASS 41 (U.S. CLS. 100, 101 AND 107).

**SERVICE MARK**

FIRST USE 12-15-2011; IN COMMERCE 12-20-2011.

**PRINCIPAL REGISTER**

THE MARK CONSISTS OF STANDARD CHARACTERS WITHOUT CLAIM TO ANY PARTICULAR FONT, STYLE, SIZE, OR COLOR.

SN 85-217,139, FILED 1-13-2011.

EMILY CHUO, EXAMINING ATTORNEY



*David J. Kyffers*

Director of the United States Patent and Trademark Office

# United States of America

United States Patent and Trademark Office

# P-LIFT

**Reg. No. 4,126,526**

SPINEFRONTIER, INC. (DELAWARE CORPORATION)  
500 CUMMINGS CENTER, SUITE 3500  
BEVERLY, MA 01915

**Registered Apr. 10, 2012**

**Int. Cl.: 10**

FOR: SURGICAL IMPLANTS COMPRISING ARTIFICIAL MATERIAL AND ASSOCIATED SURGICAL INSTRUMENT SETS, IN CLASS 10 (U.S. CLS. 26, 39 AND 44).

**TRADEMARK**

FIRST USE 11-30-2011; IN COMMERCE 11-30-2011.

**PRINCIPAL REGISTER**

THE MARK CONSISTS OF STANDARD CHARACTERS WITHOUT CLAIM TO ANY PARTICULAR FONT, STYLE, SIZE, OR COLOR.

SN 85-217,189, FILED 1-13-2011.

TRACY WHITTAKER-BROWN, EXAMINING ATTORNEY



*David J. Kybas*

Director of the United States Patent and Trademark Office

# United States of America

United States Patent and Trademark Office



**Reg. No. 4,126,527**

**Registered Apr. 10, 2012**

**Int. Cls.: 6 and 7**

**TRADEMARK**

**PRINCIPAL REGISTER**

AI ENTERPRISES, INC. (SOUTH DAKOTA CORPORATION)  
P.O. BOX 20  
YANKTON, SD 57078

FOR: METAL SILOS, NAMELY, ASPHALT STORAGE SILOS, DUST SILOS AND SELF-ERECT SILOS; METAL STORAGE TANKS, NAMELY, ASPHALT STORAGE TANKS , IN CLASS 6 (U.S. CLS. 2, 12, 13, 14, 23, 25 AND 50).

FIRST USE 1-0-2012; IN COMMERCE 1-0-2012.

FOR: MACHINES, NAMELY, ASPHALT MANUFACTURING AND PROCESSING EQUIPMENT IN THE NATURE OF PORTABLE AND STATIONARY ASPHALT PLANTS, DRUM DRYERS, MIXERS, COLDFEED SYSTEMS COMPRISED OF BINS, CONVEYORS, SHAKER SCREENS AND STANDS THEREFOR, SOLD AS A UNIT, RECYCLE SYSTEMS COMPRISED OF BINS, CONVEYORS, SHAKER SCREENS AND STANDS THEREFOR, SOLD AS A UNIT, BAGHOUSES, AIR POLLUTION CONTROL SYSTEMS COMPRISED OF REVERSE PULSE BAGHOUSES, PRIMARY COLLECTORS AND CYCLONES, SOLD AS A UNIT, DRAG SLATS, TRANSFER CONVEYORS, PLANT CONTROLS AND CONTROL HOUSES, IN CLASS 7 (U.S. CLS. 13, 19, 21, 23, 31, 34 AND 35).

FIRST USE 10-0-2011; IN COMMERCE 10-0-2011.

OWNER OF U.S. REG. NOS. 1,027,027, 1,946,261, AND OTHERS.

NO CLAIM IS MADE TO THE EXCLUSIVE RIGHT TO USE "A DIVISION OF" AND "INC.", APART FROM THE MARK AS SHOWN.

THE MARK CONSISTS OF THE STYLIZED CAPITAL LETTER "A" AND LOWERCASE "I" OVERLAPPING EACH OTHER ABOVE THE WORDING "DILLMAN" AND "A DIVISION OF ASTEC, INC."

SN 85-217,242, FILED 1-13-2011.

KATINA MISTER, EXAMINING ATTORNEY



*David J. Kyffers*

Director of the United States Patent and Trademark Office

# United States of America

United States Patent and Trademark Office

# BRS

**Reg. No. 4,126,528**

**Registered Apr. 10, 2012**

**Int. Cls.: 9, 35, and 42**

**TRADEMARK**

**SERVICE MARK**

**PRINCIPAL REGISTER**

THE BURGESS GROUP, L.L.C. (DELAWARE LIMITED LIABILITY COMPANY)  
1701 DUKE STREET, 3RD FLOOR  
ALEXANDRIA, VA 22314

FOR: SOFTWARE FOR PRICING CLAIMS, ANALYZING DATA, RESEARCHING RATES AND POLICIES IN THE FIELD OF MEDICARE REIMBURSEMENT AND HEALTHCARE ECONOMICS, IN CLASS 9 (U.S. CLS. 21, 23, 26, 36 AND 38).

FIRST USE 1-4-2012; IN COMMERCE 1-4-2012.

FOR: CONSULTING SERVICES IN THE FIELD OF HEALTHCARE ECONOMICS, NAMELY, APPLYING MEDICARE PAYMENT POLICIES FOR ANALYSIS AND USING MEDICARE CLAIMS DATABASES FOR RESEARCH; BUSINESS CONSULTING SERVICES IN THE FIELD OF ADMINISTRATION OF MEDICARE REIMBURSEMENT PROGRAMS, IN CLASS 35 (U.S. CLS. 100, 101 AND 102).

FIRST USE 6-0-2011; IN COMMERCE 6-0-2011.

FOR: PROVIDING TEMPORARY USE OF ON-LINE NON-DOWNLOADABLE SOFTWARE FOR PRICING CLAIMS, ANALYZING DATA, RESEARCHING RATES AND POLICIES IN THE FIELD OF MEDICARE REIMBURSEMENT AND HEALTHCARE ECONOMICS, IN CLASS 42 (U.S. CLS. 100 AND 101).

FIRST USE 1-4-2012; IN COMMERCE 1-4-2012.

THE MARK CONSISTS OF STANDARD CHARACTERS WITHOUT CLAIM TO ANY PARTICULAR FONT, STYLE, SIZE, OR COLOR.

SN 85-217,327, FILED 1-13-2011.

MATTHEW KLINE, EXAMINING ATTORNEY



*David J. Kyjars*

Director of the United States Patent and Trademark Office

# United States of America

United States Patent and Trademark Office

## BOXES OF LOVE

**Reg. No. 4,126,529**

**Registered Apr. 10, 2012**

**Int. Cls.: 29, 35, 36, 43,  
and 45**

**TRADEMARK**

**SERVICE MARK**

**PRINCIPAL REGISTER**

CAMPUS CRUSADE FOR CHRIST, INC. (CALIFORNIA CORPORATION), AKA CAMPUS CRUSADE FOR CHRIST; CAMPUS CRUSADE FOR CHRIST INTERNATIONAL; CCCI, ATTN: GENERAL COUNSEL'S OFFICE IP TEAM  
100 LAKE HART DRIVE-3500  
ORLANDO, FL 328320100

FOR: ASSEMBLED FOOD KITS CONTAINING VARIOUS COMBINATIONS OF SELECTED FOOD ITEMS COMPRISING PRIMARILY MEAT, CANNED VEGETABLES, CANNED FRUIT, CANNED SOUP, RICE, PACKAGED MIXES FOR MUFFINS, BREAD STUFFING, DESSERT PUDDINGS, AND BAKED DESSERTS, FRESH VEGETABLES, FRESH FRUIT, NON-ALCOHOLIC BEVERAGES, AND OTHER FOOD PRODUCTS, TO BE DISTRIBUTED TO NEEDY PERSONS, IN CLASS 29 (U.S. CL. 46).

FIRST USE 11-1-1987; IN COMMERCE 11-1-1987.

FOR: CHARITABLE SERVICES, NAMELY, COORDINATION OF THE PROCUREMENT AND DISTRIBUTION OF FOOD DONATIONS FROM INDIVIDUALS, NON-PROFIT ORGANIZATIONS, MANUFACTURERS, WHOLESALERS, AND RETAILERS TO ORGANIZATIONS PROVIDING FREE FOOD TO NEEDY PEOPLE, IN CLASS 35 (U.S. CLS. 100, 101 AND 102).

FIRST USE 11-1-1987; IN COMMERCE 11-1-1987.

FOR: FUNDRAISING ACTIVITIES FOR THE DISTRIBUTION OF FOOD, GOODS AND RELIGIOUS MATERIALS TO NEEDY PERSONS, IN CLASS 36 (U.S. CLS. 100, 101 AND 102).

FIRST USE 11-1-1987; IN COMMERCE 11-1-1987.

FOR: CHARITABLE SERVICES, NAMELY, PROVIDING FOOD TO NEEDY PERSONS, IN CLASS 43 (U.S. CLS. 100 AND 101).

FIRST USE 11-1-1987; IN COMMERCE 11-1-1987.

FOR: PROVIDING INFORMATION IN THE NATURE OF RELIGIOUS WORKS AND MATERIALS TO NEEDY PERSONS, IN CLASS 45 (U.S. CLS. 100 AND 101).

FIRST USE 11-1-1987; IN COMMERCE 11-1-1987.



*David J. Kyffers*

Director of the United States Patent and Trademark Office



**Reg. No. 4,126,529** THE MARK CONSISTS OF STANDARD CHARACTERS WITHOUT CLAIM TO ANY PARTICULAR FONT, STYLE, SIZE, OR COLOR.

SN 85-217,490, FILED 1-13-2011.

LINDA POWELL, EXAMINING ATTORNEY

# United States of America

United States Patent and Trademark Office

# BioVeteria

**Reg. No. 4,126,530**

**Registered Apr. 10, 2012**

**Int. Cl.: 5**

**TRADEMARK**

**PRINCIPAL REGISTER**

BIOVETERIA LIFE SCIENCES, LLC (ARIZONA LIMITED LIABILITY COMPANY),  
FORMERLY VETERIA ANIMAL HEALTH, LLC,  
1042 WILLOW CREEK RD  
PRESCOTT, AZ 86301

FOR: VETERINARY PREPARATIONS FOR COMPANION ANIMALS AND LIVESTOCK, IN  
CLASS 5 (U.S. CLS. 6, 18, 44, 46, 51 AND 52).

FIRST USE 10-1-2011; IN COMMERCE 10-1-2011.

THE MARK CONSISTS OF STANDARD CHARACTERS WITHOUT CLAIM TO ANY PAR-  
TICULAR FONT, STYLE, SIZE, OR COLOR.

SN 85-217,800, FILED 1-14-2011.

NAAKWAMA ANKRAH, EXAMINING ATTORNEY



*David J. Kyffers*

Director of the United States Patent and Trademark Office

# United States of America

United States Patent and Trademark Office

# CIGAR LIFE

**Reg. No. 4,126,531**

**Registered Apr. 10, 2012**

**Int. Cl.: 16**

**TRADEMARK**

**PRINCIPAL REGISTER**

K. HANSOTIA & CO., INC. (FLORIDA CORPORATION)  
3705 N.W. 115 AVENUE  
BAY #5  
MIAMI, FL 33178

FOR: MAGAZINES, BOOKS, PAMPHLETS, STICKERS, NEWSLETTERS, JOURNALS, PRINTED GUIDES, POSTERS, POSTCARDS, BOOKMARKS, CALENDARS, WRITING INSTRUMENTS, AND CIGAR BANDS FEATURING THE SUBJECT OF CIGARS, IN CLASS 16 (U.S. CLS. 2, 5, 22, 23, 29, 37, 38 AND 50).

FIRST USE 7-25-2011; IN COMMERCE 7-25-2011.

THE MARK CONSISTS OF STANDARD CHARACTERS WITHOUT CLAIM TO ANY PARTICULAR FONT, STYLE, SIZE, OR COLOR.

NO CLAIM IS MADE TO THE EXCLUSIVE RIGHT TO USE "CIGAR", APART FROM THE MARK AS SHOWN.

SN 85-218,100, FILED 1-14-2011.

CARRIE GENOVESE, EXAMINING ATTORNEY



*David J. Kyffers*

Director of the United States Patent and Trademark Office

# United States of America

United States Patent and Trademark Office

# EZVIEW

**Reg. No. 4,126,532**

**Registered Apr. 10, 2012**

**Int. Cl.: 9**

SAMSUNG OPTO-ELECTRONICS AMERICA, INC. (NEW JERSEY CORPORATION), DBA  
SAMSUNG TECHWIN AMERICA,  
SUITE 700  
100 CHALLENGER ROAD  
RIDGEFIELD PARK, NJ 07660

**TRADEMARK**

FOR: BABY MONITORS, IN CLASS 9 (U.S. CLS. 21, 23, 26, 36 AND 38).

**PRINCIPAL REGISTER**

FIRST USE 12-1-2010; IN COMMERCE 5-1-2011.

THE MARK CONSISTS OF STANDARD CHARACTERS WITHOUT CLAIM TO ANY PARTICULAR FONT, STYLE, SIZE, OR COLOR.

SN 85-218,117, FILED 1-14-2011.

KIMBERLY PERRY, EXAMINING ATTORNEY



*David J. Kybas*

Director of the United States Patent and Trademark Office

# United States of America

United States Patent and Trademark Office

# SMARTVIEW

**Reg. No. 4,126,533**

**Registered Apr. 10, 2012**

**Int. Cl.: 9**

**TRADEMARK**

**PRINCIPAL REGISTER**

SAMSUNG OPTO-ELECTRONICS AMERICA, INC. (NEW JERSEY CORPORATION), DBA  
SAMSUNG TECHWIN AMERICA,  
SUITE 700  
100 CHALLENGER ROAD  
RIDGEFIELD PARK, NJ 07660

FOR: BABY MONITORS, IN CLASS 9 (U.S. CLS. 21, 23, 26, 36 AND 38).

FIRST USE 12-1-2010; IN COMMERCE 5-1-2011.

THE MARK CONSISTS OF STANDARD CHARACTERS WITHOUT CLAIM TO ANY PARTICULAR FONT, STYLE, SIZE, OR COLOR.

SN 85-218,124, FILED 1-14-2011.

KIMBERLY PERRY, EXAMINING ATTORNEY



*David J. Kyffers*

Director of the United States Patent and Trademark Office

# United States of America

United States Patent and Trademark Office

## CIGAR ADVOCATE

**Reg. No. 4,126,534**

**Registered Apr. 10, 2012**

**Int. Cl.: 16**

**TRADEMARK**

**PRINCIPAL REGISTER**

K. HANSOTIA & CO., INC. (FLORIDA CORPORATION)  
3705 N.W. 115 AVENUE  
BAY #5  
MIAMI, FL 33178

FOR: MAGAZINES, BOOKS, PAMPHLETS, STICKERS, NEWSLETTERS, JOURNALS, PRINTED GUIDES, POSTERS, POSTCARDS, BOOKMARKS, CALENDARS, WRITING INSTRUMENTS, AND CIGAR BANDS FEATURING THE SUBJECT OF CIGARS, IN CLASS 16 (U.S. CLS. 2, 5, 22, 23, 29, 37, 38 AND 50).

FIRST USE 7-25-2011; IN COMMERCE 7-25-2011.

THE MARK CONSISTS OF STANDARD CHARACTERS WITHOUT CLAIM TO ANY PARTICULAR FONT, STYLE, SIZE, OR COLOR.

NO CLAIM IS MADE TO THE EXCLUSIVE RIGHT TO USE "CIGAR", APART FROM THE MARK AS SHOWN.

SN 85-218,138, FILED 1-14-2011.

CARRIE GENOVESE, EXAMINING ATTORNEY



*David J. Kybas*

Director of the United States Patent and Trademark Office

# United States of America

United States Patent and Trademark Office

## CIGAR SPECTATOR

**Reg. No. 4,126,535**

**Registered Apr. 10, 2012**

**Int. Cl.: 16**

**TRADEMARK**

**PRINCIPAL REGISTER**

K. HANSOTIA & CO., INC. (FLORIDA CORPORATION)  
3705 N.W. 115 AVENUE  
BAY #5  
MIAMI, FL 33178

FOR: MAGAZINES, BOOKS, PAMPHLETS, STICKERS, NEWSLETTERS, JOURNALS, PRINTED GUIDES, POSTERS, POSTCARDS, BOOKMARKS, CALENDARS, WRITING INSTRUMENTS, AND CIGAR BANDS FEATURING THE SUBJECT OF CIGARS, IN CLASS 16 (U.S. CLS. 2, 5, 22, 23, 29, 37, 38 AND 50).

FIRST USE 7-25-2011; IN COMMERCE 7-25-2011.

THE MARK CONSISTS OF STANDARD CHARACTERS WITHOUT CLAIM TO ANY PARTICULAR FONT, STYLE, SIZE, OR COLOR.

NO CLAIM IS MADE TO THE EXCLUSIVE RIGHT TO USE "CIGAR", APART FROM THE MARK AS SHOWN.

SN 85-218,168, FILED 1-14-2011.

CARRIE GENOVESE, EXAMINING ATTORNEY



*David J. Kyffers*

Director of the United States Patent and Trademark Office

# United States of America

United States Patent and Trademark Office

# Nowakie

**Reg. No. 4,126,536**

NOWAKIE LLC (FLORIDA LIMITED LIABILITY COMPANY)  
1129 OCOEE APOPKA RD BLD B  
APOPKA, FL 32703

**Registered Apr. 10, 2012**

**Int. Cl.: 12**

FOR: LIGHTWEIGHT NON-CORROSIVE PLASTIC PONTOON BOAT, IN CLASS 12 (U.S. CLS. 19, 21, 23, 31, 35 AND 44).

**TRADEMARK**

FIRST USE 6-1-2011; IN COMMERCE 6-1-2011.

**PRINCIPAL REGISTER**

THE MARK CONSISTS OF STANDARD CHARACTERS WITHOUT CLAIM TO ANY PARTICULAR FONT, STYLE, SIZE, OR COLOR.

SN 85-218,504, FILED 1-14-2011.

ROBERT STRUCK, EXAMINING ATTORNEY



*David J. Kybas*

Director of the United States Patent and Trademark Office



# United States of America

United States Patent and Trademark Office

## SUTHERLAND LIVING

**Reg. No. 4,126,537**

**Registered Apr. 10, 2012**

**Int. Cl.: 41**

**SERVICE MARK**

**PRINCIPAL REGISTER**

SUTHERLAND LIVING LLC (WYOMING LIMITED LIABILITY COMPANY)  
3406 LAKESIDE VIEW CT.  
CARY, NC 27513

FOR: MAGAZINE PUBLISHING; MULTIMEDIA PUBLISHING OF BOOKS, MAGAZINES, JOURNALS, SOFTWARE, GAMES, MUSIC, AND ELECTRONIC PUBLICATIONS; ON-LINE JOURNALS, NAMELY, BLOGS FEATURING LIFE STYLE EDITORIAL; ON-LINE PUBLICATION OF LIFE STYLE MAGAZINE; PROVIDING A WEBSITE FEATURING BLOGS AND NON-DOWNLOADABLE PUBLICATIONS IN THE NATURE OF ARTICLES AND MAGAZINES IN THE FIELD(S) OF ENTERTAINMENT AND LIFE STYLE EDITORIAL; PROVIDING A WEBSITE FEATURING NON-DOWNLOADABLE PUBLICATIONS IN THE NATURE OF MAGAZINES IN THE FIELD OF ENTERTAINMENT AND LIFE STYLE EDITORIAL; PROVIDING INFORMATION, NEWS AND COMMENTARY IN THE FIELD OF RECREATION AND LEISURE ACTIVITIES; PROVIDING ON-LINE MAGAZINES IN THE FIELD OF ENTERTAINMENT AND LIFE STYLE EDITORIAL; PROVIDING ON-LINE NEWSLETTERS IN THE FIELD OF ENTERTAINMENT AND LIFE STYLE EDITORIAL; PROVIDING ON-LINE NON-DOWNLOADABLE GENERAL FEATURE MAGAZINES; PUBLICATION OF BOOKS, OF MAGAZINES, OF JOURNALS, OF NEWSPAPERS, OF PERIODICALS, OF CATALOGS, OF BROCHURES; PUBLICATION OF ELECTRONIC MAGAZINES; PUBLICATION OF JOURNALS; PUBLICATION OF MAGAZINES; PUBLICATION OF THE EDITORIAL CONTENT OF SITES ACCESSIBLE VIA A GLOBAL COMPUTER NETWORK; PUBLISHING OF ELECTRONIC PUBLICATIONS; PUBLISHING OF WEB MAGAZINES, IN CLASS 41 (U.S. CLS. 100, 101 AND 107).

FIRST USE 1-12-2012; IN COMMERCE 1-12-2012.

THE MARK CONSISTS OF STANDARD CHARACTERS WITHOUT CLAIM TO ANY PARTICULAR FONT, STYLE, SIZE, OR COLOR.

SN 85-218,558, FILED 1-14-2011.

LINDA M. KING, EXAMINING ATTORNEY



*David J. Kybas*

Director of the United States Patent and Trademark Office

# United States of America

United States Patent and Trademark Office

## SUTHERLAND LIFE

**Reg. No. 4,126,538**

**Registered Apr. 10, 2012**

**Int. Cl.: 41**

**SERVICE MARK**

**PRINCIPAL REGISTER**

SUTHERLAND LIVING LLC (WYOMING LIMITED LIABILITY COMPANY)  
3406 LAKESIDE VIEW CT  
CARY, NC 27513

FOR: MAGAZINE PUBLISHING; MULTIMEDIA PUBLISHING OF BOOKS, MAGAZINES, JOURNALS, SOFTWARE, GAMES, MUSIC, AND ELECTRONIC PUBLICATIONS; ON-LINE JOURNALS, NAMELY, BLOGS FEATURING LIFE STYLE EDITORIAL; ON-LINE PUBLICATION OF LIFE STYLE MAGAZINE; PROVIDING A WEBSITE FEATURING BLOGS AND NON-DOWNLOADABLE PUBLICATIONS IN THE NATURE OF ARTICLES AND MAGAZINES IN THE FIELD(S) OF ENTERTAINMENT AND LIFE STYLE EDITORIAL; PROVIDING A WEBSITE FEATURING NON-DOWNLOADABLE PUBLICATIONS IN THE NATURE OF MAGAZINES IN THE FIELD OF ENTERTAINMENT AND LIFE STYLE EDITORIAL; PROVIDING INFORMATION, NEWS AND COMMENTARY IN THE FIELD OF RECREATION AND LEISURE ACTIVITIES; PROVIDING ON-LINE MAGAZINES IN THE FIELD OF ENTERTAINMENT AND LIFE STYLE EDITORIAL; PROVIDING ON-LINE NEWSLETTERS IN THE FIELD OF ENTERTAINMENT AND LIFE STYLE EDITORIAL; PROVIDING ON-LINE NON-DOWNLOADABLE GENERAL FEATURE MAGAZINES; PUBLICATION OF BOOKS, OF MAGAZINES, OF JOURNALS, OF NEWSPAPERS, OF PERIODICALS, OF CATALOGS, OF BROCHURES; PUBLICATION OF ELECTRONIC MAGAZINES; PUBLICATION OF JOURNALS; PUBLICATION OF MAGAZINES; PUBLICATION OF THE EDITORIAL CONTENT OF SITES ACCESSIBLE VIA A GLOBAL COMPUTER NETWORK; PUBLISHING OF ELECTRONIC PUBLICATIONS; PUBLISHING OF WEB MAGAZINES, IN CLASS 41 (U.S. CLS. 100, 101 AND 107).

FIRST USE 1-12-2012; IN COMMERCE 1-12-2012.

THE MARK CONSISTS OF STANDARD CHARACTERS WITHOUT CLAIM TO ANY PARTICULAR FONT, STYLE, SIZE, OR COLOR.

SN 85-218,567, FILED 1-14-2011.

LINDA M. KING, EXAMINING ATTORNEY



*David J. Kybas*

Director of the United States Patent and Trademark Office

United States of America  
United States Patent and Trademark Office

# SINGLERU

**Reg. No. 4,126,539**

**Registered Apr. 10, 2012**

**Int. Cl.: 25**

**TRADEMARK**

**PRINCIPAL REGISTER**

SHELL, MARTIN (UNITED STATES INDIVIDUAL)  
196 SOUTH GRANT AVENUE # 505  
COLUMBUS, OH 43215

FOR: ATHLETIC APPAREL, NAMELY, SHIRTS, PANTS, JACKETS, FOOTWEAR, HATS AND CAPS, ATHLETIC UNIFORMS; ATHLETIC SHOES; ATHLETIC TIGHTS; ATHLETIC UNIFORMS; HEADWEAR; LINGERIE; SPORT COATS; SPORT SHIRTS; SPORT STOCKINGS; SPORTS BRA; SPORTS CAPS AND HATS; SPORTS JACKETS; SPORTS JERSEYS; SPORTS OVER UNIFORMS; SPORTS PANTS; SPORTS SHIRTS; SPORTS VESTS; T-SHIRTS; UNDERWEAR, IN CLASS 25 (U.S. CLS. 22 AND 39).

FIRST USE 1-1-2011; IN COMMERCE 3-1-2011.

THE MARK CONSISTS OF STANDARD CHARACTERS WITHOUT CLAIM TO ANY PARTICULAR FONT, STYLE, SIZE, OR COLOR.

SN 85-219,205, FILED 1-17-2011.

SETH A. RAPPAPORT, EXAMINING ATTORNEY



*David J. Kybas*

Director of the United States Patent and Trademark Office

# United States of America

United States Patent and Trademark Office



**MAINE.FM**

**Reg. No. 4,126,540**

FRANK COPSIDAS JR (UNITED STATES INDIVIDUAL)

**Registered Apr. 10, 2012**

PO BOX 15308  
PORTLAND, ME 04112

**Int. Cls.: 9, 38, and 41**

FOR: SOUND RECORDINGS FEATURING MUSIC, NAMELY, PHONOGRAPH RECORDS, PRE-RECORDED AUDIO TAPES, ENHANCED CD'S, COMPACT DISCS, PRE-RECORDED VIDEOTAPES, PRE-RECORDED VIDEOCASSETTES, PRE-RECORDED DIGITAL AUDIO TAPES AND DVDS FEATURING MUSICAL PERFORMANCES AND MOTION PICTURES FOR ENTERTAINMENT, IN CLASS 9 (U.S. CLS. 21, 23, 26, 36 AND 38).

**TRADEMARK**

**SERVICE MARK**

**PRINCIPAL REGISTER**

FIRST USE 1-4-2011; IN COMMERCE 1-4-2011.

FOR: INTERNET RADIO SERVICES, NAMELY, PROVIDING A STREAM OF LIVE AND PRE-RECORDED AUDIO MATERIAL VIA A GLOBAL COMMUNICATIONS NETWORK, IN CLASS 38 (U.S. CLS. 100, 101 AND 104).

FIRST USE 1-17-2011; IN COMMERCE 1-17-2011.

FOR: ENTERTAINMENT, NAMELY, LIVE MUSIC CONCERTS, IN CLASS 41 (U.S. CLS. 100, 101 AND 107).

FIRST USE 1-4-2011; IN COMMERCE 1-4-2011.

NO CLAIM IS MADE TO THE EXCLUSIVE RIGHT TO USE "MAINE.FM", APART FROM THE MARK AS SHOWN.

THE MARK CONSISTS OF "MAINE.FM" LOGO WITH THREE RADIO WAVES DOTTING THE "I" IN "MAINE".

SN 85-219,324, FILED 1-17-2011.

ROSELLE HERRERA, EXAMINING ATTORNEY



*David J. Kyros*

Director of the United States Patent and Trademark Office

# United States of America

United States Patent and Trademark Office



**Reg. No. 4,126,541**

**Registered Apr. 10, 2012**

**Int. Cl.: 33**

**TRADEMARK**

**PRINCIPAL REGISTER**

SPIRITS INTERNATIONAL B.V. (NETHERLANDS BESLOTEN VENNOOTSCHAP (B.V.))  
7 RUE NICOLAS BOVÉ  
LUXEMBOURG, LUXEMBOURG L-1253

FOR: DISTILLED SPIRITS; VODKA; FLAVORED VODKA, IN CLASS 33 (U.S. CLS. 47 AND 49).

FIRST USE 12-1-2010; IN COMMERCE 12-1-2010.

OWNER OF U.S. REG. NOS. 865,462, 1,291,454, AND 1,852,552.

THE NON-LATIN CHARACTERS IN THE MARK TRANSLITERATE TO "STOLICHNAYA" AND THIS MEANS "CAPITAL" IN ENGLISH.

THE MARK CONSISTS OF THE WORD "STOLICHNAYA" WHICH APPEARS IN CURSIVE SCRIPT SUPERIMPOSED OVER AN IMAGE OF A FICTITIOUS BUILDING WHICH APPEARS IN THE CENTER OF TWO FANCY SEMI-CIRCLES WHICH MEET TO FORM A FANCY CIRCLE. THE WORD "STOLICHNAYA" APPEARS IN THE LEFT SEMI-CIRCLE ON A DIFFERENTIATED BACKGROUND WHICH IS SLIGHTLY LARGER AND OVERLAPS THE RIGHT SEMI-CIRCLE. THE NON-LATIN CHARACTERS CONSIST OF THE WORD "STOLICHNAYA" IN CYRILLIC LETTERS AGAINST A DIFFERENTIATED BACKGROUND IN THE RIGHT SEMI-CIRCLE.

THE ENGLISH TRANSLATION OF "STOLICHNAYA" IN THE MARK IS "CAPITAL".

SN 85-219,536, FILED 1-18-2011.

NICHOLAS COLEMAN, EXAMINING ATTORNEY



*David J. Kyros*

Director of the United States Patent and Trademark Office

# United States of America

United States Patent and Trademark Office

# BusinessPlays

**Reg. No. 4,126,542**

BUSINESSPLAYS, LLC (NORTH CAROLINA LIMITED LIABILITY COMPANY)  
921 RAVENDALE PLACE  
CARY, NC 27513

**Registered Apr. 10, 2012**

**Int. Cl.: 35**

FOR: BUSINESS MANAGEMENT CONSULTING, IN CLASS 35 (U.S. CLS. 100, 101 AND 102).

**SERVICE MARK**

FIRST USE 6-0-2011; IN COMMERCE 6-0-2011.

**PRINCIPAL REGISTER**

THE MARK CONSISTS OF STANDARD CHARACTERS WITHOUT CLAIM TO ANY PARTICULAR FONT, STYLE, SIZE, OR COLOR.

SN 85-219,562, FILED 1-18-2011.

MICHAEL TANNER, EXAMINING ATTORNEY



*David J. Kybas*

Director of the United States Patent and Trademark Office

# United States of America

United States Patent and Trademark Office

## Win the Game

**Reg. No. 4,126,543**

BUSINESSPLAYS, LLC (NORTH CAROLINA LIMITED LIABILITY COMPANY)  
921 RAVENDALE PLACE  
CARY, NC 27513

**Registered Apr. 10, 2012**

**Int. Cl.: 35**

FOR: BUSINESS MANAGEMENT CONSULTING, IN CLASS 35 (U.S. CLS. 100, 101 AND 102).

**SERVICE MARK**

FIRST USE 6-0-2011; IN COMMERCE 6-0-2011.

**PRINCIPAL REGISTER**

THE MARK CONSISTS OF STANDARD CHARACTERS WITHOUT CLAIM TO ANY PARTICULAR FONT, STYLE, SIZE, OR COLOR.

SN 85-219,566, FILED 1-18-2011.

MICHAEL TANNER, EXAMINING ATTORNEY



*David J. Kybas*

Director of the United States Patent and Trademark Office

# United States of America

United States Patent and Trademark Office

# H-SPERSE

**Reg. No. 4,126,544**

HARCROS CHEMICALS INC. (KANSAS CORPORATION)  
5200 SPEAKER ROAD  
KANSAS CITY, KS 66106

**Registered Apr. 10, 2012**

**Int. Cl.: 1**

FOR: CHEMICALS, NAMELY, DISPERSANTS FOR USE IN PAINTS AND INDUSTRIAL COATINGS, IN CLASS 1 (U.S. CLS. 1, 5, 6, 10, 26 AND 46).

**TRADEMARK**

FIRST USE 6-23-2011; IN COMMERCE 6-23-2011.

**PRINCIPAL REGISTER**

THE MARK CONSISTS OF STANDARD CHARACTERS WITHOUT CLAIM TO ANY PARTICULAR FONT, STYLE, SIZE, OR COLOR.

SN 85-219,614, FILED 1-18-2011.

JOHN E. MICHOS, EXAMINING ATTORNEY



*David J. Kyffers*

Director of the United States Patent and Trademark Office



# United States of America

United States Patent and Trademark Office

# DOMINION

**Reg. No. 4,126,545**

PERFORMANCE FOOD GROUP, INC. (COLORADO CORPORATION)  
12500 WEST CREEK PARKWAY  
RICHMOND, VA 23238

**Registered Apr. 10, 2012**

**Int. Cl.: 29**

FOR: BULK BOXED FRESH BEEF; FRESH AND FROZEN PROCESSED CUT BEEF, IN CLASS 29 (U.S. CL. 46).

**TRADEMARK**

FIRST USE 11-6-2011; IN COMMERCE 11-6-2011.

**PRINCIPAL REGISTER**

THE MARK CONSISTS OF STANDARD CHARACTERS WITHOUT CLAIM TO ANY PARTICULAR FONT, STYLE, SIZE, OR COLOR.

SN 85-219,723, FILED 1-18-2011.

KATHLEEN M. VANSTON, EXAMINING ATTORNEY



*David J. Kybas*

Director of the United States Patent and Trademark Office

# United States of America

United States Patent and Trademark Office

## BETS FOR VETS

**Reg. No. 4,126,546**

SLABY AND ASSOCIATES, INC. (ILLINOIS CORPORATION)  
2150 WEST WARNER AVENUE  
CHICAGO, IL 60618

**Registered Apr. 10, 2012**

**Int. Cl.: 36**

FOR: CHARITABLE FOUNDATION SERVICES, NAMELY, PROVIDING FUNDRAISING ACTIVITIES, FUNDING, SCHOLARSHIPS AND/OR FINANCIAL ASSISTANCE FOR CHILDREN AND SPOUSES OF MILITARY SERVICE MEN AND WOMEN, IN CLASS 36 (U.S. CLS. 100, 101 AND 102).

**SERVICE MARK**

**PRINCIPAL REGISTER**

FIRST USE 2-0-2011; IN COMMERCE 2-0-2011.

THE MARK CONSISTS OF STANDARD CHARACTERS WITHOUT CLAIM TO ANY PARTICULAR FONT, STYLE, SIZE, OR COLOR.

NO CLAIM IS MADE TO THE EXCLUSIVE RIGHT TO USE "VETS", APART FROM THE MARK AS SHOWN.

SN 85-219,783, FILED 1-18-2011.

ANDREA HACK, EXAMINING ATTORNEY



*David J. Kybas*

Director of the United States Patent and Trademark Office

# United States of America

United States Patent and Trademark Office



**Reg. No. 4,126,547**

PIMA FEDERAL CREDIT UNION (ARIZONA CORPORATION)  
3730 N. STONE AVE.  
TUCSON, AZ 85705

**Registered Apr. 10, 2012**

**Int. Cl.: 36**

FOR: ATM BANKING SERVICES; BANK TENDERING, NAMELY, TENDERING OF MONEY; BANKING; BANKING AND FINANCING SERVICES; BANKING CONSULTATION; BANKING SERVICES; BANKING SERVICES PROVIDED BY MOBILE TELEPHONE CONNECTIONS, IN CLASS 36 (U.S. CLS. 100, 101 AND 102).

**SERVICE MARK**

**PRINCIPAL REGISTER**

FIRST USE 4-1-2011; IN COMMERCE 4-1-2011.

NO CLAIM IS MADE TO THE EXCLUSIVE RIGHT TO USE "PIMA FEDERAL CREDIT UNION", APART FROM THE MARK AS SHOWN.

THE COLOR(S) GREEN AND GREY IS/ARE CLAIMED AS A FEATURE OF THE MARK.

THE MARK CONSISTS OF THE WORDING "PIMAFEDERAL CREDIT UNION", WITH THE WORDING "PIMA" AND "CREDIT UNION" APPEARING IN THE COLOR GREY, THE WORDING "FEDERAL" APPEARS IN THE COLOR GREEN, AND THE DESIGN OF 3 INTERSECTING OVALS APPEARING IN THE COLORS GREY AND GREEN.

THE WORDING "PIMA" HAS NO MEANING IN A FOREIGN LANGUAGE.

SN 85-219,879, FILED 1-18-2011.

JOHN DALIER, EXAMINING ATTORNEY



*David J. Kyros*

Director of the United States Patent and Trademark Office

# United States of America

United States Patent and Trademark Office

## SWEET CHERRY & ISLAND LIME

**Reg. No. 4,126,548**

**Registered Apr. 10, 2012**

**Int. Cl.: 30**

**TRADEMARK**

**PRINCIPAL REGISTER**

KRAFT FOODS GLOBAL BRANDS LLC (DELAWARE LIMITED LIABILITY COMPANY)  
THREE LAKES DRIVE  
NORTHFIELD, IL 60093

FOR: CONFECTIONERY, NAMELY, CHEWING GUM, IN CLASS 30 (U.S. CL. 46).

FIRST USE 9-1-2011; IN COMMERCE 9-1-2011.

THE MARK CONSISTS OF STANDARD CHARACTERS WITHOUT CLAIM TO ANY PARTICULAR FONT, STYLE, SIZE, OR COLOR.

NO CLAIM IS MADE TO THE EXCLUSIVE RIGHT TO USE "SWEET CHERRY" AND "LIME", APART FROM THE MARK AS SHOWN.

SN 85-219,933, FILED 1-18-2011.

EVELYN BRADLEY, EXAMINING ATTORNEY



*David J. Kybas*

Director of the United States Patent and Trademark Office

# United States of America

United States Patent and Trademark Office

# WILCO

**Reg. No. 4,126,549**

**Registered Apr. 10, 2012**

**Int. Cl.: 20**

**TRADEMARK**

**PRINCIPAL REGISTER**

TIPPMANN SPORTS, LLC (DELAWARE LIMITED LIABILITY COMPANY)  
975 WEILAND ROAD, SUITE 120  
BUFFALO GROVE, IL 60089

FOR: SLEEPING BAGS, IN CLASS 20 (U.S. CLS. 2, 13, 22, 25, 32 AND 50).

FIRST USE 3-0-2011; IN COMMERCE 4-0-2011.

THE MARK CONSISTS OF STANDARD CHARACTERS WITHOUT CLAIM TO ANY PARTICULAR FONT, STYLE, SIZE, OR COLOR.

SN 85-219,964, FILED 1-18-2011.

STEVEN JACKSON, EXAMINING ATTORNEY



*David J. Kybas*

Director of the United States Patent and Trademark Office

# United States of America

United States Patent and Trademark Office

# TANGO

**Reg. No. 4,126,550**

**Registered Apr. 10, 2012**

**Int. Cl.: 20**

**TRADEMARK**

**PRINCIPAL REGISTER**

TIPPMANN SPORTS, LLC (DELAWARE LIMITED LIABILITY COMPANY)  
975 WEILAND ROAD, SUITE 120  
BUFFALO GROVE, IL 60089

FOR: SLEEPING BAGS, IN CLASS 20 (U.S. CLS. 2, 13, 22, 25, 32 AND 50).

FIRST USE 3-0-2011; IN COMMERCE 4-0-2011.

THE MARK CONSISTS OF STANDARD CHARACTERS WITHOUT CLAIM TO ANY PARTICULAR FONT, STYLE, SIZE, OR COLOR.

SN 85-219,998, FILED 1-18-2011.

STEVEN JACKSON, EXAMINING ATTORNEY



*David J. Kybas*

Director of the United States Patent and Trademark Office

# United States of America

United States Patent and Trademark Office



**Reg. No. 4,126,551**

**Registered Apr. 10, 2012**

**Int. Cl.: 41**

**SERVICE MARK**

**PRINCIPAL REGISTER**

UMUADA NDI-IGBO IN DIASPORA, INC (CALIFORNIA CORPORATION)  
7130 MAGNOLIA AVE. #A  
RIVERSIDE, CA 92504

FOR: PROVIDING CULTURAL AWARENESS PROGRAMS ABOUT AFRICAN WOMEN IN THE AREA OF LANGUAGE, LIFESTYLE, AND PERSONAL GROWTH, IN CLASS 41 (U.S. CLS. 100, 101 AND 107).

FIRST USE 11-20-2011; IN COMMERCE 11-20-2011.

NO CLAIM IS MADE TO THE EXCLUSIVE RIGHT TO USE "UMUADA NDI-IGBO" AND "INC.", APART FROM THE MARK AS SHOWN.

THE COLOR(S) BLUE, BROWN, ORANGE, RED, BLACK, WHITE, SILVER AND YELLOW IS/ARE CLAIMED AS A FEATURE OF THE MARK.

THE MARK CONSISTS OF THE FOLLOWING: THE WORDS "UMUADA NDI-IGBO" APPEAR IN THE COLOR BLACK ON A YELLOW BANNER AND BETWEEN SILVER AND WHITE LINES ARE AT THE TOP OF THE LOGO, WHILE THE WORDS "IN DIASPORA, INC." APPEAR IN THE COLOR BLACK ON A YELLOW BANNER AND BETWEEN SILVER AND WHITE LINES AT THE BOTTOM OF THE LOGO; THE DESIGN CONSISTS OF A GLOBE APPEARING IN THE COLORS BLUE, YELLOW AND WHITE WITHIN A HEART OF CHECKERED RED LINED, YELLOW, WHITE, BROWN AND ORANGE SMALL BOXES AND STARS TO DEPICT A SPARKLING EFFECT APPEARING IN THE COLOR WHITE; THERE ARE TWO ARMS APPEARING IN THE COLORS BROWN, RED AND BLUE AT THE BOTTOM OF THE HEART SHAKING HANDS; TO THE LEFT SIDE OF THE GLOBE AND ABOVE THE SHAKING HANDS BUT WITHIN THE HEART APPEAR THE WORDS "PEACE", "UNITY" AND "LOVE" IN THE COLOR BLACK, AND TO THE RIGHT OF THE GLOBE ABOVE THE SHAKING HANDS BUT WITHIN THE HEART APPEAR THE WORDS "RESPECT" AND "EMPOWERMENT" IN THE COLOR BLACK.

THE ENGLISH TRANSLATION OF "UMUADA NDI-IGBO IN DIASPORA" IN THE MARK IS "WOMEN OF THE IGBO TRIBE OF NIGERIA IN DIASPORA".

SN 85-220,016, FILED 1-18-2011.

RONALD AIKENS, EXAMINING ATTORNEY



*David J. Kyros*

Director of the United States Patent and Trademark Office

# United States of America

United States Patent and Trademark Office

## THE SPROUTED BAKEHOUSE

**Reg. No. 4,126,552**

**Registered Apr. 10, 2012**

**Int. Cl.: 30**

**TRADEMARK**

**PRINCIPAL REGISTER**

CYBROS, INC. (WISCONSIN CORPORATION)  
PO BOX 851  
WAUKESHA, WI 53187

FOR: BREAD; BREAD ROLLS; BUNS, IN CLASS 30 (U.S. CL. 46).

FIRST USE 3-0-2011; IN COMMERCE 3-0-2011.

THE MARK CONSISTS OF STANDARD CHARACTERS WITHOUT CLAIM TO ANY PARTICULAR FONT, STYLE, SIZE, OR COLOR.

NO CLAIM IS MADE TO THE EXCLUSIVE RIGHT TO USE "BAKEHOUSE", APART FROM THE MARK AS SHOWN.

SN 85-220,020, FILED 1-18-2011.

ALEX KEAM, EXAMINING ATTORNEY



*David J. Kybas*

Director of the United States Patent and Trademark Office



# United States of America

United States Patent and Trademark Office

## WHERE INNOVATION MEETS SOPHISTICATED

**Reg. No. 4,126,553**

AMERICAN AXLE & MANUFACTURING, INC. (DELAWARE CORPORATION)  
ONE DAUCH DRIVE  
DETROIT, MI 482111198

**Registered Apr. 10, 2012**

**Int. Cl.: 40**

FOR: CUSTOM MANUFACTURING SERVICES IN THE FIELD OF ELECTRIC DRIVELINE SYSTEMS, IN CLASS 40 (U.S. CLS. 100, 103 AND 106).

**SERVICE MARK**

FIRST USE 9-0-2010; IN COMMERCE 9-0-2010.

**PRINCIPAL REGISTER**

THE MARK CONSISTS OF STANDARD CHARACTERS WITHOUT CLAIM TO ANY PARTICULAR FONT, STYLE, SIZE, OR COLOR.

SN 85-220,127, FILED 1-18-2011.

MARILYN IZZI, EXAMINING ATTORNEY



*David J. Kybas*

Director of the United States Patent and Trademark Office

# United States of America

United States Patent and Trademark Office

## BEST OF BOTH WORLDS

**Reg. No. 4,126,554**

**Registered Apr. 10, 2012**

**Int. Cl.: 20**

**TRADEMARK**

**PRINCIPAL REGISTER**

DREAMWELL, LTD. (NEVADA LIMITED LIABILITY COMPANY)  
SUITE 12  
2215-B RENAISSANCE DRIVE  
LAS VEGAS, NV 89119

FOR: MATTRESSES AND BOX SPRINGS, IN CLASS 20 (U.S. CLS. 2, 13, 22, 25, 32 AND 50).

FIRST USE 12-1-2011; IN COMMERCE 12-1-2011.

THE MARK CONSISTS OF STANDARD CHARACTERS WITHOUT CLAIM TO ANY PARTICULAR FONT, STYLE, SIZE, OR COLOR.

SN 85-220,182, FILED 1-18-2011.

COURTNEY ALVAREZ, EXAMINING ATTORNEY



*David J. Kybas*

Director of the United States Patent and Trademark Office

# United States of America

United States Patent and Trademark Office

## BASIC TRAINING

**Reg. No. 4,126,555**

**Registered Apr. 10, 2012**

**Int. Cl.: 22**

**TRADEMARK**

**PRINCIPAL REGISTER**

TIPPMANN SPORTS, LLC (DELAWARE LIMITED LIABILITY COMPANY)  
975 WEILAND ROAD, SUITE 120  
BUFFALO GROVE, IL 60089

FOR: TENTS, IN CLASS 22 (U.S. CLS. 1, 2, 7, 19, 22, 42 AND 50).

FIRST USE 3-0-2011; IN COMMERCE 4-0-2011.

THE MARK CONSISTS OF STANDARD CHARACTERS WITHOUT CLAIM TO ANY PARTICULAR FONT, STYLE, SIZE, OR COLOR.

SN 85-220,234, FILED 1-18-2011.

STEVEN JACKSON, EXAMINING ATTORNEY



*David J. Kyffers*

Director of the United States Patent and Trademark Office

# United States of America

United States Patent and Trademark Office

# GAME BOY

**Reg. No. 4,126,556**

NINTENDO OF AMERICA INC. (WASHINGTON CORPORATION)  
4600 150TH AVENUE NE  
REDMOND, WA 98052

**Registered Apr. 10, 2012**

**Int. Cl.: 9**

FOR: DOWNLOADABLE MULTIMEDIA FILES, NAMELY, VIDEO GAMES; DOWNLOADABLE ELECTRONIC GAME PROGRAMS; DOWNLOADABLE ELECTRONIC GAME SOFTWARE; ELECTRONIC GAME PROGRAMS; ELECTRONIC GAME SOFTWARE; VIDEO GAME PROGRAMS; VIDEO GAME SOFTWARE, IN CLASS 9 (U.S. CLS. 21, 23, 26, 36 AND 38).

**TRADEMARK**

**PRINCIPAL REGISTER**

FIRST USE 6-2-1989; IN COMMERCE 6-3-1989.

THE MARK CONSISTS OF STANDARD CHARACTERS WITHOUT CLAIM TO ANY PARTICULAR FONT, STYLE, SIZE, OR COLOR.

OWNER OF U.S. REG. NOS. 2,404,601, 2,550,938, AND 2,974,450.

SN 85-220,424, FILED 1-18-2011.

JANICE L. MCMORROW, EXAMINING ATTORNEY



*David J. Kyros*

Director of the United States Patent and Trademark Office

# United States of America

United States Patent and Trademark Office

## SUPER MARIO LAND

**Reg. No. 4,126,557**

**Registered Apr. 10, 2012**

**Int. Cl.: 9**

**TRADEMARK**

**PRINCIPAL REGISTER**

NINTENDO OF AMERICA INC. (WASHINGTON CORPORATION)  
4600 150TH AVENUE NE  
REDMOND, WA 98052

FOR: DOWNLOADABLE MULTIMEDIA FILES, NAMELY, VIDEO GAMES; DOWNLOADABLE ELECTRONIC GAME PROGRAMS; DOWNLOADABLE ELECTRONIC GAME SOFTWARE; ELECTRONIC GAME PROGRAMS; ELECTRONIC GAME SOFTWARE; VIDEO GAME PROGRAMS; VIDEO GAME SOFTWARE, IN CLASS 9 (U.S. CLS. 21, 23, 26, 36 AND 38).

FIRST USE 6-2-1989; IN COMMERCE 6-2-1989.

THE MARK CONSISTS OF STANDARD CHARACTERS WITHOUT CLAIM TO ANY PARTICULAR FONT, STYLE, SIZE, OR COLOR.

OWNER OF U.S. REG. NOS. 2,319,991, 2,345,441, AND OTHERS.

SN 85-220,431, FILED 1-18-2011.

JANICE L. MCMORROW, EXAMINING ATTORNEY



*David J. Kyros*

Director of the United States Patent and Trademark Office

# United States of America

United States Patent and Trademark Office

# Mii MAKER

**Reg. No. 4,126,558**

**Registered Apr. 10, 2012**

**Int. Cl.: 9**

**TRADEMARK**

**PRINCIPAL REGISTER**

NINTENDO OF AMERICA INC. (WASHINGTON CORPORATION)  
4600 150TH AVENUE NE  
REDMOND, WA 98052

FOR: COMPUTER AND VIDEO GAME PROGRAM FOR CREATING, VIEWING, MANIPULATING, EDITING, AND STORING GRAPHIC IMAGES AND RELATED TEXT; COMPUTER AND VIDEO GAME PROGRAM FOR TRANSFERRING AND EXCHANGING GRAPHIC IMAGES AND RELATED TEXT OVER COMPUTER AND VIDEO GAME NETWORKS, WIRELESS NETWORKS, AND GLOBAL COMMUNICATION NETWORKS; ELECTRONIC GAME PROGRAMS; ELECTRONIC GAME SOFTWARE; VIDEO GAME PROGRAMS; VIDEO GAME SOFTWARE, IN CLASS 9 (U.S. CLS. 21, 23, 26, 36 AND 38).

FIRST USE 3-27-2011; IN COMMERCE 3-27-2011.

THE MARK CONSISTS OF STANDARD CHARACTERS WITHOUT CLAIM TO ANY PARTICULAR FONT, STYLE, SIZE, OR COLOR.

OWNER OF U.S. REG. NO. 3,451,478.

SN 85-220,434, FILED 1-18-2011.

JANICE L. MCMORROW, EXAMINING ATTORNEY



*David J. Kyffers*

Director of the United States Patent and Trademark Office

# United States of America

United States Patent and Trademark Office

# Koom

**Reg. No. 4,126,559**

MALLET, MARK (UNITED STATES INDIVIDUAL)  
12211 PREECE COURT  
CYPRESS, TX 77429

**Registered Apr. 10, 2012**

**Int. Cl.: 25**

FOR: SPORTS AND ATHLETIC APPAREL, NAMELY, BASEBALL CAPS, SHIRTS, JACKETS, BOARD SHORTS, AND SHORT PANTS, IN CLASS 25 (U.S. CLS. 22 AND 39).

**TRADEMARK**

FIRST USE 5-1-2011; IN COMMERCE 5-1-2011.

**PRINCIPAL REGISTER**

THE MARK CONSISTS OF THE STYLIZED TEXT "KOOM" WITH A LINE ON THE TOP.

SN 85-220,506, FILED 1-18-2011.

BRIAN NEVILLE, EXAMINING ATTORNEY



*David J. Kybas*

Director of the United States Patent and Trademark Office

# United States of America

United States Patent and Trademark Office

## SOFTENER REINVENTED

**Reg. No. 4,126,560**

PURE & NATURAL COMPANY (ARIZONA CORPORATION)

**Registered Apr. 10, 2012**

MS 01.45  
19001 NORTH SCOTTSDALE ROAD  
SCOTTSDALE, AZ 85255

**Int. Cl.: 3**

FOR: FABRIC SOFTENERS, IN CLASS 3 (U.S. CLS. 1, 4, 6, 50, 51 AND 52).

**TRADEMARK**

FIRST USE 4-6-2011; IN COMMERCE 4-6-2011.

**PRINCIPAL REGISTER**

THE MARK CONSISTS OF STANDARD CHARACTERS WITHOUT CLAIM TO ANY PARTICULAR FONT, STYLE, SIZE, OR COLOR.

NO CLAIM IS MADE TO THE EXCLUSIVE RIGHT TO USE "SOFTENER", APART FROM THE MARK AS SHOWN.

SN 85-220,716, FILED 1-19-2011.

DEBRA LEE, EXAMINING ATTORNEY



*David J. Kyffers*

Director of the United States Patent and Trademark Office



# United States of America

United States Patent and Trademark Office

## Transforming Dimensions

**Reg. No. 4,126,561**

VERSCH, LISA A (UNITED STATES INDIVIDUAL)  
20017 NALL AVENUE  
STILWELL, KS 66085

**Registered Apr. 10, 2012**

**Int. Cl.: 35**

FOR: ASSISTANCE, ADVISORY SERVICES AND CONSULTANCY WITH REGARD TO BUSINESS PLANNING, BUSINESS ANALYSIS, BUSINESS MANAGEMENT, AND BUSINESS ORGANIZATION, IN CLASS 35 (U.S. CLS. 100, 101 AND 102).

**SERVICE MARK**

FIRST USE 1-1-2011; IN COMMERCE 5-9-2011.

**PRINCIPAL REGISTER**

THE MARK CONSISTS OF STANDARD CHARACTERS WITHOUT CLAIM TO ANY PARTICULAR FONT, STYLE, SIZE, OR COLOR.

SN 85-220,863, FILED 1-19-2011.

AMY C. KEAN, EXAMINING ATTORNEY



*David J. Kappas*

Director of the United States Patent and Trademark Office

# United States of America

United States Patent and Trademark Office

## PAWNSHOP CHOPPERS

**Reg. No. 4,126,562**

ROBERT ALAN SHEPPARD (UNITED STATES INDIVIDUAL)  
1186 PATTON AVENUE  
ASHEVILLE, NC 28806

**Registered Apr. 10, 2012**

**Int. Cl.: 35**

FOR: ONLINE RETAIL STORE SERVICES FEATURING CLOTHING AND HEADWEAR;  
ONLINE RETAIL STORE SERVICES FEATURING PHONE-IN ORDERING FOR CLOTHING  
AND HEADWEAR, IN CLASS 35 (U.S. CLS. 100, 101 AND 102).

**SERVICE MARK**

FIRST USE 1-1-2012; IN COMMERCE 1-1-2012.

**PRINCIPAL REGISTER**

THE MARK CONSISTS OF STANDARD CHARACTERS WITHOUT CLAIM TO ANY PARTICULAR FONT, STYLE, SIZE, OR COLOR.

NO CLAIM IS MADE TO THE EXCLUSIVE RIGHT TO USE "PAWNSHOP", APART FROM THE MARK AS SHOWN.

SN 85-220,931, FILED 1-19-2011.

TRACY WHITTAKER-BROWN, EXAMINING ATTORNEY



*David J. Kybas*

Director of the United States Patent and Trademark Office

# United States of America

United States Patent and Trademark Office

## PAWNSHOP HOTRODS

**Reg. No. 4,126,563**

ROBERT ALAN SHEPPARD (UNITED STATES INDIVIDUAL)  
1186 PATTON AVENUE  
ASHEVILLE, NC 28806

**Registered Apr. 10, 2012**

**Int. Cl.: 35**

FOR: ONLINE RETAIL STORE SERVICES FEATURING CLOTHING AND HEADWEAR;  
ONLINE RETAIL STORE SERVICES FEATURING PHONE-IN ORDERING FOR CLOTHING  
AND HEADWEAR, IN CLASS 35 (U.S. CLS. 100, 101 AND 102).

**SERVICE MARK**

FIRST USE 1-2-2012; IN COMMERCE 1-2-2012.

**PRINCIPAL REGISTER**

THE MARK CONSISTS OF STANDARD CHARACTERS WITHOUT CLAIM TO ANY PARTICULAR FONT, STYLE, SIZE, OR COLOR.

NO CLAIM IS MADE TO THE EXCLUSIVE RIGHT TO USE "PAWNSHOP", APART FROM THE MARK AS SHOWN.

SN 85-220,944, FILED 1-19-2011.

TRACY WHITTAKER-BROWN, EXAMINING ATTORNEY



*David J. Kybas*

Director of the United States Patent and Trademark Office

# United States of America

United States Patent and Trademark Office

## Spotlight at Night

**Reg. No. 4,126,564**

BRYANT, STEVEN (UNITED STATES INDIVIDUAL)  
2649 NE 13 AVE.

**Registered Apr. 10, 2012**

POMPANO BEACH, FL 33064

**Int. Cl.: 42**

FOR: COMPUTER SERVICES, NAMELY, CREATING AN ON-LINE COMMUNITY FOR REGISTERED USERS TO PARTICIPATE IN DISCUSSIONS, GET FEEDBACK FROM THEIR PEERS, FORM VIRTUAL COMMUNITIES, AND ENGAGE IN SOCIAL NETWORKING, IN CLASS 42 (U.S. CLS. 100 AND 101).

**SERVICE MARK**

**PRINCIPAL REGISTER**

FIRST USE 6-0-2011; IN COMMERCE 6-0-2011.

THE MARK CONSISTS OF STANDARD CHARACTERS WITHOUT CLAIM TO ANY PARTICULAR FONT, STYLE, SIZE, OR COLOR.

SN 85-220,971, FILED 1-19-2011.

BRIAN PINO, EXAMINING ATTORNEY



*David J. Kybas*

Director of the United States Patent and Trademark Office

# United States of America

United States Patent and Trademark Office

# MICHELIN

**Reg. No. 4,126,565**

**Registered Apr. 10, 2012**

**Int. Cls.: 36, 37, and 39**

**SERVICE MARK**

**PRINCIPAL REGISTER**

MICHELIN NORTH AMERICA, INC. (NEW YORK CORPORATION)  
ONE PARKWAY SOUTH  
GREENVILLE, SC 29615

FOR: INSURANCE SERVICES, NAMELY, PROVIDING WARRANTIES ON TIRES RELATING TO MILEAGE FOR COMPENSATING THE RESIDUAL VALUE OF A TIRE IN THE EVENT OF REPLACEMENT, IN CLASS 36 (U.S. CLS. 100, 101 AND 102).

FIRST USE 0-0-1992; IN COMMERCE 0-0-1992.

FOR: INSTALLATION, MAINTENANCE AND REPAIR OF TIRES, NAMELY, VEHICLE TIRE FITTING AND REMOVAL SERVICES; MAINTENANCE AND REPAIR SERVICES FOR VEHICLE TIRES, IN CLASS 37 (U.S. CLS. 100, 103 AND 106).

FIRST USE 0-0-2005; IN COMMERCE 0-0-2005.

FOR: TOWING SERVICES IN THE EVENT OF VEHICLE BREAKDOWN, IN CLASS 39 (U.S. CLS. 100 AND 105).

FIRST USE 0-0-2005; IN COMMERCE 0-0-2005.

THE MARK CONSISTS OF STANDARD CHARACTERS WITHOUT CLAIM TO ANY PARTICULAR FONT, STYLE, SIZE, OR COLOR.

OWNER OF U.S. REG. NOS. 892,045, 2,960,396, AND OTHERS.

SN 85-221,318, FILED 1-19-2011.

REBECCA GILBERT, EXAMINING ATTORNEY



*David J. Kybas*

Director of the United States Patent and Trademark Office

# United States of America

United States Patent and Trademark Office

# BREW IQ

**Reg. No. 4,126,566**

**Registered Apr. 10, 2012**

**Int. Cl.: 11**

**TRADEMARK**

**PRINCIPAL REGISTER**

BREVILLE PTY LIMITED (AUSTRALIA PROPRIETARY LIMITED COMPANY (P/L OR PTY. LTD.))  
BUILDING 2, PORT AIR INDUSTRIAL ESTATE  
1A HALE STREET  
BOTANY, NSW, AUSTRALIA 2019

FOR: ELECTRIC COFFEE MAKERS, IN CLASS 11 (U.S. CLS. 13, 21, 23, 31 AND 34).

FIRST USE 10-31-2011; IN COMMERCE 10-31-2011.

THE MARK CONSISTS OF STANDARD CHARACTERS WITHOUT CLAIM TO ANY PARTICULAR FONT, STYLE, SIZE, OR COLOR.

NO CLAIM IS MADE TO THE EXCLUSIVE RIGHT TO USE "BREW", APART FROM THE MARK AS SHOWN.

SN 85-221,418, FILED 1-19-2011.

KATINA MISTER, EXAMINING ATTORNEY



*David J. Kybas*

Director of the United States Patent and Trademark Office

# United States of America

United States Patent and Trademark Office

## Ville De Luxe

**Reg. No. 4,126,567**

VIE VIE LUXE BOUTIQUE, INC (COLORADO CORPORATION)  
909 MAIN STREET

**Registered Apr. 10, 2012**

LOUISVILLE, CO 800271853

**Int. Cl.: 35**

FOR: ONLINE AND IN-STORE RETAIL STORE SERVICES FEATURING WOMEN'S CLOTHING AND ACCESSORIES FOR ALL AGES, JEWELRY, GIFTS, CARDS AND ART BY LOCAL ARTISTS, IN CLASS 35 (U.S. CLS. 100, 101 AND 102).

**SERVICE MARK**

FIRST USE 1-10-2012; IN COMMERCE 1-10-2012.

**PRINCIPAL REGISTER**

THE MARK CONSISTS OF STANDARD CHARACTERS WITHOUT CLAIM TO ANY PARTICULAR FONT, STYLE, SIZE, OR COLOR.

THE ENGLISH TRANSLATION OF "VILLE DE LUXE" IN THE MARK IS CITY OF LUXURY.

SN 85-221,634, FILED 1-19-2011.

LAURIE MAYES, EXAMINING ATTORNEY



*David J. Kyffers*

Director of the United States Patent and Trademark Office

# United States of America

United States Patent and Trademark Office

# TUMI ZR3

**Reg. No. 4,126,568**

TUMI, INC. (NEW JERSEY CORPORATION)  
1001 DURHAM AVENUE  
SOUTH PLAINFIELD, NJ 07080

**Registered Apr. 10, 2012**

**Int. Cl.: 9**

FOR: LENS COATING SOLD AS A COMPONENT OF EYEWEAR, IN CLASS 9 (U.S. CLS. 21, 23, 26, 36 AND 38).

**TRADEMARK**

FIRST USE 2-28-2011; IN COMMERCE 2-28-2011.

**PRINCIPAL REGISTER**

THE MARK CONSISTS OF STANDARD CHARACTERS WITHOUT CLAIM TO ANY PARTICULAR FONT, STYLE, SIZE, OR COLOR.

OWNER OF U.S. REG. NOS. 2,925,555, 3,245,012, AND OTHERS.

SN 85-221,795, FILED 1-20-2011.

MAYUR VAGHANI, EXAMINING ATTORNEY



*David J. Kyffers*

Director of the United States Patent and Trademark Office



# United States of America

United States Patent and Trademark Office

## NENO BUSCOTTI

**Reg. No. 4,126,569**

**Registered Apr. 10, 2012**

**Int. Cl.: 14**

**TRADEMARK**

**PRINCIPAL REGISTER**

SETA CORPORATION OF BOCA, INC. (DELAWARE CORPORATION)  
6400 EAST ROGERS CIRCLE  
BOCA RATON, FL 33499

FOR: JEWELRY, IN CLASS 14 (U.S. CLS. 2, 27, 28 AND 50).

FIRST USE 6-29-2000; IN COMMERCE 6-29-2000.

THE MARK CONSISTS OF STANDARD CHARACTERS WITHOUT CLAIM TO ANY PARTICULAR FONT, STYLE, SIZE, OR COLOR.

THE NAME(S), PORTRAIT(S), AND/OR SIGNATURE(S) SHOWN IN THE MARK DOES NOT IDENTIFY A PARTICULAR LIVING INDIVIDUAL.

SN 85-221,843, FILED 1-20-2011.

MICHAEL KEATING, EXAMINING ATTORNEY



*David J. Kybas*

Director of the United States Patent and Trademark Office

# United States of America

United States Patent and Trademark Office

## TOSCANA COLLECTION

**Reg. No. 4,126,570**

**Registered Apr. 10, 2012**

**Int. Cl.: 14**

**TRADEMARK**

**PRINCIPAL REGISTER**

SETA CORPORATION OF BOCA, INC. (DELAWARE CORPORATION)  
6400 EAST ROGERS CIRCLE  
BOCA RATON, FL 33499

FOR: JEWELRY, IN CLASS 14 (U.S. CLS. 2, 27, 28 AND 50).

FIRST USE 4-21-1999; IN COMMERCE 4-21-1999.

THE MARK CONSISTS OF STANDARD CHARACTERS WITHOUT CLAIM TO ANY PARTICULAR FONT, STYLE, SIZE, OR COLOR.

NO CLAIM IS MADE TO THE EXCLUSIVE RIGHT TO USE "COLLECTION", APART FROM THE MARK AS SHOWN.

SN 85-221,880, FILED 1-20-2011.

MICHAEL KEATING, EXAMINING ATTORNEY



*David J. Kybas*

Director of the United States Patent and Trademark Office

# United States of America

United States Patent and Trademark Office

## ISABELLA COLLECTION

**Reg. No. 4,126,571**

**Registered Apr. 10, 2012**

**Int. Cl.: 14**

**TRADEMARK**

**PRINCIPAL REGISTER**

SETA CORPORATION OF BOCA, INC. (DELAWARE CORPORATION)  
6400 EAST ROGERS CIRCLE  
BOCA RATON, FL 33499

FOR: JEWELRY, IN CLASS 14 (U.S. CLS. 2, 27, 28 AND 50).

FIRST USE 4-3-2011; IN COMMERCE 4-3-2011.

THE MARK CONSISTS OF STANDARD CHARACTERS WITHOUT CLAIM TO ANY PARTICULAR FONT, STYLE, SIZE, OR COLOR.

NO CLAIM IS MADE TO THE EXCLUSIVE RIGHT TO USE "COLLECTION", APART FROM THE MARK AS SHOWN.

SN 85-221,913, FILED 1-20-2011.

MICHAEL KEATING, EXAMINING ATTORNEY



*David J. Kyffers*

Director of the United States Patent and Trademark Office

# United States of America

United States Patent and Trademark Office

## PHONOGRAPHY

**Reg. No. 4,126,572**

**Registered Apr. 10, 2012**

**Int. Cl.: 42**

**SERVICE MARK**

**PRINCIPAL REGISTER**

DAVID HOPTMAN (UNITED STATES INDIVIDUAL)  
1692 LAS CANOAS RD.  
SANTA BARBARA, CA 93105

FOR: PROVIDING A SECURED-ACCESS, MEMBERS ONLY WEBSITE FEATURING TECHNOLOGY THAT GIVES MEMBERS THE ABILITY TO POOL INFORMATION ENABLING THEM TO COLLABORATE ON ARTISTIC ENDEAVORS AND PROJECTS ADDRESSING SOCIAL ISSUES VIA CELL PHONES AND SMART PHONE TECHNOLOGY; COMPUTER SERVICES, NAMELY, CREATING AN ON-LINE COMMUNITY FOR REGISTERED USERS TO CREATE COLLABORATIVE PROJECTS BY PARTICIPATING IN DISCUSSIONS, GETTING FEEDBACK FROM THEIR PEERS, FORM VIRTUAL COMMUNITIES, AND ENGAGE IN SOCIAL NETWORKING IN ORDER TO REALIZE A FINAL RESULT IN THE NATURE OF BOOK ART, FINE ART, VIDEO ART, LIVE NEWSFEEDS AND SHORT OR FULL LENGTH MOVIES, IN CLASS 42 (U.S. CLS. 100 AND 101).

FIRST USE 5-11-2011; IN COMMERCE 6-6-2011.

THE MARK CONSISTS OF STANDARD CHARACTERS WITHOUT CLAIM TO ANY PARTICULAR FONT, STYLE, SIZE, OR COLOR.

SN 85-222,249, FILED 1-20-2011.

DAVID HOFFMAN, EXAMINING ATTORNEY



*David J. Kyros*

Director of the United States Patent and Trademark Office

# United States of America

United States Patent and Trademark Office

## The New Journey

**Reg. No. 4,126,573**

**Registered Apr. 10, 2012**

**Int. Cl.: 41**

**SERVICE MARK**

**PRINCIPAL REGISTER**

THREE ANGELS BROADCASTING NETWORK, INC. (ILLINOIS CORPORATION)  
P.O. BOX 220  
WEST FRANKFORT, IL 62896

FOR: EDUCATIONAL AND ENTERTAINMENT SERVICES, NAMELY, A CONTINUING PROGRAM ABOUT INSPIRATION AND EDUCATION FOR EX-OFFENDERS TO GUIDE THEM TO A NEW PATH OF LIFE ACCESSIBLE BY RADIO, TELEVISION, SATELLITE, AUDIO, VIDEO AND COMPUTER NETWORKS; ENTERTAINMENT IN THE NATURE OF ON-GOING TELEVISION PROGRAMS IN THE FIELD OF EDUCATION AND INSPIRATION FOR EX-OFFENDERS TO GUIDE THEM TO A NEW PATH OF LIFE; PRODUCTION OF DVDS AND VIDEOTAPES FEATURING TELEVISION SHOWS ABOUT EDUCATION AND INSPIRATION FOR EX-OFFENDERS TO GUIDE THEM TO A NEW PATH OF LIFE; PRODUCTION OF RADIO AND TELEVISION PROGRAMS, IN CLASS 41 (U.S. CLS. 100, 101 AND 107).

FIRST USE 1-1-2012; IN COMMERCE 1-1-2012.

THE MARK CONSISTS OF STANDARD CHARACTERS WITHOUT CLAIM TO ANY PARTICULAR FONT, STYLE, SIZE, OR COLOR.

SN 85-222,449, FILED 1-20-2011.

DAVID YONTEF, EXAMINING ATTORNEY



*David J. Kyffers*

Director of the United States Patent and Trademark Office

# United States of America

United States Patent and Trademark Office

## Anchors of Truth

**Reg. No. 4,126,574**

THREE ANGELS BROADCASTING NETWORK, INC. (ILLINOIS CORPORATION)  
P.O. BOX 220

**Registered Apr. 10, 2012**

WEST FRANKFORT, IL 62896

**Int. Cl.: 41**

FOR: EDUCATIONAL AND ENTERTAINMENT SERVICES, NAMELY, A CONTINUING PROGRAM ABOUT RELIGION AND THE BIBLE ACCESSIBLE BY RADIO, TELEVISION, SATELLITE, AUDIO, VIDEO AND COMPUTER NETWORKS; ENTERTAINMENT IN THE NATURE OF ON-GOING TELEVISION PROGRAMS IN THE FIELD OF RELIGION AND THE BIBLE; PRODUCTION OF DVDS AND VIDEOTAPES FEATURING TELEVISION SHOWS ABOUT RELIGION AND THE BIBLE; PRODUCTION OF RADIO AND TELEVISION PROGRAMS, IN CLASS 41 (U.S. CLS. 100, 101 AND 107).

**SERVICE MARK**

**PRINCIPAL REGISTER**

FIRST USE 2-23-2011; IN COMMERCE 2-23-2011.

THE MARK CONSISTS OF STANDARD CHARACTERS WITHOUT CLAIM TO ANY PARTICULAR FONT, STYLE, SIZE, OR COLOR.

SN 85-222,467, FILED 1-20-2011.

DAVID YONTEF, EXAMINING ATTORNEY



*David J. Kyfos*

Director of the United States Patent and Trademark Office

# United States of America

United States Patent and Trademark Office



**Reg. No. 4,126,575**

**Registered Apr. 10, 2012**

**Int. Cl.: 36**

**SERVICE MARK**

**PRINCIPAL REGISTER**

WELTMAN, JOHN. J. (UNITED STATES INDIVIDUAL)  
CIRCLE SURROGACY, SUITE 600  
200 HIGH STREET  
BOSTON, MA 02110 AND

ATKINS JR., JAMES C. (UNITED STATES INDIVIDUAL)  
CIRCLE SURROGACY, LTD., SUITE 600  
200 HIGH STREET  
BOSTON, MA 02110

FOR: INSURANCE SERVICES, NAMELY, UNDERWRITING, ISSUANCE AND ADMINISTRATION OF HEALTH INSURANCE, IN CLASS 36 (U.S. CLS. 100, 101 AND 102).

FIRST USE 4-1-2011; IN COMMERCE 4-1-2011.

NO CLAIM IS MADE TO THE EXCLUSIVE RIGHT TO USE FAMILY INSURANCE, APART FROM THE MARK AS SHOWN.

THE COLOR(S) GREEN AND PURPLE IS/ARE CLAIMED AS A FEATURE OF THE MARK.

THE MARK CONSISTS OF A DRAWING OF TWO INTERSECTING PLANETARY RINGS WITH A "SMILEY FACE" IN THE MIDDLE WITH THE LETTER "U" OF THE WORD "UNIVERSAL" CONSTITUTING THE SMILE AND EACH OF THE "EYES" SET ABOVE THE ENDS OF THE "U". THE PLANETARY RINGS AND THE WORDS "FAMILY INSURANCE" ARE PURPLE WHILE THE TWO "EYES" AND WORD "UNIVERSAL" ARE GREEN.

SN 85-222,672, FILED 1-20-2011.

ZHALEH DELANEY, EXAMINING ATTORNEY



*David J. Kybas*

Director of the United States Patent and Trademark Office

# United States of America

United States Patent and Trademark Office

## UNIVERSAL FAMILY INSURANCE

**Reg. No. 4,126,576**

**Registered Apr. 10, 2012**

**Int. Cl.: 36**

**SERVICE MARK**

**PRINCIPAL REGISTER**

WELTMAN, JOHN J. (UNITED STATES INDIVIDUAL)  
CIRCLE SURROGACY, LTD., SUITE 600  
200 HIGH STREET  
BOSTON, MA 02110 AND

ATKINS JR., JAMES, C. (UNITED STATES INDIVIDUAL)  
CIRCLE SURROGACY, LTD., SUITE 600  
200 HIGH STREET  
BOSTON, MA 02110

FOR: INSURANCE SERVICES, NAMELY, UNDERWRITING, ISSUANCE AND ADMINISTRATION OF HEALTH INSURANCE, IN CLASS 36 (U.S. CLS. 100, 101 AND 102).

FIRST USE 4-1-2011; IN COMMERCE 4-1-2011.

THE MARK CONSISTS OF STANDARD CHARACTERS WITHOUT CLAIM TO ANY PARTICULAR FONT, STYLE, SIZE, OR COLOR.

NO CLAIM IS MADE TO THE EXCLUSIVE RIGHT TO USE "FAMILY INSURANCE", APART FROM THE MARK AS SHOWN.

SN 85-222,674, FILED 1-20-2011.

ZHALEH DELANEY, EXAMINING ATTORNEY



*David J. Kybas*

Director of the United States Patent and Trademark Office



# United States of America

United States Patent and Trademark Office

## SAFE BABY SYSTEM

**Reg. No. 4,126,577**

**Registered Apr. 10, 2012**

**Int. Cl.: 9**

**TRADEMARK**

**PRINCIPAL REGISTER**

QUANTUM BIRTHING LLC (CALIFORNIA LIMITED LIABILITY COMPANY)  
20001 CANYON DR.  
YORBA LINDA, CA 92886

FOR: ELECTRONIC PUBLICATIONS, NAMELY, DOWNLOADABLE DIGITAL TEXT, AUDIO, VISUAL AND MULTIMEDIA FILES FEATURING C-SECTIONS (CESAREAN SECTIONS), VAGINAL DELIVERIES, ANESTHESIA, OBSTETRICS AND GYNECOLOGY, RECORDED ON COMPUTER MEDIA; DOWNLOADABLE WEBINARS IN THE FIELD OF C-SECTIONS (CESAREAN SECTIONS), VAGINAL DELIVERIES, ANESTHESIA, OBSTETRICS AND GYNECOLOGY, IN CLASS 9 (U.S. CLS. 21, 23, 26, 36 AND 38).

FIRST USE 12-20-2010; IN COMMERCE 12-20-2010.

THE MARK CONSISTS OF STANDARD CHARACTERS WITHOUT CLAIM TO ANY PARTICULAR FONT, STYLE, SIZE, OR COLOR.

NO CLAIM IS MADE TO THE EXCLUSIVE RIGHT TO USE "BABY SYSTEM", APART FROM THE MARK AS SHOWN.

SN 85-222,709, FILED 1-20-2011.

CHARLOTTE CORWIN, EXAMINING ATTORNEY



*David J. Kyffers*

Director of the United States Patent and Trademark Office

# United States of America

United States Patent and Trademark Office

## GetOutMom.com

**Reg. No. 4,126,578**

**Registered Apr. 10, 2012**

**Int. Cl.: 35**

**SERVICE MARK**

**PRINCIPAL REGISTER**

GET OUT MOM, LLC (INDIANA LIMITED LIABILITY COMPANY), DBA  
GETOUTMOM.COM LLC,  
13397 ALSTON DRIVE  
FISHERS, IN 46037

FOR: PROVIDING AN INTERNET WEBSITE PORTAL FEATURING PROMOTION AND  
ADVERTISING FOR WOMEN SERVICE PROVIDERS, IN CLASS 35 (U.S. CLS. 100, 101 AND  
102).

FIRST USE 3-1-2011; IN COMMERCE 3-2-2011.

THE MARK CONSISTS OF STANDARD CHARACTERS WITHOUT CLAIM TO ANY PAR-  
TICULAR FONT, STYLE, SIZE, OR COLOR.

SN 85-222,838, FILED 1-21-2011.

NATALIE POLZER, EXAMINING ATTORNEY



*David J. Kyffers*

Director of the United States Patent and Trademark Office

# United States of America

United States Patent and Trademark Office



**Reg. No. 4,126,579**

**Registered Apr. 10, 2012**

**Int. Cl.: 35**

**SERVICE MARK**

**PRINCIPAL REGISTER**

GET OUT MOM, LLC (INDIANA LIMITED LIABILITY COMPANY), DBA  
GETOUTMOM.COM LLC,  
13397 ALSTON DRIVE  
FISHERS, IN 46037

FOR: PROVIDING AN INTERNET WEBSITE PORTAL FEATURING PROMOTION AND  
ADVERTISING FOR WOMEN SERVICE PROVIDERS, IN CLASS 35 (U.S. CLS. 100, 101 AND  
102).

FIRST USE 3-1-2011; IN COMMERCE 3-2-2011.

NO CLAIM IS MADE TO THE EXCLUSIVE RIGHT TO USE "MOMS", APART FROM THE  
MARK AS SHOWN.

THE COLOR(S) GREEN, TEAL, PURPLE AND GRAY IS/ARE CLAIMED AS A FEATURE  
OF THE MARK.

THE MARK CONSISTS OF A STYLIZED LAWN IN THE FORM OF A GREEN UNDULATING  
LINE FOLLOWED BY A STYLIZED TEAL STICK FIGURE OF A RUNNING MOM CARRYING  
A STYLIZED PURPLE PURSE, BELOW WHICH APPEARS THE STYLIZED MEDIUM GRAY  
LETTERS "GETOUTMOM.COM", AND BELOW WHICH APPEARS THE LIGHTER GRAY  
LETTERS "HAPPIER, HEALTHIER, WEALTHIER MOMS". THE COLOR WHITE APPEARS  
AS BACKGROUND IN THE MARK AND IS NOT CLAIMED AS A FEATURE OF THE MARK.

SN 85-222,864, FILED 1-21-2011.

NATALIE POLZER, EXAMINING ATTORNEY



*David J. Kybas*

Director of the United States Patent and Trademark Office

# United States of America

United States Patent and Trademark Office

## HAPPIER, HEALTHIER, WEALTHIER MOMS

**Reg. No. 4,126,580**

**Registered Apr. 10, 2012**

**Int. Cl.: 35**

**SERVICE MARK**

**PRINCIPAL REGISTER**

GET OUT MOM, LLC (INDIANA LIMITED LIABILITY COMPANY), DBA  
GETOUTMOM.COM LLC,  
13397 ALSTON DRIVE  
FISHERS, IN 46037

FOR: PROVIDING AN INTERNET WEBSITE PORTAL FEATURING PROMOTION AND  
ADVERTISING FOR WOMEN SERVICE PROVIDERS, IN CLASS 35 (U.S. CLS. 100, 101 AND  
102).

FIRST USE 3-1-2011; IN COMMERCE 3-1-2011.

THE MARK CONSISTS OF STANDARD CHARACTERS WITHOUT CLAIM TO ANY PAR-  
TICULAR FONT, STYLE, SIZE, OR COLOR.

NO CLAIM IS MADE TO THE EXCLUSIVE RIGHT TO USE "MOMS", APART FROM THE  
MARK AS SHOWN.

SN 85-222,887, FILED 1-21-2011.

NATALIE POLZER, EXAMINING ATTORNEY



*David J. Kyffers*

Director of the United States Patent and Trademark Office

# United States of America

United States Patent and Trademark Office

## SEA GRAPE SCRUBS

**Reg. No. 4,126,581**

ZIER, INC. (FLORIDA CORPORATION)  
150 SOUTH PINE ISLAND ROAD; SUITE 300  
PLANTATION, FL 33324

**Registered Apr. 10, 2012**

**Int. Cls.: 10 and 25**

FOR: MEDICAL WEARING APPAREL, NAMELY, SCRUB TOPS, SCRUB PANTS AND SCRUB JACKETS, IN CLASS 10 (U.S. CLS. 26, 39 AND 44).

**TRADEMARK**

FIRST USE 4-28-2011; IN COMMERCE 8-31-2011.

**PRINCIPAL REGISTER**

FOR: UNIFORMS; CLOTHING, NAMELY, TOPS, PANTS AND JACKETS, IN CLASS 25 (U.S. CLS. 22 AND 39).

FIRST USE 4-28-2011; IN COMMERCE 8-31-2011.

THE MARK CONSISTS OF STANDARD CHARACTERS WITHOUT CLAIM TO ANY PARTICULAR FONT, STYLE, SIZE, OR COLOR.

NO CLAIM IS MADE TO THE EXCLUSIVE RIGHT TO USE "SCRUBS", APART FROM THE MARK AS SHOWN.

SN 85-223,267, FILED 1-21-2011.

JAMES GRIFFIN, EXAMINING ATTORNEY



*David J. Kyros*

Director of the United States Patent and Trademark Office

# United States of America

United States Patent and Trademark Office



**Reg. No. 4,126,582**

**Registered Apr. 10, 2012**

**Int. Cls.: 10 and 25**

**TRADEMARK**

**PRINCIPAL REGISTER**

ZIER, INC. (FLORIDA CORPORATION)  
150 SOUTH PINE ISLAND ROAD; SUITE 300  
PLANTATION, FL 33324

FOR: MEDICAL WEARING APPAREL, NAMELY, SCRUB TOPS, SCRUB PANTS AND SCRUB JACKETS, IN CLASS 10 (U.S. CLS. 26, 39 AND 44).

FIRST USE 4-28-2011; IN COMMERCE 8-31-2011.

FOR: UNIFORMS; CLOTHING, NAMELY, TOPS, PANTS AND JACKETS, IN CLASS 25 (U.S. CLS. 22 AND 39).

FIRST USE 4-28-2011; IN COMMERCE 8-31-2011.

NO CLAIM IS MADE TO THE EXCLUSIVE RIGHT TO USE "SCRUBS", APART FROM THE MARK AS SHOWN.

THE MARK CONSISTS OF A LEAF BETWEEN THE WORDS "SEA" AND "GRAPE SCRUBS".

SN 85-223,418, FILED 1-21-2011.

JAMES GRIFFIN, EXAMINING ATTORNEY



*David J. Kyros*

Director of the United States Patent and Trademark Office

United States of America  
United States Patent and Trademark Office

FORM VS  
FUNKTION

**Reg. No. 4,126,583**

M.O.D. 2.0, INC. (NEW YORK CORPORATION)  
P.O. BOX 36-20869, PABT  
NEW YORK, NY 101290869

**Registered Apr. 10, 2012**

**Int. Cl.: 25**

FOR: CLOTHING, NAMELY, JACKETS, COATS, VESTS, JERSEYS, PULL-OVERS, PANTS, SWEATERS, SWEAT SHIRTS, T-SHIRTS, SHORTS, JEANS; WEARING ACCESSORIES, NAMELY, KERCHIEFS; HEADWEAR, NAMELY, HATS, CAPS, HOODS, IN CLASS 25 (U.S. CLS. 22 AND 39).

**TRADEMARK**

**PRINCIPAL REGISTER**

FIRST USE 9-0-2011; IN COMMERCE 9-0-2011.

THE MARK CONSISTS OF THE WORDS "FORM VS" IN A STYLIZED TYPEFONT ABOVE THE MIRRORED IMAGED WORD "FUNKTION" IN A STYLIZED TYPEFONT.

SN 85-223,424, FILED 1-21-2011.

SALLY SHIH, EXAMINING ATTORNEY



*David J. Kybas*

Director of the United States Patent and Trademark Office

# United States of America

United States Patent and Trademark Office

# DYNAMOO

**Reg. No. 4,126,584**

**Registered Apr. 10, 2012**

**Int. Cl.: 29**

**TRADEMARK**

**PRINCIPAL REGISTER**

AGROPUR INC. (WISCONSIN CORPORATION)  
P.O. BOX 223  
2701 FREEDOM ROAD  
LITTLE CHUTE, WI 541400223

FOR: CHOCOLATE MILK; COWS' MILK; MILK; MILK BASED BEVERAGES CONTAINING  
FRUIT JUICE; MILK-BASED ENERGY DRINKS; STRAWBERRY MILK; VANILLA MILK,  
IN CLASS 29 (U.S. CL. 46).

FIRST USE 6-1-2011; IN COMMERCE 6-1-2011.

THE MARK CONSISTS OF STANDARD CHARACTERS WITHOUT CLAIM TO ANY PAR-  
TICULAR FONT, STYLE, SIZE, OR COLOR.

SN 85-223,795, FILED 1-22-2011.

CURTIS FRENCH, EXAMINING ATTORNEY



*David J. Kybas*

Director of the United States Patent and Trademark Office



# United States of America

United States Patent and Trademark Office

## LA CHICK POO POO

**Reg. No. 4,126,585**

SIMONE CHICKENBONE, LLC (KANSAS LIMITED LIABILITY COMPANY)  
524 COMMERCE  
WICHITA, KS 67203

**Registered Apr. 10, 2012**

**Int. Cl.: 3**

FOR: LIP MOISTURIZER AND COLORIZER IN THE NATURE OF LIP COLORING PREPARATIONS FOR COSMETIC PURPOSES, IN CLASS 3 (U.S. CLS. 1, 4, 6, 50, 51 AND 52).

**TRADEMARK**

FIRST USE 4-0-2010; IN COMMERCE 4-0-2011.

**PRINCIPAL REGISTER**

THE MARK CONSISTS OF STANDARD CHARACTERS WITHOUT CLAIM TO ANY PARTICULAR FONT, STYLE, SIZE, OR COLOR.

SN 85-223,804, FILED 1-22-2011.

JAMES LOVELACE, EXAMINING ATTORNEY



*David J. Kybas*

Director of the United States Patent and Trademark Office

# United States of America

United States Patent and Trademark Office

## FLORIDA'S NATURAL EARTH'S OWN

**Reg. No. 4,126,586**

CITRUS WORLD, INC. (FLORIDA CORPORATION)  
P.O. BOX 1111  
LAKE WALES, FL 33859

**Registered Apr. 10, 2012**

**Int. Cl.: 30**

FOR: ICED TEA; TEA-BASED BEVERAGES, IN CLASS 30 (U.S. CL. 46).

**TRADEMARK**

FIRST USE 2-28-2011; IN COMMERCE 2-28-2011.

**PRINCIPAL REGISTER**

THE MARK CONSISTS OF STANDARD CHARACTERS WITHOUT CLAIM TO ANY PARTICULAR FONT, STYLE, SIZE, OR COLOR.

OWNER OF U.S. REG. NOS. 3,314,846, 3,795,104, AND OTHERS.

NO CLAIM IS MADE TO THE EXCLUSIVE RIGHT TO USE "FLORIDA'S NATURAL", APART FROM THE MARK AS SHOWN.

SN 85-224,281, FILED 1-24-2011.

EDWARD FENNESSY, EXAMINING ATTORNEY



*David J. Kyfos*

Director of the United States Patent and Trademark Office

# United States of America

United States Patent and Trademark Office

# NATUREAL

**Reg. No. 4,126,587**

**Registered Apr. 10, 2012**

**Int. Cl.: 29**

**TRADEMARK**

**PRINCIPAL REGISTER**

SARTORI COMPANY (WISCONSIN CORPORATION)  
P.O. BOX 258, 107 PLEASANT VIEW ROAD  
PLYMOUTH, WI 53073

FOR: CHEESE, IN CLASS 29 (U.S. CL. 46).

FIRST USE 1-17-2012; IN COMMERCE 1-17-2012.

THE MARK CONSISTS OF STANDARD CHARACTERS WITHOUT CLAIM TO ANY PARTICULAR FONT, STYLE, SIZE, OR COLOR.

SN 85-224,529, FILED 1-24-2011.

MARGERY A. TIERNEY, EXAMINING ATTORNEY



*David J. Kyffers*

Director of the United States Patent and Trademark Office

# United States of America

United States Patent and Trademark Office



**Reg. No. 4,126,588**

**Registered Apr. 10, 2012**

**Int. Cl.: 43**

**SERVICE MARK**

**PRINCIPAL REGISTER**

TACO BELL CORP. (CALIFORNIA CORPORATION)  
1 GLEN BELL WAY  
IRVINE, CA 92618

FOR: RESTAURANT SERVICES, IN CLASS 43 (U.S. CLS. 100 AND 101).

FIRST USE 1-31-2011; IN COMMERCE 1-31-2011.

OWNER OF U.S. REG. NOS. 3,880,952 AND 3,880,957.

THE MARK CONSISTS OF A TILTED BELL DESIGN THAT IS INTENDED TO REPRESENT A RISING SUN. THE BELL IS SURROUNDED BY LINES, WHICH ARE SUGGESTIVE OF SUN RAYS AND A HORIZON. UNDERNEATH THE DESIGN IS THE WORDING "FIRST MEAL".

SN 85-224,620, FILED 1-24-2011.

JENNIFER VASQUEZ, EXAMINING ATTORNEY



*David J. Kybas*

Director of the United States Patent and Trademark Office

# United States of America

United States Patent and Trademark Office

# ELECTRIFY

**Reg. No. 4,126,589**

**Registered Apr. 10, 2012**

**Int. Cl.: 9**

**TRADEMARK**

**PRINCIPAL REGISTER**

MOTOROLA TRADEMARK HOLDINGS, LLC (DELAWARE LIMITED LIABILITY COMPANY)  
600 NORTH U.S. HIGHWAY 45  
LIBERTYVILLE, IL 60048

FOR: CELLULAR PHONES; CELLULAR PHONES WITH ELECTRONIC MESSAGING CAPABILITIES; CELLULAR PHONES WITH DIGITAL CAMERA AND VIDEO CAMERA CAPABILITIES; CELLULAR PHONES WITH MP3, AUDIO, AND VIDEO PLAYER CAPABILITIES; CELLULAR PHONES WITH ELECTRONIC GAME CAPABILITIES; CELLULAR PHONES WITH NAVIGATION AND GLOBAL POSITIONING (GPS) CAPABILITIES; WIRELESS COMMUNICATION DEVICES FEATURING VOICE, DATA AND IMAGE TRANSMISSION, IN CLASS 9 (U.S. CLS. 21, 23, 26, 36 AND 38).

FIRST USE 9-26-2011; IN COMMERCE 9-26-2011.

THE MARK CONSISTS OF STANDARD CHARACTERS WITHOUT CLAIM TO ANY PARTICULAR FONT, STYLE, SIZE, OR COLOR.

SN 85-224,746, FILED 1-24-2011.

KEVIN DINALLO, EXAMINING ATTORNEY



*David J. Kyros*

Director of the United States Patent and Trademark Office

# United States of America

United States Patent and Trademark Office

# VB<sup>2</sup>

**Reg. No. 4,126,590**

AALBA DENT, INC. (CALIFORNIA CORPORATION)  
400 WATT DRIVE  
FAIRFIELD, CA 94534

**Registered Apr. 10, 2012**

**Int. Cl.: 5**

FOR: BASE METALS AND ALLOYS FOR DENTISTRY USE, IN CLASS 5 (U.S. CLS. 6, 18, 44, 46, 51 AND 52).

**TRADEMARK**

FIRST USE 11-16-2011; IN COMMERCE 11-16-2011.

**PRINCIPAL REGISTER**

THE MARK CONSISTS OF THE LETTERS "V" AND "B" WITH SHADOW OUTLINE, THE LETTER "B" BEING RAISED TO THE POWER OF "2", THE EXPONENT BEING SIMILARLY SHOWN IN SHADOW OUTLINE.

SN 85-224,840, FILED 1-24-2011.

REBECCA POVARCHUK, EXAMINING ATTORNEY



*David J. Kyros*

Director of the United States Patent and Trademark Office

# United States of America

United States Patent and Trademark Office

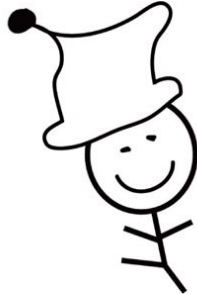

## ABOUNDING LIFESTYLE

**Reg. No. 4,126,591**

**Registered Apr. 10, 2012**

**Int. Cl.: 16**

**TRADEMARK**

**PRINCIPAL REGISTER**

KAPELONIS, STEVE (UNITED STATES INDIVIDUAL)  
13046 RACE TRACK ROAD, 237  
TAMPA, FL 33626 AND

KAPELONIS, ELENA (UNITED STATES INDIVIDUAL)  
13046 RACE TRACK ROAD, 237  
TAMPA, FL 33626

FOR: BOOKS IN THE FIELD OF LIFESTYLE AND COOKING , IN CLASS 16 (U.S. CLS. 2, 5, 22, 23, 29, 37, 38 AND 50).

FIRST USE 6-9-2011; IN COMMERCE 6-9-2011.

NO CLAIM IS MADE TO THE EXCLUSIVE RIGHT TO USE "LIFESTYLE", APART FROM THE MARK AS SHOWN.

THE MARK CONSISTS OF A SMILING STICK FIGURE CHARACTER WITH A LARGE HAT AND BOTH ARMS AND THE LEFT LEG RAISED AS IF IN ACTION. THE CHARACTER DESIGN IS CENTERED ABOVE THE STYLIZED WORDING "ABOUNDING LIFESTYLE" IN A RECTANGULAR CARRIER.

SN 85-225,169, FILED 1-25-2011.

TRACY WHITTAKER-BROWN, EXAMINING ATTORNEY



*David J. Kybas*

Director of the United States Patent and Trademark Office

**United States of America**  
United States Patent and Trademark Office

# PURELAST

**Reg. No. 4,126,592**

ALICE INK, INC. (FLORIDA CORPORATION)  
350 1ST STREET  
DELRAY BEACH, FL 33483

**Registered Apr. 10, 2012**

**Int. Cl.: 21**

FOR: CUTTING BOARDS; MIXING CUPS IN THE NATURE OF PREP CUPS AND PINCH CUPS; MIXING BOWLS, IN CLASS 21 (U.S. CLS. 2, 13, 23, 29, 30, 33, 40 AND 50).

**TRADEMARK**

FIRST USE 6-15-2011; IN COMMERCE 6-15-2011.

**PRINCIPAL REGISTER**

THE MARK CONSISTS OF STANDARD CHARACTERS WITHOUT CLAIM TO ANY PARTICULAR FONT, STYLE, SIZE, OR COLOR.

SN 85-225,176, FILED 1-25-2011.

HENRY S. ZAK, EXAMINING ATTORNEY



*David J. Kyffers*

Director of the United States Patent and Trademark Office



# United States of America

United States Patent and Trademark Office

# NUXY

**Reg. No. 4,126,593**

**Registered Apr. 10, 2012**

**Int. Cl.: 30**

**TRADEMARK**

**PRINCIPAL REGISTER**

SIMPLEFARE, LLC (OREGON LIMITED LIABILITY COMPANY)  
735 SW 158TH AVE.  
BEAVERTON, OR 97006

FOR: FROZEN CASHEW-BASED DESSERTS, IN CLASS 30 (U.S. CL. 46).

FIRST USE 9-15-2011; IN COMMERCE 9-15-2011.

THE MARK CONSISTS OF STANDARD CHARACTERS WITHOUT CLAIM TO ANY PARTICULAR FONT, STYLE, SIZE, OR COLOR.

SN 85-225,277, FILED 1-25-2011.

DAVID I, EXAMINING ATTORNEY



*David J. Kyfos*

Director of the United States Patent and Trademark Office

# United States of America

United States Patent and Trademark Office

a vacation in every bite!

**Reg. No. 4,126,594**

SCUDERI, STEPHANIE (UNITED STATES INDIVIDUAL)  
127 N ROLLING HILL RD.  
TAVERNIER, FL 33070

**Registered Apr. 10, 2012**

**Int. Cl.: 30**

FOR: BAKERY GOODS, IN CLASS 30 (U.S. CL. 46).

**TRADEMARK**

FIRST USE 7-5-2011; IN COMMERCE 6-12-2011.

**PRINCIPAL REGISTER**

THE MARK CONSISTS OF STANDARD CHARACTERS WITHOUT CLAIM TO ANY PARTICULAR FONT, STYLE, SIZE, OR COLOR.

SN 85-225,553, FILED 1-25-2011.

JOHN HWANG, EXAMINING ATTORNEY



*David J. Kyffers*

Director of the United States Patent and Trademark Office

# United States of America

United States Patent and Trademark Office

## REVLON INTENSITY

**Reg. No. 4,126,595**

REVLON CONSUMER PRODUCTS CORPORATION (DELAWARE CORPORATION)  
237 PARK AVENUE  
NEW YORK, NY 10017

**Registered Apr. 10, 2012**

**Int. Cl.: 11**

FOR: HAND-HELD ELECTRIC HAIR DRYERS, IN CLASS 11 (U.S. CLS. 13, 21, 23, 31 AND 34).

**TRADEMARK**

FIRST USE 3-31-2011; IN COMMERCE 3-31-2011.

**PRINCIPAL REGISTER**

THE MARK CONSISTS OF STANDARD CHARACTERS WITHOUT CLAIM TO ANY PARTICULAR FONT, STYLE, SIZE, OR COLOR.

OWNER OF U.S. REG. NOS. 1,886,476 AND 2,891,418.

SN 85-225,692, FILED 1-25-2011.

GEORGE LORENZO, EXAMINING ATTORNEY



*David J. Kybas*

Director of the United States Patent and Trademark Office

# United States of America

United States Patent and Trademark Office

FIND IT, LIST IT, SHARE IT.

**Reg. No. 4,126,596**

SHARED BUSINESS SPACE.COM (WASHINGTON LIMITED LIABILITY COMPANY)  
1100 DEXTER AVE N, SUITE 100  
SEATTLE, WA 98109

**Registered Apr. 10, 2012**

**Int. Cl.: 35**

FOR: PROVIDING A WEBSITE WHERE OWNERS CAN POST ITEMS AND SERVICES AVAILABLE FOR RENT BY OTHERS, IN CLASS 35 (U.S. CLS. 100, 101 AND 102).

**SERVICE MARK**

FIRST USE 1-24-2012; IN COMMERCE 1-24-2012.

**PRINCIPAL REGISTER**

THE MARK CONSISTS OF STANDARD CHARACTERS WITHOUT CLAIM TO ANY PARTICULAR FONT, STYLE, SIZE, OR COLOR.

SN 85-225,751, FILED 1-25-2011.

ROBERT C. CLARK JR., EXAMINING ATTORNEY



*David J. Kybas*

Director of the United States Patent and Trademark Office

# United States of America

United States Patent and Trademark Office

# PDI<sup>H</sup>

**Reg. No. 4,126,597**

AALBA DENT, INC. (CALIFORNIA CORPORATION)  
400 WATT DRIVE  
FAIRFIELD, CA 94534

**Registered Apr. 10, 2012**

**Int. Cl.: 5**

FOR: BASE METALS AND ALLOYS FOR DENTISTRY USE, IN CLASS 5 (U.S. CLS. 6, 18, 44, 46, 51 AND 52).

**TRADEMARK**

FIRST USE 12-13-2011; IN COMMERCE 12-13-2011.

**PRINCIPAL REGISTER**

THE MARK CONSISTS OF THE LETTERS "P", "D" AND "I" WITH SHADOW OUTLINE, THE LETTER "I" BEING RAISED TO THE POWER OF "H", THE EXPONENT BEING SIMILARLY SHOWN IN SHADOW OUTLINE.

SN 85-225,890, FILED 1-25-2011.

REBECCA POVARCHUK, EXAMINING ATTORNEY



*David J. Kyffers*

Director of the United States Patent and Trademark Office

# United States of America

United States Patent and Trademark Office

## G GLAMOUR DIVINISSIMA

**Reg. No. 4,126,598**

**Registered Apr. 10, 2012**

**Int. Cl.: 3**

**TRADEMARK**

**PRINCIPAL REGISTER**

ANGELICA FUENTES TELLEZ (MEXICO INDIVIDUAL), DBA FUTA630202G52,  
CAMPOS ELISEOS 9050-3,COL.CAMPOS ELISEOS  
CD. JUAREZ, CHIHUAHUA, MEXICO 32470

FOR: COLOGNES, PERFUMES AND COSMETICS; FRAGRANCES AND PERFUMERY, IN  
CLASS 3 (U.S. CLS. 1, 4, 6, 50, 51 AND 52).

FIRST USE 2-5-2011; IN COMMERCE 8-13-2011.

THE MARK CONSISTS OF STANDARD CHARACTERS WITHOUT CLAIM TO ANY PAR-  
TICULAR FONT, STYLE, SIZE, OR COLOR.

THE ENGLISH TRANSLATION OF "DIVINISSIMA" IN THE MARK IS MOST DIVINE.

SN 85-226,481, FILED 1-26-2011.

JANICE KIM, EXAMINING ATTORNEY



*David J. Kybas*

Director of the United States Patent and Trademark Office

# United States of America

United States Patent and Trademark Office

## R ROMANCE DIVINISSIMA

**Reg. No. 4,126,599**

**Registered Apr. 10, 2012**

**Int. Cl.: 3**

**TRADEMARK**

**PRINCIPAL REGISTER**

ANGELICA FUENTES TELLEZ (MEXICO INDIVIDUAL), DBA FUTA630202G52,  
CAMPOS ELISEOS 9050-3,COL.CAMPOS ELISEOS  
CD. JUAREZ, CHIHUAHUA, MEXICO 32470

FOR: COLOGNES, PERFUMES AND COSMETICS; FRAGRANCES AND PERFUMERY, IN  
CLASS 3 (U.S. CLS. 1, 4, 6, 50, 51 AND 52).

FIRST USE 2-5-2011; IN COMMERCE 8-13-2011.

THE MARK CONSISTS OF STANDARD CHARACTERS WITHOUT CLAIM TO ANY PAR-  
TICULAR FONT, STYLE, SIZE, OR COLOR.

THE ENGLISH TRANSLATION OF "DIVINISSIMA" IN THE MARK IS MOST DIVINE.

SN 85-226,501, FILED 1-26-2011.

JANICE KIM, EXAMINING ATTORNEY



*David J. Kybas*

Director of the United States Patent and Trademark Office

# United States of America

United States Patent and Trademark Office

## H HAPPY DIVINISSIMA

**Reg. No. 4,126,600**

**Registered Apr. 10, 2012**

**Int. Cl.: 3**

**TRADEMARK**

**PRINCIPAL REGISTER**

ANGELICA FUENTES TELLEZ (MEXICO INDIVIDUAL), DBA FUTA630202G52,  
CAMPOS ELISEOS 9050-3,COL.CAMPOS ELISEOS  
CD. JUAREZ, CHIHUAHUA, MEXICO 32470

FOR: COLOGNES, PERFUMES AND COSMETICS; FRAGRANCES AND PERFUMERY, IN  
CLASS 3 (U.S. CLS. 1, 4, 6, 50, 51 AND 52).

FIRST USE 2-5-2011; IN COMMERCE 8-13-2011.

THE MARK CONSISTS OF STANDARD CHARACTERS WITHOUT CLAIM TO ANY PAR-  
TICULAR FONT, STYLE, SIZE, OR COLOR.

THE ENGLISH TRANSLATION OF "DIVINISSIMA" IN THE MARK IS MOST DIVINE.

SN 85-226,516, FILED 1-26-2011.

JANICE KIM, EXAMINING ATTORNEY



*David J. Kybas*

Director of the United States Patent and Trademark Office



# United States of America

United States Patent and Trademark Office

## G GOLD DIVINISSIMA

**Reg. No. 4,126,601**

**Registered Apr. 10, 2012**

**Int. Cl.: 3**

**TRADEMARK**

**PRINCIPAL REGISTER**

ANGELICA FUENTES TELLEZ (MEXICO INDIVIDUAL), DBA FUTA630202G52,  
CAMPOS ELISEOS 9050-3, COL. CAMPOS ELISEOS  
CD. JUAREZ, CHIHUAHUA, MEXICO 32470

FOR: COLOGNES, PERFUMES AND COSMETICS; FRAGRANCES AND PERFUMERY, IN  
CLASS 3 (U.S. CLS. 1, 4, 6, 50, 51 AND 52).

FIRST USE 2-5-2011; IN COMMERCE 8-13-2011.

THE MARK CONSISTS OF STANDARD CHARACTERS WITHOUT CLAIM TO ANY PAR-  
TICULAR FONT, STYLE, SIZE, OR COLOR.

THE ENGLISH TRANSLATION OF "DIVINISSIMA" IN THE MARK IS MOST DIVINE.

SN 85-226,525, FILED 1-26-2011.

JANICE KIM, EXAMINING ATTORNEY



*David J. Kybas*

Director of the United States Patent and Trademark Office

# United States of America

United States Patent and Trademark Office

## THRIFTY BEE

**Reg. No. 4,126,602**

**Registered Apr. 10, 2012**

**Int. Cl.: 30**

**TRADEMARK**

**PRINCIPAL REGISTER**

GOLDEN HERITAGE FOODS, LLC (DELAWARE LIMITED LIABILITY COMPANY)  
120 SANTA FE STREET  
HILLSBORO, KS 67063

FOR: HONEY, IN CLASS 30 (U.S. CL. 46).

FIRST USE 3-15-2011; IN COMMERCE 3-15-2011.

THE MARK CONSISTS OF STANDARD CHARACTERS WITHOUT CLAIM TO ANY PARTICULAR FONT, STYLE, SIZE, OR COLOR.

SN 85-226,560, FILED 1-26-2011.

KAELIE KUNG, EXAMINING ATTORNEY



*David J. Kyffers*

Director of the United States Patent and Trademark Office

# United States of America

United States Patent and Trademark Office

  
**Wheat Ridge**  
MINISTRIES

*Be inspired—Make an impact*

**Reg. No. 4,126,603**

**Registered Apr. 10, 2012**

**Int. Cl.: 45**

**SERVICE MARK**

**PRINCIPAL REGISTER**

WHEAT RIDGE MINISTRIES (COLORADO NON-PROFIT CORPORATION)  
SUITE 250E  
ONE PIERCE PLACE  
ITASCA, IL 60143

FOR: MINISTERIAL SERVICES, IN CLASS 45 (U.S. CLS. 100 AND 101).

FIRST USE 3-2-2011; IN COMMERCE 3-2-2011.

OWNER OF U.S. REG. NOS. 3,008,758 AND 3,011,058.

NO CLAIM IS MADE TO THE EXCLUSIVE RIGHT TO USE "MINISTRIES", APART FROM THE MARK AS SHOWN.

THE MARK CONSISTS OF THE STYLIZED WORDS "WHEAT RIDGE" WITH A STAR DESIGN DOTTING THE LETTER "I" ABOVE A LINE AND THE STYLIZED WORD "MINISTRIES" UNDERNEATH THE LINE AND THE STYLIZED WORDS "BE INSPIRED - MAKE AN IMPACT" UNDERNEATH THE STYLIZED WORD "MINISTRIES".

SN 85-227,148, FILED 1-26-2011.

SANJEEV VOHRA, EXAMINING ATTORNEY



*David J. Kyros*

Director of the United States Patent and Trademark Office

# United States of America

United States Patent and Trademark Office

## Jot 2 Jot

**Reg. No. 4,126,604**

**Registered Apr. 10, 2012**

**Int. Cl.: 16**

**TRADEMARK**

**PRINCIPAL REGISTER**

JOT 2 JOT, INC. (MINNESOTA CORPORATION)  
10407 TOLEDO DRIVE NORTH  
BROOKLYN PARK, MN 55443

FOR: SERIES OF JOURNALS, NAMELY, PARTIALLY BLANK BINDERS, NOTEBOOKS,  
AND PERSONAL ORGANIZERS IN THE FIELD OF LIFE EVENTS, IN CLASS 16 (U.S. CLS.  
2, 5, 22, 23, 29, 37, 38 AND 50).

FIRST USE 2-7-2011; IN COMMERCE 2-7-2011.

THE MARK CONSISTS OF STANDARD CHARACTERS WITHOUT CLAIM TO ANY PAR-  
TICULAR FONT, STYLE, SIZE, OR COLOR.

SN 85-227,166, FILED 1-26-2011.

AMY HELLA, EXAMINING ATTORNEY



*David J. Kyffers*

Director of the United States Patent and Trademark Office

# United States of America

United States Patent and Trademark Office

## COMFORT ZONE CHECK IN

**Reg. No. 4,126,605**

**Registered Apr. 10, 2012**

**Int. Cl.: 45**

**SERVICE MARK**

**PRINCIPAL REGISTER**

ALZHEIMER'S DISEASE AND RELATED DISORDERS ASSOCIATION, INC. (DELAWARE  
NON-PROFIT CORPORATION)  
225 N. MICHIGAN AVENUE, 17TH FLOOR  
CHICAGO, IL 60601

FOR: ELECTRONIC MONITORING AND TRACKING SERVICES FOR THE PURPOSE OF  
LOCATING PERSONS WITH DEMENTIA BY USING WIRELESS COMMUNICATIONS  
DEVICES VIA A GLOBAL COMPUTER NETWORK, IN CLASS 45 (U.S. CLS. 100 AND 101).

FIRST USE 3-21-2011; IN COMMERCE 3-21-2011.

THE MARK CONSISTS OF STANDARD CHARACTERS WITHOUT CLAIM TO ANY PAR-  
TICULAR FONT, STYLE, SIZE, OR COLOR.

OWNER OF U.S. REG. NO. 3,815,643.

NO CLAIM IS MADE TO THE EXCLUSIVE RIGHT TO USE "CHECK IN", APART FROM  
THE MARK AS SHOWN.

SN 85-227,251, FILED 1-26-2011.

JAMES STEIN, EXAMINING ATTORNEY



*David J. Kyffers*

Director of the United States Patent and Trademark Office

# United States of America

United States Patent and Trademark Office

## Slow To Move Quick To Do Nothing

**Reg. No. 4,126,606**

MAYNARD, CLAUDE (UNITED STATES INDIVIDUAL)  
13703 RICHMOND PARK DR. N  
JACKSONVILLE, FL 32224

**Registered Apr. 10, 2012**

**Int. Cl.: 25**

FOR: CLOTHING, NAMELY, SHIRTS, T-SHIRTS, JACKETS, CAPS, HATS, SHORTS, PANTS,  
IN CLASS 25 (U.S. CLS. 22 AND 39).

**TRADEMARK**

FIRST USE 12-13-2011; IN COMMERCE 12-13-2011.

**PRINCIPAL REGISTER**

THE MARK CONSISTS OF STANDARD CHARACTERS WITHOUT CLAIM TO ANY PAR-  
TICULAR FONT, STYLE, SIZE, OR COLOR.

SN 85-227,267, FILED 1-26-2011.

NICHOLAS COLEMAN, EXAMINING ATTORNEY



*David J. Kyffers*

Director of the United States Patent and Trademark Office

# United States of America

United States Patent and Trademark Office

## INSIDE THE VAULT

**Reg. No. 4,126,607**

GENERAL MOTORS LLC (DELAWARE LIMITED LIABILITY COMPANY)  
300 RENAISSANCE CENTER  
DETROIT, MI 482653000

**Registered Apr. 10, 2012**

**Int. Cl.: 41**

FOR: ENTERTAINMENT SERVICES IN THE NATURE OF A TELEVISION SERIES FEATURING LIFESTYLE INTERESTS, IN CLASS 41 (U.S. CLS. 100, 101 AND 107).

**SERVICE MARK**

FIRST USE 2-4-2011; IN COMMERCE 2-4-2011.

**PRINCIPAL REGISTER**

THE MARK CONSISTS OF STANDARD CHARACTERS WITHOUT CLAIM TO ANY PARTICULAR FONT, STYLE, SIZE, OR COLOR.

SN 85-227,320, FILED 1-27-2011.

HOWARD SMIGA, EXAMINING ATTORNEY



*David J. Kybas*

Director of the United States Patent and Trademark Office

# United States of America

United States Patent and Trademark Office



**Reg. No. 4,126,608**

**Registered Apr. 10, 2012**

**Int. Cl.: 43**

**SERVICE MARK**

**PRINCIPAL REGISTER**

PASCUA YAQUI TRIBE (UNITED STATES FEDERALLY-RECOGNIZED INDIAN TRIBE)  
7474 S. CAMINO DE OESTE  
TUCSON, AZ 85746

FOR: HOTEL SERVICES; PROVIDING BANQUET AND SOCIAL FUNCTION FACILITIES FOR SPECIAL OCCASIONS; CATERING; RESTAURANT AND BAR SERVICES, IN CLASS 43 (U.S. CLS. 100 AND 101).

FIRST USE 11-11-2011; IN COMMERCE 11-11-2011.

OWNER OF U.S. REG. NOS. 3,027,158 AND 3,571,799.

THE COLOR(S) BROWN, GOLD, YELLOW, AND RED IS/ARE CLAIMED AS A FEATURE OF THE MARK.

NO CLAIM IS MADE TO THE EXCLUSIVE RIGHT TO USE "CASINO" AND "RESORT SPA CONFERENCE CENTER AMPHITHEATER", APART FROM THE MARK AS SHOWN.

THE MARK CONSISTS OF THE STYLIZED WORDS "CASINO DEL SOL" IN BROWN AND GOLD WITH BROWN AND GOLD OVER-LINING AND UNDERLINING ABOVE THE WORDS "RESORT SPA CONFERENCE CENTER AMPHITHEATER" IN BROWN AND SEPARATED BY GOLD CIRCLES, ALL BELOW A RED DOMED BUILDING WITH BROWN, GOLD AND YELLOW ACCENTS IN FRONT OF BROWN AND GOLD MOUNTAINS AND A YELLOW SUN.

THE ENGLISH TRANSLATION OF "DEL SOL" IN THE MARK IS "OF THE SUN".

SN 85-227,588, FILED 1-27-2011.

KATHLEEN M. VANSTON, EXAMINING ATTORNEY



*David J. Kyffers*

Director of the United States Patent and Trademark Office



# United States of America

United States Patent and Trademark Office



**Reg. No. 4,126,609**

PASCUA YAQUI TRIBE (UNITED STATES FEDERALLY-RECOGNIZED INDIAN TRIBE)  
7474 S. CAMINO DE OESTE  
TUCSON, AZ 85746

**Registered Apr. 10, 2012**

**Int. Cl.: 44**

FOR: HEALTH SPA SERVICE, NAMELY, PROVIDING FACIAL AND BODY TREATMENT SERVICES, COSMETIC BODY CARE SERVICES, MANICURES AND PEDICURES, MASSAGE SERVICES AND HAIR CARE SERVICES, IN CLASS 44 (U.S. CLS. 100 AND 101).

**SERVICE MARK**

FIRST USE 11-11-2011; IN COMMERCE 11-11-2011.

**PRINCIPAL REGISTER**

OWNER OF U.S. REG. NOS. 2,965,247, 3,571,799, AND OTHERS.

THE COLOR(S) BROWN, GOLD, YELLOW, AND RED IS/ARE CLAIMED AS A FEATURE OF THE MARK.

NO CLAIM IS MADE TO THE EXCLUSIVE RIGHT TO USE "CASINO" AND "RESORT SPA CONFERENCE CENTER AMPHITHEATER", APART FROM THE MARK AS SHOWN.

THE MARK CONSISTS OF THE STYLIZED WORDS "CASINO DEL SOL" IN BROWN AND GOLD ABOVE THE WORDS "RESORT SPA CONFERENCE CENTER AMPHITHEATER" IN BROWN, ALL BELOW A RED DOMED BUILDING IN FRONT OF BROWN AND GOLD MOUNTAINS AND A YELLOW SUN.

THE ENGLISH TRANSLATION OF "DEL SOL" IN THE MARK IS "OF THE SUN".

SN 85-227,597, FILED 1-27-2011.

KATHY DE JONGE, EXAMINING ATTORNEY



*David J. Kybas*

Director of the United States Patent and Trademark Office

# United States of America

United States Patent and Trademark Office



**Reg. No. 4,126,610**

**Registered Apr. 10, 2012**

**Int. Cl.: 35**

**SERVICE MARK**

**PRINCIPAL REGISTER**

PASCUA YAQUI TRIBE (UNITED STATES FEDERALLY-RECOGNIZED INDIAN TRIBE)  
7474 S. CAMINO DE OESTE  
TUCSON, AZ 85746

FOR: SPECIAL EVENT PLANNING FOR BUSINESS PURPOSES; PROVIDING FACILITIES FOR BUSINESS MEETINGS, BUSINESS CONFERENCES, AND TRADE SHOWS, IN CLASS 35 (U.S. CLS. 100, 101 AND 102).

FIRST USE 11-11-2011; IN COMMERCE 11-11-2011.

OWNER OF U.S. REG. NOS. 2,965,247, 3,027,158, AND 3,571,799.

THE COLOR(S) BROWN, GOLD, YELLOW AND RED IS/ARE CLAIMED AS A FEATURE OF THE MARK.

NO CLAIM IS MADE TO THE EXCLUSIVE RIGHT TO USE "CASINO" AND "RESORT SPA CONFERENCE CENTER AMPHITHEATER", APART FROM THE MARK AS SHOWN.

THE MARK CONSISTS OF THE STYLIZED WORDS "CASINO DEL SOL" IN BROWN AND GOLD ABOVE THE WORDS "RESORT SPA CONFERENCE CENTER AMPHITHEATER" IN BROWN, ALL BELOW A RED DOMED BUILDING IN FRONT OF BROWN AND GOLD MOUNTAINS AND A YELLOW SUN.

THE ENGLISH TRANSLATION OF "DEL SOL" IN THE MARK IS "OF THE SUN".

SN 85-227,601, FILED 1-27-2011.

KATHY DE JONGE, EXAMINING ATTORNEY

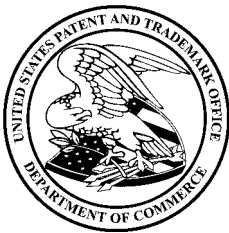

*David J. Kybas*

Director of the United States Patent and Trademark Office

# United States of America

United States Patent and Trademark Office

## TUMBLING KEY SIGNATURES

**Reg. No. 4,126,611**

MUSIC DYNAMICS OF WALES, INC. (WISCONSIN CORPORATION)  
110 E. OAK CREST DR.  
WALES, WI 53183

**Registered Apr. 10, 2012**

**Int. Cl.: 28**

FOR: DICE GAMES, IN CLASS 28 (U.S. CLS. 22, 23, 38 AND 50).

**TRADEMARK**

FIRST USE 3-26-2011; IN COMMERCE 3-26-2011.

**PRINCIPAL REGISTER**

THE MARK CONSISTS OF STANDARD CHARACTERS WITHOUT CLAIM TO ANY PARTICULAR FONT, STYLE, SIZE, OR COLOR.

SN 85-227,639, FILED 1-27-2011.

JAY FLOWERS, EXAMINING ATTORNEY



*David J. Kyffers*

Director of the United States Patent and Trademark Office

# United States of America

United States Patent and Trademark Office

## Sound Rules!

**Reg. No. 4,126,612**

HOUSE RESEARCH INSTITUTE (CALIFORNIA CORPORATION)  
2100 WEST THIRD STREET  
LOS ANGELES, CA 90057

**Registered Apr. 10, 2012**

**Int. Cl.: 35**

FOR: PROMOTING PUBLIC AWARENESS OF HEARING HEALTH, IN CLASS 35 (U.S. CLS. 100, 101 AND 102).

**SERVICE MARK**

FIRST USE 4-7-2011; IN COMMERCE 4-7-2011.

**PRINCIPAL REGISTER**

THE MARK CONSISTS OF STANDARD CHARACTERS WITHOUT CLAIM TO ANY PARTICULAR FONT, STYLE, SIZE, OR COLOR.

NO CLAIM IS MADE TO THE EXCLUSIVE RIGHT TO USE "SOUND", APART FROM THE MARK AS SHOWN.

SN 85-227,731, FILED 1-27-2011.

TINA L. SNAPP, EXAMINING ATTORNEY



*David J. Kyffers*

Director of the United States Patent and Trademark Office

# United States of America

United States Patent and Trademark Office

## CARGO ELITE EXPRESS

**Reg. No. 4,126,613**

**Registered Apr. 10, 2012**

**Int. Cl.: 36**

**SERVICE MARK**

**PRINCIPAL REGISTER**

THE TRAVELERS INDEMNITY COMPANY (CONNECTICUT CORPORATION)  
ONE TOWER SQUARE  
HARTFORD, CT 06183

FOR: PROPERTY AND CASUALTY INSURANCE UNDERWRITING SERVICES, NAMELY, INTERNATIONAL AND DOMESTIC TRANSIT INSURANCE FOR CARGO OWNERS AND SHIPPERS, IN CLASS 36 (U.S. CLS. 100, 101 AND 102).

FIRST USE 9-15-2010; IN COMMERCE 9-15-2010.

THE MARK CONSISTS OF STANDARD CHARACTERS WITHOUT CLAIM TO ANY PARTICULAR FONT, STYLE, SIZE, OR COLOR.

OWNER OF U.S. REG. NO. 3,345,569.

NO CLAIM IS MADE TO THE EXCLUSIVE RIGHT TO USE "CARGO", APART FROM THE MARK AS SHOWN.

SN 85-227,758, FILED 1-27-2011.

IRA J. GOODSAY, EXAMINING ATTORNEY



*David J. Kyffers*

Director of the United States Patent and Trademark Office

# United States of America

United States Patent and Trademark Office

# VIBER

**Reg. No. 4,126,614**

**Registered Apr. 10, 2012**

**Int. Cl.: 38**

**SERVICE MARK**

**PRINCIPAL REGISTER**

VIBER MEDIA, INC. (PANAMA CORPORATION)  
40 KIMONOS ST.  
LIMASSOL, CYPRUS 3095

FOR: INTERNET AND PEER-TO-PEER COMPUTER SERVICES, NAMELY, ELECTRONIC TRANSMISSION OF AUDIO, VIDEO AND OTHER DATA AND DOCUMENTS AMONG COMPUTERS, ELECTRONIC TRANSMISSION OF DATA AND DOCUMENTS OVER COMPUTER TERMINALS AND INSTANT MESSAGING SERVICES; COMMUNICATIONS BY MEANS OF OR AIDED BY COMPUTER, NAMELY, TRANSMISSION OF VOICE, DATA, GRAPHICS, IMAGES, AUDIO AND VIDEO BY MEANS OF TELECOMMUNICATIONS NETWORKS, WIRELESS COMMUNICATION NETWORKS, AND THE INTERNET; TRANSMISSION OF AUDIO, VIDEO, IMAGES, TEXT AND OTHER DATA BY MEANS OF A COMMUNICATIONS NETWORK; COMMUNICATION SERVICES, NAMELY, PROVIDING ELECTRONIC TRANSMISSION OF INFORMATION AND DATA; ELECTRONIC, ELECTRIC AND DIGITAL TRANSMISSION OF VOICE, DATA, IMAGES, SIGNALS AND MESSAGES; TELECOMMUNICATIONS AND INFORMATION TECHNOLOGY SERVICES, NAMELY, TRANSMISSION OF VOICE, DATA, IMAGES, AUDIO, VIDEO AND INFORMATION VIA TELEPHONE AND GLOBAL COMMUNICATION NETWORKS; WIRELESS TELECOMMUNICATIONS SERVICES, NAMELY, THE WIRELESS TRANSMISSION OF VOICE AND DATA; TELECOMMUNICATIONS SERVICES, NAMELY, PROVIDING VOICE OVER INTERNET PROTOCOL SERVICES; TELECOMMUNICATIONS SERVICES, NAMELY, PROVIDING NETWORK ACCESS POINT FOR THIRD PARTY USERS; TELECOMMUNICATIONS SERVICES, NAMELY, PROVIDING VOICE OVER INTERNET PROTOCOL SERVICES. PROVIDING NETWORK ACCESS POINT SERVICES FOR THE EXCHANGE OF INTERNET TRAFFIC AMONG INTERNET TRAFFIC CARRIERS; TELECOMMUNICATION SERVICES, NAMELY, TRANSMISSION OF VOICE, DATA, GRAPHICS, IMAGES, AUDIO AND VIDEO BY MEANS OF TELECOMMUNICATIONS NETWORKS, WIRELESS COMMUNICATION NETWORKS, AND THE INTERNET; TELECOMMUNICATIONS SERVICES, NAMELY, ELECTRONIC TRANSMISSION OF DATA, MESSAGES AND INFORMATION.; COMPUTER AIDED TRANSMISSION OF MESSAGES AND IMAGES; ELECTRONIC MESSAGING SERVICES, NAMELY, SENDING, RECEIVING AND FORWARDING MESSAGES IN THE FORM OF TEXT, AUDIO, IMAGES OR VIDEO; PROVISION AND OPERATION OF ELECTRONIC CONFERENCING, DISCUSSION GROUPS AND CHAT ROOMS VIA THE INTERNET; INTERNET AND VIDEO-CONFERENCE SERVICES; CONFERENCE SERVICES, NAMELY, CONFERENCES ACROSS A COMPUTER NETWORK; INSTANT MESSAGING SERVICES; STREAMING OF AUDIO-VISUAL MATERIAL ON THE INTERNET; PROVIDING ON-LINE ELECTRONIC BULLETIN BOARDS AND FORUMS FOR TRANSMISSION OF



*David J. Kyros*

Director of the United States Patent and Trademark Office

**Reg. No. 4,126,614** MESSAGES AMONG COMPUTER USERS; ELECTRONIC TRANSMISSION OF MESSAGES AND DATA; ELECTRONIC MESSAGING SERVICES, NAMELY, SIMPLE MESSAGE SERVICE (SMS) AND MULTIMEDIA MESSAGE SERVICE (MMS) VIA TELECOMMUNICATIONS AND COMPUTER NETWORKS; COMMUNICATION SERVICES, NAMELY, COMPUTER TRANSMISSION OF INFORMATION, MESSAGING, VOIP, VIDEO CALLING AND CONFERENCING ACCESSED BY MEANS OF AN ACCESS NUMBER; COMMUNICATIONS SERVICES THROUGH THE USE OF SUBSCRIBER IDENTITY MODULE (SIM) CARDS, NAMELY, COMPUTER TRANSMISSION OF INFORMATION, VOIP, MESSAGING, VIDEO CALLING AND CONFERENCING; PERSONAL COMMUNICATIONS SERVICES; TELECOMMUNICATION SERVICES, NAMELY, TRANSMISSION OF DATA AND INFORMATION VIA PAGERS; ELECTRONIC MAIL SERVICES; PROVIDING MULTIPLE USER INTERACTIVE ACCESS TO A GLOBAL COMMUNICATIONS NETWORK; TRANSMISSION AND BROADCAST OF AUDIO AND VIDEO PROGRAMMING OF ALL TYPES VIA TELEPHONE, TELEVISION, AND GLOBAL COMMUNICATIONS NETWORKS; VIDEO AND AUDIO TELECONFERENCING VIA THE INTERNET, ASYNCHRONOUS TRANSFER MODE SERVICES, INTEGRATED SERVICE DIGITAL NETWORK (ISDN) SERVICES, INTERNET PROTOCOL (IP) COMMUNICATIONS SERVICES, NAMELY, VOIP, IPTV SERVICES; COMMUNICATION SERVICES, NAMELY, VIRTUAL PRIVATE NETWORK (VPN) SERVICES AND PRIVATE TELEPHONE LINE SERVICES; SWITCHED VOICE, DATA, VIDEO AND MULTIMEDIA SERVICES, NAMELY, COMPUTER TRANSMISSION OF INFORMATION, VOIP, MESSAGING, VIDEO CALLING AND CONFERENCING; PROVIDING FACSIMILE TRANSMISSION SERVICES; VOICE MAIL SERVICES; TELECOMMUNICATIONS SERVICES, NAMELY, PROVIDING TOLL FREE TELEPHONE SERVICES AND CALL ROUTING SERVICES; MESSAGING CENTER SERVICES IN THE NATURE OF TELEPHONE VOICE MESSAGING SERVICES; VIDEO, AUDIO AND DATA TELEPHONE CONFERENCE SERVICES; ELECTRONIC MESSAGING SERVICES; TELECOMMUNICATION SERVICES, NAMELY, CELLULAR TELEPHONE SERVICES; PROVIDING MULTIPLE-USER ACCESS TO A COMMUNICATIONS NETWORK; ON-LINE FORUMS FOR TRANSMISSION OF MESSAGES AMONG COMPUTER USERS CONCERNING SOFTWARE DEVELOPMENT; ONLINE CHAT ROOMS AND ELECTRONIC BULLETIN BOARDS FOR REGISTERED USERS FOR TRANSMISSION OF MESSAGES CONCERNING COLLEGIATE LIFE, GENERAL INTEREST, CLASSIFIEDS, VIRTUAL COMMUNITY, SOCIAL NETWORKING, PHOTO SHARING, AND TRANSMISSION OF PHOTOGRAPHIC IMAGES; PROVISION OF ON-LINE FORUMS FOR THE TRANSMISSION OF PHOTOGRAPHIC IMAGES; PROVISION OF ON-LINE FORUMS FOR TRANSMISSION OF MESSAGES ON TOPICS OF GENERAL INTEREST; PROVIDING ACCESS TO COMPUTER, ELECTRONIC AND ONLINE DATABASES; PROVIDING ONLINE FORUMS FOR TRANSMISSION OF MESSAGES ON TOPICS OF GENERAL INTEREST; PROVIDING ONLINE COMMUNICATIONS LINKS WHICH TRANSFER WEB SITE USERS TO OTHER LOCAL AND GLOBAL WEB PAGES; PROVIDING INTERNET ACCESS TO WEB SITES FOR OTHERS HOSTED ON COMPUTER SERVERS ACCESSIBLE VIA A GLOBAL COMPUTER NETWORK; PROVIDING INTERNET ACCESS TO THIRD PARTY WEB SITES BY ENABLING USERS TO LOG IN THROUGH A UNIVERSAL USERNAME AND PASSWORD VIA A GLOBAL COMPUTER NETWORK AND OTHER COMMUNICATION NETWORKS; PROVIDING ONLINE CHAT ROOMS AND ELECTRONIC BULLETIN BOARDS FOR TRANSMISSION OF MESSAGES AMONG USERS IN THE FIELD OF GENERAL INTEREST; AUDIO, TEXT AND VIDEO BROADCASTING SERVICES OVER THE INTERNET OR OTHER COMMUNICATIONS NETWORKS FEATURING THE UPLOADED, POSTED AND TAGGED AUDIO, TEXT AND VIDEO CONTENT OF OTHERS; AUDIO, TEXT AND VIDEO BROADCASTING SERVICES OVER THE INTERNET OR OTHER COMMUNICATIONS NETWORKS, NAMELY, ELECTRONICALLY TRANSMITTING AUDIO CLIPS, TEXT AND VIDEO CLIPS OF OTHERS; PROVIDING ACCESS TO COMPUTER DATABASES IN THE FIELDS OF SOCIAL NETWORKING, IN CLASS 38 (U.S. CLS. 100, 101 AND 104).

FIRST USE 11-9-2010; IN COMMERCE 11-9-2010.

THE MARK CONSISTS OF STANDARD CHARACTERS WITHOUT CLAIM TO ANY PARTICULAR FONT, STYLE, SIZE, OR COLOR.

**Reg. No. 4,126,614** SN 85-227,957, FILED 1-27-2011.

DAVID HOFFMAN, EXAMINING ATTORNEY



# United States of America

United States Patent and Trademark Office

## MOUNTAIN COFFEE OVER 80

**Reg. No. 4,126,615**

**Registered Apr. 10, 2012**

**Int. Cl.: 30**

**TRADEMARK**

**PRINCIPAL REGISTER**

MOUNTAIN COFFEE CORP. (FLORIDA CORPORATION)  
6971 WEST SUNRISE BLVD., SUITE 104  
PLANTATION, FL 33313

FOR: RAW, UNROASTED COFFEE BEANS, IN CLASS 30 (U.S. CL. 46).

FIRST USE 1-0-2011; IN COMMERCE 1-0-2011.

THE MARK CONSISTS OF STANDARD CHARACTERS WITHOUT CLAIM TO ANY PARTICULAR FONT, STYLE, SIZE, OR COLOR.

NO CLAIM IS MADE TO THE EXCLUSIVE RIGHT TO USE "MOUNTAIN COFFEE", APART FROM THE MARK AS SHOWN.

SN 85-228,536, FILED 1-28-2011.

JOHN E. MICHOS, EXAMINING ATTORNEY



*David J. Kyffers*

Director of the United States Patent and Trademark Office

# United States of America

United States Patent and Trademark Office

# EXPRESSBUY

**Reg. No. 4,126,616**

**Registered Apr. 10, 2012**

**Int. Cl.: 35**

**SERVICE MARK**

**PRINCIPAL REGISTER**

PREMIER, INC. (DELAWARE CORPORATION)  
13034 BALLANTYNE CORPORATE PLACE  
CHARLOTTE, NC 282668800

FOR: ADMINISTRATION OF A DISCOUNT PROGRAM FOR ENABLING PARTICIPANTS TO OBTAIN DISCOUNTS ON GOODS AND SERVICES, NAMELY, PROVIDING A WEBSITE AND E-MAIL NOTIFICATIONS FEATURING DISCOUNTS, COUPONS, REBATES AND OTHER FORMS OF LOWER PRICES TO PARTICIPANTS, IN CLASS 35 (U.S. CLS. 100, 101 AND 102).

FIRST USE 2-0-2011; IN COMMERCE 2-0-2011.

THE MARK CONSISTS OF STANDARD CHARACTERS WITHOUT CLAIM TO ANY PARTICULAR FONT, STYLE, SIZE, OR COLOR.

SN 85-228,740, FILED 1-28-2011.

KATHERINE STOIDES, EXAMINING ATTORNEY



*David J. Kyros*

Director of the United States Patent and Trademark Office

# United States of America

United States Patent and Trademark Office

## FIDELITY TARGET INCOME MIX

**Reg. No. 4,126,617**

FMR LLC (DELAWARE LIMITED LIABILITY COMPANY)  
82 DEVONSHIRE STREET  
BOSTON, MA 02109

**Registered Apr. 10, 2012**

**Int. Cl.: 36**

FOR: FINANCIAL SERVICES, NAMELY, INVESTMENT PLANNING FOR RETIREMENT,  
IN CLASS 36 (U.S. CLS. 100, 101 AND 102).

**SERVICE MARK**

FIRST USE 1-17-2011; IN COMMERCE 1-17-2011.

**PRINCIPAL REGISTER**

THE MARK CONSISTS OF STANDARD CHARACTERS WITHOUT CLAIM TO ANY PAR-  
TICULAR FONT, STYLE, SIZE, OR COLOR.

OWNER OF U.S. REG. NOS. 3,096,560, 3,473,427, AND OTHERS.

NO CLAIM IS MADE TO THE EXCLUSIVE RIGHT TO USE "TARGET INCOME MIX",  
APART FROM THE MARK AS SHOWN.

SN 85-228,904, FILED 1-28-2011.

LIEF MARTIN, EXAMINING ATTORNEY



*David J. Kybas*

Director of the United States Patent and Trademark Office

# United States of America

United States Patent and Trademark Office

## CONTINUOUS PLAY

**Reg. No. 4,126,618**

MISSION PRODUCT HOLDINGS, INC. (DELAWARE CORPORATION)  
185 MADISON AVENUE  
NEW YORK, NY 10016

**Registered Apr. 10, 2012**

**Int. Cl.: 3**

FOR: SUN SCREEN PREPARATIONS, IN CLASS 3 (U.S. CLS. 1, 4, 6, 50, 51 AND 52).

**TRADEMARK**

FIRST USE 2-0-2011; IN COMMERCE 5-0-2011.

**PRINCIPAL REGISTER**

THE MARK CONSISTS OF STANDARD CHARACTERS WITHOUT CLAIM TO ANY PARTICULAR FONT, STYLE, SIZE, OR COLOR.

SN 85-229,122, FILED 1-28-2011.

DAVID I, EXAMINING ATTORNEY



*David J. Kyffers*

Director of the United States Patent and Trademark Office

# United States of America

United States Patent and Trademark Office

## LEARNING ALLY

**Reg. No. 4,126,619**

**Registered Apr. 10, 2012**

**Int. Cls.: 9 and 41**

**TRADEMARK**

**SERVICE MARK**

**PRINCIPAL REGISTER**

RECORDING FOR THE BLIND & DYSLEXIC INCORPORATED (NEW JERSEY NON-PROFIT CORPORATION)  
20 ROSZEL ROAD  
PRINCETON, NJ 08540

FOR: EDUCATIONAL RECORDABLE MEDIA FILES AND PORTABLE ELECTRONIC STORAGE MEDIA, NAMELY, E-BASED LITERATURE FEATURING A WIDE VARIETY OF PRINTED MATERIALS, BOOKS AND LITERARY WORKS WHICH ARE AVAILABLE IN DOWNLOADABLE ELECTRONIC FILE FORMATS AND RECORDED MEDIA STORAGE DEVICE FORMATS AND PLAYABLE ON PORTABLE MEDIA PLAYERS FOR PEOPLE WITH VISUAL IMPAIRMENTS, LEARNING OR PERCEPTUAL DISABILITIES AND DIFFERENCES OR OTHER PHYSICAL DISABILITIES; SOFTWARE FOR MANIPULATING DIGITAL AUDIO INFORMATION FOR USE IN AUDIO MEDIA APPLICATIONS, IN CLASS 9 (U.S. CLS. 21, 23, 26, 36 AND 38).

FIRST USE 4-11-2011; IN COMMERCE 4-11-2011.

FOR: EDUCATIONAL SERVICES, NAMELY, CONDUCTING WORKSHOPS, COURSES, AND CONFERENCES IN THE FIELDS OF GENERAL AND SPECIAL EDUCATION, DISABILITY AWARENESS, AND THE AVAILABILITY, ROLE AND USE OF EDUCATIONAL ACCOMMODATIONS; PROVIDING A WEB-SITE FOR EDUCATORS TO FACILITATE READING AND STUDY SKILLS; PROVIDING AN ON-LINE COMPUTER DATABASE IN THE FIELD OF GENERAL AND SPECIAL EDUCATION, IN CLASS 41 (U.S. CLS. 100, 101 AND 107).

FIRST USE 4-11-2011; IN COMMERCE 4-11-2011.

THE MARK CONSISTS OF STANDARD CHARACTERS WITHOUT CLAIM TO ANY PARTICULAR FONT, STYLE, SIZE, OR COLOR.

NO CLAIM IS MADE TO THE EXCLUSIVE RIGHT TO USE "LEARNING", APART FROM THE MARK AS SHOWN.

SN 85-229,822, FILED 1-31-2011.

JOHN HWANG, EXAMINING ATTORNEY



*David J. Kyffers*

Director of the United States Patent and Trademark Office

# United States of America

United States Patent and Trademark Office

# COYOTE 500

**Reg. No. 4,126,620**

**Registered Apr. 10, 2012**

**Int. Cl.: 28**

**TRADEMARK**

**PRINCIPAL REGISTER**

MATTEL, INC. (DELAWARE CORPORATION)  
M1-1518  
333 CONTINENTAL BOULEVARD  
EL SEGUNDO, CA 90245

FOR: TOY VEHICLES AND ACCESSORIES THEREFOR, IN CLASS 28 (U.S. CLS. 22, 23, 38 AND 50).

FIRST USE 9-9-2011; IN COMMERCE 9-9-2011.

THE MARK CONSISTS OF STANDARD CHARACTERS WITHOUT CLAIM TO ANY PARTICULAR FONT, STYLE, SIZE, OR COLOR.

SN 85-229,978, FILED 1-31-2011.

LIEF MARTIN, EXAMINING ATTORNEY



*David J. Kyffers*

Director of the United States Patent and Trademark Office

# United States of America

United States Patent and Trademark Office

## NITRO SPEEDERS

**Reg. No. 4,126,621**

**Registered Apr. 10, 2012**

**Int. Cl.: 28**

**TRADEMARK**

**PRINCIPAL REGISTER**

MATTEL, INC. (DELAWARE CORPORATION)  
M1-1518  
333 CONTINENTAL BOULEVARD  
EL SEGUNDO, CA 90245

FOR: REMOTE-CONTROLLED TOY VEHICLES AND ACCESSORIES THEREFOR, IN CLASS 28 (U.S. CLS. 22, 23, 38 AND 50).

FIRST USE 6-20-2011; IN COMMERCE 6-20-2011.

THE MARK CONSISTS OF STANDARD CHARACTERS WITHOUT CLAIM TO ANY PARTICULAR FONT, STYLE, SIZE, OR COLOR.

SN 85-229,985, FILED 1-31-2011.

LIEF MARTIN, EXAMINING ATTORNEY



*David J. Kybas*

Director of the United States Patent and Trademark Office

# United States of America

United States Patent and Trademark Office

## HEROES OF THE DEEP

**Reg. No. 4,126,622**

**Registered Apr. 10, 2012**

**Int. Cl.: 28**

**TRADEMARK**

**PRINCIPAL REGISTER**

MATTEL, INC. (DELAWARE CORPORATION)  
M1-1518  
333 CONTINENTAL BOULEVARD  
EL SEGUNDO, CA 90245

FOR: TOY ACTION FIGURES AND ACCESSORIES THEREFOR, IN CLASS 28 (U.S. CLS. 22, 23, 38 AND 50).

FIRST USE 1-18-2012; IN COMMERCE 1-18-2012.

THE MARK CONSISTS OF STANDARD CHARACTERS WITHOUT CLAIM TO ANY PARTICULAR FONT, STYLE, SIZE, OR COLOR.

SN 85-229,991, FILED 1-31-2011.

MARY CRAWFORD, EXAMINING ATTORNEY



*David J. Kyjars*

Director of the United States Patent and Trademark Office



# United States of America

United States Patent and Trademark Office

## THE ACTIVE CALORIE DIET

**Reg. No. 4,126,623**

RODALE INC. (PENNSYLVANIA CORPORATION)  
33 EAST MINOR STREET  
EMMAUS, PA 180980099

**Registered Apr. 10, 2012**

**Int. Cl.: 16**

FOR: SERIES OF BOOKS IN THE FIELDS OF DIET, HEALTH, FITNESS AND NUTRITION,  
IN CLASS 16 (U.S. CLS. 2, 5, 22, 23, 29, 37, 38 AND 50).

**TRADEMARK**

FIRST USE 0-0-2011; IN COMMERCE 0-0-2011.

**PRINCIPAL REGISTER**

THE MARK CONSISTS OF STANDARD CHARACTERS WITHOUT CLAIM TO ANY PAR-  
TICULAR FONT, STYLE, SIZE, OR COLOR.

NO CLAIM IS MADE TO THE EXCLUSIVE RIGHT TO USE "DIET", APART FROM THE  
MARK AS SHOWN.

SN 85-230,203, FILED 1-31-2011.

KATHERINE CONNOLLY, EXAMINING ATTORNEY



*David J. Kybas*

Director of the United States Patent and Trademark Office

# United States of America

United States Patent and Trademark Office

IF YOU'RE TALKING MONEY,  
WE SPEAK YOUR LANGUAGE

**Reg. No. 4,126,624**

MORTON BERGER (UNITED STATES INDIVIDUAL)  
15 MAIDEN LANE, SUITE 1003  
NEW YORK, NY 10038

**Registered Apr. 10, 2012**

**Int. Cl.: 36**

FOR: FINANCIAL CONSULTANCY; FINANCIAL CONSULTATION; FINANCIAL CONSULTING, IN CLASS 36 (U.S. CLS. 100, 101 AND 102).

**SERVICE MARK**

FIRST USE 1-17-2012; IN COMMERCE 1-17-2012.

**PRINCIPAL REGISTER**

THE MARK CONSISTS OF STANDARD CHARACTERS WITHOUT CLAIM TO ANY PARTICULAR FONT, STYLE, SIZE, OR COLOR.

SN 85-230,637, FILED 1-31-2011.

KIM MONINGHOFF, EXAMINING ATTORNEY



*David J. Kyffers*

Director of the United States Patent and Trademark Office

# United States of America

United States Patent and Trademark Office

## LIQUID RIPPER

**Reg. No. 4,126,625**

**Registered Apr. 10, 2012**

**Int. Cl.: 1**

**TRADEMARK**

**PRINCIPAL REGISTER**

ORO AGRI INC (MISSOURI CORPORATION)  
TM45US00  
IP SERVICE DEPARTMENT  
TROPHY CLUB, TX 76262

FOR: SOIL AMENDMENTS, IN CLASS 1 (U.S. CLS. 1, 5, 6, 10, 26 AND 46).

FIRST USE 10-1-2011; IN COMMERCE 10-1-2011.

THE MARK CONSISTS OF STANDARD CHARACTERS WITHOUT CLAIM TO ANY PARTICULAR FONT, STYLE, SIZE, OR COLOR.

NO CLAIM IS MADE TO THE EXCLUSIVE RIGHT TO USE "LIQUID", APART FROM THE MARK AS SHOWN.

SN 85-230,838, FILED 2-1-2011.

MICHAEL SOUDERS, EXAMINING ATTORNEY



*David J. Kyffers*

Director of the United States Patent and Trademark Office

# United States of America

United States Patent and Trademark Office

## Leading Edge Fundraising

**Reg. No. 4,126,626**

**Registered Apr. 10, 2012**

**Int. Cl.: 36**

**SERVICE MARK**

**PRINCIPAL REGISTER**

BUELING'S, INC. (FLORIDA CORPORATION), DBA LEADING EDGE FUNDRAISING,  
10604 DEERBERRY DRIVE  
LAND O'LAKES, FL 34638

FOR: CHARITABLE FUNDRAISING; CHARITABLE FUNDRAISING SERVICES; CHARITABLE SERVICES, NAMELY, ORGANIZING FUNDRAISING SERVICES AND EVENTS TO RAISE FUNDS IN THE FIELD OF SCHOOLS, YOUTH GROUPS AND SPORTS LEAGUES; FINANCIAL SERVICES, NAMELY, BUSINESS FUNDRAISING FOR OTHERS; FUNDRAISING SERVICES, NAMELY, ORGANIZING FUNDRAISERS FOR SCHOOLS AND OTHER GROUPS; FUNDRAISING SERVICES, NAMELY, ORGANIZING, ARRANGING AND CONDUCTING FUNDRAISING PROGRAMS FOR THE BENEFIT OF SCHOOLS AND NON-PROFIT ORGANIZATIONS, IN CLASS 36 (U.S. CLS. 100, 101 AND 102).

FIRST USE 1-30-2011; IN COMMERCE 2-25-2011.

THE MARK CONSISTS OF STANDARD CHARACTERS WITHOUT CLAIM TO ANY PARTICULAR FONT, STYLE, SIZE, OR COLOR.

NO CLAIM IS MADE TO THE EXCLUSIVE RIGHT TO USE "FUNDRAISING", APART FROM THE MARK AS SHOWN.

SN 85-231,138, FILED 2-1-2011.

KIMBERLY PERRY, EXAMINING ATTORNEY



*David J. Kyffers*

Director of the United States Patent and Trademark Office

# United States of America

United States Patent and Trademark Office

## UPGRADE YOUR PET'S LIFE

**Reg. No. 4,126,627**

**Registered Apr. 10, 2012**

**Int. Cl.: 35**

**SERVICE MARK**

**PRINCIPAL REGISTER**

LABRADOR FRANCHISES, INC. (CALIFORNIA CORPORATION)  
SUITE 102  
2001 FINANCIAL WAY  
GLEN DORA, CA 91741

FOR: ON-LINE RETAIL STORE SERVICES FEATURING PET FOOD AND RELATED SUPPLIES, IN CLASS 35 (U.S. CLS. 100, 101 AND 102).

FIRST USE 11-1-2011; IN COMMERCE 11-1-2011.

THE MARK CONSISTS OF STANDARD CHARACTERS WITHOUT CLAIM TO ANY PARTICULAR FONT, STYLE, SIZE, OR COLOR.

SN 85-231,142, FILED 2-1-2011.

KIMBERLY PERRY, EXAMINING ATTORNEY



*David J. Kybas*

Director of the United States Patent and Trademark Office

# United States of America

United States Patent and Trademark Office

## TURN TABLET

**Reg. No. 4,126,628**

**Registered Apr. 10, 2012**

**Int. Cl.: 9**

**TRADEMARK**

**PRINCIPAL REGISTER**

THE HANDLET, LLC (FLORIDA LIMITED LIABILITY COMPANY)  
1725 RIVERS EDGE DRIVE  
ORLANDO, FL 32825

FOR: COMPUTER CASES, IN CLASS 9 (U.S. CLS. 21, 23, 26, 36 AND 38).

FIRST USE 1-6-2011; IN COMMERCE 9-21-2011.

THE MARK CONSISTS OF STANDARD CHARACTERS WITHOUT CLAIM TO ANY PARTICULAR FONT, STYLE, SIZE, OR COLOR.

NO CLAIM IS MADE TO THE EXCLUSIVE RIGHT TO USE "TABLET", APART FROM THE MARK AS SHOWN.

SN 85-231,191, FILED 2-1-2011.

CHRIS WELLS, EXAMINING ATTORNEY



*David J. Kyffers*

Director of the United States Patent and Trademark Office

# United States of America

United States Patent and Trademark Office

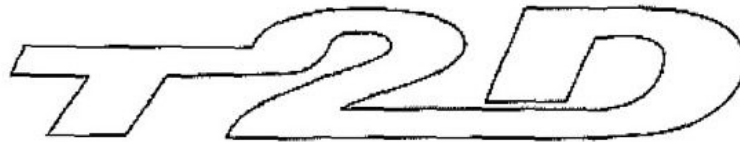
The logo consists of the letters 'T2D' in a stylized, outlined font. The 'T' is on the left, followed by a '2' that is partially enclosed by the 'D' on the right. The 'D' is a large, rounded letter with a thick outline.

**Reg. No. 4,126,629**

**Registered Apr. 10, 2012**

**Int. Cl.: 28**

**TRADEMARK**

**PRINCIPAL REGISTER**

TECNOLOGÍA, SERVICIOS Y MATERIALES PARA EL DESARROLLO DEL DEPORTE, S.L.  
(SPAIN LIMITED LIABILITY COMPANY)  
AV. CORTES VALENCIANAS 39, PISO 1  
AV. CORTES VALENCIANAS 39, PISO 1  
VALENCIA, SPAIN 46530

FOR: HOCKEY GLOVES; HOCKEY GOALS; HOCKEY PUCKS; HOCKEY STICK BLADES;  
HOCKEY STICK SHAFTS; HOCKEY STICKS; ICE HOCKEY GOALIE PADS; ICE HOCKEY  
STICKS, IN CLASS 28 (U.S. CLS. 22, 23, 38 AND 50).

FIRST USE 1-1-2009; IN COMMERCE 9-30-2011.

THE MARK CONSISTS OF THE LETTER "T" ATTACHED TO THE NUMBER "2" ATTACHED  
TO THE LETTER "D" ALL TOGETHER.

SN 85-231,249, FILED 2-1-2011.

KIMBERLY PERRY, EXAMINING ATTORNEY



*David J. Kyffers*

Director of the United States Patent and Trademark Office

# United States of America

United States Patent and Trademark Office

# REVELER

**Reg. No. 4,126,630**

TOKI CORPORATION (JAPAN CORPORATION)  
43-15, OHMORIKITA 3-CHOME, OHTA-KU  
TOKYO, JAPAN 1430016

**Registered Apr. 10, 2012**

**Int. Cl.: 11**

FOR: ELECTRIC LAMPS AND LIGHTING FIXTURES, IN CLASS 11 (U.S. CLS. 13, 21, 23, 31 AND 34).

**TRADEMARK**

FIRST USE 4-0-2011; IN COMMERCE 4-0-2011.

**PRINCIPAL REGISTER**

THE MARK CONSISTS OF STANDARD CHARACTERS WITHOUT CLAIM TO ANY PARTICULAR FONT, STYLE, SIZE, OR COLOR.

SN 85-231,318, FILED 2-1-2011.

KELLY CHOE, EXAMINING ATTORNEY



*David J. Kybas*

Director of the United States Patent and Trademark Office



# United States of America

United States Patent and Trademark Office



**Reg. No. 4,126,631**

SAMBRISKI, JOSEPH (UNITED STATES INDIVIDUAL)  
212 BLUE POINT ROAD WEST  
HOLTSVILLE, NY 11742

**Registered Apr. 10, 2012**

**Int. Cl.: 28**

FOR: BOARD GAMES, IN CLASS 28 (U.S. CLS. 22, 23, 38 AND 50).

**TRADEMARK**

FIRST USE 10-1-2011; IN COMMERCE 12-8-2011.

**PRINCIPAL REGISTER**

THE MARK CONSISTS OF NINE GEOMETRIC SYMBOLS WITH A SHADOW IN THE DOWN AND RIGHT DIRECTION WHERE EACH SYMBOL CONTAINS ONE LETTER WHICH SPELLS OUT THE NAME OF THE PRODUCT "DICEATHON". THE SYMBOLS USED ARE, IN ORDER OF APPEARANCE: FIRST A CIRCLE, FOLLOWED BY A TRIANGLE, FOLLOWED BY A SQUARE, FOLLOWED BY A PENTAGON, FOLLOWED BY A SIX SIDED SYMBOL, FOLLOWED BY A SQUARE ROTATED 45 DEGREES, FOLLOWED BY A CIRCLE, FOLLOWED BY A TRIANGLE AND FINALLY A PENTAGON.

SN 85-231,498, FILED 2-1-2011.

MARC LEIPZIG, EXAMINING ATTORNEY



*David J. Kybas*

Director of the United States Patent and Trademark Office

# United States of America

United States Patent and Trademark Office

## BE A PART OF THE HEART

**Reg. No. 4,126,632**

**Registered Apr. 10, 2012**

**Int. Cl.: 36**

**SERVICE MARK**

**PRINCIPAL REGISTER**

NATIONAL ACADEMY OF RECORDING ARTS & SCIENCES, INC. (DELAWARE CORPORATION)  
3030 OLYMPIC BLVD.  
SANTA MONICA, CA 90404

FOR: CHARITABLE FUNDRAISING, IN CLASS 36 (U.S. CLS. 100, 101 AND 102).

FIRST USE 2-14-2011; IN COMMERCE 2-14-2011.

THE MARK CONSISTS OF STANDARD CHARACTERS WITHOUT CLAIM TO ANY PARTICULAR FONT, STYLE, SIZE, OR COLOR.

SN 85-231,581, FILED 2-1-2011.

CHRISIE B. KING, EXAMINING ATTORNEY



*David J. Kybas*

Director of the United States Patent and Trademark Office

United States of America  
United States Patent and Trademark Office

ASTRO FX

**Reg. No. 4,126,633**

CELESTRON ACQUISITION LLC (DELAWARE LIMITED LIABILITY COMPANY)  
2835 COLUMBIA STREET  
TORRANCE, CA 90503

**Registered Apr. 10, 2012**

**Int. Cl.: 9**

FOR: COMPUTER SOFTWARE FOR ASTROPHOTOGRAPHY IMAGE ACQUISITION,  
STACKING, AND PROCESSING, IN CLASS 9 (U.S. CLS. 21, 23, 26, 36 AND 38).

**TRADEMARK**

FIRST USE 8-1-2011; IN COMMERCE 11-1-2011.

**PRINCIPAL REGISTER**

THE MARK CONSISTS OF STANDARD CHARACTERS WITHOUT CLAIM TO ANY PAR-  
TICULAR FONT, STYLE, SIZE, OR COLOR.

NO CLAIM IS MADE TO THE EXCLUSIVE RIGHT TO USE "FX", APART FROM THE MARK  
AS SHOWN.

SN 85-232,261, FILED 2-2-2011.

REBECCA EISINGER, EXAMINING ATTORNEY



*David J. Kyffers*

Director of the United States Patent and Trademark Office

# United States of America

United States Patent and Trademark Office

# SKYQ

**Reg. No. 4,126,634**

**Registered Apr. 10, 2012**

**Int. Cl.: 9**

**TRADEMARK**

**PRINCIPAL REGISTER**

CELESTRON ACQUISITION LLC (DELAWARE LIMITED LIABILITY COMPANY)  
2835 COLUMBIA STREET  
TORRANCE, CA 90503

FOR: COMPUTER SOFTWARE APPLICATION FOR THE REMOTE CONTROL OF A TELESCOPE AND FOR VIEWING AN INTERACTIVE CELESTIAL MAP, FOR USE ON COMPUTERS AND HANDHELD ELECTRONIC DEVICES, IN CLASS 9 (U.S. CLS. 21, 23, 26, 36 AND 38).

FIRST USE 7-6-2011; IN COMMERCE 7-6-2011.

THE MARK CONSISTS OF STANDARD CHARACTERS WITHOUT CLAIM TO ANY PARTICULAR FONT, STYLE, SIZE, OR COLOR.

SN 85-232,282, FILED 2-2-2011.

REBECCA EISINGER, EXAMINING ATTORNEY



*David J. Kybas*

Director of the United States Patent and Trademark Office

# United States of America

United States Patent and Trademark Office



**Reg. No. 4,126,635**

**Registered Apr. 10, 2012**

**Int. Cl.: 39**

**SERVICE MARK**

**PRINCIPAL REGISTER**

WADA FARMS MARKETING GROUP LLC (IDAHO LIMITED LIABILITY COMPANY)  
2155 PROVIDENCE WAY  
IDAHO FALLS, ID 83404

FOR: FREIGHT TRANSPORTATION BY TRUCK, IN CLASS 39 (U.S. CLS. 100 AND 105).

FIRST USE 10-1-2011; IN COMMERCE 10-1-2011.

NO CLAIM IS MADE TO THE EXCLUSIVE RIGHT TO USE "LOGISTICS", APART FROM THE MARK AS SHOWN.

THE MARK CONSISTS OF TWO BOXES, WITH ONE SMALLER BOX INSIDE THE LARGER BOX, THE UPPER AND LOWER PORTIONS OF EACH BOX HAVING A CONVEX CONFIGURATION. THE SMALLER INNER BOX CONTAINS THE STYLIZED LETTERS "WFM" CENTERED WITH A SEMI-OVAL LIGHTER SHADED FIGURE BEHIND IT. THE LARGER OUTER BOX HAS THE WORDS "LOGISTICS" CENTERED WITHIN IT BELOW THE SMALLER BOX.

SN 85-232,299, FILED 2-2-2011.

ESTHER BELENKER, EXAMINING ATTORNEY



*David J. Kyffers*

Director of the United States Patent and Trademark Office

# United States of America

United States Patent and Trademark Office

## Tinytwinies, bringing joy and lots of smiles

**Reg. No. 4,126,636**

PUJALKA, MARIA ELIZABETH (ARGENTINA INDIVIDUAL)  
FONROUGE 1314 DTO 1

**Registered Apr. 10, 2012**

C. A. DE BUENOS AIRES, ARGENTINA 1440

**Int. Cl.: 16**

FOR: BOOKMARKS; CALENDARS; DECALCOMANIAS; DECALS; GRAPHIC ART REPRODUCTIONS; GREETINGS CARDS AND POSTCARDS; NOTE CARDS; NOTEBOOKS; PATTERNS FOR MAKING CLOTHES; PATTERNS FOR EMBROIDERING; POSTERS; RUBBER STAMPS; STATIONERY, IN CLASS 16 (U.S. CLS. 2, 5, 22, 23, 29, 37, 38 AND 50).

**TRADEMARK**

**PRINCIPAL REGISTER**

FIRST USE 3-8-2011; IN COMMERCE 6-28-2011.

THE MARK CONSISTS OF STANDARD CHARACTERS WITHOUT CLAIM TO ANY PARTICULAR FONT, STYLE, SIZE, OR COLOR.

SN 85-232,903, FILED 2-3-2011.

ERNEST SHOSHO, EXAMINING ATTORNEY



*David J. Kyros*

Director of the United States Patent and Trademark Office

# United States of America

United States Patent and Trademark Office

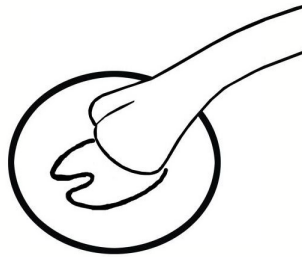

**Reg. No. 4,126,637**

**Registered Apr. 10, 2012**

**Int. Cl.: 20**

**TRADEMARK**

**PRINCIPAL REGISTER**

SLEEP INNOVATIONS, INC. (NEW JERSEY CORPORATION)  
187 ROUTE 36, SUITE 101  
WEST LONG BRANCH, NJ 07784

FOR: MATTRESSES, IN CLASS 20 (U.S. CLS. 2, 13, 22, 25, 32 AND 50).

FIRST USE 9-0-2010; IN COMMERCE 9-0-2010.

THE MARK CONSISTS OF A FANCIFUL REPRESENTATION OF AN ANIMAL HOOF, WHICH IS STEPPING INTO OR OUT OF A HOOF PRINT, AND SHADOWING AROUND THE HOOF AND PARTIALLY COVERING THE HOOF PRINT CREATES A THREE-DIMENSIONAL EFFECT.

SN 85-233,138, FILED 2-3-2011.

LOURDES AYALA, EXAMINING ATTORNEY



*David J. Kybas*

Director of the United States Patent and Trademark Office

# United States of America

United States Patent and Trademark Office

# STACK-IT

**Reg. No. 4,126,638**

CHI SYSTEMS INC. (PENNSYLVANIA CORPORATION)  
1035 VIRGINIA DRIVE, SUITE 300  
FORT WASHINGTON, PA 19034

**Registered Apr. 10, 2012**

**Int. Cl.: 42**

FOR: COMPUTER SERVICES, CREATING SOFTWARE FOR OTHERS TO SUPPORT THE ANALYSIS AND PRESENTATION OF TACTICAL, CULTURAL, SOCIAL, AND INTELLIGENCE INFORMATION BY APPLYING ADVANCED VISUALIZATION AND DECISION SUPPORT TECHNOLOGIES, IN CLASS 42 (U.S. CLS. 100 AND 101).

**SERVICE MARK**

**PRINCIPAL REGISTER**

FIRST USE 12-1-2011; IN COMMERCE 12-1-2011.

THE MARK CONSISTS OF STANDARD CHARACTERS WITHOUT CLAIM TO ANY PARTICULAR FONT, STYLE, SIZE, OR COLOR.

SN 85-233,181, FILED 2-3-2011.

DEIRDRE ROBERTSON, EXAMINING ATTORNEY



*David J. Kyros*

Director of the United States Patent and Trademark Office



# United States of America

United States Patent and Trademark Office

# SLMi

**Reg. No. 4,126,639**

DUN & BRADSTREET, INC. (DELAWARE CORPORATION)  
103 JFK PARKWAY  
SHORT HILLS, NJ 07078

**Registered Apr. 10, 2012**

**Int. Cl.: 35**

FOR: BUSINESS SERVICES, NAMELY, BUSINESS INFORMATION, ADVICE, AND CONSULTATION IN THE FIELD OF SUPPLY LIFECYCLE MANAGEMENT PROCESSES AND FUNCTIONAL NEEDS IN THE AREAS OF SUPPLIER RISK, COMPLIANCE, DIVERSITY AND INFORMATION MANAGEMENT, IN CLASS 35 (U.S. CLS. 100, 101 AND 102).

**SERVICE MARK**

**PRINCIPAL REGISTER**

FIRST USE 3-0-2011; IN COMMERCE 3-0-2011.

THE MARK CONSISTS OF STANDARD CHARACTERS WITHOUT CLAIM TO ANY PARTICULAR FONT, STYLE, SIZE, OR COLOR.

SN 85-233,440, FILED 2-3-2011.

PATRICIA EVANKO, EXAMINING ATTORNEY



*David J. Kybas*

Director of the United States Patent and Trademark Office

# United States of America

United States Patent and Trademark Office

## ASPEN RIDGE

**Reg. No. 4,126,640**

**Registered Apr. 10, 2012**

**Int. Cl.: 29**

**TRADEMARK**

**PRINCIPAL REGISTER**

SWIFT BRANDS COMPANY (DELAWARE CORPORATION)  
1770 PROMONTORY CIRCLE  
GREELEY, CO 80634

FOR: FRESH, FROZEN, GROUND, PRECOOKED, SEASONED, MARINATED AND PROCESSED BEEF AND PORK, AND BEEF BY-PRODUCTS, NAMELY, HEARTS, LIVERS AND BEEF TRIPE, AND PORK BY-PRODUCTS, NAMELY, HEARTS, LIVERS AND PIGS FEET, IN CLASS 29 (U.S. CL. 46).

FIRST USE 1-6-2012; IN COMMERCE 1-6-2012.

THE MARK CONSISTS OF STANDARD CHARACTERS WITHOUT CLAIM TO ANY PARTICULAR FONT, STYLE, SIZE, OR COLOR.

SN 85-233,467, FILED 2-3-2011.

JILL C. ALT, EXAMINING ATTORNEY



*David J. Kybas*

Director of the United States Patent and Trademark Office

# United States of America

United States Patent and Trademark Office

# MYBOAT.COM

**Reg. No. 4,126,641**

**Registered Apr. 10, 2012**

**Int. Cls.: 35 and 37**

**SERVICE MARK**

**PRINCIPAL REGISTER**

MARINEMAX, INC. (DELAWARE CORPORATION)  
18167 U.S. 19 NORTH  
SUITE 300  
CLEARWATER, FL 33764

FOR: PROVIDING ON-LINE INFORMATION AND REFERRALS RELATING TO THE BUSINESS OF SALES AND SERVICES OF RECREATIONAL BOATS, IN CLASS 35 (U.S. CLS. 100, 101 AND 102).

FIRST USE 2-9-2011; IN COMMERCE 6-3-2011.

FOR: PROVIDING ON-LINE INFORMATION AND EXPERT TECHNICAL ADVICE RELATING TO SERVICING AND REPAIR OF RECREATIONAL BOATS, IN CLASS 37 (U.S. CLS. 100, 103 AND 106).

FIRST USE 2-9-2011; IN COMMERCE 6-3-2011.

THE MARK CONSISTS OF STANDARD CHARACTERS WITHOUT CLAIM TO ANY PARTICULAR FONT, STYLE, SIZE, OR COLOR.

OWNER OF U.S. REG. NOS. 2,401,921, 2,618,170, AND OTHERS.

SN 85-233,491, FILED 2-3-2011.

JOHN WILKE, EXAMINING ATTORNEY



*David J. Kyros*

Director of the United States Patent and Trademark Office

# United States of America

United States Patent and Trademark Office

## PAWS ALERT ID

**Reg. No. 4,126,642**

PYLE, ROCHELLE (UNITED STATES INDIVIDUAL)  
11345 ESPADRILLE CT  
LAS VEGAS, NV 89138

**Registered Apr. 10, 2012**

**Int. Cls.: 18 and 44**

FOR: PET EMERGENCY PACKS COMPRISED OF A CARRIER, PET FOOD, WATER, TREATS, TOYS, PET COLLARS AND LEASHES, IN CLASS 18 (U.S. CLS. 1, 2, 3, 22 AND 41).

**TRADEMARK**

FIRST USE 10-1-2011; IN COMMERCE 10-1-2011.

**SERVICE MARK**

FOR: MAINTAINING PERSONAL PET OWNERSHIP RECORDS AND EMERGENCY CONTACT INFORMATION; PROVIDING EMERGENCY INFORMATION SERVICES IN THE NATURE OF COLLECTING AND SUMMARIZING AN INDIVIDUAL'S PET OWNERSHIP INFORMATION AND EMERGENCY CONTACT THAT IS TRANSFERRED ONTO A CARD FOR REFERENCE IN THE EVENT OF AN EMERGENCY OF LIFE THREATENING SITUATION; PROVIDING AN ON-LINE DATABASE CONTAINING USER SPECIFIC PET OWNERSHIP INFORMATION AND EMERGENCY CONTACT INFORMATION, IN CLASS 44 (U.S. CLS. 100 AND 101).

**PRINCIPAL REGISTER**

FIRST USE 10-1-2011; IN COMMERCE 10-1-2011.

THE MARK CONSISTS OF STANDARD CHARACTERS WITHOUT CLAIM TO ANY PARTICULAR FONT, STYLE, SIZE, OR COLOR.

NO CLAIM IS MADE TO THE EXCLUSIVE RIGHT TO USE "ID", APART FROM THE MARK AS SHOWN.

SN 85-233,952, FILED 2-4-2011.

HENRY S. ZAK, EXAMINING ATTORNEY



*David J. Kypos*

Director of the United States Patent and Trademark Office

# United States of America

United States Patent and Trademark Office

## TIO CARLITO'S

**Reg. No. 4,126,643**

KLN ENTERPRISES, INC. (MINNESOTA CORPORATION)  
800 - 4TH STREET N.W., P.O. BOX 230  
PERHAM, MN 56573

**Registered Apr. 10, 2012**

**Int. Cls.: 29 and 30**

FOR: POTATO-BASED SNACK FOODS, IN CLASS 29 (U.S. CL. 46).

**TRADEMARK**

FIRST USE 12-29-2011; IN COMMERCE 12-29-2011.

**PRINCIPAL REGISTER**

FOR: CORN-BASED SNACK FOODS, IN CLASS 30 (U.S. CL. 46).

FIRST USE 5-19-2011; IN COMMERCE 5-19-2011.

THE MARK CONSISTS OF STANDARD CHARACTERS WITHOUT CLAIM TO ANY PARTICULAR FONT, STYLE, SIZE, OR COLOR.

THE ENGLISH TRANSLATION OF "TIO" IN THE MARK IS "UNCLE".

SN 85-234,127, FILED 2-4-2011.

JANICE KIM, EXAMINING ATTORNEY



*David J. Kybas*

Director of the United States Patent and Trademark Office

# United States of America

United States Patent and Trademark Office

# SPEEDCELL

**Reg. No. 4,126,644**

**Registered Apr. 10, 2012**

**Int. Cl.: 20**

**TRADEMARK**

**PRINCIPAL REGISTER**

SPEEDRACK PRODUCTS GROUP, LTD. (MICHIGAN CORPORATION)  
7903 VENTURE AVE.  
SPARTA, MI 493459309

FOR: INDUSTRIAL STORAGE RACKS, IN CLASS 20 (U.S. CLS. 2, 13, 22, 25, 32 AND 50).

FIRST USE 9-15-2011; IN COMMERCE 9-16-2011.

THE MARK CONSISTS OF STANDARD CHARACTERS WITHOUT CLAIM TO ANY PARTICULAR FONT, STYLE, SIZE, OR COLOR.

OWNER OF U.S. REG. NO. 665,387.

SN 85-234,277, FILED 2-4-2011.

ANNE FARRELL, EXAMINING ATTORNEY



*David J. Kyffers*

Director of the United States Patent and Trademark Office

# United States of America

United States Patent and Trademark Office

# ScoreCheck✓

**Reg. No. 4,126,645**

INTERSECTIONS INC. (DELAWARE CORPORATION)  
3901 STONECROFT BLVD.  
CHANTILLY, VA 20151

**Registered Apr. 10, 2012**

**Int. Cls.: 35, 36, and 45**

FOR: MONITORING CONSUMER CREDIT REPORTS AND CREDIT SCORES; PROVIDING AN ALERT AS TO CERTAIN CHANGES IN CREDIT REPORTS, IN CLASS 35 (U.S. CLS. 100, 101 AND 102).

**SERVICE MARK**

FIRST USE 5-25-2011; IN COMMERCE 5-25-2011.

**PRINCIPAL REGISTER**

FOR: PROVIDING CREDIT REPORTING DATA MAINTAINED BY OTHERS; PROVIDING IDENTITY THEFT INSURANCE UNDERWRITTEN BY OTHERS; PROVIDING CONSULTATION REGARDING CREDIT REPORTS AND CREDIT SCORES; FRAUD RESOLUTION ASSISTANCE, NAMELY, ASSISTANCE WITH DISPUTING FRAUDULENT ACTIVITY ON CREDIT REPORTS AND RESTORING CREDIT DAMAGED BY IDENTITY THEFT; PROVIDING FINANCIAL CALCULATORS, IN CLASS 36 (U.S. CLS. 100, 101 AND 102).

FIRST USE 5-25-2001; IN COMMERCE 5-25-2011.

FOR: PROVIDING ADVICE AND CONSULTATION IN THE FIELD OF IDENTITY THEFT; IDENTITY THEFT PROTECTION SERVICES, NAMELY, MONITORING PERSONAL IDENTITY INFORMATION AND FINANCIAL IDENTITY FOR PREVENTION OF IDENTITY THEFT AND FRAUD; IDENTITY MANAGEMENT SERVICES, NAMELY, OBTAINING CREDIT INFORMATION AND OTHER PUBLIC AND PERSONAL IDENTITY INFORMATION FOR USE IN PROVIDING REPORTS ON IMPACT OF ACTIVITIES ON CREDIT SCORES, IN CLASS 45 (U.S. CLS. 100 AND 101).

FIRST USE 5-25-2011; IN COMMERCE 5-25-2011.

THE MARK CONSISTS OF THE WORDS "SCORECHECK" FOLLOWED BY A CHECKMARK.

SN 85-234,546, FILED 2-4-2011.

MAYUR VAGHANI, EXAMINING ATTORNEY



*David J. Kyros*

Director of the United States Patent and Trademark Office

# United States of America

United States Patent and Trademark Office

## RIMAGE SIGNAL VIRTUAL PUBLISHING

**Reg. No. 4,126,646**

RIMAGE CORPORATION (MINNESOTA CORPORATION)  
7725 WASHINGTON AVENUE SO.  
EDINA, MN 55439

**Registered Apr. 10, 2012**

**Int. Cls.: 9 and 42**

FOR: COMPUTER SOFTWARE THAT ALLOWS CONTENT OWNERS TO SECURELY PUBLISH, DISTRIBUTE AND SELL DIGITAL CONTENT VIA THE INTERNET TO MULTIPLE USER PLATFORMS, IN CLASS 9 (U.S. CLS. 21, 23, 26, 36 AND 38).

**TRADEMARK**

FIRST USE 7-0-2011; IN COMMERCE 7-0-2011.

**SERVICE MARK**

FOR: PROVIDING A SECURED-ACCESS ONLINE SOFTWARE HOST PLATFORM ON THE INTERNET THAT ALLOWS THE SECURE PUBLICATION, DISTRIBUTION, AND LICENSING OF DIGITAL CONTENT TO MULTIPLE USERS, IN CLASS 42 (U.S. CLS. 100 AND 101).

**PRINCIPAL REGISTER**

FIRST USE 7-0-2011; IN COMMERCE 7-0-2011.

THE MARK CONSISTS OF STANDARD CHARACTERS WITHOUT CLAIM TO ANY PARTICULAR FONT, STYLE, SIZE, OR COLOR.

OWNER OF U.S. REG. NO. 2,546,159.

NO CLAIM IS MADE TO THE EXCLUSIVE RIGHT TO USE "VIRTUAL PUBLISHING", APART FROM THE MARK AS SHOWN.

SN 85-234,777, FILED 2-4-2011.

LEIGH CAROLINE CASE, EXAMINING ATTORNEY



*David J. Kypos*

Director of the United States Patent and Trademark Office



# United States of America

United States Patent and Trademark Office

## POWERED BY FRIENDSHIP!

**Reg. No. 4,126,647**

**Registered Apr. 10, 2012**

**Int. Cl.: 28**

**TRADEMARK**

**PRINCIPAL REGISTER**

MATTEL, INC. (DELAWARE CORPORATION)  
M1-1518  
333 CONTINENTAL BOULEVARD  
EL SEGUNDO, CA 90245

FOR: TOY ROBOTS; TALKING DOLLS, IN CLASS 28 (U.S. CLS. 22, 23, 38 AND 50).

FIRST USE 6-6-2011; IN COMMERCE 6-6-2011.

THE MARK CONSISTS OF STANDARD CHARACTERS WITHOUT CLAIM TO ANY PARTICULAR FONT, STYLE, SIZE, OR COLOR.

SN 85-236,048, FILED 2-7-2011.

MARY CRAWFORD, EXAMINING ATTORNEY



*David J. Kybas*

Director of the United States Patent and Trademark Office

# United States of America

United States Patent and Trademark Office

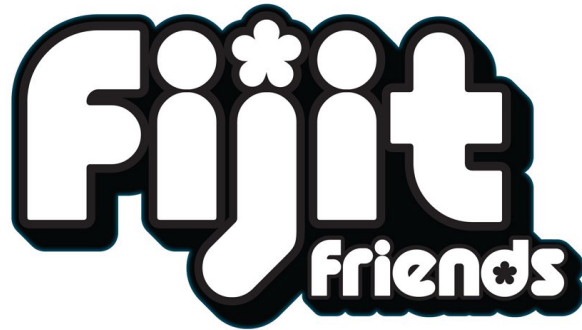

**Reg. No. 4,126,648**

**Registered Apr. 10, 2012**

**Int. Cl.: 28**

**TRADEMARK**

**PRINCIPAL REGISTER**

MATTEL, INC. (DELAWARE CORPORATION)  
M1-1518  
333 CONTINENTAL BOULEVARD  
EL SEGUNDO, CA 90245

FOR: TOY ROBOTS; TALKING DOLLS, IN CLASS 28 (U.S. CLS. 22, 23, 38 AND 50).

FIRST USE 6-6-2011; IN COMMERCE 6-6-2011.

SN 85-236,052, FILED 2-7-2011.

MARY CRAWFORD, EXAMINING ATTORNEY



*David J. Kybas*

Director of the United States Patent and Trademark Office

# United States of America

United States Patent and Trademark Office

## A SPECIAL PRINCESS DAY

**Reg. No. 4,126,649**

**Registered Apr. 10, 2012**

**Int. Cl.: 28**

**TRADEMARK**

**PRINCIPAL REGISTER**

MATTEL, INC. (DELAWARE CORPORATION)  
M1-1518  
333 CONTINENTAL BOULEVARD  
EL SEGUNDO, CA 90245

FOR: DOLLS, DOLL CLOTHING AND DOLL ACCESSORIES, IN CLASS 28 (U.S. CLS. 22, 23, 38 AND 50).

FIRST USE 7-20-2011; IN COMMERCE 7-20-2011.

THE MARK CONSISTS OF STANDARD CHARACTERS WITHOUT CLAIM TO ANY PARTICULAR FONT, STYLE, SIZE, OR COLOR.

SN 85-236,065, FILED 2-7-2011.

JULIE VEPPUMTHARA, EXAMINING ATTORNEY



*David J. Kyffers*

Director of the United States Patent and Trademark Office

# United States of America

United States Patent and Trademark Office

YOU ARE BEAUTIFUL AND YOU  
CAN CHANGE THE WORLD

**Reg. No. 4,126,650**

VAN DER VEER, KAREN (UNITED STATES INDIVIDUAL)  
662 N. PINE CLIFF DR.  
FLAGSTAFF, AZ 86001

**Registered Apr. 10, 2012**

**Int. Cl.: 25**

FOR: CLOTHING, NAMELY, TOPS, BOTTOMS, UNDERWEAR, T-SHIRTS, SWEATSHIRTS, YOGA PANTS, YOGA TOPS, HATS, HEADWEAR, TANK TOPS, SWEATPANTS, JEANS, PAJAMAS, ONE PIECE GARMENTS FOR INFANTS AND TODDLERS, CLOTH BIBS, IN CLASS 25 (U.S. CLS. 22 AND 39).

**TRADEMARK**

**PRINCIPAL REGISTER**

FIRST USE 11-11-2010; IN COMMERCE 6-24-2011.

THE MARK CONSISTS OF STANDARD CHARACTERS WITHOUT CLAIM TO ANY PARTICULAR FONT, STYLE, SIZE, OR COLOR.

SN 85-236,283, FILED 2-8-2011.

PAM WILLIS, EXAMINING ATTORNEY



*David J. Kybas*

Director of the United States Patent and Trademark Office

# United States of America

United States Patent and Trademark Office

# VALUE PLUS

**Reg. No. 4,126,651**

JONES STEPHENS CORP. (ALABAMA CORPORATION)  
3249 MOODY PARKWAY  
MOODY, AL 35004

**Registered Apr. 10, 2012**

**Int. Cl.: 11**

FOR: TOILET SEATS, IN CLASS 11 (U.S. CLS. 13, 21, 23, 31 AND 34).

**TRADEMARK**

FIRST USE 1-1-2012; IN COMMERCE 1-1-2012.

**PRINCIPAL REGISTER**

THE MARK CONSISTS OF STANDARD CHARACTERS WITHOUT CLAIM TO ANY PARTICULAR FONT, STYLE, SIZE, OR COLOR.

SN 85-237,052, FILED 2-8-2011.

KIM MONINGHOFF, EXAMINING ATTORNEY



*David J. Kybas*

Director of the United States Patent and Trademark Office

# United States of America

United States Patent and Trademark Office



**Reg. No. 4,126,652**

**Registered Apr. 10, 2012**

**Int. Cl.: 45**

E.J. CONFIDENTIAL, INC. (MICHIGAN CORPORATION), DBA  
MARRYMEYESTERDAY.COM,  
APT. 106  
21888 COLONY PARK CIRCLE  
SOUTHFIELD, MI 48076

**SERVICE MARK**

**PRINCIPAL REGISTER**

FOR: COMPUTER DATING SERVICES; DATING SERVICES; DATING SERVICES, NAMELY, PROVIDING AN ON-LINE COMPUTER DATABASE FEATURING SINGLE PEOPLE INTERESTED IN MEETING OTHER SINGLE PEOPLE; INTERNET BASED SOCIAL NETWORKING, INTRODUCTION, AND DATING SERVICES; INTERNET-BASED DATING, SOCIAL INTRODUCTION AND SOCIAL NETWORKING SERVICES; MARRIAGE PARTNER INTRODUCTION OR DATING SERVICES; MATCHMAKING SERVICES; WEB SITE SERVICES FEATURING ON-LINE DATING CLUB, IN CLASS 45 (U.S. CLS. 100 AND 101).

FIRST USE 2-7-2012; IN COMMERCE 2-7-2012.

THE MARK CONSISTS OF THE FOLLOWING: THE LETTER "E" INSIDE A CIRCLE ABOVE THE LETTER "J" AND THE WORDING "CONFIDENTIAL" APPEARING BELOW THE LETTER "J". THE RECTANGLE DESIGN IS FOR BACKGROUND PURPOSES ONLY AND IS NOT A FEATURE OF THE MARK.

SN 85-237,094, FILED 2-8-2011.

SETH A. RAPPAPORT, EXAMINING ATTORNEY



*David J. Kybas*

Director of the United States Patent and Trademark Office

# United States of America

United States Patent and Trademark Office

## NEWTEK PAYROLL

**Reg. No. 4,126,653**

NEWTEK BUSINESS SERVICES, INC. (NEW YORK CORPORATION)

**Registered Apr. 10, 2012**

1440 BROADWAY  
NEW YORK, NY 10018

**Int. Cl.: 35**

**SERVICE MARK**

**PRINCIPAL REGISTER**

FOR: ACCOUNTING SERVICES; ONLINE ACCOUNTING SERVICES; COMPUTERIZED ACCOUNTING SERVICES; ACCOUNTING SERVICES FOR ELECTRONIC FUNDS SERVICES; ADMINISTRATION OF BUSINESS PAYROLL FOR OTHERS; PAYROLL PREPARATION; FINANCIAL STATEMENT PREPARATION AND ANALYSIS FOR BUSINESS; INTEGRATED TRACKING AND MANAGEMENT OF COMMERCIAL TRANSACTIONS ON A GLOBAL COMPUTER NETWORK; NOTIFICATION SERVICES TO BUSINESSES IN THE NATURE OF PROVIDING INFORMATION REGARDING BUSINESS FILING REQUIREMENTS AND FILING DATES VIA THE INTERNET AND EMAIL; INCOME TAX CONSULTATION AND PREPARATION SERVICES; BUSINESS AUDITING; BUSINESS CONSULTATION; BUSINESS DEVELOPMENT SERVICES, NAMELY, PROVIDING START-UP SUPPORT FOR BUSINESSES OF OTHERS; BUSINESS INVOICING SERVICES; BUSINESS PLANNING; CONSULTING SERVICES IN THE FIELD OF BUSINESS MANAGEMENT, MANAGEMENT, AND HUMAN RESOURCES, IN CLASS 35 (U.S. CLS. 100, 101 AND 102).

FIRST USE 12-6-2011; IN COMMERCE 12-6-2011.

THE MARK CONSISTS OF STANDARD CHARACTERS WITHOUT CLAIM TO ANY PARTICULAR FONT, STYLE, SIZE, OR COLOR.

OWNER OF U.S. REG. NOS. 3,312,445, 3,318,058, AND 3,344,122.

NO CLAIM IS MADE TO THE EXCLUSIVE RIGHT TO USE "PAYROLL" , APART FROM THE MARK AS SHOWN.

SN 85-237,164, FILED 2-8-2011.

KIMBERLY PERRY, EXAMINING ATTORNEY



*David J. Kypos*

Director of the United States Patent and Trademark Office

# United States of America

United States Patent and Trademark Office

## OCEAN MISSION: QUAD STRIKE

**Reg. No. 4,126,654**

**Registered Apr. 10, 2012**

**Int. Cl.: 28**

**TRADEMARK**

**PRINCIPAL REGISTER**

MATTEL, INC. (DELAWARE CORPORATION)  
M1-1518  
333 CONTINENTAL BOULEVARD  
EL SEGUNDO, CA 90245

FOR: TOY VEHICLES AND ACCESSORIES THEREFOR; TOY VEHICLE PLAYSETS AND ACCESSORIES THEREFOR, IN CLASS 28 (U.S. CLS. 22, 23, 38 AND 50).

FIRST USE 9-9-2011; IN COMMERCE 9-9-2011.

THE MARK CONSISTS OF STANDARD CHARACTERS WITHOUT CLAIM TO ANY PARTICULAR FONT, STYLE, SIZE, OR COLOR.

SN 85-237,245, FILED 2-8-2011.

JULIE VEPPUMTHARA, EXAMINING ATTORNEY



*David J. Kyros*

Director of the United States Patent and Trademark Office



# United States of America

United States Patent and Trademark Office

## EDITOR LIVE

**Reg. No. 4,126,655**

**Registered Apr. 10, 2012**

**Int. Cl.: 35**

**SERVICE MARK**

**PRINCIPAL REGISTER**

EDITORLIVE, INC. (DELAWARE CORPORATION)  
12 GEARY STREET  
SUITE 808  
SAN FRANCISCO, CA 94108

FOR: PROVIDING A WEBSITE FEATURING EMPLOYMENT OPPORTUNITIES IN THE FIELDS OF LANGUAGE TRANSLATION, CUSTOM WRITING, TEXT ADAPTATION, INTERPRETING, AND PROOFREADING, IN CLASS 35 (U.S. CLS. 100, 101 AND 102).

FIRST USE 2-1-2012; IN COMMERCE 2-1-2012.

THE MARK CONSISTS OF STANDARD CHARACTERS WITHOUT CLAIM TO ANY PARTICULAR FONT, STYLE, SIZE, OR COLOR.

NO CLAIM IS MADE TO THE EXCLUSIVE RIGHT TO USE "EDITOR", APART FROM THE MARK AS SHOWN.

SN 85-237,312, FILED 2-8-2011.

JOHN GARTNER, EXAMINING ATTORNEY



*David J. Kybas*

Director of the United States Patent and Trademark Office

# United States of America

United States Patent and Trademark Office

## SILVERLINE ELITE

**Reg. No. 4,126,656**

UNIVERSAL POLYMER & RUBBER, LTD. (OHIO CORPORATION)  
15730 S. MADISON ROAD  
MIDDLEFIELD, OH 44062

**Registered Apr. 10, 2012**

**Int. Cl.: 22**

FOR: CARGO AND CARRIER EQUIPMENT FOR VEHICLES, NAMELY, TARP STRAPS, IN CLASS 22 (U.S. CLS. 1, 2, 7, 19, 22, 42 AND 50).

**TRADEMARK**

FIRST USE 7-25-2011; IN COMMERCE 7-25-2011.

**PRINCIPAL REGISTER**

THE MARK CONSISTS OF STANDARD CHARACTERS WITHOUT CLAIM TO ANY PARTICULAR FONT, STYLE, SIZE, OR COLOR.

OWNER OF U.S. REG. NOS. 2,511,694 AND 3,125,538.

NO CLAIM IS MADE TO THE EXCLUSIVE RIGHT TO USE "ELITE", APART FROM THE MARK AS SHOWN.

SN 85-237,792, FILED 2-9-2011.

CHARISMA HAMPTON, EXAMINING ATTORNEY



*David J. Kyros*

Director of the United States Patent and Trademark Office

# United States of America

United States Patent and Trademark Office

## TEXTURES OF THAILAND

**Reg. No. 4,126,657**

TSI ACCESSORY GROUP, INC. (MISSOURI CORPORATION)  
1031 EXECUTIVE PARKWAY DRIVE  
ST. LOUIS, MO 63141

**Registered Apr. 10, 2012**

**Int. Cl.: 14**

FOR: JEWELRY, IN CLASS 14 (U.S. CLS. 2, 27, 28 AND 50).

**TRADEMARK**

FIRST USE 8-0-2011; IN COMMERCE 8-0-2011.

**PRINCIPAL REGISTER**

THE MARK CONSISTS OF STANDARD CHARACTERS WITHOUT CLAIM TO ANY PARTICULAR FONT, STYLE, SIZE, OR COLOR.

NO CLAIM IS MADE TO THE EXCLUSIVE RIGHT TO USE "THAILAND", APART FROM THE MARK AS SHOWN.

SN 85-237,942, FILED 2-9-2011.

GRETТА YAO, EXAMINING ATTORNEY



*David J. Kyffers*

Director of the United States Patent and Trademark Office

# United States of America

United States Patent and Trademark Office

## THE CHOICE OF ATHLETES

**Reg. No. 4,126,658**

**Registered Apr. 10, 2012**

**Int. Cl.: 28**

**TRADEMARK**

**PRINCIPAL REGISTER**

ATTACK PRODUCTS, LLC (ILLINOIS LIMITED LIABILITY COMPANY)  
2641 W. HARRISON STREET  
CHICAGO, IL 60612

FOR: ARM BAND FOR AIDING BASKETBALL PLAYER'S SHOOTING TECHNIQUE AND CONTROL; FINGER PLACEMENT DEVICE FOR AIDING BASKETBALL PLAYER'S SHOOTING TECHNIQUE AND CONTROL, IN CLASS 28 (U.S. CLS. 22, 23, 38 AND 50).

FIRST USE 6-0-2011; IN COMMERCE 6-0-2011.

THE MARK CONSISTS OF STANDARD CHARACTERS WITHOUT CLAIM TO ANY PARTICULAR FONT, STYLE, SIZE, OR COLOR.

NO CLAIM IS MADE TO THE EXCLUSIVE RIGHT TO USE "ATHLETES", APART FROM THE MARK AS SHOWN.

SN 85-237,996, FILED 2-9-2011.

KEVIN CORWIN, EXAMINING ATTORNEY



*David J. Kybas*

Director of the United States Patent and Trademark Office

# United States of America

United States Patent and Trademark Office

# Property Fox

**Reg. No. 4,126,659**

FOX GLOBAL VENTURES LLC (NEVADA LIMITED LIABILITY COMPANY)  
1000 N. GREEN VALLEY PKWY #440-470  
HENDERSON, NV 89074

**Registered Apr. 10, 2012**

**Int. Cl.: 36**

FOR: REAL ESTATE SERVICES, NAMELY, PROVIDING A DATABASE OF HOMES AND APARTMENTS FOR SALE AND RENT, IN CLASS 36 (U.S. CLS. 100, 101 AND 102).

**SERVICE MARK**

FIRST USE 4-1-2011; IN COMMERCE 4-1-2011.

**PRINCIPAL REGISTER**

THE MARK CONSISTS OF STANDARD CHARACTERS WITHOUT CLAIM TO ANY PARTICULAR FONT, STYLE, SIZE, OR COLOR.

SN 85-238,217, FILED 2-9-2011.

ANDREW LEASER, EXAMINING ATTORNEY



*David J. Kybas*

Director of the United States Patent and Trademark Office

# United States of America

United States Patent and Trademark Office

# SIXELL

**Reg. No. 4,126,660**

KUHLMANN, KYLE (UNITED STATES INDIVIDUAL)  
4916 MT. GAYWAS DR  
SAN DIEGO, CA 92117

**Registered Apr. 10, 2012**

**Int. Cl.: 25**

FOR: CLOTHING, NAMELY, SHORT-SLEEVED T-SHIRTS, IN CLASS 25 (U.S. CLS. 22 AND 39).

**TRADEMARK**

FIRST USE 1-15-2010; IN COMMERCE 11-1-2011.

**PRINCIPAL REGISTER**

THE MARK CONSISTS OF STANDARD CHARACTERS WITHOUT CLAIM TO ANY PARTICULAR FONT, STYLE, SIZE, OR COLOR.

SN 85-238,400, FILED 2-9-2011.

CHARLOTTE CORWIN, EXAMINING ATTORNEY



*David J. Kybas*

Director of the United States Patent and Trademark Office

# United States of America

United States Patent and Trademark Office

# iDigiTip

**Reg. No. 4,126,661**

DURDEN, ANASTASIA (UNITED STATES INDIVIDUAL)  
P.O. BOX 2868  
APOPKA, FL 32704

**Registered Apr. 10, 2012**

**Int. Cl.: 9**

FOR: ELECTRONIC PEN-LIKE DEVICE, THAT CAN ALSO FIT ONTO THE DIGIT OF A HAND, USED IN CONJUNCTION WITH A WRITING SURFACE, TO ENTER COMMANDS OR DATA INTO A COMPUTER, IN CLASS 9 (U.S. CLS. 21, 23, 26, 36 AND 38).

**TRADEMARK**

FIRST USE 3-17-2011; IN COMMERCE 3-17-2011.

**PRINCIPAL REGISTER**

THE MARK CONSISTS OF STANDARD CHARACTERS WITHOUT CLAIM TO ANY PARTICULAR FONT, STYLE, SIZE, OR COLOR.

SN 85-238,427, FILED 2-9-2011.

SAMUEL E. SHARPER JR., EXAMINING ATTORNEY



*David J. Kyffers*

Director of the United States Patent and Trademark Office

# United States of America

United States Patent and Trademark Office

# AMRAM

**Reg. No. 4,126,662**

**Registered Apr. 10, 2012**

**Int. Cl.: 18**

**TRADEMARK**

**PRINCIPAL REGISTER**

G-III LEATHER FASHIONS, INC. (NEW YORK CORPORATION)  
512 SEVENTH AVENUE  
NEW YORK, NY 10103

FOR: BACKPACKS, IN CLASS 18 (U.S. CLS. 1, 2, 3, 22 AND 41).

FIRST USE 8-0-2011; IN COMMERCE 8-0-2011.

THE MARK CONSISTS OF STANDARD CHARACTERS WITHOUT CLAIM TO ANY PARTICULAR FONT, STYLE, SIZE, OR COLOR.

SN 85-238,428, FILED 2-9-2011.

ESTHER A. BORSUK, EXAMINING ATTORNEY



*David J. Kybas*

Director of the United States Patent and Trademark Office



# United States of America

United States Patent and Trademark Office



**Reg. No. 4,126,663**

**Registered Apr. 10, 2012**

**Int. Cl.: 18**

**TRADEMARK**

**PRINCIPAL REGISTER**

G-III LEATHER FASHIONS, INC. (NEW YORK CORPORATION)  
512 SEVENTH AVENUE  
NEW YORK, NY 10103

FOR: BACKPACKS, IN CLASS 18 (U.S. CLS. 1, 2, 3, 22 AND 41).

FIRST USE 8-0-2011; IN COMMERCE 8-0-2011.

THE MARK CONSISTS OF THE LETTERS "AMRAM"; ABOVE AND BELOW "AMRAM" ARE RECTANGLES; TO THE LEFT OF "AMRAM" IS THE NUMBER "5" WITHIN THE NUMBER "1".

SN 85-238,441, FILED 2-9-2011.

ESTHER A. BORSUK, EXAMINING ATTORNEY



*David J. Kybas*

Director of the United States Patent and Trademark Office

# United States of America

United States Patent and Trademark Office

## LIPOTRIAD VISIONARY

**Reg. No. 4,126,664**

LIPOTRIAD LLC (DELAWARE LIMITED LIABILITY COMPANY)  
8 SOUND SHORE DRIVE  
GREENWICH, CT 06830

**Registered Apr. 10, 2012**

**Int. Cl.: 5**

FOR: NUTRITIONAL SUPPLEMENTS, IN CLASS 5 (U.S. CLS. 6, 18, 44, 46, 51 AND 52).

**TRADEMARK**

FIRST USE 11-30-2011; IN COMMERCE 11-30-2011.

**PRINCIPAL REGISTER**

THE MARK CONSISTS OF STANDARD CHARACTERS WITHOUT CLAIM TO ANY PARTICULAR FONT, STYLE, SIZE, OR COLOR.

OWNER OF U.S. REG. NOS. 599,889 AND 1,496,525.

SN 85-239,221, FILED 2-10-2011.

ANDREW LEASER, EXAMINING ATTORNEY



*David J. Kyffers*

Director of the United States Patent and Trademark Office

# United States of America

United States Patent and Trademark Office

# DITTIE

**Reg. No. 4,126,665**

BARBARA CAREY STACHOWSKI (UNITED STATES INDIVIDUAL)  
19 ORINDA WAY, SUITE L  
ORINDA, CA 94563

**Registered Apr. 10, 2012**

**Int. Cl.: 35**

FOR: ONLINE RETAIL STORE SERVICES FEATURING A WIDE VARIETY OF CONSUMER GOODS OF OTHERS, IN CLASS 35 (U.S. CLS. 100, 101 AND 102).

**SERVICE MARK**

FIRST USE 1-30-2011; IN COMMERCE 1-30-2011.

**PRINCIPAL REGISTER**

THE MARK CONSISTS OF STANDARD CHARACTERS WITHOUT CLAIM TO ANY PARTICULAR FONT, STYLE, SIZE, OR COLOR.

SN 85-239,327, FILED 2-10-2011.

NORA BUCHANAN WILL, EXAMINING ATTORNEY



*David J. Kybas*

Director of the United States Patent and Trademark Office

# United States of America

United States Patent and Trademark Office

# krazy greek

**Reg. No. 4,126,666**

PRAPAS, KONSTANTINE (UNITED STATES INDIVIDUAL)  
529 HILL ST  
ROCHESTER, MI 48307

**Registered Apr. 10, 2012**

**Int. Cls.: 25 and 43**

FOR: HATS; JACKETS; SHIRTS; SWEAT SHIRTS, IN CLASS 25 (U.S. CLS. 22 AND 39).

**TRADEMARK**

FIRST USE 2-1-1974; IN COMMERCE 2-1-1974.

**SERVICE MARK**

FOR: MOBILE RESTAURANT SERVICES; RESTAURANT SERVICES, IN CLASS 43 (U.S. CLS. 100 AND 101).

**PRINCIPAL REGISTER**

FIRST USE 9-10-1975; IN COMMERCE 1-1-1976.

THE MARK CONSISTS OF STANDARD CHARACTERS WITHOUT CLAIM TO ANY PARTICULAR FONT, STYLE, SIZE, OR COLOR.

NO CLAIM IS MADE TO THE EXCLUSIVE RIGHT TO USE "GREEK", APART FROM THE MARK AS SHOWN.

SN 85-239,406, FILED 2-10-2011.

SAIMA MAKHDOOM, EXAMINING ATTORNEY



*David J. Kyros*

Director of the United States Patent and Trademark Office

# United States of America

United States Patent and Trademark Office

# cardioforlife

**Reg. No. 4,126,667**

THE HEALTH GUARDIAN (DELAWARE LIMITED LIABILITY COMPANY)  
1804 PRINCETON CIRCLE  
NAPERVILLE, IL 60565

**Registered Apr. 10, 2012**

**Int. Cl.: 5**

FOR: DIETARY AND NUTRITIONAL SUPPLEMENTS, IN CLASS 5 (U.S. CLS. 6, 18, 44, 46, 51 AND 52).

**TRADEMARK**

FIRST USE 3-18-2011; IN COMMERCE 3-18-2011.

**PRINCIPAL REGISTER**

THE MARK CONSISTS OF STANDARD CHARACTERS WITHOUT CLAIM TO ANY PARTICULAR FONT, STYLE, SIZE, OR COLOR.

SN 85-239,488, FILED 2-10-2011.

FONG HSU, EXAMINING ATTORNEY



*David J. Kybas*

Director of the United States Patent and Trademark Office

# United States of America

United States Patent and Trademark Office

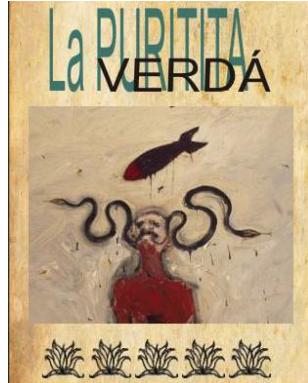

**Reg. No. 4,126,668**

**Registered Apr. 10, 2012**

**Int. Cl.: 33**

**TRADEMARK**

**PRINCIPAL REGISTER**

BARBIERI JONATHAN FRANK (UNITED STATES INDIVIDUAL)  
INDEPENDENCIA 523, COL. SAN FRANCISCO  
OAXACA, MEXICO

FOR: MEZCAL, IN CLASS 33 (U.S. CLS. 47 AND 49).

FIRST USE 12-21-2010; IN COMMERCE 3-22-2011.

THE MARK CONSISTS OF THE WORDING "LA PURITITA" IN GREEN AND "VERDÁ" IN BLACK ON A LARGE YELLOW RECTANGLE. BELOW THE WORDING IS A SMALLER GREY SQUARE CONTAINING THE BODY OF A MAN WITH BLACK FEATURES AND A GREY FACE WITH A RED NECK AND CHEST. BLACK SNAKES WITH GREY HEADS APPEAR AT THE HEIGHT OF THE MAN'S HEAD. ABOVE THE HEAD IS A MISSILE IN BLACK AND RED WITH SCATTERED BLACK DOTS. BELOW THE GREY SQUARE IS THE DESIGN OF FIVE AGAVES IN BLACK.

THE COLOR(S) GREEN, BLACK, RED, YELLOW AND GREY IS/ARE CLAIMED AS A FEATURE OF THE MARK.

THE ENGLISH TRANSLATION OF "LA PURITITA VERDÁ" IS "THE GOSPEL TRUTH".

SN 85-240,174, FILED 2-11-2011.

LEIGH CAROLINE CASE, EXAMINING ATTORNEY



*David J. Kybas*

Director of the United States Patent and Trademark Office

# United States of America

United States Patent and Trademark Office

## Toya: A Family Affair

**Reg. No. 4,126,669**

**Registered Apr. 10, 2012**

**Int. Cl.: 41**

**SERVICE MARK**

**PRINCIPAL REGISTER**

BLACK ENTERTAINMENT TELEVISION LLC (D.C. LIMITED LIABILITY COMPANY),  
DBA BET,  
BUSINESS & LEGAL AFFAIRS  
ONE BET PLAZA, 1235 W STREET, N.E.  
WASHINGTON, DC 20018

FOR: ENTERTAINMENT IN THE NATURE OF ON-GOING TELEVISION PROGRAMS IN  
THE FIELD OF REALITY VIA TELEVISION, CABLE, WIRELESS, SATELLITE AND THE  
INTERNET, IN CLASS 41 (U.S. CLS. 100, 101 AND 107).

FIRST USE 4-12-2011; IN COMMERCE 4-12-2011.

THE MARK CONSISTS OF STANDARD CHARACTERS WITHOUT CLAIM TO ANY PAR-  
TICULAR FONT, STYLE, SIZE, OR COLOR.

THE NAME(S), PORTRAIT(S), AND/OR SIGNATURE(S) SHOWN IN THE MARK IDENTIFIES  
"TOYA", WHOSE CONSENT(S) TO REGISTER IS MADE OF RECORD.

SN 85-240,208, FILED 2-11-2011.

AMY HELLA, EXAMINING ATTORNEY



*David J. Kyffers*

Director of the United States Patent and Trademark Office

# United States of America

United States Patent and Trademark Office

# ROOT ERASE

**Reg. No. 4,126,670**

REVLON CONSUMER PRODUCTS CORPORATION (DELAWARE CORPORATION)  
237 PARK AVENUE  
NEW YORK, NY 10017

**Registered Apr. 10, 2012**

**Int. Cl.: 3**

FOR: HAIR COLORING PREPARATIONS, IN CLASS 3 (U.S. CLS. 1, 4, 6, 50, 51 AND 52).

**TRADEMARK**

FIRST USE 12-31-2011; IN COMMERCE 12-31-2011.

**PRINCIPAL REGISTER**

THE MARK CONSISTS OF STANDARD CHARACTERS WITHOUT CLAIM TO ANY PARTICULAR FONT, STYLE, SIZE, OR COLOR.

SN 85-240,247, FILED 2-11-2011.

GEORGE LORENZO, EXAMINING ATTORNEY



*David J. Kyffers*

Director of the United States Patent and Trademark Office



# United States of America

United States Patent and Trademark Office

# Bevfridge

**Reg. No. 4,126,671**

BLUE MARBLE CONCEPTS (FLORIDA LIMITED LIABILITY COMPANY)  
6111 BARBARA ST  
JUPITER, FL 33458

**Registered Apr. 10, 2012**

**Int. Cl.: 21**

FOR: NON-ELECTRIC, PORTABLE BEVERAGE COOLERS USING ICE AND WATER AS COOLANT MEDIUM, IN CLASS 21 (U.S. CLS. 2, 13, 23, 29, 30, 33, 40 AND 50).

**TRADEMARK**

FIRST USE 3-2-2011; IN COMMERCE 8-1-2011.

**PRINCIPAL REGISTER**

THE MARK CONSISTS OF STANDARD CHARACTERS WITHOUT CLAIM TO ANY PARTICULAR FONT, STYLE, SIZE, OR COLOR.

SN 85-241,351, FILED 2-14-2011.

KHANH LE, EXAMINING ATTORNEY



*David J. Kyros*

Director of the United States Patent and Trademark Office

# United States of America

United States Patent and Trademark Office

UNPARALLELED EXPERIENCE =  
POWERFUL SOLUTIONS

**Reg. No. 4,126,672**

ENERGY MANAGEMENT RESOURCES OF MISSOURI, INC. (MISSOURI CORPORATION)  
1536 NE 96TH STREET  
LIBERTY, MO 64068

**Registered Apr. 10, 2012**

**Int. Cl.: 35**

FOR: BUSINESS CONSULTING AND ADVISORY SERVICES IN THE FIELD OF ENERGY EFFICIENCY, ENERGY REQUIREMENTS, ENERGY REGULATION, TAX EXEMPTION EVALUATION, TARIFF OPTIMIZATION, RISK ASSESSMENT, BUDGET PREPARATION, BILLING ANALYSIS, AUDITING, CONTRACT NEGOTIATIONS, CARBON MANAGEMENT IN THE FIELD OF ENERGY; CONDUCTING ENERGY AUDITS; ENERGY USAGE AND EFFICIENCY MANAGEMENT SERVICES; ENERGY PROCUREMENT SERVICES; ENERGY PRICE COMPARISON SERVICES; ENERGY USAGE MANAGEMENT AND INFORMATION SERVICES, IN CLASS 35 (U.S. CLS. 100, 101 AND 102).

**SERVICE MARK**

**PRINCIPAL REGISTER**

FIRST USE 3-0-2011; IN COMMERCE 3-0-2011.

THE MARK CONSISTS OF STANDARD CHARACTERS WITHOUT CLAIM TO ANY PARTICULAR FONT, STYLE, SIZE, OR COLOR.

SN 85-241,680, FILED 2-14-2011.

JENNIFER VASQUEZ, EXAMINING ATTORNEY



*David J. Kyffers*

Director of the United States Patent and Trademark Office

# United States of America

United States Patent and Trademark Office

## HERTZ GOLD CHOICE

**Reg. No. 4,126,673**

HERTZ SYSTEM, INC. (DELAWARE CORPORATION)  
225 BRAE BOULEVARD  
PARK RIDGE, NJ 07656

**Registered Apr. 10, 2012**

**Int. Cl.: 39**

FOR: VEHICLE RENTAL SERVICES, IN CLASS 39 (U.S. CLS. 100 AND 105).

**SERVICE MARK**

FIRST USE 8-8-2011; IN COMMERCE 9-2-2011.

**PRINCIPAL REGISTER**

THE MARK CONSISTS OF STANDARD CHARACTERS WITHOUT CLAIM TO ANY PARTICULAR FONT, STYLE, SIZE, OR COLOR.

OWNER OF U.S. REG. NOS. 614,123, 759,388, AND OTHERS.

SN 85-241,686, FILED 2-14-2011.

JESSICA FATHY, EXAMINING ATTORNEY



*David J. Kybas*

Director of the United States Patent and Trademark Office

# United States of America

United States Patent and Trademark Office

## CLEARLY CORRECTIVE

**Reg. No. 4,126,674**

L'OREAL USA CREATIVE, INC. (DELAWARE CORPORATION)  
575 FIFTH AVENUE  
NEW YORK, NY 10017

**Registered Apr. 10, 2012**

**Int. Cl.: 3**

FOR: NON-MEDICATED SKINCARE PREPARATIONS, IN CLASS 3 (U.S. CLS. 1, 4, 6, 50, 51 AND 52).

**TRADEMARK**

FIRST USE 1-0-2012; IN COMMERCE 1-0-2012.

**PRINCIPAL REGISTER**

THE MARK CONSISTS OF STANDARD CHARACTERS WITHOUT CLAIM TO ANY PARTICULAR FONT, STYLE, SIZE, OR COLOR.

NO CLAIM IS MADE TO THE EXCLUSIVE RIGHT TO USE "CORRECTIVE", APART FROM THE MARK AS SHOWN.

SN 85-241,703, FILED 2-14-2011.

ELISSA GARBER KON, EXAMINING ATTORNEY



*David J. Kybas*

Director of the United States Patent and Trademark Office

# United States of America

United States Patent and Trademark Office

## A PLUMBER LIKE NO OTHER

**Reg. No. 4,126,675**

JORDAN & SONS PLUMBING, INC. (SOUTH CAROLINA CORPORATION)  
2200 W. JODY ROAD  
FLORENCE, SC 29501

**Registered Apr. 10, 2012**

**Int. Cl.: 37**

FOR: PLUMBING SERVICES, IN CLASS 37 (U.S. CLS. 100, 103 AND 106).

**SERVICE MARK**

FIRST USE 1-9-2012; IN COMMERCE 1-9-2012.

**PRINCIPAL REGISTER**

THE MARK CONSISTS OF STANDARD CHARACTERS WITHOUT CLAIM TO ANY PARTICULAR FONT, STYLE, SIZE, OR COLOR.

NO CLAIM IS MADE TO THE EXCLUSIVE RIGHT TO USE "PLUMBER", APART FROM THE MARK AS SHOWN.

SN 85-241,868, FILED 2-14-2011.

MARC LEIPZIG, EXAMINING ATTORNEY



*David J. Kyffers*

Director of the United States Patent and Trademark Office

# United States of America

United States Patent and Trademark Office



**Reg. No. 4,126,676**

MAYES COATINGS & INSULATION, INC. (KENTUCKY CORPORATION)  
6082 PETERS LONDON RD  
REED, KY 42451

**Registered Apr. 10, 2012**

**Int. Cl.: 2**

FOR: COATINGS FOR EIFS (EXTERNAL INSULATION FINISHING SYSTEMS), IN CLASS 2 (U.S. CLS. 6, 11 AND 16).

**TRADEMARK**

FIRST USE 1-13-2012; IN COMMERCE 1-13-2012.

**PRINCIPAL REGISTER**

THE MARK CONSISTS OF DOUBLE PARALLEL BLACK LINES SURROUNDING THE WORD "RIDGLOK" IN RED IN A WHITE RECTANGLE. THE RED LETTERS ARE EDGED IN BLACK, AND THE LETTER "L" IS EDGED WITH DOUBLE PARALLEL BLACK LINES.

THE COLOR(S) BLACK, WHITE AND RED. IS/ARE CLAIMED AS A FEATURE OF THE MARK.

SN 85-241,892, FILED 2-14-2011.

LEIGH CAROLINE CASE, EXAMINING ATTORNEY



*David J. Kyffers*

Director of the United States Patent and Trademark Office

# United States of America

United States Patent and Trademark Office

## The For the City Center

**Reg. No. 4,126,677**

**Registered Apr. 10, 2012**

**Int. Cl.: 35**

**SERVICE MARK**

**PRINCIPAL REGISTER**

THE FOR THE CITY NETWORK (TEXAS CORPORATION)  
500 E. ST. JOHNS AVE.  
AUSTIN, TX 78752

FOR: PROMOTING COLLABORATION AMONG NONPROFIT ORGANIZATIONS AT A CENTRALIZED LOCATION TO PROVIDE A WIDE RANGE OF COMMUNITY SERVICE PROJECTS AND VOLUNTEER SERVICES; CHARITABLE SERVICES, NAMELY, ORGANIZING AND CONDUCTING VOLUNTEER PROGRAMS AND COMMUNITY SERVICE PROJECTS PROVIDED THROUGH COLLABORATION WITH AND AMONG NONPROFIT ORGANIZATIONS, IN CLASS 35 (U.S. CLS. 100, 101 AND 102).

FIRST USE 9-1-2010; IN COMMERCE 9-1-2010.

THE MARK CONSISTS OF STANDARD CHARACTERS WITHOUT CLAIM TO ANY PARTICULAR FONT, STYLE, SIZE, OR COLOR.

NO CLAIM IS MADE TO THE EXCLUSIVE RIGHT TO USE "CENTER", APART FROM THE MARK AS SHOWN.

SN 85-242,426, FILED 2-15-2011.

KATHERINE CONNOLLY, EXAMINING ATTORNEY



*David J. Kybas*

Director of the United States Patent and Trademark Office

# United States of America

United States Patent and Trademark Office

# H-E-BUDDY

**Reg. No. 4,126,678**

**Registered Apr. 10, 2012**

**Int. Cl.: 3**

**TRADEMARK**

**PRINCIPAL REGISTER**

HEB GROCERY COMPANY, LP (TEXAS LIMITED PARTNERSHIP)  
CORPORATE LAW DEPARTMENT  
646 SOUTH MAIN  
SAN ANTONIO, TX 78204

FOR: BABY WIPES, IN CLASS 3 (U.S. CLS. 1, 4, 6, 50, 51 AND 52).

FIRST USE 9-12-2011; IN COMMERCE 9-12-2011.

THE MARK CONSISTS OF STANDARD CHARACTERS WITHOUT CLAIM TO ANY PARTICULAR FONT, STYLE, SIZE, OR COLOR.

OWNER OF U.S. REG. NOS. 2,728,909, 3,409,525, AND OTHERS.

SN 85-242,602, FILED 2-15-2011.

SANJEEV VOHRA, EXAMINING ATTORNEY



*David J. Kybas*

Director of the United States Patent and Trademark Office



# United States of America

United States Patent and Trademark Office

## FAITHFUL FRIENDS

**Reg. No. 4,126,679**

SHARE MEMORIES, LLC (COLORADO LIMITED LIABILITY COMPANY)  
2800 SOUTH UNIVERSITY BOULEVARD, #71  
DENVER, CO 80210

**Registered Apr. 10, 2012**

**Int. Cl.: 9**

FOR: AUDIO BOOKS IN THE FIELD OF PETS; BLANK USB FLASH DRIVES, IN CLASS 9  
(U.S. CLS. 21, 23, 26, 36 AND 38).

**TRADEMARK**

FIRST USE 10-0-2011; IN COMMERCE 10-0-2011.

**PRINCIPAL REGISTER**

THE MARK CONSISTS OF STANDARD CHARACTERS WITHOUT CLAIM TO ANY PARTICULAR FONT, STYLE, SIZE, OR COLOR.

OWNER OF U.S. REG. NOS. 3,794,077, 3,796,634, AND 3,796,635.

SN 85-243,045, FILED 2-15-2011.

ROBERT C. CLARK JR., EXAMINING ATTORNEY



*David J. Kyffers*

Director of the United States Patent and Trademark Office

# United States of America

United States Patent and Trademark Office

# CUMMINS

**Reg. No. 4,126,680**

**Registered Apr. 10, 2012**

**Int. Cl.: 25**

**TRADEMARK**

**PRINCIPAL REGISTER**

CUMMINS INC. (INDIANA CORPORATION)  
500 JACKSON ST.  
COLUMBUS, IN 47201

FOR: MEN'S AND WOMEN'S CLOTHING, NAMELY, SWEATSHIRTS, HOODED SWEATSHIRTS, APRONS, SHIRTS, SPORT SHIRTS, JACKETS, T-SHIRTS, POLO SHIRTS, BASEBALL CAPS AND HATS, SKI CAPS, FLEECE CAPS, HEADBANDS, SCARVES, QUILTED VESTS, COVERALLS, LEATHER JACKETS, T-SHIRTS FOR TODDLERS AND CHILDREN, IN CLASS 25 (U.S. CLS. 22 AND 39).

FIRST USE 11-15-1973; IN COMMERCE 11-15-1973.

THE MARK CONSISTS OF STANDARD CHARACTERS WITHOUT CLAIM TO ANY PARTICULAR FONT, STYLE, SIZE, OR COLOR.

SEC. 2(F).

SN 85-244,287, FILED 2-16-2011.

HEATHER THOMPSON, EXAMINING ATTORNEY



*David J. Kyjars*

Director of the United States Patent and Trademark Office

# United States of America

United States Patent and Trademark Office

## SHIFT HAPPENS!

**Reg. No. 4,126,681**

FELDMAN, JAMES D. (UNITED STATES INDIVIDUAL)  
505 NORTH LAKE SHORE DRIVE, SUITE 6601  
CHICAGO, IL 60611

**Registered Apr. 10, 2012**

**Int. Cl.: 16**

FOR: BOOKS IN THE FIELD OF CHANGE MANAGEMENT, IN CLASS 16 (U.S. CLS. 2, 5, 22, 23, 29, 37, 38 AND 50).

**TRADEMARK**

FIRST USE 5-1-2011; IN COMMERCE 5-1-2011.

**PRINCIPAL REGISTER**

THE MARK CONSISTS OF STANDARD CHARACTERS WITHOUT CLAIM TO ANY PARTICULAR FONT, STYLE, SIZE, OR COLOR.

OWNER OF U.S. REG. NOS. 2,052,915 AND 2,055,523.

SN 85-244,651, FILED 2-17-2011.

JIM RINGLE, EXAMINING ATTORNEY



*David J. Kybas*

Director of the United States Patent and Trademark Office

# United States of America

United States Patent and Trademark Office

# TechCXO

**Reg. No. 4,126,682**

**Registered Apr. 10, 2012**

**Int. Cls.: 35, 36, and 42**

**SERVICE MARK**

**PRINCIPAL REGISTER**

TECHCFO HOLDING, INC. (GEORGIA CORPORATION)  
SUITE 405B  
75 5TH STREET NW  
ATLANTA, GA 30308

FOR: BUSINESS CONSULTING AND ADVISORY SERVICES IN THE FIELDS OF CORPORATE STRATEGY, EXECUTIVE AND LEADERSHIP DEVELOPMENT, CORPORATE GOVERNANCE, BUSINESS PLANNING, SALES STRATEGY AND PLANNING, SALES PROCESS OPTIMIZATION AND ALIGNMENT, SALES MANAGEMENT AND MENTORING, SALES OPERATIONS AND METRICS, SALES EXECUTION, AND SALES AND MARKETING ALIGNMENT, MARKETING STRATEGY, ELECTRONIC MESSAGING, BRAND POSITIONING, DEMAND GENERATION, PRODUCT MARKETING, CHANNEL MARKETING, PUBLIC RELATIONS, EMPLOYMENT RECRUITING, AND HUMAN RESOURCE MANAGEMENT; BUSINESS OPERATIONS CONSULTANCY FOR FINANCIAL FIRMS, NAMELY, ADVISING CLIENTS ON ACCOUNTING PROCESSES, KEY BUSINESS PERFORMANCE INDICATORS, AND INTERNAL BUSINESS MANAGEMENT CONTROLS, IN CLASS 35 (U.S. CLS. 100, 101 AND 102).

FIRST USE 10-25-2011; IN COMMERCE 10-25-2011.

FOR: ADVISORY SERVICES IN THE FIELDS OF FINANCIAL MANAGEMENT, FINANCIAL PLANNING, FINANCIAL FORECASTING, AND FINANCIAL DUE DILIGENCE; FINANCIAL CONSULTING IN THE FIELD OF CAPITAL FORMATION AND DEBT FINANCING, IN CLASS 36 (U.S. CLS. 100, 101 AND 102).

FIRST USE 10-25-2011; IN COMMERCE 10-25-2011.

FOR: ADVISORY SERVICES IN THE FIELDS OF PRODUCT DEVELOPMENT, NEW PRODUCT DESIGN, COMPUTER SOFTWARE DEVELOPMENT, AND QUALITY ASSURANCE, IN CLASS 42 (U.S. CLS. 100 AND 101).

FIRST USE 10-25-2011; IN COMMERCE 10-25-2011.

OWNER OF U.S. REG. NOS. 3,539,901 AND 3,886,251.

THE COLOR(S) YELLOW AND GREY IS/ARE CLAIMED AS A FEATURE OF THE MARK.



*David J. Kyjars*

Director of the United States Patent and Trademark Office

**Reg. No. 4,126,682** THE MARK CONSISTS OF THE STYLIZED WORDING "TECHCXO" WITH THE TERM "TECH" AND THE LEFT PORTION OF THE LETTER "X" IN "CXO" APPEARING IN YELLOW AND WITH THE LETTERS "C", "O" AND THE RIGHT PORTION OF THE "X" IN "CXO" APPEARING IN GREY.

SN 85-244,778, FILED 2-17-2011.

AMY KERTGATE, EXAMINING ATTORNEY

# United States of America

United States Patent and Trademark Office

# CROSSROADS

**Reg. No. 4,126,683**

**Registered Apr. 10, 2012**

**Int. Cl.: 44**

**SERVICE MARK**

**PRINCIPAL REGISTER**

CROSSROADS FOR WOMEN, INC. (MAINE NON-PROFIT CORPORATION)  
SUITE 201  
66 PEARL STREET  
PORTLAND, ME 04101

FOR: REHABILITATIVE SERVICES, NAMELY, SUBSTANCE ABUSE TREATMENT, IN CLASS 44 (U.S. CLS. 100 AND 101).

FIRST USE 11-14-2011; IN COMMERCE 11-14-2011.

THE MARK CONSISTS OF STANDARD CHARACTERS WITHOUT CLAIM TO ANY PARTICULAR FONT, STYLE, SIZE, OR COLOR.

OWNER OF U.S. REG. NO. 2,989,538.

SN 85-245,173, FILED 2-17-2011.

CARYN GLASSER, EXAMINING ATTORNEY



*David J. Kyffers*

Director of the United States Patent and Trademark Office

# United States of America

United States Patent and Trademark Office

# LM482

**Reg. No. 4,126,684**

**Registered Apr. 10, 2012**

**Int. Cl.: 9**

**TRADEMARK**

**PRINCIPAL REGISTER**

NOVITÁ TECHNOLOGIES, INC. (TENNESSEE CORPORATION)  
166 MOLLY WALTON DRIVE  
HENDERSONVILLE, TN 37075

FOR: ELECTRIC RELAYS, IN CLASS 9 (U.S. CLS. 21, 23, 26, 36 AND 38).

FIRST USE 10-1-2011; IN COMMERCE 11-1-2011.

THE MARK CONSISTS OF STANDARD CHARACTERS WITHOUT CLAIM TO ANY PARTICULAR FONT, STYLE, SIZE, OR COLOR.

SN 85-245,250, FILED 2-17-2011.

DAVID COLLIER, EXAMINING ATTORNEY



*David J. Kybas*

Director of the United States Patent and Trademark Office

# United States of America

United States Patent and Trademark Office

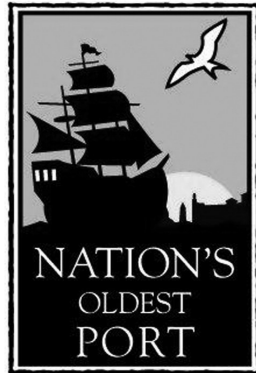

**Reg. No. 4,126,685**

**Registered Apr. 10, 2012**

**Int. Cl.: 25**

**TRADEMARK**

**PRINCIPAL REGISTER**

THE SAINT AUGUSTINE LIGHTHOUSE AND MUSEUM, INC. (FLORIDA CORPORATION)  
81 LIGHTHOUSE AVENUE  
ST. AUGUSTINE, FL 32080

FOR: T-SHIRTS, IN CLASS 25 (U.S. CLS. 22 AND 39).

FIRST USE 1-4-2012; IN COMMERCE 1-4-2012.

THE MARK CONSISTS OF A SILHOUETTE OF A HISTORICAL SHIP SAILING TOWARDS A FORT WITH A RISING SUN APPEARING IN THE BACKGROUND, AND TO THE RIGHT APPEARS A SILHOUETTE OF A FLYING BIRD AND BELOW THE HISTORICAL SHIP APPEARS THE WORDING "NATION'S OLDEST PORT" ALL CONTAINED WITHIN A DOUBLE-SIDED RECTANGULAR CARRIER.

SN 85-245,474, FILED 2-17-2011.

KELLY CHOE, EXAMINING ATTORNEY



*David J. Kybas*

Director of the United States Patent and Trademark Office



# United States of America

United States Patent and Trademark Office

# LEGALIS

**Reg. No. 4,126,686**

**Registered Apr. 10, 2012**

**Int. Cl.: 28**

**TRADEMARK**

**PRINCIPAL REGISTER**

GLOBERIDE, INC. (JAPAN CORPORATION)  
3-14-16, MAESAWA HIGASHIKURUME-SHI  
TOKYO, JAPAN 203-8511

FOR: FISHING REELS, IN CLASS 28 (U.S. CLS. 22, 23, 38 AND 50).

FIRST USE 4-0-2009; IN COMMERCE 10-0-2011.

THE MARK CONSISTS OF STANDARD CHARACTERS WITHOUT CLAIM TO ANY PARTICULAR FONT, STYLE, SIZE, OR COLOR.

SN 85-245,770, FILED 2-18-2011.

ERNEST SHOSHO, EXAMINING ATTORNEY



*David J. Kyffers*

Director of the United States Patent and Trademark Office

# United States of America

United States Patent and Trademark Office

## GILLINGTON "GIL" WEBBER

**Reg. No. 4,126,687**

**Registered Apr. 10, 2012**

**Int. Cl.: 28**

**TRADEMARK**

**PRINCIPAL REGISTER**

MATTEL, INC. (DELAWARE CORPORATION)  
M1-1518  
333 CONTINENTAL BOULEVARD  
EL SEGUNDO, CA 90245

FOR: DOLLS, DOLL CLOTHING AND DOLL ACCESSORIES, IN CLASS 28 (U.S. CLS. 22, 23, 38 AND 50).

FIRST USE 1-18-2012; IN COMMERCE 1-18-2012.

THE MARK CONSISTS OF STANDARD CHARACTERS WITHOUT CLAIM TO ANY PARTICULAR FONT, STYLE, SIZE, OR COLOR.

THE NAME(S), PORTRAIT(S), AND/OR SIGNATURE(S) SHOWN IN THE MARK DOES NOT IDENTIFY A PARTICULAR LIVING INDIVIDUAL.

SN 85-245,999, FILED 2-18-2011.

JULIE VEPPUMTHARA, EXAMINING ATTORNEY



*David J. Kybas*

Director of the United States Patent and Trademark Office

# United States of America

United States Patent and Trademark Office

## Shift Happens!

**Reg. No. 4,126,688**

FELDMAN, JAMES D. (UNITED STATES INDIVIDUAL)  
505 NORTH LAKE SHORE DRIVE, #6601  
CHICAGO, IL 60611

**Registered Apr. 10, 2012**

**Int. Cl.: 16**

FOR: BOOKS IN THE FIELD OF CHANGE MANAGEMENT, IN CLASS 16 (U.S. CLS. 2, 5, 22, 23, 29, 37, 38 AND 50).

**TRADEMARK**

FIRST USE 5-1-2011; IN COMMERCE 5-1-2011.

**PRINCIPAL REGISTER**

OWNER OF U.S. REG. NOS. 2,052,915, 2,055,523, AND 2,558,123.

THE MARK CONSISTS OF THE WORDS "SHIFT HAPPENS!" WITH THE LETTER "F" SLIGHTLY ELEVATED ABOVE REST OF THE WORDING.

SN 85-246,085, FILED 2-18-2011.

JIM RINGLE, EXAMINING ATTORNEY



*David J. Kybas*

Director of the United States Patent and Trademark Office

# United States of America

United States Patent and Trademark Office



**Reg. No. 4,126,689**

**Registered Apr. 10, 2012**

**Int. Cls.: 35 and 43**

**SERVICE MARK**

**PRINCIPAL REGISTER**

KILWINS CHOCOLATES FRANCHISE, INC. (MICHIGAN CORPORATION), DBA KILWINS,  
355 NORTH DIVISION ROAD  
PETOSKEY, MI 49770

FOR: RETAIL STORE SERVICES FEATURING CANDY, CONFECTIONS AND ICE CREAM,  
IN CLASS 35 (U.S. CLS. 100, 101 AND 102).

FIRST USE 7-7-2011; IN COMMERCE 7-7-2011.

FOR: ICE CREAM SHOP SERVICES IN THE NATURE OF A RESTAURANT, IN CLASS 43  
(U.S. CLS. 100 AND 101).

FIRST USE 7-7-2011; IN COMMERCE 7-7-2011.

OWNER OF U.S. REG. NOS. 3,870,465, 3,870,468, AND OTHERS.

THE COLOR(S) "RED", "DARK RED" AND "WHITE" IS/ARE CLAIMED AS A FEATURE  
OF THE MARK.

THE MARK CONSISTS OF THE WORD "KILWINS" IN WHITE ABOVE A DECORATIVE  
WHITE SCROLL OVER A CURVED LINE WITH RED BACKGROUND AND DARK RED  
UNDER THE LINE IN AN OVER ALL TRIANGULAR SHAPE ON THE LOWER RIGHT HAND  
CORNER.

SN 85-246,125, FILED 2-18-2011.

SALLY SHIH, EXAMINING ATTORNEY



*David J. Kybas*

Director of the United States Patent and Trademark Office

# United States of America

United States Patent and Trademark Office

## Lavera Creek Software

**Reg. No. 4,126,690**

**Registered Apr. 10, 2012**

**Int. Cl.: 9**

**TRADEMARK**

**PRINCIPAL REGISTER**

LAVERA CREEK SOFTWARE LLC (TEXAS LIMITED LIABILITY COMPANY)  
9907 LAVERA DRIVE  
AUSTIN, TX 78726

FOR: COMPUTER APPLICATION SOFTWARE FOR MOBILE DEVICES FOR LOCATING, ORGANIZING AND PLAYING MUSIC AND VIDEOS, IN CLASS 9 (U.S. CLS. 21, 23, 26, 36 AND 38).

FIRST USE 10-5-2011; IN COMMERCE 10-5-2011.

THE MARK CONSISTS OF STANDARD CHARACTERS WITHOUT CLAIM TO ANY PARTICULAR FONT, STYLE, SIZE, OR COLOR.

NO CLAIM IS MADE TO THE EXCLUSIVE RIGHT TO USE "SOFTWARE", APART FROM THE MARK AS SHOWN.

SN 85-246,597, FILED 2-18-2011.

IRA J. GOODSaid, EXAMINING ATTORNEY



*David J. Kyffers*

Director of the United States Patent and Trademark Office

United States of America  
United States Patent and Trademark Office

# TRESOR

**Reg. No. 4,126,691**

**Registered Apr. 10, 2012**

**Int. Cl.: 9**

**TRADEMARK**

**PRINCIPAL REGISTER**

TRESOR LIMITED (HONG KONG LIMITED COMPANY (LTD.))  
7B, PO CHAI INDUSTRIAL BUILDING  
28 WONG CHUK HANG ROAD  
ABERDEEN, HONG KONG

FOR: AMPLIFIERS; AUDIO HEADPHONES; AUDIO SPEAKERS; CASES FOR MOBILE PHONES; HANDS FREE KITS FOR PHONES; LOUDSPEAKERS; PROTECTIVE COVERS AND CASES FOR CELL PHONES, LAPTOPS AND PORTABLE MEDIA PLAYERS, IN CLASS 9 (U.S. CLS. 21, 23, 26, 36 AND 38).

FIRST USE 11-20-2011; IN COMMERCE 11-20-2011.

THE MARK CONSISTS OF THE STYLIZED WORD "TRESOR".

THE WORDING "TRESOR" HAS NO MEANING IN A FOREIGN LANGUAGE.

SN 85-247,152, FILED 2-20-2011.

SUNG IN, EXAMINING ATTORNEY



*David J. Kyfos*

Director of the United States Patent and Trademark Office

# United States of America

United States Patent and Trademark Office

## ST BARTH BUSINESS SCHOOL

**Reg. No. 4,126,692**

**Registered Apr. 10, 2012**

**Int. Cl.: 41**

**SERVICE MARK**

**PRINCIPAL REGISTER**

SECURITIES AND COMMERCE INSTITUTE, LLC (FLORIDA LIMITED LIABILITY COMPANY)  
SUITE 1100-1111 BRICKELL AVENUE  
MIAMI, FL 331313120

FOR: EDUCATION SERVICES, NAMELY, ARRANGING AND CONDUCTING COURSES, ONLINE COURSES, SEMINARS, WEBINARS, AND WORKSHOPS FEATURING BUSINESS, INFORMATION TECHNOLOGY, AND HOSPITALITY; PROVIDING COURSES OF INSTRUCTION AND TRAINING AT THE COLLEGE AND UNIVERSITY LEVEL IN THE FIELD OF BUSINESS AND SUBJECTS RELATING TO BUSINESS, INFORMATION TECHNOLOGY, AND HOSPITALITY, IN CLASS 41 (U.S. CLS. 100, 101 AND 107).

FIRST USE 3-12-2011; IN COMMERCE 5-15-2011.

THE MARK CONSISTS OF STANDARD CHARACTERS WITHOUT CLAIM TO ANY PARTICULAR FONT, STYLE, SIZE, OR COLOR.

NO CLAIM IS MADE TO THE EXCLUSIVE RIGHT TO USE "BUSINESS SCHOOL", APART FROM THE MARK AS SHOWN.

SN 85-247,203, FILED 2-21-2011.

DOMINIC J. FERRAIUOLO, EXAMINING ATTORNEY



*David J. Kyffers*

Director of the United States Patent and Trademark Office

# United States of America

United States Patent and Trademark Office

# LIPREFRESH

**Reg. No. 4,126,693**

ASPIRE BRANDS, INC. (NEVADA CORPORATION)  
1006 CROCKER ROAD  
WESTLAKE, OH 44145

**Registered Apr. 10, 2012**

**Int. Cl.: 3**

FOR: COSMETICS; LIP BALMS; LIP GLOSS; LIPSTICKS, IN CLASS 3 (U.S. CLS. 1, 4, 6, 50, 51 AND 52).

**TRADEMARK**

FIRST USE 12-1-2011; IN COMMERCE 12-1-2011.

**PRINCIPAL REGISTER**

THE MARK CONSISTS OF STANDARD CHARACTERS WITHOUT CLAIM TO ANY PARTICULAR FONT, STYLE, SIZE, OR COLOR.

SN 85-248,180, FILED 2-22-2011.

CHRISTOPHER BUONGIORNO, EXAMINING ATTORNEY



*David J. Kybas*

Director of the United States Patent and Trademark Office



# United States of America

United States Patent and Trademark Office



**Reg. No. 4,126,694**

**Registered Apr. 10, 2012**

**Int. Cl.: 44**

**SERVICE MARK**

**PRINCIPAL REGISTER**

GLAXO GROUP LIMITED (UNITED KINGDOM CORPORATION)  
GLAXO WELLCOME HOUSE  
BERKELEY AVENUE  
GREENFORD, MIDDLESEX, UNITED KINGDOM UB60NN

FOR: PROVIDING HEALTH INFORMATION SERVICES, NAMELY, PROVIDING INFORMATION RELATING TO MEDICAL HEALTHCARE PLANS, IN CLASS 44 (U.S. CLS. 100 AND 101).

FIRST USE 4-30-2011; IN COMMERCE 4-30-2011.

THE MARK CONSISTS OF THE WORD MARK "SPARQ" WITH AN ARCH ABOVE COMPOSED OF LARGER DOTS ON THE LEFT AND GETTING SMALLER AS IT MOVES TO THE RIGHT AND ENDING WITH A SUN BURST.

SN 85-248,383, FILED 2-22-2011.

KAPIL BHANOT, EXAMINING ATTORNEY



*David J. Kybas*

Director of the United States Patent and Trademark Office

# United States of America

United States Patent and Trademark Office

★ U ★ N ★ I ★ T ★

**Reg. No. 4,126,695**

**Registered Apr. 10, 2012**

**Int. Cl.: 8**

**TRADEMARK**

**PRINCIPAL REGISTER**

DAVID H BROWN (UNITED STATES INDIVIDUAL)  
1410 VANTAGE COURT  
VISTA, CA 92081

FOR: ALL-IN-ONE SKATEBOARD HAND TOOL COMPRISED OF A "T" HANDLE WITH SOCKET WRENCHES ON THE TIPS AND A COMBINATION ALLEN KEY AND SCREW-DRIVER STORED IN THE HANDLE, IN CLASS 8 (U.S. CLS. 23, 28 AND 44).

FIRST USE 1-1-1998; IN COMMERCE 1-1-1998.

OWNER OF U.S. REG. NO. 3,114,023.

THE MARK CONSISTS OF "UNIT" WITH STARS IN BETWEEN EACH LETTER.

SN 85-248,420, FILED 2-22-2011.

ANDREW LEASER, EXAMINING ATTORNEY



*David J. Kyffers*

Director of the United States Patent and Trademark Office

# United States of America

United States Patent and Trademark Office



**Reg. No. 4,126,696**

**Registered Apr. 10, 2012**

**Int. Cl.: 30**

**TRADEMARK**

**PRINCIPAL REGISTER**

MAMA JESS, LLC (ILLINOIS LIMITED LIABILITY COMPANY)  
251 WOODBINE PLACE  
BARRINGTON, IL 60010

FOR: SAUCES, IN CLASS 30 (U.S. CL. 46).

FIRST USE 3-10-2011; IN COMMERCE 3-31-2011.

THE NAME "MAMA JESS" IDENTIFIES A LIVING INDIVIDUAL WHOSE CONSENT IS OF RECORD.

THE COLOR(S) WHITE, RED, MAGENTA, AND GREEN IS/ARE CLAIMED AS A FEATURE OF THE MARK.

THE MARK CONSISTS OF THE WORDS "MAMA JESS" IN WHITE ON THE BACKGROUND OF A RED CIRCLE, A MAGENTA CIRCLE AROUND THE RED CIRCLE, AND A GREEN LEAF ON TOP.

SN 85-248,445, FILED 2-22-2011.

RAUL CORDOVA, EXAMINING ATTORNEY



*David J. Kybas*

Director of the United States Patent and Trademark Office

# United States of America

United States Patent and Trademark Office

## COOLER THAN ICE!

**Reg. No. 4,126,697**

AIRGAS, INC. (DELAWARE CORPORATION)  
259 N. RADNOR-CHESTER ROAD  
RADNOR, PA 19087

**Registered Apr. 10, 2012**

**Int. Cl.: 1**

FOR: DRY ICE, IN CLASS 1 (U.S. CLS. 1, 5, 6, 10, 26 AND 46).

**TRADEMARK**

FIRST USE 4-0-2011; IN COMMERCE 4-0-2011.

**PRINCIPAL REGISTER**

THE MARK CONSISTS OF STANDARD CHARACTERS WITHOUT CLAIM TO ANY PARTICULAR FONT, STYLE, SIZE, OR COLOR.

SN 85-248,511, FILED 2-22-2011.

LAURIE MAYES, EXAMINING ATTORNEY



*David J. Kyffers*

Director of the United States Patent and Trademark Office

# United States of America

United States Patent and Trademark Office

## DREAM BOUNCY BLUSH

**Reg. No. 4,126,698**

L'OREAL USA CREATIVE, INC. (DELAWARE CORPORATION)  
575 FIFTH AVENUE  
NEW YORK, NY 10017

**Registered Apr. 10, 2012**

**Int. Cl.: 3**

FOR: COSMETICS, NAMELY, BLUSH, IN CLASS 3 (U.S. CLS. 1, 4, 6, 50, 51 AND 52).

**TRADEMARK**

FIRST USE 1-0-2012; IN COMMERCE 1-0-2012.

**PRINCIPAL REGISTER**

THE MARK CONSISTS OF STANDARD CHARACTERS WITHOUT CLAIM TO ANY PARTICULAR FONT, STYLE, SIZE, OR COLOR.

OWNER OF U.S. REG. NOS. 2,950,384, 3,696,688, AND OTHERS.

NO CLAIM IS MADE TO THE EXCLUSIVE RIGHT TO USE "BLUSH", APART FROM THE MARK AS SHOWN.

SN 85-249,557, FILED 2-23-2011.

ELISSA GARBER KON, EXAMINING ATTORNEY



*David J. Kyffers*

Director of the United States Patent and Trademark Office

# United States of America

United States Patent and Trademark Office

## Health Enhanced

**Reg. No. 4,126,699**

ST. JOHN HEALTH (MICHIGAN NON-PROFIT CORPORATION)  
2800 DEQUINDRE  
WARREN, MI 48092

**Registered Apr. 10, 2012**

**Int. Cl.: 44**

FOR: HEALTH CARE SERVICES, NAMELY, WELLNESS PROGRAMS AND MANAGED HEALTH CARE SERVICES, IN CLASS 44 (U.S. CLS. 100 AND 101).

**SERVICE MARK**

FIRST USE 2-1-2011; IN COMMERCE 3-7-2011.

**PRINCIPAL REGISTER**

THE MARK CONSISTS OF STANDARD CHARACTERS WITHOUT CLAIM TO ANY PARTICULAR FONT, STYLE, SIZE, OR COLOR.

NO CLAIM IS MADE TO THE EXCLUSIVE RIGHT TO USE "HEALTH", APART FROM THE MARK AS SHOWN.

SN 85-250,225, FILED 2-24-2011.

BARBARA BROWN, EXAMINING ATTORNEY



*David J. Kyjars*

Director of the United States Patent and Trademark Office

# United States of America

United States Patent and Trademark Office

# GO-BUDZ

**Reg. No. 4,126,700**

B4 CONCEPTS, LLC (KANSAS LIMITED LIABILITY COMPANY)  
4936 CONSTANCE  
SHAWNEE, KS 66216

**Registered Apr. 10, 2012**

**Int. Cl.: 9**

FOR: EAR PHONES, IN CLASS 9 (U.S. CLS. 21, 23, 26, 36 AND 38).

**TRADEMARK**

FIRST USE 9-19-2011; IN COMMERCE 9-19-2011.

**PRINCIPAL REGISTER**

THE MARK CONSISTS OF BLACK STYLIZED LETTERS FOR THE WORDS "GO-BUDZ".

SN 85-250,633, FILED 2-24-2011.

CHARLES L. JENKINS, EXAMINING ATTORNEY



*David J. Kybas*

Director of the United States Patent and Trademark Office

# United States of America

United States Patent and Trademark Office

# TRUEWIRE

**Reg. No. 4,126,701**

**Registered Apr. 10, 2012**

**Int. Cl.: 12**

**TRADEMARK**

**PRINCIPAL REGISTER**

MOTORSPOT, INC. (CALIFORNIA CORPORATION)  
SUITE 703  
5256 SOUTH MISSION ROAD  
BONSALL, CA 92003

FOR: CAPS FOR WHEEL RIMS; HUB CAP COVERS; HUB CAPS; LAND VEHICLE PARTS, NAMELY, WHEELS; VEHICLE WHEEL RIMS; VEHICLE WHEEL RIMS AND STRUCTURAL PARTS THEREFOR; VEHICLE WHEELS; WHEEL HUBS FOR LAND VEHICLES FEATURING CHROME WIRE RIMS; WHEEL RIMS; WHEEL RIMS FOR MOTOR CARS, IN CLASS 12 (U.S. CLS. 19, 21, 23, 31, 35 AND 44).

FIRST USE 2-4-2011; IN COMMERCE 1-15-2012.

OWNER OF U.S. REG. NOS. 3,657,871, 3,657,993, AND OTHERS.

THE MARK CONSISTS OF THE STYLIZED WORDING "TRUEWIRE" WITH THREE HORIZONTAL BARS REPRESENTING THE FIRST LETTER "E".

SN 85-250,778, FILED 2-24-2011.

NICHOLAS ALTREE, EXAMINING ATTORNEY



*David J. Kyffers*

Director of the United States Patent and Trademark Office



# United States of America

United States Patent and Trademark Office

# CUMMINS

**Reg. No. 4,126,702**

**Registered Apr. 10, 2012**

**Int. Cl.: 16**

**TRADEMARK**

**PRINCIPAL REGISTER**

CUMMINS, INC. (INDIANA CORPORATION)  
500 JACKSON STREET  
COLUMBUS, IN 47201

FOR: DECORATIVE DECALS FOR VEHICLES, PENS, GIFT BAGS, PLASTIC BAGS FOR PACKING, DESKTOP BUSINESS CARD HOLDERS, BLANK JOURNALS, NOTE PADS, NOTE PAPER, PRESENTATION FOLDERS, MANUALS AND BROCHURES IN THE FIELD OF OPERATION AND MAINTENANCE OF ENGINES, MANUALS AND BROCHURES IN THE FIELD OF OPERATION AND MAINTENANCE OF POWER GENERATORS AND ALTERNATORS, CATALOGS IN THE FIELD OF REPLACEMENT PARTS FOR ENGINES, CATALOGS IN THE FIELD OF REPLACEMENT PARTS FOR POWER GENERATORS AND ALTERNATORS, IN CLASS 16 (U.S. CLS. 2, 5, 22, 23, 29, 37, 38 AND 50).

FIRST USE 11-15-1973; IN COMMERCE 11-15-1973.

THE MARK CONSISTS OF STANDARD CHARACTERS WITHOUT CLAIM TO ANY PARTICULAR FONT, STYLE, SIZE, OR COLOR.

SEC. 2(F).

SN 85-251,192, FILED 2-24-2011.

HEATHER THOMPSON, EXAMINING ATTORNEY



*David J. Kyffers*

Director of the United States Patent and Trademark Office

# United States of America

United States Patent and Trademark Office



**Reg. No. 4,126,703**

**Registered Apr. 10, 2012**

**Int. Cl.: 43**

**SERVICE MARK**

**PRINCIPAL REGISTER**

LOPEZ, JR., JIMMY (UNITED STATES INDIVIDUAL)  
201 GARRETT STREET  
AUSTIN, TX 78737

FOR: RESTAURANT SERVICES, IN CLASS 43 (U.S. CLS. 100 AND 101).

FIRST USE 6-24-2011; IN COMMERCE 6-24-2011.

THE MARK CONSISTS OF A MAN WITH A HANDLE BAR MUSTACHE, CLOSED EYES  
AND WEARING A SOMBRERO.

SN 85-253,273, FILED 2-28-2011.

BARBARA BROWN, EXAMINING ATTORNEY



*David J. Kybas*

Director of the United States Patent and Trademark Office

# United States of America

United States Patent and Trademark Office



ANGEL COMPANIONS

**Reg. No. 4,126,704**

NURSEBANK AMERICA, LLC (PENNSYLVANIA LIMITED LIABILITY COMPANY)  
582 LANCASTER AVENUE  
BERWYN, PA 19312

**Registered Apr. 10, 2012**

**Int. Cls.: 37, 43, and 45**

FOR: LIGHT HOUSEKEEPING IN THE NATURE OF MAID SERVICES AND LAUNDRY SERVICES FOR MENTALLY AND PHYSICALLY CHALLENGED INDIVIDUALS, IN CLASS 37 (U.S. CLS. 100, 103 AND 106).

**SERVICE MARK**

FIRST USE 4-1-2011; IN COMMERCE 4-1-2011.

**PRINCIPAL REGISTER**

FOR: PREPARATION OF MEALS FOR MENTALLY AND PHYSICALLY CHALLENGED INDIVIDUALS, IN CLASS 43 (U.S. CLS. 100 AND 101).

FIRST USE 4-1-2011; IN COMMERCE 4-1-2011.

FOR: IN-HOME SUPPORT SERVICES PROVIDED TO SENIOR PERSONS, NAMELY, GERIATRIC CARE MANAGEMENT SERVICES AND PERSONAL AFFAIRS MANAGEMENT SERVICES IN THE NATURE OF THE COORDINATION OF NECESSARY SERVICES AND CARE FOR OLDER INDIVIDUALS; PERSONAL CARE ASSISTANCE OF ACTIVITIES OF DAILY LIVING, SUCH AS BATHING, GROOMING AND PERSONAL MOBILITY FOR MENTALLY OR PHYSICALLY CHALLENGED PEOPLE; PROVIDING NON-MEDICAL PERSONAL ASSISTANT SERVICES FOR OTHERS IN THE NATURE OF PLANNING, ORGANIZING, COORDINATING, ARRANGING AND ASSISTING INDIVIDUALS IN THE PERFORMANCE OF DAILY TASKS, IN CLASS 45 (U.S. CLS. 100 AND 101).

FIRST USE 4-1-2011; IN COMMERCE 4-1-2011.

OWNER OF U.S. REG. NO. 3,969,570.

NO CLAIM IS MADE TO THE EXCLUSIVE RIGHT TO USE "COMPANIONS", APART FROM THE MARK AS SHOWN.

THE MARK CONSISTS OF THE WORDS "ANGEL COMPANIONS" UNDERNEATH AN IMAGE COMPRISING A CENTERED STYLIZED "V" AND A SMALLER STYLIZED "V" SET TO THE LEFT AND RIGHT OF THE CENTER "V", EACH "V" HAVING A CIRCLE INSET ABOVE THE JUNCTION OF EACH "V", A HALO ABOVE THE CIRCLE OF THE CENTER



*David J. Kybas*

Director of the United States Patent and Trademark Office

**Reg. No. 4,126,704** "V", AND ALL THREE VS SET UNDERNEATH AN OUTLINE OF A ROOF WITH A CHIMNEY  
ON THE RIGHT.

SN 85-253,520, FILED 2-28-2011.

BRIAN CALLAGHAN, EXAMINING ATTORNEY

# United States of America

United States Patent and Trademark Office

# InTemp

**Reg. No. 4,126,705**

**Registered Apr. 10, 2012**

**Int. Cl.: 20**

**TRADEMARK**

**PRINCIPAL REGISTER**

INMARK, LLC (DELAWARE LIMITED LIABILITY COMPANY)  
675 HARTMAN ROAD  
SUITE 100  
AUSTELL, GA 30168

FOR: NON-METAL AND NON-PAPER INSULATED SHIPPING CONTAINERS FOR TRANSPORTING FROZEN AND REFRIGERATED MATERIALS, IN CLASS 20 (U.S. CLS. 2, 13, 22, 25, 32 AND 50).

FIRST USE 9-30-2011; IN COMMERCE 9-30-2011.

THE MARK CONSISTS OF STANDARD CHARACTERS WITHOUT CLAIM TO ANY PARTICULAR FONT, STYLE, SIZE, OR COLOR.

SN 85-253,584, FILED 2-28-2011.

PAUL MORENO, EXAMINING ATTORNEY



*David J. Kyffers*

Director of the United States Patent and Trademark Office

# United States of America

United States Patent and Trademark Office

# DUOGLIDE

**Reg. No. 4,126,706**

C. R. BARD, INC. (NEW JERSEY CORPORATION)  
730 CENTRAL AVENUE  
MURRAY HILL, NJ 07974

**Registered Apr. 10, 2012**

**Int. Cl.: 10**

FOR: MEDICAL DEVICES AND APPARATUS, NAMELY, DIALYSIS CATHETERS AND PARTS AND FITTINGS THEREOF, IN CLASS 10 (U.S. CLS. 26, 39 AND 44).

**TRADEMARK**

FIRST USE 8-19-2011; IN COMMERCE 8-19-2011.

**PRINCIPAL REGISTER**

THE MARK CONSISTS OF STANDARD CHARACTERS WITHOUT CLAIM TO ANY PARTICULAR FONT, STYLE, SIZE, OR COLOR.

OWNER OF U.S. REG. NOS. 2,414,336, 2,712,101, AND OTHERS.

SN 85-254,264, FILED 3-1-2011.

EMILY CHUO, EXAMINING ATTORNEY



*David J. Kybas*

Director of the United States Patent and Trademark Office

# United States of America

United States Patent and Trademark Office

# Groundskeeper

**Reg. No. 4,126,707**

**Registered Apr. 10, 2012**

**Int. Cl.: 21**

**TRADEMARK**

**PRINCIPAL REGISTER**

HELEN OF TROY LIMITED (BARBADOS CORPORATION)  
P.O. BOX 836E  
13 8TH AVENUE, BELLEVILLE  
ST. MICHAEL, BARBADOS

FOR: NON-ELECTRIC COFFEE MAKERS, IN CLASS 21 (U.S. CLS. 2, 13, 23, 29, 30, 33, 40 AND 50).

FIRST USE 7-0-2011; IN COMMERCE 7-0-2011.

THE MARK CONSISTS OF STANDARD CHARACTERS WITHOUT CLAIM TO ANY PARTICULAR FONT, STYLE, SIZE, OR COLOR.

SN 85-254,499, FILED 3-1-2011.

DAWN FELDMAN, EXAMINING ATTORNEY



*David J. Kyffers*

Director of the United States Patent and Trademark Office

# United States of America

United States Patent and Trademark Office

# DUPLICITY

**Reg. No. 4,126,708**

AUSTRALIAN GOLD, LLC (INDIANA LIMITED LIABILITY COMPANY)  
6270 CORPORATE DR.

**Registered Apr. 10, 2012**

INDIANAPOLIS, IN 46278

**Int. Cl.: 3**

FOR: INDOOR AND OUTDOOR NON-MEDICATED SKIN TANNING PREPARATION, IN CLASS 3 (U.S. CLS. 1, 4, 6, 50, 51 AND 52).

**TRADEMARK**

FIRST USE 11-1-2011; IN COMMERCE 11-1-2011.

**PRINCIPAL REGISTER**

THE MARK CONSISTS OF STANDARD CHARACTERS WITHOUT CLAIM TO ANY PARTICULAR FONT, STYLE, SIZE, OR COLOR.

SN 85-255,317, FILED 3-2-2011.

DOMINIC J. FERRAIUOLO, EXAMINING ATTORNEY



*David J. Kyffers*

Director of the United States Patent and Trademark Office



# United States of America

United States Patent and Trademark Office

## 3D PROTECT

**Reg. No. 4,126,709**

AUSTRALIAN GOLD, LLC (INDIANA LIMITED LIABILITY COMPANY)  
6270 CORPORATE DR.

**Registered Apr. 10, 2012**

INDIANAPOLIS, IN 46278

**Int. Cl.: 3**

FOR: INDOOR AND OUTDOOR NON-MEDICATED SKIN TANNING PREPARATION, IN CLASS 3 (U.S. CLS. 1, 4, 6, 50, 51 AND 52).

**TRADEMARK**

FIRST USE 11-1-2011; IN COMMERCE 11-1-2011.

**PRINCIPAL REGISTER**

THE MARK CONSISTS OF STANDARD CHARACTERS WITHOUT CLAIM TO ANY PARTICULAR FONT, STYLE, SIZE, OR COLOR.

NO CLAIM IS MADE TO THE EXCLUSIVE RIGHT TO USE "PROTECT", APART FROM THE MARK AS SHOWN.

SN 85-255,411, FILED 3-2-2011.

JOHN DWYER, EXAMINING ATTORNEY



*David J. Kybas*

Director of the United States Patent and Trademark Office

# United States of America

United States Patent and Trademark Office

## CENTSIBLE WATER

**Reg. No. 4,126,710**

**Registered Apr. 10, 2012**

**Int. Cls.: 32 and 35**

**TRADEMARK**

**SERVICE MARK**

**PRINCIPAL REGISTER**

PURELY WATER, LLC (OHIO LIMITED LIABILITY COMPANY)  
601 OAKCREST DRIVE  
WADSWORTH, OH 44281

FOR: DRINKING WATER, IN CLASS 32 (U.S. CLS. 45, 46 AND 48).

FIRST USE 11-29-2011; IN COMMERCE 11-29-2011.

FOR: WATER VENDING MACHINE SERVICES, IN CLASS 35 (U.S. CLS. 100, 101 AND 102).

FIRST USE 11-29-2011; IN COMMERCE 11-29-2011.

THE MARK CONSISTS OF STANDARD CHARACTERS WITHOUT CLAIM TO ANY PARTICULAR FONT, STYLE, SIZE, OR COLOR.

NO CLAIM IS MADE TO THE EXCLUSIVE RIGHT TO USE "WATER", APART FROM THE MARK AS SHOWN.

SN 85-255,666, FILED 3-2-2011.

PAM WILLIS, EXAMINING ATTORNEY



*David J. Kyfos*

Director of the United States Patent and Trademark Office

# United States of America

United States Patent and Trademark Office

# PËRKA

**Reg. No. 4,126,711**

**Registered Apr. 10, 2012**

**Int. Cl.: 21**

**TRADEMARK**

**PRINCIPAL REGISTER**

LOGOMARK, INC. (CALIFORNIA CORPORATION)  
1201 BELL AVENUE  
TUSTIN, CA 92780

FOR: MUGS, IN CLASS 21 (U.S. CLS. 2, 13, 23, 29, 30, 33, 40 AND 50).

FIRST USE 6-9-2011; IN COMMERCE 6-9-2011.

THE MARK CONSISTS OF STANDARD CHARACTERS WITHOUT CLAIM TO ANY PARTICULAR FONT, STYLE, SIZE, OR COLOR.

SN 85-255,816, FILED 3-2-2011.

LINDA M. KING, EXAMINING ATTORNEY



*David J. Kyffers*

Director of the United States Patent and Trademark Office

# United States of America

United States Patent and Trademark Office

## SHADOW WARRIOR

**Reg. No. 4,126,712**

**Registered Apr. 10, 2012**

**Int. Cl.: 34**

**TRADEMARK**

**PRINCIPAL REGISTER**

K. HANSOTIA & CO., INC. (FLORIDA CORPORATION)  
BAY #5  
3705 N.W. 115 AVENUE  
MIAMI, FL 33178

FOR: CIGARS, TOBACCO, CIGARILLOS, ROLLING PAPERS FOR TOBACCO PRODUCTS, STUBS IN THE NATURE OF CIGARS; ARTICLES FOR SMOKERS NOT OF PRECIOUS METAL, NAMELY, CIGAR LIGHTERS, CIGARETTE LIGHTERS, CIGAR CASES, CIGARETTE CASES, CIGAR CUTTERS, CIGAR HOLDERS, CIGARETTE HOLDERS, CIGAR TUBES; ROLL YOUR OWN TOBACCO, IN CLASS 34 (U.S. CLS. 2, 8, 9 AND 17).

FIRST USE 8-1-2011; IN COMMERCE 8-1-2011.

THE MARK CONSISTS OF STANDARD CHARACTERS WITHOUT CLAIM TO ANY PARTICULAR FONT, STYLE, SIZE, OR COLOR.

OWNER OF U.S. REG. NOS. 3,640,747, 3,785,896, AND OTHERS.

SN 85-255,908, FILED 3-2-2011.

CARRIE GENOVESE, EXAMINING ATTORNEY



*David J. Kyffers*

Director of the United States Patent and Trademark Office

# United States of America

United States Patent and Trademark Office

## LEATHERNECK

**Reg. No. 4,126,713**

**Registered Apr. 10, 2012**

**Int. Cl.: 34**

**TRADEMARK**

**PRINCIPAL REGISTER**

K. HANSOTIA & CO., INC. (FLORIDA CORPORATION)  
BAY #5  
3705 N.W. 115 AVENUE  
MIAMI, FL 33178

FOR: CIGARS, TOBACCO, CIGARILLOS, ROLLING PAPERS FOR TOBACCO PRODUCTS, STUBS IN THE NATURE OF CIGARS; ARTICLES FOR SMOKERS NOT OF PRECIOUS METAL, NAMELY, CIGAR LIGHTERS, CIGARETTE LIGHTERS, CIGAR CASES, CIGARETTE CASES, CIGAR CUTTERS, CIGAR HOLDERS, CIGARETTE HOLDERS, CIGAR TUBES; ROLL YOUR OWN TOBACCO, IN CLASS 34 (U.S. CLS. 2, 8, 9 AND 17).

FIRST USE 8-1-2011; IN COMMERCE 8-1-2011.

THE MARK CONSISTS OF STANDARD CHARACTERS WITHOUT CLAIM TO ANY PARTICULAR FONT, STYLE, SIZE, OR COLOR.

SN 85-255,926, FILED 3-2-2011.

CARRIE GENOVESE, EXAMINING ATTORNEY



*David J. Kyffers*

Director of the United States Patent and Trademark Office

# United States of America

United States Patent and Trademark Office

# NIGHTRIDER

**Reg. No. 4,126,714**

**Registered Apr. 10, 2012**

**Int. Cl.: 34**

**TRADEMARK**

**PRINCIPAL REGISTER**

K. HANSOTIA & CO., INC. (FLORIDA CORPORATION)  
BAY #5  
3705 N.W. 115 AVENUE  
MIAMI, FL 33178

FOR: CIGARS, TOBACCO, CIGARILLOS, ROLLING PAPERS FOR TOBACCO PRODUCTS, STUBS IN THE NATURE OF CIGARS; ARTICLES FOR SMOKERS NOT OF PRECIOUS METAL, NAMELY, CIGAR LIGHTERS, CIGARETTE LIGHTERS, CIGAR CASES, CIGARETTE CASES, CIGAR CUTTERS, CIGAR HOLDERS, CIGARETTE HOLDERS, CIGAR TUBES; ROLL YOUR OWN TOBACCO, IN CLASS 34 (U.S. CLS. 2, 8, 9 AND 17).

FIRST USE 8-1-2011; IN COMMERCE 8-1-2011.

THE MARK CONSISTS OF STANDARD CHARACTERS WITHOUT CLAIM TO ANY PARTICULAR FONT, STYLE, SIZE, OR COLOR.

SN 85-255,945, FILED 3-2-2011.

CARRIE GENOVESE, EXAMINING ATTORNEY



*David J. Kyffers*

Director of the United States Patent and Trademark Office

# United States of America

United States Patent and Trademark Office

## ACI VIDEODEFENDER

**Reg. No. 4,126,715**

**Registered Apr. 10, 2012**

**Int. Cls.: 9, 37, 42, and 45**

**TRADEMARK**

**SERVICE MARK**

**PRINCIPAL REGISTER**

ACI PROTECTION LLC (OHIO LIMITED LIABILITY COMPANY)  
970 PITTSBURGH DRIVE  
DELAWARE, OH 43015

FOR: CUSTOM DESIGNED AND INSTALLED SECURITY SYSTEM THAT ENABLES REMOTE CENTRAL STATION SUPERVISION, NAMELY, SECURITY ALARMS, MOTION DETECTORS, DOOR AND WINDOW CONTACT SENSORS, AUDIO TRANSMITTERS AND RECEIVERS, VIDEO TRANSMITTERS; CENTRAL PROCESSING COMPONENT THAT ENABLES LIVE INTERACTIVE SUPERVISION OF PREMISES AND LIVE INTERCOM COMMUNICATION WITH PERSONNEL ON THE PREMISES FROM A CENTRAL OBSERVATION STATION, NAMELY, A DATA PROCESSOR AND A USER INPUT DEVICE FOR CONNECTING THE DATA PROCESSOR TO AN ALARM MONITORING ENTITY THROUGH A COMMUNICATION NETWORK ENABLING AUDIO AND VIDEO COMMUNICATION BETWEEN THE PROCESSOR AND THE ENTITY, IN CLASS 9 (U.S. CLS. 21, 23, 26, 36 AND 38).

FIRST USE 11-17-2011; IN COMMERCE 11-17-2011.

FOR: INSTALLATION, MAINTENANCE AND REPAIR OF RESIDENTIAL AND COMMERCIAL SECURITY SYSTEMS; INSTALLATION OF SECURITY SYSTEMS; MAINTENANCE AND REPAIR SERVICES OF SECURITY SYSTEMS, IN CLASS 37 (U.S. CLS. 100, 103 AND 106).

FIRST USE 11-17-2011; IN COMMERCE 11-17-2011.

FOR: DESIGN OF RESIDENTIAL AND COMMERCIAL SECURITY SYSTEMS; PROFESSIONAL CONSULTATION IN THE FIELD OF DESIGN OF SECURITY SYSTEMS; DESIGN OF SECURITY SYSTEMS, IN CLASS 42 (U.S. CLS. 100 AND 101).

FIRST USE 11-17-2011; IN COMMERCE 11-17-2011.

FOR: MONITORING OF SECURITY SYSTEMS, NAMELY, LIVE SUPERVISION OF SECURITY SYSTEM FROM REMOTE CENTRAL OBSERVATION STATION; EMERGENCY RESPONSE ALARM MONITORING SERVICES BY MEANS OF LIVE SECURITY INTERACTION WITH PERSONNEL AT THE MONITORED SITE THROUGH VOCAL INTERACTION VIA TRANSMITTER AND RECEIVER SPEAKERS TO CONFIRM THE NEED FOR DISPATCH OF EMERGENCY SECURITY SERVICES; MONITORING OF SECURITY SYSTEMS,



*David J. Kyffers*

Director of the United States Patent and Trademark Office

**Reg. No. 4,126,715** NAMELY, REAL TIME SECURITY SYSTEM OVERSIGHT TO REDUCE FALSE ALARMS,  
IN CLASS 45 (U.S. CLS. 100 AND 101).

FIRST USE 11-17-2011; IN COMMERCE 11-17-2011.

THE MARK CONSISTS OF STANDARD CHARACTERS WITHOUT CLAIM TO ANY PARTICULAR FONT, STYLE, SIZE, OR COLOR.

SN 85-256,198, FILED 3-2-2011.

KIM MONINGHOFF, EXAMINING ATTORNEY



# United States of America

United States Patent and Trademark Office

# FilmBreak

**Reg. No. 4,126,716**

**Registered Apr. 10, 2012**

**Int. Cl.: 42**

**SERVICE MARK**

**PRINCIPAL REGISTER**

WHOUYOUKNOW LLC (CALIFORNIA LIMITED LIABILITY COMPANY)  
203  
5437 CORTEEN PL  
VALLEY VILLAGE, CA 91607

FOR: COMPUTER SERVICES, NAMELY, CREATING AN ON-LINE COMMUNITY FOR REGISTERED USERS TO CREATE FILMS USING SOCIAL MEDIA TOOLS, PROMOTE THEIR TALENTS, SHARE AND SHOWCASE THEIR WORK, MAKE CONNECTIONS, AND ENGAGE IN SOCIAL NETWORKING, IN CLASS 42 (U.S. CLS. 100 AND 101).

FIRST USE 6-17-2010; IN COMMERCE 11-16-2011.

THE MARK CONSISTS OF STANDARD CHARACTERS WITHOUT CLAIM TO ANY PARTICULAR FONT, STYLE, SIZE, OR COLOR.

SN 85-256,269, FILED 3-2-2011.

TASNEEM HUSSAIN, EXAMINING ATTORNEY



*David J. Kybas*

Director of the United States Patent and Trademark Office

# United States of America

United States Patent and Trademark Office

# ISO-BOW

**Reg. No. 4,126,717**

JOHN K HUGHES (UNITED STATES INDIVIDUAL)  
8433 N BLACK CANYON HWY, #100  
PHOENIX, AZ 85021

**Registered Apr. 10, 2012**

**Int. Cl.: 28**

FOR: MANUALLY-OPERATED EXERCISE EQUIPMENT, IN CLASS 28 (U.S. CLS. 22, 23, 38 AND 50).

**TRADEMARK**

FIRST USE 1-25-2012; IN COMMERCE 1-25-2012.

**PRINCIPAL REGISTER**

THE MARK CONSISTS OF STANDARD CHARACTERS WITHOUT CLAIM TO ANY PARTICULAR FONT, STYLE, SIZE, OR COLOR.

SN 85-256,396, FILED 3-2-2011.

MIDGE BUTLER, EXAMINING ATTORNEY



*David J. Kyffers*

Director of the United States Patent and Trademark Office

# United States of America

United States Patent and Trademark Office

## THE SAYERS CLUB

**Reg. No. 4,126,718**

SBE LICENSING, LLC (DELAWARE LIMITED LIABILITY COMPANY)  
8000 BEVERLY BOULEVARD  
LOS ANGELES, CA 90048

**Registered Apr. 10, 2012**

**Int. Cls.: 41 and 43**

FOR: NIGHT CLUB SERVICES, IN CLASS 41 (U.S. CLS. 100, 101 AND 107).

**SERVICE MARK**

FIRST USE 6-0-2011; IN COMMERCE 6-0-2011.

**PRINCIPAL REGISTER**

FOR: BAR AND RESTAURANT SERVICES, IN CLASS 43 (U.S. CLS. 100 AND 101).

FIRST USE 6-0-2011; IN COMMERCE 6-0-2011.

THE MARK CONSISTS OF STANDARD CHARACTERS WITHOUT CLAIM TO ANY PARTICULAR FONT, STYLE, SIZE, OR COLOR.

NO CLAIM IS MADE TO THE EXCLUSIVE RIGHT TO USE "CLUB", APART FROM THE MARK AS SHOWN.

SN 85-256,583, FILED 3-3-2011.

JAY FLOWERS, EXAMINING ATTORNEY

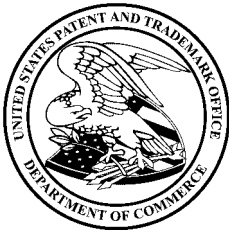

*David J. Kyffers*

Director of the United States Patent and Trademark Office

# United States of America

United States Patent and Trademark Office

## HOLIDAY HOSTESS

**Reg. No. 4,126,719**

**Registered Apr. 10, 2012**

**Int. Cl.: 28**

**TRADEMARK**

**PRINCIPAL REGISTER**

MATTEL, INC. (DELAWARE CORPORATION)  
M1-1518  
333 CONTINENTAL BOULEVARD  
EL SEGUNDO, CA 90245

FOR: DOLLS, DOLL CLOTHING AND DOLL ACCESSORIES, IN CLASS 28 (U.S. CLS. 22, 23, 38 AND 50).

FIRST USE 1-18-2012; IN COMMERCE 1-18-2012.

THE MARK CONSISTS OF STANDARD CHARACTERS WITHOUT CLAIM TO ANY PARTICULAR FONT, STYLE, SIZE, OR COLOR.

SN 85-256,690, FILED 3-3-2011.

COLLEEN KEARNEY, EXAMINING ATTORNEY



*David J. Kybas*

Director of the United States Patent and Trademark Office

# United States of America

United States Patent and Trademark Office

## LINKED FOR LIFE

**Reg. No. 4,126,720**

BAYER HEALTHCARE LLC (DELAWARE LIMITED LIABILITY COMPANY)  
100 BAYER ROAD  
PITTSBURGH, PA 15205

**Registered Apr. 10, 2012**

**Int. Cl.: 45**

FOR: PROVIDING INFORMATION VIA WEBSITES, BROCHURES AND POSTERS IN THE FIELD OF UNIVERSAL PET IDENTIFICATION SYSTEMS THAT REUNITE OWNERS AND THEIR PETS AND HELP FACILITATE SHELTER PET ADOPTION, IN CLASS 45 (U.S. CLS. 100 AND 101).

**SERVICE MARK**

**PRINCIPAL REGISTER**

FIRST USE 7-1-2011; IN COMMERCE 7-1-2011.

THE MARK CONSISTS OF STANDARD CHARACTERS WITHOUT CLAIM TO ANY PARTICULAR FONT, STYLE, SIZE, OR COLOR.

SN 85-257,718, FILED 3-4-2011.

JACLYN KIDWELL WALKER, EXAMINING ATTORNEY



*David J. Kybas*

Director of the United States Patent and Trademark Office

# United States of America

United States Patent and Trademark Office

## SWAN LAKE TEA COMPANY

**Reg. No. 4,126,721**

ICEE DISTRIBUTORS, LLC (LOUISIANA LIMITED LIABILITY COMPANY)  
1513 SWAN LAKE ROAD  
BOSSIER CITY, LA 71111

**Registered Apr. 10, 2012**

**Int. Cl.: 30**

FOR: ICED TEA AND TEA-BASED BEVERAGES AND MIXES IN THE NATURE OF CONCENTRATES, SYRUPS OR POWDERS USED IN THE PREPARATION OF TEA-BASED BEVERAGES, IN CLASS 30 (U.S. CL. 46).

**TRADEMARK**

FIRST USE 1-24-2012; IN COMMERCE 1-24-2012.

**PRINCIPAL REGISTER**

THE MARK CONSISTS OF STANDARD CHARACTERS WITHOUT CLAIM TO ANY PARTICULAR FONT, STYLE, SIZE, OR COLOR.

NO CLAIM IS MADE TO THE EXCLUSIVE RIGHT TO USE "TEA COMPANY", APART FROM THE MARK AS SHOWN.

SN 85-258,344, FILED 3-4-2011.

ALEXANDER L. POWERS, EXAMINING ATTORNEY



*David J. Kyros*

Director of the United States Patent and Trademark Office

# United States of America

United States Patent and Trademark Office

## WE GUIDE, YOU DECIDE

**Reg. No. 4,126,722**

**Registered Apr. 10, 2012**

**Int. Cl.: 45**

**SERVICE MARK**

**PRINCIPAL REGISTER**

ICANCIERGE (CALIFORNIA CORPORATION)  
121 WEST WASHINGTON AVE  
EL CAJON, CA 92020

FOR: HOTEL CONCIERGE SERVICES, IN CLASS 45 (U.S. CLS. 100 AND 101).

FIRST USE 3-1-2011; IN COMMERCE 3-1-2011.

THE MARK CONSISTS OF STANDARD CHARACTERS WITHOUT CLAIM TO ANY PARTICULAR FONT, STYLE, SIZE, OR COLOR.

SN 85-258,402, FILED 3-4-2011.

CAROLYN CATALDO, EXAMINING ATTORNEY



*David J. Kyffers*

Director of the United States Patent and Trademark Office

# United States of America

United States Patent and Trademark Office



**Reg. No. 4,126,723**

BASIL ROAD VENTURES, LLC (MASSACHUSETTS LIMITED LIABILITY COMPANY)  
2 GARFIELD ST.  
DENVER, CO 80206

**Registered Apr. 10, 2012**

**Int. Cl.: 42**

FOR: PROVIDING TEMPORARY USE OF ON-LINE NONDOWNLOADABLE SOFTWARE AND APPLICATIONS FOR THE INITIATING AND CONDUCTING OF ONLINE MEETINGS, IN CLASS 42 (U.S. CLS. 100 AND 101).

**SERVICE MARK**

FIRST USE 12-1-2011; IN COMMERCE 2-1-2012.

**PRINCIPAL REGISTER**

THE MARK CONSISTS OF THE STYLIZED WORDS "MEETINGZIP". AN IMAGE OF THREE CIRCLES CONNECTED AND THREE SMALLER CIRCLES ATTACHED.

SN 85-258,642, FILED 3-4-2011.

SAIMA MAKHDOOM, EXAMINING ATTORNEY



*David J. Kybas*

Director of the United States Patent and Trademark Office



# United States of America

United States Patent and Trademark Office

# Om Comb

**Reg. No. 4,126,724**

ANDRIETTE CAMPBELL (UNITED STATES INDIVIDUAL)  
5134 LONDONDERRY LANE  
WESLEY CHAPEL, FL 33543

**Registered Apr. 10, 2012**

**Int. Cl.: 21**

FOR: COMB USED FOR HAIR AND SCALP TREATMENT AND MASSAGE, IN CLASS 21  
(U.S. CLS. 2, 13, 23, 29, 30, 33, 40 AND 50).

**TRADEMARK**

FIRST USE 12-24-2011; IN COMMERCE 12-24-2011.

**PRINCIPAL REGISTER**

THE MARK CONSISTS OF STANDARD CHARACTERS WITHOUT CLAIM TO ANY PARTICULAR FONT, STYLE, SIZE, OR COLOR.

NO CLAIM IS MADE TO THE EXCLUSIVE RIGHT TO USE "COMB", APART FROM THE MARK AS SHOWN.

SN 85-259,062, FILED 3-5-2011.

HANNO RITTNER, EXAMINING ATTORNEY



*David J. Kyffers*

Director of the United States Patent and Trademark Office

# United States of America

United States Patent and Trademark Office

# UNIFIED

**Reg. No. 4,126,725**

COMSCORE, INC. (DELAWARE CORPORATION)  
11950 DEMOCRACY DRIVE, 6TH FLOOR  
RESTON, VA 20190

**Registered Apr. 10, 2012**

**Int. Cl.: 35**

FOR: BUSINESS CONSULTING AND MARKET RESEARCH INFORMATION SERVICES, NAMELY, MONITORING, TRACKING, AND REPORTING OF CONSUMER TRENDS RELATED TO THE USE OF DIGITAL MEDIA, IN CLASS 35 (U.S. CLS. 100, 101 AND 102).

**SERVICE MARK**

FIRST USE 3-15-2010; IN COMMERCE 5-1-2010.

**PRINCIPAL REGISTER**

THE MARK CONSISTS OF STANDARD CHARACTERS WITHOUT CLAIM TO ANY PARTICULAR FONT, STYLE, SIZE, OR COLOR.

SN 85-259,079, FILED 3-5-2011.

KIMBERLY PERRY, EXAMINING ATTORNEY



*David J. Kybas*

Director of the United States Patent and Trademark Office

# United States of America

United States Patent and Trademark Office

# Aloevive

**Reg. No. 4,126,726**

**Registered Apr. 10, 2012**

**Int. Cl.: 3**

**TRADEMARK**

**PRINCIPAL REGISTER**

SMART PRODUCTS AND SERVICES (NEW JERSEY CORPORATION), DBA ALOEVIVE,  
491 WINDING BROOK WAY  
BRIDGEWATER, NJ 08807

FOR: BEAUTY CREAMS; BODY CREAM; FRAGRANCED FACIAL MOISTURIZER; MOIS-  
TURIZING CREAMS; MOISTURIZING PREPARATIONS FOR THE SKIN; MOISTURIZING  
SOLUTIONS FOR THE SKIN; SHAVE CREAMS; SHAVING BALM; SHAVING CREAM;  
SHAVING FOAM; SHAVING GEL; SHAVING LOTION; SKIN MOISTURIZER; SKIN  
MOISTURIZING GEL, IN CLASS 3 (U.S. CLS. 1, 4, 6, 50, 51 AND 52).

FIRST USE 7-19-2011; IN COMMERCE 11-1-2011.

THE MARK CONSISTS OF STANDARD CHARACTERS WITHOUT CLAIM TO ANY PAR-  
TICULAR FONT, STYLE, SIZE, OR COLOR.

SN 85-259,322, FILED 3-7-2011.

CHERYL CLAYTON, EXAMINING ATTORNEY



*David J. Kybas*

Director of the United States Patent and Trademark Office

# United States of America

United States Patent and Trademark Office

## Will Meets Skill

**Reg. No. 4,126,727**

JENKINS, TISHAUN AMIR (UNITED STATES INDIVIDUAL)  
27 LYONS ST

**Registered Apr. 10, 2012**

WORCESTER, MA 016043653

**Int. Cl.: 41**

FOR: ATHLETIC TRAINING SERVICES; BASKETBALL CAMPS, IN CLASS 41 (U.S. CLS. 100, 101 AND 107).

**SERVICE MARK**

FIRST USE 10-22-2011; IN COMMERCE 12-29-2011.

**PRINCIPAL REGISTER**

THE MARK CONSISTS OF STANDARD CHARACTERS WITHOUT CLAIM TO ANY PARTICULAR FONT, STYLE, SIZE, OR COLOR.

SN 85-259,407, FILED S.R. 3-7-2011; AM. P.R. 6-8-2011.

EMILY CHUO, EXAMINING ATTORNEY



*David J. Kybas*

Director of the United States Patent and Trademark Office

# United States of America

United States Patent and Trademark Office

## CARRIAZO TALENT

**Reg. No. 4,126,728**

MIRIAM CARRIAZO (UNITED STATES INDIVIDUAL)  
3 FRANKLIN STREET  
NATICK, MA 01760

**Registered Apr. 10, 2012**

**Int. Cl.: 35**

FOR: EVENT PLANNING AND MANAGEMENT FOR MARKETING, BRANDING, PROMOTING OR ADVERTISING THE GOODS AND SERVICES OF OTHERS; MODELING AGENCY SERVICES; PROMOTING THE PARTIES AND SPECIAL EVENTS OF OTHERS, IN CLASS 35 (U.S. CLS. 100, 101 AND 102).

**SERVICE MARK**

**PRINCIPAL REGISTER**

FIRST USE 1-1-2011; IN COMMERCE 1-1-2011.

THE MARK CONSISTS OF STANDARD CHARACTERS WITHOUT CLAIM TO ANY PARTICULAR FONT, STYLE, SIZE, OR COLOR.

NO CLAIM IS MADE TO THE EXCLUSIVE RIGHT TO USE "TALENT", APART FROM THE MARK AS SHOWN.

SN 85-259,438, FILED 3-7-2011.

DEBRA LEE, EXAMINING ATTORNEY



*David J. Kyffers*

Director of the United States Patent and Trademark Office

# United States of America

United States Patent and Trademark Office

## PICTURE-PERFECT MEALS

**Reg. No. 4,126,729**

**Registered Apr. 10, 2012**

**Int. Cls.: 16 and 43**

**TRADEMARK**

**SERVICE MARK**

**PRINCIPAL REGISTER**

HUTCHSTONE, LLC (NORTH CAROLINA LIMITED LIABILITY COMPANY)  
6490 HEMLOCK ROAD  
JONAS RIDGE, NC 28641

FOR: COOKBOOKS FEATURING RECIPES FOR PREPARING FOODS WITHOUT HIGH FRUCTOSE CORN SYRUP, ARTIFICIAL SWEETENERS, ADDED MSG AND HYDROGENATED OILS, AND TECHNIQUES FOR PLANNING AND PRESENTING THOSE FOODS AND MEALS IN A MANNER WHICH IS VISUALLY DISTINCTIVE, IN CLASS 16 (U.S. CLS. 2, 5, 22, 23, 29, 37, 38 AND 50).

FIRST USE 11-24-2009; IN COMMERCE 11-24-2009.

FOR: PROVIDING AN INTERACTIVE WEB SITE IN THE FIELD OF RECIPES, MENUS AND FOOD PRESENTATION AND COOKING TECHNIQUES AND TIPS, IN CLASS 43 (U.S. CLS. 100 AND 101).

FIRST USE 6-16-2009; IN COMMERCE 6-16-2009.

THE MARK CONSISTS OF STANDARD CHARACTERS WITHOUT CLAIM TO ANY PARTICULAR FONT, STYLE, SIZE, OR COLOR.

NO CLAIM IS MADE TO THE EXCLUSIVE RIGHT TO USE "MEALS", APART FROM THE MARK AS SHOWN.

SN 85-259,440, FILED 3-7-2011.

ANNE FARRELL, EXAMINING ATTORNEY



*David J. Kyros*

Director of the United States Patent and Trademark Office

# United States of America

United States Patent and Trademark Office

## I AM...CREATIVE

**Reg. No. 4,126,730**

MCKAY, JENNIFER (UNITED STATES INDIVIDUAL)  
17041 BOLLINGER DRIVE  
PACIFIC PALISADES, CA 90272

**Registered Apr. 10, 2012**

**Int. Cls.: 4 and 16**

FOR: CANDLES, IN CLASS 4 (U.S. CLS. 1, 6 AND 15).

**TRADEMARK**

FIRST USE 12-15-2010; IN COMMERCE 12-15-2010.

**PRINCIPAL REGISTER**

FOR: PENCILS, PENS, PAPER STATIONERY AND NOTEPADS, IN CLASS 16 (U.S. CLS. 2, 5, 22, 23, 29, 37, 38 AND 50).

FIRST USE 12-15-2010; IN COMMERCE 12-15-2010.

THE MARK CONSISTS OF STANDARD CHARACTERS WITHOUT CLAIM TO ANY PARTICULAR FONT, STYLE, SIZE, OR COLOR.

SN 85-260,275, FILED 3-7-2011.

MATTHEW MCDOWELL, EXAMINING ATTORNEY



*David J. Kybas*

Director of the United States Patent and Trademark Office

# United States of America

United States Patent and Trademark Office

# Sporteer

**Reg. No. 4,126,731**

**Registered Apr. 10, 2012**

**Int. Cl.: 9**

**TRADEMARK**

**PRINCIPAL REGISTER**

PORTABLE DEVICE OUTFITTERS (ARIZONA LIMITED LIABILITY COMPANY)  
9159 N. 108TH PLACE  
SCOTTSDALE, AZ 85259

FOR: CARRYING CASE FOR CELL PHONES AND PORTABLE MUSIC PLAYERS, NAMELY,  
AN ARMBAND DESIGNED TO FUNCTION AS A CARRYING CASE FOR CELL PHONES  
AND PORTABLE MUSIC PLAYERS, IN CLASS 9 (U.S. CLS. 21, 23, 26, 36 AND 38).

FIRST USE 6-12-2009; IN COMMERCE 6-12-2009.

THE MARK CONSISTS OF STANDARD CHARACTERS WITHOUT CLAIM TO ANY PAR-  
TICULAR FONT, STYLE, SIZE, OR COLOR.

SN 85-260,296, FILED 3-7-2011.

SOPHIA S. KIM, EXAMINING ATTORNEY



*David J. Kyffers*

Director of the United States Patent and Trademark Office



# United States of America

United States Patent and Trademark Office

## Health Through Understanding

**Reg. No. 4,126,732**

**Registered Apr. 10, 2012**

**Int. Cl.: 42**

**SERVICE MARK**

**PRINCIPAL REGISTER**

POLYGLOT SYSTEMS, INC. (DELAWARE CORPORATION)  
2000 AERIAL CENTER PARKWAY, SUITE 101  
MORRISVILLE, NC 27560

FOR: COMPUTER SERVICE, NAMELY, ACTING AS AN APPLICATION SERVICE PROVIDER IN THE FIELD OF KNOWLEDGE MANAGEMENT TO HOST COMPUTER APPLICATION SOFTWARE FOR CREATING SEARCHABLE DATABASES OF INFORMATION AND DATA; COMPUTER SERVICE, NAMELY, ACTING AS AN APPLICATION SERVICE PROVIDER IN THE FIELD OF KNOWLEDGE MANAGEMENT TO HOST COMPUTER APPLICATION SOFTWARE FOR SEARCHING AND RETRIEVING INFORMATION FROM DATABASES AND COMPUTER NETWORKS; COMPUTER SERVICE, NAMELY, ACTING AS AN APPLICATION SERVICE PROVIDER IN THE FIELD OF KNOWLEDGE MANAGEMENT TO HOST COMPUTER APPLICATION SOFTWARE FOR THE COLLECTION, EDITING, ORGANIZING, MODIFYING, BOOK MARKING, TRANSMISSION, STORAGE AND SHARING OF DATA AND INFORMATION; COMPUTER SOFTWARE CONSULTATION; COMPUTER SOFTWARE DESIGN FOR OTHERS; COMPUTER SOFTWARE DESIGN, COMPUTER PROGRAMMING, OR MAINTENANCE OF COMPUTER SOFTWARE; COMPUTER SOFTWARE DEVELOPMENT; CONSULTANCY IN THE FIELD OF SOFTWARE DESIGN; CONSULTATION SERVICES IN THE FIELDS OF SELECTION, IMPLEMENTATION AND USE OF COMPUTER HARDWARE AND SOFTWARE SYSTEMS FOR OTHERS; CONSULTING SERVICES IN THE FIELD OF DESIGN, SELECTION, IMPLEMENTATION AND USE OF COMPUTER HARDWARE AND SOFTWARE SYSTEMS FOR OTHERS; DESIGN AND DEVELOPMENT OF ONLINE COMPUTER SOFTWARE SYSTEMS; DESIGN, DEVELOPMENT AND IMPLEMENTATION OF SOFTWARE; DEVELOPMENT, UPDATING AND MAINTENANCE OF SOFTWARE AND DATA BASES; SOFTWARE AUTHORING; TECHNICAL SUPPORT SERVICES, NAMELY, TROUBLESHOOTING OF COMPUTER SOFTWARE PROBLEMS; UPDATING OF COMPUTER SOFTWARE, IN CLASS 42 (U.S. CLS. 100 AND 101).

FIRST USE 12-13-2011; IN COMMERCE 12-13-2011.

THE MARK CONSISTS OF STANDARD CHARACTERS WITHOUT CLAIM TO ANY PARTICULAR FONT, STYLE, SIZE, OR COLOR.

SN 85-260,305, FILED 3-7-2011.

CHRISTOPHER BUONGIORNO, EXAMINING ATTORNEY



*David J. Kyffers*

Director of the United States Patent and Trademark Office

# United States of America

United States Patent and Trademark Office

## CONTEXT IS EVERYTHING

**Reg. No. 4,126,733**

**Registered Apr. 10, 2012**

**Int. Cl.: 35**

**SERVICE MARK**

**PRINCIPAL REGISTER**

ELECTRONIC ENTERTAINMENT DESIGN AND RESEARCH (CALIFORNIA CORPORATION), DBA EEDAR,  
2075 CORTE DEL NOGAL STE B  
CARLSBAD, CA 920111414

FOR: ANALYSIS OF MARKET RESEARCH DATA AND STATISTICS, IN CLASS 35 (U.S. CLS. 100, 101 AND 102).

FIRST USE 12-1-2011; IN COMMERCE 12-1-2011.

THE MARK CONSISTS OF STANDARD CHARACTERS WITHOUT CLAIM TO ANY PARTICULAR FONT, STYLE, SIZE, OR COLOR.

SN 85-260,320, FILED 3-7-2011.

THOMAS MANOR, EXAMINING ATTORNEY



*David J. Kyfos*

Director of the United States Patent and Trademark Office

# United States of America

United States Patent and Trademark Office

# MSTR

**Reg. No. 4,126,734**

MEISTER INTERNATIONAL, INC. (CALIFORNIA CORPORATION)  
20545 E. WALNUT DR N.,  
WALNUT, CA 91789

**Registered Apr. 10, 2012**

**Int. Cl.: 14**

FOR: WATCHES AND STRAPS FOR WATCHES; WRISTWATCHES, IN CLASS 14 (U.S. CLS. 2, 27, 28 AND 50).

**TRADEMARK**

FIRST USE 12-31-2011; IN COMMERCE 12-31-2011.

**PRINCIPAL REGISTER**

THE MARK CONSISTS OF STANDARD CHARACTERS WITHOUT CLAIM TO ANY PARTICULAR FONT, STYLE, SIZE, OR COLOR.

SN 85-260,373, FILED 3-7-2011.

DANNEAN HETZEL, EXAMINING ATTORNEY



*David J. Kyffers*

Director of the United States Patent and Trademark Office

# United States of America

United States Patent and Trademark Office

## LET US ARRANGE A SMILE FOR YOU

**Reg. No. 4,126,735**

**Registered Apr. 10, 2012**

**Int. Cl.: 35**

**SERVICE MARK**

**PRINCIPAL REGISTER**

1-800-FLOWERS.COM, INC. (DELAWARE CORPORATION)  
ONE OLD COUNTRY ROAD, SUITE 500  
CARLE PLACE, NY 11514

FOR: RETAIL STORE SERVICES, MAIL ORDER AND CATALOG SERVICES, TELEPHONE-, INTERACTIVE TELEVISION-, AND ONLINE-ACCESSED RETAIL STORE SERVICES FEATURING ARTIFICIAL, FRESH CUT AND DRIED FLOWERS, FLORAL BOUQUETS AND ARRANGEMENTS, PLANTS, TREES, GIFTS, GIFT BASKETS, GOURMET FOODS, POPCORN, PRODUCE, CANDY, CHOCOLATE, BAKERY ITEMS, HOME FURNISHINGS, HOME DECORATING ITEMS AND ACCESSORIES, KITCHENWARE AND ACCESSORIES, COLLECTIBLES, STATIONERY ITEMS AND ACCESSORIES, AROMATHERAPY GIFT BASKETS, CANDLES AND CANDLE ACCESSORIES, JEWELRY, WATCHES, GAMES, TOYS, PLUSH TOYS AND ANIMALS, BOOKS, PRERECORDED AUDIO AND/OR VIDEO TAPES, CASSETTES AND DISKS, PICTURE FRAMES, PHOTO ALBUMS, AND GENERAL MERCHANDISE, IN CLASS 35 (U.S. CLS. 100, 101 AND 102).

FIRST USE 3-0-2010; IN COMMERCE 3-0-2010.

THE MARK CONSISTS OF STANDARD CHARACTERS WITHOUT CLAIM TO ANY PARTICULAR FONT, STYLE, SIZE, OR COLOR.

SN 85-260,605, FILED 3-8-2011.

KELLEY WELLS, EXAMINING ATTORNEY



*David J. Kyffers*

Director of the United States Patent and Trademark Office

# United States of America

United States Patent and Trademark Office

## CORE ELEMENTS

**Reg. No. 4,126,736**

**Registered Apr. 10, 2012**

**Int. Cl.: 3**

**TRADEMARK**

**PRINCIPAL REGISTER**

AVON PRODUCTS, INC. (NEW YORK CORPORATION)  
LEGAL DEPARTMENT, 3RD FLOOR  
777 THIRD AVENUE  
NEW YORK, NY 10017

FOR: BAR SOAP; BODY SPRAYS; SHOWER AND BATH GEL, IN CLASS 3 (U.S. CLS. 1, 4, 6, 50, 51 AND 52).

FIRST USE 11-10-2011; IN COMMERCE 11-12-2011.

THE MARK CONSISTS OF STANDARD CHARACTERS WITHOUT CLAIM TO ANY PARTICULAR FONT, STYLE, SIZE, OR COLOR.

OWNER OF U.S. REG. NO. 3,782,005.

SN 85-260,664, FILED 3-8-2011.

MARC LEIPZIG, EXAMINING ATTORNEY



*David J. Kyffers*

Director of the United States Patent and Trademark Office

# United States of America

United States Patent and Trademark Office

# El Halcon

**Reg. No. 4,126,737**

**Registered Apr. 10, 2012**

**Int. Cl.: 33**

**TRADEMARK**

**PRINCIPAL REGISTER**

OLE IMPORTS, LLC (NEW YORK LIMITED LIABILITY COMPANY), DBA OLE,  
SUITE 405  
56 HARRISON ST.  
NEW ROCHELLE, NY 10801

FOR: WINE, IN CLASS 33 (U.S. CLS. 47 AND 49).

FIRST USE 1-10-2012; IN COMMERCE 1-10-2012.

THE MARK CONSISTS OF STANDARD CHARACTERS WITHOUT CLAIM TO ANY PARTICULAR FONT, STYLE, SIZE, OR COLOR.

THE ENGLISH TRANSLATION OF THE WORD "EL HALCON" IN THE MARK IS "THE RAPACIOUS" OR "THE FALCON".

SN 85-261,604, FILED 3-8-2011.

CHRIS DONINGER, EXAMINING ATTORNEY



*David J. Kybas*

Director of the United States Patent and Trademark Office

# United States of America

United States Patent and Trademark Office

# BOUT

**Reg. No. 4,126,738**

**Registered Apr. 10, 2012**

**Int. Cl.: 28**

**TRADEMARK**

**PRINCIPAL REGISTER**

BOUT BOXING, INC. (MASSACHUSETTS CORPORATION)  
38 GROVER STREET  
REVERE, MA 02151

FOR: SPORTS EQUIPMENT FOR BOXING AND MARTIAL ARTS, NAMELY, BOXING GLOVES, BOXING BAGS, PUNCHING MITTS, BELLY PROTECTORS, GROIN PROTECTORS AND SHIN GUARDS; SPORTS EQUIPMENT FOR BOXING AND MARTIAL ARTS, NAMELY, BOXING GLOVES, MIXED MARTIAL ARTS GLOVES, PUNCHING MITTS, AND SHIN GUARDS; SPORTS EQUIPMENT FOR BOXING, MARTIAL ARTS, AND THE LIKE, NAMELY, AN APPARATUS TO SUPPORT A MOVING HEAVY BAG; SPORTS EQUIPMENT FOR BOXING, MARTIAL ARTS, AND THE LIKE, NAMELY, PROTECTIVE BRAS, IN CLASS 28 (U.S. CLS. 22, 23, 38 AND 50).

FIRST USE 3-8-2011; IN COMMERCE 12-27-2011.

THE MARK CONSISTS OF STANDARD CHARACTERS WITHOUT CLAIM TO ANY PARTICULAR FONT, STYLE, SIZE, OR COLOR.

SN 85-261,927, FILED 3-9-2011.

KATHERINE CHANG, EXAMINING ATTORNEY



*David J. Kyros*

Director of the United States Patent and Trademark Office

# United States of America

United States Patent and Trademark Office

## CLEARGUARD

**Reg. No. 4,126,739**

**Registered Apr. 10, 2012**

**Int. Cl.: 9**

**TRADEMARK**

**PRINCIPAL REGISTER**

CLEAR TECHNOLOGIES OF VIRGINIA (VIRGINIA LIMITED LIABILITY COMPANY)  
SUITE 102  
422 PEPPERS FERRY ROAD.  
CHRISTIANSBURG, VA 24073

FOR: FITTED CLEAR URETHANE FILM KNOWN AS SKIN FOR COVERING, PROTECTING, AND PROVIDING A SCRATCH RESISTANT PROTECTIVE SURFACE FOR ELECTRONIC DEVICES, NAMELY, MP3 PLAYERS, MOBILE TELEPHONES, MOBILE SMART TELEPHONE, GLOBAL POSITIONING SYSTEMS, DIGITAL CAMERAS, LAPTOP COMPUTERS, PERSONAL DIGITAL ASSISTANTS, HOME GAMING CONSOLES, PORTABLE GAMING CONSOLES, IN CLASS 9 (U.S. CLS. 21, 23, 26, 36 AND 38).

FIRST USE 4-1-2011; IN COMMERCE 4-1-2011.

THE MARK CONSISTS OF STANDARD CHARACTERS WITHOUT CLAIM TO ANY PARTICULAR FONT, STYLE, SIZE, OR COLOR.

SN 85-262,184, FILED 3-9-2011.

TOBY BULLOFF, EXAMINING ATTORNEY



*David J. Kybas*

Director of the United States Patent and Trademark Office



# United States of America

United States Patent and Trademark Office

## CANVASBACK

**Reg. No. 4,126,740**

**Registered Apr. 10, 2012**

**Int. Cl.: 16**

**TRADEMARK**

**PRINCIPAL REGISTER**

BROWN PAPER GOODS COMPANY (DELAWARE CORPORATION)  
3530 BIRCHWOOD DRIVE  
WAUKEGAN, IL 60085

FOR: PAPER BAGS, IN CLASS 16 (U.S. CLS. 2, 5, 22, 23, 29, 37, 38 AND 50).

FIRST USE 4-30-2011; IN COMMERCE 4-30-2011.

THE MARK CONSISTS OF STANDARD CHARACTERS WITHOUT CLAIM TO ANY PARTICULAR FONT, STYLE, SIZE, OR COLOR.

SN 85-262,476, FILED 3-9-2011.

CHARLOTTE CORWIN, EXAMINING ATTORNEY



*David J. Kybas*

Director of the United States Patent and Trademark Office

# United States of America

United States Patent and Trademark Office

## POCKET THINS

**Reg. No. 4,126,741**

**Registered Apr. 10, 2012**

**Int. Cl.: 30**

**TRADEMARK**

**PRINCIPAL REGISTER**

ARNOLD PRODUCTS, INC. (DELAWARE CORPORATION)  
255 BUSINESS CENTER DRIVE  
HORSHAM, PA 19044

FOR: BAKERY GOODS, IN CLASS 30 (U.S. CL. 46).

FIRST USE 10-20-2011; IN COMMERCE 10-20-2011.

THE MARK CONSISTS OF STANDARD CHARACTERS WITHOUT CLAIM TO ANY PARTICULAR FONT, STYLE, SIZE, OR COLOR.

OWNER OF U.S. REG. NO. 3,637,950.

NO CLAIM IS MADE TO THE EXCLUSIVE RIGHT TO USE "POCKET", APART FROM THE MARK AS SHOWN.

SN 85-263,229, FILED 3-10-2011.

JORDAN BAKER, EXAMINING ATTORNEY



*David J. Kyffers*

Director of the United States Patent and Trademark Office

# United States of America

United States Patent and Trademark Office

## COLOR TEXT

**Reg. No. 4,126,742**

**Registered Apr. 10, 2012**

**Int. Cl.: 25**

**TRADEMARK**

**PRINCIPAL REGISTER**

THE ECHO DESIGN GROUP, INC. (NEW YORK CORPORATION)  
10 EAST 40TH STREET  
NEW YORK, NY 10016

FOR: GLOVES, IN CLASS 25 (U.S. CLS. 22 AND 39).

FIRST USE 7-7-2011; IN COMMERCE 7-7-2011.

THE MARK CONSISTS OF STANDARD CHARACTERS WITHOUT CLAIM TO ANY PARTICULAR FONT, STYLE, SIZE, OR COLOR.

SN 85-263,593, FILED 3-10-2011.

LINDA POWELL, EXAMINING ATTORNEY



*David J. Kybas*

Director of the United States Patent and Trademark Office

# United States of America

United States Patent and Trademark Office

## LIKE WATER OFF A DUCK

**Reg. No. 4,126,743**

**Registered Apr. 10, 2012**

**Int. Cl.: 16**

**TRADEMARK**

**PRINCIPAL REGISTER**

BROWN PAPER GOODS COMPANY (DELAWARE CORPORATION)  
3530 BIRCHWOOD DRIVE  
WAUKEGAN, IL 60085

FOR: PAPER BAGS, IN CLASS 16 (U.S. CLS. 2, 5, 22, 23, 29, 37, 38 AND 50).

FIRST USE 4-30-2011; IN COMMERCE 4-30-2011.

THE MARK CONSISTS OF STANDARD CHARACTERS WITHOUT CLAIM TO ANY PARTICULAR FONT, STYLE, SIZE, OR COLOR.

SN 85-263,686, FILED 3-10-2011.

CHARLOTTE CORWIN, EXAMINING ATTORNEY



*David J. Kybas*

Director of the United States Patent and Trademark Office

# United States of America

United States Patent and Trademark Office

Getting into college is  
one thing. Paying for it  
is another.

**Reg. No. 4,126,744**

**Registered Apr. 10, 2012**

**Int. Cl.: 36**

**SERVICE MARK**

**PRINCIPAL REGISTER**

PAUL, NANCY (UNITED STATES INDIVIDUAL)  
SUITE 235  
2629 TOWNSGATE ROAD  
WESTLAKE VILLAGE, CA 91361

FOR: COLLEGE CONSULTING SERVICES, NAMELY, ASSISTING STUDENTS IN APPLYING FOR SCHOLARSHIPS AND FINANCIAL AID, IN CLASS 36 (U.S. CLS. 100, 101 AND 102).

FIRST USE 2-0-2011; IN COMMERCE 3-0-2011.

THE MARK CONSISTS OF STANDARD CHARACTERS WITHOUT CLAIM TO ANY PARTICULAR FONT, STYLE, SIZE, OR COLOR.

SN 85-263,896, FILED 3-10-2011.

TRACY FLETCHER, EXAMINING ATTORNEY



*David J. Kybas*

Director of the United States Patent and Trademark Office

# United States of America

United States Patent and Trademark Office

## GET UNREFINED

**Reg. No. 4,126,745**

LANDIS, SHEILA (UNITED STATES INDIVIDUAL)  
11105 SW Tanager Terrace  
Beaverton, OR 97007

**Registered Apr. 10, 2012**

**Int. Cls.: 16 and 41**

FOR: PRINTED EDUCATIONAL MATERIALS IN THE FIELDS OF HEALTH AND NUTRITION, IN CLASS 16 (U.S. CLS. 2, 5, 22, 23, 29, 37, 38 AND 50).

**TRADEMARK**

FIRST USE 1-20-2011; IN COMMERCE 3-16-2011.

**SERVICE MARK**

FOR: EDUCATIONAL SERVICES, NAMELY, CONDUCTING CLASSES, SEMINARS, CONFERENCES AND WORKSHOPS IN THE FIELD OF HEALTH AND NUTRITION AND DISTRIBUTION OF COURSE MATERIAL IN CONNECTION THEREWITH, IN CLASS 41 (U.S. CLS. 100, 101 AND 107).

**PRINCIPAL REGISTER**

FIRST USE 2-5-2011; IN COMMERCE 3-16-2011.

THE MARK CONSISTS OF STANDARD CHARACTERS WITHOUT CLAIM TO ANY PARTICULAR FONT, STYLE, SIZE, OR COLOR.

SN 85-263,958, FILED 3-10-2011.

FLORENTINA BLANDU, EXAMINING ATTORNEY



*David J. Kybas*

Director of the United States Patent and Trademark Office

# United States of America

United States Patent and Trademark Office

## JEWISH LEARNING VENTURE

**Reg. No. 4,126,746**

**Registered Apr. 10, 2012**

**Int. Cls.: 35 and 41**

**SERVICE MARK**

**PRINCIPAL REGISTER**

AUERBACH CENTRAL AGENCY FOR JEWISH EDUCATION/JEWISH OUTREACH  
PARTNERSHIP (PENNSYLVANIA NON-PROFIT CORPORATION)  
7607 OLD YORK ROAD  
MELROSE PARK, PA 19126

FOR: PROMOTING THE INTERESTS OF THE JEWISH COMMUNITY, IN CLASS 35 (U.S. CLS. 100, 101 AND 102).

FIRST USE 9-21-2011; IN COMMERCE 9-21-2011.

FOR: JEWISH COMMUNITY OUTREACH SERVICES, NAMELY, PROVIDING EDUCATIONAL PROGRAMS IN THE FIELD OF JEWISH COMMUNITY PRACTICES; AND JEWISH RELIGIOUS EDUCATIONAL SERVICES, NAMELY, WORKSHOPS, CONFERENCES, CONSULTATION, COACHING AND MENTORING TO INDIVIDUALS AND INSTITUTIONS, IN CLASS 41 (U.S. CLS. 100, 101 AND 107).

FIRST USE 9-21-2011; IN COMMERCE 9-21-2011.

THE MARK CONSISTS OF STANDARD CHARACTERS WITHOUT CLAIM TO ANY PARTICULAR FONT, STYLE, SIZE, OR COLOR.

NO CLAIM IS MADE TO THE EXCLUSIVE RIGHT TO USE "JEWISH LEARNING", APART FROM THE MARK AS SHOWN.

SN 85-264,495, FILED 3-11-2011.

GRETCHEN ULRICH, EXAMINING ATTORNEY



*David J. Kyros*

Director of the United States Patent and Trademark Office

# United States of America

United States Patent and Trademark Office

## SERENDIPITY WINERY

**Reg. No. 4,126,747**

**Registered Apr. 10, 2012**

**Int. Cl.: 33**

**TRADEMARK**

**PRINCIPAL REGISTER**

M&T BUSINESS VENTURES, INC. (KENTUCKY CORPORATION), DBA TRI-STATE  
BEER&WINE CRAFTING,  
2013 WYNDEMERE CT  
HEBRON, KY 41048

FOR: WINES, IN CLASS 33 (U.S. CLS. 47 AND 49).

FIRST USE 12-20-2011; IN COMMERCE 12-20-2011.

THE MARK CONSISTS OF STANDARD CHARACTERS WITHOUT CLAIM TO ANY PARTICULAR FONT, STYLE, SIZE, OR COLOR.

NO CLAIM IS MADE TO THE EXCLUSIVE RIGHT TO USE "WINERY", APART FROM THE MARK AS SHOWN.

SN 85-265,595, FILED 3-13-2011.

DEBRA LEE, EXAMINING ATTORNEY



*David J. Kybas*

Director of the United States Patent and Trademark Office



# United States of America

United States Patent and Trademark Office

# Spike Social

**Reg. No. 4,126,748**

ATTAINABLE SUSTAINABLE STRATEGIES, LLC (IDAHO LIMITED LIABILITY COMPANY)  
1718 WARM SPRINGS AVENUE  
BOISE, ID 83712

**Registered Apr. 10, 2012**

**Int. Cl.: 35**

FOR: ADVERTISING AND PROMOTION SERVICES AND RELATED CONSULTING, IN CLASS 35 (U.S. CLS. 100, 101 AND 102).

**SERVICE MARK**

FIRST USE 3-28-2011; IN COMMERCE 6-1-2011.

**PRINCIPAL REGISTER**

THE MARK CONSISTS OF STANDARD CHARACTERS WITHOUT CLAIM TO ANY PARTICULAR FONT, STYLE, SIZE, OR COLOR.

NO CLAIM IS MADE TO THE EXCLUSIVE RIGHT TO USE "SOCIAL", APART FROM THE MARK AS SHOWN.

SN 85-265,597, FILED 3-13-2011.

DEBRA LEE, EXAMINING ATTORNEY



*David J. Kyffers*

Director of the United States Patent and Trademark Office

# United States of America

United States Patent and Trademark Office



## FUTURE HOME REALTY

**Reg. No. 4,126,749**

**Registered Apr. 10, 2012**

**Int. Cls.: 35 and 36**

**SERVICE MARK**

**PRINCIPAL REGISTER**

FUTURE HOME REALTY FRANCHISE SERVICES, INC. (DELAWARE CORPORATION)  
13045 W. LINEBAUGH AVE.  
SUITE 102  
TAMPA, FL 33626

FOR: REAL ESTATE BROKERAGE FRANCHISING SERVICES, NAMELY, RENDERING TECHNICAL ASSISTANCE IN THE NATURE OF OFFERING BUSINESS MANAGEMENT ASSISTANCE TO OTHERS IN THE ESTABLISHMENT AND/OR OPERATION OF REAL ESTATE BROKERAGE BUSINESSES, IN CLASS 35 (U.S. CLS. 100, 101 AND 102).

FIRST USE 10-31-2011; IN COMMERCE 10-31-2011.

FOR: COMMERCIAL AND RESIDENTIAL REAL ESTATE AGENCY SERVICES; REAL ESTATE PROPERTY MANAGEMENT SERVICES; REAL ESTATE SERVICES, NAMELY, ARRANGING FOR TITLE INSURANCE AND REAL ESTATE FINANCING FOR OTHERS; LEASING OF REAL ESTATE; REAL ESTATE APPRAISAL AND VALUATION; REAL ESTATE BROKERAGE FINANCING SERVICES, NAMELY, RENDERING TECHNICAL ASSISTANCE IN THE NATURE OF PROVIDING FINANCIAL INFORMATION AND ADVICE TO OTHERS IN THE ESTABLISHMENT AND/OR OPERATION OF REAL ESTATE BROKERAGE BUSINESSES, IN CLASS 36 (U.S. CLS. 100, 101 AND 102).

FIRST USE 1-1-2001; IN COMMERCE 1-1-2001.

NO CLAIM IS MADE TO THE EXCLUSIVE RIGHT TO USE "HOME REALTY", APART FROM THE MARK AS SHOWN.

THE MARK CONSISTS OF THE WORDS "FUTURE HOME REALTY" IN A STYLIZED FONT. A TRIANGLE APPEARS ABOVE THE WORDS "HOME REALTY". A DESIGN OF SWOOSH APPEARS BELOW THE WORDS "FUTURE HOME REALTY".

SN 85-266,225, FILED 3-14-2011.

WILLIAM VERHOSEK, EXAMINING ATTORNEY



*David J. Kyffers*

Director of the United States Patent and Trademark Office

# United States of America

United States Patent and Trademark Office

## EXPERIENCE THE IDEAL

**Reg. No. 4,126,750**

**Registered Apr. 10, 2012**

**Int. Cls.: 14 and 35**

**TRADEMARK**

**SERVICE MARK**

**PRINCIPAL REGISTER**

DIMEND SCAASI, LTD. (ILLINOIS CORPORATION)  
5 S. WABASH AVE 17TH FLOOR  
CHICAGO, IL 60603

FOR: JEWELRY, IN CLASS 14 (U.S. CLS. 2, 27, 28 AND 50).

FIRST USE 12-13-2011; IN COMMERCE 12-13-2011.

FOR: ON-LINE RETAIL STORE SERVICES FEATURING JEWELRY; RETAIL JEWELRY STORES; WHOLESALE STORES FEATURING JEWELRY, IN CLASS 35 (U.S. CLS. 100, 101 AND 102).

FIRST USE 8-18-2011; IN COMMERCE 8-18-2011.

THE MARK CONSISTS OF STANDARD CHARACTERS WITHOUT CLAIM TO ANY PARTICULAR FONT, STYLE, SIZE, OR COLOR.

SN 85-266,398, FILED 3-14-2011.

DAVID C. REIHNER, EXAMINING ATTORNEY

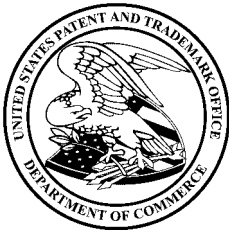

*David J. Kyros*

Director of the United States Patent and Trademark Office

# United States of America

United States Patent and Trademark Office

## THE REAL CHRISTMAS TREE

**Reg. No. 4,126,751**

**Registered Apr. 10, 2012**

**Int. Cl.: 20**

**TRADEMARK**

**PRINCIPAL REGISTER**

GRACE GUTHRIE (UNITED STATES INDIVIDUAL)  
102 TIMBER HILLS DRIVE  
HENDERSONVILLE, TN 37075

FOR: WORKS OF ART MADE OF WOOD, IN CLASS 20 (U.S. CLS. 2, 13, 22, 25, 32 AND 50).

FIRST USE 12-8-2011; IN COMMERCE 12-8-2011.

THE MARK CONSISTS OF STANDARD CHARACTERS WITHOUT CLAIM TO ANY PARTICULAR FONT, STYLE, SIZE, OR COLOR.

SN 85-266,538, FILED 3-14-2011.

GINA FINK, EXAMINING ATTORNEY



*David J. Kybas*

Director of the United States Patent and Trademark Office

# United States of America

United States Patent and Trademark Office

## Chuck-n-wood

**Reg. No. 4,126,752**

BENV-D CONCEPTS LLC (COLORADO LIMITED LIABILITY COMPANY)  
13013 TEJON CT  
WESTMINSTER, CO 80234

**Registered Apr. 10, 2012**

**Int. Cl.: 9**

FOR: COMPUTER GAME SOFTWARE; COMPUTER GAME SOFTWARE FOR USE ON MOBILE AND CELLULAR PHONES; COMPUTER GAME SOFTWARE FOR USE WITH PERSONAL COMPUTERS, HOME VIDEO GAME CONSOLES USED WITH TELEVISIONS AND ARCADE-BASED VIDEO GAME CONSOLES; COMPUTER GAME SOFTWARE FOR PERSONAL COMPUTERS AND HOME VIDEO GAME CONSOLES; COMPUTER GAME SOFTWARE DOWNLOADABLE FROM A GLOBAL COMPUTER NETWORK; VIDEO GAME PROGRAMS FOR USE WITH MOBILE DEVICES, PERSONAL COMPUTERS, HOME VIDEO GAME CONSOLES, AND TABLET COMPUTERS; ELECTRONIC GAME PROGRAMS; DOWNLOADABLE ELECTRONIC GAME PROGRAMS; ELECTRONIC GAME SOFTWARE; COMPUTER GAME PROGRAMS; DOWNLOADABLE COMPUTER GAME PROGRAMS; INTERACTIVE GAME PROGRAMS; INTERACTIVE GAME SOFTWARE, IN CLASS 9 (U.S. CLS. 21, 23, 26, 36 AND 38).

**TRADEMARK**

**PRINCIPAL REGISTER**

FIRST USE 11-1-2011; IN COMMERCE 11-1-2011.

THE MARK CONSISTS OF STANDARD CHARACTERS WITHOUT CLAIM TO ANY PARTICULAR FONT, STYLE, SIZE, OR COLOR.

SN 85-266,637, FILED 3-14-2011.

KATHERINE CONNOLLY, EXAMINING ATTORNEY



*David J. Kyffers*

Director of the United States Patent and Trademark Office

# United States of America

United States Patent and Trademark Office

# Hopelings

**Reg. No. 4,126,753**

ZWICKL, STEPHEN (UNITED STATES INDIVIDUAL)  
1407 MOORES MANOR  
INDIANAPOLIS, IN 46229

**Registered Apr. 10, 2012**

**Int. Cl.: 28**

FOR: PLUSH TOYS, IN CLASS 28 (U.S. CLS. 22, 23, 38 AND 50).

**TRADEMARK**

FIRST USE 2-15-2011; IN COMMERCE 12-7-2011.

**PRINCIPAL REGISTER**

THE MARK CONSISTS OF STANDARD CHARACTERS WITHOUT CLAIM TO ANY PARTICULAR FONT, STYLE, SIZE, OR COLOR.

SN 85-267,883, FILED 3-15-2011.

AMY KERTGATE, EXAMINING ATTORNEY



*David J. Kyffers*

Director of the United States Patent and Trademark Office

# United States of America

United States Patent and Trademark Office

# EF Hutton

**Reg. No. 4,126,754**

**Registered Apr. 10, 2012**

**Int. Cl.: 36**

**SERVICE MARK**

**PRINCIPAL REGISTER**

DOMINANT BRANDS LLC (NEW YORK LIMITED LIABILITY COMPANY)  
28-42 210TH STREET  
BAYSIDE, NY 11360

FOR: FINANCIAL SERVICES, NAMELY, INVESTMENT ANALYSIS AND ADVICE, INVESTMENT BROKERAGE, PLANNING AND MANAGEMENT, INVESTMENT FUND TRANSFER AND TRANSACTION SERVICES, AND FINANCIAL CONSULTATION SERVICES RELATING TO STOCKS, BONDS, SECURITIES, COMMODITIES, OPTIONS, REAL ESTATE, FIXED INCOME PRODUCTS, PRECIOUS METALS, MUTUAL FUNDS AND RETIREMENT PLANS; FINANCIAL SERVICES, NAMELY, MONEY LENDING, IN CLASS 36 (U.S. CLS. 100, 101 AND 102).

FIRST USE 1-18-2012; IN COMMERCE 1-18-2012.

THE NAME(S), PORTRAIT(S), AND/OR SIGNATURE(S) SHOWN IN THE MARK DOES NOT IDENTIFY A PARTICULAR LIVING INDIVIDUAL.

THE MARK CONSISTS OF THE STYLIZED LITERAL ELEMENT "EF HUTTON" WITH THE "EF" APPEARING IN DIFFERING FONT THAN THE TERM "HUTTON".

SN 85-268,140, FILED 3-16-2011.

THOMAS MANOR, EXAMINING ATTORNEY



*David J. Kyros*

Director of the United States Patent and Trademark Office

# United States of America

United States Patent and Trademark Office

# Q-STAR

**Reg. No. 4,126,755**

**Registered Apr. 10, 2012**

**Int. Cl.: 28**

**TRADEMARK**

**PRINCIPAL REGISTER**

SRI SPORTS LIMITED (JAPAN CORPORATION)  
6-9, WAKINOHAMA-CHO 3-CHOME, CHUO-KU  
KOBE-SHI, HYOGO, JAPAN

FOR: GOLF BALLS, IN CLASS 28 (U.S. CLS. 22, 23, 38 AND 50).

FIRST USE 5-16-2011; IN COMMERCE 5-16-2011.

THE MARK CONSISTS OF STANDARD CHARACTERS WITHOUT CLAIM TO ANY PARTICULAR FONT, STYLE, SIZE, OR COLOR.

OWNER OF U.S. REG. NOS. 3,664,828 AND 3,723,264.

SN 85-268,615, FILED 3-16-2011.

BARBARA BROWN, EXAMINING ATTORNEY



*David J. Kyffers*

Director of the United States Patent and Trademark Office



# United States of America

United States Patent and Trademark Office



**Reg. No. 4,126,756**

**Registered Apr. 10, 2012**

**Int. Cl.: 42**

**SERVICE MARK**

**PRINCIPAL REGISTER**

ECOHEALTH ALLIANCE INC. (MASSACHUSETTS NON-PROFIT CORPORATION)  
460 WEST 34TH STREET, 17TH FLOOR  
NEW YORK, NY 10001

FOR: PROVIDING A CONSUMER-FOCUSED WEBSITE FEATURING SCIENTIFIC RESEARCH AND DATA ABOUT EXOTIC PET SPECIES AND THE VARIOUS SPECIES' IMPACT ON BIODIVERSITY, NATIVE ANIMAL AND PLANT SPECIES, AND PUBLIC HEALTH, WHICH WEBSITE IS ALSO ACCESSIBLE BY MOBILE DEVICES, IN CLASS 42 (U.S. CLS. 100 AND 101).

FIRST USE 5-19-2011; IN COMMERCE 5-19-2011.

OWNER OF U.S. REG. NO. 3,902,024.

NO CLAIM IS MADE TO THE EXCLUSIVE RIGHT TO USE "ALLIANCE", APART FROM THE MARK AS SHOWN.

THE MARK CONSISTS OF THE SILHOUETTE OF A LIZARD ABOVE THE WORDS "PET-WATCH A PROGRAM OF ECOHEALTH ALLIANCE".

SN 85-268,623, FILED 3-16-2011.

KIMBERLY FRYE, EXAMINING ATTORNEY



*David J. Kyjars*

Director of the United States Patent and Trademark Office

# United States of America

United States Patent and Trademark Office

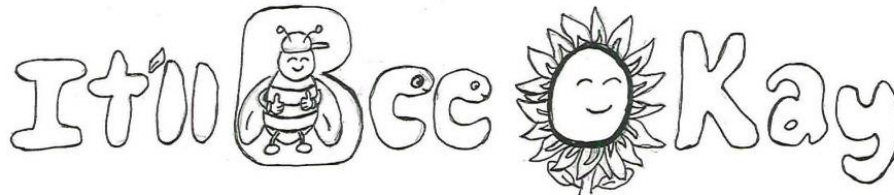

**Reg. No. 4,126,757**

IT'LL BEE OKAY GRAPHICS, LLC (VIRGINIA LIMITED LIABILITY COMPANY)  
401 S. COLORADO STREET  
SALEM, VA 24153

**Registered Apr. 10, 2012**

**Int. Cl.: 25**

FOR: PAJAMAS; SHORT-SLEEVED OR LONG-SLEEVED T-SHIRTS; SWEATSHIRTS; T-SHIRTS, IN CLASS 25 (U.S. CLS. 22 AND 39).

**TRADEMARK**

FIRST USE 10-7-2011; IN COMMERCE 1-23-2012.

**PRINCIPAL REGISTER**

THE MARK CONSISTS OF THE STYLIZED WORDS "IT'LL BEE OKAY" WHERE THE APOSTROPHE IN THE WORD "IT'LL" IS IN THE SHAPE OF A LEAF, A STYLIZED DRAWING OF A BEE IS WITHIN THE LETTER "B" IN THE WORD "BEE", THE LETTERS "E" IN THE WORD "BEE" ARE BOTH STYLIZED DRAWINGS OF WORMS, AND THE LETTER "O" IN THE WORD "OKAY" IS A STYLIZED DRAWING OF A SUNFLOWER.

SN 85-269,381, FILED 3-17-2011.

CHARISMA HAMPTON, EXAMINING ATTORNEY



*David J. Kybas*

Director of the United States Patent and Trademark Office

# United States of America

United States Patent and Trademark Office



**Reg. No. 4,126,758**

**Registered Apr. 10, 2012**

**Int. Cl.: 41**

**SERVICE MARK**

**PRINCIPAL REGISTER**

WMC INSURANCE SERVICES, INC. (CALIFORNIA CORPORATION), DBA BETA BENEFITS  
INSURANCE SERVICES,  
322 WEST 3RD STREET  
SANTA ANA, CA 92701

FOR: CONDUCTING LIVE OR ONLINE EDUCATIONAL WORKSHOPS AND SEMINARS FOR SENIORS TURNING SIXTY-FIVE YEARS OLD TO LEARN ABOUT THE BASICS OF MEDICARE, MEDICARE PART D PRESCRIPTION DRUG PLANS, AND THE TYPES OF MEDICARE HEALTH PLANS AVAILABLE TO THEM, IN CLASS 41 (U.S. CLS. 100, 101 AND 107).

FIRST USE 7-1-2011; IN COMMERCE 7-1-2011.

NO CLAIM IS MADE TO THE EXCLUSIVE RIGHT TO USE "TURNING 65", APART FROM THE MARK AS SHOWN.

THE COLOR(S) BLACK, ORANGE, GOLD, YELLOW AND BLUE IS/ARE CLAIMED AS A FEATURE OF THE MARK.

THE MARK CONSISTS OF THE PARTIALLY UNDERLINED, STYLIZED WORDING "TURNING 65" AS WELL AS THE DEPICTION OF A SUN. THE COLOR BLACK APPEARS IN THE WORDING "TURNING". THE COLOR BLUE APPEARS IN THE WORDING "65". THE COLORS YELLOW, GOLD AND ORANGE APPEAR ON THE DEPICTION OF SUN. THE COLOR YELLOW APPEARS ON THE DEPICTION OF THE LINE UNDER THE TERM "TURNING".

SN 85-269,938, FILED 3-17-2011.

MICHAEL TANNER, EXAMINING ATTORNEY



*David J. Kybas*

Director of the United States Patent and Trademark Office

# United States of America

United States Patent and Trademark Office

# TWOBOLT

**Reg. No. 4,126,759**

MERCURY PRINT & MAIL CO., INC. (RHODE ISLAND CORPORATION)  
1110 CENTRAL AVENUE  
PAWTUCKET, RI 02861

**Registered Apr. 10, 2012**

**Int. Cl.: 35**

FOR: ADVERTISING AND MARKETING SERVICES PROVIDED BY MEANS OF INDIRECT METHODS OF MARKETING COMMUNICATIONS, NAMELY, SOCIAL MEDIA, SEARCH ENGINE MARKETING, INQUIRY MARKETING, INTERNET MARKETING, MOBILE MARKETING, BLOGGING AND OTHER FORMS OF PASSIVE, SHARABLE OR VIRAL COMMUNICATIONS CHANNELS; ADVERTISING SERVICES, PUBLIC RELATIONS AND MARKETING SERVICES, NAMELY, PROMOTING AND MARKETING THE GOODS AND SERVICES OF OTHERS THROUGH ALL PUBLIC COMMUNICATION MEANS; CONSULTATION SERVICES, NAMELY, CREATIVE AND STRATEGIC CONSULTATION REGARDING DEVELOPMENT AND PRODUCTION OF MARKETING CAMPAIGNS FOR OTHERS; CONSULTING SERVICES IN THE FIELD OF INTERNET MARKETING; ON-LINE ADVERTISING AND MARKETING SERVICES; PROVIDING A WEBSITE FEATURING INFORMATION ON MULTI-LEVEL MARKETING BUSINESS SERVICES; SOCIAL MEDIA STRATEGY AND MARKETING CONSULTANCY FOCUSING ON HELPING CLIENTS CREATE AND EXTEND THEIR PRODUCT AND BRAND STRATEGIES BY BUILDING VIRALLY ENGAGING MARKETING SOLUTIONS, IN CLASS 35 (U.S. CLS. 100, 101 AND 102).

**SERVICE MARK**

**PRINCIPAL REGISTER**

FIRST USE 7-21-2011; IN COMMERCE 7-21-2011.

THE MARK CONSISTS OF STANDARD CHARACTERS WITHOUT CLAIM TO ANY PARTICULAR FONT, STYLE, SIZE, OR COLOR.

SN 85-270,465, FILED 3-18-2011.

JANET LEE, EXAMINING ATTORNEY



*David J. Kyffers*

Director of the United States Patent and Trademark Office

# United States of America

United States Patent and Trademark Office



**Reg. No. 4,126,760**

**Registered Apr. 10, 2012**

**Int. Cl.: 5**

**TRADEMARK**

**PRINCIPAL REGISTER**

GEOFFREY, LLC (DELAWARE LIMITED LIABILITY COMPANY)  
ONE GEOFFREY WAY  
WAYNE, NJ 07470

FOR: INFANT FORMULA, IN CLASS 5 (U.S. CLS. 6, 18, 44, 46, 51 AND 52).

FIRST USE 5-0-2011; IN COMMERCE 5-0-2011.

THE MARK CONSISTS OF A BEAR HOLDING A SIPPY CUP.

SN 85-270,613, FILED 3-18-2011.

KAELIE KUNG, EXAMINING ATTORNEY



*David J. Kappas*

Director of the United States Patent and Trademark Office

# United States of America

United States Patent and Trademark Office

## MAKING THINGS BETTER

**Reg. No. 4,126,761**

INDUSTRIAL MAGNETICS, INC. (MICHIGAN CORPORATION)  
1385 M-75 SOUTH  
BOYNE CITY, MI 49712

**Registered Apr. 10, 2012**

**Int. Cls.: 9 and 42**

FOR: MAGNETS, MAGNETS FOR INDUSTRIAL PURPOSES, IN CLASS 9 (U.S. CLS. 21, 23, 26, 36 AND 38).

**TRADEMARK**

FIRST USE 10-27-2011; IN COMMERCE 10-27-2011.

**SERVICE MARK**

FOR: DESIGN, ENGINEERING, RESEARCH, DEVELOPMENT AND TESTING IN THE FIELD OF MAGNETICS, IN CLASS 42 (U.S. CLS. 100 AND 101).

**PRINCIPAL REGISTER**

FIRST USE 10-27-2011; IN COMMERCE 10-27-2011.

THE MARK CONSISTS OF STANDARD CHARACTERS WITHOUT CLAIM TO ANY PARTICULAR FONT, STYLE, SIZE, OR COLOR.

SN 85-270,615, FILED 3-18-2011.

SANJEEV VOHRA, EXAMINING ATTORNEY



*David J. Kyros*

Director of the United States Patent and Trademark Office

# United States of America

United States Patent and Trademark Office

## BEAUTIFUL TEXTURES

**Reg. No. 4,126,762**

STRENGTH OF NATURE, LLC (GEORGIA LIMITED LIABILITY COMPANY)  
64 ROSS ROAD  
SAVANNAH, GA 31405

**Registered Apr. 10, 2012**

**Int. Cl.: 3**

FOR: HAIR CARE PREPARATIONS, IN CLASS 3 (U.S. CLS. 1, 4, 6, 50, 51 AND 52).

**TRADEMARK**

FIRST USE 11-21-2011; IN COMMERCE 11-21-2011.

**PRINCIPAL REGISTER**

THE MARK CONSISTS OF STANDARD CHARACTERS WITHOUT CLAIM TO ANY PARTICULAR FONT, STYLE, SIZE, OR COLOR.

SN 85-271,962, FILED 3-21-2011.

TOBY BULLOFF, EXAMINING ATTORNEY



*David J. Kyffers*

Director of the United States Patent and Trademark Office

# United States of America

United States Patent and Trademark Office

## Benefit Edition

**Reg. No. 4,126,763**

**Registered Apr. 10, 2012**

**Int. Cl.: 35**

**SERVICE MARK**

**PRINCIPAL REGISTER**

KOREK, BETTINA (UNITED STATES INDIVIDUAL)  
1802  
10490 WILSHIRE BLVD.  
LOS ANGELES, CA 90024

FOR: ADVERTISING AND PROMOTING THE GOODS AND SERVICES OF A VISUAL ARTIST; ART GALLERY SERVICES; ON-LINE ART GALLERIES; PROMOTING VISUAL AND PERFORMING ARTS EVENTS BY MEANS OF PROVIDING AN ONLINE EVENTS CALENDAR, ORIGINAL ARTICLES, INTERVIEWS, AND INFORMATION ABOUT ART, ARTISTS AND ARTS EVENTS VIA AN INTERNET WEB SITE, ALL FOR PROMOTIONAL PURPOSES; PROVIDING A SEARCHABLE ONLINE ADVERTISING WEBSITE AND INFORMATIONAL GUIDE FEATURING THE GOODS AND SERVICES OF OTHER VENDORS VIA THE INTERNET IN THE FIELD OF ART; PROVIDING A WEBSITE FOR MANAGING, CONDUCTING AND ORGANIZING ONLINE AUCTIONS THAT ARE DESIGNED TO RAISE MONEY FOR SELECTED CHARITIES, IN CLASS 35 (U.S. CLS. 100, 101 AND 102).

FIRST USE 1-1-2008; IN COMMERCE 5-1-2010.

THE MARK CONSISTS OF STANDARD CHARACTERS WITHOUT CLAIM TO ANY PARTICULAR FONT, STYLE, SIZE, OR COLOR.

NO CLAIM IS MADE TO THE EXCLUSIVE RIGHT TO USE "BENEFIT", APART FROM THE MARK AS SHOWN.

SN 85-272,053, FILED 3-21-2011.

SUE LAWRENCE, EXAMINING ATTORNEY



*David J. Kybas*

Director of the United States Patent and Trademark Office



# United States of America

United States Patent and Trademark Office

## LIGHT MASTER

**Reg. No. 4,126,764**

**Registered Apr. 10, 2012**

**Int. Cl.: 9**

**TRADEMARK**

**PRINCIPAL REGISTER**

CHU, ROBERT (UNITED STATES INDIVIDUAL)  
10501 VALLEY BLVD, #1872  
EL MONTE, CA 91731

FOR: ELECTRONIC LED SIGNS; LED AND HID LIGHT CONTROLS; LED VEHICLE TRAFFIC SIGNALS; LIGHT EMITTING DIODE (LED) DISPLAYS; LIGHT EMITTING DIODES (LEDS); PORTABLE LED SAFETY LIGHTING DEVICES FOR PERSONAL USE FOR SAFETY PURPOSES; RED LED LASER POINTING DEVICES THAT CONTAIN A SUBTLE ENERGY FIELD, IN CLASS 9 (U.S. CLS. 21, 23, 26, 36 AND 38).

FIRST USE 9-1-2011; IN COMMERCE 9-1-2011.

THE MARK CONSISTS OF STANDARD CHARACTERS WITHOUT CLAIM TO ANY PARTICULAR FONT, STYLE, SIZE, OR COLOR.

NO CLAIM IS MADE TO THE EXCLUSIVE RIGHT TO USE "LIGHT", APART FROM THE MARK AS SHOWN.

SN 85-272,255, FILED 3-21-2011.

JOHN SCHUYLER YARD, EXAMINING ATTORNEY



*David J. Kyfos*

Director of the United States Patent and Trademark Office

# United States of America

United States Patent and Trademark Office

# COCOAFISH

**Reg. No. 4,126,765**

**Registered Apr. 10, 2012**

**Int. Cl.: 42**

**SERVICE MARK**

**PRINCIPAL REGISTER**

COCOAFISH, INC. (DELAWARE CORPORATION)  
88 TOWNSEND ST., #226  
SAN FRANCISCO, CA 94107

FOR: APPLICATION SERVICE PROVIDER, NAMELY, HOSTING, MANAGING, DEVELOPING, AND MAINTAINING APPLICATIONS, SOFTWARE, AND WEB SITES, IN THE FIELDS OF MOBILE AND SOCIAL NETWORKING APPLICATIONS, AND REMOTE DATA MANAGEMENT FOR WIRELESS DELIVERY OF CONTENT TO HANDHELD COMPUTERS, LAPTOPS AND MOBILE ELECTRONIC DEVICES, IN CLASS 42 (U.S. CLS. 100 AND 101).

FIRST USE 4-15-2010; IN COMMERCE 4-3-2011.

THE MARK CONSISTS OF STANDARD CHARACTERS WITHOUT CLAIM TO ANY PARTICULAR FONT, STYLE, SIZE, OR COLOR.

SN 85-272,350, FILED 3-21-2011.

TRACY CROSS, EXAMINING ATTORNEY



*David J. Kyffers*

Director of the United States Patent and Trademark Office

# United States of America

United States Patent and Trademark Office

## ATHEROMOBILE

**Reg. No. 4,126,766**

**Registered Apr. 10, 2012**

**Int. Cl.: 9**

**TRADEMARK**

**PRINCIPAL REGISTER**

BIOMEDICAL TECHNOLOGIES, INC. (COLORADO CORPORATION)  
208 OTTER GLEN COURT  
ROSEVILLE, CA 95661

FOR: COMPUTER PROGRAMS FOR USE IN MEDICAL IMAGE ANALYSIS, DIAGNOSIS, AND TREATMENT, NAMELY, SOFTWARE FOR PROCESSING DIGITAL IMAGES OF THE ANATOMY FOR ANALYSIS, DIAGNOSIS AND TREATMENT, AND SOFTWARE FOR PROCESSING DIGITAL IMAGES OF THE ANATOMY TO ADD ADDITIONAL VISUAL ELEMENTS TO THE DIGITAL IMAGES FOR ENHANCED ANALYSIS, DIAGNOSIS AND TREATMENT; COMPUTER SOFTWARE FOR CREATING SEARCHABLE MEDICAL DIAGNOSIS AND TREATMENT DATABASES, IN CLASS 9 (U.S. CLS. 21, 23, 26, 36 AND 38).

FIRST USE 10-2-2010; IN COMMERCE 2-5-2012.

THE MARK CONSISTS OF STANDARD CHARACTERS WITHOUT CLAIM TO ANY PARTICULAR FONT, STYLE, SIZE, OR COLOR.

SN 85-272,771, FILED 3-21-2011.

FRANK LATTUCA, EXAMINING ATTORNEY



*David J. Kybas*

Director of the United States Patent and Trademark Office

# United States of America

United States Patent and Trademark Office

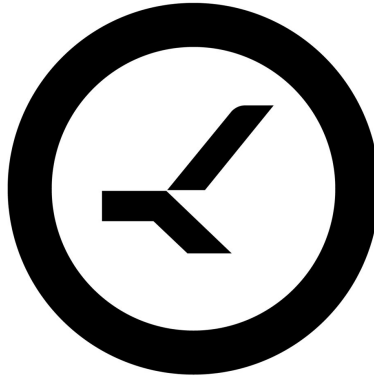

**Reg. No. 4,126,767**

ANHEUSER-BUSCH, LLC (MISSOURI LIMITED LIABILITY COMPANY)  
ONE BUSCH PLACE  
ST. LOUIS, MO 63118

**Registered Apr. 10, 2012**

**Int. Cl.: 21**

FOR: PORTABLE BEVERAGE DISPENSERS, IN CLASS 21 (U.S. CLS. 2, 13, 23, 29, 30, 33, 40 AND 50).

**TRADEMARK**

FIRST USE 12-13-2011; IN COMMERCE 12-13-2011.

**PRINCIPAL REGISTER**

THE MARK CONSISTS OF A HANDLE IN A CIRCLE.

SN 85-273,483, FILED 3-22-2011.

EUGENIA MARTIN, EXAMINING ATTORNEY



*David J. Kybas*

Director of the United States Patent and Trademark Office

# United States of America

United States Patent and Trademark Office

# MANTARAY

**Reg. No. 4,126,768**

COREFILING SARL (LUXEMBOURG SOCIÉTÉ À RESPONSABILITÉ LIMITÉE (SARL))  
PARC D'ACTIVITÉS 75  
CAPELLEN, L-8308, LUXEMBOURG

**Registered Apr. 10, 2012**

**Int. Cl.: 9**

FOR: COMPUTER SOFTWARE, NAMELY, SOFTWARE TO PREPARE, READ OR REVIEW  
EXTENSIBLE BUSINESS REPORTING LANGUAGE OR INLINE EXTENSIBLE BUSINESS  
REPORTING LANGUAGE, IN CLASS 9 (U.S. CLS. 21, 23, 26, 36 AND 38).

**TRADEMARK**

FIRST USE 6-30-2006; IN COMMERCE 6-30-2006.

**PRINCIPAL REGISTER**

THE MARK CONSISTS OF STANDARD CHARACTERS WITHOUT CLAIM TO ANY PAR-  
TICULAR FONT, STYLE, SIZE, OR COLOR.

SN 85-273,600, FILED 3-22-2011.

JUDITH HELFMAN, EXAMINING ATTORNEY



*David J. Kyfos*

Director of the United States Patent and Trademark Office

# United States of America

United States Patent and Trademark Office

# AQUA SMART

**Reg. No. 4,126,769**

GREENE, DOUGLAS C. (UNITED STATES INDIVIDUAL)  
2425 NW 69TH STREET  
VANCOUVER, WA 98665

**Registered Apr. 10, 2012**

**Int. Cl.: 9**

FOR: THERMOSTATS; WATER HEATER CONTROLS, IN CLASS 9 (U.S. CLS. 21, 23, 26, 36 AND 38).

**TRADEMARK**

FIRST USE 6-28-2011; IN COMMERCE 1-15-2012.

**PRINCIPAL REGISTER**

THE MARK CONSISTS OF STANDARD CHARACTERS WITHOUT CLAIM TO ANY PARTICULAR FONT, STYLE, SIZE, OR COLOR.

NO CLAIM IS MADE TO THE EXCLUSIVE RIGHT TO USE "SMART", APART FROM THE MARK AS SHOWN.

SN 85-273,759, FILED 3-22-2011.

JAY FLOWERS, EXAMINING ATTORNEY



*David J. Kybas*

Director of the United States Patent and Trademark Office

# United States of America

United States Patent and Trademark Office



**Reg. No. 4,126,770**

TIMES THREE CLOTHIER, LLC (NEW YORK LIMITED LIABILITY COMPANY)  
561 SEVENTH AVENUE, 12TH FLOOR  
NEW YORK, NY 10018

**Registered Apr. 10, 2012**

**Int. Cl.: 25**

FOR: CLOTHING, NAMELY, DRESSES, SHIRTS, UNDERGARMENTS, LINGERIE, SHORTS, HOSIERY AND LEGGINGS, IN CLASS 25 (U.S. CLS. 22 AND 39).

**TRADEMARK**

FIRST USE 4-1-2011; IN COMMERCE 4-1-2011.

**PRINCIPAL REGISTER**

THE NAME(S), PORTRAIT(S), AND/OR SIGNATURE(S) SHOWN IN THE MARK IDENTIFIES "HEATHER THOMSON", WHOSE CONSENT(S) TO REGISTER IS MADE OF RECORD.

THE MARK CONSISTS OF A SQUARE REPRESENTING A DOT IN BETWEEN TWO OPEN ENDED PARENTHESES AND WORDING "YUMMIE BY HEATHER THOMSON".

SN 85-275,285, FILED 3-24-2011.

DAVID C. REIHNER, EXAMINING ATTORNEY



*David J. Kybas*

Director of the United States Patent and Trademark Office

# United States of America

United States Patent and Trademark Office

# USFRA

**Reg. No. 4,126,771**

**Registered Apr. 10, 2012**

**Int. Cl.: 9**

**TRADEMARK**

**PRINCIPAL REGISTER**

U.S. FARMERS & RANCHERS ALLIANCE, INC. (MISSOURI NON-PROFIT CORPORATION)  
SUITE 300  
16020 SWINGLEY RIDGE ROAD  
CHESTERFIELD, MO 63017

FOR: DOWNLOADABLE ELECTRONIC PUBLICATIONS IN THE NATURE OF NEWSLETTERS, POWER POINT PRESENTATIONS, POINT OF PURCHASE MATERIALS, BROCHURES AND HANDOUTS IN THE FIELD OF TODAY'S MODERN AGRICULTURE, IN CLASS 9 (U.S. CLS. 21, 23, 26, 36 AND 38).

FIRST USE 6-1-2011; IN COMMERCE 6-1-2011.

THE MARK CONSISTS OF STANDARD CHARACTERS WITHOUT CLAIM TO ANY PARTICULAR FONT, STYLE, SIZE, OR COLOR.

SN 85-275,381, FILED 3-24-2011.

ERIN FALK, EXAMINING ATTORNEY



*David J. Kybas*

Director of the United States Patent and Trademark Office



# United States of America

United States Patent and Trademark Office

## CHAMPION ECO

**Reg. No. 4,126,772**

**Registered Apr. 10, 2012**

**Int. Cl.: 25**

**TRADEMARK**

**PRINCIPAL REGISTER**

HBI BRANDED APPAREL ENTERPRISES, LLC (DELAWARE LIMITED LIABILITY COMPANY)  
1000 EAST HANES MILL ROAD  
WINSTON-SALEM, NC 27105

FOR: JACKETS; PANTS; SWEAT PANTS; SWEAT SHIRTS, IN CLASS 25 (U.S. CLS. 22 AND 39).

FIRST USE 6-30-2011; IN COMMERCE 6-30-2011.

THE MARK CONSISTS OF STANDARD CHARACTERS WITHOUT CLAIM TO ANY PARTICULAR FONT, STYLE, SIZE, OR COLOR.

OWNER OF U.S. REG. NOS. 1,323,337, 1,819,014, AND 3,000,691.

SN 85-275,437, FILED 3-24-2011.

COLLEEN KEARNEY, EXAMINING ATTORNEY



*David J. Kyffers*

Director of the United States Patent and Trademark Office

# United States of America

United States Patent and Trademark Office

## DOUBLE DRY ECO

**Reg. No. 4,126,773**

**Registered Apr. 10, 2012**

**Int. Cl.: 25**

**TRADEMARK**

**PRINCIPAL REGISTER**

HBI BRANDED APPAREL ENTERPRISES, LLC (DELAWARE LIMITED LIABILITY COMPANY)  
1000 EAST HANES MILL ROAD  
WINSTON-SALEM, NC 27105

FOR: JACKETS; PANTS; SHIRTS; SHORTS; SWEAT PANTS; SWEAT SHIRTS; T-SHIRTS; TOPS, IN CLASS 25 (U.S. CLS. 22 AND 39).

FIRST USE 6-30-2011; IN COMMERCE 6-30-2011.

THE MARK CONSISTS OF STANDARD CHARACTERS WITHOUT CLAIM TO ANY PARTICULAR FONT, STYLE, SIZE, OR COLOR.

OWNER OF U.S. REG. NOS. 2,764,466 AND 3,474,035.

SN 85-275,447, FILED 3-24-2011.

COLLEEN KEARNEY, EXAMINING ATTORNEY



*David J. Kybas*

Director of the United States Patent and Trademark Office

# United States of America

United States Patent and Trademark Office

# USFRA

**Reg. No. 4,126,774**

**Registered Apr. 10, 2012**

**Int. Cl.: 16**

**TRADEMARK**

**PRINCIPAL REGISTER**

U.S. FARMERS & RANCHERS ALLIANCE, INC. (MISSOURI NON-PROFIT CORPORATION)  
SUITE 300  
16020 SWINGLEY RIDGE ROAD  
CHESTERFIELD, MO 63017

FOR: PRINTED MATTER, NAMELY, NEWSLETTERS, BROCHURES AND HANDOUTS IN OR RELATING TO THE FIELD OF TODAY'S MODERN AGRICULTURE, IN CLASS 16 (U.S. CLS. 2, 5, 22, 23, 29, 37, 38 AND 50).

FIRST USE 3-1-2011; IN COMMERCE 3-1-2011.

THE MARK CONSISTS OF STANDARD CHARACTERS WITHOUT CLAIM TO ANY PARTICULAR FONT, STYLE, SIZE, OR COLOR.

SN 85-275,592, FILED 3-24-2011.

ERIN FALK, EXAMINING ATTORNEY



*David J. Kyjars*

Director of the United States Patent and Trademark Office

# United States of America

United States Patent and Trademark Office

## COUNTERFEIT SOCIETY

**Reg. No. 4,126,775**

**Registered Apr. 10, 2012**

**Int. Cl.: 41**

**SERVICE MARK**

**PRINCIPAL REGISTER**

GISONDI, JAMES (UNITED STATES INDIVIDUAL)  
10 REEBACK DRIVE  
VALHALLA, NY 10595

FOR: ENTERTAINMENT RENDERED BY A MUSICAL ARTISTS, NAMELY, ENTERTAINMENT IN THE NATURE OF VISUAL AND AUDIO PERFORMANCES BY A MUSICAL ACT; LIVE PERFORMANCES BY A MUSICAL ACT; MULTIMEDIA ENTERTAINMENT SERVICES IN THE NATURE OF RECORDING, PRODUCTION AND POST-PRODUCTION SERVICES IN THE FIELD OF MUSIC AND VIDEO; ENTERTAINMENT SERVICES BY A MUSICAL ARTIST, NAMELY, PRODUCTION OF MUSICAL SOUND RECORDINGS, IN CLASS 41 (U.S. CLS. 100, 101 AND 107).

FIRST USE 7-14-2008; IN COMMERCE 7-14-2008.

THE MARK CONSISTS OF STANDARD CHARACTERS WITHOUT CLAIM TO ANY PARTICULAR FONT, STYLE, SIZE, OR COLOR.

SN 85-276,507, FILED 3-25-2011.

MARK SHINER, EXAMINING ATTORNEY



*David J. Kyffers*

Director of the United States Patent and Trademark Office

# United States of America

United States Patent and Trademark Office

## Hold Me Tight

**Reg. No. 4,126,776**

**Registered Apr. 10, 2012**

**Int. Cls.: 3 and 5**

**TRADEMARK**

**PRINCIPAL REGISTER**

EAU ZONE HUILES & FRAGRANCES LTD (CANADA CORPORATION)  
SUITE 825  
1625 CHABANEL ST WEST  
MONTREAL, QUEBEC, CANADA H4N2S7

FOR: INTIMATE MASSAGE GELS, IN CLASS 3 (U.S. CLS. 1, 4, 6, 50, 51 AND 52).

FIRST USE 12-1-2011; IN COMMERCE 12-1-2011.

FOR: ORGASM CREAMS; TOPICAL PREPARATIONS, NAMELY, TIGHTENING GEL, CREAM, LOTION FOR ENHANCING SEXUAL AROUSAL; GELS FOR USE AS PERSONAL SEXUAL LUBRICANT; PERSONAL LUBRICANTS; PERSONAL SEXUAL LUBRICANTS; SEXUAL STIMULATING GELS; SILICONE-BASED PERSONAL LUBRICANTS, IN CLASS 5 (U.S. CLS. 6, 18, 44, 46, 51 AND 52).

FIRST USE 2-1-2011; IN COMMERCE 2-1-2011.

THE MARK CONSISTS OF STANDARD CHARACTERS WITHOUT CLAIM TO ANY PARTICULAR FONT, STYLE, SIZE, OR COLOR.

SN 85-277,133, FILED 3-25-2011.

HEATHER BIDDULPH, EXAMINING ATTORNEY



*David J. Kyros*

Director of the United States Patent and Trademark Office

# United States of America

United States Patent and Trademark Office

## GACOFIRESTOP

**Reg. No. 4,126,777**

**Registered Apr. 10, 2012**

**Int. Cl.: 17**

**TRADEMARK**

**PRINCIPAL REGISTER**

GACO WESTERN, LLC (WASHINGTON LIMITED LIABILITY COMPANY)  
200 W MERCER STREET, SUITE 202  
SEATTLE, WA 98119

FOR: SPRAY FOAM INSULATION WITH FIRE RETARDANT CHARACTERISTICS FOR USE IN BUILDING AND CONSTRUCTION AND AS BUILDING INSULATION , IN CLASS 17 (U.S. CLS. 1, 5, 12, 13, 35 AND 50).

FIRST USE 5-1-2011; IN COMMERCE 5-1-2011.

THE MARK CONSISTS OF STANDARD CHARACTERS WITHOUT CLAIM TO ANY PARTICULAR FONT, STYLE, SIZE, OR COLOR.

OWNER OF U.S. REG. NOS. 2,916,185, 3,273,362, AND OTHERS.

SN 85-277,428, FILED 3-25-2011.

ERNEST SHOSHO, EXAMINING ATTORNEY



*David J. Kybas*

Director of the United States Patent and Trademark Office

# United States of America

United States Patent and Trademark Office

## CUSTOMWAVE

**Reg. No. 4,126,778**

SLEEP INNOVATIONS, INC. (NEW JERSEY CORPORATION)  
187 ROUTE 36, SUITE 101

**Registered Apr. 10, 2012**

WEST LONG BRANCH, NJ 07764

**Int. Cl.: 20**

FOR: MATTRESSES AND MATTRESS TOPPERS, IN CLASS 20 (U.S. CLS. 2, 13, 22, 25, 32 AND 50).

**TRADEMARK**

FIRST USE 6-0-2011; IN COMMERCE 6-0-2011.

**PRINCIPAL REGISTER**

THE MARK CONSISTS OF STANDARD CHARACTERS WITHOUT CLAIM TO ANY PARTICULAR FONT, STYLE, SIZE, OR COLOR.

SN 85-278,442, FILED 3-28-2011.

LOURDES AYALA, EXAMINING ATTORNEY



*David J. Kybas*

Director of the United States Patent and Trademark Office

# United States of America

United States Patent and Trademark Office

# EYELIGHTS

**Reg. No. 4,126,779**

**Registered Apr. 10, 2012**

**Int. Cl.: 28**

**TRADEMARK**

**PRINCIPAL REGISTER**

BATTAT INCORPORATED (DELAWARE CORPORATION)  
1560 MILITARY TURNPIKE  
PLATTSBURGH, NY 12901

FOR: ELECTRONIC LEARNING TOYS, IN CLASS 28 (U.S. CLS. 22, 23, 38 AND 50).

FIRST USE 10-31-2011; IN COMMERCE 10-31-2011.

THE MARK CONSISTS OF STANDARD CHARACTERS WITHOUT CLAIM TO ANY PARTICULAR FONT, STYLE, SIZE, OR COLOR.

SN 85-278,760, FILED 3-28-2011.

SOPHIA S. KIM, EXAMINING ATTORNEY



*David J. Kybas*

Director of the United States Patent and Trademark Office



# United States of America

United States Patent and Trademark Office

## CAR GO CARGO

**Reg. No. 4,126,780**

BATTAT INCORPORATED (DELAWARE CORPORATION)  
1560 MILITARY TURNPIKE  
PLATTSBURGH, NY 12901

**Registered Apr. 10, 2012**

**Int. Cl.: 28**

FOR: TOY VEHICLES, IN CLASS 28 (U.S. CLS. 22, 23, 38 AND 50).

**TRADEMARK**

FIRST USE 7-31-2011; IN COMMERCE 7-31-2011.

**PRINCIPAL REGISTER**

THE MARK CONSISTS OF STANDARD CHARACTERS WITHOUT CLAIM TO ANY PARTICULAR FONT, STYLE, SIZE, OR COLOR.

SN 85-278,771, FILED 3-28-2011.

SOPHIA S. KIM, EXAMINING ATTORNEY



*David J. Kybas*

Director of the United States Patent and Trademark Office

# United States of America

United States Patent and Trademark Office

## TRENDS WITH BENEFITS

**Reg. No. 4,126,781**

**Registered Apr. 10, 2012**

**Int. Cl.: 38**

**SERVICE MARK**

**PRINCIPAL REGISTER**

SUPERSTATION, INC. (GEORGIA CORPORATION)  
C/O TURNER BROADCASTING SYSTEM, INC.  
ONE CNN CENTER, 10N  
ATLANTA, GA 30303

FOR: STREAMING OF TELEVISION PROGRAMMING OVER THE INTERNET; TRANSMISSION OF TELEVISION PROGRAMMING OVER WIRELESS COMMUNICATIONS NETWORKS, IN CLASS 38 (U.S. CLS. 100, 101 AND 104).

FIRST USE 10-29-2011; IN COMMERCE 10-29-2011.

THE MARK CONSISTS OF STANDARD CHARACTERS WITHOUT CLAIM TO ANY PARTICULAR FONT, STYLE, SIZE, OR COLOR.

SN 85-278,831, FILED 3-28-2011.

MATTHEW MCDOWELL, EXAMINING ATTORNEY



*David J. Kybas*

Director of the United States Patent and Trademark Office

# United States of America

United States Patent and Trademark Office

## TRENDS WITH BENEFITS

**Reg. No. 4,126,782**

**Registered Apr. 10, 2012**

**Int. Cl.: 41**

**SERVICE MARK**

**PRINCIPAL REGISTER**

SUPERSTATION, INC. (GEORGIA CORPORATION)  
C/O TURNER BROADCASTING SYSTEM, INC.  
ONE CNN CENTER, 10N  
ATLANTA, GA 30303

FOR: ENTERTAINMENT SERVICES, NAMELY, A MULTIMEDIA PROGRAM SERIES FEATURING COMEDY, DRAMA AND REALITY DISTRIBUTED VIA VARIOUS PLATFORMS ACROSS MULTIPLE FORMS OF TRANSMISSION MEDIA, IN CLASS 41 (U.S. CLS. 100, 101 AND 107).

FIRST USE 10-1-2011; IN COMMERCE 10-1-2011.

THE MARK CONSISTS OF STANDARD CHARACTERS WITHOUT CLAIM TO ANY PARTICULAR FONT, STYLE, SIZE, OR COLOR.

SN 85-278,837, FILED 3-28-2011.

MATTHEW MCDOWELL, EXAMINING ATTORNEY



*David J. Kyffers*

Director of the United States Patent and Trademark Office

# United States of America

United States Patent and Trademark Office



**Reg. No. 4,126,783**

**Registered Apr. 10, 2012**

**Int. Cl.: 37**

**SERVICE MARK**

**PRINCIPAL REGISTER**

AMENTO GROUP, INC. (WASHINGTON CORPORATION)  
SUITE 820  
710 2ND AVENUE  
SEATTLE, WA 98104

FOR: CONSULTING IN THE FIELD OF BUILDING CONSTRUCTION, IN CLASS 37 (U.S. CLS. 100, 103 AND 106).

FIRST USE 9-1-2011; IN COMMERCE 10-1-2011.

THE MARK CONSISTS OF A STYLIZED LETTER "A" ABOVE A STYLIZED LETTER "G"; ONE STRAIGHT HORIZONTAL LINE BETWEEN THE LETTER "A" AND THE LETTER "G" (THE MIRROR IMAGE OF THE LETTER "A" SERVES AS THE LETTER "G").

SN 85-279,109, FILED 3-28-2011.

DOMINIC FATHY, EXAMINING ATTORNEY



*David J. Kybas*

Director of the United States Patent and Trademark Office

# United States of America

United States Patent and Trademark Office

# JAKAFI

**Reg. No. 4,126,784**

**Registered Apr. 10, 2012**

**Int. Cl.: 5**

**TRADEMARK**

**PRINCIPAL REGISTER**

INCYTE CORPORATION (DELAWARE CORPORATION)  
EXPERIMENTAL STATION,  
BUILDING 336, RT. 141 & HENRY CLAY ROAD  
WILMINGTON, DE 19880

FOR: PHARMACEUTICAL PREPARATIONS FOR THE PREVENTION AND TREATMENT  
OF ONCOLOGY DISORDERS, HEMATOLOGY DISORDERS, INFLAMMATORY DISORDERS,  
IN CLASS 5 (U.S. CLS. 6, 18, 44, 46, 51 AND 52).

FIRST USE 11-22-2011; IN COMMERCE 11-22-2011.

THE MARK CONSISTS OF STANDARD CHARACTERS WITHOUT CLAIM TO ANY PAR-  
TICULAR FONT, STYLE, SIZE, OR COLOR.

SN 85-280,226, FILED 3-29-2011.

KARANENDRA S. CHHINA, EXAMINING ATTORNEY



*David J. Kybas*

Director of the United States Patent and Trademark Office

# United States of America

United States Patent and Trademark Office



**Reg. No. 4,126,785**

**Registered Apr. 10, 2012**

**Int. Cl.: 33**

**TRADEMARK**

**PRINCIPAL REGISTER**

TEQUILA HAPPY HOUR, S.A. DE C.V. (MEXICO SOCIEDAD ANONIMA (SA DE CV))  
AV. TOLUCA #438 COL OLIVAR DE LOS PADRES  
MEXICO, D.F., MEXICO 01780

FOR: DISTILLED SPIRITS, IN CLASS 33 (U.S. CLS. 47 AND 49).

FIRST USE 3-29-2011; IN COMMERCE 8-24-2011.

THE MARK CONSISTS OF DESIGN OF A CURVED FRAME, INSIDE OF IT, THREE ABSTRACTED AGAVE LEAVES, ON THE BOTTOM THE WORDING OF THE MARK. OUTSIDE OF THE FRAME, AN ABSTRACT AGAVE PLANT INSIDE OF A CIRCLE.

THE ENGLISH TRANSLATION OF "SABOR A MI" IN THE MARK IS FLAVOR TO ME.

SN 85-280,247, FILED 3-29-2011.

KARANENDRA S. CHHINA, EXAMINING ATTORNEY



*David J. Kybas*

Director of the United States Patent and Trademark Office

# United States of America

United States Patent and Trademark Office

# FIBER TC

**Reg. No. 4,126,786**

LUBRIZOL ADVANCED MATERIALS, INC. (DELAWARE CORPORATION)  
9911 BRECKSVILLE ROAD  
CLEVELAND, OH 441413247

**Registered Apr. 10, 2012**

**Int. Cl.: 22**

FOR: TEXTILE FILAMENTS; SYNTHETIC FIBERS AND FILAMENTS FOR USE IN WOVEN, NON-WOVEN AND KNIT FABRICS, IN CLASS 22 (U.S. CLS. 1, 2, 7, 19, 22, 42 AND 50).

**TRADEMARK**

FIRST USE 1-5-2012; IN COMMERCE 1-5-2012.

**PRINCIPAL REGISTER**

THE MARK CONSISTS OF STANDARD CHARACTERS WITHOUT CLAIM TO ANY PARTICULAR FONT, STYLE, SIZE, OR COLOR.

NO CLAIM IS MADE TO THE EXCLUSIVE RIGHT TO USE "FIBER", APART FROM THE MARK AS SHOWN.

SN 85-280,367, FILED 3-29-2011.

NICHOLAS ALTREE, EXAMINING ATTORNEY



*David J. Kybas*

Director of the United States Patent and Trademark Office

# United States of America

United States Patent and Trademark Office

## People Engagement

**Reg. No. 4,126,787**

**Registered Apr. 10, 2012**

**Int. Cl.: 42**

**SERVICE MARK**

**PRINCIPAL REGISTER**

JOSTLE CORPORATION (CANADA CORPORATION)  
2009 OCEAN WIND DRIVE  
SURREY, B.C., CANADA V4A9K5

FOR: PROVIDING TEMPORARY USE OF ON-LINE NON-DOWNLOADABLE SOFTWARE TO ORGANIZATIONS, ENABLING THEIR MEMBERS AND ASSOCIATES TO COLLABORATIVELY SHARE, RETRIEVE, EXCHANGE AND ACCESS DATA ABOUT THEMSELVES, THEIR ACTIVITIES AND THEIR RELATIONSHIPS THROUGH VISUALIZATIONS AND VISUAL DEPICTIONS, IN CLASS 42 (U.S. CLS. 100 AND 101).

FIRST USE 12-11-2011; IN COMMERCE 12-11-2011.

THE MARK CONSISTS OF STANDARD CHARACTERS WITHOUT CLAIM TO ANY PARTICULAR FONT, STYLE, SIZE, OR COLOR.

SN 85-281,085, FILED 3-30-2011.

MARIA-VICTORIA SUAREZ, EXAMINING ATTORNEY



*David J. Kybas*

Director of the United States Patent and Trademark Office



# United States of America

United States Patent and Trademark Office

# AHH PANTY

**Reg. No. 4,126,788**

SHEAR ENTERPRISES, LLC (FLORIDA LIMITED LIABILITY COMPANY)  
12120 28TH STREET N  
ST. PETERSBURG, FL 33716

**Registered Apr. 10, 2012**

**Int. Cl.: 25**

FOR: LADIES' UNDERWEAR; PANTIES; PANTIES, SHORTS AND BRIEFS; THONGS; UNDERWEAR; WOMEN'S UNDERWEAR, IN CLASS 25 (U.S. CLS. 22 AND 39).

**TRADEMARK**

FIRST USE 2-0-2009; IN COMMERCE 2-0-2009.

**PRINCIPAL REGISTER**

THE MARK CONSISTS OF STANDARD CHARACTERS WITHOUT CLAIM TO ANY PARTICULAR FONT, STYLE, SIZE, OR COLOR.

NO CLAIM IS MADE TO THE EXCLUSIVE RIGHT TO USE "PANTY", APART FROM THE MARK AS SHOWN.

SN 85-281,361, FILED 3-30-2011.

DEIRDRE ROBERTSON, EXAMINING ATTORNEY



*David J. Kyffers*

Director of the United States Patent and Trademark Office

# United States of America

United States Patent and Trademark Office

# KUKS

**Reg. No. 4,126,789**

**Registered Apr. 10, 2012**

**Int. Cl.: 25**

**TRADEMARK**

**PRINCIPAL REGISTER**

JACOBS, NATALIA (ARGENTINA INDIVIDUAL)  
25 JAY ST  
#504  
BROOKLYN, NY 11201

FOR: CLOTHING, NAMELY, DRESSES, TOPS, PANTS, SKIRTS, SWEATERS, COATS, GLOVES; HEADGEAR, NAMELY, SCARVES, HATS; FOOTWEAR, NAMELY, SHOES, SANDALS, AND BOOTS, IN CLASS 25 (U.S. CLS. 22 AND 39).

FIRST USE 9-1-2011; IN COMMERCE 9-1-2011.

THE MARK CONSISTS OF STANDARD CHARACTERS WITHOUT CLAIM TO ANY PARTICULAR FONT, STYLE, SIZE, OR COLOR.

SN 85-284,493, FILED 4-2-2011.

STEVEN JACKSON, EXAMINING ATTORNEY



*David J. Kyffers*

Director of the United States Patent and Trademark Office

# United States of America

United States Patent and Trademark Office

## ASK ME ANOTHER

**Reg. No. 4,126,790**

NATIONAL PUBLIC RADIO, INC. (D.C. CORPORATION)  
635 MASSACHUSETTS AVE., N.W.  
WASHINGTON, DC 20001

**Registered Apr. 10, 2012**

**Int. Cl.: 41**

FOR: ENTERTAINMENT, NAMELY, A CONTINUING GAME SHOW BROADCAST OVER THE RADIO AND INTERNET, IN CLASS 41 (U.S. CLS. 100, 101 AND 107).

**SERVICE MARK**

FIRST USE 3-15-2011; IN COMMERCE 3-15-2011.

**PRINCIPAL REGISTER**

THE MARK CONSISTS OF STANDARD CHARACTERS WITHOUT CLAIM TO ANY PARTICULAR FONT, STYLE, SIZE, OR COLOR.

SN 85-284,917, FILED 4-4-2011.

ANDREA HACK, EXAMINING ATTORNEY



*David J. Kyffers*

Director of the United States Patent and Trademark Office

# United States of America

United States Patent and Trademark Office

## PLANET FRIENDLY SMILE COLLECTION

**Reg. No. 4,126,791**

1-800-FLOWERS.COM, INC. (DELAWARE CORPORATION)  
ONE OLD COUNTRY ROAD, SUITE 500  
CARLE PLACE, NY 11514

**Registered Apr. 10, 2012**

**Int. Cl.: 35**

FOR: RETAIL STORE SERVICES, MAIL ORDER SERVICES, MAIL ORDER CATALOG SERVICES, AND ONLINE RETAIL STORE SERVICES AVAILABLE BY TELEPHONE, AND THROUGH INTERACTIVE TELEVISION AND COMPUTER COMMUNICATIONS, ALL OF THE FOREGOING FEATURING FRESH CUT FLOWERS, FLORAL BOUQUETS AND ARRANGEMENTS, PLANTS, TREES, GIFTS, GIFT BASKETS, GIFT BASKETS OF FRESH FRUIT, GOURMET FOODS, FRESH FRUIT, ARRANGEMENTS MADE OF FRUIT, POPCORN, CANDY, CHOCOLATE, BAKERY ITEMS, AROMATHERAPY GIFT BASKETS, CANDLES AND CANDLE ACCESSORIES, PLUSH TOYS AND ANIMALS, BOOKS, PRE-RECORDED AUDIO AND/OR VIDEOTAPES AND DISKS, PICTURE FRAMES, PHOTO ALBUMS, AND GENERAL MERCHANDISE, IN CLASS 35 (U.S. CLS. 100, 101 AND 102).

**SERVICE MARK**

**PRINCIPAL REGISTER**

FIRST USE 4-25-2011; IN COMMERCE 4-25-2011.

THE MARK CONSISTS OF STANDARD CHARACTERS WITHOUT CLAIM TO ANY PARTICULAR FONT, STYLE, SIZE, OR COLOR.

NO CLAIM IS MADE TO THE EXCLUSIVE RIGHT TO USE "COLLECTION", APART FROM THE MARK AS SHOWN.

SN 85-285,058, FILED 4-4-2011.

KELLEY WELLS, EXAMINING ATTORNEY



*David J. Kypos*

Director of the United States Patent and Trademark Office

# United States of America

United States Patent and Trademark Office



**Reg. No. 4,126,792**

**Registered Apr. 10, 2012**

**Int. Cl.: 4**

**TRADEMARK**

**PRINCIPAL REGISTER**

C. WONDER LLC (DELAWARE LIMITED LIABILITY COMPANY)  
11TH FLOOR  
598 MADISON AVENUE  
NEW YORK, NY 10022

FOR: CANDLES, IN CLASS 4 (U.S. CLS. 1, 6 AND 15).

FIRST USE 10-22-2011; IN COMMERCE 10-22-2011.

THE MARK CONSISTS OF A STYLIZED LETTER "C" WITH THE WORD "WONDER" INSIDE AND A PERIOD TO THE RIGHT OF IT.

SN 85-285,595, FILED 4-4-2011.

MICHAEL ENGEL, EXAMINING ATTORNEY



*David J. Kyffers*

Director of the United States Patent and Trademark Office

# United States of America

United States Patent and Trademark Office

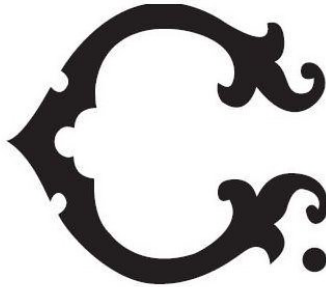

**Reg. No. 4,126,793**

**Registered Apr. 10, 2012**

**Int. Cl.: 14**

**TRADEMARK**

**PRINCIPAL REGISTER**

C. WONDER LLC (DELAWARE LIMITED LIABILITY COMPANY)  
11TH FLOOR  
598 MADISON AVENUE  
NEW YORK, NY 10022

FOR: JEWELRY, NAMELY, EARRINGS, NECKLACES, BRACELETS, AND WATCHES, IN CLASS 14 (U.S. CLS. 2, 27, 28 AND 50).

FIRST USE 10-22-2011; IN COMMERCE 10-22-2011.

THE MARK CONSISTS OF A STYLIZED LETTER "C".

SN 85-285,613, FILED 4-4-2011.

JULIE VEPPUMTHARA, EXAMINING ATTORNEY



*David J. Kyffers*

Director of the United States Patent and Trademark Office

# United States of America

United States Patent and Trademark Office

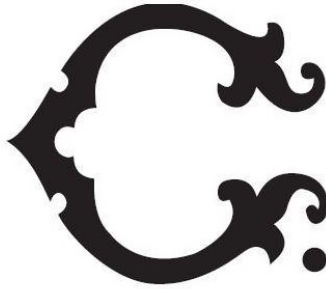

**Reg. No. 4,126,794**

**Registered Apr. 10, 2012**

**Int. Cl.: 4**

**TRADEMARK**

**PRINCIPAL REGISTER**

C. WONDER LLC (DELAWARE LIMITED LIABILITY COMPANY)  
11TH FLOOR  
598 MADISON AVENUE  
NEW YORK, NY 10022

FOR: CANDLES, IN CLASS 4 (U.S. CLS. 1, 6 AND 15).

FIRST USE 10-22-2011; IN COMMERCE 10-22-2011.

THE MARK CONSISTS OF A STYLIZED LETTER "C".

SN 85-285,617, FILED 4-4-2011.

JULIE VEPPUMTHARA, EXAMINING ATTORNEY



*David J. Kyffers*

Director of the United States Patent and Trademark Office

# United States of America

United States Patent and Trademark Office

# EZ Lip

**Reg. No. 4,126,795**

STOYNOV, STEFAN (BULGARIA INDIVIDUAL)  
12533 SE 42ND ST  
BELLEVUE, WA 98006

**Registered Apr. 10, 2012**

**Int. Cl.: 12**

FOR: FRONT BUMPER LIP FOR AUTOMOBILES, IN CLASS 12 (U.S. CLS. 19, 21, 23, 31, 35 AND 44).

**TRADEMARK**

FIRST USE 11-15-2011; IN COMMERCE 12-20-2011.

**PRINCIPAL REGISTER**

THE MARK CONSISTS OF STANDARD CHARACTERS WITHOUT CLAIM TO ANY PARTICULAR FONT, STYLE, SIZE, OR COLOR.

NO CLAIM IS MADE TO THE EXCLUSIVE RIGHT TO USE "LIP", APART FROM THE MARK AS SHOWN.

SN 85-285,794, FILED 4-4-2011.

NAKIA HENRY, EXAMINING ATTORNEY



*David J. Kyffers*

Director of the United States Patent and Trademark Office



United States of America  
United States Patent and Trademark Office

X OUT

**Reg. No. 4,126,796**

**Registered Apr. 10, 2012**

**Int. Cls.: 3 and 5**

**TRADEMARK**

**PRINCIPAL REGISTER**

GUTHY-RENKER LLC (DELAWARE LIMITED LIABILITY COMPANY)  
41-550 ECLECTIC STREET, SUITE #200  
PALM DESERT, CA 92260

FOR: SKIN AND BODY CARE PREPARATIONS, NAMELY, SKIN CLEANSERS, SKIN MOISTURIZERS, SKIN LOTIONS, SKIN SOAPS, COSMETICS, AND NON-MEDICATED SKIN CARE PREPARATIONS, IN CLASS 3 (U.S. CLS. 1, 4, 6, 50, 51 AND 52).

FIRST USE 9-22-2011; IN COMMERCE 9-22-2011.

FOR: ACNE TREATMENT PREPARATIONS, IN CLASS 5 (U.S. CLS. 6, 18, 44, 46, 51 AND 52).

FIRST USE 9-22-2011; IN COMMERCE 9-22-2011.

THE MARK CONSISTS OF STANDARD CHARACTERS WITHOUT CLAIM TO ANY PARTICULAR FONT, STYLE, SIZE, OR COLOR.

SN 85-286,367, FILED 4-5-2011.

ANNE E. GUSTASON, EXAMINING ATTORNEY



*David J. Kyfos*

Director of the United States Patent and Trademark Office

United States of America  
United States Patent and Trademark Office

**bruce**  
**布魯斯**

**Reg. No. 4,126,797**

**Registered Apr. 10, 2012**

**Int. Cl.: 7**

**TRADEMARK**

**PRINCIPAL REGISTER**

NEW JACK SEWING MACHINE CO., LTD. (CHINA LIMITED COMPANY (LTD.))  
NO.15, AIRPORT SOUTH ROAD  
JIAOJIANG DISTRICT, TAIZHOU CITY  
ZHEJIANG PROVINCE, CHINA

FOR: ELECTRIC CLOTHING PRESSING MACHINES FOR COMMERCIAL DRY CLEANING AND LAUNDRY PURPOSES INCLUDING SHIRT PRESS, COLLAR AND CUFF PRESS, UTILITY PRESS, LEGGER PRESS, DRAPERY PRESS, PANTS TOPPER, MUSHROOM TOPPER AND PUFF IRON; FIBER CUTTING MACHINES; INDUSTRIAL SEWING MACHINES; LACE MAKING MACHINES AND PARTS THEREOF; SERVO MOTORS FOR SEWING MACHINES; SEWING MACHINES; SPRAY DAMPING MACHINES; TEXTILE BONDING MACHINES, IN CLASS 7 (U.S. CLS. 13, 19, 21, 23, 31, 34 AND 35).

FIRST USE 11-26-1998; IN COMMERCE 3-21-2008.

THE NAME(S), PORTRAIT(S), AND/OR SIGNATURE(S) SHOWN IN THE MARK DOES NOT IDENTIFY A PARTICULAR LIVING INDIVIDUAL.

THE NON-LATIN CHARACTERS IN THE MARK TRANSLITERATE TO "BU, LU, SI" AND THIS MEANS "CLOTH, RASH, GENTLE" IN ENGLISH.

THE MARK CONSISTS OF THE STYLIZED WORD "BRUCE" ABOVE THE THREE CHINESE CHARACTERS WHICH TRANSLITERATE INTO "BU, LU, SI".

SN 85-287,331, FILED 4-6-2011.

JULIE GUTTADAURO, EXAMINING ATTORNEY



*David J. Kypos*

Director of the United States Patent and Trademark Office

# United States of America

United States Patent and Trademark Office



**Reg. No. 4,126,798**

**Registered Apr. 10, 2012**

**Int. Cls.: 35 and 39**

**SERVICE MARK**

**PRINCIPAL REGISTER**

CREDIT UNION SERVICES, INC. (DELAWARE CORPORATION)  
8131 LBJ FREEWAY, SUITE 400  
DALLAS, TX 75251

FOR: AUTOMOBILE DEALERSHIP SERVICES; PROMOTING THE GOODS AND SERVICES OF OTHERS IN THE AUTOMOBILE INDUSTRY BY PROVIDING AUTO DEALER NETWORK INFORMATION OF MEMBERS PARTICIPATING IN A CONSUMER PURCHASE PROGRAM WHEREBY CONSUMERS RECEIVE DISCOUNTED SALES AND LEASING OF VEHICLES BY SELECTED PARTICIPATING DEALERS; PROVIDING USED CAR SALES LEADS FOR OTHERS; PROVIDING INFORMATION ABOUT AUTOMOBILES FOR SALE BY MEANS OF THE INTERNET, IN CLASS 35 (U.S. CLS. 100, 101 AND 102).

FIRST USE 7-15-2011; IN COMMERCE 7-15-2011.

FOR: MOTOR VEHICLE LEASING SERVICES, IN CLASS 39 (U.S. CLS. 100 AND 105).

FIRST USE 7-15-2011; IN COMMERCE 7-15-2011.

OWNER OF U.S. REG. NO. 2,588,144.

THE MARK CONSISTS OF A TALK BUBBLE CONTAINING THE LETTERS "L" (FACING FORWARD) AND "F" (TURNED BACKWARDS TO FACE THE "L"). THE NEGATIVE SPACE BETWEEN THESE TWO LETTERS FORMS THE SHAPE OF A HUMAN IN AN AUTOMOBILE DRIVER'S SEAT FACING THE RIGHT WITH THE WORD "RENEW" TO THE RIGHT AND "BY FAIRLEASE" DIRECTLY UNDERNEATH.

SN 85-287,868, FILED 4-6-2011.

DAVID I, EXAMINING ATTORNEY



*David J. Kypos*

Director of the United States Patent and Trademark Office

# United States of America

United States Patent and Trademark Office

# reACT

**Reg. No. 4,126,799**

REACT FITNESS HOLDINGS, LLC (DELAWARE LIMITED LIABILITY COMPANY)  
218 MAIN STREET, #482  
KIRKLAND, WA 98033

**Registered Apr. 10, 2012**

**Int. Cl.: 28**

FOR: NO-IMPACT RAPID ECCENTRIC ANAEROBIC CORE TRAINING EXERCISE MACHINE, IN CLASS 28 (U.S. CLS. 22, 23, 38 AND 50).

**TRADEMARK**

FIRST USE 2-1-2012; IN COMMERCE 2-1-2012.

**PRINCIPAL REGISTER**

THE MARK CONSISTS OF STANDARD CHARACTERS WITHOUT CLAIM TO ANY PARTICULAR FONT, STYLE, SIZE, OR COLOR.

SN 85-287,996, FILED 4-6-2011.

ANDREW LEASER, EXAMINING ATTORNEY



*David J. Kybas*

Director of the United States Patent and Trademark Office

# United States of America

United States Patent and Trademark Office

*Lustre Max*

**Reg. No. 4,126,800**

**Registered Apr. 10, 2012**

**Int. Cl.: 3**

**TRADEMARK**

**PRINCIPAL REGISTER**

ECOCOM INC (NEW JERSEY CORPORATION)  
SUITE 168  
221 W. GRAND AVENUE  
MONTVALE, NJ 07645

FOR: DISPOSABLE CLOTHS EMBEDDED WITH CHEMICALS TO CLEAN AND POLISH JEWELRY AND PRECIOUS METALS; JEWELRY CLEANING KITS COMPRISED OF CLEANING FLUID AND A CLEANING CLOTH; CLEANER FOR USE ON JEWELRY; FOAM CLEANING PREPARATIONS; CLEANING PREPARATIONS FOR JEWELRY AND DIAMONDS SOLD AS A UNIT WITH AN APPLICATOR; JEWELRY CLEANING SOLUTIONS AND POLISHES; JEWELRY CLEANING PREPARATIONS, NAMELY, JEWELRY CLEANING SOLUTION; CLEANING PREPARATIONS, NAMELY, PEARL CLEANER, COSTUME JEWELRY CLEANER, GEM CLEANER, JEWELRY CLEANER, SILVER CLEANER, CYMBAL CLEANER, LIQUID BRASS CLEANER, SILVER POLISH AND COPPER POLISH, IN CLASS 3 (U.S. CLS. 1, 4, 6, 50, 51 AND 52).

FIRST USE 10-26-2010; IN COMMERCE 12-29-2010.

THE MARK CONSISTS OF THE STYLIZED WORDING "LUSTRE MAX".

SN 85-287,999, FILED 4-6-2011.

ANDREW LEASER, EXAMINING ATTORNEY



*David J. Kybas*

Director of the United States Patent and Trademark Office

# United States of America

United States Patent and Trademark Office

## reACT Trainer

**Reg. No. 4,126,801**

REACT FITNESS HOLDINGS, LLC (DELAWARE LIMITED LIABILITY COMPANY)  
218 MAIN STREET, #482  
KIRKLAND, WA 98033

**Registered Apr. 10, 2012**

**Int. Cl.: 28**

FOR: NO-IMPACT RAPID ECCENTRIC ANAEROBIC CORE TRAINING EXERCISE MACHINES, IN CLASS 28 (U.S. CLS. 22, 23, 38 AND 50).

**TRADEMARK**

FIRST USE 2-1-2012; IN COMMERCE 2-1-2012.

**PRINCIPAL REGISTER**

THE MARK CONSISTS OF STANDARD CHARACTERS WITHOUT CLAIM TO ANY PARTICULAR FONT, STYLE, SIZE, OR COLOR.

NO CLAIM IS MADE TO THE EXCLUSIVE RIGHT TO USE "TRAINER", APART FROM THE MARK AS SHOWN.

SN 85-288,008, FILED 4-6-2011.

ANDREW LEASER, EXAMINING ATTORNEY



*David J. Kyffers*

Director of the United States Patent and Trademark Office

# United States of America

United States Patent and Trademark Office

# PROLAMINA

**Reg. No. 4,126,802**

**Registered Apr. 10, 2012**

**Int. Cls.: 6, 16, 17, 24,  
and 40**

**TRADEMARK**

**SERVICE MARK**

**PRINCIPAL REGISTER**

PROLAMINA CORPORATION (DELAWARE CORPORATION)  
% SNR REGISTERED AGENT SERVICES, INC.  
4520 MAIN STREET, SUITE 1100  
KANSAS CITY, MO 64111

FOR: FLEXIBLE METAL FOILS PACKAGING MATERIALS FOR USE IN THE MANUFACTURE OF POUCHES, BAGS AND LIDS, IN CLASS 6 (U.S. CLS. 2, 12, 13, 14, 23, 25 AND 50).

FIRST USE 12-31-2011; IN COMMERCE 12-31-2011.

FOR: POLYETHYLENE COATED PAPERS FOR PRODUCING FLEXIBLE PACKAGING STRUCTURES AND LIDS; EXTRUSION COATED AND EXTRUSION LAMINATED PAPER BASED SUBSTRATES FOR PACKAGING STRUCTURES; POLY-COATED PLASTIC FREEZER WRAP AND PLASTIC RELEASE LINERS FOR PACKAGING STRUCTURES; THERMAL TRANSFER LABEL PAPERS; POLYPROPYLENE LAMINATED PAPER FOR HIGH VOLTAGE INSULATED OIL-FILLED TRANSMISSION CABLES; PAPER BASED SUBSTRATES FOR PACKAGING STRUCTURES; COMBINATION PAPER AND POLYESTER FILM FOR MANUFACTURING USE IN THE ENVELOPE, PACKAGING, TAG/LABEL AND BAG INDUSTRIES, IN CLASS 16 (U.S. CLS. 2, 5, 22, 23, 29, 37, 38 AND 50).

FIRST USE 12-31-2011; IN COMMERCE 12-31-2011.

FOR: PLASTIC FILMS FOR COMMERCIAL AND INDUSTRIAL PACKAGING USE; FLEXIBLE PACKAGING MATERIALS, NAMELY, PLASTIC ROLL STOCK THAT IS COMBINED WITH OTHER MATERIALS FOR USE BY THE FOOD, MEDICAL, PERSONAL HYGIENE, AND ENVELOPE INDUSTRIES, IN CLASS 17 (U.S. CLS. 1, 5, 12, 13, 35 AND 50).

FIRST USE 12-31-2011; IN COMMERCE 12-31-2011.

FOR: MULTI-LAYER COATED NONWOVEN TEXTILE FABRICS FOR USE AND FABRICS FOR TEXTILE USE IN THE HEALTH CARE INDUSTRY, IN CLASS 24 (U.S. CLS. 42 AND 50).

FIRST USE 12-31-2011; IN COMMERCE 12-31-2011.



*David J. Kyjars*

Director of the United States Patent and Trademark Office

**Reg. No. 4,126,802** FOR: CUSTOM MANUFACTURING OF PAPER, PLASTIC, FILM, FOIL AND NON-WOVEN FABRIC, AND FOOD PACKAGING MATERIALS; FLEXOGRAPHY AND OFFSET PRINTING, IN CLASS 40 (U.S. CLS. 100, 103 AND 106).

FIRST USE 12-31-2011; IN COMMERCE 12-31-2011.

THE MARK CONSISTS OF STANDARD CHARACTERS WITHOUT CLAIM TO ANY PARTICULAR FONT, STYLE, SIZE, OR COLOR.

SN 85-288,065, FILED 4-6-2011.

LOURDES AYALA, EXAMINING ATTORNEY



# United States of America

United States Patent and Trademark Office

## VERY FUNNY NEWS

**Reg. No. 4,126,803**

**Registered Apr. 10, 2012**

**Int. Cl.: 38**

**SERVICE MARK**

**PRINCIPAL REGISTER**

SUPERSTATION, INC. (GEORGIA CORPORATION)  
C/O TURNER BROADCASTING SYSTEM, INC.  
ONE CNN CENTER, 10N  
ATLANTA, GA 30303

FOR: STREAMING OF TELEVISION PROGRAMMING OVER THE INTERNET; TRANSMISSION OF TELEVISION PROGRAMMING OVER WIRELESS COMMUNICATIONS NETWORKS, IN CLASS 38 (U.S. CLS. 100, 101 AND 104).

FIRST USE 10-29-2011; IN COMMERCE 10-29-2011.

THE MARK CONSISTS OF STANDARD CHARACTERS WITHOUT CLAIM TO ANY PARTICULAR FONT, STYLE, SIZE, OR COLOR.

OWNER OF U.S. REG. NOS. 2,996,033 AND 3,127,642.

NO CLAIM IS MADE TO THE EXCLUSIVE RIGHT TO USE "NEWS", APART FROM THE MARK AS SHOWN.

SN 85-289,184, FILED 4-7-2011.

MATTHEW MCDOWELL, EXAMINING ATTORNEY



*David J. Kybas*

Director of the United States Patent and Trademark Office

# United States of America

United States Patent and Trademark Office

## FedEx Custom Critical SecureComm

**Reg. No. 4,126,804**

**Registered Apr. 10, 2012**

**Int. Cl.: 39**

**SERVICE MARK**

**PRINCIPAL REGISTER**

FEDERAL EXPRESS CORPORATION (DELAWARE CORPORATION)  
3620 HACKS CROSS ROAD  
BLDG B, 3RD FLOOR  
MEMPHIS, TN 38125

FOR: PICK-UP, TRANSPORTATION, STORAGE AND DELIVERY OF DOCUMENTS,  
PACKAGES AND FREIGHT BY LAND AND AIR, IN CLASS 39 (U.S. CLS. 100 AND 105).

FIRST USE 5-1-2011; IN COMMERCE 5-1-2011.

THE MARK CONSISTS OF STANDARD CHARACTERS WITHOUT CLAIM TO ANY PAR-  
TICULAR FONT, STYLE, SIZE, OR COLOR.

OWNER OF U.S. REG. NOS. 3,125,953, 3,764,608, AND OTHERS.

SN 85-289,328, FILED 4-7-2011.

ELISSA GARBER KON, EXAMINING ATTORNEY



*David J. Kyjars*

Director of the United States Patent and Trademark Office

# United States of America

United States Patent and Trademark Office

## COASTAL ROAST

**Reg. No. 4,126,805**

THE PARADISE SHOPS, LLC (GEORGIA LIMITED LIABILITY COMPANY)  
5950 FULTON INDUSTRIAL BLVD SW  
ATLANTA, GA 30336

**Registered Apr. 10, 2012**

**Int. Cl.: 30**

FOR: COFFEE; BEVERAGES MADE OF COFFEE; COFFEE BASED BEVERAGES; COFFEE BEANS; GROUND COFFEE BEANS; PREPARED COFFEE; COFFEE AND TEA; TEA; TEA BAGS; TEA-BASED BEVERAGES; BEVERAGES MADE OF TEA; BEVERAGES WITH A TEA BASE, IN CLASS 30 (U.S. CL. 46).

**TRADEMARK**

**PRINCIPAL REGISTER**

FIRST USE 8-20-2011; IN COMMERCE 8-20-2011.

THE MARK CONSISTS OF STANDARD CHARACTERS WITHOUT CLAIM TO ANY PARTICULAR FONT, STYLE, SIZE, OR COLOR.

NO CLAIM IS MADE TO THE EXCLUSIVE RIGHT TO USE "ROAST", APART FROM THE MARK AS SHOWN.

SN 85-289,349, FILED 4-7-2011.

DAVID TAYLOR, EXAMINING ATTORNEY



*David J. Kyros*

Director of the United States Patent and Trademark Office

# United States of America

United States Patent and Trademark Office

## ATIF CLOSING SOLUTIONS

**Reg. No. 4,126,806**

**Registered Apr. 10, 2012**

**Int. Cl.: 36**

**SERVICE MARK**

**PRINCIPAL REGISTER**

TRUSTEES OF THE ATTORNEYS' TITLE INSURANCE FUND, THE (FLORIDA FLORIDA  
COMMON LAW DECLARATION OF TRUST)  
6545 CORPORATE CENTER BOULEVARD  
ORLANDO, FL 32822

FOR: INSURANCE AND FINANCIAL INFORMATION AND CONSULTANCY SERVICES;  
INSURANCE AGENCY AND BROKERAGE SERVICES; REAL ESTATE TITLE INSURANCE  
UNDERWRITING SERVICES; REAL ESTATE CONSULTANCY SERVICES; REAL ESTATE  
INVESTMENT TRUST SERVICES; REAL ESTATE ESCROW SERVICES; FINANCIAL  
CONSULTANCY SERVICES; PROVIDING AN INTERNET WEBSITE AND INTERNET  
WEBSITE PORTAL FEATURING INFORMATION IN THE FIELDS OF REAL ESTATE TITLE  
INSURANCE, REAL ESTATE TRANSACTIONS, REAL ESTATE TRUSTS, REAL ESTATE  
ESCROW AND REAL ESTATE FINANCING AND INVESTMENTS, IN CLASS 36 (U.S. CLS.  
100, 101 AND 102).

FIRST USE 5-5-2011; IN COMMERCE 5-5-2011.

THE MARK CONSISTS OF STANDARD CHARACTERS WITHOUT CLAIM TO ANY PAR-  
TICULAR FONT, STYLE, SIZE, OR COLOR.

NO CLAIM IS MADE TO THE EXCLUSIVE RIGHT TO USE "CLOSING SOLUTIONS", APART  
FROM THE MARK AS SHOWN.

SN 85-290,082, FILED 4-8-2011.

KEVIN DINALLO, EXAMINING ATTORNEY



*David J. Kybas*

Director of the United States Patent and Trademark Office

# United States of America

United States Patent and Trademark Office

## ATIF INSURANCE SOLUTIONS

**Reg. No. 4,126,807**

**Registered Apr. 10, 2012**

**Int. Cl.: 36**

**SERVICE MARK**

**PRINCIPAL REGISTER**

THE TRUSTEES OF THE ATTORNEYS' TITLE INSURANCE FUND (FLORIDA FLORIDA  
COMMON LAW DECLARATION OF TRUST)  
6545 CORPORATE CENTER BOULEVARD  
ORLANDO, FL 32822

FOR: INSURANCE AND FINANCIAL INFORMATION AND CONSULTANCY SERVICES;  
INSURANCE AGENCY AND BROKERAGE SERVICES; REAL ESTATE TITLE INSURANCE  
UNDERWRITING SERVICES; REAL ESTATE CONSULTANCY SERVICES; REAL ESTATE  
INVESTMENT TRUST SERVICES; REAL ESTATE ESCROW SERVICES; FINANCIAL  
CONSULTANCY SERVICES; PROVIDING AN INTERNET WEBSITE AND INTERNET  
WEBSITE PORTAL FEATURING INFORMATION IN THE FIELDS OF REAL ESTATE TITLE  
INSURANCE, REAL ESTATE TRANSACTIONS, REAL ESTATE TRUSTS, REAL ESTATE  
ESCROW AND REAL ESTATE FINANCING AND INVESTMENTS, IN CLASS 36 (U.S. CLS.  
100, 101 AND 102).

FIRST USE 5-5-2011; IN COMMERCE 5-5-2011.

THE MARK CONSISTS OF STANDARD CHARACTERS WITHOUT CLAIM TO ANY PAR-  
TICULAR FONT, STYLE, SIZE, OR COLOR.

NO CLAIM IS MADE TO THE EXCLUSIVE RIGHT TO USE "INSURANCE SOLUTIONS",  
APART FROM THE MARK AS SHOWN.

SN 85-290,088, FILED 4-8-2011.

KEVIN DINALLO, EXAMINING ATTORNEY



*David J. Kyffers*

Director of the United States Patent and Trademark Office

# United States of America

United States Patent and Trademark Office



**Reg. No. 4,126,808**

**Registered Apr. 10, 2012**

**Int. Cl.: 43**

**SERVICE MARK**

**PRINCIPAL REGISTER**

KALBQ, INC. (NEW JERSEY CORPORATION), DBA KBG KOREAN BBQ & GRILL,  
6 EASTON AVENUE  
NEW BRUNSWICK, NJ 08901

FOR: FOOD PREPARATION SERVICES FEATURING KOREAN BBQ AND KOREAN CUISINE; RESTAURANT SERVICES FEATURING KOREAN BBQ AND CUISINE AND GRILLING, IN CLASS 43 (U.S. CLS. 100 AND 101).

FIRST USE 4-19-2011; IN COMMERCE 4-19-2011.

NO CLAIM IS MADE TO THE EXCLUSIVE RIGHT TO USE "KOREAN BBQ & GRILL", APART FROM THE MARK AS SHOWN.

THE COLOR(S) RED AND WHITE IS/ARE CLAIMED AS A FEATURE OF THE MARK.

THE MARK CONSISTS OF MULTIPLE STYLIZED LOWER-CASE WHITE LETTERS SPELLING "KBG", MULTIPLE STYLIZED CAPITAL WHITE LETTERS SPELLING "KOREAN BBQ", A WHITE STYLIZED AMPERSAND AND MULTIPLE STYLIZED CAPITAL WHITE LETTERS SPELLING "GRILL" ON A RED BACKGROUND SURROUNDED BY A WHITE BORDER OF WHICH THE PREVIOUSLY REFERRED TO MULTIPLE STYLIZED LOWER-CASE WHITE LETTERS SPELLING "KBG" JOINS AND CONNECTS TO IN CERTAIN PARTS OF THE LETTERS.

SN 85-290,160, FILED 4-8-2011.

SUSAN STIGLITZ, EXAMINING ATTORNEY

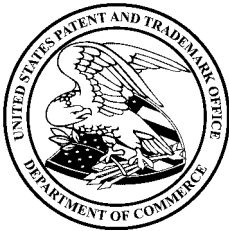

*David J. Kybas*

Director of the United States Patent and Trademark Office

# United States of America

United States Patent and Trademark Office

## SNOOTY FOX

**Reg. No. 4,126,809**

**Registered Apr. 10, 2012**

**Int. Cl.: 33**

**TRADEMARK**

**PRINCIPAL REGISTER**

BEVERAGE INFOSYSTEMS (DELAWARE LIMITED LIABILITY COMPANY)  
SUITE 77  
501 SILVERSIDE RD.  
WILMINGTON, DE 19809

FOR: WINE; WINES, IN CLASS 33 (U.S. CLS. 47 AND 49).

FIRST USE 10-21-2011; IN COMMERCE 10-21-2011.

THE MARK CONSISTS OF STANDARD CHARACTERS WITHOUT CLAIM TO ANY PARTICULAR FONT, STYLE, SIZE, OR COLOR.

SN 85-290,191, FILED 4-8-2011.

GINA FINK, EXAMINING ATTORNEY



*David J. Kybas*

Director of the United States Patent and Trademark Office

# United States of America

United States Patent and Trademark Office

# scribbleband

**Reg. No. 4,126,810**

SCRIBBLEBAND LLC (INDIANA LIMITED LIABILITY COMPANY)  
873 BUR OAK DRIVE  
CHESTERTON, IN 46304

**Registered Apr. 10, 2012**

**Int. Cl.: 14**

FOR: COLORFUL WRISTBAND IN THE NATURE OF A BRACELET, MADE OF SILICON RUBBER OR RUBBER THAT CAN BE WRITTEN ON AND ERASED ON USING ERASABLE MARKERS OR PENS, NAMELY, A WRISTBAND WHICH CONTAINS A RUBBER PAD TO BE WRITTEN ON, IN CLASS 14 (U.S. CLS. 2, 27, 28 AND 50).

**TRADEMARK**

**PRINCIPAL REGISTER**

FIRST USE 1-15-2012; IN COMMERCE 1-15-2012.

THE MARK CONSISTS OF STANDARD CHARACTERS WITHOUT CLAIM TO ANY PARTICULAR FONT, STYLE, SIZE, OR COLOR.

SN 85-290,845, FILED 4-8-2011.

JORDAN BAKER, EXAMINING ATTORNEY



*David J. Kyjars*

Director of the United States Patent and Trademark Office



# United States of America

United States Patent and Trademark Office

## HEAVYWEIGHT

**Reg. No. 4,126,811**

**Registered Apr. 10, 2012**

**Int. Cl.: 9**

**TRADEMARK**

**PRINCIPAL REGISTER**

ALEXANDER ANDREW, INC. (CALIFORNIA CORPORATION), DBA FALLTECH,  
1306 S. ALAMEDA STREET  
COMPTON, CA 90221

FOR: PERSONAL PROTECTIVE EQUIPMENT FOR FALL PROTECTION, FALL ARREST, POSITIONING AND RESTRAINT, SPECIFICALLY FULL-BODY HARNESSSES, SHOCK-ABSORBING LANYARDS, POSITIONING AND RESTRAINT LANYARDS AND BELTS, CONNECTORS AND CONNECTING DEVICES, NAMELY, STEEL AND ALUMINUM CARABINERS AND DOUBLE-LOCKING SNAP HOOKS, ANCHORAGES, NAMELY, ANCHORAGE CONNECTORS MADE OF POLYESTER, NYLON OR POLYAMIDE WEBBING AND ROPE USED IN HEIGHT SAFETY, VERTICAL AND HORIZONTAL LIFELINES, CONFINED SPACE ENTRY DEVICES, NAMELY, PERSONNEL AND MATERIAL HANDLING HOISTS, SELF RETRACTING LANYARDS WITH RETRIEVAL CAPABILITY, AND RESCUE AND RETRIEVAL DEVICES, NAMELY, SELF RETRACTING LIFELINES, LIFELINES USED FOR ATTACHMENT TO A FULL-BODY HARNESSSES DURING ASCENT AND DESCENT, SHOCK-ABSORBING LANYARDS, AND NON-SHOCK ABSORBING LANYARDS, IN CLASS 9 (U.S. CLS. 21, 23, 26, 36 AND 38).

FIRST USE 6-11-2011; IN COMMERCE 12-12-2011.

THE MARK CONSISTS OF STANDARD CHARACTERS WITHOUT CLAIM TO ANY PARTICULAR FONT, STYLE, SIZE, OR COLOR.

SN 85-290,995, FILED 4-9-2011.

SHAUNIA CARLYLE, EXAMINING ATTORNEY



*David J. Kyros*

Director of the United States Patent and Trademark Office

# United States of America

United States Patent and Trademark Office

*Éclectique*

**Reg. No. 4,126,812**

HAKIM, ARIEL (GEORGIA LIMITED LIABILITY COMPANY)  
8942 CRESTVIEW CIRCLE  
UNION CITY, GA 30291

**Registered Apr. 10, 2012**

**Int. Cl.: 35**

FOR: RETAIL CLOTHING BOUTIQUES, IN CLASS 35 (U.S. CLS. 100, 101 AND 102).

**SERVICE MARK**

FIRST USE 8-26-2011; IN COMMERCE 8-29-2011.

**PRINCIPAL REGISTER**

THE MARK CONSISTS OF THE WORD "ECLECTIQUE". THE MARK IS IN SCRIPTINA FONT AND THE "E" HAS AN APOSTROPHE OVER THE TOP OF IT. THE "T" IN THE MIDDLE OF THE WORD IS CAPITALIZED. THE TEXT IS WRITTEN IN BOLD FONT. THE ENTIRE TEXT IS WRITTEN IN THE COLOR BLACK.

THE COLOR(S) BLACK IS/ARE CLAIMED AS A FEATURE OF THE MARK.

SN 85-291,552, FILED 4-11-2011.

KELLY BOULTON, EXAMINING ATTORNEY



*David J. Kybas*

Director of the United States Patent and Trademark Office

# United States of America

United States Patent and Trademark Office

## HGTV MAGAZINE

**Reg. No. 4,126,813**

**Registered Apr. 10, 2012**

**Int. Cl.: 16**

**TRADEMARK**

**PRINCIPAL REGISTER**

SCRIPPS NETWORKS, LLC (DELAWARE LIMITED LIABILITY COMPANY)  
9721 SHERRILL BOULEVARD  
KNOXVILLE, TN 37932

FOR: PRINTED MATERIALS AND PUBLICATIONS, NAMELY, A MAGAZINE ABOUT INTERIOR DESIGN AND DECORATING, ARCHITECTURE AND HOME DESIGN, HOME BUILDING, HOME IMPROVEMENT, HOME REPAIR, AND HOME RENOVATION, IN CLASS 16 (U.S. CLS. 2, 5, 22, 23, 29, 37, 38 AND 50).

FIRST USE 10-4-2011; IN COMMERCE 10-4-2011.

THE MARK CONSISTS OF STANDARD CHARACTERS WITHOUT CLAIM TO ANY PARTICULAR FONT, STYLE, SIZE, OR COLOR.

OWNER OF U.S. REG. NOS. 2,405,267, 3,336,010, AND OTHERS.

NO CLAIM IS MADE TO THE EXCLUSIVE RIGHT TO USE "MAGAZINE", APART FROM THE MARK AS SHOWN.

SN 85-292,468, FILED 4-12-2011.

CHRISTINE MARTIN, EXAMINING ATTORNEY



*David J. Kyffers*

Director of the United States Patent and Trademark Office

# United States of America

United States Patent and Trademark Office

# SYNAPSE

**Reg. No. 4,126,814**

JOHNSON, LANNY (UNITED STATES INDIVIDUAL)  
PO BOX 2220  
FRANKFORT, OH 49635

**Registered Apr. 10, 2012**

**Int. Cl.: 28**

FOR: GOLF CLUB GRIPS, IN CLASS 28 (U.S. CLS. 22, 23, 38 AND 50).

**TRADEMARK**

FIRST USE 12-21-2011; IN COMMERCE 12-21-2011.

**PRINCIPAL REGISTER**

THE MARK CONSISTS OF STANDARD CHARACTERS WITHOUT CLAIM TO ANY PARTICULAR FONT, STYLE, SIZE, OR COLOR.

SN 85-292,690, FILED 4-12-2011.

JAY BESCH, EXAMINING ATTORNEY



*David J. Kyffers*

Director of the United States Patent and Trademark Office

# United States of America

United States Patent and Trademark Office

# ATHEROPOINT

**Reg. No. 4,126,815**

**Registered Apr. 10, 2012**

**Int. Cl.: 9**

**TRADEMARK**

**PRINCIPAL REGISTER**

BIOMEDICAL TECHNOLOGIES, INC. (COLORADO CORPORATION)  
208 OTTER GLEN COURT  
ROSEVILLE, CA 95661

FOR: COMPUTER PROGRAMS FOR USE IN MEDICAL IMAGE ANALYSIS, DIAGNOSIS, AND TREATMENT, NAMELY, SOFTWARE FOR PROCESSING DIGITAL IMAGES OF THE ANATOMY FOR ANALYSIS, DIAGNOSIS AND TREATMENT, AND SOFTWARE FOR PROCESSING DIGITAL IMAGES OF THE ANATOMY TO ADD ADDITIONAL VISUAL ELEMENTS TO THE DIGITAL IMAGES FOR ENHANCED ANALYSIS, DIAGNOSIS AND TREATMENT; COMPUTER SOFTWARE FOR CREATING SEARCHABLE MEDICAL DIAGNOSIS AND TREATMENT DATABASES, IN CLASS 9 (U.S. CLS. 21, 23, 26, 36 AND 38).

FIRST USE 10-2-2010; IN COMMERCE 2-14-2012.

THE MARK CONSISTS OF STANDARD CHARACTERS WITHOUT CLAIM TO ANY PARTICULAR FONT, STYLE, SIZE, OR COLOR.

SN 85-292,932, FILED 4-12-2011.

FRANK LATTUCA, EXAMINING ATTORNEY



*David J. Kyjars*

Director of the United States Patent and Trademark Office

# United States of America

United States Patent and Trademark Office

## SAVE A LOT TODAY

**Reg. No. 4,126,816**

SAVE-A-LOT FOOD STORES, LTD. (BERMUDA CORPORATION)  
100 CORPORATE OFFICE DRIVE  
EARTH CITY, MO 63045

**Registered Apr. 10, 2012**

**Int. Cls.: 16 and 30**

FOR: PAPER TOWELS; TOILET TISSUE, IN CLASS 16 (U.S. CLS. 2, 5, 22, 23, 29, 37, 38 AND 50).

**TRADEMARK**

FIRST USE 4-30-2011; IN COMMERCE 4-30-2011.

**PRINCIPAL REGISTER**

FOR: COOKIES; PANCAKE MIXES; SALAD DRESSING; MIXES FOR BAKERY GOODS, IN CLASS 30 (U.S. CL. 46).

FIRST USE 4-30-2011; IN COMMERCE 4-30-2011.

THE MARK CONSISTS OF STANDARD CHARACTERS WITHOUT CLAIM TO ANY PARTICULAR FONT, STYLE, SIZE, OR COLOR.

SN 85-293,141, FILED 4-12-2011.

JANICE KIM, EXAMINING ATTORNEY



*David J. Kybas*

Director of the United States Patent and Trademark Office

# United States of America

United States Patent and Trademark Office

## MANDARE FOUNDATION

**Reg. No. 4,126,817**

MANDARE FOUNDATION (OHIO NON-PROFIT CORPORATION)  
1875 KEYS CRESCENT  
CINCINNATI, OH 45206

**Registered Apr. 10, 2012**

**Int. Cl.: 36**

FOR: PROVIDING CHARITABLE GRANTS FOR SUPPORT OF EDUCATION, THE ARTS, CHILDREN AND HEALTH; CHARITABLE FOUNDATION SERVICES, NAMELY, PROVIDING FINANCIAL ASSISTANCE FOR SUPPORT OF EDUCATION, THE ARTS, CHILDREN AND HEALTH, IN CLASS 36 (U.S. CLS. 100, 101 AND 102).

**SERVICE MARK**

**PRINCIPAL REGISTER**

FIRST USE 3-0-2011; IN COMMERCE 3-0-2011.

THE MARK CONSISTS OF STANDARD CHARACTERS WITHOUT CLAIM TO ANY PARTICULAR FONT, STYLE, SIZE, OR COLOR.

NO CLAIM IS MADE TO THE EXCLUSIVE RIGHT TO USE "FOUNDATION", APART FROM THE MARK AS SHOWN.

SN 85-293,168, FILED 4-12-2011.

JOHN WILKE, EXAMINING ATTORNEY



*David J. Kybas*

Director of the United States Patent and Trademark Office

# United States of America

United States Patent and Trademark Office



**Reg. No. 4,126,818**

**Registered Apr. 10, 2012**

**Int. Cl.: 36**

**SERVICE MARK**

**PRINCIPAL REGISTER**

MANDARE FOUNDATION (OHIO NON-PROFIT CORPORATION)  
1875 KEYS CRESCENT  
CINCINNATI, OH 45206

FOR: PROVIDING CHARITABLE GRANTS FOR SUPPORT OF EDUCATION, THE ARTS, CHILDREN AND HEALTH; CHARITABLE FOUNDATION SERVICES, NAMELY, PROVIDING FINANCIAL ASSISTANCE FOR SUPPORT OF EDUCATION, THE ARTS, CHILDREN AND HEALTH, IN CLASS 36 (U.S. CLS. 100, 101 AND 102).

FIRST USE 3-0-2011; IN COMMERCE 3-0-2011.

NO CLAIM IS MADE TO THE EXCLUSIVE RIGHT TO USE "FOUNDATION", APART FROM THE MARK AS SHOWN.

THE MARK CONSISTS OF A DESIGN OF A VINE WITH FOUR LEAVES WITHIN A WHITE RING ON A SHADED CIRCLE ABOVE THE WORD "MANDARE" OVER AN HORIZONTAL LINE ABOVE THE WORD "FOUNDATION".

SN 85-293,186, FILED 4-12-2011.

JOHN WILKE, EXAMINING ATTORNEY



*David J. Kyffers*

Director of the United States Patent and Trademark Office



# United States of America

United States Patent and Trademark Office

## ALL-AROUND PROTECTION

**Reg. No. 4,126,819**

**Registered Apr. 10, 2012**

**Int. Cl.: 3**

**TRADEMARK**

**PRINCIPAL REGISTER**

THE PROCTER & GAMBLE COMPANY (OHIO CORPORATION)  
ONE PROCTER & GAMBLE PLAZA  
CINCINNATI, OH 45202

FOR: DENTIFRICES, IN CLASS 3 (U.S. CLS. 1, 4, 6, 50, 51 AND 52).

FIRST USE 12-5-2011; IN COMMERCE 12-5-2011.

THE MARK CONSISTS OF STANDARD CHARACTERS WITHOUT CLAIM TO ANY PARTICULAR FONT, STYLE, SIZE, OR COLOR.

OWNER OF U.S. REG. NO. 3,351,788.

NO CLAIM IS MADE TO THE EXCLUSIVE RIGHT TO USE "PROTECTION", APART FROM THE MARK AS SHOWN.

SN 85-293,607, FILED 4-13-2011.

WENDY GOODMAN, EXAMINING ATTORNEY



*David J. Kybas*

Director of the United States Patent and Trademark Office

# United States of America

United States Patent and Trademark Office

# FOGBITER

**Reg. No. 4,126,820**

WILLIAM F. LEEK (UNITED STATES INDIVIDUAL), DBA SLEEK PRODUCTS,  
2995 RIBERA ROAD  
CARMEL, CA 93923

**Registered Apr. 10, 2012**

**Int. Cl.: 9**

FOR: BREATHING APPARATUS FOR UNDERWATER SWIMMING, IN CLASS 9 (U.S. CLS. 21, 23, 26, 36 AND 38).

**TRADEMARK**

FIRST USE 3-1-2011; IN COMMERCE 4-1-2011.

**PRINCIPAL REGISTER**

THE MARK CONSISTS OF STANDARD CHARACTERS WITHOUT CLAIM TO ANY PARTICULAR FONT, STYLE, SIZE, OR COLOR.

SN 85-294,222, FILED 4-13-2011.

GIANCARLO CASTRO, EXAMINING ATTORNEY



*David J. Kyffers*

Director of the United States Patent and Trademark Office

# United States of America

United States Patent and Trademark Office

## CAKE BY DEWEY'S

**Reg. No. 4,126,821**

**Registered Apr. 10, 2012**

**Int. Cls.: 30 and 35**

**TRADEMARK**

**SERVICE MARK**

**PRINCIPAL REGISTER**

DEWEY'S BAKERY, INC. (NORTH CAROLINA CORPORATION)  
224 SOUTH CHERRY STREET  
WINSTON-SALEM, NC 27101

FOR: BAKERY PRODUCTS, IN CLASS 30 (U.S. CL. 46).

FIRST USE 4-22-2011; IN COMMERCE 4-22-2011.

FOR: RETAIL BAKERY SHOPS, IN CLASS 35 (U.S. CLS. 100, 101 AND 102).

FIRST USE 4-22-2011; IN COMMERCE 4-22-2011.

THE MARK CONSISTS OF STANDARD CHARACTERS WITHOUT CLAIM TO ANY PARTICULAR FONT, STYLE, SIZE, OR COLOR.

OWNER OF U.S. REG. NO. 3,472,052.

NO CLAIM IS MADE TO THE EXCLUSIVE RIGHT TO USE "CAKE", APART FROM THE MARK AS SHOWN.

SN 85-294,453, FILED 4-13-2011.

ELISSA GARBER KON, EXAMINING ATTORNEY



*David J. Kybas*

Director of the United States Patent and Trademark Office

# United States of America

United States Patent and Trademark Office

# FIXOLOGY

**Reg. No. 4,126,822**

GOLD BUYERS OF AMERICA, LLC (FLORIDA LIMITED LIABILITY COMPANY)  
1301 N. CONGRESS AVE.

**Registered Apr. 10, 2012**

BOYNTON BEACH, FL 33426

**Int. Cl.: 37**

FOR: REPAIR OF JEWELRY AND WATCHES, IN CLASS 37 (U.S. CLS. 100, 103 AND 106).

**SERVICE MARK**

FIRST USE 7-1-2011; IN COMMERCE 7-1-2011.

**PRINCIPAL REGISTER**

THE MARK CONSISTS OF STANDARD CHARACTERS WITHOUT CLAIM TO ANY PARTICULAR FONT, STYLE, SIZE, OR COLOR.

SN 85-295,952, FILED 4-15-2011.

KHANH LE, EXAMINING ATTORNEY



*David J. Kyffers*

Director of the United States Patent and Trademark Office

# United States of America

United States Patent and Trademark Office

## 2 SPRAYS & GO!

**Reg. No. 4,126,823**

**Registered Apr. 10, 2012**

**Int. Cl.: 5**

**TRADEMARK**

**PRINCIPAL REGISTER**

PROPHASE LABS, INC. (NEVADA CORPORATION), FORMERLY THE QUIGLEY CORPORATION,  
621 N. SHADY RETREAT ROAD  
DOYLESTOWN, PA 18901

FOR: HOMEOPATHIC COMMON COLD, FLU AND ALLERGY ORAL SPRAY PREPARATIONS TO REDUCE THE DURATION AND SEVERITY OF THE COMMON COLD, FLU AND ALLERGIES, IN CLASS 5 (U.S. CLS. 6, 18, 44, 46, 51 AND 52).

FIRST USE 7-31-2011; IN COMMERCE 7-31-2011.

THE MARK CONSISTS OF STANDARD CHARACTERS WITHOUT CLAIM TO ANY PARTICULAR FONT, STYLE, SIZE, OR COLOR.

NO CLAIM IS MADE TO THE EXCLUSIVE RIGHT TO USE "2 SPRAYS", APART FROM THE MARK AS SHOWN.

SN 85-295,963, FILED 4-15-2011.

TRICIA SONNEBORN, EXAMINING ATTORNEY



*David J. Kyros*

Director of the United States Patent and Trademark Office

# United States of America

United States Patent and Trademark Office

# 1800Fix.com

**Reg. No. 4,126,824**

1800FIX.COM INC. (NEW YORK CORPORATION)  
171 LINCOLN AVE.  
BRONX, NY 10454

**Registered Apr. 10, 2012**

**Int. Cls.: 9, 35, 37, and  
42**

FOR: DECORATIVE CHARMS FOR CELLULAR TELEPHONES; PROTECTIVE COVERS AND CASES FOR CELL PHONES, LAPTOPS AND PORTABLE MEDIA PLAYERS, IN CLASS 9 (U.S. CLS. 21, 23, 26, 36 AND 38).

**TRADEMARK**

FIRST USE 11-1-2007; IN COMMERCE 11-1-2007.

**SERVICE MARK**

FOR: RETAIL STORE AND ON-LINE RETAIL STORE SERVICES FEATURING NEW AND REFURBISHED CONSUMER ELECTRONICS, ALLOWING FOR TRADE-INS OF SUCH EQUIPMENT TOWARD PURCHASES, IN CLASS 35 (U.S. CLS. 100, 101 AND 102).

**PRINCIPAL REGISTER**

FIRST USE 11-1-2007; IN COMMERCE 11-1-2007.

FOR: MAINTENANCE AND/OR REPAIR OF CELL PHONES, COMPUTERS, AND CONSUMER ELECTRONICS; TECHNICAL SUPPORT SERVICES, NAMELY, TECHNICAL ADVICE RELATED TO THE REPAIR OF CELL PHONES, COMPUTERS, AND CONSUMER ELECTRONICS, IN CLASS 37 (U.S. CLS. 100, 103 AND 106).

FIRST USE 11-1-2007; IN COMMERCE 11-1-2007.

FOR: COMPUTER VIRUS PROTECTION SERVICES; REMOTE COMPUTER BACKUP SERVICES; TECHNICAL SUPPORT SERVICES, NAMELY, TROUBLESHOOTING IN THE NATURE OF DIAGNOSING COMPUTER HARDWARE AND SOFTWARE PROBLEMS, IN CLASS 42 (U.S. CLS. 100 AND 101).

FIRST USE 11-1-2007; IN COMMERCE 11-1-2007.

THE MARK CONSISTS OF STANDARD CHARACTERS WITHOUT CLAIM TO ANY PARTICULAR FONT, STYLE, SIZE, OR COLOR.

OWNER OF U.S. REG. NO. 3,515,489.

SN 85-296,454, FILED 4-15-2011.



*David J. Kyros*

Director of the United States Patent and Trademark Office

**Reg. No. 4,126,824** SHAILA SETTLES, EXAMINING ATTORNEY

# United States of America

United States Patent and Trademark Office

# sneezX

**Reg. No. 4,126,825**

MARX, GUSTAV DAVID (CANADA INDIVIDUAL)  
44 BROOKSHIRE CIRCLE  
THORNHILL, CANADA L3T7B4

**Registered Apr. 10, 2012**

**Int. Cl.: 10**

FOR: HAND HELD MASK TO CONTROL THE SPREAD OF GERMS CAUSED BY COUGHING AND SNEEZING, IN CLASS 10 (U.S. CLS. 26, 39 AND 44).

**TRADEMARK**

FIRST USE 12-28-2011; IN COMMERCE 12-28-2011.

**PRINCIPAL REGISTER**

THE MARK CONSISTS OF STANDARD CHARACTERS WITHOUT CLAIM TO ANY PARTICULAR FONT, STYLE, SIZE, OR COLOR.

SN 85-297,373, FILED 4-18-2011.

ALLISON HOLTZ, EXAMINING ATTORNEY



*David J. Kybas*

Director of the United States Patent and Trademark Office



# United States of America

United States Patent and Trademark Office



**Reg. No. 4,126,826**

**Registered Apr. 10, 2012**

**Int. Cl.: 11**

**TRADEMARK**

**PRINCIPAL REGISTER**

RADICKE, HERB (UNITED STATES INDIVIDUAL)  
P.O. BOX 1588  
UVALDE, TX 78801

FOR: GAS COOKERS, IN CLASS 11 (U.S. CLS. 13, 21, 23, 31 AND 34).

FIRST USE 10-25-2011; IN COMMERCE 10-25-2011.

NO CLAIM IS MADE TO THE EXCLUSIVE RIGHT TO USE "COCINA OUTDOORS", APART FROM THE MARK AS SHOWN.

THE COLOR(S) BLUE, GREY AND WHITE IS/ARE CLAIMED AS A FEATURE OF THE MARK.

THE MARK CONSISTS OF AN ELEVATED VIEW OF A STYLIZED GAS FLAME HAVING TWO SHADES OF BLUE SHOWN ABOUT A WHITE CIRCULAR INTERIOR: THE OUTER PORTION OF THE FLAME HAVING A SHADE OF BLUE THAT IS LIGHTER IN APPEARANCE THAN THE DARKER INTERIOR BLUE; THE STYLIZED WORDING, COCINA OUTDOORS, APPEARS BENEATH THE DESIGN IN GREY AND THE WORD, COCINA, IS SHOWN WITH A SUPERIOR FONT SUPERIMPOSED DIRECTLY OVER THE WORD, OUTDOORS, SHOWN WITH AN INFERIOR FONT.

THE ENGLISH TRANSLATION OF "COCINA" IN THE MARK IS KITCHEN.

SN 85-297,734, FILED 4-18-2011.

ANNE MADDEN, EXAMINING ATTORNEY



*David J. Kybas*

Director of the United States Patent and Trademark Office

# United States of America

United States Patent and Trademark Office

# NUTRA-APPS

**Reg. No. 4,126,827**

CARDIUM THERAPEUTICS, INC. (DELAWARE CORPORATION)  
12255 EL CAMINO REAL, SUITE 250  
SAN DIEGO, CA 92130

**Registered Apr. 10, 2012**

**Int. Cl.: 5**

FOR: NUTRACEUTICALS FOR USE AS A DIETARY SUPPLEMENT; HERBAL PREPARATIONS FOR USE AS A DIETARY SUPPLEMENT; PHARMACEUTICAL PREPARATIONS FOR USE AS A DIETARY SUPPLEMENT, IN CLASS 5 (U.S. CLS. 6, 18, 44, 46, 51 AND 52).

**TRADEMARK**

FIRST USE 11-8-2011; IN COMMERCE 11-8-2011.

**PRINCIPAL REGISTER**

THE MARK CONSISTS OF STANDARD CHARACTERS WITHOUT CLAIM TO ANY PARTICULAR FONT, STYLE, SIZE, OR COLOR.

SN 85-297,995, FILED 4-18-2011.

JORDAN BAKER, EXAMINING ATTORNEY



*David J. Kyffers*

Director of the United States Patent and Trademark Office

# United States of America

United States Patent and Trademark Office

## The Central Coast Starts Here

**Reg. No. 4,126,828**

STOWELL, RUDY B. (UNITED STATES INDIVIDUAL)  
180 S MARY AVE  
NIPOMO, CA 93444

**Registered Apr. 10, 2012**

**Int. Cl.: 35**

FOR: CHAMBER OF COMMERCE SERVICES, NAMELY, PROMOTING BUSINESS AND TOURISM IN THE NIPOMO, CALIFORNIA AREA, IN CLASS 35 (U.S. CLS. 100, 101 AND 102).

**SERVICE MARK**

FIRST USE 4-26-2011; IN COMMERCE 4-26-2011.

**PRINCIPAL REGISTER**

THE MARK CONSISTS OF STANDARD CHARACTERS WITHOUT CLAIM TO ANY PARTICULAR FONT, STYLE, SIZE, OR COLOR.

SN 85-298,195, FILED 4-18-2011.

RON FAIRBANKS, EXAMINING ATTORNEY



*David J. Kyffers*

Director of the United States Patent and Trademark Office

# United States of America

United States Patent and Trademark Office

# DERMABON

**Reg. No. 4,126,829**

**Registered Apr. 10, 2012**

**Int. Cl.: 3**

**TRADEMARK**

**PRINCIPAL REGISTER**

LICONA SAENZ, JOSE MARIA (MEXICO INDIVIDUAL)  
PRIVADA DE CUAUHEMOC NO. 401  
CHIHUAHUA, MEXICO 31020

FOR: MEDICATED SOAP, IN CLASS 3 (U.S. CLS. 1, 4, 6, 50, 51 AND 52).

FIRST USE 5-1-2011; IN COMMERCE 5-1-2011.

THE MARK CONSISTS OF STANDARD CHARACTERS WITHOUT CLAIM TO ANY PARTICULAR FONT, STYLE, SIZE, OR COLOR.

SN 85-298,334, FILED 4-19-2011.

TRACY CROSS, EXAMINING ATTORNEY



*David J. Kyffers*

Director of the United States Patent and Trademark Office

# United States of America

United States Patent and Trademark Office

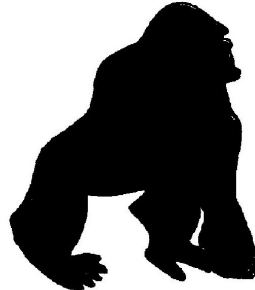

**ISTONE**

**Reg. No. 4,126,830**

**Registered Apr. 10, 2012**

**Int. Cl.: 8**

**TRADEMARK**

**PRINCIPAL REGISTER**

HUANG BUFFALO CO., LTD. (TAIWAN CORPORATION)  
22F-2, NO. 698, SEC 4, WEN SHIN ROAD  
TAICHUNG, TAIWAN R.O.C.

FOR: BITS FOR HAND DRILLS; BLADES FOR HAND SAWS; CROSSCUT SAW BLADES; DRILL BITS FOR HAND DRILLS; FRAMES FOR HANDSAWS; GARDENING TOOLS, NAMELY, TROWELS, WEEDING FORKS, SPADES, HOES; HAND OPERATED LIFTING JACKS; HAND TOOLS, NAMELY, DIES, DRILLS, HAMMERS, MANUALLY-OPERATED GRINDSTONES, MILLING CUTTERS, PLIERS SETS, RATCHET WRENCHES, RIPPING BARS, RIVETERS, SAWS, SOCKET SETS, SOCKET SPANNERS, SOCKET WRENCHES, WRENCHES; HAND-OPERATED CUTTING TOOLS; HAND-OPERATED CUTTING TOOLS, NAMELY, SAFETY CUTTERS; HAND-OPERATED JIGSAWS; HAND-OPERATED PIPE CUTTERS; HAND-OPERATED SCRAPING TOOL FOR CLEANING CLEATS FOR ATTACHMENT TO SPORTS SHOES; HAND-OPERATED SHARPENING TOOLS AND INSTRUMENTS; HAND-OPERATED TOOLS, NAMELY, CHISELS; LAWN AND GARDEN TOOLS, NAMELY, CULTIVATORS; MANUAL DRILLS; MANUALLY OPERATED TREE PRUNERS; PLANING BLADES; PRUNING SCISSORS; SCREWDRIVERS; SHARPENING WHEELS FOR KNIVES AND BLADES; SPANNERS, IN CLASS 8 (U.S. CLS. 23, 28 AND 44).

FIRST USE 5-10-2011; IN COMMERCE 5-10-2011.

THE MARK CONSISTS OF THE WORD "ISTONE" ALL IN UPPERCASE ITALIC FONT PLACED BELOW A SILHOUETTED DEPICTION OF A GORILLA.

SN 85-298,570, FILED 4-19-2011.

CHARLOTTE CORWIN, EXAMINING ATTORNEY



*David J. Kyffers*

Director of the United States Patent and Trademark Office

# United States of America

United States Patent and Trademark Office



**Reg. No. 4,126,831**

**Registered Apr. 10, 2012**

**Int. Cls.: 37 and 42**

**SERVICE MARK**

**PRINCIPAL REGISTER**

HAPPY GREEN HOMES INC. (ILLINOIS CORPORATION)  
865 RUTHENBECK LANE  
NEW LENOX, IL 60451

FOR: CONSTRUCTION SERVICES, NAMELY, INSTALLATION OF ENVIRONMENTAL CONTAINMENT SYSTEMS; GENERAL CONSTRUCTION CONTRACTING, IN CLASS 37 (U.S. CLS. 100, 103 AND 106).

FIRST USE 4-1-2011; IN COMMERCE 10-1-2011.

FOR: ENGINEERING SERVICES IN THE FIELD OF ENERGY EFFICIENCY; PROVIDING A WEBSITE FEATURING INFORMATION ABOUT GREEN ARCHITECTURE, INTERIOR DESIGN, SUSTAINABLE COMMUNITY PLANNING AND INFRASTRUCTURE DEVELOPMENT; PROVIDING TECHNOLOGICAL AND SCIENTIFIC INFORMATION ABOUT ENVIRONMENTALLY-CONSCIOUS AND GREEN INNOVATIONS; PROVIDING TECHNOLOGICAL INFORMATION ABOUT ENVIRONMENTALLY-CONSCIOUS AND GREEN INNOVATIONS, IN CLASS 42 (U.S. CLS. 100 AND 101).

FIRST USE 4-1-2011; IN COMMERCE 10-1-2011.

NO CLAIM IS MADE TO THE EXCLUSIVE RIGHT TO USE "GREEN HOMES", APART FROM THE MARK AS SHOWN.

THE MARK CONSISTS OF A STYLIZED IMAGE OF THE EARTH WITH A STYLIZED LETTER "G" OVERLAPPING THE CROSSBAR AND INSIDE OF A LARGER LETTER "H" WHICH IS SUPERIMPOSED OVER THE CENTER OF THE EARTH, AND BOTH "H" AND "G" HAVE ARROWS ON THE ENDS OF THE LETTERS; THE WORDING "HAPPY GREEN HOMES" APPEARS IN AN ARC OVER THE TOP OF THE EARTH WITH THE FIRST LETTER OF EACH WORD IN BOLD

SN 85-299,362, FILED 4-19-2011.

ANTHONY RINKER, EXAMINING ATTORNEY



*David J. Kyffers*

Director of the United States Patent and Trademark Office

# United States of America

United States Patent and Trademark Office

## ADVENTURES WITH MUSIC

**Reg. No. 4,126,832**

ADVENTURES WITH MUSIC, INC. (ILLINOIS CORPORATION)  
6900 MEADOWCREST DRIVE  
DOWNERS GROVE, IL 60516

**Registered Apr. 10, 2012**

**Int. Cl.: 16**

FOR: A SERIES OF NOVELS, IN CLASS 16 (U.S. CLS. 2, 5, 22, 23, 29, 37, 38 AND 50).

**TRADEMARK**

FIRST USE 12-9-2011; IN COMMERCE 12-9-2011.

**PRINCIPAL REGISTER**

THE MARK CONSISTS OF STANDARD CHARACTERS WITHOUT CLAIM TO ANY PARTICULAR FONT, STYLE, SIZE, OR COLOR.

NO CLAIM IS MADE TO THE EXCLUSIVE RIGHT TO USE "MUSIC", APART FROM THE MARK AS SHOWN.

SN 85-301,535, FILED 4-21-2011.

DEBRA LEE, EXAMINING ATTORNEY



*David J. Kyffers*

Director of the United States Patent and Trademark Office

# United States of America

United States Patent and Trademark Office

# TAMARISK

**Reg. No. 4,126,833**

**Registered Apr. 10, 2012**

**Int. Cl.: 9**

**TRADEMARK**

**PRINCIPAL REGISTER**

DRS RSTA, INC. (DELAWARE CORPORATION)  
13544 NORTH CENTRAL EXPRESSWAY  
DALLAS, TX 75243

FOR: THERMAL IMAGING CAMERA, IN CLASS 9 (U.S. CLS. 21, 23, 26, 36 AND 38).

FIRST USE 4-25-2011; IN COMMERCE 6-10-2011.

THE MARK CONSISTS OF STANDARD CHARACTERS WITHOUT CLAIM TO ANY PARTICULAR FONT, STYLE, SIZE, OR COLOR.

SN 85-303,350, FILED 4-25-2011.

KATHERINE CONNOLLY, EXAMINING ATTORNEY



*David J. Kybas*

Director of the United States Patent and Trademark Office



# United States of America

United States Patent and Trademark Office

# BISTRO 360

**Reg. No. 4,126,834**

TROPICAL FOODS, LLC (FLORIDA LIMITED LIABILITY COMPANY)  
10900 NW 25TH ST # 200  
MIAMI, FL 33172

**Registered Apr. 10, 2012**

**Int. Cl.: 29**

FOR: CHEESE; DAIRY PRODUCTS EXCLUDING ICE CREAM, ICE MILK AND FROZEN YOGURT; YOGURT, IN CLASS 29 (U.S. CL. 46).

**TRADEMARK**

FIRST USE 12-1-2010; IN COMMERCE 12-1-2010.

**PRINCIPAL REGISTER**

THE MARK CONSISTS OF STANDARD CHARACTERS WITHOUT CLAIM TO ANY PARTICULAR FONT, STYLE, SIZE, OR COLOR.

SN 85-303,813, FILED 4-25-2011.

JOHN WILKE, EXAMINING ATTORNEY



*David J. Kyffers*

Director of the United States Patent and Trademark Office

# United States of America

United States Patent and Trademark Office

## CROWN APPEAL

**Reg. No. 4,126,835**

**Registered Apr. 10, 2012**

**Int. Cl.: 34**

**TRADEMARK**

**PRINCIPAL REGISTER**

SID-B CONSULTANTS, INC. (NEW YORK CORPORATION)  
592 COUNTY ROUTE 29  
BURKE, NY 12917

FOR: CIGARS, IN CLASS 34 (U.S. CLS. 2, 8, 9 AND 17).

FIRST USE 11-3-2011; IN COMMERCE 11-3-2011.

THE MARK CONSISTS OF STANDARD CHARACTERS WITHOUT CLAIM TO ANY PARTICULAR FONT, STYLE, SIZE, OR COLOR.

SN 85-303,918, FILED 4-25-2011.

ZACHARY BELLO, EXAMINING ATTORNEY



*David J. Kyffers*

Director of the United States Patent and Trademark Office

# United States of America

United States Patent and Trademark Office



**Reg. No. 4,126,836**

**Registered Apr. 10, 2012**

**Int. Cl.: 16**

**TRADEMARK**

**PRINCIPAL REGISTER**

NEON 2000, INC. (FLORIDA CORPORATION), DBA DGS - DIGITAL GRAPHIC SYSTEMS,  
5512 NW 161 STREET  
MIAMI, FL 33014

FOR: PRINT SUBSTRATE, NAMELY, TRANSPARENT, OPAQUE AND TRANSLUCENT FILMS FOR USE WITH INK JET PRINTERS, IN CLASS 16 (U.S. CLS. 2, 5, 22, 23, 29, 37, 38 AND 50).

FIRST USE 4-28-2011; IN COMMERCE 4-28-2011.

NO CLAIM IS MADE TO THE EXCLUSIVE RIGHT TO USE "ECO FRIENDLY PRODUCT LINE", APART FROM THE MARK AS SHOWN.

THE COLOR(S) GREEN AND BLACK IS/ARE CLAIMED AS A FEATURE OF THE MARK.

THE MARK CONSISTS OF THE WORD "ROOTS" IN GREEN LETTERS WITH THE FIRST "O" DESIGNED WITH 3 GREEN LEAVES; THE LETTER "R" HAS A CURVE THAT GOES UNDER THE FIRST LETTER "O" WITH THE WORDING "DGS ECO FRIENDLY PRODUCT LINE" IN BLACK.

SN 85-304,026, FILED 4-25-2011.

FONG HSU, EXAMINING ATTORNEY



*David J. Kybas*

Director of the United States Patent and Trademark Office

# United States of America

United States Patent and Trademark Office

## A BRAND IS A PROMISE

**Reg. No. 4,126,837**

RILEY WEISS, INC. (OREGON CORPORATION)  
2061 NW HOYT STREET  
PORTLAND, OR 97204

**Registered Apr. 10, 2012**

**Int. Cl.: 35**

FOR: PUBLIC RELATIONS, NAMELY, BUILDING IMAGES OF OTHERS IN CONNECTION WITH THEIR PRODUCTS AND SERVICES, IN CLASS 35 (U.S. CLS. 100, 101 AND 102).

**SERVICE MARK**

FIRST USE 7-0-2008; IN COMMERCE 7-0-2008.

**PRINCIPAL REGISTER**

THE MARK CONSISTS OF STANDARD CHARACTERS WITHOUT CLAIM TO ANY PARTICULAR FONT, STYLE, SIZE, OR COLOR.

SN 85-304,163, FILED 4-25-2011.

DORITT L. CARROLL, EXAMINING ATTORNEY



*David J. Kybas*

Director of the United States Patent and Trademark Office

# United States of America

United States Patent and Trademark Office

## Better Balance Equals Maximum Performance

**Reg. No. 4,126,838**

**Registered Apr. 10, 2012**

**Int. Cl.: 28**

**TRADEMARK**

**PRINCIPAL REGISTER**

ROSENBERG, STEVEN L. (UNITED STATES INDIVIDUAL)  
SLRFTPROD@AOL.COM  
2901 WILSHIRE BLVD. # 110  
SANTA MONICA, CA 90403

FOR: SPORTING GOODS, NAMELY, A SPORTS TRAINING DEVICE TO IMPROVE STRENGTH, TONING, CONDITIONING, BALANCE, AND PROPRIOCEPTION, IN CLASS 28 (U.S. CLS. 22, 23, 38 AND 50).

FIRST USE 1-20-2012; IN COMMERCE 1-20-2012.

THE MARK CONSISTS OF STANDARD CHARACTERS WITHOUT CLAIM TO ANY PARTICULAR FONT, STYLE, SIZE, OR COLOR.

SN 85-304,360, FILED 4-25-2011.

SUSAN LESLIE DUBOIS, EXAMINING ATTORNEY



*David J. Kybas*

Director of the United States Patent and Trademark Office

# United States of America

United States Patent and Trademark Office

## THE SUPER HARD

**Reg. No. 4,126,839**

SY, BENITO (PHILIPPINES INDIVIDUAL)  
PO BOX 2482

**Registered Apr. 10, 2012**

RANCHO CORDOVA, CA 95741

**Int. Cl.: 5**

FOR: HERBAL MALE ENHANCEMENT CAPSULES; PHARMACEUTICALS FOR THE TREATMENT OF ERECTILE DYSFUNCTION AND IMPOTENCE; NATURAL SUPPLEMENTS FOR TREATING ERECTILE DYSFUNCTION AND IMPOTENCE , IN CLASS 5 (U.S. CLS. 6, 18, 44, 46, 51 AND 52).

**TRADEMARK**

**PRINCIPAL REGISTER**

FIRST USE 5-17-2011; IN COMMERCE 8-11-2011.

THE MARK CONSISTS OF STANDARD CHARACTERS WITHOUT CLAIM TO ANY PARTICULAR FONT, STYLE, SIZE, OR COLOR.

SN 85-304,387, FILED 4-26-2011.

LINDA M. KING, EXAMINING ATTORNEY



*David J. Kyffers*

Director of the United States Patent and Trademark Office

# United States of America

United States Patent and Trademark Office

## GLOBAL LIGHT

**Reg. No. 4,126,840**

**Registered Apr. 10, 2012**

**Int. Cl.: 9**

**TRADEMARK**

**PRINCIPAL REGISTER**

GLOBAL LIGHT, LLC (MASSACHUSETTS LIMITED LIABILITY COMPANY)  
328 HARVARD STREET, SUITE 3  
CAMBRIDGE, MA 02139

FOR: CUSTOM IDENTIFICATION AND INTERFACE PARTS, NAMELY, MEMBRANE KEYPADS FOR INCORPORATION IN CONSUMER AND INDUSTRIAL ELECTRONIC DEVICES; TOUCH SCREENS, CIRCUIT BOARDS, ELECTRIC AND ELECTRONIC CIRCUITS, FLEXIBLE ELECTRONIC AND ELECTRIC CIRCUITS; CASINGS AND CASING PARTS FOR ELECTRICAL EQUIPMENT, NAMELY, HOUSING FOR ELECTRONIC KEYPADS, SEMI-CONDUCTORS, MEMBRANE SWITCHES; ELECTRONIC RUBBER KEYPADS FOR DATA ENTRY FOR ELECTRONIC DEVICES; OVERLAYS SPECIFICALLY ADAPTED FOR TOUCH SCREEN DISPLAYS; ELECTRICAL INSULATORS, NAMELY, ELECTROMAGNETIC INTERFERENCE INSULATORS AND INSULATORS FOR ELECTRIC CABLES; ELECTRIC CABLES, ELECTRICAL CONNECTORS, ELECTRIC LUMINESCENT DISPLAY PANELS AND LAMPS, PRINTED CIRCUIT BOARDS; TOUCH SCREEN KEYPADS FOR INCORPORATION IN CONSUMER AND INDUSTRIAL ELECTRONIC DEVICES; REPLACEMENT PARTS FOR PETROLEUM PUMPS AND PERIPHERAL EQUIPMENT, NAMELY, CASINGS AND CASING PARTS FOR ELECTRICAL EQUIPMENT, NAMELY, HOUSING FOR ELECTRONIC KEYPADS, MEMBRANE AND RUBBER DATA ENTRY TOUCH PADS, LCD TOUCH SCREENS AND DISPLAYS, AND ELECTRONIC CIRCUITS; REPLACEMENT PARTS FOR BARCODE SCANNERS AND READERS, NAMELY, CASINGS AND CASING PARTS FOR ELECTRICAL EQUIPMENT, NAMELY, HOUSING FOR ELECTRONIC KEYPADS, MEMBRANE AND RUBBER DATA ENTRY TOUCH PADS, LCD TOUCH SCREENS AND DISPLAYS, AND ELECTRONIC CIRCUITS; REPLACEMENT PARTS FOR POINT OF PURCHASE SIGNATURE CAPTURE PADS, NAMELY, CASINGS AND CASING PARTS FOR ELECTRICAL EQUIPMENT, NAMELY, HOUSING FOR ELECTRONIC KEYPADS, MEMBRANE AND RUBBER DATA ENTRY TOUCH PADS, LCD TOUCH SCREENS AND DISPLAYS, AND ELECTRONIC CIRCUITS; REPLACEMENT PARTS FOR ELECTRONIC GAMING MACHINES, NAMELY, CASINGS AND CASING PARTS FOR ELECTRICAL EQUIPMENT, NAMELY, HOUSING FOR ELECTRONIC KEYPADS, MEMBRANE AND RUBBER DATA ENTRY TOUCH PADS, LCD TOUCH SCREENS AND DISPLAYS, AND ELECTRONIC CIRCUITS, IN CLASS 9 (U.S. CLS. 21, 23, 26, 36 AND 38).



*David J. Kappas*

Director of the United States Patent and Trademark Office

FIRST USE 9-0-2005; IN COMMERCE 9-0-2005.

THE MARK CONSISTS OF STANDARD CHARACTERS WITHOUT CLAIM TO ANY PARTICULAR FONT, STYLE, SIZE, OR COLOR.

**Reg. No. 4,126,840** OWNER OF U.S. REG. NOS. 3,044,039 AND 3,099,762.

SN 85-304,441, FILED 4-26-2011.

LINDA MICKLEBURGH, EXAMINING ATTORNEY



# United States of America

United States Patent and Trademark Office



**Reg. No. 4,126,841**

COMBS ENTERPRISES, INC. (FLORIDA CORPORATION)  
7523 TRAILS END  
JACKSONVILLE, FL 32277

**Registered Apr. 10, 2012**

**Int. Cl.: 16**

FOR: STICKERS, IN CLASS 16 (U.S. CLS. 2, 5, 22, 23, 29, 37, 38 AND 50).

**TRADEMARK**

FIRST USE 10-1-2011; IN COMMERCE 10-1-2011.

**PRINCIPAL REGISTER**

THE MARK CONSISTS OF THE STYLIZED WORDING "SEAHEAD" FORMING A SHARK,  
WITH TWO CURVED BANDS ON EITHER SIDE OF THE SHARK.

SN 85-304,560, FILED 4-26-2011.

EVELYN BRADLEY, EXAMINING ATTORNEY



*David J. Kybas*

Director of the United States Patent and Trademark Office

# United States of America

United States Patent and Trademark Office

# LaRose

**Reg. No. 4,126,842**

**Registered Apr. 10, 2012**

**Int. Cl.: 11**

**TRADEMARK**

**PRINCIPAL REGISTER**

PROLINK MICROSYSTEMS CORPORATION (TAIWAN CORPORATION)  
6F, NO. 349  
YANG-KUANG ST., NEI-HU  
TAIPEI, TAIWAN R.O.C.

FOR: LIGHTING INSTALLATIONS FOR AIRCRAFT, AQUARIUM LIGHTS, ARC LAMPS, AUTOMOBILE LIGHTS, BICYCLE LIGHTS, ACETYLENE BURNERS, BURNERS FOR LAMPS, CEILING LIGHTS, CHANDELIERS, ELECTRIC LIGHTS FOR CHRISTMAS TREES, CYCLE LIGHTS, DIVING LIGHTS, ELECTRIC LAMPS, FLARES, FLASHLIGHTS, TORCHES, HEADLIGHTS FOR AUTOMOBILES, LIGHT BULBS, ELECTRIC LIGHT BULBS, LIGHT BULBS FOR DIRECTIONAL SIGNALS FOR VEHICLES, LIGHT DIFFUSERS, LIGHTING APPARATUS AND INSTALLATIONS, LIGHTING APPARATUS FOR VEHICLES, LIGHTS FOR VEHICLES, MAGNESIUM FILAMENTS FOR LIGHTING, MINERS' LAMPS, PROJECTOR LAMPS, SAFETY LAMPS, STANDARD LAMPS, VEHICLE HEADLIGHTS , IN CLASS 11 (U.S. CLS. 13, 21, 23, 31 AND 34).

FIRST USE 9-19-2011; IN COMMERCE 12-19-2011.

THE MARK CONSISTS OF THE WORD "LAROSE" IN HIGHLY STYLIZED, UPPER-AND-LOWER-CASE LETTERING

SN 85-304,685, FILED 4-26-2011.

JILL C. ALT, EXAMINING ATTORNEY



*David J. Kybas*

Director of the United States Patent and Trademark Office

# United States of America

United States Patent and Trademark Office



**Reg. No. 4,126,843**

VU HONG PHAM (UNITED STATES INDIVIDUAL)  
5052 SHARON DRIVE  
LA PALMA, CA 90623

**Registered Apr. 10, 2012**

**Int. Cl.: 9**

FOR: CHILDREN'S EDUCATIONAL SOFTWARE; EDUCATIONAL SOFTWARE FEATURING INSTRUCTION IN ESSAY WRITING AND ESSAY COMPOSITION, IN CLASS 9 (U.S. CLS. 21, 23, 26, 36 AND 38).

**TRADEMARK**

FIRST USE 1-1-2011; IN COMMERCE 12-1-2011.

**PRINCIPAL REGISTER**

NO CLAIM IS MADE TO THE EXCLUSIVE RIGHT TO USE "ESSAY SYSTEM", APART FROM THE MARK AS SHOWN.

THE COLOR(S) BLACK, GREY, YELLOW, AND BLUE IS/ARE CLAIMED AS A FEATURE OF THE MARK.

THE MARK CONSISTS OF THE BLACK STYLIZED WORD "ESSAY SYSTEM" POSITIONED ON THE RIGHT SIDE OF THE MARK. ON THE LEFT SIDE OF THE MARK, THERE IS A BLUE PENCIL OUTLINED IN YELLOW WITH A YELLOW TIP AND ERASERS, IN A BLUE SPHERE INSIDE A GREY GEAR-SHAPED CIRCLE. THE MARK HAS A GREY SHADOW ON THE BOTTOM.

SN 85-305,215, FILED 4-26-2011.

RENEE MCCRAY, EXAMINING ATTORNEY



*David J. Kybas*

Director of the United States Patent and Trademark Office

# United States of America

United States Patent and Trademark Office



**Reg. No. 4,126,844**

**Registered Apr. 10, 2012**

**Int. Cl.: 9**

**TRADEMARK**

**PRINCIPAL REGISTER**

GLOBAL LIGHT, LLC (MASSACHUSETTS LIMITED LIABILITY COMPANY)  
328 HARVARD STREET, SUITE 3  
CAMBRIDGE, MA 02139

FOR: CUSTOM IDENTIFICATION AND INTERFACE PARTS, NAMELY, MEMBRANE KEYPADS FOR INCORPORATION IN CONSUMER AND INDUSTRIAL ELECTRONIC DEVICES; TOUCH SCREENS, CIRCUIT BOARDS, ELECTRIC AND ELECTRONIC CIRCUITS, FLEXIBLE ELECTRONIC AND ELECTRIC CIRCUITS; CASINGS AND CASING PARTS FOR ELECTRICAL EQUIPMENT, NAMELY, HOUSING FOR ELECTRONIC KEYPADS, SEMI-CONDUCTORS, MEMBRANE SWITCHES; ELECTRONIC RUBBER KEYPADS FOR DATA ENTRY FOR ELECTRONIC DEVICES; OVERLAYS SPECIFICALLY ADAPTED FOR TOUCH SCREEN DISPLAYS; ELECTRICAL INSULATORS, NAMELY, ELECTROMAGNETIC INTERFERENCE INSULATORS AND INSULATORS FOR ELECTRIC CABLES; ELECTRIC CABLES, ELECTRICAL CONNECTORS, ELECTRIC LUMINESCENT DISPLAY PANELS AND LAMPS, PRINTED CIRCUIT BOARDS; TOUCH SCREEN KEYPADS FOR INCORPORATION IN CONSUMER AND INDUSTRIAL ELECTRONIC DEVICES; REPLACEMENT PARTS FOR PETROLEUM PUMPS AND PERIPHERAL EQUIPMENT, NAMELY, CASINGS AND CASING PARTS FOR ELECTRICAL EQUIPMENT, NAMELY, HOUSING FOR ELECTRONIC KEYPADS, MEMBRANE AND RUBBER DATA ENTRY TOUCH PADS, LCD TOUCH SCREENS AND DISPLAYS, AND ELECTRONIC CIRCUITS; REPLACEMENT PARTS FOR BARCODE SCANNERS AND READERS, NAMELY, CASINGS AND CASING PARTS FOR ELECTRICAL EQUIPMENT, NAMELY, HOUSING FOR ELECTRONIC KEYPADS, MEMBRANE AND RUBBER DATA ENTRY TOUCH PADS, LCD TOUCH SCREENS AND DISPLAYS, AND ELECTRONIC CIRCUITS; REPLACEMENT PARTS FOR POINT OF PURCHASE SIGNATURE CAPTURE PADS, NAMELY, CASINGS AND CASING PARTS FOR ELECTRICAL EQUIPMENT, NAMELY, HOUSING FOR ELECTRONIC KEYPADS, MEMBRANE AND RUBBER DATA ENTRY TOUCH PADS, LCD TOUCH SCREENS AND DISPLAYS, AND ELECTRONIC CIRCUITS; REPLACEMENT PARTS FOR ELECTRONIC GAMING MACHINES, NAMELY, CASINGS AND CASING PARTS FOR ELECTRICAL EQUIPMENT, NAMELY, HOUSING FOR ELECTRONIC KEYPADS, MEMBRANE AND RUBBER DATA ENTRY TOUCH PADS, LCD TOUCH SCREENS AND DISPLAYS, AND ELECTRONIC CIRCUITS, IN CLASS 9 (U.S. CLS. 21, 23, 26, 36 AND 38).

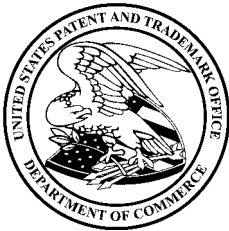

*David J. Kybas*

FIRST USE 9-0-2005; IN COMMERCE 9-0-2005.

OWNER OF U.S. REG. NOS. 3,044,039 AND 3,099,762.

**Reg. No. 4,126,844** THE MARK CONSISTS OF THE WORDS "GLOBAL LIGHT" WITH A SHADED BOX SURROUNDING THE WORD "LIGHT" AND THE WORD "GLOBAL" BEING UNDERLINED WITH AN ARC DESIGN ELEMENT EXTENDING THROUGH A PORTION OF, AND BEHIND, THE WORD "GLOBAL".

SN 85-305,225, FILED 4-26-2011.

LINDA MICKLEBURGH, EXAMINING ATTORNEY

# United States of America

United States Patent and Trademark Office

## FEDEX, GET AHEAD

**Reg. No. 4,126,845**

**Registered Apr. 10, 2012**

**Int. Cls.: 35 and 39**

**SERVICE MARK**

**PRINCIPAL REGISTER**

FEDERAL EXPRESS CORPORATION (DELAWARE CORPORATION)  
3620 HACKS CROSS ROAD  
BLDG B, 3RD FLOOR  
MEMPHIS, TN 38125

FOR: SMALL BUSINESS CONSULTING SERVICES, IN CLASS 35 (U.S. CLS. 100, 101 AND 102).

FIRST USE 8-16-2011; IN COMMERCE 8-16-2011.

FOR: PICK-UP, TRANSPORTATION, STORAGE AND DELIVERY OF DOCUMENTS, PACKAGES AND FREIGHT BY LAND AND AIR, IN CLASS 39 (U.S. CLS. 100 AND 105).

FIRST USE 8-16-2011; IN COMMERCE 8-16-2011.

THE MARK CONSISTS OF STANDARD CHARACTERS WITHOUT CLAIM TO ANY PARTICULAR FONT, STYLE, SIZE, OR COLOR.

OWNER OF U.S. REG. NOS. 1,311,503, 3,874,982, AND OTHERS.

SN 85-305,630, FILED 4-27-2011.

ELISSA GARBER KON, EXAMINING ATTORNEY



*David J. Kybas*

Director of the United States Patent and Trademark Office

# United States of America

United States Patent and Trademark Office



WICKED CATCH

**Reg. No. 4,126,846**

**Registered Apr. 10, 2012**

**Int. Cls.: 16 and 25**

**TRADEMARK**

**PRINCIPAL REGISTER**

SILVERS, JOSHUA S. (UNITED STATES INDIVIDUAL)  
SUITE 711  
300 AUSTRALIAN AVE.  
WEST PALM BEACH, FL 33401

FOR: DECALS; DECORATIVE DECALS FOR VEHICLE WINDOWS; STICKERS, IN CLASS 16 (U.S. CLS. 2, 5, 22, 23, 29, 37, 38 AND 50).

FIRST USE 12-5-2010; IN COMMERCE 6-9-2011.

FOR: CAPS WITH VISORS; FISHING SHIRTS; HATS; HEADGEAR, NAMELY, HATS, CAPS, VISORS; LONG-SLEEVED SHIRTS; SHIRTS; SHORT-SLEEVED OR LONG-SLEEVED T-SHIRTS; T-SHIRTS, IN CLASS 25 (U.S. CLS. 22 AND 39).

FIRST USE 12-5-2010; IN COMMERCE 6-9-2011.

THE MARK CONSISTS OF THE STYLIZED WORDS "WICKED CATCH" WITH A STYLIZED FISH SKELETON APPEARING ABOVE THE WORDS.

SN 85-306,259, FILED 4-27-2011.

LINDA POWELL, EXAMINING ATTORNEY



*David J. Kybas*

Director of the United States Patent and Trademark Office

# United States of America

United States Patent and Trademark Office

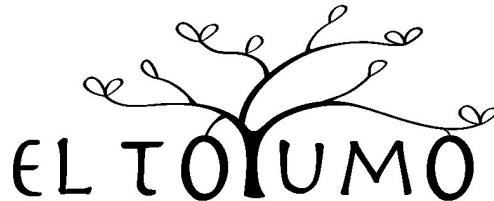

**Reg. No. 4,126,847**

**Registered Apr. 10, 2012**

**Int. Cls.: 18 and 25**

**TRADEMARK**

**PRINCIPAL REGISTER**

EL TOTUMO (CALIFORNIA LIMITED LIABILITY COMPANY)  
POB 459  
EL GRANADA, CA 94018

FOR: HANDBAGS, MADE IN PART FROM THE TOTUMO FRUIT, IN CLASS 18 (U.S. CLS. 1, 2, 3, 22 AND 41).

FIRST USE 5-1-2011; IN COMMERCE 6-1-2011.

FOR: BLOUSES; DRESSES; SHIRTS, IN CLASS 25 (U.S. CLS. 22 AND 39).

FIRST USE 5-1-2011; IN COMMERCE 6-1-2011.

NO CLAIM IS MADE TO THE EXCLUSIVE RIGHT TO USE "EL TOTUMO", APART FROM THE MARK AS SHOWN.

THE MARK CONSISTS OF "EL TOTUMO" IN STYLIZED TEXT. THE SECOND LETTER "T" IS IN THE SHAPE OF A TREE WITH LEAVES. EACH OF THE "O'S" DEPICT A TOTUMO FRUIT.

SN 85-310,013, FILED 5-2-2011.

FRANK LATTUCA, EXAMINING ATTORNEY



*David J. Kybas*

Director of the United States Patent and Trademark Office



# United States of America

United States Patent and Trademark Office

## DEARLY BELOVED

**Reg. No. 4,126,848**

**Registered Apr. 10, 2012**

**Int. Cl.: 33**

**TRADEMARK**

**PRINCIPAL REGISTER**

H.D.D. LLC (CALIFORNIA LIMITED LIABILITY COMPANY), DBA TRUETT HURST  
WINERY,  
5610 DRY CREEK ROAD  
HEALDSBURG, CA 95448

FOR: ALCOHOLIC BEVERAGES EXCEPT BEERS, IN CLASS 33 (U.S. CLS. 47 AND 49).

FIRST USE 10-31-2011; IN COMMERCE 10-31-2011.

THE MARK CONSISTS OF STANDARD CHARACTERS WITHOUT CLAIM TO ANY PARTICULAR FONT, STYLE, SIZE, OR COLOR.

SN 85-310,260, FILED 5-2-2011.

NAAKWAMA ANKRAH, EXAMINING ATTORNEY



*David J. Kyffers*

Director of the United States Patent and Trademark Office

# United States of America

United States Patent and Trademark Office

## TITANIUM TOURS

**Reg. No. 4,126,849**

TITANIUM GLOBAL, LLC (NEW JERSEY LIMITED LIABILITY COMPANY)  
16 SOUTH AVE W. SUITE 262  
CRANFORD, NJ 07016

**Registered Apr. 10, 2012**

**Int. Cl.: 39**

FOR: ARRANGING AND COORDINATING TRAVEL ARRANGEMENTS FOR INDIVIDUALS AND GROUPS, NAMELY, GOLF TOURS, IN CLASS 39 (U.S. CLS. 100 AND 105).

**SERVICE MARK**

FIRST USE 1-20-2012; IN COMMERCE 1-20-2012.

**PRINCIPAL REGISTER**

THE MARK CONSISTS OF STANDARD CHARACTERS WITHOUT CLAIM TO ANY PARTICULAR FONT, STYLE, SIZE, OR COLOR.

NO CLAIM IS MADE TO THE EXCLUSIVE RIGHT TO USE "TOURS", APART FROM THE MARK AS SHOWN.

SN 85-310,488, FILED 5-3-2011.

ALYSSA STEEL, EXAMINING ATTORNEY



*David J. Kybas*

Director of the United States Patent and Trademark Office

United States of America  
United States Patent and Trademark Office

# Mayodorée

**Reg. No. 4,126,850**

THE NISSHIN OILIO GROUP, LTD. (JAPAN CORPORATION)  
23-1, SHINKAWA 1-CHOME, CHUO-KU  
TOKYO, 104-8285, JAPAN

**Registered Apr. 10, 2012**

**Int. Cl.: 30**

FOR: MAYONNAISE; EGG-FREE MAYONNAISE; VEGETABLE MAYONNAISE; SALAD DRESSINGS, IN CLASS 30 (U.S. CL. 46).

**TRADEMARK**

FIRST USE 9-13-2011; IN COMMERCE 9-13-2011.

**PRINCIPAL REGISTER**

THE MARK CONSISTS OF THE STYLIZED WORD "MAYODORÉE".

SN 85-311,159, FILED 5-3-2011.

MARK SHINER, EXAMINING ATTORNEY



*David J. Kybas*

Director of the United States Patent and Trademark Office

# United States of America

United States Patent and Trademark Office



**Reg. No. 4,126,851**

**Registered Apr. 10, 2012**

**Int. Cl.: 16**

**TRADEMARK**

**PRINCIPAL REGISTER**

ROSS II, VICTOR (UNITED STATES INDIVIDUAL)  
511  
840 SOUTH HOBART BLVD  
LOS ANGELES, CA 900056613

FOR: BOOKS IN THE FIELD OF POETRY; DRAWINGS; PAINTINGS, IN CLASS 16 (U.S. CLS. 2, 5, 22, 23, 29, 37, 38 AND 50).

FIRST USE 12-1-2011; IN COMMERCE 12-1-2011.

THE MARK CONSISTS OF THE STYLIZED TEXT "VR II".

SN 85-311,978, FILED 5-4-2011.

RENEE MCCRAY, EXAMINING ATTORNEY



*David J. Kybas*

Director of the United States Patent and Trademark Office

# United States of America

United States Patent and Trademark Office

## Live Love Yogurt

**Reg. No. 4,126,852**

LIVE LOVE YOGURT, INC. (TENNESSEE CORPORATION)  
1106A BILTMORE DRIVE  
NASHVILLE, TN 37204

**Registered Apr. 10, 2012**

**Int. Cl.: 43**

FOR: FROZEN YOGURT SHOP SERVICES IN THE NATURE OF A RESTAURANT, IN CLASS 43 (U.S. CLS. 100 AND 101).

**SERVICE MARK**

FIRST USE 7-5-2011; IN COMMERCE 12-25-2011.

**PRINCIPAL REGISTER**

THE MARK CONSISTS OF STANDARD CHARACTERS WITHOUT CLAIM TO ANY PARTICULAR FONT, STYLE, SIZE, OR COLOR.

NO CLAIM IS MADE TO THE EXCLUSIVE RIGHT TO USE "YOGURT", APART FROM THE MARK AS SHOWN.

SN 85-312,392, FILED 5-4-2011.

JOHN E. MICHOS, EXAMINING ATTORNEY



*David J. Kyffers*

Director of the United States Patent and Trademark Office

# United States of America

United States Patent and Trademark Office

## BEARDED LADY

**Reg. No. 4,126,853**

**Registered Apr. 10, 2012**

**Int. Cl.: 43**

**SERVICE MARK**

**PRINCIPAL REGISTER**

BOGMAN, LLC (NEW YORK LIMITED LIABILITY COMPANY)  
C/O PATRICK BRITTON  
774 FRANKLIN AVENUE, #4C  
BROOKLYN, NY 11238

FOR: BAR AND RESTAURANT SERVICES; BAR SERVICES; RESTAURANT; RESTAURANT AND BAR SERVICES; RESTAURANT AND BAR SERVICES, INCLUDING RESTAURANT CARRYOUT SERVICES; RESTAURANT SERVICES; RESTAURANT SERVICES FEATURING SANDWICHES; RESTAURANT SERVICES, INCLUDING SIT-DOWN SERVICE OF FOOD AND TAKE-OUT RESTAURANT SERVICES; RESTAURANTS, IN CLASS 43 (U.S. CLS. 100 AND 101).

FIRST USE 7-28-2011; IN COMMERCE 7-28-2011.

THE MARK CONSISTS OF STANDARD CHARACTERS WITHOUT CLAIM TO ANY PARTICULAR FONT, STYLE, SIZE, OR COLOR.

SN 85-312,622, FILED 5-4-2011.

JULIE WATSON, EXAMINING ATTORNEY



*David J. Kyros*

Director of the United States Patent and Trademark Office

# United States of America

United States Patent and Trademark Office

Live Love Yogurt

**Reg. No. 4,126,854**

LIVE LOVE YOGURT, INC. (TENNESSEE CORPORATION)  
1106A BILTMORE DRIVE  
NASHVILLE, TN 37204

**Registered Apr. 10, 2012**

**Int. Cl.: 43**

FOR: FROZEN YOGURT SHOP SERVICES IN THE NATURE OF A RESTAURANT, IN CLASS 43 (U.S. CLS. 100 AND 101).

**SERVICE MARK**

FIRST USE 7-5-2011; IN COMMERCE 12-25-2011.

**PRINCIPAL REGISTER**

NO CLAIM IS MADE TO THE EXCLUSIVE RIGHT TO USE "YOGURT", APART FROM THE MARK AS SHOWN.

THE MARK CONSISTS OF THE WORDS "LIVE LOVE YOGURT" IN FANCIFUL FONT WITH THE "I" OF "LIVE" CONTAINING A LEAF FLOURISH, THE "O" OF LOVE BEING A STRAWBERRY, AND THE "O" OF YOGURT CONTAINING A CROWN.

SN 85-312,626, FILED 5-4-2011.

JOHN E. MICHOS, EXAMINING ATTORNEY



David J. Kyjars

Director of the United States Patent and Trademark Office

# United States of America

United States Patent and Trademark Office

# LiftLite

**Reg. No. 4,126,855**

**Registered Apr. 10, 2012**

**Int. Cl.: 19**

**TRADEMARK**

**PRINCIPAL REGISTER**

LAFARGE NORTH AMERICA INC. (MARYLAND CORPORATION)  
12018 SUNRISE VALLEY DRIVE  
SUITE 500  
RESTON, VA 20191

FOR: GYPSUM, IN CLASS 19 (U.S. CLS. 1, 12, 33 AND 50).

FIRST USE 5-18-2011; IN COMMERCE 5-18-2011.

THE MARK CONSISTS OF STANDARD CHARACTERS WITHOUT CLAIM TO ANY PARTICULAR FONT, STYLE, SIZE, OR COLOR.

SN 85-312,991, FILED 5-5-2011.

GIANCARLO CASTRO, EXAMINING ATTORNEY



*David J. Kybas*

Director of the United States Patent and Trademark Office



# United States of America

United States Patent and Trademark Office



**Reg. No. 4,126,856**

**Registered Apr. 10, 2012**

**Int. Cls.: 3 and 44**

**TRADEMARK**

**SERVICE MARK**

**PRINCIPAL REGISTER**

HARRER, MARTINA (FED REP GERMANY INDIVIDUAL), DBA ORANGE BERLIN,  
BEVERLY BLVD  
8317 1/2 BEVERLY BLVD.  
LOS ANGELES, CA 90048

FOR: BEAUTY CREAMS; BEAUTY CREAMS FOR BODY CARE; BODY AND BEAUTY CARE COSMETICS; BODY CREAM; BODY CREAMS; COSMETIC PREPARATIONS FOR SKIN CARE; COSMETIC PREPARATIONS FOR SKIN RENEWAL; COSMETIC PREPARATIONS, NAMELY, SKIN BALSAMS; FACE AND BODY BEAUTY CREAMS; FACE AND BODY CREAMS; SKIN AND BODY TOPICAL LOTIONS, CREAMS AND OILS FOR COSMETIC USE; SKIN CREAM; SKIN CREAMS; SKIN CREAMS IN LIQUID AND IN SOLID FORM; SKIN CREAMS IN LIQUID AND SOLID; SKIN CREAMS IN LIQUID AND SOLID FORM; SKIN LOTION; SKIN LOTIONS; SKIN MOISTURIZER; 3-IN-1 HAIR CONDITIONERS; 3-IN-1 HAIR SHAMPOOS; ANTIBACTERIAL SKIN SOAPS; AROMATIC BODY CARE PRODUCTS, NAMELY, BODY LOTION, SHOWER GEL, CUTICLE CREAM, SHAMPOO, CONDITIONER, NON-MEDICATED LIP BALM, SOAP, BODY POLISH, BODY AND FOOT SCRUB AND NON-MEDICATED FOOT CREAM; BABY HAIR CONDITIONER; BEAUTY LOTIONS; BEAUTY MASKS; BEAUTY MILKS; BEAUTY SERUMS; BEAUTY SOAP; BLEACHING PREPARATIONS FOR THE HAIR; BODY CREAM SOAP; BODY DEODORANTS; BODY EMULSIONS; BODY GLITTER; BODY LOTION; BODY LOTIONS; BODY MASK CREAM; BODY MASK LOTION; BODY MASK POWDER; BODY MASKS; BODY MILK; BODY MILKS; BODY OIL; BODY OILS; BODY POWDER; BODY SCRUB; BODY SPLASH; BODY SPRAY USED AS A PERSONAL DEODORANT AND AS FRAGRANCE; BODY SPRAYS; BODY SPRAYS, NAMELY, WATER IN ATOMIZED CONTAINERS USED TO PRODUCE A COOLING EFFECT; BODY WASH; CLOTHS OR TISSUES IMPREGNATED WITH A SKIN CLEANSER; CONDITIONERS; COSMETIC CREAMS FOR SKIN CARE; COSMETIC HAIR DRESSING PREPARATIONS; COSMETIC HAIR FILLING POWDERS FOR COVERING BALD AND THINNING SPOTS ON THE SCALP; COSMETIC OLIVE OIL FOR THE FACE AND BODY; COSMETIC PREPARATIONS FOR BODY CARE; COSMETIC PREPARATIONS FOR PROTECTING THE SKIN FROM THE SUN'S RAYS; COSMETIC PREPARATIONS FOR THE HAIR AND SCALP; COSMETIC PRODUCTS IN THE FORM OF AEROSOLS FOR SKIN CARE; COSMETIC SKIN FRESHENERS; DEODORANTS FOR BODY CARE; EXFOLIANTS FOR HAIR, SCALP; FACE AND BODY GLITTER; FACE AND BODY LOTIONS; FACE AND BODY MILK; FACE CREAMS; FACE CREAMS AND CLEANSERS CONTAINING BENZOYL PEROXIDE FOR COSMETIC PURPOSES; FACE CREAMS FOR COSMETIC USE; FACE GLITTER; FACE MILK AND LOTIONS; FACE PAINT; FACE PAINTING KITS; FACIAL BEAUTY MASKS; FRAGRANCED BODY CARE PREPARATIONS,



*David J. Kybas*

Director of the United States Patent and Trademark Office

**Reg. No. 4,126,856** NAMELY, GELS, CREAMS, SCRUBS, OILS, LOTIONS; FRAGRANCED FACE CARE PREPARATIONS, NAMELY, CREAMS, MOISTURIZERS; GEL FOR HAIR; HAIR BALSAM; HAIR BLEACH; HAIR BLEACHES; HAIR BLEACHING PREPARATIONS; HAIR CARE CREAMS; HAIR CARE LOTIONS; HAIR CARE PREPARATIONS; HAIR CARE PREPARATIONS CONSISTING OF ORGANIC COCONUT VIRGIN OIL AND COCONUT VIRGIN OIL; HAIR CARE PRODUCTS, NAMELY, HEAT PROTECTION SPRAYS; HAIR CLEANING PREPARATIONS; HAIR COLOR; HAIR COLOR REMOVERS; HAIR COLORANTS; HAIR COLORING PREPARATIONS; HAIR COLOURANTS; HAIR COLOURING; HAIR COLOURING AND DYES; HAIR COLOURING PREPARATIONS; HAIR CONDITIONER; HAIR CONDITIONERS; HAIR CONDITIONERS FOR BABIES; HAIR CREAMS; HAIR CURLING PREPARATIONS; HAIR DECOLORANTS; HAIR DRESSINGS FOR MEN; HAIR DRESSINGS FOR WOMEN; HAIR DYE; HAIR DYES; HAIR EMOLLIENTS; HAIR FIXERS; HAIR FROSTS; HAIR GEL; HAIR GEL AND HAIR MOUSSE; HAIR GELS; HAIR GLAZE; HAIR LACQUERS; HAIR LIGHTENERS; HAIR LOTION; HAIR LOTIONS; HAIR MASCARA; HAIR MASKS; HAIR MOUSSE; HAIR MOUSSES; HAIR NOURISHERS; HAIR OILS; HAIR PIECE BONDING GLUE; HAIR POMADES; HAIR PRODUCTS, NAMELY, THICKENING CONTROL CREAMS; HAIR RELAXERS; HAIR RELAXING PREPARATIONS; HAIR REMOVING CREAM; HAIR RINSES; HAIR RINSES; HAIR SHAMPOO; HAIR SHAMPOOS AND CONDITIONERS; HAIR SHEEN SPRAY; HAIR SPRAY; HAIR SPRAYS; HAIR SPRAYS AND HAIR GELS; HAIR STRAIGHTENING PREPARATIONS; HAIR STYLING FIXATIVE IN THE NATURE OF HAIR WAX; HAIR STYLING GEL; HAIR STYLING PREPARATIONS; HAIR STYLING SPRAY; HAIR TONIC; HAIR TONICS; HAIR WAVING LOTION; HAIR WAVING PREPARATIONS; HAIR WAX; HAIR-WASHING POWDER; HYDROGEN PEROXIDE FOR USE ON THE HAIR; JAPANESE HAIR FIXING OIL (BINTSUKE-ABURA); LIQUID SOAPS FOR HANDS AND FACE; LIQUID SOAPS FOR HANDS, FACE AND BODY; LOOSE FACE POWDER; LOTIONS FOR FACE AND BODY CARE; LOTIONS FOR HAIR, SCALP, FACE, HANDS, BODY, SKIN; MAKE-UP FOR THE FACE AND BODY; MAKE-UP PREPARATIONS FOR THE FACE AND BODY; MOISTURIZING PREPARATIONS FOR THE SKIN; MOISTURIZING SOLUTIONS FOR THE SKIN; MOUSSE FOR HAIR; NATURAL COCOA BUTTER BASED PERSONAL CARE PRODUCTS, NAMELY, BODY LOTION, SHOWER GEL, SOAP, BODY POLISH, BODY AND FOOT SCRUB AND NON-MEDICATED SKIN CREAMS; NON-MEDICATED BALMS FOR USE ON HAIR, SCALP, FACE, HANDS, BODY, SKIN; NON-MEDICATED BODY SOAKS; NON-MEDICATED HAIR SERUMS; NON-MEDICATED HAIR TREATMENT PREPARATIONS FOR COSMETIC PURPOSES; NON-MEDICATED HERBAL BODY CARE PRODUCTS, NAMELY, BODY OILS, SALVES, AND LIP BALMS; NON-MEDICATED HERBAL BODY CARE PRODUCTS, NAMELY, GELS, CREAMS, SCRUBS, OILS, LOTIONS; NON-MEDICATED PREPARATIONS ALL FOR THE CARE OF SKIN, HAIR AND SCALP; NON-MEDICATED SERUMS FOR USE ON HAIR, SCALP, FACE, HANDS, BODY, SKIN; NON-MEDICATED SKIN CARE CREAMS AND LOTIONS; NON-MEDICATED SKIN CARE PREPARATION, NAMELY, BODY MIST; NON-MEDICATED SKIN CARE PREPARATIONS; NON-MEDICATED SKIN CARE PREPARATIONS, NAMELY, CREAMS, LOTIONS, GELS, TONERS, CLEANERS AND PEELS; NON-MEDICATED SKIN CREAM FOR GENERAL SKIN RASH AND IRRITATION RESULTING FROM SKIN SHINGLES; NON-MEDICATED SKIN CREAMS; NON-MEDICATED SKIN CREAMS WITH ESSENTIAL OILS FOR USE IN AROMATHERAPY; NON-MEDICATED SKIN TONERS; NON-MEDICATED STIMULATING LOTIONS FOR THE SKIN; NON-MEDICATED HAIR, SCALP, FACE, HANDS, BODY, SKIN CARE PREPARATIONS; OIL BATHS FOR HAIR CARE; OILS FOR HAIR CONDITIONING; PATCHES CONTAINING SUN SCREEN AND SUN BLOCK FOR USE ON THE SKIN; POMADES FOR HAIR; PREPARATIONS FOR PERMANENT HAIR WAVES; PREPARATIONS FOR SETTING HAIR; PRESSED FACE POWDER; SCENTED BODY SPRAY; SEAWATER-BASED SKIN CARE PREPARATIONS FOR SKIN RENEWAL; SKIN ABRASIVE PREPARATIONS; SKIN BRONZER; SKIN BRONZING CREAMS; SKIN CARE PREPARATION, NAMELY, BODY POLISH; SKIN CARE PREPARATIONS, NAMELY, BODY BALM; SKIN CARE PREPARATIONS, NAMELY, CHEMICAL PEELS FOR SKIN; SKIN CARE PREPARATIONS, NAMELY, FRUIT ACID PEELS FOR SKIN; SKIN CARE PREPARATIONS, NAMELY, SKIN PEELS; SKIN CARE PRODUCTS, NAMELY, NON-MEDICATED SKIN SERUM; SKIN CLARIFIERS; SKIN CLEANSER IN LIQUID SPRAY FORM FOR USE AS A BABY WIPE ALTERNATIVE; SKIN CLEANSERS; SKIN CLEANSING CREAM; SKIN CLEANSING LOTION; SKIN CONDITIONERS; SKIN

**Reg. No. 4,126,856** CONDITIONING CREAMS FOR COSMETIC PURPOSES; SKIN EMOLLIENTS; SKIN FRESHENERS; SKIN GELS FOR ACCELERATING, ENHANCING OR EXTENDING TANS; SKIN LIGHTENERS; SKIN LIGHTENING CREAMS; SKIN MASKS; SKIN MOISTURIZER MASKS; SKIN MOISTURIZING GEL; SKIN POLISHING RICE BRAN (ARAI-NUKA); SKIN SOAP; SKIN TEXTURIZERS; SKIN TONERS; SKIN WHITENING CREAMS; SKIN WHITENING PREPARATIONS; SOAPS FOR BODY CARE; STYLING CLAY FOR HAIR; STYLING FOAM FOR HAIR; STYLING PASTE FOR HAIR; TONING LOTION, FOR THE FACE, BODY AND HANDS; TOPICAL SKIN SPRAYS FOR COSMETIC PURPOSES; WAX FOR REMOVING BODY HAIR; WAX STRIPS FOR REMOVING BODY HAIR; WIPES IMPREGNATED WITH A SKIN CLEANSER; WRINKLE REMOVING SKIN CARE PREPARATIONS, IN CLASS 3 (U.S. CLS. 1, 4, 6, 50, 51 AND 52).

FIRST USE 2-1-2010; IN COMMERCE 5-1-2010.

FOR: HAIR COLOR SALON SERVICES; HAIR SALON SERVICES; HAIR SALON SERVICES, NAMELY, HAIR CUTTING, STYLING, COLORING, AND HAIR EXTENSION SERVICES; HAIR SALON SERVICES, NAMELY, TREATMENTS TO PROTECT HAIR FROM EFFECTS OF EXPOSURE TO SUNLIGHT, HEAT, HUMIDITY AND CHLORINATED WATER; HAIRDRESSING SALONS; PROVIDING INFORMATION ABOUT BEAUTY; PROVIDING NEWS AND INFORMATION IN THE FIELD OF PERSONAL BEAUTY; PROVIDING ON-SITE BEAUTY SERVICES, NAMELY, HAIR STYLING AND MAKE-UP APPLICATION SERVICES; BEAUTY SALON SERVICES; BEAUTY SALONS; BEAUTY SPA SERVICES, NAMELY, COSMETIC BODY CARE; COSMETIC SKIN CARE SERVICES; HYGIENIC AND BEAUTY CARE; MAKING RESERVATIONS AND BOOKINGS FOR OTHERS AT BEAUTY SALONS; MAKING RESERVATIONS AND BOOKINGS FOR OTHERS FOR PHYSICAL AND BEAUTY TREATMENTS AT HEALTH SPAS; MEDICAL, HYGIENIC AND BEAUTY CARE; MEDSPA SERVICES FOR HEALTH AND BEAUTY OF THE BODY AND SPIRIT; NAIL CARE SALONS; SALON SERVICES, NAMELY, FACIALS, MANICURES AND MESSAGES THAT ARE PROVIDED IN A TRAILER OUTFITTED WITH CHAIR, TABLE AND SINK ACCESSORIES; SKIN CARE SALONS; TANNING SALONS , IN CLASS 44 (U.S. CLS. 100 AND 101).

FIRST USE 2-1-2010; IN COMMERCE 5-1-2010.

THE MARK CONSISTS OF A STYLIZED BEAR STANDING ON HIND LEGS HOLDING LARGE OPEN SCISSORS IN HIS PAWS. THE WORDS "ORANGE" AND "BERLIN" STAND TO THE LEFT AND RIGHT OF THE BEAR, RESPECTIVELY. ALL THREE ELEMENTS ARE COLORED IN GRADINGS OF ORANGE.

THE COLOR(S) ORANGE IS/ARE CLAIMED AS A FEATURE OF THE MARK.

SN 85-313,436, FILED 5-5-2011.

ROSELLE HERRERA, EXAMINING ATTORNEY

# United States of America

United States Patent and Trademark Office

## STAGECOACHED

**Reg. No. 4,126,857**

**Registered Apr. 10, 2012**

**Int. Cl.: 42**

**SERVICE MARK**

**PRINCIPAL REGISTER**

STAGECOACHED, LLC (NEW JERSEY LIMITED LIABILITY COMPANY)  
15 COLONIAL RIDGE DR.  
HADDONFIELD, NJ 08033

FOR: TEMPORARY INTERIOR HOME DECORATION CONSULTATION FOR THE PURPOSE OF MAKING THE INTERIOR OF A HOME OR OTHER DWELLING MORE APPEALING TO PROSPECTIVE BUYERS, IN CLASS 42 (U.S. CLS. 100 AND 101).

FIRST USE 10-21-2011; IN COMMERCE 10-21-2011.

THE MARK CONSISTS OF STANDARD CHARACTERS WITHOUT CLAIM TO ANY PARTICULAR FONT, STYLE, SIZE, OR COLOR.

SN 85-314,564, FILED 5-6-2011.

LAKEISHA LEWIS, EXAMINING ATTORNEY



*David J. Kybas*

Director of the United States Patent and Trademark Office

# United States of America

United States Patent and Trademark Office

# GangBucks

**Reg. No. 4,126,858**

**Registered Apr. 10, 2012**

**Int. Cls.: 35 and 42**

**SERVICE MARK**

**PRINCIPAL REGISTER**

GANGBUCKS, LLC (MARYLAND LIMITED LIABILITY COMPANY)  
28 SNOWBERRY COURT  
COCKEYSVILLE, MD 21030

FOR: PROMOTING THE GOODS AND SERVICES OF OTHERS BY PROVIDING A WEBSITE FEATURING COUPONS, REBATES, PRICE-COMPARISON INFORMATION, PRODUCT REVIEWS, LINKS TO THE RETAIL WEBSITES OF OTHERS AND DISCOUNT INFORMATION; PROVIDING ONLINE INFORMATION ABOUT AND MAKING REFERRALS IN THE FIELD OF CONSUMER PRODUCTS AND SERVICES FOR RETAIL SERVICES CONCERNING PRODUCTS, SERVICES, EVENTS, ACTIVITIES, ATTRACTIONS AND FACILITIES IN PARTICULAR GEOGRAPHIC LOCATIONS, IN CLASS 35 (U.S. CLS. 100, 101 AND 102).

FIRST USE 9-22-2011; IN COMMERCE 9-22-2011.

FOR: APPLICATION SERVICE PROVIDER (ASP) FEATURING SOFTWARE FOR USE BY OTHERS IN PROVIDING ONLINE PROMOTIONAL MATTER TO CONSUMERS, NAMELY, COUPONS, REBATES, PRICE-COMPARISON INFORMATION, PRODUCT REVIEWS, LINKS TO THE RETAIL WEBSITES OF OTHERS, DISCOUNT INFORMATION, REFERRALS REGARDING CONSUMER PRODUCTS AND SERVICES, AND INFORMATION REGARDING EVENTS, ACTIVITIES, ATTRACTIONS AND FACILITIES IN PARTICULAR GEOGRAPHIC LOCATIONS, IN CLASS 42 (U.S. CLS. 100 AND 101).

FIRST USE 9-22-2011; IN COMMERCE 9-22-2011.

THE MARK CONSISTS OF STANDARD CHARACTERS WITHOUT CLAIM TO ANY PARTICULAR FONT, STYLE, SIZE, OR COLOR.

SN 85-314,644, FILED 5-6-2011.

STEVEN PEREZ, EXAMINING ATTORNEY



*David J. Kyros*

Director of the United States Patent and Trademark Office

United States of America  
United States Patent and Trademark Office

COLD SHOT

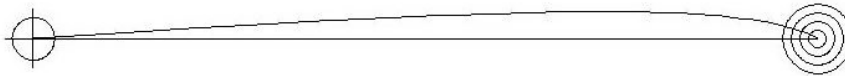

**Reg. No. 4,126,859**

**Registered Apr. 10, 2012**

**Int. Cl.: 13**

**TRADEMARK**

**PRINCIPAL REGISTER**

COLD SHOT LLC (COLORADO LIMITED LIABILITY COMPANY)  
2420 APPLEWOOD CIRCLE  
GRAND JUNCTION, CO 81506

FOR: FIREARM ATTACHMENTS, NAMELY, MOUNTS FOR ATTACHING TRADITIONAL, OPEN, APERTURE, OPTICAL, TELESCOPIC, AND ELECTRONIC SIGHTS TO A FIREARM, IN CLASS 13 (U.S. CLS. 2 AND 9).

FIRST USE 6-15-2011; IN COMMERCE 6-15-2011.

THE MARK CONSISTS OF THE WORDS "COLD SHOT" WITH GUNSIGHT FINE CROSSHAIR IN "O" OF "COLD" AND "SHOT," WITH A GUNSIGHT FINE CROSSHAIR UNDER THE LETTER "C" WITH AN ARCHING LINE AND A STRAIGHT LINE CONNECTING THE CENTER OF THE CROSSHAIR TO CENTER OF TARGET UNDER THE LETTERS "O" AND "T" OF "SHOT".

SN 85-314,649, FILED 5-6-2011.

TRACY FLETCHER, EXAMINING ATTORNEY



*David J. Kyros*

Director of the United States Patent and Trademark Office

# United States of America

United States Patent and Trademark Office

## PARK & BOND

**Reg. No. 4,126,860**

GILT GROUPE, INC. (DELAWARE CORPORATION)  
2 PARK AVENUE, 4TH FLOOR  
NEW YORK, NY 10016

**Registered Apr. 10, 2012**

**Int. Cl.: 45**

FOR: PROVIDING A WEBSITE FEATURING INFORMATION ABOUT MEN'S LIFESTYLE,  
IN CLASS 45 (U.S. CLS. 100 AND 101).

**SERVICE MARK**

FIRST USE 8-8-2011; IN COMMERCE 8-8-2011.

**PRINCIPAL REGISTER**

THE MARK CONSISTS OF STANDARD CHARACTERS WITHOUT CLAIM TO ANY PAR-  
TICULAR FONT, STYLE, SIZE, OR COLOR.

SN 85-315,333, FILED 5-9-2011.

SUE LAWRENCE, EXAMINING ATTORNEY



*David J. Kybas*

Director of the United States Patent and Trademark Office

# United States of America

United States Patent and Trademark Office

## BLACK MUMBA

**Reg. No. 4,126,861**

YZY INC (FLORIDA CORPORATION)

**Registered Apr. 10, 2012**

6300 NW 72ND AVENUE  
MIAMI, FL 33166

**Int. Cl.: 3**

FOR: COLOGNES, PERFUMES AND COSMETICS; EAU DE TOILETTE AND EAU DE COLOGNE; PERFUMES, EAU DE COLOGNES AND AFTERSHAVES, IN CLASS 3 (U.S. CLS. 1, 4, 6, 50, 51 AND 52).

**TRADEMARK**

FIRST USE 11-21-2011; IN COMMERCE 11-21-2011.

**PRINCIPAL REGISTER**

THE MARK CONSISTS OF STANDARD CHARACTERS WITHOUT CLAIM TO ANY PARTICULAR FONT, STYLE, SIZE, OR COLOR.

SN 85-316,088, FILED 5-9-2011.

MICHAEL SOUDERS, EXAMINING ATTORNEY



*David J. Kyffers*

Director of the United States Patent and Trademark Office



# United States of America

United States Patent and Trademark Office

## Fruit Shack Smoothies & Yogurt

**Reg. No. 4,126,862**

OFF AIR VENTURES, INC. (ARIZONA CORPORATION)  
2371 E SKIPPING ROCK WAY  
ORO VALLEY, AZ 85737

**Registered Apr. 10, 2012**

**Int. Cl.: 43**

FOR: RESTAURANT SERVICES FEATURING SMOOTHIES, FROZEN YOGURT, PRETZELS, SALADS AND SANDWICHES, IN CLASS 43 (U.S. CLS. 100 AND 101).

**SERVICE MARK**

FIRST USE 7-8-2011; IN COMMERCE 7-8-2011.

**PRINCIPAL REGISTER**

THE MARK CONSISTS OF STANDARD CHARACTERS WITHOUT CLAIM TO ANY PARTICULAR FONT, STYLE, SIZE, OR COLOR.

NO CLAIM IS MADE TO THE EXCLUSIVE RIGHT TO USE "FRUIT" AND "SMOOTHIES & YOGURT", APART FROM THE MARK AS SHOWN.

SN 85-317,354, FILED 5-10-2011.

JOHN E. MICHOS, EXAMINING ATTORNEY



*David J. Kyfos*

Director of the United States Patent and Trademark Office

# United States of America

United States Patent and Trademark Office



**Reg. No. 4,126,863**

**Registered Apr. 10, 2012**

**Int. Cl.: 29**

**TRADEMARK**

**PRINCIPAL REGISTER**

BIG IDEA HOLDINGS, LLC (DELAWARE LIMITED LIABILITY COMPANY)  
900 WORK STREET  
SALINAS, CA 93901

FOR: PACKAGED PROCESSED FRESH VEGETABLES, IN CLASS 29 (U.S. CL. 46).

FIRST USE 4-23-2011; IN COMMERCE 4-23-2011.

NO CLAIM IS MADE TO THE EXCLUSIVE RIGHT TO USE "POWER GREENS" , APART FROM THE MARK AS SHOWN.

THE COLOR(S) RED, YELLOW, WHITE AND BLACK IS/ARE CLAIMED AS A FEATURE OF THE MARK.

THE MARK CONSISTS OF THE WORDING "POWER GREENS!" IN STYLIZED LETTERING. THE TERM "POWER" APPEARS IN WHITE WITH A BLACK OUTLINE, AND THE WORDING "GREENS!" APPEARS IN BLACK. A RED AND WHITE COMIC BLAST DESIGN APPEARS BEHIND THE WORD "POWER." THE COMIC BLAST DESIGN IS FORMED BY A RED IRREGULARLY SHAPED OVAL HAVING SCALLOPED EDGES WITH IRREGULARLY PLACED WHITE AND RED BORDERS. THREE ARROWHEADS IN YELLOW WITH A BLACK OUTLINE APPEAR ABOVE THE WORD "POWER", AND TWO ARROWHEADS IN YELLOW WITH A BLACK OUTLINE APPEAR BELOW THE WORD "POWER".

SN 85-317,453, FILED 5-10-2011.

DEBRA LEE, EXAMINING ATTORNEY



*David J. Kybas*

Director of the United States Patent and Trademark Office

# United States of America

United States Patent and Trademark Office

# THERAPYDIA

**Reg. No. 4,126,864**

THERAPYDIA, INC. (DELAWARE CORPORATION)  
18 E. BLITHDALE AVE, SUITE 21  
MILL VALLEY, CA 94941

**Registered Apr. 10, 2012**

**Int. Cl.: 45**

FOR: ONLINE SOCIAL NETWORKING IN THE FIELD OF PHYSICAL THERAPY, IN CLASS 45 (U.S. CLS. 100 AND 101).

**SERVICE MARK**

FIRST USE 8-1-2011; IN COMMERCE 8-1-2011.

**PRINCIPAL REGISTER**

THE MARK CONSISTS OF STANDARD CHARACTERS WITHOUT CLAIM TO ANY PARTICULAR FONT, STYLE, SIZE, OR COLOR.

SN 85-318,088, FILED 5-11-2011.

WARREN L. OLANDRIA, EXAMINING ATTORNEY



*David J. Kyros*

Director of the United States Patent and Trademark Office

# United States of America

United States Patent and Trademark Office

YOU ARE LOVE. PASS IT ON.

**Reg. No. 4,126,865**

**Registered Apr. 10, 2012**

**Int. Cl.: 14**

**TRADEMARK**

**PRINCIPAL REGISTER**

AMY CONWAY STUDIO LLC (NEW MEXICO LIMITED LIABILITY COMPANY)  
1012 MARQUEZ PLACE #104B  
SANTA FE, NM 87505

FOR: BRACELETS; EARRINGS; JEWELRY CHAINS; JEWELRY, NAMELY, ARM CUFFS;  
MEDALLIONS; NECKLACES; PENDANTS; RINGS, IN CLASS 14 (U.S. CLS. 2, 27, 28 AND  
50).

FIRST USE 11-17-2011; IN COMMERCE 11-17-2011.

THE MARK CONSISTS OF STANDARD CHARACTERS WITHOUT CLAIM TO ANY PAR-  
TICULAR FONT, STYLE, SIZE, OR COLOR.

SN 85-318,212, FILED 5-11-2011.

ERIN FALK, EXAMINING ATTORNEY



*David J. Kybas*

Director of the United States Patent and Trademark Office

# United States of America

United States Patent and Trademark Office

## FREEDOM II

**Reg. No. 4,126,866**

SAN ANTONIO LIGHTHOUSE (TEXAS NON-PROFIT CORPORATION)  
2305 ROOSEVELT AVENUE  
SAN ANTONIO, TX 78210

**Registered Apr. 10, 2012**

**Int. Cl.: 16**

FOR: WRITING INSTRUMENTS, IN CLASS 16 (U.S. CLS. 2, 5, 22, 23, 29, 37, 38 AND 50).

**TRADEMARK**

FIRST USE 8-22-2011; IN COMMERCE 8-22-2011.

**PRINCIPAL REGISTER**

THE MARK CONSISTS OF STANDARD CHARACTERS WITHOUT CLAIM TO ANY PARTICULAR FONT, STYLE, SIZE, OR COLOR.

SN 85-318,523, FILED 5-11-2011.

BARBARA BROWN, EXAMINING ATTORNEY



*David J. Kyffers*

Director of the United States Patent and Trademark Office

# United States of America

United States Patent and Trademark Office

## PEARANORMAL ACTIVITY

**Reg. No. 4,126,867**

**Registered Apr. 10, 2012**

**Int. Cl.: 3**

**TRADEMARK**

**PRINCIPAL REGISTER**

BURT'S BEES, INC. (DELAWARE CORPORATION)  
701 DISTRIBUTION DRIVE  
DURHAM, NC 27709

FOR: BODY LOTIONS; BODY WASH; HAIR SHAMPOOS AND CONDITIONERS; HAND CREAMS; HAND SOAPS; NON-MEDICATED SKIN CARE PREPARATION, NAMELY, BODY MIST; PERFUME; SHOWER GELS, IN CLASS 3 (U.S. CLS. 1, 4, 6, 50, 51 AND 52).

FIRST USE 11-16-2011; IN COMMERCE 11-16-2011.

THE MARK CONSISTS OF STANDARD CHARACTERS WITHOUT CLAIM TO ANY PARTICULAR FONT, STYLE, SIZE, OR COLOR.

SN 85-319,796, FILED 5-12-2011.

JOHN DWYER, EXAMINING ATTORNEY



*David J. Kyros*

Director of the United States Patent and Trademark Office

# United States of America

United States Patent and Trademark Office

## POINT BRIDGE REALTY ADVISORS

**Reg. No. 4,126,868**

**Registered Apr. 10, 2012**

**Int. Cl.: 36**

**SERVICE MARK**

**PRINCIPAL REGISTER**

POINT BRIDGE REALTY ADVISORS, LLC (PENNSYLVANIA LIMITED LIABILITY COMPANY)  
911 SEWICKLEY HEIGHTS DRIVE  
SEWICKLEY, PA 15143

FOR: REAL ESTATE CONSULTING, ADVISORY, INVESTMENT, AND BROKERAGE SERVICES, IN CLASS 36 (U.S. CLS. 100, 101 AND 102).

FIRST USE 10-11-2011; IN COMMERCE 10-11-2011.

THE MARK CONSISTS OF STANDARD CHARACTERS WITHOUT CLAIM TO ANY PARTICULAR FONT, STYLE, SIZE, OR COLOR.

NO CLAIM IS MADE TO THE EXCLUSIVE RIGHT TO USE "REALTY ADVISORS", APART FROM THE MARK AS SHOWN.

SN 85-320,026, FILED 5-13-2011.

MATTHEW PAPPAS, EXAMINING ATTORNEY



*David J. Kyffers*

Director of the United States Patent and Trademark Office

# United States of America

United States Patent and Trademark Office

## SLENDER SHAPES

**Reg. No. 4,126,869**

ROUSSO APPAREL GROUP INC. (NEW YORK CORPORATION)  
1407 BROADWAY, SUITE 1602  
NEW YORK, NY 10018

**Registered Apr. 10, 2012**

**Int. Cl.: 25**

FOR: CLOTHING, NAMELY, WOMEN'S TOPS, BLOUSES, SHORTS AND PANTS, IN CLASS 25 (U.S. CLS. 22 AND 39).

**TRADEMARK**

FIRST USE 11-30-2011; IN COMMERCE 11-30-2011.

**PRINCIPAL REGISTER**

THE MARK CONSISTS OF STANDARD CHARACTERS WITHOUT CLAIM TO ANY PARTICULAR FONT, STYLE, SIZE, OR COLOR.

SN 85-320,542, FILED 5-13-2011.

KAPIL BHANOT, EXAMINING ATTORNEY



*David J. Kybas*

Director of the United States Patent and Trademark Office



# United States of America

United States Patent and Trademark Office

# HataBoix

**Reg. No. 4,126,870**

HATABOIX, LLC (FLORIDA LIMITED LIABILITY COMPANY)  
850 GRAND HARBOUR EAST  
MIRAMAR BEACH, FL 32550

**Registered Apr. 10, 2012**

**Int. Cl.: 25**

FOR: HEADGEAR, NAMELY, VISORS, HATS, AND CAPS; SHIRTS, IN CLASS 25 (U.S. CLS. 22 AND 39).

**TRADEMARK**

FIRST USE 7-1-2011; IN COMMERCE 9-1-2011.

**PRINCIPAL REGISTER**

THE MARK CONSISTS OF STANDARD CHARACTERS WITHOUT CLAIM TO ANY PARTICULAR FONT, STYLE, SIZE, OR COLOR.

SN 85-320,587, FILED 5-13-2011.

EMILY CARLSEN, EXAMINING ATTORNEY



*David J. Kyffers*

Director of the United States Patent and Trademark Office

# United States of America

United States Patent and Trademark Office

## Proud To Be A New Mexican Where The Chips And Salsa Are Free

**Reg. No. 4,126,871**

MARTINEZ, SUZZANNA M (UNITED STATES INDIVIDUAL)  
6700 W. 11TH AVENUE, #207  
LAKEWOOD, CO 80214

**Registered Apr. 10, 2012**

**Int. Cls.: 21 and 25**

FOR: BEER MUGS; COFFEE CUPS, TEA CUPS AND MUGS; COFFEE MUGS; CUPS AND MUGS; DRINKING FLASKS; DRINKING FLASKS; DRINKING GLASSES; DRINKING GLASSES, NAMELY, TUMBLERS; DRINKING STEINS; EARTHENWARE MUGS; GLASS BEVERAGeware; GLASS CARAFES; GLASS MUGS; GLASS STORAGE JARS; MUGS; PILSNER DRINKING GLASSES; PORCELAIN MUGS; SHOT GLASSES, IN CLASS 21 (U.S. CLS. 2, 13, 23, 29, 30, 33, 40 AND 50).

**TRADEMARK**

**PRINCIPAL REGISTER**

FIRST USE 8-21-2011; IN COMMERCE 8-21-2011.

FOR: ATHLETIC APPAREL, NAMELY, SHIRTS, PANTS, JACKETS, FOOTWEAR, HATS AND CAPS, ATHLETIC UNIFORMS; BASEBALL CAPS AND HATS; HOODED SWEATSHIRTS; SHORT-SLEEVED OR LONG-SLEEVED T-SHIRTS; SPORTS CAPS AND HATS; SWEATSHIRTS; T-SHIRTS; WOOLLY HATS, IN CLASS 25 (U.S. CLS. 22 AND 39).

FIRST USE 8-21-2011; IN COMMERCE 8-21-2011.

THE MARK CONSISTS OF STANDARD CHARACTERS WITHOUT CLAIM TO ANY PARTICULAR FONT, STYLE, SIZE, OR COLOR.

SN 85-321,323, FILED 5-15-2011.

WARREN L. OLANDRIA, EXAMINING ATTORNEY



*David J. Kyros*

Director of the United States Patent and Trademark Office

# United States of America

United States Patent and Trademark Office

## MINDSLINGER

**Reg. No. 4,126,872**

**Registered Apr. 10, 2012**

**Int. Cl.: 9**

**TRADEMARK**

**PRINCIPAL REGISTER**

BACKSHACK PRODUCTIONS (CALIFORNIA SOLE PROPRIETORSHIP)  
APARTMENT 8  
7605 WEST MANCHESTER AVE.  
PLAYA DEL REY, CA 90293

FOR: COMPUTER GAME PROGRAMS; COMPUTER GAME SOFTWARE; COMPUTER GAME SOFTWARE FOR USE ON MOBILE AND CELLULAR PHONES; INTERACTIVE VIDEO GAME PROGRAMS, IN CLASS 9 (U.S. CLS. 21, 23, 26, 36 AND 38).

FIRST USE 12-1-2011; IN COMMERCE 12-1-2011.

THE MARK CONSISTS OF STANDARD CHARACTERS WITHOUT CLAIM TO ANY PARTICULAR FONT, STYLE, SIZE, OR COLOR.

SN 85-321,329, FILED 5-15-2011.

PAUL E. FAHRENKOPF, EXAMINING ATTORNEY



*David J. Kyffers*

Director of the United States Patent and Trademark Office

# United States of America

United States Patent and Trademark Office

## NEVER ENDING LOW PRICES

**Reg. No. 4,126,873**

ALDI INC. (ILLINOIS CORPORATION)  
1200 N. KIRK ROAD  
BATAVIA, IL 60510

**Registered Apr. 10, 2012**

**Int. Cl.: 35**

FOR: RETAIL GROCERY STORES AND SUPERMARKETS, IN CLASS 35 (U.S. CLS. 100, 101 AND 102).

**SERVICE MARK**

FIRST USE 6-1-2011; IN COMMERCE 6-1-2011.

**PRINCIPAL REGISTER**

THE MARK CONSISTS OF STANDARD CHARACTERS WITHOUT CLAIM TO ANY PARTICULAR FONT, STYLE, SIZE, OR COLOR.

SN 85-321,580, FILED 5-16-2011.

FRANK LATTUCA, EXAMINING ATTORNEY



*David J. Kyffers*

Director of the United States Patent and Trademark Office

# United States of America

United States Patent and Trademark Office



**Reg. No. 4,126,874**

ALDI INC. (ILLINOIS CORPORATION)  
1200 N. KIRK ROAD  
BATAVIA, IL 60510

**Registered Apr. 10, 2012**

**Int. Cl.: 35**

FOR: RETAIL GROCERY STORES AND SUPERMARKETS, IN CLASS 35 (U.S. CLS. 100, 101 AND 102).

**SERVICE MARK**

FIRST USE 6-1-2011; IN COMMERCE 6-1-2011.

**PRINCIPAL REGISTER**

THE MARK CONSISTS OF AN ARROW DESIGN.

SN 85-321,617, FILED 5-16-2011.

FRANK LATTUCA, EXAMINING ATTORNEY



*David J. Kyffers*

Director of the United States Patent and Trademark Office

# United States of America

United States Patent and Trademark Office

BACON | FARMER | WORKMAN

**Reg. No. 4,126,875**

**Registered Apr. 10, 2012**

**Int. Cl.: 42**

BACON FARMER WORKMAN ENGINEERING & TESTING, INC. (KENTUCKY CORPORATION)  
P.O. BOX 120  
500 SOUTH 17TH STREET  
PADUCAH, KY 420020120

**SERVICE MARK**

FOR: CONDUCTING ENGINEERING SURVEYS; ENGINEERING, IN CLASS 42 (U.S. CLS. 100 AND 101).

**PRINCIPAL REGISTER**

FIRST USE 9-1-2011; IN COMMERCE 9-1-2011.

THE MARK CONSISTS OF STANDARD CHARACTERS WITHOUT CLAIM TO ANY PARTICULAR FONT, STYLE, SIZE, OR COLOR.

SN 85-321,691, FILED 5-16-2011.

BRENDAN MCCAULEY, EXAMINING ATTORNEY



*David J. Kyffers*

Director of the United States Patent and Trademark Office

# United States of America

United States Patent and Trademark Office



NEVER  
ENDING  
LOW PRICES

**Reg. No. 4,126,876**

ALDI INC. (ILLINOIS CORPORATION)  
1200 N. KIRK ROAD  
BATAVIA, IL 60510

**Registered Apr. 10, 2012**

**Int. Cl.: 35**

FOR: RETAIL GROCERY STORES AND SUPERMARKETS, IN CLASS 35 (U.S. CLS. 100, 101 AND 102).

**SERVICE MARK**

FIRST USE 6-1-2011; IN COMMERCE 6-1-2011.

**PRINCIPAL REGISTER**

THE MARK CONSISTS OF "NEVER ENDING LOW PRICES" APPEARING WITHIN AN ARROW DESIGN.

SN 85-321,808, FILED 5-16-2011.

FRANK LATTUCA, EXAMINING ATTORNEY



*David J. Kyffers*

Director of the United States Patent and Trademark Office

# United States of America

United States Patent and Trademark Office

## EXTENDED MOISTURE

**Reg. No. 4,126,877**

BEIERSDORF AG (FED REP GERMANY JOINT STOCK COMPANY)  
UNNASTRASSE 48

**Registered Apr. 10, 2012**

HAMBURG, FED REP GERMANY 20253

**Int. Cl.: 3**

FOR: COSMETIC PREPARATIONS FOR SKIN CARE, IN CLASS 3 (U.S. CLS. 1, 4, 6, 50, 51 AND 52).

**TRADEMARK**

FIRST USE 12-15-2011; IN COMMERCE 12-15-2011.

**PRINCIPAL REGISTER**

THE MARK CONSISTS OF STANDARD CHARACTERS WITHOUT CLAIM TO ANY PARTICULAR FONT, STYLE, SIZE, OR COLOR.

NO CLAIM IS MADE TO THE EXCLUSIVE RIGHT TO USE "MOISTURE", APART FROM THE MARK AS SHOWN.

SN 85-322,118, FILED 5-16-2011.

MICHAEL TANNER, EXAMINING ATTORNEY



*David J. Kyffers*

Director of the United States Patent and Trademark Office



# United States of America

United States Patent and Trademark Office



## POINT BRIDGE

REALTY ADVISORS, LLC

**Reg. No. 4,126,878**

**Registered Apr. 10, 2012**

**Int. Cl.: 36**

**SERVICE MARK**

**PRINCIPAL REGISTER**

POINT BRIDGE REALTY ADVISORS, LLC (PENNSYLVANIA LIMITED LIABILITY COMPANY)  
911 SEWICKLEY HEIGHTS DRIVE  
SEWICKLEY, PA 15143

FOR: REAL ESTATE CONSULTING, ADVISORY, INVESTMENT, AND BROKERAGE SERVICES, IN CLASS 36 (U.S. CLS. 100, 101 AND 102).

FIRST USE 10-11-2011; IN COMMERCE 10-11-2011.

NO CLAIM IS MADE TO THE EXCLUSIVE RIGHT TO USE "REALTY ADVISORS, LLC", APART FROM THE MARK AS SHOWN.

THE MARK CONSISTS OF AN IMAGE OF A SUSPENSION BRIDGE WITHIN AN OTHERWISE SHADED SQUARE AT THE TOP OF THE MARK, WITH THE WORDS "POINT BRIDGE" IN ALL CAPITAL LETTERS UNDER THE IMAGE AND THE WORDS "REALTY ADVISORS, LLC" IN SMALLER ALL CAPITAL LETTERS UNDER THE WORDS "POINT BRIDGE".

SN 85-322,605, FILED 5-17-2011.

MATTHEW PAPPAS, EXAMINING ATTORNEY



*David J. Kappas*

Director of the United States Patent and Trademark Office

# United States of America

United States Patent and Trademark Office

## GIGGLEDEALS

**Reg. No. 4,126,879**

**Registered Apr. 10, 2012**

**Int. Cl.: 35**

**SERVICE MARK**

**PRINCIPAL REGISTER**

GIGGLE, INC. (DELAWARE CORPORATION)  
158 WEST 27TH STREET, 8TH FLOOR  
NEW YORK, NY 10001

FOR: ON-LINE RETAIL STORE SERVICES FEATURING INFANTS' AND CHILDREN'S FURNITURE, CLOTHING, BEDDING, BLANKETS AND THROWS, BOOKS, TOYS, CAR SEATS, STROLLERS, DIAPER BAGS, INFANT CARE PRODUCTS, HOUSEHOLD CLEANING PRODUCTS, LAUNDRY DETERGENT AND FABRIC SOFTENERS, ELECTRONICS, STATIONERY, AND NOTE CARDS, GIFTS, JEWELRY, AND FOOD, IN CLASS 35 (U.S. CLS. 100, 101 AND 102).

FIRST USE 7-0-2011; IN COMMERCE 7-0-2011.

THE MARK CONSISTS OF STANDARD CHARACTERS WITHOUT CLAIM TO ANY PARTICULAR FONT, STYLE, SIZE, OR COLOR.

OWNER OF U.S. REG. NOS. 3,122,969, 3,939,046, AND OTHERS.

SN 85-323,010, FILED 5-17-2011.

GIANCARLO CASTRO, EXAMINING ATTORNEY



*David J. Kyffers*

Director of the United States Patent and Trademark Office

# United States of America

United States Patent and Trademark Office

## CLEANING UP OUR WORLD ONE BID AT A TIME

**Reg. No. 4,126,880**

**Registered Apr. 10, 2012**

**Int. Cl.: 35**

**SERVICE MARK**

**PRINCIPAL REGISTER**

ENTRAMCORP (FLORIDA CORPORATION)  
C4-310  
24123 PEACHLAND BLVD  
PORT CHARLOTTE, FL 33954

FOR: PROVIDING A WEB SITE WHEREBY BUYERS OF GOODS OR SERVICES LOCATE AND RECEIVE QUOTATIONS FROM MULTIPLE COMPETITIVE SOURCES AND SELLERS OF GOODS OR SERVICES IDENTIFY AND BID ON MULTIPLE NEW SALES OPPORTUNITIES, IN CLASS 35 (U.S. CLS. 100, 101 AND 102).

FIRST USE 3-10-2011; IN COMMERCE 3-10-2011.

THE MARK CONSISTS OF STANDARD CHARACTERS WITHOUT CLAIM TO ANY PARTICULAR FONT, STYLE, SIZE, OR COLOR.

SN 85-323,183, FILED 5-17-2011.

TRACY FLETCHER, EXAMINING ATTORNEY



*David J. Kyffers*

Director of the United States Patent and Trademark Office

# United States of America

United States Patent and Trademark Office

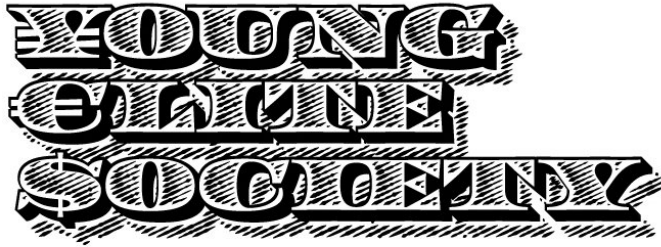

**Reg. No. 4,126,881**

**Registered Apr. 10, 2012**

**Int. Cl.: 25**

**TRADEMARK**

**PRINCIPAL REGISTER**

SEI SHIMURA (JAPAN INDIVIDUAL), DBA YOUNG ELITE SOCIETY,  
6220 CANTERBURY DR. #312  
CULVER CITY, CA 90230

FOR: A-SHIRTS; ANKLE SOCKS; ANKLETS; ANTI-PERSPIRANT SOCKS; APPAREL FOR DANCERS, NAMELY, TEE SHIRTS, SWEATSHIRTS, PANTS, LEGGINGS, SHORTS AND JACKETS; ATHLETIC APPAREL, NAMELY, SHIRTS, PANTS, JACKETS, FOOTWEAR, HATS AND CAPS, ATHLETIC UNIFORMS; BALLOON PANTS; BASEBALL CAPS; BASEBALL CAPS AND HATS; BATHING CAPS; BED JACKETS; BELTS; BELTS FOR CLOTHING; BELTS MADE FROM IMITATION LEATHER; BELTS MADE OF LEATHER; BELTS MADE OUT OF CLOTH; BELTS OF TEXTILE; BELTS THAT ARE DESIGNED TO ACCOMMODATE PREGNANCY SIZE CHANGES; BODY SHIRTS; BOMBER JACKETS; BRIEFS; BUCKET CAPS; BUTTON DOWN SHIRTS; BUTTON-FRONT ALOHA SHIRTS; CAMOUFLAGE JACKETS; CAMOUFLAGE PANTS; CAMOUFLAGE SHIRTS; CAMP SHIRTS; CAP PEAKS; CAP VISORS; CAPRI PANTS; CAPS; CAPS WITH VISORS; CARGO PANTS; CHEF'S HATS; CLOTHING FOR ATHLETIC USE, NAMELY, PADDED PANTS; CLOTHING FOR ATHLETIC USE, NAMELY, PADDED SHIRTS; CLOTHING FOR BABIES, TODDLERS AND CHILDREN, TREATED WITH FIRE AND HEAT RETARDANTS, NAMELY, PAJAMAS, JACKETS, SHIRTS, PANTS, JUMPERS; CLOTHING SHIELDS, NAMELY, PADS APPLIED TO THE UNDERARMS OF SHIRTS, BLOUSES AND SWEATERS; COATS OF DENIM; COLLARED SHIRTS; CREW NECK SWEATERS; CROP PANTS; DENIM JACKETS; DENIMS; DISPOSABLE UNDERWEAR; DOWN JACKETS; DRESS PANTS; DRESS SHIRTS; FABRIC BELTS; FISHERMEN'S JACKETS; FISHING SHIRTS; FLOOD PANTS; FUR COATS AND JACKETS; FUR HATS; FUR JACKETS; GARTER BELTS; GOLF CAPS; GOLF PANTS, SHIRTS AND SKIRTS; GOLF SHIRTS; GYM PANTS; HAT BANDS; HATS; HATS FOR INFANTS, BABIES, TODDLERS AND CHILDREN; HEAVY JACKETS; HOODED SWEAT SHIRTS; HUNTING JACKETS; HUNTING PANTS; HUNTING SHIRTS; JACKET LINERS; JACKETS; JACKETS AND SOCKS; JAPANESE STYLE SOCKS (TABI COVERS); JAPANESE STYLE SOCKS (TABI); JEANS; JEGGINGS, NAMELY, PANTS THAT ARE PARTIALLY JEANS AND PARTIALLY LEGGINGS; JOGGING PANTS; KNIT JACKETS; KNIT SHIRTS; KNITTED CAPS; KNITTED UNDERWEAR; KNOT CAPS; KNOTTED CAPS; LADIES' UNDERWEAR; LEATHER BELTS; LEATHER HATS; LEATHER JACKETS; LEATHER PANTS; LEATHER SHIRTS; LEG SHIELDING DEVICE, ATTACHABLE TO AND DETACHABLE FROM A PERSON'S PANTS, COMPRISED OF PADDING TO SHIELD THE LEGS FROM FLYING DEBRIS WHEN MOWING WITH A STRING TRIMMER; LIGHT-REFLECTING JACKETS; LONG JACKETS; LONG UNDERWEAR; LONG-SLEEVED SHIRTS; LOUNGE PANTS; MEN'S AND WOMEN'S JACKETS, COATS, TROUSERS, VESTS; MEN'S DRESS SOCKS; MEN'S SOCKS; MEN'S UNDERWEAR; MOCK TURTLE-NECK SWEATERS;



*David J. Kybas*

Director of the United States Patent and Trademark Office

**Reg. No. 4,126,881** MOISTURE-WICKING SPORTS PANTS; MOISTURE-WICKING SPORTS SHIRTS; MONEY BELTS; MOTORCYCLE JACKETS; NIGHT SHIRTS; NON-DISPOSABLE CLOTH TRAINING PANTS; NON-SLIP SOCKS; NURSE PANTS; OPEN-NECKED SHIRTS; OUTER JACKETS; OVER SHIRTS; PADDED JACKETS; PADDING JACKETS; PANTS; PAPER HATS FOR USE AS CLOTHING ITEMS; PAPER SHOES USED WHEN GOING THROUGH METAL DETECTORS TO KEEP FEET AND SOCKS CLEAN; PARTS OF CLOTHING, NAMELY, GUSSETS FOR TIGHTS, GUSSETS FOR STOCKINGS, GUSSETS FOR BATHING SUITS, GUSSETS FOR UNDERWEAR, GUSSETS FOR LEOTARDS AND GUSSETS FOR FOOTLETS; PARTY HATS; PERSPIRATION ABSORBENT STRAP TO BE USED IN THE BILL OF A HAT; PERSPIRATION ABSORBENT UNDERWEAR CLOTHING; PETTI-PANTS; PIQUE SHIRTS; POLO SHIRTS; RACE NUMBER BELTS THAT HOLD A PAPER NUMBER ON THE RACE PARTICIPANT'S FRONT OR BACK DURING COMPETITION; RAIN HATS; RAIN JACKETS; RAINPROOF JACKETS; REVERSIBLE JACKETS; RUGBY SHIRTS; SCARFS; SCIENTIFIC AND TECHNOLOGICAL APPAREL, NAMELY, SHIRTS, PANTS, JACKETS, FOOTWEAR, HATS AND CAPS, UNIFORMS; SEDGE HATS (SUGE-GASA); SHELL JACKETS; SHIRT FRONTS; SHIRT INSERTS, NAMELY, DICKIES; SHIRT YOKES; SHIRTS; SHIRTS AND SHORT-SLEEVED SHIRTS; SHIRTS AND SLIPS; SHIRTS FOR INFANTS, BABIES, TODDLERS AND CHILDREN; SHIRTS FOR SUITS; SHORT-SLEEVED OR LONG-SLEEVED T-SHIRTS; SHORT-SLEEVED SHIRTS; SHOWER CAPS; SKI JACKETS; SKI PANTS; SKULL CAPS; SLEEP PANTS; SLEEP SHIRTS; SLEEVED OR SLEEVELESS JACKETS; SLEEVES WORN SEPARATE AND APART FROM BLOUSES, SHIRTS AND OTHER TOPS; SLIPPER SOCKS; SMALL HATS; SMOKING JACKETS; SNAP CROTCH SHIRTS FOR INFANTS AND TODDLERS; SNOW PANTS; SNOWBOARD JACKETS; SNOWBOARD PANTS; SOCK SUSPENDERS; SOCKS; SOCKS AND STOCKINGS; SPORT SHIRTS; SPORTS CAPS AND HATS; SPORTS JACKETS; SPORTS PANTS; SPORTS SHIRTS; SPORTS SHIRTS WITH SHORT SLEEVES; STRETCH PANTS; STUFF JACKETS; SUEDE JACKETS; SUSPENDER BELTS; SUSPENDER BELTS FOR MEN; SUSPENDER BELTS FOR WOMEN; SWEAT JACKETS; SWEAT PANTS; SWEAT SHIRTS; SWEATERS; T-SHIRTS; TAP PANTS; TEE SHIRTS; THERMAL SOCKS; THERMAL UNDERWEAR; THONGS; TOBOGGAN HATS, PANTS AND CAPS; TOE CAPS; TRACK JACKETS; TRACK PANTS; TRAVEL CLOTHING CONTAINED IN A PACKAGE COMPRISING REVERSIBLE JACKETS, PANTS, SKIRTS, TOPS AND A BELT OR SCARF; TRIATHLON CLOTHING, NAMELY, TRIATHLON TIGHTS, TRIATHLON SHORTS, TRIATHLON SINGLET, TRIATHLON SHIRTS, TRIATHLON SUITS; TURTLE NECK SHIRTS; TURTLENECK SWEATERS; TUXEDO BELTS; UNDERWEAR; UNDERWEAR, NAMELY, BOY SHORTS; V-NECK SWEATERS; WAIST BELTS; WATER SOCKS; WATER-PROOF JACKETS AND PANTS; WEARABLE GARMENTS AND CLOTHING, NAMELY, SHIRTS; WIND PANTS; WIND RESISTANT JACKETS; WIND SHIRTS; WIND-JACKETS; WOMEN'S CLOTHING, NAMELY, SHIRTS, DRESSES, SKIRTS, BLOUSES; WOMEN'S HATS AND HOODS; WOMEN'S UNDERWEAR; WOOLLEN SOCKS, IN CLASS 25 (U.S. CLS. 22 AND 39).

FIRST USE 11-11-2011; IN COMMERCE 12-2-2011.

THE MARK CONSISTS OF THE WORDING "YOUNG ELITE SOCIETY" CONSISTING OF A YEN CURRENCY SYMBOL, EURO CURRENCY SYMBOL, AND DOLLAR SYMBOL IN A STYLIZED LETTERING WITH A THREE DIMENSIONAL EXTRUSION AND DROP SHADOW, WITH A STYLIZED DESIGN ELEMENT INSPIRED BY THE LETTERS "Y", "E", AND "S".

SN 85-323,475, FILED 5-18-2011.

KAPIL BHANOT, EXAMINING ATTORNEY

# United States of America

United States Patent and Trademark Office

## make money sharing stuff

**Reg. No. 4,126,882**

**Registered Apr. 10, 2012**

**Int. Cl.: 35**

**SERVICE MARK**

**PRINCIPAL REGISTER**

POWEROVOICE, LLC (MICHIGAN LIMITED LIABILITY COMPANY)  
176 N. OLD WOODWARD AVE.  
BIRMINGHAM, MI 48009

FOR: ADVERTISING AND MARKETING SERVICES PROVIDED BY MEANS OF INDIRECT METHODS OF MARKETING COMMUNICATIONS, NAMELY, SOCIAL MEDIA, SEARCH ENGINE MARKETING, INQUIRY MARKETING, INTERNET MARKETING, MOBILE MARKETING, BLOGGING AND OTHER FORMS OF PASSIVE, SHARABLE OR VIRAL COMMUNICATIONS CHANNELS; CONSULTING SERVICES IN THE FIELD OF INTERNET MARKETING; INTERNET ADVERTISING SERVICES, IN CLASS 35 (U.S. CLS. 100, 101 AND 102).

FIRST USE 1-1-2012; IN COMMERCE 1-1-2012.

THE MARK CONSISTS OF STANDARD CHARACTERS WITHOUT CLAIM TO ANY PARTICULAR FONT, STYLE, SIZE, OR COLOR.

SN 85-323,801, FILED 5-18-2011.

FLORENTINA BLANDU, EXAMINING ATTORNEY



*David J. Kyffers*

Director of the United States Patent and Trademark Office

# United States of America

United States Patent and Trademark Office

## I AM GAME RECRUITING

**Reg. No. 4,126,883**

ANETTS, ANNE (AUSTRALIA INDIVIDUAL)  
15 MACGILLIVRAY STREET  
YARRALUMLA, AUSTRALIA

**Registered Apr. 10, 2012**

**Int. Cl.: 35**

FOR: PERSONNEL PLACEMENT AND RECRUITMENT, IN CLASS 35 (U.S. CLS. 100, 101 AND 102).

**SERVICE MARK**

FIRST USE 6-14-2010; IN COMMERCE 6-20-2010.

**PRINCIPAL REGISTER**

THE MARK CONSISTS OF STANDARD CHARACTERS WITHOUT CLAIM TO ANY PARTICULAR FONT, STYLE, SIZE, OR COLOR.

NO CLAIM IS MADE TO THE EXCLUSIVE RIGHT TO USE "GAME RECRUITING", APART FROM THE MARK AS SHOWN.

SN 85-324,099, FILED 5-18-2011.

PRISCILLA MILTON, EXAMINING ATTORNEY



*David J. Kybas*

Director of the United States Patent and Trademark Office

# United States of America

United States Patent and Trademark Office

## CHEEKMATES

**Reg. No. 4,126,884**

JPV, LLC (MINNESOTA LIMITED LIABILITY COMPANY)  
9890 CRESTWOOD TERRACE  
EDEN PRAIRIE, MN 55347

**Registered Apr. 10, 2012**

**Int. Cl.: 10**

FOR: CHEEK DEPRESSORS, IN CLASS 10 (U.S. CLS. 26, 39 AND 44).

**TRADEMARK**

FIRST USE 10-2-2011; IN COMMERCE 10-2-2011.

**PRINCIPAL REGISTER**

THE MARK CONSISTS OF STANDARD CHARACTERS WITHOUT CLAIM TO ANY PARTICULAR FONT, STYLE, SIZE, OR COLOR.

SN 85-324,216, FILED 5-18-2011.

ANDREA HACK, EXAMINING ATTORNEY



*David J. Kybas*

Director of the United States Patent and Trademark Office



United States of America  
United States Patent and Trademark Office

# ZIALIPRO

**Reg. No. 4,126,885**

HEALTHY GROOVES LIMITED (NEW ZEALAND LIMITED COMPANY (LTD.))  
PO BOX 1792

**Registered Apr. 10, 2012**

AUCKLAND, NEW ZEALAND 1140

**Int. Cl.: 5**

FOR: DIETARY SUPPLEMENT, IN CLASS 5 (U.S. CLS. 6, 18, 44, 46, 51 AND 52).

**TRADEMARK**

FIRST USE 7-13-2011; IN COMMERCE 7-13-2011.

**PRINCIPAL REGISTER**

THE MARK CONSISTS OF STANDARD CHARACTERS WITHOUT CLAIM TO ANY PARTICULAR FONT, STYLE, SIZE, OR COLOR.

SN 85-324,250, FILED 5-18-2011.

FONG HSU, EXAMINING ATTORNEY



*David J. Kyffers*

Director of the United States Patent and Trademark Office

# United States of America

United States Patent and Trademark Office

# DESIGNRITE

**Reg. No. 4,126,886**

RIDLEY USA INC. (MINNESOTA CORPORATION), FORMERLY HUBBARD FEEDS INC.,  
424 N. RIVERFRONT DRIVE  
MANKATO, MN 56002

**Registered Apr. 10, 2012**

**Int. Cl.: 31**

FOR: ANIMAL FEED; ANIMAL FOOD; ANIMAL FEED SUPPLEMENT; ANIMAL FEED  
ADDITIVE, IN CLASS 31 (U.S. CLS. 1 AND 46).

**TRADEMARK**

FIRST USE 6-15-2011; IN COMMERCE 7-15-2011.

**PRINCIPAL REGISTER**

THE MARK CONSISTS OF STANDARD CHARACTERS WITHOUT CLAIM TO ANY PAR-  
TICULAR FONT, STYLE, SIZE, OR COLOR.

SN 85-324,261, FILED 5-18-2011.

JULIE GUTTADAURO, EXAMINING ATTORNEY



*David J. Kyffers*

Director of the United States Patent and Trademark Office

United States of America  
United States Patent and Trademark Office

# POACHED

**Reg. No. 4,126,887**

40 GROUP, LLC (OREGON LIMITED LIABILITY COMPANY)  
3424 SE SCHILLER

**Registered Apr. 10, 2012**

PORTLAND, OR 97202

**Int. Cl.: 35**

FOR: PROVIDING AN ON-LINE SEARCHABLE DATABASE FEATURING EMPLOYMENT OPPORTUNITIES; PROVIDING AN ON-LINE SEARCHABLE DATABASE FEATURING EMPLOYMENT OPPORTUNITIES AND CONTENT ABOUT EMPLOYMENT; PROVIDING AN ON-LINE SEARCHABLE DATABASE FEATURING EMPLOYMENT OPPORTUNITIES AND CONTENT ABOUT EMPLOYMENT RELEVANT TO RESTAURANTS AND BARS; PROVIDING EMPLOYMENT INFORMATION; PROVIDING ON-LINE EMPLOYMENT PLACEMENT SERVICES, NAMELY, MATCHING RESUMES AND POTENTIAL EMPLOYERS VIA A GLOBAL COMPUTER NETWORK; PROVIDING ONLINE DATABASES FEATURING INFORMATION RELATING TO EMPLOYERS AND EMPLOYEES AND PLACES OF EMPLOYMENT, IN CLASS 35 (U.S. CLS. 100, 101 AND 102).

**SERVICE MARK**

**PRINCIPAL REGISTER**

FIRST USE 7-9-2011; IN COMMERCE 7-9-2011.

THE MARK CONSISTS OF STANDARD CHARACTERS WITHOUT CLAIM TO ANY PARTICULAR FONT, STYLE, SIZE, OR COLOR.

SN 85-324,344, FILED 5-18-2011.

REGINA DRUMMOND, EXAMINING ATTORNEY



*David J. Kyjars*

Director of the United States Patent and Trademark Office

# United States of America

United States Patent and Trademark Office

## KINGS CROSS

**Reg. No. 4,126,888**

ARAKELIAN, DAREN (UNITED STATES INDIVIDUAL)  
5 FOREST HILLS BOULEVARD  
RENSSELAER, NY 12144

**Registered Apr. 10, 2012**

**Int. Cl.: 25**

FOR: JACKETS; KNICKERS; SHIRTS; SOCKS; SWEATERS, IN CLASS 25 (U.S. CLS. 22 AND 39).

**TRADEMARK**

FIRST USE 8-8-2011; IN COMMERCE 8-8-2011.

**PRINCIPAL REGISTER**

THE MARK CONSISTS OF STANDARD CHARACTERS WITHOUT CLAIM TO ANY PARTICULAR FONT, STYLE, SIZE, OR COLOR.

SN 85-324,670, FILED 5-19-2011.

WARREN L. OLANDRIA, EXAMINING ATTORNEY



*David J. Kyffers*

Director of the United States Patent and Trademark Office

# United States of America

United States Patent and Trademark Office

**TEKMAX**

**Reg. No. 4,126,889**

**Registered Apr. 10, 2012**

**Int. Cl.: 9**

**TRADEMARK**

**PRINCIPAL REGISTER**

U-WAY CORPORATION (TAIWAN CORPORATION)  
3F-2, NO. 125, LANE 235, BAOCIAO RD.  
SINDIAN CITY, TAIWAN 231

FOR: COMPUTER MOUSE; COMPUTER STYLUS; ELECTRONIC MULTI CARD READERS; TABLE COMPUTER BAGS; JOYSTICKS FOR VIDEO GAMES; COMPUTER JOYSTICKS; LITHIUM ION BATTERIES; NICKEL-METAL HYDRIDE BATTERY; MOBILE PHONE BATTERIES; CELL PHONE BATTERY CHARGERS; BATTERY CHARGERS; CHARGERS FOR BATTERIES; EAR PHONES; HEADSETS FOR VIDEO GAME CONSOLES, MOBILE PHONES AND COMPUTERS; LOUDSPEAKER CABINETS; USB AUDIO SPEAKERS; LOUDSPEAKERS; MOBILE PHONE ACCESSORIES, NAMELY, BATTERY CHARGERS, ELECTRICAL CABLES, PROTECTIVE CASES, FITTED PLASTIC FILMS KNOWN AS SKINS FOR COVERING AND PROTECTING MOBILE PHONES, EXTERNAL BATTERIES FOR MOBILE PHONES, DEVICES FOR HANDS-FREE USE OF MOBILE PHONES, KEYBOARDS FOR MOBILE PHONES AND TABLET COMPUTERS; AND WIRELESS POWER APPLICATIONS, NAMELY, WIRELESS BATTERY CHARGER, RECEIVERS FOR MOBILE PHONES, AND WIRELESS HAND HELD GAMES WITH LIQUID CRYSTAL DISPLAYS, IN CLASS 9 (U.S. CLS. 21, 23, 26, 36 AND 38).

FIRST USE 6-1-2011; IN COMMERCE 6-1-2011.

THE MARK CONSISTS OF THE WORD "TEKMAX" WITH A STYLIZED "T" AND A STYLIZED "X" COMPRISED OF TWO INCOMPLETE OVALS.

SN 85-325,065, FILED 5-19-2011.

KATHERINE E. HALMEN, EXAMINING ATTORNEY



*David J. Kyjars*

Director of the United States Patent and Trademark Office

# United States of America

United States Patent and Trademark Office

The logo for Marriola features a stylized, bold letter 'M' on the left. To its right is the word 'marriola' in a lowercase, italicized, sans-serif font. The word is underlined, and the underline wraps around the final letter 'a'.

**Reg. No. 4,126,890**

**Registered Apr. 10, 2012**

**Int. Cl.: 9**

**TRADEMARK**

**PRINCIPAL REGISTER**

SAGA AUDIO EQUIPMENT CO., LTD (CHINA CORPORATION)  
NO.1 SAGA ROAD SHASHUI VILLAGE, SONGGANG  
NANHAI DISTICT, FOSHAN CITY,  
GUANGDONG PROVINCE, CHINA

FOR: CABINETS FOR LOUDSPEAKERS; TELEVISIONS; JUKE BOXES; MICROPHONES;  
PERSONAL STEREOS; RECORDING AND PLAYING DEVICES FOR SOUND AND IMAGE  
CARRIERS; VEHICLE RADIOS; LOUDSPEAKERS; NAVIGATION APPARATUS FOR  
VEHICLES IN THE NATURE OF ON-BOARD COMPUTERS; HORNS FOR LOUDSPEAKERS,  
IN CLASS 9 (U.S. CLS. 21, 23, 26, 36 AND 38).

FIRST USE 3-18-2008; IN COMMERCE 8-15-2011.

THE MARK CONSISTS OF A STYLIZED LETTER "M" TO THE RIGHT OF THE STYLIZED  
UNDERLINED WORD "MARRIOLA" IN WHICH THE UNDERLINE WRAPS AROUND THE  
LAST LETTER "A".

SN 85-325,278, FILED 5-19-2011.

JULIE VEPPUMTHARA, EXAMINING ATTORNEY



*David J. Kyffers*

Director of the United States Patent and Trademark Office

# United States of America

United States Patent and Trademark Office

## UTILITY PLUS

**Reg. No. 4,126,891**

**Registered Apr. 10, 2012**

**Int. Cl.: 35**

**SERVICE MARK**

**PRINCIPAL REGISTER**

SAFEGUARD PROPERTIES, LLC (OHIO LIMITED LIABILITY COMPANY)  
7887 SAFEGUARD CIRCLE  
VALLEY VIEW, OH 44125

FOR: AUDITING UTILITY RATES FOR OTHERS; PROCUREMENT SERVICES, NAMELY, NEGOTIATING ENERGY RATES AND SERVICES FOR OTHERS; BILLING, NAMELY, PROCESSING UTILITY INVOICES FOR THIRD PARTIES; ENERGY-USAGE MANAGEMENT; UTILITY-BILL MANAGEMENT SERVICES, NAMELY, TRACKING, REPORTING, ANALYZING, AND DELIVERING ENERGY INFORMATION IN THE FORM OF UTILITY BILLS AND UTILITY METER DATA RATE SCHEDULES REGARDING THE REAL-ESTATE PROPERTIES OF OTHERS; CONSULTING SERVICES IN THE FIELD OF ENERGY MEASUREMENT TO IMPROVE ENERGY EFFICIENCY WITHIN RESIDENCES, IN CLASS 35 (U.S. CLS. 100, 101 AND 102).

FIRST USE 7-31-2011; IN COMMERCE 7-31-2011.

THE MARK CONSISTS OF STANDARD CHARACTERS WITHOUT CLAIM TO ANY PARTICULAR FONT, STYLE, SIZE, OR COLOR.

NO CLAIM IS MADE TO THE EXCLUSIVE RIGHT TO USE "UTILITY", APART FROM THE MARK AS SHOWN.

SN 85-325,302, FILED 5-19-2011.

HOWARD SMIGA, EXAMINING ATTORNEY



*David J. Kyros*

Director of the United States Patent and Trademark Office

# United States of America

United States Patent and Trademark Office

## Now You Tell Me!

**Reg. No. 4,126,892**

SCOTT, SHARON (UNITED STATES INDIVIDUAL)  
36 CRYSTAL FARM ROAD  
WARWICK, NY 10990

**Registered Apr. 10, 2012**

**Int. Cl.: 16**

FOR: SERIES OF BOOKS IN THE FIELD OF ADVICE, IN CLASS 16 (U.S. CLS. 2, 5, 22, 23, 29, 37, 38 AND 50).

**TRADEMARK**

FIRST USE 1-17-2012; IN COMMERCE 1-17-2012.

**PRINCIPAL REGISTER**

THE MARK CONSISTS OF STANDARD CHARACTERS WITHOUT CLAIM TO ANY PARTICULAR FONT, STYLE, SIZE, OR COLOR.

SN 85-325,742, FILED 5-20-2011.

MATTHEW PAPPAS, EXAMINING ATTORNEY



*David J. Kappas*

Director of the United States Patent and Trademark Office



# United States of America

United States Patent and Trademark Office

## Fight for a Cure

**Reg. No. 4,126,893**

**Registered Apr. 10, 2012**

**Int. Cls.: 18 and 25**

**TRADEMARK**

**PRINCIPAL REGISTER**

SOLE CREATIONS, INC (NEW YORK CORPORATION)  
33 MERRIVALE ROAD  
GREAT NECK, NY 11020

FOR: HANDBAGS, IN CLASS 18 (U.S. CLS. 1, 2, 3, 22 AND 41).

FIRST USE 4-1-2011; IN COMMERCE 9-15-2011.

FOR: CAPS; FOOTWEAR; HEADWEAR; SHORT-SLEEVED OR LONG-SLEEVED T-SHIRTS;  
SLIPPERS, IN CLASS 25 (U.S. CLS. 22 AND 39).

FIRST USE 4-1-2011; IN COMMERCE 9-15-2011.

THE MARK CONSISTS OF STANDARD CHARACTERS WITHOUT CLAIM TO ANY PARTICULAR FONT, STYLE, SIZE, OR COLOR.

SN 85-326,157, FILED 5-20-2011.

ERIN FALK, EXAMINING ATTORNEY



*David J. Kybas*

Director of the United States Patent and Trademark Office

# United States of America

United States Patent and Trademark Office

## THE INTERGROW GROUP

**Reg. No. 4,126,894**

**Registered Apr. 10, 2012**

**Int. Cl.: 35**

**SERVICE MARK**

**PRINCIPAL REGISTER**

THE INTERGROW GROUP, LLC (NEW JERSEY LIMITED LIABILITY COMPANY)  
SUITE 332  
16 MOUNT BETHEL ROAD  
WARREN, NJ 070595604

FOR: BUSINESS DEVELOPMENT CONSULTING SERVICES; BUSINESS MANAGEMENT CONSULTING; BUSINESS ORGANIZATION AND MANAGEMENT CONSULTING , IN CLASS 35 (U.S. CLS. 100, 101 AND 102).

FIRST USE 5-30-2011; IN COMMERCE 7-1-2011.

THE MARK CONSISTS OF STANDARD CHARACTERS WITHOUT CLAIM TO ANY PARTICULAR FONT, STYLE, SIZE, OR COLOR.

NO CLAIM IS MADE TO THE EXCLUSIVE RIGHT TO USE "GROUP", APART FROM THE MARK AS SHOWN.

SN 85-327,205, FILED 5-23-2011.

ALICIA COLLINS, EXAMINING ATTORNEY



*David J. Kybas*

Director of the United States Patent and Trademark Office

# United States of America

United States Patent and Trademark Office

## *Substantial*

**Reg. No. 4,126,895**

LLOYD, JR., DAVID E (UNITED STATES INDIVIDUAL)  
2311 MCCLELLAN CT  
DUMFRIES, VA 220262503

**Registered Apr. 10, 2012**

**Int. Cl.: 35**

FOR: BUSINESS ADMINISTRATION CONSULTANCY, IN CLASS 35 (U.S. CLS. 100, 101 AND 102).

**SERVICE MARK**

FIRST USE 5-1-2011; IN COMMERCE 5-1-2011.

**PRINCIPAL REGISTER**

THE MARK CONSISTS OF THE STYLIZED WORD "SUBSTANTIAL".

SN 85-327,620, FILED 5-23-2011.

MAYUR VAGHANI, EXAMINING ATTORNEY



*David J. Kybas*

Director of the United States Patent and Trademark Office

# United States of America

United States Patent and Trademark Office

# PERMA\*SHINE

**Reg. No. 4,126,896**

PERMA\*SHINE INSIGNIA LLC (DELAWARE LIMITED LIABILITY COMPANY)  
9437 BRIDGEBROOK DRIVE  
BOCA RATON, FL 33496

**Registered Apr. 10, 2012**

**Int. Cl.: 26**

FOR: UNIFORM ACCESSORIES MADE FROM EMBROIDERY OR NON-PRECIOUS METAL, NAMELY, INSIGNIA, BADGES, MEDALS AND PINS, IN CLASS 26 (U.S. CLS. 37, 39, 40, 42 AND 50).

**TRADEMARK**

FIRST USE 1-9-2012; IN COMMERCE 1-9-2012.

**PRINCIPAL REGISTER**

THE MARK CONSISTS OF STANDARD CHARACTERS WITHOUT CLAIM TO ANY PARTICULAR FONT, STYLE, SIZE, OR COLOR.

SN 85-328,925, FILED 5-24-2011.

TINA MAI, EXAMINING ATTORNEY



*David J. Kyros*

Director of the United States Patent and Trademark Office

# United States of America

United States Patent and Trademark Office

## THERMA-PUR

**Reg. No. 4,126,897**

GARLOCK SEALING TECHNOLOGIES LLC (DELAWARE LIMITED LIABILITY COMPANY)  
1666 DIVISION STREET  
PALMYRA, NY 14522

**Registered Apr. 10, 2012**

**Int. Cl.: 17**

FOR: NON-METALLIC GASKETS FOR USE IN EXTREME TEMPERATURE APPLICATIONS SUCH AS EXHAUST, REFINERY AND CHEMICAL INDUSTRIES, IN CLASS 17 (U.S. CLS. 1, 5, 12, 13, 35 AND 50).

**TRADEMARK**

FIRST USE 7-0-2011; IN COMMERCE 7-0-2011.

**PRINCIPAL REGISTER**

THE MARK CONSISTS OF STANDARD CHARACTERS WITHOUT CLAIM TO ANY PARTICULAR FONT, STYLE, SIZE, OR COLOR.

SN 85-329,240, FILED 5-24-2011.

RON FAIRBANKS, EXAMINING ATTORNEY



*David J. Kyffers*

Director of the United States Patent and Trademark Office

# United States of America

United States Patent and Trademark Office

## ZINAPALOOZA

**Reg. No. 4,126,898**

BROWN ESTATE VINEYARDS, LLC (CALIFORNIA LIMITED LIABILITY COMPANY)  
3233 SAGE CANYON ROAD  
ST. HELENA, CA 94574

**Registered Apr. 10, 2012**

**Int. Cl.: 41**

FOR: ENTERTAINMENT SERVICES, NAMELY, WINE AND FOOD TASTINGS, IN CLASS 41 (U.S. CLS. 100, 101 AND 107).

**SERVICE MARK**

FIRST USE 5-28-2011; IN COMMERCE 5-28-2011.

**PRINCIPAL REGISTER**

THE MARK CONSISTS OF STANDARD CHARACTERS WITHOUT CLAIM TO ANY PARTICULAR FONT, STYLE, SIZE, OR COLOR.

SN 85-329,939, FILED 5-25-2011.

MICHELLE DUBOIS, EXAMINING ATTORNEY



*David J. Kybas*

Director of the United States Patent and Trademark Office

# United States of America

United States Patent and Trademark Office

# RAIDER

**Reg. No. 4,126,899**

AIRBORNE SYSTEMS NORTH AMERICA OF NJ INC. (NEW JERSEY CORPORATION)  
5800 MAGNOLIA AVENUE  
PENNSAUKEN, NJ 081091399

**Registered Apr. 10, 2012**

**Int. Cl.: 12**

FOR: PARACHUTE SYSTEMS, NAMELY, A MAN-CARRYING HARNESS, IN CLASS 12  
(U.S. CLS. 19, 21, 23, 31, 35 AND 44).

**TRADEMARK**

FIRST USE 12-16-2011; IN COMMERCE 12-16-2011.

**PRINCIPAL REGISTER**

THE MARK CONSISTS OF STANDARD CHARACTERS WITHOUT CLAIM TO ANY PARTICULAR FONT, STYLE, SIZE, OR COLOR.

SN 85-330,061, FILED 5-25-2011.

C. DIONNE CLYBURN, EXAMINING ATTORNEY



*David J. Kybas*

Director of the United States Patent and Trademark Office

# United States of America

United States Patent and Trademark Office

# INTRUDER

**Reg. No. 4,126,900**

AIRBORNE SYSTEMS NORTH AMERICA OF NJ INC. (NEW JERSEY CORPORATION)  
5800 MAGNOLIA AVENUE  
PENNSAUKEN, NJ 081091399

**Registered Apr. 10, 2012**

**Int. Cl.: 12**

FOR: PARACHUTE SYSTEMS, NAMELY, A PARACHUTE CANOPY, IN CLASS 12 (U.S. CLS. 19, 21, 23, 31, 35 AND 44).

**TRADEMARK**

FIRST USE 12-16-2011; IN COMMERCE 12-16-2011.

**PRINCIPAL REGISTER**

THE MARK CONSISTS OF STANDARD CHARACTERS WITHOUT CLAIM TO ANY PARTICULAR FONT, STYLE, SIZE, OR COLOR.

SN 85-330,083, FILED 5-25-2011.

C. DIONNE CLYBURN, EXAMINING ATTORNEY



*David J. Kyffers*

Director of the United States Patent and Trademark Office



# United States of America

United States Patent and Trademark Office

## CARBIDE SERIES

**Reg. No. 4,126,901**

CORSAIR MEMORY, INC. (DELAWARE CORPORATION)  
46221 LANDING PARKWAY  
FREMONT, CA 94538

**Registered Apr. 10, 2012**

**Int. Cl.: 9**

FOR: COMPUTER COMPONENTS, NAMELY, COMPUTER CASINGS, IN CLASS 9 (U.S. CLS. 21, 23, 26, 36 AND 38).

**TRADEMARK**

FIRST USE 6-0-2011; IN COMMERCE 6-0-2011.

**PRINCIPAL REGISTER**

THE MARK CONSISTS OF STANDARD CHARACTERS WITHOUT CLAIM TO ANY PARTICULAR FONT, STYLE, SIZE, OR COLOR.

NO CLAIM IS MADE TO THE EXCLUSIVE RIGHT TO USE "SERIES", APART FROM THE MARK AS SHOWN.

SN 85-330,500, FILED 5-25-2011.

REBECCA EISINGER, EXAMINING ATTORNEY



*David J. Kybas*

Director of the United States Patent and Trademark Office

# United States of America

United States Patent and Trademark Office

# VALOCORDIN

**Reg. No. 4,126,902**

SALEM BOTANICALS CORPORATION (NEW JERSEY CORPORATION)  
100 CENTRAL SCHOOLHOUSE RD.  
CARNEYS POINT, NJ 08069

**Registered Apr. 10, 2012**

**Int. Cl.: 5**

FOR: DIETARY AND NUTRITIONAL SUPPLEMENTS, IN CLASS 5 (U.S. CLS. 6, 18, 44, 46, 51 AND 52).

**TRADEMARK**

FIRST USE 5-0-2010; IN COMMERCE 5-0-2010.

**PRINCIPAL REGISTER**

THE MARK CONSISTS OF STANDARD CHARACTERS WITHOUT CLAIM TO ANY PARTICULAR FONT, STYLE, SIZE, OR COLOR.

SN 85-330,723, FILED 5-26-2011.

GEORGE LORENZO, EXAMINING ATTORNEY



*David J. Kybas*

Director of the United States Patent and Trademark Office

# United States of America

United States Patent and Trademark Office

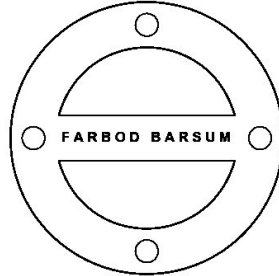

**Reg. No. 4,126,903**

**Registered Apr. 10, 2012**

**Int. Cls.: 18 and 25**

**TRADEMARK**

**PRINCIPAL REGISTER**

BARSUM FASHION GROUP, INC. (CALIFORNIA CORPORATION)  
8950 W. OLYMPIC BLVD.  
#303  
BEVERLY HILLS, CA 90211

FOR: DUFFEL BAGS; HANDBAGS; WALLETS, IN CLASS 18 (U.S. CLS. 1, 2, 3, 22 AND 41).

FIRST USE 6-30-2011; IN COMMERCE 8-29-2011.

FOR: BELTS; DRESSES; JACKETS; PANTS; SHOES; SHORTS; SKIRTS; SWEAT SHIRTS;  
T-SHIRTS; TANK TOPS, IN CLASS 25 (U.S. CLS. 22 AND 39).

FIRST USE 6-30-2011; IN COMMERCE 8-29-2011.

THE NAME "FARBOD BARSUM" IDENTIFIES A LIVING INDIVIDUAL WHOSE CONSENT IS OF RECORD.

THE MARK CONSISTS OF THE STYLIZED WORDS "FARBOD BARSUM" INSIDE A CIRCULAR SHAPE DESIGN.

SN 85-331,077, FILED 5-26-2011.

STEVEN R. FINE, EXAMINING ATTORNEY



*David J. Kybas*

Director of the United States Patent and Trademark Office

United States of America  
United States Patent and Trademark Office

CATWAD

**Reg. No. 4,126,904**

BENTON, JAMES K. (UNITED STATES INDIVIDUAL)  
1080 FOREST LANE  
BLOOMFIELD TWP., MI 48301

**Registered Apr. 10, 2012**

**Int. Cl.: 16**

FOR: ILLUSTRATIONS, IN CLASS 16 (U.S. CLS. 2, 5, 22, 23, 29, 37, 38 AND 50).

**TRADEMARK**

FIRST USE 5-31-2011; IN COMMERCE 5-31-2011.

**PRINCIPAL REGISTER**

THE MARK CONSISTS OF STANDARD CHARACTERS WITHOUT CLAIM TO ANY PARTICULAR FONT, STYLE, SIZE, OR COLOR.

SN 85-331,328, FILED 5-26-2011.

ALLISON HOLTZ, EXAMINING ATTORNEY



*David J. Kybas*

Director of the United States Patent and Trademark Office

# United States of America

United States Patent and Trademark Office



**Reg. No. 4,126,905**

**Registered Apr. 10, 2012**

**Int. Cl.: 34**

**TRADEMARK**

**PRINCIPAL REGISTER**

GOLD STANDARD ENTERPRISES, INC. (ILLINOIS CORPORATION)  
5100 DEMPSTER  
CHICAGO, IL 60077

FOR: CIGARS, IN CLASS 34 (U.S. CLS. 2, 8, 9 AND 17).

FIRST USE 9-17-2011; IN COMMERCE 9-17-2011.

THE MARK CONSISTS OF THE STYLIZED WORDING "EL SENOR" HAVING AN UNDERLINE UNDER THE WORDING "SEÑOR", WHERE THE WORDING IS SUPERIMPOSED OVER A GENERALLY CIRCULAR DESIGN FORMED BY CONCENTRIC OUTLINES OF A CIRCLE WITH NUMEROUS SHADED CIRCLES FORMING A BORDER BETWEEN THE CONCENTRIC CIRCULAR OUTLINES AND A LEAF DESIGN IN THE CENTER OF THE CIRCLE.

THE ENGLISH TRANSLATION OF "EL SEÑOR" IN THE MARK IS THE GENTLEMAN.

SN 85-331,453, FILED 5-26-2011.

JAY BESCH, EXAMINING ATTORNEY



*David J. Kyros*

Director of the United States Patent and Trademark Office

# United States of America

United States Patent and Trademark Office

# Bio-algin

**Reg. No. 4,126,906**

DING, ZIXIONG (UNITED STATES INDIVIDUAL)  
135 MARGUERITA AVE.

**Registered Apr. 10, 2012**

MONTEREY PARK, CA 91754

**Int. Cl.: 5**

FOR: DIETARY AND NUTRITIONAL SUPPLEMENTS, IN CLASS 5 (U.S. CLS. 6, 18, 44, 46, 51 AND 52).

**TRADEMARK**

FIRST USE 5-29-2011; IN COMMERCE 5-29-2011.

**PRINCIPAL REGISTER**

THE MARK CONSISTS OF STANDARD CHARACTERS WITHOUT CLAIM TO ANY PARTICULAR FONT, STYLE, SIZE, OR COLOR.

SN 85-332,246, FILED 5-27-2011.

LESLIE RICHARDS, EXAMINING ATTORNEY



*David J. Kyffers*

Director of the United States Patent and Trademark Office

# United States of America

United States Patent and Trademark Office



**Reg. No. 4,126,907**

**Registered Apr. 10, 2012**

**Int. Cl.: 43**

**SERVICE MARK**

**PRINCIPAL REGISTER**

E & E HOLDINGS GROUP LLC (NEW YORK LIMITED LIABILITY COMPANY)  
C/O IDS 166 MADISON AVENUE, 5TH FLOOR  
NEW YORK, NY 10016

FOR: RESTAURANT, BAR, AND COCKTAIL LOUNGE SERVICES, IN CLASS 43 (U.S. CLS. 100 AND 101).

FIRST USE 7-7-2011; IN COMMERCE 7-7-2011.

OWNER OF U.S. REG. NO. 4,017,227.

THE COLOR(S) RED, BLACK AND WHITE IS/ARE CLAIMED AS A FEATURE OF THE MARK.

NO CLAIM IS MADE TO THE EXCLUSIVE RIGHT TO USE "GRILL HOUSE", APART FROM THE MARK AS SHOWN.

THE MARK CONSISTS OF TWO UPPER CASE "E"'S IN RED AND OUTLINED IN BLACK WITH A WHITE AMPERSAND SIGN IN BETWEEN THE LETTERS. THE WORDS "GRILL" AND "HOUSE" ARE IN WHITE AND OUTLINED IN BLACK UNDERNEATH THE TWO UPPER CASE LETTER "E"'S.

SN 85-332,524, FILED 5-27-2011.

MARK SHINER, EXAMINING ATTORNEY



*David J. Kybas*

Director of the United States Patent and Trademark Office

# United States of America

United States Patent and Trademark Office

(ai)<sup>2</sup>

**Reg. No. 4,126,908**

VULCAN INC. (WASHINGTON CORPORATION)  
505 UNION STATION SUITE 900  
SEATTLE, WA 98104

**Registered Apr. 10, 2012**

**Int. Cl.: 42**

**SERVICE MARK**

**PRINCIPAL REGISTER**

FOR: COMPUTER PROGRAMMING SERVICES FOR THE DEVELOPMENT OF INTELLIGENT AGENT DEVICES; PROVIDING SCIENTIFIC INFORMATION IN THE FIELD OF SEARCH AND RETRIEVAL OF DATA, KNOWLEDGE MANAGEMENT AND THE STUDY AND DESIGN OF INTELLIGENT AGENTS; RESEARCH AND DEVELOPMENT FOR NEW PRODUCTS FOR OTHERS; RESEARCH AND DEVELOPMENT IN THE FIELD OF KNOWLEDGE MANAGEMENT AND THE STUDY AND DESIGN OF INTELLIGENT AGENTS; SCIENTIFIC RESEARCH AND DEVELOPMENT; SCIENTIFIC STUDY AND RESEARCH IN THE FIELDS OF KNOWLEDGE MANAGEMENT AND THE STUDY AND DESIGN OF INTELLIGENT AGENTS, IN CLASS 42 (U.S. CLS. 100 AND 101).

FIRST USE 5-16-2011; IN COMMERCE 5-16-2011.

THE MARK CONSISTS OF THE LETTERS "A" AND "I" ENCLOSED BY STANDARD BRACKETS WITH A NUMERAL "2" IN SUPERSCRIPIT IN UPPER RIGHT CORNER.

SN 85-332,973, FILED 5-27-2011.

JANICE L. MCMORROW, EXAMINING ATTORNEY



*David J. Kyros*

Director of the United States Patent and Trademark Office



# United States of America

United States Patent and Trademark Office

## S/Cap RFID Tag

**Reg. No. 4,126,909**

**Registered Apr. 10, 2012**

**Int. Cl.: 9**

**TRADEMARK**

**PRINCIPAL REGISTER**

ENABLE IPC CORPORATION (DELAWARE CORPORATION)  
C-110  
26893 BOUQUET CANYON ROAD  
SAUGUS, CA 91350

FOR: RADIO FREQUENCY IDENTIFICATION (RFID) TAGS, IN CLASS 9 (U.S. CLS. 21, 23, 26, 36 AND 38).

FIRST USE 6-11-2011; IN COMMERCE 6-27-2011.

THE MARK CONSISTS OF STANDARD CHARACTERS WITHOUT CLAIM TO ANY PARTICULAR FONT, STYLE, SIZE, OR COLOR.

NO CLAIM IS MADE TO THE EXCLUSIVE RIGHT TO USE "RFID TAG", APART FROM THE MARK AS SHOWN.

SN 85-332,979, FILED 5-27-2011.

ESTHER A. BORSUK, EXAMINING ATTORNEY



*David J. Kyffers*

Director of the United States Patent and Trademark Office

# United States of America

United States Patent and Trademark Office

# AI2

**Reg. No. 4,126,910**

**Registered Apr. 10, 2012**

**Int. Cl.: 42**

**SERVICE MARK**

**PRINCIPAL REGISTER**

VULCAN INC. (WASHINGTON CORPORATION)  
505 UNION STATION SUITE 900  
SEATTLE, WA 98104

FOR: COMPUTER PROGRAMMING SERVICES FOR THE DEVELOPMENT OF INTELLIGENT AGENT DEVICES; PROVIDING SCIENTIFIC INFORMATION IN THE FIELD OF SEARCH AND RETRIEVAL OF DATA, KNOWLEDGE MANAGEMENT AND THE STUDY AND DESIGN OF INTELLIGENT AGENTS; RESEARCH AND DEVELOPMENT FOR NEW PRODUCTS FOR OTHERS; RESEARCH AND DEVELOPMENT IN THE FIELD OF KNOWLEDGE MANAGEMENT AND THE STUDY AND DESIGN OF INTELLIGENT AGENTS; SCIENTIFIC RESEARCH AND DEVELOPMENT; SCIENTIFIC STUDY AND RESEARCH IN THE FIELDS OF KNOWLEDGE MANAGEMENT AND THE STUDY AND DESIGN OF INTELLIGENT AGENTS, IN CLASS 42 (U.S. CLS. 100 AND 101).

FIRST USE 5-16-2011; IN COMMERCE 5-16-2011.

THE MARK CONSISTS OF STANDARD CHARACTERS WITHOUT CLAIM TO ANY PARTICULAR FONT, STYLE, SIZE, OR COLOR.

SN 85-332,987, FILED 5-27-2011.

JANICE L. MCMORROW, EXAMINING ATTORNEY



*David J. Kybas*

Director of the United States Patent and Trademark Office

# United States of America

United States Patent and Trademark Office

# Ninja Lawyer

**Reg. No. 4,126,911**

EA VENTURES, LLC (CONNECTICUT LIMITED LIABILITY COMPANY)  
218 BEDFORD, 5F  
STAMFORD, CT 06901

**Registered Apr. 10, 2012**

**Int. Cl.: 9**

FOR: COMPUTER APPLICATION SOFTWARE FOR MOBILE PHONES AND HANDHELD MOBILE COMPUTERS, NAMELY, SOFTWARE FOR DISPLAYING ADVERTISING, SENDING EMAILS, PROVIDING LEGAL INFORMATION, AND CALLING THE OFFICE FOR LAWYERS, IN CLASS 9 (U.S. CLS. 21, 23, 26, 36 AND 38).

**TRADEMARK**

**PRINCIPAL REGISTER**

FIRST USE 9-15-2011; IN COMMERCE 9-15-2011.

THE MARK CONSISTS OF STANDARD CHARACTERS WITHOUT CLAIM TO ANY PARTICULAR FONT, STYLE, SIZE, OR COLOR.

NO CLAIM IS MADE TO THE EXCLUSIVE RIGHT TO USE "LAWYER", APART FROM THE MARK AS SHOWN.

SN 85-333,343, FILED 5-30-2011.

SIMON TENG, EXAMINING ATTORNEY



*David J. Kyros*

Director of the United States Patent and Trademark Office

# United States of America

United States Patent and Trademark Office

# TEAC100

**Reg. No. 4,126,912**

JURA ELEKTROAPPARATE AG (SWITZERLAND CORPORATION)  
KAFFEEWELTSTRASSE 10

**Registered Apr. 10, 2012**

NIEDERBUCHSITEN, SWITZERLAND CH-4626

**Int. Cl.: 11**

FOR: ELECTRIC KETTLES; ELECTRIC TEA KETTLES, IN CLASS 11 (U.S. CLS. 13, 21, 23, 31 AND 34).

**TRADEMARK**

FIRST USE 5-31-2011; IN COMMERCE 5-31-2011.

**PRINCIPAL REGISTER**

THE MARK CONSISTS OF STANDARD CHARACTERS WITHOUT CLAIM TO ANY PARTICULAR FONT, STYLE, SIZE, OR COLOR.

SN 85-333,781, FILED 5-31-2011.

GEORGE LORENZO, EXAMINING ATTORNEY



*David J. Kybas*

Director of the United States Patent and Trademark Office

# United States of America

United States Patent and Trademark Office

## WESTERN EDGE

**Reg. No. 4,126,913**

**Registered Apr. 10, 2012**

**Int. Cl.: 8**

**TRADEMARK**

**PRINCIPAL REGISTER**

TAYLOR BRANDS, LLC (TENNESSEE LIMITED LIABILITY COMPANY)  
1043 FORDTOWN ROAD  
KINGSPORT, TN 37663

FOR: KNIVES, IN CLASS 8 (U.S. CLS. 23, 28 AND 44).

FIRST USE 9-1-2011; IN COMMERCE 9-1-2011.

THE MARK CONSISTS OF STANDARD CHARACTERS WITHOUT CLAIM TO ANY PARTICULAR FONT, STYLE, SIZE, OR COLOR.

NO CLAIM IS MADE TO THE EXCLUSIVE RIGHT TO USE "EDGE", APART FROM THE MARK AS SHOWN.

SN 85-333,897, FILED 5-31-2011.

STEVEN R. FINE, EXAMINING ATTORNEY



*David J. Kybas*

Director of the United States Patent and Trademark Office

# United States of America

United States Patent and Trademark Office

# ACCUSTOM

**Reg. No. 4,126,914**

PACIFIC COAST FEATHER COMPANY (WASHINGTON CORPORATION)  
P.O. BOX 80385  
SEATTLE, WA 98108

**Registered Apr. 10, 2012**

**Int. Cl.: 20**

FOR: PILLOWS, IN CLASS 20 (U.S. CLS. 2, 13, 22, 25, 32 AND 50).

**TRADEMARK**

FIRST USE 10-1-2011; IN COMMERCE 10-1-2011.

**PRINCIPAL REGISTER**

THE MARK CONSISTS OF STANDARD CHARACTERS WITHOUT CLAIM TO ANY PARTICULAR FONT, STYLE, SIZE, OR COLOR.

SN 85-334,206, FILED 5-31-2011.

GEOFFREY FOSDICK, EXAMINING ATTORNEY



*David J. Kyffers*

Director of the United States Patent and Trademark Office

# United States of America

United States Patent and Trademark Office

## SIMPLY COCOA

**Reg. No. 4,126,915**

STACY'S PITA CHIP COMPANY, INC. (MASSACHUSETTS CORPORATION)  
663 NORTH STREET  
RANDOLF, MA 02368

**Registered Apr. 10, 2012**

**Int. Cl.: 30**

FOR: BAGEL CHIPS; FLOUR-BASED CHIPS; PITA CHIPS; WHEAT-BASED SNACK FOODS,  
IN CLASS 30 (U.S. CL. 46).

**TRADEMARK**

FIRST USE 10-0-2011; IN COMMERCE 10-0-2011.

**PRINCIPAL REGISTER**

THE MARK CONSISTS OF STANDARD CHARACTERS WITHOUT CLAIM TO ANY PAR-  
TICULAR FONT, STYLE, SIZE, OR COLOR.

OWNER OF U.S. REG. NOS. 3,202,061 AND 3,332,680.

NO CLAIM IS MADE TO THE EXCLUSIVE RIGHT TO USE "COCOA", APART FROM THE  
MARK AS SHOWN.

SN 85-334,252, FILED 5-31-2011.

JENNY PARK, EXAMINING ATTORNEY



*David J. Kyros*

Director of the United States Patent and Trademark Office

# United States of America

United States Patent and Trademark Office

Harry  
♥eets Sally.com

**Reg. No. 4,126,916**

MORCOS, SAMIR (UNITED STATES INDIVIDUAL)  
1470 PALOMA STREET  
PASADENA, CA 91104

**Registered Apr. 10, 2012**

**Int. Cl.: 45**

FOR: DATING SERVICES, NAMELY, PROVIDING AN ON-LINE COMPUTER DATABASE FEATURING SINGLE PEOPLE INTERESTED IN MEETING OTHER SINGLE PEOPLE; MATCHMAKING SERVICES, IN CLASS 45 (U.S. CLS. 100 AND 101).

**SERVICE MARK**

FIRST USE 12-1-2011; IN COMMERCE 12-12-2011.

**PRINCIPAL REGISTER**

NO CLAIM IS MADE TO THE EXCLUSIVE RIGHT TO USE ".COM", APART FROM THE MARK AS SHOWN.

THE MARK CONSISTS OF THE STYLIZED TEXT "HARRY MEETS SALLY .COM" WITH THE "M" IN "MEETS" IN THE SHAPE OF A HEART.

SN 85-334,389, FILED 5-31-2011.

VERNA BETH RIRIE, EXAMINING ATTORNEY



*David J. Kyros*

Director of the United States Patent and Trademark Office



# United States of America

United States Patent and Trademark Office

## KENTUCKY CLASSIC

**Reg. No. 4,126,917**

HERITAGE TOBACCO GROUP, LLC (KENTUCKY LIMITED LIABILITY COMPANY)  
1660 HARRODSBURG ROAD  
PERRYVILLE, KY 40468

**Registered Apr. 10, 2012**

**Int. Cl.: 34**

FOR: PIPE TOBACCO, IN CLASS 34 (U.S. CLS. 2, 8, 9 AND 17).

**TRADEMARK**

FIRST USE 12-13-2011; IN COMMERCE 12-13-2011.

**PRINCIPAL REGISTER**

THE MARK CONSISTS OF STANDARD CHARACTERS WITHOUT CLAIM TO ANY PARTICULAR FONT, STYLE, SIZE, OR COLOR.

NO CLAIM IS MADE TO THE EXCLUSIVE RIGHT TO USE "KENTUCKY", APART FROM THE MARK AS SHOWN.

SN 85-335,268, FILED 6-1-2011.

MIDGE BUTLER, EXAMINING ATTORNEY



*David J. Kyffers*

Director of the United States Patent and Trademark Office

# United States of America

United States Patent and Trademark Office

## POWER BREEZER

**Reg. No. 4,126,918**

**Registered Apr. 10, 2012**

**Int. Cl.: 11**

**TRADEMARK**

**PRINCIPAL REGISTER**

BREEZER HOLDINGS, LLC (DELAWARE LIMITED LIABILITY COMPANY)  
321 EAST HILLSBORO BLVD.  
DEERFIELD BEACH, FL 33441

FOR: AIR COOLING APPARATUS, IN CLASS 11 (U.S. CLS. 13, 21, 23, 31 AND 34).

FIRST USE 4-1-2011; IN COMMERCE 12-14-2011.

THE MARK CONSISTS OF STANDARD CHARACTERS WITHOUT CLAIM TO ANY PARTICULAR FONT, STYLE, SIZE, OR COLOR.

NO CLAIM IS MADE TO THE EXCLUSIVE RIGHT TO USE "POWER", APART FROM THE MARK AS SHOWN.

SN 85-335,970, FILED 6-2-2011.

PAM WILLIS, EXAMINING ATTORNEY



*David J. Kyffers*

Director of the United States Patent and Trademark Office

# United States of America

United States Patent and Trademark Office

## SOUTH PARADE

**Reg. No. 4,126,919**

SOUTH PARADE STUDIO, SA (PANAMA CORPORATION)  
AVE SAMUEL LEWIS, ED.OMEGA, OFF. 5B  
PANAMA CITY, PANAMA

**Registered Apr. 10, 2012**

**Int. Cl.: 25**

FOR: DRESSES; SHIRTS; SHORT-SLEEVED OR LONG-SLEEVED T-SHIRTS; SHORTS;  
SKIRTS AND DRESSES; SWEAT SHIRTS; SWEATERS; T-SHIRTS; TANK-TOPS; TOPS, IN  
CLASS 25 (U.S. CLS. 22 AND 39).

**TRADEMARK**

FIRST USE 9-1-2011; IN COMMERCE 11-12-2011.

**PRINCIPAL REGISTER**

THE MARK CONSISTS OF STANDARD CHARACTERS WITHOUT CLAIM TO ANY PAR-  
TICULAR FONT, STYLE, SIZE, OR COLOR.

SN 85-336,302, FILED 6-2-2011.

AMY KERTGATE, EXAMINING ATTORNEY



*David J. Kyffers*

Director of the United States Patent and Trademark Office

# United States of America

United States Patent and Trademark Office

# STYLESUITE

**Reg. No. 4,126,920**

**Registered Apr. 10, 2012**

**Int. Cl.: 42**

**SERVICE MARK**

**PRINCIPAL REGISTER**

K. HOV IP, II, INC. (CALIFORNIA CORPORATION)  
110 WEST FRONT STREET  
RED BANK, NJ 07701

FOR: PROVIDING A WEBSITE FEATURING ON-LINE NON-DOWNLOADABLE SOFTWARE THAT ENABLES USERS TO SEARCH, REVIEW AND SELECT INTERIOR AND EXTERIOR HOME FINISHES AND DÉCOR; INTERIOR DESIGN SERVICES, NAMELY, ON-LINE INFORMATION AND ADVICE FOR INTERIOR AND EXTERIOR HOME FINISHES AND DÉCOR, IN CLASS 42 (U.S. CLS. 100 AND 101).

FIRST USE 7-1-2011; IN COMMERCE 7-1-2011.

THE MARK CONSISTS OF STANDARD CHARACTERS WITHOUT CLAIM TO ANY PARTICULAR FONT, STYLE, SIZE, OR COLOR.

SN 85-336,424, FILED 6-2-2011.

SAMUEL E. SHARPER JR., EXAMINING ATTORNEY



*David J. Kyffers*

Director of the United States Patent and Trademark Office

**United States of America**  
United States Patent and Trademark Office

# TWIST-IT

**Reg. No. 4,126,921**

PIC CORPORATION (NEW JERSEY CORPORATION)  
1101-1107 WEST ELIZABETH AVENUE  
LINDEN, NJ 07036

**Registered Apr. 10, 2012**

**Int. Cl.: 5**

FOR: INSECT AND RODENT REPELLENTS, IN CLASS 5 (U.S. CLS. 6, 18, 44, 46, 51 AND 52).

**TRADEMARK**

FIRST USE 5-0-2011; IN COMMERCE 12-0-2011.

**PRINCIPAL REGISTER**

THE MARK CONSISTS OF STANDARD CHARACTERS WITHOUT CLAIM TO ANY PARTICULAR FONT, STYLE, SIZE, OR COLOR.

SN 85-336,611, FILED 6-2-2011.

SKYE YOUNG, EXAMINING ATTORNEY



*David J. Kybas*

Director of the United States Patent and Trademark Office

# United States of America

United States Patent and Trademark Office



**Reg. No. 4,126,922**

VOTELA, INC (DELAWARE CORPORATION)  
1820 MARGARET AVE.  
ANNAPOLIS, MD 21401

**Registered Apr. 10, 2012**

**Int. Cl.: 38**

FOR: VOICE OVER IP SERVICES, IN CLASS 38 (U.S. CLS. 100, 101 AND 104).

**SERVICE MARK**

FIRST USE 3-1-2011; IN COMMERCE 3-1-2011.

**PRINCIPAL REGISTER**

THE MARK CONSISTS OF A SQUARED BACKGROUND WITH A CLOUD AND THE TEXT "VOTELA" IN THE MIDDLE.

SN 85-337,193, FILED 6-3-2011.

LINDA ESTRADA, EXAMINING ATTORNEY



*David J. Kyffers*

Director of the United States Patent and Trademark Office

**United States of America**  
United States Patent and Trademark Office

# TROUPE

**Reg. No. 4,126,923**

**Registered Apr. 10, 2012**

**Int. Cl.: 9**

**TRADEMARK**

**PRINCIPAL REGISTER**

TRIZENTER, LLC (KENTUCKY LIMITED LIABILITY COMPANY)  
4350 BROWNSBORO RD  
SUITE 110  
LOUISVILLE, KY 40207

FOR: COMPUTER SOFTWARE FOR CREATING AND DISPLAYING PRESENTATIONS, IN CLASS 9 (U.S. CLS. 21, 23, 26, 36 AND 38).

FIRST USE 4-12-2011; IN COMMERCE 10-18-2011.

THE MARK CONSISTS OF STANDARD CHARACTERS WITHOUT CLAIM TO ANY PARTICULAR FONT, STYLE, SIZE, OR COLOR.

SN 85-339,169, FILED 6-6-2011.

EMILY CARLSEN, EXAMINING ATTORNEY



*David J. Kyffers*

Director of the United States Patent and Trademark Office

# United States of America

United States Patent and Trademark Office

# The AUMF

**Reg. No. 4,126,924**

THE AUMF (NEW YORK CORPORATION)  
275 MADISON AVENUE FLOOR 14  
NEW YORK, NY 10016

**Registered Apr. 10, 2012**

**Int. Cl.: 35**

FOR: ASSOCIATION SERVICES, NAMELY, PROMOTING THE INTERESTS OF UNDERREPRESENTED MINORITY SCIENCE STUDENTS AND PROFESSIONALS, AND PROMOTING GREATER MINORITY PARTICIPATION IN THE BIOMEDICAL SCIENCES INDUSTRY, IN CLASS 35 (U.S. CLS. 100, 101 AND 102).

**SERVICE MARK**

**PRINCIPAL REGISTER**

FIRST USE 6-1-2007; IN COMMERCE 1-1-2011.

THE MARK CONSISTS OF STANDARD CHARACTERS WITHOUT CLAIM TO ANY PARTICULAR FONT, STYLE, SIZE, OR COLOR.

SN 85-339,176, FILED 6-6-2011.

AMY ALFIERI, EXAMINING ATTORNEY



*David J. Kybas*

Director of the United States Patent and Trademark Office



# United States of America

United States Patent and Trademark Office

# FLUSH!

**Reg. No. 4,126,925**

**Registered Apr. 10, 2012**

**Int. Cl.: 28**

**TRADEMARK**

**PRINCIPAL REGISTER**

FOTORAMA USA, LLC (TEXAS LIMITED LIABILITY COMPANY)  
19925 STEVENS CREEK BLVD., SUITE 100  
CUPERTINO, CA 95014

FOR: PARLOR GAMES, IN CLASS 28 (U.S. CLS. 22, 23, 38 AND 50).

FIRST USE 8-0-2011; IN COMMERCE 8-0-2011.

THE MARK CONSISTS OF STANDARD CHARACTERS WITHOUT CLAIM TO ANY PARTICULAR FONT, STYLE, SIZE, OR COLOR.

SN 85-339,569, FILED 6-7-2011.

FLORENTINA BLANDU, EXAMINING ATTORNEY



*David J. Kybas*

Director of the United States Patent and Trademark Office

# United States of America

United States Patent and Trademark Office

## SURE GUARD POOL FENCE

**Reg. No. 4,126,926**

SURE GUARD POOL FENCE, INC. (FLORIDA CORPORATION)  
6438 126TH AVENUE  
LARGO, FL 33773

**Registered Apr. 10, 2012**

**Int. Cl.: 19**

FOR: NON-METAL REMOVABLE SAFETY SWIMMING POOL FENCING, IN CLASS 19  
(U.S. CLS. 1, 12, 33 AND 50).

**TRADEMARK**

FIRST USE 7-18-2011; IN COMMERCE 7-18-2011.

**PRINCIPAL REGISTER**

THE MARK CONSISTS OF STANDARD CHARACTERS WITHOUT CLAIM TO ANY PARTICULAR FONT, STYLE, SIZE, OR COLOR.

NO CLAIM IS MADE TO THE EXCLUSIVE RIGHT TO USE "GUARD POOL FENCE", APART FROM THE MARK AS SHOWN.

SN 85-339,763, FILED 6-7-2011.

ESTHER BELENKER, EXAMINING ATTORNEY



*David J. Kybas*

Director of the United States Patent and Trademark Office

# United States of America

United States Patent and Trademark Office

## DEARLY BELOVED FOREVER RED

**Reg. No. 4,126,927**

**Registered Apr. 10, 2012**

**Int. Cl.: 33**

**TRADEMARK**

**PRINCIPAL REGISTER**

H.D.D. LLC (CALIFORNIA LIMITED LIABILITY COMPANY), DBA TRUETT HURST  
WINERY,  
5610 DRY CREEK ROAD  
HEALDSBURG, CA 95448

FOR: ALCOHOLIC BEVERAGES EXCEPT BEERS, IN CLASS 33 (U.S. CLS. 47 AND 49).

FIRST USE 10-31-2011; IN COMMERCE 10-31-2011.

THE MARK CONSISTS OF STANDARD CHARACTERS WITHOUT CLAIM TO ANY PARTICULAR FONT, STYLE, SIZE, OR COLOR.

NO CLAIM IS MADE TO THE EXCLUSIVE RIGHT TO USE "RED", APART FROM THE MARK AS SHOWN.

SN 85-339,793, FILED 6-7-2011.

NAAKWAMA ANKRAH, EXAMINING ATTORNEY



*David J. Kyffers*

Director of the United States Patent and Trademark Office

# United States of America

United States Patent and Trademark Office

# OMNADREN

**Reg. No. 4,126,928**

DYNAMIC SPORTS NUTRITION, LLC (TEXAS LIMITED LIABILITY COMPANY)  
1330 POST OAK BLVD., STE. 2900  
HOUSTON, TX 77056

**Registered Apr. 10, 2012**

**Int. Cl.: 5**

FOR: DIETARY AND NUTRITIONAL SUPPLEMENTS, IN CLASS 5 (U.S. CLS. 6, 18, 44, 46, 51 AND 52).

**TRADEMARK**

FIRST USE 1-1-2012; IN COMMERCE 1-1-2012.

**PRINCIPAL REGISTER**

THE MARK CONSISTS OF STANDARD CHARACTERS WITHOUT CLAIM TO ANY PARTICULAR FONT, STYLE, SIZE, OR COLOR.

SN 85-340,030, FILED 6-7-2011.

JANICE KIM, EXAMINING ATTORNEY



*David J. Kyffers*

Director of the United States Patent and Trademark Office

# United States of America

United States Patent and Trademark Office

# TRENBOLONE

**Reg. No. 4,126,929**

DYNAMIC SPORTS NUTRITION, LLC (TEXAS LIMITED LIABILITY COMPANY)  
1330 POST OAK BLVD., STE. 2900  
HOUSTON, TX 77056

**Registered Apr. 10, 2012**

**Int. Cl.: 5**

FOR: DIETARY AND NUTRITIONAL SUPPLEMENTS, IN CLASS 5 (U.S. CLS. 6, 18, 44, 46, 51 AND 52).

**TRADEMARK**

FIRST USE 1-1-2012; IN COMMERCE 1-1-2012.

**PRINCIPAL REGISTER**

THE MARK CONSISTS OF STANDARD CHARACTERS WITHOUT CLAIM TO ANY PARTICULAR FONT, STYLE, SIZE, OR COLOR.

SN 85-340,039, FILED 6-7-2011.

JANICE KIM, EXAMINING ATTORNEY



*David J. Kyffers*

Director of the United States Patent and Trademark Office

# United States of America

United States Patent and Trademark Office

## TRUE GRAPEFRUIT

**Reg. No. 4,126,930**

**Registered Apr. 10, 2012**

**Int. Cl.: 30**

**TRADEMARK**

**PRINCIPAL REGISTER**

GRAND BRANDS, INC. (DELAWARE CORPORATION)  
8989 YELLOW BRICK ROAD  
BALTIMORE, MD 21237

FOR: POWDERED FOOD AND BEVERAGE SEASONING, IN CLASS 30 (U.S. CL. 46).

FIRST USE 5-31-2011; IN COMMERCE 6-30-2011.

THE MARK CONSISTS OF STANDARD CHARACTERS WITHOUT CLAIM TO ANY PARTICULAR FONT, STYLE, SIZE, OR COLOR.

OWNER OF U.S. REG. NOS. 2,967,697, 3,068,674, AND 3,472,825.

NO CLAIM IS MADE TO THE EXCLUSIVE RIGHT TO USE "GRAPEFRUIT", APART FROM THE MARK AS SHOWN.

SN 85-340,880, FILED 6-8-2011.

WENDY GOODMAN, EXAMINING ATTORNEY



*David J. Kybas*

Director of the United States Patent and Trademark Office

# United States of America

United States Patent and Trademark Office

## AUNT MAPLE'S

**Reg. No. 4,126,931**

ALDI INC. (ILLINOIS CORPORATION)  
1200 N. KIRK ROAD  
BATAVIA, IL 60510

**Registered Apr. 10, 2012**

**Int. Cl.: 30**

FOR: PANCAKE SYRUP, IN CLASS 30 (U.S. CL. 46).

**TRADEMARK**

FIRST USE 11-23-2011; IN COMMERCE 11-23-2011.

**PRINCIPAL REGISTER**

THE MARK CONSISTS OF STANDARD CHARACTERS WITHOUT CLAIM TO ANY PARTICULAR FONT, STYLE, SIZE, OR COLOR.

OWNER OF U.S. REG. NO. 2,657,204.

SN 85-341,802, FILED 6-9-2011.

FRANK LATTUCA, EXAMINING ATTORNEY



*David J. Kyffers*

Director of the United States Patent and Trademark Office

# United States of America

United States Patent and Trademark Office

## GenTrust Wealth Management

**Reg. No. 4,126,932**

GENTRUST WEALTH MANAGEMENT, LLC (DELAWARE LIMITED LIABILITY COMPANY)  
322 W. 57TH ST. APT. 49U  
NEW YORK, NY 10019

**Registered Apr. 10, 2012**

**Int. Cls.: 35 and 36**

FOR: TAX AND TAXATION PLANNING, ADVICE, INFORMATION AND CONSULTANCY SERVICES, IN CLASS 35 (U.S. CLS. 100, 101 AND 102).

**SERVICE MARK**

FIRST USE 12-9-2011; IN COMMERCE 12-9-2011.

**PRINCIPAL REGISTER**

FOR: FINANCIAL PLANNING AND INVESTMENT ADVISORY SERVICES; FINANCIAL SERVICES, NAMELY, WEALTH MANAGEMENT SERVICES, IN CLASS 36 (U.S. CLS. 100, 101 AND 102).

FIRST USE 12-9-2011; IN COMMERCE 12-9-2011.

THE MARK CONSISTS OF STANDARD CHARACTERS WITHOUT CLAIM TO ANY PARTICULAR FONT, STYLE, SIZE, OR COLOR.

NO CLAIM IS MADE TO THE EXCLUSIVE RIGHT TO USE "WEALTH MANAGEMENT", APART FROM THE MARK AS SHOWN.

SN 85-342,081, FILED 6-9-2011.

CHARLES L. JENKINS, EXAMINING ATTORNEY



*David J. Kybas*

Director of the United States Patent and Trademark Office



# United States of America

United States Patent and Trademark Office

# Earnmailer

**Reg. No. 4,126,933**

ION CLOUD TECHNOLOGIES CORP. (BR. VIRGIN ISLANDS PRIVATE LIMITED COMPANY)  
2234 IFS CHAMBERS, ROAD TOWN  
TORTOLA, BR. VIRGIN ISLANDS

**Registered Apr. 10, 2012**

**Int. Cl.: 35**

FOR: ADVERTISING AND MARKETING SERVICES, IN CLASS 35 (U.S. CLS. 100, 101 AND 102).

**SERVICE MARK**

FIRST USE 6-21-2011; IN COMMERCE 6-21-2011.

**PRINCIPAL REGISTER**

THE MARK CONSISTS OF STANDARD CHARACTERS WITHOUT CLAIM TO ANY PARTICULAR FONT, STYLE, SIZE, OR COLOR.

SN 85-342,137, FILED 6-9-2011.

JAMES A. RAUEN, EXAMINING ATTORNEY



*David J. Kyffers*

Director of the United States Patent and Trademark Office

# United States of America

United States Patent and Trademark Office

## CGI ENTERPRISE INTELLIGENCE360

**Reg. No. 4,126,934**

**Registered Apr. 10, 2012**

**Int. Cl.: 42**

**SERVICE MARK**

**PRINCIPAL REGISTER**

CGI TECHNOLOGIES AND SOLUTIONS INC. (DELAWARE CORPORATION)  
11325 RANDOM HILLS ROAD  
FAIRFAX, VA 22030

FOR: COMPUTER SOFTWARE DESIGN; CONSULTING SERVICES IN THE FIELD OF COMPUTER-BASED INFORMATION SYSTEMS FOR BUSINESSES; HOSTING ON-LINE WEB FACILITIES FOR OTHERS FOR BUILDING AND MAINTAINING DATABASES OF BUSINESS INFORMATION, AND FOR ANALYZING AND REPORTING BUSINESS INFORMATION; INFORMATION TECHNOLOGY CONSULTATION; TECHNICAL SUPPORT SERVICES, NAMELY, TROUBLESHOOTING OF COMPUTER SOFTWARE PROBLEMS, IN CLASS 42 (U.S. CLS. 100 AND 101).

FIRST USE 12-27-2011; IN COMMERCE 12-27-2011.

THE MARK CONSISTS OF STANDARD CHARACTERS WITHOUT CLAIM TO ANY PARTICULAR FONT, STYLE, SIZE, OR COLOR.

OWNER OF U.S. REG. NOS. 3,664,147, 3,895,369, AND OTHERS.

NO CLAIM IS MADE TO THE EXCLUSIVE RIGHT TO USE "ENTERPRISE", APART FROM THE MARK AS SHOWN.

SN 85-342,318, FILED 6-9-2011.

REBECCA SMITH, EXAMINING ATTORNEY



*David J. Kyros*

Director of the United States Patent and Trademark Office

**United States of America**  
United States Patent and Trademark Office

# DEADSTOP

**Reg. No. 4,126,935**

**Registered Apr. 10, 2012**

**Int. Cl.: 9**

**TRADEMARK**

**PRINCIPAL REGISTER**

LCOA COMPOSITES, INC. (CALIFORNIA CORPORATION)  
20322 WINDROW DRIVE  
LAKE FOREST, CA 92630

FOR: HAND-HELD PROTECTIVE SHIELD FOR USE BY POLICE, DETENTION CENTERS, CORRECTIONAL FACILITIES AND THE LIKE, IN CLASS 9 (U.S. CLS. 21, 23, 26, 36 AND 38).

FIRST USE 12-21-2010; IN COMMERCE 12-21-2010.

THE MARK CONSISTS OF STANDARD CHARACTERS WITHOUT CLAIM TO ANY PARTICULAR FONT, STYLE, SIZE, OR COLOR.

SN 85-343,147, FILED 6-10-2011.

CHARLOTTE CORWIN, EXAMINING ATTORNEY



*David J. Kyffers*

Director of the United States Patent and Trademark Office

# United States of America

United States Patent and Trademark Office

## iSci Management

**Reg. No. 4,126,936**

**Registered Apr. 10, 2012**

**Int. Cls.: 35 and 42**

**SERVICE MARK**

**PRINCIPAL REGISTER**

FOSTER, COLIN (UNITED STATES INDIVIDUAL)  
117 BEECHER ROAD  
WOODBIDGE, CT 06525

FOR: BUSINESS CONSULTING AND MANAGEMENT IN THE FIELD OF CLINICAL TRIALS, NAMELY, CLINICAL DATA AND REGULATORY SUBMISSION MANAGEMENT ON BEHALF OF MEDICAL, BIOPHARMACEUTICAL AND BIOTECHNOLOGY COMPANIES TO ASSIST THEM WITH CLINICAL RESEARCH, CLINICAL TRIALS AND APPLICATIONS FOR DRUG APPROVAL, IN CLASS 35 (U.S. CLS. 100, 101 AND 102).

FIRST USE 6-1-2011; IN COMMERCE 6-1-2011.

FOR: CONSULTING SERVICES IN THE FIELDS OF BIOTECHNOLOGY, PHARMACEUTICAL RESEARCH AND DEVELOPMENT, LABORATORY TESTING, DIAGNOSTICS, AND PHARMACOGENETICS, IN CLASS 42 (U.S. CLS. 100 AND 101).

FIRST USE 6-1-2011; IN COMMERCE 6-1-2011.

THE MARK CONSISTS OF STANDARD CHARACTERS WITHOUT CLAIM TO ANY PARTICULAR FONT, STYLE, SIZE, OR COLOR.

NO CLAIM IS MADE TO THE EXCLUSIVE RIGHT TO USE "MANAGEMENT", APART FROM THE MARK AS SHOWN.

SN 85-343,182, FILED 6-10-2011.

HENRY S. ZAK, EXAMINING ATTORNEY



*David J. Kyjars*

Director of the United States Patent and Trademark Office

# United States of America

United States Patent and Trademark Office

# YA

**Reg. No. 4,126,937**

GUINANE, GEORGE T (UNITED STATES INDIVIDUAL)  
4 WOODHOLM LN.  
MANCHESTER, MA 01944

**Registered Apr. 10, 2012**

**Int. Cl.: 41**

FOR: ENTERTAINMENT IN THE NATURE OF LIVE PERFORMANCES BY A MUSICAL GROUP, IN CLASS 41 (U.S. CLS. 100, 101 AND 107).

**SERVICE MARK**

FIRST USE 3-21-2009; IN COMMERCE 3-21-2009.

**PRINCIPAL REGISTER**

THE MARK CONSISTS OF STANDARD CHARACTERS WITHOUT CLAIM TO ANY PARTICULAR FONT, STYLE, SIZE, OR COLOR.

SN 85-343,301, FILED 6-10-2011.

BARBARA A. GOLD, EXAMINING ATTORNEY



*David J. Kybas*

Director of the United States Patent and Trademark Office

# United States of America

United States Patent and Trademark Office

# BarBandit

**Reg. No. 4,126,938**

FEY, WAYNE D. (UNITED STATES INDIVIDUAL)  
12 TRAILRIDGE ROAD  
ASHEVILLE, NC 28804

**Registered Apr. 10, 2012**

**Int. Cl.: 6**

FOR: REBAR INSTALLATION AND RETAINING SYSTEM, NAMELY, A GROUP OF METAL RODS, BARS, AND CONNECTORS USED TO FORM A GRID FOR REINFORCING AND REHABILITATING DETERIORATED PILINGS FOR BRIDGES, IN CLASS 6 (U.S. CLS. 2, 12, 13, 14, 23, 25 AND 50).

**TRADEMARK**

**PRINCIPAL REGISTER**

FIRST USE 7-15-2011; IN COMMERCE 7-15-2011.

THE MARK CONSISTS OF STANDARD CHARACTERS WITHOUT CLAIM TO ANY PARTICULAR FONT, STYLE, SIZE, OR COLOR.

SN 85-343,414, FILED 6-10-2011.

ROBIN CHOSID, EXAMINING ATTORNEY



*David J. Kyffers*

Director of the United States Patent and Trademark Office

# United States of America

United States Patent and Trademark Office

## PURE CLOUD

**Reg. No. 4,126,939**

HEALTHFUSION, INC. (DELAWARE CORPORATION)  
100 NORTH RIOS AVENUE  
SOLANA BEACH, CA 92075

**Registered Apr. 10, 2012**

**Int. Cl.: 42**

FOR: PROVIDING TEMPORARY USE OF ONLINE NON DOWNLOADABLE SOFTWARE FOR THE TRANSMISSION AND SHARING OF DATA AND INFORMATION IN THE HEALTHCARE FIELD, IN CLASS 42 (U.S. CLS. 100 AND 101).

**SERVICE MARK**

FIRST USE 6-9-2011; IN COMMERCE 8-31-2011.

**PRINCIPAL REGISTER**

THE MARK CONSISTS OF STANDARD CHARACTERS WITHOUT CLAIM TO ANY PARTICULAR FONT, STYLE, SIZE, OR COLOR.

NO CLAIM IS MADE TO THE EXCLUSIVE RIGHT TO USE "CLOUD", APART FROM THE MARK AS SHOWN.

SN 85-343,616, FILED 6-10-2011.

ELLEN PERKINS, EXAMINING ATTORNEY



*David J. Kyros*

Director of the United States Patent and Trademark Office

# United States of America

United States Patent and Trademark Office

# Bundelow

**Reg. No. 4,126,940**

BLAKE LINDEMANN (UNITED STATES INDIVIDUAL)  
433 N. CAMDEN DRIVE, 4TH FLOOR  
BEVERLY HILLS, AZ 90210

**Registered Apr. 10, 2012**

**Int. Cl.: 35**

FOR: PROMOTING THE GOODS AND SERVICES OF OTHERS BY PROVIDING A WEBSITE FEATURING COUPONS, REBATES, PRICE-COMPARISON INFORMATION, PRODUCT REVIEWS, LINKS TO THE RETAIL WEBSITES OF OTHERS, AND DISCOUNT INFORMATION, IN CLASS 35 (U.S. CLS. 100, 101 AND 102).

**SERVICE MARK**

**PRINCIPAL REGISTER**

FIRST USE 1-12-2011; IN COMMERCE 4-12-2011.

THE MARK CONSISTS OF STANDARD CHARACTERS WITHOUT CLAIM TO ANY PARTICULAR FONT, STYLE, SIZE, OR COLOR.

SN 85-343,897, FILED 6-11-2011.

REGINA DRUMMOND, EXAMINING ATTORNEY



*David J. Kybas*

Director of the United States Patent and Trademark Office



# United States of America

United States Patent and Trademark Office

# Unstuck

**Reg. No. 4,126,941**

**Registered Apr. 10, 2012**

**Int. Cl.: 16**

**TRADEMARK**

**PRINCIPAL REGISTER**

UNSTUCK BOOKS, LLC (TEXAS LIMITED LIABILITY COMPANY)  
4505 DUVAL ST.  
#204  
AUSTIN, TX 78751

FOR: PRINTED MATERIALS, NAMELY, JOURNALS FEATURING FICTION, POETRY, ESSAYS, AND VISUAL ART, IN CLASS 16 (U.S. CLS. 2, 5, 22, 23, 29, 37, 38 AND 50).

FIRST USE 5-1-2011; IN COMMERCE 10-1-2011.

THE MARK CONSISTS OF STANDARD CHARACTERS WITHOUT CLAIM TO ANY PARTICULAR FONT, STYLE, SIZE, OR COLOR.

SN 85-344,084, FILED 6-12-2011.

MICHELLE DUBOIS, EXAMINING ATTORNEY



*David J. Kyffers*

Director of the United States Patent and Trademark Office

# United States of America

United States Patent and Trademark Office

# RELOGIC

**Reg. No. 4,126,942**

**Registered Apr. 10, 2012**

**Int. Cl.: 35**

**SERVICE MARK**

**PRINCIPAL REGISTER**

RESOLUTION RESEARCH & MARKETING, INC. (COLORADO CORPORATION)  
UNIT E  
490 S. SANTA FE DRIVE  
DENVER, CO 802232105

FOR: COLLECTION OF MARKET RESEARCH INFORMATION; COMPUTERIZED MARKET RESEARCH SERVICES; INFORMATION AND DATA COMPILING AND ANALYZING RELATING TO BUSINESS MANAGEMENT; MARKET RESEARCH AND MARKET INTELLIGENCE SERVICES; MARKET RESEARCH BY MEANS OF A COMPUTER DATABASE, IN CLASS 35 (U.S. CLS. 100, 101 AND 102).

FIRST USE 9-1-2011; IN COMMERCE 9-1-2011.

THE MARK CONSISTS OF STANDARD CHARACTERS WITHOUT CLAIM TO ANY PARTICULAR FONT, STYLE, SIZE, OR COLOR.

SN 85-344,178, FILED 6-13-2011.

H. M. FISHER, EXAMINING ATTORNEY



*David J. Kypos*

Director of the United States Patent and Trademark Office

# United States of America

United States Patent and Trademark Office

## TECHSMITH FUSE

**Reg. No. 4,126,943**

**Registered Apr. 10, 2012**

**Int. Cl.: 9**

**TRADEMARK**

**PRINCIPAL REGISTER**

TECHSMITH CORPORATION (MICHIGAN CORPORATION)  
2405 WOODLAKE DRIVE  
OKEMOS, MI 48864

FOR: DOWNLOADABLE SOFTWARE FOR MOBILE DEVICES AND PERSONAL COMPUTERS FOR USE IN CONNECTION WITH CAPTURING AND UPLOADING VIDEOS AND IMAGES THAT ARE DELIVERABLE TO MEDIA SERVERS, DEVICES, AND SERVICES, IN CLASS 9 (U.S. CLS. 21, 23, 26, 36 AND 38).

FIRST USE 7-20-2011; IN COMMERCE 7-20-2011.

THE MARK CONSISTS OF STANDARD CHARACTERS WITHOUT CLAIM TO ANY PARTICULAR FONT, STYLE, SIZE, OR COLOR.

OWNER OF U.S. REG. NOS. 1,749,869, 2,320,170, AND 2,706,748.

SN 85-344,399, FILED 6-13-2011.

SHANNON TWOHIG, EXAMINING ATTORNEY



*David J. Kyfos*

Director of the United States Patent and Trademark Office

# United States of America

United States Patent and Trademark Office

# NeuroCare

**Reg. No. 4,126,944**

JOHNSTON, JAMES C. (UNITED STATES INDIVIDUAL)  
321 HIGH SCHOOL ROAD NE, SUITE D3 - 750  
BAINBRIDGE ISLAND, WA 98110

**Registered Apr. 10, 2012**

**Int. Cl.: 44**

FOR: CHARITABLE SERVICES, NAMELY, PROVIDING MEDICAL SERVICES TO UNDER-DEVELOPED COUNTRIES, IN CLASS 44 (U.S. CLS. 100 AND 101).

**SERVICE MARK**

FIRST USE 6-15-2011; IN COMMERCE 8-26-2011.

**PRINCIPAL REGISTER**

THE MARK CONSISTS OF STANDARD CHARACTERS WITHOUT CLAIM TO ANY PARTICULAR FONT, STYLE, SIZE, OR COLOR.

SN 85-345,119, FILED 6-13-2011.

ANNE E. GUSTASON, EXAMINING ATTORNEY



*David J. Kybas*

Director of the United States Patent and Trademark Office

# United States of America

United States Patent and Trademark Office

## Gettin' Hitched

**Reg. No. 4,126,945**

**Registered Apr. 10, 2012**

**Int. Cl.: 25**

**TRADEMARK**

**PRINCIPAL REGISTER**

MAXEY, RICK (UNITED STATES INDIVIDUAL)  
727 S. SHANNON DRIVE  
ROMEDEVILLE, IL 60446

FOR: A-SHIRTS, IN CLASS 25 (U.S. CLS. 22 AND 39).

FIRST USE 11-15-2011; IN COMMERCE 12-10-2011.

THE MARK CONSISTS OF STANDARD CHARACTERS WITHOUT CLAIM TO ANY PARTICULAR FONT, STYLE, SIZE, OR COLOR.

SN 85-345,279, FILED 6-14-2011.

SHAUNIA CARLYLE, EXAMINING ATTORNEY



*David J. Kyffers*

Director of the United States Patent and Trademark Office

United States of America  
United States Patent and Trademark Office

TASHIKA

**Reg. No. 4,126,946**

TOP YEAR INTERNATIONAL INC. (CALIFORNIA CORPORATION)  
22425 E LA PALMA AVE  
YORBA LINDA, CA 92887

**Registered Apr. 10, 2012**

**Int. Cl.: 9**

FOR: CAMERA CASES; DIGITAL CAMERAS, IN CLASS 9 (U.S. CLS. 21, 23, 26, 36 AND 38).

**TRADEMARK**

FIRST USE 8-1-2011; IN COMMERCE 8-1-2011.

**PRINCIPAL REGISTER**

THE MARK CONSISTS OF STANDARD CHARACTERS WITHOUT CLAIM TO ANY PARTICULAR FONT, STYLE, SIZE, OR COLOR.

SN 85-345,830, FILED 6-14-2011.

JORDAN BAKER, EXAMINING ATTORNEY



*David J. Kybas*

Director of the United States Patent and Trademark Office

# United States of America

United States Patent and Trademark Office

## PRIVATE PLAYBOOK

**Reg. No. 4,126,947**

ARGO GROUP INTERNATIONAL HOLDINGS, LTD. (BERMUDA CORPORATION)  
110 PITTS BAY ROAD

**Registered Apr. 10, 2012**

PEMBROKE, CANADA HM08

**Int. Cl.: 36**

FOR: INSURANCE SERVICES, NAMELY, UNDERWRITING IN THE FIELDS OF DIRECTORS' AND OFFICERS' LIABILITY, EMPLOYEE PRACTICES LIABILITY, FIDUCIARY AND MISCELLANEOUS PROFESSIONAL LIABILITY, ALL FOR PRIVATE COMPANIES, IN CLASS 36 (U.S. CLS. 100, 101 AND 102).

**SERVICE MARK**

**PRINCIPAL REGISTER**

FIRST USE 8-2-2011; IN COMMERCE 8-2-2011.

THE MARK CONSISTS OF STANDARD CHARACTERS WITHOUT CLAIM TO ANY PARTICULAR FONT, STYLE, SIZE, OR COLOR.

SN 85-346,923, FILED 6-15-2011.

MAYUR VAGHANI, EXAMINING ATTORNEY



*David J. Kybas*

Director of the United States Patent and Trademark Office

# United States of America

United States Patent and Trademark Office

# 1IN3PEOPLE

**Reg. No. 4,126,948**

NOVARTIS AG (SWITZERLAND CORPORATION)  
4002

**Registered Apr. 10, 2012**

BASEL, SWITZERLAND

**Int. Cl.: 44**

FOR: MEDICAL SERVICES AND INFORMATION PROVIDED VIA A WEBSITE TO HEALTH CARE PROFESSIONALS AND PATIENTS, IN CLASS 44 (U.S. CLS. 100 AND 101).

**SERVICE MARK**

FIRST USE 9-1-2011; IN COMMERCE 9-1-2011.

**PRINCIPAL REGISTER**

THE MARK CONSISTS OF STANDARD CHARACTERS WITHOUT CLAIM TO ANY PARTICULAR FONT, STYLE, SIZE, OR COLOR.

SN 85-347,636, FILED 6-16-2011.

AMY C. KEAN, EXAMINING ATTORNEY



*David J. Kappas*

Director of the United States Patent and Trademark Office



# United States of America

United States Patent and Trademark Office

# JAVAJIG

**Reg. No. 4,126,949**

JAVAJIG LLC (US VIRGIN ISLANDS LIMITED LIABILITY COMPANY)  
22 SOUTH SAINT CLAIR STREET  
DAYTON, OK 45402

**Registered Apr. 10, 2012**

**Int. Cl.: 11**

FOR: COFFEE BASKETS BEING PART OF ELECTRIC COFFEE MAKERS, IN CLASS 11  
(U.S. CLS. 13, 21, 23, 31 AND 34).

**TRADEMARK**

FIRST USE 1-15-2012; IN COMMERCE 1-15-2012.

**PRINCIPAL REGISTER**

THE MARK CONSISTS OF STANDARD CHARACTERS WITHOUT CLAIM TO ANY PARTICULAR FONT, STYLE, SIZE, OR COLOR.

SN 85-348,030, FILED 6-16-2011.

ELISSA GARBER KON, EXAMINING ATTORNEY



*David J. Kybas*

Director of the United States Patent and Trademark Office

# United States of America

United States Patent and Trademark Office

# ELEVATE

**Reg. No. 4,126,950**

**Registered Apr. 10, 2012**

**Int. Cl.: 41**

**SERVICE MARK**

**PRINCIPAL REGISTER**

ALI INTERNATIONAL, LLC (CALIFORNIA LIMITED LIABILITY COMPANY)  
2029 CENTURY PARK EAST  
SUITE 1400  
LOS ANGELES, CA 90067

FOR: PROFESSIONAL COACHING SERVICES IN THE FIELD OF SMALL BUSINESS MARKETING AND INTERNET MARKETING; EDUCATIONAL SERVICES, NAMELY, CONDUCTING ONE ON ONE WORKSHOPS IN THE FIELD OF SMALL BUSINESS MARKETING AND INTERNET MARKETING AND DISTRIBUTION OF COURSE MATERIAL IN CONNECTION THEREWITH, IN CLASS 41 (U.S. CLS. 100, 101 AND 107).

FIRST USE 11-3-2011; IN COMMERCE 11-3-2011.

THE MARK CONSISTS OF STANDARD CHARACTERS WITHOUT CLAIM TO ANY PARTICULAR FONT, STYLE, SIZE, OR COLOR.

SN 85-348,096, FILED 6-16-2011.

GISELLE AGOSTO, EXAMINING ATTORNEY



*David J. Kyros*

Director of the United States Patent and Trademark Office

# United States of America

United States Patent and Trademark Office

# realiTV

**Reg. No. 4,126,951**

WIEGARD, RICHARD (UNITED STATES INDIVIDUAL)  
4499 BLARNEY STONE COURT  
FRISCO, TX 75034

**Registered Apr. 10, 2012**

**Int. Cl.: 45**

FOR: PROVIDING A SOCIAL NETWORKING WEBSITE FOR REALITY TELEVISION SHOW-BASED ENTERTAINMENT PURPOSES, IN CLASS 45 (U.S. CLS. 100 AND 101).

**SERVICE MARK**

FIRST USE 9-1-2011; IN COMMERCE 1-15-2012.

**PRINCIPAL REGISTER**

THE MARK CONSISTS OF STANDARD CHARACTERS WITHOUT CLAIM TO ANY PARTICULAR FONT, STYLE, SIZE, OR COLOR.

SN 85-348,545, FILED 6-16-2011.

KIM SAITO, EXAMINING ATTORNEY



*David J. Kybas*

Director of the United States Patent and Trademark Office

# United States of America

United States Patent and Trademark Office

# LAURABOLIN

**Reg. No. 4,126,952**

DYNAMIC SPORTS NUTRITION, LLC (TEXAS LIMITED LIABILITY COMPANY)  
1330 POST OAK BLVD., STE. 2900  
HOUSTON, TX 77056

**Registered Apr. 10, 2012**

**Int. Cl.: 5**

FOR: DIETARY AND NUTRITIONAL SUPPLEMENTS, IN CLASS 5 (U.S. CLS. 6, 18, 44, 46, 51 AND 52).

**TRADEMARK**

FIRST USE 1-1-2012; IN COMMERCE 1-1-2012.

**PRINCIPAL REGISTER**

THE MARK CONSISTS OF STANDARD CHARACTERS WITHOUT CLAIM TO ANY PARTICULAR FONT, STYLE, SIZE, OR COLOR.

SN 85-349,105, FILED 6-17-2011.

JANICE KIM, EXAMINING ATTORNEY



*David J. Kyffers*

Director of the United States Patent and Trademark Office

# United States of America

United States Patent and Trademark Office

# PRIMOBOLAN

**Reg. No. 4,126,953**

DYNAMIC SPORTS NUTRITION, LLC (TEXAS LIMITED LIABILITY COMPANY)  
1330 POST OAK BLVD., STE. 2900  
HOUSTON, TX 77056

**Registered Apr. 10, 2012**

**Int. Cl.: 5**

FOR: DIETARY AND NUTRITIONAL SUPPLEMENTS, IN CLASS 5 (U.S. CLS. 6, 18, 44, 46, 51 AND 52).

**TRADEMARK**

FIRST USE 1-1-2012; IN COMMERCE 1-1-2012.

**PRINCIPAL REGISTER**

THE MARK CONSISTS OF STANDARD CHARACTERS WITHOUT CLAIM TO ANY PARTICULAR FONT, STYLE, SIZE, OR COLOR.

SN 85-349,222, FILED 6-17-2011.

JANICE KIM, EXAMINING ATTORNEY



*David J. Kyffers*

Director of the United States Patent and Trademark Office

# United States of America

United States Patent and Trademark Office

## PRIMOTESTON

**Reg. No. 4,126,954**

DYNAMIC SPORTS NUTRITION, LLC (TEXAS LIMITED LIABILITY COMPANY)  
1330 POST OAK BLVD., STE. 2900  
HOUSTON, TX 77056

**Registered Apr. 10, 2012**

**Int. Cl.: 5**

FOR: DIETARY AND NUTRITIONAL SUPPLEMENTS, IN CLASS 5 (U.S. CLS. 6, 18, 44, 46, 51 AND 52).

**TRADEMARK**

FIRST USE 1-1-2012; IN COMMERCE 1-1-2012.

**PRINCIPAL REGISTER**

THE MARK CONSISTS OF STANDARD CHARACTERS WITHOUT CLAIM TO ANY PARTICULAR FONT, STYLE, SIZE, OR COLOR.

SN 85-349,233, FILED 6-17-2011.

JANICE KIM, EXAMINING ATTORNEY



*David J. Kybas*

Director of the United States Patent and Trademark Office

# United States of America

United States Patent and Trademark Office

# HALOTESTIN

**Reg. No. 4,126,955**

DYNAMIC SPORTS NUTRITION, LLC (TEXAS LIMITED LIABILITY COMPANY)  
1330 POST OAK BLVD., STE. 2900  
HOUSTON, TX 77056

**Registered Apr. 10, 2012**

**Int. Cl.: 5**

FOR: DIETARY AND NUTRITIONAL SUPPLEMENTS, IN CLASS 5 (U.S. CLS. 6, 18, 44, 46, 51 AND 52).

**TRADEMARK**

FIRST USE 1-1-2012; IN COMMERCE 1-1-2012.

**PRINCIPAL REGISTER**

THE MARK CONSISTS OF STANDARD CHARACTERS WITHOUT CLAIM TO ANY PARTICULAR FONT, STYLE, SIZE, OR COLOR.

SN 85-349,248, FILED 6-17-2011.

JANICE KIM, EXAMINING ATTORNEY



*David J. Kyffers*

Director of the United States Patent and Trademark Office

# United States of America

United States Patent and Trademark Office



**Reg. No. 4,126,956**

**Registered Apr. 10, 2012**

**Int. Cl.: 28**

**TRADEMARK**

**PRINCIPAL REGISTER**

SONRISA ENTERPRISES, INC. (CALIFORNIA CORPORATION)  
15073 KESWICK ST.  
VAN NUYS, CA 91405

FOR: EQUIPMENT AND APPAREL USED FOR BOXING, MARTIAL ARTS, MIXED MARTIAL ARTS, FITNESS, AND KICKBOXING, NAMELY, PROTECTIVE GLOVES, SHIN PADS, PUNCHING BAGS AND SHIELDS, JUMP ROPES, RESISTANCE BANDS, HAND WRAPS, MEDICINE BALLS, ELBOW AND KNEE PADS, ANKLE WRAPS INTENDED FOR USE AS ATHLETIC JOINT SUPPORTS, PROTECTIVE ATHLETIC CUPS, MOUTH GUARDS AND PUNCH MITTS; ATHLETIC MATS FOR PERSONAL USE IN BOXING, MARTIAL ARTS, MIXED MARTIAL ARTS, FITNESS AND KICKBOXING; ATHLETIC PROTECTIVE HAND, ARM, LEG, AND BODY PADDING AND ATHLETIC WRIST SUPPORTS FOR USE IN BOXING, KICKBOXING, MARTIAL ARTS, MIXED MARTIAL ARTS, TRAINING IN SELF-DEFENSE AND DEFENSIVE TACTICS, CARDIO-BOXING, BOX-AEROBICS, AEROBIC KARATE AND FITNESS TRAINING, IN CLASS 28 (U.S. CLS. 22, 23, 38 AND 50).

FIRST USE 11-25-2011; IN COMMERCE 11-25-2011.

THE MARK CONSISTS OF THE LETTER "R" STYLIZED.

SN 85-349,395, FILED 6-17-2011.

MARTHA FROMM, EXAMINING ATTORNEY



*David J. Kyros*

Director of the United States Patent and Trademark Office



# United States of America

United States Patent and Trademark Office

## IN AIR. ONLINE.

**Reg. No. 4,126,957**

**Registered Apr. 10, 2012**

**Int. Cl.: 38**

**SERVICE MARK**

**PRINCIPAL REGISTER**

GOGO LLC (DELAWARE LIMITED LIABILITY COMPANY)  
1250 N. ARLINGTON HEIGHTS ROAD  
ITASCA, IL 60143

FOR: BROADBAND AND NARROWBAND COMMUNICATION SERVICES ONBOARD AIRCRAFTS TO ENABLE USERS TO TRANSMIT AND RECEIVE VOICE, VIDEO, AND DATA WITHIN THE AIRCRAFTS, BETWEEN THE AIRCRAFTS, BETWEEN THE AIRCRAFTS AND THE GROUND, AND BETWEEN THE GROUND AND THE AIRCRAFTS; BROADBAND AND NARROWBAND COMMUNICATION SERVICES TO INTERCONNECT USERS, LOCATED ONBOARD AN AIRCRAFT, WITH USERS LOCATED ONBOARD ANOTHER AIRCRAFT, TO INTERCONNECT USERS LOCATED ONBOARD AN AIRCRAFT WITH USERS AND DESTINATIONS ON THE GROUND, TO INTERCONNECT USERS AND DESTINATIONS ON THE GROUND WITH USERS ONBOARD THE AIRCRAFTS, AND TO INTERCONNECT USERS LOCATED ONBOARD AN AIRCRAFT; PROVISION OF ACCESS TO VIDEO AND AUDIO CONTENT VIA VIDEO-ON-DEMAND SERVICES, IN CLASS 38 (U.S. CLS. 100, 101 AND 104).

FIRST USE 6-15-2011; IN COMMERCE 6-15-2011.

THE MARK CONSISTS OF STANDARD CHARACTERS WITHOUT CLAIM TO ANY PARTICULAR FONT, STYLE, SIZE, OR COLOR.

SN 85-349,559, FILED 6-17-2011.

ELLEN B. AWRICH, EXAMINING ATTORNEY



*David J. Kyffers*

Director of the United States Patent and Trademark Office

# United States of America

United States Patent and Trademark Office

## IN AIR. ONLINE.

**Reg. No. 4,126,958**

**Registered Apr. 10, 2012**

**Int. Cl.: 9**

**TRADEMARK**

**PRINCIPAL REGISTER**

GOGO LLC (DELAWARE LIMITED LIABILITY COMPANY)  
1250 N. ARLINGTON HEIGHTS ROAD  
ITASCA, IL 60143

FOR: COMPUTER AND TELECOMMUNICATIONS NETWORK SOFTWARE FOR TRANSMITTING AND RECEIVING VOICE, VIDEO, AND DATA BETWEEN COMPUTER AND TELECOMMUNICATIONS USERS, LOCATED ONBOARD AN AIRCRAFT, AND COMPUTER, AND TELECOMMUNICATIONS SYSTEMS LOCATED ONBOARD THE AIRCRAFT, COMPUTER AND TELECOMMUNICATION SYSTEMS LOCATED ONBOARD ANOTHER AIRCRAFT, AND COMPUTER AND TELECOMMUNICATIONS SYSTEMS LOCATED ON THE GROUND, IN CLASS 9 (U.S. CLS. 21, 23, 26, 36 AND 38).

FIRST USE 6-15-2011; IN COMMERCE 6-15-2011.

THE MARK CONSISTS OF STANDARD CHARACTERS WITHOUT CLAIM TO ANY PARTICULAR FONT, STYLE, SIZE, OR COLOR.

SN 85-349,568, FILED 6-17-2011.

ELLEN B. AWRICH, EXAMINING ATTORNEY



*David J. Kybas*

Director of the United States Patent and Trademark Office

# United States of America

United States Patent and Trademark Office

# SMARTS

**Reg. No. 4,126,959**

ELDERWOOD AFFILIATES, INC. (NEW YORK CORPORATION)  
7 LIMESTONE DRIVE  
WILLIAMSVILLE, NY 14221

**Registered Apr. 10, 2012**

**Int. Cl.: 44**

FOR: SKILLED NURSING CARE SERVICES FOR SENIORS, IN CLASS 44 (U.S. CLS. 100 AND 101).

**SERVICE MARK**

FIRST USE 9-30-2010; IN COMMERCE 9-30-2010.

**PRINCIPAL REGISTER**

THE MARK CONSISTS OF STANDARD CHARACTERS WITHOUT CLAIM TO ANY PARTICULAR FONT, STYLE, SIZE, OR COLOR.

SN 85-350,493, FILED 6-20-2011.

JAY FLOWERS, EXAMINING ATTORNEY



*David J. Kybas*

Director of the United States Patent and Trademark Office

# United States of America

United States Patent and Trademark Office

## Payless 4 Smokes

**Reg. No. 4,126,960**

**Registered Apr. 10, 2012**

**Int. Cl.: 35**

**SERVICE MARK**

**PRINCIPAL REGISTER**

KCBL, LLC (ARIZONA LIMITED LIABILITY COMPANY)  
SUITE 2100  
1850 N. CENTRAL AVENUE  
PHOENIX, AZ 85004

FOR: WHOLESALE AND RETAIL STORE SERVICES FEATURING TOBACCO PRODUCTS,  
IN CLASS 35 (U.S. CLS. 100, 101 AND 102).

FIRST USE 10-1-2011; IN COMMERCE 1-1-2012.

THE MARK CONSISTS OF STANDARD CHARACTERS WITHOUT CLAIM TO ANY PAR-  
TICULAR FONT, STYLE, SIZE, OR COLOR.

NO CLAIM IS MADE TO THE EXCLUSIVE RIGHT TO USE "SMOKES", APART FROM THE  
MARK AS SHOWN.

SN 85-350,542, FILED 6-20-2011.

BRIAN PINO, EXAMINING ATTORNEY



*David J. Kyffers*

Director of the United States Patent and Trademark Office

# United States of America

United States Patent and Trademark Office

## Liquore di Avellino

**Reg. No. 4,126,961**

AVELLINO SPIRITS, LLC (NEW YORK LIMITED LIABILITY COMPANY)  
101 VILLAGE SQUARE  
SOMERS, NY 10589

**Registered Apr. 10, 2012**

**Int. Cl.: 33**

FOR: SPIRITS, IN CLASS 33 (U.S. CLS. 47 AND 49).

**TRADEMARK**

FIRST USE 8-1-2011; IN COMMERCE 1-31-2011.

**PRINCIPAL REGISTER**

THE MARK CONSISTS OF STANDARD CHARACTERS WITHOUT CLAIM TO ANY PARTICULAR FONT, STYLE, SIZE, OR COLOR.

NO CLAIM IS MADE TO THE EXCLUSIVE RIGHT TO USE "LIQUORE", APART FROM THE MARK AS SHOWN.

THE ENGLISH TRANSLATION OF "LIQUORE DI AVELLINO" IS "LIQUEUR OF AVELLINO".

SN 85-350,873, FILED 6-20-2011.

BENJAMIN OKEKE, EXAMINING ATTORNEY



*David J. Kyffers*

Director of the United States Patent and Trademark Office

# United States of America

United States Patent and Trademark Office

## TOUCH OF RENEWAL

**Reg. No. 4,126,962**

BEIERSDORF AG (FED REP GERMANY CORPORATION)  
UNNASTRASSE 48

**Registered Apr. 10, 2012**

HAMBURG, FED REP GERMANY 20253

**Int. Cl.: 3**

FOR: BODY WASH FOR HUMANS; COSMETIC PREPARATIONS FOR BATH AND SHOWER,  
IN CLASS 3 (U.S. CLS. 1, 4, 6, 50, 51 AND 52).

**TRADEMARK**

FIRST USE 12-15-2011; IN COMMERCE 12-15-2011.

**PRINCIPAL REGISTER**

THE MARK CONSISTS OF STANDARD CHARACTERS WITHOUT CLAIM TO ANY PARTICULAR FONT, STYLE, SIZE, OR COLOR.

SN 85-351,663, FILED 6-21-2011.

MICHAEL TANNER, EXAMINING ATTORNEY



*David J. Kybas*

Director of the United States Patent and Trademark Office

# United States of America

United States Patent and Trademark Office

## CK ONE SHOCK

**Reg. No. 4,126,963**

**Registered Apr. 10, 2012**

**Int. Cl.: 3**

**TRADEMARK**

**PRINCIPAL REGISTER**

CALVIN KLEIN TRADEMARK TRUST (DELAWARE CORPORATION)  
205 WEST 39TH STREET  
NEW YORK, NY 10018

FOR: EAU DE TOILETTE, SKIN MOISTURIZER, BODY MASSAGE OIL, BODY WASH, SOAP, PERSONAL DEODORANT, TALC OILS FOR HAIR CONDITIONING, SHAMPOO, HAIR GEL, IN CLASS 3 (U.S. CLS. 1, 4, 6, 50, 51 AND 52).

FIRST USE 9-30-2011; IN COMMERCE 9-30-2011.

THE MARK CONSISTS OF STANDARD CHARACTERS WITHOUT CLAIM TO ANY PARTICULAR FONT, STYLE, SIZE, OR COLOR.

OWNER OF U.S. REG. NO. 3,916,700.

SN 85-352,868, FILED 6-22-2011.

GENE MACIOL, EXAMINING ATTORNEY



*David J. Kyffers*

Director of the United States Patent and Trademark Office

# United States of America

United States Patent and Trademark Office

## EASY-GRILLERS

**Reg. No. 4,126,964**

WADA FARMS MARKETING GROUP LLC (IDAHO LIMITED LIABILITY COMPANY)  
2155 PROVIDENCE WAY  
IDAHO FALLS, ID 83404

**Registered Apr. 10, 2012**

**Int. Cl.: 31**

FOR: FRESH POTATOES, IN CLASS 31 (U.S. CLS. 1 AND 46).

**TRADEMARK**

FIRST USE 6-1-2011; IN COMMERCE 6-1-2011.

**PRINCIPAL REGISTER**

THE MARK CONSISTS OF STANDARD CHARACTERS WITHOUT CLAIM TO ANY PARTICULAR FONT, STYLE, SIZE, OR COLOR.

SN 85-352,889, FILED 6-22-2011.

BRIAN PINO, EXAMINING ATTORNEY



*David J. Kybas*

Director of the United States Patent and Trademark Office



# United States of America

United States Patent and Trademark Office

## THINKING PANTIES

**Reg. No. 4,126,965**

**Registered Apr. 10, 2012**

**Int. Cl.: 25**

**TRADEMARK**

**PRINCIPAL REGISTER**

THINKING GRANDE INC. (CALIFORNIA CORPORATION)  
2412 CANADA BLVD.  
GLENDALE, CA 91208

FOR: PANTIES; UNDERWEAR, IN CLASS 25 (U.S. CLS. 22 AND 39).

FIRST USE 1-1-2012; IN COMMERCE 1-1-2012.

THE MARK CONSISTS OF STANDARD CHARACTERS WITHOUT CLAIM TO ANY PARTICULAR FONT, STYLE, SIZE, OR COLOR.

NO CLAIM IS MADE TO THE EXCLUSIVE RIGHT TO USE "PANTIES", APART FROM THE MARK AS SHOWN.

SN 85-353,109, FILED 6-22-2011.

LINDA E. BLOHM, EXAMINING ATTORNEY



*David J. Kyffers*

Director of the United States Patent and Trademark Office

# United States of America

United States Patent and Trademark Office

# TESTOVIRON

**Reg. No. 4,126,966**

DYNAMIC SPORTS NUTRITION, LLC (TEXAS LIMITED LIABILITY COMPANY)  
1330 POST OAK BLVD., STE. 2900  
HOUSTON, TX 77056

**Registered Apr. 10, 2012**

**Int. Cl.: 5**

FOR: DIETARY AND NUTRITIONAL SUPPLEMENTS, IN CLASS 5 (U.S. CLS. 6, 18, 44, 46, 51 AND 52).

**TRADEMARK**

FIRST USE 1-1-2012; IN COMMERCE 1-1-2012.

**PRINCIPAL REGISTER**

THE MARK CONSISTS OF STANDARD CHARACTERS WITHOUT CLAIM TO ANY PARTICULAR FONT, STYLE, SIZE, OR COLOR.

SN 85-353,385, FILED 6-22-2011.

JANICE KIM, EXAMINING ATTORNEY



*David J. Kybas*

Director of the United States Patent and Trademark Office

# United States of America

United States Patent and Trademark Office

# Sports-Fire

**Reg. No. 4,126,967**

**Registered Apr. 10, 2012**

**Int. Cl.: 11**

**TRADEMARK**

**PRINCIPAL REGISTER**

NEW ENERGY DISTRIBUTING, INC. (IOWA CORPORATION)  
601 6TH AVE NW  
DYERSVILLE, IA 52040

FOR: TABLE TOP FIREPLACES, IN CLASS 11 (U.S. CLS. 13, 21, 23, 31 AND 34).

FIRST USE 8-30-2011; IN COMMERCE 8-30-2011.

THE MARK CONSISTS OF STANDARD CHARACTERS WITHOUT CLAIM TO ANY PARTICULAR FONT, STYLE, SIZE, OR COLOR.

SN 85-354,015, FILED 6-23-2011.

JORDAN BAKER, EXAMINING ATTORNEY



*David J. Kyffers*

Director of the United States Patent and Trademark Office

# United States of America

United States Patent and Trademark Office

## OXANDROLONE

**Reg. No. 4,126,968**

DYNAMIC SPORTS NUTRITION, LLC (TEXAS LIMITED LIABILITY COMPANY)  
1330 POST OAK BLVD., STE. 2900  
HOUSTON, TX 77056

**Registered Apr. 10, 2012**

**Int. Cl.: 5**

FOR: DIETARY AND NUTRITIONAL SUPPLEMENTS, IN CLASS 5 (U.S. CLS. 6, 18, 44, 46, 51 AND 52).

**TRADEMARK**

FIRST USE 1-1-2012; IN COMMERCE 1-1-2012.

**PRINCIPAL REGISTER**

THE MARK CONSISTS OF STANDARD CHARACTERS WITHOUT CLAIM TO ANY PARTICULAR FONT, STYLE, SIZE, OR COLOR.

SN 85-354,270, FILED 6-23-2011.

JANICE KIM, EXAMINING ATTORNEY



*David J. Kybas*

Director of the United States Patent and Trademark Office

# United States of America

United States Patent and Trademark Office

# Ursobolic

**Reg. No. 4,126,969**

**Registered Apr. 10, 2012**

**Int. Cl.: 5**

**TRADEMARK**

**PRINCIPAL REGISTER**

SAVIND INCORPORATED (ILLINOIS CORPORATION)

B  
205 SOUTH MAIN STREET  
SEYMOUR, IL 61875

FOR: DIETARY FOOD SUPPLEMENTS, IN CLASS 5 (U.S. CLS. 6, 18, 44, 46, 51 AND 52).

FIRST USE 9-20-2011; IN COMMERCE 9-20-2011.

THE MARK CONSISTS OF STANDARD CHARACTERS WITHOUT CLAIM TO ANY PARTICULAR FONT, STYLE, SIZE, OR COLOR.

SN 85-355,141, FILED 6-24-2011.

IRA J. GOODSID, EXAMINING ATTORNEY



*David J. Kybas*

Director of the United States Patent and Trademark Office

# United States of America

United States Patent and Trademark Office

# REVITALIFE

**Reg. No. 4,126,970**

FREIJE TREATMENT SYSTEMS, INC. (INDIANA CORPORATION)  
4202 N. AWNING COURT  
GREENFIELD, IN 46140

**Registered Apr. 10, 2012**

**Int. Cl.: 11**

FOR: WATER PURIFICATION AND TREATMENT UNITS, NAMELY, REVERSE OSMOSIS AND FILTRATION UNITS; WATER TREATMENT SYSTEMS CONSISTING PRIMARILY OF WATER STORAGE TANKS, WATER FILTERS AND FILTER ADAPTERS, MEMBRANES, AND FLOW RESTRICTORS, SOLD TOGETHER AS A UNIT, IN CLASS 11 (U.S. CLS. 13, 21, 23, 31 AND 34).

**TRADEMARK**

**PRINCIPAL REGISTER**

FIRST USE 10-7-2011; IN COMMERCE 10-7-2011.

THE MARK CONSISTS OF STANDARD CHARACTERS WITHOUT CLAIM TO ANY PARTICULAR FONT, STYLE, SIZE, OR COLOR.

SN 85-355,917, FILED 6-24-2011.

MARIA-VICTORIA SUAREZ, EXAMINING ATTORNEY



*David J. Kybas*

Director of the United States Patent and Trademark Office

# United States of America

United States Patent and Trademark Office



**Reg. No. 4,126,971**

**Registered Apr. 10, 2012**

**Int. Cl.: 42**

**SERVICE MARK**

**PRINCIPAL REGISTER**

STAGECOACHED, LLC (NEW JERSEY LIMITED LIABILITY COMPANY)  
15 COLONIAL RIDGE DR.  
HADDONFIELD, NJ 08033

FOR: TEMPORARY INTERIOR HOME DECORATION CONSULTATION FOR THE PURPOSE OF MAKING THE INTERIOR OF A HOME OR OTHER DWELLING MORE APPEALING TO PROSPECTIVE BUYERS, IN CLASS 42 (U.S. CLS. 100 AND 101).

FIRST USE 10-21-2011; IN COMMERCE 10-21-2011.

THE MARK CONSISTS OF A STYLIZED REPRESENTATION OF THREE INTERLOCKING HOUSES. THE OUTER TWO HOUSES ARE GRAY AND THE CENTER HOUSE IS GREEN. BELOW THE HOUSES THERE APPEARS A STYLIZED GRAY ARC. BELOW THAT APPEARS THE WORDING "STAGECOACHEDHOME" IN STYLIZED GRAY LETTERS. THE BACKGROUND IS TRANSPARENT.

THE COLOR(S) GRAY AND GREEN IS/ARE CLAIMED AS A FEATURE OF THE MARK.

SN 85-356,259, FILED 6-25-2011.

LAKEISHA LEWIS, EXAMINING ATTORNEY



*David J. Kybas*

Director of the United States Patent and Trademark Office

# United States of America

United States Patent and Trademark Office

## RED AND BLUE BANKING

**Reg. No. 4,126,972**

**Registered Apr. 10, 2012**

**Int. Cl.: 36**

**SERVICE MARK**

**PRINCIPAL REGISTER**

COMPASS BANCSHARES, INC. (ALABAMA CORPORATION)  
15 SOUTH 20TH STREET, 12TH FLOOR  
BIRMINGHAM, AL 35233

FOR: BANKING SERVICES, IN CLASS 36 (U.S. CLS. 100, 101 AND 102).

FIRST USE 5-19-2011; IN COMMERCE 6-9-2011.

THE MARK CONSISTS OF STANDARD CHARACTERS WITHOUT CLAIM TO ANY PARTICULAR FONT, STYLE, SIZE, OR COLOR.

NO CLAIM IS MADE TO THE EXCLUSIVE RIGHT TO USE "BANKING", APART FROM THE MARK AS SHOWN.

SN 85-357,152, FILED 6-27-2011.

PRISCILLA MILTON, EXAMINING ATTORNEY



*David J. Kyffers*

Director of the United States Patent and Trademark Office



# United States of America

United States Patent and Trademark Office

# enVision.360

**Reg. No. 4,126,973**

**Registered Apr. 10, 2012**

**Int. Cl.: 35**

**SERVICE MARK**

**PRINCIPAL REGISTER**

WILTZIUS ASSOCIATES, LLC (WISCONSIN LIMITED LIABILITY COMPANY)  
W6849 MARRIHILL COURT  
GREENVILLE, WI 54942

FOR: BUSINESS CONSULTATION SERVICES; CONSULTING SERVICES IN BUSINESS LEADERSHIP DEVELOPMENT AND BUSINESS MANAGEMENT, IN CLASS 35 (U.S. CLS. 100, 101 AND 102).

FIRST USE 1-1-2012; IN COMMERCE 1-1-2012.

THE MARK CONSISTS OF STANDARD CHARACTERS WITHOUT CLAIM TO ANY PARTICULAR FONT, STYLE, SIZE, OR COLOR.

SN 85-359,211, FILED 6-29-2011.

STEVEN JACKSON, EXAMINING ATTORNEY



*David J. Kybas*

Director of the United States Patent and Trademark Office

# United States of America

United States Patent and Trademark Office

# MOTIF

**Reg. No. 4,126,974**

**Registered Apr. 10, 2012**

**Int. Cl.: 44**

**SERVICE MARK**

**PRINCIPAL REGISTER**

SYNERON CANADA CORPORATION (CANADA CORPORATION)  
UNIT #8  
28 FULTON WAY  
RICHMOND HILL, ONTARIO, CANADA L4B1J5

FOR: MEDICAL AND AESTHETIC PROCEDURE FOR BODY SCULPTING AND CONTOURING, IN CLASS 44 (U.S. CLS. 100 AND 101).

FIRST USE 11-8-2011; IN COMMERCE 11-8-2011.

THE MARK CONSISTS OF STANDARD CHARACTERS WITHOUT CLAIM TO ANY PARTICULAR FONT, STYLE, SIZE, OR COLOR.

SN 85-362,493, FILED 7-3-2011.

NORA BUCHANAN WILL, EXAMINING ATTORNEY



*David J. Kyros*

Director of the United States Patent and Trademark Office

# United States of America

United States Patent and Trademark Office

# SUBLIME

**Reg. No. 4,126,975**

**Registered Apr. 10, 2012**

**Int. Cl.: 44**

**SERVICE MARK**

**PRINCIPAL REGISTER**

SYNERON CANADA CORPORATION (CANADA CORPORATION)  
UNIT #8  
28 FULTON WAY  
RICHMOND HILL, ONTARIO, CANADA L4B1J5

FOR: MEDICAL AND AESTHETIC PROCEDURE FOR BODY SCULPTING AND CONTOURING, IN CLASS 44 (U.S. CLS. 100 AND 101).

FIRST USE 10-20-2011; IN COMMERCE 10-20-2011.

THE MARK CONSISTS OF STANDARD CHARACTERS WITHOUT CLAIM TO ANY PARTICULAR FONT, STYLE, SIZE, OR COLOR.

SN 85-362,495, FILED 7-3-2011.

NORA BUCHANAN WILL, EXAMINING ATTORNEY



*David J. Kyros*

Director of the United States Patent and Trademark Office

# United States of America

United States Patent and Trademark Office

# Duby Xpress

**Reg. No. 4,126,976**

SUN TAIYANG CO., LTD. (NEW JERSEY CORPORATION)  
90 TRIANGLE BLVD.  
CARLSTADT, NJ 07072

**Registered Apr. 10, 2012**

**Int. Cl.: 26**

FOR: HAIR EXTENSIONS; HAIR PIECES; HAIR PIECES AND WIGS; WIG CAPS; WIGS; WIGS, HAIRPIECES, AND ADD-IN AND ADD-ON HAIR ACCESSORIES CONSTRUCTED PRIMARILY OF SYNTHETIC AND/OR HUMAN HAIR, IN CLASS 26 (U.S. CLS. 37, 39, 40, 42 AND 50).

**TRADEMARK**

**PRINCIPAL REGISTER**

FIRST USE 7-7-2011; IN COMMERCE 10-11-2011.

THE MARK CONSISTS OF STANDARD CHARACTERS WITHOUT CLAIM TO ANY PARTICULAR FONT, STYLE, SIZE, OR COLOR.

OWNER OF U.S. REG. NO. 3,500,433.

NO CLAIM IS MADE TO THE EXCLUSIVE RIGHT TO USE "DUBY", APART FROM THE MARK AS SHOWN.

SN 85-364,911, FILED 7-7-2011.

NELSON SNYDER, EXAMINING ATTORNEY



*David J. Kyffers*

Director of the United States Patent and Trademark Office

# United States of America

United States Patent and Trademark Office



**Reg. No. 4,126,977**

**Registered Apr. 10, 2012**

**Int. Cl.: 3**

**TRADEMARK**

**PRINCIPAL REGISTER**

BB ENDEAVORS LLC (NEW YORK LIMITED LIABILITY COMPANY)  
P.O. BOX 2088  
NEW YORK, NY 10013

FOR: SKINCARE PRODUCTS, NAMELY, FACIAL CLEANSERS, FACIAL EXFOLIANTS, FACIAL TONERS, FACIAL CREAMS, FACIAL LOTIONS, FACIAL MOISTURIZERS, FACIAL EMULSIONS, FACIAL MASKS, FACIAL SCRUBS, ANTI-AGING CREAMS AND LOTIONS, ANTI-WRINKLE CREAMS, LOTIONS AND SKIN CONDITIONERS; LIP GLOSS; MAKE-UP; AROMATIC BODY CARE PRODUCTS, NAMELY, BODY LOTION, SHOWER GEL, NON-MEDICATED LIP BALM, SOAP, BODY POLISH, BODY AND FOOT SCRUB; BODY AND BEAUTY CARE COSMETICS; FACE AND BODY CREAMS; FRAGRANCES AND PERFUMES; BUBBLE BATH, IN CLASS 3 (U.S. CLS. 1, 4, 6, 50, 51 AND 52).

FIRST USE 11-21-2011; IN COMMERCE 11-21-2011.

THE MARK CONSISTS OF THE STYLIZED, SHADED SILHOUETTE OF A SLENDER GIRL WEARING A TIE-BELTED ROBE. THE GIRL FACES OUTWARD, BUT HER PONY-TAILED HEAD IS TURNED TO THE VIEWERS' RIGHT TO GAZE AT HER HAND WHICH IS FULL OF BUBBLES; HER OTHER HAND AND FOREARM ARE EXTENDED AT A NINETY-DEGREE ANGLE FROM HER SIDE.

SN 85-365,685, FILED 7-7-2011.

JILL C. ALT, EXAMINING ATTORNEY



*David J. Kyjars*

Director of the United States Patent and Trademark Office

# United States of America

United States Patent and Trademark Office

## CREATIVE ROOTS

**Reg. No. 4,126,978**

HORIZON GROUP USA, INC. (NEW JERSEY CORPORATION)  
76 STIRLING RD #101  
WARREN, NJ 07059

**Registered Apr. 10, 2012**

**Int. Cl.: 14**

FOR: JEWELRY BOXES, IN CLASS 14 (U.S. CLS. 2, 27, 28 AND 50).

**TRADEMARK**

FIRST USE 5-31-2011; IN COMMERCE 5-31-2011.

**PRINCIPAL REGISTER**

THE MARK CONSISTS OF STANDARD CHARACTERS WITHOUT CLAIM TO ANY PARTICULAR FONT, STYLE, SIZE, OR COLOR.

SN 85-370,507, FILED 7-13-2011.

REGINA DRUMMOND, EXAMINING ATTORNEY



*David J. Kybas*

Director of the United States Patent and Trademark Office

# United States of America

United States Patent and Trademark Office



**Reg. No. 4,126,979**

**Registered Apr. 10, 2012**

**Int. Cls.: 9 and 41**

**TRADEMARK**

**SERVICE MARK**

**PRINCIPAL REGISTER**

KNOWLEDGE ADVENTURE, INC. (DELAWARE CORPORATION)  
LEGAL  
2377 CRENSHAW BLVD., STE. 302  
TORRANCE, CA 90501

FOR: COMPUTER GAME PROGRAMMES DOWNLOADABLE VIA THE INTERNET; COMPUTER GAME PROGRAMS; COMPUTER GAME SOFTWARE; COMPUTER GAME SOFTWARE FOR USE ON MOBILE AND CELLULAR PHONES; DOWNLOADABLE COMPUTER GAME PROGRAMS; DOWNLOADABLE COMPUTER GAME SOFTWARE VIA A GLOBAL COMPUTER NETWORK AND WIRELESS DEVICES; ELECTRONIC GAME SOFTWARE FOR CELLULAR TELEPHONES; ELECTRONIC GAME SOFTWARE FOR HANDHELD ELECTRONIC DEVICES; ELECTRONIC GAME SOFTWARE FOR WIRELESS DEVICES; GAME SOFTWARE, IN CLASS 9 (U.S. CLS. 21, 23, 26, 36 AND 38).

FIRST USE 6-1-2011; IN COMMERCE 9-1-2011.

FOR: ENTERTAINMENT SERVICES, NAMELY, PROVIDING A WEBSITE FEATURING GAMES AND PUZZLES, IN CLASS 41 (U.S. CLS. 100, 101 AND 107).

FIRST USE 9-1-2011; IN COMMERCE 9-1-2011.

NO CLAIM IS MADE TO THE EXCLUSIVE RIGHT TO USE "GAMES", APART FROM THE MARK AS SHOWN.

THE COLOR(S) BLACK AND RED IS/ARE CLAIMED AS A FEATURE OF THE MARK.

THE MARK CONSISTS OF RED TWISTER GRAPHIC, WITH BLACK TEXT OF WORDS "TWISTED" AND "GAMES" THE LETTER "I" OF "TWISTED" CONSISTING OF BLACK BAR WITH RED DOT, FIGURATIVE LETTER "S".

SN 85-372,086, FILED 7-15-2011.

REGINA DRUMMOND, EXAMINING ATTORNEY



*David J. Kybas*

Director of the United States Patent and Trademark Office

# United States of America

United States Patent and Trademark Office

## COMMAND EXPERT

**Reg. No. 4,126,980**

**Registered Apr. 10, 2012**

**Int. Cl.: 9**

**TRADEMARK**

**PRINCIPAL REGISTER**

AGILENT TECHNOLOGIES, INC. (DELAWARE CORPORATION)  
5301 STEVENS CREEK BLVD.  
SANTA CLARA, CA 95051

FOR: ELECTRONIC TEST AND MEASUREMENT INSTRUMENT SOFTWARE FOR USE IN AUTOMATING MEASUREMENTS OF SCIENTIFIC AND DIAGNOSTIC INSTRUMENTS BY PRESENTING INSTRUMENT SPECIFIC INSTRUCTIONS AND ASSISTING IN CREATING SEQUENCES THAT CAN BE USED IN VARIOUS APPLICATION DEVELOPMENT ENVIRONMENTS, IN CLASS 9 (U.S. CLS. 21, 23, 26, 36 AND 38).

FIRST USE 10-25-2011; IN COMMERCE 10-25-2011.

THE MARK CONSISTS OF STANDARD CHARACTERS WITHOUT CLAIM TO ANY PARTICULAR FONT, STYLE, SIZE, OR COLOR.

SN 85-378,177, FILED 7-22-2011.

JOHN E. MICHOS, EXAMINING ATTORNEY



*David J. Kyffers*

Director of the United States Patent and Trademark Office



# United States of America

United States Patent and Trademark Office

## SARAH VIOLET

**Reg. No. 4,126,981**

FOSSIL, INC. (DELAWARE CORPORATION)  
2280 N. GREENVILLE AVENUE  
RICHARDSON, TX 75280

**Registered Apr. 10, 2012**

**Int. Cl.: 18**

FOR: HANDBAGS AND WALLETS, IN CLASS 18 (U.S. CLS. 1, 2, 3, 22 AND 41).

**TRADEMARK**

FIRST USE 1-30-2012; IN COMMERCE 1-30-2012.

**PRINCIPAL REGISTER**

THE MARK CONSISTS OF STANDARD CHARACTERS WITHOUT CLAIM TO ANY PARTICULAR FONT, STYLE, SIZE, OR COLOR.

THE NAME "SARAH VIOLET" DOES NOT IDENTIFY A LIVING INDIVIDUAL.

SN 85-385,875, FILED 8-1-2011.

JAMES MACFARLANE, EXAMINING ATTORNEY



*David J. Kyffers*

Director of the United States Patent and Trademark Office

# United States of America

United States Patent and Trademark Office

STARTS PURE. STAYS PURE.

**Reg. No. 4,126,982**

**Registered Apr. 10, 2012**

**Int. Cl.: 29**

**TRADEMARK**

**PRINCIPAL REGISTER**

DEAN FOODS COMPANY (DELAWARE CORPORATION)  
2711 NORTH HASKELL AVENUE  
SUITE 3400  
DALLAS, TX 75204

FOR: DAIRY PRODUCTS EXCLUDING ICE CREAM, ICE MILK AND FROZEN YOGURT,  
IN CLASS 29 (U.S. CL. 46).

FIRST USE 10-0-2011; IN COMMERCE 10-0-2011.

THE MARK CONSISTS OF STANDARD CHARACTERS WITHOUT CLAIM TO ANY PAR-  
TICULAR FONT, STYLE, SIZE, OR COLOR.

SN 85-385,893, FILED 8-1-2011.

JANET LEE, EXAMINING ATTORNEY



*David J. Kybas*

Director of the United States Patent and Trademark Office

# United States of America

United States Patent and Trademark Office

## TRUST COUNTS

**Reg. No. 4,126,983**

**Registered Apr. 10, 2012**

**Int. Cl.: 35**

**SERVICE MARK**

**PRINCIPAL REGISTER**

MJCM, LLC (TEXAS LIMITED LIABILITY COMPANY), DBA PINNACLE FINANCIAL STRATEGIES,  
1235 NORTH LOOP WEST, SUITE 800  
HOUSTON, TX 77008

FOR: BUSINESS CONSULTATION SERVICES; BUSINESS MARKETING CONSULTING SERVICES; BUSINESS MARKETING SERVICES; PROMOTION AND MARKETING SERVICES AND RELATED CONSULTING, IN CLASS 35 (U.S. CLS. 100, 101 AND 102).

FIRST USE 6-1-2010; IN COMMERCE 6-1-2010.

THE MARK CONSISTS OF STANDARD CHARACTERS WITHOUT CLAIM TO ANY PARTICULAR FONT, STYLE, SIZE, OR COLOR.

SN 85-389,413, FILED 8-4-2011.

MARIA-VICTORIA SUAREZ, EXAMINING ATTORNEY



*David J. Kyffers*

Director of the United States Patent and Trademark Office

# United States of America

United States Patent and Trademark Office

## CHARTER RESERVE

**Reg. No. 4,126,984**

CARGILL MEAT SOLUTIONS CORPORATION (DELAWARE CORPORATION)  
151 NORTH MAIN  
WICHITA, KS 67202

**Registered Apr. 10, 2012**

**Int. Cl.: 29**

FOR: MEAT; POULTRY, IN CLASS 29 (U.S. CL. 46).

**TRADEMARK**

FIRST USE 10-26-2011; IN COMMERCE 10-26-2011.

**PRINCIPAL REGISTER**

THE MARK CONSISTS OF STANDARD CHARACTERS WITHOUT CLAIM TO ANY PARTICULAR FONT, STYLE, SIZE, OR COLOR.

SN 85-390,867, FILED 8-5-2011.

JACQUELINE A. LAVINE, EXAMINING ATTORNEY



*David J. Kyffers*

Director of the United States Patent and Trademark Office

# United States of America

United States Patent and Trademark Office

# BK CROWN

**Reg. No. 4,126,985**

**Registered Apr. 10, 2012**

**Int. Cl.: 41**

**SERVICE MARK**

**PRINCIPAL REGISTER**

BURGER KING CORPORATION (FLORIDA CORPORATION)  
8TH FLOOR, LEGAL DEPARTMENT  
5505 BLUE LAGOON DRIVE  
MIAMI, FL 33126

FOR: ENTERTAINMENT SERVICES, NAMELY, PROVIDING ON-LINE COMPUTER GAMES FOR CHILDREN, IN CLASS 41 (U.S. CLS. 100, 101 AND 107).

FIRST USE 11-14-2011; IN COMMERCE 11-14-2011.

THE MARK CONSISTS OF STANDARD CHARACTERS WITHOUT CLAIM TO ANY PARTICULAR FONT, STYLE, SIZE, OR COLOR.

OWNER OF U.S. REG. NOS. 2,790,924, 3,534,987, AND OTHERS.

SN 85-400,880, FILED 8-18-2011.

ZACHARY BELLO, EXAMINING ATTORNEY



*David J. Kyffers*

Director of the United States Patent and Trademark Office

# United States of America

United States Patent and Trademark Office



**Reg. No. 4,126,986**

**Registered Apr. 10, 2012**

**Int. Cl.: 35**

**SERVICE MARK**

**PRINCIPAL REGISTER**

FEDERAL HEATH SIGN COMPANY, LLC (DELAWARE LIMITED LIABILITY COMPANY)  
2300 NORTH HIGHWAY 121  
EULESS, TX 76039

FOR: DEVELOPMENT OF CUSTOMER ENGAGEMENT PLATFORMS AND DEVICES, RETAIL DISPLAY AND MERCHANDISING FIXTURES, WAYFINDING AND DISPLAY SIGNAGE WHICH HELPS SELL PRODUCTS AND FOSTER CUSTOMER ENGAGEMENT, LOYALTY AND SALES; DEVELOPMENT OF INTERACTIVE DISPLAYS, SIGNAGE AND GAMES WHICH CONTAIN MEDIA AND CONTENT USEFUL IN FOSTERING SALES, CUSTOMER LOYALTY AND CUSTOMER ENGAGEMENT, IN CLASS 35 (U.S. CLS. 100, 101 AND 102).

FIRST USE 2-8-2012; IN COMMERCE 2-8-2012.

OWNER OF U.S. REG. NOS. 2,934,950 AND 2,991,957.

THE COLOR(S) GREEN AND BLACK ARE CLAIMED AS A FEATURE OF THE MARK IS/ARE CLAIMED AS A FEATURE OF THE MARK.

NO CLAIM IS MADE TO THE EXCLUSIVE RIGHT TO USE "SOLUTIONS" AND "COMPANY", APART FROM THE MARK AS SHOWN.

THE MARK CONSISTS OF THE WORD "IN" WITHIN A CIRCLE APPEARING IN GREEN, FOLLOWED BY "GAGE" IN BLACK, AND "SOLUTIONS" APPEARING IN GREEN, ALL APPEARING ABOVE THE WORDING "A FEDERAL HEATH COMPANY" APPEARING IN BLACK.

SN 85-401,565, FILED 8-18-2011.

KELLY TRUSILO, EXAMINING ATTORNEY



*David J. Kybas*

Director of the United States Patent and Trademark Office

# United States of America

United States Patent and Trademark Office



**Reg. No. 4,126,987**

**Registered Apr. 10, 2012**

**Int. Cl.: 41**

**SERVICE MARK**

**PRINCIPAL REGISTER**

SEMINOLE TRIBE OF FLORIDA (UNITED STATES FEDERALLY-RECOGNIZED INDIAN TRIBE)  
6300 STIRLING ROAD  
HOLLYWOOD, FL 33024

FOR: CASINOS, IN CLASS 41 (U.S. CLS. 100, 101 AND 107).

FIRST USE 12-1-2011; IN COMMERCE 12-1-2011.

OWNER OF U.S. REG. NO. 3,501,804.

NO CLAIM IS MADE TO THE EXCLUSIVE RIGHT TO USE "CASINO COCONUT CREEK", APART FROM THE MARK AS SHOWN.

THE MARK CONSISTS OF THE STYLIZED WORD "COCO" IN A RECTANGLE, WITH THE FIRST TWO LETTERS "CO" ABOVE THE LAST TWO LETTERS "CO", TO THE LEFT OF THE WORDS "SEMINOLE CASINO COCONUT CREEK".

SN 85-426,965, FILED 9-20-2011.

KATHY DE JONGE, EXAMINING ATTORNEY



*David J. Kyffers*

Director of the United States Patent and Trademark Office

# United States of America

United States Patent and Trademark Office

# SO LA VITA

**Reg. No. 4,126,988**

**Registered Apr. 10, 2012**

**Int. Cl.: 25**

**TRADEMARK**

**PRINCIPAL REGISTER**

LIVEIAM LLC (NEW YORK LIMITED LIABILITY COMPANY)  
9TH FLOOR  
34 WEST 33RD STREET  
NEW YORK, NY 10001

FOR: INFANTS' AND CHILDREN'S CLOTHING, NAMELY, T-SHIRTS, SHIRTS, TOPS, PANTS, BOTTOMS, SHORT SETS, SHORTS, SKIRTS, SKORTS, DRESSES, BODY SUITS, COORDINATING SETS COMPRISING TOPS AND BOTTOMS, JEANS, JUMPSUITS, LAYETTE SETS COMPRISING TOPS AND BOTTOMS, OVERALLS, SWEATSHIRTS, SWEATPANTS, PAJAMAS, SLEEPERS, ROBES, SWIMSUITS, COVERUPS, COATS, JACKETS, RAIN JACKETS, SNOWSUITS, SWEATERS, WIND RESISTANT JACKETS, CLOTH BABY BIBS, COSTUMES FOR USE IN CHILDREN'S DRESS-UP PLAY, TIGHTS, SOCKS, BOOTIES, SHOES, CAPS, HATS, MITTENS, GLOVES, IN CLASS 25 (U.S. CLS. 22 AND 39).

FIRST USE 9-0-2010; IN COMMERCE 9-2-2010.

THE MARK CONSISTS OF STANDARD CHARACTERS WITHOUT CLAIM TO ANY PARTICULAR FONT, STYLE, SIZE, OR COLOR.

THE ENGLISH TRANSLATION OF "SO LA VITA" IN THE MARK IS "I KNOW THE LIFE".

SN 85-975,566, FILED 9-29-2010.

NAAKWAMA ANKRAH, EXAMINING ATTORNEY



*David J. Kyros*

Director of the United States Patent and Trademark Office



# United States of America

United States Patent and Trademark Office

## THE KNOWLEDGE EFFECT

**Reg. No. 4,126,989**

**Registered Apr. 10, 2012**

**Int. Cls.: 35, 36, 38, 39,  
41, 42, 44, and 45**

**SERVICE MARK**

**PRINCIPAL REGISTER**

THOMSON REUTERS GLOBAL RESOURCES (IRELAND UNLIMITED COMPANY)  
NEUHOFSTRASSE 1  
BAAR, SWITZERLAND 6340

FOR: HEALTH CARE COST REVIEW AND DATA PROCESSING SERVICES FOR HEALTH CARE AND HEALTH CLAIMS AND INSURANCE INFORMATION AND INFORMATION FOR CONTROLLING MEDICAL COSTS, MEASURING HEALTH CARE MARKETS AND RESEARCH PURPOSES; COMPUTER SERVICES, NAMELY, PROVIDING A DATABASE FEATURING BUSINESS NEWS AND INFORMATION, BUSINESS CORPORATE FILINGS, AND BUSINESS REPORTS FOR LEGAL RESEARCH; PROVIDE CUSTOMIZED STATISTICAL REPORTS CONCERNING DEMOGRAPHIC DATA; ADVERTISING SERVICES, NAMELY, DISSEMINATING THE ADVERTISING MATTER OF OTHERS; BUSINESS APPRAISAL SERVICES; BUSINESS INFORMATION SERVICES; BUSINESS INVESTIGATION SERVICES; COMMERCIAL INFORMATION AGENCIES; ECONOMIC FORECASTING SERVICES; RENTAL OF OFFICE MACHINERY AND EQUIPMENT; BUSINESS RESEARCH SERVICES; PROVIDING STATISTICAL INFORMATION; PROVIDING TAX ESTIMATES; PROVISION OF INFORMATION ON THE TOPICS OF ACCOUNTING AND AUDITING, AND TAX PLANNING; PROVIDING RESEARCH ASSISTANCE ON THE TOPICS OF ACCOUNTING AND AUDITING, AND TAX PLANNING; PROVIDING A DATABASE AND INDICES FEATURING INFORMATION ON SOCIAL SCIENCE, NAMELY, POLITICAL SCIENCE AND ECONOMICS, GOVERNMENT AND POLITICS FOR LEGAL RESEARCH; BUSINESS INFORMATION REPORTING SERVICES THAT PROVIDE CUSTOMIZED STATISTICAL REPORTS CONCERNING HEALTH CARE PROVIDER, PATIENT, CLINICAL AND HEALTH CLAIMS; PROVIDING INFORMATION, ANALYSIS AND REPORTS ON MUNICIPAL MARKETS, MERGERS AND ACQUISITIONS, OWNERSHIP OF CORPORATIONS, INFORMATION REGARDING CORPORATE AND FINANCIAL EXECUTIVES, POST TRADE OPERATIONS IN THE GLOBAL SECURITIES MARKETS; PROVIDING INFORMATION SERVICES IN THE FIELD OF ECONOMICS, IN CLASS 35 (U.S. CLS. 100, 101 AND 102).

FIRST USE 1-24-2011; IN COMMERCE 1-24-2011.

FOR: PROVIDING INFORMATION, ANALYSIS AND REPORTS ON TREASURY CASH, FINANCIAL EXECUTIVES, POST TRADE OPERATIONS IN THE GLOBAL SECURITIES MARKETS; PROVIDING INFORMATION SERVICES IN THE FIELDS OF FINANCIAL, MONETARY AND STOCK EXCHANGE INFORMATION, CURRENCY TRADING INFORMATION; PROVISION OF INFORMATION ON THE TOPIC OF FINANCIAL ADVISORY SERVICES; PROVIDING RESEARCH ASSISTANCE ON THE TOPIC OF FINANCIAL ADVIS-



*David J. Kyjars*

Director of the United States Patent and Trademark Office

**Reg. No. 4,126,989** ORY SERVICES; PROVIDING CUSTOMIZED STATISTICAL REPORTS CONCERNING FINANCIAL DATA; FINANCIAL ANALYSIS; FINANCIAL CONSULTANCY; FISCAL ASSESSMENTS; STOCK EXCHANGE PRICE QUOTATIONS; ELECTRONIC FUNDS TRANSFERS; PROVIDING FINANCIAL INFORMATION ON BONDS, WARRANT BONDS, COMMERCIAL SALES, AND EXCHANGE AND INVESTMENT TRUSTS, IN CLASS 36 (U.S. CLS. 100, 101 AND 102).

FIRST USE 1-24-2011; IN COMMERCE 1-24-2011.

FOR: TELECOMMUNICATIONS SERVICES, NAMELY, PROVIDING TELECOMMUNICATIONS CONNECTIONS TO A GLOBAL COMPUTER NETWORK; BROADCASTING SERVICES, NAMELY, TELEVISION, RADIO AND CABLE TELEVISION BROADCASTING SERVICES; COMMUNICATION BY COMPUTER TERMINALS, NAMELY, ELECTRONIC TRANSMISSION OF DATA, MESSAGES, AND DOCUMENTS VIA COMPUTER TERMINALS; COMPUTER-AIDED TRANSMISSION OF DATA, MESSAGES, INFORMATION AND IMAGES; ELECTRONIC MAIL SERVICES; ELECTRONIC TRANSMISSION OF MESSAGES; RENTAL OF MESSAGE SENDING APPARATUS; TELEGRAPH SERVICES, IN CLASS 38 (U.S. CLS. 100, 101 AND 104).

FIRST USE 1-24-2011; IN COMMERCE 1-24-2011.

FOR: COMPUTERIZED INFORMATION STORAGE OF FILES AND DOCUMENTS IN THE AREA OF LEGAL RESEARCH, IN CLASS 39 (U.S. CLS. 100 AND 105).

FIRST USE 1-24-2011; IN COMMERCE 1-24-2011.

FOR: PROVISION OF CONTINUING PROFESSIONAL EDUCATIONAL (CPE) COURSES TO THE ACCOUNTING FIRM MARKET VIA A GLOBAL COMPUTER NETWORK; PROVIDING CONTINUING LEGAL EDUCATION (CLE) PROGRAMS; PROVIDING A DATABASE FEATURING INFORMATION ON LIBRARY SCIENCE, HUMANITIES, NAMELY, THE ARTS, HISTORICAL EVENTS, AND BIOGRAPHICAL DATA FOR LEGAL RESEARCH; PROVIDING ONLINE PUBLICATIONS IN THE NATURE OF DIRECTORIES AND REFERENCE MATERIAL, NAMELY, JOURNALS FEATURING INFORMATION ON SOCIAL SCIENCE AND THE HUMANITIES, GOVERNMENT AND POLITICS, LIBRARY SCIENCE, MEDICAL AND BIOGRAPHICAL DATA; PROVIDING INDICES FEATURING INFORMATION ON SOCIAL SCIENCE, NAMELY, ANTHROPOLOGY, HUMANITIES, NAMELY, THE ARTS, HISTORICAL EVENTS, LIBRARY SCIENCE, AND BIOGRAPHICAL DATA, IN CLASS 41 (U.S. CLS. 100, 101 AND 107).

FIRST USE 1-24-2011; IN COMMERCE 1-24-2011.

FOR: CUSTOMIZED COMPUTER RESEARCH IN THE FIELD OF SCIENCE; ONLINE DATABASES WHICH PROVIDE SCIENTIFIC INFORMATION; MAINTENANCE OF COMPUTER SOFTWARE; COMPUTERIZED INFORMATION RETRIEVAL SERVICES IN THE NATURE OF SEARCH ENGINES FOR RETRIEVING LEGAL RESEARCH, IN CLASS 42 (U.S. CLS. 100 AND 101).

FIRST USE 1-24-2011; IN COMMERCE 1-24-2011.

FOR: PROVIDING MEDICAL AND CLINICAL HEALTH CARE INFORMATION VIA THE INTERNET; AND PROVIDING HEALTH CARE INFORMATION; PROVIDING A DATABASE FEATURING INFORMATION ON SOCIAL SCIENCE, NAMELY, PSYCHOLOGY AND MEDICAL DATA, IN CLASS 44 (U.S. CLS. 100 AND 101).

FIRST USE 1-24-2011; IN COMMERCE 1-24-2011.

FOR: PROVIDING LINKS TO LEGAL PUBLICATIONS AND INFORMATION WEB SITES OF OTHERS FEATURING LEGAL MATTERS; PROVIDING ONLINE DATABASES FEATUR-

**Reg. No. 4,126,989** ING INFORMATION ON STATE AND FEDERAL LAWS AND STATUTES, CASE LAW, NEW LEGISLATION AND REGULATIONS FOR LEGAL RESEARCH; LICENSING OF COMPUTER SOFTWARE AND CUSTOMIZED DATABASES, TABLES AND DATA SUMMARIES FOR THE PROCESSING OF HEALTH CARE AND HEALTH CLAIMS INFORMATION AND INFORMATION FOR CONTROLLING MEDICAL COSTS, MEASURING HEALTH CARE MARKETS AND HEALTH CARE RESEARCH PURPOSES; TRADEMARK RESEARCH SERVICES, NAMELY, PROVIDING COMPREHENSIVE INFORMATION AS TO THE USE, STATUS, HISTORY AND OWNERSHIP OF TRADEMARKS AND COMPANY NAMES; PROVISION OF INFORMATION ON COMPLIANCE WITH IRS AND STATE TAX LAWS AND REGULATION; PROVIDING RESEARCH ASSISTANCE ON THE TOPIC OF COMPLIANCE WITH IRS AND STATE TAX LAWS AND REGULATIONS; PROVIDING ONLINE DATABASES WHICH PROVIDE PATENT INFORMATION, IN CLASS 45 (U.S. CLS. 100 AND 101).

FIRST USE 1-24-2011; IN COMMERCE 1-24-2011.

THE MARK CONSISTS OF STANDARD CHARACTERS WITHOUT CLAIM TO ANY PARTICULAR FONT, STYLE, SIZE, OR COLOR.

NO CLAIM IS MADE TO THE EXCLUSIVE RIGHT TO USE "KNOWLEDGE", APART FROM THE MARK AS SHOWN.

SN 85-976,079, FILED 9-13-2010.

DEZMONA MIZELLE, EXAMINING ATTORNEY

# United States of America

United States Patent and Trademark Office

## SHIFTING THE POWER TO YOU

**Reg. No. 4,126,990**

**Registered Apr. 10, 2012**

**Int. Cls.: 35, 37, and 42**

**SERVICE MARK**

**PRINCIPAL REGISTER**

U.S. AUTO PARTS NETWORK, INC. (DELAWARE CORPORATION)  
17150 SOUTH MARGAY AVENUE  
CARSON, CA 90746

FOR: ADVERTISING SERVICES, NAMELY, PROMOTING THE SERVICES OF OTHERS; PROVIDING A WEBSITE FEATURING INFORMATION ABOUT VEHICLES FOR THE PURPOSE OF IDENTIFYING VEHICLE REPAIR COSTS AND ENABLING CUSTOMERS TO MAKE VEHICLE REPAIR DECISIONS, AND INFORMATION ABOUT VEHICLE SERVICE SHOPS, IN CLASS 35 (U.S. CLS. 100, 101 AND 102).

FIRST USE 12-31-2009; IN COMMERCE 12-31-2009.

FOR: PROVIDING A WEBSITE FEATURING INFORMATION ABOUT VEHICLE REPAIR AND MAINTENANCE, IN CLASS 37 (U.S. CLS. 100, 103 AND 106).

FIRST USE 12-31-2009; IN COMMERCE 12-31-2009.

FOR: COMPUTER SERVICES, NAMELY, CREATING AN ON-LINE COMMUNITY WEBSITE FOR REGISTERED USERS TO PARTICIPATE IN DISCUSSIONS, GET FEEDBACK, FORM VIRTUAL COMMUNITIES, AND ENGAGE IN SOCIAL NETWORKING ON THE TOPIC OF VEHICLES, IN CLASS 42 (U.S. CLS. 100 AND 101).

FIRST USE 1-31-2010; IN COMMERCE 1-31-2010.

THE MARK CONSISTS OF STANDARD CHARACTERS WITHOUT CLAIM TO ANY PARTICULAR FONT, STYLE, SIZE, OR COLOR.

SN 85-976,112, FILED 6-3-2010.

SUZANNE BLANE, EXAMINING ATTORNEY



*David J. Kypos*

Director of the United States Patent and Trademark Office

# United States of America

United States Patent and Trademark Office

## CHASING DREAMS

**Reg. No. 4,126,991**

**Registered Apr. 10, 2012**

**Int. Cl.: 20**

**TRADEMARK**

**PRINCIPAL REGISTER**

PETRAGEOUS DESIGNS, LIMITED (MASSACHUSETTS CORPORATION)  
SUITE 11A  
20 BLANCHARD STREET  
BURLINGTON, MA 01803

FOR: PET BEDS AND PET CUSHIONS FOR CRATES, IN CLASS 20 (U.S. CLS. 2, 13, 22, 25, 32 AND 50).

FIRST USE 7-8-2011; IN COMMERCE 7-8-2011.

THE MARK CONSISTS OF STANDARD CHARACTERS WITHOUT CLAIM TO ANY PARTICULAR FONT, STYLE, SIZE, OR COLOR.

SN 85-976,139, FILED 4-20-2011.

ODESSA BIBBINS, EXAMINING ATTORNEY



*David J. Kyffers*

Director of the United States Patent and Trademark Office

# United States of America

United States Patent and Trademark Office

# AUTOMD

**Reg. No. 4,126,992**

U.S. AUTO PARTS NETWORK, INC. (DELAWARE CORPORATION)  
17150 SOUTH MARGAY AVENUE  
CARSON, CA 90746

**Registered Apr. 10, 2012**

**Int. Cls.: 35, 37, and 42**

FOR: ADVERTISING SERVICES, NAMELY, PROMOTING THE SERVICES OF OTHERS; PROVIDING A WEBSITE FEATURING INFORMATION ABOUT VEHICLES FOR THE PURPOSE OF IDENTIFYING VEHICLE REPAIR COSTS AND ENABLING CUSTOMERS TO MAKE VEHICLE REPAIR DECISIONS, AND INFORMATION ABOUT VEHICLE SERVICE SHOPS, IN CLASS 35 (U.S. CLS. 100, 101 AND 102).

**SERVICE MARK**

**PRINCIPAL REGISTER**

FIRST USE 10-31-2008; IN COMMERCE 10-31-2008.

FOR: PROVIDING A WEBSITE FEATURING INFORMATION ABOUT VEHICLE REPAIR AND MAINTENANCE, IN CLASS 37 (U.S. CLS. 100, 103 AND 106).

FIRST USE 10-31-2008; IN COMMERCE 10-31-2008.

FOR: COMPUTER SERVICES, NAMELY, CREATING AN ON-LINE COMMUNITY WEBSITE FOR REGISTERED USERS TO PARTICIPATE IN DISCUSSIONS, GET FEEDBACK, FORM VIRTUAL COMMUNITIES, AND ENGAGE IN SOCIAL NETWORKING ON THE TOPIC OF VEHICLES, IN CLASS 42 (U.S. CLS. 100 AND 101).

FIRST USE 1-31-2010; IN COMMERCE 1-31-2010.

THE MARK CONSISTS OF STANDARD CHARACTERS WITHOUT CLAIM TO ANY PARTICULAR FONT, STYLE, SIZE, OR COLOR.

SN 85-976,168, FILED 5-7-2010.

SUZANNE BLANE, EXAMINING ATTORNEY



*David J. Kypos*

Director of the United States Patent and Trademark Office

# United States of America

United States Patent and Trademark Office

## BACKYARD FLAVORS

**Reg. No. 4,126,993**

**Registered Apr. 10, 2012**

**Int. Cl.: 29**

**TRADEMARK**

**PRINCIPAL REGISTER**

TYSON FRESH MEATS, INC. (DELAWARE CORPORATION)  
2200 DON TYSON PARKWAY  
SPRINGDALE, AR 72762

FOR: BEEF, IN CLASS 29 (U.S. CL. 46).

FIRST USE 6-20-2011; IN COMMERCE 6-20-2011.

THE MARK CONSISTS OF STANDARD CHARACTERS WITHOUT CLAIM TO ANY PARTICULAR FONT, STYLE, SIZE, OR COLOR.

NO CLAIM IS MADE TO THE EXCLUSIVE RIGHT TO USE "FLAVORS", APART FROM THE MARK AS SHOWN.

SN 85-976,174, FILED 12-23-2010.

DARRYL SPRUILL, EXAMINING ATTORNEY



*David J. Kyffers*

Director of the United States Patent and Trademark Office

# United States of America

United States Patent and Trademark Office

## AMERICAN LETTERS PRESS

**Reg. No. 4,126,994**

AMERICAN LETTERS PRESS, LLC (DELAWARE LIMITED LIABILITY COMPANY)  
5419 HOLLYWOOD BOULEVARD, SUITE C745  
LOS ANGELES, CA 90027

**Registered Apr. 10, 2012**

**Int. Cl.: 41**

FOR: MULTIMEDIA PUBLISHING OF BOOKS, ELECTRONIC PUBLICATIONS AND  
MULTIMEDIA PUBLISHING SERVICES, IN CLASS 41 (U.S. CLS. 100, 101 AND 107).

**SERVICE MARK**

FIRST USE 10-0-2011; IN COMMERCE 10-0-2011.

**PRINCIPAL REGISTER**

THE MARK CONSISTS OF STANDARD CHARACTERS WITHOUT CLAIM TO ANY PAR-  
TICULAR FONT, STYLE, SIZE, OR COLOR.

NO CLAIM IS MADE TO THE EXCLUSIVE RIGHT TO USE "AMERICAN" AND "PRESS",  
APART FROM THE MARK AS SHOWN.

SN 85-976,177, FILED 6-4-2010.

JEAN IM, EXAMINING ATTORNEY



*David J. Kybas*

Director of the United States Patent and Trademark Office



# United States of America

United States Patent and Trademark Office

## THE FIRE INSIDE

**Reg. No. 4,126,995**

BERTUCCI'S RESTAURANT CORP. (MASSACHUSETTS CORPORATION)  
155 OTIS STREET  
NORTHBOROUGH, MA 01532

**Registered Apr. 10, 2012**

**Int. Cl.: 43**

FOR: RESTAURANT, TAKE-OUT RESTAURANT, CATERING AND BAR SERVICES, IN CLASS 43 (U.S. CLS. 100 AND 101).

**SERVICE MARK**

FIRST USE 4-3-2011; IN COMMERCE 4-3-2011.

**PRINCIPAL REGISTER**

THE MARK CONSISTS OF STANDARD CHARACTERS WITHOUT CLAIM TO ANY PARTICULAR FONT, STYLE, SIZE, OR COLOR.

SN 85-976,178, FILED 2-28-2011.

LINDA MICKLEBURGH, EXAMINING ATTORNEY



*David J. Kybas*

Director of the United States Patent and Trademark Office

# United States of America

United States Patent and Trademark Office

# YAPP

**Reg. No. 4,126,996**

YAPP, INC. (DELAWARE CORPORATION)  
244 5TH AVENUE, SUITE M-231  
NEW YORK, NY 10001

**Registered Apr. 10, 2012**

**Int. Cl.: 42**

FOR: SOFTWARE AS A SERVICE FOR CREATION AND PUBLICATION OF SOFTWARE APPLICATIONS AND INTERNET WEBSITES; PROVIDING TEMPORARY USE OF NON-DOWNLOADABLE SOFTWARE FOR THE CREATION AND PUBLICATION OF SOFTWARE APPLICATIONS AND INTERNET WEBSITES, IN CLASS 42 (U.S. CLS. 100 AND 101).

**SERVICE MARK**

**PRINCIPAL REGISTER**

FIRST USE 12-31-2011; IN COMMERCE 12-31-2011.

THE MARK CONSISTS OF STANDARD CHARACTERS WITHOUT CLAIM TO ANY PARTICULAR FONT, STYLE, SIZE, OR COLOR.

SN 85-976,191, FILED 1-8-2011.

ARETHA SOMERVILLE, EXAMINING ATTORNEY



*David J. Kybas*

Director of the United States Patent and Trademark Office

# United States of America

United States Patent and Trademark Office

**it happens**

**Reg. No. 4,126,997**

**Registered Apr. 10, 2012**

**Int. Cl.: 25**

**TRADEMARK**

**PRINCIPAL REGISTER**

BRAWLEY, BARRY ALLEN (UNITED STATES INDIVIDUAL)  
167 BLACK ROAD  
STATESVILLE, NC 28677

FOR: SHIRTS, IN CLASS 25 (U.S. CLS. 22 AND 39).

FIRST USE 5-24-2011; IN COMMERCE 6-10-2011.

THE MARK CONSISTS OF THE STYLIZED WORDING "IT HAPPENS 2 YOU" IN WHICH THE "2" IS PLACED IN THE WORDING "IT" AND THE "YOU" IS PLACED IN THE WORDING "HAPPENS".

SN 85-976,199, FILED 2-28-2011.

TIMOTHY FINNEGAN, EXAMINING ATTORNEY



*David J. Kybas*

Director of the United States Patent and Trademark Office

# United States of America

United States Patent and Trademark Office



**Reg. No. 4,126,998**

**Registered Apr. 10, 2012**

**Int. Cl.: 41**

**SERVICE MARK**

**PRINCIPAL REGISTER**

RUGBY PROPERTIES, LLC (NEW JERSEY LIMITED LIABILITY COMPANY)  
220 LAUREL ROAD  
VOORHEES, NJ 08043

FOR: ENTERTAINMENT SERVICES, NAMELY, PARTICIPATION IN RUGBY MATCHES,  
IN CLASS 41 (U.S. CLS. 100, 101 AND 107).

FIRST USE 1-1-2011; IN COMMERCE 1-1-2011.

NO CLAIM IS MADE TO THE EXCLUSIVE RIGHT TO USE "CONNECTICUT", APART  
FROM THE MARK AS SHOWN.

THE COLOR(S) ORANGE, BLACK, AND WHITE IS/ARE CLAIMED AS A FEATURE OF  
THE MARK.

THE MARK CONSISTS OF AN ORANGE, BLACK AND WHITE PROFILE OF THE HEAD  
OF A WILDCAT, ABOVE THE BLACK WORD "WILDCATS", WHICH IS ABOVE THE OR-  
ANGE WORD "CONNECTICUT".

SN 85-976,213, FILED 1-20-2011.

AMY C. KEAN, EXAMINING ATTORNEY



*David J. Kappas*

Director of the United States Patent and Trademark Office

# United States of America

United States Patent and Trademark Office

## PROTECT YOUR LAZY ASS

**Reg. No. 4,126,999**

**Registered Apr. 10, 2012**

**Int. Cl.: 25**

**TRADEMARK**

**PRINCIPAL REGISTER**

AGILITY SPORTS LLC (MICHIGAN LIMITED LIABILITY COMPANY)  
SUITE 210  
4940 CASCADE RD SE  
GRAND RAPIDS, MI 49546

FOR: HEADWEAR; T-SHIRTS, IN CLASS 25 (U.S. CLS. 22 AND 39).

FIRST USE 1-0-2012; IN COMMERCE 1-0-2012.

THE MARK CONSISTS OF STANDARD CHARACTERS WITHOUT CLAIM TO ANY PARTICULAR FONT, STYLE, SIZE, OR COLOR.

SN 85-976,252, FILED 1-28-2011.

SUE LAWRENCE, EXAMINING ATTORNEY



*David J. Kyffers*

Director of the United States Patent and Trademark Office

# United States of America

United States Patent and Trademark Office

# REPROCESS

**Reg. No. 4,127,000**

**Registered Apr. 10, 2012**

**Int. Cl.: 37**

**SERVICE MARK**

**PRINCIPAL REGISTER**

MITSUBISHI POLYESTER FILM, INC. (SOUTH CAROLINA CORPORATION)  
2001 HOOD ROAD  
GREER, SC 29650

FOR: COLLECTING POLYESTER FILM LABEL BACKING FOR RECYCLING, IN CLASS 37 (U.S. CLS. 100, 103 AND 106).

FIRST USE 9-0-2011; IN COMMERCE 9-0-2011.

THE MARK CONSISTS OF STANDARD CHARACTERS WITHOUT CLAIM TO ANY PARTICULAR FONT, STYLE, SIZE, OR COLOR.

SN 85-976,254, FILED 7-14-2010.

ROBERT STRUCK, EXAMINING ATTORNEY



*David J. Kyros*

Director of the United States Patent and Trademark Office

# United States of America

United States Patent and Trademark Office

# VOGUEPEDIA

**Reg. No. 4,127,001**

**Registered Apr. 10, 2012**

**Int. Cl.: 41**

**SERVICE MARK**

**PRINCIPAL REGISTER**

ADVANCE MAGAZINE PUBLISHERS INC. (NEW YORK CORPORATION)  
FOUR TIMES SQUARE  
NEW YORK, NY 10036

FOR: PROVIDING AN ONLINE INTERACTIVE ENCYCLOPEDIA IN THE FIELD OF FASHION, STYLE, PEOPLE AND ENTERTAINMENT, IN CLASS 41 (U.S. CLS. 100, 101 AND 107).

FIRST USE 5-1-2011; IN COMMERCE 5-1-2011.

THE MARK CONSISTS OF STANDARD CHARACTERS WITHOUT CLAIM TO ANY PARTICULAR FONT, STYLE, SIZE, OR COLOR.

OWNER OF U.S. REG. NOS. 1,336,659, 3,069,976, AND OTHERS.

SN 85-976,277, FILED 4-23-2010.

SALLY SHIH, EXAMINING ATTORNEY



*David J. Kybas*

Director of the United States Patent and Trademark Office

# United States of America

United States Patent and Trademark Office

## IN THE RAW

**Reg. No. 4,127,002**

**Registered Apr. 10, 2012**

**Int. Cl.: 30**

**TRADEMARK**

**PRINCIPAL REGISTER**

CUMBERLAND PACKING CORP. (NEW YORK CORPORATION)  
2 CUMBERLAND STREET  
BROOKLYN, NY 11205

FOR: NATURAL SWEETENERS, IN CLASS 30 (U.S. CL. 46).

FIRST USE 12-5-2011; IN COMMERCE 12-5-2011.

THE MARK CONSISTS OF STANDARD CHARACTERS WITHOUT CLAIM TO ANY PARTICULAR FONT, STYLE, SIZE, OR COLOR.

OWNER OF U.S. REG. NOS. 937,695, 3,747,787, AND OTHERS.

SN 85-976,319, FILED 5-6-2010.

KAREN BRACEY, EXAMINING ATTORNEY



*David J. Kyffers*

Director of the United States Patent and Trademark Office



# United States of America

United States Patent and Trademark Office

# NUDE

**Reg. No. 4,127,003**

**Registered Apr. 10, 2012**

**Int. Cl.: 9**

**TRADEMARK**

**PRINCIPAL REGISTER**

SWITCHEASY LIMITED (HONG KONG LIMITED LIABILITY COMPANY)  
RM. 314, SING WIN FACTORY BLDG.  
NO. 15-17 SHING YIP STREET, KWUN TONG  
KOWLOON, HONG KONG

FOR: PROTECTIVE CASES AND CARRYING CASES FOR PERSONAL ELECTRONIC DEVICES, NAMELY, PORTABLE COMPUTING DEVICES AND HANDHELD PERSONAL ELECTRONIC DEVICES, NAMELY, DIGITAL MEDIA PLAYER DEVICES, PERSONAL DIGITAL ASSISTANTS, HANDHELD WIRELESS DEVICES, CELLULAR HANDSETS, HANDHELD DIGITAL AUDIO AND/OR VIDEO CAPTURE DEVICES, IN CLASS 9 (U.S. CLS. 21, 23, 26, 36 AND 38).

FIRST USE 12-31-2009; IN COMMERCE 12-31-2009.

THE MARK CONSISTS OF STANDARD CHARACTERS WITHOUT CLAIM TO ANY PARTICULAR FONT, STYLE, SIZE, OR COLOR.

SN 85-976,324, FILED 2-21-2011.

ANDREW LEASER, EXAMINING ATTORNEY



*David J. Kyros*

Director of the United States Patent and Trademark Office

# United States of America

United States Patent and Trademark Office

# IPRAYUPRAY

**Reg. No. 4,127,004**

IRUNURUN, LLC (GEORGIA LIMITED LIABILITY COMPANY)  
3414 PEACHTREE ROAD, NE, SUITE 112  
ATLANTA, GA 30326

**Registered Apr. 10, 2012**

**Int. Cl.: 42**

FOR: PROVIDING TEMPORARY USE OF ON-LINE NON-DOWNLOADABLE SOFTWARE THAT ENABLES USERS TO FACILITATE AND ARCHIVE PRAYER REQUESTS AND ANSWERS TO PRAYERS , IN CLASS 42 (U.S. CLS. 100 AND 101).

**SERVICE MARK**

FIRST USE 1-12-2012; IN COMMERCE 1-12-2012.

**PRINCIPAL REGISTER**

THE MARK CONSISTS OF STANDARD CHARACTERS WITHOUT CLAIM TO ANY PARTICULAR FONT, STYLE, SIZE, OR COLOR.

SN 85-976,329, FILED 1-3-2011.

JOHN DWYER, EXAMINING ATTORNEY



*David J. Kybas*

Director of the United States Patent and Trademark Office

# United States of America

United States Patent and Trademark Office

# VERSANTO

**Reg. No. 4,127,005**

**Registered Apr. 10, 2012**

**Int. Cl.: 30**

**TRADEMARK**

**PRINCIPAL REGISTER**

NAPCO, INC. (ILLINOIS CORPORATION)  
1141 NORTH RADDANT ROAD  
BATAVIA, IL 60510

FOR: COFFEE, IN CLASS 30 (U.S. CL. 46).

FIRST USE 9-1-2011; IN COMMERCE 9-1-2011.

THE MARK CONSISTS OF STANDARD CHARACTERS WITHOUT CLAIM TO ANY PARTICULAR FONT, STYLE, SIZE, OR COLOR.

THE ENGLISH TRANSLATION OF "VERSANTO" IN THE MARK IS "SIDE".

SN 85-976,345, FILED 3-2-2011.

JULIE WATSON, EXAMINING ATTORNEY



*David J. Kyffers*

Director of the United States Patent and Trademark Office

# United States of America

United States Patent and Trademark Office



**Reg. No. 4,127,006**

**Registered Apr. 10, 2012**

**Int. Cls.: 39 and 41**

**SERVICE MARK**

**PRINCIPAL REGISTER**

THE VIRGINIA GOLF TRAIL, LLC (VIRGINIA LIMITED LIABILITY COMPANY)  
9000 CELEBRATE VIRGINIA PARKWAY  
FREDERICKSBURG, VA 22406

FOR: COORDINATING TRAVEL ARRANGEMENTS FOR INDIVIDUALS AND FOR GROUPS;  
ONLINE TRIP AND TRAVEL RESERVATION SERVICES; ORGANISATION OF TRAVEL;  
PROVIDING A WEBSITE FEATURING INFORMATION ON TRAVEL; TRAVEL BOOKING  
AGENCIES, IN CLASS 39 (U.S. CLS. 100 AND 105).

FIRST USE 10-7-2010; IN COMMERCE 10-7-2010.

FOR: PROVIDING A WEB SITE THROUGH WHICH GOLFERS RESERVE TEE TIMES AT  
GOLF COURSES, IN CLASS 41 (U.S. CLS. 100, 101 AND 107).

FIRST USE 10-7-2010; IN COMMERCE 10-7-2010.

NO CLAIM IS MADE TO THE EXCLUSIVE RIGHT TO USE "VIRGINIA GOLF TRAIL",  
APART FROM THE MARK AS SHOWN.

THE COLOR(S) RED AND BLACK IS/ARE CLAIMED AS A FEATURE OF THE MARK.

THE MARK CONSISTS OF THE FIGURE OF A PERSON IN BLACK OUTLINE SWINGING  
A GOLF CLUB, WITHIN A GENERALLY RED HEART SHAPED OUTLINE, WITH THE  
WORDS "VIRGINIA" IN RED AND "GOLF TRAIL" IN BLACK SET FORTH ON A RIGHT  
HAND SIDE THEREOF.

SN 85-976,363, FILED 10-8-2010.

JOHN E. MICHOS, EXAMINING ATTORNEY



*David J. Kybas*

Director of the United States Patent and Trademark Office

# United States of America

United States Patent and Trademark Office

## PATI'S MEXICAN TABLE

**Reg. No. 4,127,007**

MEXICAN TABLE, LLC (DELAWARE LIMITED LIABILITY COMPANY)  
4724 DRUMMOND AVENUE  
CHEVY CHASE, MD 20815

**Registered Apr. 10, 2012**

**Int. Cl.: 41**

FOR: ENTERTAINMENT IN THE NATURE OF ON-GOING TELEVISION PROGRAMS IN THE FIELD OF COOKING, CUISINE, CUISINE TECHNIQUES, MEXICO AND GENERAL TOPICS RELATING TO CUISINE AND CUISINE CULTURE, IN CLASS 41 (U.S. CLS. 100, 101 AND 107).

**SERVICE MARK**

**PRINCIPAL REGISTER**

FIRST USE 4-0-2011; IN COMMERCE 4-0-2011.

THE MARK CONSISTS OF STANDARD CHARACTERS WITHOUT CLAIM TO ANY PARTICULAR FONT, STYLE, SIZE, OR COLOR.

OWNER OF U.S. REG. NO. 3,889,044.

NO CLAIM IS MADE TO THE EXCLUSIVE RIGHT TO USE "MEXICAN", APART FROM THE MARK AS SHOWN.

THE NAME(S), PORTRAIT(S), AND/OR SIGNATURE(S) SHOWN IN THE MARK IDENTIFIES A LIVING INDIVIDUAL, WHOSE CONSENT(S) TO REGISTER IS MADE OF RECORD.

SN 85-976,367, FILED 1-17-2011.

LIEF MARTIN, EXAMINING ATTORNEY



*David J. Kybas*

Director of the United States Patent and Trademark Office

# United States of America

United States Patent and Trademark Office



**Reg. No. 4,127,008**

**Registered Apr. 10, 2012**

**Int. Cl.: 21**

**TRADEMARK**

**PRINCIPAL REGISTER**

SUMMIT ENTERTAINMENT, LLC (DELAWARE LIMITED LIABILITY COMPANY)  
1630 STEWART STREET, SUITE 120  
SANTA MONICA, CA 90404

FOR: BEVERAGEWARE; CANDY BOXES; CERAMIC FIGURINES; DINNERWARE, NAMELY, PLATES AND CUPS, LUNCH BOXES WITH THERMAL CONTAINERS; TRAVEL MUGS; AND WATER BOTTLES SOLD EMPTY, IN CLASS 21 (U.S. CLS. 2, 13, 23, 29, 30, 33, 40 AND 50).

FIRST USE 10-1-2009; IN COMMERCE 10-1-2009.

THE MARK CONSISTS OF A CIRCULAR TRIBAL TATTOO DESIGN DEPICTING TWO WOLVES FACING ONE ANOTHER IN A HOWLING POSITION, SET AMONGST NUMEROUS INTERWOVEN LINES AND SHAPES AND ALL WITHIN THE CIRCLE.

SN 85-976,368, FILED 4-6-2010.

TRACY FLETCHER, EXAMINING ATTORNEY



*David J. Kybas*

Director of the United States Patent and Trademark Office

# United States of America

United States Patent and Trademark Office

## STAR FAMILY RESERVE

**Reg. No. 4,127,009**

**Registered Apr. 10, 2012**

**Int. Cl.: 29**

**TRADEMARK**

**PRINCIPAL REGISTER**

BORGES USA, INC. (DELAWARE CORPORATION)  
2680 W. SHAW AVENUE  
FRESNO, CA 93711

FOR: GRAPSEED OIL; FLAVORED EDIBLE OILS; SOUP; COCKTAIL ONIONS; MARINATED ARTICHOKEs; PROCESSED ARTICHOKEs; PROCESSED GARLIC; PIMENTOS; MARASCHINO CHERRIES; PROCESSED OLIVES; PROCESSED SPANISH STYLE OLIVES; MARINATED SALAD OLIVES WITH RED PEPPERS; SUN DRIED TOMATOES; TAPENADE MADE FROM OLIVES OR GARLIC; PROCESSED ANCHOVIES; ANCHOVY PASTE; MARINATED VEGETABLES, NAMELY, CARROTS, ASPARAGUS, ONIONS, SWEET CHERRY PEPPERS, ITALIAN PEPPERS, GOLDEN PEPPERS, WAX PEPPERS, JALAPENO PEPPERS, CASABELLA PEPPERS, PEPPERONCINI, CELERY, MUSHROOMS, BRUSSELS SPROUTS AND CAULIFLOWER; BRUSCHETTA TOPPINGS, IN CLASS 29 (U.S. CL. 46).

FIRST USE 8-1-2011; IN COMMERCE 8-1-2011.

THE MARK CONSISTS OF STANDARD CHARACTERS WITHOUT CLAIM TO ANY PARTICULAR FONT, STYLE, SIZE, OR COLOR.

OWNER OF U.S. REG. NOS. 1,633,309, 3,803,062, AND OTHERS.

NO CLAIM IS MADE TO THE EXCLUSIVE RIGHT TO USE "RESERVE", APART FROM THE MARK AS SHOWN.

SN 85-976,371, FILED 1-20-2011.

MEGHAN REINHART, EXAMINING ATTORNEY



*David J. Kyros*

Director of the United States Patent and Trademark Office

# United States of America

United States Patent and Trademark Office



**Reg. No. 4,127,010**

AHOLD LICENSING SARL (SWITZERLAND LIMITED LIABILITY COMPANY)  
2 RUE JEAN-PETITOT  
GENEVA, SWITZERLAND 1204

**Registered Apr. 10, 2012**

**Int. Cls.: 3, 18, and 28**

FOR: PET ODOR REMOVERS; PET SHAMPOO; PET STAIN REMOVERS, IN CLASS 3 (U.S. CLS. 1, 4, 6, 50, 51 AND 52).

**TRADEMARK**

FIRST USE 11-0-2011; IN COMMERCE 11-0-2011.

**PRINCIPAL REGISTER**

FOR: COLLARS FOR PETS; LEASHES FOR ANIMALS; RAWHIDE CHEWS FOR DOGS, IN CLASS 18 (U.S. CLS. 1, 2, 3, 22 AND 41).

FIRST USE 11-0-2011; IN COMMERCE 11-0-2011.

FOR: PET TOYS, IN CLASS 28 (U.S. CLS. 22, 23, 38 AND 50).

FIRST USE 11-0-2011; IN COMMERCE 11-0-2011.

OWNER OF U.S. REG. NOS. 3,544,836, 3,731,995, AND OTHERS.

THE COLOR(S) BLUE, WHITE, YELLOW, ORANGE, PURPLE AND GREEN IS/ARE CLAIMED AS A FEATURE OF THE MARK.

THE MARK CONSISTS OF A GENERALLY OVAL-SHAPED BLUE DESIGN FEATURES THE WORD "COMPANION" IN WHITE, WITH A DESIGN OVER THE LETTER M FEATURING FOUR WEDGE SHAPES IN VARYING SIZES AND DEGREES OF ROTATION. THE WEDGE SHAPES APPEAR IN YELLOW, ORANGE, PURPLE AND GREEN.

SN 85-976,380, FILED 8-27-2010.

BRIDGETT SMITH, EXAMINING ATTORNEY



*David J. Kybas*

Director of the United States Patent and Trademark Office



# United States of America

United States Patent and Trademark Office

# G-TAC

**Reg. No. 4,127,011**

**Registered Apr. 10, 2012**

**Int. Cls.: 12 and 37**

**TRADEMARK**

**SERVICE MARK**

**PRINCIPAL REGISTER**

G-TEKT AMERICA CORPORATION (MICHIGAN CORPORATION), FORMERLY TAKAO AMERICA CORPORATION,  
7075 COMMERCE BOULEVARD  
CANTON, MI 48187

FOR: AUTOMOBILES AND STRUCTURAL PARTS THEREFOR, IN CLASS 12 (U.S. CLS. 19, 21, 23, 31, 35 AND 44).

FIRST USE 4-30-2011; IN COMMERCE 4-30-2011.

FOR: MACHINERY MAINTENANCE AND REPAIR, IN CLASS 37 (U.S. CLS. 100, 103 AND 106).

FIRST USE 4-30-2011; IN COMMERCE 4-30-2011.

THE MARK CONSISTS OF STANDARD CHARACTERS WITHOUT CLAIM TO ANY PARTICULAR FONT, STYLE, SIZE, OR COLOR.

SN 85-976,385, FILED 6-7-2011.

KIMBERLY PERRY, EXAMINING ATTORNEY



*David J. Kypos*

Director of the United States Patent and Trademark Office

# United States of America

United States Patent and Trademark Office

## BIG BUDDHA

**Reg. No. 4,127,012**

BIG BUDDHA, INC. (CALIFORNIA CORPORATION)  
52-16 BARNETT AVENUE  
LONG ISLAND CITY, NY 11104

**Registered Apr. 10, 2012**

**Int. Cl.: 9**

FOR: EYEGASSES, SUNGLASSES AND CASES THEREFOR, IN CLASS 9 (U.S. CLS. 21, 23, 26, 36 AND 38).

**TRADEMARK**

FIRST USE 2-25-2011; IN COMMERCE 2-25-2011.

**PRINCIPAL REGISTER**

THE MARK CONSISTS OF STANDARD CHARACTERS WITHOUT CLAIM TO ANY PARTICULAR FONT, STYLE, SIZE, OR COLOR.

OWNER OF U.S. REG. NO. 3,765,728.

SN 85-976,407, FILED 8-3-2010.

KATHY DE JONGE, EXAMINING ATTORNEY



*David J. Kyffers*

Director of the United States Patent and Trademark Office

# United States of America

United States Patent and Trademark Office

## POINT OF USE POWER MANAGEMENT

**Reg. No. 4,127,013**

GROUP DEKKO, INC. (INDIANA CORPORATION)  
GARRETT, IN 46738

**Registered Apr. 10, 2012**

**Int. Cl.: 9**

FOR: ELECTRICAL DISTRIBUTION SYSTEMS AND PARTS, THEREFOR, CONSISTING OF ELECTRICAL DISTRIBUTION HARNESES, ELECTRICAL RECEPTACLES, ELECTRICAL POWER FEEDS AND JUMPER CABLES , IN CLASS 9 (U.S. CLS. 21, 23, 26, 36 AND 38).

**TRADEMARK**

FIRST USE 12-16-2011; IN COMMERCE 12-16-2011.

**SUPPLEMENTAL REGISTER**

THE MARK CONSISTS OF STANDARD CHARACTERS WITHOUT CLAIM TO ANY PARTICULAR FONT, STYLE, SIZE, OR COLOR.

SER. NO. 76-707,510, FILED P.R. 5-5-2011; AM. S.R. 1-17-2012.

SCOTT BIBB, EXAMINING ATTORNEY



*David J. Kybas*

Director of the United States Patent and Trademark Office

# United States of America

United States Patent and Trademark Office

## THE CUSTOM SUSHI SHOP

**Reg. No. 4,127,014**

HDYR, L.L.C. (TEXAS LIMITED LIABILITY COMPANY)  
10435 BURNET ROAD, STE. 107  
AUSTIN, TX 78758

**Registered Apr. 10, 2012**

**Int. Cl.: 43**

FOR: RESTAURANT SERVICES, IN CLASS 43 (U.S. CLS. 100 AND 101).

**SERVICE MARK**

FIRST USE 10-1-2011; IN COMMERCE 10-1-2011.

**SUPPLEMENTAL REGISTER**

THE MARK CONSISTS OF STANDARD CHARACTERS WITHOUT CLAIM TO ANY PARTICULAR FONT, STYLE, SIZE, OR COLOR.

SER. NO. 76-709,629, FILED 11-3-2011.

ALLISON HOLTZ, EXAMINING ATTORNEY



*David J. Kybas*

Director of the United States Patent and Trademark Office

# United States of America

United States Patent and Trademark Office

# tmcanada

**Reg. No. 4,127,015**

SMUGLER, JACK (CANADA INDIVIDUAL)  
240 HOLMWOOD AVE.

**Registered Apr. 10, 2012**

OTTAWA, ONTARIO, CANADA K1S2P9

**Int. Cl.: 45**

FOR: LEGAL SERVICES, IN CLASS 45 (U.S. CLS. 100 AND 101).

**SERVICE MARK**

THE MARK CONSISTS OF STANDARD CHARACTERS WITHOUT CLAIM TO ANY PARTICULAR FONT, STYLE, SIZE, OR COLOR.

**SUPPLEMENTAL REGISTER**

PRIORITY CLAIMED UNDER SEC. 44(D) ON CANADA APPLICATION NO. 1330812, FILED 1-10-2007, REG. NO. TMA815233, DATED 1-10-2012, EXPIRES 1-10-2027.

OWNER OF U.S. REG. NO. 3,589,452.

SER. NO. 77-087,480, FILED P.R. 1-21-2007; AM. S.R. 3-6-2012.

KAPIL BHANOT, EXAMINING ATTORNEY



*David J. Kybas*

Director of the United States Patent and Trademark Office

# United States of America

United States Patent and Trademark Office

## ELECTRONIC INFORMATION EXPRESS

**Reg. No. 4,127,016**

IMSGER, INC. (CALIFORNIA CORPORATION)  
567 IRVEN COURT  
PALO ALTO, CA 94306

**Registered Apr. 10, 2012**

**Int. Cl.: 38**

FOR: DELIVERY OF MESSAGES BY ELECTRONIC TRANSMISSION, IN CLASS 38 (U.S. CLS. 100, 101 AND 104).

**SERVICE MARK**

FIRST USE 6-16-2010; IN COMMERCE 6-16-2010.

**SUPPLEMENTAL REGISTER**

THE MARK CONSISTS OF STANDARD CHARACTERS WITHOUT CLAIM TO ANY PARTICULAR FONT, STYLE, SIZE, OR COLOR.

SER. NO. 77-707,149, FILED P.R. 4-6-2009; AM. S.R. 12-5-2009.

MICHELE SWAIN, EXAMINING ATTORNEY



*David J. Kybas*

Director of the United States Patent and Trademark Office

# United States of America

United States Patent and Trademark Office

## STARK INDUSTRIES

**Reg. No. 4,127,017**

MARVEL CHARACTERS, INC. (DELAWARE CORPORATION)  
1600 ROSECRANS AVENUE  
MANHATTAN BEACH, CA 90266

**Registered Apr. 10, 2012**

**Int. Cl.: 25**

FOR: T-SHIRTS, IN CLASS 25 (U.S. CLS. 22 AND 39).

FIRST USE 5-31-2010; IN COMMERCE 5-31-2010.

**TRADEMARK**

THE MARK CONSISTS OF STANDARD CHARACTERS WITHOUT CLAIM TO ANY PARTICULAR FONT, STYLE, SIZE, OR COLOR.

**SUPPLEMENTAL REGISTER**

NO CLAIM IS MADE TO THE EXCLUSIVE RIGHT TO USE "INDUSTRIES", APART FROM THE MARK AS SHOWN.

SER. NO. 77-780,535, FILED P.R. 7-14-2009; AM. S.R. 2-17-2012.

WON TEAK OH, EXAMINING ATTORNEY



*David J. Kyros*

Director of the United States Patent and Trademark Office

# United States of America

United States Patent and Trademark Office

## Climate Change TV

**Reg. No. 4,127,018**

RAMSEY, JAMES (UNITED KINGDOM INDIVIDUAL)  
83B ASHLEY GARDENS

**Registered Apr. 10, 2012**

LONDON, UNITED KINGDOM SW1P1HG

**Int. Cls.: 38 and 41**

FOR: AUDIO, VIDEO AND TELECOMMUNICATION SERVICES, NAMELY, THE BROADCASTING OF AUDIO, DATA AND VIDEO PROGRAMS FEATURING A RANGE OF ENVIRONMENTAL TOPICS OVER WIRED AND WIRELESS TELEVISION, SATELLITE, CABLE, TELEPHONE, PERSONAL DIGITAL ASSISTANT AND GLOBAL COMMUNICATION NETWORK SYSTEMS, IN CLASS 38 (U.S. CLS. 100, 101 AND 104).

**SERVICE MARK**

**SUPPLEMENTAL REGISTER**

FIRST USE 12-1-2004; IN COMMERCE 12-1-2004.

FOR: EDUCATIONAL AND ENTERTAINMENT SERVICES, NAMELY, THE PRODUCTION OF AUDIO, DATA AND VIDEO PROGRAMS FEATURING A RANGE OF ENVIRONMENTAL TOPICS FOR DISSEMINATION OVER TELEVISION, SATELLITE, OTHER AUDIO AND VIDEO MEDIA AND OVER A GLOBAL COMPUTER NETWORK, IN CLASS 41 (U.S. CLS. 100, 101 AND 107).

FIRST USE 12-1-2004; IN COMMERCE 12-1-2004.

THE MARK CONSISTS OF STANDARD CHARACTERS WITHOUT CLAIM TO ANY PARTICULAR FONT, STYLE, SIZE, OR COLOR.

SER. NO. 77-797,157, FILED P.R. 8-5-2009; AM. S.R. 1-6-2012.

KATHLEEN M. VANSTON, EXAMINING ATTORNEY



*David J. Kyros*

Director of the United States Patent and Trademark Office



# United States of America

United States Patent and Trademark Office

# Thérapie

**Reg. No. 4,127,019**

**Registered Apr. 10, 2012**

**Int. Cls.: 3 and 4**

**TRADEMARK**

**SUPPLEMENTAL REGISTER**

FEDERAL EASTERN CHEMISTS LLC (NEW YORK CORPORATION)  
309 COLUMBUS AVENUE  
NEW YORK, NY 10023

FOR: NON-MEDICATED SKIN CARE PREPARATIONS FOR BODY, FACE, AND HANDS; BODY CARE PREPARATIONS, BODY LOTIONS, BODY CREAMS, HAND CREAM, NON-MEDICATED LIP BALM; NON-MEDICATED HAND WASH, FACIAL SCRUB, FACIAL MOISTURIZER, SKIN CLEANSERS, SKIN MOISTURIZERS, SKIN LOTIONS, SKIN SOAPS, CLEANSERS FOR BODY, FACE, AND HANDS, IN CLASS 3 (U.S. CLS. 1, 4, 6, 50, 51 AND 52).

FIRST USE 1-5-2012; IN COMMERCE 1-5-2012.

FOR: CANDLES, IN CLASS 4 (U.S. CLS. 1, 6 AND 15).

FIRST USE 1-5-2012; IN COMMERCE 1-5-2012.

THE MARK CONSISTS OF STANDARD CHARACTERS WITHOUT CLAIM TO ANY PARTICULAR FONT, STYLE, SIZE, OR COLOR.

OWNER OF U.S. REG. NO. 3,748,109.

THE ENGLISH TRANSLATION OF "THÉRAPIE" IN THE MARK IS "THERAPY".

SER. NO. 77-942,176, FILED P.R. 2-23-2010; AM. S.R. 1-10-2012.

NICHOLAS COLEMAN, EXAMINING ATTORNEY



*David J. Kypos*

Director of the United States Patent and Trademark Office

United States of America  
United States Patent and Trademark Office

KLEINLIPO

**Reg. No. 4,127,020**

JEFFREY A. KLEIN (UNITED STATES INDIVIDUAL)  
30280 RANCHO VIEJO ROAD  
SAN JUAN CAPISTRANO, CA 92675

**Registered Apr. 10, 2012**

**Int. Cl.: 44**

FOR: PROVIDING EDUCATIONAL INFORMATION PERTAINING TO LIPOSUCTION SURGERY VIA A GLOBAL COMPUTER NETWORK, IN CLASS 44 (U.S. CLS. 100 AND 101).

**SERVICE MARK**

FIRST USE 11-11-2010; IN COMMERCE 11-11-2010.

**SUPPLEMENTAL REGISTER**

THE MARK CONSISTS OF STANDARD CHARACTERS WITHOUT CLAIM TO ANY PARTICULAR FONT, STYLE, SIZE, OR COLOR.

SER. NO. 77-944,186, FILED P.R. 2-24-2010; AM. S.R. 5-24-2011.

DOMINIC FATHY, EXAMINING ATTORNEY



*David J. Kybas*

Director of the United States Patent and Trademark Office

# United States of America

United States Patent and Trademark Office

## SLIDE TOUCH CONTROL

**Reg. No. 4,127,021**

SAMSUNG ELECTRONICS CO., LTD. (REPUBLIC OF KOREA CORPORATION)  
416, MAETAN-DONG, YEONGTONG-GU

**Registered Apr. 10, 2012**

SUWON-SI, GYEONGGI-DO, REPUBLIC OF KOREA

**Int. Cl.: 9**

FOR: TELEVISION RECEIVERS; DVD PLAYERS; OPTICAL DISC DRIVES; COMPUTER MONITORS; AUDIO AMPLIFIERS; AUDIO SPEAKERS , IN CLASS 9 (U.S. CLS. 21, 23, 26, 36 AND 38).

**TRADEMARK**

THE MARK CONSISTS OF STANDARD CHARACTERS WITHOUT CLAIM TO ANY PARTICULAR FONT, STYLE, SIZE, OR COLOR.

**SUPPLEMENTAL REGISTER**

PRIORITY CLAIMED UNDER SEC. 44(D) ON REPUBLIC OF KOREA APPLICATION NO. 2010-0012575, FILED 3-11-2010, REG. NO. 0867963, DATED 6-8-2011, EXPIRES 6-8-2021.

SER. NO. 77-956,657, FILED P.R. 3-11-2010; AM. S.R. 2-23-2012.

MARK SPARACINO, EXAMINING ATTORNEY



*David J. Kyros*

Director of the United States Patent and Trademark Office

# United States of America

United States Patent and Trademark Office

## EVERY GIRLS PROBLEM

**Reg. No. 4,127,022**

EVERY GIRLS PROBLEM (CALIFORNIA PARTNERSHIP)  
341 61ST STREET  
SAN DIEGO, CA 92114

**Registered Apr. 10, 2012**

**Int. Cl.: 25**

FOR: APPAREL FOR DANCERS, NAMELY, TEE SHIRTS, SWEATSHIRTS, PANTS, LEGGINGS, SHORTS AND JACKETS, IN CLASS 25 (U.S. CLS. 22 AND 39).

**TRADEMARK**

FIRST USE 10-1-2011; IN COMMERCE 10-1-2011.

**SUPPLEMENTAL REGISTER**

THE MARK CONSISTS OF STANDARD CHARACTERS WITHOUT CLAIM TO ANY PARTICULAR FONT, STYLE, SIZE, OR COLOR.

SER. NO. 77-964,039, FILED P.R. 3-20-2010; AM. S.R. 3-1-2012.

GILBERT SWIFT, EXAMINING ATTORNEY



*David J. Kybas*

Director of the United States Patent and Trademark Office

# United States of America

United States Patent and Trademark Office

## 20 MULE TEAM

**Reg. No. 4,127,023**

**Registered Apr. 10, 2012**

**Int. Cl.: 28**

U.S. BORAX INC. (DELAWARE CORPORATION)  
ATT. MANAGER, INTELLECTUAL PROPERTY  
8051 E. MAPLEWOOD AVENUE, BUILDING 4  
GREENWOOD VILLAGE, CO 80111

FOR: SCALE MODEL KITS, IN CLASS 28 (U.S. CLS. 22, 23, 38 AND 50).

**TRADEMARK**

FIRST USE 7-0-2008; IN COMMERCE 7-0-2008.

**SUPPLEMENTAL REGISTER**

THE MARK CONSISTS OF STANDARD CHARACTERS WITHOUT CLAIM TO ANY PARTICULAR FONT, STYLE, SIZE, OR COLOR.

OWNER OF U.S. REG. NOS. 50,383, 2,511,551, AND OTHERS.

SER. NO. 77-982,128, FILED P.R. 1-11-2010; AM. S.R. 6-6-2011.

TARA PATE, EXAMINING ATTORNEY



*David J. Kyffers*

Director of the United States Patent and Trademark Office

# United States of America

United States Patent and Trademark Office

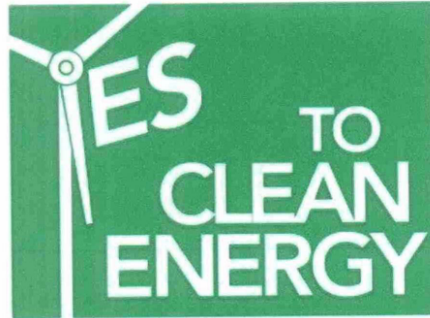

**Reg. No. 4,127,024**

**Registered Apr. 10, 2012**

**Int. Cl.: 9**

**TRADEMARK**

**SUPPLEMENTAL REGISTER**

INVENERGY, LLC (ILLINOIS LIMITED LIABILITY COMPANY)  
ONE SOUTH WACKER DRIVE, SUITE 2020  
CHICAGO, IL 60606

FOR: REFRIGERATOR MAGNETS, IN CLASS 9 (U.S. CLS. 21, 23, 26, 36 AND 38).

FIRST USE 11-0-2008; IN COMMERCE 11-0-2008.

NO CLAIM IS MADE TO THE EXCLUSIVE RIGHT TO USE "CLEAN ENERGY", APART FROM THE MARK AS SHOWN.

THE COLOR(S) GREEN AND WHITE IS/ARE CLAIMED AS A FEATURE OF THE MARK.

THE MARK CONSISTS OF A WIND TURBINE WHICH IS ALSO THE "Y" IN THE WORD "YES" AND THE WORDS "TO CLEAN ENERGY" ALL IN WHITE ON A GREEN FIELD.

SER. NO. 77-982,509, FILED P.R. 10-24-2007; AM. S.R. 2-24-2012.

SETH A. RAPPAPORT, EXAMINING ATTORNEY



*David J. Kyffers*

Director of the United States Patent and Trademark Office

# United States of America

United States Patent and Trademark Office

## Thérapie New York

**Reg. No. 4,127,025**

FEDERAL EASTERN CHEMISTS LLC (NEW YORK LIMITED LIABILITY COMPANY)  
309 COLUMBUS AVENUE

**Registered Apr. 10, 2012**

NEW YORK, NY 10023

**Int. Cls.: 3 and 4**

FOR: NON-MEDICATED SKIN CARE PREPARATIONS FOR BODY, FACE, AND HANDS; BODY CARE PREPARATIONS, BODY LOTIONS, BODY CREAMS, HAND CREAM, NON-MEDICATED LIP BALM; NON-MEDICATED HAND WASH, FACIAL SCRUB, FACIAL MOISTURIZER, SKIN CLEANSERS, SKIN MOISTURIZERS, SKIN LOTIONS, SKIN SOAPS, CLEANSERS FOR BODY, FACE, AND HANDS, IN CLASS 3 (U.S. CLS. 1, 4, 6, 50, 51 AND 52).

**TRADEMARK**

**SUPPLEMENTAL REGISTER**

FIRST USE 1-5-2012; IN COMMERCE 1-5-2012.

FOR: CANDLES, IN CLASS 4 (U.S. CLS. 1, 6 AND 15).

FIRST USE 1-5-2012; IN COMMERCE 1-5-2012.

THE MARK CONSISTS OF STANDARD CHARACTERS WITHOUT CLAIM TO ANY PARTICULAR FONT, STYLE, SIZE, OR COLOR.

OWNER OF U.S. REG. NO. 3,748,109.

THE ENGLISH TRANSLATION OF "THÉRAPIE" IN THE MARK IS "THERAPY".

SER. NO. 77-982,998, FILED P.R. 2-11-2010; AM. S.R. 1-10-2012.

NICHOLAS COLEMAN, EXAMINING ATTORNEY



*David J. Kypos*

Director of the United States Patent and Trademark Office

# United States of America

United States Patent and Trademark Office

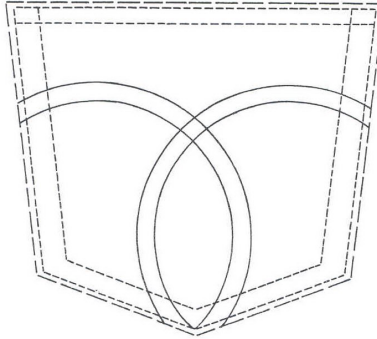

**Reg. No. 4,127,026**

JORDACHE ENTERPRISES, INC. (NEW YORK CORPORATION)  
1400 BROADWAY, 15TH FLOOR  
NEW YORK, NY 10018

**Registered Apr. 10, 2012**

**Int. Cl.: 25**

FOR: MEN'S, WOMEN'S, AND CHILDREN'S JEANS, IN CLASS 25 (U.S. CLS. 22 AND 39).

FIRST USE 6-28-2005; IN COMMERCE 6-28-2005.

**TRADEMARK**

**SUPPLEMENTAL REGISTER**

THE MARK CONSISTS OF DOUBLE STITCHING ACROSS A POCKET. THE STITCHING APPEARS TO BE TWO OVERLAPPING SEMI-CIRCLES, RUNNING FROM ONE SIDE OF THE POCKET TO THE OTHER SIDE AND CREATED AN OVAL IN THE CENTER. THE DOTTED LINES IN THE DRAWING ARE NOT A PART OF THE MARK AND ARE ONLY TO SHOW THE POSITION OF THE MARK.

SER. NO. 78-842,013, FILED P.R. 3-21-2006; AM. S.R. 2-28-2012.

WENDY JUN, EXAMINING ATTORNEY



*David J. Kybas*

Director of the United States Patent and Trademark Office



# United States of America

United States Patent and Trademark Office

## THE RIGHT SIZE FOR THE MICROSURGEON

**Reg. No. 4,127,027**

**Registered Apr. 10, 2012**

**Int. Cl.: 10**

SYNOVIS LIFE TECHNOLOGIES, INC. (MINNESOTA CORPORATION)  
SUITE 180  
2575 UNIVERSITY AVENUE WEST  
ST. PAUL, MN 551141024

FOR: SURGICAL MICROCLIPS, IN CLASS 10 (U.S. CLS. 26, 39 AND 44).

**TRADEMARK**

FIRST USE 3-31-2010; IN COMMERCE 3-31-2010.

**SUPPLEMENTAL REGISTER**

THE MARK CONSISTS OF STANDARD CHARACTERS WITHOUT CLAIM TO ANY PARTICULAR FONT, STYLE, SIZE, OR COLOR.

SER. NO. 85-010,234, FILED P.R. 4-9-2010; AM. S.R. 8-2-2011.

ROBERT C. CLARK JR., EXAMINING ATTORNEY



*David J. Kybas*

Director of the United States Patent and Trademark Office

# United States of America

United States Patent and Trademark Office

# RADIAL

**Reg. No. 4,127,028**

BIOLITEC, INC. (NEW JERSEY CORPORATION)  
515 SHAKER ROAD  
EAST LONGMEADOW, MA 01028

**Registered Apr. 10, 2012**

**Int. Cl.: 10**

FOR: OPTICAL FIBER SYSTEM AND PARTS AND ACCESSORIES THEREFORE, FOR USE IN MEDICAL AND SURGICAL TREATMENTS; OPTICAL FIBERS FOR SURGICAL TREATMENTS; OPTICAL FIBER KIT, FOR USE IN MEDICAL AND SURGICAL TREATMENTS COMPRISING OPTICAL FIBER AND PARTS AND ACCESSORIES THEREFOR, ALL FOR MEDICAL USE, IN CLASS 10 (U.S. CLS. 26, 39 AND 44).

**TRADEMARK**

**SUPPLEMENTAL REGISTER**

FIRST USE 4-27-2010; IN COMMERCE 4-27-2010.

THE MARK CONSISTS OF STANDARD CHARACTERS WITHOUT CLAIM TO ANY PARTICULAR FONT, STYLE, SIZE, OR COLOR.

SER. NO. 85-038,171, FILED P.R. 5-13-2010; AM. S.R. 12-17-2010.

MARK SHINER, EXAMINING ATTORNEY



*David J. Kyffers*

Director of the United States Patent and Trademark Office

# United States of America

## United States Patent and Trademark Office



**Reg. No. 4,127,029**

PORT BREWING, LLC (CALIFORNIA LIMITED LIABILITY COMPANY)  
155 MATA WAY STE 104  
SAN MARCOS, CA 92069

**Registered Apr. 10, 2012**

**Int. Cl.: 20**

FOR: NON-METAL BEER TAP HANDLES FOR BEER KEGS, IN CLASS 20 (U.S. CLS. 2, 13, 22, 25, 32 AND 50).

**TRADEMARK**

FIRST USE 7-1-2007; IN COMMERCE 7-1-2007.

**SUPPLEMENTAL REGISTER**

NO CLAIM IS MADE TO THE EXCLUSIVE RIGHT TO USE "BREWING", APART FROM THE MARK AS SHOWN.

THE MARK CONSISTS OF A CONFIGURATION OF A BEER TAP HANDLE IN THE SHAPE OF A FLIP FLOP. ON THE SOLE OF THE FLIP FLOP IS THE WORDING "PORT BREWING" WRITTEN IN THE SHAPE OF A CROSS AND SHARING THE LETTER "R". BELOW "PORT BREWING" IS THE CURVED WORDING "SAN DIEGO CA". THE STEM OF THE HANDLE IS DOTTED TO SHOW PLACEMENT OF THE FLIP FLOP HANDLE AND IS NOT CLAIMED AS A FEATURE OF THE MARK.

SER. NO. 85-038,388, FILED P.R. 5-14-2010; AM. S.R. 2-29-2012.

ALYSSA STEEL, EXAMINING ATTORNEY



*David J. Kybas*

Director of the United States Patent and Trademark Office

# United States of America

United States Patent and Trademark Office



**Reg. No. 4,127,030**

JOHNSON & JOHNSON (NEW JERSEY CORPORATION)  
ONE JOHNSON & JOHNSON PLAZA  
NEW BRUNSWICK, NJ 089337001

**Registered Apr. 10, 2012**

**Int. Cl.: 3**

FOR: HAIR CARE PREPARATIONS, NAMELY, CONDITIONER, IN CLASS 3 (U.S. CLS. 1, 4, 6, 50, 51 AND 52).

**TRADEMARK**

FIRST USE 1-12-2011; IN COMMERCE 1-12-2011.

**SUPPLEMENTAL REGISTER**

THE MARK CONSISTS OF THE COLOR LIGHT BROWN APPLIED TO THE CAP OF THE BOTTLE WHICH IS THE PACKAGING FOR THE GOODS AS WELL AS GRADATIONS OF THE COLOR PURPLE APPLIED TO THE BOTTOM OF THE BOTTLE AND GETTING LIGHTER TOWARDS THE MIDDLE OF THE BOTTLE AND THE COLOR CREAM APPLIED TOWARDS THE TOP OF BOTTLE. THE MATTER IN BROKEN LINES IS NOT PART OF THE MARK AND SERVES ONLY TO SHOW THE PLACEMENT OF THE MARK.

THE COLOR(S) BROWN, PURPLE AND CREAM IS/ARE CLAIMED AS A FEATURE OF THE MARK.

SER. NO. 85-056,113, FILED P.R. 6-7-2010; AM. S.R. 10-20-2011.

LINDA ESTRADA, EXAMINING ATTORNEY



*David J. Kyros*

Director of the United States Patent and Trademark Office

# United States of America

United States Patent and Trademark Office

## BEST PRACTICE PARTNER

**Reg. No. 4,127,031**

CBLPATH HOLDINGS CORPORATION (DELAWARE CORPORATION)  
2100 SE 17TH STREET, BUILDING 300  
OCALA, FL 34471

**Registered Apr. 10, 2012**

**Int. Cls.: 35, 42, and 44**

FOR: BUSINESS SERVICES, NAMELY, PROVISION OF ASSISTANCE IN MEDICAL BILLING IN THE FIELD OF PATHOLOGY; BUSINESS SERVICES, NAMELY, PROVISION OF SALES RESOURCES AND INFORMATION ABOUT SALES METHODS IN THE FIELD OF PATHOLOGY, IN CLASS 35 (U.S. CLS. 100, 101 AND 102).

**SERVICE MARK**

**SUPPLEMENTAL REGISTER**

FIRST USE 11-24-2010; IN COMMERCE 11-24-2010.

FOR: PROVIDING ON-LINE NON-DOWNLOADABLE SOFTWARE FOR MANAGEMENT OF MEDICAL DIAGNOSTIC, PROGNOSTIC AND THERANOSTIC INFORMATION BY PATHOLOGISTS AND OTHER LABORATORY PROFESSIONALS; TECHNICAL SUPPORT SERVICES, NAMELY, TROUBLESHOOTING OF COMPUTER SOFTWARE PROBLEMS, IN CLASS 42 (U.S. CLS. 100 AND 101).

FIRST USE 11-24-2010; IN COMMERCE 11-24-2010.

FOR: PROVIDING MEDICAL INFORMATION, NAMELY, PREPARATION AND PROVISION OF WRITTEN PATHOLOGY REPORTS TO DOCTORS TO GIVE TO PATIENTS TO AID IN COUNSELING PATIENTS REGARDING DIAGNOSIS AND TREATMENT; CONSULTING SERVICES IN THE FIELD OF MEDICAL CARE, NAMELY, PROVISION OF DIAGNOSTIC, PROGNOSTIC AND THERAPEUTIC GUIDANCE TO DOCTORS, IN CLASS 44 (U.S. CLS. 100 AND 101).

FIRST USE 11-24-2010; IN COMMERCE 11-24-2010.

THE MARK CONSISTS OF STANDARD CHARACTERS WITHOUT CLAIM TO ANY PARTICULAR FONT, STYLE, SIZE, OR COLOR.

SER. NO. 85-066,896, FILED P.R. 6-18-2010; AM. S.R. 2-3-2011.

MARK SHINER, EXAMINING ATTORNEY



*David J. Kyffers*

Director of the United States Patent and Trademark Office

# United States of America

United States Patent and Trademark Office

## CONTEMPORARY IDIOMS

**Reg. No. 4,127,032**

CONSERVATORY CANADA (CANADA CORPORATION)  
130 KING STREET

**Registered Apr. 10, 2012**

LONDON N6A 1C5 ONTARIO, CANADA

**Int. Cl.: 16**

FOR: A SERIES OF PRINTED PUBLICATIONS IN THE NATURE OF BOOKS FOR INSTRUCTION, TESTING AND ASSESSMENT IN RESPECT OF MUSICAL IMPROVISATION AND PERFORMANCE TECHNIQUES, IN CLASS 16 (U.S. CLS. 2, 5, 22, 23, 29, 37, 38 AND 50).

**TRADEMARK**

THE MARK CONSISTS OF STANDARD CHARACTERS WITHOUT CLAIM TO ANY PARTICULAR FONT, STYLE, SIZE, OR COLOR.

**SUPPLEMENTAL REGISTER**

PRIORITY CLAIMED UNDER SEC. 44(D) ON CANADA APPLICATION NO. 1464460, FILED 12-31-2009, REG. NO. TMA812411, DATED 11-23-2011, EXPIRES 11-23-2026.

SER. NO. 85-073,705, FILED P.R. 6-29-2010; AM. S.R. 4-8-2011.

ANNE FARRELL, EXAMINING ATTORNEY



*David J. Kybas*

Director of the United States Patent and Trademark Office

# United States of America

United States Patent and Trademark Office

# RADPHP

**Reg. No. 4,127,033**

**Registered Apr. 10, 2012**

**Int. Cls.: 9 and 42**

**TRADEMARK**

**SERVICE MARK**

**SUPPLEMENTAL REGISTER**

EMBARCADERO TECHNOLOGIES, INC. (DELAWARE CORPORATION)  
100 CALIFORNIA STREET, 12TH FLOOR  
SAN FRANCISCO, CA 94111

FOR: COMPUTER PROGRAMS, NAMELY, COMPILER SOFTWARE, COMPUTER SOFTWARE DEVELOPMENT TOOLKITS, COMPUTER SOFTWARE FOR CREATING RUNTIME ENVIRONMENTS, VISUAL DEVELOPMENT SOFTWARE AND SOFTWARE APPLICATION DEVELOPMENT ENVIRONMENTS FOR USE BY OTHERS TO DEVELOP APPLICATION-SPECIFIC SOFTWARE PROGRAMS OF THEIR OWN CHOOSING; COMPUTER SOFTWARE USED TO DESIGN, BUILD, OPTIMIZE AND RUN SOFTWARE APPLICATIONS AND DATABASES ACROSS MULTIPLE PLATFORMS AND PROGRAMMING LANGUAGES; COMPUTER SOFTWARE FOR DEVELOPMENT OF SOFTWARE APPLICATIONS; COMPUTER SOFTWARE WHICH PROVIDES AN INTEGRATED DEVELOPMENT ENVIRONMENT (IDE) TO ENABLE THE DEVELOPMENT OF SPECIFIC SOFTWARE APPLICATION PROGRAMS, IN CLASS 9 (U.S. CLS. 21, 23, 26, 36 AND 38).

FIRST USE 8-1-2010; IN COMMERCE 9-1-2010.

FOR: TECHNICAL SUPPORT SERVICES FOR COMPUTER SOFTWARE, NAMELY, TELEPHONE CONSULTATION FOR TROUBLESHOOTING OF COMPUTER SOFTWARE PROBLEMS, DEBUGGING COMPUTER SOFTWARE FOR OTHERS AND OPTIMIZING THE CODE PERFORMANCE FOR OTHERS, UPDATING COMPUTER SOFTWARE FOR OTHERS, PROVIDING ON-LINE DATABASE OF ELECTRONIC REFERENCE INFORMATION, AND WEB SITES, ALL IN THE FIELD OF COMPUTER SOFTWARE, APPLICATION DEVELOPMENT TOOLS, APPLICATION AND CODE PERFORMANCE ANALYSIS TOOLS, IN CLASS 42 (U.S. CLS. 100 AND 101).

FIRST USE 8-1-2010; IN COMMERCE 9-1-2010.

THE MARK CONSISTS OF STANDARD CHARACTERS WITHOUT CLAIM TO ANY PARTICULAR FONT, STYLE, SIZE, OR COLOR.

SER. NO. 85-086,012, FILED P.R. 7-15-2010; AM. S.R. 2-29-2012.

WILLIAM VERHOSEK, EXAMINING ATTORNEY



*David J. Kypos*

Director of the United States Patent and Trademark Office

# United States of America

United States Patent and Trademark Office

# GROSVENOR

**Reg. No. 4,127,034**

MCPHERSON'S LIMITED (AUSTRALIA COMPANY)

**Registered Apr. 10, 2012**

5 DUNLOP ROAD  
MULGRAVE, VIC, 3170, AUSTRALIA

**Int. Cl.: 8**

FOR: HAND OPERATED NON-ELECTRIC TOOLS AND IMPLEMENTS, NAMELY, KITCHEN KNIVES, KNIVES, FORKS AND SPOONS; CUTLERY SETS FEATURING KNIVES, FORKS AND SPOONS AND STANDS FOR SAME SOLD AS A UNIT THEREWITH; KITCHEN KNIFE SETS; SCISSORS; KITCHEN SHEARS; SCABBARDS, MANUALLY OPERATED SHARPENERS FOR CUTLERY; KNIFE BLOCKS; CAKE CUTTERS; HAND TOOLS, NAMELY, TONGS, NON-ELECTRIC FOOD PREPARATION, PROCESSING AND SERVING HAND TOOLS AND IMPLEMENTS, NAMELY, CAN OPENERS, HAND OPERATED NON-ELECTRIC FRUIT AND VEGETABLE PEELERS; CITRUS ZESTERS; PIZZA CUTTERS, IN CLASS 8 (U.S. CLS. 23, 28 AND 44).

**TRADEMARK**

**SUPPLEMENTAL REGISTER**

THE MARK CONSISTS OF STANDARD CHARACTERS WITHOUT CLAIM TO ANY PARTICULAR FONT, STYLE, SIZE, OR COLOR.

PRIORITY CLAIMED UNDER SEC. 44(D) ON AUSTRALIA APPLICATION NO. 1371646, FILED 7-9-2010, REG. NO. 1371646, DATED 5-5-2011, EXPIRES 7-9-2020.

SER. NO. 85-086,283, FILED P.R. 7-16-2010; AM. S.R. 7-20-2010.

HOWARD SMIGA, EXAMINING ATTORNEY



*David J. Kypos*

Director of the United States Patent and Trademark Office



# United States of America

United States Patent and Trademark Office

## DATA GOVERNANCE DIRECTOR

**Reg. No. 4,127,035**

KALIDO INC. (DELAWARE CORPORATION)  
1 WALL STREET  
BURLINGTON, MA 01803

**Registered Apr. 10, 2012**

**Int. Cl.: 9**

FOR: COMPUTER SOFTWARE FOR THE MANAGEMENT OF RULES AND POLICIES FOR USE IN INFORMATION MANAGEMENT SYSTEMS, IN CLASS 9 (U.S. CLS. 21, 23, 26, 36 AND 38).

**TRADEMARK**

FIRST USE 1-6-2011; IN COMMERCE 1-6-2011.

**SUPPLEMENTAL REGISTER**

THE MARK CONSISTS OF STANDARD CHARACTERS WITHOUT CLAIM TO ANY PARTICULAR FONT, STYLE, SIZE, OR COLOR.

SER. NO. 85-090,219, FILED P.R. 7-22-2010; AM. S.R. 2-2-2012.

MARTHA FROMM, EXAMINING ATTORNEY



*David J. Kyffers*

Director of the United States Patent and Trademark Office

# United States of America

United States Patent and Trademark Office

# JAM HOOK

**Reg. No. 4,127,036**

**Registered Apr. 10, 2012**

**Int. Cl.: 6**

**TRADEMARK**

**SUPPLEMENTAL REGISTER**

KEVIN D. POSTON (UNITED STATES INDIVIDUAL)  
SUITE NO. 375  
1999 AMIDON  
WICHTIA, KS 67203 AND

JOEL ASSOCIATES, L.L.C. (UNITED STATES LIMITED LIABILITY COMPANY)  
SUITE NO. 302  
221 SOUTH BROADWAY  
WICHITA, KS 67202

FOR: METAL BRACKETS INSTALLABLE UPON DOORWAYS AND UPON DOORWAY FRAMES, SUCH BRACKETS HAVING DOORWAY AND DOORWAY FRAME ENGAGING FLANGES FOR RESISTING KICK INDUCED MOTIONS OF THE DOORWAY FRAME IN RELATION TO THE DOORWAY, IN CLASS 6 (U.S. CLS. 2, 12, 13, 14, 23, 25 AND 50).

FIRST USE 8-15-2010; IN COMMERCE 8-15-2010.

THE MARK CONSISTS OF STANDARD CHARACTERS WITHOUT CLAIM TO ANY PARTICULAR FONT, STYLE, SIZE, OR COLOR.

SER. NO. 85-093,747, FILED P.R. 7-27-2010; AM. S.R. 12-1-2011.

DEBRA LEE, EXAMINING ATTORNEY



*David J. Kyffers*

Director of the United States Patent and Trademark Office

# United States of America

United States Patent and Trademark Office

## TUSCAN KITCHEN

**Reg. No. 4,127,037**

TUSCAN KITCHEN, LLC (NEW HAMPSHIRE LIMITED LIABILITY COMPANY)  
67 MAIN STREET  
SALEM, NH 03079

**Registered Apr. 10, 2012**

**Int. Cl.: 43**

FOR: RESTAURANT SERVICES, IN CLASS 43 (U.S. CLS. 100 AND 101).

**SERVICE MARK**

FIRST USE 11-22-2010; IN COMMERCE 11-22-2010.

**SUPPLEMENTAL REGISTER**

THE MARK CONSISTS OF STANDARD CHARACTERS WITHOUT CLAIM TO ANY PARTICULAR FONT, STYLE, SIZE, OR COLOR.

NO CLAIM IS MADE TO THE EXCLUSIVE RIGHT TO USE "TUSCAN", APART FROM THE MARK AS SHOWN.

SER. NO. 85-105,794, FILED P.R. 8-12-2010; AM. S.R. 5-13-2011.

WILLIAM VERHOSEK, EXAMINING ATTORNEY



*David J. Kyffers*

Director of the United States Patent and Trademark Office

# United States of America

United States Patent and Trademark Office

## TEACHERS AS THERAPISTS

**Reg. No. 4,127,038**

**Registered Apr. 10, 2012**

**Int. Cls.: 35 and 41**

THE INTERNATIONAL MEDICAL AND EDUCATIONAL FOUNDATION (MISSOURI CORPORATION), DBA THE INTERNATIONAL MEDICAL AND EDUCATIONAL TRUST,  
7TH FL  
7700 BONHOMME AVENUE  
ST. LOUIS, MO 63105

**SERVICE MARK**

FOR: CHARITABLE SERVICES, NAMELY, ORGANIZING AND CONDUCTING A VOLUNTEER PROGRAM FOR PSYCHOLOGICAL EDUCATION AND TRAINING TARGETED AT ELEMENTARY SCHOOL TEACHERS WHO ARE PUT IN THE POSITION OF TEACHING STUDENTS WHO HAVE BEEN TRAUMATIZED BY WAR OR VIOLENCE, IN CLASS 35 (U.S. CLS. 100, 101 AND 102).

**SUPPLEMENTAL REGISTER**

FIRST USE 11-11-2011; IN COMMERCE 11-11-2011.

FOR: EDUCATIONAL SERVICES, NAMELY, TRAINING TEACHERS TO IDENTIFY AND TREAT CHILDREN WHO ARE TRAUMATIZED BY WAR OR VIOLENCE, IN CLASS 41 (U.S. CLS. 100, 101 AND 107).

FIRST USE 11-11-2011; IN COMMERCE 11-11-2011.

THE MARK CONSISTS OF STANDARD CHARACTERS WITHOUT CLAIM TO ANY PARTICULAR FONT, STYLE, SIZE, OR COLOR.

SER. NO. 85-123,013, FILED P.R. 9-3-2010; AM. S.R. 1-28-2012.

SARA BENJAMIN, EXAMINING ATTORNEY



*David J. Kyros*

Director of the United States Patent and Trademark Office

# United States of America

United States Patent and Trademark Office

## AMERICAN PERFORMANCE TECHNOLOGIES

**Reg. No. 4,127,039**

APT IP HOLDINGS, LLC (WYOMING LIMITED LIABILITY COMPANY)  
8844 HILLCREST ROAD  
KANSAS CITY, MO 64105

**Registered Apr. 10, 2012**

**Int. Cl.: 7**

FOR: CARBURETORS; MOTORCYCLE ENGINE PARTS, NAMELY, CARBURETORS, IN CLASS 7 (U.S. CLS. 13, 19, 21, 23, 31, 34 AND 35).

**TRADEMARK**

FIRST USE 0-0-2011; IN COMMERCE 0-0-2011.

**SUPPLEMENTAL REGISTER**

THE MARK CONSISTS OF STANDARD CHARACTERS WITHOUT CLAIM TO ANY PARTICULAR FONT, STYLE, SIZE, OR COLOR.

NO CLAIM IS MADE TO THE EXCLUSIVE RIGHT TO USE "TECHNOLOGIES", APART FROM THE MARK AS SHOWN.

SER. NO. 85-125,223, FILED P.R. 9-8-2010; AM. S.R. 1-19-2012.

WANDA KAY PRICE, EXAMINING ATTORNEY



*David J. Kybas*

Director of the United States Patent and Trademark Office

# United States of America

United States Patent and Trademark Office

# Encase

**Reg. No. 4,127,040**

**Registered Apr. 10, 2012**

**Int. Cl.: 24**

**TRADEMARK**

**SUPPLEMENTAL REGISTER**

MALOUF MARKETING, INC. (UTAH CORPORATION), DBA MALOUF FINE LINENS,  
1189 WEST 1700 NORTH  
LOGAN, UT 84321

FOR: MATTRESS PROTECTORS, NAMELY, MATTRESS COVERS; MATTRESS PROTECTORS, NAMELY, MATTRESS COVERS THAT SUBSTANTIALLY SURROUND THE ENTIRETY OF THE MATTRESS; MATTRESS PROTECTORS, NAMELY, MATTRESS COVERS THAT COVER THE ENTIRETY OF THE MATTRESS AND HAVE A REMOVABLE TOP PORTION, IN CLASS 24 (U.S. CLS. 42 AND 50).

FIRST USE 9-29-2010; IN COMMERCE 2-15-2011.

THE MARK CONSISTS OF STANDARD CHARACTERS WITHOUT CLAIM TO ANY PARTICULAR FONT, STYLE, SIZE, OR COLOR.

SER. NO. 85-125,990, FILED P.R. 9-9-2010; AM. S.R. 2-10-2012.

JORDAN BAKER, EXAMINING ATTORNEY



*David J. Kyffers*

Director of the United States Patent and Trademark Office

# United States of America

United States Patent and Trademark Office

## CENTERFOLDS CABARET

**Reg. No. 4,127,041**

PAIK, STEVE (UNITED STATES INDIVIDUAL)  
2176 JEFFERSON LANE  
HUNTINGDON VALLEY, PA 19006

**Registered Apr. 10, 2012**

**Int. Cl.: 41**

FOR: NIGHT CLUBS, IN CLASS 41 (U.S. CLS. 100, 101 AND 107).

**SERVICE MARK**

FIRST USE 8-0-2010; IN COMMERCE 8-0-2010.

**SUPPLEMENTAL REGISTER**

THE MARK CONSISTS OF STANDARD CHARACTERS WITHOUT CLAIM TO ANY PARTICULAR FONT, STYLE, SIZE, OR COLOR.

NO CLAIM IS MADE TO THE EXCLUSIVE RIGHT TO USE "CABARET", APART FROM THE MARK AS SHOWN.

SER. NO. 85-129,781, FILED P.R. 9-15-2010; AM. S.R. 12-13-2011.

DEBRA LEE, EXAMINING ATTORNEY



*David J. Kybas*

Director of the United States Patent and Trademark Office

# United States of America

United States Patent and Trademark Office

# FOD FINDER

**Reg. No. 4,127,042**

TREX ENTERPRISES CORPORATION (CALIFORNIA CORPORATION)  
10455 PACIFIC CENTER COURT  
SAN DIEGO, CA 92121

**Registered Apr. 10, 2012**

**Int. Cl.: 9**

FOR: A MOBILE, VEHICLE MOUNTED RADAR SYSTEM COMPRISED OF RADAR OBJECT DETECTORS FOR USE ON VEHICLES, DATA PROCESSORS AND LAPTOP COMPUTER , IN CLASS 9 (U.S. CLS. 21, 23, 26, 36 AND 38).

**TRADEMARK**

FIRST USE 10-1-2008; IN COMMERCE 10-1-2008.

**SUPPLEMENTAL REGISTER**

THE MARK CONSISTS OF STANDARD CHARACTERS WITHOUT CLAIM TO ANY PARTICULAR FONT, STYLE, SIZE, OR COLOR.

SER. NO. 85-132,265, FILED P.R. 9-17-2010; AM. S.R. 6-27-2011.

HEATHER BIDDULPH, EXAMINING ATTORNEY



*David J. Kyfos*

Director of the United States Patent and Trademark Office



# United States of America

United States Patent and Trademark Office

## OAKLAND GREEN DENTAL

**Reg. No. 4,127,043**

HAMID, HAMID REZA (UNITED STATES INDIVIDUAL)  
13044 BROADWAY TERRACE  
OAKLAND, CA 94611

**Registered Apr. 10, 2012**

**Int. Cl.: 44**

FOR: DENTISTRY, IN CLASS 44 (U.S. CLS. 100 AND 101).

**SERVICE MARK**

FIRST USE 8-1-2010; IN COMMERCE 8-1-2010.

**SUPPLEMENTAL REGISTER**

THE MARK CONSISTS OF STANDARD CHARACTERS WITHOUT CLAIM TO ANY PARTICULAR FONT, STYLE, SIZE, OR COLOR.

NO CLAIM IS MADE TO THE EXCLUSIVE RIGHT TO USE "DENTAL", APART FROM THE MARK AS SHOWN.

SER. NO. 85-138,750, FILED P.R. 9-27-2010; AM. S.R. 8-5-2011.

NAAKWAMA ANKRAH, EXAMINING ATTORNEY



*David J. Kyffers*

Director of the United States Patent and Trademark Office

# United States of America

United States Patent and Trademark Office

## Synchronized Survey Scan

**Reg. No. 4,127,044**

**Registered Apr. 10, 2012**

**Int. Cl.: 9**

**TRADEMARK**

**SUPPLEMENTAL REGISTER**

SHIMADZU CORPORATION (JAPAN CORPORATION)  
1, NISHINOKYO-KUWABARACHO, NAKAGYO-KU  
KYOTO, JAPAN

FOR: COMPONENT PART OF MEASURING OR TESTING MACHINES AND INSTRUMENTS, NAMELY, CHROMATOGRAPH ANALYZERS AND MASS SPECTROGRAPH APPARATUS AND COMPUTER SOFTWARE FOR USE FOR ANALYZING AND COMPILING THE OUTPUT SIGNALS OF THE LIQUID CHROMATOGRAPH AND LIQUID CHROMATOGRAPH MASS SPECTROGRAPH SOLD THEREWITH, IN CLASS 9 (U.S. CLS. 21, 23, 26, 36 AND 38).

FIRST USE 9-1-2010; IN COMMERCE 9-1-2010.

THE MARK CONSISTS OF STANDARD CHARACTERS WITHOUT CLAIM TO ANY PARTICULAR FONT, STYLE, SIZE, OR COLOR.

PRIORITY CLAIMED UNDER SEC. 44(D) ON JAPAN APPLICATION NO. 2001-65021, FILED 8-18-2010, REG. NO. 5396789, DATED 3-11-2011, EXPIRES 3-11-2021.

SER. NO. 85-139,538, FILED P.R. 9-28-2010; AM. S.R. 11-7-2011.

JULIE WATSON, EXAMINING ATTORNEY



*David J. Kyros*

Director of the United States Patent and Trademark Office

# United States of America

United States Patent and Trademark Office

## Authentic Small Starz

**Reg. No. 4,127,045**

**Registered Apr. 10, 2012**

**Int. Cl.: 20**

HDS MARKETING, INC. (PENNSYLVANIA CORPORATION)  
112 TECHNOLOGY DRIVE  
SUITE 201  
PITTSBURGH, PA 15275

FOR: FIGURES OF PLASTIC, IN CLASS 20 (U.S. CLS. 2, 13, 22, 25, 32 AND 50).

**TRADEMARK**

FIRST USE 9-1-2011; IN COMMERCE 9-1-2011.

**SUPPLEMENTAL REGISTER**

THE MARK CONSISTS OF STANDARD CHARACTERS WITHOUT CLAIM TO ANY PARTICULAR FONT, STYLE, SIZE, OR COLOR.

SER. NO. 85-157,114, FILED P.R. 10-20-2010; AM. S.R. 2-27-2012.

SUSAN STIGLITZ, EXAMINING ATTORNEY



*David J. Kybas*

Director of the United States Patent and Trademark Office

# United States of America

United States Patent and Trademark Office

## MINDFUL HEALTH

**Reg. No. 4,127,046**

**Registered Apr. 10, 2012**

**Int. Cl.: 16**

**TRADEMARK**

**SUPPLEMENTAL REGISTER**

KATHLEEN A. HALL (UNITED STATES INDIVIDUAL)  
495 OWLS NEST LANE  
CLARKESVILLE, GA 30523

FOR: PRINTED MATERIALS, NAMELY, NEWSLETTERS, MAGAZINES, TEXTBOOKS, BOOKS, PAMPHLETS, BOOKLETS, TEACHING MATERIALS, INSPIRATIONAL CARDS, GREETING CARDS, NOTE CARDS, AND JOURNALS FOR PERSONAL REFLECTION, FEATURING PHYSICAL, MENTAL AND SPIRITUAL HEALTH, HEALING AND WELLNESS, LIFESTYLE MANAGEMENT, DISEASE PREVENTION, AND IDENTIFYING, OVERCOMING AND AVOIDING STRESS AND DESTRUCTIVE BEHAVIOR, IN CLASS 16 (U.S. CLS. 2, 5, 22, 23, 29, 37, 38 AND 50).

FIRST USE 10-6-2010; IN COMMERCE 10-6-2010.

THE MARK CONSISTS OF STANDARD CHARACTERS WITHOUT CLAIM TO ANY PARTICULAR FONT, STYLE, SIZE, OR COLOR.

OWNER OF U.S. REG. NOS. 3,444,965, 3,877,402, AND OTHERS.

SER. NO. 85-158,867, FILED P.R. 10-22-2010; AM. S.R. 8-8-2011.

KELLY BOULTON, EXAMINING ATTORNEY



*David J. Kyffers*

Director of the United States Patent and Trademark Office

# United States of America

United States Patent and Trademark Office

## PRACTICE VIABILITY INDEX

**Reg. No. 4,127,047**

**Registered Apr. 10, 2012**

**Int. Cl.: 42**

**SERVICE MARK**

**SUPPLEMENTAL REGISTER**

AXIOMA OECONOMIA (ST.KITTS-NEVIS LIMITED LIABILITY COMPANY)  
1739 EAGLES NEST DRIVE  
BELLEAIR, FL 33756

FOR: PROVIDING, ONLINE NON-DOWNLOADABLE COMPUTER SOFTWARE FOR THE EVALUATION, GROWTH, EXPANSION, AND DEVELOPMENT OF A BUSINESS, IN THE FIELDS OF FINANCE, FINANCIAL PLANNING, BUSINESS CONSULTING, PRACTICE MANAGEMENT, AND INFORMATIONAL SERVICES, IN CLASS 42 (U.S. CLS. 100 AND 101).

FIRST USE 6-6-2010; IN COMMERCE 6-6-2010.

THE MARK CONSISTS OF STANDARD CHARACTERS WITHOUT CLAIM TO ANY PARTICULAR FONT, STYLE, SIZE, OR COLOR.

SER. NO. 85-162,408, FILED 10-27-2010.

BERNICE MIDDLETON, EXAMINING ATTORNEY



*David J. Kyffers*

Director of the United States Patent and Trademark Office

# United States of America

United States Patent and Trademark Office

## NATIONAL COLLABORATION FOR FAMILIES

**Reg. No. 4,127,048**

NATIONAL HUMAN SERVICES ASSEMBLY (NEW YORK NON-PROFIT CORPORATION)  
1319 F STREET, N.W., SUITE 601  
WASHINGTON, DC 20004

**Registered Apr. 10, 2012**

**Int. Cls.: 16 and 35**

FOR: PRINTED PUBLICATIONS, NAMELY, BROCHURES AND STUDIES IN THE NATURE OF RESEARCH REPORTS PERTAINING TO HEALTH, HUMAN SERVICES, FAMILY, YOUTH, COMMUNITY, AND SOCIAL ISSUES, IN CLASS 16 (U.S. CLS. 2, 5, 22, 23, 29, 37, 38 AND 50).

**TRADEMARK**

**SERVICE MARK**

FIRST USE 2-14-2012; IN COMMERCE 2-14-2012.

**SUPPLEMENTAL REGISTER**

FOR: ASSOCIATION SERVICES, NAMELY, PROMOTING THE INTERESTS OF ORGANIZATIONS IN THE HEALTH, HUMAN, FAMILY, YOUTH AND COMMUNITY DEVELOPMENT FIELDS; PROVIDING INFORMATION AND RESEARCH IN THE FIELD OF GOVERNMENT AFFAIRS AND POLITICAL ISSUES AS THEY RELATE TO HEALTH, HUMAN AND COMMUNITY DEVELOPMENT, HUMAN SERVICES, FAMILIES AND YOUTH; PUBLIC POLICY RESEARCH SERVICES; GOVERNMENT RELATIONS CONSULTANCY SERVICES; LOBBYING SERVICES, NAMELY, PROMOTING THE INTERESTS OF FAMILIES AND YOUTH IN THE FIELDS OF LEGISLATION AND REGULATION; PROMOTING PUBLIC AWARENESS OF FAMILY, YOUTH AND SOCIAL ISSUES, INDIVIDUAL AND PROFESSIONAL DEVELOPMENT AND THE IMPORTANCE OF THE NONPROFIT HEALTH AND HUMAN SERVICES, IN CLASS 35 (U.S. CLS. 100, 101 AND 102).



FIRST USE 10-7-2010; IN COMMERCE 10-7-2010.

THE MARK CONSISTS OF STANDARD CHARACTERS WITHOUT CLAIM TO ANY PARTICULAR FONT, STYLE, SIZE, OR COLOR.

SER. NO. 85-163,672, FILED P.R. 10-28-2010; AM. S.R. 2-14-2012.

JOHN GARTNER, EXAMINING ATTORNEY

*David J. Kyffers*

Director of the United States Patent and Trademark Office

# United States of America

United States Patent and Trademark Office

## SMOOTH FINISH

**Reg. No. 4,127,049**

HBI BRANDED APPAREL LIMITED, INC. (DELAWARE CORPORATION)  
1000 EAST HANES MILL ROAD  
WINSTON-SALEM, NC 27105

**Registered Apr. 10, 2012**

**Int. Cl.: 25**

FOR: BRAS, IN CLASS 25 (U.S. CLS. 22 AND 39).

**TRADEMARK**

FIRST USE 1-20-2012; IN COMMERCE 1-20-2012.

**SUPPLEMENTAL REGISTER**

THE MARK CONSISTS OF STANDARD CHARACTERS WITHOUT CLAIM TO ANY PARTICULAR FONT, STYLE, SIZE, OR COLOR.

SER. NO. 85-164,433, FILED P.R. 10-29-2010; AM. S.R. 2-6-2012.

LINDSEY RUBIN, EXAMINING ATTORNEY



*David J. Kybas*

Director of the United States Patent and Trademark Office

# United States of America

United States Patent and Trademark Office

## RICHMAN CAPITAL MANAGEMENT

**Reg. No. 4,127,050**

CRAIG G. RICHMAN, P.A. (FLORIDA CORPORATION)  
5550 GLADES ROAD, SUITE 500  
BOCA RATON, FL 33431

**Registered Apr. 10, 2012**

**Int. Cl.: 36**

FOR: FINANCIAL ADVISORY AND CONSULTANCY SERVICES; FINANCIAL ASSET MANAGEMENT; FINANCIAL PLANNING AND INVESTMENT ADVISORY SERVICES, IN CLASS 36 (U.S. CLS. 100, 101 AND 102).

**SERVICE MARK**

FIRST USE 1-4-2010; IN COMMERCE 1-4-2010.

**SUPPLEMENTAL REGISTER**

THE MARK CONSISTS OF STANDARD CHARACTERS WITHOUT CLAIM TO ANY PARTICULAR FONT, STYLE, SIZE, OR COLOR.

OWNER OF U.S. REG. NO. 3,374,486.

NO CLAIM IS MADE TO THE EXCLUSIVE RIGHT TO USE "CAPITAL MANAGEMENT", APART FROM THE MARK AS SHOWN.

SER. NO. 85-168,920, FILED P.R. 11-4-2010; AM. S.R. 2-25-2011.

ANDREA K. NADELMAN, EXAMINING ATTORNEY



*David J. Kybas*

Director of the United States Patent and Trademark Office



# United States of America

United States Patent and Trademark Office

## Personal Visual Mapping

**Reg. No. 4,127,051**

PARENTPOW LLC (SOUTH CAROLINA LIMITED LIABILITY COMPANY)  
334 EAST BAY STREET #194  
CHARLESTON, SC 29401

**Registered Apr. 10, 2012**

**Int. Cl.: 42**

FOR: FEATURE OF COMPUTER SOFTWARE THAT ALLOWS THE USER TO MAP EDUCATIONAL ADVANCEMENT AND PERSONAL ENRICHMENT, SOLD AS AN INTEGRAL FEATURE OF ONLINE, NON-DOWNLOADABLE COMPUTER SOFTWARE, IN CLASS 42 (U.S. CLS. 100 AND 101).

**SERVICE MARK**

**SUPPLEMENTAL REGISTER** FIRST USE 5-1-2011; IN COMMERCE 7-1-2011.

THE MARK CONSISTS OF STANDARD CHARACTERS WITHOUT CLAIM TO ANY PARTICULAR FONT, STYLE, SIZE, OR COLOR.

SER. NO. 85-170,807, FILED P.R. 11-5-2010; AM. S.R. 8-17-2011.

SARA BENJAMIN, EXAMINING ATTORNEY



*David J. Kyffers*

Director of the United States Patent and Trademark Office

# United States of America

United States Patent and Trademark Office

## augmented reality for learning

**Reg. No. 4,127,052**

LOGICAL CHOICE TECHNOLOGIES, INC. (GEORGIA CORPORATION)  
1045 PROGRESS CIRCLE

**Registered Apr. 10, 2012**

LAWRENCEVILLE, GA 30043

**Int. Cls.: 9 and 28**

FOR: EDUCATIONAL SOFTWARE FEATURING INTERACTIVE AUGMENTED REALITY PLATFORMS TO PROVIDE INSTRUCTION FOR PRE-KINDERGARTEN TO COLLEGE AGED STUDENTS BY UTILIZING INTERACTIVE LEARNING AND GAMING SOFTWARE APPLICATIONS, IN CLASS 9 (U.S. CLS. 21, 23, 26, 36 AND 38).

**TRADEMARK**

**SUPPLEMENTAL REGISTER**

FIRST USE 1-1-2012; IN COMMERCE 1-1-2012.

FOR: ELECTRONIC GAMES FOR THE TEACHING OF CHILDREN, IN CLASS 28 (U.S. CLS. 22, 23, 38 AND 50).

FIRST USE 1-1-2012; IN COMMERCE 1-1-2012.

THE MARK CONSISTS OF STANDARD CHARACTERS WITHOUT CLAIM TO ANY PARTICULAR FONT, STYLE, SIZE, OR COLOR.

SER. NO. 85-175,064, FILED P.R. 11-11-2010; AM. S.R. 2-16-2012.

BRIAN NEVILLE, EXAMINING ATTORNEY



*David J. Kybas*

Director of the United States Patent and Trademark Office

# United States of America

United States Patent and Trademark Office

## IN-CAB ADVISOR

**Reg. No. 4,127,053**

**Registered Apr. 10, 2012**

**Int. Cls.: 9 and 41**

**TRADEMARK**

**SERVICE MARK**

**SUPPLEMENTAL REGISTER**

VNOMICS, CORP. (DELAWARE CORPORATION)  
175 SULLY'S TRAIL  
SUITE 203  
PITTSFORD, NY 14534

FOR: HARDWARE AND SOFTWARE FOR DETECTING AND MONITORING VEHICULAR FUEL USAGE, VEHICULAR LOAD, ENVIRONMENTAL CONDITIONS, OPERATOR EFFICIENCY AND SAFETY, VEHICULAR MAINTENANCE, VEHICULAR LOCATION, OPERATIONAL STATUS, OPERATIONAL SAFETY PROFILE; HARDWARE AND SOFTWARE FOR COLLECTING, STORING AND RELAYING DATA PERTAINING TO VEHICULAR OPERATIONAL EFFICIENCY, HEALTH, USAGE, AND SAFETY TO ONE OR MORE REMOTE LOCATIONS; HARDWARE AND SOFTWARE FOR MONITORING VEHICULAR OPERATIONAL PARAMETERS TO ENHANCE FUEL EFFICIENCY, SAFETY, AND MECHANICAL RELIABILITY, IN CLASS 9 (U.S. CLS. 21, 23, 26, 36 AND 38).

FIRST USE 10-5-2010; IN COMMERCE 10-5-2010.

FOR: DRIVER EDUCATION, TRAINING AND COACHING SERVICES, IN CLASS 41 (U.S. CLS. 100, 101 AND 107).

FIRST USE 10-5-2010; IN COMMERCE 10-5-2010.

THE MARK CONSISTS OF STANDARD CHARACTERS WITHOUT CLAIM TO ANY PARTICULAR FONT, STYLE, SIZE, OR COLOR.

SER. NO. 85-180,177, FILED P.R. 11-18-2010; AM. S.R. 3-1-2012.

RONALD MCMORROW, EXAMINING ATTORNEY



*David J. Kybas*

Director of the United States Patent and Trademark Office

# United States of America

United States Patent and Trademark Office

## FITNESS ZONE

**Reg. No. 4,127,054**

**Registered Apr. 10, 2012**

**Int. Cl.: 41**

**SERVICE MARK**

**SUPPLEMENTAL REGISTER**

THE TRUST FOR PUBLIC LAND (CALIFORNIA NON-PROFIT PUBLIC BENEFIT CORPORATION)  
101 MONTGOMERY STREET, SUITE 900  
SAN FRANCISCO, CA 94104

FOR: PROVIDING OUTDOOR PHYSICAL TRAINING, FITNESS, EXERCISE, AND PLAY SITES AND FACILITIES; PROVIDING OUTDOOR PLAYGROUND FACILITIES; PROVIDING OUTDOOR SITES FEATURING PLAYGROUND EQUIPMENT FOR PHYSICAL FITNESS PURPOSES; PROVIDING OUTDOOR SITES FEATURING EXERCISE EQUIPMENT FOR PHYSICAL FITNESS PURPOSES; PROVIDING OUTDOOR SITES FEATURING PLAYGROUND EQUIPMENT, NAMELY, A SERIES OF EXERCISE, FITNESS AND ACTIVITY STATIONS, IN CLASS 41 (U.S. CLS. 100, 101 AND 107).

FIRST USE 11-30-2007; IN COMMERCE 11-30-2007.

THE MARK CONSISTS OF STANDARD CHARACTERS WITHOUT CLAIM TO ANY PARTICULAR FONT, STYLE, SIZE, OR COLOR.

NO CLAIM IS MADE TO THE EXCLUSIVE RIGHT TO USE "FITNESS", APART FROM THE MARK AS SHOWN.

SER. NO. 85-180,638, FILED P.R. 11-19-2010; AM. S.R. 2-22-2012.

KIM MONINGHOFF, EXAMINING ATTORNEY



*David J. Kyjars*

Director of the United States Patent and Trademark Office

# United States of America

United States Patent and Trademark Office

## HEMORRHOID CONTROL

**Reg. No. 4,127,055**

FORCES OF NATURE, INC. (CALIFORNIA CORPORATION)  
505 MONTGOMERY STREET, 5TH FLOOR  
SAN FRANCISCO, CA 94111

**Registered Apr. 10, 2012**

**Int. Cl.: 5**

FOR: MEDICATED SKIN CARE PREPARATIONS; NATURAL SUPPLEMENTS IN THE NATURE OF IMMUNE SYSTEM BOOSTERS; HOMEOPATHIC PHARMACEUTICALS FOR USE IN THE TREATMENT OF HEMORRHOIDS, IN CLASS 5 (U.S. CLS. 6, 18, 44, 46, 51 AND 52).

**TRADEMARK**

**SUPPLEMENTAL REGISTER** FIRST USE 6-0-2011; IN COMMERCE 6-0-2011.

THE MARK CONSISTS OF STANDARD CHARACTERS WITHOUT CLAIM TO ANY PARTICULAR FONT, STYLE, SIZE, OR COLOR.

NO CLAIM IS MADE TO THE EXCLUSIVE RIGHT TO USE "HEMORRHOID", APART FROM THE MARK AS SHOWN.

SER. NO. 85-181,565, FILED P.R. 11-19-2010; AM. S.R. 2-17-2012.

KIMBERLY PERRY, EXAMINING ATTORNEY



*David J. Kybas*

Director of the United States Patent and Trademark Office

# United States of America

United States Patent and Trademark Office

## NAIL FUNGUS CONTROL

**Reg. No. 4,127,056**

FORCES OF NATURE, INC. (CALIFORNIA CORPORATION)  
505 MONTGOMERY STREET, 5TH FLOOR  
SAN FRANCISCO, CA 94111

**Registered Apr. 10, 2012**

**Int. Cl.: 5**

FOR: MEDICATED SKIN CARE PREPARATIONS; NATURAL SUPPLEMENTS IN THE NATURE OF IMMUNE SYSTEM BOOSTERS; HOMEOPATHIC PHARMACEUTICALS FOR USE IN THE TREATMENT OF NAIL FUNGUS, IN CLASS 5 (U.S. CLS. 6, 18, 44, 46, 51 AND 52).

**TRADEMARK**

**SUPPLEMENTAL REGISTER** FIRST USE 6-0-2011; IN COMMERCE 6-0-2011.

THE MARK CONSISTS OF STANDARD CHARACTERS WITHOUT CLAIM TO ANY PARTICULAR FONT, STYLE, SIZE, OR COLOR.

NO CLAIM IS MADE TO THE EXCLUSIVE RIGHT TO USE "NAIL FUNGUS", APART FROM THE MARK AS SHOWN.

SER. NO. 85-181,586, FILED P.R. 11-19-2010; AM. S.R. 2-17-2012.

KIMBERLY PERRY, EXAMINING ATTORNEY



*David J. Kyros*

Director of the United States Patent and Trademark Office

# United States of America

United States Patent and Trademark Office

## WART CONTROL

**Reg. No. 4,127,057**

FORCES OF NATURE, INC. (CALIFORNIA CORPORATION)  
505 MONTGOMERY STREET, 5TH FLOOR  
SAN FRANCISCO, CA 94111

**Registered Apr. 10, 2012**

**Int. Cl.: 5**

FOR: MEDICATED SKIN CARE PREPARATIONS; NATURAL SUPPLEMENTS IN THE NATURE OF IMMUNE SYSTEM BOOSTERS; HOMEOPATHIC PHARMACEUTICALS FOR USE IN THE TREATMENT OF WARTS, IN CLASS 5 (U.S. CLS. 6, 18, 44, 46, 51 AND 52).

**TRADEMARK**

FIRST USE 6-0-2011; IN COMMERCE 6-0-2011.

**SUPPLEMENTAL REGISTER**

THE MARK CONSISTS OF STANDARD CHARACTERS WITHOUT CLAIM TO ANY PARTICULAR FONT, STYLE, SIZE, OR COLOR.

NO CLAIM IS MADE TO THE EXCLUSIVE RIGHT TO USE "WART", APART FROM THE MARK AS SHOWN.

SER. NO. 85-181,596, FILED P.R. 11-19-2010; AM. S.R. 2-17-2012.

KIMBERLY PERRY, EXAMINING ATTORNEY



*David J. Kyjars*

Director of the United States Patent and Trademark Office

# United States of America

United States Patent and Trademark Office

## Network Optix

**Reg. No. 4,127,058**

NETWORK OPTIX, INC. (CALIFORNIA CORPORATION)  
1146 NORTH CENTRAL AVENUE, #624  
GLENDALE, CA 91202

**Registered Apr. 10, 2012**

**Int. Cl.: 42**

FOR: DESIGN AND DEVELOPMENT OF COMPUTER SOFTWARE, IN CLASS 42 (U.S. CLS. 100 AND 101).

**SERVICE MARK**

FIRST USE 4-15-2011; IN COMMERCE 4-15-2011.

**SUPPLEMENTAL REGISTER**

THE MARK CONSISTS OF STANDARD CHARACTERS WITHOUT CLAIM TO ANY PARTICULAR FONT, STYLE, SIZE, OR COLOR.

SER. NO. 85-185,794, FILED P.R. 11-28-2010; AM. S.R. 7-26-2011.

KELLY BOULTON, EXAMINING ATTORNEY



*David J. Kybas*

Director of the United States Patent and Trademark Office



# United States of America

United States Patent and Trademark Office

# re|shod

**Reg. No. 4,127,059**

**Registered Apr. 10, 2012**

**Int. Cl.: 25**

**TRADEMARK**

**SUPPLEMENTAL REGISTER**

RESHOD WALKING SHOES, LLC (OREGON LIMITED LIABILITY COMPANY)  
18815 SW HONEYWOOD DRIVE  
ALOHA, OR 97006

FOR: FOOTWEAR, IN CLASS 25 (U.S. CLS. 22 AND 39).

FIRST USE 7-9-2008; IN COMMERCE 8-25-2008.

THE MARK CONSISTS OF STANDARD CHARACTERS WITHOUT CLAIM TO ANY PARTICULAR FONT, STYLE, SIZE, OR COLOR.

SER. NO. 85-189,676, FILED P.R. 12-2-2010; AM. S.R. 12-16-2011.

STEVEN JACKSON, EXAMINING ATTORNEY



*David J. Kybas*

Director of the United States Patent and Trademark Office

# United States of America

United States Patent and Trademark Office

## MARTIAL FITNESS

**Reg. No. 4,127,060**

THE WELCH EXPERIENCE, INC. (GEORGIA CORPORATION)

**Registered Apr. 10, 2012**

P.O. BOX 723296  
ATLANTA, GA 31139

**Int. Cl.: 41**

FOR: FITNESS COACHING AND MOTIVATIONAL TRAINING, IN CLASS 41 (U.S. CLS. 100, 101 AND 107).

**SERVICE MARK**

FIRST USE 10-31-2003; IN COMMERCE 10-31-2003.

**SUPPLEMENTAL REGISTER**

THE MARK CONSISTS OF STANDARD CHARACTERS WITHOUT CLAIM TO ANY PARTICULAR FONT, STYLE, SIZE, OR COLOR.

NO CLAIM IS MADE TO THE EXCLUSIVE RIGHT TO USE "FITNESS", APART FROM THE MARK AS SHOWN.

SER. NO. 85-189,951, FILED P.R. 12-3-2010; AM. S.R. 2-21-2012.

DAVID H. STINE, EXAMINING ATTORNEY



*David J. Kyfos*

Director of the United States Patent and Trademark Office

# United States of America

United States Patent and Trademark Office

## CANDLES FOR EVERY OCCASION

**Reg. No. 4,127,061**

MVP GROUP INTERNATIONAL, INC. (KENTUCKY CORPORATION)  
1031 LE GRAND BLVD.  
CHARLESTON, SC 29492

**Registered Apr. 10, 2012**

**Int. Cl.: 4**

FOR: CANDLES; SCENTED CANDLES, IN CLASS 4 (U.S. CLS. 1, 6 AND 15).

**TRADEMARK**

FIRST USE 11-30-2011; IN COMMERCE 11-30-2011.

**SUPPLEMENTAL REGISTER**

THE MARK CONSISTS OF STANDARD CHARACTERS WITHOUT CLAIM TO ANY PARTICULAR FONT, STYLE, SIZE, OR COLOR.

SER. NO. 85-190,095, FILED P.R. 12-3-2010; AM. S.R. 2-27-2012.

MIDGE BUTLER, EXAMINING ATTORNEY



*David J. Kyffers*

Director of the United States Patent and Trademark Office

# United States of America

United States Patent and Trademark Office

# CANDLES

*for every occasion*

**Reg. No. 4,127,062**

MVP GROUP INTERNATIONAL, INC. (KENTUCKY CORPORATION)  
1031 LE GRAND BLVD.  
CHARLESTON, SC 29492

**Registered Apr. 10, 2012**

**Int. Cl.: 4**

FOR: CANDLES; SCENTED CANDLES, IN CLASS 4 (U.S. CLS. 1, 6 AND 15).

**TRADEMARK**

FIRST USE 11-30-2011; IN COMMERCE 11-30-2011.

**SUPPLEMENTAL REGISTER**

NO CLAIM IS MADE TO THE EXCLUSIVE RIGHT TO USE "CANDLES", APART FROM THE MARK AS SHOWN.

THE MARK CONSISTS OF THE WORD "CANDLES" ABOVE THE WORDS "FOR EVERY OCCASION".

SER. NO. 85-190,098, FILED P.R. 12-3-2010; AM. S.R. 2-27-2012.

MIDGE BUTLER, EXAMINING ATTORNEY



*David J. Kyffers*

Director of the United States Patent and Trademark Office

# United States of America

United States Patent and Trademark Office

## Don't Touch My Kitty

**Reg. No. 4,127,063**

MCGORRY, LORRAINE (UNITED STATES INDIVIDUAL)  
8281 NORTHWIND WAY  
ORANGEVALE, CA 95662 AND

**Registered Apr. 10, 2012**

**Int. Cls.: 16 and 25**

ROGERS, TANNA RAE (UNITED STATES INDIVIDUAL)  
2130 CAROL ANN COURT  
MISSOULA, MT 59801 AND

**TRADEMARK**

RIGGERT, CINDY (UNITED STATES INDIVIDUAL)  
P.O. BOX 4891  
MISSOULA, MT 59806

**SUPPLEMENTAL REGISTER**

FOR: BUMPER STICKERS; PRINTED EMBLEMS; STICKERS AND DECALCOMANIAS, IN CLASS 16 (U.S. CLS. 2, 5, 22, 23, 29, 37, 38 AND 50).

FIRST USE 12-22-2010; IN COMMERCE 12-22-2010.

FOR: HATS; UNDERWEAR; WEARABLE GARMENTS AND CLOTHING, NAMELY, SHIRTS, IN CLASS 25 (U.S. CLS. 22 AND 39).

FIRST USE 12-22-2010; IN COMMERCE 12-22-2010.

THE MARK CONSISTS OF STANDARD CHARACTERS WITHOUT CLAIM TO ANY PARTICULAR FONT, STYLE, SIZE, OR COLOR.

SER. NO. 85-195,955, FILED P.R. 12-12-2010; AM. S.R. 3-1-2012.

ERIN FALK, EXAMINING ATTORNEY



*David J. Kybas*

Director of the United States Patent and Trademark Office

# United States of America

United States Patent and Trademark Office

## PRESSURE CONTROL

**Reg. No. 4,127,064**

ROBERT BOSCH TOOL CORPORATION (DELAWARE CORPORATION)  
1800 WEST CENTRAL ROAD  
MOUNT PROSPECT, IL 60056

**Registered Apr. 10, 2012**

**Int. Cl.: 7**

FOR: POWER TOOLS, NAMELY, SANDERS, IN CLASS 7 (U.S. CLS. 13, 19, 21, 23, 31, 34 AND 35).

**TRADEMARK**

FIRST USE 7-0-2008; IN COMMERCE 7-0-2008.

**SUPPLEMENTAL REGISTER**

THE MARK CONSISTS OF STANDARD CHARACTERS WITHOUT CLAIM TO ANY PARTICULAR FONT, STYLE, SIZE, OR COLOR.

SER. NO. 85-204,086, FILED P.R. 12-22-2010; AM. S.R. 2-8-2012.

MARCIE MILONE, EXAMINING ATTORNEY



*David J. Kybas*

Director of the United States Patent and Trademark Office

# United States of America

United States Patent and Trademark Office

## IBERICO FRESCO

**Reg. No. 4,127,065**

LIGHTHOUSE TRADE INC. (CALIFORNIA CORPORATION)  
3649 MILITARY AVE  
LOS ANGELES, CA 90034 AND

**Registered Apr. 10, 2012**

**Int. Cl.: 29**

S.C.A. GANADERA DEL VALLE DE LOS PEDROCHES (COVAP) (SPAIN SOCIEDAD  
COOPERATIVA)  
14400 POZOBLANCO  
CARRETERA CANALEJA S/N  
CÓRDOBA, CA 90034

**TRADEMARK**

**SUPPLEMENTAL REGISTER**

FOR: HAM, MEAT AND PORK ORIGINATING FROM THE IBERIAN PENINSULA, IN CLASS  
29 (U.S. CL. 46).

FIRST USE 4-0-2011; IN COMMERCE 4-0-2011.

THE MARK CONSISTS OF STANDARD CHARACTERS WITHOUT CLAIM TO ANY PAR-  
TICULAR FONT, STYLE, SIZE, OR COLOR.

NO CLAIM IS MADE TO THE EXCLUSIVE RIGHT TO USE "FRESCO", APART FROM THE  
MARK AS SHOWN.

THE ENGLISH TRANSLATION OF "IBERICO FRESCO" IN THE MARK IS "FRESH IBERIAN".

SER. NO. 85-212,355, FILED P.R. 1-6-2011; AM. S.R. 2-14-2012.

KEVON CHISOLM, EXAMINING ATTORNEY



*David J. Kyros*

Director of the United States Patent and Trademark Office

# United States of America

United States Patent and Trademark Office

## ANNUITY OPTIONS

**Reg. No. 4,127,066**

CDOC, INC. (DELAWARE CORPORATION)  
11825 N. PENNSYLVANIA STREET  
CARMEL, IN 46082

**Registered Apr. 10, 2012**

**Int. Cl.: 36**

FOR: INSURANCE AND FINANCIAL SERVICES, NAMELY, ANNUITY UNDERWRITING AND ADMINISTRATION, IN CLASS 36 (U.S. CLS. 100, 101 AND 102).

**SERVICE MARK**

FIRST USE 9-1-2011; IN COMMERCE 9-1-2011.

**SUPPLEMENTAL REGISTER**

THE MARK CONSISTS OF STANDARD CHARACTERS WITHOUT CLAIM TO ANY PARTICULAR FONT, STYLE, SIZE, OR COLOR.

SER. NO. 85-213,720, FILED P.R. 1-10-2011; AM. S.R. 2-16-2012.

ALICE BENMAMAN, EXAMINING ATTORNEY



*David J. Kybas*

Director of the United States Patent and Trademark Office



# United States of America

United States Patent and Trademark Office

## RUSSIAN AMBER IMPERIAL

**Reg. No. 4,127,067**

PHILIP SCOTT, INC. (CALIFORNIA CORPORATION), DBA PHILIP B, INC.,  
2630 TOWNSGATE RD., STE. H  
WESTLAKE VILLAGE, CA 91361

**Registered Apr. 10, 2012**

**Int. Cl.: 3**

FOR: HAIR SHAMPOOS AND HAIR CONDITIONERS ALL MADE IN SIGNIFICANT PART  
OF RUSSIAN AMBER OIL, IN CLASS 3 (U.S. CLS. 1, 4, 6, 50, 51 AND 52).

**TRADEMARK**

FIRST USE 12-0-2008; IN COMMERCE 12-0-2008.

**SUPPLEMENTAL REGISTER**

THE MARK CONSISTS OF STANDARD CHARACTERS WITHOUT CLAIM TO ANY PAR-  
TICULAR FONT, STYLE, SIZE, OR COLOR.

NO CLAIM IS MADE TO THE EXCLUSIVE RIGHT TO USE "RUSSIAN AMBER", APART  
FROM THE MARK AS SHOWN.

SER. NO. 85-215,995, FILED P.R. 1-12-2011; AM. S.R. 1-30-2012.

RUDY R. SINGLETON, EXAMINING ATTORNEY



*David J. Kybas*

Director of the United States Patent and Trademark Office

# United States of America

United States Patent and Trademark Office

## PH RESTORATIVE

**Reg. No. 4,127,068**

PHILIP SCOTT, INC. (CALIFORNIA CORPORATION), DBA PHILIP B, INC.,  
2630 TOWNSGATE RD., STE. H  
WESTLAKE VILLAGE, CA 91361

**Registered Apr. 10, 2012**

**Int. Cl.: 3**

FOR: HAIR CARE PRODUCTS, NAMELY, HAIR CARE PREPARATIONS, IN CLASS 3 (U.S. CLS. 1, 4, 6, 50, 51 AND 52).

**TRADEMARK**

FIRST USE 10-0-2008; IN COMMERCE 10-0-2008.

**SUPPLEMENTAL REGISTER**

THE MARK CONSISTS OF STANDARD CHARACTERS WITHOUT CLAIM TO ANY PARTICULAR FONT, STYLE, SIZE, OR COLOR.

SER. NO. 85-216,146, FILED P.R. 1-12-2011; AM. S.R. 1-30-2012.

RUDY R. SINGLETON, EXAMINING ATTORNEY



*David J. Kybas*

Director of the United States Patent and Trademark Office

# United States of America

United States Patent and Trademark Office

## WHITE TRUFFLE

**Reg. No. 4,127,069**

PHILIP SCOTT, INC. (CALIFORNIA CORPORATION), DBA PHILIP B, INC.,  
2630 TOWNSGATE RD., STE. H  
WESTLAKE VILLAGE, CA 91361

**Registered Apr. 10, 2012**

**Int. Cl.: 3**

FOR: HAIR SHAMPOOS AND HAIR CONDITIONERS ALL MADE IN SIGNIFICANT PART  
OF WHITE TRUFFLE EXTRACT, IN CLASS 3 (U.S. CLS. 1, 4, 6, 50, 51 AND 52).

**TRADEMARK**

FIRST USE 12-0-1995; IN COMMERCE 12-0-1995.

**SUPPLEMENTAL REGISTER**

THE MARK CONSISTS OF STANDARD CHARACTERS WITHOUT CLAIM TO ANY PAR-  
TICULAR FONT, STYLE, SIZE, OR COLOR.

SER. NO. 85-216,212, FILED P.R. 1-12-2011; AM. S.R. 1-30-2012.

RUDY R. SINGLETON, EXAMINING ATTORNEY



*David J. Kyfos*

Director of the United States Patent and Trademark Office

# United States of America

United States Patent and Trademark Office

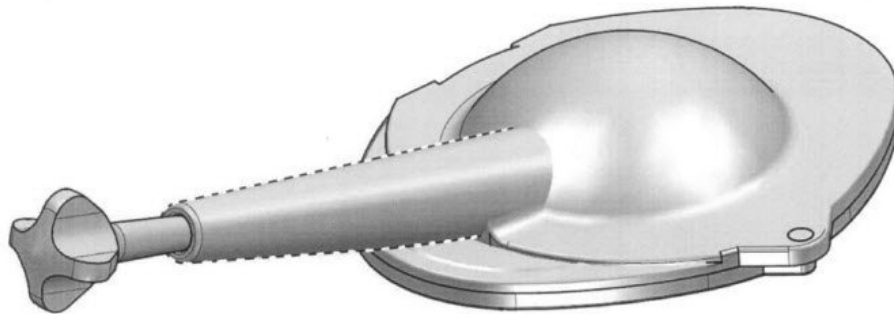

**Reg. No. 4,127,070**

**Registered Apr. 10, 2012**

**Int. Cl.: 5**

**TRADEMARK**

**SUPPLEMENTAL REGISTER**

MET P PHARMA AG (SWITZERLAND AKTIENGESELLSCHAFT)  
MUEHLEBACHSTRASSE 3  
6370 STANS, SWITZERLAND

FOR: PHARMACEUTICAL PREPARATIONS FOR TREATING FEMALE SEXUAL DYSFUNCTION AND LOSS OF LIBIDO, IN CLASS 5 (U.S. CLS. 6, 18, 44, 46, 51 AND 52).

PRIORITY CLAIMED UNDER SEC. 44(D) ON ERPN CMNTY TM OFC APPLICATION NO. 009644642, FILED 1-7-2011, REG. NO. 009644642, DATED 6-15-2011, EXPIRES 1-7-2021.

THE MARK CONSISTS OF THREE-DIMENSIONAL PACKAGING FOR THE GOODS COMPRISING A CIRCULAR AND FLATTENED BAG CONNECTED TO AN ELONGATED DOSING TUBE WITH A NOZZLE TIP FOR DISPENSING PHARMACEUTICAL PREPARATIONS. THE BROKEN LINES DEPICTING THE ELONGATED DOSING TUBE INDICATE PLACEMENT OF THE MARK ON THE GOODS AND ARE NOT PART OF THE MARK.

SER. NO. 85-217,681, FILED P.R. 1-14-2011; AM. S.R. 2-27-2012.

APRIL HESIK, EXAMINING ATTORNEY



*David J. Kypos*

Director of the United States Patent and Trademark Office

# United States of America

United States Patent and Trademark Office

# COLOURFOOD

**Reg. No. 4,127,071**

GNT BEHEER B.V. (NETHERLANDS LIMITED LIABILITY COMPANY)  
INDUSTRIEWEG 26

**Registered Apr. 10, 2012**

5731 HR MIERLO, NETHERLANDS

**Int. Cls.: 2, 29, 30, and 32**

FOR: NATURAL DYES FOR FOODSTUFFS AND BEVERAGES, IN CLASS 2 (U.S. CLS. 6, 11 AND 16).

**TRADEMARK**

FOR: PRESERVED FRUIT AND VEGETABLES; DRIED FRUIT AND VEGETABLES, IN CLASS 29 (U.S. CL. 46).

**SUPPLEMENTAL REGISTER**

FOR: PLANT EXTRACTS USED AS FLAVOURING IN FOODS, IN CLASS 30 (U.S. CL. 46).

FOR: NON-ALCOHOLIC FRUIT AND VEGETABLE EXTRACTS USED IN THE PREPARATION OF BEVERAGES AND FOOD, IN CLASS 32 (U.S. CLS. 45, 46 AND 48).

PRIORITY CLAIMED UNDER SEC. 44(D) ON ERPN CMNTY TM OFC APPLICATION NO. 009344482, FILED 8-31-2010, REG. NO. 009344482, DATED 2-10-2011, EXPIRES 8-31-2020.

THE COLOR(S) RED, ORANGE, YELLOW, GREEN, BLUE, AND PURPLE IS/ARE CLAIMED AS A FEATURE OF THE MARK.

THE MARK CONSISTS OF THE TERM "COLOURFOOD" SHOWN FROM LEFT TO RIGHT IN THE CHANGING COLORS OF THE SPECTRUM RANGING FROM RED TO ORANGE, YELLOW, GREEN, BLUE AND PURPLE.

SER. NO. 85-226,297, FILED P.R. 1-26-2011; AM. S.R. 10-24-2011.

PAM WILLIS, EXAMINING ATTORNEY



*David J. Kybas*

Director of the United States Patent and Trademark Office

# United States of America

United States Patent and Trademark Office

# H2Sponge

**Reg. No. 4,127,072**

INTERNATIONAL FINE CHEMICALS LLC (INDIANA LIMITED LIABILITY COMPANY)  
1601 1ST AV  
EVANSVILLE, IN 47724

**Registered Apr. 10, 2012**

**Int. Cl.: 1**

FOR: A GRANULAR FIBROUS MATERIAL TO BE USED AS A GAS, WATER, OR VAPOR FILTERING MEDIA WITHIN CARTRIDGES, FILTERS, OR PACKETS, NAMELY, COMPLEX LIQUID CHEMICAL PREPARATIONS APPLIED TO A VARIETY OF GRANULAR SOLIDS, WHICH IN TURN ACTS AS A SPONGE REMOVAL MEDIA OF HYDROGEN SULFIDE GASES BY USING ABOVE MENTIONED MECHANISMS, IN CLASS 1 (U.S. CLS. 1, 5, 6, 10, 26 AND 46).

**TRADEMARK**

**SUPPLEMENTAL REGISTER**

FIRST USE 11-3-2010; IN COMMERCE 2-7-2011.

THE MARK CONSISTS OF STANDARD CHARACTERS WITHOUT CLAIM TO ANY PARTICULAR FONT, STYLE, SIZE, OR COLOR.

SER. NO. 85-228,695, FILED P.R. 1-28-2011; AM. S.R. 3-1-2012.

CARRIE GENOVESE, EXAMINING ATTORNEY



*David J. Kyros*

Director of the United States Patent and Trademark Office

# United States of America

United States Patent and Trademark Office

## UTILITY SERIES

**Reg. No. 4,127,073**

**Registered Apr. 10, 2012**

**Int. Cl.: 9**

**TRADEMARK**

**SUPPLEMENTAL REGISTER**

OTTER PRODUCTS, LLC (COLORADO LIMITED LIABILITY COMPANY)  
401 WEST MOUNTAIN AVENUE  
SUITE 200  
FORT COLLINS, CO 80521

FOR: ACCESSORIES SPECIALLY ADAPTED FOR USE WITH HAND-HELD DIGITAL ELECTRONIC DEVICES, NAMELY, BACKPACKS, PROTECTIVE CASES, COVERS AND HOLDERS MADE OF PLASTIC OR OF NYLON, IN CLASS 9 (U.S. CLS. 21, 23, 26, 36 AND 38).

FIRST USE 2-3-2011; IN COMMERCE 2-3-2011.

THE MARK CONSISTS OF STANDARD CHARACTERS WITHOUT CLAIM TO ANY PARTICULAR FONT, STYLE, SIZE, OR COLOR.

OWNER OF U.S. REG. NO. 4,064,940.

NO CLAIM IS MADE TO THE EXCLUSIVE RIGHT TO USE "SERIES", APART FROM THE MARK AS SHOWN.

SER. NO. 85-233,781, FILED P.R. 2-3-2011; AM. S.R. 9-12-2011.

HAI-LY LAM, EXAMINING ATTORNEY



*David J. Kyros*

Director of the United States Patent and Trademark Office

# United States of America

United States Patent and Trademark Office

# DIY HOOP

**Reg. No. 4,127,074**

LIN, KUN YUAN (UNITED STATES INDIVIDUAL)  
2517 EL CAPITAN AVENUE  
ARCADIA, CA 91006

**Registered Apr. 10, 2012**

**Int. Cl.: 28**

FOR: EXERCISE EQUIPMENT IN THE NATURE OF HOOPS AND TOY HOOP SETS, IN CLASS 28 (U.S. CLS. 22, 23, 38 AND 50).

**TRADEMARK**

FIRST USE 12-15-2010; IN COMMERCE 12-15-2010.

**SUPPLEMENTAL REGISTER**

THE MARK CONSISTS OF STANDARD CHARACTERS WITHOUT CLAIM TO ANY PARTICULAR FONT, STYLE, SIZE, OR COLOR.

NO CLAIM IS MADE TO THE EXCLUSIVE RIGHT TO USE "HOOP", APART FROM THE MARK AS SHOWN.

SER. NO. 85-238,331, FILED P.R. 2-9-2011; AM. S.R. 2-17-2012.

DAVID HOFFMAN, EXAMINING ATTORNEY



*David J. Kyffers*

Director of the United States Patent and Trademark Office



# United States of America

United States Patent and Trademark Office

## West Virginia Ortho and Oral Surgery Specialists

**Reg. No. 4,127,075**

**Registered Apr. 10, 2012**

**Int. Cl.: 44**

**SERVICE MARK**

**SUPPLEMENTAL REGISTER**

WILSON MARTINO DENTAL, PLLC (WEST VIRGINIA LIMITED LIABILITY COMPANY),  
DBA WILSON MARTINO DENTAL,  
516 COST AVENUE  
STONEWOOD, WV 26301

FOR: ORTHODONTIC AND ORAL SURGERY SERVICES, IN CLASS 44 (U.S. CLS. 100 AND 101).

FIRST USE 6-15-2011; IN COMMERCE 6-15-2011.

THE MARK CONSISTS OF STANDARD CHARACTERS WITHOUT CLAIM TO ANY PARTICULAR FONT, STYLE, SIZE, OR COLOR.

NO CLAIM IS MADE TO THE EXCLUSIVE RIGHT TO USE "ORTHO AND ORAL SURGERY", APART FROM THE MARK AS SHOWN.

SER. NO. 85-257,274, FILED P.R. 3-3-2011; AM. S.R. 8-2-2011.

ANNE MADDEN, EXAMINING ATTORNEY



*David J. Kyffers*

Director of the United States Patent and Trademark Office

# United States of America

United States Patent and Trademark Office

## WE SELL RESTAURANTS

**Reg. No. 4,127,076**

WE SELL RESTAURANTS, INC. (GEORGIA CORPORATION)  
101 CENTENNIAL OLYMPIC PARK DRIVE, S.W.  
ATLANTA, GA 30313

**Registered Apr. 10, 2012**

**Int. Cl.: 36**

FOR: BUSINESS BROKERAGE SERVICES, IN CLASS 36 (U.S. CLS. 100, 101 AND 102).

**SERVICE MARK**

FIRST USE 7-30-2004; IN COMMERCE 7-30-2004.

**SUPPLEMENTAL REGISTER**

THE MARK CONSISTS OF STANDARD CHARACTERS WITHOUT CLAIM TO ANY PARTICULAR FONT, STYLE, SIZE, OR COLOR.

OWNER OF U.S. REG. NO. 3,597,409.

SER. NO. 85-268,071, FILED P.R. 3-16-2011; AM. S.R. 2-2-2012.

KELLEY WELLS, EXAMINING ATTORNEY



*David J. Kyffers*

Director of the United States Patent and Trademark Office

# United States of America

United States Patent and Trademark Office

## THE HCG DIET EXPERT

**Reg. No. 4,127,077**

ZENA LICENSES, LLC (DELAWARE LIMITED LIABILITY COMPANY)  
399 TERESA DR  
LARGO, FL 33770

**Registered Apr. 10, 2012**

**Int. Cls.: 41 and 44**

FOR: PROVIDING PERSONAL AND PROFESSIONAL EDUCATIONAL COACHING, AND TRAINING SERVICES AND EDUCATIONAL PROGRAMS IN THE FIELD OF WEIGHT LOSS, WEIGHT MANAGEMENT, AND GENERAL HEALTH AND WELLNESS BEFORE, DURING AND AFTER THE HCG DIET, WHICH SERVICES ARE PROVIDED IN-PERSON, TELEPHONICALLY AND ELECTRONICALLY VIA SEMINARS, LECTURES, WORKSHOPS, CONFERENCES AND WEBINARS, IN CLASS 41 (U.S. CLS. 100, 101 AND 107).

**SERVICE MARK**

**SUPPLEMENTAL REGISTER**

FIRST USE 10-18-2008; IN COMMERCE 8-13-2010.

FOR: PROVIDING INFORMATION, NEWS AND COMMENTARY IN THE FIELD OF WEIGHT LOSS, WEIGHT MANAGEMENT, HEALTH AND WELLNESS BEFORE, DURING AND AFTER THE HCG DIET; PROVIDING CONSULTATION SERVICES IN THE FIELD OF WEIGHT LOSS, WEIGHT MANAGEMENT, HEALTH AND WELLNESS BEFORE, DURING AND AFTER THE HCG DIET, IN CLASS 44 (U.S. CLS. 100 AND 101).

FIRST USE 10-18-2008; IN COMMERCE 8-13-2010.

THE MARK CONSISTS OF STANDARD CHARACTERS WITHOUT CLAIM TO ANY PARTICULAR FONT, STYLE, SIZE, OR COLOR.

NO CLAIM IS MADE TO THE EXCLUSIVE RIGHT TO USE "THE HCG DIET", APART FROM THE MARK AS SHOWN.

SER. NO. 85-269,726, FILED P.R. 3-17-2011; AM. S.R. 12-23-2011.

KIMBERLY FRYE, EXAMINING ATTORNEY



*David J. Kyjars*

Director of the United States Patent and Trademark Office

# United States of America

United States Patent and Trademark Office

## CASTING BILLBOARD

**Reg. No. 4,127,078**

CASTING NETWORKS, INC. (CALIFORNIA CORPORATION)

**Registered Apr. 10, 2012**

3250 WILSHIRE BLVD. #1800  
LOS ANGELES, CA 90010

**Int. Cl.: 42**

FOR: COMPUTER SERVICES, NAMELY, PROVIDING TEMPORARY USE OF A NON-DOWNLOADABLE WEB BASED SOFTWARE APPLICATION WHERE CASTING PROJECTS CAN BE POSTED AND TALENT CAN SUBMIT THEMSELVES FOR CONSIDERATION, VIA AN INTERACTIVE WEBSITE ON THE INTERNET, IN CLASS 42 (U.S. CLS. 100 AND 101).

**SERVICE MARK**

**SUPPLEMENTAL REGISTER**

FIRST USE 5-16-2008; IN COMMERCE 5-16-2008.

THE MARK CONSISTS OF STANDARD CHARACTERS WITHOUT CLAIM TO ANY PARTICULAR FONT, STYLE, SIZE, OR COLOR.

SER. NO. 85-271,077, FILED P.R. 3-18-2011; AM. S.R. 2-9-2012.

TRACY CROSS, EXAMINING ATTORNEY



*David J. Kyfos*

Director of the United States Patent and Trademark Office

# United States of America

United States Patent and Trademark Office

# PiercingCare

**Reg. No. 4,127,079**

THE HYMED GROUP (DELAWARE CORPORATION)  
1890 BUCKNELL DRIVE  
BETHLEHEM, PA 18015

**Registered Apr. 10, 2012**

**Int. Cl.: 5**

FOR: ANTISEPTICS, IN CLASS 5 (U.S. CLS. 6, 18, 44, 46, 51 AND 52).

**TRADEMARK**

FIRST USE 8-18-1997; IN COMMERCE 8-18-1997.

**SUPPLEMENTAL REGISTER**

THE MARK CONSISTS OF STANDARD CHARACTERS WITHOUT CLAIM TO ANY PARTICULAR FONT, STYLE, SIZE, OR COLOR.

SER. NO. 85-274,690, FILED 3-23-2011.

JENNIFER MARTIN, EXAMINING ATTORNEY



*David J. Kybas*

Director of the United States Patent and Trademark Office

# United States of America

United States Patent and Trademark Office

## CPAs as Financial Advisors

**Reg. No. 4,127,080**

**Registered Apr. 10, 2012**

**Int. Cl.: 36**

**SERVICE MARK**

**SUPPLEMENTAL REGISTER**

JOHN AZODI (UNITED STATES INDIVIDUAL), DBA JOHN AZODI, CPA,  
WWW.AZODICPA.COM  
6051 N CHESTNUT AVE STE B  
KANSAS CITY, MO 64119

FOR: FINANCIAL PLANNING AND INVESTMENT ADVISORY SERVICES, IN CLASS 36  
(U.S. CLS. 100, 101 AND 102).

FIRST USE 11-17-2011; IN COMMERCE 11-17-2011.

THE MARK CONSISTS OF STANDARD CHARACTERS WITHOUT CLAIM TO ANY PAR-  
TICULAR FONT, STYLE, SIZE, OR COLOR.

NO CLAIM IS MADE TO THE EXCLUSIVE RIGHT TO USE "FINANCIAL ADVISORS",  
APART FROM THE MARK AS SHOWN.

SER. NO. 85-277,559, FILED P.R. 3-25-2011; AM. S.R. 12-28-2011.

ANNE MADDEN, EXAMINING ATTORNEY



*David J. Kybas*

Director of the United States Patent and Trademark Office

# United States of America

United States Patent and Trademark Office

# HerbNZest

**Reg. No. 4,127,081**

HERBNZEST, LLC (NEW JERSEY LIMITED LIABILITY COMPANY)  
135 SOUTH BARROW PLACE  
PRINCETON, NJ 08540

**Registered Apr. 10, 2012**

**Int. Cl.: 30**

FOR: FOODSTUFFS AND CONDIMENTS, NAMELY, SAUCES, RELISHES, CHUTNEYS, SALAD DRESSINGS, MARINADES, SAUCE MIXES, VEGETABLE CONCENTRATES USED FOR SEASONING, FRUIT PASTE FOR FLAVORING OF FOOD, FLAVORINGS FOR CHEESES, SAUCES FOR BARBECUED MEAT, SEASONING PASTE FOR MEAT, FISH, AND POULTRY, IN CLASS 30 (U.S. CL. 46).

**TRADEMARK**

**SUPPLEMENTAL REGISTER**

FIRST USE 7-1-2011; IN COMMERCE 7-1-2011.

THE MARK CONSISTS OF STANDARD CHARACTERS WITHOUT CLAIM TO ANY PARTICULAR FONT, STYLE, SIZE, OR COLOR.

SER. NO. 85-278,557, FILED P.R. 3-28-2011; AM. S.R. 12-19-2011.

ROBERT L. LORENZO, EXAMINING ATTORNEY



*David J. Kybas*

Director of the United States Patent and Trademark Office

# United States of America

United States Patent and Trademark Office

# ITExecutive

**Reg. No. 4,127,082**

BROKER POWER, INC. (DELAWARE CORPORATION)  
7000 INFANTRY RIDGE ROAD, SUITE 104  
MANASSAS, VA 20109

**Registered Apr. 10, 2012**

**Int. Cls.: 9 and 41**

FOR: PROVIDING DOWNLOADABLE ELECTRONIC WEEKLY NEWSLETTER ON INTERNATIONAL TRADE, IN CLASS 9 (U.S. CLS. 21, 23, 26, 36 AND 38).

**TRADEMARK**

FIRST USE 9-24-2010; IN COMMERCE 9-24-2010.

**SERVICE MARK**

FOR: PROVIDING ON-LINE ELECTRONIC WEEKLY NEWSLETTER ON INTERNATIONAL TRADE, IN CLASS 41 (U.S. CLS. 100, 101 AND 107).

**SUPPLEMENTAL REGISTER**

FIRST USE 9-24-2010; IN COMMERCE 9-24-2010.

THE MARK CONSISTS OF STANDARD CHARACTERS WITHOUT CLAIM TO ANY PARTICULAR FONT, STYLE, SIZE, OR COLOR.

SER. NO. 85-278,627, FILED P.R. 3-28-2011; AM. S.R. 2-7-2012.

SANI KHOURI, EXAMINING ATTORNEY



*David J. Kybas*

Director of the United States Patent and Trademark Office



# United States of America

United States Patent and Trademark Office

## LONG BEACH MEMORIAL

**Reg. No. 4,127,083**

MEMORIAL HEALTH SERVICES, INC. (CALIFORNIA CORPORATION)  
17360 BROOKHURST, FIRST FLOOR  
FOUNTAIN VALLEY, CA 92708

**Registered Apr. 10, 2012**

**Int. Cl.: 44**

FOR: HEALTHCARE; HOSPITALS; PROVIDING A WEB SITE FEATURING INFORMATION ON HEALTH AND NUTRITION; PROVIDING HEALTH INFORMATION; PROVIDING HEALTHCARE INFORMATION, IN CLASS 44 (U.S. CLS. 100 AND 101).

**SERVICE MARK**

FIRST USE 9-20-2010; IN COMMERCE 9-20-2010.

**SUPPLEMENTAL REGISTER**

THE MARK CONSISTS OF STANDARD CHARACTERS WITHOUT CLAIM TO ANY PARTICULAR FONT, STYLE, SIZE, OR COLOR.

SER. NO. 85-279,171, FILED P.R. 3-28-2011; AM. S.R. 12-15-2011.

PAM WILLIS, EXAMINING ATTORNEY



*David J. Kyffers*

Director of the United States Patent and Trademark Office

# United States of America

United States Patent and Trademark Office

## ORANGE COAST MEMORIAL

**Reg. No. 4,127,084**

MEMORIAL HEALTH SERVICES, INC. (CALIFORNIA CORPORATION)  
17360 BROOKHURST, FIRST FLOOR  
FOUNTAIN VALLEY, CA 92708

**Registered Apr. 10, 2012**

**Int. Cl.: 44**

FOR: HEALTHCARE; HOSPITALS; PROVIDING A WEB SITE FEATURING INFORMATION ON HEALTH AND NUTRITION; PROVIDING HEALTH INFORMATION; PROVIDING HEALTHCARE INFORMATION, IN CLASS 44 (U.S. CLS. 100 AND 101).

**SERVICE MARK**

FIRST USE 9-20-2010; IN COMMERCE 9-20-2010.

**SUPPLEMENTAL REGISTER**

THE MARK CONSISTS OF STANDARD CHARACTERS WITHOUT CLAIM TO ANY PARTICULAR FONT, STYLE, SIZE, OR COLOR.

SER. NO. 85-279,183, FILED P.R. 3-28-2011; AM. S.R. 12-15-2011.

PAM WILLIS, EXAMINING ATTORNEY



*David J. Kyffers*

Director of the United States Patent and Trademark Office

# United States of America

United States Patent and Trademark Office

## DOWNNS CLUBHOUSE & LOUNGE

**Reg. No. 4,127,085**

MTR GAMING GROUP, INC. (DELAWARE CORPORATION)  
ROUTE 2  
CHESTER, WV 26034

**Registered Apr. 10, 2012**

**Int. Cl.: 43**

FOR: BAR AND RESTAURANT SERVICES, IN CLASS 43 (U.S. CLS. 100 AND 101).

**SERVICE MARK**

FIRST USE 1-5-2011; IN COMMERCE 1-5-2011.

**SUPPLEMENTAL REGISTER**

THE MARK CONSISTS OF STANDARD CHARACTERS WITHOUT CLAIM TO ANY PARTICULAR FONT, STYLE, SIZE, OR COLOR.

NO CLAIM IS MADE TO THE EXCLUSIVE RIGHT TO USE "CLUBHOUSE & LOUNGE", APART FROM THE MARK AS SHOWN.

SER. NO. 85-281,142, FILED P.R. 3-30-2011; AM. S.R. 1-26-2012.

TAMARA FRAZIER, EXAMINING ATTORNEY



*David J. Kybas*

Director of the United States Patent and Trademark Office

# United States of America

United States Patent and Trademark Office

## INTELLIGENT ARRAY

**Reg. No. 4,127,086**

SOLAR POWER TECHNOLOGIES (DELAWARE CORPORATION)  
3006 BEE CAVES ROAD, SUITE A330  
AUSTIN, TX 78746

**Registered Apr. 10, 2012**

**Int. Cl.: 42**

FOR: PROVIDING TEMPORARY USE OF ONLINE NON-DOWNLOADABLE SOFTWARE AND APPLICATIONS ENABLING USERS TO REVIEW, EVALUATE AND MANAGE THE OPERATION OF SOLAR POWER CELLS, SOLAR MODULES AND SOLAR ARRAYS IN ORDER TO MAXIMIZE THE POWER PRODUCED, IMPROVE SAFETY AND SECURITY, DIAGNOSE IMPAIRMENTS, ASSESS MAINTENANCE REQUIREMENTS, MONITOR THE PERFORMANCE OF AND TEST SOLAR POWER INSTALLATIONS; PROVIDING A WEBSITE FEATURING TEMPORARY USE OF NON-DOWNLOADABLE SOFTWARE ALLOWING WEBSITE USERS TO REVIEW, EVALUATE AND MANAGE THE OPERATION OF SOLAR POWER CELLS, SOLAR MODULES AND SOLAR ARRAYS IN ORDER TO MAXIMIZE THE POWER PRODUCED, IMPROVE SAFETY AND SECURITY, DIAGNOSE IMPAIRMENTS, ASSESS MAINTENANCE REQUIREMENTS, MONITOR THE PERFORMANCE OF AND TEST SOLAR POWER INSTALLATIONS, IN CLASS 42 (U.S. CLS. 100 AND 101).

**SERVICE MARK**

**SUPPLEMENTAL REGISTER**

FIRST USE 10-0-2011; IN COMMERCE 10-0-2011.

THE MARK CONSISTS OF STANDARD CHARACTERS WITHOUT CLAIM TO ANY PARTICULAR FONT, STYLE, SIZE, OR COLOR.

SER. NO. 85-283,924, FILED P.R. 4-1-2011; AM. S.R. 2-10-2012.

H. M. FISHER, EXAMINING ATTORNEY



*David J. Kyros*

Director of the United States Patent and Trademark Office

# United States of America

United States Patent and Trademark Office

## BrandEncounter

**Reg. No. 4,127,087**

CHATTHREADS CORP. (DELAWARE CORPORATION)  
1318 BEACON STREET, SUITE 9  
BROOKLINE, MA 02446

**Registered Apr. 10, 2012**

**Int. Cl.: 35**

FOR: MARKETING RESEARCH SERVICES, NAMELY, CONDUCTING MARKETING RESEARCH RELATED TO COMMUNICATIONS MEDIA BY MEANS OF TRACKING HOW, WHEN AND WHERE CONSUMERS COME INTO CONTACT WITH BRANDS AND ANALYZING HOW THESE ENCOUNTERS CONTRIBUTE TO PURCHASE BEHAVIOR, IN CLASS 35 (U.S. CLS. 100, 101 AND 102).

**SERVICE MARK**

**SUPPLEMENTAL REGISTER**

FIRST USE 9-30-2011; IN COMMERCE 9-30-2011.

THE MARK CONSISTS OF STANDARD CHARACTERS WITHOUT CLAIM TO ANY PARTICULAR FONT, STYLE, SIZE, OR COLOR.

SER. NO. 85-286,888, FILED P.R. 4-5-2011; AM. S.R. 1-6-2012.

DEBRA LEE, EXAMINING ATTORNEY



*David J. Kybas*

Director of the United States Patent and Trademark Office

# United States of America

United States Patent and Trademark Office

## GRAINTRACKER

**Reg. No. 4,127,088**

IT'S A GOLDEN OPPORTUNITY, INC (ILLINOIS CORPORATION)  
1706 SUPERIOR AVE  
SAVANNA, IL 61074

**Registered Apr. 10, 2012**

**Int. Cl.: 42**

FOR: PROVIDING ONLINE NON-DOWNLOADABLE COMPUTER SOFTWARE FOR FARMERS AND RELATED BUSINESSES TO USE IN ORDER TO CREATE A MARKETING PLAN, RECORD GRAIN SALES AND PURCHASES, TRACK COSTS, AND PROVIDE SELL ALERTS BASED ON TARGET PRICE, IN CLASS 42 (U.S. CLS. 100 AND 101).

**SERVICE MARK**

**SUPPLEMENTAL REGISTER** FIRST USE 12-24-2007; IN COMMERCE 1-5-2009.

THE MARK CONSISTS OF STANDARD CHARACTERS WITHOUT CLAIM TO ANY PARTICULAR FONT, STYLE, SIZE, OR COLOR.

SER. NO. 85-289,823, FILED P.R. 4-8-2011; AM. S.R. 2-21-2012.

SANJEEV VOHRA, EXAMINING ATTORNEY

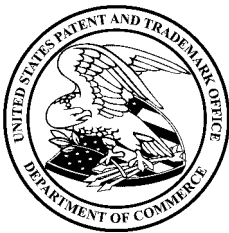

*David J. Kybas*

Director of the United States Patent and Trademark Office

# United States of America

United States Patent and Trademark Office

## MLS CERTIFIED

**Reg. No. 4,127,089**

YARDI SYSTEMS, INC. (CALIFORNIA CORPORATION)  
430 SOUTH FAIRVIEW AVE  
SANTA BARBARA, CA 93117

**Registered Apr. 10, 2012**

**Int. Cl.: 35**

FOR: PROVIDING AN ON-LINE COMMERCIAL INFORMATION DIRECTORY ON THE INTERNET; PROMOTING THE GOODS AND SERVICES OF OTHERS BY PROVIDING A WEBSITE FEATURING REAL ESTATE PROFESSIONALS WHOSE LISTING SERVICES HAVE BEEN REVIEWED AND QUALIFIED AND PROVIDING A DIRECTORY THEREFOR, IN CLASS 35 (U.S. CLS. 100, 101 AND 102).

**SERVICE MARK**

**SUPPLEMENTAL REGISTER**

FIRST USE 11-23-2009; IN COMMERCE 4-25-2011.

THE MARK CONSISTS OF STANDARD CHARACTERS WITHOUT CLAIM TO ANY PARTICULAR FONT, STYLE, SIZE, OR COLOR.

SER. NO. 85-294,462, FILED P.R. 4-13-2011; AM. S.R. 2-12-2012.

KATHLEEN LORENZO, EXAMINING ATTORNEY



*David J. Kyffers*

Director of the United States Patent and Trademark Office

# United States of America

United States Patent and Trademark Office

## SHORTENS YOUR COLD, WORKS FAST

**Reg. No. 4,127,090**

**Registered Apr. 10, 2012**

**Int. Cl.: 5**

**TRADEMARK**

**SUPPLEMENTAL REGISTER**

PROPHASE LABS, INC. (NEVADA CORPORATION), FORMERLY THE QUIGLEY CORPORATION,  
621 N. SHADY RETREAT ROAD  
DOYLESTOWN, PA 18901

FOR: HOMEOPATHIC COMMON COLD, FLU AND ALLERGY PREPARATIONS WHICH REDUCE THE DURATION AND SEVERITY OF THE COMMON COLD, FLU AND ALLERGIES, IN CLASS 5 (U.S. CLS. 6, 18, 44, 46, 51 AND 52).

FIRST USE 7-15-2010; IN COMMERCE 7-15-2010.

THE MARK CONSISTS OF STANDARD CHARACTERS WITHOUT CLAIM TO ANY PARTICULAR FONT, STYLE, SIZE, OR COLOR.

SER. NO. 85-295,983, FILED P.R. 4-15-2011; AM. S.R. 1-25-2012.

TRICIA SONNEBORN, EXAMINING ATTORNEY



*David J. Kybas*

Director of the United States Patent and Trademark Office



# United States of America

United States Patent and Trademark Office

## Chart and Chat

**Reg. No. 4,127,091**

**Registered Apr. 10, 2012**

**Int. Cl.: 9**

**TRADEMARK**

**SUPPLEMENTAL REGISTER**

EVERGLADE SOLUTIONS, INC. (NEVADA CORPORATION)  
119  
1835 US HWY 1 SOUTH  
ST AUGUSTINE, FL 32084

FOR: COMPUTER APPLICATION SOFTWARE FOR MOBILE PHONES, PORTABLE MEDIA PLAYERS, HANDHELD COMPUTERS, AND COMPUTERS, NAMELY, SOFTWARE FOR CREATING PIE CHARTS WITH A USER-INTERACTIVE PROGRAM, IN CLASS 9 (U.S. CLS. 21, 23, 26, 36 AND 38).

FIRST USE 6-1-2010; IN COMMERCE 6-1-2010.

THE MARK CONSISTS OF STANDARD CHARACTERS WITHOUT CLAIM TO ANY PARTICULAR FONT, STYLE, SIZE, OR COLOR.

SER. NO. 85-298,232, FILED P.R. 4-18-2011; AM. S.R. 1-18-2012.

GRETCHEN ULRICH, EXAMINING ATTORNEY



*David J. Kyjars*

Director of the United States Patent and Trademark Office

# United States of America

United States Patent and Trademark Office

## CHICKEN & CAKES

**Reg. No. 4,127,092**

CRAWFORD, KENNETH (UNITED STATES INDIVIDUAL)  
10418 CAMINO MEDIA  
BAKERSFIELD, CA 93311

**Registered Apr. 10, 2012**

**Int. Cl.: 43**

FOR: RESTAURANT SERVICES, IN CLASS 43 (U.S. CLS. 100 AND 101).

**SERVICE MARK**

FIRST USE 2-14-2011; IN COMMERCE 2-14-2011.

**SUPPLEMENTAL REGISTER**

THE MARK CONSISTS OF STANDARD CHARACTERS WITHOUT CLAIM TO ANY PARTICULAR FONT, STYLE, SIZE, OR COLOR.

SER. NO. 85-298,332, FILED P.R. 4-19-2011; AM. S.R. 2-4-2012.

TRACY CROSS, EXAMINING ATTORNEY



*David J. Kyfos*

Director of the United States Patent and Trademark Office

# United States of America

United States Patent and Trademark Office

# GRIPSTRIP

**Reg. No. 4,127,093**

CGS GRIPSTRIP PRODUCTS LTD. (CANADA CORPORATION)  
16594 - 59A AVE.

**Registered Apr. 10, 2012**

SURREY, BC, CANADA V3S4N9

**Int. Cl.: 19**

FOR: NON-SKID DEVICES INSTALLED ON STAIRS, FLOORS, SLOPED PASSAGES AND THE LIKE TO PREVENT SLIPPAGE, NAMELY, TREADS, NOT OF METAL, FOR STAIRS, FLOORS, SLOPED PASSAGES AND THE LIKE, IN CLASS 19 (U.S. CLS. 1, 12, 33 AND 50).

**TRADEMARK**

FIRST USE 7-15-2010; IN COMMERCE 11-18-2011.

**SUPPLEMENTAL REGISTER**

THE MARK CONSISTS OF STANDARD CHARACTERS WITHOUT CLAIM TO ANY PARTICULAR FONT, STYLE, SIZE, OR COLOR.

PRIORITY CLAIMED UNDER SEC. 44(D) ON CANADA APPLICATION NO. 1503958, FILED 11-16-2010.

SER. NO. 85-299,081, FILED P.R. 4-19-2011; AM. S.R. 1-20-2012.

KRISTINA MORRIS, EXAMINING ATTORNEY



*David J. Kybas*

Director of the United States Patent and Trademark Office

# United States of America

United States Patent and Trademark Office

## National Association of Specialty Health Organizations

**Reg. No. 4,127,094**

**Registered Apr. 10, 2012**

**Int. Cl.: 35**

NATIONAL ASSOCIATION OF SPECIALTY HEALTH ORGANIZATIONS, INC. (D.C. CORPORATION)  
SUITE 303  
222 SOUTH FIRST STREET  
LOUISVILLE, KY 40202

**SERVICE MARK**

**SUPPLEMENTAL REGISTER**

FOR: ASSOCIATION SERVICES, NAMELY, PROMOTING THE INTERESTS OF SPECIALTY HEALTH PROVIDER NETWORK AND PLAN ORGANIZATIONS INCLUDING, WITHOUT LIMITATION, VISION, HEARING, CHIROPRACTIC CARE, DENTAL, BEHAVIORAL HEALTH SERVICES, PHARMACY BENEFIT MANAGEMENT, PHYSICAL THERAPY AND OTHER ANCILLARY HEALTH CARE SERVICES, IN CLASS 35 (U.S. CLS. 100, 101 AND 102).

FIRST USE 1-0-2002; IN COMMERCE 1-0-2002.

THE MARK CONSISTS OF STANDARD CHARACTERS WITHOUT CLAIM TO ANY PARTICULAR FONT, STYLE, SIZE, OR COLOR.

NO CLAIM IS MADE TO THE EXCLUSIVE RIGHT TO USE "ASSOCIATION OF SPECIALTY HEALTH ORGANIZATIONS" , APART FROM THE MARK AS SHOWN.

SER. NO. 85-303,229, FILED P.R. 4-25-2011; AM. S.R. 2-13-2012.

WILLIAM P. SHANAHAN, EXAMINING ATTORNEY



*David J. Kyffers*

Director of the United States Patent and Trademark Office

# United States of America

United States Patent and Trademark Office

## Evangelical Protestant Church (GCEPC) Lutheran Evangelical Protestant Church (LEPC)

**Reg. No. 4,127,095**

**Registered Apr. 10, 2012**

**Int. Cl.: 45**

**SERVICE MARK**

**SUPPLEMENTAL REGISTER**

EVANGELICAL PROTESTANT CHURCH (GCEPC) (SOUTH CAROLINA CORPORATION),  
AKA LUTHERAN EVANGELICAL PROTESTANT CHURCH (LEPC),  
921 MICHAELMAS AVENUE  
CAYCE, SC 29033

FOR: RELIGIOUS AND SPIRITUAL SERVICES, NAMELY, CONDUCTING RELIGIOUS  
WORSHIP, MARRIAGE CEREMONIES, BAPTISMAL CEREMONIES, BABY DEDICATIONS,  
BEREAVEMENT CEREMONIES, AND RELIGIOUS COUNSELING, IN CLASS 45 (U.S. CLS.  
100 AND 101).

FIRST USE 1-1-2000; IN COMMERCE 1-1-2002.

THE MARK CONSISTS OF STANDARD CHARACTERS WITHOUT CLAIM TO ANY PAR-  
TICULAR FONT, STYLE, SIZE, OR COLOR.

NO CLAIM IS MADE TO THE EXCLUSIVE RIGHT TO USE "CHURCH", APART FROM THE  
MARK AS SHOWN.

SER. NO. 85-304,192, FILED 4-25-2011.

DEIRDRE ROBERTSON, EXAMINING ATTORNEY



*David J. Kyjars*

Director of the United States Patent and Trademark Office

# United States of America

United States Patent and Trademark Office

# GREEN FAIR

**Reg. No. 4,127,096**

ARAG INSURANCE COMPANY (IOWA CORPORATION)  
400 LOCUST, SUITE 480  
DES MOINES, IA 50309

**Registered Apr. 10, 2012**

**Int. Cl.: 35**

FOR: ORGANIZING, CONDUCTING AND ADVERTISING TRADE SHOWS WITH RESPECT TO ENVIRONMENTALLY CONSCIOUS PRODUCTS FOR COMMERCIAL PURPOSES, IN CLASS 35 (U.S. CLS. 100, 101 AND 102).

**SERVICE MARK**

FIRST USE 9-7-2010; IN COMMERCE 9-7-2010.

**SUPPLEMENTAL REGISTER**

THE MARK CONSISTS OF STANDARD CHARACTERS WITHOUT CLAIM TO ANY PARTICULAR FONT, STYLE, SIZE, OR COLOR.

NO CLAIM IS MADE TO THE EXCLUSIVE RIGHT TO USE "FAIR", APART FROM THE MARK AS SHOWN.

SER. NO. 85-304,593, FILED P.R. 4-26-2011; AM. S.R. 2-6-2012.

CARYN GLASSER, EXAMINING ATTORNEY



*David J. Kybas*

Director of the United States Patent and Trademark Office

# United States of America

United States Patent and Trademark Office



**Reg. No. 4,127,097**

**Registered Apr. 10, 2012**

**Int. Cl.: 35**

**SERVICE MARK**

**SUPPLEMENTAL REGISTER**

HARVEST GROWTH LLC (COLORADO LIMITED LIABILITY COMPANY)  
753 MALETA LANE  
SUITE 204  
CASTLE ROCK, CO 80108

FOR: CONSULTATION IN THE FIELD OF COMMERCIALS OR INFOMERCIALS; PRODUCING AUDIO OR VIDEO INFOMERCIALS, IN CLASS 35 (U.S. CLS. 100, 101 AND 102).

FIRST USE 11-24-2010; IN COMMERCE 11-24-2010.

THE MARK CONSISTS OF A RED ROUNDED SQUARE SHAPE WITH THE WORDS "SELL ON TV" IN WHITE WITH "SELL ON" ABOVE AND SMALLER THAN THE WORD "TV".

THE COLOR(S) RED AND WHITE IS/ARE CLAIMED AS A FEATURE OF THE MARK.

SER. NO. 85-305,240, FILED P.R. 4-26-2011; AM. S.R. 2-2-2012.

B. PARADEWELAI, EXAMINING ATTORNEY



*David J. Kyffers*

Director of the United States Patent and Trademark Office

# United States of America

United States Patent and Trademark Office

## TRADE-IN MARKETPLACE

**Reg. No. 4,127,098**

**Registered Apr. 10, 2012**

**Int. Cl.: 36**

**SERVICE MARK**

**SUPPLEMENTAL REGISTER**

AUTOTRADER.COM, INC. (DELAWARE CORPORATION)  
SUITE 200  
3003 SUMMIT BOULEVARD  
ATLANTA, GA 30319

FOR: PROVIDING INFORMATION ON VEHICLES FOR SALE VIA THE INTERNET, MOBILE NETWORKS AND OTHER ELECTRONIC COMMUNICATIONS NETWORKS, NAMELY, VEHICLE VALUATION QUOTATIONS AND FINANCIAL INFORMATION CONCERNING VALUE-BASED OFFERS OF USED VEHICLES TO OWNERS WHO SEEK TO SELL AND TRADE IN THEIR VEHICLES, IN CLASS 36 (U.S. CLS. 100, 101 AND 102).

FIRST USE 6-0-2009; IN COMMERCE 6-0-2009.

THE MARK CONSISTS OF STANDARD CHARACTERS WITHOUT CLAIM TO ANY PARTICULAR FONT, STYLE, SIZE, OR COLOR.

NO CLAIM IS MADE TO THE EXCLUSIVE RIGHT TO USE "MARKETPLACE", APART FROM THE MARK AS SHOWN.

SER. NO. 85-305,726, FILED P.R. 4-27-2011; AM. S.R. 2-6-2012.

DAVID YONTEF, EXAMINING ATTORNEY



*David J. Kyfos*

Director of the United States Patent and Trademark Office



# United States of America

United States Patent and Trademark Office

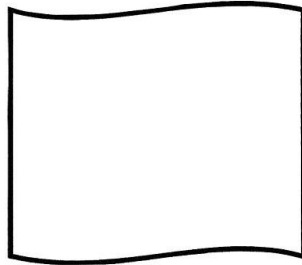

**Reg. No. 4,127,099**

**Registered Apr. 10, 2012**

**Int. Cl.: 20**

**TRADEMARK**

**SUPPLEMENTAL REGISTER**

HERCHMER ENTERPRISES, LLC (CALIFORNIA LIMITED LIABILITY COMPANY)  
3152 ELLINGTON DRIVE  
LOS ANGELES, CA 90068

FOR: PICTURE FRAMES, IN CLASS 20 (U.S. CLS. 2, 13, 22, 25, 32 AND 50).

FIRST USE 1-1-2011; IN COMMERCE 1-1-2011.

THE MARK CONSISTS OF A UNIQUE FOUR-SIDED FIGURE.

SER. NO. 85-305,800, FILED P.R. 4-27-2011; AM. S.R. 2-8-2012.

JOHN HWANG, EXAMINING ATTORNEY



*David J. Kybas*

Director of the United States Patent and Trademark Office

# United States of America

United States Patent and Trademark Office

## FARM TO TABLE

**Reg. No. 4,127,100**

**Registered Apr. 10, 2012**

**Int. Cl.: 41**

**SERVICE MARK**

**SUPPLEMENTAL REGISTER**

TRIUMPH GROUP, INC. (ILLINOIS CORPORATION)  
SUITE 443  
2300 N. BARRINGTON ROAD  
HOFFMAN ESTATES, IL 60169

FOR: VOCATIONAL EDUCATION IN THE FIELD OF CULINARY ARTS, IN CLASS 41 (U.S. CLS. 100, 101 AND 107).

FIRST USE 7-6-2010; IN COMMERCE 7-6-2010.

THE MARK CONSISTS OF STANDARD CHARACTERS WITHOUT CLAIM TO ANY PARTICULAR FONT, STYLE, SIZE, OR COLOR.

SER. NO. 85-306,309, FILED P.R. 4-27-2011; AM. S.R. 2-7-2012.

PATRICIA EVANKO, EXAMINING ATTORNEY



*David J. Kyffers*

Director of the United States Patent and Trademark Office

# United States of America

United States Patent and Trademark Office

## ROASTED MEALS

**Reg. No. 4,127,101**

PROFESSOR CONNOR'S, INC. (DELAWARE CORPORATION), DBA FRESHPET,  
400 PLAZA DRIVE, 1ST FLOOR  
SECAUCUS, NJ 07904

**Registered Apr. 10, 2012**

**Int. Cl.: 31**

FOR: PET FOOD, IN CLASS 31 (U.S. CLS. 1 AND 46).

FIRST USE 7-11-2011; IN COMMERCE 7-11-2011.

**TRADEMARK**

THE MARK CONSISTS OF STANDARD CHARACTERS WITHOUT CLAIM TO ANY PARTICULAR FONT, STYLE, SIZE, OR COLOR.

**SUPPLEMENTAL REGISTER**

NO CLAIM IS MADE TO THE EXCLUSIVE RIGHT TO USE "MEALS", APART FROM THE MARK AS SHOWN.

SER. NO. 85-306,362, FILED P.R. 4-27-2011; AM. S.R. 2-9-2012.

GINA FINK, EXAMINING ATTORNEY



*David J. Kybas*

Director of the United States Patent and Trademark Office

# United States of America

United States Patent and Trademark Office

## VETERINARY NUTRITION

**Reg. No. 4,127,102**

PROFESSOR CONNOR'S, INC. (DELAWARE CORPORATION), DBA FRESHPET,  
400 PLAZA DRIVE, 1ST FLOOR  
SECAUCUS, NJ 07904

**Registered Apr. 10, 2012**

**Int. Cl.: 31**

FOR: PET FOOD, IN CLASS 31 (U.S. CLS. 1 AND 46).

**TRADEMARK**

FIRST USE 10-1-2009; IN COMMERCE 10-1-2009.

**SUPPLEMENTAL REGISTER**

THE MARK CONSISTS OF STANDARD CHARACTERS WITHOUT CLAIM TO ANY PARTICULAR FONT, STYLE, SIZE, OR COLOR.

NO CLAIM IS MADE TO THE EXCLUSIVE RIGHT TO USE "NUTRITION", APART FROM THE MARK AS SHOWN.

SER. NO. 85-306,401, FILED P.R. 4-27-2011; AM. S.R. 2-7-2012.

GINA FINK, EXAMINING ATTORNEY



*David J. Kybas*

Director of the United States Patent and Trademark Office

# United States of America

United States Patent and Trademark Office

SAVINGS  
I N T H E  
City

**Reg. No. 4,127,103**

**Registered Apr. 10, 2012**

**Int. Cl.: 35**

ATLANTA CONVENTION AND VISITORS BUREAU, INC (GEORGIA NON-PROFIT CORPORATION)  
SUITE 1400  
233 PEACHTREE STREET, NE  
ATLANTA, GA 30303

**SERVICE MARK**

**SUPPLEMENTAL REGISTER**

FOR: ADMINISTRATION OF A PROGRAM FOR ENABLING PARTICIPANTS TO OBTAIN DISCOUNTS ON PRODUCTS AND SERVICES BY PROMOTING THE GOODS AND SERVICES OF OTHERS IN THE CITY OF ATLANTA TO ENCOURAGE THE PATRONAGE OF TOURISTS AND RESIDENTS; PROMOTIONAL SERVICES, NAMELY, PROMOTING THE CITY OF ATLANTA AS A CONVENTION, MEETING, TRADE SHOW AND LEISURE TRAVEL DESTINATION ON A REGIONAL, DOMESTIC, AND INTERNATIONAL LEVEL TO BOTH GROUPS AND INDIVIDUALS, IN CLASS 35 (U.S. CLS. 100, 101 AND 102).

FIRST USE 2-9-2012; IN COMMERCE 2-9-2012.

THE MARK CONSISTS OF THE WORD "SAVINGS" OVER THE WORDS "IN THE" OVER THE WORD "CITY" IN STYLIZED LETTERING WITH A STYLIZED DOT OVER THE LETTER "I" IN THE WORD "CITY".

SER. NO. 85-307,084, FILED P.R. 4-28-2011; AM. S.R. 2-9-2012.

PRISCILLA MILTON, EXAMINING ATTORNEY



*David J. Kybas*

Director of the United States Patent and Trademark Office

# United States of America

United States Patent and Trademark Office

## BACKYARD BIRDS

**Reg. No. 4,127,104**

VITAL FARMS INC. (TEXAS CORPORATION)  
4507 BRANDT RD.  
AUSTIN, TX 78744

**Registered Apr. 10, 2012**

**Int. Cl.: 29**

FOR: CHICKEN; POULTRY, IN CLASS 29 (U.S. CL. 46).

FIRST USE 8-0-2010; IN COMMERCE 8-0-2010.

**TRADEMARK**

THE MARK CONSISTS OF STANDARD CHARACTERS WITHOUT CLAIM TO ANY PARTICULAR FONT, STYLE, SIZE, OR COLOR.

**SUPPLEMENTAL REGISTER**

NO CLAIM IS MADE TO THE EXCLUSIVE RIGHT TO USE "BIRDS", APART FROM THE MARK AS SHOWN.

SER. NO. 85-307,406, FILED P.R. 4-28-2011; AM. S.R. 2-21-2012.

RENEE MCCRAY, EXAMINING ATTORNEY



*David J. Kyffers*

Director of the United States Patent and Trademark Office

# United States of America

United States Patent and Trademark Office



**Reg. No. 4,127,105**

**Registered Apr. 10, 2012**

**Int. Cls.: 30 and 32**

**TRADEMARK**

**SUPPLEMENTAL REGISTER**

TWELVE BEVERAGE LLC (DELAWARE LIMITED LIABILITY COMPANY)  
ONE DOCK STREET  
STAMFORD, CT 06902

FOR: TEA-BASED BEVERAGES WITH FRUIT FLAVORING, IN CLASS 30 (U.S. CL. 46).

FIRST USE 5-1-2010; IN COMMERCE 5-1-2010.

FOR: NON-ALCOHOLIC BEVERAGES WITH TEA OR FRUIT FLAVOR, IN CLASS 32 (U.S. CLS. 45, 46 AND 48).

FIRST USE 5-1-2010; IN COMMERCE 5-1-2010.

THE MARK CONSISTS OF A THREE-DIMENSIONAL CONFIGURATION OF A FROSTED BEVERAGE BOTTLE WITH A PROMINENT CIRCLE IN THE MIDDLE OF A RECTANGULARLY SHAPED LABEL. THE BROKEN LINES DEPICTING THE BOTTLE, CAP AND CAP WRAPPER INDICATE PLACEMENT OF THE MARK ON THE GOODS AND ARE NOT PART OF THE MARK.

SER. NO. 85-307,700, FILED P.R. 4-28-2011; AM. S.R. 2-8-2012.

B. PARADEWELAI, EXAMINING ATTORNEY



*David J. Kybas*

Director of the United States Patent and Trademark Office

# United States of America

United States Patent and Trademark Office

## THE OUTDOOR EXERCISE MACHINE

**Reg. No. 4,127,106**

AEROBIC CRUISER HYBRID CYCLES, LLC (TENNESSEE LIMITED LIABILITY COMPANY)  
850 RIDGE LAKE BOULEVARD, SUITE 1  
MEMPHIS, TN 38120

**Registered Apr. 10, 2012**

**Int. Cl.: 12**

FOR: LAND VEHICLES, NAMELY, COMBINED HUMAN POWERED AND ELECTRIC POWER-ASSISTED VEHICLES PRIMARILY USED FOR PERSONAL TRANSPORTATION WHILE ALSO PROVIDING AEROBIC EXERCISE, IN CLASS 12 (U.S. CLS. 19, 21, 23, 31, 35 AND 44).

**TRADEMARK**

**SUPPLEMENTAL REGISTER** FIRST USE 9-22-2011; IN COMMERCE 9-22-2011.

THE MARK CONSISTS OF STANDARD CHARACTERS WITHOUT CLAIM TO ANY PARTICULAR FONT, STYLE, SIZE, OR COLOR.

SER. NO. 85-308,084, FILED P.R. 4-29-2011; AM. S.R. 2-17-2012.

REBECCA EISINGER, EXAMINING ATTORNEY



*David J. Kyros*

Director of the United States Patent and Trademark Office



# United States of America

United States Patent and Trademark Office

## BLANCHARD TRUCK CENTERS

**Reg. No. 4,127,107**

**Registered Apr. 10, 2012**

**Int. Cls.: 35, 37, and 39**

**SERVICE MARK**

**SUPPLEMENTAL REGISTER**

BLANCHARD MACHINERY COMPANY (SOUTH CAROLINA CORPORATION), DBA  
BLANCHARD,  
3151 CHALESTON HIGHWAY  
WEST COLUMBIA, SC 29169

FOR: RETAIL STORE SERVICES FEATURING TRUCKS AND HEAVY EQUIPMENT, IN  
CLASS 35 (U.S. CLS. 100, 101 AND 102).

FIRST USE 5-16-2011; IN COMMERCE 5-16-2011.

FOR: MACHINERY MAINTENANCE AND REPAIR, IN CLASS 37 (U.S. CLS. 100, 103 AND  
106).

FIRST USE 5-16-2011; IN COMMERCE 5-16-2011.

FOR: RENTAL OF TRUCKS, IN CLASS 39 (U.S. CLS. 100 AND 105).

FIRST USE 5-16-2011; IN COMMERCE 5-16-2011.

THE MARK CONSISTS OF STANDARD CHARACTERS WITHOUT CLAIM TO ANY PAR-  
TICULAR FONT, STYLE, SIZE, OR COLOR.

NO CLAIM IS MADE TO THE EXCLUSIVE RIGHT TO USE "TRUCK CENTERS", APART  
FROM THE MARK AS SHOWN.

SER. NO. 85-308,234, FILED P.R. 4-29-2011; AM. S.R. 2-13-2012.

YAT SYE, LEE, EXAMINING ATTORNEY



*David J. Kyros*

Director of the United States Patent and Trademark Office

# United States of America

United States Patent and Trademark Office

## FRESH BONES

**Reg. No. 4,127,108**

PROFESSOR CONNOR'S, INC. (DELAWARE CORPORATION), DBA FRESHPET,  
400 PLAZA DRIVE, 1ST FLOOR  
SECAUCUS, NJ 07904

**Registered Apr. 10, 2012**

**Int. Cl.: 31**

FOR: PET TREATS, IN CLASS 31 (U.S. CLS. 1 AND 46).

FIRST USE 7-11-2011; IN COMMERCE 7-11-2011.

**TRADEMARK**

THE MARK CONSISTS OF STANDARD CHARACTERS WITHOUT CLAIM TO ANY PARTICULAR FONT, STYLE, SIZE, OR COLOR.

**SUPPLEMENTAL REGISTER**

OWNER OF U.S. REG. NO. 3,383,087.

NO CLAIM IS MADE TO THE EXCLUSIVE RIGHT TO USE "BONES", APART FROM THE MARK AS SHOWN.

SER. NO. 85-309,674, FILED P.R. 5-2-2011; AM. S.R. 2-9-2012.

GINA FINK, EXAMINING ATTORNEY



*David J. Kybas*

Director of the United States Patent and Trademark Office

# United States of America

United States Patent and Trademark Office

## SPORTSMEDICINEWEEKLY

**Reg. No. 4,127,109**

SPORTS MEDICINE WEEKLY LLC (ILLINOIS LIMITED LIABILITY COMPANY)  
1611 WEST HARRISON STREET, SUITE 300  
CHICAGO, IL 60612

**Registered Apr. 10, 2012**

**Int. Cl.: 41**

FOR: EDUCATIONAL AND ENTERTAINMENT SERVICES, NAMELY, A CONTINUING PROGRAM ABOUT INJURIES THAT OCCUR ON THE FIELD AND IN EVERYDAY LIFE ACCESSIBLE BY RADIO, IN CLASS 41 (U.S. CLS. 100, 101 AND 107).

**SERVICE MARK**

FIRST USE 5-14-2011; IN COMMERCE 5-14-2011.

**SUPPLEMENTAL REGISTER**

THE MARK CONSISTS OF STANDARD CHARACTERS WITHOUT CLAIM TO ANY PARTICULAR FONT, STYLE, SIZE, OR COLOR.

SER. NO. 85-309,705, FILED P.R. 5-2-2011; AM. S.R. 2-16-2012.

KRISTINA MORRIS, EXAMINING ATTORNEY



*David J. Kyffers*

Director of the United States Patent and Trademark Office

# United States of America

United States Patent and Trademark Office

## STAMFORD WINE FESTIVAL

**Reg. No. 4,127,110**

INPLAY EVENTS LLC (ILLINOIS LIMITED LIABILITY COMPANY)

**Registered Apr. 10, 2012**

30 OLD HART ROAD  
BARRINGTON, IL 60010

**Int. Cl.: 41**

FOR: ORGANIZING COMMUNITY FESTIVALS FEATURING PRIMARILY WINE TASTING AND ALSO PROVIDING ENTERTAINMENT, IN CLASS 41 (U.S. CLS. 100, 101 AND 107).

**SERVICE MARK**

FIRST USE 1-31-2011; IN COMMERCE 1-31-2011.

**SUPPLEMENTAL REGISTER**

THE MARK CONSISTS OF STANDARD CHARACTERS WITHOUT CLAIM TO ANY PARTICULAR FONT, STYLE, SIZE, OR COLOR.

NO CLAIM IS MADE TO THE EXCLUSIVE RIGHT TO USE "WINE FESTIVAL", APART FROM THE MARK AS SHOWN.

SER. NO. 85-310,270, FILED P.R. 5-2-2011; AM. S.R. 2-14-2012.

PRISCILLA MILTON, EXAMINING ATTORNEY



*David J. Kybas*

Director of the United States Patent and Trademark Office

# United States of America

United States Patent and Trademark Office

## PASTA INSTITUTE OF TECHNOLOGY

**Reg. No. 4,127,111**

DEFRANCISCI MACHINE COMPANY, LLC (FLORIDA LIMITED LIABILITY COMPANY)  
7610 CORAL DRIVE

**Registered Apr. 10, 2012**

WEST MELBOURNE, FL 329041102

**Int. Cl.: 41**

FOR: PUBLISHING AND ISSUING OF SCIENTIFIC RESEARCH IN THE FIELD OF PASTA CUISINE AND TECHNOLOGY, IN CLASS 41 (U.S. CLS. 100, 101 AND 107).

**SERVICE MARK**

FIRST USE 11-28-2011; IN COMMERCE 11-28-2011.

**SUPPLEMENTAL REGISTER**

THE MARK CONSISTS OF STANDARD CHARACTERS WITHOUT CLAIM TO ANY PARTICULAR FONT, STYLE, SIZE, OR COLOR.

NO CLAIM IS MADE TO THE EXCLUSIVE RIGHT TO USE "INSTITUTE OF TECHNOLOGY", APART FROM THE MARK AS SHOWN.

SER. NO. 85-310,574, FILED P.R. 5-3-2011; AM. S.R. 12-15-2011.

SUE LAWRENCE, EXAMINING ATTORNEY



*David J. Kybas*

Director of the United States Patent and Trademark Office

# United States of America

United States Patent and Trademark Office

## ROCK CAMP FOR DADS

**Reg. No. 4,127,112**

**Registered Apr. 10, 2012**

**Int. Cl.: 41**

**SERVICE MARK**

**SUPPLEMENTAL REGISTER**

UP PAST ELEVEN PRODUCTIONS, LLC. (MINNESOTA LIMITED LIABILITY COMPANY),  
DBA ROCK CAMP FOR DADS,  
2751 HENNEPIN AVENUE SO. #171  
MINNEAPOLIS, MN 55408

FOR: PROVIDING CLASSES, WORKSHOPS AND CAMPS IN THE FIELD OF MUSIC AND ENTERTAINMENT; AND ENTERTAINMENT SERVICES, NAMELY, PRESENTING MUSIC, IN CLASS 41 (U.S. CLS. 100, 101 AND 107).

FIRST USE 7-16-2009; IN COMMERCE 7-16-2009.

THE MARK CONSISTS OF STANDARD CHARACTERS WITHOUT CLAIM TO ANY PARTICULAR FONT, STYLE, SIZE, OR COLOR.

NO CLAIM IS MADE TO THE EXCLUSIVE RIGHT TO USE "CAMP", APART FROM THE MARK AS SHOWN.

SER. NO. 85-311,364, FILED P.R. 5-3-2011; AM. S.R. 2-15-2012.

ERNEST SHOSHO, EXAMINING ATTORNEY



*David J. Kyfos*

Director of the United States Patent and Trademark Office

# United States of America

United States Patent and Trademark Office

## STOGIE STEIN

**Reg. No. 4,127,113**

KATZ, JASON (UNITED STATES INDIVIDUAL)  
2321 ROUALT ST.  
DAVIS, CA 95618

**Registered Apr. 10, 2012**

**Int. Cl.: 34**

FOR: ASHTRAYS, IN CLASS 34 (U.S. CLS. 2, 8, 9 AND 17).

**TRADEMARK**

FIRST USE 7-18-2011; IN COMMERCE 7-18-2011.

**SUPPLEMENTAL REGISTER**

THE MARK CONSISTS OF STANDARD CHARACTERS WITHOUT CLAIM TO ANY PARTICULAR FONT, STYLE, SIZE, OR COLOR.

SER. NO. 85-311,493, FILED P.R. 5-3-2011; AM. S.R. 2-15-2012.

KELLY BOULTON, EXAMINING ATTORNEY



*David J. Kybas*

Director of the United States Patent and Trademark Office

# United States of America

United States Patent and Trademark Office

## The EDUCATION Partnership

**Reg. No. 4,127,114**

STOREHOUSE FOR TEACHERS, INC. (PENNSYLVANIA NON-PROFIT CORPORATION)  
281 CORLISS STREET  
PITTSBURGH, PA 15220

**Registered Apr. 10, 2012**

**Int. Cl.: 41**

FOR: CHARITABLE SERVICES, NAMELY, PROVIDING SCHOOL SUPPLIES TO STUDENTS AND TEACHERS IN NEED, IN CLASS 41 (U.S. CLS. 100, 101 AND 107).

**SERVICE MARK**

FIRST USE 5-0-2011; IN COMMERCE 5-0-2011.

**SUPPLEMENTAL REGISTER**

THE MARK CONSISTS OF STANDARD CHARACTERS WITHOUT CLAIM TO ANY PARTICULAR FONT, STYLE, SIZE, OR COLOR.

SER. NO. 85-314,108, FILED P.R. 5-6-2011; AM. S.R. 2-16-2012.

ALEXANDER L. POWERS, EXAMINING ATTORNEY



*David J. Kyffers*

Director of the United States Patent and Trademark Office



# United States of America

United States Patent and Trademark Office

## CRAB CAKE SUPREME

**Reg. No. 4,127,115**

GEL SPICE COMPANY, INC. (NEW YORK CORPORATION)  
48 HOOK ROAD  
BAYONNE, NJ 07002

**Registered Apr. 10, 2012**

**Int. Cl.: 30**

FOR: SPICE MIXES FOR USE IN CRAB CAKES, IN CLASS 30 (U.S. CL. 46).

FIRST USE 5-15-2011; IN COMMERCE 5-15-2011.

**TRADEMARK**

THE MARK CONSISTS OF STANDARD CHARACTERS WITHOUT CLAIM TO ANY PARTICULAR FONT, STYLE, SIZE, OR COLOR.

**SUPPLEMENTAL REGISTER**

OWNER OF U.S. REG. NO. 3,921,636.

SER. NO. 85-317,186, FILED P.R. 5-10-2011; AM. S.R. 2-7-2012.

ESTHER BELENKER, EXAMINING ATTORNEY



*David J. Kyffers*

Director of the United States Patent and Trademark Office

# United States of America

United States Patent and Trademark Office

## ASIA PACIFIC LAND

**Reg. No. 4,127,116**

**Registered Apr. 10, 2012**

**Int. Cls.: 35, 36, and 37**

**SERVICE MARK**

**SUPPLEMENTAL REGISTER**

ASIA PACIFIC LAND LIMITED (HONG KONG LIMITED COMPANY (LTD.))  
NINE QUEEN'S ROAD CENTRAL, SUITE 2102  
HONG KONG, HONG KONG

FOR: ADVERTISING; MARKETING, NAMELY, PROMOTING OR ADVERTISING THE GOODS AND SERVICES OF OTHERS; COMMERCIAL AND BUSINESS MANAGEMENT; BUSINESS PLANNING AND MANAGEMENT OF BUILDINGS; BUSINESS MANAGEMENT OF REAL ESTATE FOR OTHERS; BUSINESS MANAGEMENT AND BUSINESS ADMINISTRATION; BUSINESS RESEARCH; BUSINESS MANAGEMENT AND BUSINESS ADMINISTRATION FOR BUSINESSES OF REAL ESTATE, RESIDENTIAL, INDUSTRIAL AND COMMERCIAL PROPERTIES, OFFICES, BUSINESS CENTERS, DEPARTMENTAL STORES, SHOPPING CENTERS, RETAIL AND WHOLESALE OUTLETS, TEMPORARY ACCOMMODATION, HOTELS, MOTELS, RESORTS, SERVICE APARTMENTS, BUILDINGS, HOUSES, CONDOMINIUMS, APARTMENTS, FLATS, WAREHOUSES, FACTORIES AND DEVELOPMENTS; ORGANIZATION OF EXHIBITIONS FOR BUSINESS AND COMMERCIAL PURPOSES; BUSINESS MANAGEMENT IN RELATION TO COMMERCIAL PROPERTY; THE BRINGING TOGETHER, FOR THE BENEFIT OF OTHERS, OF A VARIETY OF GOODS, ENABLING CUSTOMERS TO CONVENIENTLY VIEW AND PURCHASE THOSE GOODS IN THE FIELD OF REAL ESTATE; COMPILATION OF MAILING LISTS; DIRECT MAIL ADVERTISING; BUSINESS MERCHANDISING DISPLAY SERVICES; PUBLICITY SERVICES; MARKETING AND PROMOTIONAL SERVICES, MARKET ANALYSIS AND RESEARCH; ORGANIZATION OF BUSINESS COMPETITIONS; PROJECT MANAGEMENT SERVICES FOR OTHERS FOR BUSINESS PURPOSES IN THE FIELD OF REAL ESTATE; TURNKEY RETAIL START-UP SERVICES, NAMELY, COORDINATION AND ASSUMPTION OF RESPONSIBILITY FOR ALL ASPECTS OF THE STORE-OPENING PROCESS OF OTHERS; ADVISORY AND CONSULTANCY SERVICES RELATING TO THE AFORESAID, IN CLASS 35 (U.S. CLS. 100, 101 AND 102).

FIRST USE 12-0-1994; IN COMMERCE 12-0-1994.

FOR: FUND MANAGEMENT; FUND INVESTMENT; INTERNATIONAL FUND INVESTMENT; FINANCIAL SERVICES, NAMELY, INVESTMENT ADVICE, INVESTMENT MANAGEMENT, INVESTMENT CONSULTATION AND INVESTMENT OF FUNDS FOR OTHERS, INCLUDING PRIVATE AND PUBLIC EQUITY AND DEBT INVESTMENT SERVICES; REAL ESTATE FINANCING; REAL ESTATE EQUITY SHARING, NAMELY, MANAGING AND ARRANGING FOR CO-OWNERSHIP OF REAL ESTATE; DEVELOPING AND ORGANIZING SECURITIZATION FINANCIAL STRUCTURES, NAMELY, ADMINISTERING THE ISSUANCE, UNDER-



*David J. Kybas*

Director of the United States Patent and Trademark Office

**Reg. No. 4,127,116** WRITING AND DISTRIBUTION OF SECURITIES; FINANCIAL EVALUATION OF REAL ESTATE; CAPITAL INVESTMENT; REAL ESTATE INVESTMENT; ADMINISTRATION OF TRUSTS, NAMELY, INVESTMENT AND TRUST COMPANY SERVICES; CORPORATE TRUSTS SERVICES, NAMELY, INVESTMENT AND TRUST COMPANY SERVICES; FINANCIAL TRUST MANAGEMENT; INVESTMENT TRUST MANAGEMENT; INVESTMENT TRUST SERVICES, NAMELY, INVESTMENT AND TRUST COMPANY SERVICES; PRIVATE CLIENT UNIT INVESTMENT TRUST MANAGEMENT SERVICES; PROPERTY UNIT TRUST, NAMELY, REAL ESTATE INVESTMENT TRUST SERVICES; UNIT INVESTMENT TRUST MANAGEMENT AND UNIT TRUST SERVICES, NAMELY, FINANCIAL TRUST OPERATIONS; REAL ESTATE TRUSTEE SERVICES; ACQUISITION OF REAL ESTATE; REAL ESTATE MANAGEMENT OF BUILDING DEVELOPMENTS; LEASING OF BUILDINGS; REAL ESTATE MANAGEMENT OF THE BUILDINGS` ENVIRONMENT; ADVISORY AND INFORMATION SERVICES RELATING TO REAL ESTATE BROKERAGE; REAL ESTATE AFFAIRS, NAMELY, RENTAL, BROKERAGE, LEASING AND MANAGEMENT OF COMMERCIAL PROPERTY, OFFICES AND OFFICE SPACE; REAL ESTATE AGENCY SERVICES; LETTING AND LEASING OF REAL ESTATE, RESIDENTIAL, INDUSTRIAL AND COMMERCIAL PROPERTIES, OFFICES, BUSINESS CENTERS, DEPARTMENTAL STORES, SHOPPING CENTERS, RETAIL AND WHOLESALE OUTLETS, SERVICE APARTMENTS, BUILDINGS, HOUSES, CONDOMINIUMS, APARTMENTS, FLATS, WAREHOUSES, FACTORIES AND DEVELOPMENTS; REAL ESTATE MANAGEMENT AND VALUATION; FINANCIAL ASSET MANAGEMENT; CAPITAL FUND MANAGEMENT, CORPORATE FUND MANAGEMENT, FINANCIAL FUND MANAGEMENT AND INVESTMENT FUND MANAGEMENT; UNIT INVESTMENT TRUST FUND INVESTMENT SERVICES; FINANCIAL MARKET INFORMATION SERVICES; ORGANIZATION OF STOCK EXCHANGES FOR THE BENEFIT OF THE TRADE OF STOCKS AND OTHER FINANCIAL VALUES; CORPORATE FINANCE, NAMELY, CONSULTATION IN THE FIELD OF ASSET SALES; SECURITIES BROKERAGE; MANAGEMENT OF SECURITIES PORTFOLIOS; FINANCIAL SERVICES, NAMELY, DEALING IN SECURITIES AS A MARKET MAKER AND IN TRADING COMMODITIES, SECURITIES, OPTIONS, FUTURES, EQUITIES AND FIXED INCOME PRODUCTS IN THE U.S. AND OVERSEAS MARKET SECURITIES; TRADING IN SECURITIES; SECURITIES INVESTMENT SERVICES, NAMELY, MANAGEMENT AND BROKERAGE IN THE FIELDS OF STOCKS, BONDS, OPTIONS, COMMODITIES, FUTURES AND OTHER SECURITIES, AND THE INVESTMENT OF FUNDS OF OTHERS; STOCKS AND BONDS BROKERAGE; BUSINESS TRUST SERVICES, NAMELY, FINANCIAL TRUST PLANNING; CORPORATE TRUST MANAGEMENT AND FINANCIAL TRUST MANAGEMENT SERVICES; SURETY SERVICES; TRUSTEESHIP REPRESENTATIVES; TRUST SERVICES, NAMELY, INVESTMENT AND TRUST COMPANY SERVICES; REAL ESTATE INVESTMENT TRUST MANAGEMENT SERVICES; ESTABLISHMENT OF REAL ESTATE INVESTMENT TRUSTS; FINANCIAL ADVISORY, MANAGEMENT AND CONSULTANCY SERVICES; FINANCIAL EVALUATION AND ANALYSIS; FINANCIAL UNDERWRITING, NAMELY, ADMINISTERING THE ISSUANCE, UNDERWRITING AND DISTRIBUTION OF SECURITIES; FINANCING SERVICES; CREDIT SERVICES, NAMELY, CREDIT AGENCIES FEATURING CREDIT PROCESSING, NAMELY, CREDIT CHECKING, CREDIT ANALYZING, AND FINANCIAL REPORTING SERVICES; FINANCIAL GUARANTEE SERVICES; PRIVATE PLACEMENT OF FUNDS AND SECURITIES; ADVISORY AND CONSULTANCY SERVICES RELATING TO THE AFORESAID, IN CLASS 36 (U.S. CLS. 100, 101 AND 102).

FIRST USE 12-0-1994; IN COMMERCE 12-0-1994.

FOR: REAL ESTATE DEVELOPMENT; LAND DEVELOPMENT SERVICES, NAMELY, PLANNING AND LAYING OUT OF RESIDENTIAL AND/OR COMMERCIAL COMMUNITIES; BUILDING CONSTRUCTION SERVICES; CONSTRUCTION, RENOVATION, REFURBISHMENT, MAINTENANCE AND REPAIR OF REAL ESTATE, RESIDENTIAL, INDUSTRIAL AND COMMERCIAL PROPERTIES, OFFICES, BUSINESS CENTERS, DEPARTMENTAL STORES, SHOPPING CENTERS, RETAIL AND WHOLESALE OUTLETS, TEMPORARY ACCOMMODATION, HOTELS, MOTELS, RESORTS, SERVICE APARTMENTS, BUILDINGS, HOUSES, CONDOMINIUMS, APARTMENTS, FLATS, WAREHOUSES, FACTORIES AND DEVELOPMENTS; REAL ESTATE DEVELOPMENT; REAL ESTATE SITE SELECTION;

**Reg. No. 4,127,116** ADVISORY AND CONSULTANCY SERVICES RELATING TO THE AFORESAID, IN CLASS 37 (U.S. CLS. 100, 103 AND 106).

FIRST USE 12-0-1994; IN COMMERCE 12-0-1994.

THE MARK CONSISTS OF STANDARD CHARACTERS WITHOUT CLAIM TO ANY PARTICULAR FONT, STYLE, SIZE, OR COLOR.

SER. NO. 85-317,954, FILED P.R. 5-11-2011; AM. S.R. 1-26-2012.

KELLY BOULTON, EXAMINING ATTORNEY

# United States of America

United States Patent and Trademark Office

## PORTABLE GLORY HOLE

**Reg. No. 4,127,117**

MIRACLE MANUFACTURING, LLC (FLORIDA LIMITED LIABILITY COMPANY)  
701 S HOWARD AVE #106-221  
TAMPA, FL 33606

**Registered Apr. 10, 2012**

**Int. Cl.: 10**

FOR: ADULT SEXUAL STIMULATION AIDS, NAMELY, FRAMED, ADJUSTABLE, PORTABLE WALL USED FOR ADULT SEXUAL RELATIONS, IN CLASS 10 (U.S. CLS. 26, 39 AND 44).

**TRADEMARK**

FIRST USE 11-29-2010; IN COMMERCE 8-2-2011.

**SUPPLEMENTAL REGISTER**

THE MARK CONSISTS OF STANDARD CHARACTERS WITHOUT CLAIM TO ANY PARTICULAR FONT, STYLE, SIZE, OR COLOR.

NO CLAIM IS MADE TO THE EXCLUSIVE RIGHT TO USE "GLORY HOLE", APART FROM THE MARK AS SHOWN.

SER. NO. 85-320,648, FILED P.R. 5-13-2011; AM. S.R. 2-7-2012.

KIM MONINGHOFF, EXAMINING ATTORNEY



*David J. Kyffers*

Director of the United States Patent and Trademark Office

# United States of America

United States Patent and Trademark Office

## SOCCER NIGHT IN AMERICA

**Reg. No. 4,127,118**

**Registered Apr. 10, 2012**

**Int. Cl.: 41**

**SERVICE MARK**

**SUPPLEMENTAL REGISTER**

TWENTIETH CENTURY FOX FILM CORPORATION (DELAWARE CORPORATION)  
10201 WEST PICO BOULEVARD  
LOS ANGELES, CA 90035

FOR: ENTERTAINMENT SERVICES, NAMELY, PROVISION OF ON-GOING MULTIMEDIA PROGRAMS IN THE FIELD OF SPORTS; PROVIDING ON-LINE ENTERTAINMENT INFORMATION IN THE FIELD OF SPORTS; ENTERTAINMENT SERVICES IN THE NATURE OF AUDIO VISUAL ENTERTAINMENT FEATURING ONGOING TELEVISION SHOWS FEATURING SPORTS TRANSMITTED VIA THE INTERNET, IN CLASS 41 (U.S. CLS. 100, 101 AND 107).

FIRST USE 5-6-2011; IN COMMERCE 5-6-2011.

THE MARK CONSISTS OF STANDARD CHARACTERS WITHOUT CLAIM TO ANY PARTICULAR FONT, STYLE, SIZE, OR COLOR.

SER. NO. 85-321,008, FILED P.R. 5-13-2011; AM. S.R. 1-24-2012.

PAUL MORENO, EXAMINING ATTORNEY



*David J. Kyffers*

Director of the United States Patent and Trademark Office

# United States of America

United States Patent and Trademark Office

## BAZAR KRAKOWSKI

**Reg. No. 4,127,119**

KMK IMPORTS, LLC (ILLINOIS LIMITED LIABILITY COMPANY)  
10342 S TERRY DR  
PALOS HILLS, IL 60465

**Registered Apr. 10, 2012**

**Int. Cl.: 35**

FOR: EXPORT AND IMPORT AGENCIES; EXPORT AND IMPORT AGENCIES IN THE FIELD OF ORNAMENTS; ON-LINE WHOLESALE AND RETAIL STORE SERVICES FEATURING HOLIDAY ITEMS SUCH AS ORNAMENTS, IN CLASS 35 (U.S. CLS. 100, 101 AND 102).

**SERVICE MARK**

FIRST USE 1-1-2012; IN COMMERCE 1-1-2012.

**SUPPLEMENTAL REGISTER**

THE MARK CONSISTS OF STANDARD CHARACTERS WITHOUT CLAIM TO ANY PARTICULAR FONT, STYLE, SIZE, OR COLOR.

NO CLAIM IS MADE TO THE EXCLUSIVE RIGHT TO USE "MARKET", APART FROM THE MARK AS SHOWN.

THE ENGLISH TRANSLATION OF "BAZAR KRAKOWSKI" IN THE MARK IS "MARKET KRAKOW".

SER. NO. 85-323,639, FILED P.R. 5-18-2011; AM. S.R. 1-23-2012.

CHERYL CLAYTON, EXAMINING ATTORNEY



*David J. Kybas*

Director of the United States Patent and Trademark Office

# United States of America

United States Patent and Trademark Office

# PASSINI

**Reg. No. 4,127,120**

**Registered Apr. 10, 2012**

**Int. Cl.: 3**

**TRADEMARK**

**SUPPLEMENTAL REGISTER**

COSQUIM, S.A. DE C.V. (MEXICO CORPORATION)  
GAMMA 105, FRACC. INDUSTRIAL DELTA  
LEON, GUANAJUATO, MEXICO 780404515

FOR: COSMETIC PREPARATIONS FOR THE HAIR AND SCALP; COSMETICS; ESSENTIAL OILS; HAIR CARE LOTIONS; HAIR COLOR; HAIR DECOLORANTS; HAIR DYES; HAIR REMOVING CREAM; HAIR SHAMPOOS AND CONDITIONERS; HAIR SPRAYS AND HAIR GELS; HAIR WAVING PREPARATIONS; HYDROGEN PEROXIDE FOR COSMETIC PURPOSES; NAIL CARE PREPARATIONS; PERFUMERY, IN CLASS 3 (U.S. CLS. 1, 4, 6, 50, 51 AND 52).

FIRST USE 5-15-2011; IN COMMERCE 5-15-2011.

THE MARK CONSISTS OF STANDARD CHARACTERS WITHOUT CLAIM TO ANY PARTICULAR FONT, STYLE, SIZE, OR COLOR.

SER. NO. 85-327,298, FILED P.R. 5-23-2011; AM. S.R. 3-5-2012.

JOHN SCHUYLER YARD, EXAMINING ATTORNEY



*David J. Kyfos*

Director of the United States Patent and Trademark Office



# United States of America

United States Patent and Trademark Office

## FLIPPING VEGAS

**Reg. No. 4,127,121**

A&E TELEVISION NETWORKS, LLC (DELAWARE LIMITED LIABILITY COMPANY)  
235 EAST 45TH STREET  
NEW YORK, NY 10017

**Registered Apr. 10, 2012**

**Int. Cl.: 41**

FOR: ENTERTAINMENT SERVICES, NAMELY, A MULTIMEDIA PROGRAM SERIES FEATURING SUBJECTS OF GENERAL HUMAN INTEREST DISTRIBUTED VIA VARIOUS PLATFORMS ACROSS MULTIPLE FORMS OF TRANSMISSION MEDIA; ENTERTAINMENT SERVICES, NAMELY, AN ONGOING TELEVISION SERIES FEATURING SUBJECTS OF GENERAL HUMAN INTEREST; PROVIDING A WEBSITE FOR ENTERTAINMENT PURPOSES ONLY FEATURING GENERAL HUMAN INTEREST, NAMELY, INFORMATION ON HOME IMPROVEMENT AND REAL ESTATE DEVELOPMENT, IN CLASS 41 (U.S. CLS. 100, 101 AND 107).

**SERVICE MARK**

**SUPPLEMENTAL REGISTER**

FIRST USE 8-21-2010; IN COMMERCE 8-21-2010.

THE MARK CONSISTS OF STANDARD CHARACTERS WITHOUT CLAIM TO ANY PARTICULAR FONT, STYLE, SIZE, OR COLOR.

NO CLAIM IS MADE TO THE EXCLUSIVE RIGHT TO USE "VEGAS", APART FROM THE MARK AS SHOWN.

SER. NO. 85-327,878, FILED P.R. 5-23-2011; AM. S.R. 2-15-2012.

BRENDAN REGAN, EXAMINING ATTORNEY



*David J. Kyffers*

Director of the United States Patent and Trademark Office

# United States of America

United States Patent and Trademark Office

## VETERANS' FIRE PROTECTION

**Reg. No. 4,127,122**

**Registered Apr. 10, 2012**

**Int. Cl.: 37**

**SERVICE MARK**

**SUPPLEMENTAL REGISTER**

AAA CHAMPION DIVING SERVICE L.L.C. D.B.A. VETERANS' FIRE PROTECTION  
(WASHINGTON LIMITED LIABILITY COMPANY)  
P.O. BOX 98141  
LAKEWOOD, WA 98496

FOR: INSTALLATION AND MAINTENANCE OF FIRE PROTECTION SYSTEMS AND  
EQUIPMENT, IN CLASS 37 (U.S. CLS. 100, 103 AND 106).

FIRST USE 4-13-2011; IN COMMERCE 4-13-2011.

THE MARK CONSISTS OF STANDARD CHARACTERS WITHOUT CLAIM TO ANY PAR-  
TICULAR FONT, STYLE, SIZE, OR COLOR.

NO CLAIM IS MADE TO THE EXCLUSIVE RIGHT TO USE "FIRE PROTECTION", APART  
FROM THE MARK AS SHOWN.

SER. NO. 85-328,476, FILED P.R. 5-24-2011; AM. S.R. 2-17-2012.

MEGHAN REINHART, EXAMINING ATTORNEY



*David J. Kybas*

Director of the United States Patent and Trademark Office

# United States of America

United States Patent and Trademark Office

# The Hair Bar

**Reg. No. 4,127,123**

G&S HAIR BAR DALLAS LLC (TEXAS LIMITED LIABILITY COMPANY)

**Registered Apr. 10, 2012**

#3 BLUFF PARK  
DALLAS, TX 75220

**Int. Cl.: 44**

FOR: HAIR SALON SERVICES; HAIR STYLING; MAKE-UP APPLICATION SERVICES, IN CLASS 44 (U.S. CLS. 100 AND 101).

**SERVICE MARK**

FIRST USE 5-20-2011; IN COMMERCE 6-20-2011.

**SUPPLEMENTAL REGISTER**

THE MARK CONSISTS OF STANDARD CHARACTERS WITHOUT CLAIM TO ANY PARTICULAR FONT, STYLE, SIZE, OR COLOR.

SER. NO. 85-330,264, FILED P.R. 5-26-2011; AM. S.R. 2-18-2012.

CYNTHIA TRIPI, EXAMINING ATTORNEY



*David J. Kyffers*

Director of the United States Patent and Trademark Office

# United States of America

United States Patent and Trademark Office

## 66 DRIVE-IN THEATRE

**Reg. No. 4,127,124**

GOODMAN, MARK (UNITED STATES INDIVIDUAL)  
17231 OLD 66 BLVD.  
CARTHAGE, MO 64836

**Registered Apr. 10, 2012**

**Int. Cl.: 41**

FOR: MOVIE THEATERS, NAMELY, DRIVE-IN MOVIE THEATERS, IN CLASS 41 (U.S. CLS. 100, 101 AND 107).

**SERVICE MARK**

FIRST USE 9-22-1949; IN COMMERCE 9-22-1949.

**SUPPLEMENTAL REGISTER**

THE MARK CONSISTS OF STANDARD CHARACTERS WITHOUT CLAIM TO ANY PARTICULAR FONT, STYLE, SIZE, OR COLOR.

NO CLAIM IS MADE TO THE EXCLUSIVE RIGHT TO USE "DRIVE-IN THEATRE", APART FROM THE MARK AS SHOWN.

SER. NO. 85-332,118, FILED P.R. 5-27-2011; AM. S.R. 2-17-2012.

SHAUNIA CARLYLE, EXAMINING ATTORNEY



*David J. Kybas*

Director of the United States Patent and Trademark Office

# United States of America

United States Patent and Trademark Office

## INDIAWEB.COM

**Reg. No. 4,127,125**

VISTAEDGE INC (DELAWARE CORPORATION)  
421 WILLINGHAM RD  
MORRISVILLE, NC 27560

**Registered Apr. 10, 2012**

**Int. Cl.: 42**

FOR: PROVIDING A WEBSITE FEATURING NON-DOWNLOADABLE SOFTWARE FOR CLASSIFIEDS, VIRTUAL COMMUNITY, SOCIAL NETWORKING, PHOTO SHARING, AND TRANSMISSION OF PHOTOGRAPHIC IMAGES , IN CLASS 42 (U.S. CLS. 100 AND 101).

**SERVICE MARK**

FIRST USE 2-10-2005; IN COMMERCE 2-10-2005.

**SUPPLEMENTAL REGISTER**

THE MARK CONSISTS OF STANDARD CHARACTERS WITHOUT CLAIM TO ANY PARTICULAR FONT, STYLE, SIZE, OR COLOR.

SER. NO. 85-346,421, FILED P.R. 6-15-2011; AM. S.R. 2-9-2012.

NORA BUCHANAN WILL, EXAMINING ATTORNEY



*David J. Kyros*

Director of the United States Patent and Trademark Office

# United States of America

United States Patent and Trademark Office

# Smokes 2 Go

**Reg. No. 4,127,126**

SMOKES 2 GO CORP. (PENNSYLVANIA CORPORATION)  
73 PLEASANT STREET  
MONTICELLO, NY 12701

**Registered Apr. 10, 2012**

**Int. Cl.: 35**

FOR: RETAIL STORE SERVICES FEATURING TOBACCO, IN CLASS 35 (U.S. CLS. 100, 101 AND 102).

**SERVICE MARK**

FIRST USE 6-1-2011; IN COMMERCE 6-1-2011.

**SUPPLEMENTAL REGISTER**

THE MARK CONSISTS OF STANDARD CHARACTERS WITHOUT CLAIM TO ANY PARTICULAR FONT, STYLE, SIZE, OR COLOR.

SER. NO. 85-349,276, FILED P.R. 6-17-2011; AM. S.R. 2-23-2012.

NICHOLAS ALTREE, EXAMINING ATTORNEY



*David J. Kybas*

Director of the United States Patent and Trademark Office

# United States of America

United States Patent and Trademark Office

## DIRECT SURETY

**Reg. No. 4,127,127**

DIRECT SURETY, INC. (DELAWARE CORPORATION), DBA DIRECTSURETY.COM,  
1135 FARRAGUT BLVD.

**Registered Apr. 10, 2012**

FOSTER CITY, CA 94404

**Int. Cl.: 36**

FOR: FINANCIAL GUARANTEE AND SURETY, IN CLASS 36 (U.S. CLS. 100, 101 AND 102).

**SERVICE MARK**

FIRST USE 1-1-2011; IN COMMERCE 6-15-2011.

**SUPPLEMENTAL REGISTER**

THE MARK CONSISTS OF STANDARD CHARACTERS WITHOUT CLAIM TO ANY PARTICULAR FONT, STYLE, SIZE, OR COLOR.

NO CLAIM IS MADE TO THE EXCLUSIVE RIGHT TO USE "SURETY", APART FROM THE MARK AS SHOWN.

SER. NO. 85-349,900, FILED 6-18-2011.

DOUGLAS LEE, EXAMINING ATTORNEY



*David J. Kyffers*

Director of the United States Patent and Trademark Office

# United States of America

United States Patent and Trademark Office

## AMERICAN FALLEN WARRIOR MEMORIAL FOUNDATION

**Reg. No. 4,127,128**

TAYLOR AND EVANS (MISSOURI PARTNERSHIP)  
2453 S. FOREST HEIGHTS AVE.  
SPRINGFIELD, MO 65809

**Registered Apr. 10, 2012**

**Int. Cl.: 36**

FOR: MEMORIAL FUNDRAISING, IN CLASS 36 (U.S. CLS. 100, 101 AND 102).

**SERVICE MARK**

FIRST USE 6-22-2011; IN COMMERCE 6-22-2011.

**SUPPLEMENTAL REGISTER**

THE MARK CONSISTS OF STANDARD CHARACTERS WITHOUT CLAIM TO ANY PARTICULAR FONT, STYLE, SIZE, OR COLOR.

NO CLAIM IS MADE TO THE EXCLUSIVE RIGHT TO USE "MEMORIAL FOUNDATION", APART FROM THE MARK AS SHOWN.

SER. NO. 85-353,046, FILED P.R. 6-22-2011; AM. S.R. 1-31-2012.

KATHLEEN M. VANSTON, EXAMINING ATTORNEY



*David J. Kybas*

Director of the United States Patent and Trademark Office



# United States of America

United States Patent and Trademark Office

## THANKYOUBRICKS.COM

**Reg. No. 4,127,129**

TAYLOR AND EVANS (MISSOURI PARTNERSHIP)  
2453 S. FOREST HEIGHTS AVE.  
SPRINGFIELD, MO 65809

**Registered Apr. 10, 2012**

**Int. Cl.: 36**

FOR: MEMORIAL FUNDRAISING, IN CLASS 36 (U.S. CLS. 100, 101 AND 102).

**SERVICE MARK**

FIRST USE 6-22-2011; IN COMMERCE 6-22-2011.

**SUPPLEMENTAL REGISTER**

THE MARK CONSISTS OF STANDARD CHARACTERS WITHOUT CLAIM TO ANY PARTICULAR FONT, STYLE, SIZE, OR COLOR.

SER. NO. 85-353,122, FILED P.R. 6-22-2011; AM. S.R. 1-31-2012.

KATHLEEN M. VANSTON, EXAMINING ATTORNEY



*David J. Kybas*

Director of the United States Patent and Trademark Office

# United States of America

United States Patent and Trademark Office

# Capture HD

**Reg. No. 4,127,130**

**Registered Apr. 10, 2012**

**Int. Cl.: 9**

**TRADEMARK**

**SUPPLEMENTAL REGISTER**

CRESTRON ELECTRONICS, INC. (NEW JERSEY CORPORATION)  
ATTN: BRADLEY M. MARAZAS  
15 VOLVO DRIVE  
ROCKLEIGH, NJ 07647

FOR: LECTURE CAPTURE SYSTEM COMPRISED PRIMARILY OF COMPUTER HARDWARE AND SOFTWARE FOR USE IN RECORDING, POST-PROCESSING, ONLINE DISTRIBUTION, AND REMOTE VIEWING OF LECTURES OR PRESENTATIONS ALONG WITH MULTIMEDIA SOURCES, NAMELY, AUDIO, VIDEO, COMPUTER SLIDE SHOWS, WHITEBOARDS, AND ANNOTATORS PRESENTED DURING THE LECTURE OR PRESENTATION, IN CLASS 9 (U.S. CLS. 21, 23, 26, 36 AND 38).

FIRST USE 6-15-2011; IN COMMERCE 6-15-2011.

THE MARK CONSISTS OF STANDARD CHARACTERS WITHOUT CLAIM TO ANY PARTICULAR FONT, STYLE, SIZE, OR COLOR.

SER. NO. 85-354,031, FILED P.R. 6-23-2011; AM. S.R. 2-13-2012.

B. PARADEWELAI, EXAMINING ATTORNEY



*David J. Kyffers*

Director of the United States Patent and Trademark Office

# United States of America

United States Patent and Trademark Office

## COMFORT CLOGS

**Reg. No. 4,127,131**

**Registered Apr. 10, 2012**

**Int. Cl.: 25**

**TRADEMARK**

**SUPPLEMENTAL REGISTER**

MIDWEST QUALITY GLOVES, INC. (MISSOURI CORPORATION)  
835 INDUSTRIAL ROAD  
CHILLICOTHE, MO 64601

FOR: CLOGS, IN CLASS 25 (U.S. CLS. 22 AND 39).

FIRST USE 5-10-2011; IN COMMERCE 5-10-2011.

THE MARK CONSISTS OF STANDARD CHARACTERS WITHOUT CLAIM TO ANY PARTICULAR FONT, STYLE, SIZE, OR COLOR.

NO CLAIM IS MADE TO THE EXCLUSIVE RIGHT TO USE "CLOGS", APART FROM THE MARK AS SHOWN.

SER. NO. 85-355,563, FILED P.R. 6-24-2011; AM. S.R. 2-14-2012.

JESSICA A. POWERS, EXAMINING ATTORNEY



*David J. Kybas*

Director of the United States Patent and Trademark Office

# United States of America

United States Patent and Trademark Office

## US FUNERAL HOMES DIRECTORY

**Reg. No. 4,127,132**

GRAND CHAPELS, LLC (KENTUCKY LIMITED LIABILITY COMPANY)  
4832 CANE RUN ROAD  
LOUISVILLE, KY 40216

**Registered Apr. 10, 2012**

**Int. Cl.: 16**

FOR: DIRECTORIES OF FUNERAL HOMES, FUNERAL ARRANGEMENT SERVICES PROVIDERS, FUNERAL SERVICE UNDERTAKING PROVIDERS, AND CREMATION FUNERARY SERVICES PROVIDERS, IN CLASS 16 (U.S. CLS. 2, 5, 22, 23, 29, 37, 38 AND 50).

**TRADEMARK**

FIRST USE 2-10-2012; IN COMMERCE 2-10-2012.

**SUPPLEMENTAL REGISTER**

THE MARK CONSISTS OF STANDARD CHARACTERS WITHOUT CLAIM TO ANY PARTICULAR FONT, STYLE, SIZE, OR COLOR.

NO CLAIM IS MADE TO THE EXCLUSIVE RIGHT TO USE "FUNERAL HOMES DIRECTORY", APART FROM THE MARK AS SHOWN.

SER. NO. 85-357,235, FILED P.R. 6-27-2011; AM. S.R. 2-13-2012.

CURTIS FRENCH, EXAMINING ATTORNEY



*David J. Kybas*

Director of the United States Patent and Trademark Office

# United States of America

United States Patent and Trademark Office

## DISCIPLINED CREATIVITY

**Reg. No. 4,127,133**

SPENCER HALL, INC. (OHIO CORPORATION)  
11321 TERWILLIGERS CREEK DRIVE  
CINCINNATI, OH 45249

**Registered Apr. 10, 2012**

**Int. Cls.: 35 and 42**

FOR: BRAINSTORMING AND CREATION OF IDEAS, NAMELY, BUSINESS AND MARKETING CONSULTING, IN CLASS 35 (U.S. CLS. 100, 101 AND 102).

**SERVICE MARK**

FIRST USE 1-31-2011; IN COMMERCE 1-31-2011.

**SUPPLEMENTAL REGISTER**

FOR: INNOVATION CONSULTING SERVICES, NAMELY, ADVISING OTHERS IN THE AREAS OF PRODUCT DEVELOPMENT, IN CLASS 42 (U.S. CLS. 100 AND 101).

FIRST USE 1-31-2011; IN COMMERCE 1-31-2011.

THE MARK CONSISTS OF STANDARD CHARACTERS WITHOUT CLAIM TO ANY PARTICULAR FONT, STYLE, SIZE, OR COLOR.

SER. NO. 85-374,557, FILED P.R. 7-19-2011; AM. S.R. 1-18-2012.

ESTHER BELENKER, EXAMINING ATTORNEY



*David J. Kybas*

Director of the United States Patent and Trademark Office

# United States of America

United States Patent and Trademark Office

## PRATT FAMILY

**Reg. No. 4,127,134**

PRATT FAMILY FOOD PRODUCTS INC. (ARKANSAS CORPORATION)  
14811 HEINKE ROAD  
MABELVALE, AR 72103

**Registered Apr. 10, 2012**

**Int. Cl.: 30**

FOR: SALSA, IN CLASS 30 (U.S. CL. 46).

FIRST USE 2-12-2011; IN COMMERCE 2-12-2011.

**TRADEMARK**

THE MARK CONSISTS OF STANDARD CHARACTERS WITHOUT CLAIM TO ANY PARTICULAR FONT, STYLE, SIZE, OR COLOR.

**SUPPLEMENTAL REGISTER**

SER. NO. 85-377,565, FILED P.R. 7-21-2011; AM. S.R. 2-14-2012.

ELI HELLMAN, EXAMINING ATTORNEY



*David J. Kyffers*

Director of the United States Patent and Trademark Office

# United States of America

United States Patent and Trademark Office

## PIGEON HOLD

**Reg. No. 4,127,135**

STEVEN P. GRENIER (UNITED STATES INDIVIDUAL)  
75 BABOOSIC LAKE ROAD  
MERRIMACK, NH 03054

**Registered Apr. 10, 2012**

**Int. Cl.: 28**

FOR: TARGET EQUIPMENT, NAMELY, BACKERS AND STANDS FOR TARGETS, IN CLASS 28 (U.S. CLS. 22, 23, 38 AND 50).

**TRADEMARK**

FIRST USE 9-13-2011; IN COMMERCE 9-13-2011.

**SUPPLEMENTAL REGISTER**

THE MARK CONSISTS OF STANDARD CHARACTERS WITHOUT CLAIM TO ANY PARTICULAR FONT, STYLE, SIZE, OR COLOR.

SER. NO. 85-379,837, FILED P.R. 7-25-2011; AM. S.R. 2-14-2012.

ELLEN B. AWRICH, EXAMINING ATTORNEY



*David J. Kyffers*

Director of the United States Patent and Trademark Office

# United States of America

United States Patent and Trademark Office

# vitaminchips

**Reg. No. 4,127,136**

TOTAL HEALTH ADVANCED NUTRITON, INC (MINNESOTA CORPORATION)  
1027 E. MOORE LAKE DR  
FRIDLEY, MN 55432

**Registered Apr. 10, 2012**

**Int. Cl.: 29**

FOR: POTATO CHIPS; POTATO CRISPS; POTATO STICKS; POTATO-BASED SNACK FOODS; SOY CHIPS; VEGETABLE CHIPS, ALL ENHANCED WITH VITAMINS, IN CLASS 29 (U.S. CL. 46).

**TRADEMARK**

FIRST USE 7-18-2011; IN COMMERCE 7-18-2011.

**SUPPLEMENTAL REGISTER**

THE MARK CONSISTS OF STANDARD CHARACTERS WITHOUT CLAIM TO ANY PARTICULAR FONT, STYLE, SIZE, OR COLOR.

SER. NO. 85-380,397, FILED P.R. 7-25-2011; AM. S.R. 1-23-2012.

NATALIE POLZER, EXAMINING ATTORNEY



*David J. Kybas*

Director of the United States Patent and Trademark Office



# United States of America

United States Patent and Trademark Office

## Florida Energy Conservation Advisors, Inc.

**Reg. No. 4,127,137**

FLORIDA ENERGY CONSERVATION ADVISORS, INC (FLORIDA CORPORATION)  
32730 US HWY 19 N  
PALM HARBOR, FL 34684

**Registered Apr. 10, 2012**

**Int. Cl.: 35**

FOR: ADVISORY SERVICES IN THE FIELD OF ENERGY CONSERVATION; ENERGY EVALUATION SERVICES; DISTRIBUTORSHIP SERVICES IN THE FIELD OF WINDOW FILM, INSULATION, POWER CORRECTOR DEVICES, THERMONOMICS, PROGRAMMABLE THERMOSTATS, WINDOW AND DOOR REFURBISHMENTS, IN CLASS 35 (U.S. CLS. 100, 101 AND 102).

**SERVICE MARK**

**SUPPLEMENTAL REGISTER**

FIRST USE 8-1-2008; IN COMMERCE 2-1-2009.

THE MARK CONSISTS OF STANDARD CHARACTERS WITHOUT CLAIM TO ANY PARTICULAR FONT, STYLE, SIZE, OR COLOR.

NO CLAIM IS MADE TO THE EXCLUSIVE RIGHT TO USE "ENERGY CONSERVATION ADVISORS, INC.", APART FROM THE MARK AS SHOWN.

SER. NO. 85-380,405, FILED P.R. 7-25-2011; AM. S.R. 2-1-2012.

DAWN FELDMAN, EXAMINING ATTORNEY



*David J. Kyros*

Director of the United States Patent and Trademark Office

# United States of America

United States Patent and Trademark Office

## Football in Paradise

**Reg. No. 4,127,138**

**Registered Apr. 10, 2012**

**Int. Cl.: 25**

**TRADEMARK**

**SUPPLEMENTAL REGISTER**

NOLL, MARK (UNITED STATES INDIVIDUAL)  
5101 MALLARDS PLACE  
COCONUT CREEK, FL 33073

FOR: FLIP FLOPS; HATS; SHIRTS, IN CLASS 25 (U.S. CLS. 22 AND 39).

FIRST USE 6-20-2011; IN COMMERCE 7-1-2011.

THE MARK CONSISTS OF STANDARD CHARACTERS WITHOUT CLAIM TO ANY PARTICULAR FONT, STYLE, SIZE, OR COLOR.

SER. NO. 85-382,487, FILED P.R. 7-27-2011; AM. S.R. 2-15-2012.

LINDA MICKLEBURGH, EXAMINING ATTORNEY



*David J. Kyffers*

Director of the United States Patent and Trademark Office

# United States of America

United States Patent and Trademark Office

## BAVARIA'S FINEST YOGURT

**Reg. No. 4,127,139**

**Registered Apr. 10, 2012**

**Int. Cl.: 29**

**TRADEMARK**

**SUPPLEMENTAL REGISTER**

EHRMANN USA, LLC (DELAWARE LIMITED LIABILITY COMPANY)  
SUITE 300  
515 PARK PLACE CIRCLE  
MISHAWAKA, IN 46545

FOR: DAIRY PRODUCTS, NAMELY, YOGURT, YOGURT WITH FRUIT, IN CLASS 29 (U.S. CL. 46).

FIRST USE 8-19-2011; IN COMMERCE 8-19-2011.

THE MARK CONSISTS OF STANDARD CHARACTERS WITHOUT CLAIM TO ANY PARTICULAR FONT, STYLE, SIZE, OR COLOR.

NO CLAIM IS MADE TO THE EXCLUSIVE RIGHT TO USE "YOGURT", APART FROM THE MARK AS SHOWN.

SER. NO. 85-386,325, FILED P.R. 8-1-2011; AM. S.R. 2-6-2012.

SHAILA SETTLES, EXAMINING ATTORNEY



*David J. Kyffers*

Director of the United States Patent and Trademark Office

# United States of America

United States Patent and Trademark Office

# Blunt

**Reg. No. 4,127,140**

**Registered Apr. 10, 2012**

**Int. Cl.: 26**

**TRADEMARK**

**SUPPLEMENTAL REGISTER**

SIGNATURE NEEDLE ARTS LLC (WISCONSIN LIMITED LIABILITY COMPANY)  
6901 46TH STREET  
KENOSHA, WI 53144

FOR: KNITTING NEEDLES, IN CLASS 26 (U.S. CLS. 37, 39, 40, 42 AND 50).

FIRST USE 4-1-2006; IN COMMERCE 6-18-2007.

THE MARK CONSISTS OF STANDARD CHARACTERS WITHOUT CLAIM TO ANY PARTICULAR FONT, STYLE, SIZE, OR COLOR.

SER. NO. 85-387,966, FILED P.R. 8-3-2011; AM. S.R. 2-14-2012.

KIMBERLY PERRY, EXAMINING ATTORNEY



*David J. Kybas*

Director of the United States Patent and Trademark Office

# United States of America

United States Patent and Trademark Office

## NEW ENGLAND CENTER FOR CHRONIC PAIN

**Reg. No. 4,127,141**

RIVERSIDE MEDICAL, LLC (CONNECTICUT LIMITED LIABILITY COMPANY)  
1081 EAST PUTNAM AVE.

**Registered Apr. 10, 2012**

RIVERSIDE, CT 06878

**Int. Cl.: 35**

FOR: BUSINESS MANAGEMENT FOR THOSE THAT PROVIDE PAIN MANAGEMENT AND TREATMENT SERVICES, IN CLASS 35 (U.S. CLS. 100, 101 AND 102).

**SERVICE MARK**

FIRST USE 10-15-2011; IN COMMERCE 10-15-2011.

**SUPPLEMENTAL REGISTER**

THE MARK CONSISTS OF STANDARD CHARACTERS WITHOUT CLAIM TO ANY PARTICULAR FONT, STYLE, SIZE, OR COLOR.

NO CLAIM IS MADE TO THE EXCLUSIVE RIGHT TO USE "CENTER", APART FROM THE MARK AS SHOWN.

SER. NO. 85-388,205, FILED P.R. 8-3-2011; AM. S.R. 2-16-2012.

DAVID COLLIER, EXAMINING ATTORNEY



*David J. Kyros*

Director of the United States Patent and Trademark Office

# United States of America

United States Patent and Trademark Office

## MAINTENANCE PERFORMANCE INDEX

**Reg. No. 4,127,142**

**Registered Apr. 10, 2012**

**Int. Cl.: 41**

**SERVICE MARK**

**SUPPLEMENTAL REGISTER**

EPAC SOFTWARE TECHNOLOGIES, INC. (RHODE ISLAND CORPORATION)  
SUITE 316  
42 LADD ST.  
EAST GREENWICH, RI 02818

FOR: EDUCATION SERVICES, NAMELY, PROVIDING SEMINARS AND TRAINING IN THE USE AND OPERATION OF SOFTWARE IN THE FIELDS OF COMPUTERIZED MAINTENANCE OPERATIONS AND PERFORMANCE MANAGEMENT, IN CLASS 41 (U.S. CLS. 100, 101 AND 107).

FIRST USE 9-19-2011; IN COMMERCE 9-19-2011.

THE MARK CONSISTS OF STANDARD CHARACTERS WITHOUT CLAIM TO ANY PARTICULAR FONT, STYLE, SIZE, OR COLOR.

SER. NO. 85-390,542, FILED P.R. 8-5-2011; AM. S.R. 12-8-2011.

WILLIAM JACKSON, EXAMINING ATTORNEY



*David J. Kyfos*

Director of the United States Patent and Trademark Office

# United States of America

United States Patent and Trademark Office

# LOGO LAMP

**Reg. No. 4,127,143**

GIBLIN BRIAN G (UNITED STATES INDIVIDUAL)  
P.O. BOX 1962  
COTUIT, MA 02635

**Registered Apr. 10, 2012**

**Int. Cl.: 11**

FOR: TABLE AND FLOOR LAMPS THAT DISPLAY IMAGES OF LOGOS, PICTURES AND GEOGRAPHICAL LOCATIONS, IN CLASS 11 (U.S. CLS. 13, 21, 23, 31 AND 34).

**TRADEMARK**

FIRST USE 8-1-2011; IN COMMERCE 8-1-2011.

**SUPPLEMENTAL REGISTER**

THE MARK CONSISTS OF STANDARD CHARACTERS WITHOUT CLAIM TO ANY PARTICULAR FONT, STYLE, SIZE, OR COLOR.

NO CLAIM IS MADE TO THE EXCLUSIVE RIGHT TO USE "LAMP", APART FROM THE MARK AS SHOWN.

SER. NO. 85-390,822, FILED P.R. 8-5-2011; AM. S.R. 2-13-2012.

JILL PRATER, EXAMINING ATTORNEY



*David J. Kybas*

Director of the United States Patent and Trademark Office

# United States of America

United States Patent and Trademark Office

# PRICE LOCK

**Reg. No. 4,127,144**

COLUMBIA INSURANCE COMPANY (NEBRASKA CORPORATION)  
3024 HARNEY STREET  
OMAHA, NE 68131

**Registered Apr. 10, 2012**

**Int. Cl.: 35**

FOR: ONLINE RETAIL STORE SERVICES FEATURING JEWELRY IN WHICH CUSTOMERS ARE ALLOWED TO PURCHASE GOODS ON A LAYAWAY BASIS, IN CLASS 35 (U.S. CLS. 100, 101 AND 102).

**SERVICE MARK**

FIRST USE 7-25-2011; IN COMMERCE 7-25-2011.

**SUPPLEMENTAL REGISTER**

THE MARK CONSISTS OF STANDARD CHARACTERS WITHOUT CLAIM TO ANY PARTICULAR FONT, STYLE, SIZE, OR COLOR.

SER. NO. 85-392,536, FILED P.R. 8-8-2011; AM. S.R. 9-6-2011.

LAKEISHA LEWIS, EXAMINING ATTORNEY



*David J. Kyffers*

Director of the United States Patent and Trademark Office



# United States of America

United States Patent and Trademark Office

## THE JINGLE PLAYER

**Reg. No. 4,127,145**

JINGLE PUNKS MUSIC, LLC (DELAWARE LIMITED LIABILITY COMPANY)  
20 WEST 22ND STREET, SUITE 905  
NEW YORK, NY 10010

**Registered Apr. 10, 2012**

**Int. Cls.: 35, 41, and 42**

FOR: COMMERCIAL ADMINISTRATION OF THE LICENSING OF THE MUSIC OF OTHERS,  
IN CLASS 35 (U.S. CLS. 100, 101 AND 102).

**SERVICE MARK**

FIRST USE 10-31-2008; IN COMMERCE 10-31-2008.

**SUPPLEMENTAL REGISTER**

FOR: PROVIDING AN ONLINE COMPUTER DATABASE IN THE FIELDS OF MUSIC AND  
ENTERTAINMENT FEATURING ALGORITHMS FOR MUSIC-BASED AND NON-MUSIC-  
BASED SEARCH FUNCTIONS, IN CLASS 41 (U.S. CLS. 100, 101 AND 107).

FIRST USE 10-31-2008; IN COMMERCE 10-31-2008.

FOR: PROVIDING A SEARCH ENGINE FOR OBTAINING DATA ON A GLOBAL COMPUTER  
NETWORK IN THE FIELDS OF MUSIC AND ENTERTAINMENT FEATURING ALGORITHMS  
FOR MUSIC-BASED AND NON-MUSIC-BASED SEARCH FUNCTIONS , IN CLASS 42 (U.S.  
CLS. 100 AND 101).

FIRST USE 10-31-2008; IN COMMERCE 10-31-2008.

THE MARK CONSISTS OF STANDARD CHARACTERS WITHOUT CLAIM TO ANY PAR-  
TICULAR FONT, STYLE, SIZE, OR COLOR.

SER. NO. 85-393,020, FILED P.R. 8-9-2011; AM. S.R. 1-23-2012.

HEATHER BIDDULPH, EXAMINING ATTORNEY



*David J. Kybas*

Director of the United States Patent and Trademark Office

# United States of America

United States Patent and Trademark Office

## STUDY JUICE

**Reg. No. 4,127,146**

**Registered Apr. 10, 2012**

**Int. Cl.: 5**

**TRADEMARK**

**SUPPLEMENTAL REGISTER**

BRAIN FORZA DIETARY SUPPLEMENTS LLC (WASHINGTON LIMITED LIABILITY COMPANY)  
936 PEACE PORTAL DRIVE  
BLAINE, WA 98230

FOR: DIETARY SUPPLEMENTS; NUTRITIONAL SUPPLEMENTS, IN CLASS 5 (U.S. CLS. 6, 18, 44, 46, 51 AND 52).

FIRST USE 7-15-2011; IN COMMERCE 7-15-2011.

THE MARK CONSISTS OF STANDARD CHARACTERS WITHOUT CLAIM TO ANY PARTICULAR FONT, STYLE, SIZE, OR COLOR.

NO CLAIM IS MADE TO THE EXCLUSIVE RIGHT TO USE "JUICE", APART FROM THE MARK AS SHOWN.

SER. NO. 85-398,606, FILED P.R. 8-16-2011; AM. S.R. 2-6-2012.

NICHOLAS ALTREE, EXAMINING ATTORNEY



*David J. Kyffers*

Director of the United States Patent and Trademark Office

# United States of America

United States Patent and Trademark Office

## PODHALANIN

**Reg. No. 4,127,147**

POLISH HIGHLANDERS ALLIANCE IN AMERICA (ILLINOIS NON-PROFIT CORPORATION)  
4808 SOUTH ARCHER AVENUE  
CHICAGO, IL 60632

**Registered Apr. 10, 2012**

**Int. Cl.: 16**

FOR: PRINTED PERIODICALS IN THE FIELD OF MAGAZINES FEATURING ARTICLES ABOUT CURRENT EVENTS AND ACTIVITIES OF POLISH HIGHLANDERS, THE PODHALA REGION OF POLAND, AND POLISH CULTURE, IN CLASS 16 (U.S. CLS. 2, 5, 22, 23, 29, 37, 38 AND 50).

**TRADEMARK**

**SUPPLEMENTAL REGISTER** FIRST USE 10-0-2005; IN COMMERCE 10-0-2005.

THE MARK CONSISTS OF STANDARD CHARACTERS WITHOUT CLAIM TO ANY PARTICULAR FONT, STYLE, SIZE, OR COLOR.

THE ENGLISH TRANSLATION OF "PODHALANIN" IN THE MARK IS "HIGHLANDER".

SER. NO. 85-399,218, FILED P.R. 8-16-2011; AM. S.R. 2-21-2012.

MARC LEIPZIG, EXAMINING ATTORNEY



*David J. Kypos*

Director of the United States Patent and Trademark Office

# United States of America

United States Patent and Trademark Office

## STRONG HEALTHY BONES & TEETH

**Reg. No. 4,127,148**

**Registered Apr. 10, 2012**

**Int. Cl.: 5**

**TRADEMARK**

**SUPPLEMENTAL REGISTER**

PRIMARY INVESTMENTS GROUP LIMITED (BR. VIRGIN ISLANDS CORPORATION)  
C/O TRUSTNET CHAMBERS  
P. O. BOX 3444  
ROAD TOWN, TORTOLA, BR. VIRGIN ISLANDS

FOR: DIETARY SUPPLEMENTS; FOOD SUPPLEMENTS; HERBAL SUPPLEMENTS; NUTRITIONAL SUPPLEMENTS; VITAMIN SUPPLEMENTS; MINERAL SUPPLEMENTS; MULTI-VITAMIN AND MINERAL SUPPLEMENTS, IN CLASS 5 (U.S. CLS. 6, 18, 44, 46, 51 AND 52).

FIRST USE 9-30-2011; IN COMMERCE 9-30-2011.

THE MARK CONSISTS OF STANDARD CHARACTERS WITHOUT CLAIM TO ANY PARTICULAR FONT, STYLE, SIZE, OR COLOR.

SER. NO. 85-400,378, FILED P.R. 8-17-2011; AM. S.R. 2-17-2012.

JEFFERY COWARD, EXAMINING ATTORNEY



*David J. Kyfos*

Director of the United States Patent and Trademark Office

# United States of America

United States Patent and Trademark Office

## BLUEBERRY DETOX

**Reg. No. 4,127,149**

**Registered Apr. 10, 2012**

**Int. Cl.: 5**

**TRADEMARK**

**SUPPLEMENTAL REGISTER**

WATER PURE INC. (NEW YORK CORPORATION), DBA PURITY PRODUCTS,  
200 TERMINAL DRIVE  
PLAINVIEW, NY 11083

FOR: DIETARY AND NUTRITIONAL SUPPLEMENTS CONTAINING BLUEBERRIES; DIETARY FOOD SUPPLEMENTS CONTAINING BLUEBERRIES; DIETARY SUPPLEMENTS CONTAINING BLUEBERRIES, IN CLASS 5 (U.S. CLS. 6, 18, 44, 46, 51 AND 52).

FIRST USE 7-9-2011; IN COMMERCE 7-9-2011.

THE MARK CONSISTS OF STANDARD CHARACTERS WITHOUT CLAIM TO ANY PARTICULAR FONT, STYLE, SIZE, OR COLOR.

SER. NO. 85-401,360, FILED P.R. 8-18-2011; AM. S.R. 2-21-2012.

JAMES STEIN, EXAMINING ATTORNEY



*David J. Kybas*

Director of the United States Patent and Trademark Office

# United States of America

United States Patent and Trademark Office

## PATRIOTIC PRODUCTS

**Reg. No. 4,127,150**

**Registered Apr. 10, 2012**

**Int. Cl.: 35**

**SERVICE MARK**

**SUPPLEMENTAL REGISTER**

SUPPORT OUR TROOPS FOUNDATION, INC. (FLORIDA CORPORATION)  
P. O. BOX 30  
DAYTONA BEACH, FL 321150030

FOR: ADVERTISING SERVICES, NAMELY, PROMOTING AND MARKETING THE GOODS AND SERVICES OF OTHERS THROUGH ALL PUBLIC COMMUNICATION MEANS, IN CLASS 35 (U.S. CLS. 100, 101 AND 102).

FIRST USE 5-15-2010; IN COMMERCE 5-15-2010.

THE MARK CONSISTS OF STANDARD CHARACTERS WITHOUT CLAIM TO ANY PARTICULAR FONT, STYLE, SIZE, OR COLOR.

NO CLAIM IS MADE TO THE EXCLUSIVE RIGHT TO USE "PRODUCTS", APART FROM THE MARK AS SHOWN.

SER. NO. 85-403,166, FILED P.R. 8-21-2011; AM. S.R. 2-8-2012.

HELENE LIWINSKI, EXAMINING ATTORNEY



*David J. Kybas*

Director of the United States Patent and Trademark Office

# United States of America

United States Patent and Trademark Office

# VAN LEER

**Reg. No. 4,127,151**

**Registered Apr. 10, 2012**

**Int. Cls.: 6 and 20**

**TRADEMARK**

**SUPPLEMENTAL REGISTER**

GREIF INTERNATIONAL HOLDING B.V. (NETHERLANDS BESLOTEN VENNOOTSCHAP  
(B.V.))  
BERGSEWEG 6  
3633 AK VREELAND, NETHERLANDS

FOR: PACKAGING CONTAINERS OF METAL, NAMELY, SHIPPING CONTAINERS, BARRELS, KEGS AND DRUMS MADE OF METAL, IN CLASS 6 (U.S. CLS. 2, 12, 13, 14, 23, 25 AND 50).

FOR: PACKAGING CONTAINERS NOT OF METAL, NAMELY, SHIPPING CONTAINERS, BARRELS, KEGS AND DRUMS MADE OF PLASTIC, IN CLASS 20 (U.S. CLS. 2, 13, 22, 25, 32 AND 50).

THE MARK CONSISTS OF STANDARD CHARACTERS WITHOUT CLAIM TO ANY PARTICULAR FONT, STYLE, SIZE, OR COLOR.

OWNER OF ERPN CMNTY TM OFC REG. NO. 005779608, DATED 2-12-2008, EXPIRES 3-22-2017.

SER. NO. 85-403,535, FILED P.R. 8-22-2011; AM. S.R. 1-12-2012.

MARIA-VICTORIA SUAREZ, EXAMINING ATTORNEY



*David J. Kyffers*

Director of the United States Patent and Trademark Office

# United States of America

United States Patent and Trademark Office

## CLASSIC COLLECTION

**Reg. No. 4,127,152**

**Registered Apr. 10, 2012**

**Int. Cl.: 3**

**TRADEMARK**

**SUPPLEMENTAL REGISTER**

AST DISTRIBUTORS, INC (CALIFORNIA CORPORATION), DBA 21ST CENTURY  
PERFUMES,  
757 S LOS ANGELES ST STE 401  
LOS ANGELES, CA 90014

FOR: PERFUMES; COLOGNES; OILS FOR PERFUMES AND SCENTS, IN CLASS 3 (U.S.  
CLS. 1, 4, 6, 50, 51 AND 52).

FIRST USE 1-10-2011; IN COMMERCE 3-1-2011.

THE MARK CONSISTS OF STANDARD CHARACTERS WITHOUT CLAIM TO ANY PAR-  
TICULAR FONT, STYLE, SIZE, OR COLOR.

NO CLAIM IS MADE TO THE EXCLUSIVE RIGHT TO USE "COLLECTION", APART FROM  
THE MARK AS SHOWN.

SER. NO. 85-404,103, FILED P.R. 8-22-2011; AM. S.R. 1-11-2012.

DOMINICK J. SALEMI, EXAMINING ATTORNEY



*David J. Kybas*

Director of the United States Patent and Trademark Office



# United States of America

United States Patent and Trademark Office

## Contract Diagnostics Organization

**Reg. No. 4,127,153**

RESEARCHDX (CALIFORNIA LIMITED LIABILITY COMPANY)  
13766 ALTON PARKWAY, SUITE 147  
IRVINE, CA 92618

**Registered Apr. 10, 2012**

**Int. Cl.: 42**

FOR: MEDICAL AND SCIENTIFIC RESEARCH, NAMELY, DESIGNING AND CONDUCTING CLINICAL TRIALS; MEDICAL AND SCIENTIFIC LABORATORY SERVICES; PHARMACEUTICAL AND RELATED MEDICAL DIAGNOSTIC PRODUCT RESEARCH AND DEVELOPMENT; CONSULTING SERVICES IN THE FIELDS OF MEDICAL AND SCIENTIFIC CLINICAL TRIALS, MEDICAL AND SCIENTIFIC LABORATORIES, AND RESEARCH AND DEVELOPMENT OF DEVELOPING DIAGNOSTIC PRODUCTS TO ACCOMPANY PHARMACEUTICALS, IN CLASS 42 (U.S. CLS. 100 AND 101).

**SERVICE MARK**

**SUPPLEMENTAL REGISTER**

FIRST USE 2-22-2011; IN COMMERCE 2-22-2011.

THE MARK CONSISTS OF STANDARD CHARACTERS WITHOUT CLAIM TO ANY PARTICULAR FONT, STYLE, SIZE, OR COLOR.

NO CLAIM IS MADE TO THE EXCLUSIVE RIGHT TO USE "DIAGNOSTICS", APART FROM THE MARK AS SHOWN.

SER. NO. 85-404,260, FILED P.R. 8-22-2011; AM. S.R. 3-3-2012.

JILL C. ALT, EXAMINING ATTORNEY



*David J. Kyfos*

Director of the United States Patent and Trademark Office

# United States of America

United States Patent and Trademark Office

## MANGA FOR THE BEGINNER

**Reg. No. 4,127,154**

STAR FIRE, LLC (CONNECTICUT LIMITED LIABILITY COMPANY)  
5 BRIGHTFIELD LANE  
WESTPORT, CT 06880

**Registered Apr. 10, 2012**

**Int. Cl.: 16**

FOR: A SERIES OF BOOKS WITH INSTRUCTIONS ON HOW TO CREATE CERTAIN TYPES OF DRAWINGS, IN CLASS 16 (U.S. CLS. 2, 5, 22, 23, 29, 37, 38 AND 50).

**TRADEMARK**

FIRST USE 8-5-2008; IN COMMERCE 8-5-2008.

**SUPPLEMENTAL REGISTER**

THE MARK CONSISTS OF STANDARD CHARACTERS WITHOUT CLAIM TO ANY PARTICULAR FONT, STYLE, SIZE, OR COLOR.

SER. NO. 85-407,222, FILED P.R. 8-25-2011; AM. S.R. 2-15-2012.

INGA ERVIN, EXAMINING ATTORNEY



*David J. Kybas*

Director of the United States Patent and Trademark Office

# United States of America

United States Patent and Trademark Office

## MOTHER'S DAY EVE

**Reg. No. 4,127,155**

MAMALODE, LLC (MONTANA LIMITED LIABILITY COMPANY)  
1107 DICKINSON ST.

**Registered Apr. 10, 2012**

MISSOULA, MT 59802

**Int. Cl.: 41**

FOR: ENTERTAINMENT SERVICES, NAMELY, ORGANIZING AND PROVIDING SPECIAL PARTY EVENTS HONORING MOTHERS, IN CLASS 41 (U.S. CLS. 100, 101 AND 107).

**SERVICE MARK**

FIRST USE 5-10-2003; IN COMMERCE 5-10-2003.

**SUPPLEMENTAL REGISTER**

THE MARK CONSISTS OF STANDARD CHARACTERS WITHOUT CLAIM TO ANY PARTICULAR FONT, STYLE, SIZE, OR COLOR.

SER. NO. 85-409,406, FILED P.R. 8-29-2011; AM. S.R. 2-13-2012.

HOWARD B. LEVINE, EXAMINING ATTORNEY



*David J. Kyffers*

Director of the United States Patent and Trademark Office

# United States of America

United States Patent and Trademark Office

## EAT SLEEP WORKOUT LIKE AN ANIMAL

**Reg. No. 4,127,156**

EAT SLEEP WORKOUT LIKE AN ANIMAL (CALIFORNIA SOLE PROPRIETORSHIP)  
1556 THOMAS AVE, APT. 7  
SAN DIEGO, CA 92109

**Registered Apr. 10, 2012**

**Int. Cl.: 25**

FOR: GYM PANTS; GYM SHORTS; HOODED SWEATSHIRTS; PANTS; SHORT-SLEEVED OR LONG-SLEEVED T-SHIRTS; SHORTS; SWEATERS; SWEATSHIRTS; T-SHIRTS; TANK TOPS , IN CLASS 25 (U.S. CLS. 22 AND 39).

**TRADEMARK**

FIRST USE 7-1-2011; IN COMMERCE 7-1-2011.

**SUPPLEMENTAL REGISTER**

THE MARK CONSISTS OF STANDARD CHARACTERS WITHOUT CLAIM TO ANY PARTICULAR FONT, STYLE, SIZE, OR COLOR.

SER. NO. 85-410,501, FILED P.R. 8-30-2011; AM. S.R. 2-17-2012.

LINDA M. KING, EXAMINING ATTORNEY



*David J. Kybas*

Director of the United States Patent and Trademark Office

# United States of America

United States Patent and Trademark Office

# Note Binder

**Reg. No. 4,127,157**

**Registered Apr. 10, 2012**

**Int. Cl.: 9**

**TRADEMARK**

**SUPPLEMENTAL REGISTER**

PEN VENTURES, LLC (IOWA LIMITED LIABILITY COMPANY)  
24595 215TH ST  
CARROLL, IA 51401

FOR: COMPUTER SOFTWARE FOR ORGANIZING AND VIEWING DIGITAL IMAGES, DOCUMENTS AND PHOTOGRAPHS; COMPUTER SOFTWARE FOR USE IN NOTE TAKING AND CREATING DIGITAL DRAWINGS; COMPUTER SOFTWARE FOR USE IN DIGITAL IMAGE MANIPULATION AND CREATION OF AUDIO RECORDINGS; COMPUTER SOFTWARE FOR TYPING, NAMELY, SOFTWARE WHICH PRESENTS AN ONSCREEN VIRTUAL KEYBOARD FOR PURPOSES OF ENTERING INFORMATION INTO A COMPUTER DEVICE, IN CLASS 9 (U.S. CLS. 21, 23, 26, 36 AND 38).

FIRST USE 12-4-2011; IN COMMERCE 12-4-2011.

THE MARK CONSISTS OF STANDARD CHARACTERS WITHOUT CLAIM TO ANY PARTICULAR FONT, STYLE, SIZE, OR COLOR.

NO CLAIM IS MADE TO THE EXCLUSIVE RIGHT TO USE "NOTE" , APART FROM THE MARK AS SHOWN.

SER. NO. 85-410,795, FILED P.R. 8-30-2011; AM. S.R. 2-9-2012.

STEVEN PEREZ, EXAMINING ATTORNEY



*David J. Kyffers*

Director of the United States Patent and Trademark Office

# United States of America

United States Patent and Trademark Office

## Sparkling

O<sup>Berry</sup><sub>2</sub>

**Reg. No. 4,127,158**

**Registered Apr. 10, 2012**

**Int. Cl.: 32**

PAK, VICTOR (UNITED STATES INDIVIDUAL)  
SUITE 108  
9900 BELL RANCH DRIVE  
SANTA FE SPRINGS, CA 90670

FOR: SOFT DRINKS, IN CLASS 32 (U.S. CLS. 45, 46 AND 48).

**TRADEMARK**

FIRST USE 7-16-2011; IN COMMERCE 7-16-2011.

**SUPPLEMENTAL REGISTER**

THE MARK CONSISTS OF THE TEXT "SPARKLING" AT THE TOP, THE THREE DIMENSIONAL LETTER "O" BELOW WITH A SMALL STALK AT THE BEGINNING, CURLED TAIL AT THE END OF THE LETTER, NOT COMPLETELY CLOSED, THE THREE DIMENSIONAL NUMERIC NUMBER "2" WITH CURLED IN THE BEGINNING AND AT THE END OF THE NUMBER, AND THE THREE DIMENSIONAL LETTERS "BERRY" ABOVE THE AND TO THE RIGHT OF THE TEXT "O2".

SER. NO. 85-410,821, FILED P.R. 8-30-2011; AM. S.R. 1-9-2012.

NORA BUCHANAN WILL, EXAMINING ATTORNEY



*David J. Kybas*

Director of the United States Patent and Trademark Office

# United States of America

United States Patent and Trademark Office

## Beauties of the Nation

**Reg. No. 4,127,159**

SARAH AHMADINIA (UNITED STATES INDIVIDUAL)  
12421 CHRISTY LANE

**Registered Apr. 10, 2012**

LOS ALAMITOS, CA 90720

**Int. Cl.: 41**

FOR: ENTERTAINMENT IN THE NATURE OF BEAUTY PAGEANTS, IN CLASS 41 (U.S. CLS. 100, 101 AND 107).

**SERVICE MARK**

FIRST USE 8-6-2011; IN COMMERCE 8-7-2011.

**SUPPLEMENTAL REGISTER**

THE MARK CONSISTS OF STANDARD CHARACTERS WITHOUT CLAIM TO ANY PARTICULAR FONT, STYLE, SIZE, OR COLOR.

SER. NO. 85-412,918, FILED P.R. 9-1-2011; AM. S.R. 2-15-2012.

ESTHER BELENKER, EXAMINING ATTORNEY



*David J. Kybas*

Director of the United States Patent and Trademark Office

# United States of America

United States Patent and Trademark Office

## No Pits Racing

**Reg. No. 4,127,160**

LAYCO, LLC. (COLORADO LIMITED LIABILITY COMPANY)

**Registered Apr. 10, 2012**

P.O. BOX 4553  
EAGLE, CO 81631

**Int. Cl.: 41**

FOR: ENTERTAINMENT SERVICES IN THE NATURE OF A TELEVISION SERIES FEATURING MOTORSPORTS RACING ; PROVIDING ON-LINE INFORMATION IN THE FIELD OF MOTORSPORTS RACING VIA THE INTERNET , IN CLASS 41 (U.S. CLS. 100, 101 AND 107).

**SERVICE MARK**

**SUPPLEMENTAL REGISTER** FIRST USE 6-1-2010; IN COMMERCE 1-1-2011.

THE MARK CONSISTS OF STANDARD CHARACTERS WITHOUT CLAIM TO ANY PARTICULAR FONT, STYLE, SIZE, OR COLOR.

NO CLAIM IS MADE TO THE EXCLUSIVE RIGHT TO USE "RACING", APART FROM THE MARK AS SHOWN.

SER. NO. 85-413,975, FILED P.R. 9-2-2011; AM. S.R. 2-14-2012.

RONALD AIKENS, EXAMINING ATTORNEY



*David J. Kyfos*

Director of the United States Patent and Trademark Office



# United States of America

United States Patent and Trademark Office

## COMFORT TOP

**Reg. No. 4,127,161**

NASH MANUFACTURING, INC. (TEXAS CORPORATION)  
315 W. RIPPY STREET  
FORT WORTH, TX 76110

**Registered Apr. 10, 2012**

**Int. Cl.: 28**

FOR: INFLATABLE INNER TUBES FOR AQUATIC RECREATIONAL USE; INFLATABLE RIDE-ON TOYS, IN CLASS 28 (U.S. CLS. 22, 23, 38 AND 50).

**TRADEMARK**

FIRST USE 7-1-2011; IN COMMERCE 7-1-2011.

**SUPPLEMENTAL REGISTER**

THE MARK CONSISTS OF STANDARD CHARACTERS WITHOUT CLAIM TO ANY PARTICULAR FONT, STYLE, SIZE, OR COLOR.

SER. NO. 85-416,688, FILED P.R. 9-7-2011; AM. S.R. 1-19-2012.

NATALIE POLZER, EXAMINING ATTORNEY



*David J. Kybas*

Director of the United States Patent and Trademark Office

# United States of America

United States Patent and Trademark Office

## MedImage Cases

**Reg. No. 4,127,162**

PROJECTS IN KNOWLEDGE, INC. (NEW YORK CORPORATION)  
150 CLOVE ROAD  
LITTLE FALLS, NJ 07424

**Registered Apr. 10, 2012**

**Int. Cls.: 9 and 41**

FOR: PROVIDING DOWNLOADABLE POINT-OF-CARE ELECTRONIC MEDICAL RESOURCES, NAMELY, EDUCATIONAL ETEXTBOOKS FEATURING A COMPILATION OF PATIENT CASES THAT EXPLORES THE COMPLEXITIES OF VARIOUS MODALITIES USED TO DIAGNOSE AND MONITOR A VARIETY OF DISEASES, IN CLASS 9 (U.S. CLS. 21, 23, 26, 36 AND 38).

**TRADEMARK**

**SERVICE MARK**

FIRST USE 6-24-2011; IN COMMERCE 6-24-2011.

**SUPPLEMENTAL REGISTER**

FOR: PROVIDING NON-DOWNLOADABLE POINT-OF-CARE ELECTRONIC MEDICAL RESOURCES, NAMELY, EDUCATIONAL ETEXTBOOKS FEATURING A COMPILATION OF PATIENT CASES THAT EXPLORES THE COMPLEXITIES OF VARIOUS MODALITIES USED TO DIAGNOSE AND MONITOR A VARIETY OF DISEASES, IN CLASS 41 (U.S. CLS. 100, 101 AND 107).

FIRST USE 6-24-2011; IN COMMERCE 6-24-2011.

THE MARK CONSISTS OF STANDARD CHARACTERS WITHOUT CLAIM TO ANY PARTICULAR FONT, STYLE, SIZE, OR COLOR.

NO CLAIM IS MADE TO THE EXCLUSIVE RIGHT TO USE "CASES", APART FROM THE MARK AS SHOWN.

SER. NO. 85-417,506, FILED P.R. 9-8-2011; AM. S.R. 2-14-2012.

JULIE WATSON, EXAMINING ATTORNEY



*David J. Kyros*

Director of the United States Patent and Trademark Office

# United States of America

United States Patent and Trademark Office

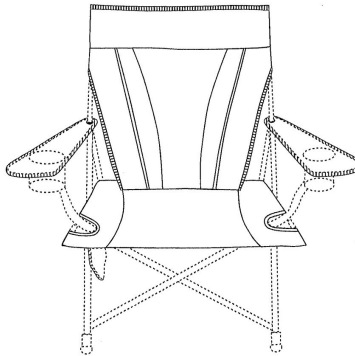

**Reg. No. 4,127,163**

**Registered Apr. 10, 2012**

**Int. Cl.: 20**

DENOVO BRANDS, LLC (ARKANSAS LIMITED LIABILITY COMPANY)  
SUITE 8  
2406 SE COTTONWOOD STREET  
BENTONVILLE, AR 72712

FOR: CHAIRS, IN CLASS 20 (U.S. CLS. 2, 13, 22, 25, 32 AND 50).

**TRADEMARK**

FIRST USE 8-31-2009; IN COMMERCE 8-31-2009.

**SUPPLEMENTAL REGISTER**

THE MARK CONSISTS OF THE ORNAMENTAL SEAT AND SEAT BACK PATTERN ON A FOLDING CHAIR. THE BROKEN LINES DEPICT THE FRAME AND ARMS OF THE CHAIR, WHICH ARE NOT CLAIMED AS A PORTION OF THE MARK.

SER. NO. 85-418,834, FILED P.R. 9-9-2011; AM. S.R. 2-16-2012.

KAREN BRACEY, EXAMINING ATTORNEY



*David J. Kybas*

Director of the United States Patent and Trademark Office

# United States of America

United States Patent and Trademark Office

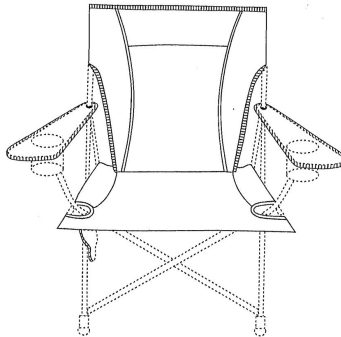

**Reg. No. 4,127,164**

**Registered Apr. 10, 2012**

**Int. Cl.: 20**

DENOVO BRANDS, LLC (ARKANSAS LIMITED LIABILITY COMPANY)  
SUITE 8  
2406 SE COTTONWOOD STREET  
BENTONVILLE, AR 72712

FOR: CHAIRS, IN CLASS 20 (U.S. CLS. 2, 13, 22, 25, 32 AND 50).

**TRADEMARK**

FIRST USE 8-31-2009; IN COMMERCE 8-31-2009.

**SUPPLEMENTAL REGISTER**

THE MARK CONSISTS OF THE ORNAMENTAL SEAT AND SEAT BACK PATTERN ON A FOLDING CHAIR. THE BROKEN LINES DEPICT THE FRAME AND ARMS OF THE CHAIR, WHICH ARE NOT CLAIMED AS A PORTION OF THE MARK.

SER. NO. 85-418,844, FILED P.R. 9-9-2011; AM. S.R. 2-16-2012.

KAREN BRACEY, EXAMINING ATTORNEY



*David J. Kyffers*

Director of the United States Patent and Trademark Office

# United States of America

United States Patent and Trademark Office

## The Leader in Frac Fluids Heating

**Reg. No. 4,127,165**

**Registered Apr. 10, 2012**

**Int. Cl.: 37**

**SERVICE MARK**

**SUPPLEMENTAL REGISTER**

MCADA DRILLING FLUIDS, INC. (TEXAS CORPORATION)  
P.O. BOX 1080  
BAY CITY, TX 77404

FOR: WELL IMPROVEMENT SERVICES, NAMELY, HYDRAULIC FRACTURING OF  
SUBSURFACE GEOLOGIC FORMATIONS TO ENHANCE WELL PRODUCTION, IN CLASS  
37 (U.S. CLS. 100, 103 AND 106).

FIRST USE 11-5-2010; IN COMMERCE 11-5-2010.

THE MARK CONSISTS OF STANDARD CHARACTERS WITHOUT CLAIM TO ANY PAR-  
TICULAR FONT, STYLE, SIZE, OR COLOR.

NO CLAIM IS MADE TO THE EXCLUSIVE RIGHT TO USE "FRAC FLUIDS HEATING",  
APART FROM THE MARK AS SHOWN.

SER. NO. 85-419,702, FILED P.R. 9-11-2011; AM. S.R. 2-13-2012.

GISELLE AGOSTO, EXAMINING ATTORNEY



*David J. Kyffers*

Director of the United States Patent and Trademark Office

# United States of America

United States Patent and Trademark Office

# TECH TOYS

**Reg. No. 4,127,166**

REVERA ENTERTAINMENT INC. (CALIFORNIA CORPORATION)  
1928 COTNER AVE  
LOS ANGELES, CA 90025

**Registered Apr. 10, 2012**

**Int. Cl.: 35**

FOR: PROMOTING THE GOODS AND SERVICES OF OTHERS BY PROVIDING A WEBSITE FEATURING PRODUCT REVIEWS ABOUT CONSUMER ELECTRONICS PRODUCTS; ELECTRONIC CATALOG SERVICES FEATURING CONSUMER ELECTRONICS PRODUCTS; MAIL ORDER CATALOG SERVICES FEATURING CONSUMER ELECTRONICS PRODUCTS; PROVIDING A WEB SITE WHERE USERS CAN POST RATINGS, REVIEWS AND RECOMMENDATIONS ON PRODUCTS AND SERVICES FOR COMMERCIAL PURPOSES, IN CLASS 35 (U.S. CLS. 100, 101 AND 102).

**SERVICE MARK**

**SUPPLEMENTAL REGISTER**

FIRST USE 11-15-2011; IN COMMERCE 11-15-2011.

THE MARK CONSISTS OF STANDARD CHARACTERS WITHOUT CLAIM TO ANY PARTICULAR FONT, STYLE, SIZE, OR COLOR.

SER. NO. 85-425,301, FILED P.R. 9-17-2011; AM. S.R. 2-15-2012.

TEJBIR SINGH, EXAMINING ATTORNEY



*David J. Kyffers*

Director of the United States Patent and Trademark Office

# United States of America

United States Patent and Trademark Office

## MAXIMUM DIVERSIFICATION

**Reg. No. 4,127,167**

TOBAM (FRANCE SOCIÉTÉ PAR ACTIONS SIMPLIFIÉE (SAS))  
20 RUE QUENTIN BAUCHART  
PARIS, FRANCE F-75008

**Registered Apr. 10, 2012**

**Int. Cl.: 35**

FOR: COMPILING FINANCIAL INDEX VALUE INFORMATION FOR BUSINESS PURPOSES;  
PROVIDING FINANCIAL INDICES BASED IN SELECTED GROUP OF SECURITIES , IN  
CLASS 35 (U.S. CLS. 100, 101 AND 102).

**SERVICE MARK**

THE MARK CONSISTS OF STANDARD CHARACTERS WITHOUT CLAIM TO ANY PAR-  
TICULAR FONT, STYLE, SIZE, OR COLOR.

**SUPPLEMENTAL REGISTER**

OWNER OF FRANCE REG. NO. 3652090, DATED 10-30-2009, EXPIRES 5-22-2019.

SER. NO. 85-427,223, FILED 9-20-2011.

MARILYN IZZI, EXAMINING ATTORNEY



*David J. Kyffers*

Director of the United States Patent and Trademark Office

# United States of America

United States Patent and Trademark Office

# SEQMONITOR

**Reg. No. 4,127,168**

ILLUMINA, INC. (DELAWARE CORPORATION)  
5200 ILLUMINA WAY  
SAN DIEGO, CA 92122

**Registered Apr. 10, 2012**

**Int. Cl.: 9**

FOR: COMPUTER APPLICATION SOFTWARE FOR USE ON MOBILE OR NETWORKED COMPUTING DEVICES FOR RECEIVING AND DISPLAYING INFORMATION FROM SCIENTIFIC INSTRUMENTS, IN CLASS 9 (U.S. CLS. 21, 23, 26, 36 AND 38).

**TRADEMARK**

FIRST USE 1-20-2011; IN COMMERCE 1-20-2011.

**SUPPLEMENTAL REGISTER**

THE MARK CONSISTS OF STANDARD CHARACTERS WITHOUT CLAIM TO ANY PARTICULAR FONT, STYLE, SIZE, OR COLOR.

SER. NO. 85-427,565, FILED P.R. 9-20-2011; AM. S.R. 1-26-2012.

LINDA ESTRADA, EXAMINING ATTORNEY



*David J. Kyros*

Director of the United States Patent and Trademark Office



# United States of America

United States Patent and Trademark Office

## Corporate Receivables Program

**Reg. No. 4,127,169**

**Registered Apr. 10, 2012**

**Int. Cl.: 35**

**SERVICE MARK**

**SUPPLEMENTAL REGISTER**

NEW ORLEANS EXCHANGE, INC. (LOUISIANA CORPORATION)  
935 GRAVIER STREET  
935 GRAVIER STREET  
NEW ORLEANS, LA 70112

FOR: CONNECTING BUYERS AND SELLERS OF FINANCIAL ASSETS OF PUBLICLY-TRADED AND LARGE COMPANIES, IN CLASS 35 (U.S. CLS. 100, 101 AND 102).

FIRST USE 9-14-2011; IN COMMERCE 9-14-2011.

THE MARK CONSISTS OF STANDARD CHARACTERS WITHOUT CLAIM TO ANY PARTICULAR FONT, STYLE, SIZE, OR COLOR.

NO CLAIM IS MADE TO THE EXCLUSIVE RIGHT TO USE "RECEIVABLES", APART FROM THE MARK AS SHOWN.

SER. NO. 85-427,829, FILED P.R. 9-21-2011; AM. S.R. 2-10-2012.

SIMON TENG, EXAMINING ATTORNEY



*David J. Kyffers*

Director of the United States Patent and Trademark Office

# United States of America

United States Patent and Trademark Office

## Brand Yourself Online

**Reg. No. 4,127,170**

**Registered Apr. 10, 2012**

**Int. Cl.: 35**

**SERVICE MARK**

**SUPPLEMENTAL REGISTER**

BRANDEGO LLC (FLORIDA LIMITED LIABILITY COMPANY)  
8466 N LOCKWOOD RIDGE ROAD  
#330  
SARASOTA, FL 34243

FOR: BRAND CONCEPT AND BRAND DEVELOPMENT SERVICES FOR CORPORATE AND INDIVIDUAL CLIENTS, IN CLASS 35 (U.S. CLS. 100, 101 AND 102).

FIRST USE 9-26-2009; IN COMMERCE 9-26-2009.

THE MARK CONSISTS OF STANDARD CHARACTERS WITHOUT CLAIM TO ANY PARTICULAR FONT, STYLE, SIZE, OR COLOR.

SER. NO. 85-434,787, FILED P.R. 9-28-2011; AM. S.R. 2-16-2012.

REBECCA SMITH, EXAMINING ATTORNEY



*David J. Kyffers*

Director of the United States Patent and Trademark Office

# United States of America

United States Patent and Trademark Office

## THE PET SHIPPING EXPERTS

**Reg. No. 4,127,171**

**Registered Apr. 10, 2012**

**Int. Cl.: 35**

**SERVICE MARK**

**SUPPLEMENTAL REGISTER**

INTERNATIONAL PET AND ANIMAL TRANSPORTATION ASSOCIATION (TEXAS CORPORATION)  
745 WINDING TRAIL  
HOLLY LAKE RANCH, TX 75765

FOR: ASSOCIATION SERVICES, NAMELY, PROMOTING THE INTERESTS OF PET SHIPPERS AND PROMOTING PROFESSIONAL WORLD-WIDE PET TRANSPORTATION RELOCATION SERVICES, IN CLASS 35 (U.S. CLS. 100, 101 AND 102).

FIRST USE 10-1-2010; IN COMMERCE 10-1-2010.

THE MARK CONSISTS OF STANDARD CHARACTERS WITHOUT CLAIM TO ANY PARTICULAR FONT, STYLE, SIZE, OR COLOR.

NO CLAIM IS MADE TO THE EXCLUSIVE RIGHT TO USE "THE PET SHIPPING", APART FROM THE MARK AS SHOWN.

SER. NO. 85-436,613, FILED P.R. 9-30-2011; AM. S.R. 2-13-2012.

SANDRA BUJA, EXAMINING ATTORNEY



*David J. Kyffers*

Director of the United States Patent and Trademark Office

# United States of America

United States Patent and Trademark Office

## D.A.D.D.A. Dads Against Daughters Doing Anything

**Reg. No. 4,127,172**

LENTINE, CHARLES (UNITED STATES INDIVIDUAL)  
212 ROCKLEDGE AVE  
ROCKLEDGE, PA 19046 AND

**Registered Apr. 10, 2012**

**Int. Cl.: 25**

LENTINE, GWEN (UNITED STATES INDIVIDUAL)  
212 ROCKLEDGE AVE.  
ROCKLEDGE, PA 19046

**TRADEMARK**

**SUPPLEMENTAL REGISTER**

FOR: GOLF SHIRTS; HOODED SWEATSHIRTS; LONG-SLEEVED SHIRTS; SHIRTS; SHORT-SLEEVED OR LONG-SLEEVED T-SHIRTS; SHORT-SLEEVED SHIRTS; SWEAT SHIRTS; T-SHIRTS, IN CLASS 25 (U.S. CLS. 22 AND 39).

FIRST USE 9-30-2011; IN COMMERCE 9-30-2011.

THE MARK CONSISTS OF STANDARD CHARACTERS WITHOUT CLAIM TO ANY PARTICULAR FONT, STYLE, SIZE, OR COLOR.

SER. NO. 85-437,216, FILED P.R. 10-1-2011; AM. S.R. 2-14-2012.

WILLIAM VERHOSEK, EXAMINING ATTORNEY



*David J. Kyfos*

Director of the United States Patent and Trademark Office

# United States of America

United States Patent and Trademark Office

## HEALTHY GREAT PLAINS

**Reg. No. 4,127,173**

HEALTHY NEBRASKA, INC. (NEBRASKA CORPORATION)  
923 TEAL COURT  
NORTH PLATTE, NE 69101

**Registered Apr. 10, 2012**

**Int. Cl.: 44**

FOR: MEDICAL CONSULTATIONS, IN CLASS 44 (U.S. CLS. 100 AND 101).

**SERVICE MARK**

FIRST USE 10-2-2011; IN COMMERCE 10-2-2011.

**SUPPLEMENTAL REGISTER**

THE MARK CONSISTS OF STANDARD CHARACTERS WITHOUT CLAIM TO ANY PARTICULAR FONT, STYLE, SIZE, OR COLOR.

SER. NO. 85-437,453, FILED P.R. 10-3-2011; AM. S.R. 2-1-2012.

CIMMERIAN COLEMAN, EXAMINING ATTORNEY



*David J. Kyfos*

Director of the United States Patent and Trademark Office

# United States of America

United States Patent and Trademark Office

## ExpandED Schools

**Reg. No. 4,127,174**

**Registered Apr. 10, 2012**

**Int. Cl.: 41**

**SERVICE MARK**

**SUPPLEMENTAL REGISTER**

AFTER-SCHOOL CORPORATION, THE (NEW YORK NON-PROFIT CORPORATION)  
1440 BROADWAY  
16TH FLOOR  
NEW YORK, NY 10018

FOR: CONSULTING SERVICES IN THE FIELD OF EDUCATION AND YOUTH DEVELOPMENT; PROVIDING TRAINING TO ORGANIZATIONS FOR THE PROVISION OF EDUCATIONAL, ENRICHMENT AND EXTRA-CURRICULAR PROGRAMS FOR CHILDREN AND TEENS; PROVIDING EDUCATIONAL, TEACHING, TRAINING AND EDUCATION-RELATED EVALUATION INFORMATION TO ORGANIZATIONS FOR THE SUPERVISION, PLANNING AND MANAGEMENT OF PROGRAMS PROVIDING EDUCATIONAL, ENRICHMENT AND EXTRA-CURRICULAR PROGRAMS FOR CHILDREN AND TEENS; PROVIDING ADVISORY SERVICES IN THE FIELD OF EDUCATION, NAMELY, PROFESSIONAL DEVELOPMENT, RESEARCH, ADVOCACY FOR SCHOOLS, COMMUNITY ORGANIZATIONS, AND FOR THE PROVISION OF EDUCATIONAL, ENRICHMENT AND EXTRA-CURRICULAR PROGRAMS FOR CHILDREN AND TEENS, IN CLASS 41 (U.S. CLS. 100, 101 AND 107).

FIRST USE 10-3-2011; IN COMMERCE 10-3-2011.

THE MARK CONSISTS OF STANDARD CHARACTERS WITHOUT CLAIM TO ANY PARTICULAR FONT, STYLE, SIZE, OR COLOR.

NO CLAIM IS MADE TO THE EXCLUSIVE RIGHT TO USE "SCHOOLS", APART FROM THE MARK AS SHOWN.

SER. NO. 85-438,276, FILED P.R. 10-3-2011; AM. S.R. 2-13-2012.

KATINA MISTER, EXAMINING ATTORNEY



*David J. Kyffers*

Director of the United States Patent and Trademark Office

# United States of America

United States Patent and Trademark Office

## ExpandedED School

**Reg. No. 4,127,175**

**Registered Apr. 10, 2012**

**Int. Cl.: 41**

**SERVICE MARK**

**SUPPLEMENTAL REGISTER**

AFTER-SCHOOL CORPORATION, THE (NEW YORK NON-PROFIT CORPORATION)  
1440 BROADWAY  
16TH FLOOR  
NEW YORK, NY 10018

FOR: CONSULTING SERVICES IN THE FIELD OF EDUCATION AND YOUTH DEVELOPMENT; PROVIDING TRAINING TO ORGANIZATIONS FOR THE PROVISION OF EDUCATIONAL, ENRICHMENT AND EXTRA-CURRICULAR PROGRAMS FOR CHILDREN AND TEENS; PROVIDING EDUCATIONAL, TEACHING, TRAINING AND EDUCATION-RELATED EVALUATION INFORMATION TO ORGANIZATIONS FOR THE SUPERVISION, PLANNING AND MANAGEMENT OF PROGRAMS PROVIDING EDUCATIONAL, ENRICHMENT AND EXTRA-CURRICULAR PROGRAMS FOR CHILDREN AND TEENS; PROVIDING ADVISORY SERVICES IN THE FIELD OF EDUCATION, NAMELY, PROFESSIONAL DEVELOPMENT, RESEARCH, ADVOCACY FOR SCHOOLS, COMMUNITY ORGANIZATIONS, AND FOR THE PROVISION OF EDUCATIONAL, ENRICHMENT AND EXTRA-CURRICULAR PROGRAMS FOR CHILDREN AND TEENS, IN CLASS 41 (U.S. CLS. 100, 101 AND 107).

FIRST USE 10-3-2011; IN COMMERCE 10-3-2011.

THE MARK CONSISTS OF STANDARD CHARACTERS WITHOUT CLAIM TO ANY PARTICULAR FONT, STYLE, SIZE, OR COLOR.

NO CLAIM IS MADE TO THE EXCLUSIVE RIGHT TO USE "SCHOOL", APART FROM THE MARK AS SHOWN.

SER. NO. 85-438,277, FILED P.R. 10-3-2011; AM. S.R. 2-13-2012.

KATINA MISTER, EXAMINING ATTORNEY



*David J. Kyffers*

Director of the United States Patent and Trademark Office

# United States of America

United States Patent and Trademark Office

# HEAT 'N EAT

**Reg. No. 4,127,176**

VENTURA FOODS, LLC (DELAWARE LIMITED LIABILITY COMPANY)  
40 POINTE DRIVE  
BREA, CA 92821

**Registered Apr. 10, 2012**

**Int. Cl.: 29**

FOR: DIPS, IN CLASS 29 (U.S. CL. 46).

**TRADEMARK**

FIRST USE 9-27-2011; IN COMMERCE 9-27-2011.

**SUPPLEMENTAL REGISTER**

THE MARK CONSISTS OF STANDARD CHARACTERS WITHOUT CLAIM TO ANY PARTICULAR FONT, STYLE, SIZE, OR COLOR.

SER. NO. 85-440,077, FILED P.R. 10-5-2011; AM. S.R. 2-10-2012.

TEJBIR SINGH, EXAMINING ATTORNEY



*David J. Kyffers*

Director of the United States Patent and Trademark Office



# United States of America

United States Patent and Trademark Office

## Mobile Emergency Response Center

**Reg. No. 4,127,177**

**Registered Apr. 10, 2012**

**Int. Cl.: 38**

**SERVICE MARK**

**SUPPLEMENTAL REGISTER**

COMPREHENSIVE COMMUNICATION SERVICES, LLC (TEXAS LIMITED LIABILITY COMPANY)  
507 MEADOWLARK PLACE  
HEATH, TX 75032

FOR: PROVIDING INFORMATION TRANSMISSION VIA MOBILE ELECTRONIC COMMUNICATION NETWORKS FOR EMERGENCY AND DISASTER RELIEF OPERATIONS, IN CLASS 38 (U.S. CLS. 100, 101 AND 104).

FIRST USE 1-22-2007; IN COMMERCE 9-26-2008.

THE MARK CONSISTS OF STANDARD CHARACTERS WITHOUT CLAIM TO ANY PARTICULAR FONT, STYLE, SIZE, OR COLOR.

SER. NO. 85-442,522, FILED P.R. 10-7-2011; AM. S.R. 2-14-2012.

ESTHER A. BORSUK, EXAMINING ATTORNEY



*David J. Kybas*

Director of the United States Patent and Trademark Office

# United States of America

United States Patent and Trademark Office

## Super Bump Relief

**Reg. No. 4,127,178**

UBU/ELEMENTS, INC. (PENNSYLVANIA CORPORATION)

**Registered Apr. 10, 2012**

900 RUTTER AVE  
FORTY FORT, PA 18704

**Int. Cl.: 3**

FOR: AFTER-SHAVE LOTIONS; AFTERSHAVE PREPARATIONS; NON-MEDICATED SKIN CARE LOTIONS FOR RELIEF OF IRRITATION ASSOCIATED WITH SHAVING, INCLUDING BUMPS AND BURNS; MOISTURIZING SOLUTIONS FOR THE SKIN; NON-MEDICATED SKIN CARE PREPARATIONS; SHAVING LOTION; SHAVING PREPARATIONS, IN CLASS 3 (U.S. CLS. 1, 4, 6, 50, 51 AND 52).

**TRADEMARK**

**SUPPLEMENTAL REGISTER**

FIRST USE 1-15-2005; IN COMMERCE 5-8-2006.

THE MARK CONSISTS OF STANDARD CHARACTERS WITHOUT CLAIM TO ANY PARTICULAR FONT, STYLE, SIZE, OR COLOR.

SER. NO. 85-443,621, FILED 10-10-2011.

MICHAEL TANNER, EXAMINING ATTORNEY



*David J. Kyffers*

Director of the United States Patent and Trademark Office

# United States of America

United States Patent and Trademark Office

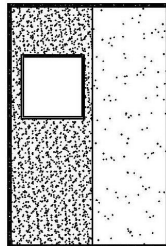

**Reg. No. 4,127,179**

DAVID HOWELL PRODUCT DESIGN, INC. (NEW YORK CORPORATION)  
405 ADAMS STREET  
BEDFORD HILLS, NY 10507

**Registered Apr. 10, 2012**

**Int. Cl.: 14**

FOR: EARRINGS; ORNAMENTAL PINS; PENDANTS, IN CLASS 14 (U.S. CLS. 2, 27, 28 AND 50).

**TRADEMARK**

FIRST USE 2-1-2011; IN COMMERCE 2-1-2011.

**SUPPLEMENTAL REGISTER**

THE STIPPLING IS FOR SHADING PURPOSES.

THE MARK CONSISTS OF THE BACKGROUND OF PRODUCT PACKAGING. THE DESIGN CONSISTS OF A RECTANGLE DIVIDED INTO TWO SIDE-BY-SIDE RECTANGLES WITH A DARK RECTANGLE ON ONE SIDE AND A LIGHT RECTANGLE ON THE OTHER SIDE, WITH A SMALLER LIGHT RECTANGLE PRESENT WITHIN THE DARK RECTANGLE.

SER. NO. 85-445,616, FILED 10-12-2011.

JENNIFER DIXON, EXAMINING ATTORNEY



*David J. Kybas*

Director of the United States Patent and Trademark Office

# United States of America

United States Patent and Trademark Office

# Writing Yoga

**Reg. No. 4,127,180**

LIPSEY, STEFANIE (UNITED STATES INDIVIDUAL)  
95 8TH AVE.

**Registered Apr. 10, 2012**

SEA CLIFF, NY 11579

**Int. Cl.: 41**

FOR: EDUCATION AND ENTERTAINMENT SERVICES, NAMELY, PROVIDING LIVE AND ON-LINE WORKSHOPS IN THE FIELD OF YOGA AND WRITING INSTRUCTION AND DISTRIBUTION OF COURSE MATERIAL IN CONNECTION THEREWITH ; ON-LINE JOURNALS, NAMELY, BLOGS FEATURING YOGA AND WRITING INSTRUCTION, IN CLASS 41 (U.S. CLS. 100, 101 AND 107).

**SERVICE MARK**

**SUPPLEMENTAL REGISTER**

FIRST USE 12-31-2007; IN COMMERCE 12-31-2007.

THE MARK CONSISTS OF STANDARD CHARACTERS WITHOUT CLAIM TO ANY PARTICULAR FONT, STYLE, SIZE, OR COLOR.

NO CLAIM IS MADE TO THE EXCLUSIVE RIGHT TO USE "YOGA", APART FROM THE MARK AS SHOWN.

SER. NO. 85-446,389, FILED P.R. 10-13-2011; AM. S.R. 2-20-2012.

GIANCARLO CASTRO, EXAMINING ATTORNEY



*David J. Kypos*

Director of the United States Patent and Trademark Office

# United States of America

United States Patent and Trademark Office

## SPEED HARNESS

**Reg. No. 4,127,181**

THRILLWORKS, INC. (CALIFORNIA CORPORATION)  
9198-B RIDGE ROAD  
NEWCASTLE, CA 95658

**Registered Apr. 10, 2012**

**Int. Cl.: 28**

FOR: CLIMBERS' HARNESSES, IN CLASS 28 (U.S. CLS. 22, 23, 38 AND 50).

**TRADEMARK**

FIRST USE 0-0-2003; IN COMMERCE 0-0-2003.

**SUPPLEMENTAL REGISTER**

THE MARK CONSISTS OF STANDARD CHARACTERS WITHOUT CLAIM TO ANY PARTICULAR FONT, STYLE, SIZE, OR COLOR.

NO CLAIM IS MADE TO THE EXCLUSIVE RIGHT TO USE "HARNESS", APART FROM THE MARK AS SHOWN.

SER. NO. 85-446,940, FILED P.R. 10-13-2011; AM. S.R. 2-12-2012.

SANI KHOURI, EXAMINING ATTORNEY



*David J. Kybas*

Director of the United States Patent and Trademark Office

# United States of America

United States Patent and Trademark Office

## MCHUGH INSURANCE

**Reg. No. 4,127,182**

WALCHLE, JONATHAN (UNITED STATES INDIVIDUAL)  
P.O. 3298 WEBB BRIDGE STATION  
ALPHARETTA, GA 30005

**Registered Apr. 10, 2012**

**Int. Cl.: 36**

FOR: INSURANCE AGENCY AND BROKERAGE, IN CLASS 36 (U.S. CLS. 100, 101 AND 102).

**SERVICE MARK**

FIRST USE 4-1-2011; IN COMMERCE 4-1-2011.

**SUPPLEMENTAL REGISTER**

THE MARK CONSISTS OF STANDARD CHARACTERS WITHOUT CLAIM TO ANY PARTICULAR FONT, STYLE, SIZE, OR COLOR.

NO CLAIM IS MADE TO THE EXCLUSIVE RIGHT TO USE "INSURANCE", APART FROM THE MARK AS SHOWN.

SER. NO. 85-447,516, FILED P.R. 10-14-2011; AM. S.R. 2-14-2012.

AMY ALFIERI, EXAMINING ATTORNEY



*David J. Kybas*

Director of the United States Patent and Trademark Office

# United States of America

United States Patent and Trademark Office

## HIGH TICKET PROCESSING

**Reg. No. 4,127,183**

WALCHLE, JONATHAN (UNITED STATES INDIVIDUAL)  
P.O. 3298 WEBB BRIDGE STATION  
ALPHARETTA, GA 30005

**Registered Apr. 10, 2012**

**Int. Cl.: 36**

FOR: CREDIT CARD PAYMENT AND TRANSACTION PROCESSING SERVICES, IN CLASS 36 (U.S. CLS. 100, 101 AND 102).

**SERVICE MARK**

FIRST USE 5-0-2011; IN COMMERCE 5-0-2011.

**SUPPLEMENTAL REGISTER**

THE MARK CONSISTS OF STANDARD CHARACTERS WITHOUT CLAIM TO ANY PARTICULAR FONT, STYLE, SIZE, OR COLOR.

NO CLAIM IS MADE TO THE EXCLUSIVE RIGHT TO USE "PROCESSING", APART FROM THE MARK AS SHOWN.

SER. NO. 85-447,519, FILED P.R. 10-14-2011; AM. S.R. 2-14-2012.

AMY ALFIERI, EXAMINING ATTORNEY



*David J. Kybas*

Director of the United States Patent and Trademark Office

# United States of America

United States Patent and Trademark Office

## The Search Engine for Car Shopping

**Reg. No. 4,127,184**

**Registered Apr. 10, 2012**

**Int. Cl.: 35**

**SERVICE MARK**

**SUPPLEMENTAL REGISTER**

ASHTON, JOSEPH L. (UNITED STATES INDIVIDUAL), DBA AUTOGOGO,  
235 WHITE DEER ROCK ROAD  
WOODBURY, CT 06798

FOR: ADVERTISING AND DIRECTORY SERVICES, NAMELY, PROMOTING THE SERVICES OF OTHERS BY PROVIDING A WEB PAGE FEATURING LINKS TO THE WEBSITES OF OTHERS; ADVERTISING SERVICES, NAMELY, PROMOTING CAR DEALERSHIPS OF OTHERS; PROMOTING, ADVERTISING AND MARKETING ON-LINE WEB SITES OF OTHERS; PROVIDING USED CAR SALES LEADS FOR OTHERS, IN CLASS 35 (U.S. CLS. 100, 101 AND 102).

FIRST USE 10-8-2011; IN COMMERCE 10-8-2011.

THE MARK CONSISTS OF STANDARD CHARACTERS WITHOUT CLAIM TO ANY PARTICULAR FONT, STYLE, SIZE, OR COLOR.

NO CLAIM IS MADE TO THE EXCLUSIVE RIGHT TO USE "SEARCH ENGINE", APART FROM THE MARK AS SHOWN.

SER. NO. 85-448,438, FILED P.R. 10-16-2011; AM. S.R. 2-15-2012.

EMILY CARLSEN, EXAMINING ATTORNEY



*David J. Kybas*

Director of the United States Patent and Trademark Office



# United States of America

United States Patent and Trademark Office

## PORTFOLIO PAY

**Reg. No. 4,127,185**

**Registered Apr. 10, 2012**

**Int. Cl.: 36**

**SERVICE MARK**

**SUPPLEMENTAL REGISTER**

PRIMAVERA FINANCIAL, INC. (DELAWARE CORPORATION)  
20062 S.W. BIRCH STREET  
SUITE 220  
NEWPORT BEACH, CA 92660

FOR: FINANCIAL SERVICES, NAMELY, PROVISION OF LOANS AND FINANCING TO HEALTHCARE PROVIDERS, IN CLASS 36 (U.S. CLS. 100, 101 AND 102).

FIRST USE 9-17-2009; IN COMMERCE 9-17-2009.

THE MARK CONSISTS OF STANDARD CHARACTERS WITHOUT CLAIM TO ANY PARTICULAR FONT, STYLE, SIZE, OR COLOR.

SER. NO. 85-449,342, FILED P.R. 10-17-2011; AM. S.R. 2-13-2012.

MATTHEW PAPPAS, EXAMINING ATTORNEY



*David J. Kyffers*

Director of the United States Patent and Trademark Office

# United States of America

United States Patent and Trademark Office

# top grain

**Reg. No. 4,127,186**

AHMED MUHSIN (SRI LANKA INDIVIDUAL)  
6100 EASTVIEW ST.  
BETHESDA, MD 20817

**Registered Apr. 10, 2012**

**Int. Cl.: 35**

FOR: ON-LINE RETAIL STORE SERVICES FEATURING A WIDE VARIETY OF CONSUMER GOODS OF OTHERS; ON-LINE RETAIL STORE SERVICES FEATURING FURNITURE, NAMELY, CHAIRS, COUCHES, SOFAS, TABLES, BEDDING, BEDS, DRESSERS, BOOKCASES, RUGS, SHEETS, DESKS; ON-LINE WHOLESALE AND RETAIL STORE SERVICES FEATURING FURNITURE, NAMELY, CHAIRS, COUCHES, SOFAS, TABLES, BEDDING, BEDS, DRESSERS, BOOKCASES, RUGS, SHEETS, DESKS; RETAIL FURNITURE STORES, IN CLASS 35 (U.S. CLS. 100, 101 AND 102).

**SERVICE MARK**

**SUPPLEMENTAL REGISTER**

FIRST USE 10-2-2011; IN COMMERCE 10-2-2011.

THE MARK CONSISTS OF STANDARD CHARACTERS WITHOUT CLAIM TO ANY PARTICULAR FONT, STYLE, SIZE, OR COLOR.

SER. NO. 85-450,373, FILED P.R. 10-18-2011; AM. S.R. 2-22-2012.

MARK T. MULLEN, EXAMINING ATTORNEY



*David J. Kyffers*

Director of the United States Patent and Trademark Office

# United States of America

United States Patent and Trademark Office

## BLIND IN A BAG

**Reg. No. 4,127,187**

GAMESETTER, LLC (MISSOURI LIMITED LIABILITY COMPANY)  
876 S.E. 50TH ROAD  
GOLDEN CITY, MO 64748

**Registered Apr. 10, 2012**

**Int. Cl.: 28**

FOR: HUNTING BLINDS, IN CLASS 28 (U.S. CLS. 22, 23, 38 AND 50).

FIRST USE 2-15-2012; IN COMMERCE 2-15-2012.

**TRADEMARK**

THE MARK CONSISTS OF STANDARD CHARACTERS WITHOUT CLAIM TO ANY PARTICULAR FONT, STYLE, SIZE, OR COLOR.

**SUPPLEMENTAL REGISTER**

NO CLAIM IS MADE TO THE EXCLUSIVE RIGHT TO USE "BLIND", APART FROM THE MARK AS SHOWN.

SER. NO. 85-452,212, FILED P.R. 10-20-2011; AM. S.R. 2-15-2012.

ANDREA HACK, EXAMINING ATTORNEY



*David J. Kyjars*

Director of the United States Patent and Trademark Office

# United States of America

United States Patent and Trademark Office

## UNION BAY CAPITAL

**Reg. No. 4,127,188**

**Registered Apr. 10, 2012**

**Int. Cl.: 36**

UNION BAY CAPITAL MANAGEMENT LLC (WASHINGTON LIMITED LIABILITY COMPANY), DBA UNION BAY CAPITAL,  
1910 FAIRVIEW AVE. E.  
SUITE 500  
SEATTLE, WA 98102

**SERVICE MARK**

FOR: MANAGEMENT OF A CAPITAL INVESTMENT FUND, IN CLASS 36 (U.S. CLS. 100, 101 AND 102).

**SUPPLEMENTAL REGISTER**

FIRST USE 5-1-2011; IN COMMERCE 5-1-2011.

THE MARK CONSISTS OF STANDARD CHARACTERS WITHOUT CLAIM TO ANY PARTICULAR FONT, STYLE, SIZE, OR COLOR.

NO CLAIM IS MADE TO THE EXCLUSIVE RIGHT TO USE "CAPITAL", APART FROM THE MARK AS SHOWN.

SER. NO. 85-452,315, FILED P.R. 10-20-2011; AM. S.R. 2-14-2012.

LINDA POWELL, EXAMINING ATTORNEY



*David J. Kyffers*

Director of the United States Patent and Trademark Office

# United States of America

United States Patent and Trademark Office



**Reg. No. 4,127,189**

24-7 LONG TERM CARE, INC. (UTAH CORPORATION), DBA 24-7 CARE AND REHAB,  
450 S 400 E, SUITE 200  
BOUNTIFUL, UT 84010

**Registered Apr. 10, 2012**

**Int. Cl.: 44**

FOR: NURSING HOMES, IN CLASS 44 (U.S. CLS. 100 AND 101).

**SERVICE MARK**

FIRST USE 2-10-2011; IN COMMERCE 2-10-2011.

**SUPPLEMENTAL REGISTER**

THE MARK CONSISTS OF THE WORDING "24/7 CARE + REHAB" ON A CONTRASTING SQUARE BACKGROUND.

SER. NO. 85-453,161, FILED P.R. 10-21-2011; AM. S.R. 2-13-2012.

AISHA SALEM, EXAMINING ATTORNEY



*David J. Kybas*

Director of the United States Patent and Trademark Office

# United States of America

United States Patent and Trademark Office

## INTERNATIONAL CABERNET SYMPOSIUM

**Reg. No. 4,127,190**

OAKVILLE WINEGROWERS (CALIFORNIA MUTUAL NON-BENEFIT CORPORATION)  
P.O. BOX 101  
OAKVILLE, CA 94562

**Registered Apr. 10, 2012**

**Int. Cl.: 41**

FOR: ARRANGING AND CONDUCTING MEETINGS, SEMINARS AND SYMPOSIA IN THE  
FIELD OF CULTURAL AND TECHNICAL EXCHANGE OF WINEGROWER KNOWLEDGE  
, IN CLASS 41 (U.S. CLS. 100, 101 AND 107).

**SERVICE MARK**

FIRST USE 9-0-2007; IN COMMERCE 6-0-2008.

**SUPPLEMENTAL REGISTER**

THE MARK CONSISTS OF STANDARD CHARACTERS WITHOUT CLAIM TO ANY PAR-  
TICULAR FONT, STYLE, SIZE, OR COLOR.

NO CLAIM IS MADE TO THE EXCLUSIVE RIGHT TO USE "SYMPOSIUM", APART FROM  
THE MARK AS SHOWN.

SER. NO. 85-453,232, FILED 10-21-2011.

CAROLYN CATALDO, EXAMINING ATTORNEY



*David J. Kybas*

Director of the United States Patent and Trademark Office

# United States of America

United States Patent and Trademark Office

## AMERICA'S SUPERMODEL PRODUCTIONS

**Reg. No. 4,127,191** AMERICA'S SUPERMODEL PRODUCTIONS LLC (TEXAS LIMITED LIABILITY COMPANY)  
**Registered Apr. 10, 2012** 3923 CONFERENCE COVE  
AUSTIN, TX 78730

**Int. Cl.: 41** FOR: ENTERTAINMENT IN THE NATURE OF BEAUTY PAGEANTS, IN CLASS 41 (U.S. CLS. 100, 101 AND 107).

**SERVICE MARK** FIRST USE 10-20-2011; IN COMMERCE 10-20-2011.

**SUPPLEMENTAL REGISTER** THE MARK CONSISTS OF STANDARD CHARACTERS WITHOUT CLAIM TO ANY PARTICULAR FONT, STYLE, SIZE, OR COLOR.

NO CLAIM IS MADE TO THE EXCLUSIVE RIGHT TO USE "PRODUCTIONS", APART FROM THE MARK AS SHOWN.

SER. NO. 85-453,327, FILED P.R. 10-21-2011; AM. S.R. 2-10-2012.

KRISTIN DAHLING, EXAMINING ATTORNEY



*David J. Kybas*

Director of the United States Patent and Trademark Office

# United States of America

United States Patent and Trademark Office

## CO-DELIVERY

**Reg. No. 4,127,192**

**Registered Apr. 10, 2012**

**Int. Cl.: 35**

**SERVICE MARK**

**SUPPLEMENTAL REGISTER**

LOFT 9 CONSULTING (WASHINGTON LIMITED LIABILITY COMPANY)  
SUITE 400  
800 BELLEVUE WAY NE  
BELLEVUE, WA 98004

FOR: BUSINESS ADVISORY SERVICES, CONSULTANCY AND INFORMATION; BUSINESS CONSULTATION SERVICES; BUSINESS MANAGEMENT AND CONSULTATION IN THE FIELD OF BUSINESS PROJECT MANAGEMENT; BUSINESS MANAGEMENT CONSULTANCY AND ADVISORY SERVICES; BUSINESS MANAGEMENT CONSULTANCY AS WELL AS DEVELOPMENT OF PROCESSES FOR THE ANALYSIS AND THE IMPLEMENTATION OF STRATEGY PLANS AND MANAGEMENT PROJECTS, IN CLASS 35 (U.S. CLS. 100, 101 AND 102).

FIRST USE 1-1-2010; IN COMMERCE 1-1-2010.

THE MARK CONSISTS OF STANDARD CHARACTERS WITHOUT CLAIM TO ANY PARTICULAR FONT, STYLE, SIZE, OR COLOR.

SER. NO. 85-453,340, FILED P.R. 10-21-2011; AM. S.R. 2-14-2012.

BARNEY CHARLON, EXAMINING ATTORNEY



*David J. Kybas*

Director of the United States Patent and Trademark Office



United States of America  
United States Patent and Trademark Office

Budget  
Graduation 

**Reg. No. 4,127,193**

RHYME UNIVERSITY, INC. (DELAWARE CORPORATION)  
PO BOX 90069

**Registered Apr. 10, 2012**

LONG BEACH, CA 90069

**Int. Cl.: 25**

FOR: CLOTHING, NAMELY, GRADUATION CAPS, GOWNS AND SASHES; GRADUATION CAP AND GOWN OUTFITS COMPRISED OF GRADUATION CAP AND GOWN, TASSEL AND SASH, ALL SOLD TOGETHER AS A UNIT , IN CLASS 25 (U.S. CLS. 22 AND 39).

**TRADEMARK**

FIRST USE 10-11-2011; IN COMMERCE 10-11-2011.

**SUPPLEMENTAL REGISTER**

NO CLAIM IS MADE TO THE EXCLUSIVE RIGHT TO USE "GRADUATION", APART FROM THE MARK AS SHOWN.

THE COLOR(S) GREEN, BLACK AND WHITE IS/ARE CLAIMED AS A FEATURE OF THE MARK.

THE MARK CONSISTS OF THE TEXT "BUDGET GRADUATION" IN GREEN, TO THE RIGHT OF THE TEXT A GRADUATION CAP WITH ATTACHED TASSEL IN BLACK AND WHITE.

SER. NO. 85-453,623, FILED 10-21-2011.

GINA FINK, EXAMINING ATTORNEY



*David J. Kybas*

Director of the United States Patent and Trademark Office

# United States of America

United States Patent and Trademark Office



**Reg. No. 4,127,194**

**Registered Apr. 10, 2012**

**Int. Cl.: 35**

**SERVICE MARK**

**SUPPLEMENTAL REGISTER**

LARSON DESIGN GROUP, INC. (PENNSYLVANIA CORPORATION)  
2ND FLOOR  
1000 COMMERCE PARK DRIVE  
WILLIAMSPORT, PA 17701

FOR: PROMOTING PUBLIC AWARENESS OF THE BENEFITS OF COMPRESSED NATURAL GAS AS A FUEL FOR VEHICLES, TRANSPORTATION AND INFRASTRUCTURE DEVELOPMENT, IN CLASS 35 (U.S. CLS. 100, 101 AND 102).

FIRST USE 4-14-2011; IN COMMERCE 4-14-2011.

THE MARK CONSISTS OF THE WORD "CNG" IN A BLUE DIAMOND WITH THE LETTERS "CNG" IN WHITE TO THE LEFT OF THE WORDS "FOCUS GROUP" IN BLUE.

THE COLOR(S) BLUE AND WHITE IS/ARE CLAIMED AS A FEATURE OF THE MARK.

SER. NO. 85-454,184, FILED P.R. 10-24-2011; AM. S.R. 2-13-2012.

JEAN IM, EXAMINING ATTORNEY



*David J. Kybas*

Director of the United States Patent and Trademark Office

# United States of America

United States Patent and Trademark Office

## CNG FOCUS GROUP

**Reg. No. 4,127,195**

**Registered Apr. 10, 2012**

**Int. Cl.: 35**

**SERVICE MARK**

**SUPPLEMENTAL REGISTER**

LARSON DESIGN GROUP, INC. (PENNSYLVANIA CORPORATION)  
2ND FLOOR  
1000 COMMERCE PARK DRIVE  
WILLIAMSPORT, PA 17701

FOR: PROMOTING PUBLIC AWARENESS OF THE BENEFITS OF COMPRESSED NATURAL GAS AS A FUEL FOR VEHICLES, TRANSPORTATION AND INFRASTRUCTURE DEVELOPMENT, IN CLASS 35 (U.S. CLS. 100, 101 AND 102).

FIRST USE 4-14-2011; IN COMMERCE 4-14-2011.

THE MARK CONSISTS OF STANDARD CHARACTERS WITHOUT CLAIM TO ANY PARTICULAR FONT, STYLE, SIZE, OR COLOR.

SER. NO. 85-454,632, FILED P.R. 10-24-2011; AM. S.R. 2-13-2012.

JEAN IM, EXAMINING ATTORNEY



*David J. Kybas*

Director of the United States Patent and Trademark Office

# United States of America

United States Patent and Trademark Office

## KALE KRINKLES

**Reg. No. 4,127,196**

THE KALE FACTORY, INC. (NEW YORK CORPORATION)  
790 WASHINGTON AVE #202  
BROOKLYN, NY 11238

**Registered Apr. 10, 2012**

**Int. Cl.: 29**

FOR: VEGETABLE-BASED SNACK FOODS, IN CLASS 29 (U.S. CL. 46).

FIRST USE 9-15-2011; IN COMMERCE 9-15-2011.

**TRADEMARK**

THE MARK CONSISTS OF STANDARD CHARACTERS WITHOUT CLAIM TO ANY PARTICULAR FONT, STYLE, SIZE, OR COLOR.

**SUPPLEMENTAL REGISTER**

NO CLAIM IS MADE TO THE EXCLUSIVE RIGHT TO USE "KALE", APART FROM THE MARK AS SHOWN.

SER. NO. 85-455,054, FILED P.R. 10-25-2011; AM. S.R. 2-13-2012.

MATTHEW KLINE, EXAMINING ATTORNEY



*David J. Kyffers*

Director of the United States Patent and Trademark Office

# United States of America

United States Patent and Trademark Office

TOPTENREALESTATEDEALS.COM

**Reg. No. 4,127,197**

TOPTENREALESTATEDEALS.COM, LLC (FLORIDA LIMITED LIABILITY COMPANY)  
801 BRINY AVENUE, SUITE 303  
POMPANO BEACH, FL 33062

**Registered Apr. 10, 2012**

**Int. Cl.: 36**

FOR: PROVIDING REAL ESTATE INFORMATION AND REAL ESTATE LISTINGS VIA THE  
WEB, IN CLASS 36 (U.S. CLS. 100, 101 AND 102).

**SERVICE MARK**

FIRST USE 3-0-2010; IN COMMERCE 3-0-2010.

**SUPPLEMENTAL REGISTER**

THE MARK CONSISTS OF STANDARD CHARACTERS WITHOUT CLAIM TO ANY PAR-  
TICULAR FONT, STYLE, SIZE, OR COLOR.

SER. NO. 85-455,175, FILED P.R. 10-25-2011; AM. S.R. 2-14-2012.

AMY KELLY, EXAMINING ATTORNEY



*David J. Kybas*

Director of the United States Patent and Trademark Office

# United States of America

United States Patent and Trademark Office

## YOUNG CATHOLIC PROFESSIONALS

**Reg. No. 4,127,198**

YOUNG CATHOLIC PROFESSIONALS (TEXAS NON-PROFIT CORPORATION)  
2701 FITZHUGH AVENUE, #1212  
DALLAS, TX 75204

**Registered Apr. 10, 2012**

**Int. Cl.: 35**

FOR: PROVIDING CATHOLIC BUSINESS NETWORKING GROUPS, IN CLASS 35 (U.S. CLS. 100, 101 AND 102).

**SERVICE MARK**

FIRST USE 8-31-2010; IN COMMERCE 8-31-2010.

**SUPPLEMENTAL REGISTER**

THE MARK CONSISTS OF STANDARD CHARACTERS WITHOUT CLAIM TO ANY PARTICULAR FONT, STYLE, SIZE, OR COLOR.

SER. NO. 85-455,411, FILED P.R. 10-25-2011; AM. S.R. 2-15-2012.

JAMES GRIFFIN, EXAMINING ATTORNEY



*David J. Kybas*

Director of the United States Patent and Trademark Office

# United States of America

United States Patent and Trademark Office

## WEIGHT RELEASE ENERGETIX

**Reg. No. 4,127,199**

BARON-REID, COLETTE (CANADA INDIVIDUAL)  
PO BOX 987  
HAMPTON, NH 03843

**Registered Apr. 10, 2012**

**Int. Cl.: 41**

FOR: EDUCATIONAL SERVICES, NAMELY, CONDUCTING LIVE CLASSES, SEMINARS, WORKSHOPS, AND LECTURES IN THE FIELDS OF MENTAL, PHYSICAL AND SPIRITUAL WELLNESS AND PERSONAL MOTIVATION AND INSPIRATION, IN CLASS 41 (U.S. CLS. 100, 101 AND 107).

**SERVICE MARK**

**SUPPLEMENTAL REGISTER** FIRST USE 9-1-2011; IN COMMERCE 9-1-2011.

THE MARK CONSISTS OF STANDARD CHARACTERS WITHOUT CLAIM TO ANY PARTICULAR FONT, STYLE, SIZE, OR COLOR.

SER. NO. 85-456,808, FILED P.R. 10-26-2011; AM. S.R. 2-23-2012.

LINDA ORNDORFF, EXAMINING ATTORNEY



*David J. Kyffers*

Director of the United States Patent and Trademark Office

# United States of America

United States Patent and Trademark Office

## Academy of Spiritual Healing Arts

**Reg. No. 4,127,200**

**Registered Apr. 10, 2012**

**Int. Cl.: 41**

**SERVICE MARK**

**SUPPLEMENTAL REGISTER**

LINDA EVANS (UNITED STATES INDIVIDUAL)  
1213 PRESCOTT DRIVE  
CHINO VALLEY, AZ 86323

FOR: EDUCATIONAL SERVICES, NAMELY, CONDUCTING WORKSHOPS AND SEMINARS IN THE FIELD OF SPIRITUAL HEALING AND DISTRIBUTION OF TRAINING MATERIAL IN CONNECTION THEREWITH; EDUCATIONAL SERVICES, NAMELY, CONDUCTING WORKSHOPS AND SEMINARS IN THE FIELD OF SPIRITUAL HEALING, IN CLASS 41 (U.S. CLS. 100, 101 AND 107).

FIRST USE 8-1-2011; IN COMMERCE 8-1-2011.

THE MARK CONSISTS OF STANDARD CHARACTERS WITHOUT CLAIM TO ANY PARTICULAR FONT, STYLE, SIZE, OR COLOR.

NO CLAIM IS MADE TO THE EXCLUSIVE RIGHT TO USE "SPIRITUAL HEALING ARTS", APART FROM THE MARK AS SHOWN.

SER. NO. 85-457,174, FILED P.R. 10-26-2011; AM. S.R. 2-16-2012.

EDWARD NELSON, EXAMINING ATTORNEY



*David J. Kyfos*

Director of the United States Patent and Trademark Office



# United States of America

United States Patent and Trademark Office

## Excellence in Export Education

**Reg. No. 4,127,201**

**Registered Apr. 10, 2012**

**Int. Cl.: 41**

**SERVICE MARK**

**SUPPLEMENTAL REGISTER**

EXPORT UNIVERSITY, INC. (FLORIDA CORPORATION)  
SUITE 160  
3355 ENTERPRISE AVENUE  
WESTON, FL 33331

FOR: EDUCATIONAL SERVICES, NAMELY, DEVELOPING, ARRANGING, AND CONDUCTING EDUCATIONAL CONFERENCES AND PROGRAMS AND PROVIDING COURSES OF INSTRUCTION IN THE FIELD OF EXPORT OPERATIONS AT CORPORATE MANAGEMENT AND EXECUTIVE LEVELS, IN CLASS 41 (U.S. CLS. 100, 101 AND 107).

FIRST USE 11-12-2010; IN COMMERCE 9-22-2011.

THE MARK CONSISTS OF STANDARD CHARACTERS WITHOUT CLAIM TO ANY PARTICULAR FONT, STYLE, SIZE, OR COLOR.

NO CLAIM IS MADE TO THE EXCLUSIVE RIGHT TO USE "EXPORT EDUCATION", APART FROM THE MARK AS SHOWN.

SER. NO. 85-458,367, FILED P.R. 10-27-2011; AM. S.R. 2-21-2012.

JOHN E. MICHOS, EXAMINING ATTORNEY



*David J. Kypos*

Director of the United States Patent and Trademark Office

# United States of America

United States Patent and Trademark Office

## THERAPEUTIC WRITING INSTITUTE

**Reg. No. 4,127,202**

**Registered Apr. 10, 2012**

**Int. Cl.: 41**

**SERVICE MARK**

**SUPPLEMENTAL REGISTER**

CENTER FOR JOURNAL THERAPY, INC. (COLORADO CORPORATION)  
SUITE 5  
3798 MARSHALL ST  
WHEAT RIDGE, CO 80033

FOR: EDUCATION SERVICES, NAMELY, PROVIDING ON-LINE AND LIVE CLASSES, WORKSHOPS, SUPERVISION AND CONTINUING EDUCATION TRAINING IN THE FIELD OF THERAPEUTIC WRITING, INCLUDING JOURNAL WRITING, JOURNAL THERAPY, POETRY THERAPY, MEMOIR AND VISUAL JOURNALING, IN CLASS 41 (U.S. CLS. 100, 101 AND 107).

FIRST USE 7-30-2009; IN COMMERCE 10-13-2009.

THE MARK CONSISTS OF STANDARD CHARACTERS WITHOUT CLAIM TO ANY PARTICULAR FONT, STYLE, SIZE, OR COLOR.

NO CLAIM IS MADE TO THE EXCLUSIVE RIGHT TO USE "INSTITUTE", APART FROM THE MARK AS SHOWN.

SER. NO. 85-460,879, FILED 10-31-2011.

ANDREW LEASER, EXAMINING ATTORNEY



*David J. Kyros*

Director of the United States Patent and Trademark Office

# United States of America

United States Patent and Trademark Office

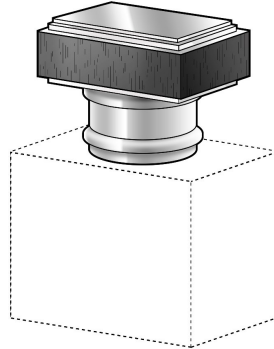

**Reg. No. 4,127,203**

**Registered Apr. 10, 2012**

**Int. Cl.: 3**

**TRADEMARK**

**SUPPLEMENTAL REGISTER**

ABERCROMBIE & FITCH TRADING CO. (OHIO CORPORATION)  
ATTN: JACOB KRAMER  
6301 FITCH PATH  
NEW ALBANY, OH 43054

FOR: FRAGRANCES FOR PERSONAL USE; PERFUME, IN CLASS 3 (U.S. CLS. 1, 4, 6, 50, 51 AND 52).

FIRST USE 10-22-2011; IN COMMERCE 10-22-2011.

THE MARK CONSISTS OF A PORTION OF PACKAGING FOR THE GOODS, WHICH INCLUDES A RECTANGULAR SHAPED CAP WITH TWO SMALLER RECTANGLES STACKED ON TOP FOR A BEVELED EFFECT. THE TOP AND BOTTOM ARE REFLECTIVE SILVER METAL AND THE SIDES ARE BLACK WOOD WITH VISIBLE GRAIN. THE MATTER SHOWN IN THE BROKEN LINES IS NOT A PORTION OF THE MARK, BUT IS ONLY INCLUDED TO SHOW THE POSITION OF THE MARK.

THE COLOR(S) BLACK AND REFLECTIVE SILVER IS/ARE CLAIMED AS A FEATURE OF THE MARK.

SER. NO. 85-462,549, FILED 11-2-2011.

MELISSA VALLILLO, EXAMINING ATTORNEY



*David J. Kappas*

Director of the United States Patent and Trademark Office

# United States of America

United States Patent and Trademark Office

## STACK ADVISORS

**Reg. No. 4,127,204**

**Registered Apr. 10, 2012**

**Int. Cl.: 42**

**SERVICE MARK**

**SUPPLEMENTAL REGISTER** FIRST USE 12-4-2011; IN COMMERCE 12-4-2011.

MARATHON CONSULTING, LLC (NEW YORK LIMITED LIABILITY COMPANY)  
181 N 11TH ST.  
SUITE 106  
BROOKLYN, NY 11211

FOR: COMPUTER CONSULTING SERVICES, NAMELY, ADVISING COMPANIES ON THE IMPLEMENTATION OF ENTERPRISE SOFTWARE APPLICATIONS, IN CLASS 42 (U.S. CLS. 100 AND 101).

THE MARK CONSISTS OF STANDARD CHARACTERS WITHOUT CLAIM TO ANY PARTICULAR FONT, STYLE, SIZE, OR COLOR.

NO CLAIM IS MADE TO THE EXCLUSIVE RIGHT TO USE "ADVISORS", APART FROM THE MARK AS SHOWN.

SER. NO. 85-470,657, FILED P.R. 11-11-2011; AM. S.R. 3-5-2012.

CHRISTOPHER BUONGIORNO, EXAMINING ATTORNEY



*David J. Kybas*

Director of the United States Patent and Trademark Office

# United States of America

United States Patent and Trademark Office

## TARATORY MARKETING

**Reg. No. 4,127,205**

TARATORY MARKETING LLC (ARIZONA LIMITED LIABILITY COMPANY)

**Registered Apr. 10, 2012**

10660 N. 44TH COURT  
PHOENIX, AZ 85028

**Int. Cl.: 35**

FOR: MARKETING SERVICES, NAMELY, PROMOTING OR ADVERTISING THE GOODS AND SERVICES OF OTHERS, IN CLASS 35 (U.S. CLS. 100, 101 AND 102).

**SERVICE MARK**

FIRST USE 5-13-2011; IN COMMERCE 5-13-2011.

**SUPPLEMENTAL REGISTER**

THE MARK CONSISTS OF STANDARD CHARACTERS WITHOUT CLAIM TO ANY PARTICULAR FONT, STYLE, SIZE, OR COLOR.

NO CLAIM IS MADE TO THE EXCLUSIVE RIGHT TO USE "TERRITORY MARKETING", APART FROM THE MARK AS SHOWN.

SER. NO. 85-474,104, FILED P.R. 11-16-2011; AM. S.R. 3-5-2012.

ALEXANDER L. POWERS, EXAMINING ATTORNEY



*David J. Kybas*

Director of the United States Patent and Trademark Office

# United States of America

United States Patent and Trademark Office

## THE INDEX OF TELEVISION

**Reg. No. 4,127,206**

MIXAROO, INC. (DELAWARE CORPORATION)  
687 COWPER STREET  
PALO ALTO, CA 94301

**Registered Apr. 10, 2012**

**Int. Cl.: 42**

FOR: PROVIDING A WEBSITE FEATURING A SEARCH ENGINE FOR TELEVISION CONTENT, IN CLASS 42 (U.S. CLS. 100 AND 101).

**SERVICE MARK**

FIRST USE 12-1-2011; IN COMMERCE 2-1-2012.

**SUPPLEMENTAL REGISTER**

THE MARK CONSISTS OF STANDARD CHARACTERS WITHOUT CLAIM TO ANY PARTICULAR FONT, STYLE, SIZE, OR COLOR.

SER. NO. 85-487,175, FILED P.R. 12-5-2011; AM. S.R. 2-10-2012.

KATHERINE CHANG, EXAMINING ATTORNEY



*David J. Kybas*

Director of the United States Patent and Trademark Office

# United States of America

United States Patent and Trademark Office

## WORLD PEACE CRUISES

**Reg. No. 4,127,207**

HERRERA, ORLANDO A. (UNITED STATES INDIVIDUAL)  
2751 S. OCEAN DRIVE, SUITE 805-S  
HOLLYWOOD, FL 33019 AND

**Registered Apr. 10, 2012**

**Int. Cl.: 39**

GOLDMEER, CONSTANCE (UNITED STATES INDIVIDUAL)  
2751 S. OCEAN DRIVE, SUITE 705-S  
HOLLYWOOD, FL 33019 AND

**SERVICE MARK**

**SUPPLEMENTAL REGISTER**

THE WORLD PEACE PROGRAM, LLC (FLORIDA LIMITED LIABILITY COMPANY)  
2751 S. OCEAN DRIVE, SUITE 705-S  
HOLLYWOOD, FL 33019

FOR: ARRANGING OF TOURS AND CRUISES AND CRUISE SHIP SERVICES WHICH PROVIDE FOR A PORTION OF THE TICKET PROCEEDS TO BE UTILIZED FOR WORLD PEACE, HUMANITARIAN AID AND VETERAN HELP EFFORTS, IN CLASS 39 (U.S. CLS. 100 AND 105).

FIRST USE 9-1-2011; IN COMMERCE 9-1-2011.

THE MARK CONSISTS OF STANDARD CHARACTERS WITHOUT CLAIM TO ANY PARTICULAR FONT, STYLE, SIZE, OR COLOR.

NO CLAIM IS MADE TO THE EXCLUSIVE RIGHT TO USE "CRUISES", APART FROM THE MARK AS SHOWN.

SER. NO. 85-492,276, FILED P.R. 12-10-2011; AM. S.R. 2-15-2012.

JENNIFER VASQUEZ, EXAMINING ATTORNEY



*David J. Kybas*

Director of the United States Patent and Trademark Office

# United States of America

United States Patent and Trademark Office

## THE WORLD PEACE CUP

**Reg. No. 4,127,208**

HERRERA, ORLANDO A. (UNITED STATES INDIVIDUAL)  
2751 S. OCEAN DRIVE, SUITE 805-S  
HOLLYWOOD, FL 33019 AND

**Registered Apr. 10, 2012**

**Int. Cl.: 41**

GOLDMEER, CONSTANCE (UNITED STATES INDIVIDUAL)  
2751 S. OCEAN DRIVE, SUITE 705-S  
HOLLYWOOD, FL 33019 AND

**SERVICE MARK**

**SUPPLEMENTAL REGISTER**

THE WORLD PEACE PROGRAM, LLC (FLORIDA LIMITED LIABILITY COMPANY)  
2751 S. OCEAN DRIVE, SUITE 705-S  
HOLLYWOOD, FL 33019

FOR: ORGANIZING SPORTING EVENTS, NAMELY, SOCCER COMPETITION, BASKETBALL COMPETITION, FOOTBALL COMPETITION, TENNIS TOURNAMENTS, GOLF TOURNAMENTS, AND ANY OTHER MAJOR SPORT COMPETITION WHICH PROVIDE FOR A PORTION OF THE TICKET PROCEEDS TO BE UTILIZED FOR WORLD PEACE, HUMANITARIAN AID AND VETERAN HELP EFFORTS, IN CLASS 41 (U.S. CLS. 100, 101 AND 107).

FIRST USE 9-1-2011; IN COMMERCE 9-1-2011.

THE MARK CONSISTS OF STANDARD CHARACTERS WITHOUT CLAIM TO ANY PARTICULAR FONT, STYLE, SIZE, OR COLOR.

SER. NO. 85-492,312, FILED P.R. 12-10-2011; AM. S.R. 2-15-2012.

JENNIFER VASQUEZ, EXAMINING ATTORNEY



*David J. Kyros*

Director of the United States Patent and Trademark Office



# United States of America

United States Patent and Trademark Office

## NATIONAL INSTITUTE OF LYMPHOLOGY

**Reg. No. 4,127,209**

**Registered Apr. 10, 2012**

**Int. Cls.: 16, 35, and 44**

NATIONAL INSTITUTE OF LYMPHOLOGY, LLC (ILLINOIS LIMITED LIABILITY COMPANY)

#214

505 NORTH LAKE SHORE DRIVE

CHICAGO, IL 60611

**TRADEMARK**

FOR: PRINTED PUBLICATIONS, NAMELY, PAMPHLETS, BROCHURES, NEWSLETTERS, JOURNALS FEATURING LYMPHOLOGY INFORMATION, IN CLASS 16 (U.S. CLS. 2, 5, 22, 23, 29, 37, 38 AND 50).

**SERVICE MARK**

FIRST USE 1-11-2012; IN COMMERCE 1-11-2012.

**SUPPLEMENTAL REGISTER**

FOR: ASSOCIATION SERVICES, NAMELY, PROMOTING THE INTERESTS OF THOSE IN THE FIELD OF LYMPHOLOGY AND LYMPHEDEMA, IN CLASS 35 (U.S. CLS. 100, 101 AND 102).

FIRST USE 1-25-2011; IN COMMERCE 1-25-2011.

FOR: PROVIDING AN INTERNET WEBSITE PORTAL FEATURING INFORMATION ABOUT LYMPHOLOGY, IN CLASS 44 (U.S. CLS. 100 AND 101).

FIRST USE 1-25-2011; IN COMMERCE 1-25-2011.

THE MARK CONSISTS OF STANDARD CHARACTERS WITHOUT CLAIM TO ANY PARTICULAR FONT, STYLE, SIZE, OR COLOR.

NO CLAIM IS MADE TO THE EXCLUSIVE RIGHT TO USE "INSTITUTE", APART FROM THE MARK AS SHOWN.

SER. NO. 85-976,333, FILED P.R. 10-15-2010; AM. S.R. 2-15-2012.

ALEX KEAM, EXAMINING ATTORNEY



*David J. Keam*

Director of the United States Patent and Trademark Office