

# United States of America

United States Patent and Trademark Office

 Acoustitherapy

**Reg. No. 4,133,448**

**Registered May 1, 2012**

**Int. Cl.: 9**

**TRADEMARK**

**PRINCIPAL REGISTER**

SKANSON, DARREN C. (UNITED STATES INDIVIDUAL), DBA COLORADO CREATIVE  
MUSIC  
P.O. BOX 3674  
LITTLETON, CO 801613674

FOR: SOUND AND VIDEO RECORDINGS, NAMELY, COMPACT DISCS AND CASSETTES  
FEATURING MUSIC SELECTED TO PROVIDE EMOTIONAL THERAPY, IN CLASS 9 (U.S.  
CLS. 21, 23, 26, 36 AND 38).

FIRST USE 5-1-1997; IN COMMERCE 9-1-1997.

SER. NO. 75-280,194, FILED 4-24-1997.

THOMAS V. SHAW, EXAMINING ATTORNEY



*David J. Kyffers*

Director of the United States Patent and Trademark Office



# United States of America

United States Patent and Trademark Office

## LIFE NET

**Reg. No. 4,133,449**

**Registered May 1, 2012**

**Int. Cl.: 35**

**SERVICE MARK**

**PRINCIPAL REGISTER**

ROCKY MOUNTAIN HOLDINGS, L.L.C. (DELAWARE LIMITED LIABILITY COMPANY)  
800 SOUTH 3110 WEST  
PROVO, UT 84601

FOR: RECEIVING TELEPHONE CALLS FROM REQUESTORS OF EMERGENCY MEDICAL SERVICES AND NOTIFYING EMERGENCY FACILITIES, IN CLASS 35 (U.S. CLS. 100, 101 AND 102).

FIRST USE 12-15-1996; IN COMMERCE 12-15-1996.

REGISTRATION LIMITED TO THE AREA COMPRISING (1) THE ENTIRE STATES OF TEXAS AND ARKANSAS, AND (2) THOSE PORTIONS OF OKLAHOMA AND LOUISIANA THAT ARE WITHIN A 200-MILE RADIUS OF TEXARKANA, TEXAS PURSUANT TO THE DECREE OF THE UNITED STATES DISTRICT COURT FOR THE EASTERN DISTRICT OF TEXAS, TEXARKANA DIVISION, CIVIL ACTION NO. 5:98-CV-168, DECEMBER 21, 1999. CONCURRENT USE WITH REGISTRATION NO. 3024887.

SER. NO. 75-370,945, FILED 10-9-1997.

WILLIAM P. SHANAHAN, EXAMINING ATTORNEY



*David J. Kyffers*

Director of the United States Patent and Trademark Office

# United States of America

United States Patent and Trademark Office

NOW

**Reg. No. 4,133,450**

**Registered May 1, 2012**

**Int. Cls.: 9 and 38**

**TRADEMARK**

**SERVICE MARK**

**PRINCIPAL REGISTER**

SPRINT COMMUNICATIONS COMPANY L.P. (DELAWARE LIMITED PARTNERSHIP)  
6200 SPRINT  
OVERLAND PARK, KS 66251

FOR: SOFTWARE FOR BROWSING, SEARCHING, RETRIEVING, MANAGING AND GRAPHICALLY DISPLAYING INFORMATION ACROSS A GLOBAL COMMUNICATIONS NETWORK IN THE FIELD OF ELECTRONIC DIRECTORIES OF PERSONAL INFORMATION, NAMELY, NAMES, ADDRESSES, AND TELEPHONE NUMBERS, IN CLASS 9 (U.S. CLS. 21, 23, 26, 36 AND 38).

FIRST USE 9-8-1995; IN COMMERCE 9-8-1995.

FOR: TELECOMMUNICATIONS SERVICES, NAMELY, PROVIDING ACCESS TO TELECOMMUNICATIONS NETWORKS FOR THE PURPOSE OF TRANSMITTING VOICE, DATA, IMAGES, AUDIO, VIDEO, AND INFORMATION VIA TELEPHONE AND GLOBAL COMMUNICATION NETWORKS; PERSONAL COMMUNICATIONS SERVICES, PAGER SERVICES AND TWO-WAY RADIO SERVICES, ELECTRONIC MAIL SERVICES; VOICE AND TEXT MESSAGING SERVICES; PROVIDING MULTIPLE-USER ACCESS TO A GLOBAL COMMUNICATIONS NETWORK; BROADCASTING AUDIO AND VIDEO PROGRAMMING BY MEANS OF WIRELESS NETWORKS; LONG DISTANCE TELEPHONE COMMUNICATION SERVICES VIA GLOBAL COMPUTER NETWORK, VOICE OVER INTERNET PROTOCOL SERVICES; PROVIDING LONG DISTANCE AND WIRELESS MOBILE TELEPHONE CALLING PLANS, IN CLASS 38 (U.S. CLS. 100, 101 AND 104).

FIRST USE 9-8-1995; IN COMMERCE 9-8-1995.

SER. NO. 75-950,935, FILED 3-3-2000.

SUSAN STIGLITZ, EXAMINING ATTORNEY



*David J. Kybas*

Director of the United States Patent and Trademark Office

# United States of America

United States Patent and Trademark Office

## VIPRE

**Reg. No. 4,133,451**

**Registered May 1, 2012**

**Int. Cl.: 9**

**TRADEMARK**

**PRINCIPAL REGISTER**

VHB TECHNOLOGIES, INC. (TEXAS CORPORATION)  
405 INTERNATIONAL PARKWAY SUITE 203  
RICHARDSON, TX 75081

FOR: COMPUTER HARDWARE, NAMELY, CONTENT AWARE INTELLIGENT RECOGNITION SYSTEM FOR USE IN FACILITATING SEARCH ENGINE SOFTWARE, IN CLASS 9 (U.S. CLS. 21, 23, 26, 36 AND 38).

FIRST USE 5-10-2000; IN COMMERCE 6-1-2000.

SER. NO. 76-107,690, FILED 8-8-2000.

MICHAEL KEATING, EXAMINING ATTORNEY



*David J. Kybas*

Director of the United States Patent and Trademark Office

# United States of America

United States Patent and Trademark Office

# TPO

**Reg. No. 4,133,452**

**Registered May 1, 2012**

**Int. Cl.: 10**

**TRADEMARK**

**PRINCIPAL REGISTER**

TP ORTHODONTICS, INC. (INDIANA CORPORATION)  
100 CENTER PLAZA  
LAPORTE, IN 463509672

FOR: ORTHODONTIC APPLIANCES, NAMELY, BRACKETS WITH OR WITHOUT POSITIONING JIGS, MOLAR TUBES, WIRES AND ELASTOMERIC LIGATURES, SOLD INDIVIDUALLY AND IN KIT FORM, IN CLASS 10 (U.S. CLS. 26, 39 AND 44).

FIRST USE 7-1-2006; IN COMMERCE 7-1-2006.

SER. NO. 76-703,874, FILED 7-23-2010.

RAUL CORDOVA, EXAMINING ATTORNEY



*David J. Kyffers*

Director of the United States Patent and Trademark Office

# United States of America

United States Patent and Trademark Office



**Reg. No. 4,133,453**

HYDROPRO, INC. (CALIFORNIA CORPORATION)  
2631 HIGHWAY J  
BOURBON, MO 65441

**Registered May 1, 2012**

**Int. Cl.: 9**

FOR: POWER SUPPLY FOR TOOLING THAT IS USED IN PREPARATION OF WELDING OPERATIONS, IN CLASS 9 (U.S. CLS. 21, 23, 26, 36 AND 38).

**TRADEMARK**

FIRST USE 0-0-2009; IN COMMERCE 0-0-2009.

**PRINCIPAL REGISTER**

THE MARK CONSIST OF THE STYLIZED WORDING "WELDLCK" AND THE DESIGN OF A DOTTED CIRCLE BORDERING A PLAIN CIRCLE. BOTH THE WORDING AND THE DESIGN ARE ENCLOSED WITHIN AN OVAL.

SER. NO. 76-704,030, FILED 8-4-2010.

BARBARA GAYNOR, EXAMINING ATTORNEY



*David J. Kyros*

Director of the United States Patent and Trademark Office

# United States of America

United States Patent and Trademark Office

## Carolina Road

**Reg. No. 4,133,454**

**Registered May 1, 2012**

**Int. Cls.: 9 and 41**

**TRADEMARK**

**SERVICE MARK**

**PRINCIPAL REGISTER**

LORRAINE JORDAN (UNITED STATES INDIVIDUAL)  
3751 JUNCTION BLVD  
RALEIGH, NC 27603

FOR: MUSICAL SOUND RECORDINGS; COMPACT DISCS FEATURING MUSIC, IN CLASS 9 (U.S. CLS. 21, 23, 26, 36 AND 38).

FIRST USE 1-1-1999; IN COMMERCE 1-1-1999.

FOR: ENTERTAINMENT SERVICES IN THE NATURE OF LIVE MUSICAL PERFORMANCES, IN CLASS 41 (U.S. CLS. 100, 101 AND 107).

FIRST USE 1-1-1999; IN COMMERCE 1-1-1999.

THE MARK CONSISTS OF STANDARD CHARACTERS WITHOUT CLAIM TO ANY PARTICULAR FONT, STYLE, SIZE, OR COLOR.

SER. NO. 76-705,956, FILED 1-10-2011.

JENNIFER DIXON, EXAMINING ATTORNEY



*David J. Kyros*

Director of the United States Patent and Trademark Office

# United States of America

United States Patent and Trademark Office



**Reg. No. 4,133,455**

**Registered May 1, 2012**

**Int. Cl.: 42**

**SERVICE MARK**

**PRINCIPAL REGISTER**

ENDPLAY, INC. (DELAWARE CORPORATION)  
5870 W. JEFFERSON BLVD., STUDIO H  
LOS ANGELES, CA 90016

FOR: SOFTWARE, INFRASTRUCTURE AND TECHNICAL OPERATIONS SERVICE PROVIDER, NAMELY, HOSTING, MANAGING, DEVELOPING, AND MAINTAINING APPLICATIONS, SOFTWARE, AND WEB SITES, IN THE FIELDS OF PRODUCTIVITY, COMMUNICATION, INFORMATION ACCESS, AND REMOTE DATA MANAGEMENT FOR DELIVERY OF CONTENT TO COMPUTERS, MOBILE DEVICES, AND HOSTING COMPUTER SOFTWARE APPLICATIONS OF OTHERS, IN CLASS 42 (U.S. CLS. 100 AND 101).

FIRST USE 4-11-2011; IN COMMERCE 4-11-2011.

THE MARK CONSISTS OF A CIRCULAR DESIGN FORMED BY GEOMETRIC PAISLEY-LIKE SHAPES WHICH FORM A HUMAN PERSON.

SER. NO. 76-707,270, FILED 4-14-2011.

JANICE KIM, EXAMINING ATTORNEY



*David J. Kybas*

Director of the United States Patent and Trademark Office

# United States of America

United States Patent and Trademark Office

## LUBRICATION TRANSFORMATION

**Reg. No. 4,133,456**

**Registered May 1, 2012**

**Int. Cls.: 35 and 41**

**SERVICE MARK**

**PRINCIPAL REGISTER**

DES-CASE CORPORATION (TENNESSEE CORPORATION)  
675 NORTH MAIN STREET  
GOODLETTSVILLE, TN 37072

FOR: MANAGEMENT AND BUSINESS CONSULTING SERVICES IN THE FIELD OF MANUFACTURING AND RELIABILITY PRACTICES, PRODUCTS, EQUIPMENT MODIFICATIONS, ASSET MANAGEMENT, EVALUATION TECHNIQUES, AND INDUSTRIAL LUBRICATION PRACTICES AND ASSOCIATED EDUCATIONAL SERVICES, IN CLASS 35 (U.S. CLS. 100, 101 AND 102).

FIRST USE 1-25-2011; IN COMMERCE 1-25-2011.

FOR: EDUCATIONAL SERVICES, NAMELY, CONDUCTING CLASSES, SEMINARS, CONFERENCES, AND WORKSHOPS IN THE FIELDS OF MANUFACTURING AND RELIABILITY PRACTICES, PRODUCT MANUFACTURING, INDUSTRIAL EQUIPMENT MODIFICATIONS, BUSINESS ASSET MANAGEMENT, BUSINESS EVALUATION TECHNIQUES, AND INDUSTRIAL LUBRICATION PRACTICES, IN CLASS 41 (U.S. CLS. 100, 101 AND 107).

FIRST USE 1-25-2011; IN COMMERCE 1-25-2011.

THE MARK CONSISTS OF STANDARD CHARACTERS WITHOUT CLAIM TO ANY PARTICULAR FONT, STYLE, SIZE, OR COLOR.

SER. NO. 76-707,557, FILED 5-10-2011.

NELSON SNYDER, EXAMINING ATTORNEY



*David J. Kyros*

Director of the United States Patent and Trademark Office



# United States of America

United States Patent and Trademark Office

## VIAL SAFE

**Reg. No. 4,133,457**

**Registered May 1, 2012**

**Int. Cl.: 5**

**TRADEMARK**

**PRINCIPAL REGISTER**

SALINAS, VICTOR REY (UNITED STATES INDIVIDUAL)  
9225 KATY FREEWAY, SUITE 103  
HOUSTON, TX 77024

FOR: SILICONE COVERS ESPECIALLY ADAPTED FOR PHARMACEUTICAL VIALS, IN CLASS 5 (U.S. CLS. 6, 18, 44, 46, 51 AND 52).

FIRST USE 3-8-2010; IN COMMERCE 3-8-2010.

THE MARK CONSISTS OF STANDARD CHARACTERS WITHOUT CLAIM TO ANY PARTICULAR FONT, STYLE, SIZE, OR COLOR.

NO CLAIM IS MADE TO THE EXCLUSIVE RIGHT TO USE "VIAL", APART FROM THE MARK AS SHOWN.

SER. NO. 76-707,805, FILED 5-31-2011.

CHRISIE B. KING, EXAMINING ATTORNEY



*David J. Kyros*

Director of the United States Patent and Trademark Office

# United States of America

United States Patent and Trademark Office

## SHAFTKEEPER

**Reg. No. 4,133,458**

GLOBE COMPOSITE SOLUTIONS, LTD. (TEXAS LIMITED PARTNERSHIP)  
4925 GREENVILLE AVE., SUITE 1400  
DALLAS, TX 75206

**Registered May 1, 2012**

**Int. Cl.: 7**

FOR: CONVEYOR EQUIPMENT, NAMELY, ROLLER BRACKETS, IN CLASS 7 (U.S. CLS. 13, 19, 21, 23, 31, 34 AND 35).

**TRADEMARK**

FIRST USE 2-0-1999; IN COMMERCE 2-0-1999.

**PRINCIPAL REGISTER**

THE MARK CONSISTS OF STANDARD CHARACTERS WITHOUT CLAIM TO ANY PARTICULAR FONT, STYLE, SIZE, OR COLOR.

SER. NO. 76-707,886, FILED 6-8-2011.

KATHRYN COWARD, EXAMINING ATTORNEY



*David J. Kybas*

Director of the United States Patent and Trademark Office

# United States of America

United States Patent and Trademark Office

## TRIPLE PLAY

**Reg. No. 4,133,459**

**Registered May 1, 2012**

**Int. Cls.: 1 and 19**

**TRADEMARK**

**PRINCIPAL REGISTER**

GROUNDS KEEPERS SELECT LLC (UTAH LIMITED LIABILITY COMPANY)  
PO BOX 387  
COALVILLE, UT 84017

FOR: CHEMICAL SOIL CONDITIONERS FOR BASEBALL FIELDS, IN CLASS 1 (U.S. CLS. 1, 5, 6, 10, 26 AND 46).

FIRST USE 10-0-2009; IN COMMERCE 10-0-2009.

FOR: RAW CLAY BRICK AND MOUND CLAY FOR USE IN CONSTRUCTING OR REPAIRING BASEBALL FIELDS, IN CLASS 19 (U.S. CLS. 1, 12, 33 AND 50).

FIRST USE 10-0-2009; IN COMMERCE 10-0-2009.

THE MARK CONSISTS OF STANDARD CHARACTERS WITHOUT CLAIM TO ANY PARTICULAR FONT, STYLE, SIZE, OR COLOR.

SER. NO. 76-708,156, FILED 6-27-2011.

STEVEN R. FINE, EXAMINING ATTORNEY



*David J. Kybas*

Director of the United States Patent and Trademark Office

# United States of America

United States Patent and Trademark Office

## REAL CONVERSATIONS

**Reg. No. 4,133,460**

**Registered May 1, 2012**

**Int. Cl.: 41**

**SERVICE MARK**

**PRINCIPAL REGISTER**

LIGHT STORM CONSULTING, INC. (UTAH COMPANY)  
1805 EAST 875 SOUTH  
SPRINGVILLE, UT 84663

FOR: EDUCATIONAL SERVICES, NAMELY, CONDUCTING TRAINING, CLASSES, WORKSHOPS AND PRESENTATIONS IN THE FIELD OF INTERPERSONAL COMMUNICATION SKILLS, IN CLASS 41 (U.S. CLS. 100, 101 AND 107).

FIRST USE 5-30-2008; IN COMMERCE 5-30-2008.

THE MARK CONSISTS OF STANDARD CHARACTERS WITHOUT CLAIM TO ANY PARTICULAR FONT, STYLE, SIZE, OR COLOR.

SER. NO. 76-708,161, FILED 6-27-2011.

ANNE E. GUSTASON, EXAMINING ATTORNEY



*David J. Kybas*

Director of the United States Patent and Trademark Office

# United States of America

United States Patent and Trademark Office

# Your Workout Is My Warmup

**Reg. No. 4,133,461**

**Registered May 1, 2012**

**Int. Cl.: 41**

**SERVICE MARK**

**PRINCIPAL REGISTER**

KINARD, D'ANGELO M. (UNITED STATES INDIVIDUAL)  
1303 WHISTLING DUCK DRIVE  
UPPER MARLBORO, MD 20774

FOR: HEALTH AND FITNESS INSTRUCTION, IN CLASS 41 (U.S. CLS. 100, 101 AND 107).

FIRST USE 3-0-2005; IN COMMERCE 1-2-2008.

THE MARK CONSISTS OF STANDARD CHARACTERS WITHOUT CLAIM TO ANY PARTICULAR FONT, STYLE, SIZE, OR COLOR.

SER. NO. 76-708,284, FILED 7-11-2011.

DOUGLAS LEE, EXAMINING ATTORNEY



*David J. Kyfos*

Director of the United States Patent and Trademark Office

# United States of America

United States Patent and Trademark Office

ACCUTRACE INVESTIGATIONS AND PROTECTIVE SERVICES, LLC.

**Reg. No. 4,133,462**

**Registered May 1, 2012**

**Int. Cl.: 45**

**SERVICE MARK**

**PRINCIPAL REGISTER**

ACCUTRACE INVESTIGATIONS AND PROTECTIVE SERVICES, LLC. (NEW YORK LIMITED LIABILITY COMPANY)  
28 HIGHLAND AVENUE  
EASTCHESTER, NY 10709

FOR: PROVIDING INFORMATION IN THE FIELD OF PERSONAL PHYSICAL SECURITY; SECURITY SERVICES, NAMELY, PROVIDING ARMED EXECUTIVE PROTECTION AND PROVIDING UNARMED SECURITY PROTECTION; PRIVATE INVESTIGATION SERVICES, NAMELY, BACKGROUND INVESTIGATION SERVICES, SURVEILLANCE SERVICES, INVESTIGATION OF ASSETS, MISSING PERSONS INVESTIGATIONS, NOTARY PUBLIC SERVICES, EXPERT WITNESS SERVICES IN LEGAL MATTERS IN THE FIELDS OF PERSONAL INJURY, CRIME AND WORKERS COMPENSATION; AND BACKGROUND RESEARCH OF TELEPHONE AND CELL PHONE RECORDS, IN CLASS 45 (U.S. CLS. 100 AND 101).

FIRST USE 4-22-2011; IN COMMERCE 4-22-2011.

THE MARK CONSISTS OF STANDARD CHARACTERS WITHOUT CLAIM TO ANY PARTICULAR FONT, STYLE, SIZE, OR COLOR.

NO CLAIM IS MADE TO THE EXCLUSIVE RIGHT TO USE "INVESTIGATIONS AND PROTECTIVE SERVICES, LLC.", APART FROM THE MARK AS SHOWN.

SER. NO. 76-708,479, FILED 7-26-2011.

BERYL GARDNER, EXAMINING ATTORNEY



*David J. Kybas*

Director of the United States Patent and Trademark Office

# United States of America

United States Patent and Trademark Office

## WORDSTR

**Reg. No. 4,133,463**

**Registered May 1, 2012**

**Int. Cl.: 9**

**TRADEMARK**

**PRINCIPAL REGISTER**

LITTLE FUN & GAMES LLC (CALIFORNIA LIMITED LIABILITY COMPANY)  
2320 BRYANT STREET  
PALO ALTO, CA 94301

FOR: COMPUTER GAME SOFTWARE; VIDEO GAME SOFTWARE; INTERACTIVE COMPUTER GAME PROGRAMS; INTERACTIVE VIDEO GAME PROGRAMS; DOWNLOADABLE COMPUTER GAME PROGRAMS; DOWNLOADABLE VIDEO GAME PROGRAMS; DOWNLOADABLE ENTERTAINMENT SOFTWARE FOR PLAYING COMPUTER GAMES; DOWNLOADABLE ENTERTAINMENT SOFTWARE FOR PLAYING VIDEO GAMES; INSTRUCTIONAL AND LITERATURE MATERIALS SOLD THEREWITH, IN CLASS 9 (U.S. CLS. 21, 23, 26, 36 AND 38).

FIRST USE 11-9-2010; IN COMMERCE 11-9-2010.

THE MARK CONSISTS OF STANDARD CHARACTERS WITHOUT CLAIM TO ANY PARTICULAR FONT, STYLE, SIZE, OR COLOR.

SER. NO. 76-708,697, FILED 8-12-2011.

BARBARA RUTLAND, EXAMINING ATTORNEY



*David J. Kyffers*

Director of the United States Patent and Trademark Office

# United States of America

United States Patent and Trademark Office

## RAMP UNIVERSITY

**Reg. No. 4,133,464**

**Registered May 1, 2012**

**Int. Cl.: 41**

**SERVICE MARK**

**PRINCIPAL REGISTER**

TRAINING WHEELS OF NE, INC. (MASSACHUSETTS CORPORATION)  
P.O. BOX 784  
E. ORLEANS, MA 02643

FOR: SKATEBOARDING CAMPS, IN CLASS 41 (U.S. CLS. 100, 101 AND 107).

FIRST USE 1-1-2011; IN COMMERCE 1-1-2011.

THE MARK CONSISTS OF STANDARD CHARACTERS WITHOUT CLAIM TO ANY PARTICULAR FONT, STYLE, SIZE, OR COLOR.

NO CLAIM IS MADE TO THE EXCLUSIVE RIGHT TO USE "UNIVERSITY", APART FROM THE MARK AS SHOWN.

SER. NO. 76-708,718, FILED 8-12-2011.

KELLY CHOE, EXAMINING ATTORNEY



*David J. Kybas*

Director of the United States Patent and Trademark Office



# United States of America

United States Patent and Trademark Office



**Reg. No. 4,133,465**

**Registered May 1, 2012**

**Int. Cl.: 40**

**SERVICE MARK**

**PRINCIPAL REGISTER**

MOELLER MANUFACTURING & SUPPLY, INC. (CALIFORNIA CORPORATION)  
805 E. CERRITOS AVENUE  
ANAHEIM, CA 92805

FOR: MANUFACTURING OF CUSTOM MADE STAMPINGS TO ORDER AND SPECIFICATION FOR OTHERS IN THE AIRCRAFT INDUSTRY, IN CLASS 40 (U.S. CLS. 100, 103 AND 106).

FIRST USE 7-29-1988; IN COMMERCE 7-29-1988.

THE MARK CONSISTS OF THE WORDING "MOELLER" FEATURED WITH LINES DEPICTING SPEED OR WIND, AND ABOVE APPEARS A STYLIZED DESIGN OF AN AIRCRAFT WITH LINES DEPICTING SPEED OR WIND.

SER. NO. 76-708,719, FILED 8-12-2011.

KELLY CHOE, EXAMINING ATTORNEY



*David J. Kyffers*

Director of the United States Patent and Trademark Office

# United States of America

United States Patent and Trademark Office

# catalyst

MORTGAGE

**Reg. No. 4,133,466**

**Registered May 1, 2012**

**Int. Cl.: 36**

**SERVICE MARK**

**PRINCIPAL REGISTER**

CATALYST MORTGAGE (CALIFORNIA CORPORATION)  
1375 EXPOSITION BLVD.  
SUITE 207  
SACRAMENTO, CA 95815

FOR: DIRECT MORTGAGE LENDING, MORTGAGE BROKERAGE, MORTGAGE PROCUREMENT FOR OTHERS, IN CLASS 36 (U.S. CLS. 100, 101 AND 102).

FIRST USE 6-1-2011; IN COMMERCE 6-1-2011.

NO CLAIM IS MADE TO THE EXCLUSIVE RIGHT TO USE "MORTGAGE", APART FROM THE MARK AS SHOWN.

THE MARK CONSISTS OF THE WORDING "CATALYST" IN LOWERCASE LETTERS WITH THE DESIGN OF A SIX-POINT STARBURST APPEARING INSIDE OF THE BOWL OF THE SECOND LETTER "A" AND A CURVED LINE EXTENDING THROUGH ALL OF THE LETTERS; BENEATH APPEARS THE SMALLER WORDING "MORTGAGE" IN UPPERCASE LETTERS.

SER. NO. 76-708,720, FILED 8-12-2011.

RON FAIRBANKS, EXAMINING ATTORNEY



*David J. Kybas*

Director of the United States Patent and Trademark Office

# United States of America

United States Patent and Trademark Office

## EZ TRAC

**Reg. No. 4,133,467**

**Registered May 1, 2012**

**Int. Cl.: 20**

**TRADEMARK**

**PRINCIPAL REGISTER**

EZ TRAC, INC. (ILLINOIS CORPORATION)  
402 N. FOURTH ST.  
SPRINGFIELD, IL 62702

FOR: NON-ELECTRIC, SIGN ACCESSORY, NAMELY, A METAL TRACK FOR RECEIVING AND HOLDING LETTERS AND NUMBERS BELOW THE SIGN TO ENHANCE THE SIGN MESSAGE, IN CLASS 20 (U.S. CLS. 2, 13, 22, 25, 32 AND 50).

FIRST USE 10-1-1997; IN COMMERCE 11-1-1997.

THE MARK CONSISTS OF STANDARD CHARACTERS WITHOUT CLAIM TO ANY PARTICULAR FONT, STYLE, SIZE, OR COLOR.

NO CLAIM IS MADE TO THE EXCLUSIVE RIGHT TO USE "TRACK", APART FROM THE MARK AS SHOWN.

SER. NO. 76-708,723, FILED 8-15-2011.

SUSAN RICHARDS, EXAMINING ATTORNEY



*David J. Kybas*

Director of the United States Patent and Trademark Office

# United States of America

United States Patent and Trademark Office



HAPPY PANDA MANDARIN SCHOOL

快乐熊猫中文学校

**Reg. No. 4,133,468**

**Registered May 1, 2012**

**Int. Cl.: 41**

**SERVICE MARK**

**PRINCIPAL REGISTER**

HAPPY PANDA MANDARIN SCHOOL LLC. (CONNECTICUT LIMITED LIABILITY COMPANY)  
5 RIVER ROAD, SUITE 29  
WILTON, CT 06897

FOR: EDUCATIONAL SERVICES, NAMELY, CHINESE LANGUAGE LEARNING CENTER AND CHINESE-ENGLISH BILINGUAL SCHOOL, IN CLASS 41 (U.S. CLS. 100, 101 AND 107).

FIRST USE 6-1-2010; IN COMMERCE 8-1-2010.

NO CLAIM IS MADE TO THE EXCLUSIVE RIGHT TO USE "MANDARIN SCHOOL" AND THE NON-LATIN CHARACTERS THAT TRANSLITERATE TO "ZHONG WEN XUE XIAO", APART FROM THE MARK AS SHOWN.

GREEN, DARK GREEN, ORANGE, GREY, BLACK AND WHITE

THE TRANSLITERATION OF THE NON-LATIN CHARACTERS IN THE MARK IS KUAILE XIONG MAO ZHONG WEN XUE XIAO.

THE MARK CONSISTS OF THE WORDING "HAPPY PANDA MANDARIN SCHOOL" IN STYLIZED UPPERCASE GREEN LETTERING. A THIN DARK GREEN OUTLINE APPEARS IN THE WORDING "HAPPY PANDA MANDARIN SCHOOL". A GREY DROP SHADOW APPEARS IN THE WORDING "HAPPY PANDA MANDARIN SCHOOL". THE WORDING "HAPPY PANDA MANDARIN SCHOOL" APPEARS ARCHED OVER ORANGE CHINESE CHARACTERS. A BLACK AND WHITE PANDA HOLDING A BLACK AND WHITE CHINESE BOOK APPEARS TO THE LEFT OF THE WORDING "HAPPY PANDA MANDARIN SCHOOL".

THE ENGLISH TRANSLATION OF THE FOREIGN WORDING IN THE MARK IS "HAPPY PANDA MANDARIN SCHOOL".

SER. NO. 76-708,846, FILED 8-24-2011.

NATALIE POLZER, EXAMINING ATTORNEY

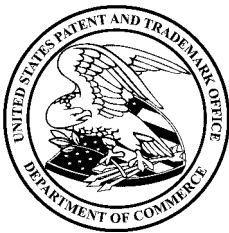

*David J. Kappas*

Director of the United States Patent and Trademark Office

# United States of America

United States Patent and Trademark Office

# GELLÉRT

**Reg. No. 4,133,469**

**Registered May 1, 2012**

**Int. Cls.: 5 and 35**

**TRADEMARK**

**SERVICE MARK**

**PRINCIPAL REGISTER**

GELLERT HEALTH SOLUTIONS, LLC (MASSACHUSETTS LIMITED LIABILITY COMPANY)  
22 OHIO AVENUE  
NEWTON, MA 02464

FOR: PHARMACEUTICAL AND NUTRACEUTICAL PREPARATIONS, NAMELY, OVER THE COUNTER PHARMACEUTICALS AND NUTRACEUTICALS DERIVED FROM GLUCOSAMINE AND MEDICINAL HERBS FOR THE TREATMENT OF ARTHRITIS AND JOINT PAIN, IN CLASS 5 (U.S. CLS. 6, 18, 44, 46, 51 AND 52).

FIRST USE 5-0-2011; IN COMMERCE 5-0-2011.

FOR: ONLINE RETAIL STORE SERVICES FEATURING PHARMACEUTICAL AND NUTRACEUTICAL PREPARATIONS, IN CLASS 35 (U.S. CLS. 100, 101 AND 102).

FIRST USE 4-0-2011; IN COMMERCE 4-0-2011.

THE MARK CONSISTS OF STANDARD CHARACTERS WITHOUT CLAIM TO ANY PARTICULAR FONT, STYLE, SIZE, OR COLOR.

SER. NO. 76-708,865, FILED 8-26-2011.

MATTHEW MCDOWELL, EXAMINING ATTORNEY



*David J. Kyros*

Director of the United States Patent and Trademark Office

# United States of America

United States Patent and Trademark Office

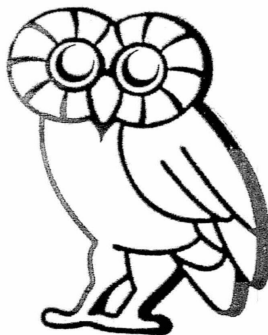

**Reg. No. 4,133,470**

**Registered May 1, 2012**

**Int. Cl.: 14**

**TRADEMARK**

**PRINCIPAL REGISTER**

WILLIAM MARSH RICE UNIVERSITY (TEXAS NON-PROFIT CORPORATION)  
6100 MAIN STREET  
HOUSTON, TX 77005

FOR: JEWELRY, NAMELY, RINGS, WATCHES, CUFF-LINKS, EARRINGS, PENDANTS, CLOCKS, CHARMS, LAPEL PINS AND TIE TACKS, IN CLASS 14 (U.S. CLS. 2, 27, 28 AND 50).

FIRST USE 12-1-2008; IN COMMERCE 12-1-2009.

OWNER OF U.S. REG. NOS. 3,571,020, 3,909,621 AND OTHERS.

THE MARK CONSISTS OF A STYLIZED OWL.

SER. NO. 76-708,873, FILED 8-26-2011.

MICHAEL SOUDERS, EXAMINING ATTORNEY



*David J. Kybas*

Director of the United States Patent and Trademark Office

# United States of America

United States Patent and Trademark Office

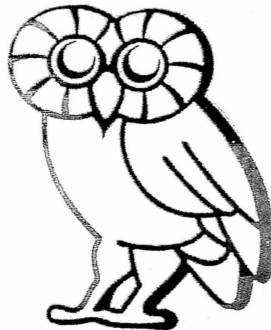

**Reg. No. 4,133,471**

**Registered May 1, 2012**

**Int. Cl.: 24**

**TRADEMARK**

**PRINCIPAL REGISTER**

WILLIAM MARSH RICE UNIVERSITY (TEXAS NON-PROFIT CORPORATION)  
6100 MAIN STREET  
HOUSTON, TX 77005

FOR: CLOTH MATERIALS, NAMELY, FLAGS, PENNANTS, TOWELS AND BLANKETS  
FOR OUTDOOR USE, IN CLASS 24 (U.S. CLS. 42 AND 50).

FIRST USE 12-1-2008; IN COMMERCE 12-1-2009.

OWNER OF U.S. REG. NOS. 3,571,020, 3,909,621 AND OTHERS.

THE MARK CONSISTS OF A STYLIZED OWL.

SER. NO. 76-708,874, FILED 8-26-2011.

MICHAEL SOUDERS, EXAMINING ATTORNEY



*David J. Kyffers*

Director of the United States Patent and Trademark Office

# United States of America

United States Patent and Trademark Office

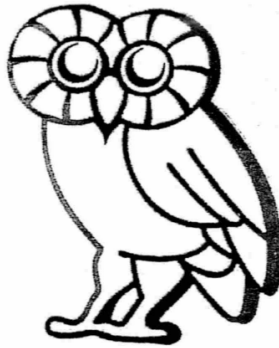

**Reg. No. 4,133,472**

**Registered May 1, 2012**

**Int. Cl.: 28**

**TRADEMARK**

**PRINCIPAL REGISTER**

WILLIAM MARSH RICE UNIVERSITY (TEXAS NON-PROFIT CORPORATION)  
6100 MAIN STREET  
HOUSTON, TX 77005

FOR: TOYS AND SPORTING GOODS, NAMELY, STUFFED TOY ANIMALS, BOARD GAMES, FOOTBALLS, BASEBALLS, GOLF BALLS, GOLF CLUBS, FLYING DISCS, AND CHRISTMAS TREE ORNAMENTS, IN CLASS 28 (U.S. CLS. 22, 23, 38 AND 50).

FIRST USE 12-1-2008; IN COMMERCE 8-1-2010.

OWNER OF U.S. REG. NOS. 3,652,982, 3,909,621 AND OTHERS.

THE MARK CONSISTS OF A STYLIZED OWL.

SER. NO. 76-708,875, FILED 8-26-2011.

MICHAEL SOUDERS, EXAMINING ATTORNEY



*David J. Kybas*

Director of the United States Patent and Trademark Office



# United States of America

United States Patent and Trademark Office

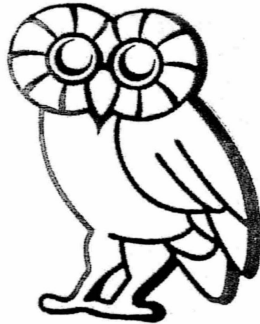

**Reg. No. 4,133,473**

**Registered May 1, 2012**

**Int. Cl.: 6**

**TRADEMARK**

**PRINCIPAL REGISTER**

WILLIAM MARSH RICE UNIVERSITY (TEXAS NON-PROFIT CORPORATION)  
6100 MAIN STREET  
HOUSTON, TX 77005

FOR: METAL RINGS AND CHAINS FOR KEYS; METAL NOTE CLIPS, FIGURINES OF COMMON METAL; BRONZE HOLIDAY ORNAMENTS; HOLIDAY ORNAMENTS OF COMMON METAL; STATUES OF NON-PRECIOUS METAL, STATUETTES OF NON-PRECIOUS METAL; SCULPTURES AND TROPHIES OF COMMON METALS; PRINTED METAL COVERS FOR COLLECTION PURPOSES, NAMELY, COLLECTIBLE PRINTED BOTTLE CAPS MADE OF COMMON METALS; METAL NAME BADGES, IN CLASS 6 (U.S. CLS. 2, 12, 13, 14, 23, 25 AND 50).

FIRST USE 12-1-2008; IN COMMERCE 7-1-2011.

OWNER OF U.S. REG. NOS. 3,652,982, 3,909,621 AND OTHERS.

THE MARK CONSISTS OF A STYLIZED OWL.

SER. NO. 76-708,876, FILED 8-26-2011.

MICHAEL SOUDERS, EXAMINING ATTORNEY



*David J. Kyffers*

Director of the United States Patent and Trademark Office

# United States of America

United States Patent and Trademark Office

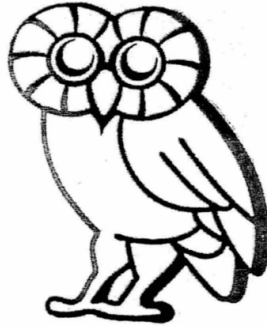

**Reg. No. 4,133,474**

**Registered May 1, 2012**

**Int. Cl.: 18**

**TRADEMARK**

**PRINCIPAL REGISTER**

WILLIAM MARSH RICE UNIVERSITY (TEXAS NON-PROFIT CORPORATION)  
6100 MAIN STREET  
HOUSTON, TX 77006

FOR: WALLETS, UMBRELLAS, BACKPACKS, BRIEFCASES, TOTE BAGS, GARMENT BAGS FOR TRAVEL AND ALL PURPOSE SPORT BAGS, IN CLASS 18 (U.S. CLS. 1, 2, 3, 22 AND 41).

FIRST USE 12-1-2008; IN COMMERCE 7-1-2010.

OWNER OF U.S. REG. NOS. 3,652,982, 3,909,621 AND OTHERS.

THE MARK CONSISTS OF A STYLIZED OWL.

SER. NO. 76-708,877, FILED 8-26-2011.

MICHAEL SOUDERS, EXAMINING ATTORNEY



*David J. Kyffers*

Director of the United States Patent and Trademark Office

# United States of America

United States Patent and Trademark Office

## DESIGN FOCUS

**Reg. No. 4,133,475**

**Registered May 1, 2012**

**Int. Cls.: 16 and 26**

**TRADEMARK**

**PRINCIPAL REGISTER**

INTERNATIONAL GREETINGS USA, INC. (GEORGIA CORPORATION)  
338 INDUSTRIAL BOULEVARD  
MIDWAY, GA 31320

FOR: WRAPPING PAPER, GREETING CARDS, TISSUE PAPER, IN CLASS 16 (U.S. CLS. 2, 5, 22, 23, 29, 37, 38 AND 50).

FIRST USE 12-31-1988; IN COMMERCE 12-31-1988.

FOR: RIBBONS AND ORNAMENTAL BOWS OF TEXTILE FOR DECORATION, IN CLASS 26 (U.S. CLS. 37, 39, 40, 42 AND 50).

FIRST USE 12-31-1988; IN COMMERCE 12-31-1988.

THE MARK CONSISTS OF STANDARD CHARACTERS WITHOUT CLAIM TO ANY PARTICULAR FONT, STYLE, SIZE, OR COLOR.

SER. NO. 76-709,001, FILED 9-6-2011.

KATHERINE E. HALMEN, EXAMINING ATTORNEY



*David J. Kyros*

Director of the United States Patent and Trademark Office

# United States of America

United States Patent and Trademark Office

## STEPHEN LAWRENCE

**Reg. No. 4,133,476**

**Registered May 1, 2012**

**Int. Cl.: 16**

**TRADEMARK**

**PRINCIPAL REGISTER**

INTERNATIONAL GREETINGS USA, INC. (GEORGIA CORPORATION)  
338 INDUSTRIAL BOULEVARD  
MIDWAY, GA 31320

FOR: WRAPPING PAPER, GREETING CARDS, STATIONERY, GIFT BAGS, GIFT BOXES, GIFT CARD POUCHES OF PAPER SOLD EMPTY, GOODIE BAGS OF PAPER OR PLASTIC, CELLOPHANE TREAT BAGS, PAPER TAKE-OUT CONTAINERS, CUPCAKE BOXES OF PAPER, PAPER GIFT LABELS, PAPER GIFT TAGS, IN CLASS 16 (U.S. CLS. 2, 5, 22, 23, 29, 37, 38 AND 50).

FIRST USE 12-31-1988; IN COMMERCE 12-31-1988.

THE MARK CONSISTS OF STANDARD CHARACTERS WITHOUT CLAIM TO ANY PARTICULAR FONT, STYLE, SIZE, OR COLOR.

"STEPHEN LAWRENCE" DOES NOT IDENTIFY A LIVING INDIVIDUAL

SER. NO. 76-709,003, FILED 9-6-2011.

KATHERINE E. HALMEN, EXAMINING ATTORNEY



*David J. Kyros*

Director of the United States Patent and Trademark Office

# United States of America

United States Patent and Trademark Office

# X4D

**Reg. No. 4,133,477**

**Registered May 1, 2012**

**Int. Cl.: 20**

**TRADEMARK**

**PRINCIPAL REGISTER**

MEDIAMATION, INC. (CALIFORNIA CORPORATION)  
2213 BORDER AVENUE  
TORRANCE, CA 90501

FOR: STATIC AND MOTION EFFECTS SEATS THAT MOVE BACK TO FRONT, SIDE TO SIDE AND UP AND DOWN WITH AN ARRAY OF EFFECTS BUILT INTO THE SEAT, IN CLASS 20 (U.S. CLS. 2, 13, 22, 25, 32 AND 50).

FIRST USE 5-10-2007; IN COMMERCE 5-10-2007.

THE MARK CONSISTS OF STANDARD CHARACTERS WITHOUT CLAIM TO ANY PARTICULAR FONT, STYLE, SIZE, OR COLOR.

SER. NO. 76-709,099, FILED 9-16-2011.

SHANNON TWOHIG, EXAMINING ATTORNEY



*David J. Kybas*

Director of the United States Patent and Trademark Office

# United States of America

United States Patent and Trademark Office

## MICRO ACTIVE

**Reg. No. 4,133,478**

**Registered May 1, 2012**

**Int. Cl.: 1**

**TRADEMARK**

**PRINCIPAL REGISTER**

SHAMMAS, MILO (UNITED STATES INDIVIDUAL)  
P.O. BOX 460  
WINTERS, CA 95694

FOR: AMMONIUM CHLORIDE FERTILIZER; AMMONIUM NITRATE FERTILIZER; AMMONIUM SULPHATE FERTILIZER; BLOOD POWDER; BONE MEAL; BREWERS' GRAIN; CALCINED POTASSIUM FERTILIZER; CALCIUM SILICATE FERTILIZER; CALCIUM SUPERPHOSPHATE FERTILIZER; CHEMICAL FERTILIZERS; CHEMICALLY CONVERTED COMPOUND FERTILIZERS; COMPLEX FERTILIZER; COMPLEX FERTILIZERS; COMPOST; DOUBLE OR TRIPLE SUPERPHOSPHATE FERTILIZER; FERTILIZERS; FERTILIZERS AND MANURES; FERTILIZERS FOR AGRICULTURAL USE; FERTILIZERS FOR DOMESTIC USE; FERTILIZING PREPARATIONS; GYPSUM FOR USE AS A FERTILIZER; LEAF MOLD; MANGANESE FERTILIZER; MARINE FERTILIZER; MIXED FERTILIZERS; NATURAL FERTILIZERS; NON-CHEMICAL BIO-FERTILIZERS; NUTRITIVE ADDITIVE TO ENHANCE THE BIOLOGICAL ACTIVITY OF WATER, SOIL, SEEDS AND PLANTS FOR PURPOSES OF FERTILIZATION AND BIOREMEDIATION OF POLLUTANTS; PEAT; POTASSIUM CHLORIDE FERTILIZER; POTASSIUM SULPHATE FERTILIZER; RICE BRAN; SODIUM NITRATE FERTILIZER; THOMAS PHOSPHATIC FERTILIZER; UREA FERTILIZER; PLANTING SOIL, IN CLASS 1 (U.S. CLS. 1, 5, 6, 10, 26 AND 46).

FIRST USE 8-12-2011; IN COMMERCE 8-12-2011.

THE MARK CONSISTS OF STANDARD CHARACTERS WITHOUT CLAIM TO ANY PARTICULAR FONT, STYLE, SIZE, OR COLOR.

SER. NO. 76-709,116, FILED 9-19-2011.

DOMINIC J. FERRAIUOLO, EXAMINING ATTORNEY



*David J. Kyros*

Director of the United States Patent and Trademark Office

# United States of America

United States Patent and Trademark Office

## OCEAN RICH

**Reg. No. 4,133,479**

**Registered May 1, 2012**

**Int. Cl.: 1**

**TRADEMARK**

**PRINCIPAL REGISTER**

SHAMMAS, MILO (UNITED STATES INDIVIDUAL)  
P.O. BOX 460  
WINTERS, CA 95694

FOR: AMMONIUM CHLORIDE FERTILIZER; AMMONIUM NITRATE FERTILIZER; AMMONIUM SULPHATE FERTILIZER; BLOOD POWDER; BONE MEAL; BREWERS' GRAIN; CALCINED POTASSIUM FERTILIZER; CALCIUM SILICATE FERTILIZER; CALCIUM SUPERPHOSPHATE FERTILIZER; CHEMICAL FERTILIZERS; CHEMICALLY CONVERTED COMPOUND FERTILIZERS; COMPLEX FERTILIZER; COMPLEX FERTILIZERS; COMPOST; DOUBLE OR TRIPLE SUPERPHOSPHATE FERTILIZER; FERTILIZERS; FERTILIZERS AND MANURES; FERTILIZERS FOR AGRICULTURAL USE; FERTILIZERS FOR DOMESTIC USE; FERTILIZING PREPARATIONS; GYPSUM FOR USE AS A FERTILIZER; LEAF MOLD; MANGANESE FERTILIZER; MARINE FERTILIZER; MIXED FERTILIZERS; NATURAL FERTILIZERS; NON-CHEMICAL BIO-FERTILIZERS; NUTRITIVE ADDITIVE TO ENHANCE THE BIOLOGICAL ACTIVITY OF WATER, SOIL, SEEDS AND PLANTS FOR PURPOSES OF FERTILIZATION AND BIOREMEDIATION OF POLLUTANTS; PEAT; POTASSIUM CHLORIDE FERTILIZER; POTASSIUM SULPHATE FERTILIZER; RICE BRAN; SODIUM NITRATE FERTILIZER; THOMAS PHOSPHATIC FERTILIZER; UREA FERTILIZER; PLANTING SOIL, IN CLASS 1 (U.S. CLS. 1, 5, 6, 10, 26 AND 46).

FIRST USE 8-12-2011; IN COMMERCE 8-12-2011.

THE MARK CONSISTS OF STANDARD CHARACTERS WITHOUT CLAIM TO ANY PARTICULAR FONT, STYLE, SIZE, OR COLOR.

SER. NO. 76-709,127, FILED 9-19-2011.

DOMINIC J. FERRAIUOLO, EXAMINING ATTORNEY



*David J. Kyros*

Director of the United States Patent and Trademark Office

# United States of America

United States Patent and Trademark Office

## TRANCENTRAL

**Reg. No. 4,133,480**

**Registered May 1, 2012**

**Int. Cl.: 36**

**SERVICE MARK**

**PRINCIPAL REGISTER**

TCI BUSINESS CAPITAL, INC. (MINNESOTA CORPORATION)  
12270 NICOLLET AVENUE SOUTH  
BURNSVILLE, MN 55337

FOR: FINANCIAL SERVICES, NAMELY, FACTORING SERVICES, PROVIDING SHORT-TERM BUSINESS CREDIT AND ACCOUNTS RECEIVABLE FINANCING, IN CLASS 36 (U.S. CLS. 100, 101 AND 102).

FIRST USE 8-1-1994; IN COMMERCE 8-1-1994.

THE MARK CONSISTS OF STANDARD CHARACTERS WITHOUT CLAIM TO ANY PARTICULAR FONT, STYLE, SIZE, OR COLOR.

SER. NO. 76-709,135, FILED 9-19-2011.

DOMINIC J. FERRAIUOLO, EXAMINING ATTORNEY



*David J. Kyros*

Director of the United States Patent and Trademark Office



# United States of America

United States Patent and Trademark Office

## THE BOSSMAKER

**Reg. No. 4,133,481**

**Registered May 1, 2012**

**Int. Cl.: 16**

**TRADEMARK**

**PRINCIPAL REGISTER**

THE BOSSMAKER INCORPORATED (MINNESOTA CORPORATION)  
5001 76TH AVENUE NORTH  
BROOKLYN PARK, MN 55443

FOR: UNIVERSAL ANGLE PAINT ROLLERS; ROTATABLE PAINT APPLICATOR SYSTEMS COMPRISING PAINT ROLLERS, PAINT TRAYS, PAINT ROLLER COVERS AND PAINT BRUSHES; PAINT ROLLER ACCESSORY MOUNTING FIXTURES, NAMELY, PAINT ROLLER HANDLES; PAINTING ACCESSORIES FOR THE HANDICAPPED, NAMELY, PAINT ROLLER HANDLES; ROTARY GRID CUT-IN CUSTOM SPECIAL-MOLDED PAINT APPLICATORS; PROTOTYPE CUSTOM PAINT APPLICATORS FOR PROFESSIONAL PAINTERS, IN CLASS 16 (U.S. CLS. 2, 5, 22, 23, 29, 37, 38 AND 50).

FIRST USE 1-1-2000; IN COMMERCE 1-1-2000.

THE MARK CONSISTS OF STANDARD CHARACTERS WITHOUT CLAIM TO ANY PARTICULAR FONT, STYLE, SIZE, OR COLOR.

SER. NO. 76-709,157, FILED 9-21-2011.

PATRICIA EVANKO, EXAMINING ATTORNEY



*David J. Kybas*

Director of the United States Patent and Trademark Office

# United States of America

United States Patent and Trademark Office



**Reg. No. 4,133,482**

**Registered May 1, 2012**

**Int. Cl.: 36**

**SERVICE MARK**

**PRINCIPAL REGISTER**

CATALYST MORTGAGE (CALIFORNIA CORPORATION)  
1375 EXPOSITION BLVD., SUITE 207  
SACRAMENTO, CA 95815

FOR: DIRECT MORTGAGE LENDING, MORTGAGE BROKERAGE, MORTGAGE PROCUREMENT FOR OTHERS, IN CLASS 36 (U.S. CLS. 100, 101 AND 102).

FIRST USE 1-14-2011; IN COMMERCE 1-14-2011.

NO CLAIM IS MADE TO THE EXCLUSIVE RIGHT TO USE "CALSTATE" AND "EMPLOYEE" AND "HOME LOAN PROGRAM", OR THE SILHOUETTE OF THE STATE OF CALIFORNIA, APART FROM THE MARK AS SHOWN.

THE MARK CONSISTS OF THE DESIGN OF A HOUSE WITH A SILHOUETTE OF THE STATE OF CALIFORNIA CONTAINED THEREIN; BENEATH APPEARS THE WORDING "CALSTATE" UNDERLINED; THEN BENEATH THAT APPEARS THE WORDING "EMPLOYEE", AND DIRECT BENEATH THIS APPEARS THE WORDING "HOME LOAN PROGRAM".

SER. NO. 76-709,486, FILED 10-21-2011.

RON FAIRBANKS, EXAMINING ATTORNEY



*David J. Kyffers*

Director of the United States Patent and Trademark Office

# United States of America

United States Patent and Trademark Office

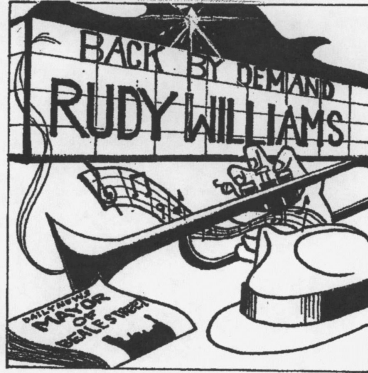

**Reg. No. 4,133,483**

**Registered May 1, 2012**

**Int. Cl.: 41**

**SERVICE MARK**

**PRINCIPAL REGISTER**

BROWN, MARVA (UNITED STATES INDIVIDUAL)  
1275 ROYAL OAKS COVE  
MEMPHIS, TN 38116

FOR: ENTERTAINMENT SERVICES, NAMELY, PRESENTING LIVE MUSICAL PERFORMANCES; NIGHTCLUB SERVICES FEATURING LIVE AND RECORDED MUSICAL ENTERTAINMENT, IN CLASS 41 (U.S. CLS. 100, 101 AND 107).

FIRST USE 6-11-2011; IN COMMERCE 6-11-2011.

NO CLAIM IS MADE TO THE EXCLUSIVE RIGHT TO USE "BEALE STREET", APART FROM THE MARK AS SHOWN.

THE NAME "RUDY WILLIAMS" DOES NOT IDENTIFY A LIVING INDIVIDUAL.

THE MARK CONSISTS OF A STYLIZED REPRESENTATION OF A MARQUEE SIGN WITH THE WORDS "BACK BY DEMAND" ABOVE THE WORDS "RUDY WILLIAMS". IMAGES OF A HAND PLAYING A TRUMPET, MUSIC SCORE, HAT, AND FOLDED NEWSPAPER WITH THE WORDS "DAILY NEWS MAYOR OF BEALE STREET" APPEAR BELOW THE SIGN.

SER. NO. 76-709,734, FILED 11-15-2011.

DEBORAH LOBO, EXAMINING ATTORNEY



*David J. Kyjars*

Director of the United States Patent and Trademark Office

# United States of America

United States Patent and Trademark Office

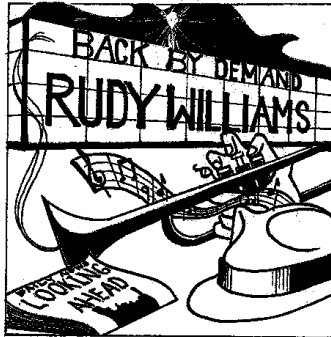

**Reg. No. 4,133,484**

**Registered May 1, 2012**

**Int. Cl.: 41**

**SERVICE MARK**

**PRINCIPAL REGISTER**

BROWN, MARVA (UNITED STATES INDIVIDUAL)  
1275 ROYAL OAKS COVE  
MEMPHIS, TN 38116

FOR: ENTERTAINMENT SERVICES, NAMELY, PRESENTING LIVE MUSICAL PERFORMANCES; NIGHTCLUB SERVICES FEATURING LIVE AND RECORDED MUSICAL ENTERTAINMENT, IN CLASS 41 (U.S. CLS. 100, 101 AND 107).

FIRST USE 6-11-2011; IN COMMERCE 6-11-2011.

THE NAME "RUDY WILLIAMS" DOES NOT IDENTIFY A LIVING INDIVIDUAL.

THE MARK CONSISTS OF A STYLIZED REPRESENTATION OF A MARQUEE SIGN WITH THE WORDS "BACK BY DEMAND" ABOVE THE WORDS "RUDY WILLIAMS", IMAGES OF A HAND PLAYING A TRUMPET, MUSIC SCORE, HAT, AND FOLDED NEWSPAPER WITH THE WORDS "DAILY NEWS LOOKING AHEAD" APPEAR BELOW THE SIGN.

SER. NO. 76-709,735, FILED 11-15-2011.

DEBORAH LOBO, EXAMINING ATTORNEY



*David J. Kyffers*

Director of the United States Patent and Trademark Office

# United States of America

United States Patent and Trademark Office

# CHS

**Reg. No. 4,133,485**

**Registered May 1, 2012**

**Int. Cl.: 44**

**SERVICE MARK**

**PRINCIPAL REGISTER**

CRITICAL HOMECARE SOLUTIONS, INC. (DELAWARE CORPORATION)  
TWO TOWER BRIDGE, SUITE 150  
ONE FAYETTE STREET  
CONSHOHOCKEN, PA 19428

FOR: HOME HEALTH CARE SERVICES, NAMELY, HOME INFUSION THERAPY, NURSING, SPECIALTY PHARMACY, NAMELY, PREPARATION AND DISPENSING OF MEDICATIONS, AND RESPIRATORY SERVICES; LEASING OF HOME MEDICAL EQUIPMENT AND SUPPLIES, IN CLASS 44 (U.S. CLS. 100 AND 101).

FIRST USE 6-2-2007; IN COMMERCE 6-2-2007.

THE MARK CONSISTS OF STANDARD CHARACTERS WITHOUT CLAIM TO ANY PARTICULAR FONT, STYLE, SIZE, OR COLOR.

REGISTRATION LIMITED TO THE AREA COMPRISING THE UNITED STATES EXCEPT FOR THE COUNTIES OF NASSAU, SUFFOLK, AND QUEENS IN THE STATE OF NEW YORK PURSUANT TO CONCURRENT USE PROCEEDING NO. 94002351. CONCURRENT USE WITH CATHOLIC HEALTH SERVICES OF LONG ISLAND AND/OR ETC, 15 POWER DRIVE, HAUPPAUGE, NY 11788.

SER. NO. 77-012,845, FILED 10-3-2006.

ROBIN CHOSID, EXAMINING ATTORNEY



*David J. Kyros*

Director of the United States Patent and Trademark Office

# United States of America

United States Patent and Trademark Office

# C21

**Reg. No. 4,133,486**

**Registered May 1, 2012**

**Int. Cls.: 6, 7, 9, 11, 17,  
19, 37 and 40**

**TRADEMARK**

**SERVICE MARK**

**PRINCIPAL REGISTER**

SOLAR CENTURY HOLDINGS LIMITED (UNITED KINGDOM LIMITED COMPANY)  
91-94 LOWER MARSH  
LONDON, UNITED KINGDOM SE17AB

FOR: METALLIC BUILDING MATERIALS, NAMELY, METALLIC FASCIA, METALLIC ROOF TILES, METALLIC ROOF SHEETS, METALLIC PIPES AND FITTINGS; METALLIC ROOF TILES INCORPORATING SOLAR CELLS; METALLIC CONDUITS; METALLIC HOSES, METALLIC PIPES AND FITTINGS; WATER TANKS OF METAL FOR HOUSEHOLD PURPOSES, IN CLASS 6 (U.S. CLS. 2, 12, 13, 14, 23, 25 AND 50).

FOR: SOLAR POWERED ELECTRICAL AND ELECTRONIC APPARATUS, NAMELY, SOLAR POWERED ELECTRICITY GENERATORS; WIND TURBINES; WIND-POWERED ELECTRICITY GENERATORS, IN CLASS 7 (U.S. CLS. 13, 19, 21, 23, 31, 34 AND 35).

FOR: APPARATUS FOR THE SUPPLY, REGULATION, TRANSMISSION, CONTROL, STORAGE AND DISTRIBUTION OF ELECTRICITY, NAMELY, ELECTRICITY GENERATING APPARATUS UTILIZING RENEWABLE ENERGY RESOURCES, NAMELY, SOLAR CELLS, PHOTOVOLTAIC CELLS; APPARATUS FOR CONVERTING ELECTRONIC RADIATION TO ELECTRICAL ENERGY, NAMELY, PHOTOVOLTAIC SOLAR MODULES; APPARATUS FOR CONVERTING ELECTRONIC RADIATION TO ELECTRICAL ENERGY, NAMELY, SOLAR ENERGY OPERATING APPARATUS MODULES; METERS, NAMELY, RENEWABLE ENERGY METERS; SOLAR ENERGY METERS, NAMELY, ELECTRICITY METERS AND WATER METERS; ENERGY LEVEL INDICATORS, NAMELY, RENEWABLE ENERGY INDICATORS; SOLAR ENERGY INDICATORS; ELECTRICITY INDICATORS; WATER INDICATORS; WATER LEVEL INDICATORS; WATER FLOW INDICATORS; WATER TEMPERATURE INDICATORS AND WATER PRESSURE INDICATORS; INDICATORS FOR INDICATING ELECTRICITY GENERATED; INDICATORS FOR INDICATING ELECTRICITY DEMANDED; INDICATORS FOR INDICATING HOT WATER GENERATED; INDICATORS FOR INDICATING HOT WATER DEMANDED; WATER PRESSURE GAUGES; ELECTRICAL COMPONENTS, NAMELY, ELECTRICAL TRANSFORMERS, ELECTRICITY CONNECTORS, ELECTRICITY CABLES, WIRES AND LEADS, BATTERIES, BATTERY CHARGERS, ELECTRIC SWITCHES, ELECTRIC POWER CONTROLLERS, CHARGE REGULATORS; DIODES, ELECTRICAL PLUGS AND SOCKETS, INVERTERS, THERMOSTATS, AUTOMATIC TIME SWITCHES, COMPUTER CHIPS, INTEGRATED CIRCUITS; SOLAR POWERED COMMUNICATIONS AND TELECOMMUNICATIONS APPARATUS, NAMELY, SOLAR POWERED TELEPHONES, SOLAR POWERED RADIOS, SOLAR POWERED PERSONAL ORGANIZERS, COMPUTER CHIPS, BLANK SMART CARDS, INTEGRATED CIRCUITS;



*David J. Kyros*

Director of the United States Patent and Trademark Office

**Reg. No. 4,133,486** SOLAR POWERED WIRES FOR ELECTRIC FENCES; CATHODIC PROTECTION APPARATUS FOR CORROSION PROTECTION, WATER HEATING CONTROLS, NAMELY, WATER TEMPERATURE CONTROLS; WATER FLOW CONTROLS, NAMELY, WATER PRESSURE CONTROLS AND WATER LEVEL CONTROLS; APPARATUS FOR CONVERTING ELECTRONIC RADIATION TO ELECTRICAL ENERGY, NAMELY, SOLAR PANEL ARRAYS; PHOTOVOLTAIC SOLAR PANELS FOR GENERATING ELECTRICITY, IN CLASS 9 (U.S. CLS. 21, 23, 26, 36 AND 38).

FOR: METALLIC ARTICLES FOR USE AS PLUMBING FITTINGS, NAMELY, METALLIC VALVES, METALLIC SPOUTS, METALLIC ADAPTORS, METALLIC DRAINS; SOLAR COLLECTORS; SOLAR ENERGY COLLECTORS; SOLAR LIGHT FIXTURES, NAMELY, INDOOR AND OUTDOOR SOLAR POWERED LIGHTING UNITS AND FIXTURES; SOLAR HEAT EXCHANGERS; FLASHLIGHTS; SOLAR POWERED LAMPS; ELECTRIC LIGHT BULBS; WATER HEATERS, NAMELY, WATER HEATERS UTILIZING RENEWABLE ENERGY AND WATER HEATERS UTILIZING SOLAR ENERGY; PLUMBING FITTINGS, NAMELY, ADAPTORS, TAPS, STOP COCKS; VALVES, NAMELY, WATER CONTROL VALVES; WATER FILTERING APPARATUS FOR DOMESTIC, COMMERCIAL OR INDUSTRIAL USE; PLUMBING FITTINGS, NAMELY, METALLIC FAUCETS, METALLIC BAFFLES, METALLIC STOP COCKS; NON-METALLIC ARTICLES FOR USE AS PLUMBING FITTINGS, NAMELY, NON-METALLIC VALVES, NON-METALLIC SPOUTS, NON-METALLIC ADAPTORS, NON-METALLIC DRAINS; SOLAR HEAT COLLECTION PANELS FOR COLLECTING HEAT FOR HEATING HOT WATER; AND PORTABLE SOLAR PANELS FOR COLLECTING HEAT FOR HEATING HOT WATER , IN CLASS 11 (U.S. CLS. 13, 21, 23, 31 AND 34).

FOR: PIPES, NAMELY, NON-METAL FLEXIBLE PIPES; TUBES AND HOSES MADE OF RUBBER, PLASTIC OR SILICONE FOR PLUMBING USE; SEALING PLUGS MADE PRIMARILY FROM SILICONE OR RUBBER, IN CLASS 17 (U.S. CLS. 1, 5, 12, 13, 35 AND 50).

FOR: NON-METALLIC BUILDING MATERIALS, NAMELY, NON-METALLIC FASCIA, NON-METALLIC ROOF TILES, NON-METALLIC MEMBRANE ROOFING, NON-METALLIC ROOF TILES INCORPORATING SOLAR CELLS; NON-METALLIC ROOFING SLATES, IN CLASS 19 (U.S. CLS. 1, 12, 33 AND 50).

FOR: BUILDINGS OF SOLAR OPERATING PLANTS; BUILDINGS OF ELECTRICITY GENERATION, SUPPLY, REGULATION, TRANSMISSION, CONTROL, STORAGE AND DISTRIBUTION PLANTS; CONSULTANCY, ADVISORY AND INFORMATION SERVICES RELATING TO THE CONSTRUCTION OF RENEWABLE ENERGY AND ELECTRICITY GENERATION FACILITIES, IN CLASS 37 (U.S. CLS. 100, 103 AND 106).

FOR: ELECTRICITY GENERATING; PRODUCTION OF RENEWABLE ENERGY; PRODUCTION OF SOLAR ENERGY; CUSTOMIZED CONSTRUCTION OF RENEWABLE ENERGY POWERED ELECTRICITY GENERATION, SUPPLY, REGULATION, TRANSMISSION, CONTROL, STORAGE AND DISTRIBUTION APPARATUS; CUSTOMIZED CONSTRUCTION OF RENEWABLE ENERGY POWERED LIGHTING, HEATING, STEAM GENERATING, COOKING, REFRIGERATING, DRYING, VENTILATING, WATER SUPPLY AND SANITARY APPARATUS; CUSTOMIZED CONSTRUCTION OF SOLAR ENERGY GENERATING APPARATUS; CUSTOMIZED CONSTRUCTION OF SOLAR ROOFS AND SOLAR PANELS; CONSULTANCY, ADVISORY AND INFORMATION SERVICES RELATING TO THE CONSTRUCTION OF RENEWABLE ENERGY AND ELECTRICITY GENERATION APPARATUS, IN CLASS 40 (U.S. CLS. 100, 103 AND 106).

THE MARK CONSISTS OF STANDARD CHARACTERS WITHOUT CLAIM TO ANY PARTICULAR FONT, STYLE, SIZE, OR COLOR.

PRIORITY CLAIMED UNDER SEC. 44(D) ON UNITED KINGDOM APPLICATION NO. 2419360, FILED 4-13-2006, REG. NO. 2419360, DATED 2-16-2007, EXPIRES 4-13-2016.

**Reg. No. 4,133,486** SER. NO. 77-020,164, FILED 10-12-2006.

SUSAN RICHARDS, EXAMINING ATTORNEY



# United States of America

United States Patent and Trademark Office

# GEOCLOCK

**Reg. No. 4,133,487**

**Registered May 1, 2012**

**Int. Cls.: 5 and 10**

**TRADEMARK**

**PRINCIPAL REGISTER**

JAGOTEC AG (SWITZERLAND CORPORATION)  
P.O. BOX 764  
EPTINGERSTRASSE 51  
CH-4132 MUTTENZ, SWITZERLAND

FOR: PHARMACEUTICALS HAVING A TIME RELEASE EFFECT USED FOR THE TREATMENT OF DISEASES AND DISORDERS OF THE CENTRAL NERVOUS SYSTEM, CARDIOVASCULAR SYSTEM, RESPIRATORY SYSTEM, GENITOR-UNITARY SYSTEM, RENAL SYSTEM, GASTRO-INTESTINAL SYSTEM, EYE, HEPATIC SYSTEM, VASCULAR SYSTEM, IMMUNE SYSTEM, NEUROLOGICAL DISORDERS, HORMONAL AND ENDOCRINOLOGY DISORDERS, MUSCULOSKELETAL AND INFLAMMATORY DISORDERS, NEUROMUSCULAR DISORDERS AND FOR USE IN ONCOLOGY AND HEMATOLOGY; PHARMACEUTICAL AND VETERINARY PREPARATIONS USED FOR THE TREATMENT OF DISEASES AND DISORDERS OF THE CENTRAL NERVOUS SYSTEM, CARDIOVASCULAR SYSTEM, RESPIRATORY SYSTEM, GENITOR-UNITARY SYSTEM, RENAL SYSTEM, GASTRO-INTESTINAL SYSTEM, EYE, HEPATIC SYSTEM, VASCULAR SYSTEM, IMMUNE SYSTEM, NEUROLOGICAL DISORDERS, HORMONAL AND ENDOCRINOLOGY DISORDERS, MUSCULOSKELETAL AND INFLAMMATORY DISORDERS, NEUROMUSCULAR DISORDERS AND FOR USE IN ONCOLOGY AND HEMATOLOGY; PREPARATIONS FOR MEDICAL, SURGICAL AND BIOLOGICAL PURPOSES FOR THE TREATMENT OF DISEASES OF THE NERVOUS SYSTEM, SLEEP DISORDERS AND ARTHRITIS; DIETETIC FOODS CONTAINING PHARMACEUTICALLY ACTIVE SUBSTANCES ADAPTED FOR MEDICAL OR VETERINARY USE; BEVERAGES, SOLUTIONS AND FOODS FOR THE PURPOSE OF PROVIDING A TIME RELEASE EFFECT, FOR USE IN THE TREATMENT OF DISEASES AND DISORDERS OF THE CENTRAL NERVOUS SYSTEM, CARDIOVASCULAR SYSTEM, RESPIRATORY SYSTEM, GENITOR-UNITARY SYSTEM, RENAL SYSTEM, GASTRO-INTESTINAL SYSTEM, EYE, HEPATIC SYSTEM, VASCULAR SYSTEM, IMMUNE SYSTEM, NEUROLOGICAL DISORDERS, HORMONAL AND ENDOCRINOLOGY DISORDERS, MUSCULOSKELETAL AND INFLAMMATORY DISORDERS, NEUROMUSCULAR DISORDERS AND FOR USE IN ONCOLOGY AND HEMATOLOGY; CHRONOTHERAPY-FOCUSED PRESS COATED TABLETS, ANALGESICS; BACTERIAL PREPARATIONS FOR MEDICAL AND VETERINARY PURPOSES; CHEMICAL REAGENTS FOR MEDICAL AND VETERINARY PURPOSES; DIAGNOSTIC REAGENTS FOR MEDICAL USE; CHEMICAL REAGENTS AND CHEMICAL PREPARATIONS FOR PHARMACEUTICAL USE IN THE TREATMENT OF DISEASES AND DISORDERS OF THE CENTRAL NERVOUS SYSTEM, CARDIOVASCULAR SYSTEM, RESPIRATORY SYSTEM, GENITOR-UNITARY SYSTEM, RENAL SYSTEM, GASTRO-INTESTINAL SYSTEM, EYE, HEPATIC SYSTEM, VASCULAR



*David J. Kybas*

Director of the United States Patent and Trademark Office

**Reg. No. 4,133,487** SYSTEM, IMMUNE SYSTEM, NEUROLOGICAL DISORDERS, HORMONAL AND ENDOCRINOLOGY DISORDERS, MUSCULOSKELETAL AND INFLAMMATORY DISORDERS, NEUROMUSCULAR DISORDERS AND FOR USE IN ONCOLOGY AND HEMATOLOGY; MEDICINAL AND VETERINARY OILS USED FOR THE TREATMENT OF DISEASES AND DISORDERS OF THE CENTRAL NERVOUS SYSTEM, CARDIOVASCULAR SYSTEM, RESPIRATORY SYSTEM, GENITOR-UNITARY SYSTEM, RENAL SYSTEM, GASTRO-INTESTINAL SYSTEM, EYE, HEPATIC SYSTEM, VASCULAR SYSTEM, IMMUNE SYSTEM, NEUROLOGICAL DISORDERS, HORMONAL AND ENDOCRINOLOGY DISORDERS, MUSCULOSKELETAL AND INFLAMMATORY DISORDERS, NEUROMUSCULAR DISORDERS AND FOR USE IN ONCOLOGY AND HEMATOLOGY; DIAGNOSTIC PREPARATIONS FOR MEDICAL AND VETERINARY PURPOSES; MEDICINES AND MEDICINAL PREPARATIONS USED FOR THE TREATMENT OF DISEASES AND DISORDERS OF THE CENTRAL NERVOUS SYSTEM, CARDIOVASCULAR SYSTEM, RESPIRATORY SYSTEM, GENITOR-UNITARY SYSTEM, RENAL SYSTEM, GASTRO-INTESTINAL SYSTEM, EYE, HEPATIC SYSTEM, VASCULAR SYSTEM, IMMUNE SYSTEM, NEUROLOGICAL DISORDERS, HORMONAL AND ENDOCRINOLOGY DISORDERS, MUSCULOSKELETAL AND INFLAMMATORY DISORDERS, NEUROMUSCULAR DISORDERS AND FOR USE IN ONCOLOGY AND HEMATOLOGY; TABLETS FOR THE RELEASE OF COLONIC DRUG DELIVERY; DRUGS FOR THE TREATMENT OF SLEEP DISORDERS; MEDICAL AND VETERINARY PREPARATIONS FOR SLIMMING PURPOSES; OINTMENTS, CREAMS AND POWDERS FOR MEDICAL AND VETERINARY PURPOSES USED FOR THE TREATMENT OF DISEASES AND DISORDERS OF THE CENTRAL NERVOUS SYSTEM, CARDIOVASCULAR SYSTEM, RESPIRATORY SYSTEM, GENITOR-UNITARY SYSTEM, RENAL SYSTEM, GASTRO-INTESTINAL SYSTEM, EYE, HEPATIC SYSTEM, VASCULAR SYSTEM, IMMUNE SYSTEM, NEUROLOGICAL DISORDERS, HORMONAL AND ENDOCRINOLOGY DISORDERS, MUSCULOSKELETAL AND INFLAMMATORY DISORDERS, NEUROMUSCULAR DISORDERS AND FOR USE IN ONCOLOGY AND HEMATOLOGY; CAPSULES, SUPPOSITORIES, TABLETS AND PILLS FOR PHARMACEUTICAL, MEDICAL AND VETERINARY PURPOSES USED FOR THE TREATMENT OF DISEASES AND DISORDERS OF THE CENTRAL NERVOUS SYSTEM, CARDIOVASCULAR SYSTEM, RESPIRATORY SYSTEM, GENITOR-UNITARY SYSTEM, RENAL SYSTEM, GASTRO-INTESTINAL SYSTEM, EYE, HEPATIC SYSTEM, VASCULAR SYSTEM, IMMUNE SYSTEM, NEUROLOGICAL DISORDERS, HORMONAL AND ENDOCRINOLOGY DISORDERS, MUSCULOSKELETAL AND INFLAMMATORY DISORDERS, NEUROMUSCULAR DISORDERS AND FOR USE IN ONCOLOGY AND HEMATOLOGY; PRE-FILLED INSTRUMENTS AND APPARATUS FOR THE ADMINISTRATION OF TIME RELEASE THERAPY AND PROPHYLAXIS PREPARATIONS AND SUBSTANCES, NAMELY, VIALS, INHALERS, SYRINGES, NEEDLES AND INJECTORS USED FOR THE TREATMENT OF DISEASES AND DISORDERS OF THE CENTRAL NERVOUS SYSTEM, CARDIOVASCULAR SYSTEM, RESPIRATORY SYSTEM, GENITOR-UNITARY SYSTEM, RENAL SYSTEM, GASTRO-INTESTINAL SYSTEM, EYE, HEPATIC SYSTEM, VASCULAR SYSTEM, IMMUNE SYSTEM, NEUROLOGICAL DISORDERS, HORMONAL AND ENDOCRINOLOGY DISORDERS, MUSCULOSKELETAL AND INFLAMMATORY DISORDERS, NEUROMUSCULAR DISORDERS AND FOR USE IN ONCOLOGY AND HEMATOLOGY; MEDICAL, VETERINARY AND SURGICAL APPARATUS, INSTRUMENTS AND DEVICES, NAMELY, PRE-FILLED VIALS, SYRINGES AND INJECTORS FOR MEDICAL PURPOSES FOR THE TREATMENT OF DISEASES AND DISORDERS OF THE CENTRAL NERVOUS SYSTEM, CARDIOVASCULAR SYSTEM, RESPIRATORY SYSTEM, GENITOR-UNITARY SYSTEM, RENAL SYSTEM, GASTRO-INTESTINAL SYSTEM, EYE, HEPATIC SYSTEM, VASCULAR SYSTEM, IMMUNE SYSTEM, NEUROLOGICAL DISORDERS, HORMONAL AND ENDOCRINOLOGY DISORDERS, MUSCULOSKELETAL AND INFLAMMATORY DISORDERS, NEUROMUSCULAR DISORDERS AND FOR USE IN ONCOLOGY AND HEMATOLOGY, IN CLASS 5 (U.S. CLS. 6, 18, 44, 46, 51 AND 52).

FOR: INHALERS FOR MEDICAL PURPOSES, AND MEDICAL AND VETERINARY SYRINGES AND NEEDLES; CATHETERS; SYRINGES AND INJECTORS FOR MEDICAL PURPOSES, IN CLASS 10 (U.S. CLS. 26, 39 AND 44).

**Reg. No. 4,133,487** THE MARK CONSISTS OF STANDARD CHARACTERS WITHOUT CLAIM TO ANY PARTICULAR FONT, STYLE, SIZE, OR COLOR.

PRIORITY CLAIMED UNDER SEC. 44(D) ON ERPN CMNTY TM OFC APPLICATION NO. 005406053, FILED 10-20-2006, REG. NO. 005406053, DATED 11-27-2007, EXPIRES 10-20-2016.

SER. NO. 77-027,863, FILED 10-24-2006.

KELLEY WELLS, EXAMINING ATTORNEY

# United States of America

United States Patent and Trademark Office

## CANINE STYLES

**Reg. No. 4,133,488**

**Registered May 1, 2012**

**Int. Cls.: 18, 20, 35 and 44**

CANINE STYLES, INC. (NEW YORK CORPORATION)  
830 LEXINGTON AVENUE  
NEW YORK, NY 10021

FOR: CLOTHING FOR ANIMALS; CLOTHING FOR DOMESTIC PETS; PET CLOTHING; PET CARRIERS, TOTE BAGS AND BAGS FOR CARRYING PETS; PET ACCESSORIES, NAMELY, LEASHES, LEADS, HARNESSSES, COLLARS, BOWS IN THE NATURE OF PET COLLAR ACCESSORIES, IN CLASS 18 (U.S. CLS. 1, 2, 3, 22 AND 41).

**TRADEMARK**

FIRST USE 12-0-2001; IN COMMERCE 12-0-2001.

**SERVICE MARK**

**PRINCIPAL REGISTER**

FOR: PORTABLE BEDS FOR PETS; PET BEDS; PET PADS FOR USE AS PET BEDS; CUSHIONED PILLOWS FOR PETS; AND MATS FOR PETS TO REST, IN CLASS 20 (U.S. CLS. 2, 13, 22, 25, 32 AND 50).

FIRST USE 12-0-2001; IN COMMERCE 12-0-2001.

FOR: PET SUPPLY RETAIL AND WHOLESALE STORE SERVICES AND ONLINE PET SUPPLY RETAIL AND WHOLESALE STORE SERVICES FEATURING PET GOODS, NAMELY, PET CLOTHES, PET CARRIERS, PET BEDS, PET COLLARS, LEADS, HARNESSSES AND LEASHES, PET TOYS, FOOD BOWLS AND FEEDERS, PET FURNITURE, PET CHARMS AND JEWELRY, GIFT ITEMS RELATED TO PETS, BOOKS ON PETS, STATIONARY RELATED TO PETS, PET SUPPLIES AND RELATED PET ACCESSORIES, CHEWS FOR DOGS, GROOMING ACCESSORIES FOR CATS AND DOGS, NAMELY, LINT ROLLERS, CLEANING SPONGES, COMBS AND BRUSHES, PET TOYS, PET FOOD, NAMELY, DOG BISCUITS, CANNED DOG AND CAT FOOD, DRY DOG AND CAT FOOD, AND EDIBLE PET TREATS, PET BEVERAGES, ANIMAL LITTER, EDIBLE CHEWS FOR ANIMALS, DOG TAGS, PET STROLLERS AND CLOTHING FOR ADULTS AND CHILDREN, NAMELY, SHIRTS, SWEATSHIRTS, JACKETS, HATS, COATS, BELTS, IN CLASS 35 (U.S. CLS. 100, 101 AND 102).

FIRST USE 12-0-1959; IN COMMERCE 12-0-1959.

FOR: ANIMAL GROOMING, IN CLASS 44 (U.S. CLS. 100 AND 101).

FIRST USE 12-0-1959; IN COMMERCE 12-0-1959.



*David J. Kyjars*

Director of the United States Patent and Trademark Office

**Reg. No. 4,133,488** THE MARK CONSISTS OF STANDARD CHARACTERS WITHOUT CLAIM TO ANY PARTICULAR FONT, STYLE, SIZE, OR COLOR.

SEC. 2(F).

SER. NO. 77-148,659, FILED 4-4-2007.

CHARLOTTE CORWIN, EXAMINING ATTORNEY

# United States of America

United States Patent and Trademark Office

## BABY ON BOARD

**Reg. No. 4,133,489**

**Registered May 1, 2012**

**Int. Cls.: 9, 12 and 26**

**TRADEMARK**

**PRINCIPAL REGISTER**

COSCO MANAGEMENT, INC. (DELAWARE CORPORATION)  
300 DELAWARE AVENUE, STE 1285  
WILMINGTON, DE 19801

FOR: CAR MAGNETS, IN CLASS 9 (U.S. CLS. 21, 23, 26, 36 AND 38).

FIRST USE 0-0-2000; IN COMMERCE 0-0-2000.

FOR: MIRRORS FOR VEHICLES, NAMELY, BACKSEAT BABY AND CHILD VIEW MIRRORS; AUTOMOBILE WINDOW SHADE SCREENS, IN CLASS 12 (U.S. CLS. 19, 21, 23, 31, 35 AND 44).

FIRST USE 0-0-2000; IN COMMERCE 0-0-2000.

FOR: SAFETY HARNESES FOR CHILDREN IN THE NATURE OF A LEASH, IN CLASS 26 (U.S. CLS. 37, 39, 40, 42 AND 50).

FIRST USE 0-0-1985; IN COMMERCE 0-0-1985.

THE MARK CONSISTS OF STANDARD CHARACTERS WITHOUT CLAIM TO ANY PARTICULAR FONT, STYLE, SIZE, OR COLOR.

OWNER OF U.S. REG. NO. 2,898,525.

SER. NO. 77-150,188, FILED 4-5-2007.

ROBIN CHOSID, EXAMINING ATTORNEY



*David J. Kyffers*

Director of the United States Patent and Trademark Office

# United States of America

United States Patent and Trademark Office

## BENTLEY BROOKLANDS

**Reg. No. 4,133,490**

**Registered May 1, 2012**

**Int. Cls.: 3, 9, 11 and 22**

**TRADEMARK**

**PRINCIPAL REGISTER**

BENTLEY MOTORS LIMITED (UNITED KINGDOM CORPORATION)  
PYMS LANE  
CREWE, CHESHIRE, UNITED KINGDOM CW13PL

FOR: CLEANING, POLISHING, SCOURING AND ABRASIVE PREPARATIONS, ALL BEING CARE PRODUCTS FOR MOTOR VEHICLES; POLISHES, SOAPS, ESSENTIAL OILS, PERFUMERY, ALL BEING CARE PRODUCTS FOR MOTOR VEHICLES; ALL OF THE FOREGOING SOLD AS AFTER-MARKET PRODUCTS EXCLUSIVELY THROUGH AUTHORIZED DEALERS AND AUTHORIZED SERVICE OUTLETS, IN CLASS 3 (U.S. CLS. 1, 4, 6, 50, 51 AND 52).

FOR: RADIOS FOR MOTOR VEHICLES; CASSETTE PLAYERS FOR MOTOR VEHICLES; COMPACT DISC PLAYERS FOR MOTOR VEHICLES; MINI-DISC PLAYERS FOR MOTOR VEHICLES; MP3 PLAYERS FOR MOTOR VEHICLES; DVD PLAYERS FOR MOTOR VEHICLES; WALLETS FOR HOLDING AUDIO CASSETTES, COMPACT DISCS, MINI-DISCS; BATTERY CHARGERS; AND BATTERY CHARGING MONITORS; ALL OF THE FOREGOING SOLD AS AFTER-MARKET PARTS EXCLUSIVELY THROUGH AUTHORIZED DEALERS AND AUTHORIZED SERVICE OUTLETS, IN CLASS 9 (U.S. CLS. 21, 23, 26, 36 AND 38).

FOR: APPARATUS FOR LIGHTING, HEATING AND VENTILATING, ALL BEING FOR MOTOR VEHICLES, NAMELY, COMPONENT PARTS OF VEHICLE AIR CONDITIONING AND HEATING APPARATUS IN THE NATURE OF RADIATOR AND INTERIOR GRILLS FOR USE IN DIRECTING WARM AND COLD AIR, HEATERS FOR VEHICLES, AIR CONDITIONERS FOR VEHICLES, INTERNAL AND EXTERNAL LIGHTS FOR VEHICLES, AND SEAT HEATERS FOR VEHICLES; AND PORTABLE AIR CHAMBERS, NAMELY, BATTERY AND ELECTRIC POWERED FANS AND AIR FILTERING INSTALLATIONS FOR USE IN STORING AND PROTECTING MOTOR VEHICLES, SOLD AS A UNIT; ALL OF THE FOREGOING SOLD AS AFTER-MARKET PARTS EXCLUSIVELY THROUGH AUTHORIZED DEALERS AND AUTHORIZED SERVICE OUTLETS, IN CLASS 11 (U.S. CLS. 13, 21, 23, 31 AND 34).

FOR: UNFITTED COVERS FOR MOTOR CARS; CAR TOWING ROPES; TENTS; AND HAMMOCKS, ALL OF THE FOREGOING SOLD AS AFTER-MARKET PARTS EXCLUSIVELY THROUGH AUTHORIZED DEALERS AND AUTHORIZED SERVICE OUTLETS, IN CLASS 22 (U.S. CLS. 1, 2, 7, 19, 22, 42 AND 50).



*David J. Kyros*

Director of the United States Patent and Trademark Office

**Reg. No. 4,133,490** THE MARK CONSISTS OF STANDARD CHARACTERS WITHOUT CLAIM TO ANY PARTICULAR FONT, STYLE, SIZE, OR COLOR.

OWNER OF ERPN CMNTY TM OFC REG. NO. 005821517, DATED 6-5-2008, EXPIRES 4-10-2017.

OWNER OF U.S. REG. NOS. 2,569,278 AND 2,847,970.

THE WORDING "BENTLEY" HAS NO MEANING IN A FOREIGN LANGUAGE.

SER. NO. 77-152,909, FILED 4-10-2007.

LAURA HAMMEL, EXAMINING ATTORNEY



# United States of America

United States Patent and Trademark Office



**Reg. No. 4,133,491**

**Registered May 1, 2012**

**Int. Cls.: 7, 9, 11, 14, 16,  
20, 37 and 39**

**TRADEMARK**

**SERVICE MARK**

**PRINCIPAL REGISTER**

CIRCUS WORLD DISPLAYS LIMITED (CANADA CORPORATION)  
4080 MONTROSE RD  
NIAGRA FALLS, ONTARIO, CANADA L2H 1J9

FOR: WASHING MACHINES FOR CLOTHES; VACUUM CLEANERS, NAMELY, FILTER BAGGED VACUUM CLEANERS, BAG-FREE VACUUM CLEANERS, CANISTERS VACUUM CLEANERS, CENTRAL VACUUM SYSTEMS COMPRISED OF ELECTRIC MOTOR-DRIVEN APPARATUS FOR CREATING A VACUUM, HOSES, ELECTRICAL EXTENSION CORDS, CADDY FOR STORING/CLEANING ATTACHMENTS AND TOOLS, PLASTIC TUBING AND FITTINGS, AUTOMATIC ON/OFF INLETS, DISPOSABLE VACUUM CLEANER SOIL BAGS, EXTENSION TUBE WANDS, COMMERCIAL VACUUM CLEANERS, CORDLESS VACUUM CLEANERS, HANDHELD VACUUM CLEANERS, ROBOTIC VACUUM CLEANERS, UPRIGHT VACUUM CLEANERS, WET/DRY VACUUM CLEANERS; STEAM CLEANERS; ELECTRIC BROOMS; ACCESSORIES FOR VACUUM CLEANERS, NAMELY, BAGS, FILTERS AND PARTS; VACUUM CLEANER PARTS, IN CLASS 7 (U.S. CLS. 13, 19, 21, 23, 31, 34 AND 35).

FOR: AUDIO PRODUCTS, NAMELY, RADIOS, RADIOS INCORPORATING CLOCKS, RADIOS INCORPORATING ALARM CLOCKS, COMBINATION RADIOS INCORPORATING CLOCKS AND CD PLAYERS; STEREO CONSOLES; RADIO RECEIVERS AND STEREO RECEIVERS; CASSETTE RECORDERS; COMPACT DISC PLAYERS; TAPE RECORDERS; BLANK VIDEO CASSETTES; AUDIO SPEAKERS; MICRO AUDIO SYSTEMS COMPRISED OF AM/FM RECEIVERS, CD/DVD PLAYERS, MP3 CAPABILITY, AUX-INPUT, PORTABLE MEDIA PLAYER DOCKING SYSTEMS, SPEAKERS, SUBWOOFERS, INPUTS FOR INTERNET CONNECTIVITY; HOME AUDIO SYSTEMS COMPRISED OF AM/FM RECEIVERS, CD/DVD PLAYERS, MP3 CAPABILITY, AUX-INPUT, PORTABLE MEDIA PLAYER DOCKING SYSTEMS, SPEAKERS, SUBWOOFERS, INPUTS FOR INPUTS FOR INTERNET CONNECTIVITY; MP3 PLAYERS, COMBINATION CD/MP3 PLAYERS; COMBINATION RADIO/CD PLAYERS; COMBINATION RADIO/MP3 PLAYERS; MP3 ACCESSORIES, NAMELY, DOCKING STATIONS; MP3 PLAYER CAR KITS COMPRISED OF WIRELESS SIGNAL TRANSMITTERS FROM SOURCE TO CAR STEREO; PORTABLE SPEAKER SYSTEMS, NAMELY, SPEAKERS AND PARTS FOR MP3 PLAYERS, PORTABLE MEDIA PLAYERS, PERSONAL CD PLAYERS, PORTABLE DVD PLAYERS; SHELF AUDIO SYSTEM COMPRISED OF AM/FM RECEIVERS, CD/DVD PLAYERS, MP3 CAPABILITY, AUX-INPUT, PORTABLE MEDIA PLAYER DOCKING SYSTEMS, SPEAKERS, SUBWOOFERS, INPUTS FOR INTERNET CONNECTIVITY; KARAOKE MUSIC PLAYERS; WIRED AND WIRELESS HEADPHONES; WIRELESS SPEAKER; CD BOOM BOXES COMPRISED OF PORTABLE MUSIC PLAYERS AND AUDIO SPEAKERS, WITH AC AND DC POWER CAPABILITY,



*David J. Kybas*

Director of the United States Patent and Trademark Office

**Reg. No. 4,133,491** CONTAINING AM/FM RADIO, WITH OR WITHOUT CD PLAYER OR AUDIO CASSETTE PLAYER; A/V ACCESSORIES, NAMELY, AMPLIFIERS AND STEREO TUNERS; VIDEO EQUIPMENT, NAMELY, VIDEO CASSETTE RECORDERS/PLAYERS; TELEVISION SETS; PORTABLE AND STATIONARY TELEVISIONS; COMBINATION TELEVISION/DVD PLAYERS, COMBINATION TELEVISION/VCR PLAYERS, COMBINATION TELEVISION/DVD/VCR PLAYERS, RADIO AND TELEVISION COMBINATIONS; CAMERAS; REMOTE CONTROLS FOR AM/FM RECEIVERS, CD/DVD PLAYERS, TELEVISIONS, STEREOS AND PORTABLE MEDIA PLAYER DOCKING SYSTEMS; HOME THEATRE SYSTEMS COMPRISED OF AM/FM RECEIVERS, CD/DVD PLAYERS, MP3 CAPABILITY, AUX-INPUT, PORTABLE MEDIA PLAYER DOCKING SYSTEMS, AUDIO SPEAKERS, SURROUND SOUND SYSTEMS, SUBWOOFERS, INPUTS FOR INTERNET CONNECTIVITY; DVD MICRO SYSTEMS COMPRISED OF TELEVISION, AM/FM RECEIVERS, CD/DVD PLAYERS, MP3 CAPABILITY, AUX-INPUT, PORTABLE MEDIA PLAYER DOCKING SYSTEMS, SPEAKERS, SUBWOOFERS, INPUTS FOR INTERNET CONNECTIVITY; DVD/HDD PLAYERS AND RECORDERS; DVD/VCR PLAYERS; DVD PLAYERS; PORTABLE DVD PLAYERS; VIDEO MONITORS; COMPUTER MONITORS; ELECTRONIC DISPLAY MONITORS; COMMERCIAL AND CONSUMER SATELLITE RECEIVERS AND COMPONENTS, NAMELY, PARABOLIC SHAPED SATELLITE DISH, SATELLITE OUTPUT LNB SIGNAL RECEIVERS, TV RECEIVERS AND CONNECTING CABLES; LARGE SCREEN PROJECTORS CAPABLE OF PROJECTING AN ELECTRONIC SIGNAL FROM A COMPUTER GENERATED SOURCE AND ACCESSORIES, NAMELY, VIDEO DECODERS, SIGNAL-SOURCE SWITCHERS FOR AUDIO AND VIDEO SIGNALS, SCAN DOUBLERS SCAN CONVERTERS, CAMERA LENSES, AND MECHANICAL MOUNTING RACKS AND BRACKETS THEREFORE; AUDIOVISUAL EQUIPMENT, NAMELY, AUDIO CLEANING CASSETTE CARTRIDGES; VIDEO CLEANING CASSETTES CARTRIDGES; CD/DVD CLEANING DISCS; DVD CLEANING DISCS; CONTAINERS FOR CDS; CONTAINERS FOR DVDS; ELECTRIC POWER CORDS; POWER SUPPLY ADAPTORS FOR USE WITH PORTABLE ELECTRONIC DEVICES, ELECTRONIC POWER CONVERTERS, ELECTRICAL PLUGS, JACKS FOR ELECTRICAL APPARATUS, ELECTRICAL CABLES, EXTENSION CORDS, ELECTRICAL WIRES, ELECTRICAL SWITCHES, SWITCH BOXES, HEADPHONES, AUDIO VISUAL SELECTORS, RE-MODULATORS, DIPLEXERS, AMPLIFIERS, VIDEO SIGNAL SPLITTERS, SIGNAL BAND SEPARATORS, TRANSFORMERS, ELECTRICAL CONNECTORS, VOLTAGE STABILIZERS, SPEAKER PINS; TELEPHONE ACCESSORIES, NAMELY, JACKS FOR TELEPHONE APPARATUS, ACOUSTIC COUPLERS, TELEPHONE PLUGS, TELEPHONE CORDS, PLASTIC ROTATING ATTACHMENT AFFIXED TO A TELEPHONE TO PREVENT TANGLING, TELEPHONE HEADSETS, ANSWERING MACHINE CASSETTES; ELECTRIC PLUGS; ELECTRIC CONVERTERS; ELECTRIC PLUGS AND ELECTRIC CONVERTERS SOLD AS COMBINED APPARATUS; VOLTAGE SURGE PROTECTORS AND BATTERIES; MOBILE EQUIPMENT, NAMELY, CAR AUDIO SYSTEMS, NAMELY, AM/FM RECEIVERS, STEREOS, SPEAKERS, POWER AMPLIFIERS, EQUALIZERS, CROSSOVER NETWORKS, DISPLAYS, TRANSCEIVERS FOR RECEIVING WIRELESS SIGNALS, SPEAKER HOUSINGS, CAR SPEAKERS, CAR DVD PLAYERS; GPS VEHICLE NAVIGATION SYSTEMS; COMMUNICATIONS EQUIPMENT AND SYSTEMS, NAMELY, TELEPHONES, CORDED AND CORDLESS TELEPHONES, INTERCOMS, AUTOMATIC TELEPHONE DIALERS, TELEPHONE ANSWERING MACHINES, VOIP PHONES, GMRS/FRS 2-WAY RADIOS; CALCULATORS; PERSONAL CARE AND CLOTHING IRONS, ELECTRIC WITH STEAM CAPABILITY IRONS, IN CLASS 9 (U.S. CLS. 21, 23, 26, 36 AND 38).

FOR: HOME APPLIANCES, NAMELY, MICROWAVE OVENS, REFRIGERATORS, FREEZERS, WINE COOLERS, NAMELY, REFRIGERATED CABINETS CONTAINING RACKS FOR WINE BOTTLES AND STORAGE SHELVES, WATER DISPENSERS, NAMELY, WATER COOLERS; CLOTHES DRYERS, ELECTRIC CLOTHES DRYERS, AIR CONDITIONERS, AIR PURIFIERS, ELECTROSTATIC AIR CLEANERS, VENTILATING KITCHEN EXHAUST FANS, RANGE HOODS, ELECTRIC LIGHTING FIXTURES, HUMIDIFIERS, DEHUMIDIFIERS, ELECTRIC FANS, PORTABLE AND FIXED ELECTRICAL SPACE HEATERS, PORTABLE BASEBOARD HEATERS, LAMPS, FAN HEATERS; SMALL APPLIANCES, NAMELY, RICE COOKERS, ELECTRIC KETTLES, ELECTRIC TOASTERS; ELECTRIC TOASTER OVENS, STEAM

**Reg. No. 4,133,491** OVENS, THERMOELECTRIC COOLER/HEATERS, ELECTRIC HEATED SERVING TRAYS, IN CLASS 11 (U.S. CLS. 13, 21, 23, 31 AND 34).

FOR: ALARM CLOCKS; CLOCKS, IN CLASS 14 (U.S. CLS. 2, 27, 28 AND 50).

FOR: PAPER SHREDDERS; CD-DVD SHREDDERS, CREDIT CARD SHREDDERS, DOCUMENT LAMINATORS FOR OFFICE USE, SPIRAL BINDING MACHINES FOR OFFICE USE; PENCIL SHARPENERS, IN CLASS 16 (U.S. CLS. 2, 5, 22, 23, 29, 37, 38 AND 50).

FOR: NON-METAL AUDIO, VIDEO AND COMPUTER WALL AND CEILING JACK MOUNTS, IN CLASS 20 (U.S. CLS. 2, 13, 22, 25, 32 AND 50).

FOR: REPAIR AND SERVICING OF HOME ELECTRONICS, HOME OFFICE PRODUCTS AND HOME APPLIANCE PRODUCTS, IN CLASS 37 (U.S. CLS. 100, 103 AND 106).

FOR: DELIVERY OF HOME ELECTRONICS, HOME OFFICE PRODUCTS AND HOME APPLIANCE PRODUCTS, IN CLASS 39 (U.S. CLS. 100 AND 105).

PRIORITY CLAIMED UNDER SEC. 44(D) ON CANADA APPLICATION NO. 1351179, FILED 6-11-2007, REG. NO. TMA771075, DATED 7-2-2010, EXPIRES 7-2-2025.

OWNER OF U.S. REG. NO. 815,737.

SER. NO. 77-213,571, FILED 6-22-2007.

NAKIA HENRY, EXAMINING ATTORNEY

# United States of America

United States Patent and Trademark Office

# TURFSIDER

**Reg. No. 4,133,492**

**Registered May 1, 2012**

**Int. Cl.: 12**

**TRADEMARK**

**PRINCIPAL REGISTER**

PETELKA INVESTMENTS LTD. (CANADA COMPANY)  
33 APPALOOSA TRAILER  
CARLISLE, ONTARIO L0R 3H0, CANADA

FOR: TRUCK TRAILERS AND FITTED TARPULIN COVERS FOR TRUCK TRAILERS FOR HAULING SOD, IN CLASS 12 (U.S. CLS. 19, 21, 23, 31, 35 AND 44).

THE MARK CONSISTS OF STANDARD CHARACTERS WITHOUT CLAIM TO ANY PARTICULAR FONT, STYLE, SIZE, OR COLOR.

PRIORITY CLAIMED UNDER SEC. 44(D) ON CANADA APPLICATION NO. 1,335,826, FILED 2-16-2007, REG. NO. TMA724634, DATED 9-26-2008, EXPIRES 9-26-2018.

SER. NO. 77-238,062, FILED 7-25-2007.

JESSICA A. POWERS, EXAMINING ATTORNEY



*David J. Kybas*

Director of the United States Patent and Trademark Office

# United States of America

United States Patent and Trademark Office



# ACCOR

**Reg. No. 4,133,493**

**Registered May 1, 2012**

**Int. Cls.: 9, 16, 35, 36, 38  
and 43**

**TRADEMARK**

**SERVICE MARK**

**PRINCIPAL REGISTER**

ACCOR (FRANCE SOCIÉTÉ ANONYME (SA))  
110 AVENUE DE FRANCE  
75013 PARIS, FRANCE

FOR: APPARATUS FOR RECORDING, TRANSMISSION, REPRODUCTION OF SOUND OR IMAGES; BLANK MAGNETIC DATA CARRIERS, TELEVISION APPARATUS FOR PROJECTION PURPOSES AND MONITORS, DIGITAL RADIO TRANSMITTERS AND RECEIVERS; EDUCATIONAL CD-ROMS FEATURING HOSPITALITY AND TRAVEL, ACCOMMODATION AND FOOD PROVIDING MATTERS; PHONOGRAPH RECORDS, RECORDING DISKS, AUDIO-CASSETTES, COMPACT DISKS, VIDEO CASSETTES, PRE-RECORDED VIDEODISKS ALL FEATURING HOSPITALITY AND TRAVEL, ACCOMMODATION AND FOOD PROVIDING MATTERS; HOTEL BOOKING MANAGEMENT SOFTWARE; APPARATUS FOR EDUCATIONAL VIDEO GAMES ADAPTED FOR USE ONLY AN EXTERNAL DISPLAY SCREEN OR MONITOR, NAMELY, VIDEO GAME DISCS; FILM PROJECTION APPARATUS, NAMELY, PROJECTION SCREENS FOR MOVIE SCREENS; MAGNETIC AND ELECTRONIC ENCODED CREDIT CARDS, ENCODED SMART CARDS CONTAINING PROGRAMMING USED FOR PAYMENT IN THE FIELD OF HOSPITALITY, TRAVEL, ACCOMMODATION AND FOOD PROVIDING SERVICES; MAGNETIC LOYALTY CARDS; AUTOMATIC VENDING MACHINES; ELECTRONIC PUBLICATIONS IN THE NATURE OF DOWNLOADABLE NEWSLETTERS IN THE FIELD OF HOSPITALITY AND TRAVEL, ACCOMMODATION AND FOOD PROVIDING SERVICES, IN CLASS 9 (U.S. CLS. 21, 23, 26, 36 AND 38).



FOR: PAPER AND CARDBOARD, FOR STATIONERY AND PRINTING; PRINTED MATTERS, NAMELY, WRITING PAPER PADS STATIONERY; SIGNBOARDS OF PAPER OR CARDBOARD; CARDBOARD, PAPER, PLASTIC GIFT WRAP, PLASTIC WRAP; PRINTED MATTERS AND PRINTED MATTERS FOR ADVERTISING PURPOSES, NAMELY, PRINTED GUIDES FOR ACCOMMODATION AND RESTAURANTS; CATALOGUES IN THE FIELD OF HOSPITALITY AND TRAVEL, ACCOMMODATION AND FOOD PROVIDING SERVICES; WRITING PAPER; PHOTOGRAPHS; PRINTING PAPERS; POSTCARDS; BUSINESS CARDS; GREETING CARDS; MUSICAL GREETING CARDS; POSTERS AND ADVERTISING POSTERS, ADVERTISING BOARD OF PAPER OR CARDBOARD; FLAGS OF PAPER; FOLDERS FOR PAPER AND DOCUMENTS; FORMS, NAMELY, PRINTED FORMS; PRINTED PROSPECTUSES, PAMPHLETS, MAGAZINES ALL IN THE FIELD OF HOSPITALITY AND TRAVEL, PRINTED PUBLICATIONS, NAMELY, NEWSPAPERS AND PERIODICALS ALL IN THE FIELD OF HOSPITALITY AND TRAVEL; A SERIES OF BOOKS AND WRITTEN ARTICLES IN THE FIELD OF HOSPITALITY AND TRAVEL, ACCOMMODATION AND FOOD PROVIDING SERVICES, NOTEBOOKS, ALBUMS AND CALENDARS; SCHOOL

*David J. Kyffers*

Director of the United States Patent and Trademark Office

**Reg. No. 4,133,493** SUPPLIES, NAMELY, STATIONERY; WRITING AND DRAWING MATERIALS, NAMELY, WRITING PADS; PRINTING BLOCKS; PHOTOGRAPHS; PRINTING TYPE; COASTERS OF PAPER; BOOKMARKERS; ORDER TO PAY IN THE FORM OF PRINTED TICKETS OR PAPER COUPONS, IN CLASS 16 (U.S. CLS. 2, 5, 22, 23, 29, 37, 38 AND 50).

FOR: EFFICIENCY EXPERTS AND BUSINESS INFORMATION; BUSINESS MANAGEMENT AND ORGANIZATION CONSULTANCY; ADMINISTRATIVE HELPING FOR THE DRAFTING OF SPECIFICATIONS, NAMELY, BUSINESS ADMINISTRATION CONSULTANCY; HELPING FOR THE MANAGEMENT OF TENDER OFFERS AND HELPING FOR ANALYZING THE SUPPLIERS' ANSWERS, NAMELY, BUSINESS MANAGEMENT CONSULTANCY; OPINION POLLING; BUSINESS INQUIRIES; BUSINESS RESEARCH; BUSINESS MANAGEMENT; BUSINESS ADMINISTRATION; OFFICE FUNCTIONS; EFFICIENCY EXPERTS; ECONOMIC FORECASTING; ASSISTANCE IN MANAGEMENT OF BUSINESS PROJECTS, NAMELY, ASSISTANCE SERVICES IN THE FIELD OF BUSINESS MANAGEMENT RELATING TO HOSPITALITY AND PREPAID SERVICES; BOOK KEEPING; DOCUMENT REPRODUCTION; EMPLOYMENT AGENCIES; BUSINESS RESEARCH AND INQUIRIES SUPPLIED BY COUNCILORS OPERATING IN CONTACT CENTERS BY PHONE, ELECTRONIC AND FACSIMILE COMMUNICATION; DATA SEARCH IN COMPUTER FILES FOR OTHERS, NAMELY, DATA PROCESSING FOR OTHERS; TRANSCRIPTION OF WRITTEN COMMUNICATION AND DATA; COMPILATION AND SYSTEMATIZATION OF DATA INFORMATION INTO COMPUTER DATABASES; SECRETARIAL SERVICES IN PARTICULAR PHONE SWITCHBOARD; COMPUTERIZED FILES MANAGEMENT; COMPILATION AND PROCESSING OF COMPUTERIZED DATA, SIGNALS, IMAGES AND INFORMATION, NAMELY, DATA PROCESSING; CONSTITUTION OF A PICTURE LIBRARY, NAMELY COLLECTION, COMPILATION AND SYSTEMATIZATION OF WRITTEN INFORMATION INTO COMPUTER DATABASES; ADVERTISING SERVICES IN CONNECTION WITH THE ORGANIZATION AND THE MANAGEMENT OF HOTELS; ADVERTISING ON SALE LOCATIONS; DISTRIBUTION OF PROSPECTUSES, SAMPLES, PROMOTIONAL AND ADVERTISING SERVICES; DISSEMINATION OF ADVERTISING AND PROMOTIONAL MATTERS; PUBLICATION OF PUBLICITY TEXTS; DISSEMINATION OF ADVERTISING MATTERS BY PHONE, COMPUTERS, NEWS SERVICES; RENTAL OF ADVERTISING SPACES; MARKET RESEARCHES; ADVERTISING MAILS; SALES PROMOTION FOR OTHERS; MARKETING CONSULTATION IN THE FIELD OF HOSPITALITY AND TRAVEL, ACCOMMODATION AND FOOD PROVIDING SERVICES, ADVERTISING CONSULTANCY; MARKETING PLAN DEVELOPMENT, DEVELOPMENT OF MARKETING STRATEGY; ADVERTISING AGENCIES; VENDING MACHINE RENTAL, OFFICE EQUIPMENT AND ADVERTISING SIGN RENTAL; DOCUMENT REPRODUCTION; UPDATING OF ADVERTISING MATERIAL; ADVERTISING BY MAIL ORDER; ADVERTISING SERVICES OF A RADIO AND TELEVISION ADVERTISING AGENCY; ARRANGING AND CONDUCTING OF COMMERCIAL AND ADVERTISING EVENTS AND SHOWS FOR BUSINESS AND ADVERTISING PURPOSES; ORGANIZATION OF EXHIBITIONS FOR COMMERCIAL PURPOSES; PUBLICITY MATERIAL RENTAL; RETAIL STORE SERVICES FEATURING CLOTHING, ACCESSORIES, LIGHTERS, LEATHERWARE, UMBRELLAS, GLASSES, BATH TOWELS, BATHROBES, GOLF BALLS, COMPUTING ACCESSORIES, DISHES; BUSINESS ADMINISTRATIVE AND BUSINESS ORGANIZING CONSULTANCY IN THE FIELD OF FINANCIAL PRODUCTS INTENDED FOR EMPLOYEES AND SHAREHOLDERS; BUSINESS MANAGEMENT OF HOTELS FOR OTHERS; BUSINESS MANAGEMENT ASSISTANCE AND BUSINESS MANAGEMENT AND BUSINESS ORGANIZATION CONSULTANCY IN THE FIELD OF ENVIRONMENTAL PROTECTION AND SUSTAINABLE DEVELOPMENT, IN CLASS 35 (U.S. CLS. 100, 101 AND 102).

FOR: INSURANCE SERVICES, NAMELY, UNDERWRITING, ISSUING AND ADMINISTRATION OF LIFE INSURANCE, FINANCIAL AND MONETARY AFFAIRS, NAMELY, ISSUING OF TRAVELER'S CHECKS AND OF LETTERS OF CREDIT, CREDIT CARDS SERVICES, ISSUING CHEQUES; PROVIDING FINANCIAL, FISCAL AND INSURANCE INFORMATION; FINANCIAL CONSULTATION FOR OTHERS; PROVIDING INFORMATION RELATED TO FINANCIAL PRODUCTS, NAMELY, STOCK OPTIONS OR CONVERTIBLE BONDS PLANS,

**Reg. No. 4,133,493** EMPLOYEE SAVINGS PLAN; PROVIDING REAL-ESTATE INFORMATION AND CONSULTATION FOR OTHERS, IN CLASS 36 (U.S. CLS. 100, 101 AND 102).

FOR: TELECOMMUNICATION CONSULTATION IN THE NATURE OF TECHNICAL CONSULTING IN THE FIELD OF AUDIO, TEXT AND VISUAL DATA COMMUNICATION, IN CLASS 38 (U.S. CLS. 100, 101 AND 104).

FOR: HOTEL SERVICES AND PROVIDING FOOD AND DRINK; PROVIDING TEMPORARY ACCOMMODATION; MOTELS, RESTAURANTS, CAFETERIAS, TEA ROOMS, BARS WITH THE EXCEPTION OF CLUBS; HOTEL ROOM RESERVATION FOR TRAVELERS; CONSULTING SERVICES IN THE FIELD OF HOSPITALITY; HOTEL SERVICES WHICH FEATURE PROVIDING HYGIENE AND COSMETIC ARTICLES, HAIRDRYER, BATH AND BED LINEN, CLOTHING ARTICLES SUCH AS BATHROBES AND SLIPPERS, SHOE POLISH AS A FEATURE OF THE HOTEL SERVICE AND NOT AS A RETAIL SERVICE; DAY-NURSERIES FOR CHILDREN; RENTAL OF ROOMS FOR RECEPTION, CONFERENCE, SEMINARS, EXHIBITIONS AND MEETINGS; RENTAL OF CHAIRS, TABLES, TABLE LINEN AND GLASSWARE, IN CLASS 43 (U.S. CLS. 100 AND 101).

PRIORITY CLAIMED UNDER SEC. 44(D) ON FRANCE APPLICATION NO. 037483859, FILED 2-23-2007.

THE COLOR(S) BLUE AND BEIGE IS/ARE CLAIMED AS A FEATURE OF THE MARK.

PRIORITY CLAIMED UNDER SEC. 44(D) ON FRANCE APPLICATION NO. 073483859, FILED 2-23-2007.

OWNER OF FRANCE REG. NO. 073483859, DATED 3-27-2008, EXPIRES 2-23-2017.

OWNER OF U.S. REG. NOS. 2,532,400, 2,838,984, AND 3,286,528.

THE COLOR BLUE APPEARS IN THE WORDING "ACCOR", AND THE COLOR BEIGE APPEARS IN THE DESIGN PORTION.

SER. NO. 77-238,500, FILED 7-25-2007.

ELIZABETH KAJUBI, EXAMINING ATTORNEY

# United States of America

United States Patent and Trademark Office

## PHASE 2 CARB CONTROLLER

**Reg. No. 4,133,494**

**Registered May 1, 2012**

**Int. Cls.: 1 and 5**

**TRADEMARK**

**PRINCIPAL REGISTER**

PHARMACHEM LABORATORIES, INC. (NEW JERSEY CORPORATION)  
265 HARRISON AVENUE  
KEARNY, NJ 07032

FOR: INGREDIENTS, NAMELY, BEAN EXTRACTS FOR USE IN THE MANUFACTURE OF DIETARY AND NUTRITIONAL SUPPLEMENTS AND FOOD, IN CLASS 1 (U.S. CLS. 1, 5, 6, 10, 26 AND 46).

FIRST USE 3-17-2006; IN COMMERCE 3-17-2006.

FOR: INGREDIENTS, NAMELY, BEAN EXTRACTS BEING INTEGRAL COMPONENTS OF DIETARY AND NUTRITIONAL SUPPLEMENTS, IN CLASS 5 (U.S. CLS. 6, 18, 44, 46, 51 AND 52).

FIRST USE 3-17-2006; IN COMMERCE 3-17-2006.

THE MARK CONSISTS OF STANDARD CHARACTERS WITHOUT CLAIM TO ANY PARTICULAR FONT, STYLE, SIZE, OR COLOR.

OWNER OF U.S. REG. NOS. 2,708,864, 2,708,894, AND 2,798,669.

NO CLAIM IS MADE TO THE EXCLUSIVE RIGHT TO USE "CARB CONTROLLER", APART FROM THE MARK AS SHOWN.

SER. NO. 77-288,350, FILED 9-25-2007.

MARK RADEMACHER, EXAMINING ATTORNEY



*David J. Kybas*

Director of the United States Patent and Trademark Office



# United States of America

United States Patent and Trademark Office



**Reg. No. 4,133,495**

**Registered May 1, 2012**

**Int. Cls.: 36, 37 and 42**

**SERVICE MARK**

**PRINCIPAL REGISTER**

DRAGADOS, S.A. (SPAIN CORPORATION)  
AVDA. DE TENERIFE 4 Y 6  
28700 SAN SEBASTIEN DE LOS REYES  
MADRID, SPAIN

FOR: APPRAISAL OF REAL ESTATE; BUILDING MANAGEMENT; BUILDING LEASING; BROKERAGE IN THE FIELD OF REAL ESTATE AGENCIES; REAL ESTATE RENTAL SERVICES, NAMELY, RENTAL OF RESIDENTIAL HOUSING, COMMERCIAL PROPERTY, OFFICES AND OFFICE SPACE; AGENCIES OR BROKERAGE FOR RENTING LAND, AGENCIES OR BROKERAGE FOR RENTING OF BUILDINGS; CAPITAL INVESTMENT SERVICES; CASH MANAGEMENT; CAPITAL INVESTMENT SERVICES; TRUST SERVICES, NAMELY, INVESTMENT AND TRUST COMPANY SERVICES, IN CLASS 36 (U.S. CLS. 100, 101 AND 102).

FOR: BUILDING CONSTRUCTION SERVICES; BUILDING DEMOLITION; BUILDING CONSTRUCTION SUPERVISION; SCAFFOLDING ERECTION; INSTALLATION, REPAIR AND MAINTENANCE OF CONDENSING APPARATUS, STEAM CONDENSERS, RADIATORS FOR MOTORS AND ENGINES, AIR REHEATERS, BOILER TUBES; ASPHALTING; PLUMBING SERVICES; DRILLING OF WELLS; MINING EXTRACTION; QUARRY SERVICES, WASTE DISPOSAL FOR OTHERS, INSPECTION SERVICES IN THE COURSE OF COMMERCIAL BUILDING CONSTRUCTION; RENTAL OF HAND AND POWER TOOLS AND CONSTRUCTION EQUIPMENT CONSTRUCTION PLANNING, CONSTRUCTION REPAIR BUILDING MAINTENANCE, IN CLASS 37 (U.S. CLS. 100, 103 AND 106).

FOR: SCIENTIFIC ANALYSIS AND INDUSTRIAL RESEARCH, RESEARCH AND DEVELOPMENT OF COMPUTER SOFTWARE; TECHNICAL PROJECT STUDIES, NAMELY, ENGINEERING FOR CONSTRUCTION OF BUILDINGS, CIVIL, UNDERGROUND AND STRUCTURAL ENGINEERING OF ELECTRICAL OF ELECTRICAL, GAS, WATER AND TELEPHONY SYSTEMS; RESEARCH AND DEVELOPMENT OF NEW PRODUCTS, ARCHITECTURAL SERVICES, FURNITURE DESIGN, INTERIOR DECORATION CONSULTATION; ENGINEERING SERVICES, NAMELY, DEVELOPMENT AND RESEARCH SERVICES; TECHNOLOGICAL DESIGN SERVICES, NAMELY, STRUCTURAL, CIVIL AND UNDERGROUND ENGINEERING DESIGN SERVICES, AND ELECTRICAL, GAS, WATER AND TELEPHONY SYSTEMS DESIGN SERVICES, AND INDUSTRIAL DESIGN SERVICES; PROFESSIONAL CONSULTATION IN THE FIELD OF ARCHITECTURE, ENGINEERING, COMPUTER SOFTWARE AND ARCHITECTURAL DESIGN, IN CLASS 42 (U.S. CLS. 100 AND 101).



*David J. Kyros*

Director of the United States Patent and Trademark Office

**Reg. No. 4,133,495** OWNER OF SPAIN REG. NO. 2590879, DATED 4-12-2004, EXPIRES 4-12-2014.

THE COLOR(S) YELLOW AND BLUE IS/ARE CLAIMED AS A FEATURE OF THE MARK.

THE MARK CONSISTS OF THE WORD "DRAGADOS" IN YELLOW ON A BLUE BACKGROUND.

THE ENGLISH TRANSLATION OF THE WORD "DRAGADOS" IN THE MARK IS DREDGINGS.

SER. NO. 77-361,286, FILED 12-28-2007.

RONALD AIKENS, EXAMINING ATTORNEY

# United States of America

United States Patent and Trademark Office

# PROVANT

**Reg. No. 4,133,496**

**Registered May 1, 2012**

**Int. Cl.: 10**

**TRADEMARK**

**PRINCIPAL REGISTER**

REGENESIS BIOMEDICAL, INC. (DELAWARE CORPORATION)  
1435 NORTH HAYDEN ROAD  
SCOTTSDALE, AZ 852573773

FOR: MEDICAL ELECTROMAGNETIC RADIATOR DEVICES FOR INDUCING CELL PROLIFERATION, NAMELY, FOR STIMULATING ANGIOGENESIS, SOFT TISSUE REGENERATION, WOUND HEALING, PAIN AND EDEMA ABATEMENT, POST SURGICAL TISSUE REPAIR AND REGENERATION, IN CLASS 10 (U.S. CLS. 26, 39 AND 44).

FIRST USE 10-13-1999; IN COMMERCE 10-13-1999.

THE MARK CONSISTS OF STANDARD CHARACTERS WITHOUT CLAIM TO ANY PARTICULAR FONT, STYLE, SIZE, OR COLOR.

OWNER OF U.S. REG. NO. 2,506,665.

SER. NO. 77-361,331, FILED 12-28-2007.

LEIGH LOWRY, EXAMINING ATTORNEY



*David J. Kypos*

Director of the United States Patent and Trademark Office

# United States of America

United States Patent and Trademark Office

## REGENESIS BIOMEDICAL

**Reg. No. 4,133,497**

**Registered May 1, 2012**

**Int. Cl.: 10**

**TRADEMARK**

**PRINCIPAL REGISTER**

REGENESIS BIOMEDICAL, INC. (DELAWARE CORPORATION)  
1435 NORTH HAYDEN ROAD  
SCOTTSDALE, AZ 852573773

FOR: MEDICAL ELECTROMAGNETIC RADIATOR DEVICES FOR INDUCING CELL PROLIFERATION, NAMELY, FOR STIMULATING ANGIOGENESIS, SOFT TISSUE REGENERATION, WOUND HEALING, PAIN AND EDEMA ABATEMENT, POST SURGICAL TISSUE REPAIR AND REGENERATION, IN CLASS 10 (U.S. CLS. 26, 39 AND 44).

FIRST USE 10-13-1999; IN COMMERCE 10-13-1999.

THE MARK CONSISTS OF STANDARD CHARACTERS WITHOUT CLAIM TO ANY PARTICULAR FONT, STYLE, SIZE, OR COLOR.

OWNER OF U.S. REG. NOS. 2,265,365 AND 2,265,366.

NO CLAIM IS MADE TO THE EXCLUSIVE RIGHT TO USE "BIOMEDICAL", APART FROM THE MARK AS SHOWN.

SER. NO. 77-361,334, FILED 12-28-2007.

LEIGH LOWRY, EXAMINING ATTORNEY



*David J. Kyros*

Director of the United States Patent and Trademark Office

# United States of America

United States Patent and Trademark Office

# REGENESIS

**Reg. No. 4,133,498**

**Registered May 1, 2012**

**Int. Cl.: 10**

**TRADEMARK**

**PRINCIPAL REGISTER**

REGENESIS BIOMEDICAL, INC. (DELAWARE CORPORATION)  
1435 NORTH HAYDEN ROAD  
SCOTTSDALE, AZ 852573773

FOR: MEDICAL ELECTROMAGNETIC RADIATOR DEVICES FOR INDUCING CELL PROLIFERATION, NAMELY, FOR STIMULATING ANGIOGENESIS, SOFT TISSUE REGENERATION, WOUND HEALING, PAIN AND EDEMA ABATEMENT, POST SURGICAL TISSUE REPAIR AND REGENERATION, IN CLASS 10 (U.S. CLS. 26, 39 AND 44).

FIRST USE 10-13-1999; IN COMMERCE 10-13-1999.

THE MARK CONSISTS OF STANDARD CHARACTERS WITHOUT CLAIM TO ANY PARTICULAR FONT, STYLE, SIZE, OR COLOR.

OWNER OF U.S. REG. NOS. 2,265,365 AND 2,265,366.

SER. NO. 77-361,335, FILED 12-28-2007.

LEIGH LOWRY, EXAMINING ATTORNEY



*David J. Kyros*

Director of the United States Patent and Trademark Office

# United States of America

United States Patent and Trademark Office

# CPI

**Reg. No. 4,133,499**

**Registered May 1, 2012**

**Int. Cl.: 10**

**TRADEMARK**

**PRINCIPAL REGISTER**

REGENESIS BIOMEDICAL, INC. (DELAWARE CORPORATION)  
1435 NORTH HAYDEN ROAD  
SCOTTSDALE, AZ 852573773

FOR: MEDICAL ELECTROMAGNETIC RADIATOR DEVICES FOR INDUCING CELL PROLIFERATION, NAMELY, FOR STIMULATING ANGIOGENESIS, SOFT TISSUE REGENERATION, WOUND HEALING, PAIN AND EDEMA ABATEMENT, POST SURGICAL TISSUE REPAIR AND REGENERATION, IN CLASS 10 (U.S. CLS. 26, 39 AND 44).

FIRST USE 10-13-1999; IN COMMERCE 10-13-1999.

THE MARK CONSISTS OF STANDARD CHARACTERS WITHOUT CLAIM TO ANY PARTICULAR FONT, STYLE, SIZE, OR COLOR.

OWNER OF U.S. REG. NOS. 2,285,969 AND 2,398,802.

SER. NO. 77-361,336, FILED 12-28-2007.

LEIGH LOWRY, EXAMINING ATTORNEY



*David J. Kyffers*

Director of the United States Patent and Trademark Office

# United States of America

United States Patent and Trademark Office

## HONEY DROP

**Reg. No. 4,133,500**

**Registered May 1, 2012**

**Int. Cl.: 30**

**TRADEMARK**

**PRINCIPAL REGISTER**

ISLAND ABBEY FOODS LTD. (CANADA CORPORATION)  
5522 UNION ROAD  
MONTAGUE, CANADA C0A1R0

FOR: SWEETENER CONSISTING OF DRIED OR DEHYDRATED HONEY FOR USE IN BEVERAGES, IN CLASS 30 (U.S. CL. 46).

FIRST USE 7-0-2004; IN COMMERCE 1-0-2008.

THE MARK CONSISTS OF STANDARD CHARACTERS WITHOUT CLAIM TO ANY PARTICULAR FONT, STYLE, SIZE, OR COLOR.

PRIORITY CLAIMED UNDER SEC. 44(D) ON CANADA APPLICATION NO. 1365826, FILED 10-1-2007.

NO CLAIM IS MADE TO THE EXCLUSIVE RIGHT TO USE "HONEY", APART FROM THE MARK AS SHOWN.

SER. NO. 77-362,704, FILED 1-2-2008.

MARK RADEMACHER, EXAMINING ATTORNEY



*David J. Kyros*

Director of the United States Patent and Trademark Office

# United States of America

United States Patent and Trademark Office

# PHAT

**Reg. No. 4,133,501**

**Registered May 1, 2012**

**Int. Cls.: 1 and 11**

**TRADEMARK**

**PRINCIPAL REGISTER**

EVAN D. TOWNSLEY (UNITED STATES INDIVIDUAL)  
2643 S. FAIRFAX AVE.  
CULVER CITY, CA 90232

FOR: FERTILIZERS; PLANT FOOD; FOOD SUPPLEMENTS FOR AGRICULTURAL PRODUCTS AND OTHER PLANTS; PLANT NUTRIENTS DESIGNED FOR HYDROPONIC GROWING , IN CLASS 1 (U.S. CLS. 1, 5, 6, 10, 26 AND 46).

FIRST USE 10-13-1998; IN COMMERCE 10-13-1998.

FOR: PLUMBING FITTINGS FOR PLANT GROWING SYSTEMS, NAMELY, DRAINS, PLUMBING PIPES AND HOSES, PARTS AND FITTINGS FOR ALL OF THE FOREGOING; AIR PURIFYING EQUIPMENT, NAMELY, CHARCOAL CARBON FILTERS, IN CLASS 11 (U.S. CLS. 13, 21, 23, 31 AND 34).

FIRST USE 10-13-1998; IN COMMERCE 10-13-1998.

THE MARK CONSISTS OF STANDARD CHARACTERS WITHOUT CLAIM TO ANY PARTICULAR FONT, STYLE, SIZE, OR COLOR.

OWNER OF U.S. REG. NOS. 2,504,911, 2,995,349, AND 3,308,222.

SER. NO. 77-375,831, FILED 1-18-2008.

PAUL E. FAHRENKOPF, EXAMINING ATTORNEY



*David J. Kyros*

Director of the United States Patent and Trademark Office



# United States of America

United States Patent and Trademark Office



# VISION

**Reg. No. 4,133,502**

**Registered May 1, 2012**

**Int. Cl.: 9**

SIGNET ARMORLITE EUROPE LIMITED (UNITED KINGDOM PUBLIC LIMITED COMPANY (PLC))  
OLYMPUS PARK  
NO. 1, APOLLO  
GLOUCESTER, UNITED KINGDOM GL24NF

**TRADEMARK**

**PRINCIPAL REGISTER**

FOR: SPECTACLES, OPTICAL GLASSES, SUNGLASSES; OPTICAL LENSES; SPECTACLE CASES, CHAINS, FRAMES, HOLDERS AND PINCE-NEZ MOUNTINGS; GLASSES FOR OPTICAL USE OR ADAPTED TO PROTECT THE EYES; EYE GLASSES; EYE GLASS SHIELDS IN THE NATURE OF CLIP ON AUXILIARY LENSES FOR EYE GLASSES AND SPECTACLES AND EYE GLASS RESTRAINING STRAPS; EYE GLASSES CASES AND FRAMES; PROTECTIVE EYE PIECES; MONOCLES; PINCE-NEZ; EYEWEAR; EYE PROTECTION WEAR FOR SPORTS; GOGGLES FOR SPORTS; MAGNIFYING GLASSES; ANTI-GLARE GLASSES; EYE GLASS CASES, CHAINS, CORDS, FRAMES, HOLDERS AND PINCE-NEZ MOUNTINGS; CONTACT LENSES; CONTACT LENS CASES, CONTAINERS AND HOLDERS; EAR PLUGS NOT FOR MEDICAL PURPOSES; EAR PROTECTORS IN THE NATURE OF PROTECTIVE EAR COVERINGS; ADAPTORS FOR CONNECTING TELEPHONES TO HEARING AIDS; PLUGS FOR CONNECTING HEARING AIDS TO PROGRAMMING APPARATUS; APPARATUS FOR THE PROGRAMMING OF HEARING AIDS, NAMELY, HANDHELD ELECTRONIC UNITS FOR ADJUSTING SOUND LEVELS IN HEARING AIDS; RADIO RECEIVERS FOR CONNECTION TO HEARING AIDS; REMOTE CONTROL LOUDNESS CONTROLLERS FOR CONNECTING TO HEARING AIDS; PARTS AND FITTINGS FOR ALL THE AFORESAID GOODS; NONE OF THE FOREGOING FOR USE IN CONNECTION WITH WELDING, IN CLASS 9 (U.S. CLS. 21, 23, 26, 36 AND 38).



OWNER OF ERPN CMNTY TM OFC REG. NO. 006054597, DATED 8-8-2011, EXPIRES 6-29-2017.

THE COLOR(S) BLACK AND ORANGE IS/ARE CLAIMED AS A FEATURE OF THE MARK.

NO CLAIM IS MADE TO THE EXCLUSIVE RIGHT TO USE "VISION", APART FROM THE MARK AS SHOWN.

THE MARK CONSISTS OF THE COLOR BLACK IN THE WORDING "VISION" AND THE DESIGN IN ORANGE.

SER. NO. 77-396,715, FILED 2-14-2008.

*David J. Kyros*

Director of the United States Patent and Trademark Office

**Reg. No. 4,133,502** ANN E. SAPPENFIELD, EXAMINING ATTORNEY

# United States of America

United States Patent and Trademark Office

## POWERPACKS

**Reg. No. 4,133,503**

**Registered May 1, 2012**

**Int. Cl.: 3**

**TRADEMARK**

**PRINCIPAL REGISTER**

RECKITT BENCKISER N.V. (NETHERLANDS NAAMLOZE VENNOOTSCHAP (NV))  
SIRIUSDREEF 14 - 2132 WT  
HOOFDDORP, NETHERLANDS

FOR: DISHWASHING DETERGENTS; COMBINATION CLEANERS, FRESHENERS AND DEODORIZERS FOR MACHINE DISHWASHERS; RINSE AGENTS FOR MACHINE DISHWASHERS; DECALCIFYING AND DESCALING PREPARATIONS FOR HOUSEHOLD CLEANING PURPOSES; SALTS FOR USE IN MACHINE DISHWASHERS, NAMELY, DISHWASHER ADDITIVES FOR SOFTENING WATER, PREVENTING LIMESCALE ACCUMULATION ON THE DISHWASHER AND ON GLASSES AND DISHES, AND FOR INCREASING THE CLEANING POWER OF DISHWASHING DETERGENT, IN CLASS 3 (U.S. CLS. 1, 4, 6, 50, 51 AND 52).

THE MARK CONSISTS OF STANDARD CHARACTERS WITHOUT CLAIM TO ANY PARTICULAR FONT, STYLE, SIZE, OR COLOR.

PRIORITY CLAIMED UNDER SEC. 44(D) ON ERPN CMNTY TM OFC APPLICATION NO. 006247522, FILED 9-7-2007, REG. NO. 6247522, DATED 8-7-2008, EXPIRES 9-7-2017.

SER. NO. 77-415,820, FILED 3-7-2008.

JIM RINGLE, EXAMINING ATTORNEY



*David J. Kypos*

Director of the United States Patent and Trademark Office

# United States of America

United States Patent and Trademark Office

# ColorPro

**Reg. No. 4,133,504**

**Registered May 1, 2012**

**Int. Cl.: 2**

**TRADEMARK**

**PRINCIPAL REGISTER**

BASF COATINGS GMBH (FED REP GERMANY LIMITED LIABILITY COMPANY)  
GLASURITSTR. 1  
MUNSTER, FED REP GERMANY 48165

FOR: PIGMENTED PAINTS FOR USE IN AUTOMOTIVE COATING APPLICATIONS, IN CLASS 2 (U.S. CLS. 6, 11 AND 16).

THE MARK CONSISTS OF STANDARD CHARACTERS WITHOUT CLAIM TO ANY PARTICULAR FONT, STYLE, SIZE, OR COLOR.

OWNER OF FED REP GERMANY REG. NO. 30351335, DATED 10-8-2003, EXPIRES 10-31-2013.

SER. NO. 77-440,264, FILED 4-4-2008.

KAREN SEVERSON, EXAMINING ATTORNEY



*David J. Kyros*

Director of the United States Patent and Trademark Office

# United States of America

United States Patent and Trademark Office

# BOMBARDIER

**Reg. No. 4,133,505**

**Registered May 1, 2012**

**Int. Cls.: 9, 12 and 37**

**TRADEMARK**

**SERVICE MARK**

**PRINCIPAL REGISTER**

BOMBARDIER INC. (CANADA CORPORATION)  
800, RENÉ-LEVESQUE BOULEVARD WEST  
MONTREAL, CANADA H3B1Y8

FOR: SIGNALLING, AUTOMATIC TRAIN CONTROL, INTERLOCKING AND CONTROL ROOM SYSTEMS COMPRISING COMPUTERS, COMPUTER SOFTWARE, RADIOS, COMMUNICATION EQUIPMENT, POSITIONING EQUIPMENT AND SPEED SENSORS, IN CLASS 9 (U.S. CLS. 21, 23, 26, 36 AND 38).

FOR: (BASED ON USE IN COMMERCE) AIRCRAFT AND STRUCTURAL PARTS THEREOF; RAIL VEHICLES, NAMELY, PASSENGER TRAINS AND STRUCTURAL PARTS FOR THE AFORESAID GOODS, IN CLASS 12 (U.S. CLS. 19, 21, 23, 31, 35 AND 44).

FIRST USE 0-0-1978; IN COMMERCE 0-0-1978.

FOR: (BASED ON USE IN COMMERCE) MAINTENANCE SERVICES FOR RAIL VEHICLES; REFURBISHING AND RE-ENGINEERING SERVICES FOR RAIL VEHICLES, NAMELY, REDESIGNING OF STRUCTURAL PARTS, COMPONENTS OR SYSTEMS OF A RAIL VEHICLE, ESPECIALLY TO OVERCOME TECHNOLOGICAL OBSOLESCENCE; AIRCRAFT MAINTENANCE SERVICES, NAMELY, REPAIR AND REPLACEMENT OF AIRCRAFT COMPONENTS, ENGINE COMPONENTS AND SECONDARY STRUCTURAL COMPONENTS, IN CLASS 37 (U.S. CLS. 100, 103 AND 106).

FIRST USE 0-0-1987; IN COMMERCE 0-0-1987.

THE MARK CONSISTS OF STANDARD CHARACTERS WITHOUT CLAIM TO ANY PARTICULAR FONT, STYLE, SIZE, OR COLOR.

PRIORITY CLAIMED UNDER SEC. 44(D) ON CANADA APPLICATION NO. 1390780, FILED 4-10-2008, REG. NO. TMA808,299, DATED 10-4-2011, EXPIRES 10-4-2026.

OWNER OF U.S. REG. NOS. 1,936,417, 3,406,425 AND OTHERS.

SER. NO. 77-477,345, FILED 5-17-2008.

BRIDGETT SMITH, EXAMINING ATTORNEY



*David J. Kyros*

Director of the United States Patent and Trademark Office

# United States of America

United States Patent and Trademark Office

## SECUREMASTER

**Reg. No. 4,133,506**

**Registered May 1, 2012**

**Int. Cls.: 6, 9 and 37**

**TRADEMARK**

**SERVICE MARK**

**PRINCIPAL REGISTER**

SAFEGUARDS TECHNOLOGY, LLC (DELAWARE LIMITED LIABILITY COMPANY)  
75 ATLANTIC STREET  
HACKENSACK, NJ 07601

FOR: PRIMARILY METAL MECHANICAL SECURITY SYSTEMS AND PARTS THEREFORE, NAMELY, FENCES, CRASH BARRIERS, VEHICLE GATES, PEDESTRIAN GATES, SECURITY TURNSTILES, AND LOCKING MECHANISMS, IN CLASS 6 (U.S. CLS. 2, 12, 13, 14, 23, 25 AND 50).

FIRST USE 6-15-2006; IN COMMERCE 6-15-2006.

FOR: ELECTRONIC SECURITY SYSTEMS CONSISTING OF ELECTRIC FENCES, ELECTRIC DETECTION FENCES, MONITORING CAMERAS, INTRUSION DETECTION SENSORS AND ELECTRONIC CONTROLS FOR SUCH SENSORS; PERIMETER INTRUSION DETECTION AND ALARM SYSTEMS; ANTI-INTRUSION ALARMS; ALARM CONTROL UNITS; ALARM MONITORING SYSTEMS CONSISTING OF COMPUTERS, COMPUTER SOFTWARE AND DISPLAY MONITORS; AND ACCESS CONTROL SYSTEMS CONSISTING OF COMPUTERS, COMPUTER SOFTWARE AND DISPLAY MONITORS EXCLUDING GARAGE DOOR OPERATORS, COMMERCIAL OPERATORS, LIGHTING FIXTURES, AND GATE OPERATORS, IN CLASS 9 (U.S. CLS. 21, 23, 26, 36 AND 38).

FIRST USE 6-15-2006; IN COMMERCE 6-15-2006.

FOR: INSTALLATION SERVICES FOR SECURITY SYSTEMS FOR PROPERTY REQUIRING HEIGHTENED SECURITY, IN CLASS 37 (U.S. CLS. 100, 103 AND 106).

FIRST USE 6-15-2006; IN COMMERCE 6-15-2006.

THE MARK CONSISTS OF STANDARD CHARACTERS WITHOUT CLAIM TO ANY PARTICULAR FONT, STYLE, SIZE, OR COLOR.

SER. NO. 77-498,671, FILED 6-13-2008.

INGA ERVIN, EXAMINING ATTORNEY



*David J. Kyros*

Director of the United States Patent and Trademark Office

# United States of America

United States Patent and Trademark Office

# TAL SHI

**Reg. No. 4,133,507**

**Registered May 1, 2012**

**Int. Cl.: 3**

**TRADEMARK**

**PRINCIPAL REGISTER**

SUPPLEMENT FORMULATORS, INC. (DELAWARE CORPORATION)  
1100 W. COMMERCIAL BLVD.  
FT. LAUDERDALE, FL 33309

FOR: COSMETIC PREPARATIONS FOR EYE LASHES; COSMETICS AND MAKE-UP; COSMETICS IN GENERAL, INCLUDING PERFUMES; EYEBROW COSMETICS; FACE CREAMS FOR COSMETIC USE; LIP GLOSS; LIP LINER, IN CLASS 3 (U.S. CLS. 1, 4, 6, 50, 51 AND 52).

FIRST USE 9-8-2004; IN COMMERCE 9-8-2004.

THE MARK CONSISTS OF STANDARD CHARACTERS WITHOUT CLAIM TO ANY PARTICULAR FONT, STYLE, SIZE, OR COLOR.

SER. NO. 77-556,962, FILED 8-27-2008.

JEFFERY COWARD, EXAMINING ATTORNEY



*David J. Kyros*

Director of the United States Patent and Trademark Office

# United States of America

United States Patent and Trademark Office

## First Descents

**Reg. No. 4,133,508**

**Registered May 1, 2012**

**Int. Cl.: 25**

**TRADEMARK**

**PRINCIPAL REGISTER**

FIRST DESCENTS, INC. (COLORADO CORPORATION)  
PO BOX 2193  
VAIL, CO 81658

FOR: BASEBALL CAPS; CAPS; CAPS WITH VISORS; HEADGEAR, NAMELY, HATS, CAPS; HOODED PULLOVERS; HOODED SWEAT SHIRTS; JACKETS; POLO SHIRTS; SHORT-SLEEVED OR LONG-SLEEVED T-SHIRTS; T-SHIRTS; WEARABLE GARMENTS AND CLOTHING, NAMELY, SHIRTS, IN CLASS 25 (U.S. CLS. 22 AND 39).

FIRST USE 7-1-2001; IN COMMERCE 7-1-2001.

THE MARK CONSISTS OF STANDARD CHARACTERS WITHOUT CLAIM TO ANY PARTICULAR FONT, STYLE, SIZE, OR COLOR.

OWNER OF U.S. REG. NO. 2,695,260.

SER. NO. 77-576,914, FILED 9-23-2008.

DANIEL BRODY, EXAMINING ATTORNEY



*David J. Kyros*

Director of the United States Patent and Trademark Office



# United States of America

United States Patent and Trademark Office



**Reg. No. 4,133,509**

**Registered May 1, 2012**

**Int. Cl.: 25**

**TRADEMARK**

**PRINCIPAL REGISTER**

MATTERN, TRAVIS (UNITED STATES INDIVIDUAL)  
1311 BEAVER RIDGE ROAD  
BEAVERTOWN, PA 17813

FOR: HEADWEAR; JACKETS; PANTS; SHIRTS; SHORTS, IN CLASS 25 (U.S. CLS. 22 AND 39).

FIRST USE 10-1-2009; IN COMMERCE 10-1-2009.

NO CLAIM IS MADE TO THE EXCLUSIVE RIGHT TO USE "ATTIRE", APART FROM THE MARK AS SHOWN.

THE MARK CONSISTS OF A SKULL-AND-CROSSBONES DESIGN, IN WHICH THE SKULL IS FORMED BY THE STYLIZED LETTERS "MOON SHINE". THE PHRASE "ATTITUDE ATTIRE" APPEARS BELOW THE PHRASE "MOON SHINE".

SER. NO. 77-588,017, FILED 10-8-2008.

EDWARD NELSON, EXAMINING ATTORNEY



*David J. Kybas*

Director of the United States Patent and Trademark Office

# United States of America

United States Patent and Trademark Office

## HIGH STREET RESIDENTIAL

**Reg. No. 4,133,510**

**Registered May 1, 2012**

**Int. Cl.: 37**

**SERVICE MARK**

**PRINCIPAL REGISTER**

TRAMMELL CROW COMPANY (DELAWARE CORPORATION)  
SUITE 3400  
2001 ROSS AVENUE  
DALLAS, TX 75201

FOR: REAL ESTATE DEVELOPMENT, IN CLASS 37 (U.S. CLS. 100, 103 AND 106).

FIRST USE 9-20-2002; IN COMMERCE 9-20-2002.

THE MARK CONSISTS OF STANDARD CHARACTERS WITHOUT CLAIM TO ANY PARTICULAR FONT, STYLE, SIZE, OR COLOR.

NO CLAIM IS MADE TO THE EXCLUSIVE RIGHT TO USE "RESIDENTIAL", APART FROM THE MARK AS SHOWN.

SER. NO. 77-589,724, FILED 10-9-2008.

JULIE VEPPUMTHARA, EXAMINING ATTORNEY



*David J. Kyros*

Director of the United States Patent and Trademark Office

# United States of America

United States Patent and Trademark Office

## 'h' UNIT

**Reg. No. 4,133,511**

**Registered May 1, 2012**

**Int. Cl.: 11**

**TRADEMARK**

**PRINCIPAL REGISTER**

BLUE PLANET ENVIRONMENTAL INC. (CANADA CORPORATION)  
565 EDWARD AVENUE, UNIT 15  
RICHMOND HILL, ONTARIO, CANADA L4C9W8

FOR: WATER BODY PURIFICATION AND RESTORATION SYSTEM CONSISTING OF A WATER PROCESSING UNIT HAVING A WATER INTAKE TUBE, A GAS DIFFUSER HOUSED IN THE INTAKE TUBE FOR PROVIDING GAS TO BE TRANSFERRED TO THE WATER AND FOR PROVIDING THE MEANS TO ADVANCE THE WATER THROUGH THE INTAKE TUBE, AND A CONNECTOR TUBE CONNECTING THE INTAKE TUBE TO A WATER DISCHARGE TUBE HAVING A SECTION TO ALLOW DISPERSION OF EXCESS GASES FROM THE WATER, IN CLASS 11 (U.S. CLS. 13, 21, 23, 31 AND 34).

THE MARK CONSISTS OF STANDARD CHARACTERS WITHOUT CLAIM TO ANY PARTICULAR FONT, STYLE, SIZE, OR COLOR.

OWNER OF CANADA REG. NO. TMA762,147, DATED 3-22-2010, EXPIRES 3-22-2025.

NO CLAIM IS MADE TO THE EXCLUSIVE RIGHT TO USE "UNIT", APART FROM THE MARK AS SHOWN.

SER. NO. 77-595,230, FILED 10-17-2008.

NAAKWAMA ANKRAH, EXAMINING ATTORNEY



*David J. Kypos*

Director of the United States Patent and Trademark Office

# United States of America

United States Patent and Trademark Office

## WHERE THE WORLD MEETS

**Reg. No. 4,133,512**

**Registered May 1, 2012**

**Int. Cl.: 35**

**SERVICE MARK**

**PRINCIPAL REGISTER**

JACOBS CENTER FOR NEIGHBORHOOD INNOVATION (CALIFORNIA CORPORATION)  
JOE & VI JACOBS CENTER  
404 EUCLID AVENUE  
SAN DIEGO, CA 92114

FOR: RETAIL AND CONSIGNMENT STORE SERVICES OFFERING GENERAL CONSUMER MERCHANDISE, GIFTS, PRODUCTS MADE BY LOCAL ARTISANS, AND PRODUCTS REPRESENTING COMMUNITY CULTURES; RETAIL GIFT SHOPS; OPERATING AND ORGANIZING OUTDOOR FLEA MARKETS, IN CLASS 35 (U.S. CLS. 100, 101 AND 102).

FIRST USE 2-0-2003; IN COMMERCE 2-0-2003.

THE MARK CONSISTS OF STANDARD CHARACTERS WITHOUT CLAIM TO ANY PARTICULAR FONT, STYLE, SIZE, OR COLOR.

SER. NO. 77-596,593, FILED 10-20-2008.

CURTIS FRENCH, EXAMINING ATTORNEY



*David J. Kyros*

Director of the United States Patent and Trademark Office

# United States of America

United States Patent and Trademark Office

## TOMASSO SENSIA

**Reg. No. 4,133,513**

**Registered May 1, 2012**

**Int. Cls.: 29 and 30**

**TRADEMARK**

**PRINCIPAL REGISTER**

PIAZZA TOMASSO INTERNATIONAL INC. (CANADA CORPORATION)  
SUITE 2120  
300, RUE LEO-PARISEAU  
MONTREAL, QUEBEC, CANADA H2X4B3

FOR: FROZEN ENTREES CONSISTING PRIMARILY OF MEAT, FISH, POULTRY OR VEGETABLES, IN CLASS 29 (U.S. CL. 46).

FOR: FROZEN ENTREES CONSISTING PRIMARILY OF PASTA OR RICE, IN CLASS 30 (U.S. CL. 46).

THE MARK CONSISTS OF STANDARD CHARACTERS WITHOUT CLAIM TO ANY PARTICULAR FONT, STYLE, SIZE, OR COLOR.

PRIORITY CLAIMED UNDER SEC. 44(D) ON CANADA APPLICATION NO. 1413606, FILED 10-7-2008, REG. NO. TMA809,955, DATED 10-25-2011, EXPIRES 10-25-2026.

THE WORDING "SENSIA" HAS NO MEANING IN A FOREIGN LANGUAGE.

SER. NO. 77-599,549, FILED 10-23-2008.

MATTHEW KLINE, EXAMINING ATTORNEY



*David J. Kypas*

Director of the United States Patent and Trademark Office

**United States of America**  
United States Patent and Trademark Office

# TOMASSO

**Reg. No. 4,133,514**

**Registered May 1, 2012**

**Int. Cls.: 29 and 30**

**TRADEMARK**

**PRINCIPAL REGISTER**

PIAZZA TOMASSO INTERNATIONAL INC. (CANADA CORPORATION)  
SUITE 2120  
300, RUE LEO-PARISEAU  
MONTREAL, QUEBEC, CANADA H2X4B3

FOR: FROZEN ENTREES CONSISTING PRIMARILY OF MEAT, FISH, POULTRY OR VEGETABLES, IN CLASS 29 (U.S. CL. 46).

FOR: FROZEN ENTREES CONSISTING PRIMARILY OF PASTA OR RICE, IN CLASS 30 (U.S. CL. 46).

THE MARK CONSISTS OF STANDARD CHARACTERS WITHOUT CLAIM TO ANY PARTICULAR FONT, STYLE, SIZE, OR COLOR.

PRIORITY CLAIMED UNDER SEC. 44(D) ON CANADA APPLICATION NO. 1413603, FILED 10-7-2008, REG. NO. TMA810,956, DATED 11-3-2011, EXPIRES 11-3-2026.

SER. NO. 77-599,556, FILED 10-23-2008.

MATTHEW KLINE, EXAMINING ATTORNEY



*David J. Kyros*

Director of the United States Patent and Trademark Office

# United States of America

United States Patent and Trademark Office

## dress up your drink

**Reg. No. 4,133,515**

**Registered May 1, 2012**

**Int. Cl.: 29**

**TRADEMARK**

**PRINCIPAL REGISTER**

MAPLE GROVE PRODUCTS, INC. (GEORGIA CORPORATION)  
PO BOX 8026  
ATLANTA, GA 31106

FOR: WHIPPED CREAM, IN CLASS 29 (U.S. CL. 46).

FIRST USE 11-15-2009; IN COMMERCE 11-15-2009.

THE MARK CONSISTS OF STANDARD CHARACTERS WITHOUT CLAIM TO ANY PARTICULAR FONT, STYLE, SIZE, OR COLOR.

SER. NO. 77-600,588, FILED 10-25-2008.

SIMON TENG, EXAMINING ATTORNEY



*David J. Kyffers*

Director of the United States Patent and Trademark Office

# United States of America

United States Patent and Trademark Office



**Reg. No. 4,133,516**

**Registered May 1, 2012**

**Int. Cl.: 36**

**SERVICE MARK**

**PRINCIPAL REGISTER**

CHINA INTERNATIONAL CAPITAL CORPORATION LIMITED (CHINA CORPORATION)  
28TH FLOOR, CHINA WORLD TOWER 2 NO. 1  
JIAN GUO MEN WAI AVENUE  
BEIJING 100004, CHINA

FOR: ADMINISTRATION OF EMPLOYEE BENEFIT PLANS CONCERNING INSURANCE AND FINANCE; ADMINISTRATION OF EMPLOYEE PENSION PLANS; ADMINISTRATION OF EMPLOYEE WELFARE BENEFIT PLANS; ADMINISTRATION OF PRE-PAID HEALTH CARE PLANS; ADVICE RELATING TO INVESTMENTS; AGENCIES FOR BROKERAGE OF SECURITIES TRADING IN OVERSEAS SECURITIES MARKETS AND OF TRANSACTIONS ON COMMISSION OF OVERSEAS MARKET SECURITIES FUTURES; AGENCIES FOR COMMODITY FUTURES TRADING; AGENCIES IN THE FIELD OF BONDS AND OTHER SECURITIES; AGENCIES OR BROKERAGE FOR TRADING OF SECURITIES, SECURITIES INDEX FUTURES, SECURITIES OPTIONS, AND OVERSEAS MARKET SECURITIES FUTURES; ASSUMING FINANCIAL RISK OF OTHERS BY ENTERING INTO OPTIONS AND SWAPS; AUTOMATED SECURITIES BROKERAGE; BROKERAGE IN THE FIELD OF STOCKS, COMMODITIES AND SECURITIES; BROKERAGE OF SHARES AND OTHER SECURITIES; BROKERAGE OF SHARES OR STOCKS AND OTHER SECURITIES; BUSINESS, STOCK OPTION AND PENSION VALUATION SERVICES; CAPITAL INVESTMENT CONSULTATION; CASH AND FOREIGN EXCHANGE TRANSACTIONS; CASH MANAGEMENT; CREDIT RISK MANAGEMENT; ESTABLISHING MUTUAL FUNDS FOR OTHERS; FINANCIAL ANALYSIS AND CONSULTATION; FINANCIAL CONSULTATION; FINANCIAL DUE DILIGENCE; FINANCIAL FORECASTING; FINANCIAL INFORMATION PROCESSING; FINANCIAL MANAGEMENT; FINANCIAL PLANNING; FINANCIAL PLANNING CONSULTATION; FINANCIAL PORTFOLIO MANAGEMENT; FINANCIAL RESEARCH; FINANCIAL RISK MANAGEMENT; FINANCIAL SERVICES IN THE NATURE OF AN INVESTMENT SECURITY; FINANCIAL SERVICES, NAMELY, ASSISTING OTHERS WITH THE COMPLETION OF FINANCIAL TRANSACTIONS FOR STOCKS, BONDS, SECURITIES AND EQUITIES; FINANCIAL SERVICES, NAMELY, A TOTAL PORTFOLIO OFFERING FOR HIGH NET WORTH CLIENTS CONSISTING OF BOTH SEPARATE ACCOUNTS AND MUTUAL FUNDS FOR EQUITY AND FIXED INCOME INVESTMENTS; FINANCIAL SERVICES, NAMELY, ISSUANCE AND MANAGEMENT OF CERTIFICATES BACKED BY LOAN PORTFOLIOS WHICH ARE SUBSEQUENTLY MANAGED TO INSURE THE INTEGRITY OF THE CERTIFICATES; FUND INVESTMENT CONSULTATION; FUNDS INVESTMENT; INVESTMENT ADVICE; INVESTMENT BANKING SERVICES; INVESTMENT BROKERAGE; INVESTMENT BY ELECTRONIC MEANS; INVESTMENT CLUBS; INVESTMENT CONSULTATION; INVESTMENT MANAGEMENT; INVESTMENT MANAGEMENT OF AND



*David J. Kybas*

Director of the United States Patent and Trademark Office



**Reg. No. 4,133,516** DISTRIBUTION OF VARIABLE ANNUITIES; INVESTMENT OF FUNDS FOR OTHERS; INVESTMENT SERVICES, NAMELY, ASSET ACQUISITION, CONSULTATION, DEVELOPMENT AND MANAGEMENT SERVICES; MANAGEMENT OF A CAPITAL INVESTMENT FUND; MANAGEMENT OF PORTFOLIOS COMPRISING SECURITIES; MANAGEMENT OF PORTFOLIOS OF TRANSFERABLE SECURITIES; MUTUAL FUND BROKERAGE; MUTUAL FUND DISTRIBUTION; MUTUAL FUND INVESTMENT; PROJECT FINANCING; PROVIDING STOCK MARKET INFORMATION; PROVIDING STOCK/SECURITIES MARKET INFORMATION; FINANCIAL RISK MANAGEMENT CONSULTATION; STOCK BROKERAGE; TRUST SERVICES, NAMELY, INVESTMENT AND TRUST COMPANY SERVICES; VENTURE CAPITAL FUNDING SERVICES TO EMERGING AND START-UP COMPANIES; VENTURE CAPITAL SERVICES, NAMELY, PROVIDING FINANCING TO EMERGING AND START-UP COMPANIES, IN CLASS 36 (U.S. CLS. 100, 101 AND 102).

FIRST USE 8-11-1996; IN COMMERCE 8-1-2000.

OWNER OF U.S. REG. NO. 3,158,330.

THE NON-LATIN CHARACTERS IN THE MARK TRANSLITERATE TO ZHONG, JIN, GONG AND SI AND THIS MEANS MIDDLE, GOLD, PUBLIC AND TO BE IN CHARGE IN ENGLISH.

THE MARK CONSISTS OF A SPIRAL CIRCULAR DESIGN, WITH THE STYLIZED WORDING "CICC" APPEARING ABOVE A SERIES OF CHINESE CHARACTERS.

THE WORDING "CICC" HAS NO MEANING IN A FOREIGN LANGUAGE.

SER. NO. 77-621,191, FILED 11-25-2008.

PAM WILLIS, EXAMINING ATTORNEY

# United States of America

United States Patent and Trademark Office

# Glad Pits

**Reg. No. 4,133,517**

**Registered May 1, 2012**

**Int. Cl.: 3**

**TRADEMARK**

**PRINCIPAL REGISTER**

SOAP & GLORY LIMITED (UNITED KINGDOM LIMITED LIABILITY COMPANY)  
3 LOGAN PLACE  
LONDON, UNITED KINGDOM W86QN

FOR: ANTI-PERSPIRANTS AND DEODORANTS FOR PERSONAL USE; SCENTED BODY  
SPRAYS, IN CLASS 3 (U.S. CLS. 1, 4, 6, 50, 51 AND 52).

THE MARK CONSISTS OF STANDARD CHARACTERS WITHOUT CLAIM TO ANY PAR-  
TICULAR FONT, STYLE, SIZE, OR COLOR.

OWNER OF UNITED KINGDOM REG. NO. 2503272, DATED 11-25-2008, EXPIRES 11-25-  
2018.

NO CLAIM IS MADE TO THE EXCLUSIVE RIGHT TO USE "PITS", APART FROM THE  
MARK AS SHOWN.

SER. NO. 77-621,277, FILED 11-25-2008.

MATTHEW KLINE, EXAMINING ATTORNEY



*David J. Kyffers*

Director of the United States Patent and Trademark Office

# United States of America

United States Patent and Trademark Office

# SurfMax

**Reg. No. 4,133,518**

**Registered May 1, 2012**

**Int. Cl.: 9**

**TRADEMARK**

**PRINCIPAL REGISTER**

CARL ZEISS AG (FED REP GERMANY CORPORATION)  
CARL-ZEISS-STRASSE 22  
OBERKOCHEN, FED REP GERMANY 73447

FOR: COORDINATE MEASURING MACHINES AND PARTS THEREOF, IN CLASS 9 (U.S. CLS. 21, 23, 26, 36 AND 38).

THE MARK CONSISTS OF STANDARD CHARACTERS WITHOUT CLAIM TO ANY PARTICULAR FONT, STYLE, SIZE, OR COLOR.

PRIORITY CLAIMED UNDER SEC. 44(D) ON FED REP GERMANY APPLICATION NO. 302008053095, FILED 8-18-2008, REG. NO. 302008053095, DATED 9-25-2008, EXPIRES 8-31-2018.

SER. NO. 77-621,833, FILED 11-25-2008.

RENEE SERVANCE, EXAMINING ATTORNEY



*David J. Kybas*

Director of the United States Patent and Trademark Office

# United States of America

United States Patent and Trademark Office



**Reg. No. 4,133,519**

**Registered May 1, 2012**

**Int. Cl.: 25**

**TRADEMARK**

**PRINCIPAL REGISTER**

HOBBS LIMITED (UNITED KINGDOM LIMITED LIABILITY COMPANY)  
42 GLOUCESTER AVENUE  
LONDON, UNITED KINGDOM NW18JD

FOR: WOMEN'S CLOTHING, NAMELY, JACKETS, SKIRTS, TROUSERS, DRESSES, COATS, JEANS, SHIRTS, SCARVES, TUNIC TOPS, TANK TOPS, T-SHIRTS, SWEATERS, CARDIGAN SWEATERS, VESTS, PANTS AND SUITS; WOMEN'S FOOTWEAR; AND WOMEN'S HEADGEAR, NAMELY, HATS, CAPS, SCARVES, HOODS, TOQUES, BERETS, HEADBANDS AND EARMUFFS, IN CLASS 25 (U.S. CLS. 22 AND 39).

OWNER OF ERPN CMNTY TM OFC REG. NO. 007589393, DATED 9-9-2009, EXPIRES 2-9-2019.

THE MARK CONSISTS OF THE LETTERS "N" AND "W" FOLLOWED BY THE NUMBER "3", WITH A PERIOD FOLLOWING EACH OF THE LETTERS OR NUMBER, ALL APPEARING WITHIN A BLACK RECTANGULAR BOX. THERE IS A WHITE VERTICAL LINE APPEARING BEFORE THE LETTER "N" AND ANOTHER APPEARING AFTER THE "W.", AND THE RECTANGULAR BOX HAS A JAGGED EDGE.

SER. NO. 77-667,261, FILED 2-10-2009.

FLORENTINA BLANDU, EXAMINING ATTORNEY



*David J. Kybas*

Director of the United States Patent and Trademark Office

# United States of America

United States Patent and Trademark Office

# CICERO

**Reg. No. 4,133,520**

**Registered May 1, 2012**

**Int. Cl.: 41**

**SERVICE MARK**

**PRINCIPAL REGISTER**

DEBOOR, C. THOMAS (UNITED STATES INDIVIDUAL)  
2136 WEST THOMAS STREET  
CHICAGO, IL 60622

FOR: ENTERTAINMENT SERVICES, NAMELY, PROVIDING AN ONLINE COMPUTER GAME ABOUT CURRENT EVENTS AND POLITICS, IN CLASS 41 (U.S. CLS. 100, 101 AND 107).

FIRST USE 4-1-2006; IN COMMERCE 4-1-2006.

THE MARK CONSISTS OF STANDARD CHARACTERS WITHOUT CLAIM TO ANY PARTICULAR FONT, STYLE, SIZE, OR COLOR.

SER. NO. 77-677,451, FILED 2-24-2009.

JOHN DWYER, EXAMINING ATTORNEY



*David J. Kyffers*

Director of the United States Patent and Trademark Office

# United States of America

United States Patent and Trademark Office



**Reg. No. 4,133,521**

**Registered May 1, 2012**

**Int. Cl.: 19**

**TRADEMARK**

**PRINCIPAL REGISTER**

WOOD DISTRIBUTORS, INC. (PUERTO RICO CORPORATION)  
BARRIO CARRIZALES  
CARRETERA #2, KM. 84.6  
HATILLO, PUERTO RICO 00659

FOR: PRE-FABRICATED HOMES, IN CLASS 19 (U.S. CLS. 1, 12, 33 AND 50).

FIRST USE 8-20-2008; IN COMMERCE 8-20-2008.

OWNER OF U.S. REG. NO. 3,809,229.

THE COLOR(S) GREEN, YELLOW, KHAKI, BROWN IS/ARE CLAIMED AS A FEATURE OF THE MARK.

NO CLAIM IS MADE TO THE EXCLUSIVE RIGHT TO USE "MODELOS BORICUA", APART FROM THE MARK AS SHOWN.

THE MARK CONSISTS OF A LOGO WITH WORD IN BROWN "MODELOS" IN STANDARD TYPE, PLACED ABOVE AND ON THE RIGHT HAND SIDE OF THE LARGER WORD IN STYLIZED FONT "BORICUA". THE WORD "BORICUA" IS THE COLOR GREEN AND EACH LETTER, EXCEPT FOR THE "O", HAS A YELLOW SHADOW EFFECT. THE LETTER "O" IS REPRESENTED BY A TRADITIONAL PUERTO RICAN HAT IN THE COLOR KHAKI. BENEATH THE LOGO THERE IS A SEMI OVAL SHAPED BROWN LINE, PLACED IN ORDER TO UNDERLINE THE DESIGN.

THE ENGLISH TRANSLATION OF "MODELOS BORICUA" IN THE MARK IS "MODELS FROM PUERTO RICO".

SER. NO. 77-730,284, FILED 5-6-2009.

ELIZABETH KAJUBI, EXAMINING ATTORNEY



*David J. Kybas*

Director of the United States Patent and Trademark Office

# United States of America

United States Patent and Trademark Office



LAS MOMIAS  
DE GUANAJUATO

**Reg. No. 4,133,522**

**Registered May 1, 2012**

**Int. Cls.: 28, 41 and 43**

**TRADEMARK**

**SERVICE MARK**

**PRINCIPAL REGISTER**

MUNICIPIO DE GUANAJUATO (MEXICO CORPORATION)  
COL. CENTRO HISTORICO  
PLAZA DE LA PAZ #12  
GUANAJUATO, GUANAJUATO, MEXICO 36000

FOR: ARCHERY SETS; BACKGAMMON GAMES; BADMINTON SETS; BALLS FOR GAMES; BALLS FOR SPORTS; BUBBLE MAKING WAND AND SOLUTION SETS; CARD GAMES; CHECKER SETS; CHESS GAMES; CONFETTI; COSTUME MASKS; DARTS; DICE GAMES; DOMINOES; GAME EQUIPMENT, NAMELY, CHIPS; KITES; MUSICAL TOYS; PINATAS; PLAY BALLOONS; PLAYING CARDS; PUPPETS; PUZZLES; RACKETS; ROLLER SKATES; ROULETTE WHEELS; SKATEBOARDS; SPINNING TOPS; TARGETS; THEATRICAL MASKS; TOY BALLOONS; TOY CARS; TOY GUNS; TOY HOOP SETS; TOY MASKS, IN CLASS 28 (U.S. CLS. 22, 23, 38 AND 50).

FOR: EDUCATIONAL SERVICES, NAMELY, CONDUCTING ON-LINE EXHIBITIONS AND DISPLAYS AND INTERACTIVE EXHIBITS IN THE FIELD OF ARCHEOLOGY, ANTHROPOLOGY AND FORENSIC SCIENCE; EDUCATIONAL SERVICES, NAMELY, CONDUCTING EXHIBITIONS, CONFERENCES, WORKSHOPS, PANEL DISCUSSIONS, SEMINARS AND COLLOQUY IN THE FIELD OF ARCHEOLOGY, ANTHROPOLOGY AND FORENSIC SCIENCE; ORGANIZATION OF EXHIBITIONS FOR CULTURAL OR EDUCATIONAL PURPOSES; ORGANIZING AND ARRANGING EXHIBITIONS FOR ENTERTAINMENT PURPOSES; PRODUCTION OF FILMS; PROVIDING A WEB SITE THAT FEATURES INFORMAL INSTRUCTION ON ARCHEOLOGY, ANTHROPOLOGY AND FORENSIC SCIENCE; RECREATIONAL CAMPS, IN CLASS 41 (U.S. CLS. 100, 101 AND 107).

FOR: CAFETERIAS; CANTEEN SERVICES; HOTEL SERVICES; PROVIDING TEMPORARY ACCOMMODATION; PROVIDING TEMPORARY LODGING SERVICES IN THE NATURE OF A CONDOMINIUM HOTEL; RESTAURANT AND BAR SERVICES; TOURIST HOSTELS, IN CLASS 43 (U.S. CLS. 100 AND 101).



PRIORITY CLAIMED UNDER SEC. 44(D) ON MEXICO APPLICATION NO. 980054, FILED 12-15-2008, REG. NO. 1085486, DATED 12-18-2009, EXPIRES 12-15-2018.

PRIORITY CLAIMED UNDER SEC. 44(D) ON MEXICO APPLICATION NO. 980055, FILED 12-15-2008, REG. NO. 1085486, DATED 12-18-2009, EXPIRES 12-15-2018.

*David J. Kyros*

Director of the United States Patent and Trademark Office

**Reg. No. 4,133,522** PRIORITY CLAIMED UNDER SEC. 44(D) ON MEXICO APPLICATION NO. 980061, FILED 12-15-2008, REG. NO. 1085486, DATED 2-18-2009, EXPIRES 12-15-2018.

OWNER OF MEXICO REG. NO. 1085486, DATED 2-18-2009, EXPIRES 12-15-2018.

NO CLAIM IS MADE TO THE EXCLUSIVE RIGHT TO USE "LAS MOMIAS DE GUANAJUATO", APART FROM THE MARK AS SHOWN.

THE MARK CONSISTS OF FIVE VERTICAL FIGURES, EACH HAVING A DOT ON TOP, SIMILAR TO FIVE LOWER CASE LETTERS "I", FOLLOWED BY THE STACKED WORDING "LAS MOMIAS" AND "DE GUANAJUATO" IN STYLIZED LETTERS. THERE IS A SINGLE HORIZONTAL LINE UNDER THE "O" IN "GUANAJUATO".

THE ENGLISH TRANSLATION OF THE WORDS "LAS MOMIAS DE" IN THE MARK IS THE MUMMIES OF.

SER. NO. 77-736,760, FILED 5-14-2009.

PAULA MAHONEY, EXAMINING ATTORNEY



# United States of America

United States Patent and Trademark Office

## ECO Together

**Reg. No. 4,133,523**

**Registered May 1, 2012**

**Int. Cls.: 1 and 3**

**TRADEMARK**

**PRINCIPAL REGISTER**

KAO KABUSHIKI KAISHA (JAPAN CORPORATION), TA KAO CORPORATION  
14-10, NIHONBASHI KAYABACHO, 1-CHOME  
CHUO-KU, TOKYO, JAPAN 103-8210

FOR: INDUSTRIAL CHEMICALS HAVING A REDUCED ENVIRONMENTAL IMPACT, IN CLASS 1 (U.S. CLS. 1, 5, 6, 10, 26 AND 46).

FOR: COSMETICS, PERFUMERY, NON-MEDICATED SKIN CARE PREPARATIONS, HAIR CARE PREPARATIONS, LAUNDRY DETERGENTS, BLEACHING PREPARATIONS FOR HOUSEHOLD AND LAUNDRY USE, FABRIC SOFTENERS, DISHWASHING DETERGENTS, HOUSEHOLD DETERGENTS, DENTIFRICES, ALL OF THE FOREGOING INCORPORATING ENVIRONMENTALLY FRIENDLY PACKAGING, IN CLASS 3 (U.S. CLS. 1, 4, 6, 50, 51 AND 52).

THE MARK CONSISTS OF STANDARD CHARACTERS WITHOUT CLAIM TO ANY PARTICULAR FONT, STYLE, SIZE, OR COLOR.

PRIORITY CLAIMED UNDER SEC. 44(D) ON JAPAN APPLICATION NO. 2009-024478, FILED 4-2-2009, REG. NO. 5396915, DATED 3-1-2011, EXPIRES 3-11-2021.

NO CLAIM IS MADE TO THE EXCLUSIVE RIGHT TO USE "ECO", APART FROM THE MARK AS SHOWN.

SER. NO. 77-760,027, FILED 6-15-2009.

DAVID H. STINE, EXAMINING ATTORNEY



*David J. Kyros*

Director of the United States Patent and Trademark Office

United States of America  
United States Patent and Trademark Office

**SIX**

**Reg. No. 4,133,524**

**Registered May 1, 2012**

**Int. Cl.: 9**

**TRADEMARK**

**PRINCIPAL REGISTER**

NUMAX ENTERTAINMENT, INC. (NEVADA CORPORATION)  
P.O. BOX 740  
BRANSON, MO 65615

FOR: PRE-RECORDED DIGITAL MEDIA FEATURING MUSIC, SPOKEN WORD, MUSICAL PERFORMANCES AND PERFORMING ARTISTS, ALL BY THE PERFORMING GROUP KNOWN AS SIX, IN CLASS 9 (U.S. CLS. 21, 23, 26, 36 AND 38).

FIRST USE 12-0-2006; IN COMMERCE 12-0-2006.

OWNER OF U.S. REG. NOS. 3,415,718 AND 3,430,742.

THE MARK CONSISTS OF THE WORD "SIX" IN A STYLIZED MANNER.

SER. NO. 77-775,160, FILED 7-6-2009.

MEGHAN REINHART, EXAMINING ATTORNEY



*David J. Kyffers*

Director of the United States Patent and Trademark Office

# United States of America

United States Patent and Trademark Office

## COMMUNITY INSIGHTS

**Reg. No. 4,133,525**

**Registered May 1, 2012**

**Int. Cl.: 35**

**SERVICE MARK**

**PRINCIPAL REGISTER**

JGSC GROUP, LLC (NEW JERSEY LIMITED LIABILITY COMPANY)  
P.O. BOX 1148  
16 NORTH CENTRE STREET  
MERCHANTVILLE, NJ 08109

FOR: BUSINESS RESEARCH FOR OTHERS, NAMELY, CUSTOM MARKET RESEARCH REGARDING COMMERCIAL DISTRICTS AND RETAIL CORRIDORS; MARKET RESEARCH, NAMELY, ASSESSMENT OF COMMUNITY RESIDENTS, SHOPPERS, BUSINESS OWNERS, AND STAKEHOLDERS FOR THE PURPOSE OF REVITALIZATION AND ENHANCEMENT OF LOCAL ECONOMIC DEVELOPMENT, IN CLASS 35 (U.S. CLS. 100, 101 AND 102).

FIRST USE 9-0-2003; IN COMMERCE 9-0-2003.

THE MARK CONSISTS OF STANDARD CHARACTERS WITHOUT CLAIM TO ANY PARTICULAR FONT, STYLE, SIZE, OR COLOR.

NO CLAIM IS MADE TO THE EXCLUSIVE RIGHT TO USE "COMMUNITY", APART FROM THE MARK AS SHOWN.

SER. NO. 77-775,253, FILED 7-7-2009.

CORY BOONE, EXAMINING ATTORNEY



*David J. Kyffers*

Director of the United States Patent and Trademark Office

# United States of America

United States Patent and Trademark Office

## BORN BY TED BAKER

**Reg. No. 4,133,526**

**Registered May 1, 2012**

**Int. Cls.: 18 and 25**

**TRADEMARK**

**PRINCIPAL REGISTER**

NO ORDINARY DESIGNER LABEL LTD. (UNITED KINGDOM COMPANY), TA TED BAKER  
6A ST. PANCRAS WAY  
THE UGLY BROWN BUILDING  
LONDON, UNITED KINGDOM NW10TB

FOR: BAGS, NAMELY, LUGGAGE AND TRAVEL BAGS; SPORTS BAGS; HOLDALLS; SUITCASES; RUCKSACKS; OVERNIGHT BAGS; HANDBAGS; TEXTILE SHOPPING BAGS; SHOULDER BAGS; TOILETRY AND COSMETIC BAGS SOLD EMPTY; TIE CASES; BRIEFCASES; DOCUMENT CASES; LEATHER SHOULDER BELTS; WALLETS; CREDIT CARD CASES; KEYCASES; CREDIT CARD HOLDERS; PURSES; WALKING STICKS; UMBRELLAS AND PARASOLS EXCLUDING ALL LADIES' BAGS, NAMELY, HANDBAGS, PURSES, SHOULDER BAGS, OVERNIGHT BAGS, WALLETS, TOILETRY AND COSMETIC BAGS SOLD EMPTY, IN CLASS 18 (U.S. CLS. 1, 2, 3, 22 AND 41).

FOR: ARTICLES OF CLOTHING, NAMELY, SHIRTS; T-SHIRTS; SWEATSHIRTS; SWEATERS; TIES; BRACES; BELTS; CARDIGANS; JUMPERS; SCARVES; GLOVES; UNDERWEAR; BLOUSES; SKIRTS AND DRESSES; COATS; SUITS; JACKETS; TROUSERS; JEANS; ARTICLES OF HEADWEAR; HATS; CAPS, IN CLASS 25 (U.S. CLS. 22 AND 39).

THE MARK CONSISTS OF STANDARD CHARACTERS WITHOUT CLAIM TO ANY PARTICULAR FONT, STYLE, SIZE, OR COLOR.

OWNER OF ERPN CMNTY TM OFC REG. NO. 007588262, DATED 3-29-2010, EXPIRES 2-9-2019.

OWNER OF U.S. REG. NOS. 2,097,769, 2,672,649 AND OTHERS.

THE NAME(S), PORTRAIT(S), AND/OR SIGNATURE(S) SHOWN IN THE MARK DOES NOT IDENTIFY A PARTICULAR LIVING INDIVIDUAL.

SER. NO. 77-775,566, FILED 7-7-2009.

MARTHA FROMM, EXAMINING ATTORNEY



*David J. Kyffers*

Director of the United States Patent and Trademark Office

# United States of America

United States Patent and Trademark Office

# Enduro

**Reg. No. 4,133,527**

**Registered May 1, 2012**

**Int. Cl.: 2**

**TRADEMARK**

**PRINCIPAL REGISTER**

GREENE, TWEED OF DELAWARE, INC. (DELAWARE CORPORATION)  
1101 N. MARKET STREET, SUITE 780  
WILMINGTON, DE 19890

FOR: COATINGS IN THE NATURE OF POLYTETRAFLUOROETHYLENE COATINGS BE APPLIED IN MANUFACTURING AND AS A COMPONENT OF FINISHED MANUFACTURED PRODUCTS IN THE NATURE OF PLASTICS, ELASTOMERS, AND METAL OR CERAMIC SUBSTRATES, FOR REDUCING WEAR AND FRICTION, FOR USE IN THE SEMICONDUCTOR, OIL AND GAS, AEROSPACE AND CHEMICAL INDUSTRIES, IN CLASS 2 (U.S. CLS. 6, 11 AND 16).

FIRST USE 7-0-2008; IN COMMERCE 7-0-2008.

THE MARK CONSISTS OF STANDARD CHARACTERS WITHOUT CLAIM TO ANY PARTICULAR FONT, STYLE, SIZE, OR COLOR.

SER. NO. 77-781,845, FILED 7-15-2009.

DAWN HAN, EXAMINING ATTORNEY



*David J. Kyffers*

Director of the United States Patent and Trademark Office

**United States of America**  
United States Patent and Trademark Office



**Reg. No. 4,133,528**

**Registered May 1, 2012**

**Int. Cl.: 28**

**TRADEMARK**

**PRINCIPAL REGISTER**

USA SPORTS, INC. (TEXAS CORPORATION)  
2516 FAIRWAY PARK DRIVE  
HOUSTON, TX 77092

FOR: WEIGHT LIFTING EQUIPMENT AND ACCESSORIES, NAMELY, WEIGHT PLATES, BARBELLS, WEIGHT BARS, AND WEIGHT LIFTING BELTS, IN CLASS 28 (U.S. CLS. 22, 23, 38 AND 50).

FIRST USE 12-31-1996; IN COMMERCE 12-31-1996.

NO CLAIM IS MADE TO THE EXCLUSIVE RIGHT TO USE "SPORTS, INC.", APART FROM THE MARK AS SHOWN.

THE MARK CONSISTS OF THE WORD "USA" ABOVE THE STYLIZED WORDING "USA SPORTS, INC.". IN THE FIRST "USA", THE LETTER "A" IS COMPOSED OF A 5-POINT STAR AND A WAVY BAR.

SEC. 2(F).

SER. NO. 77-781,892, FILED 7-15-2009.

KIM SAITO, EXAMINING ATTORNEY



*David J. Kyffers*

Director of the United States Patent and Trademark Office

# United States of America

United States Patent and Trademark Office



**Reg. No. 4,133,529**

**Registered May 1, 2012**

**Int. Cl.: 33**

**TRADEMARK**

**PRINCIPAL REGISTER**

MAJOR, FRANCOIS (CANADA INDIVIDUAL)  
6-2055 PIE-IX BOULEVARD  
MONTREAL QUEBEC, CANADA H1V2C9

FOR: ALCOHOLIC BEVERAGES, NAMELY, ALCOHOLIC FRUIT JUICE AND FLAVORED ALCOHOLIC BEVERAGES MIXED WITH LIQUORS, NAMELY, VODKA, RUM, GIN, WHISKEY, BRANDY OR TEQUILA, IN CLASS 33 (U.S. CLS. 47 AND 49).

OWNER OF CANADA REG. NO. TMA768160, DATED 5-31-2010, EXPIRES 5-31-2025.

THE MARK CONSISTS OF A BUTTERFLY OVER THE WORD "URB'NLILI".

SER. NO. 77-792,416, FILED 7-29-2009.

ALICE BENMAMAN, EXAMINING ATTORNEY



*David J. Kybas*

Director of the United States Patent and Trademark Office

# United States of America

United States Patent and Trademark Office



**Reg. No. 4,133,530**

**Registered May 1, 2012**

**Int. Cl.: 9**

**TRADEMARK**

**PRINCIPAL REGISTER**

GAMATRONIC ELECTRONIC INDUSTRIES LTD. (ISRAEL CORPORATION)  
P.O. BOX 45029  
SCIENCE-BASED INDUSTRIES PARK  
JERUSALEM, ISRAEL 91450

FOR: UPS (UNINTERRUPTIBLE POWER SUPPLY); INVERTERS; BATTERY CHARGERS;  
DC POWER SUPPLIES; FREQUENCY CHARGERS, IN CLASS 9 (U.S. CLS. 21, 23, 26, 36  
AND 38).

OWNER OF ISRAEL REG. NO. 219620, DATED 6-15-2011, EXPIRES 5-3-2019.

THE MARK CONSISTS OF THE STYLIZED LETTER "G" WITH AN ARROWHEAD ON ONE  
END ON THE LEFT OF A DIAGONAL BAR THAT RESEMBLES A BACKSLASH SIGN, ALL  
APPEARING ATOP THE WORD "GAMATRONIC".

SER. NO. 77-819,759, FILED 9-3-2009.

GRETCHEN ULRICH, EXAMINING ATTORNEY



*David J. Kybas*

Director of the United States Patent and Trademark Office



# United States of America

United States Patent and Trademark Office



**Reg. No. 4,133,531**

ASTRAZENECA AB (SWEDEN AKTIEBOLAG (AB))  
VASTRA MALAREHAMNEN 9  
SODERTALJE, SWEDEN SE-15185

**Registered May 1, 2012**

**Int. Cls.: 42 and 44**

FOR: PHARMACEUTICAL RESEARCH AND DEVELOPMENT, IN CLASS 42 (U.S. CLS. 100 AND 101).

**SERVICE MARK**

FOR: PROVIDING MEDICAL INFORMATION, IN CLASS 44 (U.S. CLS. 100 AND 101).

**PRINCIPAL REGISTER**

PRIORITY CLAIMED UNDER SEC. 44(D) ON ERPN CMNTY TM OFC APPLICATION NO. 008359036, FILED 6-12-2009, REG. NO. 008359036, DATED 1-19-2010, EXPIRES 6-12-2019.

OWNER OF U.S. REG. NOS. 2,663,581, 3,024,901 AND OTHERS.

THE MARK CONSISTS OF THE WORDS "ASTRAZENECA HEALTH CONNECTS US ALL" AND HIGHLY STYLIZED AND INTERCONNECTED LETTERS "A" AND "Z".

SER. NO. 77-826,717, FILED 9-15-2009.

CHRISTINE MARTIN, EXAMINING ATTORNEY



*David J. Kybas*

Director of the United States Patent and Trademark Office

# United States of America

United States Patent and Trademark Office

## HEALTH CONNECTS US ALL

**Reg. No. 4,133,532**

ASTRAZENECA AB (SWEDEN AKTIEBOLAG (AB))  
VASTRA MALAREHAMNEN 9  
SODERTALJE, SWEDEN SE-15185

**Registered May 1, 2012**

**Int. Cls.: 42 and 44**

FOR: PHARMACEUTICAL RESEARCH AND DEVELOPMENT, IN CLASS 42 (U.S. CLS. 100 AND 101).

**SERVICE MARK**

FOR: PROVIDING MEDICAL INFORMATION, IN CLASS 44 (U.S. CLS. 100 AND 101).

**PRINCIPAL REGISTER**

THE MARK CONSISTS OF STANDARD CHARACTERS WITHOUT CLAIM TO ANY PARTICULAR FONT, STYLE, SIZE, OR COLOR.

PRIORITY CLAIMED UNDER SEC. 44(D) ON ERPN CMNTY TM OFC APPLICATION NO. 008359093, FILED 6-12-2009, REG. NO. 008359093, DATED 1-19-2010, EXPIRES 6-12-2019.

SER. NO. 77-826,721, FILED 9-15-2009.

CHRISTINE MARTIN, EXAMINING ATTORNEY



*David J. Kybas*

Director of the United States Patent and Trademark Office

# United States of America

United States Patent and Trademark Office

# GENIEMAT

**Reg. No. 4,133,533**

**Registered May 1, 2012**

**Int. Cl.: 17**

**TRADEMARK**

**PRINCIPAL REGISTER**

PLITEQ INC. (CANADA CORPORATION)  
UNIT 300  
1370 DON MILLS ROAD  
TORONTO, ONTARIO, CANADA M3B3N7

FOR: ACOUSTIC TILING SYSTEM COMPRISED OF ACOUSTICAL TILES, IN CLASS 17  
(U.S. CLS. 1, 5, 12, 13, 35 AND 50).

THE MARK CONSISTS OF STANDARD CHARACTERS WITHOUT CLAIM TO ANY PAR-  
TICULAR FONT, STYLE, SIZE, OR COLOR.

PRIORITY CLAIMED UNDER SEC. 44(D) ON CANADA APPLICATION NO. 1,449,340, FILED  
8-18-2009, REG. NO. TMA812071, DATED 11-18-2011, EXPIRES 11-18-2026.

SER. NO. 77-843,832, FILED 10-7-2009.

MAYUR VAGHANI, EXAMINING ATTORNEY



*David J. Kybas*

Director of the United States Patent and Trademark Office

# United States of America

United States Patent and Trademark Office



**Reg. No. 4,133,534**

**Registered May 1, 2012**

**Int. Cl.: 36**

**SERVICE MARK**

**PRINCIPAL REGISTER**

AMERI-TECH COMMUNITY MANAGEMENT, INC. (FLORIDA CORPORATION)  
24701 U.S HIGHWAY 19 NORTH, SUITE 102  
CLEARWATER, FL 33763

FOR: REAL ESTATE SERVICE, NAMELY, RENTAL PROPERTY MANAGEMENT; REAL ESTATE SERVICES, NAMELY, PROPERTY MANAGEMENT SERVICES FOR CONDOMINIUM ASSOCIATIONS, HOMEOWNER ASSOCIATIONS AND APARTMENT BUILDINGS; REAL ESTATE SERVICES, NAMELY, RENTAL, BROKERAGE, LEASING AND MANAGEMENT OF COMMERCIAL PROPERTY, OFFICES AND OFFICE SPACE, IN CLASS 36 (U.S. CLS. 100, 101 AND 102).

FIRST USE 10-15-2009; IN COMMERCE 10-15-2009.

NO CLAIM IS MADE TO THE EXCLUSIVE RIGHT TO USE "COMMUNITY MANAGEMENT, INC.", APART FROM THE MARK AS SHOWN.

THE COLOR(S) RED, WHITE, BLUE AND BLACK IS/ARE CLAIMED AS A FEATURE OF THE MARK.

THE MARK CONSISTS OF THE WORDING "AMERI-TECH COMMUNITY MANAGEMENT, INC." IN BLACK, BENEATH A BLUE TRIANGLE WITH 10 WHITE STARS INSIDE, ALL ABOVE 13 VERTICAL RED AND WHITE ALTERNATING STRIPES, ACROSS WHICH IS A WHITE RIBBON OUTLINED IN BLACK, WITH BLUE NEAR EACH END AND THE WORDS "LIVING YOUR DREAM" IN BLACK WRITTEN ACROSS THE RIBBON.

SER. NO. 77-850,429, FILED 10-16-2009.

KAREN K. BUSH, EXAMINING ATTORNEY



*David J. Kybas*

Director of the United States Patent and Trademark Office

# United States of America

United States Patent and Trademark Office



**Reg. No. 4,133,535**

**Registered May 1, 2012**

**Int. Cl.: 9**

**TRADEMARK**

**PRINCIPAL REGISTER**

LG ELECTRONICS INC. (REPUBLIC OF KOREA CORPORATION)  
20 YEOUIDO-DONG YEONGDEUNGPO-GU  
SEOUL 150-721, REPUBLIC OF KOREA

FOR: COMPUTER MONITORS; NOTEBOOK COMPUTERS; TELEVISION RECEIVERS, IN CLASS 9 (U.S. CLS. 21, 23, 26, 36 AND 38).

PRIORITY CLAIMED UNDER SEC. 44(D) ON REPUBLIC OF KOREA APPLICATION NO. 40-2009-0040, FILED 8-21-2009.

OWNER OF EUROPEAN UNION REG. NO. 008637159, DATED 5-17-2010, EXPIRES 10-23-2019.

NO CLAIM IS MADE TO THE EXCLUSIVE RIGHT TO USE "SMART VOLUME CONTROLLER", APART FROM THE MARK AS SHOWN.

THE MARK CONSISTS OF THE WORDING "SMART VOLUME" APPEARING ABOVE THE WORD "CONTROLLER". THREE ROUNDED VERTICAL BARS, REPRESENTING SOUND BARS, APPEAR ON EACH SIDE OF THE WORDS, INCREASING IN HEIGHT ON THE LEFT SIDE AND DECREASING ON HEIGHT ON THE RIGHT SIDE.

SER. NO. 77-856,324, FILED 10-23-2009.

KATHERINE CHANG, EXAMINING ATTORNEY



*David J. Kyros*

Director of the United States Patent and Trademark Office

# United States of America

United States Patent and Trademark Office

## GENERAL SOCIETY OF MAYFLOWER DESCENDANTS

**Reg. No. 4,133,536**

**Registered May 1, 2012**

**Int. Cls.: 35, 41 and 42**

**SERVICE MARK**

**PRINCIPAL REGISTER**

THE GENERAL SOCIETY OF MAYFLOWER DESCENDANTS (MASSACHUSETTS  
NON-PROFIT CORPORATION)  
P.O. BOX 3297  
PLYMOUTH, MA 023613297

FOR: ASSOCIATION SERVICES, NAMELY, PROMOTING THE INTERESTS OF MAYFLOWER DESCENDANTS BY PROMOTING PUBLIC AWARENESS AND EDUCATION ABOUT THE PILGRIMS WHO CAME IN 1620 TO WHAT IS NOW PLYMOUTH, MASSACHUSETTS ON THE VESSEL MAYFLOWER; ABOUT THEIR GENEALOGY AND THE EARLY HISTORY AND DEVELOPMENT OF THE PLYMOUTH COLONY IN WHAT LATER WAS TO BECOME THE UNITED STATES OF AMERICA, IN CLASS 35 (U.S. CLS. 100, 101 AND 102).

FIRST USE 12-31-1897; IN COMMERCE 12-31-1897.

FOR: PUBLICATION BY USE OF VARIOUS TECHNOLOGIES OF BOOKS, PAMPHLETS, MAGAZINES, NEWSLETTERS, AND PERIODICALS IN THE FIELD OF THE PILGRIMS WHO CAME IN 1620 TO WHAT IS NOW PLYMOUTH, MASSACHUSETTS ON THE VESSEL MAYFLOWER, IN CLASS 41 (U.S. CLS. 100, 101 AND 107).

FIRST USE 10-31-1901; IN COMMERCE 10-31-1901.

FOR: COMPUTER SERVICES, NAMELY, ELECTRONIC IMAGING OF HISTORICAL AND GENEALOGICAL DOCUMENTS AND IMAGES IN THE FIELD OF THE PILGRIMS WHO CAME IN 1620 TO WHAT IS NOW PLYMOUTH, MASSACHUSETTS ON THE VESSEL MAYFLOWER, IN CLASS 42 (U.S. CLS. 100 AND 101).

FIRST USE 12-31-1901; IN COMMERCE 12-31-1901.

THE MARK CONSISTS OF STANDARD CHARACTERS WITHOUT CLAIM TO ANY PARTICULAR FONT, STYLE, SIZE, OR COLOR.

NO CLAIM IS MADE TO THE EXCLUSIVE RIGHT TO USE "SOCIETY", APART FROM THE MARK AS SHOWN.

SEC. 2(F).



*David J. Kybas*

Director of the United States Patent and Trademark Office

**Reg. No. 4,133,536** SER. NO. 77-864,906, FILED 11-4-2009.

ALLISON HOLTZ, EXAMINING ATTORNEY

# United States of America

United States Patent and Trademark Office

## IT'S YOUR CALL

**Reg. No. 4,133,537**

**Registered May 1, 2012**

**Int. Cl.: 38**

**SERVICE MARK**

**PRINCIPAL REGISTER**

CONFERENCE AMERICA, INC. (ALABAMA CORPORATION)  
7079 UNIVERSITY COURT  
MONTGOMERY, AL 36117

FOR: TELECOMMUNICATION SERVICES, NAMELY, TELECONFERENCING, VIDEO TELECONFERENCING, DATA TELECONFERENCING, AND INTERNET TELECONFERENCING, IN CLASS 38 (U.S. CLS. 100, 101 AND 104).

FIRST USE 6-0-1992; IN COMMERCE 6-0-1992.

THE MARK CONSISTS OF STANDARD CHARACTERS WITHOUT CLAIM TO ANY PARTICULAR FONT, STYLE, SIZE, OR COLOR.

SER. NO. 77-867,247, FILED 11-6-2009.

MARC LEIPZIG, EXAMINING ATTORNEY



*David J. Kyros*

Director of the United States Patent and Trademark Office



# United States of America

United States Patent and Trademark Office



Atneed.com

**Reg. No. 4,133,538**

**Registered May 1, 2012**

**Int. Cl.: 35**

**SERVICE MARK**

**PRINCIPAL REGISTER**

ATNEED.COM, INC. (ILLINOIS CORPORATION)  
REAR SUITE  
5118 S. BLACKSTONE AVE.  
CHICAGO, IL 60615

FOR: WHOLESALE STORE, RETAIL STORE, ON-LINE WHOLESALE STORE, ON-LINE RETAIL STORE, ELECTRONIC CATALOG, AND MAIL ORDER CATALOG SERVICES FEATURING GOODS FOR THE FUNERAL INDUSTRY, NAMELY, FUNERAL GOODS, CREMATION GOODS, BEREAVEMENT GOODS, MEMORIAL CEREMONY GOODS, MORTICIAN SUPPLIES, AND FUNERAL HOME OFFICE SUPPLIES, IN CLASS 35 (U.S. CLS. 100, 101 AND 102).

FIRST USE 8-25-2008; IN COMMERCE 8-25-2008.

OWNER OF U.S. REG. NO. 3,578,008.

THE COLOR(S) BLACK, LIGHT GREEN, AND DARK GREEN IS/ARE CLAIMED AS A FEATURE OF THE MARK.

NO CLAIM IS MADE TO THE EXCLUSIVE RIGHT TO USE "ATNEED.COM", APART FROM THE MARK AS SHOWN.

THE MARK CONSISTS OF THE WORDING "ATNEED.COM" IN BLACK AND IN A STYLIZED FONT, WITH LIGHT GREEN AND DARK GREEN ARCHES COMBINED TO FORM AN ARCH DESIGN OVER THE WORDING.

SER. NO. 77-886,184, FILED 12-4-2009.

JASON LOTT, EXAMINING ATTORNEY



*David J. Kybas*

Director of the United States Patent and Trademark Office

# United States of America

United States Patent and Trademark Office

## ONE WORLD UNIVERSITY

**Reg. No. 4,133,539**

**Registered May 1, 2012**

**Int. Cl.: 9**

**TRADEMARK**

**PRINCIPAL REGISTER**

GOLDEN SHELTERS PRIVATE LIMITED (INDIA COMPANY)  
33, SHAFEE MOHAMMED ROAD  
4TH FLOOR, RUTLAND TOWERS  
CHENNAI, TAMIL NADU, INDIA 600006

FOR: COMPUTER SOFTWARE FOR COLLECTING, EDITING, ORGANIZING AND SHARING OF DATA AND INFORMATION ON SELF-IMPROVEMENT AND EMPOWERMENT, RELIGION, AND SPIRITUALITY; DOWNLOADABLE ELECTRONIC PUBLICATIONS IN THE NATURE OF MAGAZINES, NEWSLETTERS, BROCHURES AND CATALOGS IN THE FIELD OF SELF-IMPROVEMENT AND PERSONAL EMPOWERMENT, RELIGION, AND SPIRITUALITY; VIDEO TAPES AND VIDEO CASSETTES FEATURING SUBJECT MATTER RELATING TO SELF IMPROVEMENT AND PERSONAL EMPOWERMENT, RELIGION, AND SPIRITUALITY, IN CLASS 9 (U.S. CLS. 21, 23, 26, 36 AND 38).

THE MARK CONSISTS OF STANDARD CHARACTERS WITHOUT CLAIM TO ANY PARTICULAR FONT, STYLE, SIZE, OR COLOR.

PRIORITY CLAIMED UNDER SEC. 44(D) ON ERPN CMNTY TM OFC APPLICATION NO. 008763237, FILED 12-16-2009, REG. NO. 008763237, DATED 6-11-2010, EXPIRES 12-16-2019.

NO CLAIM IS MADE TO THE EXCLUSIVE RIGHT TO USE "UNIVERSITY", APART FROM THE MARK AS SHOWN.

SER. NO. 77-895,832, FILED 12-17-2009.

MAYUR VAGHANI, EXAMINING ATTORNEY



*David J. Kyros*

Director of the United States Patent and Trademark Office

# United States of America

United States Patent and Trademark Office



**Reg. No. 4,133,540**

**Registered May 1, 2012**

**Int. Cl.: 35**

**SERVICE MARK**

**PRINCIPAL REGISTER**

STRONG, LLC (ALABAMA LIMITED LIABILITY COMPANY)  
201 OFFICE PARK DRIVE, SUITE 220  
2700 ROGERS DRIVE  
BIRMINGHAM, AL 35223

FOR: ADVERTISING AND MARKETING; MARKET REPORTS AND STUDIES; MARKET RESEARCH SERVICES, IN CLASS 35 (U.S. CLS. 100, 101 AND 102).

FIRST USE 6-3-2008; IN COMMERCE 6-24-2008.

NO CLAIM IS MADE TO THE EXCLUSIVE RIGHT TO USE "RESOURCES DATA", APART FROM THE MARK AS SHOWN.

THE COLOR(S) BLACK, BLUE, WHITE AND SILVER IS/ARE CLAIMED AS A FEATURE OF THE MARK.

THE MARK CONSISTS OF THE WORDS "CAPTURE INTENDER RESOURCE DATA" IN BLACK AND A SQUARE WITH ONE SIDE FORMING AN ARROW IN BLUE WITH A WHITE AND SILVER OUTLINE AND A WHITE EYE/TARGET SHAPE.

SER. NO. 77-898,140, FILED 12-21-2009.

KELLY BOULTON, EXAMINING ATTORNEY



*David J. Kyffers*

Director of the United States Patent and Trademark Office

# United States of America

United States Patent and Trademark Office



**Reg. No. 4,133,541**

**Registered May 1, 2012**

**Int. Cls.: 9, 35, 38, 40, 41  
and 42**

**TRADEMARK**

**SERVICE MARK**

**PRINCIPAL REGISTER**

TECHNICOLOR TRADEMARK MANAGEMENT (FRANCE SOCIÉTÉ PAR ACTIONS  
SIMPLIFIÉE (SAS))  
46, QUAI ALPHONSE LE GALLO  
BOULOGNE-BILLANCOURT, FRANCE 92100

FOR: APPARATUS FOR RECEIVING, RECORDING, TRANSMISSION, REPRODUCTION, STORAGE, ENCODING OR DECODING OF SOUND OR IMAGES, NAMELY, TRANSMITTERS AND RECEIVERS OF DIGITAL DATA, DECODERS FOR RECEIVING MULTIMEDIA CONTENT, IN PARTICULAR VIDEOS, PHOTOS OR SOUNDS, ELECTRONIC DECODERS, MEDIA PLAYERS; TVS, CD, DVD AND OPTICAL DISC PLAYERS AND RECORDERS; MP3 AND MP4 PLAYERS; MULTIMEDIA SERVERS; COMPUTER SERVERS, COMPUTERS; COMPUTER TERMINALS, DATA TRANSMISSION AND TELEPHONE TERMINALS, IN PARTICULAR FOR GLOBAL COMMUNICATIONS NETWORKS SUCH AS THE INTERNET; TELEPHONE APPARATUS; MODEMS AND TELECOMMUNICATION ROUTERS; HOME NETWORKING DEVICES; MULTIMEDIA TERMINALS; ACCESS AND ACCESS CONTROL DEVICES FOR DATA PROCESSING EQUIPMENT, AUTHENTICATION DEVICES FOR TELECOMMUNICATIONS NETWORKS, NAMELY, AUTHENTICATION COMPUTER SERVERS, ELECTRONIC TOKEN AND ELECTRONIC ENCODED CHIP CARDS; SOFTWARE AND HARDWARE PLATFORMS FOR THE DIGITAL DISTRIBUTION OF AUDIO VIDEO CONTENTS AND GAMES; APPARATUS FOR GAMES, NAMELY, HANDHELD ELECTRONIC GAMES ADAPTED FOR USE WITH TELEVISION RECEIVERS; PROJECTION SCREENS AND PROJECTORS; TV AND MOVIE STUDIO APPARATUS, NAMELY, CAMERAS, TV MONITORS, MIXING CONSOLES, DIGITAL VIDEO EFFECTS APPARATUS; SOFTWARE FOR THE CREATION, MANAGEMENT, EDITING AND USE OF DATA BASES; SOFTWARE FOR PROVIDING ACCESS TO COMPUTER OR DATA TRANSMISSION NETWORKS, IN PARTICULAR TO A GLOBAL COMMUNICATIONS NETWORK SUCH AS THE INTERNET; COMPUTER PROGRAMS AND SOFTWARE, NAMELY, SOFTWARE AND HARDWARE PLATFORMS FOR CONTENT DISTRIBUTION OF VIDEO, DATA AND VOICE, IN THE FIELD OF MEDIA, ENTERTAINMENT AND COMMUNICATION; SOFTWARE AND HARDWARE PLATFORMS FOR DIGITAL DISTRIBUTION OF AUDIO VIDEO CONTENT AND VIDEO GAMES; SOFTWARE FOR THE CREATION AND DEVELOPMENT OF VIDEO GAMES MOTION PICTURE FILMS, DVDS, SOUND AND VIDEO RECORDINGS FEATURING A WIDE VARIETY OF SUBJECTS; PRERECORDED AUDIO AND VIDEO OPTICAL DISCS FEATURING MUSIC AND MOTION PICTURES ON A WIDE VARIETY OF SUBJECTS; COMPUTER PROGRAMS FOR VIDEO GAMES; COMPUTER MEMORY CARDS AND MEMORY CHIPS; 3D MOVIE THEATRE GLASSES, IN CLASS 9 (U.S. CLS. 21, 23, 26, 36 AND 38).



*David J. Kappas*

Director of the United States Patent and Trademark Office

**Reg. No. 4,133,541** FOR: BUSINESS MANAGEMENT AND ADMINISTRATION, ADVERTISING; REPRODUCTION OF DOCUMENTS; BUSINESS SERVICES, NAMELY MANAGEMENT OF BROADCAST OPERATIONS RELATING TO TELEVISION STUDIOS, NEWSROOMS AND PRODUCTION CONTROL ROOMS, IN CLASS 35 (U.S. CLS. 100, 101 AND 102).

FOR: TELECOMMUNICATIONS, NAMELY, TRANSMISSION OF VIDEO, DATA OR VOICE IN THE FIELD OF MEDIA, ENTERTAINMENT AND COMMUNICATION; BROADCASTING AND TRANSMISSION OF AUDIOVISUAL SIGNALS AND/OR DATA BY SATELLITE, CABLE, AERIAL OR FIBER OPTIC NETWORKS; DISSEMINATION OF INFORMATION AND DATA BY ELECTRONIC MEANS, IN PARTICULAR FOR GLOBAL COMMUNICATIONS NETWORKS SUCH AS THE INTERNET OR PRIVATE OR RESTRICTED ACCESS NETWORKS; DIGITAL TRANSMISSION OF FILMS, LIVE EVENTS, AND OTHER ENTERTAINMENT MEDIA; RADIO AND TELEVISION BROADCASTING, BROADCASTING OF MUSIC, TRANSMISSION OF INFORMATION IN THE AUDIOVISUAL FIELD, IN PARTICULAR VIDEOS ON DEMAND (VOD); PODCASTING SERVICES, NAMELY, BROADCASTING OF AUDIOVISUAL SIGNALS AND DATA FOR PERSONAL PLAYERS, AND COMMUNICATIONS BETWEEN COMPUTER TERMINALS; CABLE TELEVISION; PROVIDING VOICE OVER INTERNET PROTOCOL (VOIP) COMMUNICATION SERVICES; VIDEO CONFERENCING; RENTAL OF TELECOMMUNICATION EQUIPMENT FOR THE TRANSMISSION OF SOUND, IMAGES OR DATA, NAMELY, TELEPHONE TERMINALS, TELECOMMUNICATION ROUTERS; RENTAL, LEASING AND PROVIDING OF MODEMS FOR OTHERS; TELECOMMUNICATION GATEWAY SERVICES; TECHNICAL CONSULTANCY SERVICES IN THE FIELD OF TELECOMMUNICATION TRANSMISSION OF DATA, IN CLASS 38 (U.S. CLS. 100, 101 AND 104).

FOR: PROCESSING STILL PICTURE FILM AFTER EXPOSURE; DYEING STILL PICTURE FILM, PHOTOGRAPHIC FILM, CINEMATOGRAPHIC FILM; COLOR CORRECTION SERVICES; DEVELOPING, PRINTING, ENLARGING, ETCHING, PHOTOFINISHING AND REPRODUCTION OF PHOTOGRAPHIC FILMS, CINEMATOGRAPHIC FILMS, AUDIO TAPES, VIDEO TAPES, VIDEO DISCS OR OTHER RECORDING MEDIA; DVD DUPLICATION, IN CLASS 40 (U.S. CLS. 100, 103 AND 106).

FOR: ENTERTAINMENT SERVICES, NAMELY, FILM PRODUCTION; ELECTRONIC AND DIGITAL PRODUCTION AND DISTRIBUTION OF FILMS, BROADCAST PROGRAMS, COMMERCIAL PROGRAMS FOR OTHERS; PRODUCTION OF COMPUTER GAME SOFTWARE; PROVIDING ON LINE COMPUTER GAMES; DIGITAL IMAGING SERVICES; 3D FILM PRODUCTION; POSTPRODUCTION SERVICES FOR FILM, VIDEO AND MUSIC; RECORDING STUDIO SERVICES; MOTION PICTURE PLAY DATE SCHEDULING, NAMELY, THE SCHEDULING OF FILM PLAY DATES FOR OTHERS; PROVIDING VISUAL EFFECTS FOR CINEMATOGRAPHIC FILMS, ADVERTISING AND TELEVISION PROGRAMS; ANIMATION SERVICES FOR THE TV, VIDEO AND THEATRICAL MARKETS, NAMELY, ANIMATION PRODUCTION SERVICES; VIDEO TAPES AND DVD FILM RENTAL, FILM RENTAL, RENTAL OF APPARATUS FOR RECEIVING AND PROCESSING SOUND, IMAGES OR DATA; RENTAL OF MOVIE AND TV EQUIPMENT AND ACCESSORIES, NAMELY, PROJECTION SCREENS AND PROJECTORS, TV AND MOVIE STUDIO APPARATUS, NAMELY, CAMERAS, TV MONITORS, MIXING CONSOLES, DIGITAL VIDEO EFFECTS APPARATUS; ORGANIZATION OF CONFERENCES AND EXHIBITION FOR CULTURE AND ENTERTAINMENT PURPOSES; PROVIDING OF TRAINING IN THE FIELD OF FILM PRODUCTION, VIDEO GAME PRODUCTION; PROVIDING OF INFORMATION RELATING TO ORGANIZING SPORTING AND CULTURAL ACTIVITIES, FILM EDITING; PHOTOMONTAGE, NAMELY, EDITING AND ASSEMBLY OF PHOTOS, DIGITAL FILES AND VIDEOS INTO COMPILATIONS; EDITING OF PHOTOGRAPHIC FILMS, CINEMATOGRAPHIC FILMS, AUDIO TAPES, VIDEO TAPES, VIDEO DISCS OR OTHER RECORDING MEDIA, IN CLASS 41 (U.S. CLS. 100, 101 AND 107).

FOR: SCIENTIFIC AND TECHNOLOGICAL SERVICES, NAMELY, SCIENTIFIC RESEARCH, ANALYSIS AND TESTING IN THE FIELD OF TELECOMMUNICATION, FILM INDUSTRY, IMAGING, VIDEO AND VIDEO GAME INDUSTRY; ENGINEERING AND RESEARCH

**Reg. No. 4,133,541** SERVICES IN THE FIELD OF TELECOMMUNICATION, FILM INDUSTRY, IMAGING, VIDEO AND VIDEO GAME INDUSTRY; DESIGN AND DEVELOPMENT OF COMPUTER SOFTWARE; DESIGN AND DEVELOPMENT OF COMPUTER AND TELECOMMUNICATION SYSTEMS; GRAPHIC ART DESIGNING; PRODUCT DESIGN SERVICES; CHEMICAL LABORATORIES; MAGNETIC ENCODING; CONVERSION SERVICES, NAMELY, CONVERSION OF DATA AND DOCUMENTS FROM ONE RECORDING MEDIUM TO ANOTHER; DOCUMENT DATA TRANSFER FROM ONE COMPUTER FORMAT TO ANOTHER, IN CLASS 42 (U.S. CLS. 100 AND 101).

PRIORITY CLAIMED UNDER SEC. 44(D) ON FRANCE APPLICATION NO. 093670861, FILED 8-14-2009, REG. NO. 093670861, DATED 1-22-2010, EXPIRES 8-14-2019.

THE COLOR(S) BLUE, PURPLE, RED, ORANGE, YELLOW, GREEN AND GRAY IS/ARE CLAIMED AS A FEATURE OF THE MARK.

OWNER OF U.S. REG. NOS. 267,288, 2,413,837 AND OTHERS.

THE MARK CONSISTS OF "TECHNICOLOR" IN GREY APPEARING ABOVE BLUE, PURPLE, RED, ORANGE, YELLOW AND GREEN ADJOINING BLOCKS FORMING A BAR.

SER. NO. 77-899,163, FILED 12-22-2009.

ARETHA SOMERVILLE, EXAMINING ATTORNEY

# United States of America

United States Patent and Trademark Office

# technicolor

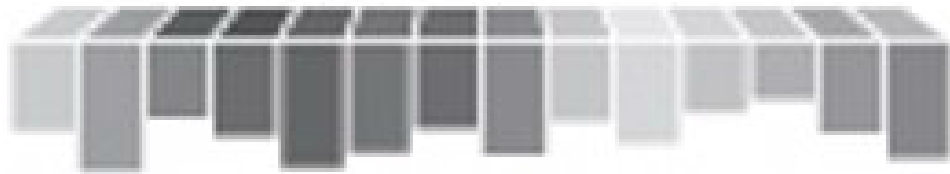

**Reg. No. 4,133,542**

**Registered May 1, 2012**

**Int. Cls.: 9, 35, 38, 40, 41  
and 42**

**TRADEMARK**

**SERVICE MARK**

**PRINCIPAL REGISTER**

TECHNICOLOR TRADEMARK MANAGEMENT (FRANCE SOCIÉTÉ PAR ACTIONS  
SIMPLIFIÉE (SAS))  
46, QUAI ALPHONSE LE GALLO  
BOULOGNE-BILLANCOURT, FRANCE 92100

FOR: APPARATUS FOR RECEIVING, RECORDING, TRANSMISSION, REPRODUCTION, STORAGE, ENCODING OR DECODING OF SOUND OR IMAGES, NAMELY, TRANSMITTERS AND RECEIVERS OF DIGITAL DATA, DECODERS FOR RECEIVING MULTIMEDIA CONTENT, IN PARTICULAR VIDEOS, PHOTOS OR SOUNDS, ELECTRONIC DECODERS, MEDIA PLAYERS; TVS, CD, DVD AND OPTICAL DISC PLAYERS AND RECORDERS; MP3 AND MP4 PLAYERS; MULTIMEDIA SERVERS; COMPUTER SERVERS, COMPUTERS; COMPUTER TERMINALS, DATA TRANSMISSION AND TELEPHONE TERMINALS, IN PARTICULAR FOR GLOBAL COMMUNICATIONS NETWORKS SUCH AS THE INTERNET; TELEPHONE APPARATUS; MODEMS AND TELECOMMUNICATION ROUTERS; HOME NETWORKING DEVICES; MULTIMEDIA TERMINALS; ACCESS AND ACCESS CONTROL DEVICES FOR DATA PROCESSING EQUIPMENT, AUTHENTICATION DEVICES FOR TELECOMMUNICATIONS NETWORKS, NAMELY, AUTHENTICATION COMPUTER SERVERS, ELECTRONIC TOKEN AND ELECTRONIC ENCODED CHIP CARDS; SOFTWARE AND HARDWARE PLATFORMS FOR THE DIGITAL DISTRIBUTION OF AUDIO VIDEO CONTENTS AND GAMES; APPARATUS FOR GAMES, NAMELY, HANDHELD ELECTRONIC GAMES ADAPTED FOR USE WITH TELEVISION RECEIVERS; PROJECTION SCREENS AND PROJECTORS; TV AND MOVIE STUDIO APPARATUS, NAMELY, CAMERAS, TV MONITORS, MIXING CONSOLES, DIGITAL VIDEO EFFECTS APPARATUS; SOFTWARE FOR THE CREATION, MANAGEMENT, EDITING AND USE OF DATA BASES; SOFTWARE FOR PROVIDING ACCESS TO COMPUTER OR DATA TRANSMISSION NETWORKS, IN PARTICULAR TO A GLOBAL COMMUNICATIONS NETWORK SUCH AS THE INTERNET; COMPUTER PROGRAMS AND SOFTWARE, NAMELY, SOFTWARE AND HARDWARE PLATFORMS FOR CONTENT DISTRIBUTION OF VIDEO, DATA AND VOICE, IN THE FIELD OF MEDIA, ENTERTAINMENT AND COMMUNICATION; SOFTWARE AND HARDWARE PLATFORMS FOR DIGITAL DISTRIBUTION OF AUDIO VIDEO CONTENT AND VIDEO GAMES; SOFTWARE FOR THE CREATION AND DEVELOPMENT OF VIDEO GAMES MOTION PICTURE FILMS, DVDS, SOUND AND VIDEO RECORDINGS FEATURING A WIDE VARIETY OF SUBJECTS; PRERECORDED AUDIO AND VIDEO OPTICAL DISCS FEATURING MUSIC AND MOTION PICTURES ON A WIDE VARIETY OF SUBJECTS; COMPUTER PROGRAMS FOR VIDEO GAMES; COMPUTER MEMORY CARDS AND MEMORY CHIPS; 3D MOVIE THEATRE GLASSES, IN CLASS 9 (U.S. CLS. 21, 23, 26, 36 AND 38).



*David J. Kappas*

Director of the United States Patent and Trademark Office

**Reg. No. 4,133,542** FOR: BUSINESS MANAGEMENT AND ADMINISTRATION, ADVERTISING; REPRODUCTION OF DOCUMENTS; BUSINESS SERVICES, NAMELY MANAGEMENT OF BROADCAST OPERATIONS RELATING TO TELEVISION STUDIOS, NEWSROOMS AND PRODUCTION CONTROL ROOMS, IN CLASS 35 (U.S. CLS. 100, 101 AND 102).

FOR: TELECOMMUNICATIONS, NAMELY, TRANSMISSION OF VIDEO, DATA OR VOICE IN THE FIELD OF MEDIA, ENTERTAINMENT AND COMMUNICATION; BROADCASTING AND TRANSMISSION OF AUDIOVISUAL SIGNALS AND/OR DATA BY SATELLITE, CABLE, AERIAL OR FIBER OPTIC NETWORKS; DISSEMINATION OF INFORMATION AND DATA BY ELECTRONIC MEANS, IN PARTICULAR FOR GLOBAL COMMUNICATIONS NETWORKS SUCH AS THE INTERNET OR PRIVATE OR RESTRICTED ACCESS NETWORKS; DIGITAL TRANSMISSION OF FILMS, LIVE EVENTS, AND OTHER ENTERTAINMENT MEDIA; RADIO AND TELEVISION BROADCASTING, BROADCASTING OF MUSIC, TRANSMISSION OF INFORMATION IN THE AUDIOVISUAL FIELD, IN PARTICULAR VIDEOS ON DEMAND (VOD); PODCASTING SERVICES, NAMELY, BROADCASTING OF AUDIOVISUAL SIGNALS AND DATA FOR PERSONAL PLAYERS, AND COMMUNICATIONS BETWEEN COMPUTER TERMINALS; CABLE TELEVISION; PROVIDING VOICE OVER INTERNET PROTOCOL (VOIP) COMMUNICATION SERVICES; VIDEO CONFERENCING; RENTAL OF TELECOMMUNICATION EQUIPMENT FOR THE TRANSMISSION OF SOUND, IMAGES OR DATA, NAMELY, TELEPHONE TERMINALS, TELECOMMUNICATION ROUTERS; RENTAL, LEASING AND PROVIDING OF MODEMS FOR OTHERS; TELECOMMUNICATION GATEWAY SERVICES; TECHNICAL CONSULTANCY SERVICES IN THE FIELD OF TELECOMMUNICATION TRANSMISSION OF DATA, IN CLASS 38 (U.S. CLS. 100, 101 AND 104).

FOR: PROCESSING STILL PICTURE FILM AFTER EXPOSURE; DYEING STILL PICTURE FILM, PHOTOGRAPHIC FILM, CINEMATOGRAPHIC FILM; COLOR CORRECTION SERVICES; DEVELOPING, PRINTING, ENLARGING, ETCHING, PHOTOFINISHING AND REPRODUCTION OF PHOTOGRAPHIC FILMS, CINEMATOGRAPHIC FILMS, AUDIO TAPES, VIDEO TAPES, VIDEO DISCS OR OTHER RECORDING MEDIA; DVD DUPLICATION, IN CLASS 40 (U.S. CLS. 100, 103 AND 106).

FOR: ENTERTAINMENT SERVICES, NAMELY, FILM PRODUCTION; ELECTRONIC AND DIGITAL PRODUCTION AND DISTRIBUTION OF FILMS, BROADCAST PROGRAMS, COMMERCIAL PROGRAMS FOR OTHERS; PRODUCTION OF COMPUTER GAME SOFTWARE; PROVIDING ON LINE COMPUTER GAMES; DIGITAL IMAGING SERVICES; 3D FILM PRODUCTION; POSTPRODUCTION SERVICES FOR FILM, VIDEO AND MUSIC; RECORDING STUDIO SERVICES; MOTION PICTURE PLAY DATE SCHEDULING, NAMELY, THE SCHEDULING OF FILM PLAY DATES FOR OTHERS; PROVIDING VISUAL EFFECTS FOR CINEMATOGRAPHIC FILMS, ADVERTISING AND TELEVISION PROGRAMS; ANIMATION SERVICES FOR THE TV, VIDEO AND THEATRICAL MARKETS, NAMELY, ANIMATION PRODUCTION SERVICES; VIDEO TAPES AND DVD FILM RENTAL, FILM RENTAL, RENTAL OF APPARATUS FOR RECEIVING AND PROCESSING SOUND, IMAGES OR DATA; RENTAL OF MOVIE AND TV EQUIPMENT AND ACCESSORIES, NAMELY, PROJECTION SCREENS AND PROJECTORS, TV AND MOVIE STUDIO APPARATUS, NAMELY, CAMERAS, TV MONITORS, MIXING CONSOLES, DIGITAL VIDEO EFFECTS APPARATUS; ORGANIZATION OF CONFERENCES AND EXHIBITION FOR CULTURE AND ENTERTAINMENT PURPOSES; PROVIDING OF TRAINING IN THE FIELD OF FILM PRODUCTION, VIDEO GAME PRODUCTION; PROVIDING OF INFORMATION RELATING TO ORGANIZING SPORTING AND CULTURAL ACTIVITIES, FILM EDITING; PHOTOMONTAGE, NAMELY, EDITING AND ASSEMBLY OF PHOTOS, DIGITAL FILES AND VIDEOS INTO COMPILATIONS; EDITING OF PHOTOGRAPHIC FILMS, CINEMATOGRAPHIC FILMS, AUDIO TAPES, VIDEO TAPES, VIDEO DISCS OR OTHER RECORDING MEDIA, IN CLASS 41 (U.S. CLS. 100, 101 AND 107).

FOR: SCIENTIFIC AND TECHNOLOGICAL SERVICES, NAMELY, SCIENTIFIC RESEARCH, ANALYSIS AND TESTING IN THE FIELD OF TELECOMMUNICATION, FILM INDUSTRY, IMAGING, VIDEO AND VIDEO GAME INDUSTRY; ENGINEERING AND RESEARCH



**Reg. No. 4,133,542** SERVICES IN THE FIELD OF TELECOMMUNICATION, FILM INDUSTRY, IMAGING, VIDEO AND VIDEO GAME INDUSTRY; DESIGN AND DEVELOPMENT OF COMPUTER SOFTWARE; DESIGN AND DEVELOPMENT OF COMPUTER AND TELECOMMUNICATION SYSTEMS; GRAPHIC ART DESIGNING; PRODUCT DESIGN SERVICES; CHEMICAL LABORATORIES; MAGNETIC ENCODING; CONVERSION SERVICES, NAMELY, CONVERSION OF DATA AND DOCUMENTS FROM ONE RECORDING MEDIUM TO ANOTHER; DOCUMENT DATA TRANSFER FROM ONE COMPUTER FORMAT TO ANOTHER, IN CLASS 42 (U.S. CLS. 100 AND 101).

PRIORITY CLAIMED UNDER SEC. 44(D) ON FRANCE APPLICATION NO. 093696968, FILED 12-7-2009, REG. NO. 093696968, DATED 5-14-2010, EXPIRES 12-7-2019.

OWNER OF U.S. REG. NOS. 267,288, 2,413,837 AND OTHERS.

THE MARK CONSISTS OF "TECHNICOLOR" APPEARING ABOVE ADJOINING BLOCKS FORMING A BAR.

SER. NO. 77-899,203, FILED 12-22-2009.

ARETHA SOMERVILLE, EXAMINING ATTORNEY

# United States of America

United States Patent and Trademark Office

## TECHNICOLOR

**Reg. No. 4,133,543**

**Registered May 1, 2012**

**Int. Cls.: 9, 35, 38, 40, 41  
and 42**

**TRADEMARK**

**SERVICE MARK**

**PRINCIPAL REGISTER**

TECHNICOLOR TRADEMARK MANAGEMENT (FRANCE SOCIÉTÉ PAR ACTIONS  
SIMPLIFIÉE (SAS))  
46, QUAI ALPHONSE LE GALLO  
BOULOGNE-BILLANCOURT, FRANCE 92100

FOR: APPARATUS FOR RECEIVING, RECORDING, TRANSMISSION, REPRODUCTION, STORAGE, ENCODING OR DECODING OF SOUND OR IMAGES, NAMELY, TRANSMITTERS AND RECEIVERS OF DIGITAL DATA, DECODERS FOR RECEIVING MULTIMEDIA CONTENT, IN PARTICULAR VIDEOS, PHOTOS OR SOUNDS, ELECTRONIC DECODERS, MEDIA PLAYERS; TVS, CD, DVD AND OPTICAL DISC PLAYERS AND RECORDERS; MP3 AND MP4 PLAYERS; MULTIMEDIA SERVERS; COMPUTER SERVERS, COMPUTERS; COMPUTER TERMINALS, DATA TRANSMISSION AND TELEPHONE TERMINALS, IN PARTICULAR FOR GLOBAL COMMUNICATIONS NETWORKS SUCH AS THE INTERNET; TELEPHONE APPARATUS; MODEMS AND TELECOMMUNICATION ROUTERS; HOME NETWORKING DEVICES; MULTIMEDIA TERMINALS; ACCESS AND ACCESS CONTROL DEVICES FOR DATA PROCESSING EQUIPMENT, AUTHENTICATION DEVICES FOR TELECOMMUNICATIONS NETWORKS, NAMELY, AUTHENTICATION COMPUTER SERVERS, ELECTRONIC TOKEN AND ELECTRONIC ENCODED CHIP CARDS; SOFTWARE AND HARDWARE PLATFORMS FOR THE DIGITAL DISTRIBUTION OF AUDIO VIDEO CONTENTS AND GAMES; APPARATUS FOR GAMES, NAMELY, HANDHELD ELECTRONIC GAMES ADAPTED FOR USE WITH TELEVISION RECEIVERS; PROJECTION SCREENS AND PROJECTORS; TV AND MOVIE STUDIO APPARATUS, NAMELY, CAMERAS, TV MONITORS, MIXING CONSOLES, DIGITAL VIDEO EFFECTS APPARATUS; SOFTWARE FOR THE CREATION, MANAGEMENT, EDITING AND USE OF DATA BASES; SOFTWARE FOR PROVIDING ACCESS TO COMPUTER OR DATA TRANSMISSION NETWORKS, IN PARTICULAR TO A GLOBAL COMMUNICATIONS NETWORK SUCH AS THE INTERNET; COMPUTER PROGRAMS AND SOFTWARE, NAMELY, SOFTWARE AND HARDWARE PLATFORMS FOR CONTENT DISTRIBUTION OF VIDEO, DATA AND VOICE, IN THE FIELD OF MEDIA, ENTERTAINMENT AND COMMUNICATION; SOFTWARE AND HARDWARE PLATFORMS FOR DIGITAL DISTRIBUTION OF AUDIO VIDEO CONTENT AND VIDEO GAMES; SOFTWARE FOR THE CREATION AND DEVELOPMENT OF VIDEO GAMES MOTION PICTURE FILMS, DVDS, SOUND AND VIDEO RECORDINGS FEATURING A WIDE VARIETY OF SUBJECTS; PRERECORDED AUDIO AND VIDEO OPTICAL DISCS FEATURING MUSIC AND MOTION PICTURES ON A WIDE VARIETY OF SUBJECTS; COMPUTER PROGRAMS FOR VIDEO GAMES; COMPUTER MEMORY CARDS AND MEMORY CHIPS; 3D MOVIE THEATRE GLASSES, IN CLASS 9 (U.S. CLS. 21, 23, 26, 36 AND 38).



*David J. Kybas*

Director of the United States Patent and Trademark Office

**Reg. No. 4,133,543** FOR: BUSINESS MANAGEMENT AND ADMINISTRATION, ADVERTISING; REPRODUCTION OF DOCUMENTS; BUSINESS SERVICES, NAMELY, MANAGEMENT OF BROADCAST OPERATIONS RELATING TO TELEVISION STUDIOS, NEWSROOMS AND PRODUCTION CONTROL ROOMS, IN CLASS 35 (U.S. CLS. 100, 101 AND 102).

FOR: TELECOMMUNICATIONS, NAMELY, TRANSMISSION OF VIDEO, DATA OR VOICE IN THE FIELD OF MEDIA, ENTERTAINMENT AND COMMUNICATION; BROADCASTING AND TRANSMISSION OF AUDIOVISUAL SIGNALS AND/OR DATA BY SATELLITE, CABLE, AERIAL OR FIBER OPTIC NETWORKS; DISSEMINATION OF INFORMATION AND DATA BY ELECTRONIC MEANS, IN PARTICULAR FOR GLOBAL COMMUNICATIONS NETWORKS SUCH AS THE INTERNET OR PRIVATE OR RESTRICTED ACCESS NETWORKS; DIGITAL TRANSMISSION OF FILMS, LIVE EVENTS, AND OTHER ENTERTAINMENT MEDIA; RADIO AND TELEVISION BROADCASTING, BROADCASTING OF MUSIC, TRANSMISSION OF INFORMATION IN THE AUDIOVISUAL FIELD, IN PARTICULAR VIDEOS ON DEMAND (VOD); PODCASTING SERVICES, NAMELY, BROADCASTING OF AUDIOVISUAL SIGNALS AND DATA FOR PERSONAL PLAYERS, AND COMMUNICATIONS BETWEEN COMPUTER TERMINALS; CABLE TELEVISION; PROVIDING VOICE OVER INTERNET PROTOCOL (VOIP) COMMUNICATION SERVICES; VIDEO CONFERENCING; RENTAL OF TELECOMMUNICATION EQUIPMENT FOR THE TRANSMISSION OF SOUND, IMAGES OR DATA, NAMELY, TELEPHONE TERMINALS, TELECOMMUNICATION ROUTERS; RENTAL, LEASING AND PROVIDING OF MODEMS FOR OTHERS; TELECOMMUNICATION GATEWAY SERVICES; TECHNICAL CONSULTANCY SERVICES IN THE FIELD OF TELECOMMUNICATION TRANSMISSION OF DATA, IN CLASS 38 (U.S. CLS. 100, 101 AND 104).

FOR: PROCESSING STILL PICTURE FILM AFTER EXPOSURE; DYEING STILL PICTURE FILM, PHOTOGRAPHIC FILM, CINEMATOGRAPHIC FILM; COLOR CORRECTION SERVICES; DEVELOPING, PRINTING, ENLARGING, ETCHING, PHOTO FINISHING AND REPRODUCTION OF PHOTOGRAPHIC FILMS, CINEMATOGRAPHIC FILMS, AUDIO TAPES, VIDEO TAPES, VIDEO DISCS OR OTHER RECORDING MEDIA; DVD DUPLICATION, IN CLASS 40 (U.S. CLS. 100, 103 AND 106).

FOR: ENTERTAINMENT SERVICES, NAMELY, FILM PRODUCTION; ELECTRONIC AND DIGITAL PRODUCTION AND DISTRIBUTION OF FILMS, BROADCAST PROGRAMS, COMMERCIAL PROGRAMS FOR OTHERS; PRODUCTION OF COMPUTER GAME SOFTWARE; PROVIDING ON LINE COMPUTER GAMES; DIGITAL IMAGING SERVICES; 3D FILM PRODUCTION; POST PRODUCTION SERVICES FOR FILM, VIDEO AND MUSIC; RECORDING STUDIO SERVICES; MOTION PICTURE PLAY DATE SCHEDULING, NAMELY, THE SCHEDULING OF FILM PLAY DATES FOR OTHERS; PROVIDING VISUAL EFFECTS FOR CINEMATOGRAPHIC FILMS, ADVERTISING AND TELEVISION PROGRAMS; ANIMATION SERVICES FOR THE TV, VIDEO AND THEATRICAL MARKETS, NAMELY, ANIMATION PRODUCTION SERVICES; VIDEO TAPES AND DVD FILM RENTAL, FILM RENTAL, RENTAL OF APPARATUS FOR RECEIVING AND PROCESSING SOUND, IMAGES OR DATA; RENTAL OF MOVIE AND TV EQUIPMENT AND ACCESSORIES, NAMELY, PROJECTION SCREENS AND PROJECTORS, TV AND MOVIE STUDIO APPARATUS, NAMELY, CAMERAS, TV MONITORS, MIXING CONSOLES, DIGITAL VIDEO EFFECTS APPARATUS; ORGANIZATION OF CONFERENCES AND EXHIBITION FOR CULTURE AND ENTERTAINMENT PURPOSES; PROVIDING OF TRAINING IN THE FIELD OF FILM PRODUCTION, VIDEO GAME PRODUCTION; PROVIDING OF INFORMATION RELATING TO ORGANIZING SPORTING AND CULTURAL ACTIVITIES, FILM EDITING; PHOTOMONTAGE, NAMELY, EDITING AND ASSEMBLY OF PHOTOS, DIGITAL FILES AND VIDEOS INTO COMPILATIONS; EDITING OF PHOTOGRAPHIC FILMS, CINEMATOGRAPHIC FILMS, AUDIO TAPES, VIDEO TAPES, VIDEO DISCS OR OTHER RECORDING MEDIA, IN CLASS 41 (U.S. CLS. 100, 101 AND 107).

FOR: SCIENTIFIC AND TECHNOLOGICAL SERVICES, NAMELY, SCIENTIFIC RESEARCH, ANALYSIS AND TESTING IN THE FIELD OF TELECOMMUNICATION, FILM INDUSTRY, IMAGING, VIDEO AND VIDEO GAME INDUSTRY; ENGINEERING AND RESEARCH

**Reg. No. 4,133,543** SERVICES IN THE FIELD OF TELECOMMUNICATION, FILM INDUSTRY, IMAGING, VIDEO AND VIDEO GAME INDUSTRY; DESIGN AND DEVELOPMENT OF COMPUTER SOFTWARE; DESIGN AND DEVELOPMENT OF COMPUTER AND TELECOMMUNICATION SYSTEMS; GRAPHIC ART DESIGNING; PRODUCT DESIGN SERVICES; CHEMICAL LABORATORIES; MAGNETIC ENCODING; CONVERSION SERVICES, NAMELY, CONVERSION OF DATA AND DOCUMENTS FROM ONE RECORDING MEDIUM TO ANOTHER; DOCUMENT DATA TRANSFER FROM ONE COMPUTER FORMAT TO ANOTHER, IN CLASS 42 (U.S. CLS. 100 AND 101).

THE MARK CONSISTS OF STANDARD CHARACTERS WITHOUT CLAIM TO ANY PARTICULAR FONT, STYLE, SIZE, OR COLOR.

PRIORITY CLAIMED UNDER SEC. 44(D) ON FRANCE APPLICATION NO. 093670862, FILED 8-14-2009, REG. NO. 093670862, DATED 1-22-2010, EXPIRES 8-14-2019.

OWNER OF U.S. REG. NOS. 267,288, 2,413,837 AND OTHERS.

SER. NO. 77-899,222, FILED 12-22-2009.

ARETHA SOMERVILLE, EXAMINING ATTORNEY

# United States of America

United States Patent and Trademark Office

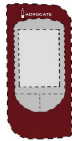

**Reg. No. 4,133,544**

**Registered May 1, 2012**

**Int. Cl.: 10**

**TRADEMARK**

**PRINCIPAL REGISTER**

DIABETIC SUPPLY OF SUNCOAST (PUERTO RICO CORPORATION)  
HC 3 BOX 7017  
DORADO, PUERTO RICO 00646

FOR: DEVICES FOR MONITORING BLOOD GLUCOSE FOR MEDICAL PURPOSES, IN CLASS 10 (U.S. CLS. 26, 39 AND 44).

FIRST USE 10-1-2006; IN COMMERCE 10-1-2006.

OWNER OF U.S. REG. NOS. 3,321,780, 3,321,781, AND 3,486,798.

THE COLOR(S) BURGUNDY, WHITE, BLACK, GRAY AND SILVER IS/ARE CLAIMED AS A FEATURE OF THE MARK.

THE MARK CONSISTS OF THE WORDING "ADVOCATE" WITH A DESIGN OF A CONE IN THE OPENING OF THE LETTER "V", ALL IN THE COLOR WHITE. THE REST OF THE ELEMENTS IN THE DRAWING, NAMELY, THE BLOOD GLUCOSE METER IN THE COLOR BURGUNDY UPON WHICH THE WORDING "ADVOCATE" AND THE DESIGN OF A CONE APPEAR IN THE OPENING OF THE LETTER "V", THE SCREEN IN THE COLOR GRAY, THE BORDER OF THE SCREEN AND THE SEMI-CIRCLE WHICH IS SPLIT IN HALF, BOTH OF WHICH ARE IN THE COLOR SILVER, AND THE ELEMENT WITH THE MIDDLE AND TOP IN BURGUNDY, BOTTOM IN WHITE, AND OUTLINE IN WHITE WHICH IS TO THE LEFT OF THE WORDING "ADVOCATE" AND WHICH INDICATES THE LOCATION OF WHERE THE TEST STRIPS ARE INSERTED, ARE ALL OUTLINED IN BLACK DOTTED LINES, ARE FOR PLACEMENT PURPOSES ONLY AND NOT CLAIMED AS FEATURES OF THE MARK.

SER. NO. 77-901,908, FILED 12-29-2009.

MICHAEL WIENER, EXAMINING ATTORNEY



*David J. Kyros*

Director of the United States Patent and Trademark Office

# United States of America

United States Patent and Trademark Office

## PINK LOTUS JEWELRY INSPIRED BY ANCIENT CULTURES

**Reg. No. 4,133,545**

PINK LOTUS LLC (PENNSYLVANIA LIMITED LIABILITY COMPANY)  
2-12 ASPEN WAY  
DOYLESTOWN, PA 18901

**Registered May 1, 2012**

**Int. Cl.: 14**

FOR: JEWELRY, NAMELY, BRACELETS, NECKLACES, EARRINGS, RINGS, PENDANTS,  
CHARMS, AND GEMSTONES, IN CLASS 14 (U.S. CLS. 2, 27, 28 AND 50).

**TRADEMARK**

FIRST USE 10-28-2004; IN COMMERCE 10-28-2004.

**PRINCIPAL REGISTER**

THE MARK CONSISTS OF STANDARD CHARACTERS WITHOUT CLAIM TO ANY PAR-  
TICULAR FONT, STYLE, SIZE, OR COLOR.

OWNER OF U.S. REG. NO. 3,783,246.

NO CLAIM IS MADE TO THE EXCLUSIVE RIGHT TO USE "JEWELRY", APART FROM  
THE MARK AS SHOWN.

SER. NO. 77-905,994, FILED 1-6-2010.

DOMINICK J. SALEMI, EXAMINING ATTORNEY



*David J. Kyffers*

Director of the United States Patent and Trademark Office

# United States of America

United States Patent and Trademark Office

## Go To Nations

**Reg. No. 4,133,546**

**Registered May 1, 2012**

**Int. Cl.: 45**

**SERVICE MARK**

**PRINCIPAL REGISTER**

CALVARY INTERNATIONAL, INC. (FLORIDA CORPORATION)  
3771 SPRING PARK ROAD  
JACKSONVILLE, FL 32207

FOR: CHRISTIAN MINISTRY SERVICES, IN CLASS 45 (U.S. CLS. 100 AND 101).

FIRST USE 12-13-2006; IN COMMERCE 12-13-2006.

THE MARK CONSISTS OF STANDARD CHARACTERS WITHOUT CLAIM TO ANY PARTICULAR FONT, STYLE, SIZE, OR COLOR.

SER. NO. 77-911,934, FILED 1-14-2010.

LAURA HAMMEL, EXAMINING ATTORNEY



*David J. Kyffers*

Director of the United States Patent and Trademark Office

# United States of America

United States Patent and Trademark Office

## HERA V-FIT LIFT

**Reg. No. 4,133,547**

**Registered May 1, 2012**

**Int. Cl.: 3**

**TRADEMARK**

**PRINCIPAL REGISTER**

AMOREPACIFIC CORPORATION (REPUBLIC OF KOREA CORPORATION)  
181 HANGANG-RO 2-GA, YONGSAN-GU,  
SEOUL, REPUBLIC OF KOREA 140-777

FOR: BEAUTY MASKS; COSMETIC CREAMS; COSMETIC PREPARATIONS; DENTIFRICES;  
FOUNDATIONS; LOTIONS FOR COSMETIC PURPOSES; MAKE-UP POWDER; SHAMPOOS;  
SKIN LOTIONS, IN CLASS 3 (U.S. CLS. 1, 4, 6, 50, 51 AND 52).

THE MARK CONSISTS OF STANDARD CHARACTERS WITHOUT CLAIM TO ANY PAR-  
TICULAR FONT, STYLE, SIZE, OR COLOR.

OWNER OF TAIWAN REG. NO. 01490306, DATED 12-16-2011, EXPIRES 12-15-2021.

SER. NO. 77-912,674, FILED 1-15-2010.

MATTHEW KLINE, EXAMINING ATTORNEY



*David J. Kappas*

Director of the United States Patent and Trademark Office



# United States of America

United States Patent and Trademark Office



**Reg. No. 4,133,548**

**Registered May 1, 2012**

**Int. Cl.: 41**

**SERVICE MARK**

**PRINCIPAL REGISTER**

EDY, RICHARD (SOUTH AFRICA INDIVIDUAL)  
STAMFORDHILL  
21/25 CHURCHILL ROAD  
DURBAN, KWAZULU-NATAL, SOUTH AFRICA

FOR: INFORMATION SERVICES, NAMELY, INFORMATION SERVICES PERTAINING TO FISHING, IN CLASS 41 (U.S. CLS. 100, 101 AND 107).

OWNER OF SOUTH AFRICA REG. NO. 2009/25190, DATED 12-8-2009, EXPIRES 12-8-2019.

THE MARK CONSISTS OF THE LETTERS "GG", PARTIALLY SUPERIMPOSED UPON ONE ANOTHER, FOLLOWED BY A STYLIZED SILHOUETTE OF A FISH, FOLLOWED BY THE WORD "GWARAGWARA".

SER. NO. 77-914,451, FILED 1-19-2010.

DOUGLAS LEE, EXAMINING ATTORNEY



*David J. Kyros*

Director of the United States Patent and Trademark Office

# United States of America

United States Patent and Trademark Office

# RSII

**Reg. No. 4,133,549**

**Registered May 1, 2012**

**Int. Cl.: 9**

**TRADEMARK**

**PRINCIPAL REGISTER**

QUICKSET INTERNATIONAL, INC. (ILLINOIS CORPORATION)  
3650 WOODHEAD DRIVE  
NORTHBROOK, IL 600621895

FOR: ELECTRONIC AUDIO/VIDEO EQUIPMENT, NAMELY, ROUTING SWITCHERS AND ASSOCIATED CONTROLLERS FOR USE IN THE SECURITY INDUSTRY, IN CLASS 9 (U.S. CLS. 21, 23, 26, 36 AND 38).

FIRST USE 6-15-2005; IN COMMERCE 6-15-2005.

THE MARK CONSISTS OF STANDARD CHARACTERS WITHOUT CLAIM TO ANY PARTICULAR FONT, STYLE, SIZE, OR COLOR.

SER. NO. 77-915,529, FILED 1-20-2010.

VIVIAN MICZNIK FIRST, EXAMINING ATTORNEY



*David J. Kybas*

Director of the United States Patent and Trademark Office

# United States of America

United States Patent and Trademark Office

# RSIII

**Reg. No. 4,133,550**

**Registered May 1, 2012**

**Int. Cl.: 9**

**TRADEMARK**

**PRINCIPAL REGISTER**

QUICKSET INTERNATIONAL, INC. (ILLINOIS CORPORATION)  
3650 WOODHEAD DRIVE  
NORTHBROOK, IL 600621895

FOR: ELECTRONIC AUDIO/VIDEO EQUIPMENT, NAMELY, ROUTING SWITCHERS AND ASSOCIATED CONTROLLERS FOR USE IN THE SECURITY INDUSTRY, IN CLASS 9 (U.S. CLS. 21, 23, 26, 36 AND 38).

FIRST USE 6-15-2008; IN COMMERCE 6-15-2008.

THE MARK CONSISTS OF STANDARD CHARACTERS WITHOUT CLAIM TO ANY PARTICULAR FONT, STYLE, SIZE, OR COLOR.

SER. NO. 77-915,540, FILED 1-20-2010.

VIVIAN MICZNIK FIRST, EXAMINING ATTORNEY



*David J. Kybas*

Director of the United States Patent and Trademark Office

# United States of America

United States Patent and Trademark Office

# MICROMAX

**Reg. No. 4,133,551**

**Registered May 1, 2012**

**Int. Cls.: 40, 42 and 44**

**SERVICE MARK**

**PRINCIPAL REGISTER**

COMMONWEALTH SCIENTIFIC AND INDUSTRIAL RESEARCH ORGANISATION  
(AUSTRALIA A BODY CORPORATE)  
LIMESTONE AVENUE  
CAMPBELL, AUSTRALIA 2162

FOR: TREATMENT OF FOOD MATERIALS, PRODUCTS AND INGREDIENTS, NAMELY, FOOD/INGREDIENT PROCESSING AND ENCAPSULATION FOR USE IN HUMAN FOOD, ANIMAL FEED AND PHARMACEUTICAL APPLICATIONS, IN CLASS 40 (U.S. CLS. 100, 103 AND 106).

FOR: SCIENTIFIC AND TECHNOLOGICAL SERVICES IN THE FIELD OF MATERIALS TESTING AND EVALUATION, NAMELY, RESEARCH SERVICES, CONSULTING SERVICES, AND INFORMATION SERVICES; SCIENTIFIC AND TECHNICAL CONSULTING AND RESEARCH SERVICES RELATING TO FOODS AND DIETARY SUPPLEMENTS; RESEARCH AND DESIGN RELATING THERETO, NAMELY, FOOD RESEARCH AND PRODUCT DESIGN; ANALYSIS AND RESEARCH SERVICES, NAMELY, RESEARCH ON FOOD AND FOOD SAFETY TESTING; DESIGN AND DEVELOPMENT FOR OTHERS OF THE PRACTICAL ASPECTS OF FOOD ENCAPSULATION AND DELIVERY SYSTEMS, NAMELY, SCIENTIFIC AND TECHNICAL CONSULTING AND RESEARCH SERVICES RELATING TO FOODS AND DIETARY SUPPLEMENTS, IN CLASS 42 (U.S. CLS. 100 AND 101).

FOR: MEDICAL AND VETERINARY SERVICES RELATING TO THE TREATMENT AND SUPPLEMENTATION OF PERSONS AND ANIMALS INCLUDING TREATMENT BY RELEASE PREPARATIONS FOR THERAPEUTIC, PHARMACEUTICAL AND NUTRITIONAL AGENTS THROUGH SPECIFIC DELIVERY TO DESIGNATED PARTS WITH THE BODY, IN CLASS 44 (U.S. CLS. 100 AND 101).

THE MARK CONSISTS OF STANDARD CHARACTERS WITHOUT CLAIM TO ANY PARTICULAR FONT, STYLE, SIZE, OR COLOR.

OWNER OF AUSTRALIA REG. NO. 1416807, DATED 11-7-2011, EXPIRES 4-6-2021.

OWNER OF AUSTRALIA REG. NO. 917771, DATED 6-26-2002, EXPIRES 6-22-2012.

SER. NO. 77-916,379, FILED 1-20-2010.

DOMINIC FATHY, EXAMINING ATTORNEY



*David J. Kyros*

Director of the United States Patent and Trademark Office

# United States of America

United States Patent and Trademark Office

## AMERICAN FOLK ART MUSEUM

**Reg. No. 4,133,552**

AMERICAN FOLK ART MUSEUM (NEW YORK CORPORATION)  
45 WEST 53RD STREET  
NEW YORK, NY 10019

**Registered May 1, 2012**

**Int. Cl.: 41**

FOR: MUSEUM SERVICES, ART EXHIBITION SERVICES; EDUCATIONAL SERVICES, NAMELY, CONDUCTING LECTURES IN THE FIELD OF ART, IN CLASS 41 (U.S. CLS. 100, 101 AND 107).

**SERVICE MARK**

FIRST USE 6-12-2001; IN COMMERCE 6-12-2001.

**PRINCIPAL REGISTER**

THE MARK CONSISTS OF STANDARD CHARACTERS WITHOUT CLAIM TO ANY PARTICULAR FONT, STYLE, SIZE, OR COLOR.

NO CLAIM IS MADE TO THE EXCLUSIVE RIGHT TO USE "MUSEUM", APART FROM THE MARK AS SHOWN.

SEC. 2(F).

SER. NO. 77-917,359, FILED 1-21-2010.

JENNIFER MARTIN, EXAMINING ATTORNEY



*David J. Kyros*

Director of the United States Patent and Trademark Office

# United States of America

United States Patent and Trademark Office

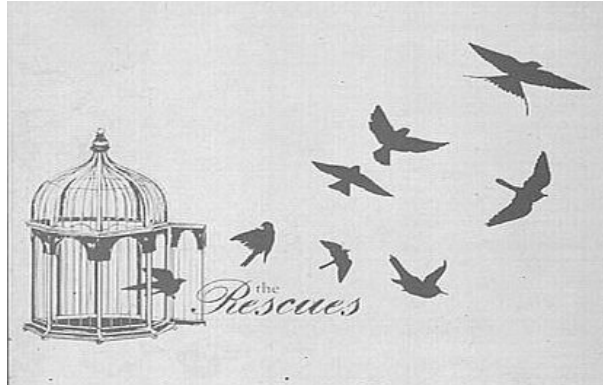

**Reg. No. 4,133,553**

**Registered May 1, 2012**

**Int. Cl.: 9**

**TRADEMARK**

**PRINCIPAL REGISTER**

THE RESCUES (CALIFORNIA PARTNERSHIP)  
1545 WILCOX AVENUE  
C/O PETER LEAK AND NETTWERK MANAGEMENT  
HOLLYWOOD, CA 90028

FOR: SERIES OF MUSICAL SOUND RECORDINGS, PRE-RECORDED CDS FEATURING MUSIC; AUDIO AND VIDEO RECORDINGS FEATURING MUSIC; DOWNLOADABLE SOFTWARE IN THE NATURE OF A MOBILE APPLICATION TO ACCESS ONLINE AND DOWNLOADABLE INFORMATION, RECORDINGS AND PERFORMANCES IN THE FIELD OF MUSIC, IN CLASS 9 (U.S. CLS. 21, 23, 26, 36 AND 38).

FIRST USE 3-19-2009, THE MARK WAS FIRST USED ANYWHERE IN A DIFFERENT FORM OTHER THAN THAT SOUGHT TO BE REGISTERED AT LEAST AS EARLY AS 10/07/2007.; IN COMMERCE 3-19-2009, THE MARK WAS FIRST USED IN COMMERCE IN A DIFFERENT FORM OTHER THAN THAT SOUGHT TO BE REGISTERED AT LEAST AS EARLY AS 01/24/2008. .

THE MARK CONSISTS OF A FANCIFUL DESIGN OF A BIRDCAGE WITH BIRDS FLYING OUT ABOVE THE WORDING "THE RESCUES".

SER. NO. 77-917,841, FILED 1-22-2010.

VIVIAN MICZNIK FIRST, EXAMINING ATTORNEY



*David J. Kybas*

Director of the United States Patent and Trademark Office

# United States of America

United States Patent and Trademark Office

# PINK LOTUS

**Reg. No. 4,133,554**

**Registered May 1, 2012**

**Int. Cl.: 14**

**TRADEMARK**

**PRINCIPAL REGISTER**

PINK LOTUS LLC (PENNSYLVANIA LIMITED LIABILITY COMPANY)  
2-12 ASPEN WAY  
DOYLESTOWN, PA 18901

FOR: JEWELRY, NAMELY, BRACELETS, NECKLACES, EARRINGS, RINGS, PENDANTS,  
CHARMS AND GEMSTONES, IN CLASS 14 (U.S. CLS. 2, 27, 28 AND 50).

FIRST USE 10-28-2004; IN COMMERCE 10-28-2004.

THE MARK CONSISTS OF STANDARD CHARACTERS WITHOUT CLAIM TO ANY PAR-  
TICULAR FONT, STYLE, SIZE, OR COLOR.

OWNER OF U.S. REG. NO. 3,783,246.

SER. NO. 77-918,340, FILED 1-22-2010.

DOMINICK J. SALEMI, EXAMINING ATTORNEY



*David J. Kybas*

Director of the United States Patent and Trademark Office

# United States of America

United States Patent and Trademark Office

## IP&MR.FAMOUS

**Reg. No. 4,133,555**

**Registered May 1, 2012**

**Int. Cls.: 18, 25 and 35**

**TRADEMARK**

**SERVICE MARK**

**PRINCIPAL REGISTER**

GIOVANNA GALLI ZUGARO (ITALY INDIVIDUAL)  
VIA DELL'ANNUNCIATA 23/4  
MILAN, ITALY 20121

FOR: TRUNKS, TRAVELING BAGS, UMBRELLAS, HANDBAGS, SUITCASES, CLUTCH BAGS, VANITY CASES SOLD EMPTY, PURSES, BILLFOLDS, ATTACHÉ CASES, WALLETS, BRIEFCASES, KEY-CASES, PASSPORT WALLETS OF LEATHER AND IMITATION OF LEATHER, BUSINESS AND CREDIT CARD WALLETS OF LEATHER AND IMITATION OF LEATHER, IN CLASS 18 (U.S. CLS. 1, 2, 3, 22 AND 41).

FOR: CLOTHING, NAMELY, COATS, MANTLES, RAINCOATS, DUSTERS; FUR COATS, JACKETS AND STOLEES; DRESSES, SUITS, SKIRTS, JACKETS, KNITWEAR, NAMELY, KNIT PANTS, KNIT SHIRTS, KNIT SWEATERS, TROUSERS, SHORTS SETS, BERMUDA SHORTS, JEANS, WAISTCOATS, SHIRTS, T-SHIRTS, TOPS, BLOUSES, JERSEYS, SWEATERS, BLAZERS, CARDIGANS, STOCKINGS, SOCKS, UNDERWEAR, CORSETS, BRASSIERES, UNDERPANTS, NIGHT-GOWNS, SHIFTS, PAJAMAS, BATHROBES, BATHING SUITS, BEACH-WRAPPS, SUN SUITS, SPORT JACKETS; WATERPROOF CLOTHING, NAMELY, WATERPROOF JACKETS, PANTS, HATS AND PONCHOS; WIND-RESISTANT JACKETS, ANORAKS, SWEAT SUITS, TIES, NECKTIES, SCARVES, SHAWLS, MUFFLERS, FOULARDS, CAPS, HATS, HOODS, GLOVES, SASHES, BELTS, IN CLASS 25 (U.S. CLS. 22 AND 39).

FOR: RETAIL DEPARTMENT STORE SERVICES, EXCLUDING RETAIL DEPARTMENT STORE SERVICES OF FOOTWEAR; RETAIL STORE SERVICES FEATURING TRUNKS, TRAVELING BAGS, UMBRELLAS, HANDBAGS, SUITCASES, CLUTCH BAGS, VANITY CASES SOLD EMPTY, PURSES, BILLFOLDS, ATTACHÉ CASES, WALLETS, BRIEFCASES, KEY-CASES, PASSPORT WALLETS OF LEATHER AND IMITATION OF LEATHER, BUSINESS AND CREDIT CARD WALLETS OF LEATHER AND IMITATION OF LEATHER, CLOTHING, COATS, MANTLES, RAINCOATS, DUSTERS, FURS, DRESSES, SUITS, SKIRTS, JACKETS, KNITWEAR, TROUSERS, SHORTS SETS, BERMUDA SHORTS, JEANS, WAISTCOATS, SHIRTS, T-SHIRTS, TOPS, BLOUSES, JERSEYS, SWEATERS, BLAZERS, CARDIGANS, STOCKINGS, SOCKS, UNDERWEAR, CORSETS, BRASSIERES, UNDERPANTS, NIGHT-GOWNS, SHIFTS, PAJAMAS, BATHROBES, BATHING SUITS, BEACH-WRAPPS, SUN SUITS, SPORT JACKETS, WATERPROOF CLOTHING, WIND-RESISTANT JACKETS, ANORAKS, SWEAT SUITS, TIES, NECKTIES, SCARVES, SHAWLS, MUFFLERS, FOULARDS, CAPS, HATS, HOODS, GLOVES, SASHES, BELTS, IN CLASS 35 (U.S. CLS. 100, 101 AND 102).



*David J. Kyros*

Director of the United States Patent and Trademark Office



**Reg. No. 4,133,555** THE MARK CONSISTS OF STANDARD CHARACTERS WITHOUT CLAIM TO ANY PARTICULAR FONT, STYLE, SIZE, OR COLOR.

PRIORITY CLAIMED UNDER SEC. 44(D) ON ERPN CMNTY TM OFC APPLICATION NO. 8642704, FILED 10-27-2009, REG. NO. 8642704, DATED 5-31-2010, EXPIRES 10-27-2019.

THE NAME(S), PORTRAIT(S), AND/OR SIGNATURE(S) SHOWN IN THE MARK DOES NOT IDENTIFY A PARTICULAR LIVING INDIVIDUAL.

SER. NO. 77-920,007, FILED 1-26-2010.

HEATHER THOMPSON, EXAMINING ATTORNEY

# United States of America

United States Patent and Trademark Office

## CARON RENAISSANCE

**Reg. No. 4,133,556**

**Registered May 1, 2012**

**Int. Cl.: 44**

**SERVICE MARK**

**PRINCIPAL REGISTER**

RICHARD J. CARON FOUNDATION (PENNSYLVANIA NON-PROFIT CORPORATION)  
P.O. BOX 150, GALEN HALL ROAD  
WERNERSVILLE, PA 19565

FOR: HEALTH CARE SERVICES, NAMELY, COUNSELING, CONSULTATION, MEDICAL EVALUATIONS AND THE PROVISION OF RESIDENTIAL AND OUTPATIENT CARE FACILITIES TO ASSIST INDIVIDUALS AND FAMILIES WITH CHEMICAL DEPENDENCIES, IN CLASS 44 (U.S. CLS. 100 AND 101).

FIRST USE 7-1-2008; IN COMMERCE 7-1-2008.

THE MARK CONSISTS OF STANDARD CHARACTERS WITHOUT CLAIM TO ANY PARTICULAR FONT, STYLE, SIZE, OR COLOR.

OWNER OF U.S. REG. NOS. 2,486,951, 3,674,608 AND OTHERS.

SER. NO. 77-928,530, FILED 2-4-2010.

KELLY CHOE, EXAMINING ATTORNEY



*David J. Kybas*

Director of the United States Patent and Trademark Office

# United States of America

United States Patent and Trademark Office

# Undie Run

**Reg. No. 4,133,557**

KUHLMANN, KYLE M. (UNITED STATES INDIVIDUAL)  
4916 MT. GAYWAS DR.  
SAN DIEGO, CA 92117 AND

**Registered May 1, 2012**

**Int. Cl.: 25**

CARLS, WESTON P. (UNITED STATES INDIVIDUAL)  
2012 EAST 22ND ST., APPT. A  
AUSTIN, TX 78722

**TRADEMARK**

FOR: SHIRTS AND UNDERWEAR, IN CLASS 25 (U.S. CLS. 22 AND 39).

**PRINCIPAL REGISTER**

FIRST USE 5-20-2008; IN COMMERCE 5-20-2008.

THE MARK CONSISTS OF STANDARD CHARACTERS WITHOUT CLAIM TO ANY PARTICULAR FONT, STYLE, SIZE, OR COLOR.

SER. NO. 77-928,619, FILED 2-4-2010.

ELI HELLMAN, EXAMINING ATTORNEY



*David J. Kybas*

Director of the United States Patent and Trademark Office

# United States of America

United States Patent and Trademark Office

# Be Flawed

**Reg. No. 4,133,558**

**Registered May 1, 2012**

**Int. Cls.: 25 and 35**

**TRADEMARK**

**SERVICE MARK**

**PRINCIPAL REGISTER**

JEANIE YUN (UNITED STATES INDIVIDUAL), AKA SIA (SKYELER INDEPENDENT ARTWORKS)  
21 S. END AVE, #335  
NEW YORK, NY 10280

FOR: CAPS; FOOTWEAR; HEADWEAR; HOODED SWEAT SHIRTS; HOODS; INFANT AND TODDLER ONE PIECE CLOTHING; JERSEYS; LONG-SLEEVED SHIRTS; NECKWEAR; POLO SHIRTS; RUGBY SHIRTS; SHIRTS; SHIRTS AND SHORT-SLEEVED SHIRTS; SHIRTS FOR INFANTS, BABIES, TODDLERS AND CHILDREN; SHORT-SLEEVED OR LONG-SLEEVED T-SHIRTS; SHORT-SLEEVED SHIRTS; SWEAT SHIRTS; T-SHIRTS; TEE SHIRTS; TIES; TOPS; UNDER GARMENTS SUCH AS TANK SHIRTS; WEARABLE GARMENTS AND CLOTHING, NAMELY, SHIRTS, IN CLASS 25 (U.S. CLS. 22 AND 39).

FIRST USE 2-7-2010; IN COMMERCE 2-8-2010.

FOR: ON-LINE RETAIL CONSIGNMENT STORES FEATURING CLOTHING/WEARABLE GARMENTS INCLUDING FOOTWEAR/HEADWEAR AND ACCESSORIES, BAGS, CAPS, TOY PRODUCTS, NAMELY, PUZZLES AND SKATEBOARDS, PHONE CASES, PET PRODUCTS, HOUSEHOLD PRODUCTS, NAMELY, MUGS, FROSTED MUGS, TRAVEL MUGS, STEINS; ON-LINE RETAIL GIFT SHOPS, IN CLASS 35 (U.S. CLS. 100, 101 AND 102).

FIRST USE 2-7-2010; IN COMMERCE 2-8-2010.

THE MARK CONSISTS OF STANDARD CHARACTERS WITHOUT CLAIM TO ANY PARTICULAR FONT, STYLE, SIZE, OR COLOR.

SER. NO. 77-929,994, FILED 2-7-2010.

ROBERT C. CLARK JR., EXAMINING ATTORNEY



*David J. Kyros*

Director of the United States Patent and Trademark Office

# United States of America

United States Patent and Trademark Office

# Fathom SEO

**Reg. No. 4,133,559**

**Registered May 1, 2012**

**Int. Cl.: 35**

**SERVICE MARK**

**PRINCIPAL REGISTER**

FATHOM SEO, LLC (OHIO LIMITED LIABILITY COMPANY)  
SUITE 100  
8200 SWEET VALLEY DRIVE  
VALLEY VIEW, OH 44125

FOR: BUSINESS MANAGEMENT CONSULTING WITH RELATION TO STRATEGY, MARKETING, SALES, OPERATION, PRODUCT DESIGN PARTICULARLY SPECIALIZING IN THE USE OF ANALYTIC AND STATISTIC MODELS FOR THE UNDERSTANDING AND PREDICTING OF CONSUMERS, BUSINESSES, AND MARKET TRENDS AND ACTIONS; BUSINESS MARKETING CONSULTING SERVICES; CONSULTING SERVICES IN THE FIELD OF INTERNET MARKETING; MARKET RESEARCH CONSULTATION; MARKETING CONSULTING; PLANNING, DESIGN, DEVELOPMENT, MAINTENANCE, TRACKING AND REPORTING OF ONLINE MARKETING ACTIVITIES FOR THIRD PARTIES; PROMOTING THE GOODS AND SERVICES OF OTHERS THROUGH SEARCH ENGINE REFERRAL TRAFFIC ANALYSIS AND REPORTING; PROMOTION AND MARKETING SERVICES AND RELATED CONSULTING; PROVIDING ADVERTISING, MARKETING AND PROMOTIONAL SERVICES, NAMELY, DEVELOPMENT OF ADVERTISING CAMPAIGNS PROVIDED THROUGH CABLE TELEVISION BROADCAST, WEB CASTS, RADIO BROADCASTS, NEWSPAPERS, MAGAZINES, ONLINE BANNERS, OUTDOOR BILLBOARDS, WILD POSTINGS, BUS AND SUBWAY ADS; PROVIDING ONLINE BUSINESS MANAGEMENT SERVICES INCLUDING ACCOUNTING, MARKETING, BUSINESS PROJECT MANAGEMENT, AND BUSINESS DEVELOPMENT, IN CLASS 35 (U.S. CLS. 100, 101 AND 102).

FIRST USE 7-7-2003; IN COMMERCE 7-7-2003.

THE MARK CONSISTS OF STANDARD CHARACTERS WITHOUT CLAIM TO ANY PARTICULAR FONT, STYLE, SIZE, OR COLOR.

NO CLAIM IS MADE TO THE EXCLUSIVE RIGHT TO USE "SEO", APART FROM THE MARK AS SHOWN.

SER. NO. 77-935,858, FILED 2-15-2010.

BARBARA RUTLAND, EXAMINING ATTORNEY



*David J. Kyffers*

Director of the United States Patent and Trademark Office

# United States of America

United States Patent and Trademark Office



**Reg. No. 4,133,560**

**Registered May 1, 2012**

**Int. Cls.: 35 and 42**

**SERVICE MARK**

**PRINCIPAL REGISTER**

FATHOM SEO, LLC (OHIO LIMITED LIABILITY COMPANY)  
SUITE 100  
8200 SWEET VALLEY DRIVE  
VALLEY VIEW, OH 44125

FOR: BUSINESS CONSULTATION AND MANAGEMENT REGARDING MARKETING ACTIVITIES AND LAUNCHING OF NEW PRODUCTS; BUSINESS MANAGEMENT CONSULTING WITH RELATION TO STRATEGY, FINANCING, MARKETING, PRODUCTION, PERSONNEL AND SALE MATTERS FOR COMPANIES INVOLVED WITH THIN FILM AND NANO TECHNOLOGIES AND PLASMA PROCESSES; BUSINESS MANAGEMENT CONSULTING WITH RELATION TO STRATEGY, MARKETING, SALES, OPERATION, PRODUCT DESIGN PARTICULARLY SPECIALIZING IN THE USE OF ANALYTIC AND STATISTIC MODELS FOR THE UNDERSTANDING AND PREDICTING OF CONSUMERS, BUSINESSES, AND MARKET TRENDS AND ACTIONS; BUSINESS MARKETING CONSULTING SERVICES; BUSINESS MONITORING AND CONSULTING SERVICES, NAMELY, TRACKING WEB SITES AND APPLICATIONS OF OTHERS TO PROVIDE STRATEGY, INSIGHT, MARKETING, SALES, OPERATION, PRODUCT DESIGN, PARTICULARLY SPECIALIZING IN THE USE OF ANALYTIC AND STATISTIC MODELS FOR THE UNDERSTANDING AND PREDICTING OF CONSUMERS, BUSINESSES, AND MARKET TRENDS AND ACTIONS; CONSULTING SERVICES IN THE FIELD OF INTERNET MARKETING; CONSUMER MARKETING RESEARCH AND CONSULTING RELATED THERETO; CONSUMER STRATEGY BUSINESS CONSULTING IN THE FIELDS OF MARKETING, SALES, OPERATION, AND PRODUCT DESIGN PARTICULARLY SPECIALIZING IN THE USE OF ANALYTIC MODELS FOR THE UNDERSTANDING AND PREDICTING OF CONSUMER, BUSINESS, AND RETAIL MARKET TRENDS AND ACTIONS; PROMOTING THE GOODS AND SERVICES OF OTHERS THROUGH SEARCH ENGINE REFERRAL TRAFFIC ANALYSIS AND REPORTING; PROVIDING ADVERTISING, MARKETING AND PROMOTIONAL SERVICES, NAMELY, DEVELOPMENT OF ADVERTISING CAMPAIGNS PROVIDED THROUGH CABLE TELEVISION BROADCAST, WEB CASTS, RADIO BROADCASTS, NEWSPAPERS, MAGAZINES, ONLINE BANNERS, OUTDOOR BILLBOARDS, WILD POSTINGS, BUS AND SUBWAY ADS; PROVIDING ONLINE BUSINESS MANAGEMENT SERVICES INCLUDING ACCOUNTING, MARKETING, BUSINESS PROJECT MANAGEMENT, AND BUSINESS DEVELOPMENT, IN CLASS 35 (U.S. CLS. 100, 101 AND 102).



*David J. Kyjars*

FIRST USE 7-7-2003; IN COMMERCE 7-7-2003.

**Reg. No. 4,133,560** FOR: COMPUTER SERVICES, NAMELY, SEARCH ENGINE OPTIMIZATION; CONSULTATION SERVICES IN THE FIELD OF SEARCH ENGINE OPTIMIZATION, IN CLASS 42 (U.S. CLS. 100 AND 101).

FIRST USE 7-7-2003; IN COMMERCE 7-7-2003.

NO CLAIM IS MADE TO THE EXCLUSIVE RIGHT TO USE "SEO" AND "SEARCH ENGINE MARKETING", APART FROM THE MARK AS SHOWN.

THE MARK CONSISTS OF LARGE LETTER "F" WITH SHADED 2/3 CIRCLE CIRCLING LETTER WITH MIDPOINT ON UPPER RIGHT HAND SIDE, CONNECTED ON THE RIGHT WITH TEXT STATING "FATHOM SEO" IN ALL CAPITAL LETTERS, WITH SMALLER "SEARCH ENGINE MARKETING TEXT" RUNNING UNDERNEATH.

SER. NO. 77-935,933, FILED 2-15-2010.

BARBARA RUTLAND, EXAMINING ATTORNEY

# United States of America

United States Patent and Trademark Office

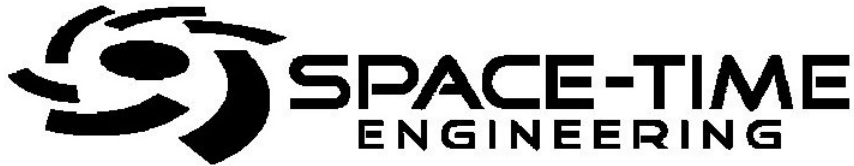

**Reg. No. 4,133,561**

**Registered May 1, 2012**

**Int. Cl.: 42**

**SERVICE MARK**

**PRINCIPAL REGISTER**

SPACE-TIME ENGINEERING, LLC (CALIFORNIA LIMITED LIABILITY COMPANY)  
777 SILVER SPUR ROAD, SUITE 227  
ROLLING HILLS ESTATES, CA 90274

FOR: COMPUTER SOFTWARE DEVELOPMENT IN THE FIELD OF SIMULATION OF NETWORKED SYSTEMS FOR SYSTEM ANALYSIS AND EVALUATION, IN CLASS 42 (U.S. CLS. 100 AND 101).

FIRST USE 11-0-2007; IN COMMERCE 11-0-2007.

NO CLAIM IS MADE TO THE EXCLUSIVE RIGHT TO USE "ENGINEERING", APART FROM THE MARK AS SHOWN.

THE MARK CONSISTS OF A WHIRLPOOL WITH THE STYLIZED TEXT "SPACE-TIME ENGINEERING".

SER. NO. 77-936,477, FILED 2-16-2010.

NATALIE POLZER, EXAMINING ATTORNEY



*David J. Kyffers*

Director of the United States Patent and Trademark Office



# United States of America

United States Patent and Trademark Office



Linear  
Compressor

**Reg. No. 4,133,562**

**Registered May 1, 2012**

**Int. Cl.: 7**

**TRADEMARK**

**PRINCIPAL REGISTER**

LG ELECTRONICS INC. (REPUBLIC OF KOREA CORPORATION)  
20, YEOUIDO-DONG, YEONGDEUNGPO-GU  
SEOUL, REPUBLIC OF KOREA 150-721

FOR: CLOTHES WASHING MACHINES; DISHWASHERS; VACUUM CLEANERS, IN CLASS  
7 (U.S. CLS. 13, 19, 21, 23, 31, 34 AND 35).

PRIORITY CLAIMED UNDER SEC. 44(D) ON REPUBLIC OF KOREA APPLICATION NO.  
40-2010-0006, FILED 2-4-2010, REG. NO. 0862733, DATED 4-28-2011, EXPIRES 4-28-2021.

NO CLAIM IS MADE TO THE EXCLUSIVE RIGHT TO USE "LINEAR COMPRESSOR",  
APART FROM THE MARK AS SHOWN.

THE MARK CONSISTS OF THE WORDS "LINEAR COMPRESSOR" BELOW A SQUARE  
WITH ROUNDED EDGES. WITHIN THE SQUARE ARE THE LETTERS "L" AND "C". HORI-  
ZONTAL LINES ARE ABOVE AND BELOW THE "L" AND "C".

SER. NO. 77-937,835, FILED 2-17-2010.

TAMARA FRAZIER, EXAMINING ATTORNEY



*David J. Kyffers*

Director of the United States Patent and Trademark Office

# United States of America

United States Patent and Trademark Office

## VISIONS CENTER ON BLINDNESS

**Reg. No. 4,133,563**

**Registered May 1, 2012**

**Int. Cls.: 41 and 44**

**SERVICE MARK**

**PRINCIPAL REGISTER**

VISIONS/SERVICES FOR THE BLIND AND VISUALLY IMPAIRED (NEW YORK  
NON-PROFIT CORPORATION)  
500 GREENWICH ST., 3RD FLOOR  
NEW YORK, NY 10013

FOR: VOCATIONAL TRAINING FOR PEOPLE WITH VISION LOSS; EDUCATIONAL PROGRAMS IN THE NATURE OF BRAILLE CLASSES, COMPUTERS CLASSES MOBILITY LESSONS, COOKING CLASSES, PERSONAL AND HOME MANAGEMENT TRAINING; EDUCATIONAL SERVICES, NAMELY PROVIDING SPEAKERS ON TOPICS OF INTEREST FOR PEOPLE WITH VISION LOSS; RECREATIONAL CAMP SERVICES, IN CLASS 41 (U.S. CLS. 100, 101 AND 107).

FIRST USE 5-13-2009; IN COMMERCE 5-13-2009.

FOR: VISION REHABILITATION SERVICES, IN CLASS 44 (U.S. CLS. 100 AND 101).

FIRST USE 5-13-2009; IN COMMERCE 5-13-2009.

THE MARK CONSISTS OF STANDARD CHARACTERS WITHOUT CLAIM TO ANY PARTICULAR FONT, STYLE, SIZE, OR COLOR.

NO CLAIM IS MADE TO THE EXCLUSIVE RIGHT TO USE "CENTER ON BLINDNESS", APART FROM THE MARK AS SHOWN.

SEC. 2(F) AS TO "VISIONS".

SER. NO. 77-938,737, FILED 2-18-2010.

MARGERY A. TIERNEY, EXAMINING ATTORNEY



*David J. Kybas*

Director of the United States Patent and Trademark Office

# United States of America

United States Patent and Trademark Office

# SKYTEX

**Reg. No. 4,133,564**

**Registered May 1, 2012**

**Int. Cl.: 9**

**TRADEMARK**

**PRINCIPAL REGISTER**

SKYTEX TECHNOLOGY INC. (CALIFORNIA CORPORATION)  
21671 GATEWAY CENTER DR., #113  
DIAMOND BAR, CA 91765

FOR: OPTICAL DISC PLAYER, DVD PLAYER, PORTABLE DVD PLAYER, TELEVISION, LCD TV, LED TV, LCD TV/DVD COMBO, PORTABLE TV, MP3 PLAYER, MPEG4 PLAYER, MPEG5 PLAYER, PORTABLE MEDIA PLAYER, E-BOOK READER, DIGITAL CAMERA, VIDEO PROJECTORS, GPS NAVIGATION DEVICE, HEADPHONE, EARPHONES, NETBOOK COMPUTER, NOTEBOOK COMPUTER, LAPTOP COMPUTER, DESKTOP COMPUTER, NETTOP COMPUTER, ALL-IN-ONE COMPUTER, NAMELY, A COMPUTER COMBINED WITH A LCD MONITOR AND KEYBOARD, LCD MONITOR, MEDIA CENTER, NAMELY, A COMPUTER COMBINED WITH A LCD MONITOR, KEYBOARD AND SPEAKERS; INTERNET TABLET COMPUTER, PRINTER, COPIER, ALL-IN-ONE PRINTER, NAMELY, A COMBINATION OF A PRINTER, COPIER, SCANNER AND FAX MACHINE; SCANNER, FAX MACHINE, CD RECORDER, CD WRITER, CD REWRITER, DVD RECORDER, DVD WRITER, DVD REWRITER, OPTICAL DISC ROM PLAYER, OPTICAL DISC ROM REWRITER, EXTERNAL DVD REWRITER, EXTERNAL OPTICAL DISC REWRITER, COMPUTER PERIPHERALS, COMPUTER NETWORKING HARDWARE, WIRELESS ROUTER, PCI CARD, USB EXTERNAL ENCLOSURE HARDWARE, KEYBOARD, MOUSE, WEBCAMS, IN CLASS 9 (U.S. CLS. 21, 23, 26, 36 AND 38).

FIRST USE 3-1-2008; IN COMMERCE 3-1-2008.

OWNER OF U.S. REG. NO. 3,627,969.

THE MARK CONSISTS OF STYLIZED WORDING "SKYTEX" WITH TRIANGLES IN THE "Y" AND "X".

SER. NO. 77-944,547, FILED 2-25-2010.

ANTHONY RINKER, EXAMINING ATTORNEY



*David J. Kyros*

Director of the United States Patent and Trademark Office

# United States of America

United States Patent and Trademark Office

# MOCH

**Reg. No. 4,133,565**

**Registered May 1, 2012**

**Int. Cl.: 33**

**TRADEMARK**

**PRINCIPAL REGISTER**

DIAGEO SCOTLAND LIMITED (UNITED KINGDOM CORPORATION)  
EDINBURGH PARK 5 LOCHSIDE WAY  
EDINBURGH EH12 9DT, UNITED KINGDOM

FOR: ALCOHOLIC BEVERAGES EXCEPT BEERS, IN CLASS 33 (U.S. CLS. 47 AND 49).

THE MARK CONSISTS OF STANDARD CHARACTERS WITHOUT CLAIM TO ANY PARTICULAR FONT, STYLE, SIZE, OR COLOR.

PRIORITY CLAIMED UNDER SEC. 44(D) ON ERPN CMNTY TM OFC APPLICATION NO. 008818437, FILED 1-19-2010, REG. NO. 008818437, DATED 6-10-2010, EXPIRES 1-19-2020.

SER. NO. 77-945,645, FILED 2-26-2010.

BARNEY CHARLON, EXAMINING ATTORNEY



*David J. Kyffers*

Director of the United States Patent and Trademark Office

# United States of America

United States Patent and Trademark Office

# SPORTECH

**Reg. No. 4,133,566**

**Registered May 1, 2012**

**Int. Cls.: 9, 16, 28, 36  
and 41**

**TRADEMARK**

**SERVICE MARK**

**PRINCIPAL REGISTER**

SPORTECH PLC (UNITED KINGDOM PRIVATE LIMITED COMPANY)  
WAVERTREE TECHNOLOGY PARK  
SPORTECH HOUSE, 2 ENTERPRISE WAY  
LIVERPOOL, UNITED KINGDOM L131FB

FOR: ELECTRONIC GAMING APPARATUS, DEVICES AND MACHINES, NAMELY, DEVICES WHICH ACCEPT A WAGER AND IN PARTICULAR WAGERS ON HORSERACING; COIN, TOKEN AND CARD OPERATED GAMING DEVICES AND MACHINES WHICH ACCEPT A WAGER; ELECTRONIC LOTTERY, BINGO AND PARI-MUTUEL GAMING MACHINES; SLOT MACHINES; ELECTRONIC LOTTERY TERMINALS AND LOTTERY TERMINALS WITH TOUCH SCREEN MONITORS; SOFTWARE FOR ELECTRONIC GAMING MACHINES AND TERMINALS WHICH ACCEPT A WAGER; SOFTWARE, FIRMWARE AND PROGRAMS FOR USE IN OR RELATING TO GAMING, FORECASTING EVENTS AND RESULTS, LOTTERIES, POOLS, AND BETTING; SOFTWARE, FIRMWARE AND PROGRAMS FOR USE IN, OR RELATING TO, RACING, COMPETITIONS, GAMES AND EVENTS, ALL FOR USE IN CONNECTION WITH BETTING OR GAMING, IN CLASS 9 (U.S. CLS. 21, 23, 26, 36 AND 38).

FOR: PRINTED BETTING FORMS; BETTING SLIPS; COMPETITION FORMS; FOOTBALL POOLS FORMS AND SLIPS AND RACING BETTING FORMS AND SLIPS; SCRATCH CARDS, IN CLASS 16 (U.S. CLS. 2, 5, 22, 23, 29, 37, 38 AND 50).

FOR: LOTTERY TICKETS; SCRATCH CARDS FOR PLAYING LOTTERY GAMES, IN CLASS 28 (U.S. CLS. 22, 23, 38 AND 50).

FOR: FINANCIAL ADVISORY AND CONSULTANCY SERVICES; TRANSFER OF MONEY TO BOOKMAKERS, IN CLASS 36 (U.S. CLS. 100, 101 AND 102).

FOR: GAMING SERVICES; GAMBLING SERVICES; LOTTERY SERVICES; BETTING POOLS SERVICES; ENTERTAINMENT IN THE NATURE OF PROVIDING BINGO GAMES; BETTING SERVICES; INFORMATION SERVICES RELATED THERETO, IN CLASS 41 (U.S. CLS. 100, 101 AND 107).

THE MARK CONSISTS OF STANDARD CHARACTERS WITHOUT CLAIM TO ANY PARTICULAR FONT, STYLE, SIZE, OR COLOR.

OWNER OF UNITED KINGDOM REG. NO. 2307465, DATED 5-20-2005, EXPIRES 8-5-2012.



*David J. Kyros*

Director of the United States Patent and Trademark Office

**Reg. No. 4,133,566** SER. NO. 77-947,457, FILED 3-1-2010.

NATALIE POLZER, EXAMINING ATTORNEY

# United States of America

United States Patent and Trademark Office

## LIFE CHOICE

**Reg. No. 4,133,567**

**Registered May 1, 2012**

**Int. Cl.: 44**

**SERVICE MARK**

**PRINCIPAL REGISTER**

NATIONAL HOSPICE HOLDINGS, LLC (DELAWARE LIMITED LIABILITY COMPANY)  
37TH FLOOR  
825 THIRD AVENUE  
NEW YORK, NY 10022

FOR: HEALTHCARE SERVICES, NAMELY, HOSPICE SERVICES, PALLIATIVE CARE SERVICES, AND MEDICAL ADVISORY SERVICES FOR TREATING PERSONS AT HOME; PROVIDING INFORMATION IN THE FIELD OF HOSPICE AND PALLIATIVE CARE, IN CLASS 44 (U.S. CLS. 100 AND 101).

FIRST USE 10-8-2003; IN COMMERCE 10-8-2003.

THE MARK CONSISTS OF STANDARD CHARACTERS WITHOUT CLAIM TO ANY PARTICULAR FONT, STYLE, SIZE, OR COLOR.

SER. NO. 77-948,452, FILED 3-2-2010.

REBECCA SMITH, EXAMINING ATTORNEY



*David J. Kybas*

Director of the United States Patent and Trademark Office

# United States of America

United States Patent and Trademark Office

# VERISMA

**Reg. No. 4,133,568**

**Registered May 1, 2012**

**Int. Cl.: 9**

**TRADEMARK**

**PRINCIPAL REGISTER**

INTUNE NETWORKS LIMITED (IRELAND LIMITED COMPANY)  
PARKWEST  
9B BECKETT WAY  
DUBLIN, IRELAND 12

FOR: TELECOMMUNICATIONS AND DATA NETWORKING HARDWARE, NAMELY, DEVICES FOR TRANSPORTING AND AGGREGATING VOICE, DATA, AND VIDEO COMMUNICATIONS ACROSS MULTIPLE NETWORK INFRASTRUCTURES AND COMMUNICATIONS PROTOCOLS; OPTICAL COMMUNICATIONS SYSTEMS COMPRISED OF OPTICAL AND ELECTRONIC HARDWARE AND COMPUTER SOFTWARE FOR THE TRANSMISSION OF DATA BETWEEN TWO POINTS; AUTOMATIC SWITCHING APPARATUS FOR TELECOMMUNICATION; DIGITAL TELEPHONE SWITCHING APPARATUS; WIRELESS TELEPHONY APPARATUS; ELECTRONIC AND OPTICAL COMMUNICATIONS INSTRUMENTS AND COMPONENTS, NAMELY, OPTICAL TRANSMITTERS, OPTICAL RECEIVERS, OPTICAL DATA LINKS, DIGITAL TRANSMITTERS, COMMUNICATION LINK TESTERS, AND OPTICAL TRANSCEIVERS; TELECOMMUNICATIONS HARDWARE AND SOFTWARE, NAMELY, COMPUTER HARDWARE AND SOFTWARE FOR INTERCONNECTING, MANAGING, SECURING AND OPERATING LOCAL AND WIDE AREA NETWORKS AND TELEPHONY SYSTEMS; SWITCHING AND INTERCONNECTING UNITS FOR OPTICAL COMMUNICATIONS NETWORKS, IN CLASS 9 (U.S. CLS. 21, 23, 26, 36 AND 38).

THE MARK CONSISTS OF STANDARD CHARACTERS WITHOUT CLAIM TO ANY PARTICULAR FONT, STYLE, SIZE, OR COLOR.

PRIORITY CLAIMED UNDER SEC. 44(D) ON ERPN CMNTY TM OFC APPLICATION NO. 008925174, FILED 3-3-2010, REG. NO. 008925174, DATED 10-4-2010, EXPIRES 3-3-2020.

SER. NO. 77-950,746, FILED 3-4-2010.

MARK SHINER, EXAMINING ATTORNEY



*David J. Kypos*

Director of the United States Patent and Trademark Office



# United States of America

United States Patent and Trademark Office

# YoParfait

**Reg. No. 4,133,569**

**Registered May 1, 2012**

**Int. Cl.: 29**

**TRADEMARK**

**PRINCIPAL REGISTER**

YASSOO INC. (CALIFORNIA CORPORATION)  
WWW.YOPARFAIT.COM  
8078 SAN FERNANDO ROAD  
SUN VALLEY, CA 91352

FOR: DAIRY PRODUCTS EXCLUDING ICE CREAM, ICE MILK AND FROZEN YOGURT;  
YOGURT, IN CLASS 29 (U.S. CL. 46).

FIRST USE 2-1-2008; IN COMMERCE 2-1-2008.

THE MARK CONSISTS OF STANDARD CHARACTERS WITHOUT CLAIM TO ANY PAR-  
TICULAR FONT, STYLE, SIZE, OR COLOR.

SER. NO. 77-954,329, FILED 3-9-2010.

REBECCA EISINGER, EXAMINING ATTORNEY



*David J. Kyjars*

Director of the United States Patent and Trademark Office

# United States of America

United States Patent and Trademark Office

# Thunder

**Reg. No. 4,133,570**

**Registered May 1, 2012**

**Int. Cl.: 11**

**TRADEMARK**

**PRINCIPAL REGISTER**

QUEST TECHNOLOGIES, INC (GEORGIA CORPORATION), DBA CRYSTAL QUEST MFG  
355 BRIARWOOD CT  
MARIETTA, GA 30068

FOR: WATER PURIFICATION AND FILTRATION APPARATUS; WATER TREATMENT  
EQUIPMENT, NAMELY, REVERSE OSMOSIS FILTRATION UNITS, IN CLASS 11 (U.S. CLS.  
13, 21, 23, 31 AND 34).

FIRST USE 6-1-2009; IN COMMERCE 6-1-2009.

THE MARK CONSISTS OF STANDARD CHARACTERS WITHOUT CLAIM TO ANY PAR-  
TICULAR FONT, STYLE, SIZE, OR COLOR.

SER. NO. 77-955,661, FILED 3-10-2010.

DAVID MURRAY, EXAMINING ATTORNEY



*David J. Kyffers*

Director of the United States Patent and Trademark Office

# United States of America

United States Patent and Trademark Office



**MOST HATED  
GEAR**

**Reg. No. 4,133,571**

VELA, OSCAR (UNITED STATES INDIVIDUAL)  
2810 DON SERGIO  
LAREDO, TX 78045

**Registered May 1, 2012**

**Int. Cl.: 25**

FOR: BEANIES; BLOUSES; CAPS; DRESSES; JACKETS; PANTS; SHOES; SHORTS;  
SWEATERS; T-SHIRTS, IN CLASS 25 (U.S. CLS. 22 AND 39).

**TRADEMARK**

FIRST USE 3-0-2009; IN COMMERCE 3-0-2009.

**PRINCIPAL REGISTER**

NO CLAIM IS MADE TO THE EXCLUSIVE RIGHT TO USE "GEAR", APART FROM THE  
MARK AS SHOWN.

THE MARK CONSISTS OF THE STYLIZED LETTERING "MH" CENTRALLY LOCATED  
ABOVE THE STYLIZED WORDS "MOST HATED GEAR". THE STYLIZED LETTERING  
"MH" CONTAINS THE LETTERS OVERLAPPING ONE ANOTHER AND IN A SQUARE  
CARRIER. THE STYLIZED "M" LOCATED WITHIN THE SQUARE CARRIER SERVES AS  
A BACKGROUND TO CONTRAST THE STYLIZED LETTER "H" IN SMALLER FONT. BE-  
NEATH THE DESIGN, THE STYLIZED WORDING "MOST HATED GEAR" APPEARS.

SER. NO. 77-956,987, FILED 3-11-2010.

MARILYN IZZI, EXAMINING ATTORNEY



*David J. Kyffers*

Director of the United States Patent and Trademark Office

# United States of America

United States Patent and Trademark Office

# TRUPROX

**Reg. No. 4,133,572**

**Registered May 1, 2012**

**Int. Cl.: 9**

**TRADEMARK**

**PRINCIPAL REGISTER**

PROXENSE, LLC (DELAWARE LIMITED LIABILITY COMPANY)  
689 NW STONEPINE  
BEND, OR 97710

FOR: COMPUTER SOFTWARE TO ALLOW USERS TO PERFORM ELECTRONIC BUSINESS TRANSACTIONS VIA A GLOBAL COMPUTER NETWORK; ELECTRONIC AND MAGNETIC IDENTIFICATION CARDS FOR USE IN CONNECTION WITH PAYMENT FOR GOODS AND SERVICES AND TRACKING USERS AND ASSETS; ENCODED ELECTRONIC CHIP CARDS CONTAINING PROGRAMMING USED TO FUNCTION AS A TANGIBLE ELECTRONIC KEY STORING A SECURITY CODE THAT IS USED TO ACCESS DIGITAL CONTENT, IN CLASS 9 (U.S. CLS. 21, 23, 26, 36 AND 38).

FIRST USE 11-30-2005; IN COMMERCE 3-6-2010.

THE MARK CONSISTS OF STANDARD CHARACTERS WITHOUT CLAIM TO ANY PARTICULAR FONT, STYLE, SIZE, OR COLOR.

SER. NO. 77-962,476, FILED 3-18-2010.

EUGENIA MARTIN, EXAMINING ATTORNEY



*David J. Kyffers*

Director of the United States Patent and Trademark Office

# United States of America

United States Patent and Trademark Office

## BORDERLESS Nano

**Reg. No. 4,133,573**

**Registered May 1, 2012**

**Int. Cl.: 9**

**TRADEMARK**

**PRINCIPAL REGISTER**

LG ELECTRONICS INC. (REPUBLIC OF KOREA CORPORATION)  
20, YEOUIDO-DONG, YEONGDEUNGPO-GU  
SEOUL, REPUBLIC OF KOREA 150-721

FOR: TELEVISION RECEIVERS, IN CLASS 9 (U.S. CLS. 21, 23, 26, 36 AND 38).

THE MARK CONSISTS OF STANDARD CHARACTERS WITHOUT CLAIM TO ANY PARTICULAR FONT, STYLE, SIZE, OR COLOR.

PRIORITY CLAIMED UNDER SEC. 44(D) ON REPUBLIC OF KOREA APPLICATION NO. 40-2010-0011, FILED 3-4-2010, REG. NO. 0865398, DATED 5-19-2011, EXPIRES 5-19-2021.

NO CLAIM IS MADE TO THE EXCLUSIVE RIGHT TO USE "BORDERLESS", APART FROM THE MARK AS SHOWN.

SER. NO. 77-963,505, FILED 3-19-2010.

JAMES MACFARLANE, EXAMINING ATTORNEY



*David J. Kyffers*

Director of the United States Patent and Trademark Office

United States of America  
United States Patent and Trademark Office

**Uncle  
Milton**

**Reg. No. 4,133,574**

**Registered May 1, 2012**

**Int. Cl.: 28**

**TRADEMARK**

**PRINCIPAL REGISTER**

UNCLE MILTON INDUSTRIES, INC. (CALIFORNIA CORPORATION)  
31186 LA BAYA DRIVE  
WESTLAKE VILLAGE, CA 91362

FOR: SCIENCE AND NATURE TOYS, EDUCATIONAL PLAYTHINGS AND ACTIVITY KITS, NAMELY, TOY INSECT VIEWERS, WIND-UP TOYS, TOY GLOBES, TOY ROCKS, PLANETARIUMS, MOON REPLICATE, TOY SOLAR SYSTEM, TOY RAINBOW, TOY ROCKETS, HOBBY CRAFT PLANT GROWING KITS, HOBBY CRAFT BIOLOGY SETS, HOBBY CRAFT EARTH SCIENCE SETS, HOBBY CRAFT PHYSICS SETS, RADIO CONTROLLED TOYS, ANIMALS, REPTILES AND INSECTS, NAMELY, TOY VEHICLES, TOY TELESCOPES, TOY CAMERAS, TOY MECHANICAL ARMS, TOY AIRPLANES AND TOY VOLCANOES, IN CLASS 28 (U.S. CLS. 22, 23, 38 AND 50).

FIRST USE 8-31-1999, THE MARK WAS FIRST USED ANYWHERE IN A DIFFERENT FORM OTHER THAN THAT SOUGHT TO BE REGISTERED AT LEAST AS EARLY AS 12/31/1958.; IN COMMERCE 8-31-1999, THE MARK WAS FIRST USED IN COMMERCE IN A DIFFERENT FORM OTHER THAN THAT SOUGHT TO BE REGISTERED AT LEAST AS EARLY AS 12/31/1958..

OWNER OF U.S. REG. NO. 2,858,040.

THE MARK CONSISTS OF THE TWO WORDS "UNCLE" AND "MILTON" WITH THE FIRST LETTERS "U" AND "M" IN CAPITAL LETTERS AND THE REMAINING LETTERS IN LOWER CASE, ALL IN A HIGHLY STYLIZED TYPE FONT.

SER. NO. 77-963,809, FILED 3-19-2010.

ANNE FARRELL, EXAMINING ATTORNEY



*David J. Kypos*

Director of the United States Patent and Trademark Office

# United States of America

United States Patent and Trademark Office



**Reg. No. 4,133,575**

**Registered May 1, 2012**

**Int. Cl.: 35**

**SERVICE MARK**

**PRINCIPAL REGISTER**

RUSSELL, JOHN R (UNITED STATES INDIVIDUAL), AKA WILE E  
HIGASHIOKAMISAWA 3 CHOME 41-310  
MISAWA-SHI, AOMORI-KEN, JAPAN 033-0025

FOR: CLUB SERVICES, NAMELY, PROMOTING THE INTERESTS OF MOTORCYCLE  
RIDING, IN CLASS 35 (U.S. CLS. 100, 101 AND 102).

FIRST USE 1-1-2001; IN COMMERCE 1-1-2001.

NO CLAIM IS MADE TO THE EXCLUSIVE RIGHT TO USE "MC", APART FROM THE  
MARK AS SHOWN.

THE COLOR(S) BLUE, YELLOW, RED, WHITE, BROWN, GREEN, BLACK, SILVER, AND  
ORANGE IS/ARE CLAIMED AS A FEATURE OF THE MARK.

THE NON-LATIN CHARACTERS IN THE MARK TRANSLITERATE TO "KOUSHIN" AND  
THIS MEANS JAPANESE GOD OF ROADS, TRAVEL AND PROGRESS. THE MEANING OF  
"CRUISERZ" IS LARGE OR BIG. IN ENGLISH.

THE MARK CONSISTS OF TOP AND BOTTOM ROCKERS ARE YELLOW WITH BLUE  
BORDER AND "KOUSHIN'S" WRITTEN IN BLUE, VERTICAL SIDE ROCKERS ARE YELLOW  
WITH BLUE BORDER AND BLUE JAPANESE CHARACTERS, THE CENTER IS OVAL  
WITH BLACK BACKGROUND WITH A OUTER BLUE BORDER, FOLLOWED BY A YELLOW  
OVAL THEN THE FACE WITH A RED, WHITE YELLOW GREEN COLOR, 3 ARROWS  
GOING THROUGH THE FACE THAT ARE BROWN, WHITE AND SILVER, ONE EACH SIDE  
OF THE FACE THERE ARE A BURNING POT THAT IS SILVER WITH WHITE STAR BURST  
IN THE CENTER AND A ORANGE/YELLOW AND RED FLAME COMING FROM THE TOP  
OF THE BURNING POT, THE BOTTOM RIGHT CORNER SQUARE IS YELLOW WITH BLUE  
BORDER WITH "CRUISERZ MC" WRITTEN IN BLUE. THE ENTIRE MARK IS ON A BLACK  
BACKGROUND.

THE ENGLISH TRANSLATION OF THE NON-LATIN CHARACTERS IN THE MARK IS  
"KOUSHIN" AND "CRUISERZ".

SER. NO. 77-968,950, FILED 3-25-2010.

SHAUNIA CARLYLE, EXAMINING ATTORNEY



*David J. Kyros*

Director of the United States Patent and Trademark Office

# United States of America

United States Patent and Trademark Office

# STELLA

**Reg. No. 4,133,576**

**Registered May 1, 2012**

**Int. Cls.: 7, 10 and 11**

**TRADEMARK**

**PRINCIPAL REGISTER**

TRISTEL PLC (UNITED KINGDOM PUBLIC LIMITED COMPANY (PLC))  
UNIT 4C, LYNX BUSINESS PARK  
FORDHAM ROAD  
SNAILWELL, NEWMARKET, UNITED KINGDOM CB87NY

FOR: PUMPS FOR USE WITH CHLORINE DIOXIDE GENERATORS FOR USE IN STERILIZING MEDICAL INSTRUMENTS AND EQUIPMENT, AND FOR STERILIZING WATER IN CONNECTION WITH THE STERILIZATION OF MEDICAL INSTRUMENTS AND EQUIPMENT, IN CLASS 7 (U.S. CLS. 13, 19, 21, 23, 31, 34 AND 35).

FOR: STERILIZER AND DISINFECTING UNITS FOR MEDICAL INSTRUMENTS AND EQUIPMENT, AND PARTS THEREFOR, IN CLASS 10 (U.S. CLS. 26, 39 AND 44).

FOR: CHLORINE DIOXIDE GENERATORS FOR USE IN STERILIZING MEDICAL INSTRUMENTS AND EQUIPMENT, AND FOR STERILIZING WATER IN CONNECTION WITH THE STERILIZATION OF MEDICAL INSTRUMENTS AND EQUIPMENT; AND PARTS FOR ALL THE AFORESAID GOODS, IN CLASS 11 (U.S. CLS. 13, 21, 23, 31 AND 34).

THE MARK CONSISTS OF STANDARD CHARACTERS WITHOUT CLAIM TO ANY PARTICULAR FONT, STYLE, SIZE, OR COLOR.

OWNER OF ERPN CMNTY TM OFC REG. NO. 007450621, DATED 7-21-2009, EXPIRES 12-9-2018.

SER. NO. 77-969,619, FILED 3-26-2010.

ESTHER BELENKER, EXAMINING ATTORNEY



*David J. Kyffers*

Director of the United States Patent and Trademark Office



# United States of America

## United States Patent and Trademark Office



ROOSEVELT

**Reg. No. 4,133,577**

**Registered May 1, 2012**

**Int. Cls.: 14, 16, 18 and 26**

**TRADEMARK**

**PRINCIPAL REGISTER**

ROOSEVELT, TSE & COMPANY LIMITED (BR. VIRGIN ISLANDS CORPORATION)  
33 BROAD STREET  
BOSTON, MA 02109

FOR: PRECIOUS METALS AND THEIR ALLOYS; JEWELRY, PRECIOUS STONES; HOROLOGICAL AND CHRONOMETRIC INSTRUMENTS; BRACELETS; BROOCHES; CASES ADAPTED TO CONTAIN ITEMS OF JEWELRY; JEWELRY CHAINS; CHARMS; DRESS ORNAMENTS IN THE NATURE OF JEWELRY; EAR ORNAMENTS IN THE NATURE OF JEWELRY; EAR RINGS; FASHION JEWELRY; NECKLACES; JEWELRY WATCHES; WATCHES; PENDANTS; ORNAMENTAL PINS; TIE PINS, TIE CLIPS; RING BANDS IN THE NATURE OF JEWELRY; RINGS; WRISTLETS IN THE NATURE OF BRACELETS; ALARM WATCHES; BANDS FOR WATCHES; BRACELETS FOR WATCHES; CASES FITTED FOR WATCHES; CASES ADAPTED TO CONTAIN WATCHES; CHAINS FOR WATCHES; DIALS FOR WATCHES; FACES FOR WATCHES; HANDS FOR WATCHES; MECHANICAL WATCHES WITH AUTOMATIC WINDING; MECHANICAL WATCHES WITH AUTOMATIC MANUAL WINDING; STRAPS FOR WATCHES; STRAPS FOR WRIST WATCHES; WRISTLET WATCHES IN THE NATURE OF BRACELET WATCHES; WRIST WATCHES; CUFF LINKS; HAT ORNAMENTS OF PRECIOUS METAL; KEY RINGS OF PRECIOUS METAL; MEDALS; SHOE ORNAMENTS OF PRECIOUS METAL; STOP WATCHES; SUNDIALS; PRECIOUS STONES; ALLOYS OF PRECIOUS METAL; CHAINS FOR JEWELRY, IN CLASS 14 (U.S. CLS. 2, 27, 28 AND 50).



*David J. Kybas*

Director of the United States Patent and Trademark Office

FOR: PAPER, CARDBOARD AND GOODS MADE FROM THESE MATERIALS, NAMELY, WRITING PADS AND INVITATION CARDS; BOOKBINDING MATERIAL; PHOTOGRAPHS; STATIONERY; ADHESIVES FOR STATIONERY OR HOUSEHOLD PURPOSES; ARTISTS' MATERIALS, NAMELY, PAINT BOXES, PAINT DISHES, DRAWING PAINTS; PAINT BRUSHES; TYPEWRITERS AND OFFICE REQUISITES (EXCEPT FURNITURE), NAMELY, PENS, PENCIL SHARPENERS, BALL PENS, HIGHLIGHT PENS, MARKERS, COLOR PENCILS, COLOR PENS, LEAD REFILL PENS, STAPLERS, HOLE PUNCHERS; PRINTERS' TYPE; PRINTING BLOCKS; ALBUMS; ANNOUNCEMENT CARDS; ATLASES; ENVELOPES; BAGS OF PAPER OR PLASTIC FOR PACKAGING; BALLS FOR BALL-POINT PENS; BINDERS; BLOTTERS; BOOKENDS; BOOKLETS IN THE FIELD OF ARCHITECTURE, ARTS, BOATS, BEAUTY, CARS, COSMETICS, ENTERTAINMENT, FASHION, FICTION, FOOD, HOME DECORATION, PLANES, ROMANCE, SELF-HELP, SHIPS, SPORTS, SUSPENSE, TRAVEL, WEDDINGS; BOOKMARKERS; BOOKS IN THE FIELD OF ARCHITECTURE, ARTS, BOATS, BEAUTY, CARS, COSMETICS, ENTERTAINMENT, FASHION, FICTION, FOOD, HOME DECORATION, PLANES, ROMANCE, SELF-HELP, SHIPS, SPORTS

**Reg. No. 4,133,577** SUSPENSE, TRAVEL, WEDDINGS; PAPER BOWS FOR GIFT WRAPPING; BOXES FOR PENS; BOXES OF CARDBOARD OR PAPER; CALENDARS; CANVAS FOR PAINTINGS; CARDBOARD; CARDS; CATALOGUES IN THE FIELD OF ARCHITECTURE, ARTS, BOATS, BEAUTY, CARS, COSMETICS, ENTERTAINMENT, FASHION, FOOD, HOME DECORATION, PLANES, REAL ESTATE, SHIPS, SPORTS, TRAVEL, WEDDINGS; PRINTED CHARTS; CLIPBOARDS; CLOTH FOR BOOKBINDINGS; CORDS FOR BOOKBINDING; BOOK COVERS; DOCUMENT FILES; DRAWING INSTRUMENTS; DRAWING PADS; ENGRAVINGS; ENGRAVING PLATES; FIGURES OF PAPIER MÂCHÉ; PAPER FLAGS; PAPER FORMS; FOUNTAIN PENS; GREETING CARDS; HAT BOXES OF CARDBOARDS; INDEX CARDS; INK, NAMELY, WRITING INK AND PEN INK REFILLS; INKWELLS; LABELS' LEDGER, NAMELY, LEDGER BOOKS; MAGAZINES IN THE FIELD OF ARCHITECTURE, ARTS, BOATS, BEAUTY, CARS, COSMETICS, ENTERTAINMENT, FASHION, FOOD, HOME DECORATION, PLANES, REAL ESTATE, SHIPS, SPORTS, TRAVEL, WEDDINGS; MUSICAL GREETING CARDS; NEWSLETTERS IN THE FIELD OF ART, BOATS, BEAUTY, CARS, COSMETICS, ENTERTAINMENT, FASHION, FOOD, HOME DECORATION, PLANES, REAL ESTATE, SHIPS, SPORTS, TRAVEL, WEDDINGS; NEWSPAPERS; NOTE BOOKS; PACKING PAPER; PADS; PAINTERS' EASELS; PAPER CLIPS; PAPER WEIGHTS; PEN CASES; PENCILS; PHOTOGRAPH STANDS; PICTURES; PLACE MATS OF PAPER; POSTCARDS; POSTERS; RIBBON (PAPER); RUBBER ERASERS; RULERS; SCHOOL SUPPLIES NAMELY, PENCILS, PENS, PENCIL SHARPENERS, BALL PENS, FOUNTAIN PENS, HIGHLIGHT PENS, MARKERS, COLOR PENCILS, CRAYONS, COLOR PENS, LEAD REFILL PENS, COMPASSES, STAPLERS, HOLE PUNCHERS; SCRAPBOOKS; SEALING STAMPS; SEALING WAFERS; SEALING WAX; STAMP PADS; STAMP STANDS; STANDS FOR PENS AND PENCILS; WATERCOLORS; WAXED PAPER; WRITING PAPER; WRAPPING PAPER, IN CLASS 16 (U.S. CLS. 2, 5, 22, 23, 29, 37, 38 AND 50).

FOR: LEATHER AND IMITATION LEATHER, AND GOODS MADE OF THESE MATERIALS AND NOT INCLUDED IN OTHER CLASSES, NAMELY, WALLETS, AND WAIST BAGS; ANIMAL SKINS AND HIDES; TRUNKS AND TRAVELING BAGS; UMBRELLAS, PARASOLS AND WALKING STICKS; WHIPS, HARNESS AND SADDLERY; ATTACHÉ CASES; BACKPACKS; BAGS, NAMELY, ALL PURPOSE CARRYING BAGS; BEACH BAGS; BOXES OF LEATHER; BRIEFCASES; CARRYING CASES; GAME BAGS; GARMENT BAGS FOR TRAVEL; HANDBAGS; KEY CASES; NET BAGS FOR SHOPPING; PURSES; RUCKSACKS; SCHOOL BAGS; SHOPPING BAGS; SHOULDER BELTS OF LEATHER; SLING BAGS FOR CARRYING INFANTS; SUITCASE HANDLES; SUITCASES; TOOL BAGS OF LEATHER SOLD EMPTY; TRAVELING SETS, NAMELY, LUGGAGE; TRAVELING TRUNKS; TRUNKS; VALISES; BAGS FOR CAMPERS; BAGS FOR CLIMBERS; SPORTS BAGS; CARD CASES; CASES OF LEATHER; CHAIN MESH PURSES OF PRECIOUS METAL, IN CLASS 18 (U.S. CLS. 1, 2, 3, 22 AND 41).

FOR: BUCKLES OF PRECIOUS METALS, IN CLASS 26 (U.S. CLS. 37, 39, 40, 42 AND 50).

OWNER OF HONG KONG REG. NO. 301225539, DATED 10-22-2008, EXPIRES 10-22-2018.

THE NAME SHOWN IN THE MARK DOES NOT IDENTIFY A PARTICULAR LIVING INDIVIDUAL.

THE MARK CONSISTS OF THE TERM "ROOSEVELT" ABOVE WHICH IS A DESIGN COMPOSED OF THE ARMS, WHICH IS COMPRISED OF A ROSE BUSH WITH THREE BARBED ROSES ON A GRASSY MOUND SURROUND BY AN ORNAMENTAL BORDER AND TOPPED WITH A CREST WHICH IS COMPRISED OF THREE OSTRICH PLUMES. A BANNER WITH THE WORDS "QUI PLANTAVIT CURABIT" APPEARS BELOW THE CREST AND THE ARMS.

THE ENGLISH TRANSLATION OF "QUI PLANTAVIT CURABIT" IN THE MARK IS "HE WHO PLANTED WILL PRESERVE".

SER. NO. 77-978,620, FILED 11-7-2008.

**Reg. No. 4,133,577** RONALD DELGIZZI, EXAMINING ATTORNEY

# United States of America

United States Patent and Trademark Office



**Reg. No. 4,133,578**

**Registered May 1, 2012**

**Int. Cl.: 3**

**TRADEMARK**

**PRINCIPAL REGISTER**

BUTTERCUP NATURALS, LLC (DELAWARE LIMITED LIABILITY COMPANY)  
1130 BEDFORD RD.  
PLEASANTVILLE, NY 10570

FOR: COSMETICS AND SKIN TREATMENTS, NAMELY, SKIN CLEANSERS, SKIN TONERS, SKIN MOISTURIZERS, SKIN ENHANCEMENT TREATMENTS, NAMELY, CREAMS, GELS, LOTIONS AND NON-MEDICATED SERUMS; SKIN CREAMS, SKIN LOTIONS, FACIAL MASKS; HAND CREAMS, FOOT CREAMS AND NON-MEDICATED SERUMS; NON-MEDICATED ACNE TREATMENTS, NAMELY, CREAMS, GELS, LOTIONS AND NON-MEDICATED SERUMS; EYE TREATMENTS, NAMELY, EYE CREAMS, EYE SHADOWS, MASCARAS, CONCEALERS; LIP TREATMENTS, NAMELY, LIPSTICK, NON-MEDICATED LIP BALM, LIP GLOSS; SKIN FOUNDATIONS; FACE POWDERS; BLUSHES; BODY BATH PRODUCTS, NAMELY, BODY CLEANSERS, BODY MOISTURIZERS, BODY OILS, SOAPS, BUBBLE BATH FLUIDS, BATH GEL, BATH SALTS; HAIR CARE PRODUCTS, NAMELY, SHAMPOO, CONDITIONERS, DETANGLERS, STYLING GELS, IN CLASS 3 (U.S. CLS. 1, 4, 6, 50, 51 AND 52).

FIRST USE 1-1-2009; IN COMMERCE 1-1-2009.

THE MARK CONSISTS OF A STYLIZED SMALL HAMSTER CHARACTER TO THE LEFT OF A STYLIZED LARGER RABBIT CHARACTER. THE WORDING "BUTTERCUP & JAKE" APPEARS IN A STYLIZED FONT IN AN ARC ABOVE THE STYLIZED ANIMAL CHARACTERS. THE "&" APPEARS IN SHADED CIRCLE.

SER. NO. 77-980,244, FILED 5-9-2009.

GRETCHEN ULRICH, EXAMINING ATTORNEY



*David J. Kybas*

Director of the United States Patent and Trademark Office

# United States of America

United States Patent and Trademark Office



**Reg. No. 4,133,579**

**Registered May 1, 2012**

**Int. Cl.: 40**

**SERVICE MARK**

**PRINCIPAL REGISTER**

JOE PICASSO'S, INC. (FLORIDA CORPORATION)  
515 SW 1 AVENUE  
FT. LAUDERDALE, FL 33301

FOR: CUSTOMER POTTERY PAINTING AND MOSAIC MAKING, NAMELY, DO IT YOURSELF POTTERY AND MOSAIC STUDIO SERVICES PROVIDING THE USE OF VARIOUS SUPPLIES AND EQUIPMENT SUCH AS TABLES, CERAMIC AND BISQUE OBJECTS, MOSAIC TILES, GROUT, GLASS, BEADS AND FINISHING SUPPLIES, TO INDIVIDUALS MAKING AND DECORATING THEIR OWN POTTERY AND MOSAIC PIECES, IN CLASS 40 (U.S. CLS. 100, 103 AND 106).

FIRST USE 2-0-2007; IN COMMERCE 2-0-2007.

THE NAME "JOE PICASSO" DOES NOT IDENTIFY A LIVING INDIVIDUAL.

THE MARK CONSISTS OF THE WORDS "JOE PICASSO'S" IN A STYLIZED FONT, WITH THE STYLIZED DESIGN OF A POT IN PLACE OF THE "O". UNDERNEATH THE WORDING AND POT IS THE PHRASE "THE ARTISTIC EXPERIENCE WITH TASTE", ALSO IN A STYLIZED FONT. ALL OF THE WORDING AND THE DESIGN ARE IN A RECTANGLE FLANKED BY VINE-LIKE DECORATIONS ON BOTH ENDS.

SER. NO. 77-980,641, FILED 11-2-2009.

JAMES MACFARLANE, EXAMINING ATTORNEY



*David J. Kyros*

Director of the United States Patent and Trademark Office

# United States of America

United States Patent and Trademark Office

**ALBANY**  
*INTERNATIONAL*

**Reg. No. 4,133,580**

**Registered May 1, 2012**

**Int. Cls.: 35 and 42**

**SERVICE MARK**

**PRINCIPAL REGISTER**

ALBANY INTERNATIONAL CORP. (NEW YORK CORPORATION)  
1373 BROADWAY  
ALBANY, NY 12204

FOR: PROVIDING INFORMATION IN THE FIELD OF THE PAPER MACHINE CLOTHING INDUSTRY BY MEANS OF A GLOBAL COMPUTER NETWORK; PROVIDING BUSINESS INFORMATION IN THE FIELD OF THE PAPER MACHINE CLOTHING INDUSTRY BY MEANS OF A GLOBAL COMPUTER NETWORK, IN CLASS 35 (U.S. CLS. 100, 101 AND 102).

FIRST USE 12-31-2005; IN COMMERCE 12-31-2005.

FOR: RESEARCH AND DEVELOPMENT SERVICES IN THE FIELD OF FABRIC TECHNOLOGY, IN CLASS 42 (U.S. CLS. 100 AND 101).

FIRST USE 12-31-2005; IN COMMERCE 12-31-2005.

THE MARK CONSISTS OF THE WORDS "ALBANY INTERNATIONAL" IN STYLIZED FORM.

SEC. 2(F).

SER. NO. 77-982,837, FILED 1-21-2010.

BERNICE MIDDLETON, EXAMINING ATTORNEY



*David J. Kybas*

Director of the United States Patent and Trademark Office

# United States of America

United States Patent and Trademark Office

## Axon Nutritionals

**Reg. No. 4,133,581**

**Registered May 1, 2012**

**Int. Cl.: 42**

**SERVICE MARK**

**PRINCIPAL REGISTER**

AXON NUTRITIONALS, INC. (VIRGINIA CORPORATION)  
SUITE 1200M  
2220 KRAFT DRIVE  
BLACKSBURG, VA 24060

FOR: PRODUCT DEVELOPMENT CONSULTATION RELATING TO NUTRITIONAL SUPPLEMENTS AND NUTRACEUTICALS; AND ANALYTICAL TESTING, REGULATORY MEDICAL WRITING, AND SAFETY CERTIFICATION OF NUTRITIONAL SUPPLEMENTS AND NUTRACEUTICALS, IN CLASS 42 (U.S. CLS. 100 AND 101).

FIRST USE 7-2-2008; IN COMMERCE 12-22-2008.

THE MARK CONSISTS OF STANDARD CHARACTERS WITHOUT CLAIM TO ANY PARTICULAR FONT, STYLE, SIZE, OR COLOR.

NO CLAIM IS MADE TO THE EXCLUSIVE RIGHT TO USE "NUTRITIONALS", APART FROM THE MARK AS SHOWN.

SER. NO. 77-982,857, FILED 11-25-2008.

MICHAEL W. BAIRD, EXAMINING ATTORNEY



*David J. Kyros*

Director of the United States Patent and Trademark Office

# United States of America

United States Patent and Trademark Office

## FRIENDORFOE

**Reg. No. 4,133,582**

FRIEND OR FOE, LLC (CALIFORNIA LIMITED LIABILITY COMPANY)  
450 NORTH ROSSMORE AVENUE  
LOS ANGELES, CA 90004

**Registered May 1, 2012**

**Int. Cl.: 25**

FOR: TEE SHIRTS, WOVEN SHIRTS, PANTS, AND SWEATERS, IN CLASS 25 (U.S. CLS. 22 AND 39).

**TRADEMARK**

FIRST USE 4-3-2006; IN COMMERCE 8-28-2006.

**PRINCIPAL REGISTER**

THE MARK CONSISTS OF STANDARD CHARACTERS WITHOUT CLAIM TO ANY PARTICULAR FONT, STYLE, SIZE, OR COLOR.

SER. NO. 77-983,102, FILED 12-3-2007.

MICHAEL TANNER, EXAMINING ATTORNEY



*David J. Kyffers*

Director of the United States Patent and Trademark Office



# United States of America

United States Patent and Trademark Office

## THE CANADIAN DIAMOND CERTIFICATE

The mark of a diamond that is mined, cut and polished in Canada

**Reg. No. 4,133,583**

**Registered May 1, 2012**

**Int. Cls.: 14, 16 and 36**

WORLDWIDE DIAMOND TRADEMARKS LIMITED (CANADA CORPORATION)  
SUITE 2160  
1066 WEST HASTINGS  
VANCOUVER, BC, CANADA V6E 3X1

FOR: DIAMONDS, IN CLASS 14 (U.S. CLS. 2, 27, 28 AND 50).

**TRADEMARK**

FIRST USE 0-0-2001; IN COMMERCE 0-0-2001.

**SERVICE MARK**

FOR: PRINTED CERTIFICATES FOR DIAMONDS, IN CLASS 16 (U.S. CLS. 2, 5, 22, 23, 29, 37, 38 AND 50).

**PRINCIPAL REGISTER**

FIRST USE 0-0-2001; IN COMMERCE 0-0-2001.

FOR: DIAMOND APPRAISAL SERVICES, IN CLASS 36 (U.S. CLS. 100, 101 AND 102).

FIRST USE 0-0-2001; IN COMMERCE 0-0-2001.

NO CLAIM IS MADE TO THE EXCLUSIVE RIGHT TO USE "A DIAMOND THAT IS MINED, CUT AND POLISHED IN CANADA" WITH RESPECT TO DIAMONDS AND "CANADIAN DIAMOND CERTIFICATE", WITH RESPECT TO THE GOODS DIAMOND CERTIFICATES, APART FROM THE MARK AS SHOWN.

SER. NO. 78-495,106, FILED 10-5-2004.

SHAUNIA CARLYLE, EXAMINING ATTORNEY



*David J. Kybas*

Director of the United States Patent and Trademark Office

# United States of America

United States Patent and Trademark Office

## SAFE-D-RIDE

**Reg. No. 4,133,584**

**Registered May 1, 2012**

**Int. Cl.: 9**

**TRADEMARK**

**PRINCIPAL REGISTER**

SAFE-D-RIDE RODEO SYSTEMS INC. (CANADA CORPORATION)  
26641 FRASER HIGHWAY  
ALDERGROVE, CANADA V4W 3L1

FOR: ELECTRO-MECHANICAL LOCKS, NAMELY, REMOTELY CONTROLLED TENSION RELEASE BELT LOCK FOR RELEASING FLANK STRAPS FROM RODEO ANIMALS , IN CLASS 9 (U.S. CLS. 21, 23, 26, 36 AND 38).

THE MARK CONSISTS OF STANDARD CHARACTERS WITHOUT CLAIM TO ANY PARTICULAR FONT, STYLE, SIZE, OR COLOR.

PRIORITY CLAIMED UNDER SEC. 44(D) ON CANADA APPLICATION NO. 1246089, FILED 2-4-2005, REG. NO. TMA721570, DATED 8-21-2008, EXPIRES 2-4-2020.

SER. NO. 78-680,625, FILED 7-28-2005.

ALYSSA STEEL, EXAMINING ATTORNEY



*David J. Kybas*

Director of the United States Patent and Trademark Office

# United States of America

United States Patent and Trademark Office



**Reg. No. 4,133,585**

**Registered May 1, 2012**

**Int. Cl.: 36**

**SERVICE MARK**

**PRINCIPAL REGISTER**

CASTLE POINT MORTGAGE, INC. (MARYLAND CORPORATION)  
6085 MARSHALEE DRIVE, SUITE 210  
ELKRIDGE, MD 21075

FOR: MORTGAGE BANKING, IN CLASS 36 (U.S. CLS. 100, 101 AND 102).

FIRST USE 5-0-2002; IN COMMERCE 5-0-2002.

OWNER OF U.S. REG. NO. 3,068,067.

THE COLORS LIGHT BLUE, DARK BLUE, WHITE AND GRAY ARE CLAIMED AS A FEATURE OF THE MARK.

NO CLAIM IS MADE TO THE EXCLUSIVE RIGHT TO USE "MORTGAGE", APART FROM THE MARK AS SHOWN.

THE MARK CONSISTS OF THE WORDS "CASTLE POINT MORTGAGE" WITH A LARGE STYLIZED "C" INTERSECTING THE "C" IN THE WORD "CASTLE", WITH A RECTANGULAR BOX SURROUNDING THE WORD "MORTGAGE". THE WORDS "CASTLE POINT" AND THE RECTANGULAR BOX APPEAR IN DARK BLUE, AND THE STYLIZED "C" APPEARS IN A LIGHTER SHADE OF BLUE. THE WORD "MORTGAGE" APPEARS IN WHITE. THE LETTERS IN THE WORDS "CASTLE POINT" ARE SHADOWED IN THE COLOR GRAY.

SER. NO. 78-852,691, FILED 4-3-2006.

JANICE L. MCMORROW, EXAMINING ATTORNEY



*David J. Kybas*

Director of the United States Patent and Trademark Office

# United States of America

United States Patent and Trademark Office

## WHEN SECONDS COUNT

**Reg. No. 4,133,586**

**Registered May 1, 2012**

**Int. Cls.: 35, 39 and 44**

**SERVICE MARK**

**PRINCIPAL REGISTER**

AIR EVAC EMS, INC. (MISSOURI CORPORATION)  
P.O. BOX 768  
WEST PLAINS, MO 65775

FOR: ADMINISTRATION OF A MEMBERSHIP PROGRAM THAT ENABLES PARTICIPANTS TO OBTAIN AIR AMBULANCE SERVICES FOR EMERGENCIES AT NO ADDITIONAL COST, IN CLASS 35 (U.S. CLS. 100, 101 AND 102).

FIRST USE 0-0-1986; IN COMMERCE 0-0-1986.

FOR: AIR AMBULANCE SERVICES; PROVIDING AIR TRANSPORTATION FEATURING EMERGENCY MEDICAL CARE BY AIR TRANSPORT; PROVIDING AIR AMBULANCE SERVICES FEATURING AN AIR AMBULANCE SERVICE MEMBERSHIP PROGRAM FOR RURAL COMMUNITIES; TRANSPORTING VIA AIRCRAFT LIFE-SAVING EQUIPMENT AND MEDICAL PERSONNEL TO DISASTER OR MEDICAL EMERGENCY LOCATIONS, IN CLASS 39 (U.S. CLS. 100 AND 105).

FIRST USE 0-0-1986; IN COMMERCE 0-0-1986.

FOR: AMBULANT MEDICAL CARE; PROVIDING REGISTERED NURSES AND PARAMEDICS IN MEDICAL EMERGENCY AND LIFE-THREATENING SITUATIONS; PROVIDING MEDICAL CARE SERVICES USING CRITICAL CARE EQUIPMENT AND EMERGENCY MEDICAL PERSONNEL, ALL OF THE AFORESAID SERVICES TO BE OFFERED ONLY IN CONJUNCTION WITH AIR AMBULANCE SERVICES, IN CLASS 44 (U.S. CLS. 100 AND 101).

FIRST USE 0-0-1986; IN COMMERCE 0-0-1986.

THE MARK CONSISTS OF STANDARD CHARACTERS WITHOUT CLAIM TO ANY PARTICULAR FONT, STYLE, SIZE, OR COLOR.

REGISTRATION LIMITED TO THE AREA CONSISTING OF ALL OF THE UNITED STATES EXCEPT FOR THE COUNTIES OF HARRIS, MONTGOMERY, BRAZORIA, LIBERTY, FORT BEND, CHAMBERS, WALLER, AND GALVESTON IN THE STATE OF TEXAS PURSUANT TO CONCURRENT USE PROCEEDING NO. 94002403. CONCURRENT REGISTRATION WITH REGISTRATION NO. 3260501.



*David J. Kybas*

Director of the United States Patent and Trademark Office

**Reg. No. 4,133,586** SUBJECT TO CONCURRENT USE PROCEEDING WITH REGISTRATION NO. 3,260,501.  
APPLICANT CLAIMS EXCLUSIVE RIGHT TO USE THE MARK IN THE AREA COMPRISING  
ALL OF THE UNITED STATES, INCLUDING ITS POSSESSIONS AND TERRITORIES, EX-  
CEPT NORTHERN HARRIS COUNTY, TEXAS.

SER. NO. 78-856,578, FILED 4-7-2006.

RUDY R. SINGLETON, EXAMINING ATTORNEY

# United States of America

United States Patent and Trademark Office

## THE CITY BEAUTIFUL

**Reg. No. 4,133,587**

**Registered May 1, 2012**

**Int. Cl.: 35**

**SERVICE MARK**

**PRINCIPAL REGISTER**

CITY OF ORLANDO (FLORIDA MUNICIPAL CORPORATION)  
400 S. ORANGE AVE  
ORLANDO, FL 32801

FOR: PROMOTING THE BUSINESS, COMMUNITY, CULTURAL, HISTORIC, MUNICIPAL AND CIVIC INTERESTS OF THE CITY OF ORLANDO, FLORIDA; PROMOTING TOURISM, BUSINESS, RESIDENTIAL AND COMMERCIAL GROWTH, ECONOMIC DEVELOPMENT, CULTURAL AND HISTORIC ATTRACTIONS, AND GOVERNMENT SERVICES IN THE CITY OF ORLANDO, FLORIDA; PROVIDING DEMOGRAPHIC INFORMATION VIA A GLOBAL COMPUTER NETWORK ABOUT RESIDENTIAL AND COMMERCIAL GROWTH, ECONOMIC AND BUSINESS DEVELOPMENT SERVICES, CULTURAL AND HISTORIC ATTRACTIONS, AND GOVERNMENT SERVICES AND EMPLOYMENT OPPORTUNITIES IN THE CITY OF ORLANDO, FLORIDA, IN CLASS 35 (U.S. CLS. 100, 101 AND 102).

FIRST USE 4-30-1908; IN COMMERCE 4-30-1908.

THE MARK CONSISTS OF STANDARD CHARACTERS WITHOUT CLAIM TO ANY PARTICULAR FONT, STYLE, SIZE, OR COLOR.

NO CLAIM IS MADE TO THE EXCLUSIVE RIGHT TO USE CITY, APART FROM THE MARK AS SHOWN.

SER. NO. 78-921,313, FILED 6-30-2006.

STEVEN R. FINE, EXAMINING ATTORNEY



*David J. Kyros*

Director of the United States Patent and Trademark Office

# United States of America

United States Patent and Trademark Office



**Reg. No. 4,133,588**

**Registered May 1, 2012**

**Int. Cls.: 29, 30 and 32**

AROMA-BURSA MEYVE SULARI VE GIDA; SANAYI ANONIM SIRKETI (TURKEY JOINT STOCK COMPANY)  
ATATURK CADDESI  
KURTULUS MAHALLESİ, NO: 232; GURSU, BURSA  
TURKEY

**TRADEMARK**

**PRINCIPAL REGISTER**

FOR: MEAT, FISH, POULTRY AND GAME MEAT AND PROCESSED MEAT; PROCESSED EDIBLE LEGUMINOUS SEEDS; READYMADE SOUPS; PROCESSED OLIVES, OLIVE PASTE; MILK AND MILK PRODUCTS, EXCLUDING ICE CREAM, ICE MILK, AND FROZEN YOGURT; MILK PRODUCTS, NAMELY, BUTTER; EDIBLE VEGETABLE OILS; DRIED FRUITS AND VEGETABLES, CANNED FRUITS AND VEGETABLES, FROZEN FRUITS AND VEGETABLES, COOKED FRUITS AND VEGETABLES; HAZELNUT AND PISTACHIO PASTES; EGGS, POWDERED DRIED EGGS; PROCESSED BEE POLLEN FOR HUMAN CONSUMPTION FOR FOOD PURPOSES AND NOT FOR MEDICAL PURPOSES; POTATO CHIPS, IN CLASS 29 (U.S. CL. 46).

FOR: COFFEE, COCOA, COFFEE AND COCOA BASED BEVERAGES, CHOCOLATE-BASED FOOD BEVERAGES NOT BEING DAIRY-BASED OR VEGETABLE BASED; PASTRY; HONEY; ROYAL JELLY FOR HUMAN CONSUMPTION, PROPOLIS FOR HUMAN CONSUMPTION; FOOD FLAVORINGS; YEASTS, BAKING POWDERS; FLOUR, PROCESSED SEMOLINA, FOOD STARCH; GRANULATED SUGAR, LUMP SUGAR, POWDERED SUGAR; TEA, ICED TEA; CONFECTIONERY, NAMELY, BONBONS, FROZEN CONFECTIONERY, FONDANTS AND TOFFEES; CHOCOLATES, BISCUITS, CRACKERS, WAFERS; CHEWING GUMS, ICE CREAM, EDIBLE ICE; SALT; CEREAL AND CEREAL PRODUCTS, NAMELY, CEREAL FOR BREAKFAST, CEREAL BASED SNACK FOOD, IN CLASS 30 (U.S. CL. 46).



FOR: BEERS, PREPARATION FOR MAKING BEER, NAMELY, HOPS EXTRACTS; DRINKING WATER; MINERAL WATER, SODA WATER, TONICS IN THE NATURE OF QUININE WATERS; VEGETABLE JUICES, FRUIT JUICES, FRUIT CONCENTRATES AND EXTRACTS, NAMELY, FRUIT JUICE CONCENTRATES, FRUIT CONCENTRATES USED AS INGREDIENTS OF BEVERAGES, AND NON-ALCOHOLIC FRUIT EXTRACTS USED IN THE PREPARATION OF BEVERAGES, IN CLASS 32 (U.S. CLS. 45, 46 AND 48).

*David J. Kybas*

THE MARK CONSISTS OF THE WORD "MELTEM" WITH WAVY LINES BEHIND, ABOVE AND BELOW THE WORDING IN A QUADRILATERAL DESIGN.

**Reg. No. 4,133,588** OWNER OF INTERNATIONAL REGISTRATION 0949210 DATED 8-10-2007, EXPIRES 8-10-2017.

THE ENGLISH TRANSLATION OF THE FOREIGN WORD(S) IN THE MARK IS: LIGHT BREEZE.

SER. NO. 79-048,384, FILED 8-10-2007.

LAURA HAMMEL, EXAMINING ATTORNEY



# United States of America

United States Patent and Trademark Office

# K-Flex

**Reg. No. 4,133,589**

**Registered May 1, 2012**

**Int. Cls.: 6, 7 and 17**

**TRADEMARK**

**PRINCIPAL REGISTER**

L'ISOLANTE K-FLEX S.R.L. (ITALY COMPANY WITH LIMITED LIABILITY)  
VIA DON G. LOCATELLI 35  
I-20040 RONCELLO, ITALY

FOR: METAL VALVES NOT BEING PARTS OF MACHINES AND PARTS AND FITTINGS THEREFOR, IN CLASS 6 (U.S. CLS. 2, 12, 13, 14, 23, 25 AND 50).

FOR: METAL VALVES BEING PARTS OF MACHINES AND PARTS AND FITTINGS THEREFOR, IN CLASS 7 (U.S. CLS. 13, 19, 21, 23, 31, 34 AND 35).

FOR: NON-METAL SEALING RINGS OF FILLED POLYTETRAFLUOROETHYLENE FOR USE IN VALVES, TANKS AND PIPE CONNECTIONS AND PIPE COUPLINGS, IN CLASS 17 (U.S. CLS. 1, 5, 12, 13, 35 AND 50).

THE MARK CONSISTS OF STANDARD CHARACTERS WITHOUT CLAIM TO ANY PARTICULAR FONT, STYLE, SIZE, OR COLOR.

PRIORITY DATE OF 10-31-2007 IS CLAIMED.

OWNER OF INTERNATIONAL REGISTRATION 0961531 DATED 3-13-2008, EXPIRES 3-13-2018.

THE MARK "K-FLEX" HAS NO MEANING IN A FOREIGN LANGUAGE.

SER. NO. 79-052,851, FILED 3-13-2008.

SKYE YOUNG, EXAMINING ATTORNEY



*David J. Kybas*

Director of the United States Patent and Trademark Office

# United States of America

United States Patent and Trademark Office

## OPERA UNITE

**Reg. No. 4,133,590**

**Registered May 1, 2012**

**Int. Cls.: 9, 35, 42 and 45**

**TRADEMARK**

**SERVICE MARK**

**PRINCIPAL REGISTER**

OPERA SOFTWARE ASA (NORWAY CORPORATION)  
WALDEMAR THRANES GATE 98  
N-0175 OSLO, NORWAY

FOR: COMPUTER PROGRAMS FOR NETWORK SEARCHING AND COMMUNICATION, ENCRYPTION SOFTWARE FOR USE IN CONNECTION WITH NETWORK QUERIES AND SEARCHES, NETWORK BROWSER SOFTWARE USED TO DISPLAY WEBSITES RETRIEVED FROM GLOBAL AND INTERNAL COMPUTER NETWORKS, WEB BROWSER SOFTWARE AND INTER-BROWSER COMMUNICATION PLATFORMS, NAMELY, SOFTWARE FOR FACILITATING INTER-BROWSER COMMUNICATIONS, IN CLASS 9 (U.S. CLS. 21, 23, 26, 36 AND 38).

FOR: ADVERTISING SERVICES, NAMELY, SYSTEMIZATION AND COMPILATION OF INFORMATION INTO COMPUTER DATABASES, COMPILATION OF COMPUTERIZED ADVERTISING INFORMATION FOR USE ON WEBSITES, IN CLASS 35 (U.S. CLS. 100, 101 AND 102).

FOR: COMPUTER PROGRAMMING; PROFESSIONAL AND TECHNICAL SUPPORT, NAMELY, TROUBLESHOOTING OF COMPUTER SOFTWARE PROBLEMS BY PROVIDING SUPPORT AND TECHNICAL ASSISTANCE IN THE FIELD OF BROWSER SOFTWARE, COMPONENTS AND ACCESSORIES, RENTAL OF SOFTWARE, COMPUTER SOFTWARE CONSULTANCY, INDIVIDUAL DESIGN AND DEVELOPMENT OF COMPUTER SOFTWARE, ONLINE COMPUTER SOFTWARE SYSTEMS, HOMEPAGES AND WEBSITES, WEB BROWSERS AND NETWORKS FOR OTHERS, IN CLASS 42 (U.S. CLS. 100 AND 101).

FOR: LICENSING OF SOFTWARE, IN CLASS 45 (U.S. CLS. 100 AND 101).

THE MARK CONSISTS OF STANDARD CHARACTERS WITHOUT CLAIM TO ANY PARTICULAR FONT, STYLE, SIZE, OR COLOR.

PRIORITY DATE OF 3-12-2008 IS CLAIMED.

OWNER OF INTERNATIONAL REGISTRATION 0990471 DATED 9-12-2008, EXPIRES 9-12-2018.

OWNER OF U.S. REG. NOS. 2,556,770, 2,718,373 AND OTHERS.



*David J. Kyjars*

Director of the United States Patent and Trademark Office

**Reg. No. 4,133,590** SER. NO. 79-064,274, FILED 9-12-2008.

CARRIE GENOVESE, EXAMINING ATTORNEY

# United States of America

United States Patent and Trademark Office

# NETOP

**Reg. No. 4,133,591**

**Registered May 1, 2012**

**Int. Cls.: 9, 16, 38 and 42**

**TRADEMARK**

**SERVICE MARK**

**PRINCIPAL REGISTER**

NETOP BUSINESS SOLUTIONS A/S (DENMARK CORPORATION)  
BREGNERØDVEJ 127  
DK-3460 BIRKERØD  
DENMARK

FOR: COMPUTER SOFTWARE FOR CLASSROOM MANAGEMENT OF STUDENTS AND COURSEWORK IN TEACHING WITH PERSONAL COMPUTERS, CLASSROOM ASSISTANCE FOR TEACHERS TEACHING WITH PERSONAL COMPUTERS, COMPUTER OPERATING PROGRAMS FOR APPLICATION CONTROL, ON-SCREEN ANNOTATIONS, SECURE REMOTE MANAGEMENT AND SUPPORT OF COMPUTER SOFTWARE WITHIN AND FOR USE WITH MOBILE AND EMBEDDED SYSTEMS, WEB-BASED REMOTE SUPPORT OF COMPUTER SOFTWARE, VIRUS PROTECTION, WEB FILTERING, PRINT MANAGEMENT, AND WEB COMMUNICATION; DOWNLOADABLE PUBLICATIONS IN THE NATURE OF MANUALS, ARTICLES, VIDEOS, AND TUTORIALS IN THE FIELD OF COMPUTER AND SOFTWARE SERVICES FOR CLASSROOM MANAGEMENT, CLASSROOM ASSISTANCE, APPLICATION CONTROL, ON-SCREEN ANNOTATIONS, SECURE REMOTE MANAGEMENT AND SUPPORT FOR USE WITH MOBILE AND EMBEDDED SYSTEMS, WEB-BASED REMOTE SUPPORT, VIRUS PROTECTION, WEB FILTERING, PRINT MANAGEMENT, AND WEB COMMUNICATION, IN CLASS 9 (U.S. CLS. 21, 23, 26, 36 AND 38).

FOR: PHYSICAL MANUALS FOR COMPUTER SOFTWARE SERVICES IN THE FIELD OF CLASSROOM MANAGEMENT, CLASSROOM ASSISTANCE, APPLICATION CONTROL, ON-SCREEN ANNOTATIONS, SECURE REMOTE MANAGEMENT AND SUPPORT FOR USE WITH MOBILE AND EMBEDDED SYSTEMS, WEB-BASED REMOTE SUPPORT, VIRUS PROTECTION, WEB FILTERING, PRINT MANAGEMENT, AND WEB COMMUNICATION, IN CLASS 16 (U.S. CLS. 2, 5, 22, 23, 29, 37, 38 AND 50).

FOR: TELECOMMUNICATIONS SERVICES, NAMELY, PROVIDING INTERFACES FOR WEBSITES WITH LIVE CHAT, AUDIO AND VIDEO, NAMELY, PROVIDING ON-LINE FACILITIES FOR REAL-TIME INTERACTION WITH OTHER COMPUTER USERS CONCERNING TOPICS OF GENERAL INTEREST, IN CLASS 38 (U.S. CLS. 100, 101 AND 104).

FOR: DESIGN, MAINTENANCE, AND UPDATING OF COMPUTER SOFTWARE FOR CLASSROOM MANAGEMENT, CLASSROOM ASSISTANCE, APPLICATION CONTROL, ON-SCREEN ANNOTATIONS, SECURE REMOTE MANAGEMENT AND SUPPORT FOR USE WITH MOBILE AND EMBEDDED SYSTEMS, WEB-BASED REMOTE SUPPORT,



*David J. Kyros*

Director of the United States Patent and Trademark Office

**Reg. No. 4,133,591** VIRUS PROTECTION, WEB FILTERING, PRINT MANAGEMENT, AND WEB COMMUNICATION, IN CLASS 42 (U.S. CLS. 100 AND 101).

THE MARK CONSISTS OF STANDARD CHARACTERS WITHOUT CLAIM TO ANY PARTICULAR FONT, STYLE, SIZE, OR COLOR.

PRIORITY DATE OF 12-3-2008 IS CLAIMED.

OWNER OF INTERNATIONAL REGISTRATION 1001409 DATED 12-22-2008, EXPIRES 12-22-2018.

OWNER OF U.S. REG. NOS. 1,636,004 AND 3,625,628.

SER. NO. 79-068,307, FILED 12-22-2008.

FONG HSU, EXAMINING ATTORNEY

# United States of America

United States Patent and Trademark Office

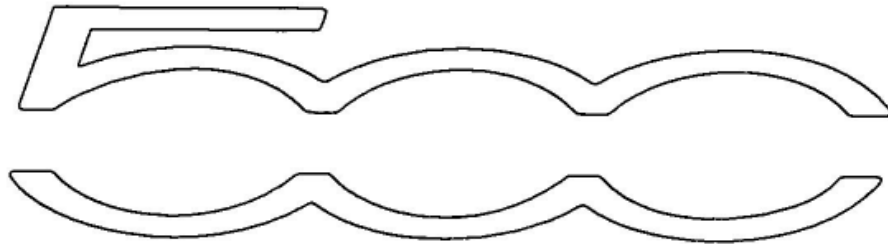

**Reg. No. 4,133,592**

**Registered May 1, 2012**

**Int. Cls.: 12 and 28**

**TRADEMARK**

**PRINCIPAL REGISTER**

FIAT GROUP AUTOMOBILES S.P.A. (ITALY SOCIÉTÉ PAR ACTIONS)  
CORSO GIOVANNI AGNELLI, 200  
I-10135 TORINO  
ITALY

FOR: VEHICLES, NAMELY, AUTOMOBILES, SPORTS CARS, MOTOR BUSES, OMNIBUSES, MOTOR HOMES, TRUCKS, TRAILERS; BICYCLES, MOTORCYCLES, APPARATUS FOR LOCOMOTION BY LAND, AIR AND WATER, NAMELY, AUTOMOBILES, AIRPLANES AND BOATS, IN CLASS 12 (U.S. CLS. 19, 21, 23, 31, 35 AND 44).

FOR: GAMES, NAMELY, BOARD GAMES, BEACH BALLS, TABLETOP GAMES, TOYS, NAMELY, TOY MODELS AND COLLECTION MODELS REPRODUCING AUTOMOBILES; GYMNAS TIC AND SPORTING ARTICLES NOT INCLUDED IN OTHER CLASSES, NAMELY, BALANCE BEAMS, SPORT BALLS, HURDLES, JAVELINS; DECORATIONS FOR CHRISTMAS TREES, IN CLASS 28 (U.S. CLS. 22, 23, 38 AND 50).

OWNER OF INTERNATIONAL REGISTRATION 0940985 DATED 8-27-2007, EXPIRES 8-27-2017.

SER. NO. 79-074,180, FILED 9-9-2009.

LINDA ORNDORFF, EXAMINING ATTORNEY



*David J. Kybas*

Director of the United States Patent and Trademark Office

# United States of America

United States Patent and Trademark Office

**born**  
BY TED BAKER

**Reg. No. 4,133,593**

**Registered May 1, 2012**

**Int. Cls.: 18 and 25**

**TRADEMARK**

**PRINCIPAL REGISTER**

NO ORDINARY DESIGNER LABEL LIMITED,; TRADING AS TED BAKER (UNITED KINGDOM LIMITED COMPANY)  
THE UGLY BROWN BUILDING,  
6A ST PANCRAS WAY; LONDON NW1 0TB  
UNITED KINGDOM

FOR: BAGS, HOLDALLS AND ARTICLES MADE OF LEATHER OR IMITATION LEATHER, NAMELY, LUGGAGE, TRAVEL BAGS, ALL PURPOSE CARRYING LEISURE BAGS, SPORTS BAGS, LEATHER CASES, RUCKSACKS, OVERNIGHT BAGS, HANDBAGS, REUSABLE SHOPPING BAGS, SHOULDER BAGS, TOILETRY AND COSMETIC BAGS BOTH SOLD EMPTY; TIE CASES; BRIEFCASES; DOCUMENT CASES; WALLETS; CREDIT CARD CASES; KEY CASES; PURSES; WALKING STICKS, UMBRELLAS AND PARASOLS EXCLUDING ALL LADIES' BAGS, NAMELY, HANDBAGS, PURSES, SHOULDER BAGS, OVERNIGHT BAGS, WALLETS, TOILETRY AND COSMETIC BAGS SOLD EMPTY, IN CLASS 18 (U.S. CLS. 1, 2, 3, 22 AND 41).

FOR: ARTICLES OF CLOTHING, NAMELY, SHIRTS, T-SHIRTS, SWEATSHIRTS, SWEATERS, TIES, BRACES, BELTS, CARDIGANS, JUMPERS, SCARVES, GLOVES, UNDERWEAR, BLOUSES, SKIRTS AND DRESSES, COATS, SUITS, JACKETS, TROUSERS, JEANS; ARTICLES OF HEADWEAR; HATS; CAPS, IN CLASS 25 (U.S. CLS. 22 AND 39).

OWNER OF U.S. REG. NOS. 2,644,551, 3,561,180 AND OTHERS.

PRIORITY DATE OF 2-12-2009 IS CLAIMED.

OWNER OF INTERNATIONAL REGISTRATION 1018103 DATED 7-8-2009, EXPIRES 7-8-2019.

THE NAME(S), PORTRAIT(S), AND/OR SIGNATURE(S) SHOWN IN THE MARK DOES NOT IDENTIFY A PARTICULAR LIVING INDIVIDUAL.

THE MARK CONSISTS OF STYLIZED WORDING "BORN BY TED BAKER".

SER. NO. 79-074,676, FILED 7-8-2009.

DOMINIC FATHY, EXAMINING ATTORNEY



*David J. Kyros*

Director of the United States Patent and Trademark Office

# United States of America

United States Patent and Trademark Office

# MOSO

**Reg. No. 4,133,594**

**Registered May 1, 2012**

**Int. Cl.: 2**

**TRADEMARK**

**PRINCIPAL REGISTER**

LYNETTE JUNE ACHESON; C/- TRADEMARK WORKS (AUSTRALIA INDIVIDUAL)  
LEVEL 29,  
CHIFLEY TOWER 2.; CHIFLEY SQUARE; SYDNEY  
AUSTRALIA

FOR: COATINGS FOR WOOD AS PAINTS; FIXATIVES IN SPRAY FORM FOR INDUSTRIAL  
USE IN THE NATURE OF AN ACRYLIC PROTECTIVE COATING; LACQUERS; LACQUER  
IN THE NATURE OF A SPRAY COATING; WOOD LACQUERS; NATURAL RESINS FOR  
COATING PURPOSES, IN CLASS 2 (U.S. CLS. 6, 11 AND 16).

THE MARK CONSISTS OF STANDARD CHARACTERS WITHOUT CLAIM TO ANY PAR-  
TICULAR FONT, STYLE, SIZE, OR COLOR.

OWNER OF INTERNATIONAL REGISTRATION 1028955 DATED 11-2-2009, EXPIRES 11-  
2-2019.

SER. NO. 79-078,988, FILED 11-2-2009.

MAYUR VAGHANI, EXAMINING ATTORNEY



*David J. Kyffers*

Director of the United States Patent and Trademark Office



# United States of America

United States Patent and Trademark Office

The logo features the word "BISON" in large, bold, blue capital letters. Above the letters "I" and "O" are grey, curved shapes resembling horns. To the right of "BISON" is the word "BIAL" in smaller, grey capital letters.

Factory of Tooling and Chucks

**Reg. No. 4,133,595**

**Registered May 1, 2012**

**Int. Cls.: 6, 7 and 8**

FABRYKA PRZYRZADÓW I UCHWYTÓW; "BISON-BIAL" S.A. (POLAND JOINT STOCK COMPANY)  
LAKOWA 3  
PL-15 950 BIALYSTOK  
POLAND

**TRADEMARK**

FOR: METAL REDUCER AND EXPANSION SLEEVES FOR WORKHOLDING, IN CLASS 6 (U.S. CLS. 2, 12, 13, 14, 23, 25 AND 50).

**PRINCIPAL REGISTER**

FOR: MACHINES AND MACHINE TOOLS AND PARTS THEREOF, NAMELY, MANUAL CHUCKS FOR LATHES AND MACHINE CLAMPING; TOOL HOLDERS FOR BORING, TOOL HOLDERS FOR TAPPING, TOOL HOLDERS FOR MACHINE TOOLS EQUIPPED WITH DIGITAL CONTROL; INDEXING DRIVE MACHINES; MILLING MACHINES; MILLING TOOLS, NAMELY, MILLING MACHINES CONTAINING TURNTABLES AND MILLING TAILSTOCKS; MILLING TOOLS, NAMELY, MANDRELS, HOLDERS AND GRINDING SLEEVES FOR SECURING MACHINING TOOLS; MACHINE PARTS, NAMELY, HYDRAULIC AND PNEUMATIC CYLINDERS; PNEUMATIC PRESSES; DRILL CHUCKS FOR POWER DRILLS; AND MACHINE COUPLING AND TRANSMISSION COMPONENTS NOT FOR USE IN COMBUSTION ENGINES OR LAND VEHICLES, IN CLASS 7 (U.S. CLS. 13, 19, 21, 23, 31, 34 AND 35).

FOR: VICES; HAND TOOLS, NAMELY, LATHE CHUCKS SECURED MANUALLY, AND HAND-OPERATED PRESS MACHINES FOR WORKHOLDING, IN CLASS 8 (U.S. CLS. 23, 28 AND 44).



NO CLAIM IS MADE TO THE EXCLUSIVE RIGHT TO USE "FACTORY OF TOOLING AND CHUCKS", APART FROM THE MARK AS SHOWN.

PRIORITY DATE OF 5-21-2009 IS CLAIMED.

OWNER OF INTERNATIONAL REGISTRATION 1029537 DATED 9-1-2009, EXPIRES 9-1-2019.

THE COLOR(S) BLUE AND GREY IS/ARE CLAIMED AS A FEATURE OF THE MARK.

THE WORD "BISON" IN BLUE; THE GRAPHIC ELEMENTS IN GREY; THE WORDS "BIAL" AND "FACTORY OF TOOLING AND CHUCKS" IN GREY.

*David J. Kyros*

Director of the United States Patent and Trademark Office

**Reg. No. 4,133,595** STYLIZED INSCRIPTION "BISON BIAL FACTORY OF TOOLING AND CHUCKS", WHERE THE WORD "BISON" IS BLUE, WHILE THE REMAINING WORD ELEMENTS, MEANING THE WORD "BIAL" PLACED VERTICALLY NEXT TO THE LETTER "N" AND WORDS "FACTORY OF TOOLING AND CHUCKS" PLACED BENEATH THE WORD "BISON", TOGETHER WITH GRAPHIC ELEMENTS IN THE SHAPE OF HORNS, ONE OF THEM REPRESENTING A DOT ABOVE THE LETTER "I" AND THE OTHER PLACED ON A TOP OF THE WORD "BIAL", ARE ALL GREY.

SER. NO. 79-079,171, FILED 9-1-2009.

CHARLES L. JENKINS, EXAMINING ATTORNEY

# United States of America

United States Patent and Trademark Office

**SEA HAWK** 

**Reg. No. 4,133,596**

**Registered May 1, 2012**

**Int. Cl.: 12**

ZODIAC INTERNATIONAL (FRANCE SOCIÉTÉ PAR ACTIONS SIMPLIFIÉE  
UNIPERSONNELLE)  
1, QUAI DE GRENELLE  
F-75015 PARIS  
FRANCE

**TRADEMARK**

**PRINCIPAL REGISTER**

FOR: BOATS, NAMELY, INFLATABLE PLEASURE BOATS, SHIPS' HULLS, BOAT HOOKS,  
STEERING GEARS FOR SHIPS, DISENGAGING GEAR FOR BOATS, SLIDE OUT RAMPS  
BEING PART OF A BOAT, SCREW-PROPELLERS FOR BOATS, IN CLASS 12 (U.S. CLS. 19,  
21, 23, 31, 35 AND 44).

THE MARK CONSISTS OF THE STYLIZED WORDING "SEA HAWK" WITH A DESIGN OF  
A HAWK APPEARING TO THE RIGHT OF THE WORDING.

OWNER OF INTERNATIONAL REGISTRATION 1036864 DATED 3-12-2010, EXPIRES 3-12-  
2020.

SER. NO. 79-081,892, FILED 3-12-2010.

CIMMERIAN COLEMAN, EXAMINING ATTORNEY



*David J. Kyffers*

Director of the United States Patent and Trademark Office

# United States of America

United States Patent and Trademark Office



**Reg. No. 4,133,597**

**Registered May 1, 2012**

**Int. Cls.: 1, 4, 6, 7, 9, 11,  
12, 17, 19, 20, 35, 36, 37,  
38, 39, 40, 41, 42 and 44**

THYSSENKRUPP AG (FED REP GERMANY AG)  
THYSSENKRUPP ALLEE 1  
45143 ESSEN  
FED REP GERMANY AND

THYSSENKRUPP AG (FED REP GERMANY AG)  
ALTENDORFER STRASSE 120  
45143 ESSEN  
FED REP GERMANY

**TRADEMARK**

**SERVICE MARK**

**PRINCIPAL REGISTER**

FOR: CHEMICALS FOR INDUSTRIAL PURPOSES; CHEMICALS FOR USE IN THE PRODUCTION OF METALS AND THEIR ALLOYS; FERTILIZER; FOUNDRY SANDS, FOUNDRY MOULDING PREPARATIONS, FOUNDRY BINDING SUBSTANCES; ADHESIVES USED IN INDUSTRY; TOLUENE, IN CLASS 1 (U.S. CLS. 1, 5, 6, 10, 26 AND 46).

FOR: BENZOL, COAL AND COKE FUELS, IN CLASS 4 (U.S. CLS. 1, 6 AND 15).

FOR: METAL ORES; COMMON METALS AND THEIR ALLOYS, NAMELY, PRODUCTS MADE OF THE FOREMENTIONED METALS AND ALLOYS INCLUDED IN THIS CLASS, NAMELY, BANDS OF METAL, METAL LATCH BARS, BEAMS, BILLETS, METAL CABLE WIRE, CHAINS, COATED METAL WIRES, CASTINGS, STEEL IN THE FORM OF COILS, COIN BANKS, COMPOSITE WIRES, CORD WIRES, PIPE AND HOSE FITTINGS AND FLANGES, FLEXIBLE PLATES FOR USE IN CONNECTION WITH MANUFACTURING AND FOR TRANSPORTATION OF PERSONNEL, FINISHED GOODS, AND FREIGHT, FOILS, FORGINGS, INGOTS OF COMMON METAL, JOISTS, METAL DOOR KICK PLATES, DECORATIVE METAL PROFILES FOR USE IN FURTHER MANUFACTURE, RAILS, METAL SEALING AND GASKET RINGS, METAL WELDING RODS, ROPES, DOOR PANELS, STEEL PLATES AND SHEETS, SLABS, SPRINGS, METAL BINDING STRIPS USED ON PACKING, WELDING FILLER, NAMELY, METAL SOLDER MATERIAL, WELDING WIRES, METAL CABLE WIRES; CAST METAL PARTS, NAMELY, ANGLES, BOLTS, CLAMPS, PIPE AND HOSE FITTINGS, FLANGES, HOOKS, NAILS, NUTS PINS, PLUMBING NAILS, PROFILES, SCREW NAILS SCREWS, SHAPED PINS, AND WIRE LOOPS; METAL SOLDER MATERIAL, NAMELY, SOLDER WIRE, SOLDER SLAT MADE FROM METAL; GOODS OF COMMON METAL INCLUDED IN THIS CLASS, NAMELY, FITTINGS, CONTAINERS, ROOF PANELS, FACADE PANELS, SPRINGS, WINDOWS, WINDOW SILLS, WINDOW FRAMES, FORGING DIES, WIRE CLOTH, GRIDS, HOOKS, CRAMPS, RUNNING RAILS, NAILS, PROFILES, SPATIAL TRUSSED STRUCTURES, RINGS, LOOPS, LOCKS, SCREWS, SILOS, PINS,



*David J. Kyros*

Director of the United States Patent and Trademark Office

**Reg. No. 4,133,597** FRAMES FOR DOORS AND GATES, DOORS AND GATES, SUPPORTING FRAMEWORK, STAIRS, DOOR PANELS, DOOR HANDLES, PARTS FOR SCREW FITTINGS, WALL PANELS, ANGLES, FENCES AND PARTS THEREOF, ACCESSORIES FOR THE ABOVE MENTIONED GOODS INCLUDED IN THIS CLASS; BUILDING MATERIALS, NAMELY, PREFABRICATED MEMBERS IN SANDWICH TECHNIQUE PREDOMINANTLY MADE OF SHEET METAL FOR INDUSTRIAL, HALL AND DOMESTIC CONSTRUCTION; LOCKSMITH GOODS AND IRONMONGERY, NAMELY, ANGLES, BOLTS, CLAMPS, PIPE AND HOSE FITTINGS, FLANGES, HOOKS, NAILS, NUTS, PINS, PLUMBING NAILS, PROFILES, SCREW NAILS, SCREWS, SHAPED PINS, AND WIRE LOOPS; PIPES AND TUBES OF METAL; CABLE AND WIRES OF COMMON METAL, NON ELECTRIC; TRANSPORTABLE BUILDINGS OF METAL; METAL BUILDING MATERIALS, NAMELY, METAL BUILDING MATERIALS, NAMELY, ANCHOR DRILLING PILES, ANCHORS, ANGLES, ARMOURING BLINDS, CANAL BRACES, CANAL SHEETING, CASINGS, CEILING- AND ROOF-CONSTRUCTION-ELEMENTS IN THE NATURE OF SUPPORTS, BEAMS, PANELS AND SHORES, CEILING- AND ROOF-PANELS, CHAMBER PLATES, COILS AND SLITTED STRIPS, COVERS, CRAMP, EDGE CONNECTORS, FLAT PROFILES, GUTTER AND DRAIN TUBES, HOOKS, LIGHT PROFILES, NAILS, PINS, PLATES, PLUMBING NAILS, PRESS PILES, PROFILES, RAM PILES, RAM PROFILES, RAM TUBES, REVETMENTS, SCREW NAILS, SCREWS, SEALINGS, SHAPED PINS, SHEET PILES, SHEETING PLATES, SHEETINGS, SHEETS, SHIELDS, STRIPS, TUBE CEILINGS, TUBES, WAINSCOTS, WALL ANCHORS, WALL COMBINATIONS MADE OF RAM PROFILES, WALL-PANELS, WIRE, WIRE LOOPS; SCAFFOLDINGS INCLUDED IN THIS CLASS AND SHEATHING ELEMENTS AND PARTS THEREOF MADE OF METAL; RAILROAD TRACKS AND RAILROAD POINTS MADE OF METAL; RAILWAY MATERIALS OF METAL; METAL DERAILER RAILROAD TRACKS, IN CLASS 6 (U.S. CLS. 2, 12, 13, 14, 23, 25 AND 50).

FOR: DRIVES FOR MACHINES; PRIMARY SHAFTS, NOT FOR VEHICLES; CONSTRUCTION MACHINERY, NAMELY, BULLDOZERS, STEAM SHOVELS, DUMP TRUCKS, GRADERS, EXCAVATORS, AND STEAM ROLLERS; MOTOR DRIVEN APPARATUS AND MOTOR DRIVEN INSTALLATIONS, NAMELY, APPLICANT MUST SPECIFY THE COMMON COMMERCIAL NAME FOR THE GOODS USING CLASS 07 GOODS ONLY FOR THE PRODUCTION OF FABRICATED MATERIALS OR PRODUCTS FOR THE PHARMACEUTICAL INDUSTRY AND FOOD INDUSTRY, CHEMICAL INDUSTRY, FERTILIZER INDUSTRY, SYNTHETIC FIBRES INDUSTRY AND COSMETIC INDUSTRY; MECHANICAL SYNTHESIS GAS PRODUCERS, NAMELY, AMMONIUM-EXTRACTION UNITS, INDUSTRIAL GAS GENERATORS, METHANOL-REACTORS, REACTORS FOR THE PRODUCTION OF SYNTHESIS GAS EXCEPT GAS PRODUCERS FOR VEHICLES; MACHINES FOR THE FOOD-STUFF INDUSTRY, NAMELY, MACHINES FOR OILSEED PROCESSING, FLAKING MILLS, FLUTED BREAKER ROLLING MILLS, CONDITIONERS, SCREW PRESSES, EXPPELLERS, AND CAROUSEL OR SLIDING BED EXTRACTORS; INSTALLATIONS FOR THE MANUFACTURE OF CHEMICAL PRODUCTS CONSISTING OF STEAM REFORMING MACHINES FOR THE CHEMICAL INDUSTRY; INSTALLATIONS FOR THE MANUFACTURE OF CHEMICAL PRODUCTS, NAMELY, FERTILIZER DISTRIBUTORS; APPARATUS FOR THE TREATMENT OF GASES, NAMELY, COMPRESSORS; GAS COMPRESSORS; PRESSURE INTENSIFIERS FOR THE TREATMENT OF FLUIDS; MACHINES FOR TREATING OF FLUIDS, NAMELY, PRESSURE INTENSIFIERS; MACHINES FOR THE TEXTILE INDUSTRY, NAMELY, TEXTILE DYING MACHINES; ELEVATORS INCLUDED IN THIS CLASS, NAMELY, MECHANICAL ESCALATORS AND MOVING STAIRCASES, PLATFORM ELEVATORS, LIFTING PLATFORMS FOR PEOPLE, PASSENGER BRIDGES, MOVING STAIRWAYS, STAIRWAY LIFTS; PARTS OF ELEVATORS, ESCALATORS, MOVING SIDEWALKS, PLATFORM ELEVATORS, LIFTING PLATFORMS FOR PEOPLE, PASSENGER BRIDGES, MOVING STAIRWAYS, STAIRWAY LIFTS; FLUIDIZER, NAMELY, APPARATUS FOR FLUIDIZING OF BULK MATERIAL BY GAS STREAMS TO ENHANCE ITS FLOW CHARACTERISTICS; ELECTRIC GENERATORS FOR DRIVING MACHINES; MACHINES FOR WINNING OF ENERGY, NAMELY, POWER STATIONS, USING WIND, WATER, GAS, OR STEAM; WIND, WATER, GAS OR STEAM POWERED GENERATOR FOR ELECTRICITY; INDUSTRIAL ROBOTS; METAL, WOOD, PLASTICS WORKING MACHINES FOR SHAPING AND MANUFACTURING PARTS MADE OF METAL, WOOD, AND PLASTICS; MACHINE

**Reg. No. 4,133,597** TOOLS, NAMELY, AUTOMATIC PRECISION ROTARY TRANSFER MACHINES FOR METAL PIECES, COMBINED BORERS AND GRINDERS, CONNECTING ROD ALIGNERS, CYLINDER AND CYLINDER BORING MACHINES, GAS OPERATED WELDING MACHINES, GRINDERS, HONING MACHINES, HORIZONTAL AND VERTICAL BORING MILLS, HYDRAULIC PRESSES FOR THE ASSEMBLY AND DISASSEMBLY OF CHAINS, LAPPING MACHINES AND TOOLS, LASER WELDING MACHINES AND TOOLS, LATHES, MACHINE TOOLS FOR BORING CYLINDER BLOCKS AND BEARINGS THEREFORE, MACHINES FOR BALANCING CRANKSHAFTS, MACHINES FOR CUTTING SHEETS OF PLASTIC, WOOD, OR METAL MATERIAL, MACHINES FOR DEEP DRAWING OF PLASTIC, WOOD, OR METAL MATERIAL, MACHINES FOR EDGE-FORMING OF PLASTIC, WOOD, OR METAL MATERIAL, MACHINES FOR HYDRO-FORMING OF PLASTIC, WOOD, OR METAL MATERIAL, MACHINES FOR PUNCHING SHEETS OF PLASTIC, WOOD, OR METAL MATERIAL, MACHINES FOR TURNING OVER SHEETS OF PLASTIC, WOOD, OR METAL MATERIAL, MACHINES FOR WINDING TRACK SHOES OF TRACTORS, MACHINING CENTERS AND TRANSFER LINES FOR PLASTIC, METAL, OR WOOD WORKING, MILLING MACHINES, MULTI-STATION MACHINES FOR THE MACHINING OF WORK PIECES OF COMMON METAL OR PLASTIC, PISTON RING FILLERS, PRESSES, VALVE REFACEERS, VALVE SEAT CUTTERS, VALVE SEAT INSERTION TOOLS, VERTICAL TURNING MACHINES FOR THE CUTTING AND FORMING OF METALS AND PLASTICS; DRILLING MACHINES AND PARTS THEREFORE; MACHINES FOR POSITIONING, ADJUSTING AND HOLDING OF WORK PIECES, NAMELY, CLAMPS AND BARS; CONVEYORS FOR THE FEEDING OF WORK PIECES TO WORK PIECE PROCESSING AND ASSEMBLING MACHINES; CUSTOM-MADE MACHINES FOR USE IN LOADING AND STACKING IN THE FIELD OF MANUFACTURING, MACHINE DRIVEN LIFTING DEVICES AND LIFTING APPARATUS, NAMELY, JACKS; MACHINES FOR SECURING, WINNING, PREPARING AND DEMOLISHING OF MINERALS, EARTH, ROCK, EXCAVATED MATERIAL, USED MATERIALS, ORES, BOULDERS AND BRICKWORK, NAMELY, BULLDOZERS, STEAM SHOVELS, DUMP TRUCKS, GRADERS, EXCAVATORS, AND STEAM ROLLERS; MACHINES FOR LOADING BULK AND UNIT MATERIAL, NAMELY, CONVEYORS; MACHINES FOR THE PRODUCTION OF MORTAR AND CONCRETE AND FOR THE PRODUCTION OF ASSEMBLY UNITS MADE OF THESE MATERIALS, NAMELY, CONVEYORS, MIXERS, AND CONTAINERS, FOR MIXING MATERIALS; EARTH MOVING MACHINES, NAMELY, EXCAVATORS; CONVEYORS; MACHINES FOR THE TREATMENT OF METAL MELT, NAMELY, MACHINES FOR HOMOGENIZING, REFINING, AND HOMOGENEOUSLY COOLING MELTED METAL AND FOR ALLOYING METAL MELTS; MACHINES FOR THE PRODUCTION OF COKE, NAMELY, MIXERS, CONVEYORS, AND FURNACES; FLAME CHIPPING INSTALLATIONS, NAMELY, MACHINES FOR DESEAMING AND SCARFING METAL; GAS-POWERED CUTTING TORCHES; MIXING MACHINES; INDUSTRIAL MACHINE MILLS, NAMELY, CAKE-FODDER CRUSHING MACHINES; INDUSTRIAL MACHINE PRESSES; ELECTRICAL AND CENTRIFUGAL PUMPS, NAMELY, BURSTING TESTS AND PRESSURE TEST PUMPS, DOSING PUMPS, GROUND WATER PUMPS, INJECTION PUMPS, POSITIVE DISPLACEMENT PUMPS; ELECTRIC PRESSURE GENERATORS FOR WATER-JET CUTTING PLANTS AND PRESSING PLANTS, ELECTRIC PUMPS FOR PRESSING RAMPROFILES, RAM PILES, RAM TUBES AND SHEET PILES; ELECTRICAL STIRRING MACHINES, NAMELY, MACHINES USED TO MIX AND COMBINE RAW MATERIALS DURING THE MANUFACTURING PROCESS; MOTORS AND PARTS THEREOF NOT FOR LAND VEHICLES; TURBINES AND THEIR PARTS NOT FOR LAND VEHICLES; GEAR BOXES OTHER THAN FOR LAND VEHICLES AND PARTS THEREOF; DRIVES FOR DOORS, NAMELY, HYDRAULIC DRIVES FOR OPENING AND CLOSING DOORS, ELECTRIC DRIVES FOR OPENING AND CLOSING DOORS, MECHANICAL DRIVES FOR OPENING AND CLOSING DOORS, PNEUMATIC DRIVES FOR OPENING AND CLOSING DOORS, TOOLS AS PARTS OF MACHINES, NAMELY, TOOLS FOR SETTING UP AND MAINTAINING INDIVIDUAL MACHINES NAMELY, WRENCHES, PLIERS, SCREW DRIVERS, AND HAMMERS; PISTON RODS AS PARTS OF MACHINE; BEARINGS AS PARTS OF MACHINES; CENTRIFUGES AS PART OF MACHINES; RAILWAY TRACK MACHINERY, NAMELY, MACHINES FOR MANUFACTURING RAILWAY TRACK, MACHINES FOR LAYING RAILWAY TRACK; TUMBLING FOR MACHINES, NAMELY, ROTATING DRUMS AND CONTAINERS FOR FINISHING AND POLISHING RAW METALS; ELECTRICAL STARTERS

**Reg. No. 4,133,597** FOR ENGINES; ELECTRICAL COLD WEATHER STARTING DEVICES, NAMELY, REMOTE ELECTRICAL STARTERS FOR ENGINES; MOTORS FOR SHIP AND AIRCRAFTS AND PARTS THEREOF; MACHINE PARTS, NAMELY, BEARINGS, BEARINGS AS PARTS OF ENGINES FOR SHIPS, IN CLASS 7 (U.S. CLS. 13, 19, 21, 23, 31, 34 AND 35).

FOR: SIMULATOR FOR NAVIGATING AND CONTROL OF VEHICLES FOR CIVIL AND MILITARY USE; APPARATUS AND INSTRUMENTS FOR CONDUCTING, SWITCHING, TRANSFORMING, ACCUMULATING, REGULATING AND CONTROLLING OF ELECTRICITY; APPARATUS FOR RECORDING, TRANSMITTING, PROCESSING AND REPRODUCING OF SOUND, IMAGES AND DATA; DATA CARRIERS; DATA PROCESSING APPARATUS AND COMPUTERS; ELECTRIC LASER AND WELDING APPARATUS; ELECTRODES INCLUDED IN THIS CLASS, ELECTRICAL CABLES; FIRE EXTINGUISHING APPARATUS; CHECKING APPARATUS AND INSTRUMENTS, NAMELY, ELECTRICAL APPARATUS FOR MONITORING ELEVATORS, ESCALATORS, PASSENGER CONVEYORS, MOVING WALKS, INCLINED PLATFORMS, VERTICAL PLATFORMS, STAIRWAY LIFTS, BOARDING BRIDGES; MAGNETS; MEASURING APPARATUS AND INSTRUMENTS, NAMELY, LEAK TESTERS, MEASURING APPARATUS FOR DETECTING THE POLARIZATION OF MAGNETS, DIAGNOSTIC APPARATUS FOR EVALUATING / DETERMINING ERRORS DURING OPERATION OF ELEVATORS, ESCALATORS, PASSENGER CONVEYORS, MOVING WALKS, INCLINED PLATFORMS, VERTICAL PLATFORMS, STAIRWAY LIFTS, BOARDING BRIDGES; PHOTOVOLTAIC ELEMENTS, NAMELY, SOLAR MODULES FOR POWER GENERATING; LIFE-SAVING APPARATUS, NAMELY, LIFTS AND HOISTS FOR REMOVAL OF INDIVIDUALS FROM HAZARDOUS SITUATIONS; SONAR, IN CLASS 9 (U.S. CLS. 21, 23, 26, 36 AND 38).

FOR: APPARATUS AND MACHINES FOR STEAM GENERATING, NAMELY, ACCUMULATORS AND GENERATORS; APPARATUS FOR DISTILLING; HEATING AND COOLING INSTALLATIONS, APPARATUS AND MACHINES, NAMELY, AIR CONDITIONERS, AIR CONDITIONING UNITS, AIR FILTERS, AIR PURIFIERS, BATTERY WARMERS, CAR INTERIOR WARMERS, COOLERS, ENGINE HEATERS, ENGINE WARMING UNITS, FUEL WARMERS, HEAT EXCHANGERS, HEATERS FOR ENGINE OIL, RADIATOR HOSE HEATERS, VEHICLE OIL PAN HEATERS, VEHICLE TANK HEATERS, VENTILATORS, ALL FOR COMMERCIAL, DOMESTIC AND INDUSTRIAL USE; DRYING INSTALLATIONS AND APPARATUS, NAMELY, INDUSTRIAL DRYERS FOR DEHUMIDIFYING; MACHINES FOR THE THERMAL TREATMENT OF WASTE MATERIALS; FURNACES FOR INDUSTRIAL USE; SOLAR COLLECTORS, IN CLASS 11 (U.S. CLS. 13, 21, 23, 31 AND 34).

FOR: VEHICLES AND APPARATUS FOR LOCOMOTION BY LAND, WATER OR AIR; PARTS OF VEHICLES AND APPARATUS FOR LOCOMOTION BY LAND, WATER OR AIR INCLUDED IN THIS CLASS; CAR BODIES MADE OF METAL FOR VEHICLES AND APPARATUS FOR LOCOMOTION BY LAND, WATER OR AIR; MOTORS OF LAND VEHICLES; PARTS OF AIRCRAFT ENGINE, IN CLASS 12 (U.S. CLS. 19, 21, 23, 31, 35 AND 44).

FOR: PLASTIC PRODUCTS, NAMELY, NON-METAL TUBING, TUBING COUPLINGS FOR JOINING AND TERMINATING PIPES; PLASTIC SEMI FINISHED PRODUCTS ESPECIALLY PLASTIC PREFORMED PARTS, NAMELY, BARS, BEAMS, BILLETS, BLOCKS, CASTINGS, CHAINS, CIRCLES, EXTRUDED PARTS, FITTINGS AND FLANGES, FOILS, JOISTS, LIGHT CUP GLASS, PANELS, PELLETS, PLATES, PROFILES, RAILS, RINGS, RODS, ROPES, SANDWICH PANELS, SECTIONS, SHEETS, SHIELDS, SLABS, SPRINGS, STRANDS, STRIPS, TUBES, TUBULARS, WAINSCOTS, ALL AFOREMENTIONED GOODS FOR USE IN MANUFACTURING, BUILDING AND GARDENING; STOPPING, PACKING AND INSULATING MATERIALS, NAMELY, NON METAL MATERIALS FOR PACKING, NONMETAL STOPPING AND INSULATING WALL-, CEILING- AND ROOF-CONSTRUCTION-ELEMENTS, NON METAL GASKETS FOR USE IN DOORS, WINDOWS, COOLING AND AIR CONDITIONING ROOMS; PLASTIC FOILS OTHER THAN FOR PACKAGING; ADHESIVE BANDS, NAMELY, ADHESIVE PACKING TAPE FOR INDUSTRIAL OR COMMERCIAL USE; FILLERS FOR WELDING OF PLASTICS AS WIRE, POWDER OR GRANULATE INCLUDED IN THIS CLASS; GASKETS FOR WINDOWS, IN CLASS 17 (U.S. CLS. 1, 5, 12, 13, 35 AND 50).

**Reg. No. 4,133,597** FOR: ASPHALT, PITCH AND BITUMEN; BUILDING MATERIALS, NAMELY, WALL, HARDWOOD, DECKING, WOOD, PARTICLE BOARDS AND OTHER NON-METAL BUILDING MATERIAL, NAMELY, ANGLES, BLOCKS, BOLTS, CEILING- AND ROOF-CONSTRUCTION-ELEMENTS, NAMELY, IN THE NATURE OF SUPPORTS, BEAMS, PANELS AND SHORES, CRAMP, DOORS, FASTENERS FOR FASTENING RAILS, FITTINGS, FRAMEWORKS, GATES, HOOKS, LIGHT CUP GLASS, NAILS, PANELS, PINS, PLATES, PLUMBING NAILS, PROFILES, RAIL CLIPS, RODS, SCREW NAILS, SCREWS, SHAPED PINS, SHIELDS, SPRING WASHERS, TRUSSED STRUCTURES, TUBES, WAINSCOTS, WALL-, CEILING- AND ROOF-PANELS, WALLS FOR BUILDING, WINDOWS, WIRE; SCAFFOLDINGS AND CONSTRUCTION FORMS AND PARTS THEREOF INCLUDED IN THIS CLASS, NOT MADE OF METAL; WINDOWS, WINDOWSILLS AND WINDOW FRAMES NOT MADE OF METAL; DOOR AND GATE FRAMINGS, NOT MADE OF METAL; PROFILES FOR WINDOWS, DOORS, SHUTTERS AND FACADES, NOT MADE OF METAL; ROOF, WALL AND FACADES PANELS NOT MADE OF METAL, DOOR PANELS NOT OF METAL; DOOR HANDLE NOT OF METAL; LIGHT WELLS NOT MADE OF METAL, NAMELY, CONTAINERS THAT ENABLE A LIGHTING FIXTURE TO BE RECESSED; NON METAL DRAINAGE BOXES; REFRACTORY RAW MATERIALS NOT MADE OF METAL, NAMELY, REFRACTORY BLOCKS, REFRACTORY BRICKS, REFRACTORY CAST ABLE MIXES, REFRACTORY FURNACE LININGS, REFRACTORY MORTARS, RAW MATERIALS FOR THE PRODUCTION OF BLOCKS, REFRACTORY SHAPES; RAILROAD TIES NOT MADE OF METAL; DOORS AND GATES NOT OF METAL; TRANSPORTABLE BUILDINGS NOT OF METAL; STAIRS NOT MADE OF METAL; PREFABRICATED SIDE RAILS FOR BALCONIES NOT OF METAL; FENCES AND PARTS THEREOF NOT MADE OF METAL; MASONRY TANKS MADE OUT OF BRICK WORK FOR INDUSTRIAL PURPOSES; TUBES AND PIPES MADE FROM PLASTIC; SECTIONAL STRIPS MADE OF PLASTIC FOR BUILDING FUNCTION; PIPE FITTINGS FOR USE WITH RIGID PIPES NOT OF METAL, IN CLASS 19 (U.S. CLS. 1, 12, 33 AND 50).

FOR: PLASTIC PRODUCTS IN THE NATURE OF NON-METAL FASTENERS, NAMELY CRAMPS, HOOKS, NAILS, NUTS, PINS, SCREWS, SCREW NAILS, WIRES; DOOR HANDLES NOT OF METAL AND NOT OF PORCELAIN; PACKAGING CONTAINERS NOT MADE OF METAL; TANKS NOT MADE OF METAL AND NOT MADE OF BRICK WORK FOR HOLDING LIQUIDS AND PIECES USED DURING MANUFACTURING; SIGNBOARDS OF PLASTICS; ANGLES, CRAMPS, HOOKS, NAILS, NUTS, PINS, SCREWS, SCREW NAILS, BRACES AND WIRE NOT MADE OF METAL; NON METAL BUILDING MATERIALS IN THE NATURE OF NON-METAL FASTENERS, NAMELY, ANGLES, BOLTS, CRAMP, FASTENERS FOR FASTENING RAILS, HOOKS, NAILS, PINS, PLUMBING NAILS, PROFILES, RAIL CLIPS, SCREW NAILS, SCREWS, SHAPED PINS AND SPRING WASHERS; TABLES; PACKAGING CONTAINERS NOT MADE OF METAL; STORAGE TANKS NOT MADE OF METAL AND NOT MADE OF BRICK WORK; SIGNBOARDS OF PLASTICS; PLASTIC FASTENING PRODUCTS, NAMELY, ANGLES, CRAMPS, HOOKS, NAILS, NUTS, PINS, PROFILES, SCREWS, IN CLASS 20 (U.S. CLS. 2, 13, 22, 25, 32 AND 50).

FOR: PERSONNEL MANAGEMENT CONSULTANCY; TEMPORARY EMPLOYEE ASSIGNMENT; BUSINESS MANAGEMENT CONSULTANCY AND ORGANIZATION CONSULTANCY; ANALYSIS OF BUSINESS PROCESSES; BUSINESS MANAGEMENT; BUSINESS ADMINISTRATION; INVESTIGATIONS INTO BUSINESS MATTERS; BOOKKEEPING; OFFICE FUNCTIONS, NAMELY, PHOTOCOPYING AND TELEPHONE ANSWERING SERVICES; STATISTIC SERVICES, NAMELY, PREPARING OF STATISTICS; NEGOTIATING AND CONCLUDING BUSINESS FOR OTHERS; HOLDING AUCTIONS; MARKETING; ADVERTISING; MARKET RESEARCH AND ANALYSIS; OPINION POLLING; ORGANIZATION OF FAIRS AND EXHIBITIONS FOR INDUSTRIAL OR ADVERTISING PURPOSES; RENTAL OF OFFICE MACHINES AND EQUIPMENT; SERVICES OF A MEDIA CONSULTANT, NAMELY, ORGANIZATIONAL CONSULTANCY REGARDING PRESSWORK AND PUBLIC RELATIONS, IN CLASS 35 (U.S. CLS. 100, 101 AND 102).

FOR: FINANCIAL AFFAIRS, NAMELY, FINANCIAL ANALYSIS AND CONSULTATION, FINANCIAL MANAGEMENT, FINANCIAL PLANNING; FINANCIAL SPONSORING,



**Reg. No. 4,133,597** NAMELY, FINANCIAL SPONSORSHIP OF SPORTS ACTIVITIES, SPORTSMAN AND - WOMEN; REAL ESTATE AFFAIRS, NAMELY, FACILITY MANAGEMENT, REAL ESTATE AGENCIES, REAL ESTATE APPRAISAL, REAL ESTATE ACQUISITION SERVICES, REAL ESTATE BROKERAGE, REAL ESTATE INVESTMENT, REAL ESTATE MANAGEMENT, REAL ESTATE PROCUREMENT FOR OTHERS, REAL ESTATE SYNDICATION, REAL ESTATE TRUSTEE SERVICES; REAL ESTATE LEASING SERVICES, NAMELY, THE LISTING AND LEASING OF REAL ESTATE; INSURANCE, NAMELY, INSURANCE ADMINISTRATION, SERVICES OF AN INSURANCE AGENCY, IN CLASS 36 (U.S. CLS. 100, 101 AND 102).

FOR: BUILDING CONSTRUCTION; RENTAL OF SCAFFOLDS, CONSTRUCTION FORMS, STAGES AND CONSTRUCTION MACHINES; PAINTING SERVICES; RENTAL OF BUILDING MACHINES; RENTAL OF INDUSTRIAL MACHINES INCLUDED IN THIS CLASS; FACILITY MANAGEMENT IN THE FIELD OF TECHNICAL INSTALLATIONS, NAMELY, REPAIR, SERVICES AND REPAIR OF REAL ESTATE AS WELL AS THE RELATED PUBLIC UTILITY USE; CLEANING OF BUILDINGS; INSTALLATION, MAINTENANCE AND REPAIR OF ELEVATORS, ESCALATORS, PLATFORM ELEVATOR, MOVING SIDEWALKS, LIFTING PLATFORMS FOR PEOPLE, PASSENGER BRIDGES, MOVING STAIRWAYS, STAIRWAY LIFTS; INSTALLATION, MAINTENANCE AND REPAIR OF EQUIPMENT AND APPARATUS FOR USE IN MINING, OPEN PIT MINING, QUARRYING, WORKING ON ORES AND COAL, DESTRUCTION AND ROAD BUILDING; INSTALLATION, MAINTENANCE AND REPAIR OF BUILDINGS; INSTALLATION, MAINTENANCE AND REPAIR OF INDUSTRIAL MACHINERY AND MANUFACTURING PLANTS; INSTALLATION, MAINTENANCE AND REPAIR OF TELECOMMUNICATIONS EQUIPMENT; INSTALLATION, MAINTENANCE AND REPAIR OF MODULES OR SYSTEMS FOR DRIVING AND RUNNING OF VEHICLES AND APPARATUS FOR LOCOMOTION BY LAND, WATER OR AIR; INSTALLATION, MAINTENANCE AND REPAIR OF VEHICLES AND APPARATUS FOR LOCOMOTION BY LAND, WATER OR AIR AND PARTS THEREOF; INSTALLATION, MAINTENANCE AND REPAIR OF THE TECHNICAL EQUIPMENT INSTALLED IN BUILDINGS; INSTALLATION, MAINTENANCE AND REPAIR OF TRANSPORTABLE BUILDINGS, SPACE CABINS, COOLING AND AIR CONDITION ROOMS AND THEIR PARTS; INSTALLATION, MAINTENANCE AND REPAIR OF FENCE AND DOOR INSTALLATIONS, INSTALLATION, MAINTENANCE AND REPAIR OF TRACKS; SCAFFOLD SERVICES, NAMELY, RENTAL OF SCAFFOLDS, CONSTRUCTION FORMS, STAGES AND CONSTRUCTION MACHINES, SCAFFOLDING ERECTION AND REPAIR; SCAFFOLDING ERECTION AND DISMANTLING SERVICES, SCAFFOLDING REPAIR, IN CLASS 37 (U.S. CLS. 100, 103 AND 106).

FOR: BROADCASTING OF RADIO AND TELEVISION; PROVIDING OF AIR TIMES IN RADIO AND TELEVISION; COORDINATION AND PROVISION OF INTERNET AND INTRANET SERVICES, NAMELY, PROVIDING OF ACCESS TO A WORLD WIDE COMPUTER NETWORK, PROVIDING OF PLATFORMS VIA THE INTERNET, PROVIDING OF INTERNET PORTALS; PROVISION OF FORUMS, CHAT LINES AND CHAT ROOMS VIA THE INTERNET, E-MAIL SERVICES; TELECOMMUNICATION NAMELY, OPERATION OF TELECOMMUNICATION NETWORKS; RENTAL OF TELECOMMUNICATIONS EQUIPMENT; TRANSMISSION OF INFORMATION, TEXTS, DRAWINGS, NEWS AND DATA IN COMPUTER NETWORKS RELATED TO BUSINESS AFFAIRS, REPAIR, INSTALLATION AND CONSTRUCTION, ENTERTAINMENT AND EDUCATION; SERVICES OF AN ONLINE SERVICE PROVIDER, NAMELY, RENTAL OF ACCESS TIME TO DATABASES, IN CLASS 38 (U.S. CLS. 100, 101 AND 104).

FOR: JUNK AND WASTE REMOVAL SERVICES; TRANSPORTATION SERVICES, NAMELY, TRANSPORT OF PERSONS AND PEOPLE BY RAIL, BOAT, AUTOMOBILE, TRUCK, AND AIRPLANE; PACKAGING AND STORAGE OF GOODS; LOGISTICS IN THE FIELD OF TRANSPORT AND STORAGE, NAMELY, ARRANGING THE STORAGE, TRANSPORTATION AND DELIVERY OF THE GOODS OF OTHERS BY RAIL, BOAT, AUTOMOBILE, TRUCK, AND AIRPLANE; WATER, STEAM, ELECTRICITY AND GAS DISTRIBUTION; WATER, STEAM, ELECTRICITY AND GAS SUPPLY TRANSPORT, NAMELY, TRANSPORT OF ELECTRICITY AND GAS BY RAIL, BOAT, AUTOMOBILES, TRUCKS, AND AIRPLANES;

**Reg. No. 4,133,597** EVACUATION OF WASTE AND HAZARDOUS WASTE, AS WELL AS OF CONTAMINATED GROUND, NAMELY, TRANSPORT OF WASTE, HAZARDOUS WASTE, AND CONTAMINATED LANDFILL BY RAIL, BOAT, AUTOMOBILE, AND TRUCK, IN CLASS 39 (U.S. CLS. 100 AND 105).

FOR: TREATMENT OF MATERIALS, NAMELY, MANUFACTURE OF METAL PRODUCTS TO THE ORDER AND/ OR CONSTRUCTION OF OTHERS IN INDUSTRY; JOB ORDER MANUFACTURE OF CAR BODIES, PARTS OF CHASSIS, COMPONENTS FOR VEHICLE UNDERCARRIAGE AND COMPONENTS FOR VEHICLE DRIVE, ESPECIALLY COMBUSTION ENGINES TO THE ORDER OF OTHERS; MANUFACTURE OF TOOLS AS JOB ORDER MANUFACTURE TO THE ORDER OF OTHERS; TREATMENT OF WASTE WATER, EFFLUENT AND HARMFUL SUBSTANCES; RECYCLING OF WASTE, EFFLUENT, SCRAP AND TRASH; PRINTING SERVICES; LOCKSMITHING, NAMELY, CUSTOM FABRICATION OF KEYS OR LOCKS; WOODWORKING, IN CLASS 40 (U.S. CLS. 100, 103 AND 106).

FOR: EDUCATIONAL SERVICES, NAMELY, PROVIDING CLASSES, SEMINARS, AND WORKSHOPS IN THE FIELD OF MANUFACTURING; PROVIDING OF SPORTING AND CULTURAL ACTIVITIES; RADIO, TELEVISION, VIDEO AND FILM PRODUCTIONS; PUBLICATION OF BOOKS, MAGAZINES, NEWSPAPERS; RENTAL OF BOOKS, MAGAZINES, NEWSPAPERS; RENTAL OF RADIOS, TELEVISIONS, VIDEO RECORDERS, FILMING EQUIPMENT, CD, TAPE AND DVD PLAYERS AND RECORDERS, CAMERAS; TRANSLATION SERVICES; EDUCATION AND TRAINING IN THE FIELD OF PRESSWORK AND PUBLIC RELATIONS; PHOTOGRAPHIC SERVICES, IN CLASS 41 (U.S. CLS. 100, 101 AND 107).

FOR: SERVICES OF AN ARCHITECT; TOWN AND CITY PLANNING SERVICES; SERVICES OF A CIVIL ENGINEER; SERVICES OF A MINING ENGINEER; SERVICES OF A CHEMIST; SERVICES OF AN INFORMATION TECHNOLOGIST; ENGINEERING SERVICES; SERVICES OF AN INTERIOR DECORATOR; TECHNICAL CONSULTING AND ASSISTANCE WITH COMPUTER-BASED INFORMATION SYSTEMS AND COMPONENTS; SCIENTIFIC RESEARCH; COMPUTER SOFTWARE PROGRAMMING; SERVICES OF AN ENGINEER ENGAGED IN STATISTICAL CALCULATIONS, NAMELY, CONSTRUCTION PLANNING; DRAFTING; SURVEYING; SCIENTIFIC RESEARCH SERVICES; MATERIAL TESTING; TECHNICAL ADVICE AND INFORMATION SERVICES IN THE FIELD OF COMPUTERS; INSTALLATION AND MAINTENANCE OF COMPUTER SOFTWARE; RENTAL OF DATA PROCESSING EQUIPMENT AND COMPUTERS; CONSTRUCTION OF PROTOTYPES FOR SCIENTIFIC RESEARCH AND TECHNICAL DEVELOPMENT OF PRODUCTS; TECHNICAL ANALYSIS OF IT INFRASTRUCTURES; TECHNICAL PROJECTING AND TECHNICAL PLANNING OF INSTALLATION AND APPARATUS FOR TELECOMMUNICATION; MANAGEMENT OF ABANDONED POLLUTED AREAS, NAMELY, TECHNICAL PROJECTING OF RECONSTRUCTION OF REAL ESTATE, NAMELY, CONSTRUCTION PLANNING, IN CLASS 42 (U.S. CLS. 100 AND 101).

FOR: PEST CONTROL SERVICES FOR AGRICULTURE, HORTICULTURE OR FORESTRY; RECULTIVATION OF INDUSTRIAL WASTELAND, NAMELY, REPLANTING AGRICULTURE, HORTICULTURE OR FORESTRY IN ABANDONED LAND FORMERLY USED IN THE INDUSTRY, MINING, AND MANUFACTURING INDUSTRIES, IN CLASS 44 (U.S. CLS. 100 AND 101).

OWNER OF U.S. REG. NOS. 3,038,951, 3,174,672 AND OTHERS.

PRIORITY DATE OF 8-28-2009 IS CLAIMED.

OWNER OF INTERNATIONAL REGISTRATION 1039406 DATED 11-18-2009, EXPIRES 11-18-2019.

THE COLOR(S) BLUE, GREY AND WHITE IS/ARE CLAIMED AS A FEATURE OF THE MARK.

**Reg. No. 4,133,597** THE MARK CONSISTS OF A GREY AND BLUE RECTANGLE FEATURING A STYLIZED DESIGN OF A WHITE ARC AND THREE WHITE OVERLAPPING CIRCLES ALL ENCLOSED IN A WHITE CIRCLE WITH A BLUE BACKGROUND, TO THE RIGHT APPEARS THE WORD "THYSSENKRUPP" IN THE COLOR WHITE.

SER. NO. 79-082,785, FILED 11-18-2009.

JAY FLOWERS, EXAMINING ATTORNEY

# United States of America

United States Patent and Trademark Office



**Reg. No. 4,133,598**

**Registered May 1, 2012**

**Int. Cls.: 14, 25 and 36**

**TRADEMARK**

**SERVICE MARK**

**PRINCIPAL REGISTER**

DR. DRAZEN MARIO ODAK (FED REP GERMANY INDIVIDUAL)  
FRIEDRICHSDORFER STR. 29A  
61352 BAD HOMBURG  
FED REP GERMANY

FOR: PRECIOUS METALS, PRECIOUS METAL ALLOYS; GOODS MANUFACTURED OF PRECIOUS METALS OR PRECIOUS METAL ALLOYS, NAMELY, DECORATIVE BOXES, PINS, SCULPTURES, WATCHES AND JEWELRY, GOODS PLATED WITH PRECIOUS METALS OR PRECIOUS METAL ALLOYS, NAMELY, DECORATIVE BOXES, PINS, SCULPTURES, WATCHES AND JEWELRY; JEWELRY, ORNAMENTAL GOODS, NAMELY, ORNAMENTAL PINS, ORNAMENTS OF PRECIOUS METAL AND PERSONAL ORNAMENTS AND SHOE ORNAMENTS OF PRECIOUS METAL, PRECIOUS STONES, PARTICULARLY DIAMONDS; WATCHES AND CHRONOMETRIC DEVICES, IN CLASS 14 (U.S. CLS. 2, 27, 28 AND 50).

FOR: CLOTHING, NAMELY, SHIRTS, PANTS, JACKETS, COATS, DRESSES, SKIRTS, UNDERWEAR; FOOTWEAR; HEADGEAR, NAMELY, HATS AND CAPS, IN CLASS 25 (U.S. CLS. 22 AND 39).

FOR: INSURANCE AGENCY AND BROKERAGE; ADMINISTRATION OF EMPLOYEE PENSION PLANS, IN CLASS 36 (U.S. CLS. 100, 101 AND 102).

THE MARK CONSISTS OF THE STYLIZED WORDING "FAIRPLAYINVESTMENT" WITH AN OVAL DESIGN BELOW THE WORDING WITH A CIRCLE INSIDE THE OVAL AND THE DESIGN OF A TRIANGLE COMPRISED OF FIFTEEN HEXAGONS INSIDE THE CIRCLE AND WITH AN INCOMPLETE OVAL AROUND THE ENTIRE WORDING AND DESIGN.

PRIORITY DATE OF 10-16-2009 IS CLAIMED.

OWNER OF INTERNATIONAL REGISTRATION 1042083 DATED 3-6-2010, EXPIRES 3-6-2020.

SER. NO. 79-083,763, FILED 3-6-2010.

KELLEY WELLS, EXAMINING ATTORNEY



*David J. Kappas*

Director of the United States Patent and Trademark Office

# United States of America

United States Patent and Trademark Office

# SQOOM

**Reg. No. 4,133,599**

**Registered May 1, 2012**

**Int. Cls.: 3, 9, 10 and 44**

**TRADEMARK**

**SERVICE MARK**

**PRINCIPAL REGISTER**

SCHICK MEDICAL GMBH (FED REP GERMANY CORPORATION OF GERMANY)  
AUF DEM WALL 29  
78628 ROTTWEIL  
FED REP GERMANY

FOR: BLEACHING PREPARATIONS FOR LAUNDRY USE; CLEANING, POLISHING, SCOURING AND ABRASIVE PREPARATIONS; SOAPS, PERFUMERY, ESSENTIAL OILS, COSMETICS, HAIR LOTIONS, DENTIFRICES, IN CLASS 3 (U.S. CLS. 1, 4, 6, 50, 51 AND 52).

FOR: SURVEYING AND WEIGHING APPARATUS AND INSTRUMENTS; APPARATUS AND INSTRUMENTS FOR CONVEYING, TRANSFORMING, REGULATING OR CONTROLLING ELECTRIC CURRENT; APPARATUS FOR RECORDING, TRANSMISSION OR REPRODUCTION OF SOUND OR IMAGES; BLANK MAGNETIC DATA CARRIERS; BLANK RECORD DISKS; BLANK RECORDABLE OPTICAL DISCS; AUTOMATIC VENDING MACHINES AND MECHANISMS FOR COIN-OPERATED APPARATUS; CASH REGISTERS, CALCULATING MACHINES; DATA PROCESSORS; COMPUTERS; FIRE-EXTINGUISHING APPARATUS; ULTRASONIC APPARATUS SENSORS; LABORATORY INSTRUMENTS USED FOR RESEARCH AND EXPERIMENTATION IN THE FIELDS OF IONOPHORESIS, THERMOPHORESIS AND PHONOPHORESIS, IN CLASS 9 (U.S. CLS. 21, 23, 26, 36 AND 38).



*David J. Kyros*

Director of the United States Patent and Trademark Office

FOR: SURGICAL, MEDICAL, DENTAL AND VETERINARY APPARATUS AND INSTRUMENTS, NAMELY, ELECTRIC MASSAGE APPARATUS FOR MEDICAL PURPOSES; MEDICAL INSTRUMENTS FOR INTRADERMAL USE, ELECTRO THERAPY, ULTRASONIC THERAPY, AND MAGNETOTHERAPY; APPARATUS FOR CELLULITE TREATMENT, REDUCTION AND ELIMINATION; ELECTRONIC STIMULATORS FOR SKIN; MEDICAL APPARATUS FOR INTRODUCING PHARMACEUTICAL PREPARATIONS INTO THE HUMAN BODY; MEDICAL ULTRASOUND APPARATUS; ULTRASONIC STIMULATORS AND MAGNET THERAPY STIMULATORS FOR SKIN, MUSCLE AND NERVE; SUTURE MATERIALS; ULTRASONIC APPARATUS FOR MEDICAL DIAGNOSTIC PURPOSES; MEDICAL APPARATUS FOR SKIN TREATMENT, NAMELY, ELECTRONIC STIMULATORS FOR SKIN, MUSCLE, AND NERVE; AESTHETIC MASSAGE APPARATUS; ELECTRO MEDICAL INSTRUMENTS FOR TREATMENT OF THE CUTANEOUS, MUSCULAR AND ARTICULAR TISSUE; MEDICAL INSTRUMENTS FOR ULTRASONIC THERAPY, NAMELY, HANDHELD ULTRASOUND APPARATUSES; MEDICAL INSTRUMENTS FOR MAGNETOTHERAPY; ULTRASONIC MASSAGE APPARATUS FOR COSMETIC PURPOSES FOR DOMESTIC USE;

**Reg. No. 4,133,599** ULTRASONIC MASSAGE APPARATUS FOR COSMETIC PURPOSES FOR PROFESSIONAL USE, IN CLASS 10 (U.S. CLS. 26, 39 AND 44).

FOR: MEDICAL SERVICES; VETERINARY SERVICES; HYGIENIC AND BEAUTY CARE FOR HUMAN BEINGS OR ANIMALS, IN CLASS 44 (U.S. CLS. 100 AND 101).

THE MARK CONSISTS OF STANDARD CHARACTERS WITHOUT CLAIM TO ANY PARTICULAR FONT, STYLE, SIZE, OR COLOR.

OWNER OF INTERNATIONAL REGISTRATION 0993449 DATED 9-19-2008, EXPIRES 9-19-2018.

SER. NO. 79-084,339, FILED 4-26-2010.

STEVEN R. FINE, EXAMINING ATTORNEY

# United States of America

United States Patent and Trademark Office

# ASA

**Reg. No. 4,133,600**

**Registered May 1, 2012**

**Int. Cls.: 9 and 10**

**TRADEMARK**

**PRINCIPAL REGISTER**

ASA S.R.L. (ITALY LIMITED LIABILITY COMPANY)  
VIA A. VOLTA, 9  
I-36057 ARCUGNANO (VI)  
ITALY

FOR: ELECTRONIC SCIENTIFIC EQUIPMENT FOR LASER THERAPY, MAGNETIC THERAPY, AND LASER SURGERY, NAMELY, STATIONARY LASERS AND ASSOCIATED CONTROL CIRCUITRY AND DISPLAYS, MOBILE LASERS AND ASSOCIATED CONTROL CIRCUITRY AND DISPLAYS, PORTABLE LASERS AND ASSOCIATED CONTROL CIRCUITRY AND DISPLAYS, ROBOTIZED LASERS AND ASSOCIATED CONTROL CIRCUITRY AND DISPLAYS, ALL FOR NON-MEDICAL PURPOSES, IN CLASS 9 (U.S. CLS. 21, 23, 26, 36 AND 38).

FOR: ELECTROMEDICAL REHABILITATIVE AND PAIN MANAGEMENT PRODUCTS FOR CLINICAL AND HOME USE, NAMELY, ELECTRICAL NERVE AND MUSCLE STIMULATORS, ULTRASONIC STIMULATORS, MAGNET THERAPY STIMULATORS, AND LASER THERAPY STIMULATORS; LASERS AND ASSOCIATED CONTROL CIRCUITRY AND DISPLAYS FOR SURGICAL, MEDICAL AND PARAMEDICAL USE UNRELATED TO ADVANCED SURFACE ABLATION SURGERY, IN CLASS 10 (U.S. CLS. 26, 39 AND 44).

THE TRADEMARK CONSISTS IN THE WORD "ASA" WRITTEN IN FANCIFUL CAPITAL LETTERS, IN WHICH THE LAST LETTER "A" IS UPSIDE DOWN.

OWNER OF INTERNATIONAL REGISTRATION 0768673 DATED 10-3-2001, EXPIRES 10-3-2021.

SER. NO. 79-085,422, FILED 5-31-2010.

SEAN CROWLEY, EXAMINING ATTORNEY



*David J. Kyros*

Director of the United States Patent and Trademark Office

# United States of America

United States Patent and Trademark Office



**Reg. No. 4,133,601**

**Registered May 1, 2012**

**Int. Cls.: 6, 7 and 17**

**TRADEMARK**

**PRINCIPAL REGISTER**

DIPL.-ING. ROLAND KÜPER (FED REP GERMANY INDIVIDUAL)  
CASTROPER STR. 102  
44791 BOCHUM  
FED REP GERMANY

FOR: METALS AND METAL ALLOYS; COMMON METALS, UNWROUGHT AND SEMI-WORKED, FOR FURTHER MANUFACTURE; METAL POLES; SHEET METAL, IN CLASS 6 (U.S. CLS. 2, 12, 13, 14, 23, 25 AND 50).

FOR: SNOW PLOW BLADES FOR VEHICLES; STREET SWEEPING MACHINE BRUSHES; BASES FOR EARTH MOVING MACHINES; SNOW PLOWS; STREET SWEEPERS AND PARTS THEREOF; SIEVES, NAMELY, SCREENS FOR USE WITH VIBRATORY EARTH SCREENING MACHINES; SIFTERS FOR SIEVES; WEAR PLATES FOR SIEVES, NAMELY, SCREEN PANELS; STRIPPER PLATES; SIEVE INSERTS OF METAL, IN CLASS 7 (U.S. CLS. 13, 19, 21, 23, 31, 34 AND 35).

FOR: SEMI-PROCESSED PLASTIC IN THE FORM OF SHEETS, TUBES, OR RODS; SEMI-PROCESSED SIEVE LININGS MADE OF PLASTIC OR RUBBER, NAMELY, SCREEN PANELS SOLD SEPARATELY BUT FOR USE WITH VIBRATORY EARTH SCREENING MACHINES WHICH ARE MADE OF RUBBER OR PLASTIC AND USED TO SEPARATE DIFFERENT SOLIDS AND LIQUIDS FOR INDUSTRIAL PURPOSES; SEMI-PROCESSED WEAR LININGS MADE OF PLASTIC OR RUBBER, NAMELY, SCREEN PANELS FOR SIEVES MADE OF RUBBER OR PLASTIC AND USED TO SEPARATE SOLIDS AND LIQUIDS FOR INDUSTRIAL PURPOSES; SEMI-PROCESSED STRIPPER PLATES MADE OF PLASTIC OR RUBBER, NAMELY, SCREEN PANELS MADE OF RUBBER OR PLASTIC SOLD SEPARATELY BUT FOR USE WITH VIBRATORY EARTH SCREENING MACHINES AND SNOW PLOWS AND WHICH ARE USED TO SEPARATE SOLIDS AND LIQUIDS FOR INDUSTRIAL PURPOSES, IN CLASS 17 (U.S. CLS. 1, 5, 12, 13, 35 AND 50).



THE MARK CONSISTS OF THE WORD "KUPER" IN BLOOD ORANGE, WITH A STYLIZED SQUARE ACCENT OVER THE LETTER "U" THE COLOR WHITE REPRESENTS BACKGROUND AND IS NOT PART OF THE MARK.

*David J. Kyros*

OWNER OF INTERNATIONAL REGISTRATION 1046365 DATED 4-30-2010, EXPIRES 4-30-2020.

Director of the United States Patent and Trademark Office

THE COLOR(S) BLOOD ORANGE IS/ARE CLAIMED AS A FEATURE OF THE MARK.



**Reg. No. 4,133,601** SEC. 2(F).

SER. NO. 79-085,574, FILED 4-30-2010.

EDWARD FENNESSY, EXAMINING ATTORNEY

# United States of America

United States Patent and Trademark Office

# IMMO

**Reg. No. 4,133,602**

**Registered May 1, 2012**

**Int. Cls.: 11, 20 and 21**

**TRADEMARK**

**PRINCIPAL REGISTER**

ALOYS F. DORNBRACHT GMBH & CO. KG (FED REP GERMANY GMBH & CO. KG)  
KÖBBINGSER MÜHLE 6  
58640 ISERLOHN  
FED REP GERMANY

FOR: ELECTRIC AND ELECTRONIC PLUMBING FITTINGS FOR SUPPLYING, DISTRIBUTING, CONTROLLING AND REGULATING WATER, NAMELY, CONTROL VALVES, COUPLERS, ELECTRIC THERMOSTATS SOLD AS PART OF SINK, TUB OR SHOWER CONTROL VALVES FOR REGULATING WATER TEMPERATURE, AND BIBBS, FAUCETS, TAPS, TETHERED, MECHANICAL, ELECTRICAL AND ELECTRONIC STOPS FOR SINKS AND DRAINS SOLD AS A PART OF PLUMBING DRAINS, MIXERS FOR REGULATING FLOW, DISTRIBUTION, AND TEMPERATURE OF WATER; SHOWER HEADS, SETS COMPRISING SHOWER HEADS, SHOWER RISER RAILS AND STRUCTURAL PARTS AND FIXTURES IN THE NATURE OF SHOWER MIXERS, SETS COMPRISING HANDHELD SHOWER HEADS AND STRUCTURAL PARTS AND FIXTURES THEREFOR IN THE NATURE OF SHOWER MIXERS, SHOWER CONTROL VALVES, THERMOSTATIC VALVES; APPARATUS FOR LIGHTING, HEATING, STEAM GENERATING, COOKING, REFRIGERATING, DRYING, VENTILATING, WATER SUPPLY AND SANITARY PURPOSES, IN PARTICULAR SANITARY FITTINGS OF METAL AND PLASTIC FOR TOILETS, BATHROOMS AND KITCHENS, NAMELY, DRAINS, FAUCETS, FAUCET FILTERS, SPOUTS, SINK STRAINERS, TRAPS, TAPS, TETHERED, MECHANICAL, ELECTRICAL AND ELECTRONIC STOPS FOR SINKS AND DRAINS SOLD AS A PART OF PLUMBING DRAINS, MIXER FAUCETS FOR WATER PIPES FOR REGULATING FLOW, DISTRIBUTION AND TEMPERATURE OF WATER, SHOWER HEAD SETS COMPRISING SHOWER HEADS AND STRUCTURAL PARTS AND FIXTURES THEREFOR IN THE NATURE OF SHOWER MIXERS, SHOWER CONTROL VALVES, THERMOSTATIC VALVES; INSTANTANEOUS WATER HEATERS, WATER TREATMENT INSTALLATIONS IN THE NATURE OF BATH WATER PURIFYING APPARATUS FOR HOUSEHOLD PURPOSES, FLOW RESTRICTORS FOR REVERSE OSMOSIS, WATER PURIFICATION UNITS AND HOT WATER TANKS, CARTRIDGE FILTRATION UNITS, CHEMICAL STERILIZATION UNITS, WATER SOFTENING UNITS; WASHBASINS BEING PART OF SANITARY INSTALLATIONS, WASHSTAND INSTALLATIONS IN THE NATURE OF TAPS, TOILET INSTALLATIONS, NAMELY, BIDETS, TOILET BOWLS, PORTABLE TOILETS, URINALS, TOILET SEATS, WASHSTAND STORAGE UNITS BEING PART OF SANITARY INSTALLATIONS, PREASSEMBLED INSTALLATION UNITS FOR SHOWERS COMPRISED OF SHOWER HEADS, FAUCETS, VALVES, HOSES, SHOWER DOORS, SHOWER STANDS, SHOWER ENCLOSURES AND SHOWER PLATFORMS, AND STRUCTURAL PARTS AND FIXTURES THEREFOR IN THE NATURE OF SHOWER MIXERS,



*David J. Kyros*

Director of the United States Patent and Trademark Office

**Reg. No. 4,133,602** SHOWER DEVICES IN THE NATURE OF SHOWER HEAD SPRAYERS, LIGHTS IN THE NATURE OF WALL LIGHTS AND LIGHTING FIXTURES; SHOWER CUBICLES OF PLASTIC WITH INTEGRATED SHOWER FITTINGS AND SHOWER INSTALLATIONS; SANITARY FITTINGS OF METAL, PLASTIC AND GLASS, IN PARTICULAR BATH TUB HANDLES SOLD AS PART OF SANITARY INSTALLATIONS; COMPONENTS FOR SANITARY INSTALLATIONS, IN PARTICULAR ASSEMBLY ELEMENTS FOR SANITARY UNITS IN THE NATURE OF SHOWER PANELS, PRESSURE REGULATORS AND SHOWER MIXERS; CONNECTING PILLARS BEING PART OF SANITARY UNITS, NAMELY, PART OF BATH, HOT AND/OR SHOWER TUBS AND BASINS BEING PART OF SANITARY INSTALLATIONS OF PLASTIC, CERAMIC AND METAL FOR SANITARY PURPOSES, INCLUDING TUBS AND BASINS WITH SWIRL NOZZLES AND AERATING NOZZLES, NOZZLE FITTINGS AND PUMPS FOR TUBS WITH SWIRL NOZZLES; BLOWING MACHINES BEING PART OF SANITARY INSTALLATIONS, INCLUDING BLOWING MACHINES WITH HEATING MECHANISMS FOR HEATING THE BLAST AIR, FOR AERATING BATHING WATER IN TUBS; HEATING MECHANISMS AND FILTERS FOR BATHING WATER, STEAM BATH INSTALLATIONS AND ACCESSORIES IN THE NATURE OF STEAM VALVES, FITTINGS FOR STEAM BATHS, STEAM GENERATORS, WATER VAPORIZATION APPARATUS, WATER SOFTENING APPARATUS, LIGHTING DEVICES FOR TUBS, LIGHTING DEVICES FOR STEAM BATHS AND SHOWERS; MOBILE COMPACT-WHIRL APPARATUS FOR FITTING IN BATH TUBS TO WHIRL WATER, WITH MOTORS, PUMPS AND NOZZLE SYSTEMS BEING CONSTRUCTION UNITS, ALL SOLD AS A UNIT, IN CLASS 11 (U.S. CLS. 13, 21, 23, 31 AND 34).

FOR: FURNITURE, MIRRORS, PICTURE FRAMES; GOODS OF WOOD, CORK, REED, CANE, WICKER, HORN, BONE, IVORY, WHALEBONE, SHELL, AMBER, MOTHER-OF-PEARL, MEERSCHAUM AND SUBSTITUTES FOR ALL THESE MATERIALS, OR OF PLASTICS, NAMELY, STORAGE AND ORGANIZATIONAL SYSTEMS COMPRISING SHELVES, DRAWERS, CUPBOARDS, BASKETS AND CLOTHES RODS SOLD AS A UNIT, CURTAIN HOLDERS IN THE NATURE OF CURTAIN RAILS, CURTAIN RINGS, CURTAIN RODS; SANITARY FITTINGS OF PLASTIC AND GLASS, NAMELY, BATHTUB GRAB BARS, BATHTUB RAILS; CORRUGATED PLASTIC, RIGID PLASTIC AND THERMOFORMED PLASTIC TRAYS; HOLDERS OF TOWELS IN THE FORM OF RACKS, STANDS AND CLOSETS; DOOR AND FURNITURE HANDLES NOT OF METAL; TOWEL HANGERS IN THE NATURE OF STANDS, CLOSETS AND RACKS; NON-METAL BRACKETS FOR ATTACHMENT TO FURNITURE TO SUPPORT ITEMS TO BE KEPT IN HANDS' REACH, AS COMPONENTS OF INTERIOR DISPLAY ASSEMBLIES COMPOSED PRIMARILY OF FIBERGLASS AND AS COMPONENTS OF SHELVING, ALL SOLD AS A UNIT; STORAGE UNITS FITTED WITH MIRRORS, NAMELY, SHELVES AND CABINETS, MIRRORS, ALL SOLD AS A UNIT; COMBINED WASH BASIN AND TABLE STORAGE UNITS IN THE NATURE OF WASHSTANDS, SHELVES AND CABINETS, ALL SOLD AS A UNIT; FITTINGS FOR SANITARY INSTALLATIONS AND WALL HOOKS, NOT OF METAL, BEING PART OF FURNITURE; NONE OF THE AFORESAID GOODS IN RELATION TO BABY OR CHILDREN PRODUCTS, IN CLASS 20 (U.S. CLS. 2, 13, 22, 25, 32 AND 50).

FOR: HOUSEHOLD AND KITCHEN UTENSILS IN THE NATURE OF SKIMMERS, GRILLS, SPLATTER SCREENS, POT AND PAN SCRAPERS, ROLLING PINS, SPATULAS, TURNERS, WHISKS, AND CONTAINERS FOR HOUSEHOLD AND KITCHEN USE NOT OF PRECIOUS METALS OR COATED THEREWITH; COMBS AND SPONGES, NAMELY, BATH SPONGES, CLEANING SPONGES; BRUSHES, EXCEPT PAINT BRUSHES, NAMELY, HAIR BRUSHES, DISHWASHING BRUSHES; BRUSH-MAKING MATERIALS; ARTICLES FOR CLEANING PURPOSES, NAMELY, CLEANING RAGS; STEEL WOOL FOR CLEANING; UNWORKED OR SEMI-WORKED GLASS NOT USED IN BUILDING, NAMELY, COMMON SHEET GLASS, DECORATIVE GLASS; GLASSWARE, PORCELAIN AND EARTHENWARE, ALSO CONTAINING METAL AND PLASTIC, IN PARTICULAR SANITARY FITTINGS, NAMELY, SOAP DISHES, SOAP HOLDERS, TOWEL HOLDERS IN THE NATURE OF RAILS AND RINGS AND TOILET ROLL HOLDERS, TOILET BRUSHES AND HOLDERS THEREFOR, IN CLASS 21 (U.S. CLS. 2, 13, 23, 29, 30, 33, 40 AND 50).

**Reg. No. 4,133,602** THE MARK CONSISTS OF STANDARD CHARACTERS WITHOUT CLAIM TO ANY PARTICULAR FONT, STYLE, SIZE, OR COLOR.

PRIORITY DATE OF 4-14-2010 IS CLAIMED.

OWNER OF INTERNATIONAL REGISTRATION 1046987 DATED 6-25-2010, EXPIRES 6-25-2020.

THE WORDING "IMO" HAS NO MEANING IN A FOREIGN LANGUAGE.

SER. NO. 79-085,802, FILED 6-25-2010.

TINA MAI, EXAMINING ATTORNEY

# United States of America

## United States Patent and Trademark Office

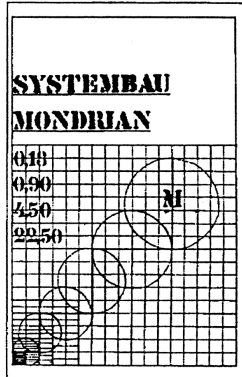

**Reg. No. 4,133,603**

**Registered May 1, 2012**

**Int. Cl.: 37**

**SERVICE MARK**

**PRINCIPAL REGISTER**

DIPL.-ING. VINCENT BÖLL (FED REP GERMANY INDIVIDUAL)  
MARTINSTRABE, 13  
53332 BORNHEIM, FED REP GERMANY

FOR: CONSTRUCTION, IN CLASS 37 (U.S. CLS. 100, 103 AND 106).

NO CLAIM IS MADE TO THE EXCLUSIVE RIGHT TO USE "SYSTEMBAU" AND "0,18" AND "0,90" AND "4,50" AND "22,50", APART FROM THE MARK AS SHOWN.

OWNER OF INTERNATIONAL REGISTRATION 0739991 DATED 8-11-2000, EXPIRES 8-11-2020.

THE MARK CONSISTS OF THE STYLIZED UNDERLINED WORDING "SYSTEMBAU" ON TOP OF "MONDRIAN" WITHIN TWO RECTANGLES, THE INSIDE RECTANGLE CONTAINING A GRAPH DESIGN COMPOSED OF SMALL INTERSECTING SQUARE BOXES, WITH THE NUMERALS "0,18", "0,90", "4,50" AND "22,50" VERTICALLY ARRANGED IN THE UPPER LEFT OF THE GRAPH. EMANATING FROM THE LOWER LEFT CORNER OF THE GRAPH TO THE UPPER RIGHT ARE SIX INTERSECTING CIRCLES INCREASING IN SIZE FROM SMALL TO LARGE, WITH THE FINAL LARGE CIRCLE CONTAINING THE LETTER "M" IN ITS CENTER.

THE ENGLISH TRANSLATION OF "SYSTEMBAU" IN THE MARK IS "PLANNING" AND "CONSTRUCTION SYSTEM".

SER. NO. 79-086,016, FILED 8-12-2010.

SCOTT BIBB, EXAMINING ATTORNEY



*David J. Kybas*

Director of the United States Patent and Trademark Office

# United States of America

## United States Patent and Trademark Office

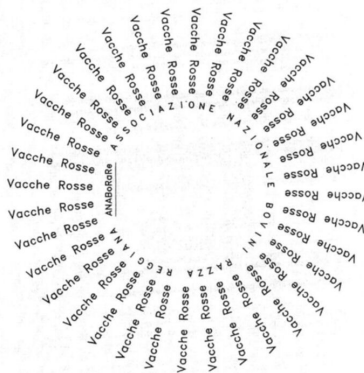

**Reg. No. 4,133,604**

**Registered May 1, 2012**

**Int. Cl.: 29**

ASSOCIAZIONE NAZIONALE ALLEVATORI BOVINI DI RAZZA REGGIANA (ITALY ASSOCIAZIONE)  
VIA MASACCIO, 11  
I-42100 REGGIO EMILIA, ITALY

FOR: CHEESE, IN CLASS 29 (U.S. CL. 46).

**CERTIFICATION MARK**

**PRINCIPAL REGISTER**

THE MARK CONSISTS OF THE REPETITIVE WORDING "VACCHE ROSSE" APPEARING MULTIPLE TIMES FORMING THE OVERALL SHAPE OF A CIRCLE. INSIDE THE CIRCLE IS THE WORDING "ASSOCIAZIONE NAZIONALE BOVINI RAZZA REGGIANA ANABOR-ARE".

PRIORITY DATE OF 6-7-2010 IS CLAIMED.

OWNER OF INTERNATIONAL REGISTRATION 1047594 DATED 7-13-2010, EXPIRES 7-13-2020.

THE ENGLISH TRANSLATION OF "VACCHE ROSSE" AND "ASSOCIAZIONE NAZIONALE BOVINI RAZZA REGGIANA" IN THE MARK IS "RED COW" AND "NATIONAL ASSOCIATION OF THE REGGIANA BREED".

THE CERTIFICATION MARK, AS INTENDED TO BE USED BY PERSONS AUTHORIZED BY THE CERTIFIER, IS INTENDED TO CERTIFY THAT THE GOODS (CHEESE) PROVIDED HAVE COMPLIED WITH THE STANDARDS OF THE CERTIFIER IN THE BREEDING AND RAISING OF QUALIFYING REGGIANA COWS, THE PRODUCTION OF MILK FROM THOSE COWS AND THEREAFTER THE PROCESSING AND MANUFACTURING OF CHEESE FROM THAT MILK, ALL ORIGINATING FROM THE PARMIGIANO REGGIANO PROTECTED DESIGNATION OF ORIGIN AREA OF ITALY, SPECIFICALLY THE ZONE COMPRISING THE TERRITORY OF THE PROVINCES OF PARMA, REGGIO EMILIA, MODENA AND MANTUA ON THE RIGHT BANK OF THE RIVER PO AND BOLOGNA ON THE LEFT BANK OF THE RIVER RENO.

SEC. 2(F) AS TO "VACCHE ROSSE" AND "ASSOCIAZIONE NAZIONALE BOVINI RAZZA REGGIANA".

SER. NO. 79-086,054, FILED 7-13-2010.



*David J. Kyros*

Director of the United States Patent and Trademark Office

**Reg. No. 4,133,604** KATHERINE E. HALMEN, EXAMINING ATTORNEY

# United States of America

United States Patent and Trademark Office



**Reg. No. 4,133,605**

**Registered May 1, 2012**

**Int. Cls.: 12 and 25**

**TRADEMARK**

**PRINCIPAL REGISTER**

BASSO ALCIDE (ITALY INDIVIDUAL)  
VIA VOLPATO, 24  
I-36061 BASSANO DEL GRAPPA (VICENZA), ITALY

FOR: BICYCLES; TANDEM BICYCLES; RACING BICYCLES; ROAD RACING BICYCLES; MOUNTAIN BICYCLES; TOURING BICYCLES; DELIVERY BICYCLES; TRICYCLES; DRESS GUARDS FOR BICYCLES; FRAMES FOR BICYCLES; HANDLE BARS FOR BICYCLES; HANDLEBAR STEMS FOR BICYCLES; HANDLEBAR RIBBONS FOR BICYCLES; FORKS FOR BICYCLES; PUMPS FOR BICYCLES; RIMS FOR WHEELS OF BICYCLES; SADDLES FOR BICYCLES; SEAT POSTS FOR BICYCLES; STANDS FOR BICYCLES; WHEELS FOR BICYCLES; HUBS FOR BICYCLES; CRANKS FOR BICYCLES; DERAILLEUR GEARS FOR BICYCLES; BOTTLE CAGES FOR BICYCLES; BICYCLE HEAD SETS, IN CLASS 12 (U.S. CLS. 19, 21, 23, 31, 35 AND 44).

FOR: CYCLING SHOES; GYMNAS TIC SHOES; BOOTS; LEATHER SHOES; SHOE SOLES; HEELS; MOUNTAINEERING BOOTS; INNER SOLES; OVERSHOES; ATHLETIC FOOTWEAR; BOOTS FOR SPORTS; TRACK AND FIELD SHOES; BIB TIGHTS; CYCLISTS' JERSEYS; VESTS; TIGHTS; BODYSUITS; UNDERWEAR; TROUSERS; SHORTS; SINGLET S; SUITS; JACKETS; STUFF JACKETS; RAIN PROOF JACKETS; GILETS; WINDCHEATERS; RAIN-COATS; MANTLES; BANDANAS; SOCKS; GLOVES BEING CLOTHING; HOODS; HEAD-BANDS; BALACLAVAS; UNDERHELMETS IN THE NATURE OF SKULL CAPS TO WEAR UNDER HELMETS; CYCLING UNIFORMS; OVER-TROUSERS; T-SHIRTS; SHIRTS; UNDER-SHIRTS; SWEAT PANTS; SWEAT SUITS; SWEAT SHIRTS; SPORT SHIRTS; POLO SHIRTS; JERSEYS BEING CLOTHING; SPORTS JERSEYS; MUFFS BEING CLOTHING; CAPS; BERETS; SUN VISORS; WRISTBANDS BEING CLOTHING; SWEATBANDS, IN CLASS 25 (U.S. CLS. 22 AND 39).



THE NAME(S), PORTRAIT(S), AND/OR SIGNATURE(S) SHOWN IN THE MARK DOES NOT IDENTIFY A PARTICULAR LIVING INDIVIDUAL.

PRIORITY DATE OF 5-10-2010 IS CLAIMED.

OWNER OF INTERNATIONAL REGISTRATION 1049469 DATED 7-19-2010, EXPIRES 7-19-2020.

*David J. Kybas*

Director of the United States Patent and Trademark Office

THE MARK CONSISTS OF A DOUBLE BAND DEPICTING THE JOINED, STYLIZED LETTERS "S" AND "P" OVER THE STYLIZED WORDING "POGLIAGHI".



**Reg. No. 4,133,605** SER. NO. 79-086,735, FILED 7-19-2010.

MARY BOAGNI, EXAMINING ATTORNEY

# United States of America

United States Patent and Trademark Office

## SWEDISH ORPHAN BIOVITRUM

**Reg. No. 4,133,606**

**Registered May 1, 2012**

**Int. Cls.: 5, 10, 35, 42  
and 45**

**TRADEMARK**

**SERVICE MARK**

**PRINCIPAL REGISTER**

SWEDISH ORPHAN BIOVITRUM AB (PUBL) (SWEDEN JOINT STOCK COMPANY)  
SE-112 76 STOCKHOLM  
SWEDEN

FOR: PHARMACEUTICAL PREPARATIONS IN THE FIELD OF HUMAN MEDICINE FOR THE PREVENTION AND TREATMENT OF HEMATOLOGICAL DISEASES, INTESTINAL FAT MALABSORPTION DISEASES, INFLAMMATORY DISEASES, RHEUMATOID ARTHRITIS, CANCER, INHERITED METABOLIC DISEASES AND CYSTIC FIBROSIS, ALL OF THE FOREGOING EXCLUDING VITAMIN AND MINERAL PREPARATIONS AND VITAMINIZED TONIC DRINKS FOR MEDICAL PURPOSES; DIAGNOSTIC PREPARATIONS FOR MEDICAL USE, CHEMICAL REAGENTS FOR MEDICAL USE, IN CLASS 5 (U.S. CLS. 6, 18, 44, 46, 51 AND 52).

FOR: SURGICAL INSTRUMENTS AND APPARATUS; MEDICAL APPARATUS AND INSTRUMENTS FOR USE IN GENERAL SURGERY; MEDICAL APPARATUS AND INSTRUMENTS, NAMELY, MEDICAL APPARATUS FOR INTRODUCING PHARMACEUTICAL PREPARATIONS INTO THE HUMAN BODY AND FACILITATING THE INHALATION OF PHARMACEUTICAL PREPARATIONS; TESTING APPARATUS FOR MEDICAL PURPOSES FOR TESTING FOR THE PRESENCE OF DRUGS; AND MEDICAL INFUSION AND INJECTION DEVICES FOR ADMINISTERING DRUGS, IN CLASS 10 (U.S. CLS. 26, 39 AND 44).

FOR: RETAIL DISTRIBUTORSHIP SERVICES IN THE FIELD OF PHARMACEUTICALS, MEDICAL PREPARATIONS, VACCINES, NATURAL REMEDIES, DIAGNOSTICS AND MEDICAL DEVICES, IN CLASS 35 (U.S. CLS. 100, 101 AND 102).

FOR: MEDICAL RESEARCH; BIOLOGICAL AND CHEMICAL RESEARCH; RESEARCH AND DEVELOPMENT OF NEW MEDICINES AND MEDICAL PREPARATIONS; MEDICAL AND CHEMICAL LABORATORIES; SCIENTIFIC RESEARCH AND INDUSTRIAL RESEARCH IN THE FIELD OF MEDICINES, IN CLASS 42 (U.S. CLS. 100 AND 101).

FOR: LICENSING WITHIN THE FIELD OF MEDICINES; LICENSING OF INTELLECTUAL PROPERTY, IN CLASS 45 (U.S. CLS. 100 AND 101).

THE MARK CONSISTS OF STANDARD CHARACTERS WITHOUT CLAIM TO ANY PARTICULAR FONT, STYLE, SIZE, OR COLOR.

PRIORITY DATE OF 4-6-2010 IS CLAIMED.



*David J. Kyros*

Director of the United States Patent and Trademark Office

**Reg. No. 4,133,606** OWNER OF INTERNATIONAL REGISTRATION 1049852 DATED 6-8-2010, EXPIRES 6-8-2020.

OWNER OF U.S. REG. NO. 3,639,635.

NO CLAIM IS MADE TO THE EXCLUSIVE RIGHT TO USE "SWEDISH ORPHAN", APART FROM THE MARK AS SHOWN.

SER. NO. 79-086,907, FILED 6-8-2010.

DOMINIC FATHY, EXAMINING ATTORNEY

# United States of America

United States Patent and Trademark Office



**Reg. No. 4,133,607**

**Registered May 1, 2012**

**Int. Cls.: 9, 35 and 42**

**TRADEMARK**

**SERVICE MARK**

**PRINCIPAL REGISTER**

TECTIA CORPORATION (FINLAND JOINT STOCK COMPANY)  
KUMPULANTIE 3  
FI-00520 HELSINKI  
FINLAND

FOR: DATA PROCESSING EQUIPMENT AND COMPUTERS, NAMELY, COMPUTER HARDWARE AND SOFTWARE FOR PREVENTING UNAUTHORIZED ACCESS TO COMPUTER NETWORKS, AND FOR PROVIDING ENCRYPTED AND SECURE DATA COMMUNICATIONS IN COMPUTER NETWORKS, AND FOR PROVIDING IDENTIFICATION AND AUTHENTICATION IN COMPUTER NETWORKS, AND FOR MANAGING, INSTALLING, UPDATING, AND REMOVAL OF SOFTWARE IN COMPUTER NETWORKS, AND FOR CONTROLLING OF COMPUTER SYSTEMS USED FOR ENCRYPTED AND SECURE COMMUNICATIONS, IN CLASS 9 (U.S. CLS. 21, 23, 26, 36 AND 38).

FOR: ADVERTISING; BUSINESS MANAGEMENT; BUSINESS ADMINISTRATION; OFFICE FUNCTIONS, IN CLASS 35 (U.S. CLS. 100, 101 AND 102).

FOR: DESIGN AND DEVELOPMENT OF COMPUTER HARDWARE AND SOFTWARE, SCIENTIFIC AND TECHNOLOGICAL SERVICES AND RESEARCH AND DESIGN RELATING THERETO, NAMELY, COMPUTER PROGRAMMING IN THE FIELD OF ENCRYPTED AND SECURE COMMUNICATIONS; COMPUTER SOFTWARE DESIGN FOR OTHERS; INSTALLATION, UP-DATING AND MAINTENANCE OF COMPUTER SOFTWARE; COMPUTER SYSTEM ANALYSIS; COMPUTER CONSULTATION; COMPUTER CONSULTING SERVICES IN THE FIELD OF ENCRYPTED AND SECURE COMMUNICATIONS; DATA ENCRYPTION AND DECRYPTION SERVICES; TECHNOLOGICAL CONSULTATION IN THE TECHNOLOGY FIELD OF ENCRYPTED AND SECURE COMMUNICATIONS, IDENTIFICATION AND AUTHENTICATION FOR COMPUTER HARDWARE AND SOFTWARE SYSTEMS, AND OF TECHNOLOGICAL MANAGEMENT OF SYSTEMS PROVIDING ENCRYPTED AND SECURE COMMUNICATIONS; LEASING OF COMPUTER FACILITIES; COMPUTER CODE CONVERSION FOR OTHERS; COMPUTER DIAGNOSTIC SERVICES; RENTAL OF COMPUTER HARDWARE AND SOFTWARE; INTEGRATION OF COMPUTER SYSTEMS AND NETWORKS; TECHNICAL SUPPORT, NAMELY, MONITORING AND MANAGEMENT OF COMPUTER NETWORK SYSTEMS FOR TECHNICAL PURPOSES, IN CLASS 42 (U.S. CLS. 100 AND 101).



*David J. Kyjars*

Director of the United States Patent and Trademark Office

THE MARK CONSISTS OF THE STYLIZED LETTER "T" APPEARING WITHIN A CIRCLE.

**Reg. No. 4,133,607** PRIORITY DATE OF 6-2-2010 IS CLAIMED.

OWNER OF INTERNATIONAL REGISTRATION 1049927 DATED 8-17-2010, EXPIRES 8-17-2020.

SER. NO. 79-086,928, FILED 8-17-2010.

HEATHER BIDDULPH, EXAMINING ATTORNEY

United States of America  
United States Patent and Trademark Office

RENÉ

**Reg. No. 4,133,608**

**Registered May 1, 2012**

**Int. Cls.: 9 and 10**

**TRADEMARK**

**PRINCIPAL REGISTER**

KONINKLIJKE PHILIPS ELECTRONICS N.V. (NETHERLANDS ANTILLES PUBLIC LIMITED LIABILITY COMPANY)  
GROENEWOUDSEWEG 1  
EINDHOVEN, NETHERLANDS NL5621

FOR: SOFTWARE BEING ALGORITHMS USED IN FLOW SENSORS, IN ADULT, PEDIATRIC AND NEONATAL FLOW SENSORS AND IN CO2 FLOW SENSORS ALL FOR MONITORING MECHANICALLY VENTILATED PATIENTS; SOFTWARE BEING ALGORITHMS FOR MONITORING MECHANICALLY VENTILATED PATIENTS, IN CLASS 9 (U.S. CLS. 21, 23, 26, 36 AND 38).

FOR: MEDICAL AND SURGICAL APPARATUS AND INSTRUMENTS, NAMELY, VENTILATION, RESPIRATORY AND MONITORING RESPIRATORY GAS FLOW SENSORS, ADULT, PEDIATRIC AND NEONATAL RESPIRATORY GAS FLOW SENSORS AND CO2 FLOW SENSORS; SENSORS FOR MONITORING MECHANICALLY VENTILATED PATIENTS, IN CLASS 10 (U.S. CLS. 26, 39 AND 44).

THE MARK CONSISTS OF STANDARD CHARACTERS WITHOUT CLAIM TO ANY PARTICULAR FONT, STYLE, SIZE, OR COLOR.

PRIORITY DATE OF 1-18-2010 IS CLAIMED.

OWNER OF INTERNATIONAL REGISTRATION 1050055 DATED 7-12-2010, EXPIRES 7-12-2020.

SER. NO. 79-086,966, FILED 7-12-2010.

ALICE BENMAMAN, EXAMINING ATTORNEY



*David J. Kybas*

Director of the United States Patent and Trademark Office

# United States of America

United States Patent and Trademark Office



**Reg. No. 4,133,609**

**Registered May 1, 2012**

**Int. Cl.: 9**

ATRAL SYSTEM SOCIÉTÉ PAR ACTIONS SIMPLIFIÉE (FRANCE SOCIÉTÉ PAR ACTIONS SIMPLIFIÉE)  
RUE DU PRÉ DE L'ORME  
F-38920 CROLLES  
FRANCE

**TRADEMARK**

**PRINCIPAL REGISTER**

FOR: APPARATUS FOR RECORDING, TRANSMISSION OR REPRODUCTION OF SOUND OR IMAGES; BLANK MAGNETIC DATA CARRIERS, BLANK RECORDING DISCS, BLANK CD-ROMS FOR COMPUTERS, DATA PROCESSING EQUIPMENT AND COMPUTERS; FIRE EXTINGUISHERS; ELECTRICAL AND ELECTRONIC APPARATUS AND INSTRUMENTS FOR TRANSMITTING AND RECEIVING SIGNALS, NAMELY, RADIO TRANSMITTER AND TELEPHONE TRANSMITTERS; ELECTRIC AND ELECTRONIC SECURITY ALARM AND SECURITY APPARATUS AND INSTRUMENTS, NAMELY, RADIO LINKED ALARM SECURITY MONITORING SYSTEMS, AND REMOTE CONTROL UNITS FOR SECURITY PRODUCTS AND EQUIPMENT; DOOR OR WINDOW OPENING DETECTORS, MOTION DETECTORS, SMOKE DETECTORS, BURGLAR, FIRE AND ANTI-INTRUSION ALARMS AND SIRENS, AND CENTRAL PROCESSOR UNITS FOR PROCESSING MULTIPLE INPUTS, CENTRAL PROCESSING UNITS FOR ELECTRICAL AND ELECTRONIC EQUIPMENT FOR THE REMOTE AND AUTOMATIC OPERATION OF GATES, DOORS, SHUTTERS, BLINDS AND/OR WINDOWS; ELECTRICAL OR ELECTRONIC SECURITY AND FAULT MONITORS FOR PERSONAL PROTECTION AND FOR USE IN SECURITY OF BUILDINGS AND FACILITIES; ELECTRICAL OR ELECTRONIC CONTROLLERS FOR OPERATING ALARM SYSTEMS FOR PERSONAL PROTECTION AND FOR USE IN SECURITY OF BUILDINGS AND FACILITIES; FLOW REGULATORS FOR WATER AND GAS PIPES FOR DOMESTIC USE, SIREN AND ELECTRICAL REMOTE CONTROLLERS FOR SECURITY PRODUCTS AND EQUIPMENT IN CONNECTION WITH INTRUDER PROTECTION, HOME PROTECTION AND PERSONAL PROTECTION; SOLAR BATTERIES; ELECTRIC OR ELECTRONIC APPARATUS FOR ACTIVATING GATES, DOORS, SHUTTERS, BLINDS, WINDOWS; SOLAR-POWERED ELECTRICAL OR ELECTRONIC CONTROL AND REGULATION APPARATUS AND INSTRUMENTS FOR ACTIVATING GATES, DOORS, SHUTTERS, BLINDS, WINDOWS; ELECTRONIC APPARATUS AND INSTRUMENTS, NAMELY, CONTROL AND SURVEILLANCE APPARATUS AND INSTRUMENTS FOR THE PROTECTION OF PERSONS, BUILDINGS, APARTMENTS, HOUSES, FACTORIES AND OFFICES; BURGLAR, FIRE, AND ANTI-INTRUSION ALARMS AND DETECTORS; TELEPHONE TRANSMITTERS, RADIOS, SIRENS, RADIO TRANSMITTERS, REMOTE-CONTROL UNITS FOR SECURITY PRODUCTS AND EQUIPMENT IN CONNECTION WITH INTRUDER PROTECTION, HOME PROTECTION AND PERSONAL PROTECTION, IN CLASS 9 (U.S. CLS. 21, 23, 26, 36 AND 38).



*David J. Kybas*

Director of the United States Patent and Trademark Office

**Reg. No. 4,133,609** OWNER OF INTERNATIONAL REGISTRATION 0655773 DATED 6-12-1996, EXPIRES 6-12-2016.

SER. NO. 79-087,757, FILED 4-6-2010.

TEJBIR SINGH, EXAMINING ATTORNEY



# United States of America

United States Patent and Trademark Office



**Reg. No. 4,133,610**

**Registered May 1, 2012**

**Int. Cls.: 5 and 10**

**TRADEMARK**

**PRINCIPAL REGISTER**

CHIESI FARMACEUTICI S.P.A. (ITALY JOINT STOCK COMPANY)  
VIA PALERMO, 26/A  
I-43122 PARMA (PR)  
ITALY

FOR: PHARMACEUTICAL PREPARATIONS AND SUBSTANCES FOR THE TREATMENT OF PAIN, CARDIOVASCULAR DISORDERS, ALIMENTARY TRACT AND METABOLISM PROBLEMS, RESPIRATORY DISEASES, ENDOCRINE, MUSCULOSKELETAL, CARDIOPULMONARY, GENITOURINARY, ONCOLOGICAL, HEPATOLOGICAL, OPHTHALMOLOGICAL, OTOLOGICALS, NEUROLOGICAL, GASTROINTESTINAL, HORMONAL, DERMATOLOGICAL AND PSYCHIATRIC RELATED DISEASES AND DISORDERS AND FOR THE TREATMENT OF DAMAGED SKIN AND TISSUE; ANTI-INFLAMMATORY AND ANTI-RHEUMATICS DRUGS; PHARMACEUTICAL PREPARATIONS, NAMELY, IMMUNOMODULATORS; HEMATOLOGICAL AGENTS BEING PHARMACEUTICALS FOR THE TREATMENT OF HEMATOLOGICAL DISEASES , IN CLASS 5 (U.S. CLS. 6, 18, 44, 46, 51 AND 52).

FOR: DEVICES FOR THE ADMINISTRATION OF MEDICINAL SUBSTANCES IN POWDER FORM, NAMELY, METERED DOSE INHALERS, DRY POWDER INHALERS AND NEBULIZERS; INHALERS FOR MEDICAL PURPOSES SOLD EMPTY; AEROSOL DISPENSERS FOR MEDICAL USE; INJECTABLE AND INFUSION DRUG DELIVERY SYSTEMS; DEVICES FOR CUTANEOUS ADMINISTRATION, NAMELY, CUTANEOUS APPLICATORS FOR APPLYING PHARMACEUTICAL PREPARATIONS; PARTS FOR THE AFORESAID APPARATUS , IN CLASS 10 (U.S. CLS. 26, 39 AND 44).

OWNER OF U.S. REG. NO. 2,221,478.

PRIORITY DATE OF 6-3-2010 IS CLAIMED.

OWNER OF INTERNATIONAL REGISTRATION 1052814 DATED 8-2-2010, EXPIRES 8-2-2020.

THE MARK CONSISTS OF THE STYLIZED WORDING "CHIESI" WITH A HEXAGON DESIGN HAVING TWO DETACHED SIDES FORMING AN ARROW POINTING TOWARDS THE WORDING. A SMALL CIRCLE IS DISPLAYED AT ONE END OF THE ARROW.

THE ENGLISH TRANSLATION OF "CHIESI" IN THE MARK IS "I ASKED".



*David J. Kyros*

Director of the United States Patent and Trademark Office

**Reg. No. 4,133,610** SER. NO. 79-087,977, FILED 8-2-2010.

EVELYN BRADLEY, EXAMINING ATTORNEY

# United States of America

United States Patent and Trademark Office

# Petra

**Reg. No. 4,133,611**

**Registered May 1, 2012**

**Int. Cl.: 30**

**TRADEMARK**

**PRINCIPAL REGISTER**

MOLINO QUAGLIA S.P.A. (ITALY JOINT STOCK COMPANY)  
VIA ROMA, 6  
I-35040 VIGHIZZOLO D'ESTE (PD), ITALY

FOR: FLOUR FOR PROFESSIONAL USE FOR RESTAURANTS, PIZZA MAKERS, BAKERIES,  
CONFECTIONERIES, AND PASTRY STORES, IN CLASS 30 (U.S. CL. 46).

THE MARK CONSISTS OF THE STYLIZED WORDING "PETRA" IN WHITE WITH A GREY  
OUTLINE.

OWNER OF INTERNATIONAL REGISTRATION 1054259 DATED 9-10-2010, EXPIRES 9-10-  
2020.

THE COLOR(S) WHITE AND GREY IS/ARE CLAIMED AS A FEATURE OF THE MARK.

THE WORDING "PETRA" HAS NO MEANING IN A FOREIGN LANGUAGE.

SER. NO. 79-088,460, FILED 9-10-2010.

TASNEEM HUSSAIN, EXAMINING ATTORNEY



*David J. Kybas*

Director of the United States Patent and Trademark Office

United States of America  
United States Patent and Trademark Office

Unical

**Reg. No. 4,133,612**

**Registered May 1, 2012**

**Int. Cl.: 9**

**TRADEMARK**

**PRINCIPAL REGISTER**

PETER HUBER KÄLTEMASCHINENBAU GMBH (FED REP GERMANY LIMITED LIABILITY COMPANY)  
WERNER-VON-SIEMENS-STR. 1  
77656 OFFENBURG, FED REP GERMANY

FOR: ELECTRICAL LABORATORY EQUIPMENT FOR SCIENTIFIC AND INDUSTRIAL PURPOSES, NAMELY, TEMPERATURE REGULATING APPARATUS IN THE NATURE OF AN ISOLATED CALIBRATION BATH USING WATER, ALCOHOL OR TRANSFER OIL AS TEMPERATURE REGULATION LIQUID, IN CLASS 9 (U.S. CLS. 21, 23, 26, 36 AND 38).

THE MARK CONSISTS OF STANDARD CHARACTERS WITHOUT CLAIM TO ANY PARTICULAR FONT, STYLE, SIZE, OR COLOR.

PRIORITY DATE OF 9-30-2009 IS CLAIMED.

OWNER OF INTERNATIONAL REGISTRATION 1054724 DATED 3-24-2010, EXPIRES 3-24-2020.

THE WORDING "UNICAL" HAS NO MEANING IN A FOREIGN LANGUAGE.

SER. NO. 79-088,645, FILED 3-24-2010.

SUE LAWRENCE, EXAMINING ATTORNEY



*David J. Kyffers*

Director of the United States Patent and Trademark Office

# United States of America

United States Patent and Trademark Office



**Reg. No. 4,133,613**

**Registered May 1, 2012**

**Int. Cls.: 9, 38, 41 and 42**

**TRADEMARK**

**SERVICE MARK**

**PRINCIPAL REGISTER**

OPENBET LIMITED (UNITED KINGDOM LIMITED COMPANY)  
ONE LONDON ROAD  
STAINES, MIDDLESEX TW18 4EX  
UNITED KINGDOM

FOR: SOFTWARE AND SOFTWARE SYSTEMS FOR GAMBLING, GAMING AND BETTING; SOFTWARE AND SOFTWARE SYSTEMS FOR USE IN ACCOUNTING, PAYMENT PROCESSING, CURRENCY CONVERSION, RUNNING AND HOSTING TOURNAMENTS, AND THE ALLOCATION AND DISTRIBUTION OF PRIZE MONEY; SOFTWARE, SOFTWARE SYSTEMS, SOFTWARE PLATFORMS, HARDWARE AND FIRMWARE FOR USE IN THE GAMBLING, GAMING AND BETTING INDUSTRIES FOR ENABLING GAMBLING, GAMING AND BETTING, NAMELY, OPERATING AND RUNNING TOURNAMENTS, COMPETITIONS, PRIZE DRAWS, LOTTERIES, GAMES OF CHANCE AND GAMES OF SKILL, TAKING, PROCESSING, MANAGING AND TRACKING BETS, PROCESSING, MANAGING, CALCULATING, MONITORING AND TRACKING TRANSACTIONS, FUNDS AND PAYOUTS, BOOK-MAKING, CALCULATING AND MONITORING PROBABILITY, STAKES, ODDS, AND RETURNS, CALCULATION, ALLOCATION, MONITORING AND DISTRIBUTION OF PAYMENTS AND RAKES, ADMINISTRATION, BUSINESS MANAGEMENT, DATABASE MANAGEMENT AND DATA MANAGEMENT FOR FINANCE MANAGEMENT AND ADMINISTRATION, CASH MANAGEMENT, ANALYZING, ASSESSING AND REVIEWING GAMBLING, GAMING AND BETTING PROCESSES, IDENTIFYING AND MANAGING LIABILITY, RISK IDENTIFICATION AND ANALYSIS, FRAUD IDENTIFICATION AND MANAGEMENT, MONITORING, MANAGEMENT AND ADMINISTRATION OF CUSTOMER ACCOUNTS, MARKETING AND PROMOTION, AND THE PROVISION OF MARKETING AND PROMOTIONAL ASSISTANCE, COLLATING, DISPLAYING AND ANALYZING INFORMATION AND DATA ON CUSTOMER BEHAVIOR AND CUSTOMER TRANSACTIONS, OPERATING GAMBLING, GAMING AND BETTING EQUIPMENT AND MACHINES, PROVISION OF ONLINE GAMING, GAMBLING AND BETTING SERVICES; COMPUTER AND ELECTRONIC GAMES SOFTWARE; GAMING EQUIPMENT, NAMELY, SLOT MACHINES, ELECTRONIC GAMES TERMINALS, SELF-SERVICE VIDEO BETTING TERMINALS, FIXED-ODDS BETTING TERMINALS, ELECTRONIC LOTTERY TERMINALS, AND GAMING MACHINES, NAMELY, ELECTRONIC FRUIT MACHINES, POKER MACHINES, BLACKJACK MACHINES, ROULETTE MACHINES, AND MACHINES FOR PLAYING TRADITIONAL CASINO TABLE GAMES; TELECOMMUNICATIONS AND COMMUNICATIONS SOFTWARE AND HARDWARE, FOR USE IN THE GAMBLING, GAMING AND BETTING INDUSTRIES FOR PROVIDING ACCESS TO GLOBAL COMPUTER NETWORKS AND ONLINE GAMING SERVICES; COMPUTER OPERATING SYSTEMS FOR USE IN THE GAMBLING, GAMING



*David J. Kyros*

Director of the United States Patent and Trademark Office

**Reg. No. 4,133,613** AND BETTING INDUSTRIES; ELECTRONIC PUBLICATIONS, NAMELY, MANUALS, BROCHURES, GUIDES, MAGAZINES, AND ARTICLES, WHICH ARE DOWNLOADABLE OR ARE RECORDED ON COMPUTER MEDIA, FEATURING INFORMATION ON SOFTWARE FOR GAMBLING, BETTING, GAMING, GAMES OF CHANCE, GAMES OF SKILL AND INFORMATION ON SOFTWARE USED IN THE GAMBLING, GAMING AND BETTING INDUSTRIES, IN CLASS 9 (U.S. CLS. 21, 23, 26, 36 AND 38).

FOR: PROVISION OF TELECOMMUNICATIONS AND COMMUNICATIONS SERVICES TO THE GAMBLING, GAMING AND BETTING INDUSTRIES, NAMELY, PROVISION OF TELECOMMUNICATIONS ACCESS TO GAMING SERVICES OVER THE INTERNET; PROVISION OF ACCESS TO WEBSITES; PROVISION OF ACCESS TO THE INTERNET; PROVISION OF INFORMATION, ADVICE AND CONSULTANCY IN RELATION TO TELECOMMUNICATIONS AND TELECOMMUNICATIONS HARDWARE AND SOFTWARE, IN CLASS 38 (U.S. CLS. 100, 101 AND 104).

FOR: GAMBLING SERVICES; PROVIDING GAMING SERVICES BY MEANS OF WEBSITES AND GLOBAL COMPUTER NETWORKS; BETTING SERVICES; EDUCATION SERVICES, NAMELY, PROVIDING COURSES, SEMINARS, WORKSHOPS, CLASSES, TUTORIALS, AND ON-LINE COURSES OF INSTRUCTION AND COMPUTER EDUCATION TRAINING RELATING TO THE USE OF SOFTWARE AND SOFTWARE SYSTEMS FOR THE GAMING, GAMBLING, AND BETTING INDUSTRIES; PROVIDING ON ON-LINE PORTAL FOR CUSTOMERS TO PARTICIPATE IN ON-LINE GAMING; PROVISION OF INFORMATION, ADVICE AND CONSULTANCY IN RELATION TO GAMBLING, GAMING AND BETTING SERVICES, IN CLASS 41 (U.S. CLS. 100, 101 AND 107).

FOR: COMPUTER CONSULTANCY; SOFTWARE CONSULTANCY SERVICES; SOFTWARE DESIGN, INSTALLATION, PROGRAMMING AND MAINTENANCE; CUSTOMIZATION OF SOFTWARE; ADVISORY SERVICES IN THE FIELD OF SOFTWARE DEVELOPMENT; SOFTWARE DEVELOPMENT; SOFTWARE RENTAL; SOFTWARE ENGINEERING; UP-GRADING OF SOFTWARE; COMPUTER PROGRAMMING; COMPUTER SYSTEMS DESIGN; HOSTING WEBSITES; HOSTING ONLINE FACILITIES FOR OTHERS; DESIGN AND CREATION OF GAMES, SOFTWARE AND ELECTRONIC GAMES FOR OTHERS; PROVISION OF ADVICE AND INFORMATION IN RELATION TO SOFTWARE DEVELOPMENT AND CUSTOMIZATION, IN CLASS 42 (U.S. CLS. 100 AND 101).

PRIORITY DATE OF 5-21-2010 IS CLAIMED.

OWNER OF INTERNATIONAL REGISTRATION 1055386 DATED 6-30-2010, EXPIRES 6-30-2020.

SER. NO. 79-088,887, FILED 6-30-2010.

PATRICIA EVANKO, EXAMINING ATTORNEY

# United States of America

United States Patent and Trademark Office

# BABYSNUG

**Reg. No. 4,133,614**

**Registered May 1, 2012**

**Int. Cl.: 20**

**TRADEMARK**

**PRINCIPAL REGISTER**

MAMAS & PAPAS (HOLDINGS) LIMITED (UNITED KINGDOM COMPANY)  
COLNE BRIDGE ROAD  
HUDDERSFIELD, WEST YORKSHIRE, HD5 0RH  
UNITED KINGDOM

FOR: BABY BOUNCERS; SEATS; SEATS FOR INFANTS AND BABIES; SUPPORT SEATS, NAMELY, CUSHIONED CHAIRS; CUSHIONED SEATS, IN CLASS 20 (U.S. CLS. 2, 13, 22, 25, 32 AND 50).

THE MARK CONSISTS OF STANDARD CHARACTERS WITHOUT CLAIM TO ANY PARTICULAR FONT, STYLE, SIZE, OR COLOR.

OWNER OF INTERNATIONAL REGISTRATION 1056225 DATED 8-13-2010, EXPIRES 8-13-2020.

SER. NO. 79-089,186, FILED 8-13-2010.

SEAN CROWLEY, EXAMINING ATTORNEY



*David J. Kyffers*

Director of the United States Patent and Trademark Office

# United States of America

United States Patent and Trademark Office

## ONE TEASPOON

**Reg. No. 4,133,615**

**Registered May 1, 2012**

**Int. Cl.: 25**

**TRADEMARK**

**PRINCIPAL REGISTER**

PINK FACTORY PTY LTD (AUSTRALIA PRIVATE COMPANY)  
1/28-34 ROSEBERRY STREET  
BALGOWLAH NSW 2093, AUSTRALIA

FOR: CLOTHING, NAMELY, TOPS, SHIRTS, T-SHIRTS, SINGLETs, BLOUSES, SWEATERS, SWEATSHIRTS, JERSEYS, CARDIGANS, JUMPERS, COATS, JACKETS, BLAZERS, OVERCOATS, RAINCOATS, KIMONOS, KAFTANS, BODYSUITS, JUMPSUITS, TRACKSUITS, PANTS, JEANS, BOTTOMS, LEGGINGS, SHORTS, SKIRTS, DRESSES AND UNDERWEAR; SPORTSWEAR, NAMELY, TOPS, T-SHIRTS, SINGLETs, SWEATSHIRTS, SWEATPANTS, SHORTS, TIGHTS, PULLOVERS, SKIRTS, TENNIS SKIRTS, HEADBANDS AND SPORTS BRAS; FOOTWEAR; HEADWEAR; KNITWEAR, NAMELY, KNIT COATS, KNIT PANTS, KNIT SHIRTS, KNIT SWEATERS, KNIT DRESSES, AND KNIT HATS; BELTS, SCARVES, SOCKS AND SWIMSUITS, IN CLASS 25 (U.S. CLS. 22 AND 39).

THE MARK CONSISTS OF STANDARD CHARACTERS WITHOUT CLAIM TO ANY PARTICULAR FONT, STYLE, SIZE, OR COLOR.

OWNER OF INTERNATIONAL REGISTRATION 1056397 DATED 9-22-2010, EXPIRES 9-22-2020.

SER. NO. 79-089,245, FILED 9-22-2010.

LEIGH LOWRY, EXAMINING ATTORNEY



*David J. Kyffers*

Director of the United States Patent and Trademark Office



# United States of America

United States Patent and Trademark Office

**FIISH**  
Instinct  
Innovation  
Intelligence

**Reg. No. 4,133,616**

**Registered May 1, 2012**

**Int. Cl.: 28**

**TRADEMARK**

**PRINCIPAL REGISTER**

FIISH (FRANCE SOCIÉTÉ À RESPONSABILITÉ LIMITÉE)  
10 RUE DUMONT D'URVILLE  
F-29200 BREST  
FRANCE

FOR: FISHING TACKLE; ARTIFICIAL FISHING BAIT; RODS FOR FISHING; FLY RODS FOR FISHING; FISHING TACKLE, NAMELY, BITE DETECTORS; HAND-HELD LANDING NETS FOR FISHING; NETS FOR FISHING; FLOATS FOR FISHING; FISH HOOKS; LINES FOR FISHING; SCENTED AND UNSCENTED LURES FOR FISHING; REELS FOR FISHING; FISHING EQUIPMENT, NAMELY, CREELS; FISHING SINKERS; STANDS AND CASES FOR FISHING RODS, IN CLASS 28 (U.S. CLS. 22, 23, 38 AND 50).

NO CLAIM IS MADE TO THE EXCLUSIVE RIGHT TO USE "FISH", APART FROM THE MARK AS SHOWN.

OWNER OF INTERNATIONAL REGISTRATION 1056441 DATED 9-20-2010, EXPIRES 9-20-2020.

THE MARK CONSISTS OF THE WORD "FIISH" WITH THREE STARS ABOVE THE THREE LETTER "I'S. BELOW "FIISH" IS THE WORDING "INSTINCT", "INNOVATION" AND "INTELLIGENCE" STACKED ON TOP OF EACH OTHER.

SER. NO. 79-089,265, FILED 9-20-2010.

MARLENE BELL, EXAMINING ATTORNEY



*David J. Kybas*

Director of the United States Patent and Trademark Office

# United States of America

United States Patent and Trademark Office



**Reg. No. 4,133,617**

**Registered May 1, 2012**

**Int. Cls.: 30, 35 and 43**

**TRADEMARK**

**SERVICE MARK**

**PRINCIPAL REGISTER**

WAYNE OCH MARGARETA'S COFFEE AB (SWEDEN AKTIEBOLAG)  
DROTTNINGGATAN 55  
SE-111 21 STOCKHOLM  
SWEDEN

FOR: COFFEE, TEA, ARTIFICIAL COFFEE; FLOUR AND PREPARATIONS MADE FROM CEREALS, NAMELY, BREAD, PASTRY AND CONFECTIONERY; SAUCES AS CONDIMENTS; ICE; COFFEE BY WEIGHT; COFFEE BEANS; TEA BAGS; CAKE MIXES; COFFEE-BASED BEVERAGES; COFFEE FLAVOURINGS; UNROASTED COFFEE; COFFEE BEVERAGES WITH MILK, IN CLASS 30 (U.S. CL. 46).

FOR: RETAIL STORE SERVICES FEATURING FOOD AND DRINK, COFFEE-MAKING EQUIPMENT, PORCELAIN, PRINTED MATTER, CDS, VIDEOS AND DVDS, BAGS AND CLOTHES; FRANCHISE SERVICES, NAMELY, BUSINESS MANAGEMENT ASSISTANCE IN THE ESTABLISHMENT AND OPERATION OF A RETAIL STORE; ADVERTISING, IN CLASS 35 (U.S. CLS. 100, 101 AND 102).

FOR: CAFÉ AND RESTAURANT SERVICES, IN CLASS 43 (U.S. CLS. 100 AND 101).

NO CLAIM IS MADE TO THE EXCLUSIVE RIGHT TO USE "COFFEE", APART FROM THE MARK AS SHOWN.

OWNER OF INTERNATIONAL REGISTRATION 1056709 DATED 8-27-2010, EXPIRES 8-27-2020.

THE COLOR(S) BLUE AND WHITE IS/ARE CLAIMED AS A FEATURE OF THE MARK.

THE MARK CONSISTS OF THE WORDING "WAYNE'S COFFEE" IN WHITE IN THE MIDDLE OF A BLUE RECTANGLE.

SER. NO. 79-089,349, FILED 8-27-2010.

ANNE E. GUSTASON, EXAMINING ATTORNEY



*David J. Kyffers*

Director of the United States Patent and Trademark Office

# United States of America

United States Patent and Trademark Office



**Reg. No. 4,133,618**

**Registered May 1, 2012**

**Int. Cl.: 17**

**TRADEMARK**

**PRINCIPAL REGISTER**

INSIT INDUSTRIA S.P.A. (ITALY CORPORATION)  
C.SO G. GOVONE, 18  
I-10129 TORINO, ITALY

FOR: TECHNICAL ARTICLES OF SYNTHETIC, NATURAL AND THERMOPLASTIC MOLDED RUBBER FOR THE AUTOMOTIVE FIELD, NAMELY, CONNECTING HOSES AND TUBES FOR VEHICLE RADIATORS, CONNECTING HOSES AND TUBES FOR VEHICLE FUEL INJECTORS, HOSES AND TUBES FOR VEHICLE HEATERS, AND HOSES AND TUBES MADE OF RUBBER OR PLASTIC FOR USE IN VEHICLE ENGINE COMPARTMENTS FOR THE TRANSPORT OF GASES OR FLUIDS, IN CLASS 17 (U.S. CLS. 1, 5, 12, 13, 35 AND 50).

PRIORITY DATE OF 3-31-2010 IS CLAIMED.

OWNER OF INTERNATIONAL REGISTRATION 1056784 DATED 7-28-2010, EXPIRES 7-28-2020.

SER. NO. 79-089,381, FILED 7-28-2010.

KHANH LE, EXAMINING ATTORNEY



*David J. Kybas*

Director of the United States Patent and Trademark Office

# United States of America

United States Patent and Trademark Office



**Reg. No. 4,133,619**

**Registered May 1, 2012**

**Int. Cl.: 25**

PINK FACTORY PTY LTD (AUSTRALIA AUSTRALIAN PROPRIETARY COMPANY,  
LIMITED BY SHARES)  
1/28-34 ROSEBERRY STREET  
BALGOWLAH NSW 2093  
AUSTRALIA

**TRADEMARK**

**PRINCIPAL REGISTER**

FOR: CLOTHING OF IMITATIONS OF LEATHER, NAMELY, JACKETS, COATS, SKIRTS, SHORTS, BELTS, HATS AND PANTS; CLOTHING OF LEATHER, NAMELY, JACKETS, COATS, SKIRTS, SHORTS, BELTS, HATS AND PANTS; BEACHWEAR; CLOTHING, NAMELY, TOPS, SHIRTS, T-SHIRTS, SINGLET, BLOUSES, SWEATSHIRTS, CARDIGANS, JUMPERS, COATS, BLAZERS, OVERCOATS, RAINCOATS, KIMONOS, KAFTANS, BODYSUITS, JUMPSUITS, TRACKSUITS, PANTS, JEANS, BOTTOMS, LEGGINGS, SHORTS, SKIRTS, DRESSES, SCARVES, HATS, CAPS AND BEANIES; KNITWEAR, NAMELY, KNIT COATS, KNIT PANTS, KNIT SHIRTS, KNIT SWEATERS, KNIT DRESSES, KNIT HATS AND KNIT BEANIES; WATERPROOF CLOTHING, NAMELY, JACKETS, COATS, WIND RESISTANT JACKETS, OVERCOATS, PANTS AND HATS; READY-MADE CLOTHING, NAMELY, TOPS, SHIRTS, T-SHIRTS, SINGLET, BLOUSES, SWEATSHIRTS, CARDIGANS, JUMPERS, COATS, BLAZERS, OVERCOATS, RAINCOATS, KIMONOS, KAFTANS, BODYSUITS, JUMPSUITS, TRACKSUITS, PANTS, JEANS, BOTTOMS, LEGGINGS, SHORTS, SKIRTS, DRESSES, SCARVES, HATS, CAPS AND BEANIES; SPORTSWEAR, NAMELY, TOPS, T-SHIRTS, SINGLET, SWEATSHIRTS, SWEATPANTS, SHORTS, TIGHTS, PULLOVERS, SKIRTS, TENNIS SKIRTS, HEADBANDS AND SPORTS BRAS; CLOTHING FOR GYMNASTICS, NAMELY, LEOTARDS, TIGHTS, BODYSUITS, JUMPSUITS, TRACKSUITS, LEGGINGS, PANTS, GYMNASTIC SHOES, AND SHORTS; WRISTBANDS, BELTS, BABIES' PANTS, BATHING SUITS, BATHING TRUNKS, UNDERWEAR, GABERDINES, GLOVES, HEADBANDS, HOODS, JACKETS, JERSEYS, LAYETTES, BODY LINEN, FINISHED TEXTILE LININGS FOR GARMENTS, STUFF JACKETS, SUITS, UNDERCLOTHES, VEILS, SPORTS JERSEYS, COMBINATIONS, PULLOVERS, SWEATERS, PARKAS, CAMISOLES, FURS, NAMELY, FUR COATS, FUR MUFFS, FUR SCARVES, FUR STOLE, FUR SHAWLS, FUR WRAPS, FUR HATS AND FUR GLOVES, IN CLASS 25 (U.S. CLS. 22 AND 39).



THE MARK CONSISTS OF A SOLID BIRD IN FLIGHT WITH A CHAIN AROUND ITS NECK AND A BONE PENDANT AT THE BASE OF THE CHAIN.

*David J. Kyros*

OWNER OF INTERNATIONAL REGISTRATION 1056845 DATED 9-22-2010, EXPIRES 9-22-2020.

**Reg. No. 4,133,619** SER. NO. 79-089,436, FILED 9-22-2010.

LEIGH LOWRY, EXAMINING ATTORNEY

# United States of America

United States Patent and Trademark Office

# PAYMENTICS

**Reg. No. 4,133,620**

**Registered May 1, 2012**

**Int. Cls.: 9, 16, 35, 36  
and 42**

**TRADEMARK**

**SERVICE MARK**

**PRINCIPAL REGISTER**

CANTON-CONSULTING (FRANCE SOCIÉTÉ PAR ACTION SIMPLIFIÉE)  
9-11 AVENUE F-D ROOSEVELT  
F-75008 PARIS  
FRANCE

FOR: EQUIPMENT AND APPARATUS FOR DATA PROCESSING , IN CLASS 9 (U.S. CLS. 21, 23, 26, 36 AND 38).

FOR: PAPER, CARDBOARD, PRINTED MATTER, NAMELY, PRINTED INFORMATION FORMS IN THE FIELD OF FINANCE; NEWSPAPERS, PERIODICALS IN THE FIELD OF FINANCE, BOOKBINDING MATERIAL; PHOTOGRAPHS; STATIONERY; ADHESIVE GULES FOR STATIONERY OR HOUSEHOLD PURPOSES; ARTISTS' MATERIALS, NAMELY, PAPER, DRAWING PAD, PAPER BOARD; PAINTBRUSHES; TYPEWRITERS AND OFFICE REQUISITES EXCEPT FURNITURE, NAMELY, PENCILS, PENS, NOTE PADS, FOLDERS; PRINTED INSTRUCTIONAL AND TEACHING MATERIAL EXCEPT APPARATUS IN THE FIELD OF FINANCE; PRINTING TYPE; PRINTING BLOCKS, IN CLASS 16 (U.S. CLS. 2, 5, 22, 23, 29, 37, 38 AND 50).

FOR: ADVERTISING SERVICES; BUSINESS MANAGEMENT; BUSINESS ADMINISTRATION; PROVIDING OFFICE FUNCTIONS; BUSINESS MANAGEMENT ASSISTANCE; BUSINESS ORGANIZATION AND MANAGEMENT ADVICE AND CONSULTING; MARKET STUDIES; DATA COMPILATION AND SYSTEMIZATION OF INFORMATION IN A COMPUTER DATABASE, IN CLASS 35 (U.S. CLS. 100, 101 AND 102).

FOR: FINANCIAL CONSULTING; FINANCIAL EVALUATION, IN CLASS 36 (U.S. CLS. 100, 101 AND 102).

FOR: ENGINEERING SERVICES, NAMELY, ASSESSMENTS, ESTIMATES AND RESEARCH IN SCIENTIFIC AND TECHNOLOGIC FIELDS PROVIDED BY ENGINEERS, RESEARCH AND DEVELOPMENT ON NEW PRODUCTS; DESIGN AND DEVELOPMENT OF COMPUTERS AND SOFTWARE, IN CLASS 42 (U.S. CLS. 100 AND 101).

THE MARK CONSISTS OF STANDARD CHARACTERS WITHOUT CLAIM TO ANY PARTICULAR FONT, STYLE, SIZE, OR COLOR.

PRIORITY DATE OF 4-16-2010 IS CLAIMED.



*David J. Kybas*

Director of the United States Patent and Trademark Office

**Reg. No. 4,133,620** OWNER OF INTERNATIONAL REGISTRATION 1056867 DATED 10-8-2010, EXPIRES 10-8-2020.

SER. NO. 79-089,445, FILED 10-8-2010.

DOMINIC FATHY, EXAMINING ATTORNEY

# United States of America

United States Patent and Trademark Office



**Reg. No. 4,133,621**

**Registered May 1, 2012**

**Int. Cls.: 25, 26 and 35**

**TRADEMARK**

**SERVICE MARK**

**PRINCIPAL REGISTER**

MONSIEUR ILAN SAMAMA (FRANCE INDIVIDUAL)  
81 AVENUE DE WAGRAM  
F-75017 PARIS  
FRANCE

FOR: CLOTHING, NAMELY, SHIRTS, DRESSES, BRIDESMAID DRESSES, PANTS, JACKETS, TOPS, BANDEAU TOPS, EVENING GOWNS, CAPES; HEADGEAR, NAMELY, HATS, CAPS, BERETS, HEADWEAR, AND HEAD SCARVES; LEATHER AND IMITATION LEATHER CLOTHING, NAMELY, SKIRTS OF LEATHER, SKIRTS MADE FROM IMITATION LEATHER, JACKETS OF LEATHER, JACKETS MADE FROM IMITATION LEATHER, PANTS OF LEATHER, PANTS MADE FROM IMITATION LEATHER, DRESSES OF LEATHER, DRESSES MADE FROM IMITATION LEATHER, TOPS OF LEATHER, TOPS MADE FROM IMITATION OF LEATHER, GLOVES OF LEATHER, GLOVES MADE FROM IMITATION LEATHER, BELTS OF LEATHER; CLOTHING FURS, NAMELY, FUR JACKETS, FUR COATS, FUR GLOVES, FUR STOLE, FUR SCARVES; FOUNDATION CLOTHING, NAMELY, CORSETS, GARTERS, GARTER BELTS, SHAWLS AND STOLE, SCARVES, CLOTHING GLOVES, BELTS FOR CLOTHING, WAIST BELTS, PANTYHOSE, STOCKINGS, KNEE-HIGH STOCKINGS, LADIES' UNDERWEAR, BRAS, BRASSIERES, STRAPS FOR BRAS, SOCKS, NECKTIES, IN CLASS 25 (U.S. CLS. 22 AND 39).

FOR: LACE AND EMBROIDERY; RIBBONS AND BRAID; BUTTONS; HOOKS AND EYES; PINS, NAMELY, SEWING PINS, HAIR PINS, SAFETY PINS, HAT PINS, BONNET PINS; ARTIFICIAL FLOWERS; HABERDASHERY EXCEPT THREAD AND YARN, NAMELY, BEADS OTHER THAN FOR MAKING JEWELRY, RIBBON, LACE AND EMBROIDERY; TRIMMING MATERIAL, NAMELY, LACE TRIMMING, LACING NEEDLES, DARNING NEEDLES, EMBROIDERY NEEDLES, THIMBLES; WIGS; CLOTHING FASTENERS, NAMELY, BUTTONS, PRESS BUTTONS, RIVET BUTTONS, SLIDE FASTENERS, ZIPPER FASTENERS, BUCKLES FOR CLOTHING; CLOTHING CLASPS, NAMELY, CLIPS WITH HOLDER FOR ATTACHING CORSAGE AND BOUTONNIERES FOR CLOTHING, CLASPS FOR CLOTHING, BELT CLASPS; HAIR ORNAMENTS; SPANGLES; NON-ELECTRIC HAIR ROLLERS; HAIR ELASTICS; HAIR CLIPS; HAIR BUCKLES; HAIR BANDS; HAIR SCRUNCHIES, IN CLASS 26 (U.S. CLS. 37, 39, 40, 42 AND 50).



*David J. Kyros*

Director of the United States Patent and Trademark Office

FOR: ADVERTISING, BUSINESS MANAGEMENT AND ORGANIZATION CONSULTANCY, DOCUMENT REPRODUCTION, EMPLOYMENT AGENCIES, COMPUTERIZED FILE MANAGEMENT, ORGANIZATION OF EXHIBITIONS FOR COMMERCIAL OR ADVERTISING PURPOSES, ON-LINE ADVERTISING ON A COMPUTER NETWORK, RENTAL OF



**Reg. No. 4,133,621** ADVERTISING TIME ON COMMUNICATION MEDIA, PUBLICATION OF ADVERTISING TEXTS, RENTAL OF ADVERTISING SPACE, DISSEMINATION OF ADVERTISING MATTER, PUBLIC RELATIONS, IN CLASS 35 (U.S. CLS. 100, 101 AND 102).

NO CLAIM IS MADE TO THE EXCLUSIVE RIGHT TO USE "COUTURE NUPTIALE", APART FROM THE MARK AS SHOWN.

PRIORITY DATE OF 5-5-2010 IS CLAIMED.

OWNER OF INTERNATIONAL REGISTRATION 1056962 DATED 10-13-2010, EXPIRES 10-13-2020.

THE MARK CONSISTS OF A RECTANGLE CONTAINING A LETTER "C" IN THE CENTER WITH A LETTER "N" IN THE CENTER OF THE LETTER "C". THE WORD "COUTURE" APPEARS CENTERED BELOW THE RECTANGLE WITH THE WORD "NUPTIALE" CENTERED BELOW THE WORD "COUTURE".

THE ENGLISH TRANSLATION OF THE FOREIGN WORDS IN THE MARK IS BRIDAL COUTURE.

SER. NO. 79-089,482, FILED 10-13-2010.

TINA BROWN, EXAMINING ATTORNEY

United States of America  
United States Patent and Trademark Office

Tango

**Reg. No. 4,133,622**

**Registered May 1, 2012**

**Int. Cl.: 9**

PETER HUBER KÄLTEMASCHINENBAU GMBH (FED REP GERMANY LIMITED LIABILITY COMPANY)  
WERNER-VON-SIEMENS-STR. 1  
77656 OFFENBURG  
FED REP GERMANY

**TRADEMARK**

**PRINCIPAL REGISTER**

FOR: ELECTRICAL LABORATORY EQUIPMENT FOR SCIENTIFIC AND INDUSTRIAL PURPOSES, INCLUDED IN THIS CLASS, NAMELY, TEMPERATURE REGULATING APPARATUS, LABORATORY THERMOSTATS, NAMELY, COLD AND HEAT THERMOSTATS, BATH THERMOSTATS, PENDANT THERMOSTATS AS WELL AS CIRCULATORY THERMOSTATS, IN CLASS 9 (U.S. CLS. 21, 23, 26, 36 AND 38).

THE MARK CONSISTS OF STANDARD CHARACTERS WITHOUT CLAIM TO ANY PARTICULAR FONT, STYLE, SIZE, OR COLOR.

PRIORITY DATE OF 10-16-2009 IS CLAIMED.

OWNER OF INTERNATIONAL REGISTRATION 1057162 DATED 3-24-2010, EXPIRES 3-24-2020.

SER. NO. 79-089,569, FILED 3-24-2010.

WILLIAM ROSSMAN, EXAMINING ATTORNEY



*David J. Kypos*

Director of the United States Patent and Trademark Office

# United States of America

United States Patent and Trademark Office

one teaspoon.

**Reg. No. 4,133,623**

**Registered May 1, 2012**

**Int. Cl.: 25**

**TRADEMARK**

**PRINCIPAL REGISTER**

PINK FACTORY PTY LTD (AUSTRALIA PRIVATE COMPANY)  
1/28-34 ROSEBERRY STREET  
BALGOWLAH NSW 2093  
AUSTRALIA

FOR: CLOTHING OF IMITATIONS OF LEATHER, NAMELY, JACKETS, COATS, SKIRTS, SHORTS, BELTS, HATS AND PANTS; CLOTHING OF LEATHER, NAMELY, JACKETS, COATS, SKIRTS, SHORTS, BELTS, HATS AND PANTS; BEACHWEAR; CLOTHING, NAMELY, TOPS, SHIRTS, T-SHIRTS, SINGLET, BLOUSES, SWEATSHIRTS, CARDIGANS, JUMPERS, COATS, BLAZERS, OVERCOATS, RAINCOATS, KIMONOS, KAFTANS, BODYSUITS, JUMPSUITS, TRACKSUITS, PANTS, JEANS, BOTTOMS, LEGGINGS, SHORTS, SKIRTS, DRESSES, SCARVES, HATS, CAPS AND BEANIES; KNITWEAR, NAMELY, KNIT COATS, KNIT PANTS, KNIT SHIRTS, KNIT SWEATERS, KNIT DRESSES, KNIT HATS AND KNIT BEANIES; WATERPROOF CLOTHING, NAMELY, JACKETS, COATS, WIND RESISTANT JACKETS, OVERCOATS, PANTS AND HATS; READY-MADE CLOTHING, NAMELY, TOPS, SHIRTS, T-SHIRTS, SINGLET, BLOUSES, SWEATSHIRTS, CARDIGANS, JUMPERS, COATS, BLAZERS, OVERCOATS, RAINCOATS, KIMONOS, KAFTANS, BODYSUITS, JUMPSUITS, TRACKSUITS, PANTS, JEANS, BOTTOMS, LEGGINGS, SHORTS, SKIRTS, DRESSES, SCARVES, HATS, CAPS AND BEANIES; SPORTSWEAR, NAMELY, TOPS, T-SHIRTS, SINGLET, SWEATSHIRTS, SWEATPANTS, SHORTS, TIGHTS, PULLOVERS, SKIRTS, TENNIS SKIRTS, HEADBANDS AND SPORTS BRAS; CLOTHING FOR GYMNASTICS, NAMELY, LEOTARDS, TIGHTS, BODYSUITS, JUMPSUITS, TRACKSUITS, LEGGINGS, PANTS, GYMNASTIC SHOES, AND SHORTS; WRISTBANDS, BELTS, BABIES' PANTS, BATHING SUITS, BATHING TRUNKS, UNDERWEAR, GABERDINES, GLOVES, HEADBANDS, HOODS, JACKETS, JERSEYS, LAYETTES, BODY LINEN, FINISHED TEXTILE LININGS FOR GARMENTS, STUFF JACKETS, SUITS, UNDERCLOTHES, VEILS, SPORTS JERSEYS, COMBINATIONS, PULLOVERS, SWEATERS, PARKAS, CAMISOLES, FURS, NAMELY, FUR COATS, FUR MUFFS, FUR SCARVES, FUR STOLES, FUR SHAWLS, FUR WRAPS, FUR HATS AND FUR GLOVES, IN CLASS 25 (U.S. CLS. 22 AND 39).



THE MARK CONSISTS OF THE WORD "ONE" IN SOLID TYPE FONT FOLLOWED BY THE WORD "TEASPOON" IN A HANDWRITTEN SCRIPT.

*David J. Kyros*

OWNER OF INTERNATIONAL REGISTRATION 1057711 DATED 9-22-2010, EXPIRES 9-22-2020.

Director of the United States Patent and Trademark Office

SER. NO. 79-089,767, FILED 9-22-2010.

**Reg. No. 4,133,623** LEIGH LOWRY, EXAMINING ATTORNEY

# United States of America

United States Patent and Trademark Office



荣利  
RONGLI

**Reg. No. 4,133,624**

**Registered May 1, 2012**

**Int. Cl.: 7**

**TRADEMARK**

**PRINCIPAL REGISTER**

SHANDONG RONGLI PETROLEUM MACHINERY CO., LTD (CHINA CORPORATION)  
NO. 3333, QINGZHOU NORTH ROAD  
QINGZHOU CITY  
SHANDONG PROVINCE, CHINA 262515

FOR: DRILLING MACHINES; MIXING MACHINES; EARTH MOVING MACHINES, NAMELY, EXCAVATORS; HOISTS; CENTRIFUGAL MACHINES; CENTRIFUGAL PUMPS, IN CLASS 7 (U.S. CLS. 13, 19, 21, 23, 31, 34 AND 35).

THE MARK CONSISTS OF THE WORD "RONGLI" WITH A DESIGN ABOVE IT, AND CHINESE CHARACTERS ALONG EITHER SIDE.

OWNER OF INTERNATIONAL REGISTRATION 1057773 DATED 11-3-2010, EXPIRES 11-3-2020.

THE NON-LATIN CHARACTERS IN THE MARK TRANSLITERATE TO "RONGLI" AND IT HAS NO MEANING.

THE ENGLISH TRANSLATION OF "RONGLI" IN THE MARK IS WITHOUT MEANING IN ANY LANGUAGE.

SER. NO. 79-089,790, FILED 11-3-2010.

FRANK LATTUCA, EXAMINING ATTORNEY



*David J. Kyffers*

Director of the United States Patent and Trademark Office

# United States of America

United States Patent and Trademark Office

# INTERFLOOR

**Reg. No. 4,133,625**

**Registered May 1, 2012**

**Int. Cls.: 6, 8, 19, 20 and  
27**

**TRADEMARK**

**PRINCIPAL REGISTER**

INTERFLOOR LIMITED (UNITED KINGDOM A LIMITED COMPANY)  
BROADWAY, HASLINGDEN  
ROSSENDALE, LANCASHIRE BB4 4LS  
UNITED KINGDOM

FOR: METALLIC ARTICLES FOR ANCHORING, FASTENING AND/OR FIXING CARPETS, FLOOR COVERINGS AND STAIRS, NAMELY, NAILS, PRE-NAILS IN THE NATURE OF NAILS PRE-INSERTED INTO METAL FLOORING PRODUCTS, STAPLES AND BRADS; DEVICES MADE WHOLLY AND SIMPLY OF COMMON METAL FOR ANCHORING OR EDGING FLOOR COVERINGS, NAMELY, METAL PROFILES FOR JOINING FLOOR COVERINGS, METAL PROFILES FOR EDGING FLOOR COVERINGS, METAL PROFILES FOR USE IN CREATING LINED RECESS IN FLOOR COVERINGS, METAL PROFILES FOR TRIMMING FLOOR COVERINGS, JOINT COVER STRIPS OF METAL, METAL TRIM, METAL EDGINGS, METAL Z-SECTION TRIM, METAL ANGLE SECTION TRIM, METAL STAIR RODS, METAL STAIR BRACKETS AND STAIR NOSINGS; AND METAL STAIR STEPS, IN CLASS 6 (U.S. CLS. 2, 12, 13, 14, 23, 25 AND 50).

FOR: WOOD AND LAMINATE FLOOR COVERING INSTALLATION HAND TOOL KITS COMPRISED OF COMPRESSION RATCHETS, COMPRESSION CLAMPS, PULLING IRONS, PARALLEL SCRIBERS, SAWS, HAMMERS, TAPPING BLOCKS, HAND BLOCKS AND CARRYING CASE, ALL SOLD AS A UNIT; MANUALLY OPERATED TOOLS AND IMPLEMENTS FOR USE IN CUTTING, FITTING AND LAYING FLOOR COVERINGS AND FLOOR COVERING MATERIALS, NAMELY, HAMMERS, SHEARS, SCISSORS, SNIPS, TACK AND MOLDING LIFTERS, CARPET SEAM WEIGHTS, CARPET SEAM ROLLERS, CARPET TRIMMERS, CARPET TUCKERS, PULLING IRONS, PARALLEL SCRIBERS, SAWS, TAPPING BLOCKS AND WEDGES, SUCTION CLAMPS, HAND BLOCKS, TONGUE AND GROOVE SKIMMERS, TROWELS, GLIDERS, SCRAPERS, CARPET CLAWS, GRINDING STONE AND HANDLE COMBINATIONS, CHALK LINE AND REELS, CUTTERS, SEAM CUTTERS, CUTTING GUIDES, MANUALLY OPERATED STAPLE GUNS, AWLS, MALLETS, NAIL DRIVING BARS, KNEE KICKERS, CORNER SUPPORTS OF USE WITH CARPET STRETCHERS, KNIVES, STAIR TOOLS IN THE NATURE OF WIDE BLADE AND HANDLE COMBINATIONS, HAND TOOL BLADES AND MANUALLY OPERATED ADHESIVE APPLICATOR GUNS; AND PARTS AND FITTING FOR ALL OF THE AFORESAID GOODS, IN CLASS 8 (U.S. CLS. 23, 28 AND 44).



*David J. Kappas*

Director of the United States Patent and Trademark Office

FOR: NON-METALLIC BUILDING MATERIALS, NAMELY, WOODEN QUADRANTS AND SKIRTING FOR FINISHING ROOM PERIPHERIES, WOODEN PIPE COLLARS, LAMINATED

**Reg. No. 4,133,625** FLOOR AND WALL EDGINGS, FLOORING UNDERLAYMENTS IN THE NATURE OF PAPER FELT FOR SUB-FLOORING APPLICATIONS, WOODEN STRIPS, WOODEN THRESHOLD STRIPS, LAMINATED NON-METALLIC EDGINGS AND WOODEN EDGINGS FOR FLOORS AND WALLS, IN CLASS 19 (U.S. CLS. 1, 12, 33 AND 50).

FOR: DEVICES MADE WHOLLY OR PRIMARILY OF NON-METALLIC MATERIALS FOR ANCHORING, FASTENING AND/OR FIXING CARPETS, FLOOR COVERINGS AND STAIRS, NAMELY, NON-METAL FASTENERS, NAMELY, NAILS, STAPLES AND TACKS FOR FLOOR COVERINGS, IN CLASS 20 (U.S. CLS. 2, 13, 22, 25, 32 AND 50).

FOR: FLOOR COVERINGS, NAMELY, FIRE SAFE FLOOR COVERINGS AND FLOOR COVERINGS COMPOSED OF RUBBER SHEETING AND MATTING; CARPET UNDERLAYS; ANTI-SLIP RUG GRIPS IN THE NATURE OF RUG GRIPPERS; COVERINGS FOR EXISTING FLOORS, NAMELY, VINYL CARPET PROTECTORS; CARPET BACKINGS MADE OF LATEX AND OF FOAM MATERIALS; CARPETS; RUGS; NON-TEXTILE WALL HANGINGS; BATHMATS; DOORMATS; NON-SLIP RUG MATS; AND WALLPAPER, IN CLASS 27 (U.S. CLS. 19, 20, 37, 42 AND 50).

THE MARK CONSISTS OF STANDARD CHARACTERS WITHOUT CLAIM TO ANY PARTICULAR FONT, STYLE, SIZE, OR COLOR.

OWNER OF INTERNATIONAL REGISTRATION 1059311 DATED 10-2-2010, EXPIRES 10-2-2020.

SER. NO. 79-090,305, FILED 10-2-2010.

ANDREA K. NADELMAN, EXAMINING ATTORNEY

# United States of America

United States Patent and Trademark Office

## CLICK CAR STICK

**Reg. No. 4,133,626**

**Registered May 1, 2012**

**Int. Cl.: 9**

**TRADEMARK**

**PRINCIPAL REGISTER**

PAWAS TRADING GMBH (SWITZERLAND SOCIÉTÉ À RESPONSABILITÉ LIMITÉE)  
BAHNHOFSTRASSE 2  
CH-9100 HERISAU, SWITZERLAND

FOR: COMPUTER HARDWARE AND PERIPHERAL DEVICES; COMPUTER MEMORY HARDWARE; BLANK USB FLASH DRIVES; USB HUBS; COMPUTER SERIAL PORTS; LOUDSPEAKERS; TELEPHONE APPARATUS; MOBILE PHONES; CABLE CONNECTORS; CARRYING CASES, HOLDERS, PROTECTIVE CASES AND STANDS FEATURING POWER SUPPLY CONNECTORS, ADAPTORS, SPEAKERS AND BATTERY CHARGING DEVICES, SPECIALLY ADAPTED FOR USE WITH HANDHELD DIGITAL ELECTRONIC DEVICES; CARRYING CASES FOR CELL PHONES; BATTERY CHARGE DEVICES, IN CLASS 9 (U.S. CLS. 21, 23, 26, 36 AND 38).

THE MARK CONSISTS OF STANDARD CHARACTERS WITHOUT CLAIM TO ANY PARTICULAR FONT, STYLE, SIZE, OR COLOR.

PRIORITY DATE OF 1-31-2010 IS CLAIMED.

OWNER OF INTERNATIONAL REGISTRATION 1040274 DATED 3-28-2010, EXPIRES 3-28-2020.

NO CLAIM IS MADE TO THE EXCLUSIVE RIGHT TO USE "CAR STICK", APART FROM THE MARK AS SHOWN.

SER. NO. 79-090,454, FILED 7-23-2010.

ANDREA K. NADELMAN, EXAMINING ATTORNEY



*David J. Kybas*

Director of the United States Patent and Trademark Office



# United States of America

United States Patent and Trademark Office

## merci for being you

**Reg. No. 4,133,627**

**Registered May 1, 2012**

**Int. Cl.: 30**

**TRADEMARK**

**PRINCIPAL REGISTER**

AUGUST STORCK KG (FED REP GERMANY LIMITED PARTNERSHIP)  
WALDSTRASSE 27  
13403 BERLIN  
FED REP GERMANY

FOR: CONFECTIONERY, NAMELY, NOUGAT, NUT BRITTLE, MARZIPAN, CANDY, CARAMEL, CHOCOLATE, CHOCOLATES, CHOCOLATE CANDY, CHOCOLATE PRALINES, CHOCOLATE BARS, CHOCOLATE CANDY FIGURES; PASTRIES, ICE-CREAM, AND PREPARATIONS FOR MAKING THE AFOREMENTIONED CONFECTIONERY PRODUCTS, PASTRIES AND ICE-CREAM, NAMELY, COCOA POWDER, CAKE MIXES, COOKIE MIXES, PASTRY CREAM, MIXES FOR MAKING ICE-CREAM; CARAMEL BASED SPREAD FOR PASTRIES AND CHOCOLATES, CHOCOLATE BASED SPREAD FOR PASTRIES AND CHOCOLATES, COFFEE MIXES, COFFEE SPREAD FOR PASTRIES AND CHOCOLATES, AND COFFEE EXTRACTS, IN CLASS 30 (U.S. CL. 46).

THE MARK CONSISTS OF STANDARD CHARACTERS WITHOUT CLAIM TO ANY PARTICULAR FONT, STYLE, SIZE, OR COLOR.

PRIORITY DATE OF 6-28-2010 IS CLAIMED.

OWNER OF INTERNATIONAL REGISTRATION 1061342 DATED 11-16-2010, EXPIRES 11-16-2020.

OWNER OF U.S. REG. NO. 843,319.

THE ENGLISH TRANSLATION OF "MERCII" IN THE MARK IS "THANKS".

SER. NO. 79-091,141, FILED 11-16-2010.

RAMONA ORTIGA, EXAMINING ATTORNEY



*David J. Kyffers*

Director of the United States Patent and Trademark Office

# United States of America

United States Patent and Trademark Office

**Reg. No. 4,133,628**

**Registered May 1, 2012**

**Int. Cl.: 1**

**TRADEMARK**

**PRINCIPAL REGISTER**

FOMA BOHEMIA, SPOL. S R.O. (CZECH REPUBLIC LIMITED LIABILITY COMPANY)  
UL. J. KRUSINKY CP. 1604  
CZ-501 04 HRADEC KRÁLOVÉ  
CZECH REPUBLIC

FOR: PLATES, FILMS, PAPER AND CHEMICAL PRODUCTS FOR USE IN PHOTOGRAPHY, NAMELY, PHOTOGRAPHIC DRY PLATES, UNEXPOSED PHOTOGRAPHIC EMULSION, UNEXPOSED DENTAL X-RAY FILMS FOR INTRAORAL AND EXTRAORAL USE, UNEXPOSED PANORAMIC X-RAY FILMS, UNEXPOSED INDUSTRIAL TECHNICAL X-RAY FILMS USED IN NON-DESTRUCTIVE TESTING, UNEXPOSED FILMS FOR PERSONAL DOSIMETRY AND MONITORING, CHEMICALS FOR PROCESSING, BATHS FOR ALL TYPES OF LIGHT SENSITIVE MATERIALS, PHOTSENSITIVE PAPER, IN CLASS 1 (U.S. CLS. 1, 5, 6, 10, 26 AND 46).

THE MARK CONSISTS OF THE WORD "FOMA" IN STYLIZED LETTERING.

OWNER OF INTERNATIONAL REGISTRATION 0207485 DATED 2-17-1958, EXPIRES 2-17-2018.

SER. NO. 79-091,487, FILED 8-3-2010.

FRED CARL, EXAMINING ATTORNEY



*David J. Kyffers*

Director of the United States Patent and Trademark Office

# United States of America

United States Patent and Trademark Office

# AGUARD

**Reg. No. 4,133,629**

**Registered May 1, 2012**

**Int. Cls.: 1, 2 and 11**

**TRADEMARK**

**PRINCIPAL REGISTER**

WATERLOGIC INTERNATIONAL LIMITED (BAHAMAS LIMITED COMPANY)  
308 EAST BAY STREET BUILDING,  
3RD FLOOR, EAST BAY STREET,; PO BOX CB-12407; NASSAU  
BAHAMAS

FOR: CHEMICAL PREPARATIONS FOR USE IN DRINKING WATER TREATMENT IN CONNECTION WITH WATER DISPENSING APPARATUS, NONE BEING CHEMICAL PREPARATIONS FOR USE IN AGRICULTURE, HORTICULTURE AND FORESTRY, IN CLASS 1 (U.S. CLS. 1, 5, 6, 10, 26 AND 46).

FOR: ANTIBACTERIAL PAINTS AND PREVENTATIVE ANTIBACTERIAL COATINGS AND ANTI-MICROBIAL PAINTS AND PREVENTATIVE ANTIBACTERIAL COATINGS, ALL FOR DRINKING WATER DISPENSING AND PURIFYING APPARATUS, IN CLASS 2 (U.S. CLS. 6, 11 AND 16).

FOR: HOT AND COLD DRINKING WATER DISPENSING APPARATUS AND WATER PURIFICATION AND FILTRATION APPARATUS AND PARTS AND FITTINGS THEREFOR, IN CLASS 11 (U.S. CLS. 13, 21, 23, 31 AND 34).

THE MARK CONSISTS OF STANDARD CHARACTERS WITHOUT CLAIM TO ANY PARTICULAR FONT, STYLE, SIZE, OR COLOR.

PRIORITY DATE OF 7-19-2010 IS CLAIMED.

OWNER OF INTERNATIONAL REGISTRATION 1062956 DATED 11-18-2010, EXPIRES 11-18-2020.

SER. NO. 79-091,776, FILED 11-18-2010.

MICHELLE DUBOIS, EXAMINING ATTORNEY



*David J. Kyffers*

Director of the United States Patent and Trademark Office

United States of America  
United States Patent and Trademark Office

# BioCrack

**Reg. No. 4,133,630**

**Registered May 1, 2012**

**Int. Cls.: 7, 11 and 40**

**TRADEMARK**

**SERVICE MARK**

**PRINCIPAL REGISTER**

HUGO VOGELSSANG MASCHINENBAU GMBH (FED REP GERMANY GMBH)  
HOLTHÖGE 10-14  
49632 ESSEN  
FED REP GERMANY

FOR: DISSOLVING MACHINES FOR LIQUIDS, NAMELY, BIO SUSPENSIONS BASED ON ELECTROPHYSICAL AND/OR ELECTROKINETIC DISINTEGRATION, IN CLASS 7 (U.S. CLS. 13, 19, 21, 23, 31, 34 AND 35).

FOR: CLARIFYING INSTALLATIONS IN THE NATURE OF WATER PURIFICATION INSTALLATIONS BASED ON ELECTROPHYSICAL AND/OR ELECTROKINETIC DISINTEGRATION; WASTE PROCESSING MACHINES USING HEAT AND CHEMICAL BREAKDOWN PROCESSES FOR LIQUIDS, NAMELY, BIO SUSPENSIONS, LIQUID MANURE, CLARIFIED SLUDGE OR FERMENTED LIQUIDS BASED ON ELECTROPHYSICAL AND/OR ELECTROKINETIC DISINTEGRATION, IN CLASS 11 (U.S. CLS. 13, 21, 23, 31 AND 34).

FOR: TREATMENT OF HAZARDOUS LIQUIDS, NAMELY, BIO SUSPENSIONS, LIQUID MANURE, CLARIFIED SLUDGE OR FERMENTED LIQUIDS, NAMELY, TREATMENT OF LIQUIDS BY MEANS OF ELECTROPHYSICAL AND/OR ELECTROKINETIC DISINTEGRATION, IN CLASS 40 (U.S. CLS. 100, 103 AND 106).

THE MARK CONSISTS OF STANDARD CHARACTERS WITHOUT CLAIM TO ANY PARTICULAR FONT, STYLE, SIZE, OR COLOR.

OWNER OF INTERNATIONAL REGISTRATION 1063122 DATED 11-29-2010, EXPIRES 11-29-2020.

SER. NO. 79-091,832, FILED 11-29-2010.

TASNEEM HUSSAIN, EXAMINING ATTORNEY



*David J. Kyros*

Director of the United States Patent and Trademark Office

# United States of America

United States Patent and Trademark Office

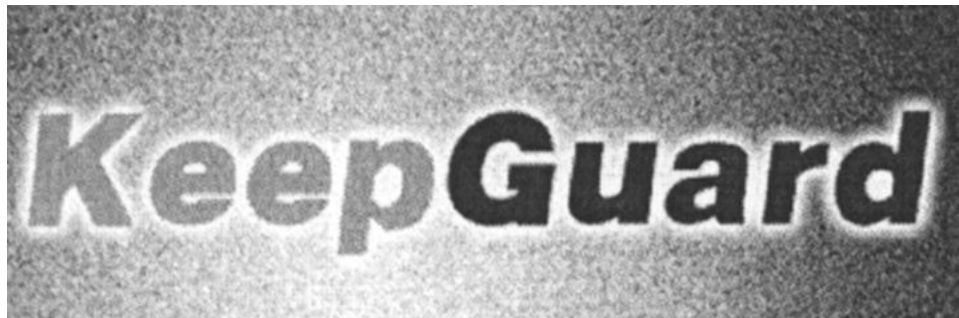

**Reg. No. 4,133,631**

**Registered May 1, 2012**

**Int. Cl.: 9**

**TRADEMARK**

**PRINCIPAL REGISTER**

HUARUI YANNENG TECHNOLOGY (SHENZHEN) CO., LTD. (CHINA CORPORATION)  
SECTION B, F3, BUILDING G  
XINGHUI TECHNOLOGY INDUSTRIAL PARK; HUANING WEST ROAD, DALANG  
COMMUNITY; DALANG STREET, BAOAN DISTRICT; 518109 SHENZHEN CITY  
GUANGDONG PROVINCE, CHINA

FOR: PHOTOGRAPHY CAMERAS; CAMCORDERS; TRANSMITTERS OF ELECTRONIC SIGNALS; SATELLITE NAVIGATIONAL APPARATUS, NAMELY, GPS NAVIGATION DEVICE; SATELLITE NAVIGATIONAL SYSTEM IN THE NATURE OF A GLOBAL POSITIONING SYSTEM (GPS); SATELLITE NAVIGATION APPARATUS FOR VEHICLES IN THE NATURE OF ON-BOARD COMPUTERS; PHOTOGRAPHIC SPEED MEASURING APPARATUS, NAMELY, LASER SPEED DETECTORS THAT ALSO PHOTOGRAPH A VEHICLE TRAVELING ABOVE A CERTAIN SPEED; PHOTOGRAPHIC FILTERS; COMPUTER PERIPHERAL DEVICES; PHOTOVOLTAIC CELLS; GALVANIC CELL BATTERIES; BATTERY CHARGERS, IN CLASS 9 (U.S. CLS. 21, 23, 26, 36 AND 38).

THE MARK CONSISTS OF THE STYLIZED WORDING "KEEPGUARD" SURROUNDED BY A RECTANGLE. THE RECTANGLE CONTAINS STIPPLING. THE STIPPLING IS A FEATURE OF THE MARK.

OWNER OF INTERNATIONAL REGISTRATION 1064205 DATED 11-8-2010, EXPIRES 11-8-2020.

SER. NO. 79-092,259, FILED 11-8-2010.

BRETT J. GOLDEN, EXAMINING ATTORNEY



*David J. Kybas*

Director of the United States Patent and Trademark Office

# United States of America

United States Patent and Trademark Office

## merci Chocolat Délice

**Reg. No. 4,133,632**

**Registered May 1, 2012**

**Int. Cl.: 30**

**TRADEMARK**

**PRINCIPAL REGISTER**

AUGUST STORCK KG (FED REP GERMANY KOMMANDITGESELLSCHAFT)  
WALDSTRASSE 27  
13403 BERLIN  
FED REP GERMANY

FOR: CONFECTIONERY, NAMELY, NOUGAT, NUT BRITTLE, MARZIPAN, CANDY, CARAMEL, CHOCOLATE, CHOCOLATES, CHOCOLATE CANDY, CHOCOLATE PRALINES, CHOCOLATE BARS, CHOCOLATE CANDY FIGURES; PASTRIES, ICE-CREAM, AND PREPARATIONS FOR MAKING THE AFOREMENTIONED CONFECTIONERY PRODUCTS, PASTRIES AND ICE-CREAM, NAMELY, COCOA POWDER, CAKE MIXES, COOKIE MIXES, PASTRY CREAM, MIXES FOR MAKING ICE-CREAM; CARAMEL BASED SPREAD FOR PASTRIES AND CHOCOLATES, CHOCOLATE BASED SPREAD FOR PASTRIES AND CHOCOLATES, COFFEE MIXES, COFFEE SPREAD FOR PASTRIES AND CHOCOLATES, AND COFFEE EXTRACTS, IN CLASS 30 (U.S. CL. 46).

THE MARK CONSISTS OF STANDARD CHARACTERS WITHOUT CLAIM TO ANY PARTICULAR FONT, STYLE, SIZE, OR COLOR.

PRIORITY DATE OF 7-6-2010 IS CLAIMED.

OWNER OF INTERNATIONAL REGISTRATION 1064385 DATED 1-3-2011, EXPIRES 1-3-2021.

OWNER OF U.S. REG. NO. 843,319.

NO CLAIM IS MADE TO THE EXCLUSIVE RIGHT TO USE "CHOCOLAT", APART FROM THE MARK AS SHOWN.

THE ENGLISH TRANSLATION OF "MERCİ CHOCOLAT DÉLİCE" IN THE MARK IS "THANK YOU CHOCOLATE DELIGHT".

SER. NO. 79-092,325, FILED 1-3-2011.

RAMONA ORTİGA, EXAMINING ATTORNEY



*David J. Kyros*

Director of the United States Patent and Trademark Office

# United States of America

United States Patent and Trademark Office

# POPCORN

**Reg. No. 4,133,633**

**Registered May 1, 2012**

**Int. Cls.: 14 and 43**

**TRADEMARK**

**SERVICE MARK**

**PRINCIPAL REGISTER**

ROBERT ANTHAMATTEN (SWITZERLAND INDIVIDUAL)  
HAUS AHORN  
CH-3906 SAAS-FEE, SWITZERLAND

FOR: PRECIOUS METALS AND THEIR ALLOYS; JEWELLERY, PRECIOUS STONES, WATCHES AND CHRONOMETRIC INSTRUMENTS, IN CLASS 14 (U.S. CLS. 2, 27, 28 AND 50).

FOR: TEMPORARY ACCOMMODATION SERVICES, IN CLASS 43 (U.S. CLS. 100 AND 101).

THE MARK CONSISTS OF STANDARD CHARACTERS WITHOUT CLAIM TO ANY PARTICULAR FONT, STYLE, SIZE, OR COLOR.

OWNER OF INTERNATIONAL REGISTRATION 1064966 DATED 1-4-2011, EXPIRES 1-4-2021.

SER. NO. 79-092,512, FILED 1-4-2011.

AISHA SALEM, EXAMINING ATTORNEY



*David J. Kybas*

Director of the United States Patent and Trademark Office

# United States of America

United States Patent and Trademark Office

corethree

**Reg. No. 4,133,634**

**Registered May 1, 2012**

**Int. Cls.: 9 and 38**

**TRADEMARK**

**SERVICE MARK**

**PRINCIPAL REGISTER**

CORETHREE LIMITED (UNITED KINGDOM LIMITED LIABILITY COMPANY)  
KINGS HOUSE  
202 LOWER HIGH STREET; WATFORD, HERTFORDSHIRE WD17 2EH  
UNITED KINGDOM

FOR: SOFTWARE FOR THE PROVISION OF TELECOMMUNICATIONS CONNECTIONS ,  
IN CLASS 9 (U.S. CLS. 21, 23, 26, 36 AND 38).

FOR: PROVISION OF TELECOMMUNICATION CONNECTIONS FOR THE ORDERING AND  
SUPPLY OF GOODS, SERVICES AND INFORMATION, IN CLASS 38 (U.S. CLS. 100, 101  
AND 104).

PRIORITY DATE OF 5-12-2010 IS CLAIMED.

OWNER OF INTERNATIONAL REGISTRATION 1065056 DATED 11-11-2010, EXPIRES 11-  
11-2020.

SER. NO. 79-092,543, FILED 11-11-2010.

CAROLYN CATALDO, EXAMINING ATTORNEY



*David J. Kybas*

Director of the United States Patent and Trademark Office



# United States of America

United States Patent and Trademark Office

## CLEAR CORRECT

**Reg. No. 4,133,635**

**Registered May 1, 2012**

**Int. Cls.: 10, 41 and 44**

**TRADEMARK**

**SERVICE MARK**

**PRINCIPAL REGISTER**

BE PERFECT CLINICS BV (NETHERLANDS BESLOTEN VENNOOTSCHAP (LIMITED))  
HANDWEG 119  
NL-1185 TW AMSTELVEEN  
NETHERLANDS

FOR: SURGICAL INSTRUMENTS AND APPARATUS, MEDICAL INSTRUMENTS AND APPARATUS FOR TREATING MALOCCLUSION AND/OR OTHER ORTHODONTIC TREATMENTS, DENTAL APPARATUS AND INSTRUMENTS, NAMELY, ORTHODONTIC MACHINES AND INSTRUMENTS, ARTIFICIAL LIMBS, EYES AND TEETH, IN CLASS 10 (U.S. CLS. 26, 39 AND 44).

FOR: EDUCATIONAL SERVICES, NAMELY, PROVIDING WORKSHOPS, SEMINARS AND CLASSES IN THE FIELD OF ORTHODONTICS; PROVIDING OF TRAINING IN THE FIELD OF ORTHODONTICS; ENTERTAINMENT, NAMELY, LIVE PERFORMANCES BY A MUSICAL GROUP; ORGANIZING COMMUNITY SPORTING AND CULTURAL EVENTS, IN CLASS 41 (U.S. CLS. 100, 101 AND 107).

FOR: MEDICAL SERVICES; VETERINARY ASSISTANCE, NAMELY, VETERINARY SURGERY AND DENTISTRY; HYGIENIC AND BEAUTY CARE FOR HUMAN BEINGS OR ANIMALS, IN CLASS 44 (U.S. CLS. 100 AND 101).

THE MARK CONSISTS OF STANDARD CHARACTERS WITHOUT CLAIM TO ANY PARTICULAR FONT, STYLE, SIZE, OR COLOR.

OWNER OF INTERNATIONAL REGISTRATION 1065583 DATED 10-13-2010, EXPIRES 10-13-2020.

SER. NO. 79-092,712, FILED 10-13-2010.

ERNEST SHOSHO, EXAMINING ATTORNEY



*David J. Kyffers*

Director of the United States Patent and Trademark Office

# United States of America

United States Patent and Trademark Office

# FOPE

**Reg. No. 4,133,636**

**Registered May 1, 2012**

**Int. Cl.: 14**

**TRADEMARK**

**PRINCIPAL REGISTER**

FOPE S.R.L. (ITALY LIMITED LIABILITY COMPANY)  
31, VIA ZAMPIERI  
I-36100 VICENZA, ITALY

FOR: NECKLACES, BRACELETS, EARRINGS, RINGS, BROOCHES, CHARMS, PENDANTS, CUFF-LINKS, TIE BARS, TIE CLIPS, TIE FASTENERS, JEWELRY FOR USE IN THE HAIR, ALL OF THE AFOREMENTIONED OBJECTS PRODUCED IN GOLD AND/OR OTHER PRECIOUS METALS, WITH OR WITHOUT PRECIOUS STONES; CLOCKS AND STRAPS FOR THE AFOREMENTIONED, IN CLASS 14 (U.S. CLS. 2, 27, 28 AND 50).

THE MARK CONSISTS OF THE WORDING "FOPE" IN STYLIZED FONT, WITH THE LETTER "O" REPRESENTED BY A CIRCLE THAT IS OPEN AT THE TOP AND WITH A SHADED CIRCLE IN THE CENTER OF THE OPENING.

OWNER OF INTERNATIONAL REGISTRATION 0867252 DATED 4-15-2005, EXPIRES 4-15-2015.

THE WORD(S) "FOPE" HAS NO MEANING IN A FOREIGN LANGUAGE.

SER. NO. 79-093,110, FILED 11-15-2010.

KAREN SEVERSON, EXAMINING ATTORNEY



*David J. Kybas*

Director of the United States Patent and Trademark Office

# United States of America

United States Patent and Trademark Office

# DURU VITAL

**Reg. No. 4,133,637**

**Registered May 1, 2012**

**Int. Cls.: 29 and 30**

**TRADEMARK**

**PRINCIPAL REGISTER**

DURU BULGUR GIDA SANAYI VE TICARET ANONIM SIRKETI (TURKEY JOINT STOCK COMPANY)  
ORGANIZE SANAYI BOLGESI PK: 3  
KARAMAN  
TURKEY

FOR: MEAT; FISH; MEAT OF POULTRY AND GAME; PROCESSED MEAT; DRIED BEANS; READY-MADE SOUPS; BOUILLONS; PROCESSED OLIVES; OLIVE PASTE; MILK AND MILK PRODUCTS, NAMELY, BUTTER; EDIBLE VEGETABLE OILS; DRIED, PRESERVED, FROZEN, COOKED, SMOKED, PICKLED FRUITS AND VEGETABLES; PROCESSED NUTS; HAZELNUT AND PEANUT SPREAD; CRUSHED SESAME SEEDS, NAMELY, TAHINI; EGGS, POWDERED EGGS, POTATO CRISPS, IN CLASS 29 (U.S. CL. 46).

FOR: COFFEE; COCOA; COFFEE OR COCOA-BASED BEVERAGES; CHOCOLATE-BASED BEVERAGES; MACARONI; MEAT PIES; VERMICELLI; PASTRY AND BAKERY GOODS; HONEY; BEE GLUE, NAMELY, PROPOLIS FOR HUMAN CONSUMPTION; FLAVOURINGS FOR FOODS; YEAST; BAKING-POWDER; FLOUR-MILLING PRODUCTS AND PREPARATIONS, NAMELY, PROCESSED WHEAT ; FLOUR; PROCESSED SEMOLINA; FOOD STARCH; SUGAR; LUMP SUGAR; POWDERED SUGAR; TEAS; ICED TEAS.; CONFECTIONERIES MADE OF SUGAR; CHOCOLATES; BISCUITS; CRACKERS; WAFERS; CHEWING-GUMS; ICE CREAMS; EDIBLE ICES; SALT; PROCESSED CEREAL AND THEIR PRODUCTS, NAMELY, BREAKFAST CEREAL; CARBOHYDRATE-BASED FOOD PRODUCTS FOR NON-MEDICAL PURPOSES, NAMELY, BULGAR AND POPCORN, IN CLASS 30 (U.S. CL. 46).



OWNER OF U.S. REG. NO. 3,085,873.

PRIORITY DATE OF 8-5-2010 IS CLAIMED.

OWNER OF INTERNATIONAL REGISTRATION 1066698 DATED 8-17-2010, EXPIRES 8-17-2020.

THE ENGLISH TRANSLATION OF THE WORD "DURU" IN THE MARK IS PURE.

SER. NO. 79-093,159, FILED 8-17-2010.

KATHLEEN LORENZO, EXAMINING ATTORNEY

*David J. Kyros*

Director of the United States Patent and Trademark Office

# United States of America

United States Patent and Trademark Office

# MECTALIF

**Reg. No. 4,133,638**

**Registered May 1, 2012**

**Int. Cl.: 10**

**TRADEMARK**

**PRINCIPAL REGISTER**

MEDACTA INTERNATIONAL S.A. (SWITZERLAND CORPORATION)  
STRADA REGINA  
CH-6874 CASTEL SAN PIETRO, SWITZERLAND

FOR: IMPLANTATIONS, INSTRUMENTS AND DEVICES FOR TREATING THE SPINE, NAMELY, SPINAL IMPLANTS COMPOSED OF ARTIFICIAL MATERIAL, SPINAL CROSS CONNECTORS, SURGICAL INSTRUMENTS FOR USE IN ORTHOPEDIC AND SPINAL SURGERY; DEVICES FOR INTER VERTEBRAL FUSION IN THE NATURE OF SPINAL FUSION DEVICES; SPINAL FUSION DEVICES FOR INTER VERTEBRAL SPACING; DEVICES FOR PEDICLE SCREW FIXATION, NAMELY, BONE SCREW, MEDICAL SCREW CONNECTIONS, IN CLASS 10 (U.S. CLS. 26, 39 AND 44).

OWNER OF U.S. REG. NOS. 3,828,497, 3,828,498 AND OTHERS.

PRIORITY DATE OF 6-8-2010 IS CLAIMED.

OWNER OF INTERNATIONAL REGISTRATION 1067412 DATED 9-21-2010, EXPIRES 9-21-2020.

THE TRADEMARK CONSISTS OF THE NAME "MECTALIF" WHEREIN THE LETTER "M" IS FORMED BY TWO SAIL-LIKE TRIANGLES. THE LAST THREE LETTERS "LIF" ARE IN CAPITAL LETTERS.

SER. NO. 79-093,689, FILED 9-21-2010.

BARBARA GAYNOR, EXAMINING ATTORNEY



*David J. Kybas*

Director of the United States Patent and Trademark Office

# United States of America

United States Patent and Trademark Office



**Reg. No. 4,133,639**

**Registered May 1, 2012**

**Int. Cls.: 35, 38, 41, 43,  
44 and 45**

**SERVICE MARK**

**PRINCIPAL REGISTER**

FOSTER CARE ASSOCIATES LIMITED (UNITED KINGDOM LIMITED COMPANY)  
MALVERN VIEW,  
SAXON BUSINESS PARK, HANBURY ROAD,, STOKE PRIOR, BROMSGROVE B60 4AD  
UNITED KINGDOM

FOR: EMPLOYMENT PLACEMENT SERVICES; RECRUITMENT SERVICES, NAMELY, RECRUITMENT AND PLACEMENT OF CHILD CARERS, CARERS FOR ADULTS, RESIDENTIAL CARERS, RESPITE CARERS, PSYCHOLOGISTS, PSYCHOTHERAPISTS, NUTRITIONISTS, COUNSELLORS AND TEACHERS; RECRUITMENT OF FOSTER CARE PROVIDERS; DATABASE SERVICES, NAMELY, COMPILATION AND SYSTEMISATION OF INFORMATION INTO COMPUTER DATABASES, DATABASE MANAGEMENT AND PROVISION OF COMMERCIAL INFORMATION SERVICES PROVIDED BY ACCESS TO A COMPUTER DATABASE; PROVISION OF STATISTICAL INFORMATION, NAMELY, COMPILATION OR EXPLOITATION OF STATISTICAL DATA AND STATISTICAL ANALYSIS FOR BUSINESS AND COMMERCIAL PURPOSES; PROVIDING INFORMATION, CONSULTANCY AND ADVISORY SERVICES RELATING TO ALL OF THE AFORESAID SERVICES, IN CLASS 35 (U.S. CLS. 100, 101 AND 102).

FOR: RENTAL OF TELECOMMUNICATION FACILITIES AND EQUIPMENT FOR TRAINING, TEACHING, ACADEMIC, EDUCATION, INSTRUCTION, EXAMINATION, TESTING AND ASSESSMENT PURPOSES; TELECOMMUNICATION SERVICES, NAMELY, PROVIDING ACCESS TO DATABASES CONTAINING ELECTRONIC PUBLICATIONS AND COMMUNICATIONS IN ELECTRONIC FORM; PROVISION OF ACCESS TO DATA OR DOCUMENTS STORED ELECTRONICALLY IN CENTRAL FILES FOR REMOTE CONSULTATION; PROVIDING MULTIPLE USER ACCESS TO GLOBAL COMPUTER INFORMATION NETWORKS; PROVISION OF ON-LINE FORUMS IN THE NATURE OF CHAT ROOMS; PROVISION OF ON-LINE BULLETIN BOARDS AND CHAT ROOM SERVICES FOR TRANSMISSION OF MESSAGES AMONG COMPUTER USERS ON THE SUBJECTS OF FOSTER CARE, CHILD CARE, ADULT CARE, RESIDENTIAL CARE, SHELTERED HOUSING, RESPITE CARE, CHILD PLACEMENT, ADULT PLACEMENT, CHILD DAY CARE SERVICES, ADULT DAY CARE SERVICE, ADULT DOMICILIARY CARE SERVICES, CHILD DOMICILIARY CARE SERVICES, PARENTING, PSYCHOLOGY, PSYCHOTHERAPY, NUTRITION, EMPLOYMENT PLACEMENT, SOCIAL POLICY, SOCIAL SCIENCE, COUNSELING SERVICES, NURSING, HEALTHCARE AND MENTAL HEALTH; TRANSMISSION OF EDUCATIONAL FILMS, TELEVISION PROGRAMMES AND VIDEO RECORDINGS VIA THE INTERNET, TELEVISION, BROADCAST AND RADIO; PROVIDING INFORMATION, ADVISORY AND CON-



*David J. Kappas*

Director of the United States Patent and Trademark Office

**Reg. No. 4,133,639** SULTANCY SERVICES RELATING TO ALL THE AFORESAID , IN CLASS 38 (U.S. CLS. 100, 101 AND 104).

FOR: EDUCATION SERVICES, NAMELY, TRAINING, TEACHING AND INSTRUCTION ON THE SUBJECT OF FOSTER CARE, CHILD CARE, ADULT CARE, RESIDENTIAL CARE, SHELTERED HOUSING, RESPITE CARE, CHILD PLACEMENT, ADULT PLACEMENT, CHILD DAY CARE SERVICES, ADULT DAY CARE SERVICE, ADULT DOMICILIARY CARE SERVICES, CHILD DOMICILIARY CARE SERVICES, PARENTING, PSYCHOLOGY, PSYCHOTHERAPY, NUTRITION, EMPLOYMENT PLACEMENT, SOCIAL POLICY, SOCIAL SCIENCE, COUNSELING SERVICES, NURSING, HEALTHCARE AND MENTAL HEALTH; EDUCATIONAL EXAMINATION, EDUCATIONAL TESTING AND EDUCATIONAL ASSESSMENT SERVICES; PROVISION OF TRAINING, TEACHING AND INSTRUCTION ON THE SUBJECT OF FOSTER CARE, CHILD CARE, ADULT CARE, RESIDENTIAL CARE, SHELTERED HOUSING, RESPITE CARE, CHILD PLACEMENT, ADULT PLACEMENT, CHILD DAY CARE SERVICES, ADULT DAY CARE SERVICE, ADULT DOMICILIARY CARE SERVICES, CHILD DOMICILIARY CARE SERVICES, PARENTING, PSYCHOLOGY, PSYCHOTHERAPY, NUTRITION, EMPLOYMENT PLACEMENT, SOCIAL POLICY, SOCIAL SCIENCE, COUNSELING SERVICES, NURSING, HEALTHCARE AND MENTAL HEALTH, OFFERED ELECTRONICALLY, BY MEANS OF TELECOMMUNICATIONS NETWORKS, BY ONLINE DELIVERY, BY WAY OF THE INTERNET OR WORLD WIDE WEB; EDUCATIONAL EXAMINATION, EDUCATIONAL TESTING AND EDUCATIONAL ASSESSMENT SERVICES OFFERED ELECTRONICALLY, BY MEANS OF TELECOMMUNICATIONS NETWORKS, BY ONLINE DELIVERY, BY WAY OF THE INTERNET OR WORLD WIDE WEB; PUBLICATION OF INSTRUCTION, TEACHING, TRAINING, EXAMINATION, TESTING AND ASSESSMENT MATERIAL; PUBLICATION OF TEXTS, BOOKS, TEXTBOOKS, BROCHURES, MAGAZINES, JOURNALS AND NEWSPAPERS; ELECTRONIC DESKTOP PUBLISHING; ONLINE PUBLICATION OF ELECTRONIC TEXTS, BOOKS, TEXTBOOKS, BROCHURES, MAGAZINES, JOURNALS AND NEWSPAPERS; PUBLICATION OF ELECTRONIC TEXTS, BOOKS, TEXTBOOKS, BROCHURES, MAGAZINES, JOURNALS AND NEWSPAPERS, ALL BEING DOWNLOADABLE FROM AN ON-LINE DATABASE OR FROM A GLOBAL COMPUTER NETWORK; EDUCATIONAL ASSESSMENT SERVICES; DISTANCE LEARNING COURSES, TRAINING AND INSTRUCTION IN THE FIELDS OF FOSTER CARE, CHILD CARE, ADULT CARE, RESIDENTIAL CARE, SHELTERED HOUSING, RESPITE CARE, CHILD PLACEMENT, ADULT PLACEMENT, CHILD DAY CARE SERVICES, ADULT DAY CARE SERVICE, ADULT DOMICILIARY CARE SERVICES, CHILD DOMICILIARY CARE SERVICES, PARENTING, PSYCHOLOGY, PSYCHOTHERAPY, NUTRITION, EMPLOYMENT PLACEMENT, SOCIAL POLICY, SOCIAL SCIENCE, COUNSELING SERVICES, NURSING, HEALTHCARE AND MENTAL HEALTH; ORGANIZATION AND PROVISION OF COURSES, ASSESSMENT, TEACHING AND TRAINING IN THE FIELD OF FOSTER CARE, CHILD CARE, ADULT CARE, RESIDENTIAL CARE, SHELTERED HOUSING, RESPITE CARE, CHILD PLACEMENT, ADULT PLACEMENT, CHILD DAY CARE SERVICES, ADULT DAY CARE SERVICE, ADULT DOMICILIARY CARE SERVICES, CHILD DOMICILIARY CARE SERVICES, PARENTING, PSYCHOLOGY, PSYCHOTHERAPY, NUTRITION, EMPLOYMENT PLACEMENT, SOCIAL POLICY, SOCIAL SCIENCE, COUNSELING SERVICES, NURSING, HEALTHCARE AND MENTAL HEALTH; RESEARCH IN THE FIELD OF EDUCATION; PROVISION OF CORRESPONDENCE COURSES IN THE FIELD OF FOSTER CARE, CHILD CARE, ADULT CARE, RESIDENTIAL CARE, SHELTERED HOUSING, RESPITE CARE, CHILD PLACEMENT, ADULT PLACEMENT, CHILD DAY CARE SERVICES, ADULT DAY CARE SERVICE, ADULT DOMICILIARY CARE SERVICES, CHILD DOMICILIARY CARE SERVICES, PARENTING, PSYCHOLOGY, PSYCHOTHERAPY, NUTRITION, EMPLOYMENT PLACEMENT, SOCIAL POLICY, SOCIAL SCIENCE, COUNSELING SERVICES, NURSING, HEALTHCARE AND MENTAL HEALTH; ARRANGING, ORGANIZING AND CONDUCTING COURSES, SEMINARS, SYMPOSIUMS, CONFERENCES, CONGRESSES AND EXHIBITIONS IN THE FIELD OF FOSTER CARE, CHILD CARE, ADULT CARE, RESIDENTIAL CARE, SHELTERED HOUSING, RESPITE CARE, CHILD PLACEMENT, ADULT PLACEMENT, CHILD DAY CARE SERVICES, ADULT DAY CARE SERVICE, ADULT DOMICILIARY CARE SERVICES, CHILD DOMICILIARY CARE SERVICES, PARENTING, PSYCHOLOGY, PSYCHOTHERAPY, NUTRITION, EMPLOYMENT PLACEMENT,

**Reg. No. 4,133,639** SOCIAL POLICY, SOCIAL SCIENCE, COUNSELING SERVICES, NURSING, HEALTHCARE AND MENTAL HEALTH; PROVISION OF EXAMINATION PAPERS IN THE NATURE OF PROVIDING EDUCATIONAL EXAMINATION AND TESTING SERVICES; PROVISION OF EXAMINATION PAPERS IN THE NATURE OF PUBLISHING EXAM TEST QUESTIONS AND MODEL ANSWERS SO PEOPLE CAN PREPARE AND STUDY FOR STANDARDIZED EXAMS AND TESTS; CAREER COUNSELING; EDUCATION LIAISON SERVICES NAMELY, TUTORING AND EDUCATIONAL PLACEMENT SCHEMES ON THE SUBJECT OF FOSTER CARE, CHILD CARE, ADULT CARE, RESIDENTIAL CARE, SHELTERED HOUSING, RESPITE CARE, CHILD PLACEMENT, ADULT PLACEMENT, CHILD DAY CARE SERVICES, ADULT DAY CARE SERVICE, ADULT DOMICILIARY CARE SERVICES, CHILD DOMICILIARY CARE SERVICES, PARENTING, PSYCHOLOGY, PSYCHOTHERAPY, NUTRITION, EMPLOYMENT PLACEMENT, SOCIAL POLICY, SOCIAL SCIENCE, COUNSELING SERVICES, NURSING, HEALTHCARE AND MENTAL HEALTH; TRAINING AND ASSESSMENT OF FOSTER CARE PROVIDERS; PARENTING SKILLS TRAINING; PRODUCTION AND DISTRIBUTION OF EDUCATIONAL FILMS, TELEVISION PROGRAMMES AND VIDEO RECORDINGS VIA THE INTERNET, TELEVISION, BROADCAST AND RADIO; PROVIDING INFORMATION, ADVISORY AND CONSULTANCY SERVICES RELATING TO ALL OF THE AFORESAID SERVICES, IN CLASS 41 (U.S. CLS. 100, 101 AND 107).

FOR: CHILD CARE CENTERS; PROVISION AND ARRANGEMENT OF TEMPORARY ACCOMMODATIONS; PROVISION OF CARE IN RESIDENTIAL ACCOMMODATIONS, NAMELY, THE PROVISION OF MEALS AND TEMPORARY ACCOMMODATIONS; PROVIDING INFORMATION, CONSULTANCY AND ADVISORY SERVICES RELATING TO ALL OF THE AFORESAID SERVICES, IN CLASS 43 (U.S. CLS. 100 AND 101).

FOR: PROVISION OF RESPITE CARE, NAMELY, PLANNED SHORT-TERM AND TIME LIMITED BREAKS FOR CARE GIVERS OF INDIVIDUALS WHO REQUIRE SPECIALIZED CARE OR SUPERVISION; COUNSELING SERVICES, NAMELY, BEREAVEMENT COUNSELING SERVICES, DRUG ADDICTION COUNSELING SERVICES, DRUG REHABILITATION COUNSELING SERVICES, PSYCHOTHERAPY COUNSELING, PSYCHOLOGY COUNSELING; FAMILY COUNSELING IN THE NATURE OF PSYCHOTHERAPY FOR CHILDREN AND ADULTS IN INDIVIDUAL AND FAMILY SESSIONS; MENTAL HEALTH COUNSELING SERVICES; PROVIDING INFORMATION, CONSULTANCY AND ADVISORY SERVICES RELATING TO ALL OF THE AFORESAID SERVICES, IN CLASS 44 (U.S. CLS. 100 AND 101).

FOR: SOCIAL WORK SERVICES, NAMELY, CASE MANAGEMENT IN THE NATURE OF THE COORDINATION AND ORGANIZATION OF LEGAL SERVICES, SOCIAL SERVICES, FOSTER CARE SERVICES, NURSING SERVICES, HEALTHCARE AND MENTAL HEALTH RESIDENTIAL CARE SERVICES, RESPITE CARE SERVICES, PSYCHOLOGY SERVICES, PSYCHOTHERAPY SERVICES AND COUNSELING SERVICES FOR ADULTS, CHILDREN AND FAMILIES; FOSTER CARE SERVICES; FOSTER CARE SERVICES, NAMELY, FOSTERING OF MOTHERS AND BABIES; FOSTER CARE SERVICES, NAMELY, FOSTERING OF CHILDREN; PERSONAL AND SOCIAL SERVICES RENDERED BY OTHERS, NAMELY, FOSTER PLACEMENT OF CHILDREN AND YOUNG PEOPLE; PROVISION OF PERSONAL SUPPORT SERVICES, NAMELY, PROVIDING EMOTIONAL GUIDANCE, THERAPY, COUNSELING AND ADVICE TO FOSTER CARERS; PROVISION OF PERSONAL SUPPORT SERVICES FOR YOUNG PEOPLE AND CHILDREN, NAMELY, PROVIDING EMOTIONAL REHABILITATION SERVICES, EMOTIONAL GUIDANCE, COUNSELING, THERAPY AND ADVICE TO YOUNG PEOPLE AND CHILDREN; REHOMING SERVICES IN THE NATURE OF PROVIDING PLACEMENT OF CHILDREN AND YOUNG PEOPLE IN NEW FOSTER HOMES; ASSESSMENT SERVICES RELATING TO FOSTER CARERS, NAMELY, CONDUCTING RESEARCH ON FOSTER CARERS, INVESTIGATIONS ON FOSTER CARERS AND SCREENING OF FOSTER CARERS TO ENSURE THEIR CONTINUED SUITABILITY TO PERFORM THEIR ROLE; CARRYING OUT CHECKS AND COMPILING REPORTS ON FOSTER CARERS, NAMELY, CONDUCTING RESEARCH ON FOSTER CARERS, INVESTIGATIONS ON FOSTER CARERS AND SCREENING OF FOSTER CARERS TO ENSURE THEIR CONTINUED SUITABILITY TO PERFORM THEIR ROLE; EMPLOYMENT

**Reg. No. 4,133,639** SCREENING SERVICES, NAMELY, CONDUCTING BACKGROUND RESEARCH ON FOSTER CARERS, BACKGROUND INVESTIGATIONS ON FOSTER CARERS AND PRE-EMPLOYMENT BACKGROUND SCREENING SERVICES ON FOSTER CARERS; LIAISON SERVICES WITH LOCAL AUTHORITIES RELATING TO FOSTER CARE, NAMELY, ACTING AS A LIAISON BETWEEN FOSTER CARE PROVIDERS AND LOCAL AUTHORITIES TO ADDRESS THE LEGAL AND PERSONAL SUPPORT NEEDS OF FOSTER CARE PROVIDERS AND INDIVIDUALS RESIDING IN FOSTER CARE; PROVIDING INFORMATION, CONSULTANCY AND ADVISORY SERVICES RELATING TO ALL OF THE AFORESAID SERVICES, IN CLASS 45 (U.S. CLS. 100 AND 101).

THE MARK CONSISTS OF FOUR GEOMETRIC SHAPES REPRESENTING PEOPLE SITTING BACK-TO-BACK IN A SQUARE PATTERN. THE SHAPES CONSIST OF A SHADED BOOMERANG SHAPE WITH A SHADED CIRCLE CENTERED BETWEEN EACH BOOMERANG. TO THE RIGHT OF THE DESIGN IS THE WORDING "CORE ASSETS" IN STYLIZED FORM.

PRIORITY DATE OF 2-17-2010 IS CLAIMED.

OWNER OF INTERNATIONAL REGISTRATION 1068751 DATED 8-14-2010, EXPIRES 8-14-2020.

SER. NO. 79-094,180, FILED 8-14-2010.

JEFFREY LOOK, EXAMINING ATTORNEY



# United States of America

United States Patent and Trademark Office

## OLIVER SWEENEY

**Reg. No. 4,133,640**

**Registered May 1, 2012**

**Int. Cls.: 21 and 35**

**TRADEMARK**

**SERVICE MARK**

**PRINCIPAL REGISTER**

OLIVER SWEENEY HOLDINGS LTD (UNITED KINGDOM PRIVATE LIMITED COMPANY)  
34/36 FORE STREET,  
BOVEY TRACEY; NEWTON ABBOT, DEVON TQ13 9AE  
UNITED KINGDOM

FOR: COMBS; BATH SPONGES; HAIR BRUSHES; CLOTHES BRUSHES; BRUSH-MAKING MATERIALS; ARTICLES FOR PERSONAL CLEANING PURPOSES, NAMELY LOOFAHS FOR HOUSEHOLD PURPOSES, DENTAL TAPE AND FLOSS, EXFOLIATING PADS AND MITTS; ARTICLES FOR HOUSEHOLD CLEANING PURPOSES, NAMELY ABRASIVE PADS, SPONGES, BRUSHES, BROOMS, BUCKETS, CARPET BEATERS AND SWEEPERS, CLEANING, DUSTING AND POLISHING CLOTHS, CRUMB BRUSHES AND TRAYS, DISHWASHING BRUSHES, DUSTERS, DUST PANS, FEATHER DUSTERS, MOPS, SCRUBBING BRUSHES, SAUCEPAN SCOURERS, SQUEEGEES, TOILET BRUSHES; STEEL WOOL; ELECTRIC AND NON-ELECTRIC TOOTHBRUSHES; SHAVING BRUSHES, SHAVING BRUSH STANDS, SHAVING BOWLS; BOTTLE OPENERS, COCKTAIL SHAKERS, COCKTAIL STIRRERS, CORKSCREWS, ICE BUCKETS, LIQUEUR SETS, PORTABLE WINE COOLERS, DECANTERS, PITCHERS, HIP FLASKS; CANDLE EXTINGUISHERS, CANDLE HOLDERS, CANDLESTICKS; VASES; GLASS BOWLS; PERFUME BURNERS, PERFUME SPRAYERS, PERFUME VAPORIZERS SOLD EMPTY; FIGURINES, STATUES AND STATUETTES OF PORCELAIN, TERRACOTTA OR GLASS; CROCKERY, NAMELY POTS, DISHES, DRINKING CUPS AND SAUCERS, BOWLS, SERVING BOWLS AND TRAYS; CUPS, DISHES, SOUP BOWLS, PLATES, TABLE PLATES, SAUCERS, DISHES, BOWLS; DRINKING GLASSES, DRINKING VESSELS OF GLASS AND PLASTIC, MUGS; BUTTER DISHES, SUGAR BOWLS; COFFEE SERVICES, COFFEEPOTS, NON-ELECTRIC PERCOLATORS, TEAPOTS, COOKIE JARS; CRUETS; COASTERS, NOT OF PAPER AND OTHER THAN TABLE LINEN, NAPKIN RINGS; BEER MUGS, TANKARDS; SCULPTURES, ORNAMENTS, VESSELS, BOWLS, PLATES AND POTS OF CERAMIC, GLASS, PORCELAIN, AND EARTHENWARE; KITCHEN AND COOKING UTENSILS AND ARTICLES FOR COOKING PURPOSES, NAMELY BAKING DISHES AND TRAYS, CAKE TINS, BASINS, BOWLS, BASTING SPOONS, CASSEROLES, CHEESE GRATERS, MOULDS, CHOPPING BOARDS, COLANDERS, COOKIE AND PASTRY CUTTERS, COOKING PANS, ROASTING POTS AND PANS, SIEVES AND SIFTERS, STEAMERS, FRYING PANS, GRIDDLES, HAND OPERATED SPICE GRINDERS, SPATULAS, ROLLING PINS, WHISKS, TONGS, JUGS, KNIFE BLOCKS AND RESTS, OVENWARE, POTATO RICERS, SALAD SPINNERS, SAUCEPANS; HOUSEHOLD CONTAINERS, NAMELY COMPOST CONTAINERS, DUSTBINS, WASTE BASKETS, STORAGE BINS NAMELY PLASTIC STORAGE CONTAINERS FOR HOUSEHOLD USE, LAUNDRY BASKETS, PLASTIC BAG HOLDERS; COOKING POTS; HOUSEHOLD CON-



*David J. Kybas*

Director of the United States Patent and Trademark Office

**Reg. No. 4,133,640** TAINERS FOR FOOD AND DRINK; KETTLES, PEPPER MILLS, SALT CELLARS, SPICE RACKS, IN CLASS 21 (U.S. CLS. 2, 13, 23, 29, 30, 33, 40 AND 50).

FOR: ONLINE RETAIL STORE SERVICES FEATURING CLOTHING, FOOTWEAR, ACCESSORIES, TOILETRIES, JEWELLERY, LUGGAGE, HOMEWARES AND OTHER PERSONAL GOODS; RETAIL STORE SERVICES FEATURING CLOTHING, FOOTWEAR, ACCESSORIES, TOILETRIES, JEWELLERY, LUGGAGE, HOMEWARES AND OTHER PERSONAL GOODS; MAIL ORDER SERVICES FEATURING CLOTHING, FOOTWEAR, ACCESSORIES, TOILETRIES, JEWELLERY, LUGGAGE, HOMEWARES AND OTHER PERSONAL GOODS, IN CLASS 35 (U.S. CLS. 100, 101 AND 102).

THE MARK CONSISTS OF STANDARD CHARACTERS WITHOUT CLAIM TO ANY PARTICULAR FONT, STYLE, SIZE, OR COLOR.

PRIORITY DATE OF 7-8-2010 IS CLAIMED.

OWNER OF INTERNATIONAL REGISTRATION 1069002 DATED 11-20-2010, EXPIRES 11-20-2020.

OWNER OF U.S. REG. NO. 3,274,244.

THE NAME(S), PORTRAIT(S), AND/OR SIGNATURE(S) SHOWN IN THE MARK IDENTIFIES "OLIVER SWEENEY", WHOSE CONSENT(S) TO REGISTER IS MADE OF RECORD.

SER. NO. 79-094,306, FILED 11-20-2010.

SCOTT BIBB, EXAMINING ATTORNEY

United States of America  
United States Patent and Trademark Office

# FeraTrack

**Reg. No. 4,133,641**

**Registered May 1, 2012**

**Int. Cls.: 1 and 5**

**TRADEMARK**

**PRINCIPAL REGISTER**

MILTENYI BIOTEC GMBH (FED REP GERMANY GMBH)  
FRIEDRICH-EBERT-STR. 68  
51429 BERGISCH GLADBACH  
FED REP GERMANY

FOR: CHEMICALS USED IN SCIENCE, NAMELY, DIAGNOSTIC AGENTS, PREPARATIONS AND SUBSTANCES FOR SCIENTIFIC USE, CONTRASTING AGENTS FOR USE IN MRI IMAGING AND IN VIVO LABELING OF CELL TYPES FOR SCIENTIFIC USE, DIAGNOSTIC PREPARATIONS FOR IN VIVO IMAGING FOR SCIENTIFIC PURPOSES, DIAGNOSTIC REAGENTS FOR CLINICAL OR MEDICAL LABORATORY USE, IN CLASS 1 (U.S. CLS. 1, 5, 6, 10, 26 AND 46).

FOR: PHARMACEUTICAL AND VETERINARY PREPARATIONS, NAMELY, DIAGNOSTIC REAGENTS AND CONTRAST MEDIA FOR MEDICAL USE, DIAGNOSTIC AGENTS, PREPARATIONS AND SUBSTANCES FOR MEDICAL PURPOSES, DIAGNOSTIC PREPARATIONS FOR MEDICAL OR VETERINARY PURPOSES, CONTRASTING AGENTS FOR USE IN MRI IMAGING AND IN VIVO LABELING OF CELL TYPES FOR MEDICAL OR VETERINARY PURPOSES, DIAGNOSTIC PREPARATIONS FOR IN VIVO IMAGING FOR MEDICAL OR VETERINARY PURPOSES, IN CLASS 5 (U.S. CLS. 6, 18, 44, 46, 51 AND 52).

THE MARK CONSISTS OF STANDARD CHARACTERS WITHOUT CLAIM TO ANY PARTICULAR FONT, STYLE, SIZE, OR COLOR.

PRIORITY DATE OF 10-11-2010 IS CLAIMED.

OWNER OF INTERNATIONAL REGISTRATION 1069306 DATED 2-21-2011, EXPIRES 2-21-2021.

SER. NO. 79-094,411, FILED 2-21-2011.

HEATHER BIDDULPH, EXAMINING ATTORNEY



*David J. Kypos*

Director of the United States Patent and Trademark Office

# United States of America

United States Patent and Trademark Office

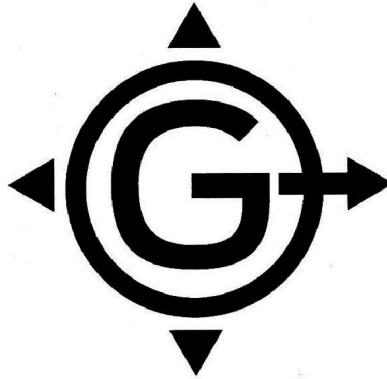

**Reg. No. 4,133,642**

**Registered May 1, 2012**

**Int. Cls.: 9, 37 and 42**

**TRADEMARK**

**SERVICE MARK**

**PRINCIPAL REGISTER**

LOCANIS AG (FED REP GERMANY AKTIENGESELLSCHAFT)  
MÜNCHNER STR. 18  
85774 UNTERFÖHRING  
FED REP GERMANY

FOR: COMPUTER PROGRAMS FOR USE IN DATABASE MANAGEMENT IN THE FIELD OF WAREHOUSE MANAGEMENT AND LOGISTICS; DATA PROCESSING EQUIPMENT FOR WAREHOUSE MANAGEMENT; ELECTRONIC REMOTE CONTROL APPARATUS FOR WAREHOUSE MANAGEMENT IN INDUSTRIAL OPERATIONS FOR FORKLIFT TRUCKS, AUTOMATED HIGH RACKS, CONVEYOR BELT SYSTEMS, SCANNERS, ROBOTS, PICK-TO-LIGHT SYSTEMS, AND PICK-TO-VOICE SYSTEMS; AUTOMATED DIGITAL CONTROLS FOR COMMERCIAL EQUIPMENT FOR WAREHOUSES; CONTROL SYSTEMS FOR THE REMOTE OBSERVATION, MANAGEMENT AND OPERATION OF WAREHOUSES, FORKLIFT TRUCKS, AUTOMATED HIGH RACKS, CONVEYOR BELT SYSTEMS, SCANNERS, ROBOTS, PICK-TO-LIGHT SYSTEMS, PICK-TO-VOICE SYSTEMS, COMPRISING COMPUTERS, SOFTWARE, FIRMWARE, HARDWARE, INTERFACES, SENSORS, WIRED AND WIRELESS NETWORKS, GPS ANTENNAS, DGPS BASE STATIONS, POWER SYSTEMS AND ALGORITHMS; ELECTROMECHANICAL CONTROLS FOR USE IN WAREHOUSES, INDUSTRIAL AUTOMATION CONTROLS FOR WAREHOUSES, WIRELESS CONTROLLER TO MONITOR AND CONTROL THE FUNCTIONING OF OTHER ELECTRONIC DEVICES FOR WAREHOUSES; ELECTRONIC POSITION-FINDING APPARATUS, NAMELY, GLOBAL POSITION SYSTEMS; AND POSITION-MEASURING APPARATUS, NAMELY, DISTANCE-MEASURING APPARATUS, IN CLASS 9 (U.S. CLS. 21, 23, 26, 36 AND 38).

FOR: MAINTENANCE AND REPAIR OF DATA PROCESSING APPARATUS, AND APPARATUS, NAMELY, FORKLIFT EQUIPMENT, BEARING SYSTEMS, INDOOR AND OUTDOOR NAVIGATION SYSTEMS AND GLOBAL POSITIONING SYSTEMS, IN CLASS 37 (U.S. CLS. 100, 103 AND 106).

FOR: COMPUTER PROGRAMMING AND MAINTENANCE OF COMPUTER PROGRAMS; MAINTENANCE, SERVICING AND REPAIR OF COMPUTER PROGRAMS FOR DATA PROCESSING EQUIPMENT, CONTROL INSTALLATIONS AND APPARATUS, IN CLASS 42 (U.S. CLS. 100 AND 101).

THE MARK CONSISTS OF THE STYLIZED LETTER "G" SURROUNDED BY A CIRCLE. A TRIANGLE APPEARS ABOVE, BELOW AND TO THE LEFT OF THE CIRCLE. AN ARROW



*David J. Kybas*

Director of the United States Patent and Trademark Office

**Reg. No. 4,133,642** EMANATES FROM INSIDE THE CIRCLE AND POINTS TO THE RIGHT OUTSIDE THE CIRCLE.

PRIORITY DATE OF 8-19-2010 IS CLAIMED.

OWNER OF INTERNATIONAL REGISTRATION 1069388 DATED 2-17-2011, EXPIRES 2-17-2021.

SER. NO. 79-094,440, FILED 2-17-2011.

COLLEEN DOMBROW, EXAMINING ATTORNEY

# United States of America

United States Patent and Trademark Office

# TEKNIA<sup>®</sup>

**Reg. No. 4,133,643**

**Registered May 1, 2012**

**Int. Cl.: 12**

**TRADEMARK**

**PRINCIPAL REGISTER**

TEKNIA MANUFACTURING GROUP, S.L. (SPAIN SOCIEDAD LIMITADA)  
CAMINO URIBARRI A ERANDIONDO, 3  
E-48950 ERANDIO (VIZCAYA)  
SPAIN

FOR: VEHICLES, NAMELY, LAND VEHICLES, AUTOMOBILES, CARS, TRUCKS, LORRIES, VANS, BUSES; AND APPARATUS FOR LOCOMOTION BY LAND, NAMELY, AUTOMOBILES, CARS, TRUCKS, LORRIES, BICYCLES, VANS, BUSES, MOTORIZED GOLF CARTS, MOTORCYCLES INCLUDING PARTS AND FITTINGS FOR LAND VEHICLES, NAMELY, TRANSMISSIONS, CLUTCHES, CLUTCH MECHANISMS, FRICTION DISKS, CLUTCH RELEASE BEARINGS, TORSIONAL DAMPERS FOR CLUTCHES, INERTIAL WHEELS, INERTIAL WHEELS WITH TORSIONAL DAMPERS, HYDRAULIC CONTROLS FOR CLUTCHES, ELECTRIC CONTROLS FOR CLUTCHES, ELECTRONIC AND HYDRAULIC ACTUATORS FOR CLUTCH CONTROL, COUPLERS, TORQUE CONVERTERS FOR VEHICLES, RETARDERS, BRAKES AND BRAKING FACILITIES FOR VEHICLES, HYDRODYNAMIC BRAKES AND RETARDERS, SAFETY BELTS FOR VEHICLE PASSENGERS, HOODS, DOORS, BUMPERS, STEERING WHEELS, CONVERTIBLE TOPS FOR VEHICLES, GEARBOXES, AXLES, WHEELS, WHEEL RIMS, HUB CAPS, TIRE PUMPS, SEATS, SCAT COVERS, SAFETY SEATS FOR CHILDREN, HEAD REST FOR SEATS, TRAILER HITCHES, LUGGAGE RACKS, SKI RACKS, ELECTRIC AND/OR ELECTRONIC POWER STEERING DEVICES, ELECTRONIC POWER SUSPENSION DEVICES, BRAKE LININGS, STEERING WHEEL LOCKS, LOCK ACTUATORS, WINDSHIELD WIPER ARMS, SPOILERS, TRANSMISSION ASSEMBLIES FOR MOVING WINDSHIELDS, SUPPORT PLATES FOR WINDSHIELDS WIPERS, CONTAINERS FOR WINDSHIELDS CLEANING LIQUIDS, LOCKLESS PETROL TANK CAPS, BRAKE CYLINDERS FOR HYDRAULIC CLUTCH CONTROL, MASTER CYLINDERS FOR BRAKES OR CLUTCHES, DOOR HINGES AND HANDLES FOR VEHICLES, GEARBOXES FOR LAND VEHICLES, HYDRAULIC CIRCUITS FOR VEHICLES, UPHOLSTERY FOR VEHICLES, TANK CAPS EQUIPPED WITH LOCKS, ROBOTIC GEARBOXES, AUTOMATIC BRAKING SYSTEMS, HEADLIGHT WASHERS, HEADLIGHT WIPERS, AND SIGNAL LIGHTS, INTERIOR DOOR AND ROOF FITTINGS, DASHBOARD, DOOR AND ROOF PANELS FOR LAND VEHICLES, IN CLASS 12 (U.S. CLS. 19, 21, 23, 31, 35 AND 44).



*David J. Kyros*

Director of the United States Patent and Trademark Office

THE MARK CONSISTS OF THE WORD "TEKNIA" AND A CIRCLE DESIGN WITH AN OVAL IN THE UPPER RIGHT CORNER.

PRIORITY DATE OF 7-20-2010 IS CLAIMED.

**Reg. No. 4,133,643** OWNER OF INTERNATIONAL REGISTRATION 1069409 DATED 1-11-2011, EXPIRES 1-11-2021.

SER. NO. 79-094,445, FILED 1-11-2011.

MICHELE SWAIN, EXAMINING ATTORNEY

# United States of America

United States Patent and Trademark Office

**NO**  
**BRETT**  
**INSIDE**

**Reg. No. 4,133,644**

**Registered May 1, 2012**

**Int. Cl.: 1**

DANSTAR FERMENT AG (SWITZERLAND SOCIÉTÉ ANONYME (SA) / JOINT STOCK COMPANY)  
BAHNHOFSTRASSE 7  
CH-6301 ZUG  
SWITZERLAND

**TRADEMARK**

**PRINCIPAL REGISTER**

FOR: CHEMICALS FOR USE IN THE WINE INDUSTRY, NAMELY, CHEMICALS FOR FERMENTING WINE; CHITOSAN AND CHITOSAN DERIVATIVES FOR USE IN THE MANUFACTURE OF WINE, IN CLASS 1 (U.S. CLS. 1, 5, 6, 10, 26 AND 46).

NO CLAIM IS MADE TO THE EXCLUSIVE RIGHT TO USE "BRETT", APART FROM THE MARK AS SHOWN.

PRIORITY DATE OF 9-29-2010 IS CLAIMED.

OWNER OF INTERNATIONAL REGISTRATION 1069873 DATED 2-28-2011, EXPIRES 2-28-2021.

THE MARK CONSISTS OF THE STYLIZED WORDING "NO BRETT INSIDE" WITH THE "O" IN "NO" BEING FORMED BY A HORSESHOE.

SER. NO. 79-094,631, FILED 2-28-2011.

JENNIFER MARTIN, EXAMINING ATTORNEY



*David J. Kybas*

Director of the United States Patent and Trademark Office



# United States of America

United States Patent and Trademark Office

## NLT Technologies

**Reg. No. 4,133,645**

**Registered May 1, 2012**

**Int. Cls.: 9 and 42**

**TRADEMARK**

**SERVICE MARK**

**PRINCIPAL REGISTER**

NEC LCD TECHNOLOGIES, LTD. (JAPAN CORPORATION)  
1753, SHIMONUMABE,  
NAKAHARA-KU; KAWASAKI-SHI, KANAGAWA 211-0011  
JAPAN

FOR: LIQUID CRYSTAL DISPLAYS; LIQUID CRYSTAL DISPLAY MODULES; LIQUID CRYSTAL DISPLAY PANELS; LIQUID CRYSTAL DISPLAY MONITORS; LIQUID CRYSTAL DISPLAY TELEVISIONS; COMPUTER MONITORS; COMPUTER DISPLAYS; TELEVISION MONITORS, IN CLASS 9 (U.S. CLS. 21, 23, 26, 36 AND 38).

FOR: PROVIDING TECHNICAL ADVICE RELATING TO THE PERFORMANCE AND OPERATION OF LIQUID CRYSTAL DISPLAYS, COMPUTER MONITORS AND COMPUTER DISPLAYS THAT REQUIRE HIGH LEVELS OF PERSONAL KNOWLEDGE SKILL OR EXPERIENCE OF THE OPERATORS TO MEET THE REQUIRED ACCURACY IN OPERATING THEM; DESIGN OF LIQUID CRYSTAL DISPLAYS, COMPUTER MONITORS AND COMPUTER DISPLAYS, IN CLASS 42 (U.S. CLS. 100 AND 101).

NO CLAIM IS MADE TO THE EXCLUSIVE RIGHT TO USE "TECHNOLOGIES", APART FROM THE MARK AS SHOWN.

PRIORITY DATE OF 12-13-2010 IS CLAIMED.

OWNER OF INTERNATIONAL REGISTRATION 1069887 DATED 1-11-2011, EXPIRES 1-11-2021.

SER. NO. 79-094,639, FILED 1-11-2011.

GRETCHEN ULRICH, EXAMINING ATTORNEY



*David J. Kyros*

Director of the United States Patent and Trademark Office

# United States of America

United States Patent and Trademark Office

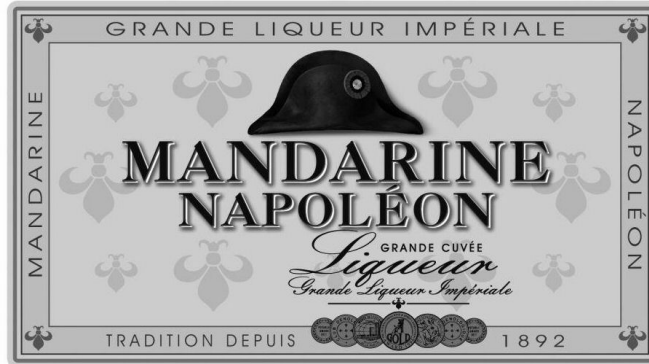

**Reg. No. 4,133,646**

**Registered May 1, 2012**

**Int. Cl.: 33**

**TRADEMARK**

**PRINCIPAL REGISTER**

KONINKLIJKE DE KUYPER B.V. (NETHERLANDS B.V.)  
BUITENHAVENWEG 98  
NL-3113 BE SCHIEDAM  
NETHERLANDS

FOR: ALCOHOLIC BEVERAGES EXCEPT BEERS, IN CLASS 33 (U.S. CLS. 47 AND 49).

OWNER OF U.S. REG. NO. 2,492,093.

PRIORITY DATE OF 9-6-2010 IS CLAIMED.

OWNER OF INTERNATIONAL REGISTRATION 1070071 DATED 1-31-2011, EXPIRES 1-31-2021.

NO CLAIM IS MADE TO THE EXCLUSIVE RIGHT TO USE "MANDARINE" OR "GRANDE CUVÉE LIQUEUR" OR "GRANDE LIQUEUR" OR "TRADITION DEPUIS 1892" OR "POTABLE AWARD 1977" OR "MONDE SELECTION BRUXELLES SELECTION DE LA QUALITE" OR "THE INTERNATIONAL WINE & SPIRIT COMPETITION GOLD AWARD 1996", APART FROM THE MARK AS SHOWN.

THE MARK CONSISTS OF THE WORDING "MANDARINE NAPOLEON" BELOW A HAT AND ABOVE THE WORDING "GRANDE CUVÉE LIQUEUR GRANDE LIQUEUR IMPERIALE" AND A LINE WITH A FLEUR-DE-LIS ABOVE SEVEN MEDALLIONS. THE ENTIRE DESIGN SITS ON A SHADED BACKGROUND OF FLEUR-DE-LIS AND IS OUTLINED BY A DOUBLE LINED FRAME. IN EACH CORNER OF THE FRAME IS A FLEUR-DE-LIS. IN THE TOP PORTION OF THE FRAME IS THE WORDING "GRANDE LIQUEUR IMPERIALE". ON THE RIGHT PORTION OF THE FRAME IS THE TERM "NAPOLEON", ON THE BOTTOM PORTION OF THE FRAME IS THE WORDING "TRADITION DEPUIS 1892", AND ON THE LEFT PORTION OF THE FRAME IS THE WORDING "MANDARINE". THE MEDALLIONS APPEAR AS FOLLOWS FROM LEFT TO RIGHT: THE FIRST MEDALLION CONTAINS THE WORDING "POTABLE AWARD 1977" AND THERE IS A CIRCULAR WREATH DESIGN INSIDE OF A DOUBLE LINED BORDER. THE SECOND MEDALLION CONTAINS THE PARTIALLY HIDDEN WORDING "CLUB OENOLOGIQUE" AND THERE IS A 5-POINTED STAR DEVICE AT THE BOTTOM OF THE MEDALLION, A CIRCLE WITH A CUTOUT DIAMOND SHAPED CENTER AND FOUR ARROWHEAD DESIGNS POINTING TOWARDS THE CENTER. THE THIRD MEDALLION CONTAINS THE WORDING "MONDE SELECTION BRUXELLES SELECTION DE LA QUALITE". THE DESIGN IS AN ELONGATED GLOBE,



*David J. Kappas*

Director of the United States Patent and Trademark Office

**Reg. No. 4,133,646** ON WHICH IS SUPERIMPOSED THE DESIGN OF A BUILDING. THE FOURTH MEDALLION CONTAINS THE WORDING "THE INTERNATIONAL WINE & SPIRIT COMPETITION GOLD AWARD 1996". THERE IS A SEATED HUMAN FIGURE IN FRONT OF A GREEK COLUMN AND THE WORD "GOLD" APPEARS IN LARGE LETTERS AT THE BOTTOM. THE FIFTH MEDALLION CONTAINS THE PARTIALLY HIDDEN SLOVENIAN WORDING "OCENJEVANJE ZGANIH PIJAC", AND NEXT TO IT IS THE WORDING "LJUBLIANA 1977". THE FIGURE IS A DEVIL HOLDING TWO BIRDS AND THE LETTERS "ONO" ALSO APPEAR. THE SIXTH MEDALLION CONTAINS THE PARTIALLY HIDDEN WORDING "CLUB OENOLOGIQUE". THERE IS A FIVED POINTED STAR DEVICE AT THE BOTTOM OF THE MEDALLION, A CIRCLE WITH A CUTOUT DIAMOND-SHAPED CENTER AND FOUR ARROWHEAD DESIGNS POINTING TOWARDS THE CENTER. THE SEVENTH MEDALLION CONTAINS THE WORDING "POTABLE AWARD 1977" AND THERE IS A CIRCULAR WREATH DESIGN INSIDE OF A DOUBLE-LINED BORDER.

THE ENGLISH TRANSLATION OF "MANDARINE" AND "GRANDE CUVÉE LIQUEUR" AND "GRANDE LIQUEUR IMPERIALE" AND "DEPUIS" AND "OENOLOGIQUE" AND "MONDE SELECTION BRUXELLES SELECTION DE LA QUALITE" AND "OCENJEVANJE ZGANIH PIJAC" IN THE MARK IS "MANDARIN", AND "GRAND VINTAGE LIQUEUR" AND "GRAND IMPERIAL LIQUEUR" AND "SINCE" AND "OENOLOGICAL" AND "WORLD SELECTION BRUSSELS QUALITY SELECTION" AND "EVALUATION SPIRITS".

SER. NO. 79-094,710, FILED 1-31-2011.

JESSICA A. POWERS, EXAMINING ATTORNEY

**United States of America**  
United States Patent and Trademark Office

**SQUALL**

**Reg. No. 4,133,647**

**Registered May 1, 2012**

**Int. Cl.: 5**

GREENA B.V., BESLOTEN VENNOOTSCHAP (NETHERLANDS BESLOTEN  
VENNOOTSCHAP (B.V.))  
VONDELSTRAAT 7 B 3  
NL-1054 GB AMSTERDAM  
NETHERLANDS

**TRADEMARK**

FOR: ADDITIVES FOR PESTICIDES, NAMELY, A FUNGICIDE, INSECTICIDE OR HERBI-  
CIDE PREPARATION FOR USE WITH AGRICULTURAL PESTICIDES, IN CLASS 5 (U.S.  
CLS. 6, 18, 44, 46, 51 AND 52).

**PRINCIPAL REGISTER**

THE MARK CONSISTS OF STANDARD CHARACTERS WITHOUT CLAIM TO ANY PAR-  
TICULAR FONT, STYLE, SIZE, OR COLOR.

PRIORITY DATE OF 11-8-2010 IS CLAIMED.

OWNER OF INTERNATIONAL REGISTRATION 1070129 DATED 2-22-2011, EXPIRES 2-22-  
2021.

SER. NO. 79-094,737, FILED 2-22-2011.

LIEF MARTIN, EXAMINING ATTORNEY



*David J. Kyros*

Director of the United States Patent and Trademark Office

# United States of America

United States Patent and Trademark Office

# EBUDDY XMS

**Reg. No. 4,133,648**

EBUDDY HOLDING B.V. (NETHERLANDS B.V.)  
KEIZERSGRACHT 583-585  
NL-1017 DR AMSTERDAM, NETHERLANDS

**Registered May 1, 2012**

**Int. Cls.: 9, 38 and 42**

FOR: SOFTWARE, NAMELY, SOFTWARE FOR RECEIVING AND TRANSMISSION OF MULTIMEDIA MESSAGES, IN CLASS 9 (U.S. CLS. 21, 23, 26, 36 AND 38).

**TRADEMARK**

FOR: TELECOMMUNICATION SERVICES, NAMELY, ELECTRONIC TRANSMISSION OF MULTIMEDIA MESSAGES THAT INCLUDE TEXT, IMAGE, SOUND, LINKS AND DIGITAL FILES; ELECTRONIC DATA TRANSMISSION, IN CLASS 38 (U.S. CLS. 100, 101 AND 104).

**SERVICE MARK**

**PRINCIPAL REGISTER**

FOR: DESIGN AND DEVELOPMENT OF SOFTWARE FOR RECEIVING AND TRANSMISSION OF MULTIMEDIA MESSAGES, INCLUDING TEXT, IMAGE, SOUND, LINKS, DIGITAL FILES AND VIRTUAL GOODS, BETWEEN ELECTRONIC DEVICES OF USERS OF ELECTRONIC DEVICES; DESIGN AND DEVELOPMENT OF SOFTWARE FOR SYNCHRONIC COMMUNICATION, INCLUDING INSTANT MESSAGING, CHATTING, VOIP, TELEPHONY AND VIDEO CALLING, BETWEEN ELECTRONIC DEVICES OF USERS OF ELECTRONIC DEVICES; DESIGN AND DEVELOPMENT OF SOFTWARE FOR CREATING, UPDATING AND TRANSMISSION OF PERSONAL DIGITAL PROFILES, ADDRESS BOOKS AND CONTACT LISTS, IN CLASS 42 (U.S. CLS. 100 AND 101).

THE MARK CONSISTS OF STANDARD CHARACTERS WITHOUT CLAIM TO ANY PARTICULAR FONT, STYLE, SIZE, OR COLOR.

PRIORITY DATE OF 1-7-2011 IS CLAIMED.

OWNER OF INTERNATIONAL REGISTRATION 1070255 DATED 2-11-2011, EXPIRES 2-11-2021.

OWNER OF U.S. REG. NOS. 3,492,789 AND 3,512,632.

NO CLAIM IS MADE TO THE EXCLUSIVE RIGHT TO USE "XMS", APART FROM THE MARK AS SHOWN.

SER. NO. 79-094,795, FILED 2-11-2011.

SEAN CROWLEY, EXAMINING ATTORNEY



*David J. Kyros*

Director of the United States Patent and Trademark Office

# United States of America

United States Patent and Trademark Office



## ParkTrent

**Reg. No. 4,133,649**

**Registered May 1, 2012**

**Int. Cls.: 35 and 36**

**SERVICE MARK**

**PRINCIPAL REGISTER**

PARKTRENT PROPERTIES GROUP PTY LTD (AUSTRALIA LIMITED LIABILITY COMPANY)  
39 MONTAGUE STREET  
NORTH WOLLONGONG NSW 2500  
AUSTRALIA

FOR: ORGANIZATION OF DISPLAYS AND EXHIBITIONS OF HOUSING AND REAL ESTATE FOR PROMOTION AND ADVERTISING PURPOSES; REAL ESTATE AUCTIONEERING, IN CLASS 35 (U.S. CLS. 100, 101 AND 102).

FOR: APPRAISAL OF REAL ESTATE; MANAGEMENT OF REAL ESTATE; PROVISION OF INFORMATION IN RELATION TO REAL ESTATE; REAL ESTATE ADMINISTRATION; REAL ESTATE AGENCIES; REAL ESTATE FINANCING; REAL ESTATE INVESTMENT SERVICES, IN CLASS 36 (U.S. CLS. 100, 101 AND 102).

THE NAME "PARKTRENT" DOES NOT IDENTIFY A LIVING INDIVIDUAL.

PRIORITY DATE OF 10-14-2010 IS CLAIMED.

OWNER OF INTERNATIONAL REGISTRATION 1070384 DATED 2-14-2011, EXPIRES 2-14-2021.

THE MARK CONSISTS OF A JIGSAW PUZZLE DESIGN CONSISTING OF FOUR JIGSAW PIECES SLANTING TO THE LEFT WITH THE TOP RIGHT PIECE DISCONNECTED FROM THE OTHER THREE CONNECTED PIECES. TO THE RIGHT OF THE DESIGN IS THE WORDING "PARK TRENT".

SER. NO. 79-094,835, FILED 2-14-2011.

JAMES STEIN, EXAMINING ATTORNEY



*David J. Kybas*

Director of the United States Patent and Trademark Office

# United States of America

United States Patent and Trademark Office

# Z e r o t e c h

**Reg. No. 4,133,650**

**Registered May 1, 2012**

**Int. Cl.: 12**

**TRADEMARK**

**PRINCIPAL REGISTER**

TSUBAKIMOTO CHAIN CO. (JAPAN CORPORATION)  
3-3, NAKANOSHIMA, 3-CHOME  
KITA-KU,; OSAKA-SHI; OSAKA 530-0005  
JAPAN

FOR: TRANSMISSION CHAINS FOR LAND VEHICLES, CHAINS FOR MOTOR CARS, AND  
MOTORCYCLE DRIVE CHAINS, IN CLASS 12 (U.S. CLS. 19, 21, 23, 31, 35 AND 44).

THE MARK CONSISTS OF STANDARD CHARACTERS WITHOUT CLAIM TO ANY PAR-  
TICULAR FONT, STYLE, SIZE, OR COLOR.

PRIORITY DATE OF 8-3-2010 IS CLAIMED.

OWNER OF INTERNATIONAL REGISTRATION 1070758 DATED 12-13-2010, EXPIRES 12-  
13-2020.

SER. NO. 79-094,980, FILED 12-13-2010.

CHRISTINE MARTIN, EXAMINING ATTORNEY



*David J. Kybas*

Director of the United States Patent and Trademark Office

# United States of America

United States Patent and Trademark Office

# DAILYCER

**Reg. No. 4,133,651**

**Registered May 1, 2012**

**Int. Cls.: 29, 30 and 35**

**TRADEMARK**

**SERVICE MARK**

**PRINCIPAL REGISTER**

DE-VAU-GE CEREALS HOLDING GMBH (FED REP GERMANY HOLDING LIMITED COMPANY)  
LÜNER RENNBAHN 18  
21339 LÜNEBURG, FED REP GERMANY

FOR: FRUIT-BASED SNACK FOOD, NAMELY, FRUIT-BASED RAW FOOD BARS, PROCESSED FRUIT-BASED FOOD BARS, AND FRUIT CHIPS; FROSTED FRUITS; POTATO CHIPS, POTATO FLAKES; COOKED, DRIED, AND PRESERVED FRUITS AND VEGETABLES; COOKED OR PRESERVED FRUITS, JAMS, FRUIT JELLIES, FRUIT COMPOTES; VEGETABLE JUICES FOR COOKING; SOYA MILK, WHEY; MILK BASED BEVERAGES WITH ADDED CEREALS AND FRUIT, NAMELY, YOGHURT AND KEPHIR, IN CLASS 29 (U.S. CL. 46).

FOR: CEREAL PREPARATIONS FOR NUTRITIONAL PURPOSES, NAMELY, OAT FLAKES, MUESLIS; CEREAL-BASED SNACK FOOD, NAMELY, CHIPS; CORN FLAKES; CORN-BASED SNACK FOOD, NAMELY, POPCORN; RICE-BASED SNACK FOOD; RICE; CRACKERS, BISCUITS, COOKIES; BREAD, BUNS, CAKES; FLOUR; PASTRIES, CONFECTIONERY MADE OF SUGAR; COCOA PRODUCTS IN THE NATURE OF COCOA POWDER, IN CLASS 30 (U.S. CL. 46).

FOR: RETAIL AND WHOLESALE STORE SERVICES FEATURING FOOD INCLUDING NON-ALCOHOLIC DRINKS, DIETETIC SUBSTANCES ADAPTED FOR MEDICAL USE, FOOD FOR BABIES; ADVERTISING; MODELING FOR ADVERTISING OR SALES PROMOTION; SALES PROMOTION FOR OTHERS; DEMONSTRATION OF GOODS; SHOP WINDOW DRESSING SERVICES; DISTRIBUTION OF SAMPLES; PRESENTATION OF GOODS ON COMMUNICATION MEDIA FOR RETAIL PURPOSES; COMMERCIAL INFORMATION AND ADVICE FOR CONSUMERS; ACCOUNTING, BOOKKEEPING; ADMINISTRATIVE PROCESSING OF PURCHASE ORDERS, BUSINESS MANAGEMENT ASSISTANCE, PROFESSIONAL BUSINESS CONSULTANCY; SECRETARIAL SERVICES; BUSINESS INFORMATION, BUSINESS RESEARCH, MARKETING RESEARCH, MARKETING STUDIES; COMMERCIAL ADMINISTRATION OF THE LICENSING OF GOODS AND SERVICES OF OTHERS AND INTELLECTUAL PROPERTY; RENTAL OF VENDING MACHINES, IN CLASS 35 (U.S. CLS. 100, 101 AND 102).



*David J. Kyjars*

Director of the United States Patent and Trademark Office

THE MARK CONSISTS OF STANDARD CHARACTERS WITHOUT CLAIM TO ANY PARTICULAR FONT, STYLE, SIZE, OR COLOR.



**Reg. No. 4,133,651** PRIORITY DATE OF 9-7-2010 IS CLAIMED.

OWNER OF INTERNATIONAL REGISTRATION 1070776 DATED 1-25-2011, EXPIRES 1-25-2021.

SER. NO. 79-094,991, FILED 1-25-2011.

ALYSSA STEEL, EXAMINING ATTORNEY

# United States of America

United States Patent and Trademark Office

# SEADRY

**Reg. No. 4,133,652**

**Registered May 1, 2012**

**Int. Cls.: 36 and 39**

**SERVICE MARK**

**PRINCIPAL REGISTER**

SOVENAX (FRANCE SOCIETE A RESPONSABILITE LIMITEE A ASSOCIE UNIQUE)  
BOULEVARD DES OISEAUX PORT RVSL  
F-76530 GRAND COURONNE  
FRANCE

FOR: CUSTOMS BROKERAGE SERVICES; CUSTOMS AGENT SERVICES, NAMELY, ACTING AS AN AGENT FOR PAYMENT OF CUSTOMS DUTIES ON GOODS SHIPPED OR RECEIVED BY FOREIGN OR DOMESTIC SHIPPERS AND RECEIVERS, PROVIDING TAX PAYMENT PROCESSING SERVICES, PROVIDING RECLAMATION OF IMPORT DUTIES FOR OTHERS, AND PROVIDING FINANCIAL SPONSORSHIP OF TRANSPORTATION OF MERCHANDISE, IN CLASS 36 (U.S. CLS. 100, 101 AND 102).

FOR: TRANSPORTATION, PARTICULARLY TRANSPORTATION OF MERCHANDISE AND GOODS BY MOTOR VEHICLES, CARS, TRUCKS, RAIL, BOATS OR AIRCRAFT; PACKAGING, WAREHOUSING, HOLDING, AND STORAGE OF GOODS FOR TRANSPORTATION FOR OTHERS; TRANSPORTATION INFORMATION; FREIGHT BROKERAGE; UNLOADING OF CARGO; STORAGE INFORMATION, NAMELY, PROVIDING INFORMATION ON METHODS OF STORAGE OF GOODS; TRANSPORT LOGISTICS, NAMELY, SUPPLY CHAIN LOGISTICS AND REVERSE LOGISTICS IN THE NATURE OF THE STORAGE, TRANSPORT AND DELIVERY OF GOODS FOR OTHERS BY AIR, RAIL, SHIP AND TRUCK; COLLECTION, TRANSPORTATION AND DELIVERY OF GOODS; LOADING OF FREIGHT ON SHIPS, AIRPLANES, RAILWAY CARS, CARS, MOTORIZED VEHICLES AND TRUCKS; MARKING AND TRACING SERVICES, NAMELY, STORAGE OF ELECTRONIC DATA USED IN THE TRACKING OF GOODS AND CONTAINERS; MANAGEMENT AND OPERATION OF STORAGE AREAS, NAMELY, WAREHOUSING SERVICES; RENTAL OF WAREHOUSES; ORGANIZATION AND PROCESSING OF RETURNED DISPATCHES VIA ELECTRONIC STORAGE OF DATA RELATING THE MANAGEMENT OF REJECTED DISPATCHES OF GOODS; RENTAL OF STORAGE CONTAINERS; TRANSPORTATION CONSULTATION, NAMELY, TRANSPORTATION LOGISTICS CONSULTING RELATED TO THE TRANSPORTATION AND DELIVERY OF GOODS FOR OTHERS BY AIR, RAIL, SHIP, AND TRUCK; ELECTRONIC STORAGE OF DATA FOR PROCESSING AND EXECUTION OF SHIPMENT OF GOODS; SUPPLY OF INFORMATION AND DATA VIA DATABASES AND/OR THE INTERNET, WITH RESPECT TO TRANSPORT SERVICES AND PARTICULARLY THE TRANSPORT OF GOODS; REFRIGERATOR RENTAL, BOAT STORAGE; STORAGE OF GOODS, DELIVERY OF GOODS; PACKAGING OF GOODS FOR STORAGE AND TRANSPORTATION; PACKING OF GOODS FOR STORAGE AND TRANSPORTATION; FREIGHT BROKERAGE, TRANSPORT BROKERAGE; SHIPPING BROKERAGE, TRANSIT COMMIS-



*David J. Kyros*

Director of the United States Patent and Trademark Office

**Reg. No. 4,133,652** SIONS IN THE NATURE OF FREIGHT TRANSPORTATION BROKERAGE; FREIGHT FORWARDING SERVICES, IN CLASS 39 (U.S. CLS. 100 AND 105).

THE MARK CONSISTS OF STANDARD CHARACTERS WITHOUT CLAIM TO ANY PARTICULAR FONT, STYLE, SIZE, OR COLOR.

PRIORITY DATE OF 1-18-2011 IS CLAIMED.

OWNER OF INTERNATIONAL REGISTRATION 1070844 DATED 3-11-2011, EXPIRES 3-11-2021.

SER. NO. 79-095,012, FILED 3-11-2011.

SHAILA SETTLES, EXAMINING ATTORNEY

# United States of America

United States Patent and Trademark Office



**Reg. No. 4,133,653**

**Registered May 1, 2012**

**Int. Cl.: 25**

**TRADEMARK**

**PRINCIPAL REGISTER**

PINTO WAHINTO, S.L. (SPAIN SOCIEDAD LIMITADA)  
CALLE GRANJA SAN JAVIER, ESCALERA 4 3ºB  
E-11500 EL PUERTO DE SANTA MARÍA  
SPAIN

FOR: CLOTHING, NAMELY, SHIRTS, PANTS, COATS, DRESSES; FOOTWEAR; HEADGEAR, NAMELY, CAPS, HATS, BEANIES, BERETS, IN CLASS 25 (U.S. CLS. 22 AND 39).

NO CLAIM IS MADE TO THE EXCLUSIVE RIGHT TO USE "WEAR", APART FROM THE MARK AS SHOWN.

OWNER OF INTERNATIONAL REGISTRATION 1071016 DATED 2-10-2011, EXPIRES 2-10-2021.

THE MARK CONSISTS OF THE WORDING "FORCEFUL WEAR" BELOW A CIRCLE WITH A SYMBOL OF TWO IRREGULAR HORIZONTAL LINES CROSSING TWO IRREGULAR VERTICAL LINES.

SER. NO. 79-095,084, FILED 2-10-2011.

KRISTIN CARLSON, EXAMINING ATTORNEY



*David J. Kybas*

Director of the United States Patent and Trademark Office

# United States of America

United States Patent and Trademark Office

# INCAR

**Reg. No. 4,133,654**

**Registered May 1, 2012**

**Int. Cls.: 12 and 42**

**TRADEMARK**

**SERVICE MARK**

**PRINCIPAL REGISTER**

THYSSENKRUPP STEEL EUROPE AG (FED REP GERMANY AG)  
KAISER-WILHELM-STR. 100  
47166 DUISBURG, FED REP GERMANY

FOR: VEHICLES, APPARATUS FOR LOCOMOTION BY LAND, AIR OR WATER, NAMELY, LAND VEHICLES; PARTS OF VEHICLES AND APPARATUS FOR LOCOMOTION BY LAND, AIR OR WATER, NAMELY, EXTERNAL COMPONENT STRUCTURAL PARTS FOR THE BODIES OF LAND VEHICLES; VEHICLE BODIES OF METAL; DRIVES FOR VEHICLES, NAMELY, DRIVE GEARS; PARTS FOR DRIVES FOR VEHICLES, NAMELY, COMPONENT PARTS OF DRIVE SHAFTS FOR LAND VEHICLES, IN CLASS 12 (U.S. CLS. 19, 21, 23, 31, 35 AND 44).

FOR: ENGINEERING, NAMELY, CONSTRUCTION DRAFTING AND CONSULTANCY, RESEARCH IN THE FIELD OF TECHNOLOGY, TECHNICAL PROJECT STUDIES, IN CLASS 42 (U.S. CLS. 100 AND 101).

THE MARK CONSISTS OF STANDARD CHARACTERS WITHOUT CLAIM TO ANY PARTICULAR FONT, STYLE, SIZE, OR COLOR.

OWNER OF INTERNATIONAL REGISTRATION 1071436 DATED 3-2-2011, EXPIRES 3-2-2021.

OWNER OF U.S. REG. NO. 3,991,796.

SER. NO. 79-095,205, FILED 3-2-2011.

GRETТА YAO, EXAMINING ATTORNEY



*David J. Kybas*

Director of the United States Patent and Trademark Office

# United States of America

United States Patent and Trademark Office



**Reg. No. 4,133,655**

**Registered May 1, 2012**

**Int. Cls.: 9, 41 and 42**

**TRADEMARK**

**SERVICE MARK**

**PRINCIPAL REGISTER**

MOREDAYS, S.R.O. (CZECH REPUBLIC LIMITED LIABILITY COMPANY)  
JESENIOVA 2829/20  
CZ-130 00 PRAHA 3  
CZECH REPUBLIC

FOR: BLANK DATA CARRIERS OF ALL KINDS INCLUDING THEIR PACKAGING ALL SOLD TOGETHER AS SINGLE COMPONENT UNITS; ELECTRONIC PUBLICATIONS, NAMELY, ADDRESS BOOKS, MANUALS, PLANNERS AND DIARIES FEATURING PERSONAL ORGANISERS RECORDED ON COMPUTER MEDIA; COMPUTER SOFTWARE FOR USE IN ORGANISING PERSONAL DATA, STORING AND SHARING INFORMATION, PERSONAL MANAGEMENT SYSTEM AND PRODUCTIVITY TOOL, PRE-RECORDED MAGNETIC DATA CARRIERS FEATURING MUSIC, DATA, PERSONAL DATA, CONTACTS, NOTES, EVENTS, PHOTOS AND OTHER MEDIA; DATABASES, NAMELY, DOWNLOADABLE ELECTRONIC DATABASES, NAMELY, DATABASE FOR STORING PERSONAL INFORMATION, DIARY, PLANNER, ORGANIZER, SCRAPBOOK, FOR USE WITH COMPUTER SOFTWARE; PRE-RECORDED MAGNETIC DATA CARRIERS FEATURING PERSONAL ORGANISERS; COMPUTER SOFTWARE FOR ACCESSING INFORMATION DIRECTORIES THAT MAY BE DOWNLOADED FROM THE GLOBAL COMPUTER AND TELECOMMUNICATION NETWORKS; DOWNLOADABLE MULTIMEDIA INFORMATION CATALOGUES FEATURE INFORMATION IN THE FIELD OF PERSONAL ORGANISERS, IN CLASS 9 (U.S. CLS. 21, 23, 26, 36 AND 38).



FOR: EDUCATIONAL SERVICES, NAMELY, PROVIDING CLASSES, SEMINARS AND TRAINING IN THE FIELD OF MUSIC, PERSONAL DEVELOPMENT, BUSINESS, AND INFORMATION AND COMMUNICATIONS TECHNOLOGY (ICT); DIGITAL VIDEO, AUDIO, AND MULTIMEDIA PUBLISHING SERVICES; ORGANIZING AND MANAGING CONFERENCE, CONGRESSES, SEMINARS IN THE FIELDS OF EDUCATION, SPORTS AND ENTERTAINMENT FOR NON-BUSINESS AND NON-COMMERCIAL PURPOSES; EDUCATION FOR PERSONAL AND BUSINESS DEVELOPMENT, NAMELY, CONDUCTING CLASSES, SEMINARS, CONFERENCES, AND WORKSHOPS IN THE FIELDS OF TIME MANAGEMENT, LIFE PLANNING, COMPUTER SOFTWARE FOR ORGANISING PERSONAL DATA, STORING AND SHARING INFORMATION, AND PERSONAL MANAGEMENT SYSTEM AND PRODUCTIVITY TOOLS; ORGANIZING CULTURAL EVENTS, IN CLASS 41 (U.S. CLS. 100, 101 AND 107).

*David J. Kybas*

Director of the United States Patent and Trademark Office

FOR: CREATION AND DEVELOPMENT OF SOFTWARE AND DATABASES; SOFTWARE REPAIR SERVICES; PROVIDING ON-LINE NON-DOWNLOADABLE SOFTWARE FOR

**Reg. No. 4,133,655** PERSONAL DEVELOPMENT AND TIME MANAGEMENT SOFTWARE, PRODUCTIVITY TOOLS FOR PERSONAL AND BUSINESS USE; COMPUTER SOFTWARE CONSULTANCY; DESIGN AND CREATING WEB SITES FOR OTHERS; HOSTING OF WEB SITES; CONSULTANCY IN THE FIELD OF WEB DESIGN AND WEB HOSTING, IN CLASS 42 (U.S. CLS. 100 AND 101).

THE MARK CONSISTS OF A DESIGN OF A TREE WITH TWELVE SHADED LEAVES EMANATING OUTWARDS IN THE MIDDLE OF WHICH IS LOCATED A PLUS SYMBOL WITHIN A CIRCLE. TO THE RIGHT OF THE DESIGN OF THE TREE IS THE SILHOUETTE OF A CHILD READING. BELOW THE DESIGN OF THE TREE IS THE STYLIZED WORDING "MOREDAYS" IN LARGE FONT AND IN CAPITAL LETTERS. BELOW THE WORDING "MOREDAYS" IS LOCATED THE STYLIZED WORDING "ENJOY YOUR EXTRA DAYS" IN SMALLER FONT AND ALSO IN CAPITAL LETTERS.

PRIORITY DATE OF 11-24-2010 IS CLAIMED.

OWNER OF INTERNATIONAL REGISTRATION 1071973 DATED 11-24-2010, EXPIRES 11-24-2020.

SER. NO. 79-095,377, FILED 11-24-2010.

NAPOLEON SHARMA, EXAMINING ATTORNEY

# United States of America

United States Patent and Trademark Office

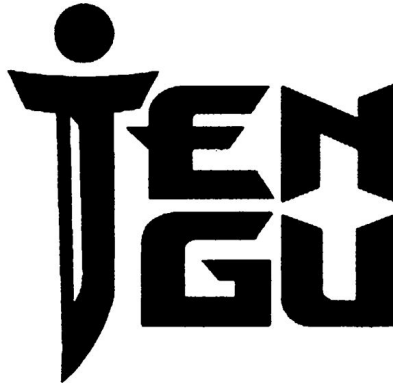

**Reg. No. 4,133,656**

**Registered May 1, 2012**

**Int. Cls.: 18, 22, 24 and 25**

**TRADEMARK**

**PRINCIPAL REGISTER**

SOLE TRADER KAYACHEV ALEKSANDR IVANOVICH (RUSSIAN FED. INDIVIDUAL)  
HOLODOVO ST., D.54  
RAMENSKIY R-N  
RU-140105 MOSCOW REGION, RUSSIAN FED.

FOR: ALPENSTOCKS; LEATHERWARE, NAMELY, TRAVELLING SETS COMPRISING LUGGAGE; KNAPSACKS; BAGS AND SACKS FOR SPORTS; BAGS FOR CLIMBERS IN THE NATURE OF ALL-PURPOSE CARRYING BAGS; GARMENT BAGS FOR TRAVEL; BAGS FOR CAMPERS, NAMELY, RUCKSACKS; BACKPACKS; GAME BAGS, NAMELY, HUNTERS' GAME BAGS, IN CLASS 18 (U.S. CLS. 1, 2, 3, 22 AND 41).

FOR: HAMMOCKS; ROPES, NOT OF METAL; ROPES; STRING; TENTS; AWNINGS OF TEXTILE; SUN AWNINGS, IN CLASS 22 (U.S. CLS. 1, 2, 7, 19, 22, 42 AND 50).

FOR: SLEEPING BAGS; BED BLANKETS; LAP ROBES, NAMELY, TRAVELLING RUGS, IN CLASS 24 (U.S. CLS. 42 AND 50).

FOR: CLOTHING, PARTICULARLY SPORTSWEAR, NAMELY, SWEAT PANTS, ATHLETIC UNIFORMS; SWEAT-ABSORBENT UNDERCLOTHING, NAMELY, UNDERSHIRTS; THERMAL UNDERWEAR; FOOTWEAR; HEADWEAR; SOCKS; GLOVES AND HATS FOR SPORT, IN CLASS 25 (U.S. CLS. 22 AND 39).

THE NAME(S), PORTRAIT(S), AND/OR SIGNATURE(S) SHOWN IN THE MARK DOES NOT IDENTIFY A PARTICULAR LIVING INDIVIDUAL.

OWNER OF INTERNATIONAL REGISTRATION 1072091 DATED 11-17-2010, EXPIRES 11-17-2020.

THE MARK CONSISTS OF THE WORDING "JEN GU" WHEREIN THE LETTER "J" IN "JEN" IS REPRESENTED BY A DAGGER WITH A SHADED CIRCLE.

THE WORDING IN THE MARK HAS NO MEANING IN A FOREIGN LANGUAGE.

SER. NO. 79-095,436, FILED 11-17-2010.

MELISSA VALLILLO, EXAMINING ATTORNEY



*David J. Kybas*

Director of the United States Patent and Trademark Office



# United States of America

United States Patent and Trademark Office



**Reg. No. 4,133,657**

**Registered May 1, 2012**

**Int. Cl.: 37**

**SERVICE MARK**

**PRINCIPAL REGISTER**

BENCHIMOL JONATHAN-ISAAC (FRANCE INDIVIDUAL)  
68 AVENUE GEORGES V  
LIEU DIT LA COLOMBE  
NICE, FRANCE 06000

FOR: CONSTRUCTION OF VEHICLES BODYWORKS AND BUILDING FACADES; APPLICATION OF PROTECTIVE COATINGS ON VEHICLES; REPAIR OF VEHICLE BODYWORKS AND GLAZINGS; REPAIR OF BUILDING FAÇADES AND GLAZINGS; INSTALLATION AND APPLICATION OF COATINGS TO VEHICLES IN THE NATURE OF PROTECTIVE, SAFETY OR DECORATIVE FILMS ON VEHICLE BODYWORKS AND GLAZINGS; INSTALLATION AND APPLICATION OF COATINGS TO BUILDING FACADES IN THE NATURE OF PROTECTIVE, SAFETY OR DECORATIVE FILMS ON BUILDING FAÇADES AND GLAZINGS; INSTALLATION OF VEHICLE ACCESSORIES, SPARE PARTS OR DECORATIVE ADHESIVES ON INTERIOR COMPARTMENTS OF VEHICLES AND BODYWORKS OF VEHICLES; MOTOR VEHICLE MAINTENANCE AND REPAIR; VEHICLE CLEANING; VEHICLE MAINTENANCE; VEHICLE WASHING; VEHICLE POLISHING; VEHICLE LUBRICATION; MOTOR VEHICLE PAINTING; INSTALLATION OF SECURITY SYSTEMS FOR VEHICLES; INSTALLATION OF DOORS AND WINDOWS; WINDOW CLEANING; PROVIDING INFORMATION IN THE FIELD OF CONSTRUCTION, REPAIR, INSULATION INSTALLATION, CLEANING OF EDIFICES, AND CLEANING OF BUILDING EXTERIOR SURFACES; CLEANING OF BUILDINGS; PAINTING OF BUILDINGS, EDIFICES AND EXTERIOR SURFACES; VEHICLE BREAKDOWN SERVICES, EXCEPT TOWING, NAMELY, VEHICLES REPAIR SERVICES, IN CLASS 37 (U.S. CLS. 100, 103 AND 106).



THE MARK CONSISTS OF THE WORD "ODIAM" WITH A DIAMOND SHAPED DESIGN APPEARING TO THE LEFT OF THE WORD.

PRIORITY DATE OF 8-13-2010 IS CLAIMED.

OWNER OF INTERNATIONAL REGISTRATION 1072374 DATED 2-11-2011, EXPIRES 2-11-2021.

SER. NO. 79-095,520, FILED 2-11-2011.

KATHERINE E. HALMEN, EXAMINING ATTORNEY

*David J. Kyros*

Director of the United States Patent and Trademark Office

# United States of America

United States Patent and Trademark Office



**Reg. No. 4,133,658**

**Registered May 1, 2012**

**Int. Cls.: 7 and 9**

**TRADEMARK**

**PRINCIPAL REGISTER**

TECO S.R.L. (ITALY CORPORATION)  
VIA PIO LA TORRE, 10  
I-42015 CORREGGIO (REGGIO EMILIA)  
ITALY

FOR: POWERED TIRE CHANGER MACHINES FOR LAND VEHICLES; POWERED TOE-IN MACHINES FOR LAND VEHICLES; POWERED LIFTS FOR LAND VEHICLES; WASHERS FOR WHEELS OF LAND VEHICLES, IN CLASS 7 (U.S. CLS. 13, 19, 21, 23, 31, 34 AND 35).

FOR: TIRE BALANCING MACHINES FOR LAND VEHICLES, IN CLASS 9 (U.S. CLS. 21, 23, 26, 36 AND 38).

THE MARK COMPRISES THE CAPTION "TECO" WRITTEN IN FANCY ROUNDED BLOCK LETTERS CONNECTED TO EACH OTHER WITH THE INITIAL LETTER "T" LEANING TO THE RIGHT.

OWNER OF INTERNATIONAL REGISTRATION 0696603 DATED 7-10-1998, EXPIRES 7-10-2018.

SER. NO. 79-095,619, FILED 5-14-2010.

MARGARET POWER, EXAMINING ATTORNEY



*David J. Kybas*

Director of the United States Patent and Trademark Office

# United States of America

United States Patent and Trademark Office

# KALDRA

**Reg. No. 4,133,659**

**Registered May 1, 2012**

**Int. Cls.: 16 and 21**

**TRADEMARK**

**PRINCIPAL REGISTER**

AHLSTROM CORPORATION (FINLAND PUBLIC LIMITED COMPANY)  
SALMISAARENAUKIO 1  
FI-00180 HELSINKI, FINLAND

FOR: PAPERS FOR USE IN THE PRODUCTION OF FOOD TRAYS, FOOD CONTAINERS, BAKING TRAYS AND BAKING MOULDS; PARCHMENT PAPER FOR USE IN THE PRODUCTION OF FOOD TRAYS, FOOD CONTAINERS, BAKING TRAYS AND BAKING MOULDS, IN CLASS 16 (U.S. CLS. 2, 5, 22, 23, 29, 37, 38 AND 50).

FOR: FOOD TRAYS FOR DOMESTIC PURPOSES, FOOD CONTAINERS FOR HOUSEHOLD OR KITCHEN USE, BAKING TRAYS AND BAKING MOULDS MADE OF PAPERS; FOOD TRAYS, FOOD CONTAINERS, BAKING TRAYS AND BAKING MOULDS MADE OF PARCHMENT PAPER, IN CLASS 21 (U.S. CLS. 2, 13, 23, 29, 30, 33, 40 AND 50).

PRIORITY DATE OF 7-14-2010 IS CLAIMED.

OWNER OF INTERNATIONAL REGISTRATION 1072709 DATED 11-22-2010, EXPIRES 11-22-2020.

SER. NO. 79-095,652, FILED 11-22-2010.

YAT SYE, LEE, EXAMINING ATTORNEY



*David J. Kypos*

Director of the United States Patent and Trademark Office

United States of America  
United States Patent and Trademark Office

# Tangens

**Reg. No. 4,133,660**

**Registered May 1, 2012**

**Int. Cls.: 11 and 20**

**TRADEMARK**

**PRINCIPAL REGISTER**

ALAPE GMBH (FED REP GERMANY LIMITED LIABILITY COMPANY)  
AM GRÄBICHT 1-9  
38644 GOSLAR  
FED REP GERMANY

FOR: APPARATUS FOR HEATING, STEAM GENERATING, REFRIGERATING, DRYING, VENTILATING AND WATER SUPPLY AND SANITARY PURPOSES, IN PARTICULAR BUILD-IN SINKS, SHOWER TUBS; WATER TAPS; LIGHTING APPARATUS, IN PARTICULAR WALL LAMPS AND KITCHEN LAMPS AND BATHROOM LAMPS; AIR CONDITIONING APPARATUS, IN CLASS 11 (U.S. CLS. 13, 21, 23, 31 AND 34).

FOR: FURNITURE, IN PARTICULAR BATHROOM FURNITURE, INCLUDED IN THIS CLASS, SIDE TABLES, SHELVES FOR STORAGE, STORAGE SHELVES FOR WASHSTANDS; MIRRORED WARDROBES; MIRRORS, PICTURE FRAMES, IN CLASS 20 (U.S. CLS. 2, 13, 22, 25, 32 AND 50).

THE MARK CONSISTS OF STANDARD CHARACTERS WITHOUT CLAIM TO ANY PARTICULAR FONT, STYLE, SIZE, OR COLOR.

PRIORITY DATE OF 8-5-2010 IS CLAIMED.

OWNER OF INTERNATIONAL REGISTRATION 1072849 DATED 2-3-2011, EXPIRES 2-3-2021.

SER. NO. 79-095,699, FILED 2-3-2011.

DEBRA LEE, EXAMINING ATTORNEY



*David J. Kypos*

Director of the United States Patent and Trademark Office

# United States of America

United States Patent and Trademark Office



**Reg. No. 4,133,661**

**Registered May 1, 2012**

**Int. Cl.: 25**

**TRADEMARK**

**PRINCIPAL REGISTER**

INDUSTRIAS SOMBRERERAS ESPAÑOLAS, S.A. - (I.S.E.S.A) (SPAIN SOCIEDAD ANÓNIMA)  
POL. IND. "LOS LLANOS"  
CASTILLA LA MANCHA, 202  
E-41909 SALTERAS (SEVILLA), SPAIN

FOR: HATS, IN CLASS 25 (U.S. CLS. 22 AND 39).

OWNER OF U.S. REG. NO. 1,626,080.

PRIORITY DATE OF 2-1-2011 IS CLAIMED.

OWNER OF INTERNATIONAL REGISTRATION 1072915 DATED 2-16-2011, EXPIRES 2-16-2021.

NO CLAIM IS MADE TO THE EXCLUSIVE RIGHT TO USE "SEVILLA.", APART FROM THE MARK AS SHOWN.

THE ENGLISH TRANSLATION OF "ROCHE" IN THE MARK IS "ROCK".

SER. NO. 79-095,733, FILED 2-16-2011.

RON FAIRBANKS, EXAMINING ATTORNEY



*David J. Kyffers*

Director of the United States Patent and Trademark Office

United States of America  
United States Patent and Trademark Office

**kolor**

**Reg. No. 4,133,662**

**Registered May 1, 2012**

**Int. Cl.: 18**

**TRADEMARK**

**PRINCIPAL REGISTER**

KOLOR INCORPORATED (JAPAN CORPORATION)  
5-9, HIMONYA 4-CHOME  
MEGURO-KU; TOKYO 152-0003  
JAPAN

FOR: BOSTON BAGS; CARRY-ON BAGS; FOLDING BRIEFCASES; GLADSTONE BAGS; SHOULDER BAGS; SUITCASES; BRIEFCASES; TRAVELLING TRUNKS; KEY CASES; BUSINESS CARD CASES; CANVAS SHOPPING BAGS; LEATHER SHOPPING BAGS; PURSES; WALLETS; BACKPACKS; BEACH BAGS; ATTACHÉ CASES MADE OF LEATHER OR TEXTILE; CREDIT CARD WALLETS; HANDBAGS; POUCHES OF LEATHER OR TEXTILE; RUCKSACKS; SHOULDER BELTS OF LEATHER; GARMENT BAGS FOR TRAVEL MADE OF LEATHER OR TEXTILE; SCHOOLBAGS; TRAVELING BAGS OF LEATHER OR TEXTILE; UNFITTED VANITY CASES; BAGS FOR UMBRELLAS; BEACH UMBRELLAS; SUN UMBRELLAS; RAINPROOF PARASOLS; TELESCOPIC UMBRELLAS; UMBRELLA COVERS; UMBRELLAS; BAGS FOR PACKAGING OF LEATHER; CLOTHING FOR DOMESTIC PETS; DOG SHOES, IN CLASS 18 (U.S. CLS. 1, 2, 3, 22 AND 41).

PRIORITY DATE OF 12-16-2010 IS CLAIMED.

OWNER OF INTERNATIONAL REGISTRATION 1073242 DATED 2-4-2011, EXPIRES 2-4-2021.

SER. NO. 79-095,849, FILED 2-4-2011.

IRA J. GOODSaid, EXAMINING ATTORNEY



*David J. Kyfos*

Director of the United States Patent and Trademark Office

# United States of America

United States Patent and Trademark Office

# Multi-Matic

**Reg. No. 4,133,663**

**Registered May 1, 2012**

**Int. Cl.: 7**

**TRADEMARK**

**PRINCIPAL REGISTER**

KARL MAYER TEXTILMASCHINENFABRIK GMBH (FED REP GERMANY GESELLSCHAFT  
MIT BESCHRÄNKTER HAFTUNG (GMBH))  
BRÜHLSTRASSE 25  
63179 OBERTSHAUSEN, FED REP GERMANY

FOR: YARN WARP PREPARATION MACHINES FOR TEXTILE MANUFACTURING, YARN  
WARPING MACHINES, DIRECT BEAMERS, NAMELY, THREADING MACHINES, BEAMING  
MACHINES FOR USE IN TEXTILE MANUFACTURING; YARN WARPING MACHINES FOR  
THE PRODUCTION OF STENCILS AND SAMPLE WARPS; TEXTILE MACHINES, NAMELY,  
MACHINES FOR PRINTING TEXTILES, TEXTILE BONDING MACHINES, TEXTILE DYEING  
MACHINES, TEXTILE TENTERING MACHINES, AND WEAVING MACHINES, IN CLASS  
7 (U.S. CLS. 13, 19, 21, 23, 31, 34 AND 35).

THE MARK CONSISTS OF STANDARD CHARACTERS WITHOUT CLAIM TO ANY PAR-  
TICULAR FONT, STYLE, SIZE, OR COLOR.

PRIORITY DATE OF 11-20-2010 IS CLAIMED.

OWNER OF INTERNATIONAL REGISTRATION 1073285 DATED 3-16-2011, EXPIRES 3-16-  
2021.

OWNER OF U.S. REG. NO. 3,784,908.

SER. NO. 79-095,859, FILED 3-16-2011.

MARY BOAGNI, EXAMINING ATTORNEY



*David J. Kyffers*

Director of the United States Patent and Trademark Office

United States of America  
United States Patent and Trademark Office

L'ACTION  
BY MEDIATIC LABS

**Reg. No. 4,133,664**

**Registered May 1, 2012**

**Int. Cl.: 3**

**TRADEMARK**

**PRINCIPAL REGISTER**

MEDIATIC (FRANCE SOCIÉTÉ À RESPONSABILITÉ LIMITÉE (SARL))  
18, RUE SAINT LAZARE  
F-75009 PARIS, FRANCE

FOR: CLEANING, POLISHING, SCOURING AND ABRASIVE PREPARATIONS; SOAP; PERFUMERY PRODUCTS, NAMELY, PERFUMES AND TOILET WATERS; ESSENTIAL OILS, COSMETICS, HAIR LOTIONS, DENTIFRICES, IN CLASS 3 (U.S. CLS. 1, 4, 6, 50, 51 AND 52).

OWNER OF U.S. REG. NO. 2,925,485.

PRIORITY DATE OF 9-15-2010 IS CLAIMED.

OWNER OF INTERNATIONAL REGISTRATION 1073358 DATED 3-10-2011, EXPIRES 3-10-2021.

NO CLAIM IS MADE TO THE EXCLUSIVE RIGHT TO USE "LABS", APART FROM THE MARK AS SHOWN.

THE MARK CONSISTS OF THE STYLIZED WORDING "L'ACTION" ABOVE A CURVED BAND. BELOW THE BAND IS THE STYLIZED WORDING "BY MEDIATIC LABS".

THE ENGLISH TRANSLATION OF "L'ACTION" IN THE MARK IS "ACTION".

SER. NO. 79-095,891, FILED 3-10-2011.

DAVID HOFFMAN, EXAMINING ATTORNEY



*David J. Kyros*

Director of the United States Patent and Trademark Office



# United States of America

United States Patent and Trademark Office

# BEAUMANOIR

**Reg. No. 4,133,665**

**Registered May 1, 2012**

**Int. Cls.: 14, 18, 25 and 35**

**TRADEMARK**

**SERVICE MARK**

**PRINCIPAL REGISTER**

HELEA (FRANCE SOCIÉTÉ PAR ACTIONS SIMPLIFIÉE)  
LA GROTTÉ  
CHÂTEAU-MALO  
F-35400 SAINT-MALO, FRANCE

FOR: PRECIOUS METALS AND ALLOYS THEREOF OTHER THAN FOR DENTAL USE, JEWELRY, PRECIOUS STONES, HOROLOGICAL AND CHRONOMETRIC INSTRUMENTS; RINGS AS JEWELRY, EARRINGS, BRACELETS, BROOCHES AS JEWELRY, NECKLACES, JEWELRY CASES OF PRECIOUS METAL, FASHION JEWELRY, CHARMS, BROOCHES AS JEWELRY, NECKLACES, BRACELETS, TIE PINS, JEWELRY CASKETS OF PRECIOUS METAL, TIE CLIPS, CLOCKS, WATCHES, WATCH CASES, WATCH BANDS, PURSES OF PRECIOUS METAL, ALARM CLOCKS; PRECIOUS METAL BOXES; STATUES OF PRECIOUS METAL, IN CLASS 14 (U.S. CLS. 2, 27, 28 AND 50).

FOR: LEATHER AND IMITATION LEATHER, GOODS MADE OF LEATHER AND IMITATION LEATHER NOT INCLUDED IN OTHER CLASSES, NAMELY, TRAVELLING TRUNKS, TRAVEL BAGS AND TRAVEL BAG SETS, VANITY CASES NOT FITTED, TRUNKS, SUITCASES, SCHOOL BAGS, BRIEFCASES, VALISES, CREDIT CARD CASES AND HOLDERS, PURSES AND POCKET WALLETS NOT MADE OF PRECIOUS MATERIAL, RUCKSACKS, HANDBAGS; UMBRELLAS, PARASOLS AND WALKING STICKS; WHIPS, HARNESS AND SADDLERY; KEY CASES OF LEATHER; ATTACHÉ CASES; SCHOOL SATCHELS AND SCHOOL BAGS; PURSES; SUITCASES; BUSINESS CASES; RUCKSACKS; COLLEGE SATCHELS; BEACH BAGS; SHOPPING BAGS, NAMELY, CANVAS SHOPPING BAGS, MESH SHOPPING BAGS, REUSABLE SHOPPING BAGS, TEXTILE SHOPPING BAGS MADE OF SKIN, STRING BAGS FOR SHOPPING; SHOPPING BAGS WITH WHEELS; GARMENT BAGS FOR TRAVEL; SPORTS BAGS OTHER THAN THOSE ADAPTED FOR THEIR CONTENTS, WALLETS, PURSES; BOXES OF LEATHER OR IMITATION LEATHER; TRAVELLING BAG SETS; LEATHER OR IMITATION LEATHER THONGS; LEATHER OR IMITATION LEATHER OR LEATHERBOARD STRAPS; LEATHER OR IMITATION LEATHER COLLARS FOR ANIMALS; CLOTHING FOR ANIMALS; LEATHER LEASHES; MUZZLE; ANIMAL SKINS, ANIMAL HIDES; PARASOLS, IN CLASS 18 (U.S. CLS. 1, 2, 3, 22 AND 41).



*David J. Kyros*

Director of the United States Patent and Trademark Office

FOR: CLOTHING, NAMELY, DRESSES, SHIRTS, SKIRTS, UNDERSKIRTS, PANTS, JEANS, CAPRIS, SHORTS, BERMUDA SHORTS, BOXER SHORTS, BLOUSES, TOPS, T-SHIRTS, TANK TOPS, SWEATERS, SWEATSHIRTS, POLO SHIRTS, CARDIGANS, SWEATPANTS, FOOTWEAR, SUITS, JOGGING SUITS, JOGGING OUTFITS, CAPS, WARM-UP SUITS,

**Reg. No. 4,133,665** BLAZERS, VESTS, JACKETS, COATS, STUFF JACKETS, JERSEYS, RAINWEAR, CAPES, PONCHOS, NECKWEAR, SCARVES, SHAWLS, GLOVES, BATHING SUITS, BEACH WEAR, BEACH COVER-UPS, NIGHTGOWNS, PAJAMAS, NEGLIGEEES, STOCKINGS, MUFFS, BODY LINEN, HOSIERY; FOOTWEAR EXCEPT FOR ORTHOPAEDIC FOOTWEAR, HEADGEAR, NAMELY, HATS, CAPS, HEADBANDS, BANDANNAS, BEANIES, VISORS, BATHING CAPS, BATHING TRUNKS, BATHING SUITS, BLOUSES, BATH-ROBES, BATH SANDALS, BATH SLIPPERS, HEAD BANDS AS CLOTHING, BERETS, BONNETS, BOOTS, BRACES, MUFFLERS, BRIEFS, HOODS, CAPS, DRESSING GOWNS, JERSEYS, HATS, CHASUBLES, SOCKS, SLIPPERS, SPORTS FOOTWEAR, SHIRTS, CHEMISETTES, BELTS, TIGHTS, UNDERCLOTHING IN THE NATURE OF UNDERWEAR, COVERALLS, SLIPS AS UNDERWEAR, SUITS, EAR MUFFS, PANTS FOR CYCLING, SHORTS, SASHES FOR WEAR, ESPADRILLES, SHOULDER WRAPS, SCARVES, FURS, NAMELY, FUR CLOAKS, FUR COATS, FUR JACKETS, FUR HATS, FUR MUFFS, FUR STOLEES, FUR GLOVES, GABARDINES, NAMELY, RAINCOATS; WAISTCOATS, LAYETTES, WATERPROOF CLOTHING, NAMELY, WATERPROOF JACKETS, COATS, OVERCOATS, PARKAS, PANTS, RAINCOATS, SHORTS, TOPS, STOCKINGS, SWEATERS, SHIRTS, SHOES, BOOTS, HATS; SKIRTS, PETTICOATS, UNDERWEAR AS LINGERIE, SINGLET, MUFFS, COATS, MITTENS, TROUSERS, SLIPPERS, OVERCOATS, PARKAS, BATH-ROBES, PULLOVER SWEATERS, PAJAMAS, DRESSES, TEE-SHIRTS, BODYSUITS, NAMELY, LEOTARDS; DRESSING GOWNS, SANDALS, BRIEFS AND PANTS, KNITWEAR, NAMELY, JACKETS, PULLOVERS, SWEATERS, DRESSES, SKIRTS, SHIRTS, KNITTED CAPS AND UNDERWEAR; PEA JACKETS, JACKETS, SPORTS CLOTHING, NAMELY, SPORTS UNDERWEAR, SPORTS PANTS, SPORTS SHORTS, SPORTS SOCKS, SPORTS GLOVES, SPORTS SHIRTS, SPORTS TIGHTS, SPORTS SINGLET, SPORTS SUITS, SPORTS COATS, SPORTS BRA, SPORTS JACKETS, SPORTS JERSEY, SPORT OVER UNIFORMS; TANK TOPS, VESTS, GLOVES AS CLOTHING; CLOTHING OF LEATHER OR IMITATION LEATHER, NAMELY, DRESSES, SKIRTS, PANTS, JEANS, CAPRIS, BERMUDA SHORTS, TROUSERS, BLOUSES, SHIRTS, T-SHIRTS, TANK TOPS, SWEATERS, SWEATSHIRTS, POLO SHIRTS, SWEATPANTS, JOGGING SUITS, JOGGING OUTFITS, CAPS, PONCHOS, NECKWEAR, SCARVES, SHAWLS, BELTS, GLOVES, BATHING SUITS, BEACH WEAR, BEACH COVER-UPS, NIGHTGOWNS, PAJAMAS, LINGERIE, UNDERWEAR AND HOSIERY, IN CLASS 25 (U.S. CLS. 22 AND 39).

FOR: RETAIL STORE SERVICES FOR FEATURING CLOTHING, FOOTWEAR, HEADGEAR, FASHION ACCESSORIES, HOME ACCESSORIES, HOUSEHOLD LINEN, JEWELLERY, COSMETICS, PERFUMERY, LUGGAGE; WHOLESALE STORE SERVICES FEATURING CLOTHING, FOOTWEAR, HEADGEAR, FASHION ACCESSORIES, HOME ACCESSORIES, HOUSEHOLD LINEN, JEWELRY, COSMETICS, PERFUMERY, LUGGAGE; RETAIL STORE SERVICES FEATURING GOODS FOR ENTERTAINMENT, NAMELY, AUDIOVISUAL AND PRE-RECORDED MUSICAL WORKS; COMMERCIAL INFORMATION AND ADVICE TO CONSUMERS; IMPORT-EXPORT AGENCY SERVICES IN THE FIELD OF CLOTHING, FOOTWEAR, HEADGEAR, FASHION ACCESSORIES, HOME ACCESSORIES, HOUSEHOLD LINEN, JEWELRY, COSMETICS, PERFUMERY, LUGGAGE; ADVERTISING; DISTRIBUTION OF ADVERTISING MATERIALS, ADVERTISING TEXT PUBLICATION SERVICES, SALES PROMOTION SERVICES FOR OTHERS, BILLING OF POSTERS, NAMELY, PROVIDING ADVERTISING AND PROMOTIONAL SERVICES PROVIDED THROUGH ONLINE BANNERS, OUTDOOR BILLBOARDS, WILD POSTING; SERVICES FOR UPDATING ADVERTISING MATERIAL; DISTRIBUTION AND DISSEMINATION OF ADVERTISING MATERIALS, NAMELY, SAMPLES; PRODUCT DEMONSTRATION SERVICES; MODELING FOR ADVERTISING OR SALES PROMOTION; ADVERTISING, NAMELY, PREPARATION OF MEDIA PLANS; SERVICES RELATING TO EXHIBITION PLANNING FOR COMMERCIAL OR PROMOTIONAL PURPOSES; ADVERTISING SPONSORSHIP SERVICE, NAMELY, PROMOTIONAL SPONSORSHIP OF BEAUTY CONTESTS AND EVENTS IN THE FASHION INDUSTRY; BUSINESS MANAGEMENT; BUSINESS ADMINISTRATION; OFFICE FUNCTIONS; SERVICES COMPRISING THE RECORDING, INPUT PROCESSING, COMPILATION AND SYSTEMIZATION OF WRITTEN COMMUNICATIONS AND RECORDINGS; COMPUTER FILE MANAGEMENT SERVICES; COMPILATION OF INFORMATION INTO COMPUTER DATABASES; SYSTEMIZATION OF INFORMATION INTO COMPUTER DATABASES; BUSINESS MANAGEMENT ASSISTANCE SERVICES TO INDUSTRIAL AND COMMERCIAL

**Reg. No. 4,133,665** COMPANIES; BUSINESS ORGANIZATION AND MANAGEMENT CONSULTING; CORPORATE MANAGEMENT ASSISTANCE PROVIDED TO COMMERCIAL OR INDUSTRIAL COMPANIES, IN CLASS 35 (U.S. CLS. 100, 101 AND 102).

THE ENGLISH TRANSLATION OF THE WORD "BEAUMANOIR" IN THE MARK IS "BEAUTIFUL MANOR".

OWNER OF INTERNATIONAL REGISTRATION 0939337 DATED 9-20-2007, EXPIRES 9-20-2017.

SER. NO. 79-095,940, FILED 3-9-2011.

CARYN GLASSER, EXAMINING ATTORNEY

# United States of America

United States Patent and Trademark Office

## comexposium

**Reg. No. 4,133,666**

**Registered May 1, 2012**

**Int. Cls.: 9, 16, 35, 38, 41  
and 42**

**TRADEMARK**

**SERVICE MARK**

**PRINCIPAL REGISTER**

COMEXPOSIUM HOLDING (FRANCE SOCIÉTÉ ANONYME)  
70 AVENUE DU GÉNÉRAL DE GAULLE  
F-92058 PARIS LA DEFENSE CEDEX  
FRANCE

FOR: RECORDED DATA MEDIA IN THE FORM OF COMPACT DISCS, COMPACT DISKETTES, MAGNETIC TAPES, AUDIO AND VIDEO CASSETTES, CD-ROMS, DIGITAL VIDEO DISKS, MAGNETIC DISCS, OPTICAL DISCS, AUDIO-VIDEO COMPACT DISCS FEATURING MUSIC; TEACHING APPARATUS AND INSTRUMENTS, NAMELY, COMPUTERS; APPARATUS AND INSTRUMENTS FOR DATA PROCESSING, NAMELY, DATA PROCESSING EQUIPMENT; RECORDED COMPUTER SOFTWARE RECORDED PROGRAMS FOR USE IN DATABASE MANAGEMENT; DOWNLOADABLE ELECTRONIC PUBLICATIONS, IN THE NATURE OF MAGAZINES, BROCHURES IN THE FIELD OF ORGANIZATION OF EXHIBITIONS, TRADE SHOW AND FAIRS, IN CLASS 9 (U.S. CLS. 21, 23, 26, 36 AND 38).

FOR: PRINTED MATTER, NAMELY, NEWSPAPERS, MAGAZINES, PRODUCT REVIEWS, PERIODICALS, BOOKS, CATALOGUES AND PAMPHLETS, INFORMATION BULLETINS, DATA SHEETS, MANUALS IN THE FIELD OF ORGANIZATION OF EXHIBITIONS, TRADE SHOW AND FAIRS, SCRAPBOOKS, ANTHOLOGIES FEATURING INFORMATION ABOUT ORGANIZATION OF EXHIBITIONS, TRADE SHOW AND FAIRS, GUIDES FEATURING INFORMATION ABOUT EXHIBITIONS, TRADE SHOW AND FAIRS, DIRECTORIES FEATURING INFORMATION ABOUT EXHIBITIONS, TRADE SHOW AND FAIRS, POSTERS; PENCILS; PENS; CALENDARS; PRINTED BUSINESS PROSPECTUSES; CARDS, NAMELY, BUSINESS CARDS, BLANK CARDS; CARDBOARD CARTONS; PHOTOGRAPHS; GRAPHIC REPRESENTATIONS; STATIONERY; PLASTIC MATERIALS FOR PACKAGING NOT INCLUDED IN OTHER CLASSES, NAMELY, PLASTIC BAGS, SMALL PLASTIC BAGS, FILMS AND SHEETS, WRAPPING PAPERS; SMALL BAGS AND BAGS, NAMELY, ENVELOPES AND POUCHES FOR WRAPPING MADE OF PAPER OR PLASTIC; PAPER OR CARDBOARD SIGNBOARD, IN CLASS 16 (U.S. CLS. 2, 5, 22, 23, 29, 37, 38 AND 50).

FOR: ORGANIZATION OF EXHIBITIONS, TRADE SHOWS AND FAIRS FOR COMMERCIAL OR ADVERTISING PURPOSES; COMPETITION ORGANIZATION SERVICES FOR PROMOTIONAL PURPOSES WITH OR WITHOUT AWARD OF PRIZES OR ALLOCATION OF REWARDS, ESPECIALLY IN THE CONTEXT OF TRADE SHOWS, COLLOQUIUMS CONFERENCES, CONVENTIONS, EXHIBITIONS, FAIRS; ADMINISTRATIVE BUSINESS MANAGEMENT OF EXHIBITION SITES; SERVICES FOR ORGANIZING BUSINESS MEETINGS IN



*David J. Kappas*

Director of the United States Patent and Trademark Office

**Reg. No. 4,133,666** THE CONTEXT OF TRADE SHOWS, COLLOQUIUMS, CONFERENCES, CONVENTIONS, EXHIBITIONS, FAIRS, NAMELY, PUTTING EXHIBITORS AND VISITORS IN CONTACT WITH EACH OTHER FOR THE PURPOSES OF HOLDING BUSINESS MEETINGS; DISSEMINATION OF ADVERTISING MATERIAL IN THE NATURE OF LEAFLETS, PROSPECTUSES, PRINTED MATTER AND SAMPLES; PROMOTION SERVICES FOR OTHERS; PRESENTATION AND DEMONSTRATION OF GOODS AND SERVICES FOR PROMOTIONAL PURPOSES; STATISTICAL, BUSINESS AND COMMERCIAL INFORMATION IN THE FIELD OF EXHIBITIONS AND ESPECIALLY IN CONNECTION WITH ORGANIZING EXHIBITIONS; ADVERTISING BY TELEVISION, RADIO, MAIL; ONLINE ADVERTISING ON A COMPUTER NETWORK; DIRECT MAIL ADVERTISING; RENTAL OF ADVERTISING SPACE ON ALL MEANS OF COMMUNICATION; RENTAL OF ADVERTISING SPACE; DISSEMINATION OF ADVERTISEMENTS AND CLASSIFIED ADVERTISEMENTS, ESPECIALLY FOR EMPLOYMENT, INCLUDING ON THE INTERNET; ORGANIZATION OF PROMOTIONAL ACTIVITIES WITH A VIEW TO DEVELOPING CUSTOMER LOYALTY FOR BUSINESS PURPOSES; ORGANIZING REGIONAL AND NATIONAL PROMOTIONAL CAMPAIGNS FOR BUSINESS; NEWSPAPER SUBSCRIPTION SERVICES FOR THIRD PARTIES; SUBSCRIPTION MANAGEMENT SERVICES AS A SUBSCRIPTION AGENT BETWEEN PUBLISHERS AND CUSTOMERS; COMPUTER FILE MANAGEMENT SERVICES; BUSINESS MANAGEMENT; PUBLISHING OF ADVERTISING TEXTS; CONDUCTING PUBLIC OPINION POLLS, IN CLASS 35 (U.S. CLS. 100, 101 AND 102).

FOR: SERVICES OF DISCUSSION FORUMS, NAMELY, ELECTRONIC TRANSMISSION OF INFORMATION POSTED TO USENET DISCUSSION GROUPS VIA A GLOBAL COMPUTER NETWORK; PROVIDING ONLINE FORUMS IN THE FIELD OF ORGANIZATION OF EXHIBITIONS, TRADE SHOW, FAIRS AND OF ALL TYPES OF EVENTS; TELECOMMUNICATIONS SERVICES, NAMELY, PROVIDING TELECOMMUNICATION CONNECTIONS TO THE INTERNET OR DATABASES; COMMUNICATIONS BY COMPUTER TERMINALS; AUDIOVISUAL COMMUNICATION, NAMELY, TRANSMISSION OF AUDIO VISUAL IMAGES VIA A GLOBAL COMPUTER NETWORK OR THE INTERNET; RADIO, TELEGRAPH AND TELEPHONE COMMUNICATION; TRANSMISSION OF INFORMATION, SOUND, VIDEO VIA ELECTRONIC COMMUNICATION NETWORKS AND GLOBAL COMPUTER INFORMATION NETWORKS; PROVIDING ACCESS TO DATABASES; TRANSMISSION OF INFORMATION BY ELECTRONIC COMMUNICATION NETWORKS, IN CLASS 38 (U.S. CLS. 100, 101 AND 104).

FOR: ORGANIZATION OF EXHIBITIONS, FAIRS AND EVENTS FOR CULTURAL PURPOSES; ARRANGING AND CONDUCTING OF EDUCATIONAL COLLOQUIUMS, CONFERENCES, CONVENTIONS AND SEMINARS AND SYMPOSIUMS IN THE FIELD OF AGRICULTURE, FOOD, TRADE, LOGISTICS, PACKING, BUSINESS, ELECTRONICS, REAL ESTATE, INDUSTRY, FASHION, HEALTH, SECURITY, TOURISM, TRANSPORT; PRODUCTION OF FILMS, SHORT FEATURE FILMS, DOCUMENTARIES, RADIO OR TELEVISION PROGRAMS, PRODUCTION OF RADIO OR TELEVISION PROGRAMS; INFORMATION ON EDUCATION AND ENTERTAINMENT, INFORMATION IN THE FIELD OF CULTURAL EXHIBITIONS AND ESPECIALLY IN CONNECTION WITH ORGANIZING CULTURAL EXHIBITIONS; SERVICES FOR ORGANIZING AND PRODUCING SHOWS, NAMELY, PRODUCTION OF TELEVISION SHOWS, ORGANIZING AND HOSTING OF EVENTS EDUCATIONAL AND CULTURAL PURPOSES; COMPETITION ORGANIZATION SERVICES REGARDING EDUCATION, ENTERTAINMENT, WITH OR WITHOUT AWARD OR PRIZES OR PRESENTING AWARDS, ESPECIALLY IN THE CONTEXT OF TRADE SHOWS, COLLOQUIUMS, CONFERENCES, CONVENTIONS, EXHIBITIONS, FAIRS, NAMELY, ORGANIZATION OF QUIZ COMPETITIONS, SPELLING COMPETITIONS AND COOKING COMPETITIONS; PUBLISHING SERVICES OF PRINTED MATTER, NAMELY, NEWSPAPER PUBLISHING, MAGAZINE PUBLISHING, PUBLISHING OF REVIEWS, PERIODICALS, BOOKS, PUBLICATION OF TEXTS OTHER THAN ADVERTISING TEXTS, NAMELY, TEXT BOOKS, MAGAZINES; PARTY-PLANNING AND ARRANGING EVENTS FOR SOCIAL ENTERTAINMENT PURPOSES; PUBLISHING OF ELECTRONIC PUBLICATIONS, IN CLASS 41 (U.S. CLS. 100, 101 AND 107).

**Reg. No. 4,133,666** FOR: INTERNET WEB SITE DESIGN AND HOSTING SERVICES FOR OTHERS; DESIGN, DEVELOPMENT OF COMPUTER PROGRAMS AND HOSTING OF COMPUTER APPLICATION PROGRAMS, DESIGN AND DEVELOPMENT OF COMPUTER SOFTWARE FOR DATABASES AND INFORMATION SYSTEMS, IN CLASS 42 (U.S. CLS. 100 AND 101).

THE MARK CONSISTS OF STANDARD CHARACTERS WITHOUT CLAIM TO ANY PARTICULAR FONT, STYLE, SIZE, OR COLOR.

OWNER OF INTERNATIONAL REGISTRATION 0998023 DATED 7-11-2008, EXPIRES 7-11-2018.

SER. NO. 79-095,943, FILED 3-1-2011.

CARYN GLASSER, EXAMINING ATTORNEY

# United States of America

United States Patent and Trademark Office



**Reg. No. 4,133,667**

**Registered May 1, 2012**

**Int. Cls.: 12, 25 and 35**

**TRADEMARK**

**SERVICE MARK**

**PRINCIPAL REGISTER**

MORGAN MOTOR COMPANY LIMITED (UNITED KINGDOM LIMITED COMPANY)  
PICKERSLEIGH ROAD  
MALVERN LINK WORCESTERSHIRE WR14 2LL, UNITED KINGDOM

FOR: LAND VEHICLES; AUTOMOBILES; APPARATUS FOR LOCOMOTION BY LAND, NAMELY, CARS, MOTOR CARS, ELECTRIC CARS, MOTOR CARS WITH CONVERTIBLE TOPS, RACING CARS, SPORTS CARS, SCOOTERS, MOTOR CYCLES, BICYCLES; PEDAL-PROPELLED CARS; REPLACEMENT PARTS FOR ALL THE AFOREMENTIONED GOODS; SPECIFICALLY EXCLUDING RECREATIONAL VEHICLES (RV'S), IN CLASS 12 (U.S. CLS. 19, 21, 23, 31, 35 AND 44).

FOR: CLOTHING, NAMELY, T-SHIRTS, SWEATSHIRTS, FLEECE TOPS AND JACKETS, TIES, SCARVES, GLOVES, WATERPROOF COATS AND JACKETS, LEATHER JACKETS, KNITWEAR, SWEATERS; FOOTWEAR; HEADGEAR, NAMELY, BASEBALL CAPS, BEANIE HATS; ALL PRIMARILY SOLD THROUGH AUTOMOBILE DEALERSHIPS; SPECIFICALLY EXCLUDING WOMEN'S DRESSES, IN CLASS 25 (U.S. CLS. 22 AND 39).

FOR: BUSINESS ADVISORY SERVICES RELATING TO FRANCHISING OF A MOTOR DEALERSHIP; BUSINESS ADVISORY SERVICES RELATING TO THE ESTABLISHMENT OF MOTOR DEALERSHIPS; THE BRINGING TOGETHER, FOR THE BENEFIT OF OTHERS, A VARIETY OF MOTOR VEHICLES, ENABLING CUSTOMERS TO CONVENIENTLY VIEW AND PURCHASE THOSE GOODS; RETAIL STORE SERVICES FEATURING MOTOR VEHICLES; DEALERSHIP RETAIL STORE SERVICES, MAIL ORDER SERVICES, AND OPERATING ONLINE SHOPPING SITES ALL FEATURING MOTOR VEHICLES; ADVERTISING AND MARKETING SERVICES PROVIDED BY TELEVISION, OVER THE INTERNET OR VIA A DATABASE RELATING TO MOTOR VEHICLES AND ASSOCIATED ACCESSORIES; ORGANIZING, ARRANGING AND CONDUCTING COMPETITIONS, DEMONSTRATIONS, DISPLAYS, EVENTS, TRADE FAIRS, EXHIBITIONS, FESTIVALS AND PRESENTATIONS FOR ADVERTISING OR MARKETING PURPOSES; DISSEMINATION OR DISTRIBUTION OF ADVERTISING MATERIAL; SPECIFICALLY EXCLUDING SERVICES ASSOCIATED WITH RECREATIONAL VEHICLES (RV'S), IN CLASS 35 (U.S. CLS. 100, 101 AND 102).



*David J. Kybas*

Director of the United States Patent and Trademark Office

THE MARK CONSISTS OF THE WORDING "MORGAN" IN WHITE, PLACED ACROSS A BLUE CROSS THAT IS OUTLINED IN WHITE HAS AN OUTER SHADING OF SILVER ON THE TOP AND BLACK ON THE BOTTOM. BEHIND THE CROSS IS THE IMAGE OF A WHEEL WITH BLUE SPOKES SHADED WITH SILVER HIGHLIGHTS, AND A WHITE TIRE

**Reg. No. 4,133,667** OUTLINED IN BLUE. THERE ARE SILVER WINGS TO EITHER SIDE OF THE WHEEL, WITH WHITE HIGHLIGHTS IN THE MIDDLE AREA OF THE WINGS.

OWNER OF INTERNATIONAL REGISTRATION 1073508 DATED 3-11-2011, EXPIRES 3-11-2021.

THE COLOR(S) WHITE, SILVER, BLUE AND BLACK IS/ARE CLAIMED AS A FEATURE OF THE MARK.

SER. NO. 79-095,978, FILED 3-11-2011.

JASON BLAIR, EXAMINING ATTORNEY



# United States of America

United States Patent and Trademark Office



**Reg. No. 4,133,668**

**Registered May 1, 2012**

**Int. Cl.: 29**

**TRADEMARK**

**PRINCIPAL REGISTER**

H. & E. REINERT WESTFÄLISCHE, PRIVAT-FLEISCHEREI GMBH & CO. KG (FED REP GERMANY LIMITED PARTNERSHIP)  
MITTEL-LOXTEN 37  
33775 VERSMOLD, FED REP GERMANY

FOR: CHARCUTERIE, PROCESSED AND UNPROCESSED MEAT, FISH, POULTRY AND GAME; MEAT EXTRACTS; MEAT AND SAUSAGE PRESERVES; MIXED MEAT AND VEGETABLE PRESERVES; PRESERVED, DRIED AND COOKED FRUITS AND VEGETABLES; JELLIES; MEAT, FISH AND VEGETABLE PÂTÉS, INCLUDED IN THIS CLASS; PREPARED MEALS, PRIMARILY CONSISTING OF MEAT, FISH AND/OR VEGETABLES; EGGS, MILK AND MILK PRODUCTS EXCLUDING ICE CREAM, ICE MILK AND FROZEN YOGHURT; EDIBLE OILS AND FATS; MEAT AND SAUSAGE SUBSTITUTES WITH A VEGETABLE BASE; ALL THE AFORESAID GOODS, WHERE POSSIBLE, IN FROZEN OR PRESERVED FORM, IN CLASS 29 (U.S. CL. 46).

THE MARK CONSISTS OF THE DESIGN OF A STANDING BEAR WEARING A BOW TIE. THE COLORS BLUE AND LIGHT BLUE APPEAR ON THE DEPICTION OF THE BOW TIE. THE COLOR WHITE APPEARS ON THE DEPICTION OF THE EYES AND NOSE OF THE BEAR. THE COLOR BLACK APPEARS IN THE OUTLINE AND HIGHLIGHTING OF THE BEAR AS WELL AS ON THE DEPICTION OF THE EYES, EARS, NOSE AND MOUTH OF THE BEAR. THE COLOR DARK BROWN APPEARS ON THE DEPICTION OF THE MOUTH OF THE BEAR AS WELL AS SHADING ON THE HANDS AND FEET OF THE BEAR. THE COLOR BROWN APPEARS ON THE DEPICTION OF THE EYES AND EARS OF THE BEAR AS WELL AS SHADING ON THE HANDS, FEET AND NECK OF THE BEAR. THE COLOR LIGHT BROWN APPEARS ON THE DEPICTION OF THE FUR OF THE BEAR.

OWNER OF INTERNATIONAL REGISTRATION 1073559 DATED 10-20-2010, EXPIRES 10-20-2020.

THE COLOR(S) BROWN, LIGHT BROWN, DARK BROWN, BLACK, WHITE, BLUE AND LIGHT BLUE IS/ARE CLAIMED AS A FEATURE OF THE MARK.

SER. NO. 79-096,000, FILED 10-20-2010.

MICHAEL TANNER, EXAMINING ATTORNEY



*David J. Kyros*

Director of the United States Patent and Trademark Office

# United States of America

United States Patent and Trademark Office

# LYRA

**Reg. No. 4,133,669**

**Registered May 1, 2012**

**Int. Cl.: 9**

**TRADEMARK**

**PRINCIPAL REGISTER**

SELEX SISTEMI INTEGRATI S.P.A. (ITALY JOINT STOCK COMPANY)  
VIA TIBURTINA, 1231  
ROMA, ITALY

FOR: ELECTRONIC SYSTEMS FOR THE SURVEILLANCE AND PROTECTION OF TERRITORIES AND AIRSPACE COMPRISING ELECTRIC AND ELECTRONIC VIDEO SURVEILLANCE INSTALLATIONS AND RADAR APPARATUSES, NAMELY, TRANSMITTERS, RECEIVERS WITH AMPLIFIERS, ANTENNAS, DISPLAYS, COMPUTER HARDWARE AND COMPUTER SOFTWARE FOR OPERATING THE AFORESAID APPARATUSES; ELECTRONIC SYSTEMS FOR THE DETECTION AND CHASING AIR TARGETS COMPRISING ELECTRIC AND ELECTRONIC VIDEO SURVEILLANCE INSTALLATIONS AND RADAR APPARATUSES, NAMELY, TRANSMITTERS, RECEIVERS WITH AMPLIFIERS, ANTENNAS, DISPLAYS, COMPUTER HARDWARE AND COMPUTER SOFTWARE FOR OPERATING THE AFORESAID APPARATUSES; ELECTRONIC SYSTEMS FOR THE SURVEILLANCE OF SURFACES, OF TERRITORIAL WATERS, OF EXCLUSIVE ECONOMIC AREAS, OF HARBOURS, OF OFF-SHORE AND ON-SHORE PLATFORMS COMPRISING ELECTRIC AND ELECTRONIC VIDEO SURVEILLANCE INSTALLATIONS AND RADAR APPARATUSES, NAMELY, TRANSMITTERS, RECEIVERS WITH AMPLIFIERS, ANTENNAS, DISPLAYS, COMPUTER HARDWARE AND COMPUTER SOFTWARE FOR OPERATING THE AFORESAID APPARATUSES; ELECTRONIC SYSTEMS FOR THE PROTECTION OF PETROL AND GAS PLATFORMS COMPRISING ELECTRIC AND ELECTRONIC VIDEO SURVEILLANCE INSTALLATIONS AND RADAR APPARATUSES, NAMELY, TRANSMITTERS, RECEIVERS WITH AMPLIFIERS, ANTENNAS, DISPLAYS, COMPUTER HARDWARE AND COMPUTER SOFTWARE FOR OPERATING THE AFORESAID APPARATUSES; COAST SURVEILLANCE SYSTEMS COMPRISING ELECTRIC AND ELECTRONIC VIDEO SURVEILLANCE INSTALLATIONS AND RADAR APPARATUSES, NAMELY, TRANSMITTERS, RECEIVERS WITH AMPLIFIERS, ANTENNAS, DISPLAYS, COMPUTER HARDWARE AND COMPUTER SOFTWARE FOR OPERATING THE AFORESAID APPARATUSES; SENSOR SYSTEMS FOR THE SURVEILLANCE OF CRITICAL INFRASTRUCTURES AND FOR THE PROTECTION OF BIG EVENTS COMPRISING ELECTRIC AND ELECTRONIC VIDEO SURVEILLANCE INSTALLATIONS AND RADAR APPARATUSES, NAMELY, TRANSMITTERS, RECEIVERS WITH AMPLIFIERS, ANTENNAS, DISPLAYS, COMPUTER HARDWARE AND COMPUTER SOFTWARE FOR OPERATING THE AFORESAID APPARATUSES; RADAR SYSTEMS USED FOR THE PROTECTION OF NATIONAL TERRITORIES, FOR THE MARITIME TRAFFIC MANAGEMENT, FOR MOBILE RADARS, FOR MARITIME SURVEILLANCE, FOR THE MOVEMENT IN THE AIRPORT AREAS AND FOR THE RAPID DEPLOYMENT FORCE COMPRISING TRANSMITTERS, RECEIVERS WITH AMPLIFIERS, ANTEN-



*David J. Kappas*

Director of the United States Patent and Trademark Office

**Reg. No. 4,133,669** NAS, DISPLAYS, COMPUTER HARDWARE AND COMPUTER SOFTWARE FOR OPERATING THE AFORESAID APPARATUSES; RADAR; FIXED AND MOBILE RADAR AND PARTS THEREOF, COMPRISING, TRANSMITTERS, RECEIVERS WITH AMPLIFIERS, ANTENNAS, DISPLAYS, COMPUTER HARDWARE AND COMPUTER SOFTWARE FOR OPERATING THE AFORESAID APPARATUSES, IN CLASS 9 (U.S. CLS. 21, 23, 26, 36 AND 38).

THE MARK CONSISTS OF STANDARD CHARACTERS WITHOUT CLAIM TO ANY PARTICULAR FONT, STYLE, SIZE, OR COLOR.

PRIORITY DATE OF 8-26-2010 IS CLAIMED.

OWNER OF INTERNATIONAL REGISTRATION 1073579 DATED 2-25-2011, EXPIRES 2-25-2021.

THE WORD(S) "LYRA" HAS NO MEANING IN A FOREIGN LANGUAGE.

SER. NO. 79-096,008, FILED 2-25-2011.

MATTHEW MCDOWELL, EXAMINING ATTORNEY

# United States of America

United States Patent and Trademark Office

## CGGVeritas University

**Reg. No. 4,133,670**

**Registered May 1, 2012**

**Int. Cls.: 9 and 41**

**TRADEMARK**

**SERVICE MARK**

**PRINCIPAL REGISTER**

CGGVERITAS SERVICES SA (FRANCE SOCIÉTÉ ANONYME)  
1 RUE LÉON MIGAUX  
F-91300 MASSY  
FRANCE

FOR: COMPUTER SOFTWARE PROGRAMS, NAMELY, SOFTWARE FOR USE IN TEACHING AND TRAINING IN THE FIELD OF GEOPHYSICS, SEISMOLOGY AND OIL, GAS AND MINERAL EXPLORATION, IN CLASS 9 (U.S. CLS. 21, 23, 26, 36 AND 38).

FOR: EDUCATIONAL SERVICES, NAMELY, PROVIDING TRAINING WORKSHOPS IN THE FIELD OF GEOPHYSICS, SEISMOLOGY, AND OIL, GAS AND MINERAL EXPLORATION, IN CLASS 41 (U.S. CLS. 100, 101 AND 107).

THE MARK CONSISTS OF STANDARD CHARACTERS WITHOUT CLAIM TO ANY PARTICULAR FONT, STYLE, SIZE, OR COLOR.

PRIORITY DATE OF 9-16-2010 IS CLAIMED.

OWNER OF INTERNATIONAL REGISTRATION 1073621 DATED 3-11-2011, EXPIRES 3-11-2021.

OWNER OF U.S. REG. NOS. 3,557,773 AND 3,811,052.

NO CLAIM IS MADE TO THE EXCLUSIVE RIGHT TO USE "UNIVERSITY", APART FROM THE MARK AS SHOWN.

THE ENGLISH TRANSLATION OF "VERITAS" APPEARING AS PART OF "CGGVERITAS" IN THE MARK IS "TRUTH".

SER. NO. 79-096,025, FILED 3-11-2011.

RAUL CORDOVA, EXAMINING ATTORNEY



*David J. Kybas*

Director of the United States Patent and Trademark Office

United States of America  
United States Patent and Trademark Office

Mylos

**Reg. No. 4,133,671**

DIETMAR SCHNEIDER (FED REP GERMANY INDIVIDUAL)  
HERDERWEG 3

**Registered May 1, 2012**

74193 SCHWAIGERN, FED REP GERMANY

**Int. Cl.: 9**

FOR: SOFTWARE, NAMELY, COMPUTER OPERATING PROGRAMS AND COMPUTER OPERATING SYSTEMS, IN CLASS 9 (U.S. CLS. 21, 23, 26, 36 AND 38).

**TRADEMARK**

THE MARK CONSISTS OF STANDARD CHARACTERS WITHOUT CLAIM TO ANY PARTICULAR FONT, STYLE, SIZE, OR COLOR.

**PRINCIPAL REGISTER**

PRIORITY DATE OF 9-14-2010 IS CLAIMED.

OWNER OF INTERNATIONAL REGISTRATION 1073646 DATED 3-2-2011, EXPIRES 3-2-2021.

THE WORDING "MYLOS" HAS NO MEANING IN A FOREIGN LANGUAGE.

SER. NO. 79-096,032, FILED 3-2-2011.

LINDA ESTRADA, EXAMINING ATTORNEY



*David J. Kyffers*

Director of the United States Patent and Trademark Office

# United States of America

United States Patent and Trademark Office



**Reg. No. 4,133,672**

**Registered May 1, 2012**

**Int. Cl.: 10**

**TRADEMARK**

**PRINCIPAL REGISTER**

"CHM" - MIKOLAJ CHARKIEWICZ, LEWICKIE K/BIALEGOSTOKU, POLSKA (POLAND INDIVIDUAL)  
LEWICKIE K/BIALEGOSTOKU  
POLAND

FOR: MEDICAL INSTRUMENTS, APPARATUSES AND ARTICLES FOR OSTEOSYNTHESIS, NAMELY, IMPLANTABLE NAILS, AND NAILING SYSTEMS AND INSTRUMENTS USED IN ASSOCIATION THEREWITH, IN CLASS 10 (U.S. CLS. 26, 39 AND 44).

NO CLAIM IS MADE TO THE EXCLUSIVE RIGHT TO USE "SYSTEM", APART FROM THE MARK AS SHOWN.

OWNER OF INTERNATIONAL REGISTRATION 1073769 DATED 3-3-2011, EXPIRES 3-3-2021.

THE MARK CONSISTS OF THE WORDING "CHARFIX SYSTEM" IN STYLIZED FORM UPON A SHADED RECTANGLE.

THE WORDING "CHARFIX" HAS NO MEANING IN A FOREIGN LANGUAGE.

SER. NO. 79-096,100, FILED 3-3-2011.

ALLISON HOLTZ, EXAMINING ATTORNEY



*David J. Kybas*

Director of the United States Patent and Trademark Office

# United States of America

United States Patent and Trademark Office



## NumeroProtecta

**Reg. No. 4,133,673**

**Registered May 1, 2012**

**Int. Cls.: 7, 9, 37 and 41**

**TRADEMARK**

**SERVICE MARK**

**PRINCIPAL REGISTER**

KBA-NOTASYS SA (SWITZERLAND SOCIÉTÉ ANONYME (SA))  
AVENUE DU GREY 55  
CASE POSTALE 347  
CH-1000 LAUSANNE 22, SWITZERLAND

FOR: MECHANICAL MACHINES FOR MAKING AND PACKING BANK-NOTES; MECHANICAL MACHINES FOR PRINTING BANK-NOTES; MACHINES USED TO APPLY SECURITY ELEMENTS ON SECURITIES, NOTABLY, BANK-NOTES AND FIDUCIARY PAPERS; MECHANICAL MACHINES FOR MANUFACTURING SECURITY DOCUMENT AND SECURITIES WITH BIOMETRIC DATA, IN CLASS 7 (U.S. CLS. 13, 19, 21, 23, 31, 34 AND 35).

FOR: ELECTRONIC MACHINES FOR MAKING AND PRINTING BANK-NOTES; ELECTRONIC MACHINES FOR CONTROLLING THE PRINTING QUALITY OF PRINTED DOCUMENTS, NAMELY, BANK-NOTES AND FIDUCIARY PAPERS; ELECTRONIC MACHINES FOR SORTING BANK-NOTES; ELECTRONIC MACHINES FOR MEASURING AND CONTROLLING BIOMETRIC DATA, IN CLASS 9 (U.S. CLS. 21, 23, 26, 36 AND 38).

FOR: REPAIR AND MAINTENANCE OF MECHANICAL AND ELECTRONIC MACHINES FOR MAKING, PRINTING, CHECKING, AND/OR NUMBERING BANK-NOTES AND FIDUCIARY PAPERS, IN CLASS 37 (U.S. CLS. 100, 103 AND 106).

FOR: PROVIDING TRAINING FOR STAFF OF OTHERS IN THE FIELD OF CUSTOM INSTALLATION OF MECHANICAL OR ELECTRONIC MACHINES FOR MAKING, PRINTING, CHECKING, AND/OR NUMBERING BANK-NOTES AND FIDUCIARY PAPERS, IN CLASS 41 (U.S. CLS. 100, 101 AND 107).

OWNER OF U.S. REG. NOS. 2,837,810, 3,335,376, AND 4,054,562.

PRIORITY DATE OF 9-28-2010 IS CLAIMED.

OWNER OF INTERNATIONAL REGISTRATION 1073770 DATED 3-22-2011, EXPIRES 3-22-2021.

THE MARK CONSISTS OF THE STYLIZED WORDING "NUMEROPROTECTA" APPEARING TO THE LEFT OF A DESIGN FEATURING AN OUTLINE OF THE UPPER PORTION OF A PEGASUS.



*David J. Kybas*

Director of the United States Patent and Trademark Office

**Reg. No. 4,133,673** THE WORDING "NUMEROPROTECTA" HAS NO MEANING IN A FOREIGN LANGUAGE.

SER. NO. 79-096,101, FILED 3-22-2011.

KEVIN CORWIN, EXAMINING ATTORNEY



# United States of America

United States Patent and Trademark Office

# Magneo

**Reg. No. 4,133,674**

**Registered May 1, 2012**

**Int. Cls.: 6, 7, 9 and 19**

**TRADEMARK**

**PRINCIPAL REGISTER**

DORMA GMBH + CO. KG (FED REP GERMANY LIMITED PARTNERSHIP)  
DORMA PLATZ 1  
58256 ENNEPETAL  
FED REP GERMANY

FOR: MECHANICAL LOCKS OF METAL; METAL KEYS FOR LOCKS; FITTINGS OF METAL FOR BUILDINGS, NAMELY, DOOR HINGES, LATCHKEYS, LOCKS AND COUNTERCASINGS FOR DOOR LOCKS, METAL FITTINGS FOR ALL-GLASS DOORS AND GLASS PANES; DOOR FITTINGS OF METAL FOR ALL-GLASS INSTALLATIONS, NAMELY, LOCKS AND LOCK CASINGS, STRIKES, HANDLES, DOOR KNOBS, GRAB BARS, SCREW MOUNTINGS, CLAMP FITTINGS, CONNECTING DOOR FITTINGS, PROTECTIVE DOOR FITTINGS; DOORS OF METAL; BUILDING MATERIALS, NAMELY, METAL STATIONARY PARTITIONS IN PARTICULAR WITH STATIONARY AND MOBILE INDIVIDUAL ELEMENTS, SLIDING DOORS, SLIDING REVOLVING DOORS, FOLDING DOORS; METAL DOOR CLOSERS THAT ARE NOT ELECTRIC, PNEUMATIC OR HYDRAULIC; DOOR STOPS OF METAL, IN CLASS 6 (U.S. CLS. 2, 12, 13, 14, 23, 25 AND 50).

FOR: MECHANICAL, PNEUMATIC AND HYDRAULIC METAL POWER-OPERATED DRIVES, MOTORS AND GEARS FOR MOVING OR CONTROLLING SINGLE-COMPONENT OR MULTI-COMPONENT DOORS AND GATES, NAMELY, SLIDING DOORS, REVOLVING DOORS, REVOLVING DOUBLE DOORS, CURVED SLIDING DOORS, TELESCOPIC SLIDING DOORS, FOLDING DOORS, DOUBLE WING DOORS, FOLDING GATES, SLIDING GATES AND PARTITIONS; ELECTRIC DRIVES FOR SLIDING DOORS, REVOLVING DOORS, REVOLVING DOUBLE DOORS, CURVED SLIDING DOORS, TELESCOPIC SLIDING DOORS, FOLDING DOORS, DOUBLE WING DOORS, FOLDING GATES, SLIDING GATES AND/OR PARTITIONS; MOTORIZED GARAGE DOOR DRIVES; FITTINGS FOR MOTORS, GEARS, AND DRIVES FOR MOVING SINGLE-COMPONENT OR MULTI-COMPONENT DOORS AND GATES, NAMELY, LINKAGES, OPERATING LEVERS, SLIDE RAILS, MOUNTING PLATES, COVER PLATES, IN CLASS 7 (U.S. CLS. 13, 19, 21, 23, 31, 34 AND 35).

FOR: ELECTRIC REGULATING AND CONTROL APPARATUS FOR SLIDING DOORS, DOUBLE WING DOORS, REVOLVING SECURITY DOORS, REVOLVING DOUBLE DOORS, CURVED SLIDING DOORS, TELESCOPIC SLIDING DOORS, PARTITIONS, FOLDING DOORS, DOUBLE WING DOORS, FOLDING GATES AND SLIDING GATES; ACCESSORIES FOR ELECTRIC REGULATING AND CONTROL APPARATUS FOR SLIDING DOORS, DOUBLE WING DOORS, REVOLVING SECURITY DOORS, REVOLVING DOUBLE DOORS, CURVED SLIDING DOORS, TELESCOPIC SLIDING DOORS, PARTITIONS, FOLDING



*David J. Kybas*

Director of the United States Patent and Trademark Office

**Reg. No. 4,133,674** DOORS, DOUBLE WING DOORS, FOLDING GATES AND SLIDING GATES, NAMELY, SENSE SWITCHES, RADAR MOTION DETECTORS, LIGHT BARRIERS; ELECTRIC LOCKS; ELECTRICAL SWITCHES, AUTOMATIC CONTROLLERS, ACCESS CONTROL MONITORING SYSTEMS, SECURITY CAMERAS FOR DOOR LOCKS AND WINDOWS; ELECTRIC DOOR OPENERS; ELECTRONIC KEY CARDS, MAGNETICALLY ENCODED CARDS FOR ACCESS TO BUILDINGS, MAGNETICALLY ENCODED KEY CARDS, MAGNETICALLY ENCODED IDENTITY CARDS, ELECTRONICALLY ENCODED IDENTITY CARDS AND MAGNETIC IDENTITY CARDS; ACCESS CONTROL DEVICES, AND APPARATUS AND DEVICES FOR PERSONAL IDENTIFICATION, NAMELY, CARD READERS FOR MAGNETICALLY ENCODED CARDS, RFID READERS, CENTRAL PROCESSING UNITS (FOR DATA PROCESSING) AND TIME RECORDING APPARATUS; ALARM APPARATUS, NAMELY, BURGLAR ALARMS, ELECTRONIC DOOR ALARMS, FIRE ALARMS; SMOKE DETECTING APPARATUS, IN CLASS 9 (U.S. CLS. 21, 23, 26, 36 AND 38).

FOR: BUILDING MATERIALS, NAMELY, NON-METAL STATIONARY PARTITIONS IN PARTICULAR WITH STATIONARY AND MOBILE INDIVIDUAL ELEMENTS, SLIDING DOORS, SLIDING REVOLVING DOORS, FOLDING DOORS; ALL THE AFORESAID GOODS MAINLY OF GLASS, WOOD, PLASTIC OR COMPOSITE MATERIALS, IN CLASS 19 (U.S. CLS. 1, 12, 33 AND 50).

THE MARK CONSISTS OF STANDARD CHARACTERS WITHOUT CLAIM TO ANY PARTICULAR FONT, STYLE, SIZE, OR COLOR.

OWNER OF INTERNATIONAL REGISTRATION 1073796 DATED 3-22-2011, EXPIRES 3-22-2021.

SER. NO. 79-096,115, FILED 3-22-2011.

CHARLOTTE CORWIN, EXAMINING ATTORNEY

# United States of America

United States Patent and Trademark Office



# Westmatic

**Reg. No. 4,133,675**

**Registered May 1, 2012**

**Int. Cls.: 7 and 37**

**TRADEMARK**

**SERVICE MARK**

**PRINCIPAL REGISTER**

WESTMATIC INVEST AB (SWEDEN AKTIEBOLAG)  
BOX 958  
SE-671 29 ARVIKA  
SWEDEN

FOR: VEHICLE WASHING INSTALLATIONS AND STRUCTURAL PARTS AND FITTINGS THEREOF, IN CLASS 7 (U.S. CLS. 13, 19, 21, 23, 31, 34 AND 35).

FOR: CAR WASHING; RENTAL OF VEHICLE WASHING INSTALLATIONS; REPAIR AND MAINTENANCE OF CAR WASHING INSTALLATIONS, IN CLASS 37 (U.S. CLS. 100, 103 AND 106).

OWNER OF U.S. REG. NO. 3,142,345.

PRIORITY DATE OF 2-24-2011 IS CLAIMED.

OWNER OF INTERNATIONAL REGISTRATION 1073958 DATED 3-7-2011, EXPIRES 3-7-2021.

THE COLOR(S) BLUE AND YELLOW IS/ARE CLAIMED AS A FEATURE OF THE MARK.

THE MARK CONSISTS OF THE STYLIZED WORDING "WESTMATIC" IN BLUE, UNDERNEATH A STYLIZED "W" COMPRISED OF A SLANTED RECTANGLE ON EACH SIDE OF A DIAMOND WITH THE LEFT RECTANGLE IN BLUE AND THE DIAMOND AND RIGHT RECTANGLE IN YELLOW.

SER. NO. 79-096,178, FILED 3-7-2011.

TASNEEM HUSSAIN, EXAMINING ATTORNEY



*David J. Kypos*

Director of the United States Patent and Trademark Office

United States of America  
United States Patent and Trademark Office

# Birko

**Reg. No. 4,133,676**

**Registered May 1, 2012**

**Int. Cls.: 10 and 25**

**TRADEMARK**

**PRINCIPAL REGISTER**

BIRKO ORTHOPÄDIE GMBH (FED REP GERMANY LIMITED LIABILITY COMPANY)  
BURG OCKENFELS  
53545 LINZ  
FED REP GERMANY

FOR: ORTHOPEDIC ARCH SUPPORTS AND ORTHOPEDIC SOLES FOR FOOTWEAR; ORTHOPEDIC SANDALS, IN CLASS 10 (U.S. CLS. 26, 39 AND 44).

FOR: FOOTWEAR, NAMELY, SHOES AND SANDALS; SHOE SOLES; HEEL PIECES FOR SHOES; INNER SOLES FOR SPORTS FOOTWEAR, NAMELY, FOR SKI BOOTS, RUNNING, TENNIS AND WALKING SHOES, AND MOUNTAINEERING BOOTS, IN CLASS 25 (U.S. CLS. 22 AND 39).

OWNER OF INTERNATIONAL REGISTRATION 0492826 DATED 3-7-1985, EXPIRES 3-7-2015.

SER. NO. 79-096,203, FILED 3-8-2011.

EDWARD FENNESSY, EXAMINING ATTORNEY



*David J. Kyros*

Director of the United States Patent and Trademark Office

United States of America  
United States Patent and Trademark Office

# Parster

**Reg. No. 4,133,677**

**Registered May 1, 2012**

**Int. Cls.: 23, 24 and 25**

NEO-CONCEPT (HOLDINGS) CO. LTD (HONG KONG LIMITED LIABILITY COMPANY)  
UNITS 1201-1206 12TH FLOOR  
LU PLAZA NO. 2-4 WINGYIP ST.  
KWUN TONG, HONG KONG

FOR: YARNS AND THREADS, FOR TEXTILE USE, IN CLASS 23 (U.S. CL. 43).

**TRADEMARK**

FOR: TEXTILE, NAMELY, FELT AND NON-WOVEN TEXTILE FABRICS; FABRICS INCORPORATING SYNTHETIC FILAMENT YARN AND NATURAL YAM; TEXTILE GOODS, NAMELY, HAND TOWELS OF TEXTILE; HOUSEHOLD LINEN OF TEXTILE; BED BLANKETS; BLANKET THROWS; QUILTS; BED SHEETS; PILLOW COVERS; DUVET COVERS; CURTAINS AND DRAPERIES; TABLE NAPKINS OF TEXTILE; TABLE LINEN OF TEXTILE; GIFT WRAP OF TEXTILE, HANDKERCHIEFS OF TEXTILE, IN CLASS 24 (U.S. CLS. 42 AND 50).

**PRINCIPAL REGISTER**

FOR: CLOTHING, NAMELY, JERSEYS, JUMPERS, CARDIGANS, PULLOVERS, T-SHIRT, WOMEN'S CLOTHING, NAMELY, DRESSES, SKIRTS, BLOUSES, TOPS, SHIRTS; TROUSERS, SHORTS, BERMUDA SHORTS, JACKETS, WAISTCOATS, VESTS, MEN'S SUITS, STOCKINGS, SOCKS, SHOES, HATS, BERETS, SCARVES, GLOVES, UNDERWEAR; ARTICLES OF CLOTHING OF LEATHER OR IMITATIONS OF LEATHER, NAMELY, COATS, PANTS; BELTS, IN CLASS 25 (U.S. CLS. 22 AND 39).

THE MARK CONSISTS OF STANDARD CHARACTERS WITHOUT CLAIM TO ANY PARTICULAR FONT, STYLE, SIZE, OR COLOR.

OWNER OF INTERNATIONAL REGISTRATION 1074040 DATED 12-20-2010, EXPIRES 12-20-2020.

SER. NO. 79-096,214, FILED 12-20-2010.

CAROLINE WOOD, EXAMINING ATTORNEY



*David J. Kyros*

Director of the United States Patent and Trademark Office

# United States of America

United States Patent and Trademark Office

## NET-A-PORTER

**Reg. No. 4,133,678**

**Registered May 1, 2012**

**Int. Cls.: 9, 16 and 41**

**TRADEMARK**

**SERVICE MARK**

**PRINCIPAL REGISTER**

THE NET-A-PORTER GROUP LIMITED (UNITED KINGDOM LIMITED COMPANY)  
1 THE VILLAGE OFFICES  
WESTFIELD, ARIEL WAY  
LONDON W12 7GF, UNITED KINGDOM

FOR: ELECTRONIC DOWNLOADABLE PUBLICATIONS IN THE NATURE OF NEWSPAPERS, MAGAZINES, ARTICLES, BROCHURES, BOOKS, AND PERIODICALS IN THE FIELDS OF FASHION, NEWS, LIFESTYLE, CULTURE, ENTERTAINMENT, TRAVEL, AND SOCIAL NETWORKING; ELECTRONIC APPLICATIONS FOR ELECTRONIC TELECOMMUNICATIONS EQUIPMENT, IN CLASS 9 (U.S. CLS. 21, 23, 26, 36 AND 38).

FOR: PRINTED PUBLICATIONS, NAMELY, ARTICLES AND NEWSLETTERS IN THE FIELD OF FASHION, NEWS, LIFESTYLE, CULTURE, ENTERTAINMENT AND TRAVEL; PRINTED MATTER, NAMELY, MAGAZINES AND PUBLICATIONS IN RELATION TO FASHION AND LIFESTYLE; BOOKS IN THE FIELD OF FASHION, NEWS, LIFESTYLE, CULTURE, ENTERTAINMENT, AND TRAVEL; ADDRESS BOOKS; PAMPHLETS, MANUALS, MAGAZINES, NEWSLETTERS AND PERIODICAL PUBLICATIONS IN THE FIELD OF FASHION, NEWS, LIFESTYLE, CULTURE, ENTERTAINMENT, AND TRAVEL; NEWSPAPERS; DECALCOMANIAS; PRESSURE SENSITIVE STICKERS; PHOTOGRAPHS; GREETING CARDS; PAPER GIFT TAGS; DIARIES, POSTCARDS, POSTERS, STATIONERY; WRITING AND DRAWING IMPLEMENTS; PAPER TISSUES; CALENDARS, IN CLASS 16 (U.S. CLS. 2, 5, 22, 23, 29, 37, 38 AND 50).

FOR: ENTERTAINMENT AND EDUCATIONAL SERVICES IN THE NATURE OF PROVIDING ONLINE NON-DOWNLOADABLE ELECTRONIC MEDIA IN THE NATURE OF IMAGES, SOUND, AND IMAGES WITH SOUND, MULTIMEDIA CONTENT IN THE NATURE OF IMAGES, SOUND, AND IMAGES WITH SOUND, VIDEOS, MOVIES, PICTURES, IMAGES, TEXT, PHOTOS, USER-GENERATED CONTENT, AUDIO CONTENT, AND RELATED INFORMATION VIA THE INTERNET AND OTHER COMMUNICATIONS NETWORKS IN THE FIELD OF FASHION, GENERAL INTEREST, CULTURAL EVENTS AND ENTERTAINMENT RELATED TOPICS; PRODUCTION OF FILMS ON VIDEOTAPES AND ALL TYPES OF AUDIOVISUAL OR SOUND MEDIA IN THE FIELD OF FASHION, GENERAL INTEREST, CULTURAL EVENTS AND ENTERTAINMENT RELATED TOPICS; ELECTRONIC PUBLISHING OF ON-LINE BOOKS, MAGAZINES AND PERIODICALS IN THE FIELD OF FASHION, GENERAL INTEREST, CULTURAL EVENTS AND ENTERTAINMENT RELATED TOPICS; PROVIDING ON-LINE NON-DOWNLOADABLE ELECTRONIC PUBLICATIONS IN THE FIELD OF FASHION, GENERAL INTEREST, CULTURAL EVENTS AND ENTERTAINMENT



*David J. Kyros*

Director of the United States Patent and Trademark Office

**Reg. No. 4,133,678** RELATED TOPICS; DIGITAL VIDEO, AUDIO AND MULTIMEDIA ENTERTAINMENT PUBLISHING SERVICES IN THE FIELD OF FASHION, GENERAL INTEREST, CULTURAL EVENTS AND ENTERTAINMENT RELATED TOPICS; ONLINE DIGITAL PUBLISHING SERVICES IN THE FIELD OF FASHION, GENERAL INTEREST, CULTURAL EVENTS AND ENTERTAINMENT RELATED TOPICS; FASHION SHOW SERVICES, NAMELY, PRODUCTION OF FASHION SHOWS PROVIDED ONLINE FROM A COMPUTER DATABASE OR THE INTERNET AND TRANSMITTED VIA WIRELESS COMMUNICATION DEVICE; NEWS REPORTING; PROVIDING INFORMATION ABOUT ENTERTAINMENT, CURRENT EVENTS, CULTURAL EVENTS AND ACTIVITIES AND NEWS; PUBLICATION OF ELECTRONIC SOFTWARE APPLICATIONS FOR FASHION, ENTERTAINMENT THAT PROVIDE INFORMATION ON FASHION; CONSULTANCY, INFORMATION AND ADVISORY SERVICES RELATING TO THE AFORESAID SERVICES; PROVIDING ELECTRONIC LIBRARY SERVICES CONTAINING IMAGES, PICTURES, PHOTOGRAPHS, TEXT AND OTHER MULTIMEDIA CONTENT VIA AN ONLINE COMPUTER NETWORK AND OTHER ELECTRONIC COMMUNICATION NETWORKS; PUBLISHING ONLINE JOURNALS, NAMELY, BLOGS FEATURING PERSONAL INFORMATION AND OPINIONS; ORGANIZING ENTERTAINMENT AND CULTURAL EVENTS, NAMELY, ART AND FASHION GALLERY; ENTERTAINMENT IN THE NATURE OF CONTESTS, COMPETITIONS AND GAMES, IN CLASS 41 (U.S. CLS. 100, 101 AND 107).

THE MARK CONSISTS OF STANDARD CHARACTERS WITHOUT CLAIM TO ANY PARTICULAR FONT, STYLE, SIZE, OR COLOR.

PRIORITY DATE OF 10-22-2010 IS CLAIMED.

OWNER OF INTERNATIONAL REGISTRATION 1074088 DATED 3-28-2011, EXPIRES 3-28-2021.

SER. NO. 79-096,237, FILED 3-28-2011.

JACLYN KIDWELL WALKER, EXAMINING ATTORNEY

# United States of America

United States Patent and Trademark Office

# BOFOOD

**Reg. No. 4,133,679**

**Registered May 1, 2012**

**Int. Cls.: 2 and 16**

**TRADEMARK**

**PRINCIPAL REGISTER**

EPPLER DRUCKFARBEN AG (FED REP GERMANY PUBLIC LIMITED COMPANY)  
GUTENBERGSTR. 5  
86356 NEUSÄß  
FED REP GERMANY

FOR: PAINTS, VARNISHES, PRINTING INKS, PRINTING INKS FOR FOOD PACKAGING, PRINTING INKS FOR CONTACT WITH FOOD; TONER AND FILLED TONER CARTRIDGES FOR PHOTOCOPIERS AND PRINTERS; INKS AND FILLED INK CARTRIDGES FOR PRINTERS; INKS FOR WRITING INSTRUMENTS, IN CLASS 2 (U.S. CLS. 6, 11 AND 16).

FOR: PRINTED MATTER, NAMELY, CALENDARS; PRINTED OR PRINTABLE PACKAGING MATERIAL FOR FOODSTUFFS, NAMELY, CARDBOARD BOXES, WRAPPING PAPER, PAPER TABLE CLOTHS, PAPER NAPKINS, PAPER PLACEMATS, CARDBOARD CONTAINERS, PAPER DISHES, PAPER CUPS, AND PAPER BAGS; PRINTED OR PRINTABLE PACKAGING MATERIAL, FOR TOBACCO AND TOBACCO PRODUCTS, NAMELY, CARDBOARD BOXES, WRAPPING PAPER, PAPER CONTAINERS, AND PAPER BAGS, IN CLASS 16 (U.S. CLS. 2, 5, 22, 23, 29, 37, 38 AND 50).

THE MARK CONSISTS OF STANDARD CHARACTERS WITHOUT CLAIM TO ANY PARTICULAR FONT, STYLE, SIZE, OR COLOR.

PRIORITY DATE OF 9-17-2010 IS CLAIMED.

OWNER OF INTERNATIONAL REGISTRATION 1074188 DATED 3-11-2011, EXPIRES 3-11-2021.

SER. NO. 79-096,285, FILED 3-11-2011.

RAUL CORDOVA, EXAMINING ATTORNEY



*David J. Kyros*

Director of the United States Patent and Trademark Office



# United States of America

United States Patent and Trademark Office

# la contrie

**Reg. No. 4,133,680**

**Registered May 1, 2012**

**Int. Cls.: 3, 18 and 25**

**TRADEMARK**

**PRINCIPAL REGISTER**

MARIE-EDWINA DE CHARRETTE DE LA CONTRIE, ÉPOUSE WISE (FRANCE INDIVIDUAL)  
15 RUE DU LOUVRE  
F-75001 PARIS, FRANCE

FOR: SOAP; PERFUMES, ESSENTIAL OILS, COSMETICS, HAIR LOTIONS; MAKE-UP REMOVER; LIPSTICKS; BEAUTY MASKS; SHAVING PRODUCTS, NAMELY, GELS, CREAMS, FOAMS, LOTIONS, BALMS, MOUSSES, SOAPS, IN CLASS 3 (U.S. CLS. 1, 4, 6, 50, 51 AND 52).

FOR: LEATHER AND IMITATIONS OF LEATHER; ANIMAL SKINS; TRUNKS AND SUITCASES; UMBRELLAS, PARASOLS AND WALKING STICKS; WALLETS; PURSES; HANDBAGS, BACKPACKS, WHEELED BAGS; BAGS FOR CLIMBERS IN THE NATURE OF ALL-PURPOSE CARRYING BAGS, BAGS FOR CAMPERS, NAMELY, BACKPACKS, TRAVELING BAGS, BEACH BAGS, SCHOOL BAGS; UNFITTED VANITY CASES; COLLARS OR COVERS FOR ANIMALS; SHOPPING NETS AND BAGS OF MESH, IN CLASS 18 (U.S. CLS. 1, 2, 3, 22 AND 41).

FOR: CLOTHING, NAMELY, TOPS, BOTTOMS, PANTS, SUITS, JACKETS, SWEATERS, SKIRTS, DRESSES, PARKAS, T-SHIRTS, FOOTWEAR, HEADGEAR, NAMELY, HATS AND CAPS; SHIRTS; LEATHER OR IMITATION LEATHER CLOTHING, NAMELY, TOPS, BOTTOMS, PANTS, SHIRTS, SUITS, JACKETS, SKIRTS, DRESSES, PARKAS; BELTS; GLOVES; SCARVES; NECKTIES; HOSIERY; SOCKS; SLIPPERS; BEACH, SKI OR SPORTS FOOTWEAR, IN CLASS 25 (U.S. CLS. 22 AND 39).

THE NAME(S), PORTRAIT(S), AND/OR SIGNATURE(S) SHOWN IN THE MARK IDENTIFIES MS. DE CHARRETTE DE LA CONTRIE, ÉPOUSE WISE, WHOSE CONSENT(S) TO REGISTER IS MADE OF RECORD.

OWNER OF INTERNATIONAL REGISTRATION 1074251 DATED 3-23-2011, EXPIRES 3-23-2021.

THE WORDING "LA CONTRIE" HAS NO MEANING IN A FOREIGN LANGUAGE.

SER. NO. 79-096,313, FILED 3-23-2011.

DAVID HOFFMAN, EXAMINING ATTORNEY



*David J. Kyffers*

Director of the United States Patent and Trademark Office

# United States of America

United States Patent and Trademark Office



**Reg. No. 4,133,681**

**Registered May 1, 2012**

**Int. Cl.: 42**

**SERVICE MARK**

**PRINCIPAL REGISTER**

UGL SERVICES PTY LTD (AUSTRALIA COMPANY)  
LEVEL 30  
CASSELDEN PLACE,; 2 LONSDALE STREET; MELBOURNE VIC 3000  
AUSTRALIA

FOR: ADVISORY SERVICES RELATING TO ENVIRONMENTAL MATTERS, NAMELY, CONSULTING SERVICES IN THE FIELD OF ENVIRONMENTAL ASSESSMENT AND PLANNING; ENVIRONMENTAL STRATEGY, NAMELY, CONSULTING SERVICES IN THE FIELD OF ENVIRONMENTAL PLANNING; ENVIRONMENTAL RISK ASSESSMENT AND RISK MANAGEMENT, NAMELY, CONSULTING SERVICES IN THE FIELD OF ENVIRONMENTAL ASSESSMENT; ENVIRONMENTAL REPORTING, NAMELY, RESEARCH IN THE FIELD OF ENVIRONMENTAL PROTECTION; ENVIRONMENTAL PROGRAM DELIVERY; NAMELY, DESIGN FOR OTHERS IN THE FIELD OF ENVIRONMENTAL ENGINEERING; DELIVERY OF ENVIRONMENTAL SERVICES, NAMELY, ENVIRONMENTAL ENGINEERING, TESTING AND INSPECTION SERVICES, IN CLASS 42 (U.S. CLS. 100 AND 101).

THE MARK CONSISTS OF THE WORD "BEYOND" IN BLUE FONT ABOVE THE WORD "GREEN" IN GREEN FONT; ABOVE BOTH WORDS AND TO THE RIGHT IS A FIVE PETAL FLOWER WITH ALL BUT ONE PETAL BEING BLUE, AND THE FIFTH PETAL IN GREEN.

PRIORITY DATE OF 8-6-2010 IS CLAIMED.

OWNER OF INTERNATIONAL REGISTRATION 1074319 DATED 2-4-2011, EXPIRES 2-4-2021.

THE COLOR(S) BLUE AND GREEN IS/ARE CLAIMED AS A FEATURE OF THE MARK.

SER. NO. 79-096,338, FILED 2-4-2011.

LINDA MICKLEBURGH, EXAMINING ATTORNEY



*David J. Kybas*

Director of the United States Patent and Trademark Office

# United States of America

United States Patent and Trademark Office

# Happy Hospital

**Reg. No. 4,133,682**

**Registered May 1, 2012**

**Int. Cls.: 9, 25, 28, 35, 38  
and 41**

**TRADEMARK**

**SERVICE MARK**

**PRINCIPAL REGISTER**

WOOGA GMBH (FED REP GERMANY LIMITED LIABILITY COMPANY)  
SAARBRÜCKER STR. 38  
10405 BERLIN, FED REP GERMANY

FOR: COMPUTERS; RECORDED AND DOWNLOADABLE COMPUTER PROGRAMS AND SOFTWARE FOR VIDEO, ONLINE AND BROWSER GAMES; COMPUTER GAME SOFTWARE FOR USE ON MOBILE AND CELLULAR PHONES, IN CLASS 9 (U.S. CLS. 21, 23, 26, 36 AND 38).

FOR: CLOTHING, NAMELY, T-SHIRTS; HEADGEAR, NAMELY, HATS AND CAPS; OUTERWEAR, NAMELY, JACKETS, IN CLASS 25 (U.S. CLS. 22 AND 39).

FOR: ELECTRONIC GAMES OTHER THAN THOSE ADAPTED FOR USE WITH TELEVISION RECEIVERS ONLY; BOARD GAMES; HAND-HELD UNITS FOR PLAYING ELECTRONIC GAMES OTHER THAN THOSE ADAPTED FOR USE WITH AN EXTERNAL DISPLAY SCREEN OR MONITOR; LCD GAME MACHINES, IN CLASS 28 (U.S. CLS. 22, 23, 38 AND 50).

FOR: ADVERTISING SERVICES; ONLINE ADVERTISING FOR OTHERS ON A COMPUTER NETWORK; DISSEMINATION OF ADVERTISEMENTS FOR OTHERS; DISTRIBUTION OF ADVERTISING MATERIAL IN THE NATURE OF FLYERS, LEAFLETS, PRINTED MATTER, AND SAMPLES, IN CLASS 35 (U.S. CLS. 100, 101 AND 102).



FOR: PROVIDING ACCESS TO AN INTERNET PAGE AND PROVIDING ELECTRONIC TRANSMISSION OF INFORMATION IN THE FORM OF TEXT, IMAGES, SPEECH AND SOUNDS VIA AN INTERNET PAGE; RENTAL OF ACCESS TIME TO AN INTERNET PAGE; PROVIDING ACCESS TO GLOBAL COMPUTER INFORMATION DATA NETWORK FEATURING SOFTWARE FOR INTERNET ACCESS; BROADCASTING OF MOVIE, TELEVISION, RADIO, VIDEO TEXT, AND TELETEXT PROGRAMS; BROADCASTING SERVICES, NAMELY, TRANSMISSION OF ADVERTISING PROGRAMS ON ADVERTISING SPOTS VIA ELECTRONIC COMMUNICATION NETWORKS; PROVIDING ACCESS TO DATABASES; PROVIDING ACCESS TO DATABASES OR THE INTERNET, IN CLASS 38 (U.S. CLS. 100, 101 AND 104).

*David J. Kyros*

Director of the United States Patent and Trademark Office

FOR: ORGANIZING OF VIDEO GAME COMPETITIONS ON THE INTERNET; ENTERTAINMENT SERVICES, NAMELY, PROVIDING ONLINE COMPUTER, VIDEO, AND BROWSER GAMES, AND PROVIDING ONLINE COMPUTER GAME PROGRAMS FOR MOBILE PHONES;

**Reg. No. 4,133,682** PROVIDING ENTERTAINMENT INFORMATION ON THE INTERNET, IN CLASS 41 (U.S. CLS. 100, 101 AND 107).

THE MARK CONSISTS OF STANDARD CHARACTERS WITHOUT CLAIM TO ANY PARTICULAR FONT, STYLE, SIZE, OR COLOR.

PRIORITY DATE OF 8-17-2010 IS CLAIMED.

OWNER OF INTERNATIONAL REGISTRATION 1074444 DATED 2-17-2011, EXPIRES 2-17-2021.

NO CLAIM IS MADE TO THE EXCLUSIVE RIGHT TO USE "HOSPITAL" FOR CLASSES 9, 28, 35, 38, & 41, APART FROM THE MARK AS SHOWN.

SER. NO. 79-096,397, FILED 2-17-2011.

SIMON TENG, EXAMINING ATTORNEY

# United States of America

United States Patent and Trademark Office

## WHY THE BEST HOTELS

**Reg. No. 4,133,683**

**Registered May 1, 2012**

**Int. Cl.: 43**

**SERVICE MARK**

**PRINCIPAL REGISTER**

BELVEDERE ANGELICO S.R.L. (ITALY LIMITED LIABILITY COMPANY)  
VIALE GIACOMO MATTEOTTI, 2 B/C  
I-50031 BARBERINO DI MUGELLO (FI)  
ITALY

FOR: HOTELS AND PROVIDING FOOD AND DRINK SERVICES; HOTEL AND RESTAURANT RESERVATION SERVICES, IN CLASS 43 (U.S. CLS. 100 AND 101).

THE MARK CONSISTS OF STANDARD CHARACTERS WITHOUT CLAIM TO ANY PARTICULAR FONT, STYLE, SIZE, OR COLOR.

OWNER OF INTERNATIONAL REGISTRATION 1074541 DATED 2-28-2011, EXPIRES 2-28-2021.

NO CLAIM IS MADE TO THE EXCLUSIVE RIGHT TO USE "BEST HOTELS", APART FROM THE MARK AS SHOWN.

SER. NO. 79-096,429, FILED 2-28-2011.

ROBERT C. CLARK JR., EXAMINING ATTORNEY



*David J. Kyffers*

Director of the United States Patent and Trademark Office

United States of America  
United States Patent and Trademark Office

**DERIVO**

**Reg. No. 4,133,684**

**Registered May 1, 2012**

**Int. Cl.: 10**

**TRADEMARK**

**PRINCIPAL REGISTER**

ACANDIS GMBH & CO. KG (FED REP GERMANY GMBH & CO. KG)  
KOLPINGSTRASSE 5  
76327 PFINZTAL  
FED REP GERMANY

FOR: SURGICAL AND MEDICAL APPARATUSES, DEVICES AND INSTRUMENTS, NAMELY, SURGICAL IMPLANTS MADE OF ARTIFICIAL MATERIALS, NAMELY, MEDICAL STENTS, SURGICAL IMPLANTS MADE OF ARTIFICIAL MATERIALS, NAMELY, GRAFTS, SURGICAL IMPLANTS MADE OF ARTIFICIAL MATERIALS, NAMELY, FLOW DIVERTERS, MEDICAL GUIDEWIRES AND MEDICAL FILTERS FOR USE IN THE RADIOLOGICAL, CARDIOLOGICAL AND NEUROLOGICAL FIELD, IN PARTICULAR FOR THE TREATMENT OF STROKES AND NEUROVASCULAR DISEASES; SURGICAL AND MEDICAL INSTRUMENTS, NAMELY, RETRIEVERS FOR USE IN THE RADIOLOGICAL, CARDIOLOGICAL AND NEUROLOGICAL FIELD, IN PARTICULAR FOR THE TREATMENT OF STROKES AND NEUROVASCULAR DISEASES; MEDICAL EMBOLIZATION DEVICES FOR THE TREATMENT OF STROKES AND NEUROVASCULAR DISEASES; MEDICAL APPLICATION SYSTEMS FOR SURGICAL AND MEDICAL APPARATUSES, DEVICES AND INSTRUMENTS INCLUDED IN THIS CLASS, IN PARTICULAR CATHETERS, IN CLASS 10 (U.S. CLS. 26, 39 AND 44).

THE MARK CONSISTS OF STANDARD CHARACTERS WITHOUT CLAIM TO ANY PARTICULAR FONT, STYLE, SIZE, OR COLOR.

OWNER OF INTERNATIONAL REGISTRATION 1074800 DATED 2-28-2011, EXPIRES 2-28-2021.

SER. NO. 79-096,531, FILED 2-28-2011.

NICHOLAS COLEMAN, EXAMINING ATTORNEY



*David J. Kybas*

Director of the United States Patent and Trademark Office

# United States of America

United States Patent and Trademark Office



**Reg. No. 4,133,685**

**Registered May 1, 2012**

**Int. Cls.: 12, 25 and 35**

**TRADEMARK**

**SERVICE MARK**

**PRINCIPAL REGISTER**

MORGAN MOTOR COMPANY LIMITED (UNITED KINGDOM LIMITED COMPANY)  
PICKERSLEIGH ROAD  
MALVERN LINK WORCESTERSHIRE WR14 2LL, UNITED KINGDOM

FOR: LAND VEHICLES; AUTOMOBILES; APPARATUS FOR LOCOMOTION BY LAND, NAMELY, CARS, MOTOR CARS, ELECTRIC CARS, MOTOR CARS WITH CONVERTIBLE TOPS, RACING CARS, SPORTS CARS, SCOOTERS, MOTOR CYCLES, BICYCLES; PEDAL-PROPELLED CARS; REPLACEMENT PARTS FOR ALL THE AFOREMENTIONED GOODS; SPECIFICALLY EXCLUDING RECREATIONAL VEHICLES (RV'S), IN CLASS 12 (U.S. CLS. 19, 21, 23, 31, 35 AND 44).

FOR: CLOTHING, NAMELY, T-SHIRTS, SWEATSHIRTS, FLEECE TOPS AND JACKETS, TIES, SCARVES, GLOVES, WATERPROOF COATS AND JACKETS, LEATHER JACKETS, KNITWEAR, SWEATERS; FOOTWEAR; HEADGEAR, NAMELY, BASEBALL CAPS, BEANIE HATS; ALL PRIMARILY SOLD THROUGH AUTOMOBILE DEALERSHIPS; SPECIFICALLY EXCLUDING WOMEN'S DRESSES, IN CLASS 25 (U.S. CLS. 22 AND 39).

FOR: BUSINESS ADVISORY SERVICES RELATING TO FRANCHISING OF A MOTOR DEALERSHIP; BUSINESS ADVISORY SERVICES RELATING TO THE ESTABLISHMENT OF MOTOR DEALERSHIPS; THE BRINGING TOGETHER, FOR THE BENEFIT OF OTHERS, A VARIETY OF MOTOR VEHICLES, ENABLING CUSTOMERS TO CONVENIENTLY VIEW AND PURCHASE THOSE GOODS; RETAIL STORE SERVICES FEATURING MOTOR VEHICLES; DEALERSHIP RETAIL STORE SERVICES, MAIL ORDER SERVICES, AND OPERATING ONLINE SHOPPING SITES ALL FEATURING MOTOR VEHICLES; ADVERTISING AND MARKETING SERVICES PROVIDED BY TELEVISION, OVER THE INTERNET OR VIA A DATABASE RELATING TO MOTOR VEHICLES AND ASSOCIATED ACCESSORIES; ORGANIZING, ARRANGING AND CONDUCTING COMPETITIONS, DEMONSTRATIONS, DISPLAYS, EVENTS, TRADE FAIRS, EXHIBITIONS, FESTIVALS AND PRESENTATIONS FOR ADVERTISING OR MARKETING PURPOSES; DISSEMINATION OR DISTRIBUTION OF ADVERTISING MATERIAL; SPECIFICALLY EXCLUDING SERVICES ASSOCIATED WITH RECREATIONAL VEHICLES (RV'S), IN CLASS 35 (U.S. CLS. 100, 101 AND 102).

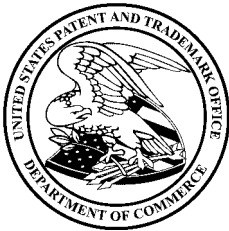

*David J. Kybas*

Director of the United States Patent and Trademark Office

THE MARK CONSISTS OF THE WORDING "MORGAN" IN WHITE, WITH TWO WHITE PISTONS ABOVE, AND A GRAY NUMBER "3" BELOW. THE PISTONS, WORDING, AND NUMBERS ARE SURROUNDED IN RED, AND THE RED AREA IS SURROUNDED IN WHITE. OUTSIDE THE WHITE OUTLINING IS GRAY SHADING ABOVE AND BLACK

**Reg. No. 4,133,685** SHADING BELOW. BEHIND THE RED AREA IS A BLACK CIRCLE WITH WHITE CIRCULAR GROOVES. A GRAY CIRCLE OUTLINES THE BLACK CIRCLE. THERE ARE GRAY WINGS TO EITHER SIDE OF THE CIRCLE, WITH WHITE HIGHLIGHTS IN THE MIDDLE AREA OF THE WINGS.

PRIORITY DATE OF 9-14-2010 IS CLAIMED.

OWNER OF INTERNATIONAL REGISTRATION 1074884 DATED 3-11-2011, EXPIRES 3-11-2021.

THE COLOR(S) RED, WHITE, BLACK AND GREY IS/ARE CLAIMED AS A FEATURE OF THE MARK.

SER. NO. 79-096,569, FILED 3-11-2011.

JASON BLAIR, EXAMINING ATTORNEY



# United States of America

United States Patent and Trademark Office

## Phoenix Testlab

**Reg. No. 4,133,686**

**Registered May 1, 2012**

**Int. Cls.: 41 and 42**

**SERVICE MARK**

**PRINCIPAL REGISTER**

PHOENIX TESTLAB GMBH (FED REP GERMANY LIMITED LIABILITY COMPANY)  
KÖNIGSWINKEL 10  
32825 BLOMBERG  
FED REP GERMANY

FOR: ARRANGING AND CONDUCTING OF SEMINARS, ARRANGING AND CONDUCTING OF WORKSHOPS, ALL IN PARTICULAR FOR THE PROVIDING OF TRAINING, INSTRUCTION, FURTHER TRAINING, AND ALL IN PARTICULAR IN THE FIELD OF TESTING, MEASURING, CONFORMITY ASSESSMENT, LICENSING AND APPROVAL PROCESSES, ACCREDITATION, CERTIFICATION, CONFORMITY ASSESSMENT, ACCREDITATION AND CONSULTANCY RELATING TO ELECTROMAGNETIC COMPATIBILITY, PROTOCOL TESTING, FIELD BUSES, ENVIRONMENTAL SIMULATION, ELECTRIC DEVICE SAFETY, RADIO DEVICES, TELECOMMUNICATIONS, IN CLASS 41 (U.S. CLS. 100, 101 AND 107).

FOR: ENGINEERING, CALIBRATION, SURVEYING, MATERIALS TESTING, ALL IN PARTICULAR, IN THE FIELDS OF TESTING, MEASURING, CONFORMITY ASSESSMENT, LICENSING AND APPROVAL PROCESSES, CERTIFICATION, CONFORMITY ASSESSMENT, ACCREDITATION AND CONSULTANCY, AND ALL RELATING TO ELECTROMAGNETIC COMPATIBILITY, PROTOCOL TESTING, FIELD BUSES, ENVIRONMENTAL SIMULATION, ELECTRIC DEVICE SAFETY, RADIO DEVICES, TELECOMMUNICATIONS, IN CLASS 42 (U.S. CLS. 100 AND 101).



THE MARK CONSISTS OF STANDARD CHARACTERS WITHOUT CLAIM TO ANY PARTICULAR FONT, STYLE, SIZE, OR COLOR.

PRIORITY DATE OF 8-26-2010 IS CLAIMED.

OWNER OF INTERNATIONAL REGISTRATION 1074917 DATED 2-25-2011, EXPIRES 2-25-2021.

NO CLAIM IS MADE TO THE EXCLUSIVE RIGHT TO USE "TEST LAB", APART FROM THE MARK AS SHOWN.

SER. NO. 79-096,583, FILED 2-25-2011.

MARGARET POWER, EXAMINING ATTORNEY

*David J. Kyffers*

Director of the United States Patent and Trademark Office

# United States of America

United States Patent and Trademark Office

# ANDOPLAST

**Reg. No. 4,133,687**

**Registered May 1, 2012**

**Int. Cls.: 1 and 2**

ÖZ ANADOLU KIMYA SANAYI VE TICARET LIMITED SIRKETI (TURKEY LIMITED LIABILITY COMPANY)  
MAHMUTBEY MERKEZ MAH.  
KARAOGLANOGLU CAD.,; SERVET SOK. NO: 8;BAGCILAR ISTANBUL  
TURKEY

**TRADEMARK**

**PRINCIPAL REGISTER**

FOR: INDUSTRIAL CHEMICALS, NAMELY, CHEMICALS FOR USE IN TEXTILE MANUFACTURING, AND TANNING EXCLUDING PAINTS, UNPROCESSED SYNTHETIC MATERIALS, NAMELY, UNPROCESSED SYNTHETIC RESINS; UNPROCESSED PLASTICS, UNPROCESSED ARTIFICIAL RESINS, OIL-SEPARATING CHEMICALS, NAMELY, OIL RECLAMATION FLUID FOR THE SEPARATION OF CRUDE OIL FROM SOIL AND WATER AND OIL DISPERSANTS, DISTILLED WATER, INDUSTRIAL GASES, NAMELY, SULPHUROUS ACID GAS AND CARBONIC ACID GAS, SUBSTANCES FOR PRESERVING AND MAINTAINING FRESH FOODSTUFFS, NAMELY, FOOD PRESERVING CHEMICALS, SALTS FOR INDUSTRIAL PURPOSES, NAMELY, SALTS FOR GALVANIC CELLS; CHEMICAL PREPARATIONS FOR SCIENTIFIC PURPOSES, NAMELY, DIAGNOSTIC PREPARATIONS FOR SCIENTIFIC USE, TEST PAPERS, NAMELY, CHEMICAL TEST PAPER, RADIOACTIVE ELEMENTS FOR SCIENTIFIC PURPOSES, NAMELY, RADIATION CURABLE UNPROCESSED SYNTHETIC RESINS AND FUEL FOR NUCLEAR REACTORS, REAGENTS, NAMELY, DIAGNOSTIC REAGENTS FOR SCIENTIFIC OR RESEARCH USE; CHEMICAL PREPARATIONS FOR USE IN PHOTOGRAPHY, NAMELY, CHEMICAL PREPARATIONS FOR THE TREATMENT OF PHOTOSENSITIVE PAPERS, PHOTOSENSITIVE FOILS, AND SENSITIZED PHOTOGRAPHIC FILMS; UNEXPOSED CINEMATOGRAPHIC AND PHOTOGRAPHIC FILMS, UNEXPOSED ROENTGEN FILMS, NAMELY, UNEXPOSED X-RAY FILM, CHEMICAL PREPARATIONS USED IN X-RAY AND PHOTOGRAPHIC FILM PROCESSING; CHEMICALS FOR USE IN AGRICULTURE, HORTICULTURE, AND FORESTRY, NAMELY, CHEMICAL PREPARATIONS FOR THE TREATMENT OF FERTILIZERS, SEAWEED-BASED FERTILIZERS, HUMUS, CULTURE SOIL, SOIL-CONDITIONING CHEMICALS, PLANT GROWTH REGULATING PREPARATIONS, GRAFTING MASTIC FOR TREES AND TREE CAVITY FILLERS, FERTILIZING PEAT, CHEMICAL PREPARATIONS TO PREVENT MILDEW AND FUNGUS; FIRE EXTINGUISHING COMPOSITIONS, AGGLUTINANTS FOR CONCRETE AND CEMENT, WATERPROOFING CHEMICAL COMPOSITIONS; ADHESIVES FOR WALL TILES, GLUES FOR USE IN PAINT INDUSTRY OTHER THAN FOR STATIONERY OR HOUSEHOLD PURPOSES; CHEMICAL ADDITIVES FOR MOTOR FUEL, ENGINE DECARBONISING CHEMICALS, BRAKE FLUIDS, ANTIFREEZE, ENGINE PROTECTING ARTIFICIAL PREPARATIONS, NAMELY, CHEMICAL ADDITIVES FOR USE WITH INTERNAL COMBUSTION ENGINE FUELS, COOLANTS FOR VEHICLE ENGINES AND ANTI-



*David J. Kypas*

Director of the United States Patent and Trademark Office

**Reg. No. 4,133,687** FREEZE; CHEMICAL PREPARATIONS IN THE NATURE OF FILTERING MATERIALS IN PAINT INDUSTRY; PREPARATIONS FOR LIME, NAMELY, AGRICULTURAL LIME, CHEMICAL PREPARATIONS IN THE NATURE OF LIME-REMOVING PREPARATIONS, CHEMICAL PREPARATIONS, NAMELY, DEGREASING AND CLEANING SOLVENTS FOR USE CLEANING CHIMNEYS; DRILLING MUDS FOR USE IN OIL WELL DRILLING MACHINES; GLAZIERS' PUTTY, IN CLASS 1 (U.S. CLS. 1, 5, 6, 10, 26 AND 46).

FOR: PAINTS, VARNISHES, LACQUERS; ANTI-CORROSIVE PREPARATIONS, NAMELY, ANTI-CORROSIVE COATINGS, WOOD PROTECTING AGENTS, NAMELY, WOOD PRESERVATIVES, BINDING AGENTS AND THINNING AGENTS, NAMELY, PAINT THINNERS FOR PAINTS, PIGMENTS FOR PAINTS, METAL PROTECTING AGENTS, NAMELY, ANTI-TARNISHING PREPARATIONS FOR COATING METALS, SHOE DYES, NAMELY, STAINING AGENTS AND SYNTHETIC DYES FOR USE IN DYEING SHOES, PRINTING COMPOSITIONS, NAMELY, INK, TONERS FOR PHOTOCOPIERS; COLORANTS, NAMELY, SUBSTANCES FOR DYEING FOOD PRODUCTS, PHARMACEUTICAL SUBSTANCES, AND BEVERAGES; LINSEED OIL-BASED VARNISHES; METAL FOIL FOR PAINTERS, METALS IN POWDER FORM FOR PAINTERS, DECORATORS, PRINTERS AND ARTISTS; PAINTERS' PUTTY, NAMELY, PAINT SEALERS, AND AGGLUTINANTS FOR PAINTS AND FOR PUTTY, IN CLASS 2 (U.S. CLS. 6, 11 AND 16).

THE MARK CONSISTS OF THE TERM "ANDOPLAST" IN A STYLIZED FONT.

OWNER OF INTERNATIONAL REGISTRATION 1074996 DATED 10-11-2010, EXPIRES 10-11-2020.

SER. NO. 79-096,620, FILED 10-11-2010.

COLLEEN KEARNEY, EXAMINING ATTORNEY

# United States of America

United States Patent and Trademark Office

## CONTRÁ D'ALFAEDO

**Reg. No. 4,133,688**

**Registered May 1, 2012**

**Int. Cl.: 33**

**TRADEMARK**

**PRINCIPAL REGISTER**

BENEDETTI SOC. AGR. CORTE ANTICA DI GIUSEPPE, DAVIDE E SIMONE S.N.C. (ITALY UNLIMITED PARTNERSHIP)  
VIA CASE SPARSE PRUNEA DI SOTTO, 5  
SANT'AMBROGIO DI VALPOLICELLA FRAZ.  
GARGAGNAGO (VR), ITALY I37020

FOR: WINES, IN CLASS 33 (U.S. CLS. 47 AND 49).

THE MARK CONSISTS OF STANDARD CHARACTERS WITHOUT CLAIM TO ANY PARTICULAR FONT, STYLE, SIZE, OR COLOR.

OWNER OF INTERNATIONAL REGISTRATION 1075080 DATED 3-1-2011, EXPIRES 3-1-2021.

THE WORDING "CONTRA D'ALFAEDO" HAS NO MEANING IN A FOREIGN LANGUAGE.

SER. NO. 79-096,650, FILED 3-1-2011.

CARYN GLASSER, EXAMINING ATTORNEY



*David J. Kybas*

Director of the United States Patent and Trademark Office

# United States of America

United States Patent and Trademark Office



**Reg. No. 4,133,689**

**Registered May 1, 2012**

**Int. Cls.: 9 and 41**

**TRADEMARK**

**SERVICE MARK**

**PRINCIPAL REGISTER**

ALTERNATIVE SHIFT (FRANCE SOCIÉTÉ PAR ACTIONS SIMPLIFIÉE)  
CNRS -  
1919 ROUTE DE MENDE  
F-34090 MONTPELLIER, FRANCE

FOR: DOWNLOADABLE VIDEO GAMES VIA THE INTERNET AND WIRELESS DEVICES, FOR USE IN SINGLE OR MULTIPLE PLAYER MODE AND PROVIDED OVER PLATFORMS CONNECTED VIA WEB BROWSERS, MOBILE TELEPHONES AND OTHER CONNECTED CONSOLES, IN CLASS 9 (U.S. CLS. 21, 23, 26, 36 AND 38).

FOR: ENTERTAINMENT SERVICES, NAMELY, PROVIDING ONLINE VIDEO GAMES AND ELECTRONIC GAMES FROM A COMPUTER NETWORK, VIDEO GAME RENTAL, PROVIDING INFORMATION IN THE FIELD OF ENTERTAINMENT AND LEISURE ACTIVITIES, ORGANIZATION OF VIDEO GAMES COMPETITIONS, ONLINE PUBLICATION OF ELECTRONIC BOOKS AND JOURNALS, MULTIMEDIA PUBLISHING OF GAMES AND ELECTRONIC PUBLICATIONS, IN CLASS 41 (U.S. CLS. 100, 101 AND 107).

THE MARK CONSISTS OF THE DESIGN OF A RECTANGLE AND A CIRCLE INTERSECTED WHERE THE BACKGROUND IS REPRESENTED BY A CIRCUIT BOARD APPEARING IN THE COLORS LIGHT GRAY, DARK GRAY AND BLACK. THE TERM "BESYDE" APPEARS INSIDE THE RECTANGLE WHERE, FROM TOP TO BOTTOM, THE TERM APPEARS IN THE COLORS GREEN, LIGHT GREEN AND YELLOW. FEATURED INSIDE THE MIDDLE PORTION OF THE RECTANGLE IS THE DESIGN OF A CIRCLE FORMED BY THE DESIGN OF CONCENTRIC SEMI-CIRCLE AND A LEAF-BRANCH DESIGN APPEARING IN THE COLORS, FROM BOTTOM TO TOP, GREEN, DARK GREEN AND BLACK. APPEARING AT THE BOTTOM OF THE CIRCLE IS A SEMI-CIRCLE BISECTED BY A BAND APPEARING IN THE COLORS YELLOW AND WHITE.

PRIORITY DATE OF 7-7-2010 IS CLAIMED.

OWNER OF INTERNATIONAL REGISTRATION 1075100 DATED 1-5-2011, EXPIRES 1-5-2021.

THE COLOR(S) DARK GREEN, GREEN, LIGHT GREEN, YELLOW, DARK GRAY, LIGHT GRAY, WHITE AND BLACK IS/ARE CLAIMED AS A FEATURE OF THE MARK.

THE WORDING "BESYDE" HAS NO MEANING IN A FOREIGN LANGUAGE.



*David J. Kappas*

Director of the United States Patent and Trademark Office

**Reg. No. 4,133,689** SER. NO. 79-096,657, FILED 1-5-2011.

CHARISMA HAMPTON, EXAMINING ATTORNEY

# United States of America

United States Patent and Trademark Office

# PDR24

**Reg. No. 4,133,690**

**Registered May 1, 2012**

**Int. Cls.: 35, 37 and 38**

**SERVICE MARK**

**PRINCIPAL REGISTER**

SIRA CONSULTING AG (SWITZERLAND SOCIÉTÉ ANONYME)  
WÜLFINGERSTRASSE 296  
CH-8408 WINTERTHUR  
SWITZERLAND

FOR: ADVERTISING; BUSINESS MANAGEMENT; BUSINESS ADMINISTRATION ASSISTANCE; PROVIDING OFFICE FUNCTIONS; BROKERING OF COMMERCIAL AND ECONOMIC CONTACTS FOR THIRD PARTIES OVER THE INTERNET; BROKERING OF BUSINESS CONTACTS FOR THIRD PARTIES; COMMERCIAL INFORMATION AGENCIES, IN CLASS 35 (U.S. CLS. 100, 101 AND 102).

FOR: VEHICLE REPAIRS, PARTICULARLY BODY REPAIRS; MAINTENANCE AND CLEANING OF VEHICLES; MAINTENANCE WORK ON VEHICLES; RESTORATION OF VEHICLES, IN CLASS 37 (U.S. CLS. 100, 103 AND 106).

FOR: PROVIDING MULTIPLE-USER ACCESS TO A GLOBAL COMPUTER NETWORK; SERVICES OF INTERNET PLATFORMS AND DATA BANKS, NAMELY, DATA BANKS RELATED TO DENT REPAIR; PROVIDING AN ON-LINE FORUM FOR CONSUMERS OF ELECTRONIC PUBLICATIONS, IN CLASS 38 (U.S. CLS. 100, 101 AND 104).

THE MARK CONSISTS OF STANDARD CHARACTERS WITHOUT CLAIM TO ANY PARTICULAR FONT, STYLE, SIZE, OR COLOR.

PRIORITY DATE OF 2-21-2011 IS CLAIMED.

OWNER OF INTERNATIONAL REGISTRATION 1075154 DATED 4-1-2011, EXPIRES 4-1-2021.

SER. NO. 79-096,682, FILED 4-1-2011.

RON FAIRBANKS, EXAMINING ATTORNEY



*David J. Kyffers*

Director of the United States Patent and Trademark Office

# United States of America

United States Patent and Trademark Office

## GUDRUN SJÖDÉN

**Reg. No. 4,133,691**

**Registered May 1, 2012**

**Int. Cls.: 24, 25 and 27**

**TRADEMARK**

**PRINCIPAL REGISTER**

GUDRUN SJÖDÉN DESIGN AB (SWEDEN CORPORATION)  
BOX 47633  
SE-117 94 STOCKHOLM  
SWEDEN

FOR: TEXTILES AND TEXTILE GOODS, NAMELY, CURTAINS, TEXTILE WALL HANGINGS, HAND TOWELS, WASH CLOTHS, BED LINEN, TABLE CLOTHS, IN CLASS 24 (U.S. CLS. 42 AND 50).

FOR: CLOTHING, NAMELY, SKIRTS, DRESSES, TROUSERS, JACKETS, BLOUSES, TUNICS, VESTS, CARDIGANS, SWEATERS, T-SHIRTS, TOPS, SOCKS, GLOVES, HATS, BATHING COSTUMES AND BIKINIS, BELTS; FOOTWEAR, IN CLASS 25 (U.S. CLS. 22 AND 39).

FOR: CARPETS, RUGS, DOOR AND FLOOR MATS, NON-TEXTILE WALL HANGINGS, IN CLASS 27 (U.S. CLS. 19, 20, 37, 42 AND 50).

THE MARK CONSISTS OF STANDARD CHARACTERS WITHOUT CLAIM TO ANY PARTICULAR FONT, STYLE, SIZE, OR COLOR.

OWNER OF INTERNATIONAL REGISTRATION 1075257 DATED 3-29-2011, EXPIRES 3-29-2021.

OWNER OF U.S. REG. NO. 3,142,360.

THE NAME "GUDRUN SJÖDÉN" IDENTIFIES A LIVING INDIVIDUAL WHOSE CONSENT IS OF RECORD.

SER. NO. 79-096,720, FILED 3-29-2011.

SUSAN RICHARDS, EXAMINING ATTORNEY



*David J. Kybas*

Director of the United States Patent and Trademark Office



# United States of America

United States Patent and Trademark Office

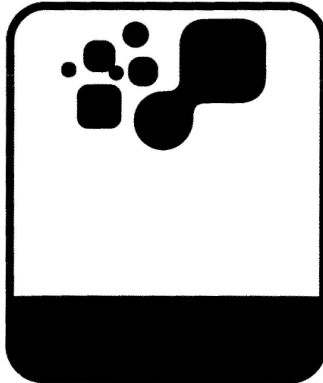

**Reg. No. 4,133,692**

**Registered May 1, 2012**

**Int. Cls.: 17 and 19**

**TRADEMARK**

**PRINCIPAL REGISTER**

PAREXLANKO (FRANCE SOCIÉTÉ ANONYME)  
19 PLACE DE LA RÉSISTANCE  
F-92440 ISSY LES MOULINEAUX  
FRANCE

FOR: COMPOSITIONS AND PREPARATIONS FOR INSULATION AGAINST MOISTURE IN BUILDINGS, NAMELY, READY-MADE WALL SCREEDS IN THE FORM OF POWDER FOR INSULATION AGAINST MOISTURE IN BUILDINGS; INSULATING MORTARS AND COATINGS, NAMELY, INSULATING PLASTERS FOR SEALING, FINISHING, PROOFING AND RENDERING SURFACES, IN CLASS 17 (U.S. CLS. 1, 5, 12, 13, 35 AND 50).

FOR: BUILDING MATERIALS, NOT OF METAL, NAMELY, CEMENT BASED POWDER FOR THE CONSTRUCTION OF BUILDINGS; NON-METAL CONSTRUCTION MATERIALS, NAMELY, SEALING, FINISHING AND RENDERING PLASTERS FOR WALLS AND FLOORS; MORTARS, CONCRETES, CEMENTS ALL IN THE FORM OF READY MADE POWDER; MORTARS AND COATINGS FOR PATCHING, NAMELY, CEMENT BASED POWDER FOR PATCHING, IN CLASS 19 (U.S. CLS. 1, 12, 33 AND 50).

THE MARK CONSISTS OF A RECTANGLE SHADED AT THE BOTTOM WITH THREE SHADED CIRCLES ON TOP AND ONE SHADED SQUARE AND TWO ADDITIONAL SHADED CIRCLES, BOTH CONNECTED TO A SHADED SQUARE.

PRIORITY DATE OF 2-11-2011 IS CLAIMED.

OWNER OF INTERNATIONAL REGISTRATION 1075311 DATED 3-31-2011, EXPIRES 3-31-2021.

SER. NO. 79-096,753, FILED 3-31-2011.

MELISSA VALLILLO, EXAMINING ATTORNEY



*David J. Kybas*

Director of the United States Patent and Trademark Office

# United States of America

United States Patent and Trademark Office



**Reg. No. 4,133,693**

**Registered May 1, 2012**

**Int. Cl.: 33**

MANFREDI ALDO & C. - AZIENDA VITIVINICOLA CANTINE CASTELVECCHIO - PATRIZI  
- CANTINA TORRALTA - AZIENDA AGRICOLA BRICCO ROSSO - GI-EMME - S.A.S.  
(SIGLABILE MANFREDI ALDO & C. S.A.S.) (ITALY LIMITED PARTNERSHIP)  
VIA TORINO, 15  
I-12060 FARIGLIANO (CN)  
ITALY

**TRADEMARK**

FOR: WINES , IN CLASS 33 (U.S. CLS. 47 AND 49).

**PRINCIPAL REGISTER**

THE MARK CONSISTS OF THE DESIGN OF A VILLAGE WITHIN A CIRCLE WITH A BANNER ABOVE THE VILLAGE CONSISTING OF THE WORDING ANNO DOMINI. ABOVE THE CIRCLE IS A LARGER BANNER THAT IS CURVED AROUND THE CIRCLE DESIGN CONSISTING OF THE WORDING "CASTELVECCHIO". ABOVE THE LARGER BANNER ARE GRAPES AND VINES, ALL WITHIN A RECTANGULAR CARRIER THAT IS OPEN AT THE BOTTOM.

OWNER OF INTERNATIONAL REGISTRATION 1075517 DATED 3-23-2011, EXPIRES 3-23-2021.

THE ENGLISH TRANSLATION OF "CASTELVECCHIO" IN THE MARK IS "OLD CASTLE."

SER. NO. 79-096,810, FILED 3-23-2011.

DAVID HOFFMAN, EXAMINING ATTORNEY



*David J. Kybas*

Director of the United States Patent and Trademark Office

# United States of America

United States Patent and Trademark Office

# CAPILARIK

**Reg. No. 4,133,694**

**Registered May 1, 2012**

**Int. Cls.: 3, 5, 29, 30 and  
32**

OTKRYTOE AKTSIONERNOE OBSHCHESTVO ZAVOD EKOLOGICHESKOY TEKHNIKI  
I EKOPITANIYA "DIOD" (RUSSIAN FED. JOINT STOCK COMPANY)  
UL. DERBENEVSKAYA, D. 11A  
RU-115114 MOSCOW  
RUSSIAN FED.

**TRADEMARK**

**PRINCIPAL REGISTER**



*David J. Kyros*

Director of the United States Patent and Trademark Office

FOR: BLEACHING PREPARATIONS AND OTHER SUBSTANCES FOR LAUNDRY USE, NAMELY, LAUNDRY DETERGENT, LAUNDRY BLEACH; CLEANING, POLISHING, SCOURING AND ABRASIVE PREPARATIONS; SOAPS; PERFUMERY, ESSENTIAL OILS, COSMETICS, HAIR LOTIONS; DENTIFRICES; ABRASIVES, NAMELY, SKIN ABRASIVE PREPARATIONS, FLEXIBLE ABRASIVES; AMBER, NAMELY, PERFUME; SCALE REMOVING PREPARATIONS FOR HOUSEHOLD PURPOSES; ANTISTATIC PREPARATIONS FOR HOUSEHOLD PURPOSES; BREATH FRESHENING SPRAYS; CANNED PRESSURIZED AIR FOR CLEANING AND DUSTING PURPOSES; SHAVING STONES, ANTISEPTIC; POLISHING STONES; ABRASIVE PAPER; EMERY PAPER; POLISHING PAPER; PETROLEUM JELLY FOR COSMETIC PURPOSES; COTTON WOOL FOR COSMETIC PURPOSES; COTTON STICKS FOR COSMETIC PURPOSES; AROMATICS, NAMELY, ESSENTIAL OILS; ESSENTIAL OILS FOR FLAVORING CAKES; ESSENTIAL OILS FOR BEVERAGES; SACHETS FOR PERFUMING LINEN; SCENTED LINEN WATER; JAVELLE WATER, NAMELY, BLEACHING PREPARATIONS FOR HOUSEHOLD USE; LAVENDER WATER; TOILET WATER; LAUNDRY WAX; FLOOR WAX, PARQUET FLOOR WAX; NON-SLIPPING WAX FOR FLOORS; MOUSTACHE WAX; TAILORS' WAX; POLISH FOR FURNITURE AND FLOORING; SHOE WAX; HELIOTROPINE, NAMELY, OILS FOR PERFUMES AND SCENTS; DENTAL BLEACHING GELS; GERANIOL AS PERFUMERY; MAKE-UP; DEODORANTS FOR PERSONAL USE; SCENTED WOOD; PERFUMES; NON-SLIPPING LIQUIDS FOR FLOORS; WINDSCREEN CLEANING LIQUIDS; GREASES FOR COSMETIC PURPOSES; VOLCANIC ASH FOR CLEANING; DECORATIVE TRANSFERS FOR COSMETIC PURPOSES; IONONE AS PERFUMERY; SMOOTHING STONES; EYEBROW PENCILS; COSMETIC PENCILS; SILICON CARBIDE AS GENERAL PURPOSE ABRASIVE CLEANING PREPARATION; CARBIDES OF METAL AS GENERAL PURPOSE ABRASIVE CLEANING PREPARATION; ALUM STONES AS ANTISEPTICS; TRIPOLI STONE FOR POLISHING; ADHESIVES FOR AFFIXING FALSE EYELASHES; ADHESIVES FOR AFFIXING FALSE HAIR; CLEANING PREPARATIONS, NAMELY, QUILLAIA BARK FOR WASHING; CORUNDUM AS GENERAL PURPOSE ABRASIVE CLEANING PREPARATION; BLUEING FOR LAUNDRY; BEARD DYES; COLORANTS FOR TOILET PURPOSE, NAMELY, FOR HAIR; COSMETIC DYES FOR HAIR; LAUNDRY STARCH; COSMETIC CREAMS; SKIN WHITENING CREAMS; CREAMS FOR LEATHER, WAXES FOR LEATHER; JEWELLERS' ROUGE, POLISHING

**Reg. No. 4,133,694** ROUGE; INCENSE; HAIR SPRAY; NAIL POLISH, NAIL VARNISH; AFTER-SHAVE LOTIONS; HAIR LOTIONS; LOTIONS FOR COSMETIC PURPOSES; BEAUTY MASKS; OILS FOR PERFUMES AND SCENTS; OILS FOR COSMETIC PURPOSES; OILS FOR TOILET PURPOSES; ESSENTIAL OILS; ESSENTIAL OILS OF CEDARWOOD; ESSENTIAL OILS OF CITRON; OILS FOR CLEANING PURPOSES; BERGAMOT OIL; GAULTHERIA OIL AS ESSENTIAL OILS; JASMINE OIL AS ESSENTIAL OILS; LAVENDER OIL; ALMOND OIL AS ESSENTIAL OILS; ROSE OIL AS ESSENTIAL OILS; OIL OF TURPENTINE FOR DEGREASING; ADHESIVES FOR COSMETIC PURPOSES; WHITING, NAMELY, LAUNDRY BLEACH; CLEANING CHALK FOR COSMETIC USE; ALMOND MILK FOR COSMETIC PURPOSES; CLEANSING MILK FOR TOILET PURPOSES; MUSK AS PERFUMERY; DISINFECTANT SOAP; DEODORANT SOAP; SHAVING SOAP; SOAP FOR BRIGHTENING TEXTILE; CAKES OF TOILET SOAP; MEDICATED SOAP; ANTIPERSPIRANT SOAP; SOAP FOR FOOT PERSPIRATION; ALMOND SOAP; MINT FOR PERFUMERY; COSMETIC KITS COMPRISED OF COSMETICS AND PERFUMERY; EMERY BOARDS; EMERY CLOTH; EMERY PAPER; FALSE NAILS; EAU DE COLOGNE; BASES FOR FLOWER PERFUMES NAMELY, OILS FOR PERFUMES; JOSS STICKS; POLISHING CREAMS, POLISHING WAX; PASTES FOR RAZOR STROPS, NAMELY, SHAVING CREAM; PUMICE STONE FOR PERSONAL USE; HYDROGEN PEROXIDE FOR COSMETIC PURPOSES; ABRASIVE CLOTH, EMERY CLOTH; GLASS CLOTH; LIPSTICKS; POMADES FOR COSMETIC PURPOSES; SHAVING PREPARATIONS; COSMETIC PREPARATIONS FOR BATHS; NON-MEDICATED TOILETRIES; HAIR WAVING PREPARATIONS; LAUNDRY SOAKING PREPARATIONS, NAMELY, LAUNDRY PRE-SOAK; GRINDING PREPARATIONS, NAMELY, ABRASIVE ROLLS, ABRASIVE SHEETS, ABRASIVE STRIPS; SMOOTHING PREPARATIONS, NAMELY, LAUNDRY STARCH; LEATHER BLEACHING PREPARATIONS; DENTURE POLISHES; FURBISHING PREPARATIONS, NAMELY, FURNITURE POLISH, LEATHER POLISH; POLISHING PREPARATIONS; MOUTH WASHES, NOT FOR MEDICAL PURPOSES; COSMETIC PREPARATIONS FOR SLIMMING PURPOSES; LAUNDRY GLAZE; FABRIC SOFTENERS FOR LAUNDRY USE; BLEACHING PREPARATIONS FOR LAUNDRY USE; DRY-CLEANING PREPARATIONS, NAMELY, DRY-CLEANING FLUIDS; MAKE-UP REMOVING PREPARATIONS; COLOR-REMOVING PREPARATIONS, NAMELY, NAIL POLISH REMOVER; LACQUER-REMOVING PREPARATIONS, NAMELY, PAINT REMOVER; NAIL LACQUER REMOVER; SCOURING PREPARATION, NAMELY, FLOOR WAX REMOVERS; RUST REMOVING PREPARATIONS; NAIL CARE PREPARATIONS; PREPARATIONS FOR CLEANING DENTURES; WALLPAPER CLEANING PREPARATIONS; PREPARATIONS FOR CLEANING WASTE PIPES; COLOR-BRIGHTENING CHEMICALS FOR HOUSEHOLD LAUNDRY PURPOSES; MAKE-UP POWDER; DIAMANTINE AS A GENERAL PURPOSE CLEANING ABRASIVE PREPARATION; SCOURING SOLUTIONS; FALSE EYELASHES; TISSUES IMPREGNATED WITH COSMETIC LOTIONS; ESSENTIAL OILS, NAMELY, SAFROL; POTPOURRI; BLEACHING SODA; WASHING SODA, FOR CLEANING; BATH SALTS, NOT FOR MEDICAL PURPOSES; BLEACHING SALTS; LEATHER PRESERVATIVES, NAMELY, LEATHER POLISHES; FUMIGATION PREPARATIONS, NAMELY, PERFUMES; VOLATILE ALKALI, NAMELY, AMMONIA DETERGENT FOR CLEANING PURPOSES; ASTRINGENTS FOR COSMETIC PURPOSES; EYEBROW COSMETICS; STAIN REMOVERS; MAKE-UP PREPARATIONS; COSMETIC SUNSCREEN PREPARATIONS; HAIR COLORANTS; NEUTRALIZERS FOR PERMANENT WAVING; PREPARATIONS TO MAKE SHINY THE LEAVES OF PLANTS; COSMETIC PREPARATIONS FOR EYELASHES; DEPILATORIES; COSMETIC PREPARATIONS FOR SKIN CARE; BOOT CREAM, BOOT POLISH, SHOE CREAM, SHOE POLISH; COSMETICS FOR ANIMALS; MASCARA; DETERGENTS OTHER THAN FOR USE IN MANUFACTURING OPERATIONS AND FOR MEDICAL PURPOSES, NAMELY, DETERGENTS FOR HOUSEHOLD USE AND AUTOMOBILES; BLEACHING PREPARATIONS, NAMELY, DECOLORANTS FOR COSMETIC PURPOSES; ANTIPERSPIRANTS AS TOILETRIES; TALCUM POWDER, FOR TOILET USE; ESSENTIAL OILS, NAMELY, TERPENES; CLOTHS IMPREGNATED WITH A DETERGENT FOR CLEANING; SHAMPOOS; SHAMPOOS FOR PETS; GLASS PAPER IN THE NATURE OF ABRASIVE PAPER; SODA LYE IN THE NATURE OF HOUSEHOLD CLEANING PREPARATIONS; EXTRACTS OF FLOWERS AS PERFUMES; ETHEREAL ESSENCES AS PERFUMES; BADIAN ESSENCE AS PERFUMES; MINT ESSENCE AS ESSENTIAL OIL, IN CLASS 3 (U.S. CLS. 1, 4, 6, 50, 51 AND 52).

**Reg. No. 4,133,694** FOR: PHARMACEUTICAL PREPARATIONS, NAMELY, ANTIOXIDANTS, MICROCIRCULATION IMPROVING PREPARATIONS, PREPARATIONS FOR CHILD'S ORGANISM DISBALANCES PROPHYLAXIA; SANITARY PREPARATIONS FOR MEDICAL PURPOSES; DIETETIC SUBSTANCES ADAPTED FOR MEDICAL USE, NAMELY, DIETETIC BEVERAGES AND FOODS; FOOD FOR BABIES; MEDICAL PLASTERS, MATERIALS FOR MEDICAL DRESSINGS, NAMELY, GAUZE; MATERIAL FOR STOPPING TEETH, DENTAL WAX; ALL PURPOSE DISINFECTANTS; PREPARATIONS FOR DESTROYING VERMIN; FUNGICIDES, HERBICIDES; ACARICIDES FOR AGRICULTURAL, COMMERCIAL AND DOMESTIC USE; ACONITINE FOR AGRICULTURAL, COMMERCIAL AND DOMESTIC USE; ALKALOIDS FOR MEDICAL PURPOSES; ALGICIDES; ALDEHYDES FOR PHARMACEUTICAL PURPOSES; DENTAL AMALGAMS OF GOLD; DENTAL AMALGAMS; AMINO ACIDS FOR VETERINARY PURPOSES; AMINO ACIDS FOR MEDICAL PURPOSES; ANTIBIOTICS; ALUMINIUM ACETATE FOR PHARMACEUTICAL PURPOSES; ACETATES FOR PHARMACEUTICAL PURPOSES; GERMICIDES; BALMS FOR MEDICAL PURPOSES; HYGIENIC BANDAGES FOR DRESSINGS AND SKIN WOUNDS; BANDAGES FOR DRESSINGS; BIOCIDES; MAGNETIC BRACELETS FOR MEDICAL PURPOSES; MAGNETIC ANTI-RHEUMATISM BRACELETS FOR MEDICAL PURPOSES; BROMINE FOR PHARMACEUTICAL PURPOSES; PAPER FOR MEDICAL MUSTARD PLASTERS; FLY CATCHING PAPER; MOTHPROOFING PAPER; PETROLEUM JELLY FOR MEDICAL PURPOSES; OXYGEN BATHS FOR MEDICAL PURPOSES; ANTISEPTIC COTTON; ABSORBENT COTTON FOR MEDICAL PURPOSES; ABSORBENT WADDING FOR MEDICAL PURPOSES; COTTON FOR MEDICAL PURPOSES, COTTON WADDING FOR MEDICAL PURPOSES; RADIOLOGICAL CONTRAST SUBSTANCES FOR MEDICAL PURPOSES; NUTRITIVE SUBSTANCES FOR MICROORGANISMS FOR MEDICAL PURPOSES; RADIOACTIVE SUBSTANCES FOR MEDICAL PURPOSES; BISMUTH SUBNITRATE FOR PHARMACEUTICAL PURPOSES; MELISSA WATER FOR PHARMACEUTICAL PURPOSES; SEA WATER FOR MEDICINAL BATHING; MINERAL WATER FOR MEDICAL PURPOSES; THERMAL WATER FOR MEDICAL PURPOSES; EDIBLE PLANT FIBER AS A DIETARY SUPPLEMENT, NON-NUTRITIVE; MOLDING WAX FOR DENTISTS; GASES FOR MEDICAL PURPOSES; GUAIACOL FOR PHARMACEUTICAL PURPOSES; HAEMATOGEN; HAEMOGLOBIN; HYDRASTINE; HYDRASTININE; GLYCERINE FOR MEDICAL PURPOSES; GLYCEROPHOSPHATES FOR MEDICAL PURPOSES; HORMONES FOR MEDICAL PURPOSES; MUSTARD FOR PHARMACEUTICAL PURPOSES; MUSTARD PLASTERS FOR MEDICAL PURPOSES; MUD FOR BATHS FOR MEDICAL PURPOSES; MEDICINAL MUD; GAMBOGE FOR MEDICAL PURPOSES; GURJUN BALSAM FOR MEDICAL PURPOSES; DEODORANTS, OTHER THAN FOR PERSONAL USE, NAMELY, FOR HOUSEHOLD PURPOSES; DEODORANTS FOR CLOTHING AND TEXTILES; DIASTASE FOR MEDICAL PURPOSES; DIGITALIN FOR MEDICAL PURPOSES; ADDITIVES TO FODDER FOR MEDICAL PURPOSES; MINERAL FOOD-SUPPLEMENTS; NUTRITIONAL ADDITIVES FOR MEDICAL PURPOSES; YEAST FOR PHARMACEUTICAL PURPOSES; GELATIN FOR MEDICAL PURPOSES; COD LIVER OIL; ISOTOPES FOR MEDICAL PURPOSES; INSECTICIDES; IODINE FOR PHARMACEUTICAL PURPOSES; IODIDES FOR PHARMACEUTICAL PURPOSES; ALKALINE IODIDES FOR PHARMACEUTICAL PURPOSES; IODOFORM FOR MEDICAL PURPOSES; CALOMEL FOR MEDICAL PURPOSES; CREAM OF TARTAR FOR PHARMACEUTICAL PURPOSES; TARTAR FOR PHARMACEUTICAL PURPOSES; CAMPHOR FOR MEDICAL PURPOSES; CAPSULES SOLD EMPTY FOR MEDICINES; CACHETS FOR PHARMACEUTICAL PURPOSES; CANDY FOR MEDICAL PURPOSES; LOZENGES FOR PHARMACEUTICAL PURPOSES; PASTILLES FOR PHARMACEUTICAL PURPOSES; HAEMOSTATIC PENCILS FOR MEDICAL PURPOSES; WART PENCILS FOR MEDICAL PURPOSES; CAUSTIC PENCILS FOR MEDICAL PURPOSES; CARBOLINEUM AS A PARASITICIDE; CAUSTICS FOR PHARMACEUTICAL PURPOSES; CACHOU FOR PHARMACEUTICAL PURPOSES; QUEBRACHO FOR MEDICAL PURPOSES; OXYGEN FOR MEDICAL PURPOSES; GALLIC ACID FOR PHARMACEUTICAL PURPOSES; ACIDS FOR PHARMACEUTICAL PURPOSES, NAMELY, AMINO ACIDS; ADHESIVES FOR DENTURES; ADHESIVE BANDS FOR MEDICAL PURPOSES, ADHESIVE TAPES FOR MEDICAL PURPOSES; COLLODION FOR PHARMACEUTICAL PURPOSES; CORN RINGS FOR THE FEET; ANTI-RHEUMATISM RINGS; CANDY, MEDICATED; ANGOSTURA BARK FOR MEDICAL PURPOSES; BARKS FOR

**Reg. No. 4,133,694** PHARMACEUTICAL PURPOSES; CEDAR WOOD FOR USE AS AN INSECT REPELLENT; CONDURANGO BARK FOR MEDICAL PURPOSES; CROTON BARK FOR MEDICAL PURPOSES; MANGROVE BARK FOR PHARMACEUTICAL PURPOSES; MYROBALAN BARK FOR PHARMACEUTICAL PURPOSES; CINCHONA FOR MEDICAL PURPOSES; MEDICINAL ROOTS; RHUBARB ROOTS FOR PHARMACEUTICAL PURPOSES; LINT FOR MEDICAL PURPOSES; STARCH FOR DIETETIC OR PHARMACEUTICAL PURPOSES; CREOSOTE FOR PHARMACEUTICAL PURPOSES; BLOOD FOR MEDICAL PURPOSES; CULTURES OF MICROORGANISMS FOR MEDICAL AND VETERINARY USE; CURARE FOR MEDICAL USE; DENTAL LACQUER; LIQUORICE FOR PHARMACEUTICAL PURPOSES; LACTOSE FOR MEDICAL USE; ADHESIVE PLASTER FOR MEDICAL USE; MEDICINES FOR ALLEVIATING CONSTIPATION; LECITHIN FOR MEDICAL PURPOSES; SKIN LOTIONS FOR VETERINARY PURPOSES; DOG SKIN LOTIONS; SKIN LOTIONS FOR PHARMACEUTICAL PURPOSES; LUPULIN FOR PHARMACEUTICAL PURPOSES; MAGNESIA FOR PHARMACEUTICAL PURPOSES; LINIMENTS; OINTMENTS FOR PHARMACEUTICAL PURPOSES, NAMELY, FOR IMPROVING MICROCIRCULATION, ANTI-INFLAMMATORY OINTMENTS; SUNBURN OINTMENTS, NAMELY, ANTIBIOTIC, ANTI-INFLAMMATORY OINTMENTS; MERCURIAL OINTMENTS, NAMELY, ANTIBIOTIC, ANTI-INFLAMMATORY OINTMENTS; FROSTBITE SALVE FOR PHARMACEUTICAL PURPOSES; GAUZE FOR DRESSINGS; ANTI-HORSE-FLY OILS; MEDICINAL OILS; MUSTARD OIL FOR MEDICAL PURPOSES; CAMPHOR OIL FOR MEDICAL PURPOSES; CASTOR OIL FOR MEDICAL PURPOSES; OIL OF TURPENTINE FOR PHARMACEUTICAL PURPOSES; DILL OIL FOR MEDICAL PURPOSES; DENTAL MASTICS; DENTAL ABRASIVES; DENTAL IMPRESSION MATERIALS; TEETH FILLING MATERIALS, DRESSING, MEDICAL; SURGICAL DRESSINGS; DRUGS FOR MEDICAL USE, NAMELY, MICROCIRCULATION IMPROVEMENT PREPARATIONS, PREPARATIONS FOR CHILD'S ORGANISM DISBALANCES PROPHYLAXIS; SEROTHERAPEUTIC MEDICINES; MEDICINES FOR HUMAN PURPOSES, NAMELY, FOR MICROCIRCULATION IMPROVEMENT PREPARATIONS AND PREPARATIONS FOR CHILD'S ORGANISM DISBALANCES PROPHYLAXIS; MEDICINES FOR DENTAL PURPOSES; MENTHOL FOR MEDICAL PURPOSES; MEDICINAL DRINKS; MOLESKIN FOR MEDICAL PURPOSES; ALBUMINOUS MILK FOR MEDICAL PURPOSES; MILK OF ALMONDS FOR PHARMACEUTICAL PURPOSES; ROYAL JELLY FOR MEDICAL PURPOSES; MILK FERMENTS FOR PHARMACEUTICAL PURPOSES; IRISH MOSS FOR MEDICAL PURPOSES; LACTEAL FLOUR FOR BABIES; FLOUR FOR PHARMACEUTICAL PURPOSES, MEAL FOR PHARMACEUTICAL PURPOSES; LINSEED MEAL FOR PHARMACEUTICAL PURPOSES; FISHMEAL FOR PHARMACEUTICAL PURPOSES; FLY CATCHING ADHESIVES, FLY GLUE; MINT FOR PHARMACEUTICAL PURPOSES; FIRST-AID BOXES, FILLED; MEDICINE CASES, PORTABLE, FILLED; DIETETIC BEVERAGES ADAPTED FOR MEDICAL PURPOSES; MALTED MILK BEVERAGES FOR MEDICAL PURPOSE; MEDICINAL INFUSIONS, NAMELY, MICROCIRCULATION IMPROVEMENT PREPARATIONS AND PREPARATIONS FOR CHILD'S ORGANISM DISBALANCES PROPHYLAXIS; TINCTURE OF IODINE; EUCALYPTOL FOR PHARMACEUTICAL PURPOSES; TINCTURES FOR MEDICAL PURPOSES, NAMELY, MICROCIRCULATION IMPROVEMENT PREPARATIONS AND PREPARATIONS FOR CHILD'S ORGANISM DISBALANCES PROPHYLAXIS; OPODELDOC FOR MEDICAL PURPOSES; DECOCTIONS FOR PHARMACEUTICAL PURPOSES, NAMELY, MICROCIRCULATION IMPROVEMENT PREPARATIONS AND PREPARATIONS FOR CHILD'S ORGANISM DISBALANCES PROPHYLAXIS; ANTIPARASITIC COLLARS FOR ANIMALS; STICK LIQUORICE FOR PHARMACEUTICAL PURPOSES; SULFUR STICKS AS DISINFECTANTS; PANTS, ABSORBENT, FOR INCONTINENCE; PECTIN FOR PHARMACEUTICAL PURPOSES; NAPKINS FOR INCONTINENCE; PEPSINS FOR PHARMACEUTICAL PURPOSES; PEPTONES FOR PHARMACEUTICAL PURPOSES; HYDROGEN PEROXIDE FOR MEDICAL PURPOSES; PILLS FOR PHARMACEUTICAL PURPOSES, NAMELY, ANTI-OXIDANTS, MICROCIRCULATION IMPROVEMENT PREPARATIONS AND PREPARATIONS FOR CHILD'S ORGANISM DISBALANCES PROPHYLAXIS; LEECHES FOR MEDICAL PURPOSES; BLOOD PLASMA; PLASTERS FOR MEDICAL PURPOSES; EYEPATCHES FOR MEDICAL PURPOSES; POULTICES; MEDICATED COMPRESSES; SCAPULARS FOR SURGICAL PURPOSES; BUNION PADS; BREAST-NURSING PADS; POMADES FOR MEDICAL PURPOSES; POWDER OF CANTHARIDES FOR MEDICAL PURPOSES; PYRETHRUM POWDER FOR MEDICAL PURPOSES; BELTS FOR SANITARY NAPKINS AND

**Reg. No. 4,133,694** TOWELS; ANTI-URIC PREPARATIONS; BACTERIAL PREPARATIONS FOR MEDICAL AND VETERINARY USE; BACTERIOLOGICAL PREPARATIONS FOR MEDICAL AND VETERINARY USE; BALSAMIC PREPARATIONS FOR MEDICAL PURPOSES; ALBUMINOUS PREPARATIONS FOR MEDICAL PURPOSES; BIOLOGICAL PREPARATIONS FOR VETERINARY PURPOSES FOR THE TREATMENT OF MICROCIRCULATION AND CHILD'S ORGANISM DISBALANCES PROPHYLAXIS; BIOLOGICAL PREPARATIONS FOR MEDICAL PURPOSES FOR THE TREATMENT OF MICROCIRCULATION AND CHILD'S ORGANISM DISBALANCES PROPHYLAXIS; BISMUTH PREPARATIONS FOR PHARMACEUTICAL PURPOSES; VITAMIN PREPARATIONS; DIAGNOSTIC PREPARATIONS FOR MEDICAL PURPOSES; THERAPEUTIC MEDICATED PREPARATIONS FOR THE BATH; HAEMORRHOID TREATMENT PREPARATIONS; PREPARATIONS FOR CALLOUSES, NAMELY, CALLOUS CREAMS, OINTMENTS AND GELS; MEDICATED PREPARATIONS TO FACILITATE TEETHING; MEDICATED PREPARATIONS FOR TREATMENT OF BURNS; FUMIGATION PREPARATIONS FOR MEDICAL PURPOSES; OPOTHERAPY PREPARATIONS FOR MEDICAL PURPOSES; AIR FRESHENING PREPARATIONS; AIR PURIFYING PREPARATIONS; BRONCHODILATING PREPARATIONS; SANITARY STERILIZING PREPARATIONS; SOIL STERILIZING PREPARATIONS FOR SANITARY PURPOSES; CORN REMEDIES, NAMELY, CORN CREAM, OINTMENTS AND GELS; PHARMACEUTICAL PREPARATIONS FOR TREATING DANDRUFF; PREPARATIONS FOR DESTROYING NOXIOUS ANIMALS, NAMELY, PESTICIDES; PREPARATIONS FOR DESTROYING DRY ROT FUNGUS, NAMELY, FUNGICIDE; LARVAE EXTERMINATING PREPARATIONS, NAMELY, INSECTICIDES; FLY DESTROYING PREPARATIONS, NAMELY, INSECTICIDES; PREPARATIONS FOR DESTROYING MICE, NAMELY, PESTICIDES; SLUG EXTERMINATING PREPARATIONS, NAMELY, INSECTICIDE; PHARMACEUTICAL PREPARATIONS FOR SKIN CARE; CONTACT LENS CLEANING PREPARATIONS; PREPARATIONS OF LIME FOR PHARMACEUTICAL PURPOSES; BATH PREPARATIONS, MEDICATED; MEDICINAL HAIR GROWTH PREPARATIONS; ANTICRYPTOGAMIC PREPARATIONS FOR MEDICAL PURPOSES; MEDICINAL PREPARATIONS OF TRACE ELEMENTS FOR HUMAN AND ANIMAL USE, NAMELY, ANTIOXIDANTS, MICROCIRCULATION IMPROVEMENT PREPARATIONS, PREPARATIONS FOR CHILD'S ORGANISM DISBALANCES PROPHYLAXIS IN THE FORM OF PILLS, CAPSULES, PASTILLES, DRAGEE, CAMELS, MARMALADE, BEVERAGES; SULPHONAMIDES AS MEDICINES; PHARMACEUTICAL PREPARATIONS FOR THE TREATMENT OF MICROCIRCULATION AND CHILD'S ORGANISM DISBALANCES PROPHYLAXIS; SUNBURN PREPARATIONS FOR PHARMACEUTICAL PURPOSES; ENZYME PREPARATIONS FOR VETERINARY PURPOSES; ENZYME PREPARATIONS FOR MEDICAL PURPOSES; CHEMICO-PHARMACEUTICAL PREPARATIONS FOR THE TREATMENT OF MICROCIRCULATION AND CHILD'S ORGANISM DISBALANCES PROPHYLAXIS; CHEMICAL PREPARATIONS FOR THE DIAGNOSIS OF PREGNANCY; CHEMICAL PREPARATIONS FOR MEDICAL PURPOSES FOR THE TREATMENT OF MICROCIRCULATION AND CHILD'S ORGANISM DISBALANCES PROPHYLAXIS; CHEMICAL PREPARATIONS TO TREAT WHEAT BLIGHT AND WHEAT SMUT; VINE DISEASE TREATING CHEMICALS; CHEMICAL PREPARATIONS TO TREAT MILDEW; CHEMICAL PREPARATIONS FOR TREATING PHYLLOXERA; CHEMICAL PREPARATIONS FOR PHARMACEUTICAL PURPOSES FOR THE TREATMENT OF MICROCIRCULATION AND CHILD'S ORGANISM DISBALANCES PROPHYLAXIS; CHILBLAIN PREPARATIONS FOR MEDICAL PURPOSES; MOTHPROOFING PREPARATIONS; EYE-WASH; GOULARD WATER AND LEAD WATER FOR MEDICAL PURPOSES; CHEMICAL CONDUCTORS FOR ELECTROCARDIOGRAPH ELECTRODES; ALBUMINOUS FOODSTUFFS FOR MEDICAL PURPOSES; DIETETIC FOODS ADAPTED FOR MEDICAL PURPOSES; BY-PRODUCTS OF THE PROCESSING OF CEREALS FOR MEDICAL PURPOSES; MENSTRUATION BANDAGES, SANITARY PADS; SANITARY PANTY LINERS; RADIUM FOR MEDICAL PURPOSES; HYDRATED CHLORAL FOR PHARMACEUTICAL PURPOSES; SOLVENTS FOR REMOVING ADHESIVE PLASTERS FOR MEDICAL PURPOSES; VAGINAL WASHES; SOLUTIONS FOR CONTACT LENSES; CHEMICAL REAGENTS FOR MEDICAL OR VETERINARY PURPOSES; GUM FOR MEDICAL PURPOSES; RUBBER FOR DENTAL PURPOSES; CHEWING GUM FOR MEDICAL PURPOSES; INSECT REPELLENT INCENSE; INSECT REPELLENTS; REPELLENTS FOR DOGS; SANITARY NAPKINS, SANITARY TOWELS; TISSUES IMPREGNATED WITH PHARMACEUTICAL LOTIONS; SARSAPARILLA FOR MEDICAL PURPOSES; SUGAR FOR MEDICAL

**Reg. No. 4,133,694** PURPOSES; ASTHMATIC TEA; FUMIGATING PASTILLES AND FUMIGATING STICKS FOR MEDICAL PURPOSES; SUPPOSITORIES; LINSEED FOR PHARMACEUTICAL PURPOSES; TOBACCO-FREE CIGARETTES FOR MEDICAL PURPOSES; SICCATIVES, NAMELY, DRYING AGENTS FOR MEDICAL PURPOSES; SYRUPS FOR PHARMACEUTICAL PURPOSES; TURPENTINE FOR PHARMACEUTICAL PURPOSES; MILKING GREASE FOR MEDICAL PURPOSES; GREASES FOR VETERINARY PURPOSES; GREASES FOR MEDICAL PURPOSES; SOPORIFICS; BICARBONATE OF SODA FOR PHARMACEUTICAL PURPOSES; MEDICATED SALTS FOR MINERAL WATER BATHS; BATH SALTS FOR MEDICAL PURPOSES; SALTS FOR MEDICAL PURPOSES; POTASSIUM SALTS FOR MEDICAL PURPOSES; SODIUM SALTS FOR MEDICAL PURPOSES; SMELLING SALTS; MINERAL WATER SALTS FOR MEDICAL PURPOSES; MALT FOR PHARMACEUTICAL PURPOSES; SEMEN FOR ARTIFICIAL INSEMINATION; ALCOHOL FOR PHARMACEUTICAL PURPOSES; ALLOYS OF PRECIOUS METALS FOR DENTAL PURPOSES; ERGOT FOR PHARMACEUTICAL PURPOSES; ANAESTHETICS; ANTISEPTICS; ANALGESICS; ADJUVANTS FOR MEDICAL PURPOSES; STYPTIC PREPARATIONS, NAMELY, STYPTIC PENCILS; ANTHELMINTICS FOR MEDICAL PURPOSES; DISINFECTANTS FOR HYGIENE PURPOSES; DISINFECTANTS FOR CHEMICAL TOILETS; APPETITE SUPPRESSANTS FOR MEDICAL PURPOSES; MEDICAL PREPARATIONS FOR SLIMMING PURPOSES; PARASITICIDES; MOUTHWASHES FOR MEDICAL PURPOSES; FEBRIFUGES; DEPURATIVES; MEDICATED ANIMAL WASHES; DETERGENTS FOR MEDICAL PURPOSES; MEDICATED CATTLE WASHES; MEDICATED DOG WASHES; VESICANTS; HEADACHE PENCILS; CHEMICAL CONTRACEPTIVES; ANTIPARASITIC PREPARATIONS; EVACUANTS, LAXATIVES, PURGATIVES; TONICS FOR MEDICAL PURPOSES; NERVINESS; DIGESTIVES FOR PHARMACEUTICAL PURPOSES; BOUILLONS FOR BACTERIOLOGICAL CULTURES, MEDIA FOR BACTERIOLOGICAL CULTURES; STEROIDS; STRYCHNINE FOR MEDICAL PURPOSES; MEDICATED SERUMS FOR TREATMENT OF HAIR, SKIN, LIPS; SAL AMMONIAC LOZENGES FOR MEDICAL PURPOSES; MENSTRUATION TAMPONS; VULNERARY SPONGES; THYMOL FOR PHARMACEUTICAL PURPOSES; SURGICAL CLOTH, NAMELY, TISSUES; SURGICAL TISSUES; SEDATIVES; TRANQUILIZERS; SURGICAL IMPLANTS COMPRISING LIVING TISSUES; MENSTRUATION KNICKERS, SANITARY KNICKERS, SANITARY PANTIES; CHARCOAL FOR PHARMACEUTICAL PURPOSES; FENNEL FOR MEDICAL PURPOSES; PORCELAIN FOR DENTAL PROSTHESES; PHENOL FOR PHARMACEUTICAL PURPOSES; ENZYMES FOR VETERINARY PURPOSES; ENZYMES FOR MEDICAL PURPOSES; FERMENTS FOR PHARMACEUTICAL PURPOSES; FORMIC ALDEHYDE FOR PHARMACEUTICAL PURPOSES; PHOSPHATES FOR PHARMACEUTICAL PURPOSES; QUININE FOR MEDICAL PURPOSES; CHINOLINE FOR MEDICAL PURPOSES; DIABETIC BREAD; CHLOROFORM; FLOWERS OF SULPHUR FOR PHARMACEUTICAL PURPOSES CEMENT FOR ANIMAL HOOVES; BONE CEMENT FOR SURGICAL AND ORTHOPAEDIC PURPOSES; DENTAL CEMENTS; HERBS TEAS FOR MEDICINAL PURPOSES; MEDICINAL TEA; REDUCING TEA FOR MEDICAL PURPOSES; EUCALYPTUS FOR PHARMACEUTICAL PURPOSES; TOBACCO EXTRACTS AS INSECTICIDES; EXTRACTS OF HOPS FOR PHARMACEUTICAL PURPOSES; ELIXIRS AS PHARMACEUTICAL PREPARATIONS FOR THE TREATMENT OF MICROCIRCULATION AND CHILD'S ORGANISM DISBALANCES PROPHYLAXIS; ETHERS FOR PHARMACEUTICAL PURPOSES; ESTERS FOR PHARMACEUTICAL PURPOSES; CELLULOSE ESTERS FOR PHARMACEUTICAL PURPOSES; CELLULOSE ETHERS FOR PHARMACEUTICAL PURPOSES; MEDICATED JUJUBE; RAT POISON; BACTERIA POISONS; BACTERIAL POISONS; JALAP AS A PURGATIVE; BIOLOGICALLY ACTIVE FOOD SUPPLEMENTS , IN CLASS 5 (U.S. CLS. 6, 18, 44, 46, 51 AND 52).

FOR: MEAT, FISH, POULTRY, AND GAME; MEAT EXTRACTS; PRESERVED, FROZEN, DRIED, AND COOKED FRUITS AND VEGETABLES; JELLIES, JAMS, COMPOTES; EGGS, MILK AND MILK PRODUCTS EXCLUDING ICE CREAM, ICE MILK, FROZEN YOGURT AND MILK PRODUCT ENRICHED WITH ANTIOXIDANTS AND DIETARY FIBERS; EDIBLE OILS AND FATS; ALGINATES FOR FOOD; PROCESSED ANCHOVY; PEANUTS, PROCESSED; ALBUMEN FOR FOOD; WHITES OF EGGS; BEANS, PRESERVES; SOYA BEANS, PRESERVED, FOR FOOD; BOUILLON; GINGER JAM; FATTY SUBSTANCES FOR THE MANUFACTURE OF EDIBLE FATS; EDIBLE BIRDS NESTS; PEAS, PRESERVED; MUSHROOMS, PRESERVED; GAME, NOT LIVE; UNFLAVORED AND UNSWEETENED GELATIN



**Reg. No. 4,133,694** FOR FOOD; MEAT JELLIES; JELLIES FOR FOOD; FRUIT JELLIES; YOLK OF EGGS; COCONUT FAT; BONE OIL, EDIBLE; LARD FOR FOOD; SUET FOR FOOD; FRUIT-BASED SNACK FOOD; CHARCUTERIE, SAUSAGES; RAISINS; CAVIAR; CASEIN FOR FOOD; SAUERKRAUT; ISINGLASS FOR FOOD; BLACK PUDDING, BLOOD SAUSAGE; MEAT, TINNED; VEGETABLES, TINNED; FISH, TINNED; FRUITS, TINNED; BOUILLON CONCENTRATES; GHERKINS; PRAWNS, NOT LIVE; BUTTER CREAM; CROQUETTES; SILKWORM CHRYSALIS, FOR HUMAN CONSUMPTION; TOASTED LAVER; SPINY LOBSTERS, NOT LIVE; SALMON; ONIONS, PRESERVED; MARGARINE; PICCALILLI; MARMALADE; COCONUT OIL, COLZA OIL FOR FOOD, CORN OIL, MAIZE OIL, OLIVE OIL FOR FOOD, PALM KERNEL OIL FOR FOOD, PALM OIL FOR FOOD, RAPE OIL FOR FOOD, SESAME OIL, SUNFLOWER OIL FOR FOOD; PEANUT BUTTER; CHOCOLATE NUT BUTTER, COCOA BUTTER; COCONUT BUTTER; BUTTER; SHELLFISH, NOT LIVE; ALMONDS, GROUND; ANIMAL MARROW FOR FOOD; CLAMS, NOT LIVE; MUSSELS, NOT LIVE; SOYA MILK AS A MILK SUBSTITUTE; FISHMEAL FOR HUMAN CONSUMPTION; FRUIT PULP; MEAT, PRESERVED; POTATO FRITTERS; OLIVES, PRESERVED; LOBSTERS, NOT LIVE; COCONUT, DESICCATED; NUTS, PREPARED; TOMATO PUREE; LIVER PATE; PECTIN FOR FOOD; LIVER; PICKLES; POWDERED EGGS; HAM; MILK PRODUCTS, NAMELY, CREAM, KEFIR, KOUMISS, BEVERAGES CONSISTING PRINCIPALLY OF MILK, WHEY, YOGHURT; FERMENTED VEGETABLE FOODS BEING KIMCHI; SALTED FISH, FOODS PREPARED FROM FISH, NAMELY, FISH AND CHIPS, AND FISH CAKES; CURD; PROTEIN BEING FOODSTUFFS FOR HUMAN CONSUMPTION; POLLEN PREPARED AS A FOODSTUFF; CRANBERRY SAUCE COMPOTE; APPLE PUREE; CRAYFISH, NOT LIVE; CRUSTACEANS, NOT LIVE; FISH, PRESERVED; VEGETABLE SALADS; FRUIT SALADS; BACON; SARDINE; PORK; HERRINGS; WHIPPED CREAM; FAT-CONTAINING MIXTURES FOR BREAD SLICES, NAMELY, CHEESE SPREADS, DAIRY BASED SPREADS; TOMATO JUICE FOR COOKING; VEGETABLE JUICES FOR COOKING; SALTED MEATS; SAUSAGES IN BATTER; PREPARATIONS FOR MAKING BOUILLON; PREPARATIONS FOR MAKING SOUP; TRIPE; SOUPS; VEGETABLE SOUP PREPARATIONS; CHEESE; TAHINI; TOFU; SEA-CUCUMBERS, NOT LIVE; TRUFFLES, PRESERVED; TUNA FISH; OYSTERS, NOT LIVE; RENNET; FISH FILLETS; PROCESSED DATES; CRYSTALLIZED FRUITS, FROSTED FRUITS; FROZEN FRUITS; FRUIT PRESERVED IN ALCOHOL; POTATO FLAKES; HUMMUS; FRUIT PEEL; LENTILS, PRESERVED; POTATO CHIPS; FRUIT CHIPS; WEED EXTRACTS FOR FOODS; SNAIL EGGS FOR CONSUMPTION, IN CLASS 29 (U.S. CL. 46).

FOR: COFFEE, TEA, COCOA, SUGAR, RICE, TAPIOCA, SAGO, ARTIFICIAL COFFEE; FLOUR AND PREPARATIONS MADE FROM CEREALS, NAMELY, CEREAL BASED SNACK FOOD, BISCUITS TARTS AND CAKES MADE WITH CEREALS, ALL ENRICHED WITH DIETARY FIBERS; BREAD, PASTRY, AND CONFECTIONERY, NAMELY, FLOUR AND SUGAR CONFECTIONERY ALSO ENRICHED WITH DIETARY FIBERS; ICES; HONEY, TREACLE; YEAST, BAKING-POWDER; SALT, MUSTARD; VINEGAR; SAUCES AS CONDIMENTS, NAMELY, KETCHUP, MAYONNAISE; SPICES; AROMATIC PREPARATIONS FOR FOODS, NAMELY, PEPPER, GINGER, CURRY; FLAVORINGS, OTHER THAN ESSENTIAL OILS; FLAVORINGS, OTHER THAN ESSENTIAL OILS, FOR BEVERAGES; FLAVORINGS, OTHER THAN ESSENTIAL OILS, FOR CAKES; STAR ANISEED; COOKIES; PANCAKES; BUNS; BREAD ROLLS; VANILLIN AS VANILLA SUBSTITUTE; VANILLA FLAVORING; WAFFLES; VERMICELLI NOODLES; COFFEE FLAVORINGS; NATURAL SWEETENERS; STARCH-BASED SAUSAGE BINDING MATERIALS; STARCH-BASED BINDING AGENTS FOR ICE CREAM; SEA WATER FOR COOKING; GLUCOSE FOR FOOD; THICKENING AGENTS FOR COOKING FOODSTUFFS; RICEBASED SNACK FOOD; CEREAL-BASED SNACK FOOD; VEGETAL PREPARATIONS FOR USE AS COFFEE SUBSTITUTES; PASTRIES; CONFECTIONERY MADE OF SUGAR FOR DECORATING CHRISTMAS TREES; FRUIT JELLIES BEING CONFECTIONERY; CAKES; PEANUT CONFECTIONERY; ALMOND CONFECTIONERY; FARINACEOUS FOOD PASTES; MACARONI; PASTS; PASTRIES, NAMELY, PASTY; FROZEN YOGHURT; COCOA PRODUCTS, NAMELY, COCOA POWDER, COCOA MIXES; CAPERS; CARAMELS; GRUEL, WITH A MILK BASE, FOR FOOD; QUICHES; GLUTEN FOR FOOD; SWEETMEATS; LIQUORICE; STICK LIQUORICE; PEPPERMINT SWEETS; UNROASTED COFFEE; STARCH FOR FOOD; CRACKERS; HOMINY GRITS; GROATS FOR HUMAN FOOD; HUSKED BARELY; SEMOLINA; CORN, MILLED;

**Reg. No. 4,133,694** CORN, ROASTED; MEAT PIES; TURMERIC FOR FOOD; COUSCOUS; FARINACEOUS FOODS; NOODLES; ICE FOR REFRESHMENT; ICE, NATURAL OR ARTIFICIAL; EDIBLE ICES; CANDY FOR FOOD; RICE CAKES; MALTOSE; HOMINY; MARZIPAN; CUSTARD; ROYAL JELLY FOR HUMAN CONSUMPTION, NOT FOR MEDICAL PURPOSES; ICE CREAM; SHERBETS; SORBETS; BARLEY MEAL; BEAN MEAL; CORN FLOUR; CORN MEAL; FLOUR FOR FOOD; MAIZE FLOUR; MAIZE MEAL; MUSTARD MEAL; OATMEAL; POTATO FLOUR FOR FOOD; SOYA FLOUR; TAPIOCA FLOUR FOR FOOD; WHEAT FLOUR; MUESLI; MINT FOR CONFECTIONERY; COCOA BEVERAGES WITH MILK; COFFEE-BASED BEVERAGES; TEA-BASED BEVERAGES; CHOCOLATE BEVERAGES WITH MILK; CHOCOLATE-BASED BEVERAGES; COCOA-BASED BEVERAGES; HERBAL INFUSIONS, NOT MEDICINAL; CRUSHED OATS; HUSKED OATS; NUTMEGS; LOZENGES AS CONFECTIONERY; PASTILLES AS CONFECTIONERY; GOLDEN SYRUP; MOLASSES FOR FOOD; PEPPER; PETTIS FOURS; BISCUITS; MACAROONS; MALT BISCUITS; PIES, PIZZAS; FONDANTS AS CONFECTIONERY; POPOCORN; POWDERS FOR ICE CREAM; PRALINES; CHOW-CHOW; CHUTNEYS; CONDIMENTS, NAMELY, MUSTARD, KETCHUP, MAYONNAISE; DRESSINGS FOR SALAD; MEAT GRAVIES; KETCHUP; MAYONNAISE; RELISH; SOYA SAUCE; TOMATO SAUCE; WEEDS AS A CONDIMENT; MEAT TENDERIZERS, FOR HOUSEHOLD PURPOSES; CEREAL PREPARATIONS, NAMELY, CEREAL BASED SNACK FOOD, BISCUITS TARTS AND CAKES MADE WITH CEREALS, ENRICHED WITH DIETARY FIBERS; FLOUR-MILLING PRODUCTS, NAMELY, FLOUR; OAT-BASED FOOD, NAMELY, CEREAL BARS, GRUELS AND SOLID MIXTURES, CONTAINING DIETARY FIBERS; BEE GLUE FOR HUMAN CONSUMPTION; GINGERBREAD; ALLSPICE; CINNAMON; CLOVES; CURRY; GINGER; SPICES; PUDDINGS; CAKE POWDER, NAMELY, YEAST POWDER, BAKING POWDER, ENRICHED WITH DIETARY FIBERS; RAVIOLI; CHEWING GUM, NOT FOR MEDICAL PURPOSES; SPRING ROLLS; ANISEED; CAKE PASTE, NAMELY, CHOCOLATE PASTE, FRUIT PASTE FOR FLAVORING OF FOOD, ENRICHED WITH DIETARY FIBER; BAKING SODA; MALT FOR HUMAN CONSUMPTION; SALT FOR PRESERVING FOODSTUFFS; COOKING SALT; CELERY SALT; SPAGHETTI; PEPPERS AS SEASONINGS; SAFFRON AS SEASONING; SEASONINGS; STARCH-BASED THICKENING PREPARATIONS FOR STIFFENING WHIPPED CREAM; RUSKS; BREADCRUMBS; SUSHI; SANDWICHES; YEAST IN PILL FORM, NOT FOR MEDICAL USE; TABBOULEH; TACOS; SOYA BEAN PASTE; ALMOND PASTE; TORTILLAS; TARTS; FARMEN HERBS, PRESERVED AS SEASONINGS; EDIBLE DECORATIONS FOR CAKES; FERMENTS FOR PASTES FOR HUMAN CONSUMPTION; LEAVEN, NAMELY, FOOD LEAVENING AGENTS; YEAST; HALVAH; BREAD; UNLEAVENED BREAD; GRAIN-BASED CHIPS AS CEREAL PRODUCTS; CORN FLAKES; MAIZE FLAKES; OAT FLAKES; CHICORY AS A COFFEE SUBSTITUTE; ICED TEA; CHOCOLATE; MALT EXTRACT FOR FOOD; ESSENCES FOR FOODSTUFFS, EXCEPT ETHERIC ESSENCES AND ESSENTIAL OILS, NAMELY, COFFEE ESSENCES, IN CLASS 30 (U.S. CL. 46).

FOR: BEERS; MINERAL AND AERATED WATERS; NON-ALCOHOLIC DRINKS, NAMELY, CIDER, SODA POPS, CONTAINING ANTIOXIDANTS AND DIETARY FIBERS; FRUIT DRINKS AND FRUIT JUICES; SYRUPS AND OTHER PREPARATIONS FOR MAKING BEVERAGES, NAMELY, SODA POP SYRUPS; APERITIFS, NON-ALCOHOLIC; LITHIA WATER, MINERAL WATER, SELTZER WATER, SODA WATER, TABLE WATER, WATER BEVERAGES; KVASS, AS A NON-ALCOHOLIC BEVERAGE; COCKTAILS, NON-ALCOHOLIC; LEMONADES; PEANUT MILK; NON-ALCOHOLIC BEVERAGES, NAMELY, CIDER, FRUIT JUICE, SODA POPS; ISOTONIC BEVERAGES; NONALCOHOLIC HONEY-BASED BEVERAGES; WHEY BEVERAGES; NON-ALCOHOLIC FRUIT JUICE BEVERAGES; MILK OF ALMONDS; FRUIT NECTARS, NON-ALCOHOLIC; ORGEAT AS A NON-ALCOHOLIC FRUIT BEVERAGE; GINGER ALE, GINGER BEER, MALT BEER; POWDERS FOR EFFERVESCING BEVERAGES, NAMELY, SODA POPS; SARSAPARILLA AS A SOFT DRINK; SYRUPS FOR LEMONADE; SYRUPS FOR BEVERAGES; TOMATO JUICE; CIDER, NON-ALCOHOLIC; VEGETABLE JUICES; PREPARATIONS FOR MAKING AERATED WATER, NAMELY, DRINKING WATER; PREPARATIONS FOR MAKING LIQUEURS, NAMELY, ESSENCES USED IN THE PREPARATION OF LIQUEURS; PREPARATIONS FOR MAKING MINERAL WATER, NAMELY, SYRUPS FOR MAKING FLAVOURED MINERAL WATERS; MUST; GRAPE MUST, UNFERMENTED; BEER WORT; MALT WORT; PASTILLES FOR

**Reg. No. 4,133,694** EFFERVESCING BEVERAGES, NAMELY, SODA POPS; SHERBETS BEING BEVERAGES; SORBETS BEING BEVERAGES; NONALCOHOLIC FRUIT EXTRACTS USED IN THE PREPARATION OF BEVERAGES; EXTRACTS OF HOPS FOR MAKING BEER; ESSENCES FOR MAKING NON-ALCOHOLIC BEVERAGES, IN CLASS 32 (U.S. CLS. 45, 46 AND 48).

THE MARK CONSISTS OF THE WORD "CAPILARIK" IN CAPITAL BLOCK LETTERS.

PRIORITY DATE OF 11-22-2010 IS CLAIMED.

OWNER OF INTERNATIONAL REGISTRATION 1075630 DATED 2-8-2011, EXPIRES 2-8-2021.

THE WORDING "CAPILARIK" HAS NO MEANING IN A FOREIGN LANGUAGE.

SER. NO. 79-096,855, FILED 2-8-2011.

LINDSEY RUBIN, EXAMINING ATTORNEY

# United States of America

United States Patent and Trademark Office

# CAPILASHKA

**Reg. No. 4,133,695**

**Registered May 1, 2012**

**Int. Cls.: 3, 5, 29, 30 and  
32**

OTKRYTOE AKTSIONERNOE OBSHESTVO ZAVOD EKOLOGICHESKOY TEKHNIKI I  
EKOPITANIYA "DIOD" (RUSSIAN FED. JOINT STOCK COMPANY)  
UL. DERBENEVSKAYA, D. 11A  
RU-115114 MOSCOW  
RUSSIAN FED.

**TRADEMARK**

**PRINCIPAL REGISTER**



*David J. Kappas*

Director of the United States Patent and Trademark Office

FOR: BLEACHING PREPARATIONS AND OTHER SUBSTANCES FOR LAUNDRY USE, NAMELY, LAUNDRY DETERGENT, LAUNDRY BLEACH; CLEANING, POLISHING, SCOURING AND ABRASIVE PREPARATIONS; SOAPS; PERFUMERY, ESSENTIAL OILS, COSMETICS, HAIR LOTIONS; DENTIFRICES; ABRASIVES, NAMELY, SKIN ABRASIVE PREPARATIONS, FLEXIBLE ABRASIVES; AMBER, NAMELY, PERFUME; SCALE REMOVING PREPARATIONS FOR HOUSEHOLD PURPOSES; ANTISTATIC PREPARATIONS FOR HOUSEHOLD PURPOSES; BREATH FRESHENING SPRAYS; CANNED PRESSURIZED AIR FOR CLEANING AND DUSTING PURPOSES; SHAVING STONES, ANTISEPTIC; POLISHING STONES; ABRASIVE PAPER; EMERY PAPER; POLISHING PAPER; PETROLEUM JELLY FOR COSMETIC PURPOSES; COTTON WOOL FOR COSMETIC PURPOSES; COTTON STICKS FOR COSMETIC PURPOSES; AROMATICS, NAMELY, ESSENTIAL OILS; ESSENTIAL OILS FOR FLAVORING CAKES; ESSENTIAL OILS FOR BEVERAGES; SACHETS FOR PERFUMING LINEN; SCENTED LINEN WATER; JAVELLE WATER, NAMELY, BLEACHING PREPARATIONS FOR HOUSEHOLD USE; LAVENDER WATER; TOILET WATER; LAUNDRY WAX; FLOOR WAX, PARQUET FLOOR WAX; NON-SLIPPING WAX FOR FLOORS; MOUSTACHE WAX; TAILORS' WAX; POLISH FOR FURNITURE AND FLOORING; SHOE WAX; HELIOTROPINE, NAMELY, OILS FOR PERFUMES AND SCENTS; DENTAL BLEACHING GELS; GERANIOL AS PERFUMERY; MAKE-UP; DEODORANTS FOR PERSONAL USE; SCENTED WOOD; PERFUMES; NON-SLIPPING LIQUIDS FOR FLOORS; WINDSCREEN CLEANING LIQUIDS; GREASES FOR COSMETIC PURPOSES; VOLCANIC ASH FOR CLEANING; DECORATIVE TRANSFERS FOR COSMETIC PURPOSES; IONONE AS PERFUMERY; SMOOTHING STONES; EYEBROW PENCILS; COSMETIC PENCILS; SILICON CARBIDE AS GENERAL PURPOSE ABRASIVE CLEANING PREPARATION; CARBIDES OF METAL AS GENERAL PURPOSE ABRASIVE CLEANING PREPARATION; ALUM STONES AS ANTISEPTICS; TRIPOLI STONE FOR POLISHING; ADHESIVES FOR AFFIXING FALSE EYELASHES; ADHESIVES FOR AFFIXING FALSE HAIR; CLEANING PREPARATIONS, NAMELY, QUILLAIA BARK FOR WASHING; CORUNDUM AS GENERAL PURPOSE ABRASIVE CLEANING PREPARATION; BLUEING FOR LAUNDRY; BEARD DYES; COLORANTS FOR TOILET PURPOSE, NAMELY, FOR HAIR; COSMETIC DYES FOR HAIR; LAUNDRY STARCH; COSMETIC CREAMS; SKIN WHITENING CREAMS; CREAMS FOR LEATHER, WAXES FOR LEATHER; JEWELLERS' ROUGE, POLISHING

**Reg. No. 4,133,695** ROUGE; INCENSE; HAIR SPRAY; NAIL POLISH, NAIL VARNISH; AFTER-SHAVE LOTIONS; HAIR LOTIONS; LOTIONS FOR COSMETIC PURPOSES; BEAUTY MASKS; OILS FOR PERFUMES AND SCENTS; OILS FOR COSMETIC PURPOSES; OILS FOR TOILET PURPOSES; ESSENTIAL OILS; ESSENTIAL OILS OF CEDARWOOD; ESSENTIAL OILS OF CITRON; OILS FOR CLEANING PURPOSES; BERGAMOT OIL; GAULTHERIA OIL AS ESSENTIAL OILS; JASMINE OIL AS ESSENTIAL OILS; LAVENDER OIL; ALMOND OIL AS ESSENTIAL OILS; ROSE OIL AS ESSENTIAL OILS; OIL OF TURPENTINE FOR DEGREASING; ADHESIVES FOR COSMETIC PURPOSES; WHITING, NAMELY, LAUNDRY BLEACH; CLEANING CHALK FOR COSMETIC USE; ALMOND MILK FOR COSMETIC PURPOSES; CLEANSING MILK FOR TOILET PURPOSES; MUSK AS PERFUMERY; DISINFECTANT SOAP; DEODORANT SOAP; SHAVING SOAP; SOAP FOR BRIGHTENING TEXTILE; CAKES OF TOILET SOAP; MEDICATED SOAP; ANTIPERSPIRANT SOAP; SOAP FOR FOOT PERSPIRATION; ALMOND SOAP; MINT FOR PERFUMERY; COSMETIC KITS COMPRISED OF COSMETIC AND PERFUMERY; EMERY BOARDS; EMERY CLOTH; EMERY PAPER; FALSE NAILS; EAU DE COLOGNE; BASES FOR FLOWER PERFUMES NAMELY, OILS FOR PERFUMES; JOSS STICKS; POLISHING CREAMS, POLISHING WAX; PASTES FOR RAZOR STROPS, NAMELY, SHAVING CREAM; PUMICE STONE FOR PERSONAL USE; HYDROGEN PEROXIDE FOR COSMETIC PURPOSES; ABRASIVE CLOTH, EMERY CLOTH; GLASS CLOTH; LIPSTICKS; POMADES FOR COSMETIC PURPOSES; SHAVING PREPARATIONS; COSMETIC PREPARATIONS FOR BATHS; NON-MEDICATED TOILETRIES; HAIR WAVING PREPARATIONS; LAUNDRY SOAKING PREPARATIONS, NAMELY, LAUNDRY PRE-SOAK; GRINDING PREPARATIONS, NAMELY, ABRASIVE ROLLS, ABRASIVE SHEETS, ABRASIVE STRIPS; SMOOTHING PREPARATIONS, NAMELY, LAUNDRY STARCH; LEATHER BLEACHING PREPARATIONS; DENTURE POLISHES; FURBISHING PREPARATIONS, NAMELY, FURNITURE POLISH, LEATHER POLISH; POLISHING PREPARATIONS; MOUTH WASHES, NOT FOR MEDICAL PURPOSES; COSMETIC PREPARATIONS FOR SLIMMING PURPOSES; LAUNDRY GLAZE; FABRIC SOFTENERS FOR LAUNDRY USE; BLEACHING PREPARATIONS FOR THE LAUNDRY; DRY-CLEANING PREPARATIONS, NAMELY, DRY-CLEANING FLUIDS; MAKE-UP REMOVING PREPARATIONS; COLOR-REMOVING PREPARATIONS, NAMELY, NAIL POLISH REMOVER; LACQUER-REMOVING PREPARATIONS, NAMELY, PAINT REMOVER; NAIL LACQUER REMOVER; SCOURING PREPARATION, NAMELY, FLOOR WAX REMOVERS; RUST REMOVING PREPARATIONS; NAIL CARE PREPARATIONS; PREPARATIONS FOR CLEANING DENTURES; WALLPAPER CLEANING PREPARATIONS; PREPARATIONS FOR CLEANING WASTE PIPES; COLOR-BRIGHTENING CHEMICALS FOR HOUSEHOLD LAUNDRY PURPOSES; MAKE-UP POWDER; DIAMANTINE AS A GENERAL PURPOSE CLEANING ABRASIVE PREPARATION; SCOURING SOLUTIONS; FALSE EYELASHES; TISSUES IMPREGNATED WITH COSMETIC LOTIONS; ESSENTIAL OILS, NAMELY, SAFROL; POTPOURRI; BLEACHING SODA; WASHING SODA, FOR CLEANING; BATH SALTS, NOT FOR MEDICAL PURPOSES; BLEACHING SALTS; LEATHER PRESERVATIVES, NAMELY, LEATHER POLISHES; FUMIGATION PREPARATIONS, NAMELY, PERFUMES; VOLATILE ALKALI, NAMELY, AMMONIA DETERGENT FOR CLEANING PURPOSES; ASTRINGENTS FOR COSMETIC PURPOSES; EYEBROW COSMETICS; STAIN REMOVERS; MAKE-UP PREPARATIONS; COSMETIC SUNSCREEN PREPARATIONS; HAIR COLORANTS; NEUTRALIZERS FOR PERMANENT WAVING; PREPARATIONS TO MAKE SHINY THE LEAVES OF PLANTS; COSMETIC PREPARATIONS FOR EYELASHES; DEPILATORIES; COSMETIC PREPARATIONS FOR SKIN CARE; BOOT CREAM, BOOT POLISH, SHOE CREAM, SHOE POLISH; COSMETICS FOR ANIMALS; MASCARA; DETERGENTS OTHER THAN FOR USE IN MANUFACTURING OPERATIONS AND FOR MEDICAL PURPOSES, NAMELY, DETERGENTS FOR HOUSEHOLD USE AND AUTOMOBILES; BLEACHING PREPARATIONS, NAMELY, DECOLORANTS FOR COSMETIC PURPOSES; ANTIPERSPIRANTS AS TOILETRIES; TALCUM POWDER, FOR TOILET USE; ESSENTIAL OILS, NAMELY, TERPENES; CLOTHS IMPREGNATED WITH A DETERGENT FOR CLEANING; SHAMPOOS; SHAMPOOS FOR PETS; GLASS PAPER IN THE NATURE OF ABRASIVE PAPER; SODA LYE IN THE NATURE OF HOUSEHOLD CLEANING PREPARATIONS; EXTRACTS OF FLOWERS AS PERFUMES; ETHEREAL ESSENCES AS PERFUMES; BADIAN ESSENCE AS PERFUMES; MINT ESSENCE AS ESSENTIAL OIL, IN CLASS 3 (U.S. CLS. 1, 4, 6, 50, 51 AND 52).

**Reg. No. 4,133,695** FOR: PHARMACEUTICAL PREPARATIONS, NAMELY, ANTIOXIDANTS, MICROCIRCULATION IMPROVING PREPARATIONS, PREPARATIONS FOR CHILD'S ORGANISM DISBALANCES PROPHYLAXIA; SANITARY PREPARATIONS FOR MEDICAL PURPOSES; DIETETIC SUBSTANCES ADAPTED FOR MEDICAL USE, NAMELY, DIETETIC BEVERAGES AND FOODS; FOOD FOR BABIES; MEDICAL PLASTERS, MATERIALS FOR MEDICAL DRESSINGS, NAMELY, GAUZE; MATERIAL FOR STOPPING TEETH, DENTAL WAX; ALL PURPOSE DISINFECTANTS; PREPARATIONS FOR DESTROYING VERMIN; FUNGICIDES, HERBICIDES; ACARICIDES FOR AGRICULTURAL, COMMERCIAL AND DOMESTIC USE; ACONITINE FOR AGRICULTURAL, COMMERCIAL AND DOMESTIC USE; ALKALOIDS FOR MEDICAL PURPOSES; ALGICIDES; ALDEHYDES FOR PHARMACEUTICAL PURPOSES; DENTAL AMALGAMS OF GOLD; DENTAL AMALGAMS; AMINO ACIDS FOR VETERINARY PURPOSES; AMINO ACIDS FOR MEDICAL PURPOSES; ANTIBIOTICS; ALUMINUM ACETATE FOR PHARMACEUTICAL PURPOSES; ACETATES FOR PHARMACEUTICAL PURPOSES; GERMICIDES; BALMS FOR MEDICAL PURPOSES; HYGIENIC BANDAGES FOR DRESSINGS AND SKIN WOUNDS; BANDAGES FOR DRESSINGS; BIOCIDES; MAGNETIC BRACELETS FOR MEDICAL PURPOSES; MAGNETIC ANTI-RHEUMATISM BRACELETS FOR MEDICAL PURPOSES; BROMINE FOR PHARMACEUTICAL PURPOSES; PAPER FOR MEDICAL MUSTARD PLASTERS; FLY CATCHING PAPER; MOTHPROOFING PAPER; PETROLEUM JELLY FOR MEDICAL PURPOSES; OXYGEN BATHS FOR MEDICAL PURPOSES; ANTISEPTIC COTTON; ABSORBENT COTTON FOR MEDICAL PURPOSES; ABSORBENT WADDING FOR MEDICAL PURPOSES; COTTON FOR MEDICAL PURPOSES, COTTON WADDING FOR MEDICAL PURPOSES; RADIOLOGICAL CONTRAST SUBSTANCES FOR MEDICAL PURPOSES; NUTRITIVE SUBSTANCES FOR MICROORGANISMS FOR MEDICAL PURPOSES; RADIOACTIVE SUBSTANCES FOR MEDICAL PURPOSES; BISMUTH SUBNITRATE FOR PHARMACEUTICAL PURPOSES; MELISSA WATER FOR PHARMACEUTICAL PURPOSES; SEA WATER FOR MEDICINAL BATHING; MINERAL WATER FOR MEDICAL PURPOSES; THERMAL WATER FOR MEDICAL PURPOSES; EDIBLE PLANT FIBER AS A DIETARY SUPPLEMENT, NON-NUTRITIVE; MOLDING WAX FOR DENTISTS; GASES FOR MEDICAL PURPOSES; GUAIACOL FOR PHARMACEUTICAL PURPOSES; HAEMATOGEN; HAEMOGLOBIN; HYDRASTINE; HYDRASTININE; GLYCERINE FOR MEDICAL PURPOSES; GLYCEROPHOSPHATES FOR MEDICAL PURPOSES; HORMONES FOR MEDICAL PURPOSES; MUSTARD FOR PHARMACEUTICAL PURPOSES; MUSTARD PLASTERS FOR MEDICAL PURPOSES; MUD FOR BATHS FOR MEDICAL PURPOSES; MEDICINAL MUD; GAMBOGE FOR MEDICAL PURPOSES; GURJUN BALSAM FOR MEDICAL PURPOSES; DEODORANTS, OTHER THAN FOR PERSONAL USE, NAMELY, FOR HOUSEHOLD PURPOSES; DEODORANTS FOR CLOTHING AND TEXTILES; DIASTASE FOR MEDICAL PURPOSES; DIGITALIN FOR MEDICAL PURPOSES; ADDITIVES TO FODDER FOR MEDICAL PURPOSES; MINERAL FOOD-SUPPLEMENTS; NUTRITIONAL ADDITIVES FOR MEDICAL PURPOSES; YEAST FOR PHARMACEUTICAL PURPOSES; GELATIN FOR MEDICAL PURPOSES; COD LIVER OIL; ISOTOPES FOR MEDICAL PURPOSES; INSECTICIDES; IODINE FOR PHARMACEUTICAL PURPOSES; IODIDES FOR PHARMACEUTICAL PURPOSES; ALKALINE IODIDES FOR PHARMACEUTICAL PURPOSES; IODOFORM FOR MEDICAL PURPOSES; CALOMEL FOR MEDICAL PURPOSES; CREAM OF TARTAR FOR PHARMACEUTICAL PURPOSES; TARTAR FOR PHARMACEUTICAL PURPOSES; CAMPHOR FOR MEDICAL PURPOSES; CAPSULES SOLD EMPTY FOR MEDICINES; CACHETS FOR PHARMACEUTICAL PURPOSES; CANDY FOR MEDICAL PURPOSES; LOZENGES FOR PHARMACEUTICAL PURPOSES; PASTILLES FOR PHARMACEUTICAL PURPOSES; HAEMOSTATIC PENCILS FOR MEDICAL PURPOSES; WART PENCILS FOR MEDICAL PURPOSES; CAUSTIC PENCILS FOR MEDICAL PURPOSES; CARBOLINEUM AS A PARASITICIDE; CAUSTICS FOR PHARMACEUTICAL PURPOSES; CACHOU FOR PHARMACEUTICAL PURPOSES; QUEBRACHO FOR MEDICAL PURPOSES; OXYGEN FOR MEDICAL PURPOSES; GALLIC ACID FOR PHARMACEUTICAL PURPOSES; ACIDS FOR PHARMACEUTICAL PURPOSES, NAMELY, AMINO ACIDS; ADHESIVES FOR DENTURES; ADHESIVE BANDS FOR MEDICAL PURPOSES, ADHESIVE TAPES FOR MEDICAL PURPOSES; COLLODION FOR PHARMACEUTICAL PURPOSES; CORN RINGS FOR THE FEET; ANTI-RHEUMATISM RINGS; CANDY, MEDICATED; ANGOSTURA BARK FOR MEDICAL PURPOSES; BARKS FOR

**Reg. No. 4,133,695** PHARMACEUTICAL PURPOSES; CEDAR WOOD FOR USE AS AN INSECT REPELLENT; CONDURANGO BARK FOR MEDICAL PURPOSES; CROTON BARK FOR MEDICAL PURPOSES; MANGROVE BARK FOR PHARMACEUTICAL PURPOSES; MYROBALAN BARK FOR PHARMACEUTICAL PURPOSES; CINCHONA FOR MEDICAL PURPOSES; MEDICINAL ROOTS; RHUBARB ROOTS FOR PHARMACEUTICAL PURPOSES; LINT FOR MEDICAL PURPOSES; STARCH FOR DIETETIC OR PHARMACEUTICAL PURPOSES; CREOSOTE FOR PHARMACEUTICAL PURPOSES; BLOOD FOR MEDICAL PURPOSES; CULTURES OF MICROORGANISMS FOR MEDICAL AND VETERINARY USE; CURARE FOR MEDICAL USE; DENTAL LACQUER; LIQUORICE FOR PHARMACEUTICAL PURPOSES; LACTOSE FOR MEDICAL USE; ADHESIVE PLASTER FOR MEDICAL USE; MEDICINES FOR ALLEVIATING CONSTIPATION; LECITHIN FOR MEDICAL PURPOSES; SKIN LOTIONS FOR VETERINARY PURPOSES; DOG SKIN LOTIONS; SKIN LOTIONS FOR PHARMACEUTICAL PURPOSES; LUPULIN FOR PHARMACEUTICAL PURPOSES; MAGNESIA FOR PHARMACEUTICAL PURPOSES; LINIMENTS; OINTMENTS FOR PHARMACEUTICAL PURPOSES, NAMELY, FOR IMPROVING MICROCIRCULATION, ANTI-INFLAMMATORY OINTMENTS; SUNBURN OINTMENTS, NAMELY, ANTIBIOTIC, ANTI-INFLAMMATORY OINTMENTS; MERCURIAL OINTMENTS, NAMELY, ANTIBIOTIC, ANTI-INFLAMMATORY OINTMENTS; FROSTBITE SALVE FOR PHARMACEUTICAL PURPOSES; GAUZE FOR DRESSINGS; ANTI-HORSE-FLY OILS; MEDICINAL OILS; MUSTARD OIL FOR MEDICAL PURPOSES; CAMPHOR OIL FOR MEDICAL PURPOSES; CASTOR OIL FOR MEDICAL PURPOSES; OIL OF TURPENTINE FOR PHARMACEUTICAL PURPOSES; DILL OIL FOR MEDICAL PURPOSES; DENTAL MASTICS; DENTAL ABRASIVES; DENTAL IMPRESSION MATERIALS; TEETH FILLING MATERIALS, DRESSING, MEDICAL; SURGICAL DRESSINGS; DRUGS FOR MEDICAL USE, NAMELY, MICROCIRCULATION IMPROVEMENT PREPARATIONS, PREPARATIONS FOR CHILD'S ORGANISM DISBALANCES PROPHYLAXIS; SEROTHERAPEUTIC MEDICINES; MEDICINES FOR HUMAN PURPOSES, NAMELY, FOR MICROCIRCULATION IMPROVEMENT PREPARATIONS AND PREPARATIONS FOR CHILD'S ORGANISM DISBALANCES PROPHYLAXIS; MEDICINES FOR DENTAL PURPOSES; MENTHOL FOR MEDICAL PURPOSES; MEDICINAL DRINKS; MOLESKIN FOR MEDICAL PURPOSES; ALBUMINOUS MILK FOR MEDICAL PURPOSES; MILK OF ALMONDS FOR PHARMACEUTICAL PURPOSES; ROYAL JELLY FOR MEDICAL PURPOSES; MILK FERMENTS FOR PHARMACEUTICAL PURPOSES; IRISH MOSS FOR MEDICAL PURPOSES; LACTEAL FLOUR FOR BABIES; FLOUR FOR PHARMACEUTICAL PURPOSES, MEAL FOR PHARMACEUTICAL PURPOSES; LINSEED MEAL FOR PHARMACEUTICAL PURPOSES; FISHMEAL FOR PHARMACEUTICAL PURPOSES; FLY CATCHING ADHESIVES, FLY GLUE; MINT FOR PHARMACEUTICAL PURPOSES; FIRST-AID BOXES, FILLED; MEDICINE CASES, PORTABLE, FILLED; DIETETIC BEVERAGES ADAPTED FOR MEDICAL PURPOSES; MALTED MILK BEVERAGES FOR MEDICAL PURPOSE; MEDICINAL INFUSIONS, NAMELY, MICROCIRCULATION IMPROVEMENT PREPARATIONS AND PREPARATIONS FOR CHILD'S ORGANISM DISBALANCES PROPHYLAXIS; TINCTURE OF IODINE; EUCALYPTOL FOR PHARMACEUTICAL PURPOSES; TINCTURES FOR MEDICAL PURPOSES, NAMELY, MICROCIRCULATION IMPROVEMENT PREPARATIONS AND PREPARATIONS FOR CHILD'S ORGANISM DISBALANCES PROPHYLAXIS; OPODELDOC FOR MEDICAL PURPOSES; DECOCTIONS FOR PHARMACEUTICAL PURPOSES, NAMELY, MICROCIRCULATION IMPROVEMENT PREPARATIONS AND PREPARATIONS FOR CHILD'S ORGANISM DISBALANCES PROPHYLAXIS; ANTIPARASITIC COLLARS FOR ANIMALS; STICK LIQUORICE FOR PHARMACEUTICAL PURPOSES; SULFUR STICKS AS DISINFECTANTS; PANTS, ABSORBENT, FOR INCONTINENCE; PECTIN FOR PHARMACEUTICAL PURPOSES; NAPKINS FOR INCONTINENCE; PEPSINS FOR PHARMACEUTICAL PURPOSES; PEPTONES FOR PHARMACEUTICAL PURPOSES; HYDROGEN PEROXIDE FOR MEDICAL PURPOSES; PILLS FOR PHARMACEUTICAL PURPOSES, NAMELY, ANTI-OXIDANTS, MICROCIRCULATION IMPROVEMENT PREPARATIONS AND PREPARATIONS FOR CHILD'S ORGANISM DISBALANCES PROPHYLAXIS; LEECHES FOR MEDICAL PURPOSES; BLOOD PLASMA; PLASTERS FOR MEDICAL PURPOSES; EYEPATCHES FOR MEDICAL PURPOSES; POULTICES; MEDICATED COMPRESSES; SCAPULARS FOR SURGICAL PURPOSES; BUNION PADS; BREAST-NURSING PADS; POMADES FOR MEDICAL PURPOSES; POWDER OF CANTHARIDES FOR MEDICAL PURPOSES; PYRETHRUM POWDER FOR MEDICAL PURPOSES; BELTS FOR SANITARY NAPKINS AND

**Reg. No. 4,133,695** TOWELS; ANTI-URIC PREPARATIONS; BACTERIAL PREPARATIONS FOR MEDICAL AND VETERINARY USE; BACTERIOLOGICAL PREPARATIONS FOR MEDICAL AND VETERINARY USE; BALSAMIC PREPARATIONS FOR MEDICAL PURPOSES; ALBUMINOUS PREPARATIONS FOR MEDICAL PURPOSES; BIOLOGICAL PREPARATIONS FOR VETERINARY PURPOSES FOR THE TREATMENT OF MICROCIRCULATION AND CHILD'S ORGANISM DISBALANCES PROPHYLAXIS; BIOLOGICAL PREPARATIONS FOR MEDICAL PURPOSES FOR THE TREATMENT OF MICROCIRCULATION AND CHILD'S ORGANISM DISBALANCES PROPHYLAXIS; BISMUTH PREPARATIONS FOR PHARMACEUTICAL PURPOSES; VITAMIN PREPARATIONS; DIAGNOSTIC PREPARATIONS FOR MEDICAL PURPOSES; THERAPEUTIC MEDICATED PREPARATIONS FOR THE BATH; HAEMORRHOID TREATMENT PREPARATIONS; PREPARATIONS FOR CALLOUSES, NAMELY, CALLOUS CREAMS, OINTMENTS AND GELS; MEDICATED PREPARATIONS TO FACILITATE TEETHING; MEDICATED PREPARATIONS FOR TREATMENT OF BURNS; FUMIGATION PREPARATIONS FOR MEDICAL PURPOSES; OPOTHERAPY PREPARATIONS FOR MEDICAL PURPOSES; AIR FRESHENING PREPARATIONS; AIR PURIFYING PREPARATIONS; BRONCHODILATING PREPARATIONS; SANITARY STERILIZING PREPARATIONS; SOIL STERILIZING PREPARATIONS FOR SANITARY PURPOSES; CORN REMEDIES, NAMELY, CORN CREAM, OINTMENTS AND GELS; PHARMACEUTICAL PREPARATIONS FOR TREATING DANDRUFF; PREPARATIONS FOR DESTROYING NOXIOUS ANIMALS, NAMELY, PESTICIDES; PREPARATIONS FOR DESTROYING DRY ROT FUNGUS, NAMELY, FUNGICIDE; LARVAE EXTERMINATING PREPARATIONS, NAMELY, INSECTICIDES; FLY DESTROYING PREPARATIONS, NAMELY, INSECTICIDES; PREPARATIONS FOR DESTROYING MICE, NAMELY, PESTICIDES; SLUG EXTERMINATING PREPARATIONS, NAMELY, INSECTICIDE; PHARMACEUTICAL PREPARATIONS FOR SKIN CARE; CONTACT LENS CLEANING PREPARATIONS; PREPARATIONS OF LIME FOR PHARMACEUTICAL PURPOSES; BATH PREPARATIONS, MEDICATED; MEDICINAL HAIR GROWTH PREPARATIONS; ANTICRYPTOGAMIC PREPARATIONS FOR MEDICAL PURPOSES; MEDICINAL PREPARATIONS OF TRACE ELEMENTS FOR HUMAN AND ANIMAL USE, NAMELY, ANTIOXIDANTS, MICROCIRCULATION IMPROVEMENT PREPARATIONS, PREPARATIONS FOR CHILD'S ORGANISM DISBALANCES PROPHYLAXIS IN THE FORM OF PILLS, CAPSULES, PASTILLES, DRAGEE, CAMELS, MARMALADE, BEVERAGES; SULPHONAMIDES AS MEDICINES; PHARMACEUTICAL PREPARATIONS FOR THE TREATMENT OF MICROCIRCULATION AND CHILD'S ORGANISM DISBALANCES PROPHYLAXIS; SUNBURN PREPARATIONS FOR PHARMACEUTICAL PURPOSES; ENZYME PREPARATIONS FOR VETERINARY PURPOSES; ENZYME PREPARATIONS FOR MEDICAL PURPOSES; CHEMICO-PHARMACEUTICAL PREPARATIONS FOR THE TREATMENT OF MICROCIRCULATION AND CHILD'S ORGANISM DISBALANCES PROPHYLAXIS; CHEMICAL PREPARATIONS FOR THE DIAGNOSIS OF PREGNANCY; CHEMICAL PREPARATIONS FOR MEDICAL PURPOSES FOR THE TREATMENT OF MICROCIRCULATION AND CHILD'S ORGANISM DISBALANCES PROPHYLAXIS; CHEMICAL PREPARATIONS TO TREAT WHEAT BLIGHT AND WHEAT SMUT; VINE DISEASE TREATING CHEMICALS; CHEMICAL PREPARATIONS TO TREAT MILDEW; CHEMICAL PREPARATIONS FOR TREATING PHYLLOXERA; CHEMICAL PREPARATIONS FOR PHARMACEUTICAL PURPOSES FOR THE TREATMENT OF MICROCIRCULATION AND CHILD'S ORGANISM DISBALANCES PROPHYLAXIS; CHILBLAIN PREPARATIONS FOR MEDICAL PURPOSES; MOTHPROOFING PREPARATIONS; EYE-WASH; GOULARD WATER AND LEAD WATER FOR MEDICAL PURPOSES; CHEMICAL CONDUCTORS FOR ELECTROCARDIOGRAPH ELECTRODES; ALBUMINOUS FOODSTUFFS FOR MEDICAL PURPOSES; DIETETIC FOODS ADAPTED FOR MEDICAL PURPOSES; BY-PRODUCTS OF THE PROCESSING OF CEREALS FOR MEDICAL PURPOSES; MENSTRUATION BANDAGES, SANITARY PADS; SANITARY PANTY LINERS; RADIUM FOR MEDICAL PURPOSES; HYDRATED CHLORAL FOR PHARMACEUTICAL PURPOSES; SOLVENTS FOR REMOVING ADHESIVE PLASTERS FOR MEDICAL PURPOSES; VAGINAL WASHES; SOLUTIONS FOR CONTACT LENSES; CHEMICAL REAGENTS FOR MEDICAL OR VETERINARY PURPOSES; GUM FOR MEDICAL PURPOSES; RUBBER FOR DENTAL PURPOSES; CHEWING GUM FOR MEDICAL PURPOSES; INSECT REPELLENT INCENSE; INSECT REPELLENTS; REPELLENTS FOR DOGS; SANITARY NAPKINS, SANITARY TOWELS; TISSUES IMPREGNATED WITH PHARMACEUTICAL LOTIONS; SARSAPARILLA FOR MEDICAL PURPOSES; SUGAR FOR MEDICAL



**Reg. No. 4,133,695** PURPOSES; ASTHMATIC TEA; FUMIGATING PASTILLES AND FUMIGATING STICKS FOR MEDICAL PURPOSES; SUPPOSITORIES; LINSEED FOR PHARMACEUTICAL PURPOSES; TOBACCO-FREE CIGARETTES FOR MEDICAL PURPOSES; SICCATIVES, NAMELY, DRYING AGENTS FOR MEDICAL PURPOSES; SYRUPS FOR PHARMACEUTICAL PURPOSES; TURPENTINE FOR PHARMACEUTICAL PURPOSES; MILKING GREASE FOR MEDICAL PURPOSES; GREASES FOR VETERINARY PURPOSES; GREASES FOR MEDICAL PURPOSES; SOPORIFICS; BICARBONATE OF SODA FOR PHARMACEUTICAL PURPOSES; MEDICATED SALTS FOR MINERAL WATER BATHS; BATH SALTS FOR MEDICAL PURPOSES; SALTS FOR MEDICAL PURPOSES; POTASSIUM SALTS FOR MEDICAL PURPOSES; SODIUM SALTS FOR MEDICAL PURPOSES; SMELLING SALTS; MINERAL WATER SALTS FOR MEDICAL PURPOSES; MALT FOR PHARMACEUTICAL PURPOSES; SEMEN FOR ARTIFICIAL INSEMINATION; ALCOHOL FOR PHARMACEUTICAL PURPOSES; ALLOYS OF PRECIOUS METALS FOR DENTAL PURPOSES; ERGOT FOR PHARMACEUTICAL PURPOSES; ANAESTHETICS; ANTISEPTICS; ANALGESICS; ADJUVANTS FOR MEDICAL PURPOSES; STYPTIC PREPARATIONS, NAMELY, STYPTIC PENCILS; ANTHELMINTICS FOR MEDICAL PURPOSES; DISINFECTANTS FOR HYGIENE PURPOSES; DISINFECTANTS FOR CHEMICAL TOILETS; APPETITE SUPPRESSANTS FOR MEDICAL PURPOSES; MEDICAL PREPARATIONS FOR SLIMMING PURPOSES; PARASITICIDES; MOUTHWASHES FOR MEDICAL PURPOSES; FEBRIFUGES; DEPURATIVES; MEDICATED ANIMAL WASHES; DETERGENTS FOR MEDICAL PURPOSES; MEDICATED CATTLE WASHES; MEDICATED DOG WASHES; VESICANTS; HEADACHE PENCILS; CHEMICAL CONTRACEPTIVES; ANTIPARASITIC PREPARATIONS; EVACUANTS, LAXATIVES, PURGATIVES; TONICS FOR MEDICAL PURPOSES; NERVINESS; DIGESTIVES FOR PHARMACEUTICAL PURPOSES; BOUILLONS FOR BACTERIOLOGICAL CULTURES, MEDIA FOR BACTERIOLOGICAL CULTURES; STEROIDS; STRYCHNINE FOR MEDICAL PURPOSES; MEDICATED SERUMS FOR TREATMENT OF HAIR, SKIN, LIPS; SAL AMMONIAC LOZENGES FOR MEDICAL PURPOSES; MENSTRUATION TAMPONS; VULNERARY SPONGES; THYMOL FOR PHARMACEUTICAL PURPOSES; SURGICAL CLOTH, NAMELY, TISSUES; SURGICAL TISSUES; SEDATIVES; TRANQUILIZERS; SURGICAL IMPLANTS COMPRISING LIVING TISSUES; MENSTRUATION KNICKERS, SANITARY KNICKERS, SANITARY PANTIES; CHARCOAL FOR PHARMACEUTICAL PURPOSES; FENNEL FOR MEDICAL PURPOSES; PORCELAIN FOR DENTAL PROSTHESES; PHENOL FOR PHARMACEUTICAL PURPOSES; ENZYMES FOR VETERINARY PURPOSES; ENZYMES FOR MEDICAL PURPOSES; FERMENTS FOR PHARMACEUTICAL PURPOSES; FORMIC ALDEHYDE FOR PHARMACEUTICAL PURPOSES; PHOSPHATES FOR PHARMACEUTICAL PURPOSES; QUININE FOR MEDICAL PURPOSES; CHINOLINE FOR MEDICAL PURPOSES; DIABETIC BREAD; CHLOROFORM; FLOWERS OF SULPHUR FOR PHARMACEUTICAL PURPOSES CEMENT FOR ANIMAL HOOVES; BONE CEMENT FOR SURGICAL AND ORTHOPAEDIC PURPOSES; DENTAL CEMENTS; HERBS TEAS FOR MEDICINAL PURPOSES; MEDICINAL TEA; REDUCING TEA FOR MEDICAL PURPOSES; EUCALYPTUS FOR PHARMACEUTICAL PURPOSES; TOBACCO EXTRACTS AS INSECTICIDES; EXTRACTS OF HOPS FOR PHARMACEUTICAL PURPOSES; ELIXIRS AS PHARMACEUTICAL PREPARATIONS FOR THE TREATMENT OF MICROCIRCULATION AND CHILD'S ORGANISM DISBALANCES PROPHYLAXIS; ETHERS FOR PHARMACEUTICAL PURPOSES; ESTERS FOR PHARMACEUTICAL PURPOSES; CELLULOSE ESTERS FOR PHARMACEUTICAL PURPOSES; CELLULOSE ETHERS FOR PHARMACEUTICAL PURPOSES; MEDICATED JUJUBE; RAT POISON; BACTERIA POISONS; BACTERIAL POISONS; JALAP AS A PURGATIVE; BIOLOGICALLY ACTIVE FOOD SUPPLEMENTS , IN CLASS 5 (U.S. CLS. 6, 18, 44, 46, 51 AND 52).

FOR: MEAT, FISH, POULTRY, AND GAME; MEAT EXTRACTS; PRESERVED, FROZEN, DRIED, AND COOKED FRUITS AND VEGETABLES; JELLIES, JAMS, COMPOTES; EGGS, MILK AND MILK PRODUCTS EXCLUDING ICE CREAM, ICE MILK, FROZEN YOGURT AND MILK PRODUCT ENRICHED WITH ANTIOXIDANTS AND DIETARY FIBERS; EDIBLE OILS AND FATS; ALGINATES FOR FOOD; PROCESSED ANCHOVY; PEANUTS, PROCESSED; ALBUMEN FOR FOOD; WHITES OF EGGS; BEANS, PRESERVES; SOYA BEANS, PRESERVED, FOR FOOD; BOUILLON; GINGER JAM; FATTY SUBSTANCES FOR THE MANUFACTURE OF EDIBLE FATS; EDIBLE BIRDS? NESTS; PEAS, PRESERVED; MUSHROOMS, PRESERVED; GAME, NOT LIVE; UNFLAVORED AND UNSWEETENED GELATIN

**Reg. No. 4,133,695** FOR FOOD; MEAT JELLIES; JELLIES FOR FOOD; FRUIT JELLIES; YOLK OF EGGS; COCONUT FAT; BONE OIL, EDIBLE; LARD FOR FOOD; SUET FOR FOOD; FRUIT-BASED SNACK FOOD; CHARCUTERIE, SAUSAGES; RAISINS; CAVIAR; CASEIN FOR FOOD; SAUERKRAUT; ISINGLASS FOR FOOD; BLACK PUDDING, BLOOD SAUSAGE; MEAT, TINNED; VEGETABLES, TINNED; FISH, TINNED; FRUITS, TINNED; BOUILLON CONCENTRATES; GHERKINS; PRAWNS, NOT LIVE; BUTTER CREAM; CROQUETTES; SILKWORM CHRYSALIS, FOR HUMAN CONSUMPTION; TOASTED LAVER; SPINY LOBSTERS, NOT LIVE; SALMON; ONIONS, PRESERVED; MARGARINE; PICCALILLI; MARMALADE; COCONUT OIL, COLZA OIL FOR FOOD, CORN OIL, MAIZE OIL, OLIVE OIL FOR FOOD, PALM KERNEL OIL FOR FOOD, PALM OIL FOR FOOD, RAPE OIL FOR FOOD, SESAME OIL, SUNFLOWER OIL FOR FOOD; PEANUT BUTTER; CHOCOLATE NUT BUTTER, COCOA BUTTER; COCONUT BUTTER; BUTTER; SHELLFISH, NOT LIVE; ALMONDS, GROUND; ANIMAL MARROW FOR FOOD; CLAMS, NOT LIVE; MUSSELS, NOT LIVE; SOYA MILK AS A MILK SUBSTITUTE; FISHMEAL FOR HUMAN CONSUMPTION; FRUIT PULP; MEAT, PRESERVED; POTATO FRITTERS; OLIVES, PRESERVED; LOBSTERS, NOT LIVE; COCONUT, DESICCATED; NUTS, PREPARED; TOMATO PUREE; LIVER PATE; PECTIN FOR FOOD; LIVER; PICKLES; POWDERED EGGS; HAM; MILK PRODUCTS, NAMELY, CREAM, KEFIR, KOUMISS, BEVERAGES CONSISTING PRINCIPALLY OF MILK, WHEY, YOGHURT; FERMENTED VEGETABLE FOODS BEING KIMCHI; SALTED FISH, FOODS PREPARED FROM FISH, NAMELY, FISH AND CHIPS, AND FISH CAKES; CURD; PROTEIN BEING FOODSTUFFS FOR HUMAN CONSUMPTION; POLLEN PREPARED AS A FOODSTUFF; CRANBERRY SAUCE COMPOTE; APPLE PUREE; CRAYFISH, NOT LIVE; CRUSTACEANS, NOT LIVE; FISH, PRESERVED; VEGETABLE SALADS; FRUIT SALADS; BACON; SARDINE; PORK; HERRINGS; WHIPPED CREAM; FAT-CONTAINING MIXTURES FOR BREAD SLICES, NAMELY, CHEESE SPREADS, DAIRY BASED SPREADS; TOMATO JUICE FOR COOKING; VEGETABLE JUICES FOR COOKING; SALTED MEATS; SAUSAGES IN BATTER; PREPARATIONS FOR MAKING BOUILLON; PREPARATIONS FOR MAKING SOUP; TRIPE; SOUPS; VEGETABLE SOUP PREPARATIONS; CHEESE; TAHINI; TOFU; SEA-CUCUMBERS, NOT LIVE; TRUFFLES, PRESERVED; TUNA FISH; OYSTERS, NOT LIVE; RENNET; FISH FILLETS; PROCESSED DATES; CRYSTALLIZED FRUITS, FROSTED FRUITS; FROZEN FRUITS; FRUIT PRESERVED IN ALCOHOL; POTATO FLAKES; HUMMUS; FRUIT PEEL; LENTILS, PRESERVED; POTATO CHIPS; FRUIT CHIPS; WEED EXTRACTS FOR FOODS; SNAIL EGGS FOR CONSUMPTION, IN CLASS 29 (U.S. CL. 46).

FOR: COFFEE, TEA, COCOA, SUGAR, RICE, TAPIOCA, SAGO, ARTIFICIAL COFFEE; FLOUR AND PREPARATIONS MADE FROM CEREALS, NAMELY, CEREAL BASED SNACK FOOD, BISCUITS TARTS AND CAKES MADE WITH CEREALS, ALL ENRICHED WITH DIETARY FIBERS; BREAD, PASTRY, AND CONFECTIONERY, NAMELY, FLOUR AND SUGAR CONFECTIONERY ALSO ENRICHED WITH DIETARY FIBERS; ICES; HONEY, TREACLE; YEAST, BAKING-POWDER; SALT, MUSTARD; VINEGAR; SAUCES AS CONDIMENTS, NAMELY, KETCHUP, MAYONNAISE; SPICES; AROMATIC PREPARATIONS FOR FOODS, NAMELY, PEPPER, GINGER, CURRY; FLAVORINGS, OTHER THAN ESSENTIAL OILS; FLAVORINGS, OTHER THAN ESSENTIAL OILS, FOR BEVERAGES; FLAVORINGS, OTHER THAN ESSENTIAL OILS, FOR CAKES; STAR ANISEED; COOKIES; PANCAKES; BUNS; BREAD ROLLS; VANILLIN AS VANILLA SUBSTITUTE; VANILLA FLAVORING; WAFFLES; VERMICELLI NOODLES; COFFEE FLAVORINGS; NATURAL SWEETENERS; STARCH-BASED SAUSAGE BINDING MATERIALS; STARCH-BASED BINDING AGENTS FOR ICE CREAM; SEA WATER FOR COOKING; GLUCOSE FOR FOOD; THICKENING AGENTS FOR COOKING FOODSTUFFS; RICEBASED SNACK FOOD; CEREAL-BASED SNACK FOOD; VEGETAL PREPARATIONS FOR USE AS COFFEE SUBSTITUTES; PASTRIES; CONFECTIONERY MADE OF SUGAR FOR DECORATING CHRISTMAS TREES; FRUIT JELLIES BEING CONFECTIONERY; CAKES; PEANUT CONFECTIONERY; ALMOND CONFECTIONERY; FARINACEOUS FOOD PASTES; MACARONI; PASTS; PASTRIES, NAMELY, PASTY; FROZEN YOGHURT; COCOA PRODUCTS, NAMELY, COCOA POWDER, COCOA MIXES; CAPERS; CARAMELS; GRUEL, WITH A MILK BASE, FOR FOOD; QUICHES; GLUTEN FOR FOOD; SWEETMEATS; LIQUORICE; STICK LIQUORICE; PEPPERMINT SWEETS; UNROASTED COFFEE; STARCH FOR FOOD; CRACKERS; HOMINY GRITS; GROATS FOR HUMAN FOOD; HUSKED BARELY; SEMOLINA; CORN, MILLED;

**Reg. No. 4,133,695** CORN, ROASTED; MEAT PIES; TURMERIC FOR FOOD; COUSCOUS; FARINACEOUS FOODS; NOODLES; ICE FOR REFRESHMENT; ICE, NATURAL OR ARTIFICIAL; EDIBLE ICES; CANDY FOR FOOD; RICE CAKES; MALTOSE; HOMINY; MARZIPAN; CUSTARD; ROYAL JELLY FOR HUMAN CONSUMPTION, NOT FOR MEDICAL PURPOSES; ICE CREAM; SHERBETS; SORBETS; BARLEY MEAL; BEAN MEAL; CORN FLOUR; CORN MEAL; FLOUR FOR FOOD; MAIZE FLOUR; MAIZE MEAL; MUSTARD MEAL; OATMEAL; POTATO FLOUR FOR FOOD; SOYA FLOUR; TAPIOCA FLOUR FOR FOOD; WHEAT FLOUR; MUESLI; MINT FOR CONFECTIONERY; COCOA BEVERAGES WITH MILK; COFFEE-BASED BEVERAGES; TEA-BASED BEVERAGES; CHOCOLATE BEVERAGES WITH MILK; CHOCOLATE-BASED BEVERAGES; COCOA-BASED BEVERAGES; HERBAL INFUSIONS, NOT MEDICINAL; CRUSHED OATS; HUSKED OATS; NUTMEGS; LOZENGES AS CONFECTIONERY; PASTILLES AS CONFECTIONERY; GOLDEN SYRUP; MOLASSES FOR FOOD; PEPPER; PETTIS FOURS; BISCUITS; MACAROONS; MALT BISCUITS; PIES, PIZZAS; FONDANTS AS CONFECTIONERY; POPCORN; POWDERS FOR ICE CREAM; PRALINES; CHOW-CHOW; CHUTNEYS; CONDIMENTS, NAMELY, MUSTARD, KETCHUP, MAYONNAISE; DRESSINGS FOR SALAD; MEAT GRAVIES; KETCHUP; MAYONNAISE; RELISH; SOYA SAUCE; TOMATO SAUCE; WEEDS AS A CONDIMENT; MEAT TENDERIZERS, FOR HOUSEHOLD PURPOSES; CEREAL PREPARATIONS, NAMELY, CEREAL BASED SNACK FOOD, BISCUITS TARTS AND CAKES MADE WITH CEREALS, ENRICHED WITH DIETARY FIBERS; FLOUR-MILLING PRODUCTS, NAMELY, FLOUR; OAT-BASED FOOD, NAMELY, CEREAL BARS, GRUELS AND SOLID MIXTURES, CONTAINING DIETARY FIBERS; BEE GLUE FOR HUMAN CONSUMPTION; GINGERBREAD; ALLSPICE; CINNAMON; CLOVES; CURRY; GINGER; SPICES; PUDDINGS; CAKE POWDER, NAMELY, YEAST POWDER, BAKING POWDER, ENRICHED WITH DIETARY FIBERS; RAVIOLI; CHEWING GUM, NOT FOR MEDICAL PURPOSES; SPRING ROLLS; ANISEED; CAKE PASTE, NAMELY, CHOCOLATE PASTE, FRUIT PASTE FOR FLAVORING OF FOOD, ENRICHED WITH DIETARY FIBER; BAKING SODA; MALT FOR HUMAN CONSUMPTION; SALT FOR PRESERVING FOODSTUFFS; COOKING SALT; CELERY SALT; SPAGHETTI; PEPPERS AS SEASONINGS; SAFFRON AS SEASONING; SEASONINGS; STARCH-BASED THICKENING PREPARATIONS FOR STIFFENING WHIPPED CREAM; RUSKS; BREADCRUMBS; SUSHI; SANDWICHES; YEAST IN PILL FORM, NOT FOR MEDICAL USE; TABBOULEH; TACOS; SOYA BEAN PASTE; ALMOND PASTE; TORTILLAS; TARTS; GARDEN HERBS, PRESERVED AS SEASONINGS; EDIBLE DECORATIONS FOR CAKES; FERMENTS FOR PASTES FOR HUMAN CONSUMPTION; LEAVEN, NAMELY, FOOD LEAVENING AGENTS; YEAST; HALVAH; BREAD; UNLEAVENED BREAD; GRAIN-BASED CHIPS AS CEREAL PRODUCTS; CORN FLAKES; MAIZE FLAKES; OAT FLAKES; CHICORY AS A COFFEE SUBSTITUTE; ICED TEA; CHOCOLATE; MALT EXTRACT FOR FOOD; ESSENCES FOR FOODSTUFFS, EXCEPT ETHERIC ESSENCES AND ESSENTIAL OILS, NAMELY, COFFEE ESSENCES, IN CLASS 30 (U.S. CL. 46).

FOR: BEERS; MINERAL AND AERATED WATERS; NON-ALCOHOLIC DRINKS, NAMELY, CIDER, SODA POPS, CONTAINING ANTIOXIDANTS AND DIETARY FIBERS; FRUIT DRINKS AND FRUIT JUICES; SYRUPS AND OTHER PREPARATIONS FOR MAKING BEVERAGES, NAMELY, SODA POP SYRUPS; APERITIFS, NON-ALCOHOLIC; LITHIA WATER, MINERAL WATER, SELTZER WATER, SODA WATER, TABLE WATER, WATER BEVERAGES; KVASS, AS A NON-ALCOHOLIC BEVERAGE; COCKTAILS, NON-ALCOHOLIC; LEMONADES; PEANUT MILK; NON-ALCOHOLIC BEVERAGES, NAMELY, CIDER, FRUIT JUICE, SODA POPS; ISOTONIC BEVERAGES; NONALCOHOLIC HONEY-BASED BEVERAGES; WHEY BEVERAGES; NON-ALCOHOLIC FRUIT JUICE BEVERAGES; MILK OF ALMONDS; FRUIT NECTARS, NON-ALCOHOLIC; ORGEAT AS A NON-ALCOHOLIC FRUIT BEVERAGE; GINGER ALE, GINGER BEER, MALT BEER; POWDERS FOR EFFERVESCING BEVERAGES, NAMELY, SODA POPS; SARSAPARILLA AS A SOFT DRINK; SYRUPS FOR LEMONADE; SYRUPS FOR BEVERAGES; TOMATO JUICE; CIDER, NON-ALCOHOLIC; VEGETABLE JUICES; PREPARATIONS FOR MAKING AERATED WATER, NAMELY, DRINKING WATER; PREPARATIONS FOR MAKING LIQUEURS, NAMELY, ESSENCES USED IN THE PREPARATION OF LIQUEURS; PREPARATIONS FOR MAKING MINERAL WATER, NAMELY, SYRUPS FOR MAKING FLAVORED MINERAL WATERS; MUST; GRAPE MUST, UNFERMENTED; BEER WORT; MALT WORT; PASTILLES FOR

**Reg. No. 4,133,695** EFFERVESCING BEVERAGES, NAMELY, SODA POPS; SHERBETS BEING BEVERAGES; SORBETS BEING BEVERAGES; NONALCOHOLIC FRUIT EXTRACTS USED IN THE PREPARATION OF BEVERAGES; EXTRACTS OF HOPS FOR MAKING BEER; ESSENCES FOR MAKING NON-ALCOHOLIC BEVERAGES, IN CLASS 32 (U.S. CLS. 45, 46 AND 48).

THE MARK CONSISTS OF THE WORD "CAPILASHKA" IN CAPITAL BLOCK LETTERS.

PRIORITY DATE OF 11-22-2010 IS CLAIMED.

OWNER OF INTERNATIONAL REGISTRATION 1075631 DATED 2-9-2011, EXPIRES 2-9-2021.

THE WORDING "CAPILASHKA" HAS NO MEANING IN A FOREIGN LANGUAGE.

SER. NO. 79-096,856, FILED 2-9-2011.

LINDSEY RUBIN, EXAMINING ATTORNEY

# United States of America

United States Patent and Trademark Office



**Reg. No. 4,133,696**

**Registered May 1, 2012**

**Int. Cl.: 12**

**TRADEMARK**

**PRINCIPAL REGISTER**

FAHLÉNS MEKANISKA VERKSTAD FAMEK AKTIEBOLAG (SWEDEN JOINT STOCK COMPANY)  
STRANDVÄGEN 64  
SE-870 52 NYLAND, SWEDEN

FOR: PEDESTRIAN TRUCKS FOR MOVING VEHICLES, NAMELY, TRUCKS HAVING A STEERING ROD FOR A WALKING OPERATOR AND USED FOR TRANSPORTING VEHICLES; PEDESTRIAN TRUCKS FOR MOVING CARRIAGES, NAMELY, TRUCKS HAVING A STEERING ROD FOR A WALKING OPERATOR AND USED FOR TRANSPORTING TROLLEYS; CARRIAGES FOR MOVING VEHICLES, NAMELY, TRUCKS HAVING A SEAT OR A RIDE-ON PLATFORM FOR AN OPERATOR AND USED FOR TRANSPORTING VEHICLES, IN CLASS 12 (U.S. CLS. 19, 21, 23, 31, 35 AND 44).

THE MARK CONSISTS OF THE WORDING "STRINGO" AND THE DESIGN OF TWO ELONGATED DIRECTIONAL ARROWS THAT UNDERLINE AND OVERLINE THE MARK.

PRIORITY DATE OF 12-23-2010 IS CLAIMED.

OWNER OF INTERNATIONAL REGISTRATION 1075726 DATED 3-28-2011, EXPIRES 3-28-2021.

SER. NO. 79-096,881, FILED 3-28-2011.

SEAN CROWLEY, EXAMINING ATTORNEY



*David J. Kyffers*

Director of the United States Patent and Trademark Office

# United States of America

United States Patent and Trademark Office



**Reg. No. 4,133,697**

**Registered May 1, 2012**

**Int. Cls.: 16 and 41**

**TRADEMARK**

**SERVICE MARK**

**PRINCIPAL REGISTER**

DIMITRIOS DASKALEAS (GREECE INDIVIDUAL)  
53 KALLIKRATIDA STR.  
GR-185 44 PIRAEUS  
GREECE

FOR: COMIC BOOKS; MAGAZINES FEATURING PRINTED STORIES IN ILLUSTRATED FORM AND COMIC BOOK STORIES AND ARTWORK; PRINTED MATTER, NAMELY, JOURNALS FEATURING ART, GRAPHIC DESIGN, MEDIA, BUSINESS, TECHNOLOGY; BOOKS IN THE FIELD OF ART, GRAPHIC DESIGN, MEDIA, BUSINESS, TECHNOLOGY; MAPS, IN CLASS 16 (U.S. CLS. 2, 5, 22, 23, 29, 37, 38 AND 50).

FOR: EDUCATION SERVICES, NAMELY, PROVIDING CLASSES, SEMINARS, WORKSHOPS IN THE FIELD OF WRITING COMICS, ART, GRAPHIC DESIGN, MEDIA, BUSINESS, TECHNOLOGY; NON-DOWNLOADABLE ELECTRONIC PUBLICATIONS IN THE NATURE OF COMIC BOOKS, CARTOON PANELS, BOOKS, MAGAZINES, AND JOURNALS IN THE FIELD OF ART, GRAPHIC DESIGN, MEDIA, BUSINESS, TECHNOLOGY; PUBLICATION OF COMIC BOOKS, BOOKS, MAGAZINES, JOURNALS, IN CLASS 41 (U.S. CLS. 100, 101 AND 107).

NO CLAIM IS MADE TO THE EXCLUSIVE RIGHT TO USE "COMICS", APART FROM THE MARK AS SHOWN.

PRIORITY DATE OF 3-30-2011 IS CLAIMED.

OWNER OF INTERNATIONAL REGISTRATION 1075769 DATED 4-5-2011, EXPIRES 4-5-2021.

THE COLOR(S) BLACK, RED, GRAY, AND WHITE IS/ARE CLAIMED AS A FEATURE OF THE MARK.

THE MARK CONSISTS OF THE STYLIZED WORD "DEIMOS" IN THE COLOR RED; A BOX ABOVE THE WORD "DEIMOS" IN THE COLORS RED, WHITE, AND BLACK; A STYLIZED WORD "COMICS" IN THE COLOR WHITE INSIDE A BLACK RECTANGULAR FRAME WITH A GRAY SHADOW.

SER. NO. 79-096,892, FILED 4-5-2011.



*David J. Kybas*

Director of the United States Patent and Trademark Office

**Reg. No. 4,133,697** B. PARADEWELAI, EXAMINING ATTORNEY

# United States of America

United States Patent and Trademark Office

# TOMBOLINI

**Reg. No. 4,133,698**

**Registered May 1, 2012**

**Int. Cl.: 33**

**TRADEMARK**

**PRINCIPAL REGISTER**

SANFRANCESCO S.R.L. - SOCIETA' AGRICOLA (ITALY LIMITED LIABILITY COMPANY)  
CONTRADA CAVALLINE, 2  
I-60039 STAFFOLO (AN)  
ITALY

FOR: WINES, IN CLASS 33 (U.S. CLS. 47 AND 49).

THE MARK CONSISTS OF STANDARD CHARACTERS WITHOUT CLAIM TO ANY PARTICULAR FONT, STYLE, SIZE, OR COLOR.

PRIORITY DATE OF 3-4-2011 IS CLAIMED.

OWNER OF INTERNATIONAL REGISTRATION 1075840 DATED 3-10-2011, EXPIRES 3-10-2021.

SER. NO. 79-096,916, FILED 3-10-2011.

JESSICA FATHY, EXAMINING ATTORNEY



*David J. Kyffers*

Director of the United States Patent and Trademark Office



# United States of America

United States Patent and Trademark Office

# Compass VMS

**Reg. No. 4,133,699**

**Registered May 1, 2012**

**Int. Cls.: 9, 35 and 42**

**TRADEMARK**

**SERVICE MARK**

**PRINCIPAL REGISTER**

GIESECKE & DEVRIENT GMBH (FED REP GERMANY GMBH)  
PRINZREGENTENSTR. 159  
81677 MÜNCHEN  
FED REP GERMANY

FOR: MONEY MANAGEMENT SYSTEM SOFTWARE, IN PARTICULAR SOFTWARE FOR BANKS, OTHER FINANCIAL AND CREDIT INSTITUTIONS AND CASH-TRANSPORT ENTERPRISES AS WELL AS FOR THEIR CUSTOMERS, FOR MANAGING, PROCESSING, RECONCILING, MONITORING AND OPTIMIZING MONEY TRANSFERS, IN PARTICULAR IN THE FORM OF SOFTWARE MODULES FOR SERVER/PC APPLICATION AND FOR PERIPHERAL DEVICES NETWORKED THERETO, IN CLASS 9 (U.S. CLS. 21, 23, 26, 36 AND 38).

FOR: BUSINESS CONSULTING RELATING TO MONEY MANAGEMENT SYSTEMS AND MONEY MANAGEMENT SYSTEM SOFTWARE, IN CLASS 35 (U.S. CLS. 100, 101 AND 102).

FOR: DEVELOPMENT OF MONEY MANAGEMENT SYSTEM SOFTWARE, IN PARTICULAR SOFTWARE FOR BANKS, OTHER FINANCIAL AND CREDIT INSTITUTIONS AND CASH-TRANSPORT ENTERPRISES AS WELL AS FOR THEIR CUSTOMERS, FOR MANAGING, PROCESSING, RECONCILING, MONITORING AND OPTIMIZING MONEY TRANSFERS, IN PARTICULAR IN THE FORM OF SOFTWARE MODULES FOR SERVER/PC APPLICATION AND FOR PERIPHERAL DEVICES NETWORKED THERETO, IN CLASS 42 (U.S. CLS. 100 AND 101).



THE MARK CONSISTS OF STANDARD CHARACTERS WITHOUT CLAIM TO ANY PARTICULAR FONT, STYLE, SIZE, OR COLOR.

PRIORITY DATE OF 9-24-2010 IS CLAIMED.

OWNER OF INTERNATIONAL REGISTRATION 1075937 DATED 3-23-2011, EXPIRES 3-23-2021.

NO CLAIM IS MADE TO THE EXCLUSIVE RIGHT TO USE "VMS", APART FROM THE MARK AS SHOWN.

SER. NO. 79-096,940, FILED 3-23-2011.

*David J. Kybas*

Director of the United States Patent and Trademark Office

**Reg. No. 4,133,699** DAVID HOFFMAN, EXAMINING ATTORNEY

# United States of America

United States Patent and Trademark Office

# Viscopen

**Reg. No. 4,133,700**

**Registered May 1, 2012**

**Int. Cls.: 9, 10 and 42**

**TRADEMARK**

**SERVICE MARK**

**PRINCIPAL REGISTER**

ANDREAS HETTICH GMBH & CO. KG (FED REP GERMANY GMBH & CO. KG)  
FÖHRENSTRASSE 12  
78532 TUTTLINGEN  
FED REP GERMANY

FOR: LABORATORY CENTRIFUGES; DOSING DEVICES, NAMELY, DISPENSERS FOR ADMITTING SAMPLES INTO LABORATORY EQUIPMENT, NAMELY, VESSELS, CENTRIFUGES, AND BLOOD ANALYZERS; SUCTION DEVICES, NAMELY, PIPETTES; DISPENSING PIPETTES BEING LABORATORY INSTRUMENTS; VESSEL HOLDERS FOR LABORATORY CENTRIFUGES; CENTRIFUGE RACKS FOR TEST TUBES BEING PARTS OF LABORATORY CENTRIFUGES; LABORATORY EQUIPMENT, NAMELY, TEST TUBE RACKS; CENTRIFUGE BEAKERS; TEMPERATURE CONTROLLERS FOR CENTRIFUGES AND BLOOD ANALYZERS FOR THE PURPOSE OF CONTROLLING THE BLOOD SPECIMEN TEMPERATURE; LABORATORY APPARATUS, NAMELY, CIRCULAR CENTRIFUGE CHAMBERS FOR THE SEPARATION OF BLOOD; CENTRIFUGE CHAMBERS BEING PARTS OF LABORATORY CENTRIFUGES; PARTS OF LABORATORY CENTRIFUGES, NAMELY, ELECTRICAL AND ELECTRONIC OPERATING, REGULATING, MONITORING, AND CONTROLLING INSTRUMENTATION FOR CENTRIFUGES, BLOOD HOMOGENIZATION AND BLOOD ANALYZERS; FUNCTION AND OPERATION OF KEYPADS AS PARTS OF AUTOMATIC CONTROL UNITS FOR LABORATORY CENTRIFUGES, BLOOD HOMOGENIZATION AND BLOOD ANALYZERS; MICROPROCESSORS; DRIVES AS PARTS OF LABORATORY CENTRIFUGES AND DRIVE SYSTEMS CONSISTING THEREOF; PARTS OF LABORATORY CENTRIFUGES, NAMELY, SPEED CONTROL INSTRUMENTATION FOR THE DRIVES; PARTS OF LABORATORY CENTRIFUGES, NAMELY, DATA STORAGE FOR CENTRIFUGES AND BLOOD ANALYZERS, NAMELY, HARD DISKS, REMOVABLE DISKS, FLASH DEVICES; PARTS OF LABORATORY CENTRIFUGES, NAMELY, FILTERS; INCUBATORS FOR BACTERIA CULTURE; INCUBATORS BEING LABORATORY EQUIPMENT; DNA CHIPS; RETORTS; FERMENTATION APPARATUS; LABORATORY EQUIPMENT, NAMELY, LABORATORY TRAYS; MEASURING GLASSWARE; MEASURING INSTRUMENTS, NAMELY, BLOOD ANALYZERS; OSCILLOGRAPHS; PARTS OF CENTRIFUGES, NAMELY, WEIGHING EQUIPMENT BEING PRECISION BALANCES; DEVICES FOR PRODUCTION OF MICROSTRUCTURES; BLOOD HANDLING DEVICES, NAMELY, SMALL SURFACE STRUCTURES FOR THE HOMOGENIZATION OF BLOOD, FOR BLOOD ANALYSIS AND THE MOVEMENT AND STORAGE OF BLOOD; CRYSTAL OSCILLATORS FOR FLUID ANALYSIS, ELECTROCHEMISTRY, INSTRUMENTAL ANALYSIS, PROCESS ENGINEERING AND FLUIDIC ANALYSIS; RAPID PROTOTYPING EQUIPMENT FOR FLUIDIC MICROCHIPS, NAMELY, CENTRIFUGES, ROTORS, MOLDS, DISC SPACERS, INSERTS, PDMS



*David J. Kyjars*

Director of the United States Patent and Trademark Office

**Reg. No. 4,133,700** (POLYDIMETHYLSILOXANE), MICROFLUIDIC CHIPS, AND SILICONE; FERMENTATION APPARATUSES; LEVELING STAFFS; INCUBATORS FOR ANALYSIS AND BIOTECHNOLOGY; MULTIDOSE DROPPERS FOR LABORATORY USE; AND, BEAKERS, IN CLASS 9 (U.S. CLS. 21, 23, 26, 36 AND 38).

FOR: DEVICES FOR ANALYZING BLOOD; ANALYSIS EQUIPMENT AND INSTRUMENTS FOR ANALYZING BLOOD; DIAGNOSTIC EQUIPMENT OF MEDICAL PURPOSES, NAMELY, CENTRIFUGES, INCUBATORS AND BLOOD ANALYZERS; CRYSTAL OSCILLATOR FOR MEDICAL DIAGNOSIS; MEASURING DEVICES FOR ANALYZING BLOOD, NAMELY, CENTRIFUGES AND BLOOD ANALYZERS; BLOOD ANALYSIS DEVICES, NAMELY, EVALUATION DEVICES FOR THE HEMATOCRIT DETERMINATION OF BLOOD, IN CLASS 10 (U.S. CLS. 26, 39 AND 44).

FOR: SERVICES IN THE FIELDS OF SCIENCE AND TECHNOLOGY, NAMELY, MEDICAL RESEARCH AND DEVELOPMENT; TECHNICAL CONSULTATION IN REGARD TO THE USE OF CENTRIFUGES AND BLOOD ANALYZERS FOR THE HOMOGENIZATION, SEPARATION, AND ANALYSIS OF BLOOD; DESIGN AND DEVELOPMENT OF COMPUTER HARDWARE AND SOFTWARE; AND, ENGINEERING SERVICES IN THE FIELDS OF SCIENCE AND TECHNOLOGY, IN CLASS 42 (U.S. CLS. 100 AND 101).

THE MARK CONSISTS OF STANDARD CHARACTERS WITHOUT CLAIM TO ANY PARTICULAR FONT, STYLE, SIZE, OR COLOR.

PRIORITY DATE OF 6-22-2010 IS CLAIMED.

OWNER OF INTERNATIONAL REGISTRATION 1075973 DATED 12-21-2010, EXPIRES 12-21-2020.

THE WORDING "VISCOPEN" HAS NO MEANING IN A FOREIGN LANGUAGE.

SER. NO. 79-096,950, FILED 12-21-2010.

BRIAN PINO, EXAMINING ATTORNEY

# United States of America

United States Patent and Trademark Office

# TERMIS

**Reg. No. 4,133,701**

**Registered May 1, 2012**

**Int. Cls.: 9, 37 and 42**

**TRADEMARK**

**SERVICE MARK**

**PRINCIPAL REGISTER**

7-TECHNOLOGIES A/S (DENMARK LIMITED LIABILITY COMPANY)  
BISTRUPHAVE 3  
DK-3460 BIRKERØD  
DENMARK

FOR: DOWNLOADABLE COMPUTER PROGRAMS FOR MONITORING AND CONTROLLING DISTRICT ENERGY AND DISTRIBUTION NETWORKS FOR DISTRICT ENERGY; OPERATIONAL TOOLS, NAMELY, COMPUTER SOFTWARE FOR MONITORING AND CONTROLLING DISTRICT ENERGY AND DISTRIBUTION NETWORKS FOR DISTRICT ENERGY, IN CLASS 9 (U.S. CLS. 21, 23, 26, 36 AND 38).

FOR: INSTALLATION, REPAIR AND MAINTENANCE OF COMPUTER NETWORKS AND COMPUTER SYSTEMS CONSISTING OF COMPUTER HARDWARE AND PERIPHERAL DEVICES THEREFOR ALL IN RELATION TO DISTRICT ENERGY AND DISTRIBUTION NETWORKS FOR DISTRICT ENERGY, IN CLASS 37 (U.S. CLS. 100, 103 AND 106).

FOR: DESIGN AND DEVELOPMENT OF COMPUTER HARDWARE AND SOFTWARE; COMPUTER PROGRAMMING; DEVELOPMENT, DESIGN AND UPGRADING OF COMPUTER SOFTWARE, NAMELY, SOFTWARE FOR USE IN CONNECTION WITH INTEGRATED BUSINESS SOLUTIONS; RENTAL OF COMPUTER PROGRAMS OR APPLICATIONS FOR COMPUTER PROGRAMS FOR USE WITH ACCESS SERVICE PROVIDER SERVICES FACILITATING COLLECTION AND PROCESSING OF DATA TO A CENTRAL DATABASE VIA LOCAL AND GLOBAL COMPUTER NETWORKS; PROFESSIONAL NON-BUSINESS CONSULTANCY, NAMELY, CONSULTANCY AND TECHNICAL SUPPORT, NAMELY, TROUBLESHOOTING IN THE NATURE OF DIAGNOSING COMPUTER SOFTWARE AND HARDWARE PROBLEMS; CONSULTANCY IN THE FIELD OF INFORMATION TECHNOLOGY SECURITY; ONLINE TECHNICAL SUPPORT IN THE FIELD OF COMPUTERS, COMPUTER SOFTWARE AND COMPUTER SYSTEMS, NAMELY, HELP DESK SERVICES; COMPUTER AND COMPUTER SOFTWARE CONSULTATION; COMPUTER DIAGNOSTIC SERVICES; TECHNICAL SUPPORT SERVICES, NAMELY, TROUBLESHOOTING IN THE NATURE OF DIAGNOSING COMPUTER HARDWARE AND SOFTWARE PROBLEMS; MAINTENANCE OF COMPUTER SOFTWARE; PROVIDING BACK-UP COMPUTER PROGRAMS AND FACILITIES; UPDATING OF COMPUTER SOFTWARE FOR OTHERS; ALL THE AFOREMENTIONED SERVICES RELATING TO COMPUTER HARDWARE AND COMPUTER PROGRAMS AND SOFTWARE FOR MONITORING AND CONTROLLING DISTRICT ENERGY AND DISTRIBUTION NETWORKS FOR DISTRICT ENERGY, IN CLASS 42 (U.S. CLS. 100 AND 101).



*David J. Kyjars*

Director of the United States Patent and Trademark Office

**Reg. No. 4,133,701** THE MARK CONSISTS OF STANDARD CHARACTERS WITHOUT CLAIM TO ANY PARTICULAR FONT, STYLE, SIZE, OR COLOR.

OWNER OF INTERNATIONAL REGISTRATION 1075980 DATED 2-21-2011, EXPIRES 2-21-2021.

THE WORDING "TERMIS" HAS NO MEANING IN A FOREIGN LANGUAGE.

SER. NO. 79-096,954, FILED 2-21-2011.

NATALIE POLZER, EXAMINING ATTORNEY

United States of America  
United States Patent and Trademark Office

# FOAMET

**Reg. No. 4,133,702**

**Registered May 1, 2012**

**Int. Cl.: 6**

**TRADEMARK**

**PRINCIPAL REGISTER**

HOLLOMET GMBH (FED REP GERMANY GMBH)  
GRUNAER WEG 26  
01277 DRESDEN  
FED REP GERMANY

FOR: METALLIC POWDER USED IN MANUFACTURING; METALLIC FOAMS, NAMELY, OPEN-CELLED METAL FOAMS CREATED FROM AN ORGANIC CARRIER FOAM THAT IS COATED WITH A METAL POWDER BINDER SUSPENSION; SEMI-FINISHED PRODUCTS AND CONSTRUCTIONAL ELEMENTS OF METAL FOR USE IN FILTERS, CATALYST CARRIERS, HEAT EXCHANGERS AND BONE REPLACEMENT MATERIAL; CATALYST CARRIERS CONSISTING OF METALLIC FOAMS, NAMELY, METALLIC FOAM SUBSTRATE MATERIALS FOR CATALYST, IN CLASS 6 (U.S. CLS. 2, 12, 13, 14, 23, 25 AND 50).

THE MARK CONSISTS OF STANDARD CHARACTERS WITHOUT CLAIM TO ANY PARTICULAR FONT, STYLE, SIZE, OR COLOR.

OWNER OF INTERNATIONAL REGISTRATION 1005334 DATED 4-9-2009, EXPIRES 4-9-2019.

OWNER OF U.S. REG. NO. 3,876,361.

THE WORDING "FOAMET" HAS NO MEANING IN A FOREIGN LANGUAGE.

SER. NO. 79-096,973, FILED 12-15-2010.

NATALIE POLZER, EXAMINING ATTORNEY



*David J. Kybas*

Director of the United States Patent and Trademark Office

United States of America  
United States Patent and Trademark Office

**BANKIA**

**Reg. No. 4,133,703**

**Registered May 1, 2012**

**Int. Cl.: 36**

**SERVICE MARK**

**PRINCIPAL REGISTER**

BANKIA, S.A. (SPAIN SOCIEDAD ANÓNIMA)  
MONTE ESQUINZA, 48  
E-28010 MADRID  
SPAIN

FOR: INSURANCE SERVICES, NAMELY, INSURANCE BROKERAGE, INSURANCE AGENCIES, UNDERWRITING SERVICES FOR ALL TYPES OF INSURANCE; FINANCIAL OPERATIONS, NAMELY, FINANCIAL ASSET MANAGEMENT, FINANCIAL ANALYSIS, BANKING, HOME BANKING, SECURITIES BROKERAGE AND STOCK QUOTATION, FINANCIAL MANAGEMENT AND CAPITAL INVESTMENT SERVICES, INVESTMENT AND TRUST COMPANY SERVICES, MUTUAL FUND INVESTMENT BROKERAGE SERVICES, MORTGAGE BANKING, PERSONAL AND COMMERCIAL BANKING SERVICES; MONETARY OPERATIONS, NAMELY, CURRENCY EXCHANGES; REAL ESTATE SERVICES, NAMELY, REAL ESTATE MANAGEMENT SERVICES, REAL ESTATE BROKERAGE, ASSESSMENT AND MANAGEMENT OF REAL ESTATE, REAL ESTATE RENTAL SERVICES, NAMELY, RENTAL PROPERTY MANAGEMENT, LISTING SERVICES FOR HOUSING RENTALS AND APARTMENT RENTALS, AND RENTAL OF RESIDENTIAL HOUSING, COMMERCIAL AND RESIDENTIAL REAL ESTATE AGENCY SERVICES, RENTAL, BROKERAGE, LEASING AND MANAGEMENT OF COMMERCIAL PROPERTY, OFFICES AND OFFICE SPACE, IN CLASS 36 (U.S. CLS. 100, 101 AND 102).

THE WORDING "BANKIA" HAS NO MEANING IN A FOREIGN LANGUAGE.

PRIORITY DATE OF 1-18-2011 IS CLAIMED.

OWNER OF INTERNATIONAL REGISTRATION 1076003 DATED 2-7-2011, EXPIRES 2-7-2021.

SER. NO. 79-096,978, FILED 2-7-2011.

KRISTINA MORRIS, EXAMINING ATTORNEY



*David J. Kyffers*

Director of the United States Patent and Trademark Office



# United States of America

United States Patent and Trademark Office



VIGNAIOLI  
*di Canelli*

**Reg. No. 4,133,704**

**Registered May 1, 2012**

**Int. Cl.: 33**

CANTINA SOCIALE DI CANELLI - SOCIETA' COOPERATIVA AGRICOLA A  
RESPONSABILITA' LIMITATA SIGLABILE C.S.C. S.C. A.R.L. (ITALY FARM  
COOPERATIVE SOCIETY WITH LIMITED LIABILITY)  
VIA LUIGI BOSCA, 30  
CANELLI (ASTI)  
ITALY

**TRADEMARK**

FOR: WINES, ALCOHOLIC BEVERAGES EXCEPT BEERS, IN CLASS 33 (U.S. CLS. 47 AND 49).

**PRINCIPAL REGISTER**

NO CLAIM IS MADE TO THE EXCLUSIVE RIGHT TO USE "VIGNAIOLI DI CANELLI", APART FROM THE MARK AS SHOWN.

PRIORITY DATE OF 2-23-2011 IS CLAIMED.

OWNER OF INTERNATIONAL REGISTRATION 1076025 DATED 3-18-2011, EXPIRES 3-18-2021.

THE MARK CONSISTS OF THE WORDING "VIGNAIOLI DI CANELLI" WRITTEN IN STYLIZED CHARACTERS AND PUT ON TWO LINES; BESIDE THESE WORDS THERE IS A CIRCULAR FIGURE WITH A DOUBLE EDGE IN THE NATURE OF A STAINED-GLASS WINDOW DIVIDED INTO FOUR PARTS, INSIDE WHICH THERE ARE THE STYLIZED FIGURES OF A TREE, A TURRET, A BUNCH OF GRAPES AND A GRIFFON IN AN UPRIGHT POSITION.

THE ENGLISH TRANSLATION OF "VIGNAIOLI" IN THE MARK IS "VINE- GROWERS".

SER. NO. 79-096,991, FILED 3-18-2011.

KATHLEEN LORENZO, EXAMINING ATTORNEY



*David J. Kybas*

Director of the United States Patent and Trademark Office

# United States of America

United States Patent and Trademark Office

E n z y m e   H o m o g e n e o u s   P e r m e a t i o n

**Reg. No. 4,133,705**

**Registered May 1, 2012**

**Int. Cls.: 29, 30 and 40**

**TRADEMARK**

**SERVICE MARK**

**PRINCIPAL REGISTER**

EN OTSUKA PHARMACEUTICAL CO., LTD. (JAPAN CORPORATION)  
4-3-5 NIMAIBASHI  
HANAMAKI CITY; IWATE 025-0312  
JAPAN

FOR: MILK PRODUCTS EXCLUDING ICE CREAM, ICE MILK AND FROZEN YOGURT; MILK BEVERAGES WITH HIGH MILK CONTENT; FRESH, CHILLED OR FROZEN MEAT FOR HUMAN CONSUMPTION; EGGS; FRESH, CHILLED OR FROZEN MEAT FOR HUMAN CONSUMPTION; FISH, NOT LIVE; PROCESSED MEAT; MEAT, PRESERVED; CANNED COOKED MEAT; PROCESSED FISH PRODUCTS, NAMELY, PROCESSED FISH ROE, FISH FILLETS, STEAMED OR TOASTED CAKES OF FISH PASTE (KAMABOKO), DRIED FISH, SMOKED FISH, FERMENTED FISH GUTS, SALTED FISH, PICKLED FISH, TUBE-SHAPED TOASTED CAKES OF FISH PASTE (CHIKUWA); CANNED FISH; BLOCKS OF BOILED, SMOKED AND THEN DRIED BONITO (KATSUO-BUSHI); DRIED PIECES OF AGAR JELLY (KANTEN); FLAKES OF DRIED FISH MEAT (KEZURI-BUSHI); FISHMEAL FOR HUMAN CONSUMPTION; EDIBLE SHAVINGS OF DRIED KELP (TORORO-KOMBU); SHEETS OF DRIED LAVER (HOSHI-NORI); DRIED BROWN ALGA (HOSHI-HIJIKI); DRIED EDIBLE SEAWEED (HOSHI-WAKAME); TOASTED LAVER; PROCESSED VEGETABLES AND FRUITS; VEGETABLE JUICES FOR COOKING; VEGETABLES, COOKED; VEGETABLES, DRIED; VEGETABLES, TINNED; FRUITS, TINNED; MIXES FOR MAKING SOUP; PREPARED FOOD PRIMARILY MADE FROM MEAT OR PROCESSED MEAT PRODUCTS; PREPARED FOOD PRIMARILY MADE FROM PROCESSED FISH PRODUCTS; PREPARED FOOD PRIMARILY MADE FROM SEAWEEDS; PREPARED FOOD PRIMARILY MADE FROM PROCESSED FRUITS; PREPARED FOOD PRIMARILY MADE FROM PROCESSED VEGETABLES; PREPARED FOOD PRIMARILY MADE FROM PROCESSED EGGS; PREPARED FOOD PRIMARILY MADE FROM PROCESSED BEANS, IN CLASS 29 (U.S. CL. 46).

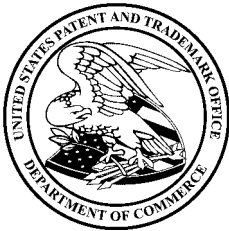

*David J. Kyros*

Director of the United States Patent and Trademark Office

FOR: PROCESSED CEREALS; GRAIN-BASED CHIPS; FARINACEOUS FOOD PASTES; FARINACEOUS FOODS, NAMELY, BOILED RICE, STEAMED RICE, PILAF, POUNDED RICE CAKES (MOCHI), PASTA AND NOODLES, PASTRY, RICE DUMPLINGS, BREADS AND BUNS; CHINESE STUFFED DUMPLINGS (GYOZA, COOKED); SANDWICHES; CHINESE STEAMED DUMPLINGS (SHUMAI, COOKED); SUSHI; FRIED BALLS OF BATTER MIX WITH SMALL PIECES OF OCTOPUS (TAKOYAKI); STEAMED BUNS STUFFED WITH MINCED MEAT (NIKU-MANJU); HAMBURGERS SANDWICHES; PIZZAS; BOX LUNCHES CONSISTING OF RICE, WITH ADDED MEAT, FISH OR VEGETABLES; HOT DOGS SANDWICHES; MEAT PIES; RAVIOLI; COOKED RICE; PREPARED FOOD PRIMARILY

**Reg. No. 4,133,705** MADE FROM CEREAL OR PROCESSED CEREALS; MEAT TENDERIZERS FOR HOUSEHOLD PURPOSES, IN CLASS 30 (U.S. CL. 46).

FOR: PROCESSING OF FOOD FOR USE IN MANUFACTURE, IN CLASS 40 (U.S. CLS. 100, 103 AND 106).

THE MARK CONSISTS OF STANDARD CHARACTERS WITHOUT CLAIM TO ANY PARTICULAR FONT, STYLE, SIZE, OR COLOR.

PRIORITY DATE OF 12-15-2010 IS CLAIMED.

OWNER OF INTERNATIONAL REGISTRATION 1076032 DATED 12-20-2010, EXPIRES 12-20-2020.

NO CLAIM IS MADE TO THE EXCLUSIVE RIGHT TO USE "ENZYME" AND "PERMEATION", APART FROM THE MARK AS SHOWN.

SER. NO. 79-096,994, FILED 12-20-2010.

LIEF MARTIN, EXAMINING ATTORNEY

# United States of America

United States Patent and Trademark Office



**Reg. No. 4,133,706**

**Registered May 1, 2012**

**Int. Cls.: 9, 12, 37, 38, 39  
and 42**

**TRADEMARK**

**SERVICE MARK**

**PRINCIPAL REGISTER**

SVENSKA RYMDAKTIEBOLAGET (SWEDEN JOINT STOCK COMPANY)  
BOX 4207  
SE-171 04 SOLNA  
SWEDEN

FOR: SATELLITES; SATELLITES FOR SCIENTIFIC PURPOSES; SATELLITE NAVIGATION EQUIPMENT, NAMELY, GPS NAVIGATION DEVICE; APPARATUS AND INSTRUMENTS FOR SURVEILLANCE, REMOTE CONTROL, CONTROL AND MEASURING OF ELECTRICITY AND CONSUMPTION OF ENERGY, NAMELY, ELECTRONIC MONITORS AND MONITOR MODULES FOR MONITORING ELECTRIC CURRENT AND ELECTRICAL SIGNALS, ELECTRICAL CONTROLLERS, ELECTRIC METERS; COMPUTER PROGRAMS FOR AIRBORNE MARITIME SURVEILLANCE, SEA SURFACE SURVEILLANCE OF ENVIRONMENTAL CHANGES, ILLEGAL FISHING AND SMUGGLING, ILLEGAL SEA CROSS-BORDER ACTIVITIES, POLLUTION, TRAFFIC CONTROL BY SEA, NEED FOR RESCUE OPERATIONS AT SEA; APPARATUS AND INSTRUMENTS FOR CONTROL AND SUPERVISION, NAMELY, ELECTRONIC CONTROLS FOR MARITIME SURVEILLANCE SERVICES; TELECOMMUNICATIONS DEVICES, NAMELY, RADIO TRANSMITTERS; TELECOMMUNICATIONS DEVICES, NAMELY, TRANSCEIVERS IN THE NATURE OF TRANSCEIVER BASE STATIONS; TELECOMMUNICATION SYSTEMS COMPRISED OF RADIO TRANSMITTERS AND RECEIVERS FOR REMOTE CONTROLS, RADIO CONTROLS; TELECOMMUNICATIONS DEVICES, NAMELY, TRANSMITTERS OF ELECTRONIC SIGNALS; SIMULATORS FOR DRIVING OR CONTROL OF VEHICLES, NAMELY, SIMULATORS FOR THE STEERING AND CONTROL OF VEHICLES AND CRAFT; NAVIGATION APPARATUS FOR VEHICLES, NAMELY, AUTOMATIC STEERING APPARATUS FOR VEHICLES, AIRCRAFT, AND SPACECRAFT, IN CLASS 9 (U.S. CLS. 21, 23, 26, 36 AND 38).

FOR: SPACE VEHICLES; AIRCRAFTS, IN CLASS 12 (U.S. CLS. 19, 21, 23, 31, 35 AND 44).

FOR: VEHICLE MAINTENANCE SERVICES; AIRCRAFT MAINTENANCE SERVICES; SPACECRAFT MAINTENANCE SERVICES, IN CLASS 37 (U.S. CLS. 100, 103 AND 106).

FOR: TELECOMMUNICATIONS SERVICES, NAMELY, ELECTRONIC TRANSMISSION OF MESSAGES AND DATA; SATELLITE TRANSMISSION, IN CLASS 38 (U.S. CLS. 100, 101 AND 104).



*David J. Kappas*

Director of the United States Patent and Trademark Office

**Reg. No. 4,133,706** FOR: TRANSPORT SERVICES, NAMELY, AIR TRANSPORT, MARINE TRANSPORT; LAUNCHING OF ROCKETS AND SATELLITES FOR OTHERS, IN CLASS 39 (U.S. CLS. 100 AND 105).

FOR: SCIENTIFIC AND TECHNOLOGICAL SERVICES, NAMELY, SCIENTIFIC RESEARCH, ANALYSIS, TESTING IN THE FIELD OF SPACE PROJECTS; SCIENTIFIC RESEARCH IN THE AFOREMENTIONED FIELDS; DESIGN FOR OTHERS IN THE FIELD OF AIRBORNE MARITIME SURVEILLANCE SERVICES, COMPUTER SOFTWARE AS IT RELATES TO THE AFOREMENTIONED SERVICES; NETWORK SURVEILLANCE, NAMELY, REMOTE MONITORING OF NETWORK SYSTEMS FOR TECHNICAL PURPOSES; COMPUTER ASSISTED DIAGNOSTICS TESTING SERVICES, NAMELY, DIAGNOSTIC SERVICES IN THE FIELD OF AIRCRAFT AND SPACECRAFT; DESIGN, TESTING AND DEVELOPMENT OF SATELLITES, MARITIME SURVEILLANCE SYSTEMS FOR AIRPLANES, SPACECRAFT, RESEARCH BALLOONS FOR SPACE, UNMANNED AIRCRAFT; INDUSTRIAL ANALYSIS, NAMELY, ANALYSIS OF INDUSTRIAL FLUIDS; INDUSTRIAL RESEARCH IN THE FIELD OF SATELLITE MANAGEMENT SERVICES; DESIGN AND DEVELOPMENT OF COMPUTER HARDWARE AND SOFTWARE, IN CLASS 42 (U.S. CLS. 100 AND 101).

THE MARK CONSISTS OF THE WORDING "SSC" APPEARING IN THE LOWER HALF OF A CIRCULAR BACKGROUND, WITH AN ABSTRACT DESIGN COMPRISED OF SMALL CIRCLES ARRANGED TO RESEMBLE A HUMAN FIGURE, WITH TWO FOUR-POINTED STARS APPEARING ABOVE THE HUMAN DESIGN.

PRIORITY DATE OF 9-24-2010 IS CLAIMED.

OWNER OF INTERNATIONAL REGISTRATION 1076045 DATED 3-22-2011, EXPIRES 3-22-2021.

SER. NO. 79-096,999, FILED 3-22-2011.

KEVIN CORWIN, EXAMINING ATTORNEY

# United States of America

United States Patent and Trademark Office

# hajom

**Reg. No. 4,133,707**

**Registered May 1, 2012**

**Int. Cls.: 6, 19, 20, 24  
and 37**

**TRADEMARK**

**SERVICE MARK**

**PRINCIPAL REGISTER**

HAJOM SKJUTDÖRRAR AB (SWEDEN JOINT STOCK COMPANY)  
KVARNBACKEN 2  
SE-511 97 HAJOM  
SWEDEN

FOR: WINDOWS OF METAL; METALLIC DOORS; OUTDOOR BLINDS OF METAL; METAL EXTERIOR BLINDS AND ROLLER BLINDS FOR GUIDING LIGHT; DOOR HANDLES OF METAL; DOOR FRAMES OF METAL; DOOR FITTINGS OF METAL; METAL DOOR BOLTS; DOOR PANELS OF METAL; DOOR STOPS OF METAL; WINDOW HANDLES OF METAL; KNOBS OF METAL; WINDOW CATCHES OF METAL; METAL WINDOW SHUTTERS; METAL WINDOW FRAMES; WINDOW CASEMENT METAL BOLTS; SASH FASTENERS OF METAL FOR WINDOWS; FITTINGS OF METAL FOR WINDOWS; BOLTS OF METAL FOR SASH WINDOWS; VENTILATION WINDOWS OF METAL; DOOR CASINGS OF IRON; METAL GARAGE ENTRANCE DOORS, IN CLASS 6 (U.S. CLS. 2, 12, 13, 14, 23, 25 AND 50).

FOR: NON-METAL WINDOW GLASS AND NON-METAL WINDOW FRAMES, EXCLUDING GLASS FOR VEHICLE WINDOWS; WINDOW GLASS, FOR BUILDING; NON-METAL BUILDING PRODUCTS, NAMELY, SHUTTERS; WINDOW FRAMES, NOT OF METAL; STAINED-GLASS WINDOWS; MOSQUITO WINDOW SCREENS, NOT OF METAL; CASEMENT WINDOWS, NOT OF METAL; NON-METAL DOORS; DOOR FRAMES, NOT OF METAL; DOOR CASING, NOT OF METAL; DOOR PANELS, NOT OF METAL; NON-METAL AND NON-TEXTILE EXTERIOR SUN BLINDS FOR OUTDOORS; GARAGE DOORS, NOT OF METAL, IN CLASS 19 (U.S. CLS. 1, 12, 33 AND 50).

FOR: INDOOR BLINDS FOR WINDOWS; CURTAIN ROLLERS; PULLEYS OF PLASTIC FOR BLINDS; INDOOR BLINDS OF WOVEN TIMBER; INTERIOR VERTICAL CURTAIN TEXTILE WINDOW BLINDS; DOOR HANDLES, NOT OF METAL; WINDOW FITTINGS, NOT OF METAL; CURTAIN RINGS; CURTAIN RODS, IN CLASS 20 (U.S. CLS. 2, 13, 22, 25, 32 AND 50).

FOR: TEXTILE FABRICS FOR THE MANUFACTURE OF CURTAINS; CURTAINS OF TEXTILES OR PLASTIC; CURTAIN TIE-BACKS IN THE NATURE OF TEXTILE CURTAIN HOLDERS; NET CURTAINS; MOSQUITO NETS; DOOR CURTAINS, IN CLASS 24 (U.S. CLS. 42 AND 50).



*David J. Kappas*

Director of the United States Patent and Trademark Office

**Reg. No. 4,133,707** FOR: INSTALLATION OF DOORS AND WINDOWS; REPAIR AND MAINTENANCE OF WINDOWS AND DOORS, IN CLASS 37 (U.S. CLS. 100, 103 AND 106).

THE MARK CONSISTS OF THE WORDING "HAJOM" IN A BLACK STYLIZED FONT FOLLOWED BY A RIGHT ANGLE DESIGN IN RED.

PRIORITY DATE OF 9-14-2010 IS CLAIMED.

OWNER OF INTERNATIONAL REGISTRATION 1076056 DATED 2-17-2011, EXPIRES 2-17-2021.

THE COLOR(S) BLACK & RED IS/ARE CLAIMED AS A FEATURE OF THE MARK.

SER. NO. 79-097,005, FILED 2-17-2011.

SEAN CROWLEY, EXAMINING ATTORNEY

# United States of America

United States Patent and Trademark Office

# UNDERMAN

**Reg. No. 4,133,708**

**Registered May 1, 2012**

**Int. Cls.: 9, 14, 16, 18, 25  
and 28**

**TRADEMARK**

**PRINCIPAL REGISTER**

UNDER COVER CO., LTD. (JAPAN CORPORATION)  
UNDER COVER LABORATORIES  
23-16, JINGUMAE 4-CHOME,; SHIBUYA-KU; TOKYO 150-0001  
JAPAN

FOR: EYEGLASSES; TELECOMMUNICATION DEVICES AND APPARATUS, NAMELY, TELEPHONES, CELL PHONES, CELL PHONES STRAPS, CD PLAYERS, DIGITAL CAMERAS, VIDEO CAMERAS, DVD PLAYERS, DVD RECORDERS; ELECTRONIC MACHINES, APPARATUS AND THEIR PARTS, NAMELY, COMPUTERS, POWER ADAPTERS FOR COMPUTERS; AMUSEMENT APPARATUS ADAPTED FOR USE WITH AN EXTERNAL DISPLAY SCREEN OR MONITOR; ELECTRONIC CIRCUITS AND CD-ROMS RECORDED WITH PROGRAMS FOR HAND-HELD GAMES WITH LIQUID CRYSTAL DISPLAYS; PHONOGRAPH RECORDS FEATURING MUSICAL RECORDINGS; METRONOMES; ELECTRONIC CIRCUITS AND CD-ROMS RECORDED WITH AUTOMATIC PERFORMANCE PROGRAMS FOR ELECTRONIC MUSICAL INSTRUMENTS; DOWNLOADABLE MP3 FILES FEATURING MUSIC; EXPOSED CINEMATOGRAPHIC FILMS; EXPOSED SLIDE FILMS; SLIDE FILM MOUNTS; DOWNLOADABLE IMAGE FILES IN THE FIELD OF FASHION, MUSIC AND SPORTS; PRERECORDED VIDEO DISCS AND VIDEO TAPES FEATURING FASHION, SPORTS AND MUSICAL RECORDINGS; DOWNLOADABLE ELECTRONIC PUBLICATIONS IN THE NATURE OF MAGAZINES IN THE FIELD OF FASHION, MUSIC AND SPORTS, IN CLASS 9 (U.S. CLS. 21, 23, 26, 36 AND 38).

FOR: PERSONAL ORNAMENTS OF PRECIOUS METAL; KEY RINGS OF PRECIOUS METAL; JEWEL CASES OF PRECIOUS METAL; CLOCKS AND WATCHES, IN CLASS 14 (U.S. CLS. 2, 27, 28 AND 50).

FOR: PAPER AND CARDBOARD; STATIONERY; PRINTED MATTER, NAMELY, BOOKS IN THE FIELD OF FASHION; PAINTINGS AND CALLIGRAPHIC WORKS; PHOTOGRAPHS; PHOTOGRAPH STANDS; INDUSTRIAL PACKAGING CONTAINERS OF PAPER; HYGIENIC HAND TOWELS OF PAPER; TOWELS OF PAPER; TABLE NAPKINS OF PAPER; HAND TOWELS OF PAPER; HANDKERCHIEFS OF PAPER, IN CLASS 16 (U.S. CLS. 2, 5, 22, 23, 29, 37, 38 AND 50).

FOR: BAGS, NAMELY, ATHLETIC BAGS, BOOK BAGS, SPORTS BAGS, BUM BAGS, SHOULDER BAGS, BOSTON BAGS, TRAVELING TRUNKS, RUCK SACKS; POUCHES, NAMELY, POUCHES FOR HOLDING KEYS, POUCHES OF LEATHER, FELT POUCHES, JEWELRY POUCHES, PURSES, WALLETS; CLOTHING FOR DOMESTIC PETS; VANITY



*David J. Kyros*

Director of the United States Patent and Trademark Office



**Reg. No. 4,133,708** CASES, NOT FITTED; UMBRELLAS; WALKING STICKS; CANES; METAL PARTS OF CANES AND WALKING-STICKS; WALKING STICK HANDLES; UNWORKED AND SEMI-WORKED LEATHER; AND FUR PELTS, IN CLASS 18 (U.S. CLS. 1, 2, 3, 22 AND 41).

FOR: CLOTHING, NAMELY, PANTS, TROUSERS, SWEATERS, SWEAT SHIRTS, TOPS, T-SHIRTS, BLOUSES, JACKETS, COATS, JERSEYS, SOCKS, SHIRTS, UNDER GARMENTS, SWIM WEAR, PAJAMAS; GARTERS; SOCK SUSPENDERS; BRACES FOR CLOTHING IN THE NATURE OF SUSPENDERS; WAISTBANDS; BELTS FOR CLOTHING; FOOTWEAR OTHER THAN BOOTS FOR SPORTS; MASQUERADE COSTUMES; CLOTHES FOR SPORTS, NAMELY, SPORT COATS, SPORTS JERSEYS AND BREECHES FOR SPORTS; BOOTS FOR SPORTS, IN CLASS 25 (U.S. CLS. 22 AND 39).

FOR: GO GAMES; JAPANESE PLAYING CARDS (UTAGARUTA); JAPANESE CHESS (SHOGI GAMES); DICE; JAPANESE DICE GAMES (SUGOROKU); CUPS FOR DICE; DIAMOND GO GAMES; CHESS GAMES; CHECKERS; CHECKER SETS; CONJURING APPARATUS IN THE NATURE OF MAGIC TRICKS; DOMINOES; PLAYING CARDS; JAPANESE PLAYING CARDS (HANAFUDA); MAH-JONG; SPORTS EQUIPMENT IN THE NATURE OF SOCCER BALLS; TOYS FOR DOMESTIC PETS; TOYS IN THE NATURE OF DOLLS AND TOY FIGURES, IN CLASS 28 (U.S. CLS. 22, 23, 38 AND 50).

THE MARK CONSISTS OF STANDARD CHARACTERS WITHOUT CLAIM TO ANY PARTICULAR FONT, STYLE, SIZE, OR COLOR.

OWNER OF INTERNATIONAL REGISTRATION 1076145 DATED 2-21-2011, EXPIRES 2-21-2021.

SER. NO. 79-097,018, FILED 2-21-2011.

SEAN CROWLEY, EXAMINING ATTORNEY

# United States of America

United States Patent and Trademark Office

# SMART ASS

**Reg. No. 4,133,709**

**Registered May 1, 2012**

**Int. Cl.: 41**

RED MEDIA PTY LTD (AUSTRALIA PROPRIETARY LIMITED COMPANY (P/L OR PTY. LTD.))  
PO BOX 637  
SOUTH YARRA VIC 3141  
AUSTRALIA

**SERVICE MARK**

**PRINCIPAL REGISTER**

FOR: CONDUCTING A TELEVISION GAME SHOW; ENTERTAINMENT SERVICES, NAMELY, ON-GOING TELEVISION PROGRAMS IN THE FIELD OF VARIETY; ENTERTAINMENT SERVICES, NAMELY, THE DISTRIBUTION OF TELEVISION PROGRAMS FOR OTHERS; ENTERTAINMENT SERVICES RELATING TO TELEVISION, NAMELY, DISTRIBUTION OF TELEVISION PROGRAMS FOR OTHERS; PRODUCTION AND PRESENTATION OF TELEVISION PROGRAMMES AND SHOWS; ORGANIZATION OF GAME SHOW COMPETITIONS; PRODUCTION OF CINEMATOGRAPHIC SHOWS AND TELEVISION PROGRAMMES; PROVISION OF ON-GOING TELEVISION PROGRAMS IN THE FIELD OF GAME SHOWS BY MEANS OF TELEVISION, SATELLITE, CABLE, THE WORLD WEB AND THE INTERNET; ORGANIZATION OF GAME SHOWS; RENTAL OF SOUND RECORDINGS AND OF PRE-RECORDED SHOWS AND TELEVISION PERFORMANCES; TELEVISION ENTERTAINMENT, NAMELY, GAME SHOWS; PROVISION OF GAME SHOWS; TELEVISION ENTERTAINMENT SERVICES, NAMELY, TELEVISION GAME SHOWS, IN CLASS 41 (U.S. CLS. 100, 101 AND 107).

THE MARK CONSISTS OF STANDARD CHARACTERS WITHOUT CLAIM TO ANY PARTICULAR FONT, STYLE, SIZE, OR COLOR.

PRIORITY DATE OF 10-21-2010 IS CLAIMED.

OWNER OF INTERNATIONAL REGISTRATION 1076458 DATED 4-7-2011, EXPIRES 4-7-2021.

SER. NO. 79-097,128, FILED 4-7-2011.

KELLY TRUSILO, EXAMINING ATTORNEY



*David J. Kyffers*

Director of the United States Patent and Trademark Office

# United States of America

United States Patent and Trademark Office



**Reg. No. 4,133,710**

**Registered May 1, 2012**

**Int. Cl.: 28**

**TRADEMARK**

**PRINCIPAL REGISTER**

MAC DUE S.P.A. (ITALY JOINT STOCK COMPANY)  
CORSO SEMPIONE, 77  
I-20149 MILANO  
ITALY

FOR: ACTION FIGURES AND ACCESSORIES THEREFOR; BATTERY OPERATED ACTION TOYS; ELECTRONIC TOY VEHICLES; ELECTRONICALLY OPERATED TOY MOTOR VEHICLES; MODEL CARS; MODEL RACING CAR BODIES; NON-ELECTRONIC TOY VEHICLES; RADIO CONTROLLED MODEL VEHICLES; RADIO CONTROLLED TOY VEHICLES; RADIO TRANSMITTERS FOR USE WITH RADIO-CONTROLLED TOYS; REMOTE CONTROL TOYS, NAMELY, CARS, RACE CARS, TOY MOTORBIKES, TOY TRUCKS, TOY HELICOPTERS, TOY OFF-ROAD VEHICLES, TOY POLICE VANS, TOY DIGGERS, TOY CRANES, AIRPLANES, BOATS; RIDEABLE TOY VEHICLES; RIDE-ON GAME MACHINES; RIDE-ON TOYS; SCALE MODEL AIRPLANES; SCALE MODEL KITS BEING TOYS; SCALE MODEL VEHICLES; TOY ACTION FIGURES AND ACCESSORIES THEREFOR; TOY AIRPLANES; TOY BUILDING STRUCTURES AND TOY VEHICLE TRACKS; TOY CARS; TOY CONSTRUCTION SETS; TOY MODEL CARS; TOY MODEL HOBBY CRAFT KITS FOR CONSTRUCTING TOY MODEL LANDSCAPES, SCENERY AND ACTION FIGURES; TOY MODEL KIT CARS; TOY MODEL TRAIN SETS; TOY MODEL VEHICLES AND RELATED ACCESSORIES SOLD AS UNITS; TOY TRAINS AND PARTS AND ACCESSORIES THEREFOR; TOY VEHICLE TRACK SETS AND ROADWAYS AND ACCESSORIES THEREFOR; TOY VEHICLES, IN CLASS 28 (U.S. CLS. 22, 23, 38 AND 50).

NO CLAIM IS MADE TO THE EXCLUSIVE RIGHT TO USE "TOY" OR "HOBBY", APART FROM THE MARK AS SHOWN.

OWNER OF INTERNATIONAL REGISTRATION 1076720 DATED 12-10-2010, EXPIRES 12-10-2020.

THE MARK CONSISTS OF A SIGN DEPICTING THE WORDING "TOY HOBBY" IN FANCY PROFILED CHARACTERS PLACED ON TWO LEVELS AND SLANTING SLIGHTLY FROM LEFT TOWARDS RIGHT, THE PORTION "OY" OF "TOY" BEING ABOVE THE PORTION "HO" OF "HOBBY", THE UPPER LEFT-HAND LINE AND THAT UNDER THE LETTER "Y" OF "HOBBY" EXTENDING RESPECTIVELY ABOVE THE TWO "B" LETTERS AND UNDERLINING THE WORD "HOBBY", ALL PLACED INSIDE A LABEL PROFILED FOLLOWING THE CONTOUR OF THE SAME WORDING.



*David J. Kybas*

Director of the United States Patent and Trademark Office

**Reg. No. 4,133,710** SER. NO. 79-097,219, FILED 12-10-2010.

LINDA MICKLEBURGH, EXAMINING ATTORNEY

# United States of America

United States Patent and Trademark Office

# DELTANIL

**Reg. No. 4,133,711**

**Registered May 1, 2012**

**Int. Cl.: 5**

**TRADEMARK**

**PRINCIPAL REGISTER**

VIRBAC (FRANCE SOCIÉTÉ ANONYME)  
1ÈRE AVENUE - 2065 M - L.I.D.  
F-06516 CARROS  
FRANCE

FOR: VETERINARY PRODUCTS, NAMELY, EXTERNAL ANTIPARASITIC FOR VETERINARY USE, IN CLASS 5 (U.S. CLS. 6, 18, 44, 46, 51 AND 52).

THE MARK CONSISTS OF STANDARD CHARACTERS WITHOUT CLAIM TO ANY PARTICULAR FONT, STYLE, SIZE, OR COLOR.

PRIORITY DATE OF 10-7-2010 IS CLAIMED.

OWNER OF INTERNATIONAL REGISTRATION 1076743 DATED 4-5-2011, EXPIRES 4-5-2021.

SER. NO. 79-097,227, FILED 4-5-2011.

JENNY PARK, EXAMINING ATTORNEY



*David J. Kyros*

Director of the United States Patent and Trademark Office

# United States of America

United States Patent and Trademark Office

# Enterosgel

**Reg. No. 4,133,712**

**Registered May 1, 2012**

**Int. Cls.: 1, 3 and 5**

**TRADEMARK**

**PRINCIPAL REGISTER**

OBSHCHESTVO S OGRANICHENNOY OTVETSTVENNOSTYU "TNK SILMA" (RUSSIAN FED. OBSHCHESTVO S OGRANICHENNOY OTVETSTVENNOSTYU (OOO))  
50, CORP. 1, STR.2, UL. SHIPILOVSKAYA  
RU-115573 MOSCOW  
RUSSIAN FED.

FOR: SILICON ORGANIC COMPOUNDS, NAMELY, SILOXANES FOR USE IN MAKING SORPTION-DETOXIFICATION PREPARATIONS, IN CLASS 1 (U.S. CLS. 1, 5, 6, 10, 26 AND 46).

FOR: COSMETIC PREPARATIONS FOR SKIN CARE; BEAUTY MASKS; COSMETIC PREPARATIONS FOR HAIR CARE; DENTIFRICES, IN CLASS 3 (U.S. CLS. 1, 4, 6, 50, 51 AND 52).

FOR: MEDICINES FOR HUMANS, NAMELY, PREPARATIONS USED FOR TREATMENT OF INTESTINAL DISORDERS, NUTRITIONAL ADDITIVES FOR MEDICAL PURPOSES FOR USE IN FOODS FOR HUMAN CONSUMPTION FOR FULL DETOXIFICATION OF THE ORGANISM, DIETETIC FOOD ADAPTED FOR MEDICAL PURPOSES, MEDICINAL HERBS, IN CLASS 5 (U.S. CLS. 6, 18, 44, 46, 51 AND 52).

OWNER OF INTERNATIONAL REGISTRATION 0896788 DATED 3-31-2006, EXPIRES 3-31-2016.

SER. NO. 79-097,241, FILED 2-21-2011.

HAI-LY LAM, EXAMINING ATTORNEY



*David J. Kybas*

Director of the United States Patent and Trademark Office

# United States of America

United States Patent and Trademark Office

**KONIG**

THE BAKER'S  
CROWN

**Reg. No. 4,133,713**

**Registered May 1, 2012**

**Int. Cls.: 7 and 11**

**TRADEMARK**

**PRINCIPAL REGISTER**

KÖNIG MASCHINEN GESELLSCHAFT M.B.H. (AUSTRIA LIMITED LIABILITY COMPANY)  
STATTEGGERSTRASSE 80  
A-8045 GRAZ  
AUSTRIA

FOR: BAKERY MACHINES, NAMELY, MACHINES FOR DIVIDING DOUGH, MACHINES FOR FORMING DOUGH, MACHINES FOR ROLLING DOUGH, MACHINES FOR PRESSING, MACHINES FOR STAMPING DOUGH, MACHINES FOR FERMENTING DOUGH, MACHINES FOR TRANSPORTING DOUGH, MACHINES FOR DIVIDING DOUGH, FORMING DOUGH, ROLLING DOUGH, PRESSING, STAMPING DOUGH, FERMENTING DOUGH AND FOR TRANSPORTING DOUGH, AND DOUGH BELT FORMING MACHINES; DOUGH BAND FORMING MACHINES; DOUGH SHEETING MACHINES; AND LAMINATING MACHINES FOR PASTRIES, IN CLASS 7 (U.S. CLS. 13, 19, 21, 23, 31, 34 AND 35).

FOR: BAKING OVENS; FERMENTATION CABINETS FOR PREPARATION OF FOODS; VACUUM COOLING MACHINES FOR PASTRIES; AND VACUUM COOLING CHAMBERS FOR PREPARATION OF FOODS, IN CLASS 11 (U.S. CLS. 13, 21, 23, 31 AND 34).

NO CLAIM IS MADE TO THE EXCLUSIVE RIGHT TO USE "BAKER'S", APART FROM THE MARK AS SHOWN.

OWNER OF INTERNATIONAL REGISTRATION 0915777 DATED 11-23-2006, EXPIRES 11-23-2016.

THE COLOR(S) RED AND WHITE IS/ARE CLAIMED AS A FEATURE OF THE MARK.

THE MARK CONSISTS OF THE STYLIZED WORDING "KONIG THE BAKER'S CROWN" WITH THE WORDING "KONIG" IN RED ON A WHITE RECTANGULAR BACKGROUND AND THE WORDING "THE BAKER'S CROWN" IN WHITE ON A RED RECTANGULAR BACKGROUND.

THE ENGLISH TRANSLATION OF "KONIG" IN THE MARK IS "KING".

SER. NO. 79-097,242, FILED 3-8-2011.

PATRICIA EVANKO, EXAMINING ATTORNEY



*David J. Kyffers*

Director of the United States Patent and Trademark Office

# United States of America

United States Patent and Trademark Office

# groupTime

**Reg. No. 4,133,714**

TOBIAS STEPAN (FED REP GERMANY INDIVIDUAL)  
TITTMONINGER STR. 111  
MÜNCHEN, FED REP GERMANY 81679

**Registered May 1, 2012**

**Int. Cls.: 9, 38, 42 and 45**

FOR: COMPUTER SOFTWARE, NAMELY, SOFTWARE FOR INFORMATION MANAGEMENT, FOR E-MAIL AND INSTANT MESSAGING, FOR CALENDAR ORGANIZATION AND SCHEDULING FOR MEETINGS, FOR PROJECT MANAGEMENT, FOR DOCUMENT COLLABORATION AND FOR THE STORAGE AND PROCESSING OF DOCUMENTS, IN CLASS 9 (U.S. CLS. 21, 23, 26, 36 AND 38).

**TRADEMARK**

**SERVICE MARK**

**PRINCIPAL REGISTER**

FOR: TELECOMMUNICATIONS, NAMELY, PROVIDING ONLINE AND TELECOMMUNICATION FACILITIES FOR REAL-TIME INTERACTION BETWEEN USERS OF COMPUTERS, MOBILE COMPUTERS AND HAND-HELD COMPUTERS, AND CABLE AND WIRELESS COMMUNICATION DEVICES, NAMELY, PROVIDING TEXT MESSAGING, INSTANT MESSAGING, EMAIL, CHAT ROOMS, ELECTRONIC BULLETIN BOARDS ONLINE AND FORUMS FOR TRANSMISSION OF MESSAGES, ALL FOR GENERAL INTEREST ; TELECOMMUNICATION SERVICES, NAMELY, ENABLING INDIVIDUALS TO SEND AND RECEIVE MESSAGES VIA EMAIL, INSTANT MESSAGING ON WEBSITES ON THE INTERNET IN THE FIELD OF GENERAL INTEREST; PROVIDING ON-LINE INTERNET CHAT ROOMS AND ELECTRONIC BULLETIN BOARDS FOR TRANSMISSION OF MESSAGES AMONG USERS IN THE FIELD OF GENERAL INTEREST; ELECTRONIC MAIL SERVICES; INSTANT MESSAGING SERVICES, WEB MESSAGING SERVICES, AND TEXT MESSAGING SERVICES; ELECTRONIC COMMUNICATION SERVICES, NAMELY, PROVIDING TEXT MESSAGING, INSTANT MESSAGING, ELECTRONIC MAIL, INTERNET CHAT ROOMS, ELECTRONIC BULLETIN BOARDS, ALL FOR GENERAL INTEREST; PROVIDING ONLINE FORUMS FOR TRANSMISSION OF GENERAL INTEREST MESSAGES AMONG COMPUTER USERS; WEBCASTING SERVICES; TRANSMISSION OF MESSAGES, DATA AND CONTENT VIA A GLOBAL COMPUTER NETWORK AND OTHER COMPUTER AND COMMUNICATIONS NETWORKS; TRANSMISSION OF UPDATED MESSAGES, COMMENTS, INFORMATION, AND MULTIMEDIA CONTENT, ALL FOR GENERAL INTEREST, BY ELECTRONIC MAIL, INSTANT MESSAGING, TEXT MESSAGING, AND VIA A GLOBAL COMPUTER NETWORK AND OTHER COMPUTER AND COMMUNICATIONS NETWORKS; PROVIDING ONLINE FORUMS AND CHAT ROOMS FOR THE TRANSMISSION OF MESSAGES AMONG USERS IN THE FIELD OF GENERAL INTEREST; TELECOMMUNICATION SERVICES, ELECTRONIC TRANSMISSION OF MESSAGES, COMMENTS, MULTIMEDIA CONTENT, VIDEOS, MOVIES, FILMS, PHOTOS, AUDIO CONTENT, ANIMATION, PICTURES, IMAGES, TEXT, INFORMATION, AND OTHER USER-GENERATED CONTENT VIA A GLOBAL



*David J. Kybas*

Director of the United States Patent and Trademark Office



**Reg. No. 4,133,714** COMPUTER NETWORK AND OTHER COMPUTER AND COMMUNICATIONS NETWORKS; BROADCASTING SERVICES VIA A GLOBAL COMPUTER NETWORK AND OTHER COMPUTER AND COMMUNICATIONS NETWORKS, NAMELY, UPLOADING, DOWNLOADING, POSTING, SHOWING, DISPLAYING, TAGGING, SHARING AND ELECTRONICALLY TRANSMITTING MESSAGES, COMMENTS, MULTIMEDIA CONTENT, VIDEOS, MOVIES, FILMS, PHOTOS, AUDIO CONTENT, ANIMATION, PICTURES, IMAGES, TEXT, INFORMATION, AND OTHER USER-GENERATED CONTENT, IN CLASS 38 (U.S. CLS. 100, 101 AND 104).

FOR: APPLICATION SERVICE PROVIDER (ASP), NAMELY, HOSTING AN INTERACTIVE WEBSITE AND ONLINE NON-DOWNLOADABLE SOFTWARE FOR UPLOADING, DOWNLOADING, POSTING, SHOWING, DISPLAYING, TAGGING, SHARING AND TRANSMITTING MESSAGES, COMMENTS, MULTIMEDIA CONTENT, VIDEOS, MOVIES, FILMS, PHOTOS, AUDIO CONTENT, ANIMATION, PICTURES, IMAGES, TEXT, INFORMATION, AND OTHER USER-GENERATED CONTENT; HOSTING AN INTERACTIVE WEBSITE FOR OTHERS AND PROVIDING ONLINE NON-DOWNLOADABLE SOFTWARE THAT ENABLES USERS TO POST, SEARCH, WATCH, SHARE, CRITIQUE, RATE, AND COMMENT ON, MESSAGES, COMMENTS, MULTIMEDIA CONTENT, VIDEOS, MOVIES, FILMS, PHOTOS, AUDIO CONTENT, ANIMATION, PICTURES, IMAGES, TEXT, INFORMATION, AND OTHER USER-GENERATED CONTENT VIA A GLOBAL COMPUTER NETWORK AND OTHER COMPUTER AND COMMUNICATIONS NETWORKS; PROVIDING TEMPORARY USE OF ONLINE NON-DOWNLOADABLE SOFTWARE TOOLS FOR TEXT, IMAGE, VIDEO, AND DATA PROCESSING AND THE TRANSMISSION OF ELECTRONIC FILES; HOSTING OF DIGITAL CONTENT ONLINE; APPLICATION SERVICE PROVIDER (ASP), NAMELY, HOSTING COMPUTER SOFTWARE APPLICATIONS OF OTHERS; HOSTING MULTIMEDIA CONTENT FOR OTHERS; SCIENTIFIC AND TECHNOLOGICAL SERVICES IN THE FIELD OF INFORMATION TECHNOLOGY; INDUSTRIAL ANALYSIS AND RESEARCH SERVICES IN THE FIELD OF INFORMATION TECHNOLOGY; DESIGN AND DEVELOPMENT OF COMPUTER HARDWARE AND SOFTWARE; HOSTING OF ONLINE WEBSITE COMMUNITIES FOR REGISTERED USERS, FOR THE SHARING OF INFORMATION, PHOTOGRAPHS, AUDIO AND VIDEO CONTENT RELATING TO THEMSELVES, THEIR LIKES AND DISLIKES, AND EVERYDAY ACTIVITIES, TO GET FEEDBACK FROM THEIR PEERS, FORM VIRTUAL COMMUNITIES, AND ENGAGE IN SOCIAL NETWORKING, IN CLASS 42 (U.S. CLS. 100 AND 101).

FOR: PROVIDING A SOCIAL NETWORKING WEBSITE FOR THE COMMUNICATION OF PERSONAL ISSUES OF REGISTERED USERS, FOR THE SHARING OF INFORMATION, PHOTOGRAPHS, AUDIO AND VIDEO CONTENT RELATING TO THEMSELVES, THEIR LIKES AND DISLIKES, AND EVERYDAY ACTIVITIES, TO GET FEEDBACK FROM THEIR PEERS AND TO FORM VIRTUAL COMMUNITIES , IN CLASS 45 (U.S. CLS. 100 AND 101).

PRIORITY DATE OF 7-27-2010 IS CLAIMED.

OWNER OF INTERNATIONAL REGISTRATION 1077042 DATED 12-15-2010, EXPIRES 12-15-2020.

THE COLOR(S) GREY, BLACK AND WHITE IS/ARE CLAIMED AS A FEATURE OF THE MARK.

LETTERS FORMING "GROUP" IN GREY COLOUR, LETTERS FORMING "TIME" IN BLACK COLOUR, BACKGROUND COLOUR IS WHITE.

SER. NO. 79-097,352, FILED 12-15-2010.

DEZMONA MIZELLE, EXAMINING ATTORNEY

# United States of America

United States Patent and Trademark Office

# RUD-ID-Point

**Reg. No. 4,133,715**

**Registered May 1, 2012**

**Int. Cls.: 6, 7, 8 and 9**

RUD KETTEN RIEGER & DIETZ GMBH U. CO. KG (FED REP GERMANY LIMITED PARTNERSHIP)  
FRIEDENSINSEL  
73432 AALEN-UNTERKOCHEN  
FED REP GERMANY

**TRADEMARK**

**PRINCIPAL REGISTER**

FOR: CHAINS, CHAIN LINKS, LINK PINS, CHAIN JOINTS, CHAIN SPROCKETS, AND SWIVEL SHACKLE, ALL MADE OF METAL; METAL DEVICES AND COMPONENTS OF METAL FOR THE SECURING, COUPLING, SHORTENING, GUIDING AND TENSIONING OF CHAINS, BELTS AND/OR ROPES; GRABS, HOOKS, EYES, RETAINING LOOPS, EXPANSION BRACES, CLAWS AND SHACKLES, ALL OF METAL, FOR USE IN CONNECTION WITH CHAINS, BELTS AND/OR ROPES; SHAPED METAL PARTS; METAL CHAIN HARNESSSES FOR LIFTING AND SUSPENDING LOADS, COMPRISING METAL CHAIN ASSEMBLIES; ALL THE AFORESAID GOODS IN PARTICULAR WITH INTEGRATED DATA TRANSMISSION AND DATA RECORDING DEVICES, IN PARTICULAR RFID TRANSPONDERS, AND/OR SENSORS, IN PARTICULAR LOAD SENSORS, IN CLASS 6 (U.S. CLS. 2, 12, 13, 14, 23, 25 AND 50).

FOR: MECHANICAL APPARATUS FOR LIFTING AND SUSPENDING LOADS WITH THE AID OF CHAINS, STRAPS AND/OR ROPES; CHAIN CONVEYORS, AND COGGED WHEELS, DEFLECTOR WHEELS, CONVEYOR WHEELS, CONVEYOR ROLLERS, TRACK ROLLERS AND CONVEYOR RAILS; MECHANICAL EXPANSION DEVICES FOR CHAIN HARNESSSES, OTHER THAN HAND-OPERATED; MECHANICAL TENSIONING APPARATUS AND SPRING BUFFERS FOR LASHING LOADS, OTHER THAN HAND-OPERATED; ALL THE AFORESAID GOODS IN PARTICULAR WITH INTEGRATED DATA TRANSMISSION AND DATA RECORDING DEVICES, IN PARTICULAR RFID TRANSPONDERS, AND/OR SENSORS, IN PARTICULAR LOAD SENSORS, IN CLASS 7 (U.S. CLS. 13, 19, 21, 23, 31, 34 AND 35).

FOR: HAND-OPERATED EXPANSION DEVICES FOR CHAIN HARNESSSES; HAND-OPERATED TENSIONING APPARATUS AND SPRING BUFFERS FOR LASHING LOADS; HAND-OPERATED APPARATUS FOR LIFTING AND SUSPENDING LOADS WITH THE AID OF CHAINS, STRAPS AND/OR ROPES; ALL THE AFORESAID GOODS IN PARTICULAR WITH INTEGRATED DATA TRANSMISSION AND DATA RECORDING DEVICES, IN PARTICULAR RFID TRANSPONDERS, AND/OR SENSORS, IN PARTICULAR LOAD SENSORS, IN CLASS 8 (U.S. CLS. 23, 28 AND 44).



*David J. Kyjars*

Director of the United States Patent and Trademark Office

**Reg. No. 4,133,715** FOR: MEASURING, SIGNALING AND TESTING AND REGULATING APPARATUS AND INSTRUMENTS, NAMELY, ELECTRIC SENSORS, LOAD SENSORS, WEAR SENSORS, STRAIN SENSORS, AND STRESS SENSORS, FOR USE IN MEASURING AND INSPECTING THE WEAR, LIFETIME, LOAD, STRAIN AND STRESS OF LIFTING, SUSPENDING AND LASHING MEANS; APPARATUS FOR RECORDING, TRANSMISSION AND REPRODUCTION OF ELECTRIC DATA; BLANK MAGNETIC DATA CARRIERS, DATA PROCESSING EQUIPMENT AND COMPUTERS; COMPUTER PERIPHERAL DEVICES, IN PARTICULAR DOCKING STATIONS; ELECTRIC DISPLAY APPARATUS; COMPUTER PROGRAMS AND COMPUTER SOFTWARE FOR USE IN MAINTENANCE, ANALYSIS, ADMINISTRATION AND DOCUMENTATION OF DATA, REPORTS AND DOCUMENTS, FOR USE IN TEST INSPECTION, FOR USE IN FORMING A CONNECTION TO INFORMATION AND DOCUMENTS AS WELL AS IN ACCESSING A WEB PORTAL; BLANK DATA CARRIERS; MATERIALS TESTING APPARATUS AND MACHINES FOR USE IN THE INSPECTION OF LIFTING, SUSPENDING AND LASHING MEANS; ELECTRICAL SIGNAL TRANSMITTERS AND RECEIVERS; TRANSPONDERS, IN PARTICULAR RADIO-FREQUENCY TRANSPONDERS; WRITING AND READING APPARATUS FOR ELECTRIC DATA; RFID HARDWARE AND ACCESSORIES, NAMELY, RFID-CHIPS, RFID-TAGS, RFID-TRANSPONDERS, RFID-READERS; ELECTRIC IDENTIFICATION SYSTEMS, IN PARTICULAR RFID SYSTEMS, NAMELY, RFID-CHIPS, RFID-TAGS, RFID-TRANSPONDERS, RFID-READERS; ELECTRONIC TESTING SYSTEMS, IN PARTICULAR INSPECTION TESTING SYSTEMS FOR MEASURING AND INSPECTING THE WEAR, LIFETIME, LOAD, STRAIN AND STRESS OF LIFTING, SUSPENDING AND LASHING MEANS; ELECTRONIC INFORMATION DELIVERY SYSTEMS COMPRISING AN ELECTRONIC INTERFACE EQUIPMENT TO INPUT OR OUTPUT OF DATA AND AT LEAST ONE OF AN IDENTIFICATION TAG AND A SENSOR, IN PARTICULAR A LOAD SENSOR; ELECTRONIC LOAD AND OVERLOAD INDICATOR DEVICES AND ELEMENTS FOR CHAINS, ROPES AND/OR STRAPS, AND LOADING FORKS, IN PARTICULAR WITH INTEGRATED DATA TRANSMISSION AND DATA RECORDING DEVICES AND/OR SENSORS, IN PARTICULAR LOAD SENSORS; ALL THE AFORESAID GOODS IN PARTICULAR FOR THE MONITORING AND/OR TESTING, CONTROLLING AND/OR LOAD MONITORING OF LOAD-SECURING AND LASHING DEVICES, IN CLASS 9 (U.S. CLS. 21, 23, 26, 36 AND 38).

THE MARK CONSISTS OF STANDARD CHARACTERS WITHOUT CLAIM TO ANY PARTICULAR FONT, STYLE, SIZE, OR COLOR.

PRIORITY DATE OF 7-28-2010 IS CLAIMED.

OWNER OF INTERNATIONAL REGISTRATION 1077058 DATED 1-25-2011, EXPIRES 1-25-2021.

SER. NO. 79-097,358, FILED 1-25-2011.

MELISSA VALLILLO, EXAMINING ATTORNEY

# United States of America

United States Patent and Trademark Office

## JOHN-ROCH RECORDS

**Reg. No. 4,133,716**

**Registered May 1, 2012**

**Int. Cls.: 3, 9, 32, 33, 35,  
38, 41 and 43**

**TRADEMARK**

**SERVICE MARK**

**PRINCIPAL REGISTER**

PEDRI JEAN-ROCH (FRANCE INDIVIDUAL)  
188 BIS RUE DE RIVOLI  
F-75001 PARIS  
FRANCE

FOR: BLEACHING PREPARATIONS AND DETERGENT FOR LAUNDRY USE; CLEANING, POLISHING, AND SCOURING PREPARATIONS; ABRASIVE LIQUIDS AND POWDERS FOR GENERAL PURPOSE CLEANING; SOAP FOR HOUSEHOLD AND PERSONAL USE; PERFUMERY, ESSENTIAL OILS, COSMETICS, HAIR LOTIONS; DENTIFRICES, IN CLASS 3 (U.S. CLS. 1, 4, 6, 50, 51 AND 52).

FOR: APPARATUS FOR RECORDING, TRANSMISSION OR REPRODUCTION OF SOUND OR IMAGES; PRERECORDED VIDEO TAPES FEATURING MUSIC; RECORDINGS FEATURING MUSIC, NAMELY, AUDIO DISCS, COMPACT DISCS, DIGITAL AUDIO DISKS, DIGITAL AUDIO COMPACT DISKS, AUDIO TAPES, AUDIO CASSETTES, VIDEO TAPES, VIDEO CASSETTES, MAGNETIC TAPES, AND MAGNETIC DISKS, ALL CONTAINING AUDIO OR VIDEO RECORDINGS FEATURING MUSIC; CABLES FOR CARRYING AUDIO OR VIDEO; OPTICAL DISKS CONTAINING AUDIO OR VIDEO RECORDINGS FEATURING MUSIC; COMPUTER PROGRAMS USED FOR DOWNLOADING MUSIC; COMPUTER SOFTWARE USED FOR PROCESSING DIGITAL MUSIC FILES; DOWNLOADABLE ELECTRONIC NEWSLETTERS FEATURING MUSIC REVIEWS AND NEWS IN THE NATURE OF CURRENT EVENTS IN THE MUSIC INDUSTRY; CD-ROMS FEATURING MUSIC; DVDS FEATURING MUSIC; DIGITAL MUSIC DOWNLOADABLE FROM THE INTERNET; DOWNLOADABLE MP3 FILES AND MP3 RECORDINGS FEATURING MUSIC; MP3 PLAYERS, IN CLASS 9 (U.S. CLS. 21, 23, 26, 36 AND 38).

FOR: BEER; MINERAL AND AERATED WATERS; SOFT DRINKS; PREPARATIONS FOR MAKING BEVERAGES EXCEPT THOSE MADE WITH COFFEE, TEA OR COCOA AND MILK BEVERAGES, NAMELY, CONCENTRATES, SYRUPS, OR POWDERS USED IN THE PREPARATION OF SOFT DRINKS; FRUIT DRINKS AND FRUIT JUICES; SYRUPS FOR MAKING FRUIT FLAVORED DRINKS, IN CLASS 32 (U.S. CLS. 45, 46 AND 48).

FOR: ALCOHOLIC BEVERAGES, EXCEPT BEER, IN CLASS 33 (U.S. CLS. 47 AND 49).

FOR: ADVERTISING, PROMOTION AND MARKETING SERVICES; BUSINESS MANAGEMENT AND BUSINESS ADMINISTRATION; RETAIL STORE SERVICES IN THE FIELD OF



*David J. Kybas*

Director of the United States Patent and Trademark Office

**Reg. No. 4,133,716** SOUND RECORDING DISKS, COMPACT DISKS, AUDIO AND VIDEO CASSETTES, TAPES AND CARTRIDGES, MAGNETIC CASSETTES, TAPES, AND DISKS, ALL CONTAINING AUDIO OR VIDEO RECORDINGS, CABLES FOR CARRYING AUDIO AND VIDEO, CD-ROMS, AND MP3 PLAYERS; COMPILATION OF ADVERTISEMENTS FOR USE AS WEB PAGES ON THE INTERNET; RENTAL OF ADVERTISING SPACE ON WEB SITES FOR ADVERTISING THE GOODS AND SERVICES OF OTHERS; PROVIDING INFORMATION AND CONSULTING SERVICES IN THE FIELDS OF ADVERTISING, MARKETING, BUSINESS MANAGEMENT, BUSINESS ADMINISTRATION, RETAIL STORE SERVICES, AND RENTAL OF ADVERTISING SPACE ON WEB SITES, IN CLASS 35 (U.S. CLS. 100, 101 AND 102).

FOR: TELECOMMUNICATION ACCESS SERVICES; COMMUNICATIONS VIA COMPUTER TERMINALS AND VIA FIBER-OPTIC NETWORKS; RADIO AND TELEPHONE COMMUNICATION; INTERNET BROADCASTING OF RADIO AND TELEVISION ENTERTAINMENT; AUDIO BROADCASTING OF MUSIC; NEWS AGENCY SERVICES FOR ELECTRONIC TRANSMISSION; ELECTRONIC TRANSMISSION OF DATA OR DOCUMENTS BY MEANS OF COMPUTER TERMINALS, RADIO, CABLE, SATELLITE, AND THE INTERNET; ELECTRONIC MAIL SERVICES, IN CLASS 38 (U.S. CLS. 100, 101 AND 104).

FOR: TEACHING IN THE FIELD OF MUSIC; TRAINING SERVICES IN THE FIELD OF MUSIC; ENTERTAINMENT IN THE NATURE OF VISUAL AND AUDIO PERFORMANCES, AND MUSICAL, VARIETY, NEWS AND COMEDY SHOWS; ORGANIZING COMMUNITY SPORTING AND CULTURAL EVENTS; PROVIDING INFORMATION ON ENTERTAINMENT AND EDUCATION; PROVIDING RECREATION FACILITIES; ORGANIZATION OF SINGING AND DANCE COMPETITIONS; PUBLICATION OF BOOKS; LENDING LIBRARIES; EDUCATIONAL SERVICES, NAMELY, ARRANGING AND CONDUCTING OF EDUCATIONAL COLLOQUIUMS, CONFERENCES, AND CONGRESSES IN THE FIELD OF MUSIC; ORGANIZATION OF EXHIBITIONS FOR CULTURAL OR EDUCATIONAL PURPOSES; BOOKING OF SEATS FOR SHOWS; PRESENTATION OF LIVE SHOW PERFORMANCES OF VOCAL AND INSTRUMENTAL GROUPS; AUDIO AND VIDEO RECORDING SERVICES; PRODUCTION OF RADIO AND TELEVISION PROGRAMS; AUDIO AND VIDEO PRODUCTION OF AUDIO AND VIDEO RECORDINGS; PRODUCTION OF LIVE THEATER SHOWS, MUSICAL ENTERTAINMENT LIVE SHOWS, CONCERTS, VIDEOS, MULTIMEDIA VIDEOS AND RADIO AND TELEVISION PROGRAMS; CINEMA THEATERS; RECORDING STUDIO SERVICES; VIDEO AND TELEVISION SHOW PRODUCTION SERVICES; AUDIO RECORDING SERVICES; CINEMATOGRAPHIC SERVICES, NAMELY, MOVIE FILMING SERVICES; VIDEO AND TELEVISION FILMING SERVICES; MUSIC PUBLISHING SERVICES; PRODUCTION SERVICES FOR SOUND RECORDINGS, FILMS AND VIDEOS; ENTERTAINMENT SERVICES, NAMELY, PROVIDING NON-DOWNLOADABLE PLAYBACK OF MUSIC VIA GLOBAL COMMUNICATIONS NETWORKS; ENTERTAINMENT SERVICES, NAMELY, NON-DOWNLOADABLE PRE-RECORDED MUSIC PRESENTED TO MOBILE COMMUNICATIONS DEVICES VIA A GLOBAL COMPUTER NETWORK AND WIRELESS NETWORKS; PUBLISHING OF ELECTRONIC PUBLICATIONS, NAMELY, ON-LINE PUBLISHING OF NON-DOWNLOADABLE ELECTRONIC PUBLICATIONS; ARRANGING AND CONDUCTING NIGHTCLUB ENTERTAINMENT EVENTS; DISCOTHEQUE SERVICES, IN CLASS 41 (U.S. CLS. 100, 101 AND 107).

FOR: BAR SERVICES, CAFÉS, CAFETERIAS, HOTELS, FOOD AND DRINK CATERING, IN CLASS 43 (U.S. CLS. 100 AND 101).

THE MARK CONSISTS OF STANDARD CHARACTERS WITHOUT CLAIM TO ANY PARTICULAR FONT, STYLE, SIZE, OR COLOR.

PRIORITY DATE OF 7-23-2010 IS CLAIMED.

OWNER OF INTERNATIONAL REGISTRATION 1077205 DATED 1-21-2011, EXPIRES 1-21-2021.

**Reg. No. 4,133,716** NO CLAIM IS MADE TO THE EXCLUSIVE RIGHT TO USE "RECORDS", APART FROM THE MARK AS SHOWN.

THE NAME(S), PORTRAIT(S), AND/OR SIGNATURE(S) SHOWN IN THE MARK IDENTIFIES JEAN-ROCH PEDRI, WHOSE CONSENT(S) TO REGISTER IS MADE OF RECORD.

SER. NO. 79-097,404, FILED 1-21-2011.

TINA L. SNAPP, EXAMINING ATTORNEY

# United States of America

United States Patent and Trademark Office

# L'essager

**Reg. No. 4,133,717**

**Registered May 1, 2012**

**Int. Cls.: 25 and 35**

**TRADEMARK**

**SERVICE MARK**

**PRINCIPAL REGISTER**

BAYCREW'S CO., LTD. (JAPAN CORPORATION)  
1-5-6, JINNAN  
SHIBUYA-KU  
TOKYO, JAPAN 1500041

FOR: CLOTHING, NAMELY, NON-JAPANESE STYLE DRESSES, EVENING DRESSES, WEDDING DRESSES, SCHOOL UNIFORMS; CHILDREN'S JACKETS, SHIRTS, TIES, PANTS, SOCKS, SHOES, SUITS, SKIRTS, TROUSERS, COATS, CARDIGAN SWEATERS, PAJAMAS, UNDERWEAR, BELTS, MUFFLERS, HEADWEAR, BANDANAS, GLOVES; WORKING OVERALLS, JACKETS, JOGGING PANTS, SWEAT PANTS, SUITS, SKIRTS, SKI JACKETS, SKI PANTS, TROUSERS, SMOCKS, TUXEDOS, MORNING COATS, BLAZERS, BLOUSON, JERKINS, KNICKERS, BEACHWEAR, COATS FOR MEN AND WOMEN, OVERCOATS, TOPCOATS, MANTLES, RAINCOATS, GREAT COATS, TRENCH COATS, DUST COATS; SWEATERS AND THE LIKE, NAMELY, CARDIGANS, SWEATERS, VESTS AND WAIST-COATS, TWIN SETS; SHIRTS AND THE LIKE, NAMELY, OPEN-NECKED SHIRTS, CUFFS, COLLARS FOR CLOTHING, SPORT SHIRTS, BLOUSES, POLO SHIRTS, SHIRTS FOR SUITS, T-SHIRTS; NIGHTWEAR, NAMELY, NIGHT GOWNS, NEGLIGEEES, BABY DOLL PAJAMAS, PEIGNOIRS, JAPANESE SLEEPING ROBES (NEMAKI), PAJAMAS, BATH ROBES; UNDERWEAR, NAMELY, CAMISOLES, CORSETS, COMBINATIONS, UNDERSHIRTS, CHEMISES, DRAWERS AND UNDERPANTS, SLIPS, PANTIES, SHORTS AND BRIEFS, BERMUDA SHORTS, BOXER SHORTS, BRASSIERES, PETTICOATS, TANK-TOPS; SWIMWEAR, NAMELY, BATHING SUITS; SWIMMING CAPS; JAPANESE TRADITIONAL CLOTHING, NAMELY, SASH BANDS FOR KIMONO (OBI), BUSTLE HOLDER BANDS FOR OBI (OBIAGE), BUSTLES FOR OBI-KNOTS (OBIAGE-SHIN), WAIST STRINGS FOR KIMONOS (KOSHIHIMO), UNDERSHIRTS FOR KIMONOS (KOSHIMAKI, JUBAN), TIGHTENING-UP STRINGS FOR KIMONOS (DATEJIME), WRAP BELTS FOR KIMONOS (DATEMAKI), FULL-LENGTH KIMONOS (NAGAGI), SHORT OVERCOAT FOR KIMONO (HAORI), STRING FASTENERS FOR HAORI (HAORI-HIMO), PLEATED SKIRTS FOR FORMAL KIMONOS (HAKAMA), DETACHABLE NECKPIECES FOR KIMONOS (HANERI); APRONS; COLLAR PROTECTORS FOR WEAR; SOCKS AND STOCKINGS; ANKLE SOCKS; KNEE-HIGH STOCKINGS; PANTYHOSE; PUTTEES AND GAITERS; FUR STOLEES; PAREUS; SHAWLS; SERAPES; SCARVES; JAPANESE STYLE SOCKS (TABI, TABI COVERS); GLOVES AND MITTENS; BABIES' DIAPERS OF TEXTILE; NECKTIES; BOW TIES; NECKERCHIEVES; BANDANAS; WARMTH-KEEPING SUPPORTS, NAMELY, LEG WARMERS; MUFFLERS; EAR MUFFS; HOODS; SEDGE HATS (SUGE-GASA); NIGHTCAPS; HEADWEAR FOR CLOTHING; KNITTED CAPS; CAP VISORS; LEG-WARMERS; GARTERS; SOCK SUSPENDERS; SUSPENDERS BEING BRACES; WAISTBANDS; BELTS FOR CLOTHING; FOOTWEAR



*David J. Kappas*

Director of the United States Patent and Trademark Office

**Reg. No. 4,133,717** FOR MEN AND WOMEN; CLOTHES FOR SPORTS, NAMELY, ANORAKS, KARATE SUITS, SPORTS OVER UNIFORMS, KENDO OUTFITS, JUDO SUITS, SKI SUITS FOR COMPETITION, HEADBANDS, WIND-JACKETS, UNIFORMS AND STOCKINGS FOR SPECIAL SPORTSWEAR, WRISTBANDS; BOOTS FOR SPORTS, IN CLASS 25 (U.S. CLS. 22 AND 39).

FOR: RETAIL STORE SERVICES AND WHOLESALE DISTRIBUTORSHIP SERVICES FEATURING WOVEN FABRICS AND BEDDING; RETAIL STORE SERVICES AND WHOLESALE DISTRIBUTORSHIP SERVICES FEATURING CLOTHING; RETAIL STORE SERVICES AND WHOLESALE DISTRIBUTORSHIP SERVICES FEATURING FOOTWEAR; RETAIL STORE SERVICES AND WHOLESALE DISTRIBUTORSHIP SERVICES FEATURING BAGS AND POUCHES; RETAIL STORE SERVICES AND WHOLESALE DISTRIBUTORSHIP SERVICES FEATURING PERSONAL ARTICLES IN THE NATURE OF BELTS, JEWELRY, EARRINGS, BRACELETS, PENDANTS, BROOCHES, RINGS, CUFF LINKS, TIE PINS, TIE CLIPS, HAIR BANDS, HAIR PINS, UMBRELLAS AND PARASOLS, WALKING STICKS AND CANES; ADVERTISING AND PUBLICITY SERVICES; PROMOTING THE GOODS AND SERVICES OF OTHERS BY MEANS OF ISSUANCE OF TRADING STAMPS; BUSINESS MANAGEMENT ANALYSIS AND BUSINESS CONSULTANCY; MARKETING RESEARCH; PROVIDING INFORMATION ON SALES OF MERCHANDISE, NAMELY, PROVIDING MARKET RESEARCH INFORMATION; BUSINESS MANAGEMENT; AUCTIONEERING; IMPORT-EXPORT AGENCIES; PUBLICITY MATERIAL RENTAL, IN CLASS 35 (U.S. CLS. 100, 101 AND 102).

THE WORD(S) "L'ESSAGE" HAS NO MEANING IN A FOREIGN LANGUAGE.

PRIORITY DATE OF 11-30-2010 IS CLAIMED.

OWNER OF INTERNATIONAL REGISTRATION 1077370 DATED 3-3-2011, EXPIRES 3-3-2021.

SER. NO. 79-097,463, FILED 3-3-2011.

TRACY FLETCHER, EXAMINING ATTORNEY



United States of America  
United States Patent and Trademark Office

*Susino*

**Reg. No. 4,133,718**

**Registered May 1, 2012**

**Int. Cls.: 9, 14 and 25**

**TRADEMARK**

**PRINCIPAL REGISTER**

SUSINO UMBRELLA CO., LTD. (CHINA LIMITED COMPANY)  
JINOU INDUSTRY AREA  
DONGSHI TOWN JINJIANG CITY  
362771 FUJIAN PROVINCE, CHINA

FOR: AUTOMATIC TICKET DISPENSERS; FACSIMILE MACHINES; ELECTRIC SWITCHES; ELECTROLYSIS APPARATUS FOR ELECTROPLATING PURPOSES; FIRE EXTINGUISHING APPARATUS; PINCE-NEZ; BATTERIES; FLAT IRONS, ELECTRIC, IN CLASS 9 (U.S. CLS. 21, 23, 26, 36 AND 38).

FOR: STATUES OF PRECIOUS METAL AND THEIR ALLOYS; JEWELLERY BOXES; BRACELETS; CHARMS; NECKLACES; RINGS; EARRINGS; TIE PINS; CLOCKS; WATCHES, IN CLASS 14 (U.S. CLS. 2, 27, 28 AND 50).

FOR: CLOTHING SHIELDS, NAMELY, PADS APPLIED TO THE UNDERARMS OF SHIRTS, BLOUSES AND SWEATERS; BABY LAYETTES FOR CLOTHING; RAINCOATS; BATHING SUITS; FOOTWEAR; HATS; HOSIERY; GLOVES; SCARVES; GIRDLES, IN CLASS 25 (U.S. CLS. 22 AND 39).

THE MARK CONSISTS OF THE WORD "SUSINO" IN STYLIZED TEXT.

OWNER OF INTERNATIONAL REGISTRATION 1077404 DATED 4-21-2011, EXPIRES 4-21-2021.

THE WORD "SUSINO" HAS NO ENGLISH TRANSLATION.

SER. NO. 79-097,478, FILED 4-21-2011.

SHANNON TWOHIG, EXAMINING ATTORNEY



*David J. Kyros*

Director of the United States Patent and Trademark Office

# United States of America

United States Patent and Trademark Office

# iknit

**Reg. No. 4,133,719**

**Registered May 1, 2012**

**Int. Cls.: 7, 9 and 42**

KARL MAYER TEXTILMASCHINENFABRIK GMBH (FED REP GERMANY GESELLSCHAFT  
MIT BESCHRÄNKTER HAFTUNG (GMBH))  
BRÜHLSTRASSE 25  
63179 OBERTSHAUSEN  
FED REP GERMANY

**TRADEMARK**

FOR: WARP KNITTING MACHINES, ELECTRIC MOTOR DRIVES AS PARTS OF WARP  
KNITTING MACHINES, IN CLASS 7 (U.S. CLS. 13, 19, 21, 23, 31, 34 AND 35).

**SERVICE MARK**

FOR: ELECTRIC AND ELECTRONIC REGULATING, CONTROLLING AND MONITORING  
APPARATUS AND INSTRUMENTS FOR WARP KNITTING MACHINES, NAMELY, ELEC-  
TRIC AND ELECTRONIC CONTROLLERS FOR WARP KNITTING MACHINES, ELECTRONIC  
CONTROL UNITS FOR REGULATING WARP KNITTING MACHINES, AND COMPUTER  
HARDWARE FOR MONITORING INDUSTRIAL WARP KNITTING MACHINES, IN CLASS  
9 (U.S. CLS. 21, 23, 26, 36 AND 38).

**PRINCIPAL REGISTER**

FOR: COMPUTER PROGRAMMING , IN CLASS 42 (U.S. CLS. 100 AND 101).

THE MARK CONSISTS OF STANDARD CHARACTERS WITHOUT CLAIM TO ANY PAR-  
TICULAR FONT, STYLE, SIZE, OR COLOR.

PRIORITY DATE OF 2-26-2011 IS CLAIMED.

OWNER OF INTERNATIONAL REGISTRATION 1077417 DATED 4-20-2011, EXPIRES 4-20-  
2021.

SER. NO. 79-097,484, FILED 4-20-2011.

MARY BOAGNI, EXAMINING ATTORNEY



*David J. Kybas*

Director of the United States Patent and Trademark Office

# United States of America

United States Patent and Trademark Office



**Reg. No. 4,133,720**

**Registered May 1, 2012**

**Int. Cl.: 25**

**TRADEMARK**

**PRINCIPAL REGISTER**

NU TEKSTİL VE KONFEKSİYON ÜRÜNLERİ SANAYİ VE TİCARET LİMİTED SİRKETİ  
(TURKEY CORPORATION)  
AKGÜL SOK. NO: 7  
ÇAGLAYAN İSTANBUL  
TURKEY

FOR: CLOTHING, INNER AND OUTER CLOTHING, MADE FROM ALL KINDS OF MATERIAL, NAMELY, SHIRTS, SHORTS, DRESSES, TOPS, BOTTOMS, SKIRTS, BLOUSES, BELTS, WRAPS, PANTS; SOCKS; FOOTWEAR; HEADWEAR, IN CLASS 25 (U.S. CLS. 22 AND 39).

THE MARK CONSISTS OF THE LITERAL ELEMENT, "NU", IN LOWERCASE, ENCOMPASSED BY A SINGLE LINE RECTANGLE.

OWNER OF INTERNATIONAL REGISTRATION 1077474 DATED 3-2-2011, EXPIRES 3-2-2021.

SER. NO. 79-097,500, FILED 3-2-2011.

HELENE LIWINSKI, EXAMINING ATTORNEY



*David J. Kyffers*

Director of the United States Patent and Trademark Office

# United States of America

United States Patent and Trademark Office

carfitsme 

**Reg. No. 4,133,721**

**Registered May 1, 2012**

**Int. Cls.: 12, 35 and 38**

**TRADEMARK**

**SERVICE MARK**

**PRINCIPAL REGISTER**

CARFI OÜ (ESTONIA LIMITED LIABILITY COMPANY)  
AKADEEMIA TEE 64A-20  
EE-12614 TALLINN, HARJUMAA  
ESTONIA

FOR: VEHICLES, NAMELY, LAND VEHICLES; APPARATUS FOR LOCOMOTION BY LAND, AIR OR WATER, NAMELY, LAND VEHICLES, IN CLASS 12 (U.S. CLS. 19, 21, 23, 31, 35 AND 44).

FOR: ADVERTISING; BUSINESS MANAGEMENT; BUSINESS ADMINISTRATION; OFFICE FUNCTIONS, NAMELY, OFFICE FUNCTIONS IN THE NATURE OF MAINTAINING RECORDS OF OWNERSHIP OF GOODS AND MAINTAINING SALES TRANSACTIONS INFORMATION; ONLINE ADVERTISING ON A COMPUTER NETWORK, IN CLASS 35 (U.S. CLS. 100, 101 AND 102).

FOR: TELECOMMUNICATIONS, NAMELY, ELECTRONIC EXCHANGE OF DATA STORED IN DATABASES ACCESSIBLE VIA TELECOMMUNICATION NETWORKS; PROVIDING TELECOMMUNICATIONS CONNECTIONS TO A GLOBAL COMPUTER NETWORK, IN CLASS 38 (U.S. CLS. 100, 101 AND 104).

THE MARK CONSISTS OF THE WORDING "CARFITSME" IN STYLIZED FONT WITH A CAR SILHOUETTE RISING FROM THE LETTER "E" AS A THOUGHT BUBBLE WITH TWO CIRCLES EXTENDING DIAGONALLY FROM THE CAR TO THE LETTER "E". THE COLOR LIME GREEN APPEARS IN THE WORDING "CARFITS", THE CAR SILHOUETTE AND THE TWO CIRCLES. THE COLOR BURGUNDY RED APPEARS IN THE WORD "ME".

PRIORITY DATE OF 10-7-2010 IS CLAIMED.

OWNER OF INTERNATIONAL REGISTRATION 1077579 DATED 3-2-2011, EXPIRES 3-2-2021.

THE COLOR(S) LIME GREEN AND BURGUNDY RED IS/ARE CLAIMED AS A FEATURE OF THE MARK.

SER. NO. 79-097,539, FILED 3-2-2011.

TINA BROWN, EXAMINING ATTORNEY



*David J. Kybas*

Director of the United States Patent and Trademark Office

# United States of America

United States Patent and Trademark Office



**Reg. No. 4,133,722**

**Registered May 1, 2012**

**Int. Cl.: 9**

YUYAO VISTAR ELECTRONIC SCIENCE & TECHNOLOGY CO., LTD. (CHINA CORPORATION)  
QUNLI VILLAGE  
XIBEI ROAD; YUYAO CITY  
ZHEJIANG PROVINCE, CHINA

**TRADEMARK**

**PRINCIPAL REGISTER**

FOR: OBJECTIVES IN THE NATURE OF OPTICAL LENSES; PHOTOGRAPHIC CAMERAS; FLASH-BULBS; PHOTOGRAPHIC DRYING RACKS; PHOTOGRAPHIC FILTERS; STANDS FOR PHOTOGRAPHIC APPARATUS; FILTERS FOR ULTRAVIOLET RAYS FOR USE IN PHOTOGRAPHY; TRIPODS FOR CAMERAS; FLASHLIGHTS FOR USE IN PHOTOGRAPHY; CASES ESPECIALLY MADE FOR PHOTOGRAPHIC APPARATUS AND INSTRUMENTS, IN CLASS 9 (U.S. CLS. 21, 23, 26, 36 AND 38).

THE MARK CONSISTS OF A OVAL SHAPE CONSISTING OF TWO MISCELLANEOUS CURVES AND THE WORDING "VISICO" IN STYLIZED LETTERING.

OWNER OF INTERNATIONAL REGISTRATION 1077701 DATED 1-4-2011, EXPIRES 1-4-2021.

SER. NO. 79-097,576, FILED 1-4-2011.

JERI J. FICKES, EXAMINING ATTORNEY



*David J. Kybas*

Director of the United States Patent and Trademark Office

# United States of America

United States Patent and Trademark Office

# COLOR KIDS

**Reg. No. 4,133,723**

**Registered May 1, 2012**

**Int. Cls.: 18 and 25**

**TRADEMARK**

**PRINCIPAL REGISTER**

ACTIVE SPORTSWEAR INT. A/S (DENMARK CORPORATION)  
MALTVEJ 15  
DK-9700 BRØNDERSLEV, DENMARK

FOR: GOODS MADE OF LEATHER AND IMITATION LEATHER AND NOT INCLUDED IN OTHER CLASSES, NAMELY, CHILDREN'S BACKPACKS AND ALL-PURPOSE SPORTS BAGS MADE OF NYLON OR POLYESTER; ANIMAL SKINS, ANIMAL HIDES; TRUNKS AND TRAVELLING BAGS; UMBRELLAS, PARASOLS AND WALKING STICKS; WHIPS, HARNESS AND SADDLERY, IN CLASS 18 (U.S. CLS. 1, 2, 3, 22 AND 41).

FOR: SKI WEAR FOR CHILDREN; WINTER OUTWEAR FOR CHILDREN, NAMELY, COVERALLS, JACKETS, DOWN JACKETS AND RAIN JACKETS, PANTS, INCLUDING RAIN PANTS, SOFTSHELL JACKETS, FOOTWEAR AND HEADWEAR, NAMELY, BALACLAVAS AND BEANIES, IN CLASS 25 (U.S. CLS. 22 AND 39).

THE MARK CONSISTS OF STANDARD CHARACTERS WITHOUT CLAIM TO ANY PARTICULAR FONT, STYLE, SIZE, OR COLOR.

OWNER OF INTERNATIONAL REGISTRATION 1077899 DATED 11-8-2010, EXPIRES 11-8-2020.

NO CLAIM IS MADE TO THE EXCLUSIVE RIGHT TO USE "KIDS", APART FROM THE MARK AS SHOWN.

SER. NO. 79-097,639, FILED 11-8-2010.

MICHAEL WIENER, EXAMINING ATTORNEY



*David J. Kyros*

Director of the United States Patent and Trademark Office

# United States of America

United States Patent and Trademark Office



## BONTIMES

**Reg. No. 4,133,724**

**Registered May 1, 2012**

**Int. Cls.: 25 and 35**

**TRADEMARK**

**SERVICE MARK**

**PRINCIPAL REGISTER**

S.C. BONTIMES S.R.L. (ROMANIA LIMITED LIABILITY COMPANY)  
STR. GRAMMA II, NR. 1  
DUMBRAVITA  
JUD. TIMIS, ROMANIA

FOR: FOOTWEAR, SHOES, IN CLASS 25 (U.S. CLS. 22 AND 39).

FOR: ADVERTISING AGENCIES; BUSINESS MANAGEMENT; BUSINESS ADMINISTRATION; PROVIDING OFFICE FUNCTIONS, IN CLASS 35 (U.S. CLS. 100, 101 AND 102).

THE MARK CONSISTS OF TWO CURVED LINES SURROUNDING THE WORD "BIT". BELOW THE CURVED LINES IS THE WORD "BONTIMES".

OWNER OF INTERNATIONAL REGISTRATION 1077955 DATED 3-31-2011, EXPIRES 3-31-2021.

SER. NO. 79-097,653, FILED 3-31-2011.

SHANNON TWOHIG, EXAMINING ATTORNEY



*David J. Kyfos*

Director of the United States Patent and Trademark Office

# United States of America

United States Patent and Trademark Office

# CEELab

**Reg. No. 4,133,725**

**Registered May 1, 2012**

**Int. Cls.: 9, 38 and 42**

**TRADEMARK**

**SERVICE MARK**

**PRINCIPAL REGISTER**

CEELAB AS (NORWAY LIMITED CORPORATION)  
KARENSLYST ALLÉ 8 B  
N-0278 OSLO  
NORWAY

FOR: VIDEOCONFERENCING APPARATUS AND EQUIPMENT, NAMELY, VIDEO MONITORS AND SET-TOP BOXES SOLD AS A UNIT DESIGNED FOR TRANSMISSION AND RECEPTION OF AUDIO AND VIDEO TELECOMMUNICATIONS, IN CLASS 9 (U.S. CLS. 21, 23, 26, 36 AND 38).

FOR: VIDEO CONFERENCING SERVICES, IN CLASS 38 (U.S. CLS. 100, 101 AND 104).

FOR: DEVELOPMENT AND CREATION OF VIDEOCONFERENCING SYSTEMS AND NETWORKS; CONSULTATION AND ADVISORY SERVICES RELATED TO DEVELOPMENT AND CREATION OF VIDEOCONFERENCING SYSTEMS AND NETWORKS, IN CLASS 42 (U.S. CLS. 100 AND 101).

THE MARK CONSISTS OF THE WORDING "CEELAB" IN A GREEN STYLIZED FONT.

PRIORITY DATE OF 8-11-2010 IS CLAIMED.

OWNER OF INTERNATIONAL REGISTRATION 1078025 DATED 2-2-2011, EXPIRES 2-2-2021.

THE COLOR(S) GREEN IS/ARE CLAIMED AS A FEATURE OF THE MARK.

SER. NO. 79-097,675, FILED 2-2-2011.

TINA BROWN, EXAMINING ATTORNEY



*David J. Kyjars*

Director of the United States Patent and Trademark Office



# United States of America

United States Patent and Trademark Office



SELFRAG  
HIGH VOLTAGE PULSE  
POWER FRAGMENTATION

**Reg. No. 4,133,726**

**Registered May 1, 2012**

**Int. Cls.: 7, 9 and 40**

**TRADEMARK**

**SERVICE MARK**

**PRINCIPAL REGISTER**

SELFRAG AG (SWITZERLAND SOCIÉTÉ ANONYME (SA))  
BIBERENZELGLI 18  
CH-3210 KERZERS, SWITZERLAND

FOR: MACHINES AND MACHINE TOOLS FOR SEPARATION AND MILLING OF SOLID MATERIALS, FOR SEPARATING GOODS INTO THEIR COMPONENT MATERIALS, IN PARTICULAR OF INSULATING MATERIALS AND MINERAL SUBSTANCES, NAMELY, MACHINES AND MACHINE TOOLS FOR APPLYING ELECTRICAL PULSES TO MATERIALS TO FRAGMENT THE MATERIALS, IN CLASS 7 (U.S. CLS. 13, 19, 21, 23, 31, 34 AND 35).

FOR: LABORATORY APPARATUS AND INSTRUMENTS FOR SEPARATION AND SCIENTIFIC ANALYSIS OF SOLID MATERIALS, IN PARTICULAR INSULATING MATERIALS AND MINERAL SUBSTANCES, NAMELY, LABORATORY APPARATUS AND INSTRUMENTS FOR APPLYING ELECTRICAL IMPULSES FOR THE SEPARATION OR MILLING AND ANALYSIS OF SOLID MATERIALS, IN CLASS 9 (U.S. CLS. 21, 23, 26, 36 AND 38).

FOR: MATERIAL TREATMENT SERVICES FOR OTHERS, NAMELY, SEPARATION OR MILLING OF SOLID MATERIALS BY APPLYING ELECTRICAL PULSES TO FRAGMENT THE MATERIALS; RECYCLING OF WASTE AND TRASH, IN CLASS 40 (U.S. CLS. 100, 103 AND 106).

OWNER OF U.S. REG. NOS. 3,476,781 AND 3,476,782.

PRIORITY DATE OF 11-3-2010 IS CLAIMED.

OWNER OF INTERNATIONAL REGISTRATION 1078095 DATED 3-24-2011, EXPIRES 3-24-2021.

THE COLOR(S) RED AND GRAY IS/ARE CLAIMED AS A FEATURE OF THE MARK.

NO CLAIM IS MADE TO THE EXCLUSIVE RIGHT TO USE "HIGH VOLTAGE PULSE POWER FRAGMENTATION", APART FROM THE MARK AS SHOWN.

THE MARK CONSISTS OF THE WORDING "SELFRAG HIGH VOLTAGE PULSE POWER FRAGMENTATION" IN GRAY, ACCOMPANIED TO THE LEFT BY A LARGE NUMBER OF RED AND GRAY DOTS.



*David J. Kybas*

Director of the United States Patent and Trademark Office

**Reg. No. 4,133,726** SER. NO. 79-097,696, FILED 3-24-2011.

DORITT L. CARROLL, EXAMINING ATTORNEY

# United States of America

United States Patent and Trademark Office

# FLIPBIKE

**Reg. No. 4,133,727**

**Registered May 1, 2012**

**Int. Cls.: 12 and 28**

**TRADEMARK**

**PRINCIPAL REGISTER**

FLIP INNOVATIONS PTY LTD (AUSTRALIA INCORPORATED COMPANY)  
PO BOX 5012  
SOUTH MELBOURNE VIC 3205, AUSTRALIA

FOR: VEHICLES, NAMELY, BICYCLES, TRICYCLES, SCOOTERS AND LAND VEHICLES; APPARATUS FOR LOCOMOTION BY LAND, AIR OR WATER, NAMELY, BICYCLES, TRICYCLES AND SCOOTERS; BICYCLES AND TRICYCLES; BICYCLES AND TRICYCLES WITHOUT PEDALS IN PARTICULAR THOSE WITH HANDLES FOR PUSHING; SCOOTERS; LAND VEHICLES WITH PEDALS; FRAMES FOR BICYCLES OR TRICYCLES; TYRES FOR VEHICLES, BICYCLES AND TRICYCLES; STROLLERS AND BABY CARRIAGES; ACCESSORIES FOR THE AFORESAID GOODS, NAMELY, PEDALS, BRAKE LEVERS, HANDLE BARS, COG WHEELS AND WHEELS; STRUCTURAL PARTS FOR ALL OF THE AFORESAID GOODS, IN CLASS 12 (U.S. CLS. 19, 21, 23, 31, 35 AND 44).

FOR: TOYS, GAMES AND PLAYTHINGS, NAMELY, TOY SCOOTERS, TOY BICYCLES AND TOY TRICYCLES OTHER THAN FOR TRANSPORT; GYMNAS TIC AND SPORTING ARTICLES, NAMELY, GYMNAS TIC APPARATUS; SPORTS EXERCISE EQUIPMENT, NAMELY, STATIONARY EXERCISE BICYCLES AND STATIONARY EXERCISE TRICYCLES; TOY VEHICLES BEING MODEL TOY BICYCLES, TRICYCLES AND SCOOTERS; PROTECTORS IN THE NATURE OF PADS FOR ELBOWS AND KNEES WHEN RIDING SCOOTER, BICYCLES AND TRICYCLES; ACCESSORIES FOR THE AFORESAID GOODS, NAMELY, ROLLERS FOR STATIONERY EXERCISE BICYCLES AND STATIONERY EXERCISE TRICYCLES; STRUCTURAL PARTS FOR ALL OF THE AFORESAID GOODS, IN CLASS 28 (U.S. CLS. 22, 23, 38 AND 50).

THE MARK CONSISTS OF STANDARD CHARACTERS WITHOUT CLAIM TO ANY PARTICULAR FONT, STYLE, SIZE, OR COLOR.

OWNER OF INTERNATIONAL REGISTRATION 1078101 DATED 3-3-2011, EXPIRES 3-3-2021.

SER. NO. 79-097,700, FILED 3-3-2011.

ALYSSA STEEL, EXAMINING ATTORNEY



*David J. Kyffers*

Director of the United States Patent and Trademark Office

# United States of America

United States Patent and Trademark Office

# WIND MADE

**Reg. No. 4,133,728**

VESTAS WIND SYSTEMS A/S (DENMARK PUBLIC LIMITED COMPANY)  
ALSVEJ 21

**Registered May 1, 2012**

DK-8940 RANDERS SV, DENMARK

**Int. Cls.: 7, 9, 37 and 42**

FOR: WIND MILLS, WIND POWER PLANTS AND WIND TURBINES; STRUCTURAL PARTS AND ACCESSORIES FOR THE AFORESAID GOODS NOT INCLUDED IN OTHER CLASSES, NAMELY, MILL TOWERS AND MASTS, BLADES, BLADE HUBS, MILL HOUSINGS, MACHINE BEDS, ROTATION DEVICES, YAW RINGS AND GEARS; STRUCTURAL PARTS AND ACCESSORIES FOR WIND MILLS AND WIND TURBINES, NAMELY, DEVICES FOR SETTING THE PITCH OF THE WINGS, BRAKES AND BRAKE DEVICES, MAIN SHAFTS, UNIVERSAL JOINTS, TRANSMISSION DEVICES, CLUTCHES AND ELECTRIC GENERATORS AND RESERVE WIND POWER SUPPLY PLANTS; STRUCTURAL PARTS FOR THE AFORESAID GOODS NOT INCLUDED IN OTHER CLASSES, IN CLASS 7 (U.S. CLS. 13, 19, 21, 23, 31, 34 AND 35).

**TRADEMARK**

**SERVICE MARK**

**PRINCIPAL REGISTER**

FOR: ELECTRICAL AND ELECTRONIC EQUIPMENT AS WELL AS COMPUTER EQUIPMENT FOR WIND MILLS, WIND POWER PLANTS, WIND TURBINES AND OTHER WIND-OPERATED MACHINES, NAMELY, COMPUTERS, COMPUTER HARDWARE AND ELECTRICAL CONTROLLERS; ELECTRICAL CONTROLLERS AND MONITORING DEVICES FOR AUTOMATICALLY TURNING POWER GENERATORS ON AND OFF AND FOR AUTOMATIC STARTING AFTER PUBLIC POWER LINE BREAK-DOWNS; APPARATUS FOR OVERVOLTAGE PROTECTION AGAINST STROKES OF LIGHTNING; MICROPROCESSORS FOR CONTROLLING AND MONITORING CONSTANT VOLTAGE, FREQUENCY, PHASE CONDITIONS, ROTOR SPEED, CONTROL OF EFFICIENCY AND THICKNESS OF BRAKE PADS, TEMPERATURE, WIND DIRECTION AND WIND SPEED; ELECTRICAL AND ELECTRONIC VIBRATION SENSORS FOR INSTALLATION IN WIND MILL HOUSINGS; WATT-HOUR METERS; STRUCTURAL PARTS FOR THE AFORESAID GOODS NOT INCLUDED IN OTHER CLASSES, IN CLASS 9 (U.S. CLS. 21, 23, 26, 36 AND 38).



FOR: ERECTION, CONSTRUCTION, INSTALLATION, MAINTENANCE AND REPAIR OF WIND MILLS, WIND POWER PLANTS, WIND TURBINES AND OTHER WIND-OPERATED MACHINES; ADVISORY, CONSULTANCY AND INFORMATION SERVICES RELATING TO ALL THE AFORESAID SERVICES, IN CLASS 37 (U.S. CLS. 100, 103 AND 106).

*David J. Kyjars*

FOR: TECHNICAL ASSISTANCE CONCERNING WIND MILL AND WIND POWER PROJECTS AND DEVELOPING SUCH PROJECTS, NAMELY, CONSULTATION CONCERNING THE DESIGN AND DEVELOPMENT OF WIND MILLS AND WIND POWER PLANT PROJECTS;

Director of the United States Patent and Trademark Office

**Reg. No. 4,133,728** DEVELOPMENT AND TESTING FOR OTHERS OF WIND MILLS, WIND POWER PLANTS, WIND TURBINES, WIND-OPERATED MACHINES AND COMPONENTS THEREFOR; TECHNICAL RESEARCH PROJECTS FOR OTHERS CONCERNING WIND MILLS, WIND POWER PLANTS, WIND TURBINES AND OTHER WIND-OPERATED MACHINES; ADVISORY, CONSULTANCY AND INFORMATION SERVICES RELATING TO ALL THE AFORESAID SERVICES, IN CLASS 42 (U.S. CLS. 100 AND 101).

THE MARK CONSISTS OF STANDARD CHARACTERS WITHOUT CLAIM TO ANY PARTICULAR FONT, STYLE, SIZE, OR COLOR.

OWNER OF INTERNATIONAL REGISTRATION 1078143 DATED 11-25-2010, EXPIRES 11-25-2020.

NO CLAIM IS MADE TO THE EXCLUSIVE RIGHT TO USE "WIND", APART FROM THE MARK AS SHOWN.

SER. NO. 79-097,710, FILED 11-25-2010.

KATHERINE CONNOLLY, EXAMINING ATTORNEY

# United States of America

United States Patent and Trademark Office

## MOROZPRODUCT

## МОРОЗПРОДУКТ

**Reg. No. 4,133,729**

**Registered May 1, 2012**

**Int. Cls.: 29, 30, 32 and 35**

**TRADEMARK**

**SERVICE MARK**

**PRINCIPAL REGISTER**

INOSTRANNOE OBCHTCHESTVO S OGRANITCHENNOI OTVETSTVENNOSTIOU  
"MOROZPRODUKT" (BELARUS SOCIÉTÉ ÉTRANGÈRE À RESPONSABILITÉ LIMITÉE)  
D. 133, K. 5, OUL. OKTIABRSKAIA  
G. MARINA GORKA.,; POUKHOVITCHSKI R-N; 222810 MINSKAIA OBL.  
BELARUS

FOR: MEAT, FISH, POULTRY AND GAME; MEAT EXTRACTS; PRESERVED, FROZEN, DRIED AND COOKED FRUITS AND VEGETABLES; VEGETABLE JUICES FOR COOKING; JELLIES, JAMS, COMPOTES; EGGS, MILK AND MILK PRODUCTS EXCLUDING ICE CREAM; PETIT-SUISSE CHEESES; FROZEN PETIT-SUISSE CHEESES; EDIBLE OILS AND FATS; WEED EXTRACTS FOR FOOD, IN CLASS 29 (U.S. CL. 46).

FOR: COFFEE, TEA, COCOA, SUGAR, RICE, TAPIOCA, SAGO, ARTIFICIAL COFFEE; FLOUR AND PREPARATIONS MADE FROM CEREALS, NAMELY, CEREAL-BASED SNACK FOODS; BREAD, PASTRY AND CONFECTIONERY, NAMELY, COOKIES, WAFFLES, CAKES, PASTRIES, PEANUT CONFECTIONERY, ALMOND CONFECTIONERY, CARMELS, SWEETMEATS, LICORICE, PEPPERMINT SWEETS, CHOCOLATE SWEETS, CANDY FOR FOOD, FRUIT JELLIES, MARZIPAN, CONFECTIONARY, NAMELY, PASTILLES, BISCUITS, FONDANTS, FROZEN CONFECTIONERY, FRUIT JELLIES; ICES, NAMELY, ICE CREAM, ITALIAN ICE, ICE MILK; RUSSIAN RAVIOLI, NAMELY, PELMENIS, HONEY, TRECACLE; YEAST, BAKING-POWDER; SALT, MUSTARD; VINEGAR, SAUCES CONDIMENTS; SPICES; ICE FOR REFRESHMENT, IN CLASS 30 (U.S. CL. 46).

FOR: BEER; MINERAL AND AERATED WATERS AND OTHER NON-ALCOHOLIC DRINKS, NAMELY, LEMONADE, SOFT DRINKS; FRUIT DRINKS AND FRUIT JUICES; SYRUPS AND OTHER PREPARATIONS FOR MAKING BEVERAGES, NAMELY, CONCENTRATES AND POWDERS USED IN THE PREPARATION OF SOFT DRINKS, IN CLASS 32 (U.S. CLS. 45, 46 AND 48).

FOR: ADVERTISING; BUSINESS MANAGEMENT; BUSINESS ADMINISTRATION; OFFICE FUNCTIONS, WHOLESALE AND RETAIL STORE SERVICES FOR MEAT, FISH, POULTRY AND GAME, MEAT EXTRACTS, PRESERVED, FROZEN, DRIED AND COOKED FRUITS AND VEGETABLES, VEGETABLE JUICES FOR COOKING, JELLIES, JAMS, COMPOTES, EGGS, MILK AND MILK PRODUCTS EXCLUDING ICE CREAM, PETIT-SUISSE CHEESES, FROZEN PETIT-SUISSE CHEESES, EDIBLE OILS AND FATS, WEED EXTRACTS FOR FOOD, COFFEE, TEA, COCOA, SUGAR, RICE, TAPIOCA, SAGO, ARTIFICIAL COFFEE FLOUR AND PREPARATIONS MADE FROM CEREALS, NAMELY, CEREAL-BASED SNACK



*David J. Kappas*

Director of the United States Patent and Trademark Office

**Reg. No. 4,133,729** FOODS, BREAD, PASTRY AND CONFECTIONERY, NAMELY, COOKIES, WAFFLES, CAKES, PASTRIES, PEANUT CONFECTIONERY, ALMOND CONFECTIONERY, CARMELS, SWEETMEATS, LICORICE, PEPPERMINT SWEETS, CHOCOLATE SWEETS, CANDY FOR FOOD, FRUIT JELLIES, MARZIPAN, CONFECTIONARY, NAMELY, PASTILLES, BISCUITS, FONDANTS, FROZEN CONFECTIONERY, FRUIT JELLIES, ICES, NAMELY, ICE CREAM, ITALIAN ICE, ICE MILK, RUSSIAN RAVIOLI, NAMELY, PELMENIS, HONEY, TREACLE, YEAST, BAKING-POWDER, SALT, MUSTARD, VINEGAR, SAUCES CONDIMENTS, SPICES, ICE FOR REFRESHMENT, BEER, MINERAL AND AERATED WATERS AND OTHER NON-ALCOHOLIC DRINKS, NAMELY, LEMONADE, SOFT DRINKS, FRUIT DRINKS AND FRUIT JUICES, SYRUPS AND OTHER PREPARATIONS FOR MAKING BEVERAGES, NAMELY, CONCENTRATES AND POWDERS USED IN THE PREPARATION OF SOFT DRINKS, IN CLASS 35 (U.S. CLS. 100, 101 AND 102).

OWNER OF INTERNATIONAL REGISTRATION 1078152 DATED 11-30-2010, EXPIRES 11-30-2020.

THE NON-LATIN CHARACTERS IN THE MARK TRANSLITERATE TO "MOROZPRO-DOUKT" AND THIS HAS NO MEANING IN A FOREIGN LANGUAGE.

SER. NO. 79-097,712, FILED 11-30-2010.

MATTHEW EINSTEIN, EXAMINING ATTORNEY

# United States of America

United States Patent and Trademark Office



**Reg. No. 4,133,730**

**Registered May 1, 2012**

**Int. Cls.: 11 and 40**

**TRADEMARK**

**SERVICE MARK**

**PRINCIPAL REGISTER**

CLEANSTGAS GMBH (AUSTRIA GMBH)  
INDUSTRIESTRASSE 12  
A-8321 ST. MARGARETHEN A.D. RAAB, AUSTRIA

FOR: HEATING INSTALLATIONS, IN CLASS 11 (U.S. CLS. 13, 21, 23, 31 AND 34).

FOR: PRODUCTION OF ENERGY, IN CLASS 40 (U.S. CLS. 100, 103 AND 106).

NO CLAIM IS MADE TO THE EXCLUSIVE RIGHT TO USE "CLEAN STAGED GASIFICATION SYSTEMS", APART FROM THE MARK AS SHOWN.

OWNER OF INTERNATIONAL REGISTRATION 1009190 DATED 11-17-2008, EXPIRES 11-17-2018.

THE COLOR(S) GREEN, BLUE AND BLACK IS/ARE CLAIMED AS A FEATURE OF THE MARK.

THE MARK CONSISTS OF THE WORDING "CLEANSTGAS" WHERE "CLEANST" APPEARS IN GREEN AND "GAS" APPEARS IN BLUE. BELOW "CLEANSTGAS" APPEARS THE BLACK WORDING "CLEAN STAGED GASIFICATION SYSTEMS". TO THE RIGHT OF THE WORDING APPEAR TWO LONG ARCHING BANDS, ONE IN BLUE AND ONE IN GREEN, THAT EXTEND OVER THE TOP OF THE WORDING.

SER. NO. 79-097,742, FILED 9-2-2010.

KATHERINE E. HALMEN, EXAMINING ATTORNEY



*David J. Kybas*

Director of the United States Patent and Trademark Office



# United States of America

United States Patent and Trademark Office

## ROBERTO RICETTI

**Reg. No. 4,133,731**

**Registered May 1, 2012**

**Int. Cl.: 25**

**TRADEMARK**

**PRINCIPAL REGISTER**

RICETTI ROBERTO (ITALY INDIVIDUAL)  
VIA DE AMICIS, 11  
I-25063 GARDONE V.T. (BS)  
ITALY

FOR: CLOTHING, NAMELY, BOOTS, SHOES, SLIPPERS, BELTS, SOCKS, SHIRTS, PAJAMAS, DRESSING GOWNS AND UNDERWEAR, IN CLASS 25 (U.S. CLS. 22 AND 39).

THE NAME "ROBERTO RICETTI" IDENTIFIES A LIVING INDIVIDUAL WHOSE CONSENT IS OF RECORD.

OWNER OF INTERNATIONAL REGISTRATION 1078383 DATED 3-18-2011, EXPIRES 3-18-2021.

THE MARK CONSISTS OF THE STYLIZED WORDING "ROBERTO RICETTI".

SER. NO. 79-097,813, FILED 3-18-2011.

EVELYN BRADLEY, EXAMINING ATTORNEY



*David J. Kybas*

Director of the United States Patent and Trademark Office

# United States of America

United States Patent and Trademark Office

# Appgyver

**Reg. No. 4,133,732**

**Registered May 1, 2012**

**Int. Cls.: 9, 35, 38 and 42**

**TRADEMARK**

**SERVICE MARK**

**PRINCIPAL REGISTER**

APPGYVER OY (FINLAND CORPORATION)  
VUORIKATU 15 A  
FI-00100 HELSINKI  
FINLAND

FOR: COMMUNICATIONS SOFTWARE FOR CONNECTING COMPUTER NETWORK USERS,  
IN CLASS 9 (U.S. CLS. 21, 23, 26, 36 AND 38).

FOR: ADVERTISING AGENCIES; BUSINESS MANAGEMENT AND ADMINISTRATION;  
OFFICE FUNCTIONS, IN CLASS 35 (U.S. CLS. 100, 101 AND 102).

FOR: COMMUNICATION SERVICES, NAMELY, PROVIDING ELECTRONIC TRANSMISSION  
OF INFORMATION STORED IN A DATABASE VIA INTERACTIVELY COMMUNICATING  
COMPUTER SYSTEMS, IN CLASS 38 (U.S. CLS. 100, 101 AND 104).

FOR: SOFTWARE DESIGN AND DEVELOPMENT, IN CLASS 42 (U.S. CLS. 100 AND 101).

PRIORITY DATE OF 10-14-2010 IS CLAIMED.

OWNER OF INTERNATIONAL REGISTRATION 1078566 DATED 4-7-2011, EXPIRES 4-7-  
2021.

SER. NO. 79-097,851, FILED 4-7-2011.

LAURA KOVALSKY, EXAMINING ATTORNEY



*David J. Kyros*

Director of the United States Patent and Trademark Office

# United States of America

United States Patent and Trademark Office

## PIERRE BISCUITERIE

**Reg. No. 4,133,733**

**Registered May 1, 2012**

**Int. Cl.: 30**

**TRADEMARK**

**PRINCIPAL REGISTER**

BISCUITERIE DE L'ABBAYE (FRANCE SOCIÉTÉ PAR ACTIONS SIMPLIFIÉE)  
ROUTE DU VAL  
F-61700 LONLAY L'ABBAYE  
FRANCE

FOR: COFFEE, TEA, COCOA, SUGAR, RICE, TAPIOCA, SAGO, ARTIFICIAL COFFEE;  
FLOUR; BREAD, PASTRY, EDIBLE ICES; HONEY, TREACLE; YEAST, BAKING-POWDER;  
SALT, MUSTARD; VINEGAR, SAUCES BEING CONDIMENTS; SPICES; ICE FOR REFRESH-  
MENT; SANDWICHES, PIZZAS; PANCAKES; COOKIES; CAKES; RUSKS; SUGAR CONFEC-  
TIONERY; CHOCOLATE; BEVERAGES MADE OF COCOA, COFFEE, CHOCOLATE OR  
TEA, IN CLASS 30 (U.S. CL. 46).

THE MARK CONSISTS OF STANDARD CHARACTERS WITHOUT CLAIM TO ANY PAR-  
TICULAR FONT, STYLE, SIZE, OR COLOR.

PRIORITY DATE OF 10-20-2010 IS CLAIMED.

OWNER OF INTERNATIONAL REGISTRATION 1078775 DATED 3-21-2011, EXPIRES 3-21-  
2021.

NO CLAIM IS MADE TO THE EXCLUSIVE RIGHT TO USE "BISCUITERIE", APART FROM  
THE MARK AS SHOWN.

THE ENGLISH TRANSLATION OF "BISCUITERIE" IN THE MARK IS "BISCUIT FACTORY".

SER. NO. 79-097,915, FILED 3-21-2011.

EVELYN BRADLEY, EXAMINING ATTORNEY



*David J. Kyros*

Director of the United States Patent and Trademark Office

# United States of America

United States Patent and Trademark Office

## HAMO JEANS

**Reg. No. 4,133,734**

**Registered May 1, 2012**

**Int. Cl.: 25**

**TRADEMARK**

**PRINCIPAL REGISTER**

KWON, YOUNGJIN (REPUBLIC OF KOREA INDIVIDUAL)  
779-26, BANGBAE-DONG  
SEOCHO-GU; SEOUL  
REPUBLIC OF KOREA

FOR: CLOTHING, NAMELY, BUTTON-FRONT ALOHA SHIRTS, ANORAKS, BADMINTON SHIRTS AND SHORTS, BALLET SLIPPERS AND SHOES, ATHLETIC UNIFORMS, BABIES' PANTS, BABY DOLL PAJAMAS, BASKETBALL UNIFORMS AND SHOES, BASKETBALL PANTS, BATH ROBES, BATHING CAPS, BATHING COSTUMES FOR WOMEN, SWIM TRUNKS, BATHING SUITS, BATHING SUITS FOR MEN, BEACHWEAR, BELTS, BERMUDA SHORTS, BLAZERS, BLOUSES, BLOUSONS, BLUE JEANS, BODICES, LINGERIE, BODY SHIRTS, BOXER SHORTS, BRASSIERES, CAMISOLES, CAPES, CAPS, HEADWEAR, CARDIGANS, WOMEN'S CEREMONIAL DRESSES, CHASUBLES, CHEMISES, CHEMISETTES, SHIRT FRONTS; CHILDREN'S CLOTHING, NAMELY, SHIRTS, PANTS, AND SOCKS; CLIMBING CLOTHING, NAMELY, FOOTWEAR, TROUSERS, AND VESTS; CLOTHES FOR FISHING, NAMELY, SHIRTS, VESTS, AND WADERS; DANCE COSTUMES AND SHOES; GYMNASTIC SHOES; SKATING OUTFITS; CLOTHING FOR WEAR IN WRESTLING GAMES; CLOTHING MADE FROM IMITATION LEATHER, NAMELY, SHIRTS, AND PANTS; RUNNING SHOES AND RUNNING SUITS; COATS; DENIM COATS; COLLARS; CUFFS; COLLAR PROTECTORS; REMOVABLE COLLARS; UNDERWEAR; COMBINATIONS; CORSELETS; FOUNDATION CLOTHING, NAMELY, CORSETS; UNDERGARMENTS; COTTON COATS; COVERALLS; CYCLISTS' JERSEYS; DOWN JACKETS; DRESS SHIRTS; DRESS SUITS; DRESSES; DRESSES MADE FROM SKINS; DRESSING GOWNS; DUST COATS; EVENING DRESSES; FISHERMEN'S JACKETS; FISHING JACKETS; FISHING TROUSERS; FISHING VESTS; FROCKS; FUR COATS; GIRDLES; JUMPERS; GOLF SHIRTS; GOLF SKIRTS; GOLF TROUSERS; GOLF VESTS; GOWNS; SCRUBS NOT FOR MEDICAL PURPOSES; GREATCOATS; MID-LENGTH COATS; HEAVY JACKETS; HOSIERY; INFANT AND TODDLER ONE PIECE CLOTHING; JACKETS; JERKINS; JERSEYS; JOGGING PANTS; JOGGING SUITS; JUMPERS; KIMONOS; KNICKERS; KNITWEAR, NAMELY, KNITTED UNDERWEAR; COATS AND JACKETS; PANTS FOR WOMEN; SUITS FOR WOMEN; LEOTARDS; LIVERIES; LONG COATS; LONG JACKETS; LONG SLEEVED SHIRTS; MANTILLAS; MANTLES; RUNNING SUITS; MEN'S SUITS; MORNING COATS; NEGLIGEEES; NIGHT-GOWNS; ONE-PIECE PLAY SUITS; OPEN NECK SHIRTS; OVERALLS; OVERCOATS; OVER-TROUSERS; PAJAMAS; PANTS; PANTYHOSE; PAPER HATS FOR USE AS CLOTHING ITEMS; PAREUS; PARKAS; PELISSES; PETTICOATS; PIQUE SHIRTS; POLO SHIRTS; PULLOVERS; RAIN COATS; RAINPROOF JACKETS; ROMPERS; RUNNING SHIRTS; CLOTHING, NAMELY, SUITS FOR USE ON SAFARI; SARIS; SCHOOL UNIFORMS;



*David J. Kappas*

Director of the United States Patent and Trademark Office

**Reg. No. 4,133,734** SHIRT YOKES; SHORTS; SHORT-SLEEVED OR LONG-SLEEVED T-SHIRTS; SHORT-SLEEVED SHIRTS; SHOWER CAPS; SINGLETS; SKATEBOARD PANTS; SKI JACKETS; SKI PANTS; SPORT SHIRTS; SKI WEAR; SKIRT SUITS; SKIRTS; SLACKS; SLEEPING GARMENTS; SLEEVELESS JERSEYS; SLIPS; SMOCKS; SMOKING JACKETS; SNOW BOARDING SUITS; SNOWBOARD JACKETS; SNOWBOARD PANTS; SOCKS; SPORTS JACKETS; SPORTS JERSEYS; SPORTS OVERCOATS; SPORTS SHIRTS WITH SHORT SLEEVES; STRAPLESS BRASSIERES; STUFF JACKETS; SUEDE JACKETS; SWEAT PANTS; SWEAT SHIRTS; SWEAT SUITS; SWEAT-ABSORBENT UNDERWEAR; SWEATERS; TUXEDOS; TANK TOPS; TEDDIES; TENNIS SHORTS; TENNIS SKIRTS; TOGAS; TOP COATS; TOPCOATS; TRACK SUITS; TRAINING SUITS; TRENCH COATS; TROUSERS; TUNICS; TWIN SETS; TEE-SHIRTS; TWO PIECE SUITS; UNDERPANTS; UNDERSHIRTS; UNDERSKIRTS; WORK UNIFORMS; UNITARDS; VESTS; WARM-UP SUITS; WEDDING DRESSES; WEDDING GOWNS; WIND COATS; WIND RESISTANT JACKETS; WOMEN'S UNDERWEAR; WOMEN'S WAISTCOATS; WORKING OVERALLS; WOVEN OR KNITTED UNDERWEAR, IN CLASS 25 (U.S. CLS. 22 AND 39).

NO CLAIM IS MADE TO THE EXCLUSIVE RIGHT TO USE "JEANS", APART FROM THE MARK AS SHOWN.

OWNER OF INTERNATIONAL REGISTRATION 1078831 DATED 1-14-2011, EXPIRES 1-14-2021.

THE WORDING "HAMO" FOUND IN THE MARK HAS NO MEANING IN A FOREIGN LANGUAGE.

SER. NO. 79-097,932, FILED 1-14-2011.

JIM RINGLE, EXAMINING ATTORNEY

# United States of America

United States Patent and Trademark Office

# BILTIC

**Reg. No. 4,133,735**

**Registered May 1, 2012**

**Int. Cl.: 6**

**TRADEMARK**

**PRINCIPAL REGISTER**

BILSTEIN GMBH & CO. KG (FED REP GERMANY LIMITED LIABILITY COMPANY)  
IM WEINHOF 36  
58119 HAGEN, FED REP GERMANY

FOR: SEMI-FINISHED PRODUCTS MADE OF METALS OR METAL ALLOYS IN THE FORM OF BLOCKS. COILS, PLATES, SHEETS, STRIPS, THIN STRIPS, RODS, TUBES AND OTHER SHAPES OF COMMON METALS FOR FURTHER MANUFACTURE; LAMINATES, MADE MOSTLY OF METALS OR METAL ALLOYS FOR USE IN THE MANUFACTURE OF FINISHED GOODS; METALS AND METAL ALLOYS; ALUMINUM ALLOYS; STEEL UNWROUGHT OR SEMI-WROUGHT; IRON UNWROUGHT OR SEMI-WROUGHT; COMMON METALS UNWROUGHT OR SEMI-WROUGHT, FOR FURTHER MANUFACTURE; ALLOYS OF COMMON METAL; TITANIUM; TITANIUM IRON; WIRE OF COMMON METAL; ALUMINUM WIRE; IRON WIRE; STEEL WIRE; WIRE OF COMMON METAL ALLOYS EXCEPT FUSE WIRE; BINDINGS OF METAL USED ON PACKAGING; IRON STRIPS USED ON PACKAGING; STEEL STRIPS USED ON PACKAGING; SHEETS AND PLATES OF METAL; STEEL SHEETS; INGOTS OF COMMON METAL; JOISTS OF METAL; IRON SLABS; STEEL ALLOYS; GIRDERS OF METAL, IN CLASS 6 (U.S. CLS. 2, 12, 13, 14, 23, 25 AND 50).

THE MARK CONSISTS OF STANDARD CHARACTERS WITHOUT CLAIM TO ANY PARTICULAR FONT, STYLE, SIZE, OR COLOR.

PRIORITY DATE OF 3-2-2011 IS CLAIMED.

OWNER OF INTERNATIONAL REGISTRATION 1079002 DATED 3-21-2011, EXPIRES 3-21-2021.

THE WORDING "BILTIC" HAS NO MEANING IN A FOREIGN LANGUAGE.

SER. NO. 79-097,985, FILED 3-21-2011.

KRISTIN CARLSON, EXAMINING ATTORNEY



*David J. Kybas*

Director of the United States Patent and Trademark Office

United States of America  
United States Patent and Trademark Office

**ECOMODE**

**Reg. No. 4,133,736**

**Registered May 1, 2012**

**Int. Cls.: 6 and 20**

**TRADEMARK**

**PRINCIPAL REGISTER**

HÄNEL GMBH & CO. KG (FED REP GERMANY GMBH & CO. KG)  
KOCHERWALDSTR. 25  
74177 BAD FRIEDRICHSHALL  
FED REP GERMANY

FOR: METAL SUPPORTS FOR METAL SHELVING AS PART OF STORAGE UNITS, IN PARTICULAR, FOR USE WITH AUTOMATIC LOADING AND UNLOADING SHELVING STORAGE UNITS, AND FOR USE WITH SHELVES OF METAL IN HIGH STORAGE UNITS, IN CLASS 6 (U.S. CLS. 2, 12, 13, 14, 23, 25 AND 50).

FOR: METAL SHELVES FOR USE IN AUTOMATIC LOADING AND UNLOADING SHELVING STORAGE UNITS; METAL SHELVES FOR USE IN HIGH STORAGE UNITS, IN CLASS 20 (U.S. CLS. 2, 13, 22, 25, 32 AND 50).

THE MARK CONSISTS OF STANDARD CHARACTERS WITHOUT CLAIM TO ANY PARTICULAR FONT, STYLE, SIZE, OR COLOR.

PRIORITY DATE OF 9-30-2010 IS CLAIMED.

OWNER OF INTERNATIONAL REGISTRATION 1079152 DATED 3-15-2011, EXPIRES 3-15-2021.

SER. NO. 79-098,035, FILED 3-15-2011.

ROBIN CHOSID, EXAMINING ATTORNEY



*David J. Kyffers*

Director of the United States Patent and Trademark Office

**United States of America**  
United States Patent and Trademark Office

# RIPOSATO

**Reg. No. 4,133,737**

**Registered May 1, 2012**

**Int. Cl.: 33**

**TRADEMARK**

**PRINCIPAL REGISTER**

AZ. AGR. LE RUINE DI FURIA EROS E LUCIO (ITALY AGRICULTURAL COMPANY)  
VIA NEGARINE, 14  
I-37029 SAN PIETRO IN CARIANO (VR)  
ITALY

FOR: ALCOHOLIC BEVERAGES, EXCEPT BEERS, IN CLASS 33 (U.S. CLS. 47 AND 49).

THE MARK CONSISTS OF STANDARD CHARACTERS WITHOUT CLAIM TO ANY PARTICULAR FONT, STYLE, SIZE, OR COLOR.

OWNER OF INTERNATIONAL REGISTRATION 1079157 DATED 5-4-2011, EXPIRES 5-4-2021.

THE ENGLISH TRANSLATION OF "RIPOSATO" IN THE MARK IS "RESTED" OR "FRESH".

SER. NO. 79-098,039, FILED 5-4-2011.

DAVID HOFFMAN, EXAMINING ATTORNEY



*David J. Kyffers*

Director of the United States Patent and Trademark Office



United States of America  
United States Patent and Trademark Office

NIAGA

**Reg. No. 4,133,738**

**Registered May 1, 2012**

**Int. Cl.: 27**

**TRADEMARK**

**PRINCIPAL REGISTER**

Q B.V. (NETHERLANDS LIMITED LIABILITY COMPANY)  
MERCURIUSPLEIN 1  
GRUBBENVORST, NETHERLANDS NL5971 LW

FOR: FLOOR COVERINGS, NAMELY, REUSABLE CARPETS AND REUSABLE CARPET  
TILES, IN CLASS 27 (U.S. CLS. 19, 20, 37, 42 AND 50).

THE MARK CONSISTS OF STANDARD CHARACTERS WITHOUT CLAIM TO ANY PAR-  
TICULAR FONT, STYLE, SIZE, OR COLOR.

PRIORITY DATE OF 9-21-2010 IS CLAIMED.

OWNER OF INTERNATIONAL REGISTRATION 1079252 DATED 3-18-2011, EXPIRES 3-18-  
2021.

THE WORD(S) "NIAGA" HAS NO MEANING IN A FOREIGN LANGUAGE.

SER. NO. 79-098,075, FILED 3-18-2011.

KIMBERLY FRYE, EXAMINING ATTORNEY



*David J. Kyffers*

Director of the United States Patent and Trademark Office

# United States of America

United States Patent and Trademark Office

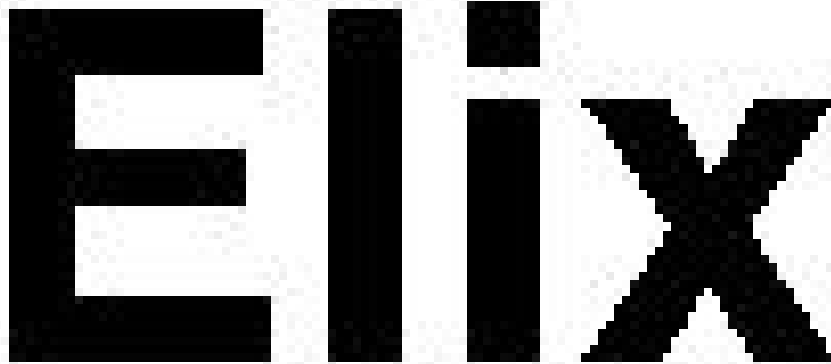

**Reg. No. 4,133,739**

**Registered May 1, 2012**

**Int. Cls.: 4, 35, 36, 39, 40  
and 42**

EUROPEAN ENERGY EXCHANGE AG (FED REP GERMANY AKTIENGESELLSCHAFT)  
AUGUSTUSPLATZ 9  
04109 LEIPZIG  
FED REP GERMANY

FOR: ELECTRICAL ENERGY; ELECTRICAL ENERGY, NAMELY, ELECTRICITY, IN CLASS 4 (U.S. CLS. 1, 6 AND 15).

**TRADEMARK**

FOR: BUSINESS MANAGEMENT SERVICES; BUSINESS ADMINISTRATION; SYSTEMISATION AND COMPILATION OF DATA IN COMPUTER DATABASES; ALL THE AFORESAID SERVICES OTHER THAN FOR COMPILING ECONOMIC CLIMATE INDICES, IN CLASS 35 (U.S. CLS. 100, 101 AND 102).

**SERVICE MARK**

**PRINCIPAL REGISTER**

FOR: QUOTATION OF STOCK EXCHANGE PRICES; FINANCIAL AFFAIRS AND MONETARY AFFAIRS, NAMELY, FINANCIAL INFORMATION, MANAGEMENT AND ANALYSIS SERVICES; FINANCIAL CONSULTANCY IN THE ENERGY SECTOR; ALL THE AFORESAID SERVICES OTHER THAN IN THE FIELD OF ECONOMIC CLIMATE INDICES, IN CLASS 36 (U.S. CLS. 100, 101 AND 102).

FOR: TRANSPORT, IN PARTICULAR TRANSPORT AND DISTRIBUTION OF ELECTRICITY, IN CLASS 39 (U.S. CLS. 100 AND 105).

FOR: GENERATION OF ENERGY, NAMELY, ELECTRICITY, IN CLASS 40 (U.S. CLS. 100, 103 AND 106).

FOR: TECHNICAL CONSULTANCY IN THE FIELD OF WHOLESALE ENERGY TRADING; CREATING AND UPDATING OF COMPUTER PROGRAMS AND DATABASE SOFTWARE; ALL THE AFORESAID SERVICES OTHER THAN FOR COMPELLING ECONOMIC CLIMATE INDICES, IN CLASS 42 (U.S. CLS. 100 AND 101).

THE MARK CONSISTS OF STANDARD CHARACTERS WITHOUT CLAIM TO ANY PARTICULAR FONT, STYLE, SIZE, OR COLOR.

PRIORITY DATE OF 10-1-2010 IS CLAIMED.

OWNER OF INTERNATIONAL REGISTRATION 1079514 DATED 4-1-2011, EXPIRES 4-1-2021.



*David J. Kappas*

Director of the United States Patent and Trademark Office

**Reg. No. 4,133,739** SER. NO. 79-098,197, FILED 4-1-2011.

CHRISIE B. KING, EXAMINING ATTORNEY

# United States of America

United States Patent and Trademark Office

# 98

**GAMBLE STEPPER**

**Reg. No. 4,133,740**

**Registered May 1, 2012**

**Int. Cls.: 9 and 28**

**TRADEMARK**

**PRINCIPAL REGISTER**

UNIVERSAL ENTERTAINMENT CORPORATION (JAPAN CORPORATION)  
ARIAKE FRONTIER BUILDING, TOWER A  
3-7-26 ARIAKE, KOTO-KU  
TOKYO, JAPAN 1350063

FOR: ELECTRONIC CIRCUITS, OPTICAL DISKS, MAGNETIC COMPUTER TAPES, MAGNETIC DISKS, MAGNETIC CARDS, MAGNETO-OPTICAL DISKS, CD-ROMS, ROM-CARTRIDGES AND DVDS, ALL OF WHICH STORE PROGRAMS FOR ARCADE VIDEO GAME MACHINES; DOWNLOADABLE PROGRAMS FOR ARCADE VIDEO GAME MACHINES; GAMING MACHINES ADAPTED FOR USE WITH EXTERNAL DISPLAY SCREENS OR MONITORS; ELECTRONIC CIRCUITS, OPTICAL DISKS, MAGNETIC COMPUTER TAPES, MAGNETIC DISKS, MAGNETIC CARDS, MAGNETO-OPTICAL DISKS, CD-ROMS, ROM-CARTRIDGES AND DVDS, ALL OF WHICH STORE PROGRAMS FOR GAMING MACHINES; DOWNLOADABLE PROGRAMS FOR GAMING MACHINES; ELECTRONIC CIRCUITS, OPTICAL DISKS, MAGNETIC COMPUTER TAPES, MAGNETIC DISKS, MAGNETIC CARDS, MAGNETO-OPTICAL DISKS, CD-ROMS, ROM-CARTRIDGES AND DVDS, ALL OF WHICH STORE PROGRAMS FOR SLOT MACHINES; DOWNLOADABLE COMPUTER PROGRAMS FOR SLOT MACHINES; APPARATUS FOR GAMES FOR HOME USE ADAPTED FOR USE WITH AN EXTERNAL DISPLAY SCREEN OR MONITOR; ELECTRONIC CIRCUITS, OPTICAL DISKS, MAGNETIC COMPUTER TAPES, MAGNETIC DISKS, MAGNETIC CARDS, MAGNETO-OPTICAL DISKS, CD-ROMS, ROM-CARTRIDGES AND DVDS, ALL OF WHICH STORE PROGRAMS FOR GAMES FOR HOME USE ADAPTED FOR USE WITH EXTERNAL DISPLAY SCREENS OR MONITORS; DOWNLOADABLE PROGRAMS FOR GAMES FOR HOME USE ADAPTED FOR USE WITH EXTERNAL DISPLAY SCREENS OR MONITORS; ELECTRONIC CIRCUITS, OPTICAL DISKS, MAGNETIC COMPUTER TAPES, MAGNETIC DISKS, MAGNETIC CARDS, MAGNETO-OPTICAL DISKS, CD-ROMS, ROM-CARTRIDGES AND DVDS, ALL OF WHICH STORE PROGRAMS FOR HAND-HELD GAMES WITH LIQUID CRYSTAL DISPLAYS; DOWNLOADABLE PROGRAMS FOR HAND-HELD GAMES WITH LIQUID CRYSTAL DISPLAYS, IN CLASS 9 (U.S. CLS. 21, 23, 26, 36 AND 38).



*David J. Kyros*

Director of the United States Patent and Trademark Office

FOR: COIN-OPERATED ARCADE VIDEO GAME MACHINES; MAGNETIC CARD OPERATED ARCADE VIDEO GAME MACHINES; STAND ALONE ARCADE VIDEO GAME MACHINES WITH MULTI-TERMINALS; CABINETS FOR ARCADE VIDEO GAME MACHINES; PARTS AND FITTINGS FOR STAND ALONE ARCADE VIDEO GAME MACHINES; STAND ALONE ARCADE VIDEO GAME MACHINES; SLOT MACHINES; CABINETS FOR SLOT MACHINES; GAMING MACHINES OTHER THAN THOSE ADAPTED FOR USE WITH EXTERNAL DIS-

**Reg. No. 4,133,740** PLAY SCREENS OR MONITORS; GAMING MACHINES WITH MULTI-TERMINALS OTHER THAN THOSE ADAPTED FOR USE WITH EXTERNAL DISPLAY SCREENS OR MONITORS; HAND-HELD GAMES WITH LIQUID CRYSTAL DISPLAYS, IN CLASS 28 (U.S. CLS. 22, 23, 38 AND 50).

NO CLAIM IS MADE TO THE EXCLUSIVE RIGHT TO USE "GAMBLE STEPPER", APART FROM THE MARK AS SHOWN.

PRIORITY DATE OF 4-11-2011 IS CLAIMED.

OWNER OF INTERNATIONAL REGISTRATION 1079535 DATED 4-14-2011, EXPIRES 4-14-2021.

SER. NO. 79-098,204, FILED 4-14-2011.

ANTHONY RINKER, EXAMINING ATTORNEY

United States of America  
United States Patent and Trademark Office

# DEGSON

**Reg. No. 4,133,741**

**Registered May 1, 2012**

**Int. Cl.: 9**

**TRADEMARK**

**PRINCIPAL REGISTER**

NINGBO DEGSON ELECTRONICS CO., LTD. (CHINA CORPORATION)  
SHATANLU VILLAGE,  
XIAOLIN TOWN, CIXI CITY, ZHEJIANG PROVINCE  
CHINA

FOR: COUNTERS, NAMELY, GEIGER COUNTERS; MATERIAL FOR ELECTRICITY MAINS, NAMELY, ELECTRIC WIRES, ELECTRIC CABLES; ELECTRIC SWITCHES; ELECTRIC TERMINAL BLOCKS; ELECTRIC CONNECTORS; ELECTRIC CONTACTS; ELECTRIC JUNCTION BOXES; ELECTRIC INSTALLATIONS FOR THE REMOTE CONTROL OF INDUSTRIAL OPERATIONS; ELECTRIC IRONS, IN CLASS 9 (U.S. CLS. 21, 23, 26, 36 AND 38).

THE MARK CONSISTS OF THE WORDING "DEGSON" IN STYLIZED FONT.

OWNER OF INTERNATIONAL REGISTRATION 1079579 DATED 5-10-2011, EXPIRES 5-10-2021.

SER. NO. 79-098,222, FILED 5-10-2011.

ALYSSA STEEL, EXAMINING ATTORNEY



*David J. Kyffers*

Director of the United States Patent and Trademark Office

United States of America  
United States Patent and Trademark Office

**MVSA**  
*de Vallformosa*

**Reg. No. 4,133,742**

**Registered May 1, 2012**

**Int. Cl.: 33**

**TRADEMARK**

**PRINCIPAL REGISTER**

MASIA VALLFORMOSA, S.L. (SPAIN SOCIEDAD LIMITADA)  
LA SALA, 45  
E-08735 VILOBI DEL PENEDES  
SPAIN

FOR: ALCOHOLIC BEVERAGES EXCEPT BEER, IN CLASS 33 (U.S. CLS. 47 AND 49).

OWNER OF U.S. REG. NO. 1,833,997.

OWNER OF INTERNATIONAL REGISTRATION 1079763 DATED 6-1-2011, EXPIRES 6-1-2021.

THE ENGLISH TRANSLATION OF "DE VALLFORMOSA" IN THE MARK IS "OF THE BEAUTIFUL VALLEY".

SER. NO. 79-098,300, FILED 6-1-2011.

EUGENIA MARTIN, EXAMINING ATTORNEY



*David J. Kyffers*

Director of the United States Patent and Trademark Office

# United States of America

United States Patent and Trademark Office

## **bürkert** TwinPower

**Reg. No. 4,133,743**

**Registered May 1, 2012**

**Int. Cls.: 7 and 9**

**TRADEMARK**

**PRINCIPAL REGISTER**

BÜRKERT WERKE GMBH (FED REP GERMANY LIMITED LIABILITY COMPANY)  
CHRISTIAN-BÜRKERT-STR. 13-17  
74653 INGELFINGEN  
FED REP GERMANY

FOR: VALVES AS MACHINE PARTS, IN CLASS 7 (U.S. CLS. 13, 19, 21, 23, 31, 34 AND 35).

FOR: ELECTRONIC VALVES FOR CONTROLLING GAS AND LIQUIDS; ELECTROMAGNETIC SWITCHES, NAMELY, SOLENOID VALVES, IN CLASS 9 (U.S. CLS. 21, 23, 26, 36 AND 38).

THE MARK CONSISTS OF THE TERMS "BURKERT TWINPOWER" WITH AN UMLAUT OVER THE "U" AND A HORIZONTAL LINE OVER THE OTHER LETTERS OF "BURKERT".

PRIORITY DATE OF 11-22-2010 IS CLAIMED.

OWNER OF INTERNATIONAL REGISTRATION 1080319 DATED 5-20-2011, EXPIRES 5-20-2021.

SER. NO. 79-098,542, FILED 5-20-2011.

ANTHONY RINKER, EXAMINING ATTORNEY



*David J. Kybas*

Director of the United States Patent and Trademark Office



# United States of America

United States Patent and Trademark Office



**Reg. No. 4,133,744**

**Registered May 1, 2012**

**Int. Cl.: 12**

**TRADEMARK**

**PRINCIPAL REGISTER**

ELDOR CORPORATION S.P.A. (ITALY JOINT-STOCK COMPANY)  
VIA CAIO PLINIO, 18  
I-22030 ORSENIGO (CO)  
ITALY

FOR: ELECTRIC VEHICLE, NAMELY, AUTOMOBILES; ENGINES FOR LAND VEHICLES; HYDRAULIC CIRCUITS FOR VEHICLES; MOTORS ELECTRIC FOR LAND VEHICLES; MOTORS FOR LAND VEHICLES; ELECTRIC MOTORS; THROTTLE BODIES FOR LAND VEHICLES; MECHANICAL AND ELECTRONIC INTEGRATED DEVICE TO CONTROL THE MOTOR OPERATION OF VEHICLE, NAMELY, MOTOR AND ENGINE CONTROL UNIT, IN CLASS 12 (U.S. CLS. 19, 21, 23, 31, 35 AND 44).

OWNER OF U.S. REG. NOS. 3,537,292 AND 3,781,368.

PRIORITY DATE OF 11-3-2010 IS CLAIMED.

OWNER OF INTERNATIONAL REGISTRATION 1080379 DATED 2-11-2011, EXPIRES 2-11-2021.

SER. NO. 79-098,561, FILED 2-11-2011.

RAUL CORDOVA, EXAMINING ATTORNEY



*David J. Kyffers*

Director of the United States Patent and Trademark Office

United States of America  
United States Patent and Trademark Office

**E L D O R**

**Reg. No. 4,133,745**

**Registered May 1, 2012**

**Int. Cl.: 12**

**TRADEMARK**

**PRINCIPAL REGISTER**

ELDOR CORPORATION S.P.A. (ITALY JOINT-STOCK COMPANY)  
VIA CAIO PLINIO, 18  
I-22030 ORSENIGO (CO)  
ITALY

FOR: ELECTRIC VEHICLE, NAMELY, AUTOMOBILES; ENGINES FOR LAND VEHICLES; HYDRAULIC CIRCUITS FOR VEHICLES; MOTORS ELECTRIC FOR LAND VEHICLES; MOTORS FOR LAND VEHICLES; ELECTRIC MOTORS; THROTTLE BODIES FOR LAND VEHICLES; MECHANICAL AND ELECTRONIC INTEGRATED DEVICE TO CONTROL THE MOTOR OPERATION OF VEHICLE, NAMELY, MOTOR AND ENGINE CONTROL UNIT, IN CLASS 12 (U.S. CLS. 19, 21, 23, 31, 35 AND 44).

THE MARK CONSISTS OF STANDARD CHARACTERS WITHOUT CLAIM TO ANY PARTICULAR FONT, STYLE, SIZE, OR COLOR.

PRIORITY DATE OF 11-3-2010 IS CLAIMED.

OWNER OF INTERNATIONAL REGISTRATION 1080380 DATED 2-11-2011, EXPIRES 2-11-2021.

OWNER OF U.S. REG. NO. 3,537,292.

SER. NO. 79-098,562, FILED 2-11-2011.

RAUL CORDOVA, EXAMINING ATTORNEY



*David J. Kyffers*

Director of the United States Patent and Trademark Office

# United States of America

United States Patent and Trademark Office

## BIA BUSINESS INTELLIGENCE ACCELERATOR

**Reg. No. 4,133,746**

**Registered May 1, 2012**

**Int. Cl.: 9**

**TRADEMARK**

**PRINCIPAL REGISTER**

MARKUS KRENN (AUSTRIA EINZELFIRMA)  
BIESENFELDWEG 12  
A-4040 LINZ  
AUSTRIA

FOR: COMPUTER SOFTWARE FOR APPLICATION AND DATABASE INTEGRATION, IN CLASS 9 (U.S. CLS. 21, 23, 26, 36 AND 38).

THE MARK CONSISTS OF STANDARD CHARACTERS WITHOUT CLAIM TO ANY PARTICULAR FONT, STYLE, SIZE, OR COLOR.

PRIORITY DATE OF 1-10-2011 IS CLAIMED.

OWNER OF INTERNATIONAL REGISTRATION 1080696 DATED 4-1-2011, EXPIRES 4-1-2021.

NO CLAIM IS MADE TO THE EXCLUSIVE RIGHT TO USE "BUSINESS INTELLIGENCE", APART FROM THE MARK AS SHOWN.

SER. NO. 79-098,655, FILED 4-1-2011.

TOBY BULLOFF, EXAMINING ATTORNEY



*David J. Kybas*

Director of the United States Patent and Trademark Office

# United States of America

United States Patent and Trademark Office

# REFINDER

**Reg. No. 4,133,747**

**Registered May 1, 2012**

**Int. Cls.: 9 and 42**

GNOWSIS E.U. (AUSTRIA SOLE PROPRIETORSHIP), DBA GNOWSIS E.U. LEOPOLD SAUERMANN  
GRAUMANNGASSE 7  
STIEGE B/5.STOCK  
A-1150 WIEN, AUSTRIA

**TRADEMARK**

FOR: COMPUTER SOFTWARE FOR LINKING DATA, OPENING HYPERLINKS AND FOR PERSONAL INFORMATION MANAGEMENT, IN CLASS 9 (U.S. CLS. 21, 23, 26, 36 AND 38).

**SERVICE MARK**

FOR: SOFTWARE DEVELOPMENT AND CONSULTING IN THE FIELD OF PERSONAL INFORMATION MANAGEMENT, IN CLASS 42 (U.S. CLS. 100 AND 101).

**PRINCIPAL REGISTER**

THE MARK CONSISTS OF STANDARD CHARACTERS WITHOUT CLAIM TO ANY PARTICULAR FONT, STYLE, SIZE, OR COLOR.

PRIORITY DATE OF 11-9-2010 IS CLAIMED.

OWNER OF INTERNATIONAL REGISTRATION 1080950 DATED 5-6-2011, EXPIRES 5-6-2021.

SER. NO. 79-098,745, FILED 5-6-2011.

TRACY FLETCHER, EXAMINING ATTORNEY



*David J. Kyffers*

Director of the United States Patent and Trademark Office

# United States of America

United States Patent and Trademark Office

## BAUME DU SOURIRE

**Reg. No. 4,133,748**

**Registered May 1, 2012**

**Int. Cl.: 3**

**TRADEMARK**

**PRINCIPAL REGISTER**

L'OCCITANE INTERNATIONAL S.A. (LUXEMBOURG SOCIÉTÉ ANONYME)  
1, RUE DU FORT RHEINSHEIM  
L-2419 LUXEMBOURG  
LUXEMBOURG

FOR: COSMETICS; DENTIFRICES; COSMETIC PREPARATIONS FOR SKIN CARE; COSMETIC CREAMS; NON-MEDICATED TOILETRIES, IN CLASS 3 (U.S. CLS. 1, 4, 6, 50, 51 AND 52).

NO CLAIM IS MADE TO THE EXCLUSIVE RIGHT TO USE "BAUME", APART FROM THE MARK AS SHOWN.

PRIORITY DATE OF 11-18-2010 IS CLAIMED.

OWNER OF INTERNATIONAL REGISTRATION 1081164 DATED 5-12-2011, EXPIRES 5-12-2021.

THE ENGLISH TRANSLATION OF "BAUME DU SOURIRE" IN THE MARK IS "SMILE BALM".

SER. NO. 79-098,826, FILED 5-12-2011.

CAROLINE WOOD, EXAMINING ATTORNEY



*David J. Kypos*

Director of the United States Patent and Trademark Office

# United States of America

United States Patent and Trademark Office

# CASTELLI DEL GREVEPESA

**Reg. No. 4,133,749**

**Registered May 1, 2012**

**Int. Cls.: 29, 35 and 43**

CASTELLI DEL GREVEPESA SOCIETÀ COOPERATIVA AGRICOLA (ITALY COOPERATIVE ASSOCIATION)  
VIA GABBIANO, 34  
FRAZ. MERCATALE  
I-50026 SAN CASCIANO INVAL DI PESA (FI), ITALY

**TRADEMARK**

FOR: MEAT, FISH, POULTRY AND GAME; MEAT EXTRACTS; PRESERVED, DRIED AND COOKED FRUITS AND VEGETABLES; JELLIES, JAMS, COMPOTES; EGGS, MILK AND MILK PRODUCTS EXCLUDING ICE CREAM, ICE MILK, AND FROZEN YOGURT; EDIBLE OILS AND FATS, NAMELY, EXTRA VIRGIN OLIVE OIL, IN CLASS 29 (U.S. CL. 46).

**SERVICE MARK**

**PRINCIPAL REGISTER**

FOR: ON-LINE WHOLESALE AND RETAIL STORE SERVICES, FEATURING FOODSTUFFS AND ALCOHOLIC BEVERAGES, NAMELY, EXTRA VIRGIN OLIVE OIL AND OLIVE OIL, WINE, LIGHT WINE, VIN SANTO, GRAPPA; RETAIL STORE SHOPS FEATURING FOODSTUFFS AND ALCOHOLIC BEVERAGES, NAMELY, EXTRA VIRGIN OLIVE OIL AND OLIVE OIL, WINE, LIGHT WINE, VIN SANTO, GRAPPA; FRANCHISING, NAMELY, OFFERING BUSINESS MANAGEMENT ASSISTANCE IN THE ESTABLISHMENT AND OPERATION OF RETAIL STORES FEATURING FOODSTUFFS AND ALCOHOLIC BEVERAGES, NAMELY, EXTRA VIRGIN OLIVE OIL AND OLIVE OIL, WINE, LIGHT WINE, VIN SANTO, GRAPPA; ADVERTISING; BUSINESS MANAGEMENT; BUSINESS ADMINISTRATION; PROVIDING OFFICE FUNCTIONS, IN CLASS 35 (U.S. CLS. 100, 101 AND 102).



FOR: SERVICES FOR PROVIDING FOOD AND DRINK; WINE BARS, WINERIES, PUBS, RESTAURANTS, BARS; PROVIDING TEMPORARY ACCOMMODATION; AGRI-TOURISM, NAMELY, TOURIST INNS; BED AND BREAKFAST, RELAIS, NAMELY, HOTELS, RESIDENTIAL HOTELS; PROVIDING TEMPORARY ACCOMMODATIONS, NAMELY, HOLIDAY HOMES AND HOLIDAY VILLAGES, IN CLASS 43 (U.S. CLS. 100 AND 101).

THE MARK CONSISTS OF STANDARD CHARACTERS WITHOUT CLAIM TO ANY PARTICULAR FONT, STYLE, SIZE, OR COLOR.

OWNER OF INTERNATIONAL REGISTRATION 1081270 DATED 4-12-2011, EXPIRES 4-12-2021.

*David J. Kyros*

OWNER OF U.S. REG. NO. 3,995,995.

**Reg. No. 4,133,749** THE ENGLISH TRANSLATION OF THE FOREIGN WORD(S) IN THE MARK IS CASTLE  
OF GREVEPESA.

SER. NO. 79-098,858, FILED 4-12-2011.

MATTHEW EINSTEIN, EXAMINING ATTORNEY

# United States of America

United States Patent and Trademark Office



## BASE FORMULA

**Reg. No. 4,133,750**

**Registered May 1, 2012**

**Int. Cls.: 3 and 44**

BASE FORMULA LTD (UNITED KINGDOM LIMITED LIABILITY COMPANY)  
UNITS 38 & 40 PATE ROAD,  
LEICESTER ROAD INDUSTRIAL ESTATE; MELTONMOWBRAY, LEICESTERSHIRE LE13  
ORG  
UNITED KINGDOM

**TRADEMARK**

**SERVICE MARK**

**PRINCIPAL REGISTER**

FOR: SOAPS; PERFUMERY; ESSENTIAL OILS; BODY AND BEAUTY CARE COSMETICS; NON-MEDICATED PREPARATIONS FOR THE HAIR AND FOR THE CARE OF THE SKIN, INCLUDING COSMETIC PREPARATIONS; LOTIONS FOR BODY AND FACE, INCLUDING COSMETIC LOTIONS; MILKS, CREAMS, OILS AND GELS FOR THE BATH AND SHOWER; NON-MEDICATED HAND WASHES; HAND MOISTURIZER; COSMETICS AND COSMETIC PREPARATIONS, NAMELY, COSMETIC MILKS, NON-MEDICATED BALMS FOR USE ON SKIN AND HAIR, COSMETIC CREAMS AND COSMETIC LOTIONS, COSMETIC OILS AND COSMETIC GELS FOR THE SKIN AND HAIR; MASSAGE OILS; ESSENTIAL OILS FOR HOUSEHOLD USE; SALTS, OILS, GELS AND LOTIONS, ALL FOR THE BATH; BATH AND TALCUM POWDERS; TALCUM POWDER; NON-MEDICATED HAIR SHAMPOOS; DENTIFRICES; NON-MEDICATED PERFUMED COSMETIC SKIN CREAMS WITH ESSENTIAL OILS FOR USE IN AROMATHERAPY; NON-MEDICATED PERFUMED COSMETIC SKIN LOTIONS WITH ESSENTIAL OILS FOR USE IN AROMATHERAPY; AROMATHERAPY ESSENTIAL OILS; AROMATHERAPY PREPARATIONS, NAMELY, ESSENTIAL OILS FOR USE IN AROMATHERAPY; COSMETICS, NAMELY, CARRIER OILS; BIOLOGICAL PRODUCTS USED AS COSMETICS; OILS BEING COSMETICS; GELS BEING COSMETICS; BUTTERS BEING COSMETICS; COSMETIC ADDITIVES SOLD AS INTEGRAL INGREDIENT OF COSMETICS, NAMELY, BEESWAX, CITRIC ACID, COCONUT FAT, VEGETABLE GLYCERIN, GRAPEFRUIT SEED EXTRACT, SEAWEED EXTRACT, SODIUM BICARBONATE; BALMS BEING COSMETICS; NON-MEDICATED SALTS FOR USE IN COSMETICS; BATH AND SHOWER GELS; BUBBLE BATH; ROOM PERFUME SPRAYS; PILLOW PERFUME SPRAYS, IN CLASS 3 (U.S. CLS. 1, 4, 6, 50, 51 AND 52).



FOR: HEALTH CARE RELATING TO RELAXATION THERAPY; AROMA THERAPY SERVICES; BEAUTY THERAPY SERVICES, NAMELY, MASSAGE THERAPY, THE APPLICATION OF COSMETICS, AROMATHERAPY MASSAGE, REFLEXOLOGY MASSAGE, INDIAN HEAD MASSAGE, STONE THERAPY MASSAGE, IN CLASS 44 (U.S. CLS. 100 AND 101).

*David J. Kappas*

NO CLAIM IS MADE TO THE EXCLUSIVE RIGHT TO USE "BASE FORMULA" AND "ENGLAND", APART FROM THE MARK AS SHOWN.



**Reg. No. 4,133,750** PRIORITY DATE OF 12-13-2010 IS CLAIMED.

OWNER OF INTERNATIONAL REGISTRATION 1081376 DATED 5-13-2011, EXPIRES 5-13-2021.

THE COLOR(S) DARK BLUE AND YELLOW IS/ARE CLAIMED AS A FEATURE OF THE MARK.

THE WORDS "BASE FORMULA" ARE SHOWN IN DARK BLUE; THE FIRST LETTER "F" AND THE LAST LETTER "A" OF THE SECOND WORD "FORMULA" CONTAIN A YELLOW DESIGN ELEMENT; A YELLOW FLOWER WITH SEVEN PETAL IS LOCATED IN THE LEFT AND UPPER SIDE OF THE WORDS "BASE FORMULA" AND IS SURROUNDED BY THE WORDS "BASE FORMULA" AND "ENGLAND" SHOWN IN DARK BLUE LETTERS SEPARATED THROUGH A YELLOW DOT.

SER. NO. 79-098,898, FILED 5-13-2011.

LAURA HAMMEL, EXAMINING ATTORNEY

# United States of America

United States Patent and Trademark Office

# KANEKA

**Reg. No. 4,133,751**

**Registered May 1, 2012**

**Int. Cl.: 11**

**TRADEMARK**

**PRINCIPAL REGISTER**

KANEKA CORPORATION (JAPAN CORPORATION)  
2-4, NAKANOSHIMA 3-CHOME  
KITA-KU; OSAKA-SHI  
OSAKA 530-8288, JAPAN

FOR: LIGHTING FIXTURES AND INSTALLATIONS USING ELECTROLUMINESCENT ELEMENT; ELECTRIC LAMPS AND OTHER LIGHTING FIXTURES AND INSTALLATIONS , IN CLASS 11 (U.S. CLS. 13, 21, 23, 31 AND 34).

THE MARK CONSISTS OF STANDARD CHARACTERS WITHOUT CLAIM TO ANY PARTICULAR FONT, STYLE, SIZE, OR COLOR.

PRIORITY DATE OF 5-12-2011 IS CLAIMED.

OWNER OF INTERNATIONAL REGISTRATION 1081434 DATED 6-3-2011, EXPIRES 6-3-2021.

OWNER OF U.S. REG. NOS. 1,314,161, 3,933,877 AND OTHERS.

THE WORDING "KANEKA" HAS NO MEANING IN A FOREIGN LANGUAGE.

SER. NO. 79-098,914, FILED 6-3-2011.

ELIZABETH HUGHITT, EXAMINING ATTORNEY



*David J. Kybas*

Director of the United States Patent and Trademark Office

United States of America  
United States Patent and Trademark Office

**GRAFIS**

**Reg. No. 4,133,752**

**Registered May 1, 2012**

**Int. Cls.: 9 and 42**

**TRADEMARK**

**SERVICE MARK**

**PRINCIPAL REGISTER**

VOLKER FRIEDRICH (FED REP GERMANY INDIVIDUAL)  
SEVERINSTR. 31  
41748 VIERSEN  
FED REP GERMANY AND

KERSTIN FRIEDRICH (FED REP GERMANY INDIVIDUAL)  
IN DEN DELLEN 12  
41748 VIERSEN  
FED REP GERMANY

FOR: COMPUTER SOFTWARE FOR THE GARMENT, SHOE, TEXTILE AND LEATHER INDUSTRIES, NAMELY, COMPUTER SOFTWARE FOR DESIGNING, GRADING, MAKING AND VISUALIZING PATTERNS; COMPUTER SOFTWARE FOR LAY-OUT OF MATERIAL FOR PATTERN MAKING; COMPUTER SOFTWARE FOR MADE-TO-MEASURE PATTERNS, STYLE AND PRODUCTION PATTERNS, PATTERN DEVELOPMENT AND GRADING WITH INCREMENTS, PATTERN MODIFICATION, PATTERN DIGITIZATION, PATTERN STYLING, PATTERN PLOTTING AND MARKER MAKING, LAYPLANNING, IN CLASS 9 (U.S. CLS. 21, 23, 26, 36 AND 38).

FOR: COMPUTER PROGRAMMING, IN PARTICULAR FOR CAD PROGRAMS FOR THE CLOTHING INDUSTRY, IN CLASS 42 (U.S. CLS. 100 AND 101).

THE WORDING "GRAFIS" HAS NO MEANING IN A FOREIGN LANGUAGE.

OWNER OF INTERNATIONAL REGISTRATION 0902684 DATED 10-20-2006, EXPIRES 10-20-2016.

SER. NO. 79-098,926, FILED 5-24-2011.

ELIZABETH HUGHITT, EXAMINING ATTORNEY



*David J. Kyjars*

Director of the United States Patent and Trademark Office

# United States of America

United States Patent and Trademark Office

# EYEFILL

**Reg. No. 4,133,753**

**Registered May 1, 2012**

**Int. Cl.: 5**

**TRADEMARK**

**PRINCIPAL REGISTER**

CROMA-PHARMA GESELLSCHAFT M.B.H. (AUSTRIA LIMITED LIABILITY COMPANY)  
INDUSTRIEZEILE 6  
A-2100 LEOBENDORF  
AUSTRIA

FOR: PHARMACEUTICAL PRODUCTS, NAMELY, VISCOELASTIC SOLUTIONS FOR INTRAOCULAR USE, IN CLASS 5 (U.S. CLS. 6, 18, 44, 46, 51 AND 52).

THE MARK CONSISTS OF STANDARD CHARACTERS WITHOUT CLAIM TO ANY PARTICULAR FONT, STYLE, SIZE, OR COLOR.

OWNER OF INTERNATIONAL REGISTRATION 0947592 DATED 11-12-2007, EXPIRES 11-12-2017.

SER. NO. 79-098,929, FILED 5-12-2011.

ELIZABETH HUGHITT, EXAMINING ATTORNEY



*David J. Kybas*

Director of the United States Patent and Trademark Office

# United States of America

United States Patent and Trademark Office

## OPERATION G.H.O.S.T.

**Reg. No. 4,133,754**

**Registered May 1, 2012**

**Int. Cls.: 9 and 28**

**TRADEMARK**

**PRINCIPAL REGISTER**

KABUSHIKI KAISHA SEGA, D/B/A SEGA CORPORATION (JAPAN CORPORATION)  
1-2-12, HANEDA  
OHTA-KU  
TOKYO, JAPAN 1448531

FOR: COMPUTER GAME PROGRAMS; VIDEO GAME SOFTWARE; VIDEO GAME PROGRAMS; VIDEO GAME DISCS AND CARTRIDGES; GAME PROGRAMS FOR ARCADE GAME MACHINES, IN CLASS 9 (U.S. CLS. 21, 23, 26, 36 AND 38).

FOR: ARCADE GAME MACHINES WITH BUILT-IN SCREENS, STAND ALONE VIDEO GAME MACHINES, STAND ALONE VIDEO OUTPUT GAME MACHINES, IN CLASS 28 (U.S. CLS. 22, 23, 38 AND 50).

THE MARK CONSISTS OF STANDARD CHARACTERS WITHOUT CLAIM TO ANY PARTICULAR FONT, STYLE, SIZE, OR COLOR.

PRIORITY DATE OF 4-15-2011 IS CLAIMED.

OWNER OF INTERNATIONAL REGISTRATION 1081458 DATED 5-24-2011, EXPIRES 5-24-2021.

OWNER OF U.S. REG. NOS. 3,662,696 AND 3,688,172.

SER. NO. 79-098,947, FILED 5-24-2011.

BERYL GARDNER, EXAMINING ATTORNEY



*David J. Kyffers*

Director of the United States Patent and Trademark Office

# United States of America

United States Patent and Trademark Office



**Reg. No. 4,133,755**

**Registered May 1, 2012**

**Int. Cls.: 9, 35 and 39**

**TRADEMARK**

**SERVICE MARK**

**PRINCIPAL REGISTER**

ALLMYFLIGHTS LIMITED (BR.VIRGIN ISLANDS LIMITED COMPANY)  
TRIDENT CHAMBERS ROAD TOWN  
TORTOLA  
BR.VIRGIN ISLANDS

FOR: COMPUTER SOFTWARE FOR PROVIDING GEOGRAPHIC MAPS, TRAVEL ROUTE INFORMATION AND RECOMMENDATIONS, AND TRAVEL INFORMATION GUIDES, IN CLASS 9 (U.S. CLS. 21, 23, 26, 36 AND 38).

FOR: ADVERTISING SERVICES, PROVIDING INFORMATION ON BUSINESS MATTERS; PROVIDING PRICE COMPARISON INFORMATION FOR OTHERS IN CONNECTION WITH TRAVEL AND TRANSPORTATION SERVICE PROVIDERS; THE BRINGING TOGETHER, FOR THE BENEFIT OF OTHERS, OF A VARIETY OF SERVICE PROVIDERS WHO OFFER TRANSPORT AND TRAVEL INFORMATION AND ENABLING CUSTOMERS TO CONVENIENTLY VIEW AND PURCHASE BOOKINGS AND TICKETS FOR TRANSPORTATION AND TRAVEL FROM AN INTERNET WEBSITE PARTICULARLY SPECIALIZED IN THE MARKETING OF THE SALE OF TRAVEL SERVICES FOR OTHERS; INFORMATION AND ADVISORY SERVICE RELATING TO ALL OF THE AFORESAID SERVICES, IN CLASS 35 (U.S. CLS. 100, 101 AND 102).

FOR: TRAVEL ARRANGEMENT AND TRAVEL TICKET RESERVATION SERVICES; MAKING RESERVATIONS AND BOOKINGS FOR TRANSPORTATION; PROVIDING INFORMATION RELATING TO TRAVEL; PROVIDING A WEBSITE AND WEBSITE LINKS TO GEOGRAPHIC INFORMATION, MAP IMAGES AND TRIP ROUTING INFORMATION; PROVISION OF TRAVEL INFORMATION; INFORMATION AND ADVISORY SERVICE RELATING TO ALL OF THE AFORESAID SERVICES, IN CLASS 39 (U.S. CLS. 100 AND 105).

NO CLAIM IS MADE TO THE EXCLUSIVE RIGHT TO USE "FLIGHTS", APART FROM THE MARK AS SHOWN.

PRIORITY DATE OF 9-10-2010 IS CLAIMED.

OWNER OF INTERNATIONAL REGISTRATION 1082151 DATED 3-8-2011, EXPIRES 3-8-2021.



*David J. Kyros*

Director of the United States Patent and Trademark Office

**Reg. No. 4,133,755** THE COLOR(S) BLUE, YELLOW AND BLACK IS/ARE CLAIMED AS A FEATURE OF THE MARK.

THE MARK CONSISTS OF THE WORDING "ALL MY FLIGHTS" IN STYLIZED BLUE FONT. THE MARK ALSO INCLUDES A DESIGN ELEMENT CONSISTING OF A YELLOW CIRCLE WITH A BLACK AIRPLANE DESIGN INSIDE THE CIRCLE.

SER. NO. 79-099,180, FILED 3-8-2011.

RUSS HERMAN, EXAMINING ATTORNEY

# United States of America

United States Patent and Trademark Office



**Reg. No. 4,133,756**

**Registered May 1, 2012**

**Int. Cl.: 13**

**TRADEMARK**

**PRINCIPAL REGISTER**

ARMI PERAZZI SPA (ITALY SOCIÉTÉ PAR ACTIONS)  
VIA FONTANELLE 1/3  
I-25080 BOTTICINO MATTINA (BS)  
ITALY

FOR: FIREARMS, IN CLASS 13 (U.S. CLS. 2 AND 9).

THE MARK CONSISTS OF THE WORDING "PERAZZI" BELOW A STYLIZED REPRESENTATION OF A GUN WITHIN AN OVAL.

OWNER OF INTERNATIONAL REGISTRATION 0565845 DATED 2-26-1991, EXPIRES 2-26-2021.

SER. NO. 79-099,216, FILED 3-16-2011.

TRACY FLETCHER, EXAMINING ATTORNEY



*David J. Kybas*

Director of the United States Patent and Trademark Office



# United States of America

United States Patent and Trademark Office

## ART BASEL HONG KONG

**Reg. No. 4,133,757**

**Registered May 1, 2012**

**Int. Cls.: 35 and 41**

**SERVICE MARK**

**PRINCIPAL REGISTER**

MCH GROUP AG RECHTSDIENST (SWITZERLAND PRIVATE LIMITED COMPANY)  
POSTFACH  
CH-4005 BASEL  
SWITZERLAND

FOR: ARRANGING AND ORGANIZATION OF EXHIBITIONS, TRADE FAIRS, TRADE SHOWS AND EVENTS FOR ADVERTISING AND COMMERCIAL PURPOSES, IN CLASS 35 (U.S. CLS. 100, 101 AND 102).

FOR: ARRANGING AND ORGANIZATION OF EXHIBITIONS, TRADE FAIRS, TRADE SHOWS AND EVENTS FOR CULTURAL AND EDUCATIONAL PURPOSES; ARRANGING AND ORGANIZATION OF CONGRESSES FOR CULTURAL AND EDUCATIONAL PURPOSES, IN CLASS 41 (U.S. CLS. 100, 101 AND 107).

THE MARK CONSISTS OF STANDARD CHARACTERS WITHOUT CLAIM TO ANY PARTICULAR FONT, STYLE, SIZE, OR COLOR.

PRIORITY DATE OF 2-1-2011 IS CLAIMED.

OWNER OF INTERNATIONAL REGISTRATION 1082289 DATED 5-26-2011, EXPIRES 5-26-2021.

OWNER OF U.S. REG. NO. 3,055,679.

NO CLAIM IS MADE TO THE EXCLUSIVE RIGHT TO USE "ART" AND "HONG KONG", APART FROM THE MARK AS SHOWN.

THE NAME "ART BASEL" DOES NOT IDENTIFY A LIVING INDIVIDUAL.

SER. NO. 79-099,258, FILED 5-26-2011.

KEVIN CORWIN, EXAMINING ATTORNEY



*David J. Kybas*

Director of the United States Patent and Trademark Office

# United States of America

United States Patent and Trademark Office

## Active Soft Pearls

**Reg. No. 4,133,758**

**Registered May 1, 2012**

**Int. Cl.: 3**

PETER GREVEN PHYSIODERM GMBH (FED REP GERMANY GMBH (LIMITED LIABILITY COMPANY))  
PROCTER-&-GAMBLE-STR. 26  
53881 EUSKIRCHEN  
FED REP GERMANY

**TRADEMARK**

FOR: HAND CLEANERS, NAMELY, HAND-WASHING PASTES FOR INDUSTRIAL AND CRAFT PURPOSES, IN CLASS 3 (U.S. CLS. 1, 4, 6, 50, 51 AND 52).

**PRINCIPAL REGISTER**

THE MARK CONSISTS OF STANDARD CHARACTERS WITHOUT CLAIM TO ANY PARTICULAR FONT, STYLE, SIZE, OR COLOR.

PRIORITY DATE OF 12-27-2010 IS CLAIMED.

OWNER OF INTERNATIONAL REGISTRATION 1082354 DATED 6-17-2011, EXPIRES 6-17-2021.

OWNER OF U.S. REG. NOS. 3,983,675 AND 3,995,031.

NO CLAIM IS MADE TO THE EXCLUSIVE RIGHT TO USE "SOFT PEARLS", APART FROM THE MARK AS SHOWN.

SER. NO. 79-099,283, FILED 6-17-2011.

ELI HELLMAN, EXAMINING ATTORNEY



*David J. Kyffers*

Director of the United States Patent and Trademark Office

# United States of America

United States Patent and Trademark Office

## ART BASEL ASIA

**Reg. No. 4,133,759**

**Registered May 1, 2012**

**Int. Cls.: 35 and 41**

**SERVICE MARK**

**PRINCIPAL REGISTER**

MCH GROUP AG RECHTSDIENST (SWITZERLAND PRIVATE LIMITED COMPANY)  
POSTFACH  
CH-4005 BASEL  
SWITZERLAND

FOR: ARRANGING AND ORGANIZATION OF EXHIBITIONS, TRADE FAIRS, TRADE SHOWS AND EVENTS FOR ADVERTISING AND COMMERCIAL PURPOSES, IN CLASS 35 (U.S. CLS. 100, 101 AND 102).

FOR: ARRANGING AND ORGANIZATION OF EXHIBITIONS, TRADE FAIRS, TRADE SHOWS AND EVENTS FOR CULTURAL AND EDUCATIONAL PURPOSES; ARRANGING AND ORGANIZATION OF CONGRESSES FOR CULTURAL AND EDUCATIONAL PURPOSES, IN CLASS 41 (U.S. CLS. 100, 101 AND 107).

THE MARK CONSISTS OF STANDARD CHARACTERS WITHOUT CLAIM TO ANY PARTICULAR FONT, STYLE, SIZE, OR COLOR.

PRIORITY DATE OF 2-1-2011 IS CLAIMED.

OWNER OF INTERNATIONAL REGISTRATION 1082357 DATED 5-26-2011, EXPIRES 5-26-2021.

OWNER OF U.S. REG. NOS. 3,055,679 AND 4,030,474.

NO CLAIM IS MADE TO THE EXCLUSIVE RIGHT TO USE "ART" AND "ASIA", APART FROM THE MARK AS SHOWN.

THE NAME "ART BASEL" DOES NOT IDENTIFY A LIVING INDIVIDUAL.

SER. NO. 79-099,285, FILED 5-26-2011.

KEVIN CORWIN, EXAMINING ATTORNEY



*David J. Kybas*

Director of the United States Patent and Trademark Office

# United States of America

United States Patent and Trademark Office

# UNI HITEN

**Reg. No. 4,133,760**

**Registered May 1, 2012**

**Int. Cl.: 6**

**TRADEMARK**

**PRINCIPAL REGISTER**

JFE STEEL KABUSHIKI KAISHA (JAPAN CORPORATION)  
2-2-3 UCHISAIWAICHO  
CHIYODA-KU; TOKYO 100-0011  
JAPAN

FOR: HIGH TENSILE STRENGTH STEEL; HIGH TENSILE STRENGTH STEEL SHEETS; HIGH TENSILE STRENGTH STEEL PIPES; HIGH TENSILE STRENGTH STEEL BARS; HIGH TENSILE STRENGTH WIRE; BUILDING AND CONSTRUCTION MATERIALS OF METAL MADE OF HIGH TENSILE STRENGTH STEEL, NAMELY, METAL DOOR FRAMES, STEEL FRAMES FOR BUILDING, METAL WINDOW FRAMES, METAL GREENHOUSE FRAMES, METAL CEILING PANELS, METAL ROOFING PANELS, WALL PANELS OF METAL, METAL DOOR PANELS AND METAL FENCE PANELS; PREFABRICATED BUILDINGS MADE SUBSTANTIALLY OF METAL MADE OF HIGH TENSILE STRENGTH STEEL; LOADING AND UNLOADING PALLETS OF METAL MADE OF HIGH TENSILE STRENGTH STEEL; TURN-TABLES FOR LOAD HANDLING MADE OF HIGH TENSILE STRENGTH STEEL; TRAVERSERS FOR LOAD HANDLING MADE OF HIGH TENSILE STRENGTH STEEL; JUNCTIONS OF METAL FOR PIPES MADE OF HIGH TENSILE STRENGTH STEEL; METAL FLANGES MADE OF HIGH TENSILE STRENGTH STEEL; INDUSTRIAL PACKAGING CONTAINERS OF METAL MADE OF HIGH TENSILE STRENGTH STEEL, IN CLASS 6 (U.S. CLS. 2, 12, 13, 14, 23, 25 AND 50).

THE MARK CONSISTS OF STANDARD CHARACTERS WITHOUT CLAIM TO ANY PARTICULAR FONT, STYLE, SIZE, OR COLOR.

PRIORITY DATE OF 4-1-2011 IS CLAIMED.

OWNER OF INTERNATIONAL REGISTRATION 1082616 DATED 5-13-2011, EXPIRES 5-13-2021.

THE WORDING "UNI HITEN" HAS NO MEANING IN A FOREIGN LANGUAGE.

SER. NO. 79-099,390, FILED 5-13-2011.

DAVID HOFFMAN, EXAMINING ATTORNEY



*David J. Kyffers*

Director of the United States Patent and Trademark Office

United States of America  
United States Patent and Trademark Office

phamax

**Reg. No. 4,133,761**

**Registered May 1, 2012**

**Int. Cl.: 35**

**SERVICE MARK**

**PRINCIPAL REGISTER**

PHAMAX AG (SWITZERLAND SOCIÉTÉ ANONYME)  
PASSAGE 6  
CH-4104 OBERWIL, SWITZERLAND

FOR: BUSINESS CONSULTING FOR MANAGING PROJECTS, CHIEFLY PHARMACEUTICAL PROJECTS, PARTICULARLY IN THE FIELD OF MANAGING DATA, NAMELY, COMPILING, EXAMINATION, PREPARING AND PROCESSING OF DATA ORIGINATING FROM VARIOUS PARTS OF BUSINESSES, CHIEFLY MARKETING AND COMMERCIAL SERVICES; MARKETING ANALYSES OF THE COMPETITION, CONDUCTING MARKETING STUDIES AND FORECASTS, IN CLASS 35 (U.S. CLS. 100, 101 AND 102).

THE MARK CONSISTS OF STANDARD CHARACTERS WITHOUT CLAIM TO ANY PARTICULAR FONT, STYLE, SIZE, OR COLOR.

PRIORITY DATE OF 1-24-2011 IS CLAIMED.

OWNER OF INTERNATIONAL REGISTRATION 1082750 DATED 4-5-2011, EXPIRES 4-5-2021.

SER. NO. 79-099,429, FILED 4-5-2011.

JANICE L. MCMORROW, EXAMINING ATTORNEY



*David J. Kybas*

Director of the United States Patent and Trademark Office

United States of America  
United States Patent and Trademark Office

# Screwfinder

**Reg. No. 4,133,762**

**Registered May 1, 2012**

**Int. Cl.: 8**

**TRADEMARK**

**PRINCIPAL REGISTER**

INNOVATIV RESURS NORDEN AB (SWEDEN COMPANY)  
GELBGJUTAREVAGEN 4  
SE-171 48 SOLNA  
SWEDEN

FOR: HAND-OPERATED HAND TOOLS, NAMELY, COMBINED SCREW LOCATING AND WALL PUNCHING TOOL, IN CLASS 8 (U.S. CLS. 23, 28 AND 44).

THE MARK CONSISTS OF STANDARD CHARACTERS WITHOUT CLAIM TO ANY PARTICULAR FONT, STYLE, SIZE, OR COLOR.

PRIORITY DATE OF 11-17-2010 IS CLAIMED.

OWNER OF INTERNATIONAL REGISTRATION 1082842 DATED 3-22-2011, EXPIRES 3-22-2021.

SER. NO. 79-099,457, FILED 3-22-2011.

TOBY BULLOFF, EXAMINING ATTORNEY



*David J. Kyffers*

Director of the United States Patent and Trademark Office

# United States of America

United States Patent and Trademark Office

新辣道

**Reg. No. 4,133,763**

**Registered May 1, 2012**

**Int. Cl.: 29**

**TRADEMARK**

**PRINCIPAL REGISTER**

BEIJING XINLADAO CANYIN GUANLI YOUXIANGONGSI (CHINA CORPORATION)  
SUITE B402, ZIGUANGFAZHAN BUILDING  
11, HUIXIN EAST ROAD.; CHAOYANG DISTRICT; 100086 BEIJING  
CHINA

FOR: BOUILLON; PREPARATIONS FOR MAKING BOUILLON; BROTH CONCENTRATES;  
SAUSAGES; PRESERVED MEAT, SALTED DUCK; FISH FILLETS; CANNED FISH; PRE-  
SERVED FISH; SALTED FISH; FISH, NOT LIVE; CANNED FRUITS; CANNED MEAT;  
CANNED VEGETABLES; TINNED SEAFOOD; TINNED QUAIL EGGS; PICKLES; SOUPS;  
PRESERVED VEGETABLES; COOKED VEGETABLES; DRIED VEGETABLES; PICCALILLI;  
PREPARATIONS FOR MAKING SOUP; FERMENTED VEGETABLES; PRESERVED  
SZECHUAN PICKLES; FROZEN VEGETABLES, IN CLASS 29 (U.S. CL. 46).

THE MARK CONSISTS OF THREE CHINESE CHARACTERS.

OWNER OF INTERNATIONAL REGISTRATION 1083139 DATED 6-1-2011, EXPIRES 6-1-  
2021.

THE NON-LATIN CHARACTERS IN THE MARK TRANSLITERATE TO "XIN" "LA" "DAO"  
AND THIS MEANS "NEW" "HOT" "WAY" IN ENGLISH.

SER. NO. 79-099,592, FILED 6-1-2011.

DAVID ELTON, EXAMINING ATTORNEY



*David J. Kyros*

Director of the United States Patent and Trademark Office

# United States of America

United States Patent and Trademark Office

## BORGO SANLEO

**Reg. No. 4,133,764**

**Registered May 1, 2012**

**Int. Cl.: 33**

**TRADEMARK**

**PRINCIPAL REGISTER**

CASA VINICOLA ZONIN S.P.A. (ITALY JOINT STOCK COMPANY)  
VIA BORGOLECCO, 9  
I-36053 GAMBELLARA (VI), ITALY

FOR: WINES AND SPARKLING WINES, IN CLASS 33 (U.S. CLS. 47 AND 49).

THE MARK CONSISTS OF STANDARD CHARACTERS WITHOUT CLAIM TO ANY PARTICULAR FONT, STYLE, SIZE, OR COLOR.

OWNER OF INTERNATIONAL REGISTRATION 1083181 DATED 5-13-2011, EXPIRES 5-13-2021.

THE ENGLISH TRANSLATION OF THE FOREIGN WORD(S) IN THE MARK IS: "SANLEO VILLAGE".

SER. NO. 79-099,604, FILED 5-13-2011.

EVELYN BRADLEY, EXAMINING ATTORNEY



*David J. Kyffers*

Director of the United States Patent and Trademark Office



# United States of America

United States Patent and Trademark Office



**Reg. No. 4,133,765**

**Registered May 1, 2012**

**Int. Cl.: 33**

**TRADEMARK**

**PRINCIPAL REGISTER**

H. UNDERBERG-ALBRECHT GMBH & CO. VERWALTUNGS- UND VERTRIEBS KG (FED REP GERMANY LIMITED PARTNERSHIP)  
UNDERBERGSTRASSE 1-3  
47495 RHEINBERG, FED REP GERMANY

FOR: ALCOHOLIC BEVERAGES EXCEPT BEERS, IN CLASS 33 (U.S. CLS. 47 AND 49).

OWNER OF U.S. REG. NOS. 2,899,747 AND 3,055,693.

PRIORITY DATE OF 1-12-2011 IS CLAIMED.

OWNER OF INTERNATIONAL REGISTRATION 1083465 DATED 4-19-2011, EXPIRES 4-19-2021.

THE COLOR(S) LIGHT BLUE, DARK BLUE, LIGHT GREEN, DARK GREEN, LIGHT BROWN, DARK BROWN, BLACK, AND WHITE IS/ARE CLAIMED AS A FEATURE OF THE MARK.

THE MARK CONSISTS OF THE WORDING "GRASOVKA" IN WHITE WITH DARK BLUE OUTLINING AND A DARK BLUE AND WHITE CURVED LINE ABOVE AND BELOW THE WORD "GRASOVKA"; UNDERNEATH THE WORDING IS THE IMAGE OF A DARK GREEN AND LIGHT GREEN BAND RISING FROM THE BOTTOM LEFT OF THE MARK CURVING UPWARD AND OVER TO THE RIGHT MID-SECTION OF THE MARK; IMMEDIATELY BENEATH THE BAND IN THE BOTTOM RIGHT CORNER OF THE MARK IS A LIGHT BLUE SKY WITH WHITE CLOUDS BEHIND A BISON SHADED IN LIGHT BROWN, DARK BROWN, AND BLACK COLORING STANDING IN GRASS SHADED IN LIGHT GREEN AND DARK GREEN, WITH A LIGHT BLUE AND WHITE HORIZONTAL BAND AT THE BOTTOM.

SER. NO. 79-099,757, FILED 4-19-2011.

SHAILA SETTLES, EXAMINING ATTORNEY



*David J. Kybas*

Director of the United States Patent and Trademark Office

# United States of America

## United States Patent and Trademark Office



**Reg. No. 4,133,766**

**Registered May 1, 2012**

**Int. Cl.: 3**

**TRADEMARK**

**PRINCIPAL REGISTER**

GG CORPORATION KABUSHIKI KAISYA (JAPAN CORPORATION)  
HASHIMOTO BUILDING 4F  
7-11, NISHI-SHINSAIBASHI 1-CHOME,; CHUOU-KU,; OSAKA-SHI; OSAKA 542-0068  
JAPAN

FOR: CLEANING AGENT FOR THE STERILIZATION AND DISINFECTION OF ARTIFICIAL NAILS; ADHESIVE FOR THE APPLICATION OF ARTIFICIAL NAILS; REMOVER OF ADHESIVE USED IN THE APPLICATION OF ARTIFICIAL NAILS; NAIL COSMETICS; ARTIFICIAL NAILS, IN CLASS 3 (U.S. CLS. 1, 4, 6, 50, 51 AND 52).

OWNER OF U.S. REG. NO. 3,699,224.

OWNER OF INTERNATIONAL REGISTRATION 1083800 DATED 5-31-2011, EXPIRES 5-31-2021.

THE COLOR(S) PINK AND WHITE IS/ARE CLAIMED AS A FEATURE OF THE MARK.

THE MARK CONSISTS OF THE WORD "SUNSHINE BABE" IN PINK, REPEATED FOUR TIMES, EACH SEPARATED BY A SMALL CIRCLE. THE TEXTUAL ELEMENTS SURROUND A PINK CIRCLE CONTAINING A STYLIZED CROWN IN WHITE. THESE PORTIONS OF THE MARK ARE SURROUND BY EIGHT PINK AND WHITE CASTLES AND EIGHT FIVE POINT STARS.

SER. NO. 79-099,868, FILED 5-31-2011.

SEAN CROWLEY, EXAMINING ATTORNEY



*David J. Kybas*

Director of the United States Patent and Trademark Office

United States of America  
United States Patent and Trademark Office

yataghan

**Reg. No. 4,133,767**

**Registered May 1, 2012**

**Int. Cl.: 25**

**TRADEMARK**

**PRINCIPAL REGISTER**

LIU XINZHANG (CHINA INDIVIDUAL)  
NO. 6, GROUP 1, LIANGBAO VILLAGE  
GUANGSHAN TOWNSHIP; DONGTAI CITY  
JIANGSU PROVINCE, CHINA

FOR: CLOTHING, NAMELY, COATS, TROUSERS, TOPS, BOTTOMS, SHIRTS, T-SHIRTS, JERSEYS, JACKETS, PANTS, UNDERWEAR, PAJAMAS, BRASSIERES; LAYETTES AS CLOTHING; SWIMSUITS; FOOTBALL SHOES; SHOES; HATS; HOSIERY; NECKTIES; LEATHER BELTS AS CLOTHING; GLOVES AS CLOTHING, IN CLASS 25 (U.S. CLS. 22 AND 39).

THE MARK CONSISTS OF THE WORDING "YATAGHAN" IN STYLIZED FONT.

OWNER OF INTERNATIONAL REGISTRATION 1083863 DATED 6-29-2011, EXPIRES 6-29-2021.

THE WORDING "YATAGHAN" HAS NO MEANING IN A FOREIGN LANGUAGE.

SER. NO. 79-099,889, FILED 6-29-2011.

WILLIAM ROSSMAN, EXAMINING ATTORNEY



*David J. Kypos*

Director of the United States Patent and Trademark Office

# United States of America

United States Patent and Trademark Office

# ROCKABLE

**Reg. No. 4,133,768**

**Registered May 1, 2012**

**Int. Cls.: 9 and 41**

**TRADEMARK**

**SERVICE MARK**

**PRINCIPAL REGISTER**

ENVATO PTY LIMITED (AUSTRALIA CORPORATION)  
PO BOX 21177  
LITTLE LONSDALE STREET VIC 8011  
AUSTRALIA

FOR: DOWNLOADABLE ELECTRONIC PUBLICATIONS IN THE NATURE OF BOOKS, MAGAZINES, JOURNALS, NEWSPAPERS AND TUTORIALS, IN THE FIELDS OF BUSINESS, COMMUNICATION, PRODUCTIVITY, PERSONAL DEVELOPMENT, INFORMATION TECHNOLOGY, CREATIVE DESIGN, STATISTICS AND ENTERTAINMENT; DOWNLOADABLE AND STREAMED AUDIO, SCREEN CASTS, IMAGES, PHOTOGRAPHS AND VIDEO FEATURING CONTENT ABOUT BUSINESS, COMMUNICATION, PRODUCTIVITY, PERSONAL DEVELOPMENT, INFORMATION TECHNOLOGY, CREATIVE DESIGN, STATISTICS AND ENTERTAINMENT, IN CLASS 9 (U.S. CLS. 21, 23, 26, 36 AND 38).

FOR: PUBLISHING OF PRINTED MATTER, BOOKS, MAGAZINES, JOURNALS, NEWSPAPERS, NEWSLETTERS, TUTORIALS, MAPS, SOFTWARE, GRAPHICS, PHOTOGRAPHS, VIDEOS, GAMES AND MUSIC; ELECTRONIC PUBLISHING SERVICES, NAMELY, PUBLICATION OF TEXT, GRAPHIC, AUDIO AND VISUAL WORKS OF OTHERS ON-LINE; MULTIMEDIA PUBLISHING OF PRINTED MATTER, BOOKS, MAGAZINES, JOURNALS, NEWSPAPERS, NEWSLETTERS, TUTORIALS, MAPS, SOFTWARE, GRAPHICS, PHOTOGRAPHS, VIDEOS, GAMES, MUSIC AND ELECTRONIC PUBLICATIONS; ENTERTAINMENT SERVICES, NAMELY, PROVIDING ON-LINE COMPUTER GAMES; EDUCATION SERVICES, NAMELY, PROVIDING COURSES, SEMINARS AND TUTORIAL SESSIONS IN THE FIELDS OF GRAPHICS, ANIMATION, DESIGN, PHOTOGRAPHY, VIDEOS, WRITING, MUSIC, BUSINESS, COMMUNICATION, BUSINESS PRODUCTIVITY, INFORMATION TECHNOLOGY, PERSONAL DEVELOPMENT AND CREATIVE DESIGN, IN CLASS 41 (U.S. CLS. 100, 101 AND 107).

THE MARK CONSISTS OF STANDARD CHARACTERS WITHOUT CLAIM TO ANY PARTICULAR FONT, STYLE, SIZE, OR COLOR.

PRIORITY DATE OF 11-8-2010 IS CLAIMED.

OWNER OF INTERNATIONAL REGISTRATION 1079563 DATED 4-18-2011, EXPIRES 4-18-2021.

SER. NO. 79-099,944, FILED 4-18-2011.



*David J. Kyros*

Director of the United States Patent and Trademark Office

**Reg. No. 4,133,768** ZACHARY BELLO, EXAMINING ATTORNEY

# United States of America

United States Patent and Trademark Office



**Reg. No. 4,133,769**

**Registered May 1, 2012**

**Int. Cl.: 12**

**TRADEMARK**

**PRINCIPAL REGISTER**

AUSTRALIAN PERFORMANCE VEHICLES PTY LTD (AUSTRALIA CORPORATION)  
"CULLARNEE"  
367 BROOKLANDS ROAD; HALL ACT 2618  
AUSTRALIA

FOR: BARS AND OTHER PROTECTIVE FITTINGS SPECIALLY ADAPTED FOR USE WITH VEHICLES, NAMELY, ROO BARS, BULL BARS, ROLL BARS, ROLL CAGES AND RELATED ACCESSORIES, NAMELY, ROLL CAPE BARS, TORSION BARS, STRUCTURAL AND REPLACEMENT PARTS THEREOF; CHASSIS BEING PARTS OF TRUCKS; DUMPER BODIES FOR TRUCKS; TIPPING BODIES FOR TRUCKS, CUSTOMIZED UTILITY BODIES FOR VEHICLES; CANOPIES FOR TRUCKS AND OTHER VEHICLES USED FOR CARRYING GOODS; CUSTOMIZED TRAYS FOR TRUCKS AND OTHER VEHICLES USED FOR CARRYING GOODS, NAMELY, CARGO TRAYS; TRAILERS FOR USE WITH TRUCKS; MODIFIED TRAYS ADAPTED FOR USE ON VEHICLES, NAMELY, CARGO TRAYS, DRIP TRAYS, TRAYS FOR LUGGAGE OR LOAD, DASH UTILITY TRAYS AND RELATED ACCESSORIES, NAMELY, LUGGAGE CARRIER TRAYS FOR VEHICLES, STRUCTURAL AND REPLACEMENT PARTS THEREOF, IN CLASS 12 (U.S. CLS. 19, 21, 23, 31, 35 AND 44).

NO CLAIM IS MADE TO THE EXCLUSIVE RIGHT TO USE "VEHICLE SOLUTIONS", APART FROM THE MARK AS SHOWN.

PRIORITY DATE OF 4-18-2011 IS CLAIMED.

OWNER OF INTERNATIONAL REGISTRATION 1084259 DATED 6-17-2011, EXPIRES 6-17-2021.

THE MARK CONSISTS OF THE LITERAL ELEMENTS "APV" ABOVE THE WORDING "VEHICLE SOLUTIONS" WITH A DESIGN ELEMENTAL TWO ARCS TO THE SIDE AND BEHIND "APV".

SER. NO. 79-100,054, FILED 6-17-2011.

ALAIN LAPTEK, EXAMINING ATTORNEY



*David J. Kyffers*

Director of the United States Patent and Trademark Office

# United States of America

United States Patent and Trademark Office

# E l e k i o

**Reg. No. 4,133,770**

**Registered May 1, 2012**

**Int. Cl.: 10**

**TRADEMARK**

**PRINCIPAL REGISTER**

ASAHI KASEI KABUSHIKI KAISHA (JAPAN CORPORATION)  
3-23, NAKANOSHIMA 3-CHOME  
KITA-KU,; OSAKA-SHI; OSAKA 530-8205  
JAPAN

FOR: ELECTRONIC STETHOSCOPE; PHONOCARDIOGRAPH, IN CLASS 10 (U.S. CLS. 26, 39 AND 44).

THE MARK CONSISTS OF STANDARD CHARACTERS WITHOUT CLAIM TO ANY PARTICULAR FONT, STYLE, SIZE, OR COLOR.

OWNER OF INTERNATIONAL REGISTRATION 1084295 DATED 6-22-2011, EXPIRES 6-22-2021.

THE WORDING "ELEKIO" HAS NO MEANING IN A FOREIGN LANGUAGE.

SER. NO. 79-100,066, FILED 6-22-2011.

SEAN CROWLEY, EXAMINING ATTORNEY



*David J. Kyffers*

Director of the United States Patent and Trademark Office

# United States of America

United States Patent and Trademark Office

# MAKAI WARS

**Reg. No. 4,133,771**

**Registered May 1, 2012**

**Int. Cl.: 9**

**TRADEMARK**

**PRINCIPAL REGISTER**

NIPPON ICHI SOFTWARE, INC. (JAPAN CORPORATION)  
3-17,SOHARA TSUKIOKA-CHO  
KAKAMIGAHARA-SHI; GIFU-KEN 504-0903  
JAPAN

FOR: COMPUTER GAME PROGRAMS RECORDED ON ELECTRONIC CIRCUITS; COMPUTER VIDEO GAME PROGRAMS RECORDED ON ELECTRONIC CIRCUITS; COMPUTER VIDEO GAME PROGRAMS RECORDED ON MAGNETIC AND OPTICAL DISCS; VIDEO GAME CARTRIDGES; COMPUTER GAME PROGRAMS RECORDED ON ELECTRONIC CIRCUITS FOR USE WITH PORTABLE GAMES FEATURING LIQUID CRYSTAL DISPLAYS; COMPUTER GAME PROGRAMS FOR MOBILE PHONES; PRERECORDED COMPACT DISCS FEATURING GAMES, IN CLASS 9 (U.S. CLS. 21, 23, 26, 36 AND 38).

THE MARK CONSISTS OF STANDARD CHARACTERS WITHOUT CLAIM TO ANY PARTICULAR FONT, STYLE, SIZE, OR COLOR.

PRIORITY DATE OF 12-8-2010 IS CLAIMED.

OWNER OF INTERNATIONAL REGISTRATION 1084339 DATED 4-14-2011, EXPIRES 4-14-2021.

OWNER OF U.S. REG. NO. 3,335,515.

THE ENGLISH TRANSLATION OF "MAKAI" IN THE MARK IS "DEVIL WORLD".

SER. NO. 79-100,080, FILED 4-14-2011.

TRACY FLETCHER, EXAMINING ATTORNEY



*David J. Kyffers*

Director of the United States Patent and Trademark Office



# United States of America

United States Patent and Trademark Office

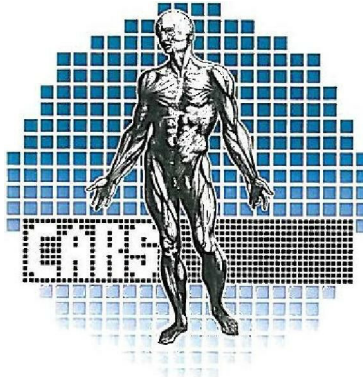

**Reg. No. 4,133,772**

**Registered May 1, 2012**

**Int. Cl.: 41**

**SERVICE MARK**

**PRINCIPAL REGISTER**

LEMKE, HEINZ (FED REP GERMANY INDIVIDUAL)  
IM GUT 11  
79790 KÜSSABERG-BECHTERSBOHL  
FED REP GERMANY AND

SCHWEIKERT, FRANZISKA (FED REP GERMANY INDIVIDUAL)  
IM GUT 11  
79790 KÜSSABERG  
FED REP GERMANY

FOR: ARRANGING AND CONDUCTING OF EDUCATIONAL CONFERENCES AND SEMINARS FOR MEDICAL DIAGNOSTICS BY COMPUTERS, IN CLASS 41 (U.S. CLS. 100, 101 AND 107).

THE MARK CONSISTS OF A PICTURE OF THE ANATOMICAL MUSCULATURE OF A HUMAN BEING IN BLACK ON A BACKGROUND OF BLUE TILES ARRANGED IN A CIRCULAR SHAPE, THE TILES BECOMING A LIGHT BLUE AS THEY PROGRESS DOWNWARDS; IN THE LOWER SECTION THERE IS A HORIZONTAL STRIPE COMPRISING BLACK TILES, WHICH RUNS BEHIND THE HUMAN FIGURE; THE WORD "CARS" IS FORMED FROM OMITTED TILES AND APPEARS ON THE LEFT SIDE OF THE PICTURE; THE COLOR WHITE REPRESENTS BACKGROUND AND IS NOT CLAIMED AS A FEATURE OF THE MARK.



OWNER OF INTERNATIONAL REGISTRATION 1084513 DATED 5-17-2011, EXPIRES 5-17-2021.

THE COLOR(S) BLUE, LIGHT BLUE, AND BLACK IS/ARE CLAIMED AS A FEATURE OF THE MARK.

SER. NO. 79-100,155, FILED 5-17-2011.

DAVID TOOLEY, EXAMINING ATTORNEY

*David J. Kypos*

Director of the United States Patent and Trademark Office

# United States of America

United States Patent and Trademark Office



**Reg. No. 4,133,773**

**Registered May 1, 2012**

**Int. Cl.: 21**

**TRADEMARK**

**PRINCIPAL REGISTER**

HUTA SZKLA GOSPODARCZEGO IRENA S.A. W UPADLOSCI LIKWIDACYJNEJ (POLAND  
JOINT STOCK COMPANY LIQUIDATION UNDER THE BANKRUPTCY LAW)  
UL. SZKLARSKA 9  
PL-88-100 INOWROCLAW, POLAND

FOR: GLASS PRODUCTS AND GLASS ACCESSORIES MADE OF SODA GLASS AND CRYSTAL GLASS, NAMELY, CANDY BOXES, BOTTLES SOLD EMPTY, SUGAR BOWLS, PITCHERS, CUPS, DECANTERS, STEMWARE, STOPPERS, BASKETS, DECORATIVE GLASS IN THE SHAPE OF CROSSES, ICE BUCKETS, BEER MUGS, SPOONS, BUTTER DISHES, HONEY JARS, SOAP DISHES, FRUIT BOWLS, VINEGAR DECANTERS, COMPORTS IN THE NATURE OF DECORATIVE BOWLS, MIRROR BALLS, CUTLERY CONTAINERS, NAPKIN CONTAINERS, DESKTOP STATUARY, COOKIE JARS, NAPKIN HOLDERS, SALT SHAKERS, SAUCE BOATS, STATUES, TUMBLERS, FISH DISHES, CANDLESTICKS, TRAYS FOR DOMESTIC USE, PLATES, CAKE PLATES, VASES, VASES WITH A COVER, PUNCH BOWLS, IN CLASS 21 (U.S. CLS. 2, 13, 23, 29, 30, 33, 40 AND 50).

THE MARK CONSISTS OF THE WORD "IRENA" WRITTEN IN CAPITAL AND BLOCK LETTERS, OVER WHICH THERE ARE THREE FOUR-POINTED STARS. THE LETTERS IN THE WORD "IRENA" ARE DARK BLUE, THE STARS ARE TURQUOISE.

PRIORITY DATE OF 12-23-2010 IS CLAIMED.

OWNER OF INTERNATIONAL REGISTRATION 1084561 DATED 2-23-2011, EXPIRES 2-23-2021.

THE COLOR(S) DARK BLUE AND TURQUOISE IS/ARE CLAIMED AS A FEATURE OF THE MARK.

SER. NO. 79-100,173, FILED 2-23-2011.

TOBY BULLOFF, EXAMINING ATTORNEY



*David J. Kyffers*

Director of the United States Patent and Trademark Office

# United States of America

United States Patent and Trademark Office



**Reg. No. 4,133,774**

**Registered May 1, 2012**

**Int. Cls.: 9, 38 and 45**

**TRADEMARK**

**SERVICE MARK**

**PRINCIPAL REGISTER**

ZODIAK ACTIVE S.R.L. (ITALY LIMITED LIABILITY COMPANY)  
LARGO ADUA, 1  
I-24128 BERGAMO (BG), ITALY

FOR: APPARATUS FOR TREATMENT OF INFORMATION, NAMELY, WORD PROCESSOR; INTERCOMMUNICATION APPARATUS, NAMELY, FACSIMILE MACHINE; RECORDED COMPUTER SOFTWARE AND RECORDED COMPUTER PROGRAMS FOR DATABASE MANAGEMENT IN THE FIELD OF DATING; COMPUTERS; APPARATUS FOR ACCESS TO A CHAT ROOM OR WEBSITE, TRANSMISSION, REPRODUCTION OF SOUND OR IMAGES; SOFTWARE FOR PRIVACY TREATMENT OF INFORMATION AND COMPUTERS; PRERECORDED PHONOGRAPH RECORDS, COMPACT DISCS, OPTICAL COMPACT DISCS, DVDS FEATURING MUSIC, IN CLASS 9 (U.S. CLS. 21, 23, 26, 36 AND 38).

FOR: TELECOMMUNICATIONS, NAMELY, COMPUTER AIDED TRANSMISSION OF INFORMATION AND IMAGES; COMMUNICATIONS, NAMELY, TRANSMISSION OF INFORMATION AND IMAGES VIA COMPUTER AND COMPUTER TERMINALS AND BETWEEN COMPUTERS AND COMPUTER TERMINALS; COMMUNICATION SERVICES, NAMELY, BROADCASTING OF RADIO AND TELEVISION PROGRAMS VIA RADIO, TELEPHONE OR CABLE; TELEVISION PROGRAM BROADCASTING; BROADCASTING OF RADIO PROGRAMMES; TELEVISION TRANSMISSION; ELECTRONIC MAIL; ELECTRONIC MESSAGE TRANSMISSION; ELECTRONIC IMAGE AND MESSAGE TRANSMISSION VIA COMPUTER; TELEPHONE CONNECTIONS, NAMELY, COMMUNICATIONS BY TELEPHONE; TELEPHONE SERVICES, NAMELY, COMMUNICATIONS BY TELEPHONE; RENTAL OF ACCESS TIMES TO A DATABANK; PROVIDING ACCESS TO CHAT LINES, CHAT ROOMS AND FORUMS FOR THE TRANSMISSION OF MESSAGES AMONG COMPUTER USERS CONCERNING DATING ON THE INTERNET; PROVIDING ONLINE CHAT ROOM OR DISCUSSION SERVICES IN THE NATURE OF ONLINE FORUMS FOR THE TRANSMISSION OF MESSAGES AMONG COMPUTER USERS CONCERNING DATING; PROVIDING ON-LINE CHAT ROOMS FOR TRANSMISSION OF MESSAGES AMONG COMPUTER USERS IN THE FIELD OF DATING, IN CLASS 38 (U.S. CLS. 100, 101 AND 104).

FOR: MARRIAGE AGENCIES, IN CLASS 45 (U.S. CLS. 100 AND 101).

THE MARK CONSISTS OF A SHADED BACKGROUND FEATURING A QUADRILATERAL SHAPE FEATURING A STREET MAP GRID OVER WHICH IS SUPERIMPOSED A HEART AND THE WORDING "FLIRT MAPS".



*David J. Kybas*

Director of the United States Patent and Trademark Office

**Reg. No. 4,133,774** PRIORITY DATE OF 1-13-2011 IS CLAIMED.

OWNER OF INTERNATIONAL REGISTRATION 1084707 DATED 1-28-2011, EXPIRES 1-28-2021.

SER. NO. 79-100,222, FILED 1-28-2011.

YAT SYE, LEE, EXAMINING ATTORNEY

# United States of America

United States Patent and Trademark Office



**Reg. No. 4,133,775**

**Registered May 1, 2012**

**Int. Cls.: 29, 30, 32, 33,  
35 and 43**

**TRADEMARK**

**SERVICE MARK**

**PRINCIPAL REGISTER**

RANUCCI DAVID (MONACO INDIVIDUAL)  
44, BOULEVARD D'ITALIE  
MONTECARLO  
MONACO

FOR: MEAT, FISH, POULTRY AND GAME; MEAT EXTRACTS; PRESERVED, FROZEN, DRIED AND COOKED FRUITS AND VEGETABLES; JELLIES, JAMS; EGGS, MILK; CHEESE; CREAM; DAIRY PRODUCTS, NAMELY, DAIRY-BASED CHOCOLATE FOOD BEVERAGES, DAIRY-BASED DIPS, DAIRY-BASED FOOD BEVERAGES; MARGARINE, MARGARINE SUBSTITUTES; SOUR CREAM, SOUR CREAM SUBSTITUTES; BUTTER, BUTTER SUBSTITUTES, PEANUT BUTTER; YOGURT; WHIPPING CREAM; EDIBLE OILS AND FATS, IN CLASS 29 (U.S. CL. 46).

FOR: COFFEE, TEA, COCOA, SUGAR, RICE, TAPIOCA, SAGO, ARTIFICIAL COFFEE; FLOUR AND PROCESSED CEREALS, BREAD, PASTRY AND CONFECTIONERY MADE OF SUGAR; CONFECTIONERY CHIPS FOR BAKING; FLAVORED ICES; HONEY, TREACLE; YEAST, BAKING POWDER; SALT, MUSTARD; VINEGAR, SAUCES, CONDIMENTS, NAMELY, SALAD DRESSING, SPICES; ICE; FRUIT SAUCES EXCLUDING CRANBERRY SAUCE AND APPLESAUCE, IN CLASS 30 (U.S. CL. 46).

FOR: COLAS; NON-ALCOHOLIC MALT BEVERAGES; POP SOFT DRINKS; SOFT DRINKS; NON-ALCOHOLIC PUNCH; SPORTS DRINKS; TOMATO JUICE; VEGETABLE JUICE; NON-ALCOHOLIC AND DE-ALCOHOLIZED WINE; FRUIT DRINKS AND FRUIT JUICES; SYRUPS AND POWDERS FOR THE PREPARATION OF SOFT DRINKS, IN CLASS 32 (U.S. CLS. 45, 46 AND 48).

FOR: ALCOHOLIC BEVERAGES EXCEPT BEERS, IN CLASS 33 (U.S. CLS. 47 AND 49).

FOR: SERVICES RELATED TO SALES ORGANIZATION ON BEHALF OF THIRD PARTIES THAT ARE CARRIED OUT IN ANY WAY, NAMELY, ARRANGING AND CONDUCTING SALES FOR OTHERS IN CONNECTION TO MEAT, FISH, POULTRY AND GAME, MEAT EXTRACTS, PRESERVED, FROZEN, DRIED AND COOKED FRUITS AND VEGETABLES, JELLIES, JAMS, FRUIT SAUCES, EGGS, MILK, CHEESES, CREAM, DAIRY PRODUCTS, NAMELY, DAIRY-BASED CHOCOLATE FOOD BEVERAGES, DAIRY-BASED DIPS, DAIRY-BASED FOOD BEVERAGES, MARGARINE, MARGARINE SUBSTITUTES, SOUR CREAM, SOUR CREAM SUBSTITUTES, BUTTER, BUTTER SUBSTITUTES, PEANUT BUTTER; YOGURT, WHIPPING CREAM, EDIBLE OILS AND FATS, COFFEE, TEA, COCOA, SUGAR,



*David J. Kybas*

Director of the United States Patent and Trademark Office

**Reg. No. 4,133,775** RICE, TAPIOCA, SAGO, ARTIFICIAL COFFEE, FLOUR AND PROCESSED CEREALS, BREAD, PASTRY AND CONFECTIONERY, CONFECTIONERY CHIPS FOR BAKING, FLAVORED ICES, HONEY, TREACLE, YEAST, BAKING POWDER, SALT, MUSTARD, VINEGAR, SAUCES, CONDIMENTS, NAMELY, SALAD DRESSING, SPICES; AND ICE, COLAS, NON-ALCOHOLIC MALT BEVERAGES, POP SOFT DRINKS, SOFT DRINKS, NON-ALCOHOLIC PUNCH, SPORT DRINKS, TOMATO JUICE, VEGETABLE JUICE, NON-ALCOHOLIC AND DE-ALCOHOLIZED WINE, FRUIT DRINKS AND FRUIT JUICES, SYRUPS AND POWDERS FOR THE PREPARATION OF SOFT DRINKS, ALCOHOLIC BEVERAGES EXCEPT BEERS, IN CLASS 35 (U.S. CLS. 100, 101 AND 102).

FOR: SERVICES FOR PROVIDING FOOD AND DRINK; TEMPORARY ACCOMMODATION, IN CLASS 43 (U.S. CLS. 100 AND 101).

PRIORITY DATE OF 3-2-2011 IS CLAIMED.

OWNER OF INTERNATIONAL REGISTRATION 1085051 DATED 3-15-2011, EXPIRES 3-15-2021.

SER. NO. 79-100,398, FILED 3-15-2011.

THEODORE MCBRIDE, EXAMINING ATTORNEY

# United States of America

United States Patent and Trademark Office

# EARLY RISE

**Reg. No. 4,133,776**

**Registered May 1, 2012**

**Int. Cl.: 28**

**TRADEMARK**

**PRINCIPAL REGISTER**

ELAN, D.O.O. (SLOVENIA LIMITED LIABILITY COMPANY)  
BEGUNJE NA GORENJSKEM 1  
SI-4275 BEGUNJE NA GORENJSKEM  
SLOVENIA

FOR: SKIS; SNOWBOARDS; WATER SKIS, IN CLASS 28 (U.S. CLS. 22, 23, 38 AND 50).

THE MARK CONSISTS OF STANDARD CHARACTERS WITHOUT CLAIM TO ANY PARTICULAR FONT, STYLE, SIZE, OR COLOR.

PRIORITY DATE OF 1-12-2011 IS CLAIMED.

OWNER OF INTERNATIONAL REGISTRATION 1085201 DATED 6-20-2011, EXPIRES 6-20-2021.

SER. NO. 79-100,454, FILED 6-20-2011.

LEIGH LOWRY, EXAMINING ATTORNEY



*David J. Kyffers*

Director of the United States Patent and Trademark Office

# United States of America

United States Patent and Trademark Office



**Reg. No. 4,133,777**

**Registered May 1, 2012**

**Int. Cls.: 9, 28 and 41**

**TRADEMARK**

**SERVICE MARK**

**PRINCIPAL REGISTER**

BABOGBABY LIMITED (IRELAND LIMITED COMPANY)  
59 BUN NA COULLE  
MOYCULLEN  
GALWAY, IRELAND

FOR: PRE-RECORDED ELECTRONIC AND DIGITAL MEDIA FEATURING ANIMATED PROGRAMS, SONGS AND STORIES, AND PROGRAMS FOR THE PURPOSE OF TEACHING LANGUAGES AND GENERAL LIFE LESSONS FOR CHILDREN, IN CLASS 9 (U.S. CLS. 21, 23, 26, 36 AND 38).

FOR: TOYS, NAMELY, TEDDY BEARS, DOLLS; INFANT DEVELOPMENT TOYS; ELECTRONIC LEARNING TOYS; CHILDREN'S EDUCATIONAL TOYS FOR DEVELOPING COGNITIVE AND LANGUAGE SKILLS, IN CLASS 28 (U.S. CLS. 22, 23, 38 AND 50).

FOR: EDUCATIONAL AND ENTERTAINMENT SERVICES, NAMELY, ONGOING TELEVISION PROGRAMS IN THE FIELD OF CHILDREN'S ENTERTAINMENT AND EDUCATION; NON-DOWNLOADABLE ELECTRONIC BOOKS, ONLINE GAMES AND ACTIVITIES IN THE FIELD OF LANGUAGES AND LIFE LESSONS FOR CHILDREN, IN CLASS 41 (U.S. CLS. 100, 101 AND 107).

NO CLAIM IS MADE TO THE EXCLUSIVE RIGHT TO USE "BABOG BABY" IN INTERNATIONAL CLASS 28 ONLY, APART FROM THE MARK AS SHOWN.

PRIORITY DATE OF 8-24-2010 IS CLAIMED.

OWNER OF INTERNATIONAL REGISTRATION 1085379 DATED 2-11-2011, EXPIRES 2-11-2021.

THE COLOR(S) LIGHT PINK, PINK, BROWN, ORANGE, RED, BLACK AND PURPLE IS/ARE CLAIMED AS A FEATURE OF THE MARK.

BROWN- SHOES, HAT, HAIR, LETTER BORDERING; PINK- FLOWERS, FACE AND LETTERS; BLACK- EYES, MOUTH AND LEGS; ORANGE- CLOTHING AND LETTERS; DARK RED- CLOTHING AND LETTERS.

THE MARK CONSISTS OF THE WORD "BABOG" APPEARING IN LIGHT PINK WITH A BROWN BORDER AND THE WORD "BABY" APPEARING IN ORANGE WITH A BROWN



*David J. Kybas*

Director of the United States Patent and Trademark Office



**Reg. No. 4,133,777** BORDER TO THE LEFT OF AN ANIMATED BABY WEARING AN ORANGE SHIRT WITH THE LETTERS "BB" APPEARING IN RED, A RED BOWTIE AND PANTS, ORANGE AND BLACK SOCKS WITH BROWN SHOWS, A BROWN HAT, BROWN HAIR, PURPLE FLOWERS IN THE HAIR, AND PINK CHEEKS.

THE ENGLISH TRANSLATION OF "BABOG" IN THE MARK IS "DOLL".

SER. NO. 79-100,509, FILED 2-11-2011.

DAVID COLLIER, EXAMINING ATTORNEY

# United States of America

United States Patent and Trademark Office

# BlueKat

**Reg. No. 4,133,778**

**Registered May 1, 2012**

**Int. Cl.: 7**

BOGE & CO. MASCHINENHANDELSGESELLSCHAFT GMBH & CO. KG (FED REP GERMANY GMBH & CO. KG)  
OTTO-BOGE-STR. 1-7  
33739 BIELEFELD  
FED REP GERMANY

**TRADEMARK**

**PRINCIPAL REGISTER**

FOR: COMPRESSORS, NAMELY, AIR COMPRESSORS, ELECTRIC COMPRESSORS, AIR COMPRESSORS FOR VEHICLES, COMPRESSORS FOR AIR CONDITIONERS, COMPRESSORS FOR DEHUMIDIFYING MACHINES, COMPRESSORS FOR MACHINES, COMPRESSORS AS PARTS FOR COMPRESSED AIR TOOLS, AIR COMPRESSORS FOR WATER AERATION SYSTEMS, GAS COMPRESSORS, OIL-LUBRICATED SCREW COMPRESSORS WITH BUILT-IN CONVERTER FOR REDUCING THE OIL CONTENT IN COMPRESSED GASES, COMPRESSORS AS PARTS OF MACHINES, COMPRESSORS AS PARTS OF MOTORS, COMPRESSORS AS PARTS OF ENGINES; COMPRESSORS WITH CONVERTERS FOR REDUCING THE OIL CONTENT IN COMPRESSED GASES, NAMELY, AIR COMPRESSORS, ELECTRIC COMPRESSORS, AIR COMPRESSORS FOR VEHICLES, COMPRESSORS FOR AIR CONDITIONERS, COMPRESSORS FOR DEHUMIDIFYING MACHINES, COMPRESSORS FOR MACHINES, COMPRESSORS AS PARTS FOR COMPRESSED AIR TOOLS, AIR COMPRESSORS FOR WATER AERATION SYSTEMS, GAS COMPRESSORS, OIL-LUBRICATED SCREW COMPRESSORS, COMPRESSORS AS PARTS OF MACHINES, COMPRESSORS AS PARTS OF MOTORS, COMPRESSORS AS PARTS OF ENGINES; COMPRESSORS WITH CATALYTIC CONVERTERS FOR REDUCING THE OIL CONTENT IN COMPRESSED GASES, NAMELY, AIR COMPRESSORS, ELECTRIC COMPRESSORS, AIR COMPRESSORS FOR VEHICLES, COMPRESSORS FOR AIR CONDITIONERS, COMPRESSORS FOR DEHUMIDIFYING MACHINES, COMPRESSORS FOR MACHINES, COMPRESSORS AS PARTS FOR COMPRESSED AIR TOOLS, AIR COMPRESSORS FOR WATER AERATION SYSTEMS, GAS COMPRESSORS, OIL-LUBRICATED SCREW COMPRESSORS WITH BUILT-IN CONVERTER FOR REDUCING THE OIL CONTENT IN COMPRESSED GASES, COMPRESSORS AS PARTS OF MACHINES, COMPRESSORS AS PARTS OF MOTORS, COMPRESSORS AS PARTS OF ENGINES; CONVERTERS FOR REDUCING THE OIL CONTENT IN COMPRESSED GASES, NAMELY, CATALYTIC CONVERTERS, IN CLASS 7 (U.S. CLS. 13, 19, 21, 23, 31, 34 AND 35).



*David J. Kyjars*

Director of the United States Patent and Trademark Office

THE MARK CONSISTS OF STANDARD CHARACTERS WITHOUT CLAIM TO ANY PARTICULAR FONT, STYLE, SIZE, OR COLOR.

PRIORITY DATE OF 1-13-2011 IS CLAIMED.

**Reg. No. 4,133,778** OWNER OF INTERNATIONAL REGISTRATION 1085429 DATED 7-4-2011, EXPIRES 7-4-2021.

SER. NO. 79-100,527, FILED 7-4-2011.

HAI-LY LAM, EXAMINING ATTORNEY

# United States of America

United States Patent and Trademark Office



**Reg. No. 4,133,779**

**Registered May 1, 2012**

**Int. Cls.: 7 and 21**

**TRADEMARK**

**PRINCIPAL REGISTER**

PACOTRADE AG (SWITZERLAND SOCIÉTÉ ANONYME (SA))  
BUNDESSTRASSE 7  
CH-6300 ZUG  
SWITZERLAND

FOR: KITCHEN MACHINES, NAMELY, ELECTRIC STANDING MIXERS; ELECTRIC FOOD BLENDERS FOR HOUSEHOLD PURPOSES; ELECTRIC MIXERS; ELECTRIC FOOD PROCESSORS, IN CLASS 7 (U.S. CLS. 13, 19, 21, 23, 31, 34 AND 35).

FOR: NON-ELECTRIC FOOD BLENDERS FOR HOUSEHOLD PURPOSES; NON-ELECTRIC FOOD MIXER, IN CLASS 21 (U.S. CLS. 2, 13, 23, 29, 30, 33, 40 AND 50).

OWNER OF U.S. REG. NO. 1,805,810.

PRIORITY DATE OF 3-4-2011 IS CLAIMED.

OWNER OF INTERNATIONAL REGISTRATION 1085535 DATED 6-29-2011, EXPIRES 6-29-2021.

THE MARK CONSISTS OF THE WORDING "PACO JET" WITH "PACO" IN CHALK-LIKE WRITING AND "JET" IN A STYLIZED SOLID LINE FONT BELOW AND AN UNDERLINING LINE IN THE SAME CHALK-LIKE FORMAT.

SER. NO. 79-100,577, FILED 6-29-2011.

GINA FINK, EXAMINING ATTORNEY



*David J. Kybas*

Director of the United States Patent and Trademark Office

# United States of America

United States Patent and Trademark Office

# NAERSI LING

**Reg. No. 4,133,780**

**Registered May 1, 2012**

**Int. Cl.: 18**

**TRADEMARK**

**PRINCIPAL REGISTER**

SHENZHEN EEKA FASHION CO. LTD. (CHINA CORPORATION)

5TH FLOOR, 8TH BUILDING

XIASHA INDUSTRY ZONE,; FUTIAN DISTRICT,; SHENZHEN; GUANGDONG PROVINCE  
CHINA

FOR: HANDBAGS; UMBRELLAS; PURSES; CLOTHING FOR ANIMALS; BRIEFCASES;  
IMITATION LEATHER; LEATHER STRAPS; KEY CASES OF LEATHER OR IMITATION  
LEATHER, IN CLASS 18 (U.S. CLS. 1, 2, 3, 22 AND 41).

OWNER OF U.S. REG. NOS. 3,619,626 AND 3,927,933.

OWNER OF INTERNATIONAL REGISTRATION 1085642 DATED 6-29-2011, EXPIRES 6-29-  
2021.

THE WORDING "NAERSI LING" DOES NOT IDENTIFY A LIVING INDIVIDUAL.

THE MARK CONSISTS OF TWO INVENTED WORDS "NAERSI LING" AND A NON-CLOSED  
CIRCLE WITHIN WHICH THERE IS A SIX PETALS FLOWER ON A SHADED CIRCLE  
BACKGROUND.

THE WORDING "NAERSI LING" HAS NO MEANING IN A FOREIGN LANGUAGE.

SER. NO. 79-100,631, FILED 6-29-2011.

GINA FINK, EXAMINING ATTORNEY



*David J. Kyffers*

Director of the United States Patent and Trademark Office

# United States of America

United States Patent and Trademark Office

# POSTURFIL

**Reg. No. 4,133,781**

**Registered May 1, 2012**

**Int. Cls.: 6 and 20**

**TRADEMARK**

**PRINCIPAL REGISTER**

HARRISON SPINKS BEDS LIMITED (ENGLAND LIMITED COMPANY)  
WESTLAND ROAD  
LEEDS LS11 5SN, UNITED KINGDOM

FOR: METAL HARDWARE, NAMELY, SPRINGS AND SPRING ASSEMBLIES, IN CLASS 6 (U.S. CLS. 2, 12, 13, 14, 23, 25 AND 50).

FOR: BEDS, DIVAN BEDS, MATTRESSES, TOPPERS FOR MATTRESSES, PILLOWS, CUSHIONS, UPHOLSTERED FURNITURE, IN CLASS 20 (U.S. CLS. 2, 13, 22, 25, 32 AND 50).

THE MARK CONSISTS OF STANDARD CHARACTERS WITHOUT CLAIM TO ANY PARTICULAR FONT, STYLE, SIZE, OR COLOR.

OWNER OF INTERNATIONAL REGISTRATION 1086324 DATED 7-4-2011, EXPIRES 7-4-2021.

SER. NO. 79-100,898, FILED 7-4-2011.

HAI-LY LAM, EXAMINING ATTORNEY



*David J. Kybas*

Director of the United States Patent and Trademark Office

# United States of America

United States Patent and Trademark Office

# MyBewatec

**Reg. No. 4,133,782**

BEWATEC KOMMUNIKATIONSTECHNIK GMBH (FED REP GERMANY GMBH)  
ORKOTTEN, 65

**Registered May 1, 2012**

48291 TELGTE, FED REP GERMANY

**Int. Cls.: 9, 35, 38 and 42**

FOR: DOWNLOADABLE COMPUTER PROGRAMS, NAMELY, OPERATION SYSTEMS FOR NETWORK MULTIMEDIA TERMINALS, MONITORING SOFTWARE FOR NETWORK MULTIMEDIA TERMINALS, APPLICATION SOFTWARE FOR MULTI-MEDIA AUDIO, VIDEO, TEXT CONTENT FOR ENTERTAINMENT AND INFORMATIONAL USE BY PATIENTS IN HOSPITALS AND NURSING HOMES, IN CLASS 9 (U.S. CLS. 21, 23, 26, 36 AND 38).

**TRADEMARK**

**SERVICE MARK**

**PRINCIPAL REGISTER**

FOR: RETAIL STORE AND WHOLESALE STORE SERVICES VIA THE INTERNET IN THE FIELD OF COMPUTER PROGRAMS, IN CLASS 35 (U.S. CLS. 100, 101 AND 102).

FOR: ACCESS PROVISION TO COMPUTER PROGRAMS IN DATA NETWORKS; ACCESS PROVISION TO INFORMATION IN THE INTERNET, NAMELY, PROVIDING INTERNET ACCESS, IN CLASS 38 (U.S. CLS. 100, 101 AND 104).

FOR: INSTALLATION AND MAINTENANCE OF SOFTWARE, NAMELY, OPERATION SYSTEMS FOR NETWORK MULTIMEDIA TERMINALS, APPLICATION SOFTWARE FOR MULTI-MEDIA AUDIO, VIDEO, TEXT CONTENT FOR ENTERTAINMENT AND INFORMATIONAL USE BY PATIENTS IN HOSPITALS AND NURSING HOMES; UPDATING SOFTWARE, NAMELY, OPERATION SYSTEMS FOR NETWORK MULTIMEDIA TERMINALS, APPLICATION SOFTWARE FOR MULTI-MEDIA AUDIO, VIDEO, TEXT CONTENT FOR ENTERTAINMENT AND INFORMATIONAL USE BY PATIENTS IN HOSPITALS AND NURSING HOMES; CREATION OF COMPUTER PROGRAMS FOR DATA PROCESSING, CONSULTING AND ADVICE IN RELATION TO THE EVALUATION, SELECTION AND IMPLEMENTATION OF COMPUTER SOFTWARE, COMPUTER FIRMWARE, COMPUTER HARDWARE AND OF DATA PROCESSING SYSTEMS FOR PATIENTS IN HOSPITALS AND CARE INSTITUTIONS, IN CLASS 42 (U.S. CLS. 100 AND 101).



THE MARK CONSISTS OF STANDARD CHARACTERS WITHOUT CLAIM TO ANY PARTICULAR FONT, STYLE, SIZE, OR COLOR.

*David J. Kypos*

PRIORITY DATE OF 11-18-2010 IS CLAIMED.

**Reg. No. 4,133,782** OWNER OF INTERNATIONAL REGISTRATION 1086814 DATED 4-15-2011, EXPIRES 4-15-2021.

OWNER OF U.S. REG. NO. 3,903,197.

SER. NO. 79-101,068, FILED 4-15-2011.

KATHRYN COWARD, EXAMINING ATTORNEY



# United States of America

United States Patent and Trademark Office

# the medhyk

**Reg. No. 4,133,783**

**Registered May 1, 2012**

**Int. Cl.: 33**

**TRADEMARK**

**PRINCIPAL REGISTER**

ANGOVE'S PROPRIETARY LIMITED (AUSTRALIA PROPRIETARY LIMITED COMPANY  
(PTY LTD))  
BOOKMARK AVENUE  
RENMARK SA 5341, AUSTRALIA

FOR: WINES, NAMELY, RED TABLE WINE, WHITE TABLE WINE, IN CLASS 33 (U.S. CLS.  
47 AND 49).

THE MARK CONSISTS OF STANDARD CHARACTERS WITHOUT CLAIM TO ANY PAR-  
TICULAR FONT, STYLE, SIZE, OR COLOR.

OWNER OF INTERNATIONAL REGISTRATION 1087048 DATED 7-11-2011, EXPIRES 7-11-  
2021.

THE ENGLISH TRANSLATION OF "MEDHYK" IN THE MARK IS "DOCTOR".

SER. NO. 79-101,151, FILED 7-11-2011.

DAVID HOFFMAN, EXAMINING ATTORNEY



*David J. Kyffers*

Director of the United States Patent and Trademark Office

# United States of America

United States Patent and Trademark Office



**Reg. No. 4,133,784**

**Registered May 1, 2012**

**Int. Cl.: 3**

SEBA KIMYA SANAYI VE TICARET ANONIM SIRKETI (TURKEY JOINT STOCK COMPANY)

TUZLA KIMYA SANAYICILERI

ORGANIZE SANAYI BÖLGESİ, MELEK ARAS BULVARI TUNA CADDESİ NO: 6, TUZLA - ISTANBUL  
TURKEY

**TRADEMARK**

**PRINCIPAL REGISTER**

FOR: BLEACHING PREPARATIONS FOR LAUNDRY USE; EMERY CLOTHS AND EMERY PAPERS, ABRASIVE PASTE, PUMICE STONES FOR PERSONAL USE; LEATHER POLISHES, POLISHES FOR METALLIC ITEMS, FURNITURE POLISHES, FLOOR POLISHES, IN CLASS 3 (U.S. CLS. 1, 4, 6, 50, 51 AND 52).

THE MARK CONSISTS OF THE WORDING "SIR" IN WHITE, OUTLINED IN BLACK, ABOVE A WHITE HORIZONTAL ARC AND FOUR WHITE CIRCLES, ALL ON A RED CIRCULAR BACKGROUND.

OWNER OF INTERNATIONAL REGISTRATION 1043899 DATED 5-14-2010, EXPIRES 5-14-2020.

THE COLOR(S) RED, WHITE AND BLACK IS/ARE CLAIMED AS A FEATURE OF THE MARK.

THE ENGLISH TRANSLATION OF THE FOREIGN WORD(S) IN THE MARK IS "SECRET".

SER. NO. 79-101,179, FILED 6-13-2011.

TRACY CROSS, EXAMINING ATTORNEY



*David J. Kyffers*

Director of the United States Patent and Trademark Office

# United States of America

United States Patent and Trademark Office

# KRONOS

**Reg. No. 4,133,785**

**Registered May 1, 2012**

**Int. Cls.: 9 and 42**

**TRADEMARK**

**SERVICE MARK**

**PRINCIPAL REGISTER**

SELEX SISTEMI INTEGRATI S.P.A. (ITALY JOINT STOCK COMPANY)  
VIA TIBURTINA, 1231  
ROMA, ITALY

FOR: FIXED AND/OR MOVABLE ELECTRICAL AND ELECTRONIC APPARATUSES AND INSTRUMENTS, AND COMPONENTS THEREOF, FOR DETECTION, LOCALIZATION, TRACKING AND CONFIRMATION OF MOVING OBJECTS, NAMELY, GROUND-BASED 2D/3D RADAR, COMPUTER OPERATING SOFTWARE AND COMPUTER HARDWARE; ELECTRICAL AND ELECTRONIC APPARATUSES AND INSTRUMENTS FOR DETECTION OF SHIPS AND SURFACE SEA MEANS, NAMELY, MARITIME PATROL RADAR AND SHIPBORNE 2D/3D RADAR, COMPUTER OPERATING SOFTWARE AND COMPUTER HARDWARE; ELECTRICAL AND ELECTRONIC APPARATUSES AND INSTRUMENTS FOR DETECTION OF TRAFFIC WITHIN PORTS AND AIRPORTS, NAMELY, 2D/3D RADAR, COMPUTER OPERATING SOFTWARE AND COMPUTER HARDWARE; RADAR COMPRISED OF ACTIVE PHASED ARRAY MULTIFUNCTION 3D ANTENNAS, RADAR RECEIVERS, DATA PROCESSING EQUIPMENT, COMPUTERS, COMPUTER OPERATING SOFTWARE, COMPUTER HARDWARE AND COMPUTER SCREENS, IN CLASS 9 (U.S. CLS. 21, 23, 26, 36 AND 38).

FOR: SCIENTIFIC AND TECHNOLOGICAL SERVICES, NAMELY, SCIENTIFIC RESEARCH, DESIGN, ANALYSIS, AND TESTING IN THE FIELD OF RADAR SYSTEMS; HARDWARE AND SOFTWARE DESIGNING AND DEVELOPING; ALL WITH REFERENCE TO GOODS INDICATED IN THE AFOREMENTIONED CLASS, IN CLASS 42 (U.S. CLS. 100 AND 101).

THE MARK CONSISTS OF STANDARD CHARACTERS WITHOUT CLAIM TO ANY PARTICULAR FONT, STYLE, SIZE, OR COLOR.

OWNER OF INTERNATIONAL REGISTRATION 1087195 DATED 4-26-2011, EXPIRES 4-26-2021.

THE WORDING "KRONOS" HAS NO MEANING IN A FOREIGN LANGUAGE.

SER. NO. 79-101,230, FILED 4-26-2011.

MICHAEL WIENER, EXAMINING ATTORNEY



*David J. Kyros*

Director of the United States Patent and Trademark Office

**United States of America**  
United States Patent and Trademark Office

# WEEKTO

**Reg. No. 4,133,786**

**Registered May 1, 2012**

**Int. Cl.: 35**

**SERVICE MARK**

**PRINCIPAL REGISTER**

PROJETCLUB (FRANCE CORPORATION)  
4 BOULEVARD DE MONS  
F-59650 VILLENEUVE D'ASCQ  
FRANCE

FOR: RETAIL STORE SERVICES FEATURING SPORTING GOODS, SPORTS CLOTHING AND FOOTWEAR; ADVERTISING SERVICES, IN CLASS 35 (U.S. CLS. 100, 101 AND 102).

THE MARK CONSISTS OF STANDARD CHARACTERS WITHOUT CLAIM TO ANY PARTICULAR FONT, STYLE, SIZE, OR COLOR.

OWNER OF INTERNATIONAL REGISTRATION 1087459 DATED 6-27-2011, EXPIRES 6-27-2021.

SER. NO. 79-101,328, FILED 6-27-2011.

KELLY TRUSILO, EXAMINING ATTORNEY



*David J. Kyffers*

Director of the United States Patent and Trademark Office

# United States of America

United States Patent and Trademark Office

# SOMNOLOGIC

**Reg. No. 4,133,787**

**Registered May 1, 2012**

**Int. Cls.: 9, 10 and 11**

**TRADEMARK**

**PRINCIPAL REGISTER**

GINGO BILOBA, SOCIÉTÉ ANONYME (BELGIUM JOINT STOCK COMPANY)  
RUE MAURICE LIÉTART 16 B  
B-1150 BRUXELLES  
BELGIUM

FOR: SOUND RECORDING DISKS AND SOUND RECORDING CARRIERS, NAMELY, BLANK COMPACT DISKS, USB FLASH DRIVES AND CASSETTES; COMPUTER PROGRAMS, NAMELY, DOWNLOADABLE COMPUTER SOFTWARE FOR RECORDING SOUND, FOR DATABASE MANAGEMENT, FOR TRANSMITTING SOUND RECORDINGS; APPARATUS FOR RECORDING, REPRODUCING, AND TRANSMITTING SOUND, NAMELY, APPARATUS FOR REPRODUCING AND TRANSMITTING SOUNDS FOR USE IN TREATING INSOMNIA, APPARATUS FOR REPRODUCING AND TRANSMITTING SOUNDS HELPING TO SLEEP, APPARATUS FOR AMPLIFYING SOUND, NAMELY, AMPLIFIERS, SOUND PROJECTORS, RADIOS, LOUDSPEAKERS; ACOUSTIC DIAPHRAGMS IN THE NATURE OF MEMBRANES, ACOUSTIC CONDUITS, ACOUSTIC COUPLERS, SOUND TRANSMITTING APPARATUS, NAMELY, SPEAKING TUBES, IN CLASS 9 (U.S. CLS. 21, 23, 26, 36 AND 38).

FOR: MEDICAL APPARATUS FOR USE IN TREATING INSOMNIA, NAMELY, AUDIO APPARATUS AGAINST INSOMNIA; PHOTOTHERAPY APPARATUS IN THE NATURE OF PHOTOTHERAPEUTIC APPARATUS FOR MEDICAL PURPOSES; REFLEXOLOGY APPARATUS AND INSTRUMENTS, NAMELY, MASSAGE APPARATUS AND INSTRUMENTS, IN CLASS 10 (U.S. CLS. 26, 39 AND 44).

FOR: LIGHTING APPARATUS, NAMELY, LAMPS, LIGHTING FIXTURES, LIGHTING INSTALLATIONS; HUMIDIFIERS AND MIST BLOWERS IN THE NATURE OF FANS FOR DOMESTIC USE; ELECTRIC ROOM FRAGRANCE DISPENSERS; AIR PURIFIERS AND IONIZERS FOR DOMESTIC USE; LIGHT DIFFUSERS, ESPECIALLY READING LAMPS, DAWN SIMULATORS IN THE NATURE OF LAMPS, SCONCES AND LIGHTING FIXTURES, IN CLASS 11 (U.S. CLS. 13, 21, 23, 31 AND 34).

THE MARK CONSISTS OF STANDARD CHARACTERS WITHOUT CLAIM TO ANY PARTICULAR FONT, STYLE, SIZE, OR COLOR.

PRIORITY DATE OF 10-8-2010 IS CLAIMED.

OWNER OF INTERNATIONAL REGISTRATION 1087829 DATED 4-7-2011, EXPIRES 4-7-2021.



*David J. Kyjars*

Director of the United States Patent and Trademark Office

**Reg. No. 4,133,787** SER. NO. 79-101,480, FILED 4-7-2011.

NICHOLAS COLEMAN, EXAMINING ATTORNEY

# United States of America

United States Patent and Trademark Office

# ARTUCE

**Reg. No. 4,133,788**

**Registered May 1, 2012**

**Int. Cl.: 11**

**TRADEMARK**

**PRINCIPAL REGISTER**

ECLAIRAGE ROGER PRADIER (FRANCE SOCIÉTÉ ANONYME)  
46 AVENUE D'OCCITANIE - CAP SUD  
F-36250 SAINT MAUR  
FRANCE

FOR: LIGHTING APPARATUS AND INSTALLATIONS, NAMELY, WALL LAMPS, LAMP POSTS, SUSPENSION LAMPS, TABLE LAMPS, PORTABLE LAMPS, CEILING LIGHTS, LAMPS AND LIGHT BULBS, IN CLASS 11 (U.S. CLS. 13, 21, 23, 31 AND 34).

THE MARK CONSISTS OF STANDARD CHARACTERS WITHOUT CLAIM TO ANY PARTICULAR FONT, STYLE, SIZE, OR COLOR.

PRIORITY DATE OF 2-25-2011 IS CLAIMED.

OWNER OF INTERNATIONAL REGISTRATION 1088115 DATED 7-1-2011, EXPIRES 7-1-2021.

SER. NO. 79-101,594, FILED 7-1-2011.

REBECCA POVARCHUK, EXAMINING ATTORNEY



*David J. Kyffers*

Director of the United States Patent and Trademark Office

# United States of America

United States Patent and Trademark Office

# SYNCROSTIM

**Reg. No. 4,133,789**

**Registered May 1, 2012**

**Int. Cl.: 5**

**TRADEMARK**

**PRINCIPAL REGISTER**

CEVA SANTE ANIMALE (FRANCE SOCIÉTÉ ANONYME)  
10 AVENUE DE LA BALLASTIÈRE  
F-33500 LIBOURNE  
FRANCE

FOR: VETERINARY PREPARATIONS, NAMELY, HORMONAL PREPARATIONS USED TO IMPROVE REPRODUCTION IN CATTLE, IN CLASS 5 (U.S. CLS. 6, 18, 44, 46, 51 AND 52).

THE MARK CONSISTS OF STANDARD CHARACTERS WITHOUT CLAIM TO ANY PARTICULAR FONT, STYLE, SIZE, OR COLOR.

PRIORITY DATE OF 2-9-2011 IS CLAIMED.

OWNER OF INTERNATIONAL REGISTRATION 1088297 DATED 8-8-2011, EXPIRES 8-8-2021.

SER. NO. 79-101,668, FILED 8-8-2011.

JACLYN KIDWELL WALKER, EXAMINING ATTORNEY



*David J. Kyros*

Director of the United States Patent and Trademark Office



**United States of America**  
United States Patent and Trademark Office

# Phyto-drip

**Reg. No. 4,133,790**

**Registered May 1, 2012**

**Int. Cls.: 5 and 11**

**TRADEMARK**

**PRINCIPAL REGISTER**

PRECISION DRIP B.V. (NETHERLANDS PRIVATE LIMITED LIABILITY COMPANY)  
BURGEMEESTER CREZEELAAN 40  
NL-2678 KX DE LIER  
NETHERLANDS

FOR: PLANT PROTECTION AND GROWING ENHANCEMENT AGENTS OF A PROPHY-LACTIC NATURE, IN CLASS 5 (U.S. CLS. 6, 18, 44, 46, 51 AND 52).

FOR: AGRICULTURAL IRRIGATION UNIT FEATURING A UNIT FOR SUPPLYING LIQUID PLANT PROTECTION AND GROWING ENHANCEMENT AGENTS, IN CLASS 11 (U.S. CLS. 13, 21, 23, 31 AND 34).

THE MARK CONSISTS OF STANDARD CHARACTERS WITHOUT CLAIM TO ANY PARTICULAR FONT, STYLE, SIZE, OR COLOR.

OWNER OF INTERNATIONAL REGISTRATION 1088626 DATED 5-31-2011, EXPIRES 5-31-2021.

SER. NO. 79-101,790, FILED 5-31-2011.

REGINA DRUMMOND, EXAMINING ATTORNEY



*David J. Kyfos*

Director of the United States Patent and Trademark Office

# United States of America

United States Patent and Trademark Office

# DS SMITH

**Reg. No. 4,133,791**

**Registered May 1, 2012**

**Int. Cls.: 7 and 16**

**TRADEMARK**

**PRINCIPAL REGISTER**

DS SMITH PLC (UNITED KINGDOM CORPORATION)  
BEECH HOUSE, WHITEBROOK PARK  
68 LOWER COOKHAM ROAD  
MAIDENHEAD, UNITED KINGDOM SL6 8XY

FOR: FILLING MACHINES; LIQUID-FILLING MACHINES; MACHINES AND APPARATUS FOR FILLING CONTAINERS WITH FLUID; FILLING MACHINE FOR FILLING POUCHES WITH LIQUIDS; FILLING MACHINES FOR FILLING SACHETS WITH LIQUIDS; DOSING MACHINES, NAMELY, MACHINERY USED FOR DOSE-REGULATED LOADING OF LIQUIDS, AND REPLACEMENT PARTS FOR ALL THE AFORESAID GOODS, IN CLASS 7 (U.S. CLS. 13, 19, 21, 23, 31, 34 AND 35).

FOR: PLASTIC POUCHES, LINERS AND BAGS FOR PACKAGING LIQUIDS, IN CLASS 16 (U.S. CLS. 2, 5, 22, 23, 29, 37, 38 AND 50).

THE MARK CONSISTS OF STANDARD CHARACTERS WITHOUT CLAIM TO ANY PARTICULAR FONT, STYLE, SIZE, OR COLOR.

OWNER OF INTERNATIONAL REGISTRATION 1089169 DATED 4-26-2011, EXPIRES 4-26-2021.

OWNER OF U.S. REG. NO. 2,947,188.

THE NAME(S), PORTRAIT(S), AND/OR SIGNATURE(S) SHOWN IN THE MARK DOES NOT IDENTIFY A PARTICULAR LIVING INDIVIDUAL.

SER. NO. 79-101,974, FILED 4-26-2011.

MICHAEL TANNER, EXAMINING ATTORNEY



*David J. Kybas*

Director of the United States Patent and Trademark Office

# United States of America

United States Patent and Trademark Office



**Reg. No. 4,133,792**

**Registered May 1, 2012**

**Int. Cl.: 1**

**TRADEMARK**

**PRINCIPAL REGISTER**

DENKI KAGAKU KOGYO KABUSHIKI KAISHA (JAPAN CORPORATION)  
1-1, NIHONBASHI MUROMACHI 2-CHOME  
CHUO-KU; TOKYO 103-8338  
JAPAN

FOR: SYNTHETIC RESIN ADHESIVES OTHER THAN FOR STATIONERY OR HOUSEHOLD PURPOSES, FOR ELECTRONIC COMPONENTS, COMPONENTS FOR SPEAKERS, BUILDING MATERIALS OF METAL, SHEET METAL, TRAIN CARS, ELEVATOR PANELS, OPTICAL LENS, PRIMS, ART GLASS AND GOLF CLUBS; ACRYLIC RESIN BASED ADHESIVES OTHER THAN FOR STATIONERY OR HOUSEHOLD PURPOSES, FOR USE IN A WIDE VARIETY OF FIELDS; TWO-COMPONENT PLASTICS AND GUMS ADHESIVES OTHER THAN FOR STATIONERY OR HOUSEHOLD PURPOSES FOR USE IN A WIDE VARIETY OF FIELDS, IN CLASS 1 (U.S. CLS. 1, 5, 6, 10, 26 AND 46).

THE MARK CONSISTS OF A RECTANGLE WITH RED ON THE LEFT SIDE AND GREEN ON THE RIGHT SIDE WITH A PARTIALLY CLOSED RED SEMI-CIRCLE ON THE GREEN PORTION OF THE RECTANGLE AND A PARTIALLY CLOSED GREEN SEMI-CIRCLE ON THE RED PORTION OF THE RECTANGLE; THE COLOR WHITE REPRESENT TRANSPARENT AREAS AND IS NOT A PART OF THE MARK

OWNER OF INTERNATIONAL REGISTRATION 1089262 DATED 5-30-2011, EXPIRES 5-30-2021.

THE COLOR(S) GREEN AND RED IS/ARE CLAIMED AS A FEATURE OF THE MARK.

SER. NO. 79-102,024, FILED 5-30-2011.

HEATHER BIDDULPH, EXAMINING ATTORNEY



*David J. Kyjars*

Director of the United States Patent and Trademark Office

# United States of America

United States Patent and Trademark Office

## SEGA Bass Fishing Challenge

**Reg. No. 4,133,793**

**Registered May 1, 2012**

**Int. Cls.: 9 and 41**

**TRADEMARK**

**SERVICE MARK**

**PRINCIPAL REGISTER**

KABUSHIKI KAISHA SEGA, D/B/A SEGA CORPORATION (JAPAN CORPORATION)  
1-2-12, HANEDA  
OHTA-KU  
TOKYO 144-8531, JAPAN

FOR: VIDEO GAME SOFTWARE; VIDEO GAME PROGRAMS; COMPUTER GAME SOFTWARE; COMPUTER GAME SOFTWARE FOR USE ON MOBILE AND CELLULAR PHONES; COMPUTER GAME PROGRAMS; DOWNLOADABLE GRAPHICS AND IMAGES FEATURING VIDEO GAMES OR SPORTING SCENES VIA A GLOBAL COMPUTER NETWORK AND WIRELESS DEVICES, AND DOWNLOADABLE MUSIC VIA A GLOBAL COMPUTER NETWORK AND WIRELESS DEVICES, IN CLASS 9 (U.S. CLS. 21, 23, 26, 36 AND 38).

FOR: ENTERTAINMENT SERVICES, NAMELY, PROVIDING ON-LINE VIDEO GAMES AND ON-LINE COMPUTER GAMES; PROVIDING INFORMATION ON ON-LINE GAMES, IN CLASS 41 (U.S. CLS. 100, 101 AND 107).

THE MARK CONSISTS OF STANDARD CHARACTERS WITHOUT CLAIM TO ANY PARTICULAR FONT, STYLE, SIZE, OR COLOR.

PRIORITY DATE OF 6-7-2011 IS CLAIMED.

OWNER OF INTERNATIONAL REGISTRATION 1089598 DATED 6-30-2011, EXPIRES 6-30-2021.

OWNER OF U.S. REG. NOS. 3,713,104, 3,972,721 AND OTHERS.

NO CLAIM IS MADE TO THE EXCLUSIVE RIGHT TO USE "BASS FISHING CHALLENGE", APART FROM THE MARK AS SHOWN.

SER. NO. 79-102,118, FILED 6-30-2011.

DAVID H. STINE, EXAMINING ATTORNEY



*David J. Kyros*

Director of the United States Patent and Trademark Office

# United States of America

United States Patent and Trademark Office



**Reg. No. 4,133,794**

**Registered May 1, 2012**

**Int. Cl.: 8**

CNBM INVESTMENT CO., LTD. (CHINA CORPORATION)

SOUTH OF 12/F

INTERNATIONAL TRADE BUILDING,; SOUTH OFRENMIN ROAD,; LUOHU DISTRICT,  
SHENZHEN CITY; GUANGDONG

CHINA

**TRADEMARK**

**PRINCIPAL REGISTER**

FOR: BOW SAWS; FRAMES FOR HANDSAWS; SPANNERS IN THE NATURE OF HAND TOOLS; PLANES; HAND-OPERATED PIPE CUTTERS; CLAMPS FOR CARPENTERS OR COOPERS IN THE NATURE OF HAND TOOLS; HAMMERS; CHISELS; SCREWDRIVERS; PLIERS; HAND HELD CUTTING TOOLS; VICES; HAND-OPERATED LIFTING JACKS; RIVETERS IN THE NATURE OF HAND TOOLS; HAND-OPERATED GUNS FOR THE EXTRUSION OF MASTICS; GLAZIERS' DIAMONDS, BEING PARTS OF HAND TOOLS; MASON'S' HAMMERS; SCISSORS; FILES IN THE NATURE OF HAND TOOLS; AWLS IN THE NATURE OF HAND TOOLS, IN CLASS 8 (U.S. CLS. 23, 28 AND 44).

NO CLAIM IS MADE TO THE EXCLUSIVE RIGHT TO USE "FORGE", APART FROM THE MARK AS SHOWN.

OWNER OF INTERNATIONAL REGISTRATION 1089918 DATED 4-21-2011, EXPIRES 4-21-2021.

THE MARK CONSISTS OF THE LETTERS "BND" ABOVE THE WORD "FORGE", WITH HORIZONTAL LINES EXTENDING FROM THE "F" AND LAST "E" IN "FORGE". THE ENTIRE MARK IS CONTAINED IN A ROUNDED RECTANGULAR SHAPE.

SER. NO. 79-102,253, FILED 4-21-2011.

LINDSEY RUBIN, EXAMINING ATTORNEY



*David J. Kyffers*

Director of the United States Patent and Trademark Office

# United States of America

United States Patent and Trademark Office

# ACCUSD

**Reg. No. 4,133,795**

**Registered May 1, 2012**

**Int. Cl.: 18**

**TRADEMARK**

**PRINCIPAL REGISTER**

SHIMANO INC. (JAPAN CORPORATION)  
3-77, OIMATSU-CHO  
SAKAI-KU, SAKAI CITY; OSAKA 590-8577  
JAPAN

FOR: BAGS, NAMELY, BACKPACKS, WHEELED BAGS, SUITCASES WITH OR WITHOUT WHEELS, TRAVELLING BAGS WITH OR WITHOUT WHEELS, BAGS FOR CAMPERS IN THE NATURE OF CARRY-ALL BAGS, HANDBAGS, PURSES, SPORTS BAGS, TRAVELLING BAGS, POUCHES OF LEATHER, POUCHES OF IMITATION LEATHER, POUCHES OF TEXTILE, POUCHES OF CLOTH, WEARABLE STRAP-ON POUCHES, WAIST BAGS, WAIST POUCHES, SHOULDER BAGS, BOSTON BAGS, IN CLASS 18 (U.S. CLS. 1, 2, 3, 22 AND 41).

THE MARK CONSISTS OF STANDARD CHARACTERS WITHOUT CLAIM TO ANY PARTICULAR FONT, STYLE, SIZE, OR COLOR.

PRIORITY DATE OF 4-8-2011 IS CLAIMED.

OWNER OF INTERNATIONAL REGISTRATION 1089938 DATED 6-3-2011, EXPIRES 6-3-2021.

OWNER OF U.S. REG. NO. 3,158,965.

SER. NO. 79-102,260, FILED 6-3-2011.

ALEX KEAM, EXAMINING ATTORNEY



*David J. Kyfos*

Director of the United States Patent and Trademark Office

# United States of America

United States Patent and Trademark Office

**Stena**  
**Drill Slim**

**Reg. No. 4,133,796**

**Registered May 1, 2012**

**Int. Cl.: 37**

**SERVICE MARK**

**PRINCIPAL REGISTER**

STENA ÄB  
SE-405 19 GÖTEBORG  
SWEDEN

FOR: DRILLING OF WELLS; OFFSHORE OIL AND GAS DRILLING, IN CLASS 37 (U.S. CLS. 100, 103 AND 106).

NO CLAIM IS MADE TO THE EXCLUSIVE RIGHT TO USE "DRILL SLIM", APART FROM THE MARK AS SHOWN.

PRIORITY DATE OF 9-16-2010 IS CLAIMED.

OWNER OF INTERNATIONAL REGISTRATION 1090482 DATED 3-15-2011, EXPIRES 3-15-2021.

THE WORD "STENA" IN THE MARK HAS NO MEANING IN ENGLISH.

SER. NO. 79-102,447, FILED 3-15-2011.

JIM RINGLE, EXAMINING ATTORNEY



*David J. Kyffers*

Director of the United States Patent and Trademark Office

# United States of America

United States Patent and Trademark Office

## FREDERIQUE CONSTANT

**Reg. No. 4,133,797**

**Registered May 1, 2012**

**Int. Cl.: 16**

FREDERIQUE CONSTANT HOLDING N.V. (CURACAO PUBLIC LIMITED LIABILITY COMPANY)  
BINNENWEG 15  
CURAÇAO  
CURACAO

**TRADEMARK**

**PRINCIPAL REGISTER**

FOR: PRINTED MATTER, NAMELY, BROCHURES IN THE FIELD OF WATCHES OR PENS; PENS, BALLPOINT PENS, FOUNTAIN PENS AND PROPELLING PENCIL BEING A TYPE OF RETRACTABLE PENCIL; ARTISTS MATERIALS, NAMELY, ARTISTS PENS AND ARTISTS PENCILS, IN CLASS 16 (U.S. CLS. 2, 5, 22, 23, 29, 37, 38 AND 50).

THE MARK CONSISTS OF STANDARD CHARACTERS WITHOUT CLAIM TO ANY PARTICULAR FONT, STYLE, SIZE, OR COLOR.

PRIORITY DATE OF 12-20-2010 IS CLAIMED.

OWNER OF INTERNATIONAL REGISTRATION 1090577 DATED 6-16-2011, EXPIRES 6-16-2021.

OWNER OF U.S. REG. NO. 1,950,637.

THE NAME(S), PORTRAIT(S), AND/OR SIGNATURE(S) SHOWN IN THE MARK DOES NOT IDENTIFY A PARTICULAR LIVING INDIVIDUAL.

SER. NO. 79-102,483, FILED 6-16-2011.

LYDIA BELZER, EXAMINING ATTORNEY



*David J. Kyffers*

Director of the United States Patent and Trademark Office



# United States of America

United States Patent and Trademark Office

## GELSOMINO NOBILE

**Reg. No. 4,133,798**

**Registered May 1, 2012**

**Int. Cl.: 3**

**TRADEMARK**

**PRINCIPAL REGISTER**

ACQUA DI PARMA S.R.L. (ITALY LIMITED LIABILITY COMPANY)  
VIA G. RIPAMONTI, 99  
I-20141 MILANO  
ITALY

FOR: PERFUMERY, NAMELY, PERFUMES, EAU-DE-COLOGNE, TOILET WATER, ESSENTIAL OILS, DEODORANTS FOR PERSONAL USE, SCENTED LOTIONS FOR THE SKIN, SCENTED SKIN SOAPS, BATH SALTS, BATH OILS, SHAMPOOS, BATH GELS, SHOWER GELS; COSMETICS, NAMELY, FACE, BODY AND HAND CREAMS, GELS, MILKS, POWDERS AND LOTIONS, NAMELY, BATH GELS, HAIR GELS; BEAUTY MILKS, COSMETIC MILKS, FACE POWDER, MAKE-UP POWDER, LOTIONS FOR COSMETIC PURPOSES; INCENSE, POTPOURRIS, IN CLASS 3 (U.S. CLS. 1, 4, 6, 50, 51 AND 52).

THE MARK CONSISTS OF STANDARD CHARACTERS WITHOUT CLAIM TO ANY PARTICULAR FONT, STYLE, SIZE, OR COLOR.

PRIORITY DATE OF 4-1-2011 IS CLAIMED.

OWNER OF INTERNATIONAL REGISTRATION 1090697 DATED 5-12-2011, EXPIRES 5-12-2021.

OWNER OF U.S. REG. NOS. 3,117,345 AND 3,916,290.

NO CLAIM IS MADE TO THE EXCLUSIVE RIGHT TO USE "GELSOMINO", APART FROM THE MARK AS SHOWN.

THE ENGLISH TRANSLATION OF "GELSOMINO NOBILE" IN THE MARK IS "NOBLE JASMINE".

SER. NO. 79-102,519, FILED 5-12-2011.

ALLISON HOLTZ, EXAMINING ATTORNEY



*David J. Kyros*

Director of the United States Patent and Trademark Office

# United States of America

United States Patent and Trademark Office



**Reg. No. 4,133,799**

**Registered May 1, 2012**

**Int. Cls.: 3, 24 and 25**

**TRADEMARK**

**PRINCIPAL REGISTER**

EDMUND FRETTE S.A.R.L. (LUXEMBOURG SOCIETÀ A RESPONSABILITÀ LIMITATA)  
2, AVENUE CHARLES DE GAULLE  
L-1653 LUXEMBOURG  
LUXEMBOURG

FOR: PERFUMES, TOILET SOAPS; COSMETICS, NAMELY, DEODORANTS FOR PERSONAL USE; CREAMS, LOTIONS AND OILS FOR THE FACE AND THE BODY; CLEANSING MILKS, CREAMS AND OILS; MAKE-UP CREAMS; BEAUTY MASKS; MAKE-UP REMOVERS; EYE SHADOWS; LIPSTICKS; MASCARA; ROUGE; CRAYONS FOR THE EYES AND THE LIPS; POWDERS, CREAMS, OILS AND LOTIONS FOR SUNTANNING AND AFTER SUN EXPOSURE; PRE- AND AFTER SHAVE CREAMS AND LOTIONS; TALCUM POWDERS; BATH SALTS, BATH FOAMS AND OILS; AFTER-BATH CREAMS AND LOTIONS; HAIR SHAMPOOS; DEPILATORY PREPARATIONS; NAIL POLISHES; HAIR LOTIONS; AND DENTIFRICES, IN CLASS 3 (U.S. CLS. 1, 4, 6, 50, 51 AND 52).

FOR: PILLOW CASES; BED SHEETS, BED SPREADS, BED BLANKETS, COMFORTERS FOR BEDS; TABLECLOTHS, NOT OF PAPER; CURTAINS; TEXTILE NAPKINS; TOWELS; PLACEMATS OF FABRIC; OVEN GLOVES; DISH-CLOTHS, IN CLASS 24 (U.S. CLS. 42 AND 50).

FOR: CLOTHING, COATS, MANTLES, RAINCOATS, DRESSES, SUITS, SKIRTS, JACKETS, TROUSERS, JEANS, WAISTCOATS, SHIRTS, T-SHIRTS, BLOUSES, JERSEYS, SWEATERS, BLAZERS, CARDIGANS, VESTS, CAMISOLES, STOCKINGS, SOCKS, TIGHTS, UNDERWEAR FOR MAN, WOMAN AND CHILDREN, UNDERPANTS, KNICKERS, BRASSIERE, VESTS, CORSETS, CORSELETTES, TOPS, SLIPS, BOXER SHORTS, UNDERSKIRTS, NIGHTGOWNS, BED JACKETS, PAJAMAS, BATHING SUITS, SUN SUITS, SPORT JACKETS, WIND-RESISTANT JACKETS, ANORAKS, SWEATSUITS, TIES, NECKTIES, SCARVES, SHAWLS, FOULARDS, CAPS, HATS, GLOVES, SASHES, BELTS, FOOTWEAR, BOOTS, SHOES AND SLIPPERS, IN CLASS 25 (U.S. CLS. 22 AND 39).

NO CLAIM IS MADE TO THE EXCLUSIVE RIGHT TO USE "1860", APART FROM THE MARK AS SHOWN.

OWNER OF INTERNATIONAL REGISTRATION 1090831 DATED 7-25-2011, EXPIRES 7-25-2021.



*David J. Kyjars*

Director of the United States Patent and Trademark Office

**Reg. No. 4,133,799** THE MARK CONSISTS OF THE INTERLOCKING STYLIZED LETTERS "FF" ABOVE THE YEAR "1860" IN STYLIZED FORM IN AN OVAL DESIGN CARRIER WITH A SPRIG OF LEAVES AT THE TOP.

SER. NO. 79-102,605, FILED 7-25-2011.

PATRICIA EVANKO, EXAMINING ATTORNEY

# United States of America

United States Patent and Trademark Office

## The Neighbourhood Dogs

**Reg. No. 4,133,800**

**Registered May 1, 2012**

**Int. Cls.: 9, 16 and 41**

**TRADEMARK**

**SERVICE MARK**

**PRINCIPAL REGISTER**

ANDREA ROHANNA MENDICK (AUSTRALIA INDIVIDUAL)  
173 HASTINGS PARADE  
NORTH BONDI NSW 2026  
AUSTRALIA

FOR: CDS, LP RECORDS, MAGNETIC TAPES, FEATURING ORIGINAL POETRY, LYRICS AND MUSIC; DOWNLOADABLE DIGITAL MUSIC FROM THE INTERNET; DOWNLOADABLE AUDIO VISUAL MATERIAL FROM THE INTERNET FEATURING ORIGINAL POETRY LYRICS AND MUSIC; DOWNLOADABLE PUBLICATIONS IN THE NATURE OF BOOKS AND SONGSHEETS FEATURING ORIGINAL POETRY AND SONG LYRICS, AND POP, COUNTRY, AND FOLK MUSIC, IN CLASS 9 (U.S. CLS. 21, 23, 26, 36 AND 38).

FOR: SONG AND POETRY BOOKS, IN CLASS 16 (U.S. CLS. 2, 5, 22, 23, 29, 37, 38 AND 50).

FOR: MUSIC WRITING, RECORDING AND PERFORMANCE SERVICES, NAMELY, PRODUCTION OF SOUND RECORDINGS OF POETRY AND ORIGINAL LYRICS, LIVE PERFORMANCES BY A MUSICAL BAND, PROVIDING NON-DOWNLOADABLE PLAYBACK OF DIGITAL MUSIC AND POETRY VIA GLOBAL COMMUNICATIONS NETWORKS, IN CLASS 41 (U.S. CLS. 100, 101 AND 107).

THE MARK CONSISTS OF STANDARD CHARACTERS WITHOUT CLAIM TO ANY PARTICULAR FONT, STYLE, SIZE, OR COLOR.

PRIORITY DATE OF 2-1-2011 IS CLAIMED.

OWNER OF INTERNATIONAL REGISTRATION 1090863 DATED 5-11-2011, EXPIRES 5-11-2021.

SER. NO. 79-102,617, FILED 5-11-2011.

SANI KHOURI, EXAMINING ATTORNEY



*David J. Kyros*

Director of the United States Patent and Trademark Office

# United States of America

United States Patent and Trademark Office



**Reg. No. 4,133,801**

**Registered May 1, 2012**

**Int. Cl.: 9**

**TRADEMARK**

**PRINCIPAL REGISTER**

VIVANCO GRUPPE AG (FED REP GERMANY AKTIENGESELLSCHAFT)  
EWIGE WEIDE 15  
22926 AHRENSBURG  
FED REP GERMANY

FOR: ELECTRIC CABLES, FIBRE OPTIC CABLES; AUDIO, VIDEO AND DATA CABLES, ELECTRIC AND OPTICAL CABLES EQUIPPED WITH PLUGS AND/OR BUSHINGS; PLUGS, JACKS, CABLE RETAINERS, CABLE ADAPTORS, WALL OUTLETS, POWER STRIP, SIGNALING AND CURRENT DISTRIBUTORS, SIGNAL SWITCHES, IN CLASS 9 (U.S. CLS. 21, 23, 26, 36 AND 38).

THE MARK CONSISTS OF THE STYLIZED WORDING "SOUND" IN BLACK, & IN GREY WITH A BLACK AND GREY BAR AND "IMAGE" IN BLACK ON A WHITE BACKGROUND.

PRIORITY DATE OF 2-16-2011 IS CLAIMED.

OWNER OF INTERNATIONAL REGISTRATION 1092082 DATED 8-4-2011, EXPIRES 8-4-2021.

THE COLOR(S) BLACK, GREY AND WHITE IS/ARE CLAIMED AS A FEATURE OF THE MARK.

SER. NO. 79-103,063, FILED 8-4-2011.

KEVON CHISOLM, EXAMINING ATTORNEY



*David J. Kyffers*

Director of the United States Patent and Trademark Office

# United States of America

United States Patent and Trademark Office

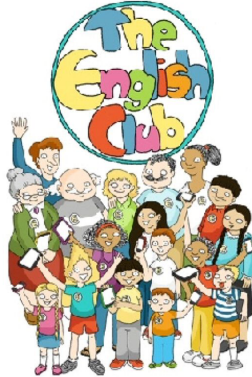

**Reg. No. 4,133,802**

**Registered May 1, 2012**

**Int. Cls.: 9, 16 and 41**

**TRADEMARK**

**SERVICE MARK**

**PRINCIPAL REGISTER**

FERN LEVITT (ISRAEL INDIVIDUAL)  
57/4 HECHALUTZ  
96269 JERUSALEM  
ISRAEL

FOR: COMPUTER SOFTWARE, NAMELY, AN INTERACTIVE APPLICATION FOR MOBILE PHONES, TABLETS, HANDHELD OR DESKTOP COMPUTERS AND OTHER DIGITAL DEVICES FOR LEARNING IN AN ENTERTAINING WAY HOW TO READ AND WRITE IN THE ENGLISH LANGUAGE, IN CLASS 9 (U.S. CLS. 21, 23, 26, 36 AND 38).

FOR: BOOKS, PAMPHLETS, STUDY GUIDES AND OTHER PRINTED INSTRUCTIONAL MATERIAL FOR LEARNING TO READ AND WRITE IN THE ENGLISH LANGUAGE, IN CLASS 16 (U.S. CLS. 2, 5, 22, 23, 29, 37, 38 AND 50).

FOR: INSTRUCTIONAL AND EDUCATIONAL SERVICES, NAMELY, CONDUCTING CLASSES, SEMINARS, CONFERENCES AND WORKSHOPS IN THE FIELD OF TEACHING HOW TO READ AND WRITE IN THE ENGLISH LANGUAGE BY MEANS OF AN INTERACTIVE APPLICATION FOR MOBILE PHONES, TABLETS, HANDHELD OR DESKTOP COMPUTERS AND OTHER DIGITAL DEVICES, IN CLASS 41 (U.S. CLS. 100, 101 AND 107).

NO CLAIM IS MADE TO THE EXCLUSIVE RIGHT TO USE "THE ENGLISH CLUB", APART FROM THE MARK AS SHOWN.

OWNER OF INTERNATIONAL REGISTRATION 1092947 DATED 7-31-2011, EXPIRES 7-31-2021.

THE COLOR(S) BLUE, BLACK, YELLOW, GREEN, WHITE, GRAY, PEACH, PINK, TURQUOISE, ORANGE, PURPLE AND RED IS/ARE CLAIMED AS A FEATURE OF THE MARK.

THE MARK CONSISTS OF THE FOLLOWING: A WHITE CIRCLE OUTLINED IN BLUE AND BLACK WITH THE WORDING "THE ENGLISH CLUB" ABOVE A GROUP OF SEVENTEEN PEOPLE WITH TEN OF THE PEOPLE HOLDING ELECTRONIC DEVICES. THE LETTER "T" IN "THE", THE LETTERS "L" AND "H" IN "ENGLISH" AND THE LETTER "L" IN "CLUB" APPEAR IN BLUE. THE LETTERS "H" IN "THE", "E" IN "ENGLISH" AND "B" IN "CLUB" APPEAR IN YELLOW. THE LETTERS "E" IN "THE" AND "G" IN "ENGLISH" APPEAR IN GREEN. THE LETTERS "N" IN "ENGLISH" AND "U" IN "CLUB" APPEAR IN PINK. THE LETTERS "I" IN "ENGLISH" AND "C" IN "CLUB" APPEAR IN RED. THE COLORS



*David J. Kyjars*

Director of the United States Patent and Trademark Office

**Reg. No. 4,133,802** BLUE, BLACK, YELLOW, GREEN, WHITE, GRAY, PEACH, PINK, TURQUOISE, ORANGE, PURPLE AND RED APPEAR IN THE CLOTHING, SHOES, HAIR, SKIN AND EYES OF THE PEOPLE. THE COLORS WHITE, PURPLE, BLACK AND GREEN APPEAR IN THE ELECTRONIC DEVICES.

SER. NO. 79-103,389, FILED 7-31-2011.

MEGHAN REINHART, EXAMINING ATTORNEY

# United States of America

United States Patent and Trademark Office

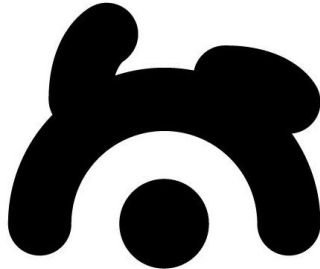

## MÆLSON

**Reg. No. 4,133,803**

**Registered May 1, 2012**

**Int. Cls.: 18, 20 and 21**

**TRADEMARK**

**PRINCIPAL REGISTER**

MARK GALLAGHER (UNITED KINGDOM INDIVIDUAL)  
DONAUSCHWABENSTR. 28  
73230 KIRCHHEIM  
FED REP GERMANY

FOR: COVERS FOR ANIMALS; COLLARS FOR ANIMALS; LEASHES FOR ANIMALS; MUZZLES; HARNESS FOR ANIMALS; TRAVELLING BAGS IN THE NATURE OF A CARRIER FOR HOUSEHOLD PETS, IN CLASS 18 (U.S. CLS. 1, 2, 3, 22 AND 41).

FOR: KENNELS FOR ANIMALS; BEDS FOR HOUSEHOLD PETS; CUSHIONS FOR HOUSEHOLD PETS; COUCHES FOR PETS; NESTING BOXES FOR HOUSEHOLD PETS; SCRATCHING POSTS FOR CATS; DOG RUGS, IN CLASS 20 (U.S. CLS. 2, 13, 22, 25, 32 AND 50).

FOR: TANKARDS; LITTER BOXES FOR HOUSEHOLD PETS; CAGES FOR HOUSEHOLD PETS, IN CLASS 21 (U.S. CLS. 2, 13, 23, 29, 30, 33, 40 AND 50).

THE MARK CONSISTS OF THE STYLIZED WORD "MAELSON" UNDER THE DESIGN OF A CURVED LINE/ARC WITH A CIRCLE UNDER THE ARC; THE ARC HAS STYLIZED EARS ON TOP.

OWNER OF INTERNATIONAL REGISTRATION 1015756 DATED 6-8-2009, EXPIRES 6-8-2019.

SER. NO. 79-103,479, FILED 5-24-2011.

CHRISIE B. KING, EXAMINING ATTORNEY



*David J. Kybas*

Director of the United States Patent and Trademark Office



# United States of America

United States Patent and Trademark Office

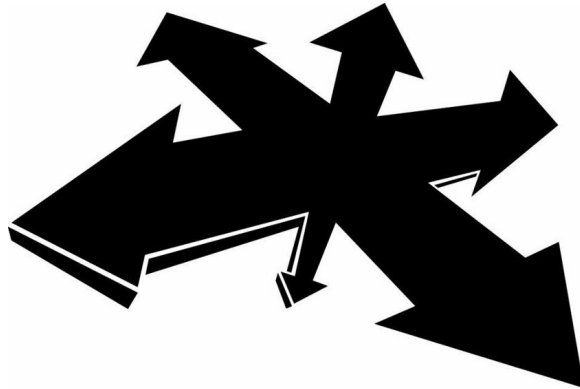

**Reg. No. 4,133,804**

**Registered May 1, 2012**

**Int. Cls.: 7, 9 and 12**

**TRADEMARK**

**PRINCIPAL REGISTER**

AMPCO FLASHLIGHT HOLDING B.V. (NETHERLANDS LIMITED LIABILITY COMPANY)  
PROOSTWETERING 50  
NL-3543 AH UTRECHT  
NETHERLANDS

FOR: MACHINES AND MACHINE TOOLS FOR USE IN LIFTING AND ELEVATING;  
CRANES, IN CLASS 7 (U.S. CLS. 13, 19, 21, 23, 31, 34 AND 35).

FOR: ELECTRICAL CONTROLLING DEVICES FOR CONTROLLING MACHINES AND  
MACHINE TOOLS FOR USE IN CRANES AND LIFTING AND ELEVATING APPARATUS;  
ELECTRICAL CONTROLLING DEVICES FOR CRANES, IN CLASS 9 (U.S. CLS. 21, 23, 26,  
36 AND 38).

FOR: VEHICLES; TROLLEYS, IN CLASS 12 (U.S. CLS. 19, 21, 23, 31, 35 AND 44).

THE MARK CONSISTS OF INTERSECTING ARROWS POINTING IN SIX DIRECTIONS.

PRIORITY DATE OF 2-24-2011 IS CLAIMED.

OWNER OF INTERNATIONAL REGISTRATION 1093284 DATED 8-10-2011, EXPIRES 8-10-  
2021.

SER. NO. 79-103,560, FILED 8-10-2011.

JOHN HWANG, EXAMINING ATTORNEY



*David J. Kybas*

Director of the United States Patent and Trademark Office

# United States of America

United States Patent and Trademark Office

## SERVO-DRIVE UNO

**Reg. No. 4,133,805**

**Registered May 1, 2012**

**Int. Cls.: 6, 9 and 20**

**TRADEMARK**

**PRINCIPAL REGISTER**

JULIUS BLUM GMBH (AUSTRIA GESELLSCHAFT MIT BESCHRÄNKTER HAFTUNG)  
INDUSTRIESTR. 1  
A-6973 HÖCHST, AUSTRIA

FOR: FITTINGS FOR FURNITURE, WHOLLY OR MAINLY OF METAL; HINGES, IN PARTICULAR HINGES FOR FURNITURE, WHOLLY OR MAINLY OF METAL; SLIDES FOR DRAWERS AND CONNECTION PEGS, WHOLLY OR MAINLY OF METAL; TOUCH-LATCH FITTINGS WHOLLY OR MAINLY MADE OF METAL FOR FURNITURE; ADJUSTABLE ARMS WHOLLY OR MAINLY MADE OF METAL FOR FURNITURE; FITTINGS AND ADJUSTABLE ARM DRIVES FOR FURNITURE FLAPS AND CABINET DOORS WHOLLY OR MAINLY MADE OF METAL; FITTINGS FOR FASTENING FRONT SCREENS TO DRAWERS WHOLLY OR MAINLY MADE OF METAL, IN CLASS 6 (U.S. CLS. 2, 12, 13, 14, 23, 25 AND 50).

FOR: ELECTRONIC DRIVES FOR FURNITURE PARTS, IN PARTICULAR DRAWERS, DOORS AND FLAPS; ELECTRONIC CONTROLS FOR DRIVES FOR FURNITURE PARTS; ELECTRIC CABLES AND CABLE CONNECTORS FOR DRIVES FOR FURNITURE PARTS, IN CLASS 9 (U.S. CLS. 21, 23, 26, 36 AND 38).

FOR: FURNITURE COMPONENT PARTS, IN PARTICULAR DRAWERS AND DRAWER COMPONENTS, NOT OF METAL, NAMELY, DRAWER PULLS OF PLASTIC OR WOOD, DRAWER SIDE WALLS, DRAWER REAR WALLS, DRAWER FRONT WALLS, DRAWER BOTTOMS, GALLERY RAILS, CONNECTORS FOR CONNECTING DRAWER WALLS; FURNITURE FITTINGS NOT OF METAL; DRAWER SLIDES NOT OF METAL; HINGES AND CONNECTOR PEGS, WHOLLY OR MAINLY OF PLASTIC; FURNITURE, IN PARTICULAR KITCHEN FURNITURE; CABINETS, IN PARTICULAR CORNER CABINETS FOR KITCHENS; FURNITURE DOORS AND FURNITURE FLAPS; SIDE WALLS AND REAR WALLS FOR FURNITURE; DRAWER SIDE WALLS, PARTITIONS AND INSERTS FOR DRAWERS; TOUCH-LATCH FITTINGS, WHOLLY OR MAINLY OF PLASTIC, IN CLASS 20 (U.S. CLS. 2, 13, 22, 25, 32 AND 50).

THE MARK CONSISTS OF STANDARD CHARACTERS WITHOUT CLAIM TO ANY PARTICULAR FONT, STYLE, SIZE, OR COLOR.

PRIORITY DATE OF 3-3-2011 IS CLAIMED.



*David J. Kyppas*

Director of the United States Patent and Trademark Office

**Reg. No. 4,133,805** OWNER OF INTERNATIONAL REGISTRATION 1093297 DATED 9-1-2011, EXPIRES 9-1-2021.

OWNER OF U.S. REG. NO. 3,544,035.

NO CLAIM IS MADE TO THE EXCLUSIVE RIGHT TO USE "SERVO-DRIVE", APART FROM THE MARK AS SHOWN.

SER. NO. 79-103,562, FILED 9-1-2011.

JANICE L. MCMORROW, EXAMINING ATTORNEY

# United States of America

United States Patent and Trademark Office

# LATVISION

**Reg. No. 4,133,806**

**Registered May 1, 2012**

**Int. Cl.: 9**

LATECOERE (FRANCE SOCIÉTÉ ANONYME À DIRECTOIRE ET À CONSEIL DE  
SURVEILLANCE)  
135 RUE DE PÉRIOLE  
F-31500 TOULOUSE  
FRANCE

**TRADEMARK**

FOR: CAMERAS AND PANORAMIC CAMERAS FOR MILITARY, AERONAUTICAL AND  
SPACE USE, IN CLASS 9 (U.S. CLS. 21, 23, 26, 36 AND 38).

**PRINCIPAL REGISTER**

THE MARK CONSISTS OF STANDARD CHARACTERS WITHOUT CLAIM TO ANY PAR-  
TICULAR FONT, STYLE, SIZE, OR COLOR.

PRIORITY DATE OF 3-18-2011 IS CLAIMED.

OWNER OF INTERNATIONAL REGISTRATION 1093923 DATED 9-16-2011, EXPIRES 9-16-  
2021.

SER. NO. 79-103,818, FILED 9-16-2011.

ERIN FALK, EXAMINING ATTORNEY



*David J. Kyffers*

Director of the United States Patent and Trademark Office

# United States of America

United States Patent and Trademark Office

# MECHFIT

**Reg. No. 4,133,807**

**Registered May 1, 2012**

**Int. Cl.: 17**

**TRADEMARK**

**PRINCIPAL REGISTER**

HIGASHIO MECH CO., LTD. (JAPAN CORPORATION)  
8-22, KIKUSUI-CHO  
KAWACHINAGANO-SHI; OSAKA 586-0012  
JAPAN

FOR: PIPE JOINTS NOT OF METAL, IN CLASS 17 (U.S. CLS. 1, 5, 12, 13, 35 AND 50).

PRIORITY DATE OF 8-19-2011 IS CLAIMED.

OWNER OF INTERNATIONAL REGISTRATION 1094431 DATED 9-15-2011, EXPIRES 9-15-2021.

SER. NO. 79-103,997, FILED 9-15-2011.

NAPOLEON SHARMA, EXAMINING ATTORNEY



*David J. Kyffers*

Director of the United States Patent and Trademark Office

# United States of America

United States Patent and Trademark Office

송가네

**Reg. No. 4,133,808**

**Registered May 1, 2012**

**Int. Cl.: 30**

**TRADEMARK**

**PRINCIPAL REGISTER**

GOSEI CORPORATION CO., LTD. (JAPAN CORPORATION)  
58-9, TAKINOGAWA 3-CHOME  
KITA-KU; TOKYO 114-0023  
JAPAN

FOR: TEA; COFFEE; COCOA; SAUCES; NOODLES; POUNDED RICE CAKES (MOCHI);  
RICE; HUSKED OATS; HUSKED BARLEY; FLOUR FOR FOOD, IN CLASS 30 (U.S. CL. 46).

THE ENGLISH TRANSLATION OF THE FOREIGN WORD(S) IN THE MARK IS: "SONG  
FAMILY'S".

OWNER OF INTERNATIONAL REGISTRATION 1094434 DATED 9-14-2011, EXPIRES 9-14-  
2021.

THE TRANSLITERATION OF THE NON-LATIN CHARACTERS IN THE MARK IS: SONGANE.

SER. NO. 79-103,999, FILED 9-14-2011.

PRISCILLA MILTON, EXAMINING ATTORNEY



*David J. Kyffers*

Director of the United States Patent and Trademark Office

# United States of America

United States Patent and Trademark Office



**Reg. No. 4,133,809**

**Registered May 1, 2012**

**Int. Cl.: 21**

**TRADEMARK**

**PRINCIPAL REGISTER**

BORMIOLI LUIGI S.P.A. (ITALY JOINT STOCK COMPANY)  
VIALE EUROPA, 72/A  
I-43100 PARMA (PR)  
ITALY

FOR: SMALL DOMESTIC UTENSILS AND CONTAINERS, NAMELY, ICE BUCKETS, CHAMPAGNE BUCKETS, WINE BUCKETS, COOLING BUCKETS FOR WINE, SALT AND PEPPER SHAKERS, MUSTARD CRUETS NOT OF PRECIOUS METAL, SALT CELLARS, PEPPER GRINDERS, SAUCEBOATS, PLASTIC EGG HOLDERS FOR DOMESTIC USE, BUTTER COOLERS, BUTTER DISHES, CANDLE HOLDERS NOT OF PRECIOUS METAL, CASSEROLE DISHES, CAVIAR COOLERS, APPLE GRATERS FOR HOUSEHOLD PURPOSES, SERVING TRAYS NOT OF PRECIOUS METAL, ICE PAILS, CRUETS, FLOWER VASES, GLASS DECORATIVE BOXES, CANISTER SETS, GLASS BOTTLES FOR PERFUME SOLD EMPTY, GLASS CONTAINERS FOR COSMETICS SOLD EMPTY; SCULPTURES, STATUES, AND FIGURINES MADE OF CHINA, CRYSTAL, EARTHENWARE, GLASS, PORCELAIN AND TERRA COTTA; DINNER WARE OF GLASS, PORCELAIN AND EARTHENWARE, NAMELY, PLATES, DISHES, DISH COVERS, DISH STANDS, CUPS, SAUCERS, TEA AND COFFEE POTS, GLASSES, NAMELY, DRINKING GLASSES, BEER MUGS, PORTABLE BEVERAGE DISPENSERS, BEVERAGE GLASSWARE, BEVERAGE WARE, BOWLS, RINSING BOWLS, SALAD BOWLS, DRINKING GLASSES, NAMELY, TUMBLERS, PITCHERS, BOTTLES SOLD EMPTY, CARAFES, DRINKING FLASKS, DECANTERS, GLASS JARS, JUGS, POTS, IN CLASS 21 (U.S. CLS. 2, 13, 23, 29, 30, 33, 40 AND 50).

NO CLAIM IS MADE TO THE EXCLUSIVE RIGHT TO USE "ULTRA CLEAR & DURABLE GLASS" AND "ECO-FRIENDLY", APART FROM THE MARK AS SHOWN.

PRIORITY DATE OF 3-1-2011 IS CLAIMED.

OWNER OF INTERNATIONAL REGISTRATION 1094947 DATED 5-16-2011, EXPIRES 5-16-2021.

THE MARK CONSISTS OF A SQUARE DESIGN WITH THE FOLLOWING LITERAL ELEMENTS: THE WORDING "ULTRA CLEAR & DURABLE GLASS" APPEARS AT THE TOP OF THE MARK; IN THE CENTER IS THE LARGER, ALL LOWERCASE WORDING "SPARKX", AND IMMEDIATELY BELOW IS THE WORDING "ECO-FRIENDLY", POSITIONED TO THE RIGHT OF A TREE-IN-A-CIRCLE DESIGN. THE BORDERS OF THE SQUARE ARE SHOWN WITH A THICK OUTLINE.



*David J. Kyros*

Director of the United States Patent and Trademark Office

**Reg. No. 4,133,809** SER. NO. 79-104,224, FILED 5-16-2011.

JORDAN BAKER, EXAMINING ATTORNEY



# United States of America

United States Patent and Trademark Office

# A & M

**Reg. No. 4,133,810**

**Registered May 1, 2012**

**Int. Cl.: 10**

**TRADEMARK**

**PRINCIPAL REGISTER**

SIEMENS MEDICAL INSTRUMENTS PTE LTD. (SINGAPORE PRIVATE LIMITED COMPANY)  
BLOCK 28, AYER RAJAH CRESCENT  
#06-08; SINGAPORE 139959  
SINGAPORE

FOR: MEDICAL HEARING AIDS AND PARTS THEREOF, IN CLASS 10 (U.S. CLS. 26, 39 AND 44).

THE MARK CONSISTS OF STANDARD CHARACTERS WITHOUT CLAIM TO ANY PARTICULAR FONT, STYLE, SIZE, OR COLOR.

PRIORITY DATE OF 3-15-2011 IS CLAIMED.

OWNER OF INTERNATIONAL REGISTRATION 1095043 DATED 9-14-2011, EXPIRES 9-14-2021.

SER. NO. 79-104,258, FILED 9-14-2011.

PRISCILLA MILTON, EXAMINING ATTORNEY



*David J. Kyffers*

Director of the United States Patent and Trademark Office

# United States of America

United States Patent and Trademark Office

# NEXIMID

**Reg. No. 4,133,811**

**Registered May 1, 2012**

**Int. Cl.: 1**

**TRADEMARK**

**PRINCIPAL REGISTER**

NEXAM CHEMICAL AB (SWEDEN PRIVATE LIMITED LIABILITY COMPANY)  
BMC D10  
KLINIKGATAN 32; SE-221 84 LUND  
SWEDEN

FOR: CHEMICALS USED IN INDUSTRY AND SCIENCE; UNPROCESSED ARTIFICIAL RESINS; UNPROCESSED PLASTICS; TEMPERING PREPARATIONS; ADHESIVES USED IN INDUSTRY , IN CLASS 1 (U.S. CLS. 1, 5, 6, 10, 26 AND 46).

THE MARK CONSISTS OF STANDARD CHARACTERS WITHOUT CLAIM TO ANY PARTICULAR FONT, STYLE, SIZE, OR COLOR.

OWNER OF INTERNATIONAL REGISTRATION 1095496 DATED 9-21-2011, EXPIRES 9-21-2021.

SER. NO. 79-104,443, FILED 9-21-2011.

DORITT L. CARROLL, EXAMINING ATTORNEY



*David J. Kyffers*

Director of the United States Patent and Trademark Office

# United States of America

United States Patent and Trademark Office

# Immomet

**Reg. No. 4,133,812**

**Registered May 1, 2012**

**Int. Cl.: 1**

**TRADEMARK**

**PRINCIPAL REGISTER**

EVONIK DEGUSSA GMBH (FED REP GERMANY LIMITED LIABILITY COMPANY)  
RELLINGHAUSER STRABE 1-11  
45128 ESSEN  
FED REP GERMANY

FOR: CHEMICAL PRODUCTS FOR USE IN INDUSTRY, PARTICULARLY FOR IMMOBILIZING HEAVY METALS IN SOLID MATERIALS, IN CLASS 1 (U.S. CLS. 1, 5, 6, 10, 26 AND 46).

OWNER OF INTERNATIONAL REGISTRATION 0654296 DATED 3-21-1996, EXPIRES 3-21-2016.

SER. NO. 79-104,702, FILED 6-6-2011.

FRANK LATTUCA, EXAMINING ATTORNEY



*David J. Kybas*

Director of the United States Patent and Trademark Office

United States of America  
United States Patent and Trademark Office

LOIRSAFE

**Reg. No. 4,133,813**

**Registered May 1, 2012**

**Int. Cl.: 7**

**TRADEMARK**

**PRINCIPAL REGISTER**

LOIRE SOCIEDAD ANONIMA; FRANCO ESPAÑOLA (SPAIN SOCIEDAD ANONIMA)  
ZIKUÑAGA, 22,  
E-20120 HERNANI (GUIPÚZCOA)  
SPAIN

FOR: MACHINES AND MACHINE-TOOLS, NAMELY, INDUSTRIAL MACHINE PRESSES,  
HYDRAULIC PRESSES, STAMPING PRESSES AND PUNCHING PRESSES, IN CLASS 7  
(U.S. CLS. 13, 19, 21, 23, 31, 34 AND 35).

THE MARK CONSISTS OF STANDARD CHARACTERS WITHOUT CLAIM TO ANY PAR-  
TICULAR FONT, STYLE, SIZE, OR COLOR.

OWNER OF INTERNATIONAL REGISTRATION 0674545 DATED 5-20-1997, EXPIRES 5-20-  
2017.

SER. NO. 79-104,704, FILED 7-26-2011.

FRANK LATTUCA, EXAMINING ATTORNEY



*David J. Kyffers*

Director of the United States Patent and Trademark Office

# United States of America

United States Patent and Trademark Office

## LUNAS DE PONCE

**Reg. No. 4,133,814**

**Registered May 1, 2012**

**Int. Cl.: 33**

**TRADEMARK**

**PRINCIPAL REGISTER**

SANTIAGO BAEZA BENAVIDES (SPAIN INDIVIDUAL)  
C/ MAYOR, 25 DE SANTERVAS DE CAMPOS  
E-47609 VALLADOLID  
SPAIN

FOR: WINE, IN CLASS 33 (U.S. CLS. 47 AND 49).

THE MARK CONSISTS OF STANDARD CHARACTERS WITHOUT CLAIM TO ANY PARTICULAR FONT, STYLE, SIZE, OR COLOR.

OWNER OF INTERNATIONAL REGISTRATION 1096142 DATED 7-13-2011, EXPIRES 7-13-2021.

THE ENGLISH TRANSLATION OF "LUNAS DE PONCE" IN THE MARK IS "POUNCE MOONS".

SER. NO. 79-104,778, FILED 7-13-2011.

TINA BROWN, EXAMINING ATTORNEY



*David J. Kybas*

Director of the United States Patent and Trademark Office

# United States of America

United States Patent and Trademark Office

# RICHEVILLE

**Reg. No. 4,133,815**

**Registered May 1, 2012**

**Int. Cl.: 14**

**TRADEMARK**

**PRINCIPAL REGISTER**

SOWIND S.A. (SWITZERLAND SOCIÉTÉ ANONYME)  
1, PLACE GIRARDET  
CH-2301 LA CHAUX-DE-FONDS  
SWITZERLAND

FOR: TIMEPIECES AND CHRONOMETRIC INSTRUMENTS, NAMELY WATCHES, WRISTWATCHES, CHRONOMETERS, CLOCKS, TABLE CLOCKS, MOVEMENTS FOR CLOCKS AND WATCHES; JEWELRY, IN CLASS 14 (U.S. CLS. 2, 27, 28 AND 50).

THE MARK CONSISTS OF STANDARD CHARACTERS WITHOUT CLAIM TO ANY PARTICULAR FONT, STYLE, SIZE, OR COLOR.

OWNER OF INTERNATIONAL REGISTRATION 1098429 DATED 9-19-2011, EXPIRES 9-19-2021.

SER. NO. 79-105,771, FILED 9-19-2011.

TINA MAI, EXAMINING ATTORNEY



*David J. Kybas*

Director of the United States Patent and Trademark Office

# United States of America

United States Patent and Trademark Office

## GLAMOUR RECHARGE

**Reg. No. 4,133,816**

**Registered May 1, 2012**

**Int. Cl.: 3**

**TRADEMARK**

**PRINCIPAL REGISTER**

WELLA GMBH (FED REP GERMANY GMBH)  
SULZBACHER STRAÙE 40  
65824 SCHWALBACH AM TAUNUS  
FED REP GERMANY

FOR: HAIR CARE PREPARATIONS, HAIR STYLING PREPARATIONS, IN CLASS 3 (U.S. CLS. 1, 4, 6, 50, 51 AND 52).

THE MARK CONSISTS OF STANDARD CHARACTERS WITHOUT CLAIM TO ANY PARTICULAR FONT, STYLE, SIZE, OR COLOR.

PRIORITY DATE OF 4-20-2011 IS CLAIMED.

OWNER OF INTERNATIONAL REGISTRATION 1099785 DATED 9-21-2011, EXPIRES 9-21-2021.

SER. NO. 79-106,431, FILED 9-21-2011.

KAREN K. BUSH, EXAMINING ATTORNEY



*David J. Kyffers*

Director of the United States Patent and Trademark Office

# United States of America

United States Patent and Trademark Office



**Reg. No. 4,133,817**

**Registered May 1, 2012**

**Int. Cl.: 14**

**TRADEMARK**

**PRINCIPAL REGISTER**

PROGOLD S.P.A. (ITALY JOINT STOCK COMPANY)  
VIA POSTALE VECCHIA, 26/A  
I-36070 TRISSINO (VI)  
ITALY

FOR: PRECIOUS METALS AND THEIR ALLOYS AND GOODS IN PRECIOUS METALS OR COATED THEREWITH, NOT INCLUDED IN OTHER CLASSES; JEWELLERY, PRECIOUS STONES; HOROLOGICAL AND CHRONOMETRIC INSTRUMENTS, IN CLASS 14 (U.S. CLS. 2, 27, 28 AND 50).

THE MARK CONSISTS OF THE WORD PROGOLD IN FANCY CHARACTERS.

PRIORITY DATE OF 4-19-2011 IS CLAIMED.

OWNER OF INTERNATIONAL REGISTRATION 1099986 DATED 9-21-2011, EXPIRES 9-21-2021.

SER. NO. 79-106,492, FILED 9-21-2011.

KIMBERLY PERRY, EXAMINING ATTORNEY



*David J. Kybas*

Director of the United States Patent and Trademark Office



# United States of America

United States Patent and Trademark Office

# VOSKIN

**Reg. No. 4,133,818**

**Registered May 1, 2012**

**Int. Cl.: 10**

**TRADEMARK**

**PRINCIPAL REGISTER**

CHANG, TAE SOUN (REPUBLIC OF KOREA INDIVIDUAL)  
102-805 HANYANG APT., 82 HONGJE-DONG  
SEODAEMUN-GU; SEOUL 120-090  
REPUBLIC OF KOREA

FOR: ELECTRIC MASSAGE APPARATUS FOR HOUSEHOLD USE, IN CLASS 10 (U.S. CLS. 26, 39 AND 44).

OWNER OF INTERNATIONAL REGISTRATION 1101706 DATED 8-23-2011, EXPIRES 8-23-2021.

SER. NO. 79-107,216, FILED 8-23-2011.

ARETHA SOMERVILLE, EXAMINING ATTORNEY



*David J. Kyros*

Director of the United States Patent and Trademark Office

# United States of America

United States Patent and Trademark Office

# ACHILLES

**Reg. No. 4,133,819**

**Registered May 1, 2012**

**Int. Cl.: 28**

**TRADEMARK**

**PRINCIPAL REGISTER**

HOGAN HOCKEY INC. (CANADA CORPORATION)  
1110 NELSON STREET  
FORT FRANCES, ONTARIO, CANADA P9A1C2

FOR: PROTECTIVE SPORTING EQUIPMENT, NAMELY, CUT-RESISTANT HOCKEY SKATE GUARDS, CUT-RESISTANT HOCKEY GOALIE UNDERWEAR, CUT-RESISTANT HOCKEY WRIST GUARDS AND CUT-RESISTANT HOCKEY NECK GUARDS, IN CLASS 28 (U.S. CLS. 22, 23, 38 AND 50).

THE MARK CONSISTS OF STANDARD CHARACTERS WITHOUT CLAIM TO ANY PARTICULAR FONT, STYLE, SIZE, OR COLOR.

OWNER OF CANADA REG. NO. TMA813909, DATED 12-13-2011, EXPIRES 12-13-2026.

SER. NO. 85-006,138, FILED 4-5-2010.

ALLISON SCHRODY, EXAMINING ATTORNEY



*David J. Kyros*

Director of the United States Patent and Trademark Office

# United States of America

United States Patent and Trademark Office

명의초 明禕草

HERBLINIC SERUM

**Reg. No. 4,133,820**

**Registered May 1, 2012**

**Int. Cl.: 3**

**TRADEMARK**

**PRINCIPAL REGISTER**

AMOREPACIFIC CORPORATION (REPUBLIC OF KOREA CORPORATION)  
181, 2-KA, HANGANG-RO  
YONGSAN-KU, SEOUL, REPUBLIC OF KOREA

FOR: HAIR SHAMPOOS; CLEANING PREPARATIONS; POLISHING WAX; ABRASIVE PREPARATIONS; DENTIFRICES; POTPOURRI; COSMETICS FOR ANIMALS; COSMETIC PREPARATIONS FOR SKIN CARE; SKIN CARE PRODUCTS, NAMELY, NON-MEDICATED SKIN SERUM; MOISTURIZING ESSENCE, NAMELY, LOTIONS IN THE FORM OF MILKS, IN CLASS 3 (U.S. CLS. 1, 4, 6, 50, 51 AND 52).

OWNER OF SINGAPORE REG. NO. T1004102B, DATED 4-6-2010, EXPIRES 4-6-2020.

THE FIRST THREE NON-LATIN KOREAN CHARACTERS TRANSLITERATE TO "MYUNG-EUI-CHO" AND THE REAR THREE NON-LATIN CHINESE CHARACTERS ARE ALSO TRANSLITERATED INTO "MYUNG EUI CHO", AND THIS MEANS "BRIGHT, BEAUTIFUL" AND "GRASS" IN ENGLISH.

OWNER OF U.S. REG. NOS. 3,317,102 AND 4,082,056.

NO CLAIM IS MADE TO THE EXCLUSIVE RIGHT TO USE "SERUM", APART FROM THE MARK AS SHOWN.

THE MARK CONSISTS OF "HERBLINIC SERUM" STYLIZED WITH A COMBINATION OF KOREAN AND CHINESE CHARACTERS ABOVE THE WORDING.

SER. NO. 85-007,994, FILED 4-7-2010.

BERYL GARDNER, EXAMINING ATTORNEY



*David J. Kyros*

Director of the United States Patent and Trademark Office

# United States of America

United States Patent and Trademark Office



**Reg. No. 4,133,821**

**Registered May 1, 2012**

**Int. Cls.: 41 and 42**

**SERVICE MARK**

**PRINCIPAL REGISTER**

AMERICAN SOCIETY OF SANITARY ENGINEERING (D.C. CORPORATION)  
901 CANTERBURY RD STE A  
WESTLAKE, OH 441451480

FOR: EDUCATIONAL SERVICES, NAMELY, CONDUCTING SEMINARS IN THE FIELD OF THE PLUMBING INDUSTRY AND DISTRIBUTION OF TRAINING MATERIAL IN CONNECTION THEREWITH, IN CLASS 41 (U.S. CLS. 100, 101 AND 107).

FIRST USE 6-1-2010; IN COMMERCE 6-1-2010.

FOR: DEVELOPMENT OF VOLUNTARY STANDARDS IN THE FIELD OF THE PLUMBING INDUSTRY, IN CLASS 42 (U.S. CLS. 100 AND 101).

FIRST USE 6-1-2010; IN COMMERCE 6-1-2010.

OWNER OF U.S. REG. NOS. 2,301,456, 2,323,383, AND 2,351,162.

NO CLAIM IS MADE TO THE EXCLUSIVE RIGHT TO USE "SANITARY ENGINEERING", APART FROM THE MARK AS SHOWN.

THE MARK CONSISTS OF A CIRCLE WHICH ENCOMPASSES A GLOBE WITH THE OUTLINES OF THE CONTINENTS AND MERIDIAN LINES, OVER WHICH IS WRITTEN "ASSE"; ABOVE THE GLOBE IS THE WORD "SANITARY" AND BELOW THE GLOBE IS THE WORD "ENGINEERING"; BELOW THE OUTER CIRCLE IS THE PHRASE "PREVENTION RATHER THAN CURE".

SER. NO. 85-009,266, FILED 4-8-2010.

TINA L. SNAPP, EXAMINING ATTORNEY



*David J. Kybas*

Director of the United States Patent and Trademark Office

# United States of America

United States Patent and Trademark Office

## LET'S DRIVE BUSINESS

**Reg. No. 4,133,822**

**Registered May 1, 2012**

**Int. Cls.: 9, 38 and 39**

**TRADEMARK**

**SERVICE MARK**

**PRINCIPAL REGISTER**

TOMTOM INTERNATIONAL B.V. (NETHERLANDS BESLOTEN VENNOOTSCHAP (B.V.))  
REMBRANDTPLEIN 35  
AMSTERDAM, NETHERLANDS 1017CT

FOR: COMPUTER HARDWARE AND SOFTWARE TO BE USED WITH SATELLITE AND/OR GPS NAVIGATION SYSTEMS FOR NAVIGATION PURPOSES; COMPUTER SOFTWARE TO BE USED WITH ROUTE PLANNERS, ELECTRONIC MAPS, AND DIGITAL DICTIONARIES FOR NAVIGATION AND TRANSLATION PURPOSES; SOFTWARE FOR TRAVEL INFORMATION SYSTEMS FOR THE PROVISION OR RENDERING OF TRAVEL ADVICE AND/OR INFORMATION CONCERNING SERVICE STATIONS, CAR PARKS, RESTAURANTS, CAR DEALERS AND OTHER TRAVEL AND TRANSPORT RELATED INFORMATION; SOFTWARE FOR INFORMATION MANAGEMENT FOR THE TRANSPORT AND TRAFFIC INDUSTRIES; SOFTWARE TO BE USED FOR VIEWING ELECTRONIC MAPS; DOWNLOADABLE ELECTRONIC MAPS; SOFTWARE FOR OPERATING ROUTE PLANNERS; ROUTE PLANNERS IN THE NATURE OF HANDHELD PERSONAL COMPUTERS; SOFTWARE FOR OPERATING ELECTRONIC DIGITAL DICTIONARIES; HANDHELD ELECTRONIC DICTIONARIES; LOCATION, ORIENTATION AND NAVIGATION, AND GLOBAL POSITIONING SYSTEMS (GPS) CONSISTING OF COMPUTERS, COMPUTER SOFTWARE, TRANSMITTERS, GPS AND/OR SATELLITE RECEIVERS, NETWORK INTERFACE DEVICES, CONNECTION CABLES, AND PARTS AND FITTINGS THEREOF; HOLDERS FOR POCKET-SIZED PERSONAL COMPUTERS; SATELLITE AND RADIO TRANSMISSION APPARATUS TECHNOLOGY, NAMELY, PROCESSORS, MOBILE TELEPHONES AND RECEIVERS; TELECOMMUNICATIONS INSTALLATIONS, NETWORKS AND APPARATUS, NAMELY, MOUNTING RACKS FOR TELECOMMUNICATIONS HARDWARE AND TELECOMMUNICATION SWITCHES; COMPUTER TERMINALS, ALL IN PARTICULAR TO BE USED WITH NAVIGATION SYSTEMS, ROUTE PLANNERS AND/OR DIGITAL MAPS; BLANK MAGNETIC AND DISC SHAPED DATA CARRIERS; AUDIO AND VIDEO APPARATUS, NAMELY, AUDIO AND VIDEO RECEIVERS AND PROCESSORS; HANDHELD PERSONAL COMPUTERS; PERSONAL DIGITAL ASSISTANTS, IN CLASS 9 (U.S. CLS. 21, 23, 26, 36 AND 38).



*David J. Kyjars*

Director of the United States Patent and Trademark Office

FOR: SECURED OR UNSECURED TELECOMMUNICATION SERVICES, NAMELY, TRANSMISSION AND TRANSFER OF DIGITAL DATA, LIGHT FILES, SOUND, DATA, INFORMATION AND IMAGE SIGNALS BY MEANS OF COMPUTER, CABLE, RADIO AND SATELLITE TRANSMISSIONS, ALL IN PARTICULAR FOR NAVIGATION SYSTEMS, ROUTE PLANNERS, AND THE USE OF ELECTRONIC MAPS; SECURED OR UNSECURED TELECOMMUNICATION SERVICES, NAMELY, TRANSMISSION OF CODED IMAGE AND

**Reg. No. 4,133,822** SOUND SIGNALS BY MEANS OF COMPUTER, CABLE, RADIO AND SATELLITE TRANSMISSIONS, ALL IN PARTICULAR FOR NAVIGATION SYSTEMS, ROUTE PLANNERS, AND THE USE OF ELECTRONIC MAPS; WIRELESS TRANSMISSION OF DATA, BY MEANS OF VIDEO TEXT, THE INTERNET, GSM AND WAP; WIRELESS TRANSMISSION OF DIGITAL DATA; ELECTRONIC TRANSMISSION OF DATA AND DOCUMENTS VIA COMPUTER TERMINALS; RENTAL OF TELECOMMUNICATION EQUIPMENT; TECHNICAL CONSULTATION IN CONNECTION WITH ALL OF THE ABOVE, IN CLASS 38 (U.S. CLS. 100, 101 AND 104).

FOR: ELECTRONIC STORAGE OF DIGITAL DATA, LIGHT FILES, SOUND, DATA, INFORMATION AND IMAGE SIGNALS, ALL IN PARTICULAR FOR NAVIGATION SYSTEMS, ROUTE PLANNERS AND THE USE OF ELECTRONIC MAPS; PROVIDING NAVIGATION AND INFORMATION SERVICES, NAMELY, INFORMATION REGARDING TRAFFIC AND TRAFFIC CONGESTION; PROVISION OF INFORMATION REGARDING TRAVEL; PROVISION OF INFORMATION TO TRAVELLERS REGARDING FARES, TIME TABLES AND MEANS OF PUBLIC TRANSPORT; SERVICES OF A TRAVEL AGENCY, NAMELY, THE BOOKING OF RENTAL SERVICES OF CARS, BOATS AND OTHER VEHICLES; ALL OF THE AFORESAID SERVICES ALSO PROVIDED VIA A COMMUNICATIONS NETWORK OR A MOBILE TELEPHONE OR A WIRELESS NAVIGATION DEVICE, IN CLASS 39 (U.S. CLS. 100 AND 105).

THE MARK CONSISTS OF STANDARD CHARACTERS WITHOUT CLAIM TO ANY PARTICULAR FONT, STYLE, SIZE, OR COLOR.

OWNER OF ERPN CMNTY TM OFC REG. NO. 009627902, DATED 2-24-2011, EXPIRES 12-27-2020.

SER. NO. 85-014,900, FILED 4-15-2010.

ERNEST SHOSHO, EXAMINING ATTORNEY

# United States of America

United States Patent and Trademark Office

## DENT HARDWARE

**Reg. No. 4,133,823**

**Registered May 1, 2012**

**Int. Cl.: 6**

**TRADEMARK**

**PRINCIPAL REGISTER**

DENT DESIGN HARDWARE, LTD. (PENNSYLVANIA CORPORATION)  
6343 WINSIDE DRIVE  
BETHLEHEM, PA 18017

FOR: METAL CLASPS FOR DOOR SECURITY HARDWARE; METAL DOOR LATCHES;  
METAL HINGES; METAL LATCHES, IN CLASS 6 (U.S. CLS. 2, 12, 13, 14, 23, 25 AND 50).

FIRST USE 12-31-1894; IN COMMERCE 12-31-1894.

THE MARK CONSISTS OF STANDARD CHARACTERS WITHOUT CLAIM TO ANY PARTICULAR FONT, STYLE, SIZE, OR COLOR.

NO CLAIM IS MADE TO THE EXCLUSIVE RIGHT TO USE "HARDWARE", APART FROM THE MARK AS SHOWN.

SER. NO. 85-015,397, FILED 4-16-2010.

TRACY WHITTAKER-BROWN, EXAMINING ATTORNEY



*David J. Kybas*

Director of the United States Patent and Trademark Office

# United States of America

United States Patent and Trademark Office



**Reg. No. 4,133,824**

**Registered May 1, 2012**

**Int. Cl.: 19**

**TRADEMARK**

**PRINCIPAL REGISTER**

CEMENTOS ARGOS S.A. (COLOMBIA CORPORATION)  
VIA 40 LAS FLORES  
BARRANQUILLA, COLOMBIA

FOR: CEMENT, NAMELY, CEMENT MIXES, BLENDED CEMENT, WHITE CEMENT, NON-AGRICULTURAL QUICK LIME FOR USE IN CONSTRUCTION, NON-AGRICULTURAL HYDRATED LIME FOR USE IN CONSTRUCTION; CONCRETE, NAMELY, READY MIX CONCRETE, COLOR READY MIX CONCRETE, SOIL-CEMENT, MORTARS, IN CLASS 19 (U.S. CLS. 1, 12, 33 AND 50).

OWNER OF COLOMBIA REG. NO. 318278, DATED 6-30-2006, EXPIRES 6-30-2016.

THE COLOR(S) BLUE AND GREEN IS/ARE CLAIMED AS A FEATURE OF THE MARK.

OWNER OF U.S. REG. NOS. 3,224,374, 3,264,368, AND 3,265,082.

THE MARK CONSISTS OF THE LETTERING "ARGOS" IN BLUE AND A FANCIFUL DESIGN IN BLUE, ALL ON A GREEN BACKGROUND.

SER. NO. 85-019,942, FILED 4-21-2010.

TRACY FLETCHER, EXAMINING ATTORNEY



*David J. Kypos*

Director of the United States Patent and Trademark Office



# United States of America

United States Patent and Trademark Office

## AROMA BAKERY CAFÉ

**Reg. No. 4,133,825**

IZHAK TWIG (UNITED STATES INDIVIDUAL)  
7373 W. SUNSET BLVD.  
LOS ANGELES, CA 90046

**Registered May 1, 2012**

**Int. Cl.: 43**

FOR: RESTAURANT SERVICES, IN CLASS 43 (U.S. CLS. 100 AND 101).

**SERVICE MARK**

FIRST USE 1-4-2005; IN COMMERCE 1-4-2005.

**PRINCIPAL REGISTER**

THE MARK CONSISTS OF STANDARD CHARACTERS WITHOUT CLAIM TO ANY PARTICULAR FONT, STYLE, SIZE, OR COLOR.

NO CLAIM IS MADE TO THE EXCLUSIVE RIGHT TO USE "BAKERY CAFE", APART FROM THE MARK AS SHOWN.

SER. NO. 85-021,875, FILED 4-23-2010.

DAVID H. STINE, EXAMINING ATTORNEY



*David J. Kyffers*

Director of the United States Patent and Trademark Office

# United States of America

United States Patent and Trademark Office



**Reg. No. 4,133,826**

**Registered May 1, 2012**

**Int. Cls.: 5 and 44**

**TRADEMARK**

**SERVICE MARK**

**PRINCIPAL REGISTER**

AMSTERDAM MOLECULAR THERAPEUTICS (AMT) IP B.V. (NETHERLANDS BESLOTEN VENNOOTSCHAP (B.V.))  
MEIBERGDREEF 61  
AMSTERDAM, NETHERLANDS 1105BA

FOR: GENE THERAPY SYSTEMS; PHARMACEUTICAL PRODUCTS FOR THE PREVENTION AND TREATMENT OF METABOLIC DISORDERS, OCULAR DISORDERS, DISEASES OF THE NERVOUS SYSTEM, BLOOD DISORDERS, LIVER DISORDERS, MUSCULAR DISORDERS, MUSCULAR SKELETAL DISORDERS, CANCERS, INFECTIOUS DISEASES, FUNGAL DISEASES, DISEASES CAUSED BY PARASITES, DISEASES AFFECTING THE IMMUNE SYSTEM, INFLAMMATORY AND AUTO-IMMUNE DISEASES, VASCULAR DISORDERS, BONE DISEASES, INHERITED DISORDERS, GENETIC DISORDERS AND SINGLE GENE DISORDERS; PHARMACEUTICAL PREPARATIONS AND SUBSTANCES FOR THE TREATMENT OF METABOLIC DISORDERS, OCULAR DISORDERS, DISEASES OF THE NERVOUS SYSTEM, BLOOD DISORDERS, LIVER DISORDERS, MUSCULAR DISORDERS, MUSCULAR SKELETAL DISORDERS, CANCERS, INFECTIOUS DISEASES, FUNGAL DISEASES, DISEASES CAUSED BY PARASITES, DISEASES AFFECTING THE IMMUNE SYSTEM, INFLAMMATORY AND AUTO-IMMUNE DISEASES, VASCULAR DISORDERS, BONE DISEASES, INHERITED DISORDERS, GENETIC DISORDERS, SINGLE GENE DISORDERS AND CANCERS; BIOLOGICAL PREPARATIONS FOR USE IN MEDICAL AND CLINICAL GENE THERAPY, NON-VIRAL VECTORS, GENE THERAPY VECTORS, NUCLEIC ACID DELIVERY VECTORS, AND CELLS TRANSFORMED BY VIRAL VECTORS, NON-VIRAL VECTORS, GENE THERAPY VECTORS OR NUCLEIC ACID DELIVERY VECTORS, ALL FOR THE TREATMENT OF METABOLIC DISORDERS, OCULAR DISORDERS, DISEASES OF THE NERVOUS SYSTEM, BLOOD DISORDERS, LIVER DISORDERS, MUSCULAR DISORDERS, MUSCULAR SKELETAL DISORDERS, CANCERS, INFECTIOUS DISEASES, FUNGAL DISEASES, DISEASES CAUSED BY PARASITES, DISEASES AFFECTING THE IMMUNE SYSTEM, INFLAMMATORY AND AUTO-IMMUNE DISEASES, VASCULAR DISORDERS, BONE DISEASES, INHERITED DISORDERS, GENETIC DISORDERS AND SINGLE GENE DISORDERS; BIOLOGICAL PREPARATIONS FOR MEDICAL AND CLINICAL USE, NAMELY, THE PREVENTION AND TREATMENT OF METABOLIC DISORDERS, OCULAR DISORDERS, DISEASES OF THE NERVOUS SYSTEM, BLOOD DISORDERS, LIVER DISORDERS, MUSCULAR DISORDERS, MUSCULAR SKELETAL DISORDERS, CANCERS, INFECTIOUS DISEASES, FUNGAL DISEASES, DISEASES CAUSED BY PARASITES, DISEASES AFFECTING THE IMMUNE SYSTEM, INFLAMMATORY AND AUTO-IMMUNE DISEASES, VASCULAR DISORDERS, BONE DISEASES, INHERITED DISORDERS, GENETIC DISORDERS AND SINGLE GENE DISORDERS;



*David J. Kyjars*

Director of the United States Patent and Trademark Office

**Reg. No. 4,133,826** PHARMACEUTICAL PREPARATIONS AND SUBSTANCES FOR THE TREATMENT OF METABOLIC DISORDERS, OCULAR DISORDERS, DISEASES OF THE NERVOUS SYSTEM, BLOOD DISORDERS, LIVER DISORDERS, MUSCULAR DISORDERS, MUSCULAR SKELETAL DISORDERS, CANCERS, INFECTIOUS DISEASES, FUNGAL DISEASES, DISEASES CAUSED BY PARASITES, DISEASES AFFECTING THE IMMUNE SYSTEM, INFLAMMATORY AND AUTO-IMMUNE DISEASES, VASCULAR DISORDERS, BONE DISEASES, INHERITED DISORDERS, GENETIC DISORDERS, SINGLE GENE DISORDERS AND CANCERS; CLINICAL MEDICAL REAGENTS FOR USE IN NUCLEIC ACID-BASED THERAPY, GENE THERAPY, CELL THERAPY, GENE DIAGNOSIS AND GENE TESTING; PHARMACEUTICAL PREPARATIONS, NAMELY, VACCINES AND PROPHYLAXIS PRODUCTS FOR USE IN NUCLEIC ACID-BASED THERAPY, GENE THERAPY AND CELL THERAPY; GENE AND NUCLEIC ACID MODULATION FOR THE TREATMENT OF METABOLIC DISORDERS, OCULAR DISORDERS, DISEASES OF THE NERVOUS SYSTEM, BLOOD DISORDERS, LIVER DISORDERS, MUSCULAR DISORDERS, MUSCULAR SKELETAL DISORDERS, CANCERS, INFECTIOUS DISEASES, FUNGAL DISEASES, DISEASE CAUSED BY PARASITES, DISEASES AFFECTING THE IMMUNE SYSTEM, INFLAMMATORY AND AUTO-IMMUNE DISEASES, VASCULAR DISORDERS, BONE DISEASES, INHERITED DISORDERS, GENETIC DISORDERS AND SINGLE GENE DISORDERS; GENE THERAPY AND PROPHYLAXIS PRODUCTS, NAMELY, GENE DELIVERY AND GENE TRANSFER FOR THE TREATMENT OF METABOLIC DISORDERS, OCULAR DISORDERS, DISEASES OF THE NERVOUS SYSTEM, BLOOD DISORDERS, LIVER DISORDERS, MUSCULAR DISORDERS, MUSCULAR SKELETAL DISORDERS, CANCERS, INFECTIOUS DISEASES, FUNGAL DISEASES, DISEASES CAUSED BY PARASITES, DISEASES AFFECTING THE IMMUNE SYSTEM, INFLAMMATORY AND AUTO-IMMUNE DISEASES, VASCULAR DISORDERS, BONE DISEASE, INHERITED DISORDERS, GENETIC DISORDERS AND SINGLE GENE DISORDERS; CHEMICAL REAGENTS FOR CLINICAL OR MEDICAL USE, NAMELY, VECTORS, USED IN THE DELIVERY OF GENETIC MATTER AND NUCLEIC ACIDS, USED IN GENE OR NUCLEIC ACID DELIVERY SYSTEMS AND USED FOR DIAGNOSTIC PURPOSES; GENE THERAPY AND PROPHYLAXIS PRODUCTS, NAMELY, GENE TRANSFER FOR THE TREATMENT OF THE PREVENTION AND TREATMENT OF METABOLIC DISORDERS, OCULAR DISORDERS, DISEASES OF THE NERVOUS SYSTEM, BLOOD DISORDERS, LIVER DISORDERS, MUSCULAR DISORDERS, MUSCULAR SKELETAL DISORDERS, CANCERS, INFECTIOUS DISEASES, FUNGAL DISEASES, DISEASES CAUSED BY PARASITES, DISEASES AFFECTING THE IMMUNE SYSTEM, INFLAMMATORY AND AUTO-IMMUNE DISEASES, VASCULAR DISORDERS, BONE DISEASES, INHERITED DISORDERS, GENETIC DISORDERS AND SINGLE GENE DISORDERS; PHARMACEUTICAL PREPARATIONS AND SUBSTANCES FOR THE TREATMENT OF METABOLIC DISORDERS, OCULAR DISORDERS, DISEASES OF THE NERVOUS SYSTEM, BLOOD DISORDERS, LIVER DISORDERS, MUSCULAR DISORDERS, MUSCULAR SKELETAL DISORDERS, CANCERS, INFECTIOUS DISEASES, FUNGAL DISEASES, DISEASES CAUSED BY PARASITES, DISEASES AFFECTING THE IMMUNE SYSTEM, INFLAMMATORY AND AUTO-IMMUNE DISEASES, VASCULAR DISORDERS, BONE DISEASES, INHERITED DISORDERS, GENETIC DISORDERS, SINGLE GENE DISORDERS AND CANCERS, IN CLASS 5 (U.S. CLS. 6, 18, 44, 46, 51 AND 52).

FOR: MEDICAL TREATMENT OF METABOLIC DISORDERS, OCULAR DISORDERS, DISEASES OF THE NERVOUS SYSTEM, BLOOD DISORDERS, LIVER DISORDERS, MUSCULAR DISORDERS, MUSCULAR SKELETAL DISORDERS, CANCERS, INFECTIOUS DISEASES, INFLAMMATORY AND AUTO-IMMUNE DISEASES, VASCULAR DISORDERS, INHERITED DISORDERS, GENETIC DISORDERS AND SINGLE GENE DISORDERS THROUGH GENE AND NUCLEIC ACID DELIVERY, GENE AND NUCLEIC ACID TRANSFER, GENE AND NUCLEIC ACID REGULATION AND GENE AND NUCLEIC ACID MODULATION, IN CLASS 44 (U.S. CLS. 100 AND 101).

PRIORITY CLAIMED UNDER SEC. 44(D) ON ERPN CMNTY TM OFC APPLICATION NO. 8640609, FILED 10-26-2009, REG. NO. 8640609, DATED 5-10-2010, EXPIRES 10-26-2019.

THE MARK CONSISTS OF THE LETTER "G" WITH A DOT.

**Reg. No. 4,133,826** SER. NO. 85-021,938, FILED 4-23-2010.

INGA ERVIN, EXAMINING ATTORNEY

# United States of America

United States Patent and Trademark Office

# RUB A DUB

**Reg. No. 4,133,827**

**Registered May 1, 2012**

**Int. Cl.: 28**

**TRADEMARK**

**PRINCIPAL REGISTER**

PANLINE U.S.A. INC. (NEW JERSEY CORPORATION)  
251 UNION STREET  
NORTHVALE, NJ 07647

FOR: BATH TOYS, IN CLASS 28 (U.S. CLS. 22, 23, 38 AND 50).

FIRST USE 2-13-2001; IN COMMERCE 2-13-2001.

THE MARK CONSISTS OF STANDARD CHARACTERS WITHOUT CLAIM TO ANY PARTICULAR FONT, STYLE, SIZE, OR COLOR.

SER. NO. 85-023,085, FILED 4-26-2010.

GRETCHEN ULRICH, EXAMINING ATTORNEY



*David J. Kyffers*

Director of the United States Patent and Trademark Office

# United States of America

United States Patent and Trademark Office

## SMALL & SMOOTH S.S. LUMINOUS BASE

**Reg. No. 4,133,828**

**Registered May 1, 2012**

**Int. Cl.: 3**

**TRADEMARK**

**PRINCIPAL REGISTER**

AMOREPACIFIC CORPORATION (REPUBLIC OF KOREA CORPORATION)  
181, 2-GA, HANGANG-RO, YONGSAN-GU,  
SEOUL, REPUBLIC OF KOREA

FOR: BLUSHER; COSMETICS; CREAMY FOUNDATION; MAKE-UP FOUNDATIONS;  
MAKE-UP POWDER; MAKE-UP PREPARATIONS FOR THE FACE AND BODY; SOLID  
POWDER FOR COMPACTS, IN CLASS 3 (U.S. CLS. 1, 4, 6, 50, 51 AND 52).

OWNER OF CHINA REG. NO. 8218878, DATED 4-28-2011, EXPIRES 4-27-2021.

NO CLAIM IS MADE TO THE EXCLUSIVE RIGHT TO USE "BASE", APART FROM THE  
MARK AS SHOWN.

SER. NO. 85-023,505, FILED 4-26-2010.

TRICIA SONNEBORN, EXAMINING ATTORNEY



*David J. Kyros*

Director of the United States Patent and Trademark Office

# United States of America

United States Patent and Trademark Office

# BCR

**Reg. No. 4,133,829**

**Registered May 1, 2012**

**Int. Cl.: 35**

**SERVICE MARK**

**PRINCIPAL REGISTER**

FRANCHISE INFORMATION SERVICES, INC. (DELAWARE CORPORATION)  
4300 WILSON BOULEVARD, SUITE 480  
ARLINGTON, VA 22203

FOR: PROVIDING INFORMATION AND ANALYSIS IN THE NATURE OF PREPARING  
ECONOMIC AND BUSINESS DATA REPORTS RELATING TO THE FRANCHISE INDUSTRY  
, IN CLASS 35 (U.S. CLS. 100, 101 AND 102).

FIRST USE 8-0-2008; IN COMMERCE 8-0-2008.

THE MARK CONSISTS OF STANDARD CHARACTERS WITHOUT CLAIM TO ANY PAR-  
TICULAR FONT, STYLE, SIZE, OR COLOR.

SER. NO. 85-038,804, FILED 5-14-2010.

C. DIONNE CLYBURN, EXAMINING ATTORNEY



*David J. Kyffers*

Director of the United States Patent and Trademark Office

# United States of America

United States Patent and Trademark Office

# SAKROOTS

**Reg. No. 4,133,830**

INDONESIAN IMPORTS, INC. (DELAWARE CORPORATION)  
440 ALABAMA STREET  
SAN FRANCISCO, CA 94110

**Registered May 1, 2012**

**Int. Cl.: 18**

FOR: BACK PACKS; COSMETIC BAGS SOLD EMPTY; DIAPER BAGS; HANDBAGS; TOTE BAGS, IN CLASS 18 (U.S. CLS. 1, 2, 3, 22 AND 41).

**TRADEMARK**

FIRST USE 7-24-2008; IN COMMERCE 7-24-2008.

**PRINCIPAL REGISTER**

THE MARK CONSISTS OF STANDARD CHARACTERS WITHOUT CLAIM TO ANY PARTICULAR FONT, STYLE, SIZE, OR COLOR.

OWNER OF U.S. REG. NOS. 2,387,283, 3,670,344 AND OTHERS.

SER. NO. 85-040,139, FILED 5-17-2010.

DANNEAN HETZEL, EXAMINING ATTORNEY



*David J. Kyffers*

Director of the United States Patent and Trademark Office



# United States of America

United States Patent and Trademark Office

## Solar Home Specialists

**Reg. No. 4,133,831**

**Registered May 1, 2012**

**Int. Cl.: 37**

**SERVICE MARK**

**PRINCIPAL REGISTER**

SUNGEVITY, INC. (DELAWARE CORPORATION)  
66 FRANKLIN ST., STE 310  
OAKLAND, CA 94607

FOR: INSTALLATION AND MAINTENANCE OF SOLAR ENERGY EQUIPMENT FOR USE IN CONVERTING SOLAR ENERGY INTO ELECTRICITY, IN CLASS 37 (U.S. CLS. 100, 103 AND 106).

FIRST USE 3-1-2010; IN COMMERCE 3-1-2010.

THE MARK CONSISTS OF STANDARD CHARACTERS WITHOUT CLAIM TO ANY PARTICULAR FONT, STYLE, SIZE, OR COLOR.

NO CLAIM IS MADE TO THE EXCLUSIVE RIGHT TO USE "SOLAR", APART FROM THE MARK AS SHOWN.

SEC. 2(F).

SER. NO. 85-040,743, FILED S.R. 5-17-2010 AM. P.R. 5-17-2010.

LEIGH CAROLINE CASE, EXAMINING ATTORNEY



*David J. Kyros*

Director of the United States Patent and Trademark Office

# United States of America

United States Patent and Trademark Office

## COLAGEINA 10

**Reg. No. 4,133,832**

**Registered May 1, 2012**

**Int. Cl.: 3**

**TRADEMARK**

**PRINCIPAL REGISTER**

RUVALCABA LARA, CELIA ALEJANDRA (MEXICO INDIVIDUAL)  
CALLE 59, NO. 69, INT 301-A  
COL. PUEBLA, DELEG. VENUSTIANO CARRANZA  
MEXICO D.F., MEXICO, MEXICO 15020

FOR: COSMETICS AND COSMETIC PREPARATIONS; ESSENTIAL OILS; NON-MEDICATED SKIN CARE PREPARATIONS; PERFUMERY; SKIN CREAMS; SKIN LOTIONS, IN CLASS 3 (U.S. CLS. 1, 4, 6, 50, 51 AND 52).

THE MARK CONSISTS OF STANDARD CHARACTERS WITHOUT CLAIM TO ANY PARTICULAR FONT, STYLE, SIZE, OR COLOR.

OWNER OF MEXICO REG. NO. 1125145, DATED 10-9-2009, EXPIRES 9-22-2019.

THE WORDING "COLAGEINA" HAS NO MEANING IN A FOREIGN LANGUAGE.

SER. NO. 85-040,759, FILED 5-17-2010.

TAMARA FRAZIER, EXAMINING ATTORNEY



*David J. Kybas*

Director of the United States Patent and Trademark Office

# United States of America

United States Patent and Trademark Office

백삼젤

焕颜白参磨砂啫喱

## WHITE GINSENG LIGHTENING GEL

**Reg. No. 4,133,833**

**Registered May 1, 2012**

**Int. Cl.: 3**

**TRADEMARK**

**PRINCIPAL REGISTER**

AMOREPACIFIC CORPORATION (REPUBLIC OF KOREA CORPORATION)  
181, 2GA, HANGANG-RO, YONGSAN-GU  
SEOUL, REPUBLIC OF KOREA

FOR: COSMETICS; COSMETIC PREPARATIONS FOR SKIN CARE; GEL FOR HAIR; GEL FOR COSMETIC PURPOSES, NAMELY, AFTER-SHAVE GEL, BATH GEL, BEAUTY GEL, EYE GEL, SHAVING GEL, SHOWER GEL; MASSAGE GEL; DENTIFRICES, IN CLASS 3 (U.S. CLS. 1, 4, 6, 50, 51 AND 52).

PRIORITY CLAIMED UNDER SEC. 44(D) ON REPUBLIC OF KOREA APPLICATION NO. 40-2010-0002, FILED 1-14-2010.

OWNER OF JAPAN REG. NO. 5386539, DATED 1-28-2011, EXPIRES 1-28-2021.

NO CLAIM IS MADE TO THE EXCLUSIVE RIGHT TO USE "WHITE GINSENG LIGHTENING GEL" APART FROM THE MARK AS SHOWN; NO CLAIM IS MADE TO THE EXCLUSIVE RIGHT TO USE THE KOREAN CHARACTERS THAT TRANSLITERATE TO "WHITE GINSENG GEL" APART FROM THE MARK AS SHOWN; NO CLAIM IS MADE TO THE EXCLUSIVE RIGHT TO USE THE CHINESE CHARACTERS THAT TRANSLITERATE TO "FACE WHITE GINSENG EXFOLIATING GEL", APART FROM THE MARK AS SHOWN.

THE MARK CONSISTS OF KOREAN CHARACTERS WHICH TRANSLITERATE TO BAEK-SAM-GEL, CHINESE CHARACTERS WHICH TRANSLITERATE TO HWAN-AN-BAEK-SAM-MA-SA-JA-RI AND "WHITE GINSENG LIGHTENING GEL".

THE KOREAN CHARACTERS IN THE MARK TRANSLITERATE TO "BAEK-SAM-GEL" AND THIS MEANS "WHITE GINSENG GEL" IN ENGLISH; THE CHINESE CHARACTERS IN THE MARK TRANSLITERATE TO "HWAN-AN-BAEK-SAM-MA-SA-JA-RI" AND THIS MEANS "GLOWING FACE WHITE GINSENG EXFOLIATING GEL" IN ENGLISH.

SER. NO. 85-043,198, FILED 5-19-2010.

TRICIA SONNEBORN, EXAMINING ATTORNEY



*David J. Kappas*

Director of the United States Patent and Trademark Office

# United States of America

United States Patent and Trademark Office

# EBM

**Reg. No. 4,133,834**

**Registered May 1, 2012**

**Int. Cl.: 9**

**TRADEMARK**

**PRINCIPAL REGISTER**

TOTAL DYNAMICS SOLUTIONS, LLC (MINNESOTA LIMITED LIABILITY COMPANY)  
7455 FRANCE AVENUE SOUTH, #363  
EDINA, MN 55435

FOR: COMPUTER SOFTWARE CONSISTING OF A SUITE OF BUSINESS MANAGEMENT AND OPERATIONS TOOLS/MODULES, FOR USE WITH ENTERPRISE RESOURCE PLANNING SYSTEMS, FOR ORGANIZING AND PRESENTING COMPANY DATA IN REAL TIME VIEWS AND ANALYSIS FOR USE IN DECISIONS RELATING TO BUSINESS OPERATIONS IN THE AREAS OF: SALES ORDER MANAGEMENT, TRADE DEAL/PRICING MANAGEMENT, SALES FORECASTING, FINANCIAL PLANNING, REPORTING ANALYSIS AND BUSINESS FORECASTING, PURCHASING AND COST MANAGEMENT, OPERATIONS/PRODUCTION/DEMAND PLANNING, INVENTORY AND TRANSPORTATION/WAREHOUSING MANAGEMENT, HUMAN RESOURCES AND TALENT MANAGEMENT AND PROJECT MANAGEMENT, IN CLASS 9 (U.S. CLS. 21, 23, 26, 36 AND 38).

FIRST USE 4-8-2010; IN COMMERCE 4-8-2010.

THE MARK CONSISTS OF STANDARD CHARACTERS WITHOUT CLAIM TO ANY PARTICULAR FONT, STYLE, SIZE, OR COLOR.

SER. NO. 85-046,975, FILED 5-25-2010.

HENRY S. ZAK, EXAMINING ATTORNEY



*David J. Kybas*

Director of the United States Patent and Trademark Office

# United States of America

United States Patent and Trademark Office

## SKYPE MANAGER

**Reg. No. 4,133,835**

**Registered May 1, 2012**

**Int. Cls.: 9, 38 and 42**

**TRADEMARK**

**SERVICE MARK**

**PRINCIPAL REGISTER**

SKYPE LIMITED (IRELAND CORPORATION)  
70 SIR JOHN ROGERSON'S QUAY  
DUBLIN 2, IRELAND

FOR: COMPUTER SOFTWARE FOR THE MANAGEMENT AND ANALYSIS OF INTERNET COMMUNICATIONS AND PEER-TO-PEER COMPUTER SOFTWARE, TECHNOLOGY, APPARATUS AND EQUIPMENT; COMPUTER SOFTWARE FOR THE MANAGEMENT AND ANALYSIS OF VOIP (VOICE OVER INTERNET PROTOCOL), SIP (SESSION INITIATION PROTOCOL), PBX (PRIVATE BRANCH EXCHANGE) AND UC (UNIFIED COMMUNICATIONS) COMPUTER SOFTWARE, TECHNOLOGY, APPARATUS AND EQUIPMENT; COMPUTER SOFTWARE FOR BUSINESS MANAGEMENT AND ANALYSIS; COMPUTER SOFTWARE FOR BUSINESS MANAGEMENT AND ANALYSIS OF USAGE OF INTERNET COMMUNICATIONS AND PEER-TO-PEER COMPUTER SOFTWARE, TECHNOLOGY, APPARATUS AND EQUIPMENT; COMPUTER SOFTWARE FOR USE IN COLLECTING, COORDINATING, MANAGING, ORGANIZING, CREATING, PRESENTING, TRANSMITTING, ANALYZING, MANIPULATING, FILTERING AND REVIEWING INFORMATION, TEXT, DATA, REPORTS AND AUDIO, VIDEO AND AUDIO-VISUAL FILES; COMPUTER SOFTWARE FOR USE IN COMMUNICATIONS APPLICATIONS, DATA TRANSMISSION AND INSTANT MESSAGING SERVICES, AND FOR COLLECTING, COORDINATING, MANAGING, ORGANIZING, CREATING, PRESENTING, TRANSMITTING, ANALYZING, MANIPULATING, FILTERING AND REVIEWING INFORMATION, TEXT, DATA, REPORTS AND AUDIO FILES; COMPUTER SOFTWARE FOR CREATING AND MANAGING USER ACCOUNTS OF INDIVIDUALS OR GROUPS OF USERS OF INTERNET COMMUNICATIONS AND PEER-TO-PEER SERVICES; COMPUTER SOFTWARE FOR MANAGING, ORGANIZING, ANALYZING, REVIEWING, ACQUIRING AND RENEWING INTERNET COMMUNICATIONS AND PEER-TO-PEER SERVICES; COMPUTER SOFTWARE FOR MANAGING, ORGANIZING, ANALYZING, REVIEWING, TRACKING, PURCHASING, ALLOCATING AND DISTRIBUTING CREDIT FOR INTERNET COMMUNICATION SERVICES; COMPUTER SOFTWARE FOR MANAGING, ORGANIZING, ANALYZING, REVIEWING AND TRACKING FINANCIAL TRANSACTIONS VIA A GLOBAL COMPUTER NETWORK, ELECTRONIC PAYMENTS TO AND FROM THIRD PARTIES CONDUCTED VIA A GLOBAL COMPUTER NETWORK AND ELECTRONIC CREDIT AND DEBIT TRANSACTIONS; COMPUTER SOFTWARE FOR MANAGING, ORGANIZING, ANALYZING, REVIEWING, CONTROLLING AND TRACKING EXPENDITURES; COMPUTER SOFTWARE FOR THE PROVISION OF TRAINING AND EDUCATIONAL SERVICES, NAMELY, FOR PROVIDING ON-LINE TUTORIALS, INTERACTIVE TRAINING AND ACCESS TO EDUCATION RESOURCES, ALL IN THE FIELD OF INTERNET AND PEER TO PEER COMMUNICATIONS; COMPUTER SOFTWARE FOR DATA



*David J. Kyjars*

Director of the United States Patent and Trademark Office

**Reg. No. 4,133,835** PROCESSING; DATA PROCESSORS; APPARATUS AND COMPUTER SOFTWARE FOR RECORDING, TRANSMISSION, PROCESSING AND REPRODUCTION OF SOUND, IMAGES OR DATA; INTERNET COMMUNICATIONS APPARATUS AND EQUIPMENT, NAMELY, INTERNET TELEPHONES, INTERNET TELEPHONE PROTOCOL EQUIPMENT, SIP-ENABLED PRIVATE BRANCH EXCHANGES (PBXS), INTERNET PROTOCOL PRIVATE BRANCH EXCHANGES (IP PBXS), AND GATEWAY EQUIPMENT, NAMELY, ROUTERS AND SWITCHES; COMPUTER SOFTWARE TO ENABLE INTERNET AND PEER-TO-PEER COMMUNICATIONS VIA A COMPUTER NETWORK; COMPUTER SOFTWARE FOR HOSTING, JOINING, MANAGING, SCHEDULING AND STREAMING COMPUTER NETWORK CONFERENCE CALLS, AND FOR INSTANT MESSAGING VIA THE INTERNET; COMPUTER SOFTWARE FOR COMMUNICATION VIA THE INTERNET; COMPUTER SOFTWARE TO ENABLE UPLOADING, POSTING, SHOWING, DISPLAYING, TAGGING, BLOGGING, SHARING OR OTHERWISE PROVIDING ELECTRONIC MEDIA OR INFORMATION OVER THE INTERNET OR OTHER COMPUTER NETWORKS; COMPUTER SOFTWARE TO ENABLE WEB LOGS, FORUMS, JOURNALS AND CLIENT GROUPS; DOWNLOADABLE ELECTRONIC PUBLICATIONS AND ELECTRONIC PUBLICATIONS RECORDED ON COMPUTER MEDIA IN THE NATURE OF NEWSPAPERS, BOOKS, MANUALS, MAGAZINES, E-ZINES AND NEWSLETTERS IN THE FIELDS OF GENERAL INTEREST, INTERNET COMMUNICATIONS, UNIFIED COMMUNICATIONS AND BUSINESS, IN CLASS 9 (U.S. CLS. 21, 23, 26, 36 AND 38).

FOR: PROVIDING VOICE OVER INTERNET PROTOCOL (VOIP), INTERNET AND PEER-TO-PEER NETWORK COMPUTER SERVICES, NAMELY, ELECTRONIC TRANSMISSION OF AUDIO, VIDEO AND OTHER DATA AND DOCUMENTS AMONG COMPUTERS AND PORTABLE AND HANDHELD DIGITAL ELECTRONIC DEVICES FOR RECORDING, ORGANIZING, TRANSMITTING, MANIPULATING, AND REVIEWING TEXT, DATA, IMAGE, AND AUDIO FILES; ELECTRONIC TRANSMISSION OF DATA AND DOCUMENTS OVER COMPUTER TERMINALS; INSTANT MESSAGING SERVICES; PROVIDING A HIGH SPEED ACCESS TO AREA NETWORKS AND GLOBAL COMPUTER NETWORKS; COMMUNICATIONS BY COMPUTER TERMINALS; TRANSMISSION OF AUDIO, VIDEO, IMAGES, TEXT AND OTHER DATA BY MEANS OF AN ELECTRONIC TELECOMMUNICATIONS NETWORK; COMPUTER AIDED TRANSMISSION OF MESSAGES AND IMAGES; ELECTRONIC MESSAGING SERVICES, NAMELY, SENDING, RECEIVING AND FORWARDING MESSAGES IN THE FORM OF TEXT, AUDIO, IMAGES OR VIDEO; PROVIDING TELEPHONE CONFERENCING SERVICES, VIDEO CONFERENCING SERVICES AND WEB CONFERENCING SERVICES; PROVIDING ON-LINE DISCUSSION GROUP FORUMS AND CHAT ROOMS FOR TRANSMISSION OF MESSAGES AMONG COMPUTER USERS IN THE FIELD OF GENERAL INTEREST; PROVIDING WIRELESS APPLICATION PROTOCOL SERVICES UTILIZING COMMUNICATIONS CHANNELS, NAMELY, PROVIDING VOICE OVER INTERNET PROTOCOL (VOIP) SERVICES; PROVISION OF INFORMATION IN THE FIELD OF COMMUNICATIONS APPARATUS AND INSTRUMENTS FOR TELECOMMUNICATIONS PURPOSES; PROVIDING ON-LINE COMMUNICATIONS LINKS WHICH TRANSFER THE WEBSITE USER TO OTHER COMPUTER DATABASES, WEBSITES, AND LOCAL AND GLOBAL WEB PAGES ON THE INTERNET; STREAMING OF AUDIO-VISUAL MATERIAL ON THE INTERNET; PROVIDING ON-LINE ELECTRONIC BULLETIN BOARDS FOR TRANSMISSION OF MESSAGES AMONG COMPUTER USERS CONCERNING TOPICS OF GENERAL INTEREST TO USERS; ELECTRONIC TRANSMISSION OF MESSAGES AND DATA; ELECTRONIC, ELECTRIC AND DIGITAL TRANSMISSION OF VOICE, DATA, IMAGES, SIGNALS AND MESSAGES; SIMPLE MESSAGE SERVICE (SMS) AND MULTIMEDIA MESSAGE SERVICE (MMS) VIA TELECOMMUNICATIONS AND COMPUTER NETWORKS; TECHNICAL SUPPORT SERVICES REGARDING THE USAGE OF COMMUNICATIONS EQUIPMENT, IN CLASS 38 (U.S. CLS. 100, 101 AND 104).

FOR: DESIGN AND DEVELOPMENT OF COMPUTER SOFTWARE; PROVIDING TEMPORARY USE OF ON-LINE NON-DOWNLOADABLE COMPUTER SOFTWARE FOR DATA PROCESSING, THE MANAGEMENT AND ANALYSIS OF INTERNET COMMUNICATIONS AND PEER-TO-PEER COMPUTER SOFTWARE, TECHNOLOGY, APPARATUS AND EQUIPMENT; PROVIDING TEMPORARY USE OF ON-LINE NON-DOWNLOADABLE

**Reg. No. 4,133,835** COMPUTER SOFTWARE FOR THE MANAGEMENT AND ANALYSIS OF VOIP (VOICE OVER INTERNET PROTOCOL), SIP (SESSION INITIATION PROTOCOL), PBX (PRIVATE BRANCH EXCHANGE) AND UC (UNIFIED COMMUNICATIONS) COMPUTER SOFTWARE TECHNOLOGY, APPARATUS AND EQUIPMENT; PROVIDING TEMPORARY USE OF ON-LINE NON-DOWNLOADABLE COMPUTER SOFTWARE FOR BUSINESS MANAGEMENT AND ANALYSIS OF USAGE OF INTERNET COMMUNICATIONS AND PEER-TO-PEER COMPUTER SOFTWARE, TECHNOLOGY, APPARATUS AND EQUIPMENT; PROVIDING TEMPORARY USE OF ON-LINE NON-DOWNLOADABLE COMPUTER SOFTWARE FOR USE IN COLLECTING, COORDINATING, MANAGING, ORGANIZING, CREATING, PRESENTING, TRANSMITTING, ANALYZING, MANIPULATING, FILTERING AND REVIEWING INFORMATION, TEXT, DATA, REPORTS AND AUDIO AND AUDIO-VISUAL FILES; COMPUTER SERVICES, NAMELY, PROVIDING SEARCH ENGINES FOR OBTAINING DATA ON A GLOBAL COMPUTER NETWORK AND CREATING INDEXES OF INFORMATION, SITES AND OTHER RESOURCES AVAILABLE ON A COMPUTER NETWORK; PROVIDING TEMPORARY USE OF ON-LINE NON-DOWNLOADABLE COMPUTER SOFTWARE FOR USE IN SEARCHING FOR USER CONTACT INFORMATION; HOSTING WEB SITES FOR OTHERS FOR INTERNET COMMUNICATIONS, CONFERENCE CALLING, AUDIO VISUAL CONFERENCES AND VIDEO CONFERENCES; CREATING AND MAINTAINING WEB SITES FOR OTHERS; HOSTING WEB SITES OF OTHERS ON A COMPUTER SERVER FOR A GLOBAL COMPUTER NETWORK; TECHNICAL SUPPORT SERVICES, NAMELY, TROUBLESHOOTING IN THE NATURE OF DIAGNOSING COMPUTER HARDWARE AND SOFTWARE PROBLEMS; PROVIDING ADVICE, CONSULTATION, AND; INFORMATION, ALL RELATING TO THE AFORESAID SERVICES, IN CLASS 42 (U.S. CLS. 100 AND 101).

THE MARK CONSISTS OF STANDARD CHARACTERS WITHOUT CLAIM TO ANY PARTICULAR FONT, STYLE, SIZE, OR COLOR.

PRIORITY CLAIMED UNDER SEC. 44(D) ON ERPN CMNTY TM OFC APPLICATION NO. 009047821, FILED 4-22-2010, REG. NO. 009047821, DATED 11-12-2011, EXPIRES 4-22-2020.

OWNER OF U.S. REG. NOS. 3,005,039, 3,403,727, AND 3,773,537.

NO CLAIM IS MADE TO THE EXCLUSIVE RIGHT TO USE "MANAGER", APART FROM THE MARK AS SHOWN.

SER. NO. 85-051,532, FILED 6-1-2010.

BARBARA GAYNOR, EXAMINING ATTORNEY

# United States of America

United States Patent and Trademark Office

## ORIGINALITYCHECK

**Reg. No. 4,133,836**

**Registered May 1, 2012**

**Int. Cl.: 42**

**SERVICE MARK**

**PRINCIPAL REGISTER**

IPARADIGMS, LLC (CALIFORNIA LIMITED LIABILITY COMPANY)  
1111 BROADWAY, 3RD FLOOR  
OAKLAND, CA 94607

FOR: PROVIDING SERVICES IN THE NATURE OF NON-DOWNLOADABLE COMPUTER SOFTWARE-BASED PLAGIARISM DETECTION, ANALYSIS, AND REVIEW OF ACADEMIC WORKS, IN CLASS 42 (U.S. CLS. 100 AND 101).

FIRST USE 8-23-2010; IN COMMERCE 9-4-2010.

THE MARK CONSISTS OF STANDARD CHARACTERS WITHOUT CLAIM TO ANY PARTICULAR FONT, STYLE, SIZE, OR COLOR.

SER. NO. 85-053,190, FILED 6-2-2010.

RON FAIRBANKS, EXAMINING ATTORNEY



*David J. Kyros*

Director of the United States Patent and Trademark Office



# United States of America

United States Patent and Trademark Office



**Reg. No. 4,133,837**

**Registered May 1, 2012**

**Int. Cl.: 4**

**TRADEMARK**

**PRINCIPAL REGISTER**

VELAS HISPANIOLA, S.A. (BR.VIRGIN ISLANDS CORPORATION), DBA VELAS HISPANIOLA, S.A.  
AVE LA PISTA #10 ZONA FRANCA HAINAMOS  
PARQUE 2, NAVE 1  
SANTO DOMINGO ESTE, DOMINICAN REP

FOR: CANDLES, PILLAR CANDLES, AND CANDLE MATERIALS FOR ILLUMINATION, NAMELY, WAXES, WICKS, WICK ASSEMBLIES, FRAGRANCES, OILS, AND CONTAINERS USED TOGETHER THEREWITH, IN CLASS 4 (U.S. CLS. 1, 6 AND 15).

FIRST USE 3-21-2007; IN COMMERCE 3-21-2007.

OWNER OF DOMINICAN REP REG. NO. 161619, DATED 6-14-2007, EXPIRES 6-14-2017.

THE COLOR(S) GREEN, BLUE, YELLOW, ORANGE AND RED IS/ARE CLAIMED AS A FEATURE OF THE MARK.

NO CLAIM IS MADE TO THE EXCLUSIVE RIGHT TO USE "AROMA", APART FROM THE MARK AS SHOWN.

THE MARK CONSISTS OF THE STYLIZED WORDING "AROMA FROM NATURE" WITH A DESIGN OF TWO SWOOSHES AND A SERIES OF FLAMES. THE WORDING "AROMA FROM NATURE" APPEARS IN THE COLOR GREEN. THE TWO SWOOSHES APPEAR IN THE COLOR GREEN. THERE ARE A SERIES OF FLAMES INCREASINGLY IN SIZE, WHEREIN THE SMALLEST FLAME IS BLUE ON THE BOTTOM AND BECOMES YELLOW/ORANGE NEAR THE TOP MOST PORTION THEREOF; THE NEXT LARGER FLAME IS ORANGE ON BOTH ENDS WITH A YELLOW GLOW IN THE MIDDLE PORTION, THE NEXT LARGER FLAME IS PARTIALLY TRANSPARENT WITH THE RIGHTMOST PORTION YELLOW AND ORANGE, AND THE LEFTMOST PORTION A DARKER ORANGE; THE LARGEST FLAME PRIMARILY RED.

SER. NO. 85-058,194, FILED 6-9-2010.

CIMMERIAN COLEMAN, EXAMINING ATTORNEY



*David J. Kypas*

Director of the United States Patent and Trademark Office

# United States of America

United States Patent and Trademark Office

# GLADIO

**Reg. No. 4,133,838**

**Registered May 1, 2012**

**Int. Cl.: 13**

**TRADEMARK**

**PRINCIPAL REGISTER**

CHEDDITE SRL (ITALY SOCIETÀ A RESPONSABILITÀ LIMITATA (SRL))  
VIA DEL GIAGGIOLO N. 189  
LIVORNO (LI)  
C.A.P. 57124, ITALY

FOR: AMMUNITION; BLANK CARTRIDGES; CARTRIDGES FOR GUNPOWDER; GUN CARTRIDGES; HUNTING GUN CARTRIDGES; RIFLE CARTRIDGES; SHOTGUN CARTRIDGES; SPORTING CARTRIDGES, IN CLASS 13 (U.S. CLS. 2 AND 9).

THE MARK CONSISTS OF STANDARD CHARACTERS WITHOUT CLAIM TO ANY PARTICULAR FONT, STYLE, SIZE, OR COLOR.

OWNER OF EUROPEAN UNION REG. NO. 009362583, DATED 2-3-2011, EXPIRES 9-9-2020.

THE ENGLISH TRANSLATION OF "GLADIO" IN THE MARK IS "SWORD".

SER. NO. 85-058,990, FILED 6-9-2010.

ELLEN BURNS, EXAMINING ATTORNEY



*David J. Kyffers*

Director of the United States Patent and Trademark Office

# United States of America

United States Patent and Trademark Office

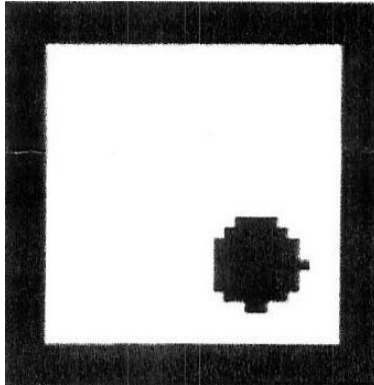

**Reg. No. 4,133,839**

**Registered May 1, 2012**

**Int. Cls.: 35, 37, 42 and 45**

**SERVICE MARK**

**PRINCIPAL REGISTER**

SECUREFACT TRANSACTION SERVICES, INC. (CANADA CORPORATION)  
330 BAY STREET, SUITE 505  
TORONTO, CANADA

FOR: AUTOMATED AND MANUAL REGISTRATION OF BUSINESS PUBLIC RECORDS; OPERATION OF PUBLIC AND PRIVATE RECORDS REGISTRIES, NAMELY, MAINTENANCE AND MANAGEMENT OF REPOSITORIES AND REGISTRATION DATABASES OF PUBLIC AND PRIVATE RECORDS; CONSULTING SERVICES ON AUTOMATED AND MANUAL PUBLIC RECORDS REGISTRATION OF REAL PROPERTY PUBLIC RECORDS, PERSONAL PROPERTY PUBLIC RECORDS AND BUSINESS PUBLIC RECORDS AND AUTOMATED DOCUMENT REGISTRATION IN THE NATURE OF MAINTAINING A REGISTRY IN THE LENDING AND INSURANCE FIELDS, AND MAINTENANCE AND MANAGEMENT OF REPOSITORIES AND REGISTRATION DATABASES OF PUBLIC AND PRIVATE RECORDS; AUTOMATED AND MANUAL REGISTRATION IN THE NATURE OF MAINTAINING A REGISTRY OF REAL PROPERTY PUBLIC RECORDS AND PERSONAL PROPERTY PUBLIC RECORDS, LENDING AND INSURANCE RELATED PROCESS AND DOCUMENT AUTOMATION SERVICES, NAMELY, AUTOMATED DOCUMENT REGISTRATION SERVICES IN THE NATURE OF MAINTAINING A REGISTRY IN THE LENDING AND INSURANCE FIELDS; CONSULTING SERVICES ON IN-HOUSE AND OUTSOURCED BUSINESS PROCESSES, NAMELY, AUTOMATED AND MANUAL REGISTRATION IN THE NATURE OF MAINTAINING A REGISTRY OF DOCUMENTS, REAL PROPERTY PUBLIC RECORDS, PERSONAL PROPERTY PUBLIC RECORDS AND BUSINESS PUBLIC RECORDS, AND MAINTENANCE AND MANAGEMENT OF REPOSITORIES AND REGISTRATION DATABASES OF PUBLIC AND PRIVATE RECORDS, ALL RELATED TO THE FINANCIAL SERVICES INDUSTRY AND ITS REGULATORS, IN CLASS 35 (U.S. CLS. 100, 101 AND 102).

FIRST USE 9-1-2004; IN COMMERCE 12-1-2004.

FOR: SYSTEMS OPERATING SERVICES, NAMELY, IMPLEMENTATION, MANAGEMENT AND MAINTENANCE OF COMPUTER HARDWARE SYSTEMS FOR AUTOMATED AND MANUAL PUBLIC RECORDS FILING, AUTOMATED AND MANUAL SEARCHING, RETRIEVAL AND REGISTRATION OF REAL PROPERTY PUBLIC RECORDS, PERSONAL PROPERTY PUBLIC RECORDS AND BUSINESS PUBLIC RECORDS, AUTOMATED DOCUMENT FILING, SEARCHING, RETRIEVAL AND REGISTRATION IN THE LENDING AND INSURANCE FIELDS, AND DESIGN, IMPLEMENTATION, MAINTENANCE AND MANAGEMENT OF REPOSITORIES AND REGISTRATION DATABASES OF PUBLIC AND PRIVATE



*David J. Kyffers*

Director of the United States Patent and Trademark Office

**Reg. No. 4,133,839** RECORDS; SYSTEMS OPERATION SERVICES OF IN-HOUSE AND OUTSOURCED BUSINESS PROCESSES, NAMELY, IMPLEMENTATION, MANAGEMENT AND MAINTENANCE OF COMPUTER HARDWARE SYSTEMS FOR IN-HOUSE AND OUTSOURCED BUSINESS PROCESSES, NAMELY, AUTOMATED AND MANUAL PUBLIC RECORDS AND DOCUMENT FILING, AUTOMATED AND MANUAL SEARCHING, RETRIEVAL AND REGISTRATION OF DOCUMENTS, REAL PROPERTY PUBLIC RECORDS, PERSONAL PROPERTY PUBLIC RECORDS AND BUSINESS PUBLIC RECORDS, AND DESIGN, IMPLEMENTATION, MAINTENANCE AND MANAGEMENT OF REPOSITORIES AND REGISTRATION DATABASES OF PUBLIC AND PRIVATE RECORDS, ALL RELATED TO THE FINANCIAL SERVICES INDUSTRY AND ITS REGULATORS, IN CLASS 37 (U.S. CLS. 100, 103 AND 106).

FIRST USE 9-1-2004; IN COMMERCE 12-1-2004.

FOR: AUTOMATED AND MANUAL SEARCHING AND RETRIEVAL OF BUSINESS PUBLIC RECORDS; OPERATION OF PUBLIC AND PRIVATE RECORDS REGISTRIES, NAMELY, IMPLEMENTATION OF REPOSITORIES AND REGISTRATION DATABASES OF PUBLIC AND PRIVATE RECORDS; CONSULTING SERVICES ON AUTOMATED AND MANUAL SEARCHING AND RETRIEVAL OF REAL PROPERTY PUBLIC RECORDS, PERSONAL PROPERTY PUBLIC RECORDS AND BUSINESS PUBLIC RECORDS AND AUTOMATED DOCUMENT SEARCHING AND RETRIEVAL IN THE LENDING AND INSURANCE FIELDS, AND DESIGN AND IMPLEMENTATION OF REPOSITORIES AND REGISTRATION DATABASES OF PUBLIC AND PRIVATE RECORDS; SYSTEMS OPERATING SERVICES, NAMELY, IMPLEMENTATION, MANAGEMENT AND MAINTENANCE OF COMPUTER SOFTWARE SYSTEMS FOR AUTOMATED AND MANUAL PUBLIC RECORDS FILING, AUTOMATED AND MANUAL SEARCHING, RETRIEVAL AND REGISTRATION OF REAL PROPERTY PUBLIC RECORDS, PERSONAL PROPERTY PUBLIC RECORDS AND BUSINESS PUBLIC RECORDS, AUTOMATED DOCUMENT FILING, SEARCHING, RETRIEVAL AND REGISTRATION IN THE LENDING AND INSURANCE FIELDS, AND DESIGN, IMPLEMENTATION, MAINTENANCE AND MANAGEMENT OF REPOSITORIES AND REGISTRATION DATABASES OF PUBLIC AND PRIVATE RECORDS; SYSTEMS OPERATION SERVICES OF IN-HOUSE AND OUTSOURCED BUSINESS PROCESSES, NAMELY, IMPLEMENTATION, MANAGEMENT AND MAINTENANCE OF COMPUTER SOFTWARE SYSTEMS FOR IN-HOUSE AND OUTSOURCED BUSINESS PROCESSES, NAMELY, AUTOMATED AND MANUAL PUBLIC RECORDS AND DOCUMENT FILING, AUTOMATED AND MANUAL SEARCHING, RETRIEVAL AND REGISTRATION OF DOCUMENTS, REAL PROPERTY PUBLIC RECORDS, PERSONAL PROPERTY PUBLIC RECORDS AND BUSINESS PUBLIC RECORDS, AND DESIGN, IMPLEMENTATION, MAINTENANCE AND MANAGEMENT OF REPOSITORIES AND REGISTRATION DATABASES OF PUBLIC AND PRIVATE RECORDS, ALL RELATED TO THE FINANCIAL SERVICES INDUSTRY AND ITS REGULATORS; AUTOMATED AND MANUAL SEARCHING AND RETRIEVAL OF REAL PROPERTY PUBLIC RECORDS AND PERSONAL PROPERTY PUBLIC RECORDS, LENDING AND INSURANCE RELATED PROCESS AND DOCUMENT AUTOMATION SERVICES, NAMELY, AUTOMATED DOCUMENT SEARCHING AND RETRIEVAL SERVICES IN THE LENDING AND INSURANCE FIELDS; DESIGN OF REPOSITORIES AND REGISTRATION DATABASES OF PUBLIC AND PRIVATE RECORDS, TECHNOLOGY AND THIRD PARTY INTEGRATION SOLUTIONS, NAMELY, DEVELOPING COMPUTER TECHNOLOGY SOLUTIONS TO INTEGRATE AUTOMATED AND MANUAL PUBLIC RECORDS FILING, AUTOMATED AND MANUAL SEARCHING, RETRIEVAL AND REGISTRATION OF REAL PROPERTY PUBLIC RECORDS, PERSONAL PROPERTY PUBLIC RECORDS AND BUSINESS PUBLIC RECORDS, AUTOMATED DOCUMENT FILING, SEARCHING, RETRIEVAL AND REGISTRATION IN THE LENDING AND INSURANCE FIELDS, AND DESIGN, IMPLEMENTATION, MAINTENANCE AND MANAGEMENT OF REPOSITORIES AND REGISTRATION DATABASES OF PUBLIC AND PRIVATE RECORDS; CONSULTING SERVICES ON IN-HOUSE AND OUTSOURCED BUSINESS PROCESSES, NAMELY, AUTOMATED AND MANUAL SEARCHING AND RETRIEVAL OF DOCUMENTS, REAL PROPERTY PUBLIC RECORDS, PERSONAL PROPERTY PUBLIC RECORDS AND BUSINESS PUBLIC RECORDS, AND DESIGN AND IMPLEMENTATION OF REPOSITORIES AND REGISTRATION DATABASES OF PUBLIC AND PRIVATE RECORDS, ALL RELATED TO THE FINANCIAL SERVICES INDUSTRY

**Reg. No. 4,133,839** AND ITS REGULATORS; TECHNOLOGY AND THIRD PARTY INTEGRATION SOLUTIONS OF IN-HOUSE AND OUTSOURCED BUSINESS PROCESSES, NAMELY, DEVELOPING COMPUTER TECHNOLOGY SOLUTIONS TO INTEGRATE IN-HOUSE AND OUTSOURCED BUSINESS PROCESSES, NAMELY, AUTOMATED AND MANUAL PUBLIC RECORDS AND DOCUMENT FILING, AUTOMATED AND MANUAL SEARCHING, RETRIEVAL AND REGISTRATION OF DOCUMENTS, REAL PROPERTY PUBLIC RECORDS, PERSONAL PROPERTY PUBLIC RECORDS AND BUSINESS PUBLIC RECORDS, AND DESIGN, IMPLEMENTATION, MAINTENANCE AND MANAGEMENT OF REPOSITORIES AND REGISTRATION DATABASES OF PUBLIC AND PRIVATE RECORDS, ALL RELATED TO THE FINANCIAL SERVICES INDUSTRY AND ITS REGULATORS, IN CLASS 42 (U.S. CLS. 100 AND 101).

FIRST USE 9-1-2004; IN COMMERCE 12-1-2004.

FOR: AUTOMATED AND MANUAL REGISTRATION OF BUSINESS PUBLIC RECORDS, NAMELY, FILING OF BUSINESS PUBLIC RECORDS; CONSULTING SERVICES ON AUTOMATED AND MANUAL PUBLIC RECORDS DOCUMENT FILING OF REAL PROPERTY PUBLIC RECORDS, PERSONAL PROPERTY PUBLIC RECORDS AND BUSINESS PUBLIC RECORD AND AUTOMATED PUBLIC DOCUMENT FILING IN THE LENDING AND INSURANCE FIELDS; CONSULTING SERVICES ON AUTOMATED AND MANUAL PUBLIC RECORDS FILING AND AUTOMATED DOCUMENT FILING IN THE LENDING AND INSURANCE FIELDS; AUTOMATED AND MANUAL PUBLIC DOCUMENT FILING OF REAL PROPERTY PUBLIC RECORDS AND PERSONAL PROPERTY PUBLIC RECORDS, LENDING AND INSURANCE RELATED PROCESS AND DOCUMENT AUTOMATION SERVICES, NAMELY, AUTOMATED PUBLIC DOCUMENT FILING SERVICES IN THE LENDING AND INSURANCE FIELDS; CONSULTING SERVICES ON IN-HOUSE AND OUTSOURCED BUSINESS PROCESSES, NAMELY, AUTOMATED AND MANUAL PUBLIC DOCUMENT FILING OF REAL PROPERTY PUBLIC RECORDS, PERSONAL PROPERTY PUBLIC RECORDS AND BUSINESS PUBLIC RECORDS, ALL RELATED TO THE FINANCIAL SERVICES INDUSTRY AND ITS REGULATORS; CONSULTING SERVICES ON IN-HOUSE AND OUTSOURCED BUSINESS PROCESSES, NAMELY, AUTOMATED AND MANUAL PUBLIC RECORDS AND DOCUMENT FILING, ALL RELATED TO THE FINANCIAL SERVICES INDUSTRY AND ITS REGULATORS; AUTOMATED AND MANUAL PUBLIC RECORDS FILING SERVICE, IN CLASS 45 (U.S. CLS. 100 AND 101).

FIRST USE 9-1-2004; IN COMMERCE 12-1-2004.

PRIORITY CLAIMED UNDER SEC. 44(D) ON CANADA APPLICATION NO. 1463947, FILED 12-17-2009, REG. NO. TMA783,598, DATED 11-29-2010, EXPIRES 11-29-2025.

THE MARK CONSISTS OF SQUARE CONTAINING A PIXELATED DOT POSITIONED IN A LOWER RIGHT CORNER OF THE SQUARE.

SER. NO. 85-060,366, FILED 6-11-2010.

EUGENIA MARTIN, EXAMINING ATTORNEY

# United States of America

United States Patent and Trademark Office

# STEPTRONIC

**Reg. No. 4,133,840**

**Registered May 1, 2012**

**Int. Cl.: 25**

**TRADEMARK**

**PRINCIPAL REGISTER**

STEPTRONIC FOOTWEAR LIMITED (UNITED KINGDOM CORPORATION)  
HEMPSTEAD  
CORNER COTTAGES  
NORWICH, UNITED KINGDOM NR12 0SH

FOR: MEN'S, WOMEN'S AND CHILDREN'S FOOTWEAR, NAMELY, INDOOR AND OUT-DOOR BOOTS, SHOES, SLIPPERS AND SANDALS, IN CLASS 25 (U.S. CLS. 22 AND 39).

THE MARK CONSISTS OF STANDARD CHARACTERS WITHOUT CLAIM TO ANY PARTICULAR FONT, STYLE, SIZE, OR COLOR.

PRIORITY CLAIMED UNDER SEC. 44(D) ON CANADA APPLICATION NO. 1472540, FILED 3-10-2010, REG. NO. TMA785138, DATED 12-16-2010, EXPIRES 12-16-2025.

SER. NO. 85-062,161, FILED 6-14-2010.

ANGELA M. MICHELI, EXAMINING ATTORNEY



*David J. Kybas*

Director of the United States Patent and Trademark Office

# United States of America

United States Patent and Trademark Office

# COGIIS

**Reg. No. 4,133,841**

**Registered May 1, 2012**

**Int. Cl.: 9**

**TRADEMARK**

**PRINCIPAL REGISTER**

SIEMENS ENTERPRISE COMMUNICATIONS GMBH & CO. KG (FED REP GERMANY CORPORATION)  
HOFMANNSTRASSE 51  
MUNCHEN, FED REP GERMANY 81379

FOR: OPTICAL, ELECTROTECHNICAL AND ELECTRONIC APPARATUS AND DEVICES, NAMELY, ELECTRICAL APPARATUS FOR RECORDING, TRANSMISSION, PROCESSING, REPRODUCTION, BROADCASTING, AND RECEIVING OF SOUND, IMAGES, AND DATA, SIGNAL PROCESSORS AND RECEIVERS, OPTICAL CHARACTER RECOGNITION APPARATUS, AND COMPUTER HARDWARE FOR THE INTEGRATION OF VOICE, IMAGE, TEXTS, DATA, NAMELY, APPARATUS FOR RECORDING, TRANSMISSION AND SENDING, PROCESSING AND REPRODUCTION OF SOUND, IMAGES AND DATA, AUTOMATIC SWITCHING APPARATUS FOR TELECOMMUNICATIONS, BLANK DIGITAL STORAGE MEDIA, COMPUTER STORAGE DEVICES IN THE NATURE OF HIGH-SPEED STORAGE SUBSYSTEMS FOR STORAGE AND BACKUP OF ELECTRONIC DATA EITHER LOCALLY OR VIA A TELECOMMUNICATIONS NETWORK, DIGITAL OUTPUT SCANNERS; COMMUNICATIONS COMPUTER HARDWARE, SOFTWARE, NAMELY, SOFTWARE FOR SPEECH RECOGNITION, FOR SPEECH ANALYSIS FOR PROVIDING OR ENABLING ACCESS TO AN ELECTRONIC COMMUNICATION DEVICE OR ELECTRONIC COMMUNICATION SYSTEM FOR USE IN CONTROLLING ELECTRONIC COMMUNICATIONS DEVICES OR ELECTRONIC COMMUNICATION SYSTEMS, FOR USE IN ANALYZING COMMUNICATION CONTENT, FOR INTERACTIVE VOICE RESPONSE, FOR DIGITAL VOICE RESPONSE, FOR PROCESSING COMMUNICATION CONTENT, FOR SPEECH TO TEXT AND TEXT TO SPEECH CONVERSATIONS; COMMUNICATION SOFTWARE FOR USE IN PROVIDING ACCESS TO THE INTERNET, INTRANETS, TELECOMMUNICATION NETWORKS, PACKET BASED COMMUNICATION NETWORKS, AND CIRCUIT SWITCHED COMMUNICATION NETWORKS; OPTICAL ELECTROTECHNICAL AND ELECTRONIC EQUIPMENT FOR VOICE, IMAGE, TEXT, DATA OR IMAGE TRANSMISSION, NAMELY, OPTICAL AND ELECTRONIC COMPUTER HARDWARE AND WIRELESS COMMUNICATION DEVICES; TELEPHONES, VIDEO TELEPHONES, VOICE BOXES IN THE NATURE OF DIGITAL VOICE RECORDERS, AUTOMATIC TELEPHONE DIALERS, INTERNAL TELEPHONES, TELEPHONE EXTENSION SWITCHBOARDS; PHOTOCOPIERS; TELECOMMUNICATION NETWORKS CONSISTING OF CONNECTING AND TRANSMISSION EQUIPMENT, NAMELY, ELECTRONIC COMPUTER HARDWARE, COMPUTER SERVERS, COMPUTER OPERATING SOFTWARE, ELECTRIC POWER SUPPLIES, BATTERIES, ELECTRIC ACCUMULATORS, POWER ADAPTERS IN THE NATURE OF ELECTRIC TRANSFORMERS, TELECOMMUNICATION CABLES, OPTICAL FIBERS AND ELECTRIC



*David J. Kybas*

Director of the United States Patent and Trademark Office

**Reg. No. 4,133,841** CONNECTIONS; INDIVIDUAL MODULES AND COMPONENTS OF TELECOMMUNICATION NETWORKS AND TRANSMISSION MEDIA, NAMELY, ELECTRIC POWER SUPPLIES, BATTERIES, ELECTRIC ACCUMULATORS, POWER ADAPTERS IN THE NATURE OF ELECTRIC TRANSFORMERS, TELECOMMUNICATION CABLES, OPTICAL FIBERS AND ELECTRIC CONNECTIONS; DEVICES FOR WIRELESS TRANSMISSION VIA INFRARED AND RADIO TRANSMISSION, NAMELY, INFRARED APPARATUS FOR TRANSMISSION OF COMMUNICATION AND DEVICES FOR WIRELESS RADIO TRANSMISSION; PARTS OF ALL AFOREMENTIONED APPARATUS AND DEVICES; INSTALLATION AND NETWORKS COMPOSED OF A COMBINATION OF SOME OF THE AFOREMENTIONED APPARATUS AND DEVICES, NAMELY, ELECTRICAL APPARATUS FOR RECORDING, TRANSMISSION, PROCESSING, REPRODUCTION, BROADCASTING, AND RECEIVING OF SOUND, IMAGES, AND DATA, AND TELEPHONES, VIDEO TELEPHONES, VOICE BOXES IN THE NATURE OF DIGITAL VOICE RECORDERS, AUTOMATIC TELEPHONE DIALERS, INTERNAL TELEPHONE EXTENSION SWITCHBOARDS, IN CLASS 9 (U.S. CLS. 21, 23, 26, 36 AND 38).

THE MARK CONSISTS OF STANDARD CHARACTERS WITHOUT CLAIM TO ANY PARTICULAR FONT, STYLE, SIZE, OR COLOR.

OWNER OF FED REP GERMANY REG. NO. 302009074221, DATED 8-23-2010, EXPIRES 12-31-2019.

SER. NO. 85-063,309, FILED 6-15-2010.

MARY CRAWFORD, EXAMINING ATTORNEY



# United States of America

United States Patent and Trademark Office

# COGIIS

**Reg. No. 4,133,842**

**Registered May 1, 2012**

**Int. Cl.: 36**

**SERVICE MARK**

**PRINCIPAL REGISTER**

SIEMENS ENTERPRISE COMMUNICATIONS GMBH & CO. KG (FED REP GERMANY CORPORATION)  
HOFMANNSTRASSE 51  
MUNCHEN, FED REP GERMANY 81379

FOR: FINANCING OF TELECOMMUNICATIONS EQUIPMENT AND TELECOMMUNICATIONS NETWORK EQUIPMENT; PROVIDING EXTENDED WARRANTIES AND EXTENDED WARRANTY SERVICE CONTRACTS ON TELECOMMUNICATIONS EQUIPMENT AND TELECOMMUNICATIONS NETWORK EQUIPMENT, IN CLASS 36 (U.S. CLS. 100, 101 AND 102).

THE MARK CONSISTS OF STANDARD CHARACTERS WITHOUT CLAIM TO ANY PARTICULAR FONT, STYLE, SIZE, OR COLOR.

PRIORITY CLAIMED UNDER SEC. 44(D) ON FED REP GERMANY APPLICATION NO. 302009074221, FILED 12-16-2009, REG. NO. 302009074221, DATED 8-23-2010, EXPIRES 12-31-2019.

SER. NO. 85-063,330, FILED 6-15-2010.

MARY CRAWFORD, EXAMINING ATTORNEY



*David J. Kybas*

Director of the United States Patent and Trademark Office

# United States of America

United States Patent and Trademark Office

# COGIIS

**Reg. No. 4,133,843**

**Registered May 1, 2012**

**Int. Cl.: 41**

**SERVICE MARK**

**PRINCIPAL REGISTER**

SIEMENS ENTERPRISE COMMUNICATIONS GMBH & CO. KG (FED REP GERMANY CORPORATION)  
HOFMANNSTRASSE 51  
MUNCHEN, FED REP GERMANY 81379

FOR: EDUCATION SERVICES, NAMELY, PROVIDING CLASSES, SEMINARS AND WORKSHOPS IN THE FIELD OF TELECOMMUNICATIONS TECHNOLOGY REGARDING THE SETTING UP AND OPERATION OF TELECOMMUNICATION SYSTEMS AND TELECOMMUNICATION NETWORKS; TRAINING SERVICES IN THE FIELD OF TELECOMMUNICATIONS TECHNOLOGY REGARDING THE SETTING UP AND OPERATION OF TELECOMMUNICATION SYSTEMS AND TELECOMMUNICATION NETWORKS, IN CLASS 41 (U.S. CLS. 100, 101 AND 107).

THE MARK CONSISTS OF STANDARD CHARACTERS WITHOUT CLAIM TO ANY PARTICULAR FONT, STYLE, SIZE, OR COLOR.

PRIORITY CLAIMED UNDER SEC. 44(D) ON FED REP GERMANY APPLICATION NO. 302009074221, FILED 12-16-2009, REG. NO. 302009074221, DATED 8-23-2010, EXPIRES 12-31-2019.

SER. NO. 85-063,347, FILED 6-15-2010.

MARY CRAWFORD, EXAMINING ATTORNEY



*David J. Kyjars*

Director of the United States Patent and Trademark Office

# United States of America

United States Patent and Trademark Office

# COGIIS

**Reg. No. 4,133,844**

**Registered May 1, 2012**

**Int. Cl.: 37**

**SERVICE MARK**

**PRINCIPAL REGISTER**

SIEMENS ENTERPRISE COMMUNICATIONS GMBH & CO. KG (FED REP GERMANY CORPORATION)  
HOFMANNSTRASSE 51  
MUNCHEN, FED REP GERMANY 81379

FOR: INSTALLATION AND REPAIR OF ELECTRICAL TELECOMMUNICATION DEVICES USED FOR RECORDING, EMISSION, TRANSMISSION, RECEPTION, REPRODUCTION AND PROCESSING OF SOUNDS, SIGNALS, CHARACTERS AND/OR IMAGES, AND FOR INTEGRATION OF VOICE, IMAGES, TEXT, DATA, MULTIMEDIA DATA, AND FULL-MOTION VIDEO FOR COMMUNICATIONS OVER COMPUTER NETWORKS; REPAIR OF TELECOMMUNICATION DEVICES USED FOR RECORDING, PROCESSING, EMITTING, TRANSMISSION, SWITCHING, STORAGE AND OUTPUT OF MESSAGES, INFORMATION AND DATA; REPAIR OF OPTICAL, ELECTROTECHNICAL AND ELECTRONIC TELECOMMUNICATIONS EQUIPMENT FOR USE IN VOICE, IMAGE, TEXT, DATA, MULTIMEDIA DATA AND FULL-MOTION VIDEO COMMUNICATION TECHNOLOGY, ESPECIALLY FOR VOICE, NAMELY, FOR SPEECH RECOGNITION, SPEECH ANALYSIS FOR PROVIDING OR ENABLING ACCESS TO AN ELECTRONIC DEVICE OR SYSTEM COMMUNICATION, FOR CONTROLLING COMMUNICATIONS DEVICES OR SYSTEMS, FOR ANALYZING COMMUNICATION CONTENT, FOR INTERACTIVE VOICE RESPONSE, FOR DIGITAL VOICE RESPONSE, FOR PROCESSING COMMUNICATION CONTENT, AND FOR SPEECH TO TEXT AND TEXT TO SPEECH CONVERSATIONS, OPTICAL ELECTROTECHNICAL AND ELECTRONIC EQUIPMENT FOR VOICE, IMAGE, TEXT, DATA OR IMAGE TRANSMISSION, TELEPHONES, VIDEO TELEPHONES, VOICE BOXES IN THE NATURE OF DIGITAL VOICE RECORDERS, AUTOMATIC TELEPHONE DIALERS, INTERNAL TELEPHONES, TELEPHONE EXTENSION SWITCHBOARDS, PHOTOCOPIERS, TELECOMMUNICATION NETWORKS CONSISTING OF CONNECTING AND TRANSMISSION EQUIPMENT, NAMELY, ELECTRONIC COMPUTER HARDWARE, COMPUTER SERVERS, ELECTRIC POWER SUPPLIES, BATTERIES, ELECTRIC ACCUMULATORS, POWER ADAPTERS IN THE NATURE OF ELECTRIC TRANSFORMERS, TELECOMMUNICATION CABLES, OPTICAL FIBERS AND ELECTRIC CONNECTIONS, INDIVIDUAL MODULES AND COMPONENTS OF TELECOMMUNICATION NETWORKS AND TRANSMISSION MEDIA, NAMELY, ELECTRIC POWER SUPPLIES, BATTERIES, ELECTRIC ACCUMULATORS, POWER ADAPTERS IN THE NATURE OF ELECTRIC TRANSFORMERS, TELECOMMUNICATION CABLES, OPTICAL FIBERS AND ELECTRIC CONNECTIONS, DEVICES FOR WIRELESS TRANSMISSION VIA ELECTROMAGNETIC WAVES AND ULTRASONIC TRANSMISSION, NAMELY, INFRARED, ELECTROMAGNETIC AND ULTRASONIC APPARATUS FOR TRANSMISSION OF COMMUNICATION, DEVICES FOR WIRELESS RADIO



*David J. Kybas*

Director of the United States Patent and Trademark Office

**Reg. No. 4,133,844** TRANSMISSION, PARTS OF ALL AFOREMENTIONED APPARATUS AND DEVICES, INSTALLATIONS AND NETWORKS COMPOSED OF A COMBINATION OF SOME OF THE AFOREMENTIONED APPARATUS AND DEVICES, NAMELY, ELECTRICAL APPARATUS FOR RECORDING, TRANSMISSION, PROCESSING, REPRODUCTION, BROADCASTING, AND RECEIVING OF SOUND, IMAGES, AND DATA, AND TELEPHONES, VIDEO TELEPHONES, VOICE BOXES IN THE NATURE OF DIGITAL VOICE RECORDERS, AUTOMATIC TELEPHONE DIALERS, INTERNAL TELEPHONE EXTENSION SWITCHBOARDS, DATA COMMUNICATION, AND OF TELEPHONES, VIDEO PHONES, VOICE BOXES IN THE NATURE OF DIGITAL VOICE RECORDERS, AUTOMATIC TELEPHONE DIALING DEVICES, INTERNAL TELEPHONE DEVICES AND TELEPHONE EXTENSION SWITCH BOARDS, REPAIR OF PHOTOCOPIERS; REPAIR OF TELECOMMUNICATION NETWORKING HARDWARE CONSISTING OF CONNECTING AND TRANSMISSION EQUIPMENT, INDIVIDUAL MODULES AND COMPONENTS OF SUCH DEVICES SUCH AS POWER SUPPLY UNITS; REPAIR OF BATTERIES, ELECTRIC ACCUMULATORS, POWER ADAPTERS IN THE NATURE OF TRANSFORMERS, TRANSMISSION MEDIA, NAMELY, TELECOMMUNICATION CABLE AND OPTICAL FIBERS, ELECTRIC CONNECTORS, AND DEVICES FOR WIRELESS TRANSMISSION VIA INFRARED AND RADIO TRANSMISSION; REPAIR OF EQUIPMENT COMPRISING A COMBINATION OF THE AFOREMENTIONED APPARATUS AND DEVICES; INSTALLATION WORK, NAMELY, COMPUTER HARDWARE, COMPUTER NETWORKING HARDWARE, IN CLASS 37 (U.S. CLS. 100, 103 AND 106).

THE MARK CONSISTS OF STANDARD CHARACTERS WITHOUT CLAIM TO ANY PARTICULAR FONT, STYLE, SIZE, OR COLOR.

PRIORITY CLAIMED UNDER SEC. 44(D) ON FED REP GERMANY APPLICATION NO. 302009074221, FILED 12-16-2009, REG. NO. 302009074221, DATED 8-23-2010, EXPIRES 12-31-2019.

SER. NO. 85-063,374, FILED 6-15-2010.

MARY CRAWFORD, EXAMINING ATTORNEY

# United States of America

United States Patent and Trademark Office

# COGIIS

**Reg. No. 4,133,845**

**Registered May 1, 2012**

**Int. Cls.: 35 and 38**

**SERVICE MARK**

**PRINCIPAL REGISTER**

SIEMENS ENTERPRISE COMMUNICATIONS GMBH & CO. KG (FED REP GERMANY CORPORATION)  
HOFMANNSTRASSE 51  
MUNCHEN, FED REP GERMANY 81379

FOR: COMMUNICATION SERVICES IN THE NATURE OF OPERATION OF COMMUNICATION SYSTEMS AND NETWORKS FOR OTHERS, NAMELY, OPERATING COMMUNICATION SYSTEMS AND NETWORKS OF CORPORATIONS AND TELECOMMUNICATION CARRIERS THAT ARE FOR USE IN ELECTRONIC TRANSMISSION OF VOICE, DATA, IMAGES, SOUND AND DOCUMENTS VIA COMPUTER TERMINALS, ELECTRONIC MAILING, FACSIMILE TRANSMISSION, TRANSMISSION OF SHORT MESSAGES (SMS), VOICE BOX SERVICES, AND SERVICES FOR FORWARDING TELEPHONE-CALLS AND CONFERENCE CALL SERVICES, IN CLASS 35 (U.S. CLS. 100, 101 AND 102).

FOR: COMMUNICATION SERVICES, NAMELY, TRANSMISSION OF VOICE, DATA, IMAGES, SOUND AND DOCUMENTS BY MEANS OF TELECOMMUNICATION NETWORKS, PACKET-BASED COMMUNICATION NETWORKS OR CIRCUIT SWITCHED COMMUNICATION NETWORKS; ELECTRONIC MAIL SERVICES; FACSIMILE COMMUNICATION; PROVISION OF SHORT MESSAGE SERVICES; VOICE BOX SERVICES, NAMELY, AUTOMATED TELEPHONE VOICE MESSAGE SERVICES; CALL FORWARDING SERVICES; RENTAL OF EQUIPMENT FOR PACKET-BASED AND CIRCUIT SWITCHED TELECOMMUNICATIONS, IN CLASS 38 (U.S. CLS. 100, 101 AND 104).

THE MARK CONSISTS OF STANDARD CHARACTERS WITHOUT CLAIM TO ANY PARTICULAR FONT, STYLE, SIZE, OR COLOR.

PRIORITY CLAIMED UNDER SEC. 44(D) ON FED REP GERMANY APPLICATION NO. 302009074221, FILED 12-16-2009, REG. NO. 302009074221, DATED 8-23-2010, EXPIRES 12-31-2019.

SER. NO. 85-063,383, FILED 6-15-2010.

MARY CRAWFORD, EXAMINING ATTORNEY



*David J. Kyjars*

Director of the United States Patent and Trademark Office

# United States of America

United States Patent and Trademark Office

# COGIIS

**Reg. No. 4,133,846**

**Registered May 1, 2012**

**Int. Cl.: 42**

**SERVICE MARK**

**PRINCIPAL REGISTER**

SIEMENS ENTERPRISE COMMUNICATIONS GMBH & CO. KG (FED REP GERMANY CORPORATION)  
HOFMANNSTRASSE 51  
MUNCHEN, FED REP GERMANY 81379

FOR: CONSULTATION IN THE FIELD OF TELECOMMUNICATIONS TECHNOLOGY REGARDING THE SETTING UP AND OPERATION OF TELECOMMUNICATION SYSTEMS AND TELECOMMUNICATION NETWORKS; PLANNING AND DEVELOPMENT OF TELECOMMUNICATION AND INFORMATION PROCESSING NETWORKS AND COMPUTER NETWORKS FOR TRANSMISSION AND RECEPTION OF VOICE, DATA AND VIDEO AND PRODUCT DEVELOPMENT FOR OTHERS OF EQUIPMENT FOR ELECTRONIC STORAGE AND RECOVERY OF DATA AND THEIR PARTS; DESIGN, DEVELOPMENT AND RENTAL OF COMPUTER PROGRAMS FOR USE IN DATA PROCESSING, IN CLASS 42 (U.S. CLS. 100 AND 101).

THE MARK CONSISTS OF STANDARD CHARACTERS WITHOUT CLAIM TO ANY PARTICULAR FONT, STYLE, SIZE, OR COLOR.

PRIORITY CLAIMED UNDER SEC. 44(D) ON FED REP GERMANY APPLICATION NO. 302009074221, FILED 12-16-2009, REG. NO. 302009074221, DATED 8-23-2010, EXPIRES 12-31-2019.

SER. NO. 85-063,393, FILED 6-15-2010.

MARY CRAWFORD, EXAMINING ATTORNEY



*David J. Kybas*

Director of the United States Patent and Trademark Office

# United States of America

United States Patent and Trademark Office

# MYCOR

**Reg. No. 4,133,847**

**Registered May 1, 2012**

**Int. Cl.: 9**

**TRADEMARK**

**PRINCIPAL REGISTER**

SIEMENS ENTERPRISE COMMUNICATIONS GMBH & CO. KG (FED REP GERMANY CORPORATION)  
HOFMANNSTRASSE 51  
MUNCHEN, FED REP GERMANY 81379

FOR: OPTICAL, ELECTROTECHNICAL AND ELECTRONIC APPARATUS AND DEVICES, NAMELY, ELECTRICAL APPARATUS FOR RECORDING, TRANSMISSION, PROCESSING, REPRODUCTION, BROADCASTING, AND RECEIVING OF SOUND, IMAGES, AND DATA, SIGNAL PROCESSORS AND RECEIVERS, OPTICAL CHARACTER RECOGNITION APPARATUS, AND COMPUTER HARDWARE FOR THE INTEGRATION OF VOICE, IMAGE, TEXTS, DATA, NAMELY, APPARATUS FOR RECORDING, TRANSMISSION AND SENDING, PROCESSING AND REPRODUCTION OF SOUND, IMAGES AND DATA, AUTOMATIC SWITCHING APPARATUS FOR TELECOMMUNICATIONS, BLANK DIGITAL STORAGE MEDIA, COMPUTER STORAGE DEVICES IN THE NATURE OF HIGH-SPEED STORAGE SUBSYSTEMS FOR STORAGE AND BACKUP OF ELECTRONIC DATA EITHER LOCALLY OR VIA A TELECOMMUNICATIONS NETWORK, DIGITAL OUTPUT SCANNERS; COMMUNICATIONS COMPUTER HARDWARE, SOFTWARE, NAMELY, SOFTWARE FOR SPEECH RECOGNITION, FOR SPEECH ANALYSIS FOR PROVIDING OR ENABLING ACCESS TO AN ELECTRONIC COMMUNICATION DEVICE OR ELECTRONIC COMMUNICATION SYSTEM, FOR USE IN CONTROLLING ELECTRONIC COMMUNICATIONS DEVICES OR ELECTRONIC COMMUNICATION SYSTEMS, FOR USE IN ANALYZING COMMUNICATION CONTENT, FOR INTERACTIVE VOICE RESPONSE, FOR DIGITAL VOICE RESPONSE, FOR PROCESSING COMMUNICATION CONTENT, AND FOR SPEECH TO TEXT AND TEXT TO SPEECH CONVERSATIONS; COMMUNICATION SOFTWARE FOR USE IN PROVIDING ACCESS TO THE INTERNET, INTRANETS, TELECOMMUNICATION NETWORKS, PACKET BASED COMMUNICATION NETWORKS, AND CIRCUIT SWITCHED COMMUNICATION NETWORKS; OPTICAL ELECTROTECHNICAL AND ELECTRONIC EQUIPMENT FOR VOICE, IMAGE, TEXT, DATA OR IMAGE TRANSMISSION, NAMELY, OPTICAL AND ELECTRONIC COMPUTER HARDWARE AND WIRELESS COMMUNICATION DEVICES; TELEPHONES, VIDEO TELEPHONES, VOICE BOXES IN THE NATURE OF DIGITAL VOICE RECORDERS, AUTOMATIC TELEPHONE DIALERS, INTERNAL TELEPHONES, TELEPHONE EXTENSION SWITCHBOARDS; PHOTOCOPIERS; TELECOMMUNICATION NETWORKS CONSISTING OF CONNECTING AND TRANSMISSION EQUIPMENT, NAMELY, ELECTRONIC COMPUTER HARDWARE, COMPUTER SERVERS, COMPUTER OPERATING SOFTWARE, ELECTRIC POWER SUPPLIES, BATTERIES, ELECTRIC ACCUMULATORS, POWER ADAPTERS IN THE NATURE OF ELECTRIC TRANSFORMERS, TELECOMMUNICATION CABLES, OPTICAL FIBERS AND ELECTRIC



*David J. Kybas*

Director of the United States Patent and Trademark Office

**Reg. No. 4,133,847** CONNECTIONS; INDIVIDUAL MODULES AND COMPONENTS OF TELECOMMUNICATION NETWORKS AND TRANSMISSION MEDIA, NAMELY, ELECTRIC POWER SUPPLIES, BATTERIES, ELECTRIC ACCUMULATORS, POWER ADAPTERS IN THE NATURE OF ELECTRIC TRANSFORMERS, TELECOMMUNICATION CABLES, OPTICAL FIBERS AND ELECTRIC CONNECTIONS; DEVICES FOR WIRELESS TRANSMISSION VIA INFRARED AND RADIO TRANSMISSION, NAMELY, INFRARED APPARATUS FOR TRANSMISSION OF COMMUNICATION AND DEVICES FOR WIRELESS RADIO TRANSMISSION; PARTS OF ALL AFOREMENTIONED APPARATUS AND DEVICES; INSTALLATION AND NETWORKS COMPOSED OF A COMBINATION OF SOME OF THE AFOREMENTIONED APPARATUS AND DEVICES, NAMELY, ELECTRICAL APPARATUS FOR RECORDING, TRANSMISSION, PROCESSING, REPRODUCTION, BROADCASTING, AND RECEIVING OF SOUND, IMAGES, AND DATA, AND TELEPHONES, VIDEO TELEPHONES, VOICE BOXES IN THE NATURE OF DIGITAL VOICE RECORDERS, AUTOMATIC TELEPHONE DIALERS, INTERNAL TELEPHONE EXTENSION SWITCHBOARDS, IN CLASS 9 (U.S. CLS. 21, 23, 26, 36 AND 38).

THE MARK CONSISTS OF STANDARD CHARACTERS WITHOUT CLAIM TO ANY PARTICULAR FONT, STYLE, SIZE, OR COLOR.

PRIORITY CLAIMED UNDER SEC. 44(D) ON FED REP GERMANY APPLICATION NO. 302009074222, FILED 12-16-2009, REG. NO. 302009074222, DATED 8-23-2010, EXPIRES 12-31-2019.

SER. NO. 85-063,421, FILED 6-15-2010.

MARY CRAWFORD, EXAMINING ATTORNEY



# United States of America

United States Patent and Trademark Office

# MYCOR

**Reg. No. 4,133,848**

**Registered May 1, 2012**

**Int. Cl.: 36**

**SERVICE MARK**

**PRINCIPAL REGISTER**

SIEMENS ENTERPRISE COMMUNICATIONS GMBH & CO. KG (FED REP GERMANY CORPORATION)  
HOFMANNSTRASSE 51  
MUNCHEN, FED REP GERMANY 81379

FOR: FINANCING TELECOMMUNICATION EQUIPMENT AND TELECOMMUNICATION NETWORKS; PROVIDING EXTENDED WARRANTIES AND SERVICE CONTRACTS ON TELECOMMUNICATION EQUIPMENT AND TELECOMMUNICATION NETWORKS, IN CLASS 36 (U.S. CLS. 100, 101 AND 102).

THE MARK CONSISTS OF STANDARD CHARACTERS WITHOUT CLAIM TO ANY PARTICULAR FONT, STYLE, SIZE, OR COLOR.

PRIORITY CLAIMED UNDER SEC. 44(D) ON FED REP GERMANY APPLICATION NO. 302009074222, FILED 12-16-2009, REG. NO. 302009074222, DATED 12-16-2009, EXPIRES 12-31-2019.

SER. NO. 85-063,449, FILED 6-15-2010.

ERIN FALK, EXAMINING ATTORNEY



*David J. Kybas*

Director of the United States Patent and Trademark Office

# United States of America

United States Patent and Trademark Office

# MYCOR

**Reg. No. 4,133,849**

**Registered May 1, 2012**

**Int. Cl.: 42**

**SERVICE MARK**

**PRINCIPAL REGISTER**

SIEMENS ENTERPRISE COMMUNICATIONS GMBH & CO. KG (FED REP GERMANY CORPORATION)  
HOFMANNSTRASSE 51  
MUNCHEN, FED REP GERMANY 81379

FOR: CONSULTATION IN THE FIELD OF TELECOMMUNICATIONS TECHNOLOGY REGARDING THE SETTING UP AND OPERATION OF TELECOMMUNICATION SYSTEMS AND TELECOMMUNICATION NETWORKS; PLANNING AND DEVELOPMENT OF TELECOMMUNICATION AND INFORMATION PROCESSING NETWORKS AND COMPUTER NETWORKS FOR TRANSMISSION AND RECEPTION OF VOICE, DATA AND VIDEO AND PRODUCT DEVELOPMENT FOR OTHERS OF EQUIPMENT FOR ELECTRONIC STORAGE AND RECOVERY OF DATA AND THEIR PARTS; DESIGN, DEVELOPMENT AND RENTAL OF COMPUTER PROGRAMS FOR USE IN DATA PROCESSING, IN CLASS 42 (U.S. CLS. 100 AND 101).

THE MARK CONSISTS OF STANDARD CHARACTERS WITHOUT CLAIM TO ANY PARTICULAR FONT, STYLE, SIZE, OR COLOR.

PRIORITY CLAIMED UNDER SEC. 44(D) ON FED REP GERMANY APPLICATION NO. 302009074222, FILED 12-16-2009, REG. NO. 302009074222, DATED 12-16-2009, EXPIRES 12-31-2019.

SER. NO. 85-063,474, FILED 6-15-2010.

MARY CRAWFORD, EXAMINING ATTORNEY



*David J. Kybas*

Director of the United States Patent and Trademark Office

# United States of America

United States Patent and Trademark Office



**Reg. No. 4,133,850**

**Registered May 1, 2012**

**Int. Cl.: 44**

**SERVICE MARK**

**PRINCIPAL REGISTER**

THOMAS G. HOSPEL (UNITED STATES INDIVIDUAL)  
87 S. HIGH STREET  
DUBLIN, OH 43017

FOR: PHYSICAL THERAPY AND SPORTS NUTRITION CONSULTATION SERVICES OFFERED TO ATHLETES AT THEIR HOMES OR BY MOBILE UNIT AT SPECIFIC TOURNAMENTS OR COMPETITIVE EVENTS, IN CLASS 44 (U.S. CLS. 100 AND 101).

FIRST USE 1-15-2009; IN COMMERCE 1-15-2009.

NO CLAIM IS MADE TO THE EXCLUSIVE RIGHT TO USE "PHYSIOFITNESS ASSOCIATES", APART FROM THE MARK AS SHOWN.

THE COLOR(S) BLACK, WHITE, BLUE, AND GREEN IS/ARE CLAIMED AS A FEATURE OF THE MARK.

THE MARK CONSISTS OF THE WORD "PHYSIOFITNESS". "PHYSIO" IN BOLD BLACK LETTERS WITH SIX LIGHT BLUE BUBBLES DOTTING THE "I" LEADING TO A BIG CIRCLE WITH A HEAD AND BODY IMAGE IN WHITE, A CIRCLE WITH DARKER BLUE, LIGHT BLUE AND GREEN SIDES AND "FITNESS" IN A LOWER CASE BLACK LETTERS, THE WORD "ASSOCIATES" IN BLUE SMALL CAPS LETTERS BELOW "FITNESS".

SER. NO. 85-065,379, FILED 6-17-2010.

JASON TURNER, EXAMINING ATTORNEY



*David J. Kybas*

Director of the United States Patent and Trademark Office

# United States of America

United States Patent and Trademark Office



**Reg. No. 4,133,851**

BRAVEHEART GROUP, LLC (NEW JERSEY LIMITED LIABILITY COMPANY)  
2 SPLIT ROCK ROAD  
MAHWAH, NJ 07430

**Registered May 1, 2012**

**Int. Cl.: 16**

FOR: PRINTED PERIODICALS IN THE FIELD OF URGENT CARE AND EMERGENCY MEDICINE, IN CLASS 16 (U.S. CLS. 2, 5, 22, 23, 29, 37, 38 AND 50).

**TRADEMARK**

FIRST USE 5-1-2010; IN COMMERCE 5-1-2010.

**PRINCIPAL REGISTER**

NO CLAIM IS MADE TO THE EXCLUSIVE RIGHT TO USE "URGENT CARE BUYER'S GUIDE", APART FROM THE MARK AS SHOWN.

THE MARK CONSISTS OF THE LETTERS "UC", A PLUS SIGN WITH THE STRIPPED SHADOW, THE LETTERS "BG" IN A BOX NEXT TO THE TEXT "URGENT CARE" OVER THE TEXT "BUYER'S GUIDE".

SER. NO. 85-070,970, FILED 6-24-2010.

BERNICE MIDDLETON, EXAMINING ATTORNEY



*David J. Kyjars*

Director of the United States Patent and Trademark Office

# United States of America

United States Patent and Trademark Office

## YOUNG PEOPLE'S CHORUS OF NEW YORK CITY

**Reg. No. 4,133,852**

**Registered May 1, 2012**

**Int. Cl.: 41**

**SERVICE MARK**

**PRINCIPAL REGISTER**

THE YOUNG PEOPLE'S CHORUS OF NEW YORK CITY, INC. (NEW YORK CORPORATION)  
1995 BROADWAY  
NEW YORK, NY 10023

FOR: ENTERTAINMENT SERVICES, NAMELY, PROVIDING LIVE PERFORMANCES IN  
THE NATURE OF CONCERTS BY A CHILDREN'S CHORUS, IN CLASS 41 (U.S. CLS. 100,  
101 AND 107).

FIRST USE 12-9-1996; IN COMMERCE 12-9-1996.

THE MARK CONSISTS OF STANDARD CHARACTERS WITHOUT CLAIM TO ANY PAR-  
TICULAR FONT, STYLE, SIZE, OR COLOR.

NO CLAIM IS MADE TO THE EXCLUSIVE RIGHT TO USE "CHORUS", APART FROM THE  
MARK AS SHOWN.

SEC. 2(F).

SER. NO. 85-070,971, FILED 6-24-2010.

BARNEY CHARLON, EXAMINING ATTORNEY



*David J. Kyffers*

Director of the United States Patent and Trademark Office

# United States of America

United States Patent and Trademark Office

# ULTRAFIT

**Reg. No. 4,133,853**

**Registered May 1, 2012**

**Int. Cl.: 16**

**TRADEMARK**

**PRINCIPAL REGISTER**

THE PROPHET CORPORATION (MINNESOTA CORPORATION)  
2525 LEMOND ST. SW  
OWATONNA, MN 55060

FOR: PRINTED FITNESS CHARTS, IN CLASS 16 (U.S. CLS. 2, 5, 22, 23, 29, 37, 38 AND 50).

FIRST USE 8-0-2006; IN COMMERCE 8-0-2006.

THE MARK CONSISTS OF STANDARD CHARACTERS WITHOUT CLAIM TO ANY PARTICULAR FONT, STYLE, SIZE, OR COLOR.

SER. NO. 85-077,480, FILED 7-2-2010.

CAROLINE WOOD, EXAMINING ATTORNEY



*David J. Kybas*

Director of the United States Patent and Trademark Office

# United States of America

United States Patent and Trademark Office

**SMART-O**

**Reg. No. 4,133,854**

**Registered May 1, 2012**

**Int. Cls.: 7 and 20**

**TRADEMARK**

**PRINCIPAL REGISTER**

RAPIDFIX INDUSTRIAL (ASIA) LIMITED (HONG KONG CORPORATION)  
90-92 JAFFE ROAD  
FLAT 2, 19/F, HENAN BUILDING  
WANCHAI, HONG KONG

FOR: VEHICLE ENGINE PARTS, NAMELY, OIL DRAIN PLUGS, IN CLASS 7 (U.S. CLS. 13, 19, 21, 23, 31, 34 AND 35).

FIRST USE 3-0-2010; IN COMMERCE 4-0-2010.

FOR: NON-METAL SCREWS, IN CLASS 20 (U.S. CLS. 2, 13, 22, 25, 32 AND 50).

FIRST USE 3-0-2010; IN COMMERCE 4-0-2010.

THE MARK CONSISTS OF A STYLIZED FORM OF THE MARK "SMART-O".

SER. NO. 85-078,349, FILED 7-6-2010.

TEJBIR SINGH, EXAMINING ATTORNEY



*David J. Kyffers*

Director of the United States Patent and Trademark Office

# United States of America

United States Patent and Trademark Office



**Reg. No. 4,133,855**

**Registered May 1, 2012**

**Int. Cl.: 43**

**SERVICE MARK**

**PRINCIPAL REGISTER**

RED RESTAURANT VENTURES, LLC (GEORGIA LIMITED LIABILITY COMPANY)  
SUITE 99  
170 NORTHSIDE DRIVE  
ATLANTA, GA 30313

FOR: RESTAURANTS, IN CLASS 43 (U.S. CLS. 100 AND 101).

FIRST USE 7-9-2010; IN COMMERCE 7-9-2010.

NO CLAIM IS MADE TO THE EXCLUSIVE RIGHT TO USE "GRILL", APART FROM THE MARK AS SHOWN.

THE MARK CONSISTS OF A SQUARE CONTAINING THE WORDS "BIG CHOW GRILL A STIR FRY EVOLUTION" ALONG WITH A BOWL WITH A FIRE FLAME EXTENDING FROM THE TOP.

SER. NO. 85-081,791, FILED 7-9-2010.

KIMBERLY FRYE, EXAMINING ATTORNEY



*David J. Kybas*

Director of the United States Patent and Trademark Office



# United States of America

United States Patent and Trademark Office



**Reg. No. 4,133,856**

**Registered May 1, 2012**

**Int. Cl.: 35**

**SERVICE MARK**

**PRINCIPAL REGISTER**

THE AMERICAN NATURAL GAS ALLIANCE, INC. (DELAWARE CORPORATION)  
SUITE 1110  
1201 NEW YORK AVENUE, NW  
WASHINGTON, DC 20005

FOR: ASSOCIATION SERVICES, NAMELY, PROMOTING THE PUBLIC INTERESTS AND AWARENESS OF THE BENEFITS OF NATURAL GAS; ADVERTISING AND MARKETING SERVICES, NAMELY, DEVELOPING AND DISSEMINATING PRINTED AND ONLINE PROMOTIONAL OR ADVERTISING MATERIALS IN THE FIELD OF NATURAL GAS, IN CLASS 35 (U.S. CLS. 100, 101 AND 102).

FIRST USE 5-4-2010; IN COMMERCE 5-4-2010.

NO CLAIM IS MADE TO THE EXCLUSIVE RIGHT TO USE "ALLIANCE", APART FROM THE MARK AS SHOWN.

THE MARK CONSISTS OF THE LETTERS "ANGA" IN FRONT OF A FLAME DESIGN WITH THE WORDS "AMERICA'S NATURAL GAS ALLIANCE" UNDERNEATH THE SECOND "A" AND FLAME DESIGN.

SEC. 2(F) AS TO "AMERICA'S NATURAL GAS".

SER. NO. 85-083,235, FILED 7-13-2010.

TRACY WHITTAKER-BROWN, EXAMINING ATTORNEY



*David J. Kyffers*

Director of the United States Patent and Trademark Office

# United States of America

United States Patent and Trademark Office

## STANDARD METHODS FOR THE EXAMINATION OF WATER AND WASTEWATER

**Reg. No. 4,133,857**

**Registered May 1, 2012**

**Int. Cls.: 16, 42 and 44**

**TRADEMARK**

**SERVICE MARK**

**PRINCIPAL REGISTER**

AMERICAN PUBLIC HEALTH ASSOCIATION (D.C. CORPORATION)  
800 I STREET, N.W.  
WASHINGTON, DC 20001 AND

AMERICAN WATER WORKS ASSOCIATION (ILLINOIS CORPORATION)  
6666 W. QUINCY AVENUE  
DENVER, CO 80235 AND

WATER ENVIRONMENT FEDERATION (ILLINOIS CORPORATION)  
601 WYTHE STREET  
ALEXANDRIA, VA 22314

FOR: PRINTED PUBLICATIONS, NAMELY, PERIODICALLY PRINTED BOOKS REGARDING  
THE WATER SUPPLY, IN CLASS 16 (U.S. CLS. 2, 5, 22, 23, 29, 37, 38 AND 50).

FIRST USE 0-0-1960; IN COMMERCE 0-0-1960.

FOR: ONLINE INFORMATION IN THE FIELD OF WATER QUALITY, IN CLASS 42 (U.S.  
CLS. 100 AND 101).

FIRST USE 4-0-2004; IN COMMERCE 4-0-2004.

FOR: ONLINE INFORMATION IN THE FIELD OF DISEASE CONTROL , IN CLASS 44 (U.S.  
CLS. 100 AND 101).

FIRST USE 4-0-2004; IN COMMERCE 4-0-2004.

THE MARK CONSISTS OF STANDARD CHARACTERS WITHOUT CLAIM TO ANY PAR-  
TICULAR FONT, STYLE, SIZE, OR COLOR.

SEC. 2(F).

SER. NO. 85-084,219, FILED 7-14-2010.

LINDA ESTRADA, EXAMINING ATTORNEY



*David J. Kyjars*

Director of the United States Patent and Trademark Office

# United States of America

United States Patent and Trademark Office

## GLEVUM ASSOCIATES

**Reg. No. 4,133,858**

**Registered May 1, 2012**

**Int. Cl.: 42**

**SERVICE MARK**

**PRINCIPAL REGISTER**

GLEVUM ASSOCIATES LLC (MASSACHUSETTS LIMITED LIABILITY COMPANY)  
SUITE 205A  
ONE NEW ENGLAND EXECUTIVE PARK  
BURLINGTON, MA 01803

FOR: SOCIAL SCIENCE RESEARCH IN THE FIELD OF INDIGENOUS POPULATIONS IN FRAGILE NATION STATES FOR BETTER UNDERSTANDING OF THEIR SOCIO-CULTURAL CHARACTERISTICS AND THEIR IMPACT ON NATIONAL SECURITY, EXCLUDING EDUCATION SERVICES IN THE NATURE OF CONDUCTING TRAINING IN THE FIELD OF CULTURAL SENSITIVITY AND CHRISTIAN EVANGELISM/DISCIPLESHIP FOR SHORT TERM MISSIONARY TEAMS, IN CLASS 42 (U.S. CLS. 100 AND 101).

FIRST USE 2-28-2010; IN COMMERCE 2-28-2010.

THE MARK CONSISTS OF STANDARD CHARACTERS WITHOUT CLAIM TO ANY PARTICULAR FONT, STYLE, SIZE, OR COLOR.

NO CLAIM IS MADE TO THE EXCLUSIVE RIGHT TO USE "ASSOCIATES", APART FROM THE MARK AS SHOWN.

SER. NO. 85-084,655, FILED 7-14-2010.

DAWN HAN, EXAMINING ATTORNEY



*David J. Kyffers*

Director of the United States Patent and Trademark Office

# United States of America

United States Patent and Trademark Office

## GLEVUM ASSOCIATES

**Reg. No. 4,133,859**

**Registered May 1, 2012**

**Int. Cl.: 45**

**SERVICE MARK**

**PRINCIPAL REGISTER**

GLEVUM ASSOCIATES LLC (MASSACHUSETTS LIMITED LIABILITY COMPANY)  
SUITE 205A  
ONE NEW ENGLAND EXECUTIVE PARK  
BURLINGTON, MA 01803

FOR: NATIONAL SECURITY CONSULTATION SERVICES FOR SOCIO-CULTURAL UNDERSTANDING OF INDIGENOUS POPULATIONS IN FRAGILE NATION STATES, EXCLUDING EDUCATION SERVICES IN THE NATURE OF CONDUCTING TRAINING IN THE FIELD OF CULTURAL SENSITIVITY AND CHRISTIAN EVANGELISM/DISCIPLESHIP FOR SHORT TERM MISSIONARY TEAMS; NATIONAL SECURITY RESEARCH FOR SOCIO-CULTURAL UNDERSTANDING OF INDIGENOUS POPULATIONS IN FRAGILE NATION STATES, EXCLUDING EDUCATION SERVICES IN THE NATURE OF CONDUCTING TRAINING IN THE FIELD OF CULTURAL SENSITIVITY AND CHRISTIAN EVANGELISM/DISCIPLESHIP FOR SHORT TERM MISSIONARY TEAMS, IN CLASS 45 (U.S. CLS. 100 AND 101).

FIRST USE 2-28-2010; IN COMMERCE 2-28-2010.

THE MARK CONSISTS OF STANDARD CHARACTERS WITHOUT CLAIM TO ANY PARTICULAR FONT, STYLE, SIZE, OR COLOR.

NO CLAIM IS MADE TO THE EXCLUSIVE RIGHT TO USE "ASSOCIATES", APART FROM THE MARK AS SHOWN.

SER. NO. 85-084,669, FILED 7-14-2010.

DAWN HAN, EXAMINING ATTORNEY



*David J. Kybas*

Director of the United States Patent and Trademark Office

# United States of America

United States Patent and Trademark Office

# F2RA

**Reg. No. 4,133,860**

**Registered May 1, 2012**

**Int. Cl.: 45**

**SERVICE MARK**

**PRINCIPAL REGISTER**

GLEVUM ASSOCIATES LLC (MASSACHUSETTS LIMITED LIABILITY COMPANY)  
ONE NEW ENGLAND EXECUTIVE PARK  
SUITE 205A  
BURLINGTON, MA 01803

FOR: NATIONAL SECURITY CONSULTATION SERVICES FOR SOCIO-CULTURAL UNDERSTANDING OF INDIGENOUS POPULATIONS IN FRAGILE NATION STATES, EXCLUDING EDUCATION SERVICES IN THE NATURE OF CONDUCTING TRAINING IN THE FIELD OF CULTURAL SENSITIVITY AND CHRISTIAN EVANGELISM/DISCIPLESHP FOR SHORT TERM MISSIONARY TEAMS; NATIONAL SECURITY RESEARCH FOR SOCIO-CULTURAL UNDERSTANDING OF INDIGENOUS POPULATIONS IN FRAGILE NATION STATES, EXCLUDING EDUCATION SERVICES IN THE NATURE OF CONDUCTING TRAINING IN THE FIELD OF CULTURAL SENSITIVITY AND CHRISTIAN EVANGELISM/DISCIPLESHP FOR SHORT TERM MISSIONARY TEAMS, IN CLASS 45 (U.S. CLS. 100 AND 101).

FIRST USE 2-28-2010; IN COMMERCE 2-28-2010.

THE MARK CONSISTS OF STANDARD CHARACTERS WITHOUT CLAIM TO ANY PARTICULAR FONT, STYLE, SIZE, OR COLOR.

SER. NO. 85-084,677, FILED 7-14-2010.

DAWN HAN, EXAMINING ATTORNEY



*David J. Kybas*

Director of the United States Patent and Trademark Office

# United States of America

United States Patent and Trademark Office



**Reg. No. 4,133,861**

**Registered May 1, 2012**

**Int. Cls.: 9, 35, 38, 41  
and 42**

**TRADEMARK**

**SERVICE MARK**

**PRINCIPAL REGISTER**

NOWCOM CO., LTD. (REPUBLIC OF KOREA CORPORATION)  
801, 201, PANGYO 7 VENTURE VALLEY, 625  
1 DANJI2DONG, SAMPYEONGDONG, BUNDANGGU  
SEONGNAMSİ, GYEONGGIDO, REPUBLIC OF KOREA

FOR: RECORDED COMPUTER PROGRAMS FOR INTERNET BROADCASTING; RECORDED COMPUTER OPERATING PROGRAMS; DOWNLOADABLE COMPUTER PROGRAMS FOR INTERNET BROADCASTING, IN CLASS 9 (U.S. CLS. 21, 23, 26, 36 AND 38).

FOR: MARKETING AND ADVERTISING SERVICES VIA ELECTRONIC MEDIA AND THE INTERNET; MARKET RESEARCH SERVICES; SYSTEMIZATION OF INFORMATION INTO COMPUTER DATABASES; ON-LINE AUCTIONEERING SERVICES; RETAIL STORE SERVICES FEATURING COMPUTER GAME PROGRAMS; ARRANGING AND CONDUCTING SALES FOR OTHERS OF MULTIMEDIA ELECTRONIC CONTENTS RELATING TO MOVIES AND BROADCASTING; SERVICES OF PROVIDING INFORMATION ON JOB OPENINGS, IN CLASS 35 (U.S. CLS. 100, 101 AND 102).

FOR: INTERNET BROADCASTING; BROADCASTING OF EDUCATIONAL PROGRAMS VIA THE INTERNET; RADIO BROADCASTING; CABLE TELEVISION BROADCASTING; TELEVISION BROADCASTING, IN CLASS 38 (U.S. CLS. 100, 101 AND 104).

FOR: FILM PRODUCTION; DIGITAL IMAGING SERVICES; PRODUCTION OF RADIO AND TELEVISION PROGRAMS; PROVISION OF NON-DOWNLOADABLE FILMS AND MOVIES VIA AN ON-LINE VIDEO-ON-DEMAND SERVICE; ENTERTAINMENT SERVICES, NAMELY, PROVIDING NON-DOWNLOADABLE PLAYBACK OF MUSIC VIA GLOBAL COMMUNICATIONS NETWORKS, IN CLASS 41 (U.S. CLS. 100, 101 AND 107).

FOR: CREATING AND MAINTAINING WEB SITES RELATING TO COMPUTER GAMES FOR OTHERS; CONVERSION OF DATA AND DOCUMENTS FROM PHYSICAL TO ELECTRONIC MEDIA; COMPUTER SOFTWARE DESIGN; MAINTENANCE OF COMPUTER SOFTWARE; COMPUTER SYSTEM DESIGN; COMPUTER SOFTWARE DEVELOPMENT; PROVIDING SEARCH ENGINES FOR THE INTERNET; RENTAL OF WEB SERVERS, IN CLASS 42 (U.S. CLS. 100 AND 101).



*David J. Kyjars*

OWNER OF REPUBLIC OF KOREA REG. NO. 0221910, DATED 11-25-2011, EXPIRES 11-25-2021.

**Reg. No. 4,133,861** OWNER OF REPUBLIC OF KOREA REG. NO. 0211268, DATED 6-2-2011, EXPIRES 6-2-2021.

OWNER OF REPUBLIC OF KOREA REG. NO. 0018455, DATED 12-27-2006, EXPIRES 12-27-2016.

THE MARK CONSISTS OF THE WORD "AFREECA" IN STYLIZED LOWER CASE FONT WITH A STYLIZED SMILEY FACE IN THE SHAPE OF A TELEVISION TO THE RIGHT.

SER. NO. 85-084,679, FILED 7-14-2010.

JULIE WATSON, EXAMINING ATTORNEY

# United States of America

United States Patent and Trademark Office

## ANTI-GRAVITY NITROUS MONSTER ENERGY

**Reg. No. 4,133,862**

**Registered May 1, 2012**

**Int. Cls.: 5 and 32**

**TRADEMARK**

**PRINCIPAL REGISTER**

HANSEN BEVERAGE COMPANY (DELAWARE CORPORATION)  
SUITE 201  
550 MONICA CIRCLE  
CORONA, CA 92880

FOR: NUTRITIONAL SUPPLEMENTS IN LIQUID FORM, IN CLASS 5 (U.S. CLS. 6, 18, 44, 46, 51 AND 52).

FIRST USE 7-0-2009; IN COMMERCE 7-0-2009.

FOR: BEVERAGES, NAMELY, CARBONATED SOFT DRINKS; NON-ALCOHOLIC CARBONATED DRINKS ENHANCED WITH VITAMINS, MINERALS, NUTRIENTS, PROTEINS, AMINO ACIDS AND/OR HERBS; CARBONATED ENERGY DRINKS AND SPORTS DRINKS; ALL THE FOREGOING GOODS EXCLUDE PERISHABLE BEVERAGE PRODUCTS THAT CONTAIN FRUIT JUICE OR SOY, WHETHER SUCH PRODUCTS ARE PASTEURIZED OR NOT, IN CLASS 32 (U.S. CLS. 45, 46 AND 48).

FIRST USE 7-0-2009; IN COMMERCE 7-0-2009.

THE MARK CONSISTS OF STANDARD CHARACTERS WITHOUT CLAIM TO ANY PARTICULAR FONT, STYLE, SIZE, OR COLOR.

OWNER OF U.S. REG. NOS. 3,044,314, 3,134,842 AND OTHERS.

NO CLAIM IS MADE TO THE EXCLUSIVE RIGHT TO USE "NITROUS" OR "ENERGY", APART FROM THE MARK AS SHOWN.

SER. NO. 85-086,119, FILED 7-16-2010.

LEIGH LOWRY, EXAMINING ATTORNEY



*David J. Kyffers*

Director of the United States Patent and Trademark Office



# United States of America

United States Patent and Trademark Office



**Reg. No. 4,133,863**

**Registered May 1, 2012**

**Int. Cl.: 32**

**TRADEMARK**

**PRINCIPAL REGISTER**

GRANVILLE ISLAND BREWING COMPANY LTD. (CANADA CORPORATION)  
SUITE 410  
1385 WEST 8TH AVE.  
VANCOUVER, BC, CANADA V643V9

FOR: BREWED ALCOHOLIC BEVERAGES, NAMELY, BEER, IN CLASS 32 (U.S. CLS. 45, 46 AND 48).

PRIORITY CLAIMED UNDER SEC. 44(D) ON CANADA APPLICATION NO. 1487430, FILED 7-5-2010, REG. NO. TMA810,354, DATED 10-26-2011, EXPIRES 10-26-2026.

NO CLAIM IS MADE TO THE EXCLUSIVE RIGHT TO USE "GRANVILLE ISLAND BREWING", APART FROM THE MARK AS SHOWN.

THE MARK CONSISTS OF THE WORDS "GRANVILLE ISLAND BREWING" IN A RIBBON DESIGN OVER A DIAMOND DESIGN CONTAINING A SKYLINE AND MOUNTAIN DESIGN.

SER. NO. 85-086,672, FILED 7-16-2010.

FRED CARL, EXAMINING ATTORNEY



*David J. Kyfos*

Director of the United States Patent and Trademark Office

# United States of America

United States Patent and Trademark Office

# VISMODE

**Reg. No. 4,133,864**

**Registered May 1, 2012**

**Int. Cl.: 9**

**TRADEMARK**

**PRINCIPAL REGISTER**

WEIR MINERALS AUSTRALIA LTD (AUSTRALIA CORPORATION)  
1-3 MARDEN STREET  
ARTARMON NSW, AUSTRALIA 2064

FOR: SCIENTIFIC APPARATUS AND INSTRUMENTS, NAMELY, MICROPROCESSOR-BASED ELECTRONIC CONTROL SYSTEMS FOR OPERATING AND MONITORING PUMPS; APPARATUS AND INSTRUMENTS FOR SWITCHING, REGULATING AND CONTROLLING ELECTRICITY, NAMELY, ELECTRICITY LIMITERS AND ELECTRIC CIRCUIT SWITCHES IN ELECTRONIC COMMUNICATION WITH PUMPS; DATA PROCESSORS AND COMPUTERS; ELECTRONIC MONITORS AND SENSORS FOR MONITORING THE OPERATIONS OF PUMPS; ELECTRONIC CONTROL PANELS AND CONTROL CABINETS SPECIALLY ADAPTED FOR HOUSING ELECTRONIC CONTROLS AND HAVING A DISPLAY SCREEN OR MONITOR FOR OPERATING AND MONITORING PUMPS, IN CLASS 9 (U.S. CLS. 21, 23, 26, 36 AND 38).

THE MARK CONSISTS OF STANDARD CHARACTERS WITHOUT CLAIM TO ANY PARTICULAR FONT, STYLE, SIZE, OR COLOR.

PRIORITY CLAIMED UNDER SEC. 44(D) ON AUSTRALIA APPLICATION NO. 1341238, FILED 1-19-2010, REG. NO. 1341238, DATED 1-19-2010, EXPIRES 1-19-2020.

SER. NO. 85-087,215, FILED 7-18-2010.

ROBERT C. CLARK JR., EXAMINING ATTORNEY



*David J. Kyros*

Director of the United States Patent and Trademark Office

# United States of America

United States Patent and Trademark Office

## HYDRO WASH SYSTEMS

**Reg. No. 4,133,865**

**Registered May 1, 2012**

**Int. Cl.: 7**

**TRADEMARK**

**PRINCIPAL REGISTER**

JONATHAN MARTIN (UNITED STATES INDIVIDUAL)  
113 ASH STREET  
MONT ALTO, PA 17237

FOR: PRESSURE WASHING EQUIPMENT, NAMELY, MACHINES FOR CLEANING EXTERIOR SURFACES ENCOUNTERED BY COMMERCIAL, INSTITUTIONAL, AGRICULTURAL, CONSTRUCTIONAL, AND INDUSTRIAL BUSINESSES, STRUCTURAL PARTS AND FITTINGS THEREFOR, IN CLASS 7 (U.S. CLS. 13, 19, 21, 23, 31, 34 AND 35).

FIRST USE 10-17-2005; IN COMMERCE 10-17-2005.

THE MARK CONSISTS OF STANDARD CHARACTERS WITHOUT CLAIM TO ANY PARTICULAR FONT, STYLE, SIZE, OR COLOR.

NO CLAIM IS MADE TO THE EXCLUSIVE RIGHT TO USE "WASH SYSTEMS", APART FROM THE MARK AS SHOWN.

SEC. 2(F).

SER. NO. 85-087,454, FILED 7-19-2010.

JUSTINE D. PARKER, EXAMINING ATTORNEY



*David J. Kyffers*

Director of the United States Patent and Trademark Office

# United States of America

United States Patent and Trademark Office

## PINNACLE PERKS

**Reg. No. 4,133,866**

**Registered May 1, 2012**

**Int. Cl.: 35**

**SERVICE MARK**

**PRINCIPAL REGISTER**

PINNACLE HEALTH, INC. (MASSACHUSETTS CORPORATION)  
159 CLOVER HILL STREET  
MARLBOROUGH, MA 01752

FOR: BUSINESS SERVICES, NAMELY, INDEPENDENT MEDICAL MANAGEMENT SERVICES FEATURING AN INCENTIVE AWARDS PROGRAM FOR SELF-FUNDED MAJOR MEDICAL HEALTH PLANS, IN CLASS 35 (U.S. CLS. 100, 101 AND 102).

FIRST USE 1-1-2009; IN COMMERCE 1-1-2009.

THE MARK CONSISTS OF STANDARD CHARACTERS WITHOUT CLAIM TO ANY PARTICULAR FONT, STYLE, SIZE, OR COLOR.

NO CLAIM IS MADE TO THE EXCLUSIVE RIGHT TO USE "PERKS", APART FROM THE MARK AS SHOWN.

SER. NO. 85-087,561, FILED 7-19-2010.

MARGARET POWER, EXAMINING ATTORNEY



*David J. Kyros*

Director of the United States Patent and Trademark Office

# United States of America

United States Patent and Trademark Office

# CHAMP

**Reg. No. 4,133,867**

**Registered May 1, 2012**

**Int. Cl.: 29**

**TRADEMARK**

**PRINCIPAL REGISTER**

CONAGRA FOODS LAMB WESTON, INC. (DELAWARE CORPORATION)  
ONE CONAGRA DRIVE  
OMAHA, NE 68102

FOR: FROZEN PROCESSED POTATOES, IN CLASS 29 (U.S. CL. 46).

FIRST USE 4-15-1994; IN COMMERCE 4-15-1994.

THE MARK CONSISTS OF STANDARD CHARACTERS WITHOUT CLAIM TO ANY PARTICULAR FONT, STYLE, SIZE, OR COLOR.

SER. NO. 85-093,085, FILED 7-26-2010.

MICHAEL GAAFAR, EXAMINING ATTORNEY



*David J. Kybas*

Director of the United States Patent and Trademark Office

# United States of America

United States Patent and Trademark Office

水神

WATER GOD

**Reg. No. 4,133,868**

**Registered May 1, 2012**

**Int. Cls.: 3 and 5**

**TRADEMARK**

**PRINCIPAL REGISTER**

TSAI HO WANT ENTERPRISE CO., LTD. TAIWAN (TAIWAN LIMITED LIABILITY COMPANY)  
NO.72, XINING N. RD.  
DATONG DIST., TAIPEI CITY 103, TAIWAN

FOR: AFTER-SHAVE LIQUID; ALL PURPOSE CLEANING PREPARATIONS; BATH HERBS; BOOT CREAM; CANNED PRESSURIZED AIR FOR DUSTING AND CLEANING PURPOSES; CLEANING PREPARATIONS; COSMETICS; COSMETICS FOR ANIMALS; EMERY PAPER; ESSENTIAL OILS FOR FLAVORING BEVERAGES; FACIAL EMULSIONS; HAIR COLORANTS; HAIR WAVING PREPARATIONS; INCENSE; LEATHER CLEANING PREPARATIONS; NON-MEDICATED MOUTH WASHES; PERFUMES; SKIN CLEANSING LOTION; STAIN REMOVING PREPARATIONS; TOILET SOAP, IN CLASS 3 (U.S. CLS. 1, 4, 6, 50, 51 AND 52).

FIRST USE 6-1-2009; IN COMMERCE 3-1-2010.

FOR: AIR FRESHENING PREPARATIONS; BABY FOOD; BANDAGES FOR DRESSINGS; BREAST-NURSING PADS; CHEMICAL PREPARATIONS FOR SANITARY PURPOSES; CONTACT LENS CLEANING PREPARATIONS; DENTAL WAX; DENTURE ADHESIVES; DIAGNOSTIC PREPARATIONS FOR MEDICAL PURPOSES; DIETARY SUPPLEMENTAL DRINKS IN THE NATURE OF VITAMIN AND MINERAL BEVERAGES; DIETETIC FOODS ADAPTED FOR MEDICAL PURPOSES; DISINFECTANTS FOR HYGIENE PURPOSES; FIRST AID KITS; FUNGICIDES; GERMICIDES; INCONTINENCE DIAPERS; INSECTICIDES; MAGNETIC BRACELETS FOR MEDICAL PURPOSES; MEDICAL DRESSINGS; MEDICATED MOUTHWASH; MENSTRUATION BANDAGES; PHARMACEUTICAL PREPARATIONS FOR ANIMAL SKINCARE; SANITARY NAPKINS, IN CLASS 5 (U.S. CLS. 6, 18, 44, 46, 51 AND 52).

FIRST USE 6-1-2009; IN COMMERCE 3-1-2010.

THE MARK CONSISTS OF THE CHINESE CHARACTERS "SHUI SHEN" AND THE WORDS "WATER GOD".

THE NON-LATIN CHARACTERS IN THE MARK TRANSLITERATE TO SHUI SHEN AND THIS MEANS "WATER GOD" IN ENGLISH.

SER. NO. 85-094,395, FILED 7-28-2010.



*David J. Kyros*

Director of the United States Patent and Trademark Office

**Reg. No. 4,133,868** SEAN CROWLEY, EXAMINING ATTORNEY

# United States of America

United States Patent and Trademark Office

# ATHIOS

**Reg. No. 4,133,869**

**Registered May 1, 2012**

**Int. Cls.: 6, 9 and 42**

**TRADEMARK**

**SERVICE MARK**

**PRINCIPAL REGISTER**

TENARIS CONNECTIONS LIMITED (ST. VINCENT/GRDN COMPANY)  
112 BONADIE STREET  
KINGSTOWN, ST. VINCENT/GRDN

FOR: COMMON METALS AND THEIR ALLOYS; METAL BUILDING MATERIALS, NAMELY, STRUCTURAL TUBES; TRANSPORTABLE BUILDINGS OF METAL; MATERIALS OF METAL FOR RAILWAY TRACKS; NON-ELECTRIC CABLES AND WIRES OF COMMON METAL; IRONMONGERY, NAMELY, METAL PIPE FITTINGS AND PIPE ASSEMBLY FITTINGS OF METAL; SMALL ITEMS OF METAL HARDWARE, NAMELY, SCREWS, NUTS, WASHERS, PULLEYS, SPRINGS, RIVETS, METAL BOLTS, RETAINING ANGLES, MOUNTING CORNERS, DOOR HINGES, ROOF HOOKS; PIPES AND TUBES OF METAL; METAL SAFES; GOODS OF COMMON METAL, NAMELY, BEAMS OF COMMON METAL; METAL ORES, IN CLASS 6 (U.S. CLS. 2, 12, 13, 14, 23, 25 AND 50).

FOR: SCIENTIFIC, NAUTICAL, SURVEYING, PHOTOGRAPHIC, CINEMATOGRAPHIC, OPTICAL, WEIGHING, MEASURING, SIGNALING, CHECKING (SUPERVISION), LIFE-SAVING AND TEACHING APPARATUS AND INSTRUMENTS, NAMELY, ACCESS CONTROL AND ALARM MONITORING SYSTEMS; APPARATUS AND INSTRUMENTS FOR CONDUCTING, SWITCHING, TRANSFORMING, ACCUMULATING, REGULATING OR CONTROLLING ELECTRICITY, NAMELY, ELECTRONIC CIRCUITS; APPARATUS FOR RECORDING, TRANSMISSION OR REPRODUCTION OF SOUND AND IMAGES; BLANK MAGNETIC DATA CARRIERS, BLANK OPTICAL RECORDING DISCS; AUTOMATIC VENDING MACHINES AND MECHANISM FOR COIN-OPERATED APPARATUS; CASH REGISTERS, CALCULATING MACHINES, DATA PROCESSING EQUIPMENT AND COMPUTERS; FIRE-EXTINGUISHING APPARATUS, IN CLASS 9 (U.S. CLS. 21, 23, 26, 36 AND 38).

FOR: SCIENTIFIC AND TECHNOLOGICAL SERVICES, NAMELY, SCIENTIFIC RESEARCH, ANALYSIS AND TESTING IN THE FIELD OF OIL AND GAS EXPLORATION; RESEARCH AND DESIGN IN THE FIELD OF TUBULAR PRODUCTS FOR USE IN OIL AND GAS EXPLORATION; INDUSTRIAL ANALYSIS AND RESEARCH SERVICES IN THE FIELD OF OIL AND GAS EXPLORATION; DESIGN AND DEVELOPMENT OF COMPUTER HARDWARE AND SOFTWARE, IN CLASS 42 (U.S. CLS. 100 AND 101).

THE MARK CONSISTS OF STANDARD CHARACTERS WITHOUT CLAIM TO ANY PARTICULAR FONT, STYLE, SIZE, OR COLOR.



*David J. Kybas*

Director of the United States Patent and Trademark Office



**Reg. No. 4,133,869** PRIORITY CLAIMED UNDER SEC. 44(D) ON ARGENTINA APPLICATION NO. 2.975.573,  
FILED 1-29-2010, REG. NO. 2407403, DATED 11-12-2010, EXPIRES 11-12-2020.

PRIORITY CLAIMED UNDER SEC. 44(D) ON ARGENTINA APPLICATION NO. 2.975.574,  
FILED 1-29-2010, REG. NO. 2407402, DATED 11-12-2010, EXPIRES 11-12-2020.

PRIORITY CLAIMED UNDER SEC. 44(D) ON ARGENTINA APPLICATION NO. 2.975.575,  
FILED 1-29-2010, REG. NO. 2407401, DATED 11-12-2010, EXPIRES 11-12-2020.

SER. NO. 85-094,996, FILED 7-28-2010.

JAMES GRIFFIN, EXAMINING ATTORNEY

# United States of America

United States Patent and Trademark Office

## CHANGEABLES

**Reg. No. 4,133,870**

**Registered May 1, 2012**

**Int. Cl.: 16**

**TRADEMARK**

**PRINCIPAL REGISTER**

THREE DESIGNING WOMEN, LLC (TEXAS LIMITED LIABILITY COMPANY)  
SUITE 220  
3330 KELLER SPRINGS ROAD  
CARROLLTON, TX 75006

FOR: INTERCHANGEABLE SELF-INKING STAMP DESIGN SYSTEM COMPOSED PRIMARILY OF STAMPERS WITH REMOVABLE AND INTERCHANGEABLE DESIGNS IN THE NATURE OF INK STAMPS, INK PADS, INK CARTRIDGES FOR USE WITH INK PADS, AND ACCESSORIES THEREFOR, NAMELY, INK STAMPS FEATURING DESIGNS, FOLD-OVER NOTE PAPER, ENVELOPES, PAPER LIST PADS, PAPER STICKERS, NOTE CARDS, BOOKMARKS, BOOKPLATES, PAPER GIFT TAGS, PAPER BOTTLE TAGS, BLANK RECIPE CARDS AND STORAGE RECEPTACLES IN THE NATURE OF STATIONERY AND STAMP CASES DESIGNED TO HOLD THE STAMPER DEVICE, STAMP DESIGNS, INK CARTRIDGES AND PAPER ACCESSORIES, IN CLASS 16 (U.S. CLS. 2, 5, 22, 23, 29, 37, 38 AND 50).

FIRST USE 11-0-2009; IN COMMERCE 11-0-2009.

THE MARK CONSISTS OF STANDARD CHARACTERS WITHOUT CLAIM TO ANY PARTICULAR FONT, STYLE, SIZE, OR COLOR.

SER. NO. 85-095,014, FILED 7-28-2010.

LAURA HAMMEL, EXAMINING ATTORNEY



*David J. Kybas*

Director of the United States Patent and Trademark Office

# United States of America

United States Patent and Trademark Office

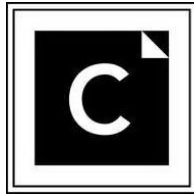

# Changeables

**Reg. No. 4,133,871**

**Registered May 1, 2012**

**Int. Cl.: 16**

**TRADEMARK**

**PRINCIPAL REGISTER**

THREE DESIGNING WOMEN, LLC (TEXAS LIMITED LIABILITY COMPANY)  
SUITE 220  
3330 KELLER SPRINGS ROAD  
CARROLLTON, TX 75006

FOR: INTERCHANGEABLE SELF-INKING STAMP DESIGN SYSTEM COMPOSED PRIMARILY OF STAMPERS WITH REMOVABLE AND INTERCHANGEABLE DESIGNS IN THE NATURE OF INK STAMPS, INK PADS, INK CARTRIDGES FOR USE WITH INK PADS, AND ACCESSORIES THEREFOR, NAMELY, INK STAMPS FEATURING DESIGNS, FOLD-OVER NOTE PAPER, ENVELOPES, PAPER LIST PADS, PAPER STICKERS, NOTE CARDS, BOOKMARKS, BOOKPLATES, PAPER GIFT TAGS, PAPER BOTTLE TAGS, BLANK RECIPE CARDS AND STORAGE RECEPTACLES IN THE NATURE OF STATIONERY AND STAMP CASES DESIGNED TO HOLD THE STAMPER DEVICE, STAMP DESIGNS, INK CARTRIDGES AND PAPER ACCESSORIES, IN CLASS 16 (U.S. CLS. 2, 5, 22, 23, 29, 37, 38 AND 50).

FIRST USE 11-0-2009; IN COMMERCE 11-0-2009.

THE MARK CONSISTS OF THE LETTER "C" IN AN OUTLINED SQUARE WITH A TRIANGULAR TAB IN THE UPPER RIGHT CORNER AND THE WORD "CHANGEABLES" TO THE RIGHT OF THE SQUARE.

SER. NO. 85-095,053, FILED 7-28-2010.

LAURA HAMMEL, EXAMINING ATTORNEY



*David J. Kybas*

Director of the United States Patent and Trademark Office

# United States of America

United States Patent and Trademark Office

## PERSONALIZE YOUR LIFE

**Reg. No. 4,133,872**

**Registered May 1, 2012**

**Int. Cl.: 16**

**TRADEMARK**

**PRINCIPAL REGISTER**

THREE DESIGNING WOMEN, LLC (TEXAS LIMITED LIABILITY COMPANY)  
SUITE 220  
3330 KELLER SPRINGS ROAD  
CARROLLTON, TX 75006

FOR: INTERCHANGEABLE SELF-INKING STAMP DESIGN SYSTEM COMPOSED PRIMARILY OF STAMPERS WITH REMOVABLE AND INTERCHANGEABLE DESIGNS IN THE NATURE OF INK STAMPS, INK PADS, INK CARTRIDGES FOR USE WITH INK PADS, AND ACCESSORIES THEREFOR, NAMELY, INK STAMPS FEATURING DESIGNS, FOLD-OVER NOTE PAPER, ENVELOPES, PAPER LIST PADS, PAPER STICKERS, NOTE CARDS, BOOKMARKS, BOOKPLATES, PAPER GIFT TAGS, PAPER BOTTLE TAGS, BLANK RECIPE CARDS AND STORAGE RECEPTACLES IN THE NATURE OF STATIONERY AND STAMP CASES DESIGNED TO HOLD THE STAMPER DEVICE, STAMP DESIGNS, INK CARTRIDGES AND PAPER ACCESSORIES, IN CLASS 16 (U.S. CLS. 2, 5, 22, 23, 29, 37, 38 AND 50).

FIRST USE 11-0-2009; IN COMMERCE 11-0-2009.

THE MARK CONSISTS OF STANDARD CHARACTERS WITHOUT CLAIM TO ANY PARTICULAR FONT, STYLE, SIZE, OR COLOR.

SER. NO. 85-095,081, FILED 7-28-2010.

LAURA HAMMEL, EXAMINING ATTORNEY



*David J. Kybas*

Director of the United States Patent and Trademark Office

# United States of America

United States Patent and Trademark Office

## Frosty's Favorite

**Reg. No. 4,133,873**

FLAVOR DYNAMICS, INC. (NEW JERSEY CORPORATION)  
640 MONTROSE AVENUE  
SOUTH PLAINFIELD, NJ 07080

**Registered May 1, 2012**

**Int. Cl.: 30**

FOR: FOOD FLAVORINGS CONSISTING OF COFFEE FLAVORS, NOT OF ESSENTIAL OILS, IN CLASS 30 (U.S. CL. 46).

**TRADEMARK**

FIRST USE 11-12-1997; IN COMMERCE 11-12-1997.

**PRINCIPAL REGISTER**

THE MARK CONSISTS OF STANDARD CHARACTERS WITHOUT CLAIM TO ANY PARTICULAR FONT, STYLE, SIZE, OR COLOR.

SER. NO. 85-098,825, FILED 8-3-2010.

MELISSA VALLILLO, EXAMINING ATTORNEY



*David J. Kybas*

Director of the United States Patent and Trademark Office

# United States of America

United States Patent and Trademark Office

## NextGen Sourcing

**Reg. No. 4,133,874**

**Registered May 1, 2012**

**Int. Cl.: 42**

**SERVICE MARK**

**PRINCIPAL REGISTER**

ANANTARA SOLUTIONS PRIVATE LIMITED (INDIA CORPORATION)  
MODULE 0104, TIDEL PARK, 4 CANAL BANK RD  
TARAMANI, CHENNAI, INDIA 600013

FOR: CONSULTING SERVICES IN THE FIELD OF COMPUTER-BASED INFORMATION SYSTEMS FOR BUSINESSES; CONSULTING SERVICES IN THE FIELD OF IDENTIFICATION, SUPPORT, AND IMPLEMENTATION OF COMPUTER-BASED INFORMATION SYSTEMS FOR BUSINESSES, IN CLASS 42 (U.S. CLS. 100 AND 101).

FIRST USE 10-1-2006; IN COMMERCE 10-1-2006.

THE MARK CONSISTS OF STANDARD CHARACTERS WITHOUT CLAIM TO ANY PARTICULAR FONT, STYLE, SIZE, OR COLOR.

NO CLAIM IS MADE TO THE EXCLUSIVE RIGHT TO USE "SOURCING", APART FROM THE MARK AS SHOWN.

SER. NO. 85-103,442, FILED 8-9-2010.

ANDREW RHIM, EXAMINING ATTORNEY



*David J. Kyffers*

Director of the United States Patent and Trademark Office

# United States of America

United States Patent and Trademark Office

# JED

**Reg. No. 4,133,875**

**Registered May 1, 2012**

**Int. Cl.: 10**

**TRADEMARK**

**PRINCIPAL REGISTER**

HYPNOZ THERAPEUTIC DEVICES, INC. (CALIFORNIA CORPORATION)  
11585 SORRENTO VALLEY ROAD, SUITE 103  
SAN DIEGO, CA 92121

FOR: SUPPORTS FOR JAWS FOR MEDICAL USE, IN CLASS 10 (U.S. CLS. 26, 39 AND 44).

FIRST USE 10-22-2008; IN COMMERCE 10-22-2008.

THE MARK CONSISTS OF STANDARD CHARACTERS WITHOUT CLAIM TO ANY PARTICULAR FONT, STYLE, SIZE, OR COLOR.

OWNER OF U.S. REG. NO. 3,782,127.

SER. NO. 85-104,219, FILED 8-10-2010.

SIMON TENG, EXAMINING ATTORNEY



*David J. Kybas*

Director of the United States Patent and Trademark Office

# United States of America

United States Patent and Trademark Office



**Reg. No. 4,133,876**

**Registered May 1, 2012**

**Int. Cl.: 10**

**TRADEMARK**

**PRINCIPAL REGISTER**

HYPNOZ THERAPEUTIC DEVICES, INC. (CALIFORNIA CORPORATION)  
11585 SORRENTO VALLEY ROAD, SUITE 103  
SAN DIEGO, CA 92121

FOR: SUPPORTS FOR JAWS FOR MEDICAL USE, IN CLASS 10 (U.S. CLS. 26, 39 AND 44).

FIRST USE 10-22-2008; IN COMMERCE 10-22-2008.

OWNER OF U.S. REG. NO. 3,782,127.

THE MARK CONSISTS OF A PROFILE OF A FACE FOLLOWED BY THE LETTERS "JED".

SER. NO. 85-104,223, FILED 8-10-2010.

SIMON TENG, EXAMINING ATTORNEY



*David J. Kyffers*

Director of the United States Patent and Trademark Office



# United States of America

United States Patent and Trademark Office

# Fusion Room

**Reg. No. 4,133,877**

**Registered May 1, 2012**

**Int. Cl.: 42**

**SERVICE MARK**

**PRINCIPAL REGISTER**

ILM PROFESSIONAL SERVICES, INC. (MINNESOTA CORPORATION)  
SUITE 140  
4445 W 77TH STREET  
EDINA, MN 55435

FOR: DESIGN AND DEVELOPMENT OF SOFTWARE, NAMELY, SOCIAL MEDIA APPLICATIONS, AND MOBILE APPLICATIONS, IN CLASS 42 (U.S. CLS. 100 AND 101).

FIRST USE 1-7-2010; IN COMMERCE 1-7-2010.

THE MARK CONSISTS OF STANDARD CHARACTERS WITHOUT CLAIM TO ANY PARTICULAR FONT, STYLE, SIZE, OR COLOR.

SER. NO. 85-105,123, FILED 8-11-2010.

SALLY SHIH, EXAMINING ATTORNEY



*David J. Kybas*

Director of the United States Patent and Trademark Office

# United States of America

United States Patent and Trademark Office

## BRAINSTORM BRILLIANCE

**Reg. No. 4,133,878**

**Registered May 1, 2012**

**Int. Cl.: 35**

**SERVICE MARK**

**PRINCIPAL REGISTER**

CLOCKWORK IP, LLC (DELAWARE LIMITED LIABILITY COMPANY)  
50 CENTRAL AVENUE  
SUITE 920  
SARASOTA, FL 34236

FOR: BUSINESS CONSULTATION AND BUSINESS MARKETING CONSULTING SERVICES  
FOR PLUMBING AND HVAC BUSINESS, IN CLASS 35 (U.S. CLS. 100, 101 AND 102).

FIRST USE 6-7-2010; IN COMMERCE 6-7-2010.

THE MARK CONSISTS OF STANDARD CHARACTERS WITHOUT CLAIM TO ANY PARTICULAR FONT, STYLE, SIZE, OR COLOR.

SER. NO. 85-106,440, FILED 8-12-2010.

DOMINICK J. SALEMI, EXAMINING ATTORNEY



*David J. Kyffers*

Director of the United States Patent and Trademark Office

# United States of America

United States Patent and Trademark Office

# O'Natra

**Reg. No. 4,133,879**

**Registered May 1, 2012**

**Int. Cl.: 30**

**TRADEMARK**

**PRINCIPAL REGISTER**

LES ALIMENTS O'NATRA INC. (CANADA CORPORATION)  
655 MELOCHE  
DORVAL, QUEBEC, CANADA H9P2T1

FOR: COOKIES; COFFEE; TEA; FLOUR AND PREPARATIONS MADE FROM CEREALS, NAMELY, MUFFINS, CEREAL-BASED SNACK BARS, CEREAL-BASED CAKES, CEREAL-BASED SNACK FOOD, BREAKFAST CEREALS, FOOD STUFFING MIXES, DRY COOKIE MIXES, DRY MUFFIN MIXES, CRACKERS; BREAD, PASTRY; CANDY; TOFFEE; SPICES, IN CLASS 30 (U.S. CL. 46).

PRIORITY CLAIMED UNDER SEC. 44(D) ON CANADA APPLICATION NO. 1469985, FILED 2-18-2010, REG. NO. TMA813180, DATED 12-1-2011, EXPIRES 12-1-2026.

THE MARK CONSISTS OF THE WORD "O'NATRA" WRITTEN IN A STYLIZED FORM AND THE DESIGN OF A LEAF INSIDE THE LETTER "O".

THE WORDING "O'NATRA" HAS NO MEANING IN A FOREIGN LANGUAGE.

SER. NO. 85-107,055, FILED 8-13-2010.

BILL DAWE, EXAMINING ATTORNEY



*David J. Kyros*

Director of the United States Patent and Trademark Office

# United States of America

United States Patent and Trademark Office

## Return on Mission

**Reg. No. 4,133,880**

**Registered May 1, 2012**

**Int. Cl.: 35**

**SERVICE MARK**

**PRINCIPAL REGISTER**

URBAN, WILLIAM ANDREW (UNITED STATES INDIVIDUAL), AKA URBAN, ANDREW  
3908 GREENMOUNTAIN LANE  
AUSTIN, TX 78759

FOR: BUSINESS MANAGEMENT CONSULTANCY IN THE FIELD OF NON-PROFIT PURCHASES, NAMELY, ASSISTING NON-PROFIT BUSINESSES IN IMPROVEMENT OF PURCHASING FUNCTIONS , IN CLASS 35 (U.S. CLS. 100, 101 AND 102).

FIRST USE 9-28-2011; IN COMMERCE 9-28-2011.

THE MARK CONSISTS OF STANDARD CHARACTERS WITHOUT CLAIM TO ANY PARTICULAR FONT, STYLE, SIZE, OR COLOR.

SER. NO. 85-108,187, FILED 8-16-2010.

REGINA DRUMMOND, EXAMINING ATTORNEY



*David J. Kyjars*

Director of the United States Patent and Trademark Office

# United States of America

United States Patent and Trademark Office



**Reg. No. 4,133,881**

**Registered May 1, 2012**

**Int. Cl.: 32**

**TRADEMARK**

**PRINCIPAL REGISTER**

TABLE BLUFF BREWING INC (CALIFORNIA CORPORATION), DBA LOST COAST  
BREWERY  
617 4TH STREET  
EUREKA, CA 95521

FOR: BEER; FLAVORED BEERS, IN CLASS 32 (U.S. CLS. 45, 46 AND 48).

FIRST USE 2-20-2008; IN COMMERCE 3-14-2008.

NO CLAIM IS MADE TO THE EXCLUSIVE RIGHT TO USE "TANGERINE", "TANGERINE WHEAT BEER" AND "1 PINT 6 FL. OZ.", APART FROM THE MARK AS SHOWN.

THE COLOR(S) ORANGE, YELLOW, GREEN, BLUE, RED, BLACK, WHITE, BROWN, AND GRAY IS/ARE CLAIMED AS A FEATURE OF THE MARK.

THE MARK CONSISTS OF THE WORDING "TANGERINE" IN ORANGE AND YELLOW ABOVE AN ABSTRACT IMAGE, BELOW WHICH IS THE ORANGE AND YELLOW WORDING "TANGERINE WHEAT BEER" AND "1 PINT 6FL. OZ.". THE IMAGE, WHICH IS FRAMED WITHIN A GENERALLY RECTANGULAR BLACK AND RED BORDER, IS A TANGERINE, ORANGE IN COLOR, AND STYLED AS AN ABSTRACT FACE WITH RED LIPS, IN A BLACK AND GRAY SUIT, BLACK TIE AND WHITE SHIRT AND CUFFS, WITH ONE GRAY EYE AND ONE BLUE EYE, WHITE TEETH, WHITE EYEBALLS, BLACK EYELIDS, AND A GREEN STEM AND LEAF EXTENDING FROM ITS HEAD, SURROUNDED BY BROWN AND YELLOW WHEAT, AND HOLDING A BROWN MUG OF BEER WITH WHITE FOAM, AND AGAINST A BLUE SKY. A RECTANGULAR OUTER BLACK BORDER FRAMES THE IMAGE AND WORDING.

SER. NO. 85-108,278, FILED 8-16-2010.

STEVEN R. FINE, EXAMINING ATTORNEY



*David J. Kyros*

Director of the United States Patent and Trademark Office

# United States of America

United States Patent and Trademark Office

# NETSHELTER

**Reg. No. 4,133,882**

**Registered May 1, 2012**

**Int. Cls.: 35 and 41**

**SERVICE MARK**

**PRINCIPAL REGISTER**

NETSHELTER INC. (CANADA CORPORATION)  
SUITE 520  
8500 LESLIE STREET  
THORNHILL, ONTARIO, CANADA L3T7M8

FOR: INTERNET ADVERTISING AND MEDIA APPLICATIONS, NAMELY, PROVIDING AND RENTAL OF ADVERTISING SPACE ON THE INTERNET; INTERNET ADVERTISING AND MEDIA APPLICATIONS, NAMELY, PROVIDING AND RENTAL OF ADVERTISING SPACE ON THIRD PARTY WEB SITES; PROMOTING THE GOODS AND SERVICES OF OTHERS BY MEANS OF DISTRIBUTING ADVERTISING ON THE INTERNET; PROMOTING THE GOODS AND SERVICES OF OTHERS BY MEANS OF DISTRIBUTING ADVERTISING ON THIRD PARTY WEB SITES; PROVIDING A SEARCHABLE ON-LINE ADVERTISING WEB SITE AND GUIDE FEATURING THE GOODS AND SERVICES OF OTHER VENDORS VIA THE INTERNET, IN CLASS 35 (U.S. CLS. 100, 101 AND 102).

FOR: MEDIA APPLICATIONS, NAMELY, PROVIDING ON-LINE PUBLICATIONS IN THE NATURE OF MAGAZINES, NEWSPAPERS, AND BLOGS IN THE FIELD OF INFORMATION TECHNOLOGY, CONSUMER ELECTRONICS, TELECOMMUNICATIONS, COMPUTER HARDWARE, COMPUTER GAMES, VIDEO GAMES, ON-LINE GAMES, SOFTWARE DEVELOPMENT, COMPUTER AND ON-LINE PROGRAMMING, IN CLASS 41 (U.S. CLS. 100, 101 AND 107).

THE MARK CONSISTS OF STANDARD CHARACTERS WITHOUT CLAIM TO ANY PARTICULAR FONT, STYLE, SIZE, OR COLOR.

PRIORITY CLAIMED UNDER SEC. 44(D) ON CANADA APPLICATION NO. 1481669, FILED 5-19-2010, REG. NO. TMA801362, DATED 7-5-2011, EXPIRES 7-5-2026.

SER. NO. 85-108,418, FILED 8-16-2010.

KATINA MISTER, EXAMINING ATTORNEY



*David J. Kyros*

Director of the United States Patent and Trademark Office

# United States of America

United States Patent and Trademark Office

# STA-PURE

**Reg. No. 4,133,883**

**Registered May 1, 2012**

**Int. Cl.: 9**

**TRADEMARK**

**PRINCIPAL REGISTER**

W. L. GORE & ASSOCIATES, INC. (DELAWARE CORPORATION)  
555 PAPER MILL ROAD, P. O. BOX 9329  
NEWARK, DE 19714

FOR: BIOPHARMACEUTICAL FLUID SAMPLING DEVICE FOR USE IN MANUFACTURE  
OF PHARMACEUTICALS, IN CLASS 9 (U.S. CLS. 21, 23, 26, 36 AND 38).

FIRST USE 8-31-2008; IN COMMERCE 8-31-2008.

THE MARK CONSISTS OF STANDARD CHARACTERS WITHOUT CLAIM TO ANY PAR-  
TICULAR FONT, STYLE, SIZE, OR COLOR.

OWNER OF U.S. REG. NO. 2,432,241.

SER. NO. 85-111,214, FILED 8-19-2010.

JOHN HWANG, EXAMINING ATTORNEY



*David J. Kyffers*

Director of the United States Patent and Trademark Office

# United States of America

United States Patent and Trademark Office

## JACKS SANDWICHES & SWEETS

**Reg. No. 4,133,884**

**Registered May 1, 2012**

**Int. Cl.: 43**

**SERVICE MARK**

**PRINCIPAL REGISTER**

HSP GAMING LP (DELAWARE LIMITED PARTNERSHIP)  
1600 ARCH STREET, SUITE 300  
PHILADELPHIA, PA 19103

FOR: RESTAURANT SERVICES IN A CASINO, NAMELY, A RESTAURANT IN A CASINO SERVING CASINO PATRONS ON A 24 HOUR BASIS, FEATURING SNACKS, SANDWICHES, SALADS, SWEET TREATS, AND BREAKFAST SANDWICHES, IN CLASS 43 (U.S. CLS. 100 AND 101).

FIRST USE 9-23-2010; IN COMMERCE 9-23-2010.

THE MARK CONSISTS OF STANDARD CHARACTERS WITHOUT CLAIM TO ANY PARTICULAR FONT, STYLE, SIZE, OR COLOR.

NO CLAIM IS MADE TO THE EXCLUSIVE RIGHT TO USE "SANDWICHES & SWEETS", APART FROM THE MARK AS SHOWN.

SER. NO. 85-112,514, FILED 8-20-2010.

LESLEY LAMOTHE, EXAMINING ATTORNEY



*David J. Kybas*

Director of the United States Patent and Trademark Office



# United States of America

United States Patent and Trademark Office

# SANTOS

**Reg. No. 4,133,885**

**Registered May 1, 2012**

**Int. Cl.: 28**

**TRADEMARK**

**PRINCIPAL REGISTER**

FOX INTERNATIONAL GROUP LIMITED (GREAT BRITAIN CORPORATION)  
56-58 FOWLER ROAD  
HAINAULT INDUSTRIAL ESTATE  
HAINAULT, ESSEX, UNITED KINGDOM IG63UT

FOR: FISHING REELS, IN CLASS 28 (U.S. CLS. 22, 23, 38 AND 50).

THE MARK CONSISTS OF STANDARD CHARACTERS WITHOUT CLAIM TO ANY PARTICULAR FONT, STYLE, SIZE, OR COLOR.

OWNER OF UNITED KINGDOM REG. NO. 006551915, DATED 4-12-2008, EXPIRES 4-12-2018.

THE ENGLISH TRANSLATION OF "SANTOS" IN THE MARK IS "SAINTS".

SER. NO. 85-112,864, FILED 8-21-2010.

INGA ERVIN, EXAMINING ATTORNEY



*David J. Kybas*

Director of the United States Patent and Trademark Office

# United States of America

United States Patent and Trademark Office



**Reg. No. 4,133,886**

**Registered May 1, 2012**

**Int. Cl.: 43**

**SERVICE MARK**

**PRINCIPAL REGISTER**

GREEN GABLES CAFE, LLC (FLORIDA LIMITED LIABILITY COMPANY)  
327 ALHAMBRA CIRCLE  
CORAL GABLES, FL 33134

FOR: CAFE AND RESTAURANT SERVICES, IN CLASS 43 (U.S. CLS. 100 AND 101).

FIRST USE 8-18-2006; IN COMMERCE 8-18-2006.

NO CLAIM IS MADE TO THE EXCLUSIVE RIGHT TO USE "CAFE", APART FROM THE MARK AS SHOWN.

THE COLOR(S) DARK GREEN, LIGHT GREEN AND BLACK IS/ARE CLAIMED AS A FEATURE OF THE MARK.

THE MARK CONSISTS OF THE WORDING "GREEN GABLES CAFE" WITH A LEAF AND SPIRAL STEM DESIGN. THE COLOR DARK GREEN APPEARS IN THE LEAF DESIGN AND IN THE WORD "CAFE"; THE COLOR LIGHT GREEN APPEARS IN THE LEAF DESIGN; AND THE COLOR BLACK APPEARS IN THE WORDING "GREEN GABLES" AND IN THE OUTLINE OF THE LEAF AND SPIRAL STEM DESIGN.

SER. NO. 85-112,899, FILED 8-21-2010.

ANDREW RHIM, EXAMINING ATTORNEY



*David J. Kybas*

Director of the United States Patent and Trademark Office

# United States of America

United States Patent and Trademark Office

## LIVE THE DREAM

**Reg. No. 4,133,887**

**Registered May 1, 2012**

**Int. Cls.: 35 and 41**

**SERVICE MARK**

**PRINCIPAL REGISTER**

UPWARD ENTERPRISES, LLC (NEW MEXICO LIMITED LIABILITY COMPANY)  
#32665  
8605 SANTA MONICA BOULEVARD  
LOS ANGELES, CA 90069

FOR: ON-LINE ADVERTISING AND MARKETING SERVICES; PROVIDING INFORMATION IN THE FIELD OF MARKETING AND ON-LINE MARKETING MEDIA VIA THE INTERNET, IN CLASS 35 (U.S. CLS. 100, 101 AND 102).

FIRST USE 6-15-2010; IN COMMERCE 6-15-2010.

FOR: EDUCATION SERVICES, NAMELY, CONDUCTING LIVE AND ON-LINE SEMINARS IN THE FIELD OF MARKETING, IN CLASS 41 (U.S. CLS. 100, 101 AND 107).

FIRST USE 6-15-2010; IN COMMERCE 6-15-2010.

THE MARK CONSISTS OF STANDARD CHARACTERS WITHOUT CLAIM TO ANY PARTICULAR FONT, STYLE, SIZE, OR COLOR.

SER. NO. 85-113,339, FILED 8-23-2010.

DEZMONA MIZELLE, EXAMINING ATTORNEY



*David J. Kybas*

Director of the United States Patent and Trademark Office

# United States of America

United States Patent and Trademark Office

# BOOKIFY

**Reg. No. 4,133,888**

**Registered May 1, 2012**

**Int. Cl.: 42**

**SERVICE MARK**

**PRINCIPAL REGISTER**

BLURB, INC. (DELAWARE CORPORATION)  
580 CALIFORNIA STREET, SUITE 300  
SAN FRANCISCO, CA 94104

FOR: APPLICATION SERVICE PROVIDER (ASP) FEATURING SOFTWARE FOR USE IN DESIGNING, DEVELOPING, CREATING AND PRINTING BOOKS; COMPUTER SOFTWARE DESIGN AND CONSULTING SERVICES; FORMATTING, GRAPHICS AND TEXTUAL DESIGN SERVICES IN THE PUBLISHING AND PRINTING INDUSTRIES, IN CLASS 42 (U.S. CLS. 100 AND 101).

FIRST USE 7-9-2010; IN COMMERCE 7-9-2010.

THE MARK CONSISTS OF STANDARD CHARACTERS WITHOUT CLAIM TO ANY PARTICULAR FONT, STYLE, SIZE, OR COLOR.

SER. NO. 85-114,426, FILED 8-24-2010.

ANNE MADDEN, EXAMINING ATTORNEY



*David J. Kybas*

Director of the United States Patent and Trademark Office

# United States of America

United States Patent and Trademark Office

## MASS DESTRUCTION

**Reg. No. 4,133,889**

MASS, ANDREW (UNITED STATES INDIVIDUAL)  
42 BROOKE  
OSSINING, NY 10562

**Registered May 1, 2012**

**Int. Cl.: 41**

FOR: MUSIC COMPOSITION FOR OTHERS; MUSIC PRODUCTION SERVICES, IN CLASS 41 (U.S. CLS. 100, 101 AND 107).

**SERVICE MARK**

FIRST USE 2-16-2006; IN COMMERCE 2-16-2006.

**PRINCIPAL REGISTER**

THE MARK CONSISTS OF STANDARD CHARACTERS WITHOUT CLAIM TO ANY PARTICULAR FONT, STYLE, SIZE, OR COLOR.

SER. NO. 85-114,969, FILED 8-24-2010.

ANNE MADDEN, EXAMINING ATTORNEY



*David J. Kybas*

Director of the United States Patent and Trademark Office

# United States of America

United States Patent and Trademark Office

## DO YOU WANT TO LEARN A DIRTY WORD?

**Reg. No. 4,133,890**

**Registered May 1, 2012**

**Int. Cl.: 35**

**SERVICE MARK**

**PRINCIPAL REGISTER**

SIDENSTECKER, MARIS (UNITED STATES INDIVIDUAL)  
1192 WARING STREET  
SEASIDE, CA 93955

FOR: ADVERTISING SERVICES, NAMELY, PROMOTING THE POLITICAL, SOCIAL AND ENVIRONMENTAL INTERESTS OF GOVERNMENT AGENCIES, CITY MUNICIPALITIES, AND PUBLIC INTEREST GROUPS THROUGH THE DISTRIBUTION OF PRINTED, AUDIO AND VIDEO PROMOTIONAL MATERIALS AND BY RENDERING PROMOTIONAL ADVICE; PROMOTING THE SERVICES OF GOVERNMENT AGENCIES, CITY MUNICIPALITIES, AND PUBLIC INTEREST GROUPS THROUGH DEVELOPMENT AND DISTRIBUTION OF BROCHURES, POSTERS, RADIO ADS, PRINT ADS, TELEVISION ADS, AND THROUGH PARTICIPATION IN COMMUNITY EVENTS AND MEETINGS; PUBLIC RELATION SERVICES FOR GOVERNMENT AGENCIES, CITY MUNICIPALITIES, PUBLIC INTEREST GROUPS TO PROMOTE ENVIRONMENTAL AWARENESS AND CONSERVATION , IN CLASS 35 (U.S. CLS. 100, 101 AND 102).

FIRST USE 3-30-2001; IN COMMERCE 3-30-2001.

THE MARK CONSISTS OF STANDARD CHARACTERS WITHOUT CLAIM TO ANY PARTICULAR FONT, STYLE, SIZE, OR COLOR.

SER. NO. 85-115,941, FILED 8-25-2010.

JEFFREY LOOK, EXAMINING ATTORNEY



*David J. Kyffers*

Director of the United States Patent and Trademark Office

# United States of America

United States Patent and Trademark Office

# eQSuite

**Reg. No. 4,133,891**

**Registered May 1, 2012**

**Int. Cls.: 9 and 42**

**TRADEMARK**

**SERVICE MARK**

**PRINCIPAL REGISTER**

EQHEALTH SOLUTIONS, INC. (LOUISIANA CORPORATION)  
SUITE 270  
8591 UNITED PLAZA BOULEVARD  
BATON ROUGE, LA 70809

FOR: COMPUTER SOFTWARE FOR CONTROLLING AND MANAGING PATIENT MEDICAL INFORMATION; MEDICAL SOFTWARE FOR CARE COORDINATION OF PATIENTS WITH CHRONIC DISEASES, IN CLASS 9 (U.S. CLS. 21, 23, 26, 36 AND 38).

FIRST USE 2-1-2008; IN COMMERCE 2-1-2008.

FOR: SOFTWARE AS A SERVICE (SAAS) SERVICES FEATURING SOFTWARE IN THE FIELD OF CARE COORDINATION OF PATIENTS WITH CHRONIC DISEASES, IN CLASS 42 (U.S. CLS. 100 AND 101).

FIRST USE 2-1-2008; IN COMMERCE 2-1-2008.

THE MARK CONSISTS OF STANDARD CHARACTERS WITHOUT CLAIM TO ANY PARTICULAR FONT, STYLE, SIZE, OR COLOR.

SER. NO. 85-116,616, FILED 8-26-2010.

SOPHIA S. KIM, EXAMINING ATTORNEY



*David J. Kybas*

Director of the United States Patent and Trademark Office

# United States of America

United States Patent and Trademark Office

# TweePLayer

**Reg. No. 4,133,892**

**Registered May 1, 2012**

**Int. Cls.: 38 and 45**

**SERVICE MARK**

**PRINCIPAL REGISTER**

TOMORROWISH, LLC (MASSACHUSETTS LIMITED LIABILITY COMPANY)  
#1  
67 WASHINGTON STREET  
NATICK, MA 01760

FOR: ELECTRONIC TRANSMISSION AND STREAMING OF DIGITAL MEDIA CONTENT FOR OTHERS VIA GLOBAL AND LOCAL COMPUTER NETWORKS; PROVIDING ON-LINE CHAT ROOMS AND ELECTRONIC BULLETIN BOARDS FOR TRANSMISSION OF MESSAGES AMONG USERS IN THE FIELD OF GENERAL INTEREST; PROVIDING ON-LINE FORUMS FOR TRANSMISSION OF MESSAGES AMONG COMPUTER USERS; TELECOMMUNICATION SERVICES, NAMELY, TRANSMISSION OF VOICE, DATA, GRAPHICS, IMAGES, AUDIO AND VIDEO BY MEANS OF TELECOMMUNICATIONS NETWORKS, WIRELESS COMMUNICATION NETWORKS, AND THE INTERNET, IN CLASS 38 (U.S. CLS. 100, 101 AND 104).

FIRST USE 3-1-2010; IN COMMERCE 3-1-2010.

FOR: ON-LINE SOCIAL NETWORKING SERVICES; PROVIDING ON-LINE COMPUTER DATABASES AND ON-LINE SEARCHABLE DATABASES IN THE FIELD OF SOCIAL NETWORKING, IN CLASS 45 (U.S. CLS. 100 AND 101).

FIRST USE 3-1-2010; IN COMMERCE 3-1-2010.

THE MARK CONSISTS OF STANDARD CHARACTERS WITHOUT CLAIM TO ANY PARTICULAR FONT, STYLE, SIZE, OR COLOR.

SER. NO. 85-117,356, FILED 8-27-2010.

EMILY CHUO, EXAMINING ATTORNEY



*David J. Kyros*

Director of the United States Patent and Trademark Office



# United States of America

United States Patent and Trademark Office

## THE COLLECTION

**Reg. No. 4,133,893**

**Registered May 1, 2012**

**Int. Cl.: 41**

**SERVICE MARK**

**PRINCIPAL REGISTER**

THE COLLECTION EVENT STUDIO, INC. (CALIFORNIA CORPORATION)  
SUITE B  
521 BROADWAY  
SONOMA, CA 95476

FOR: PARTY AND WEDDING PLANNING, COORDINATION AND CONSULTATION SERVICES, IN CLASS 41 (U.S. CLS. 100, 101 AND 107).

FIRST USE 1-3-2011; IN COMMERCE 1-3-2011.

THE MARK CONSISTS OF STANDARD CHARACTERS WITHOUT CLAIM TO ANY PARTICULAR FONT, STYLE, SIZE, OR COLOR.

SER. NO. 85-118,250, FILED 8-29-2010.

JOHN DWYER, EXAMINING ATTORNEY



*David J. Kybas*

Director of the United States Patent and Trademark Office

# United States of America

United States Patent and Trademark Office



**Reg. No. 4,133,894**

**Registered May 1, 2012**

**Int. Cls.: 35 and 42**

**SERVICE MARK**

**PRINCIPAL REGISTER**

ASSOCIATION OF BOARDS OF CERTIFICATION (IOWA NON-PROFIT CORPORATION)  
2805 SNYDER BLVD.  
ANKENY, IA 50023

FOR: ASSOCIATION SERVICES, NAMELY, PROMOTING THE INTERESTS OF THE PUBLIC AND PROFESSIONALS WORKING IN ALL ASPECTS OF THE WATER ENVIRONMENT FIELD STRIVING TO PROTECT THE PUBLIC HEALTH AND THE OVERALL ENVIRONMENT; ASSOCIATION SERVICES, NAMELY, PROMOTING THE INTERESTS AND CONCERNS OF MEMBERS AND THE PUBLIC OF THE PROFESSIONAL COMPETENCY OF THOSE ENGAGING IN ADVANCING WATER QUALITY AND PROTECTING THE PUBLIC HEALTH; ASSOCIATION SERVICES, NAMELY, PROMOTING THE INTERESTS OF THE PUBLIC AND PROFESSIONALS IN THE WATER INDUSTRY THROUGH PROMOTION OF UNIFORMITY OF STANDARDS AND PRACTICES OF CERTIFYING AUTHORITIES; ASSOCIATION SERVICES, NAMELY, SERVICES IN PROMOTING NATIONALLY RECOGNIZED STANDARDS FOR QUALIFICATIONS FOR CERTIFICATION, PUBLIC AWARENESS FOR THE NEED OF TRAINED AND CERTIFIED PROFESSIONALS AND ASSURANCE OF THE INTEGRITY OF WATER QUALITY AND THE PUBLIC'S HEALTH, IN CLASS 35 (U.S. CLS. 100, 101 AND 102).

FIRST USE 10-0-2008; IN COMMERCE 10-0-2008.

FOR: TESTING, ANALYZING AND EVALUATING THE GOODS AND SERVICES OF OTHERS FOR THE PURPOSE OF CERTIFICATION; COMPUTER SERVICES, NAMELY, PROVIDING WEB-BASED SYSTEM AND ONLINE PORTAL FEATURING SOFTWARE THAT ENABLES USERS TO ACCESS TRAINING, EDUCATION, TESTING AND CERTIFICATION MATERIALS IN THE ENVIRONMENTAL FIELD OF WATER AND WATER-RELATED SERVICES AND PRODUCTS, IN CLASS 42 (U.S. CLS. 100 AND 101).

FIRST USE 10-0-2008; IN COMMERCE 10-0-2008.

NO CLAIM IS MADE TO THE EXCLUSIVE RIGHT TO USE "ASSOCIATION OF BOARDS OF CERTIFICATION", APART FROM THE MARK AS SHOWN.

THE MARK CONSISTS OF A MAP OF THE WORLD THAT IS INSIDE A WATER DROP TO THE LEFT OF STYLIZED LETTERS "ABC" WHICH ARE ABOVE THE STYLIZED TEXT OF "ASSOCIATION OF BOARDS OF CERTIFICATION".



*David J. Kyjars*

Director of the United States Patent and Trademark Office

**Reg. No. 4,133,894** SER. NO. 85-119,842, FILED 8-31-2010.

MARY BOAGNI, EXAMINING ATTORNEY

# United States of America

United States Patent and Trademark Office

# TURFMUTT

**Reg. No. 4,133,895**

**Registered May 1, 2012**

**Int. Cl.: 41**

**SERVICE MARK**

**PRINCIPAL REGISTER**

OPEI EDUCATION AND RESEARCH FOUNDATION, INC. (VIRGINIA NON-PROFIT CORPORATION)  
341 SOUTH PATRICK STREET  
ALEXANDRIA, VA 22314

FOR: EDUCATIONAL AND ENTERTAINMENT SERVICES, NAMELY, PROVIDING A WEB SITE IN THE ACADEMIC FIELDS OF SCIENCE AND THE ENVIRONMENT FOR THE PURPOSE OF ACADEMIC STUDY, AND ON-LINE JOURNALS, NAMELY, EDUCATIONAL BLOGS IN THE FIELD OF SCIENCE AND THE ENVIRONMENT, IN CLASS 41 (U.S. CLS. 100, 101 AND 107).

FIRST USE 10-0-2009; IN COMMERCE 10-0-2009.

THE MARK CONSISTS OF STANDARD CHARACTERS WITHOUT CLAIM TO ANY PARTICULAR FONT, STYLE, SIZE, OR COLOR.

SER. NO. 85-121,905, FILED 9-2-2010.

DEZMONA MIZELLE, EXAMINING ATTORNEY



*David J. Kybas*

Director of the United States Patent and Trademark Office

# United States of America

United States Patent and Trademark Office



URBAN ESCAPE  
DAY SPA

**Reg. No. 4,133,896**

**Registered May 1, 2012**

**Int. Cl.: 44**

**SERVICE MARK**

**PRINCIPAL REGISTER**

URBAN ESCAPE DAY SPA, INC. (COLORADO CORPORATION)  
SUITE 130  
700 12TH STREET  
GOLDEN, CO 80401

FOR: AROMATHERAPY SERVICES; BEAUTY ANALYSIS TO DETERMINE COSMETICS THAT ARE BEST SUITED TO PARTICULAR INDIVIDUALS; BEAUTY CONSULTATION SERVICES; BEAUTY CONSULTATION SERVICES IN THE SELECTION AND USE OF COSMETICS, FRAGRANCES, BEAUTY AIDS, PERSONAL CARE PRODUCTS, AND BATH, BODY AND BEAUTY PRODUCTS; BEAUTY SALON SERVICES; BEAUTY SALONS; BODY WAXING SERVICES; BODY WAXING SERVICES FOR HAIR REMOVAL IN HUMANS; BODY WAXING SERVICES FOR THE HUMAN BODY; BODYWORK THERAPY; BODYWORK THERAPY SERVICES, NAMELY, STRUCTURAL INTEGRATION THERAPY AND MOVEMENT THERAPY; COSMETIC ANALYSIS; COSMETIC BODY CARE SERVICES; COSMETIC BODY CARE SERVICES IN THE NATURE OF BODY WRAPS; COSMETIC FACE CARE SERVICES; COSMETIC SERVICES, NAMELY, NON-PERMANENT HAIR REMOVAL; COSMETIC SKIN CARE SERVICES; COSMETICIAN SERVICES; COSMETOLOGY SERVICES; DAY SPA SERVICES, NAMELY, NAIL CARE, MANICURES, PEDICURES AND NAIL ENHANCEMENTS; DEPILATORY HAIR REMOVAL SERVICES; DERMATOLOGY SERVICES; FACIAL TREATMENT SERVICES, NAMELY, COSMETIC PEELS; HAIR COLOR SALON SERVICES; HAIR COLORING SERVICES; HAIR CUTTING; HAIR CUTTING SERVICES; HAIR SALON SERVICES; HAIR SALON SERVICES, NAMELY, HAIR CUTTING, STYLING, COLORING, AND HAIR EXTENSION SERVICES; HAIR STYLING; HAIRDRESSING SALONS; HAIRDRESSING SERVICES; HEALTH SPA SERVICES FOR HEALTH AND WELLNESS OF THE BODY AND SPIRIT; HEALTH SPA SERVICES FOR HEALTH AND WELLNESS OF THE BODY AND SPIRIT, NAMELY, PROVIDING MASSAGE, FACIAL AND BODY TREATMENT SERVICES, COSMETIC BODY CARE SERVICES; HEALTH SPA SERVICES FOR HEALTH AND WELLNESS OF THE MIND, BODY AND SPIRIT OFFERED IN OR FROM A REMOTE, MOBILE OR TEMPORARY ON-SITE LOCATION; HEALTH SPA SERVICES, NAMELY, BODY WRAPS, MUD TREATMENTS, SEAWEED TREATMENTS, HYDROTHERAPY BATHS, AND BODY SCRUBS; HEALTH SPA SERVICES, NAMELY, COSMETIC BODY CARE SERVICES; HEALTH SPA SERVICES, NAMELY, LASER TREATMENTS FOR ACNE, REJUVENATION, SCARS, TATTOO REMOVAL AND FOR FACIALS AND MASSAGE; INFORMATION RELATING TO MASSAGE; MAKE-UP APPLICATION SERVICES; MANICURE SERVICES; MANICURING; MASSAGE; MASSAGE AND THERAPEUTIC SHIATSU MASSAGE; MASSAGE THERAPY SERVICES; MESSAGES; MICRODERMABRASION, NAMELY, A TOPICAL SKIN TREATMENT INVOLVING ABRASION OF THE SKIN WITH A HIGH-



*David J. Kappas*

Director of the United States Patent and Trademark Office

**Reg. No. 4,133,896** PRESSURE FLOW OF CRYSTALS; NAIL CARE SALONS; NAIL CARE SERVICES; PEDICURE SERVICES; PERSONAL HAIR REMOVAL SERVICES; PROVIDING BOTH IN-PERSON AND ON-LINE VIBRATIONAL ENERGY HEALING SERVICES; PROVIDING HEALTHY LIFESTYLE AND NUTRITION SERVICES, NAMELY, PERSONAL ASSESSMENTS, PERSONALIZED ROUTINES, MAINTENANCE SCHEDULES, AND COUNSELING; PROVIDING IN-PERSON ENERGY HEALING SERVICES; PROVIDING IN-PERSON HOLISTIC HEALTH CARE SERVICES; PROVIDING INFORMATION ABOUT BEAUTY; PROVIDING INFORMATION IN THE FIELD OF HAIR STYLING; PROVIDING ON-SITE BEAUTY SERVICES, NAMELY, HAIR STYLING AND MAKE-UP APPLICATION SERVICES; REFLEXOLOGY SERVICES; SERVICES OF A MAKE-UP ARTIST; SKIN CARE SALONS; WELLNESS AND HEALTH-RELATED CONSULTING SERVICES, IN CLASS 44 (U.S. CLS. 100 AND 101).

FIRST USE 1-1-2007; IN COMMERCE 1-1-2007.

NO CLAIM IS MADE TO THE EXCLUSIVE RIGHT TO USE "DAY SPA", APART FROM THE MARK AS SHOWN.

THE COLOR(S) GREEN, WHITE, TERRACOTTA, AND BLACK IS/ARE CLAIMED AS A FEATURE OF THE MARK.

THE MARK CONSISTS OF A RECTANGLE WITH TORN SIDES, WITH THE LEFT SIDE IN GREEN AND THE RIGHT SIDE IN TERRACOTTA. A WHITE BAMBOO SHOOT APPEARS IN THE MIDDLE OF THE RECTANGLE. UNDER THE RECTANGLE ARE THE WORDS "URBAN ESCAPE" IN BLACK LETTERS AND UNDER "URBAN ESCAPE" ARE THE WORDS "DAY SPA" IN TERRACOTTA. THE WHITE BACKGROUND IS NOT PART OF THE MARK.

SER. NO. 85-122,405, FILED 9-2-2010.

RENEE SERVANCE, EXAMINING ATTORNEY

**United States of America**  
United States Patent and Trademark Office

**EFFING**

**Reg. No. 4,133,897**

EFFING CO LLC (MISSOURI LIMITED LIABILITY COMPANY)  
1007 EAST LEVEE  
DALLAS, TX 75207

**Registered May 1, 2012**

**Int. Cl.: 25**

FOR: CLOTHING, NAMELY, T-SHIRTS, SWEATSHIRTS, SHORTS, AND HOODED SWEATSHIRTS; HATS; AND WRISTBANDS, IN CLASS 25 (U.S. CLS. 22 AND 39).

**TRADEMARK**

FIRST USE 3-0-2010; IN COMMERCE 3-0-2010.

**PRINCIPAL REGISTER**

THE MARK CONSISTS OF STANDARD CHARACTERS WITHOUT CLAIM TO ANY PARTICULAR FONT, STYLE, SIZE, OR COLOR.

SER. NO. 85-122,954, FILED 9-3-2010.

ROBERT C. CLARK JR., EXAMINING ATTORNEY



*David J. Kybas*

Director of the United States Patent and Trademark Office

# United States of America

United States Patent and Trademark Office

# myHood

**Reg. No. 4,133,898**

BALL, SHERRI BRADFELD (UNITED STATES INDIVIDUAL)  
P.O. BOX 5274  
SANTA BARBARA, CA 93150

**Registered May 1, 2012**

**Int. Cl.: 16**

FOR: BABY BOOKS; JOURNALS CONCERNING DAILY CHILDCARE, IN CLASS 16 (U.S. CLS. 2, 5, 22, 23, 29, 37, 38 AND 50).

**TRADEMARK**

FIRST USE 6-20-2008; IN COMMERCE 8-26-2010.

**PRINCIPAL REGISTER**

THE MARK CONSISTS OF STANDARD CHARACTERS WITHOUT CLAIM TO ANY PARTICULAR FONT, STYLE, SIZE, OR COLOR.

SER. NO. 85-123,597, FILED 9-6-2010.

LAURA KOVALSKY, EXAMINING ATTORNEY



*David J. Kybas*

Director of the United States Patent and Trademark Office



# United States of America

United States Patent and Trademark Office

## AFCO STEEL

**Reg. No. 4,133,899**

**Registered May 1, 2012**

**Int. Cls.: 37, 40 and 42**

**SERVICE MARK**

**PRINCIPAL REGISTER**

AFCO STEEL, LLC (DELAWARE LIMITED LIABILITY COMPANY)  
1730 W. RENO  
OKLAHOMA CITY, OK 73106

FOR: STEEL ERECTORS; STEEL STRUCTURE CONSTRUCTION WORKS FOR BUILDINGS, STADIUMS, BRIDGES, CONVENTION CENTERS, LARGE CONSTRUCTION PROJECTS AND THE LIKE, SPECIFICALLY EXCLUDING METAL GRATES, COVERS AND FRAMES USED FOR CATCH BASINS, DRAINS AND CULVERTS, MANHOLE COVERS, FRAMES AND RINGS, DRAINS, GUARD RAILS AND BRIDGE RAILS, CURB ANGLE FACE PLATES, LADDERS, VENT PIPES, AND STEPS, IN CLASS 37 (U.S. CLS. 100, 103 AND 106).

FIRST USE 12-31-1909; IN COMMERCE 12-31-1909.

FOR: CUSTOM STEEL FABRICATION TO THE ORDER AND SPECIFICATION OF OTHERS OF BUILDINGS, STADIUMS, BRIDGES, CONVENTION CENTERS, LARGE CONSTRUCTION PROJECTS AND THE LIKE, SPECIFICALLY EXCLUDING METAL GRATES, COVERS AND FRAMES USED FOR CATCH BASINS, DRAINS AND CULVERTS, MANHOLE COVERS, FRAMES AND RINGS, GUARD RAILS AND BRIDGE RAILS, CURB ANGLE FACE PLATES, LADDERS, VENT PIPES, AND STEPS, IN CLASS 40 (U.S. CLS. 100, 103 AND 106).

FIRST USE 12-31-1909; IN COMMERCE 12-31-1909.

FOR: ENGINEERING AND ENGINEERING SERVICES IN THE FIELDS OF STEEL, STEEL FABRICATION AND STEEL ERECTION FOR BUILDINGS, STADIUMS, BRIDGES, CONVENTION CENTERS, LARGE CONSTRUCTION PROJECTS AND THE LIKE, SPECIFICALLY EXCLUDING METAL GRATES, COVERS AND FRAMES USED FOR CATCH BASINS, DRAINS AND CULVERTS, MANHOLE COVERS, FRAMES AND RINGS, DRAINS, GUARD RAILS AND BRIDGE RAILS, CURB ANGLE FACE PLATES, LADDERS, VENT PIPES, AND STEPS, IN CLASS 42 (U.S. CLS. 100 AND 101).

FIRST USE 12-31-1909; IN COMMERCE 12-31-1909.

THE MARK CONSISTS OF STANDARD CHARACTERS WITHOUT CLAIM TO ANY PARTICULAR FONT, STYLE, SIZE, OR COLOR.

NO CLAIM IS MADE TO THE EXCLUSIVE RIGHT TO USE "STEEL" , APART FROM THE MARK AS SHOWN.



*David J. Kyjars*

Director of the United States Patent and Trademark Office

**Reg. No. 4,133,899** SER. NO. 85-123,986, FILED 9-7-2010.

BARNEY CHARLON, EXAMINING ATTORNEY

# United States of America

United States Patent and Trademark Office

## TEXASSPORTS.COM

**Reg. No. 4,133,900**

**Registered May 1, 2012**

**Int. Cls.: 41 and 42**

**SERVICE MARK**

**PRINCIPAL REGISTER**

BOARD OF REGENTS, THE UNIVERSITY OF TEXAS SYSTEM (TEXAS STATE AGENCY)  
201 W. 7TH STREET  
AUSTIN, TX 78701

FOR: ENTERTAINMENT SERVICES, NAMELY, ORGANIZING AND CONDUCTING COLLEGE SPORT GAMES AND EVENTS RENDERED LIVE AND THROUGH THE MEDIA OF RADIO AND TELEVISION; PROVIDING INFORMATION ONLINE IN THE FIELD OF COLLEGE ATHLETICS; ENTERTAINMENT SERVICES, NAMELY, PROVIDING VIDEO AND AUDIO CONTENT, NAMELY, ON-GOING TELEVISION PROGRAMS IN THE NATURE OF CURRENT EVENTS, SPORTS NEWS AND ENTERTAINMENT NEWS ALL TRANSMITTED THROUGH A GLOBAL COMMUNICATIONS NETWORK VIA WIRELESS COMMUNICATION DEVICES, MOBILE PHONES, HAND-HELD DEVICES; PROVIDING INFORMATION IN THE FIELD OF ENTERTAINMENT VIA WIRELESS COMMUNICATION DEVICES, MOBILE PHONES, HAND-HELD DEVICES AND GLOBAL COMMUNICATION DEVICES; INTERACTIVE ONLINE NEWSLETTER PROVIDING SPORTS INFORMATION, IN CLASS 41 (U.S. CLS. 100, 101 AND 107).

FIRST USE 1-26-1997; IN COMMERCE 1-26-1997.

FOR: PROVIDING ON-LINE INTERACTIVE PUBLIC CALENDARS THAT ALLOW MULTIPLE PARTICIPANTS TO SHARE EVENT SCHEDULES, IN CLASS 42 (U.S. CLS. 100 AND 101).

FIRST USE 2-0-2005; IN COMMERCE 2-0-2005.

THE MARK CONSISTS OF STANDARD CHARACTERS WITHOUT CLAIM TO ANY PARTICULAR FONT, STYLE, SIZE, OR COLOR.

SEC. 2(F).

SER. NO. 85-126,706, FILED 9-10-2010.

EUGENIA MARTIN, EXAMINING ATTORNEY



*David J. Kyros*

Director of the United States Patent and Trademark Office

# United States of America

United States Patent and Trademark Office



**Reg. No. 4,133,901**

**Registered May 1, 2012**

**Int. Cls.: 25 and 41**

**TRADEMARK**

**SERVICE MARK**

**PRINCIPAL REGISTER**

CAPITAL CITY BOXING, INC. (CANADA CORPORATION)  
1429 RICHARDSON STREET  
VICTORIA, BC, CANADA V8S1R1

FOR: EXERCISE AND FITNESS CLOTHING, NAMELY, T-SHIRTS, IN CLASS 25 (U.S. CLS. 22 AND 39).

FOR: PHYSICAL FITNESS INSTRUCTION, IN CLASS 41 (U.S. CLS. 100, 101 AND 107).

PRIORITY CLAIMED UNDER SEC. 44(D) ON CANADA APPLICATION NO. 1483990, FILED 6-7-2010, REG. NO. TMA811,100, DATED 11-4-2011, EXPIRES 11-4-2026.

THE MARK CONSISTS OF THE WORDS "HIT TO FIT" WITH A CIRCLE ENCLOSING THE WORD "TO".

SER. NO. 85-127,056, FILED 9-10-2010.

JULIE GUTTADAURO, EXAMINING ATTORNEY



*David J. Kybas*

Director of the United States Patent and Trademark Office

# United States of America

United States Patent and Trademark Office

## Dipl. Ac. (NCCAOM)

**Reg. No. 4,133,902**

**Registered May 1, 2012**

**CERTIFICATION MARK**

**PRINCIPAL REGISTER**

NATIONAL CERTIFICATION COMMISSION FOR ACUPUNCTURE AND ORIENTAL  
MEDICINE (D.C. CORPORATION)  
SUITE 1290  
76 SOUTH LAURA STREET  
JACKSONVILLE, FL 32202

FOR: ACUPUNCTURE SERVICES, IN CLASS B (U.S. CL. B).

FIRST USE 3-28-1985; IN COMMERCE 3-28-1985.

THE MARK CONSISTS OF STANDARD CHARACTERS WITHOUT CLAIM TO ANY PARTICULAR FONT, STYLE, SIZE, OR COLOR.

OWNER OF U.S. REG. NOS. 3,655,928, 3,700,368 AND OTHERS.

THE CERTIFICATION MARK CERTIFIES THAT THE CERTIFICATION, MARK AS USED TO INTENDED TO BE USED BY PERSONS AUTHORIZED BY THE CERTIFIER, CERTIFIES OR IS INTENDED TO CERTIFY THAT THE SERVICES PROVIDED HAVE MET THE ELIGIBILITY REQUIREMENTS AND SUCCESSFULLY PASSED A CERTIFICATION EXAMINATION THAT DEMONSTRATES A LEVEL OF KNOWLEDGE IN THE FIELD OF ACUPUNCTURE.

SEC. 2(F) AS TO "DIPL. AC.".

SER. NO. 85-128,077, FILED 9-13-2010.

DARRYL SPRUILL, EXAMINING ATTORNEY



*David J. Kybas*

Director of the United States Patent and Trademark Office

# United States of America

United States Patent and Trademark Office

## FAST & FRIENDLY FRESH & FUN

**Reg. No. 4,133,903**

U-GAS, INC. (MISSOURI CORPORATION)  
895 BOLGER COURT  
FENTON, MO 63026

**Registered May 1, 2012**

**Int. Cl.: 35**

FOR: RETAIL STORE SERVICES FEATURING CONVENIENCE STORE ITEMS AND GAS-  
OLINE, IN CLASS 35 (U.S. CLS. 100, 101 AND 102).

**SERVICE MARK**

FIRST USE 0-0-2001; IN COMMERCE 0-0-2001.

**PRINCIPAL REGISTER**

THE MARK CONSISTS OF STANDARD CHARACTERS WITHOUT CLAIM TO ANY PAR-  
TICULAR FONT, STYLE, SIZE, OR COLOR.

SER. NO. 85-128,189, FILED 9-13-2010.

DEZMONA MIZELLE, EXAMINING ATTORNEY



*David J. Kybas*

Director of the United States Patent and Trademark Office

# United States of America

United States Patent and Trademark Office



**Reg. No. 4,133,904**

**Registered May 1, 2012**

**Int. Cl.: 37**

**SERVICE MARK**

**PRINCIPAL REGISTER**

FUSHENG INDUSTRIAL CO., LTD. (TAIWAN CORPORATION)  
1, 2, 3F., NO. 172, SEC. 2  
NANKING EAST RD., JHONGSHAN DISTRICT  
TAIPEI CITY, TAIWAN

FOR: MACHINERY INSTALLATION, MAINTENANCE AND REPAIR; INSTALLATION, MAINTENANCE AND REPAIR OF AIR COMPRESSORS, SCREW COMPRESSORS, DRYERS, COOLERS AND FILTERS; CHILLER INSTALLATION MAINTENANCE AND REPAIR; INSTALLATION AND REPAIR OF FREEZING APPARATUS; INSTALLATION AND REPAIR OF AIR CONDITIONING APPARATUS; INSTALLATION, MAINTENANCE AND REPAIR OF BUSINESS AND OFFICE MACHINERY AND EQUIPMENT; INSTALLATION, MAINTENANCE AND REPAIR OF COMPUTER HARDWARE; INSTALLATION, MAINTENANCE AND REPAIR OF COMPUTER NETWORKING HARDWARE, IN CLASS 37 (U.S. CLS. 100, 103 AND 106).

PRIORITY CLAIMED UNDER SEC. 44(D) ON TAIWAN APPLICATION NO. 099044977, FILED 9-9-2010, REG. NO. 01471820, DATED 9-1-2011, EXPIRES 8-31-2021.

OWNER OF U.S. REG. NO. 3,212,883.

THE MARK CONSISTS OF HIGHLY STYLIZED LETTERS "FS" WITHIN A TRIANGULAR BORDER.

SER. NO. 85-130,439, FILED 9-15-2010.

JACQUELINE A. LAVINE, EXAMINING ATTORNEY



*David J. Kybas*

Director of the United States Patent and Trademark Office

# United States of America

United States Patent and Trademark Office



**Reg. No. 4,133,905**

**Registered May 1, 2012**

**Int. Cls.: 37 and 42**

**SERVICE MARK**

**PRINCIPAL REGISTER**

GILBANE BUILDING COMPANY (RHODE ISLAND CORPORATION)  
7 JACKSON WALKWAY  
PROVIDENCE, RI 02903

FOR: CONSTRUCTION SERVICES, NAMELY, CONSTRUCTION, RENOVATION, REPAIR, MODERNIZATION, RESTORATION, AND MAINTENANCE OF VERTICAL AND NON-VERTICAL FACILITIES, NAMELY, BUILDINGS, UNDERGROUND AND ABOVEGROUND UTILITY DUCTS, PIPELINES AND CONDUITS, RUNWAYS AND ROADS; CONSTRUCTION PROJECT MANAGEMENT SERVICES; DESIGN-BUILD CONSTRUCTION OF VERTICAL AND NON-VERTICAL FACILITIES, NAMELY, BUILDINGS, UNDERGROUND AND ABOVEGROUND UTILITY DUCTS, PIPELINES AND CONDUITS, RUNWAYS AND ROADS, IN CLASS 37 (U.S. CLS. 100, 103 AND 106).

FIRST USE 9-2-2010; IN COMMERCE 9-2-2010.

FOR: ENGINEERING SERVICES, NAMELY, CIVIL ENGINEERING, ENVIRONMENTAL ENGINEERING, AND ARCHITECTURAL ENGINEERING, ALL FOR VERTICAL AND NON-VERTICAL FACILITIES; CONSTRUCTION DESIGN SERVICES, NAMELY, ARCHITECTURAL, MECHANICAL, ELECTRICAL, PLUMBING AND STRUCTURAL DESIGN SERVICES, IN CLASS 42 (U.S. CLS. 100 AND 101).

FIRST USE 9-2-2010; IN COMMERCE 9-2-2010.

THE MARK CONSISTS OF A BOX OF DARK BACKGROUND CONTAINING THE LETTERS "ITSI" IN CONTRAST TO THE BACKGROUND WITH A BOLD LINE IN CONTRAST TO THE BACKGROUND DISPOSED ABOVE THE LETTERS AND THE WORD "GILBANE" DISPOSED BELOW "ITSI" WHEREIN THE "G" IN "GILBANE" IS IN CONTRAST TO THE DARK BACKGROUND WHILE THE "ILBANE" PORTION OF "GILBANE" IS RENDERED IN DARK LETTERING AND IS DISPOSED IN A SMALLER BOX IN CONTRAST TO THE BACKGROUND.

SER. NO. 85-130,663, FILED 9-15-2010.

JOHN GARTNER, EXAMINING ATTORNEY



*David J. Kyros*

Director of the United States Patent and Trademark Office



# United States of America

United States Patent and Trademark Office



**Reg. No. 4,133,906**

**Registered May 1, 2012**

**Int. Cl.: 4**

HERSHEY CHOCOLATE & CONFECTIONERY CORPORATION (DELAWARE CORPORATION)  
SUITE 204  
4860 ROBB STREET  
WHEAT RIDGE, CO 80033

**TRADEMARK**

FOR: CANDLES, IN CLASS 4 (U.S. CLS. 1, 6 AND 15).

**PRINCIPAL REGISTER**

FIRST USE 4-30-2010; IN COMMERCE 4-30-2010.

OWNER OF U.S. REG. NOS. 54,041, 3,321,536 AND OTHERS.

THE COLOR(S) BROWN, MAROON, TAN, RED, WHITE AND BLACK IS/ARE CLAIMED AS A FEATURE OF THE MARK.

NO CLAIM IS MADE TO THE EXCLUSIVE RIGHT TO USE "VANILLA" AND "SWEET" AND "CHOCOLATE" AND "5c", APART FROM THE MARK AS SHOWN.

THE NAME(S), PORTRAIT(S), AND/OR SIGNATURE(S) SHOWN IN THE MARK DOES NOT IDENTIFY A PARTICULAR LIVING INDIVIDUAL.

THE MARK CONSISTS OF IN PART, A WHITE OVAL DESIGN WITH A BABY WITH BROWN HAIR IN A BROWN COCOA BEAN KNOWN AS THE COCOA BEAN BABY HOLDING A BROWN BAR OF CHOCOLATE WITH BROWN BRANCHES AND LEAVES IN THE BACKGROUND, ALONG WITH WHITE FLOWERS AND BROWN STEMS AROUND THE OVAL. THERE ARE SCALLOPED WHITE AND BLACK ACCENT DESIGNS IN THE FOUR CORNERS OF THE RECTANGULAR SHAPE. THE WORDING "HERSHEY'S" APPEARS IN RED AND OUTLINED IN WHITE ABOVE THE WHITE OVAL DESIGN AND THE WORDING "CHOCOLATE" APPEARS IN RED AND OUTLINED IN WHITE BELOW THE WHITE OVAL DESIGN. THE WORDING "5c" APPEARS IN BROWN LETTERS WITH RED OUTLINING TO THE LEFT AND RIGHT OF THE WHITE OVAL DESIGN. BELOW THE WORDING "5c" ON THE LEFT SIDE APPEARS THE WORDING "VANILLA" IN BLACK WITH WHITE OUTLINING AND BELOW THE WORDING "5c" ON THE RIGHT SIDE APPEARS THE WORDING "SWEET" IN BLACK WITH WHITE OUTLINING. THE LETTERS "W" AND "T" IN "SWEET" ARE MAROON. ALL OF THE AFOREMENTIONED APPEAR AGAINST A TAN BACKGROUND. THE DOTTED LINING AROUND THE MARK IS FOR PLACEMENT PURPOSES AND IS NOT A FEATURE OF THE MARK.



*David J. Kappas*

Director of the United States Patent and Trademark Office

**Reg. No. 4,133,906** SER. NO. 85-131,506, FILED 9-16-2010.

NAPOLEON SHARMA, EXAMINING ATTORNEY

# United States of America

United States Patent and Trademark Office

# DORADO

**Reg. No. 4,133,907**

**Registered May 1, 2012**

**Int. Cl.: 32**

**TRADEMARK**

**PRINCIPAL REGISTER**

HOME BREW MART, INC. (CALIFORNIA CORPORATION)  
10051 OLD GROVE ROAD, SUITE B  
SAN DIEGO, CA 92131

FOR: BEER, IN CLASS 32 (U.S. CLS. 45, 46 AND 48).

FIRST USE 9-17-2003; IN COMMERCE 9-17-2003.

THE MARK CONSISTS OF STANDARD CHARACTERS WITHOUT CLAIM TO ANY PARTICULAR FONT, STYLE, SIZE, OR COLOR.

SER. NO. 85-132,029, FILED 9-17-2010.

ERIN FALK, EXAMINING ATTORNEY



*David J. Kybas*

Director of the United States Patent and Trademark Office

# United States of America

United States Patent and Trademark Office

# SPLASH

**Reg. No. 4,133,908**

**Registered May 1, 2012**

**Int. Cl.: 41**

**SERVICE MARK**

**PRINCIPAL REGISTER**

LANDECHE, BRIAN (UNITED STATES INDIVIDUAL)  
32 WASHINGTON SQUARE WEST  
NEW YORK, NY 10011

FOR: NIGHT CLUBS, IN CLASS 41 (U.S. CLS. 100, 101 AND 107).

FIRST USE 10-0-1990; IN COMMERCE 10-0-1990.

THE MARK CONSISTS OF STANDARD CHARACTERS WITHOUT CLAIM TO ANY PARTICULAR FONT, STYLE, SIZE, OR COLOR.

SER. NO. 85-132,998, FILED 9-19-2010.

BARBARA RUTLAND, EXAMINING ATTORNEY



*David J. Kybas*

Director of the United States Patent and Trademark Office

# United States of America

United States Patent and Trademark Office

# AGRIFUELS

**Reg. No. 4,133,909**

**Registered May 1, 2012**

**Int. Cl.: 9**

**TRADEMARK**

**PRINCIPAL REGISTER**

AGRIFUELS, LLC (CONNECTICUT LIMITED LIABILITY COMPANY)  
73 DAYTON ROAD  
SOUTH GLASTONBURY, CT 06073

FOR: AUTOMATED PROCESS CONTROL SYSTEM, NAMELY, MICRO-PROCESSOR BASED HARDWARE AND SOFTWARE USED TO MONITOR THE STATUS OF INDUSTRIAL PROCESSES, NAMELY, POWER GENERATION, ELECTRICAL DISTRIBUTION AND OIL AND GAS PROCESSING; COMPUTER HARDWARE AND PERIPHERAL DEVICES AND COMPUTER SOFTWARE FOR DATA COMMUNICATION AND TRANSLATING AND TRANSMITTING DATA SOLD THEREWITH; COMPUTER HARDWARE AND SOFTWARE SYSTEM FOR REMOTELY MONITORING ENVIRONMENTAL CONDITIONS AND CONTROLLING DEVICES WITHIN A BUILDING, FACILITY, GROUNDS, OR DESIGNATED SPATIAL AREA; COMPUTER SOFTWARE FOR CREATING SEARCHABLE DATABASES OF INFORMATION AND DATA; COMPUTER SOFTWARE TO MONITOR AND CONTROL FACTORY MANUFACTURING PROCESSES; DATABASE MANAGEMENT SOFTWARE FOR MANAGEMENT OF REFINERY OPERATIONS, NAMELY, COMPILING DATA, REPORTS AND RELATED DOCUMENTATION FOR COMPLIANCE WITH APPLICABLE GOVERNMENT AND ENVIRONMENTAL STANDARDS; INDUSTRIAL PROCESS CONTROL SOFTWARE, IN CLASS 9 (U.S. CLS. 21, 23, 26, 36 AND 38).

FIRST USE 11-14-2003; IN COMMERCE 11-14-2003.

THE MARK CONSISTS OF STANDARD CHARACTERS WITHOUT CLAIM TO ANY PARTICULAR FONT, STYLE, SIZE, OR COLOR.

SEC. 2(F).

SER. NO. 85-133,865, FILED 9-20-2010.

PAULA MAHONEY, EXAMINING ATTORNEY



*David J. Kyros*

Director of the United States Patent and Trademark Office

# United States of America

United States Patent and Trademark Office

## DA VINCI DECATHLON

**Reg. No. 4,133,910**

**Registered May 1, 2012**

**Int. Cl.: 41**

**SERVICE MARK**

**PRINCIPAL REGISTER**

THE UNITING CHURCH IN AUSTRALIA PROPERTY TRUST (NSW) (AUSTRALIA CORPORATION)  
PO BOX 643  
BURWOOD NSW 1805, AUSTRALIA

FOR: ORGANIZATION OF ACADEMIC INTER-SCHOOL COMPETITIONS, IN CLASS 41 (U.S. CLS. 100, 101 AND 107).

THE MARK CONSISTS OF STANDARD CHARACTERS WITHOUT CLAIM TO ANY PARTICULAR FONT, STYLE, SIZE, OR COLOR.

OWNER OF AUSTRALIA REG. NO. 1368259, DATED 12-14-2009, EXPIRES 12-14-2019.

SER. NO. 85-139,984, FILED 9-28-2010.

JULIE WATSON, EXAMINING ATTORNEY



*David J. Kyffers*

Director of the United States Patent and Trademark Office

# United States of America

United States Patent and Trademark Office

## BCOMMUNITIES

**Reg. No. 4,133,911**

**Registered May 1, 2012**

**Int. Cls.: 9, 35 and 42**

**TRADEMARK**

**SERVICE MARK**

**PRINCIPAL REGISTER**

BECOSYSTEMS, INC. (DELAWARE CORPORATION), AKA BCOMMUNITIES.COM  
12TH FLOOR  
444 N MICHIGAN AVE.  
CHICAGO, IL 60611

FOR: COMMUNICATIONS SOFTWARE FOR CONNECTING BUSINESSES, ORGANIZATIONS AND FREELANCE PROFESSIONALS WITH EACH OTHER; COMPUTER SOFTWARE FOR USE IN CUSTOMER RELATIONSHIP MANAGEMENT (CRM); COMPUTER SOFTWARE THAT PROVIDES REAL-TIME, INTEGRATED BUSINESS MANAGEMENT INTELLIGENCE BY COMBINING INFORMATION FROM VARIOUS DATABASES AND PRESENTING IT IN AN EASY-TO-UNDERSTAND USER INTERFACE, IN CLASS 9 (U.S. CLS. 21, 23, 26, 36 AND 38).

FIRST USE 8-1-2010; IN COMMERCE 9-26-2010.

FOR: PROVIDING ONLINE BUSINESS MANAGEMENT SERVICES INCLUDING ACCOUNTING, MARKETING, BUSINESS PROJECT MANAGEMENT, AND BUSINESS DEVELOPMENT, IN CLASS 35 (U.S. CLS. 100, 101 AND 102).

FIRST USE 8-1-2010; IN COMMERCE 9-26-2010.

FOR: APPLICATION SERVICE PROVIDER FEATURING APPLICATION PROGRAMMING INTERFACE (API) SOFTWARE FOR USE IN BUILDING SOFTWARE APPLICATIONS; APPLICATION SERVICE PROVIDER FEATURING SOFTWARE FOR PROVIDING AN ON-LINE DATABASE IN THE FIELD OF TRANSACTION PROCESSING TO UPLOAD TRANSACTIONAL DATA, PROVIDE STATISTICAL ANALYSIS, AND PRODUCE NOTIFICATIONS AND REPORTS; COMPUTER PROJECT MANAGEMENT SERVICES; COMPUTER SERVICE, NAMELY, ACTING AS AN APPLICATION SERVICE PROVIDER IN THE FIELD OF INFORMATION MANAGEMENT TO HOST COMPUTER APPLICATION SOFTWARE FOR THE PURPOSE OF FACILITATING BUSINESS INTERACTIONS BETWEEN COMPANIES BY PROVIDING A COMMON ONLINE PLATFORM.; COMPUTER SERVICES, NAMELY, CREATING AN ON-LINE COMMUNITY FOR REGISTERED USERS TO SHOWCASE THEIR VEHICLES, PARTICIPATE IN COMPETITIONS, GET FEEDBACK FROM THEIR PEERS, FORM VIRTUAL COMMUNITIES, AND ENGAGE IN SOCIAL NETWORKING; SOFTWARE AS A SERVICE (SAAS) SERVICES, NAMELY, HOSTING SOFTWARE FOR USE BY OTHERS FOR USE IN NETWORKING WITH OTHERS AND MANAGING THEIR BUSINESSES AND ORGANIZATIONS, NAMELY, MANAGING THEIR INTERNAL AND EXTERNAL COMMU-



*David J. Kyros*

Director of the United States Patent and Trademark Office

**Reg. No. 4,133,911** COMMUNICATIONS WITH CLIENTS AND PROVIDERS, MANAGING THEIR CONTACTS, PROJECTS AND FINANCES AND KEEPING DATA AND DOCUMENTS FOR FUTURE REFERENCE IN A COMMON PLATFORM ENVIRONMENT, IN CLASS 42 (U.S. CLS. 100 AND 101).

FIRST USE 8-1-2010; IN COMMERCE 9-26-2010.

THE MARK CONSISTS OF STANDARD CHARACTERS WITHOUT CLAIM TO ANY PARTICULAR FONT, STYLE, SIZE, OR COLOR.

SER. NO. 85-140,349, FILED 9-28-2010.

GIANCARLO CASTRO, EXAMINING ATTORNEY



# United States of America

United States Patent and Trademark Office

## LUNA DE MAR

**Reg. No. 4,133,912**

**Registered May 1, 2012**

**Int. Cl.: 33**

**TRADEMARK**

**PRINCIPAL REGISTER**

LA BARONIA DE TURIS COOP. V. (SPAIN CORPORATION)  
CTRA. GODELLETA, NO. 22  
TURIS, SPAIN CP46389

FOR: WINES, IN CLASS 33 (U.S. CLS. 47 AND 49).

THE MARK CONSISTS OF STANDARD CHARACTERS WITHOUT CLAIM TO ANY PARTICULAR FONT, STYLE, SIZE, OR COLOR.

OWNER OF ERPN CMNTY TM OFC REG. NO. 009318131, DATED 12-31-2010, EXPIRES 8-17-2020.

THE ENGLISH TRANSLATION OF "LUNA DE MAR" IN THE MARK IS "MOON OF SEA".

SER. NO. 85-140,819, FILED 9-29-2010.

SUZANNE BLANE, EXAMINING ATTORNEY



*David J. Kyffers*

Director of the United States Patent and Trademark Office

# United States of America

United States Patent and Trademark Office

## MIDWEST DAIRY ASSOCIATION

**Reg. No. 4,133,913**

**Registered May 1, 2012**

**Int. Cl.: 35**

**SERVICE MARK**

**PRINCIPAL REGISTER**

MIDWEST DAIRY ASSOCIATION (MINNESOTA NON-PROFIT CORPORATION)  
2015 N. RICE STREET  
ST. PAUL, MN 55113

FOR: ASSOCIATION SERVICES, NAMELY, PROMOTING THE INTERESTS AND WELL-BEING OF DAIRY PRODUCERS; PROVIDING ONLINE BUSINESS INFORMATION AND NEWS IN THE FIELDS OF DAIRY PRODUCT PRODUCTION, THE BUSINESS PRACTICES OF DAIRY FARMING, AND CONSUMER INFORMATION ABOUT DAIRY PRODUCTS, IN CLASS 35 (U.S. CLS. 100, 101 AND 102).

FIRST USE 1-1-2000; IN COMMERCE 1-1-2000.

THE MARK CONSISTS OF STANDARD CHARACTERS WITHOUT CLAIM TO ANY PARTICULAR FONT, STYLE, SIZE, OR COLOR.

NO CLAIM IS MADE TO THE EXCLUSIVE RIGHT TO USE "ASSOCIATION", APART FROM THE MARK AS SHOWN.

SEC. 2(F).

SER. NO. 85-140,822, FILED 9-29-2010.

MICHAEL TANNER, EXAMINING ATTORNEY



*David J. Kyros*

Director of the United States Patent and Trademark Office

# United States of America

United States Patent and Trademark Office



**Reg. No. 4,133,914**

**Registered May 1, 2012**

**Int. Cl.: 5**

**TRADEMARK**

**PRINCIPAL REGISTER**

LIQUID INNOVATIONS, LLC (MICHIGAN LIMITED LIABILITY COMPANY)  
1885 BEVANDA COURT  
BAY CITY, MI 48706

FOR: DIETARY SUPPLEMENTS, IN CLASS 5 (U.S. CLS. 6, 18, 44, 46, 51 AND 52).

FIRST USE 7-30-2010; IN COMMERCE 7-30-2010.

OWNER OF U.S. REG. NO. 3,874,562.

THE COLOR(S) LIGHT BLUE, DARK BLUE, WHITE, BLACK, YELLOW AND ORANGE IS/ARE CLAIMED AS A FEATURE OF THE MARK.

THE MARK CONSISTS OF BLACK SILHOUETTES OF DANCING PERSONS ON A RECTANGULAR BACKGROUND WITH DARK BLUE RAYS AND WHITE RAYS THAT DEEPEN TO LIGHT BLUE AT THE TOP UNDERNEATH THE WORDS "PARTY ARMOR" IN YELLOW WITH ORANGE LINING IN THE MIDDLE OF THE LETTERS WITH BLACK SHADOWS BEHIND THE LETTERS. THE BLACK RECTANGULAR BACKGROUND IS SIMPLY BACKGROUND AND THUS NOT A FEATURE OF THE APPLIED FOR MARK.

SER. NO. 85-140,883, FILED 9-29-2010.

LINDSEY RUBIN, EXAMINING ATTORNEY



*David J. Kyros*

Director of the United States Patent and Trademark Office

# United States of America

United States Patent and Trademark Office



**Reg. No. 4,133,915**

**Registered May 1, 2012**

**Int. Cls.: 29 and 30**

**TRADEMARK**

**PRINCIPAL REGISTER**

KABUSHIKI KAISHA NAKASHIMATO SHOTEN (JAPAN CORPORATION), TA  
NAKASHIMATO CO., LTD.  
4-13, SHIBUYA 1-CHOME  
SHIBUYA-KU, TOKYO, JAPAN

FOR: JAMS; PEANUT BUTTER; CHOCOLATE SPREAD; BLACK SESAME SPREAD;  
TOASTED SOYBEAN FLOUR SPREAD; CORN SOUP; ONION SOUP; MINISTRONE SOUP;  
SOUPS; CLAM CHOWDER; CANNED CORN; CANNED CREAMY CORN; CANNED PORK  
AND BEANS; LIVER PASTE; BEEF PASTE; MEAT PASTE; ANCHOVY FILLETS; FISH  
FILLETS, IN CLASS 29 (U.S. CL. 46).

FOR: RICE PORRIDGE, IN CLASS 30 (U.S. CL. 46).

OWNER OF JAPAN REG. NO. 0987598, DATED 11-4-1972, RENEWED AS REG. NO. 0987598,  
DATED 5-9-2011, EXPIRES 11-4-2012.

THE COLOR(S) DARK BLUE AND WHITE IS/ARE CLAIMED AS A FEATURE OF THE  
MARK.

OWNER OF JAPAN REG. NO. 4408087, DATED 8-11-2000, RENEWED AS REG. NO. 4408087,  
DATED 9-8-2011, EXPIRES 8-11-2020.

OWNER OF JAPAN REG. NO. 4780410, DATED 6-18-2004, EXPIRES 6-18-2014.

OWNER OF U.S. REG. NO. 1,940,200.

THE MARK CONSISTS OF A DARK BLUE PENNANT-SHAPED FLAG ON A DARK BLUE  
FLAG POLE, WITH A WHITE STAR IN THE MIDDLE OF THE FLAG.

SER. NO. 85-142,015, FILED 9-30-2010.

GENE MACIOL, EXAMINING ATTORNEY



*David J. Kybas*

Director of the United States Patent and Trademark Office

# United States of America

United States Patent and Trademark Office

# VisibleEquity

**Reg. No. 4,133,916**

**Registered May 1, 2012**

**Int. Cls.: 35, 36 and 42**

**SERVICE MARK**

**PRINCIPAL REGISTER**

VISIBLE EQUITY, LLC (UTAH LIMITED LIABILITY COMPANY)  
4525 SOUTH WASATCH BLVD, #325  
SALT LAKE CITY, UT 84124

FOR: BUSINESS RISK MANAGEMENT, IN CLASS 35 (U.S. CLS. 100, 101 AND 102).

FIRST USE 12-14-2004; IN COMMERCE 11-30-2005.

FOR: FINANCIAL RISK MANAGEMENT, NAMELY, PROVIDING FINANCIAL ANALYSIS, FINANCIAL RESEARCH, AND PREPARING FINANCIAL ANALYST REPORTS FOR OTHERS; FINANCIAL ANALYSIS SERVICES IN THE FIELD OF FINANCIAL LENDING, IN CLASS 36 (U.S. CLS. 100, 101 AND 102).

FIRST USE 12-14-2004; IN COMMERCE 11-30-2005.

FOR: SOFTWARE AS A SERVICE (SAAS) SERVICES FEATURING SOFTWARE IN THE FIELD OF DATABASE MANAGEMENT FOR USE IN RISK MANAGEMENT AND FINANCIAL ANALYSIS, IN CLASS 42 (U.S. CLS. 100 AND 101).

FIRST USE 12-14-2004; IN COMMERCE 11-30-2005.

THE MARK CONSISTS OF STANDARD CHARACTERS WITHOUT CLAIM TO ANY PARTICULAR FONT, STYLE, SIZE, OR COLOR.

SER. NO. 85-146,352, FILED 10-6-2010.

ANTHONY RINKER, EXAMINING ATTORNEY



*David J. Kybas*

Director of the United States Patent and Trademark Office

# United States of America

United States Patent and Trademark Office

## GREENER CAR. FATTER WALLET.

**Reg. No. 4,133,917**

**Registered May 1, 2012**

**Int. Cl.: 35**

**SERVICE MARK**

**PRINCIPAL REGISTER**

GREEN AUTOMOTIVE ALLIANCE, LLC (NEW YORK LIMITED LIABILITY COMPANY)  
109 WEST 27TH STREET  
SUITE 11B  
NEW YORK, NY 10001

FOR: PROVIDING A SEARCHABLE WEBSITE FEATURING THE GOODS AND SERVICES OF OTHER VENDORS; PROMOTING THE GOODS AND SERVICES OF OTHERS BY PROVIDING A WEB SITE FEATURING COUPONS, REBATES, PRICE-COMPARISON INFORMATION, PRODUCT REVIEWS, LINKS TO THE RETAIL WEB SITES OF OTHERS, AND DISCOUNT INFORMATION; ONLINE RETAIL STORE SERVICES FEATURING PARTS AND PRODUCTS FOR MOTOR VEHICLES; PROVIDING A WEBSITE FEATURING NEWS AND INFORMATION ABOUT AUTOMOBILE PRODUCTS AND SERVICES; PROVIDING A WEB SITE WHERE USERS CAN POST RATINGS, REVIEWS AND RECOMMENDATIONS ON PRODUCTS AND SERVICES FOR COMMERCIAL PURPOSES; PROVIDING SPACE ON A WEB SITE FOR THE ADVERTISEMENT OF THE GOODS AND SERVICES OF OTHERS; DISPLAYING ADVERTISEMENTS FOR OTHERS, IN CLASS 35 (U.S. CLS. 100, 101 AND 102).

FIRST USE 6-1-2010; IN COMMERCE 6-1-2010.

THE MARK CONSISTS OF STANDARD CHARACTERS WITHOUT CLAIM TO ANY PARTICULAR FONT, STYLE, SIZE, OR COLOR.

SER. NO. 85-150,375, FILED 10-12-2010.

PAUL MORENO, EXAMINING ATTORNEY



*David J. Kybas*

Director of the United States Patent and Trademark Office

# United States of America

United States Patent and Trademark Office

## Blue Water Festival

**Reg. No. 4,133,918**

BLUE WATER FESTIVAL, INC (MICHIGAN CORPORATION)  
2857 RIVERSIDE DR.  
PORT HURON, MI 48060

**Registered May 1, 2012**

**Int. Cl.: 41**

FOR: ORGANIZING COMMUNITY FESTIVALS FEATURING PRIMARILY ENTERTAINMENT AND ALSO PROVIDING FOOD, IN CLASS 41 (U.S. CLS. 100, 101 AND 107).

**SERVICE MARK**

FIRST USE 7-1-1934; IN COMMERCE 7-1-1934.

**PRINCIPAL REGISTER**

THE MARK CONSISTS OF STANDARD CHARACTERS WITHOUT CLAIM TO ANY PARTICULAR FONT, STYLE, SIZE, OR COLOR.

OWNER OF U.S. REG. NO. 1,543,913.

NO CLAIM IS MADE TO THE EXCLUSIVE RIGHT TO USE "FESTIVAL", APART FROM THE MARK AS SHOWN.

SER. NO. 85-151,198, FILED 10-13-2010.

LINDA MICKLEBURGH, EXAMINING ATTORNEY



*David J. Kyros*

Director of the United States Patent and Trademark Office

# United States of America

United States Patent and Trademark Office

custom**media**labs

**Reg. No. 4,133,919**

**Registered May 1, 2012**

**Int. Cl.: 35**

**SERVICE MARK**

**PRINCIPAL REGISTER**

CUSTOM IT, INC. (PENNSYLVANIA CORPORATION), DBA CUSTOMEDIALABS  
460 E. SWEDESFORD ROAD SUITE 2020  
WAYNE, PA 19087

FOR: ADVERTISING AND BUSINESS SERVICES, NAMELY, PROVIDING AN ONLINE WEBSITE WHERE ADVERTISERS, MARKETERS, AND CONTENT PROVIDERS CAN INTERACT WITH USERS FOR ADVERTISING, BRANDING, AND PROMOTING KNOWLEDGE, PRODUCTS, AND SERVICES, AND TRADESHOWS, ON BEHALF OF THEMSELVES AND OTHERS, AND FOR EVALUATING AND RATING THE SAME, ALL THE FOREGOING RELEVANT TO HUMAN ACTIVITIES AFFECTING CLIMATE CHANGE AND RELATED FIELDS, IN CLASS 35 (U.S. CLS. 100, 101 AND 102).

FIRST USE 10-26-2006; IN COMMERCE 10-26-2006.

THE MARK INCLUDES THE WORDS "CUSTOMEDIALABS" AS ALL ONE WORD. THE "CUSTOM" IS BLACK INCLUDING HALF OF THE "M". THE "MEDIA" PORTION OF THE WORD, WHICH INCLUDES THE OTHER HALF OF THE "M", IS LIME GREEN. THE "LABS" PORTION OF THE WORD IS ALL BLACK.

THE COLOR(S) BLACK AND LIME GREEN IS/ARE CLAIMED AS A FEATURE OF THE MARK.

SER. NO. 85-153,078, FILED 10-14-2010.

ELIZABETH KAJUBI, EXAMINING ATTORNEY



*David J. Kyffers*

Director of the United States Patent and Trademark Office



# United States of America

United States Patent and Trademark Office

# getCredentialed GET PROMOTED!

**Reg. No. 4,133,920**

**Registered May 1, 2012**

**Int. Cl.: 35**

**SERVICE MARK**

**PRINCIPAL REGISTER**

THE TRUSTEE OF THE ROBERT L. O'BLOCK TRUST (MISSOURI TRUST)  
2750 EAST SUNSHINE  
SPRINGFIELD, MO 65804

FOR: ADVERTISING AND MARKETING, NAMELY, PROMOTING THE PROGRAMS OF OTHERS WHO PROVIDE CREDENTIALING SERVICES FOR PROFESSIONALS, IN CLASS 35 (U.S. CLS. 100, 101 AND 102).

FIRST USE 10-15-2010; IN COMMERCE 10-15-2010.

THE MARK CONSISTS OF STYLIZED DESIGN OF "GET CREDENTIALLED GET PROMOTED AND PUNCTUATION MARK".

SER. NO. 85-154,114, FILED 10-15-2010.

KAREN BRACEY, EXAMINING ATTORNEY



*David J. Kyffers*

Director of the United States Patent and Trademark Office

# United States of America

United States Patent and Trademark Office

# SORARA

**Reg. No. 4,133,921**

**Registered May 1, 2012**

**Int. Cls.: 18, 20 and 22**

**TRADEMARK**

**PRINCIPAL REGISTER**

ZHEJIANG ZHENGTE GROUP CO., LTD. (CHINA CORPORATION)  
NO. 811 ORIENTAL AVE.  
LINHAI, ZHEJIANG, CHINA 317004

FOR: (BASED ON 44(E)) BACKPACKS, BOOK BAGS, WALLETS AND HANDBAGS; BEACH UMBRELLAS; GARMENT BAGS FOR TRAVEL MADE OF LEATHER; LEATHER; LEATHER WALLETS; LEATHER SUITCASES AND WALLETS; LEATHER CASES FOR KEYS; LEATHER CREDIT CARD WALLETS; LEATHER HANDBAGS; LEATHER SHOPPING BAGS; PARASOLS; PATIO UMBRELLAS; RAINPROOF PARASOLS; REUSABLE SHOPPING BAGS; SACK PACKS, NAMELY, DRAWSTRING BAGS USED AS BACKPACKS; SMALL BACKPACKS; TRAVELLING CASES OF LEATHER; UMBRELLAS; UMBRELLAS FOR CHILDREN; WALLETS MADE OF LEATHER OR OTHER MATERIALS, IN CLASS 18 (U.S. CLS. 1, 2, 3, 22 AND 41).

FOR: (BASED ON USE IN COMMERCE) (BASED ON 44(E)) ANIMAL HORNS; ARTIFICIAL HORNS; BAMBOO BLINDS; BLINDS OF REED, RATTAN OR BAMBOO (SUDARE); CUSHIONS; DECORATIVE WOODEN WALL LETTERS FOR SPELLING NAMES AND WORDS; DRAWER PULLS OF PLASTIC OR WOOD, CORK, REED, CANE, WICKER, HORN, BONE, IVORY, WHALEBONE, SHELL, AMBER, MOTHER-OF-PEARL, MEERSCHAUM AND SUBSTITUTES FOR ALL THESE MATERIALS; FURNITURE, PICTURE FRAMES; INDOOR BLINDS; IVORY; LEATHER PICTURE FRAMES; PAPER PHOTO FRAMES; PAPER PICTURE FRAMES; PICTURE AND PHOTOGRAPH FRAMES; PICTURE FRAME MOLDINGS; PICTURE FRAMES; PICTURE FRAMES OF PRECIOUS METAL; PLASTIC FRAME TO SUPPORT AND ACCOMMODATE USE OF PLASTIC GARBAGE BAGS; PORTABLE LIGHTWEIGHT NON-METAL FRAMES FOR HOLDING AND SECURING TRASH BAGS DURING CLEAN-UP; SEA SHELLS; SLATTED INDOOR BLINDS; SLATTED INDOOR BLINDS FOR WINDOWS; WALL FRAME FOR THE DISPLAY OF MEDIA STORAGE CONTAINERS; WINDOW BLINDS FOR INDOOR USE; WOODEN BOXES WITH A LOCKED STORAGE AREA FOR PERSONAL ITEMS; WORKS OF ART OF WOOD, WAX, PLASTER OR PLASTIC; (BASED ON USE IN COMMERCE) LAWN FURNITURE, OUTDOOR FURNITURE, IN CLASS 20 (U.S. CLS. 2, 13, 22, 25, 32 AND 50).

FIRST USE 11-30-2007; IN COMMERCE 4-30-2008.

FOR: (BASED ON 44(E)) COTTON FIBERS; EIDERDOWN; FLEECE WOOL; RAW COTTON; RAW SILK; RAW WOOL; SAILS; SILK FIBERS; TEXTILE BAGS FOR MERCHANDISE PACKAGING; WOOL; YARN FIBERS, IN CLASS 22 (U.S. CLS. 1, 2, 7, 19, 22, 42 AND 50).



*David J. Kybas*

Director of the United States Patent and Trademark Office

**Reg. No. 4,133,921** THE MARK CONSISTS OF STANDARD CHARACTERS WITHOUT CLAIM TO ANY PARTICULAR FONT, STYLE, SIZE, OR COLOR.

OWNER OF CHINA REG. NO. 6675156, DATED 7-21-2010, EXPIRES 7-20-2020.

OWNER OF CHINA REG. NO. 6675158, DATED 3-28-2010, EXPIRES 3-27-2020.

OWNER OF CHINA REG. NO. 6675160, DATED 7-21-2010, EXPIRES 7-20-2020.

THE WORDING "SORARA" HAS NO MEANING IN A FOREIGN LANGUAGE.

SER. NO. 85-159,725, FILED 10-23-2010.

GENE MACIOL, EXAMINING ATTORNEY

# United States of America

United States Patent and Trademark Office

## Immersive Motion

**Reg. No. 4,133,922**

**Registered May 1, 2012**

**Int. Cl.: 9**

**TRADEMARK**

**PRINCIPAL REGISTER**

AIKEN DEVELOPMENT LLC (NORTH CAROLINA LIMITED LIABILITY COMPANY)  
520 REALTY ST SW  
LENOIR, NC 28645

FOR: COMPONENTS FOR GAMING MACHINES, NAMELY, CONTROLLERS, DISPLAYS, BUTTON PANELS, BOLSTERS, ELECTRICAL WIRING, AND COMPUTER HARDWARE AND SOFTWARE ASSOCIATED THEREWITH; COMPUTER CURSOR CONTROL DEVICES, NAMELY, COMPUTER MOUSE; COMPUTER CURSOR CONTROL DEVICES, NAMELY, DIGITIZER TABLETS; COMPUTER CURSOR CONTROL DEVICES, NAMELY, LIGHT PENS; COMPUTER CURSOR CONTROL DEVICES, NAMELY, TOUCH PADS; COMPUTER CURSOR CONTROL DEVICES, NAMELY, TRACKBALLS; COMPUTER KEYBOARD CONTROLLERS; ELECTRICAL CONTROLLING DEVICES; ELECTRONIC AND VIDEO GAME CONTROLLERS INCORPORATED INTO EXERCISE MACHINES; ELECTRONIC CONTROLLERS FOR MOTION CAPTURE; GAME CONTROLLERS FOR COMPUTER GAMES; WIRELESS CONTROLLER TO MONITOR AND CONTROL THE FUNCTIONING OF OTHER ELECTRONIC DEVICES, IN CLASS 9 (U.S. CLS. 21, 23, 26, 36 AND 38).

FIRST USE 11-19-2005; IN COMMERCE 12-21-2006.

THE MARK CONSISTS OF STANDARD CHARACTERS WITHOUT CLAIM TO ANY PARTICULAR FONT, STYLE, SIZE, OR COLOR.

SEC. 2(F).

SER. NO. 85-159,795, FILED 10-24-2010.

KAREN K. BUSH, EXAMINING ATTORNEY



*David J. Kyffers*

Director of the United States Patent and Trademark Office

# United States of America

United States Patent and Trademark Office

## USA WATER SKI

**Reg. No. 4,133,923**

**Registered May 1, 2012**

**Int. Cls.: 35 and 41**

**SERVICE MARK**

**PRINCIPAL REGISTER**

USA WATER SKI (NEW JERSEY CORPORATION)  
1251 HOLY COW ROAD  
POLK CITY, FL 33868

FOR: ASSOCIATION SERVICES, NAMELY, PROMOTING THE INTERESTS OF AMATEUR AND PROFESSIONAL WATER SKIERS, IN CLASS 35 (U.S. CLS. 100, 101 AND 102).

FIRST USE 1-1-1999; IN COMMERCE 1-1-1999.

FOR: ENCOURAGING AMATEUR AND PROFESSIONAL WATER SKIING BY SANCTIONING AMATEUR AND PROFESSIONAL WATER SKIING PROGRAMS AND ACTIVITIES; DISSEMINATION OF EDUCATIONAL MATERIALS OF OTHERS IN THE FIELD OF WATER SKIING; RATING WATER SKIERS, COACHES, OFFICIALS AND WATER SKIING PROGRAMS BY ASSIGNING NUMERIC MEASURE, IN CLASS 41 (U.S. CLS. 100, 101 AND 107).

FIRST USE 1-1-1999; IN COMMERCE 1-1-1999.

THE MARK CONSISTS OF STANDARD CHARACTERS WITHOUT CLAIM TO ANY PARTICULAR FONT, STYLE, SIZE, OR COLOR.

NO CLAIM IS MADE TO THE EXCLUSIVE RIGHT TO USE "WATER SKI", APART FROM THE MARK AS SHOWN.

SEC. 2(F).

SER. NO. 85-160,264, FILED 10-25-2010.

TARA PATE, EXAMINING ATTORNEY



*David J. Kybas*

Director of the United States Patent and Trademark Office

# United States of America

United States Patent and Trademark Office



**Reg. No. 4,133,924**

**Registered May 1, 2012**

**Int. Cl.: 17**

**TRADEMARK**

**PRINCIPAL REGISTER**

TOTO LTD. (JAPAN CORPORATION)  
1-1 NAKASHIMA 2-CHOME  
KOKURAKITA-KU  
KITAKYUSHU-SHI, JAPAN

FOR: SEMI-PROCESSED PLASTICS; LAMINATED BOARDS OF PLASTICS; PLASTIC MATERIALS IN THE FORM OF BOARDS, SHEETS, RODS; PLASTIC SHEETS AND FILMS OTHER THAN FOR WRAPPING; PLASTIC SHEETS AND FILMS FOR ARCHITECTURAL GLASSES; PLASTIC SHEETS AND FILMS FOR WINDOWS; PLASTIC SHEETS AND FILMS FOR AGRICULTURAL PURPOSES; POLYETHYLENE SHEETS AND FILMS FOR SIGNS, TRAFFIC SIGNS, WINDOWS, SKYLIGHTS, GLASSES, ARCHITECTURAL PANELS, SOLAR PANELS AND SOUND INSULATION WALLS; POLYCARBONATE SHEETS AND FILMS FOR SIGNS, TRAFFIC SIGNS, WINDOWS, SKYLIGHTS, GLASSES, ARCHITECTURAL PANELS, SOLAR PANELS AND SOUND INSULATION WALLS, IN CLASS 17 (U.S. CLS. 1, 5, 12, 13, 35 AND 50).

OWNER OF JAPAN REG. NO. 5428502, DATED 7-29-2011, EXPIRES 7-29-2021.

OWNER OF U.S. REG. NOS. 2,967,500, 3,699,714, AND 3,896,104.

THE MARK CONSISTS OF THE WORDING "HYDROTECT" AND THE STYLIZED DESIGN OF A TREE, BIRD AND SUN FORMING AN OVERALL CIRCULAR SHAPE.

SER. NO. 85-161,213, FILED 10-26-2010.

SEAN CROWLEY, EXAMINING ATTORNEY



*David J. Kybas*

Director of the United States Patent and Trademark Office

# United States of America

United States Patent and Trademark Office



**Reg. No. 4,133,925**

**Registered May 1, 2012**

**Int. Cls.: 35, 41 and 42**

**SERVICE MARK**

**PRINCIPAL REGISTER**

NEW YORK BATTERY AND ENERGY STORAGE TECHNOLOGY CONSORTIUM, INC.  
(NEW YORK CORPORATION)  
1450 WESTERN AVENUE, SUITE 101  
ALBANY, NY 12203

FOR: ASSOCIATION SERVICES, NAMELY, PROMOTING THE DEVELOPMENT OF ADVANCED BATTERY AND ENERGY STORAGE TECHNOLOGIES DEVELOPED BY ASSOCIATION MEMBERS, UNITING BATTERY AND ENERGY STORAGE COMPANIES, RESEARCHERS AND LABS TO PURSUE COMMON TECHNOLOGY INITIATIVES, PROVIDING ACCESS TO ADVANCED BATTERY AND ENERGY STORAGE TESTING AND CHARACTERIZATION CAPABILITIES; PROMOTING THE ECONOMIC DEVELOPMENT OF NEW YORK STATE AS A CENTER FOR ENERGY STORAGE TECHNOLOGIES, AND PLACING NEW YORK STATE AS AN IMPORTANT FOCUS OF ENERGY STORAGE DEVELOPMENT IN THE NATION; ASSOCIATION SERVICES, NAMELY, PROMOTING THE INTERESTS OF THE ADVANCED BATTERY AND ENERGY STORAGE TECHNOLOGY INDUSTRY BY PROVIDING SERVICES TO CONDUCT RESEARCH AND DEVELOPMENT OF MANUFACTURING TECHNIQUES FOR SAID INDUSTRY; PROJECT MANAGEMENT SERVICES FOR OTHERS FOR BUSINESS PURPOSES IN THE FIELDS OF ADVANCED BATTERY AND ENERGY STORAGE TECHNOLOGIES, AND RESEARCH AND DEVELOPMENT RELATING TO ADVANCED BATTERY AND ENERGY STORAGE TECHNOLOGIES; ADMINISTRATION AND MANAGEMENT OF RESEARCH GRANTS; WRITING OF GRANT PROPOSALS FOR OTHERS IN THE FIELDS OF ADVANCED BATTERY AND ENERGY STORAGE TECHNOLOGIES; CONSULTING SERVICES IN THE FIELDS OF ENERGY USAGE MANAGEMENT, ENERGY EFFICIENCY, AND ADVANCED BATTERY AND ENERGY STORAGE TECHNOLOGIES, IN CLASS 35 (U.S. CLS. 100, 101 AND 102).

FIRST USE 2-28-2010; IN COMMERCE 2-28-2010.

FOR: EDUCATION SERVICES, NAMELY, PROVIDING LIVE AND ON-LINE CLASSES, SEMINARS, CONFERENCES AND WORKSHOPS IN THE FIELDS OF ADVANCED BATTERY AND ENERGY STORAGE TECHNOLOGIES, CLEAN ENERGY, AND ENERGY EFFICIENCY , IN CLASS 41 (U.S. CLS. 100, 101 AND 107).

FIRST USE 2-28-2010; IN COMMERCE 2-28-2010.

FOR: PROVIDING AN ON-LINE SEARCHABLE DATABASE OF INFORMATION CONTAINING INFORMATION ABOUT THE PRESENCE AND AVAILABILITY OF TESTING AND



*David J. Kybas*

Director of the United States Patent and Trademark Office

**Reg. No. 4,133,925** MANUFACTURING EQUIPMENT AND CAPABILITIES IN THE FIELDS OF ADVANCED BATTERY AND ENERGY STORAGE TECHNOLOGIES FOR SCIENTIFIC AND RESEARCH PURPOSES, IN CLASS 42 (U.S. CLS. 100 AND 101).

FIRST USE 2-28-2010; IN COMMERCE 2-28-2010.

NO CLAIM IS MADE TO THE EXCLUSIVE RIGHT TO USE "NY", APART FROM THE MARK AS SHOWN.

THE MARK CONSISTS OF TWO CONCENTRIC CIRCLES SURROUNDING THE WORDS "NY BEST" WHERE "BEST" IS BELOW THE "NY" AND THE "T" IN "BEST" APPEARS AS A PLUS SIGN: "+".

SER. NO. 85-162,128, FILED 10-27-2010.

PAM WILLIS, EXAMINING ATTORNEY



# United States of America

United States Patent and Trademark Office

## NY BEST

**Reg. No. 4,133,926**

**Registered May 1, 2012**

**Int. Cls.: 35, 41 and 42**

**SERVICE MARK**

**PRINCIPAL REGISTER**

NEW YORK BATTERY AND ENERGY STORAGE TECHNOLOGY CONSORTIUM, INC.  
(NEW YORK CORPORATION)  
1450 WESTERN AVENUE, SUITE 101  
ALBANY, NY 12203

FOR: ASSOCIATION SERVICES, NAMELY, PROMOTING THE DEVELOPMENT OF ADVANCED BATTERY AND ENERGY STORAGE TECHNOLOGIES DEVELOPED BY ASSOCIATION MEMBERS, UNITING BATTERY AND ENERGY STORAGE COMPANIES, RESEARCHERS AND LABS TO PURSUE COMMON TECHNOLOGY INITIATIVES, PROVIDING ACCESS TO ADVANCED BATTERY AND ENERGY STORAGE TESTING AND CHARACTERIZATION CAPABILITIES; PROMOTING THE ECONOMIC DEVELOPMENT OF NEW YORK STATE AS A CENTER FOR ENERGY STORAGE TECHNOLOGIES, AND PLACING NEW YORK STATE AS AN IMPORTANT FOCUS OF ENERGY STORAGE DEVELOPMENT IN THE NATION; ASSOCIATION SERVICES, NAMELY, PROMOTING THE INTERESTS OF THE ADVANCED BATTERY AND ENERGY STORAGE TECHNOLOGY INDUSTRY BY PROVIDING SERVICES TO CONDUCT RESEARCH AND DEVELOPMENT OF MANUFACTURING TECHNIQUES FOR SAID INDUSTRY; PROJECT MANAGEMENT SERVICES FOR OTHERS FOR BUSINESS PURPOSES IN THE FIELDS OF ADVANCED BATTERY AND ENERGY STORAGE TECHNOLOGIES, AND RESEARCH AND DEVELOPMENT RELATING TO ADVANCED BATTERY AND ENERGY STORAGE TECHNOLOGIES; ADMINISTRATION AND MANAGEMENT OF RESEARCH GRANTS; WRITING OF GRANT PROPOSALS FOR OTHERS IN THE FIELDS OF ADVANCED BATTERY AND ENERGY STORAGE TECHNOLOGIES; CONSULTING SERVICES IN THE FIELDS OF ENERGY USAGE MANAGEMENT, ENERGY EFFICIENCY, AND ADVANCED BATTERY AND ENERGY STORAGE TECHNOLOGIES, IN CLASS 35 (U.S. CLS. 100, 101 AND 102).

FIRST USE 2-28-2010; IN COMMERCE 2-28-2010.

FOR: EDUCATION SERVICES, NAMELY, PROVIDING LIVE AND ON-LINE CLASSES, SEMINARS, CONFERENCES AND WORKSHOPS IN THE FIELDS OF ADVANCED BATTERY AND ENERGY STORAGE TECHNOLOGIES, CLEAN ENERGY, AND ENERGY EFFICIENCY , IN CLASS 41 (U.S. CLS. 100, 101 AND 107).

FIRST USE 2-28-2010; IN COMMERCE 2-28-2010.

FOR: PROVIDING AN ON-LINE SEARCHABLE DATABASE OF INFORMATION CONTAINING INFORMATION ABOUT THE PRESENCE AND AVAILABILITY OF TESTING AND



*David J. Kyros*

Director of the United States Patent and Trademark Office

**Reg. No. 4,133,926** MANUFACTURING EQUIPMENT AND CAPABILITIES IN THE FIELDS OF ADVANCED BATTERY AND ENERGY STORAGE TECHNOLOGIES FOR SCIENTIFIC AND RESEARCH PURPOSES, IN CLASS 42 (U.S. CLS. 100 AND 101).

FIRST USE 2-28-2010; IN COMMERCE 2-28-2010.

THE MARK CONSISTS OF STANDARD CHARACTERS WITHOUT CLAIM TO ANY PARTICULAR FONT, STYLE, SIZE, OR COLOR.

NO CLAIM IS MADE TO THE EXCLUSIVE RIGHT TO USE "NY", APART FROM THE MARK AS SHOWN.

SER. NO. 85-162,138, FILED 10-27-2010.

PAM WILLIS, EXAMINING ATTORNEY

# United States of America

United States Patent and Trademark Office

# TRIPLE-E

**Reg. No. 4,133,927**

**Registered May 1, 2012**

**Int. Cls.: 9, 16, 35, 41  
and 42**

**TRADEMARK**

**SERVICE MARK**

**PRINCIPAL REGISTER**

DET NORSKE VERITAS AS (NORWAY CORPORATION)  
VERITASVEIEN 1  
HOVIK, NORWAY 1363

FOR: COMPUTER SOFTWARE FOR USE IN THE MARITIME, OFFSHORE AND SHIPPING INDUSTRY TO QUANTIFY, VERIFY, DEMONSTRATE AND IMPROVE A SHIP, VESSEL OR OFFSHORE RIG'S COMPLIANCE WITH CURRENT REGULATIONS AND PREPAREDNESS FOR EMERGING ENVIRONMENTAL REGULATIONS AND INDUSTRY TRENDS, IN CLASS 9 (U.S. CLS. 21, 23, 26, 36 AND 38).

FOR: PRINTED MATTER, NAMELY, BROCHURES AND BOOKLETS FOR USE IN THE MARITIME, OFFSHORE AND SHIPPING INDUSTRY TO QUANTIFY, VERIFY, DEMONSTRATE AND IMPROVE A SHIP, VESSEL OR OFFSHORE RIG'S COMPLIANCE WITH CURRENT REGULATIONS AND PREPAREDNESS FOR EMERGING ENVIRONMENTAL REGULATIONS AND INDUSTRY TRENDS; INSTRUCTIONAL AND TEACHING MATERIAL, NAMELY, BROCHURES AND BOOKLETS FOR USE IN THE MARITIME, OFFSHORE AND SHIPPING INDUSTRY TO QUANTIFY, VERIFY, DEMONSTRATE AND IMPROVE A SHIP, VESSEL OR OFFSHORE RIG'S COMPLIANCE WITH CURRENT REGULATIONS AND PREPAREDNESS FOR EMERGING ENVIRONMENTAL REGULATIONS AND INDUSTRY TRENDS, IN CLASS 16 (U.S. CLS. 2, 5, 22, 23, 29, 37, 38 AND 50).

FOR: ADVERTISING; PROMOTING PUBLIC AWARENESS OF ENVIRONMENTAL ISSUES AND INITIATIVES; BUSINESS MANAGEMENT; BUSINESS MANAGEMENT RELATING TO SELF-ASSESSMENT CONSULTING SERVICES; BUSINESS ADVISORY SERVICES RELATING TO ENVIRONMENTAL PERFORMANCE, NAMELY, BUSINESS ADVICE REGARDING HOW TO IMPROVE A SHIP, VESSEL OR OFFSHORE RIG'S COMPLIANCE WITH CURRENT REGULATIONS AND PREPAREDNESS FOR EMERGING ENVIRONMENTAL REGULATIONS AND INDUSTRY TRENDS; OFFICE FUNCTIONS, INCLUDING ISSUANCE OF CERTIFICATES, IN CLASS 35 (U.S. CLS. 100, 101 AND 102).

FOR: EDUCATIONAL SERVICES, NAMELY, PROVIDING TRAINING AND CLASSES IN THE MARITIME, OFFSHORE AND SHIPPING INDUSTRY TO QUANTIFY, VERIFY, DEMONSTRATE AND IMPROVE A SHIP, VESSEL OR OFFSHORE RIG'S COMPLIANCE WITH CURRENT REGULATIONS AND PREPAREDNESS FOR EMERGING ENVIRONMENTAL REGULATIONS AND INDUSTRY TRENDS, IN CLASS 41 (U.S. CLS. 100, 101 AND 107).



*David J. Kyjars*

Director of the United States Patent and Trademark Office

**Reg. No. 4,133,927** FOR: SCIENTIFIC AND TECHNOLOGICAL SERVICES, NAMELY, RESEARCH AND DESIGN TO QUANTIFY, VERIFY, DEMONSTRATE AND IMPROVE A SHIP, VESSEL OR OFFSHORE RIG'S COMPLIANCE WITH CURRENT REGULATIONS AND PREPAREDNESS FOR EMERGING ENVIRONMENTAL REGULATIONS AND INDUSTRY TRENDS IN THE MARITIME, OFFSHORE AND SHIPPING INDUSTRY; SCIENTIFIC RESEARCH SERVICES TO QUANTIFY, VERIFY, DEMONSTRATE AND IMPROVE A SHIP, VESSEL OR OFFSHORE RIG'S COMPLIANCE WITH CURRENT REGULATIONS AND PREPAREDNESS FOR EMERGING ENVIRONMENTAL REGULATIONS AND INDUSTRY TRENDS IN THE MARITIME, OFFSHORE AND SHIPPING INDUSTRY; DESIGN AND DEVELOPMENT OF COMPUTER SOFTWARE FOR USE IN THE MARITIME, OFFSHORE AND SHIPPING INDUSTRY TO QUANTIFY, VERIFY, DEMONSTRATE AND IMPROVE A SHIP, VESSEL OR OFFSHORE RIG'S COMPLIANCE WITH CURRENT REGULATIONS AND PREPAREDNESS FOR EMERGING ENVIRONMENTAL REGULATIONS AND INDUSTRY TRENDS; CONSULTING SERVICES IN THE FIELD OF ENVIRONMENTAL ASSESSMENT AND PLANNING; RESEARCH IN THE FIELD OF ENVIRONMENTAL PROTECTION; CERTIFICATION SERVICES TO QUANTIFY, VERIFY, DEMONSTRATE AND IMPROVE A SHIP, VESSEL OR OFFSHORE RIG'S COMPLIANCE WITH CURRENT REGULATIONS AND PREPAREDNESS FOR EMERGING ENVIRONMENTAL REGULATIONS AND INDUSTRY TRENDS IN THE MARITIME, OFFSHORE AND SHIPPING INDUSTRY; VERIFICATION SERVICES TO QUANTIFY, VERIFY, DEMONSTRATE AND IMPROVE A SHIP, VESSEL OR OFFSHORE RIG'S COMPLIANCE WITH CURRENT REGULATIONS AND PREPAREDNESS FOR EMERGING ENVIRONMENTAL REGULATIONS AND INDUSTRY TRENDS IN THE MARITIME, OFFSHORE AND SHIPPING INDUSTRY; TESTING, ANALYSIS AND EVALUATION OF THE GOODS AND SERVICES OF OTHERS FOR THE PURPOSE OF CERTIFICATION; ENVIRONMENTAL PROTECTION TESTING AND INSPECTION SERVICES TO QUANTIFY, VERIFY, DEMONSTRATE AND IMPROVE A SHIP, VESSEL OR OFFSHORE RIG'S COMPLIANCE WITH CURRENT REGULATIONS AND PREPAREDNESS FOR EMERGING ENVIRONMENTAL REGULATIONS AND INDUSTRY TRENDS IN THE MARITIME, OFFSHORE AND SHIPPING INDUSTRY; ENVIRONMENTAL PROTECTION SURVEYS; TESTING, ANALYSIS AND EVALUATION OF SHIPS, MARINE VESSEL, MARINE INSTALLATIONS AND OFFSHORE UNITS FOR THE PURPOSE OF ENVIRONMENTAL PROTECTION CERTIFICATION; ENVIRONMENTAL PERFORMANCE RATING OF SHIPS, MARINE VESSEL, MARINE INSTALLATIONS AND OFFSHORE UNITS FOR THE PURPOSES OF ENVIRONMENTAL PROTECTION; ANALYSIS AND APPRAISALS OF ENTERPRISES FOR THE PURPOSE OF ENVIRONMENTAL CERTIFICATION, IN CLASS 42 (U.S. CLS. 100 AND 101).

THE MARK CONSISTS OF STANDARD CHARACTERS WITHOUT CLAIM TO ANY PARTICULAR FONT, STYLE, SIZE, OR COLOR.

PRIORITY CLAIMED UNDER SEC. 44(D) ON NORWAY APPLICATION NO. 201010980, FILED 10-22-2010, REG. NO. 259152, DATED 3-17-2011, EXPIRES 10-22-2020.

SER. NO. 85-163,569, FILED 10-28-2010.

DOMINIC J. FERRAIUOLO, EXAMINING ATTORNEY

# United States of America

United States Patent and Trademark Office

## ACCESS Science

**Reg. No. 4,133,928**

**Registered May 1, 2012**

**Int. Cls.: 9, 41 and 42**

**TRADEMARK**

**SERVICE MARK**

**PRINCIPAL REGISTER**

THE MCGRAW-HILL COMPANIES, INC. (NEW YORK CORPORATION)  
1220 AVENUE OF THE AMERICAS  
NEW YORK, NY 10020

FOR: DOWNLOADABLE TEXT FILES IN THE NATURE OF ENCYCLOPEDIA ARTICLES, RESEARCH UPDATES, BIOGRAPHIES, AND DICTIONARY ENTRIES IN THE FIELD OF SCIENCE AND TECHNOLOGY, IN CLASS 9 (U.S. CLS. 21, 23, 26, 36 AND 38).

FIRST USE 10-28-2010; IN COMMERCE 10-28-2010.

FOR: TEXT MATERIAL SERVICES, NAMELY, PROVIDING ONLINE, NON-DOWNLOADABLE ENCYCLOPEDIA ARTICLES, RESEARCH UPDATES, BIOGRAPHIES, AND DICTIONARY ENTRIES IN THE FIELD OF SCIENCE AND TECHNOLOGY, IN CLASS 41 (U.S. CLS. 100, 101 AND 107).

FIRST USE 10-28-2010; IN COMMERCE 10-28-2010.

FOR: PROVIDING NEWS AND INFORMATION IN THE FIELD OF SCIENCE AND TECHNOLOGY VIA A WEBSITE ON A GLOBAL COMPUTER NETWORK, IN CLASS 42 (U.S. CLS. 100 AND 101).

FIRST USE 10-28-2010; IN COMMERCE 10-28-2010.

OWNER OF U.S. REG. NO. 2,478,414.

NO CLAIM IS MADE TO THE EXCLUSIVE RIGHT TO USE "SCIENCE", APART FROM THE MARK AS SHOWN.

THE MARK CONSISTS OF THE TERMS "ACCESS SCIENCE" WITH A TRIANGLE BETWEEN THE TWO TERMS AND FOUR TRIANGLES BELOW THE CENTER TRIANGLE AND SIX GREY TRIANGLES ABOVE THE CENTER TRIANGLE.

SER. NO. 85-165,027, FILED 10-29-2010.

KIMBERLY FRYE, EXAMINING ATTORNEY



*David J. Kyros*

Director of the United States Patent and Trademark Office

# United States of America

United States Patent and Trademark Office

## HELP ME GROW

**Reg. No. 4,133,929**

**Registered May 1, 2012**

**Int. Cls.: 35 and 41**

**SERVICE MARK**

**PRINCIPAL REGISTER**

CONNECTICUT CHILDREN'S MEDICAL CENTER (CONNECTICUT NON-STOCK CORPORATION)  
282 WASHINGTON STREET  
HARTFORD, CT 06105

FOR: PROMOTING PUBLIC AWARENESS OF PREVENTION AND INTERVENTION SERVICES IN THE FIELD OF EARLY DETECTION OF DEVELOPMENTAL OR BEHAVIORAL PROBLEMS WITH CHILDREN, IN CLASS 35 (U.S. CLS. 100, 101 AND 102).

FIRST USE 12-31-2002; IN COMMERCE 12-31-2002.

FOR: EDUCATIONAL SERVICES FOR CHILDREN AND FAMILIES, NAMELY, CONDUCTING PROGRAMS IN THE FIELDS OF HEALTH, WELLNESS AND CHILD DEVELOPMENT OFFERED BY HEALTHCARE PROVIDERS AND COMMUNITY BASED PROVIDERS, IN CLASS 41 (U.S. CLS. 100, 101 AND 107).

FIRST USE 12-31-2002; IN COMMERCE 12-31-2002.

THE MARK CONSISTS OF STANDARD CHARACTERS WITHOUT CLAIM TO ANY PARTICULAR FONT, STYLE, SIZE, OR COLOR.

SER. NO. 85-165,894, FILED 11-1-2010.

ELIZABETH KAJUBI, EXAMINING ATTORNEY



*David J. Kybas*

Director of the United States Patent and Trademark Office

# United States of America

United States Patent and Trademark Office



**Reg. No. 4,133,930**

**Registered May 1, 2012**

**Int. Cls.: 20 and 35**

**TRADEMARK**

**SERVICE MARK**

**PRINCIPAL REGISTER**

QUEEN RIGHT COLONIES, LTD. (OHIO LIMITED LIABILITY COMPANY)  
43655 STATE ROUTE 162  
SPENCER, OH 44275

FOR: NESTING BOXES FOR HONEYBEES; HIVE BOXES; WOODENWARE IN THE NATURE OF WOOD PANELS AND PARTS FOR USE IN THE MANUFACTURE OF NESTING BOXES AND HIVE BOXES; KITS FOR ASSEMBLING THE FOREGOING CONSISTING OF WOOD PANELS AND PARTS AND ASSEMBLY INSTRUCTIONS; SECTIONS OF WOOD FOR USE IN THE MANUFACTURE OF BEEHIVES, IN CLASS 20 (U.S. CLS. 2, 13, 22, 25, 32 AND 50).

FIRST USE 1-1-1995; IN COMMERCE 1-1-1995.

FOR: RETAIL STORE SERVICES FEATURING BEES, QUEEN BEES, DIETARY SUPPLEMENTS, BEE POLLEN, HONEY, ROYAL JELLY, BEEKEEPING SUPPLIES, TOOLS, FOUNDATIONS, QUEEN REARING SUPPLIES, HONEY EXTRACTION SUPPLIES AND EQUIPMENT, SMOKERS AND FUEL, MEDICATIONS FOR BEES, BEEKEEPING CLOTHING, BULK WAX AND SUPPLIES, PLASTIC AND GLASS HONEY CONTAINERS AND LABELS THEREFOR, COSMETIC SUPPLIES AND BEE-RELATED GIFT ITEMS; CATALOG ORDERING SERVICES FEATURING BEES, QUEEN BEES, DIETARY SUPPLEMENTS, BEE POLLEN, HONEY, ROYAL JELLY, BEEKEEPING SUPPLIES, TOOLS, FOUNDATIONS, QUEEN REARING SUPPLIES, HONEY EXTRACTION SUPPLIES AND EQUIPMENT, SMOKERS AND FUEL, MEDICATIONS FOR BEES, BEEKEEPING CLOTHING, BULK WAX AND SUPPLIES, PLASTIC AND GLASS HONEY CONTAINERS AND LABELS THEREFOR, COSMETIC SUPPLIES AND BEE-RELATED GIFT ITEMS; ASSOCIATION SERVICES, NAMELY, PROMOTING THE INTERESTS OF BEEKEEPERS AND BEEKEEPING, IN CLASS 35 (U.S. CLS. 100, 101 AND 102).

FIRST USE 1-1-1995; IN COMMERCE 1-1-1995.

THE MARK CONSISTS OF HEXAGONAL BAND WITH THE WORDS "QUEEN RIGHT COLONIES" IN THE LOWER THREE SIDES OF THE HEXAGON, IN THE CENTER OF THE HEXAGON, STYLIZED CAPITAL LETTERS "QRC" WITH TWO ANTENNA EMANATING FROM THE TOP OF THE LETTER "Q" AND TWO WINGS OVER THE LETTERS "QRC", ALL IN THE CENTER OF THE HEXAGON TO RESEMBLE A HONEYBEE.

SEC. 2(F) AS TO "QUEEN RIGHT COLONIES".



*David J. Kyros*

Director of the United States Patent and Trademark Office

**Reg. No. 4,133,930** SER. NO. 85-167,346, FILED 11-2-2010.

ALICIA COLLINS, EXAMINING ATTORNEY



# United States of America

United States Patent and Trademark Office

## OLD GROWTH

**Reg. No. 4,133,931**

**Registered May 1, 2012**

**Int. Cl.: 32**

**TRADEMARK**

**PRINCIPAL REGISTER**

CALDERA BREWING COMPANY (OREGON CORPORATION)  
540 CLOVER LANE  
ASHLAND, OR 97520

FOR: BEER; PORTER; STOUT, IN CLASS 32 (U.S. CLS. 45, 46 AND 48).

FIRST USE 2-0-1999; IN COMMERCE 8-26-2000.

THE MARK CONSISTS OF STANDARD CHARACTERS WITHOUT CLAIM TO ANY PARTICULAR FONT, STYLE, SIZE, OR COLOR.

SER. NO. 85-169,705, FILED 11-4-2010.

DAWN HAN, EXAMINING ATTORNEY



*David J. Kyffers*

Director of the United States Patent and Trademark Office

# United States of America

United States Patent and Trademark Office

## EFRONT FINANCIAL SOLUTIONS

**Reg. No. 4,133,932**

**Registered May 1, 2012**

**Int. Cls.: 9, 36 and 42**

**TRADEMARK**

**SERVICE MARK**

**PRINCIPAL REGISTER**

EFRONT FINANCIAL SOLUTIONS INC. (DELAWARE CORPORATION)  
11 E. 44TH STREET, 7TH FLOOR  
NEW YORK, NY 10017

FOR: COMPUTER SOFTWARE, NAMELY, FOR USE IN FINANCIAL PORTFOLIO MANAGEMENT FOR PRIVATE EQUITY, REAL ESTATE AND OTHER FUNDS, IN CLASS 9 (U.S. CLS. 21, 23, 26, 36 AND 38).

FIRST USE 4-1-2010; IN COMMERCE 4-1-2010.

FOR: FINANCIAL AND INVESTMENT SERVICES, NAMELY, FINANCIAL INFORMATION, MANAGEMENT AND ANALYSIS SERVICES, IN CLASS 36 (U.S. CLS. 100, 101 AND 102).

FIRST USE 4-1-2010; IN COMMERCE 4-1-2010.

FOR: COMPUTER SOFTWARE DESIGN, DEVELOPMENT AND INTEGRATION SERVICES FOR THE FINANCIAL AND INVESTMENT INDUSTRY, NAMELY, FOR FINANCIAL PORTFOLIO MANAGEMENT FOR PRIVATE EQUITY, REAL ESTATE AND OTHER FUNDS AND FUND ADMINISTRATION, IN CLASS 42 (U.S. CLS. 100 AND 101).

FIRST USE 4-1-2010; IN COMMERCE 4-1-2010.

THE MARK CONSISTS OF STANDARD CHARACTERS WITHOUT CLAIM TO ANY PARTICULAR FONT, STYLE, SIZE, OR COLOR.

OWNER OF U.S. REG. NOS. 3,893,467 AND 3,893,470.

NO CLAIM IS MADE TO THE EXCLUSIVE RIGHT TO USE "FINANCIAL SOLUTIONS", APART FROM THE MARK AS SHOWN.

SER. NO. 85-173,431, FILED 11-10-2010.

ALICE BENMAMAN, EXAMINING ATTORNEY

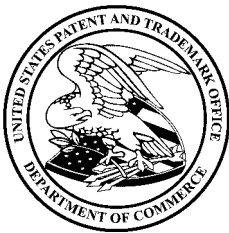

*David J. Kyffers*

Director of the United States Patent and Trademark Office

# United States of America

United States Patent and Trademark Office

## WOMEN'S NUTRITION CONNECTION

**Reg. No. 4,133,933**

**Registered May 1, 2012**

**Int. Cl.: 16**

**TRADEMARK**

**PRINCIPAL REGISTER**

BELVOIR MEDIA GROUP, LLC (DELAWARE LIMITED LIABILITY COMPANY)  
800 CONNECTICUT AVENUE  
NORWALK, CT 06854

FOR: PRINTED PUBLICATIONS, NAMELY, NEWSLETTERS IN THE FIELD OF WOMEN'S NUTRITION, IN CLASS 16 (U.S. CLS. 2, 5, 22, 23, 29, 37, 38 AND 50).

FIRST USE 10-19-2010; IN COMMERCE 10-19-2010.

THE MARK CONSISTS OF STANDARD CHARACTERS WITHOUT CLAIM TO ANY PARTICULAR FONT, STYLE, SIZE, OR COLOR.

NO CLAIM IS MADE TO THE EXCLUSIVE RIGHT TO USE "WOMEN'S NUTRITION", APART FROM THE MARK AS SHOWN.

SER. NO. 85-175,375, FILED 11-12-2010.

MICHELE SWAIN, EXAMINING ATTORNEY



*David J. Kyffers*

Director of the United States Patent and Trademark Office

# United States of America

United States Patent and Trademark Office

# O'Hara's

**Reg. No. 4,133,934**

**Registered May 1, 2012**

**Int. Cls.: 32 and 33**

**TRADEMARK**

**PRINCIPAL REGISTER**

CARLOW CRAFT BREWERY LIMITED (IRELAND LIMITED LIABILITY COMPANY)  
MUINE BHEAG BUSINESS PARK, ROYAL OAK  
CARLOW, IRELAND

FOR: BEER, IN CLASS 32 (U.S. CLS. 45, 46 AND 48).

FIRST USE 1-21-2002; IN COMMERCE 1-21-2002.

FOR: SPIRITS AND LIQUEURS; WINE , IN CLASS 33 (U.S. CLS. 47 AND 49).

FIRST USE 1-21-2002; IN COMMERCE 1-21-2002.

THE MARK CONSISTS OF STANDARD CHARACTERS WITHOUT CLAIM TO ANY PARTICULAR FONT, STYLE, SIZE, OR COLOR.

OWNER OF U.S. REG. NO. 2,637,772.

THE NAME(S), PORTRAIT(S), AND/OR SIGNATURE(S) SHOWN IN THE MARK IDENTIFIES SEAMUS O'HARA, WHOSE CONSENT(S) TO REGISTER IS MADE OF RECORD.

SEC. 2(F).

SER. NO. 85-179,302, FILED 11-17-2010.

TRACY CROSS, EXAMINING ATTORNEY



*David J. Kyffers*

Director of the United States Patent and Trademark Office

# United States of America

United States Patent and Trademark Office

## KEEPNTRACK

**Reg. No. 4,133,935**

**Registered May 1, 2012**

**Int. Cl.: 42**

**SERVICE MARK**

**PRINCIPAL REGISTER**

COMPANION CORPORATION (UTAH CORPORATION)  
1831 FORT UNION BLVD.  
SALT LAKE CITY, UT 84121

FOR: PROVIDING ON-LINE NON-DOWNLOADABLE SOFTWARE FOR MONITORING, ANALYZING AND REPORTING FACILITY ENTRY AND EXIT OF INDIVIDUALS, EXCLUDING SOFTWARE FOR PROVIDING OPERATIONAL EFFICIENCIES FOR THE MONITORING WITHIN HOSPITALS OF (I) PATIENT PLACEMENT, (II) PATIENT TRANSPORT, (III) PROCEDURE STATUS, AND (IV) MANAGEMENT OF HOSPITAL PROFESSIONALS AND STAFF, IN CLASS 42 (U.S. CLS. 100 AND 101).

FIRST USE 4-5-2007; IN COMMERCE 4-5-2007.

THE MARK CONSISTS OF STANDARD CHARACTERS WITHOUT CLAIM TO ANY PARTICULAR FONT, STYLE, SIZE, OR COLOR.

OWNER OF U.S. REG. NO. 2,924,062.

SER. NO. 85-179,382, FILED S.R. 11-17-2010 AM. P.R. 11-29-2010.

DOMINIC J. FERRAIUOLO, EXAMINING ATTORNEY



*David J. Kyffers*

Director of the United States Patent and Trademark Office

# United States of America

United States Patent and Trademark Office

# STAYFIT

**Reg. No. 4,133,936**

**Registered May 1, 2012**

**Int. Cls.: 16 and 44**

**TRADEMARK**

**SERVICE MARK**

**PRINCIPAL REGISTER**

TA OPERATING LLC (DELAWARE LIMITED LIABILITY COMPANY)  
SUITE 200  
24601 CENTER RIDGE ROAD  
WESTLAKE, OH 441455639

FOR: MAGAZINES FEATURING TOPICS RELATING TO HEALTH, WELLNESS AND NUTRITION TO TRUCK DRIVERS AND OTHER DRIVERS; JOGGING AND WALKING TRAIL MAPS, IN CLASS 16 (U.S. CLS. 2, 5, 22, 23, 29, 37, 38 AND 50).

FIRST USE 1-1-2011; IN COMMERCE 1-1-2011.

FOR: PROVIDING A WEBSITE FEATURING INFORMATION ABOUT HEALTH, WELLNESS, NUTRITION AND JOGGING AND WALKING TRAILS TO TRUCK DRIVERS AND OTHER DRIVERS, IN CLASS 44 (U.S. CLS. 100 AND 101).

FIRST USE 1-1-2011; IN COMMERCE 1-1-2011.

THE MARK CONSISTS OF STANDARD CHARACTERS WITHOUT CLAIM TO ANY PARTICULAR FONT, STYLE, SIZE, OR COLOR.

SER. NO. 85-179,764, FILED 11-18-2010.

HOWARD SMIGA, EXAMINING ATTORNEY



*David J. Kyros*

Director of the United States Patent and Trademark Office

# United States of America

United States Patent and Trademark Office

# HYDROPACK

**Reg. No. 4,133,937**

**Registered May 1, 2012**

**Int. Cl.: 11**

**TRADEMARK**

**PRINCIPAL REGISTER**

HYDRATION TECHNOLOGY INNOVATIONS, LLC (OREGON LIMITED LIABILITY COMPANY)  
9311 E. VIA DE VENTURA  
SCOTTSDALE, AZ 85258

FOR: PORTABLE WATER TREATMENT EQUIPMENT, NAMELY, DIRECT OSMOSIS FILTRATION UNITS, IN CLASS 11 (U.S. CLS. 13, 21, 23, 31 AND 34).

FIRST USE 10-0-2001; IN COMMERCE 10-0-2001.

THE MARK CONSISTS OF STANDARD CHARACTERS WITHOUT CLAIM TO ANY PARTICULAR FONT, STYLE, SIZE, OR COLOR.

SER. NO. 85-179,791, FILED 11-18-2010.

LAKEISHA LEWIS, EXAMINING ATTORNEY



*David J. Kybas*

Director of the United States Patent and Trademark Office

# United States of America

United States Patent and Trademark Office

## DOW LOHNES CAPITOL ANALYSIS

**Reg. No. 4,133,938**

**Registered May 1, 2012**

**Int. Cl.: 35**

**SERVICE MARK**

**PRINCIPAL REGISTER**

DOW LOHNES PLLC (D.C. PROFESSIONAL LIMITED LIABILITY COMPANY)  
1200 NEW HAMPSHIRE AVENUE, N.W. STE. 800  
WASHINGTON, DC 20036

FOR: CONDUCTING BUSINESS AND MARKET RESEARCH AND ANALYSIS OF LEGISLATIVE, REGULATORY AND POLICY DEVELOPMENTS AFFECTING A BROAD RANGE OF INDUSTRIES OR SECTORS FOR THE PURPOSE OF INFORMING AND ASSISTING EQUITY ANALYSIS SERVICES PROVIDED BY INVESTMENT PROFESSIONALS, IN CLASS 35 (U.S. CLS. 100, 101 AND 102).

FIRST USE 11-10-2010; IN COMMERCE 11-10-2010.

THE MARK CONSISTS OF STANDARD CHARACTERS WITHOUT CLAIM TO ANY PARTICULAR FONT, STYLE, SIZE, OR COLOR.

OWNER OF U.S. REG. NOS. 3,292,170, 3,502,334 AND OTHERS.

NO CLAIM IS MADE TO THE EXCLUSIVE RIGHT TO USE "CAPITOL ANALYSIS", APART FROM THE MARK AS SHOWN.

SER. NO. 85-180,792, FILED 11-19-2010.

MEGHAN REINHART, EXAMINING ATTORNEY



*David J. Kyros*

Director of the United States Patent and Trademark Office



# United States of America

United States Patent and Trademark Office

# UVM

**Reg. No. 4,133,939**

**Registered May 1, 2012**

**Int. Cls.: 22 and 24**

**TRADEMARK**

**PRINCIPAL REGISTER**

DIMENSION-POLYANT GMBH (FED REP GERMANY GESELLSCHAFT MIT  
BESCHRÄNKTER HAFTUNG (GMBH))  
SPEEFELD 7  
KEMPEN, FED REP GERMANY 47906

FOR: SAILS CONSISTING OF POLYESTER FILM LAMINATES HAVING LAYERS OF  
POLYESTER, POLYOLEFINE, POLYAMIDE OR CARBON FIBERS; SAILS, IN CLASS 22  
(U.S. CLS. 1, 2, 7, 19, 22, 42 AND 50).

FOR: TEXTILES AND TEXTILE GOODS, NAMELY, SAIL CLOTH, IN CLASS 24 (U.S. CLS.  
42 AND 50).

THE MARK CONSISTS OF STANDARD CHARACTERS WITHOUT CLAIM TO ANY PAR-  
TICULAR FONT, STYLE, SIZE, OR COLOR.

PRIORITY CLAIMED UNDER SEC. 44(D) ON ERPN CMNTY TM OFC APPLICATION NO.  
9223512, FILED 7-5-2010, REG. NO. 009223512, DATED 12-17-2010, EXPIRES 7-5-2020.

SER. NO. 85-181,017, FILED 11-19-2010.

MATTHEW KLINE, EXAMINING ATTORNEY



*David J. Kappas*

Director of the United States Patent and Trademark Office

# United States of America

United States Patent and Trademark Office

## 454 HORSE POWER

**Reg. No. 4,133,940**

LEO JOHNSON (CANADA INDIVIDUAL)  
P.O. BOX 2948  
INVERMERE, B.C., CANADA V0A1K0

**Registered May 1, 2012**

**Int. Cl.: 30**

FOR: COFFEE; COFFEE BEANS; COFFEE-BASED BEVERAGES; GROUND COFFEE BEANS,  
IN CLASS 30 (U.S. CL. 46).

**TRADEMARK**

FIRST USE 1-31-1999; IN COMMERCE 1-31-2000.

**PRINCIPAL REGISTER**

THE MARK CONSISTS OF STANDARD CHARACTERS WITHOUT CLAIM TO ANY PARTICULAR FONT, STYLE, SIZE, OR COLOR.

SER. NO. 85-181,191, FILED 11-19-2010.

RENEE MCCRAY, EXAMINING ATTORNEY



*David J. Kyros*

Director of the United States Patent and Trademark Office

# United States of America

United States Patent and Trademark Office

**iSD**

**Reg. No. 4,133,941**

**Registered May 1, 2012**

**Int. Cl.: 10**

**TRADEMARK**

**PRINCIPAL REGISTER**

NAKANISHI INC. (JAPAN CORPORATION)  
700, SHIMOHINATA, KANUMA-SHI  
TOCHIGI-KEN, JAPAN

FOR: DENTAL INSTRUMENTS, NAMELY, DENTAL HANDPIECES, IN CLASS 10 (U.S. CLS. 26, 39 AND 44).

OWNER OF JAPAN REG. NO. 5405119, DATED 4-8-2011, EXPIRES 4-8-2021.

THE MARK CONSISTS OF THE LETTERS "iSD".

SER. NO. 85-182,195, FILED 11-22-2010.

JOHN WILKE, EXAMINING ATTORNEY



*David J. Kybas*

Director of the United States Patent and Trademark Office

# United States of America

United States Patent and Trademark Office



**Reg. No. 4,133,942**

**Registered May 1, 2012**

**Int. Cls.: 25 and 28**

**TRADEMARK**

**PRINCIPAL REGISTER**

DRAKKAR DISTRIBUTION INC. (CANADA CORPORATION), FORMERLY BRASS  
KNUCKLE THERAPY, INC.  
23 GOLD FINCH DRIVE  
WASAGA BEACH, ON, CANADA L9Z 3B6

FOR: ATHLETIC APPAREL, NAMELY, PANTS, JACKETS, HATS AND CAPS; BANDANAS; BELTS FOR CLOTHING; GYM SHORTS; HEADGEAR, NAMELY, HATS, TOQUES, BEANIES, SKULL CAPS, SUN VISORS; HOODED SWEAT SHIRTS; JACKETS AND SOCKS; LINGERIE; PANTS; SHORT-SLEEVED OR LONG-SLEEVED T-SHIRTS; SHORTS; UNDERWEAR; WRISTBANDS, IN CLASS 25 (U.S. CLS. 22 AND 39).

FOR: ATHLETIC EQUIPMENT, NAMELY, GUARDS FOR KNUCKLES, MOUTH, HEAD; ATHLETIC EQUIPMENT, NAMELY, HAND WRAPS; ATHLETIC EQUIPMENT, NAMELY, STRIKING BAGS; ATHLETIC PROTECTIVE PADS FOR WAIST, THIGH, BELLY, ELBOW, KNEE FOR USE IN MIXED MARTIAL ARTS; BAGS SPECIALLY ADAPTED FOR SPORTS EQUIPMENT; BOXING BAGS; BOXING GLOVES; EXERCISE EQUIPMENT, NAMELY, ABDOMINAL BOARDS; JUMP ROPES; MEDICINE BALLS; MOUTH GUARDS FOR ATHLETIC USE; PADS FOR USE IN MIXED MARTIAL ARTS; PROTECTIVE ATHLETIC CUPS; PROTECTIVE PADDING FOR PLAYING MIXED MARTIAL ARTS; PUNCHING BAGS; SAFETY PADDING FOR MIXED MARTIAL ARTS; SPORTS EQUIPMENT FOR BOXING AND MARTIAL ARTS, NAMELY, BOXING GLOVES, BOXING BAGS, PUNCHING MITTS, BELLY PROTECTORS, GROIN PROTECTORS AND SHIN GUARDS, IN CLASS 28 (U.S. CLS. 22, 23, 38 AND 50).

OWNER OF CANADA REG. NO. TMA775983, DATED 8-31-2010, EXPIRES 8-31-2025.

THE MARK CONSISTS OF FIST FITTED WITH SKULLED BRASS KNUCKLES.

SER. NO. 85-182,288, FILED 11-22-2010.

KELLY BOULTON, EXAMINING ATTORNEY



*David J. Kybas*

Director of the United States Patent and Trademark Office

# United States of America

United States Patent and Trademark Office

# POLYDOR

**Reg. No. 4,133,943**

**Registered May 1, 2012**

**Int. Cl.: 36**

**SERVICE MARK**

**PRINCIPAL REGISTER**

1479830 ONTARIO LIMITED (CANADA CORPORATION)  
639 QUEEN STREET WEST, SUITE 501  
TORONTO, ONTARIO, CANADA M5V2B7

FOR: REAL ESTATE SERVICES, NAMELY, RENTAL PROPERTY MANAGEMENT AND PROPERTY MANAGEMENT SERVICES FOR COMMERCIAL AND RESIDENTIAL BUILDINGS; INVESTMENT MANAGEMENT SERVICES, IN CLASS 36 (U.S. CLS. 100, 101 AND 102).

THE MARK CONSISTS OF STANDARD CHARACTERS WITHOUT CLAIM TO ANY PARTICULAR FONT, STYLE, SIZE, OR COLOR.

PRIORITY CLAIMED UNDER SEC. 44(D) ON CANADA APPLICATION NO. 1499999, FILED 10-18-2010, REG. NO. 814392, DATED 12-20-2011, EXPIRES 12-20-2026.

SER. NO. 85-183,438, FILED 11-23-2010.

DANIEL CAPSHAW, EXAMINING ATTORNEY



*David J. Kyffers*

Director of the United States Patent and Trademark Office

# United States of America

United States Patent and Trademark Office

## TORONTO STANDARD

**Reg. No. 4,133,944**

**Registered May 1, 2012**

**Int. Cls.: 35 and 41**

**SERVICE MARK**

**PRINCIPAL REGISTER**

TORONTO STANDARD MEDIA COMPANY LIMITED (CANADA CORPORATION)  
639 QUEEN STREET WEST, SUITE 501  
TORONTO, ONTARIO, CANADA M5V2B7

FOR: CLASSIFIED AND DISPLAY ADVERTISING SERVICES FOR OTHERS; INTERNET ADVERTISING SERVICES FOR OTHERS, IN CLASS 35 (U.S. CLS. 100, 101 AND 102).

FOR: PROVIDING NON-DOWNLOADABLE ONLINE NEWSPAPERS DISSEMINATING NEWS AND INFORMATION IN FIELDS OF NEWS AND CURRENT EVENTS; PROVIDING NON-DOWNLOADABLE ELECTRONIC PUBLICATIONS IN THE NATURE OF NEWSPAPERS, FEATURING ARTICLES AND INFORMATION IN THE FIELDS OF NEWS, BUSINESS, SPORTS, ARTS AND ENTERTAINMENT, LIFE, TRAVEL, TELEVISION, WEATHER, VEHICLES, CLASSIFIED ADVERTISEMENTS AND GENERAL INTEREST, IN CLASS 41 (U.S. CLS. 100, 101 AND 107).

THE MARK CONSISTS OF STANDARD CHARACTERS WITHOUT CLAIM TO ANY PARTICULAR FONT, STYLE, SIZE, OR COLOR.

PRIORITY CLAIMED UNDER SEC. 44(D) ON CANADA APPLICATION NO. 1500001, FILED 10-18-2010, REG. NO. 814389, DATED 12-20-2011, EXPIRES 12-20-2026.

NO CLAIM IS MADE TO THE EXCLUSIVE RIGHT TO USE "TORONTO", APART FROM THE MARK AS SHOWN.

SER. NO. 85-183,464, FILED 11-23-2010.

DAVID H. STINE, EXAMINING ATTORNEY



*David J. Kybas*

Director of the United States Patent and Trademark Office

# United States of America

United States Patent and Trademark Office



**LOADSPRING**  
From Access to Empowerment

**Reg. No. 4,133,945**

**Registered May 1, 2012**

**Int. Cl.: 42**

**SERVICE MARK**

**PRINCIPAL REGISTER**

LOADSPRING SOLUTIONS, INC. (MASSACHUSETTS CORPORATION)  
SUITE 560  
15 UNION STREET  
LAWRENCE, MA 01840

FOR: COMPUTER SERVICES, IN THE FORM OF AN COMPUTER SERVICES, NAMELY, REMOTE AND ON-SITE MANAGEMENT OF THE INFORMATION TECHNOLOGY (IT) CLOUD COMPUTING SYSTEMS OF OTHERS; APPLICATION SERVICE PROVIDER, NAMELY, HOSTING, MANAGING, DEVELOPING AND MAINTAINING APPLICATIONS, SOFTWARE, AND WEBSITES OF OTHERS IN THE FIELDS OF MANUFACTURING AND SERVICES INDUSTRIES, NAMELY, ARCHITECTURE, ENGINEERING, CONSTRUCTION, ENERGY, UTILITIES, HEAVY EQUIPMENT, FINANCIAL SERVICES, AEROSPACE, REAL ESTATE DEVELOPMENT, AND GOVERNMENT TO FACILITATE ACCESS TO PROGRAMS IN ORDER TO BETTER SERVE AND RENDER EFFICIENT INDIVIDUAL CLIENTS' PROJECT MANAGEMENT WITH APPROPRIATE SECURITY AND INFRASTRUCTURE MANAGEMENT AND REAL-TIME SUPPORT, IN CLASS 42 (U.S. CLS. 100 AND 101).

FIRST USE 8-31-2008; IN COMMERCE 8-31-2008.

THE MARK CONSISTS OF A SPRINGMAN FIGURE POINTED UPWARDLY IN A NORTH-EASTERLY DIRECTION NEXT TO WHICH IS THE WORD "LOADSPRING" IN CAPITAL LETTERS AND UNDER THE LATTER WORD ARE THE WORDS "FROM ACCESS TO EMPOWERMENT".

SER. NO. 85-185,409, FILED S.R. 11-26-2010 AM. P.R. 12-3-2011.

MAYUR VAGHANI, EXAMINING ATTORNEY



*David J. Kyros*

Director of the United States Patent and Trademark Office

# United States of America

United States Patent and Trademark Office

## TOOTHY TABS

**Reg. No. 4,133,946**

**Registered May 1, 2012**

**Int. Cls.: 3 and 35**

**TRADEMARK**

**SERVICE MARK**

**PRINCIPAL REGISTER**

COSMETIC WARRIORS LTD. (UNITED KINGDOM LIMITED COMPANY (LTD.))  
29 HIGH STREET  
POOLE, DORSET BH15 1AB, UNITED KINGDOM

FOR: DENTIFRICES; PREPARATIONS AND SUBSTANCES FOR USE IN ORAL AND DENTAL HYGIENE, NAMELY, SOLID TOOTHPASTE TABS FOR CLEANING TEETH AND FRESHENING BREATH; TOOTHPASTES; TOOTHPOWDERS; TOOTH GELS, TOOTH POLISHES, BREATH FRESHENERS; PREPARATIONS FOR CLEANING DENTURES; PREPARATIONS FOR WHITENING TEETH; PREPARATIONS FOR REMOVING STAINS FROM TEETH; PREPARATIONS FOR REMOVING STAINS FROM DENTURES, IN CLASS 3 (U.S. CLS. 1, 4, 6, 50, 51 AND 52).

FOR: THE BRINGING TOGETHER, FOR THE BENEFIT OF OTHERS, OF A VARIETY OF COSMETICS AND TOILETRIES, ENABLING CUSTOMERS TO CONVENIENTLY VIEW AND PURCHASE THESE GOODS; THE BRINGING TOGETHER FOR THE BENEFIT OF OTHERS, A VARIETY OF COSMETICS AND TOILETRIES, ENABLING CUSTOMERS TO CONVENIENTLY VIEW AND PURCHASE THOSE GOODS FROM A MAIL ORDER CATALOGUE, OR FROM AN INTERNET WEB SITE, IN CLASS 35 (U.S. CLS. 100, 101 AND 102).

THE MARK CONSISTS OF STANDARD CHARACTERS WITHOUT CLAIM TO ANY PARTICULAR FONT, STYLE, SIZE, OR COLOR.

PRIORITY CLAIMED UNDER SEC. 44(D) ON UNITED KINGDOM APPLICATION NO. 2563323, FILED 11-5-2010, REG. NO. 2563323, DATED 11-5-2010, EXPIRES 11-5-2020.

NO CLAIM IS MADE TO THE EXCLUSIVE RIGHT TO USE "TABS", APART FROM THE MARK AS SHOWN.

SER. NO. 85-186,311, FILED 11-29-2010.

JOHN GARTNER, EXAMINING ATTORNEY



*David J. Kyjars*

Director of the United States Patent and Trademark Office



# United States of America

United States Patent and Trademark Office

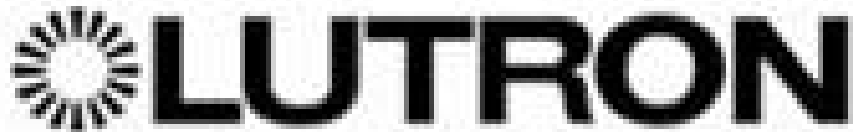

**Reg. No. 4,133,947**

LUTRON ELECTRONICS CO., INC. (PENNSYLVANIA CORPORATION)

**Registered May 1, 2012**

7200 SUTER ROAD  
COOPERSBURG, PA 18036

**Int. Cls.: 7, 9, 11, 20, 24,  
37 and 42**

FOR: MOTOR DRIVE UNITS FOR WINDOW TREATMENTS, DRAPERY TRACKS AND PROJECTION SCREENS, IN CLASS 7 (U.S. CLS. 13, 19, 21, 23, 31, 34 AND 35).

FIRST USE 6-11-2003; IN COMMERCE 6-11-2003.

**TRADEMARK**

**SERVICE MARK**

**PRINCIPAL REGISTER**

FOR: ELECTRIC LIGHTING CONTROLS, NAMELY, DIMMERS, SWITCHES AND ACCESSORIES THEREFOR, NAMELY, ELECTRICAL WALL SWITCH PLATES, ELECTRICAL RECEPTACLES, TELEPHONE WALL JACKS, COAXIAL CABLE WALL JACKS, REPLACEMENT KNOBS, NAMELY, ELECTRICAL ROTARY AND LINEAR SLIDE DIMMER KNOBS; ELECTRICAL CONNECTORS; LAMP DIMMERS, REMOTE CONTROLS FOR CONTROLLING LIGHTS AND ACCESSORIES THEREFOR, NAMELY, TETHERS, TO HOLD A REMOTE CONTROL FOR CONTROLLING LIGHTS AND SPECIALTY HOLSTERS FOR CARRYING REMOTE CONTROLS FOR CONTROLLING LIGHTS; MASTER CONTROLS, NAMELY, ELECTRONIC CONTROLLERS FOR ELECTRICAL DIMMERS AND WINDOW SHADES AND SCREENS; ELECTRONIC TRANSMITTERS FOR ELECTRICAL DIMMERS AND WINDOW SHADES AND SCREENS; ELECTRONIC RECEIVERS TRANSMITTERS FOR ELECTRICAL DIMMERS AND WINDOW SHADES AND SCREENS; INTERFACES, NAMELY, ELECTRICAL LOAD SWITCHING INTERFACES, AND ELECTRICAL LOAD DIMMING INTERFACES FOR INCANDESCENT, MAGNETIC LOW VOLTAGE, ELECTRONIC LOW VOLTAGE, FLUORESCENT, WINDOW TREATMENTS, AND PROJECTION SCREEN MOTORS; ELECTRICAL CONTROL INTERFACES, NAMELY, RS 232 INTERFACES, CONTACT CLOSURE INTERFACES, TIMECLOCK AND PROGRAMMER INTERFACES, INFRARED INTERFACES, TELEPHONE INTERFACES, AND ZERO TO TEN VOLT INTERFACES, ALL FOR USE TO ALLOW LIGHTING SYSTEMS TO COMMUNICATE AND INTERACT; OCCUPANCY SENSORS, NAMELY, ELECTRONIC DEVICES WHICH DETECT THE PRESENCE OF OCCUPANTS AND CONTROL THE LIGHTING SYSTEM ACCORDINGLY; DAYLIGHT SENSORS, PHOTOSENSORS, INFRARED PARTITION SENSORS, NAMELY, REMOTE SENSORS FOR USE IN MEASURING INFRARED RADIATION ENERGY WAVES; LIGHT DIMMING CONTROLLERS, POWER BOOSTERS, NAMELY, POWER AMPLIFIER; ELECTRICAL LAMP DEBUZZING COILS; TRANSFORMERS; LOW VOLTAGE ELECTRICAL CABLES; REPEATERS FOR RADIO FREQUENCY SIGNALS; INFRARED REPEATING KITS COMPRISING CONNECTOR BLOCK, NAMELY, ELECTRIC CONNECTORS, INFRARED RECEIVER AND TRANSFORMER AND AN INFRARED EMITTER; PROCESSORS, NAMELY,



*David J. Kyros*

Director of the United States Patent and Trademark Office

**Reg. No. 4,133,947** A CENTRAL POINT OF CONTROL FOR RESIDENTIAL AND COMMERCIAL LIGHTING SYSTEMS COMPRISING SENSORS, DIMMERS, SWITCHES AND KEYPADS; COMPUTER KEYPADS; POWER DISTRIBUTION PANELS; ENCLOSURES FOR LIGHTING CONTROLS; POWER SUPPLIES; ELECTRICAL DIMMING CONTROL PANELS; ELECTRICAL SWITCHING CONTROL PANELS; ELECTRIC SWITCHING RELAYS; ELECTRICAL KEY-SWITCHES; ELECTRIC CONTROL PANELS; THEATRICAL STAGE BOARD ELECTRICAL RECEPTACLES; SWITCHING MODULES, NAMELY, INDEPENDENT SWITCHING MODULES AND MODULES WITHIN LIGHTING CONTROL PANELS FOR TURNING ENTIRE CIRCUITS ON AND OFF; FLUORESCENT DIMMING BALLASTS FOR GAS DISCHARGE LAMPS; FLUORESCENT LIGHTING BALLAST MODULES, NAMELY, AN INTERFACE THAT ALLOWS FLUORESCENT BALLASTS ON DIFFERENT PROTOCOLS TO COMMUNICATE; ELECTRICAL FAN SPEED CONTROLS, NAMELY, TO CONTROL CEILING FAN SPEEDS; ELECTRIC WINDOW TREATMENT AND PROJECTION SCREEN CONTROLS, NAMELY, KEYPADS, CONTACT CLOSURE INPUT BOARDS, POWER SUPPLIES, REMOTE CONTROLS, TRANSFORMERS, TRANSFORMER PANELS, RECEIVERS, AND INTEGRATORS FOR COMMUNICATION BETWEEN BUILDING SYSTEMS; COMPUTER SOFTWARE FOR THE DESIGN, INTEGRATION, INSTALLATION AND MANAGEMENT OF LIGHTING SYSTEMS AND WINDOW TREATMENT SYSTEMS, IN CLASS 9 (U.S. CLS. 21, 23, 26, 36 AND 38).

FIRST USE 0-0-1962; IN COMMERCE 0-0-1962.

FOR: LIGHTING FIXTURES, IN CLASS 11 (U.S. CLS. 13, 21, 23, 31 AND 34).

FIRST USE 12-31-2007; IN COMMERCE 5-28-2010.

FOR: WINDOW SHADING SYSTEMS CONSISTING PRIMARILY OF WINDOW TREATMENTS, NAMELY, ROLLER SHADES AND ROMAN SHADES AND ALSO CONSISTING OF REMOTE CONTROLS, KEYPAD CONTROLS, POWER PANELS, TRANSFORMERS, TRANSFORMER PANELS, RECEIVERS, POWER SUPPLIES; DRAPERY HARDWARE, NAMELY, DRAPERY TRACKS, ROLLER TUBES, MOUNTING BRACKETS, FACIA, AND SIDE CHANNELS SOLD TOGETHER AS A UNIT AND SOLD SEPARATELY, IN CLASS 20 (U.S. CLS. 2, 13, 22, 25, 32 AND 50).

FIRST USE 4-12-2000; IN COMMERCE 4-12-2000.

FOR: WINDOW SHADING SYSTEMS CONSISTING PRIMARILY OF WINDOW TREATMENTS, NAMELY, DRAPERY AND ALSO CONSISTING OF REMOTE CONTROLS, KEYPAD CONTROLS, POWER PANELS, TRANSFORMERS, TRANSFORMER PANELS, RECEIVERS, POWER SUPPLIES, IN CLASS 24 (U.S. CLS. 42 AND 50).

FIRST USE 4-12-2000; IN COMMERCE 4-12-2000.

FOR: INSTALLATION, MAINTENANCE AND REPAIR OF LIGHTING CONTROL AND WINDOW TREATMENT CONTROL EQUIPMENT, IN CLASS 37 (U.S. CLS. 100, 103 AND 106).

FIRST USE 0-0-1974; IN COMMERCE 0-0-1974.

FOR: LIGHTING CONTROL SYSTEM AND WINDOW TREATMENT SYSTEM DESIGN FOR BUILDINGS; ENGINEERING SERVICES FOR THE DESIGN, INSTALLATION AND MAINTENANCE OF LIGHTING CONTROL AND WINDOW TREATMENT CONTROL SYSTEMS; COMPUTER SOFTWARE DEVELOPMENT FOR THE DESIGN OF LIGHTING CONTROL AND WINDOW TREATMENT CONTROL SYSTEMS, IN CLASS 42 (U.S. CLS. 100 AND 101).

FIRST USE 0-0-1974; IN COMMERCE 0-0-1974.

OWNER OF U.S. REG. NOS. 948,849, 1,626,714 AND OTHERS.

**Reg. No. 4,133,947** THE MARK CONSISTS OF A STARBURST DESIGN WITH "LUTRON" IN STYLIZED LETTERS TO THE RIGHT.

SER. NO. 85-186,654, FILED 11-29-2010.

MATTHEW EINSTEIN, EXAMINING ATTORNEY

# United States of America

United States Patent and Trademark Office

# LUTRON

**Reg. No. 4,133,948**

**Registered May 1, 2012**

**Int. Cls.: 7, 9, 20, 24, 37  
and 42**

LUTRON ELECTRONICS CO., INC. (PENNSYLVANIA CORPORATION)  
7200 SUTER ROAD  
COOPERSBURG, PA 18036

FOR: MOTOR DRIVE UNITS FOR WINDOW TREATMENTS, DRAPERY TRACKS AND PROJECTION SCREENS, IN CLASS 7 (U.S. CLS. 13, 19, 21, 23, 31, 34 AND 35).

FIRST USE 6-11-2003; IN COMMERCE 6-11-2003.

**TRADEMARK**

**SERVICE MARK**

**PRINCIPAL REGISTER**

FOR: ELECTRIC LIGHTING CONTROLS, NAMELY, DIMMERS, SWITCHES AND ACCESSORIES THEREFOR, NAMELY, ELECTRICAL WALL SWITCH PLATES, ELECTRICAL RECEPTACLES, TELEPHONE WALL JACKS, COAXIAL CABLE WALL JACKS, REPLACEMENT KNOBS, NAMELY, ELECTRICAL ROTARY AND LINEAR SLIDE DIMMER KNOBS; ELECTRICAL CONNECTORS; LAMP DIMMERS, REMOTE CONTROLS FOR CONTROLLING LIGHTS AND ACCESSORIES THEREFOR, NAMELY, TETHERS, TO HOLD A REMOTE CONTROL FOR CONTROLLING LIGHTS AND SPECIALTY HOLSTERS FOR CARRYING REMOTE CONTROLS FOR CONTROLLING LIGHTS; MASTER CONTROLS, NAMELY, ELECTRONIC CONTROLLERS FOR ELECTRICAL DIMMERS AND WINDOW SHADES AND SCREENS; ELECTRONIC TRANSMITTERS FOR ELECTRICAL DIMMERS AND WINDOW SHADES AND SCREENS; ELECTRONIC RECEIVERS TRANSMITTERS FOR ELECTRICAL DIMMERS AND WINDOW SHADES AND SCREENS; INTERFACES, NAMELY, ELECTRICAL LOAD SWITCHING INTERFACES, AND ELECTRICAL LOAD DIMMING INTERFACES FOR INCANDESCENT, MAGNETIC LOW VOLTAGE, ELECTRONIC LOW VOLTAGE, FLUORESCENT, WINDOW TREATMENTS, AND PROJECTION SCREEN MOTORS; ELECTRICAL CONTROL INTERFACES, NAMELY, RS 232 INTERFACES, CONTACT CLOSURE INTERFACES, TIMECLOCK AND PROGRAMMER INTERFACES, INFRARED INTERFACES, TELEPHONE INTERFACES, AND ZERO TO TEN VOLT INTERFACES, ALL FOR USE TO ALLOW LIGHTING SYSTEMS TO COMMUNICATE AND INTERACT; OCCUPANCY SENSORS, NAMELY, ELECTRONIC DEVICES WHICH DETECT THE PRESENCE OF OCCUPANTS AND CONTROL THE LIGHTING SYSTEM ACCORDINGLY; DAYLIGHT SENSORS, PHOTOSENSORS, INFRARED PARTITION SENSORS, NAMELY, REMOTE SENSORS FOR USE IN MEASURING INFRARED RADIATION ENERGY WAVES; LIGHT DIMMING CONTROLLERS, POWER BOOSTERS, NAMELY, POWER AMPLIFIER; ELECTRICAL LAMP DEBUZZING COILS; TRANSFORMERS; LOW VOLTAGE ELECTRICAL CABLES; REPEATERS FOR RADIO FREQUENCY SIGNALS; INFRARED REPEATING KITS COMPRISING CONNECTOR BLOCK, NAMELY, ELECTRIC CONNECTORS, INFRARED RECEIVER AND TRANSFORMER AND AN INFRARED EMITTER; PROCESSORS, NAMELY,



*David J. Kybas*

Director of the United States Patent and Trademark Office

**Reg. No. 4,133,948** A CENTRAL POINT OF CONTROL FOR RESIDENTIAL AND COMMERCIAL LIGHTING SYSTEMS COMPRISING SENSORS, DIMMERS, SWITCHES AND KEYPADS; COMPUTER KEYPADS; POWER DISTRIBUTION PANELS; ENCLOSURES FOR LIGHTING CONTROLS; POWER SUPPLIES; ELECTRICAL DIMMING CONTROL PANELS; ELECTRICAL SWITCHING CONTROL PANELS; ELECTRIC SWITCHING RELAYS; ELECTRICAL KEY-SWITCHES; ELECTRIC CONTROL PANELS; THEATRICAL STAGE BOARD ELECTRICAL RECEPTACLES; SWITCHING MODULES, NAMELY, INDEPENDENT SWITCHING MODULES AND MODULES WITHIN LIGHTING CONTROL PANELS FOR TURNING ENTIRE CIRCUITS ON AND OFF; FLUORESCENT DIMMING BALLASTS FOR GAS DISCHARGE LAMPS; FLUORESCENT LIGHTING BALLAST MODULES, NAMELY, AN INTERFACE THAT ALLOWS FLUORESCENT BALLASTS ON DIFFERENT PROTOCOLS TO COMMUNICATE; ELECTRICAL FAN SPEED CONTROLS, NAMELY, TO CONTROL CEILING FAN SPEEDS; ELECTRIC WINDOW TREATMENT AND PROJECTION SCREEN CONTROLS, NAMELY, KEYPADS, CONTACT CLOSURE INPUT BOARDS, POWER SUPPLIES, REMOTE CONTROLS, TRANSFORMERS, TRANSFORMER PANELS, RECEIVERS, AND INTEGRATORS FOR COMMUNICATION BETWEEN BUILDING SYSTEMS; COMPUTER SOFTWARE FOR THE DESIGN, INTEGRATION, INSTALLATION AND MANAGEMENT OF LIGHTING SYSTEMS AND WINDOW TREATMENT SYSTEMS, IN CLASS 9 (U.S. CLS. 21, 23, 26, 36 AND 38).

FIRST USE 0-0-1962; IN COMMERCE 0-0-1962.

FOR: WINDOW SHADING SYSTEMS CONSISTING PRIMARILY OF WINDOW TREATMENTS, NAMELY, ROLLER SHADES AND ROMAN SHADES AND ALSO CONSISTING OF REMOTE CONTROLS, KEYPAD CONTROLS, POWER PANELS, TRANSFORMERS, TRANSFORMER PANELS, RECEIVERS, POWER SUPPLIES; DRAPERY HARDWARE, NAMELY, DRAPERY TRACKS, ROLLER TUBES, MOUNTING BRACKETS, FACIA, AND SIDE CHANNELS SOLD TOGETHER AS A UNIT AND SOLD SEPARATELY, IN CLASS 20 (U.S. CLS. 2, 13, 22, 25, 32 AND 50).

FIRST USE 4-12-2000; IN COMMERCE 4-12-2000.

FOR: WINDOW SHADING SYSTEMS CONSISTING PRIMARILY OF WINDOW TREATMENTS, NAMELY, DRAPERY AND ALSO CONSISTING OF REMOTE CONTROLS, KEYPAD CONTROLS, POWER PANELS, TRANSFORMERS, TRANSFORMER PANELS, RECEIVERS, POWER SUPPLIES, IN CLASS 24 (U.S. CLS. 42 AND 50).

FIRST USE 4-12-2000; IN COMMERCE 4-12-2000.

FOR: INSTALLATION, MAINTENANCE AND REPAIR OF LIGHTING CONTROL AND WINDOW TREATMENT CONTROL EQUIPMENT, IN CLASS 37 (U.S. CLS. 100, 103 AND 106).

FIRST USE 0-0-1974; IN COMMERCE 0-0-1974.

FOR: LIGHTING CONTROL SYSTEM AND WINDOW TREATMENT SYSTEM DESIGN FOR BUILDINGS; ENGINEERING SERVICES FOR THE DESIGN, INSTALLATION AND MAINTENANCE OF LIGHTING CONTROL AND WINDOW TREATMENT CONTROL SYSTEMS; COMPUTER SOFTWARE DEVELOPMENT FOR THE DESIGN OF LIGHTING CONTROL AND WINDOW TREATMENT CONTROL SYSTEMS, IN CLASS 42 (U.S. CLS. 100 AND 101).

FIRST USE 0-0-1974; IN COMMERCE 0-0-1974.

THE MARK CONSISTS OF STANDARD CHARACTERS WITHOUT CLAIM TO ANY PARTICULAR FONT, STYLE, SIZE, OR COLOR.

OWNER OF U.S. REG. NOS. 948,849, 1,626,714 AND OTHERS.

**Reg. No. 4,133,948** SER. NO. 85-186,705, FILED 11-29-2010.

MATTHEW EINSTEIN, EXAMINING ATTORNEY

# United States of America

United States Patent and Trademark Office

## TD BANK GROUP

**Reg. No. 4,133,949**

**Registered May 1, 2012**

**Int. Cl.: 36**

**SERVICE MARK**

**PRINCIPAL REGISTER**

THE TORONTO-DOMINION BANK (CANADA CHARTERED BANK)  
TORONTO-DOMINION TOWER, 12TH FLOOR  
66 WELLINGTON STREET  
TORONTO, CANADA M5K1A2

FOR: BANKING SERVICES; REAL ESTATE INVESTMENT, REAL ESTATE MANAGEMENT AND REAL ESTATE FINANCING; SECURITIES BROKERAGE SERVICES; ESTATE TRUST MANAGEMENT SERVICES; CREDIT CARD SERVICES, CONSUMER LENDING SERVICES, COMMERCIAL LENDING SERVICES, MORTGAGE LENDING, REAL ESTATE LENDING SERVICES, WHOLESALE LENDING SERVICES, INVESTMENT ADVISORY SERVICES, FINANCIAL ADVISORY SERVICES; INVESTMENT MANAGEMENT AND FINANCIAL MANAGEMENT SERVICES; TRAVEL INSURANCE UNDERWRITING SERVICES, LIFE INSURANCE UNDERWRITING, HEALTH INSURANCE UNDERWRITING, ACCIDENT INSURANCE UNDERWRITING, FIRE INSURANCE UNDERWRITING, VEHICLE INSURANCE UNDERWRITING, PROPERTY INSURANCE UNDERWRITING; MUTUAL FUND INVESTMENT, MUTUAL FUND BROKERAGE SERVICES, IN CLASS 36 (U.S. CLS. 100, 101 AND 102).

THE MARK CONSISTS OF STANDARD CHARACTERS WITHOUT CLAIM TO ANY PARTICULAR FONT, STYLE, SIZE, OR COLOR.

PRIORITY CLAIMED UNDER SEC. 44(D) ON CANADA APPLICATION NO. 1505188, FILED 11-24-2010, REG. NO. TMA811393, DATED 11-8-2011, EXPIRES 11-8-2026.

OWNER OF U.S. REG. NOS. 1,649,009, 3,041,170 AND OTHERS.

NO CLAIM IS MADE TO THE EXCLUSIVE RIGHT TO USE "BANK GROUP", APART FROM THE MARK AS SHOWN.

SER. NO. 85-187,240, FILED 11-30-2010.

GRETCHEN ULRICH, EXAMINING ATTORNEY



*David J. Kybas*

Director of the United States Patent and Trademark Office

# United States of America

United States Patent and Trademark Office

# MIX 30 LOW

**Reg. No. 4,133,950**

**Registered May 1, 2012**

**Int. Cl.: 1**

**TRADEMARK**

**PRINCIPAL REGISTER**

QUALCHEM LLC (MICHIGAN LIMITED LIABILITY COMPANY)  
86 MERZ BLVD.  
AKRON, OH 44333

FOR: CAR WASH CHEMICALS, IN CLASS 1 (U.S. CLS. 1, 5, 6, 10, 26 AND 46).

FIRST USE 5-31-2003; IN COMMERCE 5-31-2003.

THE MARK CONSISTS OF STANDARD CHARACTERS WITHOUT CLAIM TO ANY PARTICULAR FONT, STYLE, SIZE, OR COLOR.

NO CLAIM IS MADE TO THE EXCLUSIVE RIGHT TO USE "MIX" AND "LOW", APART FROM THE MARK AS SHOWN.

SER. NO. 85-188,023, FILED 12-1-2010.

MELISSA VALLILLO, EXAMINING ATTORNEY



*David J. Kyffers*

Director of the United States Patent and Trademark Office



# United States of America

United States Patent and Trademark Office

## MIX 30 HIGH

**Reg. No. 4,133,951**

QUALCHEM LLC (MICHIGAN LIMITED LIABILITY COMPANY)  
86 MERZ BLVD.  
AKRON, OH 44333

**Registered May 1, 2012**

**Int. Cl.: 1**

FOR: CAR WASH CHEMICALS, IN CLASS 1 (U.S. CLS. 1, 5, 6, 10, 26 AND 46).

**TRADEMARK**

FIRST USE 5-31-2003; IN COMMERCE 5-31-2003.

**PRINCIPAL REGISTER**

THE MARK CONSISTS OF STANDARD CHARACTERS WITHOUT CLAIM TO ANY PARTICULAR FONT, STYLE, SIZE, OR COLOR.

NO CLAIM IS MADE TO THE EXCLUSIVE RIGHT TO USE "MIX" AND "HIGH", APART FROM THE MARK AS SHOWN.

SER. NO. 85-188,033, FILED 12-1-2010.

MELISSA VALLILLO, EXAMINING ATTORNEY



*David J. Kyffers*

Director of the United States Patent and Trademark Office

# United States of America

United States Patent and Trademark Office

I  My Testes!

**Reg. No. 4,133,952**

THOMAS, KELCEY S. (UNITED STATES INDIVIDUAL)  
19710 TIMBER RIDGE DRIVE  
MAGNOLIA, TX 77355

**Registered May 1, 2012**

**Int. Cl.: 14**

FOR: BRACELETS, IN CLASS 14 (U.S. CLS. 2, 27, 28 AND 50).

**TRADEMARK**

FIRST USE 5-28-2010; IN COMMERCE 11-22-2010.

**PRINCIPAL REGISTER**

THE MARK CONSISTS OF THE LETTER "I", FOLLOWED BY AN UPSIDE DOWN HEART, FOLLOWED BY THE WORDS "MY TESTES", FOLLOWED BY AN "!" EXCLAMATION POINT.

SER. NO. 85-188,343, FILED 12-1-2010.

ROBIN MITTLER, EXAMINING ATTORNEY



*David J. Kybas*

Director of the United States Patent and Trademark Office

# United States of America

## United States Patent and Trademark Office



**Reg. No. 4,133,953**

**Registered May 1, 2012**

**Int. Cls.: 16, 38, 41 and 42**

**TRADEMARK**

**SERVICE MARK**

**PRINCIPAL REGISTER**

PROMOTORA DE INFORMACIONES, S.A. (SPAIN CORPORATION)  
GRAN VÍA, 32 - SEXTA PLANTA  
MADRID, SPAIN 28013

FOR: PRINTED MATTER, NAMELY, BROCHURES, PAMPHLETS, MAGAZINES, NEWSPAPERS, BOOKS IN THE FIELD OF COMMERCIAL INFORMATION, NEWS AND CURRENT AFFAIRS; BOOK-BINDINGS; PHOTOGRAPHS; STATIONERY; ADHESIVES FOR STATIONERY PURPOSES; ARTISTS' MATERIALS, NAMELY, ARTISTS' BRUSHES, ARTISTS' PASTELS, ARTISTS' PENCILS, ARTISTS' PENS, CANVAS PANELS FOR ARTISTS, MOLDS FOR MODELING CLAYS; PAINT BRUSHES, TYPEWRITERS; PRINTED INSTRUCTIONAL AND TEACHING MATERIALS IN THE FIELD OF ECONOMIC AND COMMERCIAL INFORMATION, NEWS AND CURRENT AFFAIRS; PRINTERS' TYPE; PRINTING BLOCKS; PUBLICATIONS, NAMELY, BOOKS, MAGAZINES, NEWSPAPERS IN THE FIELD OF COMMERCIAL INFORMATION, IN CLASS 16 (U.S. CLS. 2, 5, 22, 23, 29, 37, 38 AND 50).

FOR: TELECOMMUNICATIONS SERVICES, NAMELY, TELEVISION BROADCASTING, RADIO BROADCASTING, AND INTERNET SERVICE PROVIDER SERVICES, IN CLASS 38 (U.S. CLS. 100, 101 AND 104).

FOR: PUBLICATION OF ELECTRONIC BOOKS AND JOURNALS ONLINE; PUBLICATION OF TEXTS, OTHER THAN PUBLICITY TEXTS; PUBLICATION OF BOOKS, MAGAZINES, JOURNALS, NEWSPAPERS, CATALOGS AND BROCHURES, IN CLASS 41 (U.S. CLS. 100, 101 AND 107).

FOR: SCIENTIFIC AND TECHNOLOGICAL SERVICES AND RESEARCH, NAMELY, SCIENTIFIC RESEARCH, ANALYSIS AND TESTING, IN THE FIELD OF TELECOMMUNICATIONS AND AUDIOVISUAL EQUIPMENT AND MEDIA; DESIGN RELATING TO SCIENCE AND TECHNOLOGY, NAMELY, COMPUTER SITE DESIGN; DESIGN AND DEVELOPMENT OF COMPUTER HARDWARE AND SOFTWARE; ENGINEERING SERVICES, FEATURING EVALUATIONS, APPRAISALS, RESEARCH AND REPORTS IN VARIOUS SCIENTIFIC AND TECHNOLOGICAL FIELDS, IN CLASS 42 (U.S. CLS. 100 AND 101).

PRIORITY CLAIMED UNDER SEC. 44(D) ON SPAIN APPLICATION NO. 2.950.547, FILED 10-15-2010, REG. NO. 2950547, DATED 2-2-2011, EXPIRES 10-15-2020.

THE COLOR(S) MAGENTA, YELLOW, GREEN AND BLUE IS/ARE CLAIMED AS A FEATURE OF THE MARK.



*David J. Kyjars*

Director of the United States Patent and Trademark Office

**Reg. No. 4,133,953** THE MARK CONSISTS OF FOUR WAVY LINES IN THE COLORS MAGENTA, YELLOW, GREEN AND BLUE ONE ABOVE THE OTHER WHICH APPEAR TO FORM A CIRCLE.

SER. NO. 85-189,567, FILED 12-2-2010.

GILBERT SWIFT, EXAMINING ATTORNEY

# United States of America

United States Patent and Trademark Office

## GLOBAL PARTS SUPPORT

**Reg. No. 4,133,954**

**Registered May 1, 2012**

**Int. Cl.: 35**

**SERVICE MARK**

**PRINCIPAL REGISTER**

GLOBAL PARTS SUPPORT INC. (FLORIDA CORPORATION)  
2799 SW 32ND AVENUE  
HOLLYWOOD, FL 33023

FOR: DISTRIBUTORSHIP SERVICES IN THE FIELD OF NEW AND USED AIRCRAFT PARTS,  
IN CLASS 35 (U.S. CLS. 100, 101 AND 102).

FIRST USE 11-4-2003; IN COMMERCE 11-4-2003.

THE MARK CONSISTS OF STANDARD CHARACTERS WITHOUT CLAIM TO ANY PAR-  
TICULAR FONT, STYLE, SIZE, OR COLOR.

NO CLAIM IS MADE TO THE EXCLUSIVE RIGHT TO USE "PARTS", APART FROM THE  
MARK AS SHOWN.

SEC. 2(F) AS TO "GLOBAL PARTS".

SER. NO. 85-189,591, FILED 12-2-2010.

MARIA-VICTORIA SUAREZ, EXAMINING ATTORNEY



*David J. Kybas*

Director of the United States Patent and Trademark Office

# United States of America

United States Patent and Trademark Office



# Nextag

**Reg. No. 4,133,955**

**Registered May 1, 2012**

**Int. Cls.: 35 and 36**

**SERVICE MARK**

**PRINCIPAL REGISTER**

NEXTAG, INC. (DELAWARE CORPORATION)  
SUITE 600  
1300 SOUTH EL CAMINO REAL  
SAN MATEO, CA 94402

FOR: COMPARISON SHOPPING SERVICES FEATURING A SEARCH ENGINE FOR OBTAINING PURCHASING INFORMATION; COUPON OFFERINGS, NAMELY, PROMOTING THE GOODS OR SERVICES OF OTHERS BY PROVIDING COUPONS FOR THE GOODS OR SERVICES OF OTHERS; PROMOTING THE GOODS OR SERVICES OF OTHERS BY MEANS OF PROVIDING ONLINE COUPONS, IN CLASS 35 (U.S. CLS. 100, 101 AND 102).

FIRST USE 11-13-2010; IN COMMERCE 11-13-2010.

FOR: ACCEPTING PAYMENTS ON BEHALF OF THIRD PARTY MERCHANTS FEATURED IN SEARCH RESULTS, NAMELY, PROVIDING ELECTRONIC PROCESSING OF CREDIT CARD TRANSACTIONS AND ELECTRONIC PAYMENTS VIA A GLOBAL COMPUTER NETWORK, IN CLASS 36 (U.S. CLS. 100, 101 AND 102).

FIRST USE 11-13-2010; IN COMMERCE 11-13-2010.

OWNER OF U.S. REG. NO. 2,820,935.

THE MARK CONSISTS OF A LARGE "X" FOLLOWED BY A TAG COMPRISING A HEART, AND THE STYLIZED WORDING "NEXTAG" LOCATED BELOW.

SER. NO. 85-189,716, FILED 12-2-2010.

KATHRYN COWARD, EXAMINING ATTORNEY



*David J. Kybas*

Director of the United States Patent and Trademark Office

# United States of America

United States Patent and Trademark Office

## LIZZY B CANADA

**Reg. No. 4,133,956**

**Registered May 1, 2012**

**Int. Cls.: 10 and 25**

**TRADEMARK**

**PRINCIPAL REGISTER**

INDUSTRIAL TEXTILES LIMITED (CANADA LIMITED LIABILITY COMPANY)  
UNIT 405  
4576 YOUNG STREET  
TORONTO, CANADA M2N6N4

FOR: MEDICAL WEARING APPAREL, NAMELY, SCRUB PANTS; MEDICAL WEARING APPAREL, NAMELY, SCRUB TOPS, IN CLASS 10 (U.S. CLS. 26, 39 AND 44).

FIRST USE 2-21-1985; IN COMMERCE 1-1-2005.

FOR: LAB COATS, IN CLASS 25 (U.S. CLS. 22 AND 39).

FIRST USE 2-21-1985; IN COMMERCE 1-1-2005.

THE MARK CONSISTS OF STANDARD CHARACTERS WITHOUT CLAIM TO ANY PARTICULAR FONT, STYLE, SIZE, OR COLOR.

NO CLAIM IS MADE TO THE EXCLUSIVE RIGHT TO USE "CANADA", APART FROM THE MARK AS SHOWN.

SER. NO. 85-190,172, FILED 12-3-2010.

AMY HELLA, EXAMINING ATTORNEY



*David J. Kybas*

Director of the United States Patent and Trademark Office

# United States of America

United States Patent and Trademark Office

# ORBIQUAD

**Reg. No. 4,133,957**

**Registered May 1, 2012**

**Int. Cls.: 9 and 42**

**TRADEMARK**

**SERVICE MARK**

**PRINCIPAL REGISTER**

THERMO FISHER SCIENTIFIC (BREMEN) GMBH (FED REP GERMANY LIMITED LIABILITY COMPANY)  
HANNA-KUNATH-STR. 11  
BREMEN, FED REP GERMANY 28199

FOR: MASS SPECTROMETERS; MASS SPECTROMETRY INSTRUMENTATION AND ACCESSORIES, NAMELY, PHARMACEUTICAL AND SCIENTIFIC RESEARCH EQUIPMENT FOR USE WITH MASS SPECTROMETERS, CALIBRATING DEVICES FOR CALIBRATING MASS SPECTROMETERS; SOFTWARE FOR DATABASE MANAGEMENT, SCREENING, ANALYZING AND IMAGING DATA FOR USE IN THE FIELD OF MASS SPECTROMETRY, IN CLASS 9 (U.S. CLS. 21, 23, 26, 36 AND 38).

FOR: MASS SPECTROMETRY-RELATED SERVICES, NAMELY, CALIBRATION OF MASS SPECTROMETERS AND DESIGN AND DEVELOPMENT OF MASS SPECTROMETERS, IN CLASS 42 (U.S. CLS. 100 AND 101).

THE MARK CONSISTS OF STANDARD CHARACTERS WITHOUT CLAIM TO ANY PARTICULAR FONT, STYLE, SIZE, OR COLOR.

OWNER OF EUROPEAN UNION REG. NO. 009671959, DATED 6-27-2011, EXPIRES 1-20-2021.

SER. NO. 85-190,571, FILED 12-3-2010.

TINA BROWN, EXAMINING ATTORNEY



*David J. Kybas*

Director of the United States Patent and Trademark Office



# United States of America

United States Patent and Trademark Office

## CINCHTRADE

**Reg. No. 4,133,958**

**Registered May 1, 2012**

**Int. Cls.: 35 and 42**

**SERVICE MARK**

**PRINCIPAL REGISTER**

SPENCER ASSET HOLDING LLC (WASHINGTON LIMITED LIABILITY COMPANY)  
#36  
624 SOUTH LANDER STREET  
SEATTLE, WA 98134

FOR: PROVIDING AN ONLINE WEBSITE WHERE MANUFACTURERS AND THEIR SALES REPRESENTATIVES CAN SHOWCASE THEIR PRODUCTS AND WHERE WHOLESALE PURCHASERS OF GOODS CAN REVIEW MANUFACTURER'S GOODS, PLACE ORDERS FOR GOODS AND WHERE USERS CAN COMMUNICATE WITH EACH OTHER REGARDING PURCHASE TRANSACTIONS AND POTENTIAL PURCHASE TRANSACTIONS, IN CLASS 35 (U.S. CLS. 100, 101 AND 102).

FIRST USE 8-30-2010; IN COMMERCE 11-10-2010.

FOR: HOSTING ONLINE WEBSITES OF OTHERS WHERE MANUFACTURERS AND THEIR SALES REPRESENTATIVES CAN SHOWCASE THEIR PRODUCTS AND WHERE WHOLESALE PURCHASERS OF GOODS CAN REVIEW MANUFACTURER GOODS, PLACE ORDERS FOR GOODS AND WHERE USERS CAN COMMUNICATE WITH EACH OTHER REGARDING TRANSACTIONS AND POTENTIAL TRANSACTIONS, IN CLASS 42 (U.S. CLS. 100 AND 101).

FIRST USE 8-30-2010; IN COMMERCE 11-10-2010.

THE MARK CONSISTS OF STANDARD CHARACTERS WITHOUT CLAIM TO ANY PARTICULAR FONT, STYLE, SIZE, OR COLOR.

SER. NO. 85-192,705, FILED 12-7-2010.

EVELYN BRADLEY, EXAMINING ATTORNEY



*David J. Kyros*

Director of the United States Patent and Trademark Office

# United States of America

United States Patent and Trademark Office

# NESCAFE

**Reg. No. 4,133,959**

SOCIÉTÉ DES PRODUITS NESTLÉ S.A. (SWITZERLAND SOCIÉTÉ ANONYME (SA))  
CASE POSTALE 353  
1800 VEVEY, SWITZERLAND

**Registered May 1, 2012**

**Int. Cls.: 5, 41, 42 and 44**

FOR: DIETETIC FOODS ADAPTED FOR MEDICAL AND CLINICAL USE; FOOD FOR BABIES; FOOD FOR CHILDREN AND INVALIDS ADAPTED FOR MEDICAL USE; DIET FOOD FOR MEDICAL USE, FOODS FOR PREGNANT AND NURSING MOTHERS ADAPTED FOR MEDICAL USE; NUTRITIONAL SUPPLEMENTS ADAPTED FOR MEDICAL USE; HIGH-ENERGY AND HIGH-PROTEIN MEDICAL NUTRITION PREPARATIONS; AMINO-ACID, VITAMIN, TRACE ELEMENT AND MINERAL PREPARATIONS FOR HUMAN CONSUMPTION; NUTRITIONAL COMPLEMENTS AND SUPPLEMENTS FOR MEDICAL USE; NON NUTRITIVE EDIBLE PLANT FIBER; GELATINE FOR MEDICAL USE; AMINO-ACIDS FOR HUMAN CONSUMPTION AND AMINO-ACIDS USED AS NUTRITIONAL SUPPLEMENTS FOR HUMAN CONSUMPTION, ALL THESE PRODUCTS IN LIQUID, SOLID, POWDER OR FOOD BARS; AMINO-ACID BASED FOOD BARS OR POWDER FOR HUMAN CONSUMPTION OR USED AS NUTRITIONAL SUPPLEMENTS; ENERGY BARS BASED ON AMINO-ACIDS, IN CLASS 5 (U.S. CLS. 6, 18, 44, 46, 51 AND 52).

**TRADEMARK**

**SERVICE MARK**

**PRINCIPAL REGISTER**

FOR: STAFF TRAINING IN THE FIELD OF FOOD, NUTRITION AND DIETETICS; ORGANIZATION OF COURSES, SEMINARS, CONFERENCES, CULTURAL AND EDUCATIONAL EXHIBITIONS IN THE FIELD OF FOOD, NUTRITION AND DIETETICS; PUBLICATION AND PRODUCTION OF BOOKS, PAMPHLETS, NEWSPAPERS, FILMS AND AUDIO RECORDINGS; NUTRITIONAL EDUCATION, EDUCATIONAL SERVICES RELATED TO NUTRITION AND FOOD, IN PARTICULAR TRANSMISSION OF INFORMATION AND SUGGESTIONS IN THE FIELD OF FOOD, NUTRITION AND DIETETICS; TRAINING AND ADVICE FOR PHYSICAL ACTIVITY OF THE ELDERLY, IN CLASS 41 (U.S. CLS. 100, 101 AND 107).



FOR: RESEARCH AND DEVELOPMENT IN THE FIELD OF NUTRITION, DIETETICS AND WEIGHT LOSS, CLINICAL FITNESS, NURSING AND MEDICAL SERVICES, IN CLASS 42 (U.S. CLS. 100 AND 101).

*David J. Kybas*

FOR: CONSULTING SERVICES FOR HEALTH, FOOD AND NUTRITION; MEDICAL SERVICES AND PROVISION OF INFORMATION IN THE MEDICAL FIELD; DIETARY ADVICE IN THE FIELD OF NUTRITION IN GENERAL AND IN THE FIELD OF WEIGHT LOSS; INFORMATION ON CONSULTING SERVICES AND ADVICE IN THE MEDICAL, PSYCHOLO-

**Reg. No. 4,133,959** GICAL AND IN THE NUTRITIONAL BEHAVIOR AND PHYSICAL ACTIVITY ALTERATION;  
REST HOMES; MEDICAL CLINICS, IN CLASS 44 (U.S. CLS. 100 AND 101).

THE MARK CONSISTS OF STANDARD CHARACTERS WITHOUT CLAIM TO ANY PARTICULAR FONT, STYLE, SIZE, OR COLOR.

PRIORITY CLAIMED UNDER SEC. 44(D) ON SWITZERLAND APPLICATION NO. 60644/2010,  
FILED 10-6-2010, REG. NO. 607627, DATED 10-6-2010, EXPIRES 10-6-2020.

SER. NO. 85-193,383, FILED 12-8-2010.

THOMAS MANOR, EXAMINING ATTORNEY

# United States of America

United States Patent and Trademark Office



**Reg. No. 4,133,960**

**Registered May 1, 2012**

**Int. Cl.: 42**

**SERVICE MARK**

**PRINCIPAL REGISTER**

RAYMOND, RUSSELL (UNITED STATES INDIVIDUAL)  
33 DONNA MAE LANE  
TOLLAND, CT 06084

FOR: ENGINEERING SERVICES, NAMELY, ENGINEERING FOR THE POWER OR UTILITIES INDUSTRY, IN CLASS 42 (U.S. CLS. 100 AND 101).

FIRST USE 11-21-2009; IN COMMERCE 11-21-2009.

THE MARK CONSISTS OF A DRAWING OF A BEARDED MAN WEARING A LOINCLOTH BOTTOM AND BANDANA, CARRYING A BOW AND ARROW AND WEARING A SWORD AROUND THE WAIST AND STRAPPED SANDALS. THE COLOR TAN APPEARS AS THE MAN'S SKIN; THE COLOR BLACK APPEARS IN THE BEARD AND HAIR, THE FACIAL FEATURES, THE BOOTS, THE SWORD AND BELT AND THE BOW AND ARROW; THE COLOR BROWN APPEARS AS SHADING OF THE SKIN, THE STRAP OF THE ARROWS, AND PART OF THE BOOTS, SWORD AND BOW AND ARROW; THE COLOR BLUE APPEARS IN THE LOINCLOTH AND BANDANA, THE COLOR WHITE APPEARS AS SHADING IN THE SKIN TONES, AND IN THE CLOTHING, AND THE COLOR GRAY APPEARS IN THE ELONGATED SHADOW WITHIN THE FEET OF THE MAN.

THE COLOR(S) BLACK, BROWN, TAN, WHITE, BLUE AND GRAY IS/ARE CLAIMED AS A FEATURE OF THE MARK.

SER. NO. 85-194,077, FILED 12-9-2010.

CARYN GLASSER, EXAMINING ATTORNEY



*David J. Kybas*

Director of the United States Patent and Trademark Office

# United States of America

United States Patent and Trademark Office



**Reg. No. 4,133,961**

**Registered May 1, 2012**

**Int. Cl.: 42**

**SERVICE MARK**

**PRINCIPAL REGISTER**

COPPER MOBILE INC (DELAWARE CORPORATION)  
5600 TENNYSON PKWY  
SUITE 229  
PLANO, TX 75024

FOR: COMPUTER SOFTWARE DESIGN FOR MOBILE DEVICES AND SOFTWARE DEVELOPMENT, IN CLASS 42 (U.S. CLS. 100 AND 101).

FIRST USE 7-17-2010; IN COMMERCE 7-17-2010.

THE MARK CONSISTS OF TERM "COPPERMOBILE" TO THE RIGHT OF A GREEN SQUARE DESIGN WITH ROUNDED CORNERS THAT CARRIES A LARGE STYLIZED "C" IN WHITE WITH A BROKEN LIGHT GREY CENTER STRIPE; "COPPER" APPEARS IN LIGHT GREY, "MOBILE" APPEARS IN GREEN.

THE COLOR(S) LIGHT GREY, GREEN AND WHITE IS/ARE CLAIMED AS A FEATURE OF THE MARK.

SER. NO. 85-196,748, FILED 12-13-2010.

ANTHONY RINKER, EXAMINING ATTORNEY



*David J. Kybas*

Director of the United States Patent and Trademark Office

# United States of America

United States Patent and Trademark Office

# WeatherSnoop

**Reg. No. 4,133,962**

PITRE TECHNOLOGY GROUP (KENTUCKY LIMITED LIABILITY COMPANY)  
441 SAINT PAUL AVENUE  
OPELOUSAS, LA 70570

**Registered May 1, 2012**

**Int. Cl.: 9**

FOR: COMPUTER SOFTWARE FOR COLLECTING AND DISPLAYING WEATHER RELATED INFORMATION, IN CLASS 9 (U.S. CLS. 21, 23, 26, 36 AND 38).

**TRADEMARK**

FIRST USE 9-23-2009; IN COMMERCE 9-23-2009.

**PRINCIPAL REGISTER**

THE MARK CONSISTS OF STANDARD CHARACTERS WITHOUT CLAIM TO ANY PARTICULAR FONT, STYLE, SIZE, OR COLOR.

SER. NO. 85-197,291, FILED 12-14-2010.

ELIZABETH HUGHITT, EXAMINING ATTORNEY



*David J. Kybas*

Director of the United States Patent and Trademark Office

# United States of America

United States Patent and Trademark Office

**TRESANTI**

**Reg. No. 4,133,963**

TWIN STAR INTERNATIONAL, INC. (FLORIDA CORPORATION)  
115 S. E 4TH AVENUE  
DELRAY BEACH, FL 33483

**Registered May 1, 2012**

**Int. Cl.: 20**

FOR: BATHROOM VANITIES, MEDICINE CABINETS AND BATHROOM ACCESSORIES,  
NAMELY, MIRRORS, SHELVES, IN CLASS 20 (U.S. CLS. 2, 13, 22, 25, 32 AND 50).

**TRADEMARK**

FIRST USE 10-1-2004; IN COMMERCE 10-1-2004.

**PRINCIPAL REGISTER**

OWNER OF U.S. REG. NO. 3,631,805.

THE MARK CONSISTS OF THE STYLIZED WORDING "TRESANTI" UNDERLINED AND ENCLOSED IN A RECTANGLE. THE COLORS BLACK AND WHITE REPRESENT BACKGROUND, OUTLINING, SHADING AND/OR TRANSPARENT AREAS AND ARE NOT PART OF THE MARK.

THE ENGLISH TRANSLATION OF "TRESANTI" IN THE MARK IS "THREE SAINTS".

SER. NO. 85-200,182, FILED 12-17-2010.

DARRYL SPRUILL, EXAMINING ATTORNEY



*David J. Kyffers*

Director of the United States Patent and Trademark Office

# United States of America

United States Patent and Trademark Office

## FACELESS COMMUNICATION

**Reg. No. 4,133,964**

**Registered May 1, 2012**

**Int. Cl.: 41**

**SERVICE MARK**

**PRINCIPAL REGISTER**

PROGRESSIVE COMMUNICATIONS INC. (CANADA CORPORATION)  
250 DAVISVILLE AVENUE, SUITE 108  
TORONTO, ONTARIO, CANADA M4S1H2

FOR: PERSONAL COACHING SERVICES IN THE FIELD OF SELF IMPROVEMENT AND SELF IMAGE ENHANCEMENT; BUSINESS COACHING SERVICES; EDUCATION AND ENTERTAINMENT SERVICES, NAMELY, PROVIDING MOTIVATIONAL SPEAKING SERVICES TO IMPROVE THE IMAGE, EFFECTIVENESS AND EFFICIENCY OF INDIVIDUALS AND BUSINESSES; EDUCATIONAL AND ENTERTAINMENT SERVICES, NAMELY, PROVIDING WORKSHOPS, SEMINARS AND KEYNOTE SPEAKING SESSIONS IN THE FIELDS OF BUSINESS DEVELOPMENT, EFFECTIVENESS, EFFICIENCY, SALES DEVELOPMENT, CUSTOMER SERVICE, BUSINESS COMMUNICATIONS AND PRESENTATION SKILLS, IN CLASS 41 (U.S. CLS. 100, 101 AND 107).

FIRST USE 1-31-2010; IN COMMERCE 2-28-2010.

THE MARK CONSISTS OF STANDARD CHARACTERS WITHOUT CLAIM TO ANY PARTICULAR FONT, STYLE, SIZE, OR COLOR.

PRIORITY CLAIMED UNDER SEC. 44(D) ON CANADA APPLICATION NO. 1508217, FILED 12-16-2010, REG. NO. TMA813,407, DATED 12-6-2011, EXPIRES 12-6-2026.

NO CLAIM IS MADE TO THE EXCLUSIVE RIGHT TO USE "COMMUNICATION", APART FROM THE MARK AS SHOWN.

SER. NO. 85-200,518, FILED 12-17-2010.

PRISCILLA MILTON, EXAMINING ATTORNEY



*David J. Kybas*

Director of the United States Patent and Trademark Office



# United States of America

United States Patent and Trademark Office

# COOLOUS

**Reg. No. 4,133,965**

**Registered May 1, 2012**

**Int. Cls.: 9, 18 and 25**

**TRADEMARK**

**PRINCIPAL REGISTER**

COOLOUS INC. (CALIFORNIA CORPORATION)  
3240 SOUTH WHITE RD, PMB169  
SAN JOSE, CA 95148

FOR: ACCESSORIES, NAMELY, PROTECTIVE CASES, CARRYING CASES, ADAPTORS, KEYBOARDS, STANDS AND DOCKING STATIONS, BATTERY CHARGERS FOR THE USE OF PERSONAL ELECTRONIC DEVICES, NAMELY, CELL PHONES, PORTABLE COMPUTERS, PORTABLE DIGITAL STORAGE MEDIA, DIGITAL MEDIA PLAYER, MP3 CONTROLLERS/PLAYERS, CELLULAR HANDSETS, DIGITAL AUDIO AND VIDEO RECORDERS AND PLAYERS, IN CLASS 9 (U.S. CLS. 21, 23, 26, 36 AND 38).

FIRST USE 11-1-2010; IN COMMERCE 11-17-2010.

FOR: BAGS MADE OF TEXTILE, LEATHER OR ARTIFICIAL LEATHER, NAMELY, ALL PURPOSE SPORTS BAGS, ALL PURPOSE CARRYING BAGS, ALL PURPOSE ATHLETIC BAGS, BACKPACKS, BELT BAGS, GARMENT BAGS FOR TRAVEL, MESSENGER BAGS, SHOPPING BAGS, TRAVEL BAGS, AND WALLETS, IN CLASS 18 (U.S. CLS. 1, 2, 3, 22 AND 41).

FIRST USE 4-3-2011; IN COMMERCE 4-3-2011.

FOR: CLOTHING FOR MEN, WOMEN AND CHILDREN, NAMELY, JACKETS, COATS, TROUSERS, SUITS AND VESTS, RAIN JACKETS, PANTS, BATHING SUITS, PULLOVERS, HOODS, JERSEYS, SHIRTS, UNDERWEAR, CAPS, HATS, GLOVES AND SOCKS; FOOTWEAR FOR MEN, WOMEN AND CHILDREN, NAMELY, ATHLETIC SHOES, BEACH SHOES, SANDALS, SLIPPERS AND BOOTS, IN CLASS 25 (U.S. CLS. 22 AND 39).

FIRST USE 4-3-2011; IN COMMERCE 4-3-2011.

THE MARK CONSISTS OF SEVEN LETTERS: "C", "O", "O", "L", "O", "U" AND "S". THE LETTER "C" IS AN INCOMPLETE CIRCLE WITH OPEN AREA AT NORTHEAST DIRECTION.

SER. NO. 85-201,305, FILED 12-18-2010.

SHAUNIA CARLYLE, EXAMINING ATTORNEY



*David J. Kyros*

Director of the United States Patent and Trademark Office

# United States of America

United States Patent and Trademark Office

# MXRS

**Reg. No. 4,133,966**

**Registered May 1, 2012**

**Int. Cl.: 9**

**TRADEMARK**

**PRINCIPAL REGISTER**

MICROSTRAIN, INC. (VERMONT CORPORATION)  
459 HURRICANE LANE, SUITE 102  
WILLISTON, VT 05495

FOR: ELECTRONIC MEASURING DEVICES SOLD INDIVIDUALLY AND AS A UNIT CONSISTING OF DATA LOGGING COMPUTER HARDWARE, TRANSCIEVERS AND SENSORS FOR USE IN MEASURING ACCELERATION, ANGULAR RATE, ATTITUDE, AZIMUTH, CORROSION, DISPLACEMENT, DISTANCE, ELONGATION, FATIGUE, FORCE, HEADING, HUMIDITY, IMPACT, LOAD, MAGNETIC FIELDS, MOISTURE, MOTION, MOVEMENT, ORIENTATION, OSCILLATION, PITCH, POSITION, PRESSURE, ROLL, SEISMIC ACTIVITY, STRAIN, TEMPERATURE, TILT, TORQUE, VIBRATION, WAVE HEIGHT, OR YAW IN WIRELESS SENSOR NETWORKS; ELECTRONIC MEASURING DEVICES CONSISTING OF DATA LOGGING DEVICES COMPRISED OF COMPUTER HARDWARE AND COMPUTER SOFTWARE FOR THE TRANSMISSION, RECEPTION, AND PROCESSING OF WIRELESS AND WIRED SENSOR DATA FOR MEASURING DISPLACEMENTS, DISTANCES, ELONGATIONS, MOVEMENT, ORIENTATION, POSITION, OR STRAIN, TRANSCIEVERS AND SENSORS FOR MEASURING ACCELERATION, ANGULAR RATE, ATTITUDE, AZIMUTH, CORROSION, DISPLACEMENT, DISTANCE, ELONGATION, FATIGUE, FORCE, HEADING, HUMIDITY, IMPACT, LOAD, MAGNETIC FIELDS, MOISTURE, MOTION, MOVEMENT, ORIENTATION, OSCILLATION, PITCH, POSITION, PRESSURE, ROLL, SEISMIC ACTIVITY, STRAIN, TEMPERATURE, TILT, TORQUE, VIBRATION, WAVE HEIGHT, OR YAW FOR USE IN WIRELESS SENSOR NETWORKS; SENSORS FOR MEASURING ACCELERATION, ANGULAR RATE, ATTITUDE, AZIMUTH, CORROSION, DISPLACEMENT, DISTANCE, ELONGATION, FATIGUE, FORCE, HEADING, HUMIDITY, IMPACT, LOAD, MAGNETIC FIELDS, MOISTURE, MOTION, MOVEMENT, ORIENTATION, OSCILLATION, PITCH, POSITION, PRESSURE, ROLL, SEISMIC ACTIVITY, STRAIN, TEMPERATURE, TILT, TORQUE, VIBRATION, WAVE HEIGHT, OR YAW; SYSTEMS COMPRISED OF ELECTRONIC SENSORS AND COMPUTER SOFTWARE FOR SENSING THE EXISTENCE OF DATA, DATA COLLECTION, DATA AGGREGATION, DATA MANAGEMENT, DATA REPORTING, AND RADIO FREQUENCY IDENTIFICATION IN SYNCHRONIZED, AUTONOMOUS OR USER CONTROLLED WIRELESS SENSOR NETWORKS, IN CLASS 9 (U.S. CLS. 21, 23, 26, 36 AND 38).



*David J. Kappas*

Director of the United States Patent and Trademark Office

FIRST USE 12-6-2010; IN COMMERCE 12-6-2010.

THE MARK CONSISTS OF STANDARD CHARACTERS WITHOUT CLAIM TO ANY PARTICULAR FONT, STYLE, SIZE, OR COLOR.

**Reg. No. 4,133,966** SER. NO. 85-204,839, FILED 12-23-2010.

CHRISTINA SOBRAL, EXAMINING ATTORNEY

# United States of America

United States Patent and Trademark Office



**Reg. No. 4,133,967**

**Registered May 1, 2012**

**Int. Cl.: 35**

**SERVICE MARK**

**PRINCIPAL REGISTER**

SUPERB FOOD, INC. (ALABAMA CORPORATION), AKA SUPERB FOOD CORPORATION  
8330 NICHOLS AVENUE EXT.  
FAIRHOPE, AL 36532

FOR: RETAIL GIFT SHOPS, IN CLASS 35 (U.S. CLS. 100, 101 AND 102).

FIRST USE 3-1-2010; IN COMMERCE 3-1-2010.

NO CLAIM IS MADE TO THE EXCLUSIVE RIGHT TO USE "BOUTIQUE", APART FROM THE MARK AS SHOWN.

THE MARK CONSISTS OF THE STYLIZED WORDS "GEEZ LOUISE!" WITH A FLOWER BLOOM AS THE DOT ABOVE THE "I", WITH A STYLIZED UNDERLINING UNDERNEATH WHICH ARE THE STYLIZED WORDS "THE EVERYTHING BOUTIQUE".

SER. NO. 85-205,186, FILED 12-23-2010.

KIM MONINGHOFF, EXAMINING ATTORNEY



*David J. Kybas*

Director of the United States Patent and Trademark Office

# United States of America

United States Patent and Trademark Office

# CX30

**Reg. No. 4,133,968**

**Registered May 1, 2012**

**Int. Cls.: 9, 16, 25, 28  
and 41**

**TRADEMARK**

**SERVICE MARK**

**PRINCIPAL REGISTER**

LES MILLS INTERNATIONAL LIMITED (NEW ZEALAND LIMITED LIABILITY COMPANY)  
22 CENTRE STREET  
AUCKLAND, NEW ZEALAND 1010

FOR: AUDIO AND VIDEO RECORDINGS FEATURING FITNESS AND HEALTH CLUB RELATED PROGRAMS AND AUDIO-VISUAL TEACHING RESOURCES AND AUDIO-VISUAL RECORDINGS, NAMELY, PRE-RECORDED COMPACT DISCS, DIGITAL VIDEO DISCS, CD ROMS AND DIGITAL FILES ALL FEATURING FITNESS AND HEALTH CLUB RELATED PROGRAMS, AUDIO-VISUAL TEACHING RESOURCES AND MUSIC RELATED TO FITNESS PROGRAMS; ELECTRONIC PUBLICATIONS, NAMELY, MAGAZINES, MANUALS, AND NEWSLETTERS FEATURING FITNESS AND HEALTH CLUB RELATED PROGRAMS AND AUDIO-VISUAL TEACHING RESOURCES RECORDED ON COMPUTER MEDIA; PRE-RECORDED CDS AND DVDS FEATURING FITNESS AND HEALTH CLUB RELATED PROGRAMS AND AUDIO-VISUAL TEACHING RESOURCES; DOWNLOADABLE MUSICAL SOUND RECORDINGS, AUDIO-VISUAL PRESENTATIONS AND DOWNLOADABLE ELECTRONIC PUBLICATIONS IN THE NATURE OF TEACHING BOOKLETS AND TEACHING MANUALS IN THE FIELD OF HEALTH AND FITNESS SUPPLIED ONLINE FROM DATABASES, FROM THE INTERNET, INTRANETS OR FROM EXTRANETS; DOWNLOADABLE MULTIMEDIA FILE CONTAINING ARTWORK, TEXT, AUDIO, VIDEO, GAMES, AND INTERNET WEB LINKS RELATING TO EXERCISE-TO-MUSIC PROGRAMS AND RELATED AUDIO-VISUAL TEACHING RESOURCES; DOWNLOADABLE MUSICAL SOUND RECORDINGS; DOWNLOADABLE VIDEO RECORDINGS FEATURING EXERCISE-TO-MUSIC PROGRAMS AND RELATED AUDIO-VISUAL TEACHING RESOURCES, IN CLASS 9 (U.S. CLS. 21, 23, 26, 36 AND 38).



FOR: PRINTED MATTER, NAMELY, BOOKS, BOOKLETS, NEWSLETTERS, MAGAZINES, MANUALS, POSTERS AND POSTCARDS ALL IN RELATION TO FITNESS AND HEALTH CLUB RELATED PROGRAMS AND TRAINING MATERIALS; INSTRUCTIONAL AND TEACHING MATERIALS, NAMELY, BOOKS, BOOKLETS, NEWSLETTERS, MAGAZINES, MANUALS, POSTERS AND POSTCARDS ALL IN RELATION TO THE FITNESS AND HEALTH CLUB RELATED PROGRAMS AND TRAINING MATERIALS; CALENDARS AND PRINTED PAPER BANNERS, IN CLASS 16 (U.S. CLS. 2, 5, 22, 23, 29, 37, 38 AND 50).

*David J. Kyjars*

FOR: CLOTHING, NAMELY, SHIRTS, T-SHIRTS, TANK TOPS AND SINGLETS, JACKETS, JERSEYS, JUMPERS, LEGGINGS, PANTS, SINGLETS, SWEATSHIRTS, TANK TOPS, CROP TOPS, TIGHTS, T-SHIRTS, VESTS, WARM-UP SUITS; FOOTWEAR; HEADGEAR, NAMELY,

**Reg. No. 4,133,968** CAPS, HATS, HEADBANDS, BANDANAS, VISORS, HEAD SCARVES AND BEANIES, IN CLASS 25 (U.S. CLS. 22 AND 39).

FOR: GYMNASTIC AND SPORTING ARTICLES, NAMELY, EXERCISE BANDS, RESISTANCE BANDS, RUBBER TUBING USED TO PROVIDE RESISTANCE DURING EXERCISE, STABILITY BOARDS AND DISCS, STRETCHING STRAPS AND STRETCHING HANDLES, IN CLASS 28 (U.S. CLS. 22, 23, 38 AND 50).

FOR: RECREATION SERVICES IN THE NATURE OF PROVIDING TRAINING AND EDUCATION SERVICES, NAMELY, CLASSES, SEMINARS, PROGRAMS, COURSES, WORKSHOPS AND CONFERENCES IN THE FIELDS OF HEALTH, NUTRITION AND PHYSICAL FITNESS; HEALTH CLUB, AND PHYSICAL FITNESS CLUB SERVICES, NAMELY, PROVIDING INSTRUCTION AND EQUIPMENT IN THE FIELD OF PHYSICAL EXERCISE; EDUCATION SERVICES, NAMELY, PRODUCING AND CONDUCTING PRE-CHOREOGRAPHED GROUP FITNESS EXERCISE CLASSES AND PROVIDING INSTRUCTION AND ADVICE WITH RESPECT TO SUCH GROUP FITNESS EXERCISE CLASSES; EXERCISE INSTRUCTION AND PHYSICAL FITNESS TRAINING SERVICES; PROVIDING INFORMATION AND CONSULTATION IN THE FIELDS OF RECREATION, HEALTH CLUB OPERATIONS, PHYSICAL FITNESS AND EXERCISE, IN CLASS 41 (U.S. CLS. 100, 101 AND 107).

THE MARK CONSISTS OF STANDARD CHARACTERS WITHOUT CLAIM TO ANY PARTICULAR FONT, STYLE, SIZE, OR COLOR.

PRIORITY CLAIMED UNDER SEC. 44(D) ON NEW ZEALAND APPLICATION NO. 835013, FILED 12-17-2010, REG. NO. 835013, DATED 12-17-2010, EXPIRES 12-17-2020.

SER. NO. 85-205,305, FILED 12-23-2010.

TRACY CROSS, EXAMINING ATTORNEY

# United States of America

United States Patent and Trademark Office

# mCAR

**Reg. No. 4,133,969**

**Registered May 1, 2012**

**Int. Cl.: 42**

**SERVICE MARK**

**PRINCIPAL REGISTER**

AEMC TECHNOLOGIES, LLC (ARIZONA LIMITED LIABILITY COMPANY)  
WWW.AEMCTECH.COM  
15827 N 33RD PL  
PHOENIX, AZ 85032

FOR: DEVELOPMENT OF TECHNOLOGIES FOR THE FABRICATION OF CIRCUITS FOR WIRELESS COMMUNICATION, ELECTRONIC DATA PROCESSING, CONSUMER ELECTRONIC, AUTOMOTIVE ELECTRONICS, IN CLASS 42 (U.S. CLS. 100 AND 101).

FIRST USE 12-20-2010; IN COMMERCE 12-20-2010.

THE MARK CONSISTS OF STANDARD CHARACTERS WITHOUT CLAIM TO ANY PARTICULAR FONT, STYLE, SIZE, OR COLOR.

SER. NO. 85-205,676, FILED 12-26-2010.

VERNA BETH RIRIE, EXAMINING ATTORNEY



*David J. Kyffers*

Director of the United States Patent and Trademark Office

# United States of America

United States Patent and Trademark Office

# AQUAMARINE

**Reg. No. 4,133,970**

REVLON CONSUMER PRODUCTS CORPORATION (DELAWARE CORPORATION)  
237 PARK AVENUE  
NEW YORK, NY 10017

**Registered May 1, 2012**

**Int. Cl.: 3**

FOR: NON-MEDICATED SKIN CARE PREPARATIONS, NAMELY, LOTIONS, IN CLASS 3  
(U.S. CLS. 1, 4, 6, 50, 51 AND 52).

**TRADEMARK**

FIRST USE 4-1-1946; IN COMMERCE 4-1-1946.

**PRINCIPAL REGISTER**

THE MARK CONSISTS OF STANDARD CHARACTERS WITHOUT CLAIM TO ANY PARTICULAR FONT, STYLE, SIZE, OR COLOR.

OWNER OF U.S. REG. NOS. 539,769 AND 1,477,290.

SER. NO. 85-206,550, FILED 12-28-2010.

DAWN FELDMAN, EXAMINING ATTORNEY



*David J. Kyros*

Director of the United States Patent and Trademark Office



# United States of America

United States Patent and Trademark Office

  
**LipScapes**

*It's what you put into it.*

**Reg. No. 4,133,971**

ANDERSON-STIMSON, DAWN (UNITED STATES INDIVIDUAL)  
1255 HOLMGROVE DRIVE  
SAN MARCOS, CA 92078

**Registered May 1, 2012**

**Int. Cl.: 18**

FOR: COSMETIC CASES SOLD EMPTY, IN CLASS 18 (U.S. CLS. 1, 2, 3, 22 AND 41).

**TRADEMARK**

FIRST USE 6-19-2010; IN COMMERCE 6-19-2010.

**PRINCIPAL REGISTER**

OWNER OF U.S. REG. NO. 3,926,833.

THE MARK CONSISTS OF THE STYLIZED TEXT "LIPSCAPES IT'S WHAT YOU PUT INTO IT." WITH A LINE IN THE MIDDLE. THERE IS A FLEUR-DE-LIS ON TOP OF THE LETTER "I".

SER. NO. 85-206,728, FILED 12-28-2010.

NELSON SNYDER, EXAMINING ATTORNEY



*David J. Kyffers*

Director of the United States Patent and Trademark Office

# United States of America

United States Patent and Trademark Office

# GTPI

**Reg. No. 4,133,972**

**Registered May 1, 2012**

**Int. Cl.: 44**

**SERVICE MARK**

**PRINCIPAL REGISTER**

HOLSTEIN ASSOCIATION USA, INC. (NEW YORK CORPORATION), DBA HOLSTEIN ASSOCIATION  
1 HOLSTEIN PLACE  
BRATTLEBORO, VT 053020808

FOR: PROVIDING INFORMATION IN THE FIELD OF ANIMAL BREEDING, NAMELY, GENOMIC INFORMATION FOR BREEDING PURPOSES, IN CLASS 44 (U.S. CLS. 100 AND 101).

FIRST USE 11-1-2008; IN COMMERCE 1-1-2009.

THE MARK CONSISTS OF STANDARD CHARACTERS WITHOUT CLAIM TO ANY PARTICULAR FONT, STYLE, SIZE, OR COLOR.

OWNER OF U.S. REG. NO. 3,242,104.

SEC. 2(F).

SER. NO. 85-207,405, FILED 12-29-2010.

EUGENIA MARTIN, EXAMINING ATTORNEY



*David J. Kybas*

Director of the United States Patent and Trademark Office

# United States of America

United States Patent and Trademark Office

## HIGHWAY ANGEL

**Reg. No. 4,133,973**

**Registered May 1, 2012**

**Int. Cl.: 41**

**SERVICE MARK**

**PRINCIPAL REGISTER**

TRUCKLOAD CARRIERS ASSOCIATIONS (D.C. NOT FOR PROFIT CORPORATION)  
555 E. BRADDOCK RD.  
ALEXANDRIA, VA 22314

FOR: ORGANIZING AND PROVIDING AN AWARDS PROGRAM TO RECOGNIZE AND HONOR TRUCK DRIVERS WHO ARE NOTED FOR THEIR ACTS OF KINDNESS ON THE HIGHWAYS , IN CLASS 41 (U.S. CLS. 100, 101 AND 107).

FIRST USE 7-1-1997; IN COMMERCE 7-1-1997.

THE MARK CONSISTS OF STANDARD CHARACTERS WITHOUT CLAIM TO ANY PARTICULAR FONT, STYLE, SIZE, OR COLOR.

NO CLAIM IS MADE TO THE EXCLUSIVE RIGHT TO USE "HIGHWAY", APART FROM THE MARK AS SHOWN.

SER. NO. 85-207,960, FILED 12-30-2010.

SHAUNIA CARLYLE, EXAMINING ATTORNEY



*David J. Kybas*

Director of the United States Patent and Trademark Office

# United States of America

United States Patent and Trademark Office



**Reg. No. 4,133,974**

**Registered May 1, 2012**

**Int. Cl.: 41**

**SERVICE MARK**

**PRINCIPAL REGISTER**

TRUCKLOAD CARRIERS ASSOCIATIONS (D.C. NOT FOR PROFIT CORPORATION)  
555 E. BRADDOCK RD.  
ALEXANDRIA, VA 22314

FOR: ORGANIZING AND PROVIDING AN AWARDS PROGRAM TO RECOGNIZE AND HONOR TRUCK DRIVERS WHO ARE NOTED FOR THEIR ACTS OF KINDNESS ON THE HIGHWAYS, IN CLASS 41 (U.S. CLS. 100, 101 AND 107).

FIRST USE 7-18-2008; IN COMMERCE 7-18-2008.

OWNER OF U.S. REG. NO. 3,582,496.

NO CLAIM IS MADE TO THE EXCLUSIVE RIGHT TO USE "HIGHWAY", APART FROM THE MARK AS SHOWN.

THE MARK CONSISTS OF TWO PARTIAL CONCENTRIC CIRCLES CONTAINING THE WORD "HIGHWAY" ARCHING OVER A SEMI TRUCK, WHICH HAS THE LETTERS "TCA" IN THE LOCATION OF THE LICENSE PLATE. THE SEMI TRUCK HAS A STAR TO ITS LEFT AND RIGHT WITHIN THE CONCENTRIC CIRCLES. BELOW THIS DEPICTION IS THE WORD "ANGEL" IN A RIBBON.

SER. NO. 85-207,986, FILED 12-30-2010.

SHAUNIA CARLYLE, EXAMINING ATTORNEY



*David J. Kyjars*

Director of the United States Patent and Trademark Office

# United States of America

United States Patent and Trademark Office

## Very personal banking

**Reg. No. 4,133,975**

**Registered May 1, 2012**

**Int. Cl.: 36**

**SERVICE MARK**

**PRINCIPAL REGISTER**

COMMUNITY WEST BANK (UNITED STATES NATIONAL BANKING ASSOCIATION)  
445 PINE AVENUE, GOLETA, CA 93117  
445 PINE AVENUE  
GOLETA, CA 93117

FOR: ATM BANKING SERVICES; BANKING; BANKING AND FINANCING SERVICES; BANKING CONSULTATION; BANKING SERVICES; BANKING SERVICES FEATURING THE PROVISION OF CERTIFICATES OF DEPOSIT; BANKING SERVICES PROVIDED BY MOBILE TELEPHONE CONNECTIONS; ELECTRONIC BANKING VIA A GLOBAL COMPUTER NETWORK; FINANCIAL SERVICES, NAMELY, FUNDING ONLINE CASH ACCOUNTS FROM PREPAID CASH CARDS, BANK ACCOUNTS AND CREDIT CARD ACCOUNTS; HOME BANKING; INVESTMENT BANKING SERVICES; INVESTMENT BANKING SERVICES IN THE FIELD OF EMPLOYEE STOCK OWNERSHIP PLANS (ESOP); ISSUANCE OF BANK CHECKS; ISSUING OF BANK CHEQUES; MERCHANT BANKING AND INVESTMENT BANKING SERVICES; MERCHANT BANKING SERVICES; MORTGAGE BANKING; MORTGAGE BANKING SERVICES, NAMELY, ORIGINATION, ACQUISITION, SERVICING, SECURITIZATION AND BROKERAGE OF MORTGAGE LOANS; MORTGAGE SERVICES, NAMELY, BUYER PRE-QUALIFICATION OF MORTGAGES FOR MORTGAGE BROKERS AND BANKS; ON-LINE BANKING SERVICES; PROVIDING BANK ACCOUNT INFORMATION BY TELEPHONE; SAVINGS BANK SERVICES; SAVINGS BANKS; TELEPHONE BANKING SERVICES, IN CLASS 36 (U.S. CLS. 100, 101 AND 102).

FIRST USE 1-1-2011; IN COMMERCE 1-1-2011.

THE MARK CONSISTS OF STANDARD CHARACTERS WITHOUT CLAIM TO ANY PARTICULAR FONT, STYLE, SIZE, OR COLOR.

NO CLAIM IS MADE TO THE EXCLUSIVE RIGHT TO USE "BANKING", APART FROM THE MARK AS SHOWN.

SER. NO. 85-209,488, FILED 1-3-2011.

COLLEEN KEARNEY, EXAMINING ATTORNEY



*David J. Kyffers*

Director of the United States Patent and Trademark Office

# United States of America

United States Patent and Trademark Office

# shur farms

**Reg. No. 4,133,976**

**Registered May 1, 2012**

**Int. Cl.: 7**

**TRADEMARK**

**PRINCIPAL REGISTER**

RECOVERY P.T. CORPORATION (CALIFORNIA CORPORATION)  
1890 N. 8TH ST.  
COLTON, CA 92324

FOR: AGRICULTURAL MACHINES, NAMELY, FROST PROTECTORS, IN CLASS 7 (U.S. CLS. 13, 19, 21, 23, 31, 34 AND 35).

FIRST USE 10-10-2002; IN COMMERCE 10-10-2002.

THE MARK CONSISTS OF STANDARD CHARACTERS WITHOUT CLAIM TO ANY PARTICULAR FONT, STYLE, SIZE, OR COLOR.

NO CLAIM IS MADE TO THE EXCLUSIVE RIGHT TO USE "FARMS", APART FROM THE MARK AS SHOWN.

SER. NO. 85-210,496, FILED 1-4-2011.

LESLIE RICHARDS, EXAMINING ATTORNEY



*David J. Kyffers*

Director of the United States Patent and Trademark Office

# United States of America

United States Patent and Trademark Office

# EXPLOSIVE SAVINGS

**Reg. No. 4,133,977**

ELECTRONICS EXPO LLC (NEW JERSEY LIMITED LIABILITY COMPANY)  
70 DEMAREST AVENUE  
WAYNE, NJ 07470

**Registered May 1, 2012**

**Int. Cl.: 35**

FOR: ONLINE RETAIL STORE SERVICES IN THE FIELD OF CONSUMER ELECTRONICS,  
IN CLASS 35 (U.S. CLS. 100, 101 AND 102).

**SERVICE MARK**

FIRST USE 10-19-2010; IN COMMERCE 10-19-2010.

**PRINCIPAL REGISTER**

NO CLAIM IS MADE TO THE EXCLUSIVE RIGHT TO USE "SAVINGS", APART FROM  
THE MARK AS SHOWN.

THE MARK CONSISTS OF THE WORDING "EXPLOSIVE SAVINGS" WITH THE LETTER  
"X" ENLARGED.

SER. NO. 85-210,852, FILED 1-5-2011.

REGINA DRUMMOND, EXAMINING ATTORNEY



*David J. Kyros*

Director of the United States Patent and Trademark Office

# United States of America

United States Patent and Trademark Office



**Reg. No. 4,133,978**

**Registered May 1, 2012**

**Int. Cl.: 12**

**TRADEMARK**

**PRINCIPAL REGISTER**

ZANINI AUTO GRUP, S.A. (SPAIN CORPORATION)  
MARINETA, 2-5, POL. INDUSTRIAL LLEVANT  
PARETS DEL VALLES  
BARCELONA, SPAIN 08150

FOR: AUTOMOBILES, VEHICLES, NAMELY, LAND VEHICLES; AUTOMOBILE PARTS, NAMELY, WHEEL HUBS, WHEEL COVERS FOR VEHICLES, WHEEL RIMS, TIRES AND BUMPERS, IN CLASS 12 (U.S. CLS. 19, 21, 23, 31, 35 AND 44).

OWNER OF SPAIN REG. NO. 2.226.171, DATED 11-5-1999, EXPIRES 4-9-2019.

OWNER OF U.S. REG. NO. 2,914,485.

THE MARK CONSISTS OF THE WORDING "Z ZANINI" IN STYLIZED LETTERING; THE LETTER "Z" IS INSIDE A CIRCLE.

SER. NO. 85-211,200, FILED 1-5-2011.

ADA HAN, EXAMINING ATTORNEY



*David J. Kyffers*

Director of the United States Patent and Trademark Office



# United States of America

United States Patent and Trademark Office

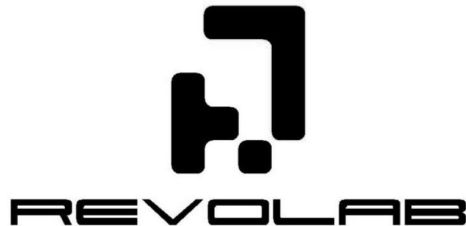

**Reg. No. 4,133,979**

**Registered May 1, 2012**

**Int. Cl.: 12**

**TRADEMARK**

**PRINCIPAL REGISTER**

TIEN HSIN INDUSTRIES CO., LTD. (TAIWAN LIMITED LIABILITY COMPANY)  
NO.6, WU-GONG 8TH RD., WUFENG DISTRICT  
TAICHUNG, TAIWAN 41353

FOR: BICYCLE PARTS, NAMELY, FRONT DERAILLEUR, GEAR SHIFT LEVERS, GEAR LEVERS, REAR DERAILLEUR; BICYCLE PARTS, NAMELY, HEAD PARTS FOR FRAME-FORK ASSEMBLY; BICYCLE HANDLE BARS; BICYCLE HANDLE BAR STEM; BICYCLE SADDLES; BICYCLE SEAT POSTS; BICYCLE BRAKES; BICYCLE CHAINS; BICYCLE PEDALS; BICYCLE CRANK; BICYCLE PARTS, NAMELY, GEAR WHEELS, AND CHAIN RINGS; BICYCLE RIMS; BICYCLE PARTS, NAMELY, RIMS FOR WHEELS OF BICYCLES; BICYCLE SPOKES; HUBS; FREEWHEELS; BICYCLE PUMPS, IN CLASS 12 (U.S. CLS. 19, 21, 23, 31, 35 AND 44).

PRIORITY CLAIMED UNDER SEC. 44(D) ON TAIWAN APPLICATION NO. 099062297, FILED 12-13-2010, REG. NO. 01476530, DATED 10-1-2011, EXPIRES 10-1-2021.

THE MARK CONSISTS OF A PART OF DESIGNS AND A PART OF STYLIZED WORD. IN THE DESIGN PART WHICH COMPOSED BY TWO GEOMETRIES AND A STYLIZED WORD, AT THE TOP RIGHT CORNER OF THIS GEOMETRY IS AN UPSIDE DOWN "L" AND AT THE LOWER LEFT CORNER OF THIS GEOMETRY IS A SMALL LETTER "R" AND A DOT. AT FIRST GLANCE OF THIS DESIGN, IT LOOKS LIKE A LETTER "R". UNDER THIS COMPOSING GEOMETRY IS A SPECIAL FONT WORD "REVOLAB".

SER. NO. 85-211,268, FILED 1-5-2011.

STEVEN JACKSON, EXAMINING ATTORNEY



*David J. Kybas*

Director of the United States Patent and Trademark Office

# United States of America

United States Patent and Trademark Office

# NATURENES

**Reg. No. 4,133,980**

**Registered May 1, 2012**

**Int. Cl.: 32**

**TRADEMARK**

**PRINCIPAL REGISTER**

SOCIÉTÉ DES PRODUITS NESTLÉ S.A. (SWITZERLAND SOCIÉTÉ ANONYME (SA))  
CASE POSTALE 353  
1800 VEVEY, SWITZERLAND

FOR: FRUIT-FLAVORED BEVERAGES AND BEVERAGES MADE WITH FRUIT, FRUIT JUICES, VEGETABLE JUICES, FRUIT AND VEGETABLE JUICES; NECTARS, FRUIT NECTAR BEVERAGES, LEMONADES, AND SODAS; SYRUPS, EXTRACTS AND ESSENCES FOR MAKING NON-ALCOHOLIC BEVERAGES, EXCEPTING ESSENTIAL OILS; WATER-BASED BEVERAGES WITH TEA EXTRACTS; MALT-BASED NON-ALCOHOLIC BEVERAGES; STILL WATER, SPARKLING WATERS, CARBONATED WATERS, SPRING WATERS, MINERAL AND TABLE WATERS, FLAVORED WATERS, IN CLASS 32 (U.S. CLS. 45, 46 AND 48).

THE MARK CONSISTS OF STANDARD CHARACTERS WITHOUT CLAIM TO ANY PARTICULAR FONT, STYLE, SIZE, OR COLOR.

PRIORITY CLAIMED UNDER SEC. 44(D) ON SWITZERLAND APPLICATION NO. 57055/2010, FILED 7-9-2010, REG. NO. 603132, DATED 7-9-2010, EXPIRES 7-9-2020.

OWNER OF U.S. REG. NO. 3,487,545.

SER. NO. 85-211,628, FILED 1-6-2011.

THOMAS MANOR, EXAMINING ATTORNEY



*David J. Kyros*

Director of the United States Patent and Trademark Office

# United States of America

United States Patent and Trademark Office

## HOPSCOTCH KIDS

**Reg. No. 4,133,981**

**Registered May 1, 2012**

**Int. Cl.: 3**

**TRADEMARK**

**PRINCIPAL REGISTER**

LILA NATURAL COSMETICS INC. (DELAWARE CORPORATION)  
3410 N. 45TH PLACE  
PHOENIX, AZ 85018

FOR: COSMETICS, IN CLASS 3 (U.S. CLS. 1, 4, 6, 50, 51 AND 52).

FIRST USE 8-14-2009; IN COMMERCE 9-17-2009.

THE MARK CONSISTS OF STANDARD CHARACTERS WITHOUT CLAIM TO ANY PARTICULAR FONT, STYLE, SIZE, OR COLOR.

NO CLAIM IS MADE TO THE EXCLUSIVE RIGHT TO USE "KIDS", APART FROM THE MARK AS SHOWN.

SER. NO. 85-212,120, FILED 1-6-2011.

VERNA BETH RIRIE, EXAMINING ATTORNEY



*David J. Kyffers*

Director of the United States Patent and Trademark Office

# United States of America

United States Patent and Trademark Office

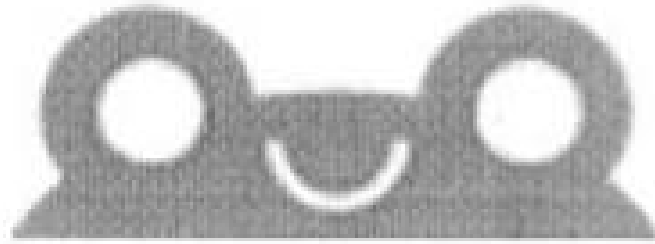

**Reg. No. 4,133,982**

**Registered May 1, 2012**

**Int. Cl.: 3**

**TRADEMARK**

**PRINCIPAL REGISTER**

LILA NATURAL COSMETICS INC. (DELAWARE CORPORATION)  
3410 N. 45TH PLACE  
PHOENIX, AZ 85018

FOR: COSMETICS, IN CLASS 3 (U.S. CLS. 1, 4, 6, 50, 51 AND 52).

FIRST USE 8-14-2009; IN COMMERCE 9-17-2009.

THE MARK CONSISTS OF A RENDITION OF A FROG'S FACE.

SER. NO. 85-212,269, FILED 1-6-2011.

VERNA BETH RIRIE, EXAMINING ATTORNEY



*David J. Kyffers*

Director of the United States Patent and Trademark Office

# United States of America

United States Patent and Trademark Office

## Small Town Integrity, World Class Service

**Reg. No. 4,133,983**

**Registered May 1, 2012**

**Int. Cl.: 39**

**SERVICE MARK**

**PRINCIPAL REGISTER**

COLUMBIA COLSTOR, INC. (WASHINGTON CORPORATION)  
2730 W. MARINA DRIVE  
MOSES LAKE, WA 98837

FOR: TRANSPORTATION OF GOODS BY RAILCAR AND TRUCK; STORAGE OF REFRIGERATED AND FROZEN FOOD; DELIVERY OF REFRIGERATED AND FROZEN FOOD AND RELATED PRODUCTS BY MEANS OF RAILCAR AND TRUCK, IN CLASS 39 (U.S. CLS. 100 AND 105).

FIRST USE 10-31-1983; IN COMMERCE 10-31-1983.

THE MARK CONSISTS OF STANDARD CHARACTERS WITHOUT CLAIM TO ANY PARTICULAR FONT, STYLE, SIZE, OR COLOR.

SER. NO. 85-212,366, FILED 1-6-2011.

ANDREW RHIM, EXAMINING ATTORNEY



*David J. Kyffers*

Director of the United States Patent and Trademark Office

# United States of America

United States Patent and Trademark Office

# MI AMORE

**Reg. No. 4,133,984**

**Registered May 1, 2012**

**Int. Cl.: 33**

**TRADEMARK**

**PRINCIPAL REGISTER**

ARCADIA IMPORTS LLC (CONNECTICUT LIMITED LIABILITY COMPANY)  
3 RIDGEWOOD ROAD  
BURLINGTON, CT 06013

FOR: WINE, IN CLASS 33 (U.S. CLS. 47 AND 49).

FIRST USE 5-1-2007; IN COMMERCE 5-1-2007.

THE MARK CONSISTS OF STANDARD CHARACTERS WITHOUT CLAIM TO ANY PARTICULAR FONT, STYLE, SIZE, OR COLOR.

THE ENGLISH TRANSLATION OF "MI AMORE" IN THE MARK IS "MY LOVE".

SER. NO. 85-214,130, FILED 1-10-2011.

STEVEN JACKSON, EXAMINING ATTORNEY



*David J. Kybas*

Director of the United States Patent and Trademark Office

# United States of America

United States Patent and Trademark Office

## PETER CHRISTIAN'S

**Reg. No. 4,133,985**

**Registered May 1, 2012**

**Int. Cl.: 43**

**SERVICE MARK**

**PRINCIPAL REGISTER**

PETER CHRISTIAN'S SPECIALTY FOOD AND GIFTS, LLC (NEW HAMPSHIRE LIMITED LIABILITY COMPANY)  
11 ABBOTTVILLE ROAD  
CONCORD, NH 03301

FOR: PROVISION OF FOOD AND DRINK IN RESTAURANTS; RESTAURANT SERVICES FEATURING TAVERN FARE, IN CLASS 43 (U.S. CLS. 100 AND 101).

FIRST USE 7-2-1973; IN COMMERCE 7-2-1973.

THE MARK CONSISTS OF STANDARD CHARACTERS WITHOUT CLAIM TO ANY PARTICULAR FONT, STYLE, SIZE, OR COLOR.

THE NAME(S), PORTRAIT(S), AND/OR SIGNATURE(S) SHOWN IN THE MARK IDENTIFIES PETER CHRISTIAN WASHBURN, WHOSE CONSENT(S) TO REGISTER IS MADE OF RECORD.

SER. NO. 85-214,650, FILED 1-11-2011.

RON FAIRBANKS, EXAMINING ATTORNEY



*David J. Kybas*

Director of the United States Patent and Trademark Office

# United States of America

United States Patent and Trademark Office

# jus d'amour

**Reg. No. 4,133,986**

**Registered May 1, 2012**

**Int. Cl.: 3**

**TRADEMARK**

**PRINCIPAL REGISTER**

MERCEDES GANON (UNITED STATES INDIVIDUAL)  
13420 MAGNOLIA BLVD  
SHERMAN OAKS, CA 91423

FOR: BODY BUTTER; BODY LOTION; BODY LOTIONS; COLOGNES, PERFUMES AND COSMETICS; COSMETIC CREAMS FOR SKIN CARE; COSMETIC PREPARATIONS FOR SKIN CARE; COSMETICS IN GENERAL, INCLUDING PERFUMES; EAU DE PARFUM; EAU DE PERFUME; LIQUID PERFUMES; MOISTURIZING PREPARATIONS FOR THE SKIN; MOISTURIZING SOLUTIONS FOR THE SKIN; NON-MEDICATED SKIN CARE PREPARATIONS; NON-MEDICATED SKIN CREAMS; PERFUME; PERFUME OILS; PERFUMED CREAMS; PERFUMED POWDER; PERFUMED POWDERS; PERFUMES; SKIN CARE PRODUCTS, NAMELY, NON-MEDICATED SKIN SERUM, IN CLASS 3 (U.S. CLS. 1, 4, 6, 50, 51 AND 52).

FIRST USE 1-31-2006; IN COMMERCE 1-31-2010.

THE MARK CONSISTS OF STANDARD CHARACTERS WITHOUT CLAIM TO ANY PARTICULAR FONT, STYLE, SIZE, OR COLOR.

OWNER OF U.S. REG. NO. 3,369,853.

THE NAME(S), PORTRAIT(S), AND/OR SIGNATURE(S) SHOWN IN THE MARK DOES NOT IDENTIFY A PARTICULAR LIVING INDIVIDUAL.

THE ENGLISH TRANSLATION OF "JUS D'AMOUR" IN THE MARK IS "LOVE JUICE".

SER. NO. 85-215,510, FILED 1-12-2011.

ROBERT C. CLARK JR., EXAMINING ATTORNEY



*David J. Kyros*

Director of the United States Patent and Trademark Office



# United States of America

United States Patent and Trademark Office

# Penn Color

**Reg. No. 4,133,987**

**Registered May 1, 2012**

**Int. Cl.: 2**

**TRADEMARK**

**PRINCIPAL REGISTER**

PENN COLOR INC. (PENNSYLVANIA CORPORATION)  
400 OLD DUBLIN PIKE  
DOYLESTOWN, PA 18901

FOR: COLOR CONCENTRATES AND PIGMENT DISPERSIONS FOR THE COLORATION OF PRINTING INKS, COATINGS, AND THERMOPLASTIC RESINS, IN CLASS 2 (U.S. CLS. 6, 11 AND 16).

FIRST USE 12-31-1972; IN COMMERCE 12-31-1972.

THE MARK CONSISTS OF STANDARD CHARACTERS WITHOUT CLAIM TO ANY PARTICULAR FONT, STYLE, SIZE, OR COLOR.

OWNER OF U.S. REG. NO. 3,293,914.

NO CLAIM IS MADE TO THE EXCLUSIVE RIGHT TO USE "COLOR", APART FROM THE MARK AS SHOWN.

SEC. 2(F).

SER. NO. 85-218,783, FILED 1-16-2011.

CORY BOONE, EXAMINING ATTORNEY



*David J. Kyffers*

Director of the United States Patent and Trademark Office

# United States of America

United States Patent and Trademark Office



**Reg. No. 4,133,988**

**Registered May 1, 2012**

**Int. Cl.: 6**

**TRADEMARK**

**PRINCIPAL REGISTER**

KVA, INC. (NEVADA CORPORATION)  
124 S. MARKET PLACE  
SUITE 200  
ESCONDIDO, CA 92029

FOR: METAL PIPES AND TUBES; METAL TUBES; METAL TUBES FOR INDUSTRIAL USE; METAL TUBING; METALLIC PIPES AND TUBES; PIPE TUBES OF METAL; PIPES AND TUBES OF METAL; TUBES OF METAL; TUBES OF STAINLESS STEEL, IN CLASS 6 (U.S. CLS. 2, 12, 13, 14, 23, 25 AND 50).

FIRST USE 1-1-2000; IN COMMERCE 2-1-2000.

NO CLAIM IS MADE TO THE EXCLUSIVE RIGHT TO USE "STAINLESS", APART FROM THE MARK AS SHOWN.

THE COLOR(S) RED, ORANGE, YELLOW, BLACK, GRAY AND WHITE IS/ARE CLAIMED AS A FEATURE OF THE MARK.

THE MARK CONSISTS OF THE LETTERS "KVA" IN BLACK, GRAY AND WHITE, AGAINST A RECTANGULAR BACKGROUND OF RED, ORANGE AND YELLOW, ABOVE THE WORD "STAINLESS" IN BLACK.

SER. NO. 85-221,955, FILED 1-20-2011.

TIMOTHY FINNEGAN, EXAMINING ATTORNEY



*David J. Kybas*

Director of the United States Patent and Trademark Office

# United States of America

United States Patent and Trademark Office

## STEELTON TOOLS

**Reg. No. 4,133,989**

**Registered May 1, 2012**

**Int. Cls.: 7 and 8**

**TRADEMARK**

**PRINCIPAL REGISTER**

OLLIE'S BARGAIN OUTLET, INC. (PENNSYLVANIA CORPORATION)  
SUITE A  
6295 ALLENTOWN BOULEVARD  
HARRISBURG, PA 17112

FOR: ACCESSORIES FOR POWER TOOLS, NAMELY, BITS FOR POWER DRILLS, BLADES FOR POWER SAWS AND PADS FOR POWER SANDERS, IN CLASS 7 (U.S. CLS. 13, 19, 21, 23, 31, 34 AND 35).

FIRST USE 12-1-2003; IN COMMERCE 1-1-2004.

FOR: HAND TOOLS, NAMELY, HAND DRILLS AND BITS THEREFOR, CHISELS, CLAMPS, FILES, HAMMERS, PLANES, PLIERS, SAWS, SCREWDRIVERS, SOCKETS, SQUARES, VISES AND WRENCHES, IN CLASS 8 (U.S. CLS. 23, 28 AND 44).

FIRST USE 12-1-2003; IN COMMERCE 1-1-2004.

THE MARK CONSISTS OF STANDARD CHARACTERS WITHOUT CLAIM TO ANY PARTICULAR FONT, STYLE, SIZE, OR COLOR.

OWNER OF U.S. REG. NO. 3,056,652.

NO CLAIM IS MADE TO THE EXCLUSIVE RIGHT TO USE "TOOLS", APART FROM THE MARK AS SHOWN.

SEC. 2(F).

SER. NO. 85-222,113, FILED 1-20-2011.

KRISTINA MORRIS, EXAMINING ATTORNEY



*David J. Kybas*

Director of the United States Patent and Trademark Office

# United States of America

United States Patent and Trademark Office

# LAT56°

**Reg. No. 4,133,990**

**Registered May 1, 2012**

**Int. Cls.: 9 and 18**

**TRADEMARK**

**PRINCIPAL REGISTER**

LATITUDE 56 DEGREES LIMITED (UNITED KINGDOM PRIVATE LIMITED COMPANY)  
SUITE 314, 4TH FLOOR CENTRAL CHAMBERS  
93 HOPE STREET  
GLASGOW, UNITED KINGDOM G26LD

FOR: LAPTOP CASES AND BAGS, CASES FOR PORTABLE COMPUTERS, BACKPACKS FOR PORTABLE COMPUTERS, SUNGLASSES, SUNGLASSES CASES, IN CLASS 9 (U.S. CLS. 21, 23, 26, 36 AND 38).

FOR: LEATHER AND IMITATIONS OF LEATHER; ANIMAL SKINS, HIDES; TRUNKS; LUGGAGE, LUGGAGE BAGS WITH ROLLERS; GARMENT CARRIERS FOR TRAVEL, PROTECTIVE GARMENT BAGS FOR TRAVEL; BACKPACKS, MESSENGER BAGS, DUFFLE BAGS; TRAVELLING BAGS, RUCKSACKS, SUITCASES, TRAVELLING TRUNKS; TOTE BAGS, HANDBAGS, PURSES; BRIEFCASES, PORTFOLIO CASES, NAMELY, BRIEFCASE-TYPE PORTFOLIOS; ATTACHÉ CASES; WALLETS; SHOULDER BAGS; LUGGAGE TAGS; LUGGAGE STRAPS; SHOE CASES, NAMELY, SHOE BAGS FOR TRAVEL; ALL PURPOSE SPORTS BAGS; UMBRELLAS; PARASOLS AND WALKING STICKS; WHIPS, HARNESS AND SADDLERY, IN CLASS 18 (U.S. CLS. 1, 2, 3, 22 AND 41).

PRIORITY CLAIMED UNDER SEC. 44(D) ON ERPN CMNTY TM OFC APPLICATION NO. 009671124, FILED 1-19-2011, REG. NO. 009671124, DATED 5-27-2011, EXPIRES 5-27-2021.

THE MARK CONSISTS OF THE FANCIFUL PHRASE "LAT56" WITH A DEGREE SYMBOL AFTER THE NUMBER "6".

SER. NO. 85-222,644, FILED 1-20-2011.

NATALIE POLZER, EXAMINING ATTORNEY



*David J. Kybas*

Director of the United States Patent and Trademark Office

# United States of America

United States Patent and Trademark Office

## PHI THETA KAPPA

**Reg. No. 4,133,991**

**Registered May 1, 2012**

**Int. Cl.: 25**

**TRADEMARK**

**PRINCIPAL REGISTER**

PHI THETA KAPPA (MISSISSIPPI CORPORATION), AKA PHI THETA KAPPA  
INTERNATIONAL HONOR SOCIETY  
1625 EASTOVER DRIVE  
JACKSON, MS 39211

FOR: ATHLETIC APPAREL, NAMELY, SHIRTS, PANTS, JACKETS, FOOTWEAR, HATS  
AND CAPS, ATHLETIC UNIFORMS, IN CLASS 25 (U.S. CLS. 22 AND 39).

FIRST USE 1-0-1918; IN COMMERCE 1-0-1918.

THE MARK CONSISTS OF STANDARD CHARACTERS WITHOUT CLAIM TO ANY PAR-  
TICULAR FONT, STYLE, SIZE, OR COLOR.

OWNER OF U.S. REG. NOS. 1,837,832, 1,844,370 AND OTHERS.

THE WORDING "PHI THETA KAPPA" HAS NO MEANING IN A FOREIGN LANGUAGE.

SER. NO. 85-222,973, FILED 1-21-2011.

ROBIN MITTLER, EXAMINING ATTORNEY



*David J. Kyros*

Director of the United States Patent and Trademark Office

# United States of America

United States Patent and Trademark Office



**Reg. No. 4,133,992**

**Registered May 1, 2012**

**Int. Cl.: 35**

**SERVICE MARK**

**PRINCIPAL REGISTER**

RUSSIAN AMERICAN DENTAL ASSOCIATION, INC. (NEW YORK CORPORATION)  
SUITE 1520  
115 EAST 57TH STREET  
NEW YORK, NY 10022

FOR: ASSOCIATION SERVICES, NAMELY, PROMOTING THE INTERESTS OF THE DENTAL INDUSTRY, IN CLASS 35 (U.S. CLS. 100, 101 AND 102).

FIRST USE 8-1-2002; IN COMMERCE 8-1-2002.

NO CLAIM IS MADE TO THE EXCLUSIVE RIGHT TO USE "RUSSIAN AMERICAN DENTAL ASSOCIATION", APART FROM THE MARK AS SHOWN.

THE COLOR(S) RED, WHITE AND BLUE IS/ARE CLAIMED AS A FEATURE OF THE MARK.

THE MARK CONSISTS OF A WHITE RECTANGLE WITH A BORDER OF VARIOUS SIZED RECTANGLES OF VARYING SHADES OF BLUE AND WITH THE INNER OUTLINE IN RED. THE WHITE RECTANGLE CONTAINS RED LETTERING FOR "RUSSIAN" AND "ASSOCIATION", BLUE LETTERING FOR "AMERICAN" AND "DENTAL" AND WHITE LETTERS "RADA" ON A BACKGROUND CONSISTING OF A BLUE RECTANGLE AND RED RECTANGLE.

SER. NO. 85-224,229, FILED 1-24-2011.

ESTHER A. BORSUK, EXAMINING ATTORNEY



*David J. Kyros*

Director of the United States Patent and Trademark Office

# United States of America

United States Patent and Trademark Office

**breeze ever**

**Reg. No. 4,133,993**

**Registered May 1, 2012**

**Int. Cl.: 25**

**TRADEMARK**

**PRINCIPAL REGISTER**

BREEZE EVER (CALIFORNIA CORPORATION)  
UNIT 220  
1458 S. SAN PEDRO STREET  
LOS ANGELES, CA 90015

FOR: BELTS; BLOUSES; COATS; DRESSES; HATS; JACKETS; PANTS; SHOES; SOCKS;  
STOCKINGS; SWEATERS; TOPS, IN CLASS 25 (U.S. CLS. 22 AND 39).

FIRST USE 3-15-1999; IN COMMERCE 4-15-1999.

OWNER OF U.S. REG. NOS. 3,710,808 AND 3,802,321.

THE COLOR(S) DARK-GREEN, LIGHT-GREEN, AND BROWN IS/ARE CLAIMED AS A  
FEATURE OF THE MARK.

THE MARK CONSISTS OF THE STYLIZED WORDING "BREEZE EVER" DEPICTED WITH  
A DARK-GREEN LOWERCASE "B" WITH THE BOTTOM RIGHT SLIGHTLY CUT, TWO  
GREEN TO LIGHT-GREEN LEAVES AND BROWN BRANCHES TO REPRESENT THE TWO  
"R"'S, FOUR SLIGHTLY ANGLED DARK-GREEN "E"'S, A DARK-GREEN "Z" WITH A  
ELONGATED BOTTOM LINE, A ROTATED DARK-GREEN "E" THAT STARTS "EVER"  
AND LOOKS THE SAME AS THE OTHER "E"'S, AND A DARK-GREEN "V" THAT LOOKS  
SLIGHTLY LIKE A CHECK WITH AN ADDED LINE TO THE RIGHT.

SER. NO. 85-226,062, FILED 1-25-2011.

BRIDGETT SMITH, EXAMINING ATTORNEY



*David J. Kyros*

Director of the United States Patent and Trademark Office

# United States of America

United States Patent and Trademark Office

## The SheArt Network

**Reg. No. 4,133,994**

**Registered May 1, 2012**

**Int. Cls.: 25 and 35**

**TRADEMARK**

**SERVICE MARK**

**PRINCIPAL REGISTER**

THE SHEART NETWORK, INC. (MASSACHUSETTS CORPORATION)  
1074 DERRY WOODS DRIVE  
HUMMELSTOWN, PA 17036

FOR: T-SHIRTS, IN CLASS 25 (U.S. CLS. 22 AND 39).

FIRST USE 12-6-2008; IN COMMERCE 12-6-2008.

FOR: ASSOCIATION SERVICES, NAMELY, PROMOTING THE INTERESTS OF WOMEN ARTISTS AND ARTISANS, IN CLASS 35 (U.S. CLS. 100, 101 AND 102).

FIRST USE 3-23-2007; IN COMMERCE 5-2-2008.

THE MARK CONSISTS OF STANDARD CHARACTERS WITHOUT CLAIM TO ANY PARTICULAR FONT, STYLE, SIZE, OR COLOR.

NO CLAIM IS MADE TO THE EXCLUSIVE RIGHT TO USE "NETWORK", APART FROM THE MARK AS SHOWN.

SER. NO. 85-226,427, FILED 1-26-2011.

BRENDAN REGAN, EXAMINING ATTORNEY



*David J. Kybas*

Director of the United States Patent and Trademark Office



# United States of America

United States Patent and Trademark Office



# ACCOR

## Académie

**Reg. No. 4,133,995**

ACCOR (FRANCE SOCIÉTÉ ANONYME (SA))  
110 AVENUE DE FRANCE  
75013 PARIS, FRANCE

**Registered May 1, 2012**

**Int. Cls.: 9, 16, 38 and 41**

FOR: CD-ROMS FOR EDUCATIONAL PURPOSES, NAMELY, MULTIMEDIA SOFTWARE RECORDED ON CD-ROMS IN THE FIELD OF HOSPITALITY AND TRAVEL; PRE-RECORDED COMPUTER HARD DISCS, OPTICAL AND DIGITAL VIDEO DISCS, AUDIO CASSETTES, COMPACT DISCS, VIDEO CASSETTES AND VIDEO DISCS IN THE FIELD OF HOSPITALITY AND TRAVEL; RECORDED COMPUTER SOFTWARE, NAMELY, EDUCATIONAL SOFTWARE IN THE FIELD OF HOSPITALITY AND TRAVEL; AUDIOVISUAL GAMES ADAPTED FOR USE WITH TELEVISION RECEIVERS ONLY; TEACHING APPARATUS ADAPTED FOR USE WITH TELEVISION RECEIVERS ONLY, NAMELY, TELEVISION APPARATUS FOR PROJECTION PURPOSES, TELEVISION MONITORS, REMOTE CONTROLS FOR TELEVISIONS; ELECTRONIC PUBLICATIONS, NAMELY, BOOKS, MANUALS, NEWSLETTERS IN THE FIELD OF HOSPITALITY AND TRAVEL RECORDED ON ELECTRONIC, DIGITAL AND COMPUTER MEDIA, IN CLASS 9 (U.S. CLS. 21, 23, 26, 36 AND 38).

**TRADEMARK**

**SERVICE MARK**

**PRINCIPAL REGISTER**

FOR: PRINTED INSTRUCTIONAL AND TEACHING MATERIAL IN THE FIELD OF HOSPITALITY AND TRAVEL, IN CLASS 16 (U.S. CLS. 2, 5, 22, 23, 29, 37, 38 AND 50).

FOR: TRANSMISSION OF INFORMATION VIA ELECTRONIC COMMUNICATIONS NETWORKS, NAMELY, INTERNET, EXTRANET, INTRANET NETWORKS IN RELATION TO TEACHING AND EDUCATIONAL PROGRAMS, IN CLASS 38 (U.S. CLS. 100, 101 AND 104).



*David J. Kyros*

Director of the United States Patent and Trademark Office

FOR: TEACHING AND EDUCATIONAL SERVICES, NAMELY, PROVIDING CLASSES, SEMINARS, WORKSHOPS IN THE FIELD OF HOSPITALITY AND TRAVEL; OCCUPATIONAL TRAINING SERVICES, NAMELY, TRAINING SERVICES IN THE FIELD OF HOSPITALITY AND TRAVEL; EDUCATION SERVICES RENDERED THROUGH ACADEMIES, NAMELY, PROVIDING SEMINARS, WORKSHOPS IN THE FIELD OF HOSPITALITY AND TRAVEL; INFORMATION ABOUT EDUCATION IN THE FIELD OF HOSPITALITY AND TRAVEL; ARRANGING AND CONDUCTING OF TRAINING WORKSHOPS IN THE FIELD OF HOSPITALITY AND TRAVEL; VOCATIONAL GUIDANCE IN THE FIELD OF HOSPITALITY AND TRAVEL; ORGANIZATION OF EXHIBITIONS FOR CULTURAL OR EDUCATIONAL PURPOSES IN THE FIELD OF HOSPITALITY AND TRAVEL; ARRANGING OF ACADEMIC COMPETITIONS FOR EDUCATION OR ENTERTAINMENT PURPOSES IN THE FIELD OF HOSPITALITY AND TRAVEL; ARRANGING AND CONDUCTING OF EDUCA-

**Reg. No. 4,133,995** TIONAL COLLOQUIUMS, CONFERENCES, CONGRESSES AND SEMINARS IN THE FIELD OF HOSPITALITY AND TRAVEL; PUBLISHING AND LOAN OF EDUCATIONAL WORKS, NAMELY, BOOKS, MANUALS, NEWSLETTERS; FILM PRODUCTION AND EDUCATION SERVICES IN THE FIELD OF HOSPITALITY AND TRAVEL RENDERED THROUGH SCREENING OF FILMS FOR EDUCATIONAL PURPOSES; RENTAL OF FILMS FOR EDUCATIONAL PURPOSES, IN CLASS 41 (U.S. CLS. 100, 101 AND 107).

OWNER OF FRANCE REG. NO. 3511688, DATED 7-5-2007, EXPIRES 7-5-2017.

THE COLOR(S) BEIGE AND BLUE IS/ARE CLAIMED AS A FEATURE OF THE MARK.

OWNER OF U.S. REG. NOS. 2,903,817, 3,720,506 AND OTHERS.

NO CLAIM IS MADE TO THE EXCLUSIVE RIGHT TO USE "ACADÉMIE", APART FROM THE MARK AS SHOWN.

THE MARK CONSISTS OF A STYLIZED DRAWING OF TWO BIRDS IN THE COLOR BEIGE BELOW WHICH ARE THE WORDS "ACCOR ACADEMIE" IN BLUE FONT.

THE ENGLISH TRANSLATION OF "ACADÉMIE" IN THE MARK IS ACADEMY.

SER. NO. 85-227,979, FILED 1-27-2011.

TARA PATE, EXAMINING ATTORNEY

# United States of America

United States Patent and Trademark Office



**Reg. No. 4,133,996**

**Registered May 1, 2012**

**Int. Cl.: 7**

**TRADEMARK**

**PRINCIPAL REGISTER**

FORMULA ONE LICENSING BV (NETHERLANDS CORPORATION)  
BEURSPLEIN 37  
ROTTERDAM, NETHERLANDS 3011AA

FOR: MOTORS AND ENGINES EXCEPT FOR LAND VEHICLES; AERATED BEVERAGES MAKING MACHINES; BAGS FOR VACUUM CLEANERS; ELECTRIC COFFEE GRINDERS, OTHER THAN HAND OPERATED; DISHWASHERS; FOOD PROCESSORS, ELECTRIC; FRUIT PRESSES, ELECTRIC, FOR HOUSEHOLD PURPOSES; HAND-HELD TOOLS, OTHER THAN HAND-OPERATED, NAMELY, ELECTRIC DRILLS; COFFEE GRINDERS, OTHER THAN HAND-OPERATED; KITCHEN MACHINES, NAMELY, ELECTRIC STANDING MIXERS; ELECTRIC KNIVES; ELECTRIC CAN OPENERS; VACUUM CLEANERS; WASHING MACHINES, NAMELY, CLOTHES WASHING MACHINES; VEHICLE WASHING MACHINES; WASTE DISPOSERS, NAMELY, FOOD WASTE DISPOSERS, IN CLASS 7 (U.S. CLS. 13, 19, 21, 23, 31, 34 AND 35).

OWNER OF BENELUX REG. NO. 0891899, DATED 6-29-2010, EXPIRES 6-29-2020.

THE MARK CONSISTS OF STYLIZED LETTERS, WORDING AND NUMERAL(S), "F1 FORMULA 1"; THE "1" IN THE "F1" ELEMENT IS COMPRISED OF HORIZONTAL LINES.

SER. NO. 85-228,538, FILED 1-28-2011.

LINDA E. BLOHM, EXAMINING ATTORNEY



*David J. Kyffers*

Director of the United States Patent and Trademark Office

# United States of America

United States Patent and Trademark Office



**Reg. No. 4,133,997**

**Registered May 1, 2012**

**Int. Cl.: 9**

**TRADEMARK**

**PRINCIPAL REGISTER**

FORMULA ONE LICENSING BV (NETHERLANDS CORPORATION)  
BEURSPLEIN 37  
ROTTERDAM, NETHERLANDS 3011AA

FOR: PHOTOGRAPHIC, CINEMATOGRAPHIC, OPTICAL, WEIGHING, MEASURING, TEACHING APPARATUS AND INSTRUMENTS, NAMELY, CAMERAS, WEIGHING SCALES; APPARATUS FOR RECORDING, TRANSMISSION OR REPRODUCTION OF SOUND OR IMAGES; BLANK MAGNETIC DATA CARRIERS, RECORDING DISCS, NAMELY, BLANK RECORDABLE OPTICAL DISC; AUTOMATIC VENDING MACHINES AND MECHANISMS FOR COIN-OPERATED APPARATUS; DATA PROCESSING EQUIPMENT AND COMPUTERS; CALCULATORS; ADAPTERS FOR USE WITH TELEPHONES; ELECTRONIC AGENDAS; AMPLIFIERS; AMUSEMENT APPARATUS ADAPTED FOR USE WITH AN EXTERNAL DISPLAY SCREEN OR MONITOR; ANIMATED CARTOONS, NAMELY, VIDEO DISKS AND VIDEO TAPES WITH RECORDED ANIMATED CARTOONS; ANSWERING MACHINES; ANTIDAZZLE SHADES; ANTI-GLARE GLASSES; ANTIGLARE SCREENS FOR COMPUTERS; ANTIGLARE VISORS; ANTI-THEFT WARNING APPARATUS, NAMELY, THEFT ALARMS; APPLICATION DEVELOPMENT TOOL PROGRAMS FOR PERSONAL AND HANDHELD COMPUTERS AUDIO RECEIVERS; AUDIOVISUAL TEACHING APPARATUS, NAMELY, MULTIMEDIA PROJECTORS; AUDIO VIDEO RECEIVERS FOR HOME THEATRES; AUTOMATIC TELLER MACHINES; BAGS AND CASES SPECIALLY ADAPTED FOR HOLDING OR CARRYING PORTABLE TELEPHONES AND TELEPHONE EQUIPMENT AND ACCESSORIES; BANK CARDS, NAMELY, MAGNETIC CODED BANK CARD FOR USE IN PERFORMING TRANSACTIONS, CHECKING STATUS OF BANK ACCOUNTS; BATTERIES, ELECTRIC; BATTERIES, ELECTRIC, FOR VEHICLES; BATTERY CHARGERS; BINOCULARS; BLANK COMPACT DISKS, CD ROMS, DVDS, BLANK MAGNETIC DATA MEDIA, BLANK OPTICAL DATA MEDIA, MAGNETIC TAPES, OPTICAL DISCS, BLANK MAGNETIC DISKS, VIDEO TAPES; BRACELETS, NAMELY, MAGNETICALLY ENCODED IDENTIFICATION BRACELETS; CABINETS FOR LOUDSPEAKERS; CAMCORDERS; CINEMATOGRAPHIC CAMERAS; CAMERAS; CAMERAS INCORPORATING SECONDARY FUNCTIONALITY; CAR INFOTAINMENT DEVICES IN THE NATURE OF PERSONAL DIGITAL ASSISTANCE AND COMPUTER; CASES FOR CAMERAS; CASES FOR COMPACT DISCS; MAGNETICALLY CODED CASH CARDS; CASSETTE PLAYERS; CD ROM DRIVES; CENTRAL PROCESSING UNITS; MAGNETICALLY CODED CHARGE CARDS; CINEMATOGRAPHIC EQUIPMENT, NAMELY, CINEMATOGRAPHIC MACHINES AND APPARATUS; CINEMATOGRAPHIC FILM FEATURING AUTO RACING; CLEANING APPARATUS FOR PHONOGRAPH RECORDS, NAMELY, CLEANING SHEETS, CLEANING PAPERS, CLEANING WIPES, CLEANING CLOTHS, CLEANING SWABS; CLEANING APPARATUS



*David J. Kappas*

Director of the United States Patent and Trademark Office

**Reg. No. 4,133,997** FOR SOUND RECORDING DISCS, NAMELY, MAGNETIC TAPE CLEANERS; TIME RECORDING DEVICES IN THE NATURE OF TIME CLOCKS; COMPACT DISC PLAYERS/RECORDERS; COMPACT DISCS COMPACT DISCS FEATURING AUTO RACING; COMPUTER GAME PROGRAMS; DOWNLOADABLE COMPUTER SOFTWARE PROGRAMS FOR USE IN DATABASE MANAGEMENT; COMPUTER KEYBOARDS; COMPUTER MEMORIES; COMPUTER PERIPHERAL DEVICES; RECORDED COMPUTER OPERATING PROGRAMS; COMPUTER PROGRAMS FOR PLAYING GAMES; COMPUTER SOFTWARE DESIGNED TO ENABLE SMART CARDS TO INTERACT WITH TERMINALS AND READERS; COMPUTER SOFTWARE FOR BETTING, GAMING AND GAMBLING AND FOR GAMING MACHINES; COMPUTER SOFTWARE FOR IMPLEMENTING SECURITY METHODOLOGY INVOLVING ENCRYPTION OF PAYMENT CARD NUMBERS AND RELATED DATA AND TRANSMISSION OVER COMPUTER NETWORKS; COMPUTER SOFTWARE FOR INTERACTIVE REEL AND SLOT GAMES; COMPUTER APPLICATION SOFTWARE FOR MOBILE PHONES; COMPUTER SOFTWARE FOR PROGRAMMING TELEVISIONS; COMPUTERS; CREDIT CARD MACHINES; MAGNETICALLY ENCODED CREDIT CARDS; CURRENCY-CONVERTING APPARATUS, NAMELY, ELECTRONIC CURRENCY CONVERTERS; CURSOR ICONS, NAMELY, COMPUTER SOFTWARE FOR CHANGING THE APPEARANCE AND FUNCTION OF COMPUTER CURSORS; DATA PROCESSING APPARATUS; MAGNETICALLY ENCODED DEBIT CARDS; DECORATIVE MAGNETS; DIGITAL CAMERAS; DIGITAL PICTURE FRAMES; DIGITAL DIRECTIONAL SIGNAGE; DISK DRIVES FOR COMPUTERS; COMPACT DISK PLAYERS AND RECORDERS; DISPOSABLE CAMERAS; DISTANCE MEASURING APPARATUS; DISTANCE RECORDING APPARATUS, NAMELY, ODOMETER; DOOR CLOSERS, ELECTRIC; DOOR OPENERS, ELECTRIC; DOWNLOADABLE RINGTONES AND GRAPHICS FOR MOBILE PHONES; DVD AUDIOVISUAL PLAYERS/RECORDERS; BLANK RECORDABLE DVDS; EAR PLUGS FOR SOUNDPROOFING, ELECTRONIC COMPUTER GAMES ADAPTED FOR USE WITH TV RECEIVERS; ELECTRONIC NOTICE BOARDS; ELECTRONIC DOWNLOADABLE PUBLICATIONS, NAMELY, BOOKS AND MAGAZINES IN THE FIELD OF AUTO RACING; ELECTRONIC TAGS FOR GOODS; ELECTRONIC VERIFICATION APPARATUS, NAMELY, COMPUTER HARDWARE AND SOFTWARE FOR VERIFYING AUTHENTICATION OF CHARGE CARDS, BANK CARDS, CREDIT CARDS, DEBIT CARDS, PREPAID CARDS AND PAYMENT CARDS; MAGNETIC ENCODED CARDS, NAMELY, MAGNETICALLY CODED STORED VALUE CARDS FOR MAKING PURCHASES AT RETAIL STORES; MAGNETICALLY ENCODED USER INCENTIVE LOYALTY CARDS; ENCRYPTION SOFTWARE; EYEGLASS FRAMES; EYEGLASSES; EYEWEAR, NAMELY, EYESHADES; FACSIMILE MACHINES; EXPOSED CAMERA FILM, EXPOSED CINEMATOGRAPHIC FILM, EXPOSED PHOTOGRAPHIC FILM, EXPOSED SLIDE FILM; FIRE ALARMS; FIRE-EXTINGUISHING APPARATUS; FLASH-BULBS; FLAT IRONS, ELECTRIC; BLANK FLOPPY DISKS; GOGGLES FOR SPORT; HAIR-CURLERS, ELECTRICALLY HEATED; HAND FREE KITS FOR PHONES; HEAD CLEANING TAPES FOR AUDIO RECORDERS AND VIDEO RECORDERS; HEADPHONES; PROTECTIVE HELMETS FOR SPORT; HOLDERS FOR MOBILE TELEPHONES; HOLDERS FOR PHOTOGRAPHIC CAMERAS; HOLOGRAMS, NAMELY, DATA CARRIERS, NAMELY, PRERECORDED OPTICAL DATA CARRIERS FEATURING HOLOGRAMS; IDENTITY CARDS, MAGNETIC; IN-CAR TELEPHONE HANDSET CRADLES; BLANK INTEGRATED CIRCUIT CARDS IN THE NATURE OF SMART CARDS; INTERACTIVE GAMES, NAMELY, INTERACTIVE GAME SOFTWARE, INTERACTIVE GAMES PROGRAMS; INTERCOMMUNICATION APPARATUS, NAMELY, CELLULAR PHONES; INTERFACES FOR COMPUTERS; INTERNET GAMES, NAMELY, COMPUTER GAME PROGRAMS DOWNLOADABLE VIA THE INTERNET; LAPTOP BAGS; LAPTOP COMPUTERS; MAGNETIC ENCODERS; MAGNETIC TAPE UNITS FOR COMPUTERS; BLANK MAGNETIC TAPES; MAGNETS; MECHANICAL SIGNS; MICROPROCESSORS; MINI DISC PLAYERS/RECORDERS; EARPHONES, HEADSETS FOR WIRELESS EXCHANGE OF INFORMATION, CASES, CHARGERS FOR MOBILE PHONES; MOBILE PHONE CHARGERS; MOBILE TELEPHONE COVERS; MOBILE TELEPHONES; MOBILE TELEPHONES INCORPORATING SECONDARY FUNCTIONALITY; MODEMS; MONITORS; COMPUTER MOUSE; COMPUTER MOUSE PADS; MPEG AUDIO LAYER-3 PLAYERS; NAVIGATION APPARATUS FOR VEHICLES (ON BOARD COMPUTERS); NAVIGATIONAL INSTRUMENTS, NAMELY, ELECTRICAL NAVIGATIONAL INSTRUMENTS; NEEDLES FOR RECORD PLAYERS; NEON SIGNS; NOTEBOOK COM-

**Reg. No. 4,133,997** PUTTERS; OPTICAL APPARATUS AND INSTRUMENTS, NAMELY, CAMERAS, MAGNIFYING GLASSES, SPECTACLE LENSES; BLANK OPTICAL DISCS; OPTICAL FIBERS; PAYMENT CARDS IN THE NATURE OF A MAGNETICALLY ENCODED DEBIT CARDS; PEDOMETERS; ELECTRONIC PENS FOR VISUAL DISPLAY UNITS; PERSONAL DIGITAL ASSISTANTS; PERSONAL STEREOS; PHONE CARDS, NAMELY, PRE-PAID TELEPHONE CALLING CARDS, MAGNETICALLY ENCODED; PHONOGRAPH RECORDS FEATURING MUSIC; PHOTOCOPIERS; PHOTOGRAPHIC EQUIPMENT, NAMELY, PHOTOCOPYING APPARATUS; POCKET CALCULATORS; POCKET TRANSLATORS; POINT OF SALE TRANSACTION TERMINALS FOR TRANSMITTING, DISPLAYING AND STORING TRANSACTION, IDENTIFICATION AND FINANCIAL INFORMATION FOR USE IN THE FINANCIAL SERVICES, BANKING, INSURANCE AND TELECOMMUNICATIONS INDUSTRIES; PORTABLE CAMERAS WITH INTEGRATED VIDEO RECORDERS; PORTABLE COMMUNICATIONS APPARATUS, NAMELY, HANDSETS; PORTABLE MULTIMEDIA VIEWING TERMINALS, NAMELY, AUDIO, VIDEO AND DATA RECEIVERS; PORTABLE TELEPHONES; PORTABLE UNITS FOR WORD PROCESSING; PRE-PAID CARDS, NAMELY, PRE-PAID TELEPHONE CARDS, MAGNETICALLY ENCODED; PRE-RECORDED COMPACT DISKS, CD ROMS, DDS MAGNETIC DATA MEDIA, MAGNETIC TAPES, OPTICAL DISCS, VIDEO TAPES FEATURING AUTO RACING; PRINTERS FOR USE WITH COMPUTERS; PROJECTION APPARATUS, NAMELY, MOVIE EDITING PROJECTORS, MOVIE PROJECTORS, SLIDE PROJECTORS; PROJECTORS FOR HOME THEATERS; RADIO PAGERS; RADIOS; AUDIO-VIDEO RECEIVERS; RECORD PLAYERS; BLANK RECORDING DISCS; REMOTE CONTROL APPARATUS FOR RADIO, TELEVISIONS, STEREOS; COMPUTER ROUTERS; NETWORK ROUTERS; SAFETY CLOTHING WITH REFLECTING BANDS; SCANNERS; SCREENSAVERS, NAMELY, COMPUTER SCREEN SAVER SOFTWARE; SELF REGULATING FUEL PUMPS FOR SERVICE STATIONS; SIGNALING DEVICES USING LIGHT, SOUND OR VIBRATION, AS ACCESSORIES FOR MOBILE TELEPHONES; SIMULATORS FOR THE STEERING AND CONTROL OF VEHICLES; BLANK SMART CARDS; SOCKETS, PLUGS AND OTHER CONTACTS, NAMELY, ELECTRICAL SOCKETS, SOLAR BATTERIES; SOUND RECORDING APPARATUS; SOUND RECORDING CARRIERS, NAMELY, BLANK RECORDING DISCS, BLANK TAPES, BLANK RECORDABLE OPTICAL DISCS; SOUND RECORDING DISCS; SOUND REPRODUCTION APPARATUS; SOUND TRANSMITTING APPARATUS; SPEAKERS FOR HOME THEATRES; SPECTACLES; SPEED CHECKING APPARATUS FOR VEHICLES; PRE-PAID STORE CARDS MAGNETICALLY ENCODED; SUBWOOFERS; SUNGLASSES; TAPE RECORDERS; TELETYPEWRITERS; TELEVISION APPARATUS FOR PROJECTION PURPOSES; COMPUTER TERMINALS; TIME RECORDING APPARATUS; TRAVEL CASES FOR PORTABLE COMPUTERS AND COMPUTER EQUIPMENT AND ACCESSORIES; STEREO TUNERS; UNIVERSAL SERIAL BUS HARDWARE; VEHICLE BREAKDOWN WARNING TRIANGLES; VEHICLE RADIOS; VENDING MACHINES; BLANK VIDEO CASSETTES; VIDEO GAME CARTRIDGES; COMPUTER PROGRAMS FOR VIDEO GAMES AND AUDIOVISUAL GAMES; VIDEO ON DEMAND SET-TOP BOXES; VIDEO PROJECTORS; VIDEO RECEIVERS; VIDEO RECORDERS; VIDEO SCREENS; VIDEO TELEPHONES; VISUAL DISPLAY UNITS; WALKIE-TALKIES; DOWNLOADABLE WALLPAPER FOR COMPUTER SCREENS; WORD PROCESSORS; WRIST REST FOR USE WITH COMPUTERS, IN CLASS 9 (U.S. CLS. 21, 23, 26, 36 AND 38).

OWNER OF BENELUX REG. NO. 0891899, DATED 6-29-2010, EXPIRES 6-29-2020.

OWNER OF U.S. REG. NO. 3,031,049.

THE MARK CONSISTS OF STYLIZED LETTERS, WORDING AND NUMERAL(S), "F1 FORMULA 1"; THE "1" IN THE "F1" ELEMENT IS COMPRISED OF HORIZONTAL LINES.

SER. NO. 85-228,550, FILED 1-28-2011.

LINDA E. BLOHM, EXAMINING ATTORNEY

# United States of America

United States Patent and Trademark Office



**Reg. No. 4,133,998**

**Registered May 1, 2012**

**Int. Cl.: 38**

**SERVICE MARK**

**PRINCIPAL REGISTER**

FORMULA ONE LICENSING BV (NETHERLANDS CORPORATION)  
BEURSPLEIN 37  
ROTTERDAM, NETHERLANDS 3011AA

FOR: BROADCASTING AND TRANSMISSION OF ANALOGUE TELEVISION, DIGITAL TELEVISION, CABLE TELEVISION, SATELLITE TELEVISION, PAY TELEVISION, INTERACTIVE TELEVISION, INTERACTIVE ENTERTAINMENT AND INTERACTIVE COMPETITIONS, RADIO AND INTERNET PROGRAMMES; BROADCASTING OF ENTERTAINMENT PROGRAMMES VIA TELEVISION AND RADIO; BROADCASTING OF MUSIC EVENTS VIA TELEVISION AND RADIO; BROADCASTING OF PROGRAMMES PROVIDED OVER THE INTERNET; BROADCASTING OF SPORTS PROGRAMMES VIA TELEVISION AND RADIO; INTERNET BROADCASTING SERVICES; TELECOMMUNICATIONS SERVICES, NAMELY, WIRELESS TELEPHONE SERVICES; COMMUNICATIONS BY AND/OR BETWEEN COMPUTER TERMINALS; COMMUNICATIONS BY CELLULAR TELEPHONE; COMMUNICATIONS BY FIBRE OPTIC NETWORKS; COMMUNICATIONS BY TELEGRAMS; COMMUNICATIONS BY TELEPHONE; COMMUNICATIONS BY FACSIMILE COMMUNICATION; PROVIDING ACCESS TO A DATABASE; COMPUTER AIDED TRANSMISSION OF MESSAGES AND IMAGES; STREAMING OF AUDIO, VIDEO, AUDIOVISUAL MATERIAL ON THE INTERNET; TRANSFER OF DATA BY TELECOMMUNICATIONS; DISSEMINATION OF TELEVISION PROGRAMS RELAYED BY SATELLITE, NAMELY, TELEVISION BROADCASTING; ELECTRONIC MAIL; COMMUNICATIONS SERVICES FOR THE ELECTRONIC, DIGITAL AND ANALOGUE DISPLAY OF INFORMATION, MESSAGES, IMAGES AND DATA; FACSIMILE TRANSMISSION; ELECTRONIC MESSAGE SENDING; MOBILE TELEPHONE SERVICES; MULTIMEDIA TELECOMMUNICATIONS SERVICES, NAMELY, LOCAL AND LONG DISTANCE TRANSMISSION OF VOICE, DATA BY MEANS OF TELEPHONE, TELEGRAPH, CABLE AND SATELLITE TRANSMISSION; NEWS AGENCY SERVICES FOR ELECTRONIC TRANSMISSION; PROVIDING INTERNET ACCESS, NAMELY, PROVIDING ACCESS TO REAL TIME DATA VIA THE INTERNET; PROVIDING ACCESS TO A MULTIPLE USER NETWORK SYSTEM WHICH ALLOWS FOR THE ACCESS TO GAMING AND BETTING INFORMATION AND SERVICES OVER THE INTERNET; PROVIDING TELECOMMUNICATIONS CONNECTIONS TO A GLOBAL COMPUTER NETWORK; PROVISION OF ACCESS TO INTERACTIVE COMPUTER DATABASES IN THE FIELD OF SPORTS; PROVISION OF BROADCASTING EQUIPMENT FOR OUTSIDE BROADCASTS; PROVISION OF TELECOMMUNICATIONS FACILITIES FOR INTERACTIVE DISCUSSION AND CONVERSATION; RADIO BROADCASTING; RECEIVING AND EXCHANGE OF INFORMATION, MESSAGES, IMAGES, AND DATA VIA MOBILE PHONE NETWORKS; RENTAL OF MESSAGE SENDING APPARATUS; SATELLITE COMMUNICA-



*David J. Kybas*

Director of the United States Patent and Trademark Office

**Reg. No. 4,133,998** TIONS SERVICES; SENDING OF TELEGRAMS; PROVIDING TELECOMMUNICATIONS CONNECTIONS TO THE INTERNET, INTRANET AND EXTRANET; TELECONFERENCING SERVICES; TELEGRAPH SERVICES; TELEPHONE COMMUNICATION SERVICES; TRANSFERRING AND DISSEMINATING INFORMATION AND DATA VIA COMPUTER NETWORKS AND THE INTERNET; TRANSMISSION OF DIGITAL INFORMATION BY MEANS OF CABLE, WIRE OR FIBRE; TRANSMISSION OF INFORMATION BY COMMUNICATIONS SATELLITE, MICROWAVE OR ELECTRONIC, DIGITAL OR ANALOGUE MEANS; TRANSMISSION OF INFORMATION BY MOBILE TELEPHONES, FACSIMILES AND FACSIMILE COMMUNICATION; TRANSMISSION OF TELEGRAMS; TRANSMISSION SERVICES, NAMELY, TRANSMISSION OF DIGITAL FILES; VIDEO TEXT AND TELETEXT TRANSMISSION SERVICES; VOICE MAIL SERVICES; WIRE SERVICES, NAMELY, TELEPHONY COMMUNICATION SERVICES; TRANSMISSION OF SOUND AND VIDEO RECORDINGS VIA THE INTERNET, IN CLASS 38 (U.S. CLS. 100, 101 AND 104).

OWNER OF BENELUX REG. NO. 0891899, DATED 6-29-2010, EXPIRES 6-29-2020.

OWNER OF U.S. REG. NO. 2,975,282.

THE MARK CONSISTS OF STYLIZED LETTERS, WORDING AND NUMERAL(S), "F1 FORMULA 1"; THE "1" IN THE "F1" ELEMENT IS COMPRISED OF HORIZONTAL LINES.

SER. NO. 85-228,597, FILED 1-28-2011.

LINDA E. BLOHM, EXAMINING ATTORNEY



# United States of America

United States Patent and Trademark Office

# ccScan

**Reg. No. 4,133,999**

**Registered May 1, 2012**

**Int. Cl.: 9**

**TRADEMARK**

**PRINCIPAL REGISTER**

CAPTURE COMPONENTS LLC (CALIFORNIA LIMITED LIABILITY COMPANY)  
SUITE A, PMB 373  
32158 CAMINO CAPISTRANO  
SAN JUAN CAPISTRANO, CA 92675

FOR: COMPUTER SOFTWARE AND DOWNLOADABLE COMPUTER SOFTWARE APPLICATIONS FOR DOCUMENT SCANNING AND CAPTURING, AND ENABLING STORAGE OF FILES, EITHER DIRECTLY TO INTERNET CLOUD-BASED STORAGE AND CONTENT MANAGEMENT SYSTEMS, OR A TO A LOCAL COMPUTER OR NETWORK FILE SYSTEM, OR INTERNET STORAGE AND CONTENT AND MANAGEMENT SYSTEM, ALL WHILE BULK IMPORTING, IDENTIFYING AND STORING EXISTING DIGITIZED DOCUMENTS, IN CLASS 9 (U.S. CLS. 21, 23, 26, 36 AND 38).

FIRST USE 12-2-2006; IN COMMERCE 11-16-2010.

THE MARK CONSISTS OF STANDARD CHARACTERS WITHOUT CLAIM TO ANY PARTICULAR FONT, STYLE, SIZE, OR COLOR.

SER. NO. 85-228,757, FILED 1-28-2011.

ANNE MADDEN, EXAMINING ATTORNEY



*David J. Kybas*

Director of the United States Patent and Trademark Office

# United States of America

United States Patent and Trademark Office

# SIMPLEX

**Reg. No. 4,134,000**

**Registered May 1, 2012**

**Int. Cl.: 35**

**SERVICE MARK**

**PRINCIPAL REGISTER**

SIMPLEX HEALTHCARE, INC. (TENNESSEE CORPORATION)  
6840 CAROTHERS PARKWAY, SUITE 600  
FRANKLIN, TN 37067

FOR: MAIL ORDER SERVICES FEATURING MEDICAL SUPPLIES, NAMELY, PROVIDING DIABETICS TESTING SUPPLIES, CONTINUOUS POSITIVE AIRWAY PRESSURE (CPAP) SUPPLIES, CATHETERS, ERECTILE DYSFUNCTION (ED) PUMPS, AND PHARMACEUTICALS, IN CLASS 35 (U.S. CLS. 100, 101 AND 102).

FIRST USE 4-3-2009; IN COMMERCE 4-3-2009.

THE MARK CONSISTS OF STANDARD CHARACTERS WITHOUT CLAIM TO ANY PARTICULAR FONT, STYLE, SIZE, OR COLOR.

SER. NO. 85-228,875, FILED 1-28-2011.

KATHERINE STOIDES, EXAMINING ATTORNEY



*David J. Kyjars*

Director of the United States Patent and Trademark Office

# United States of America

United States Patent and Trademark Office

## SIMPLEX HEALTHCARE

**Reg. No. 4,134,001**

**Registered May 1, 2012**

**Int. Cl.: 35**

**SERVICE MARK**

**PRINCIPAL REGISTER**

SIMPLEX HEALTHCARE, INC. (TENNESSEE CORPORATION)  
6840 CAROTHERS PARKWAY, SUITE 600  
FRANKLIN, TN 37067

FOR: MAIL ORDER SERVICES FEATURING MEDICAL SUPPLIES, NAMELY, PROVIDING DIABETICS TESTING SUPPLIES, CONTINUOUS POSITIVE AIRWAY PRESSURE (CPAP) SUPPLIES, CATHETERS, ERECTILE DYSFUNCTION (ED) PUMPS, AND PHARMACEUTICALS, IN CLASS 35 (U.S. CLS. 100, 101 AND 102).

FIRST USE 4-3-2009; IN COMMERCE 4-3-2009.

THE MARK CONSISTS OF STANDARD CHARACTERS WITHOUT CLAIM TO ANY PARTICULAR FONT, STYLE, SIZE, OR COLOR.

NO CLAIM IS MADE TO THE EXCLUSIVE RIGHT TO USE "HEALTHCARE", APART FROM THE MARK AS SHOWN.

SER. NO. 85-229,177, FILED 1-28-2011.

KATHERINE STOIDES, EXAMINING ATTORNEY



*David J. Kybas*

Director of the United States Patent and Trademark Office

# United States of America

United States Patent and Trademark Office

# MEDVAL

**Reg. No. 4,134,002**

**Registered May 1, 2012**

**Int. Cls.: 41 and 42**

MEDVAL SCIENTIFIC INFORMATION SERVICES, LLC (DELAWARE LIMITED LIABILITY COMPANY)  
SUITE 2  
30 VREELAND DRIVE  
SKILLMAN, NJ 08558

**SERVICE MARK**

**PRINCIPAL REGISTER**

FOR: PUBLISHING JOURNAL ARTICLES, MONOGRAPHS, PAMPHLETS AND SCIENTIFIC REPORTS, ORGANIZING AND CONDUCTING EDUCATIONAL CONFERENCES, COURSES AND SEMINARS, CONVENING ADVISORY BOARDS, DEVELOPING AND DISSEMINATION OF EDUCATIONAL MATERIALS FOR OTHERS, CUSTOM WRITING SERVICES, AND EDITORIAL CONSULTATION, ALL IN THE PHARMACEUTICAL FIELD, IN CLASS 41 (U.S. CLS. 100, 101 AND 107).

FIRST USE 11-30-2010; IN COMMERCE 11-30-2010.

FOR: MEDICAL COMMUNICATION SERVICES, NAMELY, TECHNICAL WRITING FOR OTHERS AND WEB SITE DEVELOPMENT FOR OTHERS, ALL IN THE PHARMACEUTICAL AND HEALTHCARE FIELDS, IN CLASS 42 (U.S. CLS. 100 AND 101).

FIRST USE 11-30-2010; IN COMMERCE 11-30-2010.

THE MARK CONSISTS OF STANDARD CHARACTERS WITHOUT CLAIM TO ANY PARTICULAR FONT, STYLE, SIZE, OR COLOR.

SER. NO. 85-230,522, FILED 1-31-2011.

INGA ERVIN, EXAMINING ATTORNEY



*David J. Kyffers*

Director of the United States Patent and Trademark Office

# United States of America

United States Patent and Trademark Office

## HEALTHY BY BRAVO

**Reg. No. 4,134,003**

**Registered May 1, 2012**

**Int. Cl.: 41**

**SERVICE MARK**

**PRINCIPAL REGISTER**

NBCUNIVERSAL MEDIA, LLC (DELAWARE LIMITED LIABILITY COMPANY)  
30 ROCKEFELLER PLAZA  
NEW YORK, NY 10020

FOR: ENTERTAINMENT SERVICES, NAMELY, TELEVISION PROGRAMMING RELATED TO HEALTH ISSUES; ENTERTAINMENT SERVICES, NAMELY, A WEBSITE FEATURING INFORMATION ABOUT ENTERTAINMENT PROGRAMMING IN THE FIELD OF HEALTH ISSUES AS THEY RELATE TO FOOD, PERSONAL RELATIONSHIPS, PARENTING, STYLE, BEAUTY, HOME AND HEALTH; AMUSEMENT PARK SERVICES; PROVIDING A WEBPAGE FOR VIEWING ENTERTAINMENT PROGRAMMING RELATED TO HEALTH CONCERNS; ENTERTAINMENT AND EDUCATION SERVICES, NAMELY, CONDUCTING PROGRAMS AND INITIATIVES IN THE NATURE OF WORKSHOPS, DEMONSTRATIONS, LECTURES, PRESENTATIONS AND FITNESS CLASSES RELATED TO HEALTH ISSUES AND ORGANIZING AND CONDUCTING HEALTH FAIRS, FITNESS CLASSES, INCENTIVE AWARD PROGRAMS DESIGNED TO REWARD PROGRAM PARTICIPANTS WHO EXERCISE, MAKE HEALTHY EATING CHOICES, AND ENGAGE IN OTHER HEALTH-PROMOTING ACTIVITIES AND COOKING DEMONSTRATIONS RELATED TO PROMOTING HEALTHY LIFESTYLES, ALL FOR EDUCATIONAL AND ENTERTAINMENT PURPOSES, IN CLASS 41 (U.S. CLS. 100, 101 AND 107).

FIRST USE 6-14-2010; IN COMMERCE 6-14-2010.

THE MARK CONSISTS OF STANDARD CHARACTERS WITHOUT CLAIM TO ANY PARTICULAR FONT, STYLE, SIZE, OR COLOR.

OWNER OF U.S. REG. NOS. 1,670,590, 1,934,929 AND OTHERS.

NO CLAIM IS MADE TO THE EXCLUSIVE RIGHT TO USE "HEALTHY", APART FROM THE MARK AS SHOWN.

SER. NO. 85-230,626, FILED 1-31-2011.

HAI-LY LAM, EXAMINING ATTORNEY



*David J. Kyros*

Director of the United States Patent and Trademark Office

# United States of America

United States Patent and Trademark Office

# easyflip

**Reg. No. 4,134,004**

**Registered May 1, 2012**

**Int. Cl.: 9**

**TRADEMARK**

**PRINCIPAL REGISTER**

ASPEX GROUP INC. (CANADA CORPORATION)  
5440 PARE STREET  
TOWN OF MOUNT ROYAL, CANADA H4P1R3

FOR: EYEGLOSS FRAMES; EYEGLOSS, IN CLASS 9 (U.S. CLS. 21, 23, 26, 36 AND 38).

FIRST USE 9-16-2003; IN COMMERCE 9-16-2003.

THE MARK CONSISTS OF STANDARD CHARACTERS WITHOUT CLAIM TO ANY PARTICULAR FONT, STYLE, SIZE, OR COLOR.

OWNER OF U.S. REG. NO. 2,803,742.

SEC. 2(F).

SER. NO. 85-231,633, FILED 2-1-2011.

JILL C. ALT, EXAMINING ATTORNEY



*David J. Kyffers*

Director of the United States Patent and Trademark Office

# United States of America

United States Patent and Trademark Office

# B\*SPOKE

**Reg. No. 4,134,005**

**Registered May 1, 2012**

**Int. Cl.: 41**

**SERVICE MARK**

**PRINCIPAL REGISTER**

EMMY LU, LLC (MINNESOTA LIMITED LIABILITY COMPANY)  
5748 LYNWOOD BOULEVARD  
MOUND, MN 55364

FOR: PHOTOGRAPHY SERVICES, NAMELY, DESIGNING, SETTING UP AND SHOOTING PHOTOGRAPHS; ON-LINE JOURNALS, NAMELY, BLOGS FEATURING FASHION, IN CLASS 41 (U.S. CLS. 100, 101 AND 107).

FIRST USE 9-26-2008; IN COMMERCE 9-26-2008.

THE MARK CONSISTS OF STANDARD CHARACTERS WITHOUT CLAIM TO ANY PARTICULAR FONT, STYLE, SIZE, OR COLOR.

SER. NO. 85-231,791, FILED 2-1-2011.

CIMMERIAN COLEMAN, EXAMINING ATTORNEY



*David J. Kybas*

Director of the United States Patent and Trademark Office

# United States of America

United States Patent and Trademark Office

## DAVIS FUNDS

**Reg. No. 4,134,006**

**Registered May 1, 2012**

**Int. Cl.: 36**

**SERVICE MARK**

**PRINCIPAL REGISTER**

DAVIS SELECTED ADVISERS, L.P. (COLORADO LIMITED PARTNERSHIP)  
2949 EAST ELVIRA ROAD, SUITE 101  
LEGAL DEPARTMENT  
TUCSON, AZ 85756

FOR: MANAGING AND ADMINISTERING OF INVESTMENT VEHICLES KNOWN AS INVESTMENT COMPANIES, PRINCIPALLY, OPEN END INVESTMENT COMPANIES MUTUAL FUNDS INVESTMENT, MUTUAL FUND DISTRIBUTION AND MUTUAL FUND BROKERAGE, IN CLASS 36 (U.S. CLS. 100, 101 AND 102).

FIRST USE 10-2-1995; IN COMMERCE 10-2-1995.

THE MARK CONSISTS OF STANDARD CHARACTERS WITHOUT CLAIM TO ANY PARTICULAR FONT, STYLE, SIZE, OR COLOR.

OWNER OF U.S. REG. NOS. 2,111,534, 2,838,134 AND OTHERS.

NO CLAIM IS MADE TO THE EXCLUSIVE RIGHT TO USE "FUNDS", APART FROM THE MARK AS SHOWN.

SEC. 2(F).

SER. NO. 85-233,725, FILED 2-3-2011.

MARK RADEMACHER, EXAMINING ATTORNEY



*David J. Kyffers*

Director of the United States Patent and Trademark Office



# United States of America

United States Patent and Trademark Office

## DISCOVERY STUDENT ADVENTURES

**Reg. No. 4,134,007**

**Registered May 1, 2012**

**Int. Cl.: 39**

**SERVICE MARK**

**PRINCIPAL REGISTER**

DISCOVERY COMMUNICATIONS, LLC (DELAWARE LIMITED LIABILITY COMPANY)  
ONE DISCOVERY PLACE  
SILVER SPRING, MD 20910

FOR: ORGANIZATION OF TRIPS; ORGANIZATION, BOOKING AND ARRANGEMENT OF EXCURSIONS, DAY TRIPS AND SIGHTSEEING TOURS; COORDINATING TRAVEL ARRANGEMENTS FOR INDIVIDUALS AND FOR GROUPS; ARRANGING TRAVEL TOURS; PROVIDING AN ON-LINE COMPUTER DATABASE IN THE FIELD OF TRAVEL INFORMATION SERVICES; ORGANIZATION OF EXCURSIONS, SIGHTSEEING TOURS, HOLIDAYS, TOURS AND TRAVEL; PROVIDING AN ON-LINE SEARCHABLE COMPUTER DATABASE FEATURING INFORMATION ON TRIPS AND TRAVEL ITINERARIES; TRAVEL AGENCY SERVICES, NAMELY, MAKING RESERVATIONS AND BOOKINGS FOR TRANSPORTATION; TRAVEL INFORMATION SERVICES; TRAVEL GUIDE SERVICES; TOUR GUIDE SERVICES; PROVIDING A WEBSITE FEATURING INFORMATION, NEWS AND COMMENTARY ON TRAVEL, IN CLASS 39 (U.S. CLS. 100 AND 105).

FIRST USE 3-17-2009; IN COMMERCE 3-17-2009.

THE MARK CONSISTS OF STANDARD CHARACTERS WITHOUT CLAIM TO ANY PARTICULAR FONT, STYLE, SIZE, OR COLOR.

OWNER OF U.S. REG. NOS. 883,953, 3,883,552 AND OTHERS.

NO CLAIM IS MADE TO THE EXCLUSIVE RIGHT TO USE "STUDENT ADVENTURES", APART FROM THE MARK AS SHOWN.

SER. NO. 85-233,975, FILED 2-4-2011.

DEZMONA MIZELLE, EXAMINING ATTORNEY



*David J. Kypos*

Director of the United States Patent and Trademark Office

# United States of America

United States Patent and Trademark Office



**Reg. No. 4,134,008**

**Registered May 1, 2012**

**Int. Cl.: 36**

**SERVICE MARK**

**PRINCIPAL REGISTER**

PARKMOBILE GROUP B.V. (NETHERLANDS CORPORATION)  
WISSELWERKING 40  
DIEMEN, NETHERLANDS 1112XR

FOR: FINANCIAL TRANSACTIONS, NAMELY, ASSISTING OTHERS WITH THE COMPLETION OF FINANCIAL TRANSACTIONS IN THE FIELD OF TRAFFIC PAYMENTS AND CAR PARKING PAYMENTS, USING ON-LINE SYSTEMS, THE INTERNET OR MOBILE PHONES; FINANCIAL AFFAIRS, NAMELY, FINANCIAL INFORMATION, MANAGEMENT AND ANALYSIS SERVICES IN THE FIELD OF TRAFFIC PAYMENTS AND CAR PARKING PAYMENTS; MAKING PAYMENTS FOR OTHERS ON-LINE, VIA THE INTERNET OR BY MOBILE PHONE; ELECTRONIC FUNDS TRANSFERS FOR TRAFFIC PAYMENTS AND CAR PARKING PAYMENTS, IN CLASS 36 (U.S. CLS. 100, 101 AND 102).

OWNER OF ERPN CMNTY TM OFC REG. NO. 009029364, DATED 9-14-2010, EXPIRES 4-15-2020.

THE MARK CONSISTS OF A BROKEN CIRCLE ENCLOSING THE LETTER "P" ALL WITHIN A SQUARE.

SER. NO. 85-234,440, FILED 2-4-2011.

FRED CARL, EXAMINING ATTORNEY



*David J. Kybas*

Director of the United States Patent and Trademark Office

# United States of America

United States Patent and Trademark Office

## Max Attraction

**Reg. No. 4,134,009**

**Registered May 1, 2012**

**Int. Cl.: 3**

**TRADEMARK**

**PRINCIPAL REGISTER**

LODIX CORP. (FLORIDA CORPORATION)  
3 VILLA LAGO LANE  
ORMOND BEACH, FL 32137

FOR: COLOGNE; PERFUME, IN CLASS 3 (U.S. CLS. 1, 4, 6, 50, 51 AND 52).

FIRST USE 0-0-2002; IN COMMERCE 0-0-2002.

THE MARK CONSISTS OF STANDARD CHARACTERS WITHOUT CLAIM TO ANY PARTICULAR FONT, STYLE, SIZE, OR COLOR.

SER. NO. 85-235,277, FILED 2-7-2011.

ODESSA BIBBINS, EXAMINING ATTORNEY



*David J. Kyffers*

Director of the United States Patent and Trademark Office

# United States of America

United States Patent and Trademark Office

**NESCO**  **American Harvest**

**Reg. No. 4,134,010**

THE METAL WARE CORPORATION (WISCONSIN CORPORATION)  
P.O. BOX 237

**Registered May 1, 2012**

TWO RIVERS, WI 542410237

**Int. Cls.: 7, 11, 21 and 30**

FOR: ELECTRIC COUNTER-TOP COOKING OVEN CAPACITY EXTENDERS IN THE NATURE OF FITTED RACKS AND TRAYS; ELECTRIC BLENDER WITH JUICER ATTACHMENT, IN CLASS 7 (U.S. CLS. 13, 19, 21, 23, 31, 34 AND 35).

**TRADEMARK**

FIRST USE 12-31-2000; IN COMMERCE 12-31-2000.

**PRINCIPAL REGISTER**

FOR: ELECTRIC COUNTER-TOP COOKING OVENS AND FITTED LIDS AND RACKS THEREFOR; RE-USABLE ALUMINUM OVEN LINERS FOR CATCHING SPILLS; ELECTRIC FOOD DEHYDRATORS WITH FITTED PLASTIC SCREENS, PLASTIC SHEETS, AND TRAYS; SNACK MAKING KIT FOR USE WITH ELECTRIC FOOD DEHYDRATORS, COMPOSED PRIMARILY OF NON-ELECTRIC BEEF JERKY PRESS, PLASTIC SHEETS FOR FOOD PREPARATION, REUSABLE PLASTIC PRESS LINERS, BEEF JERKY SPICES AND RECIPE BOOKS, IN CLASS 11 (U.S. CLS. 13, 21, 23, 31 AND 34).

FIRST USE 12-31-2000; IN COMMERCE 12-31-2000.

FOR: FOOD DEHYDRATOR ACCESSORIES, NAMELY, NON-ELECTRIC MEAT JERKY PRESS; ACCESSORIES FOR NON-ELECTRIC MEAT JERKY PRESS, NAMELY, FITTED PLASTIC SCREENS, TRAYS AND ATTACHMENTS TO CHANGE THE SIZE AND SHAPE OF THE JERKY, IN CLASS 21 (U.S. CLS. 2, 13, 23, 29, 30, 33, 40 AND 50).

FIRST USE 12-31-2000; IN COMMERCE 12-31-2000.

FOR: MEAT JERKY SPICE MIX, IN CLASS 30 (U.S. CL. 46).

FIRST USE 12-31-2000; IN COMMERCE 12-31-2000.

OWNER OF U.S. REG. NOS. 392,958, 1,848,007 AND OTHERS.



*David J. Kybas*

THE MARK CONSISTS OF A CIRCLE WITH "AH" AND A WHEAT STALK IN IT. TO THE LEFT OF THE CIRCLE IS THE WORD "NESCO". TO THE RIGHT OF THE CIRCLE ARE THE WORDS "AMERICAN HARVEST" WHICH ARE STACKED.

**Reg. No. 4,134,010** SER. NO. 85-235,657, FILED 2-7-2011.

AISHA CLARKE, EXAMINING ATTORNEY

# United States of America

United States Patent and Trademark Office

# PROPASS

**Reg. No. 4,134,011**

**Registered May 1, 2012**

**Int. Cls.: 39 and 41**

**SERVICE MARK**

**PRINCIPAL REGISTER**

WORLD EDUCATION SERVICES, INC. (NEW YORK CORPORATION)  
BOWLING GREEN STATION  
PO BOX 5087  
NEW YORK, NY 10004

FOR: ELECTRONIC STORAGE OF FILES AND DOCUMENTS, NAMELY, STORING TRANSCRIPTS AND OTHER DOCUMENTS AND REPORTS FROM EDUCATIONAL INSTITUTIONS, IN CLASS 39 (U.S. CLS. 100 AND 105).

FIRST USE 2-3-2011; IN COMMERCE 2-3-2011.

FOR: EDUCATIONAL SERVICES, NAMELY, OBTAINING TRANSCRIPTS AND OTHER DOCUMENTS OF EDUCATIONAL INSTITUTIONS ON BEHALF OF CUSTOMERS AND PROVIDING THE CUSTOMERS' TRANSCRIPTS AND DOCUMENTS TO SCHOOLS, EMPLOYERS, AND OTHER DESIGNATED RECIPIENTS FOR APPLICATIONS CONCERNING EMPLOYMENT AND ADMITTANCE TO EDUCATIONAL INSTITUTIONS; ONLINE EDUCATIONAL CREDIT AND DEGREE EVALUATION AND COMPARISON SERVICES, NAMELY, EVALUATING AND CALCULATING CREDENTIAL, GRADE, CREDIT, AND GRADE POINT AVERAGE EQUIVALENCIES, IN CLASS 41 (U.S. CLS. 100, 101 AND 107).

FIRST USE 2-3-2011; IN COMMERCE 2-3-2011.

THE MARK CONSISTS OF STANDARD CHARACTERS WITHOUT CLAIM TO ANY PARTICULAR FONT, STYLE, SIZE, OR COLOR.

SER. NO. 85-236,433, FILED 2-8-2011.

JAY BESCH, EXAMINING ATTORNEY



*David J. Kypos*

Director of the United States Patent and Trademark Office

# United States of America

United States Patent and Trademark Office

## CABERNET SAUVIGNON ELEVATED

**Reg. No. 4,134,012**

**Registered May 1, 2012**

**Int. Cl.: 33**

**TRADEMARK**

**PRINCIPAL REGISTER**

ROBERT CRAIG WINERY, L.P. (CALIFORNIA LIMITED PARTNERSHIP)  
625 IMPERIAL WAY, SUITE ONE  
NAPA, CA 94559

FOR: ALCOHOLIC BEVERAGES EXCEPT BEERS, IN CLASS 33 (U.S. CLS. 47 AND 49).

FIRST USE 2-2-2011; IN COMMERCE 2-2-2011.

THE MARK CONSISTS OF STANDARD CHARACTERS WITHOUT CLAIM TO ANY PARTICULAR FONT, STYLE, SIZE, OR COLOR.

NO CLAIM IS MADE TO THE EXCLUSIVE RIGHT TO USE "CABERNET SAUVIGNON", APART FROM THE MARK AS SHOWN.

SER. NO. 85-236,932, FILED 2-8-2011.

KAPIL BHANOT, EXAMINING ATTORNEY



*David J. Kyffers*

Director of the United States Patent and Trademark Office

# United States of America

United States Patent and Trademark Office

## EASYLUNCHBOXES

**Reg. No. 4,134,013**

**Registered May 1, 2012**

**Int. Cl.: 21**

**TRADEMARK**

**PRINCIPAL REGISTER**

EASYLUNCHBOXES.COM, INC. (CALIFORNIA CORPORATION)  
PO BOX 571314  
TARZANA, CA 913571314

FOR: LUNCHBOX SYSTEM COMPRISED OF A THREE COMPARTMENT BENTO-STYLE LUNCHBOX THAT FITS INSIDE A POLYESTER INSULATED BAG, IN CLASS 21 (U.S. CLS. 2, 13, 23, 29, 30, 33, 40 AND 50).

FIRST USE 10-26-2009; IN COMMERCE 10-26-2009.

THE MARK CONSISTS OF STANDARD CHARACTERS WITHOUT CLAIM TO ANY PARTICULAR FONT, STYLE, SIZE, OR COLOR.

SER. NO. 85-237,349, FILED 2-8-2011.

JOHN DWYER, EXAMINING ATTORNEY



*David J. Kyffers*

Director of the United States Patent and Trademark Office



# United States of America

United States Patent and Trademark Office



**Reg. No. 4,134,014**

**Registered May 1, 2012**

**Int. Cl.: 41**

**SERVICE MARK**

**PRINCIPAL REGISTER**

BOXMAN STUDIOS, LLC (NORTH CAROLINA LIMITED LIABILITY COMPANY)  
SUITE E  
6801 NORTH PARK BLVD.  
CHARLOTTE, NC 28216

FOR: PROVIDING MOBILE ENTERTAINMENT FACILITIES THAT CAN BE TRANSPORTED TO A PARTICULAR LOCATION FOR PARTIES AND EVENTS, NAMELY, NIGHT CLUBS, LIVE PERFORMANCES BY MUSICAL BANDS AND SINGERS, SPORTING EVENTS, WEDDINGS AND SPECIAL OCCASION EVENTS, FESTIVALS, CULTURAL SEMINARS, AND PRIVATE PARTIES, IN CLASS 41 (U.S. CLS. 100, 101 AND 107).

FIRST USE 8-0-2009; IN COMMERCE 8-0-2009.

NO CLAIM IS MADE TO THE EXCLUSIVE RIGHT TO USE "STUDIOS", APART FROM THE MARK AS SHOWN.

THE MARK CONSISTS OF THE WORDING "BOXMAN STUDIOS JUST ADD PEOPLE." WHEREIN THE "X" FORMS PART OF A FIGURE HOLDING A BOX.

SER. NO. 85-237,854, FILED 2-9-2011.

HANNO RITTNER, EXAMINING ATTORNEY



*David J. Kybas*

Director of the United States Patent and Trademark Office

# United States of America

United States Patent and Trademark Office

## CONCEPT TO CONCLUSION

**Reg. No. 4,134,015**

**Registered May 1, 2012**

**Int. Cl.: 42**

**SERVICE MARK**

**PRINCIPAL REGISTER**

MEDIDATA SOLUTIONS, INC. (DELAWARE CORPORATION)  
79 FIFTH AVENUE  
NEW YORK, NY 10003

FOR: SOFTWARE AS A SERVICE (SAAS) SERVICES FEATURING SOFTWARE FOR USE IN MANAGING DATA AND INFORMATION IN THE FIELD OF MEDICAL CLINICAL TRIALS AND RESEARCH; MEDICAL AND SCIENTIFIC RESEARCH, NAMELY, CONDUCTING CLINICAL TRIALS; CLINICAL TRIAL PROTOCOL DEVELOPMENT IN THE NATURE OF DEVELOPING PROTOCOLS FOR MEDICAL CLINICAL TRIALS AND RESEARCH; CLINICAL TRIAL PLANNING AND MANAGEMENT IN THE NATURE OF ASSISTING WITH THE DEVELOPMENT OF MEDICAL CLINICAL TRIALS AND RESEARCH AND THE MANAGEMENT OF THE DATA AND INFORMATION GENERATED IN MEDICAL CLINICAL TRIALS AND RESEARCH; CLINICAL TRIAL RANDOMIZATION AND TRIAL SUPPLY MANAGEMENT IN THE NATURE OF THE MANAGEMENT OF DATA AND INFORMATION GENERATED IN MEDICAL CLINICAL TRIALS AND RESEARCH, FOR PATIENT TRACKING AND MANAGEMENT, FOR PATIENT RANDOMIZATION AND ENROLLMENT, FOR PHARMACEUTICAL SUPPLY MANAGEMENT AND DOSING, FOR LOGISTICS MANAGEMENT, AND FOR MATERIAL INVENTORY AND SUPPLY MANAGEMENT; CLINICAL TRIAL MONITORING AND EVENTS CAPTURE IN THE NATURE OF THE GATHERING AND ORGANIZING THE INFORMATION AND DATA GENERATED IN MEDICAL CLINICAL TRIALS AND RESEARCH; CLINICAL DATA CAPTURE, MANAGEMENT AND REPORTING IN THE NATURE OF THE RESULTS OF MEDICAL CLINICAL TRIALS AND RESEARCH; PROVIDING ONLINE NON-DOWNLOADABLE SOFTWARE FOR USE IN MANAGING DATA AND INFORMATION IN THE FIELD OF MEDICAL CLINICAL TRIALS AND RESEARCH; PROVIDING ONLINE NON-DOWNLOADABLE SOFTWARE FOR USE IN MANAGING DATA AND INFORMATION IN THE FIELD OF MEDICAL CLINICAL TRIALS AND RESEARCH, NAMELY, CLINICAL TRIAL PROTOCOL DEVELOPMENT, CLINICAL TRIAL PLANNING AND MANAGEMENT, CLINICAL TRIAL USER AND LEARNING MANAGEMENT, CLINICAL TRIAL RANDOMIZATION AND TRIAL SUPPLY MANAGEMENT, CLINICAL TRIAL MONITORING AND EVENTS CAPTURE, AND CLINICAL DATA CAPTURE, MANAGEMENT AND REPORTING, IN CLASS 42 (U.S. CLS. 100 AND 101).



FIRST USE 1-17-2011; IN COMMERCE 1-17-2011.

*David J. Kyros*

THE MARK CONSISTS OF STANDARD CHARACTERS WITHOUT CLAIM TO ANY PARTICULAR FONT, STYLE, SIZE, OR COLOR.

**Reg. No. 4,134,015** SER. NO. 85-238,763, FILED 2-10-2011.

CIMMERIAN COLEMAN, EXAMINING ATTORNEY

# United States of America

United States Patent and Trademark Office

## CARSFORSALE.COM

**Reg. No. 4,134,016**

**Registered May 1, 2012**

**Int. Cl.: 35**

**SERVICE MARK**

**PRINCIPAL REGISTER**

CARSFORSALE.COM, INC. (SOUTH DAKOTA CORPORATION)  
C/O SEAN COFFMAN  
113 E. SPRUCE STREET  
BERESFORD, SD 57004

FOR: INTERNET MARKETPLACE FOR DISSEMINATION OF AUTOMOBILE ADVERTISEMENTS FOR OTHERS AND MEANS FOR CONNECTING PROSPECTIVE PURCHASERS WITH DESIRED AUTOMOBILES, IN CLASS 35 (U.S. CLS. 100, 101 AND 102).

FIRST USE 5-31-2000; IN COMMERCE 9-1-2004.

THE MARK CONSISTS OF STANDARD CHARACTERS WITHOUT CLAIM TO ANY PARTICULAR FONT, STYLE, SIZE, OR COLOR.

NO CLAIM IS MADE TO THE EXCLUSIVE RIGHT TO USE ".COM", APART FROM THE MARK AS SHOWN.

SEC. 2(F).

SER. NO. 85-238,901, FILED 2-10-2011.

KELLEY WELLS, EXAMINING ATTORNEY



*David J. Kyffers*

Director of the United States Patent and Trademark Office

# United States of America

United States Patent and Trademark Office

# VESTRA

**Reg. No. 4,134,017**

**Registered May 1, 2012**

**Int. Cls.: 9, 40, 41, 42  
and 45**

**TRADEMARK**

**SERVICE MARK**

**PRINCIPAL REGISTER**

VESTRA RESOURCES, INC. (CALIFORNIA CORPORATION)  
5300 AVIATION DRIVE  
REDDING, CA 96002

FOR: COMPUTER PROGRAMS, NAMELY, APPLICATION PROGRAMS FOR MONITORING THE STATUS OF GEOGRAPHICAL INFORMATION SYSTEMS (GIS) SOFTWARE APPLICATIONS, IN CLASS 9 (U.S. CLS. 21, 23, 26, 36 AND 38).

FIRST USE 6-1-2010; IN COMMERCE 8-1-2010.

FOR: ENVIRONMENTAL CONSULTING SERVICES RELATING TO WASTE PLANNING AND ENVIRONMENTAL REMEDIATION FOR THE TREATMENT OF SOIL, WASTE AND WATER, IN CLASS 40 (U.S. CLS. 100, 103 AND 106).

FIRST USE 2-1-1988; IN COMMERCE 5-1-1995.

FOR: COMPUTER SOFTWARE TRAINING SERVICES FEATURING COMPUTER PROGRAMS FOR MAP DESIGN AN MANAGEMENT OF GEOGRAPHICAL INFORMATION, IN CLASS 41 (U.S. CLS. 100, 101 AND 107).

FIRST USE 2-1-1988; IN COMMERCE 6-1-1988.

FOR: COMPUTER CONSULTING SERVICES RELATING TO MAPPING, MAP DESIGN AND GEOGRAPHICAL INFORMATION AND DATABASES; DESIGN, DEVELOPMENT, SYSTEM INTEGRATION, INSTALLATION OF COMPUTER SOFTWARE, IMPLEMENTATION, MANAGEMENT AND MONITORING SERVICES OF GEOGRAPHICAL INFORMATION SYSTEMS (GIS); SOFTWARE DESIGN AND COMPUTER PROGRAMMING SERVICES FOR MAPPING AND GEOGRAPHICAL INFORMATION SYSTEMS (GIS); ENVIRONMENTAL CONSULTING SERVICES RELATING TO SITE INVESTIGATION AND MONITORING, ENVIRONMENTAL STUDIES, ANALYSIS AND ASSESSMENT, AND REMEDIAL DESIGN; CIVIL ENGINEERING SERVICES RELATING TO ROADS, BRIDGES, CULVERTS, WASTE PONDS, MINES, LANDFILLS, HAZARDOUS WASTE MANAGEMENT, EROSION CONTROL AND MANAGEMENT; ENVIRONMENTAL ENGINEERING SERVICES RELATING TO ENVIRONMENTAL PROTECTION PLANS, INCLUDING REGULATORY COMPLIANCE STRATEGIES, DESIGNING AND IMPLEMENTING THESE PLANS, CONDUCTING SITE INSPECTIONS, PERFORMING REQUIRED SAMPLING, AND PREPARING THE NECESSARY DOCUMENTATION AND REPORTS, AND PROJECT MANAGEMENT; CIVIL ENGINEERING



*David J. Kybas*

Director of the United States Patent and Trademark Office

**Reg. No. 4,134,017** SERVICES, NAMELY, ENGINEERING AND LAND SURVEYING SERVICES RELATING TO MUNICIPAL PROJECTS, MINING REMEDIATION, ENVIRONMENTAL AND RESTORATION ENGINEERING, AND HYDROLOGIC EVALUATIONS FOR BRIDGE MODIFICATIONS AND CULVERT DESIGN, IN CLASS 42 (U.S. CLS. 100 AND 101).

FIRST USE 2-1-1988; IN COMMERCE 5-1-1995.

FOR: ENVIRONMENTAL CONSULTING SERVICES RELATING TO REGULATORY COMPLIANCE, IN CLASS 45 (U.S. CLS. 100 AND 101).

FIRST USE 2-1-1988; IN COMMERCE 5-1-1995.

THE MARK CONSISTS OF STANDARD CHARACTERS WITHOUT CLAIM TO ANY PARTICULAR FONT, STYLE, SIZE, OR COLOR.

SER. NO. 85-239,336, FILED 2-10-2011.

PRISCILLA MILTON, EXAMINING ATTORNEY

# United States of America

United States Patent and Trademark Office



**Reg. No. 4,134,018**

MANZEN, LLC (NEVADA LIMITED LIABILITY COMPANY)  
1335 E. SUNSET ROAD, SUITE J  
LAS VEGAS, NV 89119

**Registered May 1, 2012**

**Int. Cl.: 5**

FOR: DIETARY SUPPLEMENTS; NUTRITIONAL SUPPLEMENTS, IN CLASS 5 (U.S. CLS. 6, 18, 44, 46, 51 AND 52).

**TRADEMARK**

FIRST USE 5-20-2004; IN COMMERCE 5-20-2004.

**PRINCIPAL REGISTER**

OWNER OF U.S. REG. NOS. 3,159,491, 3,703,170 AND OTHERS.

THE MARK CONSISTS OF THE TEXT "POWERED BY" ABOVE AND TO THE RIGHT OF A BARCODE DESIGN WITH THE TEXT "XYIENCE" BELOW IT.

SER. NO. 85-239,541, FILED 2-10-2011.

RUSS HERMAN, EXAMINING ATTORNEY



*David J. Kybas*

Director of the United States Patent and Trademark Office

# United States of America

United States Patent and Trademark Office

## Healthy Home Expert

**Reg. No. 4,134,019**

**Registered May 1, 2012**

**Int. Cls.: 35, 37, 41 and 42**

**SERVICE MARK**

**PRINCIPAL REGISTER**

MY HEALTHY HOME, LLC (NEW JERSEY LIMITED LIABILITY COMPANY)  
P.O. BOX 674  
WHITEHOUSE STATION, NJ 08889

FOR: BUSINESS CONSULTATION SERVICES IN THE FIELD OF CREATING ENVIRONMENTALLY, HEALTHIER, SUSTAINABLE, AND/OR LESS TOXIC HEALTHY HOME ENVIRONMENTS; ONLINE ORDERING AND ADVERTISING SERVICES IN THE FIELD OF PRODUCTS FOR ENVIRONMENTALLY, HEALTHIER, SUSTAINABLE, AND/OR LESS TOXIC HEALTHIER HOME ENVIRONMENTS, NAMELY, WATER AND AIR PURIFIERS, HOME CARE PRODUCTS, HOME CLEANING PRODUCTS, PERSONAL CARE PRODUCTS, GREEN BUILDING CONSTRUCTION AND MATERIALS, AND HOME TESTING FOR MOLD, WATER AND INDOOR AIR QUALITY, IN CLASS 35 (U.S. CLS. 100, 101 AND 102).

FIRST USE 6-12-2002; IN COMMERCE 6-12-2002.

FOR: CUSTOM CONSTRUCTION AND BUILDING RENOVATION FOR CREATING ENVIRONMENTALLY, HEALTHIER, SUSTAINABLE, AND/OR LESS TOXIC HEALTHY HOME ENVIRONMENTS, IN CLASS 37 (U.S. CLS. 100, 103 AND 106).

FIRST USE 6-12-2002; IN COMMERCE 6-12-2002.

FOR: PROVIDING NON-DOWNLOADABLE ELECTRONIC PUBLICATIONS IN THE NATURE OF MAGAZINE ARTICLES AND E-ZINES IN THE FIELD OF CREATING ENVIRONMENTALLY, HEALTHIER, SUSTAINABLE, AND/OR LESS TOXIC HEALTHY HOME ENVIRONMENTS; ENTERTAINMENT SERVICES, NAMELY, ON-GOING TELEVISION PROGRAMS AND SEGMENTS IN THE FIELD OF CREATING ENVIRONMENTALLY, HEALTHIER, SUSTAINABLE, AND/OR LESS TOXIC HEALTHY HOME ENVIRONMENTS; ENTERTAINMENT SERVICES, NAMELY, PROVIDING ON-GOING RADIO PROGRAMS AND SEGMENTS IN THE FIELD OF CREATING ENVIRONMENTALLY, HEALTHIER, SUSTAINABLE, AND/OR LESS TOXIC HEALTHY HOME ENVIRONMENTS, IN CLASS 41 (U.S. CLS. 100, 101 AND 107).

FIRST USE 6-12-2002; IN COMMERCE 6-12-2002.

FOR: PROVIDING SCIENTIFIC AND TECHNOLOGICAL INFORMATION ABOUT ENVIRONMENTALLY CONSCIOUS AND GREEN INNOVATIONS FOR CREATING ENVIRONMENTALLY, HEALTHIER, SUSTAINABLE, AND/OR LESS TOXIC HEALTHY HOME EN-



*David J. Kyffers*

Director of the United States Patent and Trademark Office



**Reg. No. 4,134,019** VIRONMENTS; INTERIOR DESIGN CONSULTATION SERVICES FOR CREATING ENVIRONMENTALLY, HEALTHIER, SUSTAINABLE, AND/OR LESS TOXIC HEALTHY HOME ENVIRONMENTS; ENVIRONMENTAL TESTING SERVICES; CONSULTING SERVICES IN THE FIELD OF ENVIRONMENTAL ASSESSMENT, IN CLASS 42 (U.S. CLS. 100 AND 101).

FIRST USE 6-12-2002; IN COMMERCE 6-12-2002.

THE MARK CONSISTS OF STANDARD CHARACTERS WITHOUT CLAIM TO ANY PARTICULAR FONT, STYLE, SIZE, OR COLOR.

SEC. 2(F).

SER. NO. 85-239,918, FILED 2-11-2011.

ROBERT C. CLARK JR., EXAMINING ATTORNEY

# United States of America

United States Patent and Trademark Office

## KEEPING THE KEYS

**Reg. No. 4,134,020**

AMERICAN AUTOMOBILE ASSOCIATION, INC. (CONNECTICUT CORPORATION)  
1000 AAA DRIVE  
HEATHROW, FL 32746

**Registered May 1, 2012**

**Int. Cl.: 41**

FOR: EDUCATION SERVICES, NAMELY, PROVIDING CLASSES AND SEMINARS TO SENIOR CITIZENS IN THE FIELD OF DRIVING SAFETY AND THE IMPACT OF AGING ON PHYSICAL, VISUAL AND COGNITIVE ABILITIES, IN CLASS 41 (U.S. CLS. 100, 101 AND 107).

**SERVICE MARK**

**PRINCIPAL REGISTER**

FIRST USE 3-0-2010; IN COMMERCE 3-0-2010.

THE MARK CONSISTS OF STANDARD CHARACTERS WITHOUT CLAIM TO ANY PARTICULAR FONT, STYLE, SIZE, OR COLOR.

SER. NO. 85-240,223, FILED 2-11-2011.

ANNE FARRELL, EXAMINING ATTORNEY



*David J. Kyffers*

Director of the United States Patent and Trademark Office

# United States of America

United States Patent and Trademark Office

# eBackpack

**Reg. No. 4,134,021**

**Registered May 1, 2012**

**Int. Cl.: 42**

**SERVICE MARK**

**PRINCIPAL REGISTER**

EBACKPACK, INC. (TEXAS CORPORATION)  
2931 RIDGE RD STE 101-109  
ROCKWALL, TX 75032

FOR: PROVIDING ON-LINE NON-DOWNLOADABLE SOFTWARE FOR DISTRIBUTING HOMEWORK HANDOUTS, SHARING FILES AND ASSIGNMENTS WITH A CLASS, COLLECTING ASSIGNMENTS, GRADING TURNED IN STUDENT WORK, TRANSPORTING PERSONAL FILES INSTEAD OF USING A FLASH DRIVE, AND/OR INTERACTING WITH STUDENTS, PARENTS, TEACHERS, STAFF, AND COLLEAGUES IN A CLASSROOM, SCHOOL, DISTRICT, OR VIRTUAL EDUCATION SETTING, IN CLASS 42 (U.S. CLS. 100 AND 101).

FIRST USE 4-9-2003; IN COMMERCE 2-7-2011.

THE MARK CONSISTS OF STANDARD CHARACTERS WITHOUT CLAIM TO ANY PARTICULAR FONT, STYLE, SIZE, OR COLOR.

SER. NO. 85-242,258, FILED 2-15-2011.

GINA FINK, EXAMINING ATTORNEY



*David J. Kyffers*

Director of the United States Patent and Trademark Office

# United States of America

United States Patent and Trademark Office

## THE CORD BUG

**Reg. No. 4,134,022**

**Registered May 1, 2012**

**Int. Cl.: 9**

**TRADEMARK**

**PRINCIPAL REGISTER**

6144901 MANITOBA INC. (CANADA CORPORATION)  
366 JACQUES AVENUE  
WINNIPEG, MANITOBA, CANADA R3W1N5

FOR: MAGNETIC BLOCK HEATER EXTENSION CORD CLIPS TO SUPPORT A BLOCK HEATER CORD AND PREVENT IT FROM DRAGGING ON THE GROUND, IN CLASS 9 (U.S. CLS. 21, 23, 26, 36 AND 38).

THE MARK CONSISTS OF STANDARD CHARACTERS WITHOUT CLAIM TO ANY PARTICULAR FONT, STYLE, SIZE, OR COLOR.

PRIORITY CLAIMED UNDER SEC. 44(D) ON CANADA APPLICATION NO. 1495368, FILED 9-9-2010, REG. NO. TMA814,588, DATED 12-22-2011, EXPIRES 12-22-2026.

NO CLAIM IS MADE TO THE EXCLUSIVE RIGHT TO USE "CORD", APART FROM THE MARK AS SHOWN.

SER. NO. 85-242,457, FILED 2-15-2011.

ALYSSA STEEL, EXAMINING ATTORNEY



*David J. Kybas*

Director of the United States Patent and Trademark Office

# United States of America

United States Patent and Trademark Office

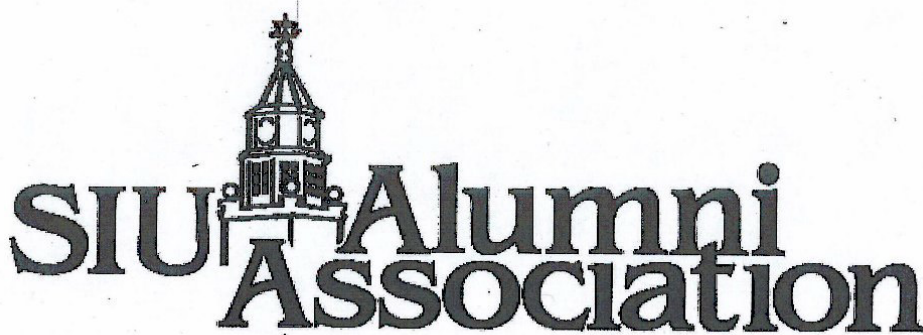

**Reg. No. 4,134,023**

**Registered May 1, 2012**

**Int. Cls.: 16, 25 and 35**

**TRADEMARK**

**SERVICE MARK**

**PRINCIPAL REGISTER**

SIU ALUMNI ASSOCIATION (ILLINOIS NON-PROFIT ASSOCIATION)  
COLYER HALL, MAILCODE 6809  
SOUTHERN ILLINOIS UNIVERSITY  
CARBONDALE, IL 629016809

FOR: PUBLICATIONS, NAMELY, BROCHURES AND MAGAZINES IN THE FIELDS OF ALUMNI INVOLVEMENT; POSTERS; NOTEBOOKS; PENCILS, IN CLASS 16 (U.S. CLS. 2, 5, 22, 23, 29, 37, 38 AND 50).

FIRST USE 12-0-1984; IN COMMERCE 12-0-1984.

FOR: CLOTHING, NAMELY, SWEATERS, SWEATSHIRTS, T-SHIRTS, POLOS, HATS, JERSEYS, VESTS AND JACKETS, IN CLASS 25 (U.S. CLS. 22 AND 39).

FIRST USE 12-0-1984; IN COMMERCE 12-0-1984.

FOR: ASSOCIATION SERVICES, NAMELY, PROMOTING THE PROFESSIONAL, SOCIAL AND EDUCATIONAL INTERESTS OF A CHAPTER OF THE ALUMNI OF A UNIVERSITY, IN CLASS 35 (U.S. CLS. 100, 101 AND 102).

FIRST USE 12-0-1984; IN COMMERCE 12-0-1984.

NO CLAIM IS MADE TO THE EXCLUSIVE RIGHT TO USE "ALUMNI ASSOCIATION", APART FROM THE MARK AS SHOWN.

THE MARK CONSISTS OF THE WORDS "SIU ALUMNI" WITH A CLOCKTOWER BUILDING IN BETWEEN THEM ABOVE THE WORD "ASSOCIATION".

SER. NO. 85-242,568, FILED 2-15-2011.

CHARISMA HAMPTON, EXAMINING ATTORNEY



*David J. Kybas*

Director of the United States Patent and Trademark Office

# United States of America

United States Patent and Trademark Office

## MAIN EVENT CHAMPIONSHIP WRESTLING

**Reg. No. 4,134,024**

**Registered May 1, 2012**

**Int. Cl.: 41**

**SERVICE MARK**

**PRINCIPAL REGISTER**

MAIN EVENT CHAMPIONSHIP WRESTLING, LLC (INDIANA LIMITED LIABILITY COMPANY)  
1708 BELLEMEADE AVE  
EVANSVILLE, IN 47714

FOR: ENTERTAINMENT SERVICES, NAMELY, THE PRODUCTION AND EXHIBITION OF PROFESSIONAL WRESTLING EVENTS RENDERED LIVE, AND PROVIDING ON-GOING TELEVISION PROGRAMS IN THE FIELD OF PROFESSIONAL WRESTLING; PROVIDING WRESTLING NEWS AND INFORMATION VIA A GLOBAL COMPUTER NETWORK, IN CLASS 41 (U.S. CLS. 100, 101 AND 107).

FIRST USE 7-1-1999; IN COMMERCE 6-1-2010.

THE MARK CONSISTS OF STANDARD CHARACTERS WITHOUT CLAIM TO ANY PARTICULAR FONT, STYLE, SIZE, OR COLOR.

NO CLAIM IS MADE TO THE EXCLUSIVE RIGHT TO USE "CHAMPIONSHIP WRESTLING", APART FROM THE MARK AS SHOWN.

SER. NO. 85-243,107, FILED 2-15-2011.

HANNO RITTNER, EXAMINING ATTORNEY



*David J. Kyros*

Director of the United States Patent and Trademark Office

# United States of America

United States Patent and Trademark Office



**Reg. No. 4,134,025**

HAMMOND JR, RALPH C (UNITED STATES INDIVIDUAL)  
500 S LAKE ST  
WASILLA, AK 99654

**Registered May 1, 2012**

**Int. Cl.: 37**

FOR: CONCRETE RESTORATION, IN CLASS 37 (U.S. CLS. 100, 103 AND 106).

**SERVICE MARK**

FIRST USE 3-1-2007; IN COMMERCE 3-1-2007.

**PRINCIPAL REGISTER**

THE MARK CONSISTS OF THE WORDS "NCSGRIND" WRITTEN IN BLACK COLOR ABOVE THE WORDS ""OUR QUALITY GUARANTEE IS SET IN CONCRETE"" IN RED COLOR, ALL INSIDE THE GRAY LEFT PART OF A RECTANGLE WHICH IS DIVIDED INTO TWO PARTS BY A CURVE WHEREIN THE RIGHT PART IS BLUE.

THE COLOR(S) BLUE, GRAY, RED AND BLACK IS/ARE CLAIMED AS A FEATURE OF THE MARK.

SER. NO. 85-243,356, FILED 2-16-2011.

CAROLINE WOOD, EXAMINING ATTORNEY



*David J. Kybas*

Director of the United States Patent and Trademark Office

# United States of America

United States Patent and Trademark Office

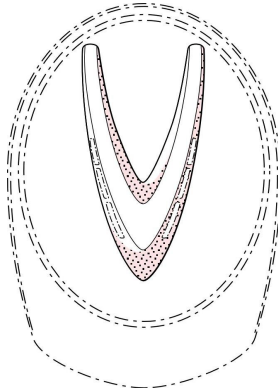

**Reg. No. 4,134,026**

**Registered May 1, 2012**

**Int. Cl.: 9**

**TRADEMARK**

**PRINCIPAL REGISTER**

MINE SAFETY APPLIANCES COMPANY (PENNSYLVANIA CORPORATION)  
1000 CRANBERRY WOODS DRIVE  
CRANBERRY TOWNSHIP, PA 16066

FOR: PROTECTIVE HELMETS AND HEADGEAR, NAMELY, SAFETY HATS AND SAFETY CAPS, IN CLASS 9 (U.S. CLS. 21, 23, 26, 36 AND 38).

FIRST USE 11-30-2003; IN COMMERCE 11-30-2003.

OWNER OF U.S. REG. NO. 1,259,212.

THE MARK CONSISTS OF A THREE-DIMENSIONAL CONFIGURATION OF A "V"-SHAPED RIDGE MOLDED INTO THE TOP OF A PROTECTIVE HELMET AND HEADGEAR, WITH THREE SLOTS CUT INTO THE RIDGE ON BOTH OUTSIDE EDGES NEAR THE POINT OF THE "V" SHAPE. THE DOTTED LINES IN THE DRAWING ARE NOT PART OF THE MARK, AND SERVE ONLY TO SHOW THE POSITION OF THE MARK ON THE GOODS.

SEC. 2(F).

SER. NO. 85-243,611, FILED 2-16-2011.

LIEF MARTIN, EXAMINING ATTORNEY



*David J. Kybas*

Director of the United States Patent and Trademark Office



# United States of America

United States Patent and Trademark Office

# RENEW

**Reg. No. 4,134,027**

RELIANCE ORTHODONTIC PRODUCTS, INC. (ILLINOIS CORPORATION)  
1540 WEST THORNDALE AVE.  
ITASCA, IL 60143

**Registered May 1, 2012**

**Int. Cl.: 10**

FOR: DENTAL INSTRUMENTS, NAMELY, BURS; ORTHODONTIC MACHINES AND INSTRUMENTS, IN CLASS 10 (U.S. CLS. 26, 39 AND 44).

**TRADEMARK**

FIRST USE 1-31-1995; IN COMMERCE 1-31-1995.

**PRINCIPAL REGISTER**

THE MARK CONSISTS OF STANDARD CHARACTERS WITHOUT CLAIM TO ANY PARTICULAR FONT, STYLE, SIZE, OR COLOR.

SER. NO. 85-243,677, FILED 2-16-2011.

GINA FINK, EXAMINING ATTORNEY



*David J. Kybas*

Director of the United States Patent and Trademark Office

# United States of America

United States Patent and Trademark Office



**Reg. No. 4,134,028**

**Registered May 1, 2012**

**Int. Cl.: 10**

**TRADEMARK**

**PRINCIPAL REGISTER**

RELIANCE ORTHODONTIC PRODUCTS, INC. (ILLINOIS CORPORATION)  
1540 WEST THORNDALE AVE.  
ITASCA, IL 60143

FOR: DENTAL INSTRUMENTS, NAMELY, BURS; ORTHODONTIC MACHINES AND INSTRUMENTS, IN CLASS 10 (U.S. CLS. 26, 39 AND 44).

FIRST USE 1-31-1995; IN COMMERCE 1-31-1995.

THE MARK CONSISTS OF A STYLIZED LETTER "R" WITHIN A CIRCLE FOLLOWED BY THE WORD "RENEW".

SER. NO. 85-243,711, FILED 2-16-2011.

GINA FINK, EXAMINING ATTORNEY



*David J. Kybas*

Director of the United States Patent and Trademark Office

# United States of America

United States Patent and Trademark Office

## Renew Finishing System

**Reg. No. 4,134,029**

RELIANCE ORTHODONTIC PRODUCTS, INC. (ILLINOIS CORPORATION)  
1540 WEST THORNDALE AVE.  
ITASCA, IL 60143

**Registered May 1, 2012**

**Int. Cl.: 10**

FOR: DENTAL INSTRUMENTS, NAMELY, BURS; ORTHODONTIC MACHINES AND INSTRUMENTS, IN CLASS 10 (U.S. CLS. 26, 39 AND 44).

**TRADEMARK**

FIRST USE 1-31-1995; IN COMMERCE 1-31-1995.

**PRINCIPAL REGISTER**

THE MARK CONSISTS OF STANDARD CHARACTERS WITHOUT CLAIM TO ANY PARTICULAR FONT, STYLE, SIZE, OR COLOR.

NO CLAIM IS MADE TO THE EXCLUSIVE RIGHT TO USE "FINISHING SYSTEM", APART FROM THE MARK AS SHOWN.

SER. NO. 85-243,717, FILED 2-16-2011.

GINA FINK, EXAMINING ATTORNEY



*David J. Kybas*

Director of the United States Patent and Trademark Office

# United States of America

United States Patent and Trademark Office

## DIGITAL ENERGY SOLUTIONS CAMPAIGN

**Reg. No. 4,134,030**

**Registered May 1, 2012**

**Int. Cl.: 42**

**SERVICE MARK**

**PRINCIPAL REGISTER**

INFORMATION TECHNOLOGY INDUSTRY COUNCIL, LTD. (DELAWARE NON-PROFIT CORPORATION)  
1101 K STREET, NW SUITE 610  
WASHINGTON, DC 20005

FOR: HOSTING AN ONLINE COMMUNITY WEBSITE THAT BRINGS TOGETHER HIGH-TECH COMPANIES, ASSOCIATIONS, NON-GOVERNMENTAL ORGANIZATIONS, AND OTHER STAKEHOLDERS TO SHARE AND ADVANCE IDEAS, BEST PRACTICES, AND POLICIES THAT PROMOTE HIGH TECH-ENABLED ENERGY EFFICIENCY, CLEAN ENERGY INNOVATION, AND SUSTAINABLE GROWTH, IN CLASS 42 (U.S. CLS. 100 AND 101).

FIRST USE 8-0-2010; IN COMMERCE 8-0-2010.

THE MARK CONSISTS OF STANDARD CHARACTERS WITHOUT CLAIM TO ANY PARTICULAR FONT, STYLE, SIZE, OR COLOR.

NO CLAIM IS MADE TO THE EXCLUSIVE RIGHT TO USE "DIGITAL ENERGY" AND "CAMPAIGN", APART FROM THE MARK AS SHOWN.

SER. NO. 85-244,167, FILED 2-16-2011.

WILLIAM P. SHANAHAN, EXAMINING ATTORNEY



*David J. Kyros*

Director of the United States Patent and Trademark Office

# United States of America

United States Patent and Trademark Office

## REPRESENT THE HUMAN SPECIES

**Reg. No. 4,134,031**

BEHRENDT, HEIDI (UNITED STATES INDIVIDUAL)  
6539 COLBATH AVE.  
VAN NUYS, CA 91401

**Registered May 1, 2012**

**Int. Cls.: 16 and 25**

FOR: BUMPER STICKERS; STICKERS, IN CLASS 16 (U.S. CLS. 2, 5, 22, 23, 29, 37, 38 AND 50).

**TRADEMARK**

FIRST USE 11-9-2010; IN COMMERCE 11-9-2010.

**PRINCIPAL REGISTER**

FOR: BASEBALL CAPS AND HATS; HOODED SWEATSHIRTS; SHORT-SLEEVED OR LONG-SLEEVED T-SHIRTS; SWEATSHIRTS, IN CLASS 25 (U.S. CLS. 22 AND 39).

FIRST USE 11-9-2010; IN COMMERCE 11-9-2010.

THE MARK CONSISTS OF STANDARD CHARACTERS WITHOUT CLAIM TO ANY PARTICULAR FONT, STYLE, SIZE, OR COLOR.

SER. NO. 85-244,475, FILED 2-17-2011.

COLLEEN DOMBROW, EXAMINING ATTORNEY



*David J. Kybas*

Director of the United States Patent and Trademark Office

# United States of America

United States Patent and Trademark Office



**Reg. No. 4,134,032**

**Registered May 1, 2012**

**Int. Cl.: 35**

**SERVICE MARK**

**PRINCIPAL REGISTER**

B2B INDUSTRIES, LLC (ILLINOIS LIMITED LIABILITY COMPANY)  
313 SOUTH ROHLWING ROAD  
WHEATON, IL 60187

FOR: BUSINESS SERVICES, NAMELY, FREIGHT INFORMATION MANAGEMENT SERVICES, SHIPMENT PROCESSING, PREPARING SHIPPING DOCUMENTS AND INVOICES, TRACKING DOCUMENTS, PACKAGES AND FREIGHT OVER COMPUTER NETWORKS, INTRANETS AND INTERNETS, IN CLASS 35 (U.S. CLS. 100, 101 AND 102).

FIRST USE 9-22-2010; IN COMMERCE 9-22-2010.

OWNER OF U.S. REG. NOS. 3,110,682, 3,110,683, AND 3,110,684.

NO CLAIM IS MADE TO THE EXCLUSIVE RIGHT TO USE "B2B" OR "INDUSTRIAL PACKAGING" OR "BEST SERVICE" OR "BEST SOLUTIONS", APART FROM THE MARK AS SHOWN.

THE MARK CONSISTS OF THE WORDING "B2B INDUSTRIAL PACKAGING", "BEST SERVICE", "BEST SOLUTIONS", WITH A SHADED CIRCLE BETWEEN THE WORDING "BEST SERVICE" AND "BEST SOLUTIONS", ALL DISPLAYED WITHIN AN INCOMPLETE OVAL.

SER. NO. 85-244,640, FILED 2-17-2011.

EVELYN BRADLEY, EXAMINING ATTORNEY



*David J. Kyros*

Director of the United States Patent and Trademark Office

# United States of America

United States Patent and Trademark Office



CLIMATE  
POLICY  
INITIATIVE

**Reg. No. 4,134,033**

**Registered May 1, 2012**

**Int. Cls.: 35, 36, 41, 42  
and 45**

**SERVICE MARK**

**PRINCIPAL REGISTER**

CLIMATE POLICY INITIATIVE INC. (DELAWARE CORPORATION)  
235 MONTGOMERY STREET, 13TH FLOOR  
SAN FRANCISCO, CA 94104

FOR: CONSULTING AND INFORMATION SERVICES IN THE FIELD OF ENERGY USAGE MANAGEMENT AND ENERGY EFFICIENCY; RECORDKEEPING SERVICES, NAMELY, COMPILING INFORMATION FOR USE BY BUSINESSES IN FILING REGULATORY REPORTS IN THE FIELD OF CLIMATE RELATED ENVIRONMENTAL PROTECTION, IN CLASS 35 (U.S. CLS. 100, 101 AND 102).

FIRST USE 2-1-2011; IN COMMERCE 2-1-2011.

FOR: FINANCIAL AFFAIRS, NAMELY, FINANCIAL ANALYSIS AND INFORMATION SERVICES ON THE IMPACTS OF ENERGY AND CLIMATE POLICIES ON COUNTRIES' ECONOMIES AND PRIVATE AND PUBLIC SECTOR INVESTMENT DECISIONS; CHARITABLE FUND RAISING SERVICES, NAMELY, RAISING FUNDS TO PROMOTE PUBLIC AWARENESS OF CLIMATE CHANGE, ENVIRONMENT AND ENERGY ISSUES; BROKERAGE OF CARBON DIOXIDE AND OTHER GREENHOUSE GAS EMISSION CREDITS; PROVIDING ADVICE TO INVESTMENT COMMUNITY AMONG OTHERS ON HOW CLIMATE AND ENERGY REGIMES AFFECT INVESTMENT DECISIONS, IN CLASS 36 (U.S. CLS. 100, 101 AND 102).

FIRST USE 2-1-2011; IN COMMERCE 2-1-2011.

FOR: EDUCATION SERVICES, NAMELY, PROVIDING COURSES AND WORKSHOPS IN THE FIELD OF GLOBAL CLIMATE CHANGE; PROVISION OF TRAINING AND LEARNING ACTIVITIES, NAMELY, PROVIDING TRAINING AND INSTRUCTION IN THE FIELD OF GLOBAL CLIMATE CHANGE; PROVISION OF INFORMATION RELATING TO EDUCATION AND TRAINING; ARRANGING, CONDUCTING AND SUPPORTING EDUCATIONAL CONFERENCES, SEMINARS AND EXHIBITIONS; PROVIDING EDUCATIONAL SERVICES, NAMELY, SEMINARS RELATING TO CLIMATE CHANGE, CLIMATE CHANGE POLICIES AND CHANGING ATTITUDES; PROVIDING ADVISORY AND INFORMATION SERVICES IN THE FIELD OF CLIMATE CHANGE EDUCATION; PUBLICATION OF BOOKS; PROVIDING ONLINE ELECTRONIC PUBLICATIONS, NAMELY, BOOKS AND JOURNALS IN THE FIELD OF CLIMATE CHANGE; PUBLICATION OF ELECTRONIC BOOKS AND JOURNALS ONLINE; PRODUCTION OF FILMS, VIDEO AND TELEVISION PROGRAMMES; CUSTOM WRITING SERVICES FOR USE IN WEB PAGE DEVELOPMENT; PROVIDING



*David J. Kybas*

Director of the United States Patent and Trademark Office

**Reg. No. 4,134,033** INFORMATION, ADVICE AND CONSULTANCY IN RELATION TO THE AFORESAID SERVICE, IN CLASS 41 (U.S. CLS. 100, 101 AND 107).

FIRST USE 2-1-2011; IN COMMERCE 2-1-2011.

FOR: SCIENTIFIC RESEARCH SERVICES; TECHNOLOGICAL RESEARCH SERVICES IN THE FIELD OF ENVIRONMENTAL PROTECTION; DESIGNING SCIENTIFIC AND TECHNOLOGICAL RESEARCH PROGRAMS IN THE FIELD OF ENVIRONMENTAL PROTECTION FOR OTHERS; RESEARCH ON CLIMATE CHANGE; TECHNICAL CONSULTING AND INFORMATION IN THE FIELD OF ENVIRONMENTAL SCIENCE; PROVISION OF TECHNICAL ADVICE, NAMELY, PROVIDING TECHNOLOGICAL CONSULTATION SERVICES IN THE FIELD OF ALTERNATIVE ENERGY GENERATION; TECHNICAL STUDIES, NAMELY, TECHNICAL RESEARCH IN THE FIELD OF CLIMATE CHANGE; PREPARING SCIENTIFIC RESEARCH REPORTS; CREATING, MAINTAINING AND HOSTING WEB SITES; GRAPHIC DESIGN SERVICES FOR USE IN WEB PAGE DEVELOPMENT; PROVIDING INFORMATION, ADVICE AND CONSULTANCY IN RELATION TO THE AFORESAID SERVICES, IN CLASS 42 (U.S. CLS. 100 AND 101).

FIRST USE 2-1-2011; IN COMMERCE 2-1-2011.

FOR: ASSESSMENT OF BUSINESSES CLIMATE CHANGE POLICIES, NAMELY, REVIEWING STANDARDS AND PRACTICES TO ASSURE COMPLIANCE WITH CLIMATE RELATED ENVIRONMENTAL LAWS AND REGULATIONS; REGULATORY COMPLIANCE CONSULTING IN THE FIELD OF CLIMATE RELATED ENVIRONMENTAL PROTECTION; PREPARING ENVIRONMENTAL COMPLIANCE REPORTS, IN CLASS 45 (U.S. CLS. 100 AND 101).

FIRST USE 2-1-2011; IN COMMERCE 2-1-2011.

NO CLAIM IS MADE TO THE EXCLUSIVE RIGHT TO USE "CLIMATE POLICY INITIATIVE", APART FROM THE MARK AS SHOWN.

THE COLOR(S) RED, BROWN, ORANGE AND GREY IS/ARE CLAIMED AS A FEATURE OF THE MARK.

THE MARK CONSISTS OF THE WORDS "CLIMATE POLICY INITIATIVE" IN GREY, A GREY VERTICAL LINE LOCATED TO THE LEFT OF THE WORDS AND A CIRCULAR DESIGN COMPRISED OF MULTIPLE CIRCLES OF DIFFERENT LENGTHS AND IN THE COLORS RED, BROWN AND ORANGE AND LOCATED TO THE LEFT OF THE VERTICAL LINE. THE WORDS "CLIMATE POLICY INITIATIVE" ARE GREY. THE VERTICAL LINE IS GREY. THE COLORS OF THE CIRCULAR DESIGN ARE RED, BROWN AND ORANGE.

SER. NO. 85-244,916, FILED 2-17-2011.

MARTHA FROMM, EXAMINING ATTORNEY



# United States of America

United States Patent and Trademark Office

## ENDURO EDGE SUPPORT

**Reg. No. 4,134,034**

**Registered May 1, 2012**

**Int. Cl.: 20**

**TRADEMARK**

**PRINCIPAL REGISTER**

KINGSDOWN, INC. (NORTH CAROLINA CORPORATION)  
P.O. BOX 388  
MEBANE, NC 27302

FOR: MATTRESS COMPONENT, NAMELY, REINFORCED SUPPORTING ELEMENTS SPACED INTERMITTENTLY ALONG THE PERIMETER OF A MATTRESS SOLD AS AN INTEGRAL COMPONENT OF THE MATTRESS, IN CLASS 20 (U.S. CLS. 2, 13, 22, 25, 32 AND 50).

FIRST USE 1-24-2011; IN COMMERCE 1-24-2011.

THE MARK CONSISTS OF STANDARD CHARACTERS WITHOUT CLAIM TO ANY PARTICULAR FONT, STYLE, SIZE, OR COLOR.

OWNER OF U.S. REG. NO. 2,872,660.

NO CLAIM IS MADE TO THE EXCLUSIVE RIGHT TO USE "EDGE SUPPORT", APART FROM THE MARK AS SHOWN.

SER. NO. 85-244,958, FILED 2-17-2011.

MICHAEL WEBSTER, EXAMINING ATTORNEY



*David J. Kyros*

Director of the United States Patent and Trademark Office

# United States of America

United States Patent and Trademark Office

## Forever Fabulous

**Reg. No. 4,134,035**

**Registered May 1, 2012**

**Int. Cl.: 41**

**SERVICE MARK**

**PRINCIPAL REGISTER**

FLAMINGO LAS VEGAS PROPCO, LLC (DELAWARE LIMITED LIABILITY COMPANY)  
ONE CAESARS PALACE DRIVE  
LAS VEGAS, NV 89109

FOR: PROVIDING ENTERTAINMENT SERVICES IN THE NATURE OF CASINO AND GAMING ACTIVITIES; CASINO SERVICES; CONDUCTING AND PROVIDING FACILITIES FOR SPECIAL EVENTS FEATURING CASINO AND GAMING CONTESTS, IN CLASS 41 (U.S. CLS. 100, 101 AND 107).

FIRST USE 3-22-2011; IN COMMERCE 3-22-2011.

THE MARK CONSISTS OF STANDARD CHARACTERS WITHOUT CLAIM TO ANY PARTICULAR FONT, STYLE, SIZE, OR COLOR.

SER. NO. 85-244,988, FILED 2-17-2011.

LINDA ESTRADA, EXAMINING ATTORNEY



*David J. Kyffers*

Director of the United States Patent and Trademark Office

# United States of America

United States Patent and Trademark Office

## Ground Observer 12

**Reg. No. 4,134,036**

**Registered May 1, 2012**

**Int. Cl.: 9**

**TRADEMARK**

**PRINCIPAL REGISTER**

THALES DEFENCE & SECURITY SYSTEMS GMBH (FED REP GERMANY LIMITED LIABILITY COMPANY)  
OSTENDSTRASSE 3  
PFORZHEIM, FED REP GERMANY 75175

FOR: RADAR; RADAR FOR AIRCRAFT DEFENSE, MISSILE WARNING, SURFACE SHIPS, PERISCOPES AT SEA, GROUND SURVEILLANCE, AND FIRE CONTROL OF MISSILES AND GUNS, AND PARTS THEREFOR, AND ACCESSORIES FOR RADAR, NAMELY, SENSORS, FLAT PANEL DISPLAYS, RADAR DOMES, COMPUTER SOFTWARE FOR RADAR FOR USE IN MONITORING AND DISPLAYING RADAR SIGNALS, AND DISPLAYS, NAMELY, ELECTRONIC DISPLAY BOARDS, ELECTRONIC DISPLAY SCREENS, ELECTRONIC DISPLAY INTERFACES, HEAD-MOUNTED VIDEO DISPLAYS, LIQUID CRYSTAL DISPLAYS, AND TRANSPARENT ELECTRONIC DISPLAYS FIXED AT HEAD-LEVEL OR HEAD-DOWN POSITIONS FOR USE IN MILITARY AND COMMERCIAL AIRCRAFT, VESSELS AND VEHICLES FOR PROVIDING CREW MEMBERS WITH NAVIGATIONAL AND OPERATIONAL INFORMATION, IN CLASS 9 (U.S. CLS. 21, 23, 26, 36 AND 38).

THE MARK CONSISTS OF STANDARD CHARACTERS WITHOUT CLAIM TO ANY PARTICULAR FONT, STYLE, SIZE, OR COLOR.

PRIORITY CLAIMED UNDER SEC. 44(D) ON FED REP GERMANY APPLICATION NO. 302010056584, FILED 9-24-2010, REG. NO. 302010056584, DATED 11-8-2010, EXPIRES 9-30-2020.

SER. NO. 85-245,129, FILED 2-17-2011.

LESLEY LAMOTHE, EXAMINING ATTORNEY



*David J. Kybas*

Director of the United States Patent and Trademark Office

# United States of America

United States Patent and Trademark Office

# GO12

**Reg. No. 4,134,037**

**Registered May 1, 2012**

**Int. Cl.: 9**

**TRADEMARK**

**PRINCIPAL REGISTER**

THALES DEFENCE & SECURITY SYSTEMS GMBH (FED REP GERMANY LIMITED LIABILITY COMPANY)  
OSTENDSTRASSE 3  
PFORZHEIM, FED REP GERMANY 75175

FOR: RADAR; RADAR FOR AIRCRAFT DEFENSE, MISSILE WARNING, SURFACE SHIPS, PERISCOPES AT SEA, GROUND SURVEILLANCE, AND FIRE CONTROL OF MISSILES AND GUNS, AND PARTS THEREFOR, AND ACCESSORIES FOR RADAR, NAMELY, SENSORS, FLAT PANEL DISPLAYS, RADAR DOMES, COMPUTER SOFTWARE FOR RADAR FOR USE IN MONITORING AND DISPLAYING RADAR SIGNALS, AND DISPLAYS, NAMELY, ELECTRONIC DISPLAY BOARDS, ELECTRONIC DISPLAY SCREENS, ELECTRONIC DISPLAY INTERFACES, HEAD-MOUNTED VIDEO DISPLAYS, LIQUID CRYSTAL DISPLAYS, AND TRANSPARENT ELECTRONIC DISPLAYS FIXED AT HEAD-LEVEL OR HEAD-DOWN POSITIONS FOR USE IN MILITARY AND COMMERCIAL AIRCRAFT, VESSELS AND VEHICLES FOR PROVIDING CREW MEMBERS WITH NAVIGATIONAL AND OPERATIONAL INFORMATION, IN CLASS 9 (U.S. CLS. 21, 23, 26, 36 AND 38).

THE MARK CONSISTS OF STANDARD CHARACTERS WITHOUT CLAIM TO ANY PARTICULAR FONT, STYLE, SIZE, OR COLOR.

PRIORITY CLAIMED UNDER SEC. 44(D) ON FED REP GERMANY APPLICATION NO. 302010056585, FILED 9-24-2010, REG. NO. 302010056585, DATED 11-8-2010, EXPIRES 9-30-2020.

SER. NO. 85-245,136, FILED 2-17-2011.

LESLEY LAMOTHE, EXAMINING ATTORNEY



*David J. Kyffers*

Director of the United States Patent and Trademark Office

# United States of America

United States Patent and Trademark Office



ShopForAHome.com

**Reg. No. 4,134,038**

SHOPFORAHOME.COM LLC (OKLAHOMA LIMITED LIABILITY COMPANY)  
2007 HUNTINGTON AVENUE  
OKLAHOMA CITY, OK 73116

**Registered May 1, 2012**

**Int. Cl.: 36**

FOR: PROVIDING REAL ESTATE LISTINGS AND REAL ESTATE INFORMATION VIA THE INTERNET; REAL ESTATE CONSULTANCY, IN CLASS 36 (U.S. CLS. 100, 101 AND 102).

**SERVICE MARK**

FIRST USE 5-2-2010; IN COMMERCE 5-2-2010.

**PRINCIPAL REGISTER**

NO CLAIM IS MADE TO THE EXCLUSIVE RIGHT TO USE "SHOPFORAHOME.COM", APART FROM THE MARK AS SHOWN.

THE MARK CONSISTS OF A DEPICTION OF A SHOPPING CART HAVING A HOUSE PLACED THEREIN AND A FLOWER EXTENDING THEREFROM, THE WHEELS OF THE SHOPPING CART POSITIONED ON A SURFACE DEPICTED BY AN OVAL SHAPE, ALL POSITIONED ADJACENT TO THE WORDING "SHOPFORAHOME.COM".

SER. NO. 85-245,345, FILED 2-17-2011.

TARA PATE, EXAMINING ATTORNEY



*David J. Kybas*

Director of the United States Patent and Trademark Office

# United States of America

United States Patent and Trademark Office

## PACO & LOLA

**Reg. No. 4,134,039**

**Registered May 1, 2012**

**Int. Cl.: 33**

**TRADEMARK**

**PRINCIPAL REGISTER**

COOPERATIVA VITIVINICOLA AROUSANA S.C.G. (SPAIN COOPERATIVE)  
36968 MEAÑO  
CALLE VALDAMOR, N°18  
(PONTEVEDRA), SPAIN

FOR: WINE, IN CLASS 33 (U.S. CLS. 47 AND 49).

THE MARK CONSISTS OF STANDARD CHARACTERS WITHOUT CLAIM TO ANY PARTICULAR FONT, STYLE, SIZE, OR COLOR.

OWNER OF ERPN CMNTY TM OFC REG. NO. 5508882, DATED 9-17-2007, EXPIRES 11-29-2016.

SER. NO. 85-246,526, FILED 2-18-2011.

GRETТА YAO, EXAMINING ATTORNEY



*David J. Kyffers*

Director of the United States Patent and Trademark Office

# United States of America

United States Patent and Trademark Office

## Victory in Mind. Strength in Body.

**Reg. No. 4,134,040**

**Registered May 1, 2012**

**Int. Cls.: 9, 28 and 41**

**TRADEMARK**

**SERVICE MARK**

**PRINCIPAL REGISTER**

GET.MD LLC (DELAWARE LIMITED LIABILITY COMPANY)  
738 LAKE TERRACE CIRCLE  
738 LAKE TERRACE CIRCLE  
DAVIS, CA 95616

FOR: COMPUTER GAME SOFTWARE; COMPUTER GAME SOFTWARE DOWNLOADABLE FROM A GLOBAL COMPUTER NETWORK; COMPUTER GAME SOFTWARE FOCUSING ON ACHIEVING A SET OF GOALS, POSITIONS, OWNERSHIP, AND CREDENTIALS, AND PROFESSIONAL AND SOCIAL STATUS, AND GOOD FORTUNE NECESSARY TO SUCCEED PROFESSIONALLY AND PERSONALLY, AND NOT REFERRING EITHER TO A GROUP OF SOFTWARE FOR USE IN COMMERCE OR TO A GROUP OF OFFICES; COMPUTER GAME SOFTWARE FOR PERSONAL COMPUTERS AND HOME VIDEO GAME CONSOLES; COMPUTER GAME SOFTWARE FOR USE ON MOBILE AND CELLULAR PHONES; COMPUTER GAME SOFTWARE FOR USE WITH PERSONAL COMPUTERS, HOME VIDEO GAME CONSOLES USED WITH TELEVISIONS AND ARCADE-BASED VIDEO GAME CONSOLES; COMPUTER PROGRAMS FOR VIDEO AND COMPUTER GAMES; DOWNLOADABLE ELECTRONIC GAME PROGRAMS; ELECTRONIC GAME PROGRAMS; ELECTRONIC GAME SOFTWARE FOR CELLULAR TELEPHONES; ELECTRONIC GAME SOFTWARE FOR HANDHELD ELECTRONIC DEVICES; ELECTRONIC GAME SOFTWARE FOR WIRELESS DEVICES; INTERACTIVE GAME SOFTWARE; INTERACTIVE MULTIMEDIA COMPUTER GAME PROGRAM; INTERACTIVE MULTIMEDIA COMPUTER PROGRAM FOR PERSONAL HEALTHCARE LEARNING AND KNOWLEDGE SHARING, IN CLASS 9 (U.S. CLS. 21, 23, 26, 36 AND 38).

FIRST USE 2-18-2011; IN COMMERCE 2-18-2011.

FOR: ARCADE-TYPE ELECTRONIC EDUCATION VIDEO GAMES; ELECTRONIC EDUCATIONAL GAME MACHINES FOR CHILDREN; ELECTRONIC LEARNING TOYS, IN CLASS 28 (U.S. CLS. 22, 23, 38 AND 50).

FIRST USE 2-18-2011; IN COMMERCE 2-18-2011.

FOR: MULTIMEDIA PUBLISHING OF BOOKS, MAGAZINES, JOURNALS, SOFTWARE, GAMES, MUSIC, AND ELECTRONIC PUBLICATIONS, IN CLASS 41 (U.S. CLS. 100, 101 AND 107).

FIRST USE 2-18-2011; IN COMMERCE 2-18-2011.



*David J. Kyros*

Director of the United States Patent and Trademark Office

**Reg. No. 4,134,040** THE MARK CONSISTS OF STANDARD CHARACTERS WITHOUT CLAIM TO ANY PARTICULAR FONT, STYLE, SIZE, OR COLOR.

SER. NO. 85-246,587, FILED 2-18-2011.

LINDSEY RUBIN, EXAMINING ATTORNEY



# United States of America

United States Patent and Trademark Office

## HOUSEHOLD 6 PHOTOGRAPHY

**Reg. No. 4,134,041**

**Registered May 1, 2012**

**Int. Cl.: 41**

**SERVICE MARK**

**PRINCIPAL REGISTER**

CARLSON, BRIDGET M (UNITED STATES INDIVIDUAL), DBA HOUSEHOLD 6 DESIGNS  
& PHOTOGRAPHY  
P.O. BOX 891  
COLONIAL HEIGHTS, VA 238340891

FOR: DIGITAL IMAGING SERVICES; PHOTOGRAPHY; PHOTOGRAPHY SERVICES, IN  
CLASS 41 (U.S. CLS. 100, 101 AND 107).

FIRST USE 0-0-2005; IN COMMERCE 0-0-2009.

THE MARK CONSISTS OF STANDARD CHARACTERS WITHOUT CLAIM TO ANY PAR-  
TICULAR FONT, STYLE, SIZE, OR COLOR.

NO CLAIM IS MADE TO THE EXCLUSIVE RIGHT TO USE "PHOTOGRAPHY", APART  
FROM THE MARK AS SHOWN.

SER. NO. 85-246,776, FILED 2-18-2011.

SALLY SHIH, EXAMINING ATTORNEY



*David J. Kybas*

Director of the United States Patent and Trademark Office

# United States of America

United States Patent and Trademark Office

# ALVEOLOGIC

**Reg. No. 4,134,042**

ALVEOLOGIC, LLC (NEW YORK LIMITED LIABILITY COMPANY)  
63 COTTONWOOD LANE  
BRIARCLIFF MANOR., NY 10510

**Registered May 1, 2012**

**Int. Cl.: 10**

FOR: ORTHODONTIC APPLIANCES; ORTHODONTIC MACHINES AND INSTRUMENTS,  
IN CLASS 10 (U.S. CLS. 26, 39 AND 44).

**TRADEMARK**

FIRST USE 11-9-2010; IN COMMERCE 11-9-2010.

**PRINCIPAL REGISTER**

THE MARK CONSISTS OF STANDARD CHARACTERS WITHOUT CLAIM TO ANY PAR-  
TICULAR FONT, STYLE, SIZE, OR COLOR.

SER. NO. 85-247,030, FILED 2-20-2011.

TINA L. SNAPP, EXAMINING ATTORNEY



*David J. Kybas*

Director of the United States Patent and Trademark Office

# United States of America

United States Patent and Trademark Office

## Ronin Metal Masters

**Reg. No. 4,134,043**

**Registered May 1, 2012**

**Int. Cl.: 42**

**SERVICE MARK**

**PRINCIPAL REGISTER**

RONIN METAL MASTERS (CALIFORNIA LIMITED LIABILITY COMPANY), DBA RONIN METAL MASTERS  
624 VICTORY WAY APT. #4  
MOUNTAIN VIEW, CA 94040

FOR: NEW PRODUCT DESIGN SERVICES FOR SHEET METAL STRUCTURES AND PRODUCTS, NOT INCLUDING TOYS, IN CLASS 42 (U.S. CLS. 100 AND 101).

FIRST USE 5-5-2010; IN COMMERCE 10-11-2010.

THE MARK CONSISTS OF STANDARD CHARACTERS WITHOUT CLAIM TO ANY PARTICULAR FONT, STYLE, SIZE, OR COLOR.

NO CLAIM IS MADE TO THE EXCLUSIVE RIGHT TO USE "METAL", APART FROM THE MARK AS SHOWN.

SER. NO. 85-247,131, FILED 2-20-2011.

JOHN SCHUYLER YARD, EXAMINING ATTORNEY



*David J. Kyros*

Director of the United States Patent and Trademark Office

# United States of America

United States Patent and Trademark Office

# Everlane

**Reg. No. 4,134,044**

**Registered May 1, 2012**

**Int. Cl.: 35**

**SERVICE MARK**

**PRINCIPAL REGISTER**

EVERLANE, INC. (DELAWARE CORPORATION)  
SUITE 210  
PIER 38 - THE EMBARCADERO  
SAN FRANCISCO, CA 94107

FOR: ADVERTISING, INCLUDING ON-LINE ADVERTISING ON A COMPUTER NETWORK;  
ADVERTISING, INCLUDING PROMOTION RELATING TO THE SALE OF ARTICLES AND  
SERVICES FOR THIRD PARTIES BY THE TRANSMISSION OF ADVERTISING MATERIAL  
AND THE DISSEMINATION OF ADVERTISING MESSAGES ON COMPUTER NETWORKS;  
ADVERTISING, MARKETING AND PROMOTION SERVICES, IN CLASS 35 (U.S. CLS. 100,  
101 AND 102).

FIRST USE 12-1-2010; IN COMMERCE 12-1-2010.

THE MARK CONSISTS OF STANDARD CHARACTERS WITHOUT CLAIM TO ANY PAR-  
TICULAR FONT, STYLE, SIZE, OR COLOR.

SER. NO. 85-247,183, FILED 2-21-2011.

JOHN DWYER, EXAMINING ATTORNEY



*David J. Kybas*

Director of the United States Patent and Trademark Office

# United States of America

United States Patent and Trademark Office

WINNING ISN'T EVERYTHING;  
YOU HAVE TO EAT, TOO.

**Reg. No. 4,134,045**

**Registered May 1, 2012**

**Int. Cl.: 25**

**TRADEMARK**

**PRINCIPAL REGISTER**

JENI MCCORMICK (UNITED STATES INDIVIDUAL)  
127 PARK AVE  
CAYUCOS, CA 93430

FOR: APPAREL FOR DANCERS, NAMELY, TEE SHIRTS, SWEATSHIRTS, PANTS, LEGGINGS, SHORTS AND JACKETS; APRONS; ATHLETIC APPAREL, NAMELY, SHIRTS, PANTS, JACKETS, FOOTWEAR, HATS AND CAPS, ATHLETIC UNIFORMS; BASEBALL CAPS AND HATS; BOMBER JACKETS; BRIEFS; CAMOUFLAGE JACKETS; CHEF'S COATS; CHEF'S HATS; CHILDREN'S AND INFANT'S APPAREL, NAMELY, JUMPERS, OVERALL SLEEPWEAR, PAJAMAS, ROMPERS AND ONE-PIECE GARMENTS; COBBLERS' APRONS; HAT BANDS; KNITTED UNDERWEAR; LADIES' UNDERWEAR; LONG UNDERWEAR; MEN'S UNDERWEAR; PAPER APRONS; PARTS OF CLOTHING, NAMELY, GUSSETS FOR TIGHTS, GUSSETS FOR STOCKINGS, GUSSETS FOR BATHING SUITS, GUSSETS FOR UNDERWEAR, GUSSETS FOR LEOTARDS AND GUSSETS FOR FOOTLETS; PLASTIC APRONS; THERMAL UNDERWEAR; THONGS; UNDERWEAR; UNDERWEAR, NAMELY, BOY SHORTS; WOMEN'S UNDERWEAR; WOVEN OR KNITTED UNDERWEAR, IN CLASS 25 (U.S. CLS. 22 AND 39).

FIRST USE 1-25-2011; IN COMMERCE 2-15-2011.

THE MARK CONSISTS OF STANDARD CHARACTERS WITHOUT CLAIM TO ANY PARTICULAR FONT, STYLE, SIZE, OR COLOR.

SER. NO. 85-247,698, FILED 2-21-2011.

JASON LOTT, EXAMINING ATTORNEY



*David J. Kyros*

Director of the United States Patent and Trademark Office

# United States of America

United States Patent and Trademark Office

## LA ADICTIVA BANDA SAN JOSE DE MESILLAS

**Reg. No. 4,134,046**

**Registered May 1, 2012**

**Int. Cls.: 9 and 41**

**TRADEMARK**

**SERVICE MARK**

**PRINCIPAL REGISTER**

VALDES, JOSE ANDRES (MEXICO INDIVIDUAL)  
MIGUEL HIDALGO NO. 20  
MESILLAS, MEXICO

FOR: DIGITAL MATERIALS, NAMELY, CDS, DVDS, DOWNLOADABLE AUDIO FILES  
FEATURING MUSIC, IN CLASS 9 (U.S. CLS. 21, 23, 26, 36 AND 38).

FIRST USE 2-1-1994; IN COMMERCE 10-3-1995.

FOR: ENTERTAINMENT, NAMELY, LIVE PERFORMANCES BY A MUSICAL BAND, IN  
CLASS 41 (U.S. CLS. 100, 101 AND 107).

FIRST USE 2-1-1994; IN COMMERCE 10-3-1995.

THE MARK CONSISTS OF STANDARD CHARACTERS WITHOUT CLAIM TO ANY PAR-  
TICULAR FONT, STYLE, SIZE, OR COLOR.

NO CLAIM IS MADE TO THE EXCLUSIVE RIGHT TO USE "BANDA" AND "DE MESILLAS",  
APART FROM THE MARK AS SHOWN.

THE ENGLISH TRANSLATION OF "LA ADICTIVA BANDA SAN JOSE DE MESILLAS" IN  
THE MARK IS "THE ADDICTIVE BAND OF SAN JOSE OF MESILLAS".

SER. NO. 85-247,848, FILED 2-22-2011.

MICHELE SWAIN, EXAMINING ATTORNEY



*David J. Kybas*

Director of the United States Patent and Trademark Office

# United States of America

United States Patent and Trademark Office



**Reg. No. 4,134,047**

**Registered May 1, 2012**

**Int. Cls.: 9, 41 and 42**

**TRADEMARK**

**SERVICE MARK**

**PRINCIPAL REGISTER**

GOMMI ARCADE, INC. (NEW YORK CORPORATION)  
NO. 1B  
749 ST. NICHOLAS AVE  
NEW YORK, NY 10031

FOR: ELECTRICAL AND SCIENTIFIC APPARATUS, NAMELY, ELECTRONIC GAME SOFTWARE; COMPUTER GAME SOFTWARE; DOWNLOADABLE COMPUTER GAMES; COMPUTER-GAME AND VIDEO-GAME CASSETTES, CARTRIDGES, DISCS AND PROGRAMS; COMPUTER GAME PROGRAMS DOWNLOADABLE VIA GLOBAL COMPUTER, DATA AND MOBILE NETWORKS; DIGITAL VIDEO DISCS, PRE-RECORDED MEMORY CARDS AND OTHER STORAGE MEDIA FEATURING MOTION PICTURES, FILMS, TELEVISION PROGRAMS, ANIMATED CARTOONS, LIVE-ACTION PERFORMANCES, LIVE ACTION PERFORMANCES BY COSTUMED CHARACTERS AND INTERACTIVE PROGRAMS, ALL IN THE FIELDS OF SCIENCE FICTION, COMEDY, DRAMA, MYSTERY, MUSIC, MUSICAL PERFORMANCES, AND MUSICAL VIDEOS; COMPACT DISCS, DIGITAL VIDEO DISCS, PHONOGRAPH RECORDS, PRE-RECORDED MEMORY CARDS AND OTHER STORAGE MEDIA FEATURING MOTION PICTURES, FILMS, TELEVISION PROGRAMS, AND ANIMATED CARTOONS; VIDEO RECORDINGS, MUSICAL SOUND RECORDINGS FEATURING MUSIC, ANIMATED CARTOONS, LIVE-ACTION PERFORMANCES AND LIVE ACTION PERFORMANCES BY COSTUMED CHARACTERS, AND RELATED FILM CLIPS AND PHOTOGRAPHS, ALL IN THE FIELD OF SCIENCE FICTION, COMEDY, DRAMA, MYSTERY, MUSIC, MUSICAL PERFORMANCES, AND MUSICAL VIDEOS; SOFTWARE AND MANUALS SOLD AS A UNIT IN THE FIELD OF SCIENCE FICTION, COMEDY, DRAMA, MYSTERY, MUSIC, MUSICAL PERFORMANCES, AND MUSICAL VIDEOS, NAMELY, FOR USE IN CREATING, UPDATING AND MAINTAINING CALENDARS, FOR INFORMATION MANAGEMENT AND FOR USE AS COMPUTER SCREEN SAVERS; HAND HELD UNITS FOR PLAYING ELECTRONIC GAMES FOR USE WITH EXTERNAL DISPLAY SCREEN OR MONITOR; DOWNLOADABLE RING TONES, MUSIC AND GRAPHICS FOR WIRELESS COMMUNICATION DEVICES, IN CLASS 9 (U.S. CLS. 21, 23, 26, 36 AND 38).

FIRST USE 1-1-2009; IN COMMERCE 7-29-2009.

FOR: ENTERTAINMENT SERVICES, NAMELY, PROVIDING TEMPORARY USE OF NON-DOWNLOADABLE INTERACTIVE GAMES THROUGH GLOBAL COMPUTER, DIGITAL AND MOBILE NETWORKS; PRODUCTION AND DISTRIBUTION OF MOTION PICTURES, FILMS, TELEVISION PROGRAMS, RADIO PROGRAMS, ALL IN THE FIELDS OF SCIENCE



*David J. Kyros*

Director of the United States Patent and Trademark Office

**Reg. No. 4,134,047** FICTION, COMEDY, DRAMA, MYSTERY, MUSIC, MUSICAL PERFORMANCES, MUSICAL VIDEOS, RELATED FILM CLIPS AND PHOTOGRAPHS; AUDIO RECORDING AND PRODUCTION OF ANIMATED AND LIVE ACTION ENTERTAINMENT IN THE FIELDS OF SCIENCE FICTION, COMEDY, DRAMA, MYSTERY, MUSIC, MUSICAL PERFORMANCES, MUSICAL VIDEOS, RELATED FILM CLIPS AND PHOTOGRAPHS; ENTERTAINMENT IN THE NATURE OF THEATER PRODUCTIONS FEATURING LIVE-ACTION ENTERTAINMENT IN THE FIELDS OF SCIENCE FICTION, COMEDY, DRAMA, MYSTERY, MUSIC, MUSICAL PERFORMANCES, MUSICAL VIDEOS, RELATED FILM CLIPS AND PHOTOGRAPHS; PUBLICATION OF BOOKS, MAGAZINES, CARTOONS, COMIC STRIPS AND COMIC BOOKS; MULTIMEDIA ENTERTAINMENT SOFTWARE PRODUCTION SERVICES; FAN CLUBS; PROVIDING ONLINE COMPUTER GAMES; PROVIDING A WEBSITE FEATURING MUSIC AND MUSICAL PERFORMANCES, MUSICAL VIDEOS, RELATED FILM CLIPS AND PHOTOGRAPHS; PROVIDING ONLINE ELECTRONIC PUBLICATIONS, NAMELY, NEWSLETTERS, BULLETINS, AND WEB BLOGS IN THE FIELD OF ENTERTAINMENT; RECORD PRODUCTION; VIDEOTAPE PRODUCTION; AUDIOTAPE PRODUCTION; ENTERTAINMENT SERVICES, NAMELY, PERSONAL APPEARANCES BY MUSICAL GROUPS, MUSICAL ARTISTS AND CELEBRITIES; ENTERTAINMENT SERVICES, NAMELY, PROVIDING A WEB SITE FEATURING ANIMATED AND LIVE-ACTION ENTERTAINMENT IN THE FIELDS OF SCIENCE FICTION, COMEDY, DRAMA, MYSTERY, MUSIC, MUSICAL PERFORMANCES, MUSICAL VIDEOS, RELATED FILM CLIPS AND PHOTOGRAPHS; CONDUCTING ENTERTAINMENT EXHIBITIONS IN THE NATURE OF MUSIC FESTIVALS; ORGANIZING EXHIBITIONS FOR THE PROMOTION OF MUSIC AND THE ARTS, IN CLASS 41 (U.S. CLS. 100, 101 AND 107).

FIRST USE 1-1-2009; IN COMMERCE 7-29-2009.

FOR: COMPUTER SERVICES, NAMELY, HOSTING AN INTERACTIVE WEB SITE FOR VIEWING AND POSTING NEWS INFORMATION, CALENDARS, AND MULTIMEDIA CONTENT, NAMELY, PODCASTS, VIDEO, AND MESSAGES ON COMPUTERS AND MOBILE COMMUNICATION DEVICES VIA GLOBAL COMPUTER, WIRELESS AND DATA NETWORKS; PROVIDING CONTENT AND DATA FEEDS, BLOG POSTS, AND LINKS TO INFORMATION AND ON-LINE CONTENT ON GLOBAL COMPUTER, DATA AND WIRELESS NETWORKS FEATURING INFORMATION ON GENERAL INTEREST TOPICS, IN CLASS 42 (U.S. CLS. 100 AND 101).

FIRST USE 1-1-2009; IN COMMERCE 7-29-2009.

THE MARK CONSISTS OF THE WORDS "GOMMI ARCADE" IN A STYLIZED FORM, WITH THE LETTER "O" IN "GOMMI" CONSISTING OF THE FACE OF A CHARACTER.

SER. NO. 85-248,249, FILED 2-22-2011.

ALLISON HOLTZ, EXAMINING ATTORNEY



# United States of America

United States Patent and Trademark Office



**Reg. No. 4,134,048**

**Registered May 1, 2012**

**Int. Cl.: 25**

**TRADEMARK**

**PRINCIPAL REGISTER**

GOMMI ARCADE, INC. (NEW YORK CORPORATION)  
NO. 1B  
749 ST. NICHOLAS AVE.  
NEW YORK, NY 10031

FOR: CLOTHING, NAMELY, ATHLETIC FOOTWEAR, BANDANAS, BASEBALL CAPS, BEANIES, UNDERWEAR, MASQUERADE COSTUMES, BUTTON DOWN SHIRTS, CAPS, CARDIGANS, COATS, GLOVES, HATS, HEADWEAR, HOODED SWEAT SHIRTS, JACKETS, JEANS, KNIT SWEATERS, PANTS, POLO SHIRTS, SARONGS, SCARVES, SHIRTS, SHOES, SHORTS, SKIRTS, SKI WEAR, SNOWBOARD BOOTS, SNOWBOARD GAITERS, SNOWBOARD GLOVES, SNOWBOARD PANTS, SNOWBOARD SOCKS, SOCKS, SWEATERS, SWEAT SUITS, T-SHIRTS, TANK TOPS, TURTLENECKS, UNDERSHIRTS, WOVEN TIES, AND KNIT TIES, IN CLASS 25 (U.S. CLS. 22 AND 39).

FIRST USE 1-1-2009; IN COMMERCE 4-15-2009.

THE MARK CONSISTS OF THE WORDS "GOMMI ARCADE" IN A STYLIZED FORM, WITH THE LETTER "O" IN "GOMMI" CONSISTING OF THE FACE OF A CHARACTER.

SER. NO. 85-248,288, FILED 2-22-2011.

ALLISON HOLTZ, EXAMINING ATTORNEY



*David J. Kybas*

Director of the United States Patent and Trademark Office

# United States of America

United States Patent and Trademark Office

# SiteBoss

**Reg. No. 4,134,049**

**Registered May 1, 2012**

**Int. Cls.: 37 and 42**

**SERVICE MARK**

**PRINCIPAL REGISTER**

US INVESTIGATIONS SERVICES, LLC (DELAWARE LIMITED LIABILITY COMPANY)  
SUITE 1100 NORTH  
7799 LEESBURG PIKE  
FALLS CHURCH, VA 22043

FOR: COMPUTER SERVICES, NAMELY, PROVIDING AN ONLINE PORTAL TO TRACK ACTIVITIES AND COLLECT, MANAGE, AND REPORT DATA RELATED TO CONSTRUCTION PROJECTS AND PHYSICAL BUILDING AND PREMISES MAINTENANCE PROJECTS, IN CLASS 37 (U.S. CLS. 100, 103 AND 106).

FIRST USE 8-22-2010; IN COMMERCE 8-22-2010.

FOR: PROVIDING TEMPORARY USE OF ON-LINE NON-DOWNLOADABLE SOFTWARE THAT ENABLES USERS TO COLLECT, MANAGE, AND REPORT DATA RELATED TO CONSTRUCTION PROJECTS AND PHYSICAL BUILDING AND PREMISES MAINTENANCE PROJECTS, IN CLASS 42 (U.S. CLS. 100 AND 101).

FIRST USE 8-22-2010; IN COMMERCE 8-22-2010.

THE MARK CONSISTS OF STANDARD CHARACTERS WITHOUT CLAIM TO ANY PARTICULAR FONT, STYLE, SIZE, OR COLOR.

SER. NO. 85-248,576, FILED 2-22-2011.

DAVID TAYLOR, EXAMINING ATTORNEY



*David J. Kyffers*

Director of the United States Patent and Trademark Office

# United States of America

United States Patent and Trademark Office

## MARGIN MANAGER

**Reg. No. 4,134,050**

**Registered May 1, 2012**

**Int. Cl.: 9**

**TRADEMARK**

**PRINCIPAL REGISTER**

EPACUBE, INC. (TEXAS CORPORATION)  
SUITE 136-392  
18352 DALLAS PARKWAY  
DALLAS, TX 75287

FOR: COMPUTER SOFTWARE THAT ENABLES THE ANALYSIS OF COST CHANGES ON MARGIN OF SELL PRICES, PROMOTIONS, DISCOUNTS, CHARGEBACKS, AND INVENTORY VALUATION AS IT RELATES TO THE SALE AND DISTRIBUTION OF PRODUCTS, IN CLASS 9 (U.S. CLS. 21, 23, 26, 36 AND 38).

FIRST USE 2-1-2004; IN COMMERCE 4-1-2004.

THE MARK CONSISTS OF STANDARD CHARACTERS WITHOUT CLAIM TO ANY PARTICULAR FONT, STYLE, SIZE, OR COLOR.

NO CLAIM IS MADE TO THE EXCLUSIVE RIGHT TO USE "MANAGER", APART FROM THE MARK AS SHOWN.

SEC. 2(F).

SER. NO. 85-248,583, FILED 2-22-2011.

TRICIA SONNEBORN, EXAMINING ATTORNEY



*David J. Kyros*

Director of the United States Patent and Trademark Office

# United States of America

United States Patent and Trademark Office

# ALFA

**Reg. No. 4,134,051**

**Registered May 1, 2012**

**Int. Cls.: 36 and 37**

**SERVICE MARK**

**PRINCIPAL REGISTER**

ALFA CORPORATION (DELAWARE CORPORATION)  
2108 E. SOUTH BOULEVARD  
MONTGOMERY, AL 36116

FOR: INSURANCE SERVICES, NAMELY, UNDERWRITING, ADMINISTRATION, CLAIMS PROCESSING AND EVALUATION AND CLAIMS ADMINISTRATION SERVICES IN THE FIELDS OF LIFE, AUTOMOBILE, PROPERTY, DENTAL AND HEALTH INSURANCE; PROPERTY AND CASUALTY INSURANCE UNDERWRITING, ADMINISTRATION, AND CLAIMS PROCESSING AND EVALUATION SERVICES; INSURANCE AGENCIES IN THE FIELDS OF LIFE, AUTOMOBILE, PROPERTY, DENTAL AND HEALTH INSURANCE; REINSURANCE UNDERWRITING SERVICES, NAMELY, CLAIMS ADMINISTRATION, CLAIMS PROCESSING AND CLAIMS EVALUATION; ANNUITY SERVICES, NAMELY ANNUITY UNDERWRITING, ACCOUNT AND INVESTMENT ADMINISTRATION AND EVALUATION; REAL ESTATE AGENCY; REAL ESTATE SERVICES, NAMELY, PROVISION OF COMMERCIAL AND RESIDENTIAL REAL ESTATE BROKERAGE SERVICES; FINANCIAL SERVICES, NAMELY, LOAN FINANCING, AUTOMOBILE LOANS AND OTHER UNSECURED LOANS; ELECTRONIC INSURANCE SERVICES, NAMELY, UNDERWRITING, ADMINISTRATION, CLAIMS PROCESSING, CLAIMS EVALUATION AND CLAIMS ADMINISTRATION SERVICES IN THE FIELDS OF LIFE, AUTOMOBILE, PROPERTY, DENTAL AND HEALTH INSURANCE VIA A GLOBAL COMPUTER NETWORK; PROPERTY SERVICES, NAMELY, MANAGING AND INVESTING IN RESIDENTIAL AND COMMERCIAL PROPERTIES, IN CLASS 36 (U.S. CLS. 100, 101 AND 102).

FIRST USE 5-1-1987; IN COMMERCE 5-1-1987.

FOR: CONSTRUCTION SERVICES, NAMELY, GENERAL CONTRACTING AND BUILDING SERVICES IN THE CONSTRUCTION INDUSTRY OF NEW HOMES, RESIDENTIAL COMMUNITIES AND COMMERCIAL PROPERTIES, IN CLASS 37 (U.S. CLS. 100, 103 AND 106).

FIRST USE 5-1-1987; IN COMMERCE 5-1-1987.

THE MARK CONSISTS OF STANDARD CHARACTERS WITHOUT CLAIM TO ANY PARTICULAR FONT, STYLE, SIZE, OR COLOR.

OWNER OF U.S. REG. NOS. 2,671,861, 3,656,202 AND OTHERS.

SER. NO. 85-248,691, FILED 2-22-2011.



*David J. Kyffers*

Director of the United States Patent and Trademark Office

**Reg. No. 4,134,051** MARK RADEMACHER, EXAMINING ATTORNEY

# United States of America

## United States Patent and Trademark Office



**Reg. No. 4,134,052**

**Registered May 1, 2012**

**Int. Cls.: 6, 16 and 39**

**TRADEMARK**

**SERVICE MARK**

**PRINCIPAL REGISTER**

TENARIS CONNECTIONS BV (NETHERLANDS COMPANY)  
LOCATELLIKADE 1  
1076 AZ  
AMSTERDAM, NETHERLANDS

FOR: STEEL AND METAL PIPES AND TUBING, INCLUDING THEIR PARTS AND FITTINGS THEREOF; METAL PIPE AND TUBE JOINTS; METAL PIPE COLLARS; METAL JUNCTIONS FOR PIPES; SEAMLESS METAL LINE PIPES; WELDED METAL LINE PIPE; METAL MOTHER PIPES; PETROCHEMICAL METAL PIPES; BOILER METAL PIPES; METAL PIPE AND TUBE EXCHANGER PIPES; METAL DRILLING PIPES; STEEL AND METAL PIPES AND VESSELS USED FOR TRANSPORTING OIL AND FUEL; METAL TUBES USED IN AUTOPORTS AND SAFETY DEVICES, IN CLASS 6 (U.S. CLS. 2, 12, 13, 14, 23, 25 AND 50).

FIRST USE 5-6-2002; IN COMMERCE 5-6-2002.

FOR: PAPER GOODS AND PRINTED MATTER, NAMELY, PERIODICAL PUBLICATIONS IN THE FORM OF NEWSLETTERS RELATED TO THE PIPE INDUSTRY AND ITS MARKETS, IN CLASS 16 (U.S. CLS. 2, 5, 22, 23, 29, 37, 38 AND 50).

FIRST USE 10-16-2001; IN COMMERCE 10-16-2001.

FOR: TRANSPORTATION SERVICES, NAMELY, FREIGHT FORWARDING; FREIGHT TRANSPORTATION BY TRUCK, TRAIN, AIR AND WATER VESSELS; CARGO HANDLING; RENTAL OF WAREHOUSE SPACE, AND WAREHOUSING SERVICES, IN CLASS 39 (U.S. CLS. 100 AND 105).

FIRST USE 5-6-2002; IN COMMERCE 5-6-2002.

OWNER OF U.S. REG. NO. 2,838,964.

THE COLOR(S) MAGENTA, GREEN AND BLUE IS/ARE CLAIMED AS A FEATURE OF THE MARK.

THE MARK CONSISTS OF A RECTANGLE MADE UP OF SEVEN HORIZONTAL LINES IN VARIOUS SIZES APPEARING IN THE FOLLOWING COLORS IN DESCENDING ORDER: MAGENTA, GREEN, BLUE, GREEN, MAGENTA, BLUE AND GREEN.



*David J. Kybas*

Director of the United States Patent and Trademark Office

**Reg. No. 4,134,052** SER. NO. 85-248,692, FILED 2-22-2011.

DAVID ELTON, EXAMINING ATTORNEY

# United States of America

United States Patent and Trademark Office



**Reg. No. 4,134,053**

**Registered May 1, 2012**

**Int. Cl.: 41**

**SERVICE MARK**

**PRINCIPAL REGISTER**

AMERICAN KETTLEBELL CLUB, LLC (OHIO LIMITED LIABILITY COMPANY), AKA  
AMERICAN KETTLEBELL CLUB  
6488 LIBERTY KNOLL DRIVE  
HAMILTON, OH 45011

FOR: ATHLETIC AND SPORTS EVENT SERVICES, NAMELY, ARRANGING, ORGANIZING,  
OPERATING AND CONDUCTING EXERCISE AND FITNESS PROGRAMS AND COMPETI-  
TIONS INCORPORATING KETTLEBELLS, IN CLASS 41 (U.S. CLS. 100, 101 AND 107).

FIRST USE 12-18-2006; IN COMMERCE 12-18-2006.

OWNER OF U.S. REG. NO. 3,649,322.

THE COLOR(S) LIGHT GREY AND DARK GREY IS/ARE CLAIMED AS A FEATURE OF  
THE MARK.

THE MARK CONSISTS OF A DARK GREY KETTLEBELL WITH LIGHT GREY CONTINENTS  
THAT APPEAR ON THE SPHERICAL PORTION OF THE KETTLEBELL.

SER. NO. 85-248,696, FILED 2-22-2011.

TINA L. SNAPP, EXAMINING ATTORNEY



*David J. Kybas*

Director of the United States Patent and Trademark Office



# United States of America

United States Patent and Trademark Office

## HOMETEL TRAVEL

**Reg. No. 4,134,054**

**Registered May 1, 2012**

**Int. Cl.: 35**

**SERVICE MARK**

**PRINCIPAL REGISTER**

WILLIAMS, RANDY (UNITED STATES INDIVIDUAL)  
1121 TIMBERGATE DR.  
JENKINTOWN, PA 19046

FOR: PROVIDING AN INTERACTIVE REAL ESTATE WEBSITE WHICH PROMOTES HOUSING AND APARTMENT PROPERTIES THROUGH OFFERING PROSPECTIVE TENANTS VIDEO WALK THROUGHs, PROPERTY DESCRIPTIONS, TEXT, PRICE, LOCATION, MAPS AND OTHER INFORMATION THAT WOULD BE INFLUENTIAL TO A PROSPECTIVE TENANT IN MAKING A RENTAL DECISION; REFERRALS IN THE FIELD OF RENTAL OF RESIDENTIAL PROPERTY, IN CLASS 35 (U.S. CLS. 100, 101 AND 102).

FIRST USE 2-18-2011; IN COMMERCE 2-18-2011.

THE MARK CONSISTS OF STANDARD CHARACTERS WITHOUT CLAIM TO ANY PARTICULAR FONT, STYLE, SIZE, OR COLOR.

NO CLAIM IS MADE TO THE EXCLUSIVE RIGHT TO USE "TRAVEL", APART FROM THE MARK AS SHOWN.

SER. NO. 85-249,112, FILED 2-23-2011.

DAVID COLLIER, EXAMINING ATTORNEY



*David J. Kyros*

Director of the United States Patent and Trademark Office

# United States of America

United States Patent and Trademark Office

## WHERE BUSINESS CLICKS

**Reg. No. 4,134,055**

ADVISION MARKETING, INC. (COLORADO CORPORATION)  
1368 26TH ST.  
DENVER, CO 80205

**Registered May 1, 2012**

**Int. Cl.: 35**

FOR: ON-LINE ADVERTISING AND MARKETING SERVICES, IN CLASS 35 (U.S. CLS. 100, 101 AND 102).

**SERVICE MARK**

FIRST USE 3-0-2010; IN COMMERCE 3-0-2010.

**PRINCIPAL REGISTER**

THE MARK CONSISTS OF STANDARD CHARACTERS WITHOUT CLAIM TO ANY PARTICULAR FONT, STYLE, SIZE, OR COLOR.

SER. NO. 85-249,168, FILED 2-23-2011.

DAVID COLLIER, EXAMINING ATTORNEY



*David J. Kyffers*

Director of the United States Patent and Trademark Office

# United States of America

United States Patent and Trademark Office

# AIR CHINA

**Reg. No. 4,134,056**

**Registered May 1, 2012**

**Int. Cls.: 9, 14, 16, 18, 25  
and 35**

**TRADEMARK**

**SERVICE MARK**

**PRINCIPAL REGISTER**

AIR CHINA LIMITED (CHINA CORPORATION)  
28 TIANZHU ROAD  
9TH FLOOR, LANTIAN MANSION  
BEIJING, CHINA

FOR: (BASED ON 44(E)) MAGNETICALLY CODED CARDS FOR USE IN AN AIRLINE LOYALTY PROGRAM TO REDEEM GIFTS OR POINTS; MAGNETICALLY ENCODED CREDIT CARDS; MP3 PLAYERS; BLANK USB FLASH DRIVES; SUNGLASSES, IN CLASS 9 (U.S. CLS. 21, 23, 26, 36 AND 38).

FOR: (BASED ON 44(E)) WORKS OF ART OF PRECIOUS METAL; ORNAMENTS, NAMELY, PERSONAL ORNAMENTS OF PRECIOUS METAL AND ORNAMENTAL PINS OF PRECIOUS METAL; DECORATIVE BOXES, SCULPTURES, AND DESKTOP STATUARY OF PRECIOUS METAL; TIE PINS; KEY RINGS AND KEY FOBs OF PRECIOUS METAL, IN CLASS 14 (U.S. CLS. 2, 27, 28 AND 50).

FOR: (BASED ON 44(E)) MAGAZINES, BROCHURES AND BOOKLETS IN THE FIELDS OF TRAVEL, LIFESTYLE AND ENTERTAINMENT; CALENDARS, IN CLASS 16 (U.S. CLS. 2, 5, 22, 23, 29, 37, 38 AND 50).

FOR: (BASED ON 44(E)) TRAVEL BAGS, TOTE BAGS, FANNY PACKS, PURSES; UMBRELLAS, IN CLASS 18 (U.S. CLS. 1, 2, 3, 22 AND 41).

FOR: (BASED ON 44(E)) TIES, SCARVES, CAPS, IN CLASS 25 (U.S. CLS. 22 AND 39).

FOR: (BASED ON USE IN COMMERCE) CONSUMER LOYALTY SERVICES FOR COMMERCIAL, PROMOTIONAL, AND/OR ADVERTISING PURPOSES, NAMELY, ADMINISTRATION OF FREQUENT FLYER PROGRAMS THAT ALLOW MEMBERS TO REDEEM MILES FOR POINTS OR AWARDS, IN CLASS 35 (U.S. CLS. 100, 101 AND 102).

FIRST USE 0-0-1994; IN COMMERCE 0-0-1994.

OWNER OF CHINA REG. NO. 6421077, DATED 5-21-2010, EXPIRES 5-21-2020.

THE 2(F) CLAIM IS RESTRICTED TO CLASS(ES) 9, 16 AND 35

OWNER OF CHINA REG. NO. 6421096, DATED 5-14-2010, EXPIRES 5-14-2020.



*David J. Kyros*

Director of the United States Patent and Trademark Office

**Reg. No. 4,134,056** OWNER OF CHINA REG. NO. 6421102, DATED 3-21-2010, EXPIRES 3-21-2020.

OWNER OF CHINA REG. NO. 6421110, DATED 3-7-2010, EXPIRES 3-7-2020.

OWNER OF CHINA REG. NO. 6421027, DATED 3-28-2010, EXPIRES 3-28-2020.

OWNER OF U.S. REG. NO. 3,909,687.

NO CLAIM IS MADE TO THE EXCLUSIVE RIGHT TO USE "CHINA" AS TO CLASSES 14, 18 AND 25, APART FROM THE MARK AS SHOWN.

THE MARK CONSISTS OF "AIR CHINA" IN A STYLIZED FONT.

SEC. 2(F).

SER. NO. 85-249,454, FILED 2-23-2011.

ALLISON SCHRODY, EXAMINING ATTORNEY

# United States of America

United States Patent and Trademark Office

## Ultra Bella Casa

**Reg. No. 4,134,057**

**Registered May 1, 2012**

**Int. Cls.: 20 and 24**

**TRADEMARK**

**PRINCIPAL REGISTER**

ULTRA BELLA, LLC (NEW YORK LIMITED LIABILITY COMPANY)  
76 LAKE PLACID CLUB WAY  
LAKE PLACID, NY 12946

FOR: HANDMADE DECORATIVE PILLOWS OF VARIOUS SIZES MADE OF FABRIC AND CRYSTALS WITH SCENTED AND UNSCENTED FILLINGS, IN CLASS 20 (U.S. CLS. 2, 13, 22, 25, 32 AND 50).

FIRST USE 11-7-2003; IN COMMERCE 11-7-2003.

FOR: HOME FURNISHING ACCESSORIES NOT MADE OF PAPER IN THE NATURE OF TABLE LINEN, NAMELY, COASTERS, NAPKINS, TABLE MATS, AND TABLE RUNNERS, IN CLASS 24 (U.S. CLS. 42 AND 50).

FIRST USE 11-7-2003; IN COMMERCE 11-7-2003.

THE MARK CONSISTS OF STANDARD CHARACTERS WITHOUT CLAIM TO ANY PARTICULAR FONT, STYLE, SIZE, OR COLOR.

OWNER OF U.S. REG. NOS. 2,948,968, 3,029,698 AND OTHERS.

NO CLAIM IS MADE TO THE EXCLUSIVE RIGHT TO USE "CASA", APART FROM THE MARK AS SHOWN.

THE ENGLISH TRANSLATION OF "BELLA CASA" IN THE MARK IS "BEAUTIFUL HOUSE" OR "BEAUTIFUL HOME".

SER. NO. 85-249,687, FILED 2-23-2011.

MICHAEL GAAFAR, EXAMINING ATTORNEY



*David J. Kyffers*

Director of the United States Patent and Trademark Office

# United States of America

United States Patent and Trademark Office

## SKIN FRIENDLY

**Reg. No. 4,134,058**

**Registered May 1, 2012**

**Int. Cl.: 3**

**TRADEMARK**

**PRINCIPAL REGISTER**

SKIN FRIENDLY, LLC (TEXAS LIMITED LIABILITY COMPANY)  
4319 BELMONT AVENUE  
DALLAS, TX 75204

FOR: PERSONAL CARE PRODUCTS FOR THE BODY, NAMELY, LOTIONS FOR SKIN AND SKIN CLEANSERS, THAT PROTECT AGAINST ENVIRONMENTAL POLLUTANTS AND ALLERGENS, IN CLASS 3 (U.S. CLS. 1, 4, 6, 50, 51 AND 52).

FIRST USE 12-29-1999; IN COMMERCE 12-29-1999.

THE MARK CONSISTS OF STANDARD CHARACTERS WITHOUT CLAIM TO ANY PARTICULAR FONT, STYLE, SIZE, OR COLOR.

NO CLAIM IS MADE TO THE EXCLUSIVE RIGHT TO USE "SKIN", APART FROM THE MARK AS SHOWN.

SER. NO. 85-249,755, FILED 2-23-2011.

TEJBIR SINGH, EXAMINING ATTORNEY



*David J. Kybas*

Director of the United States Patent and Trademark Office

# United States of America

United States Patent and Trademark Office

## VOULEZ FRENCH SPARKLING LIQUEUR

**Reg. No. 4,134,059**

**Registered May 1, 2012**

**Int. Cl.: 33**

**TRADEMARK**

**PRINCIPAL REGISTER**

DAUCOURT, JEAN-MARC, MR. (UNITED STATES INDIVIDUAL)  
14902 PRESTON ROAD  
SUITE 404 - PMB 536  
DALLAS, TX 75254

FOR: ALCOHOLIC BEVERAGES EXCEPT BEERS; SPIRITS; LIQUEURS, IN CLASS 33 (U.S. CLS. 47 AND 49).

THE MARK CONSISTS OF STANDARD CHARACTERS WITHOUT CLAIM TO ANY PARTICULAR FONT, STYLE, SIZE, OR COLOR.

PRIORITY CLAIMED UNDER SEC. 44(D) ON FRANCE APPLICATION NO. 113809395, FILED 2-24-2011, REG. NO. 113809395, DATED 2-24-2011, EXPIRES 2-24-2021.

NO CLAIM IS MADE TO THE EXCLUSIVE RIGHT TO USE "FRENCH SPARKLING LIQUEUR", APART FROM THE MARK AS SHOWN.

THE ENGLISH TRANSLATION OF "VOULEZ" IN THE MARK IS WANT.

SER. NO. 85-250,513, FILED 2-24-2011.

JILL PRATER, EXAMINING ATTORNEY



*David J. Kyros*

Director of the United States Patent and Trademark Office

# United States of America

United States Patent and Trademark Office

# GREY FOX

**Reg. No. 4,134,060**

**Registered May 1, 2012**

**Int. Cl.: 41**

**SERVICE MARK**

**PRINCIPAL REGISTER**

GREY FOX BLUEGRASS FESTIVALS, INC. (MARYLAND CORPORATION)  
2700 CAVES ROAD  
OWINGS MILLS, MD 21117

FOR: ENTERTAINMENT, NAMELY, LIVE MUSIC CONCERTS; PROVIDING INFORMATION CONCERNING LIVE MUSIC PERFORMANCES AND MUSIC CONCERTS; ENTERTAINMENT SERVICES, NAMELY, CONDUCTING MUSIC FESTIVALS, IN CLASS 41 (U.S. CLS. 100, 101 AND 107).

FIRST USE 7-0-1985; IN COMMERCE 7-0-1985.

THE MARK CONSISTS OF STANDARD CHARACTERS WITHOUT CLAIM TO ANY PARTICULAR FONT, STYLE, SIZE, OR COLOR.

SER. NO. 85-250,581, FILED 2-24-2011.

CORY BOONE, EXAMINING ATTORNEY



*David J. Kyffers*

Director of the United States Patent and Trademark Office



# United States of America

United States Patent and Trademark Office

## THOMASTON MILLS

**Reg. No. 4,134,061**

**Registered May 1, 2012**

**Int. Cl.: 24**

**TRADEMARK**

**PRINCIPAL REGISTER**

ATD-AMERICAN CO. (PENNSYLVANIA CORPORATION)  
135 GREENWOOD AVENUE  
WYNCOTE, PA 19095

FOR: TOWELS, DUVETS, BED SHEETS, PILLOW CASES, BEDSPREADS, BED BLANKETS, COMFORTERS, PILLOW SHAMS, DUST RUFFLES, AND WASH CLOTHS, IN CLASS 24 (U.S. CLS. 42 AND 50).

FIRST USE 0-0-2003; IN COMMERCE 0-0-2003.

THE MARK CONSISTS OF STANDARD CHARACTERS WITHOUT CLAIM TO ANY PARTICULAR FONT, STYLE, SIZE, OR COLOR.

OWNER OF U.S. REG. NOS. 539,350, 1,633,240, AND 1,633,241.

NO CLAIM IS MADE TO THE EXCLUSIVE RIGHT TO USE "MILLS", APART FROM THE MARK AS SHOWN.

SEC. 2(F).

SER. NO. 85-250,680, FILED 2-24-2011.

ANGELA M. MICHELI, EXAMINING ATTORNEY



*David J. Kybas*

Director of the United States Patent and Trademark Office

# United States of America

United States Patent and Trademark Office

## GO GREEN & GIVE

**Reg. No. 4,134,062**

**Registered May 1, 2012**

**Int. Cl.: 35**

**SERVICE MARK**

**PRINCIPAL REGISTER**

TRIWEST HEALTHCARE ALLIANCE CORP. (DELAWARE CORPORATION)  
16010 N. 28TH AVENUE  
PHOENIX, AZ 85053

FOR: PROVIDING INCENTIVE AWARD PROGRAMS FOR CUSTOMERS THROUGH DONATIONS TO MILITARY SUPPORT ORGANIZATIONS FOR THE PURPOSE OF REWARDING ENVIRONMENTAL RESPONSIBILITY THROUGH PAPERLESS COMMUNICATIONS, IN CLASS 35 (U.S. CLS. 100, 101 AND 102).

FIRST USE 2-7-2011; IN COMMERCE 2-7-2011.

THE MARK CONSISTS OF STANDARD CHARACTERS WITHOUT CLAIM TO ANY PARTICULAR FONT, STYLE, SIZE, OR COLOR.

SER. NO. 85-250,753, FILED 2-24-2011.

GRETCHEN ULRICH, EXAMINING ATTORNEY



*David J. Kybas*

Director of the United States Patent and Trademark Office

# United States of America

United States Patent and Trademark Office

WHEN YOU GO GREEN, WE GIVE  
GREEN.

**Reg. No. 4,134,063**

**Registered May 1, 2012**

**Int. Cl.: 35**

**SERVICE MARK**

**PRINCIPAL REGISTER**

TRIWEST HEALTHCARE ALLIANCE CORP. (DELAWARE CORPORATION)  
16010 N. 28TH AVENUE  
PHOENIX, AZ 85053

FOR: PROVIDING INCENTIVE AWARD PROGRAMS FOR CUSTOMERS THROUGH DONATIONS TO MILITARY SUPPORT ORGANIZATIONS FOR THE PURPOSE OF REWARDING ENVIRONMENTAL RESPONSIBILITY THROUGH PAPERLESS COMMUNICATIONS, IN CLASS 35 (U.S. CLS. 100, 101 AND 102).

FIRST USE 2-10-2011; IN COMMERCE 2-10-2011.

THE MARK CONSISTS OF STANDARD CHARACTERS WITHOUT CLAIM TO ANY PARTICULAR FONT, STYLE, SIZE, OR COLOR.

SER. NO. 85-250,758, FILED 2-24-2011.

GRETCHEN ULRICH, EXAMINING ATTORNEY



*David J. Kybas*

Director of the United States Patent and Trademark Office

# United States of America

United States Patent and Trademark Office

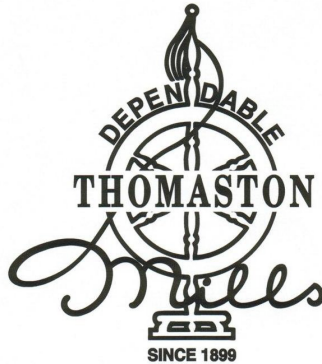

**Reg. No. 4,134,064**

**Registered May 1, 2012**

**Int. Cl.: 24**

**TRADEMARK**

**PRINCIPAL REGISTER**

ATD-AMERICAN CO. (PENNSYLVANIA CORPORATION)  
135 GREENWOOD AVENUE  
WYNCOTE, PA 19095

FOR: TOWELS, DUVETS, BED SHEETS, PILLOW CASES, BEDSPREADS, BED BLANKETS, COMFORTERS, PILLOW SHAMS, DUST RUFFLES, AND WASH CLOTHS, IN CLASS 24 (U.S. CLS. 42 AND 50).

FIRST USE 0-0-2003; IN COMMERCE 0-0-2003.

OWNER OF U.S. REG. NOS. 539,350, 1,633,240, AND 1,633,241.

NO CLAIM IS MADE TO THE EXCLUSIVE RIGHT TO USE "DEPENDABLE" OR "MILLS" OR " SINCE 1899", APART FROM THE MARK AS SHOWN.

THE MARK CONSISTS OF THE WORDS "DEPENDABLE THOMASTON MILLS SINCE 1899" AND THE DESIGN OF A SPINNING WHEEL AND THREAD.

SEC. 2(F) AS TO "THOMASTON".

SER. NO. 85-250,760, FILED 2-24-2011.

ANGELA M. MICHELI, EXAMINING ATTORNEY



*David J. Kybas*

Director of the United States Patent and Trademark Office

# United States of America

United States Patent and Trademark Office

## SENIORS ON THE GO

**Reg. No. 4,134,065**

**Registered May 1, 2012**

**Int. Cl.: 41**

**SERVICE MARK**

**PRINCIPAL REGISTER**

AGING EXCELLENCE, INC. (MAINE CORPORATION)  
P.O. BOX 8660  
PORTLAND, ME 04112

FOR: EDUCATIONAL SERVICES, NAMELY, CLASSES AND WORKSHOPS, IN THE FIELDS OF GERIATRIC CARE AND WELLNESS AND FITNESS, IN CLASS 41 (U.S. CLS. 100, 101 AND 107).

FIRST USE 9-1-2003; IN COMMERCE 9-1-2003.

THE MARK CONSISTS OF STANDARD CHARACTERS WITHOUT CLAIM TO ANY PARTICULAR FONT, STYLE, SIZE, OR COLOR.

OWNER OF U.S. REG. NOS. 2,729,613 AND 2,742,622.

NO CLAIM IS MADE TO THE EXCLUSIVE RIGHT TO USE "SENIORS", APART FROM THE MARK AS SHOWN.

SER. NO. 85-250,899, FILED 2-24-2011.

SUZANNE BLANE, EXAMINING ATTORNEY



*David J. Kybas*

Director of the United States Patent and Trademark Office

# United States of America

United States Patent and Trademark Office

## I KNOW NOT AGE, NOR WEARINESS, NOR DEFEAT!

**Reg. No. 4,134,066**

AGING EXCELLENCE, INC. (MAINE CORPORATION)  
P.O. BOX 8660  
PORTLAND, ME 04112

**Registered May 1, 2012**

**Int. Cl.: 41**

FOR: EDUCATIONAL SERVICES, NAMELY, CLASSES AND WORKSHOPS, IN THE FIELDS OF WELLNESS AND FITNESS, IN CLASS 41 (U.S. CLS. 100, 101 AND 107).

**SERVICE MARK**

FIRST USE 9-1-2003; IN COMMERCE 9-1-2003.

**PRINCIPAL REGISTER**

THE MARK CONSISTS OF STANDARD CHARACTERS WITHOUT CLAIM TO ANY PARTICULAR FONT, STYLE, SIZE, OR COLOR.

SER. NO. 85-250,918, FILED 2-24-2011.

SUZANNE BLANE, EXAMINING ATTORNEY



*David J. Kyffers*

Director of the United States Patent and Trademark Office

# United States of America

United States Patent and Trademark Office

# CEREPHEX

**Reg. No. 4,134,067**

**Registered May 1, 2012**

**Int. Cls.: 10 and 44**

**TRADEMARK**

**SERVICE MARK**

**PRINCIPAL REGISTER**

CEREPHEX CORPORATION (DELAWARE CORPORATION)  
3001 E. MILLER ROAD  
BANCROFT, MI 48414

FOR: INTEGRATED MEDICAL SYSTEMS COMPRISING MEDICAL DEVICES AND COMPUTER SOFTWARE FOR USE IN PHYSICAL EXAMINATION, ASSESSMENT, AND TREATMENT OF CENTRAL NERVOUS SYSTEM DISORDERS AND PSYCHIATRIC AND NEUROLOGICAL DISORDERS, IN CLASS 10 (U.S. CLS. 26, 39 AND 44).

FIRST USE 12-8-2009; IN COMMERCE 12-17-2009.

FOR: MEDICAL EVALUATION SERVICES PERTAINING TO THE DIAGNOSIS, ASSESSMENT, AND TREATMENT OF CENTRAL NERVOUS SYSTEM DISORDERS, PSYCHIATRIC AND NEUROLOGICAL DISORDERS; WEB-BASED EXAMINATION, ASSESSMENT, AND TREATMENT OF CENTRAL NERVOUS SYSTEM DISORDERS AND PSYCHIATRIC AND NEUROLOGICAL DISORDERS IN PATIENTS LOCATED IN A REMOTE CLINICAL SETTING FOR MEDICAL DIAGNOSTIC AND TREATMENT PURPOSES, IN CLASS 44 (U.S. CLS. 100 AND 101).

FIRST USE 12-8-2009; IN COMMERCE 12-17-2009.

THE MARK CONSISTS OF STANDARD CHARACTERS WITHOUT CLAIM TO ANY PARTICULAR FONT, STYLE, SIZE, OR COLOR.

SER. NO. 85-252,534, FILED 2-26-2011.

SKYE YOUNG, EXAMINING ATTORNEY



*David J. Kyros*

Director of the United States Patent and Trademark Office

# United States of America

United States Patent and Trademark Office

# VocaSpace

**Reg. No. 4,134,068**

**Registered May 1, 2012**

**Int. Cl.: 9**

**TRADEMARK**

**PRINCIPAL REGISTER**

SENNOTT TECHNOLOGIES LLC (DELAWARE LIMITED LIABILITY COMPANY)  
524 N. BURROWES STREET  
STATE COLLEGE, PA 16803

FOR: A VOCABULARY SET SOLD AS A FEATURE OF COMPUTER SOFTWARE FOR TEXT TO SPEECH COMMUNICATIONS THAT MAY BE DOWNLOADED FROM A GLOBAL COMPUTER NETWORK , IN CLASS 9 (U.S. CLS. 21, 23, 26, 36 AND 38).

FIRST USE 4-1-2009; IN COMMERCE 4-21-2009.

THE MARK CONSISTS OF STANDARD CHARACTERS WITHOUT CLAIM TO ANY PARTICULAR FONT, STYLE, SIZE, OR COLOR.

SER. NO. 85-252,639, FILED 2-26-2011.

JAMES MACFARLANE, EXAMINING ATTORNEY



*David J. Kybas*

Director of the United States Patent and Trademark Office



# United States of America

United States Patent and Trademark Office

## Just Like Chocolate

**Reg. No. 4,134,069**

**Registered May 1, 2012**

**Int. Cl.: 30**

**TRADEMARK**

**PRINCIPAL REGISTER**

JUST LIKE SUGAR, INC. (NEVADA CORPORATION)  
2020 PAMA LANE  
LAS VEGAS, NV 89119

FOR: CHOCOLATE; CHOCOLATE BARS, IN CLASS 30 (U.S. CL. 46).

FIRST USE 1-10-2011; IN COMMERCE 1-10-2011.

THE MARK CONSISTS OF STANDARD CHARACTERS WITHOUT CLAIM TO ANY PARTICULAR FONT, STYLE, SIZE, OR COLOR.

NO CLAIM IS MADE TO THE EXCLUSIVE RIGHT TO USE "CHOCOLATE", APART FROM THE MARK AS SHOWN.

SER. NO. 85-252,665, FILED 2-26-2011.

DAVID TAYLOR, EXAMINING ATTORNEY



*David J. Kyffers*

Director of the United States Patent and Trademark Office

# United States of America

United States Patent and Trademark Office

## THE SUPER SWEEPER

**Reg. No. 4,134,070**

**Registered May 1, 2012**

**Int. Cl.: 6**

**TRADEMARK**

**PRINCIPAL REGISTER**

SUPER SWEEP, INC. (FLORIDA CORPORATION)  
2874 SOUTH OASIS DR.  
BOYNTON BEACH, FL 33426

FOR: METAL BROOM HANDLES, IN CLASS 6 (U.S. CLS. 2, 12, 13, 14, 23, 25 AND 50).

FIRST USE 2-0-1997; IN COMMERCE 2-0-1997.

THE MARK CONSISTS OF STANDARD CHARACTERS WITHOUT CLAIM TO ANY PARTICULAR FONT, STYLE, SIZE, OR COLOR.

SEC. 2(F).

SER. NO. 85-253,115, FILED 2-28-2011.

FRANK LATTUCA, EXAMINING ATTORNEY



*David J. Kyffers*

Director of the United States Patent and Trademark Office

# United States of America

United States Patent and Trademark Office

# mod4

**Reg. No. 4,134,071**

**Registered May 1, 2012**

**Int. Cl.: 45**

**SERVICE MARK**

**PRINCIPAL REGISTER**

MOD4 LLP (CALIFORNIA LIMITED LIABILITY PARTNERSHIP)  
SUITE 400  
2150 ALLSTON WAY  
BERKELEY, CA 94704

FOR: LEGAL RESEARCH; LEGAL SERVICES, IN CLASS 45 (U.S. CLS. 100 AND 101).

FIRST USE 8-6-2010; IN COMMERCE 8-6-2010.

THE MARK CONSISTS OF STANDARD CHARACTERS WITHOUT CLAIM TO ANY PARTICULAR FONT, STYLE, SIZE, OR COLOR.

SER. NO. 85-254,232, FILED 3-1-2011.

IRA J. GOODSaid, EXAMINING ATTORNEY



*David J. Kyffers*

Director of the United States Patent and Trademark Office

# United States of America

United States Patent and Trademark Office

# ADMAGIC

**Reg. No. 4,134,072**

**Registered May 1, 2012**

**Int. Cl.: 35**

**SERVICE MARK**

**PRINCIPAL REGISTER**

AD MAGIC INC. (NEW JERSEY CORPORATION)  
125 MAIN STREET  
NETCONG, NJ 078571326

FOR: ADVERTISEMENT AND PUBLICITY SERVICES BY TELEVISION, RADIO, MAIL; ADVERTISING AGENCIES; ADVERTISING AND BUSINESS SERVICES, NAMELY, SECURING AIRTIME ON ALL FORMS OF MEDIA COMMUNICATIONS STATIONS, SYSTEMS, NETWORKS, AND SERVICES FOR THE PURPOSE OF PROMOTING THE GOODS AND SERVICES OF OTHERS; ADVERTISING AND PUBLICITY SERVICES, NAMELY, PROMOTING THE GOODS, SERVICES, BRAND IDENTITY AND COMMERCIAL INFORMATION AND NEWS OF THIRD PARTIES THROUGH PRINT, AUDIO, VIDEO, DIGITAL AND ON-LINE MEDIUM; ADVERTISING SERVICES OF A RADIO AND TELEVISION ADVERTISING AGENCY; ADVERTISING SERVICES, NAMELY, CREATING CORPORATE AND BRAND IDENTITY FOR OTHERS; ADVERTISING SERVICES, NAMELY, CREATING CORPORATE LOGOS FOR OTHERS; ADVERTISING SERVICES, PUBLIC RELATIONS AND MARKETING SERVICES, NAMELY, PROMOTING AND MARKETING THE GOODS AND SERVICES OF OTHERS THROUGH ALL PUBLIC COMMUNICATION MEANS; DESIGN OF ADVERTISING MATERIALS FOR OTHERS; DESIGN OF INTERNET ADVERTISING; ELECTRONIC COMMERCE SERVICES, NAMELY, PROVIDING INFORMATION ABOUT PRODUCTS VIA TELECOMMUNICATION NETWORKS FOR ADVERTISING AND SALES PURPOSES; ENTERTAINMENT MARKETING SERVICES, NAMELY, MARKETING, PROMOTION AND ADVERTISING FOR INDEPENDENT RECORDING ARTISTS; INTERNET ADVERTISING SERVICES; LAYOUT SERVICES FOR ADVERTISING PURPOSES; MEDIA BUYING ADVICE, NAMELY, ADVISING THE CLIENT HOW MUCH MEDIA TIME, AND AT WHAT TIMES THE CLIENT SHOULD BE PURCHASING ADVERTISING; MUSIC SELECTION SERVICES FOR USE IN ADVERTISING; ON-LINE ADVERTISING SERVICES FOR OTHERS; PAY PER CLICK (PPC) ADVERTISING MANAGEMENT SERVICES; PREPARATION OF CUSTOMIZED PROMOTIONAL AND MERCHANDISING MATERIALS FOR OTHERS; PREPARING AND PLACING OUTDOOR ADVERTISEMENTS FOR OTHERS; PRODUCING PROMOTIONAL VIDEOTAPES, VIDEO DISCS, AND AUDIO VISUAL RECORDINGS; PRODUCTION OF ADVERTISING MATTER AND COMMERCIALS; PRODUCTION OF FILM AND TELEVISION ADVERTISING; PROMOTING THE GOODS AND SERVICES OF OTHERS BY LICENSING A TOLL-FREE TELEPHONE NUMBER; PROMOTING THE GOODS AND SERVICES OF OTHERS BY PROVIDING HYPERTEXT LINKS TO THE WEB SITES OF OTHERS; PROMOTING THE GOODS AND SERVICES OF OTHERS THROUGH SEARCH ENGINE REFERRAL TRAFFIC ANALYSIS AND REPORTING; PROMOTING, ADVERTISING AND MARKETING OF THE ON-LINE WEB SITES OF OTHERS; PROMOTION, ADVERTISING AND MARKETING



*David J. Kyros*

Director of the United States Patent and Trademark Office

**Reg. No. 4,134,072** OF ON-LINE WEBSITES; PROVIDING A DATABASE OF INFORMATION PERTAINING TO THE PROMOTIONAL PRODUCTS INDUSTRY; TELEVISION ADVERTISING AGENCIES, IN CLASS 35 (U.S. CLS. 100, 101 AND 102).

FIRST USE 12-20-1997; IN COMMERCE 12-20-1997.

THE MARK CONSISTS OF STANDARD CHARACTERS WITHOUT CLAIM TO ANY PARTICULAR FONT, STYLE, SIZE, OR COLOR.

OWNER OF U.S. REG. NO. 3,510,457.

SER. NO. 85-254,315, FILED 3-1-2011.

JOHN WILKE, EXAMINING ATTORNEY

**United States of America**  
United States Patent and Trademark Office

# EXACTO

**Reg. No. 4,134,073**

U.S. ENDOSCOPY GROUP, INC. (OHIO CORPORATION)

**Registered May 1, 2012**

59  
MENTOR, OH 44060

**Int. Cl.: 10**

FOR: MEDICAL DEVICES FOR USE WITH ENDOSCOPES, NAMELY, SNARES, COLD SNARES AND POLYPECTOMY TOOLS, IN CLASS 10 (U.S. CLS. 26, 39 AND 44).

**TRADEMARK**

FIRST USE 5-11-2010; IN COMMERCE 5-11-2010.

**PRINCIPAL REGISTER**

THE MARK CONSISTS OF STANDARD CHARACTERS WITHOUT CLAIM TO ANY PARTICULAR FONT, STYLE, SIZE, OR COLOR.

SER. NO. 85-254,316, FILED 3-1-2011.

PAM WILLIS, EXAMINING ATTORNEY



*David J. Kyffers*

Director of the United States Patent and Trademark Office

# United States of America

United States Patent and Trademark Office

## Open Door MultiServices

**Reg. No. 4,134,074**

**Registered May 1, 2012**

**Int. Cl.: 35**

**SERVICE MARK**

**PRINCIPAL REGISTER**

MITCHELL, LEXSINE E. (UNITED STATES INDIVIDUAL)  
1746 BANYAN CREEK CT  
BOYNTON BEACH, FL 33436

FOR: CUSTOMER RELATIONSHIP MANAGEMENT; CUSTOMER SERVICE IN THE FIELD OF RETAIL STORE SERVICES; CUSTOMER SERVICE MANAGEMENT FOR OTHERS; CUSTOMER SERVICES, NAMELY, PROVIDING CUSTOMER SERVICE AND PRODUCT INQUIRY SERVICES VIA TELEPHONE AND E-MAIL FOR OTHERS; DATA MANAGEMENT SERVICE FOR USE IN REPORTING DEBT COLLECTION ACCOUNTS TO A COLLECTION AGENCY; DATA MANAGEMENT SERVICES FOR USE IN DEBT COLLECTION, NAMELY, ELECTRONIC DATA COLLECTION AND ON-LINE CLAIMS MANAGEMENT; DATA PROCESSING SERVICES; DEVELOPMENT OF CUSTOMIZED PERSONNEL MANAGEMENT MATERIALS FOR OTHERS, NAMELY, DEVELOPMENT OF CUSTOMIZED EMPLOYEE MANUALS AND HANDBOOKS, IN CLASS 35 (U.S. CLS. 100, 101 AND 102).

FIRST USE 6-11-2007; IN COMMERCE 10-22-2010.

THE MARK CONSISTS OF STANDARD CHARACTERS WITHOUT CLAIM TO ANY PARTICULAR FONT, STYLE, SIZE, OR COLOR.

NO CLAIM IS MADE TO THE EXCLUSIVE RIGHT TO USE "MULTISERVICES", APART FROM THE MARK AS SHOWN.

SER. NO. 85-254,390, FILED 3-1-2011.

KATINA MISTER, EXAMINING ATTORNEY



*David J. Kybas*

Director of the United States Patent and Trademark Office

# United States of America

United States Patent and Trademark Office

## Belle & Wissell, Co.

**Reg. No. 4,134,075**

**Registered May 1, 2012**

**Int. Cl.: 42**

**SERVICE MARK**

**PRINCIPAL REGISTER**

GABE KEAN DESIGN LLC (WASHINGTON LIMITED LIABILITY COMPANY), DBA BELLE & WISSELL, CO.  
6014 12TH AVE. S.  
SEATTLE, WA 98108

FOR: GRAPHIC AND PRODUCT DESIGN SERVICES FOR OTHERS IN THE FIELDS OF MULTIMEDIA, PRINTED PRODUCTS, EXHIBITIONS AND DISPLAYS; INTERACTIVE GRAPHIC AND PRODUCT DESIGN SERVICES FOR OTHERS; COMPUTER PROGRAMMING SERVICES FOR OTHERS, IN CLASS 42 (U.S. CLS. 100 AND 101).

FIRST USE 8-1-2006; IN COMMERCE 10-1-2006.

THE MARK CONSISTS OF STANDARD CHARACTERS WITHOUT CLAIM TO ANY PARTICULAR FONT, STYLE, SIZE, OR COLOR.

NO CLAIM IS MADE TO THE EXCLUSIVE RIGHT TO USE "CO.", APART FROM THE MARK AS SHOWN.

SER. NO. 85-254,539, FILED S.R. 3-1-2011 AM. P.R. 11-21-2011.

TRACY WHITTAKER-BROWN, EXAMINING ATTORNEY



*David J. Kyffers*

Director of the United States Patent and Trademark Office



# United States of America

United States Patent and Trademark Office



**Reg. No. 4,134,076**

**Registered May 1, 2012**

**Int. Cl.: 25**

**TRADEMARK**

**PRINCIPAL REGISTER**

COELHO, CARLOS (UNITED STATES INDIVIDUAL)  
4 ALDERBERRY LANE  
MATTAPOISETT, MA 02739

FOR: SCARVES, IN CLASS 25 (U.S. CLS. 22 AND 39).

FIRST USE 9-2-2005; IN COMMERCE 9-2-2005.

NO CLAIM IS MADE TO THE EXCLUSIVE RIGHT TO USE "SCARF", APART FROM THE MARK AS SHOWN.

THE MARK CONSISTS OF THE WORD "SPORTS" IN CAPITAL LETTERS ABOVE THE CAPITAL LETTERS "SS" CONNECTED IN STYLIZED FORM ABOVE THE WORD "SCARF" IN CAPITAL LETTERS ON A SOLID SQUARE BACKGROUND, SURROUNDED BY A THIN SQUARE OUTLINE.

SEC. 2(F).

SER. NO. 85-254,697, FILED S.R. 3-1-2011 AM. P.R. 12-29-2011.

SUNG IN, EXAMINING ATTORNEY



*David J. Kybas*

Director of the United States Patent and Trademark Office

# United States of America

United States Patent and Trademark Office

## CONNECTING BLOGGERS

**Reg. No. 4,134,077**

**Registered May 1, 2012**

**Int. Cl.: 35**

**SERVICE MARK**

**PRINCIPAL REGISTER**

RUSLAN KHAKIMOV (RUSSIAN FED. INDIVIDUAL)  
10987 BLUFFSIDE DR, APT 4216  
STUDIO CITY, CA 91604

FOR: ADVERTISING AND MARKETING SERVICES, NAMELY, PROMOTING GOODS AND SERVICES FOR BLOGS AND BLOGGERS; AD SERVING, NAMELY, PLACING ADVERTISEMENTS ON WEBSITES FOR OTHERS USING SPECIALIZED COMPUTER SOFTWARE; ADVERTISEMENT FOR OTHERS ON THE INTERNET; ADVERTISING AND ADVERTISEMENT SERVICES; ADVERTISING AND COMMERCIAL INFORMATION SERVICES, VIA THE INTERNET; ADVERTISING AND DIRECTORY SERVICES, NAMELY, PROMOTING THE SERVICES OF OTHERS BY PROVIDING A WEB PAGE FEATURING LINKS TO THE WEBSITES OF OTHERS; ADVERTISING, MARKETING AND PROMOTIONAL SERVICES RELATED TO ALL INDUSTRIES FOR THE PURPOSE OF FACILITATING NETWORKING AND SOCIALIZING OPPORTUNITIES FOR BUSINESS PURPOSES; ADVERTISING AND MARKETING SERVICES, NAMELY, PROMOTING THE GOODS AND SERVICES OF OTHERS; ADVERTISING VIA ELECTRONIC MEDIA AND SPECIFICALLY THE INTERNET; ADVERTISING, INCLUDING ON-LINE ADVERTISING ON A COMPUTER NETWORK; ADVERTISING, INCLUDING PROMOTION RELATING TO THE SALE OF ARTICLES AND SERVICES FOR THIRD PARTIES BY THE TRANSMISSION OF ADVERTISING MATERIAL AND THE DISSEMINATION OF ADVERTISING MESSAGES ON COMPUTER NETWORKS; ADVERTISING, PROMOTION, AND MARKETING SERVICES, NAMELY, PROVIDING A SEARCHABLE ON-LINE ADVERTISING WEBSITE FEATURING THE GOODS AND SERVICES OF OTHER VENDORS; BANNER ADVERTISING; BUSINESS RESEARCH AND SURVEY SERVICES IN THE FIELD OF ONLINE BLOGS; BUSINESS MONITORING SERVICES, NAMELY, PROVIDING TRACKING DETAILS ABOUT USER CLICK TRAFFIC OR ONLINE BLOG WEBSITE VISITS TO OTHERS; COMPILATION AND SYSTEMIZATION OF INFORMATION INTO COMPUTER DATABASES; CHARITABLE SERVICES, NAMELY, PROMOTING PUBLIC AWARENESS ABOUT COMMUNITY SERVICE; DISPLAYING ADVERTISEMENTS FOR OTHERS; DISSEMINATION OF ADVERTISEMENTS; DISSEMINATION OF ADVERTISING FOR OTHERS VIA AN ON-LINE COMMUNICATIONS NETWORK ON THE INTERNET; DISSEMINATION OF ADVERTISING FOR OTHERS VIA THE INTERNET ELECTRONIC COMMERCE SERVICES, NAMELY, PROVIDING INFORMATION ABOUT PRODUCTS AND SERVICES VIA TELECOMMUNICATION NETWORKS FOR ADVERTISING AND SALES PURPOSES; JOB PLACEMENT SERVICES, HUMAN RESOURCES CONSULTING SERVICES; ORGANIZING AND CONDUCTING JOB FAIRS; ON-LINE PROFESSIONAL NETWORKING SERVICES; ON-LINE RETAIL STORE SERVICES FEATURING DIGITAL MEDIA, CLOTHING, FOOTWEAR, HEADGEAR, PRINTED MATTER,



*David J. Kybas*

Director of the United States Patent and Trademark Office

**Reg. No. 4,134,077** STATIONERY, OFFICE ACCESSORIES, BAGS, GAMES, TOYS AND PINS; PERSONNEL RECRUITMENT AND PLACEMENT SERVICES; PROVIDING ONLINE COMPUTER DATABASES AND ONLINE SEARCHABLE DATABASES IN THE FIELDS OF BUSINESS AND PROFESSIONAL NETWORKING; PROMOTION, ADVERTISING AND MARKETING OF ON-LINE WEBSITES; PROVIDING A SEARCHABLE ON-LINE ADVERTISING WEBSITE AND GUIDE FEATURING THE GOODS AND SERVICES OF OTHER VENDORS VIA THE INTERNET; PROVIDING A SEARCHABLE ONLINE ADVERTISING GUIDE FEATURING THE GOODS AND SERVICES OF ONLINE VENDORS; PROVIDING A SEARCHABLE ON-LINE ADVERTISING GUIDE FEATURING THE GOODS AND SERVICES OF OTHER ON-LINE VENDORS ON THE INTERNET; PROVIDING A SEARCHABLE WEBSITE FEATURING THE GOODS AND SERVICES OF OTHER VENDORS; PROVIDING A WEB SITE WHICH FEATURES ADVERTISEMENTS FOR THE GOODS AND SERVICES OF OTHERS ON A GLOBAL COMPUTER NETWORK; PROMOTING THE GOODS AND SERVICES OF OTHERS VIA A GLOBAL COMPUTER NETWORK; PROVIDING BUSINESS NETWORKING SERVICES AND INFORMATION IN THE FIELDS OF EMPLOYMENT, RECRUITMENT, JOB RESOURCES, AND JOB LISTINGS; PROVIDING ADVERTISING SERVICES; PROVIDING AN ON-LINE COMMERCIAL INFORMATION DIRECTORY ON THE INTERNET; PROVIDING CONSUMER PRODUCT INFORMATION VIA THE INTERNET; PROVIDING ON-LINE DIRECTORY INFORMATION SERVICES ALSO FEATURING HYPERLINKS TO OTHER WEB SITES; PROVIDING SPACE AT A WEB SITE FOR THE ADVERTISEMENT OF THE GOODS AND SERVICES OF OTHERS; PROVIDING STATISTICAL INFORMATION; PROVISION OF SPACE ON WEBSITES FOR ADVERTISING GOODS AND SERVICES, IN CLASS 35 (U.S. CLS. 100, 101 AND 102).

FIRST USE 1-9-2011; IN COMMERCE 1-9-2011.

THE MARK CONSISTS OF STANDARD CHARACTERS WITHOUT CLAIM TO ANY PARTICULAR FONT, STYLE, SIZE, OR COLOR.

NO CLAIM IS MADE TO THE EXCLUSIVE RIGHT TO USE "BLOGGERS", APART FROM THE MARK AS SHOWN.

SER. NO. 85-254,789, FILED 3-1-2011.

JOHN SCHUYLER YARD, EXAMINING ATTORNEY

# United States of America

United States Patent and Trademark Office

## WALL DOLLS

**Reg. No. 4,134,078**

**Registered May 1, 2012**

**Int. Cl.: 16**

WRIGHT COREY W. (UNITED STATES INDIVIDUAL), DBA BRAINSTORM A SAURUS  
INC.  
SUITE 107  
1906 MAIN STREET  
PARSONS, KS 67357 AND

**TRADEMARK**

**PRINCIPAL REGISTER**

ENCARNACION SHAWN W. (UNITED STATES INDIVIDUAL), DBA BRAINSTORM A  
SAURUS  
SUITE 107  
1906 MAIN STREET  
PARSONS, KS 67357

FOR: CHILDREN'S WALL STICKERS AND MURALS, IN CLASS 16 (U.S. CLS. 2, 5, 22, 23,  
29, 37, 38 AND 50).

FIRST USE 3-1-2011; IN COMMERCE 3-1-2011.

THE MARK CONSISTS OF STANDARD CHARACTERS WITHOUT CLAIM TO ANY PAR-  
TICULAR FONT, STYLE, SIZE, OR COLOR.

NO CLAIM IS MADE TO THE EXCLUSIVE RIGHT TO USE "WALL", APART FROM THE  
MARK AS SHOWN.

SER. NO. 85-255,046, FILED S.R. 3-1-2011 AM. P.R. 12-12-2011.

BENJAMIN OKEKE, EXAMINING ATTORNEY



*David J. Kyros*

Director of the United States Patent and Trademark Office

# United States of America

United States Patent and Trademark Office



**Reg. No. 4,134,079**

**Registered May 1, 2012**

**Int. Cls.: 5 and 32**

**TRADEMARK**

**PRINCIPAL REGISTER**

INNOVATION VENTURES, LLC (MICHIGAN LIMITED LIABILITY COMPANY)  
38955 HILLS TECH DRIVE  
FARMINGTON HILLS, MI 48331

FOR: DIETARY SUPPLEMENTS, IN CLASS 5 (U.S. CLS. 6, 18, 44, 46, 51 AND 52).

FIRST USE 5-0-2007; IN COMMERCE 5-0-2007.

FOR: NON-ALCOHOLIC DRINKS, NAMELY, ENERGY SHOTS, IN CLASS 32 (U.S. CLS. 45, 46 AND 48).

FIRST USE 5-0-2007; IN COMMERCE 5-0-2007.

OWNER OF U.S. REG. NOS. 3,003,077, 4,004,225 AND OTHERS.

NO CLAIM IS MADE TO THE EXCLUSIVE RIGHT TO USE "ENERGY", APART FROM THE MARK AS SHOWN.

THE MARK CONSISTS OF A RUGGED LANDSCAPE WITH A SILHOUETTE OF A PERSON IN AN ATHLETIC POSE IN PROXIMATE RELATION TO THE FOREGROUND TERRAIN AND THE LITERAL ELEMENTS OF "5", "HOUR" AND "ENERGY" DISPOSED ADJACENT TO THE SILHOUETTE AND TERRAIN, ALL INSIDE AND OVAL.

SEC. 2(F) AS TO "5-HOUR ENERGY".

SER. NO. 85-255,911, FILED 3-2-2011.

ELISSA GARBER KON, EXAMINING ATTORNEY



*David J. Kybas*

Director of the United States Patent and Trademark Office

# United States of America

United States Patent and Trademark Office

## ONLY PROTEIN

**Reg. No. 4,134,080**

ONLY PROTEIN, LLC (UTAH LIMITED LIABILITY COMPANY)  
1111 EAST DRAPER PARKWAY, SUITE 101  
DRAPER, UT 84020

**Registered May 1, 2012**

**Int. Cl.: 5**

FOR: PROTEIN SUPPLEMENT FOR HUMAN CONSUMPTION, IN CLASS 5 (U.S. CLS. 6, 18, 44, 46, 51 AND 52).

**TRADEMARK**

FIRST USE 4-30-2011; IN COMMERCE 4-30-2011.

**PRINCIPAL REGISTER**

THE MARK CONSISTS OF STANDARD CHARACTERS WITHOUT CLAIM TO ANY PARTICULAR FONT, STYLE, SIZE, OR COLOR.

NO CLAIM IS MADE TO THE EXCLUSIVE RIGHT TO USE "PROTEIN", APART FROM THE MARK AS SHOWN.

SEC. 2(F).

SER. NO. 85-256,308, FILED 3-2-2011.

RONALD MCMORROW, EXAMINING ATTORNEY



*David J. Kyffers*

Director of the United States Patent and Trademark Office

# United States of America

United States Patent and Trademark Office

## JOURNEYSMOTHER LOTION BARS AND PELLETS

**Reg. No. 4,134,081**

GIBBS BERRY, JACQUELINE S. (UNITED STATES INDIVIDUAL)  
92 AUDUBON ROAD  
TEANECK, NJ 07666

**Registered May 1, 2012**

**Int. Cl.: 3**

FOR: FACE AND BODY LOTIONS; SOAPS; BATH LOTION; BATH BEADS; BATH PEARLS;  
BATH LOTION; BATH LOTION IN PELLET FORM; BATH LOTION BARS, IN CLASS 3 (U.S.  
CLS. 1, 4, 6, 50, 51 AND 52).

**TRADEMARK**

FIRST USE 11-15-2010; IN COMMERCE 11-15-2010.

**PRINCIPAL REGISTER**

THE MARK CONSISTS OF STANDARD CHARACTERS WITHOUT CLAIM TO ANY PAR-  
TICULAR FONT, STYLE, SIZE, OR COLOR.

NO CLAIM IS MADE TO THE EXCLUSIVE RIGHT TO USE "LOTION BARS AND PELLETS",  
APART FROM THE MARK AS SHOWN.

SER. NO. 85-256,486, FILED 3-3-2011.

EVELYN BRADLEY, EXAMINING ATTORNEY



*David J. Kybas*

Director of the United States Patent and Trademark Office

# United States of America

United States Patent and Trademark Office



BE THE CURE

FUND CANCER RESEARCH FOR KIDZ

**Reg. No. 4,134,082**

PATTON, CASEY (UNITED STATES INDIVIDUAL)  
8340 MENDING WALL DRIVE  
WOODRIDGE, IL 60517

**Registered May 1, 2012**

**Int. Cl.: 36**

FOR: CHARITABLE FUNDRAISING IN CONNECTION WITH CHILDREN'S CANCER, IN CLASS 36 (U.S. CLS. 100, 101 AND 102).

**SERVICE MARK**

FIRST USE 5-31-2007; IN COMMERCE 5-31-2007.

**PRINCIPAL REGISTER**

NO CLAIM IS MADE TO THE EXCLUSIVE RIGHT TO USE "FUND CANCER RESEARCH FOR KIDS", APART FROM THE MARK AS SHOWN.

THE MARK CONSISTS OF A SMILEY-FACE SUN DESIGN NEXT TO THE DRAWN WORDS, "BE THE CURE", AND THE WORDING "FUND CANCER RESEARCH FOR KIDS", WITH THE WORD "KIDS" SPELLED AS "KIDZ".

SER. NO. 85-256,600, FILED 3-3-2011.

SUSAN RICHARDS, EXAMINING ATTORNEY



*David J. Kybas*

Director of the United States Patent and Trademark Office



# United States of America

United States Patent and Trademark Office

# TRACK SIDE

**Reg. No. 4,134,083**

**Registered May 1, 2012**

**Int. Cl.: 35**

**SERVICE MARK**

**PRINCIPAL REGISTER**

WAL-MART STORES, INC. (DELAWARE CORPORATION)  
MS-0520  
702 SW 8TH STREET  
BENTONVILLE, AR 727160520

FOR: RETAIL STORE SERVICES FEATURING A WIDE VARIETY OF CONSUMER GOODS OF OTHERS, IN CLASS 35 (U.S. CLS. 100, 101 AND 102).

FIRST USE 7-3-2010; IN COMMERCE 7-3-2010.

THE MARK CONSISTS OF STANDARD CHARACTERS WITHOUT CLAIM TO ANY PARTICULAR FONT, STYLE, SIZE, OR COLOR.

SER. NO. 85-256,664, FILED 3-3-2011.

SAMUEL E. SHARPER JR., EXAMINING ATTORNEY



*David J. Kybas*

Director of the United States Patent and Trademark Office

# United States of America

United States Patent and Trademark Office

## Future of Health Technology Institute

**Reg. No. 4,134,084**

**Registered May 1, 2012**

**Int. Cl.: 41**

**SERVICE MARK**

**PRINCIPAL REGISTER**

BUSHKO, RENATA G. (UNITED STATES INDIVIDUAL), DBA FUTURE OF HEALTH  
TECHNOLOGY INSTITUTE  
4 LAMPLIGHTER LANE  
HOPKINTON, MA 01748

FOR: EDUCATIONAL SERVICES, NAMELY, CONDUCTING CONFERENCES ABOUT THE  
FUTURE OF HEALTH TECHNOLOGY; NON-DOWNLOADABLE ELECTRONIC PUBLICA-  
TIONS AND PROVIDING ONLINE PUBLICATIONS BOTH IN THE NATURE OF NEWSLET-  
TERS AND JOURNALS AND ABOUT THE FUTURE OF HEALTH TECHNOLOGY, IN CLASS  
41 (U.S. CLS. 100, 101 AND 107).

FIRST USE 9-25-1997; IN COMMERCE 9-25-1997.

THE MARK CONSISTS OF STANDARD CHARACTERS WITHOUT CLAIM TO ANY PAR-  
TICULAR FONT, STYLE, SIZE, OR COLOR.

OWNER OF U.S. REG. NO. 2,533,319.

NO CLAIM IS MADE TO THE EXCLUSIVE RIGHT TO USE "HEALTH TECHNOLOGY IN-  
STITUTE", APART FROM THE MARK AS SHOWN.

SER. NO. 85-256,715, FILED 3-3-2011.

GIANCARLO CASTRO, EXAMINING ATTORNEY



*David J. Kyffers*

Director of the United States Patent and Trademark Office

# United States of America

United States Patent and Trademark Office

# StyleOwner

**Reg. No. 4,134,085**

**Registered May 1, 2012**

**Int. Cl.: 35**

**SERVICE MARK**

**PRINCIPAL REGISTER**

STYLEOWNER, INC. (DELAWARE CORPORATION)  
450 7TH AVE, SUITE 209  
NEW YORK, NY 10123

FOR: OPERATING AN ONLINE SHOPPING SITE IN THE FIELD OF CLOTHING AND FASHION ACCESSORIES FEATURING ONLINE MERCHANDISE DISPLAYS OF COMBINATIONS OF SELECT RETAILERS' CLOTHING AND FASHION ACCESSORIES AND PROVIDING LINKS TO THE RETAIL WEB SITES OF OTHERS FEATURING CLOTHING AND FASHION ACCESSORIES; AND PROVISION OF A WEBSITE FEATURING COMMERCIAL INFORMATION ON SHOPPING IN THE FIELD OF CLOTHING AND FASHION ACCESSORIES, IN CLASS 35 (U.S. CLS. 100, 101 AND 102).

FIRST USE 12-1-2010; IN COMMERCE 12-1-2010.

THE MARK CONSISTS OF STANDARD CHARACTERS WITHOUT CLAIM TO ANY PARTICULAR FONT, STYLE, SIZE, OR COLOR.

SER. NO. 85-257,110, FILED 3-3-2011.

NELSON SNYDER, EXAMINING ATTORNEY



*David J. Kyffers*

Director of the United States Patent and Trademark Office

# United States of America

United States Patent and Trademark Office



**Reg. No. 4,134,086**

**Registered May 1, 2012**

**Int. Cl.: 35**

**SERVICE MARK**

**PRINCIPAL REGISTER**

FARR'S FRESH, INC. (UTAH CORPORATION)  
2575 SOUTH 300 WEST  
SALT LAKE CITY, UT 84115

FOR: RETAIL STORES FEATURING FROZEN DESSERTS; RETAIL FROZEN DESSERTS STORES, IN CLASS 35 (U.S. CLS. 100, 101 AND 102).

FIRST USE 8-15-2009; IN COMMERCE 8-15-2009.

OWNER OF U.S. REG. NO. 3,877,697.

NO CLAIM IS MADE TO THE EXCLUSIVE RIGHT TO USE "FRESH" AND "ICE CREAM & FROZEN YOGURT CAFE", APART FROM THE MARK AS SHOWN.

THE MARK CONSISTS OF AN OVAL WITH SMALL LINES MAKING AN OVAL AROUND A LARGE OVAL, THE WORDS "FARR'S FRESH" ARE INSIDE THE OVAL ON THE LEFT SIDE AND A BOWL OF ICE CREAM OR FROZEN YOGURT WITH A TOPPING, THREE STRAWBERRIES, TWO NUTS, A SPOON HANDLE AND A CHERRY ARE INSIDE THE OVAL ON THE BOTTOM RIGHT SIDE. THERE IS A BANNER GOING ACROSS THE BOTTOM OF THE OVAL WITH THE WORDS "ICE CREAM & FROZEN YOGURT CAFE" ON THE BANNER. INSIDE THE INNER OVAL ARE FINE HORIZONTAL LINES WHICH ARE FOR SHADING PURPOSES ONLY.

SER. NO. 85-257,311, FILED 3-3-2011.

AMY HELLA, EXAMINING ATTORNEY



*David J. Kyros*

Director of the United States Patent and Trademark Office

# United States of America

United States Patent and Trademark Office

## Building the Backbone of an Interactive World

**Reg. No. 4,134,087**

BLUEMODUS, INC. (COLORADO CORPORATION)  
1720 S BELLAIRE ST. SUITE 701  
DENVER, CO 80222

**Registered May 1, 2012**

**Int. Cl.: 42**

FOR: APPLICATION SERVICE PROVIDER (ASP), NAMELY, HOSTING COMPUTER SOFTWARE APPLICATIONS OF OTHERS, IN CLASS 42 (U.S. CLS. 100 AND 101).

**SERVICE MARK**

FIRST USE 1-1-2009; IN COMMERCE 1-1-2009.

**PRINCIPAL REGISTER**

THE MARK CONSISTS OF STANDARD CHARACTERS WITHOUT CLAIM TO ANY PARTICULAR FONT, STYLE, SIZE, OR COLOR.

SER. NO. 85-257,404, FILED 3-3-2011.

MEGHAN REINHART, EXAMINING ATTORNEY



*David J. Kybas*

Director of the United States Patent and Trademark Office

# United States of America

United States Patent and Trademark Office



**Reg. No. 4,134,088**

**Registered May 1, 2012**

**Int. Cl.: 35**

**SERVICE MARK**

**PRINCIPAL REGISTER**

FARR'S FRESH, INC. (UTAH CORPORATION)  
2575 SOUTH 300 WEST  
SALT LAKE CITY, UT 84115

FOR: RETAIL STORES FEATURING FROZEN DESSERTS; RETAIL FROZEN DESSERTS STORES, IN CLASS 35 (U.S. CLS. 100, 101 AND 102).

FIRST USE 8-15-2009; IN COMMERCE 8-15-2009.

OWNER OF U.S. REG. NO. 3,877,697.

NO CLAIM IS MADE TO THE EXCLUSIVE RIGHT TO USE "FRESH", APART FROM THE MARK AS SHOWN.

THE MARK CONSISTS OF THE TERM "FARR'S" IN STYLIZED, ANGLED LETTERING WITH THE LETTER "F" CAPITALIZED AND THE REMAINING LETTERS IN LOWERCASE, WHERE THE TOP ELEMENT OF THE LETTER "F" EXTENDS ACROSS THE ENTIRE TERM IN A CURVED MANNER. THE TERM "FARR'S" APPEARS ABOVE THE TERM "FRESH". THE TERM "FRESH" IS LOWERCASE AND IN STYLIZED, ANGLED CURSIVE LETTERING UNDERLINED WITH A CURVED LINE. THE GROUPING OF THE TERMS IS OUTLINED WITH A SOLID LINE.

SER. NO. 85-257,420, FILED 3-3-2011.

AMY HELLA, EXAMINING ATTORNEY



*David J. Kyros*

Director of the United States Patent and Trademark Office

# United States of America

United States Patent and Trademark Office

## PACO & LOLA

**Reg. No. 4,134,089**

**Registered May 1, 2012**

**Int. Cl.: 33**

**TRADEMARK**

**PRINCIPAL REGISTER**

COOPERATIVA VITIVINICOLA AROUSANA S.C.G. (SPAIN COOPERATIVE)  
36968 MEAÑO  
CALLE VALDAMOR, N°18  
(PONTEVEDRA), SPAIN

FOR: LIQUEURS; WINES, IN CLASS 33 (U.S. CLS. 47 AND 49).

THE MARK CONSISTS OF STANDARD CHARACTERS WITHOUT CLAIM TO ANY PARTICULAR FONT, STYLE, SIZE, OR COLOR.

OWNER OF ERPN CMNTY TM OFC REG. NO. 5508882, DATED 9-17-2007, EXPIRES 11-29-2016.

SER. NO. 85-257,546, FILED 3-3-2011.

GRETTA YAO, EXAMINING ATTORNEY



*David J. Kybas*

Director of the United States Patent and Trademark Office

# United States of America

United States Patent and Trademark Office

# REITRADER

**Reg. No. 4,134,090**

**Registered May 1, 2012**

**Int. Cl.: 16**

**TRADEMARK**

**PRINCIPAL REGISTER**

GREEN STREET ADVISORS, INC. (CALIFORNIA CORPORATION)  
567 SAN NICHOLAS DRIVE, #200  
NEWPORT BEACH, CA 92660

FOR: RESEARCH REPORTS FEATURING REAL ESTATE, FINANCE AND INVESTMENT,  
IN CLASS 16 (U.S. CLS. 2, 5, 22, 23, 29, 37, 38 AND 50).

FIRST USE 3-3-2011; IN COMMERCE 3-3-2011.

THE MARK CONSISTS OF STANDARD CHARACTERS WITHOUT CLAIM TO ANY PAR-  
TICULAR FONT, STYLE, SIZE, OR COLOR.

SER. NO. 85-257,588, FILED 3-3-2011.

KRISTIN CARLSON, EXAMINING ATTORNEY



*David J. Kybas*

Director of the United States Patent and Trademark Office



# United States of America

United States Patent and Trademark Office



**Reg. No. 4,134,091**

**Registered May 1, 2012**

**Int. Cl.: 36**

ORTUS CAPITAL MANAGEMENT LIMITED (HONG KONG LIMITED LIABILITY COMPANY)  
UNIT 2708, 27TH FLOOR  
THE CENTER, 99 QUEEN'S ROAD CENTRAL  
CENTRAL, HONG KONG

**SERVICE MARK**

**PRINCIPAL REGISTER**

FOR: FINANCIAL ANALYSIS AND CONSULTATION, MONEY TRANSFERS, FINANCIAL SERVICES, NAMELY, INVESTMENT FUND TRANSFER AND TRANSACTION SERVICES, ASSISTING OTHERS WITH THE COMPLETION OF FINANCIAL TRANSACTIONS FOR STOCKS, BONDS, SECURITIES AND EQUITIES, WEALTH MANAGEMENT SERVICES, AND INVESTMENT ADVICE, INVESTMENT MANAGEMENT, INVESTMENT CONSULTATION, INVESTMENT OF FUNDS FOR OTHERS; FINANCIAL RESEARCH SERVICES; FINANCIAL INFORMATION, FINANCIAL MANAGEMENT AND PLANNING; FINANCIAL ANALYSIS SERVICES; FINANCIAL EVALUATION SERVICES; FINANCIAL ASSET MANAGEMENT; FINANCIAL ASSET EVALUATION; ASSET ALLOCATION; ASSET-BASED FINANCING; CAPITAL INVESTMENTS; FUNDS INVESTMENTS; FINANCIAL CONSULTANCY SERVICES; SECURITIES BROKERAGE; PRIVATE EQUITY FUND INVESTING; MUTUAL FUNDS INVESTMENTS; ASSISTING OTHERS WITH THE COMPLETION OF FINANCIAL TRANSACTIONS FOR EQUITIES; RISK MANAGEMENT SERVICES AND FINANCIAL ADVISORY SERVICES; STOCKS AND BONDS BROKERAGE, IN CLASS 36 (U.S. CLS. 100, 101 AND 102).

OWNER OF HONG KONG REG. NO. 301843353, DATED 2-25-2011, EXPIRES 2-25-2021.

THE MARK CONSISTS OF THE WORD "ORTUS" UNDERLINED WITH A LARGE BLACK CIRCLE BEHIND THE "O" IN "ORTUS".

SER. NO. 85-257,791, FILED 3-4-2011.

SALLY SHIH, EXAMINING ATTORNEY



*David J. Kybas*

Director of the United States Patent and Trademark Office

# United States of America

United States Patent and Trademark Office

**B**RIDAL & **Q**UINCE  
*Extravaganza*

**Reg. No. 4,134,092**

**Registered May 1, 2012**

**Int. Cl.: 41**

**SERVICE MARK**

**PRINCIPAL REGISTER**

BEGAY, BILL C (UNITED STATES INDIVIDUAL)  
LIFETIMEOFMEMORIES@LIVE.COM  
2104 E. YANDELL SUITE U-6  
EL PASO, TX 79903 AND

DOMINGUEZ, RICK (UNITED STATES INDIVIDUAL)  
LIFETIMEOFMEMORIES@LIVE.COM  
2104 E. YANDELL U-6  
EL PASO, TX 79903

FOR: PARTY AND WEDDING PLANNING AND COORDINATION SERVICES; PARTY AND WEDDING PLANNING CONSULTATION SERVICES; PROVIDING INFORMATION IN THE FIELD OF WEDDING PARTY PLANNING; PROVIDING INFORMATION REGARDING WEDDING PLANNING FOR WEDDING PARTIES, IN CLASS 41 (U.S. CLS. 100, 101 AND 107).

FIRST USE 12-1-2010; IN COMMERCE 1-23-2011.

NO CLAIM IS MADE TO THE EXCLUSIVE RIGHT TO USE "BRIDAL & QUINCE", APART FROM THE MARK AS SHOWN.

THE COLOR(S) FUCHSIA, BLACK, AND LIME-GREEN IS/ARE CLAIMED AS A FEATURE OF THE MARK.

THE MARK CONSISTS OF THE WORDING "BRIDAL & QUINCE EXTRAVAGANZA" IN STYLIZED LETTERING WITH THE LETTER "B" IN "BRIDAL" AND THE LETTER "Q" IN "QUINCE" BEING IN THE COLOR FUCHSIA, THE REMAINDER OF THOSE WORDS AND THE AMPERSAND IN THE COLOR BLACK, AND THE WORD "EXTRAVAGANZA" IN THE COLOR LIME-GREEN.

SER. NO. 85-257,975, FILED 3-4-2011.

SUSAN STIGLITZ, EXAMINING ATTORNEY



*David J. Kyros*

Director of the United States Patent and Trademark Office

# United States of America

United States Patent and Trademark Office

**Bong Safety**

**Reg. No. 4,134,093**

**Registered May 1, 2012**

**Int. Cl.: 9**

BILLABONG ENTERPRISES COMPANY LIMITED (HONG KONG LIMITED LIABILITY COMPANY)  
1ST FLOOR, WING CHEUNG INDUSTRIAL BLDG.  
109 HOW MING STREET, KWUN TONG  
KOWLOON, HONG KONG

**TRADEMARK**

**PRINCIPAL REGISTER**

FOR: RESPIRATORS FOR FILTERING AIR, RESPIRATORY MASKS NOT FOR MEDICAL PURPOSES, PROTECTIVE EYEWEAR AND GOGGLES, PROTECTIVE GLOVES, PROTECTIVE EAR MUFFS, EAR PLUGS, PROTECTION DEVICES FOR PERSONAL USE AGAINST ACCIDENTS, NAMELY, PROTECTIVE BODY ARMOR IN THE NATURE OF SLASH RESISTANT VESTS, DUST PROTECTIVE GOGGLES AND MASKS, LIFE JACKETS, INDUSTRIAL SHOES AND BOOTS, SUITS FOR AVIATORS, FIRE-RESISTANT FLYING SUITS, DIVING SUITS, IN CLASS 9 (U.S. CLS. 21, 23, 26, 36 AND 38).

PRIORITY CLAIMED UNDER SEC. 44(D) ON HONG KONG APPLICATION NO. 301847403, FILED 3-2-2011, REG. NO. 301847403, DATED 3-2-2011, EXPIRES 3-2-2021.

THE COLOR(S) RED IS/ARE CLAIMED AS A FEATURE OF THE MARK.

NO CLAIM IS MADE TO THE EXCLUSIVE RIGHT TO USE "SAFETY", APART FROM THE MARK AS SHOWN.

THE MARK CONSISTS OF THE WORDING "BONG SAFETY" IN STYLIZED FONT. THE END OF LETTER "G" FORMS A BOX AROUND THE WORDS. THE MARK IS IN RED.

SER. NO. 85-257,999, FILED 3-4-2011.

ALLISON SCHRODY, EXAMINING ATTORNEY



*David J. Kyros*

Director of the United States Patent and Trademark Office

# United States of America

United States Patent and Trademark Office



**Reg. No. 4,134,094**

**Registered May 1, 2012**

**Int. Cl.: 35**

**SERVICE MARK**

**PRINCIPAL REGISTER**

FARR'S FRESH, INC. (UTAH CORPORATION)  
2575 SOUTH 300 WEST  
SALT LAKE CITY, UT 84115

FOR: RETAIL STORES FEATURING FROZEN DESSERTS; RETAIL FROZEN DESSERTS STORES, IN CLASS 35 (U.S. CLS. 100, 101 AND 102).

FIRST USE 11-30-2010; IN COMMERCE 11-30-2010.

OWNER OF U.S. REG. NO. 3,877,697.

NO CLAIM IS MADE TO THE EXCLUSIVE RIGHT TO USE "FRESH", "FROZEN CUSTARD", "ICE CREAM", AND "FROZEN YOGURT", APART FROM THE MARK AS SHOWN.

THE MARK CONSISTS OF THE STYLIZED TERMS "FARR'S FRESH" IN STYLIZED, ANGLED LETTERING WITH THE LETTER "F" CAPITALIZED AND THE REMAINING LETTERS IN LOWERCASE. THE TERM "FARR'S" APPEARS ABOVE THE TERM "FRESH". UNDERNEATH "FRESH" IS A CURVED BAR. TO THE RIGHT OF THE WORDS IS A BOWL OF ICE CREAM OR SIMILAR FROZEN DESSERT WITH A TOPPING, THREE STRAWBERRIES, TWO NUTS, A SPOON HANDLE AND A CHERRY. BELOW THE TERMS AND THE DESSERT ARE THREE ADJACENT OVALS WITH THE TERMS "FROZEN CUSTARD" IN THE LEFT OVAL, THE TERMS "ICE CREAM" IN THE CENTER OVAL, AND THE TERMS "FROZEN YOGURT" IN THE RIGHT OVAL.

SER. NO. 85-258,003, FILED 3-4-2011.

AMY HELLA, EXAMINING ATTORNEY



*David J. Kyros*

Director of the United States Patent and Trademark Office

# United States of America

United States Patent and Trademark Office

EpiAnywhere

**Reg. No. 4,134,095**

**Registered May 1, 2012**

**Int. Cl.: 42**

**SERVICE MARK**

**PRINCIPAL REGISTER**

JBS INTERNATIONAL, INC. (MARYLAND CORPORATION)  
5515 SECURITY LANE, SUITE 800  
NORTH BETHESDA, MD 20852

FOR: PROVIDING AN INTERACTIVE WEB SITE FEATURING TECHNOLOGY THAT EN-  
ABLES USERS TO ENTER, ACCESS, TRACK, MANAGE, MONITOR AND GENERATE  
PUBLIC HEALTH SURVEILLANCE INFORMATION AND REPORTS; PROVIDING A WEB  
SITE FEATURING NON-DOWNLOADABLE SOFTWARE FOR DATA MANAGEMENT,  
ANALYSIS AND REPORTING IN THE FIELD OF PUBLIC HEALTH SURVEILLANCE, IN  
CLASS 42 (U.S. CLS. 100 AND 101).

FIRST USE 4-9-2009; IN COMMERCE 4-9-2009.

THE MARK CONSISTS OF THE WORDING "EPIANYWHERE" WITH AN ARCH.

SER. NO. 85-258,171, FILED 3-4-2011.

SANDRA BUJA, EXAMINING ATTORNEY



*David J. Kyffers*

Director of the United States Patent and Trademark Office

# United States of America

United States Patent and Trademark Office

## EPIANYWHERE

**Reg. No. 4,134,096**

**Registered May 1, 2012**

**Int. Cl.: 42**

**SERVICE MARK**

**PRINCIPAL REGISTER**

JBS INTERNATIONAL, INC. (MARYLAND CORPORATION)  
5515 SECURITY LANE, SUITE 800  
NORTH BETHESDA, MD 20852

FOR: PROVIDING AN INTERACTIVE WEB SITE FEATURING TECHNOLOGY THAT EN-  
ABLES USERS TO ENTER, ACCESS, TRACK, MANAGE, MONITOR AND GENERATE  
PUBLIC HEALTH SURVEILLANCE INFORMATION AND REPORTS; PROVIDING A WEB  
SITE FEATURING NON-DOWNLOADABLE SOFTWARE FOR DATA MANAGEMENT,  
ANALYSIS AND REPORTING IN THE FIELD OF PUBLIC HEALTH SURVEILLANCE, IN  
CLASS 42 (U.S. CLS. 100 AND 101).

FIRST USE 4-9-2009; IN COMMERCE 4-9-2009.

THE MARK CONSISTS OF STANDARD CHARACTERS WITHOUT CLAIM TO ANY PAR-  
TICULAR FONT, STYLE, SIZE, OR COLOR.

SER. NO. 85-258,289, FILED 3-4-2011.

SANDRA BUJA, EXAMINING ATTORNEY



*David J. Kyffers*

Director of the United States Patent and Trademark Office

# United States of America

United States Patent and Trademark Office

## LEGAL LUMPING LEADERSHIP & MANAGEMENT SERVICES, INC.

**Reg. No. 4,134,097**

**Registered May 1, 2012**

**Int. Cl.: 35**

**SERVICE MARK**

**PRINCIPAL REGISTER**

AMERICAN LUMPING ASSOCIATION, INC. (COLORADO CORPORATION), DBA LEGAL LUMPING LEADERSHIP AND MANAGEMENT SERVICES  
15421 E. BATAVIA DRIVE  
AURORA, CO 80011

FOR: BUSINESS SERVICES, NAMELY BUSINESS SUPPORT, STRATEGIC PLANNING AND SYSTEM PROCESS DESIGN FOR OTHERS IN THE FIELD OF FREIGHT MANAGEMENT, IN CLASS 35 (U.S. CLS. 100, 101 AND 102).

FIRST USE 12-15-2003; IN COMMERCE 12-15-2003.

THE MARK CONSISTS OF STANDARD CHARACTERS WITHOUT CLAIM TO ANY PARTICULAR FONT, STYLE, SIZE, OR COLOR.

NO CLAIM IS MADE TO THE EXCLUSIVE RIGHT TO USE "LUMPING LEADERSHIP & MANAGEMENT SERVICES, INC.", APART FROM THE MARK AS SHOWN.

SEC. 2(F).

SER. NO. 85-258,725, FILED 3-4-2011.

KATINA MISTER, EXAMINING ATTORNEY



*David J. Kyffers*

Director of the United States Patent and Trademark Office

# United States of America

United States Patent and Trademark Office

## THE FIRST AND FOREMOST IN LEGAL LUMPING SERVICES

**Reg. No. 4,134,098**

**Registered May 1, 2012**

**Int. Cl.: 35**

**SERVICE MARK**

**PRINCIPAL REGISTER**

AMERICAN LUMPING ASSOCIATION, INC. (COLORADO CORPORATION), DBA LEGAL LUMPING LEADERSHIP AND MANAGEMENT SERVICES  
15421 E. BATAVIA DRIVE  
AURORA, CO 80011

FOR: BUSINESS SERVICES, NAMELY, BUSINESS SUPPORT, STRATEGIC PLANNING AND SYSTEM PROCESS DESIGN FOR OTHERS IN THE FIELD OF FREIGHT MANAGEMENT; LUMPING SERVICES, NAMELY, PROVIDING MANUAL LABORERS TO WAREHOUSES AND TRUCKING LINES FOR THE PURPOSE OF UNLOADING FREIGHT, IN CLASS 35 (U.S. CLS. 100, 101 AND 102).

FIRST USE 10-31-1997; IN COMMERCE 10-31-1997.

THE MARK CONSISTS OF STANDARD CHARACTERS WITHOUT CLAIM TO ANY PARTICULAR FONT, STYLE, SIZE, OR COLOR.

NO CLAIM IS MADE TO THE EXCLUSIVE RIGHT TO USE "LEGAL LUMPING SERVICES", APART FROM THE MARK AS SHOWN.

SEC. 2(F).

SER. NO. 85-258,731, FILED 3-4-2011.

KATINA MISTER, EXAMINING ATTORNEY



*David J. Kybas*

Director of the United States Patent and Trademark Office



# United States of America

United States Patent and Trademark Office

ZANY  
CORN

**Reg. No. 4,134,099**

**Registered May 1, 2012**

**Int. Cl.: 30**

HAPPY HERBERT'S FOOD CO., INC. (NEW JERSEY CORPORATION)  
SUITE 2524  
444 WASHINGTON BLVD.  
JERSEY CITY, NJ 07310

FOR: CORN-BASED SNACK FOODS, IN CLASS 30 (U.S. CL. 46).

**TRADEMARK**

FIRST USE 2-12-2003; IN COMMERCE 2-12-2003.

**PRINCIPAL REGISTER**

NO CLAIM IS MADE TO THE EXCLUSIVE RIGHT TO USE "CORN", APART FROM THE MARK AS SHOWN.

THE COLOR(S) BLACK AND BLUE IS/ARE CLAIMED AS A FEATURE OF THE MARK.

THE MARK CONSISTS OF THE WORDS "ZANY CORN" WITH THE LETTER "O" IN THE FORM OF A SPIRAL, "ZANY" AND THE LETTERS "CRN" ARE IN BLACK AND THE SPIRAL FORMING THE LETTER "O" IS IN BLUE.

SER. NO. 85-259,247, FILED 3-6-2011.

EDWARD NELSON, EXAMINING ATTORNEY



*David J. Kypos*

Director of the United States Patent and Trademark Office

# United States of America

United States Patent and Trademark Office

# EGGETARIAN

**Reg. No. 4,134,100**

**Registered May 1, 2012**

**Int. Cl.: 30**

**TRADEMARK**

**PRINCIPAL REGISTER**

THE EXPRESS CAFE & BAKERY, LLC (GEORGIA LIMITED LIABILITY COMPANY)  
39 BARNARD STREET  
SAVANNAH, GA 31401

FOR: SANDWICHES, IN CLASS 30 (U.S. CL. 46).

FIRST USE 3-2-2011; IN COMMERCE 3-2-2011.

THE MARK CONSISTS OF STANDARD CHARACTERS WITHOUT CLAIM TO ANY PARTICULAR FONT, STYLE, SIZE, OR COLOR.

SER. NO. 85-259,800, FILED 3-7-2011.

TASNEEM HUSSAIN, EXAMINING ATTORNEY



*David J. Kyffers*

Director of the United States Patent and Trademark Office

# United States of America

United States Patent and Trademark Office

# COMFYTRAY

**Reg. No. 4,134,101**

**Registered May 1, 2012**

**Int. Cl.: 10**

**TRADEMARK**

**PRINCIPAL REGISTER**

JOHNSON & JOHNSON (NEW JERSEY CORPORATION)  
ONE JOHNSON & JOHNSON PLAZA  
NEW BRUNSWICK, NJ 089337001

FOR: DENTAL TRAYS SOLD EMPTY FOR USE IN APPLYING TOOTH WHITENING PREPARATIONS, IN CLASS 10 (U.S. CLS. 26, 39 AND 44).

FIRST USE 12-0-2000; IN COMMERCE 12-0-2000.

THE MARK CONSISTS OF STANDARD CHARACTERS WITHOUT CLAIM TO ANY PARTICULAR FONT, STYLE, SIZE, OR COLOR.

SER. NO. 85-259,802, FILED 3-7-2011.

ELLEN PERKINS, EXAMINING ATTORNEY



*David J. Kyffers*

Director of the United States Patent and Trademark Office

# United States of America

United States Patent and Trademark Office

## WATER BUFFALO

**Reg. No. 4,134,102**

HOSPITALITY DEMOCRACY, LLC (WISCONSIN LIMITED LIABILITY COMPANY)  
100 EAST WISCONSIN AVENUE, SUITE 1030  
MILWAUKEE, WI 53202

**Registered May 1, 2012**

**Int. Cl.: 43**

FOR: RESTAURANT, BAR AND CATERING SERVICES, IN CLASS 43 (U.S. CLS. 100 AND 101).

**SERVICE MARK**

FIRST USE 4-12-2007; IN COMMERCE 4-12-2007.

**PRINCIPAL REGISTER**

THE MARK CONSISTS OF STANDARD CHARACTERS WITHOUT CLAIM TO ANY PARTICULAR FONT, STYLE, SIZE, OR COLOR.

SER. NO. 85-259,811, FILED 3-7-2011.

JANET LEE, EXAMINING ATTORNEY



*David J. Kybas*

Director of the United States Patent and Trademark Office

# United States of America

United States Patent and Trademark Office

## CAROL'S GLUTEN FREE

**Reg. No. 4,134,103**

**Registered May 1, 2012**

**Int. Cl.: 5**

**TRADEMARK**

**PRINCIPAL REGISTER**

KICINSKI, CAROL (UNITED STATES INDIVIDUAL)  
235 EDGEWATER DR  
DUNEDIN, FL 34698

FOR: GLUTEN-FREE FOOD TO ACCOMMODATE SPECIAL MEDICAL AND HEALTH CONDITIONS; PROTEIN REDUCED AND GLUTEN FREE FOOD FOR MEDICAL PURPOSES; BISCUITS, BREAD, BREAD ROLLS, CAKES, CEREAL PRODUCTS, CONFECTIONERY, CRACKERS, NOODLES, FISH SAUCE, RELISH, SAUCES, CEREAL-BASED SNACK-FOODS AND PREPARED DIETARY ITEMS ALL OF WHICH ARE GLUTEN -FREE TO ACCOMMODATE SPECIAL MEDICAL AND HEALTH CONDITIONS; GLUTEN-FREE BAKING MIXES TO ACCOMMODATE SPECIAL MEDICAL AND HEALTH CONDITIONS; GLUTEN-FREE FLOUR BLENDS TO ACCOMMODATE SPECIAL MEDICAL AND HEALTH CONDITIONS, IN CLASS 5 (U.S. CLS. 6, 18, 44, 46, 51 AND 52).

FIRST USE 1-14-2008; IN COMMERCE 9-20-2010.

THE MARK CONSISTS OF STANDARD CHARACTERS WITHOUT CLAIM TO ANY PARTICULAR FONT, STYLE, SIZE, OR COLOR.

NO CLAIM IS MADE TO THE EXCLUSIVE RIGHT TO USE "GLUTEN FREE", APART FROM THE MARK AS SHOWN.

SER. NO. 85-260,452, FILED 3-8-2011.

SUZANNE BLANE, EXAMINING ATTORNEY



*David J. Kybas*

Director of the United States Patent and Trademark Office

# United States of America

United States Patent and Trademark Office

# ELIO

**Reg. No. 4,134,104**

**Registered May 1, 2012**

**Int. Cl.: 11**

**TRADEMARK**

**PRINCIPAL REGISTER**

ITC INCORPORATED (MICHIGAN CORPORATION)  
230 E. LAKEWOOD BLVD.  
HOLLAND, MI 49424

FOR: LED (LIGHT EMITTING DIODES) TASK LIGHTING FIXTURES FOR USE IN DISPLAYS, NAMELY, RETAIL, FOOD, RESIDENTIAL AND WORKSPACE AND HEALTHCARE ENVIRONMENTS, IN CLASS 11 (U.S. CLS. 13, 21, 23, 31 AND 34).

FIRST USE 8-31-2009; IN COMMERCE 10-31-2009.

THE MARK CONSISTS OF STANDARD CHARACTERS WITHOUT CLAIM TO ANY PARTICULAR FONT, STYLE, SIZE, OR COLOR.

THE ENGLISH TRANSLATION OF "ELIO" IN THE MARK IS "HELIUM".

SER. NO. 85-260,539, FILED 3-8-2011.

ANDREW RHIM, EXAMINING ATTORNEY



*David J. Kybas*

Director of the United States Patent and Trademark Office

# United States of America

United States Patent and Trademark Office

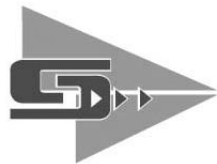

*Clinical Diagnostic Solutions, Inc.*

**Reg. No. 4,134,105**

**Registered May 1, 2012**

**Int. Cl.: 37**

**SERVICE MARK**

**PRINCIPAL REGISTER**

CLINICAL DIAGNOSTIC SOLUTIONS, INC. (FLORIDA CORPORATION)  
1800 NW 65TH AVENUE  
PLANTATION, FL 33313

FOR: REPAIR AND MAINTENANCE OF PARTICLE STUDY AND ANALYSIS INSTRUMENTS, CYTOMETRY INSTRUMENTS, HEMATOLOGY INSTRUMENTS, ACCESSORIES AND COMPONENTS THEREOF, IN THE MEDICAL, BIOLOGICAL, INDUSTRIAL, CLINICAL LABORATORY AND RESEARCH FIELDS, IN CLASS 37 (U.S. CLS. 100, 103 AND 106).

FIRST USE 4-6-1999; IN COMMERCE 5-7-1999.

NO CLAIM IS MADE TO THE EXCLUSIVE RIGHT TO USE "CLINICAL DIAGNOSTIC SOLUTIONS, INC.", APART FROM THE MARK AS SHOWN.

THE MARK CONSISTS OF THE LETTER "C" AND THE LETTER "D" COMBINED TO FORM THE LETTER S WITH THREE SMALL TRIANGLES ALL SUPERIMPOSED ON TWO LARGE TRIANGLES, ALL TO THE LEFT OF THE WORDS "CLINICAL DIAGNOSTIC SOLUTIONS, INC."

SER. NO. 85-260,572, FILED 3-8-2011.

JOHN SCHUYLER YARD, EXAMINING ATTORNEY



*David J. Kyffers*

Director of the United States Patent and Trademark Office

# United States of America

United States Patent and Trademark Office

# COL LIVE

**Reg. No. 4,134,106**

**Registered May 1, 2012**

**Int. Cl.: 41**

**SERVICE MARK**

**PRINCIPAL REGISTER**

SOFFER, YOSEF (UNITED STATES INDIVIDUAL)  
1217 PRESIDENT STREET  
BROOKLYN, NY 11225

FOR: COMMUNITY NEWS SERVICE PROVIDING BREAKING NEWS VIA PHOTOGRAPHS AND VIDEOS FOR JEWISH COMMUNITIES WORLDWIDE, NAMELY, PROVIDING ONLINE CURRENT EVENTS NEWS REPORTING , IN CLASS 41 (U.S. CLS. 100, 101 AND 107).

FIRST USE 9-30-2008; IN COMMERCE 9-30-2008.

THE MARK CONSISTS OF STANDARD CHARACTERS WITHOUT CLAIM TO ANY PARTICULAR FONT, STYLE, SIZE, OR COLOR.

NO CLAIM IS MADE TO THE EXCLUSIVE RIGHT TO USE "LIVE", APART FROM THE MARK AS SHOWN.

SER. NO. 85-261,096, FILED 3-8-2011.

APRIL ROACH, EXAMINING ATTORNEY



*David J. Kyffers*

Director of the United States Patent and Trademark Office



# United States of America

United States Patent and Trademark Office

# Steth View

**Reg. No. 4,134,107**

**Registered May 1, 2012**

**Int. Cl.: 9**

**TRADEMARK**

**PRINCIPAL REGISTER**

EXCELLUS TECHNOLOGIES, INC. (SOUTH DAKOTA CORPORATION)  
160 SOUTH LAKE DRIVE  
WATERTOWN, SD 57201

FOR: MEDICAL DIAGNOSTIC SIMULATORS FOR USE AS TEACHING AIDS FOR AUSCULTATION; MEDICAL SOFTWARE FOR CAPTURING, PLAYING BACK, AND DISPLAYING PHONOCARDIOGRAM AND PHONOPNEMOGRAM, IN CLASS 9 (U.S. CLS. 21, 23, 26, 36 AND 38).

FIRST USE 12-31-1999; IN COMMERCE 12-31-2000.

THE MARK CONSISTS OF STANDARD CHARACTERS WITHOUT CLAIM TO ANY PARTICULAR FONT, STYLE, SIZE, OR COLOR.

SER. NO. 85-261,120, FILED 3-8-2011.

ERIN FALK, EXAMINING ATTORNEY



*David J. Kybas*

Director of the United States Patent and Trademark Office

# United States of America

United States Patent and Trademark Office

## RANDOM ACTS OF FLOWERS

**Reg. No. 4,134,108**

**Registered May 1, 2012**

**Int. Cls.: 35 and 36**

**SERVICE MARK**

**PRINCIPAL REGISTER**

RANDOM ACTS OF FLOWERS (TENNESSEE CORPORATION)  
P.O. BOX 27817  
KNOXVILLE, TN 37927

FOR: CHARITABLE SERVICES, NAMELY, SOLICITING, COLLECTING, AND DISTRIBUTING NON-MONETARY DONATIONS IN SUPPORT OF THE CHARITABLE GIVING OF RECYCLED FLOWERS, FLORAL ARRANGEMENTS, AND FLORAL ACCESSORIES TO INDIVIDUALS IN NEED, IN CLASS 35 (U.S. CLS. 100, 101 AND 102).

FIRST USE 7-0-2008; IN COMMERCE 7-0-2008.

FOR: CHARITABLE SERVICES, NAMELY, SOLICITING, COLLECTING, AND DISTRIBUTING MONETARY DONATIONS IN SUPPORT OF THE CHARITABLE GIVING OF RECYCLED FLOWERS, FLORAL ARRANGEMENTS, AND FLORAL ACCESSORIES TO INDIVIDUALS IN NEED, IN CLASS 36 (U.S. CLS. 100, 101 AND 102).

FIRST USE 7-0-2008; IN COMMERCE 7-0-2008.

THE MARK CONSISTS OF STANDARD CHARACTERS WITHOUT CLAIM TO ANY PARTICULAR FONT, STYLE, SIZE, OR COLOR.

NO CLAIM IS MADE TO THE EXCLUSIVE RIGHT TO USE "FLOWERS", APART FROM THE MARK AS SHOWN.

SER. NO. 85-261,128, FILED 3-8-2011.

WILLIAM JACKSON, EXAMINING ATTORNEY



*David J. Kyjars*

Director of the United States Patent and Trademark Office

# United States of America

United States Patent and Trademark Office

## Advancing Technology to the Classroom

**Reg. No. 4,134,109**

**Registered May 1, 2012**

**Int. Cl.: 35**

**SERVICE MARK**

**PRINCIPAL REGISTER**

EDCO - EDUCATION CONSULTANTS, INC. (GEORGIA CORPORATION)  
111 MOUNTAIN VISTA BLVD. STE. 150  
CANTON, GA 30115

FOR: ON-LINE RETAIL STORE SERVICES FEATURING AUDIO/VISUAL EQUIPMENT, SOFTWARE AND OTHER EDUCATIONAL TECHNOLOGY; PROCUREMENT, NAMELY, PURCHASING AUDIO/VISUAL EQUIPMENT, SOFTWARE AND OTHER EDUCATIONAL TECHNOLOGY FOR OTHERS; RETAIL SERVICES THROUGH DIRECT SOLICITATION BY DISTRIBUTORS DIRECTED TO END-USERS FEATURING AUDIO/VISUAL EQUIPMENT, SOFTWARE AND OTHER EDUCATIONAL TECHNOLOGY, IN CLASS 35 (U.S. CLS. 100, 101 AND 102).

FIRST USE 1-1-2011; IN COMMERCE 1-1-2011.

THE MARK CONSISTS OF STANDARD CHARACTERS WITHOUT CLAIM TO ANY PARTICULAR FONT, STYLE, SIZE, OR COLOR.

SER. NO. 85-261,310, FILED 3-8-2011.

GIANCARLO CASTRO, EXAMINING ATTORNEY



*David J. Kyffers*

Director of the United States Patent and Trademark Office

# United States of America

United States Patent and Trademark Office

## Vitex2

**Reg. No. 4,134,110**

**Registered May 1, 2012**

**Int. Cl.: 20**

**TRADEMARK**

**PRINCIPAL REGISTER**

WERNER MEDIA PARTNERS, LLC (FLORIDA LIMITED LIABILITY COMPANY), DBA  
NATURE'S SLEEP, LLC  
BLDG C4  
11870 W. STATE ROAD 84  
DAVIE, FL 33325

FOR: MATTRESS TOPPERS; MATTRESSES; MATTRESSES, NAMELY, MATTRESSES  
WITH VISCOELASTIC FOAM COMPONENTS; PILLOWS, IN CLASS 20 (U.S. CLS. 2, 13,  
22, 25, 32 AND 50).

FIRST USE 10-31-2007; IN COMMERCE 10-31-2007.

THE MARK CONSISTS OF STANDARD CHARACTERS WITHOUT CLAIM TO ANY PAR-  
TICULAR FONT, STYLE, SIZE, OR COLOR.

OWNER OF U.S. REG. NO. 3,476,360.

SER. NO. 85-261,435, FILED 3-8-2011.

MICHAEL KEATING, EXAMINING ATTORNEY



*David J. Kyffers*

Director of the United States Patent and Trademark Office

# United States of America

United States Patent and Trademark Office

## Starship Empire

**Reg. No. 4,134,111**

CAMPOLO, BRUNO J (UNITED STATES INDIVIDUAL), DBA BANTAM CITY GAMES  
3 SKYTOP DR  
BRISTOL, CT 06010

**Registered May 1, 2012**

**Int. Cl.: 41**

FOR: ENTERTAINMENT SERVICES, NAMELY, PROVIDING AN ON-LINE COMPUTER GAME, IN CLASS 41 (U.S. CLS. 100, 101 AND 107).

**SERVICE MARK**

FIRST USE 2-1-2011; IN COMMERCE 2-1-2011.

**PRINCIPAL REGISTER**

THE MARK CONSISTS OF STANDARD CHARACTERS WITHOUT CLAIM TO ANY PARTICULAR FONT, STYLE, SIZE, OR COLOR.

SER. NO. 85-261,634, FILED 3-8-2011.

KATHERINE CONNOLLY, EXAMINING ATTORNEY



*David J. Kybas*

Director of the United States Patent and Trademark Office

# United States of America

United States Patent and Trademark Office

# CALIFUSION

**Reg. No. 4,134,112**

**Registered May 1, 2012**

**Int. Cl.: 43**

**SERVICE MARK**

**PRINCIPAL REGISTER**

LONGMAN, JODY (UNITED STATES INDIVIDUAL)  
APT 12  
3920 MARATHON ST.  
LOS ANGELES, CA 90029

FOR: RESTAURANT AND CATERING SERVICES, IN CLASS 43 (U.S. CLS. 100 AND 101).

FIRST USE 8-8-2010; IN COMMERCE 2-2-2011.

THE MARK CONSISTS OF STANDARD CHARACTERS WITHOUT CLAIM TO ANY PARTICULAR FONT, STYLE, SIZE, OR COLOR.

SER. NO. 85-261,713, FILED 3-9-2011.

STEVEN R. FINE, EXAMINING ATTORNEY



*David J. Kybas*

Director of the United States Patent and Trademark Office

# United States of America

United States Patent and Trademark Office



**Reg. No. 4,134,113**

**Registered May 1, 2012**

**Int. Cls.: 35 and 45**

**SERVICE MARK**

**PRINCIPAL REGISTER**

X5 MUSIC GROUP (SWEDEN CORPORATION)  
SLUSSPLAN 9  
STOCKHOLM, SWEDEN 11130

FOR: MUSIC LICENSING SERVICES, NAMELY, THE COMMERCIAL ADMINISTRATION OF THE LICENSING OF THE MUSIC OF OTHERS; ONLINE WHOLESALE AND RETAIL STORE SERVICES FEATURING DOWNLOADABLE DIGITAL SOUND AND MUSIC FILES; MUSIC SELECTION SERVICES FOR USE IN ADVERTISING, IN CLASS 35 (U.S. CLS. 100, 101 AND 102).

FIRST USE 11-11-2003; IN COMMERCE 1-1-2004.

FOR: LICENSING OF THE MUSIC OF OTHERS, IN CLASS 45 (U.S. CLS. 100 AND 101).

FIRST USE 11-11-2003; IN COMMERCE 1-1-2004.

NO CLAIM IS MADE TO THE EXCLUSIVE RIGHT TO USE "MUSIC GROUP", APART FROM THE MARK AS SHOWN.

THE MARK CONSISTS OF "X5" STYLIZED AND STACKED ABOVE "MUSIC GROUP" WITHIN A RECTANGLE.

SER. NO. 85-261,844, FILED 3-9-2011.

ELLEN PERKINS, EXAMINING ATTORNEY



*David J. Kybas*

Director of the United States Patent and Trademark Office

# United States of America

United States Patent and Trademark Office

## THE RIGHT STYLE AT THE RIGHT PRICE

**Reg. No. 4,134,114**

EDDIE Z'S BLINDS AND DRAPERY, INC. (ILLINOIS CORPORATION)  
ONE RAQUEL WAY  
HODGKINS, IL 60525

**Registered May 1, 2012**

**Int. Cl.: 35**

FOR: RETAIL STORE SERVICES FEATURING BLINDS, DRAPERIES AND HOME FURNISHINGS, IN CLASS 35 (U.S. CLS. 100, 101 AND 102).

**SERVICE MARK**

FIRST USE 3-4-2011; IN COMMERCE 3-4-2011.

**PRINCIPAL REGISTER**

THE MARK CONSISTS OF STANDARD CHARACTERS WITHOUT CLAIM TO ANY PARTICULAR FONT, STYLE, SIZE, OR COLOR.

SER. NO. 85-261,852, FILED 3-9-2011.

GISELLE AGOSTO, EXAMINING ATTORNEY



*David J. Kyffers*

Director of the United States Patent and Trademark Office



# United States of America

United States Patent and Trademark Office



**Reg. No. 4,134,115**

**Registered May 1, 2012**

**Int. Cl.: 41**

**SERVICE MARK**

**PRINCIPAL REGISTER**

X5 MUSIC GROUP (SWEDEN CORPORATION)  
SLUSSPLAN 9  
STOCKHOLM, SWEDEN 11130

FOR: PUBLICATION OF MUSIC; PRODUCTION OF MUSIC; MUSIC SELECTION SERVICES FOR USE IN TELEVISION, FILM, RADIO AND VIDEO GAMES, IN CLASS 41 (U.S. CLS. 100, 101 AND 107).

FIRST USE 11-11-2003; IN COMMERCE 1-1-2004.

NO CLAIM IS MADE TO THE EXCLUSIVE RIGHT TO USE "MUSIC GROUP", APART FROM THE MARK AS SHOWN.

THE MARK CONSISTS OF "X5" STYLIZED AND STACKED ABOVE "MUSIC GROUP" WITHIN A RECTANGLE.

SER. NO. 85-261,877, FILED 3-9-2011.

ELLEN PERKINS, EXAMINING ATTORNEY



*David J. Kyffers*

Director of the United States Patent and Trademark Office

# United States of America

## United States Patent and Trademark Office



**Reg. No. 4,134,116**

**Registered May 1, 2012**

**Int. Cls.: 14, 21 and 25**

**TRADEMARK**

**PRINCIPAL REGISTER**

FRIEDRICH HÜTTINGER (FED REP GERMANY INDIVIDUAL)  
GEISLOHE 21  
91788 PAPPENHEIM, FED REP GERMANY

FOR: JEWELRY, BIJOUTERIE, PRECIOUS METALS AND THEIR ALLOYS AND GOODS IN PRECIOUS METALS OR COATED THEREWITH, NAMELY, PENDANTS; JEWELS, PRECIOUS STONES, HOROLOGICAL AND CHRONOMETRIC INSTRUMENTS, IN CLASS 14 (U.S. CLS. 2, 27, 28 AND 50).

FOR: UNWORKED OR SEMI-WORKED GLASS, EXCEPT GLASS USED IN BUILDING; GLASSWARE, NAMELY, DRINKING GLASSES, PITCHERS, AND VASES; PORCELAIN TABLEWARE, NAMELY, TABLE PLATES, CUPS, POTS, JUGS, MUGS, JARS; EARTHENWARE TABLEWARE, NAMELY, TABLE PLATES, CUPS, POTS, JUGS, MUGS, JARS, IN CLASS 21 (U.S. CLS. 2, 13, 23, 29, 30, 33, 40 AND 50).

FOR: CLOTHING, NAMELY, TEE SHIRTS, PULLOVERS; FOOTWEAR; HEADGEAR, NAMELY, CAPS AND HATS, IN CLASS 25 (U.S. CLS. 22 AND 39).

OWNER OF FED REP GERMANY REG. NO. 302010053579, DATED 12-14-2010, EXPIRES 9-30-2020.

THE MARK CONSISTS OF A DOUBLE BORDERED DIAMOND CONTAINING A LATIN CROSS WITH TRIANGULAR SHAPES APPEARING IN THE CORNERS OF THE DIAMOND AND WITH SIX DIAGONAL LINES APPEARING ON THE TOP OF THE DIAMOND AND TWO DIAGONAL LINES APPEARING ON THE BOTTOM OF THE DIAMOND NEAR THE BORDER.

SER. NO. 85-262,334, FILED 3-9-2011.

CHRISTINE MARTIN, EXAMINING ATTORNEY



*David J. Kybas*

Director of the United States Patent and Trademark Office

# United States of America

United States Patent and Trademark Office

## THE VOICE OF TAR HEEL BARBECUE

**Reg. No. 4,134,117**

**Registered May 1, 2012**

**Int. Cl.: 9**

**TRADEMARK**

**PRINCIPAL REGISTER**

THE NORTH CAROLINA BARBECUE SOCIETY, INC. (NORTH CAROLINA CORPORATION)  
144 STERLING POINT COURT  
WINSTON-SALEM, NC 27104

FOR: DOWNLOADABLE ELECTRONIC PUBLICATIONS IN THE NATURE OF NEWSLETTERS PROVIDING A WIDE VARIETY OF INFORMATION OF GENERAL INTEREST TO BARBECUE ENTHUSIASTS, IN CLASS 9 (U.S. CLS. 21, 23, 26, 36 AND 38).

FIRST USE 10-0-2006; IN COMMERCE 10-0-2006.

THE MARK CONSISTS OF STANDARD CHARACTERS WITHOUT CLAIM TO ANY PARTICULAR FONT, STYLE, SIZE, OR COLOR.

NO CLAIM IS MADE TO THE EXCLUSIVE RIGHT TO USE "TAR HEEL BARBECUE", APART FROM THE MARK AS SHOWN.

SER. NO. 85-262,965, FILED 3-10-2011.

ELI HELLMAN, EXAMINING ATTORNEY



*David J. Kyros*

Director of the United States Patent and Trademark Office

# United States of America

United States Patent and Trademark Office

## YOU ARE WHAT YOU EAT

**Reg. No. 4,134,118**

PATRICK PALMIERI (UNITED STATES INDIVIDUAL)  
8 COVE STREET  
NEW HAVEN, CT 06512

**Registered May 1, 2012**

**Int. Cl.: 30**

FOR: FOOD PRODUCTS AND CONDIMENTS, NAMELY, PASTA SAUCE, PIZZA SAUCE, SALSA, KETCHUP, COCKTAIL SAUCE, IN CLASS 30 (U.S. CL. 46).

**TRADEMARK**

FIRST USE 10-1-2010; IN COMMERCE 10-1-2010.

**PRINCIPAL REGISTER**

THE MARK CONSISTS OF STANDARD CHARACTERS WITHOUT CLAIM TO ANY PARTICULAR FONT, STYLE, SIZE, OR COLOR.

SER. NO. 85-262,986, FILED 3-10-2011.

BRIAN NEVILLE, EXAMINING ATTORNEY



*David J. Kybas*

Director of the United States Patent and Trademark Office

# United States of America

United States Patent and Trademark Office

# KMY

**Reg. No. 4,134,119**

**Registered May 1, 2012**

**Int. Cl.: 9**

**TRADEMARK**

**PRINCIPAL REGISTER**

KAMAYA ELECTRIC CO., LTD. (JAPAN CORPORATION)  
2-1, SAKADO 3-CHOME, TAKATSU-KU  
KAWASAKI-SHI  
KANAGAWA-KEN, JAPAN

FOR: POWER DISTRIBUTION OR CONTROL MACHINES AND APPARATUS, NAMELY,  
ELECTRIC RESISTORS AND FUSES, IN CLASS 9 (U.S. CLS. 21, 23, 26, 36 AND 38).

THE MARK CONSISTS OF STANDARD CHARACTERS WITHOUT CLAIM TO ANY PAR-  
TICULAR FONT, STYLE, SIZE, OR COLOR.

PRIORITY CLAIMED UNDER SEC. 44(D) ON JAPAN APPLICATION NO. 2010-71705, FILED  
9-10-2010, REG. NO. 5401393, DATED 3-25-2011, EXPIRES 3-25-2021.

SER. NO. 85-263,024, FILED 3-10-2011.

DOMINIC FATHY, EXAMINING ATTORNEY



*David J. Kyffers*

Director of the United States Patent and Trademark Office

# United States of America

United States Patent and Trademark Office

# XENEROS

**Reg. No. 4,134,120**

**Registered May 1, 2012**

**Int. Cl.: 42**

**SERVICE MARK**

**PRINCIPAL REGISTER**

XENEROS, LLC (INDIANA LIMITED LIABILITY COMPANY)  
SUITE 300  
14701 CUMBERLAND ROAD  
NOBLESVILLE, IN 46060

FOR: PROVIDING TEMPORARY ON-LINE ACCESS TO NON-DOWNLOADABLE SOFTWARE FOR USE IN OCCUPATIONAL COMPLIANCE TRACKING, IN CLASS 42 (U.S. CLS. 100 AND 101).

FIRST USE 9-2-2010; IN COMMERCE 9-2-2010.

THE MARK CONSISTS OF STANDARD CHARACTERS WITHOUT CLAIM TO ANY PARTICULAR FONT, STYLE, SIZE, OR COLOR.

THE WORDING "XENEROS" HAS NO MEANING IN A FOREIGN LANGUAGE.

SER. NO. 85-263,077, FILED 3-10-2011.

ANNE MADDEN, EXAMINING ATTORNEY



*David J. Kybas*

Director of the United States Patent and Trademark Office

# United States of America

United States Patent and Trademark Office



**Reg. No. 4,134,121**

**Registered May 1, 2012**

**Int. Cl.: 20**

**TRADEMARK**

**PRINCIPAL REGISTER**

ARMSTRONG, SHERRY (UNITED STATES INDIVIDUAL), DBA WWW.SENDAPLAQUE.COM  
6801 SOUTH DAYTON STREET  
GREENWOOD VILLAGE, CO 80112

FOR: WALL PLAQUES MADE OF WOOD, IN CLASS 20 (U.S. CLS. 2, 13, 22, 25, 32 AND 50).

FIRST USE 4-30-2009; IN COMMERCE 4-30-2009.

THE COLORS BLACK AND/OR GRAY REPRESENT BACKGROUND, OUTLINING, SHADING AND ARE NOT PART OF THE MARK.

THE COLOR(S) BLUE IS/ARE CLAIMED AS A FEATURE OF THE MARK.

THE MARK CONSISTS OF A STYLIZED HUMAN FIGURE IN VARIOUS SHADES OF BLUE AND WITH A CIRCLE FOR A HEAD AND A FOUR-POINTED GEOMETRIC FIGURE FOR A BODY.

SER. NO. 85-263,596, FILED 3-10-2011.

MAYUR VAGHANI, EXAMINING ATTORNEY



*David J. Kybas*

Director of the United States Patent and Trademark Office

# United States of America

United States Patent and Trademark Office

## IVY & ASTER

**Reg. No. 4,134,122**

LOVELANE, LLC (GEORGIA LIMITED LIABILITY COMPANY)  
975 RIVER OVERLOOK COURT  
SANDY SPRINGS, GA 30328

**Registered May 1, 2012**

**Int. Cl.: 25**

FOR: CLOTHING, NAMELY, DRESSES, BRIDAL DRESSES, EVENING DRESSES, RECEPTION GOWNS AND BRIDESMAID'S DRESSES, IN CLASS 25 (U.S. CLS. 22 AND 39).

**TRADEMARK**

FIRST USE 10-0-2010; IN COMMERCE 10-0-2010.

**PRINCIPAL REGISTER**

THE MARK CONSISTS OF STANDARD CHARACTERS WITHOUT CLAIM TO ANY PARTICULAR FONT, STYLE, SIZE, OR COLOR.

SER. NO. 85-263,975, FILED 3-10-2011.

JAMES GRIFFIN, EXAMINING ATTORNEY



*David J. Kyffers*

Director of the United States Patent and Trademark Office



# United States of America

United States Patent and Trademark Office



# IVY & ASTER

**Reg. No. 4,134,123**

**Registered May 1, 2012**

**Int. Cl.: 25**

**TRADEMARK**

**PRINCIPAL REGISTER**

LOVELANE, LLC (GEORGIA LIMITED LIABILITY COMPANY)  
975 RIVER OVERLOOK COURT  
SANDY SPRINGS, GA 30328

FOR: CLOTHING, NAMELY, DRESSES, BRIDAL DRESSES, EVENING DRESSES, RECEPTION GOWNS AND BRIDESMAID'S DRESSES, IN CLASS 25 (U.S. CLS. 22 AND 39).

FIRST USE 10-0-2010; IN COMMERCE 10-0-2010.

THE MARK CONSISTS OF THE STYLIZED WORDS: "IVY & ASTER". A SUNFLOWER DESIGN ELEMENT APPEARS TO THE LEFT OF THE WORDS.

SER. NO. 85-263,984, FILED 3-10-2011.

JAMES GRIFFIN, EXAMINING ATTORNEY



*David J. Kyffers*

Director of the United States Patent and Trademark Office

# United States of America

United States Patent and Trademark Office



**Reg. No. 4,134,124**

**Registered May 1, 2012**

**Int. Cl.: 13**

**TRADEMARK**

**PRINCIPAL REGISTER**

VENOM INDUSTRIES, LLC (FLORIDA LIMITED LIABILITY COMPANY)  
3706 SW 30TH AVENUE  
HOLLYWOOD, FL 33312

FOR: CONCEALED WEAPON ACCESSORIES, NAMELY, CARRIERS SPECIALLY ADAPTED TO HOLD FIREARMS IN THE NATURE OF CONCEALMENT BAGS, POUCHES, BACKPACKS, WEAPON SLINGS AND BELTS, AND FIREARM BELT ACCESSORIES, NAMELY, POUCHES AND WEAPON SLINGS, IN CLASS 13 (U.S. CLS. 2 AND 9).

FIRST USE 4-0-2010; IN COMMERCE 5-0-2010.

NO CLAIM IS MADE TO THE EXCLUSIVE RIGHT TO USE "INDUSTRIES, LLC", APART FROM THE MARK AS SHOWN.

THE MARK CONSISTS OF A PICTURE OF A COBRA SNAKE INSIDE A CIRCLE WITH THE WORDING "VENOM INDUSTRIES, LLC" AND "WWW.VENOMINDUSTRIES.US" WRAPPED AROUND.

SER. NO. 85-264,233, FILED 3-11-2011.

LINDSEY RUBIN, EXAMINING ATTORNEY



*David J. Kybas*

Director of the United States Patent and Trademark Office

# United States of America

United States Patent and Trademark Office

# BODYPROUD

**Reg. No. 4,134,125**

**Registered May 1, 2012**

**Int. Cl.: 41**

**SERVICE MARK**

**PRINCIPAL REGISTER**

KIPPEL, JEFFREY (CANADA INDIVIDUAL)  
SUITE 316  
6021 YONGE STREET  
TORONTO, CANADA

FOR: PHYSICAL FITNESS INSTRUCTION, PERSONAL FITNESS TRAINING SERVICES AND CONSULTANCY, PHYSICAL FITNESS TRAINING OF INDIVIDUALS AND GROUPS, YOGA INSTRUCTION, MEDITATION TRAINING , IN CLASS 41 (U.S. CLS. 100, 101 AND 107).

FIRST USE 12-1-2006; IN COMMERCE 9-10-2008.

THE MARK CONSISTS OF STANDARD CHARACTERS WITHOUT CLAIM TO ANY PARTICULAR FONT, STYLE, SIZE, OR COLOR.

SER. NO. 85-264,852, FILED 3-11-2011.

SUE LAWRENCE, EXAMINING ATTORNEY



*David J. Kybas*

Director of the United States Patent and Trademark Office

# United States of America

United States Patent and Trademark Office

## INVEST WITH MEANING

**Reg. No. 4,134,126**

**Registered May 1, 2012**

**Int. Cl.: 36**

**SERVICE MARK**

**PRINCIPAL REGISTER**

GIVING ASSETS, INC. (MARYLAND CORPORATION)  
7315 WISCONSIN AVE, SUITE 1100W  
BETHESDA, MD 20814

FOR: PROVIDING INFORMATION IN THE FIELD OF FINANCIAL INVESTMENTS RELATED TO SOCIALLY CONSCIOUS AND ENVIRONMENTALLY CONSCIOUS INVESTMENT OPPORTUNITIES; FINANCIAL SERVICES, NAMELY, MANAGEMENT OF DONOR ADVISED FUNDS FOR CHARITABLE PURPOSES; INVESTMENT CONSULTATION IN THE FIELD OF DONOR ADVISED FUNDS, IN CLASS 36 (U.S. CLS. 100, 101 AND 102).

FIRST USE 2-15-2011; IN COMMERCE 2-15-2011.

THE MARK CONSISTS OF STANDARD CHARACTERS WITHOUT CLAIM TO ANY PARTICULAR FONT, STYLE, SIZE, OR COLOR.

SER. NO. 85-265,151, FILED 3-11-2011.

JOHN DWYER, EXAMINING ATTORNEY



*David J. Kyffers*

Director of the United States Patent and Trademark Office

# United States of America

United States Patent and Trademark Office

## The Giants Despair Hill Climb.

**Reg. No. 4,134,127**

**Registered May 1, 2012**

**Int. Cl.: 16**

**TRADEMARK**

**PRINCIPAL REGISTER**

LAUREL RUN VOL. FIRE DEPT. (PENNSYLVANIA CORPORATION)  
100 DUPONT DR  
LAUREL RUN, PA 18706

FOR: EVENTS PROGRAMMES, IN CLASS 16 (U.S. CLS. 2, 5, 22, 23, 29, 37, 38 AND 50).

FIRST USE 7-1-1906; IN COMMERCE 7-1-1906.

THE MARK CONSISTS OF STANDARD CHARACTERS WITHOUT CLAIM TO ANY PARTICULAR FONT, STYLE, SIZE, OR COLOR.

SER. NO. 85-265,383, FILED 3-12-2011.

ANNE E. GUSTASON, EXAMINING ATTORNEY



*David J. Kyffers*

Director of the United States Patent and Trademark Office

# United States of America

United States Patent and Trademark Office



**Reg. No. 4,134,128**

**Registered May 1, 2012**

**Int. Cl.: 42**

**SERVICE MARK**

**PRINCIPAL REGISTER**

B&R BUSINESS SOLUTIONS, LLC (NEW JERSEY LIMITED LIABILITY COMPANY)  
SUITE 128  
315 ROUTE 34  
COLTS NECK, NJ 07722

FOR: TECHNICAL CONSULTING SERVICES IN THE FIELDS OF SOFTWARE IMPLEMENTATION AND WEB PUBLISHING, NAMELY, CREATING A WEBSITE AND UPLOADING IT ONTO AN INTERNET SERVER, IN CLASS 42 (U.S. CLS. 100 AND 101).

FIRST USE 6-0-2002; IN COMMERCE 6-0-2002.

THE MARK CONSISTS OF A DESIGN COMPRISING A "B" ON TOP OF AND INTERTWINED WITH AN "R" WITHIN A RECTANGLE.

SER. NO. 85-265,575, FILED 3-13-2011.

MEGHAN REINHART, EXAMINING ATTORNEY



*David J. Kybas*

Director of the United States Patent and Trademark Office

# United States of America

United States Patent and Trademark Office

# COMEX

**Reg. No. 4,134,129**

**Registered May 1, 2012**

**Int. Cl.: 27**

**TRADEMARK**

**PRINCIPAL REGISTER**

CONSORCIO COMEX, S.A. DE C.V. (MEXICO CORPORATION)  
PH 1 AND 2, COLONIA LOMAS DE CHAPULTEPEC  
BOULEVARD MANUEL AVILA CAMACHO 138  
MEXICO, D.F., MEXICO 11000

FOR: CARPETS, RUGS, FLOOR MATS, LINOLEUM, FLOOR COVERINGS; TAPESTRY-  
STYLE WALL HANGINGS, NOT OF TEXTILE, IN CLASS 27 (U.S. CLS. 19, 20, 37, 42 AND  
50).

THE MARK CONSISTS OF STANDARD CHARACTERS WITHOUT CLAIM TO ANY PAR-  
TICULAR FONT, STYLE, SIZE, OR COLOR.

OWNER OF MEXICO REG. NO. 809276, DATED 10-10-2003, EXPIRES 8-13-2013.

OWNER OF U.S. REG. NOS. 1,958,222, 2,909,357 AND OTHERS.

SER. NO. 85-265,578, FILED 3-13-2011.

MARK T. MULLEN, EXAMINING ATTORNEY



*David J. Kyffers*

Director of the United States Patent and Trademark Office

# United States of America

United States Patent and Trademark Office

# BIG DEAHL

**Reg. No. 4,134,130**

**Registered May 1, 2012**

**Int. Cl.: 41**

**SERVICE MARK**

**PRINCIPAL REGISTER**

BIG DEAHL PRODUCTIONS, INC. (ILLINOIS CORPORATION)  
1450 N. DAYTON STREET  
CHICAGO, IL 60622

FOR: MEDIA PRODUCTION SERVICES, NAMELY, VIDEO AND FILM PRODUCTION;  
MOTION PICTURE FILM PRODUCTION, IN CLASS 41 (U.S. CLS. 100, 101 AND 107).

FIRST USE 12-4-1985; IN COMMERCE 12-5-1985.

THE MARK CONSISTS OF THE WORDING "BIG DEAHL" PRINTED ON SPROCKETED  
PHOTOGRAPHIC FILM.

SER. NO. 85-265,876, FILED 3-14-2011.

TIMOTHY FINNEGAN, EXAMINING ATTORNEY



*David J. Kyffers*

Director of the United States Patent and Trademark Office



# United States of America

United States Patent and Trademark Office

Making a difference in the  
lives of children, one step  
at a time

**Reg. No. 4,134,131**

**Registered May 1, 2012**

**Int. Cl.: 43**

**SERVICE MARK**

**PRINCIPAL REGISTER**

FIRST STEPS EARLY LEARNING CENTER, LLC (MASSACHUSETTS LIMITED LIABILITY COMPANY)  
273 MIDDLESEX AVENUE  
MEDFORD, MA 02155

FOR: CHILD CARE; CHILD CARE CENTERS; CHILD CARE SERVICES; PRESCHOOLER AND INFANT CARE AT DAYCARE CENTERS, IN CLASS 43 (U.S. CLS. 100 AND 101).

FIRST USE 10-1-2007; IN COMMERCE 10-1-2007.

THE MARK CONSISTS OF STANDARD CHARACTERS WITHOUT CLAIM TO ANY PARTICULAR FONT, STYLE, SIZE, OR COLOR.

SER. NO. 85-265,960, FILED 3-14-2011.

ANGELA M. MICHELI, EXAMINING ATTORNEY



*David J. Kyjars*

Director of the United States Patent and Trademark Office

# United States of America

United States Patent and Trademark Office

# REVSTREAM

**Reg. No. 4,134,132**

**Registered May 1, 2012**

**Int. Cl.: 42**

**SERVICE MARK**

**PRINCIPAL REGISTER**

CITRIX ONLINE LLC (DELAWARE LIMITED LIABILITY COMPANY)  
6500 HOLLISTER AVENUE  
GOLETA, CA 93117

FOR: COMPUTER SERVICES, NAMELY, HOSTING ONLINE WEB FACILITIES FOR OTHERS FOR CONDUCTING ONLINE CONFERENCES, MEETINGS, DEMONSTRATIONS, PRESENTATIONS, EDUCATIONAL COURSES, AND INTERACTIVE DISCUSSIONS AND FOR FACILITATING, IN CONNECTION THEREWITH, THE COLLECTION AND TRACKING PAYMENTS AND RECEIPTS PAID BY THIRD PARTIES THROUGH A THIRD PARTY PAYMENT PROCESSOR FOR ATTENDING OR HAVING ACCESS TO ONLINE CONFERENCES, MEETINGS, DEMONSTRATIONS, PRESENTATIONS, EDUCATIONAL COURSES, AND INTERACTIVE DISCUSSIONS, IN CLASS 42 (U.S. CLS. 100 AND 101).

FIRST USE 1-31-2011; IN COMMERCE 1-31-2011.

THE MARK CONSISTS OF STANDARD CHARACTERS WITHOUT CLAIM TO ANY PARTICULAR FONT, STYLE, SIZE, OR COLOR.

SER. NO. 85-266,086, FILED 3-14-2011.

NAKIA HENRY, EXAMINING ATTORNEY



*David J. Kyros*

Director of the United States Patent and Trademark Office

# United States of America

United States Patent and Trademark Office

# CALORIQUE

**Reg. No. 4,134,133**

**Registered May 1, 2012**

**Int. Cl.: 11**

**TRADEMARK**

**PRINCIPAL REGISTER**

CALORIQUE, LLC (NEW JERSEY LIMITED LIABILITY COMPANY)  
2380 CRANBERRY HIGHWAY  
WEST WAREHAM, MA 02576

FOR: HEATING ELEMENTS, NAMELY, RADIANT HEAT TRANSFER FILM FOR USE AS PRIMARY AND/OR CONVENIENCE HEAT IN RESIDENTIAL, COMMERCIAL, PET AND HOBBY APPLICATIONS, IN CLASS 11 (U.S. CLS. 13, 21, 23, 31 AND 34).

FIRST USE 12-1-1995; IN COMMERCE 12-1-1995.

THE MARK CONSISTS OF STANDARD CHARACTERS WITHOUT CLAIM TO ANY PARTICULAR FONT, STYLE, SIZE, OR COLOR.

SER. NO. 85-266,139, FILED 3-14-2011.

PAULA MAHONEY, EXAMINING ATTORNEY



*David J. Kyros*

Director of the United States Patent and Trademark Office

# United States of America

United States Patent and Trademark Office

## San Diego Family

**Reg. No. 4,134,134**

**Registered May 1, 2012**

**Int. Cl.: 16**

**TRADEMARK**

**PRINCIPAL REGISTER**

SAN DIEGO FAMILY, LLC (CALIFORNIA LIMITED LIABILITY COMPANY)  
1475 SIXTH AVENUE, 5TH FLOOR  
SAN DIEGO, CA 92101

FOR: FEATURE MAGAZINE FOCUSED ON PROVIDING PARENTING RESOURCES AND INFORMATION FOR THE BENEFIT OF THE LOCAL COMMUNITY, IN CLASS 16 (U.S. CLS. 2, 5, 22, 23, 29, 37, 38 AND 50).

FIRST USE 6-1-1983; IN COMMERCE 6-28-1983.

THE MARK CONSISTS OF STANDARD CHARACTERS WITHOUT CLAIM TO ANY PARTICULAR FONT, STYLE, SIZE, OR COLOR.

SEC. 2(F).

SER. NO. 85-266,315, FILED 3-14-2011.

KELLY BOULTON, EXAMINING ATTORNEY



*David J. Kyffers*

Director of the United States Patent and Trademark Office

# United States of America

United States Patent and Trademark Office

## FRESH REPUBLIC

**Reg. No. 4,134,135**

**Registered May 1, 2012**

**Int. Cl.: 31**

**TRADEMARK**

**PRINCIPAL REGISTER**

DIVEMEX PRODUCE, S.A. DE C.V. (MEXICO CORPORATION)  
OSTIA NO. 2756  
INT. 6. COL. LOMAS DE GUEVARA  
GUADALAJARA, MEXICO 44657

FOR: AGRICULTURAL PRODUCTS, NAMELY, FRESH PEPPERS, CUCUMBERS, AND TOMATOES; FRESH FRUITS AND VEGETABLES, IN CLASS 31 (U.S. CLS. 1 AND 46).

THE MARK CONSISTS OF STANDARD CHARACTERS WITHOUT CLAIM TO ANY PARTICULAR FONT, STYLE, SIZE, OR COLOR.

OWNER OF MEXICO REG. NO. 904738, DATED 10-25-2005, EXPIRES 8-11-2015.

NO CLAIM IS MADE TO THE EXCLUSIVE RIGHT TO USE "FRESH", APART FROM THE MARK AS SHOWN.

SER. NO. 85-266,397, FILED 3-14-2011.

KEVON CHISOLM, EXAMINING ATTORNEY



*David J. Kyfos*

Director of the United States Patent and Trademark Office

United States of America  
United States Patent and Trademark Office



**Reg. No. 4,134,136**

**Registered May 1, 2012**

**Int. Cl.: 5**

**TRADEMARK**

**PRINCIPAL REGISTER**

GENTECH PHARMACEUTICAL, LLC (DELAWARE LIMITED LIABILITY COMPANY)  
1342 COLONIAL BLVD. C-24  
FORT MYERS, FL 33908

FOR: DIETARY AND NUTRITIONAL SUPPLEMENTS, IN CLASS 5 (U.S. CLS. 6, 18, 44, 46, 51 AND 52).

FIRST USE 5-24-2010; IN COMMERCE 7-5-2010.

NO CLAIM IS MADE TO THE EXCLUSIVE RIGHT TO USE "PHARMACEUTICAL", APART FROM THE MARK AS SHOWN.

THE MARK CONSISTS OF THE WORDING "GENTECH PHARMACEUTICAL" WHERE THE WORD "GENTECH" APPEARS ABOVE THE WORD "PHARMACEUTICAL" WITH A HORIZONTAL LINE BETWEEN THE TWO WORDS. TO THE LEFT OF THIS WORDING IS A CIRCLE CONTAINING THE LETTERS "GP".

SER. NO. 85-266,426, FILED S.R. 3-14-2011 AM. P.R. 5-31-2011.

LINDA LAVACHE, EXAMINING ATTORNEY



*David J. Kyros*

Director of the United States Patent and Trademark Office

# United States of America

United States Patent and Trademark Office

## CACTUS CUSTOM ANALOG DESIGN

**Reg. No. 4,134,137**

**Registered May 1, 2012**

**Int. Cl.: 42**

**SERVICE MARK**

**PRINCIPAL REGISTER**

CACTUS SEMICONDUCTOR, INC. (ARIZONA CORPORATION)  
60 N. MCCLINTOCK DRIVE, SUITE 1  
CHANDLER, AZ 85226

FOR: DESIGN AND DEVELOPMENT OF INTEGRATED CIRCUITS, IN CLASS 42 (U.S. CLS. 100 AND 101).

FIRST USE 12-31-2002; IN COMMERCE 5-20-2004.

THE MARK CONSISTS OF STANDARD CHARACTERS WITHOUT CLAIM TO ANY PARTICULAR FONT, STYLE, SIZE, OR COLOR.

NO CLAIM IS MADE TO THE EXCLUSIVE RIGHT TO USE "CUSTOM ANALOG DESIGN", APART FROM THE MARK AS SHOWN.

SER. NO. 85-266,609, FILED 3-14-2011.

ERIN FALK, EXAMINING ATTORNEY



*David J. Kybas*

Director of the United States Patent and Trademark Office

# United States of America

United States Patent and Trademark Office

# TrueDisruption

**Reg. No. 4,134,138**

**Registered May 1, 2012**

**Int. Cl.: 42**

**SERVICE MARK**

**PRINCIPAL REGISTER**

STRENUUS LLC (DELAWARE LIMITED LIABILITY COMPANY)  
SUITE 430  
7007 COLLEGE BLVD  
OVERLAND PARK, KS 66211

FOR: PROVIDING ON-LINE NON-DOWNLOADABLE SOFTWARE FOR ANALYZING MEMBER-PROVIDER RELATIONSHIPS IN HEALTHCARE NETWORKS USING SPECIALIZED MATCHING ALGORITHMS, AND FOR USE IN THE FIELD OF HEALTHCARE INSURANCE TO PROVIDE STATISTICAL ANALYSIS AND PRODUCE GRAPHS AND REPORTS ABOUT MEMBER-PROVIDER RELATIONSHIPS IN HEALTHCARE NETWORKS, IN CLASS 42 (U.S. CLS. 100 AND 101).

FIRST USE 10-20-2010; IN COMMERCE 1-20-2011.

THE MARK CONSISTS OF STANDARD CHARACTERS WITHOUT CLAIM TO ANY PARTICULAR FONT, STYLE, SIZE, OR COLOR.

OWNER OF U.S. REG. NO. 3,672,310.

SER. NO. 85-266,915, FILED 3-15-2011.

TASNEEM HUSSAIN, EXAMINING ATTORNEY



*David J. Kyros*

Director of the United States Patent and Trademark Office



# United States of America

United States Patent and Trademark Office

## PRESENCE II PRODUCTIONS

**Reg. No. 4,134,139**

**Registered May 1, 2012**

**Int. Cls.: 35 and 42**

**SERVICE MARK**

**PRINCIPAL REGISTER**

PRESENCE II INC. (MICHIGAN CORPORATION), DBA PRESENCE II PRODUCTIONS  
3810 MYSTIC VALLEY DRIVE  
BLOOMFIELD HILLS, MI 48302

FOR: CONDUCTING, ARRANGING AND ORGANIZING TRADE SHOWS, TRADE FAIRS AND EVENTS IN THE PUBLIC AND PRIVATE SECTOR FOR PROFIT AND NON-PROFIT CLIENTS FOR COMMERCIAL, ADVERTISING AND PROMOTIONAL PURPOSES, IN CLASS 35 (U.S. CLS. 100, 101 AND 102).

FIRST USE 12-31-2006; IN COMMERCE 12-31-2006.

FOR: DESIGN OF SPECIALTY INTERIOR AND EXTERIOR ENVIRONMENT SETTINGS; DESIGN OF INTERIOR DÉCOR, HOME INTERIOR AND EXTERIOR DECORATING AND DESIGN SERVICES; HOME AND BUSINESS INTERIOR DESIGN SERVICES, IN CLASS 42 (U.S. CLS. 100 AND 101).

FIRST USE 12-31-2006; IN COMMERCE 12-31-2006.

THE MARK CONSISTS OF STANDARD CHARACTERS WITHOUT CLAIM TO ANY PARTICULAR FONT, STYLE, SIZE, OR COLOR.

NO CLAIM IS MADE TO THE EXCLUSIVE RIGHT TO USE "PRODUCTIONS", APART FROM THE MARK AS SHOWN.

SER. NO. 85-267,036, FILED 3-15-2011.

BRENDAN MCCAULEY, EXAMINING ATTORNEY



*David J. Kyros*

Director of the United States Patent and Trademark Office

# United States of America

United States Patent and Trademark Office



**Reg. No. 4,134,140**

**Registered May 1, 2012**

**Int. Cl.: 9**

**TRADEMARK**

**PRINCIPAL REGISTER**

THE COLEMAN COMPANY, INC. (KANSAS CORPORATION)  
IP LEGAL 11702  
3600 NORTH HYDRAULIC  
WICHITA, KS 67219

FOR: PERSONAL FLOTATION DEVICES, NAMELY, FLOATABLE AND INFLATABLE LIFE SAVING VESTS AND LIFE PRESERVERS, FLOATABLE AND INFLATABLE JACKETS, BUOYANCY COMPENSATOR SWIMSUITS AND SWIM SHIRTS USED AS FLOTATION DEVICES, BUOYANCY COMPENSATOR CHEST PACKS IN THE NATURE OF PROTECTIVE BAGS USED AS INFLATABLE FLOTATION DEVICES, FLOATABLE AND INFLATABLE PULLOVER VESTS, BUOYANCY COMPENSATOR BELTS USED A INFLATABLE FLOTATION DEVICES, AND PROTECTION AND SAFETY APPARATUS, NAMELY, INFLATABLE FLOTATION DEVICES IN THE NATURE OF RINGS AND FLOATABLE CUSHIONS; LIFESAVING FLOTATION BESTS FOR USE BY PETS; INDUSTRIAL SAFETY CLOTHING FOR USE IN PROTECTING AGAINST HYPOTHERMIA, NAMELY, FLOATABLE LIFE-SAVING JACKETS, IMMERSION SUITS, DRY SUITS, IN CLASS 9 (U.S. CLS. 21, 23, 26, 36 AND 38).

FIRST USE 1-1-2010; IN COMMERCE 1-1-2010.

OWNER OF U.S. REG. NO. 1,115,565.

THE MARK CONSISTS OF A STYLIZED LETTER "S" AND THE WORD "STEARNS".

SER. NO. 85-267,215, FILED 3-15-2011.

GISELLE AGOSTO, EXAMINING ATTORNEY



*David J. Kyffers*

Director of the United States Patent and Trademark Office

# United States of America

United States Patent and Trademark Office

## FLORIDA TRIBUNE

**Reg. No. 4,134,141**

**Registered May 1, 2012**

**Int. Cls.: 35, 41 and 42**

**SERVICE MARK**

**PRINCIPAL REGISTER**

LOBBTYTOOLS, INC. (FLORIDA CORPORATION)  
411 EAST COLLEGE AVENUE  
TALLAHASSEE, FL 32301

FOR: PROVIDING AN INTERNET WEBSITE FEATURING INFORMATION, NEWS AND COMMENTARY IN THE FIELD OF FLORIDA AND NATIONAL POLITICS, IN CLASS 35 (U.S. CLS. 100, 101 AND 102).

FIRST USE 2-4-2010; IN COMMERCE 2-10-2010.

FOR: PROVIDING INFORMATION, NEWS AND COMMENTARY IN THE FIELD OF CURRENT EVENTS RELATING TO POLITICS VIA A GLOBAL COMMUNICATION NETWORK; PROVIDING ON-LINE PUBLICATIONS IN THE NATURE OF ELECTRONIC NEWSPAPERS COVERING NEWS, EDITORIALS, POLICY AND POLITICS FEATURING ORIGINAL AND AGGREGATED NEWS ARTICLES, IMAGES AND MULTIMEDIA CONTENT AND DATA IN THE FIELD OF FLORIDA AND NATIONAL POLITICS, IN CLASS 41 (U.S. CLS. 100, 101 AND 107).

FIRST USE 2-4-2010; IN COMMERCE 2-4-2010.

FOR: PROVIDING ON-LINE NON-DOWNLOADABLE COMPUTER PROGRAM FOR PROVIDING ACCESS TO NEWS UPDATES AND DISPLAYING NEWS UPDATES ON A COMPUTER WEB BROWSER, IN CLASS 42 (U.S. CLS. 100 AND 101).

FIRST USE 2-4-2010; IN COMMERCE 2-4-2010.

THE MARK CONSISTS OF STANDARD CHARACTERS WITHOUT CLAIM TO ANY PARTICULAR FONT, STYLE, SIZE, OR COLOR.

NO CLAIM IS MADE TO THE EXCLUSIVE RIGHT TO USE "FLORIDA", APART FROM THE MARK AS SHOWN.

SER. NO. 85-267,459, FILED 3-15-2011.

BARBARA RUTLAND, EXAMINING ATTORNEY



*David J. Kyros*

Director of the United States Patent and Trademark Office

# United States of America

United States Patent and Trademark Office

## VOODOO TIKI

**Reg. No. 4,134,142**

**Registered May 1, 2012**

**Int. Cl.: 25**

**TRADEMARK**

**PRINCIPAL REGISTER**

VOODOO TIKI TEQUILA CORPORATION (FLORIDA CORPORATION)  
2521 NE 46TH STREET  
LIGHTHOUSE POINT, FL 33064

FOR: CLOTHING, NAMELY, SHIRTS, LONG SLEEVE SHIRTS, TANK TOPS, POLO SHIRTS, HOODED SHIRTS, AND BASEBALL HATS, IN CLASS 25 (U.S. CLS. 22 AND 39).

FIRST USE 3-0-2003; IN COMMERCE 3-0-2003.

THE MARK CONSISTS OF STANDARD CHARACTERS WITHOUT CLAIM TO ANY PARTICULAR FONT, STYLE, SIZE, OR COLOR.

OWNER OF U.S. REG. NOS. 3,294,662, 3,501,419, AND 3,701,053.

SER. NO. 85-267,461, FILED 3-15-2011.

LINDSEY RUBIN, EXAMINING ATTORNEY



*David J. Kyffers*

Director of the United States Patent and Trademark Office

# United States of America

United States Patent and Trademark Office

## Entrepreneurial Insurance Symposium

**Reg. No. 4,134,143**

**Registered May 1, 2012**

**Int. Cl.: 35**

**SERVICE MARK**

**PRINCIPAL REGISTER**

MARKETSCOUT CORPORATION (TEXAS CORPORATION)  
SUITE 300  
12700 PARK CENTRAL DRIVE  
DALLAS, TX 75251

FOR: ARRANGING BUSINESS MEETINGS FOR INDIVIDUALS AND ENTITIES ENGAGED IN THE INSURANCE, RISK MANAGEMENT, UNDERWRITING, CLAIMS, REINSURANCE, ACTUARIAL, BROKERAGE, AND FINANCIAL SERVICES BUSINESS TO, AMONG OTHER THINGS, FACILITATE THE CREATION, PROMOTION, AND SHARING OF IDEAS, INNOVATIVE STRATEGIES, NEW BUSINESS METHODS, INVESTMENT OPPORTUNITIES, BUSINESS RELATIONSHIPS, AND BUSINESS OPPORTUNITIES IN THE PROPERTY, CASUALTY, SURETY, LIFE, HEALTH AND FINANCIAL SERVICES SECTORS OF THE INSURANCE INDUSTRY AND FACILITATE THE CREATION, ESTABLISHMENT, PROMOTION, AND OPERATION OF A THINK TANK FOR INSURANCE INDUSTRY PROFESSIONALS SEEKING INFORMATION REGARDING THE FORMATION, ACQUISITION, SALE, MERGER, DIVISION, OR OTHER DISPOSITION OF INSURANCE AND FINANCIAL SERVICES COMPANIES, IN CLASS 35 (U.S. CLS. 100, 101 AND 102).

FIRST USE 6-1-2007; IN COMMERCE 6-1-2007.

THE MARK CONSISTS OF STANDARD CHARACTERS WITHOUT CLAIM TO ANY PARTICULAR FONT, STYLE, SIZE, OR COLOR.

NO CLAIM IS MADE TO THE EXCLUSIVE RIGHT TO USE "INSURANCE SYMPOSIUM", APART FROM THE MARK AS SHOWN.

SEC. 2(F).

SER. NO. 85-267,620, FILED 3-15-2011.

KATHY DE JONGE, EXAMINING ATTORNEY



*David J. Kyjars*

Director of the United States Patent and Trademark Office

# United States of America

United States Patent and Trademark Office

## CACTUS SEMICONDUCTOR

**Reg. No. 4,134,144**

**Registered May 1, 2012**

**Int. Cl.: 42**

**SERVICE MARK**

**PRINCIPAL REGISTER**

CACTUS SEMICONDUCTOR, INC. (ARIZONA CORPORATION)  
60 N. MCCLINTOCK DRIVE, SUITE 1  
CHANDLER, AZ 85226

FOR: DESIGN AND DEVELOPMENT OF INTEGRATED CIRCUITS, IN CLASS 42 (U.S. CLS. 100 AND 101).

FIRST USE 2-28-2011; IN COMMERCE 2-28-2011.

THE MARK CONSISTS OF STANDARD CHARACTERS WITHOUT CLAIM TO ANY PARTICULAR FONT, STYLE, SIZE, OR COLOR.

NO CLAIM IS MADE TO THE EXCLUSIVE RIGHT TO USE "SEMICONDUCTOR", APART FROM THE MARK AS SHOWN.

SER. NO. 85-267,639, FILED 3-15-2011.

ERIN FALK, EXAMINING ATTORNEY



*David J. Kybas*

Director of the United States Patent and Trademark Office

# United States of America

United States Patent and Trademark Office

## Entrepreneurial Insurance Alliance

**Reg. No. 4,134,145**

**Registered May 1, 2012**

**Int. Cl.: 35**

**SERVICE MARK**

**PRINCIPAL REGISTER**

MARKETSCOUT CORPORATION (TEXAS CORPORATION)  
SUITE 300  
12700 PARK CENTRAL DRIVE  
DALLAS, TX 75251

FOR: ASSOCIATION SERVICES, NAMELY, PROMOTING THE INTERESTS OF INDIVIDUALS AND ENTITIES ENGAGED IN THE PROPERTY, CASUALTY, SURETY, LIFE, HEALTH AND FINANCIAL SERVICES SECTORS OF THE INSURANCE INDUSTRY; BUSINESS SERVICES IN THE FIELD OF INSURANCE, NAMELY, THE FORMATION, OPERATION, AND MANAGEMENT OF AN ALLIANCE OF INDIVIDUALS AND ENTITIES ENGAGED IN THE PROPERTY, CASUALTY, SURETY, LIFE, HEALTH AND FINANCIAL SERVICES SECTORS OF THE INSURANCE INDUSTRY TO PROMOTE THE INNOVATION OF AND INTERACTION ON NEW CONCEPTS, UNDERWRITING PROGRAMS, TECHNOLOGY SOLUTIONS, MARKET ACCESS OR DISTRIBUTION METHODS, PROVIDE INCUBATOR SERVICES IN THE NATURE OF PROVIDING WORK SPACE CONTAINING BUSINESS EQUIPMENT TO FREE-LANCERS, START-UPS, EXISTING BUSINESSES AND NON-PROFITS, PROVIDE GENERAL BUSINESS GUIDANCE, MANAGE INCENTIVE AWARDS PROGRAMS IN THE CATEGORIES OF INSURANCE UNDERWRITING, DISTRIBUTION AND TECHNOLOGY TO PROMOTE INNOVATION IN THE FIELD OF INSURANCE; AND PROVIDE PUBLIC RELATIONS SERVICES BY LEASING WITH MEDIA OUTLETS REGARDING VARIOUS NEW OR INNOVATIVE ISSUES IN THE INSURANCE INDUSTRY, IN CLASS 35 (U.S. CLS. 100, 101 AND 102).

FIRST USE 9-1-2010; IN COMMERCE 9-1-2010.

THE MARK CONSISTS OF STANDARD CHARACTERS WITHOUT CLAIM TO ANY PARTICULAR FONT, STYLE, SIZE, OR COLOR.

NO CLAIM IS MADE TO THE EXCLUSIVE RIGHT TO USE "INSURANCE ALLIANCE", APART FROM THE MARK AS SHOWN.

SEC. 2(F).

SER. NO. 85-267,669, FILED 3-15-2011.

KATHY DE JONGE, EXAMINING ATTORNEY



*David J. Kyros*

Director of the United States Patent and Trademark Office

# United States of America

United States Patent and Trademark Office



**Reg. No. 4,134,146**

**Registered May 1, 2012**

**Int. Cls.: 6 and 20**

**TRADEMARK**

**PRINCIPAL REGISTER**

WINNER FORD, INC. (BELIZE CORPORATION)  
7F.-1, NO.176, MINSHENG 1ST RD., XINXING  
KAOHSIUNG CITY 800, TAIWAN

FOR: METAL RAILS, METAL CLOTHES HOOKS, METAL SHELF BRACKETS, METAL PEGS; METAL HOLDERS FOR SIGNS AND METAL BASKETS, BASES, STANDS, FITTINGS, CONNECTORS, BRACKETS, CLIPS, CLAMPS, AND PARTS THEREOF; METAL HANGERS FOR CLOTHES AND HANGER RETRIEVERS, METAL GARMENT CLIPS; METAL TUBES AND TUBING; FREE-STANDING METAL PANEL UNITS FOR DISPLAY AND PARTITIONING; METAL BARRIERS FOR TRAFFIC CONTROL, IN CLASS 6 (U.S. CLS. 2, 12, 13, 14, 23, 25 AND 50).

FIRST USE 2-1-2011; IN COMMERCE 2-1-2011.

FOR: STORE DISPLAY FIXTURES, NAMELY, DISPLAY AND STORAGE RACKS, DISPLAY CASES, DISPLAY BOARDS, DISPLAY STANDS, DISPLAY PEDESTALS, SHELVES, NON-METAL SHELF BRACKETS, GONDOLA DISPLAY AND STORAGE RACKS, DISPLAY BOXES AND BINS, BASES, STANDS, FITTINGS, CONNECTORS, BRACKETS, CLIPS, CLAMPS, AND PARTS THEREOF; STORAGE AND DISPLAY ORGANIZATION SYSTEMS COMPRISED OF FREE STANDING OR WALL MOUNTED SHELVING, SLATWALL AND SLATWALL ACCESSORIES, GRID WALL AND GRID WALL ACCESSORIES, PEG BOARDS AND PEG BOARD ACCESSORIES, PANELS, BINS, TRAYS, BASKETS; NON-METAL FREE STANDING AND WALL MOUNTED DISPLAY UNITS FOR MERCHANDISING PRODUCTS; MANNEQUINS; PLASTIC HUMAN MODELS FOR DISPLAY OF CLOTHING, PLASTIC HUMAN MODELS FOR DISPLAY OF JEWELRY, AND PARTS THEREOF; HANGERS FOR CLOTHES; SHOWCASES, TABLES, MIRRORS; NONMETAL HOLDERS FOR SIGNS; PLASTIC TAG PINS AND FASTENERS, IN CLASS 20 (U.S. CLS. 2, 13, 22, 25, 32 AND 50).

FIRST USE 2-1-2011; IN COMMERCE 2-1-2011.

THE MARK CONSISTS OF THE LETTERS "D" AND "J" COMBINED.

SER. NO. 85-267,833, FILED 3-15-2011.

RAUL CORDOVA, EXAMINING ATTORNEY



*David J. Kyros*

Director of the United States Patent and Trademark Office



# United States of America

United States Patent and Trademark Office



**Reg. No. 4,134,147**

**Registered May 1, 2012**

**Int. Cl.: 30**

**TRADEMARK**

**PRINCIPAL REGISTER**

DOS AMIGOS BRANDS LLC (NEVADA LIMITED LIABILITY COMPANY)  
8595 AVENIDA COSTA SUR.  
SAN DIEGO, CA 92154

FOR: NATURAL VANILLA EXTRACT FOR USE AS FLAVORING, IN CLASS 30 (U.S. CL. 46).

FIRST USE 1-31-1994; IN COMMERCE 12-31-1996.

NO CLAIM IS MADE TO THE EXCLUSIVE RIGHT TO USE "REAL VANILLA", APART FROM THE MARK AS SHOWN.

THE COLOR(S) RED, GREEN AND WHITE IS/ARE CLAIMED AS A FEATURE OF THE MARK.

THE MARK CONSISTS OF THE WORDING "REAL VANILLA" IN STYLIZED RED FONT ABOVE TWO CURVING BANDS IN RED AND GREEN WITH WHITE SHADOWING. THE COLOR GRAY REPRESENTS BACKGROUND OR TRANSPARENT AREAS AND IS NOT CLAIMED AS A FEATURE OF THE MARK.

SER. NO. 85-267,839, FILED 3-15-2011.

STEVEN PEREZ, EXAMINING ATTORNEY



*David J. Kyffers*

Director of the United States Patent and Trademark Office

# United States of America

United States Patent and Trademark Office

## HOLY-POWER

**Reg. No. 4,134,148**

**Registered May 1, 2012**

**Int. Cls.: 6 and 20**

**TRADEMARK**

**PRINCIPAL REGISTER**

WINNER FORD, INC. (BELIZE CORPORATION)  
7F-1, NO.176, MINSHENG 1ST RD., XINXING  
KAOHSIUNG CITY 800, TAIWAN

FOR: METAL RAILS, METAL CLOTHES HOOKS, METAL SHELF BRACKETS, METAL PEGS; METAL HOLDERS FOR SIGNS AND METAL BASKETS, BASES, STANDS, FITTINGS, CONNECTORS, BRACKETS, CLIPS, CLAMPS, AND PARTS THEREOF; METAL HANGERS FOR CLOTHES AND HANGER RETRIEVERS, METAL GARMENT CLIPS; METAL TUBES AND TUBING; FREE-STANDING METAL PANEL UNITS FOR DISPLAY AND PARTITIONING; METAL BARRIERS FOR TRAFFIC CONTROL, IN CLASS 6 (U.S. CLS. 2, 12, 13, 14, 23, 25 AND 50).

FIRST USE 2-1-2011; IN COMMERCE 2-1-2011.

FOR: STORE DISPLAY FIXTURES, NAMELY, DISPLAY AND STORAGE RACKS, DISPLAY CASES, DISPLAY BOARDS, DISPLAY STANDS, DISPLAY PEDESTALS, SHELVES, NON-METAL SHELF BRACKETS, GONDOLA DISPLAY AND STORAGE RACKS, DISPLAY BOXES AND BINS, BASES, STANDS, FITTINGS, CONNECTORS, BRACKETS, CLIPS, CLAMPS, AND PARTS THEREOF; STORAGE AND DISPLAY ORGANIZATION SYSTEMS COMPRISED OF FREE STANDING OR WALL MOUNTED SHELVING, SLATWALL AND SLATWALL ACCESSORIES, GRID WALL AND GRID WALL ACCESSORIES, PEG BOARDS AND PEG BOARD ACCESSORIES, PANELS, BINS, TRAYS, BASKETS; NON-METAL FREE STANDING AND WALL MOUNTED DISPLAY UNITS FOR MERCHANDISING PRODUCTS; MANNEQUINS; PLASTIC HUMAN MODELS FOR DISPLAY OF CLOTHING, PLASTIC HUMAN MODELS FOR DISPLAY OF JEWELRY, AND PARTS THEREOF; HANGERS FOR CLOTHES; SHOWCASES, TABLES, MIRRORS; NONMETAL HOLDERS FOR SIGNS; PLASTIC TAG PINS AND FASTENERS, IN CLASS 20 (U.S. CLS. 2, 13, 22, 25, 32 AND 50).

FIRST USE 2-1-2011; IN COMMERCE 2-1-2011.

THE MARK CONSISTS OF STANDARD CHARACTERS WITHOUT CLAIM TO ANY PARTICULAR FONT, STYLE, SIZE, OR COLOR.

SER. NO. 85-267,879, FILED 3-15-2011.

RAUL CORDOVA, EXAMINING ATTORNEY



*David J. Kyffers*

Director of the United States Patent and Trademark Office

# United States of America

United States Patent and Trademark Office



**Reg. No. 4,134,149**  
**Registered May 1, 2012**

**Int. Cls.: 6 and 20**

**TRADEMARK**

**PRINCIPAL REGISTER**

WINNER FORD, INC. (BELIZE CORPORATION)  
7F.-1, NO.176, MINSHENG 1ST RD., XINXING  
KAOHSIUNG CITY 800, TAIWAN

FOR: METAL RAILS, METAL CLOTHES HOOKS, METAL SHELF BRACKETS, METAL PEGS; METAL HOLDERS FOR SIGNS AND METAL BASKETS, BASES, STANDS, FITTINGS, CONNECTORS, BRACKETS, CLIPS, CLAMPS, AND PARTS THEREOF; METAL HANGERS FOR CLOTHES AND HANGER RETRIEVERS, METAL GARMENT CLIPS; METAL TUBES AND TUBING; FREE-STANDING METAL PANEL UNITS FOR DISPLAY AND PARTITIONING; METAL BARRIERS FOR TRAFFIC CONTROL, IN CLASS 6 (U.S. CLS. 2, 12, 13, 14, 23, 25 AND 50).

FIRST USE 2-1-2011; IN COMMERCE 2-1-2011.

FOR: STORE DISPLAY FIXTURES, NAMELY, DISPLAY AND STORAGE RACKS, DISPLAY CASES, DISPLAY BOARDS, DISPLAY STANDS, DISPLAY PEDESTALS, SHELVES, NON-METAL SHELF BRACKETS, GONDOLA DISPLAY AND STORAGE RACKS, DISPLAY BOXES AND BINS, BASES, STANDS, FITTINGS, CONNECTORS, BRACKETS, CLIPS, CLAMPS, AND PARTS THEREOF; STORAGE AND DISPLAY ORGANIZATION SYSTEMS COMPRISED OF FREE STANDING OR WALL MOUNTED SHELVING, SLATWALL AND SLATWALL ACCESSORIES, GRID WALL AND GRID WALL ACCESSORIES, PEG BOARDS AND PEG BOARD ACCESSORIES, PANELS, BINS, TRAYS, BASKETS; NON-METAL FREE STANDING AND WALL MOUNTED DISPLAY UNITS FOR MERCHANDISING PRODUCTS; MANNEQUINS; PLASTIC HUMAN MODELS FOR DISPLAY OF CLOTHING, PLASTIC HUMAN MODELS FOR DISPLAY OF JEWELRY, AND PARTS THEREOF; HANGERS FOR CLOTHES; SHOWCASES, TABLES, MIRRORS; NONMETAL HOLDERS FOR SIGNS; PLASTIC TAG PINS AND FASTENERS, IN CLASS 20 (U.S. CLS. 2, 13, 22, 25, 32 AND 50).

FIRST USE 2-1-2011; IN COMMERCE 2-1-2011.

THE MARK CONSISTS OF THE LETTERS "H" AND "P" COMBINED.

SER. NO. 85-267,894, FILED 3-15-2011.

RAUL CORDOVA, EXAMINING ATTORNEY



*David J. Kyros*

Director of the United States Patent and Trademark Office

# United States of America

United States Patent and Trademark Office

# SOMALIFE

**Reg. No. 4,134,150**

**Registered May 1, 2012**

**Int. Cl.: 5**

**TRADEMARK**

**PRINCIPAL REGISTER**

SOMALIFE CONSULTING LTD. (CANADA CORPORATION)  
2189 CAMPBELL PLACE  
KELOWNA, CANADA V1Z1S9

FOR: DIETARY SUPPLEMENTS FOR HUMAN CONSUMPTION, IN CLASS 5 (U.S. CLS. 6, 18, 44, 46, 51 AND 52).

FIRST USE 3-1-2001; IN COMMERCE 9-4-2001.

THE MARK CONSISTS OF STANDARD CHARACTERS WITHOUT CLAIM TO ANY PARTICULAR FONT, STYLE, SIZE, OR COLOR.

OWNER OF U.S. REG. NO. 3,306,929.

SER. NO. 85-267,996, FILED 3-15-2011.

JOHN WILKE, EXAMINING ATTORNEY



*David J. Kybas*

Director of the United States Patent and Trademark Office

# United States of America

United States Patent and Trademark Office

# 文德

**Reg. No. 4,134,151**

**Registered May 1, 2012**

**Int. Cl.: 7**

**TRADEMARK**

**PRINCIPAL REGISTER**

JIANGSU WENDE NEW ENERGY CO., LTD. (CHINA CORPORATION)  
268 NORTH HUAN-CHENG ROAD  
YANGZHONG, JIANGSU, CHINA

FOR: BEARINGS, AS PARTS OF MACHINES; HYDRAULIC POWER UNITS; WIND-POWERED ELECTRICITY GENERATORS, IN CLASS 7 (U.S. CLS. 13, 19, 21, 23, 31, 34 AND 35).

FIRST USE 7-1-2006; IN COMMERCE 7-1-2006.

THE MARK CONSISTS OF TWO CHINESE CHARACTERS. THE FIRST NON-LATIN CHARACTER IN THE MARK TRANSLITERATES TO "WEN", AND THIS MEANS "CHARACTER", "CULTURE" OR "CIVILIZATION" IN ENGLISH AND THE SECOND NON-LATIN CHARACTER IN THE MARK TRANSLITERATES TO "DE", AND THIS MEANS "MORALITY" OR "VIRTUE" IN ENGLISH.

THE FIRST NON-LATIN CHARACTER IN THE MARK TRANSLITERATES TO "WEN", AND THIS MEANS "CHARACTER", "CULTURE" OR "CIVILIZATION" IN ENGLISH AND THE SECOND NON-LATIN CHARACTER IN THE MARK TRANSLITERATES TO "DE", AND THIS MEANS "MORALITY" OR "VIRTUE" IN ENGLISH.

SER. NO. 85-268,020, FILED 3-16-2011.

HAI-LY LAM, EXAMINING ATTORNEY



*David J. Kybas*

Director of the United States Patent and Trademark Office

# United States of America

United States Patent and Trademark Office

## New York Motion

**Reg. No. 4,134,152**

**Registered May 1, 2012**

**Int. Cl.: 41**

**SERVICE MARK**

**PRINCIPAL REGISTER**

TASHA BARON-VALLIS (UNITED STATES INDIVIDUAL), DBA NEW YORK MOTION  
850 BLANCH AVENUE  
NORWOOD, NJ 07648

FOR: ENTERTAINMENT IN THE NATURE OF DANCE PERFORMANCES; ENTERTAINMENT IN THE NATURE OF LIVE PERFORMANCES BY MUSICAL BANDS, CHOREOGRAPHED DANCING, CELEBRITY AND NAME ENTERTAINERS; ENTERTAINMENT IN THE NATURE OF ORCHESTRA PERFORMANCES; ENTERTAINMENT IN THE NATURE OF THEATER PRODUCTIONS; ENTERTAINMENT SERVICES IN THE NATURE OF LIVE MUSICAL PERFORMANCES; ENTERTAINMENT SERVICES IN THE NATURE OF PRESENTING LIVE MUSICAL PERFORMANCES; ENTERTAINMENT, NAMELY, LIGHTING PRODUCTION; ENTERTAINMENT, NAMELY, LIVE PERFORMANCES BY MUSICAL BANDS; ORGANIZING AND ARRANGING EXHIBITIONS FOR ENTERTAINMENT PURPOSES; PROVISION OF INFORMATION RELATING TO LIVE ENTERTAINMENT; SPECIAL EVENT PLANNING FOR SOCIAL ENTERTAINMENT PURPOSES, IN CLASS 41 (U.S. CLS. 100, 101 AND 107).

FIRST USE 4-30-1990; IN COMMERCE 4-30-1990.

THE MARK CONSISTS OF STANDARD CHARACTERS WITHOUT CLAIM TO ANY PARTICULAR FONT, STYLE, SIZE, OR COLOR.

NO CLAIM IS MADE TO THE EXCLUSIVE RIGHT TO USE "NEW YORK", APART FROM THE MARK AS SHOWN.

SER. NO. 85-268,153, FILED 3-16-2011.

AISHA SALEM, EXAMINING ATTORNEY



*David J. Kyros*

Director of the United States Patent and Trademark Office

# United States of America

United States Patent and Trademark Office



**Reg. No. 4,134,153**

**Registered May 1, 2012**

**Int. Cls.: 9, 12 and 28**

**TRADEMARK**

**PRINCIPAL REGISTER**

THE COLEMAN COMPANY, INC. (DELAWARE CORPORATION)  
IP LEGAL 11702  
3600 NORTH HYDRAULIC  
WICHITA, KS 67219

FOR: PRESSURE GAUGES, IN CLASS 9 (U.S. CLS. 21, 23, 26, 36 AND 38).

FIRST USE 1-1-2010; IN COMMERCE 1-1-2010.

FOR: INFLATABLE BOATS, CANOES, KAYAKS AND STRUCTURAL PARTS THEREFORE; REPAIR KITS COMPRISING ADHESIVE AND PATCH KITS FOR INFLATABLE BOATS; PADDLES AND OARS FOR INFLATABLE BOATS, CANOES AND KAYAKS; SEATS FOR RECREATIONAL INFLATABLE WATERCRAFT; BOAT RACKS; AIR PUMPS FOR INFLATABLE RECREATIONAL WATERCRAFT, IN CLASS 12 (U.S. CLS. 19, 21, 23, 31, 35 AND 44).

FIRST USE 1-1-2010; IN COMMERCE 1-1-2010.

FOR: RECREATIONAL AND SPORTING ITEMS, NAMELY, INFLATABLE TOWABLE FLOATS FOR AQUATIC RECREATIONAL USE, INFLATABLE FLOAT TUBES FOR RECREATIONAL USE, FLOATING RECREATIONAL CHAIRS, LOUNGES AND MATTRESSES, INFLATABLE PLATFORMS FOR USE AS A SURFACE FOR AQUATIC RECREATIONAL USE, INFLATABLE WAKEBOARDS, INFLATABLE SURF BOARDS; PUMPS FOR INFLATING RECREATIONAL AND SPORTS EQUIPMENT, NAMELY, INFLATABLE TOWABLE FLOATS, FLOAT TUBES, CHAIRS, LOUNGES, MATTRESSES, PLATFORMS, WAKEBOARDS, AND SURF BOARDS, ALL FOR AQUATIC RECREATIONAL USE; TOYS AND PLAYTHINGS, NAMELY, BEACH BALLS, FOAM FLOTATION TUBES, INFLATABLE FLOAT TUBES, SWIMMING KICK BOARDS, AND KICK BOARD FLOTATION DEVICES FOR RECREATIONAL USE; TOW ROPES AND TOW HARNESSSES FOR AQUATIC RECREATIONAL USE; AIR PUMPS FOR INFLATABLE TOYS, IN CLASS 28 (U.S. CLS. 22, 23, 38 AND 50).

FIRST USE 1-1-2010; IN COMMERCE 1-1-2010.

THE STIPLING IS A FEATURE OF THE MARK AND DOES NOT INDICATE COLOR.

THE MARK CONSISTS OF A STYLIZED LETTER "S" PLACED ON ITS SIDE, FORMING A CIRCULAR DESIGN.



*David J. Kyros*

Director of the United States Patent and Trademark Office

**Reg. No. 4,134,153** SER. NO. 85-268,252, FILED 3-16-2011.

GISELLE AGOSTO, EXAMINING ATTORNEY



# United States of America

United States Patent and Trademark Office



**Reg. No. 4,134,154**

**Registered May 1, 2012**

**Int. Cl.: 39**

**SERVICE MARK**

**PRINCIPAL REGISTER**

BRINGER CORPORATION (FLORIDA CORPORATION)  
8351 N.W. 21ST STREET  
MIAMI, FL 33122

FOR: EXPRESS DELIVERY SERVICES OF CARGO, IN CLASS 39 (U.S. CLS. 100 AND 105).

FIRST USE 1-27-2011; IN COMMERCE 1-27-2011.

NO CLAIM IS MADE TO THE EXCLUSIVE RIGHT TO USE "ENTREGA," AND "LEGAL",  
APART FROM THE MARK AS SHOWN.

THE MARK CONSISTS OF THE STYLIZED WORD "BRABOX" WITH THE DESIGN OF A  
SHOOTING STAR INSIDE THE LETTER "O" AND THE SMALLER WORDING "A ENTREGA  
LEGAL" UNDERNEATH.

THE ENGLISH TRANSLATION OF "ENTREGA" IN THE MARK IS "DELIVERY".

SER. NO. 85-268,487, FILED 3-16-2011.

MIDGE BUTLER, EXAMINING ATTORNEY



*David J. Kyffers*

Director of the United States Patent and Trademark Office

# United States of America

United States Patent and Trademark Office

## OMNI-POWER

**Reg. No. 4,134,155**

**Registered May 1, 2012**

**Int. Cls.: 6 and 20**

**TRADEMARK**

**PRINCIPAL REGISTER**

WINNER FORD, INC. (BELIZE CORPORATION)  
7F-1, NO.176, MINSHENG 1ST RD., XINXING  
KAOHSIUNG CITY 800, TAIWAN

FOR: METAL RAILS, METAL CLOTHES HOOKS, METAL SHELF BRACKETS, METAL PEGS; METAL HOLDERS FOR SIGNS AND METAL BASKETS, BASES, STANDS, FITTINGS, CONNECTORS, BRACKETS, CLIPS, CLAMPS, AND PARTS THEREOF; METAL HANGERS FOR CLOTHES AND HANGER RETRIEVERS, METAL GARMENT CLIPS; METAL TUBES AND TUBING; FREE-STANDING METAL PANEL UNITS FOR DISPLAY AND PARTITIONING; METAL BARRIERS FOR TRAFFIC CONTROL, IN CLASS 6 (U.S. CLS. 2, 12, 13, 14, 23, 25 AND 50).

FIRST USE 2-1-2011; IN COMMERCE 2-1-2011.

FOR: STORE DISPLAY FIXTURES, NAMELY, DISPLAY AND STORAGE RACKS, DISPLAY CASES, DISPLAY BOARDS, DISPLAY STANDS, DISPLAY PEDESTALS, SHELVES, NON-METAL SHELF BRACKETS, GONDOLA DISPLAY AND STORAGE RACKS, DISPLAY BOXES AND BINS, BASES, STANDS, FITTINGS, CONNECTORS, BRACKETS, CLIPS, CLAMPS, AND PARTS THEREOF; STORAGE AND DISPLAY ORGANIZATION SYSTEMS COMPRISED OF FREE STANDING OR WALL MOUNTED SHELVING, SLATWALL AND SLATWALL ACCESSORIES, GRID WALL AND GRID WALL ACCESSORIES, PEG BOARDS AND PEG BOARD ACCESSORIES, PANELS, BINS, TRAYS, BASKETS; NON-METAL FREE STANDING AND WALL MOUNTED DISPLAY UNITS FOR MERCHANDISING PRODUCTS; MANNEQUINS; PLASTIC HUMAN MODELS FOR DISPLAY OF CLOTHING, PLASTIC HUMAN MODELS FOR DISPLAY OF JEWELRY, AND PARTS THEREOF; HANGERS FOR CLOTHES; SHOWCASES, TABLES, MIRRORS; NONMETAL HOLDERS FOR SIGNS; PLASTIC TAG PINS AND FASTENERS, IN CLASS 20 (U.S. CLS. 2, 13, 22, 25, 32 AND 50).

FIRST USE 2-1-2011; IN COMMERCE 2-1-2011.

THE MARK CONSISTS OF STANDARD CHARACTERS WITHOUT CLAIM TO ANY PARTICULAR FONT, STYLE, SIZE, OR COLOR.

SER. NO. 85-268,597, FILED 3-16-2011.

RAUL CORDOVA, EXAMINING ATTORNEY



*David J. Kyffers*

Director of the United States Patent and Trademark Office

# United States of America

United States Patent and Trademark Office



**Reg. No. 4,134,156**  
**Registered May 1, 2012**

**Int. Cls.: 6 and 20**

**TRADEMARK**

**PRINCIPAL REGISTER**

WINNER FORD, INC. (BELIZE CORPORATION)  
7F.-1, NO.176, MINSHENG 1ST RD., XINXING  
KAOHSIUNG CITY 800, TAIWAN

FOR: METAL RAILS, METAL CLOTHES HOOKS, METAL SHELF BRACKETS, METAL PEGS; METAL HOLDERS FOR SIGNS AND METAL BASKETS, BASES, STANDS, FITTINGS, CONNECTORS, BRACKETS, CLIPS, CLAMPS, AND PARTS THEREOF; METAL HANGERS FOR CLOTHES AND HANGER RETRIEVERS, METAL GARMENT CLIPS; METAL TUBES AND TUBING; FREE-STANDING METAL PANEL UNITS FOR DISPLAY AND PARTITIONING; METAL BARRIERS FOR TRAFFIC CONTROL, IN CLASS 6 (U.S. CLS. 2, 12, 13, 14, 23, 25 AND 50).

FIRST USE 2-1-2011; IN COMMERCE 2-1-2011.

FOR: STORE DISPLAY FIXTURES, NAMELY, DISPLAY AND STORAGE RACKS, DISPLAY CASES, DISPLAY BOARDS, DISPLAY STANDS, DISPLAY PEDESTALS, SHELVES, NON-METAL SHELF BRACKETS, GONDOLA DISPLAY AND STORAGE RACKS, DISPLAY BOXES AND BINS, BASES, STANDS, FITTINGS, CONNECTORS, BRACKETS, CLIPS, CLAMPS, AND PARTS THEREOF; STORAGE AND DISPLAY ORGANIZATION SYSTEMS COMPRISED OF FREE STANDING OR WALL MOUNTED SHELVING, SLATWALL AND SLATWALL ACCESSORIES, GRID WALL AND GRID WALL ACCESSORIES, PEG BOARDS AND PEG BOARD ACCESSORIES, PANELS, BINS, TRAYS, BASKETS; NON-METAL FREE STANDING AND WALL MOUNTED DISPLAY UNITS FOR MERCHANDISING PRODUCTS; MANNEQUINS; PLASTIC HUMAN MODELS FOR DISPLAY OF CLOTHING, PLASTIC HUMAN MODELS FOR DISPLAY OF JEWELRY, AND PARTS THEREOF; HANGERS FOR CLOTHES; SHOWCASES, TABLES, MIRRORS; NONMETAL HOLDERS FOR SIGNS; PLASTIC TAG PINS AND FASTENERS, IN CLASS 20 (U.S. CLS. 2, 13, 22, 25, 32 AND 50).

FIRST USE 2-1-2011; IN COMMERCE 2-1-2011.

THE MARK CONSISTS OF THE LETTERS "O" AND "P" COMBINED.

SER. NO. 85-268,669, FILED 3-16-2011.

RAUL CORDOVA, EXAMINING ATTORNEY



*David J. Kyros*

Director of the United States Patent and Trademark Office

# United States of America

United States Patent and Trademark Office

## ADVANCE COOL

**Reg. No. 4,134,157**

**Registered May 1, 2012**

**Int. Cl.: 1**

**TRADEMARK**

**PRINCIPAL REGISTER**

ADVANCE AUTO INNOVATIONS, LLC (VIRGINIA LIMITED LIABILITY COMPANY)  
5008 AIRPORT ROAD  
ROANOKE, VA 24012

FOR: ANTIFREEZE, IN CLASS 1 (U.S. CLS. 1, 5, 6, 10, 26 AND 46).

FIRST USE 8-0-2009; IN COMMERCE 8-0-2009.

THE MARK CONSISTS OF STANDARD CHARACTERS WITHOUT CLAIM TO ANY PARTICULAR FONT, STYLE, SIZE, OR COLOR.

OWNER OF U.S. REG. NO. 3,011,147.

SER. NO. 85-268,865, FILED 3-16-2011.

CHRIS WELLS, EXAMINING ATTORNEY



*David J. Kyffers*

Director of the United States Patent and Trademark Office

# United States of America

United States Patent and Trademark Office

## JIMA ANTIGUA

**Reg. No. 4,134,158**

**Registered May 1, 2012**

**Int. Cl.: 33**

**TRADEMARK**

**PRINCIPAL REGISTER**

CARLOS GIOVANNI VELAZQUEZ NARIO (MEXICO INDIVIDUAL)  
JUSTO SIERRA # 2537, C  
COL. LADRON DE GUEVARA  
GUADALAJARA, MEXICO 44600

FOR: TEQUILA, IN CLASS 33 (U.S. CLS. 47 AND 49).

THE MARK CONSISTS OF STANDARD CHARACTERS WITHOUT CLAIM TO ANY PARTICULAR FONT, STYLE, SIZE, OR COLOR.

OWNER OF MEXICO REG. NO. 969859, DATED 1-25-2007, EXPIRES 11-22-2016.

THE ENGLISH TRANSLATION OF "JIMA ANTIGUA" IN THE MARK IS "ANCIENT" OR "ANTIQUE WAY OF CUTTING OFF THE LEAVES OF THE PLANT DOWN TO ITS BASE".

SEC. 2(F).

SER. NO. 85-268,939, FILED 3-16-2011.

DORITT L. CARROLL, EXAMINING ATTORNEY



*David J. Kyros*

Director of the United States Patent and Trademark Office

# United States of America

United States Patent and Trademark Office



**Reg. No. 4,134,159**

**Registered May 1, 2012**

**Int. Cls.: 1, 6, 7 and 9**

**TRADEMARK**

**PRINCIPAL REGISTER**

THE LINCOLN ELECTRIC COMPANY (OHIO CORPORATION)  
22801 ST. CLAIR AVENUE  
CLEVELAND, OH 44117

FOR: METAL WELDING FLUXES, IN CLASS 1 (U.S. CLS. 1, 5, 6, 10, 26 AND 46).

FIRST USE 12-31-1965; IN COMMERCE 12-31-1965.

FOR: WELDING WIRE; METAL POWDERS AND ALLOYS FOR WELDING, IN CLASS 6  
(U.S. CLS. 2, 12, 13, 14, 23, 25 AND 50).

FIRST USE 12-31-1965; IN COMMERCE 12-31-1965.

FOR: ELECTRIC PLASMA CUTTERS, IN CLASS 7 (U.S. CLS. 13, 19, 21, 23, 31, 34 AND 35).

FIRST USE 12-31-1965; IN COMMERCE 12-31-1965.

FOR: ELECTRIC ARC WELDERS; WIRE FEEDERS; POWER SUPPLIES FOR ELECTRIC  
ARC WELDERS; WELDING ELECTRODES, IN CLASS 9 (U.S. CLS. 21, 23, 26, 36 AND 38).

FIRST USE 12-31-1965; IN COMMERCE 12-31-1965.

OWNER OF U.S. REG. NOS. 1,461,519, 3,359,650 AND OTHERS.

THE COLOR(S) BLACK AND RED IS/ARE CLAIMED AS A FEATURE OF THE MARK.

THE MARK CONSISTS OF A BLACK RECTANGLE OVERLAPPING A RED RECTANGLE.

SEC. 2(F).

SER. NO. 85-268,960, FILED 3-16-2011.

ELI HELLMAN, EXAMINING ATTORNEY



*David J. Kyros*

Director of the United States Patent and Trademark Office

# United States of America

United States Patent and Trademark Office

# Hot Skwash

**Reg. No. 4,134,160**

**Registered May 1, 2012**

**Int. Cl.: 26**

**TRADEMARK**

**PRINCIPAL REGISTER**

HOT SKWASH (OREGON LIMITED LIABILITY COMPANY)  
1810 CARRIAGE WAY  
WEST LINN, OR 97068

FOR: HANDMADE VELVET PUMPKINS WITH NATURAL WOODY STEMS AND HAND-  
MADE SILK SHIITAKE MUSHROOMS WITH NATURAL WOODY STEMS, IN CLASS 26  
(U.S. CLS. 37, 39, 40, 42 AND 50).

FIRST USE 8-23-2008; IN COMMERCE 10-1-2008.

THE MARK CONSISTS OF STANDARD CHARACTERS WITHOUT CLAIM TO ANY PAR-  
TICULAR FONT, STYLE, SIZE, OR COLOR.

SER. NO. 85-269,089, FILED 3-16-2011.

JOHN DALIER, EXAMINING ATTORNEY



*David J. Kybas*

Director of the United States Patent and Trademark Office

# United States of America

United States Patent and Trademark Office



**Reg. No. 4,134,161**

**Registered May 1, 2012**

**Int. Cl.: 35**

**SERVICE MARK**

**PRINCIPAL REGISTER**

EDCO - EDUCATION CONSULTANTS, INC. (GEORGIA CORPORATION)  
111 MOUNTAIN VISTA BLVD. SUITE 150  
CANTON, GA 30115

FOR: ON-LINE RETAIL STORE SERVICES FEATURING AUDIO/VISUAL EQUIPMENT, SOFTWARE AND OTHER EDUCATIONAL TECHNOLOGY; PROCUREMENT, NAMELY, PURCHASING AUDIO/VISUAL EQUIPMENT, SOFTWARE AND OTHER EDUCATIONAL TECHNOLOGY FOR OTHERS; RETAIL SERVICES THROUGH DIRECT SOLICITATION BY DISTRIBUTORS DIRECTED TO END-USERS FEATURING AUDIO/VISUAL EQUIPMENT, SOFTWARE AND OTHER EDUCATIONAL TECHNOLOGY, IN CLASS 35 (U.S. CLS. 100, 101 AND 102).

FIRST USE 1-15-2011; IN COMMERCE 1-15-2011.

THE MARK CONSISTS OF THE COMPANY NAME "EDCO" WRITTEN IN LARGE, CAPITAL LETTERS IN BLUE COLOR AND THE PHRASE "ADVANCING TECHNOLOGY TO THE CLASSROOM" IS WRITTEN IN ITALICIZED BLACK COLOR AND IS LOCATED BELOW AND SLIGHTLY TO THE RIGHT OF "EDCO"; THERE IS A RED HALF-MOON SHAPED DESIGN THAT BEGINS NEXT TO THE LETTER "E" IN "EDCO", THE RED COLOR SLIGHTLY FADES AS IT CREATES THE HALF-MOON SHAPE, THEN THE RED COLOR BECOMES DARKER AGAIN AND ENDS NEXT TO THE LETTER "A" IN "ADVANCING" AND THERE IS A LIGHT RED SHADOW UNDERNEATH THE HALF-MOON SHAPED DESIGN.

THE COLOR(S) BLUE, RED, AND BLACK IS/ARE CLAIMED AS A FEATURE OF THE MARK.

SER. NO. 85-269,619, FILED 3-17-2011.

GIANCARLO CASTRO, EXAMINING ATTORNEY



*David J. Kyffers*

Director of the United States Patent and Trademark Office



# United States of America

United States Patent and Trademark Office



**Reg. No. 4,134,162**

**Registered May 1, 2012**

**Int. Cls.: 41 and 42**

**SERVICE MARK**

**PRINCIPAL REGISTER**

STEMCELL TECHNOLOGIES INC. (CANADA CORPORATION)  
570 WEST 7TH AVENUE, SUITE 400  
VANCOUVER, B.C., CANADA V5Z1B3

FOR: TRAINING IN THE USE AND OPERATION OF COMPUTER SOFTWARE, IN CLASS 41 (U.S. CLS. 100, 101 AND 107).

FIRST USE 2-11-2008; IN COMMERCE 2-11-2008.

FOR: CONSULTING SERVICES RELATING TO COMPUTER SOFTWARE; TECHNICAL SUPPORT SERVICES, NAMELY, TROUBLESHOOTING OF COMPUTER SOFTWARE PROBLEMS; DESIGN AND DEVELOPMENT OF COMPUTER SOFTWARE; COMPUTER PROGRAMMING SERVICES, IN CLASS 42 (U.S. CLS. 100 AND 101).

FIRST USE 2-11-2008; IN COMMERCE 2-11-2008.

OWNER OF U.S. REG. NOS. 1,936,773 AND 2,055,646.

THE MARK CONSISTS OF A STYLIZED LETTER "S" WITH A CIRCLE IN ITS MIDDLE, BELOW AN INCOMPLETE AND SHADED RECTANGULAR DESIGN THAT CONTAINS MANY LITTLE CIRCLES.

SER. NO. 85-269,904, FILED 3-17-2011.

DAWN HAN, EXAMINING ATTORNEY



*David J. Kybas*

Director of the United States Patent and Trademark Office

# United States of America

United States Patent and Trademark Office

## SIZE MATTERS

**Reg. No. 4,134,163**

**Registered May 1, 2012**

**Int. Cl.: 10**

**TRADEMARK**

**PRINCIPAL REGISTER**

XR, LLC (MARYLAND LIMITED LIABILITY COMPANY)  
15251 PIPELINE LANE  
HUNTINGTON BEACH, CA 92649

FOR: ADULT SEXUAL STIMULATION AIDS, NAMELY, MALE AND FEMALE GENITALIA VACUUM PUMPS TO INCREASE MALE AND FEMALE GENITALIA, PENIS ANATOMICAL EXPANDERS AND ENLARGERS FOR SEXUALLY EROTIC PURPOSES, IN CLASS 10 (U.S. CLS. 26, 39 AND 44).

FIRST USE 10-0-2009; IN COMMERCE 11-0-2009.

THE MARK CONSISTS OF STANDARD CHARACTERS WITHOUT CLAIM TO ANY PARTICULAR FONT, STYLE, SIZE, OR COLOR.

SER. NO. 85-270,343, FILED 3-18-2011.

ALICE BENMAMAN, EXAMINING ATTORNEY



*David J. Kyros*

Director of the United States Patent and Trademark Office

# United States of America

United States Patent and Trademark Office

## TRINITY VIBES

**Reg. No. 4,134,164**

**Registered May 1, 2012**

**Int. Cl.: 10**

**TRADEMARK**

**PRINCIPAL REGISTER**

XR, LLC (MARYLAND LIMITED LIABILITY COMPANY)  
15251 PIPELINE LANE  
HUNTINGTON BEACH, CA 92649

FOR: ADULT SEXUAL STIMULATION AIDS, NAMELY, ARTIFICIAL PENISES, DILDOS, COCK RINGS, VIBRATORS AND ACCESSORIES THEREFOR, IN CLASS 10 (U.S. CLS. 26, 39 AND 44).

FIRST USE 2-0-2008; IN COMMERCE 3-0-2008.

THE MARK CONSISTS OF STANDARD CHARACTERS WITHOUT CLAIM TO ANY PARTICULAR FONT, STYLE, SIZE, OR COLOR.

NO CLAIM IS MADE TO THE EXCLUSIVE RIGHT TO USE "VIBES", APART FROM THE MARK AS SHOWN.

SER. NO. 85-270,361, FILED 3-18-2011.

ALICE BENMAMAN, EXAMINING ATTORNEY



*David J. Kybas*

Director of the United States Patent and Trademark Office

# United States of America

United States Patent and Trademark Office

## ZEUS ELECTROSEX

**Reg. No. 4,134,165**

**Registered May 1, 2012**

**Int. Cl.: 10**

**TRADEMARK**

**PRINCIPAL REGISTER**

XR, LLC (MARYLAND LIMITED LIABILITY COMPANY)  
15251 PIPELINE LANE  
HUNTINGTON BEACH, CA 92649

FOR: ADULT SEXUAL STIMULATION AIDS, NAMELY, ELECTRODES AND TRANSCUTANEOUS ELECTRICAL NERVE STIMULATION DEVICES FOR APPLYING ELECTRICAL STIMULATION TO GENITALIA AND THE ANUS , IN CLASS 10 (U.S. CLS. 26, 39 AND 44).

FIRST USE 10-0-2007; IN COMMERCE 10-0-2007.

THE MARK CONSISTS OF STANDARD CHARACTERS WITHOUT CLAIM TO ANY PARTICULAR FONT, STYLE, SIZE, OR COLOR.

NO CLAIM IS MADE TO THE EXCLUSIVE RIGHT TO USE "ELECTROSEX", APART FROM THE MARK AS SHOWN.

SER. NO. 85-270,380, FILED 3-18-2011.

ALICE BENMAMAN, EXAMINING ATTORNEY



*David J. Kyffers*

Director of the United States Patent and Trademark Office

# United States of America

United States Patent and Trademark Office

## CURRAN INVESTMENT MANAGEMENT

**Reg. No. 4,134,166**

**Registered May 1, 2012**

**Int. Cl.: 36**

**SERVICE MARK**

**PRINCIPAL REGISTER**

CIM, LLC (NEW YORK LIMITED LIABILITY COMPANY), DBA CURRAN INVESTMENT  
MANAGEMENT  
30 SOUTH PEARL STREET  
ALBANY, NY 12207

FOR: INVESTMENT MANAGEMENT SERVICES, IN CLASS 36 (U.S. CLS. 100, 101 AND  
102).

FIRST USE 1-27-2005; IN COMMERCE 1-27-2005.

THE MARK CONSISTS OF STANDARD CHARACTERS WITHOUT CLAIM TO ANY PAR-  
TICULAR FONT, STYLE, SIZE, OR COLOR.

OWNER OF U.S. REG. NO. 3,038,571.

NO CLAIM IS MADE TO THE EXCLUSIVE RIGHT TO USE "INVESTMENT MANAGEMENT",  
APART FROM THE MARK AS SHOWN.

SEC. 2(F).

SER. NO. 85-270,423, FILED 3-18-2011.

WILLIAM VERHOSEK, EXAMINING ATTORNEY



*David J. Kybas*

Director of the United States Patent and Trademark Office

# United States of America

United States Patent and Trademark Office

# OptiCV

**Reg. No. 4,134,167**

**Registered May 1, 2012**

**Int. Cl.: 5**

**TRADEMARK**

**PRINCIPAL REGISTER**

DAVIS MARKETING & INVESTMENTS, INC. (NORTH CAROLINA CORPORATION), DBA  
OPTIMUM FORMULAS  
27 ELLIOTT STREET  
MARION, NC 28752

FOR: NUTRITIONAL SUPPLEMENTS, IN CLASS 5 (U.S. CLS. 6, 18, 44, 46, 51 AND 52).

FIRST USE 3-7-2011; IN COMMERCE 3-7-2011.

THE MARK CONSISTS OF STANDARD CHARACTERS WITHOUT CLAIM TO ANY PARTICULAR FONT, STYLE, SIZE, OR COLOR.

SER. NO. 85-270,718, FILED 3-18-2011.

SANJEEV VOHRA, EXAMINING ATTORNEY



*David J. Kybas*

Director of the United States Patent and Trademark Office

# United States of America

United States Patent and Trademark Office

## So Noted Records

**Reg. No. 4,134,168**

**Registered May 1, 2012**

**Int. Cl.: 9**

**TRADEMARK**

**PRINCIPAL REGISTER**

APTHORP, JAMES CHRISTOPHER (UNITED STATES INDIVIDUAL)  
17843 SAN FERNANDO MISSION BLVD  
GRANADA HILLS, CA 91344

FOR: AUDIO AND VIDEO RECORDINGS FEATURING MUSIC AND ARTISTIC PERFORMANCES; DIGITAL MUSIC DOWNLOADABLE FROM THE INTERNET; DOWNLOADABLE MP3 FILES AND MP3 RECORDINGS FEATURING MUSICAL PERFORMANCES; MUSICAL SOUND RECORDINGS; PHONOGRAPH RECORDS FEATURING MUSIC; PRE-RECORDED CDS FEATURING MUSICAL PERFORMANCES; PRE-RECORDED CDS, VIDEO TAPES, LASER DISKS AND DVDS FEATURING MUSICAL PERFORMANCES; PRE-RECORDED DIGITAL MEDIA FEATURING MUSICAL PERFORMANCES; PRE-RECORDED ELECTRONIC AND DIGITAL MEDIA FEATURING MUSICAL PERFORMANCES; PRE-RECORDED ELECTRONIC MEDIA FEATURING MUSICAL PERFORMANCES; PRE-RECORDED FLASH DRIVES FEATURING MUSICAL PERFORMANCES; VISUAL AND AUDIO RECORDINGS FEATURING MUSICAL PERFORMANCES; VISUAL RECORDINGS AND AUDIOVISUAL RECORDINGS FEATURING MUSIC AND ANIMATION, IN CLASS 9 (U.S. CLS. 21, 23, 26, 36 AND 38).

FIRST USE 2-15-2011; IN COMMERCE 3-5-2011.

THE MARK CONSISTS OF STANDARD CHARACTERS WITHOUT CLAIM TO ANY PARTICULAR FONT, STYLE, SIZE, OR COLOR.

NO CLAIM IS MADE TO THE EXCLUSIVE RIGHT TO USE "RECORDS", APART FROM THE MARK AS SHOWN.

SER. NO. 85-270,720, FILED 3-18-2011.

ELLEN B. AWRICH, EXAMINING ATTORNEY



*David J. Kyros*

Director of the United States Patent and Trademark Office

# United States of America

United States Patent and Trademark Office

# HOMENAV

**Reg. No. 4,134,169**

**Registered May 1, 2012**

**Int. Cls.: 9 and 42**

**TRADEMARK**

**SERVICE MARK**

**PRINCIPAL REGISTER**

SUSTAINING SPACES, LLC (MISSOURI LIMITED LIABILITY COMPANY)  
739 VISTA GLEN COURT  
EUREKA, MO 63025

FOR: COMPUTER PROGRAMS FOR HOME BUILDING AND SERVICES PROFESSIONALS AND HOME OWNERS TO ACCESS INFORMATION VIA THE INTERNET TO CUSTOM DESIGN A HOMEOWNERS' MANUAL, SPECIFIC TO EACH HOME SITE; ELECTRONIC DOWNLOADABLE PUBLICATIONS, NAMELY, MANUALS FEATURING QUICK REFERENCE "HOW TO" INFORMATION ON HOME MAINTENANCE, IN CLASS 9 (U.S. CLS. 21, 23, 26, 36 AND 38).

FIRST USE 2-24-2010; IN COMMERCE 9-22-2010.

FOR: HOSTING AN ON-LINE COMMUNITY WEB SITE FEATURING AN EXCHANGE OF INFORMATION BETWEEN HOMEOWNERS, BUILDING TRADES AND MANUFACTURERS AND OFFERINGS OF COMMERCE SERVICES BETWEEN THE USERS; COMPUTER SERVICES, NAMELY, HOSTING AN INTERACTIVE WEBSITE THAT ALLOWS USERS TO CREATE HOME GUIDES AND STORE MAINTENANCE, WARRANTY AND OPERATIONS INFORMATION ABOUT HOMES' FEATURES, INCLUDING SYSTEMS, FIXTURES, APPLIANCES, AND COMPONENTS, IN CLASS 42 (U.S. CLS. 100 AND 101).

FIRST USE 2-24-2010; IN COMMERCE 9-22-2010.

THE MARK CONSISTS OF STANDARD CHARACTERS WITHOUT CLAIM TO ANY PARTICULAR FONT, STYLE, SIZE, OR COLOR.

SER. NO. 85-270,771, FILED 3-18-2011.

REBECCA SMITH, EXAMINING ATTORNEY



*David J. Kyros*

Director of the United States Patent and Trademark Office



# United States of America

United States Patent and Trademark Office

## BUILDINGS AS BATTERIES

**Reg. No. 4,134,170**

**Registered May 1, 2012**

**Int. Cl.: 42**

**SERVICE MARK**

**PRINCIPAL REGISTER**

CLEAN URBAN ENERGY, INC (INDIANA CORPORATION)  
711 SOUTH DEARBORN STREET, #404  
CHICAGO, IL 60605

FOR: ENGINEERING CONSULTATION IN THE FIELD OF ENERGY EFFICIENCY IN BUILDINGS AND ENERGY STORAGE IN BUILDINGS, IN CLASS 42 (U.S. CLS. 100 AND 101).

FIRST USE 2-7-2011; IN COMMERCE 2-7-2011.

THE MARK CONSISTS OF STANDARD CHARACTERS WITHOUT CLAIM TO ANY PARTICULAR FONT, STYLE, SIZE, OR COLOR.

NO CLAIM IS MADE TO THE EXCLUSIVE RIGHT TO USE "BUILDINGS", APART FROM THE MARK AS SHOWN.

SER. NO. 85-270,807, FILED 3-18-2011.

ROBERT C. CLARK JR., EXAMINING ATTORNEY



*David J. Kyffers*

Director of the United States Patent and Trademark Office

# United States of America

United States Patent and Trademark Office



**Reg. No. 4,134,171**

**Registered May 1, 2012**

**Int. Cls.: 35 and 41**

**SERVICE MARK**

**PRINCIPAL REGISTER**

YES THE BRONX (NEW YORK NON-PROFIT CORPORATION)  
4720 GROSVENOR AVENUE  
BRONX, NY 10471

FOR: PROMOTING PUBLIC AWARENESS OF THE OBESITY EPIDEMIC AND OF THE IMPORTANCE OF PHYSICAL ACTIVITY, IN CLASS 35 (U.S. CLS. 100, 101 AND 102).

FIRST USE 5-2-2010; IN COMMERCE 5-2-2010.

FOR: ATHLETIC AND SPORTS EVENT SERVICES, NAMELY, ARRANGING, ORGANIZING, OPERATING AND CONDUCTING RUNNING RACES, IN CLASS 41 (U.S. CLS. 100, 101 AND 107).

FIRST USE 5-2-2010; IN COMMERCE 5-2-2010.

NO CLAIM IS MADE TO THE EXCLUSIVE RIGHT TO USE "OBESITY", APART FROM THE MARK AS SHOWN.

THE COLOR(S) PURPLE, WHITE AND BLACK IS/ARE CLAIMED AS A FEATURE OF THE MARK.

THE MARK CONSISTS OF A LARGE UPPER CASE LETTER "O" IN WHITE ON A PURPLE HEART WITH THE PHRASE "PROJECT OBESITY" IN BLACK LETTERS AT THE LOWER RIGHT HAND CORNER OF THE PURPLE HEART.

SER. NO. 85-271,100, FILED 3-18-2011.

NORA BUCHANAN WILL, EXAMINING ATTORNEY



*David J. Kybas*

Director of the United States Patent and Trademark Office

# United States of America

United States Patent and Trademark Office



**Reg. No. 4,134,172**

**Registered May 1, 2012**

**Int. Cls.: 35 and 41**

**SERVICE MARK**

**PRINCIPAL REGISTER**

YES THE BRONX (NEW YORK NON-PROFIT CORPORATION)  
4720 GROSVENOR AVENUE  
BRONX, NY 10471

FOR: PROMOTING PUBLIC AWARENESS OF THE OBESITY EPIDEMIC AND OF THE IMPORTANCE OF PHYSICAL ACTIVITY, IN CLASS 35 (U.S. CLS. 100, 101 AND 102).

FIRST USE 10-24-2007; IN COMMERCE 10-24-2007.

FOR: ATHLETIC AND SPORTS EVENT SERVICES, NAMELY, ARRANGING, ORGANIZING, OPERATING AND CONDUCTING RUNNING RACES, IN CLASS 41 (U.S. CLS. 100, 101 AND 107).

FIRST USE 10-24-2007; IN COMMERCE 10-24-2007.

NO CLAIM IS MADE TO THE EXCLUSIVE RIGHT TO USE "RUN AGAINST OBESITY", APART FROM THE MARK AS SHOWN.

THE COLOR(S) PURPLE, WHITE AND BLACK IS/ARE CLAIMED AS A FEATURE OF THE MARK.

THE MARK CONSISTS OF A LARGE UPPER CASE LETTER "O" IN WHITE ON A PURPLE HEART WITH THE PHRASE "RUN AGAINST OBESITY" IN BLACK LETTERS AT THE LOWER RIGHT HAND CORNER OF THE PURPLE HEART.

SER. NO. 85-271,106, FILED 3-18-2011.

NORA BUCHANAN WILL, EXAMINING ATTORNEY



*David J. Kybas*

Director of the United States Patent and Trademark Office

# United States of America

United States Patent and Trademark Office



**Reg. No. 4,134,173**

K9 PEST DETECTIVE (CALIFORNIA CORPORATION)  
605 W. KENNETH ROAD  
GLENDALE, CA 91202

**Registered May 1, 2012**

**Int. Cl.: 42**

FOR: INSPECTIONS FOR THE PRESENCE OF BED BUGS IN COMMERCIAL, HOSPITAL, AND RESIDENTIAL LOCATIONS, IN CLASS 42 (U.S. CLS. 100 AND 101).

**SERVICE MARK**

FIRST USE 12-6-2010; IN COMMERCE 12-6-2010.

**PRINCIPAL REGISTER**

NO CLAIM IS MADE TO THE EXCLUSIVE RIGHT TO USE "K9" OR "PEST", APART FROM THE MARK AS SHOWN.

THE COLOR(S) BLUE AND BLACK IS/ARE CLAIMED AS A FEATURE OF THE MARK.

THE MARK CONSISTS OF THE ACTUAL MARK "K9 PEST DETECTIVE" ALL IN BLUE LETTERS WITH THE FACE OF A DOG DRAWN BY SHOWING BLUE EYEBROWS OVER THE FIRST TWO E'S IN THE WORD "DETECTIVE", WITH BLACK EYES DRAWN INSIDE OF THOSE E'S, AND WITH A BLACK MOUTH AND BLUE WHISKERS UNDERNEATH THOSE LETTER E'S.

SER. NO. 85-271,297, FILED 3-18-2011.

JAMES A. RAUEN, EXAMINING ATTORNEY



*David J. Kyffers*

Director of the United States Patent and Trademark Office

# United States of America

United States Patent and Trademark Office

# STUDIO PRO

**Reg. No. 4,134,174**

**Registered May 1, 2012**

**Int. Cl.: 8**

**TRADEMARK**

**PRINCIPAL REGISTER**

DIAMOND TECH INTERNATIONAL (FLORIDA CORPORATION)  
STE. C  
5600 AIRPORT BLVD  
TAMPA, FL 33634

FOR: STAINED GLASS CRAFTING HAND TOOLS, NAMELY, PLIERS, GLASS CUTTERS;  
STAINED GLASS CRAFTING KITS COMPRISED PRIMARILY OF PLIERS, GLASS CUTTERS,  
SOLDERING FLUX AND METAL STRIPS , IN CLASS 8 (U.S. CLS. 23, 28 AND 44).

FIRST USE 1-1-2000; IN COMMERCE 1-1-2000.

NO CLAIM IS MADE TO THE EXCLUSIVE RIGHT TO USE "STUDIO", APART FROM THE  
MARK AS SHOWN.

THE MARK CONSISTS OF THE WORDS "STUDIO PRO".

SER. NO. 85-271,619, FILED 3-20-2011.

HOWARD B. LEVINE, EXAMINING ATTORNEY



*David J. Kybas*

Director of the United States Patent and Trademark Office

# United States of America

United States Patent and Trademark Office

## ANTIQUITY MOSAICS

**Reg. No. 4,134,175**

**Registered May 1, 2012**

**Int. Cl.: 19**

**TRADEMARK**

**PRINCIPAL REGISTER**

DIAMOND TECH INTERNATIONAL (FLORIDA CORPORATION)  
STE. C  
5600 AIRPORT BLVD  
TAMPA, FL 33634

FOR: MOSAIC ART TILES MADE OF MARBLE, IN CLASS 19 (U.S. CLS. 1, 12, 33 AND 50).

FIRST USE 11-1-2010; IN COMMERCE 11-1-2010.

NO CLAIM IS MADE TO THE EXCLUSIVE RIGHT TO USE "MOSAICS", APART FROM THE MARK AS SHOWN.

THE MARK CONSISTS OF THE WORDS "ANTIQUITY MOSAICS".

SER. NO. 85-271,624, FILED 3-20-2011.

HOWARD B. LEVINE, EXAMINING ATTORNEY



*David J. Kyffers*

Director of the United States Patent and Trademark Office

# United States of America

United States Patent and Trademark Office

## KRAFTYBLOK

**Reg. No. 4,134,176**

**Registered May 1, 2012**

**Int. Cl.: 21**

**TRADEMARK**

**PRINCIPAL REGISTER**

DIAMOND TECH INTERNATIONAL (FLORIDA CORPORATION)  
STE. C  
5600 AIRPORT BLVD  
TAMPA, FL 33634

FOR: GLASS BLOCKS FOR CRAFT PURPOSES FEATURING STOPPER-TOP OPENINGS,  
IN CLASS 21 (U.S. CLS. 2, 13, 23, 29, 30, 33, 40 AND 50).

FIRST USE 7-1-2007; IN COMMERCE 7-1-2007.

THE MARK CONSISTS OF STANDARD CHARACTERS WITHOUT CLAIM TO ANY PAR-  
TICULAR FONT, STYLE, SIZE, OR COLOR.

SER. NO. 85-271,625, FILED 3-20-2011.

HOWARD B. LEVINE, EXAMINING ATTORNEY



*David J. Kybas*

Director of the United States Patent and Trademark Office

# United States of America

United States Patent and Trademark Office

# g<sup>2</sup> bottle cutter

**Reg. No. 4,134,177**

**Registered May 1, 2012**

**Int. Cl.: 8**

**TRADEMARK**

**PRINCIPAL REGISTER**

DIAMOND TECH INTERNATIONAL (FLORIDA CORPORATION)  
STE. C  
5600 AIRPORT BLVD  
TAMPA, FL 33634

FOR: HAND TOOL, NAMELY, BOTTLE CUTTER, IN CLASS 8 (U.S. CLS. 23, 28 AND 44).

FIRST USE 11-1-2010; IN COMMERCE 11-1-2010.

NO CLAIM IS MADE TO THE EXCLUSIVE RIGHT TO USE "BOTTLE CUTTER", APART FROM THE MARK AS SHOWN.

THE MARK CONSISTS OF THE LETTER "G" AND THE NUMBER TWO AND THE WORDS "BOTTLE CUTTER".

SER. NO. 85-271,628, FILED 3-20-2011.

HOWARD B. LEVINE, EXAMINING ATTORNEY



*David J. Kyffers*

Director of the United States Patent and Trademark Office



# United States of America

United States Patent and Trademark Office

# CHIP2GRID

**Reg. No. 4,134,178**

**Registered May 1, 2012**

**Int. Cl.: 9**

**TRADEMARK**

**PRINCIPAL REGISTER**

DIRECT POWER TECH IP, LLC (MARYLAND LIMITED LIABILITY COMPANY)  
4907 NIAGARA ROAD  
SUITE 204  
COLLEGE PARK, MD 20740

FOR: DC ELECTRICAL POWER DISTRIBUTION SYSTEM COMPRISED OF DC RECTIFIER,  
POWER DISTRIBUTION BUSWAY/WIRING TO DC LOADS, IN CLASS 9 (U.S. CLS. 21, 23,  
26, 36 AND 38).

FIRST USE 3-8-2010; IN COMMERCE 3-8-2010.

THE MARK CONSISTS OF STANDARD CHARACTERS WITHOUT CLAIM TO ANY PAR-  
TICULAR FONT, STYLE, SIZE, OR COLOR.

SER. NO. 85-272,364, FILED 3-21-2011.

JOHN SCHUYLER YARD, EXAMINING ATTORNEY



*David J. Kyffers*

Director of the United States Patent and Trademark Office

# United States of America

United States Patent and Trademark Office

# OFOIL

**Reg. No. 4,134,179**

**Registered May 1, 2012**

**Int. Cl.: 6**

**TRADEMARK**

**PRINCIPAL REGISTER**

OLIVER-TOLAS HEALTHCARE PACKAGING, LLC (DELAWARE LIMITED LIABILITY COMPANY)  
445 SIXTH STREET, N.W.  
GRAND RAPIDS, MI 49504

FOR: PACKAGING MATERIALS FOR MEDICAL DEVICES AND PHARMACEUTICAL PRODUCTS, NAMELY, ALUMINUM FOIL FOR PACKING, ALUMINUM FOIL POUCHES FOR PACKING, AND ALUMINUM FOIL CLOSURES FOR SEALING CONTAINERS, IN CLASS 6 (U.S. CLS. 2, 12, 13, 14, 23, 25 AND 50).

FIRST USE 10-22-2008; IN COMMERCE 10-22-2008.

THE MARK CONSISTS OF STANDARD CHARACTERS WITHOUT CLAIM TO ANY PARTICULAR FONT, STYLE, SIZE, OR COLOR.

SER. NO. 85-272,423, FILED 3-21-2011.

JILL C. ALT, EXAMINING ATTORNEY



*David J. Kybas*

Director of the United States Patent and Trademark Office

# United States of America

United States Patent and Trademark Office

We focus on food & service

**Reg. No. 4,134,180**

**Registered May 1, 2012**

**Int. Cl.: 35**

**SERVICE MARK**

**PRINCIPAL REGISTER**

WOLFF GROUP INC. (MICHIGAN CORPORATION)  
4035 PARK EAST CT., SE  
GRAND RAPIDS, MI 49546

FOR: BUSINESS MANAGEMENT AND CONSULTATION IN THE FIELD OF FOOD DISTRIBUTION, MARKETING, AND SALES, IN CLASS 35 (U.S. CLS. 100, 101 AND 102).

FIRST USE 1-1-2009; IN COMMERCE 1-1-2009.

THE MARK CONSISTS OF STANDARD CHARACTERS WITHOUT CLAIM TO ANY PARTICULAR FONT, STYLE, SIZE, OR COLOR.

SER. NO. 85-272,495, FILED 3-21-2011.

LINDA MICKLEBURGH, EXAMINING ATTORNEY



*David J. Kyffers*

Director of the United States Patent and Trademark Office

# United States of America

United States Patent and Trademark Office

# Canidelogical

**Reg. No. 4,134,181**

**Registered May 1, 2012**

**Int. Cls.: 35, 36 and 41**

REV. SCOTT L. AMOS, SR. (UNITED STATES INDIVIDUAL), DBA ASSOCIATION OF CANIDELOGICAL GARDENS, CANIDEA-KINGDOM, CREATOR OF THE WORD CANIDELOGICAL, CREATOR OF THE TERMS CANIDELOGICAL-GARDEN/ZOO/LIBRARY/CIRCUS/TAXIDERMY AND MUSEUM. P.O. BOX 2274 ANDERSON, IN 46018

**SERVICE MARK**

**PRINCIPAL REGISTER**

FOR: ASSOCIATION SERVICES, NAMELY, PROMOTING THE INTERESTS OF CANIDAE CONSERVATION AND THE ANIMAL GARDEN INDUSTRY; BUSINESS MANAGEMENT AND CONSULTATION FOR OTHERS IN THE FIELD OF CANIDAE CONSERVATION AND CANIDAE-ANIMAL GARDENS; PROVIDING BUSINESS MANAGEMENT ADVICE, ASSISTANCE AND CONSULTATION SERVICES TO OTHERS IN THE FIELD OF ZOOLOGICAL GARDENS WITH A CANIDAE THEME; PROMOTING THE GOODS AND SERVICES OF OTHERS, NAMELY, CANIDAE CONSERVATION AND CANIDAE-ANIMAL GARDENS VIA PRINT AND ELECTRONIC MEDIA; ADVERTISING SERVICES, NAMELY, PROMOTING THE GOODS AND SERVICES OF OTHERS VIA PRINT AND ELECTRONIC MEDIA, IN CLASS 35 (U.S. CLS. 100, 101 AND 102).

FIRST USE 10-16-2000; IN COMMERCE 9-26-2010.

FOR: CHARITABLE FUNDRAISING FOR THE BENEFIT OF CANIDAE-ANIMAL CONSERVATION, EDUCATIONAL ANIMAL EXHIBITIONS, ANIMAL RESEARCH, ZOOS, WILDLIFE PARKS, WILDLIFE SANCTUARIES, VETERINARY SCIENCE, ZOOLOGY, SCHOOLS, SPECIAL INTEREST GROUPS AND NON PROFIT ORGANIZATIONS IN THE NATURE OF NATIONAL AND INTERNATIONAL INTERN ACTIVITY GROUPS AND PROGRAMS, ANIMAL RESCUES, HUMANE SOCIETIES, ANIMAL THERAPY ORGANIZATIONS, LIBRARIES, MUSEUMS, CHURCH MINISTRIES, CHURCH GROUPS, CHURCH MISSION ACTIVITIES, SUMMER CAMPS, YOUTH AND COMMUNITY CHARITABLE GROUPS AND THE BREEDING POTENTIAL FOR VANISHING AND ENDANGERED DOMESTIC AND WILD CANIDAE DOGS AND WILDLIFE CREATURES, IN CLASS 36 (U.S. CLS. 100, 101 AND 102).

FIRST USE 10-16-2000; IN COMMERCE 9-26-2010.

FOR: AMUSEMENT PARK SERVICES, NAMELY, EDUCATION AND ENTERTAINMENT SERVICES IN THE NATURE OF AMUSEMENT PARKS, DIRECTED TO ENTERTAINMENT AND EDUCATIONAL COMPLEXES, ATTRACTIONS, AMUSEMENT RIDES, LIVE ACTION SHOWS, THEATRICAL PERFORMANCES, AND FIREWORK DISPLAYS; DEVELOPMENT



*David J. Kyros*

Director of the United States Patent and Trademark Office

**Reg. No. 4,134,181** AND DISSEMINATION OF ENTERTAINMENT AND EDUCATIONAL MATERIALS IN THE FIELD OF ANIMAL LIFE, PLANT LIFE, AND THE ENVIRONMENT; PROVIDING THEME PARK SERVICES FEATURING THE CANIDAE BIOLOGICAL FAMILY-ANIMALS; AND PRODUCTION OF SOUND AND VIDEO RECORDINGS FEATURING MULTIMEDIA CONTENT ABOUT CANIDAE-ANIMAL THEME PARKS; PUBLISHING AND DISTRIBUTION OF BOOKS, REVIEWS, AND OTHER PRINTED MATERIAL AS WELL AS RELATED ELECTRONIC DATA CARRIERS ON THE SUBJECT OF THE CANIDAE BIOLOGICAL FAMILY/ANIMALS; MUSEUM SERVICES IN THE FIELD OF THE CANIDAE BIOLOGICAL FAMILY TO EXHIBIT TO THE PUBLIC A HISTORICAL, PRESENT DAY, FUTURISTIC, CANIDAE THEME BASED EDUCATIONAL SITE, EDUCATIONAL COMPLEXES, ARTISTIC DISPLAYS, SCIENTIFIC DISPLAYS, TAXIDERMY AND ARTIFACTS; PUBLISHING AND DISTRIBUTION OF BOOKS, REVIEWS, AND OTHER PRINTED MATERIAL AS WELL AS RELATED ELECTRONIC DATA CARRIERS FEATURING INFORMATION ABOUT MUSEUMS; EDUCATIONAL SERVICES, NAMELY, PROVIDING COURSES OF INSTRUCTION AT THE COLLEGE, GRADUATE AND POST GRADUATE LEVELS IN THE FIELD OF VETERINARY SCIENCE, CANIDAE DOG CONSERVATION, RESEARCH, TRAINING AND NUTRITION, CANIDAE-ANIMAL GARDENS, AND CANIDAE-ANIMAL TAXIDERMY; EDUCATIONAL SERVICES, NAMELY, DEVELOPING, AND ORGANIZING, AND CONDUCTING CANIDAE-ANIMAL GARDEN EDUCATIONAL PROJECTS; DISSEMINATING EDUCATIONAL MATERIALS OF OTHERS IN THE FIELDS OF BEST PRACTICES AND STANDARDS FOR CANIDAE-ANIMAL GARDENS, WILD LIFE PARKS, ZOOS, AND SANCTUARIES; EDUCATIONAL RESEARCH ON THE IMPACT OF VISITS TO ANIMAL GARDENS, WILDLIFE PARKS, ZOOS, AND SANCTUARIES WITH A CANIDAE BIOLOGICAL FAMILY THEME; ON-LINE PUBLICATION OF NEWSLETTERS, MAGAZINES, REPORTS AND GUIDES IN THE FIELD OF CANIDAE-ANIMAL GARDENS AND THE CONSERVATION OF DOMESTIC AND WILD CANIDAE AND PLANT LIFE; ENTERTAINMENT SERVICES IN THE NATURE OF CIRCUS PERFORMANCES BY CANIDAE; CONDUCTING PROFESSIONAL TRAINING OR RECREATIONAL CLASSES IN THE FIELD OF CIRCUS ARTS PRODUCING CIRCUS PERFORMANCES; PRODUCTION OF SOUND AND VIDEO RECORDINGS FEATURING MULTIMEDIA CONTENT ABOUT CIRCUS ARTS; PUBLISHING AND DISTRIBUTION OF BOOKS, REVIEWS, AND OTHER PRINTED MATERIAL AS WELL AS RELATED ELECTRONIC DATA CARRIERS FEATURING CANIDAE CIRCUS ACTS; LIBRARY SERVICES FEATURING BOOKS, MANUSCRIPTS AND PERIODICALS ABOUT THE CANIDAE BIOLOGICAL FAMILY; EDUCATIONAL SERVICES, NAMELY, CONDUCTING WORKSHOPS IN THE FIELD OF THE CANIDAE BIOLOGICAL FAMILY AND CANIDAE ANIMAL CONSERVATION; DOG TRAINING SERVICES; CONDUCTING PROFESSIONAL WORKSHOPS AND SEMINARS IN THE FIELD OF WILD AND DOMESTIC DOG TRAINING; PUBLISHING AND DISTRIBUTION OF BOOKS, REVIEWS, AND OTHER PRINTED MATERIAL AS WELL AS RELATED ELECTRONIC DATA CARRIERS FEATURING CANIDAE DOG TRAINING; ZOO SERVICES FEATURING CANIDAE AND A CANIDAE THEME; GARDENS FOR PUBLIC ADMISSION; ZOOLOGICAL GARDENS; ENTERTAINMENT SERVICES IN THE NATURE OF DOG SHOWS DIRECTED TO PROVIDING DOG, CANIDAE COMPETITIONS; PROVIDING ON-GOING TELEVISION PROGRAMS IN THE FIELD OF ANIMAL COMPETITIONS INVOLVING WILD AND DOMESTIC DOGS; PUBLISHING AND DISTRIBUTION OF BOOKS, REVIEWS, AND OTHER PRINTED MATERIAL AS WELL AS RELATED ELECTRONIC DATA CARRIERS FEATURING CANIDAE-ANIMAL EXHIBITIONS AND COMPETITIONS; BOTANICAL GARDENS DIRECTED TO A CANIDAE THEME; EDUCATIONAL SERVICES, NAMELY, PROVIDING COURSES OF INSTRUCTION AND LECTURES IN THE FIELD OF BOTANY AND HORTICULTURE, IN CLASS 41 (U.S. CLS. 100, 101 AND 107).

FIRST USE 10-16-2000; IN COMMERCE 9-26-2010.

THE MARK CONSISTS OF STANDARD CHARACTERS WITHOUT CLAIM TO ANY PARTICULAR FONT, STYLE, SIZE, OR COLOR.

THE WORDING "CANIDELOGICAL" HAS NO MEANING IN A FOREIGN LANGUAGE.

**Reg. No. 4,134,181** SER. NO. 85-272,573, FILED 3-21-2011.

CIMMERIAN COLEMAN, EXAMINING ATTORNEY

# United States of America

United States Patent and Trademark Office

# IDN-WEST

**Reg. No. 4,134,182**

**Registered May 1, 2012**

**Int. Cl.: 35**

**SERVICE MARK**

**PRINCIPAL REGISTER**

IDN, INC. (TEXAS CORPORATION)  
2401 MUSTANG DRIVE, SUITE 100  
GRAPEVINE, TX 76051

FOR: BUSINESS MANAGEMENT AND MARKETING, NAMELY, ADVERTISING AND PROMOTING THE GOODS OF OTHERS; PROCUREMENT SERVICES, NAMELY, PURCHASING LOCKS AND STRUCTURAL PARTS THEREFOR, ELECTRONIC LOCKS AND ACCESS CONTROL DEVICES, KEYS, KEY ACCESSORIES, ELECTRONIC SECURITY PRODUCTS, EXIT DEVICES AND ALARMS, PADLOCKS, METAL SAFES AND SAFE LOCKS, HYDRAULIC DOOR CLOSERS AND TOOLS AND MACHINES USED FOR INSTALLATION AND SERVICING SUCH ITEMS; WHOLESALE DISTRIBUTION OF LOCKS AND STRUCTURAL PARTS THEREFOR, ELECTRONIC LOCKS AND ACCESS CONTROL DEVICES, KEYS, KEY ACCESSORIES, ELECTRONIC SECURITY PRODUCTS, EXIT DEVICES AND ALARMS, PADLOCKS, METAL SAFES AND SAFE LOCKS, HYDRAULIC DOOR CLOSERS AND TOOLS AND MACHINES USED FOR INSTALLATION AND SERVICING SUCH ITEMS, IN CLASS 35 (U.S. CLS. 100, 101 AND 102).

FIRST USE 9-28-1999; IN COMMERCE 9-28-1999.

THE MARK CONSISTS OF STANDARD CHARACTERS WITHOUT CLAIM TO ANY PARTICULAR FONT, STYLE, SIZE, OR COLOR.

OWNER OF U.S. REG. NO. 3,915,375.

SER. NO. 85-272,648, FILED 3-21-2011.

NORA BUCHANAN WILL, EXAMINING ATTORNEY



*David J. Kyffers*

Director of the United States Patent and Trademark Office

# United States of America

United States Patent and Trademark Office

# IDN-ACME

**Reg. No. 4,134,183**

**Registered May 1, 2012**

**Int. Cl.: 35**

**SERVICE MARK**

**PRINCIPAL REGISTER**

IDN, INC. (TEXAS CORPORATION)  
2401 MUSTANG DRIVE, SUITE 100  
GRAPEVINE, TX 76051

FOR: BUSINESS MANAGEMENT AND MARKETING, NAMELY, ADVERTISING AND PROMOTING THE GOODS OF OTHERS; PROCUREMENT SERVICES, NAMELY, PURCHASING LOCKS AND STRUCTURAL PARTS THEREFOR, ELECTRONIC LOCKS AND ACCESS CONTROL DEVICES, KEYS, KEY ACCESSORIES, ELECTRONIC SECURITY PRODUCTS, EXIT DEVICES AND ALARMS, PADLOCKS, METAL SAFES AND SAFE LOCKS, AND HYDRAULIC DOOR CLOSERS; WHOLESALE DISTRIBUTION OF LOCKS AND STRUCTURAL PARTS THEREFOR, ELECTRONIC LOCKS AND ACCESS CONTROL DEVICES, KEYS, KEY ACCESSORIES, ELECTRONIC SECURITY PRODUCTS, EXIT DEVICES AND ALARMS, PADLOCKS, METAL SAFES AND SAFE LOCKS, AND HYDRAULIC DOOR CLOSERS, IN CLASS 35 (U.S. CLS. 100, 101 AND 102).

FIRST USE 7-5-1995; IN COMMERCE 8-31-1995.

THE MARK CONSISTS OF STANDARD CHARACTERS WITHOUT CLAIM TO ANY PARTICULAR FONT, STYLE, SIZE, OR COLOR.

OWNER OF U.S. REG. NO. 3,915,375.

SER. NO. 85-272,680, FILED 3-21-2011.

NORA BUCHANAN WILL, EXAMINING ATTORNEY



*David J. Kyros*

Director of the United States Patent and Trademark Office



# United States of America

United States Patent and Trademark Office

## IDN-ARMSTRONG'S

**Reg. No. 4,134,184**

**Registered May 1, 2012**

**Int. Cl.: 35**

**SERVICE MARK**

**PRINCIPAL REGISTER**

IDN, INC. (TEXAS CORPORATION)  
2401 MUSTANG DRIVE, SUITE 100  
GRAPEVINE, TX 76051

FOR: BUSINESS MANAGEMENT AND MARKETING, NAMELY, ADVERTISING AND PROMOTING THE GOODS OF OTHERS; PROCUREMENT SERVICES, NAMELY, PURCHASING LOCKS AND STRUCTURAL PARTS THEREFOR, ELECTRONIC LOCKS AND ACCESS CONTROL DEVICES, KEYS, KEY ACCESSORIES, ELECTRONIC SECURITY PRODUCTS, EXIT DEVICES AND ALARMS, PADLOCKS, METAL SAFES AND SAFE LOCKS, AND HYDRAULIC DOOR CLOSERS; WHOLESALE DISTRIBUTION OF LOCKS AND STRUCTURAL PARTS THEREFOR, ELECTRONIC LOCKS AND ACCESS CONTROL DEVICES, KEYS, KEY ACCESSORIES, ELECTRONIC SECURITY PRODUCTS, EXIT DEVICES AND ALARMS, PADLOCKS, METAL SAFES AND SAFE LOCKS, AND HYDRAULIC DOOR CLOSERS, IN CLASS 35 (U.S. CLS. 100, 101 AND 102).

FIRST USE 7-5-1995; IN COMMERCE 8-31-1995.

THE MARK CONSISTS OF STANDARD CHARACTERS WITHOUT CLAIM TO ANY PARTICULAR FONT, STYLE, SIZE, OR COLOR.

OWNER OF U.S. REG. NO. 3,915,375.

SER. NO. 85-272,691, FILED 3-21-2011.

NORA BUCHANAN WILL, EXAMINING ATTORNEY



*David J. Kybas*

Director of the United States Patent and Trademark Office

# United States of America

United States Patent and Trademark Office

## IDN-HARDWARE SALES

**Reg. No. 4,134,185**

**Registered May 1, 2012**

**Int. Cl.: 35**

**SERVICE MARK**

**PRINCIPAL REGISTER**

IDN, INC. (TEXAS CORPORATION)  
2401 MUSTANG DRIVE, SUITE 100  
GRAPEVINE, TX 76051

FOR: BUSINESS MANAGEMENT AND MARKETING, NAMELY, ADVERTISING AND PROMOTING THE GOODS OF OTHERS; PROCUREMENT SERVICES, NAMELY, PURCHASING LOCKS AND STRUCTURAL PARTS THEREFOR, ELECTRONIC LOCKS AND ACCESS CONTROL DEVICES, KEYS, KEY ACCESSORIES, ELECTRONIC SECURITY PRODUCTS, EXIT DEVICES AND ALARMS, PADLOCKS, METAL SAFES AND SAFE LOCKS, HYDRAULIC DOOR CLOSERS AND TOOLS AND MACHINES USED FOR INSTALLATION AND SERVICING SUCH ITEMS; WHOLESALE DISTRIBUTION OF LOCKS AND STRUCTURAL PARTS THEREFOR, ELECTRONIC LOCKS AND ACCESS CONTROL DEVICES, KEYS, KEY ACCESSORIES, ELECTRONIC SECURITY PRODUCTS, EXIT DEVICES AND ALARMS, PADLOCKS, METAL SAFES AND SAFE LOCKS, HYDRAULIC DOOR CLOSERS AND TOOLS AND MACHINES USED FOR INSTALLATION AND SERVICING SUCH ITEMS, IN CLASS 35 (U.S. CLS. 100, 101 AND 102).

FIRST USE 7-5-1995; IN COMMERCE 8-31-1995.

THE MARK CONSISTS OF STANDARD CHARACTERS WITHOUT CLAIM TO ANY PARTICULAR FONT, STYLE, SIZE, OR COLOR.

OWNER OF U.S. REG. NO. 3,915,375.

NO CLAIM IS MADE TO THE EXCLUSIVE RIGHT TO USE "HARDWARE SALES", APART FROM THE MARK AS SHOWN.

SER. NO. 85-272,704, FILED 3-21-2011.

NORA BUCHANAN WILL, EXAMINING ATTORNEY



*David J. Kyffers*

Director of the United States Patent and Trademark Office

# United States of America

United States Patent and Trademark Office



*Executive Ground Services*

**Reg. No. 4,134,186**

**Registered May 1, 2012**

**Int. Cl.: 39**

**SERVICE MARK**

**PRINCIPAL REGISTER**

EXECUTIVE GROUND SERVICES (DELAWARE CORPORATION)  
P.O. BOX 996370  
MIAMI, FL 33299

FOR: AIR CHARTER SERVICES; AIRLINE AND SHIPPING SERVICES; AIRLINE CHECK-IN SERVICES; AIRLINE TRANSPORTATION SERVICES; AIRPORT PASSENGER CHECK-IN SERVICES; TRAVEL ASSISTANCE SERVICES, NAMELY, ARRANGING FOR THE EMERGENCY REPLACEMENT OF AIRLINE TICKETS, IN CLASS 39 (U.S. CLS. 100 AND 105).

FIRST USE 11-0-2010; IN COMMERCE 1-1-2011.

NO CLAIM IS MADE TO THE EXCLUSIVE RIGHT TO USE "EXECUTIVE GROUND SERVICES", APART FROM THE MARK AS SHOWN.

THE COLOR(S) NAVY BLUE, SKY BLUE, RED, AND WHITE IS/ARE CLAIMED AS A FEATURE OF THE MARK.

THE MARK CONSISTS OF NAVY BLUE OCEANS, SKY BLUE CONTINENTS, RED AIRCRAFT AND RED WAKE CREATED BY IT, RED OUTLINE SURROUNDING THE GLOBE, WHITE LATITUDE AND LONGITUDE LINES TOGETHER WITH WHITE "EGS" LETTERS.

SER. NO. 85-272,853, FILED 3-21-2011.

ZACHARY BELLO, EXAMINING ATTORNEY



*David J. Kyffers*

Director of the United States Patent and Trademark Office

# United States of America

## United States Patent and Trademark Office



FASHION MACK

**Reg. No. 4,134,187**

**Registered May 1, 2012**

**Int. Cl.: 25**

**TRADEMARK**

**PRINCIPAL REGISTER**

NICOLE MACK (UNITED STATES INDIVIDUAL), DBA FASHION MACK  
#2  
1132 BLAKE AVE  
BROOKLYN, NY 11208

FOR: APPAREL FOR DANCERS, NAMELY, TEE SHIRTS, SWEATSHIRTS, PANTS, LEGGINGS, SHORTS AND JACKETS; ATHLETIC APPAREL, NAMELY, SHIRTS, PANTS, JACKETS, FOOTWEAR, HATS AND CAPS, ATHLETIC UNIFORMS; BLOUSES; BODY SHIRTS; BOMBER JACKETS; BRIDESMAID DRESSES; BUTTON DOWN SHIRTS; CAPRI PANTS; CARGO PANTS; COLLARED SHIRTS; CROP PANTS; DENIM JACKETS; DENIMS; DOWN JACKETS; DRESS PANTS; DRESS SHIRTS; DRESS SUITS; DRESSES; DRESSES MADE FROM SKINS; DRESSING GOWNS; DRESSING GOWNS AND BATH ROBES; EVENING DRESSES; FUR COATS AND JACKETS; FUR JACKETS; GYM PANTS; HEAVY JACKETS; HOODED SWEAT SHIRTS; JACKETS; JEANS; JEGGINGS, NAMELY, PANTS THAT ARE PARTIALLY JEANS AND PARTIALLY LEGGINGS; JOGGING PANTS; JUMPER DRESSES; KNIT DRESSES; KNIT JACKETS; KNIT SHIRTS; KNIT SKIRTS; LEATHER JACKETS; LEATHER PANTS; LEATHER SHIRTS; LEATHER SKIRTS; LINGERIE; LONG JACKETS; LONG-SLEEVED SHIRTS; LOUNGE PANTS; MATERNITY LINGERIE; MEN'S AND WOMEN'S JACKETS, COATS, TROUSERS, VESTS; MOTORCYCLE JACKETS; NIGHT SHIRTS; OPEN-NECKED SHIRTS; OUTER JACKETS; OVER SHIRTS; PANTS; PIQUE SHIRTS; POLO SHIRTS; RAIN JACKETS; RAINPROOF JACKETS; REVERSIBLE JACKETS; RUGBY SHIRTS; SHIRTS; SHIRTS AND SHORT-SLEEVED SHIRTS; SHIRTS AND SLIPS; SHIRTS FOR SUITS; SHORT-SLEEVED OR LONG-SLEEVED T-SHIRTS; SHORT-SLEEVED SHIRTS; SKI JACKETS; SKI PANTS; SKIRT SUITS; SKIRTS; SKIRTS AND DRESSES; SLEEP PANTS; SLEEP SHIRTS; SLEEVED OR SLEEVELESS JACKETS; SLEEVES WORN SEPARATE AND APART FROM BLOUSES, SHIRTS AND OTHER TOPS; SMOKING JACKETS; SNOW PANTS; SPORT SHIRTS; SPORTS JACKETS; SPORTS PANTS; SPORTS SHIRTS; SPORTS SHIRTS WITH SHORT SLEEVES; STRETCH PANTS; SUEDE JACKETS; SWEAT JACKETS; SWEAT PANTS; SWEAT SHIRTS; T-SHIRTS; TEE SHIRTS; TENNIS DRESSES; TRACK JACKETS; TRACK PANTS; TURTLE NECK SHIRTS; WATERPROOF JACKETS AND PANTS; WEARABLE GARMENTS AND CLOTHING, NAMELY, SHIRTS; WEDDING DRESSES; WIND PANTS; WIND RESISTANT JACKETS; WIND SHIRTS; WIND-JACKETS; WOMEN'S CLOTHING, NAMELY, SHIRTS, DRESSES, SKIRTS, BLOUSES; WOVEN DRESSES; WOVEN SKIRTS, IN CLASS 25 (U.S. CLS. 22 AND 39).



*David J. Kybas*

Director of the United States Patent and Trademark Office

FIRST USE 6-1-2009; IN COMMERCE 6-1-2009.

**Reg. No. 4,134,187** NO CLAIM IS MADE TO THE EXCLUSIVE RIGHT TO USE "FASHION", APART FROM THE MARK AS SHOWN.

THE MARK CONSISTS OF A CRESCENT COMPRISED OF SIDES OR ORNAMENTAL LEAVES, TWO BERRIES AT THE BOTTOM, AND A BORDER OUTLINE AT THE TOP WITH AN OVAL IN THE MIDDLE. WITHIN THE OVAL IN THE CENTER IS THE REVERSED LETTER "F" AND THE LETTER "M". BELOW THE CRESCENT IS THE WORDING "FASHION MACK" WITH THE LETTER "F" APPEARING REVERSED.

SER. NO. 85-272,978, FILED 3-22-2011.

DANNEAN HETZEL, EXAMINING ATTORNEY

# United States of America

United States Patent and Trademark Office

# STINKY

**Reg. No. 4,134,188**

**Registered May 1, 2012**

**Int. Cl.: 9**

**TRADEMARK**

**PRINCIPAL REGISTER**

STELULU TECHNOLOGY INC. (CANADA CORPORATION)  
6088, RUE TERREBONNE  
MONTREAL, QUEBEC, CANADA H4A1B9

FOR: COMPUTER PERIPHERALS, NAMELY, FOOT ACTIVATED CONTROLLERS, IN CLASS 9 (U.S. CLS. 21, 23, 26, 36 AND 38).

THE MARK CONSISTS OF STANDARD CHARACTERS WITHOUT CLAIM TO ANY PARTICULAR FONT, STYLE, SIZE, OR COLOR.

PRIORITY CLAIMED UNDER SEC. 44(D) ON CANADA APPLICATION NO. 1,497,126, FILED 9-24-2010, REG. NO. TMA813,626, DATED 12-8-2011, EXPIRES 12-8-2026.

SER. NO. 85-273,183, FILED 3-22-2011.

HELENE LIWINSKI, EXAMINING ATTORNEY



*David J. Kybas*

Director of the United States Patent and Trademark Office

# United States of America

United States Patent and Trademark Office

## THE JOURNEY CONTINUES

**Reg. No. 4,134,189**

**Registered May 1, 2012**

**Int. Cl.: 40**

**SERVICE MARK**

**PRINCIPAL REGISTER**

JACOBS VEHICLE SYSTEMS, INC. (DELAWARE CORPORATION)  
22 EAST DUDLEY TOWN ROAD  
BLOOMFIELD, CT 06002

FOR: MANUFACTURING SERVICES TO THE ORDER AND SPECIFICATION OF OTHERS  
IN THE FIELD OF ENGINE RETARDERS, ENGINE VALVE ACTUATION MECHANISMS  
AND PARTS THEREOF, IN CLASS 40 (U.S. CLS. 100, 103 AND 106).

FIRST USE 3-0-2011; IN COMMERCE 3-0-2011.

THE MARK CONSISTS OF STANDARD CHARACTERS WITHOUT CLAIM TO ANY PAR-  
TICULAR FONT, STYLE, SIZE, OR COLOR.

SER. NO. 85-273,189, FILED 3-22-2011.

HEATHER THOMPSON, EXAMINING ATTORNEY



*David J. Kyffers*

Director of the United States Patent and Trademark Office

# United States of America

United States Patent and Trademark Office

## LANDON CASSILL

**Reg. No. 4,134,190**

**Registered May 1, 2012**

**Int. Cl.: 41**

**SERVICE MARK**

**PRINCIPAL REGISTER**

LANDON CASSILL, INC. (NORTH CAROLINA CORPORATION)  
12504 CEDAR POST LANE  
CHARLOTTE, NC 28215

FOR: ENTERTAINMENT IN THE NATURE OF AUTOMOBILE RACES, IN CLASS 41 (U.S. CLS. 100, 101 AND 107).

FIRST USE 1-1-2007; IN COMMERCE 1-1-2007.

THE MARK CONSISTS OF STANDARD CHARACTERS WITHOUT CLAIM TO ANY PARTICULAR FONT, STYLE, SIZE, OR COLOR.

THE NAME(S), PORTRAIT(S), AND/OR SIGNATURE(S) SHOWN IN THE MARK IDENTIFIES "LANDON CASSILL", WHOSE CONSENT(S) TO REGISTER IS MADE OF RECORD.

SER. NO. 85-273,221, FILED 3-22-2011.

MICHAEL SOUDERS, EXAMINING ATTORNEY



*David J. Kybas*

Director of the United States Patent and Trademark Office



# United States of America

United States Patent and Trademark Office

## LANDON CASSILL QUALIFYING CHALLENGE

**Reg. No. 4,134,191**

**Registered May 1, 2012**

**Int. Cl.: 41**

**SERVICE MARK**

**PRINCIPAL REGISTER**

LANDON CASSILL, INC. (NORTH CAROLINA CORPORATION)  
12504 CEDAR POST LANE  
CHARLOTTE, NC 28215

FOR: ENTERTAINMENT SERVICES, NAMELY, PROVIDING INTERACTIVE, ONLINE COMPUTER VIDEO GAMES WHERE PARTICIPANTS COMPETE IN SIMULATED AUTOMOBILE RACING AND QUALIFYING, IN CLASS 41 (U.S. CLS. 100, 101 AND 107).

FIRST USE 6-1-2010; IN COMMERCE 6-1-2010.

THE MARK CONSISTS OF STANDARD CHARACTERS WITHOUT CLAIM TO ANY PARTICULAR FONT, STYLE, SIZE, OR COLOR.

NO CLAIM IS MADE TO THE EXCLUSIVE RIGHT TO USE "QUALIFYING CHALLENGE", APART FROM THE MARK AS SHOWN.

THE NAME(S), PORTRAIT(S), AND/OR SIGNATURE(S) SHOWN IN THE MARK IDENTIFIES "LANDON CASSILL", WHOSE CONSENT(S) TO REGISTER IS MADE OF RECORD.

SER. NO. 85-273,241, FILED 3-22-2011.

MICHAEL SOUDERS, EXAMINING ATTORNEY



*David J. Kyros*

Director of the United States Patent and Trademark Office

# United States of America

United States Patent and Trademark Office

# ROSENBLAD

**Reg. No. 4,134,192**

**Registered May 1, 2012**

**Int. Cls.: 11, 37 and 42**

**TRADEMARK**

**SERVICE MARK**

**PRINCIPAL REGISTER**

ROSENBLAD DESIGN GROUP, INC. (NEW JERSEY CORPORATION)  
86395 GENE LASSERRE BOULEVARD  
YULEE, FL 32097

FOR: HEAT TRANSFER EQUIPMENT, NAMELY, HEAT TRANSFER EVAPORATORS; AND HEAT TRANSFER SYSTEMS COMPRISED PRIMARILY OF HEAT TRANSFER EVAPORATORS, PIPING, DUCTING AND SUPPORTS, IN CLASS 11 (U.S. CLS. 13, 21, 23, 31 AND 34).

FIRST USE 0-0-1994; IN COMMERCE 0-0-1994.

FOR: INSTALLATION, REPAIR AND MAINTENANCE OF HEAT TRANSFER EQUIPMENT AND SYSTEMS, IN CLASS 37 (U.S. CLS. 100, 103 AND 106).

FIRST USE 0-0-1995; IN COMMERCE 0-0-1995.

FOR: DESIGN AND DEVELOPMENT OF HEAT TRANSFER EQUIPMENT AND SYSTEMS, IN CLASS 42 (U.S. CLS. 100 AND 101).

FIRST USE 0-0-1994; IN COMMERCE 0-0-1994.

THE MARK CONSISTS OF STANDARD CHARACTERS WITHOUT CLAIM TO ANY PARTICULAR FONT, STYLE, SIZE, OR COLOR.

SEC. 2(F).

SER. NO. 85-273,452, FILED 3-22-2011.

DORITT L. CARROLL, EXAMINING ATTORNEY



*David J. Kyros*

Director of the United States Patent and Trademark Office

# United States of America

United States Patent and Trademark Office

## CINEMA PARADISO

**Reg. No. 4,134,193**

**Registered May 1, 2012**

**Int. Cl.: 41**

**SERVICE MARK**

**PRINCIPAL REGISTER**

BROWARD COUNTY FILM SOCIETY, INC. (FLORIDA CORPORATION)  
503 SE SIXTH STREET  
FORT LAUDERDALE, FL 33301

FOR: CINEMA THEATERS; MOTION PICTURE THEATERS; PROVIDING FACILITIES FOR MOVIES, SHOWS, PLAYS, MUSIC OR EDUCATIONAL TRAINING, IN CLASS 41 (U.S. CLS. 100, 101 AND 107).

FIRST USE 10-15-1998; IN COMMERCE 10-15-1998.

THE MARK CONSISTS OF STANDARD CHARACTERS WITHOUT CLAIM TO ANY PARTICULAR FONT, STYLE, SIZE, OR COLOR.

NO CLAIM IS MADE TO THE EXCLUSIVE RIGHT TO USE "CINEMA", APART FROM THE MARK AS SHOWN.

THE ENGLISH TRANSLATION OF "PARADISO" IN THE MARK IS "PARADISE".

SER. NO. 85-273,558, FILED 3-22-2011.

HANNO RITTNER, EXAMINING ATTORNEY



*David J. Kybas*

Director of the United States Patent and Trademark Office

# United States of America

United States Patent and Trademark Office



**THE RIGHT TO SIGHT**

**Reg. No. 4,134,194**  
**Registered May 1, 2012**  
**Int. Cls.: 36 and 41**

THE INTERNATIONAL AGENCY FOR THE PREVENTION OF BLINDNESS (UNITED KINGDOM REGISTERED CHARITY NO: 1100559, COMPANY LIMITED BY GUARANTEE NO: 4620869, REGISTERED IN ENGLAND AND WALES)  
LONDON SCHOOL OF HYGIENE & TROPICAL HEALTH  
C/- INTERNATIONAL CENTRE FOR EYE HEALTH  
KEPPEL STREET, LONDON, UNITED KINGDOM WC1E7HT

**SERVICE MARK**  
**PRINCIPAL REGISTER**

FOR: CHARITABLE FUND RAISING SERVICES, IN CLASS 36 (U.S. CLS. 100, 101 AND 102).

FIRST USE 0-0-1999; IN COMMERCE 0-0-1999.

FOR: EDUCATIONAL SERVICES, NAMELY, CONDUCTING CLASSES, WORKSHOPS, SPEAKING ENGAGEMENTS FOR THE PREVENTION AND TREATMENT OF BLINDNESS AND PROVIDING EDUCATIONAL MATERIALS IN CONNECTION THEREWITH, IN CLASS 41 (U.S. CLS. 100, 101 AND 107).

FIRST USE 0-0-1999; IN COMMERCE 0-0-1999.

THE MARK CONSISTS OF THE WORDS AND NUMERALS "VISION 2020 THE RIGHT TO SIGHT" WITH THE NUMERALS "2020" CONTAINING A SERIES OF LINES; THE SECOND NUMERAL "0" DEPICTS THE GLOBE AND TARGET SUPERIMPOSED ON THE GLOBE WITH A LINE SEPARATING THE WORDS AND NUMERALS "VISION 2020" FROM THE WORDS "THE RIGHT TO SIGHT".

SER. NO. 85-273,995, FILED 3-22-2011.

ZACHARY BELLO, EXAMINING ATTORNEY



*David J. Kyffers*

Director of the United States Patent and Trademark Office

# United States of America

United States Patent and Trademark Office

## Gold Star Morning

**Reg. No. 4,134,195**

LEANG, BENJAMIN H. (UNITED STATES INDIVIDUAL)  
PO BOX 1118  
BOYLSTON, MA 01505

**Registered May 1, 2012**

**Int. Cl.: 9**

FOR: COMPACT DISCS FEATURING MUSIC, IN CLASS 9 (U.S. CLS. 21, 23, 26, 36 AND 38).

**TRADEMARK**

FIRST USE 1-0-2009; IN COMMERCE 1-0-2009.

**PRINCIPAL REGISTER**

THE MARK CONSISTS OF STANDARD CHARACTERS WITHOUT CLAIM TO ANY PARTICULAR FONT, STYLE, SIZE, OR COLOR.

SER. NO. 85-274,011, FILED 3-22-2011.

JENNIFER MARTIN, EXAMINING ATTORNEY



*David J. Kybas*

Director of the United States Patent and Trademark Office

# United States of America

United States Patent and Trademark Office

## POMS WELLNESS

**Reg. No. 4,134,196**

**Registered May 1, 2012**

**Int. Cls.: 35, 36 and 44**

**SERVICE MARK**

**PRINCIPAL REGISTER**

POMS & ASSOCIATES INSURANCE BROKERS, INC. (CALIFORNIA CORPORATION)  
5700 CANOGA AVENUE, SUITE 400  
WOODLAND HILLS, CA 91367

FOR: PROVIDING A WEBSITE FEATURING BUSINESS CONSULTING AND BUSINESS INFORMATION, IN CLASS 35 (U.S. CLS. 100, 101 AND 102).

FIRST USE 1-31-2011; IN COMMERCE 1-31-2011.

FOR: PROVIDING A WEBSITE FEATURING INFORMATION ON ADVISORY SERVICES IN THE FIELD OF EMPLOYEE BENEFITS FOR GROUP HEALTHCARE AND BUSINESS INSURANCE OFFERED TO EMPLOYEES IN ADDITION TO STANDARD BENEFITS SUCH AS MEDICAL, DENTAL, LIFE INSURANCE INCLUDING SHORT TERM DISABILITY, LONG TERM DISABILITY, CANCER INSURANCE, ACCIDENTAL DEATH AND DISMEMBERMENT, IN CLASS 36 (U.S. CLS. 100, 101 AND 102).

FIRST USE 1-31-2011; IN COMMERCE 1-31-2011.

FOR: PROVIDING A WEBSITE FEATURING INFORMATION ABOUT HEALTH, FITNESS, PREVENTATIVE MEDICINE AND HEALTHCARE, IN CLASS 44 (U.S. CLS. 100 AND 101).

FIRST USE 1-31-2011; IN COMMERCE 1-31-2011.

THE MARK CONSISTS OF STANDARD CHARACTERS WITHOUT CLAIM TO ANY PARTICULAR FONT, STYLE, SIZE, OR COLOR.

OWNER OF U.S. REG. NOS. 3,250,927 AND 3,250,928.

NO CLAIM IS MADE TO THE EXCLUSIVE RIGHT TO USE "WELLNESS", APART FROM THE MARK AS SHOWN.

SER. NO. 85-274,034, FILED 3-22-2011.

ESTHER A. BORSUK, EXAMINING ATTORNEY



*David J. Kyffers*

Director of the United States Patent and Trademark Office

# United States of America

United States Patent and Trademark Office

## TRAIN OF THOUGHT

**Reg. No. 4,134,197**

**Registered May 1, 2012**

**Int. Cl.: 25**

**TRADEMARK**

**PRINCIPAL REGISTER**

TRAIN OF THOUGHT CLOTHING, INC. (FLORIDA CORPORATION)  
7351 HARBOUR BLVD.  
MIRAMAR, FL 33023

FOR: CLOTHING, NAMELY, MENS SHIRTS, T-SHIRTS, PANTS, JEANS, AND SHORTS;  
CLOTHING, NAMELY, WOMENS SHIRTS, BLOUSES, T-SHIRTS, SKIRTS, SHORTS, PANTS  
AND JEANS; CLOTHING, NAMELY, CHILDRENS SHIRTS, T-SHIRTS, SKIRTS, SHORTS,  
SKORTS, PANTS AND JEANS, IN CLASS 25 (U.S. CLS. 22 AND 39).

FIRST USE 2-0-2008; IN COMMERCE 2-0-2008.

THE MARK CONSISTS OF STANDARD CHARACTERS WITHOUT CLAIM TO ANY PAR-  
TICULAR FONT, STYLE, SIZE, OR COLOR.

SER. NO. 85-274,043, FILED 3-22-2011.

TAMARA FRAZIER, EXAMINING ATTORNEY



*David J. Kybas*

Director of the United States Patent and Trademark Office

# United States of America

United States Patent and Trademark Office

## Al Ritmo del Dia

**Reg. No. 4,134,198**

**Registered May 1, 2012**

**Int. Cl.: 41**

**SERVICE MARK**

**PRINCIPAL REGISTER**

POWER PRODUCTIONS GROUP, LLC (FLORIDA LIMITED LIABILITY COMPANY)  
PENTHOUSE  
3850 BIRD ROAD  
CORAL GABLES, FL 33146

FOR: ENTERTAINMENT IN THE NATURE OF AN ON-GOING SPECIAL VARIETY, NEWS, MUSIC OR COMEDY SHOW FEATURING CURRENT EVENTS BROADCAST OVER TELEVISION, SATELLITE, AUDIO, AND VIDEO MEDIA, IN CLASS 41 (U.S. CLS. 100, 101 AND 107).

FIRST USE 2-14-2011; IN COMMERCE 2-14-2011.

THE MARK CONSISTS OF STANDARD CHARACTERS WITHOUT CLAIM TO ANY PARTICULAR FONT, STYLE, SIZE, OR COLOR.

THE ENGLISH TRANSLATION OF "AL RITMO DEL DIA" IN THE MARK IS "THE RHYTHM OF THE DAY".

SER. NO. 85-274,052, FILED 3-22-2011.

TAMARA FRAZIER, EXAMINING ATTORNEY



*David J. Kyros*

Director of the United States Patent and Trademark Office



# United States of America

United States Patent and Trademark Office

# SOLENERGY

**Reg. No. 4,134,199**

**Registered May 1, 2012**

**Int. Cls.: 35 and 37**

**SERVICE MARK**

**PRINCIPAL REGISTER**

ANOUSHIAN, RAFI (UNITED STATES INDIVIDUAL)  
SUITE 5  
1163 RAYMOND AVE.  
GLENDALE, CA 91201

FOR: RETAIL AND ON-LINE RETAIL STORE SERVICES FEATURING SOLAR ENERGY AND ENERGY SAVING PRODUCTS AND SYSTEMS; CONSULTING SERVICES IN THE FIELD OF ENERGY USAGE MANAGEMENT AND ENERGY EFFICIENCY; PROCUREMENT, NAMELY, PURCHASING SOLAR ENERGY CONVERSION SYSTEMS AND DEVICES FOR OTHERS; IMPORT-EXPORT AGENCIES IN THE FIELD OF SOLAR ENERGY AND ENERGY SAVING PRODUCTS; RETAIL AND WHOLESALE STORE SERVICES FEATURING SOLAR ENERGY AND ENERGY SAVING PRODUCTS, IN CLASS 35 (U.S. CLS. 100, 101 AND 102).

FIRST USE 12-21-2011; IN COMMERCE 12-21-2011.

FOR: INSTALLATION, REPAIR AND MAINTENANCE OF SOLAR ENERGY CONVERSION SYSTEMS AND DEVICES, AND CONSULTATION THEREOF; ELECTRICAL CONTRACTOR SERVICES AND CONSULTATION THEREOF, IN CLASS 37 (U.S. CLS. 100, 103 AND 106).

FIRST USE 12-21-2011; IN COMMERCE 12-21-2011.

THE MARK CONSISTS OF STANDARD CHARACTERS WITHOUT CLAIM TO ANY PARTICULAR FONT, STYLE, SIZE, OR COLOR.

SER. NO. 85-274,088, FILED 3-23-2011.

DAWN HAN, EXAMINING ATTORNEY



*David J. Kyjars*

Director of the United States Patent and Trademark Office

# United States of America

United States Patent and Trademark Office

## FORGIVEN MINISTRY

**Reg. No. 4,134,200**

**Registered May 1, 2012**

**Int. Cl.: 45**

**SERVICE MARK**

**PRINCIPAL REGISTER**

FORGIVEN MINISTRY, INC. (NORTH CAROLINA CORPORATION)  
PO BOX 117  
200 MACEDONIA CHURCH ROAD  
TAYLORSVILLE, NC 28681

FOR: MINISTERIAL SERVICES; CHARITABLE OUTREACH SERVICES, NAMELY, PROVIDING COUNSELING SERVICES IN THE FIELD OF RELIGION TO CHILDREN OF PRISON INMATES, PRISON INMATES, FORMER PRISON INMATES AND THE FAMILIES OF PRISON INMATES AND FORMER PRISON INMATES; COUNSELING IN THE FIELD OF DEVELOPING, STRENGTHENING AND SUSTAINING FAMILY RELATIONSHIPS AMONG THE FAMILIES OF PRISON INMATES AND FORMER PRISON INMATES; COUNSELING IN THE FIELD OF PERSONAL DEVELOPMENT FOR CHILDREN OF PRISON INMATES AND CHILDREN OF FORMER PRISON INMATES, NAMELY, SELF-IMPROVEMENT, SELF-FULFILLMENT, AND INTERPERSONAL COMMUNICATION, IN CLASS 45 (U.S. CLS. 100 AND 101).

FIRST USE 10-0-2000; IN COMMERCE 10-0-2000.

THE MARK CONSISTS OF STANDARD CHARACTERS WITHOUT CLAIM TO ANY PARTICULAR FONT, STYLE, SIZE, OR COLOR.

NO CLAIM IS MADE TO THE EXCLUSIVE RIGHT TO USE "MINISTRY", APART FROM THE MARK AS SHOWN.

SER. NO. 85-274,559, FILED 3-23-2011.

JANICE KIM, EXAMINING ATTORNEY



*David J. Kybas*

Director of the United States Patent and Trademark Office

# United States of America

United States Patent and Trademark Office



**Reg. No. 4,134,201**

**Registered May 1, 2012**

**Int. Cl.: 35**

**SERVICE MARK**

**PRINCIPAL REGISTER**

LORD WILLY'S LLC (NEW YORK LIMITED LIABILITY COMPANY)  
223 MOTT STREET  
NEW YORK, NY 10012

FOR: RETAIL STORE AND ON-LINE RETAIL STORE SERVICES FEATURING TOILETRIES, PERFUMERY, EYEWEAR, JEWELRY, WATCHES, CLOTHING, FOOTWEAR, HEADWEAR, CLOTHING ACCESSORIES, BAGS, WALLETS AND UMBRELLAS, IN CLASS 35 (U.S. CLS. 100, 101 AND 102).

FIRST USE 11-15-2005; IN COMMERCE 11-15-2005.

THE MARK CONSISTS OF A SILHOUETTE OF A MAN HOLDING AN UMBRELLA WEARING A FORMAL JACKET, BOXER SHORTS, AND SHOES.

SER. NO. 85-274,778, FILED 3-23-2011.

ELI HELLMAN, EXAMINING ATTORNEY



*David J. Kybas*

Director of the United States Patent and Trademark Office

# United States of America

United States Patent and Trademark Office

# JAVA

**Reg. No. 4,134,202**

ASPEN SEATING, LLC (COLORADO LIMITED LIABILITY COMPANY)  
4211-G SOUTH NATCHES COURT  
SHERIDAN, CO 80110

**Registered May 1, 2012**

**Int. Cl.: 12**

FOR: CUSHIONED BACKRESTS SPECIALLY ADAPTED FOR WHEELCHAIRS, IN CLASS 12 (U.S. CLS. 19, 21, 23, 31, 35 AND 44).

**TRADEMARK**

FIRST USE 3-3-2011; IN COMMERCE 3-3-2011.

**PRINCIPAL REGISTER**

THE MARK CONSISTS OF STANDARD CHARACTERS WITHOUT CLAIM TO ANY PARTICULAR FONT, STYLE, SIZE, OR COLOR.

SER. NO. 85-274,960, FILED 3-23-2011.

TIMOTHY FINNEGAN, EXAMINING ATTORNEY



*David J. Kybas*

Director of the United States Patent and Trademark Office

# United States of America

United States Patent and Trademark Office

## Isn't She Lovely

**Reg. No. 4,134,203**

**Registered May 1, 2012**

**Int. Cl.: 25**

**TRADEMARK**

**PRINCIPAL REGISTER**

ALANN G. LLC (NEW YORK LIMITED LIABILITY COMPANY)  
40 HARRISON ST #4C  
NEW YORK, NY 10013

FOR: BATH SLIPPERS; BATHING SUITS; BEACH SHOES; BODY STOCKINGS; BODY SUITS; BOOTS; BRAS; BRIDESMAID DRESSES; CANVAS SHOES; CAPRI PANTS; CARDIGANS; CARGO PANTS; CAT SUITS; CROP PANTS; CROP TOPS; DENIMS; DRESS PANTS; DRESS SHIRTS; DRESS SUITS; DRESSES; EVENING DRESSES; FITTED SWIMMING COSTUMES WITH BRA CUPS; FLEECE TOPS; GLOVES; GLOVES AS CLOTHING; GLOVES FOR APPAREL; GYM PANTS; HALTER TOPS; HATS; HEAD SCARVES; HEELS; JUMPER DRESSES; KNIT DRESSES; KNIT TOPS; KNITTED GLOVES; LACE BOOTS; LADIES' BOOTS; LEATHER BOOTS; LINGERIE; LINGERIE ACCESSORIES, NAMELY, REMOVABLE SILICONE BREAST ENHANCER PADS USED IN A BRA; PANTIES; PANTIES, SHORTS AND BRIEFS; POLO KNIT TOPS; RAIN BOOTS; RIDING BOOTS; ROMPERS; SANDALS; SANDALS AND BEACH SHOES; SCARVES; SHOES; SILK SCARVES; SKIRTS AND DRESSES; SLIPPERS; SNOW BOOTS; SPORTS BRA; STILETTO HEELS; STRAPLESS BRAS; TANK TOPS; TANK-TOPS; TENNIS SHOES; TOP COATS; TOPS; TRAVEL CLOTHING CONTAINED IN A PACKAGE COMPRISING REVERSIBLE JACKETS, PANTS, SKIRTS, TOPS AND A BELT OR SCARF; TUBE TOPS; WEDDING DRESSES; WOMEN'S ATHLETIC TOPS WITH BUILT-IN BRAS; WOMEN'S CLOTHING, NAMELY, SHIRTS, DRESSES, SKIRTS, BLOUSES; WOMEN'S FOLDABLE SLIPPERS; WOMEN'S SHOES; WOMEN'S TOPS, NAMELY, CAMIS; WORK SHOES AND BOOTS; WOVEN TOPS, IN CLASS 25 (U.S. CLS. 22 AND 39).

FIRST USE 8-1-2010; IN COMMERCE 8-1-2010.

THE MARK CONSISTS OF STANDARD CHARACTERS WITHOUT CLAIM TO ANY PARTICULAR FONT, STYLE, SIZE, OR COLOR.

OWNER OF U.S. REG. NO. 4,045,873.

SER. NO. 85-275,084, FILED 3-23-2011.

SUNG IN, EXAMINING ATTORNEY



*David J. Kyffers*

Director of the United States Patent and Trademark Office

# United States of America

United States Patent and Trademark Office

# ISIS

**Reg. No. 4,134,204**

**Registered May 1, 2012**

**Int. Cl.: 9**

**TRADEMARK**

**PRINCIPAL REGISTER**

MEDISYS HEALTH COMMUNICATIONS, LLC (NEW JERSEY LIMITED LIABILITY COMPANY)  
65 MAIN STREET  
HIGH BRIDGE, NJ 08829

FOR: COMPUTER SOFTWARE FOR CREATING SEARCHABLE DATABASES OF INFORMATION AND DATA, ALL OF THE FOREGOING IN THE FIELD OF HEALTHCARE , IN CLASS 9 (U.S. CLS. 21, 23, 26, 36 AND 38).

FIRST USE 6-1-2010; IN COMMERCE 8-19-2010.

THE MARK CONSISTS OF STANDARD CHARACTERS WITHOUT CLAIM TO ANY PARTICULAR FONT, STYLE, SIZE, OR COLOR.

SER. NO. 85-275,229, FILED 3-24-2011.

GINA FINK, EXAMINING ATTORNEY



*David J. Kyffers*

Director of the United States Patent and Trademark Office

# United States of America

United States Patent and Trademark Office

# FOX

**Reg. No. 4,134,205**

**Registered May 1, 2012**

**Int. Cls.: 16, 35 and 41**

**TRADEMARK**

**SERVICE MARK**

**PRINCIPAL REGISTER**

FAMILY OFFICE EXCHANGE, LLC (DELAWARE LIMITED LIABILITY COMPANY)  
100 WEST WACKER DRIVE  
SUITE 900  
CHICAGO, IL 60606

FOR: PRINTED MATTER, NAMELY, BROCHURES, RESEARCH STUDIES, TECHNICAL PUBLICATIONS, NAMELY, BOOKS, HANDOUTS, WORKBOOKS, DATA SHEETS, FLYERS, MANUALS, JOURNALS AND GUIDES, ALL IN THE FIELD OF WEALTH MANAGEMENT, IN CLASS 16 (U.S. CLS. 2, 5, 22, 23, 29, 37, 38 AND 50).

FIRST USE 8-1-1989; IN COMMERCE 8-1-1989.

FOR: BUSINESS MANAGEMENT AND CONSULTATION SERVICES IN THE FIELD OF WEALTH MANAGEMENT; BUSINESS NETWORKING FOR PEER TO PEER LEARNING GROUPS OF HIGH NET WORTH INDIVIDUALS, IN CLASS 35 (U.S. CLS. 100, 101 AND 102).

FIRST USE 8-1-1989; IN COMMERCE 8-1-1989.

FOR: BUSINESS EDUCATION AND TRAINING SERVICES, NAMELY, DEVELOPING AND FACILITATING CUSTOMIZED LEADERSHIP AND EXECUTIVE DEVELOPMENT PROGRAMS, PROVIDING EXECUTIVE COACHING SERVICES, AND PROVIDING BUSINESS EDUCATION PROGRAMS TO EMPLOYEES AND EXECUTIVES; EDUCATION SERVICES, NAMELY, ARRANGING AND CONDUCTING MEETINGS, SEMINARS, WORKSHOPS, EXHIBITIONS AND CONFERENCES IN THE FIELD OF WEALTH MANAGEMENT, IN CLASS 41 (U.S. CLS. 100, 101 AND 107).

FIRST USE 8-1-1989; IN COMMERCE 8-1-1989.

THE MARK CONSISTS OF STANDARD CHARACTERS WITHOUT CLAIM TO ANY PARTICULAR FONT, STYLE, SIZE, OR COLOR.

SER. NO. 85-275,717, FILED 3-24-2011.

SCOTT BIBB, EXAMINING ATTORNEY



*David J. Kybas*

Director of the United States Patent and Trademark Office

# United States of America

United States Patent and Trademark Office

# MELOBAR

**Reg. No. 4,134,206**

**Registered May 1, 2012**

**Int. Cl.: 15**

**TRADEMARK**

**PRINCIPAL REGISTER**

SMITH, THEODORE (TED) (UNITED STATES INDIVIDUAL)  
PO BOX 615  
EMMETT, ID 83617

FOR: GUITARS, IN CLASS 15 (U.S. CLS. 2, 21 AND 36).

FIRST USE 3-13-1967; IN COMMERCE 3-14-1967.

THE MARK CONSISTS OF STANDARD CHARACTERS WITHOUT CLAIM TO ANY PARTICULAR FONT, STYLE, SIZE, OR COLOR.

SER. NO. 85-275,840, FILED 3-24-2011.

ALEXANDER L. POWERS, EXAMINING ATTORNEY



*David J. Kyffers*

Director of the United States Patent and Trademark Office



# United States of America

United States Patent and Trademark Office

## GRAPHIC ARTS

**Reg. No. 4,134,207**

**Registered May 1, 2012**

**Int. Cl.: 16**

**TRADEMARK**

**PRINCIPAL REGISTER**

INGRAM BOOK GROUP INC. (TENNESSEE CORPORATION)  
ONE INGRAM BLVD.  
LAVERGNE, TN 37086

FOR: BOOKS IN THE FIELD OF HISTORY, BIOGRAPHY, TRAVEL AND ILLUSTRATED PHOTO BOOKS, IN CLASS 16 (U.S. CLS. 2, 5, 22, 23, 29, 37, 38 AND 50).

FIRST USE 0-0-1974; IN COMMERCE 0-0-1974.

THE MARK CONSISTS OF STANDARD CHARACTERS WITHOUT CLAIM TO ANY PARTICULAR FONT, STYLE, SIZE, OR COLOR.

OWNER OF U.S. REG. NOS. 1,894,069, 1,939,145, AND 2,514,878.

SEC. 2(F).

SER. NO. 85-276,376, FILED 3-24-2011.

GINA FINK, EXAMINING ATTORNEY



*David J. Kybas*

Director of the United States Patent and Trademark Office

# United States of America

United States Patent and Trademark Office

## HERBAN LEGEND

**Reg. No. 4,134,208**

**Registered May 1, 2012**

**Int. Cl.: 35**

**SERVICE MARK**

**PRINCIPAL REGISTER**

DEETER, PAULA FRANCIS (UNITED STATES INDIVIDUAL)  
20005 HANSON ROAD  
FORT BRAGG, CA 95437

FOR: RETAIL STORE SERVICES FEATURING APPAREL, STICKERS, BOOKS AND OTHER LITERATURE, SOIL AMENDMENTS, JEWELRY AND ART PIECES, IN CLASS 35 (U.S. CLS. 100, 101 AND 102).

FIRST USE 0-0-2007; IN COMMERCE 0-0-2007.

THE MARK CONSISTS OF STANDARD CHARACTERS WITHOUT CLAIM TO ANY PARTICULAR FONT, STYLE, SIZE, OR COLOR.

SER. NO. 85-276,472, FILED 3-25-2011.

SIMON TENG, EXAMINING ATTORNEY



*David J. Kyffers*

Director of the United States Patent and Trademark Office

# United States of America

United States Patent and Trademark Office

## LEWIS STAGES

**Reg. No. 4,134,209**

**Registered May 1, 2012**

**Int. Cl.: 39**

**SERVICE MARK**

**PRINCIPAL REGISTER**

ALL RESORT COACH, INC. (UTAH CORPORATION), DBA LEWIS STAGES  
POST OFFICE BOX 681780  
PARK CITY, UT 84068

FOR: TRANSPORTATION OF PASSENGERS BY BUS, IN CLASS 39 (U.S. CLS. 100 AND 105).

FIRST USE 2-1-2006; IN COMMERCE 2-1-2006.

THE MARK CONSISTS OF STANDARD CHARACTERS WITHOUT CLAIM TO ANY PARTICULAR FONT, STYLE, SIZE, OR COLOR.

NO CLAIM IS MADE TO THE EXCLUSIVE RIGHT TO USE "STAGES", APART FROM THE MARK AS SHOWN.

SER. NO. 85-276,748, FILED 3-25-2011.

SUSAN LESLIE DUBOIS, EXAMINING ATTORNEY



*David J. Kyffers*

Director of the United States Patent and Trademark Office

# United States of America

United States Patent and Trademark Office

# mine4sure

**Reg. No. 4,134,210**

**Registered May 1, 2012**

**Int. Cls.: 16, 20 and 24**

**TRADEMARK**

**PRINCIPAL REGISTER**

MORIN, BENOÎT-JEAN (FRANCE INDIVIDUAL)  
4 RUE DU LANNOT  
IDRON, FRANCE 64320

FOR: PRINTED PAPER LABELS; ADHESIVES FOR STATIONERY OR HOUSEHOLD PURPOSES; PLASTIC ADHESIVES, STICKERS AND LABELS FOR IDENTIFYING CLOTHING, SHOES AND BELONGINGS; SELF-ADHESIVE TAPES FOR STATIONERY PURPOSES, IN CLASS 16 (U.S. CLS. 2, 5, 22, 23, 29, 37, 38 AND 50).

FOR: NON-METAL IDENTIFICATION BRACELETS; IDENTITY PLATES, NOT OF METAL; BLANK PLASTIC ADHESIVE LABELS; PLASTIC LABELS; THERMAL PLASTIC LABELS; PLASTIC LABELS FOR IDENTIFYING CLOTHING, SHOES, AND BELONGINGS; THERMAL PLASTIC LABELS FOR IDENTIFYING CLOTHING, SHOES AND BELONGINGS; ADHESIVE LABELS MADE OF PLASTIC, IN CLASS 20 (U.S. CLS. 2, 13, 22, 25, 32 AND 50).

FOR: TEXTILE LABELS; LABELS MADE OF TEXTILE FOR IDENTIFYING CLOTHING, SHOES AND PRODUCTS; THERMAL LABELS MADE OF TEXTILE FOR IDENTIFYING CLOTHING, SHOES AND BELONGINGS, IN CLASS 24 (U.S. CLS. 42 AND 50).

THE MARK CONSISTS OF STANDARD CHARACTERS WITHOUT CLAIM TO ANY PARTICULAR FONT, STYLE, SIZE, OR COLOR.

PRIORITY CLAIMED UNDER SEC. 44(D) ON ERPN CMNTY TM OFC APPLICATION NO. 009415589, FILED 10-1-2010, REG. NO. 009415589, DATED 3-8-2011, EXPIRES 10-1-2020.

SER. NO. 85-277,119, FILED 3-25-2011.

LINDA MICKLEBURGH, EXAMINING ATTORNEY



*David J. Kyros*

Director of the United States Patent and Trademark Office

# United States of America

United States Patent and Trademark Office

# @ THE OFFICE

**Reg. No. 4,134,211**

**Registered May 1, 2012**

**Int. Cl.: 16**

**TRADEMARK**

**PRINCIPAL REGISTER**

@ THE OFFICE HOLDINGS, INC. (NEVADA CORPORATION)  
7550 E. GREENWAY #110  
SCOTTSDALE, AZ 85260

FOR: BINDERS; CLIP BOARDS; COIN WRAPS; DESKTOP ORGANIZERS, NAMELY, PAPER CLIP STORAGE HOLDERS; DRY ERASE MARKERS; ENVELOPES; ERASERS; FILE FOLDERS; HANGING FILES; PAPER SHREDDERS FOR OFFICE USE; PENCIL SHARPENERS; PENCILS; PENS; PERMANENT MARKERS; PRESENTATION FOLDERS; PRICE TAGS; RUBBER BANDS; RUBBER STAMPS; SELF STICK NOTE PADS; STAPLERS; STATIONERY; CARDBOARD STORAGE CONTAINERS; PAPER CLIPS; BINDER CLIPS; STAMP PADS; PADS OF PAPER; CALENDARS; DATE STAMPS; PAPER TRIMMERS, IN CLASS 16 (U.S. CLS. 2, 5, 22, 23, 29, 37, 38 AND 50).

FIRST USE 3-0-2010; IN COMMERCE 3-0-2010.

THE MARK CONSISTS OF STANDARD CHARACTERS WITHOUT CLAIM TO ANY PARTICULAR FONT, STYLE, SIZE, OR COLOR.

OWNER OF U.S. REG. NOS. 3,551,484 AND 3,561,840.

SER. NO. 85-277,525, FILED 3-25-2011.

KRISTIN CARLSON, EXAMINING ATTORNEY



*David J. Kybas*

Director of the United States Patent and Trademark Office

# United States of America

United States Patent and Trademark Office

## @ THE OFFICE

**Reg. No. 4,134,212**

**Registered May 1, 2012**

**Int. Cl.: 20**

**TRADEMARK**

**PRINCIPAL REGISTER**

@ THE OFFICE HOLDINGS, INC. (NEVADA CORPORATION)  
7550 E. GREENWAY #110  
SCOTTSDALE, AZ 85260

FOR: FILE CABINETS; PLASTIC SORTING AND STORAGE CONTAINERS OF VARIOUS SIZES FOR COMMERCIAL OR INDUSTRIAL USE, IN CLASS 20 (U.S. CLS. 2, 13, 22, 25, 32 AND 50).

FIRST USE 3-0-2010; IN COMMERCE 3-0-2010.

THE MARK CONSISTS OF STANDARD CHARACTERS WITHOUT CLAIM TO ANY PARTICULAR FONT, STYLE, SIZE, OR COLOR.

OWNER OF U.S. REG. NOS. 3,551,484 AND 3,561,840.

SER. NO. 85-277,532, FILED 3-25-2011.

KRISTIN CARLSON, EXAMINING ATTORNEY



*David J. Kyffers*

Director of the United States Patent and Trademark Office

# United States of America

United States Patent and Trademark Office

## @ THE OFFICE

**Reg. No. 4,134,213**

**Registered May 1, 2012**

**Int. Cl.: 21**

**TRADEMARK**

**PRINCIPAL REGISTER**

@ THE OFFICE HOLDINGS, INC. (NEVADA CORPORATION)  
7550 E. GREENWAY #110  
SCOTTSDALE, AZ 85260

FOR: WASTE BASKETS; COLLAPSIBLE FABRIC STORAGE CONTAINER FOR DOMESTIC USE; PLASTIC SORTING AND STORAGE CONTAINERS OF VARIOUS SIZES FOR DOMESTIC OR HOUSEHOLD USE; PAPER TRAYS, IN CLASS 21 (U.S. CLS. 2, 13, 23, 29, 30, 33, 40 AND 50).

FIRST USE 3-0-2010; IN COMMERCE 3-0-2010.

THE MARK CONSISTS OF STANDARD CHARACTERS WITHOUT CLAIM TO ANY PARTICULAR FONT, STYLE, SIZE, OR COLOR.

OWNER OF U.S. REG. NOS. 3,551,484 AND 3,561,840.

SER. NO. 85-277,543, FILED 3-25-2011.

KRISTIN CARLSON, EXAMINING ATTORNEY



*David J. Kyros*

Director of the United States Patent and Trademark Office

# United States of America

United States Patent and Trademark Office

# FOQUS

**Reg. No. 4,134,214**

**Registered May 1, 2012**

**Int. Cl.: 25**

**TRADEMARK**

**PRINCIPAL REGISTER**

FOQUS MUSIC ENTERTAINMENT (NEW JERSEY LIMITED LIABILITY COMPANY), AKA  
FOQUS  
C/O IHUOMA ONWUNALI  
419 MARTIN STREET  
ROSELLE, NJ 07203

FOR: T-SHIRTS, IN CLASS 25 (U.S. CLS. 22 AND 39).

FIRST USE 1-5-2010; IN COMMERCE 5-17-2010.

THE MARK CONSISTS OF THE STYLIZED WORD "FOQUS". A MAGNIFYING GLASS WITH A GRAY-SHADED HANDLE REPRESENTS THE LETTER "Q" IN THE WORD "FOQUS", AND THE LETTERS "O" AND "U" ARE ATTACHED TO THE MAGNIFYING GLASS ON ITS LEFT AND RIGHT SIDES RESPECTIVELY. THE COLOR GRAY IS USED FOR SHADING PURPOSES ONLY AND IS NOT PART OF THE MARK.

SER. NO. 85-277,591, FILED 3-25-2011.

NICHOLAS ALTREE, EXAMINING ATTORNEY



*David J. Kyffers*

Director of the United States Patent and Trademark Office



# United States of America

United States Patent and Trademark Office

## FINKY'S KITCHEN

**Reg. No. 4,134,215**

**Registered May 1, 2012**

**Int. Cl.: 41**

**SERVICE MARK**

**PRINCIPAL REGISTER**

KIDSCOOK PRODUCTIONS, LLC (DELAWARE LIMITED LIABILITY COMPANY)  
11 HILLSIDE AVENUE  
CAMBRIDGE, MA 02140

FOR: ENTERTAINMENT IN THE NATURE OF AN ON-GOING COMEDY AND MUSIC SHOW FEATURING COOKING AND HEALTHY EATING AND NUTRITION TIPS, IN CLASS 41 (U.S. CLS. 100, 101 AND 107).

FIRST USE 8-1-2011; IN COMMERCE 8-1-2011.

THE MARK CONSISTS OF STANDARD CHARACTERS WITHOUT CLAIM TO ANY PARTICULAR FONT, STYLE, SIZE, OR COLOR.

NO CLAIM IS MADE TO THE EXCLUSIVE RIGHT TO USE "KITCHEN", APART FROM THE MARK AS SHOWN.

SER. NO. 85-277,641, FILED 3-25-2011.

HENRY S. ZAK, EXAMINING ATTORNEY



*David J. Kyros*

Director of the United States Patent and Trademark Office

# United States of America

United States Patent and Trademark Office

# COOMWAT

**Reg. No. 4,134,216**

**Registered May 1, 2012**

**Int. Cl.: 25**

**TRADEMARK**

**PRINCIPAL REGISTER**

CHANHKONGSINH, KENG (UNITED STATES INDIVIDUAL)  
615 WEST MAIN STREET  
BROUSSARD, LA 70518

FOR: CLOTHING, NAMELY, TOPS, BOTTOMS, SHIRTS, T-SHIRTS, JACKETS, SWEAT SHIRTS, HOODED SWEATERS, HOODED SWEATSHIRTS, HEADWEAR, HATS, CAPS, IN CLASS 25 (U.S. CLS. 22 AND 39).

FIRST USE 3-22-2011; IN COMMERCE 3-22-2011.

THE MARK CONSISTS OF STANDARD CHARACTERS WITHOUT CLAIM TO ANY PARTICULAR FONT, STYLE, SIZE, OR COLOR.

THE ENGLISH TRANSLATION OF "COOM WAT" IN THE MARK IS "COMMUNITY OF THE TEMPLE".

SER. NO. 85-277,736, FILED 3-26-2011.

HANNO RITTNER, EXAMINING ATTORNEY



*David J. Kyffers*

Director of the United States Patent and Trademark Office

# United States of America

United States Patent and Trademark Office

## SONS OF RADIO

**Reg. No. 4,134,217**

**Registered May 1, 2012**

**Int. Cl.: 41**

**SERVICE MARK**

**PRINCIPAL REGISTER**

SONS OF RADIO (NEW YORK JOINT VENTURE)  
14-56 31ST DRIVE  
APT 9A  
ASTORIA, NY 11106

FOR: ENTERTAINMENT SERVICES BY A MUSICAL ARTIST AND PRODUCER, NAMELY, MUSICAL COMPOSITION FOR OTHERS AND PRODUCTION OF MUSICAL SOUND RECORDINGS, IN CLASS 41 (U.S. CLS. 100, 101 AND 107).

FIRST USE 9-0-2010; IN COMMERCE 1-0-2011.

THE MARK CONSISTS OF STANDARD CHARACTERS WITHOUT CLAIM TO ANY PARTICULAR FONT, STYLE, SIZE, OR COLOR.

SER. NO. 85-278,023, FILED 3-27-2011.

H. M. FISHER, EXAMINING ATTORNEY



*David J. Kyffers*

Director of the United States Patent and Trademark Office

# United States of America

United States Patent and Trademark Office

## Reno Roofing Company

**Reg. No. 4,134,218**

**Registered May 1, 2012**

**Int. Cl.: 37**

**SERVICE MARK**

**PRINCIPAL REGISTER**

RENO ROOFING COMPANY, INC. (NEVADA CORPORATION)  
380 FREEPORT #1  
SPARKS, NV 89431

FOR: ROOFING SERVICES, IN CLASS 37 (U.S. CLS. 100, 103 AND 106).

FIRST USE 5-1-1997; IN COMMERCE 5-1-1997.

THE MARK CONSISTS OF STANDARD CHARACTERS WITHOUT CLAIM TO ANY PARTICULAR FONT, STYLE, SIZE, OR COLOR.

NO CLAIM IS MADE TO THE EXCLUSIVE RIGHT TO USE "ROOFING COMPANY", APART FROM THE MARK AS SHOWN.

SEC. 2(F).

SER. NO. 85-278,478, FILED 3-28-2011.

MARTHA SANTOMARTINO, EXAMINING ATTORNEY



*David J. Kybas*

Director of the United States Patent and Trademark Office

# United States of America

United States Patent and Trademark Office

NMRKT

**Reg. No. 4,134,219**

NMRKT, INC. (NEW YORK CORPORATION)  
121 ESSEX ST #1  
NEW YORK, NY 10002

**Registered May 1, 2012**

**Int. Cl.: 35**

FOR: ONLINE RETAIL STORE SERVICES IN THE FIELD OF FASHION FEATURING AN INCENTIVE AWARD PROGRAM WHICH PROVIDES DISCOUNTS TO CUSTOMERS BASED ON THE AMOUNT OF INTERACTION WITH THE STORE'S WEB SITE , IN CLASS 35 (U.S. CLS. 100, 101 AND 102).

**SERVICE MARK**

**PRINCIPAL REGISTER**

FIRST USE 9-1-2010; IN COMMERCE 9-1-2010.

THE MARK CONSISTS OF STANDARD CHARACTERS WITHOUT CLAIM TO ANY PARTICULAR FONT, STYLE, SIZE, OR COLOR.

SER. NO. 85-278,752, FILED 3-28-2011.

DORITT L. CARROLL, EXAMINING ATTORNEY



*David J. Kyffers*

Director of the United States Patent and Trademark Office

# United States of America

United States Patent and Trademark Office

## J2534 TOOLBOX

**Reg. No. 4,134,220**

**Registered May 1, 2012**

**Int. Cl.: 9**

**TRADEMARK**

**PRINCIPAL REGISTER**

DREW TECHNOLOGIES, INC. (MICHIGAN CORPORATION)  
3915 RESEARCH PARK DRIVE  
ANN ARBOR, MI 48108

FOR: COMPUTER SOFTWARE AND DOWNLOADABLE SOFTWARE THAT FACILITATES MEMBER ACCESS TO COMMUNITY PORTAL TO TRANSFER DATA, PERFORM SCAN TOOL OPERATIONS, COMMUNICATE WITH AUTOMOTIVE INDUSTRY PERSONNEL ON AUTOMOTIVE REPAIR ISSUES AND TO RECEIVE TRAINING AND SUPPORT, ALL IN THE FIELD OF AUTOMOTIVE REPAIR, THAT ENABLES ALL VEHICLE SERVICE, DIAGNOSTICS AND REPAIR FACILITIES TO PERFORM IN-FIELD SOFTWARE UPDATES, IN CLASS 9 (U.S. CLS. 21, 23, 26, 36 AND 38).

FIRST USE 8-15-2009; IN COMMERCE 8-15-2009.

THE MARK CONSISTS OF STANDARD CHARACTERS WITHOUT CLAIM TO ANY PARTICULAR FONT, STYLE, SIZE, OR COLOR.

NO CLAIM IS MADE TO THE EXCLUSIVE RIGHT TO USE "J2534" , APART FROM THE MARK AS SHOWN.

SER. NO. 85-279,387, FILED 3-29-2011.

ELISSA GARBER KON, EXAMINING ATTORNEY



*David J. Kyffers*

Director of the United States Patent and Trademark Office

# United States of America

United States Patent and Trademark Office

## Taste of Cuba

**Reg. No. 4,134,221**

**Registered May 1, 2012**

**Int. Cl.: 43**

**SERVICE MARK**

**PRINCIPAL REGISTER**

CASTELL ENTERPRISES, INC. (FLORIDA CORPORATION)  
875 NW 42 AVE  
MIAMI, FL 33126

FOR: RESTAURANT SERVICES; SALAD BARS; SERVING OF FOOD AND DRINK/BEVERAGES; TAKE-OUT RESTAURANT SERVICES, IN CLASS 43 (U.S. CLS. 100 AND 101).

FIRST USE 9-20-2009; IN COMMERCE 9-20-2009.

THE MARK CONSISTS OF STANDARD CHARACTERS WITHOUT CLAIM TO ANY PARTICULAR FONT, STYLE, SIZE, OR COLOR.

NO CLAIM IS MADE TO THE EXCLUSIVE RIGHT TO USE "CUBA", APART FROM THE MARK AS SHOWN.

SER. NO. 85-279,408, FILED 3-29-2011.

TRACY CROSS, EXAMINING ATTORNEY



*David J. Kyffers*

Director of the United States Patent and Trademark Office

# United States of America

United States Patent and Trademark Office

## PULSAR ENERGY

**Reg. No. 4,134,222**

**Registered May 1, 2012**

**Int. Cls.: 7 and 42**

**TRADEMARK**

**SERVICE MARK**

**PRINCIPAL REGISTER**

PULSAR ENERGY, INC. (TEXAS CORPORATION)  
P.O. BOX 670747  
DALLAS, TX 75367

FOR: SOLAR-POWERED ELECTRICITY GENERATORS, IN CLASS 7 (U.S. CLS. 13, 19, 21, 23, 31, 34 AND 35).

FIRST USE 2-1-2006; IN COMMERCE 9-11-2007.

FOR: TECHNICAL PLANNING OF SOLAR ENERGY BASED POWER PLANTS, IN CLASS 42 (U.S. CLS. 100 AND 101).

FIRST USE 2-1-2006; IN COMMERCE 9-11-2007.

THE MARK CONSISTS OF STANDARD CHARACTERS WITHOUT CLAIM TO ANY PARTICULAR FONT, STYLE, SIZE, OR COLOR.

NO CLAIM IS MADE TO THE EXCLUSIVE RIGHT TO USE "ENERGY", APART FROM THE MARK AS SHOWN.

SER. NO. 85-279,698, FILED 3-29-2011.

DAVID TOOLEY, EXAMINING ATTORNEY



*David J. Kyros*

Director of the United States Patent and Trademark Office



# United States of America

United States Patent and Trademark Office

## JOY RIDE TRANSPORT

**Reg. No. 4,134,223**

JOY RIDE TRANSPORT, LLC (IOWA LIMITED LIABILITY COMPANY)  
3000 JUSTIN DRIVE, SUITE A  
URBANDALE, IA 50322

**Registered May 1, 2012**

**Int. Cl.: 39**

FOR: NON-EMERGENCY AMBULATORY AND NON-AMBULATORY PASSENGER  
TRANSPORTATION SERVICES, IN CLASS 39 (U.S. CLS. 100 AND 105).

**SERVICE MARK**

FIRST USE 7-4-2010; IN COMMERCE 7-4-2010.

**PRINCIPAL REGISTER**

THE MARK CONSISTS OF STANDARD CHARACTERS WITHOUT CLAIM TO ANY PAR-  
TICULAR FONT, STYLE, SIZE, OR COLOR.

NO CLAIM IS MADE TO THE EXCLUSIVE RIGHT TO USE "TRANSPORT", APART FROM  
THE MARK AS SHOWN.

SER. NO. 85-280,350, FILED 3-29-2011.

RUSS HERMAN, EXAMINING ATTORNEY



*David J. Kyffers*

Director of the United States Patent and Trademark Office

# United States of America

United States Patent and Trademark Office

# RAVENFLOW

**Reg. No. 4,134,224**

**Registered May 1, 2012**

**Int. Cls.: 9, 35, 41 and 42**

**TRADEMARK**

**SERVICE MARK**

**PRINCIPAL REGISTER**

RAVENFLOW, INC. (DELAWARE CORPORATION)  
6011 WEST COURTYARD DRIVE, SUITE 250  
AUSTIN, TX 78730

FOR: SOFTWARE TO ASSIST IN DEVELOPING THE REQUIREMENTS FOR THE CREATION OF SOFTWARE; COMPUTER SOFTWARE FOR DEVELOPING BUSINESS PROCESSES, IN CLASS 9 (U.S. CLS. 21, 23, 26, 36 AND 38).

FIRST USE 1-0-2006; IN COMMERCE 1-0-2006.

FOR: BUSINESS CONSULTATION SERVICES IN THE FIELD OF BUSINESS PROCESS DEVELOPMENT, IN CLASS 35 (U.S. CLS. 100, 101 AND 102).

FIRST USE 1-0-2006; IN COMMERCE 1-0-2006.

FOR: TRAINING IN THE FIELD OF SOFTWARE APPLICATION AND BUSINESS PROCESS DEVELOPMENT, IN CLASS 41 (U.S. CLS. 100, 101 AND 107).

FIRST USE 1-0-2006; IN COMMERCE 1-0-2006.

FOR: CONSULTATION IN THE FIELD OF SOFTWARE APPLICATION DEVELOPMENT, IN CLASS 42 (U.S. CLS. 100 AND 101).

FIRST USE 1-0-2006; IN COMMERCE 1-0-2006.

THE MARK CONSISTS OF STANDARD CHARACTERS WITHOUT CLAIM TO ANY PARTICULAR FONT, STYLE, SIZE, OR COLOR.

SER. NO. 85-280,430, FILED 3-29-2011.

JEAN IM, EXAMINING ATTORNEY



*David J. Kypos*

Director of the United States Patent and Trademark Office

# United States of America

United States Patent and Trademark Office

# PhyNexus

**Reg. No. 4,134,225**

**Registered May 1, 2012**

**Int. Cls.: 1 and 9**

**TRADEMARK**

**PRINCIPAL REGISTER**

PHYNEXUS, INC. (CALIFORNIA CORPORATION)  
INTELLECTUAL PROPERTY DEPT.  
3670 CHARTER PARK DR., SUITE A  
SAN JOSE, CA 95136

FOR: CHEMICALS, NAMELY, BUFFER AND STANDARD SOLUTIONS USED IN ANALYTICAL CHEMISTRY; KIT CONTAINING PRE-PACKED COLUMNS, CHEMICALS, PRE-MADE BUFFER CONCENTRATES, SYRINGES AND INSTRUCTIONAL MANUAL FOR THE PURIFICATION OF PROTEINS FOR IN VITRO USE, IN CLASS 1 (U.S. CLS. 1, 5, 6, 10, 26 AND 46).

FIRST USE 4-1-2004; IN COMMERCE 4-1-2004.

FOR: LABORATORY APPARATUS AND INSTRUMENTS, NAMELY, PRE-PACKED COLUMNS FOR USE IN SEPARATION AND PURIFICATION; SCIENTIFIC APPARATUS AND INSTRUMENTS, NAMELY, FLUID HANDLING DEVICE USED FOR DISPOSABLE BIOPROCESSING APPLICATIONS AND PARTS AND FITTINGS THEREFOR, IN CLASS 9 (U.S. CLS. 21, 23, 26, 36 AND 38).

FIRST USE 4-1-2004; IN COMMERCE 4-1-2004.

THE MARK CONSISTS OF STANDARD CHARACTERS WITHOUT CLAIM TO ANY PARTICULAR FONT, STYLE, SIZE, OR COLOR.

SER. NO. 85-281,579, FILED 3-30-2011.

BRIAN CALLAGHAN, EXAMINING ATTORNEY



*David J. Kypos*

Director of the United States Patent and Trademark Office

# United States of America

United States Patent and Trademark Office

# ERGOMART

**Reg. No. 4,134,226**

**Registered May 1, 2012**

**Int. Cls.: 9 and 20**

**TRADEMARK**

**PRINCIPAL REGISTER**

MICHAEL SEARS (UNITED STATES INDIVIDUAL)  
5200 EAST GRAND AVE STE 500 BLDG 5  
DALLAS, TX 75223

FOR: LABORATORY FURNITURE; COMPUTER PERIPHERALS, NAMELY, LCD MONITOR ARMS, MONITOR ARM PLATFORMS, MONITOR ARM MOUNTS, TILTER DEVICES FOR ROTATABLY SUPPORTING MONITORS AND PLATFORMS IN A PLURALITY OF ORIENTATIONS, KEYBOARD HOLDERS, ADAPTER BRACKETS FOR COMPUTER FLAT PANEL DISPLAYS, SUPPORT ARMS FOR KEYBOARDS, MOUSE TRAYS, CPU HOLDERS AND STANDS, IN CLASS 9 (U.S. CLS. 21, 23, 26, 36 AND 38).

FIRST USE 5-3-2001; IN COMMERCE 5-3-2001.

FOR: COMPUTER FURNITURE; COMPUTER WORKSTATIONS COMPRISING LCD MONITOR ARMS, MONITOR ARM PLATFORMS, MONITOR ARM MOUNTS, TILTER DEVICES FOR ROTATABLY SUPPORTING MONITORS AND PLATFORMS IN A PLURALITY OF ORIENTATIONS, KEYBOARD HOLDERS, ADAPTER BRACKETS FOR COMPUTER FLAT PANEL DISPLAYS, SUPPORT ARMS FOR KEYBOARDS, MOUSE TRAYS, CPU HOLDERS AND STANDS; DRAFTING TABLES; FURNITURE; FURNITURE MADE FROM STEEL TUBING; FURNITURE OF METAL; FURNITURE, NAMELY, DISPLAY UNITS; OFFICE CHAIRS; OFFICE DESKS; OFFICE FURNITURE; OFFICE TABLES; SCHOOL FURNITURE; TELEVISION STANDS, IN CLASS 20 (U.S. CLS. 2, 13, 22, 25, 32 AND 50).

FIRST USE 5-3-2001; IN COMMERCE 5-3-2001.

THE MARK CONSISTS OF STANDARD CHARACTERS WITHOUT CLAIM TO ANY PARTICULAR FONT, STYLE, SIZE, OR COLOR.

SER. NO. 85-281,683, FILED 3-30-2011.

JOHN KELLY, EXAMINING ATTORNEY



*David J. Kyros*

Director of the United States Patent and Trademark Office

# United States of America

United States Patent and Trademark Office

# 702Shooters

**Reg. No. 4,134,227**

**Registered May 1, 2012**

**Int. Cl.: 41**

**SERVICE MARK**

**PRINCIPAL REGISTER**

702SHOOTERS LLC. (NEVADA LIMITED LIABILITY COMPANY)  
3395 S. JONES BLVD. STE 195  
LAS VEGAS, NV 89146

FOR: EDUCATIONAL SERVICES, NAMELY, CONDUCTING TRAINING IN THE FIELDS OF FIREARMS AND CONCEALED CARRY WEAPON AND DISTRIBUTION OF TRAINING MATERIALS IN CONNECTION THEREWITH, IN CLASS 41 (U.S. CLS. 100, 101 AND 107).

FIRST USE 1-11-2008; IN COMMERCE 2-1-2008.

THE MARK CONSISTS OF STANDARD CHARACTERS WITHOUT CLAIM TO ANY PARTICULAR FONT, STYLE, SIZE, OR COLOR.

SER. NO. 85-281,910, FILED 3-31-2011.

ALYSSA STEEL, EXAMINING ATTORNEY



*David J. Kyffers*

Director of the United States Patent and Trademark Office

# United States of America

United States Patent and Trademark Office

# BioUrja

**Reg. No. 4,134,228**

**Registered May 1, 2012**

**Int. Cl.: 4**

**TRADEMARK**

**PRINCIPAL REGISTER**

BIOURJA TRADING, LLC (DELAWARE LIMITED LIABILITY COMPANY)  
757 N ELDRIDGE PARKWAY, SUITE 620  
HOUSTON, TX 77079

FOR: ALCOHOL AND MIXED ALCOHOL FUEL; DIESEL FUEL; ETHANOL FUELS; FOSSIL FUEL SUBSTITUTES, NAMELY, BIOFUELS; FUEL FOR MOTOR VEHICLES, NAMELY, ETHANOL FUEL AND GASOLINE; FUEL FROM CRUDE OIL; FUEL GAS; FUEL OIL; FUELS; FUELS AND BIOFUELS BLENDED WITH CHEMICALS AND/OR BIOLOGICAL PRODUCTS; FUELS FROM BIOLOGICAL SOURCES; FUELS WITH AN ALCOHOLIC BASE; GASOLINE; HYDROCARBON FUELS; LIQUID FUELS; MOTOR FUEL; RENEWABLE FUELS, IN CLASS 4 (U.S. CLS. 1, 6 AND 15).

FIRST USE 10-12-2006; IN COMMERCE 10-12-2006.

THE MARK CONSISTS OF STANDARD CHARACTERS WITHOUT CLAIM TO ANY PARTICULAR FONT, STYLE, SIZE, OR COLOR.

SER. NO. 85-282,233, FILED 3-31-2011.

GINA FINK, EXAMINING ATTORNEY



*David J. Kyros*

Director of the United States Patent and Trademark Office

# United States of America

United States Patent and Trademark Office

## DOTS ON TURQUOISE

**Reg. No. 4,134,229**

**Registered May 1, 2012**

**Int. Cl.: 16**

**TRADEMARK**

**PRINCIPAL REGISTER**

CREATIVE TEACHING PRESS, INC. (CALIFORNIA CORPORATION)  
15342 GRAHAM STREET  
HUNTINGTON BEACH, CA 92649

FOR: PRINTED EDUCATIONAL MATERIALS, NAMELY, PAPER LETTERS, STICKERS, CHARTS, COMPUTER PAPER, PAPER CUT-OUTS COMPRISING PRINTED DIE-CUT SHAPES MADE OF PAPER FOR DECORATIVE PURPOSES, LESSON PLAN BOOKS FOR PLANNING LESSONS IN THE FIELDS OF MATHEMATICS, ENGLISH, SOCIAL STUDIES, SCIENCE, MUSIC, ART, READING, AND HISTORY, PAPER NAME TAGS, RECORD BOOKS HAVING PERFORATED RECORD-KEEPING PAGES FOR RECORDING A STUDENT'S ACADEMIC PROGRESS, AND KITS FOR DECORATING CLASSROOM BULLETIN BOARDS COMPRISING PAPER LETTERS, NUMBERS, SHAPES AND BORDERS, IN CLASS 16 (U.S. CLS. 2, 5, 22, 23, 29, 37, 38 AND 50).

FIRST USE 2-24-2011; IN COMMERCE 2-24-2011.

THE MARK CONSISTS OF STANDARD CHARACTERS WITHOUT CLAIM TO ANY PARTICULAR FONT, STYLE, SIZE, OR COLOR.

OWNER OF U.S. REG. NO. 3,937,423.

NO CLAIM IS MADE TO THE EXCLUSIVE RIGHT TO USE "TURQUOISE", APART FROM THE MARK AS SHOWN.

SER. NO. 85-282,364, FILED 3-31-2011.

WENDY JUN, EXAMINING ATTORNEY



*David J. Kyffers*

Director of the United States Patent and Trademark Office

# United States of America

United States Patent and Trademark Office

## FIT. HIP. HEALTHY.

**Reg. No. 4,134,230**

**Registered May 1, 2012**

**Int. Cl.: 41**

**SERVICE MARK**

**PRINCIPAL REGISTER**

LITHE METHOD, LLC (PENNSYLVANIA LIMITED LIABILITY COMPANY)  
4TH FLOOR  
255 SOUTH 17TH STREET  
PHILADELPHIA, PA 19103

FOR: PROVIDING A WEBSITE FEATURING INFORMATION ON FITNESS; ON-LINE JOURNAL, NAMELY, A BLOG FEATURING FITNESS, FOOD, AND TRAVEL INFORMATION; ON-LINE JOURNAL, NAMELY, A BLOG FEATURING FITNESS, FOOD, AND TRAVEL INFORMATION; PERSONAL FITNESS TRAINING SERVICES AND CONSULTANCY; PHYSICAL FITNESS CONDITIONING CLASSES; PHYSICAL FITNESS INSTRUCTION, IN CLASS 41 (U.S. CLS. 100, 101 AND 107).

FIRST USE 9-0-2008; IN COMMERCE 9-0-2008.

THE MARK CONSISTS OF STANDARD CHARACTERS WITHOUT CLAIM TO ANY PARTICULAR FONT, STYLE, SIZE, OR COLOR.

NO CLAIM IS MADE TO THE EXCLUSIVE RIGHT TO USE "FIT" OR "HEALTHY", APART FROM THE MARK AS SHOWN.

SER. NO. 85-282,425, FILED 3-31-2011.

JOHN KELLY, EXAMINING ATTORNEY



*David J. Kyffers*

Director of the United States Patent and Trademark Office



# United States of America

United States Patent and Trademark Office

## LEWIS TOURS

**Reg. No. 4,134,231**

**Registered May 1, 2012**

**Int. Cl.: 39**

**SERVICE MARK**

**PRINCIPAL REGISTER**

ALL RESORT COACH, INC. (UTAH CORPORATION), DBA LEWIS STAGES  
PO BOX 681780  
PARK CITY, UT 84068

FOR: TOUR GUIDE SERVICES, IN CLASS 39 (U.S. CLS. 100 AND 105).

FIRST USE 2-1-2006; IN COMMERCE 2-1-2006.

THE MARK CONSISTS OF STANDARD CHARACTERS WITHOUT CLAIM TO ANY PARTICULAR FONT, STYLE, SIZE, OR COLOR.

NO CLAIM IS MADE TO THE EXCLUSIVE RIGHT TO USE "TOURS", APART FROM THE MARK AS SHOWN.

SER. NO. 85-282,972, FILED 3-31-2011.

SUSAN LESLIE DUBOIS, EXAMINING ATTORNEY



*David J. Kyffers*

Director of the United States Patent and Trademark Office

# United States of America

United States Patent and Trademark Office

# WebOne

**Reg. No. 4,134,232**

**Registered May 1, 2012**

**Int. Cl.: 38**

**SERVICE MARK**

**PRINCIPAL REGISTER**

MEETINGONE.COM CORP (COLORADO CORPORATION), DBA MEETINGONE  
SUITE 1000  
501 CHERRY STREET  
DENVER, CO 80246

FOR: TELECOMMUNICATIONS, NAMELY, VIDEO, DATA, AND TELEPHONY CONFERENCING SERVICES CONSISTING OF TELECONFERENCING SERVICES, VIDEO CONFERENCING SERVICES, AND WEB CONFERENCING SERVICES, IN CLASS 38 (U.S. CLS. 100, 101 AND 104).

FIRST USE 4-1-2008; IN COMMERCE 4-1-2008.

THE MARK CONSISTS OF STANDARD CHARACTERS WITHOUT CLAIM TO ANY PARTICULAR FONT, STYLE, SIZE, OR COLOR.

SER. NO. 85-283,051, FILED 3-31-2011.

RUDY R. SINGLETON, EXAMINING ATTORNEY



*David J. Kybas*

Director of the United States Patent and Trademark Office

# United States of America

United States Patent and Trademark Office

# EventOne

**Reg. No. 4,134,233**

**Registered May 1, 2012**

**Int. Cl.: 38**

**SERVICE MARK**

**PRINCIPAL REGISTER**

MEETINGONE.COM CORP (COLORADO CORPORATION), DBA MEETINGONE  
SUITE 1000  
501 SOUTH CHERRY STREET  
DENVER, CO 80246

FOR: TELECOMMUNICATIONS, NAMELY, VIDEO, DATA, AND TELEPHONY CONFERENCING SERVICES CONSISTING OF TELECONFERENCING SERVICES, VIDEO CONFERENCING SERVICES, AND WEB CONFERENCING SERVICES, IN CLASS 38 (U.S. CLS. 100, 101 AND 104).

FIRST USE 4-1-2008; IN COMMERCE 4-1-2008.

THE MARK CONSISTS OF STANDARD CHARACTERS WITHOUT CLAIM TO ANY PARTICULAR FONT, STYLE, SIZE, OR COLOR.

SER. NO. 85-283,064, FILED 3-31-2011.

RUDY R. SINGLETON, EXAMINING ATTORNEY



*David J. Kybas*

Director of the United States Patent and Trademark Office

# United States of America

United States Patent and Trademark Office

# SPARKETING

**Reg. No. 4,134,234**

**Registered May 1, 2012**

**Int. Cl.: 35**

**SERVICE MARK**

**PRINCIPAL REGISTER**

GRIFFITH, DAVID L. (UNITED STATES INDIVIDUAL)  
1004 SILVER KNOLL  
SAN ANTONIO, TX 78258

FOR: MARKETING CONSULTING, IN CLASS 35 (U.S. CLS. 100, 101 AND 102).

FIRST USE 12-6-1999; IN COMMERCE 12-6-1999.

THE MARK CONSISTS OF STANDARD CHARACTERS WITHOUT CLAIM TO ANY PARTICULAR FONT, STYLE, SIZE, OR COLOR.

OWNER OF U.S. REG. NO. 2,514,117.

SER. NO. 85-283,306, FILED 4-1-2011.

KEVIN CORWIN, EXAMINING ATTORNEY



*David J. Kybas*

Director of the United States Patent and Trademark Office

# United States of America

United States Patent and Trademark Office

## FOUNDATION & ENDOWMENT MONEY MANAGEMENT

**Reg. No. 4,134,235**

**Registered May 1, 2012**

**Int. Cls.: 16 and 41**

**TRADEMARK**

**SERVICE MARK**

**PRINCIPAL REGISTER**

INSTITUTIONAL INVESTOR, INC. (DELAWARE CORPORATION)  
225 PARK AVENUE SOUTH  
NEW YORK, NY 10003

FOR: PRINTED PUBLICATIONS, NAMELY, NEWSLETTERS IN THE FIELD OF INVESTMENT MANAGEMENT AND INVESTMENT STRATEGIES FOR NONPROFITS, IN CLASS 16 (U.S. CLS. 2, 5, 22, 23, 29, 37, 38 AND 50).

FIRST USE 0-0-1998; IN COMMERCE 0-0-1998.

FOR: PROVIDING ONLINE FINANCIAL NEWSLETTERS IN THE FIELD OF INVESTMENT MANAGEMENT AND INVESTMENT STRATEGIES FOR NONPROFITS, IN CLASS 41 (U.S. CLS. 100, 101 AND 107).

FIRST USE 0-0-1999; IN COMMERCE 0-0-1999.

THE MARK CONSISTS OF STANDARD CHARACTERS WITHOUT CLAIM TO ANY PARTICULAR FONT, STYLE, SIZE, OR COLOR.

SEC. 2(F).

SER. NO. 85-283,515, FILED 4-1-2011.

LINDSEY RUBIN, EXAMINING ATTORNEY



*David J. Kybas*

Director of the United States Patent and Trademark Office

# United States of America

United States Patent and Trademark Office

## Money Management Letter

**Reg. No. 4,134,236**

**Registered May 1, 2012**

**Int. Cls.: 16 and 41**

**TRADEMARK**

**SERVICE MARK**

**PRINCIPAL REGISTER**

INSTITUTIONAL INVESTOR, INC. (DELAWARE CORPORATION)  
225 PARK AVENUE SOUTH  
NEW YORK, NY 10003

FOR: PRINTED PUBLICATIONS, NAMELY, NEWSLETTERS IN THE FIELD OF THE DEFINED BENEFIT PENSION FUND INDUSTRY, AND MONEY MANAGER SEARCHES AND INDUSTRY TRENDS, IN CLASS 16 (U.S. CLS. 2, 5, 22, 23, 29, 37, 38 AND 50).

FIRST USE 0-0-1977; IN COMMERCE 0-0-1977.

FOR: PROVIDING ONLINE FINANCIAL NEWSLETTERS IN THE FIELD OF THE DEFINED BENEFIT PENSION FUND INDUSTRY, AND MONEY MANAGER SEARCHES AND INDUSTRY TRENDS, IN CLASS 41 (U.S. CLS. 100, 101 AND 107).

FIRST USE 0-0-1999; IN COMMERCE 0-0-1999.

THE MARK CONSISTS OF STANDARD CHARACTERS WITHOUT CLAIM TO ANY PARTICULAR FONT, STYLE, SIZE, OR COLOR.

NO CLAIM IS MADE TO THE EXCLUSIVE RIGHT TO USE "LETTER", APART FROM THE MARK AS SHOWN.

SEC. 2(F).

SER. NO. 85-283,524, FILED 4-1-2011.

LINDSEY RUBIN, EXAMINING ATTORNEY



*David J. Kybas*

Director of the United States Patent and Trademark Office

# United States of America

United States Patent and Trademark Office

## Power Finance & Risk

**Reg. No. 4,134,237**

**Registered May 1, 2012**

**Int. Cls.: 16 and 41**

**TRADEMARK**

**SERVICE MARK**

**PRINCIPAL REGISTER**

INSTITUTIONAL INVESTOR, INC. (DELAWARE CORPORATION)  
225 PARK AVENUE SOUTH  
NEW YORK, NY 10003

FOR: PRINTED PUBLICATIONS, NAMELY, NEWSLETTERS IN THE FIELD OF PROJECT FINANCE, TRADING AND FINANCING IN THE POWER INDUSTRY, IN CLASS 16 (U.S. CLS. 2, 5, 22, 23, 29, 37, 38 AND 50).

FIRST USE 0-0-1997; IN COMMERCE 0-0-1997.

FOR: PROVIDING ONLINE FINANCIAL NEWSLETTERS IN THE FIELD OF PROJECT FINANCE, TRADING AND FINANCING IN THE POWER INDUSTRY, IN CLASS 41 (U.S. CLS. 100, 101 AND 107).

FIRST USE 0-0-1999; IN COMMERCE 0-0-1999.

THE MARK CONSISTS OF STANDARD CHARACTERS WITHOUT CLAIM TO ANY PARTICULAR FONT, STYLE, SIZE, OR COLOR.

SEC. 2(F).

SER. NO. 85-283,530, FILED 4-1-2011.

LINDSEY RUBIN, EXAMINING ATTORNEY



*David J. Kybas*

Director of the United States Patent and Trademark Office

# United States of America

United States Patent and Trademark Office

## Global Money Management

**Reg. No. 4,134,238**

**Registered May 1, 2012**

**Int. Cls.: 36 and 41**

**SERVICE MARK**

**PRINCIPAL REGISTER**

INSTITUTIONAL INVESTOR, INC. (DELAWARE CORPORATION)  
225 PARK AVENUE SOUTH  
NEW YORK, NY 10003

FOR: PROVIDING ONLINE FINANCIAL INFORMATION IN THE FIELD OF INTERNATIONAL FUND MANAGEMENT VIA E-MAIL NOTIFICATION ALERTS, IN CLASS 36 (U.S. CLS. 100, 101 AND 102).

FIRST USE 0-0-1999; IN COMMERCE 0-0-1999.

FOR: PROVIDING ONLINE FINANCIAL NEWSLETTERS IN THE FIELD OF INTERNATIONAL FUND MANAGEMENT, IN CLASS 41 (U.S. CLS. 100, 101 AND 107).

FIRST USE 0-0-1999; IN COMMERCE 0-0-1999.

THE MARK CONSISTS OF STANDARD CHARACTERS WITHOUT CLAIM TO ANY PARTICULAR FONT, STYLE, SIZE, OR COLOR.

SEC. 2(F).

SER. NO. 85-283,543, FILED 4-1-2011.

LINDSEY RUBIN, EXAMINING ATTORNEY



*David J. Kybas*

Director of the United States Patent and Trademark Office



# United States of America

United States Patent and Trademark Office

 **STORMPOWERED**

**Reg. No. 4,134,239**

**Registered May 1, 2012**

**Int. Cls.: 9 and 35**

**TRADEMARK**

**SERVICE MARK**

**PRINCIPAL REGISTER**

ALBIREO STUDIOS, LLC (VIRGINIA LIMITED LIABILITY COMPANY)  
3567 ROCKYBAR HOLLOW LANE  
FREE UNION, VA 22940

FOR: COMPUTER APPLICATION SOFTWARE FOR PCS, NAMELY, SOFTWARE USED TO PURCHASE AND MANAGE VIDEO GAMES; COMPUTER SOFTWARE FOR PUBLISHING AND DISTRIBUTION OF VIDEO GAMES FOR OTHERS, IN CLASS 9 (U.S. CLS. 21, 23, 26, 36 AND 38).

FIRST USE 4-1-2011; IN COMMERCE 4-1-2011.

FOR: ONLINE RETAIL STORE FEATURING DOWNLOADABLE VIDEO GAME SOFTWARE, IN CLASS 35 (U.S. CLS. 100, 101 AND 102).

FIRST USE 4-1-2011; IN COMMERCE 4-1-2011.

THE MARK CONSISTS OF THE STYLIZED TERM "STORMPOWERED" WITH A LIGHTNING BOLT IN A BOX.

SER. NO. 85-284,257, FILED 4-1-2011.

HOWARD B. LEVINE, EXAMINING ATTORNEY



*David J. Kybas*

Director of the United States Patent and Trademark Office

# United States of America

United States Patent and Trademark Office

# HAFLE

**Reg. No. 4,134,240**

**Registered May 1, 2012**

**Int. Cl.: 9**

**TRADEMARK**

**PRINCIPAL REGISTER**

ROCKFORD CORPORATION (ARIZONA CORPORATION)  
600 SOUTH ROCKFORD DRIVE  
TEMPE, AZ 85281

FOR: STEREO ELECTRONIC EQUIPMENT, NAMELY, HOME, MOBILE AND PROFESSIONAL AUDIO ELECTRONIC AMPLIFIERS AND STEREO TUNERS, IN CLASS 9 (U.S. CLS. 21, 23, 26, 36 AND 38).

FIRST USE 1-1-1978; IN COMMERCE 1-1-1978.

THE MARK CONSISTS OF STANDARD CHARACTERS WITHOUT CLAIM TO ANY PARTICULAR FONT, STYLE, SIZE, OR COLOR.

SEC. 2(F).

SER. NO. 85-284,302, FILED 4-1-2011.

JANICE KIM, EXAMINING ATTORNEY



*David J. Kyffers*

Director of the United States Patent and Trademark Office

# United States of America

United States Patent and Trademark Office



**Reg. No. 4,134,241**

**Registered May 1, 2012**

**Int. Cl.: 18**

**TRADEMARK**

**PRINCIPAL REGISTER**

WISE LUCK INTERNATIONAL LIMITED (HONG KONG CORPORATION)  
FLAT/ROOM D, BLOCK 2, 20/F  
WAI CHUEN ROAD, TSUEN WAN  
NEW TERRITORIES, HONG KONG

FOR: ATTACHE CASES; HANDBAGS; KEY CASES; LEATHER CASES; POCKET WALLETS;  
REUSABLE SHOPPING BAGS; SCHOOL SATCHELS; TRAVELLING BAGS; TRAVELLING  
TRUNKS; UMBRELLAS, IN CLASS 18 (U.S. CLS. 1, 2, 3, 22 AND 41).

FIRST USE 10-9-2010; IN COMMERCE 1-15-2011.

OWNER OF U.S. REG. NO. 2,728,202.

THE MARK CONSISTS OF THE "A"-SHAPE DESIGN WITH A DOT INSIDE AND THE  
STYLIZED WORDING "BY DEVITO" BELOW THE DESIGN, THE STYLIZED WORD  
"AUCHAMO" ARRANGED VERTICALLY ON THE RIGHT OF THE DESIGN.

THE WORDING "AUCHAMO" HAS NO MEANING IN A FOREIGN LANGUAGE.

SER. NO. 85-284,840, FILED 4-4-2011.

KIM SAITO, EXAMINING ATTORNEY



*David J. Kybas*

Director of the United States Patent and Trademark Office

# United States of America

United States Patent and Trademark Office



**Reg. No. 4,134,242**

**Registered May 1, 2012**

**Int. Cl.: 25**

**TRADEMARK**

**PRINCIPAL REGISTER**

WISE LUCK INTERNATIONAL LIMITED (HONG KONG CORPORATION)  
FLAT/ROOM D, BLOCK 2, 20/F  
WAI CHUEN ROAD, TSUEN WAN  
NEW TERRITORIES, HONG KONG

FOR: BELTS; CAPS; FOOTWEAR; GLOVES; HOSIERY; LAYETTES; NECKTIES; SKIRTS  
AND DRESSES; SWIMSUITS; UNDERWEAR, IN CLASS 25 (U.S. CLS. 22 AND 39).

FIRST USE 10-9-2010; IN COMMERCE 1-15-2011.

OWNER OF U.S. REG. NO. 2,728,202.

THE MARK CONSISTS OF THE "A"-SHAPE DESIGN WITH A DOT INSIDE AND THE  
STYLIZED WORDING "BY DEVITO" BELOW THE DESIGN, THE STYLIZED WORD  
"AUCHAMO" ARRANGED VERTICALLY ON THE RIGHT OF THE DESIGN.

THE WORDING "AUCHAMO" HAS NO MEANING IN A FOREIGN LANGUAGE.

SER. NO. 85-284,844, FILED 4-4-2011.

KIM SAITO, EXAMINING ATTORNEY



*David J. Kybas*

Director of the United States Patent and Trademark Office

# United States of America

United States Patent and Trademark Office

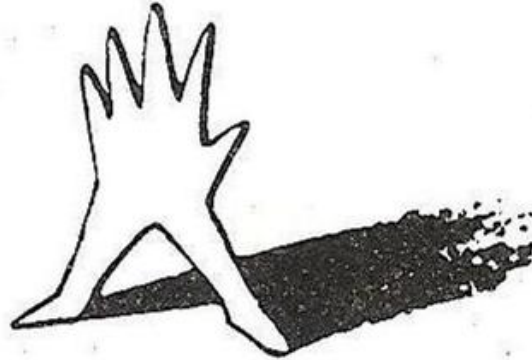

**Reg. No. 4,134,243**

**Registered May 1, 2012**

**Int. Cls.: 11 and 20**

**TRADEMARK**

**PRINCIPAL REGISTER**

STANDING OVATION, LTD. (ILLINOIS CORPORATION)  
2341 S. MICHIGAN AVE.  
SUITE 4R  
CHICAGO, IL 60616

FOR: LAMP BASES; LAMPS, IN CLASS 11 (U.S. CLS. 13, 21, 23, 31 AND 34).

FIRST USE 5-15-1997; IN COMMERCE 5-15-1997.

FOR: FURNITURE; FURNITURE FOR DISPLAYING GOODS; FURNITURE FRAMES; FURNITURE, MIRRORS, PICTURE FRAMES; FURNITURE, NAMELY, DISPLAY UNITS; MIRRORS, IN CLASS 20 (U.S. CLS. 2, 13, 22, 25, 32 AND 50).

FIRST USE 5-15-1997; IN COMMERCE 5-15-1997.

THE MARK CONSISTS OF A HAND STANDING ON TWO LEGS CASTING A SHADOW.

SER. NO. 85-285,270, FILED 4-4-2011.

JAMES STEIN, EXAMINING ATTORNEY



*David J. Kybas*

Director of the United States Patent and Trademark Office

# United States of America

United States Patent and Trademark Office



**Reg. No. 4,134,244**

**Registered May 1, 2012**

**Int. Cl.: 30**

**TRADEMARK**

**PRINCIPAL REGISTER**

THE GENE VANCE JR FOUNDATION (NORTH CAROLINA NON-PROFIT CORPORATION)  
261 MAPLE STREET  
RUTHERFORDTON, NC 281390912

FOR: COFFEE, IN CLASS 30 (U.S. CL. 46).

FIRST USE 4-1-2011; IN COMMERCE 4-1-2011.

NO CLAIM IS MADE TO THE EXCLUSIVE RIGHT TO USE "SUPERIOR QUALITY BOLD BREW COFFEE", APART FROM THE MARK AS SHOWN.

THE NAME(S), PORTRAIT(S), AND/OR SIGNATURE(S) SHOWN IN THE MARK DOES NOT IDENTIFY A PARTICULAR LIVING INDIVIDUAL.

THE MARK CONSISTS OF THE STYLIZED WORDING "BUD'S BOLD BREW COFFEE SUPERIOR QUALITY" WITH AN EAGLE DESIGN APPEARING NEXT TO THE LETTER "B" IN "BUD'S", A DESIGN OF A PORTRAIT OF GENE VANCE, JR., AND A HEART DESIGN. A LARGE LETTER "B" APPEARS AS A BACKGROUND BEHIND THE WORDING AND DESIGNS IN THE MARK.

SER. NO. 85-285,508, FILED 4-4-2011.

NATALIE POLZER, EXAMINING ATTORNEY



*David J. Kyffers*

Director of the United States Patent and Trademark Office

# United States of America

United States Patent and Trademark Office

# X WELLNESS

**Reg. No. 4,134,245**

**Registered May 1, 2012**

**Int. Cls.: 35 and 44**

**SERVICE MARK**

**PRINCIPAL REGISTER**

XY WELLNESS, LLC (WISCONSIN LIMITED LIABILITY COMPANY)  
3914 CHEROKEE DRIVE  
MADISON, WI 53711

FOR: ONLINE RETAIL STORE SERVICES FEATURING MEN'S HEALTH AND NUTRITION PRODUCTS, IN CLASS 35 (U.S. CLS. 100, 101 AND 102).

FIRST USE 9-30-2011; IN COMMERCE 9-30-2011.

FOR: PROVIDING A WEBSITE FEATURING INFORMATION REGARDING MEN'S HEALTH AND NUTRITION, IN CLASS 44 (U.S. CLS. 100 AND 101).

FIRST USE 10-31-2011; IN COMMERCE 10-31-2011.

NO CLAIM IS MADE TO THE EXCLUSIVE RIGHT TO USE "WELLNESS", APART FROM THE MARK AS SHOWN.

THE MARK CONSISTS OF A STYLIZED "XY" FOLLOWED BY THE WORD "WELLNESS".

SER. NO. 85-285,526, FILED 4-4-2011.

REGINA DRUMMOND, EXAMINING ATTORNEY



*David J. Kybas*

Director of the United States Patent and Trademark Office

# United States of America

United States Patent and Trademark Office

## SHOE DEPT. COLLECTION

**Reg. No. 4,134,246**

**Registered May 1, 2012**

**Int. Cl.: 25**

**TRADEMARK**

**PRINCIPAL REGISTER**

SHOE SHOW, INC. (NORTH CAROLINA CORPORATION)  
2201 TRINITY CHURCH ROAD  
CONCORD, NC 28027

FOR: FOOTWEAR, IN CLASS 25 (U.S. CLS. 22 AND 39).

FIRST USE 11-1-2000; IN COMMERCE 11-1-2000.

THE MARK CONSISTS OF STANDARD CHARACTERS WITHOUT CLAIM TO ANY PARTICULAR FONT, STYLE, SIZE, OR COLOR.

OWNER OF U.S. REG. NO. 1,720,873.

NO CLAIM IS MADE TO THE EXCLUSIVE RIGHT TO USE "SHOE" OR "COLLECTION", APART FROM THE MARK AS SHOWN.

SEC. 2(F).

SER. NO. 85-285,615, FILED 4-4-2011.

EVELYN BRADLEY, EXAMINING ATTORNEY



*David J. Kyffers*

Director of the United States Patent and Trademark Office



# United States of America

United States Patent and Trademark Office

## 9/11 Patriot Flag

**Reg. No. 4,134,247**

**Registered May 1, 2012**

**Int. Cl.: 24**

**TRADEMARK**

**PRINCIPAL REGISTER**

CHILTERN, DANIEL, G. (ILLINOIS CORPORATION), DBA 9/11 PATRIOT FLAG - KEYSTONE FOUNDATION  
1127 WEST WOLFRAM ST., CHICAGO, IL 60657  
1127 WEST WOLFRAM ST.  
CHICAGO, IL 60657

FOR: FABRICS THAT MAY OR MAY NOT HAVE PRINTED PATTERNS AND DESIGNS THEREON FOR USE IN TEXTILE APPLICATIONS, NAMELY, THE MANUFACTURE OF APPAREL, UPHOLSTERY, SIGNAGE, FLAGS, BANNERS AND WALLPAPER; NYLON FLAGS, IN CLASS 24 (U.S. CLS. 42 AND 50).

FIRST USE 9-1-2010; IN COMMERCE 9-1-2010.

NO CLAIM IS MADE TO THE EXCLUSIVE RIGHT TO USE "9/11" AND "FLAG", APART FROM THE MARK AS SHOWN.

THE COLOR(S) RED AND WHITE AND BLUE IS/ARE CLAIMED AS A FEATURE OF THE MARK.

THE MARK CONSISTS OF THE WORDING "9/11 PATRIOT FLAG" IN BLUE WITH RED, WHITE AND BLUE LINES BENEATH THE WORDING.

SER. NO. 85-285,927, FILED 4-4-2011.

WILLIAM BRECKENFELD, EXAMINING ATTORNEY



*David J. Kyffers*

Director of the United States Patent and Trademark Office

# United States of America

United States Patent and Trademark Office

## Control your work.

**Reg. No. 4,134,248**

**Registered May 1, 2012**

**Int. Cl.: 42**

**SERVICE MARK**

**PRINCIPAL REGISTER**

YOTTAFLOW (OHIO CORPORATION)  
29055 CLEMENS ROAD  
CLEVELAND, OH 44145

FOR: PROVIDING ONLINE NON-DOWNLOADABLE SOFTWARE FOR ACCESSING WEB-BASED APPLICATIONS AND SERVICES THROUGH A WEB OPERATING SYSTEM OR PORTAL INTERFACE, IN CLASS 42 (U.S. CLS. 100 AND 101).

FIRST USE 2-1-2011; IN COMMERCE 2-1-2011.

THE MARK CONSISTS OF STANDARD CHARACTERS WITHOUT CLAIM TO ANY PARTICULAR FONT, STYLE, SIZE, OR COLOR.

SER. NO. 85-286,075, FILED 4-5-2011.

GENE MACIOL, EXAMINING ATTORNEY



*David J. Kybas*

Director of the United States Patent and Trademark Office

# United States of America

United States Patent and Trademark Office

## 401K Study Group

**Reg. No. 4,134,249**

**Registered May 1, 2012**

**Int. Cl.: 41**

**SERVICE MARK**

**PRINCIPAL REGISTER**

RICHARDSON RETIREMENT GROUP, INC. (MARYLAND CORPORATION)  
5132 DORSEY HALL DRIVE  
ELLCOTT CITY, MD 21042

FOR: EDUCATIONAL SERVICES, NAMELY, CONDUCTING CLASSES, SEMINARS, CONFERENCES, WORKSHOPS AND PEER DISCUSSION GROUPS ALL IN THE FIELD OF BUSINESS BEST PRACTICES AND IN THE FIELD OF PENDING LEGISLATION IN THE FIELDS OF RETIREMENT PLANNING AND 401K STRUCTURING OPTIONS, AND DISTRIBUTION OF TRAINING MATERIALS IN CONNECTION THEREWITH; BUSINESS EDUCATION AND TRAINING SERVICES, NAMELY, DEVELOPING AND FACILITATING CUSTOMIZED LEADERSHIP AND EXECUTIVE DEVELOPMENT PROGRAMS, PROVIDING EXECUTIVE COACHING SERVICES, AND PROVIDING BUSINESS EDUCATION PROGRAMS TO EMPLOYEES AND EXECUTIVES; BUSINESS TRAINING, IN CLASS 41 (U.S. CLS. 100, 101 AND 107).

FIRST USE 3-7-2011; IN COMMERCE 3-7-2011.

NO CLAIM IS MADE TO THE EXCLUSIVE RIGHT TO USE "401K STUDY GROUP", APART FROM THE MARK AS SHOWN.

THE MARK CONSISTS OF THE NUMBERS "401" WITH THE NUMBER "1" ALSO APPEARING AS THE LEFT PORTION OF THE LETTER "K", FOLLOWED BY THE WORDS "STUDY GROUP" INSIDE OF SHADED RECTANGULAR SHAPE.

SER. NO. 85-286,630, FILED 4-5-2011.

ELLEN PERKINS, EXAMINING ATTORNEY



*David J. Kybas*

Director of the United States Patent and Trademark Office

**United States of America**  
United States Patent and Trademark Office

# QUICKPIN

**Reg. No. 4,134,250**

**Registered May 1, 2012**

**Int. Cl.: 6**

**TRADEMARK**

**PRINCIPAL REGISTER**

THOMAS & BETTS INTERNATIONAL, INC. (DELAWARE CORPORATION)  
SUITE 67  
501 SILVERSIDE ROAD  
WILMINGTON, DE 19809

FOR: METAL ARM CONNECTIONS FOR ELECTRICAL POLES, NAMELY, METAL ARM CONNECTION PINS FOR USE IN SECURING AND ALIGNING METAL ARMS ON DISTRIBUTION AND TRANSMISSION POLE STRUCTURES, IN CLASS 6 (U.S. CLS. 2, 12, 13, 14, 23, 25 AND 50).

FIRST USE 4-21-2008; IN COMMERCE 4-21-2008.

THE MARK CONSISTS OF STANDARD CHARACTERS WITHOUT CLAIM TO ANY PARTICULAR FONT, STYLE, SIZE, OR COLOR.

SER. NO. 85-286,897, FILED 4-5-2011.

ALICIA COLLINS, EXAMINING ATTORNEY



*David J. Kyffers*

Director of the United States Patent and Trademark Office

# United States of America

United States Patent and Trademark Office

## 5 STAR COLLECTION

**Reg. No. 4,134,251**

**Registered May 1, 2012**

**Int. Cl.: 31**

**TRADEMARK**

**PRINCIPAL REGISTER**

MISTY FLOWERS, INC. (DELAWARE CORPORATION)  
2605 N.W. 75TH STREET  
MIAMI, FL 33122

FOR: CUT FLOWERS; FLOWERS; LIVE FLOWERS, IN CLASS 31 (U.S. CLS. 1 AND 46).

FIRST USE 5-11-1995; IN COMMERCE 5-11-1995.

THE MARK CONSISTS OF STANDARD CHARACTERS WITHOUT CLAIM TO ANY PARTICULAR FONT, STYLE, SIZE, OR COLOR.

NO CLAIM IS MADE TO THE EXCLUSIVE RIGHT TO USE "COLLECTION", APART FROM THE MARK AS SHOWN.

SER. NO. 85-287,028, FILED 4-5-2011.

DAVID TOOLEY, EXAMINING ATTORNEY



*David J. Kyffers*

Director of the United States Patent and Trademark Office

# United States of America

United States Patent and Trademark Office



**Reg. No. 4,134,252**

**Registered May 1, 2012**

**Int. Cl.: 25**

**TRADEMARK**

**PRINCIPAL REGISTER**

GOD'S LYRIC INC. (MICHIGAN CORPORATION)  
32640 WEST WAYBURN STREET  
FARMINGTON HILLS, MI 48334

FOR: TEE SHIRTS, IN CLASS 25 (U.S. CLS. 22 AND 39).

FIRST USE 12-1-2009; IN COMMERCE 12-1-2010.

THE MARK CONSISTS OF THE COLOR WHITE APPEARS IN THE LETTER "G", THE COLOR TURQUOISE APPEARS IN THE LETTER "L" AND THE COLOR BLACK APPEARS IN THE SQUARE BACKGROUND DESIGN.

THE COLOR(S) WHITE, TURQUOISE, AND BLACK IS/ARE CLAIMED AS A FEATURE OF THE MARK.

SER. NO. 85-287,057, FILED S.R. 4-5-2011 AM. P.R. 12-15-2011.

JOHN KELLY, EXAMINING ATTORNEY



*David J. Kyros*

Director of the United States Patent and Trademark Office

# United States of America

United States Patent and Trademark Office

## Walking Free

**Reg. No. 4,134,253**

**Registered May 1, 2012**

**Int. Cl.: 44**

**SERVICE MARK**

**PRINCIPAL REGISTER**

PHYSICIANS FOR PEACE FOUNDATION (VIRGINIA CORPORATION), AKA PHYSICIANS  
FOR PEACE  
SUITE 900  
500 EAST MAIN STREET  
NORFOLK, VA 23510

FOR: FITTING OF PROSTHETIC DEVICES, IN CLASS 44 (U.S. CLS. 100 AND 101).

FIRST USE 7-1-2000; IN COMMERCE 7-1-2000.

THE MARK CONSISTS OF STANDARD CHARACTERS WITHOUT CLAIM TO ANY PARTICULAR FONT, STYLE, SIZE, OR COLOR.

SER. NO. 85-287,562, FILED 4-6-2011.

GRETCHEN ULRICH, EXAMINING ATTORNEY



*David J. Kyros*

Director of the United States Patent and Trademark Office

# United States of America

United States Patent and Trademark Office

## Seeing Clearly

**Reg. No. 4,134,254**

**Registered May 1, 2012**

**Int. Cl.: 44**

PHYSICIANS FOR PEACE FOUNDATION (VIRGINIA CORPORATION), AKA PHYSICIANS  
FOR PEACE  
SUITE 900  
500 E. MAIN ST.  
NORFOLK, VA 23510

**SERVICE MARK**

FOR: TREATMENT OF EYE DISEASES AND CONDITIONS, IN CLASS 44 (U.S. CLS. 100  
AND 101).

**PRINCIPAL REGISTER**

FIRST USE 4-1-2007; IN COMMERCE 4-1-2007.

THE MARK CONSISTS OF STANDARD CHARACTERS WITHOUT CLAIM TO ANY PAR-  
TICULAR FONT, STYLE, SIZE, OR COLOR.

SER. NO. 85-287,618, FILED 4-6-2011.

GRETCHEN ULRICH, EXAMINING ATTORNEY



*David J. Kyffers*

Director of the United States Patent and Trademark Office



# United States of America

United States Patent and Trademark Office

## THE SENIOR SOURCE

**Reg. No. 4,134,255**

**Registered May 1, 2012**

**Int. Cl.: 36**

**SERVICE MARK**

**PRINCIPAL REGISTER**

THE SENIOR SOURCE (DELAWARE CORPORATION)  
3910 HARRY HINES BLVD.  
DALLAS, TX 75219

FOR: FINANCIAL MANAGEMENT SERVICES, NAMELY, ASSISTING MATURE ADULTS AND RETIREES WITH FINANCIAL MANAGEMENT, IN CLASS 36 (U.S. CLS. 100, 101 AND 102).

FIRST USE 12-3-2002; IN COMMERCE 12-3-2002.

THE MARK CONSISTS OF STANDARD CHARACTERS WITHOUT CLAIM TO ANY PARTICULAR FONT, STYLE, SIZE, OR COLOR.

NO CLAIM IS MADE TO THE EXCLUSIVE RIGHT TO USE "SENIOR", APART FROM THE MARK AS SHOWN.

SER. NO. 85-287,801, FILED 4-6-2011.

APRIL ROACH, EXAMINING ATTORNEY



*David J. Kyros*

Director of the United States Patent and Trademark Office

# United States of America

United States Patent and Trademark Office



**cycloflame**

**Reg. No. 4,134,256**

**Registered May 1, 2012**

**Int. Cl.: 11**

**TRADEMARK**

**PRINCIPAL REGISTER**

PRO-IRODA INDUSTRIES, INC. (TAIWAN CORPORATION)  
NO. 68, 32ND RD.  
TAICHUNG INDUSTRIAL PARK, SITUN DISTRICT  
TAICHUNG CITY, TAIWAN

FOR: TORCHES, NAMELY, GAS OR ETHANOL TORCHES FOR LIGHTING; FIREPLACES; PORTABLE INDOOR AND OUTDOOR GEL FUEL FIREPLACES; GAS BURNING FIREPLACES INSERTS IN THE NATURE OF HEAT EXCHANGERS AND SOLID AND GAS FUEL BURNERS; GAS BURNING FIREPLACES; GAS BURNING STOVES, AND REPLACEMENT PARTS THEREFOR; AND GAS LAMPS, IN CLASS 11 (U.S. CLS. 13, 21, 23, 31 AND 34).

FIRST USE 2-28-2011; IN COMMERCE 2-28-2011.

THE MARK CONSISTS OF THE WORD "CYCLOFLAME" IN LOWERCASE IN BLACK BENEATH A STYLIZED DEPICTION OF A FLAME IN RED, ORANGE AND YELLOW THAT IS ENCASED WITHIN A QUADRILATERAL IN BLACK.

THE COLOR(S) BLACK, RED, YELLOW AND ORANGE IS/ARE CLAIMED AS A FEATURE OF THE MARK.

SER. NO. 85-288,707, FILED 4-7-2011.

ALLISON HOLTZ, EXAMINING ATTORNEY



*David J. Kybas*

Director of the United States Patent and Trademark Office

# United States of America

United States Patent and Trademark Office

## EGGTOBERFEST

**Reg. No. 4,134,257**

**Registered May 1, 2012**

**Int. Cl.: 41**

**SERVICE MARK**

**PRINCIPAL REGISTER**

BIG GREEN EGG, INC. (GEORGIA CORPORATION)  
3417 LAWRENCEVILLE HIGHWAY  
ATLANTA, GA 30084

FOR: ENTERTAINMENT SERVICES, NAMELY, PLANNED EVENTS FEATURING INSTRUCTIONAL DEMONSTRATIONS ON GRILLING AND FOOD PREPARATION AND ALSO FEATURING FOOD PREPARATION COMPETITIONS, IN CLASS 41 (U.S. CLS. 100, 101 AND 107).

FIRST USE 1-1-1998; IN COMMERCE 1-1-1998.

THE MARK CONSISTS OF STANDARD CHARACTERS WITHOUT CLAIM TO ANY PARTICULAR FONT, STYLE, SIZE, OR COLOR.

SER. NO. 85-288,789, FILED 4-7-2011.

GINA HAYES, EXAMINING ATTORNEY



*David J. Kybas*

Director of the United States Patent and Trademark Office

# United States of America

United States Patent and Trademark Office

# MIFROMA

**Reg. No. 4,134,258**

FEDERATION OF MIGROS COOPERATIVES (SWITZERLAND CORPORATION)  
LIMMATSTRASSE 152  
ZURICH, SWITZERLAND CH-8005

**Registered May 1, 2012**

**Int. Cl.: 29**

FOR: CHEESE, IN CLASS 29 (U.S. CL. 46).

**TRADEMARK**

THE MARK CONSISTS OF STANDARD CHARACTERS WITHOUT CLAIM TO ANY PARTICULAR FONT, STYLE, SIZE, OR COLOR.

**PRINCIPAL REGISTER**

OWNER OF SWITZERLAND REG. NO. 490819, DATED 10-30-2001, RENEWED AS REG. NO. 490819, DATED 10-4-2011, EXPIRES 10-4-2021.

SER. NO. 85-289,464, FILED 4-7-2011.

CURTIS FRENCH, EXAMINING ATTORNEY



*David J. Kyfos*

Director of the United States Patent and Trademark Office

# United States of America

United States Patent and Trademark Office

## CoastalFlow

LIQUID MEASUREMENT, INC.

**Reg. No. 4,134,259**

**Registered May 1, 2012**

**Int. Cls.: 9, 37 and 42**

**TRADEMARK**

**SERVICE MARK**

**PRINCIPAL REGISTER**

COASTAL FLOW LIQUID MEASUREMENT, INC. (TEXAS CORPORATION)  
SUITE 200  
2222 BAY AREA BLVD.  
HOUSTON, TX 77058

FOR: LIQUID HYDROCARBON MEASUREMENT EQUIPMENT, NAMELY, FLOW METERS, METER PROVERS FOR VERIFYING THE ACCURACY OF METERS WHICH MEASURE FLOW THROUGH PIPELINES, PYCNOMETERS, FLOW COMPUTERS, DENSITY METERS, AND TEMPERATURE AND PRESSURE TRANSMITTERS, IN CLASS 9 (U.S. CLS. 21, 23, 26, 36 AND 38).

FIRST USE 5-1-2004; IN COMMERCE 5-1-2004.

FOR: LIQUID HYDROCARBON MEASUREMENT SERVICES, NAMELY, INSTALLATION, MAINTENANCE, AND REPAIR OF FLOW METERS, FLOW COMPUTERS, METER PROVERS, PYCNOMETERS, DENSITY METERS, TEMPERATURE AND PRESSURE TRANSMITTERS, AND CONTROL SYSTEMS, IN CLASS 37 (U.S. CLS. 100, 103 AND 106).

FIRST USE 5-1-2004; IN COMMERCE 5-1-2004.

FOR: LIQUID HYDROCARBON MEASUREMENT SERVICES, NAMELY, TESTING, ANALYSIS, AND CERTIFICATION OF FLOW METERS, FLOW COMPUTERS, METER PROVERS, PYCNOMETERS, DENSITY METERS, AND TEMPERATURE AND PRESSURE TRANSMITTERS, IN CLASS 42 (U.S. CLS. 100 AND 101).

FIRST USE 5-1-2004; IN COMMERCE 5-1-2004.

NO CLAIM IS MADE TO THE EXCLUSIVE RIGHT TO USE "FLOW LIQUID MEASUREMENT, INC.", APART FROM THE MARK AS SHOWN.

THE COLOR(S) BLACK AND BLUE IS/ARE CLAIMED AS A FEATURE OF THE MARK.

THE MARK CONSISTS OF THE WORD "COASTAL" IN BLACK, AND THE WORDS "FLOW LIQUID MEASUREMENT, INC." IN BLUE, WITH A STYLIZED SEPARATION OF THE WORDS "COASTAL" AND "FLOW".

SER. NO. 85-289,581, FILED 4-7-2011.



*David J. Kyros*

Director of the United States Patent and Trademark Office

**Reg. No. 4,134,259** JOHN DWYER, EXAMINING ATTORNEY

# United States of America

United States Patent and Trademark Office

*Red* mountain

**Reg. No. 4,134,260**

**Registered May 1, 2012**

**Int. Cl.: 35**

**SERVICE MARK**

**PRINCIPAL REGISTER**

RED MOUNTAIN WHOLESALE FLORIST, LLC (UTAH LIMITED LIABILITY COMPANY)  
1109 W 100 S  
PROVO, UT 84601

FOR: WHOLESALE FLORIST SHOPS, IN CLASS 35 (U.S. CLS. 100, 101 AND 102).

FIRST USE 10-30-2002; IN COMMERCE 10-30-2002.

OWNER OF U.S. REG. NO. 3,205,257.

THE MARK CONSISTS OF THE WORDS "RED MOUNTAIN" OVERLAYED ONTO THE DESIGN OF A SINGLE FLOWER AND STEM, WITH THE FLOWER FORMING THE LETTER O IN "MOUNTAIN" AND THE STEM UNDERLINING THE WORD "RED".

SER. NO. 85-290,459, FILED 4-8-2011.

PRISCILLA MILTON, EXAMINING ATTORNEY



*David J. Kyffers*

Director of the United States Patent and Trademark Office

# United States of America

United States Patent and Trademark Office

## FARMVILLE ENGLISH COUNTRYSIDE

**Reg. No. 4,134,261**

**Registered May 1, 2012**

**Int. Cls.: 9 and 41**

**TRADEMARK**

**SERVICE MARK**

**PRINCIPAL REGISTER**

ZYNGA INC. (DELAWARE CORPORATION)  
365 VERMONT STREET  
SAN FRANCISCO, CA 94103

FOR: COMPUTER GAME SOFTWARE; VIDEO GAME PROGRAMS; AND COMPUTER SOFTWARE PLATFORMS FOR SOCIAL NETWORKING; INTERACTIVE VIDEO GAME PROGRAMS; DOWNLOADABLE ELECTRONIC GAME PROGRAMS AND COMPUTER SOFTWARE PLATFORMS FOR SOCIAL NETWORKING THAT MAY BE ACCESSED VIA THE INTERNET, COMPUTERS AND WIRELESS DEVICES, NAMELY, LAPTOP COMPUTERS, MOBILE PHONES, TABLET COMPUTERS AND HANDHELD COMPUTERS; COMPUTER SOFTWARE TO ENABLE UPLOADING, POSTING, SHOWING, DISPLAYING, TAGGING, BLOGGING, SHARING OR OTHERWISE PROVIDING ELECTRONIC MEDIA OR INFORMATION IN THE FIELDS OF VIRTUAL COMMUNITIES, ELECTRONIC GAMING, ENTERTAINMENT, AND GENERAL INTEREST VIA THE INTERNET OR OTHER COMMUNICATIONS NETWORKS WITH THIRD PARTIES; MAGNETIC ENCODED GIFT CARDS, IN CLASS 9 (U.S. CLS. 21, 23, 26, 36 AND 38).

FIRST USE 3-23-2011; IN COMMERCE 3-23-2011.

FOR: PROVIDING ONLINE COMPUTER AND ELECTRONIC GAMES, ENHANCEMENTS WITHIN ONLINE COMPUTER AND ELECTRONIC GAMES, AND GAME APPLICATIONS WITHIN ONLINE COMPUTER AND ELECTRONIC GAMES; PROVIDING ONLINE REVIEWS OF COMPUTER GAMES; PROVIDING INFORMATION RELATING TO COMPUTER GAMES PROVIDED ONLINE; ENTERTAINMENT SERVICES, NAMELY, PROVIDING VIRTUAL ENVIRONMENTS IN WHICH USERS CAN INTERACT THROUGH SOCIAL GAMES FOR RECREATIONAL, LEISURE OR ENTERTAINMENT PURPOSES, IN CLASS 41 (U.S. CLS. 100, 101 AND 107).

FIRST USE 3-23-2011; IN COMMERCE 3-23-2011.

THE MARK CONSISTS OF STANDARD CHARACTERS WITHOUT CLAIM TO ANY PARTICULAR FONT, STYLE, SIZE, OR COLOR.

NO CLAIM IS MADE TO THE EXCLUSIVE RIGHT TO USE "ENGLISH COUNTRYSIDE", APART FROM THE MARK AS SHOWN.

SER. NO. 85-290,860, FILED 4-8-2011.



*David J. Kyros*

Director of the United States Patent and Trademark Office



**Reg. No. 4,134,261** INGA ERVIN, EXAMINING ATTORNEY

# United States of America

United States Patent and Trademark Office

# EVRAS

**Reg. No. 4,134,262**

**Registered May 1, 2012**

**Int. Cl.: 11**

**TRADEMARK**

**PRINCIPAL REGISTER**

LAYNE CHRISTENSEN COMPANY (DELAWARE CORPORATION)  
1900 SHAWNEE MISSION PARKWAY  
MISSION WOODS, KS 66205

FOR: WATER TREATMENT APPARATUS FOR USE IN TREATMENT OF LIQUIDS IN THE NATURE OF WATER, WASTE WATER AND INDUSTRIAL WATER, IN CLASS 11 (U.S. CLS. 13, 21, 23, 31 AND 34).

FIRST USE 10-0-1998; IN COMMERCE 10-0-1998.

THE MARK CONSISTS OF STANDARD CHARACTERS WITHOUT CLAIM TO ANY PARTICULAR FONT, STYLE, SIZE, OR COLOR.

SER. NO. 85-291,806, FILED 4-11-2011.

KATINA MISTER, EXAMINING ATTORNEY



*David J. Kybas*

Director of the United States Patent and Trademark Office

# United States of America

United States Patent and Trademark Office



**Reg. No. 4,134,263**

**Registered May 1, 2012**

**Int. Cl.: 11**

**TRADEMARK**

**PRINCIPAL REGISTER**

LAYNE CHRISTENSEN COMPANY (DELAWARE CORPORATION)  
1900 SHAWNEE MISSION PARKWAY  
MISSION WOODS, KS 66205

FOR: WATER FILTERING SYSTEM FOR COMMERCIAL USE; WATER FILTRATION AND PURIFICATION UNITS AND REPLACEMENT CARTRIDGES AND FILTERS THEREFOR; WATER TREATMENT EQUIPMENT, NAMELY, WATER FILTRATION UNITS, IN CLASS 11 (U.S. CLS. 13, 21, 23, 31 AND 34).

FIRST USE 3-0-2006; IN COMMERCE 3-0-2006.

THE MARK CONSISTS OF A STYLIZED I INSIDE OF A CIRCLE. THE CIRCLE IS INSIDE OF A DESIGN INDICATIVE OF A WATER DROP.

SER. NO. 85-291,812, FILED 4-11-2011.

KATINA MISTER, EXAMINING ATTORNEY



*David J. Kyffers*

Director of the United States Patent and Trademark Office

# United States of America

United States Patent and Trademark Office

# INTEGRA

**Reg. No. 4,134,264**

**Registered May 1, 2012**

**Int. Cl.: 11**

**TRADEMARK**

**PRINCIPAL REGISTER**

LAYNE CHRISTENSEN COMPANY (DELAWARE CORPORATION)  
1900 SHAWNEE MISSION PARKWAY  
MISSION WOODS, KS 66205

FOR: WATER FILTERING SYSTEM FOR COMMERCIAL USE; WATER FILTRATION AND PURIFICATION UNITS AND REPLACEMENT CARTRIDGES AND FILTERS THEREFOR; WATER TREATMENT EQUIPMENT, NAMELY, WATER FILTRATION UNITS, IN CLASS 11 (U.S. CLS. 13, 21, 23, 31 AND 34).

FIRST USE 3-0-2006; IN COMMERCE 3-0-2006.

THE MARK CONSISTS OF STANDARD CHARACTERS WITHOUT CLAIM TO ANY PARTICULAR FONT, STYLE, SIZE, OR COLOR.

SER. NO. 85-291,815, FILED 4-11-2011.

KATINA MISTER, EXAMINING ATTORNEY



*David J. Kyjars*

Director of the United States Patent and Trademark Office

# United States of America

United States Patent and Trademark Office



**Reg. No. 4,134,265**

RINGSIDE PARTNERS, INC. (NEW YORK CORPORATION)  
423 RUSHMORE ROAD  
STORMVILLE, NY 12582

**Registered May 1, 2012**

**Int. Cl.: 38**

FOR: TELECOMMUNICATIONS CONSULTATION, IN CLASS 38 (U.S. CLS. 100, 101 AND 104).

**SERVICE MARK**

FIRST USE 4-1-2011; IN COMMERCE 4-1-2011.

**PRINCIPAL REGISTER**

NO CLAIM IS MADE TO THE EXCLUSIVE RIGHT TO USE "PARTNERS", APART FROM THE MARK AS SHOWN.

THE MARK CONSISTS OF A DIAMOND-SHAPED DESIGN ELEMENT DEPICTING A BOXING RING WITH THE WORDS RINGSIDE PARTNERS SUPERIMPOSED ON THE RIGHT SIDE OF THE DIAMOND-SHAPED DESIGN ELEMENT.

SER. NO. 85-293,282, FILED 4-12-2011.

RICHARD WHITE, EXAMINING ATTORNEY



*David J. Kybas*

Director of the United States Patent and Trademark Office

# United States of America

United States Patent and Trademark Office



**Reg. No. 4,134,266**

**Registered May 1, 2012**

**Int. Cls.: 35 and 41**

**SERVICE MARK**

**PRINCIPAL REGISTER**

THE WASHINGTON UPDATE, LLC (VIRGINIA LIMITED LIABILITY COMPANY)  
6481 BIRCH GROVE COURT  
MCLEAN, VA 22101

FOR: PROVIDING A WEBSITE FEATURING COMMENTARY AND ANALYSIS IN THE FIELD OF GOVERNMENT AFFAIRS CONCERNING TAX AND FISCAL POLICIES AND LEGISLATION, IN CLASS 35 (U.S. CLS. 100, 101 AND 102).

FIRST USE 8-5-2009; IN COMMERCE 8-5-2009.

FOR: EDUCATIONAL SERVICES, NAMELY, PROVIDING SPEECHES AND ORAL PRESENTATIONS TO OTHERS IN THE FIELD OF LEGISLATION, PUBLIC POLICY, SOCIAL PROGRAMS AND INVESTMENT STRATEGIES, IN CLASS 41 (U.S. CLS. 100, 101 AND 107).

FIRST USE 8-5-2009; IN COMMERCE 8-5-2009.

NO CLAIM IS MADE TO THE EXCLUSIVE RIGHT TO USE "THE WASHINGTON UPDATE", APART FROM THE MARK AS SHOWN.

THE MARK CONSISTS OF THE STYLIZED WORDS "THE WASHINGTON UPDATE" WITH A LINE UNDERNEATH THE WORDS AND A DESIGN OF THE OUTLINE OF THE CAPITOL BUILDING DOME AROUND THE WORD "THE".

SER. NO. 85-294,203, FILED 4-13-2011.

LINDA LAVACHE, EXAMINING ATTORNEY



*David J. Kybas*

Director of the United States Patent and Trademark Office

# United States of America

United States Patent and Trademark Office

## COMPLICATO

**Reg. No. 4,134,267**

**Registered May 1, 2012**

**Int. Cl.: 14**

**TRADEMARK**

**PRINCIPAL REGISTER**

LE VIAN CORP. (NEW YORK CORPORATION)  
235 GREAT NECK ROAD  
GREAT NECK, NY 11021

FOR: JEWELRY; WATCHES, IN CLASS 14 (U.S. CLS. 2, 27, 28 AND 50).

FIRST USE 5-22-2006; IN COMMERCE 12-7-2007.

THE MARK CONSISTS OF STANDARD CHARACTERS WITHOUT CLAIM TO ANY PARTICULAR FONT, STYLE, SIZE, OR COLOR.

THE ENGLISH TRANSLATION OF "COMPLICATO" IN THE MARK IS "COMPLICATED".

SER. NO. 85-294,279, FILED 4-13-2011.

INGRID C. EULIN, EXAMINING ATTORNEY



*David J. Kyffers*

Director of the United States Patent and Trademark Office

# United States of America

United States Patent and Trademark Office

## Vehicle history report raising doubt? Justthefaxx checks it out!

**Reg. No. 4,134,268**

**Registered May 1, 2012**

**Int. Cl.: 42**

**SERVICE MARK**

**PRINCIPAL REGISTER**

JUSTHEFAXX, LLC (FLORIDA LIMITED LIABILITY COMPANY)  
1316 E. MICHIGAN STREET  
ORLANDO, FL 32806

FOR: AUTOMOBILE INSPECTION SERVICES, IN CLASS 42 (U.S. CLS. 100 AND 101).

FIRST USE 10-0-2010; IN COMMERCE 10-0-2010.

THE MARK CONSISTS OF STANDARD CHARACTERS WITHOUT CLAIM TO ANY PARTICULAR FONT, STYLE, SIZE, OR COLOR.

NO CLAIM IS MADE TO THE EXCLUSIVE RIGHT TO USE "VEHICLE HISTORY REPORT", APART FROM THE MARK AS SHOWN.

SER. NO. 85-294,310, FILED 4-13-2011.

SHAUNIA CARLYLE, EXAMINING ATTORNEY



*David J. Kyffers*

Director of the United States Patent and Trademark Office



# United States of America

United States Patent and Trademark Office

## The Bentley Burger

**Reg. No. 4,134,269**

**Registered May 1, 2012**

**Int. Cl.: 30**

**TRADEMARK**

**PRINCIPAL REGISTER**

SLIM SKILLETS, LLC (TENNESSEE LIMITED LIABILITY COMPANY)  
SUITE #1  
2200 N. GERMANTOWN PARKWAY  
CORDOVA, TN 38016

FOR: HOT SANDWICHES, NAMELY, HAMBURGERS AND STEAK BURGERS, IN CLASS  
30 (U.S. CL. 46).

FIRST USE 3-15-2011; IN COMMERCE 3-15-2011.

THE MARK CONSISTS OF STANDARD CHARACTERS WITHOUT CLAIM TO ANY PAR-  
TICULAR FONT, STYLE, SIZE, OR COLOR.

NO CLAIM IS MADE TO THE EXCLUSIVE RIGHT TO USE "BURGER", APART FROM THE  
MARK AS SHOWN.

SER. NO. 85-294,332, FILED 4-13-2011.

RUSS HERMAN, EXAMINING ATTORNEY



*David J. Kybas*

Director of the United States Patent and Trademark Office

# United States of America

United States Patent and Trademark Office

# Amerigeeks

**Reg. No. 4,134,270**

**Registered May 1, 2012**

**Int. Cl.: 42**

**SERVICE MARK**

**PRINCIPAL REGISTER**

MATHENY, STEPHEN (UNITED STATES INDIVIDUAL), DBA AMERIGEESKS  
1049 WILLOW GROVE STREET  
ALTAMONTE SPRINGS, FL 32701

FOR: COMPUTER SERVICES, NAMELY, CREATING AN ON-LINE COMMUNITY FOR REGISTERED USERS TO PARTICIPATE IN DISCUSSIONS, GET FEEDBACK FROM THEIR PEERS, FORM VIRTUAL COMMUNITIES, AND ENGAGE IN SOCIAL NETWORKING FEATURING INFORMATION ABOUT COMPUTATIONAL LITERACY, IN CLASS 42 (U.S. CLS. 100 AND 101).

FIRST USE 4-7-2011; IN COMMERCE 4-7-2011.

THE MARK CONSISTS OF STANDARD CHARACTERS WITHOUT CLAIM TO ANY PARTICULAR FONT, STYLE, SIZE, OR COLOR.

SER. NO. 85-294,729, FILED 4-13-2011.

DAWN FELDMAN, EXAMINING ATTORNEY



*David J. Kybas*

Director of the United States Patent and Trademark Office

# United States of America

United States Patent and Trademark Office

# CHOP CHOP

**Reg. No. 4,134,271**

**Registered May 1, 2012**

**Int. Cl.: 9**

**TRADEMARK**

**PRINCIPAL REGISTER**

GAMERIZON STUDIO INC. (CANADA CORPORATION)  
3981, ST-LAURENT BLVD., SUITE 700  
MONTREAL QUEBEC, CANADA H2W1Y5

FOR: COMPUTER GAMES; VIDEO GAMES, ELECTRONIC GAMES AND COMPUTER GAMING SOFTWARE; DOWNLOADABLE COMPUTER GAMES, VIDEO GAMES AND ELECTRONIC GAMES FOR HANDHELD ELECTRONIC DIGITAL DEVICES, PERSONAL DIGITAL ASSISTANTS, HANDHELD MOBILE DIGITAL ELECTRONIC DEVICES AND CELLULAR TELEPHONES, IN CLASS 9 (U.S. CLS. 21, 23, 26, 36 AND 38).

FIRST USE 12-1-2009; IN COMMERCE 12-1-2009.

THE MARK CONSISTS OF STANDARD CHARACTERS WITHOUT CLAIM TO ANY PARTICULAR FONT, STYLE, SIZE, OR COLOR.

SER. NO. 85-295,158, FILED 4-14-2011.

MICHAEL KEATING, EXAMINING ATTORNEY



*David J. Kybas*

Director of the United States Patent and Trademark Office

# United States of America

United States Patent and Trademark Office

# ALTRA

**Reg. No. 4,134,272**

**Registered May 1, 2012**

**Int. Cl.: 25**

**TRADEMARK**

**PRINCIPAL REGISTER**

ICON IP, INC. (DELAWARE CORPORATION)  
1500 SOUTH 1000 WEST  
LOGAN, UT 84321

FOR: SHOES; T-SHIRTS, IN CLASS 25 (U.S. CLS. 22 AND 39).

FIRST USE 3-31-2011; IN COMMERCE 3-31-2011.

THE MARK CONSISTS OF STANDARD CHARACTERS WITHOUT CLAIM TO ANY PARTICULAR FONT, STYLE, SIZE, OR COLOR.

SER. NO. 85-295,559, FILED 4-14-2011.

JOHN GARTNER, EXAMINING ATTORNEY



*David J. Kybas*

Director of the United States Patent and Trademark Office

# United States of America

United States Patent and Trademark Office

# NATURALITH

**Reg. No. 4,134,273**

**Registered May 1, 2012**

**Int. Cl.: 2**

**TRADEMARK**

**PRINCIPAL REGISTER**

SUN CHEMICAL CORPORATION (DELAWARE CORPORATION)  
35 WATERVIEW BLVD.  
PARSIPPANY, NJ 07054

FOR: PRINTING INKS, IN CLASS 2 (U.S. CLS. 6, 11 AND 16).

FIRST USE 7-24-1989; IN COMMERCE 7-24-1989.

THE MARK CONSISTS OF STANDARD CHARACTERS WITHOUT CLAIM TO ANY PARTICULAR FONT, STYLE, SIZE, OR COLOR.

SER. NO. 85-295,874, FILED 4-15-2011.

GEORGE LORENZO, EXAMINING ATTORNEY



*David J. Kyffers*

Director of the United States Patent and Trademark Office

# United States of America

United States Patent and Trademark Office

# REVO TORO

**Reg. No. 4,134,274**

**Registered May 1, 2012**

**Int. Cl.: 28**

**TRADEMARK**

**PRINCIPAL REGISTER**

PURE FISHING, INC. (IOWA CORPORATION)  
LEGAL DEPARTMENT  
1900 18TH STREET  
SPIRIT LAKE, IA 51360

FOR: FISHING REELS; FISHING RODS, IN CLASS 28 (U.S. CLS. 22, 23, 38 AND 50).

FIRST USE 10-1-2008; IN COMMERCE 10-1-2008.

THE MARK CONSISTS OF STANDARD CHARACTERS WITHOUT CLAIM TO ANY PARTICULAR FONT, STYLE, SIZE, OR COLOR.

OWNER OF U.S. REG. NO. 3,314,233.

NO CLAIM IS MADE TO THE EXCLUSIVE RIGHT TO USE "TORO", APART FROM THE MARK AS SHOWN.

SER. NO. 85-296,366, FILED 4-15-2011.

LAURA KOVALSKY, EXAMINING ATTORNEY



*David J. Kybas*

Director of the United States Patent and Trademark Office

# United States of America

United States Patent and Trademark Office



**Reg. No. 4,134,275**

**Registered May 1, 2012**

**Int. Cls.: 9 and 41**

**TRADEMARK**

**SERVICE MARK**

**PRINCIPAL REGISTER**

ZYNGA INC. (DELAWARE CORPORATION)  
365 VERMONT STREET  
SAN FRANCISCO, CA 94103

FOR: COMPUTER GAME SOFTWARE; VIDEO GAME PROGRAMS; AND COMPUTER SOFTWARE PLATFORMS FOR SOCIAL NETWORKING; INTERACTIVE VIDEO GAME PROGRAMS; DOWNLOADABLE ELECTRONIC GAME PROGRAMS AND COMPUTER SOFTWARE PLATFORMS FOR SOCIAL NETWORKING THAT MAY BE ACCESSED VIA THE INTERNET, COMPUTERS AND WIRELESS DEVICES, NAMELY, LAPTOP COMPUTERS, MOBILE PHONES, TABLET COMPUTERS AND HANDHELD COMPUTERS; COMPUTER SOFTWARE TO ENABLE UPLOADING, POSTING, SHOWING, DISPLAYING, TAGGING, BLOGGING, SHARING OR OTHERWISE PROVIDING ELECTRONIC MEDIA OR INFORMATION IN THE FIELDS OF VIRTUAL COMMUNITIES, ELECTRONIC GAMING, ENTERTAINMENT, AND GENERAL INTEREST VIA THE INTERNET OR OTHER COMMUNICATIONS NETWORKS WITH THIRD PARTIES; MAGNETIC ENCODED GIFT CARDS, IN CLASS 9 (U.S. CLS. 21, 23, 26, 36 AND 38).

FIRST USE 3-23-2011; IN COMMERCE 3-23-2011.

FOR: PROVIDING ONLINE COMPUTER AND ELECTRONIC GAMES, ENHANCEMENTS WITHIN ONLINE COMPUTER AND ELECTRONIC GAMES, AND GAME APPLICATIONS WITHIN ONLINE COMPUTER AND ELECTRONIC GAMES; PROVIDING ONLINE REVIEWS OF COMPUTER GAMES; PROVIDING INFORMATION RELATING TO COMPUTER GAMES PROVIDED ONLINE; ENTERTAINMENT SERVICES, NAMELY, PROVIDING VIRTUAL ENVIRONMENTS IN WHICH USERS CAN INTERACT THROUGH SOCIAL GAMES FOR RECREATIONAL, LEISURE OR ENTERTAINMENT PURPOSES, IN CLASS 41 (U.S. CLS. 100, 101 AND 107).

FIRST USE 3-23-2011; IN COMMERCE 3-23-2011.

NO CLAIM IS MADE TO THE EXCLUSIVE RIGHT TO USE "ENGLISH COUNTRYSIDE", APART FROM THE MARK AS SHOWN.

THE MARK CONSISTS OF THE WORD "FARMVILLE" OVER THE WORDS "ENGLISH COUNTRYSIDE". THE WORDS "ENGLISH COUNTRYSIDE" ARE INSIDE A BANNER IN FRONT OF A PLAQUE. THE WORD "FARMVILLE" IS ON THE PLAQUE. THE TOP OF THE PLAQUE HAS DECORATIVE LEAVES ON TOP.



*David J. Kyjars*

Director of the United States Patent and Trademark Office

**Reg. No. 4,134,275** SER. NO. 85-296,464, FILED 4-15-2011.

INGA ERVIN, EXAMINING ATTORNEY



# United States of America

United States Patent and Trademark Office



# STRONG

## POOLS & SPAS

**Reg. No. 4,134,276**

**Registered May 1, 2012**

**Int. Cl.: 11**

**TRADEMARK**

**PRINCIPAL REGISTER**

STRONG INDUSTRIES, INC. (PENNSYLVANIA CORPORATION)  
3204 POINT TOWNSHIP DRIVE  
NORTHUMBERLAND, PA 17857

FOR: SPAS IN THE NATURE OF HEATED POOLS; FILTERS, HEATERS AND PUMPS SOLD AS A UNIT FOR USE IN POOLS AND SPAS; WATER JETS FOR USE IN SPAS , IN CLASS 11 (U.S. CLS. 13, 21, 23, 31 AND 34).

FIRST USE 3-3-2003; IN COMMERCE 3-3-2003.

NO CLAIM IS MADE TO THE EXCLUSIVE RIGHT TO USE "POOLS & SPAS", APART FROM THE MARK AS SHOWN.

THE MARK CONSISTS OF THE WORDS "STRONG POOLS & SPAS" WITH A CIRCLE TO THE LEFT OF THE LETTERING CONTAINING TWO STYLIZED DROPS OF WATER SEPARATED BY THE LETTER "S".

SER. NO. 85-296,630, FILED 4-15-2011.

IRA J. GOODSaid, EXAMINING ATTORNEY



*David J. Kyffers*

Director of the United States Patent and Trademark Office

# United States of America

United States Patent and Trademark Office



**Reg. No. 4,134,277**

**Registered May 1, 2012**

**Int. Cl.: 30**

**TRADEMARK**

**PRINCIPAL REGISTER**

MILLER, DEBORAH MINKOFF (UNITED STATES INDIVIDUAL), DBA BANANA LOVE  
5244 WATSON STREET, NW  
WASHINGTON, DC 20016

FOR: BAKED GOOD AND CONFECTION VEGAN PRODUCTS, NAMELY, MUFFINS,  
COOKIES, TRUFFLES, CAKES, CUPCAKES, PIES, PASTRIES, SCONES AND DANISH, IN  
CLASS 30 (U.S. CL. 46).

FIRST USE 12-1-2010; IN COMMERCE 12-1-2010.

THE MARK CONSISTS OF A STYLIZED TOP VIEW OF A MUFFIN.

SER. NO. 85-297,246, FILED 4-17-2011.

PAUL MORENO, EXAMINING ATTORNEY



*David J. Kybas*

Director of the United States Patent and Trademark Office

# United States of America

United States Patent and Trademark Office

# TITRIPAC

**Reg. No. 4,134,278**

**Registered May 1, 2012**

**Int. Cls.: 1 and 20**

**TRADEMARK**

**PRINCIPAL REGISTER**

MERCK KGAA (FED REP GERMANY KOMMANDITGESELLSCHAFT AUF AKTIEN (KGAA))  
FRANKFURTER STR. 250  
64293 DARMSTADT, FED REP GERMANY

FOR: LABORATORY CHEMICALS FOR SCIENTIFIC, DIAGNOSTIC AND RESEARCH USE,  
IN CLASS 1 (U.S. CLS. 1, 5, 6, 10, 26 AND 46).

FOR: PORTABLE CONTAINERS MADE OF PLASTIC FOR LABORATORY CHEMICALS;  
PORTABLE CONTAINERS MADE OF PLASTIC AND CARDBOARD COMPOUNDS FOR  
LABORATORY CHEMICALS, IN CLASS 20 (U.S. CLS. 2, 13, 22, 25, 32 AND 50).

THE MARK CONSISTS OF STANDARD CHARACTERS WITHOUT CLAIM TO ANY PAR-  
TICULAR FONT, STYLE, SIZE, OR COLOR.

OWNER OF ERPN CMNTY TM OFC REG. NO. 003534311, DATED 5-13-2005, EXPIRES 11-  
12-2013.

OWNER OF U.S. REG. NO. 2,942,234.

SER. NO. 85-297,586, FILED 4-18-2011.

JESSICA FATHY, EXAMINING ATTORNEY



*David J. Kybas*

Director of the United States Patent and Trademark Office

# United States of America

United States Patent and Trademark Office



**Reg. No. 4,134,279**

**Registered May 1, 2012**

**Int. Cl.: 35**

**SERVICE MARK**

**PRINCIPAL REGISTER**

C.R.A.S. (CALIFORNIA SOLE PROPRIETORSHIP)  
514 EAST SECOND AVE.  
LA HABRA, CA 90631

FOR: CHARITABLE SERVICES, NAMELY, ORGANIZING AND CONDUCTING VOLUNTEER PROGRAMS AND COMMUNITY SERVICE PROJECTS, IN CLASS 35 (U.S. CLS. 100, 101 AND 102).

FIRST USE 4-0-2008; IN COMMERCE 4-0-2008.

THE MARK CONSISTS OF A BLUE AND WHITE FIST WITH A RED IMPACT BACKGROUND THAT IS OUTLINED IN BLUE; BELOW THE FIST IS "C.R.A.S." IN RED STYLIZED LETTERS.

THE COLOR(S) RED, BLUE AND WHITE IS/ARE CLAIMED AS A FEATURE OF THE MARK.

SER. NO. 85-297,673, FILED 4-18-2011.

SARA BENJAMIN, EXAMINING ATTORNEY



*David J. Kyffers*

Director of the United States Patent and Trademark Office

# United States of America

United States Patent and Trademark Office



**Reg. No. 4,134,280**

**Registered May 1, 2012**

**Int. Cls.: 36 and 39**

**SERVICE MARK**

**PRINCIPAL REGISTER**

NORTHAMERICAN TERMINALS, LLC (DELAWARE LIMITED LIABILITY COMPANY),  
DBA NORTHAMERICAN TERMINALS  
201 WEST STREET, SUITE 200  
ANNAPOLIS, MD 21401

FOR: REAL ESTATE ACQUISITION SERVICES, REAL ESTATE PROCUREMENT FOR OTHERS, LEASING OF REAL ESTATE, REAL ESTATE MANAGEMENT, REAL ESTATE INVESTMENT AND REAL ESTATE EQUITY SHARING, NAMELY, MANAGING AND ARRANGING FOR CO-OWNERSHIP OF REAL ESTATE, IN CLASS 36 (U.S. CLS. 100, 101 AND 102).

FIRST USE 1-1-1997; IN COMMERCE 1-1-1997.

FOR: RENTAL OF WAREHOUSE SPACE, IN CLASS 39 (U.S. CLS. 100 AND 105).

FIRST USE 1-1-1997; IN COMMERCE 1-1-1997.

NO CLAIM IS MADE TO THE EXCLUSIVE RIGHT TO USE "NORTHAMERICAN TERMINALS", APART FROM THE MARK AS SHOWN.

THE MARK CONSISTS OF THE WORDING "NORTHAMERICAN" IN THE COLOR RED AND A TRIANGULAR APEX DESIGN IN THE COLOR BLUE ABOVE THE WORDING. BELOW THE RED WORDING IS A BLUE RECTANGULAR SHAPE ABOVE THE WORDING "TERMINALS" IN THE COLOR BLUE.

SER. NO. 85-297,783, FILED 4-18-2011.

WILLIAM ROSSMAN, EXAMINING ATTORNEY



*David J. Kyjars*

Director of the United States Patent and Trademark Office

# United States of America

United States Patent and Trademark Office

# GOD'S PRO

**Reg. No. 4,134,281**

ALSTON, ARTHUR (UNITED STATES INDIVIDUAL)  
2707 WOODLAND AVE  
NORFOLK, VA 23504

**Registered May 1, 2012**

**Int. Cl.: 25**

FOR: BELTS; BOTTOMS; FOOTWEAR; GLOVES AS CLOTHING; HEADGEAR, NAMELY, HATS AND CAPS; JACKETS; PANTS; TOPS, IN CLASS 25 (U.S. CLS. 22 AND 39).

**TRADEMARK**

FIRST USE 1-7-2011; IN COMMERCE 1-7-2011.

**PRINCIPAL REGISTER**

THE MARK CONSISTS OF STANDARD CHARACTERS WITHOUT CLAIM TO ANY PARTICULAR FONT, STYLE, SIZE, OR COLOR.

SER. NO. 85-297,867, FILED 4-18-2011.

MICHAEL WEBSTER, EXAMINING ATTORNEY



*David J. Kybas*

Director of the United States Patent and Trademark Office

# United States of America

United States Patent and Trademark Office

# ANYSYNC

**Reg. No. 4,134,282**

**Registered May 1, 2012**

**Int. Cl.: 9**

**TRADEMARK**

**PRINCIPAL REGISTER**

INDIVIDUAL SOFTWARE, INC. (CALIFORNIA CORPORATION)  
4255 HOPYARD ROAD, #2  
PLEASANTON, CA 94588

FOR: COMPUTER SOFTWARE, NAMELY, DATA SYNCHRONIZATION SOFTWARE FOR SYNCHRONIZATION AND TRANSFER OF DATA AND FILES BETWEEN PORTABLE AND HAND-HELD COMPUTING AND COMMUNICATION DEVICES, NAMELY, PERSONAL DIGITAL ASSISTANTS, DIGITAL PERSONAL INFORMATION MANAGERS, AND DESKTOP COMPUTING DEVICES AND SERVERS; COMPUTER SOFTWARE FOR DATA AND FILE BACKUP AND STORAGE, AND FOR DUPLICATE FILE MANAGEMENT BETWEEN PORTABLE AND HAND-HELD COMPUTING AND COMMUNICATION DEVICES, NAMELY, PERSONAL DIGITAL ASSISTANTS, DIGITAL PERSONAL INFORMATION MANAGERS, AND DESKTOP COMPUTING DEVICES AND SERVERS; INSTRUCTIONAL AND USER MANUALS SOLD AS A UNIT WITH THE PREVIOUSLY IDENTIFIED COMPUTER SOFTWARE, IN CLASS 9 (U.S. CLS. 21, 23, 26, 36 AND 38).

FIRST USE 1-1-2000; IN COMMERCE 1-1-2000.

THE MARK CONSISTS OF STANDARD CHARACTERS WITHOUT CLAIM TO ANY PARTICULAR FONT, STYLE, SIZE, OR COLOR.

SER. NO. 85-298,016, FILED 4-18-2011.

SHAILA SETTLES, EXAMINING ATTORNEY



*David J. Kyros*

Director of the United States Patent and Trademark Office

# United States of America

United States Patent and Trademark Office

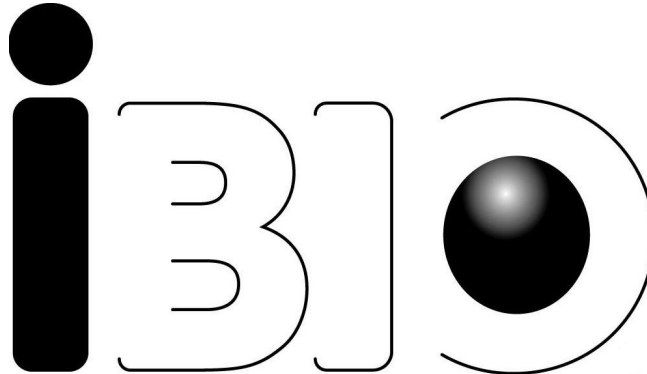

**Reg. No. 4,134,283**

**Registered May 1, 2012**

**Int. Cl.: 35**

**SERVICE MARK**

**PRINCIPAL REGISTER**

ILLINOIS BIOTECHNOLOGY INDUSTRY ORGANIZATION (ILLINOIS CORPORATION)  
SUITE 1600  
65 E. WACKER PLACE  
CHICAGO, IL 60601

FOR: ASSOCIATION SERVICES, NAMELY, PROMOTING THE INTEREST OF ENTITIES AND INDIVIDUALS IN THE LIFE SCIENCES INDUSTRY THROUGH THE PROMOTION OF LEGISLATION AND REGULATIONS, EDUCATION, TRAINING, SUPPORT OF ENTREPRENEURSHIP, PUBLIC DISCOURSE AND PUBLIC RELATIONS, IN CLASS 35 (U.S. CLS. 100, 101 AND 102).

FIRST USE 9-0-2005; IN COMMERCE 9-0-2005.

OWNER OF U.S. REG. NO. 2,943,544.

THE MARK CONSISTS OF THE WORD "IBIO" STYLIZED IN DARK AND LIGHT, WITH THE FIRST LETTER "I" SHADED DARK AND THE CENTER OF THE LETTER "O" SHADED DARK.

SER. NO. 85-298,105, FILED 4-18-2011.

TIMOTHY FINNEGAN, EXAMINING ATTORNEY



*David J. Kybas*

Director of the United States Patent and Trademark Office



# United States of America

United States Patent and Trademark Office

# PEACETONES

**Reg. No. 4,134,284**

INTERNETBAR.ORG INSTITUTE, INC. (MASSACHUSETTS CORPORATION)  
365 BOSTON POST ROAD, STE. 135  
SUDBURY, MA 01776

**Registered May 1, 2012**

**Int. Cls.: 9, 35, 36 and 41**

FOR: DIGITAL MEDIA, NAMELY, DOWNLOADABLE AUDIO FILES FEATURING MUSIC; AUDIO RECORDINGS FEATURING MUSIC; DIGITAL MUSIC DOWNLOADABLE FROM THE INTERNET, IN CLASS 9 (U.S. CLS. 21, 23, 26, 36 AND 38).

**TRADEMARK**

FIRST USE 8-24-2009; IN COMMERCE 8-24-2009.

**SERVICE MARK**

FOR: CHARITABLE AND ASSOCIATION SERVICES, NAMELY, PROMOTING PUBLIC AWARENESS OF PEACE, POVERTY ALLEVIATION, ECONOMIC OPPORTUNITY AND HUMAN RIGHTS; ONLINE RETAIL STORE SERVICES FEATURING DOWNLOADABLE PRE-RECORDED MUSIC, MUSICAL RECORDINGS, AND ARTS AND CRAFTS, IN CLASS 35 (U.S. CLS. 100, 101 AND 102).

**PRINCIPAL REGISTER**

FIRST USE 6-0-2009; IN COMMERCE 6-0-2009.

FOR: CHARITABLE FUNDRAISING SERVICES BY MEANS OF SELLING DOWNLOADABLE PRE-RECORDED MUSIC, MUSICAL RECORDINGS, AND ARTS AND CRAFTS, WITH PROCEEDS THEREFROM INTENDED FOR CHARITABLE SERVICES, IN CLASS 36 (U.S. CLS. 100, 101 AND 102).

FIRST USE 12-0-2008; IN COMMERCE 12-0-2008.

FOR: MUSIC PUBLISHING; MUSIC COMPOSITION FOR OTHERS; PROVISION OF INFORMATION RELATING TO MUSIC, IN CLASS 41 (U.S. CLS. 100, 101 AND 107).

FIRST USE 8-24-2009; IN COMMERCE 8-24-2009.

THE MARK CONSISTS OF STANDARD CHARACTERS WITHOUT CLAIM TO ANY PARTICULAR FONT, STYLE, SIZE, OR COLOR.

SER. NO. 85-298,454, FILED 4-19-2011.

RONALD MCMORROW, EXAMINING ATTORNEY

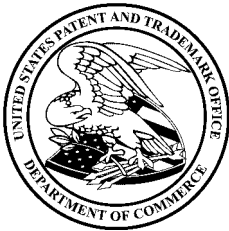

*David J. Kyros*

Director of the United States Patent and Trademark Office

# United States of America

United States Patent and Trademark Office



**Reg. No. 4,134,285**

**Registered May 1, 2012**

**Int. Cl.: 44**

**SERVICE MARK**

**PRINCIPAL REGISTER**

KARRASCH, STEVEN J (NOAH) (UNITED STATES INDIVIDUAL), DBA CORE BODYWORK  
777 E BATTLEFIELD, STE 103E  
SPRINGFIELD, MO 65807

FOR: BODYWORK THERAPY SERVICES, NAMELY, STRUCTURAL INTEGRATION  
THERAPY AND MOVEMENT THERAPY, IN CLASS 44 (U.S. CLS. 100 AND 101).

FIRST USE 1-1-1995; IN COMMERCE 1-1-1996.

NO CLAIM IS MADE TO THE EXCLUSIVE RIGHT TO USE "CORE BODYWORK", APART  
FROM THE MARK AS SHOWN.

THE MARK CONSISTS OF A BEFORE AND AFTER DRAWING OF A CLIENT OF BODY-  
WORK, WITH BEFORE IN A BLACK DOWN ARROW AND THE AFTER IN AN UPWARD  
BLACK ARROW. BETWEEN THE IMAGES IS THE WORD "CORE" AND BELOW IS THE  
WORD "BODYWORK".

SER. NO. 85-299,665, FILED 4-20-2011.

NATALIE POLZER, EXAMINING ATTORNEY



*David J. Kybas*

Director of the United States Patent and Trademark Office

# United States of America

United States Patent and Trademark Office

## HYBRID ENTERTAINMENT

**Reg. No. 4,134,286**

**Registered May 1, 2012**

**Int. Cls.: 35 and 41**

**SERVICE MARK**

**PRINCIPAL REGISTER**

PITTMAN, ELLEN (UNITED STATES INDIVIDUAL)  
1720 N. ORANGE GROVE AVENUE  
LOS ANGELES, CA 90046

FOR: BUSINESS ADVISORY SERVICES, CONSULTANCY AND INFORMATION; BUSINESS CONSULTING AND INFORMATION SERVICES; BUSINESS CONSULTING, MANAGEMENT, PLANNING AND SUPERVISION; BUSINESS MANAGEMENT CONSULTANCY AND ADVISORY SERVICES; BUSINESS MANAGEMENT CONSULTING AND ADVISORY SERVICES FOR THE ENTERTAINMENT INDUSTRY; MANAGEMENT AND BUSINESS CONSULTING SERVICES IN THE FIELD OF ENTERTAINMENT; PROVIDING CONSUMER INFORMATION AND RELATED NEWS IN THE FIELD OF ENTERTAINMENT, IN CLASS 35 (U.S. CLS. 100, 101 AND 102).

FIRST USE 4-10-2008; IN COMMERCE 4-10-2008.

FOR: ENTERTAINMENT MEDIA PRODUCTION SERVICES FOR MOTION PICTURES, TELEVISION AND INTERNET; ON-LINE JOURNALS, NAMELY, BLOGS FEATURING ENTERTAINMENT, IN CLASS 41 (U.S. CLS. 100, 101 AND 107).

FIRST USE 4-10-2008; IN COMMERCE 4-10-2008.

THE MARK CONSISTS OF STANDARD CHARACTERS WITHOUT CLAIM TO ANY PARTICULAR FONT, STYLE, SIZE, OR COLOR.

NO CLAIM IS MADE TO THE EXCLUSIVE RIGHT TO USE "ENTERTAINMENT", APART FROM THE MARK AS SHOWN.

SER. NO. 85-299,877, FILED 4-20-2011.

MICHAEL WEBSTER, EXAMINING ATTORNEY



*David J. Kyros*

Director of the United States Patent and Trademark Office

United States of America  
United States Patent and Trademark Office

**SR SENIOR REACH**

**Reg. No. 4,134,287**

**Registered May 1, 2012**

**Int. Cls.: 35, 44 and 45**

**SERVICE MARK**

**PRINCIPAL REGISTER**

JEFFERSON CENTER FOR MENTAL HEALTH, INC. (COLORADO CORPORATION)  
SUITE 200  
4851 INDEPENDENCE STREET  
WHEAT RIDGE, CO 80033

FOR: COMMUNITY SERVICE PROGRAM FOR OUTREACH AND ASSISTANCE TO OLDER ADULTS, NAMELY, REFERRAL TO COMMUNITY AGENCIES, IN CLASS 35 (U.S. CLS. 100, 101 AND 102).

FIRST USE 12-12-2005; IN COMMERCE 10-1-2008.

FOR: COMMUNITY SERVICE PROGRAM FOR OUTREACH AND ASSISTANCE TO OLDER ADULTS, NAMELY, HEALTH RISK ASSESSMENT IN THE NATURE OF HEALTHY LIFESTYLE ASSESSMENT, COUNSELING FOR MENTAL HEALTH ISSUES AS IT RELATES TO RELATIONSHIPS, AND WELLNESS CONSULTING, IN CLASS 44 (U.S. CLS. 100 AND 101).

FIRST USE 12-12-2005; IN COMMERCE 10-1-2008.

FOR: COMMUNITY SERVICE PROGRAM FOR OUTREACH AND ASSISTANCE TO OLDER ADULTS, NAMELY, IN-HOME SUPPORT SERVICES TO SENIOR PERSONS, NAMELY, GERIATRIC CARE MANAGEMENT TO COORDINATE MENTAL AND PRIMARY CARE HEALTH, IN CLASS 45 (U.S. CLS. 100 AND 101).

FIRST USE 12-12-2005; IN COMMERCE 10-1-2008.

NO CLAIM IS MADE TO THE EXCLUSIVE RIGHT TO USE "SENIOR", APART FROM THE MARK AS SHOWN.

THE MARK CONSISTS OF A STYLIZED "SR" AND THE WORDS "SENIOR REACH".

SER. NO. 85-299,881, FILED 4-20-2011.

TINA MAI, EXAMINING ATTORNEY



*David J. Kyffers*

Director of the United States Patent and Trademark Office

# United States of America

United States Patent and Trademark Office

**HYBRID**  
**ENTERTAINMENT**

**Reg. No. 4,134,288**

**Registered May 1, 2012**

**Int. Cls.: 35 and 41**

**SERVICE MARK**

**PRINCIPAL REGISTER**

PITTMAN, ELLEN (UNITED STATES INDIVIDUAL)  
1720 N. ORANGE GROVE AVENUE  
LOS ANGELES, CA 90046

FOR: BUSINESS ADVISORY SERVICES, CONSULTANCY AND INFORMATION; BUSINESS CONSULTING AND INFORMATION SERVICES; BUSINESS CONSULTING, MANAGEMENT, PLANNING AND SUPERVISION; BUSINESS MANAGEMENT CONSULTANCY AND ADVISORY SERVICES; BUSINESS MANAGEMENT CONSULTING AND ADVISORY SERVICES FOR THE ENTERTAINMENT INDUSTRY; MANAGEMENT AND BUSINESS CONSULTING SERVICES IN THE FIELD OF ENTERTAINMENT; PROVIDING CONSUMER INFORMATION AND RELATED NEWS IN THE FIELD OF ENTERTAINMENT, IN CLASS 35 (U.S. CLS. 100, 101 AND 102).

FIRST USE 4-10-2008; IN COMMERCE 4-10-2008.

FOR: ENTERTAINMENT MEDIA PRODUCTION SERVICES FOR MOTION PICTURES, TELEVISION AND INTERNET; ON-LINE JOURNALS, NAMELY, BLOGS FEATURING ENTERTAINMENT, IN CLASS 41 (U.S. CLS. 100, 101 AND 107).

FIRST USE 4-10-2008; IN COMMERCE 4-10-2008.

NO CLAIM IS MADE TO THE EXCLUSIVE RIGHT TO USE "ENTERTAINMENT", APART FROM THE MARK AS SHOWN.

THE COLOR(S) RED, GREY AND BLACK IS/ARE CLAIMED AS A FEATURE OF THE MARK.

THE MARK CONSISTS OF THE STYLIZED WORD "HYBRID". THE LETTER "H" OF THE WORD "HYBRID" IS RED. THE LETTERS "YBRID" ARE GREY. DIRECTLY BELOW THE WORD "HYBRID" IS THE WORD "ENTERTAINMENT" IN ALL BLACK CAPITAL LETTERS SUPERIMPOSED IN FRONT OF A LIGHT GREY RECTANGULAR BACKGROUND. AFTER THE FINAL LETTER "T" IN THE WORD "ENTERTAINMENT" IS A RED HORIZONTAL LINE THAT EXTENDS FROM THE END OF THE TOP OF THE "T".



*David J. Kypas*

Director of the United States Patent and Trademark Office

SER. NO. 85-299,896, FILED 4-20-2011.

MICHAEL WEBSTER, EXAMINING ATTORNEY

# United States of America

United States Patent and Trademark Office

# PERMALON

**Reg. No. 4,134,289**

**Registered May 1, 2012**

**Int. Cl.: 1**

**TRADEMARK**

**PRINCIPAL REGISTER**

GREAT LAKES ENVIRONMENTAL CONTROLS, INC. (CANADA CORPORATION)  
1387 CONFEDERATION ST.  
SARNIA, CANADA N7S-5P1

FOR: POLYMERIC LUBRICATION ADDITIVE SOLD AS AN INTEGRAL INGREDIENT OF MULTIPURPOSE WATERPROOF AND WATER RESISTANT LUBRICANT, IN CLASS 1 (U.S. CLS. 1, 5, 6, 10, 26 AND 46).

FIRST USE 3-12-2011; IN COMMERCE 3-12-2011.

THE MARK CONSISTS OF STANDARD CHARACTERS WITHOUT CLAIM TO ANY PARTICULAR FONT, STYLE, SIZE, OR COLOR.

SER. NO. 85-299,966, FILED 4-20-2011.

GRETTA YAO, EXAMINING ATTORNEY



*David J. Kyffers*

Director of the United States Patent and Trademark Office

# United States of America

United States Patent and Trademark Office

# SunForce

**Reg. No. 4,134,290**

**Registered May 1, 2012**

**Int. Cls.: 17 and 19**

**TRADEMARK**

**PRINCIPAL REGISTER**

ASAHI KASEI CHEMICALS CORPORATION (JAPAN CORPORATION)  
1-105 KANDA JINBOCHO, CHIYODA-KU  
TOKYO, JAPAN 1018101

FOR: PLASTIC SEMI-WORKED PRODUCTS, NAMELY, SEMI-WORKED SYNTHETIC PLASTIC AND SYNTHETIC RESINS AS SEMI-FINISHED PRODUCTS IN THE FORM OF PELLETS, BEADS, RODS, BARS, PIPES, TUBES, BOARDS, PLATES, SPONGES, FOAMS, TAPES, STRIPS, FOILS, FILMS, SHEETS AND FIBERS; HEAT INSULATING MATERIALS OF SYNTHETIC PLASTIC AND SYNTHETIC RESINS AS SEMI-FINISHED PRODUCTS IN THE FORM OF PELLETS, BEADS, RODS, BARS, PIPES, TUBES, BOARDS, PLATES, SPONGES, FOAMS, TAPES, STRIPS, FOILS, FILMS, SHEETS AND FIBERS, IN CLASS 17 (U.S. CLS. 1, 5, 12, 13, 35 AND 50).

FOR: NON-METAL BUILDING MATERIALS, NAMELY, SYNTHETIC PLASTIC AND SYNTHETIC RESINS FOR BUILDING IN THE FORM OF PELLETS, BEADS, RODS, BARS, PIPES, TUBES, BOARDS, PLATES, SPONGES, FOAMS, TAPES, STRIPS, FOILS, FILMS, SHEETS AND FIBERS; NON-METAL BUILDING MATERIALS, NAMELY, HEAT INSULATING MATERIALS OF SYNTHETIC PLASTIC AND SYNTHETIC RESINS AS BUILDING PARTS IN THE FORM OF PELLETS, BEADS, RODS, BARS, PIPES, TUBES, BOARDS, PLATES, SPONGES, FOAMS, TAPES, STRIPS, FOILS, FILMS, SHEETS AND FIBERS, IN CLASS 19 (U.S. CLS. 1, 12, 33 AND 50).

THE MARK CONSISTS OF STANDARD CHARACTERS WITHOUT CLAIM TO ANY PARTICULAR FONT, STYLE, SIZE, OR COLOR.

OWNER OF JAPAN REG. NO. 5437263, DATED 9-9-2011, EXPIRES 9-9-2021.

SER. NO. 85-300,034, FILED 4-20-2011.

ANNE E. GUSTASON, EXAMINING ATTORNEY



*David J. Kyros*

Director of the United States Patent and Trademark Office

# United States of America

United States Patent and Trademark Office

## Growth Revolution

**Reg. No. 4,134,291**

**Registered May 1, 2012**

**Int. Cl.: 35**

**SERVICE MARK**

**PRINCIPAL REGISTER**

GROWTH REVOLUTION INC. (KENTUCKY CORPORATION)  
2236 BOULEVARD NAPOLEON  
LOUISVILLE, KY 40205

FOR: ADVERTISING AND MARKETING CONSULTANCY; BRAND IMAGERY CONSULTING SERVICES; BRANDING SERVICES, NAMELY, CONSULTING, DEVELOPMENT, MANAGEMENT AND MARKETING OF BRANDS FOR BUSINESSES; BUSINESS CONSULTATION, IN CLASS 35 (U.S. CLS. 100, 101 AND 102).

FIRST USE 4-1-2011; IN COMMERCE 4-1-2011.

THE MARK CONSISTS OF STANDARD CHARACTERS WITHOUT CLAIM TO ANY PARTICULAR FONT, STYLE, SIZE, OR COLOR.

SER. NO. 85-300,625, FILED 4-21-2011.

JOHN DWYER, EXAMINING ATTORNEY



*David J. Kyffers*

Director of the United States Patent and Trademark Office



# United States of America

United States Patent and Trademark Office

## Susan's Selections

**Reg. No. 4,134,292**

**Registered May 1, 2012**

**Int. Cl.: 35**

**SERVICE MARK**

**PRINCIPAL REGISTER**

MORE THAN MOVING FOR SENIORS, INC. (VIRGINIA CORPORATION), DBA SUSAN'S SELECTIONS  
8008 STAPLES MILL ROAD  
RICHMOND, VA 23228

FOR: ARRANGING OF AUCTION SALES; ARRANGING, PLANNING, AND CONDUCTING TAG SALES, ESTATE LIQUIDATION SALES, YARD SALES OR GARAGE SALES FOR OTHERS; ON-LINE CONSIGNMENT SERVICES WHEREBY GOODS ARE RECEIVED ON CONSIGNMENT FOR AUCTION ON AN ONLINE AUCTION SITE; RETAIL CONSIGNMENT STORES FEATURING ANTIQUES, HOME FURNISHINGS, IN CLASS 35 (U.S. CLS. 100, 101 AND 102).

FIRST USE 8-26-1999; IN COMMERCE 8-26-1999.

THE MARK CONSISTS OF STANDARD CHARACTERS WITHOUT CLAIM TO ANY PARTICULAR FONT, STYLE, SIZE, OR COLOR.

NO CLAIM IS MADE TO THE EXCLUSIVE RIGHT TO USE "SELECTIONS", APART FROM THE MARK AS SHOWN.

THE NAME(S), PORTRAIT(S), AND/OR SIGNATURE(S) SHOWN IN THE MARK IDENTIFIES "SUSAN" CAMPBELL, WHOSE CONSENT(S) TO REGISTER IS MADE OF RECORD.

SER. NO. 85-301,460, FILED 4-21-2011.

SAIMA MAKHDOOM, EXAMINING ATTORNEY



*David J. Kyros*

Director of the United States Patent and Trademark Office

# United States of America

United States Patent and Trademark Office

# WAXPOL

**Reg. No. 4,134,293**

**Registered May 1, 2012**

**Int. Cl.: 3**

**TRADEMARK**

**PRINCIPAL REGISTER**

THE WAXPOL INDUSTRIES LIMITED (INDIA LIMITED COMPANY (LTD.))  
9 MITTER HOUSE  
71 GANESH CHANDRA AVE, KOLKATA 700 013  
KOLKATA, INDIA

FOR: AUTOMOBILE POLISH; CAR POLISH; SILICONE POLISH, NAMELY, CLEANING, POLISHING AND SCOURING PREPARATIONS; METAL CLEANING, POLISHING AND SCOURING PREPARATIONS; VINYL CLEANING, POLISHING AND SCOURING PREPARATIONS; LEATHER CLEANING POLISH; AUTOMOBILE DASHBOARD POLISH; LEATHER CONDITIONER, NAMELY, PRESERVATIVE CREAMS FOR LEATHER; AUTOMOBILE POLISH, NAMELY, PREPARATIONS FOR CLEANING, PROTECTING AND PRESERVING VEHICLE SURFACES; WINDSHIELD CLEANER FLUID; GLASS CLEANER; HAND CLEANERS AND CLEANING PREPARATIONS; RUBBING COMPOUND, NAMELY, BUFFING COMPOUND FOR VEHICLE AND GENERAL PURPOSE SURFACES; FINISHING COMPOUND, NAMELY, CLEANING, POLISHING, SCOURING AND ABRASIVE PREPARATIONS FOR VEHICLE SURFACES, COATED SURFACES AND UNCOATED SURFACES; SCOURING AND ABRASIVE PREPARATIONS, FOR CLEANING, POLISHING, WAXING, RESTORING AND RESERVING VEHICLE SURFACES, IN CLASS 3 (U.S. CLS. 1, 4, 6, 50, 51 AND 52).

THE MARK CONSISTS OF STANDARD CHARACTERS WITHOUT CLAIM TO ANY PARTICULAR FONT, STYLE, SIZE, OR COLOR.

OWNER OF INDIA REG. NO. 1225175, DATED 8-20-2003, EXPIRES 8-20-2013.

SER. NO. 85-301,503, FILED 4-21-2011.

SCOTT BIBB, EXAMINING ATTORNEY



*David J. Kyffers*

Director of the United States Patent and Trademark Office

# United States of America

United States Patent and Trademark Office

## SUMMER BRIDGE ACTIVITIES

**Reg. No. 4,134,294**

**Registered May 1, 2012**

**Int. Cl.: 16**

**TRADEMARK**

**PRINCIPAL REGISTER**

CARSON-DELLOSA PUBLISHING, LLC (DELAWARE LIMITED LIABILITY COMPANY)  
7027 ALBERT PICK ROAD  
GREENSBORO, NC 27409

FOR: SERIES OF EDUCATIONAL BOOKS FOR CHILDREN, IN CLASS 16 (U.S. CLS. 2, 5, 22, 23, 29, 37, 38 AND 50).

FIRST USE 12-31-1992; IN COMMERCE 12-31-1995.

THE MARK CONSISTS OF STANDARD CHARACTERS WITHOUT CLAIM TO ANY PARTICULAR FONT, STYLE, SIZE, OR COLOR.

NO CLAIM IS MADE TO THE EXCLUSIVE RIGHT TO USE "ACTIVITIES", APART FROM THE MARK AS SHOWN.

SEC. 2(F).

SER. NO. 85-301,521, FILED 4-21-2011.

EDWARD NELSON, EXAMINING ATTORNEY



*David J. Kyffers*

Director of the United States Patent and Trademark Office

# United States of America

United States Patent and Trademark Office

## Nutrient Expert

**Reg. No. 4,134,295**

**Registered May 1, 2012**

**Int. Cl.: 9**

**TRADEMARK**

**PRINCIPAL REGISTER**

INTERNATIONAL PLANT NUTRITION INSTITUTE (DELAWARE CORPORATION)  
3500 PARKWAY LANE SUITE 550  
NORCROSS, GA 30092

FOR: COMPUTER SOFTWARE FOR FORMULATING FERTILIZER GUIDELINES TO ASSIST FARMERS IN ATTAINING AGRICULTURAL YIELD GOALS, IN CLASS 9 (U.S. CLS. 21, 23, 26, 36 AND 38).

FIRST USE 12-16-2009; IN COMMERCE 12-16-2009.

THE MARK CONSISTS OF STANDARD CHARACTERS WITHOUT CLAIM TO ANY PARTICULAR FONT, STYLE, SIZE, OR COLOR.

NO CLAIM IS MADE TO THE EXCLUSIVE RIGHT TO USE "NUTRIENT", APART FROM THE MARK AS SHOWN.

SER. NO. 85-301,553, FILED 4-21-2011.

BARBARA GAYNOR, EXAMINING ATTORNEY



*David J. Kybas*

Director of the United States Patent and Trademark Office

# United States of America

United States Patent and Trademark Office

# MODA-FDC

**Reg. No. 4,134,296**

**Registered May 1, 2012**

**Int. Cl.: 9**

**TRADEMARK**

**PRINCIPAL REGISTER**

LONZA WALKERSVILLE, INC. (DELAWARE CORPORATION)  
8830 BIGGS FORD ROAD  
WALKERSVILLE, MD 217930127

FOR: COMPUTER HARDWARE AND SOFTWARE SYSTEM FOR DATA CAPTURE, COLLECTIONS, LABELING AND TESTING IN THE FIELD OF LIFE SCIENCES; ALL FOCUSED ON AUTOMATION, NAMELY, ENVIRONMENTAL MONITORING, UTILITY TESTING, AND PRODUCT TESTING, IN CLASS 9 (U.S. CLS. 21, 23, 26, 36 AND 38).

FIRST USE 1-0-2006; IN COMMERCE 1-0-2006.

THE MARK CONSISTS OF STANDARD CHARACTERS WITHOUT CLAIM TO ANY PARTICULAR FONT, STYLE, SIZE, OR COLOR.

THE ENGLISH TRANSLATION OF "MODA" IN THE MARK IS "TREND".

SER. NO. 85-303,593, FILED 4-25-2011.

LINDA ESTRADA, EXAMINING ATTORNEY



*David J. Kybas*

Director of the United States Patent and Trademark Office

# United States of America

United States Patent and Trademark Office

# MODA

**Reg. No. 4,134,297**

**Registered May 1, 2012**

**Int. Cl.: 9**

**TRADEMARK**

**PRINCIPAL REGISTER**

LONZA WALKERSVILLE, INC. (DELAWARE CORPORATION)  
8830 BIGGS FORD ROAD  
WALKERSVILLE, MD 217930127

FOR: COMPUTER HARDWARE AND SOFTWARE SYSTEM FOR MONITORING ENVIRONMENTAL CONDITIONS AND MANAGING QUALITY CONTROL IN THE FIELD OF LIFE SCIENCES; COMPUTER SOFTWARE THAT PROVIDES WEB-BASED ACCESS TO MANUFACTURING OPERATIONS AND TESTING DATA THROUGH A PORTAL INTERFACE; COMPUTER HARDWARE AND SOFTWARE SYSTEM FOR DATA CAPTURE, COLLECTIONS, LABELING AND TESTING IN THE FIELD OF LIFE SCIENCES; ALL FOCUSED ON AUTOMATION, NAMELY, ENVIRONMENTAL MONITORING, UTILITY TESTING, AND PRODUCT TESTING, IN CLASS 9 (U.S. CLS. 21, 23, 26, 36 AND 38).

FIRST USE 1-0-2006; IN COMMERCE 1-0-2006.

THE MARK CONSISTS OF STANDARD CHARACTERS WITHOUT CLAIM TO ANY PARTICULAR FONT, STYLE, SIZE, OR COLOR.

THE ENGLISH TRANSLATION OF "MODA" IN THE MARK IS "TREND".

SER. NO. 85-303,613, FILED 4-25-2011.

LINDA ESTRADA, EXAMINING ATTORNEY



*David J. Kybas*

Director of the United States Patent and Trademark Office

# United States of America

United States Patent and Trademark Office

## THE SECURITY DEPOSIT ALTERNATIVE.

**Reg. No. 4,134,298**

**Registered May 1, 2012**

**Int. Cl.: 36**

**SERVICE MARK**

**PRINCIPAL REGISTER**

ASSURANT, INC. (DELAWARE CORPORATION)  
ONE CHASE MANHATTAN PLAZA  
41ST FLOOR  
NEW YORK, NY 10005

FOR: FINANCIAL GUARANTEE AND SURETY SERVICES, IN CLASS 36 (U.S. CLS. 100, 101 AND 102).

FIRST USE 9-0-2004; IN COMMERCE 9-0-2004.

THE MARK CONSISTS OF STANDARD CHARACTERS WITHOUT CLAIM TO ANY PARTICULAR FONT, STYLE, SIZE, OR COLOR.

NO CLAIM IS MADE TO THE EXCLUSIVE RIGHT TO USE "SECURITY DEPOSIT", APART FROM THE MARK AS SHOWN.

SER. NO. 85-305,740, FILED 4-27-2011.

JULIE WATSON, EXAMINING ATTORNEY



*David J. Kybas*

Director of the United States Patent and Trademark Office

# United States of America

United States Patent and Trademark Office

## PRIDE OF THE NEIGHBORHOOD

**Reg. No. 4,134,299**

**Registered May 1, 2012**

**Int. Cl.: 30**

**TRADEMARK**

**PRINCIPAL REGISTER**

OROGRAIN BAKERIES PRODUCTS, INC. (DELAWARE CORPORATION)  
255 BUSINESS CENTER DRIVE  
HORSHAM, PA 19044

FOR: BAKERY PRODUCTS, IN CLASS 30 (U.S. CL. 46).

FIRST USE 4-4-2010; IN COMMERCE 4-4-2010.

THE MARK CONSISTS OF STANDARD CHARACTERS WITHOUT CLAIM TO ANY PARTICULAR FONT, STYLE, SIZE, OR COLOR.

SER. NO. 85-305,787, FILED 4-27-2011.

TIMOTHY FINNEGAN, EXAMINING ATTORNEY



*David J. Kybas*

Director of the United States Patent and Trademark Office



# United States of America

United States Patent and Trademark Office

## EIGHT PACK

**Reg. No. 4,134,300**

**Registered May 1, 2012**

**Int. Cl.: 12**

**TRADEMARK**

**PRINCIPAL REGISTER**

HUFFY CORPORATION (OHIO CORPORATION)  
6551 CENTERVILLE BUSINESS PARKWAY  
CENTERVILLE, OH 45459

FOR: BICYCLES AND STRUCTURAL PARTS THEREOF, IN CLASS 12 (U.S. CLS. 19, 21, 23, 31, 35 AND 44).

FIRST USE 3-1-1998; IN COMMERCE 3-1-1998.

THE MARK CONSISTS OF STANDARD CHARACTERS WITHOUT CLAIM TO ANY PARTICULAR FONT, STYLE, SIZE, OR COLOR.

SER. NO. 85-306,349, FILED 4-27-2011.

TINA L. SNAPP, EXAMINING ATTORNEY



*David J. Kyffers*

Director of the United States Patent and Trademark Office

# United States of America

United States Patent and Trademark Office



**Reg. No. 4,134,301**

**Registered May 1, 2012**

**Int. Cls.: 35 and 41**

**SERVICE MARK**

**PRINCIPAL REGISTER**

NAVARRO DISCOUNT PHARMACIES, LLC. (FLORIDA LIMITED LIABILITY COMPANY)  
9400 NW 104 STREET  
MEDLEY, FL 33178

FOR: WHOLESALE AND RETAIL DISCOUNT STORE SERVICES FEATURING, HEALTH-CARE PRODUCTS, BEAUTY AIDS, PREPARATIONS FOR SANITARY USE, COSMETICS, PERFUMERY, PERSONAL CARE PRODUCTS, STATIONERY, CANDY, SNACKS, CAMERAS, GIFTWARE, HARDWARE, TOBACCO PRODUCTS, SOFT DRINKS, BEER, WINE AND OTHER NON-ALCOHOLIC DRINKS, BOOKS, HOUSEHOLD, KITCHEN AND AUTOMOBILE ACCESSORIES, MOBILE PHONES, ELECTRONICS, SMALL HOME APPLIANCES, MEDICAL EQUIPMENT AND FOOD PRODUCTS; RETAIL PHARMACY SERVICES, IN CLASS 35 (U.S. CLS. 100, 101 AND 102).

FIRST USE 12-31-2007; IN COMMERCE 12-31-2007.

FOR: PHOTOGRAPHIC COMPOSITION FOR OTHERS, IN CLASS 41 (U.S. CLS. 100, 101 AND 107).

FIRST USE 12-31-2007; IN COMMERCE 12-31-2007.

OWNER OF U.S. REG. NOS. 2,098,890 AND 2,102,864.

NO CLAIM IS MADE TO THE EXCLUSIVE RIGHT TO USE "DISCOUNT PHARMACIES", APART FROM THE MARK AS SHOWN.

THE MARK CONSISTS OF THE STYLIZED WORDING "NAVARRO DISCOUNT PHARMACIES" WITH A MORTAR AND PESTLE, DISPLAYED WITHIN AN INCOMPLETE RECTANGLE.

SER. NO. 85-306,392, FILED 4-27-2011.

EVELYN BRADLEY, EXAMINING ATTORNEY



*David J. Kybas*

Director of the United States Patent and Trademark Office

# United States of America

United States Patent and Trademark Office

## LEGEND

**Reg. No. 4,134,302**

**Registered May 1, 2012**

**Int. Cl.: 12**

**TRADEMARK**

**PRINCIPAL REGISTER**

HUFFY CORPORATION (OHIO CORPORATION)  
6551 CENTERVILLE BUSINESS PARKWAY  
CENTERVILLE, OH 45459

FOR: BICYCLES AND STRUCTURAL PARTS THEREOF, IN CLASS 12 (U.S. CLS. 19, 21, 23, 31, 35 AND 44).

FIRST USE 9-1-1995; IN COMMERCE 9-1-1995.

THE MARK CONSISTS OF STANDARD CHARACTERS WITHOUT CLAIM TO ANY PARTICULAR FONT, STYLE, SIZE, OR COLOR.

SER. NO. 85-306,592, FILED 4-27-2011.

TINA L. SNAPP, EXAMINING ATTORNEY



*David J. Kyffers*

Director of the United States Patent and Trademark Office

# United States of America

United States Patent and Trademark Office



**Reg. No. 4,134,303**

**Registered May 1, 2012**

**Int. Cl.: 9**

**TRADEMARK**

**PRINCIPAL REGISTER**

TENNRICH INTERNATIONAL CORP. (TAIWAN CORPORATION)  
LUCHU HSIANG  
NO.1-3,ALLEY 5, LN.305,HSIN-NANRD.,SEC.1  
TAOYUAN HSIEH, TAIWAN

FOR: BATTERIES; RECHARGEABLE BATTERIES; BATTERY CHARGERS; SOLAR CELLS;  
ELECTRIC CONVERTERS; ELECTRIC SOCKETS; ELECTRICAL CONNECTERS; LITHIUM  
BATTERIES; COMPUTER CURSOR CONTROL DEVICES, NAMELY, COMPUTER MICE;  
POWER SUPPLIES; ADAPTERS, NAMELY, POWER SUPPLY ADAPTORS, ELECTRIC AD-  
APTORS AND PLUG ADAPTORS, IN CLASS 9 (U.S. CLS. 21, 23, 26, 36 AND 38).

FIRST USE 1-1-2011; IN COMMERCE 1-1-2011.

OWNER OF U.S. REG. NO. 3,887,276.

NO CLAIM IS MADE TO THE EXCLUSIVE RIGHT TO USE "POWER", APART FROM THE  
MARK AS SHOWN.

THE MARK CONSISTS OF THE SHADED SHAPE OF A CIRCLE WITH A FLAT BOTTOM  
AND FLAT RIGHT SIDE WITH THE WORD "XPAL" IN THE CENTER AND THE WORD  
"POWER" IN SMALLER FONT BELOW IT.

SER. NO. 85-306,673, FILED 4-27-2011.

WILLIAM P. SHANAHAN, EXAMINING ATTORNEY



*David J. Kyros*

Director of the United States Patent and Trademark Office

# United States of America

United States Patent and Trademark Office

# NEXTSTORE

**Reg. No. 4,134,304**

**Registered May 1, 2012**

**Int. Cl.: 42**

**SERVICE MARK**

**PRINCIPAL REGISTER**

NEXTCLOUD, LLC (DELAWARE LIMITED LIABILITY COMPANY)  
1100 NORTH MARKET BOULEVARD  
SACRAMENTO, CA 95834

FOR: APPLICATION SERVICE PROVIDER (ASP), NAMELY, HOSTING COMPUTER SOFTWARE APPLICATIONS OF OTHERS; COMPUTER DISASTER RECOVERY PLANNING; COMPUTER SERVICES, NAMELY, CLOUD HOSTING PROVIDER SERVICES; COMPUTER SERVICES, NAMELY, PROVIDING VIRTUAL AND NON VIRTUAL APPLICATION SERVERS, WEB SERVERS, FILE SERVERS, CO-LOCATION SERVERS, LOAD BALANCING SERVERS, REDUNDANCY SERVERS, MEDIA SERVERS AND DATABASE SERVERS OF VARIABLE CAPACITY TO THIRD PARTY COMPUTING AND DATA STORAGE FACILITIES; COMPUTER SERVICES, NAMELY, REMOTE AND ON-SITE MANAGEMENT OF CLOUD COMPUTING SYSTEMS AND APPLICATIONS FOR OTHERS; COMPUTER SERVICES, NAMELY, REMOTE AND ON-SITE MANAGEMENT OF THE INFORMATION TECHNOLOGY (IT) CLOUD COMPUTING SYSTEMS OF OTHERS; PROVIDING VIRTUAL COMPUTER SYSTEMS AND VIRTUAL COMPUTER ENVIRONMENTS THROUGH CLOUD COMPUTING, IN CLASS 42 (U.S. CLS. 100 AND 101).

FIRST USE 4-28-2011; IN COMMERCE 4-28-2011.

THE MARK CONSISTS OF STANDARD CHARACTERS WITHOUT CLAIM TO ANY PARTICULAR FONT, STYLE, SIZE, OR COLOR.

SER. NO. 85-306,931, FILED 4-28-2011.

ANGELA DUONG, EXAMINING ATTORNEY



*David J. Kybas*

Director of the United States Patent and Trademark Office

# United States of America

United States Patent and Trademark Office



**Reg. No. 4,134,305**

**Registered May 1, 2012**

**Int. Cl.: 29**

**TRADEMARK**

**PRINCIPAL REGISTER**

TIM BOB RIST (UNITED STATES INDIVIDUAL)  
2423 WORCHESTER RD.  
HENDERSON, NV 89074

FOR: APPETIZERS, NAMELY, BREADED AND FRIED JALAPENO PEPPERS; HOT CHILI PEPPER PUREE; JELLIES FOR FOOD; PICKLED JALAPENOS; PRESERVED, FROZEN, DRIED OR COOKED VEGETABLES, IN CLASS 29 (U.S. CL. 46).

FIRST USE 9-8-2008; IN COMMERCE 9-8-2008.

NO CLAIM IS MADE TO THE EXCLUSIVE RIGHT TO USE "CALIENTE PEPPER COMPANY PREMIUM ALL-NATURAL CALIENTE JALAPENO PEPPERS", APART FROM THE MARK AS SHOWN.

THE MARK CONSISTS OF A BARBED WIRE BORDER SURROUNDING A STYLIZED BARN. THE WORDS "CALIENTE PEPPER COMPANY" ARE ABOVE THE BARN. THE WORDS "PREMIUM ALL-NATURAL CALIENTE JALAPENO PEPPERS" ARE BELOW THE BARN. THE WORDS BELOW THE BARN ARE FLANKED BY STYLIZED IMAGES OF PEPPERS.

THE ENGLISH TRANSLATION OF "CALIENTE" IN THE MARK IS "HOT".

SER. NO. 85-307,737, FILED 4-28-2011.

NATALIE POLZER, EXAMINING ATTORNEY



*David J. Kybas*

Director of the United States Patent and Trademark Office

# United States of America

United States Patent and Trademark Office

# PINK'S

**Reg. No. 4,134,306**

**Registered May 1, 2012**

**Int. Cls.: 29, 30 and 43**

**TRADEMARK**

**SERVICE MARK**

**PRINCIPAL REGISTER**

PINK'S HOT DOGS, INC. (CALIFORNIA CORPORATION)  
709 N. LA BREA AVENUE  
LOS ANGELES, CA 90038

FOR: CHILI AND HOT DOGS, IN CLASS 29 (U.S. CL. 46).

FIRST USE 3-15-1975; IN COMMERCE 3-15-1975.

FOR: HOT DOG SANDWICHES , IN CLASS 30 (U.S. CL. 46).

FIRST USE 3-15-1975; IN COMMERCE 3-15-1975.

FOR: RESTAURANT SERVICES, NAMELY, DINE-IN AND CARRY-OUT FOOD SERVICES  
AND CATERING SERVICES, IN CLASS 43 (U.S. CLS. 100 AND 101).

FIRST USE 3-15-1975; IN COMMERCE 3-15-1975.

OWNER OF U.S. REG. NOS. 2,251,554 AND 2,274,399.

THE MARK CONSISTS OF THE WORD "PINK'S" IN ALL CAPITAL, SLIGHTLY CURVED  
BLOCK LETTERS.

SER. NO. 85-307,762, FILED 4-28-2011.

MICHELE SWAIN, EXAMINING ATTORNEY



*David J. Kyffers*

Director of the United States Patent and Trademark Office

# United States of America

United States Patent and Trademark Office

# Red Chariot

**Reg. No. 4,134,307**

**Registered May 1, 2012**

**Int. Cl.: 35**

**SERVICE MARK**

**PRINCIPAL REGISTER**

PROCESS DISPLAYS CO. (MINNESOTA CORPORATION), DBA RED CHARIOT  
7108 31ST AVE. N.  
MINNEAPOLIS, MN 55427

FOR: DESIGNING OF ADVERTISING MATERIALS FOR OTHERS, NAMELY, TEMPORARY AND PERMANENT POINT-OF SALE RETAIL DISPLAYS, SEASONAL SIGNAGE AND IN-STORE FIXTURES , IN CLASS 35 (U.S. CLS. 100, 101 AND 102).

FIRST USE 7-0-2010; IN COMMERCE 10-13-2010.

THE MARK CONSISTS OF STANDARD CHARACTERS WITHOUT CLAIM TO ANY PARTICULAR FONT, STYLE, SIZE, OR COLOR.

SER. NO. 85-308,604, FILED 4-29-2011.

JOHN DALIER, EXAMINING ATTORNEY



*David J. Kyffers*

Director of the United States Patent and Trademark Office



# United States of America

United States Patent and Trademark Office

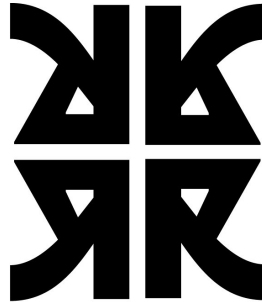

**RED CHARIOT**

**Reg. No. 4,134,308**

**Registered May 1, 2012**

**Int. Cl.: 35**

**SERVICE MARK**

**PRINCIPAL REGISTER**

PROCESS DISPLAYS CO. (MINNESOTA CORPORATION), DBA RED CHARIOT  
7108 31ST AVE. N.  
MINNEAPOLIS, MN 55427

FOR: DESIGNING OF ADVERTISING MATERIALS FOR OTHERS, NAMELY, TEMPORARY AND PERMANENT POINT-OF SALE RETAIL DISPLAYS, SEASONAL SIGNAGE AND IN-STORE FIXTURES , IN CLASS 35 (U.S. CLS. 100, 101 AND 102).

FIRST USE 7-0-2010; IN COMMERCE 10-13-2010.

THE MARK CONSISTS OF A SQUARE COMPOSED OF FOUR SYMMETRICALLY ARRANGED CAPITAL LETTER "R"S WITH THE WORDS "RED CHARIOT" UNDERNEATH.

SER. NO. 85-308,649, FILED 4-29-2011.

JOHN DALIER, EXAMINING ATTORNEY



*David J. Kyros*

Director of the United States Patent and Trademark Office

# United States of America

United States Patent and Trademark Office

## I Can Do Math!

**Reg. No. 4,134,309**

**Registered May 1, 2012**

**Int. Cl.: 41**

**SERVICE MARK**

**PRINCIPAL REGISTER**

SHAPIRO, HOWARD (SOUTH AFRICA INDIVIDUAL)  
P.O. BOX 23964  
SANTA FE, NM 87502

FOR: EDUCATIONAL SERVICES, NAMELY, CONDUCTING CLASSES, SEMINARS, CONFERENCES AND WORKSHOPS IN THE FIELD OF MATH; PROVIDING COURSES OF INSTRUCTION AT THE PRIMARY AND SECONDARY LEVEL AND DISTRIBUTION OF COURSE MATERIALS IN CONNECTION THEREWITH IN HARD COPY OR ELECTRONIC FORMAT, IN CLASS 41 (U.S. CLS. 100, 101 AND 107).

FIRST USE 4-7-2010; IN COMMERCE 4-8-2011.

THE MARK CONSISTS OF STANDARD CHARACTERS WITHOUT CLAIM TO ANY PARTICULAR FONT, STYLE, SIZE, OR COLOR.

SER. NO. 85-309,266, FILED 5-1-2011.

SIMON TENG, EXAMINING ATTORNEY



*David J. Kyffers*

Director of the United States Patent and Trademark Office

# United States of America

United States Patent and Trademark Office



**Reg. No. 4,134,310**

**Registered May 1, 2012**

**Int. Cl.: 30**

**TRADEMARK**

**PRINCIPAL REGISTER**

GRUPO BIMBO, S.A. B. DE C.V. (MEXICO CORPORATION)  
PROLONGACION PASEO DE LA REFORMA  
NO. 1000, COL. PENA BLANCA SANTA FE  
MEXICO CITY, MEXICO 01210

FOR: FRIED CORN SNACKS AND FRIED WHEAT FLOUR SNACKS, IN CLASS 30 (U.S. CL. 46).

FIRST USE 5-31-2006; IN COMMERCE 5-31-2006.

OWNER OF U.S. REG. NOS. 2,374,912, 3,847,239 AND OTHERS.

THE COLOR(S) BLACK, WHITE, YELLOW, ORANGE, RED, BLUE, BROWN, AND GREEN IS/ARE CLAIMED AS A FEATURE OF THE MARK.

NO CLAIM IS MADE TO THE EXCLUSIVE RIGHT TO USE "CHILI & CHEESE FLAVORED," "CORN CHIPS," AND THE PICTORIAL REPRESENTATION OF THE CHILI PEPPER, CHEESE AND CORN CHIPS, APART FROM THE MARK AS SHOWN.

THE MARK CONSISTS OF DESIGN FEATURES OF PRODUCT PACKAGING WITH THE WORD "TOSTACHOS" IN YELLOW OUTLINED IN BLACK; THE WORDS "CHILI & CHEESE" IN BLACK OUTLINED IN YELLOW WITH THE SMALLER WORDING "FLAVORED" UNDERNEATH IN YELLOW; THREE ORANGE AND BROWN CHIPS, A PIECE OF CHEESE IN TWO SHADES OF YELLOW AND BROWN AND A CURVING LINE IN YELLOW, AND A GREEN PEPPER WITH SHADING IN A DARKER SHADE OF GREEN, WHITE HIGHLIGHTS AND BLACK OUTLINE; ALL ON A BACKGROUND OF ORANGE WITH LIGHT ORANGE AND BROWN SPIRALS. IN THE BOTTOM RIGHT ARE THE WORDS "CORN CHIPS" IN WHITE, AND IN THE TOP LEFT IS A "B" IN WHITE AND "BARCEL" IN YELLOW ON A RED QUADRILATERAL, ALL WITH BLUE SHADOWS. THE MARK REPRESENTS DESIGN FEATURES OF PACKAGING; THE CONFIGURATION OF THE PACKAGING ITSELF, AS REPRESENTED BY DOTTED LINES, IS NOT CLAIMED AS A FEATURE OF THE MARK.

THE WORDING "TOSTACHOS" HAS NO MEANING IN A FOREIGN LANGUAGE.

SER. NO. 85-309,621, FILED 5-2-2011.

ROBIN MITTLER, EXAMINING ATTORNEY



*David J. Kappas*

Director of the United States Patent and Trademark Office

# United States of America

United States Patent and Trademark Office



**Reg. No. 4,134,311**

**Registered May 1, 2012**

**Int. Cls.: 16 and 35**

**TRADEMARK**

**SERVICE MARK**

**PRINCIPAL REGISTER**

OGDEN DIRECTORIES OF PA, INC. (PENNSYLVANIA CORPORATION)  
301 CAYUGA AVE.  
ALTOONA, PA 16602

FOR: TELEPHONE DIRECTORIES, IN CLASS 16 (U.S. CLS. 2, 5, 22, 23, 29, 37, 38 AND 50).

FIRST USE 4-1-2011; IN COMMERCE 4-1-2011.

FOR: TELEPHONE DIRECTORY INFORMATION, IN CLASS 35 (U.S. CLS. 100, 101 AND 102).

FIRST USE 7-1-2010; IN COMMERCE 7-1-2010.

NO CLAIM IS MADE TO THE EXCLUSIVE RIGHT TO USE DESIGN OF THE WALKING FINGERS ON THE OPEN DIRECTORY, "EASY TO USE.COM", "DIRECTORIES, INC.", "YOUR YELLOW PAGES CONNECTION", AND "IN PRINT & ONLINE", APART FROM THE MARK AS SHOWN.

THE MARK CONSISTS OF FINGERS ON AN OPEN DIRECTORY ABOVE THE WORDING "OGDEN DIRECTORIES INC."; TO THE RIGHT OF THE DIRECTORY DESIGN IS THE WORDING "EZTOUSE.COM" FOLLOWED BY FINGERS ON A MOUSE; UNDER ALL THESE FEATURES IS THE WORDING "YOUR YELLOW PAGES CONNECTION" INSIDE A BANNER; FOLLOWED BY THE WORDING "IN PRINT & ONLINE" IN RECTANGULAR BOX.

SER. NO. 85-309,767, FILED 5-2-2011.

PRISCILLA MILTON, EXAMINING ATTORNEY



*David J. Kybas*

Director of the United States Patent and Trademark Office

# United States of America

United States Patent and Trademark Office

愛找茶

**Reg. No. 4,134,312**

**Registered May 1, 2012**

**Int. Cl.: 43**

**SERVICE MARK**

**PRINCIPAL REGISTER**

ANS, LLC (CALIFORNIA LIMITED LIABILITY COMPANY), DBA I-TEA CAFE  
5335 VIA ZOPAPO  
YORBA LINDA, CA 92887

FOR: CAFE AND RESTAURANT SERVICES, COFFEE AND TEA BARS, IN CLASS 43 (U.S. CLS. 100 AND 101).

FIRST USE 1-5-2011; IN COMMERCE 1-5-2011.

THE MARK CONSISTS OF THREE CHINESE MANDARIN CHARACTERS, "I", "ZHAO" AND "CHA". THE SECOND CHARACTER CONTAINS A TILTED HEART IN THE UPPER RIGHT CORNER.

THE NON-LATIN CHARACTERS IN THE MARK TRANSLITERATE TO "I ZHAO CHA" AND THIS MEANS "LOVE FIND TEA" IN ENGLISH.

THE ENGLISH TRANSLATION OF THE CHINESE CHARACTERS IN THE MARK IS "LOVE FIND TEA".

SER. NO. 85-310,181, FILED 5-2-2011.

GRETCHEN ULRICH, EXAMINING ATTORNEY



*David J. Kyros*

Director of the United States Patent and Trademark Office

# United States of America

United States Patent and Trademark Office

# CARDTHIS

**Reg. No. 4,134,313**

**Registered May 1, 2012**

**Int. Cl.: 42**

**SERVICE MARK**

**PRINCIPAL REGISTER**

PIGSPIGOT, LLC (DELAWARE LIMITED LIABILITY COMPANY)  
578 DRIGGS AVENUE #2  
BROKLYN, NY 11211

FOR: PROVIDING TEMPORARY USE OF ON-LINE NON-DOWNLOADABLE SOFTWARE FOR SELECTING IMAGES TO BE PRINTED ON GREETING CARDS, MUGS, T-SHIRTS AND POSTERS, IN CLASS 42 (U.S. CLS. 100 AND 101).

FIRST USE 12-15-2010; IN COMMERCE 12-15-2010.

THE MARK CONSISTS OF STANDARD CHARACTERS WITHOUT CLAIM TO ANY PARTICULAR FONT, STYLE, SIZE, OR COLOR.

SER. NO. 85-311,813, FILED 5-4-2011.

ALYSSA STEEL, EXAMINING ATTORNEY



*David J. Kybas*

Director of the United States Patent and Trademark Office

# United States of America

United States Patent and Trademark Office



CardThis  
Share the Web in Print

**Reg. No. 4,134,314**

**Registered May 1, 2012**

**Int. Cl.: 42**

**SERVICE MARK**

**PRINCIPAL REGISTER**

PIGSPIGOT, LLC (DELAWARE LIMITED LIABILITY COMPANY)  
578 DRIGGS AVENUE #2  
BROKLYN, NY 11211

FOR: PROVIDING TEMPORARY USE OF ON-LINE NON-DOWNLOADABLE SOFTWARE FOR SELECTING IMAGES TO BE PRINTED ON GREETING CARDS, MUGS, T-SHIRTS AND POSTERS, IN CLASS 42 (U.S. CLS. 100 AND 101).

FIRST USE 12-15-2010; IN COMMERCE 12-15-2010.

THE MARK CONSISTS OF A PARTIALLY OPEN GREETING CARD IN VARYING SHADES OF MEDIUM TO LIGHT BLUE, WITH A LARGE WHITE ARROW POINTING TO THE LEFT ON THE FRONT COVER, TO THE RIGHT OF WHICH IS THE TERM "CARDTHIS" IN LIGHT GRAY LETTERING WITH A BLACK OUTLINE, OVER THE PHRASE "SHARE THE WEB IN PRINT" IN GRAY LETTERING.

THE COLOR(S) BLUE, WHITE AND GRAY AND BLACK IS/ARE CLAIMED AS A FEATURE OF THE MARK.

SER. NO. 85-311,903, FILED 5-4-2011.

ALYSSA STEEL, EXAMINING ATTORNEY



*David J. Kyjars*

Director of the United States Patent and Trademark Office

# United States of America

United States Patent and Trademark Office

## WISE CHOICE BOXING TRAINING & FITNESS

**Reg. No. 4,134,315**

**Registered May 1, 2012**

**Int. Cl.: 41**

**SERVICE MARK**

**PRINCIPAL REGISTER**

WISE CHOICE BOXING TRAINING & FITNESS, INC. (VIRGINIA CORPORATION)  
P.O. BOX 177  
EXMORE, VA 23350

FOR: ENTERTAINMENT EVENT BOOKING AGENCIES; ENTERTAINMENT IN THE NATURE OF BOXING CONTESTS; ENTERTAINMENT IN THE NATURE OF COMPETITIONS IN THE FIELD OF BOXING; ENTERTAINMENT SERVICES IN THE NATURE OF FANTASY BOXING LEAGUES; ENTERTAINMENT SERVICES IN THE NATURE OF LIVE MIXED MARTIAL ARTS (MMA) EVENTS; PROVIDING CLASSES, WORKSHOPS, SEMINARS AND CAMPS IN THE FIELDS OF FITNESS, EXERCISE, BOXING, KICK BOXING AND MIXED MARTIAL ARTS, IN CLASS 41 (U.S. CLS. 100, 101 AND 107).

FIRST USE 6-1-1986; IN COMMERCE 6-1-1989.

THE MARK CONSISTS OF STANDARD CHARACTERS WITHOUT CLAIM TO ANY PARTICULAR FONT, STYLE, SIZE, OR COLOR.

NO CLAIM IS MADE TO THE EXCLUSIVE RIGHT TO USE "BOXING TRAINING & FITNESS", APART FROM THE MARK AS SHOWN.

SER. NO. 85-312,599, FILED 5-4-2011.

ELISSA GARBER KON, EXAMINING ATTORNEY



*David J. Kybas*

Director of the United States Patent and Trademark Office



# United States of America

United States Patent and Trademark Office



**Reg. No. 4,134,316**

**Registered May 1, 2012**

**Int. Cl.: 35**

**SERVICE MARK**

**PRINCIPAL REGISTER**

CALIFORNIA EGG INDUSTRY ASSOCIATION (CALIFORNIA CORPORATION)  
1521 "I" STREET  
SACRAMENTO, CA 95814

FOR: ASSOCIATION SERVICES, NAMELY, PROMOTING THE INTERESTS OF THE CALIFORNIA EGG INDUSTRY, IN CLASS 35 (U.S. CLS. 100, 101 AND 102).

FIRST USE 2-5-1985; IN COMMERCE 2-5-1985.

NO CLAIM IS MADE TO THE EXCLUSIVE RIGHT TO USE "CALIFORNIA FRESH EGGS", APART FROM THE MARK AS SHOWN.

THE MARK CONSISTS OF AN ARTISTIC DEPICTION OF AN EGG SLICED LENGTH-WISE; SPECIFICALLY, A HALF-OVAL LINE AROUND A SMALLER HALF-CIRCLE OF HORIZONTAL LINES, ALL OF WHICH IS ABOVE THE WORDS "CALIFORNIA FRESH EGGS".

SER. NO. 85-312,656, FILED 5-4-2011.

KAPIL BHANOT, EXAMINING ATTORNEY



*David J. Kybas*

Director of the United States Patent and Trademark Office

# United States of America

United States Patent and Trademark Office

## California Fresh Eggs

**Reg. No. 4,134,317**

CALIFORNIA EGG INDUSTRY ASSOCIATION (CALIFORNIA CORPORATION)  
1521 "I" STREET  
SACRAMENTO, CA 95814

**Registered May 1, 2012**

**Int. Cl.: 35**

FOR: ASSOCIATION SERVICES, NAMELY, PROMOTING THE INTERESTS OF THE CALIFORNIA EGG INDUSTRY, IN CLASS 35 (U.S. CLS. 100, 101 AND 102).

**SERVICE MARK**

FIRST USE 2-5-1985; IN COMMERCE 2-5-1985.

**PRINCIPAL REGISTER**

THE MARK CONSISTS OF STANDARD CHARACTERS WITHOUT CLAIM TO ANY PARTICULAR FONT, STYLE, SIZE, OR COLOR.

NO CLAIM IS MADE TO THE EXCLUSIVE RIGHT TO USE "EGGS", APART FROM THE MARK AS SHOWN.

SEC. 2(F).

SER. NO. 85-312,721, FILED 5-4-2011.

KAPIL BHANOT, EXAMINING ATTORNEY



*David J. Kybas*

Director of the United States Patent and Trademark Office

# United States of America

United States Patent and Trademark Office

## STONE FOREST

**Reg. No. 4,134,318**

**Registered May 1, 2012**

**Int. Cl.: 11**

**TRADEMARK**

**PRINCIPAL REGISTER**

STONE FOREST, INC. (NEW MEXICO CORPORATION)  
PO BOX 2840  
SANTA FE, NM 87504

FOR: BATHTUBS; DECORATIVE TABLE-TOP WATER FOUNTAINS; DECORATIVE WATER FOUNTAINS; KITCHEN SINKS; LANTERNS; ORNAMENTAL FOUNTAINS; SINK PEDESTALS; SINKS; SINKS INTEGRATED INTO COUNTERS OR COUNTERTOPS; WATER FOUNTAINS, IN CLASS 11 (U.S. CLS. 13, 21, 23, 31 AND 34).

FIRST USE 7-5-1990; IN COMMERCE 9-25-1990.

THE MARK CONSISTS OF STANDARD CHARACTERS WITHOUT CLAIM TO ANY PARTICULAR FONT, STYLE, SIZE, OR COLOR.

NO CLAIM IS MADE TO THE EXCLUSIVE RIGHT TO USE "STONE", APART FROM THE MARK AS SHOWN.

SER. NO. 85-313,007, FILED 5-5-2011.

TEJBIR SINGH, EXAMINING ATTORNEY



*David J. Kyros*

Director of the United States Patent and Trademark Office

**United States of America**  
United States Patent and Trademark Office

# CYBERSEM

**Reg. No. 4,134,319**

**Registered May 1, 2012**

**Int. Cl.: 41**

**SERVICE MARK**

**PRINCIPAL REGISTER**

CYBERSEM, INC. (KENTUCKY CORPORATION), DBA CYBERSEM  
5734 MELVIN ST.  
PITTSBURGH, PA 15217

FOR: EDUCATIONAL SERVICES, NAMELY, PROVIDING CLASSES, SEMINARS, WORKSHOPS, AND MENTORING IN THE FIELD OF JUDAIC STUDIES AT SEMINARY SCHOOLS, IN CLASS 41 (U.S. CLS. 100, 101 AND 107).

FIRST USE 5-1-2010; IN COMMERCE 6-1-2010.

THE MARK CONSISTS OF STANDARD CHARACTERS WITHOUT CLAIM TO ANY PARTICULAR FONT, STYLE, SIZE, OR COLOR.

SER. NO. 85-313,527, FILED 5-5-2011.

JAY BESCH, EXAMINING ATTORNEY



*David J. Kybas*

Director of the United States Patent and Trademark Office

# United States of America

United States Patent and Trademark Office

# BLUE COAST

**Reg. No. 4,134,320**

**Registered May 1, 2012**

**Int. Cls.: 16, 22 and 25**

**TRADEMARK**

**PRINCIPAL REGISTER**

TBCC, INC. T/A THE BLUE COAST COMPANY (DELAWARE CORPORATION)  
9 CYPRESS LANE  
LEWES, DE 19958

FOR: BUMPER STICKERS, IN CLASS 16 (U.S. CLS. 2, 5, 22, 23, 29, 37, 38 AND 50).

FIRST USE 3-1-2011; IN COMMERCE 3-1-2011.

FOR: CANVAS BAGS FOR STORAGE OF ATHLETIC EQUIPMENT, IN CLASS 22 (U.S. CLS. 1, 2, 7, 19, 22, 42 AND 50).

FIRST USE 3-1-2011; IN COMMERCE 3-1-2011.

FOR: WEARABLE GARMENTS AND CLOTHING, NAMELY, SHIRTS, HATS AND PANTS, IN CLASS 25 (U.S. CLS. 22 AND 39).

FIRST USE 3-1-2011; IN COMMERCE 3-1-2011.

THE MARK CONSISTS OF STANDARD CHARACTERS WITHOUT CLAIM TO ANY PARTICULAR FONT, STYLE, SIZE, OR COLOR.

SER. NO. 85-313,675, FILED 5-5-2011.

MAYUR VAGHANI, EXAMINING ATTORNEY



*David J. Kyffers*

Director of the United States Patent and Trademark Office

# United States of America

United States Patent and Trademark Office

VISEART   
*professional make-up . paris*

**Reg. No. 4,134,321**

**Registered May 1, 2012**

**Int. Cl.: 3**

**TRADEMARK**

**PRINCIPAL REGISTER**

W&CORB (FRANCE CORPORATION)  
72 BIS RUE JEAN PIERRE TIMBAUD 75011  
PARIS, FRANCE

FOR: COSMETIC CREAMS FOR SKIN CARE; COSMETIC HAIR DRESSING PREPARATIONS; COSMETIC PENCILS; COSMETIC PREPARATIONS FOR PROTECTING THE SKIN FROM THE SUN'S RAYS; COSMETIC PREPARATIONS FOR THE HAIR AND SCALP; COSMETICS AND MAKE-UP; EYESHADOWS; HAIR SHAMPOOS AND CONDITIONERS; LIPSTICKS; MAKE UP FOUNDATIONS; MAKE-UP FOR THE FACE AND BODY; MAKE-UP PENCILS; MAKE-UP POWDER; MAKE-UP REMOVING MILK, GEL, LOTIONS AND CREAMS; MAS-CARAS; NATURAL MINERAL MAKE-UP, IN CLASS 3 (U.S. CLS. 1, 4, 6, 50, 51 AND 52).

FIRST USE 1-1-1996; IN COMMERCE 10-21-1996.

NO CLAIM IS MADE TO THE EXCLUSIVE RIGHT TO USE "PROFESSIONAL MAKE UP PARIS", APART FROM THE MARK AS SHOWN.

THE MARK CONSISTS OF "VISEART" WRITTEN IN CAPITAL LETTERS, ON THE RIGHT LOGO REPRESENTING A CINEMA DIRECTOR OR MAKEUP CHAIR, UNDER "VISEART" WORDS PROFESSIONAL MAKE UP PARIS.

SER. NO. 85-315,929, FILED 5-9-2011.

RONALD AIKENS, EXAMINING ATTORNEY



*David J. Kyros*

Director of the United States Patent and Trademark Office

# United States of America

United States Patent and Trademark Office



**Reg. No. 4,134,322**

**Registered May 1, 2012**

**Int. Cl.: 45**

**SERVICE MARK**

**PRINCIPAL REGISTER**

RIO CONSULTING SERVICES, LLC (NEW YORK DOMESTIC LIMITED LIABILITY COMPANY)  
99 MAIN STREET, SUITE 219  
NYACK, NY 10960

FOR: PRE-EMPLOYMENT BACKGROUND SCREENING, NAMELY, CRIMINAL BACKGROUND CHECKING, EDUCATION VERIFICATION SEARCHING, EMPLOYMENT VERIFICATION, PRELIMINARY INTERVIEWING, BIOMETRIC DATA COLLECTION FOR SECURITY SCREENING PURPOSES, REVIEW OF CREDIT REPORTS AND WORKER COMPENSATION RECORDS FOR EMPLOYMENT SCREENING PURPOSES, DRUG SCREENING, CHARACTER VERIFICATION, INTERNATIONAL BACKGROUND CHECKING, AND IDENTITY FRAUD CHECKING, IN CLASS 45 (U.S. CLS. 100 AND 101).

FIRST USE 7-8-2010; IN COMMERCE 7-8-2010.

NO CLAIM IS MADE TO THE EXCLUSIVE RIGHT TO USE "CONSULTING SERVICES, LLC", APART FROM THE MARK AS SHOWN.

THE MARK CONSISTS OF THE WORDING "RIO CONSULTING SERVICES, LLC" WRITTEN IN A STYLIZED FONT AND AN IMAGE OF ONE-QUARTER OF A FLOWER ADJACENT TO THE "R" IN "RIO".

SER. NO. 85-316,896, FILED 5-10-2011.

TAMARA FRAZIER, EXAMINING ATTORNEY



*David J. Kybas*

Director of the United States Patent and Trademark Office

# United States of America

United States Patent and Trademark Office

# MOTECH

**Reg. No. 4,134,323**

**Registered May 1, 2012**

**Int. Cl.: 9**

**TRADEMARK**

**PRINCIPAL REGISTER**

MOTECH INDUSTRIES INC. (TAIWAN CORPORATION)  
6F., NO. 248, SECTION. 3, PEI-SHEN ROAD  
SHENKENG DISTRICT  
NEW TAIPEI CITY, TAIWAN

FOR: SIGNAL GENERATORS; TELEPHONE TRANSMISSION LINE TESTERS; ASYMMETRIC DIGITAL SUBSCRIBER LINE (ADSL) TESTERS, NAMELY, TELEPHONE TRANSMISSION LINE TESTERS; PROGRAMMABLE POWER SUPPLIES; FUNCTION GENERATORS FOR TESTING LOGIC CIRCUITS, LINEAR AMPLIFIERS, WIRELESS COMMUNICATION SYSTEMS AND ELECTRONIC EXPERIMENTAL CIRCUITS FOR TEACHING; POWER HARMONIC ANALYZERS FOR TESTING THE POWER CONSUMPTION OF AN APPLIANCE, THE EFFICIENCY OF AN APPLIANCE AND THE QUALITY OF A POWER SYSTEM; RECTIFIERS; INVERTERS; SILICON WAFERS; PHOTOVOLTAIC CELLS; PHOTOVOLTAIC MODULES; PHOTOVOLTAIC POWER SYSTEMS COMPRISING PHOTOVOLTAIC MODULES, MONO-CRYSTALLINE SILICON SOLAR CELLS, MULTI-CRYSTALLINE SILICON SOLAR CELLS, INVERTERS, GRID-CONNECTED SINE WAVE INVERTERS, IN CLASS 9 (U.S. CLS. 21, 23, 26, 36 AND 38).

FIRST USE 4-26-2011; IN COMMERCE 4-26-2011.

THE MARK CONSISTS OF STANDARD CHARACTERS WITHOUT CLAIM TO ANY PARTICULAR FONT, STYLE, SIZE, OR COLOR.

OWNER OF U.S. REG. NO. 2,590,148.

SER. NO. 85-316,916, FILED 5-10-2011.

MARK SPARACINO, EXAMINING ATTORNEY



*David J. Kypos*

Director of the United States Patent and Trademark Office



United States of America  
United States Patent and Trademark Office

PPM

**Reg. No. 4,134,324**

ARBITRON INC. (DELAWARE CORPORATION)  
9705 PATUXENT WOODS DRIVE  
COLUMBIA, MD 21046

**Registered May 1, 2012**

**Int. Cl.: 41**

FOR: PROVIDING NON-DOWNLOADABLE ON-LINE PUBLICATIONS IN THE NATURE OF REPORTS IN THE FIELDS OF AUDIENCE MEASUREMENT, MEDIA EXPOSURE MEASUREMENT, MARKET RESEARCH AND BUSINESS RESEARCH, IN CLASS 41 (U.S. CLS. 100, 101 AND 107).

**SERVICE MARK**

**PRINCIPAL REGISTER**

FIRST USE 9-30-2008; IN COMMERCE 9-30-2008.

THE MARK CONSISTS OF STANDARD CHARACTERS WITHOUT CLAIM TO ANY PARTICULAR FONT, STYLE, SIZE, OR COLOR.

SER. NO. 85-317,811, FILED 5-11-2011.

ELI HELLMAN, EXAMINING ATTORNEY



*David J. Kyros*

Director of the United States Patent and Trademark Office

# United States of America

United States Patent and Trademark Office

# QBE FIRST

**Reg. No. 4,134,325**

**Registered May 1, 2012**

**Int. Cl.: 36**

**SERVICE MARK**

**PRINCIPAL REGISTER**

QBE HOLDINGS, INC. (DELAWARE CORPORATION)  
88 PINE STREET, 10TH FLOOR  
NEW YORK, NY 10005

FOR: INSURANCE AND FINANCIAL INFORMATION AND CONSULTANCY SERVICES; INSURANCE AGENCY AND BROKERAGE SERVICES; INSURANCE CLAIMS ADMINISTRATION; INSURANCE CLAIMS PROCESSING; INSURANCE SERVICES, NAMELY, PROCESSING SALES LEADS FOR INSURANCE QUOTES OR PROVIDING RATE QUOTES, UNDERWRITING AND/OR ADMINISTRATING AND PROCESSING LIFE, MEDICAL, MEDICARE SUPPLEMENTAL, TRAVEL, LIABILITY, HAZARD, FLOOD, FIRE, HOMEOWNERS, AND MORTGAGE INSURANCE; MAINTAINING MORTGAGE ESCROW ACCOUNTS; TAX PAYMENT PROCESSING SERVICES, IN CLASS 36 (U.S. CLS. 100, 101 AND 102).

FIRST USE 3-1-2011; IN COMMERCE 3-1-2011.

THE MARK CONSISTS OF STANDARD CHARACTERS WITHOUT CLAIM TO ANY PARTICULAR FONT, STYLE, SIZE, OR COLOR.

SER. NO. 85-318,198, FILED 5-11-2011.

BRENDAN MCCAULEY, EXAMINING ATTORNEY



*David J. Kybas*

Director of the United States Patent and Trademark Office

# United States of America

United States Patent and Trademark Office



**Reg. No. 4,134,326**

**Registered May 1, 2012**

**Int. Cl.: 31**

**TRADEMARK**

**PRINCIPAL REGISTER**

CP (DELAWARE) INC. (DELAWARE CORPORATION)  
P.O. BOX 1958  
103 FOULK ROAD, SUITE 202  
WILMINGTON, DE 19899

FOR: LIVE PLANTS, IN CLASS 31 (U.S. CLS. 1 AND 46).

FIRST USE 11-0-2009; IN COMMERCE 11-0-2009.

OWNER OF U.S. REG. NOS. 2,818,948, 3,713,266, AND 3,929,471.

THE COLOR(S) WHITE AND PANTONE 397C GREEN IS/ARE CLAIMED AS A FEATURE OF THE MARK.

NO CLAIM IS MADE TO THE EXCLUSIVE RIGHT TO USE "FAMILY OF ROSES", APART FROM THE MARK AS SHOWN.

THE MARK CONSISTS OF THE WORDING "THE KNOCK OUT FAMILY OF ROSES" IN UPPER AND LOWER CASE LETTERING ABOVE AND TO THE RIGHT OF A STYLIZED REPRESENTATION OF A FLOWER AND LEAVES ALL IN WHITE AGAINST A GREEN BACKGROUND IN PANTONE 397C.

SER. NO. 85-318,326, FILED 5-11-2011.

CAROLINE WOOD, EXAMINING ATTORNEY



*David J. Kyffers*

Director of the United States Patent and Trademark Office

# United States of America

United States Patent and Trademark Office

## THE ANAHEIM RESORT

**Reg. No. 4,134,327**

**Registered May 1, 2012**

**Int. Cls.: 37, 39, 42 and 43**

**SERVICE MARK**

**PRINCIPAL REGISTER**

CITY OF ANAHEIM (CALIFORNIA MUNICIPAL CORPORATION)  
200 S. ANAHEIM BOULEVARD  
ANAHEIM, CA 92805

FOR: LAND DEVELOPMENT SERVICES, NAMELY, PLANNING AND LAYING OUT OF RESIDENTIAL AND/OR COMMERCIAL COMMUNITIES; REAL ESTATE DEVELOPMENT AND CONSTRUCTION OF COMMERCIAL, RESIDENTIAL, AND OFFICE PROPERTIES, IN CLASS 37 (U.S. CLS. 100, 103 AND 106).

FIRST USE 0-0-2000; IN COMMERCE 0-0-2000.

FOR: MULTIMODAL TRANSPORTATION SERVICES, NAMELY, MASS TRANSIT SERVICES FOR THE GENERAL PUBLIC, IN CLASS 39 (U.S. CLS. 100 AND 105).

FIRST USE 5-0-2002; IN COMMERCE 5-0-2002.

FOR: LAND USE PLANNING SERVICES, IN CLASS 42 (U.S. CLS. 100 AND 101).

FIRST USE 0-0-2000; IN COMMERCE 0-0-2000.

FOR: ARENA SERVICES, NAMELY, PROVIDING FACILITIES FOR SPORTS, ENTERTAINMENT, CONCERTS AND CONVENTIONS; RESORT HOTELS AND RESORT LODGING SERVICES, IN CLASS 43 (U.S. CLS. 100 AND 101).

FIRST USE 0-0-2000; IN COMMERCE 0-0-2000.

THE MARK CONSISTS OF STANDARD CHARACTERS WITHOUT CLAIM TO ANY PARTICULAR FONT, STYLE, SIZE, OR COLOR.

NO CLAIM IS MADE TO THE EXCLUSIVE RIGHT TO USE "RESORT", APART FROM THE MARK AS SHOWN.

SEC. 2(F).

SER. NO. 85-318,574, FILED 5-11-2011.

CIMMERIAN COLEMAN, EXAMINING ATTORNEY



*David J. Kypas*

Director of the United States Patent and Trademark Office

# United States of America

United States Patent and Trademark Office

## CUPCAKE BEACH

Cupcakes for ALL Reasons  
...By the Beach,  
At the Beach,  
On the Beach,  
Near the Beach!!!

**Reg. No. 4,134,328**

NALU KITCHENS, INC (FLORIDA CORPORATION)  
123 ELM AVENUE  
FT WALTON BEACH, FL 32548

**Registered May 1, 2012**

**Int. Cl.: 35**

FOR: RETAIL SHOPS FEATURING CUPCAKES, CAKES, BAKED GOODS, HOT AND COLD CONFECTIONS, IN CLASS 35 (U.S. CLS. 100, 101 AND 102).

**SERVICE MARK**

FIRST USE 2-5-2007; IN COMMERCE 2-5-2007.

**PRINCIPAL REGISTER**

THE MARK CONSISTS OF STANDARD CHARACTERS WITHOUT CLAIM TO ANY PARTICULAR FONT, STYLE, SIZE, OR COLOR.

NO CLAIM IS MADE TO THE EXCLUSIVE RIGHT TO USE "CUPCAKE" AND "CUPCAKES", APART FROM THE MARK AS SHOWN.

SER. NO. 85-318,729, FILED S.R. 5-11-2011 AM. P.R. 9-14-2011.

CHARLES L. JENKINS, EXAMINING ATTORNEY



*David J. Kybas*

Director of the United States Patent and Trademark Office

United States of America  
United States Patent and Trademark Office

**2EZ**  
S P E E D

**Reg. No. 4,134,329**

**Registered May 1, 2012**

**Int. Cls.: 7 and 9**

**TRADEMARK**

**PRINCIPAL REGISTER**

NIDEC MOTOR CORPORATION (DELAWARE CORPORATION)  
LAW DEPARTMENT  
8050 WEST FLORISSANT AVENUE  
ST. LOUIS, MO 63136

FOR: ELECTRIC MOTORS FOR MACHINES, IN CLASS 7 (U.S. CLS. 13, 19, 21, 23, 31, 34 AND 35).

FIRST USE 3-1-2011; IN COMMERCE 3-1-2011.

FOR: ELECTRONIC CONTROLS AS COMPONENTS PARTS OF MOTORS FOR MACHINES, IN CLASS 9 (U.S. CLS. 21, 23, 26, 36 AND 38).

FIRST USE 3-1-2011; IN COMMERCE 3-1-2011.

NO CLAIM IS MADE TO THE EXCLUSIVE RIGHT TO USE "SPEED", APART FROM THE MARK AS SHOWN.

THE MARK CONSISTS OF THE WORDING "2EZ" WHEREIN THE LETTER "E" FEATURES A WAVY BAND DESIGN, AND BENEATH IS THE WORDING "SPEED".

SER. NO. 85-318,860, FILED 5-12-2011.

KELLY CHOE, EXAMINING ATTORNEY



*David J. Kybas*

Director of the United States Patent and Trademark Office

# United States of America

United States Patent and Trademark Office



**Reg. No. 4,134,330**

**Registered May 1, 2012**

**Int. Cl.: 30**

**TRADEMARK**

**PRINCIPAL REGISTER**

FIAT GROUP MARKETING & CORPORATE COMMUNICATIONS S.P.A. (ITALY SOCIETÀ PER AZIONI (SPA))  
VIA NIZZA, 250  
TORINO, ITALY 10126

FOR: COFFEE, TEA, COCOA, SUGAR, RICE, TAPIOCA, SAGO, ARTIFICIAL COFFEE; FLOUR; BREAD, PASTRY; CONFECTIONERY, NAMELY, CHOCOLATE, CRYSTAL SUGAR PIECES, CANDY; ICES; HONEY, TREACLE; YEAST, BAKING-POWDER, SALT, MUSTARD; VINEGAR, SAUCES (CONDIMENTS); SPICES; ICE, IN CLASS 30 (U.S. CL. 46).

PRIORITY CLAIMED UNDER SEC. 44(D) ON ITALY APPLICATION NO. TO2011C00164, FILED 5-10-2011, REG. NO. 1468982, DATED 5-10-2011, EXPIRES 5-11-2021.

OWNER OF U.S. REG. NOS. 1,150,430, 3,065,262 AND OTHERS.

THE MARK CONSISTS OF A CIRCLE WITH OUTER AND INNER BORDERS CONTAINING THE WORDS "ALFA ROMEO", A STYLIZED CROSS, A SNAKE AND A CROWN.

SER. NO. 85-319,085, FILED 5-12-2011.

KIMBERLY FRYE, EXAMINING ATTORNEY



*David J. Kyros*

Director of the United States Patent and Trademark Office

# United States of America

United States Patent and Trademark Office



**Reg. No. 4,134,331**

**Registered May 1, 2012**

**Int. Cls.: 25 and 26**

**TRADEMARK**

**PRINCIPAL REGISTER**

TIFFIE, LLC (TEXAS LIMITED LIABILITY COMPANY)  
2412 HEADWATERS RD  
BURLESON, TX 76028

FOR: CLOTHING, NAMELY, SCARVES AND SHAWLS AND GARMENT FASHION ACCESSORIES, NAMELY, SLEEVES AND ARM COVERS WORN FOR FASHION, IN CLASS 25 (U.S. CLS. 22 AND 39).

FIRST USE 6-2-2010; IN COMMERCE 6-15-2010.

FOR: ACCESSORIES, NAMELY, BARRETTES, HAIR PINS, PONYTAIL HOLDERS AND HAIR ORNAMENTS, IN CLASS 26 (U.S. CLS. 37, 39, 40, 42 AND 50).

FIRST USE 6-2-2010; IN COMMERCE 6-15-2010.

THE MARK CONSISTS OF THE STYLIZED WORD "TIFFIE" WITH A STYLIZED BLACK SILHOUETTE OF A WOMAN ON THE LEFT HAND SIDE WITH A BLUE STAR ON HER CHEST, IN WHICH THE STYLIZED SILHOUETTE ALSO FORMS THE LETTER "T" IN THE WORD "TIFFIE" WITH THE STYLIZED LETTERS "IFFIE" IN BLUE WITH THE BLACK STARS AS THE DOTS IN THE TWO LETTER "I"'S TO THE RIGHT OF THE SILHOUETTE. THE COLOR WHITE IN THE MARK REPRESENTS BACKGROUND AND IS NOT A FEATURE OF THE MARK.

THE COLOR(S) BLACK AND BLUE IS/ARE CLAIMED AS A FEATURE OF THE MARK.

SER. NO. 85-319,450, FILED 5-12-2011.

RAMONA ORTIGA, EXAMINING ATTORNEY



*David J. Kybas*

Director of the United States Patent and Trademark Office



# United States of America

United States Patent and Trademark Office

## CHILL SUNDAY

**Reg. No. 4,134,332**

**Registered May 1, 2012**

**Int. Cl.: 41**

**SERVICE MARK**

**PRINCIPAL REGISTER**

CONSEQUI GROUP INC (TEXAS CORPORATION), DBA SXS PRODUCTIONS, INC.  
#429  
1920 ABRAMS PARKWAY  
DALLAS, TX 75214

FOR: EDUCATION AND ENTERTAINMENT SERVICES, NAMELY, ARRANGING, ORGANIZING, CONDUCTING, AND HOSTING SOCIAL ENTERTAINMENT EVENTS, NAMELY, MUSIC TOURS, DANCE PARTIES, THEMED EVENTS, BAR NIGHTS, AND EVENTS AT LOUNGES; ENTERTAINMENT IN THE NATURE OF LIVE MUSIC CONCERTS, DISC JOCKEY CONCERTS, AND MUSICAL AND ARTISTIC PERFORMANCES, NIGHT CLUBS AND ART EXHIBITIONS, IN CLASS 41 (U.S. CLS. 100, 101 AND 107).

FIRST USE 7-1-2010; IN COMMERCE 8-16-2010.

THE MARK CONSISTS OF STANDARD CHARACTERS WITHOUT CLAIM TO ANY PARTICULAR FONT, STYLE, SIZE, OR COLOR.

SER. NO. 85-319,943, FILED 5-13-2011.

ROSELLE HERRERA, EXAMINING ATTORNEY



*David J. Kyffers*

Director of the United States Patent and Trademark Office

# United States of America

United States Patent and Trademark Office

## ARS TECHNICA

**Reg. No. 4,134,333**

**Registered May 1, 2012**

**Int. Cl.: 42**

**SERVICE MARK**

**PRINCIPAL REGISTER**

ADVANCE MAGAZINE PUBLISHERS INC. (NEW YORK CORPORATION)  
FOUR TIMES SQUARE  
NEW YORK, NY 10036

FOR: PROVIDING ONLINE INFORMATION, NEWS AND COMMENTARY IN THE FIELDS OF INFORMATION TECHNOLOGY, SCIENCE, COMPUTER SOFTWARE AND HARDWARE DESIGN AND DEVELOPMENT, DESIGN AND DEVELOPMENT OF COMPUTER NETWORKS, DESIGN AND DEVELOPMENT OF VIDEO GAMES, COMPUTER SECURITY, TELECOMMUNICATIONS TECHNOLOGY AND THE DESIGN AND DEVELOPMENT OF WEBSITE SEARCH ENGINES, IN CLASS 42 (U.S. CLS. 100 AND 101).

FIRST USE 7-1-1998; IN COMMERCE 7-1-1998.

THE MARK CONSISTS OF STANDARD CHARACTERS WITHOUT CLAIM TO ANY PARTICULAR FONT, STYLE, SIZE, OR COLOR.

OWNER OF U.S. REG. NO. 3,343,337.

NO CLAIM IS MADE TO THE EXCLUSIVE RIGHT TO USE "TECHNICA", APART FROM THE MARK AS SHOWN.

THE ENGLISH TRANSLATION OF THE WORD "TECHNICA" IN THE MARK IS "TECHNOLOGY".

SER. NO. 85-320,459, FILED 5-13-2011.

BILL DAWE, EXAMINING ATTORNEY



*David J. Kybas*

Director of the United States Patent and Trademark Office

# United States of America

United States Patent and Trademark Office

# Smart Cover

**Reg. No. 4,134,334**

**Registered May 1, 2012**

**Int. Cl.: 21**

**TRADEMARK**

**PRINCIPAL REGISTER**

GSB OF DC, INC (FLORIDA CORPORATION), DBA GSB  
700 US HWY 1 SUITE G  
NORTH PALM BEACH, FL 33408

FOR: IRONING BOARD COVERS, IN CLASS 21 (U.S. CLS. 2, 13, 23, 29, 30, 33, 40 AND 50).

FIRST USE 3-22-2011; IN COMMERCE 3-22-2011.

THE MARK CONSISTS OF STANDARD CHARACTERS WITHOUT CLAIM TO ANY PARTICULAR FONT, STYLE, SIZE, OR COLOR.

NO CLAIM IS MADE TO THE EXCLUSIVE RIGHT TO USE "COVER", APART FROM THE MARK AS SHOWN.

SER. NO. 85-320,580, FILED 5-13-2011.

JAY BESCH, EXAMINING ATTORNEY



*David J. Kyffers*

Director of the United States Patent and Trademark Office

# United States of America

United States Patent and Trademark Office

## KATE'S KITCHEN

**Reg. No. 4,134,335**

**Registered May 1, 2012**

**Int. Cls.: 29, 30 and 32**

**TRADEMARK**

**PRINCIPAL REGISTER**

ARGON CONSULTING & MANAGEMENT LTD (UNITED KINGDOM COMPANY)  
TRELLECK HOUSE, 1 KNAPPSWOOD CLOSE  
UPPER BASILDON, READING  
BERKSHIRE, UNITED KINGDOM RG8 8LQ

FOR: CANNED AND PRESERVED MEATS; DRIED FRUITS, IN CLASS 29 (U.S. CL. 46).

FOR: PUDDINGS AND BAKERY DESSERTS; BAKERY GOODS; BAKERY GOODS, NAMELY, BREAD, ROLLS, CAKES, BISCUITS, COOKIES, TARTS AND PASTRIES; CHOCOLATE BARS AND CANDIES, IN CLASS 30 (U.S. CL. 46).

FOR: DRINKS, NAMELY, FRUIT DRINKS, FRUIT FLAVOURED DRINKS AND FRUIT JUICES, IN CLASS 32 (U.S. CLS. 45, 46 AND 48).

THE MARK CONSISTS OF STANDARD CHARACTERS WITHOUT CLAIM TO ANY PARTICULAR FONT, STYLE, SIZE, OR COLOR.

OWNER OF UNITED KINGDOM REG. NO. 2563005, DATED 1-28-2011, EXPIRES 1-28-2016.

NO CLAIM IS MADE TO THE EXCLUSIVE RIGHT TO USE "KITCHEN", APART FROM THE MARK AS SHOWN.

SER. NO. 85-320,603, FILED 5-13-2011.

ALEXANDER L. POWERS, EXAMINING ATTORNEY



*David J. Kybas*

Director of the United States Patent and Trademark Office

# United States of America

United States Patent and Trademark Office

## GREEDOMETER

**Reg. No. 4,134,336**

**Registered May 1, 2012**

**Int. Cl.: 36**

**SERVICE MARK**

**PRINCIPAL REGISTER**

TRIANGLE WEALTH MANAGEMENT LLC (NORTH CAROLINA LIMITED LIABILITY COMPANY)  
1000 CENTRE GREEN WAY  
SUITE 200  
CARY, NC 27513

FOR: INVESTMENT ADVISORY SERVICES, IN CLASS 36 (U.S. CLS. 100, 101 AND 102).

FIRST USE 5-6-2011; IN COMMERCE 5-6-2011.

THE MARK CONSISTS OF STANDARD CHARACTERS WITHOUT CLAIM TO ANY PARTICULAR FONT, STYLE, SIZE, OR COLOR.

SER. NO. 85-321,076, FILED 5-14-2011.

LEIGH LOWRY, EXAMINING ATTORNEY



*David J. Kyffers*

Director of the United States Patent and Trademark Office

# United States of America

United States Patent and Trademark Office



**Reg. No. 4,134,337**

**Registered May 1, 2012**

**Int. Cls.: 11 and 37**

**TRADEMARK**

**SERVICE MARK**

**PRINCIPAL REGISTER**

HAMSARD 3044, LTD. (UNITED KINGDOM LIMITED CORPORATION)  
PREMIER HOUSE, HEWELL ROAD  
REDDITCH, WORCS., UNITED KINGDOM B976BW

FOR: BATHTUBS, IN CLASS 11 (U.S. CLS. 13, 21, 23, 31 AND 34).

FIRST USE 4-7-2007; IN COMMERCE 4-7-2007.

FOR: INSTALLATION AND MAINTENANCE OF BATHTUBS, IN CLASS 37 (U.S. CLS. 100, 103 AND 106).

FIRST USE 4-7-2007; IN COMMERCE 7-7-2007.

THE MARK CONSISTS OF THE UPPER CASE LETTER "G" WITH AN ARROW AT THE TOP ARCH AND A STICK FIGURE AT THE BOTTOM WITHIN THE LETTER "G".

SER. NO. 85-321,850, FILED 5-16-2011.

JAMES GRIFFIN, EXAMINING ATTORNEY



*David J. Kyffers*

Director of the United States Patent and Trademark Office

# United States of America

United States Patent and Trademark Office



**Reg. No. 4,134,338**

**Registered May 1, 2012**

**Int. Cl.: 5**

**TRADEMARK**

**PRINCIPAL REGISTER**

MENPER DISTRIBUTORS INC. (FLORIDA CORPORATION)  
6500 NW 35TH AVE  
MIAMI, FL 33147

FOR: ANALGESIC BALM, IN CLASS 5 (U.S. CLS. 6, 18, 44, 46, 51 AND 52).

FIRST USE 2-15-2002; IN COMMERCE 2-15-2002.

NO CLAIM IS MADE TO THE EXCLUSIVE RIGHT TO USE "HIELO" , APART FROM THE MARK AS SHOWN.

THE COLOR(S) BLUE, ORANGE-RED, YELLOW, RED AND WHITE IS/ARE CLAIMED AS A FEATURE OF THE MARK.

THE MARK CONSISTS OF THE STYLIZED WORD "HIELO" RENDERED IN A LIGHT BLUE COLOR OUTLINED IN WHITE WITH RED FRINGE AT THE BOTTOM OF THE LETTERS AND WHITE ELEMENTS OUTLINING EACH LETTER AND SUGGESTING ICICLES PLUS THE STYLIZED WORD "ARDIENTE" BELOW IT RENDERED IN ORANGE-RED COLOR WITH A YELLOW SHADOW SUGGESTING FIRE ALL ON A BLUE RECTANGULAR BACKGROUND.

THE ENGLISH TRANSLATION OF "HIELO ARDIENTE" IN THE MARK IS "BURNING ICE".

SER. NO. 85-322,119, FILED 5-16-2011.

LESLEY LAMOTHE, EXAMINING ATTORNEY



*David J. Kybas*

Director of the United States Patent and Trademark Office

# United States of America

United States Patent and Trademark Office



Performance on Demand

**Reg. No. 4,134,339**

**Registered May 1, 2012**

**Int. Cl.: 44**

**SERVICE MARK**

**PRINCIPAL REGISTER**

THY WYANOKE GROUP, INC. (NEW JERSEY CORPORATION)  
6900 GROVE ROAD  
THOROFARE, NJ 08086

FOR: PROVIDING A WEB SITE THAT FEATURES THE EVALUATION OF PATIENTS' DATA TO IMPROVE THE PERFORMANCE OF PHYSICIANS, IN CLASS 44 (U.S. CLS. 100 AND 101).

FIRST USE 2-28-2011; IN COMMERCE 2-28-2011.

OWNER OF U.S. REG. NO. 3,999,070.

THE COLOR(S) BLUE AND BLUE-GREEN IS/ARE CLAIMED AS A FEATURE OF THE MARK.

THE MARK CONSISTS OF THREE BLUE-GREEN DOWNWARD FACING CURVED LINES ABOVE THE WORDING "POD" IN BLUE, WHICH IS ABOVE THE WORDING "PERFORMANCE ON DEMAND" IN BLUE-GREEN.

SER. NO. 85-322,346, FILED 5-16-2011.

LINDSEY RUBIN, EXAMINING ATTORNEY



*David J. Kybas*

Director of the United States Patent and Trademark Office



# United States of America

United States Patent and Trademark Office

# JJ's House

**Reg. No. 4,134,340**

**Registered May 1, 2012**

**Int. Cl.: 25**

**TRADEMARK**

**PRINCIPAL REGISTER**

QI ZHONG (UNITED STATES INDIVIDUAL)  
5004 162ND AVE NE  
REDMOND, WA 98052

FOR: BRIDESMAID DRESSES; COSTUMES FOR USE IN CHILDREN'S DRESS UP PLAY; DRESS PANTS; DRESS SHIELDS; DRESS SHIRTS; DRESS SUITS; DRESSES; DRESSES MADE FROM SKINS; DRESSES THAT MAY ALSO BE USED AS TOWELS; DRESSING GOWNS; DRESSING GOWNS AND BATH ROBES; EVENING DRESSES; JUMPER DRESSES; KNIT DRESSES; MEN'S DRESS SOCKS; NURSE DRESSES; SKIRTS AND DRESSES; TENNIS DRESSES; WEDDING DRESSES; WOMEN'S CEREMONIAL DRESSES; WOMEN'S CLOTHING, NAMELY, SHIRTS, DRESSES, SKIRTS, BLOUSES; WOVEN DRESSES, IN CLASS 25 (U.S. CLS. 22 AND 39).

FIRST USE 12-1-2010; IN COMMERCE 12-1-2010.

THE MARK CONSISTS OF STANDARD CHARACTERS WITHOUT CLAIM TO ANY PARTICULAR FONT, STYLE, SIZE, OR COLOR.

SER. NO. 85-322,665, FILED 5-17-2011.

MICHAEL WEBSTER, EXAMINING ATTORNEY



*David J. Kyros*

Director of the United States Patent and Trademark Office

# United States of America

United States Patent and Trademark Office

## RickyMartinFoundation

**Reg. No. 4,134,341**

RICKY MARTIN FOUNDATION CORP. (PUERTO RICO CORPORATION)  
P.O. BOX 13534  
SAN JUAN, PUERTO RICO 00908

**Registered May 1, 2012**

**Int. Cl.: 35**

FOR: PROMOTING PUBLIC AWARENESS OF EXPLOITATION OF CHILDREN AROUND THE WORLD, IN CLASS 35 (U.S. CLS. 100, 101 AND 102).

**SERVICE MARK**

FIRST USE 5-0-2000; IN COMMERCE 5-0-2000.

**PRINCIPAL REGISTER**

NO CLAIM IS MADE TO THE EXCLUSIVE RIGHT TO USE "FOUNDATION", APART FROM THE MARK AS SHOWN.

THE COLOR(S) GREY, RED AND BLACK IS/ARE CLAIMED AS A FEATURE OF THE MARK.

THE NAME(S), PORTRAIT(S), AND/OR SIGNATURE(S) SHOWN IN THE MARK IDENTIFIES A LIVING INDIVIDUAL, WHOSE CONSENT(S) TO REGISTER IS MADE OF RECORD.

THE MARK CONSISTS OF THE WORD "RICKY" IN GREY FONT; THE WORD "MARTIN" IN RED FONT; AND THE WORD "FOUNDATION" IN BLACK FONT.

SER. NO. 85-324,691, FILED 5-19-2011.

ROBIN CHOSID, EXAMINING ATTORNEY



*David J. Kybas*

Director of the United States Patent and Trademark Office

# United States of America

United States Patent and Trademark Office

## MIGHTY SAW

**Reg. No. 4,134,342**

**Registered May 1, 2012**

**Int. Cl.: 8**

**TRADEMARK**

**PRINCIPAL REGISTER**

PLYMOUTH DIRECT, INC. (PENNSYLVANIA CORPORATION)  
425 STUMP ROAD  
MONTGOMERYVILLE, PA 18936 AND

NATURE'S PILLOWS, INC. (PENNSYLVANIA CORPORATION)  
2607 INTERPLEX DRIVE  
TREVOSSE, PA 19053

FOR: A MANUALLY OPERATED SAW COMPRISED OF A SERIES OF ATTACHED CUTTING LINKS, IN CLASS 8 (U.S. CLS. 23, 28 AND 44).

FIRST USE 6-20-2011; IN COMMERCE 6-20-2011.

THE MARK CONSISTS OF STANDARD CHARACTERS WITHOUT CLAIM TO ANY PARTICULAR FONT, STYLE, SIZE, OR COLOR.

NO CLAIM IS MADE TO THE EXCLUSIVE RIGHT TO USE "SAW", APART FROM THE MARK AS SHOWN.

SER. NO. 85-325,674, FILED 5-20-2011.

LIEF MARTIN, EXAMINING ATTORNEY



*David J. Kyffers*

Director of the United States Patent and Trademark Office

# United States of America

United States Patent and Trademark Office



**Reg. No. 4,134,343**

**Registered May 1, 2012**

**Int. Cls.: 9 and 17**

**TRADEMARK**

**PRINCIPAL REGISTER**

TIONG LIONG INDUSTRIAL CO., LTD. (TAIWAN CORPORATION)  
NO. 8, LANE 128, CHUNG-CHING RD.  
DAYA DIST.  
TAICHUNG CITY, TAIWAN

FOR: COMPUTER BAGS, PROTECTIVE SLEEVES FOR LAPTOP COMPUTERS, PROTECTIVE COVERS AND CASES FOR CELL PHONES, LAPTOPS, PERSONAL DIGITAL ASSISTANTS (PDA) AND PORTABLE MEDIA PLAYERS, IN CLASS 9 (U.S. CLS. 21, 23, 26, 36 AND 38).

FIRST USE 2-0-2010; IN COMMERCE 6-0-2010.

FOR: THERMOPLASTIC RUBBER; SEMI-PROCESSED RUBBER SHEET WITH LAMINATED FABRIC SURFACE; SEMI-PROCESSED PLASTIC SHEET WITH LAMINATED FABRIC SURFACE; NEOPRENE, NEOPRENE SHEETS AND LAMINATED NEOPRENE SHEETS FOR FURTHER USE IN INDUSTRIAL MANUFACTURE; FOAM RUBBER, NATURAL RUBBER, SYNTHETIC RUBBER, UNPROCESSED RUBBER, SEMI-PROCESSED RUBBER; RUBBER SHEETS; INTERIOR LINING MADE OF RUBBER FOR INDUSTRIAL USE, NAMELY, ELASTIC RUBBER-LIKE MATERIAL FOR USE IN THE MANUFACTURE OF CLOTHING, BAGS, SHOES AND HEADGEAR; SEMI-PROCESSED PLASTIC; SEMI-FINISHED INJECTION MOLDED PRODUCTS OF PLASTIC FOR USE IN A VARIETY OF INDUSTRIES; PLASTIC FILM FOR COMMERCIAL AND INDUSTRIAL USE; CUSHIONING OF RUBBER AND PLASTIC IN THE NATURE OF STUFFING; STUFFING OF RUBBER; INSULATING FABRICS, IN CLASS 17 (U.S. CLS. 1, 5, 12, 13, 35 AND 50).

FIRST USE 2-0-2010; IN COMMERCE 6-0-2010.

THE MARK CONSISTS OF A FLOWER DEVICE HAVING A BLACK DOTTED CIRCLE SURROUNDED BY 12 CHARTREUSE PETALS ON THE LEFT AND A STYLIZED WORDING "ARIAPRENE" ON THE RIGHT, OF WHICH THE LETTERS "ARIA" ARE IN GREEN AND THE LETTERS "PRENE" ARE IN BLACK.

THE COLOR(S) CHARTREUSE GREEN AND BLACK IS/ARE CLAIMED AS A FEATURE OF THE MARK.

SER. NO. 85-326,116, FILED 5-20-2011.

TASNEEM HUSSAIN, EXAMINING ATTORNEY



*David J. Kyros*

Director of the United States Patent and Trademark Office

# United States of America

United States Patent and Trademark Office

# QUANTUM

**Reg. No. 4,134,344**

**Registered May 1, 2012**

**Int. Cl.: 11**

**TRADEMARK**

**PRINCIPAL REGISTER**

MUNTERS CORPORATION (NEW YORK CORPORATION)  
79 MONROE STREET, P.O. BOX 640  
AMESBURY, MA 01913

FOR: DESICCANT WHEELS AND ROTORS FOR USE IN DEHUMIDIFIERS; DESICCANT WHEELS AND ROTORS FOR USE IN AIR-CONDITIONERS, IN CLASS 11 (U.S. CLS. 13, 21, 23, 31 AND 34).

FIRST USE 1-1-2011; IN COMMERCE 1-1-2011.

THE MARK CONSISTS OF STANDARD CHARACTERS WITHOUT CLAIM TO ANY PARTICULAR FONT, STYLE, SIZE, OR COLOR.

SER. NO. 85-328,221, FILED 5-24-2011.

JOHN KELLY, EXAMINING ATTORNEY



*David J. Kyffers*

Director of the United States Patent and Trademark Office

# United States of America

United States Patent and Trademark Office

# LES NOTES DE LANVIN

**Reg. No. 4,134,345**

**Registered May 1, 2012**

**Int. Cls.: 3 and 4**

**TRADEMARK**

**PRINCIPAL REGISTER**

INTERPARFUMS (FRANCE COMPANY)  
4 ROND POINT DES CHAMPS-ELYSEES  
PARIS, FRANCE 75008

FOR: PERFUMERY PRODUCTS AND NON-MEDICATED TOILET PREPARATIONS, NAMELY, PERFUMES FOR PERSONAL USE, COLOGNE, EAU DE TOILETTE, SOAP FOR USE ON THE PERSON, SHOWER GEL, FOAM BATH GEL, BATH SALTS, CLEANSING MILK FOR TOILET PURPOSES, COSMETIC PREPARATIONS FOR USE IN THE BATH NON-MEDICATED, ESSENTIAL OILS FOR PERSONAL USE, COSMETIC PRODUCTS FOR SKIN CARE, NAMELY, MOISTURIZING AND PERFUMED FACE, BODY AND HAND CREAMS AND LOTIONS, PRE-MOISTENED COSMETIC TOWELETTES, MOISTURIZING LIP BALM, SHAMPOO, CONDITIONER, DEODORANT FOR PERSONAL USE, ANTIPERSPIRANTS, NON-MEDICATED LOTIONS AND CREAMS FOR USE BEFORE AND AFTER SHAVING, IN CLASS 3 (U.S. CLS. 1, 4, 6, 50, 51 AND 52).

FOR: PERFUMED CANDLES, IN CLASS 4 (U.S. CLS. 1, 6 AND 15).

PRIORITY CLAIMED UNDER SEC. 44(D) ON FRANCE APPLICATION NO. 11/3832135, FILED 5-17-2011, REG. NO. 113832135, DATED 9-30-2011, EXPIRES 5-17-2021.

OWNER OF U.S. REG. NO. 698,286.

NO CLAIM IS MADE TO THE EXCLUSIVE RIGHT TO USE "NOTES", APART FROM THE MARK AS SHOWN.

THE MARK CONSISTS OF THE WORDS "LES NOTES DE" ON TOP OF THE WORD "LANVIN".

THE ENGLISH TRANSLATION OF "LES NOTES DE LAVIN" IN THE MARK IS "NOTES" FROM "LANVIN".

SER. NO. 85-328,847, FILED 5-24-2011.

H. M. FISHER, EXAMINING ATTORNEY



*David J. Kyros*

Director of the United States Patent and Trademark Office

# United States of America

United States Patent and Trademark Office



LES NOTES DE  
LANVIN

**Reg. No. 4,134,346**

**Registered May 1, 2012**

**Int. Cls.: 3 and 4**

**TRADEMARK**

**PRINCIPAL REGISTER**

INTERPARFUMS (FRANCE COMPANY)  
4 ROND POINT DES CHAMPS-ELYSEES  
PARIS, FRANCE 75008

FOR: PERFUMERY PRODUCTS AND NON-MEDICATED TOILET PREPARATIONS, NAMELY, PERFUMES FOR PERSONAL USE, COLOGNE, EAU DE TOILETTE, SOAP FOR USE ON THE PERSON, SHOWER GEL, FOAM BATH GEL, BATH SALTS, CLEANSING MILK FOR TOILET PURPOSES, COSMETIC PREPARATIONS FOR USE IN THE BATH NON-MEDICATED, ESSENTIAL OILS FOR PERSONAL USE, COSMETIC PRODUCTS FOR SKIN CARE, NAMELY, MOISTURIZING AND PERFUMED FACE, BODY AND HAND CREAMS AND LOTIONS, PRE-MOISTENED COSMETIC TOWELETTES, MOISTURIZING LIP BALM, SHAMPOO, CONDITIONER, DEODORANT FOR PERSONAL USE, ANTIPERSPIRANTS, NON-MEDICATED LOTIONS AND CREAMS FOR USE BEFORE AND AFTER SHAVING, IN CLASS 3 (U.S. CLS. 1, 4, 6, 50, 51 AND 52).

FOR: PERFUMED CANDLES, IN CLASS 4 (U.S. CLS. 1, 6 AND 15).

PRIORITY CLAIMED UNDER SEC. 44(D) ON FRANCE APPLICATION NO. 11/3832534, FILED 5-18-2011, REG. NO. 113832534, DATED 9-30-2011, EXPIRES 5-18-2021.

OWNER OF U.S. REG. NO. 698,286.

NO CLAIM IS MADE TO THE EXCLUSIVE RIGHT TO USE "NOTES", APART FROM THE MARK AS SHOWN.

THE MARK CONSISTS OF AN OCTAGON; INSIDE THE OCTAGON IS AN IMAGE OF A CHILD ON THE LEFT HOLDING HANDS WITH A MOTHER ON THE RIGHT; BELOW THE OCTAGON ARE THE WORDS "LES NOTES DE" ON TOP OF THE WORD "LANVIN".

THE ENGLISH TRANSLATION OF "LES NOTES DE LAVIN" IN THE MARK IS "NOTES" FROM "LANVIN".

SER. NO. 85-328,853, FILED 5-24-2011.

H. M. FISHER, EXAMINING ATTORNEY



*David J. Kyros*

Director of the United States Patent and Trademark Office

# United States of America

United States Patent and Trademark Office

## Balsamo Tchakowski

**Reg. No. 4,134,347**

**Registered May 1, 2012**

**Int. Cl.: 5**

**TRADEMARK**

**PRINCIPAL REGISTER**

MENPER DISTRIBUTORS INC. (FLORIDA CORPORATION)  
6500 NW 35TH AVE  
MIAMI, FL 33147

FOR: DIETARY SUPPLEMENTS, IN CLASS 5 (U.S. CLS. 6, 18, 44, 46, 51 AND 52).

FIRST USE 1-15-2004; IN COMMERCE 1-15-2004.

THE MARK CONSISTS OF STANDARD CHARACTERS WITHOUT CLAIM TO ANY PARTICULAR FONT, STYLE, SIZE, OR COLOR.

NO CLAIM IS MADE TO THE EXCLUSIVE RIGHT TO USE "BALSAMO", APART FROM THE MARK AS SHOWN.

THE NAME(S), PORTRAIT(S), AND/OR SIGNATURE(S) SHOWN IN THE MARK DOES NOT IDENTIFY A PARTICULAR LIVING INDIVIDUAL.

THE ENGLISH TRANSLATION OF "BALSAMO" IN THE MARK IS "BALSAM".

SER. NO. 85-329,101, FILED 5-24-2011.

LESLEY LAMOTHE, EXAMINING ATTORNEY



*David J. Kyros*

Director of the United States Patent and Trademark Office



# United States of America

United States Patent and Trademark Office

# VERSATREX

**Reg. No. 4,134,348**

EDDIE BAUER LICENSING SERVICES LLC (DELAWARE LIMITED LIABILITY COMPANY)  
10401 NORTHEAST 8TH STREET, SUITE 500  
BELLEVUE, WA 98004

**Registered May 1, 2012**

**Int. Cl.: 25**

FOR: CARGO PANTS; LONG SLEEVE PULLOVERS; PANTS; PULLOVERS; SHORTS, IN CLASS 25 (U.S. CLS. 22 AND 39).

**TRADEMARK**

FIRST USE 6-0-2009; IN COMMERCE 6-0-2009.

**PRINCIPAL REGISTER**

THE MARK CONSISTS OF STANDARD CHARACTERS WITHOUT CLAIM TO ANY PARTICULAR FONT, STYLE, SIZE, OR COLOR.

OWNER OF U.S. REG. NO. 3,690,317.

SER. NO. 85-329,304, FILED 5-24-2011.

GRETCHEN ULRICH, EXAMINING ATTORNEY



*David J. Kyffers*

Director of the United States Patent and Trademark Office

# United States of America

United States Patent and Trademark Office

# ProAm-X

**Reg. No. 4,134,349**

AQUATIC HABITATS, INC. (FLORIDA CORPORATION)  
2395 APOPKA BLVD.  
APOPKA, FL 32703

**Registered May 1, 2012**

**Int. Cl.: 1**

FOR: CHEMICAL PREPARATIONS FOR USE IN INDUSTRY, NAMELY, AMMONIA, CHLORINE AND CHLORAMINES REMOVER, IN CLASS 1 (U.S. CLS. 1, 5, 6, 10, 26 AND 46).

**TRADEMARK**

FIRST USE 5-1-2011; IN COMMERCE 5-1-2011.

**PRINCIPAL REGISTER**

THE MARK CONSISTS OF STANDARD CHARACTERS WITHOUT CLAIM TO ANY PARTICULAR FONT, STYLE, SIZE, OR COLOR.

SER. NO. 85-329,573, FILED 5-25-2011.

BENJAMIN OKEKE, EXAMINING ATTORNEY



*David J. Kyffers*

Director of the United States Patent and Trademark Office

# United States of America

United States Patent and Trademark Office

# BATTLE ROX

**Reg. No. 4,134,350**

**Registered May 1, 2012**

**Int. Cl.: 28**

**TRADEMARK**

**PRINCIPAL REGISTER**

BATTLE ROX, INC. (CALIFORNIA CORPORATION)  
18694 SANTA CARMELA STREET  
FOUNTAIN VALLEY, CA 92708

FOR: CARD GAMES; DICE GAMES; EQUIPMENT SOLD AS A UNIT FOR PLAYING CARD GAMES, IN CLASS 28 (U.S. CLS. 22, 23, 38 AND 50).

FIRST USE 7-8-2011; IN COMMERCE 7-23-2011.

THE MARK CONSISTS OF STANDARD CHARACTERS WITHOUT CLAIM TO ANY PARTICULAR FONT, STYLE, SIZE, OR COLOR.

OWNER OF U.S. REG. NOS. 3,309,306 AND 3,313,657.

SER. NO. 85-329,664, FILED 5-25-2011.

KAREN BRACEY, EXAMINING ATTORNEY



*David J. Kyffers*

Director of the United States Patent and Trademark Office

# United States of America

United States Patent and Trademark Office



"Home of the **GOLDEN** Deep Fried Treats"

**Reg. No. 4,134,351**

**Registered May 1, 2012**

**Int. Cl.: 43**

**SERVICE MARK**

**PRINCIPAL REGISTER**

THE FRANDY BAR, LLC (WASHINGTON LIMITED LIABILITY COMPANY)  
8043 NE 132ND STREET  
KIRKLAND, WA 98034

FOR: MOBILE RESTAURANT SERVICES; RESTAURANT; RESTAURANT AND CATERING SERVICES; RESTAURANT SERVICES; RESTAURANT SERVICES FEATURING DEEP FRIED FOODS, IN CLASS 43 (U.S. CLS. 100 AND 101).

FIRST USE 3-0-2011; IN COMMERCE 3-0-2011.

NO CLAIM IS MADE TO THE EXCLUSIVE RIGHT TO USE "BAR" AND "GOLDEN DEEP FRIED TREATS", APART FROM THE MARK AS SHOWN.

THE COLOR(S) YELLOW, BROWN AND WHITE IS/ARE CLAIMED AS A FEATURE OF THE MARK.

THE MARK CONSISTS OF A RECTANGULAR SHAPE WITH A BROWN OUTLINE. INSIDE THE RECTANGLE ARE THE WORDS "THE FRANDY BAR" IN A STYLIZED BROWN FONT. THE WORD "FRANDY" IS IN A LARGER FONT THAN THE WORDS THE AND BAR. "FRANDY" IS IN ALL CAPITALIZED LETTERS. INSIDE THE RECTANGLE ARE THE COLORS YELLOW AND WHITE. YELLOW IS THE MAIN COLOR, AND WHITE IS PARTICULARLY SURROUNDING THE WORD "FRANDY". BELOW THE RECTANGULAR SHAPE IS A STYLIZED FLOWING BROWN RECTANGLE WITH THE WORDS, "HOME OF THE GOLDEN DEEP FRIED TREATS" IN QUOTATIONS. THE WORDS "HOME OF THE DEEP FRIED TREATS" AND QUOTATIONS ARE IN A STYLIZED WHITE FONT AND "GOLDEN" IS IN A STYLIZED YELLOW FONT AND ALL CAPITALIZED.

SER. NO. 85-330,125, FILED 5-25-2011.

ROBERT C. CLARK JR., EXAMINING ATTORNEY



*David J. Kybas*

Director of the United States Patent and Trademark Office

# United States of America

United States Patent and Trademark Office

## Wake Up Wealthy

**Reg. No. 4,134,352**

ROGER P. ELY (UNITED STATES INDIVIDUAL)  
2109 BAYSHORE BLVD. PH 3  
TAMPA, FL 336063192

**Registered May 1, 2012**

**Int. Cl.: 9**

FOR: PRE-RECORDED CDS FEATURING BUSINESS GROWTH STRATEGIES, IN CLASS 9 (U.S. CLS. 21, 23, 26, 36 AND 38).

**TRADEMARK**

FIRST USE 3-15-2011; IN COMMERCE 4-15-2011.

**PRINCIPAL REGISTER**

THE MARK CONSISTS OF STANDARD CHARACTERS WITHOUT CLAIM TO ANY PARTICULAR FONT, STYLE, SIZE, OR COLOR.

SER. NO. 85-330,451, FILED 5-25-2011.

ALEXANDER L. POWERS, EXAMINING ATTORNEY



*David J. Kyros*

Director of the United States Patent and Trademark Office

# United States of America

United States Patent and Trademark Office

# RUFUS

**Reg. No. 4,134,353**

**Registered May 1, 2012**

**Int. Cls.: 9 and 41**

**TRADEMARK**

**SERVICE MARK**

**PRINCIPAL REGISTER**

MAIDEN, TONY (UNITED STATES INDIVIDUAL)  
P.O. BOX 1204  
BIG BEAR, CA 92315

FOR: MUSICAL SOUND RECORDINGS, IN CLASS 9 (U.S. CLS. 21, 23, 26, 36 AND 38).

FIRST USE 1-1-1973; IN COMMERCE 1-1-1973.

FOR: ENTERTAINMENT IN THE NATURE OF LIVE PERFORMANCES BY MUSICAL BAND,  
IN CLASS 41 (U.S. CLS. 100, 101 AND 107).

FIRST USE 1-1-1973; IN COMMERCE 1-1-1973.

THE MARK CONSISTS OF STANDARD CHARACTERS WITHOUT CLAIM TO ANY PARTICULAR FONT, STYLE, SIZE, OR COLOR.

SER. NO. 85-330,481, FILED 5-25-2011.

JAMES MACFARLANE, EXAMINING ATTORNEY



*David J. Kybas*

Director of the United States Patent and Trademark Office

# United States of America

United States Patent and Trademark Office

## VIRTUALLY THE SMARTEST WAY TO DATE

**Reg. No. 4,134,354**

**Registered May 1, 2012**

**Int. Cl.: 42**

**SERVICE MARK**

**PRINCIPAL REGISTER**

3DCHAT.COM, LLC (SOUTH CAROLINA LIMITED LIABILITY COMPANY)  
C200  
1150 HUNGRYNECK BLVD  
MT. PLEASANT, SC 29464

FOR: CREATING AN ON-LINE COMMUNITY FOR REGISTERED USERS TO PARTICIPATE AS AVATARS, VIRTUAL REALITY ICONS AND GRAPHICAL IMAGES THAT REPRESENT PERSONS, AND ENGAGE IN AN ONLINE VIRTUAL WORLD WITH OTHER AVATARS THAT INCLUDES INTERNET-BASED DATING, SOCIAL INTRODUCTION, AND SOCIAL NETWORKING SERVICES, IN CLASS 42 (U.S. CLS. 100 AND 101).

FIRST USE 1-10-2002; IN COMMERCE 1-15-2002.

THE MARK CONSISTS OF STANDARD CHARACTERS WITHOUT CLAIM TO ANY PARTICULAR FONT, STYLE, SIZE, OR COLOR.

SER. NO. 85-330,585, FILED 5-26-2011.

JOHN GARTNER, EXAMINING ATTORNEY



*David J. Kybas*

Director of the United States Patent and Trademark Office

# United States of America

United States Patent and Trademark Office



**Reg. No. 4,134,355**

**Registered May 1, 2012**

**Int. Cl.: 6**

**TRADEMARK**

**PRINCIPAL REGISTER**

NORTHWEST SPECIALTY HARDWARE INC. (OREGON CORPORATION)  
15865 SE 114TH AVENUE  
SUITE C  
CLACKAMAS, OR 97015

FOR: METAL DETENTION DOOR HARDWARE AND ACCESSORIES, NAMELY, IN THE NATURE OF METAL UTILITY HINGES, METAL DOOR PULLS FOR USE IN DETENTION AND CORRECTIONAL FACILITIES, IN CLASS 6 (U.S. CLS. 2, 12, 13, 14, 23, 25 AND 50).

FIRST USE 0-0-2002; IN COMMERCE 0-0-2002.

NO CLAIM IS MADE TO THE EXCLUSIVE RIGHT TO USE "SPECIALTY HARDWARE", APART FROM THE MARK AS SHOWN.

THE COLOR(S) GREEN AND BLACK IS/ARE CLAIMED AS A FEATURE OF THE MARK.

THE MARK CONSISTS OF A BLACK ZIGZAG AND LINE DESIGN THAT RESEMBLES A MOUNTAIN RANGE AND PARTIALLY ENCLOSES THE WORDING "NW" IN BLACK-OUTLINED GREEN LETTERING AND THE WORDING "SPECIALTY HARDWARE" IN BLACK STYLIZED LETTERING.

SER. NO. 85-330,608, FILED 5-26-2011.

JERI J. FICKES, EXAMINING ATTORNEY



*David J. Kybas*

Director of the United States Patent and Trademark Office



# United States of America

United States Patent and Trademark Office

# Sypedic

**Reg. No. 4,134,356**

**Registered May 1, 2012**

**Int. Cl.: 20**

**TRADEMARK**

**PRINCIPAL REGISTER**

MAJOR PROPERTY GROUP, L.L.C. (ILLINOIS LIMITED LIABILITY COMPANY)  
SUITE 4200  
200 WEST MADISON  
CHICAGO, IL 60606

FOR: BOX SPRINGS; MATTRESSES, IN CLASS 20 (U.S. CLS. 2, 13, 22, 25, 32 AND 50).

FIRST USE 5-5-2009; IN COMMERCE 6-26-2009.

THE MARK CONSISTS OF STANDARD CHARACTERS WITHOUT CLAIM TO ANY PARTICULAR FONT, STYLE, SIZE, OR COLOR.

SER. NO. 85-330,860, FILED 5-26-2011.

SHANNON TWOHIG, EXAMINING ATTORNEY



*David J. Kybas*

Director of the United States Patent and Trademark Office

# United States of America

United States Patent and Trademark Office



**Reg. No. 4,134,357**

**Registered May 1, 2012**

**Int. Cl.: 37**

**SERVICE MARK**

**PRINCIPAL REGISTER**

LACOSTA, INC. (ILLINOIS CORPORATION)  
440 BONNER ROAD  
WAUCONDA, IL 60084

FOR: CLEANING OF COMMERCIAL PREMISES IN THE FIELDS OF MANUFACTURING, LABORATORIES AND MAINTENANCE FACILITIES; CLEANING OF RESIDENTIAL HOUSES; CLEANING OF FLOORS AND CARPETS; CLEANING OF UPHOLSTERY, WINDOWS, AND BLINDS; CLEANING OF INDUSTRIAL PREMISES; CLEANING OF MACHINERY; PRESSURE WASHING SERVICES; REPAIR OF PLASTER AND DRYWALLS; ELECTROSTATIC PAINTING; PAINTING BUILDING INTERIORS AND BUILDING EXTERIORS; APPLICATION OF COATINGS AND SEALERS, NAMELY, TEXTURED AND HIGH HEAT COATINGS, HIGH-SOLID EPOXY FINISHES, ACOUSTIC CEILING TEXTURE COATINGS; PAINTING OF MACHINERY; MAINTENANCE OF HEATING, VENTILATION AND AIR CONDITIONING SYSTEMS; MAINTENANCE OF FILTERS; WASHING OF LABORATORY GLASSWARE; REPAIR OF DOORS; MAINTENANCE OF LIGHTING, GROUNDS AND PARKING LOTS; CLEANING OF LABORATORY ANIMAL CAGES; INSTALLATION OF INSULATION; CLEANING OF CONSTRUCTION SITES; REPAIR OF MASONRY AND DRYWALL; MAINTENANCE OF MANUFACTURING PLANTS; SNOW REMOVAL SERVICES; MAINTENANCE OF ROOFS; PLANNING AND LAYING OUT OF PRODUCTION FACILITIES; REFURBISHING OF OFFICE PARTITIONS; CLEANING OF INDUSTRIAL AND RESIDENTIAL PREMISES BEFORE AND AFTER MOVING; INSTALLATION OF OFFICE FURNITURE; MAINTENANCE OF FLOORS; CLEANING OF FLOORS, NAMELY, WAXING OF FLOORS; CONSULTATION IN THE FIELD OF FLOOR MAINTENANCE; POLISHING OF CONCRETE FLOORS; APPLICATION OF COLOR, CLEAR COAT COATINGS AND EPOXY URETHANE FINISHES TO FLOORS; POWER WASHING SERVICES FOR FLOORS; CLEANING OF FLOORS, NAMELY, SCRUBBING AND SURFACE PREPARATION; INTERIOR AND BUILDING SEALING SERVICES, NAMELY, SEALING OF EXPANSION AND FOUNDATION JOINTS; PAVEMENT MARKING SERVICES, NAMELY, APPLYING SAFETY MARKING, LETTERING, NUMBERING AND STRIPING, FIRE EQUIPMENT AND HAZARD MARKING, AND EXIT AREA AND SPECIAL LOCATION MARKINGS; CUTTING OF CONCRETE FLOORS TO MANAGE CRACKING, IN CLASS 37 (U.S. CLS. 100, 103 AND 106).



*David J. Kybas*

Director of the United States Patent and Trademark Office

FIRST USE 12-1-2010; IN COMMERCE 12-1-2010.

THE MARK CONSISTS OF THE WORDS "LACOSTA", "PEOPLE", "PROCESS" AND "PRODUCTIVITY" ARRANGED TO FORM A CIRCLE, WITH "LACOSTA" LOCATED AT THE

**Reg. No. 4,134,357** TOP AND THE WORDS "PEOPLE" AND "PROCESS" AND "PRODUCTIVITY" FORMING THE LOWER PORTION OF THE CIRCLE. A BULLET POINT SEPARATES THE WORDS "PEOPLE AND PROCESS" AND "PROCESS AND PRODUCTIVITY". A STYLIZED GLOBE FORMED OF ARCS AND INTERSECTING ARCS BEING CENTERED WITHIN THE CIRCLE AND A STAR POSITIONED BETWEEN THE LAST "A" IN "LACOSTA" AND THE "Y" IN "PRODUCTIVITY".

THE WORD "LACOSTA" HAS NO MEANING IN A FOREIGN LANGUAGE.

SER. NO. 85-331,064, FILED 5-26-2011.

ERIN FALK, EXAMINING ATTORNEY

# United States of America

United States Patent and Trademark Office

# GLOVIUS

**Reg. No. 4,134,358**

**Registered May 1, 2012**

**Int. Cl.: 9**

**TRADEMARK**

**PRINCIPAL REGISTER**

GEOMETRIC LIMITED (INDIA CORPORATION)  
VIKHROLI (WEST)  
PLANT 6, PIROJSHANAGAR  
MUMBAI - 400 079, INDIA

FOR: MULTIPLATFORM AND EXTENSIBLE SOFTWARE FOR VISUALIZATION OF THREE DIMENSIONAL MODELS FOR USE IN COMPUTER AIDED DESIGN (CAD), COMPUTER AIDED MANUFACTURING (CAM) AND COMPUTER AIDED ENGINEERING (CAE); COMPUTER SOFTWARE FOR VISUALIZATION, EDITING, AUTHORIZING, MODIFICATION AND SHARING OF COMPUTER CREATED DESIGNS, MODELS, ASSEMBLIES, AND DRAWINGS FOR GENERAL USE IN THE FIELD OF THREE DIMENSIONAL VISUALIZATION, IN CLASS 9 (U.S. CLS. 21, 23, 26, 36 AND 38).

FIRST USE 7-10-2011; IN COMMERCE 7-10-2011.

THE MARK CONSISTS OF STANDARD CHARACTERS WITHOUT CLAIM TO ANY PARTICULAR FONT, STYLE, SIZE, OR COLOR.

THE WORD(S) "GLOVIUS" HAS NO MEANING IN A FOREIGN LANGUAGE.

SER. NO. 85-331,113, FILED 5-26-2011.

MARY BOAGNI, EXAMINING ATTORNEY



*David J. Kyros*

Director of the United States Patent and Trademark Office

# United States of America

United States Patent and Trademark Office

# ARMSTRONG

**Reg. No. 4,134,359**

**Registered May 1, 2012**

**Int. Cl.: 20**

**TRADEMARK**

**PRINCIPAL REGISTER**

APEX BRANDS, INC. (DELAWARE CORPORATION)  
1000 LUFKIN ROAD  
APEX, NC 27539

FOR: TOOL AND TOOL ACCESSORY BOXES NOT MADE OF METAL SOLD EMPTY AND PARTS AND FITTINGS THEREFOR, IN CLASS 20 (U.S. CLS. 2, 13, 22, 25, 32 AND 50).

FIRST USE 0-0-1998; IN COMMERCE 0-0-1998.

THE MARK CONSISTS OF STANDARD CHARACTERS WITHOUT CLAIM TO ANY PARTICULAR FONT, STYLE, SIZE, OR COLOR.

OWNER OF U.S. REG. NOS. 243,601, 652,375 AND OTHERS.

SEC. 2(F).

SER. NO. 85-331,643, FILED 5-26-2011.

ALEX KEAM, EXAMINING ATTORNEY



*David J. Kybas*

Director of the United States Patent and Trademark Office

# United States of America

United States Patent and Trademark Office

## ENDO SMARTCAP

**Reg. No. 4,134,360**

MINNTECH CORPORATION (MINNESOTA CORPORATION)  
14605 28TH AVENUE NORTH  
MINNEAPOLIS, MN 55447

**Registered May 1, 2012**

**Int. Cl.: 10**

FOR: ENDOSCOPE ACCESSORIES, NAMELY, NON-METAL WATER BOTTLE ADAPTERS FOR MEDICAL USE, IN CLASS 10 (U.S. CLS. 26, 39 AND 44).

**TRADEMARK**

FIRST USE 2-5-1997; IN COMMERCE 2-5-1997.

**PRINCIPAL REGISTER**

THE MARK CONSISTS OF STANDARD CHARACTERS WITHOUT CLAIM TO ANY PARTICULAR FONT, STYLE, SIZE, OR COLOR.

OWNER OF U.S. REG. NO. 2,206,141.

NO CLAIM IS MADE TO THE EXCLUSIVE RIGHT TO USE "ENDO", APART FROM THE MARK AS SHOWN.

SER. NO. 85-332,583, FILED 5-27-2011.

COURTNEY ALVAREZ, EXAMINING ATTORNEY



*David J. Kyffers*

Director of the United States Patent and Trademark Office

# United States of America

United States Patent and Trademark Office

# Yin Yang USA

**Reg. No. 4,134,361**

**Registered May 1, 2012**

**Int. Cl.: 44**

**SERVICE MARK**

**PRINCIPAL REGISTER**

MAYA, MIGUEL (UNITED STATES INDIVIDUAL)  
89-87 218TH PLACE  
NEW YORK, NY 11427

FOR: ACUPUNCTURE, IN CLASS 44 (U.S. CLS. 100 AND 101).

FIRST USE 5-20-2011; IN COMMERCE 5-20-2011.

THE MARK CONSISTS OF STANDARD CHARACTERS WITHOUT CLAIM TO ANY PARTICULAR FONT, STYLE, SIZE, OR COLOR.

NO CLAIM IS MADE TO THE EXCLUSIVE RIGHT TO USE "USA", APART FROM THE MARK AS SHOWN.

SER. NO. 85-332,876, FILED 5-27-2011.

MATTHEW KLINE, EXAMINING ATTORNEY



*David J. Kyffers*

Director of the United States Patent and Trademark Office

# United States of America

United States Patent and Trademark Office

# KINEKT

**Reg. No. 4,134,362**

**Registered May 1, 2012**

**Int. Cl.: 42**

**SERVICE MARK**

**PRINCIPAL REGISTER**

KINEKT DESIGN, LLC (NEW JERSEY LIMITED LIABILITY COMPANY)  
SUITE 9-239  
184 S. LIVINGSTON AVE  
LIVINGSTON, NJ 07039

FOR: DESIGN AND TESTING FOR NEW PRODUCT DEVELOPMENT; DESIGN AND TESTING OF NEW PRODUCTS FOR OTHERS; DESIGN FOR OTHERS IN THE FIELD OF HOUSEHOLD GOODS; DESIGN OF MECHANICAL AND MICROMECHANICAL COMPONENTS; DESIGN OF MECHANICAL, ELECTROMECHANICAL AND OPTOELECTRONIC APPARATUS AND INSTRUMENTS; DESIGN SKETCHING OF PACKAGING AND CONTAINERS, DESIGNING OF MACHINES, APPARATUS, INSTRUMENTS OR SYSTEMS COMPOSED OF SUCH MACHINES, APPARATUS AND INSTRUMENTS; DESIGNING OF PACKAGING AND WRAPPING MATERIALS, IN CLASS 42 (U.S. CLS. 100 AND 101).

FIRST USE 4-1-2011; IN COMMERCE 4-1-2011.

THE MARK CONSISTS OF STANDARD CHARACTERS WITHOUT CLAIM TO ANY PARTICULAR FONT, STYLE, SIZE, OR COLOR.

SER. NO. 85-333,034, FILED 5-28-2011.

LINDA E. BLOHM, EXAMINING ATTORNEY



*David J. Kybas*

Director of the United States Patent and Trademark Office



# United States of America

United States Patent and Trademark Office



**Reg. No. 4,134,363**

**Registered May 1, 2012**

**Int. Cl.: 25**

**TRADEMARK**

**PRINCIPAL REGISTER**

C.I. CONFECCIONES COLOMBIA S.A. (COLOMBIA CORPORATION)  
CALLE 71 NO. 65-74  
MEDELLÍN, ANTIOQUIA, COLOMBIA

FOR: FOOTWEAR; HEADGEAR, NAMELY, HATS AND CAPS; HEADWEAR; JACKETS;  
PANTS; SHIRTS; SHOES; SOCKS AND STOCKINGS; T-SHIRTS; TIES; TROUSERS; UNDER-  
SHIRTS, IN CLASS 25 (U.S. CLS. 22 AND 39).

OWNER OF COLOMBIA REG. NO. 424679, DATED 5-31-2011, EXPIRES 5-31-2021.

THE COLOR(S) RED AND WHITE IS/ARE CLAIMED AS A FEATURE OF THE MARK.

THE MARK CONSISTS OF THE WORDING "BE FIT" IN WHITE STYLIZED LETTERS OVER  
A RED BACKGROUND.

SER. NO. 85-333,285, FILED 5-29-2011.

KAREN K. BUSH, EXAMINING ATTORNEY



*David J. Kyros*

Director of the United States Patent and Trademark Office

# United States of America

United States Patent and Trademark Office

## GLEEFULL GEAR

**Reg. No. 4,134,364**

**Registered May 1, 2012**

**Int. Cl.: 21**

**TRADEMARK**

**PRINCIPAL REGISTER**

WISHFULS LLC (ARIZONA LIMITED LIABILITY COMPANY)  
6525 EAST BAR Z LANE  
PARADISE VALLEY, AZ 85253

FOR: REUSABLE STAINLESS STEEL WATER BOTTLES SOLD EMPTY; REUSABLE STAINLESS STEEL TRAVEL MUGS, IN CLASS 21 (U.S. CLS. 2, 13, 23, 29, 30, 33, 40 AND 50).

FIRST USE 5-5-2011; IN COMMERCE 5-5-2011.

THE MARK CONSISTS OF STANDARD CHARACTERS WITHOUT CLAIM TO ANY PARTICULAR FONT, STYLE, SIZE, OR COLOR.

NO CLAIM IS MADE TO THE EXCLUSIVE RIGHT TO USE "GEAR", APART FROM THE MARK AS SHOWN.

SER. NO. 85-333,636, FILED 5-31-2011.

ADA HAN, EXAMINING ATTORNEY



*David J. Kyffers*

Director of the United States Patent and Trademark Office

# United States of America

United States Patent and Trademark Office



**Reg. No. 4,134,365**

**Registered May 1, 2012**

**Int. Cl.: 11**

**TRADEMARK**

**PRINCIPAL REGISTER**

FIREFLY LED LIGHTING, INC. (DELAWARE CORPORATION)  
3925 W. BRAKER LANE  
AUSTIN, TX 78759

FOR: LED LIGHT BULBS, AND LED LUMINAIRES, IN CLASS 11 (U.S. CLS. 13, 21, 23, 31 AND 34).

FIRST USE 10-15-2010; IN COMMERCE 10-22-2010.

NO CLAIM IS MADE TO THE EXCLUSIVE RIGHT TO USE "LED LIGHTING", APART FROM THE MARK AS SHOWN.

THE MARK CONSISTS OF THE WORDS "FIREFLY LED LIGHTING" IN AN OVAL CREATED BY A FIREFLY THAT IS ILLUMINATING THE LETTER "I" IN "FIREFLY".

SER. NO. 85-333,762, FILED 5-31-2011.

RONALD AIKENS, EXAMINING ATTORNEY



*David J. Kybas*

Director of the United States Patent and Trademark Office

# United States of America

United States Patent and Trademark Office



**Reg. No. 4,134,366**

**Registered May 1, 2012**

**Int. Cls.: 8 and 21**

**TRADEMARK**

**PRINCIPAL REGISTER**

THE PILLSBURY COMPANY, LLC (DELAWARE LIMITED LIABILITY COMPANY)  
NUMBER ONE GENERAL MILLS BOULEVARD  
MINNEAPOLIS, MN 55426

FOR: APPLE WEDGERS; SPREADER IN THE NATURE OF A SMALL KNIFE FOR BUTTER  
OR CHEESE, IN CLASS 8 (U.S. CLS. 23, 28 AND 44).

FIRST USE 7-31-2007; IN COMMERCE 7-31-2007.

FOR: KITCHEN GADGETS, NAMELY, PIE SERVER, CAKE SERVER, TURNER, PASTRY  
BRUSH, SPATULA; EGG SEPARATOR; FUNNELS, IN CLASS 21 (U.S. CLS. 2, 13, 23, 29, 30,  
33, 40 AND 50).

FIRST USE 7-31-2007; IN COMMERCE 7-31-2007.

OWNER OF U.S. REG. NOS. 1,669,633, 2,470,662 AND OTHERS.

THE MARK CONSISTS OF A DOUGH LIKE FIGURE WITH HIS ARMS RAISED, WEARING  
A CHEF'S HAT AND NECK SCARF. ON THE CHEF'S HAT IS THE WORDING "PILLSBURY"  
SURROUNDED BY ROWS OF DOTS ENCLOSED IN A CIRCLE.

SER. NO. 85-333,908, FILED 5-31-2011.

STEVEN R. FINE, EXAMINING ATTORNEY



*David J. Kybas*

Director of the United States Patent and Trademark Office

# United States of America

United States Patent and Trademark Office



**Reg. No. 4,134,367**

**Registered May 1, 2012**

**Int. Cl.: 35**

**SERVICE MARK**

**PRINCIPAL REGISTER**

JOY AUSTIN ASHLOCK (UNITED STATES INDIVIDUAL)  
2727 LAKE PICKETT PLACE  
CHULUOTA, FL 32766

FOR: ASSOCIATION SERVICES, NAMELY, PROMOTING THE PUBLIC INTEREST AND AWARENESS IN ENVIRONMENTALLY-CONSCIOUS AND GREEN LIFESTYLES, IN CLASS 35 (U.S. CLS. 100, 101 AND 102).

FIRST USE 0-0-2009; IN COMMERCE 0-0-2009.

NO CLAIM IS MADE TO THE EXCLUSIVE RIGHT TO USE "GREEN, PARENT AND ASSOCIATION.ORG", APART FROM THE MARK AS SHOWN.

THE COLOR(S) GREEN, WHITE, YELLOW AND GRAY IS/ARE CLAIMED AS A FEATURE OF THE MARK.

THE MARK CONSISTS OF THE WORDS "GREENPARENT", "ASSOCIATION.ORG" AND "GROWING GREENER FAMILIES", WHERE THE WORDS "GREEN", "ASSOCIATION.ORG" AND "GROWING GREENER FAMILIES" ARE IN GREEN, AND THE WORD "PARENT" IS IN WHITE. THERE IS AN IMAGE OF TWO BRUSH STROKE FIGURES, WHERE THE SHORTER FIGURE IS HOLDING A WATERING CAN ABOVE THE IMAGE OF A SMALL PLANT. THERE ARE VINE-LIKE IMAGES, AS WELL AS AN IMAGE OF LEAVES IN WHITE, YELLOW AND GRAY. THE ENTIRE IMAGE IS ON A GREEN RECTANGULAR BACKGROUND, WHERE THE BOTTOM EDGE OF THE RECTANGLE IS DARK GREEN.

SER. NO. 85-334,000, FILED 5-31-2011.

JOHN DALIER, EXAMINING ATTORNEY



*David J. Kyros*

Director of the United States Patent and Trademark Office

# United States of America

United States Patent and Trademark Office



**Reg. No. 4,134,368**

**Registered May 1, 2012**

**Int. Cl.: 43**

**SERVICE MARK**

**PRINCIPAL REGISTER**

COORDINADORA RC, S.A. DE C.V. (MEXICO CORPORATION)  
EDIFICIO "B", PISO 1  
CALZADA IGNACIO ZARAGOZA NO. 200  
COLONIA SIETE DE JULIO, MEXICO 15390MEXI

FOR: PROVIDING OF FOOD AND BEVERAGES, RESTAURANTS, SELF-SERVICE RESTAURANTS, COFFEE SHOP SERVICES, CAFETERIAS, OPEN AIR CAFES, BAR SERVICES, AND SNACK-BARS, IN CLASS 43 (U.S. CLS. 100 AND 101).

OWNER OF MEXICO REG. NO. 1172924, DATED 8-16-2010, EXPIRES 6-7-2020.

NO CLAIM IS MADE TO THE EXCLUSIVE RIGHT TO USE "CAFE", APART FROM THE MARK AS SHOWN.

THE MARK CONSISTS OF A SHADED CIRCLE, WITH AN INTERIOR UNSHADED BORDER, CONTAINING THE UNSHADED STYLIZED WORDING, "CIELITO" IN THE CENTER OF THE CIRCLE, WITH THE UNSHADED WORDING, "QUERIDO CAFÉ" BELOW IN ALL CAPS.

THE ENGLISH TRANSLATION OF "CIELITO QUERIDO" IN THE MARK IS "DEAR LITTLE HEAVEN".

SER. NO. 85-334,241, FILED 5-31-2011.

ODESSA BIBBINS, EXAMINING ATTORNEY



*David J. Kybas*

Director of the United States Patent and Trademark Office

# United States of America

United States Patent and Trademark Office

# *Cielito*

QUERIDO CAFE

**Reg. No. 4,134,369**

**Registered May 1, 2012**

**Int. Cl.: 43**

**SERVICE MARK**

**PRINCIPAL REGISTER**

COORDINADORA RC, S.A. DE C.V. (MEXICO CORPORATION)  
EDIFICIO "B", PISO 1  
CALZADA IGNACIO ZARAGOZA NO. 200  
COLONIA SIETE DE JULIO, MEXICO 15390MEXI

FOR: PROVIDING OF FOOD AND BEVERAGES, RESTAURANTS, SELF-SERVICE RESTAURANTS, COFFEE SHOP SERVICES, CAFETERIAS, OPEN AIR CAFES, BAR SERVICES, AND SNACK-BARS, IN CLASS 43 (U.S. CLS. 100 AND 101).

OWNER OF MEXICO REG. NO. 1172926, DATED 8-16-2010, EXPIRES 8-16-2020.

NO CLAIM IS MADE TO THE EXCLUSIVE RIGHT TO USE "CAFE", APART FROM THE MARK AS SHOWN.

THE MARK CONSISTS OF THE STYLIZED WORDING, "CIELITO", WITH THE WORDING, "QUERIDO CAFÉ" IN SMALL CAPS PRINTED BELOW "ITO" IN "CIELITO".

THE ENGLISH TRANSLATION OF "CIELITO QUERIDO" IN THE MARK IS DEAR LITTLE HEAVEN.

SER. NO. 85-334,767, FILED 6-1-2011.

ODESSA BIBBINS, EXAMINING ATTORNEY



*David J. Kyros*

Director of the United States Patent and Trademark Office

# United States of America

United States Patent and Trademark Office



**Reg. No. 4,134,370**

**Registered May 1, 2012**

**Int. Cls.: 8 and 21**

**TRADEMARK**

**PRINCIPAL REGISTER**

THE PILLSBURY COMPANY, LLC (DELAWARE LIMITED LIABILITY COMPANY)  
NUMBER ONE GENERAL MILLS BOULEVARD  
MINNEAPOLIS, MN 55426

FOR: APPLE WEDGERS; SPREADER IN THE NATURE OF A SMALL KNIFE FOR BUTTER  
OR CHEESE, IN CLASS 8 (U.S. CLS. 23, 28 AND 44).

FIRST USE 7-31-2007; IN COMMERCE 7-31-2007.

FOR: KITCHEN GADGETS, NAMELY, PIE SERVER, CAKE SERVER, TURNER, PASTRY  
BRUSH, SPATULA; EGG SEPARATOR; FUNNELS, IN CLASS 21 (U.S. CLS. 2, 13, 23, 29, 30,  
33, 40 AND 50).

FIRST USE 7-31-2007; IN COMMERCE 7-31-2007.

OWNER OF U.S. REG. NOS. 382,934, 698,691 AND OTHERS.

THE MARK CONSISTS OF THE WORD "PILLSBURY" SURROUNDED BY ROWS OF DOTS  
ENCLOSED IN A CIRCLE.

SER. NO. 85-334,963, FILED 6-1-2011.

STEVEN R. FINE, EXAMINING ATTORNEY



*David J. Kybas*

Director of the United States Patent and Trademark Office



# United States of America

United States Patent and Trademark Office

## Braces That Rock

**Reg. No. 4,134,371**

**Registered May 1, 2012**

**Int. Cl.: 10**

**TRADEMARK**

**PRINCIPAL REGISTER**

ALIGNCO ORTHODONTICS (NEBRASKA CORPORATION)  
14441 DUPONT COURT #301  
OMAHA, NE 68144

FOR: ORTHODONTIC BRACKETS, IN CLASS 10 (U.S. CLS. 26, 39 AND 44).

FIRST USE 5-1-2010; IN COMMERCE 5-1-2010.

THE MARK CONSISTS OF STANDARD CHARACTERS WITHOUT CLAIM TO ANY PARTICULAR FONT, STYLE, SIZE, OR COLOR.

NO CLAIM IS MADE TO THE EXCLUSIVE RIGHT TO USE "BRACES", APART FROM THE MARK AS SHOWN.

SER. NO. 85-335,010, FILED 6-1-2011.

MICHAEL WEBSTER, EXAMINING ATTORNEY



*David J. Kyffers*

Director of the United States Patent and Trademark Office

# United States of America

United States Patent and Trademark Office

## DR. SUMMER KNIGHT

**Reg. No. 4,134,372**

**Registered May 1, 2012**

**Int. Cls.: 35 and 41**

**SERVICE MARK**

**PRINCIPAL REGISTER**

DSK CORPORATE HOLDINGS, LLC (FLORIDA CORPORATION)  
1526 BELLEAU WOOD DRIVE  
TALLAHASSEE, FL 32308

FOR: BUSINESS MANAGEMENT CONSULTING AND ADVISORY SERVICES, NAMELY, PROVIDING ADVICE AND STRATEGY IN THE FIELDS OF BUSINESS LEADERSHIP DEVELOPMENT AND BUSINESS MANAGEMENT, IN CLASS 35 (U.S. CLS. 100, 101 AND 102).

FIRST USE 12-0-2006; IN COMMERCE 12-0-2006.

FOR: EDUCATIONAL SERVICES, NAMELY, PROVIDING LIVE CLASSES, SEMINARS, CONFERENCES, WORKSHOPS, LECTURES, AND MAKING PERSONAL APPEARANCES BY A MOTIVATIONAL SPEAKER IN THE FIELDS OF SELF-IMPROVEMENT, MOTIVATION, FINANCIAL IMPROVEMENT AND BUSINESS EDUCATION FOR BUSINESSES AND INDIVIDUALS; PERSONAL COACHING SERVICES IN THE FIELDS OF SELF-IMPROVEMENT, MOTIVATION, FINANCIAL IMPROVEMENT AND BUSINESS EDUCATION FOR BUSINESSES AND INDIVIDUALS, IN CLASS 41 (U.S. CLS. 100, 101 AND 107).

FIRST USE 12-0-2006; IN COMMERCE 12-0-2006.

THE MARK CONSISTS OF STANDARD CHARACTERS WITHOUT CLAIM TO ANY PARTICULAR FONT, STYLE, SIZE, OR COLOR.

THE NAME(S), PORTRAIT(S), AND/OR SIGNATURE(S) SHOWN IN THE MARK IDENTIFIES "DR. SUMMER KNIGHT", WHOSE CONSENT(S) TO REGISTER IS MADE OF RECORD.

SER. NO. 85-335,085, FILED 6-1-2011.

DOMINICK J. SALEMI, EXAMINING ATTORNEY



*David J. Kybas*

Director of the United States Patent and Trademark Office

# United States of America

United States Patent and Trademark Office

# DuraDrain

**Reg. No. 4,134,373**

**Registered May 1, 2012**

**Int. Cl.: 12**

**TRADEMARK**

**PRINCIPAL REGISTER**

BENDIX COMMERCIAL VEHICLE SYSTEMS LLC (DELAWARE LIMITED LIABILITY COMPANY)  
901 CLEVELAND STREET  
ELYRIA, OH 44035

FOR: VALVES FOR LAND VEHICLE AIR BRAKE SYSTEMS AND PARTS THEREFOR, IN CLASS 12 (U.S. CLS. 19, 21, 23, 31, 35 AND 44).

FIRST USE 8-30-2000; IN COMMERCE 8-30-2000.

THE MARK CONSISTS OF STANDARD CHARACTERS WITHOUT CLAIM TO ANY PARTICULAR FONT, STYLE, SIZE, OR COLOR.

SER. NO. 85-335,095, FILED 6-1-2011.

INGA ERVIN, EXAMINING ATTORNEY



*David J. Kybas*

Director of the United States Patent and Trademark Office

# United States of America

United States Patent and Trademark Office

# SUNNY

**Reg. No. 4,134,374**

**Registered May 1, 2012**

**Int. Cl.: 9**

**TRADEMARK**

**PRINCIPAL REGISTER**

SUNNY OPTIC, INC. (NEVADA CORPORATION)  
92 HONORS COURSE DRIVE  
LAS VEGAS, NV 89148

FOR: OPTOELECTRONICS, NAMELY, DIGITAL CAMERA MODULES AND OPTICAL OR OPTIC COMPONENTS FOR CAMERA MODULES, IN CLASS 9 (U.S. CLS. 21, 23, 26, 36 AND 38).

FIRST USE 1-1-2008; IN COMMERCE 1-1-2008.

THE MARK CONSISTS OF STANDARD CHARACTERS WITHOUT CLAIM TO ANY PARTICULAR FONT, STYLE, SIZE, OR COLOR.

SER. NO. 85-335,099, FILED 6-1-2011.

DAVID HOFFMAN, EXAMINING ATTORNEY



*David J. Kyffers*

Director of the United States Patent and Trademark Office

# United States of America

United States Patent and Trademark Office



**Reg. No. 4,134,375**

**Registered May 1, 2012**

**Int. Cl.: 30**

**TRADEMARK**

**PRINCIPAL REGISTER**

SIMONE M. RATHLE (UNITED STATES INDIVIDUAL)  
6011 CHESTERBROOK ROAD  
MCLEAN, VA 22101

FOR: CANDY COATED POPCORN; CARAMEL POPCORN; FLAVOR-COATED POPPED POPCORN; POPPED POPCORN; SNACK MIX CONSISTING PRIMARILY OF CRACKERS, PRETZELS AND/OR POPPED POPCORN, IN CLASS 30 (U.S. CL. 46).

FIRST USE 4-5-2011; IN COMMERCE 4-5-2011.

NO CLAIM IS MADE TO THE EXCLUSIVE RIGHT TO USE "SALTED CARAMEL POPCORN," "BACON" AND "BAKERY COFFEE BAR & EATERY", APART FROM THE MARK AS SHOWN.

THE COLOR(S) BLUE, MAROON AND GRAY IS/ARE CLAIMED AS A FEATURE OF THE MARK.

THE NAME(S), PORTRAIT(S), AND/OR SIGNATURE(S) SHOWN IN THE MARK IDENTIFIES "ALLAN BENTON", WHOSE CONSENT(S) TO REGISTER IS MADE OF RECORD.

THE MARK CONSISTS OF A GRAY PIG WITH THE WORD "PORKORN" WRITTEN ACROSS IT IN MAROON AND THE WORDS "SALTED CARAMEL POPCORN WITH ALLAN BENTON'S BACON" WRITTEN BELOW IN BLUE; THE PIG IS SURROUNDED BY CONCENTRIC BLUE OVALS WITH THE WORDS "BAYOU BAKERY COFFEE BAR & EATERY" WRITTEN IN MAROON ACROSS THE BASE OF THE INNER OVAL.

THE WORDING "PORKORN" HAS NO MEANING IN A FOREIGN LANGUAGE.

SER. NO. 85-335,213, FILED 6-1-2011.

SUZANNE BLANE, EXAMINING ATTORNEY



*David J. Kybas*

Director of the United States Patent and Trademark Office

# United States of America

United States Patent and Trademark Office

## STRIPED DAINTIES

**Reg. No. 4,134,376**

**Registered May 1, 2012**

**Int. Cl.: 30**

**TRADEMARK**

**PRINCIPAL REGISTER**

RIPON FOODS, INC. (WISCONSIN CORPORATION)  
420 EAST OSHKOSH STREET  
RIPON, WI 54971

FOR: COOKIES, IN CLASS 30 (U.S. CL. 46).

FIRST USE 12-31-1973; IN COMMERCE 12-31-1973.

THE MARK CONSISTS OF STANDARD CHARACTERS WITHOUT CLAIM TO ANY PARTICULAR FONT, STYLE, SIZE, OR COLOR.

OWNER OF U.S. REG. NO. 1,637,726.

NO CLAIM IS MADE TO THE EXCLUSIVE RIGHT TO USE "STRIPED", APART FROM THE MARK AS SHOWN.

SER. NO. 85-335,303, FILED 6-1-2011.

ANNE FARRELL, EXAMINING ATTORNEY



*David J. Kyffers*

Director of the United States Patent and Trademark Office

# United States of America

United States Patent and Trademark Office

## OneLOVE Chocolate

**Reg. No. 4,134,377**

**Registered May 1, 2012**

**Int. Cl.: 30**

**TRADEMARK**

**PRINCIPAL REGISTER**

TRACIE WALKER (KANSAS LIMITED LIABILITY COMPANY), DBA SIMPLY RAW  
LIFESTYLE, LLC  
9436 W 120TH ST.  
OVERLAND PARK, KS 66213

FOR: CHOCOLATE, IN CLASS 30 (U.S. CL. 46).

FIRST USE 12-1-2010; IN COMMERCE 4-25-2011.

THE MARK CONSISTS OF STANDARD CHARACTERS WITHOUT CLAIM TO ANY PARTICULAR FONT, STYLE, SIZE, OR COLOR.

NO CLAIM IS MADE TO THE EXCLUSIVE RIGHT TO USE "CHOCOLATE", APART FROM THE MARK AS SHOWN.

SER. NO. 85-335,513, FILED 6-1-2011.

C. DIONNE CLYBURN, EXAMINING ATTORNEY



*David J. Kybas*

Director of the United States Patent and Trademark Office

# United States of America

United States Patent and Trademark Office

# SIRENA

**Reg. No. 4,134,378**

**Registered May 1, 2012**

**Int. Cl.: 14**

**TRADEMARK**

**PRINCIPAL REGISTER**

MERIT DIAMOND CORPORATION (FLORIDA CORPORATION)  
1900 TYLER STREET, 3RD FLOOR  
HOLLYWOOD, FL 33020

FOR: JEWELRY CONSISTING OF PRECIOUS METALS, PRECIOUS STONES AND SEMI-PRECIOUS STONES, IN CLASS 14 (U.S. CLS. 2, 27, 28 AND 50).

FIRST USE 10-0-2002; IN COMMERCE 4-0-2003.

THE MARK CONSISTS OF STANDARD CHARACTERS WITHOUT CLAIM TO ANY PARTICULAR FONT, STYLE, SIZE, OR COLOR.

OWNER OF U.S. REG. NOS. 2,814,897 AND 3,880,656.

THE ENGLISH TRANSLATION OF THE WORD "SIRENA" IN THE MARK IS "MERMAID".

SER. NO. 85-336,511, FILED 6-2-2011.

JENNIFER MARTIN, EXAMINING ATTORNEY



*David J. Kybas*

Director of the United States Patent and Trademark Office



# United States of America

United States Patent and Trademark Office

## ENERGYTIGHT

**Reg. No. 4,134,379**

**Registered May 1, 2012**

**Int. Cls.: 37 and 42**

**SERVICE MARK**

**PRINCIPAL REGISTER**

US GREENFIBER, LLC (DELAWARE LIMITED LIABILITY COMPANY)  
2500 DISTRIBUTION ST., SUITE 200  
CHARLOTTE, NC 28203

FOR: COMMERCIAL AND RESIDENTIAL ENERGY ASSESSMENT SERVICES FOR THE PURPOSE OF DETERMINING HOME OR BUILDING IMPROVEMENTS NEEDED TO IMPROVE ENERGY USE AND EFFICIENCY; HVAC CONTRACTOR SERVICES; INSTALLATION, REPLACEMENT AND REPAIR OF WATER HEATERS AND HEATING, VENTILATING AND AIR CONDITIONING EQUIPMENT; RESIDENTIAL AND BUILDING CONSTRUCTION CONSULTING, IN CLASS 37 (U.S. CLS. 100, 103 AND 106).

FIRST USE 5-31-2010; IN COMMERCE 5-31-2010.

FOR: BUILDING INSPECTION SERVICES SPECIALIZING AIR QUALITY AND ENERGY EFFICIENCY, NAMELY, INSPECTING, MEASURING, AND EXAMINING COMMERCIAL AND RESIDENTIAL BUILDINGS AND BUILDING ENVELOPES FOR THE PURPOSES OF ASSESSING AND IDENTIFYING IMPROVEMENTS TO AIR QUALITY AND ENERGY EFFICIENCY, IN CLASS 42 (U.S. CLS. 100 AND 101).

FIRST USE 5-31-2010; IN COMMERCE 5-31-2010.

THE MARK CONSISTS OF STANDARD CHARACTERS WITHOUT CLAIM TO ANY PARTICULAR FONT, STYLE, SIZE, OR COLOR.

SER. NO. 85-336,667, FILED 6-2-2011.

TAMARA FRAZIER, EXAMINING ATTORNEY



*David J. Kypos*

Director of the United States Patent and Trademark Office

# United States of America

United States Patent and Trademark Office



**Reg. No. 4,134,380**

**Registered May 1, 2012**

**Int. Cl.: 7**

**TRADEMARK**

**PRINCIPAL REGISTER**

BALDAN IMPLEMENTOS AGRÍCOLAS S.A. (BRAZIL CORPORATION)  
RUA RUI BARBOSA, 1145  
MATÃO, SÃO PAULO, BRAZIL

FOR: AGRICULTURAL MACHINES, NAMELY, DISC PLOWS, DISC HARROWS, ROTARY CUTTERS, HYDRAULIC CULTIVATORS FOR TRACTORS; TRACTOR TOWED TRANSPORTATION PLATFORMS, SUBSOILERS, GRAIN PLANTERS, LEVELLERS, DISCS AND BLADES FOR PLOWS AND HARROWS; ANIMAL-DRAWN SULKY HARROWS, SHOVELS, GRUBBERS, SOIL SCARIFIERS, CULTIVATORS, AND PARTS OF ALL OF THE ABOVE, IN CLASS 7 (U.S. CLS. 13, 19, 21, 23, 31, 34 AND 35).

FIRST USE 11-1-1987; IN COMMERCE 2-1-2010.

OWNER OF U.S. REG. NOS. 1,156,126 AND 1,175,563.

THE MARK CONSISTS OF THE WORD "BIA" WRITTEN IN CAPITAL LETTERS WITHIN A DRAWING OF FISH THAT IS WITHIN A RECTANGLE BOX AND THE WORD "BALDAN" WRITTEN IN UPPER AND LOWER CASE LETTERS INSIDE A RECTANGLE BOX TO THE RIGHT OF THE FIRST RECTANGLE.

SER. NO. 85-337,319, FILED 6-3-2011.

JEFF DEFORD, EXAMINING ATTORNEY



*David J. Kyffers*

Director of the United States Patent and Trademark Office

# United States of America

United States Patent and Trademark Office

## BOY CHANEL

**Reg. No. 4,134,381**

**Registered May 1, 2012**

**Int. Cls.: 18 and 25**

**TRADEMARK**

**PRINCIPAL REGISTER**

CHANEL, INC. (NEW YORK CORPORATION)  
CHANEL LEGAL DEPARTMENT  
9 WEST 57TH STREET  
NEW YORK, NY 10019

FOR: WOMEN'S HANDBAGS, IN CLASS 18 (U.S. CLS. 1, 2, 3, 22 AND 41).

FIRST USE 3-0-2011; IN COMMERCE 3-0-2011.

FOR: WOMEN'S BELTS , IN CLASS 25 (U.S. CLS. 22 AND 39).

FIRST USE 3-0-2011; IN COMMERCE 3-0-2011.

THE MARK CONSISTS OF STANDARD CHARACTERS WITHOUT CLAIM TO ANY PARTICULAR FONT, STYLE, SIZE, OR COLOR.

OWNER OF U.S. REG. NOS. 195,360, 3,890,159 AND OTHERS.

SER. NO. 85-337,462, FILED 6-3-2011.

DANNEAN HETZEL, EXAMINING ATTORNEY



*David J. Kybas*

Director of the United States Patent and Trademark Office

# United States of America

United States Patent and Trademark Office

## STAY HUMBLE

**Reg. No. 4,134,382**

LIFE KIT LLC (NORTH CAROLINA LIMITED LIABILITY COMPANY)  
24203 ROSE GARDEN LN  
DURHAM, NC 27707

**Registered May 1, 2012**

**Int. Cl.: 26**

FOR: ORNAMENTAL NOVELTY BUTTONS, IN CLASS 26 (U.S. CLS. 37, 39, 40, 42 AND 50).

**TRADEMARK**

FIRST USE 5-28-2010; IN COMMERCE 6-16-2010.

**PRINCIPAL REGISTER**

THE MARK CONSISTS OF STANDARD CHARACTERS WITHOUT CLAIM TO ANY PARTICULAR FONT, STYLE, SIZE, OR COLOR.

SER. NO. 85-337,963, FILED 6-3-2011.

JEFFREY LOOK, EXAMINING ATTORNEY



*David J. Kyffers*

Director of the United States Patent and Trademark Office

# United States of America

United States Patent and Trademark Office

**iD** ideal  
dentistry

**Reg. No. 4,134,383**

**Registered May 1, 2012**

**Int. Cl.: 44**

**SERVICE MARK**

**PRINCIPAL REGISTER**

HAHN, CHRISTIAN W. (UNITED STATES INDIVIDUAL), DBA IDEAL DENTISTRY  
9527 US HWY 42  
PROSPECT, KY 40059

FOR: DENTIST SERVICES, IN CLASS 44 (U.S. CLS. 100 AND 101).

FIRST USE 9-25-1999; IN COMMERCE 2-1-2009.

NO CLAIM IS MADE TO THE EXCLUSIVE RIGHT TO USE "DENTISTRY", APART FROM THE MARK AS SHOWN.

THE MARK CONSISTS OF THE LETTER "I" NEXT TO A STYLIZED LETTER "D" NEXT TO THE WORDS "IDEAL" AND "DENTISTRY".

SER. NO. 85-338,293, FILED 6-5-2011.

DAVID C. REIHNER, EXAMINING ATTORNEY



*David J. Kyffers*

Director of the United States Patent and Trademark Office

# United States of America

United States Patent and Trademark Office

## GROWING HEALTHY FAMILIES

**Reg. No. 4,134,384**

**Registered May 1, 2012**

**Int. Cl.: 41**

**SERVICE MARK**

**PRINCIPAL REGISTER**

ROCK RANCH LLC (GEORGIA LIMITED LIABILITY COMPANY)  
5200 BUFFINGTON ROAD  
ATLANTA, GA 30349

FOR: EDUCATIONAL AND ENTERTAINMENT SERVICES, NAMELY, CONDUCTING COURSES IN THE NATURE OF WALKING TOURS OF A RANCH IN THE FIELD OF RANCH LIVING; ORGANIZATION OF EXHIBITS FOR CULTURAL OR EDUCATIONAL PURPOSES, IN CLASS 41 (U.S. CLS. 100, 101 AND 107).

FIRST USE 3-1-2011; IN COMMERCE 4-16-2011.

THE MARK CONSISTS OF STANDARD CHARACTERS WITHOUT CLAIM TO ANY PARTICULAR FONT, STYLE, SIZE, OR COLOR.

SER. NO. 85-338,414, FILED 6-6-2011.

GEOFFREY FOSDICK, EXAMINING ATTORNEY



*David J. Kyffers*

Director of the United States Patent and Trademark Office

# United States of America

United States Patent and Trademark Office



**Reg. No. 4,134,385**

RIVAL BOXING GEAR INC. (CANADA CORPORATION)  
9810 ST-URBAIN

**Registered May 1, 2012**

MONTREAL, QUEBEC, CANADA H3L2T2

**Int. Cls.: 9, 10, 25 and 28**

FOR: SPORTS HELMETS, IN CLASS 9 (U.S. CLS. 21, 23, 26, 36 AND 38).

**TRADEMARK**

FOR: SUPPORT BANDAGES FOR BOXING TRAINING, IN CLASS 10 (U.S. CLS. 26, 39 AND 44).

**PRINCIPAL REGISTER**

FOR: CLOTHING, NAMELY, BOXING SHORTS, BATHROBES, CORNER JACKETS, BOXING SHOES, IN CLASS 25 (U.S. CLS. 22 AND 39).

FOR: BOXING EQUIPMENT AND ACCESSORIES, NAMELY, BOXING GLOVES, PUNCHING BAGS, BOXING SWIVELS FOR SPEED BAGS, ABDOMINAL PADS, TRAINING BANDAGES, NAMELY, HANDWRAPS, AND TRAINER'S MITTS, IN CLASS 28 (U.S. CLS. 22, 23, 38 AND 50).

OWNER OF CANADA REG. NO. TMA661,230, DATED 3-23-2006, EXPIRES 3-23-2021.

THE MARK CONSISTS OF THE STYLIZED TERM "RIVAL" POSITIONED ON THE BOTTOM OF A HORNS DESIGN.

SER. NO. 85-338,478, FILED 6-6-2011.

CAROLINE WOOD, EXAMINING ATTORNEY



*David J. Kybas*

Director of the United States Patent and Trademark Office

# United States of America

United States Patent and Trademark Office

## AlphaNumericalWord

**Reg. No. 4,134,386**

**Registered May 1, 2012**

**Int. Cl.: 45**

**SERVICE MARK**

**PRINCIPAL REGISTER**

BREEZE, NEVADA (UNITED STATES INDIVIDUAL), DBA QUEEN OF HOOKS MUSIC  
2125 FAIR OAKS BLVD.  
UNIT C4  
SACRAMENTO, CA 95825

FOR: PROVIDING A SELECTION OF ON-LINE ELECTRONIC GREETING CARDS, IN CLASS  
45 (U.S. CLS. 100 AND 101).

FIRST USE 9-1-1988; IN COMMERCE 6-6-2011.

THE MARK CONSISTS OF STANDARD CHARACTERS WITHOUT CLAIM TO ANY PAR-  
TICULAR FONT, STYLE, SIZE, OR COLOR.

SER. NO. 85-338,536, FILED 6-6-2011.

MELISSA VALLILLO, EXAMINING ATTORNEY



*David J. Kyffers*

Director of the United States Patent and Trademark Office



# United States of America

United States Patent and Trademark Office



**Reg. No. 4,134,387**

**Registered May 1, 2012**

**Int. Cls.: 9 and 42**

**TRADEMARK**

**SERVICE MARK**

**PRINCIPAL REGISTER**

VERSA TECHNOLOGY, INC. (NEVADA CORPORATION)  
5224 BELL CT  
CHINO, CA 91710

FOR: ELECTRONIC NETWORK DEVICES, NAMELY, NETWORK HUBS, NETWORK CARDS, MODEMS, FIBER OPTIC MODEMS, MULTIPLEXERS, XDSL MODEM MULTIPLEXERS, ROUTERS, AND SWITCHES, ALL FOR USE IN THE TELECOMMUNICATIONS FIELD, IN CLASS 9 (U.S. CLS. 21, 23, 26, 36 AND 38).

FIRST USE 6-1-2008; IN COMMERCE 6-1-2008.

FOR: PROVIDING ON-LINE TECHNICAL INFORMATION IN THE FIELD OF TELECOMMUNICATION ELECTRONIC NETWORKING DEVICES, NAMELY, NETWORK HUBS, NETWORK CARDS, MODEMS, OPTICAL TRANSMISSION DEVICES, FIBER OPTIC MODEMS, MULTIPLEXERS, AND XDSL MODEM MULTIPLEXERS, FIBER CONNECTION DEVICES AND ETHERNET OPTICAL LINK DEVICES, IN CLASS 42 (U.S. CLS. 100 AND 101).

FIRST USE 6-1-2008; IN COMMERCE 6-1-2008.

OWNER OF U.S. REG. NO. 2,493,813.

NO CLAIM IS MADE TO THE EXCLUSIVE RIGHT TO USE "TECHNOLOGY", APART FROM THE MARK AS SHOWN.

THE MARK CONSISTS OF A STYLIZED "V" TO THE LEFT OF THE PHRASE "VERSA TECHNOLOGY".

THE WORDING "VERSA" HAS NO MEANING IN A FOREIGN LANGUAGE.

SER. NO. 85-338,760, FILED S.R. 6-6-2011 AM. P.R. 12-15-2011.

BILL DAWE, EXAMINING ATTORNEY

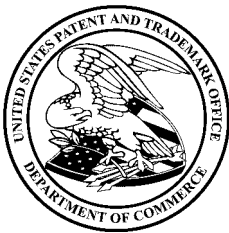

*David J. Kyros*

Director of the United States Patent and Trademark Office

# United States of America

United States Patent and Trademark Office

## NEVADA BREEZE FITNESS GRAVITY

**Reg. No. 4,134,388**

**Registered May 1, 2012**

**Int. Cl.: 35**

**SERVICE MARK**

**PRINCIPAL REGISTER**

BREEZE, NEVADA (UNITED STATES INDIVIDUAL), DBA QUEEN OF HOOKS MUSIC  
2125 FAIR OAKS BLVD., UNIT C4  
2125 FAIR OAKS AVE  
SACRAMENTO, CA 95825

FOR: RETAIL STORE AND ONLINE RETAIL STORE SERVICES FEATURING MUSICAL FITNESS VIDEOS, DVDS AND AUDIO CDS UP TO 40 MINUTES IN LENGTH TO SIGNIFY THE LENGTH OF THE RHYTHMIC CARDIO EXERCISE FEATURING MUSIC AND INSTRUCTION SONG, PRODUCED AND PERFORMED BY SINGER, SONGWRITER AND COMPOSER NEVADA BREEZE AND INCLUDES THE SONG "INSTRUCTIONAL SONG" AND FEATURING A FITNESS PROGRAM THAT USES GRAVITY AND BODY WEIGHT FOR PROLONGED PERIODS, IN CLASS 35 (U.S. CLS. 100, 101 AND 102).

FIRST USE 10-1-2010; IN COMMERCE 5-21-2011.

THE MARK CONSISTS OF STANDARD CHARACTERS WITHOUT CLAIM TO ANY PARTICULAR FONT, STYLE, SIZE, OR COLOR.

NO CLAIM IS MADE TO THE EXCLUSIVE RIGHT TO USE "FITNESS GRAVITY", APART FROM THE MARK AS SHOWN.

THE NAME "NEVADA BREEZE" IDENTIFIES A LIVING INDIVIDUAL WHOSE CONSENT IS OF RECORD.

SER. NO. 85-338,768, FILED 6-6-2011.

MELISSA VALLILLO, EXAMINING ATTORNEY



*David J. Kypos*

Director of the United States Patent and Trademark Office

# United States of America

United States Patent and Trademark Office

# Animatrhythm

**Reg. No. 4,134,389**

**Registered May 1, 2012**

**Int. Cl.: 41**

**SERVICE MARK**

**PRINCIPAL REGISTER**

BREEZE, NEVADA (UNITED STATES INDIVIDUAL), DBA QUEEN OF HOOKS MUSIC  
2125 FAIR OAKS BLVD.  
UNIT C4  
SACRAMENTO, CA 95825

FOR: MUSIC PRODUCTION AND COMPOSITION SERVICES, NAMELY, PRODUCTION AND COMPOSITION OF ANIMATED FITNESS SONGS WITH CHARACTER VOICES AND FITNESS RHYTHMS BY SINGER AND COMPOSER NEVADA BREEZE FOR USE IN CONJUNCTION WITH A FUN EXCITING MUSICAL FITNESS PROGRAM FOR KIDS OF ALL AGES AND FOR USE IN AN EXERCISE PROGRAM CALLED "RHYTHM GRAVITY AEROBICS" WHICH IS DESIGNED TO STIMULATE MOVEMENT AND PROMOTE GOOD HEALTH AND WELL-BEING FOR CHILDREN AND USED IN VARIOUS FACILITIES, IN CLASS 41 (U.S. CLS. 100, 101 AND 107).

FIRST USE 10-1-2010; IN COMMERCE 5-21-2011.

THE MARK CONSISTS OF STANDARD CHARACTERS WITHOUT CLAIM TO ANY PARTICULAR FONT, STYLE, SIZE, OR COLOR.

SER. NO. 85-338,925, FILED 6-6-2011.

MELISSA VALLILLO, EXAMINING ATTORNEY



*David J. Kyffers*

Director of the United States Patent and Trademark Office

# United States of America

United States Patent and Trademark Office

## Rhythmgravitate

**Reg. No. 4,134,390**

**Registered May 1, 2012**

**Int. Cl.: 35**

**SERVICE MARK**

**PRINCIPAL REGISTER**

BREEZE, NEVADA (UNITED STATES INDIVIDUAL), DBA QUEEN OF HOOKS MUSIC  
2125 FAIR OAKS BLVD.  
UNIT C4  
SACRAMENTO, CA 95825

FOR: RETAIL STORE AND ONLINE RETAIL STORE SERVICES FEATURING MUSICAL FITNESS CD'S AND DVD'S FEATURING EXERCISES AND MOVEMENT THAT FOCUS ON GRAVITY AND BODY WEIGHT FOR CORE STRENGTHENING AND GOOD HEALTH, IN CLASS 35 (U.S. CLS. 100, 101 AND 102).

FIRST USE 5-1-2010; IN COMMERCE 5-22-2011.

THE MARK CONSISTS OF STANDARD CHARACTERS WITHOUT CLAIM TO ANY PARTICULAR FONT, STYLE, SIZE, OR COLOR.

SER. NO. 85-339,028, FILED 6-6-2011.

MELISSA VALLILLO, EXAMINING ATTORNEY



*David J. Kyffers*

Director of the United States Patent and Trademark Office

# United States of America

United States Patent and Trademark Office

# DJ Infinity

**Reg. No. 4,134,391**

**Registered May 1, 2012**

**Int. Cl.: 41**

**SERVICE MARK**

**PRINCIPAL REGISTER**

DJ INFINITY PRODUCTIONS, LLC (ARIZONA LIMITED LIABILITY COMPANY), DBA DJ INFINITY  
2119 W PLATA AVE  
MESA, AZ 85202

FOR: DISC JOCKEY SERVICES, IN CLASS 41 (U.S. CLS. 100, 101 AND 107).

FIRST USE 1-1-1992; IN COMMERCE 1-1-1998.

THE MARK CONSISTS OF STANDARD CHARACTERS WITHOUT CLAIM TO ANY PARTICULAR FONT, STYLE, SIZE, OR COLOR.

NO CLAIM IS MADE TO THE EXCLUSIVE RIGHT TO USE "DJ", APART FROM THE MARK AS SHOWN.

SEC. 2(F).

SER. NO. 85-339,992, FILED 6-7-2011.

JASON TURNER, EXAMINING ATTORNEY



*David J. Kybas*

Director of the United States Patent and Trademark Office

# United States of America

United States Patent and Trademark Office

# Nisa Santiago

**Reg. No. 4,134,392**

DANIELLE SANTIAGO (UNITED STATES INDIVIDUAL), AKA NISA SANTIAGO  
1813 MERRIMAN AVENUE  
CHARLOTTE, NC 28203

**Registered May 1, 2012**

**Int. Cl.: 16**

FOR: A SERIES OF BOOKS AND WRITTEN ARTICLES IN THE FIELD OF FICTION, IN CLASS 16 (U.S. CLS. 2, 5, 22, 23, 29, 37, 38 AND 50).

**TRADEMARK**

FIRST USE 6-7-2007; IN COMMERCE 4-28-2009.

**PRINCIPAL REGISTER**

THE MARK CONSISTS OF STANDARD CHARACTERS WITHOUT CLAIM TO ANY PARTICULAR FONT, STYLE, SIZE, OR COLOR.

THE NAME(S), PORTRAIT(S), AND/OR SIGNATURE(S) SHOWN IN THE MARK IDENTIFIES DANIELLE "SANTIAGO", WHOSE CONSENT(S) TO REGISTER IS MADE OF RECORD.

SER. NO. 85-340,152, FILED 6-7-2011.

GRETCHEN ULRICH, EXAMINING ATTORNEY



*David J. Kyffers*

Director of the United States Patent and Trademark Office

# United States of America

United States Patent and Trademark Office

## THE WILLIS CLAN

**Reg. No. 4,134,393**

**Registered May 1, 2012**

**Int. Cl.: 41**

**SERVICE MARK**

**PRINCIPAL REGISTER**

THE WILLIS PARTNERSHIP (TENNESSEE PARTNERSHIP)  
C/O MCGHEE ENTERTAINMENT  
21 MUSIC SQUARE WEST  
NASHVILLE, TN 37203

FOR: ENTERTAINMENT SERVICES, NAMELY, LIVE PERFORMANCES BY A MUSICAL ARTIST, PERSONAL APPEARANCES BY A MUSICAL ARTIST AS WELL AS LIVE TELEVISION AND RADIO PERFORMANCES BY A MUSICAL ARTIST FEATURING MUSIC, SINGING, DRAMA, COMEDY, DANCE AND SPOKEN WORD; ENTERTAINMENT, NAMELY, PRODUCTION OF LIVE THEATRICAL SHOWS, LIVE MUSICAL SHOWS, CONCERTS, VIDEOS, MULTIMEDIA VIDEOS AND RADIO AND TELEVISION PROGRAMS; AUDIO AND VIDEO RECORDING SERVICES; PRODUCTION OF VIDEO AND AUDIO RECORDINGS ON CASSETTES, DVDS, COMPACT DISCS, RECORDS AND IN DIGITAL FORMAT, FEATURING MUSIC AND AUDIO-VISUAL ENTERTAINMENT; ENTERTAINMENT SERVICES, NAMELY, PROVIDING NON-DOWNLOADABLE PRERECORDED MUSIC AND VIDEOS FEATURING MUSIC ONLINE VIA A GLOBAL COMPUTER NETWORK; PROVIDING A WEBSITE FEATURING INFORMATION IN THE FIELDS OF MUSIC AND ENTERTAINMENT, COMMENTARY AND ARTICLES ABOUT MUSIC AND ENTERTAINMENT AND INFORMATION ABOUT A MUSICAL ARTIST, NAMELY, INFORMATION ABOUT PERFORMANCES, RECORDS, APPEARANCES AND BIOGRAPHICAL INFORMATION, ALL ONLINE VIA A GLOBAL COMPUTER NETWORK; MUSIC PUBLISHING SERVICES, IN CLASS 41 (U.S. CLS. 100, 101 AND 107).

FIRST USE 5-1-2008; IN COMMERCE 5-31-2008.

THE MARK CONSISTS OF STANDARD CHARACTERS WITHOUT CLAIM TO ANY PARTICULAR FONT, STYLE, SIZE, OR COLOR.

SER. NO. 85-340,206, FILED 6-7-2011.

STEVEN JACKSON, EXAMINING ATTORNEY



*David J. Kypos*

Director of the United States Patent and Trademark Office

# United States of America

United States Patent and Trademark Office

## BUILTTOGROW

**Reg. No. 4,134,394**

**Registered May 1, 2012**

**Int. Cls.: 20 and 35**

**TRADEMARK**

**SERVICE MARK**

**PRINCIPAL REGISTER**

STANLEY FURNITURE COMPANY, INC. (DELAWARE CORPORATION)  
1641 FAIRSTONE PARK HIGHWAY  
STANLEYTOWN, VA 24168

FOR: BEDROOM FURNITURE FOR CHILDREN, IN CLASS 20 (U.S. CLS. 2, 13, 22, 25, 32 AND 50).

FIRST USE 2-28-2010; IN COMMERCE 2-28-2010.

FOR: RETAIL STORE SERVICES FEATURING BEDROOM FURNITURE FOR CHILDREN, IN CLASS 35 (U.S. CLS. 100, 101 AND 102).

FIRST USE 10-12-2004; IN COMMERCE 10-19-2004.

THE MARK CONSISTS OF STANDARD CHARACTERS WITHOUT CLAIM TO ANY PARTICULAR FONT, STYLE, SIZE, OR COLOR.

SER. NO. 85-340,546, FILED 6-7-2011.

LEIGH LOWRY, EXAMINING ATTORNEY



*David J. Kyfos*

Director of the United States Patent and Trademark Office



# United States of America

United States Patent and Trademark Office

# MOXME

**Reg. No. 4,134,395**

**Registered May 1, 2012**

**Int. Cls.: 38 and 42**

**SERVICE MARK**

**PRINCIPAL REGISTER**

TELECHOICE, LLC (CONNECTICUT LIMITED LIABILITY COMPANY)  
803 WARRENVILLE ROAD  
MANSFIELD CENTER, CT 06250

FOR: SERVICE FOR CONNECTING USERS IN GROUPS, NAMELY, PROVIDING ELECTRONIC TELECOMMUNICATION CONNECTIONS AND TRANSMISSION OF VOICE, VIDEO, MESSAGING, DATA AND DOCUMENTS BY MEANS OF TELEPHONE, CABLE AND SATELLITE TRANSMISSION FOR GROUP MEMBERS TO PARTICIPATE IN AND COORDINATE GROUP ACTIVITIES AND INFORMATION SHARING BY COMMUNICATION VIA SOCIAL MEDIA PLATFORMS, OR ALTERNATIVELY VIA E-MAILS, TEXT MESSAGES, INSTANT MESSAGES, TELEPHONY, VOICE BROADCAST, MULTIMEDIA MESSAGES, CARRIER SIGNALING NETWORKS, OR AN INTERNET BROWSER, IN CLASS 38 (U.S. CLS. 100, 101 AND 104).

FIRST USE 4-30-2011; IN COMMERCE 4-30-2011.

FOR: SOFTWARE AS A SERVICE (SAAS) SERVICES FEATURING SOFTWARE FOR COORDINATING COMMUNICATIONS WITH INDIVIDUALS AND GROUPS FOR CONTACT MANAGEMENT, CALENDAR MANAGEMENT, FACILITIES MANAGEMENT, GROUP MANAGEMENT, ALERT SERVICES, NAMELY, ENABLING E-MAIL AND ELECTRONIC MESSAGING ALERTS AND PROVIDING OUTCALL NOTIFICATION SERVICES, COLLABORATION THROUGH FILE SHARING BY ENABLING USERS TO UPLOAD AND DOWNLOAD ELECTRONIC FILES, VIDEO SERVICES MANAGEMENT AND FOR NETWORKING, NAMELY, BY TRANSMISSION OF VOICE, TEXT, INSTANT AND EMAIL MESSAGES, VIDEO AND DATA VIA THE INTERNET AND MOBILE DEVICES, IN CLASS 42 (U.S. CLS. 100 AND 101).

FIRST USE 4-30-2011; IN COMMERCE 4-30-2011.

THE MARK CONSISTS OF STANDARD CHARACTERS WITHOUT CLAIM TO ANY PARTICULAR FONT, STYLE, SIZE, OR COLOR.

OWNER OF U.S. REG. NO. 3,538,014.

SER. NO. 85-341,399, FILED 6-8-2011.

ELLEN PERKINS, EXAMINING ATTORNEY



*David J. Kyros*

Director of the United States Patent and Trademark Office

# United States of America

United States Patent and Trademark Office

# Cirruspath

**Reg. No. 4,134,396**

**Registered May 1, 2012**

**Int. Cls.: 9 and 35**

**TRADEMARK**

**SERVICE MARK**

**PRINCIPAL REGISTER**

CIRRUSPATH, LLC (CALIFORNIA LIMITED LIABILITY COMPANY)  
23046 AVENIDA DE LA CARLOTA, SUITE 600  
LAGUNA HILLS, CA 92653

FOR: COMPUTER SOFTWARE FOR USE IN CUSTOMER RELATIONSHIP MANAGEMENT (CRM); COMPUTER SOFTWARE THAT PROVIDES REAL-TIME, INTEGRATED BUSINESS MANAGEMENT INTELLIGENCE BY COMBINING INFORMATION FROM VARIOUS DATABASES AND PRESENTING IT IN AN EASY-TO-UNDERSTAND USER INTERFACE; NONE OF THE FOREGOING BEING IN RELATION TO CREDIT CARDS, DEBIT CARDS, PAYMENT CARDS, AUTOMATIC TELLER MACHINES (ATMS), POINT OF SALE PAYMENT TERMINALS, FINANCIAL, BANKING AND CREDIT SERVICES, ATM SERVICES, ELECTRONIC FUNDS AND CURRENCY TRANSFER SERVICES, PAYMENT SERVICES AND RELATED PRODUCTS AND SERVICES, IN CLASS 9 (U.S. CLS. 21, 23, 26, 36 AND 38).

FIRST USE 5-1-2011; IN COMMERCE 5-1-2011.

FOR: CUSTOMER RELATIONSHIP MANAGEMENT; PROVIDING A WEBSITE AT WHICH CUSTOMERS CAN MANAGE ACCOUNT INFORMATION RELATED TO TELECOMMUNICATIONS PRODUCTS AND SERVICES; NONE OF THE FOREGOING BEING IN RELATION TO CREDIT CARDS, DEBIT CARDS, PAYMENT CARDS, AUTOMATIC TELLER MACHINES (ATMS), POINT OF SALE PAYMENT TERMINALS, FINANCIAL, BANKING AND CREDIT SERVICES, ATM SERVICES, ELECTRONIC FUNDS AND CURRENCY TRANSFER SERVICES, PAYMENT SERVICES AND RELATED PRODUCTS AND SERVICES, IN CLASS 35 (U.S. CLS. 100, 101 AND 102).

FIRST USE 5-1-2011; IN COMMERCE 5-1-2011.

THE MARK CONSISTS OF STANDARD CHARACTERS WITHOUT CLAIM TO ANY PARTICULAR FONT, STYLE, SIZE, OR COLOR.

SER. NO. 85-341,734, FILED 6-9-2011.

VIVIAN MICZNIK FIRST, EXAMINING ATTORNEY



*David J. Kyros*

Director of the United States Patent and Trademark Office

United States of America  
United States Patent and Trademark Office

Huayi 

**Reg. No. 4,134,397**

**Registered May 1, 2012**

**Int. Cl.: 11**

**TRADEMARK**

**PRINCIPAL REGISTER**

GUANGDONG HUAYI PLUMBING FITTINGS INDUSTRY CO., LTD. (CHINA CORPORATION)  
PLUMBING FITTINGS DISTRICT, SHUIKOU TOWN  
NO. 1 ZHONGXING ROAD, KAIPING CITY  
GUANGDONG, CHINA

FOR: HYDRANTS; MIXER FAUCETS FOR WATER PIPES; TAP WATER FAUCETS; PIPES BEING PARTS OF SANITARY FACILITIES; DECORATIVE WATER FOUNTAINS; TOILET SEATS; WASH-HAND BOWLS, BEING PARTS OF SANITARY INSTALLATIONS, IN CLASS 11 (U.S. CLS. 13, 21, 23, 31 AND 34).

FIRST USE 3-1-2008; IN COMMERCE 3-1-2008.

THE MARK CONSISTS OF THE WORD "HUAYI" WITH THE LETTER "I" IN A BLACK SQUARE BACKGROUND AND PRESENTED IN A STYLIZED MANNER FORMING A FAUCET.

THE WORDING "HUAYI" HAS NO MEANING IN A FOREIGN LANGUAGE.

SER. NO. 85-343,552, FILED 6-10-2011.

JASON TURNER, EXAMINING ATTORNEY



*David J. Kybas*

Director of the United States Patent and Trademark Office

# United States of America

United States Patent and Trademark Office



**Reg. No. 4,134,398**

**Registered May 1, 2012**

**Int. Cls.: 35 and 37**

**SERVICE MARK**

**PRINCIPAL REGISTER**

K & M TIRE, INC. (OHIO CORPORATION), DBA MR. TIRE  
1125 SPENSERVILLE ROAD  
DELPHOS, OH 45833

FOR: RETAIL STORE SERVICES IN THE FIELD OF AUTOMOTIVE, TRUCK AND FARM EQUIPMENT TIRES, IN CLASS 35 (U.S. CLS. 100, 101 AND 102).

FIRST USE 5-19-2011; IN COMMERCE 5-19-2011.

FOR: AUTOMOTIVE AND TRUCK REPAIR AND MAINTENANCE SERVICES, IN CLASS 37 (U.S. CLS. 100, 103 AND 106).

FIRST USE 5-19-2011; IN COMMERCE 5-19-2011.

OWNER OF U.S. REG. NOS. 2,853,522 AND 2,853,528.

THE COLOR(S) RED, BLACK, AND WHITE IS/ARE CLAIMED AS A FEATURE OF THE MARK.

NO CLAIM IS MADE TO THE EXCLUSIVE RIGHT TO USE "OUTLET", APART FROM THE MARK AS SHOWN.

THE MARK CONSISTS OF THE WORD "MR" IN RED ON THE LEFT SIDE OF THE MARK WITH AN EXTENSION OF THE BOTTOM PORTION OF THE LETTER "R", FOLLOWED BY A BLACK STAR, THEN THE WORD "TIRE" IN BLACK, WITH A RED LINE BELOW A PORTION OF THE LITERAL PORTION OF THE MARK, WITH THE WORD "OUTLET" IN RED NEXT TO THE RED LINE UNDER THE LETTERS "RE" OF "TIRE", WITH A WHITE STAR AS THE CENTER OF THE "O" IN "OUTLET", ALL SURROUNDED BY A BLACK PARALLELOGRAM WITH ROUNDED CORNERS.

SER. NO. 85-343,896, FILED 6-11-2011.

REGINA DRUMMOND, EXAMINING ATTORNEY



*David J. Kyros*

Director of the United States Patent and Trademark Office

# United States of America

United States Patent and Trademark Office

# WACKY JAX

**Reg. No. 4,134,399**

**Registered May 1, 2012**

**Int. Cl.: 28**

**TRADEMARK**

**PRINCIPAL REGISTER**

SV TOYS, LLC (NEW JERSEY LIMITED LIABILITY COMPANY)  
6 NICHOLAS DRIVE  
NEPTUNE, NJ 07753

FOR: PLASTIC TOY RINGS; CHINESE JACKS, IN CLASS 28 (U.S. CLS. 22, 23, 38 AND 50).

FIRST USE 3-0-2011; IN COMMERCE 3-0-2011.

THE MARK CONSISTS OF STANDARD CHARACTERS WITHOUT CLAIM TO ANY PARTICULAR FONT, STYLE, SIZE, OR COLOR.

NO CLAIM IS MADE TO THE EXCLUSIVE RIGHT TO USE "JACKS", APART FROM THE MARK AS SHOWN.

SER. NO. 85-344,360, FILED 6-13-2011.

SHANNON TWOHIG, EXAMINING ATTORNEY



*David J. Kyffers*

Director of the United States Patent and Trademark Office

# United States of America

United States Patent and Trademark Office

## HERVE CHAPELIER

**Reg. No. 4,134,400**

**Registered May 1, 2012**

**Int. Cl.: 25**

**TRADEMARK**

**PRINCIPAL REGISTER**

BUSH HOLDING (FRANCE LIMITED LIABILITY COMPANY)  
40 AVENUE EDOUARD VAILLANT  
BOULOGNE BILLANCOURT, FRANCE F-92100

FOR: CLOTHING ARTICLES FOR MEN, WOMEN AND CHILDREN, NAMELY, JACKETS, TROUSERS, SHIRTS, T-SHIRTS, POLO SHIRTS, SHORTS, SWEATERS, PULL-OVERS, SCARVES, BELTS, HATS, CAPS, SHOES, IN CLASS 25 (U.S. CLS. 22 AND 39).

THE MARK CONSISTS OF STANDARD CHARACTERS WITHOUT CLAIM TO ANY PARTICULAR FONT, STYLE, SIZE, OR COLOR.

OWNER OF FRANCE REG. NO. 1652670, DATED 3-28-1991, EXPIRES 3-28-2021.

OWNER OF U.S. REG. NOS. 1,728,789, 3,119,843, AND 3,369,470.

THE NAME "HERVE CHAPELIER" IDENTIFIES A LIVING INDIVIDUAL WHOSE CONSENT IS OF RECORD.

SER. NO. 85-344,650, FILED 6-13-2011.

PAULA MAHONEY, EXAMINING ATTORNEY



*David J. Kybas*

Director of the United States Patent and Trademark Office

# United States of America

United States Patent and Trademark Office

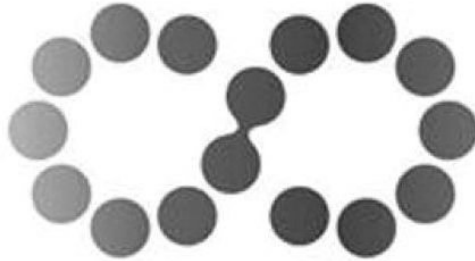

**Reg. No. 4,134,401**

**Registered May 1, 2012**

**Int. Cl.: 9**

CHINA ENERGY CONSERVATION AND ENVIRONMENTAL PROTECTION GROUP (CHINA CORPORATION)  
NO.42 XIZHIMEN NORTH STREET  
HAIDIAN DISTRICT  
BEIJING, CHINA

**TRADEMARK**

**PRINCIPAL REGISTER**

FOR: SIGNALING LIGHTS, NAMELY, ELECTRONIC BLINKERS; COMPUTERS; OPTICAL COMMUNICATION APPARATUS, NAMELY, OPTICAL TRANSCEIVERS; OPTICAL COMMUNICATION APPARATUS, NAMELY, OPTICAL CABLES; ELECTRONIC PENS; DOWNLOADABLE ELECTRONIC PUBLICATIONS, NAMELY, BOOKS, MAGAZINES, MANUALS AND NEWSLETTERS IN THE FIELD OF ENERGY SAVING AND ENVIRONMENTAL PROTECTION; AUTOMATIC PROGRAMMED TELEPHONE EXCHANGES APPARATUS; SINGLE CRYSTAL SILICON IN THE FORM OF CONDUCTORS, WAFERS, CHIPS; SILICON WAFERS; ELECTRONIC COMPONENTS, NAMELY, QUARTZ CRYSTALS AND POLYSILICON CHIPS AND WAFERS; SOLAR BATTERIES, IN CLASS 9 (U.S. CLS. 21, 23, 26, 36 AND 38).

OWNER OF CHINA REG. NO. 6828530, DATED 7-14-2010, EXPIRES 7-13-2020.

THE MARK CONSISTS OF AN INFINITY SYMBOL DESIGN FORMED BY SMALL CIRCLES, IN WHICH THE TWO CIRCLES IN THE CENTRE ARE LINKED.

SER. NO. 85-345,206, FILED 6-14-2011.

REGINA DRUMMOND, EXAMINING ATTORNEY



*David J. Kybas*

Director of the United States Patent and Trademark Office

# United States of America

United States Patent and Trademark Office

## Face It TOGETHER

**Reg. No. 4,134,402**

**Registered May 1, 2012**

**Int. Cls.: 35, 36, 42 and 44**

**SERVICE MARK**

**PRINCIPAL REGISTER**

FACE IT TOGETHER, INC. (SOUTH DAKOTA CORPORATION)  
101 S. PHILLIPS AVENUE, SUITE 104  
SIOUX FALLS, SD 57104

FOR: ASSOCIATION SERVICES, NAMELY, PROMOTING THE PUBLIC INTEREST AND AWARENESS IN RELATION TO ALCOHOL AND DRUG ABUSE AND ADDICTION AND RELATED DISORDERS, IN CLASS 35 (U.S. CLS. 100, 101 AND 102).

FIRST USE 12-1-2011; IN COMMERCE 12-1-2011.

FOR: CHARITABLE FUNDRAISING SERVICES, NAMELY, ORGANIZING AND CONDUCTING PROJECTS TO PROMOTE AWARENESS OF ALCOHOL AND DRUG ABUSE AND ADDICTION AND RELATED DISORDERS, IN CLASS 36 (U.S. CLS. 100, 101 AND 102).

FIRST USE 12-1-2011; IN COMMERCE 12-1-2011.

FOR: ACCREDITATION SERVICES, NAMELY, EVALUATING ORGANIZATIONS TO DETERMINE WHETHER THE ORGANIZATIONS CONFORM TO AN ESTABLISHED STANDARD IN RELATION TO PROMOTING COMMUNITY-WIDE INITIATIVES AND AWARENESS IN THE FIELD OF ALCOHOL AND DRUG ABUSE AND ADDICTION AND RELATED DISORDERS, IN CLASS 42 (U.S. CLS. 100 AND 101).

FIRST USE 12-1-2011; IN COMMERCE 12-1-2011.

FOR: PROVIDING INFORMATION TO THE PUBLIC REGARDING ALCOHOL AND DRUG ABUSE AND ADDICTION AND RELATED DISORDERS, IN CLASS 44 (U.S. CLS. 100 AND 101).

FIRST USE 12-1-2011; IN COMMERCE 12-1-2011.

THE MARK CONSISTS OF STANDARD CHARACTERS WITHOUT CLAIM TO ANY PARTICULAR FONT, STYLE, SIZE, OR COLOR.

SER. NO. 85-345,658, FILED 6-14-2011.

THEODORE MCBRIDE, EXAMINING ATTORNEY

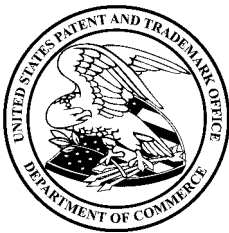

*David J. Kyros*

Director of the United States Patent and Trademark Office



# United States of America

United States Patent and Trademark Office

# eyecam

**Reg. No. 4,134,403**

**Registered May 1, 2012**

**Int. Cls.: 9, 38, 41, 42  
and 45**

**TRADEMARK**

**SERVICE MARK**

**PRINCIPAL REGISTER**

NEO IT SOLUTIONS LTD. (ISRAEL LIMITED LIABILITY COMPANY), AKA EYECAM  
11 HASHALOM RD.  
TEL AVIV, ISRAEL 67892

FOR: CLOSED CIRCUIT TV SYSTEMS FOR SECURITY AND SURVEILLANCE, NAMELY, CAMERAS, SWITCHERS, MONITORS, MICROPHONES, AND RECORDERS; INTERNET DIGITAL VIDEO RECORDERS; IP (INTERNET PROTOCOL) CAMERAS, IN CLASS 9 (U.S. CLS. 21, 23, 26, 36 AND 38).

FIRST USE 1-15-2011; IN COMMERCE 1-15-2011.

FOR: VIDEO BROADCASTING SERVICES VIA THE INTERNET; VIDEO CONFERENCING SERVICES, IN CLASS 38 (U.S. CLS. 100, 101 AND 104).

FIRST USE 1-15-2011; IN COMMERCE 1-15-2011.

FOR: AUDIO AND VIDEO RECORDING SERVICES, IN CLASS 41 (U.S. CLS. 100, 101 AND 107).

FIRST USE 1-15-2011; IN COMMERCE 1-15-2011.

FOR: PROVIDING AN ONLINE NON-DOWNLOADABLE INTERNET-BASED SYSTEM APPLICATION FEATURING TECHNOLOGY ENABLING USERS TO RECORD, VIEW, SHARE AND BROADCAST VIDEO AND AUDIO CONTENT, IN CLASS 42 (U.S. CLS. 100 AND 101).

FIRST USE 1-15-2011; IN COMMERCE 1-15-2011.

FOR: ON-LINE SOCIAL NETWORKING SERVICES, IN CLASS 45 (U.S. CLS. 100 AND 101).

FIRST USE 1-15-2011; IN COMMERCE 1-15-2011.

THE MARK CONSISTS OF STANDARD CHARACTERS WITHOUT CLAIM TO ANY PARTICULAR FONT, STYLE, SIZE, OR COLOR.

SER. NO. 85-347,553, FILED 6-16-2011.



*David J. Kybas*

Director of the United States Patent and Trademark Office

**Reg. No. 4,134,403** WILLIAM BRECKENFELD, EXAMINING ATTORNEY

# United States of America

United States Patent and Trademark Office

# ITALIAN SHOEMAKERS

**Reg. No. 4,134,404**

ITALIAN SHOEMAKERS, INC. (FLORIDA CORPORATION)  
9350 N.W. 58TH STREET  
MIAMI, FL 33178

**Registered May 1, 2012**

**Int. Cl.: 25**

FOR: FOOTWEAR, NAMELY, SHOES, SANDALS AND SLIPPERS FROM ITALY, IN CLASS 25 (U.S. CLS. 22 AND 39).

**TRADEMARK**

FIRST USE 1-1-1999; IN COMMERCE 1-1-1999.

**PRINCIPAL REGISTER**

OWNER OF U.S. REG. NO. 3,078,492.

NO CLAIM IS MADE TO THE EXCLUSIVE RIGHT TO USE "ITALIAN", APART FROM THE MARK AS SHOWN.

THE MARK CONSISTS OF STYLIZED WORD "ITALIAN" OVER STYLIZED WORD "SHOEMAKERS".

SEC. 2(F).

SER. NO. 85-348,004, FILED 6-16-2011.

MICHAEL WEBSTER, EXAMINING ATTORNEY



*David J. Kyffers*

Director of the United States Patent and Trademark Office

# United States of America

United States Patent and Trademark Office



**Reg. No. 4,134,405**

**Registered May 1, 2012**

**Int. Cls.: 35, 41 and 42**

**SERVICE MARK**

**PRINCIPAL REGISTER**

BIRGELEN, DOMINIK (FED REP GERMANY INDIVIDUAL)  
LUITPOLDSTRASSE 17  
83435 BAD REICHENHALL, FED REP GERMANY

FOR: ADVERTISING SERVICES; BUSINESS MANAGEMENT SERVICES; BUSINESS ADMINISTRATION; PROVIDING OFFICE FUNCTIONS; SALES OPTIMIZATION, NAMELY, OPTIMIZING PROCESSES, ORGANIZATION AND MANAGEMENT IN THE AREAS OF SALES EFFECTIVENESS AND EFFICIENCY; SALES SUPPORT, NAMELY, SCHEDULING BUSINESS MEETINGS FOR OTHERS; ADDRESS QUALIFICATION, NAMELY, GATHERING CUSTOMER DATA FOR OTHERS; SUPPORT FOR POTENTIAL CUSTOMERS, NAMELY, OUTSOURCING OF BACK OFFICE ACTIVITIES FOR OTHERS; NEW CUSTOMER ACQUISITION, NAMELY, GAINING NEW CUSTOMERS FOR OTHERS; SCHEDULING, NAMELY, APPOINTING BUSINESS MEETINGS FOR OTHERS; CUSTOMER DEVELOPMENT, NAMELY, CROSS- AND UP-SELLING NEW PRODUCTS TO THE CUSTOMERS OF OTHERS; INTERNATIONAL MARKET DEVELOPMENT, NAMELY, SUPPORTING CLIENTS IN THE NATURE OF CONSULTING WITH CLIENTS ABOUT ENTERING NEW MARKETS; SALES OUTSOURCING IN THE NATURE OF OUTSOURCING THE SALE OF THE WHOLE SALES PROCESS FOR OTHERS; PLACEMENT, POTENTIAL EVALUATION AND QUALIFICATION OF TOP SELLERS, NAMELY, CLASSIFYING CUSTOMERS AND ADDRESSING THEM WITH DIFFERENT SALES STRATEGIES; PROVIDING AND MANAGING INTERIM SALES PERSONNEL, NAMELY, FINDING, TRAINING AND MANAGEMENT OF EXTERNAL SALES PERSONNEL FOR OTHERS; BENCH MARKETING, NAMELY, COMPARING PROCESSES, ORGANIZATION AND MANAGEMENT WITH INTERNAL OR EXTERNAL BENCHMARKS; CONSULTING AND ADVISORY SERVICES FOR DISTRIBUTION, NAMELY, ADVISING CLIENTS IN OPTIMIZING THEIR SALES PROCESS, ORGANIZATION AND MANAGEMENT; E-COMMERCE SERVICES, NAMELY, SUPPORTING CLIENTS IN THE NATURE OF CONSULTING WITH CLIENTS ABOUT HOW TO MARKET THEIR PRODUCTS ON THE INTERNET; APPOINTMENT SCHEDULING SERVICES; NAMELY, ORGANIZING BUSINESS MEETINGS FOR OTHERS; LEAD GENERATION, NAMELY, FINDING POTENTIAL CUSTOMERS FOR OTHERS; CUSTOMER CARE, NAMELY, APPROACHING CUSTOMERS ON A REGULAR BASIS TO DO CROSS- AND UP-SELLING; QUALITY CALLS, NAMELY, CALLING CUSTOMERS OF CLIENTS IN ORDER TO ASK FOR THEIR GENERAL SATISFACTION WITH THE CLIENT COMPANY; DIALOGUE MARKETING, NAMELY, DIRECT MARKETING THROUGH TELEPHONE OR MAILING; SALES LOGISTICS MANAGEMENT AND BUSINESS MANAGEMENT SERVICES, NAMELY, DESIGN, STEERING AND CONTROL OF PRODUCT DISTRIBUTION PROCESSES; MYSTERY SHOPPING SERVICES, NAMELY, TESTING SERVICES OF CUSTOMERS IN REAL SALES SITUATIONS; INTER-



*David J. Kyjars*

Director of the United States Patent and Trademark Office

**Reg. No. 4,134,405** NATIONAL PROCUREMENT, NAMELY, PURCHASING PRODUCTS ALL OVER THE WORLD FOR OTHERS; ASSESSMENTS, NAMELY, ASSESSING SALES PERSONNEL FOR OTHERS; POTENTIAL EVALUATION OF SALES TEAMS, NAMELY, ASSESSING THE SALES POTENTIAL OF THE EMPLOYEES OF OTHERS; MARKETING OF ELECTRONIC TOOLS TO SUPPORT THE SALES PROCESS, IN CLASS 35 (U.S. CLS. 100, 101 AND 102).

FOR: EDUCATION SERVICES, NAMELY, TRAINING THE SALES PERSONNEL OF OTHERS AND PROVIDING TRAINING IN THE FIELD OF SALES OPTIMIZATION; ENTERTAINMENT SERVICES, NAMELY, SPECIAL EVENT PLANNING FOR SOCIAL ENTERTAINMENT PURPOSES; SPORTING AND CULTURAL ACTIVITIES, NAMELY, ORGANIZING AND HOSTING OF EVENTS FOR CULTURAL PURPOSES; COACHING, NAMELY, PROVIDING SALES TRAINING, IN CLASS 41 (U.S. CLS. 100, 101 AND 107).

FOR: SCIENTIFIC AND TECHNOLOGICAL SERVICES IN THE NATURE OF NEUROMARKETING, NAMELY, DEVELOPING NEW SALES STRATEGIES AND CUSTOMER CLASSIFICATION, AND COMPUTER-AIDED DESIGN SERVICES RELATING THERETO; RESEARCH SERVICES, NAMELY, RESEARCH IN THE FIELD OF INFORMATION AND COMMUNICATION TECHNOLOGY; DESIGN AND DEVELOPMENT OF COMPUTER HARDWARE AND SOFTWARE; TECHNOLOGICAL SERVICES, NAMELY, DESIGN AND DEVELOPMENT OF ELECTRONIC TOOLS TO SUPPORT THE SALES PROCESS, IN CLASS 42 (U.S. CLS. 100 AND 101).

OWNER OF ERPN CMNTY TM OFC REG. NO. 008737017, DATED 8-24-2010, EXPIRES 12-7-2019.

THE MARK CONSISTS OF A RECTANGLE CONTAINING A SQUARE LOCATED BOTTOM CENTER WITH ARCS OF LIGHT EMANATING FROM THE SQUARE AND THE WORD "SELLGATE" BELOW IT AND BELOW THAT IS A LINE THAT APPEARS LIGHTER IN SHADE AS IT APPROACHES EITHER END.

SER. NO. 85-348,211, FILED 6-16-2011.

SUZANNE BLANE, EXAMINING ATTORNEY

# United States of America

United States Patent and Trademark Office

# Fightevil.com

**Reg. No. 4,134,406**

**Registered May 1, 2012**

**Int. Cl.: 9**

**TRADEMARK**

**PRINCIPAL REGISTER**

APPWORKS CONSULTING, INC. (DELAWARE CORPORATION), DBA FIGHTEVIL.COM  
SUITE B110  
1039 E. VALLEY BLVD., #B110  
SAN GABRIEL, CA 91776

FOR: COMPUTER E-COMMERCE SOFTWARE TO ALLOW USERS TO PERFORM ELECTRONIC BUSINESS TRANSACTIONS VIA A GLOBAL COMPUTER NETWORK, IN CLASS 9 (U.S. CLS. 21, 23, 26, 36 AND 38).

FIRST USE 9-25-2001; IN COMMERCE 7-4-2004.

THE MARK CONSISTS OF STANDARD CHARACTERS WITHOUT CLAIM TO ANY PARTICULAR FONT, STYLE, SIZE, OR COLOR.

SER. NO. 85-348,401, FILED 6-16-2011.

TINA MAI, EXAMINING ATTORNEY



*David J. Kyffers*

Director of the United States Patent and Trademark Office

# United States of America

United States Patent and Trademark Office

## MAISON SCOTCH

**Reg. No. 4,134,407**

**Registered May 1, 2012**

**Int. Cl.: 3**

**TRADEMARK**

**PRINCIPAL REGISTER**

SCOTCH & SODA B.V. (NETHERLANDS BESLOTEN VENNOOTSCHAP (B.V.))  
JACOBUS SPIJKERDREEF 20-24  
2132 PZ HOOFDORP, NETHERLANDS

FOR: COSMETICS; ESSENTIAL OILS; HAIR LOTIONS; PERFUMERY; SOAPS, IN CLASS  
3 (U.S. CLS. 1, 4, 6, 50, 51 AND 52).

THE MARK CONSISTS OF STANDARD CHARACTERS WITHOUT CLAIM TO ANY PAR-  
TICULAR FONT, STYLE, SIZE, OR COLOR.

OWNER OF BENELUX REG. NO. 0900521, DATED 8-10-2011, EXPIRES 5-12-2021.

OWNER OF U.S. REG. NOS. 3,767,705 AND 3,799,773.

THE ENGLISH TRANSLATION OF "MAISON" IN THE MARK IS "HOUSE".

SER. NO. 85-349,069, FILED 6-17-2011.

CHRISTOPHER LAW, EXAMINING ATTORNEY



*David J. Kyros*

Director of the United States Patent and Trademark Office

# United States of America

United States Patent and Trademark Office

## ZYDECRUNCH

**Reg. No. 4,134,408**

**Registered May 1, 2012**

**Int. Cl.: 41**

**SERVICE MARK**

**PRINCIPAL REGISTER**

OLSON, STEVEN (UNITED STATES INDIVIDUAL)  
224 MAPLE AVENUE  
ALMA, MI 48801

FOR: ENTERTAINMENT, NAMELY, LIVE PERFORMANCES AND CONCERTS BY A MUSICAL GROUP, AND A PERFORMANCE WEBSITE ON A GLOBAL COMPUTER NETWORK FEATURING INFORMATION ON A MUSICAL GROUP AND ITS PERFORMANCES, APPEARANCES, TOUR DATES, BIOGRAPHIES AND NON-DOWNLOADABLE PLAYBACK OF SOUND AND VIDEO RECORDINGS, IN CLASS 41 (U.S. CLS. 100, 101 AND 107).

FIRST USE 1-1-2000; IN COMMERCE 1-1-2001.

THE MARK CONSISTS OF STANDARD CHARACTERS WITHOUT CLAIM TO ANY PARTICULAR FONT, STYLE, SIZE, OR COLOR.

SER. NO. 85-349,256, FILED 6-17-2011.

DOMINIC J. FERRAIUOLO, EXAMINING ATTORNEY



*David J. Kyffers*

Director of the United States Patent and Trademark Office



# United States of America

United States Patent and Trademark Office

# PixSavers

**Reg. No. 4,134,409**

**Registered May 1, 2012**

**Int. Cl.: 40**

LEHMAN, STEVE A. J. (WASHINGTON SOLE PROPRIETORSHIP), TA PIXSAVERS! PHOTO RESTORATION & PHOTOGRAPHY  
SAME AS BELOW  
14817 WHITMAN AVENUE NORTH SUITE #7  
SHORELINE, WA 98133

**SERVICE MARK**

FOR: PHOTO RESTORATION SERVICES; PHOTOGRAPHIC RESTORATION; PHOTOGRAPHIC RETOUCHING, IN CLASS 40 (U.S. CLS. 100, 103 AND 106).

**PRINCIPAL REGISTER**

FIRST USE 3-1-2005; IN COMMERCE 3-1-2005.

THE MARK CONSISTS OF STANDARD CHARACTERS WITHOUT CLAIM TO ANY PARTICULAR FONT, STYLE, SIZE, OR COLOR.

SER. NO. 85-350,042, FILED 6-20-2011.

RONALD AIKENS, EXAMINING ATTORNEY



*David J. Kyffers*

Director of the United States Patent and Trademark Office

# United States of America

United States Patent and Trademark Office

## PURPLE PRAIRIE

**Reg. No. 4,134,410**

**Registered May 1, 2012**

**Int. Cls.: 3, 4 and 35**

**TRADEMARK**

**SERVICE MARK**

**PRINCIPAL REGISTER**

PURPLE PRAIRIE BOTANICALS, LLC (MINNESOTA LIMITED LIABILITY COMPANY)  
21515 19TH AVE EAST  
CLEARWATER, MN 55320

FOR: PERSONAL BODY CARE PRODUCTS, NAMELY, SOAP, LOTION, BODY POLISH, MASSAGE OIL, SUNSCREEN LOTION AND DEODORANT, IN CLASS 3 (U.S. CLS. 1, 4, 6, 50, 51 AND 52).

FIRST USE 9-12-1999; IN COMMERCE 9-12-1999.

FOR: CANDLES, IN CLASS 4 (U.S. CLS. 1, 6 AND 15).

FIRST USE 9-12-1999; IN COMMERCE 9-12-1999.

FOR: ON-LINE RETAIL STORE SERVICES FEATURING PERSONAL BODY CARE PRODUCTS, NAMELY, SOAP, LOTION, BODY POLISH, MASSAGE OIL, SUNSCREEN LOTION AND DEODORANT; ON-LINE RETAIL STORE SERVICES FEATURING CANDLES, IN CLASS 35 (U.S. CLS. 100, 101 AND 102).

FIRST USE 9-12-1999; IN COMMERCE 9-12-1999.

THE MARK CONSISTS OF STANDARD CHARACTERS WITHOUT CLAIM TO ANY PARTICULAR FONT, STYLE, SIZE, OR COLOR.

SER. NO. 85-350,255, FILED 6-20-2011.

LINDA MICKLEBURGH, EXAMINING ATTORNEY



*David J. Kyros*

Director of the United States Patent and Trademark Office

# United States of America

United States Patent and Trademark Office

# ECOBALANCE

**Reg. No. 4,134,411**

**Registered May 1, 2012**

**Int. Cl.: 37**

**SERVICE MARK**

**PRINCIPAL REGISTER**

SYNGENTA PARTICIPATIONS AG (SWITZERLAND CORPORATION)  
215 SCHWARZWALDALLEE  
BASEL, SWITZERLAND

FOR: PROVIDING AN INTERNET WEBSITE PORTAL OFFERING INFORMATION IN THE FIELD OF PEST MANAGEMENT PRACTICES OTHER THAN FOR AGRICULTURAL PURPOSES, IN CLASS 37 (U.S. CLS. 100, 103 AND 106).

FIRST USE 3-31-2009; IN COMMERCE 3-31-2009.

THE MARK CONSISTS OF STANDARD CHARACTERS WITHOUT CLAIM TO ANY PARTICULAR FONT, STYLE, SIZE, OR COLOR.

SER. NO. 85-350,420, FILED 6-20-2011.

JOHN HWANG, EXAMINING ATTORNEY



*David J. Kybas*

Director of the United States Patent and Trademark Office

# United States of America

United States Patent and Trademark Office

# Y-PAIN

**Reg. No. 4,134,412**

**Registered May 1, 2012**

**Int. Cl.: 3**

**TRADEMARK**

**PRINCIPAL REGISTER**

DEPANNAGE LLC (WYOMING LIMITED LIABILITY COMPANY)  
2710 THOMES AVE. STE. 1168  
CHEYENNE, WY 82001

FOR: SKIN CARE PRODUCTS, NAMELY, NON-MEDICATED SKIN SERUM, IN CLASS 3  
(U.S. CLS. 1, 4, 6, 50, 51 AND 52).

FIRST USE 7-1-2010; IN COMMERCE 1-1-2011.

THE MARK CONSISTS OF STANDARD CHARACTERS WITHOUT CLAIM TO ANY PARTICULAR FONT, STYLE, SIZE, OR COLOR.

SER. NO. 85-350,422, FILED 6-20-2011.

LINDSEY RUBIN, EXAMINING ATTORNEY



*David J. Kybas*

Director of the United States Patent and Trademark Office

# United States of America

United States Patent and Trademark Office



**Reg. No. 4,134,413**

**Registered May 1, 2012**

**Int. Cl.: 29**

**TRADEMARK**

**PRINCIPAL REGISTER**

VINCENT GIORDANO CORPORATION (PENNSYLVANIA CORPORATION)  
2600 WASHINGTON AVENUE  
PHILADELPHIA, PA 19146

FOR: PREPARED FOODS, NAMELY, PREPARED MEATS, IN CLASS 29 (U.S. CL. 46).

FIRST USE 1-1-1983; IN COMMERCE 1-1-1983.

NO CLAIM IS MADE TO THE EXCLUSIVE RIGHT TO USE "TENDER" AND "TASTY",  
APART FROM THE MARK AS SHOWN.

THE COLOR(S) RED, WHITE AND BLACK IS/ARE CLAIMED AS A FEATURE OF THE  
MARK.

THE NAME "VINCENT GIORDANO" IDENTIFIES A LIVING INDIVIDUAL WHOSE CON-  
SENT IS OF RECORD.

THE MARK CONSISTS OF A RED BANNER WITH THE WORDS "VINCENT GIORDANO"  
IN WHITE WITH A BLACK SHADOW IN THE BANNER AND THE WORDS "TENDER.  
TASTY. TEMPTING." IN RED UNDERNEATH THE BANNER.

SER. NO. 85-351,554, FILED 6-21-2011.

HENRY S. ZAK, EXAMINING ATTORNEY



*David J. Kybas*

Director of the United States Patent and Trademark Office

# United States of America

United States Patent and Trademark Office

## VINCENT GIORDANO

**Reg. No. 4,134,414**

**Registered May 1, 2012**

**Int. Cl.: 29**

**TRADEMARK**

**PRINCIPAL REGISTER**

VINCENT GIORDANO CORPORATION (PENNSYLVANIA CORPORATION)  
2600 WASHINGTON AVENUE  
PHILADELPHIA, PA 19146

FOR: PREPARED FOODS, NAMELY, PREPARED MEATS, IN CLASS 29 (U.S. CL. 46).

FIRST USE 1-1-1969; IN COMMERCE 1-1-1969.

THE MARK CONSISTS OF STANDARD CHARACTERS WITHOUT CLAIM TO ANY PARTICULAR FONT, STYLE, SIZE, OR COLOR.

THE NAME "VINCENT GIORDANO" IDENTIFIES A LIVING INDIVIDUAL WHOSE CONSENT IS OF RECORD.

SER. NO. 85-351,556, FILED 6-21-2011.

HENRY S. ZAK, EXAMINING ATTORNEY



*David J. Kyffers*

Director of the United States Patent and Trademark Office

# United States of America

United States Patent and Trademark Office

## JUICY LUCY'S STEAKHOUSE

**Reg. No. 4,134,415**

**Registered May 1, 2012**

**Int. Cl.: 43**

**SERVICE MARK**

**PRINCIPAL REGISTER**

ZM, INC. (COLORADO CORPORATION)  
308 7TH STREET  
GLENWOOD SPRINGS, CO 81654

FOR: RESTAURANT AND BAR SERVICES, IN CLASS 43 (U.S. CLS. 100 AND 101).

FIRST USE 7-21-1999; IN COMMERCE 7-21-1999.

THE MARK CONSISTS OF STANDARD CHARACTERS WITHOUT CLAIM TO ANY PARTICULAR FONT, STYLE, SIZE, OR COLOR.

NO CLAIM IS MADE TO THE EXCLUSIVE RIGHT TO USE "STEAKHOUSE", APART FROM THE MARK AS SHOWN.

THE NAME "JUICY LUCY" DOES NOT IDENTIFY A LIVING INDIVIDUAL.

SER. NO. 85-351,614, FILED 6-21-2011.

ALAIN LAPTER, EXAMINING ATTORNEY



*David J. Kyffers*

Director of the United States Patent and Trademark Office

# United States of America

United States Patent and Trademark Office



**Reg. No. 4,134,416**

**Registered May 1, 2012**

**Int. Cl.: 41**

**SERVICE MARK**

**PRINCIPAL REGISTER**

ROCKETOWN OF MIDDLE TENNESSEE, INC. (TENNESSEE CORPORATION)  
601 4TH AVENUE SOUTH  
NASHVILLE, TN 37210

FOR: ENTERTAINMENT SERVICES, NAMELY, PROVIDING RECREATIONAL SPORTS FACILITIES FOR SKATEBOARDING, BICYCLING AND INLINE SKATING, ORGANIZING COMPETITIONS IN THE FIELD OF SKATEBOARDING, BICYCLING AND INLINE SKATING, ENTERTAINMENT IN THE NATURE OF LIVE SKATEBOARDING, BICYCLING AND INLINE SKATING PERFORMANCES AND EXHIBITIONS, IN CLASS 41 (U.S. CLS. 100, 101 AND 107).

FIRST USE 1-6-2003; IN COMMERCE 1-6-2003.

NO CLAIM IS MADE TO THE EXCLUSIVE RIGHT TO USE "SKATEPARK" OR "NASHVILLE", APART FROM THE MARK AS SHOWN.

THE COLOR(S) BLACK, WHITE AND RED IS/ARE CLAIMED AS A FEATURE OF THE MARK.

THE MARK CONSISTS OF A BLACK BACKGROUND WITH "SIXTHAVENUE" IN LOWER CASE TEXT WITHOUT SPACES WITH "SIXTH" COLORED WHITE AND "AVENUE" COLORED RED, "SKATEPARK NASHVILLE" LOCATED BELOW "SIXTHAVENUE" IN SMALLER, ALL CAPITALIZED, WHITE TEXT WITH "SKATEPARK" AND "NASHVILLE" SEPARATED BY A WHITE VERTICAL LINE.

SER. NO. 85-352,165, FILED 6-21-2011.

SUE LAWRENCE, EXAMINING ATTORNEY



*David J. Kybas*

Director of the United States Patent and Trademark Office



# United States of America

United States Patent and Trademark Office

# GREENBOX

**Reg. No. 4,134,417**

**Registered May 1, 2012**

**Int. Cl.: 11**

**TRADEMARK**

**PRINCIPAL REGISTER**

TEGRANT DIVERSIFIED BRANDS, INC. (PENNSYLVANIA CORPORATION)  
SUITE 450  
3930 NORTH VENTURE DRIVE  
ARLINGTON HEIGHTS, IL 60004

FOR: MEDICAL THERMAL MANAGEMENT SYSTEM COMPOSED OF PAPER OR PLASTIC PACKAGING MATERIALS, PHASE CHANGE MATERIALS, AND VACUUM INSULATED PANELS FOR TRANSPORTING TRANSPLANT ORGANS, MEDICATIONS, BLOOD AND OTHER MEDICAL ITEMS REQUIRING STABLE TEMPERATURES DURING TRANSPORT; MEDICAL CONTAINERS FOR STORAGE, TRANSPORTATION AND MAINTENANCE OF STANDARD TEMPERATURE DURING TRANSPORT FOR MEDICATIONS, TRANSPLANT ORGANS, BLOOD AND OTHER MEDICAL ITEMS, IN CLASS 11 (U.S. CLS. 13, 21, 23, 31 AND 34).

FIRST USE 8-23-2007; IN COMMERCE 8-23-2007.

THE MARK CONSISTS OF STANDARD CHARACTERS WITHOUT CLAIM TO ANY PARTICULAR FONT, STYLE, SIZE, OR COLOR.

OWNER OF U.S. REG. NOS. 3,479,401 AND 3,483,657.

SEC. 2(F).

SER. NO. 85-352,514, FILED 6-22-2011.

ANDREA K. NADELMAN, EXAMINING ATTORNEY



*David J. Kyffers*

Director of the United States Patent and Trademark Office

# United States of America

United States Patent and Trademark Office

## THE OLDEST LATINO FRATERNITY IN EXISTENCE

**Reg. No. 4,134,418**

**Registered May 1, 2012**

**Int. Cl.: 35**

**SERVICE MARK**

**PRINCIPAL REGISTER**

PHI IOTA ALPHA FRATERNITY, INC. (NEW YORK CORPORATION)  
SUITE 412  
9322 3RD AVE  
BROOKLYN, NY 11209

FOR: ASSOCIATION SERVICES, NAMELY, ORGANIZING CHAPTERS OF A FRATERNITY AND PROMOTING THE INTERESTS OF THE MEMBERS THEREOF, IN CLASS 35 (U.S. CLS. 100, 101 AND 102).

FIRST USE 8-1-1994; IN COMMERCE 8-1-1994.

THE MARK CONSISTS OF STANDARD CHARACTERS WITHOUT CLAIM TO ANY PARTICULAR FONT, STYLE, SIZE, OR COLOR.

SEC. 2(F).

SER. NO. 85-352,746, FILED 6-22-2011.

MICHELLE DUBOIS, EXAMINING ATTORNEY



*David J. Kybas*

Director of the United States Patent and Trademark Office

# United States of America

United States Patent and Trademark Office

# VacciCheck

**Reg. No. 4,134,419**

**Registered May 1, 2012**

**Int. Cls.: 1, 5, 9 and 10**

**TRADEMARK**

**PRINCIPAL REGISTER**

BIOGAL-GALED LABS (ISRAEL LIMITED PARTNERSHIP)  
KIBBUTZ GALED  
KIBBUTZ GALED, ISRAEL 19240

FOR: ACTIVE CHEMICAL INGREDIENTS FOR USE IN THE MANUFACTURE OF VETERINARY PHARMACEUTICALS FOR DIAGNOSING ANTIBODIES IN ANIMALS; DIAGNOSTIC KITS CONSISTING PRIMARILY OF MONOCLONAL ANTIBODIES, BUFFERS, AND REAGENTS TO MONITOR ANTIBODIES; CATALYSTS FOR CHEMICAL AND BIOCHEMICAL PROCESSES; CHEMICAL PREPARATIONS FOR SCIENTIFIC PURPOSES; CHEMICAL TEST KITS FOR DIAGNOSING ANTIBODIES FOR LABORATORY OR RESEARCH USE; CHEMICAL PREPARATIONS FOR USE IN THE MANUFACTURE OF VETERINARY PREPARATIONS; CHEMICALS FOR USE IN THE BIOCHEMICAL AND CHEMICAL INDUSTRY; LABORATORY CHEMICALS, NAMELY, AN ANTIBODY REAGENT USED FOR THE DETECTION OF ANTIGENS IN CELL AND TISSUE ANALYSIS FOR IN VITRO DIAGNOSTIC USE; REAGENT FOR CHEMICAL ANALYSES; REAGENTS FOR USE IN SCIENTIFIC APPARATUS FOR CHEMICAL OR BIOLOGICAL ANALYSIS; DIAGNOSTIC PREPARATIONS FOR CLINICAL OR MEDICAL LABORATORY USE; IMMUNOHISTOCHEMISTRY DETECTION KITS CONSISTING OF DOMESTIC ANIMALS' REAGENTS AND ANTIBODIES FOR USE IN INSPECTION IN THE VETERINARY DIAGNOSTICS INDUSTRY; EXCIPIENTS FOR USE IN THE MANUFACTURE OF VETERINARY PREPARATIONS; ALL OF THE FOREGOING EXCLUDING GOODS FOR USE IN BLOOD GLUCOSE MONITORING OR DIABETES CARE FOR HUMANS, IN CLASS 1 (U.S. CLS. 1, 5, 6, 10, 26 AND 46).

FIRST USE 12-31-2006; IN COMMERCE 8-24-2010.



FOR: CHEMICAL REAGENTS FOR MEDICAL OR VETERINARY PURPOSES; DIAGNOSTIC AGENTS, PREPARATIONS AND SUBSTANCES FOR VETERINARY PURPOSES; DIAGNOSTIC KITS CONSISTING PRIMARILY OF MONOCLONAL ANTIBODIES, BUFFERS, AND REAGENTS FOR USE IN DISEASE TESTING; DIAGNOSTIC PREPARATIONS FOR MEDICAL OR VETERINARY USE; IN-VITRO DIAGNOSTIC KITS FOR THE DETECTION AND MONITORING OF ANTIBODIES FOR MEDICAL OR VETERINARY USE; MEDICAL DIAGNOSTIC REAGENTS FOR THE ANALYSIS OF BODY FLUIDS; ALL OF THE FOREGOING EXCLUDING GOODS FOR USE IN BLOOD GLUCOSE MONITORING OR DIABETES CARE FOR HUMANS, IN CLASS 5 (U.S. CLS. 6, 18, 44, 46, 51 AND 52).

FIRST USE 12-31-2006; IN COMMERCE 8-24-2010.

*David J. Kyjars*

Director of the United States Patent and Trademark Office

**Reg. No. 4,134,419** FOR: LABORATORY CHEMICAL REACTORS; DIAGNOSTIC APPARATUS FOR THE DETECTION OF PATHOGENS FOR LABORATORY OR RESEARCH USE; TESTING SAMPLE COLLECTION EQUIPMENT, NAMELY, WIPES AND SWABS FOR USE IN CLINICAL AND INDUSTRIAL DIAGNOSTIC TESTING; ALL OF THE FOREGOING EXCLUDING GOODS FOR USE IN BLOOD GLUCOSE MONITORING OR DIABETES CARE FOR HUMANS, IN CLASS 9 (U.S. CLS. 21, 23, 26, 36 AND 38).

FIRST USE 12-31-2006; IN COMMERCE 8-24-2010.

FOR: DIAGNOSTIC APPARATUS FOR THE DETECTION OF ANTIBODIES TO VARIOUS PATHOGENS, NAMELY, ANTIBODIES TO INFECTIOUS CANINE HEPATITIS, CANINE PARVOVIRUS AND DISTEMPER VIRUS OR FELINE PANLEUKOPENIA, HERPES VIRUS AND CALICI VIRUS, FOR VETERINARY USE; DIAGNOSTIC KITS CONSISTING PRIMARILY OF PROBES, BUFFERS AND REAGENTS FOR USE IN MICROBIAL AND ANTIBODY TESTING; MEDICAL DIAGNOSTIC INSTRUMENTS FOR THE ANALYSIS OF BODY FLUIDS; MEDICAL BAGS ADAPTED FOR AND SOLD WITH MEDICAL, SURGICAL AND VETERINARY INSTRUMENTS; VETERINARY APPARATUS, NAMELY, TOOLS FOR EVALUATING THE ANTIBODY RESPONSE TO THE CORE VACCINATION OR INFECTION BY INFECTIOUS CANINE HEPATITIS, CANINE PARVOVIRUS AND DISTEMPER VIRUS, OR FELINE PANLEUKOPENIA, HERPES VIRUS AND CALICI VIRUS; ALL OF THE FOREGOING EXCLUDING GOODS FOR USE IN BLOOD GLUCOSE MONITORING OR DIABETES CARE FOR HUMANS, IN CLASS 10 (U.S. CLS. 26, 39 AND 44).

FIRST USE 12-31-2006; IN COMMERCE 8-24-2010.

THE MARK CONSISTS OF STANDARD CHARACTERS WITHOUT CLAIM TO ANY PARTICULAR FONT, STYLE, SIZE, OR COLOR.

SER. NO. 85-352,842, FILED 6-22-2011.

MARK T. MULLEN, EXAMINING ATTORNEY

# United States of America

United States Patent and Trademark Office

## Policing Jihad

**Reg. No. 4,134,420**

**Registered May 1, 2012**

**Int. Cl.: 41**

**SERVICE MARK**

**PRINCIPAL REGISTER**

SCHAEFER, BRITTON (UNITED STATES INDIVIDUAL)  
19968 SASSOON PL  
SAUGUS, CA 91350 AND

KIM, DAEWON (UNITED STATES INDIVIDUAL)  
D-105  
9877 CHAPMAN AVE.  
GARDEN GROVE, CA 92841

FOR: EDUCATIONAL AND ENTERTAINMENT SERVICES, NAMELY, CONDUCTING SEMINARS IN THE FIELD OF TERRORISM AND DISTRIBUTION OF COURSE MATERIALS IN CONNECTION THEREWITH, AND EDUCATION CONSULTING RELATED THERETO; TRAINING SERVICES IN THE FIELD OF TERRORISM, IN CLASS 41 (U.S. CLS. 100, 101 AND 107).

FIRST USE 5-19-2010; IN COMMERCE 3-15-2011.

THE MARK CONSISTS OF STANDARD CHARACTERS WITHOUT CLAIM TO ANY PARTICULAR FONT, STYLE, SIZE, OR COLOR.

NO CLAIM IS MADE TO THE EXCLUSIVE RIGHT TO USE "POLICING", APART FROM THE MARK AS SHOWN.

SER. NO. 85-353,065, FILED 6-22-2011.

JIM RINGLE, EXAMINING ATTORNEY



*David J. Kyros*

Director of the United States Patent and Trademark Office

# United States of America

United States Patent and Trademark Office

# AVvA

**Reg. No. 4,134,421**

**Registered May 1, 2012**

**Int. Cl.: 42**

**SERVICE MARK**

**PRINCIPAL REGISTER**

VIZUALL, INC. (FLORIDA CORPORATION), DBA SCHEDUALL  
200 PARK ROAD  
HOLLYWOOD, FL 33021

FOR: SOFTWARE AS A SERVICE (SAAS) SERVICES, NAMELY, HOSTING SOFTWARE FOR USE BY OTHERS FOR USE IN MANAGING AND SCHEDULING BUSINESS RESOURCES, AND FOR USE FOR COLLABORATION, BUYING, SELLING OR SCHEDULING BUSINESS RESOURCES ACROSS ORGANIZATIONS IN THE BROADCAST AND MEDIA MARKETPLACES, IN CLASS 42 (U.S. CLS. 100 AND 101).

FIRST USE 3-29-2010; IN COMMERCE 3-29-2010.

THE MARK CONSISTS OF STANDARD CHARACTERS WITHOUT CLAIM TO ANY PARTICULAR FONT, STYLE, SIZE, OR COLOR.

SER. NO. 85-353,774, FILED 6-23-2011.

JORDAN BAKER, EXAMINING ATTORNEY



*David J. Kyffers*

Director of the United States Patent and Trademark Office

# United States of America

United States Patent and Trademark Office

# BRAD PITT

**Reg. No. 4,134,422**

**Registered May 1, 2012**

**Int. Cl.: 41**

**SERVICE MARK**

**PRINCIPAL REGISTER**

PITT, WILLIAM B. (UNITED STATES INDIVIDUAL), AKA BRAD PITT  
C/O GRANT, TANI, BARASH & ALTMAN LLC  
9100 WILSHIRE BOULEVARD, SUITE 1000W  
BEVERLY HILLS, CA 90212

FOR: ENTERTAINMENT SERVICES, NAMELY, ACTING SERVICES IN THE NATURE OF VISUAL AND AUDIO PERFORMANCES BY AN ACTOR, AND PERSONAL APPEARANCES BY A MOTION PICTURE AND TELEVISION CELEBRITY; ENTERTAINMENT SERVICES, NAMELY, PRODUCING MOTION PICTURE FILMS AND TELEVISION PROGRAMS; VOICE SERVICES, NAMELY, PROVIDING VOICE SERVICES FOR ENTERTAINMENT AND EDUCATION PURPOSES; VOICE OVER SERVICES, NAMELY, PROVIDING VOICE OVER SERVICES FOR ENTERTAINMENT AND EDUCATION PURPOSES; NARRATION SERVICES, NAMELY, ACTING AS A NARRATOR FOR ENTERTAINMENT AND EDUCATION PURPOSES; SPOKESPERSON SERVICES, NAMELY, ACTING AS A SPOKESPERSON FOR ENTERTAINMENT AND EDUCATION PURPOSES, IN CLASS 41 (U.S. CLS. 100, 101 AND 107).

FIRST USE 0-0-1987; IN COMMERCE 0-0-1987.

THE MARK CONSISTS OF STANDARD CHARACTERS WITHOUT CLAIM TO ANY PARTICULAR FONT, STYLE, SIZE, OR COLOR.

THE NAME "BRAD PITT" IDENTIFIES THE PSEUDONYM OF "WILLIAM B. PITT", A LIVING INDIVIDUAL WHOSE CONSENT IS OF RECORD.

SER. NO. 85-354,017, FILED 6-23-2011.

BRIAN CALLAGHAN, EXAMINING ATTORNEY



*David J. Kyros*

Director of the United States Patent and Trademark Office

# United States of America

United States Patent and Trademark Office

## BROOKVILLE

**Reg. No. 4,134,423**

**Registered May 1, 2012**

**Int. Cl.: 12**

**TRADEMARK**

**PRINCIPAL REGISTER**

BROOKVILLE EQUIPMENT CORPORATION (PENNSYLVANIA CORPORATION)  
175 EVANS STREET  
BROOKVILLE, PA 15825

FOR: DIESEL, ELECTRIC, AND BATTERY POWERED LOCOMOTIVES; ELECTRIC AND BATTERY POWERED STREETCARS; MINING UNITS, NAMELY, DIESEL, ELECTRIC AND BATTERY POWERED PERSONNEL CARRIERS FOR THE UNDERGROUND TRANSPORT OF MINING WORKERS, AND DIESEL, ELECTRIC AND BATTERY POWERED MAINTENANCE VEHICLES FOR CARRYING MAINTENANCE EQUIPMENT UNDERGROUND; DIESEL AND BATTERY POWERED HAULAGE TRACTORS AND UNDERGROUND MINING SCOOPS USED TO MOVE EARTH AND RAW MATERIALS FOR MINING PURPOSES; AND MINING SUPPORT EQUIPMENT, NAMELY, FUEL TANKS FOR A MOVABLE VEHICLE USED TO RE-FUEL MINING EQUIPMENT, IN CLASS 12 (U.S. CLS. 19, 21, 23, 31, 35 AND 44).

FIRST USE 1-1-1920; IN COMMERCE 1-1-1920.

THE MARK CONSISTS OF STANDARD CHARACTERS WITHOUT CLAIM TO ANY PARTICULAR FONT, STYLE, SIZE, OR COLOR.

OWNER OF U.S. REG. NO. 555,452.

SEC. 2(F).

SER. NO. 85-354,340, FILED 6-23-2011.

ANDREW RHIM, EXAMINING ATTORNEY



*David J. Kypos*

Director of the United States Patent and Trademark Office



# United States of America

United States Patent and Trademark Office

# JUICIES

**Reg. No. 4,134,424**

LAURENS LAUDOWICZ (UNITED STATES INDIVIDUAL)  
4348 WAIALAE AVENUE # 255  
HONOLULU, HI 96816

**Registered May 1, 2012**

**Int. Cl.: 9**

FOR: CABLES, ELECTRIC; CONNECTION CABLES; ELECTRIC CABLES; EXTENSION CABLES; POWER CABLES; USB CABLES, IN CLASS 9 (U.S. CLS. 21, 23, 26, 36 AND 38).

**TRADEMARK**

FIRST USE 5-23-2011; IN COMMERCE 5-23-2011.

**PRINCIPAL REGISTER**

THE MARK CONSISTS OF STANDARD CHARACTERS WITHOUT CLAIM TO ANY PARTICULAR FONT, STYLE, SIZE, OR COLOR.

SER. NO. 85-354,613, FILED 6-23-2011.

LAURA KOVALSKY, EXAMINING ATTORNEY



*David J. Kybas*

Director of the United States Patent and Trademark Office

# United States of America

United States Patent and Trademark Office



**Reg. No. 4,134,425**

**Registered May 1, 2012**

**Int. Cl.: 9**

**TRADEMARK**

**PRINCIPAL REGISTER**

CBT NUGGETS, LLC (DELAWARE LIMITED LIABILITY COMPANY)  
44 CLUB ROAD  
44 CLUB RD, STE 150  
EUGENE, OR 97401

FOR: DOWNLOADABLE COMPUTER SOFTWARE CONTAINING TRAINING VIDEO MATERIAL FOR USE IN COMPUTER INSTRUCTION, IN CLASS 9 (U.S. CLS. 21, 23, 26, 36 AND 38).

FIRST USE 1-1-2008; IN COMMERCE 1-1-2008.

OWNER OF U.S. REG. NO. 2,518,288.

THE COLOR(S) YELLOW, WHITE AND BLACK IS/ARE CLAIMED AS A FEATURE OF THE MARK.

THE MARK CONSISTS OF A YELLOW SPHERE CONTAINING THE LETTERS "CBT" IN THE COLOR BLACK, IN UPPERCASE SANS-SERIF FONT, WITH WHITE SHADOWING.

SER. NO. 85-354,695, FILED 6-23-2011.

LINDA E. BLOHM, EXAMINING ATTORNEY



*David J. Kyffers*

Director of the United States Patent and Trademark Office

# United States of America

United States Patent and Trademark Office

# ADP

**Reg. No. 4,134,426**

**Registered May 1, 2012**

**Int. Cls.: 41 and 42**

**SERVICE MARK**

**PRINCIPAL REGISTER**

ADP, INC. (DELAWARE CORPORATION)  
ONE ADP BOULEVARD  
ROSELAND, NJ 07068

FOR: EDUCATIONAL AND TRAINING SERVICES, NAMELY, PROVIDING INSTRUCTOR-LED AND ONLINE CLASSES, SEMINARS, AND WORKSHOPS IN THE FIELD OF HUMAN RESOURCES; PROVIDING AN INSTRUCTOR-LED CLASSROOM AND ONLINE EDUCATIONAL CLASSROOM FOR EMPLOYERS PERTAINING TO PAYROLL PROCESSING, TAX DEPOSIT FILING AND REPORTING, EMPLOYEE TIME AND ATTENDANCE RECORD KEEPING, PENSION RECORD KEEPING, EMPLOYEE LEASING, SUBMITTING AND TRACKING VENDOR INVOICES; EMPLOYEE TRAINING IN THE FIELD OF CAREER DEVELOPMENT; PROVIDING ON-LINE NON-DOWNLOADABLE ELECTRONIC PUBLICATIONS, NAMELY, NEWSLETTERS, WHITE PAPERS, CASE STUDIES AND MAGAZINES IN THE FIELD OF HUMAN RESOURCES, PAYROLL ADMINISTRATION, PRE-EMPLOYMENT AND BENEFITS ADMINISTRATION, COMPUTER SECURITY AND INFORMATION TECHNOLOGY, MEDICAL RECORD KEEPING, CAREER DEVELOPMENT AND DISASTER PLANNING, COMPUTER SYSTEM SECURITY, AND MEDICAL RECORDS AND MEDICAL OFFICE ADMINISTRATION TRAINING AND CERTIFICATION; EDUCATIONAL SERVICES, NAMELY, PROVIDING AN INSTRUCTOR-LED CLASSROOM, AND ONLINE EDUCATIONAL CLASSROOM FOR AUTOMOBILE AND TRUCK DEALERS AND MANUFACTURERS IN THE FIELDS OF ACCOUNTING, INVENTORY CONTROL, FACTORY COMMUNICATIONS, SCHEDULING, LEASING, SALES, SERVICING, MARKETING, AND CREDIT PROCESSING, IN CLASS 41 (U.S. CLS. 100, 101 AND 107).

FIRST USE 3-31-2000; IN COMMERCE 3-31-2000.

FOR: PROVIDING TEMPORARY USE OF NON-DOWNLOADABLE COMPUTER SOFTWARE FOR EMPLOYEE AND PERSONNEL RELATED SERVICES, NAMELY, PAYROLL PROCESSING, PREPARATION, AND ADMINISTRATION, PAYROLL TAX CALCULATION AND PREPARATION, TAX REGULATION COMPLIANCE, ELECTRONIC PAYROLL, TAX FILING AND REPORTING, PRINTING PAYROLL REPORTS, CHECKS, AND TAX FORMS, EMPLOYEE BENEFITS ADMINISTRATION, HUMAN RESOURCES MANAGEMENT SERVICES, EMPLOYEE RISK AND SAFETY TRAINING, EMPLOYEE COUNSELING AND SUPPORT PROGRAMS, EMPLOYEE PENSION AND RETIREMENT FUNDS ADMINISTRATION, EMPLOYEE FLEXIBLE SPENDING ACCOUNTS ADMINISTRATION, WORKERS COMPENSATION, EMPLOYEE RECRUITING, AND PRE-EMPLOYMENT BACKGROUND SCREENING, TIME, ATTENDANCE, SCHEDULING, ONBOARDING, AND EMPLOYEE RECORDKEEPING,



*David J. Kybas*

Director of the United States Patent and Trademark Office

**Reg. No. 4,134,426** PERFORMANCE MANAGEMENT, COMPENSATION MANAGEMENT, LEARNING AND DEVELOPMENT, AND SUCCESSION PLANNING; PROVIDING A SECURE ELECTRONIC ONLINE SYSTEM FEATURING TECHNOLOGY WHICH ALLOWS SUBSCRIBING USERS TO SUBMIT AND TRACK VENDOR INVOICES ELECTRONICALLY, NAMELY, ALLOWING FOR SCANNING, AUTOMATED ROUTING, CODING AND APPROVAL PROCESS, AUTOMATED SUPPLIER ON-BOARDING, EARLY PAYMENT DISCOUNTS, AUTOMATIC PRICE CHECKING, LINE ITEM DETAIL, REAL TIME VISIBILITY OF CORPORATE SPENDING, AND A SUPPLIER PORTAL; PROVIDING A WEB-BASED SERVICE FEATURING TECHNOLOGY THAT ENABLES USERS TO VIEW ONLINE VIDEOS AND ACCESS INFORMATION FOR EMPLOYEE BENEFITS BROKERS AND CONSULTANTS IN THE FIELD OF BENEFITS ADMINISTRATION, PAYROLL PROCESSING, TAX DEPOSIT FILING AND REPORTING, HUMAN RESOURCES MANAGEMENT, BUSINESS MANAGEMENT, EMPLOYEE TIME AND ATTENDANCE RECORD KEEPING, PENSION RECORD KEEPING, EMPLOYEE RECRUITING, PRE-EMPLOYMENT BACKGROUND SCREENING, OUTSOURCING, HEALTH CARE REFORM AND UNEMPLOYMENT COMPENSATION MANAGEMENT SERVICES; PROVIDING A WEB-BASED SYSTEM AND ONLINE PORTAL FOR EMPLOYEE BENEFITS BROKERS AND CONSULTANTS FEATURING BENEFITS ADMINISTRATION, PENSION RECORD KEEPING, AND UNEMPLOYMENT COMPENSATION MANAGEMENT SERVICES; PROVIDING TEMPORARY USE OF ONLINE NON-DOWNLOADABLE SOFTWARE IN THE FIELD OF AUTOMOTIVE VEHICLE SALES FOR USE BY AUTOMOBILE AND TRUCK DEALERSHIPS IN MANAGING, MARKETING AND SELLING INSURANCE AND FINANCIAL DATA AND OTHER VEHICLE-RELATED PRODUCTS AND SERVICES TO CONSUMERS; PROVIDING TEMPORARY USE OF ONLINE NON-DOWNLOADABLE SOFTWARE FOR PROVIDING EMPLOYERS WITH A COMPATIBLE INTERFACE BETWEEN PAYROLL PROCESSING SOFTWARE AND SOFTWARE FOR FINANCIAL MANAGEMENT AND MANAGEMENT OF HUMAN RESOURCES; PROVIDING TEMPORARY USE OF NON-DOWNLOADABLE COMPUTER SOFTWARE FOR ACCESSING A DATABASE OF AUTOMOTIVE INDUSTRY MARKET INFORMATION TO ALLOW VEHICLE DEALERS TO GENERATE VARIOUS PAYMENT PLAN OPTIONS TO ASSIST CUSTOMERS IN CHOOSING BETWEEN VEHICLE PURCHASE AND LEASE PLANS; PROVIDING TEMPORARY USE OF NON-DOWNLOADABLE ONLINE COMPUTER SOFTWARE FOR MANAGING CUSTOMER DATA, INVENTORY, SALES, REPAIR ORDERS AND SERVICE REQUESTS IN THE AUTO AND TRUCK DEALERSHIP FIELD; INSTALLATION OF COMPUTER SOFTWARE; PROVIDING TEMPORARY USE OF ONLINE NON-DOWNLOADABLE COMPUTER SOFTWARE IN THE FIELD OF ACCOUNTING FOR PREPARING AND PROCESSING BUSINESS EMPLOYEE PAYROLL FOR EMPLOYERS, AND FOR PRINTING PAYROLL DOCUMENTS, NAMELY, REPORTS, CHECKS, AND TAX FORMS; APPLICATION SERVICE PROVIDER SERVICES, NAMELY, PROVIDING, HOSTING, MANAGING, DEVELOPING, AND MAINTAINING SOFTWARE APPLICATIONS IN THE FIELD OF EMPLOYMENT TO ALLOW OFF-SITE FIELD EMPLOYEES TO SUBMIT TIME AND LABOR DATA TO EMPLOYERS VIA WIRELESS COMMUNICATION AND WIRELESS DELIVERY OF CONTENT TO HANDHELD COMPUTERS AND MOBILE ELECTRONIC DEVICES; CLOUD COMPUTING AND ONLINE NON-DOWNLOADABLE SOFTWARE SERVICES FEATURING SOFTWARE FOR USE IN MEDICAL PRACTICE MANAGEMENT, MEDICAL RECORDKEEPING AND REVENUE CYCLE MANAGEMENT, IN CLASS 42 (U.S. CLS. 100 AND 101).

FIRST USE 1-31-2003; IN COMMERCE 1-31-2003.

THE MARK CONSISTS OF STANDARD CHARACTERS WITHOUT CLAIM TO ANY PARTICULAR FONT, STYLE, SIZE, OR COLOR.

OWNER OF U.S. REG. NOS. 3,076,111, 3,262,193 AND OTHERS.

SER. NO. 85-355,041, FILED 6-24-2011.

KAREN BRACEY, EXAMINING ATTORNEY

# United States of America

United States Patent and Trademark Office

## Smartpix Games

**Reg. No. 4,134,427**

**Registered May 1, 2012**

**Int. Cl.: 9**

**TRADEMARK**

**PRINCIPAL REGISTER**

MURANOV, VLADISLAV (RUSSIAN FED. INDIVIDUAL)  
BUILDING 8, APT. 16  
MIRA  
VORONEZH, RUSSIAN FED. AND

MURANOVA, IRINA (RUSSIAN FED. INDIVIDUAL)  
BUILDING 114/12, APT. 56  
LOMONOSOVA  
VORONEZH, RUSSIAN FED. AND

SHEPELEV, DMITRY (RUSSIAN FED. INDIVIDUAL)  
BUILDING 1A, APT. 12  
PERHOROVICHA  
VORONEZH, RUSSIAN FED.

FOR: COMPUTER GAME SOFTWARE; COMPUTER GAME SOFTWARE DOWNLOADABLE FROM A GLOBAL COMPUTER NETWORK; COMPUTER GAME SOFTWARE FOR PERSONAL COMPUTERS AND HOME VIDEO GAME CONSOLES; COMPUTER GAME SOFTWARE FOR USE ON MOBILE AND CELLULAR PHONES; COMPUTER SOFTWARE FOR COMMUNICATING WITH USERS OF HAND-HELD COMPUTERS; COMPUTER SOFTWARE FOR THE COLLECTION, EDITING, ORGANIZING, MODIFYING, BOOK MARKING, TRANSMISSION, STORAGE AND SHARING OF DATA AND INFORMATION, IN CLASS 9 (U.S. CLS. 21, 23, 26, 36 AND 38).

FIRST USE 2-21-2009; IN COMMERCE 2-21-2009.

THE MARK CONSISTS OF STANDARD CHARACTERS WITHOUT CLAIM TO ANY PARTICULAR FONT, STYLE, SIZE, OR COLOR.

NO CLAIM IS MADE TO THE EXCLUSIVE RIGHT TO USE "GAMES", APART FROM THE MARK AS SHOWN.

SER. NO. 85-355,105, FILED 6-24-2011.

HANNO RITTNER, EXAMINING ATTORNEY



*David J. Kyffers*

Director of the United States Patent and Trademark Office

# United States of America

United States Patent and Trademark Office



**Reg. No. 4,134,428**

**Registered May 1, 2012**

**Int. Cl.: 12**

**TRADEMARK**

**PRINCIPAL REGISTER**

GARY SCHROEDER ENTERPRISES INC. (CALIFORNIA CORPORATION)  
2070 FLOYD STREET  
BURBANK, CA 91504

FOR: AUTOMOTIVE PARTS AND ACCESSORIES, NAMELY, TORSION BARS, SWAY BARS, ANTI-ROLL BARS, SPRINT CAR TORSION BARS, TORSION ARMS, IN CLASS 12 (U.S. CLS. 19, 21, 23, 31, 35 AND 44).

FIRST USE 1-1-1981; IN COMMERCE 1-1-1981.

NO CLAIM IS MADE TO THE EXCLUSIVE RIGHT TO USE "TORSION BARS", APART FROM THE MARK AS SHOWN.

THE MARK CONSISTS OF A RECTANGULAR OUTLINE WITH THE WORD "SCHROEDER" WITH A LINE THROUGH THE MIDDLE OF THE WORD AND INSIDE THE TOP HALF PORTION OF THE RECTANGLE, AND A STAR SHAPE ON THE LOWER LEFT-HAND PORTION WITH 4 LINES THROUGH THE STAR, SAID LINES STOPPING AT THE WORDS "TORSION" AND THEN CONTINUING TO THE NEXT WORD "BARS" AND THEN SAID 4 LINES AFTER THE WORD "BARS" AND ENDING JUST OUTSIDE THE RIGHT EDGE OF THE RECTANGLE.

SER. NO. 85-355,599, FILED 6-24-2011.

STEVEN R. FINE, EXAMINING ATTORNEY



*David J. Kyjars*

Director of the United States Patent and Trademark Office

# United States of America

United States Patent and Trademark Office

## MUSEUM CHOICE CRATING AND SHIPPING

**Reg. No. 4,134,429**

**Registered May 1, 2012**

**Int. Cl.: 39**

**SERVICE MARK**

**PRINCIPAL REGISTER**

MUSEUM QUALITY SHIPPING AND CRATING, LLC (NEVADA LIMITED LIABILITY COMPANY), DBA MUSEUM CHOICE CRATING AND SHIPPING  
11 PIONEER BLVD. W  
MESQUITE, NV 89027

FOR: CRATING AND SHIPPING SERVICES, IN CLASS 39 (U.S. CLS. 100 AND 105).

FIRST USE 4-2-2011; IN COMMERCE 4-2-2011.

NO CLAIM IS MADE TO THE EXCLUSIVE RIGHT TO USE "MUSEUM" AND "CRATING AND SHIPPING", APART FROM THE MARK AS SHOWN.

THE COLOR(S) GREEN, BLACK AND GRAY IS/ARE CLAIMED AS A FEATURE OF THE MARK.

THE MARK CONSISTS OF "MUSEUM CHOICE" IN A STYLIZED FORM, WITH EACH LETTER IN BLACK AND GRAY, AND "CRATING AND SHIPPING" IN STYLIZED FORM, WITH THE LETTERS IN BLACK AND PLACED WITHIN A GREEN RECTANGULAR FIELD SURROUNDED BY A CONTRASTING GREEN BORDER, IMMEDIATELY BELOW "MUSEUM CHOICE".

SER. NO. 85-356,675, FILED 6-27-2011.

MARK SPARACINO, EXAMINING ATTORNEY



*David J. Kybas*

Director of the United States Patent and Trademark Office

# United States of America

United States Patent and Trademark Office

# Trimezzo

**Reg. No. 4,134,430**

**Registered May 1, 2012**

**Int. Cl.: 33**

**TRADEMARK**

**PRINCIPAL REGISTER**

ERATH, RICHARD C. (UNITED STATES INDIVIDUAL)  
19926 N.E. FAIRVIEW DRIVE  
DUNDEE, OR 97115

FOR: RED WINE, IN CLASS 33 (U.S. CLS. 47 AND 49).

FIRST USE 6-30-2010; IN COMMERCE 12-31-2010.

THE MARK CONSISTS OF STANDARD CHARACTERS WITHOUT CLAIM TO ANY PARTICULAR FONT, STYLE, SIZE, OR COLOR.

THE ENGLISH TRANSLATION OF "TRIMEZZO" IN THE MARK IS "THREE HALF".

SER. NO. 85-356,849, FILED 6-27-2011.

KELLY CHOE, EXAMINING ATTORNEY



*David J. Kybas*

Director of the United States Patent and Trademark Office



# United States of America

United States Patent and Trademark Office

**MAGNETEC**  
MAGNET - TECHNOLOGIE

**Reg. No. 4,134,431**

**Registered May 1, 2012**

**Int. Cls.: 9 and 40**

**TRADEMARK**

**SERVICE MARK**

**PRINCIPAL REGISTER**

MAGNETEC GMBH (FED REP GERMANY CORPORATION)  
7 INDUSTRIE STR.  
LANGENSELBOLD, FED REP GERMANY 63505

FOR: MAGNETIC CORES, IN CLASS 9 (U.S. CLS. 21, 23, 26, 36 AND 38).

FIRST USE 5-1-1984; IN COMMERCE 5-1-1984.

FOR: MANUFACTURE OF NANO SCALE MATERIAL TO THE ORDER AND SPECIFICATION OF OTHERS FOR USE IN THE MANUFACTURE OF OTHER GOODS, IN CLASS 40 (U.S. CLS. 100, 103 AND 106).

FIRST USE 5-1-1984; IN COMMERCE 5-1-1984.

NO CLAIM IS MADE TO THE EXCLUSIVE RIGHT TO USE "MAGNET-TECHNOLOGIE", APART FROM THE MARK AS SHOWN.

THE COLOR(S) DARK BLUE, BLACK IS/ARE CLAIMED AS A FEATURE OF THE MARK.

THE MARK CONSISTS OF THE WORD "MAGNETEC" IN DARK BLUE, WITH THE FOLLOWING WORDS IN BLACK UNDERNEATH: "MAGNET" FOLLOWED BY A HYPHEN FOLLOWED BY THE WORD "TECHNOLOGIE", FOLLOWED BY A HORIZONTAL BLACK LINE CENTERED INLINE WITH THE HYPHEN FILLING THE SPACE AND EXTENDING SLIGHTLY BEYOND THE WORD "MAGNETEC".

THE ENGLISH TRANSLATION OF "TECHNOLOGIE" IN THE MARK IS "TECHNOLOGY".

SER. NO. 85-357,026, FILED 6-27-2011.

HENRY S. ZAK, EXAMINING ATTORNEY



*David J. Kybas*

Director of the United States Patent and Trademark Office

# United States of America

United States Patent and Trademark Office

## GLOBAL STEEL AND FLAMECUTTING SERVICES

**Reg. No. 4,134,432**

**Registered May 1, 2012**

**Int. Cl.: 40**

**SERVICE MARK**

**PRINCIPAL REGISTER**

GLOBAL FABRICATION SERVICES, INC. (TEXAS CORPORATION)  
17007 LAZY ELM COURT  
HOUSTON, TX 77095

FOR: CUSTOMIZED STEEL PROCESSING SERVICES FOR OTHERS, NAMELY, DETAILING, FLAMECUTTING, BEVELING, STRAIGHTENING, STRESS RELIEVING, HEAT TREATING, MACHINING, AND PAINTING OF STEEL PRODUCTS FOR ULTIMATE USE BY THE INDUSTRIAL AND COMMERCIAL MANUFACTURING INDUSTRIES AND THE OIL INDUSTRY, IN CLASS 40 (U.S. CLS. 100, 103 AND 106).

FIRST USE 3-14-2000; IN COMMERCE 3-14-2000.

THE MARK CONSISTS OF STANDARD CHARACTERS WITHOUT CLAIM TO ANY PARTICULAR FONT, STYLE, SIZE, OR COLOR.

OWNER OF U.S. REG. NO. 2,585,440.

NO CLAIM IS MADE TO THE EXCLUSIVE RIGHT TO USE "STEEL AND FLAMECUTTING SERVICES", APART FROM THE MARK AS SHOWN.

SEC. 2(F).

SER. NO. 85-358,788, FILED 6-28-2011.

KHANH LE, EXAMINING ATTORNEY



*David J. Kyros*

Director of the United States Patent and Trademark Office

# United States of America

United States Patent and Trademark Office

## Walking Target

**Reg. No. 4,134,433**

**Registered May 1, 2012**

**Int. Cl.: 28**

**TRADEMARK**

**PRINCIPAL REGISTER**

BOW CREEK METAL, INC. (SOUTH DAKOTA CORPORATION)  
100 W FOURTH ST  
YANKTON, SD 57078

FOR: FIREARM TARGETS, IN CLASS 28 (U.S. CLS. 22, 23, 38 AND 50).

FIRST USE 5-1-2011; IN COMMERCE 5-1-2011.

THE MARK CONSISTS OF STANDARD CHARACTERS WITHOUT CLAIM TO ANY PARTICULAR FONT, STYLE, SIZE, OR COLOR.

NO CLAIM IS MADE TO THE EXCLUSIVE RIGHT TO USE "TARGET", APART FROM THE MARK AS SHOWN.

SER. NO. 85-359,274, FILED 6-29-2011.

TRACY WHITTAKER-BROWN, EXAMINING ATTORNEY



*David J. Kyffers*

Director of the United States Patent and Trademark Office

# United States of America

United States Patent and Trademark Office

## Flippin' Critters

**Reg. No. 4,134,434**

**Registered May 1, 2012**

**Int. Cl.: 28**

**TRADEMARK**

**PRINCIPAL REGISTER**

BOW CREEK METAL, INC. (SOUTH DAKOTA CORPORATION)  
100 W FOURTH ST  
YANKTON, SD 57078

FOR: FIREARM TARGETS, IN CLASS 28 (U.S. CLS. 22, 23, 38 AND 50).

FIRST USE 5-1-2011; IN COMMERCE 5-1-2011.

THE MARK CONSISTS OF STANDARD CHARACTERS WITHOUT CLAIM TO ANY PARTICULAR FONT, STYLE, SIZE, OR COLOR.

SER. NO. 85-359,287, FILED 6-29-2011.

TRACY WHITTAKER-BROWN, EXAMINING ATTORNEY



*David J. Kyffers*

Director of the United States Patent and Trademark Office

# United States of America

United States Patent and Trademark Office



**Reg. No. 4,134,435**

**Registered May 1, 2012**

**Int. Cls.: 41 and 43**

**SERVICE MARK**

**PRINCIPAL REGISTER**

GARRUBBO COMMUNICATIONS, LLC (DELAWARE LIMITED LIABILITY COMPANY)  
1230 AMERICAN BLVD.  
WEST CHESTER, PA 19380

FOR: ONLINE JOURNALS, NAMELY, BLOGS FEATURING TRAVEL, RESTAURANT AND CULTURAL INFORMATION, IN CLASS 41 (U.S. CLS. 100, 101 AND 107).

FIRST USE 6-29-2011; IN COMMERCE 6-29-2011.

FOR: PROVIDING INFORMATION IN THE FIELD OF COOKING, DINING AND RECIPES, IN CLASS 43 (U.S. CLS. 100 AND 101).

FIRST USE 6-29-2011; IN COMMERCE 6-29-2011.

OWNER OF U.S. REG. NO. 3,403,875.

THE COLOR(S) ORANGE, BLACK AND WHITE IS/ARE CLAIMED AS A FEATURE OF THE MARK.

NO CLAIM IS MADE TO THE EXCLUSIVE RIGHT TO USE "GUIDA", APART FROM THE MARK AS SHOWN.

THE MARK CONSISTS OF THE WORD "GARRUBBO" IN BLACK WITH ORANGE SHADING BETWEEN ORANGE LINES WITH WHITE STARS ON THE BOTTOM INSIDE A BLACK CIRCLE WITH WHITE LINING WITH THE TERM "GUIDA" IN WHITE.

THE ENGLISH TRANSLATION OF "GUIDA" IN THE MARK IS "GUIDE".

SER. NO. 85-359,407, FILED 6-29-2011.

MICHELE SWAIN, EXAMINING ATTORNEY



*David J. Kybas*

Director of the United States Patent and Trademark Office

# United States of America

United States Patent and Trademark Office

# PowerFilm

**Reg. No. 4,134,436**

**Registered May 1, 2012**

**Int. Cl.: 9**

**TRADEMARK**

**PRINCIPAL REGISTER**

POWERFILM, INC. (DELAWARE CORPORATION)  
2337 230TH ST.  
AMES, IA 50014

FOR: APPARATUS FOR CONVERTING ELECTRONIC RADIATION TO ELECTRICAL ENERGY, NAMELY, PHOTOVOLTAIC SOLAR MODULES, IN CLASS 9 (U.S. CLS. 21, 23, 26, 36 AND 38).

FIRST USE 11-12-2001; IN COMMERCE 11-12-2001.

THE MARK CONSISTS OF STANDARD CHARACTERS WITHOUT CLAIM TO ANY PARTICULAR FONT, STYLE, SIZE, OR COLOR.

SER. NO. 85-359,513, FILED 6-29-2011.

TEJBIR SINGH, EXAMINING ATTORNEY



*David J. Kybas*

Director of the United States Patent and Trademark Office

# United States of America

United States Patent and Trademark Office

## NATIONAL FERAL CAT DAY

**Reg. No. 4,134,437**

**Registered May 1, 2012**

**Int. Cl.: 35**

**SERVICE MARK**

**PRINCIPAL REGISTER**

ALLEY CAT ALLIES, INC. (DELAWARE NON-PROFIT CORPORATION)  
7920 NORFOLK AVE., SUITE 600  
BETHESDA, MD 20814

FOR: PROMOTING PUBLIC AWARENESS OF ISSUES SURROUNDING FERAL CATS, INCLUDING THE NEED FOR HEALTH, CARE, ABUSE PREVENTION AND HUMANE TREATMENT OF FERAL CATS, AND THE MANAGEMENT, CONTROL AND ABUSE PREVENTION OF FERAL CAT COLONIES, IN CLASS 35 (U.S. CLS. 100, 101 AND 102).

FIRST USE 0-0-1991; IN COMMERCE 0-0-1991.

THE MARK CONSISTS OF STANDARD CHARACTERS WITHOUT CLAIM TO ANY PARTICULAR FONT, STYLE, SIZE, OR COLOR.

SEC. 2(F).

SER. NO. 85-360,927, FILED 6-30-2011.

MARK T. MULLEN, EXAMINING ATTORNEY



*David J. Kyffers*

Director of the United States Patent and Trademark Office

# United States of America

United States Patent and Trademark Office

# Speci Purge

**Reg. No. 4,134,438**

**Registered May 1, 2012**

**Int. Cl.: 1**

**TRADEMARK**

**PRINCIPAL REGISTER**

MSI TECHNOLOGY LLC (ILLINOIS LIMITED LIABILITY COMPANY)  
STE #355  
3930 VENTURA DRIVE  
ARLINGTON HEIGHTS, IL 60004

FOR: READY-TO-USE PURGING COMPOUND IN PELLET FORM FOR USE IN PURGING PLASTIC INJECTION MOLDING, BLOW MOLDING, AND EXTRUSION SYSTEMS , IN CLASS 1 (U.S. CLS. 1, 5, 6, 10, 26 AND 46).

FIRST USE 11-12-2009; IN COMMERCE 12-7-2009.

THE MARK CONSISTS OF STANDARD CHARACTERS WITHOUT CLAIM TO ANY PARTICULAR FONT, STYLE, SIZE, OR COLOR.

NO CLAIM IS MADE TO THE EXCLUSIVE RIGHT TO USE "PURGE", APART FROM THE MARK AS SHOWN.

SER. NO. 85-361,529, FILED 7-1-2011.

JAMES A. RAUEN, EXAMINING ATTORNEY



*David J. Kyffers*

Director of the United States Patent and Trademark Office



# United States of America

United States Patent and Trademark Office

## BIRDIE BELT

**Reg. No. 4,134,439**

**Registered May 1, 2012**

**Int. Cl.: 28**

**TRADEMARK**

**PRINCIPAL REGISTER**

BIRDIE BELT, LLC (COLORADO LIMITED LIABILITY COMPANY)  
5678 STONEBRIDGE WAY  
MORRISON, CO 80465

FOR: GOLF ACCESSORY BELTS; WOMEN'S GOLF BELTS, IN CLASS 28 (U.S. CLS. 22, 23, 38 AND 50).

FIRST USE 11-29-2010; IN COMMERCE 11-29-2010.

THE MARK CONSISTS OF STANDARD CHARACTERS WITHOUT CLAIM TO ANY PARTICULAR FONT, STYLE, SIZE, OR COLOR.

NO CLAIM IS MADE TO THE EXCLUSIVE RIGHT TO USE "BELT", APART FROM THE MARK AS SHOWN.

SER. NO. 85-362,084, FILED 7-1-2011.

ROSELLE HERRERA, EXAMINING ATTORNEY



*David J. Kyffers*

Director of the United States Patent and Trademark Office

# United States of America

United States Patent and Trademark Office

## Silk Reflexion

**Reg. No. 4,134,440**

**Registered May 1, 2012**

**Int. Cl.: 3**

**TRADEMARK**

**PRINCIPAL REGISTER**

OWENS, JOYCE A. (UNITED STATES INDIVIDUAL), TA SILK REFLEXION  
JOYCEKO@BELLSOUTH.NET  
1960 BENTBROOKE TR.  
LAWRENCEVILLE, GA 30043

FOR: AROMATIC BODY CARE PRODUCTS, NAMELY, BODY LOTION, SHOWER GEL, CUTICLE CREAM, SHAMPOO, CONDITIONER, NON-MEDICATED LIP BALM, SOAP, BODY POLISH, BODY AND FOOT SCRUB AND NON-MEDICATED FOOT CREAM; HAIR SHAMPOOS AND CONDITIONERS, IN CLASS 3 (U.S. CLS. 1, 4, 6, 50, 51 AND 52).

FIRST USE 3-15-2011; IN COMMERCE 3-15-2011.

THE MARK CONSISTS OF STANDARD CHARACTERS WITHOUT CLAIM TO ANY PARTICULAR FONT, STYLE, SIZE, OR COLOR.

SER. NO. 85-362,635, FILED 7-4-2011.

BRENDAN MCCAULEY, EXAMINING ATTORNEY



*David J. Kyffers*

Director of the United States Patent and Trademark Office

# United States of America

United States Patent and Trademark Office

# APPTICAL

**Reg. No. 4,134,441**

**Registered May 1, 2012**

**Int. Cl.: 35**

**SERVICE MARK**

**PRINCIPAL REGISTER**

APPTICAL CORP. (FLORIDA CORPORATION)  
2255 GLADES RD., STE. 324A  
BOCA RATON, FL 33431

FOR: BUSINESS RISK MANAGEMENT SERVICES, NAMELY, PROVIDING AN ONLINE RULE AUTHORIZING INTERFACE AND RULES ENGINE SYSTEM TO ASSIST INSURERS IN UNDERWRITING OF INSURANCE APPLICATIONS; BUSINESS RISK MANAGEMENT SERVICES, NAMELY, PROVIDING AN ONLINE RULE AUTHORIZING INTERFACE AND RULES ENGINE SYSTEM TO ASSIST INSURERS IN RATING OF INSURANCE APPLICATIONS; BUSINESS RISK MANAGEMENT SERVICES, NAMELY, PROVIDING AN ONLINE RULE AUTHORIZING INTERFACE AND RULES ENGINE SYSTEM TO ASSIST INSURERS IN RISK MANAGEMENT IN THE FIELD OF INSURANCE AND INSURANCE UNDERWRITING; BUSINESS RISK MANAGEMENT SERVICES, NAMELY, ANALYSIS OF RISK IN THE FIELD OF UNDERWRITING INSURANCE APPLICANTS; BUSINESS RISK MANAGEMENT SERVICES VIA AN ONLINE COMPUTER SYSTEM FOR INSURANCE AGENCIES TO REVIEW PROSPECTIVE INSURED'S APPLICATIONS; BUSINESS DATA ANALYSIS SERVICES, NAMELY, THE ACQUISITION OF DATA RELATED TO AN INSURANCE APPLICATION VIA AN ONLINE COMPUTER SYSTEM; BUSINESS INFORMATION MANAGEMENT, NAMELY, PROVIDING AN ONLINE INSURANCE APPLICATION SYSTEM; BUSINESS INFORMATION MANAGEMENT, NAMELY, PROVIDING AN ONLINE SYSTEM FOR THE DELIVERY OF DATA RELATED TO AN INSURANCE APPLICATION; BUSINESS INFORMATION MANAGEMENT, NAMELY, PROVIDING AN ONLINE SYSTEM FOR THE RETRIEVAL AND DELIVERY OF RECORDED INSURANCE APPLICANT INTERVIEWS; BUSINESS INFORMATION MANAGEMENT, NAMELY, PROVIDING AN ONLINE SYSTEM FOR THE VERIFICATION OF INFORMATION RELATED TO INSURANCE APPLICATIONS; DATA PROCESSING SERVICES, NAMELY, PROVIDING ONLINE AND ELECTRONIC PROCESSING OF INSURANCE APPLICATIONS; BUSINESS DATA ANALYSIS SERVICES, NAMELY, CONDUCTING AUDIO INTERVIEWS REGARDING APPLICANT'S RESPONSES TO INSURANCE APPLICATION QUESTIONS; BUSINESS DATA ANALYSIS SERVICES, NAMELY, DATA ANALYZING IN THE FIELD OF INSURANCE; DATA COMPILING IN THE FIELD OF INSURANCE; OPERATION OF TELEPHONE CALL CENTERS FOR OTHERS, IN CLASS 35 (U.S. CLS. 100, 101 AND 102).



*David J. Kyjars*

Director of the United States Patent and Trademark Office

FIRST USE 0-0-2002; IN COMMERCE 0-0-2002.

THE MARK CONSISTS OF STANDARD CHARACTERS WITHOUT CLAIM TO ANY PARTICULAR FONT, STYLE, SIZE, OR COLOR.

**Reg. No. 4,134,441** SER. NO. 85-362,900, FILED 7-5-2011.

DAVID MURRAY, EXAMINING ATTORNEY

# United States of America

United States Patent and Trademark Office

# LIVEAPP

**Reg. No. 4,134,442**

**Registered May 1, 2012**

**Int. Cl.: 35**

**SERVICE MARK**

**PRINCIPAL REGISTER**

APPTICAL CORP. (FLORIDA CORPORATION)  
2255 GLADES RD., STE. 324A  
BOCA RATON, FL 33431

FOR: BUSINESS INFORMATION MANAGEMENT, NAMELY, PROVIDING AN ONLINE INSURANCE APPLICATION SYSTEM; BUSINESS INFORMATION MANAGEMENT, NAMELY, PROVIDING AN ONLINE SYSTEM FOR THE DELIVERY OF DATA RELATED TO AN INSURANCE APPLICATION; DATA PROCESSING SERVICES, NAMELY, PROVIDING ONLINE AND ELECTRONIC PROCESSING OF INSURANCE APPLICATIONS; BUSINESS RISK MANAGEMENT SERVICES, NAMELY, VIA AN ONLINE COMPUTER SYSTEM FOR INSURANCE AGENCIES TO REVIEW PROSPECTIVE INSURED'S APPLICATIONS; BUSINESS DATA ANALYSIS SERVICES, NAMELY, THE ACQUISITION OF DATA RELATED TO AN INSURANCE APPLICATION VIA AN ONLINE COMPUTER SYSTEM; DATA COMPILING IN THE FIELD OF INSURANCE, IN CLASS 35 (U.S. CLS. 100, 101 AND 102).

FIRST USE 2-1-2010; IN COMMERCE 2-1-2010.

THE MARK CONSISTS OF STANDARD CHARACTERS WITHOUT CLAIM TO ANY PARTICULAR FONT, STYLE, SIZE, OR COLOR.

SER. NO. 85-362,938, FILED 7-5-2011.

DAVID MURRAY, EXAMINING ATTORNEY



*David J. Kyffers*

Director of the United States Patent and Trademark Office

# United States of America

United States Patent and Trademark Office

## SOUNDDECISIONS

**Reg. No. 4,134,443**

**Registered May 1, 2012**

**Int. Cl.: 35**

**SERVICE MARK**

**PRINCIPAL REGISTER**

APPTICAL CORP. (FLORIDA CORPORATION)  
2255 GLADES RD., STE. 324A  
BOCA RATON, FL 33431

FOR: BUSINESS INFORMATION MANAGEMENT, NAMELY, PROVIDING AN ONLINE SYSTEM FOR THE DELIVERY OF DATA RELATED TO AN INSURANCE APPLICATION; BUSINESS INFORMATION MANAGEMENT, NAMELY, PROVIDING AN ONLINE SYSTEM FOR THE RETRIEVAL AND DELIVERY OF RECORDED INSURANCE APPLICANT INTERVIEWS; BUSINESS INFORMATION MANAGEMENT, NAMELY, PROVIDING AN ONLINE SYSTEM FOR THE VERIFICATION OF INFORMATION RELATED TO INSURANCE APPLICATIONS; BUSINESS DATA ANALYSIS SERVICES, NAMELY, CONDUCTING AUDIO INTERVIEWS REGARDING APPLICANT'S RESPONSES TO INSURANCE APPLICATION QUESTIONS; BUSINESS DATA ANALYSIS SERVICES, NAMELY, DATA ANALYZING IN THE FIELD OF INSURANCE; BUSINESS RISK MANAGEMENT SERVICES, NAMELY, VIA AN ONLINE COMPUTER SYSTEM FOR INSURANCE AGENCIES TO REVIEW PROSPECTIVE INSURED'S APPLICATIONS; BUSINESS DATA ANALYSIS SERVICES, NAMELY, THE ACQUISITION OF DATA RELATED TO AN INSURANCE APPLICATION VIA AN ONLINE COMPUTER SYSTEM; OPERATION OF TELEPHONE CALL CENTERS FOR OTHERS; DATA COMPILING AND ANALYZING IN THE FIELD OF INSURANCE, IN CLASS 35 (U.S. CLS. 100, 101 AND 102).

FIRST USE 2-1-2010; IN COMMERCE 2-1-2010.

THE MARK CONSISTS OF STANDARD CHARACTERS WITHOUT CLAIM TO ANY PARTICULAR FONT, STYLE, SIZE, OR COLOR.

SER. NO. 85-362,945, FILED 7-5-2011.

DAVID MURRAY, EXAMINING ATTORNEY



*David J. Kypos*

Director of the United States Patent and Trademark Office

# United States of America

United States Patent and Trademark Office

# PURE

**Reg. No. 4,134,444**

**Registered May 1, 2012**

**Int. Cl.: 35**

**SERVICE MARK**

**PRINCIPAL REGISTER**

APPTICAL CORP. (FLORIDA CORPORATION)  
2255 GLADES RD., STE. 324A  
BOCA RATON, FL 33431

FOR: BUSINESS RISK MANAGEMENT SERVICES, NAMELY, PROVIDING AN ONLINE RULE AUTHORIZING INTERFACE AND RULES ENGINE SYSTEM TO ASSIST INSURERS IN UNDERWRITING OF INSURANCE APPLICATIONS; BUSINESS RISK MANAGEMENT SERVICES, NAMELY, PROVIDING AN ONLINE RULE AUTHORIZING INTERFACE AND RULES ENGINE SYSTEM TO ASSIST INSURERS IN RATING OF INSURANCE APPLICATIONS; BUSINESS RISK MANAGEMENT SERVICES, NAMELY, PROVIDING AN ONLINE RULE AUTHORIZING INTERFACE AND RULES ENGINE SYSTEM TO ASSIST INSURERS IN RISK MANAGEMENT IN THE FIELD OF INSURANCE AND INSURANCE UNDERWRITING; BUSINESS RISK MANAGEMENT SERVICES, NAMELY, ANALYSIS OF RISK IN THE FIELD OF UNDERWRITING INSURANCE APPLICANTS, IN CLASS 35 (U.S. CLS. 100, 101 AND 102).

FIRST USE 9-1-2009; IN COMMERCE 9-1-2009.

THE MARK CONSISTS OF STANDARD CHARACTERS WITHOUT CLAIM TO ANY PARTICULAR FONT, STYLE, SIZE, OR COLOR.

SER. NO. 85-362,957, FILED 7-5-2011.

DAVID MURRAY, EXAMINING ATTORNEY



*David J. Kyffers*

Director of the United States Patent and Trademark Office

# United States of America

United States Patent and Trademark Office

Moms in Business  
Unite

*Dream. Discover. Lead.*

**Reg. No. 4,134,445**

**Registered May 1, 2012**

**Int. Cl.: 41**

**SERVICE MARK**

**PRINCIPAL REGISTER**

MOMS IN BUSINESS UNITE, INC., A CALIFORNIA CORPORATION (CALIFORNIA CORPORATION)  
14480 GARDEN TRAIL  
SAN DIEGO, CA 92127

FOR: EDUCATIONAL SERVICES, NAMELY, CONDUCTING CLASSES, SEMINARS, CONFERENCES, WORKSHOPS, AND MULTI-MEDIA IN THE FIELD OF BUSINESS DEVELOPMENT FOR WOMEN AND BUSINESS OWNERS AND DISTRIBUTION OF COURSE AND EDUCATIONAL MATERIALS IN CONNECTION THEREWITH; EDUCATIONAL SERVICES, NAMELY, PROVIDING CLASSES, SEMINARS, CONFERENCES, WORKSHOPS, AND INTERACTIVE LEARNING THROUGH SOCIAL MEDIA MEDIUMS IN THE FIELDS OF BUSINESS DEVELOPMENT FOR WOMEN AND BUSINESS OWNERS, IN CLASS 41 (U.S. CLS. 100, 101 AND 107).

FIRST USE 1-6-2009; IN COMMERCE 1-6-2009.

NO CLAIM IS MADE TO THE EXCLUSIVE RIGHT TO USE "MOMS IN BUSINESS", APART FROM THE MARK AS SHOWN.

THE COLOR(S) WHITE, ORANGE, BLUE, AND PURPLE IS/ARE CLAIMED AS A FEATURE OF THE MARK.

THE MARK CONSISTS OF A RECTANGULAR SHAPE IN WHITE BACKGROUND AND A BOTTOM PORTION IN PURPLE BACKGROUND. TOP PORTION OF CONTAIN WORDINGS READ: "MOMS IN BUSINESS" IN ORANGE AND "UNITE" DIRECTLY UNDER IN THE COLOR BLUE. BOTH "BUSINESS" AND "UNITED" ARE ENCLOSED BY A STROKE IN THE COLOR OF ORANGE BUT LEAVING OPENING TO THE SIDE. BOTTOM PORTION OF THIS RECTANGULAR SHAPE IS A PURPLE BANNER WITH THREE WORDS: "DREAM." DISCOVER." AND "LEAD." ALL IN WHITE LETTERS AND EACH ENDING WITH A PERIOD.

SER. NO. 85-362,972, FILED 7-5-2011.

PRISCILLA MILTON, EXAMINING ATTORNEY



*David J. Kyffers*

Director of the United States Patent and Trademark Office



# United States of America

United States Patent and Trademark Office

# KARMAPAK

**Reg. No. 4,134,446**

**Registered May 1, 2012**

**Int. Cl.: 18**

**TRADEMARK**

**PRINCIPAL REGISTER**

BARRIO DREAMS, LLC (ILLINOIS LIMITED LIABILITY COMPANY)  
629 W. CERMAK RD  
CHICAGO, IL 60616

FOR: ALL PURPOSE SPORT BAGS, ALL-PURPOSE CARRYING BAGS, BACKPACKS, BOOK BAGS, SPORTS BAGS, BUM BAGS, WALLETS AND HANDBAGS, BEACH BAGS, BRIEFCASES, SUITCASES, CARRY-ON BAGS, CLUTCH BAGS, DAYPACKS, DUFFEL BAGS, FANNY PACKS, GARMENT BAGS FOR TRAVEL, KNAPSACKS, LUGGAGE, MESSENGER BAGS, OVERNIGHT BAGS, RUCKSACKS, SATCHELS, SHOULDER BAGS, STRAPS FOR HANDBAGS, STRAPS FOR LUGGAGE, TOTE BAGS, UMBRELLAS, IN CLASS 18 (U.S. CLS. 1, 2, 3, 22 AND 41).

FIRST USE 2-4-2009; IN COMMERCE 3-12-2009.

THE MARK CONSISTS OF STANDARD CHARACTERS WITHOUT CLAIM TO ANY PARTICULAR FONT, STYLE, SIZE, OR COLOR.

SER. NO. 85-363,649, FILED 7-5-2011.

WARREN L. OLANDRIA, EXAMINING ATTORNEY



*David J. Kyffers*

Director of the United States Patent and Trademark Office

# United States of America

United States Patent and Trademark Office

# VERGENCE

**Reg. No. 4,134,447**

**Registered May 1, 2012**

**Int. Cl.: 9**

**TRADEMARK**

**PRINCIPAL REGISTER**

CUI GLOBAL, INC. (COLORADO CORPORATION)  
546 19 AVENUE NE  
ST. PETERSBURG, FL 33704

FOR: A DEVICE COMMONLY REFERRED TO AS AN ELECTRONIC NATURAL GAS INFERENTIAL METER THAT MEASURES NATURAL GAS PHYSICAL QUALITY PROPERTIES SUCH AS THERMAL CONDUCTIVITY, SPEED OF SOUND AND CARBON DIOXIDE CONTENT. FROM THESE MEASUREMENTS IT INFERS AN EFFECTIVE GAS MIXTURE COMPRISING FOUR COMPONENTS: METHANE, PROPANE, NITROGEN, AND MEASURED CARBON DIOXIDE, IN CLASS 9 (U.S. CLS. 21, 23, 26, 36 AND 38).

FIRST USE 6-14-2011; IN COMMERCE 7-1-2011.

THE MARK CONSISTS OF STANDARD CHARACTERS WITHOUT CLAIM TO ANY PARTICULAR FONT, STYLE, SIZE, OR COLOR.

SER. NO. 85-364,072, FILED 7-6-2011.

WILLIAM P. SHANAHAN, EXAMINING ATTORNEY



*David J. Kyffers*

Director of the United States Patent and Trademark Office

# United States of America

United States Patent and Trademark Office

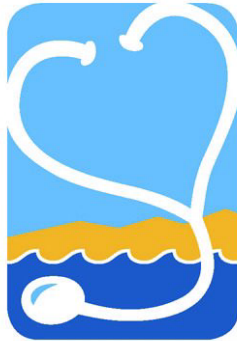

**Reg. No. 4,134,448**

**Registered May 1, 2012**

**Int. Cl.: 44**

**SERVICE MARK**

**PRINCIPAL REGISTER**

VENTURA COUNTY MEDI-CAL MANAGED CARE COMMISSION (CALIFORNIA STATE AGENCY), DBA GOLD COAST HEALTH PLAN  
2220 E. GONZALES ROAD, SUITE 200  
OXNARD, CA 93036

FOR: MANAGED HEALTH CARE SERVICES, IN CLASS 44 (U.S. CLS. 100 AND 101).

FIRST USE 10-25-2009; IN COMMERCE 7-1-2011.

THE MARK CONSISTS OF WHITE STETHOSCOPE WITH LIGHT BLUE HIGHLIGHT; DARK BLUE OCEAN WITH WHITE WAVE-TOPS; ORANGE-TAN MOUNTAINS; LIGHT BLUE SKY.

THE COLOR(S) LIGHT BLUE, WHITE, ORANGE-TAN AND DARK BLUE IS/ARE CLAIMED AS A FEATURE OF THE MARK.

SER. NO. 85-364,235, FILED 7-6-2011.

STEVEN R. FINE, EXAMINING ATTORNEY



*David J. Kyffers*

Director of the United States Patent and Trademark Office

# United States of America

United States Patent and Trademark Office

## Comerica eFX

**Reg. No. 4,134,449**

**Registered May 1, 2012**

**Int. Cl.: 36**

**SERVICE MARK**

**PRINCIPAL REGISTER**

COMERICA INCORPORATED (DELAWARE CORPORATION)  
411 LAFAYETTE  
MC 3391  
DETROIT, MI 48226

FOR: AUTOMATED FOREIGN EXCHANGE AND MONEY MARKET TRADING SERVICES THAT UTILIZES INTERNET BROWSER TECHNOLOGY AND PUBLIC AND PRIVATE ACCESS OFFERING A FULL RANGE OF FOREIGN EXCHANGE AND MONEY MARKET DEALING TRANSACTIONS, NAMELY, SPOT, FORWARD, SWAPS, EARLY TAKE-UPS, EXTENSIONS, FORWARD DATED OPTIONS, DEPOSITS, ROLLOVERS, AND LOANS, IN CLASS 36 (U.S. CLS. 100, 101 AND 102).

FIRST USE 6-1-2001; IN COMMERCE 6-1-2001.

THE MARK CONSISTS OF STANDARD CHARACTERS WITHOUT CLAIM TO ANY PARTICULAR FONT, STYLE, SIZE, OR COLOR.

NO CLAIM IS MADE TO THE EXCLUSIVE RIGHT TO USE "EFX", APART FROM THE MARK AS SHOWN.

SER. NO. 85-364,345, FILED 7-6-2011.

HELENE LIWINSKI, EXAMINING ATTORNEY



*David J. Kyros*

Director of the United States Patent and Trademark Office

# United States of America

United States Patent and Trademark Office

## FUND TITLE NOTES

**Reg. No. 4,134,450**

**Registered May 1, 2012**

**Int. Cl.: 9**

**TRADEMARK**

**PRINCIPAL REGISTER**

ATTORNEYS' TITLE INSURANCE FUND (FLORIDA DECLARATION OF TRUST)  
6545 CORPORATE CENTER BOULEVARD  
ORLANDO, FL 32822

FOR: ON-LINE, DOWN-LOADABLE HANDBOOKS AND MANUALS PROVIDING INFORMATION, ADVICE, INDUSTRY NEWS, AND LAW REPORTS IN THE FIELDS OF TITLE INSURANCE UNDERWRITING SERVICES, REAL ESTATE TRANSACTION SERVICES, REAL ESTATE CLOSING SERVICES, AND REAL ESTATE LAW SERVICES, IN CLASS 9 (U.S. CLS. 21, 23, 26, 36 AND 38).

FIRST USE 4-0-2003; IN COMMERCE 4-0-2003.

THE MARK CONSISTS OF STANDARD CHARACTERS WITHOUT CLAIM TO ANY PARTICULAR FONT, STYLE, SIZE, OR COLOR.

OWNER OF U.S. REG. NOS. 1,613,190, 4,058,601 AND OTHERS.

NO CLAIM IS MADE TO THE EXCLUSIVE RIGHT TO USE "TITLE NOTES", APART FROM THE MARK AS SHOWN.

SER. NO. 85-364,517, FILED 7-6-2011.

AMY C. KEAN, EXAMINING ATTORNEY



*David J. Kyffers*

Director of the United States Patent and Trademark Office

# United States of America

United States Patent and Trademark Office

**Next**   
**Step** *HOME*  
By CareOne

**Reg. No. 4,134,451**

**Registered May 1, 2012**

**Int. Cl.: 44**

**SERVICE MARK**

**PRINCIPAL REGISTER**

CARE ONE, LLC (DELAWARE LIMITED LIABILITY COMPANY)  
173 BRIDGE PLAZA NORTH  
FORT LEE, NJ 07024

FOR: MEDICAL SERVICES, NAMELY, COMPREHENSIVE CARE DISCHARGE PLANNING FOR PATIENTS FROM INPATIENT MEDICAL REHABILITATION SETTINGS CONCERNING PRE-DISCHARGE HOME EVALUATIONS, AFTER-DISCHARGE EVALUATIONS, THERAPY AND MEDICAL THERAPEUTIC TECHNOLOGY CONSULTATION, MEDICAL CARE COORDINATION AND HOME CARE ORIENTATION INFORMATION, IN CLASS 44 (U.S. CLS. 100 AND 101).

FIRST USE 7-0-2009; IN COMMERCE 7-0-2009.

NO CLAIM IS MADE TO THE EXCLUSIVE RIGHT TO USE "HOME", APART FROM THE MARK AS SHOWN.

THE MARK CONSISTS OF THE STYLIZED WORDING "NEXT STEP HOME BY CAREONE." A PARTIAL OUTLINE OF A HOUSE APPEARS TO THE RIGHT OF THE WORD "NEXT".

SER. NO. 85-364,643, FILED 7-6-2011.

MICHELE SWAIN, EXAMINING ATTORNEY



*David J. Kyffers*

Director of the United States Patent and Trademark Office

# United States of America

United States Patent and Trademark Office

## SMILE HIGH CLUB

**Reg. No. 4,134,452**

**Registered May 1, 2012**

**Int. Cls.: 35 and 41**

MAKE MEANING, INC. (DELAWARE CORPORATION), FORMERLY MAKE HOLDING  
LLC  
415 MADISON AVE.  
13TH FLOOR  
NEW YORK, NY 10017

**SERVICE MARK**

**PRINCIPAL REGISTER**

FOR: RETAIL STORE AND ON-LINE RETAIL STORE SERVICES FEATURING PARTY SUPPLIES FOR PARTIES, BIRTHDAY PARTIES, ADULT PARTIES, BAR AND BAT MITZVAHS AND BRIDAL SHOWERS FEATURING AN INCENTIVE AND MEMBERSHIP REWARDS PROGRAM FOR CUSTOMERS; RETAIL STORE AND ON-LINE RETAIL STORE SERVICES WHERE CANDLES, POTTERY, SOAP, JEWELRY, CREATIVITY KITS AND ART SUPPLIES ARE SOLD FEATURING AN INCENTIVE AND MEMBERSHIP REWARDS PROGRAM FOR CUSTOMERS; INCENTIVE AND MEMBERSHIP REWARDS PROGRAMS FOR CUSTOMERS FEATURING RETAIL STORE AND ON-LINE RETAIL STORE SERVICES FEATURING PARTY SUPPLIES FOR PARTIES, BIRTHDAY PARTIES, ADULT PARTIES, BAR AND BAT MITZVAHS AND BRIDAL SHOWERS, AND WHERE CANDLES, POTTERY, SOAP, JEWELRY, CREATIVITY KITS AND ART SUPPLIES ARE SOLD; INCENTIVE AND MEMBERSHIP REWARDS PROGRAMS FOR CUSTOMERS FEATURING EVENT PLANNING FOR PARTIES, BIRTHDAY PARTIES, ADULT PARTIES, BAR AND BAT MITZVAHS AND BRIDAL SHOWERS, AND PROVIDING LOCATIONS WHERE SUCH ENTERTAINMENT EVENTS ARE HELD; INCENTIVE AND MEMBERSHIP REWARDS PROGRAMS FOR CUSTOMERS FEATURING THE PROVISION OF LOCATIONS FOR CLASSES WHERE CRAFTING WITH CERAMICS, JEWELRY, GLASS, CANDLES, SOAP, PAPER AND FOOD CAN BE LEARNED, WORKED ON AND CREATED, AND PROVIDING LOCATIONS WHERE CRAFTING WITH CERAMICS, JEWELRY, GLASS, CANDLES, SOAP, PAPER AND FOOD, CAN BE LEARNED, WORKED ON AND CREATED; MEMBERSHIP DISCOUNT PROGRAMS FOR CUSTOMERS FEATURING RETAIL STORE AND ON-LINE RETAIL STORE SERVICES FEATURING PARTY SUPPLIES FOR PARTIES, BIRTHDAY PARTIES, ADULT PARTIES, BAR AND BAT MITZVAHS AND BRIDAL SHOWERS, AND WHERE CANDLES, POTTERY, SOAP, JEWELRY, CREATIVITY KITS AND ART SUPPLIES ARE SOLD; MEMBERSHIP DISCOUNT PROGRAMS FOR CUSTOMERS FEATURING EVENT PLANNING FOR PARTIES, BIRTHDAY PARTIES, ADULT PARTIES, BAR AND BAT MITZVAHS AND BRIDAL SHOWERS, AND PROVIDING LOCATIONS WHERE SUCH ENTERTAINMENT EVENTS ARE HELD; AND MEMBERSHIP DISCOUNT PROGRAMS FOR CUSTOMERS FEATURING PROVIDING LOCATIONS FOR CLASSES WHERE CRAFTING WITH CERAMICS, JEWELRY, GLASS, CANDLES, SOAP, PAPER AND FOOD CAN BE LEARNED, WORKED ON AND CREATED, AND PROVIDING LOCATIONS WHERE CRAFTING WITH CERAMICS, JEW-



*David J. Kyros*

Director of the United States Patent and Trademark Office

**Reg. No. 4,134,452** ELRY, GLASS, CANDLES, SOAP, PAPER AND FOOD, CAN BE LEARNED, WORKED ON AND CREATED, IN CLASS 35 (U.S. CLS. 100, 101 AND 102).

FIRST USE 5-0-2011; IN COMMERCE 5-0-2011.

FOR: EVENT PLANNING FOR PARTIES, BIRTHDAY PARTIES, ADULT PARTIES, BAR AND BAT MITZVAHS AND BRIDAL SHOWERS FEATURING AN INCENTIVE AND MEMBERSHIP REWARDS PROGRAM FOR CUSTOMERS; PROVIDING LOCATIONS WHERE SUCH ENTERTAINMENT EVENTS ARE HELD FEATURING AN INCENTIVE AND MEMBERSHIP REWARDS PROGRAM FOR CUSTOMERS; PROVIDING LOCATIONS FOR CLASSES WHERE CRAFTING WITH CERAMICS, JEWELRY, GLASS, CANDLES, SOAP, PAPER AND FOOD CAN BE LEARNED, WORKED ON AND CREATED FEATURING AN INCENTIVE AND MEMBERSHIP REWARDS PROGRAM FOR CUSTOMERS; PROVIDING LOCATIONS WHERE CRAFTING WITH CERAMICS, JEWELRY, GLASS, CANDLES, SOAP, PAPER AND FOOD, CAN BE LEARNED, WORKED ON AND CREATED FOR HOBBY OR ENTERTAINMENT PURPOSES FEATURING AN INCENTIVE AND MEMBERSHIP REWARDS PROGRAM FOR CUSTOMERS, IN CLASS 41 (U.S. CLS. 100, 101 AND 107).

FIRST USE 5-0-2011; IN COMMERCE 5-0-2011.

THE MARK CONSISTS OF STANDARD CHARACTERS WITHOUT CLAIM TO ANY PARTICULAR FONT, STYLE, SIZE, OR COLOR.

NO CLAIM IS MADE TO THE EXCLUSIVE RIGHT TO USE "CLUB", APART FROM THE MARK AS SHOWN.

SER. NO. 85-365,041, FILED 7-7-2011.

NICHOLAS COLEMAN, EXAMINING ATTORNEY



# United States of America

United States Patent and Trademark Office

# NAVIS

**Reg. No. 4,134,453**

**Registered May 1, 2012**

**Int. Cls.: 9 and 45**

**TRADEMARK**

**SERVICE MARK**

**PRINCIPAL REGISTER**

COALFIRE SYSTEMS, INC. (DELAWARE CORPORATION)  
SUITE 150  
361 CENTENNIAL PARKWAY  
LOUISVILLE, CO 80027

FOR: COMPUTER PROGRAMS FOR ASSESSING AND MANAGING IT GOVERNANCE AND REGULATORY COMPLIANCE PROGRAMS PERTAINING TO THE SECURE PROCESSING OF PAYMENT, FINANCIAL, AND HEALTH CARE INFORMATION, IN CLASS 9 (U.S. CLS. 21, 23, 26, 36 AND 38).

FIRST USE 12-0-2008; IN COMMERCE 12-0-2008.

FOR: REGULATORY COMPLIANCE CONSULTING IN THE FIELD OF INFORMATION SECURITY STANDARDS AND ASSOCIATED REGULATIONS, IN CLASS 45 (U.S. CLS. 100 AND 101).

FIRST USE 12-0-2008; IN COMMERCE 12-0-2008.

THE MARK CONSISTS OF STANDARD CHARACTERS WITHOUT CLAIM TO ANY PARTICULAR FONT, STYLE, SIZE, OR COLOR.

SER. NO. 85-365,270, FILED 7-7-2011.

AMY ALFIERI, EXAMINING ATTORNEY



*David J. Kybas*

Director of the United States Patent and Trademark Office

# United States of America

United States Patent and Trademark Office



**Reg. No. 4,134,454**

**Registered May 1, 2012**

**Int. Cl.: 18**

**TRADEMARK**

**PRINCIPAL REGISTER**

CASHHIMI DERI SANAYI VE TICARET LIMITED SIRKETI (TURKEY CORPORATION)  
ESKI BUYUKDERE CAD., YAMAC SK., NO.:24  
4. LEVENT, ISTANBUL, TURKEY

FOR: BRIEFCASE-TYPE LEATHER BUSINESS FOLDERS; BRIEFCASES; CARRY-ON BAGS; CASES OF IMITATION LEATHER; CLUTCH BAGS; COSMETIC BAGS SOLD EMPTY; GARMENT BAGS FOR TRAVEL MADE OF LEATHER; HAT BOXES OF LEATHER; IMITATION LEATHER KEY CHAINS; KEY CASES OF LEATHER OR IMITATION LEATHER; KEY-CASES OF LEATHER AND SKINS; LEATHER AND IMITATION LEATHER; LEATHER AND IMITATION LEATHER BAGS; LEATHER AND IMITATION LEATHER SPORT BAGS AND GENERAL PURPOSE TROLLEY BAGS; LEATHER BAGS AND WALLETS; LEATHER BAGS, SUITCASES AND WALLETS; LEATHER BRIEFCASES; LEATHER CASES; LEATHER CASES FOR KEYS; LEATHER CREDIT CARD CASES; LEATHER CREDIT CARD HOLDER; LEATHER CREDIT CARD WALLETS; LEATHER HANDBAGS; LEATHER KEY CASES; LEATHER KEY CHAINS; LEATHER POUCHES; LEATHER PURSES; LEATHER SHOPPING BAGS; LEATHER SHOULDER BELTS; LEATHER STRAPS; MAKE-UP BAGS SOLD EMPTY; OVERNIGHT SUITCASES; POUCHES MADE FROM IMITATION LEATHER; POUCHES OF LEATHER; SHOPPING BAGS MADE OF SKIN; SHOULDER BAGS; SLING BAGS; SMALL SUITCASES; SOUVENIR BAGS; SUITCASES; TOILETRY BAGS SOLD EMPTY; TRAVELLING BAGS; TRAVELLING CASES OF LEATHER; TRUNKS AND SUITCASES; WALLETS MADE OF LEATHER OR OTHER MATERIALS, IN CLASS 18 (U.S. CLS. 1, 2, 3, 22 AND 41).

FIRST USE 6-17-2007; IN COMMERCE 6-17-2007.

THE MARK CONSISTS OF THE LETTERS "C" "A" AND "S" PLACED IN A CIRCLE ON THE LEFT SIDE OF "CASHHIMI", THE LITERAL ELEMENT OF THE MARK, WHICH IS IN WHITE CAPITAL LETTERS PLACED ON BLACK BACKGROUND.

THE WORDING "CASHHIMI" HAS NO MEANING IN A FOREIGN LANGUAGE.

SER. NO. 85-365,444, FILED 7-7-2011.

KIMBERLY FRYE, EXAMINING ATTORNEY



*David J. Kyros*

Director of the United States Patent and Trademark Office

# United States of America

United States Patent and Trademark Office

## COMMUNIKEY

**Reg. No. 4,134,455**

**Registered May 1, 2012**

**Int. Cl.: 35**

**SERVICE MARK**

**PRINCIPAL REGISTER**

MILLENNIAL CONNECTIONS, LLC (NEW YORK LIMITED LIABILITY COMPANY)  
1635 SYLVIA DRIVE  
ENDICOTT, NY 13760

FOR: ADMINISTRATION OF A DISCOUNT PROGRAM FOR ENABLING PARTICIPANTS TO OBTAIN DISCOUNTS ON GOODS AND SERVICES THROUGH USE OF A DISCOUNT MEMBERSHIP CARD AS WELL AS THROUGH USE OF A WEBSITE CONTAINING ADVERTISEMENTS AND BUSINESS INFORMATION; PROMOTING THE GOODS AND SERVICES OF OTHERS THROUGH THE DISTRIBUTION OF DISCOUNT CARDS AS WELL AS BY PROVIDING A WEBSITE FEATURING DISCOUNT INFORMATION AND BY PROVIDING DISCOUNT OFFERS VIA ELECTRONIC MAIL, IN CLASS 35 (U.S. CLS. 100, 101 AND 102).

FIRST USE 6-6-2011; IN COMMERCE 6-13-2011.

THE MARK CONSISTS OF STANDARD CHARACTERS WITHOUT CLAIM TO ANY PARTICULAR FONT, STYLE, SIZE, OR COLOR.

THE WORD(S) "COMMUNIKEY" HAS NO MEANING IN A FOREIGN LANGUAGE.

SER. NO. 85-366,193, FILED 7-8-2011.

ANDREW RHIM, EXAMINING ATTORNEY



*David J. Kybas*

Director of the United States Patent and Trademark Office

# United States of America

United States Patent and Trademark Office



**Reg. No. 4,134,456**

**Registered May 1, 2012**

**Int. Cl.: 18**

**TRADEMARK**

**PRINCIPAL REGISTER**

LOPES, FATIMA (UNITED STATES INDIVIDUAL)  
UNIT #2  
162 MEYERSVILLE ROAD  
CHATHAM, NJ 07928

FOR: EVENING HANDBAGS; FASHION HANDBAGS; HANDBAGS, IN CLASS 18 (U.S. CLS. 1, 2, 3, 22 AND 41).

FIRST USE 10-1-2010; IN COMMERCE 10-1-2010.

NO CLAIM IS MADE TO THE EXCLUSIVE RIGHT TO USE "USA", APART FROM THE MARK AS SHOWN.

THE STIPPLING IS FOR SHADING PURPOSES ONLY.

THE MARK CONSISTS OF A SQUARE SURROUNDING A FLOWER WITH A RECTANGLE IN THE MIDDLE OF THE FLOWER. INSIDE THE RECTANGLE IS THE STYLIZED TEXT "FUXI USA" ABOVE THE STYLIZED TEXT "WWW.FUXIUSA.COM".

SER. NO. 85-366,204, FILED 7-8-2011.

ROBERT STRUCK, EXAMINING ATTORNEY



*David J. Kyros*

Director of the United States Patent and Trademark Office

# United States of America

United States Patent and Trademark Office



**Reg. No. 4,134,457**

**Registered May 1, 2012**

**Int. Cl.: 25**

**TRADEMARK**

**PRINCIPAL REGISTER**

LUQUE, ELIZABETH (CALIFORNIA CORPORATION), DBA FANCY SWIMWEAR BY LIZ LUQUE  
427 E ADAMS BLVD SUITE 14  
LOS ANGELES, CA 90011

FOR: SWIMSUITS, IN CLASS 25 (U.S. CLS. 22 AND 39).

FIRST USE 2-24-2011; IN COMMERCE 2-24-2011.

NO CLAIM IS MADE TO THE EXCLUSIVE RIGHT TO USE "SWIMWEAR", APART FROM THE MARK AS SHOWN.

THE NAME(S), PORTRAIT(S), AND/OR SIGNATURE(S) SHOWN IN THE MARK IDENTIFIES "ELIZABETH LUQUE", APPLICANT, WHOSE CONSENT(S) TO REGISTER IS MADE OF RECORD.

THE MARK CONSISTS OF THE WORDING "FANCY SWIMWEAR BY LIZ LUQUE", WITH THE WORDING "FANCY" APPEARING IN LARGE LETTERS ON TOP OF THE REMAINING WORDING IN A SMALLER FONT; BENEATH THE WORDING APPEARS A MISCELLANEOUS SPIRALING VINE DESIGN.

SER. NO. 85-367,333, FILED 7-9-2011.

RON FAIRBANKS, EXAMINING ATTORNEY



*David J. Kybas*

Director of the United States Patent and Trademark Office

# United States of America

United States Patent and Trademark Office



**Reg. No. 4,134,458**

**Registered May 1, 2012**

**Int. Cl.: 32**

**TRADEMARK**

**PRINCIPAL REGISTER**

THE SOCAL BEER COMPANY (CALIFORNIA CORPORATION)  
18226 VENTURA BLVD. SUITE 208  
TARZANA, CA 91356

FOR: ALCOHOL-FREE BEERS; BEER; BEER, ALE, LAGER, STOUT AND PORTER; BREWED MALT-BASED ALCOHOLIC BEVERAGE IN THE NATURE OF A BEER; FLAVORED BEERS; NON-ALCOHOLIC BEER, IN CLASS 32 (U.S. CLS. 45, 46 AND 48).

FIRST USE 7-15-2010; IN COMMERCE 7-15-2010.

NO CLAIM IS MADE TO THE EXCLUSIVE RIGHT TO USE "SOCAL BEER COMPANY", APART FROM THE MARK AS SHOWN.

THE MARK CONSISTS OF THE WORDING "SOCAL BEER COMPANY" IN FRONT OF A SUN AND IN MIDDLE OF AN OVAL SHAPED DESIGN, WITH A BEAR ON TOP SITUATED IN BETWEEN TWO PALM TREES AND HOPS AND BARLEY AT THE BOTTOM.

SER. NO. 85-367,405, FILED 7-10-2011.

MATTHEW KLINE, EXAMINING ATTORNEY



*David J. Kappas*

Director of the United States Patent and Trademark Office

# United States of America

United States Patent and Trademark Office



**Reg. No. 4,134,459**

**Registered May 1, 2012**

**Int. Cl.: 30**

**TRADEMARK**

**PRINCIPAL REGISTER**

BEVERAGE MARKETING USA, INC. (NEW YORK CORPORATION)  
60 CROSSWAYS PARK DRIVE WEST  
WOODBURY, NY 11797

FOR: TORTILLA CHIPS; SALSA; SNACK DIPS, NAMELY, SALSA; FOOD PACKAGE COMBINATIONS CONSISTING PRIMARILY OF TORTILLA CHIPS AND ALSO CONTAINING SNACK DIPS, IN CLASS 30 (U.S. CL. 46).

FIRST USE 4-0-2000; IN COMMERCE 4-0-2000.

OWNER OF U.S. REG. NOS. 2,241,415, 2,242,311, AND 2,445,642.

NO CLAIM IS MADE TO THE EXCLUSIVE RIGHT TO USE "MANUFACTURED BY" AND "BEVERAGE CO.", APART FROM THE MARK AS SHOWN.

THE MARK CONSISTS OF THE WORD "ARIZONA" APPEARING IN AN ENLARGED, STYLIZED FONT BETWEEN A SPLIT SUNBURST DESIGN; CENTERED THEREABOVE ARE THE WORDS "MANUFACTURED BY" AND CENTERED THEREBELOW ARE THE WORDS "BEVERAGE CO.", AND THESE WORDS APPEAR IN AN UPPERCASE, SMALLER, UNSTYLIZED FONT AND ENCIRCLE THE STYLIZED "ARIZONA" AND DESIGN.

SER. NO. 85-367,873, FILED 7-11-2011.

KATHY DE JONGE, EXAMINING ATTORNEY



*David J. Kyjars*

Director of the United States Patent and Trademark Office

# United States of America

United States Patent and Trademark Office

## ESCAPE FROM WONDERLAND

**Reg. No. 4,134,460**

**Registered May 1, 2012**

**Int. Cl.: 41**

**SERVICE MARK**

**PRINCIPAL REGISTER**

ROTELLA, PASQUALE (UNITED STATES INDIVIDUAL)  
648 NORTH ST. ANDREWS PLACE  
LOS ANGELES, CA 90004

FOR: ARRANGING, ORGANIZING, CONDUCTING, AND HOSTING SOCIAL ENTERTAINMENT EVENTS; ENTERTAINMENT IN THE NATURE OF LIVE MUSIC CONCERTS, DISC JOCKEY CONCERTS, MUSICAL AND ARTISTIC PERFORMANCES, MUSIC TOURS, CARNIVALS, CIRCUSES, FESTIVALS, DANCE PARTIES AND NIGHT CLUBS; ORGANIZING AND ARRANGING EXHIBITIONS FOR ENTERTAINMENT PURPOSES, IN CLASS 41 (U.S. CLS. 100, 101 AND 107).

FIRST USE 6-23-2011; IN COMMERCE 6-23-2011.

THE MARK CONSISTS OF STANDARD CHARACTERS WITHOUT CLAIM TO ANY PARTICULAR FONT, STYLE, SIZE, OR COLOR.

OWNER OF U.S. REG. NOS. 3,774,668 AND 3,814,061.

SER. NO. 85-367,934, FILED 7-11-2011.

STEPHANIE ALI, EXAMINING ATTORNEY



*David J. Kyros*

Director of the United States Patent and Trademark Office



# United States of America

United States Patent and Trademark Office

# WATTSMART

**Reg. No. 4,134,461**

**Registered May 1, 2012**

**Int. Cls.: 35 and 41**

**SERVICE MARK**

**PRINCIPAL REGISTER**

PACIFICORP (OREGON CORPORATION)  
825 NE MULTNOMAH  
PORTLAND, OR 97232

FOR: CONDUCTING INCENTIVE AWARD PROGRAMS TO PROMOTE ENERGY EFFICIENCY AND CONSERVATION BY PROVIDING INCENTIVES FOR THE IMPLEMENTATION OF ENERGY EFFICIENT TECHNOLOGIES , IN CLASS 35 (U.S. CLS. 100, 101 AND 102).

FIRST USE 3-29-2010; IN COMMERCE 3-29-2010.

FOR: EDUCATIONAL SERVICES, NAMELY, PROVIDING INFORMATION ABOUT AND PROMOTING WISE AND EFFICIENT USE OF ENERGY, IN CLASS 41 (U.S. CLS. 100, 101 AND 107).

FIRST USE 3-29-2010; IN COMMERCE 3-29-2010.

THE MARK CONSISTS OF STANDARD CHARACTERS WITHOUT CLAIM TO ANY PARTICULAR FONT, STYLE, SIZE, OR COLOR.

SER. NO. 85-368,419, FILED 7-11-2011.

SHAILA SETTLES, EXAMINING ATTORNEY



*David J. Kyros*

Director of the United States Patent and Trademark Office

# United States of America

United States Patent and Trademark Office

# Assembla

**Reg. No. 4,134,462**

**Registered May 1, 2012**

**Int. Cl.: 42**

**SERVICE MARK**

**PRINCIPAL REGISTER**

ASSEMBLA LLC (DELAWARE LIMITED LIABILITY COMPANY)  
34 TOWER AVENUE  
NEEDHAM, MA 02494

FOR: ONLINE NON-DOWNLOADABLE COMPUTER SOFTWARE FOR COMPUTER SYSTEM AND APPLICATION DEVELOPMENT, DEPLOYMENT AND MANAGEMENT, IN CLASS 42 (U.S. CLS. 100 AND 101).

FIRST USE 11-12-2004; IN COMMERCE 11-12-2004.

THE MARK CONSISTS OF STANDARD CHARACTERS WITHOUT CLAIM TO ANY PARTICULAR FONT, STYLE, SIZE, OR COLOR.

SER. NO. 85-368,848, FILED 7-12-2011.

FRANK LATTUCA, EXAMINING ATTORNEY



*David J. Kyffers*

Director of the United States Patent and Trademark Office

# United States of America

United States Patent and Trademark Office

# BRINDERSON

**Reg. No. 4,134,463**

**Registered May 1, 2012**

**Int. Cls.: 35, 37 and 42**

**SERVICE MARK**

**PRINCIPAL REGISTER**

BRINDERSON L.P. (CALIFORNIA LIMITED PARTNERSHIP)  
3330 HARBOR BOULEVARD  
COSTA MESA, CA 92626

FOR: PROCUREMENT SERVICES, NAMELY, PURCHASING OF CONSTRUCTION EQUIPMENT AND PURCHASING OF CONSTRUCTION MATERIALS; INVENTORY MANAGEMENT; BUSINESS SERVICES, NAMELY, EMPLOYMENT PRE-QUALIFICATION, HIRING AND MANAGEMENT OF SUBCONTRACTORS IN THE CONSTRUCTION INDUSTRY, IN CLASS 35 (U.S. CLS. 100, 101 AND 102).

FIRST USE 0-0-1965; IN COMMERCE 0-0-1965.

FOR: BUILDING CONSTRUCTION; CONSTRUCTION CONSULTATION, PLANNING, MANAGEMENT AND SUPERVISION; CONSTRUCTION OF STRUCTURES FOR THE PRODUCTION, TRANSPORT AND STORAGE OF CRUDE OIL, NATURAL GAS, CHEMICALS, AND RENEWABLE ENERGY AND CONSULTING AND PROJECT MANAGEMENT SERVICES FOR THE SAME; ELECTRICAL CONTRACTOR SERVICES; PIPELINE AND PIPELINE TERMINAL CONSTRUCTION AND MAINTENANCE; CONSTRUCTION PROJECT MANAGEMENT FOR GAS PLANT, OIL REFINERY, CHEMICAL PLANT AND RENEWABLE ENERGY PLANT SHUTDOWNS FOR THE PURPOSES OF MAINTENANCE, OVERHAUL, REPAIR, INSPECTION, AND TESTING, IN CLASS 37 (U.S. CLS. 100, 103 AND 106).

FIRST USE 0-0-1965; IN COMMERCE 0-0-1965.

FOR: ENGINEERING; CIVIL ENGINEERING; CONSULTING IN THE FIELD OF ENGINEERING, IN CLASS 42 (U.S. CLS. 100 AND 101).

FIRST USE 4-12-1999; IN COMMERCE 4-12-1999.

THE MARK CONSISTS OF STANDARD CHARACTERS WITHOUT CLAIM TO ANY PARTICULAR FONT, STYLE, SIZE, OR COLOR.

SER. NO. 85-368,998, FILED 7-12-2011.

TEJBIR SINGH, EXAMINING ATTORNEY



*David J. Kyffers*

Director of the United States Patent and Trademark Office

# United States of America

United States Patent and Trademark Office



**Reg. No. 4,134,464**

**Registered May 1, 2012**

**Int. Cl.: 3**

**TRADEMARK**

**PRINCIPAL REGISTER**

ZHANG, DENGPIG (CHINA INDIVIDUAL)  
43033 22ND ST WEST  
LANCASTER, CA 93536

FOR: BEAUTY LOTIONS; BEAUTY MASKS; COSMETICS; FACE AND BODY BEAUTY CREAMS; FACIAL BEAUTY MASKS; FACIAL MASKS, IN CLASS 3 (U.S. CLS. 1, 4, 6, 50, 51 AND 52).

FIRST USE 6-1-2011; IN COMMERCE 6-15-2011.

THE MARK CONSISTS OF WHITE TEXT OF "SURKRAN" IN A GREEN LEAF.

THE ENGLISH TRANSLATION OF "SURKRAN" IN THE MARK IS "GRATEFUL".

SER. NO. 85-369,014, FILED 7-12-2011.

LINDA ESTRADA, EXAMINING ATTORNEY



*David J. Kybas*

Director of the United States Patent and Trademark Office

# United States of America

United States Patent and Trademark Office

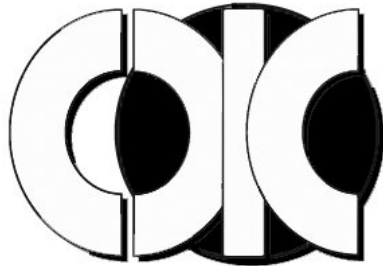

**Reg. No. 4,134,465**

**Registered May 1, 2012**

**Int. Cls.: 35 and 41**

**SERVICE MARK**

**PRINCIPAL REGISTER**

UNITED STATES TENNIS ASSOCIATION INCORPORATED (NEW YORK NON-PROFIT CORPORATION)  
70 WEST RED OAK LANE  
WHITE PLAINS, NY 10604

FOR: MANAGEMENT, NAMELY, RECRUITING AND RETAINING OFFICIALS FOR THE SPORT OF TENNIS, IN CLASS 35 (U.S. CLS. 100, 101 AND 102).

FIRST USE 11-30-2010; IN COMMERCE 11-30-2010.

FOR: TRAINING OFFICIALS IN THE SPORT OF TENNIS, IN CLASS 41 (U.S. CLS. 100, 101 AND 107).

FIRST USE 11-30-2010; IN COMMERCE 11-30-2010.

THE MARK CONSISTS OF STYLIZED LETTERS "OIC" WHERE THE "O" IS COMPRISED OF TWO HALF CIRCLES, VERTICALLY ALIGNED, WITH SOLID DARK OUTLINES, THE LETTER "I" WITH A SOLID DARK OUTLINE AND OVERLAPPING THE RIGHT SIDE OF THE LETTER "O" AND THE LETTER "C" WHICH IS WHICH IS IDENTICAL TO THE LEFT HALF OF THE LETTER "O" AND IS OVERLAPPING THE RIGHT SIDE OF THE LETTER "I"; THE RIGHT SIDE OF THE LETTER "O", THE LETTER "I" AND THE LETTER "C" ARE SYMMETRICALLY REPRESENTED ABOVE A SOLID CIRCLE.

SER. NO. 85-369,075, FILED 7-12-2011.

HENRY S. ZAK, EXAMINING ATTORNEY



*David J. Kybas*

Director of the United States Patent and Trademark Office

# United States of America

United States Patent and Trademark Office

## CROSSROADS

**Reg. No. 4,134,466**

**Registered May 1, 2012**

**Int. Cls.: 9 and 41**

**TRADEMARK**

**SERVICE MARK**

**PRINCIPAL REGISTER**

CROSSROADS ENTERTAINMENT & MARKETING (NORTH CAROLINA CORPORATION)  
50 FISK DRIVE  
ARDEN, NC 28704

FOR: DVDS, COMPACT DISCS (CDS), MP3S AND PRE-RECORDED AUDIO AND VIDEO FILES ALL FEATURING MUSIC, IN CLASS 9 (U.S. CLS. 21, 23, 26, 36 AND 38).

FIRST USE 0-0-1996; IN COMMERCE 0-0-1996.

FOR: MUSIC PUBLISHING SERVICES; MUSIC PRODUCTION SERVICES; AUDIO RECORDING AND PRODUCTION; RECORD PRODUCTION; RECORDING STUDIO SERVICES, IN CLASS 41 (U.S. CLS. 100, 101 AND 107).

FIRST USE 0-0-1996; IN COMMERCE 0-0-1996.

THE MARK CONSISTS OF STANDARD CHARACTERS WITHOUT CLAIM TO ANY PARTICULAR FONT, STYLE, SIZE, OR COLOR.

SER. NO. 85-369,495, FILED 7-12-2011.

BRIDGETT SMITH, EXAMINING ATTORNEY



*David J. Kyros*

Director of the United States Patent and Trademark Office

# United States of America

United States Patent and Trademark Office



**Reg. No. 4,134,467**

**Registered May 1, 2012**

**Int. Cls.: 3, 7 and 8**

**TRADEMARK**

**PRINCIPAL REGISTER**

ALI INDUSTRIES, INC. (OHIO CORPORATION)  
747 EAST XENIA DRIVE  
FAIRBORN, OH 30022

FOR: ABRASIVE PRODUCTS FOR SANDING, NAMELY, COATED ABRASIVES AND SANDPAPER IN THE FORM OF SANDING STRIPS, SHEETS, BELTS, SPINDLES, AND DISCS, EMERY CLOTHS, AND SANDING SCREENS IN THE NATURE OF ABRASIVE CLOTH, IN CLASS 3 (U.S. CLS. 1, 4, 6, 50, 51 AND 52).

FIRST USE 7-1-2011; IN COMMERCE 7-1-2011.

FOR: SANDING PADS FOR POWER-OPERATED SANDERS; KITS COMPRISED OF SANDPAPER SHEETS CONFIGURED IN DIFFERENT SIZES TO FIT POWER-OPERATED SANDERS, IN CLASS 7 (U.S. CLS. 13, 19, 21, 23, 31, 34 AND 35).

FIRST USE 7-1-2011; IN COMMERCE 7-1-2011.

FOR: HAND TOOLS, NAMELY, SANDING SPONGES; SANDING PADS FOR NON-ELECTRIC, HAND-OPERATED SANDERS; HAND TOOLS, NAMELY, RUBBING BRICKS IN THE NATURE OF A COMPOSITE BLOCK OF ABRASIVE MATERIAL FOR SANDING; KITS COMPRISED OF SANDPAPER SHEETS CONFIGURED IN DIFFERENT SIZES TO FIT NON-ELECTRIC, HAND-OPERATED SANDERS, IN CLASS 8 (U.S. CLS. 23, 28 AND 44).

FIRST USE 7-1-2011; IN COMMERCE 7-1-2011.

NO CLAIM IS MADE TO THE EXCLUSIVE RIGHT TO USE "PERFORMANCE & LIFE GUARANTEE", APART FROM THE MARK AS SHOWN.

THE MARK CONSISTS OF THE WORDS "4X PERFORMANCE & LIFE GUARANTEE" EN-CIRCLED.

SER. NO. 85-369,961, FILED 7-13-2011.

KATINA MISTER, EXAMINING ATTORNEY



*David J. Kyffers*

Director of the United States Patent and Trademark Office

# United States of America

United States Patent and Trademark Office

## HONOR A LIFE SAVE A LIFE CHANGE A LIFE

**Reg. No. 4,134,468**

FINEST FLOWERS INC. (NEW YORK CORPORATION), DBA TOWERS FLOWERS  
1350-32 DEER PARK AVENUE  
NORTH BABYLON, NY 11703

**Registered May 1, 2012**

**Int. Cl.: 35**

FOR: RETAIL STORE SERVICES FEATURING FLOWERS AND ONLINE FLORAL ORDERING  
FOR DELIVERY SERVICES, IN CLASS 35 (U.S. CLS. 100, 101 AND 102).

**SERVICE MARK**

FIRST USE 2-15-2011; IN COMMERCE 2-15-2011.

**PRINCIPAL REGISTER**

THE MARK CONSISTS OF STANDARD CHARACTERS WITHOUT CLAIM TO ANY PAR-  
TICULAR FONT, STYLE, SIZE, OR COLOR.

SER. NO. 85-370,457, FILED 7-13-2011.

YAT SYE, LEE, EXAMINING ATTORNEY



*David J. Kyffers*

Director of the United States Patent and Trademark Office



# United States of America

United States Patent and Trademark Office

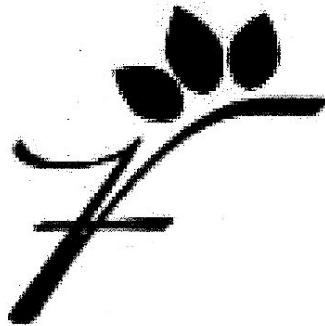

**Reg. No. 4,134,469**

**Registered May 1, 2012**

**Int. Cl.: 35**

**SERVICE MARK**

**PRINCIPAL REGISTER**

FINEST FLOWERS INC. (NEW YORK CORPORATION), DBA TOWERS FLOWERS  
1350-32 DEER PARK AVENUE  
NORTH BABYLON, NY 11703

FOR: RETAIL STORE SERVICES FEATURING FLOWERS AND ONLINE FLORAL ORDERING  
FOR DELIVERY SERVICES, IN CLASS 35 (U.S. CLS. 100, 101 AND 102).

FIRST USE 2-15-2011; IN COMMERCE 2-15-2011.

THE MARK CONSISTS OF A STYLIZED FLOWER WITH THREE PETALS ON TOP. THE  
FLOWER STEM IS COMPRISED OF THE LETTER "F".

SER. NO. 85-370,468, FILED 7-13-2011.

YAT SYE, LEE, EXAMINING ATTORNEY



*David J. Kybas*

Director of the United States Patent and Trademark Office

# United States of America

United States Patent and Trademark Office



**Reg. No. 4,134,470**

**Registered May 1, 2012**

**Int. Cl.: 35**

**SERVICE MARK**

**PRINCIPAL REGISTER**

STAMPEDE INDUSTRIES, LLC (PENNSYLVANIA LIMITED LIABILITY COMPANY)  
1019 ROUTE 519  
EIGHTY FOUR, PA 15330

FOR: ADVICE RELATING TO THE ORGANISATION AND MANAGEMENT OF BUSINESS,  
IN CLASS 35 (U.S. CLS. 100, 101 AND 102).

FIRST USE 2-28-2011; IN COMMERCE 2-28-2011.

NO CLAIM IS MADE TO THE EXCLUSIVE RIGHT TO USE "INDUSTRIES LLC", APART  
FROM THE MARK AS SHOWN.

THE MARK CONSISTS OF A BULL AND THE WORDING "STAMPEDE INDUSTRIES LLC".

SER. NO. 85-370,670, FILED 7-13-2011.

KAPIL BHANOT, EXAMINING ATTORNEY



*David J. Kyffers*

Director of the United States Patent and Trademark Office

# United States of America

United States Patent and Trademark Office

## Neuro-Visceral Applications - NVA

**Reg. No. 4,134,471**

JAUDY, DR. GILBERT (UNITED STATES INDIVIDUAL)  
42-620 CAROLINE CT. STE 103  
PALM DESERT, CA 92211

**Registered May 1, 2012**

**Int. Cl.: 41**

FOR: EDUCATION SERVICES, NAMELY, PROVIDING SEMINARS IN THE FIELD OF HEALTH CARE, IN CLASS 41 (U.S. CLS. 100, 101 AND 107).

**SERVICE MARK**

FIRST USE 2-16-2011; IN COMMERCE 2-16-2011.

**PRINCIPAL REGISTER**

THE MARK CONSISTS OF STANDARD CHARACTERS WITHOUT CLAIM TO ANY PARTICULAR FONT, STYLE, SIZE, OR COLOR.

NO CLAIM IS MADE TO THE EXCLUSIVE RIGHT TO USE "NEURO-VISCERAL APPLICATIONS", APART FROM THE MARK AS SHOWN.

SER. NO. 85-370,735, FILED 7-13-2011.

MICHELE SWAIN, EXAMINING ATTORNEY



*David J. Kyffers*

Director of the United States Patent and Trademark Office

# United States of America

United States Patent and Trademark Office

## CORNUCOPIA JARS

**Reg. No. 4,134,472**

**Registered May 1, 2012**

**Int. Cl.: 30**

**TRADEMARK**

**PRINCIPAL REGISTER**

CORNUCOPIA JARS LLC (NEW YORK LIMITED LIABILITY COMPANY)  
152 EDEN LANE  
MAYFIELD, NY 12117

FOR: PANCAKE MIXES, WAFFLE MIXES, IN CLASS 30 (U.S. CL. 46).

FIRST USE 5-7-2011; IN COMMERCE 5-7-2011.

THE MARK CONSISTS OF STANDARD CHARACTERS WITHOUT CLAIM TO ANY PARTICULAR FONT, STYLE, SIZE, OR COLOR.

NO CLAIM IS MADE TO THE EXCLUSIVE RIGHT TO USE "JARS", APART FROM THE MARK AS SHOWN.

SER. NO. 85-371,132, FILED 7-14-2011.

LESLEY LAMOTHE, EXAMINING ATTORNEY



*David J. Kyffers*

Director of the United States Patent and Trademark Office

# United States of America

United States Patent and Trademark Office

# Pratt

**Reg. No. 4,134,473**

**Registered May 1, 2012**

**Int. Cl.: 41**

**SERVICE MARK**

**PRINCIPAL REGISTER**

PRATT INSTITUTE (NEW YORK EDUCATIONAL INSTITUTION)  
200 WILLOUGHBY AVENUE  
BROOKLYN, NY 11205

FOR: EDUCATION SERVICES, NAMELY, PROVIDING INSTRUCTION AT THE UNDERGRADUATE AND GRADUATE LEVELS IN THE FIELDS OF ARCHITECTURE, ART AND DESIGN, INFORMATION AND LIBRARY SCIENCE, LIBERAL ARTS AND SCIENCES; EDUCATION SERVICES, NAMELY, PROVIDING CONTINUING EDUCATION COURSES IN THE FIELDS OF ART AND DESIGN AND COMPUTER GRAPHICS AND TECHNOLOGY; AND EDUCATION SERVICES, NAMELY, PROVIDING PROFESSIONAL STUDIES PROGRAMS IN COMPUTER GRAPHICS, PHOTOGRAPHY AND DIGITAL MEDIA, FACILITIES MANAGEMENT, FINE AND DECORATIVE ART APPRAISAL AND SUSTAINABLE BUILDING, INFRASTRUCTURE DESIGN AND MANAGEMENT, IN CLASS 41 (U.S. CLS. 100, 101 AND 107).

FIRST USE 5-19-1887; IN COMMERCE 5-19-1887.

THE MARK CONSISTS OF STANDARD CHARACTERS WITHOUT CLAIM TO ANY PARTICULAR FONT, STYLE, SIZE, OR COLOR.

SEC. 2(F).

SER. NO. 85-371,227, FILED 7-14-2011.

BILL DAWE, EXAMINING ATTORNEY



*David J. Kyffers*

Director of the United States Patent and Trademark Office

United States of America  
United States Patent and Trademark Office

**BOSSWIN**

**Reg. No. 4,134,474**

KUO KAU PAPER PRODUCTS CO., LTD. (TAIWAN CORPORATION)  
NO. 31, TIEN SHUI ROAD  
TAIPEI, TAIWAN

**Registered May 1, 2012**

**Int. Cl.: 28**

FOR: GAMING EQUIPMENT, NAMELY, POKER CHIPS; PLAYING CARDS AND CARD GAMES; CHINESE CHESS; CHESS SETS; TOY BUILDING BLOCKS; JIGSAW AND MANIPULATIVE PUZZLES; INTELLIGENCE PLASTIC TOYS, NAMELY, ACTION FIGURES AND TOY CHARACTERS, IN CLASS 28 (U.S. CLS. 22, 23, 38 AND 50).

**TRADEMARK**

**PRINCIPAL REGISTER**

FIRST USE 1-1-2004; IN COMMERCE 3-28-2008.

THE MARK CONSISTS OF THE WORD "BOSSWIN" IN CAPITAL LETTER TYPEFACE FONT WITH A LARGE "B" AND A LARGE "N", AND A SOLID CIRCLE FOR THE "O" WITH A SPADE DESIGN INSIDE THE "O". THERE ALSO APPEARS A CURVED LINE THAT BISECTS THE ENTIRE WORD "BOSSWIN".

SER. NO. 85-371,302, FILED 7-14-2011.

CAROLINE WOOD, EXAMINING ATTORNEY



*David J. Kyros*

Director of the United States Patent and Trademark Office

# United States of America

United States Patent and Trademark Office

# BELPOINTE

**Reg. No. 4,134,475**

**Registered May 1, 2012**

**Int. Cl.: 36**

**SERVICE MARK**

**PRINCIPAL REGISTER**

LACOFF, BRANDON E (UNITED STATES INDIVIDUAL)  
881 LAKE AVENUE  
GREENWICH, CT 06831

FOR: ADMINISTRATION OF EMPLOYEE BENEFIT PLANS CONCERNING INSURANCE AND FINANCE; ADMINISTRATION OF EMPLOYEE WELFARE BENEFIT PLANS CONCERNING INSURANCE AND FINANCE; ADVICE RELATING TO INVESTMENTS; ADVISING OTHERS CONCERNING INVESTMENTS IN INTELLECTUAL PROPERTY ASSETS AND INTANGIBLE BUSINESS ASSETS, BOTH DIRECTLY AND INDIRECTLY THROUGH OTHER ENTITIES; ADVISORY SERVICES IN THE FIELD OF EMPLOYEE BENEFITS FOR GROUP HEALTHCARE AND BUSINESS INSURANCE OFFERED TO EMPLOYEES IN ADDITION TO STANDARD BENEFITS SUCH AS MEDICAL, DENTAL, LIFE INSURANCE INCLUDING SHORT TERM DISABILITY, LONG TERM DISABILITY, CANCER INSURANCE, ACCIDENTAL DEATH AND DISMEMBERMENT; ADVISORY SERVICES RELATING TO CREDIT AND DEBIT CONTROL, INVESTMENT, GRANTS AND FINANCING OF LOANS; ANNUITY SERVICES, NAMELY, ACCOUNT AND INVESTMENT ADMINISTRATION; ANNUITY SERVICES, NAMELY, ACCOUNT AND INVESTMENT ADMINISTRATION AND THE INVESTMENT AND DISTRIBUTION OF ANNUITY FUNDS; APPRAISAL AND EVALUATION OF REAL ESTATE; APPRAISALS FOR INSURANCE CLAIMS OF REAL ESTATE; ARRANGING OF LEASES AND RENTAL AGREEMENTS FOR REAL ESTATE; ASSESSING INSURANCE CLAIMS; ASSESSMENT AND MANAGEMENT OF REAL ESTATE; BROKERAGE IN THE FIELD OF LIFE INSURANCE, ANNUITY UNDERWRITING AND DISABILITY INSURANCE; BROKERAGE SERVICES FOR CAPITAL INVESTMENTS; BROKERAGE SERVICES IN THE FIELD OF SECURITIES AND COMMODITIES INVESTING; CAPITAL INVESTMENT CONSULTING; CAPITAL INVESTMENT SERVICES; CHARITABLE FOUNDATION SERVICES, NAMELY, PROVIDING FUNDRAISING ACTIVITIES AND INVESTMENT MANAGEMENT SERVICES TO SUPPORT MEDICAL EDUCATION AND RESEARCH AND PROCEDURES FOR THOSE IN NEED; CLAIMS ADJUSTMENT IN THE FIELD OF INSURANCE; CLASSIFIED REAL ESTATE LISTINGS OF APARTMENT RENTALS AND HOUSING RENTALS; COMMERCIAL AND RESIDENTIAL REAL ESTATE AGENCY SERVICES; COMMODITY INVESTMENT ADVICE; CONSULTANCY OF CAPITAL INVESTMENT; CONSULTING AND INFORMATION CONCERNING INSURANCE; EQUITY CAPITAL INVESTMENT; ESTATE PLANNING; ESTATE TRUST MANAGEMENT; ESTATE TRUST PLANNING; EVALUATING REAL ESTATE TO ASSESS FEASIBILITY FOR USE AS A PROPERTY SELF-STORAGE FACILITY; EVALUATION OF REAL PROPERTY; FINANCIAL AND INVESTMENT SERVICES, NAMELY, ASSET AND INVESTMENT ACQUISITION, CONSULTATION, ADVISORY AND DEVELOPMENT; FINANCIAL AND INVESTMENT



*David J. Kyros*

Director of the United States Patent and Trademark Office

**Reg. No. 4,134,475** SERVICES, NAMELY, MANAGEMENT AND BROKERAGE IN THE FIELDS OF STOCKS, BONDS, OPTIONS, COMMODITIES, FUTURES AND OTHER SECURITIES, AND THE INVESTMENT OF FUNDS OF OTHERS; FINANCIAL CONSULTANCY AND INSURANCE CONSULTANCY; FINANCIAL CONSULTING IN THE FIELD OF REAL ESTATE NOTE BROKERAGE; FINANCIAL DUE DILIGENCE SERVICES IN THE FIELD OF REAL ESTATE; FINANCIAL INVESTMENT ANALYSIS AND STOCK RESEARCH; FINANCIAL INVESTMENT BROKERAGE; FINANCIAL INVESTMENT BROKERAGE SERVICES; FINANCIAL INVESTMENT IN THE FIELD OF REAL ESTATE, SECURITIES, INSURANCE, PRIVATE EQUITY AND VENTURE CAPITAL; FINANCIAL INVESTMENT SERVICES, NAMELY, ADMINISTERING THE ISSUANCE, UNDERWRITING AND DISTRIBUTION OF SECURITIES; FINANCIAL PLANNING AND INVESTMENT ADVISORY SERVICES; FINANCIAL SERVICES IN THE NATURE OF AN INVESTMENT SECURITY; FINANCIAL SERVICES, NAMELY, A TOTAL PORTFOLIO OFFERING FOR HIGH NET WORTH CLIENTS CONSISTING OF BOTH SEPARATE ACCOUNTS AND MUTUAL FUNDS FOR EQUITY AND FIXED INCOME INVESTMENTS; FINANCIAL SERVICES, NAMELY, ADMINISTRATION OF TRANSACTIONS INVOLVING FUNDS DRAWN FROM SECURITIES, STOCKS, FUNDS, EQUITIES, BONDS, CASH, OR OTHER TYPES OF FINANCIAL INVESTMENTS IN RETIREMENT PLANS USING A CHECK OR NEGOTIABLE ORDER OF WITHDRAWAL OVER A GLOBAL DATA NETWORK; FINANCIAL SERVICES, NAMELY, ADMINISTRATION OF TRANSACTIONS INVOLVING FUNDS DRAWN FROM SECURITIES, STOCKS, FUNDS, EQUITIES, BONDS, CASH, OR OTHER TYPES OF FINANCIAL INVESTMENTS IN RETIREMENT PLANS USING A CREDIT OR DEBIT CARD OVER A GLOBAL DATA NETWORK; FINANCIAL SERVICES, NAMELY, COORDINATION, WITHIN A SINGLE ACCOUNT, OF AN INVESTMENT PORTFOLIO'S MAINTENANCE, TRADING, REBALANCING, AND TAX MANAGEMENT NEEDS; FINANCIAL SERVICES, NAMELY, ESTATE SETTLEMENT SERVICES; FINANCIAL SERVICES, NAMELY, INVESTMENT ADVICE, INVESTMENT MANAGEMENT, INVESTMENT CONSULTATION AND INVESTMENT OF FUNDS FOR OTHERS, INCLUDING PRIVATE AND PUBLIC EQUITY AND DEBT INVESTMENT SERVICES; FINANCIAL SERVICES, NAMELY, INVESTMENT FUND TRANSFER AND TRANSACTION SERVICES; FINANCIAL SERVICES, NAMELY, ISSUANCE AND MANAGEMENT OF CERTIFICATES BACKED BY LOAN PORTFOLIOS WHICH ARE SUBSEQUENTLY MANAGED TO INSURE THE INTEGRITY OF THE CERTIFICATES; FINANCIAL SERVICES, NAMELY, LIFE INSURANCE SETTLEMENT SERVICES; FINANCIAL SERVICES, NAMELY, OPERATION AND MANAGEMENT OF HEDGE FUNDS, COMMODITY POOLS AND OTHER COLLECTIVE INVESTMENT VEHICLES, AND TRADING FOR OTHERS OF SECURITIES, OPTIONS, FUTURES, DERIVATIVES, DEBT INSTRUMENTS AND COMMODITIES; FINANCIAL SERVICES, NAMELY, PROVIDING AN INVESTMENT OPTION AVAILABLE FOR VARIABLE ANNUITY AND VARIABLE LIFE INSURANCE PRODUCTS; FINANCIAL VALUATION OF PERSONAL PROPERTY AND REAL ESTATE; FINANCING OF REAL ESTATE DEVELOPMENT PROJECTS; FUND INVESTMENT CONSULTATION; FUND INVESTMENT SERVICES FEATURING SECURITIES OFFERED ACCORDING TO PREVIOUSLY ESTABLISHED CRITERIA IN ORDER TO MAINTAIN A PREDETERMINED LEVEL OF PAYMENTS TO THE ACCOUNT HOLDER; FUND INVESTMENT SERVICES FEATURING THE TRADING OF AN ACCOUNT HOLDER'S SECURITIES ACCORDING TO PREVIOUSLY ESTABLISHED CRITERIA IN ORDER TO MAINTAIN A PREDETERMINED LEVEL OF PAYMENTS TO THE ACCOUNT HOLDER; FUNDS INVESTMENT; GLOBAL INVESTMENT RESEARCH SERVICES; HEDGE FUND INVESTMENT SERVICES; HOUSING SERVICES, NAMELY, REAL PROPERTY ACQUISITION AND CONSUMER FINANCING TO FACILITATE HOME OWNERSHIP; INFORMATION, ADVISORY, CONSULTANCY AND RESEARCH SERVICES RELATING TO FINANCE AND INVESTMENTS; INSURANCE AGENCIES; INSURANCE AGENCY AND BROKERAGE; INSURANCE AND FINANCIAL INFORMATION AND CONSULTANCY SERVICES; INSURANCE BROKERAGE; INSURANCE BROKERAGE IN THE FIELD OF LIFE INSURANCE, ANNUITY UNDERWRITING AND DISABILITY INSURANCE; INSURANCE BROKERAGE SERVICES; INVESTMENT ADVICE; INVESTMENT ADVISORY SERVICES; INVESTMENT BANKING SERVICES; INVESTMENT BANKING SERVICES IN THE FIELD OF EMPLOYEE STOCK OWNERSHIP PLANS (ESOP); INVESTMENT BROKERAGE; INVESTMENT BY ELECTRONIC MEANS; INVESTMENT CLUBS; INVESTMENT CONSULTANCY; INVESTMENT CONSULTATION; INVESTMENT MANAGEMENT;



**Reg. No. 4,134,475** INVESTMENT MANAGEMENT OF AND DISTRIBUTION OF ANNUITIES; INVESTMENT MANAGEMENT OF AND DISTRIBUTION OF VARIABLE ANNUITIES; INVESTMENT MANAGEMENT SERVICES IN THE FIELD OF ACQUIRING JOINT VENTURES; INVESTMENT OF FUNDS FOR OTHERS; INVESTMENT SERVICES, NAMELY, ASSET ACQUISITION, CONSULTATION, DEVELOPMENT AND MANAGEMENT SERVICES; LAND ACQUISITION, NAMELY, REAL ESTATE BROKERAGE; LEASE OF REAL ESTATE; LEASING OF REAL ESTATE; LEASING OF REAL PROPERTY; LEVERAGED BUY OUTS AND INVESTMENTS IN FINANCIALLY DISTRESSED OR UNDER PERFORMING COMPANIES; LIFE INSURANCE BROKERAGE; LIFE INSURANCE UNDERWRITING; MAINTAINING ESCROW ACCOUNTS FOR INVESTMENTS; MANAGEMENT OF A CAPITAL INVESTMENT FUND; MERCHANT BANKING AND INVESTMENT BANKING SERVICES; MUTUAL FUND INVESTMENT; MUTUAL FUNDS AND CAPITAL INVESTMENT; PRIVATE EQUITY FUND INVESTMENT SERVICES; PROVIDING A DATABASE FOR TRACKING, MONITORING, AND GENERATING REPORTS ON INFORMATION AND STATISTICS ABOUT PATIENT REIMBURSEMENT AND INSURANCE COVERAGE FOR PHARMACEUTICALS AND MEDICAL DEVICES; PROVIDING A WEBSITE FEATURING EDUCATIONAL INFORMATION IN THE FIELD OF BUSINESS INSURANCE; PROVIDING AN INTERNET WEBSITE PORTAL OFFERING INFORMATION IN THE FIELDS OF REAL ESTATE CONCERNING THE PURCHASE AND SALE OF NEW AND RESALE HOMES AND CONDOS; PROVIDING DETAILED INFORMATION REGARDING AVAILABLE INSURANCE PRODUCTS FOR COMMERCIAL PROPERTY AND CASUALTY, PROFESSIONAL AND PERSONAL LINES; PROVIDING FINANCIAL SERVICES WITH RESPECT TO SECURITIES AND OTHER FINANCIAL INSTRUMENTS AND PRODUCTS, NAMELY, TRADING OF AND INVESTMENTS IN SECURITIES AND FINANCIAL INSTRUMENTS AND PRODUCTS FOR OTHERS; PROVIDING INFORMATION AND ADVICE IN THE FIELD OF FINANCE, FINANCIAL INVESTMENTS, FINANCIAL VALUATIONS, AND THE FINANCIAL ASPECTS OF RETIREMENT; PROVIDING INFORMATION AND RESEARCH IN THE FIELD OF FINANCE AND FINANCIAL INVESTMENTS; PROVIDING INFORMATION IN INSURANCE MATTERS; PROVIDING INFORMATION IN THE FIELD OF REAL ESTATE BY MEANS OF LINKING THE WEB SITE TO OTHER WEB SITES FEATURING REAL ESTATE INFORMATION; PROVIDING INFORMATION IN THE FIELD OF REAL ESTATE VIA THE INTERNET; PROVIDING REAL ESTATE LISTINGS AND REAL ESTATE INFORMATION VIA THE INTERNET; PROVIDING REAL ESTATE LISTINGS VIA THE INTERNET; PROVIDING VENTURE CAPITAL, DEVELOPMENT CAPITAL, PRIVATE EQUITY AND INVESTMENT FUNDING; PUBLIC EQUITY INVESTMENT MANAGEMENT; REAL ESTATE ACQUISITION SERVICES; REAL ESTATE AGENCIES; REAL ESTATE BROKERAGE; REAL ESTATE CONSULTANCY; REAL ESTATE CONSULTATION; REAL ESTATE EQUITY SHARING, NAMELY, MANAGING AND ARRANGING FOR CO-OWNERSHIP OF REAL ESTATE; REAL ESTATE ESCROW SERVICES; REAL ESTATE FINANCING SERVICES; REAL ESTATE FUNDS INVESTMENT SERVICES; REAL ESTATE INSURANCE UNDERWRITING SERVICES; REAL ESTATE INVESTMENT SERVICES; REAL ESTATE INVESTMENT SERVICES IN THE NATURE OF PURCHASING AND SELLING OF REAL ESTATE FOR OTHERS; REAL ESTATE INVESTMENT TRUST ADVISORY SERVICES; REAL ESTATE INVESTMENT TRUST MANAGEMENT SERVICES; REAL ESTATE INVESTMENT TRUST SERVICES; REAL ESTATE LISTING; REAL ESTATE LISTING SERVICES FOR HOUSING RENTALS AND APARTMENT RENTALS; REAL ESTATE MANAGEMENT CONSULTATION; REAL ESTATE MANAGEMENT OF VACATION HOMES; REAL ESTATE MANAGEMENT OF RESIDENTIAL AND COMMERCIAL; REAL ESTATE MANAGEMENT SERVICES; REAL ESTATE MULTIPLE LISTING SERVICES; REAL ESTATE PROCUREMENT FOR OTHERS; REAL ESTATE RENTAL SERVICES, NAMELY, RENTAL OF RESIDENTIAL HOUSING; REAL ESTATE SERVICE, NAMELY, RENTAL PROPERTY MANAGEMENT; REAL ESTATE SERVICES, NAMELY, CONDOMINIUM MANAGEMENT SERVICES; REAL ESTATE SERVICES, NAMELY, LEASING AND MANAGEMENT FOR OTHERS OF RESIDENTIAL CONDOMINIUMS LOCATED WITHIN HOTEL DEVELOPMENTS; REAL ESTATE SERVICES, NAMELY, PROPERTY MANAGEMENT SERVICES FOR CONDOMINIUM ASSOCIATIONS, HOMEOWNER ASSOCIATIONS AND APARTMENT BUILDINGS; REAL ESTATE SERVICES, NAMELY, PROVIDING ONLINE QUESTIONS TO HELP USERS DETERMINE THE BEST NEIGHBORHOODS AND COMMUNITIES SUITED TO THEIR INDIVIDUAL NEEDS AND PREFERENCES; REAL ESTATE SERVICES, NAMELY,

**Reg. No. 4,134,475** RENTAL OF SHORT-TERM FURNISHED APARTMENTS; REAL ESTATE SERVICES, NAMELY, RENTAL OF VACATION HOMES; REAL ESTATE SERVICES, NAMELY, RENTAL OF VACATION HOMES, CONDOMINIUMS, CABINS, AND VILLAS USING PAY PER CLICK ADVERTISING ON A GLOBAL COMPUTER NETWORK; REAL ESTATE SERVICES, NAMELY, RENTAL, BROKERAGE, LEASING AND MANAGEMENT OF COMMERCIAL PROPERTY, OFFICES AND OFFICE SPACE; REAL ESTATE SERVICES, NAMELY, VACATION HOME RENTAL MANAGEMENT SERVICES; REAL ESTATE SYNDICATION; REAL ESTATE VALUATIONS; RESIDENTIAL REAL ESTATE AGENCY SERVICES; SECURITIES TRADING AND INVESTING SERVICES FOR OTHERS VIA THE INTERNET; TRANSFER AGENCY, SERVICES RENDERED TO ISSUERS OF INVESTMENT SECURITIES; TRUST SERVICES, NAMELY, INVESTMENT AND TRUST COMPANY SERVICES, IN CLASS 36 (U.S. CLS. 100, 101 AND 102).

FIRST USE 1-17-2011; IN COMMERCE 1-17-2011.

THE MARK CONSISTS OF STANDARD CHARACTERS WITHOUT CLAIM TO ANY PARTICULAR FONT, STYLE, SIZE, OR COLOR.

SER. NO. 85-371,452, FILED 7-14-2011.

HOWARD SMIGA, EXAMINING ATTORNEY

# United States of America

United States Patent and Trademark Office



## REGENCY

*at Monroe*

**Reg. No. 4,134,476**

**Registered May 1, 2012**

**Int. Cls.: 35, 36, 37 and 41**

**SERVICE MARK**

**PRINCIPAL REGISTER**

TB PROPRIETARY CORPORATION (DELAWARE CORPORATION)  
SUITE 1414  
1105 NORTH MARKET STREET  
WILMINGTON, DE 19801

FOR: REAL ESTATE SALES MANAGEMENT, IN CLASS 35 (U.S. CLS. 100, 101 AND 102).

FIRST USE 6-30-2001; IN COMMERCE 6-30-2001.

FOR: REAL ESTATE SERVICES, NAMELY, REAL ESTATE MANAGEMENT, LEASING, AND BROKERAGE OF CONDOMINIUMS AND RESIDENTIAL HOMES, IN CLASS 36 (U.S. CLS. 100, 101 AND 102).

FIRST USE 6-30-2001; IN COMMERCE 6-30-2001.

FOR: LAND DEVELOPMENT AND CONSTRUCTION SERVICES, NAMELY, PLANNING, LAYING OUT AND CUSTOM CONSTRUCTION OF RESIDENTIAL COMMUNITIES, IN CLASS 37 (U.S. CLS. 100, 103 AND 106).

FIRST USE 6-30-2001; IN COMMERCE 6-30-2001.

FOR: RESIDENTIAL COMMUNITY COUNTRY CLUB AND GOLF COURSE SERVICES, IN CLASS 41 (U.S. CLS. 100, 101 AND 107).

FIRST USE 6-30-2001; IN COMMERCE 6-30-2001.

OWNER OF U.S. REG. NOS. 2,792,387, 3,575,023, AND 3,700,961.

NO CLAIM IS MADE TO THE EXCLUSIVE RIGHT TO USE "MONROE", APART FROM THE MARK AS SHOWN.

THE MARK CONSISTS OF THE LETTER "R" AND A LEAF DESIGN IN A SHIELD WITH TWO GOLF CLUBS CROSSING THE SHIELD AND THE WORDS "REGENCY AT MONROE" TO THE RIGHT OF THE DESIGN.

SER. NO. 85-371,464, FILED 7-14-2011.

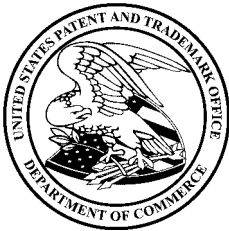

*David J. Kyros*

Director of the United States Patent and Trademark Office

**Reg. No. 4,134,476** CARYN GLASSER, EXAMINING ATTORNEY

# United States of America

United States Patent and Trademark Office

## REGENCY AT MONROE

**Reg. No. 4,134,477**

**Registered May 1, 2012**

**Int. Cls.: 35, 36, 37 and  
41**

**SERVICE MARK**

**PRINCIPAL REGISTER**

TB PROPRIETARY CORPORATION (DELAWARE CORPORATION)  
SUITE 1414  
1105 NORTH MARKET STREET  
WILMINGTON, DE 19801

FOR: REAL ESTATE SALES MANAGEMENT, IN CLASS 35 (U.S. CLS. 100, 101 AND 102).

FIRST USE 6-30-2001; IN COMMERCE 6-30-2001.

FOR: REAL ESTATE SERVICES, NAMELY, REAL ESTATE MANAGEMENT, LEASING,  
AND BROKERAGE OF CONDOMINIUMS AND RESIDENTIAL HOMES, IN CLASS 36 (U.S.  
CLS. 100, 101 AND 102).

FIRST USE 6-30-2001; IN COMMERCE 6-30-2001.

FOR: LAND DEVELOPMENT AND CONSTRUCTION SERVICES, NAMELY, PLANNING,  
LAYING OUT AND CUSTOM CONSTRUCTION OF RESIDENTIAL COMMUNITIES, IN  
CLASS 37 (U.S. CLS. 100, 103 AND 106).

FIRST USE 6-30-2001; IN COMMERCE 6-30-2001.

FOR: RESIDENTIAL COMMUNITY COUNTRY CLUB AND GOLF COURSE SERVICES, IN  
CLASS 41 (U.S. CLS. 100, 101 AND 107).

FIRST USE 6-30-2001; IN COMMERCE 6-30-2001.

THE MARK CONSISTS OF STANDARD CHARACTERS WITHOUT CLAIM TO ANY PAR-  
TICULAR FONT, STYLE, SIZE, OR COLOR.

OWNER OF U.S. REG. NOS. 2,792,387, 3,575,023, AND 3,700,961.

NO CLAIM IS MADE TO THE EXCLUSIVE RIGHT TO USE "MONROE", APART FROM  
THE MARK AS SHOWN.

SER. NO. 85-371,499, FILED 7-14-2011.

CARYN GLASSER, EXAMINING ATTORNEY



*David J. Kyros*

Director of the United States Patent and Trademark Office

# United States of America

United States Patent and Trademark Office

# SQUANGLE

**Reg. No. 4,134,478**

**Registered May 1, 2012**

**Int. Cl.: 9**

**TRADEMARK**

**PRINCIPAL REGISTER**

GREAT NECK SAW MANUFACTURERS, INC. (NEW YORK CORPORATION)  
165 EAST SECOND STREET  
MINEOLA, NY 11501

FOR: MULTI-PURPOSE MEASURING APPARATUS, NAMELY, A COMBINATION BEVEL,  
CARPENTER'S LEVEL AND SQUARE, IN CLASS 9 (U.S. CLS. 21, 23, 26, 36 AND 38).

FIRST USE 0-0-1958; IN COMMERCE 0-0-1958.

THE MARK CONSISTS OF STANDARD CHARACTERS WITHOUT CLAIM TO ANY PAR-  
TICULAR FONT, STYLE, SIZE, OR COLOR.

SER. NO. 85-371,934, FILED 7-14-2011.

ASMAT KHAN, EXAMINING ATTORNEY



*David J. Kyffers*

Director of the United States Patent and Trademark Office

# United States of America

United States Patent and Trademark Office



**Reg. No. 4,134,479**

**Registered May 1, 2012**

**Int. Cl.: 30**

**TRADEMARK**

**PRINCIPAL REGISTER**

KMSJ INC. (CALIFORNIA CORPORATION), DBA PACIFIC CHEESECAKE COMPANY  
3049 THREE SPRINGS DR.  
WESTLAKE VILLAGE, CA 91361

FOR: BAKERY GOODS AND DESSERT ITEMS, NAMELY, CHEESECAKES FOR RETAIL AND WHOLESALE DISTRIBUTION AND CONSUMPTION ON OR OFF THE PREMISES , IN CLASS 30 (U.S. CL. 46).

FIRST USE 4-0-2011; IN COMMERCE 4-0-2011.

NO CLAIM IS MADE TO THE EXCLUSIVE RIGHT TO USE "CHEESECAKE COMPANY" AND "BAKERY", APART FROM THE MARK AS SHOWN.

THE MARK CONSIST OF THE STYLIZED WORDING "PACIFIC CHEESECAKE COMPANY A UNIQUE BAKERY" AS WELL AS THE DECEPTION OF A SLICE OF CHEESECAKE CONNECTED TO A HORIZONTAL LINE. THE SLICE OF CHEESECAKE AND HORIZONTAL LINE APPEAR ABOVE THE WORDING "PACIFIC CHEESECAKE COMPANY" WHICH IS LOCATED ABOVE THE WORDING A UNIQUE BAKERY".

SER. NO. 85-371,996, FILED 7-14-2011.

MICHAEL TANNER, EXAMINING ATTORNEY



*David J. Kyros*

Director of the United States Patent and Trademark Office

# United States of America

United States Patent and Trademark Office



## Schroeder Steering

**Reg. No. 4,134,480**

**Registered May 1, 2012**

**Int. Cl.: 12**

**TRADEMARK**

**PRINCIPAL REGISTER**

GARY SCHROEDER ENTERPRISES INC. (CALIFORNIA CORPORATION)  
2070 FLOYD STREET  
BURBANK, CA 91504

FOR: AUTOMOTIVE PARTS AND ACCESSORIES, NAMELY, STEERING ASSEMBLIES, WORM AND GEAR STEERINGS, RACK AND PINION STEERINGS, STEERING GEARS, QUICK-RELEASE STEERING HUBS AND STEERING WHEELS, IN CLASS 12 (U.S. CLS. 19, 21, 23, 31, 35 AND 44).

FIRST USE 1-31-1951; IN COMMERCE 1-31-1951.

NO CLAIM IS MADE TO THE EXCLUSIVE RIGHT TO USE "STEERING", APART FROM THE MARK AS SHOWN.

THE MARK CONSISTS OF A DRAWING OF AN OPEN TOP RACE CAR BEING DRIVEN BY A HUMAN AND THE WORDS "SCHROEDER STEERING" BELOW THE DRAWING.

SER. NO. 85-372,026, FILED 7-14-2011.

STEVEN R. FINE, EXAMINING ATTORNEY



*David J. Kybas*

Director of the United States Patent and Trademark Office



# United States of America

United States Patent and Trademark Office

# TENS 3000

**Reg. No. 4,134,481**

**Registered May 1, 2012**

**Int. Cl.: 10**

**TRADEMARK**

**PRINCIPAL REGISTER**

CURRENT SOLUTIONS, LLC (TEXAS LIMITED LIABILITY COMPANY)  
3814 WOODBURY DRIVE  
AUSTIN, TX 78704

FOR: MEDICAL EQUIPMENT, NAMELY, ELECTRICAL NERVE STIMULATORS AND ELECTRODES FOR ELECTRICAL STIMULATION, IN CLASS 10 (U.S. CLS. 26, 39 AND 44).

FIRST USE 1-8-2004; IN COMMERCE 1-8-2004.

THE MARK CONSISTS OF STANDARD CHARACTERS WITHOUT CLAIM TO ANY PARTICULAR FONT, STYLE, SIZE, OR COLOR.

NO CLAIM IS MADE TO THE EXCLUSIVE RIGHT TO USE "TENS", APART FROM THE MARK AS SHOWN.

SER. NO. 85-372,167, FILED 7-15-2011.

PRISCILLA MILTON, EXAMINING ATTORNEY



*David J. Kybas*

Director of the United States Patent and Trademark Office

# United States of America

United States Patent and Trademark Office

# TENS 7000

**Reg. No. 4,134,482**

**Registered May 1, 2012**

**Int. Cl.: 10**

**TRADEMARK**

**PRINCIPAL REGISTER**

CURRENT SOLUTIONS, LLC (TEXAS LIMITED LIABILITY COMPANY)  
3814 WOODBURY DRIVE  
AUSTIN, TX 78704

FOR: MEDICAL EQUIPMENT, NAMELY, ELECTRICAL NERVE STIMULATORS AND ELECTRODES FOR ELECTRICAL STIMULATION, IN CLASS 10 (U.S. CLS. 26, 39 AND 44).

FIRST USE 7-8-2004; IN COMMERCE 7-8-2004.

THE MARK CONSISTS OF STANDARD CHARACTERS WITHOUT CLAIM TO ANY PARTICULAR FONT, STYLE, SIZE, OR COLOR.

NO CLAIM IS MADE TO THE EXCLUSIVE RIGHT TO USE "TENS", APART FROM THE MARK AS SHOWN.

SER. NO. 85-372,176, FILED 7-15-2011.

PRISCILLA MILTON, EXAMINING ATTORNEY



*David J. Kyros*

Director of the United States Patent and Trademark Office

# United States of America

United States Patent and Trademark Office

# Pratt Institute

**Reg. No. 4,134,483**

**Registered May 1, 2012**

**Int. Cl.: 41**

**SERVICE MARK**

**PRINCIPAL REGISTER**

PRATT INSTITUTE (NEW YORK EDUCATIONAL INSTITUTION)  
200 WILLOUGHBY AVENUE  
BROOKLYN, NY 11205

FOR: EDUCATION SERVICES, NAMELY, PROVIDING INSTRUCTION AT THE UNDERGRADUATE AND GRADUATE LEVELS IN THE FIELDS OF ARCHITECTURE, ART AND DESIGN, INFORMATION AND LIBRARY SCIENCE, LIBERAL ARTS AND SCIENCES; EDUCATION SERVICES, NAMELY PROVIDING CONTINUING EDUCATION COURSES IN THE FIELDS OF ART AND DESIGN AND COMPUTER GRAPHICS AND TECHNOLOGY; AND EDUCATION SERVICES, NAMELY, PROVIDING PROFESSIONAL STUDIES PROGRAMS IN COMPUTER GRAPHICS, PHOTOGRAPHY AND DIGITAL MEDIA, FACILITIES MANAGEMENT, FINE AND DECORATIVE ART APPRAISAL AND SUSTAINABLE BUILDING, INFRASTRUCTURE DESIGN AND MANAGEMENT, IN CLASS 41 (U.S. CLS. 100, 101 AND 107).

FIRST USE 5-19-1887; IN COMMERCE 5-19-1887.

THE MARK CONSISTS OF STANDARD CHARACTERS WITHOUT CLAIM TO ANY PARTICULAR FONT, STYLE, SIZE, OR COLOR.

NO CLAIM IS MADE TO THE EXCLUSIVE RIGHT TO USE "INSTITUTE", APART FROM THE MARK AS SHOWN.

SEC. 2(F).

SER. NO. 85-372,327, FILED 7-15-2011.

BILL DAWE, EXAMINING ATTORNEY



*David J. Kyros*

Director of the United States Patent and Trademark Office

# United States of America

United States Patent and Trademark Office

# CRUNCHUFFS

**Reg. No. 4,134,484**

**Registered May 1, 2012**

**Int. Cl.: 30**

**TRADEMARK**

**PRINCIPAL REGISTER**

DUFFLET GROUP INC. (CANADA CORPORATION)  
166 NORSEMAN STREET  
TORONTO, CANADA M8Z2R4

FOR: CHOCOLATE CONFECTIONS; CONFECTIONERY MADE OF SUGAR AND CONTAINING CARAMEL; RICE-BASED SNACK FOODS, IN CLASS 30 (U.S. CL. 46).

FIRST USE 6-8-2011; IN COMMERCE 6-8-2011.

THE MARK CONSISTS OF STANDARD CHARACTERS WITHOUT CLAIM TO ANY PARTICULAR FONT, STYLE, SIZE, OR COLOR.

SER. NO. 85-372,681, FILED 7-15-2011.

DOMINIC J. FERRAIUOLO, EXAMINING ATTORNEY



*David J. Kyffers*

Director of the United States Patent and Trademark Office

# United States of America

United States Patent and Trademark Office

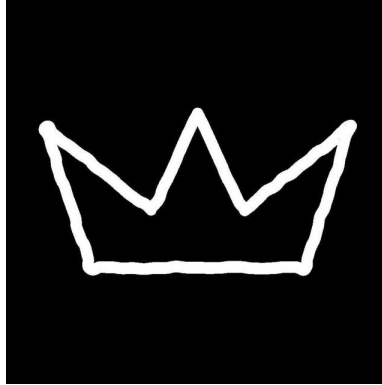

**Reg. No. 4,134,485**

**Registered May 1, 2012**

**Int. Cls.: 9 and 25**

**TRADEMARK**

**PRINCIPAL REGISTER**

WORLD OF JEANS & TOPS, INC. (CALIFORNIA CORPORATION)  
10 WHATNEY  
IRVINE, CA 92618

FOR: SUNGLASSES, IN CLASS 9 (U.S. CLS. 21, 23, 26, 36 AND 38).

FIRST USE 12-0-2010; IN COMMERCE 12-0-2010.

FOR: MEN'S AND BOY'S WEARING APPAREL, NAMELY, T-SHIRTS, SWEATSHIRTS, TANK TOPS, WOVEN SHIRTS, SWEATERS, CARDIGANS, VESTS, JACKETS, PANTS, SWEATPANTS, JEANS, SHORTS, HATS, CAPS, COATS, PAJAMAS, SOCKS, UNDERWEAR, SWIMWEAR AND TRUNKS, IN CLASS 25 (U.S. CLS. 22 AND 39).

FIRST USE 6-0-2010; IN COMMERCE 6-0-2010.

THE MARK CONSISTS OF THE DESIGN OF A CROWN. THE BLACK PORTION INSIDE THE CROWN OUTLINE IS PART OF THE MARK. THE BLACK PORTION OUTSIDE OF THE CROWN OUTLINE IS BACKGROUND AND NOT PART OF THE MARK.

SER. NO. 85-372,895, FILED 7-15-2011.

MICHAEL ENGEL, EXAMINING ATTORNEY



*David J. Kybas*

Director of the United States Patent and Trademark Office

# United States of America

United States Patent and Trademark Office

## HOMECOOKED SHORTCUTS

**Reg. No. 4,134,486**

HOME COOKED SHORTCUTS (KANSAS SOLE PROPRIETORSHIP)  
2738 N RUSHWOOD CT  
WICHITA, KS 67226

**Registered May 1, 2012**

**Int. Cl.: 16**

FOR: BAGS FOR MICROWAVE COOKING; MICROWAVE COOKING BAGS, IN CLASS 16  
(U.S. CLS. 2, 5, 22, 23, 29, 37, 38 AND 50).

**TRADEMARK**

FIRST USE 7-1-2011; IN COMMERCE 7-1-2011.

**PRINCIPAL REGISTER**

THE MARK CONSISTS OF STANDARD CHARACTERS WITHOUT CLAIM TO ANY PARTICULAR FONT, STYLE, SIZE, OR COLOR.

SER. NO. 85-373,740, FILED 7-18-2011.

DAVID ELTON, EXAMINING ATTORNEY



*David J. Kyffers*

Director of the United States Patent and Trademark Office

# United States of America

United States Patent and Trademark Office



**Reg. No. 4,134,487**

**Registered May 1, 2012**

**Int. Cl.: 36**

**SERVICE MARK**

**PRINCIPAL REGISTER**

THE DECLAN DONOGHUE FOUNDATION INC. (NORTH CAROLINA NON-PROFIT CORPORATION)  
P.O. BOX 1211  
KERNERSVILLE, NC 27285

FOR: ORGANIZING FUNDRAISING EVENTS TO RAISE MONEY FOR THE CONSTRUCTION OF PLAYGROUNDS, IN CLASS 36 (U.S. CLS. 100, 101 AND 102).

FIRST USE 2-0-2011; IN COMMERCE 2-0-2011.

THE MARK CONSISTS OF A BUTTERFLY COMPOSED OF THE FOUNDATION'S INITIALS DDF WHEREIN THE LEFT WING IS A CAPITAL "D", THE BODY OF THE BUTTERFLY IS A LOWER CASE "F", AND THE RIGHT WING IS A BACKWARDS CAPITAL "D" WITH THE WORDS "CELEBRATING THE SPIRIT OF PLAY" FORMING A CIRCLE AROUND THE BUTTERFLY WITH "CELEBRATING" AROUND THE TOP AND "THE SPIRIT OF PLAY" AROUND THE BOTTOM, WITH THE WORDING OFFSET ON EITHER SIDE BY A SINGLE SHADED CIRCLE.

SER. NO. 85-373,906, FILED 7-18-2011.

MYRIAH HABEEB, EXAMINING ATTORNEY



*David J. Kyffers*

Director of the United States Patent and Trademark Office

# United States of America

United States Patent and Trademark Office

## How sweet is that

**Reg. No. 4,134,488**

**Registered May 1, 2012**

**Int. Cl.: 25**

**TRADEMARK**

**PRINCIPAL REGISTER**

GOTTLIEB, DAVID (UNITED STATES INDIVIDUAL)  
103 HERITAGE WAY  
GANSEVOORT, NY 12831

FOR: HATS; SHORTS; SWEATPANTS; T-SHIRTS, IN CLASS 25 (U.S. CLS. 22 AND 39).

FIRST USE 8-23-2011; IN COMMERCE 8-23-2011.

THE MARK CONSISTS OF STANDARD CHARACTERS WITHOUT CLAIM TO ANY PARTICULAR FONT, STYLE, SIZE, OR COLOR.

SER. NO. 85-374,009, FILED 7-18-2011.

HANNO RITTNER, EXAMINING ATTORNEY



*David J. Kyffers*

Director of the United States Patent and Trademark Office



# United States of America

United States Patent and Trademark Office

# SlugBooks

**Reg. No. 4,134,489**

**Registered May 1, 2012**

**Int. Cl.: 35**

**SERVICE MARK**

**PRINCIPAL REGISTER**

SLUG BOOKS LLC (CALIFORNIA LIMITED LIABILITY COMPANY)  
#317  
707 LEAHY ST.  
REDWOOD CITY, CA 94061

FOR: PROMOTING THE GOODS AND SERVICES OF OTHERS BY PROVIDING A WEBSITE  
FEATURING PRICE-COMPARISON INFORMATION IN THE FIELD OF TEXTBOOKS , IN  
CLASS 35 (U.S. CLS. 100, 101 AND 102).

FIRST USE 11-30-2008; IN COMMERCE 11-30-2008.

THE MARK CONSISTS OF STANDARD CHARACTERS WITHOUT CLAIM TO ANY PAR-  
TICULAR FONT, STYLE, SIZE, OR COLOR.

SER. NO. 85-374,269, FILED 7-18-2011.

LINDA ORNDORFF, EXAMINING ATTORNEY



*David J. Kyffers*

Director of the United States Patent and Trademark Office

# United States of America

United States Patent and Trademark Office

## Fitness Fans of America

**Reg. No. 4,134,490**

**Registered May 1, 2012**

**Int. Cl.: 41**

**SERVICE MARK**

**PRINCIPAL REGISTER**

OLLODART, PETER (UNITED STATES INDIVIDUAL)  
19678 SE 310TH PL.  
KENT, WA 98042

FOR: PROVIDING FITNESS INSTRUCTIONAL PROGRAMS; PROVIDING AN ON-LINE COMPUTER DATABASE FEATURING INFORMATION REGARDING EXERCISE AND FITNESS; PROVIDING ONLINE MENTORING IN THE FIELD OF NUTRITION AND FITNESS, IN CLASS 41 (U.S. CLS. 100, 101 AND 107).

FIRST USE 2-1-2011; IN COMMERCE 2-1-2011.

THE MARK CONSISTS OF STANDARD CHARACTERS WITHOUT CLAIM TO ANY PARTICULAR FONT, STYLE, SIZE, OR COLOR.

NO CLAIM IS MADE TO THE EXCLUSIVE RIGHT TO USE "FITNESS" AND "AMERICA", APART FROM THE MARK AS SHOWN.

SER. NO. 85-374,693, FILED 7-19-2011.

ESTHER A. BORSUK, EXAMINING ATTORNEY



*David J. Kybas*

Director of the United States Patent and Trademark Office

# United States of America

United States Patent and Trademark Office



**Reg. No. 4,134,491**

**Registered May 1, 2012**

**Int. Cl.: 9**

**TRADEMARK**

**PRINCIPAL REGISTER**

NOTI-FI ADVERTISING NETWORK, LLC (DELAWARE LIMITED LIABILITY COMPANY)  
2109 AIROLE WAY  
AUSTIN, TX 78704

FOR: BROADBAND WIRELESS EQUIPMENT, NAMELY, TELECOMMUNICATIONS BASE STATION EQUIPMENT FOR CELLULAR AND FIXED NETWORKING AND COMMUNICATIONS APPLICATIONS; COMMUNICATIONS SOFTWARE FOR CONNECTING WIRELESS DEVICES; COMPUTER E-COMMERCE SOFTWARE TO ALLOW USERS TO PERFORM ELECTRONIC BUSINESS TRANSACTIONS VIA A GLOBAL COMPUTER NETWORK; COMPUTER HARDWARE AND SOFTWARE FOR SETTING UP AND CONFIGURING LOCAL AREA NETWORKS; COMPUTER HARDWARE AND SOFTWARE FOR SETTING UP AND CONFIGURING WIDE AREA NETWORKS; COMPUTER HARDWARE FOR COMMUNICATING AUDIO, VIDEO AND DATA BETWEEN COMPUTERS VIA A GLOBAL COMPUTER NETWORK, WIDE-AREA COMPUTER NETWORKS, AND PEER-TO-PEER COMPUTER NETWORKS; COMPUTER HARDWARE FOR WIRELESS CONTENT DELIVERY; COMPUTER HARDWARE, NAMELY, WIRELESS ACCESS POINT (WAP) DEVICES; COMPUTER HARDWARE, NAMELY, WIRELESS NETWORK EXTENDERS; COMPUTER HARDWARE, NAMELY, WIRELESS NETWORK REPEATERS; COMPUTER NETWORK ADAPTERS; COMPUTER NETWORK ADAPTERS, SWITCHES, ROUTERS AND HUBS, IN CLASS 9 (U.S. CLS. 21, 23, 26, 36 AND 38).

FIRST USE 2-4-2010; IN COMMERCE 11-17-2010.

THE LETTERS "NOTI" ARE ALL IN WHITE AND ENCLOSED BY A RED BACKGROUND, THE LETTERS "FI" IN BLACK AND A HYPHEN IN RED AND WHITE AND A RED SOUNDWAVE DESIGN.

THE COLOR(S) RED, BLACK AND WHITE IS/ARE CLAIMED AS A FEATURE OF THE MARK.

SER. NO. 85-374,931, FILED 7-19-2011.

MARK SPARACINO, EXAMINING ATTORNEY



*David J. Kyffers*

Director of the United States Patent and Trademark Office

# United States of America

United States Patent and Trademark Office

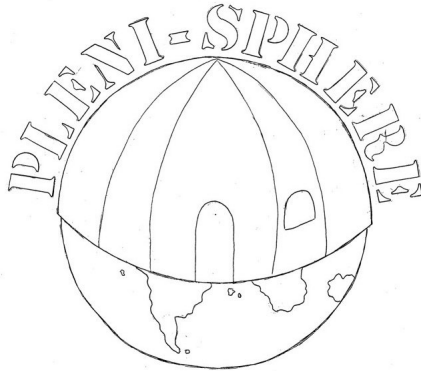

**Reg. No. 4,134,492**

**Registered May 1, 2012**

**Int. Cl.: 22**

**TRADEMARK**

**PRINCIPAL REGISTER**

PYAGA, ADONATA (FED REP GERMANY INDIVIDUAL), DBA PLENI-SPHERE  
7560 HIGHWAY 95 WEST  
CLINTON, AR 72031

FOR: TENTS, IN CLASS 22 (U.S. CLS. 1, 2, 7, 19, 22, 42 AND 50).

FIRST USE 7-1-2010; IN COMMERCE 11-1-2010.

THE MARK CONSISTS OF ROUND EARTH GLOBE WITH UPPER TWO THIRDS COVERED WITH A ROUND TENT DESIGN, WITH A CENTER DOOR AND SIDE WINDOW ON RIGHT. TENT IS SHAPED AS A HALF SPHERE AND FITS SNUGLY OVER EARTH GLOBE. ABOVE IT ALL ARE THE WORDS "PLENI-SPHERE" IN AN ARCHED RAINBOW SHAPE.

SER. NO. 85-374,965, FILED 7-19-2011.

DANNEAN HETZEL, EXAMINING ATTORNEY



*David J. Kyffers*

Director of the United States Patent and Trademark Office

# United States of America

United States Patent and Trademark Office



**Reg. No. 4,134,493**

**Registered May 1, 2012**

**Int. Cl.: 9**

**TRADEMARK**

**PRINCIPAL REGISTER**

PIC THAT WORD, LLC (DELAWARE LIMITED LIABILITY COMPANY)  
3034 MARTIN LUTHER KING, JR. WAY  
OAKLAND, CA 94609

FOR: COMPUTER GAME SOFTWARE; COMPUTER GAME SOFTWARE FOR USE ON MOBILE AND CELLULAR PHONES; DOWNLOADABLE COMPUTER GAME PROGRAMS , IN CLASS 9 (U.S. CLS. 21, 23, 26, 36 AND 38).

FIRST USE 3-21-2011; IN COMMERCE 3-21-2011.

THE MARK CONSISTS OF THE WORDS "PIC THAT WORD" WITH THE LETTERS "W"- "O"- "R"- "D" EACH INSIDE A SQUARE AND AN IMAGE OF A CAMERA.

SER. NO. 85-374,994, FILED 7-19-2011.

BARBARA RUTLAND, EXAMINING ATTORNEY



*David J. Kyffers*

Director of the United States Patent and Trademark Office

# United States of America

United States Patent and Trademark Office



**Reg. No. 4,134,494**

**Registered May 1, 2012**

**Int. Cl.: 21**

**TRADEMARK**

**PRINCIPAL REGISTER**

IP HOLDINGS LLC (WASHINGTON LIMITED LIABILITY COMPANY)  
5408 NE 88TH ST. #A-101  
VANCOUVER, WA 98665

FOR: DISPOSABLE LATEX AND NITRILE GLOVES FOR GENERAL USE; DISPOSABLE LATEX GLOVES FOR GENERAL USE; FLOWER POTS; MANUALLY ACTUATED PUMP DISPENSERS FOR ATTACHMENT TO CONTAINERS FOR USE IN DISPENSING LIQUIDS; PLASTIC LIDS FOR PLANT POTS; POT LIDS; POTS; SAUCERS FOR FLOWER POTS; SPRAYER WANDS FOR GARDEN HOSES; WATERING POTS, IN CLASS 21 (U.S. CLS. 2, 13, 23, 29, 30, 33, 40 AND 50).

FIRST USE 1-1-2005; IN COMMERCE 7-8-2011.

OWNER OF U.S. REG. NO. 3,388,278.

THE COLOR(S) BLACK, WHITE, BROWN, GREEN AND BEIGE IS/ARE CLAIMED AS A FEATURE OF THE MARK.

THE MARK CONSISTS OF A CENTRAL DESIGN OF A HAND WITH ITS THUMB EXTENDED UPWARD. THE HAND IS OUTLINED IN BROWN WITH BEIGE SKIN TONES, WITH THE EXCEPTION OF THE THUMB WHICH IS IN SHADES OF GREEN. THE HAND DESIGN IS PLACED ATOP A SOLID BLACK CIRCLE WITHIN A WHITE CIRCULAR BACKGROUND WITH A BLACK BORDER. WITHIN THE TOP PORTION OF THE BACKGROUND ARE THE WORDS "GRO" IN GREEN STYLIZED FONT AND "PRO" IN BROWN STYLIZED FONT. BETWEEN THE WORDS AND ENCIRCLING THE THUMB IS A GLOWING SUN-LIKE AURA DEPICTED IN THE COLOR GREEN.

SER. NO. 85-375,372, FILED 7-19-2011.

BRIDGETT SMITH, EXAMINING ATTORNEY



*David J. Kybas*

Director of the United States Patent and Trademark Office

# United States of America

United States Patent and Trademark Office

## YOUR DISCOVERY COUNSEL

**Reg. No. 4,134,495**

**Registered May 1, 2012**

**Int. Cl.: 45**

**SERVICE MARK**

**PRINCIPAL REGISTER**

HARDINGER & TANENHOLZ LLP (D.C. LIMITED LIABILITY PARTNERSHIP)  
1325 G ST NW  
SUITE 500  
WASHINGTON, DC 20005

FOR: LEGAL SERVICES, NAMELY, DISCOVERY AND THE EXECUTION OF END-TO-END DOCUMENT REVIEW MANAGEMENT, INCLUDING RENDERING FINAL LEGAL DETERMINATIONS ON DOCUMENTS, LEGAL SUPERVISION OF ATTORNEY REVIEW TEAMS, POTENTIAL AND FINAL PRIVILEGE REVIEW, CERTIFYING PRODUCTIONS, NEGOTIATING WITH OPPOSING COUNSEL ON DISCOVERY REQUESTS, ADVISING ON DISCOVERY ISSUES, IN CLASS 45 (U.S. CLS. 100 AND 101).

FIRST USE 10-17-2006; IN COMMERCE 10-17-2006.

THE MARK CONSISTS OF STANDARD CHARACTERS WITHOUT CLAIM TO ANY PARTICULAR FONT, STYLE, SIZE, OR COLOR.

NO CLAIM IS MADE TO THE EXCLUSIVE RIGHT TO USE "DISCOVERY COUNSEL", APART FROM THE MARK AS SHOWN.

SER. NO. 85-375,685, FILED 7-20-2011.

MICHAEL SOUDERS, EXAMINING ATTORNEY



*David J. Kybas*

Director of the United States Patent and Trademark Office

# United States of America

United States Patent and Trademark Office

## SOLID OBJECTS

**Reg. No. 4,134,496**

**Registered May 1, 2012**

**Int. Cl.: 16**

**TRADEMARK**

**PRINCIPAL REGISTER**

SOLID OBJECTS INC. (NEW YORK CORPORATION)  
P.O. BOX 296  
NEW YORK, NY 10113

FOR: FICTION, NONFICTION, POETRY, AND DRAMA BOOKS ON A VARIETY OF TOPICS,  
IN CLASS 16 (U.S. CLS. 2, 5, 22, 23, 29, 37, 38 AND 50).

FIRST USE 12-26-2010; IN COMMERCE 12-26-2010.

THE MARK CONSISTS OF STANDARD CHARACTERS WITHOUT CLAIM TO ANY PAR-  
TICULAR FONT, STYLE, SIZE, OR COLOR.

OWNER OF U.S. REG. NO. 4,038,081.

SER. NO. 85-376,635, FILED 7-20-2011.

DEZMONA MIZELLE, EXAMINING ATTORNEY



*David J. Kybas*

Director of the United States Patent and Trademark Office



# United States of America

United States Patent and Trademark Office



**Reg. No. 4,134,497**

**Registered May 1, 2012**

**Int. Cls.: 25 and 43**

**TRADEMARK**

**SERVICE MARK**

**PRINCIPAL REGISTER**

MONTAUK U.S.A., LLC (GEORGIA LIMITED LIABILITY COMPANY)  
22ND FLOOR  
360 MADISON AVENUE  
NEW YORK, NY 10017

FOR: WEARABLE GARMENTS AND CLOTHING, NAMELY, SHIRTS, IN CLASS 25 (U.S. CLS. 22 AND 39).

FIRST USE 5-27-2011; IN COMMERCE 5-27-2011.

FOR: RESTAURANT AND BAR SERVICES, IN CLASS 43 (U.S. CLS. 100 AND 101).

FIRST USE 7-10-2011; IN COMMERCE 7-10-2011.

THE MARK CONSISTS OF A GRINNING TUNA FISH WEARING SUNGLASSES AND A HAT, CARRYING A STRIPED SURFBOARD UNDER HIS LEFT FIN/ARM.

SER. NO. 85-376,721, FILED 7-20-2011.

GISELLE AGOSTO, EXAMINING ATTORNEY



*David J. Kybas*

Director of the United States Patent and Trademark Office

# United States of America

United States Patent and Trademark Office

## GULF COAST AUTO BROKERS

**Reg. No. 4,134,498**

WEINER, PAUL J. (UNITED STATES INDIVIDUAL)  
4427 EXCHANGE AVE., UNIT 11  
NAPLES, FL 34104

**Registered May 1, 2012**

**Int. Cl.: 35**

FOR: AUTOMOBILE DEALERSHIPS, IN CLASS 35 (U.S. CLS. 100, 101 AND 102).

**SERVICE MARK**

FIRST USE 6-0-1991; IN COMMERCE 6-0-1991.

**PRINCIPAL REGISTER**

THE MARK CONSISTS OF STANDARD CHARACTERS WITHOUT CLAIM TO ANY PARTICULAR FONT, STYLE, SIZE, OR COLOR.

NO CLAIM IS MADE TO THE EXCLUSIVE RIGHT TO USE "AUTO BROKERS", APART FROM THE MARK AS SHOWN.

SEC. 2(F).

SER. NO. 85-377,038, FILED 7-21-2011.

RUSS HERMAN, EXAMINING ATTORNEY



*David J. Kyffers*

Director of the United States Patent and Trademark Office

# United States of America

United States Patent and Trademark Office

## Smart Passive Income

**Reg. No. 4,134,499**

**Registered May 1, 2012**

**Int. Cl.: 41**

**SERVICE MARK**

**PRINCIPAL REGISTER**

FLYNNINDUSTRIES, LLC (CALIFORNIA LIMITED LIABILITY COMPANY)  
STE C224  
9450 MIRA MESA BLVD  
SAN DIEGO, CA 92126

FOR: ON-LINE JOURNALS, NAMELY, BLOGS FEATURING ONLINE BUSINESS AND  
MARKETING ADVICE, IN CLASS 41 (U.S. CLS. 100, 101 AND 107).

FIRST USE 10-23-2008; IN COMMERCE 10-23-2008.

THE MARK CONSISTS OF STANDARD CHARACTERS WITHOUT CLAIM TO ANY PAR-  
TICULAR FONT, STYLE, SIZE, OR COLOR.

NO CLAIM IS MADE TO THE EXCLUSIVE RIGHT TO USE "PASSIVE INCOME", APART  
FROM THE MARK AS SHOWN.

SER. NO. 85-377,050, FILED 7-21-2011.

ALICIA COLLINS, EXAMINING ATTORNEY



*David J. Kybas*

Director of the United States Patent and Trademark Office

# United States of America

United States Patent and Trademark Office



**Reg. No. 4,134,500**

**Registered May 1, 2012**

**Int. Cl.: 12**

UNIVERSAL TRAILER CARGO GROUP, INC. (DELAWARE CORPORATION), DBA WELLS CARGO  
11590 CENTURY BOULEVARD  
SUITE 103  
CINCINNATI, OH 45246

**TRADEMARK**

FOR: CARGO TRAILERS, IN CLASS 12 (U.S. CLS. 19, 21, 23, 31, 35 AND 44).

**PRINCIPAL REGISTER**

FIRST USE 4-11-1958; IN COMMERCE 4-11-1958.

NO CLAIM IS MADE TO THE EXCLUSIVE RIGHT TO USE "CARGO TRAILERS", APART FROM THE MARK AS SHOWN.

THE MARK CONSISTS OF WORDING "SINCE 1954 WELLS CARGO TRAILERS" IN STYLIZED FONT APPEARING INSIDE A CIRCLE DESIGN.

SEC. 2(F) AS TO "SINCE 1954" AND "CARGO TRAILERS".

SER. NO. 85-377,574, FILED 7-21-2011.

KELLY CHOE, EXAMINING ATTORNEY



*David J. Kybas*

Director of the United States Patent and Trademark Office

# United States of America

United States Patent and Trademark Office

## Armed Force Fitness

**Reg. No. 4,134,501**

**Registered May 1, 2012**

**Int. Cl.: 28**

**TRADEMARK**

**PRINCIPAL REGISTER**

CHI HSIN IMPEX INC. (CALIFORNIA CORPORATION)  
14777 DON JULIAN RD.  
CITY OF INDUSTRY, CA 91746

FOR: EXERCISE EQUIPMENT, NAMELY, STAIR STEPPING MACHINES, WEIGHT LIFTING BENCHES, STATIONARY EXERCISE BICYCLES, STATIONARY SKIERS AND TREADMILLS, MANUALLY OPERATED HOME-GYM EXERCISE MACHINES AND EQUIPMENT, NAMELY, AEROBIC EXERCISE FITNESS BALLS, IN CLASS 28 (U.S. CLS. 22, 23, 38 AND 50).

FIRST USE 6-24-2011; IN COMMERCE 6-24-2011.

THE MARK CONSISTS OF STANDARD CHARACTERS WITHOUT CLAIM TO ANY PARTICULAR FONT, STYLE, SIZE, OR COLOR.

NO CLAIM IS MADE TO THE EXCLUSIVE RIGHT TO USE "FITNESS", APART FROM THE MARK AS SHOWN.

SER. NO. 85-377,729, FILED 7-21-2011.

JENNY PARK, EXAMINING ATTORNEY



*David J. Kyros*

Director of the United States Patent and Trademark Office

# United States of America

United States Patent and Trademark Office

# BIGTUNA

**Reg. No. 4,134,502**

**Registered May 1, 2012**

**Int. Cl.: 43**

**SERVICE MARK**

**PRINCIPAL REGISTER**

BIGTUNA JAPANESE RESTAURANT INC. (CALIFORNIA CORPORATION)  
43530 10TH STREET W. STE. 111  
LANCASTER, CA 93534

FOR: JAPANESE RESTAURANT SERVICES, IN CLASS 43 (U.S. CLS. 100 AND 101).

FIRST USE 2-7-2005; IN COMMERCE 2-7-2005.

THE MARK CONSISTS OF STANDARD CHARACTERS WITHOUT CLAIM TO ANY PARTICULAR FONT, STYLE, SIZE, OR COLOR.

SER. NO. 85-378,278, FILED 7-22-2011.

ROBERT C. CLARK JR., EXAMINING ATTORNEY



*David J. Kyros*

Director of the United States Patent and Trademark Office

# United States of America

United States Patent and Trademark Office

# VetsHere!

**Reg. No. 4,134,503**

**Registered May 1, 2012**

**Int. Cl.: 44**

**SERVICE MARK**

**PRINCIPAL REGISTER**

FANNING, AUTUMN, LYN (UNITED STATES INDIVIDUAL), DBA VETSHERE! MOBILE  
VETERINARY SERVICES  
PO BOX 912  
SANTA YNEZ, CA 93460

FOR: VETERINARY SERVICES, IN CLASS 44 (U.S. CLS. 100 AND 101).

FIRST USE 10-1-2010; IN COMMERCE 10-1-2010.

THE MARK CONSISTS OF STANDARD CHARACTERS WITHOUT CLAIM TO ANY PARTICULAR FONT, STYLE, SIZE, OR COLOR.

SER. NO. 85-378,347, FILED 7-22-2011.

BRIDGETT SMITH, EXAMINING ATTORNEY



*David J. Kybas*

Director of the United States Patent and Trademark Office

# United States of America

United States Patent and Trademark Office

## COMPUTER RUNNING SLOW? TAKE IT TO MONROE

**Reg. No. 4,134,504**

**Registered May 1, 2012**

**Int. Cl.: 42**

**SERVICE MARK**

**PRINCIPAL REGISTER**

TOBIN, CHRIS (UNITED STATES INDIVIDUAL)  
80 SOUTH AVE SUITE D  
HILTON, NY 14468

FOR: COMPUTER TECHNICAL SUPPORT SERVICES, NAMELY, HELP DESK SERVICES FOR DIAGNOSING PROBLEMS WITH IT INFRASTRUCTURE, OPERATING SYSTEMS, DATABASE SYSTEMS, AND WEB APPLICATIONS, TROUBLESHOOTING IN THE NATURE OF DIAGNOSING COMPUTER HARDWARE AND SOFTWARE PROBLEMS, AND PROVIDING BACK-UP COMPUTER PROGRAMS AND FACILITIES; COMPUTER DIAGNOSTIC SERVICES; IT SERVICES FOR BUSINESSES, IT CONSULTING SERVICES, IN CLASS 42 (U.S. CLS. 100 AND 101).

FIRST USE 1-1-2011; IN COMMERCE 2-1-2011.

THE MARK CONSISTS OF STANDARD CHARACTERS WITHOUT CLAIM TO ANY PARTICULAR FONT, STYLE, SIZE, OR COLOR.

SER. NO. 85-378,744, FILED 7-22-2011.

APRIL ROACH, EXAMINING ATTORNEY



*David J. Kyros*

Director of the United States Patent and Trademark Office



# United States of America

United States Patent and Trademark Office

## GOVERNOR'S CUP

**Reg. No. 4,134,505**

**Registered May 1, 2012**

**Int. Cl.: 41**

**SERVICE MARK**

**PRINCIPAL REGISTER**

THE VIRGINIA WINERIES ASSOCIATION (VIRGINIA CORPORATION)  
701 EAST FRANKLIN STREET, SUITE 809  
RICHMOND, VA 23219

FOR: ENTERTAINMENT SERVICES, NAMELY, WINE COMPETITIONS AND WINE TASTINGS, IN CLASS 41 (U.S. CLS. 100, 101 AND 107).

FIRST USE 0-0-1982; IN COMMERCE 0-0-1982.

THE MARK CONSISTS OF STANDARD CHARACTERS WITHOUT CLAIM TO ANY PARTICULAR FONT, STYLE, SIZE, OR COLOR.

NO CLAIM IS MADE TO THE EXCLUSIVE RIGHT TO USE "CUP", APART FROM THE MARK AS SHOWN.

SER. NO. 85-378,889, FILED 7-22-2011.

EDWARD NELSON, EXAMINING ATTORNEY



*David J. Kyffers*

Director of the United States Patent and Trademark Office

# United States of America

United States Patent and Trademark Office



**Reg. No. 4,134,506**

**Registered May 1, 2012**

**Int. Cl.: 33**

**TRADEMARK**

**PRINCIPAL REGISTER**

BINDER YLVA E (SWEDEN INDIVIDUAL), DBA YLVA  
17A WESTWICK GARDENS  
LONDON, UNITED KINGDOM W140BU

FOR: RHUBARB LIQUEUR, IN CLASS 33 (U.S. CLS. 47 AND 49).

PRIORITY CLAIMED UNDER SEC. 44(D) ON UNITED KINGDOM APPLICATION NO.  
2584625, FILED 6-15-2011, REG. NO. 2584625, DATED 10-14-2011, EXPIRES 6-15-2021.

NO CLAIM IS MADE TO THE EXCLUSIVE RIGHT TO USE "RHUBARB LIQUEUR", APART  
FROM THE MARK AS SHOWN.

THE MARK CONSISTS OF THE WORDING "RHUBY RHUBARB LIQUEUR" WITHIN A  
RECTANGLE WITHIN AN OVAL CONTAINING A DECORATIVE PLANT DESIGN.

SER. NO. 85-379,398, FILED 7-24-2011.

KIM MONINGHOFF, EXAMINING ATTORNEY



*David J. Kyffers*

Director of the United States Patent and Trademark Office

# United States of America

United States Patent and Trademark Office



**Reg. No. 4,134,507**

**Registered May 1, 2012**

**Int. Cl.: 35**

**SERVICE MARK**

**PRINCIPAL REGISTER**

TRUE SOURCE HONEY, LLC (D.C. LIMITED LIABILITY COMPANY)  
SUITE 800  
ONE MASSACHUSETTS AVE., NW  
WASHINGTON, DC 20001

FOR: ASSOCIATION SERVICES, NAMELY, PROMOTING THE INTERESTS OF UNITED STATES HONEY PRODUCERS; PROMOTING PUBLIC AWARENESS OF THE BENEFITS OF DOMESTICALLY PRODUCED HONEY AND THE DANGERS TO SAFETY AND PURITY OF HONEY OBTAINED OR IMPORTED IN CIRCUMVENTION OF U.S. LAW, IN CLASS 35 (U.S. CLS. 100, 101 AND 102).

FIRST USE 1-11-2011; IN COMMERCE 1-11-2011.

NO CLAIM IS MADE TO THE EXCLUSIVE RIGHT TO USE "TRUE SOURCE HONEY", APART FROM THE MARK AS SHOWN.

THE COLOR(S) GREEN, YELLOW, BLACK, WHITE AND GREY IS/ARE CLAIMED AS A FEATURE OF THE MARK.

THE MARK CONSISTS OF THE WORD "HONEY" IN YELLOW, WITH A WHITE TAG ATTACHED TO THE "H" IN "HONEY" BY A BLACK LOOP. ON THE TAG IS THE WORDING "TRUE SOURCE" IN GREEN AND THE DESIGN OF A BEE. THE BEE HAS A YELLOW BODY, WHITE HEAD, AND BLACK OUTLINING.

SER. NO. 85-379,758, FILED 7-25-2011.

MARGERY A. TIERNEY, EXAMINING ATTORNEY



*David J. Kybas*

Director of the United States Patent and Trademark Office

# United States of America

United States Patent and Trademark Office

The logo for RIVERBATS features a stylized bat silhouette above the word "RIVERBATS" in a bold, sans-serif font. The bat's wings are spread wide, and its body is positioned above the letter 'V'.

**Reg. No. 4,134,508**

**Registered May 1, 2012**

**Int. Cls.: 16, 20, 21, 25  
and 41**

**TRADEMARK**

**SERVICE MARK**

**PRINCIPAL REGISTER**

AUSTIN COMMUNITY COLLEGE DISTRICT (TEXAS POLITICAL SUBDIVISION OF STATE OF TEXAS), AKA AUSTIN COMMUNITY COLLEGE AND ACC  
5930 MIDDLE FISKVILLE ROAD  
AUSTIN, TX 787524390

FOR: BUMPER STICKERS; DAILY PLANNERS; DECALS; DECORATIVE DECALS FOR VEHICLE WINDOWS; EVENT PROGRAMS; PRINTED MATERIALS, NAMELY, CURRICULA IN THE FIELD OF COMMUNITY COLLEGE EDUCATION, EXTRA-CURRICULAR ACTIVITIES AND COLLEGE EVENTS; SPIRAL-BOUND NOTEBOOKS; STICKERS AND TRANSFERS; WIRE-BOUND NOTEBOOKS, IN CLASS 16 (U.S. CLS. 2, 5, 22, 23, 29, 37, 38 AND 50).

FIRST USE 6-30-2011; IN COMMERCE 6-30-2011.

FOR: PLASTIC KEY CHAIN TAGS; PLASTIC KEY CHAINS, IN CLASS 20 (U.S. CLS. 2, 13, 22, 25, 32 AND 50).

FIRST USE 11-18-2010; IN COMMERCE 11-18-2010.

FOR: BEVERAGE GLASSWARE; BEVERAGEWARE; COFFEE MUGS; CUPS; DRINKING VESSELS; GLASS BEVERAGEWARE; GLASS MUGS; MUGS, IN CLASS 21 (U.S. CLS. 2, 13, 23, 29, 30, 33, 40 AND 50).

FIRST USE 11-18-2010; IN COMMERCE 11-18-2010.

FOR: ATHLETIC APPAREL, NAMELY, SHIRTS, PANTS, JACKETS, FOOTWEAR, HATS AND CAPS, ATHLETIC UNIFORMS; CAPS; COATS; COLLARED SHIRTS; HALTER TOPS; HEADWEAR; JACKETS AND SOCKS; SHORTS; SOCKS; SWEATSHIRTS; TANK TOPS; TEE SHIRTS; VESTS; VISORS, IN CLASS 25 (U.S. CLS. 22 AND 39).

FIRST USE 11-18-2010; IN COMMERCE 11-18-2010.

FOR: EDUCATING AT UNIVERSITY OR COLLEGES; EDUCATION SERVICES IN THE NATURE OF COURSES AT THE UNIVERSITY LEVEL; EDUCATION SERVICES, NAMELY, PROVIDING CLASSES AND ONLINE SESSIONS IN THE FIELD OF CAREER AND TECHNICAL TRAINING, PROFESSIONAL CONTINUING EDUCATION UNITS, ADULT EDUCATION, ENGLISH AS A SECOND LANGUAGE, AND THE FOLLOWING CORE CURRICULUM FIELDS DESIGNED TO BE TRANSFERRED TO ANOTHER COLLEGE OR UNIVERSITY:



*David J. Kybas*

Director of the United States Patent and Trademark Office

**Reg. No. 4,134,508** ANTHROPOLOGY, ARCHEOLOGY, ART, BIOLOGY, BUSINESS ADMINISTRATION, CHEMISTRY, COMPUTER SCIENCE, CREATIVE WRITING, DANCE, DRAMA, ECONOMICS, EDUCATION, ENGINEERING, ENGLISH, ENVIRONMENTAL SCIENCE AND TECHNOLOGY, FOREIGN LANGUAGE, GENERAL STUDIES, GEOGRAPHY, GEOLOGY, GOVERNMENT, HEALTH AND KINESIOLOGY, HISTORY, JOURNALISM, MATHEMATICS, MUSIC, PHILOSOPHY, PHYSICS/ASTRONOMY, PRE-DENTAL/PRE-MEDICAL/PRE-PHARMACY/PRE-VETERINARY, PSYCHOLOGY, RADIO-TELEVISION-FILM, SOCIAL WORK, SOCIOLOGY, SPEECH AND THE FOLLOWING CAREER AND TECHNICAL FIELDS: ACCOUNTING, AMERICAN SIGN LANGUAGE AND INTERPRETER TRAINING, ARCHITECTURAL AND ENGINEERING COMPUTER AIDED DESIGN, AUTO BODY COLLISION AND REFINISHING, AUTOMOTIVE TECHNOLOGY, BIOTECHNOLOGY, BUILDING CONSTRUCTION TECHNOLOGY, BUSINESS AND TECHNICAL COMMUNICATIONS, CHILD DEVELOPMENT, COMMERCIAL MUSIC MANAGEMENT, COMPUTER INFORMATION TECHNOLOGY, CRIMINAL JUSTICE, CULINARY ARTS, DENTAL HYGIENE, DIAGNOSTIC MEDICAL IMAGING-RADIOLOGY, ELECTRONICS AND APPLIED TECHNOLOGIES, EMERGENCY MEDICAL SERVICES PROFESSIONS, ENVIRONMENTAL TECHNOLOGY, FINANCIAL MANAGEMENT, FIRE PROTECTION, GAME DEVELOPMENT, HEATING, AIR CONDITIONING, REFRIGERATION TECHNOLOGY, HOSPITALITY MANAGEMENT, HUMAN SERVICES, INTERNATIONAL BUSINESS, JEWELRY, LAND SURVEYING TECHNOLOGY/GEOMATICS, MANAGEMENT, MARKETING, MEDICAL CODING, MEDICAL LABORATORY TECHNOLOGY, MEETING AND EVENTS PLANNING, NURSING-PROFESSIONAL, NURSING-VOCATIONAL, OCCUPATIONAL THERAPY ASSISTANT, OFFICE ADMINISTRATION, PARALEGAL, PERSONAL FITNESS TRAINER, PHARMACY TECHNICIAN, PHOTOGRAPHIC TECHNOLOGY, PHYSICAL THERAPIST ASSISTANT, RADIO-TELEVISION-FILM, REAL ESTATE BROKER LICENSE, SONOGRAPHY, TRAVEL AND TOURISM, VISUAL COMMUNICATION, WELDING TECHNOLOGY, DEVELOPMENT EDUCATION.; EDUCATIONAL COUNSELING SERVICES TO ASSIST STUDENTS IN PLANNING AND PREPARING FOR FURTHER EDUCATION; EDUCATIONAL SERVICES IN THE NATURE OF CORRESPONDENCE SCHOOLS; EDUCATIONAL TESTING; LIBRARIES; PROVIDING COURSES OF INSTRUCTION AT THE HIGH SCHOOL, COLLEGE PREPARATORY, VOCATIONAL AND UNIVERSITY LEVEL, IN CLASS 41 (U.S. CLS. 100, 101 AND 107).

FIRST USE 7-21-2011; IN COMMERCE 7-21-2011.

THE MARK CONSISTS OF A STYLIZED VERSION OF THE WORD "RIVERBATS" IN ALL CAPITAL LETTERS. THE FIGURE OF A BAT WITH A "V" SHAPED BODY SUPPLIES LETTER "V" IN THE WORD "RIVERBATS" AND THE TWO WINGS OF THE BAT FIGURE APPEAR ABOVE THE OTHER LETTERS OF THE WORD "RIVERBATS".

SER. NO. 85-379,779, FILED 7-25-2011.

FONG HSU, EXAMINING ATTORNEY

# United States of America

United States Patent and Trademark Office

## American Mystique

**Reg. No. 4,134,509**

**Registered May 1, 2012**

**Int. Cl.: 35**

**SERVICE MARK**

**PRINCIPAL REGISTER**

ADAMS, MAXINE E. (UNITED STATES INDIVIDUAL)  
709 E. SUMMIT AV.  
FERGUS FALLS, MN 56537 AND

ADAMS, DAVID J. (UNITED STATES INDIVIDUAL), DBA AMERICAN MYSTIQUE  
709 E. SUMMIT AV.  
FERGUS FALLS, MN 56537

FOR: RETAIL STORE SERVICES FEATURING CLOTHING; ONLINE RETAIL STORE SERVICES FEATURING CLOTHING, IN CLASS 35 (U.S. CLS. 100, 101 AND 102).

FIRST USE 1-1-2001; IN COMMERCE 1-1-2001.

THE MARK CONSISTS OF STANDARD CHARACTERS WITHOUT CLAIM TO ANY PARTICULAR FONT, STYLE, SIZE, OR COLOR.

NO CLAIM IS MADE TO THE EXCLUSIVE RIGHT TO USE "AMERICAN", APART FROM THE MARK AS SHOWN.

SER. NO. 85-379,911, FILED 7-25-2011.

JULIE GUTTADAURO, EXAMINING ATTORNEY



*David J. Kyffers*

Director of the United States Patent and Trademark Office

# United States of America

United States Patent and Trademark Office



**Reg. No. 4,134,510**

**Registered May 1, 2012**

**Int. Cl.: 35**

**SERVICE MARK**

**PRINCIPAL REGISTER**

ZIP INTERNATIONAL GROUP, LLC (NEW JERSEY LIMITED LIABILITY COMPANY)  
160 RARITAN CENTER PARKWAY  
#6  
EDISON, NJ 08837

FOR: WHOLESALE DISTRIBUTORSHIPS FEATURING FOOD PRODUCTS, IN CLASS 35  
(U.S. CLS. 100, 101 AND 102).

FIRST USE 1-10-1997; IN COMMERCE 2-1-1997.

THE MARK CONSISTS OF A BLUE CIRCLE WHEREIN THE WORD "ZIP" IS WRITTEN IN RED BORDERED BY WHITE. A RED CROWN IN A WHITE CIRCLE IS USED AS THE DOT FOR THE "I" IN "ZIP" AS SHOWN IN THE MARK.

THE COLOR(S) BLUE, RED AND WHITE IS/ARE CLAIMED AS A FEATURE OF THE MARK.

SER. NO. 85-380,592, FILED 7-26-2011.

NAKIA HENRY, EXAMINING ATTORNEY



*David J. Kybas*

Director of the United States Patent and Trademark Office

# United States of America

United States Patent and Trademark Office

## Meals-on-Wheels of Johnson and Ellis Counties

**Reg. No. 4,134,511**

**Registered May 1, 2012**

**Int. Cl.: 43**

**SERVICE MARK**

**PRINCIPAL REGISTER**

JOHNSON COUNTY COMMITTEE ON AGING (TEXAS NON-PROFIT CORPORATION),  
DBA MEALS-ON-WHEELS OF JOHNSON AND ELLIS COUNTIES  
106 E. KILPATRICK STREET  
CLEBURNE, TX 76031

FOR: CHARITABLE SERVICES, NAMELY, PROVIDING FOOD TO NEEDY PERSONS, IN  
CLASS 43 (U.S. CLS. 100 AND 101).

FIRST USE 1-1-2004; IN COMMERCE 1-1-2004.

THE MARK CONSISTS OF STANDARD CHARACTERS WITHOUT CLAIM TO ANY PAR-  
TICULAR FONT, STYLE, SIZE, OR COLOR.

NO CLAIM IS MADE TO THE EXCLUSIVE RIGHT TO USE "MEALS-ON-WHEELS", APART  
FROM THE MARK AS SHOWN.

SEC. 2(F).

SER. NO. 85-380,820, FILED 7-26-2011.

CHRISTOPHER LAW, EXAMINING ATTORNEY



*David J. Kyros*

Director of the United States Patent and Trademark Office



United States of America  
United States Patent and Trademark Office

# FROOTIES

**Reg. No. 4,134,512**

**Registered May 1, 2012**

**Int. Cl.: 30**

**TRADEMARK**

**PRINCIPAL REGISTER**

TOOTSIE ROLL INDUSTRIES, LLC (DELAWARE LIMITED LIABILITY COMPANY)  
7401 SOUTH CICERO AVENUE  
CHICAGO, IL 60629

FOR: CANDY, IN CLASS 30 (U.S. CL. 46).

FIRST USE 1-15-1982; IN COMMERCE 1-15-1982.

THE MARK CONSISTS OF STANDARD CHARACTERS WITHOUT CLAIM TO ANY PARTICULAR FONT, STYLE, SIZE, OR COLOR.

OWNER OF U.S. REG. NOS. 1,255,474, 3,775,158, AND 3,775,159.

SER. NO. 85-380,932, FILED 7-26-2011.

JOHN DALIER, EXAMINING ATTORNEY



*David J. Kybas*

Director of the United States Patent and Trademark Office

# United States of America

United States Patent and Trademark Office

## GARDEN STATE PARKWAY

**Reg. No. 4,134,513**

**Registered May 1, 2012**

**Int. Cl.: 37**

**SERVICE MARK**

**PRINCIPAL REGISTER**

NEW JERSEY TURNPIKE AUTHORITY (NEW JERSEY QUASI-STATE GOVERNMENT AGENCY)  
P.O. BOX 5042  
WOODBIDGE, NJ 07095

FOR: HIGHWAY MANAGEMENT AND MAINTENANCE SERVICES, NAMELY, MAINTENANCE AND REPAIR OF HIGHWAY GUIDERAILS, HIGHWAY SIGNS, TOLL BOOTHS, PEDESTRIAN WALKWAYS AND OVERPASSES, ROADS, SERVICE AREAS, REST AREAS, COMMUTER PARKING LOTS, TOLL COLLECTION EQUIPMENT, AND TOLL COLLECTION FACILITIES, IN CLASS 37 (U.S. CLS. 100, 103 AND 106).

FIRST USE 0-0-1956; IN COMMERCE 0-0-1956.

THE MARK CONSISTS OF STANDARD CHARACTERS WITHOUT CLAIM TO ANY PARTICULAR FONT, STYLE, SIZE, OR COLOR.

OWNER OF U.S. REG. NO. 2,452,349.

SEC. 2(F).

SER. NO. 85-381,312, FILED 7-26-2011.

JAY FLOWERS, EXAMINING ATTORNEY



*David J. Kyffers*

Director of the United States Patent and Trademark Office

# United States of America

United States Patent and Trademark Office

## SOUTH COUNTY HYDROPONICS

**Reg. No. 4,134,514**

**Registered May 1, 2012**

**Int. Cl.: 35**

**SERVICE MARK**

**PRINCIPAL REGISTER**

SOUTH COUNTY HYDROPONICS & ORGANICS, INC. (CALIFORNIA CORPORATION)  
22511 ASPAN STREET, UNIT A  
LAKE FOREST, CA 92630

FOR: RETAIL STORE SERVICES AND ONLINE WEBSITE BASED RETAIL STORE SERVICES  
FEATURING GARDENING PRODUCTS, IN CLASS 35 (U.S. CLS. 100, 101 AND 102).

FIRST USE 3-1-2003; IN COMMERCE 3-1-2003.

THE MARK CONSISTS OF STANDARD CHARACTERS WITHOUT CLAIM TO ANY PAR-  
TICULAR FONT, STYLE, SIZE, OR COLOR.

NO CLAIM IS MADE TO THE EXCLUSIVE RIGHT TO USE "HYDROPONICS", APART  
FROM THE MARK AS SHOWN.

SEC. 2(F).

SER. NO. 85-381,603, FILED 7-26-2011.

JANICE L. MCMORROW, EXAMINING ATTORNEY



*David J. Kyffers*

Director of the United States Patent and Trademark Office

# United States of America

United States Patent and Trademark Office

## ISLANDS OF BEAUFORT

**Reg. No. 4,134,515**

**Registered May 1, 2012**

**Int. Cl.: 35**

**SERVICE MARK**

**PRINCIPAL REGISTER**

ISLANDS OF BEAUFORT HOMEOWNERS ASSOCIATION (SOUTH CAROLINA NON-PROFIT ASSOCIATION)  
316 ISLANDS AVENUE  
BEAUFORT, SC 29902

FOR: HOMEOWNER ASSOCIATION SERVICES, NAMELY, PROMOTING THE INTERESTS OF HOMEOWNERS IN A SPECIFIC COMMUNITY AND MARKETING THE COMMUNITY NATIONWIDE TO PROSPECTIVE NEW RESIDENTS AND PROPERTY OWNERS; ADVERTISING OF RESIDENTIAL REAL ESTATE, IN CLASS 35 (U.S. CLS. 100, 101 AND 102).

FIRST USE 1-1-1999; IN COMMERCE 1-1-1999.

THE MARK CONSISTS OF STANDARD CHARACTERS WITHOUT CLAIM TO ANY PARTICULAR FONT, STYLE, SIZE, OR COLOR.

SEC. 2(F).

SER. NO. 85-381,870, FILED 7-27-2011.

SHAUNIA CARLYLE, EXAMINING ATTORNEY



*David J. Kyffers*

Director of the United States Patent and Trademark Office

# United States of America

United States Patent and Trademark Office

# deleteitnow.com

**Reg. No. 4,134,516**

**Registered May 1, 2012**

**Int. Cl.: 44**

**SERVICE MARK**

**PRINCIPAL REGISTER**

DELETE, LLC (ARIZONA LIMITED LIABILITY COMPANY)  
4902 N 45TH PLACE  
PHOENIX, AZ 85018

FOR: LASER TATTOO REMOVAL SERVICE, IN CLASS 44 (U.S. CLS. 100 AND 101).

FIRST USE 11-11-2010; IN COMMERCE 11-11-2010.

THE MARK CONSISTS OF STANDARD CHARACTERS WITHOUT CLAIM TO ANY PARTICULAR FONT, STYLE, SIZE, OR COLOR.

SER. NO. 85-382,362, FILED 7-27-2011.

SHAILA SETTLES, EXAMINING ATTORNEY



*David J. Kyffers*

Director of the United States Patent and Trademark Office

# United States of America

United States Patent and Trademark Office

**MCKINLEY**  
**ALEXANDRA**



**Reg. No. 4,134,517**

**Registered May 1, 2012**

**Int. Cl.: 42**

**SERVICE MARK**

**PRINCIPAL REGISTER**

MCKINLEY-ALEXANDRA LLC (OHIO LIMITED LIABILITY COMPANY)  
1205 ARTESIAN LANE  
FAIRBORN, OH 45324

FOR: CUSTOMIZED SOFTWARE DEVELOPMENT SERVICES; IT CONSULTING SERVICES;  
IT INTEGRATION SERVICES; REMOTE COMPUTER NETWORK TECHNICAL MONITORING  
AND SOFTWARE MAINTENANCE SERVICES , IN CLASS 42 (U.S. CLS. 100 AND 101).

FIRST USE 9-15-2008; IN COMMERCE 9-15-2008.

THE NAME(S), PORTRAIT(S), AND/OR SIGNATURE(S) SHOWN IN THE MARK DOES NOT  
IDENTIFY A PARTICULAR LIVING INDIVIDUAL.

THE MARK CONSISTS OF THE STYLIZED TEXT "MCKINLEY ALEXANDRA" WITH AN  
ABSTRACT DESIGN CONSISTING OF FOUR CURVED BARS ON THE RIGHT.

SER. NO. 85-382,718, FILED 7-27-2011.

KATHLEEN M. VANSTON, EXAMINING ATTORNEY



*David J. Kybas*

Director of the United States Patent and Trademark Office

# United States of America

United States Patent and Trademark Office

## Find To Fund

**Reg. No. 4,134,518**

**Registered May 1, 2012**

**Int. Cls.: 35 and 36**

**SERVICE MARK**

**PRINCIPAL REGISTER**

FIND TO FUND, INC. (DELAWARE CORPORATION)  
P. O. BOX 1065  
LA JOLLA, CA 92038

FOR: ADVERTISING SERVICES, NAMELY, ADVERTISING ON THE INTERNET FOR NOT-FOR-PROFIT INSTITUTIONS AND PROJECTS FOR PURPOSES OF PHILANTHROPY, IN CLASS 35 (U.S. CLS. 100, 101 AND 102).

FIRST USE 6-9-2010; IN COMMERCE 1-21-2011.

FOR: PHILANTHROPIC SERVICES CONCERNING MONETARY DONATIONS, IN CLASS 36 (U.S. CLS. 100, 101 AND 102).

FIRST USE 6-9-2010; IN COMMERCE 1-21-2011.

THE MARK CONSISTS OF STANDARD CHARACTERS WITHOUT CLAIM TO ANY PARTICULAR FONT, STYLE, SIZE, OR COLOR.

SER. NO. 85-382,720, FILED 7-27-2011.

NICHOLAS ALTREE, EXAMINING ATTORNEY



*David J. Kyjars*

Director of the United States Patent and Trademark Office

# United States of America

United States Patent and Trademark Office



**Reg. No. 4,134,519**

**Registered May 1, 2012**

**Int. Cl.: 9**

**TRADEMARK**

**PRINCIPAL REGISTER**

T-MOBILE USA, INC. (DELAWARE CORPORATION)  
12920 S.E. 38TH STREET  
BELLEVUE, WA 98006

FOR: DOWNLOADABLE COMPUTER ENTERTAINMENT SOFTWARE FOR MOBILE TELEPHONES FOR AUTOMATICALLY DOWNLOADING AND REFRESHING WALLPAPER GRAPHICS CONSISTING OF WEB CAM IMAGES FOR MOBILE TELEPHONE DISPLAYS, IN CLASS 9 (U.S. CLS. 21, 23, 26, 36 AND 38).

FIRST USE 8-5-2009; IN COMMERCE 8-5-2009.

THE MARK CONSISTS OF THE EARTH WITH CONTINENTS PRESENTED IN BLUE AND OCEANS PRESENTED IN LIGHT BLUE, WITH A ROUND WEBCAM PRESENTED IN GRAY WITH A BLACK LENS FEATURE AND A RED LIGHT RESTING ON THE NORTH POLE WITH A USB CABLE PRESENTED IN SHADES OF GRAY, WHITE AND BLACK EMERGING FROM THE WEBCAM'S LOWER RIGHT AND WRAPPING TWICE AROUND THE EARTH, AND ADDITIONALLY FEATURING TWELVE CIRCLES IDENTIFYING GEOGRAPHIC LOCATIONS ON THE EARTH AND PRESENTED IN SHADES OF RED, GREEN AND ORANGE.

THE COLOR(S) BLUE, LIGHT BLUE, RED, GREEN, ORANGE, GRAY, WHITE AND BLACK IS/ARE CLAIMED AS A FEATURE OF THE MARK.

SER. NO. 85-382,855, FILED 7-27-2011.

WILLIAM BRECKENFELD, EXAMINING ATTORNEY



*David J. Kyffers*

Director of the United States Patent and Trademark Office



# United States of America

United States Patent and Trademark Office

## YOUTH INSIGHT

**Reg. No. 4,134,520**

**Registered May 1, 2012**

**Int. Cl.: 42**

**SERVICE MARK**

**PRINCIPAL REGISTER**

TERBEN INCORPORATED (CALIFORNIA CORPORATION)  
4180 ELMER AVENUE  
STUDIO CITY, CA 916023336

FOR: SOFTWARE AS A SERVICE (SAAS) SERVICES, NAMELY, HOSTING SOFTWARE FOR USE BY OTHERS FOR USE IN THE AGGREGATION OF CASE MANAGEMENT, EDUCATION, LEGAL, HEALTH, AND OTHER DATA ABOUT INDIVIDUAL AT-RISK YOUTHS INCLUDING FOSTER CHILDREN, YOUTH ON PROBATION, HOMELESS, AND OTHER YOUTHS UNDER THE CARE AND/OR SUPERVISION OF LOCAL, STATE, OR NATIONAL GOVERNMENT AGENCIES, AND PROVIDE CONTROLLED ACCESS TO THAT DATA BY INDIVIDUALS INVOLVED IN THE CASE MANAGEMENT OR CARE PROVISION FOR THOSE YOUTHS, IN CLASS 42 (U.S. CLS. 100 AND 101).

FIRST USE 5-7-2005; IN COMMERCE 8-25-2005.

THE MARK CONSISTS OF STANDARD CHARACTERS WITHOUT CLAIM TO ANY PARTICULAR FONT, STYLE, SIZE, OR COLOR.

NO CLAIM IS MADE TO THE EXCLUSIVE RIGHT TO USE "YOUTH", APART FROM THE MARK AS SHOWN.

SER. NO. 85-382,868, FILED 7-27-2011.

TRICIA SONNEBORN, EXAMINING ATTORNEY



*David J. Kyffers*

Director of the United States Patent and Trademark Office

# United States of America

United States Patent and Trademark Office

## HEAVY WEAPON

**Reg. No. 4,134,521**

DESJARDIN, DAVID J (UNITED STATES INDIVIDUAL)  
1280 PUGET DR. E  
PORT ORCHARD, WA 98366

**Registered May 1, 2012**

**Int. Cl.: 16**

FOR: COMIC BOOKS; COMIC MAGAZINES; COMICS; GRAPHIC NOVELS, IN CLASS 16  
(U.S. CLS. 2, 5, 22, 23, 29, 37, 38 AND 50).

**TRADEMARK**

FIRST USE 9-0-2007; IN COMMERCE 1-16-2011.

**PRINCIPAL REGISTER**

THE MARK CONSISTS OF STANDARD CHARACTERS WITHOUT CLAIM TO ANY PARTICULAR FONT, STYLE, SIZE, OR COLOR.

SER. NO. 85-382,980, FILED 7-27-2011.

ANGELA M. MICHELI, EXAMINING ATTORNEY



*David J. Kybas*

Director of the United States Patent and Trademark Office

# United States of America

United States Patent and Trademark Office



**Reg. No. 4,134,522**

**Registered May 1, 2012**

**Int. Cls.: 11, 20 and 21**

**TRADEMARK**

**PRINCIPAL REGISTER**

HARDWARE HOUSE, LLC (ALABAMA LIMITED LIABILITY COMPANY)  
P.O. BOX 249  
ATCHISON, KS 66002

FOR: CEILING FANS; LIGHT BULBS, ELECTRIC LIGHTING FIXTURES; OUTDOOR ELECTRIC LIGHTING FIXTURES, IN CLASS 11 (U.S. CLS. 13, 21, 23, 31 AND 34).

FIRST USE 6-1-2001; IN COMMERCE 6-1-2001.

FOR: BATHROOM VANITIES; MEDICINE CABINETS, IN CLASS 20 (U.S. CLS. 2, 13, 22, 25, 32 AND 50).

FIRST USE 4-1-2004; IN COMMERCE 4-1-2004.

FOR: MOPS; BROOMS; FLOOR BRUSHES; TOWEL RINGS, IN CLASS 21 (U.S. CLS. 2, 13, 23, 29, 30, 33, 40 AND 50).

FIRST USE 1-1-2001; IN COMMERCE 1-1-2001.

OWNER OF U.S. REG. NOS. 3,005,372 AND 3,343,640.

THE MARK CONSISTS OF TWO STYLIZED LETTER "H"'S IN A HOUSE DESIGN.

SER. NO. 85-383,239, FILED 7-28-2011.

WILLIAM BRECKENFELD, EXAMINING ATTORNEY



*David J. Kybas*

Director of the United States Patent and Trademark Office

# United States of America

United States Patent and Trademark Office

## HARDWARE HOUSE

**Reg. No. 4,134,523**

**Registered May 1, 2012**

**Int. Cls.: 11, 19, 20 and 21**

**TRADEMARK**

**PRINCIPAL REGISTER**

HARDWARE HOUSE, LLC (ALABAMA LIMITED LIABILITY COMPANY)  
P.O. BOX 249  
ATCHISON, KS 66002

FOR: CEILING FANS, IN CLASS 11 (U.S. CLS. 13, 21, 23, 31 AND 34).

FIRST USE 6-1-2001; IN COMMERCE 6-1-2001.

FOR: ROCK MATERIALS USED IN THE MANUFACTURE OF COUNTERTOPS, WORKTOPS, AND VANITY TOPS; NON-METAL FLOOR TILES, IN CLASS 19 (U.S. CLS. 1, 12, 33 AND 50).

FIRST USE 4-1-2004; IN COMMERCE 4-1-2004.

FOR: BATHROOM VANITIES; MEDICINE CABINETS, IN CLASS 20 (U.S. CLS. 2, 13, 22, 25, 32 AND 50).

FIRST USE 4-1-2004; IN COMMERCE 4-1-2004.

FOR: MOPS; BROOMS; FLOOR BRUSHES; TOWEL RINGS, IN CLASS 21 (U.S. CLS. 2, 13, 23, 29, 30, 33, 40 AND 50).

FIRST USE 1-1-2001; IN COMMERCE 1-1-2001.

THE MARK CONSISTS OF STANDARD CHARACTERS WITHOUT CLAIM TO ANY PARTICULAR FONT, STYLE, SIZE, OR COLOR.

OWNER OF U.S. REG. NOS. 2,148,606 AND 2,969,823.

NO CLAIM IS MADE TO THE EXCLUSIVE RIGHT TO USE "HARDWARE", APART FROM THE MARK AS SHOWN.

SER. NO. 85-383,255, FILED 7-28-2011.

WILLIAM BRECKENFELD, EXAMINING ATTORNEY



*David J. Kyros*

Director of the United States Patent and Trademark Office

# United States of America

United States Patent and Trademark Office



**Reg. No. 4,134,524**

**Registered May 1, 2012**

**Int. Cl.: 41**

**SERVICE MARK**

**PRINCIPAL REGISTER**

NEW ENGLAND DRAGWAY, INC. (NEW HAMPSHIRE CORPORATION)  
P. O. BOX 1320  
EPPING, NH 03042

FOR: PROVIDING MOTOCROSS AND BIKE RACING FACILITIES, IN CLASS 41 (U.S. CLS. 100, 101 AND 107).

FIRST USE 5-15-2009; IN COMMERCE 5-15-2009.

NO CLAIM IS MADE TO THE EXCLUSIVE RIGHT TO USE "EPPING, NH", APART FROM THE MARK AS SHOWN.

THE COLOR(S) BLACK, RED AND WHITE IS/ARE CLAIMED AS A FEATURE OF THE MARK.

THE MARK CONSISTS OF A BLACK FOUR SIDED SHAPE OUTLINED IN RED CONTAINING THE LETTERS "M" AND "X" IN RED OUTLINED IN WHITE TO THE LEFT OF THE NUMBERS "101" IN RED HIGHLIGHTED MID CHARACTER IN WHITE AND OUTLINED IN WHITE WITH THE FIRST "1" TOUCHING THE "X" ABOVE THE WORD "EPPING" FOLLOWED BY A COMMA FOLLOWED BY THE LETTERS "NH" WHICH ARE IN RED, HIGHLIGHTED MID CHARACTER IN WHITE AND OUTLINED IN WHITE.

SER. NO. 85-384,219, FILED 7-29-2011.

GRETTA YAO, EXAMINING ATTORNEY



*David J. Kyffers*

Director of the United States Patent and Trademark Office

# United States of America

United States Patent and Trademark Office



**Reg. No. 4,134,525**

**Registered May 1, 2012**

**Int. Cl.: 41**

**SERVICE MARK**

**PRINCIPAL REGISTER**

NEW ENGLAND DRAGWAY, INC. (NEW HAMPSHIRE CORPORATION)  
P. O. BOX 1320  
EPPING, NH 03042

FOR: PROVIDING DRAG STRIP FACILITIES, IN CLASS 41 (U.S. CLS. 100, 101 AND 107).

FIRST USE 1-1-2001; IN COMMERCE 1-1-2001.

OWNER OF U.S. REG. NO. 920,934.

THE COLOR(S) GOLD, BLACK AND WHITE IS/ARE CLAIMED AS A FEATURE OF THE MARK.

THE MARK CONSISTS OF THE WORDS "NEW ENGLAND" IN GOLD LETTERS WITH BLACK SHADOWING ABOVE THE STYLIZED WORD "DRAGWAY" IN WHITE LETTERS OUTLINED IN BLACK AND UNDERSCORED BY DRAWING OF A GOLD MEANDERING ROADWAY OUTLINED IN BLACK.

SEC. 2(F) AS TO "NEW ENGLAND DRAGWAY".

SER. NO. 85-384,223, FILED 7-29-2011.

GRETТА YAO, EXAMINING ATTORNEY



*David J. Kybas*

Director of the United States Patent and Trademark Office

# United States of America

United States Patent and Trademark Office

## STICKMAN SKATER

**Reg. No. 4,134,526**

**Registered May 1, 2012**

**Int. Cl.: 9**

**TRADEMARK**

**PRINCIPAL REGISTER**

TURBO CHILLI PTY LTD (AUSTRALIA PRIVATE LIMITED COMPANY)  
37 YORK STREET; LEVEL 14  
SYDNEY, AUSTRALIA NSW2000

FOR: COMPUTER GAMES ENTERTAINMENT SOFTWARE; COMPUTER GAMES PROGRAMS; COMPUTER PROGRAMS FOR COMPUTER GAMES; PROGRAMS FOR USE WITH COMPUTER GAMES; COMPUTER PROGRAMS FOR VIDEO GAMES; PROGRAMMED VIDEO GAMES; ELECTRONIC GAMES FOR HAND HELD DEVICES, MOBILE PHONES, COMPUTERS AND LAPTOP COMPUTERS; ELECTRONIC ARCADE GAMES, IN CLASS 9 (U.S. CLS. 21, 23, 26, 36 AND 38).

FIRST USE 3-31-2011; IN COMMERCE 3-31-2011.

THE MARK CONSISTS OF STANDARD CHARACTERS WITHOUT CLAIM TO ANY PARTICULAR FONT, STYLE, SIZE, OR COLOR.

SER. NO. 85-384,396, FILED 7-29-2011.

ALYSSA STEEL, EXAMINING ATTORNEY



*David J. Kybas*

Director of the United States Patent and Trademark Office

# United States of America

United States Patent and Trademark Office

## STICKMAN BMX

**Reg. No. 4,134,527**

**Registered May 1, 2012**

**Int. Cl.: 9**

**TRADEMARK**

**PRINCIPAL REGISTER**

TURBO CHILLI PTY LTD (AUSTRALIA PRIVATE LIMITED COMPANY)  
37 YORK STREET; LEVEL 14  
SYDNEY, AUSTRALIA NSW2000

FOR: COMPUTER GAMES ENTERTAINMENT SOFTWARE; COMPUTER GAMES PROGRAMS; COMPUTER PROGRAMS FOR COMPUTER GAMES; PROGRAMS FOR USE WITH COMPUTER GAMES; COMPUTER PROGRAMS FOR VIDEO GAMES; PROGRAMMED VIDEO GAMES; ELECTRONIC GAMES FOR HAND HELD DEVICES, MOBILE PHONES, COMPUTERS AND LAPTOP COMPUTERS; ELECTRONIC ARCADE GAMES, IN CLASS 9 (U.S. CLS. 21, 23, 26, 36 AND 38).

FIRST USE 7-17-2011; IN COMMERCE 7-17-2011.

THE MARK CONSISTS OF STANDARD CHARACTERS WITHOUT CLAIM TO ANY PARTICULAR FONT, STYLE, SIZE, OR COLOR.

SER. NO. 85-384,405, FILED 7-29-2011.

ALYSSA STEEL, EXAMINING ATTORNEY



*David J. Kybas*

Director of the United States Patent and Trademark Office



# United States of America

United States Patent and Trademark Office



**Reg. No. 4,134,528**

**Registered May 1, 2012**

**Int. Cl.: 24**

**TRADEMARK**

**PRINCIPAL REGISTER**

JABA USA INC. (CALIFORNIA CORPORATION)  
159 N. SUNSET AVE.  
CITY OF INDUSTRY, CA 91744

FOR: COMFORTERS, BED SPREADS, CURTAINS, PILLOW CASES, SHOWER CURTAINS  
AND TABLE LINEN, IN CLASS 24 (U.S. CLS. 42 AND 50).

FIRST USE 1-1-2006; IN COMMERCE 2-1-2011.

NO CLAIM IS MADE TO THE EXCLUSIVE RIGHT TO USE "HOME COLLECTIBLE", APART  
FROM THE MARK AS SHOWN.

THE COLOR(S) BLACK, WHITE AND GOLD IS/ARE CLAIMED AS A FEATURE OF THE  
MARK.

THE MARK CONSISTS OF A DESIGN OF CROWN IN GOLD COLOR ABOVE THE STYLIZED  
BLACK LETTERS "JCROWN" WITH A GOLD UNDERLINE, AND TWO BLACK LETTER  
"HOME COLLECTIBLE" ON THE BOTTOM. THE MARK APPEARS IN A BLACK RECT-  
ANGLE AND WITH A WHITE BACKGROUND.

SER. NO. 85-384,490, FILED 7-29-2011.

DANIEL CAPSHAW, EXAMINING ATTORNEY



*David J. Kyffers*

Director of the United States Patent and Trademark Office

**United States of America**  
United States Patent and Trademark Office

**MEDOYEFF**

**Reg. No. 4,134,529**

**Registered May 1, 2012**

**Int. Cl.: 33**

**TRADEMARK**

**PRINCIPAL REGISTER**

BULL RUN DISTILLERY LLC (OREGON LIMITED LIABILITY COMPANY)  
2259 NW QUIMBY STREET  
PORTLAND, OR 97210

FOR: DISTILLED SPIRITS, IN CLASS 33 (U.S. CLS. 47 AND 49).

FIRST USE 8-1-2004; IN COMMERCE 8-1-2004.

THE MARK CONSISTS OF STANDARD CHARACTERS WITHOUT CLAIM TO ANY PARTICULAR FONT, STYLE, SIZE, OR COLOR.

THE WORDING "MEDOYEFF" HAS NO MEANING IN A FOREIGN LANGUAGE.

SER. NO. 85-384,547, FILED 7-29-2011.

RICHARD WHITE, EXAMINING ATTORNEY



*David J. Kyffers*

Director of the United States Patent and Trademark Office

# United States of America

United States Patent and Trademark Office

# LBC

**Reg. No. 4,134,530**

**Registered May 1, 2012**

**Int. Cl.: 35**

**SERVICE MARK**

**PRINCIPAL REGISTER**

LIGHT BULB CITY, INC. (CALIFORNIA CORPORATION)  
1762 TYLER AVE.  
SOUTH EL MONTE, CA 91733

FOR: ON-LINE RETAIL STORE AND DISTRIBUTORSHIP SERVICES FEATURING INDOOR AND OUTDOOR LIGHTING FIXTURES, LIGHTING SYSTEMS AND LIGHTING ACCESSORIES NAMELY, ELECTRICAL LIGHT BULBS, LED LIGHT BULBS, HALOGEN LIGHT BULBS, PORTABLE LIGHTING, SOLAR LIGHT FIXTURES, CEILING FANS, LAMPS, SCONCES, CHANDELIERS AND RECESSED LIGHTING DIMMERS, WIRES, COVER PLATES, CORDS, CLAMPS, TRACKING, HOUSINGS, CHAINS, CEILING FANS, LAMPS, SCONCES, CHANDELIERS AND RECESSED LIGHTING, IN CLASS 35 (U.S. CLS. 100, 101 AND 102).

FIRST USE 12-8-2004; IN COMMERCE 12-8-2004.

THE MARK CONSISTS OF STANDARD CHARACTERS WITHOUT CLAIM TO ANY PARTICULAR FONT, STYLE, SIZE, OR COLOR.

SER. NO. 85-385,240, FILED 7-29-2011.

RONALD AIKENS, EXAMINING ATTORNEY



*David J. Kyffers*

Director of the United States Patent and Trademark Office

# United States of America

United States Patent and Trademark Office

## Your China Desk in Silicon Valley

**Reg. No. 4,134,531**

**Registered May 1, 2012**

**Int. Cl.: 45**

**SERVICE MARK**

**PRINCIPAL REGISTER**

MARSON LAW P.C. (CALIFORNIA CORPORATION)  
SUITE 180  
800 W. EL CAMINO REAL  
MOUNTAIN VIEW, CA 94040

FOR: LEGAL CONSULTATION SERVICES, IN CLASS 45 (U.S. CLS. 100 AND 101).

FIRST USE 7-29-2011; IN COMMERCE 7-29-2011.

THE MARK CONSISTS OF STANDARD CHARACTERS WITHOUT CLAIM TO ANY PARTICULAR FONT, STYLE, SIZE, OR COLOR.

NO CLAIM IS MADE TO THE EXCLUSIVE RIGHT TO USE "SILICON VALLEY", APART FROM THE MARK AS SHOWN.

SER. NO. 85-385,258, FILED 7-29-2011.

DARRYL SPRUILL, EXAMINING ATTORNEY



*David J. Kybas*

Director of the United States Patent and Trademark Office

# United States of America

United States Patent and Trademark Office

## Optically Clean

**Reg. No. 4,134,532**

**Registered May 1, 2012**

**Int. Cls.: 3 and 30**

**TRADEMARK**

**PRINCIPAL REGISTER**

SALTWORKS, INC. (WASHINGTON CORPORATION)  
15000 WOODINVILLE REDMOND ROAD  
B-900  
WOODINVILLE, WA 98072

FOR: BATH SALTS, IN CLASS 3 (U.S. CLS. 1, 4, 6, 50, 51 AND 52).

FIRST USE 0-0-2009; IN COMMERCE 0-0-2009.

FOR: SALT; SEA SALT FOR COOKING , IN CLASS 30 (U.S. CL. 46).

FIRST USE 0-0-2009; IN COMMERCE 0-0-2009.

NO CLAIM IS MADE TO THE EXCLUSIVE RIGHT TO USE "CLEAN", APART FROM THE MARK AS SHOWN.

THE COLOR(S) DARK BLUE, BLUE AND LIGHT BLUE IS/ARE CLAIMED AS A FEATURE OF THE MARK.

THE MARK CONSISTS OF THE STYLIZED WORDING "OPTICALLY CLEAN" IN THE COLOR BLUE, WHERE THE WORDING "OPTICALLY" AND "CLEAN" ARE SEPARATED BY A DESIGN OF THREE CRESCENTS FORMING A GENERALLY CIRCULAR SHAPE. THE LEFT-MOST CRESCENT IS IN THE COLOR DARK BLUE, THE RIGHT-MOST CRESCENT IS IN THE COLOR LIGHT BLUE, AND THE CENTER CRESCENT IS IN THE COLOR BLUE. THE COLOR WHITE REPRESENTS TRANSPARENT AREAS OF THE MARK AND IS NOT A PART OF THE MARK.

SER. NO. 85-385,347, FILED 7-30-2011.

JAY BESCH, EXAMINING ATTORNEY



*David J. Kybas*

Director of the United States Patent and Trademark Office

# United States of America

United States Patent and Trademark Office



**Reg. No. 4,134,533**

**Registered May 1, 2012**

**Int. Cl.: 35**

**SERVICE MARK**

**PRINCIPAL REGISTER**

LIVE FOR ART GALLERY, LLC (MICHIGAN LIMITED LIABILITY COMPANY), DBA LIVE FOR ART GALLERY  
4819 ARBUTUS LANE  
BEULAH, MI 49617

FOR: ART GALLERIES; ART GALLERY SERVICES; ON-LINE ART GALLERIES, IN CLASS 35 (U.S. CLS. 100, 101 AND 102).

FIRST USE 6-15-2011; IN COMMERCE 6-15-2011.

NO CLAIM IS MADE TO THE EXCLUSIVE RIGHT TO USE "GALLERY", APART FROM THE MARK AS SHOWN.

THE COLOR(S) BLACK AND BLUE IS/ARE CLAIMED AS A FEATURE OF THE MARK.

THE MARK CONSISTS OF A CYAN BLUE PAINT SLOPCH AND SPATTER WITH THE WORDS "LIVE FOR ART GALLERY", WITH "LIVE" AND "GALLERY" IN BLACK AND "FOR ART" IN CYAN BLUE, IN A STACKED FORMAT BENEATH THE PAINT SLOPCH.

SER. NO. 85-385,404, FILED 7-30-2011.

AMY KELLY, EXAMINING ATTORNEY



*David J. Kyros*

Director of the United States Patent and Trademark Office

# United States of America

United States Patent and Trademark Office

# Healthy Envy

**Reg. No. 4,134,534**

**Registered May 1, 2012**

**Int. Cl.: 5**

**TRADEMARK**

**PRINCIPAL REGISTER**

GILBRETH SOLUTIONS (ARIZONA LIMITED LIABILITY COMPANY), DBA HEALTHY  
ENVY  
4015 W TOPEKA DR.  
GLENDALE, AZ 85308

FOR: NUTRITIONAL SUPPLEMENTS FOR PROMOTING WELLNESS, IN CLASS 5 (U.S.  
CLS. 6, 18, 44, 46, 51 AND 52).

FIRST USE 3-17-2009; IN COMMERCE 4-14-2009.

THE MARK CONSISTS OF STANDARD CHARACTERS WITHOUT CLAIM TO ANY PAR-  
TICULAR FONT, STYLE, SIZE, OR COLOR.

NO CLAIM IS MADE TO THE EXCLUSIVE RIGHT TO USE "HEALTHY", APART FROM  
THE MARK AS SHOWN.

SER. NO. 85-385,448, FILED 7-30-2011.

MARY CRAWFORD, EXAMINING ATTORNEY



*David J. Kyjars*

Director of the United States Patent and Trademark Office

# United States of America

United States Patent and Trademark Office



LIVE  
FOR ART  
GALLERY

**Reg. No. 4,134,535**

**Registered May 1, 2012**

**Int. Cl.: 35**

**SERVICE MARK**

**PRINCIPAL REGISTER**

LIVE FOR ART GALLERY, LLC (MICHIGAN LIMITED LIABILITY COMPANY), DBA LIVE FOR ART GALLERY  
4819 ARBUTUS LANE  
BEULAH, MI 49617

FOR: ART GALLERIES; ART GALLERY SERVICES; ON-LINE ART GALLERIES, IN CLASS 35 (U.S. CLS. 100, 101 AND 102).

FIRST USE 6-15-2011; IN COMMERCE 6-15-2011.

NO CLAIM IS MADE TO THE EXCLUSIVE RIGHT TO USE "GALLERY", APART FROM THE MARK AS SHOWN.

THE COLOR(S) BLACK AND RED IS/ARE CLAIMED AS A FEATURE OF THE MARK.

THE MARK CONSISTS OF A RED PAINT SPLOTCH WITH THE WORDS "LIVE FOR ART GALLERY", WITH "LIVE" AND "GALLERY" IN BLACK AND "FOR ART" IN RED, IN A STACKED FORMAT BENEATH THE PAINT SPLOTCH.

SER. NO. 85-385,484, FILED 7-31-2011.

AMY KELLY, EXAMINING ATTORNEY



*David J. Kypos*

Director of the United States Patent and Trademark Office



# United States of America

United States Patent and Trademark Office



**Reg. No. 4,134,536**

**Registered May 1, 2012**

**Int. Cl.: 35**

**SERVICE MARK**

**PRINCIPAL REGISTER**

LIVE FOR ART GALLERY, LLC (MICHIGAN LIMITED LIABILITY COMPANY), DBA LIVE FOR ART GALLERY  
4819 ARBUTUS LANE  
BEULAH, MI 49617

FOR: ART GALLERIES; ART GALLERY SERVICES; ON-LINE ART GALLERIES, IN CLASS 35 (U.S. CLS. 100, 101 AND 102).

FIRST USE 6-15-2011; IN COMMERCE 6-15-2011.

NO CLAIM IS MADE TO THE EXCLUSIVE RIGHT TO USE "GALLERY", APART FROM THE MARK AS SHOWN.

THE COLOR(S) BLACK AND LIME GREEN IS/ARE CLAIMED AS A FEATURE OF THE MARK.

THE MARK CONSISTS OF A LIME GREEN PAINT SPLOTCH AND SPATTER WITH THE WORDS "LIVE FOR ART GALLERY", WITH "LIVE" AND "GALLERY" IN BLACK AND "FOR ART" IN LIME GREEN, IN A STACKED FORMAT BENEATH THE PAINT SPLOTCH.

SER. NO. 85-385,485, FILED 7-31-2011.

AMY KELLY, EXAMINING ATTORNEY



*David J. Kybas*

Director of the United States Patent and Trademark Office

# United States of America

United States Patent and Trademark Office

# RLSA

**Reg. No. 4,134,537**

**Registered May 1, 2012**

**Int. Cl.: 7**

**TRADEMARK**

**PRINCIPAL REGISTER**

TOKYO ELECTRON LIMITED (JAPAN CORPORATION)  
3-1 AKASAKA 5-CHOME, MINATO-KU  
TOKYO, JAPAN

FOR: SEMICONDUCTOR MANUFACTURING MACHINES, IN CLASS 7 (U.S. CLS. 13, 19, 21, 23, 31, 34 AND 35).

THE MARK CONSISTS OF STANDARD CHARACTERS WITHOUT CLAIM TO ANY PARTICULAR FONT, STYLE, SIZE, OR COLOR.

OWNER OF JAPAN REG. NO. 5355779, DATED 9-24-2010, EXPIRES 9-24-2020.

SER. NO. 85-385,679, FILED S.R. 8-1-2011 AM. P.R. 11-28-2011.

SUNG IN, EXAMINING ATTORNEY



*David J. Kyffers*

Director of the United States Patent and Trademark Office

# United States of America

United States Patent and Trademark Office

# BLING

**Reg. No. 4,134,538**

**Registered May 1, 2012**

**Int. Cl.: 36**

**SERVICE MARK**

**PRINCIPAL REGISTER**

VISIWARE (FRANCE SOCIÉTÉ ANONYME (SA))  
2, RUE TROYON  
92310 SÈVRES, FRANCE

FOR: FINANCIAL SERVICES, NAMELY, PROVIDING A VIRTUAL CURRENCY INTENDED FOR USE BY MEMBERS OF AN ON-LINE COMMUNITY VIA A GLOBAL COMPUTER NETWORK, IN CLASS 36 (U.S. CLS. 100, 101 AND 102).

THE MARK CONSISTS OF STANDARD CHARACTERS WITHOUT CLAIM TO ANY PARTICULAR FONT, STYLE, SIZE, OR COLOR.

PRIORITY CLAIMED UNDER SEC. 44(D) ON ERPN CMNTY TM OFC APPLICATION NO. 009701822, FILED 2-1-2011, REG. NO. 009701822, DATED 7-5-2011, EXPIRES 2-1-2021.

SER. NO. 85-385,704, FILED 8-1-2011.

SHAUNIA CARLYLE, EXAMINING ATTORNEY



*David J. Kybas*

Director of the United States Patent and Trademark Office

# United States of America

United States Patent and Trademark Office

## SHARPTEK SUPPLY

**Reg. No. 4,134,539**

**Registered May 1, 2012**

**Int. Cl.: 35**

**SERVICE MARK**

**PRINCIPAL REGISTER**

MBH HOLDINGS, LLC (MARYLAND LIMITED LIABILITY COMPANY)  
7203 ROLLING DRIVE  
CHEVY CHASE, MD 20815

FOR: PROVIDING A WEBSITE USED TO PLACE ON-LINE WHOLESALE AND RETAIL ORDERS IN THE FIELD OF RESTAURANT EQUIPMENT PARTS AND ACCESSORIES, IN CLASS 35 (U.S. CLS. 100, 101 AND 102).

FIRST USE 11-1-2011; IN COMMERCE 11-1-2011.

THE MARK CONSISTS OF STANDARD CHARACTERS WITHOUT CLAIM TO ANY PARTICULAR FONT, STYLE, SIZE, OR COLOR.

NO CLAIM IS MADE TO THE EXCLUSIVE RIGHT TO USE "SUPPLY", APART FROM THE MARK AS SHOWN.

SER. NO. 85-385,840, FILED 8-1-2011.

BRIDGETT SMITH, EXAMINING ATTORNEY



*David J. Kyros*

Director of the United States Patent and Trademark Office

# United States of America

United States Patent and Trademark Office



The Power of  
Electronics  
Recycling

**Reg. No. 4,134,540**

STS ELECTRONIC RECYCLING, INC. (TEXAS CORPORATION)  
522 CR 1520  
JACKSONVILLE, TX 75766

**Registered May 1, 2012**

**Int. Cl.: 40**

FOR: SORTING OF WASTE AND RECYCLABLE MATERIAL, IN CLASS 40 (U.S. CLS. 100, 103 AND 106).

**SERVICE MARK**

FIRST USE 2-2-2011; IN COMMERCE 2-10-2011.

**PRINCIPAL REGISTER**

NO CLAIM IS MADE TO THE EXCLUSIVE RIGHT TO USE "ELECTRONICS RECYCLING", APART FROM THE MARK AS SHOWN.

THE COLOR(S) RED AND GREEN IS/ARE CLAIMED AS A FEATURE OF THE MARK.

THE MARK CONSISTS OF A GREEN CIRCLE WITH RED INLINES RESEMBLING A POWER BUTTON FROM A COMPUTER. THE INNER RED LINE IS IN THE SHAPE OF AN ELECTRONIC PLUG. THE WORDING "THE POWER OF ELECTRONICS RECYCLING" IS IN RED ON THE RIGHT SIDE OF THE POWER BUTTON. THE WHITE RECTANGLE REPRESENTS BACKGROUND ONLY AND IS NOT PART OF THE MARK.

SER. NO. 85-385,855, FILED 8-1-2011.

JAMES A. RAUEN, EXAMINING ATTORNEY



*David J. Kyffers*

Director of the United States Patent and Trademark Office

# United States of America

United States Patent and Trademark Office

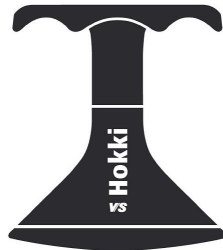

**Reg. No. 4,134,541**

**Registered May 1, 2012**

**Int. Cl.: 20**

**TRADEMARK**

**PRINCIPAL REGISTER**

VS VEREINIGTE SPEZIALMOBELFABRIKEN GMBH & CO. KG (FED REP GERMANY  
GMBH & CO. KG)  
HOCHHAUSER STR. 8  
TAUBERBISCHOFSEIM, FED REP GERMANY D-97941

FOR: SEATING FURNITURE; STOOLS, IN CLASS 20 (U.S. CLS. 2, 13, 22, 25, 32 AND 50).

FIRST USE 6-24-2010; IN COMMERCE 6-24-2010.

OWNER OF U.S. REG. NOS. 3,029,404 AND 3,976,672.

THE MARK CONSISTS OF A DEPICTION OF A STOOL WITH A TRIANGULAR BASE  
ROUNDED AT THE BOTTOM, AND WHERE THE TOP OF THE STOOL IS FLAT ON THE  
TOP AND HAS SCALLOPED EDGING BELOW. ON THE TRIANGULAR BASE OF THE  
STOOL THE WORDING "HOKKI" APPEARS IN STYLIZED VERTICAL LETTERING. BELOW  
THE WORD "HOKKI" IS THE STYLIZED LETTERING "VS" DISPLAYED HORIZONTALLY.

SER. NO. 85-385,919, FILED 8-1-2011.

ANDREA HACK, EXAMINING ATTORNEY



*David J. Kybas*

Director of the United States Patent and Trademark Office

# United States of America

United States Patent and Trademark Office

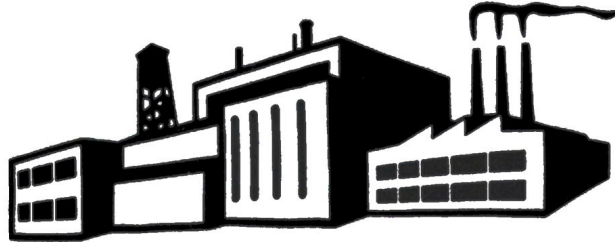

**Reg. No. 4,134,542**

**Registered May 1, 2012**

**Int. Cls.: 16, 20 and 24**

**TRADEMARK**

**PRINCIPAL REGISTER**

BRAND DESIGN COMPANY, INC. (DELAWARE CORPORATION), DBA HOUSE INDUSTRIES  
P.O. BOX 166, 1145 YORKLYN ROAD  
YORKLYN, DE 19736

FOR: PRINTED MATTER, NAMELY, PAPER SIGNS, BOOKS, MANUALS, CURRICULUM, NEWSLETTERS, INFORMATIONAL CARDS AND BROCHURES IN THE FIELD OF DESIGN, GRAPHIC DESIGN, INDUSTRIAL DESIGN, TYPOGRAPHY, TYPE FONTS, CULTURE, POP-CULTURE AND LIFESTYLE, IN CLASS 16 (U.S. CLS. 2, 5, 22, 23, 29, 37, 38 AND 50).

FIRST USE 11-1-1993; IN COMMERCE 11-1-1993.

FOR: FURNITURE, IN CLASS 20 (U.S. CLS. 2, 13, 22, 25, 32 AND 50).

FIRST USE 11-1-1993; IN COMMERCE 11-1-1993.

FOR: TABLECLOTHS OF TEXTILES; TAPESTRIES OF TEXTILE; TEXTILE FABRIC OF ANIMAL SKINS IMITATIONS; TEXTILE FABRICS FOR HOME AND COMMERCIAL INTERIORS; TEXTILE HANDKERCHIEFS; TEXTILE NAPKINS; TEXTILE PLACE MATS; TEXTILE TABLECLOTHS; TEXTILE USED AS LINING FOR CLOTHING; TEXTILE WALL HANGINGS, IN CLASS 24 (U.S. CLS. 42 AND 50).

FIRST USE 11-1-1993; IN COMMERCE 11-1-1993.

OWNER OF U.S. REG. NOS. 1,991,143 AND 2,042,762.

THE MARK CONSISTS OF THE STYLIZED SHOWING OF THE ILLUSTRATION OF A FACTORY.

SER. NO. 85-386,076, FILED 8-1-2011.

MATTHEW PAPPAS, EXAMINING ATTORNEY



*David J. Kyffers*

Director of the United States Patent and Trademark Office

# United States of America

United States Patent and Trademark Office

## usOWLS Older, Wiser & Laughing all the Way

**Reg. No. 4,134,543**

**Registered May 1, 2012**

**Int. Cl.: 41**

**SERVICE MARK**

**PRINCIPAL REGISTER**

BREM, PATRICIA (UNITED STATES INDIVIDUAL)  
26732 N VIA COLINA  
VALENCIA, CA 91381 AND

JACKMAN, MICHELE (UNITED STATES INDIVIDUAL)  
26732 N VIA COLINA  
VALENCIA, CA 91381

FOR: EDUCATION SERVICES, NAMELY, PROVIDING SEMINARS IN THE FIELD OF AGING AND NEW OPPORTUNITIES FOR SENIORS, IN CLASS 41 (U.S. CLS. 100, 101 AND 107).

FIRST USE 4-0-2009; IN COMMERCE 4-0-2009.

THE MARK CONSISTS OF STANDARD CHARACTERS WITHOUT CLAIM TO ANY PARTICULAR FONT, STYLE, SIZE, OR COLOR.

SER. NO. 85-386,207, FILED 8-1-2011.

MICHAEL WEBSTER, EXAMINING ATTORNEY



*David J. Kybas*

Director of the United States Patent and Trademark Office



# United States of America

United States Patent and Trademark Office

# HAMP

**Reg. No. 4,134,544**

**Registered May 1, 2012**

**Int. Cl.: 36**

**SERVICE MARK**

**PRINCIPAL REGISTER**

UNITED STATES DEPARTMENT OF THE TREASURY (UNITED STATES AGENCY OF THE UNITED STATES GOVERNMENT)  
U.S. MINT - OFFICE OF CHIEF COUNSEL  
801 N. NINTH STREET, N.W.  
WASHINGTON, DC 20220

FOR: MORTGAGE MITIGATION SERVICES, NAMELY, A UNITED STATES GOVERNMENT PROGRAM THAT PROVIDES SPECIAL MORTGAGE MODIFICATIONS THROUGH, AMONG OTHER MEANS, INTEREST RATE REDUCTIONS, TERM EXTENSIONS AND PRINCIPAL FORBEARANCE OR PRINCIPAL REDUCTIONS TO ELIGIBLE HOMEOWNERS WITH CERTAIN EXISTING MORTGAGE LOANS, IN CLASS 36 (U.S. CLS. 100, 101 AND 102).

FIRST USE 7-16-2009; IN COMMERCE 7-16-2009.

THE MARK CONSISTS OF STANDARD CHARACTERS WITHOUT CLAIM TO ANY PARTICULAR FONT, STYLE, SIZE, OR COLOR.

SER. NO. 85-386,246, FILED 8-1-2011.

MARY BOAGNI, EXAMINING ATTORNEY



*David J. Kyffers*

Director of the United States Patent and Trademark Office

# United States of America

United States Patent and Trademark Office

## Business. Technology. Connect.

**Reg. No. 4,134,545**

**Registered May 1, 2012**

**Int. Cl.: 38**

**SERVICE MARK**

**PRINCIPAL REGISTER**

RAIL YARD, INC. (ILLINOIS CORPORATION)  
3811 BEE CAVE ROAD  
SUITE 215  
AUSTIN, TX 78746

FOR: PROVIDING TEMPORARY ON-LINE ACCESS TO NON-DOWNLOADABLE SOFTWARE USED FOR TRACKING DOCUMENTS, MAPPING, CENTRALIZING DATA, IN CLASS 38 (U.S. CLS. 100, 101 AND 104).

FIRST USE 10-1-2010; IN COMMERCE 10-1-2010.

THE MARK CONSISTS OF STANDARD CHARACTERS WITHOUT CLAIM TO ANY PARTICULAR FONT, STYLE, SIZE, OR COLOR.

SER. NO. 85-386,294, FILED 8-1-2011.

FRANK LATTUCA, EXAMINING ATTORNEY



*David J. Kyffers*

Director of the United States Patent and Trademark Office

# United States of America

United States Patent and Trademark Office

# KOS\*USA

**Reg. No. 4,134,546**

**Registered May 1, 2012**

**Int. Cl.: 25**

**TRADEMARK**

**PRINCIPAL REGISTER**

SHIN, DONNA K (UNITED STATES INDIVIDUAL)  
2408 S. BROADWAY  
LOS ANGELES, CA 90007

FOR: A-SHIRTS; APPAREL FOR DANCERS, NAMELY, TEE SHIRTS, SWEATSHIRTS, PANTS, LEGGINGS, SHORTS AND JACKETS; ATHLETIC APPAREL, NAMELY, SHIRTS, PANTS, JACKETS, FOOTWEAR, HATS AND CAPS, ATHLETIC UNIFORMS; BALLOON PANTS; BODY SHIRTS; BUTTON DOWN SHIRTS; BUTTON-FRONT ALOHA SHIRTS; CAMOUFLAGE PANTS; CAMOUFLAGE SHIRTS; CAMP SHIRTS; CAPRI PANTS; CARGO PANTS; CLOTHING FOR ATHLETIC USE, NAMELY, PADDED PANTS; CLOTHING FOR ATHLETIC USE, NAMELY, PADDED SHIRTS; CLOTHING FOR BABIES, TODDLERS AND CHILDREN, TREATED WITH FIRE AND HEAT RETARDANTS, NAMELY, PAJAMAS, JACKETS, SHIRTS, PANTS, JUMPERS; CLOTHING SHIELDS, NAMELY, PADS APPLIED TO THE UNDERARMS OF SHIRTS, BLOUSES AND SWEATERS; COLLARED SHIRTS; CROP PANTS; DENIMS; DRESS PANTS; DRESS SHIRTS; FISHING SHIRTS; FLOOD PANTS; GOLF PANTS, SHIRTS AND SKIRTS; GOLF SHIRTS; GYM PANTS; HOODED SWEAT SHIRTS; HUNTING PANTS; HUNTING SHIRTS; JEGGINGS, NAMELY, PANTS THAT ARE PARTIALLY JEANS AND PARTIALLY LEGGINGS; JOGGING PANTS; KNIT SHIRTS; LEATHER PANTS; LEATHER SHIRTS; LEG SHIELDING DEVICE, ATTACHABLE TO AND DETACHABLE FROM A PERSON'S PANTS, COMPRISED OF PADDING TO SHIELD THE LEGS FROM FLYING DEBRIS WHEN MOWING WITH A STRING TRIMMER; LONG-SLEEVED SHIRTS; LOUNGE PANTS; MATERNITY CLOTHING, NAMELY, SHIRTS PANTS SKIRTS DRESSES; MOISTURE-WICKING SPORTS PANTS; MOISTURE-WICKING SPORTS SHIRTS; NIGHT SHIRTS; NON-DISPOSABLE CLOTH TRAINING PANTS; NURSE PANTS; OPEN-NECKED SHIRTS; OVER SHIRTS; PANTS; PETTI-PANTS; PIQUE SHIRTS; POLO SHIRTS; RUGBY SHIRTS; SCIENTIFIC AND TECHNOLOGICAL APPAREL, NAMELY, SHIRTS, PANTS, JACKETS, FOOTWEAR, HATS AND CAPS, UNIFORMS; SHIRT FRONTS; SHIRT INSERTS, NAMELY, DICKIES; SHIRT YOKES; SHIRTS; SHIRTS AND SHORT-SLEEVED SHIRTS; SHIRTS AND SLIPS; SHIRTS FOR INFANTS, BABIES, TODDLERS AND CHILDREN; SHIRTS FOR SUITS; SHORT-SLEEVED OR LONG-SLEEVED T-SHIRTS; SHORT-SLEEVED SHIRTS; SKI PANTS; SLEEP PANTS; SLEEP SHIRTS; SLEEVES WORN SEPARATE AND APART FROM BLOUSES, SHIRTS AND OTHER TOPS; SNAP CROTCH SHIRTS FOR INFANTS AND TODDLERS; SNOW PANTS; SNOWBOARD PANTS; SPORT SHIRTS; SPORTS PANTS; SPORTS SHIRTS; SPORTS SHIRTS WITH SHORT SLEEVES; STRETCH PANTS; SUN PROTECTIVE CLOTHING, NAMELY, SHIRTS PANTS SKIRTS; SWEAT PANTS; SWEAT SHIRTS; T-SHIRTS; T-SHIRTS FOR MEN WOMEN; TAP PANTS; TEE SHIRTS; TOBOGGAN HATS, PANTS AND CAPS; TRACK PANTS; TRAVEL CLOTHING CONTAINED IN A



*David J. Kyros*

Director of the United States Patent and Trademark Office

**Reg. No. 4,134,546** PACKAGE COMPRISING REVERSIBLE JACKETS, PANTS, SKIRTS, TOPS AND A BELT OR SCARF; TRIATHLON CLOTHING, NAMELY, TRIATHLON TIGHTS, TRIATHLON SHORTS, TRIATHLON SINGLET, TRIATHLON SHIRTS, TRIATHLON SUITS; TURTLE NECK SHIRTS; WATERPROOF JACKETS AND PANTS; WEARABLE GARMENTS AND CLOTHING, NAMELY, SHIRTS; WIND PANTS; WIND SHIRTS; WOMEN'S CLOTHING, NAMELY, SHIRTS, DRESSES, SKIRTS, BLOUSES; YOGA PANTS; YOGA SHIRTS, IN CLASS 25 (U.S. CLS. 22 AND 39).

FIRST USE 4-1-1990; IN COMMERCE 4-1-1990.

THE MARK CONSISTS OF STANDARD CHARACTERS WITHOUT CLAIM TO ANY PARTICULAR FONT, STYLE, SIZE, OR COLOR.

SEC. 2(F).

SER. NO. 85-386,367, FILED 8-1-2011.

TIMOTHY FINNEGAN, EXAMINING ATTORNEY

# United States of America

United States Patent and Trademark Office

## HEMISPHERE DIGITAL BALLAST

**Reg. No. 4,134,547**

**Registered May 1, 2012**

**Int. Cl.: 9**

**TRADEMARK**

**PRINCIPAL REGISTER**

ROBINSON, TYLER (UNITED STATES INDIVIDUAL)  
11731 FOSTER ROAD  
LOS ALAMITOS, CA 90720 AND

HOLDERBAUM, CHRIS (UNITED STATES INDIVIDUAL)  
395 EAST 4TH ST. #41  
LONG BEACH, CA 90802

FOR: LIGHTING BALLASTS, LIGHTING SYSTEMS COMPRISED OF LIGHTING CONTROL PANELS, LIGHTING CONTROLS, LIGHTING CONTROL SOFTWARE FOR USE IN COMMERCIAL AND INDUSTRIAL FACILITIES, ELECTRONIC LIGHTING BALLASTS, MAGNETIC LIGHTING BALLASTS, FLASH BULBS, IN CLASS 9 (U.S. CLS. 21, 23, 26, 36 AND 38).

FIRST USE 6-1-2011; IN COMMERCE 6-1-2011.

THE MARK CONSISTS OF STANDARD CHARACTERS WITHOUT CLAIM TO ANY PARTICULAR FONT, STYLE, SIZE, OR COLOR.

NO CLAIM IS MADE TO THE EXCLUSIVE RIGHT TO USE "DIGITAL BALLAST", APART FROM THE MARK AS SHOWN.

SER. NO. 85-386,821, FILED 8-2-2011.

DARRYL SPRUILL, EXAMINING ATTORNEY



*David J. Kybas*

Director of the United States Patent and Trademark Office

# United States of America

United States Patent and Trademark Office

# Heel 2 Heal

**Reg. No. 4,134,548**

**Registered May 1, 2012**

**Int. Cl.: 41**

**SERVICE MARK**

**PRINCIPAL REGISTER**

SMITH, LORRAINE JANE (UNITED STATES INDIVIDUAL)  
821 MADDOCK STREET  
WEST PALM BEACH, FL 33405

FOR: DOG TRAINING AND BEHAVIOR MODIFICATION/REHABILITATION SERVICES,  
SPECIFICALLY A HOLISTIC APPROACH TO ANIMAL BEHAVIOR AND WELL-BEING,  
IN CLASS 41 (U.S. CLS. 100, 101 AND 107).

FIRST USE 1-1-2006; IN COMMERCE 2-1-2007.

THE MARK CONSISTS OF STANDARD CHARACTERS WITHOUT CLAIM TO ANY PAR-  
TICULAR FONT, STYLE, SIZE, OR COLOR.

SER. NO. 85-387,335, FILED 8-2-2011.

GRETТА YAO, EXAMINING ATTORNEY



*David J. Kybas*

Director of the United States Patent and Trademark Office

# United States of America

United States Patent and Trademark Office

# WASP

**Reg. No. 4,134,549**

**Registered May 1, 2012**

**Int. Cl.: 12**

**TRADEMARK**

**PRINCIPAL REGISTER**

AEROVIRONMENT, INC. (DELAWARE CORPORATION)  
181 W. HUNTINGTON DRIVE, SUITE 202  
MONROVIA, CA 91016

FOR: UNMANNED AERIAL VEHICLES (UAVS), IN CLASS 12 (U.S. CLS. 19, 21, 23, 31, 35 AND 44).

FIRST USE 10-18-2002; IN COMMERCE 10-18-2002.

THE MARK CONSISTS OF STANDARD CHARACTERS WITHOUT CLAIM TO ANY PARTICULAR FONT, STYLE, SIZE, OR COLOR.

SER. NO. 85-387,569, FILED 8-2-2011.

KATHERINE CHANG, EXAMINING ATTORNEY



*David J. Kybas*

Director of the United States Patent and Trademark Office

# United States of America

United States Patent and Trademark Office

## SunaTech Inc.

**Reg. No. 4,134,550**

**Registered May 1, 2012**

**Int. Cl.: 42**

**SERVICE MARK**

**PRINCIPAL REGISTER**

SUNATECH INC. (CHINA CORPORATION)  
398 RUOSHUI ROAD, BIOBAY, SUZHOU IND PK  
SUZHOU, JIANGSU, CHINA 215125

FOR: CUSTOM DESIGN AND DEVELOPMENT OF CHEMICAL REAGENTS AND BIOCHEMICAL ASSAYS; RESEARCH AND DEVELOPMENT IN THE FIELD OF LUMINESCENT METAL COMPLEXES, OPV MATERIALS, NANOTECHNOLOGY, CONDUCTING POLYMERS, BIOANALYTICS, MEDICAL DIAGNOSTICS, IN CLASS 42 (U.S. CLS. 100 AND 101).

FIRST USE 3-1-2009; IN COMMERCE 3-1-2009.

THE MARK CONSISTS OF STANDARD CHARACTERS WITHOUT CLAIM TO ANY PARTICULAR FONT, STYLE, SIZE, OR COLOR.

NO CLAIM IS MADE TO THE EXCLUSIVE RIGHT TO USE "INC.", APART FROM THE MARK AS SHOWN.

SER. NO. 85-387,822, FILED 8-3-2011.

JACQUELINE A. LAVINE, EXAMINING ATTORNEY



*David J. Kybas*

Director of the United States Patent and Trademark Office



# United States of America

United States Patent and Trademark Office

## MEDITATION AND MARTINIS

**Reg. No. 4,134,551**

**Registered May 1, 2012**

**Int. Cl.: 44**

**SERVICE MARK**

**PRINCIPAL REGISTER**

JAFFE, LISA (UNITED STATES INDIVIDUAL)  
300 SEEMAN DRIVE  
ENCINITAS, CA 92024

FOR: INDIVIDUAL AND GROUP COUNSELING SERVICES FOR HEALTH, WELLNESS AND WELL BEING OF THE MIND, BODY AND SPIRIT THROUGH MEDITATION TECHNIQUES, IN CLASS 44 (U.S. CLS. 100 AND 101).

FIRST USE 7-10-2009; IN COMMERCE 7-10-2009.

THE MARK CONSISTS OF STANDARD CHARACTERS WITHOUT CLAIM TO ANY PARTICULAR FONT, STYLE, SIZE, OR COLOR.

NO CLAIM IS MADE TO THE EXCLUSIVE RIGHT TO USE 'MARTINIS', APART FROM THE MARK AS SHOWN.

SER. NO. 85-387,954, FILED 8-3-2011.

ROSELLE HERRERA, EXAMINING ATTORNEY



*David J. Kyffers*

Director of the United States Patent and Trademark Office

# United States of America

United States Patent and Trademark Office

## JIMMY'S BROADWAY AUTOMOTIVE

**Reg. No. 4,134,552**

D.A.S., INC. (ARIZONA CORPORATION)  
2448 EAST BROADWAY BLVD.  
TUCSON, AZ 85719

**Registered May 1, 2012**

**Int. Cl.: 37**

FOR: AUTOMOTIVE MAINTENANCE AND REPAIR, IN CLASS 37 (U.S. CLS. 100, 103 AND 106).

**SERVICE MARK**

FIRST USE 12-1-1984; IN COMMERCE 12-1-1984.

**PRINCIPAL REGISTER**

THE MARK CONSISTS OF STANDARD CHARACTERS WITHOUT CLAIM TO ANY PARTICULAR FONT, STYLE, SIZE, OR COLOR.

NO CLAIM IS MADE TO THE EXCLUSIVE RIGHT TO USE "AUTOMOTIVE", APART FROM THE MARK AS SHOWN.

SEC. 2(F) AS TO "BROADWAY".

SER. NO. 85-388,175, FILED 8-3-2011.

ERIN FALK, EXAMINING ATTORNEY



*David J. Kyffers*

Director of the United States Patent and Trademark Office

United States of America  
United States Patent and Trademark Office

**lunastAR**

**Reg. No. 4,134,553**

**Registered May 1, 2012**

**Int. Cls.: 3 and 28**

**TRADEMARK**

**PRINCIPAL REGISTER**

LUNA ORGANICS, LLC (NEW HAMPSHIRE LIMITED LIABILITY COMPANY), DBA LUNA  
STAR MAKEUP  
9812 FALLS ROAD #114-143  
POTOMAC, NH 20854

FOR: BODY AND BEAUTY CARE COSMETICS; COLOGNES, PERFUMES AND COSMETICS;  
COSMETIC CREAMS; COSMETIC CREAMS FOR SKIN CARE; COSMETIC OILS; COSMETIC  
PREPARATIONS; COSMETIC PREPARATIONS FOR BODY CARE; COSMETIC ROUGES;  
COSMETICS; COSMETICS AND COSMETIC PREPARATIONS; COSMETICS AND MAKE-  
UP; COSMETICS IN GENERAL, INCLUDING PERFUMES; COSMETICS IN THE FORM OF  
MILKS, LOTIONS AND EMULSIONS; COSMETICS, NAMELY, COMPACTS; FACE AND  
BODY BEAUTY CREAMS; FACE AND BODY CREAMS; FACE AND BODY GLITTER; FACE  
GLITTER; FACE PAINT; FACE PAINTING KITS; FACE POWDER; GLITTER FOR COSMETIC  
PURPOSES; NAIL CARE PREPARATIONS; NAIL ENAMEL; NAIL ENAMELS; NAIL POLISH;  
NAIL VARNISH FOR COSMETIC PURPOSES, IN CLASS 3 (U.S. CLS. 1, 4, 6, 50, 51 AND  
52).

FIRST USE 6-15-2011; IN COMMERCE 6-15-2011.

FOR: CHILDREN'S PLAY COSMETICS, IN CLASS 28 (U.S. CLS. 22, 23, 38 AND 50).

FIRST USE 6-15-2011; IN COMMERCE 6-15-2011.

THE MARK CONSISTS OF THE STYLIZED WORDING "LUNASTAR", WITH A LINE  
RUNNING THROUGH EACH OF THE LETTERS "STAR" AND A STAR DESIGN INSIDE  
THE LETTER "R" THEREIN.

SER. NO. 85-388,305, FILED 8-3-2011.

DAWN HAN, EXAMINING ATTORNEY



*David J. Kyffers*

Director of the United States Patent and Trademark Office

# United States of America

United States Patent and Trademark Office

# GO BEYOND

**Reg. No. 4,134,554**

**Registered May 1, 2012**

**Int. Cls.: 12 and 35**

**TRADEMARK**

**SERVICE MARK**

**PRINCIPAL REGISTER**

LAND ROVER (UNITED KINGDOM CORPORATION)  
BANBURY ROAD  
GAYDON  
WARWICK, UNITED KINGDOM CV350RR

FOR: MOTOR VEHICLES AND PARTS AND ACCESSORIES THEREFOR, IN CLASS 12 (U.S. CLS. 19, 21, 23, 31, 35 AND 44).

FOR: ADVERTISING AND PUBLICITY SERVICES, NAMELY, PROMOTING THE GOODS, SERVICES, BRAND IDENTITY AND COMMERCIAL INFORMATION AND NEWS OF THIRD PARTIES THROUGH PRINT, AUDIO, VIDEO, DIGITAL AND ON-LINE MEDIUM, IN CLASS 35 (U.S. CLS. 100, 101 AND 102).

THE MARK CONSISTS OF STANDARD CHARACTERS WITHOUT CLAIM TO ANY PARTICULAR FONT, STYLE, SIZE, OR COLOR.

OWNER OF UNITED KINGDOM REG. NO. 2365392, DATED 11-5-2004, EXPIRES 6-9-2014.

OWNER OF UNITED KINGDOM REG. NO. 2368290, DATED 12-24-2004, EXPIRES 7-15-2014.

SER. NO. 85-388,358, FILED 8-3-2011.

MARILYN IZZI, EXAMINING ATTORNEY



*David J. Kybas*

Director of the United States Patent and Trademark Office

# United States of America

United States Patent and Trademark Office

**HELLO  
BASEBALL**

**Reg. No. 4,134,555**

**Registered May 1, 2012**

**Int. Cl.: 25**

**TRADEMARK**

**PRINCIPAL REGISTER**

ERCULIANI ENTERPRISES INC. (TEXAS CORPORATION)  
3711 96TH ST.  
LUBBOCK, TX 79423

FOR: HATS; PANTS; SHIRTS; SHORT-SLEEVED OR LONG-SLEEVED T-SHIRTS; SHORTS;  
SWEAT SHIRTS, IN CLASS 25 (U.S. CLS. 22 AND 39).

FIRST USE 7-0-2011; IN COMMERCE 7-0-2011.

NO CLAIM IS MADE TO THE EXCLUSIVE RIGHT TO USE "BASEBALL", APART FROM  
THE MARK AS SHOWN.

THE COLOR(S) RED IS/ARE CLAIMED AS A FEATURE OF THE MARK.

THE MARK CONSISTS OF THE STYLIZED TERM "HELLO" IN ALL CAPITALIZED RED  
LETTERS. UNDERNEATH THAT TERM IS THE STYLIZED TERM "BASEBALL" IN ALL  
CAPITALIZED RED LETTERS.

SER. NO. 85-388,644, FILED 8-3-2011.

APRIL ROACH, EXAMINING ATTORNEY



*David J. Kybas*

Director of the United States Patent and Trademark Office

# United States of America

United States Patent and Trademark Office

# STORKSAK

**Reg. No. 4,134,556**

**Registered May 1, 2012**

**Int. Cl.: 25**

**TRADEMARK**

**PRINCIPAL REGISTER**

STORKSAK LIMITED (UNITED KINGDOM LIMITED COMPANY (LTD.))  
NO 13 SPECTRUM HOUSE  
32-34 GORDON HOUSE ROAD  
LONDON, UNITED KINGDOM NW51LP

FOR: CLOTHING, NAMELY, T-SHIRTS, TOPS, PANTS, BOTTOMS; FOOTWEAR; AND HEADGEAR, NAMELY, HATS AND CAPS, IN CLASS 25 (U.S. CLS. 22 AND 39).

THE MARK CONSISTS OF STANDARD CHARACTERS WITHOUT CLAIM TO ANY PARTICULAR FONT, STYLE, SIZE, OR COLOR.

OWNER OF UNITED KINGDOM REG. NO. 2326120, DATED 3-11-2003, EXPIRES 3-11-2013.

OWNER OF U.S. REG. NO. 2,981,194.

SER. NO. 85-388,787, FILED 8-3-2011.

MICHAEL KEATING, EXAMINING ATTORNEY



*David J. Kyffers*

Director of the United States Patent and Trademark Office

# United States of America

United States Patent and Trademark Office

## PFAELZER'S FAMOUS FILETS

**Reg. No. 4,134,557**

**Registered May 1, 2012**

**Int. Cl.: 29**

**TRADEMARK**

**PRINCIPAL REGISTER**

HICKORY FARMS, INC. (DELAWARE CORPORATION)  
1505 HOLLAND ROAD  
MAUMEE, OH 43537

FOR: BEEF; MEAT, IN CLASS 29 (U.S. CL. 46).

FIRST USE 12-31-1994; IN COMMERCE 12-31-1994.

THE MARK CONSISTS OF STANDARD CHARACTERS WITHOUT CLAIM TO ANY PARTICULAR FONT, STYLE, SIZE, OR COLOR.

OWNER OF U.S. REG. NO. 852,841.

NO CLAIM IS MADE TO THE EXCLUSIVE RIGHT TO USE "FILETS", APART FROM THE MARK AS SHOWN.

SEC. 2(F) AS TO "FAMOUS FILETS".

SER. NO. 85-389,363, FILED 8-4-2011.

ANDREA BUTLER, EXAMINING ATTORNEY



*David J. Kybas*

Director of the United States Patent and Trademark Office

# United States of America

United States Patent and Trademark Office



**Reg. No. 4,134,558**

**Registered May 1, 2012**

**Int. Cls.: 37 and 44**

**SERVICE MARK**

**PRINCIPAL REGISTER**

DAVIS, RYAN (UNITED STATES INDIVIDUAL)  
4201 CRESTMOOR AVE.  
AMES, IA 50010

FOR: CAR WASHING, IN CLASS 37 (U.S. CLS. 100, 103 AND 106).

FIRST USE 6-1-2004; IN COMMERCE 6-1-2004.

FOR: PROVIDING SELF-SERVICE PET GROOMING FACILITIES, IN CLASS 44 (U.S. CLS. 100 AND 101).

FIRST USE 6-1-2004; IN COMMERCE 6-1-2004.

NO CLAIM IS MADE TO THE EXCLUSIVE RIGHT TO USE "CAR WASH & PET WASH", APART FROM THE MARK AS SHOWN.

THE STIPPLING IS FOR SHADING PURPOSES ONLY.

THE MARK CONSISTS OF MULTIPLE ELLIPTICAL OVALS WITH WATER DROP BACKGROUND, AND THE STACKED TEXT "LYNN'S CAR WASH & PET WASH" THE DESIGN OF A HORIZONTAL BRUSH AND WATER SPRAYER BETWEEN THE WORDING "LYNN'S" AND "CAR WASH & PET WASH".

SER. NO. 85-389,631, FILED 8-4-2011.

GRETТА YAO, EXAMINING ATTORNEY



*David J. Kybas*

Director of the United States Patent and Trademark Office



# United States of America

United States Patent and Trademark Office



**Reg. No. 4,134,559**

**Registered May 1, 2012**

**Int. Cl.: 41**

**SERVICE MARK**

**PRINCIPAL REGISTER**

BOARD OF TRUSTEES OF THE UNIVERSITY OF MASSACHUSETTS (MASSACHUSETTS STATE UNIVERSITY)  
TRADEMARK AND LICENSING OFFICE, ROOM 817  
ONE CAMPUS CENTER WAY  
AMHERST, MA 01003

FOR: ORGANIZATION OF SEMINARS, WORKING GROUPS, RESEARCH GROUPS AND CONVENTIONS, IN THE FIELD OF SOFTWARE DEVELOPMENT, IN CLASS 41 (U.S. CLS. 100, 101 AND 107).

FIRST USE 4-1-2009; IN COMMERCE 4-1-2009.

NO CLAIM IS MADE TO THE EXCLUSIVE RIGHT TO USE "OPEN" AND "CONSORTIUM", APART FROM THE MARK AS SHOWN.

THE COLOR(S) ORANGE AND BLUE IS/ARE CLAIMED AS A FEATURE OF THE MARK.

THE MARK CONSISTS OF AN ORANGE LETTER "O", FOLLOWED BY A DESIGNED LETTER "I" COMPOSED OF A LARGE BLUE FIGURE WITH A BLUE AND ORANGE GLOBE HEAD AND TWO SMALLER ORANGE FIGURES ON THE SIDES, FOLLOWED BY AN ORANGE LETTER "C". THE WORDS "OPEN INDICATOR CONSORTIUM" APPEAR IN BLUE.

SER. NO. 85-389,665, FILED 8-4-2011.

JESSICA A. POWERS, EXAMINING ATTORNEY



*David J. Kyjars*

Director of the United States Patent and Trademark Office

# United States of America

United States Patent and Trademark Office

# PRIMAL

**Reg. No. 4,134,560**

**Registered May 1, 2012**

**Int. Cl.: 9**

**TRADEMARK**

**PRINCIPAL REGISTER**

PRIMAL FUSION INC. (CANADA CORPORATION)  
7-258 KING STREET NORTH  
WATERLOO, ONTARIO, CANADA N2J2Y9

FOR: COMPUTER SOFTWARE FOR SEARCHING, RETRIEVING, COMPILING, ANALYZING, TRANSFORMING, AGGREGATING, INDEXING, CATEGORIZING, ORGANIZING, MANAGING, NAVIGATING AND PRESENTING SEMANTICALLY GENERATED DATA AND INFORMATION ON COMPUTER NETWORKS, GLOBAL COMPUTER NETWORKS, COMPUTERS, COMPUTER DEVICES AND MOBILE DEVICES, IN CLASS 9 (U.S. CLS. 21, 23, 26, 36 AND 38).

FIRST USE 12-18-2009; IN COMMERCE 3-1-2010.

THE MARK CONSISTS OF STANDARD CHARACTERS WITHOUT CLAIM TO ANY PARTICULAR FONT, STYLE, SIZE, OR COLOR.

OWNER OF U.S. REG. NOS. 2,498,791 AND 3,295,192.

SER. NO. 85-389,715, FILED 8-4-2011.

JENNY PARK, EXAMINING ATTORNEY



*David J. Kybas*

Director of the United States Patent and Trademark Office

# United States of America

United States Patent and Trademark Office

## LUCKY BUCKET RIDE

**Reg. No. 4,134,561**

**Registered May 1, 2012**

**Int. Cl.: 41**

**SERVICE MARK**

**PRINCIPAL REGISTER**

QUAFF, LLC (NEBRASKA LIMITED LIABILITY COMPANY)  
11941 CENTENNIAL ROAD, SUITE 1  
LAVISTA, NE 68128

FOR: ENTERTAINMENT IN THE NATURE OF COMPETITIONS IN THE FIELD OF CYCLING AND ATHLETIC EVENTS, IN CLASS 41 (U.S. CLS. 100, 101 AND 107).

FIRST USE 7-1-2011; IN COMMERCE 7-1-2011.

THE MARK CONSISTS OF STANDARD CHARACTERS WITHOUT CLAIM TO ANY PARTICULAR FONT, STYLE, SIZE, OR COLOR.

OWNER OF U.S. REG. NO. 3,828,783.

NO CLAIM IS MADE TO THE EXCLUSIVE RIGHT TO USE "RIDE", APART FROM THE MARK AS SHOWN.

SER. NO. 85-389,718, FILED 8-4-2011.

HENRY S. ZAK, EXAMINING ATTORNEY



*David J. Kyffers*

Director of the United States Patent and Trademark Office

# United States of America

United States Patent and Trademark Office

# PRIMAL

**Reg. No. 4,134,562**

**Registered May 1, 2012**

**Int. Cl.: 42**

**SERVICE MARK**

**PRINCIPAL REGISTER**

PRIMAL FUSION INC. (CANADA CORPORATION)  
7-258 KING STREET NORTH  
WATERLOO, ONTARIO, CANADA N2J2Y9

FOR: APPLICATION SERVICE PROVIDER (ASP) FEATURING COMPUTER SOFTWARE FOR SEARCHING, RETRIEVING, COMPILING, SYNTHESIZING, GENERATING, ANALYZING, TRANSFORMING, AGGREGATING, INDEXING, CATEGORIZING, ORGANIZING, MANAGING, NAVIGATING AND PRESENTING DATA AND INFORMATION ON COMPUTER NETWORKS, GLOBAL COMPUTER NETWORKS, DISTRIBUTED COMPUTER SYSTEMS, COMPUTERS, COMPUTER DEVICES AND MOBILE DEVICES; APPLICATION SERVICE PROVIDER (ASP) FEATURING CUSTOMIZED COMPUTER SOFTWARE FOR SEARCHING, RETRIEVING, COMPILING, SYNTHESIZING, GENERATING, ANALYZING, TRANSFORMING, AGGREGATING, INDEXING, CATEGORIZING, ORGANIZING, MANAGING, NAVIGATING AND PRESENTING DATA AND INFORMATION ON COMPUTER NETWORKS, GLOBAL COMPUTER NETWORKS, DISTRIBUTED COMPUTER SYSTEMS, COMPUTERS, COMPUTER DEVICES AND MOBILE DEVICES, IN CLASS 42 (U.S. CLS. 100 AND 101).

FIRST USE 12-18-2009, THE MARK WAS FIRST USED ANYWHERE IN A DIFFERENT FORM OTHER THAN THAT SOUGHT TO BE REGISTERED AT LEAST AS EARLY AS 11/27/2007.; IN COMMERCE 3-1-2010, THE MARK WAS FIRST USED IN COMMERCE IN A DIFFERENT FORM OTHER THAN THAT SOUGHT TO BE REGISTERED AT LEAST AS EARLY AS 08/06/2008..

THE MARK CONSISTS OF STANDARD CHARACTERS WITHOUT CLAIM TO ANY PARTICULAR FONT, STYLE, SIZE, OR COLOR.

OWNER OF U.S. REG. NOS. 2,498,791 AND 3,295,192.

SER. NO. 85-389,768, FILED 8-4-2011.

JENNY PARK, EXAMINING ATTORNEY



*David J. Kybas*

Director of the United States Patent and Trademark Office

# United States of America

United States Patent and Trademark Office

# WED'ZE

**Reg. No. 4,134,563**

**Registered May 1, 2012**

**Int. Cls.: 9, 18, 25 and 28**

**TRADEMARK**

**PRINCIPAL REGISTER**

PROJETCLUB (FRANCE CORPORATION)  
4, BOULEVARD DE MONS  
VILLENEUVE D'ASC, FRANCE 59650

FOR: COMPASSES, GPS TRACKING DEVICE TO BE WORN ON THE WRIST OF AN ATHLETE DURING ENDURANCE EVENTS, GPS NAVIGATION DEVICE; AVALANCHE PROBES, NAMELY, ELONGATED RODS USED TO MANUALLY PROBE FOR PEOPLE OR OBJECTS COVERED BY AN AVALANCHE; CLOTHING AND GLOVES FOR PROTECTION AGAINST ACCIDENTS, PROTECTIVE HELMETS; SPECTACLES, NAMELY, EYEWEAR AND SKI GOGGLES; SPECTACLE CASES; TELEPHONE APPARATUS, WALKIE-TALKIES, IN CLASS 9 (U.S. CLS. 21, 23, 26, 36 AND 38).

FOR: TRUNKS AND TRAVELLING BAGS, UMBRELLAS, BACKPACKS, SPORTS BAGS, BAGS FOR CLIMBERS IN THE NATURE OF ALL-PURPOSE CARRYING BAGS, MOUNTAINEERING STICKS, GARMENT BAGS FOR TRAVEL, PURSES, POCKET WALLETS, KEY CASES OF LEATHER OR IMITATION LEATHER, SLING BAGS FOR CARRYING INFANTS, IN CLASS 18 (U.S. CLS. 1, 2, 3, 22 AND 41).

FOR: MONEY BELTS, MITTENS, JACKETS, COATS, ANORAKS, SNOW SUITS, SKI WEAR, SKI MASKS, UNDERWEAR, PANTS, TOPS, BOTTOMS, SHIRTS, BELTS, GLOVES, HEADWEAR, FOOTWEAR, SHOE COVERS FOR USE WHEN WEARING SHOES, SCARVES, EAR MUFFS, SOCKS, PULLOVERS, SWEATERS; ARM, HAND, LEG AND KNEE WARMERS; GOLF SHIRTS, SHORTS, SHOES, SPIKES, TROUSERS, SKIRTS, CLEATS, AND CAPS, IN CLASS 25 (U.S. CLS. 22 AND 39).



*David J. Kybas*

Director of the United States Patent and Trademark Office

FOR: SPORT BALLS, BOB-SLEIGHS AND SNOW SLEDS FOR RECREATIONAL USE, SNOW BOARDS, SNOW SHOES, SKIS, SKI BINDINGS, SKI EDGES, SKI POLES, PORTABLE SKI CARRIERS, SKI BAGS, SKI COVERS, SKI WAX, HARNESSES SPECIFICALLY ADAPTED FOR CARRYING SKIS AND SNOWBOARDS, SNOW BOARDS, SNOWBOARD BINDINGS, SNOWBOARD WAX, SNOWBOARD DECKS, ICE SKATES, ICE SKATE BLADES AND GUARDS, ICE HOCKEY STICKS AND PUCKS, ARTIFICIAL CLIMBING WALLS, HANG GLIDERS, PARAGLIDERS; KNEE, SHIN AND ELBOW GUARDS FOR ATHLETIC USE; GYMNASTIC APPARATUS, EXERCISE MACHINES; GOLF BAGS, GOLF CLUB COVERS, BALL PITCHING MACHINES, GOLF CLUBS, GOLF BALLS, GLOVES FOR GOLF, GOLF ACCESSORY POUCHES, GOLF BALL MARKERS, GOLF BALL RETRIEVERS, GOLF BALL SLEEVES, GOLF CLUB GRIPS, GOLF CLUB HEADS, GOLF PUTTERS, GOLF TEES, HAND GRIPS FOR GOLF CLUBS, TROLLEY BAGS FOR GOLF EQUIPMENT, STANDS SPECIALLY

**Reg. No. 4,134,563** ADAPTED FOR HOLDING GOLF CLUBS, NON-MOTORIZED GOLF CARTS, DIVOT REPAIR TOOLS, PUTTING PRACTICE MATS , IN CLASS 28 (U.S. CLS. 22, 23, 38 AND 50).

THE MARK CONSISTS OF STANDARD CHARACTERS WITHOUT CLAIM TO ANY PARTICULAR FONT, STYLE, SIZE, OR COLOR.

OWNER OF ERPN CMNTY TM OFC REG. NO. 6781108, DATED 3-12-2009, EXPIRES 3-13-2018.

OWNER OF U.S. REG. NOS. 3,254,950 AND 3,396,996.

THE WORDING "WED'ZE" HAS NO MEANING IN A FOREIGN LANGUAGE.

SER. NO. 85-389,959, FILED 8-4-2011.

KELLY TRUSILO, EXAMINING ATTORNEY

# United States of America

United States Patent and Trademark Office

# LOVEISDERMA



**Reg. No. 4,134,564**

**Registered May 1, 2012**

**Int. Cl.: 3**

**TRADEMARK**

**PRINCIPAL REGISTER**

INNOVATION BIOTECHNOLOGY LTD. (TAIWAN CORPORATION)  
ZHONGHE DIST.  
10F.-3, NO.351, SEC. 2, JHONGSHAN RD.  
NEW TAIPEI CITY, TAIWAN 235

FOR: SKIN CLEANSERS, FOAMING SKIN CLEANSERS FOR PERSONAL USE, FACIAL CLEANSING GEL, BEAUTY SERUMS, SKIN CREAMS, BEAUTY MASKS, COSMETIC MASKS, COSMETICS, BEAUTY MILKS, BEAUTY LOTIONS, IN CLASS 3 (U.S. CLS. 1, 4, 6, 50, 51 AND 52).

FIRST USE 7-0-2011; IN COMMERCE 7-0-2011.

THE MARK CONSISTS OF THE STYLIZED WORD "LOVEISDERMA" WITH A WATER DROP DANGLING FROM THE BOTTOM RIGHT OF THE LETTER "A" IN "DERMA". THE WATER DROP IS SURROUNDED BY A CIRCLE.

SER. NO. 85-390,208, FILED 8-4-2011.

MICHAEL TANNER, EXAMINING ATTORNEY



*David J. Kyros*

Director of the United States Patent and Trademark Office

# United States of America

United States Patent and Trademark Office



JBMD SKIN CARE

**Reg. No. 4,134,565**

**Registered May 1, 2012**

**Int. Cl.: 3**

**TRADEMARK**

**PRINCIPAL REGISTER**

INNOVATION BIOTECHNOLOGY LTD. (TAIWAN CORPORATION)  
ZHONGHE DIST.  
10F.-3, NO.351, SEC. 2, JHONGSHAN RD.  
NEW TAIPEI CITY, TAIWAN 235

FOR: SKIN CLEANSERS, FOAMING SKIN CLEANSERS FOR PERSONAL USE, FACIAL CLEANSING GEL, BEAUTY SERUMS, SKIN CREAMS, BEAUTY MASKS, COSMETIC MASKS, COSMETICS, BEAUTY MILKS, BEAUTY LOTIONS, IN CLASS 3 (U.S. CLS. 1, 4, 6, 50, 51 AND 52).

FIRST USE 7-0-2011; IN COMMERCE 7-0-2011.

NO CLAIM IS MADE TO THE EXCLUSIVE RIGHT TO USE "SKIN CARE", APART FROM THE MARK AS SHOWN.

THE MARK CONSISTS OF THE STYLIZED WORD "JBMD" SURROUNDED BY A SQUARE WITH ROUNDED SIDES LOCATED ABOVE THE STYLIZED WORDING "JBMD SKIN CARE".

SER. NO. 85-390,228, FILED 8-4-2011.

MICHAEL TANNER, EXAMINING ATTORNEY



*David J. Kybas*

Director of the United States Patent and Trademark Office



# United States of America

United States Patent and Trademark Office

nutraV  
nano-nutraceutical sprays

**Reg. No. 4,134,566**

**Registered May 1, 2012**

**Int. Cl.: 5**

NUE PHARMACEUTICALS, LLC (FLORIDA LIMITED LIABILITY COMPANY)  
6996 PIAZZA GRANDE AVE  
SUITE 313  
ORLANDO, FL 32835

FOR: LIQUID SPRAY VITAMINS, IN CLASS 5 (U.S. CLS. 6, 18, 44, 46, 51 AND 52).

**TRADEMARK**

FIRST USE 8-1-2011; IN COMMERCE 8-1-2011.

**PRINCIPAL REGISTER**

NO CLAIM IS MADE TO THE EXCLUSIVE RIGHT TO USE "NANO-NUTRACEUTICAL SPRAYS", APART FROM THE MARK AS SHOWN.

THE COLOR(S) BLUE IS/ARE CLAIMED AS A FEATURE OF THE MARK.

THE MARK CONSISTS OF THE WORDING "NUTRA NANO-NUTRACEUTICAL SPRAYS" APPEARING IN BLUE WITH A DESIGN OF AN UPSIDE-DOWN TRIANGLE TO THE RIGHT OF THE WORDING ALSO APPEARING IN BLUE.

SER. NO. 85-390,279, FILED 8-5-2011.

CARRIE GENOVESE, EXAMINING ATTORNEY



*David J. Kybas*

Director of the United States Patent and Trademark Office

# United States of America

United States Patent and Trademark Office

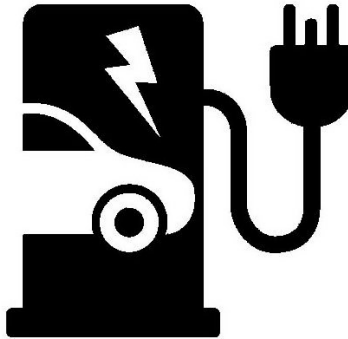

**Reg. No. 4,134,567**

**Registered May 1, 2012**

**Int. Cls.: 9 and 37**

**TRADEMARK**

**SERVICE MARK**

**PRINCIPAL REGISTER**

AMERICAN AUTOMOBILE ASSOCIATION, INC. (CONNECTICUT CORPORATION)  
1000 AAA DRIVE  
HEATHROW, FL 327465063

FOR: ELECTRICAL APPARATUS, NAMELY, CHARGING STATIONS FOR CHARGING ELECTRIC VEHICLES, IN CLASS 9 (U.S. CLS. 21, 23, 26, 36 AND 38).

FIRST USE 9-9-2011; IN COMMERCE 9-9-2011.

FOR: EMERGENCY ROAD SERVICES IN THE NATURE OF MOBILE SERVICE VEHICLES DEPLOYED TO RECHARGE ELECTRIC VEHICLES AT THE ROADSIDE; CHARGING STATION SERVICES FOR ELECTRIC VEHICLES, IN CLASS 37 (U.S. CLS. 100, 103 AND 106).

FIRST USE 9-9-2011; IN COMMERCE 9-9-2011.

THE MARK CONSISTS OF A SILHOUETTE OF A CAR IN FRONT OF AN ELECTRIC CHARGING STATION.

SER. NO. 85-390,400, FILED 8-5-2011.

TRACY FLETCHER, EXAMINING ATTORNEY



*David J. Kybas*

Director of the United States Patent and Trademark Office

# United States of America

United States Patent and Trademark Office

# NETWORK

**Reg. No. 4,134,568**

**Registered May 1, 2012**

**Int. Cl.: 41**

**SERVICE MARK**

**PRINCIPAL REGISTER**

KAMMER & ASSOCIATES, INC. (GEORGIA CORPORATION)  
5555 GLENRIDGE CONNECTOR, SUITE 200  
ATLANTA, GA 30342

FOR: BUSINESS EDUCATION AND TRAINING SERVICES, NAMELY, DEVELOPING AND FACILITATING CUSTOMIZED LEADERSHIP AND EXECUTIVE DEVELOPMENT PROGRAMS, PROVIDING EXECUTIVE COACHING SERVICES, AND PROVIDING BUSINESS EDUCATION PROGRAMS TO EMPLOYEES AND EXECUTIVES, IN CLASS 41 (U.S. CLS. 100, 101 AND 107).

FIRST USE 11-3-2010; IN COMMERCE 0-0-2010.

THE MARK CONSISTS OF STANDARD CHARACTERS WITHOUT CLAIM TO ANY PARTICULAR FONT, STYLE, SIZE, OR COLOR.

SER. NO. 85-390,681, FILED 8-5-2011.

RONALD MCMORROW, EXAMINING ATTORNEY



*David J. Kyffers*

Director of the United States Patent and Trademark Office

# United States of America

United States Patent and Trademark Office

## Stress Away Strap

**Reg. No. 4,134,569**

**Registered May 1, 2012**

**Int. Cl.: 28**

**TRADEMARK**

**PRINCIPAL REGISTER**

HAPPY BODY WELLNESS LLC (ILLINOIS LIMITED LIABILITY COMPANY)  
5465 S. RIDGEWOOD CT.  
CHICAGO, IL 60615

FOR: EXERCISE EQUIPMENT, NAMELY, EXERCISE BANDS; STRETCH BANDS USED FOR YOGA AND PHYSICAL FITNESS PURPOSES, IN CLASS 28 (U.S. CLS. 22, 23, 38 AND 50).

FIRST USE 7-7-2011; IN COMMERCE 7-7-2011.

THE MARK CONSISTS OF STANDARD CHARACTERS WITHOUT CLAIM TO ANY PARTICULAR FONT, STYLE, SIZE, OR COLOR.

NO CLAIM IS MADE TO THE EXCLUSIVE RIGHT TO USE "STRAP", APART FROM THE MARK AS SHOWN.

SER. NO. 85-391,260, FILED 8-5-2011.

ALICE BENMAMAN, EXAMINING ATTORNEY



*David J. Kyffers*

Director of the United States Patent and Trademark Office

# United States of America

United States Patent and Trademark Office

The logo for URBANFLOOR features a stylized graphic of three horizontal lines of decreasing length on the left, followed by the word "URBANFLOOR" in a bold, sans-serif font.

**Reg. No. 4,134,570**

URBAN GLOBAL, LLC (CALIFORNIA LIMITED LIABILITY COMPANY)  
3707 CAPITOL AVENUE  
CITY OF INDUSTRY, CA 90601

**Registered May 1, 2012**

**Int. Cl.: 19**

FOR: EXOTIC AND EUROPEAN UPSCALE HARDWOOD FLOORING; ENGINEERED  
HARDWOOD FLOORING, IN CLASS 19 (U.S. CLS. 1, 12, 33 AND 50).

**TRADEMARK**

FIRST USE 2-8-2004; IN COMMERCE 2-8-2004.

**PRINCIPAL REGISTER**

THE MARK CONSISTS OF THE WORD "URBANFLOOR" WRITTEN BESIDES THREE HO-  
RIZONTAL LINES WHEREIN THE FIRST LINE IS THE LONGEST AND IS BROKEN INTO  
TWO PARTS, THE SECOND LINE IS A LITTLE SHORTER AND THE THIRD LINE IS THE  
SHORTEST AS SHOWN IN THE MARK.

SER. NO. 85-391,356, FILED 8-6-2011.

DOUGLAS LEE, EXAMINING ATTORNEY



*David J. Kyffers*

Director of the United States Patent and Trademark Office

# United States of America

United States Patent and Trademark Office



**Reg. No. 4,134,571**

**Registered May 1, 2012**

**Int. Cl.: 25**

**TRADEMARK**

**PRINCIPAL REGISTER**

MANTOWN USA LLC (RHODE ISLAND LIMITED LIABILITY COMPANY)  
957 OLD SMITHFIELD ROAD  
NORTH SMITHFIELD, RI 02896

FOR: ATHLETIC APPAREL, NAMELY, SHIRTS, PANTS, JACKETS, FOOTWEAR, HATS  
AND CAPS, ATHLETIC UNIFORMS, IN CLASS 25 (U.S. CLS. 22 AND 39).

FIRST USE 1-0-2007; IN COMMERCE 6-0-2011.

NO CLAIM IS MADE TO THE EXCLUSIVE RIGHT TO USE "USA", APART FROM THE  
MARK AS SHOWN.

THE MARK CONSISTS OF A "MANTOWN" BANNER ABOVE AND A "USA" BANNER  
BELOW A SHIELD WHICH INCLUDES A HAMMER, URINAL, BASEBALL BAT AND A  
TWO, TEN, JACK, AND ACE OF DIAMONDS PLAYING CARDS.

SER. NO. 85-391,416, FILED 8-6-2011.

KATINA MISTER, EXAMINING ATTORNEY



*David J. Kybas*

Director of the United States Patent and Trademark Office

# United States of America

United States Patent and Trademark Office

## EQUITYLOCK SOLUTIONS

**Reg. No. 4,134,572**

**Registered May 1, 2012**

**Int. Cl.: 36**

**SERVICE MARK**

**PRINCIPAL REGISTER**

EQUITYLOCK SOLUTIONS, LLC (COLORADO LIMITED LIABILITY COMPANY)  
STE. 660  
8400 E. PRENTICE AVE.  
DENVER, CO 80111

FOR: FINANCIAL SERVICES, NAMELY, PROVIDING HOME PRICE PROTECTION, IN CLASS 36 (U.S. CLS. 100, 101 AND 102).

FIRST USE 4-4-2011; IN COMMERCE 4-4-2011.

THE MARK CONSISTS OF STANDARD CHARACTERS WITHOUT CLAIM TO ANY PARTICULAR FONT, STYLE, SIZE, OR COLOR.

NO CLAIM IS MADE TO THE EXCLUSIVE RIGHT TO USE "SOLUTIONS", APART FROM THE MARK AS SHOWN.

SER. NO. 85-391,439, FILED 8-6-2011.

MARIA-VICTORIA SUAREZ, EXAMINING ATTORNEY



*David J. Kybas*

Director of the United States Patent and Trademark Office

# United States of America

United States Patent and Trademark Office

## Certified Green Real Estate Professional (CG-REP)

**Reg. No. 4,134,573**

**Registered May 1, 2012**

**Int. Cl.: 41**

**SERVICE MARK**

**PRINCIPAL REGISTER**

ENERGY EFFICIENCY MANAGEMENT, INC. (CALIFORNIA CORPORATION)  
817 N. ARROYO PL.  
FULLERTON, CA 92833

FOR: DEVELOPMENT AND DISSEMINATION OF EDUCATIONAL MATERIALS FOR OTHERS IN THE FIELD OF REAL ESTATE, NAMELY, ENVIRONMENTALLY, ENERGY EFFICIENT, SUSTAINABLE AND GREEN RELATED REAL ESTATE PROCESSES, PROCEDURES, MEDIA, SUPPORT, AND GUIDANCE; EDUCATIONAL SERVICES, NAMELY, CONDUCTING CLASSES, SEMINARS, CONFERENCES, TRAINING, WORKSHOPS, TESTING AND INSTRUCTIONAL GUIDANCE IN THE FIELD OF REAL ESTATE AND GREEN REAL ESTATE, NAMELY, ENVIRONMENTALLY, ENERGY EFFICIENT, SUSTAINABLE AND GREEN REAL ESTATE OPERATIONS, PROCESSES, PROCEDURES AND SUPPORT FOR NEW AND EXISTING HOMES OR BUILDINGS, IN CLASS 41 (U.S. CLS. 100, 101 AND 107).

FIRST USE 9-6-2010; IN COMMERCE 4-28-2011.

THE MARK CONSISTS OF STANDARD CHARACTERS WITHOUT CLAIM TO ANY PARTICULAR FONT, STYLE, SIZE, OR COLOR.

NO CLAIM IS MADE TO THE EXCLUSIVE RIGHT TO USE "CERTIFIED GREEN REAL ESTATE PROFESSIONAL", APART FROM THE MARK AS SHOWN.

SER. NO. 85-391,477, FILED 8-6-2011.

JEFFREY LOOK, EXAMINING ATTORNEY



*David J. Kybas*

Director of the United States Patent and Trademark Office



# United States of America

United States Patent and Trademark Office

## Pack River Seasonal

**Reg. No. 4,134,574**

NIELSON ENTERPRISES INC (CALIFORNIA CORPORATION)  
1913 CULVERHILL WAY  
ROSEVILLE, CA 95747

**Registered May 1, 2012**

**Int. Cl.: 35**

FOR: ON-LINE RETAIL STORE SERVICES FEATURING INDOOR AND OUTDOOR HOME DECOR, IN CLASS 35 (U.S. CLS. 100, 101 AND 102).

**SERVICE MARK**

FIRST USE 7-1-2008; IN COMMERCE 7-1-2008.

**PRINCIPAL REGISTER**

THE MARK CONSISTS OF STANDARD CHARACTERS WITHOUT CLAIM TO ANY PARTICULAR FONT, STYLE, SIZE, OR COLOR.

NO CLAIM IS MADE TO THE EXCLUSIVE RIGHT TO USE "SEASONAL", APART FROM THE MARK AS SHOWN.

SER. NO. 85-391,479, FILED 8-6-2011.

JEFFREY LOOK, EXAMINING ATTORNEY



*David J. Kybas*

Director of the United States Patent and Trademark Office

# United States of America

United States Patent and Trademark Office



**Reg. No. 4,134,575**

**Registered May 1, 2012**

**Int. Cl.: 41**

**SERVICE MARK**

**PRINCIPAL REGISTER**

DALLAS/MUSIC, INC. (TEXAS CORPORATION)  
3415 MILTON  
DALLAS, TX 75205

FOR: TEACHING IN THE FIELD OF MUSIC, IN CLASS 41 (U.S. CLS. 100, 101 AND 107).

FIRST USE 5-0-1987; IN COMMERCE 5-0-1987.

NO CLAIM IS MADE TO THE EXCLUSIVE RIGHT TO USE "DALLAS MUSIC" , APART FROM THE MARK AS SHOWN.

THE MARK CONSISTS OF THE WORDING "DALLAS MUSIC" IN STYLIZED FORM WITH A STYLIZED SLASH MARK BETWEEN THE WORDS AND WITH THE WORDING DIRECTLY BENEATH A STYLIZED REPRESENTATION OF A PIANO.

SER. NO. 85-391,494, FILED 8-6-2011.

JEFFREY LOOK, EXAMINING ATTORNEY



*David J. Kyffers*

Director of the United States Patent and Trademark Office

# United States of America

United States Patent and Trademark Office

# A 3.0

**Reg. No. 4,134,576**

**Registered May 1, 2012**

**Int. Cl.: 35**

**SERVICE MARK**

**PRINCIPAL REGISTER**

PERFORMANCE MANAGEMENT INSTITUTE, INC. (CALIFORNIA CORPORATION)  
708 GRAVENSTEIN HWY, N. #135  
SEBASTOPOL, CA 954722807

FOR: BUSINESS ADMINISTRATION CONSULTANCY; BUSINESS CONSULTING AND BUSINESS INFORMATION FOR ENTERPRISES; BUSINESS CONSULTING AND INFORMATION SERVICES; BUSINESS MANAGEMENT AND CONSULTATION; BUSINESS MANAGEMENT PLANNING; BUSINESS ORGANISATION AND MANAGEMENT CONSULTING SERVICES; BUSINESS ORGANISATION CONSULTING; BUSINESS ORGANIZATION AND MANAGEMENT CONSULTING; BUSINESS ORGANIZATIONAL CONSULTATION; BUSINESS PLANNING; BUSINESS RECORDS MANAGEMENT; FINANCIAL STATEMENT PREPARATION AND ANALYSIS FOR BUSINESSES; PREPARATION OF BUSINESS REPORTS; PREPARING BUSINESS REPORTS; PROVIDING BUSINESS INTELLIGENCE SERVICES; PROVIDING BUSINESS MANAGEMENT INFORMATION IN CONNECTION WITH CONSULTING AND ADVISORY SERVICES IN THE FIELD OF STRATEGIC PLANNING, IN CLASS 35 (U.S. CLS. 100, 101 AND 102).

FIRST USE 8-3-2011; IN COMMERCE 8-5-2011.

THE MARK CONSISTS OF STANDARD CHARACTERS WITHOUT CLAIM TO ANY PARTICULAR FONT, STYLE, SIZE, OR COLOR.

OWNER OF U.S. REG. NO. 3,934,058.

SER. NO. 85-391,518, FILED 8-6-2011.

SUSAN RICHARDS, EXAMINING ATTORNEY



*David J. Kyffers*

Director of the United States Patent and Trademark Office

# United States of America

United States Patent and Trademark Office

## CLEAN TEAM

**Reg. No. 4,134,577**

**Registered May 1, 2012**

**Int. Cl.: 3**

**TRADEMARK**

**PRINCIPAL REGISTER**

ANDREA PATNIK (UNITED STATES INDIVIDUAL)  
SUITE 222  
1126 S. FEDERAL HWY  
FORT LAUDERDALE, FL 33316

FOR: CLEANING PRODUCTS FOR REMOVING CONTAMINATION FROM MAGNETIC STRIP READERS, MAGNETIC INK READERS, OPTICAL READERS, CURRENCY READERS, CURRENCY VALIDATORS, THERMAL PRINTERS, THERMAL PRINT HEADS, TICKET READERS, IDENTIFICATION READERS AND PRINTERS AND ASSOCIATED TRANSPORT ROLLERS AND BELTS, NAMELY, SOLVENT SATURATED FIBROUS, LAMINATED OR NON-LAMINATED CARDS, WIPES, PENS, AND SWABS, IN CLASS 3 (U.S. CLS. 1, 4, 6, 50, 51 AND 52).

FIRST USE 10-2-2011; IN COMMERCE 11-16-2011.

THE MARK CONSISTS OF STANDARD CHARACTERS WITHOUT CLAIM TO ANY PARTICULAR FONT, STYLE, SIZE, OR COLOR.

NO CLAIM IS MADE TO THE EXCLUSIVE RIGHT TO USE "CLEAN" , APART FROM THE MARK AS SHOWN.

SER. NO. 85-391,576, FILED 8-7-2011.

DOMINICK J. SALEMI, EXAMINING ATTORNEY



*David J. Kybas*

Director of the United States Patent and Trademark Office

# United States of America

United States Patent and Trademark Office

## New Soul Generation

**Reg. No. 4,134,578**

**Registered May 1, 2012**

**Int. Cl.: 41**

**SERVICE MARK**

**PRINCIPAL REGISTER**

JULIUS HOPE JR (UNITED STATES INDIVIDUAL)  
9806 S. KING DRIVE  
CHICAGO, IL 60628

FOR: ENTERTAINMENT IN THE NATURE OF VISUAL AND AUDIO PERFORMANCES BY MUSICAL BAND; ENTERTAINMENT SERVICES BY A MUSICAL ARTIST AND PRODUCER, NAMELY, MUSICAL COMPOSITION FOR OTHERS AND PRODUCTION OF MUSICAL SOUND RECORDINGS; ENTERTAINMENT SERVICES IN THE NATURE OF LIVE MUSICAL PERFORMANCES; ENTERTAINMENT SERVICES IN THE NATURE OF PRESENTING LIVE MUSICAL PERFORMANCES; ENTERTAINMENT, NAMELY, LIVE MUSIC CONCERTS; ENTERTAINMENT, NAMELY, LIVE PERFORMANCES BY A MUSICAL BAND; ENTERTAINMENT, NAMELY, LIVE PERFORMANCES BY MUSICAL BANDS; LIVE PERFORMANCES BY A MUSICAL GROUP; MULTIMEDIA ENTERTAINMENT SERVICES IN THE NATURE OF RECORDING, PRODUCTION AND POST-PRODUCTION SERVICES IN THE FIELDS OF MUSIC, VIDEO, AND FILMS, IN CLASS 41 (U.S. CLS. 100, 101 AND 107).

FIRST USE 3-19-2010; IN COMMERCE 3-11-2011.

THE MARK CONSISTS OF STANDARD CHARACTERS WITHOUT CLAIM TO ANY PARTICULAR FONT, STYLE, SIZE, OR COLOR.

NO CLAIM IS MADE TO THE EXCLUSIVE RIGHT TO USE "SOUL", APART FROM THE MARK AS SHOWN.

SER. NO. 85-391,667, FILED 8-7-2011.

KATHERINE CONNOLLY, EXAMINING ATTORNEY



*David J. Kyffers*

Director of the United States Patent and Trademark Office

# United States of America

United States Patent and Trademark Office

## The Winner's Brand

**Reg. No. 4,134,579**

**Registered May 1, 2012**

**Int. Cl.: 18**

**TRADEMARK**

**PRINCIPAL REGISTER**

WEAVER LEATHER LLC (DELAWARE LIMITED LIABILITY COMPANY)  
P.O. BOX 68  
MT. HOPE, OH 44660

FOR: TACK MADE OF NYLON, NAMELY, BLANKETS, COLLARS, BOX FAN HOLDERS, HALTERS, HARNESES, HOBBLERS, LEADS, MUZZLES, NECK STRAPS, OBSTETRICAL STRAPS, AND TIE STRAPS, IN CLASS 18 (U.S. CLS. 1, 2, 3, 22 AND 41).

FIRST USE 6-15-2011; IN COMMERCE 6-15-2011.

THE MARK CONSISTS OF STANDARD CHARACTERS WITHOUT CLAIM TO ANY PARTICULAR FONT, STYLE, SIZE, OR COLOR.

OWNER OF U.S. REG. NO. 3,844,663.

NO CLAIM IS MADE TO THE EXCLUSIVE RIGHT TO USE "BRAND", APART FROM THE MARK AS SHOWN.

SER. NO. 85-391,878, FILED 8-8-2011.

MICHELE SWAIN, EXAMINING ATTORNEY



*David J. Kyros*

Director of the United States Patent and Trademark Office

# United States of America

United States Patent and Trademark Office

# Amherst Gray

**Reg. No. 4,134,580**

**Registered May 1, 2012**

**Int. Cl.: 19**

**TRADEMARK**

**PRINCIPAL REGISTER**

IRG OPERATING LLC (OHIO LIMITED LIABILITY COMPANY), DBA CLEVELAND QUARRIES  
5270 DEVON DR  
VERMILION, OH 44089

FOR: SANDSTONE, IN CLASS 19 (U.S. CLS. 1, 12, 33 AND 50).

FIRST USE 0-0-1868; IN COMMERCE 0-0-1868.

THE MARK CONSISTS OF STANDARD CHARACTERS WITHOUT CLAIM TO ANY PARTICULAR FONT, STYLE, SIZE, OR COLOR.

NO CLAIM IS MADE TO THE EXCLUSIVE RIGHT TO USE "GRAY", APART FROM THE MARK AS SHOWN.

SEC. 2(F).

SER. NO. 85-391,951, FILED 8-8-2011.

BRIDGETT SMITH, EXAMINING ATTORNEY



*David J. Kyffers*

Director of the United States Patent and Trademark Office

# United States of America

United States Patent and Trademark Office

# Kaleidoloop

**Reg. No. 4,134,581**

**Registered May 1, 2012**

**Int. Cl.: 9**

**TRADEMARK**

**PRINCIPAL REGISTER**

OWEN OSBORN (UNITED STATES INDIVIDUAL), DBA CRITTER & GUITARI  
3461 INDIAN QUEEN LANE  
PHILADELPHIA, PA 19129 AND

CHRISTOPHER KUCINSKI (UNITED STATES INDIVIDUAL), DBA CRITTER & GUITARI  
4F  
103 HAVEMEYER STREET  
BROOKLYN, NY 11211

FOR: ELECTRIC AUDIO PLAYBACK UNITS WITH DIGITAL AUDIO RECORDER, IN CLASS  
9 (U.S. CLS. 21, 23, 26, 36 AND 38).

FIRST USE 9-30-2010; IN COMMERCE 9-30-2010.

THE MARK CONSISTS OF STANDARD CHARACTERS WITHOUT CLAIM TO ANY PAR-  
TICULAR FONT, STYLE, SIZE, OR COLOR.

SER. NO. 85-392,111, FILED 8-8-2011.

ELIZABETH KAJUBI, EXAMINING ATTORNEY



*David J. Kybas*

Director of the United States Patent and Trademark Office



# United States of America

United States Patent and Trademark Office



**Reg. No. 4,134,582**

**Registered May 1, 2012**

**Int. Cl.: 45**

**SERVICE MARK**

**PRINCIPAL REGISTER**

AMERI-TECH EMERGENCY MANAGEMENT SERVICES, INC. (FLORIDA CORPORATION)  
24701 U.S. HIGHWAY NORTH, SUITE 102  
CLEARWATER, FL 33763

FOR: PROVIDING CONSULTATION AND INFORMATION IN THE FIELD OF EMERGENCY RESPONSE FOR COMMUNITIES, IN CLASS 45 (U.S. CLS. 100 AND 101).

FIRST USE 4-15-2011; IN COMMERCE 4-15-2011.

NO CLAIM IS MADE TO THE EXCLUSIVE RIGHT TO USE "EMERGENCY MANAGEMENT SERVICES, INC." AND "EMERGENCY RESPONSE TEAM", APART FROM THE MARK AS SHOWN.

THE COLOR(S) RED, WHITE, BLUE, AND BLACK ARE CLAIMED AS A FEATURE OF THE MARK IS/ARE CLAIMED AS A FEATURE OF THE MARK.

THE MARK CONSISTS OF THE WORDING "AMERI-TECH EMERGENCY MANAGEMENT SERVICES, INC." IN BLACK, BENEATH A BLUE TRIANGLE WITH 10 WHITE STARS INSIDE, ALL ABOVE 13 VERTICAL RED AND WHITE ALTERNATING STRIPES, ACROSS WHICH IS A WHITE RIBBON OUTLINED IN BLUE, WITH BLUE NEAR EACH END AND THE WORDS "EMERGENCY RESPONSE TEAM" IN BLACK WRITTEN ACROSS THE RIBBON.

SER. NO. 85-392,150, FILED 8-8-2011.

SUSAN RICHARDS, EXAMINING ATTORNEY



*David J. Kyjars*

Director of the United States Patent and Trademark Office

# United States of America

United States Patent and Trademark Office



**Reg. No. 4,134,583**

**Registered May 1, 2012**

**Int. Cl.: 35**

**SERVICE MARK**

**PRINCIPAL REGISTER**

JOSEFS PHARMACY LLC (NORTH CAROLINA LIMITED LIABILITY COMPANY)  
2100 NEW BERN AVE  
RALEIGH, NC 27610

FOR: RETAIL PHARMACY SERVICES, IN CLASS 35 (U.S. CLS. 100, 101 AND 102).

FIRST USE 6-2-2010; IN COMMERCE 6-2-2010.

NO CLAIM IS MADE TO THE EXCLUSIVE RIGHT TO USE "PHARMACY", APART FROM THE MARK AS SHOWN.

THE MARK CONSISTS OF THE STYLIZED TEXT "JOSEFS PHARMACY" WITH A CUP AND A PRESSER ON THE RIGHT.

SER. NO. 85-392,178, FILED 8-8-2011.

JULIE WATSON, EXAMINING ATTORNEY



*David J. Kyffers*

Director of the United States Patent and Trademark Office

# United States of America

United States Patent and Trademark Office

## BIO AND CHIC

**Reg. No. 4,134,584**

**Registered May 1, 2012**

**Int. Cls.: 20 and 21**

**TRADEMARK**

**PRINCIPAL REGISTER**

FIRST PACK, LLC (DELAWARE LIMITED LIABILITY COMPANY)  
262 FIRST STREET, UNIT A  
HOBOKEN, NJ 07030

FOR: DRINKING STRAWS; PLASTIC LIDS, IN CLASS 20 (U.S. CLS. 2, 13, 22, 25, 32 AND 50).

FIRST USE 1-0-2011; IN COMMERCE 1-0-2011.

FOR: PLASTIC CONTAINERS FOR HOUSEHOLD USE; HOUSEHOLD CONTAINERS FOR FOOD; DISPOSABLE COOKING SKEWERS MADE OF PLASTIC, WOOD AND BAMBOO; DISPOSABLE MEAL TRAYS AND LUNCH BOXES MADE OF WOOD, BAMBOO AND PLASTIC; PLASTIC CUPS, PLATES AND BOWLS, IN CLASS 21 (U.S. CLS. 2, 13, 23, 29, 30, 33, 40 AND 50).

FIRST USE 1-0-2011; IN COMMERCE 1-0-2011.

THE MARK CONSISTS OF STANDARD CHARACTERS WITHOUT CLAIM TO ANY PARTICULAR FONT, STYLE, SIZE, OR COLOR.

NO CLAIM IS MADE TO THE EXCLUSIVE RIGHT TO USE "BIO", APART FROM THE MARK AS SHOWN.

SER. NO. 85-392,320, FILED 8-8-2011.

KELLY TRUSILO, EXAMINING ATTORNEY



*David J. Kybas*

Director of the United States Patent and Trademark Office

# United States of America

United States Patent and Trademark Office

## Gratitude Grotto

**Reg. No. 4,134,585**

**Registered May 1, 2012**

**Int. Cl.: 9**

**TRADEMARK**

**PRINCIPAL REGISTER**

TOONUP SNIPPETS, INC. (PENNSYLVANIA CORPORATION)  
11 WEST AVENUE  
WAYNE, PA 19087

FOR: PROVIDING ONLINE COMPUTER GAME SOFTWARE THAT MAY BE DOWNLOADED FROM A COMPUTER NETWORK; INTERACTIVE VIDEO GAME PROGRAMS; DOWNLOADABLE ELECTRONIC GAME PROGRAMS AND COMPUTER SOFTWARE PLATFORMS FOR SOCIAL NETWORKING THAT MAY BE ACCESSED VIA THE INTERNET, COMPUTERS AND WIRELESS DEVICES; COMPUTER SOFTWARE TO ENABLE UPLOADING, POSTING, SHOWING, DISPLAYING, TAGGING, SHARING OR OTHERWISE PROVIDING ELECTRONIC MEDIA OR INFORMATION IN THE FIELDS OF VIRTUAL COMMUNITIES, ELECTRONIC GAMING, ENTERTAINMENT, AND GENERAL INTEREST VIA THE INTERNET OF OTHER COMMUNICATIONS NETWORK WITH THIRD PARTIES, IN CLASS 9 (U.S. CLS. 21, 23, 26, 36 AND 38).

FIRST USE 11-18-2010; IN COMMERCE 11-18-2010.

THE MARK CONSISTS OF STANDARD CHARACTERS WITHOUT CLAIM TO ANY PARTICULAR FONT, STYLE, SIZE, OR COLOR.

NO CLAIM IS MADE TO THE EXCLUSIVE RIGHT TO USE "GRATITUDE", APART FROM THE MARK AS SHOWN.

SER. NO. 85-392,359, FILED 8-8-2011.

INGA ERVIN, EXAMINING ATTORNEY



*David J. Kyffers*

Director of the United States Patent and Trademark Office

# United States of America

United States Patent and Trademark Office

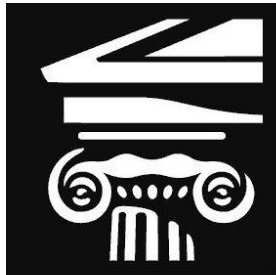

## Career Step

Quality Online Education

**Reg. No. 4,134,586**

**Registered May 1, 2012**

**Int. Cl.: 41**

**SERVICE MARK**

**PRINCIPAL REGISTER**

CAREER STEP HOLDINGS, LLC (UTAH LIMITED LIABILITY COMPANY)  
4692 NORTH 300 WEST, SUITE 150  
PROVO, UT 84604

FOR: EDUCATION SERVICES, NAMELY, PROVIDING COURSES OF ONLINE INSTRUCTION AT THE POST-SECONDARY LEVEL AND DISTRIBUTING COURSE MATERIAL IN CONNECTION THEREWITH, IN CLASS 41 (U.S. CLS. 100, 101 AND 107).

FIRST USE 6-14-2011; IN COMMERCE 6-14-2011.

OWNER OF U.S. REG. NOS. 3,843,898 AND 3,843,900.

NO CLAIM IS MADE TO THE EXCLUSIVE RIGHT TO USE "ONLINE EDUCATION", APART FROM THE MARK AS SHOWN.

THE MARK CONSISTS OF THE TOP SECTION OF A PILLAR WITH A SCROLL DESIGN ON THE TOP OF THE PILLAR, SUPPORTING THE CORNER SECTION OF A ROOF, THE WORDS "CAREER STEP" ARE DIRECTLY TO THE RIGHT OF THE PILLAR WITH THE BOTTOM OF THE LETTER "C" OF THE WORD "CAREER" OVERLAPPING THE TOP OF THE LETTER "S" OF THE WORD "STEP"; THE WORDS "QUALITY ONLINE EDUCATION" ARE CENTERED UNDER THE PILLAR AND THE WORDS "CAREER STEP".

SER. NO. 85-392,370, FILED 8-8-2011.

SUSAN RICHARDS, EXAMINING ATTORNEY



*David J. Kybas*

Director of the United States Patent and Trademark Office

# United States of America

United States Patent and Trademark Office

# GOEX

**Reg. No. 4,134,587**

**Registered May 1, 2012**

**Int. Cl.: 17**

**TRADEMARK**

**PRINCIPAL REGISTER**

GOEX CORPORATION (WISCONSIN CORPORATION)  
2532 FOSTER AVENUE  
JANESVILLE, WI 53545

FOR: PLASTIC IN EXTRUDED FORM FOR GENERAL INDUSTRIAL USE, IN CLASS 17  
(U.S. CLS. 1, 5, 12, 13, 35 AND 50).

FIRST USE 12-31-1985; IN COMMERCE 12-31-1985.

THE MARK CONSISTS OF STANDARD CHARACTERS WITHOUT CLAIM TO ANY PARTICULAR FONT, STYLE, SIZE, OR COLOR.

OWNER OF U.S. REG. NO. 1,614,866.

SER. NO. 85-392,475, FILED 8-8-2011.

HANNO RITTNER, EXAMINING ATTORNEY



*David J. Kyffers*

Director of the United States Patent and Trademark Office

# United States of America

United States Patent and Trademark Office

# CAROM

**Reg. No. 4,134,588**

**Registered May 1, 2012**

**Int. Cl.: 17**

**TRADEMARK**

**PRINCIPAL REGISTER**

GOEX CORPORATION (WISCONSIN CORPORATION)  
2532 FOSTER AVENUE  
JANESVILLE, WI 53545

FOR: PLASTIC IN EXTRUDED FORM FOR GENERAL INDUSTRIAL USE, IN CLASS 17  
(U.S. CLS. 1, 5, 12, 13, 35 AND 50).

FIRST USE 12-31-1985; IN COMMERCE 12-31-1985.

THE MARK CONSISTS OF STANDARD CHARACTERS WITHOUT CLAIM TO ANY PARTICULAR FONT, STYLE, SIZE, OR COLOR.

OWNER OF U.S. REG. NO. 1,612,937.

SER. NO. 85-392,548, FILED 8-8-2011.

HANNO RITTNER, EXAMINING ATTORNEY



*David J. Kyffers*

Director of the United States Patent and Trademark Office

# United States of America

United States Patent and Trademark Office

# CDS<sup>PLUS</sup>

**Reg. No. 4,134,589**

**Registered May 1, 2012**

**Int. Cl.: 9**

**TRADEMARK**

**PRINCIPAL REGISTER**

ANVITA, INC. (DELAWARE CORPORATION)  
7090 MIRATECH DRIVE  
SAN DIEGO, CA 92121

FOR: COMPUTER SOFTWARE IN THE MEDICAL FIELD, NAMELY, SOFTWARE THAT ANALYZES PATIENT DATA AGAINST EVIDENCE-BASED RULES AND PROVIDES REPORTS THAT HELP HEALTH CARE INSURERS TO BETTER UNDERSTAND THEIR INSUREDS AND HEALTH CARE PROVIDERS TO HAVE A MORE ACCURATE, COMPREHENSIVE MEDICAL PROFILE OF THEIR PATIENTS WITH THE INTENTION OF PROVIDING MORE PRECISE AND APPROPRIATE CARE, IN CLASS 9 (U.S. CLS. 21, 23, 26, 36 AND 38).

FIRST USE 2-21-2011; IN COMMERCE 2-21-2011.

THE MARK CONSISTS OF THE LETTERS "CDS" AND ALONG SIDE IN SMALLER FONT IS THE WORD "PLUS".

SER. NO. 85-392,561, FILED 8-8-2011.

SUSAN RICHARDS, EXAMINING ATTORNEY



*David J. Kyffers*

Director of the United States Patent and Trademark Office



# United States of America

United States Patent and Trademark Office

## SOUL CARRIER

**Reg. No. 4,134,590**

**Registered May 1, 2012**

**Int. Cl.: 22**

**TRADEMARK**

**PRINCIPAL REGISTER**

JENNIFER PAIGE DESIGNS, LLC (ARIZONA LIMITED LIABILITY COMPANY)  
3261 EAST CAMELBACK ROAD  
PHOENIX, AZ 85018

FOR: MULTI-PURPOSE CLOTH BAGS, IN CLASS 22 (U.S. CLS. 1, 2, 7, 19, 22, 42 AND 50).

FIRST USE 9-18-2011; IN COMMERCE 9-18-2011.

THE MARK CONSISTS OF STANDARD CHARACTERS WITHOUT CLAIM TO ANY PARTICULAR FONT, STYLE, SIZE, OR COLOR.

NO CLAIM IS MADE TO THE EXCLUSIVE RIGHT TO USE "CARRIER", APART FROM THE MARK AS SHOWN.

SER. NO. 85-392,562, FILED 8-8-2011.

SUSAN RICHARDS, EXAMINING ATTORNEY



*David J. Kyffers*

Director of the United States Patent and Trademark Office

# United States of America

United States Patent and Trademark Office

## 5 Meetings Before Lunch

**Reg. No. 4,134,591**

5 MEETINGS BEFORE LUNCH, L.L.C. (CALIFORNIA LIMITED LIABILITY COMPANY)  
3899 CLAY ST.  
SAN FRANCISCO, CA 94118

**Registered May 1, 2012**

**Int. Cl.: 35**

FOR: ASSISTANCE, ADVISORY SERVICES AND CONSULTANCY WITH REGARD TO BUSINESS PLANNING, BUSINESS ANALYSIS, BUSINESS MANAGEMENT, BUSINESS ORGANIZATION, MARKETING AND CUSTOMER ANALYSIS, IN CLASS 35 (U.S. CLS. 100, 101 AND 102).

**SERVICE MARK**

**PRINCIPAL REGISTER**

FIRST USE 8-19-2005; IN COMMERCE 8-19-2005.

THE MARK CONSISTS OF STANDARD CHARACTERS WITHOUT CLAIM TO ANY PARTICULAR FONT, STYLE, SIZE, OR COLOR.

SER. NO. 85-392,757, FILED 8-8-2011.

HAI-LY LAM, EXAMINING ATTORNEY



*David J. Kybas*

Director of the United States Patent and Trademark Office

# United States of America

United States Patent and Trademark Office

## B.A.F. Currency Fund

**Reg. No. 4,134,592**

B.A.F. MANAGEMENT, LP (DELAWARE LIMITED PARTNERSHIP)  
152 WEST 57TH STREET, 25TH FLOOR  
NEW YORK, NY 10019

**Registered May 1, 2012**

**Int. Cl.: 36**

FOR: FINANCIAL SERVICES WITH RESPECT TO SECURITIES, FINANCIAL INSTRUMENTS AND COMMODITIES, NAMELY, TRADING OF AND INVESTMENTS IN FOREIGN CURRENCY, PRECIOUS METALS, AND COMMODITY INVESTMENTS FOR OTHERS, IN CLASS 36 (U.S. CLS. 100, 101 AND 102).

**SERVICE MARK**

**PRINCIPAL REGISTER**

FIRST USE 5-1-2009; IN COMMERCE 5-1-2009.

THE MARK CONSISTS OF STANDARD CHARACTERS WITHOUT CLAIM TO ANY PARTICULAR FONT, STYLE, SIZE, OR COLOR.

NO CLAIM IS MADE TO THE EXCLUSIVE RIGHT TO USE "CURRENCY FUND", APART FROM THE MARK AS SHOWN.

SER. NO. 85-392,904, FILED 8-9-2011.

CHRISTOPHER LAW, EXAMINING ATTORNEY



*David J. Kyffers*

Director of the United States Patent and Trademark Office

# United States of America

United States Patent and Trademark Office

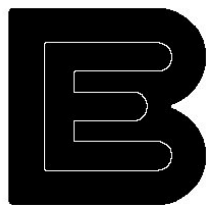

BALANCINGENERGY  
HEALTH & YOGA WELLNESS

**Reg. No. 4,134,593**

BREITENWISCHER, LISA (UNITED STATES INDIVIDUAL)  
4045 THROCKMORTON ST.  
DALLAS, TX 75219

**Registered May 1, 2012**

**Int. Cl.: 44**

FOR: COUNSELING IN THE FIELD OF HOLISTIC HEALTH, IN CLASS 44 (U.S. CLS. 100 AND 101).

**SERVICE MARK**

FIRST USE 1-19-2011; IN COMMERCE 1-19-2011.

**PRINCIPAL REGISTER**

NO CLAIM IS MADE TO THE EXCLUSIVE RIGHT TO USE "HEALTH & YOGA WELLNESS", APART FROM THE MARK AS SHOWN.

THE MARK CONSISTS OF A CAPITAL LETTER "E" SET INSIDE A CAPITAL LETTER "B", A GLOW AROUND THE "E", AND THE TEXT "BALANCINGENERGY HEALTH & YOGA WELLNESS" TO THE RIGHT OF THE CONCENTRIC LETTERS "E" AND "B", WITH "BALANCINGENERGY" ABOVE, AND "HEALTH & YOGA WELLNESS" BELOW "BALANCINGENERGY".

SER. NO. 85-392,966, FILED 8-9-2011.

WILLIAM JACKSON, EXAMINING ATTORNEY



*David J. Kyros*

Director of the United States Patent and Trademark Office

# United States of America

United States Patent and Trademark Office

# SCHMIDT

**Reg. No. 4,134,594**

**Registered May 1, 2012**

**Int. Cl.: 32**

**TRADEMARK**

**PRINCIPAL REGISTER**

PABST BREWING COMPANY (DELAWARE CORPORATION)  
9014 HERITAGE PARKWAY  
SUITE 308  
WOODRIDGE, IL 60517

FOR: BEER, BREWED MALT-BASED ALCOHOLIC BEVERAGE IN THE NATURE OF A BEER, IN CLASS 32 (U.S. CLS. 45, 46 AND 48).

FIRST USE 0-0-1990; IN COMMERCE 0-0-1990.

THE MARK CONSISTS OF STANDARD CHARACTERS WITHOUT CLAIM TO ANY PARTICULAR FONT, STYLE, SIZE, OR COLOR.

OWNER OF U.S. REG. NO. 4,029,164.

SEC. 2(F).

SER. NO. 85-392,970, FILED 8-9-2011.

ROBERT STRUCK, EXAMINING ATTORNEY



*David J. Kyffers*

Director of the United States Patent and Trademark Office

# United States of America

United States Patent and Trademark Office



**Reg. No. 4,134,595**

**Registered May 1, 2012**

**Int. Cl.: 35**

**SERVICE MARK**

**PRINCIPAL REGISTER**

VIRGINIA STATE DAIRYMEN'S ASSOCIATION (VIRGINIA CORPORATION)  
104 MAIN ST  
BRIDGEWATER, VA 22812

FOR: ASSOCIATION SERVICES, NAMELY, PROMOTING THE INTERESTS OF VIRGINIA DAIRY FARMERS, IN CLASS 35 (U.S. CLS. 100, 101 AND 102).

FIRST USE 9-15-1955; IN COMMERCE 9-15-1955.

NO CLAIM IS MADE TO THE EXCLUSIVE RIGHT TO USE "VIRGINIA PRODUCED MILK", APART FROM THE MARK AS SHOWN.

THE MARK CONSISTS OF A GLOBE WITH LATITUDINAL AND LONGITUDINAL LINES; IN THE CENTER OF THE GLOBE IS A STEMLESS GLASS WITH LIQUID INSIDE; AROUND THE PERIMETER OF THE GLOBE IS THE WORDING "VIRGINIA PRODUCED MILK" AT THE TOP, SEPARATED BY A SINGLE STAR AT THE BEGINNING AND THE END OF THIS PHRASE IS THE WORDING "THE STANDARD OF EXCELLENCE," WHICH APPEARS AROUND THE BOTTOM PERIMETER OF THE GLOBE.

SER. NO. 85-393,046, FILED 8-9-2011.

SHAILA SETTLES, EXAMINING ATTORNEY



*David J. Kyfos*

Director of the United States Patent and Trademark Office

# United States of America

United States Patent and Trademark Office



**Reg. No. 4,134,596**

**Registered May 1, 2012**

**Int. Cls.: 16 and 25**

**TRADEMARK**

**PRINCIPAL REGISTER**

DITTO DUDE, LLC (FLORIDA LIMITED LIABILITY COMPANY)  
275 BARCELONA ROAD  
WEST PALM BEACH, FL 33401

FOR: BUMPER STICKERS; MAGNETIC BUMPER STICKERS; STICKERS, IN CLASS 16  
(U.S. CLS. 2, 5, 22, 23, 29, 37, 38 AND 50).

FIRST USE 7-1-2011; IN COMMERCE 7-1-2011.

FOR: BANDANAS; HEADWEAR, NAMELY, HATS, CAPS, HEADWRAPS AND WRAPS FOR  
HATS AND CAPS; JACKETS; SHIRTS; SHORTS; SWEATSHIRTS; T-SHIRTS, IN CLASS 25  
(U.S. CLS. 22 AND 39).

FIRST USE 6-1-2011; IN COMMERCE 6-1-2011.

THE MARK CONSISTS OF A THREE DIMENSIONAL IMAGE COMPRISING THE WORD  
"DITTO" ABOVE THE WORD "DUDE" ON THE RIGHT SIDE, THE WORD "DUDE", UPSIDE  
DOWN AND REVERSED, TO THE LEFT OF AND AT A RIGHT ANGLE TO THE WORD  
"DITTO" AND THE WORD "DITTO", UPSIDE DOWN AND REVERSED, BELOW THE UPSIDE  
DOWN WORD "DUDE" ON THE LEFT SIDE AND TO THE LEFT OF AND AT A RIGHT  
ANGLE TO THE WORD "DUDE" ON THE RIGHT SIDE.

SER. NO. 85-393,476, FILED 8-9-2011.

JUSTINE D. PARKER, EXAMINING ATTORNEY



*David J. Kybas*

Director of the United States Patent and Trademark Office

# United States of America

United States Patent and Trademark Office

# BOOST

**Reg. No. 4,134,597**

**Registered May 1, 2012**

**Int. Cl.: 41**

**SERVICE MARK**

**PRINCIPAL REGISTER**

ASPEN DEVELOPMENT GROUP, INC. (NEW YORK CORPORATION)  
159 SANDY PINES BLVD.  
HOPEWELL JUNCTION, NY 12533

FOR: CONDUCTING WORKSHOPS AND SEMINARS IN PERSONAL DEVELOPMENT, PHYSICAL HEALTH, WELLNESS AND VITALITY; PERSONAL COACHING SERVICES IN THE FIELD OF PERSONAL DEVELOPMENT, PHYSICAL HEALTH, WELLNESS AND VITALITY; PROVIDING GROUP COACHING IN THE FIELD OF PERSONAL DEVELOPMENT, PHYSICAL HEALTH, WELLNESS AND VITALITY, IN CLASS 41 (U.S. CLS. 100, 101 AND 107).

FIRST USE 1-0-2011; IN COMMERCE 1-0-2011.

THE MARK CONSISTS OF STANDARD CHARACTERS WITHOUT CLAIM TO ANY PARTICULAR FONT, STYLE, SIZE, OR COLOR.

SER. NO. 85-393,618, FILED 8-9-2011.

TRACY FLETCHER, EXAMINING ATTORNEY



*David J. Kybas*

Director of the United States Patent and Trademark Office



# United States of America

United States Patent and Trademark Office

## CONNECTING THE DOTS FOR YOUR JURY

**Reg. No. 4,134,598**

**Registered May 1, 2012**

**Int. Cl.: 45**

**SERVICE MARK**

**PRINCIPAL REGISTER**

VERDIX LEGAL LLC (TEXAS LIMITED LIABILITY COMPANY)  
STE 1280  
2501 N HARWOOD ST  
DALLAS, TX 75201

FOR: LITIGATION SUPPORT SERVICES FEATURING ISSUE IDENTIFICATION AND DEVELOPMENT VIA DATABASE REVIEWS, THEME AND GRAPHIC DEVELOPMENT, VOIR DIRE QUESTION DEVELOPMENT, TRIAL STRATEGY DEVELOPMENT, JURY SELECTION AND WITNESS PREPARATION, IN CLASS 45 (U.S. CLS. 100 AND 101).

FIRST USE 4-15-2011; IN COMMERCE 6-1-2011.

THE MARK CONSISTS OF STANDARD CHARACTERS WITHOUT CLAIM TO ANY PARTICULAR FONT, STYLE, SIZE, OR COLOR.

NO CLAIM IS MADE TO THE EXCLUSIVE RIGHT TO USE "JURY", APART FROM THE MARK AS SHOWN.

SER. NO. 85-393,797, FILED 8-9-2011.

IRA J. GOODSAY, EXAMINING ATTORNEY



*David J. Kyffers*

Director of the United States Patent and Trademark Office

# United States of America

United States Patent and Trademark Office

## Stellar Memories

**Reg. No. 4,134,599**

**Registered May 1, 2012**

**Int. Cl.: 41**

**SERVICE MARK**

**PRINCIPAL REGISTER**

STELLAR, JULIE BETH (UNITED STATES INDIVIDUAL), DBA STELLAR MEMORIES  
6125 FM 2738  
BURLESON, TX 76028

FOR: PHOTOGRAPHY SERVICES, IN CLASS 41 (U.S. CLS. 100, 101 AND 107).

FIRST USE 8-31-2010; IN COMMERCE 8-31-2010.

THE MARK CONSISTS OF STANDARD CHARACTERS WITHOUT CLAIM TO ANY PARTICULAR FONT, STYLE, SIZE, OR COLOR.

SER. NO. 85-393,932, FILED 8-10-2011.

MARK SPARACINO, EXAMINING ATTORNEY



*David J. Kyffers*

Director of the United States Patent and Trademark Office

# United States of America

United States Patent and Trademark Office



**Reg. No. 4,134,600**

**Registered May 1, 2012**

**Int. Cl.: 36**

**SERVICE MARK**

**PRINCIPAL REGISTER**

GRIFFIN FINANCIAL GROUP, LLC (PENNSYLVANIA LIMITED LIABILITY COMPANY)  
111 N SIXTH ST  
READING, PA 19601

FOR: FINANCIAL CONSULTING AND ADVISING IN THE FIELD OF MERGERS AND ACQUISITIONS; FINANCING SERVICES THROUGH INSTITUTIONAL PLACEMENTS OF DEBT, MEZZANINE CAPITAL AND EQUITY; PRIVATE EQUITY CONSULTANT SERVICES, INCLUDING FINANCIAL DUE DILIGENCE, IN CLASS 36 (U.S. CLS. 100, 101 AND 102).

FIRST USE 12-31-2000; IN COMMERCE 12-31-2000.

THE MARK CONSISTS OF A STYLIZED GRIFFON.

SER. NO. 85-393,987, FILED 8-10-2011.

IRA J. GOODSaid, EXAMINING ATTORNEY



*David J. Kybas*

Director of the United States Patent and Trademark Office

# United States of America

United States Patent and Trademark Office

WE BRING A WORLD OF COLOR  
TO YOUR DOOR

**Reg. No. 4,134,601**

**Registered May 1, 2012**

**Int. Cl.: 2**

**TRADEMARK**

**PRINCIPAL REGISTER**

LANDERS-SEGAL COLOR CO., INC. (DELAWARE CORPORATION), DBA LANSCO COLORS  
ONE BLUE HILL PLAZA, 11TH FLOOR  
PEARL RIVER, NY 10965

FOR: ORGANIC PIGMENTS; INORGANIC PIGMENTS, IN CLASS 2 (U.S. CLS. 6, 11 AND 16).

FIRST USE 12-31-1992; IN COMMERCE 12-31-1992.

THE MARK CONSISTS OF STANDARD CHARACTERS WITHOUT CLAIM TO ANY PARTICULAR FONT, STYLE, SIZE, OR COLOR.

OWNER OF U.S. REG. NO. 3,023,017.

SER. NO. 85-393,995, FILED 8-10-2011.

MICHAEL LITZAU, EXAMINING ATTORNEY



*David J. Kybas*

Director of the United States Patent and Trademark Office

# United States of America

United States Patent and Trademark Office

# CPNP-PC

**Reg. No. 4,134,602**

**Registered May 1, 2012**

**Int. Cl.: 42**

**SERVICE MARK**

**PRINCIPAL REGISTER**

PEDIATRIC NURSING CERTIFICATION BOARD, INC. (MARYLAND CORPORATION)  
800 S. FREDERICK AVE., SUITE 204  
GAITHERSBURG, MD 20877

FOR: TESTING, ANALYSIS, AND EVALUATION OF THE KNOWLEDGE, SKILLS AND ABILITIES OF OTHERS FOR THE PURPOSE OF CERTIFICATION AND RE-CERTIFICATION IN THE FIELD OF PEDIATRIC NURSING, IN CLASS 42 (U.S. CLS. 100 AND 101).

FIRST USE 1-1-2006; IN COMMERCE 3-1-2006.

THE MARK CONSISTS OF STANDARD CHARACTERS WITHOUT CLAIM TO ANY PARTICULAR FONT, STYLE, SIZE, OR COLOR.

OWNER OF U.S. REG. NOS. 2,372,099, 3,802,586 AND OTHERS.

SER. NO. 85-393,997, FILED 8-10-2011.

INGRID C. EULIN, EXAMINING ATTORNEY



*David J. Kyffers*

Director of the United States Patent and Trademark Office

# United States of America

United States Patent and Trademark Office

# CPNP-AC

**Reg. No. 4,134,603**

**Registered May 1, 2012**

**Int. Cl.: 42**

**SERVICE MARK**

**PRINCIPAL REGISTER**

PEDIATRIC NURSING CERTIFICATION BOARD, INC. (MARYLAND CORPORATION)  
800 S. FREDERICK AVE., SUITE 204  
GAITHERSBURG, MD 20877

FOR: TESTING, ANALYSIS, AND EVALUATION OF THE KNOWLEDGE, SKILLS AND ABILITIES OF OTHERS FOR THE PURPOSE OF CERTIFICATION AND RE-CERTIFICATION IN THE FIELD OF PEDIATRIC NURSING, IN CLASS 42 (U.S. CLS. 100 AND 101).

FIRST USE 1-1-2006; IN COMMERCE 3-1-2006.

THE MARK CONSISTS OF STANDARD CHARACTERS WITHOUT CLAIM TO ANY PARTICULAR FONT, STYLE, SIZE, OR COLOR.

OWNER OF U.S. REG. NOS. 2,372,099, 3,802,586 AND OTHERS.

SER. NO. 85-394,013, FILED 8-10-2011.

INGRID C. EULIN, EXAMINING ATTORNEY



*David J. Kyffers*

Director of the United States Patent and Trademark Office

# United States of America

United States Patent and Trademark Office

# NOLA Chic

**Reg. No. 4,134,604**

**Registered May 1, 2012**

**Int. Cl.: 3**

**TRADEMARK**

**PRINCIPAL REGISTER**

NEW ORLEANS FLARE, LLC (MISSISSIPPI LIMITED LIABILITY COMPANY), DBA NEW ORLEANS FLARE  
5733 HEEBE STREET  
NEW ORLEANS, LA 70123

FOR: AROMATIC PREPARATIONS, NAMELY, BODY AND SKIN CARE LOTIONS, GELS, SCRUBS, BUTTERS, MILK BATHS, BUBBLE BATHS, OIL BASED MASSAGE BARS, BATH SALTS, BAR SOAPS, SHAVING SOAPS, AND LIQUID SOAPS, IN CLASS 3 (U.S. CLS. 1, 4, 6, 50, 51 AND 52).

FIRST USE 5-1-2011; IN COMMERCE 7-5-2011.

THE MARK CONSISTS OF STANDARD CHARACTERS WITHOUT CLAIM TO ANY PARTICULAR FONT, STYLE, SIZE, OR COLOR.

NO CLAIM IS MADE TO THE EXCLUSIVE RIGHT TO USE "NOLA", APART FROM THE MARK AS SHOWN.

SER. NO. 85-394,188, FILED 8-10-2011.

EDWARD FENNESSY, EXAMINING ATTORNEY



*David J. Kyffers*

Director of the United States Patent and Trademark Office

# United States of America

United States Patent and Trademark Office

# HRI

**Reg. No. 4,134,605**

**Registered May 1, 2012**

**Int. Cl.: 45**

**SERVICE MARK**

**PRINCIPAL REGISTER**

HEALTH RESEARCH, INC. (NEW YORK CORPORATION)  
RIVERVIEW CENTER  
150 BROADWAY, SUITE 150  
MENANDS, NY 122042719

FOR: CONSULTING SERVICES, NAMELY, REVIEWING STANDARDS AND PRACTICES TO ASSURE COMPLIANCE WITH FEDERAL LAWS AND REGULATIONS RELATING TO RECEIPT OF FEDERAL GRANTS OR MONEY; LICENSING OF INTELLECTUAL PROPERTY IN THE FIELD OF PUBLIC HEALTH, IN CLASS 45 (U.S. CLS. 100 AND 101).

FIRST USE 1-1-1983; IN COMMERCE 1-1-1983.

THE MARK CONSISTS OF STANDARD CHARACTERS WITHOUT CLAIM TO ANY PARTICULAR FONT, STYLE, SIZE, OR COLOR.

SER. NO. 85-394,379, FILED 8-10-2011.

FLORENTINA BLANDU, EXAMINING ATTORNEY



*David J. Kyffers*

Director of the United States Patent and Trademark Office



# United States of America

United States Patent and Trademark Office

# DOG TALK

**Reg. No. 4,134,606**

**Registered May 1, 2012**

**Int. Cl.: 41**

**SERVICE MARK**

**PRINCIPAL REGISTER**

8 PAWS LLC (DELAWARE LIMITED LIABILITY COMPANY)  
DOG WOODS  
16 WHITE PINE ROAD  
EAST HAMPTON, NY 11937

FOR: ENTERTAINMENT SERVICES, NAMELY, A SERIES OF RADIO PROGRAMS IN THE FIELD OF DOGS, IN CLASS 41 (U.S. CLS. 100, 101 AND 107).

FIRST USE 6-1-2006; IN COMMERCE 6-1-2006.

THE MARK CONSISTS OF STANDARD CHARACTERS WITHOUT CLAIM TO ANY PARTICULAR FONT, STYLE, SIZE, OR COLOR.

OWNER OF U.S. REG. NO. 3,166,934.

NO CLAIM IS MADE TO THE EXCLUSIVE RIGHT TO USE "TALK", APART FROM THE MARK AS SHOWN.

SEC. 2(F).

SER. NO. 85-394,383, FILED 8-10-2011.

EDWARD FENNESSY, EXAMINING ATTORNEY



*David J. Kyffers*

Director of the United States Patent and Trademark Office

# United States of America

United States Patent and Trademark Office

## LANSCO COLORS

**Reg. No. 4,134,607**

LANDERS-SEGAL COLOR CO., INC. (DELAWARE CORPORATION), DBA LANSCO COLORS  
ONE BLUE HILL PLAZA, 11TH FLOOR  
PEARL RIVER, NY 10965

**Registered May 1, 2012**

**Int. Cl.: 2**

FOR: ORGANIC PIGMENTS; INORGANIC PIGMENTS, IN CLASS 2 (U.S. CLS. 6, 11 AND 16).

**TRADEMARK**

FIRST USE 12-31-1988; IN COMMERCE 12-31-1988.

**PRINCIPAL REGISTER**

THE MARK CONSISTS OF STANDARD CHARACTERS WITHOUT CLAIM TO ANY PARTICULAR FONT, STYLE, SIZE, OR COLOR.

OWNER OF U.S. REG. NO. 1,311,813.

NO CLAIM IS MADE TO THE EXCLUSIVE RIGHT TO USE "COLORS", APART FROM THE MARK AS SHOWN.

SER. NO. 85-394,398, FILED 8-10-2011.

MICHAEL LITZAU, EXAMINING ATTORNEY



*David J. Kyffers*

Director of the United States Patent and Trademark Office

# United States of America

United States Patent and Trademark Office

## WEALTHCOMPENDIUM

**Reg. No. 4,134,608**

WEALTH COMPENDIUM, LLC (FLORIDA LIMITED LIABILITY COMPANY)  
5150 TAMiami TRAIL NORTH, SUITE 402  
NAPLES, FL 34103

**Registered May 1, 2012**

**Int. Cl.: 36**

FOR: FINANCIAL SERVICES, NAMELY, WEALTH MANAGEMENT SERVICES, IN CLASS  
36 (U.S. CLS. 100, 101 AND 102).

**SERVICE MARK**

FIRST USE 8-2-2011; IN COMMERCE 8-2-2011.

**PRINCIPAL REGISTER**

THE MARK CONSISTS OF STANDARD CHARACTERS WITHOUT CLAIM TO ANY PAR-  
TICULAR FONT, STYLE, SIZE, OR COLOR.

SER. NO. 85-394,415, FILED 8-10-2011.

NELSON SNYDER, EXAMINING ATTORNEY



*David J. Kybas*

Director of the United States Patent and Trademark Office

# United States of America

United States Patent and Trademark Office



Technology Group

**Reg. No. 4,134,609**

**Registered May 1, 2012**

**Int. Cl.: 40**

**SERVICE MARK**

**PRINCIPAL REGISTER**

RAPTOR TECHNOLOGY GROUP, INC (NEVADA CORPORATION)  
7064 SAMPEY ROAD  
GROVELAND, FL 34736

FOR: FAT, OIL, AND GREASE (FOG) MANAGEMENT SERVICES, NAMELY, CONVERTING COLLECTED BROWN SEWER GREASE AND FOG TO BIOFUELS; PRODUCTION OF ENERGY VIA COMBUSTION OF GREASE AND OILS; PRODUCTION, TREATMENT AND REFINEMENT OF FUEL, DIESEL FUEL, BIOFUEL AND BIODIESEL FUEL FOR OTHERS; TREATMENT OF METAL, IN CLASS 40 (U.S. CLS. 100, 103 AND 106).

FIRST USE 6-7-2010; IN COMMERCE 1-6-2011.

NO CLAIM IS MADE TO THE EXCLUSIVE RIGHT TO USE "TECHNOLOGY GROUP", APART FROM THE MARK AS SHOWN.

THE COLOR(S) BLACK, GREEN, GRAY AND WHITE IS/ARE CLAIMED AS A FEATURE OF THE MARK.

THE MARK CONSISTS OF THE STYLIZED WORDING "RAPTOR" APPEARING IN GREEN WITH A BLACK OUTLINE, ABOVE THE WORDING "TECHNOLOGY GROUP", WHICH APPEARS IN BLACK. THE FIRST LETTER "R" IN "RAPTOR" IS FLIPPED TO APPEAR BACKWARDS. THE STYLIZED TERM "RAPTOR" APPEARS IN FRONT OF A WHITE BACKGROUND WITH A THREE FINGERED CLAW RIPPING THROUGH THE BACKGROUND LEAVING BLACK SPACES SHOWING TEARS CREATED BY THE THREE CLAWS. THE CLAWS ARE GREEN, GRAY, BLACK AND WHITE.

SER. NO. 85-394,432, FILED 8-10-2011.

NELSON SNYDER, EXAMINING ATTORNEY



*David J. Kyros*

Director of the United States Patent and Trademark Office

# United States of America

United States Patent and Trademark Office

# MINI-BEEP

**Reg. No. 4,134,610**

**Registered May 1, 2012**

**Int. Cl.: 12**

**TRADEMARK**

**PRINCIPAL REGISTER**

C.F. STRUCK CORP. (WISCONSIN CORPORATION)  
PO BOX 307  
CEDARBURG, WI 53012

FOR: GARDEN TRACTORS IN KIT FORM AND INCLUDING PLANS FOR ASSEMBLING THE GARDEN TRACTOR, IN CLASS 12 (U.S. CLS. 19, 21, 23, 31, 35 AND 44).

FIRST USE 4-7-1969; IN COMMERCE 4-7-1969.

THE MARK CONSISTS OF STANDARD CHARACTERS WITHOUT CLAIM TO ANY PARTICULAR FONT, STYLE, SIZE, OR COLOR.

SER. NO. 85-394,475, FILED 8-10-2011.

CAROL SPILS, EXAMINING ATTORNEY



*David J. Kyffers*

Director of the United States Patent and Trademark Office

# United States of America

United States Patent and Trademark Office

## AMERICAN LIBERTY BAIL BONDS

**Reg. No. 4,134,611**

**Registered May 1, 2012**

**Int. Cl.: 36**

**SERVICE MARK**

**PRINCIPAL REGISTER**

AMERICAN LIBERTY BAIL BONDS, INC. (CALIFORNIA CORPORATION)  
14413 E. TELEGRAPH ROAD  
WHITTIER, CA 90604

FOR: BAIL BONDING, IN CLASS 36 (U.S. CLS. 100, 101 AND 102).

FIRST USE 12-0-1993; IN COMMERCE 12-0-1993.

THE MARK CONSISTS OF STANDARD CHARACTERS WITHOUT CLAIM TO ANY PARTICULAR FONT, STYLE, SIZE, OR COLOR.

NO CLAIM IS MADE TO THE EXCLUSIVE RIGHT TO USE "AMERICAN" AND "BAIL BONDS", APART FROM THE MARK AS SHOWN.

SER. NO. 85-394,700, FILED 8-10-2011.

ROBERT STRUCK, EXAMINING ATTORNEY



*David J. Kyffers*

Director of the United States Patent and Trademark Office

**United States of America**  
United States Patent and Trademark Office

# EZGOAL

**Reg. No. 4,134,612**

**Registered May 1, 2012**

**Int. Cl.: 28**

**TRADEMARK**

**PRINCIPAL REGISTER**

NEW ENGLAND OUTDOOR & RECREATIONAL PRODUCTS, LLC (CONNECTICUT  
LIMITED LIABILITY COMPANY)  
13 WOOD ST.  
WEST HAVEN, CT 06516

FOR: ALL-PURPOSE GOALS, REBOUND FRAMES, AND NETS FOR HOCKEY, SOCCER,  
FIELD HOCKEY, LACROSSE, BASEBALL, GOLF, BASKETBALL, FOOTBALL, AND PARTS  
AND ACCESSORIES THEREFORE, IN CLASS 28 (U.S. CLS. 22, 23, 38 AND 50).

FIRST USE 7-31-2000; IN COMMERCE 1-30-2001.

THE MARK CONSISTS OF STANDARD CHARACTERS WITHOUT CLAIM TO ANY PAR-  
TICULAR FONT, STYLE, SIZE, OR COLOR.

OWNER OF U.S. REG. NO. 2,923,471.

SER. NO. 85-394,763, FILED 8-10-2011.

LESLIE RICHARDS, EXAMINING ATTORNEY



*David J. Kyffers*

Director of the United States Patent and Trademark Office

# United States of America

United States Patent and Trademark Office

# terra verde

**Reg. No. 4,134,613**

**Registered May 1, 2012**

**Int. Cl.: 30**

**TRADEMARK**

**PRINCIPAL REGISTER**

TERRA VERDE TRADING COMPANY (OHIO LIMITED LIABILITY COMPANY)  
22 SOUTH SAINT CLAIR STREET  
DAYTON, OH 45402

FOR: COFFEE, IN CLASS 30 (U.S. CL. 46).

FIRST USE 8-9-2011; IN COMMERCE 8-9-2011.

THE MARK CONSISTS OF STANDARD CHARACTERS WITHOUT CLAIM TO ANY PARTICULAR FONT, STYLE, SIZE, OR COLOR.

THE ENGLISH TRANSLATION OF "TERRA VERDE" IN THE MARK IS "GREEN LAND".

SER. NO. 85-394,820, FILED 8-10-2011.

JESSICA FATHY, EXAMINING ATTORNEY



*David J. Kyffers*

Director of the United States Patent and Trademark Office



# United States of America

United States Patent and Trademark Office

*body*  
**CORAL**

**Reg. No. 4,134,614**

**Registered May 1, 2012**

**Int. Cls.: 14 and 25**

**TRADEMARK**

**PRINCIPAL REGISTER**

ABOU-SAYF, GINA (UNITED STATES INDIVIDUAL)  
SPACE 84  
500 RANCHEROS DR.  
SAN MARCOS, CA 92069

FOR: JEWELRY, IN CLASS 14 (U.S. CLS. 2, 27, 28 AND 50).

FIRST USE 10-13-2010; IN COMMERCE 10-13-2010.

FOR: CLOTHING, NAMELY, BOTTOMS, DRESSES, FOOTWEAR, JACKETS, SKIRTS, TOPS, BELTS, SCARVES; ACTIVEWEAR, NAMELY, TOPS AND BOTTOMS, IN CLASS 25 (U.S. CLS. 22 AND 39).

FIRST USE 10-13-2010; IN COMMERCE 10-13-2010.

NO CLAIM IS MADE TO THE EXCLUSIVE RIGHT TO USE "CORAL" IN CLASS 14, APART FROM THE MARK AS SHOWN.

THE MARK CONSISTS OF THE STYLIZED TEXT "CORAL" WITH A REEF DESIGN INSIDE THE LETTER "O". THE STYLIZED TEXT "BODY" IS ABOVE THE "C" IN "CORAL".

SER. NO. 85-394,876, FILED 8-10-2011.

RONALD MCMORROW, EXAMINING ATTORNEY



*David J. Kybas*

Director of the United States Patent and Trademark Office

# United States of America

United States Patent and Trademark Office

## TAIL WAGGIN' TRAVEL

**Reg. No. 4,134,615**

**Registered May 1, 2012**

**Int. Cl.: 35**

**SERVICE MARK**

**PRINCIPAL REGISTER**

DOGTREKKER, INC. (CALIFORNIA CORPORATION)  
P.O. BOX 151289  
SAN RAFAEL, CA 94915

FOR: PROMOTING THE GOODS AND SERVICES OF OTHERS BY PROVIDING A WEBSITE FEATURING ONLINE REVIEWS, NEWS, AND INFORMATION ABOUT DOG-FRIENDLY LODGING, FOOD, ACTIVITIES, ATTRACTIONS, AND SERVICES IN VARIOUS LOCATIONS, IN CLASS 35 (U.S. CLS. 100, 101 AND 102).

FIRST USE 6-20-2011; IN COMMERCE 6-20-2011.

THE MARK CONSISTS OF STANDARD CHARACTERS WITHOUT CLAIM TO ANY PARTICULAR FONT, STYLE, SIZE, OR COLOR.

NO CLAIM IS MADE TO THE EXCLUSIVE RIGHT TO USE "TRAVEL", APART FROM THE MARK AS SHOWN.

SER. NO. 85-394,954, FILED 8-10-2011.

ALICIA COLLINS, EXAMINING ATTORNEY



*David J. Kyros*

Director of the United States Patent and Trademark Office

# United States of America

United States Patent and Trademark Office

# DATPIFF

**Reg. No. 4,134,616**

**Registered May 1, 2012**

**Int. Cls.: 38 and 42**

**SERVICE MARK**

**PRINCIPAL REGISTER**

IDLE MEDIA, INC. (NEVADA CORPORATION)  
216 S. CENTRE AVENUE  
LEESPORT, PA 19533

FOR: PROVIDING AN ON-LINE FORUM FOR DISCUSSING MUSIC, MUSICAL ARTISTS, POP CULTURE, CELEBRITIES, AND POLITICS, IN CLASS 38 (U.S. CLS. 100, 101 AND 104).

FIRST USE 11-25-2005; IN COMMERCE 11-25-2005.

FOR: PROVIDING A WEBSITE THAT GIVES COMPUTER USERS THE ABILITY TO UPLOAD AND DOWNLOAD MUSIC, NAMELY, THE ABILITY TO UPLOAD AND DOWNLOAD MIXTAPES, WHICH ARE COMPILATIONS OF MUSIC FEATURING SONGS BY VARIOUS MUSICAL ARTISTS AND GROUPS; PROVIDING AN INTERACTIVE WEBSITE FEATURING TECHNOLOGY THAT ALLOWS USERS TO COMMENT ON ENTERTAINMENT CONTENT AND ENGAGE IN SOCIAL NETWORKING, IN CLASS 42 (U.S. CLS. 100 AND 101).

FIRST USE 11-25-2005; IN COMMERCE 11-25-2005.

THE MARK CONSISTS OF STANDARD CHARACTERS WITHOUT CLAIM TO ANY PARTICULAR FONT, STYLE, SIZE, OR COLOR.

SER. NO. 85-395,218, FILED 8-11-2011.

DOUGLAS LEE, EXAMINING ATTORNEY



*David J. Kybas*

Director of the United States Patent and Trademark Office

# United States of America

United States Patent and Trademark Office

## THE DIABETIC SOCK STORE

**Reg. No. 4,134,617**

KNIT-RITE, INC. (DELAWARE CORPORATION)  
120 OSAGE AVE.  
KANSAS CITY, KS 66103

**Registered May 1, 2012**

**Int. Cl.: 35**

FOR: ON-LINE RETAIL STORE SERVICES FEATURING THERAPEUTIC SOCKS, IN CLASS 35 (U.S. CLS. 100, 101 AND 102).

**SERVICE MARK**

FIRST USE 1-22-2005; IN COMMERCE 1-22-2005.

**PRINCIPAL REGISTER**

THE MARK CONSISTS OF STANDARD CHARACTERS WITHOUT CLAIM TO ANY PARTICULAR FONT, STYLE, SIZE, OR COLOR.

OWNER OF U.S. REG. NO. 3,120,261.

NO CLAIM IS MADE TO THE EXCLUSIVE RIGHT TO USE "STORE", APART FROM THE MARK AS SHOWN.

SEC. 2(F).

SER. NO. 85-395,350, FILED 8-11-2011.

REGINA DRUMMOND, EXAMINING ATTORNEY



*David J. Kybas*

Director of the United States Patent and Trademark Office

# United States of America

United States Patent and Trademark Office



**Reg. No. 4,134,618**

**Registered May 1, 2012**

**Int. Cl.: 41**

**SERVICE MARK**

**PRINCIPAL REGISTER**

SHUFFLE MASTER, INC. (MINNESOTA CORPORATION)  
1106 PALMS AIRPORT DRIVE  
LAS VEGAS, NV 89119

FOR: ENTERTAINMENT SERVICES, NAMELY, PROVIDING LIVE GAMES OF CHANCE  
IN GAMING ESTABLISHMENTS, IN CLASS 41 (U.S. CLS. 100, 101 AND 107).

FIRST USE 11-25-2009; IN COMMERCE 11-25-2009.

OWNER OF U.S. REG. NOS. 3,326,500 AND 3,696,620.

NO CLAIM IS MADE TO THE EXCLUSIVE RIGHT TO USE "21", APART FROM THE MARK  
AS SHOWN.

THE MARK CONSISTS OF THE WORDS "ROYAL MATCH 21" IN A SHIELD, FOUR CARDS  
EXTENDING FROM THE SHIELD, THE SHIELD HAS QUARTER ALTERNATING BLACK  
AND WHITE SHADING WITH SHARP DRAWN LINES EXTENDING FROM THE CENTER  
OF THE SHIELD OUT AND A RIBBON AROUND THE BOTTOM OF THE SHIELD WITH A  
HEART ON THE LEFT SIDE AND A CLUB ON THE RIGHT.

SER. NO. 85-395,423, FILED 8-11-2011.

JUSTINE D. PARKER, EXAMINING ATTORNEY



*David J. Kyffers*

Director of the United States Patent and Trademark Office

# United States of America

United States Patent and Trademark Office



**Reg. No. 4,134,619**

**Registered May 1, 2012**

**Int. Cl.: 16**

**TRADEMARK**

**PRINCIPAL REGISTER**

PEPPER, JAMES (UNITED STATES INDIVIDUAL)  
1008 COUNTRY ROAD  
BLANCO, TX 78606

FOR: SERIES OF FICTION WORKS, NAMELY, BOOKS, AND SHORT STORIES; SERIES OF NON-FICTION BOOKS IN THE FIELD OF HUNTING, FISHING, AND OUTDOOR ADVENTURES, IN CLASS 16 (U.S. CLS. 2, 5, 22, 23, 29, 37, 38 AND 50).

FIRST USE 9-1-2009; IN COMMERCE 9-1-2009.

OWNER OF U.S. REG. NO. 3,769,228.

NO CLAIM IS MADE TO THE EXCLUSIVE RIGHT TO USE "USA", APART FROM THE MARK AS SHOWN.

THE MARK CONSISTS OF A STYLIZED DUCK WITH THE STYLIZED WORDING "DUCK CAMP USA" IN UPPER-CASE LETTERS WITH ONE WORD ABOVE THE OTHER BELOW THE DUCK DESIGN, ALL ON A VERTICAL RECTANGULAR BACKGROUND.

SER. NO. 85-395,528, FILED 8-11-2011.

KELLEY WELLS, EXAMINING ATTORNEY



*David J. Kybas*

Director of the United States Patent and Trademark Office

# United States of America

United States Patent and Trademark Office

# webpop

**Reg. No. 4,134,620**

**Registered May 1, 2012**

**Int. Cls.: 35 and 42**

**SERVICE MARK**

**PRINCIPAL REGISTER**

DOMESTIKA NETWORKS, S.L. (SPAIN LIMITED LIABILITY COMPANY)  
PLAZA SANTA ANA, 7 28012  
MADRID, SPAIN

FOR: ON-LINE ADVERTISING AND MARKETING SERVICES, IN CLASS 35 (U.S. CLS. 100, 101 AND 102).

FOR: COMPUTER-AIDED ENGINEERING SERVICES FOR OTHERS; DESIGN, CREATION, HOSTING, MAINTENANCE OF WEBSITES FOR OTHERS; ENGINEERING SERVICES FOR BUILDING AND PROPERTY CONDITION ASSESSMENT; ENGINEERING SERVICES IN THE FIELD OF COMPUTER SCIENCE; WEB SITE DEVELOPMENT FOR OTHERS, IN CLASS 42 (U.S. CLS. 100 AND 101).

OWNER OF ERPN CMNTY TM OFC REG. NO. 6865422, DATED 1-13-2009, EXPIRES 1-13-2019.

THE COLOR(S) BLACK, PURPLE, LILAC AND GREY IS/ARE CLAIMED AS A FEATURE OF THE MARK.

THE MARK CONSISTS OF THE WORD "WEBPOP" IN STYLIZED LETTERS. THE LETTER "O" APPEARS AS A SMALL BALL WITH FOUR SMALL CURVED LINES AROUND IT AS IF IT WAS VIBRATING. THE COLOR BLACK APPEARS IN THE LETTERS "WEB", THE COLOR LILAC APPEARS IN THE LETTERS "POP". THE COLOR PURPLE APPEARS IN THE OUTER RING OF THE LITTLE BALL. THE COLOR GREY APPEARS IN THE INNER CIRCLE THAT APPEARS INSIDE THE LITTLE BALL.

THE WORDING "WEBPOP" HAS NO MEANING IN A FOREIGN LANGUAGE.

SER. NO. 85-395,541, FILED 8-11-2011.

SUSAN RICHARDS, EXAMINING ATTORNEY



*David J. Kyros*

Director of the United States Patent and Trademark Office

# United States of America

United States Patent and Trademark Office

## Vintage Elements

**Reg. No. 4,134,621**

**Registered May 1, 2012**

**Int. Cl.: 16**

**TRADEMARK**

**PRINCIPAL REGISTER**

ROSENBAUM FINE ART (FLORIDA CORPORATION)  
150 YAMATO ROAD  
BOCA RATON, FL 33431

FOR: GICLEE PRINTS, IN CLASS 16 (U.S. CLS. 2, 5, 22, 23, 29, 37, 38 AND 50).

FIRST USE 3-25-2011; IN COMMERCE 4-2-2011.

THE MARK CONSISTS OF STANDARD CHARACTERS WITHOUT CLAIM TO ANY PARTICULAR FONT, STYLE, SIZE, OR COLOR.

NO CLAIM IS MADE TO THE EXCLUSIVE RIGHT TO USE "VINTAGE", APART FROM THE MARK AS SHOWN.

SER. NO. 85-395,548, FILED 8-11-2011.

JENNIFER VASQUEZ, EXAMINING ATTORNEY



*David J. Kyffers*

Director of the United States Patent and Trademark Office



# United States of America

United States Patent and Trademark Office



**Reg. No. 4,134,622**

**Registered May 1, 2012**

**Int. Cl.: 45**

**SERVICE MARK**

**PRINCIPAL REGISTER**

NURICK LAW GROUP, LLC (PENNSYLVANIA LIMITED LIABILITY COMPANY), AKA  
NURICK LAW GROUP  
111 WEST GERMANTOWN PIKE  
PLYMOUTH MEETING, PA 19462

FOR: LITIGATION SERVICES, IN CLASS 45 (U.S. CLS. 100 AND 101).

FIRST USE 9-1-1996; IN COMMERCE 9-1-1996.

NO CLAIM IS MADE TO THE EXCLUSIVE RIGHT TO USE "JUSTICE" OR "INTEGRITY",  
APART FROM THE MARK AS SHOWN.

THE MARK CONSISTS OF A SHORT BLADED SWORD/DAGGER WITH THE SCALES OF  
JUSTICE SUSPENDED FROM EACH END OF THE CROSS BAR/HAND GUARD. ON THE  
HANDLE OF THE SWORD IS THE BLINDFOLD OF JUSTICE. THE WORDS "INTEGRITY"  
AND "JUSTICE" ARE ETCHED INTO THE CROSS BAR/HAND GUARD IN A LIGHTER  
SHADE OF GRAY. THE MARK HAS BEEN USED IN DIFFERENT COLOR SCHEMES.

SER. NO. 85-395,555, FILED 8-11-2011.

WILLIAM JACKSON, EXAMINING ATTORNEY



*David J. Kyffers*

Director of the United States Patent and Trademark Office

# United States of America

United States Patent and Trademark Office

## VERDIX LEGAL LLC

**Reg. No. 4,134,623**

**Registered May 1, 2012**

**Int. Cl.: 45**

**SERVICE MARK**

**PRINCIPAL REGISTER**

VERDIX LEGAL LLC (TEXAS LIMITED LIABILITY COMPANY)  
2501 N HARWOOD ST, STE 1280  
DALLAS, TX 75201

FOR: LITIGATION SUPPORT SERVICES FEATURING ISSUE IDENTIFICATION AND DEVELOPMENT VIA DATABASE REVIEWS, THEME AND GRAPHIC DEVELOPMENT, VOIR DIRE QUESTION DEVELOPMENT, TRIAL STRATEGY DEVELOPMENT, JURY SELECTION AND WITNESS PREPARATION, IN CLASS 45 (U.S. CLS. 100 AND 101).

FIRST USE 4-15-2011; IN COMMERCE 6-1-2011.

THE MARK CONSISTS OF STANDARD CHARACTERS WITHOUT CLAIM TO ANY PARTICULAR FONT, STYLE, SIZE, OR COLOR.

NO CLAIM IS MADE TO THE EXCLUSIVE RIGHT TO USE "LEGAL LLC", APART FROM THE MARK AS SHOWN.

SER. NO. 85-395,621, FILED 8-11-2011.

IRA J. GOODSaid, EXAMINING ATTORNEY



*David J. Kyffers*

Director of the United States Patent and Trademark Office

# United States of America

United States Patent and Trademark Office

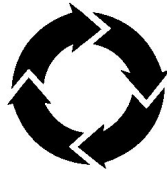

**Photo  
Maniac**

**Reg. No. 4,134,624**

**Registered May 1, 2012**

**Int. Cl.: 9**

**TRADEMARK**

**PRINCIPAL REGISTER**

KABLUYEN, VICTORIA (UNITED STATES INDIVIDUAL)  
P. O. BOX 20084  
LAS VEGAS, NV 891122084

FOR: COMPUTER APPLICATION SOFTWARE FOR MOBILE PHONES, NAMELY, SOFTWARE FOR ALLOWING USERS TO SET UP A CAMERA TIMER TO TAKE STAGE AND TIMED PICTURES, IN CLASS 9 (U.S. CLS. 21, 23, 26, 36 AND 38).

FIRST USE 5-26-2011; IN COMMERCE 5-26-2011.

NO CLAIM IS MADE TO THE EXCLUSIVE RIGHT TO USE "PHOTO", APART FROM THE MARK AS SHOWN.

THE MARK CONSISTS OF 4 ARROWS IN A CIRCULAR POSITION. BELOW THERE IS THE STYLIZED TEXT "PHOTO MANIAC".

SER. NO. 85-395,775, FILED 8-11-2011.

ZACHARY BELLO, EXAMINING ATTORNEY



*David J. Kybas*

Director of the United States Patent and Trademark Office

# United States of America

United States Patent and Trademark Office

## WREY WRINKO

**Reg. No. 4,134,625**

**Registered May 1, 2012**

**Int. Cl.: 28**

**TRADEMARK**

**PRINCIPAL REGISTER**

PRETTY UGLY, LLC (DELAWARE LIMITED LIABILITY COMPANY)  
45 FERNWOOD AVENUE  
EDISON, NJ 08837 AND

HORVATH, DAVID (UNITED STATES INDIVIDUAL)  
45 FERNWOOD AVENUE  
EDISON, NJ 08837 AND

KIM, SUN-MIN (REPUBLIC OF KOREA INDIVIDUAL)  
45 FERNWOOD AVENUE  
EDISON, NJ 08837

FOR: STUFFED AND PLUSH TOYS, IN CLASS 28 (U.S. CLS. 22, 23, 38 AND 50).

FIRST USE 7-18-2011; IN COMMERCE 7-18-2011.

THE MARK CONSISTS OF STANDARD CHARACTERS WITHOUT CLAIM TO ANY PARTICULAR FONT, STYLE, SIZE, OR COLOR.

OWNER OF U.S. REG. NO. 4,044,598.

SER. NO. 85-396,014, FILED 8-11-2011.

JOHN KELLY, EXAMINING ATTORNEY



*David J. Kybas*

Director of the United States Patent and Trademark Office

# United States of America

United States Patent and Trademark Office

## ZOLTAN ZOLTO

**Reg. No. 4,134,626**

**Registered May 1, 2012**

**Int. Cl.: 28**

**TRADEMARK**

**PRINCIPAL REGISTER**

PRETTY UGLY, LLC (DELAWARE LIMITED LIABILITY COMPANY)  
45 FERNWOOD AVENUE  
EDISON, NJ 08837 AND

HORVATH, DAVID (UNITED STATES INDIVIDUAL)  
45 FERNWOOD AVENUE  
EDISON, NJ 08837 AND

KIM, SUN-MIN (REPUBLIC OF KOREA INDIVIDUAL)  
45 FERNWOOD AVENUE  
EDISON, NJ 08837

FOR: STUFFED AND PLUSH TOYS, IN CLASS 28 (U.S. CLS. 22, 23, 38 AND 50).

FIRST USE 7-18-2011; IN COMMERCE 7-18-2011.

THE MARK CONSISTS OF STANDARD CHARACTERS WITHOUT CLAIM TO ANY PARTICULAR FONT, STYLE, SIZE, OR COLOR.

THE NAME(S), PORTRAIT(S), AND/OR SIGNATURE(S) SHOWN IN THE MARK DOES NOT IDENTIFY A PARTICULAR LIVING INDIVIDUAL.

SER. NO. 85-396,019, FILED 8-11-2011.

JOHN KELLY, EXAMINING ATTORNEY



*David J. Kyros*

Director of the United States Patent and Trademark Office

# United States of America

United States Patent and Trademark Office

## GERRY BERRY

**Reg. No. 4,134,627**

**Registered May 1, 2012**

**Int. Cl.: 28**

**TRADEMARK**

**PRINCIPAL REGISTER**

PRETTY UGLY, LLC (DELAWARE LIMITED LIABILITY COMPANY)  
45 FERNWOOD AVENUE  
EDISON, NJ 08837 AND

HORVATH, DAVID (UNITED STATES INDIVIDUAL)  
45 FERNWOOD AVENUE  
EDISON, NJ 08837 AND

KIM, SUN-MIN (REPUBLIC OF KOREA INDIVIDUAL)  
45 FERNWOOD AVENUE  
EDISON, NJ 08837

FOR: STUFFED AND PLUSH TOYS, IN CLASS 28 (U.S. CLS. 22, 23, 38 AND 50).

FIRST USE 7-18-2011; IN COMMERCE 7-18-2011.

THE MARK CONSISTS OF STANDARD CHARACTERS WITHOUT CLAIM TO ANY PARTICULAR FONT, STYLE, SIZE, OR COLOR.

THE NAME(S), PORTRAIT(S), AND/OR SIGNATURE(S) SHOWN IN THE MARK DOES NOT IDENTIFY A PARTICULAR LIVING INDIVIDUAL.

SER. NO. 85-396,021, FILED 8-11-2011.

JOHN KELLY, EXAMINING ATTORNEY



*David J. Kybas*

Director of the United States Patent and Trademark Office

# United States of America

United States Patent and Trademark Office

## A-1 DISCOUNT PHARMACY Guaranteed LOWEST PRICES IN TOWN! A1dp.com

**Reg. No. 4,134,628**

**Registered May 1, 2012**

**Int. Cl.: 35**

A-1 DME LLC (LOUISIANA LIMITED LIABILITY COMPANY), DBA A-1 DISCOUNT PHARMACY  
SUITE D-357  
1905 WEST THOMAS STREET  
HAMMOND, LA 704012901

**SERVICE MARK**

FOR: RETAIL APOTHECARY STORE SERVICES; RETAIL DRUG STORE SERVICES; RETAIL PHARMACY SERVICES; SPECIALIZED RETAIL PHARMACY SERVICES FOR PATIENTS WITH PARTICULAR MEDICAL CONDITIONS, IN CLASS 35 (U.S. CLS. 100, 101 AND 102).

**PRINCIPAL REGISTER**

FIRST USE 10-7-2009; IN COMMERCE 10-7-2009.

THE MARK CONSISTS OF STANDARD CHARACTERS WITHOUT CLAIM TO ANY PARTICULAR FONT, STYLE, SIZE, OR COLOR.

NO CLAIM IS MADE TO THE EXCLUSIVE RIGHT TO USE "DISCOUNT PHARMACY" AND "GUARANTEED LOWEST PRICES IN TOWN!", APART FROM THE MARK AS SHOWN.

SER. NO. 85-396,078, FILED 8-11-2011.

GIANCARLO CASTRO, EXAMINING ATTORNEY



*David J. Kyros*

Director of the United States Patent and Trademark Office

# United States of America

United States Patent and Trademark Office



**Reg. No. 4,134,629**

**Registered May 1, 2012**

**Int. Cl.: 12**

**TRADEMARK**

**PRINCIPAL REGISTER**

YUAN CHENG AUTO ACCESSORIES MANUFACTURER CO.,LTD. (CHINA CORPORATION)  
TANTOU SHANGZHAI INDUSTRIAL ZONE  
ZHEJIANG, CHINA

FOR: ANTI-SKID CHAINS FOR VEHICLE TIRES; ANTI-SKID CHAINS FOR VEHICLES; ANTI-SKID TEXTILE COVERS FOR TIRES; ANTI-SLIP SURFACE THAT IS AFFIXED TO UPHOLSTERED AUTOMOBILE SURFACES FOR PREVENTING ANIMAL PAWS FROM SLIPPING; ANTI-THEFT ALARMS FOR VEHICLES; ANTI-THEFT AUTOMOTIVE ALARMS; ANTI-THEFT DEVICES FOR VEHICLES; APPARATUS FOR LOCOMOTION BY AIR AND SPACE, NAMELY, AIRBORNE PLATFORMS FOR SERVING SPACECRAFTS AND CONDUCTING SPACE APPLICATIONS, AND STRUCTURAL PARTS AND STRUCTURAL FITTINGS FOR ALL OF THE AFOREMENTIONED GOODS; AUTOMOBILE HOODS; BACK-UP WARNING ALARMS FOR VEHICLES; BICYCLE WHEELS, RIMS AND STRUCTURAL PARTS THEREFOR; BURGLAR ALARMS FOR VEHICLES; CAPS FOR WHEEL RIMS; COVERS FOR VEHICLE STEERING WHEELS; LIGHT RAIL VEHICLES; MOTOR VEHICLE ALARM SYSTEMS; RAIL VEHICLES, NAMELY, PASSENGER CARRIAGES; RAIL VEHICLES, NAMELY, TRAINS AND STRUCTURAL PARTS THEREFOR; REVERSING GEARS; RIMS FOR BICYCLE WHEELS; SEAT COVERS FOR VEHICLES; SUN BLINDS ADAPTED FOR AUTOMOBILES; SUN SHIELDS AND VISORS FOR MOTOR CARS; UPHOLSTERY FOR VEHICLES; VEHICLE PARTS, NAMELY, SUN VISORS; VEHICLE WHEEL RIM PROTECTORS; VEHICLE WHEEL RIMS; VEHICLE WHEEL RIMS AND STRUCTURAL PARTS THEREFOR; WHEEL RIMS; WHEEL RIMS; WHEEL RIMS; WHEEL RIMS FOR MOTOR CARS, IN CLASS 12 (U.S. CLS. 19, 21, 23, 31, 35 AND 44).

FIRST USE 1-10-2010; IN COMMERCE 1-10-2010.

THE MARK CONSISTS OF DESIGN OF A CIRCLE WITH TWO EDGES OPPOSITE TO ONE ANOTHER ON THE PERIMETER OF THE CIRCLE, AND TWO INTERSECTING, CURVED, BANDS IN THE MIDDLE OF THE CIRCLE THAT EXTEND BEYOND THE PERIMETER OF THE CIRCLE; TO THE RIGHT OF THE DESIGN ARE THE LETTERS "YC".

SER. NO. 85-396,150, FILED 8-12-2011.

CHRISTOPHER BUONGIORNO, EXAMINING ATTORNEY



*David J. Kybas*

Director of the United States Patent and Trademark Office



# United States of America

United States Patent and Trademark Office



**Reg. No. 4,134,630**

**Registered May 1, 2012**

**Int. Cls.: 16 and 41**

**TRADEMARK**

**SERVICE MARK**

**PRINCIPAL REGISTER**

WILLBURN, MARIANNE B. (UNITED STATES INDIVIDUAL)  
209 THIRD AVE.  
BRUNSWICK, MD 21716

FOR: COLUMNS ON THE SUBJECT OF GARDENING, IN CLASS 16 (U.S. CLS. 2, 5, 22, 23, 29, 37, 38 AND 50).

FIRST USE 4-0-2009; IN COMMERCE 4-0-2009.

FOR: ON-LINE JOURNALS, NAMELY, BLOGS FEATURING GARDENING, IN CLASS 41 (U.S. CLS. 100, 101 AND 107).

FIRST USE 4-0-2009; IN COMMERCE 4-0-2009.

NO CLAIM IS MADE TO THE EXCLUSIVE RIGHT TO USE "GARDENER", APART FROM THE MARK AS SHOWN.

THE MARK CONSISTS OF THE STYLIZED WORDING "THE SMALL TOWN GARDENER" HAVING AN UNDERLINE, THE STYLIZED WORDING "CONVERSATIONS IN THE GARDEN" BELOW THE UNDERLINED WORDING, AND THE DESIGN OF A SILHOUETTE OF A WHEELBARROW WITH PLANTS IN IT TO THE LEFT OF THE WORDING IN THE MARK.

SER. NO. 85-396,518, FILED 8-12-2011.

JAY BESCH, EXAMINING ATTORNEY



*David J. Kybas*

Director of the United States Patent and Trademark Office

# United States of America

United States Patent and Trademark Office

## west coast dragons lair

**Reg. No. 4,134,631**

GALVAN , EDGAR (UNITED STATES INDIVIDUAL)  
2408 S. HACIENDA BLVD. # J-5  
HACIENDA HEIGHTS, CA 91745

**Registered May 1, 2012**

**Int. Cl.: 44**

FOR: ANIMAL BREEDING, PARTICULARLY, LIZARD BREEDING, IN CLASS 44 (U.S. CLS. 100 AND 101).

**SERVICE MARK**

FIRST USE 12-1-2010; IN COMMERCE 12-1-2010.

**PRINCIPAL REGISTER**

THE MARK CONSISTS OF STANDARD CHARACTERS WITHOUT CLAIM TO ANY PARTICULAR FONT, STYLE, SIZE, OR COLOR.

NO CLAIM IS MADE TO THE EXCLUSIVE RIGHT TO USE "WEST COAST" AND "DRAGONS", APART FROM THE MARK AS SHOWN.

SER. NO. 85-396,534, FILED 8-12-2011.

SHAILA SETTLES, EXAMINING ATTORNEY



*David J. Kyffers*

Director of the United States Patent and Trademark Office

# United States of America

United States Patent and Trademark Office

## Aunt Ellie's Gourmet Foods

**Reg. No. 4,134,632**

**Registered May 1, 2012**

**Int. Cl.: 30**

**TRADEMARK**

**PRINCIPAL REGISTER**

AUNT ELLIE'S GOURMET FOODS, INC. (NORTH CAROLINA CORPORATION), DBA AUNT ELLIE'S GOURMET FOODS  
P.O. BOX 3133  
WILMINGTON, NC 28406

FOR: SALAD SAUCES; STEAK SAUCE, IN CLASS 30 (U.S. CL. 46).

FIRST USE 6-1-2010; IN COMMERCE 3-18-2011.

THE MARK CONSISTS OF STANDARD CHARACTERS WITHOUT CLAIM TO ANY PARTICULAR FONT, STYLE, SIZE, OR COLOR.

NO CLAIM IS MADE TO THE EXCLUSIVE RIGHT TO USE "GOURMET FOODS", APART FROM THE MARK AS SHOWN.

THE NAME "AUNT ELLIE'S" SHOWN IN THE MARK IDENTIFIES ELEANOR JOHNSTON, WHOSE CONSENT TO REGISTER IS MADE OF RECORD.

SER. NO. 85-396,618, FILED 8-12-2011.

ODESSA BIBBINS, EXAMINING ATTORNEY



*David J. Kyros*

Director of the United States Patent and Trademark Office

# United States of America

United States Patent and Trademark Office

## MEZZANOTTE

**Reg. No. 4,134,633**

**Registered May 1, 2012**

**Int. Cl.: 43**

**SERVICE MARK**

**PRINCIPAL REGISTER**

KKNS CORPORATION (TEXAS CORPORATION)  
12003 VIA FIRENZE LANE  
CYPRESS, TX 77429

FOR: RESTAURANT AND BAR SERVICES, INCLUDING RESTAURANT CARRYOUT SERVICES; RESTAURANT AND CATERING SERVICES; RESTAURANT SERVICES, IN CLASS 43 (U.S. CLS. 100 AND 101).

FIRST USE 12-19-2005; IN COMMERCE 12-19-2005.

THE MARK CONSISTS OF STANDARD CHARACTERS WITHOUT CLAIM TO ANY PARTICULAR FONT, STYLE, SIZE, OR COLOR.

THE ENGLISH TRANSLATION OF "MEZZANOTTE" IN THE MARK IS "MIDNIGHT".

SER. NO. 85-396,922, FILED 8-12-2011.

DEIRDRE ROBERTSON, EXAMINING ATTORNEY



*David J. Kybas*

Director of the United States Patent and Trademark Office

# United States of America

United States Patent and Trademark Office

## HONORING CHOICES MINNESOTA IT'S ABOUT THE CONVERSATION

**Reg. No. 4,134,634**

**Registered May 1, 2012**

**Int. Cl.: 16**

**TRADEMARK**

**PRINCIPAL REGISTER**

TWIN CITIES MEDICAL SOCIETY (MINNESOTA CORPORATION)  
1300 GODWARD STR NE #2000  
MINNEAPOLIS, MN 55413

FOR: PRINTED FORMS, NAMELY, PRINTED HEALTH CARE DIRECTIVE FORMS, PRINTED FORMS, PRINTED VISUALS IN THE NATURE OF PROMOTIONAL MATERIALS, PRINTED ADVANCE PLANNING EDUCATIONAL MATERIALS AND EDUCATIONAL MATERIALS IN THE FIELD OF HEALTH CARE AND ADVANCE HEALTH CARE PLANNING, IN CLASS 16 (U.S. CLS. 2, 5, 22, 23, 29, 37, 38 AND 50).

FIRST USE 6-16-2009; IN COMMERCE 8-1-2011.

THE MARK CONSISTS OF STANDARD CHARACTERS WITHOUT CLAIM TO ANY PARTICULAR FONT, STYLE, SIZE, OR COLOR.

NO CLAIM IS MADE TO THE EXCLUSIVE RIGHT TO USE "MINNESOTA", APART FROM THE MARK AS SHOWN.

SER. NO. 85-396,994, FILED 8-12-2011.

SETH A. RAPPAPORT, EXAMINING ATTORNEY



*David J. Kyros*

Director of the United States Patent and Trademark Office

# United States of America

United States Patent and Trademark Office

## PURELY SKIN

**Reg. No. 4,134,635**

NELSON, RACHEL (UNITED STATES INDIVIDUAL)  
1994 BRAGET ST  
DUPONT, WA 98327

**Registered May 1, 2012**

**Int. Cls.: 3 and 44**

FOR: COSMETICS; SOAPS FOR CLEANING THE SKIN, IN CLASS 3 (U.S. CLS. 1, 4, 6, 50, 51 AND 52).

**TRADEMARK**

FIRST USE 3-8-2003; IN COMMERCE 3-8-2003.

**SERVICE MARK**

FOR: HYGIENIC AND BEAUTY CARE, IN CLASS 44 (U.S. CLS. 100 AND 101).

**PRINCIPAL REGISTER**

FIRST USE 3-8-2003; IN COMMERCE 3-8-2003.

THE MARK CONSISTS OF STANDARD CHARACTERS WITHOUT CLAIM TO ANY PARTICULAR FONT, STYLE, SIZE, OR COLOR.

NO CLAIM IS MADE TO THE EXCLUSIVE RIGHT TO USE "SKIN", APART FROM THE MARK AS SHOWN.

SER. NO. 85-397,044, FILED 8-12-2011.

AMY ALFIERI, EXAMINING ATTORNEY



*David J. Kybas*

Director of the United States Patent and Trademark Office

# United States of America

United States Patent and Trademark Office

## EGO PROTECTION

**Reg. No. 4,134,636**

**Registered May 1, 2012**

**Int. Cl.: 3**

**TRADEMARK**

**PRINCIPAL REGISTER**

QUALA S.A (COLOMBIA CORPORATION)  
CARRERA 68D NO. 39F - 51 SUR  
BOGOTÁ D.C., COLOMBIA

FOR: BATH SOAPS; HAIR CARE PREPARATIONS; HAIR GEL; HAIR LOTIONS; SHAMPOOS;  
SKIN SOAP, IN CLASS 3 (U.S. CLS. 1, 4, 6, 50, 51 AND 52).

THE MARK CONSISTS OF STANDARD CHARACTERS WITHOUT CLAIM TO ANY PAR-  
TICULAR FONT, STYLE, SIZE, OR COLOR.

OWNER OF COLOMBIA REG. NO. 398643, DATED 3-5-2010, EXPIRES 3-5-2020.

SER. NO. 85-397,117, FILED 8-12-2011.

JAMES A. RAUEN, EXAMINING ATTORNEY



*David J. Kyffers*

Director of the United States Patent and Trademark Office

# United States of America

United States Patent and Trademark Office

## EGO EXTREME

**Reg. No. 4,134,637**

**Registered May 1, 2012**

**Int. Cl.: 3**

**TRADEMARK**

**PRINCIPAL REGISTER**

QUALA S.A (COLOMBIA CORPORATION)  
CARRERA 68D NO. 39F - 51 SUR  
BOGOTÁ D.C., COLOMBIA

FOR: BATH SOAPS; HAIR CARE PREPARATIONS; HAIR GEL; HAIR LOTIONS; SHAMPOOS;  
SKIN SOAP, IN CLASS 3 (U.S. CLS. 1, 4, 6, 50, 51 AND 52).

THE MARK CONSISTS OF STANDARD CHARACTERS WITHOUT CLAIM TO ANY PAR-  
TICULAR FONT, STYLE, SIZE, OR COLOR.

OWNER OF COLOMBIA REG. NO. 377298, DATED 3-31-2009, EXPIRES 3-31-2019.

SER. NO. 85-397,129, FILED 8-12-2011.

JAMES A. RAUEN, EXAMINING ATTORNEY



*David J. Kyffers*

Director of the United States Patent and Trademark Office



# United States of America

United States Patent and Trademark Office

## BEAUTIFUL REALITIES

**Reg. No. 4,134,638**

**Registered May 1, 2012**

**Int. Cls.: 39 and 41**

**SERVICE MARK**

**PRINCIPAL REGISTER**

BEAUTIFUL REALITIES LLC (NEW YORK LIMITED LIABILITY COMPANY)  
PO BOX 3772  
SPARKS, NV 89432

FOR: TRAVEL, EXCURSION, TOURS AND CRUISE ARRANGEMENTS FOR OTHERS, IN CLASS 39 (U.S. CLS. 100 AND 105).

FIRST USE 4-0-2011; IN COMMERCE 4-0-2011.

FOR: YOGA INSTRUCTION, PHYSICAL FITNESS INSTRUCTION, IN CLASS 41 (U.S. CLS. 100, 101 AND 107).

FIRST USE 4-0-2011; IN COMMERCE 4-0-2011.

THE MARK CONSISTS OF STANDARD CHARACTERS WITHOUT CLAIM TO ANY PARTICULAR FONT, STYLE, SIZE, OR COLOR.

OWNER OF U.S. REG. NO. 3,701,079.

SER. NO. 85-397,160, FILED 8-12-2011.

ROBERT STRUCK, EXAMINING ATTORNEY



*David J. Kybas*

Director of the United States Patent and Trademark Office

# United States of America

United States Patent and Trademark Office

## SHUFFLE MASTER, INC.

**Reg. No. 4,134,639**

SHUFFLE MASTER, INC. (MINNESOTA CORPORATION)  
1106 PALMS AIRPORT DRIVE  
LAS VEGAS, NV 89119

**Registered May 1, 2012**

**Int. Cl.: 28**

FOR: STAND ALONE, MULTIPLE PLAYER, INTERACTIVE GAMING MACHINES WITH VIDEO OUTPUT, IN CLASS 28 (U.S. CLS. 22, 23, 38 AND 50).

**TRADEMARK**

FIRST USE 5-7-2004; IN COMMERCE 5-7-2004.

**PRINCIPAL REGISTER**

THE MARK CONSISTS OF STANDARD CHARACTERS WITHOUT CLAIM TO ANY PARTICULAR FONT, STYLE, SIZE, OR COLOR.

OWNER OF U.S. REG. NOS. 1,766,013, 3,978,648 AND OTHERS.

NO CLAIM IS MADE TO THE EXCLUSIVE RIGHT TO USE "INC.", APART FROM THE MARK AS SHOWN.

SER. NO. 85-397,183, FILED 8-12-2011.

JUSTINE D. PARKER, EXAMINING ATTORNEY



*David J. Kybas*

Director of the United States Patent and Trademark Office

# United States of America

United States Patent and Trademark Office

## CHANGING BUSINESS. TRANSFORMING LIVES.

**Reg. No. 4,134,640**

**Registered May 1, 2012**

**Int. Cl.: 41**

**SERVICE MARK**

**PRINCIPAL REGISTER**

THE COACHES TRAINING INSTITUTE (CALIFORNIA CORPORATION)  
4000 CIVIC CENTER DRIVE, STE 500  
SAN RAFAEL, CA 94903

FOR: TRAINING SERVICES IN THE FIELD OF PROFESSIONAL COACHING, IN CLASS 41  
(U.S. CLS. 100, 101 AND 107).

FIRST USE 5-8-2009; IN COMMERCE 5-8-2009.

THE MARK CONSISTS OF STANDARD CHARACTERS WITHOUT CLAIM TO ANY PARTICULAR FONT, STYLE, SIZE, OR COLOR.

SER. NO. 85-397,362, FILED 8-13-2011.

VIVIAN MICZNIK FIRST, EXAMINING ATTORNEY



*David J. Kyros*

Director of the United States Patent and Trademark Office

# United States of America

United States Patent and Trademark Office

# Tavern Books

**Reg. No. 4,134,641**

**Registered May 1, 2012**

**Int. Cl.: 16**

**TRADEMARK**

**PRINCIPAL REGISTER**

TAVERN BOOKS (OREGON CORPORATION)  
1541 SW 22ND STREET  
TROUTDALE, OR 97060

FOR: NON-FICTION BOOKS ON A VARIETY OF TOPICS; STORY BOOKS, IN CLASS 16  
(U.S. CLS. 2, 5, 22, 23, 29, 37, 38 AND 50).

FIRST USE 6-1-2009; IN COMMERCE 6-1-2009.

THE MARK CONSISTS OF STANDARD CHARACTERS WITHOUT CLAIM TO ANY PARTICULAR FONT, STYLE, SIZE, OR COLOR.

NO CLAIM IS MADE TO THE EXCLUSIVE RIGHT TO USE "BOOKS", APART FROM THE MARK AS SHOWN.

SER. NO. 85-397,410, FILED 8-13-2011.

MARY ROSSMAN, EXAMINING ATTORNEY



*David J. Kyffers*

Director of the United States Patent and Trademark Office

# United States of America

United States Patent and Trademark Office

## GREENHEALTH ACADEMY

**Reg. No. 4,134,642**

**Registered May 1, 2012**

**Int. Cl.: 41**

**SERVICE MARK**

**PRINCIPAL REGISTER**

PRACTICE GREENHEALTH (ILLINOIS NON-PROFIT CORPORATION)  
SUITE 680  
12355 SUNRISE VALLEY DRIVE  
RESTON, VA 20191

FOR: EDUCATIONAL SERVICES, NAMELY, PROVIDING ON-LINE CLASSES, WORKSHOPS AND WEBINARS ON BEST PRACTICES FOR MAKING HEALTHCARE FACILITIES MORE ENVIRONMENTALLY FRIENDLY, AND DISTRIBUTION OF COURSE MATERIALS IN CONNECTION THEREWITH, IN CLASS 41 (U.S. CLS. 100, 101 AND 107).

FIRST USE 6-0-2011; IN COMMERCE 6-0-2011.

THE MARK CONSISTS OF STANDARD CHARACTERS WITHOUT CLAIM TO ANY PARTICULAR FONT, STYLE, SIZE, OR COLOR.

OWNER OF U.S. REG. NOS. 3,653,518 AND 3,788,381.

NO CLAIM IS MADE TO THE EXCLUSIVE RIGHT TO USE "ACADEMY", APART FROM THE MARK AS SHOWN.

SER. NO. 85-397,737, FILED 8-15-2011.

ZACHARY BELLO, EXAMINING ATTORNEY



*David J. Kyffers*

Director of the United States Patent and Trademark Office

# United States of America

United States Patent and Trademark Office

# EVADER

**Reg. No. 4,134,643**

**Registered May 1, 2012**

**Int. Cl.: 8**

**TRADEMARK**

**PRINCIPAL REGISTER**

ARTHUR LANSKY LEVINE & ASSOCIATES, INC. (NEVADA CORPORATION), AKA  
LANSKY SHARPENERS  
10 AQUA LANE  
TONAWANDA, NY 14150

FOR: KNIVES, IN CLASS 8 (U.S. CLS. 23, 28 AND 44).

FIRST USE 6-1-2011; IN COMMERCE 7-4-2011.

THE MARK CONSISTS OF STANDARD CHARACTERS WITHOUT CLAIM TO ANY PARTICULAR FONT, STYLE, SIZE, OR COLOR.

SER. NO. 85-397,833, FILED 8-15-2011.

CHRISTOPHER LAW, EXAMINING ATTORNEY



*David J. Kyffers*

Director of the United States Patent and Trademark Office

# United States of America

United States Patent and Trademark Office

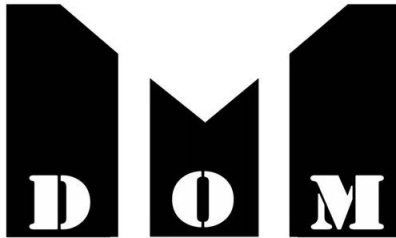

**Reg. No. 4,134,644**

**Registered May 1, 2012**

**Int. Cls.: 25 and 45**

**TRADEMARK**

**SERVICE MARK**

**PRINCIPAL REGISTER**

MANDEPENDENCE (FLORIDA LIMITED LIABILITY COMPANY)  
4030 SOUTH WESTSHORE BLVD  
TAMPA, FL 33611

FOR: HATS; SHIRTS, IN CLASS 25 (U.S. CLS. 22 AND 39).

FIRST USE 3-18-2011; IN COMMERCE 6-29-2011.

FOR: ON-LINE SOCIAL NETWORKING SERVICES, IN CLASS 45 (U.S. CLS. 100 AND 101).

FIRST USE 3-18-2011; IN COMMERCE 6-29-2011.

THE MARK CONSISTS OF THREE COLUMNS WITH THE LETTERS "D" IN THE LEFT COLUMN, "O" IN THE MIDDLE COLUMN, AND "M" IN THE RIGHT COLUMN.

SER. NO. 85-397,835, FILED 8-15-2011.

SANJEEV VOHRA, EXAMINING ATTORNEY



*David J. Kybas*

Director of the United States Patent and Trademark Office

# United States of America

United States Patent and Trademark Office

## LIGHTNING ROD

**Reg. No. 4,134,645**

**Registered May 1, 2012**

**Int. Cl.: 7**

**TRADEMARK**

**PRINCIPAL REGISTER**

LONGYEAR TM, INC. (DELAWARE CORPORATION)  
SUITE 600  
10808 SOUTH RIVER FRONT PARKWAY  
SOUTH JORDAN, UT 84095

FOR: EARTH DRILLING MACHINES AND PARTS AND ACCESSORIES THEREFOR, NAMELY, ROTARY, VIBRATORY ROTARY AND ROTARY PERCUSSION DRILLING RIGS; ROCK DRILLS; PNEUMATIC FEEDLEG DRILLS; DRILL BITS FOR ROCK DRILLING MACHINES; MACHINE PARTS FOR EARTH AND ROCK DRILLING MACHINES, NAMELY, DRILLING RODS, COUPLINGS, AND SHANKS; AND EARTH AND ROCK DRILLING INSERTS FOR USE ON ROTARY, VIBRATORY AND PERCUSSIVE ROCK DRILLING EQUIPMENT, IN CLASS 7 (U.S. CLS. 13, 19, 21, 23, 31, 34 AND 35).

FIRST USE 3-7-2011; IN COMMERCE 3-7-2011.

THE MARK CONSISTS OF STANDARD CHARACTERS WITHOUT CLAIM TO ANY PARTICULAR FONT, STYLE, SIZE, OR COLOR.

SER. NO. 85-397,836, FILED 8-15-2011.

JENNIFER WILLISTON, EXAMINING ATTORNEY



*David J. Kypos*

Director of the United States Patent and Trademark Office



# United States of America

United States Patent and Trademark Office

# CITRUSDAL

**Reg. No. 4,134,646**

**Registered May 1, 2012**

**Int. Cls.: 31 and 39**

**TRADEMARK**

**SERVICE MARK**

**PRINCIPAL REGISTER**

GOEDE HOOP CITRUS LIMITED (SOUTH AFRICA LIMITED LIABILITY COMPANY)  
108 VOORTREKKER STREET  
CITRUSDAL, SOUTH AFRICA

FOR: FRESH FRUITS AND VEGETABLES; AGRICULTURAL, FLOWER, FRUIT, VEGETABLE AND PLANT SEEDS, NATURAL PLANTS AND FLOWERS, IN CLASS 31 (U.S. CLS. 1 AND 46).

FIRST USE 1-1-2002; IN COMMERCE 1-1-2002.

FOR: TRANSPORT, PACKAGING AND STORAGE OF GOODS, IN CLASS 39 (U.S. CLS. 100 AND 105).

FIRST USE 1-1-2002; IN COMMERCE 1-1-2002.

THE MARK CONSISTS OF STANDARD CHARACTERS WITHOUT CLAIM TO ANY PARTICULAR FONT, STYLE, SIZE, OR COLOR.

SEC. 2(F).

SER. NO. 85-397,898, FILED 8-15-2011.

TOBY BULLOFF, EXAMINING ATTORNEY



*David J. Kypos*

Director of the United States Patent and Trademark Office

# United States of America

United States Patent and Trademark Office



**EasyOn**  
TOPICAL MOISTURIZING LUBRICANT

**Reg. No. 4,134,647**

JD VENTURES, LLC. (NEVADA LIMITED LIABILITY COMPANY)  
1700 A WIND RANCH RD.  
RENO, NV 89521

**Registered May 1, 2012**

**Int. Cl.: 3**

FOR: COSMETIC OILS FOR THE EPIDERMIS; COSMETIC PREPARATIONS FOR SKIN CARE; COSMETICS AND COSMETIC PREPARATIONS; NON-MEDICATED SKIN CARE PREPARATIONS; SKIN MOISTURIZER; SKIN MOISTURIZING GEL; TOPICAL SKIN SPRAYS FOR COSMETIC PURPOSES, IN CLASS 3 (U.S. CLS. 1, 4, 6, 50, 51 AND 52).

**TRADEMARK**

**PRINCIPAL REGISTER**

FIRST USE 7-17-2011; IN COMMERCE 8-2-2011.

NO CLAIM IS MADE TO THE EXCLUSIVE RIGHT TO USE "TOPICAL MOISTURISING LUBRICANT", APART FROM THE MARK AS SHOWN.

THE COLOR(S) BLUE AND BLACK IS/ARE CLAIMED AS A FEATURE OF THE MARK.

THE MARK CONSISTS OF THE WORDS "EASYON" WITH THE WORD "EASY" IN BLUE, THE WORD "ON" IN BLACK, AND THE WORDS "TOPICAL MOISTURIZING LUBRICANT" IN BLACK, BELOW "EASYON". ABOVE "EASYON" ARE FIVE CIRCLES IN BLUE.

SER. NO. 85-397,923, FILED 8-15-2011.

GRETTA YAO, EXAMINING ATTORNEY



*David J. Kybas*

Director of the United States Patent and Trademark Office

# United States of America

United States Patent and Trademark Office

# Evil EYE PA

**Reg. No. 4,134,648**

**Registered May 1, 2012**

**Int. Cl.: 32**

**TRADEMARK**

**PRINCIPAL REGISTER**

BOWEN HAYWARD GROUP, LLC (PENNSYLVANIA LIMITED LIABILITY COMPANY),  
DBA EVIL GENIUS BEER COMPANY  
284 WEST AVONDALE ROAD  
WEST GROVE, PA 19390

FOR: BEER, ALE, LAGER, STOUT, PORTER, SHANDY, IN CLASS 32 (U.S. CLS. 45, 46 AND 48).

FIRST USE 8-11-2011; IN COMMERCE 8-11-2011.

THE MARK CONSISTS OF STANDARD CHARACTERS WITHOUT CLAIM TO ANY PARTICULAR FONT, STYLE, SIZE, OR COLOR.

NO CLAIM IS MADE TO THE EXCLUSIVE RIGHT TO USE "PA", APART FROM THE MARK AS SHOWN.

SER. NO. 85-398,070, FILED 8-15-2011.

HENRY S. ZAK, EXAMINING ATTORNEY



*David J. Kyffers*

Director of the United States Patent and Trademark Office

# United States of America

United States Patent and Trademark Office

# Marination

**Reg. No. 4,134,649**

**Registered May 1, 2012**

**Int. Cls.: 30 and 43**

**TRADEMARK**

**SERVICE MARK**

**PRINCIPAL REGISTER**

MARINATION LLC (WASHINGTON LIMITED LIABILITY COMPANY)  
PO BOX 28324  
SEATTLE, WA 98118

FOR: COOKING SAUCES; DIPPING SAUCES; SAUCES, IN CLASS 30 (U.S. CL. 46).

FIRST USE 6-30-2009; IN COMMERCE 6-30-2009.

FOR: CARRY-OUT RESTAURANTS; PROVIDING OF FOOD AND DRINK VIA A MOBILE TRUCK; RESTAURANT AND BAR SERVICES; RESTAURANT AND CATERING SERVICES, IN CLASS 43 (U.S. CLS. 100 AND 101).

FIRST USE 6-30-2009; IN COMMERCE 6-30-2009.

THE MARK CONSISTS OF STANDARD CHARACTERS WITHOUT CLAIM TO ANY PARTICULAR FONT, STYLE, SIZE, OR COLOR.

SER. NO. 85-398,166, FILED 8-15-2011.

JEFFREY LOOK, EXAMINING ATTORNEY



*David J. Kypos*

Director of the United States Patent and Trademark Office

# United States of America

United States Patent and Trademark Office



**Reg. No. 4,134,650**

**Registered May 1, 2012**

**Int. Cl.: 36**

**SERVICE MARK**

**PRINCIPAL REGISTER**

COVENANT HEALTH (TENNESSEE CORPORATION)  
100 FT. SANDERS WEST BLVD.  
KNOXVILLE, TN 37922

FOR: CHARITABLE FUNDRAISING SERVICES, IN CLASS 36 (U.S. CLS. 100, 101 AND 102).

FIRST USE 8-1-2011; IN COMMERCE 8-1-2011.

NO CLAIM IS MADE TO THE EXCLUSIVE RIGHT TO USE "POLISH", APART FROM THE MARK AS SHOWN.

THE COLOR(S) BLACK, WHITE, GRAY, RED, BLUE, YELLOW, PINK AND GREEN IS/ARE CLAIMED AS A FEATURE OF THE MARK.

THE MARK CONSISTS OF THE WORD "POLISH" IN BLACK LETTERING WITH BOTTLES OF NAIL POLISH ORIENTED IN A STAR PATTERN IN THE "O", WITH THE BOTTLES HAVING BLACK CAPS WITH WHITE HIGHLIGHTS AND WITH THE POLISH COLORS BEING BLUE, RED, GREEN, PINK AND YELLOW, ALL WITH WHITE EDGES AROUND THE BOTTLES. AN EXCLAMATION POINT IS FORMED AT THE END OF THE TERM "POLISH" BY A NAIL POLISH BRUSH WITH A BLACK TOP, RED STEM AND WHITE HIGHLIGHTS, AND A DROP OF RED NAIL POLISH WITH WHITE HIGHLIGHTING. UNDERNEATH ARE THE WORDS "FOR A PURPOSE" IN BLACK OVERLYING THE WORDS "THE FIGHT TO NAIL CANCER" IN GRAY STYLIZED FONT.

SER. NO. 85-398,194, FILED 8-15-2011.

ELIZABETH HUGHITT, EXAMINING ATTORNEY



*David J. Kyjars*

Director of the United States Patent and Trademark Office

# United States of America

United States Patent and Trademark Office



**Reg. No. 4,134,651**

**Registered May 1, 2012**

**Int. Cl.: 35**

**SERVICE MARK**

**PRINCIPAL REGISTER**

REYNOLDS' RIGHT HANDS, INC. (FLORIDA NON-PROFIT INCORPORATION)  
3173 BOTHWELL COURT  
OVIEDO, FL 32765

FOR: PROMOTING PUBLIC AWARENESS OF DISTRACTED DRIVING, IN CLASS 35 (U.S. CLS. 100, 101 AND 102).

FIRST USE 4-28-2010; IN COMMERCE 4-28-2010.

THE STIPLING IS FOR SHADING PURPOSES ONLY.

THE MARK CONSISTS OF A HANDPRINT WITH HALF OF A CAR, THE TEXT "TTYL" WRITTEN INSIDE THE HANDPRINT, AND THE TEXT "I'M DRIVING.." PLACED DIAGONALLY BELOW AND ACROSS THE WIDTH OF THE IMAGE.

SER. NO. 85-398,334, FILED 8-15-2011.

JEFFREY LOOK, EXAMINING ATTORNEY



*David J. Kybas*

Director of the United States Patent and Trademark Office

# United States of America

United States Patent and Trademark Office

# Big Blue

**Reg. No. 4,134,652**

**Registered May 1, 2012**

**Int. Cl.: 43**

**SERVICE MARK**

**PRINCIPAL REGISTER**

MARINATION LLC (WASHINGTON LIMITED LIABILITY COMPANY)  
PO BOX 28324  
SEATTLE, WA 98118

FOR: PROVIDING OF FOOD AND DRINK VIA A MOBILE TRUCK; RESTAURANT AND BAR SERVICES; RESTAURANT AND CATERING SERVICES, IN CLASS 43 (U.S. CLS. 100 AND 101).

FIRST USE 8-30-2009; IN COMMERCE 8-30-2009.

THE MARK CONSISTS OF STANDARD CHARACTERS WITHOUT CLAIM TO ANY PARTICULAR FONT, STYLE, SIZE, OR COLOR.

NO CLAIM IS MADE TO THE EXCLUSIVE RIGHT TO USE "BLUE", APART FROM THE MARK AS SHOWN.

SER. NO. 85-398,340, FILED 8-15-2011.

JEFFREY LOOK, EXAMINING ATTORNEY



*David J. Kyros*

Director of the United States Patent and Trademark Office

# United States of America

United States Patent and Trademark Office

## CCT ADD AIR

**Reg. No. 4,134,653**

**Registered May 1, 2012**

**Int. Cl.: 1**

**TRADEMARK**

**PRINCIPAL REGISTER**

CCT ADD AIR INC (NEVADA CORPORATION)  
#200  
184 TECHNOLOGY DR.  
IRVINE, CA 92618

FOR: CONCRETE ADMIXTURES, IN CLASS 1 (U.S. CLS. 1, 5, 6, 10, 26 AND 46).

FIRST USE 3-1-2011; IN COMMERCE 3-1-2011.

THE MARK CONSISTS OF STANDARD CHARACTERS WITHOUT CLAIM TO ANY PARTICULAR FONT, STYLE, SIZE, OR COLOR.

NO CLAIM IS MADE TO THE EXCLUSIVE RIGHT TO USE "ADD AIR", APART FROM THE MARK AS SHOWN.

SER. NO. 85-398,349, FILED 8-15-2011.

MYRIAH HABEEB, EXAMINING ATTORNEY



*David J. Kyros*

Director of the United States Patent and Trademark Office



# United States of America

United States Patent and Trademark Office

# Digital Zen

**Reg. No. 4,134,654**

CHRISTOPHER VACANO (UNITED STATES INDIVIDUAL)  
18220 29TH PL NE  
LAKE FORREST PARK, WA 98155

**Registered May 1, 2012**

**Int. Cl.: 42**

FOR: DESIGN AND DEVELOPMENT OF COMPUTER SOFTWARE; GRAPHIC ART DESIGN;  
GRAPHIC DESIGN SERVICES; WEB SITE DEVELOPMENT, IN CLASS 42 (U.S. CLS. 100  
AND 101).

**SERVICE MARK**

FIRST USE 1-1-2009; IN COMMERCE 1-1-2009.

**PRINCIPAL REGISTER**

THE MARK CONSISTS OF STANDARD CHARACTERS WITHOUT CLAIM TO ANY PAR-  
TICULAR FONT, STYLE, SIZE, OR COLOR.

NO CLAIM IS MADE TO THE EXCLUSIVE RIGHT TO USE "DIGITAL", APART FROM THE  
MARK AS SHOWN.

SER. NO. 85-398,443, FILED 8-15-2011.

WILLIAM VERHOSEK, EXAMINING ATTORNEY



*David J. Kybas*

Director of the United States Patent and Trademark Office

# United States of America

United States Patent and Trademark Office

## SCHLOUCH INCORPORATED

**Reg. No. 4,134,655**

**Registered May 1, 2012**

**Int. Cl.: 37**

**SERVICE MARK**

**PRINCIPAL REGISTER**

SCHLOUCH EXCAVATING OF DELAWARE INC. (DELAWARE CORPORATION)  
FIRST FEDERAL PLAZA P.O BOX 33  
WILMINGTON, DE 19899

FOR: BUILDING CONSTRUCTION SERVICES, NAMELY, EROSION CONTROL, EXCAVATING, BLASTING, UTILITIES, CONCRETE, AND PAVING SERVICES, IN CLASS 37 (U.S. CLS. 100, 103 AND 106).

FIRST USE 1-1-1995; IN COMMERCE 1-1-1995.

THE MARK CONSISTS OF STANDARD CHARACTERS WITHOUT CLAIM TO ANY PARTICULAR FONT, STYLE, SIZE, OR COLOR.

NO CLAIM IS MADE TO THE EXCLUSIVE RIGHT TO USE "INCORPORATED", APART FROM THE MARK AS SHOWN.

SEC. 2(F).

SER. NO. 85-398,609, FILED 8-16-2011.

JOHN HWANG, EXAMINING ATTORNEY



*David J. Kyros*

Director of the United States Patent and Trademark Office

# United States of America

United States Patent and Trademark Office

# GNN

**Reg. No. 4,134,656**

**Registered May 1, 2012**

**Int. Cl.: 11**

**TRADEMARK**

**PRINCIPAL REGISTER**

GUANGDONG GENUIN ELECTRIC CO., LTD. (CHINA LIMITED LIABILITY COMPANY)  
GENGHE TOWN  
GAOMING ZONE  
FOSHAN CITY, GUANGDONG, CHINA

FOR: AIR-CONDITIONING INSTALLATIONS AND APPARATUS, FEATURING VENTILATING CAPABILITIES; VENTILATION HOODS; ELECTRIC FANS FOR PERSONAL USE; VENTILATING EXHAUST FANS; BATHROOM EXHAUST FANS; LAMPS, IN CLASS 11 (U.S. CLS. 13, 21, 23, 31 AND 34).

FIRST USE 5-6-2001; IN COMMERCE 10-1-2008.

THE MARK CONSISTS OF STYLIZED LETTERS "GNN".

SER. NO. 85-398,612, FILED 8-16-2011.

MELISSA VALLILLO, EXAMINING ATTORNEY



*David J. Kyffers*

Director of the United States Patent and Trademark Office

# United States of America

United States Patent and Trademark Office



**Reg. No. 4,134,657**

**Registered May 1, 2012**

**Int. Cl.: 9**

**TRADEMARK**

**PRINCIPAL REGISTER**

BIG IDEAS CORPORATION LTD. (UNITED KINGDOM LIMITED LIABILITY COMPANY)  
59 PRICES COURT  
LONDON, UNITED KINGDOM SW113YS

FOR: COMPUTER APPLICATION SOFTWARE FOR MOBILE PHONES, PORTABLE MEDIA PLAYERS, HANDHELD COMPUTERS, NAMELY, SOFTWARE FOR GAMES, IN CLASS 9 (U.S. CLS. 21, 23, 26, 36 AND 38).

FIRST USE 8-11-2010; IN COMMERCE 8-11-2010.

THE MARK CONSISTS OF THE COLOR BLUE APPEARS IN THE QUESTION MARKS IN THE UPPER LEFT CORNER AND THE LOWER RIGHT CORNER. THE COLOR PURPLE APPEARS IN THE QUESTION MARKS IN THE UPPER RIGHT CORNER AND IN THE MIDDLE QUESTION MARK ON THE LEFT SIDE. THE COLOR GREEN APPEARS IN THE QUESTION MARK IN THE MIDDLE ON THE RIGHT SIDE. THE COLOR YELLOW APPEARS IN THE QUESTION MARK IN THE LOWER LEFT CORNER THE COLOR WHITE APPEARS IN THE WORDING "SAY WHAT YOU SEE" AND IN THE BACKGROUND OF THE SQUARE. THE COLOR BLACK APPEARS AS THE BORDER OF THE SQUARE AND IN THE BOXES BEHIND THE LETTERING.

THE COLOR(S) THE COLORS BLACK, WHITE, GREEN, PURPLE, BLUE, AND YELLOW IS/ARE CLAIMED AS A FEATURE OF THE MARK.

SER. NO. 85-398,639, FILED 8-16-2011.

DANNEAN HETZEL, EXAMINING ATTORNEY



*David J. Kyffers*

Director of the United States Patent and Trademark Office

# United States of America

United States Patent and Trademark Office

# r+d chocolate

**Reg. No. 4,134,658**

**Registered May 1, 2012**

**Int. Cl.: 30**

**TRADEMARK**

**PRINCIPAL REGISTER**

R+D CHOCOLATE LLC (DELAWARE LIMITED LIABILITY COMPANY)  
61 ABERDEEN WAY  
SOUTHPORT, CT 06890

FOR: CHOCOLATE; CHOCOLATE CONFECTIONS, IN CLASS 30 (U.S. CL. 46).

FIRST USE 1-18-2008; IN COMMERCE 4-4-2008.

THE MARK CONSISTS OF STANDARD CHARACTERS WITHOUT CLAIM TO ANY PARTICULAR FONT, STYLE, SIZE, OR COLOR.

NO CLAIM IS MADE TO THE EXCLUSIVE RIGHT TO USE "CHOCOLATE", APART FROM THE MARK AS SHOWN.

SER. NO. 85-398,840, FILED 8-16-2011.

THEODORE MCBRIDE, EXAMINING ATTORNEY



*David J. Kyffers*

Director of the United States Patent and Trademark Office

# United States of America

United States Patent and Trademark Office



**Reg. No. 4,134,659**

**Registered May 1, 2012**

**Int. Cl.: 25**

**TRADEMARK**

**PRINCIPAL REGISTER**

DE-XIN XU (UNITED STATES INDIVIDUAL)  
1031 BAY RIDGE AVENUE 1/FL  
BROOKLYN, NY 11219

FOR: BODY SHIRTS; BODY STOCKINGS; BODY SUITS; BRAS; BRIEFS; PANTIES; PANTS;  
SHORTS; SPORTS BRAS; UNDERWEAR, IN CLASS 25 (U.S. CLS. 22 AND 39).

FIRST USE 7-1-2010; IN COMMERCE 7-1-2010.

OWNER OF U.S. REG. NO. 3,391,047.

NO CLAIM IS MADE TO THE EXCLUSIVE RIGHT TO USE "BODY", APART FROM THE  
MARK AS SHOWN.

THE MARK CONSISTS OF THE WORDING "MAKE BODY" AND DESIGN. THE DESIGN  
CONSISTS OF AN OVAL AND WITHIN THE OVAL IS A PARTIAL SKETCH OF A WOMAN  
AND BELOW THE WOMAN'S IMAGE IS THE WORDING "MAKE BODY".

SER. NO. 85-398,916, FILED 8-16-2011.

MARLENE BELL, EXAMINING ATTORNEY



*David J. Kybas*

Director of the United States Patent and Trademark Office

# United States of America

United States Patent and Trademark Office

## Planet Ballroom

**Reg. No. 4,134,660**

**Registered May 1, 2012**

**Int. Cl.: 41**

**SERVICE MARK**

**PRINCIPAL REGISTER**

PLANET BALLROOM, INC. (NORTH CAROLINA CORPORATION)  
9935 REA ROAD, SUITE D#310  
CHARLOTTE, NC 28277

FOR: DANCE STUDIOS, IN CLASS 41 (U.S. CLS. 100, 101 AND 107).

FIRST USE 1-1-2009; IN COMMERCE 8-1-2011.

THE MARK CONSISTS OF STANDARD CHARACTERS WITHOUT CLAIM TO ANY PARTICULAR FONT, STYLE, SIZE, OR COLOR.

OWNER OF U.S. REG. NO. 3,781,935.

NO CLAIM IS MADE TO THE EXCLUSIVE RIGHT TO USE "BALLROOM", APART FROM THE MARK AS SHOWN.

SER. NO. 85-399,042, FILED 8-16-2011.

BERYL GARDNER, EXAMINING ATTORNEY



*David J. Kyros*

Director of the United States Patent and Trademark Office

# United States of America

United States Patent and Trademark Office

# 501CTECH

**Reg. No. 4,134,661**

501CTECH, INC. (DELAWARE NON-PROFIT CORPORATION)  
2001 S STREET, N.W. SUITE 630  
WASHINGTON, DC 20009

**Registered May 1, 2012**

**Int. Cl.: 35**

FOR: IT OUTSOURCING SERVICES, NAMELY, OUTSOURCING IN THE FIELD OF INFORMATION TECHNOLOGY, IN CLASS 35 (U.S. CLS. 100, 101 AND 102).

**SERVICE MARK**

FIRST USE 9-21-2011; IN COMMERCE 9-21-2011.

**PRINCIPAL REGISTER**

THE MARK CONSISTS OF STANDARD CHARACTERS WITHOUT CLAIM TO ANY PARTICULAR FONT, STYLE, SIZE, OR COLOR.

SER. NO. 85-399,108, FILED 8-16-2011.

ZACHARY BELLO, EXAMINING ATTORNEY



*David J. Kybas*

Director of the United States Patent and Trademark Office



# United States of America

United States Patent and Trademark Office

# Dolly Clone

**Reg. No. 4,134,662**

**Registered May 1, 2012**

**Int. Cl.: 9**

**TRADEMARK**

**PRINCIPAL REGISTER**

CIRRUS THINKING LLC (DELAWARE LIMITED LIABILITY COMPANY)  
257 PARK AVE. SOUTH, STE. 1202  
NEW YORK, NY 10010

FOR: COMPUTER APPLICATION SOFTWARE FOR BUSINESS AND PERSONAL COMPUTERS, NAMELY, SOFTWARE FOR DATA BACKUP AND VOLUME CLONING, IN CLASS 9 (U.S. CLS. 21, 23, 26, 36 AND 38).

FIRST USE 7-1-2011; IN COMMERCE 7-15-2011.

THE MARK CONSISTS OF STANDARD CHARACTERS WITHOUT CLAIM TO ANY PARTICULAR FONT, STYLE, SIZE, OR COLOR.

NO CLAIM IS MADE TO THE EXCLUSIVE RIGHT TO USE "CLONE", APART FROM THE MARK AS SHOWN.

SER. NO. 85-399,332, FILED 8-16-2011.

SANJEEV VOHRA, EXAMINING ATTORNEY



*David J. Kyffers*

Director of the United States Patent and Trademark Office

# United States of America

United States Patent and Trademark Office

## Business Villains' Poker

**Reg. No. 4,134,663**

**Registered May 1, 2012**

**Int. Cl.: 28**

**TRADEMARK**

**PRINCIPAL REGISTER**

PATRISHKOFF, DAVID JOHN (UNITED STATES INDIVIDUAL), DBA INNOVATIVE SOLUTIONS GROUP  
1317 PERNOD WAY  
ORLANDO, FL 32825

FOR: CARD GAME AND INSTRUCTION MANUAL SOLD AS A UNIT, IN CLASS 28 (U.S. CLS. 22, 23, 38 AND 50).

FIRST USE 1-0-2011; IN COMMERCE 1-0-2011.

THE MARK CONSISTS OF STANDARD CHARACTERS WITHOUT CLAIM TO ANY PARTICULAR FONT, STYLE, SIZE, OR COLOR.

NO CLAIM IS MADE TO THE EXCLUSIVE RIGHT TO USE "POKER", APART FROM THE MARK AS SHOWN.

SER. NO. 85-399,457, FILED 8-16-2011.

KELLY CHOE, EXAMINING ATTORNEY



*David J. Kybas*

Director of the United States Patent and Trademark Office

# United States of America

United States Patent and Trademark Office



**Reg. No. 4,134,664**

**Registered May 1, 2012**

**Int. Cl.: 41**

**SERVICE MARK**

**PRINCIPAL REGISTER**

EIGHT TO EIGHTY ENTERTAINMENT LLC (PENNSYLVANIA LIMITED LIABILITY COMPANY)  
PO BOX 501  
LANGHORNE, PA 19047

FOR: ENTERTAINMENT SERVICES, NAMELY, A VIDEO ARCADE HOUSED IN A MOBILE TRAILER, IN CLASS 41 (U.S. CLS. 100, 101 AND 107).

FIRST USE 6-2-2011; IN COMMERCE 6-2-2011.

NO CLAIM IS MADE TO THE EXCLUSIVE RIGHT TO USE "EXTREME VIDEO GAME ZONE", APART FROM THE MARK AS SHOWN.

THE MARK CONSISTS OF THE STYLIZED TEXT "EXTREME VIDEO GAME ZONE" WITH JAGGED METAL PIECES CURLING BACK ON THE BACKGROUND OF "EXTREME".

SER. NO. 85-399,550, FILED 8-16-2011.

CHRISIE B. KING, EXAMINING ATTORNEY



*David J. Kybas*

Director of the United States Patent and Trademark Office

# United States of America

United States Patent and Trademark Office

*Bride  
of  
Christ  
designs*

**Reg. No. 4,134,665**

**Registered May 1, 2012**

**Int. Cl.: 25**

**TRADEMARK**

**PRINCIPAL REGISTER**

WORTHINGTON, JESSICA (UNITED STATES INDIVIDUAL)  
609 FAIRWAY DR  
REDLANDS, CA 92373

FOR: SHIRTS; T-SHIRTS; TANK TOPS, IN CLASS 25 (U.S. CLS. 22 AND 39).

FIRST USE 5-10-2010; IN COMMERCE 5-10-2010.

NO CLAIM IS MADE TO THE EXCLUSIVE RIGHT TO USE "DESIGNS" , APART FROM THE MARK AS SHOWN.

THE MARK CONSISTS OF THE STYLIZED TEXT "BRIDE OF CHRIST DESIGNS" WITH A DIAMOND RING TO DOT THE FIRST "I" AND A CROWN OF THORNS TO DOT THE SECOND "I".

SER. NO. 85-399,567, FILED 8-16-2011.

WARREN L. OLANDRIA, EXAMINING ATTORNEY



*David J. Kyffers*

Director of the United States Patent and Trademark Office

# United States of America

United States Patent and Trademark Office

## Mirakkul Glassware

**Reg. No. 4,134,666**

RAKKUL ENTERPRISE, LLC (NEVADA LIMITED LIABILITY COMPANY)  
2360 CORPORATE CIRCLE SUITE 400  
HENDERSON, NV 89074

**Registered May 1, 2012**

**Int. Cl.: 21**

FOR: WORKS OF ART MADE OF GLASS; GLASSWARE, NAMELY, ART GLASS, IN CLASS 21 (U.S. CLS. 2, 13, 23, 29, 30, 33, 40 AND 50).

**TRADEMARK**

FIRST USE 1-3-2011; IN COMMERCE 1-3-2011.

**PRINCIPAL REGISTER**

THE MARK CONSISTS OF STANDARD CHARACTERS WITHOUT CLAIM TO ANY PARTICULAR FONT, STYLE, SIZE, OR COLOR.

NO CLAIM IS MADE TO THE EXCLUSIVE RIGHT TO USE "GLASSWARE", APART FROM THE MARK AS SHOWN.

SER. NO. 85-399,742, FILED 8-17-2011.

JEFF DEFORD, EXAMINING ATTORNEY



*David J. Kyffers*

Director of the United States Patent and Trademark Office

# United States of America

United States Patent and Trademark Office



**Reg. No. 4,134,667**

**Registered May 1, 2012**

**Int. Cl.: 39**

**SERVICE MARK**

**PRINCIPAL REGISTER**

NANCY'S VAN-JAY, INC (INDIANA CORPORATION)  
689 W US 30  
VALPARAISO, IN 46385

FOR: FREIGHT FORWARDING SERVICES; POSTAL SERVICES, NAMELY, PARCEL DELIVERY, PACKAGING ARTICLES FOR TRANSPORTATION, RENTAL OF MAILBOXES; POSTAL SERVICES, NAMELY, PRESORTING, STUFFING, SEALING, POSTAGE METERING, BUNDLING, AND DELIVERING MAIL TO POST OFFICE; POSTAL, FREIGHT AND COURIER SERVICES; WAREHOUSING SERVICES, NAMELY, STORAGE, DISTRIBUTION, PICK-UP, AND PACKING FOR SHIPMENT OF DOCUMENTS, PACKAGES, RAW MATERIALS, AND OTHER FREIGHT FOR OTHERS, IN CLASS 39 (U.S. CLS. 100 AND 105).

FIRST USE 3-1-2011; IN COMMERCE 3-1-2011.

NO CLAIM IS MADE TO THE EXCLUSIVE RIGHT TO USE "US 30 POSTAL EXPRESS", APART FROM THE MARK AS SHOWN.

THE MARK CONSISTS OF THE STYLIZED DEPICTION OF AN INTERSTATE ROAD SIGN WITH THE TERM "US" APPEARING IN THE TOP PORTION AND THE NUMBER "30" APPEARING IN THE BOTTOM PORTION OF THE SIGN. THE STYLIZED WORDING "POSTAL EXPRESS" APPEARS STACKED TO THE RIGHT OF THE SIGN.

SER. NO. 85-399,975, FILED 8-17-2011.

AMY KERTGATE, EXAMINING ATTORNEY



*David J. Kybas*

Director of the United States Patent and Trademark Office

# United States of America

United States Patent and Trademark Office



**Reg. No. 4,134,668**

**Registered May 1, 2012**

**Int. Cls.: 29 and 30**

**TRADEMARK**

**PRINCIPAL REGISTER**

SMUDE ENTERPRISES, LLC (MINNESOTA LIMITED LIABILITY COMPANY)  
25804 173RD STREET  
PIERZ, MN 56364

FOR: BEEF; SUNFLOWER OIL, IN CLASS 29 (U.S. CL. 46).

FIRST USE 2-25-2011; IN COMMERCE 2-25-2011.

FOR: UNPOPPED POPCORN, IN CLASS 30 (U.S. CL. 46).

FIRST USE 2-25-2011; IN COMMERCE 2-25-2011.

NO CLAIM IS MADE TO THE EXCLUSIVE RIGHT TO USE "BRAND", APART FROM THE MARK AS SHOWN.

THE MARK CONSISTS OF THE POSSESSIVE VERSION OF THE LAST NAME "SMUDE" USING A LEAF FOR THE APOSTROPHE BEFORE THE POSSESSIVE "S." UNDER THE LAST PART OF THE NAME "SMUDE'S" IN A SMALLER FONT IS THE WORD "BRAND" WITH THE ENTIRE MARK SURROUNDED BY A RECTANGLE.

SER. NO. 85-399,983, FILED 8-17-2011.

CHARLES L. JENKINS, EXAMINING ATTORNEY



*David J. Kybas*

Director of the United States Patent and Trademark Office

# United States of America

United States Patent and Trademark Office

# Silo

**Reg. No. 4,134,669**

**Registered May 1, 2012**

**Int. Cl.: 9**

**TRADEMARK**

**PRINCIPAL REGISTER**

NEVERCENTER (UTAH LIMITED LIABILITY COMPANY)  
380 SOUTH 300 EAST  
CENTERVILLE, UT 84014

FOR: DOWNLOADABLE COMPUTER SOFTWARE FOR 3D MODELING, IN CLASS 9 (U.S. CLS. 21, 23, 26, 36 AND 38).

FIRST USE 8-28-2003; IN COMMERCE 8-28-2003.

THE MARK CONSISTS OF STANDARD CHARACTERS WITHOUT CLAIM TO ANY PARTICULAR FONT, STYLE, SIZE, OR COLOR.

SER. NO. 85-400,010, FILED 8-17-2011.

JENNIFER MARTIN, EXAMINING ATTORNEY



*David J. Kyffers*

Director of the United States Patent and Trademark Office



# United States of America

United States Patent and Trademark Office

## Chiropractic Black Sheep

**Reg. No. 4,134,670**

TSAI, RICK (UNITED STATES INDIVIDUAL)  
3602 DARLINGTON RD  
DARLINGTON, PA 16115

**Registered May 1, 2012**

**Int. Cl.: 41**

FOR: CONDUCTING WORKSHOPS AND SEMINARS IN THE FIELD OF CHIROPRACTICS,  
IN CLASS 41 (U.S. CLS. 100, 101 AND 107).

**SERVICE MARK**

FIRST USE 2-1-2010; IN COMMERCE 2-1-2010.

**PRINCIPAL REGISTER**

THE MARK CONSISTS OF STANDARD CHARACTERS WITHOUT CLAIM TO ANY PAR-  
TICULAR FONT, STYLE, SIZE, OR COLOR.

NO CLAIM IS MADE TO THE EXCLUSIVE RIGHT TO USE "CHIROPRACTIC", APART  
FROM THE MARK AS SHOWN.

SER. NO. 85-400,020, FILED 8-17-2011.

BRENDAN REGAN, EXAMINING ATTORNEY



*David J. Kybas*

Director of the United States Patent and Trademark Office

# United States of America

United States Patent and Trademark Office

## BLU-TEK WITH COOL SUPPORT TECHNOLOGY

**Reg. No. 4,134,671**

**Registered May 1, 2012**

**Int. Cl.: 20**

**TRADEMARK**

**PRINCIPAL REGISTER**

KINGSDOWN, INC. (NORTH CAROLINA CORPORATION)  
P.O. BOX 388  
MEBANE, NC 27302

FOR: MATTRESSES AND BOX SPRINGS, IN CLASS 20 (U.S. CLS. 2, 13, 22, 25, 32 AND 50).

FIRST USE 8-1-2011; IN COMMERCE 8-5-2011.

THE MARK CONSISTS OF STANDARD CHARACTERS WITHOUT CLAIM TO ANY PARTICULAR FONT, STYLE, SIZE, OR COLOR.

NO CLAIM IS MADE TO THE EXCLUSIVE RIGHT TO USE "SUPPORT TECHNOLOGY", APART FROM THE MARK AS SHOWN.

SER. NO. 85-400,071, FILED 8-17-2011.

MEGHAN REINHART, EXAMINING ATTORNEY



*David J. Kyros*

Director of the United States Patent and Trademark Office

# United States of America

United States Patent and Trademark Office

**innolect** Independent Thinking. Shared Intelligence.

**Reg. No. 4,134,672**

INNOLECT, INC. (SOUTH CAROLINA CORPORATION), DBA INNOLECT, INC.  
P.O. BOX 3099  
TEGA CITY, SC 29708

**Registered May 1, 2012**

**Int. Cl.: 35**

FOR: CONSULTING SERVICES IN BUSINESS LEADERSHIP DEVELOPMENT AND BUSINESS MANAGEMENT, IN CLASS 35 (U.S. CLS. 100, 101 AND 102).

**SERVICE MARK**

FIRST USE 5-25-2000; IN COMMERCE 5-25-2000.

**PRINCIPAL REGISTER**

THE MARK CONSISTS OF THE WORDING "INNOLECT" IN PURPLE, WITH THE EXCEPTION OF THE GREEN FORWARD SLANTING 'O' FOUND IN THE MIDDLE. TO THE RIGHT IS THE BLACK WORDING "INDEPENDENT THINKING. SHARED INTELLIGENCE."

THE COLOR(S) PURPLE, GREEN, AND BLACK IS/ARE CLAIMED AS A FEATURE OF THE MARK.

SER. NO. 85-400,087, FILED 8-17-2011.

EMILY CARLSEN, EXAMINING ATTORNEY



*David J. Kybas*

Director of the United States Patent and Trademark Office

# United States of America

United States Patent and Trademark Office



**Reg. No. 4,134,673**

**Registered May 1, 2012**

**Int. Cl.: 20**

**TRADEMARK**

**PRINCIPAL REGISTER**

KINGSDOWN, INC. (NORTH CAROLINA CORPORATION)  
P.O. BOX 388  
MEBANE, NC 27302

FOR: MATTRESSES AND BOX SPRINGS, IN CLASS 20 (U.S. CLS. 2, 13, 22, 25, 32 AND 50).

FIRST USE 8-1-2011; IN COMMERCE 8-5-2011.

NO CLAIM IS MADE TO THE EXCLUSIVE RIGHT TO USE "SUPPORT TECHNOLOGY",  
APART FROM THE MARK AS SHOWN.

THE MARK CONSISTS OF THE STYLIZED WORD "BLU TEK" WITH TWO CURVED LINES,  
WITH THREE HEXAGON DESIGNS ABOVE, AND THE STYLIZED WORDS "WITH COOL  
SUPPORT TECHNOLOGY" UNDERNEATH.

SER. NO. 85-400,088, FILED 8-17-2011.

MEGHAN REINHART, EXAMINING ATTORNEY



*David J. Kybas*

Director of the United States Patent and Trademark Office

# United States of America

United States Patent and Trademark Office



**Reg. No. 4,134,674**

**Registered May 1, 2012**

**Int. Cl.: 43**

**SERVICE MARK**

**PRINCIPAL REGISTER**

DANIEL PERON (UNITED STATES INDIVIDUAL), DBA CRÊPES OF BRITTANY!  
P.O. BOX 3321  
MONTEREY, CA 93942 AND

THIERRY CROCQUET (UNITED STATES INDIVIDUAL), DBA CRÊPES OF BRITTANY!  
P.O. BOX 3321  
MONTEREY, CA 93942

FOR: CAFE; CATERING SERVICES, IN CLASS 43 (U.S. CLS. 100 AND 101).

FIRST USE 5-1-2011; IN COMMERCE 5-15-2011.

NO CLAIM IS MADE TO THE EXCLUSIVE RIGHT TO USE "CRÊPES OF BRITTANY",  
APART FROM THE MARK AS SHOWN.

THE MARK CONSISTS OF THE STYLIZED TEXT "CRÊPES OF BRITTANY!" ABOVE AN  
ARCHED-SHAPED BACKGROUND. WITHIN ARE TWO MEN STANDING BEHIND A  
COUNTER, ONE DRESSED AS A CHEF AND ONE WATCHING THE CHEF COOKING  
CREPES WITH COOKING IMPLEMENTS ON THE COUNTER. THE ARTISTS' SIGNATURE  
IS IN THE BOTTOM RIGHT CORNER.

SER. NO. 85-400,220, FILED 8-17-2011.

CARYN GLASSER, EXAMINING ATTORNEY



*David J. Kyjars*

Director of the United States Patent and Trademark Office

# United States of America

United States Patent and Trademark Office



**Reg. No. 4,134,675**

**Registered May 1, 2012**

**Int. Cl.: 35**

**SERVICE MARK**

**PRINCIPAL REGISTER**

WIRELESS AMERICA, LLC (WISCONSIN LIMITED LIABILITY COMPANY)  
7003 PRESIDENTS DRIVE, SUITE 700  
WIRELESS AMERICA, LLC DBA VIVA WIRELESS  
ORLANDO, FL 32809

FOR: RETAIL STORE SERVICES FEATURING WIRELESS TELEPHONES AND WIRELESS TELEPHONE ACCESSORIES, IN CLASS 35 (U.S. CLS. 100, 101 AND 102).

FIRST USE 2-15-2002; IN COMMERCE 6-1-2002.

THE MARK CONSISTS OF THE WORDS "LIVE LIFE..." ABOVE THE WORD "VIVA" IN "VIVAWIRELESS" AND THE WORDS "...VIVE LA VIDA" BENEATH THE LETTERS "ELESS" IN "VIVAWIRELESS". A DRAWING OF A HAT IS ON TOP OF THE "L" IN WIRELESS.

THE ENGLISH TRANSLATION OF "VIVA" AND "VIVE LA VIDA" IN THE MARK IS "LIVING" AND "LIVE LIFE".

SER. NO. 85-400,326, FILED 8-17-2011.

THOMAS MANOR, EXAMINING ATTORNEY



*David J. Kyffers*

Director of the United States Patent and Trademark Office

# United States of America

United States Patent and Trademark Office



## Palate & Plate

**Reg. No. 4,134,676**

**Registered May 1, 2012**

**Int. Cl.: 21**

**TRADEMARK**

**PRINCIPAL REGISTER**

UNIVERSAL ENTERPRISES, INC. (CALIFORNIA CORPORATION), DBA PALATE & PLATE  
P.O. BOX 48439  
LOS ANGELES, CA 90048

FOR: DINNERWARE, NAMELY, PLATES, BOWLS, CUPS, SAUCERS, MUGS, AND SERVING  
PLATTERS, IN CLASS 21 (U.S. CLS. 2, 13, 23, 29, 30, 33, 40 AND 50).

FIRST USE 11-8-2007; IN COMMERCE 11-8-2007.

OWNER OF U.S. REG. NO. 2,830,529.

NO CLAIM IS MADE TO THE EXCLUSIVE RIGHT TO USE "PLATE", APART FROM THE  
MARK AS SHOWN.

THE MARK CONSISTS OF A STYLIZED OUTLINE OF A DINNER PLATE CONSISTING OF  
TWO CONCENTRIC HALF OVALS, ABOVE THE WORDS "PALATE & PLATE".

SER. NO. 85-400,426, FILED 8-17-2011.

DORITT L. CARROLL, EXAMINING ATTORNEY



*David J. Kybas*

Director of the United States Patent and Trademark Office

# United States of America

United States Patent and Trademark Office



**Reg. No. 4,134,677**

**Registered May 1, 2012**

**Int. Cl.: 18**

**TRADEMARK**

**PRINCIPAL REGISTER**

HANNAHDEES LLC (FLORIDA LIMITED LIABILITY COMPANY)  
14220 SW 24TH STREET  
DAVIE, FL 33325

FOR: ANIMAL HARNESSSES, IN CLASS 18 (U.S. CLS. 1, 2, 3, 22 AND 41).

FIRST USE 8-1-2011; IN COMMERCE 8-1-2011.

NO CLAIM IS MADE TO THE EXCLUSIVE RIGHT TO USE "HARNESS" , APART FROM THE MARK AS SHOWN.

THE COLOR(S) BLACK, WHITE, RED IS/ARE CLAIMED AS A FEATURE OF THE MARK.

THE MARK CONSISTS OF THE LITERAL ELEMENTS "HORGAN HARNESS" IN THE COLOR BLACK. THE LITERAL ELEMENTS "THE PULLING STOPS HERE" IN RED UNDERNEATH "HARNESS". A PERSON THAT IS WHITE WITH BLACK OUTLINE SITTING ON THE "H" IN "HARNESS". THE PERSON IS HOLDING A BLACK LEASH THAT EXTENDS AND ZIG ZAGS OVER THE LITERAL ELEMENT "HORGAN" AND IS ATTACHED TO A DOG STANDING IN FRONT OF THE LITERAL ELEMENT "HORGAN". THE COLLAR IS BLACK AND THE HARNESS IS RED. THE DOG IS WHITE WITH BLACK OUTLINE AND THE DOG HAS BLACK SPOTS.

SER. NO. 85-400,514, FILED 8-17-2011.

ELI HELLMAN, EXAMINING ATTORNEY



*David J. Kybas*

Director of the United States Patent and Trademark Office



# United States of America

United States Patent and Trademark Office



**Reg. No. 4,134,678**

**Registered May 1, 2012**

**Int. Cl.: 35**

**SERVICE MARK**

**PRINCIPAL REGISTER**

CABELA'S OUTDOOR FUND (NEBRASKA NON-PROFIT CORPORATION)  
ONE CABELA DRIVE  
SIDNEY, NE 69160

FOR: PROMOTING PUBLIC AWARENESS OF CONSERVATION AND OF HUNTING, FISHING, CAMPING, BOATING, AND OTHER OUTDOOR SPORTING AND RECREATIONAL ACTIVITIES, IN CLASS 35 (U.S. CLS. 100, 101 AND 102).

FIRST USE 7-25-2011; IN COMMERCE 7-25-2011.

OWNER OF U.S. REG. NOS. 1,151,981, 3,130,554 AND OTHERS.

NO CLAIM IS MADE TO THE EXCLUSIVE RIGHT TO USE "OUTDOOR FUND", APART FROM THE MARK AS SHOWN.

THE MARK CONSISTS OF THE WORD "CABELA'S" IN STYLIZED FONT ABOVE THE WORDS "OUTDOOR FUND" WITH DESIGNS OF A DEER, FISH, TREE AND BIRD UNDERNEATH.

SER. NO. 85-400,593, FILED 8-17-2011.

MARILYN IZZI, EXAMINING ATTORNEY



*David J. Kyjars*

Director of the United States Patent and Trademark Office

# United States of America

United States Patent and Trademark Office

# period tracker!

**Reg. No. 4,134,679**

**Registered May 1, 2012**

**Int. Cl.: 9**

**TRADEMARK**

**PRINCIPAL REGISTER**

GP INTERNATIONAL LLC (CALIFORNIA LIMITED LIABILITY COMPANY)  
29970 TECHNOLOGY DRIVE, # 117G  
MURRIETA, CA 92563

FOR: COMPUTER SOFTWARE FOR THE COLLECTION, EDITING, ORGANIZING, MODIFYING, BOOK MARKING, TRANSMISSION, STORAGE AND SHARING OF DATA AND INFORMATION; COMPUTER SOFTWARE FOR RECORDING, MONITORING AND PREDICTING MENSTRUAL CYCLES, OVULATION, FERTILITY, WEIGHT, TEMPERATURE AND OTHER RELATED WOMEN'S HEALTH AND PERSONAL DATA; COMPUTER SOFTWARE FOR RECORDING, MONITORING AND PREDICTING MENSTRUAL CYCLES, OVULATION, FERTILITY, WEIGHT, TEMPERATURE AND OTHER RELATED WOMEN'S HEALTH ISSUES AND PERSONAL DATA THAT MAY BE DOWNLOADED FROM A GLOBAL COMPUTER NETWORK; DOWNLOADABLE SOFTWARE IN THE NATURE OF A MOBILE APPLICATION FOR RECORDING, MONITORING AND PREDICTING MENSTRUAL CYCLES, OVULATION, FERTILITY, WEIGHT, TEMPERATURE AND OTHER RELATED WOMEN'S HEALTH ISSUES AND PERSONAL DATA, IN CLASS 9 (U.S. CLS. 21, 23, 26, 36 AND 38).

FIRST USE 9-18-2008; IN COMMERCE 9-18-2008.

NO CLAIM IS MADE TO THE EXCLUSIVE RIGHT TO USE "PERIOD TRACKER", APART FROM THE MARK AS SHOWN.

THE MARK CONSISTS OF THE WORD "PERIOD" ABOVE THE WORD "TRACKER" BESIDES A STYLIZED SEMICIRCLE CONTAINING AN EXCLAMATION POINT THEREWITHIN.

SER. NO. 85-400,701, FILED 8-17-2011.

KIMBERLY PERRY, EXAMINING ATTORNEY



*David J. Kybas*

Director of the United States Patent and Trademark Office

# United States of America

United States Patent and Trademark Office

## MATCH A RESIDENT

**Reg. No. 4,134,680**

**Registered May 1, 2012**

**Int. Cl.: 35**

**SERVICE MARK**

**PRINCIPAL REGISTER**

MUSA, ZAHRAH (UNITED STATES INDIVIDUAL)  
6347 CAMINITO TENEDOR  
SAN DIEGO, CA 92120

FOR: PROVIDING AN ON-LINE SEARCHABLE DATABASE FEATURING EMPLOYMENT OPPORTUNITIES FOR MEDICAL RESIDENTS AT EMPLOYER HOSPITALS; PROVIDING ON-LINE EMPLOYMENT PLACEMENT SERVICES FOR THE HOSPITALS TO FIND SUITABLE MEDICAL RESIDENTS TO EMPLOY, NAMELY, MATCHING RESUMES OF MEDICAL RESIDENTS AND POTENTIAL EMPLOYER HOSPITALS VIA A GLOBAL COMPUTER NETWORK; PROVIDING EMPLOYMENT PLACEMENT SERVICES WHICH MATCHES MEDICAL RESIDENTS WITH EMPLOYER HOSPITALS BASED ON INFORMATION PROVIDED BY BOTH PARTIES, VIA A WEBSITE, IN CLASS 35 (U.S. CLS. 100, 101 AND 102).

FIRST USE 0-0-2004; IN COMMERCE 0-0-2004.

THE MARK CONSISTS OF STANDARD CHARACTERS WITHOUT CLAIM TO ANY PARTICULAR FONT, STYLE, SIZE, OR COLOR.

SEC. 2(F).

SER. NO. 85-400,740, FILED 8-17-2011.

LAURA HAMMEL, EXAMINING ATTORNEY



*David J. Kybas*

Director of the United States Patent and Trademark Office

# United States of America

United States Patent and Trademark Office

# Jane Labs

**Reg. No. 4,134,681**

**Registered May 1, 2012**

**Int. Cl.: 42**

**SERVICE MARK**

**PRINCIPAL REGISTER**

JANE LABS, LLC (CALIFORNIA LIMITED LIABILITY COMPANY)  
1535 BUENA VISTA AVE  
ALAMEDA, CA 94501

FOR: CONSULTING IN THE FIELD OF SOFTWARE AND HARDWARE DEVELOPMENT AND DESIGN; CONSULTING SERVICES IN THE FIELD OF DESIGN AND DEVELOPMENT OF COMPUTER HARDWARE AND SOFTWARE ENGINEERING PROCESSES; DESIGN AND DEVELOPMENT OF COMPUTER HARDWARE AND SOFTWARE, IN CLASS 42 (U.S. CLS. 100 AND 101).

FIRST USE 8-1-2010; IN COMMERCE 8-1-2010.

THE MARK CONSISTS OF STANDARD CHARACTERS WITHOUT CLAIM TO ANY PARTICULAR FONT, STYLE, SIZE, OR COLOR.

NO CLAIM IS MADE TO THE EXCLUSIVE RIGHT TO USE "LABS", APART FROM THE MARK AS SHOWN.

SER. NO. 85-400,921, FILED 8-18-2011.

MEGHAN REINHART, EXAMINING ATTORNEY



*David J. Kyros*

Director of the United States Patent and Trademark Office

# United States of America

United States Patent and Trademark Office

## Night of Hope

**Reg. No. 4,134,682**

**Registered May 1, 2012**

**Int. Cls.: 9, 16, 25, 41  
and 45**

**TRADEMARK**

**SERVICE MARK**

**PRINCIPAL REGISTER**

LAKWOOD CHURCH (TEXAS NON-PROFIT CORPORATION)  
3700 SOUTHWEST FREEWAY  
HOUSTON, TX 77027

FOR: AUDIO AND VIDEO RECORDINGS FEATURING MUSIC AND ARTISTIC PERFORMANCES, IN CLASS 9 (U.S. CLS. 21, 23, 26, 36 AND 38).

FIRST USE 1-1-2008; IN COMMERCE 1-1-2008.

FOR: PUBLICATIONS, NAMELY, BOOKLETS, PAMPHLETS, NEWSLETTERS, HAND-OUTS IN THE FIELDS OF RELIGIOUS TOPICS, IN CLASS 16 (U.S. CLS. 2, 5, 22, 23, 29, 37, 38 AND 50).

FIRST USE 1-1-2008; IN COMMERCE 1-1-2008.

FOR: BODY SHIRTS, IN CLASS 25 (U.S. CLS. 22 AND 39).

FIRST USE 1-1-2008; IN COMMERCE 1-1-2008.

FOR: EDUCATIONAL SERVICES, NAMELY, CONDUCTING CHURCH AND BIBLE SCHOOL CLASSES, SEMINARS AND CONFERENCES IN THE FIELD OF RELIGIOUS SUBJECT MATTER, IN CLASS 41 (U.S. CLS. 100, 101 AND 107).

FIRST USE 1-1-2008; IN COMMERCE 1-1-2008.

FOR: RELIGIOUS AND SPIRITUAL SERVICES, NAMELY, CONDUCTING RELIGIOUS WORSHIP, MARRIAGE CEREMONIES, BAPTISMAL CEREMONIES, BABY DEDICATIONS, BEREAVEMENT CEREMONIES, AND RELIGIOUS COUNSELING, IN CLASS 45 (U.S. CLS. 100 AND 101).

FIRST USE 1-1-2008; IN COMMERCE 1-1-2008.

THE MARK CONSISTS OF STANDARD CHARACTERS WITHOUT CLAIM TO ANY PARTICULAR FONT, STYLE, SIZE, OR COLOR.

SER. NO. 85-400,962, FILED 8-18-2011.



*David J. Kyros*

Director of the United States Patent and Trademark Office

**Reg. No. 4,134,682** BRENDAN REGAN, EXAMINING ATTORNEY

# United States of America

United States Patent and Trademark Office

## Kingdom Konsultants

**Reg. No. 4,134,683**

**Registered May 1, 2012**

**Int. Cl.: 39**

**SERVICE MARK**

**PRINCIPAL REGISTER**

KINGDOM KONSULTANT LLC (NEW JERSEY LIMITED LIABILITY COMPANY)  
P.O. BOX 691  
LAKE HOPATCONG, NJ 07849

FOR: TRAVEL BOOKING AGENCIES, IN CLASS 39 (U.S. CLS. 100 AND 105).

FIRST USE 10-1-2005; IN COMMERCE 10-1-2005.

THE MARK CONSISTS OF STANDARD CHARACTERS WITHOUT CLAIM TO ANY PARTICULAR FONT, STYLE, SIZE, OR COLOR.

NO CLAIM IS MADE TO THE EXCLUSIVE RIGHT TO USE "CONSULTANTS", APART FROM THE MARK AS SHOWN.

SER. NO. 85-401,024, FILED 8-18-2011.

JOHN DWYER, EXAMINING ATTORNEY



*David J. Kyffers*

Director of the United States Patent and Trademark Office

**United States of America**  
United States Patent and Trademark Office

# DURACODE

**Reg. No. 4,134,684**

MOVSESIAN, PAUL R (UNITED STATES INDIVIDUAL)  
P.O. BOX 546  
SEEKONK, MA 02771

**Registered May 1, 2012**

**Int. Cl.: 16**

FOR: BAR CODE LABELS, IN CLASS 16 (U.S. CLS. 2, 5, 22, 23, 29, 37, 38 AND 50).

**TRADEMARK**

FIRST USE 1-2-2011; IN COMMERCE 1-2-2011.

**PRINCIPAL REGISTER**

THE MARK CONSISTS OF STANDARD CHARACTERS WITHOUT CLAIM TO ANY PARTICULAR FONT, STYLE, SIZE, OR COLOR.

SER. NO. 85-401,132, FILED 8-18-2011.

KIM SAITO, EXAMINING ATTORNEY



*David J. Kyffers*

Director of the United States Patent and Trademark Office



# United States of America

United States Patent and Trademark Office



**Reg. No. 4,134,685**

**Registered May 1, 2012**

**Int. Cl.: 41**

**SERVICE MARK**

**PRINCIPAL REGISTER**

FORZA, LLC (NEVADA LIMITED LIABILITY COMPANY)  
2960 W. SAHARA AVENUE  
LAS VEGAS, NV 89102

FOR: FAN CLUBS; ENTERTAINMENT INFORMATION SERVICES, NAMELY, PROVIDING INFORMATION AND NEWS RELEASES ABOUT MIXED MARTIAL ARTS, IN CLASS 41 (U.S. CLS. 100, 101 AND 107).

FIRST USE 10-3-2008; IN COMMERCE 10-3-2008.

OWNER OF U.S. REG. NOS. 3,429,439, 3,467,609, AND 4,022,947.

NO CLAIM IS MADE TO THE EXCLUSIVE RIGHT TO USE "INSIDER", APART FROM THE MARK AS SHOWN.

THE MARK CONSISTS OF THE LETTER "S" IN A SHIELD TO THE LEFT OF THE WORDS "STRIKEFORCE" IN STYLIZED LETTERS ABOVE THE WORD "INSIDER".

SER. NO. 85-401,171, FILED 8-18-2011.

LINDSEY RUBIN, EXAMINING ATTORNEY



*David J. Kyffers*

Director of the United States Patent and Trademark Office

# United States of America

United States Patent and Trademark Office



**Reg. No. 4,134,686**

**Registered May 1, 2012**

**Int. Cl.: 41**

**SERVICE MARK**

**PRINCIPAL REGISTER**

PLANET BALLROOM, INC. (NORTH CAROLINA CORPORATION)  
9935 REA ROAD, SUITE D#310  
CHARLOTTE, NC 28277

FOR: DANCE STUDIOS, IN CLASS 41 (U.S. CLS. 100, 101 AND 107).

FIRST USE 1-1-2009; IN COMMERCE 8-1-2011.

OWNER OF U.S. REG. NO. 3,781,935.

NO CLAIM IS MADE TO THE EXCLUSIVE RIGHT TO USE "BALLROOM", APART FROM THE MARK AS SHOWN.

THE MARK CONSISTS OF THE STYLIZED WORDING "PLANET BALLROOM" BELOW THE DESIGN OF A RINGED MIRROR GLOBE STREAMING STARS TO THE LEFT WHERE THERE IS A PAIR OF DANCERS, MALE AND FEMALE.

SER. NO. 85-401,263, FILED 8-18-2011.

BERYL GARDNER, EXAMINING ATTORNEY



*David J. Kyffers*

Director of the United States Patent and Trademark Office

# United States of America

United States Patent and Trademark Office

# iCoil

**Reg. No. 4,134,687**

ZINUS INC. (CALIFORNIA CORPORATION)  
30799 WIEGMAN RD.  
HAYWARD, CA 94544

**Registered May 1, 2012**

**Int. Cl.: 20**

FOR: SLEEP PRODUCTS, NAMELY, MATTRESSES, SPRING MATTRESSES, BOX SPRINGS AND MATTRESS FOUNDATIONS, IN CLASS 20 (U.S. CLS. 2, 13, 22, 25, 32 AND 50).

**TRADEMARK**

FIRST USE 1-1-2008; IN COMMERCE 1-1-2008.

**PRINCIPAL REGISTER**

THE MARK CONSISTS OF STANDARD CHARACTERS WITHOUT CLAIM TO ANY PARTICULAR FONT, STYLE, SIZE, OR COLOR.

SER. NO. 85-401,276, FILED 8-18-2011.

DOUGLAS LEE, EXAMINING ATTORNEY



*David J. Kybas*

Director of the United States Patent and Trademark Office

# United States of America

## United States Patent and Trademark Office



**Reg. No. 4,134,688**

**Registered May 1, 2012**

**Int. Cl.: 35**

**SERVICE MARK**

**PRINCIPAL REGISTER**

THE GREATEST GENERATIONS FOUNDATION (COLORADO CORPORATION)  
210 UNIVERSITY BLVD., SUITE 500  
DENVER, CO 80206

FOR: CHARITABLE SERVICES, NAMELY, ORGANIZING AND CONDUCTING VOLUNTEER PROGRAMS AND COMMUNITY SERVICE PROJECTS AIMED AT INCREASING SUPPORT AND MORALE OF FAMILIES OF DECEASED WAR VETERANS, WAR VETERANS, CURRENT MEMBERS AND FUTURE MEMBERS OF THE U.S. MILITARY, IN CLASS 35 (U.S. CLS. 100, 101 AND 102).

FIRST USE 9-16-2004; IN COMMERCE 9-16-2004.

NO CLAIM IS MADE TO THE EXCLUSIVE RIGHT TO USE "FOUNDATION" AND "WORLD WAR I, WORLD WAR II, KOREA, AND VIETNAM", APART FROM THE MARK AS SHOWN.

THE COLOR(S) BRONZE, BLACK, AND WHITE IS/ARE CLAIMED AS A FEATURE OF THE MARK.

THE STIPPLING IS A FEATURE OF THE MARK AND DOES NOT INDICATE COLOR.

THE MARK CONSISTS OF A ROUND DRAWING WHICH LOOKS LIKE A THREE-DIMENSIONAL METAL MEDALLION. THE ENTIRE MEDALLION IS BRONZE (WITH THE EXCEPTION OF A DRAWING AND WORDS THAT ARE IN COMBINATIONS OF BLACK AND WHITE), AND THE ENTIRE MEDALLION IS MARKED WITH FINE, PARALLEL STRIATIONS FROM ITS UPPER RIGHT SIDE TO ITS LOWER LEFT SIDE. CENTERED IN THE MEDALLION IS A SILHOUETTE (IN BLACK) OF A WORLD WAR I SOLDIER IN PROFILE, FACING TOWARD THE RIGHT SIDE OF THE MEDALLION, ATOP A SILHOUETTE (IN BLACK) OF A HILL, LEANING FORWARD FROM HIS HIPS WITH HIS RIGHT ARM DRAPED OVER THE MUSSEL, AND HIS LEFT HAND ON THE STOCK, OF A RIFLE (IN BLACK SILHOUETTE) WHICH IS PLACED IN FRONT OF HIM WITH THE BUTT OF THE RIFLE ON THE GROUND. THE SOLDIER SILHOUETTE SHOWS THE FIGURE IS DRESSED IN MILITARY CLOTHES, WITH A KNAP SACK ON HIS BACK, AND A PITH HELMET ON HIS HEAD. THE SOLDIER IS LOOKING DOWN AT A CROSS ( IN BLACK), PLACED AT ON THE TOP OF THE HILL, WITH VEGETATION OF SOME TYPE GROWING AT THE BASE OF THE CROSS (IN BLACK). DIRECTLY ABOVE THE CROSS IS A SMALL (WHITE) DOVE IN FLIGHT, FACING TOWARD THE RIGHT OF THE MEDALLION, AND CARRYING AN OLIVE BRANCH (IN BLACK). A HORIZON LINE IS SEEN IN THE DISTANCE RUNNING



*David J. Kybas*

Director of the United States Patent and Trademark Office

**Reg. No. 4,134,688** THROUGH THE MEDALLION AT ITS MIDPOINT AND SHOWING THE SUN (IN WHITE) JUST OVER THE HORIZON. THE AREA ABOVE THE HORIZON LINE IS LIGHT BRONZE, AND THE AREA BELOW THE HORIZON LINE IS DARK BRONZE, WITH SOME SHADING TO SUGGEST WATER. THE OUTER EDGE OF THE MEDALLION IS DRAWN TO SHOW A RAISED RIDGE, AND A SECOND RAISED RIDGE, PLACED A SHORT DISTANCE INSIDE THE EDGE RIDGE, ENCIRCLES THE PICTURE DESCRIBED ABOVE. BETWEEN THE TWO RIDGES, WORDS AND STAR SYMBOLS ENCIRCLE THE MEDALLION'S OUTER EDGE. THE WORDS ARE ALL IN CAPITAL LETTERS, RENDERED IN BLACK WITH WHITE SHADING ON THE EDGE OF THE LETTERS TO GIVE THE LETTERS A THREE-DIMENSIONAL QUALITY. THE STARS ARE FIVE POINTED, RENDERED IN BLACK WITH WHITE SHADING ON THE STAR EDGES TO GIVE THE STARS A THREE DIMENSIONAL QUALITY. READING LEFT TO RIGHT, BEGINNING JUST ABOVE THE HORIZON LINE ON THE LEFT, ARCHING OVER THE MEDALLION PICTURE, AND ENDING JUST ABOVE THE HORIZON LINE ON THE RIGHT, THE STARS AND WORDS ARE AS FOLLOWS: [STAR SYMBOL] "THE GREATEST GENERATIONS FOUNDATION" [STAR SYMBOL]. READING FROM LEFT TO RIGHT, BEGINNING JUST BELOW THE HORIZON LINE ON THE LEFT, ARCHING UNDER THE MEDALLION PICTURE, AND ENDING JUST BELOW THE HORIZON LINE ON THE RIGHT, THE STARS AND WORDS ARE AS FOLLOWS: "WORLD WAR I" [STAR SYMBOL] "WORLD WAR II" [STAR SYMBOL] "KOREA" [STAR SYMBOL] "VIETNAM".

SER. NO. 85-401,640, FILED 8-18-2011.

PATRICIA EVANKO, EXAMINING ATTORNEY

# United States of America

United States Patent and Trademark Office

## Burned By Your Broker?

**Reg. No. 4,134,689**

**Registered May 1, 2012**

**Int. Cl.: 45**

**SERVICE MARK**

**PRINCIPAL REGISTER**

EVANS, JONATHAN W. (UNITED STATES INDIVIDUAL), DBA JONATHAN W. EVANS & ASSOCIATES  
12711 VENTURA BLVD. SUITE 440  
STUDIO CITY, CA 91604

FOR: LEGAL SERVICES, NAMELY, PROVIDING CUSTOMIZED DOCUMENTATION, INFORMATION, COUNSELING, ADVICE AND CONSULTATION SERVICES IN ALL AREAS OF SECURITIES LITIGATION AND ARBITRATION; PROVIDING ON-LINE INFORMATION AND NEWS IN THE FIELD OF LAW, IN CLASS 45 (U.S. CLS. 100 AND 101).

FIRST USE 1-2-1999; IN COMMERCE 1-2-1999.

THE MARK CONSISTS OF STANDARD CHARACTERS WITHOUT CLAIM TO ANY PARTICULAR FONT, STYLE, SIZE, OR COLOR.

SER. NO. 85-401,648, FILED 8-18-2011.

WILLIAM JACKSON, EXAMINING ATTORNEY



*David J. Kyffers*

Director of the United States Patent and Trademark Office

# United States of America

United States Patent and Trademark Office



**Reg. No. 4,134,690**

**Registered May 1, 2012**

**Int. Cl.: 9**

**TRADEMARK**

**PRINCIPAL REGISTER**

BLACK CHAIR GROUP, LLC (NORTH CAROLINA LIMITED LIABILITY COMPANY)  
2820 SELWYN AVE, STE 717  
CHARLOTTE, NC 28209

FOR: DOWNLOADABLE SOFTWARE IN THE NATURE OF A MOBILE APPLICATION FOR SPORTS APPLICATION USING ELECTRONIC SATELLITE TRACKING FOR MEASURING, DISPLAYING AND RECORDING DISTANCES, STATISTICS, SCORE CARDS, AND ALLOWING COMPARISON AND COMMUNICATION REGARDING LIVE ACTION SPORT ACTIVITIES VIA THE INTERNET AND WIRELESS DEVICES, IN CLASS 9 (U.S. CLS. 21, 23, 26, 36 AND 38).

FIRST USE 8-1-2011; IN COMMERCE 8-1-2011.

NO CLAIM IS MADE TO THE EXCLUSIVE RIGHT TO USE "GOLF" AND "LIVE EVENT LEADERBOARD", APART FROM THE MARK AS SHOWN.

THE COLOR(S) GREEN, GREY, WHITE AND BLACK IS/ARE CLAIMED AS A FEATURE OF THE MARK.

THE MARK CONSISTS OF THE WORDS "GROW THE GAME" IN ALL CAPITALS AND BLACK LETTERING. BETWEEN THE WORDS "GROW" AND "THE" IS AN IMAGE OF A GREY COLOR GOLF CLUB, WITH BLACK DETAIL ON THE SHAFT, AND THE LETTERS, "GTG", ON THE HEAD OF THE GOLF CLUB IN WHITE TYPE. THE HEAD OF THE CLUB IS RESTING ON A FINE GREEN LINE RUNNING BENEATH THE WORDS "GROW THE GAME". THE WORD "GOLF", IN ALL CAPITAL GREEN LETTERING, IS CENTERED BELOW THE GREEN LINE. A SECOND GREEN LINE APPEARS BENEATH THE WORD "GOLF" EXTENDING THE SAME WIDTH OF THE FIRST GREEN LINE. BELOW THE SECOND GREEN LINE, CENTERED AND IN BLACK LETTERS, ARE THE WORDS "LIVE EVENT LEADERBOARD".

SER. NO. 85-401,661, FILED 8-18-2011.

DANNEAN HETZEL, EXAMINING ATTORNEY



*David J. Kyjars*

Director of the United States Patent and Trademark Office

# United States of America

United States Patent and Trademark Office

## Analytics Quotient

**Reg. No. 4,134,691**

**Registered May 1, 2012**

**Int. Cl.: 35**

**SERVICE MARK**

**PRINCIPAL REGISTER**

ANALYTICS QUOTIENT INC. (GEORGIA CORPORATION)  
SUITE 750  
3355 LENOX ROAD NE  
ATLANTA, GA 30326

FOR: MARKETING ANALYSIS AND CONSULTING, IN CLASS 35 (U.S. CLS. 100, 101 AND 102).

FIRST USE 3-1-2008; IN COMMERCE 3-31-2008.

THE MARK CONSISTS OF STANDARD CHARACTERS WITHOUT CLAIM TO ANY PARTICULAR FONT, STYLE, SIZE, OR COLOR.

NO CLAIM IS MADE TO THE EXCLUSIVE RIGHT TO USE "ANALYTICS", APART FROM THE MARK AS SHOWN.

SER. NO. 85-401,705, FILED 8-18-2011.

MELISSA VALLILLO, EXAMINING ATTORNEY



*David J. Kyffers*

Director of the United States Patent and Trademark Office



# United States of America

United States Patent and Trademark Office

## THE BIG WIND

**Reg. No. 4,134,692**

HART, GREGORY (UNITED STATES INDIVIDUAL)  
P.O. BOX 222  
SEA GIRT, NJ 08750

**Registered May 1, 2012**

**Int. Cl.: 35**

FOR: RETAIL AND WHOLESALE STORE SERVICES FEATURING WIND TURBINES, IN CLASS 35 (U.S. CLS. 100, 101 AND 102).

**SERVICE MARK**

FIRST USE 4-14-2009; IN COMMERCE 4-14-2009.

**PRINCIPAL REGISTER**

THE MARK CONSISTS OF STANDARD CHARACTERS WITHOUT CLAIM TO ANY PARTICULAR FONT, STYLE, SIZE, OR COLOR.

NO CLAIM IS MADE TO THE EXCLUSIVE RIGHT TO USE "WIND", APART FROM THE MARK AS SHOWN.

SER. NO. 85-401,949, FILED 8-19-2011.

ANNE MADDEN, EXAMINING ATTORNEY



*David J. Kyros*

Director of the United States Patent and Trademark Office

# United States of America

United States Patent and Trademark Office

## BERKSHIRE CHASE

**Reg. No. 4,134,693**

SILLER, DORIS (UNITED STATES INDIVIDUAL)  
8 TOLL GATE STATION  
LANCASTER, PA 17601

**Registered May 1, 2012**

**Int. Cl.: 9**

FOR: EYEGLASSES; SUNGLASSES AND SPECTACLES; EYEGLASS FRAMES; FRAMES FOR SPECTACLES AND SUNGLASSES, IN CLASS 9 (U.S. CLS. 21, 23, 26, 36 AND 38).

**TRADEMARK**

FIRST USE 10-6-1998; IN COMMERCE 10-6-1998.

**PRINCIPAL REGISTER**

THE MARK CONSISTS OF STANDARD CHARACTERS WITHOUT CLAIM TO ANY PARTICULAR FONT, STYLE, SIZE, OR COLOR.

SER. NO. 85-401,954, FILED 8-19-2011.

RUSS HERMAN, EXAMINING ATTORNEY



*David J. Kybas*

Director of the United States Patent and Trademark Office

# United States of America

United States Patent and Trademark Office



**Reg. No. 4,134,694**

**Registered May 1, 2012**

**Int. Cl.: 25**

**TRADEMARK**

**PRINCIPAL REGISTER**

SCUBA STEVE LLC. (MISSISSIPPI LIMITED LIABILITY COMPANY)  
14095 RIDGEWAY DR.  
GULFPORT, MS 39503

FOR: SHOES AND BOOTS; LEATHER SHOES; HALF-BOOTS; BEACH SHOES; SANDALS; SLIPPERS; INNER SOLES FOR SHOES AND BOOTS; SPORTS SHOES; CLOTHING, NAMELY, SHIRTS, PANTS, COATS, OVERCOATS, JACKETS, JUMPERS, BLOUSES, ANORAKS, SLACKS, SUITS, WAISTCOATS, OVERALLS, PANTS, JEANS, BREECHES; CHILDREN'S WEAR, NAMELY, SHIRTS, PANTS; INFANT WEAR, NAMELY, SHIRTS, PANTS, LIVERIES, PARKAS, SHIRTS, SPORT SHIRTS, SWEATERS, PULLOVERS, SWEAT SHIRTS, SWEAT PANTS, JERSEYS, CARDIGANS, TANK TOPS, PAJAMAS, TEE-SHIRTS; CLOTHING OF LEATHER, NAMELY, PANTS, JACKETS; CLOTHING OF IMITATIONS OF LEATHER, NAMELY, PANTS, JACKETS, COLLAR PROTECTORS, BANDANAS, NECKERCHIEFS, SCARVES, EAR MUFFS, GLOVES, MITTENS, SOCKS, HEADWEAR, FUR HATS, CAPS, HATS, SUN VISORS, TURBANS AND BELTS, IN CLASS 25 (U.S. CLS. 22 AND 39).

FIRST USE 8-1-2008; IN COMMERCE 8-1-2008.

THE LIKENESS (OR, "PORTRAIT") IN THE MARK IDENTIFIES A LIVING INDIVIDUAL WHOSE CONSENT IS OF RECORD.

THE MARK CONSISTS OF A PORTRAIT OF A MAN'S FACE, THE MAN HAS THICK HAIR AND A BEARD.

SER. NO. 85-402,093, FILED 8-19-2011.

RONALD MCMORROW, EXAMINING ATTORNEY



*David J. Kybas*

Director of the United States Patent and Trademark Office

# United States of America

United States Patent and Trademark Office



**Reg. No. 4,134,695**

**Registered May 1, 2012**

**Int. Cl.: 1**

**TRADEMARK**

**PRINCIPAL REGISTER**

GREEN HEALTH PRODUCTS, INC. (PENNSYLVANIA CORPORATION)  
137 COMMERCE DRIVE  
GLEN ROCK, PA 17327

FOR: FERTILIZERS, IN CLASS 1 (U.S. CLS. 1, 5, 6, 10, 26 AND 46).

FIRST USE 8-15-2011; IN COMMERCE 8-15-2011.

NO CLAIM IS MADE TO THE EXCLUSIVE RIGHT TO USE "GREEN HEALTH PRODUCTS, INC." AND "PLANT HEALTH", APART FROM THE MARK AS SHOWN.

THE COLOR(S) DARK GREEN, LIGHT GREEN, AND ORANGE IS/ARE CLAIMED AS A FEATURE OF THE MARK.

THE MARK CONSISTS OF THE WORDS "GREEN HEALTH PRODUCTS, INC.", IN DARK GREEN, WITH A CIRCULAR SYMBOL BETWEEN THE WORDS "HEALTH" AND "PRODUCTS". THE CIRCULAR SYMBOL IS DARK GREEN AND HAS THE WORDS "VITAL FOR PLANT HEALTH" IN ORANGE ABOVE IT AND WITHIN IT HAS THE STYLIZED LETTERS "GHP" IN LIGHT GREEN, WITH THE LETTERS BEING FORMED TO LOOK LIKE LEAVES.

SER. NO. 85-402,204, FILED 8-19-2011.

LINDSEY RUBIN, EXAMINING ATTORNEY



*David J. Kybas*

Director of the United States Patent and Trademark Office

# United States of America

United States Patent and Trademark Office



**Reg. No. 4,134,696**

**Registered May 1, 2012**

**Int. Cl.: 25**

**TRADEMARK**

**PRINCIPAL REGISTER**

ARTISANS, INC. (WISCONSIN CORPORATION)  
P.O. BOX 278  
GLEN FLORA, WI 54526

FOR: MEN'S AND WOMEN'S APPAREL, NAMELY, T-SHIRTS, SWEATSHIRTS, CAPS, HATS, JACKETS, PANTS, SHORTS, SHIRTS, SWEATERS, JOGGING SUITS, VESTS, LOUNGEWEAR AND BELTS, IN CLASS 25 (U.S. CLS. 22 AND 39).

FIRST USE 10-20-2010; IN COMMERCE 10-20-2010.

NO CLAIM IS MADE TO THE EXCLUSIVE RIGHT TO USE "TRADING COMPANY" OR "SINCE 1905", APART FROM THE MARK AS SHOWN.

THE MARK CONSISTS OF A RECTANGLE, APPEARING AS BARN WOOD, WITHIN WHICH APPEARS THE DOMINANT WORDING "GOOD OLD DAYS", AND WHERE THE WORDING "EMBRACE THE PAST" APPEARS ABOVE IN SMALLER FONT, AND THE WORDING "TRADING COMPANY" APPEARS BELOW IN A LONG OVAL IN SMALLER FONT, AND WHERE THE WORDING "SINCE 1905" ALSO APPEARS BELOW IN SMALLER FONT. THERE IS A CURVILINEAR DESIGN ON EITHER SIDE OF THE WORDING "SINCE 1905".

SER. NO. 85-402,227, FILED 8-19-2011.

ROBIN CHOSID, EXAMINING ATTORNEY



*David J. Kyffers*

Director of the United States Patent and Trademark Office

# United States of America

United States Patent and Trademark Office



**Reg. No. 4,134,697**

**Registered May 1, 2012**

**Int. Cl.: 35**

**SERVICE MARK**

**PRINCIPAL REGISTER**

THE CABINET BARN.COM INC (FLORIDA CORPORATION)  
UNIT B  
3800 W. FAIRFIELD DRIVE  
PENSACOLA, FL 32505

FOR: RETAIL STORE AND ON-LINE RETAIL STORE SERVICES FEATURING CABINETS FOR KITCHENS AND BATHROOMS, IN CLASS 35 (U.S. CLS. 100, 101 AND 102).

FIRST USE 1-1-2009; IN COMMERCE 1-1-2009.

NO CLAIM IS MADE TO THE EXCLUSIVE RIGHT TO USE "CABINET", APART FROM THE MARK AS SHOWN.

THE STIPPLING IS FOR SHADING PURPOSES ONLY.

THE MARK CONSISTS OF A BARN WITH A ROOSTER ON TOP, CABINET DOORS ON THE FRONT, AND THE TEXT "THE CABINET BARN.COM" STACKED ON THE RIGHT OF THE IMAGE.

SER. NO. 85-402,229, FILED 8-19-2011.

RON FAIRBANKS, EXAMINING ATTORNEY



*David J. Kybas*

Director of the United States Patent and Trademark Office

# United States of America

United States Patent and Trademark Office

**speednetworkx**

**Reg. No. 4,134,698**

**Registered May 1, 2012**

**Int. Cl.: 35**

**SERVICE MARK**

**PRINCIPAL REGISTER**

CONSULTNETWORK LLC (NEW JERSEY LIMITED LIABILITY COMPANY)  
5 OVERLOOK TERRACE  
CHESTER, NJ 07930

FOR: ARRANGING AND CONDUCTING BUSINESS CONFERENCES; ARRANGING AND CONDUCTING SPECIAL EVENTS FOR BUSINESS PURPOSES; BUSINESS MEETING PLANNING, IN CLASS 35 (U.S. CLS. 100, 101 AND 102).

FIRST USE 5-1-2008; IN COMMERCE 5-1-2008.

THE MARK CONSISTS OF THE WORDING "SPEEDNETWORKX" IN STYLIZED FONT. THE WORD "SPEED" APPEARS IN RED WITH WHITE WEATHERING DESIGNS ON THE LETTERS. THE WORD "NETWORKX" APPEARS IN BLACK WITH WHITE WEATHERING DESIGNS ON THE LETTERS.

THE COLOR(S) RED, BLACK AND WHITE IS/ARE CLAIMED AS A FEATURE OF THE MARK.

SER. NO. 85-402,339, FILED 8-19-2011.

TINA BROWN, EXAMINING ATTORNEY



*David J. Kybas*

Director of the United States Patent and Trademark Office

# United States of America

United States Patent and Trademark Office

# SUN CAP

**Reg. No. 4,134,699**

**Registered May 1, 2012**

**Int. Cl.: 28**

**TRADEMARK**

**PRINCIPAL REGISTER**

BRUCE CAPWELL (UNITED STATES INDIVIDUAL)  
5555 FLAT RIVER ROAD  
GREENE, RI 02827

FOR: SUN SHIELDS OR SHADES IN THE NATURE OF AN INFLATABLE CANOPY FOR USE WITH FLOATING RECREATIONAL LOUNGE CHAIRS, FLOAT MATTRESSES AND PADS, IN CLASS 28 (U.S. CLS. 22, 23, 38 AND 50).

FIRST USE 5-0-2000; IN COMMERCE 5-0-2000.

THE MARK CONSISTS OF STANDARD CHARACTERS WITHOUT CLAIM TO ANY PARTICULAR FONT, STYLE, SIZE, OR COLOR.

NO CLAIM IS MADE TO THE EXCLUSIVE RIGHT TO USE "SUN", APART FROM THE MARK AS SHOWN.

SER. NO. 85-402,365, FILED 8-19-2011.

ANDREA BUTLER, EXAMINING ATTORNEY



*David J. Kybas*

Director of the United States Patent and Trademark Office



# United States of America

United States Patent and Trademark Office

## PROFESSIONAL PHOTOGRAPHERS OF CALIFORNIA

**Reg. No. 4,134,700**

PROFESSIONAL PHOTOGRAPHERS OF CALIFORNIA, INC (CALIFORNIA CORPORATION)  
1514 N. ELM ST  
ESCONDIDO, CA 920262055

**Registered May 1, 2012**

**Int. Cl.: 35**

FOR: ASSOCIATION SERVICES, NAMELY, PROMOTING THE INTERESTS OF PROFESSIONAL PHOTOGRAPHERS, IN CLASS 35 (U.S. CLS. 100, 101 AND 102).

**SERVICE MARK**

FIRST USE 1-10-2004; IN COMMERCE 1-10-2004.

**PRINCIPAL REGISTER**

NO CLAIM IS MADE TO THE EXCLUSIVE RIGHT TO USE "PROFESSIONAL PHOTOGRAPHERS OF CALIFORNIA", APART FROM THE MARK AS SHOWN.

THE MARK CONSISTS OF THE STYLIZED TEXT "PROFESSIONAL PHOTOGRAPHERS OF CALIFORNIA".

SER. NO. 85-402,464, FILED 8-19-2011.

JACQUELINE A. LAVINE, EXAMINING ATTORNEY



*David J. Kybas*

Director of the United States Patent and Trademark Office

# United States of America

United States Patent and Trademark Office



**Reg. No. 4,134,701**

**Registered May 1, 2012**

**Int. Cl.: 9**

**TRADEMARK**

**PRINCIPAL REGISTER**

METROCKET, LLC (ALABAMA LIMITED LIABILITY COMPANY)  
1500 FIRST AVENUE N.  
UNIT 52  
BIRMINGHAM, AL 35203

FOR: COMPUTER APPLICATION SOFTWARE AND DOWNLOADABLE SOFTWARE IN THE NATURE OF MOBILE APPLICATIONS FOR HANDHELD COMPUTERS, DIGITAL ELECTRONIC DEVICES, WIRELESS DEVICES AND INTERNET CAPABLE DEVICES THAT ACTS AS A HIGHWAY TRAVEL GUIDE FOR THE USER, ALLOWING USERS TRAVELLING ON MAJOR HIGHWAYS TO FIND THE LOCATION OF AND THEIR DISTANCE FROM RESTAURANTS, HOTELS AND OTHER BUSINESSES ON UPCOMING EXITS, IN CLASS 9 (U.S. CLS. 21, 23, 26, 36 AND 38).

FIRST USE 11-1-2010; IN COMMERCE 11-1-2010.

THE MARK CONSISTS OF A SQUARE WITH ROUNDED EDGES CONTAINING THE WORD "IEXIT" ABOVE AN ARROW POINTING IN AN UPPER RIGHT DIRECTION.

SER. NO. 85-402,486, FILED 8-19-2011.

DOMINIC FATHY, EXAMINING ATTORNEY



*David J. Kybas*

Director of the United States Patent and Trademark Office

# United States of America

United States Patent and Trademark Office

## white hat holsters

**Reg. No. 4,134,702**

**Registered May 1, 2012**

**Int. Cl.: 13**

**TRADEMARK**

**PRINCIPAL REGISTER**

WHITE HAT HOLSTERS, L.L.C. (TEXAS LIMITED LIABILITY COMPANY), DBA WHITE  
HAT HOLSTERS  
1801 W. PIONEER PKWY  
ARLINGTON, TX 76013

FOR: HOLSTERS, IN CLASS 13 (U.S. CLS. 2 AND 9).

FIRST USE 2-1-2011; IN COMMERCE 2-1-2011.

THE MARK CONSISTS OF STANDARD CHARACTERS WITHOUT CLAIM TO ANY PARTICULAR FONT, STYLE, SIZE, OR COLOR.

NO CLAIM IS MADE TO THE EXCLUSIVE RIGHT TO USE "HOLSTERS", APART FROM THE MARK AS SHOWN.

SER. NO. 85-402,494, FILED 8-19-2011.

JACQUELINE A. LAVINE, EXAMINING ATTORNEY



*David J. Kybas*

Director of the United States Patent and Trademark Office

# United States of America

United States Patent and Trademark Office



**Reg. No. 4,134,703**

**Registered May 1, 2012**

**Int. Cl.: 9**

**TRADEMARK**

**PRINCIPAL REGISTER**

CREATIVE EYEWEAR INC. (NEW YORK CORPORATION), DBA CREATIVE GROUP  
1828-B TROUTMAN STREET  
RIDGWOOD, NY 11385

FOR: EYEWEAR; EYEWEAR ACCESSORIES, NAMELY, STRAPS, NECK CORDS AND HEAD STRAPS WHICH RESTRAIN EYEWEAR FROM MOVEMENT ON A WEARER; EYEWEAR CASES; EYEWEAR RETAINERS; NOSE GUARDS WHICH CAN BE WORN BY ATTACHMENT TO EYEWEAR SUCH AS SUNGLASSES AND SKI GOGGLES; SPORTS EYEWEAR, IN CLASS 9 (U.S. CLS. 21, 23, 26, 36 AND 38).

FIRST USE 3-1-2011; IN COMMERCE 3-1-2011.

THE MARK CONSISTS OF THE STYLIZED WORDS "FLYING SKULL" APPEARING IN THE FRONT WITH THE FIRST LETTER OF EACH WORD CAPITALIZED, BEHIND OF WHICH IS A HUMAN SKULL AND PAIR OF DIAGONALLY CROSSED BONES WITH A POOL OF BLOOD BEHIND AND ALL OF WHICH IS SUPERIMPOSED IN THE CENTER OF A RECTANGLE. THE COLOR BLACK APPEARS IN THE RECTANGLE BACKGROUND, IN THE SKULL CRACKS, IN THE THIN LINE DETAILING OF THE CROSSBONES, IN THE DETAILING OF THE FACIAL FEATURES ON THE SKULL, AND IN THE OUTLINING OF THE SKULL AND CROSSBONES; THE COLOR RED APPEARS IN THE BLOOD; THE COLOR WHITE APPEARS IN THE TERMS "FLYING SKULL" AND AS THE BACKGROUND COLOR OF THE HUMAN SKULL WITH CROSSED BONES; THE COLOR YELLOW APPEARS IN THE IRIS OF THE EYES OF THE HUMAN SKULL.

THE COLOR(S) RED, YELLOW, BLACK AND WHITE IS/ARE CLAIMED AS A FEATURE OF THE MARK.

SER. NO. 85-402,496, FILED 8-19-2011.

ELLEN B. AWRICH, EXAMINING ATTORNEY



*David J. Kybas*

Director of the United States Patent and Trademark Office

# United States of America

United States Patent and Trademark Office

## BARRINGTONDENTALCARE

**Reg. No. 4,134,704**

**Registered May 1, 2012**

**Int. Cl.: 44**

**SERVICE MARK**

**PRINCIPAL REGISTER**

BARRINGTON DENTAL CARE LTD. (ILLINOIS CORPORATION)  
304 SOUTH HAGER AVENUE  
BARRINGTON, IL 60010

FOR: DENTAL SERVICES AND DENTISTRY, IN CLASS 44 (U.S. CLS. 100 AND 101).

FIRST USE 5-15-2006; IN COMMERCE 5-15-2006.

THE MARK CONSISTS OF STANDARD CHARACTERS WITHOUT CLAIM TO ANY PARTICULAR FONT, STYLE, SIZE, OR COLOR.

SEC. 2(F).

SER. NO. 85-402,509, FILED 8-19-2011.

JAMES GRIFFIN, EXAMINING ATTORNEY



*David J. Kyffers*

Director of the United States Patent and Trademark Office

# United States of America

United States Patent and Trademark Office

# HELIX

**Reg. No. 4,134,705**

**Registered May 1, 2012**

**Int. Cl.: 8**

**TRADEMARK**

**PRINCIPAL REGISTER**

MUELLER, MICHAEL BERNARD (UNITED STATES INDIVIDUAL)  
823 SW KINGS BAY DRIVE  
CRYSTAL RIVER, FL 34429

FOR: HAND OPERATED HAIR REMOVAL TOOLS, IN CLASS 8 (U.S. CLS. 23, 28 AND 44).

FIRST USE 1-29-2011; IN COMMERCE 2-25-2011.

THE MARK CONSISTS OF STANDARD CHARACTERS WITHOUT CLAIM TO ANY PARTICULAR FONT, STYLE, SIZE, OR COLOR.

SER. NO. 85-402,516, FILED 8-19-2011.

JAMES GRIFFIN, EXAMINING ATTORNEY



*David J. Kybas*

Director of the United States Patent and Trademark Office

# United States of America

United States Patent and Trademark Office

# Max Tuck

**Reg. No. 4,134,706**

**Registered May 1, 2012**

**Int. Cl.: 13**

**TRADEMARK**

**PRINCIPAL REGISTER**

WHITE HAT HOLSTERS, L.L.C. (TEXAS LIMITED LIABILITY COMPANY), DBA WHITE  
HAT HOLSTERS  
1801 W. PIONEER PKWY  
ARLINGTON, TX 76013

FOR: HOLSTERS, IN CLASS 13 (U.S. CLS. 2 AND 9).

FIRST USE 2-1-2011; IN COMMERCE 2-1-2011.

THE MARK CONSISTS OF STANDARD CHARACTERS WITHOUT CLAIM TO ANY PARTICULAR FONT, STYLE, SIZE, OR COLOR.

THE NAME(S), PORTRAIT(S), AND/OR SIGNATURE(S) SHOWN IN THE MARK DOES NOT IDENTIFY A PARTICULAR LIVING INDIVIDUAL.

SER. NO. 85-402,536, FILED 8-19-2011.

JACQUELINE A. LAVINE, EXAMINING ATTORNEY



*David J. Kybas*

Director of the United States Patent and Trademark Office

# United States of America

United States Patent and Trademark Office

# DataMax

**Reg. No. 4,134,707**

**Registered May 1, 2012**

**Int. Cl.: 35**

**SERVICE MARK**

**PRINCIPAL REGISTER**

DATAMAX CORPORATION (NORTH CAROLINA CORPORATION)  
711 COLISEUM PLAZA COURT  
WINSTON SALEM, NC 27106

FOR: MEDICAL CLAIMS MANAGEMENT SERVICES, NAMELY, ARRANGING OF MANAGED CARE CONTRACTUAL SERVICES IN THE FIELDS OF PHYSICIAN PRACTICES, ELIGIBILITY PRE-CERTIFICATION SERVICES, CO-PAY AND DEDUCTIBLE DETERMINATION AND BILLING, CLAIMS SUBMISSION, REIMBURSEMENT AND REVENUE ANALYSIS AND RECEIVING, DATA ENTERING AND REPRICING OF TRANSACTIONS THAT ARE ORIGINATED BY PHYSICIANS, HOSPITALS AND ANCILLARY MEDICAL CARE PROVIDERS, IN CLASS 35 (U.S. CLS. 100, 101 AND 102).

FIRST USE 8-1-2008; IN COMMERCE 8-1-2008.

THE MARK CONSISTS OF STANDARD CHARACTERS WITHOUT CLAIM TO ANY PARTICULAR FONT, STYLE, SIZE, OR COLOR.

OWNER OF U.S. REG. NO. 1,761,687.

SER. NO. 85-402,590, FILED 8-19-2011.

KATHLEEN LORENZO, EXAMINING ATTORNEY



*David J. Kyros*

Director of the United States Patent and Trademark Office



**United States of America**  
United States Patent and Trademark Office

# PRO SEAM

**Reg. No. 4,134,708**

**Registered May 1, 2012**

**Int. Cl.: 6**

**TRADEMARK**

**PRINCIPAL REGISTER**

DEAN STEEL BUILDINGS, INC. (FLORIDA CORPORATION)  
2929 INDUSTRIAL AVENUE  
FORT MYERS, FL 33901

FOR: METAL ROOFING PANELS, IN CLASS 6 (U.S. CLS. 2, 12, 13, 14, 23, 25 AND 50).

FIRST USE 1-1-1986; IN COMMERCE 1-1-1986.

THE MARK CONSISTS OF STANDARD CHARACTERS WITHOUT CLAIM TO ANY PARTICULAR FONT, STYLE, SIZE, OR COLOR.

NO CLAIM IS MADE TO THE EXCLUSIVE RIGHT TO USE "SEAM", APART FROM THE MARK AS SHOWN.

SER. NO. 85-402,643, FILED 8-19-2011.

ASMAT KHAN, EXAMINING ATTORNEY



*David J. Kyffers*

Director of the United States Patent and Trademark Office

**United States of America**  
United States Patent and Trademark Office

# TROPICO

**Reg. No. 4,134,709**

TROPICO (NEW YORK CORPORATION)  
1407 BROADWAY SUITE 1701  
NEW YORK, NY 10018

**Registered May 1, 2012**

**Int. Cl.: 25**

FOR: JACKETS; WOMEN'S CLOTHING, NAMELY, SHIRTS, DRESSES, SKIRTS, BLOUSES,  
IN CLASS 25 (U.S. CLS. 22 AND 39).

**TRADEMARK**

FIRST USE 10-15-2000; IN COMMERCE 12-2-2000.

**PRINCIPAL REGISTER**

THE MARK CONSISTS OF STANDARD CHARACTERS WITHOUT CLAIM TO ANY PARTICULAR FONT, STYLE, SIZE, OR COLOR.

THE ENGLISH TRANSLATION OF "TROPICO" IN THE MARK IS "TROPIC".

SER. NO. 85-402,712, FILED 8-19-2011.

CHARLOTTE CORWIN, EXAMINING ATTORNEY



*David J. Kybas*

Director of the United States Patent and Trademark Office

# United States of America

United States Patent and Trademark Office

 Pixel**FLEX**

**Reg. No. 4,134,710**

**Registered May 1, 2012**

**Int. Cl.: 9**

**TRADEMARK**

**PRINCIPAL REGISTER**

ELITE MULTIMEDIA PRODUCTIONS, INC. (TENNESSEE CORPORATION)  
2756 APPLING CENTER  
CV SUITE 104  
MEMPHIS, TN 38133

FOR: PROGRAMMABLE LIGHT-EMITTING DIODE (LED) DISPLAYS FOR THE ENTERTAINMENT INDUSTRY, IN CLASS 9 (U.S. CLS. 21, 23, 26, 36 AND 38).

FIRST USE 7-0-2011; IN COMMERCE 7-0-2011.

THE MARK CONSISTS OF AN ARRAY OF DOTS, FOLLOWED BY THE WORD "PIXELFLEX".

SER. NO. 85-402,792, FILED 8-19-2011.

MELISSA VALLILLO, EXAMINING ATTORNEY



*David J. Kybas*

Director of the United States Patent and Trademark Office

# United States of America

United States Patent and Trademark Office

## AGELESS GURU

**Reg. No. 4,134,711**

**Registered May 1, 2012**

**Int. Cl.: 41**

**SERVICE MARK**

**PRINCIPAL REGISTER**

BUSHNELL, DANIEL (UNITED STATES INDIVIDUAL)  
PO BOX 1920  
SANTA MONICA, CA 90406

FOR: EDUCATIONAL SERVICES, NAMELY, PROVIDING LIVE AND ON-LINE EDUCATIONAL ACTIVITIES IN THE NATURE OF SEMINARS, WORKSHOPS, CLASSES, LECTURES, MENTORING, TELECLASSES, NON-DOWNLOADABLE WEBINARS, AND PROFESSIONAL AND PERSONAL COACHING SERVICES IN THE FIELDS OF HEALTH, WELLNESS, HOLISTIC LIVING, NUTRITION, ANTI-AGING, LONGEVITY, FITNESS, EXERCISE, YOGA, REJUVENATION, CLEANSING AND BEAUTY; ON-LINE JOURNALS, NAMELY, BLOGS AND PROVIDING ARTICLES IN THE FIELDS OF HEALTH, WELLNESS, HOLISTIC LIVING, NUTRITION, ANTI-AGING, LONGEVITY, FITNESS, EXERCISE, YOGA, REJUVENATION, CLEANSING AND BEAUTY; PROVIDING A WEBSITE FEATURING ONLINE, NON-DOWNLOADABLE VIDEO AND AUDIO RECORDINGS IN THE FIELDS OF HEALTH, WELLNESS, HOLISTIC LIVING, NUTRITION, ANTI-AGING, LONGEVITY, FITNESS, EXERCISE, YOGA, REJUVENATION, CLEANSING AND BEAUTY, IN CLASS 41 (U.S. CLS. 100, 101 AND 107).

FIRST USE 8-19-2011; IN COMMERCE 8-19-2011.

THE MARK CONSISTS OF STANDARD CHARACTERS WITHOUT CLAIM TO ANY PARTICULAR FONT, STYLE, SIZE, OR COLOR.

NO CLAIM IS MADE TO THE EXCLUSIVE RIGHT TO USE "GURU", APART FROM THE MARK AS SHOWN.

SER. NO. 85-402,827, FILED 8-19-2011.

ALAIN LAPTEY, EXAMINING ATTORNEY



*David J. Kyffers*

Director of the United States Patent and Trademark Office

# United States of America

United States Patent and Trademark Office

## live architecture

**Reg. No. 4,134,712**

**Registered May 1, 2012**

**Int. Cl.: 36**

**SERVICE MARK**

**PRINCIPAL REGISTER**

ARCHITECTURE 8, INC. (CALIFORNIA CORPORATION)  
# 1167  
264 S. LA CIENEGA BLVD.  
BEVERLY HILLS, CA 90211

FOR: REAL ESTATE BROKERAGE, IN CLASS 36 (U.S. CLS. 100, 101 AND 102).

FIRST USE 6-27-2008; IN COMMERCE 6-27-2008.

THE MARK CONSISTS OF STANDARD CHARACTERS WITHOUT CLAIM TO ANY PARTICULAR FONT, STYLE, SIZE, OR COLOR.

NO CLAIM IS MADE TO THE EXCLUSIVE RIGHT TO USE "ARCHITECTURE", APART FROM THE MARK AS SHOWN.

SER. NO. 85-402,972, FILED 8-20-2011.

RONALD AIKENS, EXAMINING ATTORNEY



*David J. Kybas*

Director of the United States Patent and Trademark Office

# United States of America

United States Patent and Trademark Office

# GENFIL

**Reg. No. 4,134,713**

**Registered May 1, 2012**

**Int. Cls.: 7 and 11**

**TRADEMARK**

**PRINCIPAL REGISTER**

G&W INTERNATIONAL CO., LTD. (CHINA LIMITED LIABILITY COMPANY)  
TAIRAN INDUSTRIAL ZONE, FUTIAN DISTRICT.  
SUITE 303, EAST OF 3/F, BLD. 211  
SHENZHEN, CHINA 518040

FOR: AIR FILTERS FOR AUTOMOBILE ENGINES; AIR FILTERS FOR MECHANICAL PURPOSES; AIR FILTERS FOR MOTORCYCLE MOTORS AND ENGINES; AIR FILTERS FOR VEHICLE MOTORS AND ENGINES; FILTER ELEMENTS FOR FUEL FILTERS; FILTERS AND PURIFIERS FOR MACHINES, NAMELY, FILTERS AND PURIFIERS FOR REMOVING CONTAMINANTS FROM GASES USED IN THE SEMICONDUCTOR INDUSTRY; FILTERS FOR MOTORS AND ENGINES; FILTERS FOR LIGHT, ON-OFF ROAD, HEAVY DUTY, INDUSTRIAL MACHINES; FUEL FILTERS; OIL FILTERS; OIL FILTERS FOR MECHANICAL PURPOSES; OIL FILTERS FOR MOTORS AND ENGINES; AIR, OIL, FUEL FILTERS FOR MOTORS AND ENGINES, IN CLASS 7 (U.S. CLS. 13, 19, 21, 23, 31, 34 AND 35).

FOR: AIR CLEANING UNITS CONTAINING AN AIR FILTER, ULTRAVIOLET LIGHTS AND A PHOTOCATALYTIC FILTER; AIR FILTERS FOR AIR CONDITIONERS IN VEHICLE PASSENGER COMPARTMENTS; AIR FILTERS FOR AIR CONDITIONING UNITS; AIR FILTERS FOR DOMESTIC USE; AIR FILTERS FOR INDUSTRIAL INSTALLATIONS; FILTERS AND FILTERING DEVICES FOR AIR AND GAS CONDITIONING; FILTERS FOR AIR CONDITIONING; FILTERS FOR DRINKING WATER; FILTERS MADE OF FIBER FOR WATER FILTRATION; HEPA FILTERS FOR HOUSEHOLD USE; INDUSTRIAL AIR FILTER MACHINES; SWIMMING POOL WATER CLEANING AND FILTERING UNITS; WATER FILTERS; WATER FILTRATION AND PURIFICATION UNITS AND REPLACEMENT CARTRIDGES AND FILTERS THEREFOR, IN CLASS 11 (U.S. CLS. 13, 21, 23, 31 AND 34).

OWNER OF CHINA REG. NO. 9070666, DATED 1-19-2011, EXPIRES 1-19-2021.

OWNER OF CHINA REG. NO. 9070638, DATED 1-19-2011, EXPIRES 1-19-2021.

THE MARK CONSISTS OF THE WORD "GENFIL". THERE IS AN OVERLAP BETWEEN THE LETTER OF "N" AND THE LETTER OF "F". THE LETTER "I" IS REPRESENTED BY A DESIGN OF THREE BUBBLES.

SER. NO. 85-403,036, FILED 8-20-2011.

TARAH HARDY, EXAMINING ATTORNEY



*David J. Kyros*

Director of the United States Patent and Trademark Office

# United States of America

United States Patent and Trademark Office

## WORLDWIDE OILFIELD MACHINE

**Reg. No. 4,134,714**

**Registered May 1, 2012**

**Int. Cl.: 9**

**TRADEMARK**

**PRINCIPAL REGISTER**

WORLDWIDE OILFIELD MACHINE, INC. (TEXAS CORPORATION)  
11809 CANEMONT  
HOUSTON, TX 77035

FOR: CONTROL VALVES FOR REGULATING THE FLOW OF GASES AND LIQUIDS, IN CLASS 9 (U.S. CLS. 21, 23, 26, 36 AND 38).

FIRST USE 1-1-2006; IN COMMERCE 1-1-2006.

THE MARK CONSISTS OF STANDARD CHARACTERS WITHOUT CLAIM TO ANY PARTICULAR FONT, STYLE, SIZE, OR COLOR.

NO CLAIM IS MADE TO THE EXCLUSIVE RIGHT TO USE "OILFIELD MACHINE", APART FROM THE MARK AS SHOWN.

SER. NO. 85-403,038, FILED 8-20-2011.

SHARON MEIER, EXAMINING ATTORNEY



*David J. Kybas*

Director of the United States Patent and Trademark Office

# United States of America

United States Patent and Trademark Office



**Reg. No. 4,134,715**

WORLDWIDE OILFIELD MACHINE, INC. (TEXAS CORPORATION)  
11809 CANEMONT  
HOUSTON, TX 77035

**Registered May 1, 2012**

**Int. Cl.: 9**

FOR: CONTROL VALVES FOR REGULATING THE FLOW OF GASES AND LIQUIDS, IN CLASS 9 (U.S. CLS. 21, 23, 26, 36 AND 38).

**TRADEMARK**

FIRST USE 1-1-2006; IN COMMERCE 1-1-2006.

**PRINCIPAL REGISTER**

THE MARK CONSISTS OF THE WORD "WOM", IN ORANGE, SUPERIMPOSED ON A GRID OF THE WORLD, WHERE THE GRID LINES ARE BLACK. THE COLOR WHITE APPEARING IN THE DRAWING REPRESENTS BACKGROUND OR TRANSPARENT AREAS AND IS NOT PART OF THE MARK.

THE COLOR(S) ORANGE AND BLACK, IS/ARE CLAIMED AS A FEATURE OF THE MARK.

SER. NO. 85-403,067, FILED 8-20-2011.

SHARON MEIER, EXAMINING ATTORNEY



*David J. Kybas*

Director of the United States Patent and Trademark Office



# United States of America

United States Patent and Trademark Office



**Reg. No. 4,134,716**

**Registered May 1, 2012**

**Int. Cl.: 25**

**TRADEMARK**

**PRINCIPAL REGISTER**

ELLINGSEN, LISE (NORWAY INDIVIDUAL)

# 1E

344 WEST, 17 STREET

NEW YORK, NY 10011

FOR: CAPS; DRESSES; GLOVES; HATS; JACKETS; JEANS; SCARFS; SHIRTS; SHOES; SHORTS; SOCKS; T-SHIRTS; UNDERWEAR, IN CLASS 25 (U.S. CLS. 22 AND 39).

FIRST USE 0-0-2006; IN COMMERCE 0-0-2010.

NO CLAIM IS MADE TO THE EXCLUSIVE RIGHT TO USE "T-SHIRTS", APART FROM THE MARK AS SHOWN.

THE MARK CONSISTS OF THE STACKED STYLIZED WORDING "BLONDES" AND "MAKE BETTER "T-SHIRTS".

SER. NO. 85-403,151, FILED 8-21-2011.

PAULA MAHONEY, EXAMINING ATTORNEY



*David J. Kybas*

Director of the United States Patent and Trademark Office

# United States of America

United States Patent and Trademark Office

## Meridian Liquid Coatings

**Reg. No. 4,134,717**

MERIDIAN LIQUID COATINGS, LLC (COLORADO LIMITED LIABILITY COMPANY)  
2536 RIMROCK AVENUE #400-453  
GRAND JUNCTION, CO 81505

**Registered May 1, 2012**

**Int. Cl.: 35**

FOR: RETAIL STORE AND ON-LINE RETAIL STORE SERVICES FEATURING LIQUID APPLIED COATINGS, IN CLASS 35 (U.S. CLS. 100, 101 AND 102).

**SERVICE MARK**

FIRST USE 4-13-2010; IN COMMERCE 6-13-2010.

**PRINCIPAL REGISTER**

THE MARK CONSISTS OF STANDARD CHARACTERS WITHOUT CLAIM TO ANY PARTICULAR FONT, STYLE, SIZE, OR COLOR.

NO CLAIM IS MADE TO THE EXCLUSIVE RIGHT TO USE "LIQUID COATINGS", APART FROM THE MARK AS SHOWN.

SER. NO. 85-403,215, FILED 8-21-2011.

BERNICE MIDDLETON, EXAMINING ATTORNEY



*David J. Kyffers*

Director of the United States Patent and Trademark Office

# United States of America

United States Patent and Trademark Office

## PNC WEALTH MANAGEMENT

**Reg. No. 4,134,718**

**Registered May 1, 2012**

**Int. Cls.: 35 and 36**

**SERVICE MARK**

**PRINCIPAL REGISTER**

THE PNC FINANCIAL SERVICES GROUP, INC. (PENNSYLVANIA CORPORATION)  
249 FIFTH AVENUE  
PITTSBURGH, PA 15222

FOR: PREPARATION OF FIDUCIARY TAX RETURNS, IN CLASS 35 (U.S. CLS. 100, 101 AND 102).

FIRST USE 3-31-2006; IN COMMERCE 3-31-2006.

FOR: BANKING SERVICES ; INVESTMENT MANAGEMENT; FIDUCIARY REPRESENTATIVE SERVICES, NAMELY, ACTING AS PERSONAL REPRESENTATIVES OF DECEDENT'S ESTATES AND AS TRUSTEES OF TRUSTS; CUSTODIAN SERVICES, NAMELY, HOLDING STOCKS, BONDS, SECURITIES AND OTHER FINANCIAL AND INVESTMENT INSTRUMENTS FOR OTHERS; FINANCIAL AND ESTATE PLANNING ; FINANCIAL PLANNING SERVICES IN THE NATURE OF RETIREMENT, GIFT, AND DISTRIBUTION PLANNING ; MORTGAGE LENDING ; FINANCIAL INVESTMENT SERVICES, NAMELY, OFFERING CERTIFICATES OF DEPOSIT, DEMAND DEPOSIT, AND TIME DEPOSIT PRODUCTS; LOAN FINANCING, INCLUDING, COMMERCIAL AND CONSUMER LENDING SERVICES, IN CLASS 36 (U.S. CLS. 100, 101 AND 102).

FIRST USE 3-31-2006; IN COMMERCE 3-31-2006.

THE MARK CONSISTS OF STANDARD CHARACTERS WITHOUT CLAIM TO ANY PARTICULAR FONT, STYLE, SIZE, OR COLOR.

OWNER OF U.S. REG. NOS. 1,416,898, 3,958,353 AND OTHERS.

NO CLAIM IS MADE TO THE EXCLUSIVE RIGHT TO USE "WEALTH MANAGEMENT", APART FROM THE MARK AS SHOWN.

SER. NO. 85-403,344, FILED 8-22-2011.

JOHN WILKE, EXAMINING ATTORNEY



*David J. Kyros*

Director of the United States Patent and Trademark Office

# United States of America

United States Patent and Trademark Office

## PNC INSTITUTIONAL INVESTMENTS

**Reg. No. 4,134,719**

**Registered May 1, 2012**

**Int. Cls.: 35 and 36**

**SERVICE MARK**

**PRINCIPAL REGISTER**

THE PNC FINANCIAL SERVICES GROUP, INC. (PENNSYLVANIA CORPORATION)  
249 FIFTH AVENUE  
PITTSBURGH, PA 15222

FOR: PREPARATION OF FIDUCIARY TAX RETURNS, IN CLASS 35 (U.S. CLS. 100, 101 AND 102).

FIRST USE 3-31-2006; IN COMMERCE 3-31-2006.

FOR: BANKING SERVICES; INVESTMENT MANAGEMENT; FIDUCIARY REPRESENTATIVE SERVICES, NAMELY, ACTING AS TRUSTEES OF TRUSTS; CUSTODIAN SERVICES, NAMELY, HOLDING STOCKS, BONDS, SECURITIES AND OTHER FINANCIAL AND INVESTMENT INSTRUMENTS FOR OTHERS; ESCROW SERVICES; FINANCIAL MANAGEMENT OF ENDOWMENTS AND CHARITABLE AND PRIVATE FOUNDATIONS; ADMINISTRATION OF EMPLOYEE BENEFIT PLANS; FINANCIAL INVESTMENT SERVICES, NAMELY, OFFERING CERTIFICATES OF DEPOSIT, DEMAND DEPOSIT, AND TIME DEPOSIT PRODUCTS; LOAN FINANCING, INCLUDING, COMMERCIAL AND CONSUMER LENDING SERVICES, IN CLASS 36 (U.S. CLS. 100, 101 AND 102).

FIRST USE 3-31-2006; IN COMMERCE 3-31-2006.

THE MARK CONSISTS OF STANDARD CHARACTERS WITHOUT CLAIM TO ANY PARTICULAR FONT, STYLE, SIZE, OR COLOR.

OWNER OF U.S. REG. NOS. 1,416,898, 2,508,843, AND 3,498,533.

NO CLAIM IS MADE TO THE EXCLUSIVE RIGHT TO USE "INSTITUTIONAL INVESTMENTS", APART FROM THE MARK AS SHOWN.

SER. NO. 85-403,346, FILED 8-22-2011.

JOHN WILKE, EXAMINING ATTORNEY



*David J. Kyffers*

Director of the United States Patent and Trademark Office

# United States of America

United States Patent and Trademark Office



**Reg. No. 4,134,720**

**Registered May 1, 2012**

**Int. Cl.: 44**

**SERVICE MARK**

**PRINCIPAL REGISTER**

BE-THIN, INC. (DELAWARE CORPORATION), DBA THE CENTER FOR MEDICAL WEIGHT LOSS  
200 WHITE PLAINS ROAD  
TARRYTOWN, NY 10591

FOR: PROVIDING A WEBSITE FEATURING INFORMATION AND ADVICE IN THE FIELDS OF DIET, WEIGHT LOSS, DIET PLANNING AND LIFESTYLE WELLNESS; PROVIDING INFORMATION ON MAINTAINING A HEALTHY LIFESTYLE AND LOSING WEIGHT; PROVIDING WEIGHT LOSS PROGRAM SERVICES; WEIGHT MANAGEMENT SERVICES, NAMELY, PROVIDING WEIGHT LOSS AND/OR WEIGHT MAINTENANCE PROGRAMS; WEIGHT REDUCTION DIET PLANNING AND SUPERVISION, IN CLASS 44 (U.S. CLS. 100 AND 101).

FIRST USE 8-19-2011; IN COMMERCE 8-19-2011.

OWNER OF U.S. REG. NOS. 3,536,929, 3,831,340 AND OTHERS.

THE MARK CONSISTS OF A STYLIZED HUMAN FIGURE WITH A HALF CIRCLE AROUND THE WAIST FOLLOWED BY THE LETTERS "CMWL".

SER. NO. 85-403,348, FILED 8-22-2011.

BERYL GARDNER, EXAMINING ATTORNEY



*David J. Kyffers*

Director of the United States Patent and Trademark Office

# United States of America

United States Patent and Trademark Office

# Sweaty Yeti

**Reg. No. 4,134,721**

**Registered May 1, 2012**

**Int. Cl.: 41**

**SERVICE MARK**

**PRINCIPAL REGISTER**

TOUGH MUDDER LLC (DELAWARE LIMITED LIABILITY COMPANY)  
SUITE 221  
45 WASHINGTON STREET  
BROOKLYN, NY 11201

FOR: ORGANIZING SPORTING EVENTS, NAMELY, MUD RUNS, CROSS-COUNTRY RACES, MILITARY STYLE OBSTACLE COURSES AND OUTDOOR SWIMMING EVENTS FEATURING AN OBSTACLE IN WHICH PARTICIPANTS MANEUVER THROUGH SNOW, IN CLASS 41 (U.S. CLS. 100, 101 AND 107).

FIRST USE 5-1-2010; IN COMMERCE 5-2-2010.

THE MARK CONSISTS OF STANDARD CHARACTERS WITHOUT CLAIM TO ANY PARTICULAR FONT, STYLE, SIZE, OR COLOR.

SER. NO. 85-403,524, FILED 8-22-2011.

JEFFERY COWARD, EXAMINING ATTORNEY



*David J. Kyffers*

Director of the United States Patent and Trademark Office

# United States of America

United States Patent and Trademark Office



THE GREAT PUMPKIN

**Reg. No. 4,134,722**

**Registered May 1, 2012**

**Int. Cl.: 32**

**TRADEMARK**

**PRINCIPAL REGISTER**

CLIPPER CITY BREWING CO., LP (MARYLAND LIMITED PARTNERSHIP)  
SUITE B  
4615 HOLLINS FERRY ROAD  
BALTIMORE, MD 21227

FOR: BEVERAGES, NAMELY, BEERS, ALES, AND MALT LIQUORS, IN CLASS 32 (U.S. CLS. 45, 46 AND 48).

FIRST USE 9-0-2009; IN COMMERCE 9-0-2009.

OWNER OF U.S. REG. NOS. 3,359,126 AND 3,972,317.

NO CLAIM IS MADE TO THE EXCLUSIVE RIGHT TO USE "PUMPKIN", APART FROM THE MARK AS SHOWN.

THE STIPLING IS A FEATURE OF THE MARK AND DOES NOT INDICATE COLOR.

THE MARK CONSISTS OF THE IMAGE OF A SKULL AND CROSS-BONES, WHEREIN THE SKULL HAS FEATURES SIMILAR TO A PUMPKIN WITH VERTICAL LINES ON THE FACE AND A FLAME INSIDE THE RIGHT EYE AND AN EYE PATCH OVER THE LEFT EYE, WITH THE WORDS "THE GREAT PUMPKIN" APPEARING UNDERNEATH.

SER. NO. 85-403,550, FILED 8-22-2011.

ELISSA GARBER KON, EXAMINING ATTORNEY



*David J. Kybas*

Director of the United States Patent and Trademark Office

# United States of America

United States Patent and Trademark Office

# HEXA POT

**Reg. No. 4,134,723**

**Registered May 1, 2012**

**Int. Cl.: 21**

**TRADEMARK**

**PRINCIPAL REGISTER**

ENERGIA USA, LLC (CALIFORNIA LIMITED LIABILITY COMPANY)  
2327 PARK AVENUE  
MONTROSE, CA 91020

FOR: COOKING POTS, IN CLASS 21 (U.S. CLS. 2, 13, 23, 29, 30, 33, 40 AND 50).

FIRST USE 5-1-2011; IN COMMERCE 5-1-2011.

THE MARK CONSISTS OF STANDARD CHARACTERS WITHOUT CLAIM TO ANY PARTICULAR FONT, STYLE, SIZE, OR COLOR.

NO CLAIM IS MADE TO THE EXCLUSIVE RIGHT TO USE "POT", APART FROM THE MARK AS SHOWN.

SER. NO. 85-403,560, FILED 8-22-2011.

WILLIAM ROSSMAN, EXAMINING ATTORNEY



*David J. Kyffers*

Director of the United States Patent and Trademark Office



# United States of America

United States Patent and Trademark Office

## Hold Your Wood

**Reg. No. 4,134,724**

**Registered May 1, 2012**

**Int. Cl.: 41**

**SERVICE MARK**

**PRINCIPAL REGISTER**

TOUGH MUDDER LLC (DELAWARE LIMITED LIABILITY COMPANY)  
SUITE 221  
45 WASHINGTON STREET  
BROOKLYN, NY 11201

FOR: ORGANIZING SPORTING EVENTS, NAMELY, MUD RUNS, CROSS-COUNTRY RACES, MILITARY STYLE OBSTACLE COURSES AND OUTDOOR SWIMMING EVENTS FEATURING AN OBSTACLE IN WHICH PARTICIPANTS CARRY A LOG OVER A PORTION OF THE COURSE, IN CLASS 41 (U.S. CLS. 100, 101 AND 107).

FIRST USE 5-1-2010; IN COMMERCE 5-2-2010.

THE MARK CONSISTS OF STANDARD CHARACTERS WITHOUT CLAIM TO ANY PARTICULAR FONT, STYLE, SIZE, OR COLOR.

SER. NO. 85-403,562, FILED 8-22-2011.

JEFFERY COWARD, EXAMINING ATTORNEY



*David J. Kyffers*

Director of the United States Patent and Trademark Office

# United States of America

United States Patent and Trademark Office

## Devil's Beard

**Reg. No. 4,134,725**

**Registered May 1, 2012**

**Int. Cl.: 41**

**SERVICE MARK**

**PRINCIPAL REGISTER**

TOUGH MUDDER LLC (DELAWARE LIMITED LIABILITY COMPANY)  
221  
45 WASHINGTON STREET #221  
BROOKLYN, NY 11201

FOR: ORGANIZING SPORTING EVENTS, NAMELY, MUD RUNS, CROSS-COUNTRY RACES, MILITARY STYLE OBSTACLE COURSES AND OUTDOOR SWIMMING EVENTS FEATURING AN OBSTACLE IN WHICH PARTICIPANTS MANEUVER UNDER LOW HANGING CARGO NETS, IN CLASS 41 (U.S. CLS. 100, 101 AND 107).

FIRST USE 5-1-2010; IN COMMERCE 5-2-2010.

THE MARK CONSISTS OF STANDARD CHARACTERS WITHOUT CLAIM TO ANY PARTICULAR FONT, STYLE, SIZE, OR COLOR.

SER. NO. 85-403,623, FILED 8-22-2011.

JEFFERY COWARD, EXAMINING ATTORNEY



*David J. Kyffers*

Director of the United States Patent and Trademark Office

# United States of America

United States Patent and Trademark Office

## Swamp Stomp

**Reg. No. 4,134,726**

**Registered May 1, 2012**

**Int. Cl.: 41**

**SERVICE MARK**

**PRINCIPAL REGISTER**

TOUGH MUDDER LLC (DELAWARE LIMITED LIABILITY COMPANY)  
221  
45 WASHINGTON STREET #221  
BROOKLYN, NY 11201

FOR: ORGANIZING SPORTING EVENTS, NAMELY, MUD RUNS, CROSS-COUNTRY RACES, MILITARY STYLE OBSTACLE COURSES AND OUTDOOR SWIMMING EVENTS FEATURING AN OBSTACLE IN WHICH PARTICIPANTS MANEUVER THROUGH DEEP MUD, IN CLASS 41 (U.S. CLS. 100, 101 AND 107).

FIRST USE 5-1-2010; IN COMMERCE 5-2-2010.

THE MARK CONSISTS OF STANDARD CHARACTERS WITHOUT CLAIM TO ANY PARTICULAR FONT, STYLE, SIZE, OR COLOR.

SER. NO. 85-403,630, FILED 8-22-2011.

JEFFERY COWARD, EXAMINING ATTORNEY



*David J. Kyffers*

Director of the United States Patent and Trademark Office

# United States of America

United States Patent and Trademark Office



**Reg. No. 4,134,727**

**Registered May 1, 2012**

**Int. Cl.: 9**

**TRADEMARK**

**PRINCIPAL REGISTER**

UNU ELECTRONICS, INC. (CALIFORNIA CORPORATION)  
24700 MISSION BLVD, UNIT 3013  
HAYWARD, CA 94544

FOR: BAGS AND CASES SPECIALLY ADAPTED FOR HOLDING OR CARRYING PORTABLE TELEPHONES AND TELEPHONE EQUIPMENT AND ACCESSORIES, IN CLASS 9 (U.S. CLS. 21, 23, 26, 36 AND 38).

FIRST USE 5-25-2010; IN COMMERCE 5-25-2010.

THE MARK CONSISTS OF THE WORDING "UNU" IN THE BLACK LETTERS WITH A DESIGN OF AN ELECTRICAL WALL SWITCH IN WHITE BETWEEN THE LETTERS "U" AND "N" AND A DESIGN OF A LEAF IN GREEN BETWEEN THE LETTERS "N" AND "U".

THE COLOR(S) GREEN, BLACK AND WHITE IS/ARE CLAIMED AS A FEATURE OF THE MARK.

SER. NO. 85-403,709, FILED 8-22-2011.

JOHN GARTNER, EXAMINING ATTORNEY



*David J. Kyffers*

Director of the United States Patent and Trademark Office

# United States of America

United States Patent and Trademark Office

FILL IN YOUR OWN SIGNATURE

**Reg. No. 4,134,728**

**Registered May 1, 2012**

**Int. Cl.: 16**

**TRADEMARK**

**PRINCIPAL REGISTER**

RENEE B. PONDER (UNITED STATES INDIVIDUAL)  
6790 SIR FRANCIS DRAKE BOULEVARD  
FOREST KNOLLS, CA 94933

FOR: ARTISTIC IMAGES, NAMELY, ART PRINTS, PHOTOGRAPHIC PRINTS, LITHOGRAPHIC PRINTS, SILK SCREEN PRINTS, ETCHING PRINTS, PAINTINGS, CALLIGRAPHIC WORKS, AND SKETCHES, IN CLASS 16 (U.S. CLS. 2, 5, 22, 23, 29, 37, 38 AND 50).

FIRST USE 4-30-2003; IN COMMERCE 5-31-2004.

THE MARK CONSISTS OF STANDARD CHARACTERS WITHOUT CLAIM TO ANY PARTICULAR FONT, STYLE, SIZE, OR COLOR.

SER. NO. 85-403,733, FILED 8-22-2011.

KELLY BOULTON, EXAMINING ATTORNEY



*David J. Kyros*

Director of the United States Patent and Trademark Office

# United States of America

United States Patent and Trademark Office

## New Vision Art

**Reg. No. 4,134,729**

NEW VISION ART, INC. (UTAH CORPORATION)  
276 RIDGE RD.  
OREM, UT 84057

**Registered May 1, 2012**

**Int. Cls.: 35 and 41**

FOR: RETAIL STORE AND ON-LINE RETAIL STORE SERVICES FEATURING FINE ART,  
IN CLASS 35 (U.S. CLS. 100, 101 AND 102).

**SERVICE MARK**

FIRST USE 10-1-1995; IN COMMERCE 10-1-1995.

**PRINCIPAL REGISTER**

FOR: FINE ART PUBLISHING SERVICES, IN CLASS 41 (U.S. CLS. 100, 101 AND 107).

FIRST USE 10-1-1995; IN COMMERCE 10-1-1995.

THE MARK CONSISTS OF STANDARD CHARACTERS WITHOUT CLAIM TO ANY PARTICULAR FONT, STYLE, SIZE, OR COLOR.

NO CLAIM IS MADE TO THE EXCLUSIVE RIGHT TO USE "ART", APART FROM THE MARK AS SHOWN.

SER. NO. 85-403,745, FILED 8-22-2011.

MICHELE SWAIN, EXAMINING ATTORNEY



*David J. Kybas*

Director of the United States Patent and Trademark Office

# United States of America

United States Patent and Trademark Office



**Reg. No. 4,134,730**

**Registered May 1, 2012**

**Int. Cl.: 44**

**SERVICE MARK**

**PRINCIPAL REGISTER**

PREVMED (DELAWARE CORPORATION)  
210 PIER ONE ROAD  
STEVENSVILLE, MD 21666

FOR: DENTAL HYGIENIST SERVICES, IN CLASS 44 (U.S. CLS. 100 AND 101).

FIRST USE 6-1-2011; IN COMMERCE 8-15-2011.

NO CLAIM IS MADE TO THE EXCLUSIVE RIGHT TO USE "ORAL HEALTH MAINTENANCE", APART FROM THE MARK AS SHOWN.

THE COLOR(S) BLUE, BLACK, WHITE, AND GRAY IS/ARE CLAIMED AS A FEATURE OF THE MARK.

THE MARK CONSISTS OF A WHITE, GRAY, AND BLACK TOOTH DESIGN ON A SOLID BLACK CIRCLE INTENDED TO REPRESENT THE LETTER "O" FOLLOWED BY THE BLACK LETTERS "H" AND "M". BELOW THIS IS THE BLUE WORDING "ORAL HEALTH MAINTENANCE". THE MARK APPEARS ON A WHITE BACKGROUND. .

SER. NO. 85-403,767, FILED 8-22-2011.

KIM MONINGHOFF, EXAMINING ATTORNEY



*David J. Kyffers*

Director of the United States Patent and Trademark Office

# United States of America

United States Patent and Trademark Office

## RETIREMENT REVOLUTION

**Reg. No. 4,134,731**

**Registered May 1, 2012**

**Int. Cl.: 36**

**SERVICE MARK**

**PRINCIPAL REGISTER**

RETIREMENT REVOLUTION, LLC (CALIFORNIA LIMITED LIABILITY COMPANY)  
7 N. FAIR OAKS AVE.  
PASADENA, CA 91103

FOR: INVESTMENT ADVICE AND GUIDANCE IN THE FIELD OF RETIREMENT PLANS,  
IN CLASS 36 (U.S. CLS. 100, 101 AND 102).

FIRST USE 6-1-2010; IN COMMERCE 7-1-2010.

THE MARK CONSISTS OF STANDARD CHARACTERS WITHOUT CLAIM TO ANY PAR-  
TICULAR FONT, STYLE, SIZE, OR COLOR.

NO CLAIM IS MADE TO THE EXCLUSIVE RIGHT TO USE "RETIREMENT", APART FROM  
THE MARK AS SHOWN.

SER. NO. 85-403,864, FILED 8-22-2011.

ELLEN BURNS, EXAMINING ATTORNEY



*David J. Kybas*

Director of the United States Patent and Trademark Office



# United States of America

United States Patent and Trademark Office



**Reg. No. 4,134,732**

**Registered May 1, 2012**

**Int. Cl.: 41**

**SERVICE MARK**

**PRINCIPAL REGISTER**

B.GAYLE WORLDWIDE ENTERPRISES, LLC (NEW JERSEY LIMITED LIABILITY COMPANY)  
230 GODWIN AVENUE  
WYCKOFF, NJ 07481

FOR: ENTERTAINMENT SERVICES IN THE NATURE OF LIVE MUSICAL PERFORMANCES; ENTERTAINMENT SERVICES IN THE NATURE OF PRESENTING LIVE MUSICAL PERFORMANCES; ENTERTAINMENT SERVICES IN THE NATURE OF RECORDING, PRODUCTION AND POST-PRODUCTION SERVICES IN THE FIELD OF MUSIC; ENTERTAINMENT SERVICES, NAMELY, NON-DOWNLOADABLE RINGTONES, PRE-RECORDED MUSIC, AND GRAPHICS PRESENTED TO MOBILE COMMUNICATIONS DEVICES VIA A GLOBAL COMPUTER NETWORK AND WIRELESS NETWORKS; ENTERTAINMENT SERVICES, NAMELY, PROVIDING A WEB SITE FEATURING NON-DOWNLOADABLE MUSICAL PERFORMANCES, MUSICAL VIDEOS, RELATED FILM CLIPS, PHOTOGRAPHS, AND OTHER MULTIMEDIA MATERIALS FEATURING MUSIC; ENTERTAINMENT SERVICES, NAMELY, PROVIDING NON-DOWNLOADABLE PLAYBACK OF MUSIC VIA GLOBAL COMMUNICATIONS NETWORKS; ENTERTAINMENT SERVICES, NAMELY, PROVIDING NON-DOWNLOADABLE PRERECORDED MUSIC, INFORMATION IN THE FIELD OF MUSIC, AND COMMENTARY AND ARTICLES ABOUT MUSIC, ALL ON-LINE VIA A GLOBAL COMPUTER NETWORK; ENTERTAINMENT SERVICES, NAMELY, PROVIDING ON-LINE REVIEWS OF MUSIC; ENTERTAINMENT SERVICES, NAMELY, PROVIDING PODCASTS IN THE FIELD OF MUSIC; ENTERTAINMENT SERVICES, NAMELY, PROVIDING VIDEO PODCASTS IN THE FIELD OF MUSIC; ENTERTAINMENT SERVICES, NAMELY, PROVIDING WEBCASTS IN THE FIELD OF MUSIC; ENTERTAINMENT, NAMELY, LIVE MUSIC CONCERTS; ENTERTAINMENT, NAMELY, LIVE PERFORMANCES BY MUSICAL BANDS; MULTIMEDIA ENTERTAINMENT SERVICES IN THE NATURE OF RECORDING, PRODUCTION AND POST-PRODUCTION SERVICES IN THE FIELDS OF MUSIC, VIDEO, AND FILMS; PROVIDING A WEBSITE FEATURING INFORMATION IN THE FIELD OF MUSIC AND ENTERTAINMENT; PROVIDING A WEBSITE FOR ENTERTAINMENT PURPOSES WHERE USERS CAN VIEW AND POST VIDEOS FEATURING MUSIC; PROVIDING AN EDUCATIONAL WEBSITE IN THE FIELDS OF MUSIC AND ENTERTAINMENT; PROVIDING AN INTERNET WEBSITE PORTAL FEATURING LINKS TO MUSICAL ARTIST WEBSITES AND MUSIC PERFORMANCE TICKET INFORMATION; PROVIDING AN INTERNET WEBSITE PORTAL IN THE FIELD OF MUSIC, IN CLASS 41 (U.S. CLS. 100, 101 AND 107).



*David J. Kybas*

Director of the United States Patent and Trademark Office

FIRST USE 3-29-2011; IN COMMERCE 4-19-2011.

**Reg. No. 4,134,732** NO CLAIM IS MADE TO THE EXCLUSIVE RIGHT TO USE "MUSIC", APART FROM THE MARK AS SHOWN.

THE COLOR(S) BLACK, WHITE, GRAY, BLUE, RED AND YELLOW IS/ARE CLAIMED AS A FEATURE OF THE MARK.

THE MARK CONSISTS OF A BLACK BACKGROUND WITH A WHITE SQUARE WITH SLIGHTLY ROUNDED CORNERS IN THE CENTER, SUGGESTING A TELEVISION TUBE; WITH A SERIES OF SMALL DOTS IN RED, YELLOW AND BLUE AROUND THE EDGES GIVING THE SUGGESTION OF MOTION. IN THE CENTER OF THE TUBE IS THE OVAL PART OF AN EIGHTH NOTE IN BLUE WITH A HUMAN EYE IN BLACK AND WHITE IN THE CENTER, WITH BLUE BROW FORMED BY THE NOTE TAIL. BELOW THE DESIGN APPEAR THE WORDS "SEE NOTE MUSIC" IN GRAY, IN A SHADED INDUSTRIAL-TYPE FONT.

SER. NO. 85-403,865, FILED 8-22-2011.

ELLEN BURNS, EXAMINING ATTORNEY

# United States of America

United States Patent and Trademark Office

## Bolder Insurance

**Reg. No. 4,134,733**

**Registered May 1, 2012**

**Int. Cl.: 36**

**SERVICE MARK**

**PRINCIPAL REGISTER**

BOLDER INSURANCE (COLORADO CORPORATION)  
800 JEFFERSON AVENUE  
LOUISVILLE, CO 80027

FOR: DESIGN AND DEVELOPMENT OF INSURANCE POLICIES FOR OTHERS; INSURANCE AGENCY AND BROKERAGE; INSURANCE CONSULTANCY; INSURANCE CONSULTANCY SERVICES, NAMELY, PROVIDING ADVICE IN THE FIELD OF PROPERTY AND CASUALTY INSURANCE; INSURANCE CONSULTATION; INSURANCE CONSULTING IN THE FIELD OF PROPERTY AND CASUALTY INSURANCE; INSURANCE INFORMATION; INSURANCE INFORMATION AND CONSULTANCY; INSURANCE SERVICES, NAMELY, INSURANCE ELIGIBILITY REVIEW AND VERIFICATION AND CONSULTATION IN THE PROPERTY AND CASUALTY INDUSTRY; PROVIDING DETAILED INFORMATION REGARDING AVAILABLE INSURANCE PRODUCTS FOR COMMERCIAL PROPERTY AND CASUALTY, PROFESSIONAL AND PERSONAL LINES, IN CLASS 36 (U.S. CLS. 100, 101 AND 102).

FIRST USE 4-11-2011; IN COMMERCE 4-11-2011.

THE MARK CONSISTS OF STANDARD CHARACTERS WITHOUT CLAIM TO ANY PARTICULAR FONT, STYLE, SIZE, OR COLOR.

NO CLAIM IS MADE TO THE EXCLUSIVE RIGHT TO USE "INSURANCE", APART FROM THE MARK AS SHOWN.

SER. NO. 85-403,959, FILED 8-22-2011.

PAUL E. FAHRENKOPF, EXAMINING ATTORNEY



*David J. Kyros*

Director of the United States Patent and Trademark Office

# United States of America

United States Patent and Trademark Office

## ORIGINAL OKAZAKI RESTORATION MASSAGE

**Reg. No. 4,134,734**

**Registered May 1, 2012**

**Int. Cl.: 44**

**SERVICE MARK**

**PRINCIPAL REGISTER**

NIKKO RESTORATION MASSAGE, INC. (HAWAII CORPORATION)  
801 S. HOTEL STREET  
HONOLULU, HI 96813

FOR: MASSAGE THERAPY SERVICES, IN CLASS 44 (U.S. CLS. 100 AND 101).

FIRST USE 1-1-2000; IN COMMERCE 1-1-2010.

THE MARK CONSISTS OF STANDARD CHARACTERS WITHOUT CLAIM TO ANY PARTICULAR FONT, STYLE, SIZE, OR COLOR.

NO CLAIM IS MADE TO THE EXCLUSIVE RIGHT TO USE "ORIGINAL" AND "RESTORATION MASSAGE", APART FROM THE MARK AS SHOWN.

SER. NO. 85-404,021, FILED 8-22-2011.

PAUL E. FAHRENKOPF, EXAMINING ATTORNEY



*David J. Kybas*

Director of the United States Patent and Trademark Office

# United States of America

United States Patent and Trademark Office

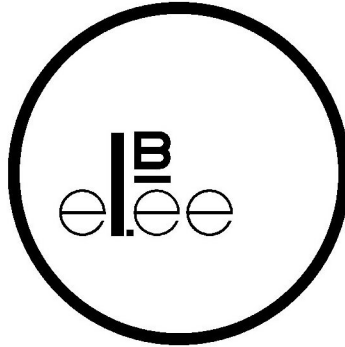

**Reg. No. 4,134,735**

**Registered May 1, 2012**

**Int. Cl.: 14**

**TRADEMARK**

**PRINCIPAL REGISTER**

ELBEE DESIGNS, LLC (ARKANSAS LIMITED LIABILITY COMPANY)  
686 LAKE TREE LANE  
SHERWOOD, AR 72120

FOR: JEWELRY; EARRINGS; RINGS; BRACELETS; NECKLACES, IN CLASS 14 (U.S. CLS. 2, 27, 28 AND 50).

FIRST USE 11-1-2010; IN COMMERCE 11-1-2010.

THE MARK CONSISTS OF A CIRCLE WITH THE STYLIZED TEXT "ELBEE" SET TO THE LEFT, OFF CENTER. THE LETTERS "ELEE" APPEAR ON ONE LINE IN LOWER CASE, WITH THE "L" SHOWN IN THICKER FONT THAN THAT USED FOR THE "E"S. BETWEEN THE "L" AND SECOND "E" IS A SMALL SQUARE. ABOVE THE SECOND "E" IN "ELEE" IS AN UPPERCASE UNDERLINED "B" WITH BOTH "B" AND UNDERLINING SHOWN IN THICKER FONT.

SER. NO. 85-404,155, FILED 8-22-2011.

JERI J. FICKES, EXAMINING ATTORNEY



*David J. Kybas*

Director of the United States Patent and Trademark Office

# United States of America

United States Patent and Trademark Office



**Reg. No. 4,134,736**

**Registered May 1, 2012**

**Int. Cl.: 35**

**SERVICE MARK**

**PRINCIPAL REGISTER**

NORTHSTAR PARTNERS CONSULTING LLC (CONNECTICUT LIMITED LIABILITY COMPANY)  
10 SAUGATUCK AVE  
WESTPORT, CT 06880

FOR: STRATEGIC BUSINESS CONSULTING AND BUSINESS DEVELOPMENT SERVICES, IN CLASS 35 (U.S. CLS. 100, 101 AND 102).

FIRST USE 3-15-2003; IN COMMERCE 3-15-2003.

NO CLAIM IS MADE TO THE EXCLUSIVE RIGHT TO USE "PARTNERS", APART FROM THE MARK AS SHOWN.

THE STIPPLING IS FOR SHADING PURPOSES ONLY.

THE MARK CONSISTS OF THE STYLIZED TEXT "NORTHSTAR PARTNERS" WITH A STAR IN PLACE OF THE LETTER "O".

SER. NO. 85-404,241, FILED 8-22-2011.

ARETHA SOMERVILLE, EXAMINING ATTORNEY



*David J. Kybas*

Director of the United States Patent and Trademark Office

# United States of America

United States Patent and Trademark Office

# POINTSTACK

**Reg. No. 4,134,737**

**Registered May 1, 2012**

**Int. Cl.: 35**

**SERVICE MARK**

**PRINCIPAL REGISTER**

INTERSLICE VENTURES LLC (MINNESOTA LIMITED LIABILITY COMPANY)  
7296 PENNY HILL ROAD  
EDEN PRAIRIE, MN 55346

FOR: ADVERTISING AND MARKETING; ADMINISTRATION OF AN INCENTIVE AWARDS PROGRAM TO PROMOTE THE SALE OF PRODUCTS AND SERVICES OF OTHERS; CUSTOMER LOYALTY SERVICES AND CUSTOMER CLUB SERVICES FOR COMMERCIAL, PROMOTIONAL AND/OR ADVERTISING PURPOSES; AND PROMOTING THE GOODS AND SERVICES OF OTHERS BY MEANS OF A PREFERRED CUSTOMER PROGRAM FEATURING DISCOUNTS, REBATES, AND INCENTIVE AWARDS, IN CLASS 35 (U.S. CLS. 100, 101 AND 102).

FIRST USE 11-1-2011; IN COMMERCE 11-1-2011.

THE MARK CONSISTS OF STANDARD CHARACTERS WITHOUT CLAIM TO ANY PARTICULAR FONT, STYLE, SIZE, OR COLOR.

SER. NO. 85-404,423, FILED 8-23-2011.

ROBERT C. CLARK JR., EXAMINING ATTORNEY



*David J. Kyffers*

Director of the United States Patent and Trademark Office

# United States of America

United States Patent and Trademark Office

## CARDIFF RANCH

**Reg. No. 4,134,738**

**Registered May 1, 2012**

**Int. Cl.: 37**

**SERVICE MARK**

**PRINCIPAL REGISTER**

LAND TEJAS COMPANIES, LTD. (TEXAS LIMITED PARTNERSHIP)  
2450 FONDREN RD., #210  
HOUSTON, TX 77063

FOR: REAL ESTATE DEVELOPMENT, IN CLASS 37 (U.S. CLS. 100, 103 AND 106).

FIRST USE 11-0-2009; IN COMMERCE 11-0-2009.

THE MARK CONSISTS OF STANDARD CHARACTERS WITHOUT CLAIM TO ANY PARTICULAR FONT, STYLE, SIZE, OR COLOR.

NO CLAIM IS MADE TO THE EXCLUSIVE RIGHT TO USE "RANCH", APART FROM THE MARK AS SHOWN.

SER. NO. 85-404,459, FILED 8-23-2011.

HAI-LY LAM, EXAMINING ATTORNEY



*David J. Kybas*

Director of the United States Patent and Trademark Office



# United States of America

United States Patent and Trademark Office

## Adleta Construction

**Reg. No. 4,134,739**

**Registered May 1, 2012**

**Int. Cls.: 37 and 39**

**SERVICE MARK**

**PRINCIPAL REGISTER**

ADLETA, INC. (OHIO CORPORATION)  
389 SOUTH WAYNE AVENUE  
CINCINNATI, OH 45215

FOR: CONSTRUCTION OF ROADS, UNDERGROUND UTILITIES, AND HOUSING PADS,  
IN CLASS 37 (U.S. CLS. 100, 103 AND 106).

FIRST USE 2-19-1985; IN COMMERCE 2-19-1985.

FOR: PUBLIC UTILITY SERVICES, IN CLASS 39 (U.S. CLS. 100 AND 105).

FIRST USE 2-19-1985; IN COMMERCE 2-19-1985.

THE MARK CONSISTS OF STANDARD CHARACTERS WITHOUT CLAIM TO ANY PAR-  
TICULAR FONT, STYLE, SIZE, OR COLOR.

NO CLAIM IS MADE TO THE EXCLUSIVE RIGHT TO USE "CONSTRUCTION", APART  
FROM THE MARK AS SHOWN.

SER. NO. 85-404,469, FILED 8-23-2011.

JOHN E. MICHOS, EXAMINING ATTORNEY



*David J. Kybas*

Director of the United States Patent and Trademark Office

# United States of America

United States Patent and Trademark Office

## CrossBay Capital Partners

**Reg. No. 4,134,740**

**Registered May 1, 2012**

**Int. Cl.: 36**

**SERVICE MARK**

**PRINCIPAL REGISTER**

CROSSBAY CAPITAL PARTNERS LLC (CONNECTICUT LIMITED LIABILITY COMPANY)  
94 WOODRIDGE CIRCLE  
NEW CANAAN, CT 06840

FOR: PRIVATE EQUITY CONSULTANT SERVICES, IN CLASS 36 (U.S. CLS. 100, 101 AND 102).

FIRST USE 7-1-2011; IN COMMERCE 7-1-2011.

THE MARK CONSISTS OF STANDARD CHARACTERS WITHOUT CLAIM TO ANY PARTICULAR FONT, STYLE, SIZE, OR COLOR.

NO CLAIM IS MADE TO THE EXCLUSIVE RIGHT TO USE "CAPITAL PARTNERS", APART FROM THE MARK AS SHOWN.

SER. NO. 85-404,485, FILED 8-23-2011.

DAVID YONTEF, EXAMINING ATTORNEY



*David J. Kyffers*

Director of the United States Patent and Trademark Office

# United States of America

United States Patent and Trademark Office

# TSRHC

**Reg. No. 4,134,741**

**Registered May 1, 2012**

**Int. Cls.: 36, 41, 42 and 44**

TEXAS SCOTTISH RITE HOSPITAL FOR CRIPPLED CHILDREN (TEXAS CORPORATION),  
DBA TEXAS SCOTTISH RITE HOSPITAL FOR CHILDREN  
OFFICE OF GENERAL COUNSEL  
2222 WELBORN ST.  
DALLAS, TX 75219

FOR: CHARITABLE FUNDRAISING, IN CLASS 36 (U.S. CLS. 100, 101 AND 102).

**SERVICE MARK**

FIRST USE 11-15-1990; IN COMMERCE 11-15-1990.

**PRINCIPAL REGISTER**

FOR: EDUCATIONAL SERVICES, NAMELY, CLASSES, SEMINARS, CONFERENCES, WORKSHOPS IN THE FIELD OF MEDICINE AND LEARNING DISABILITIES AND DISTRIBUTION OF COURSE MATERIALS IN CONNECTION THEREWITH, IN CLASS 41 (U.S. CLS. 100, 101 AND 107).

FIRST USE 11-15-1990; IN COMMERCE 11-15-1990.

FOR: MEDICAL AND SCIENTIFIC RESEARCH, IN CLASS 42 (U.S. CLS. 100 AND 101).

FIRST USE 11-15-1990; IN COMMERCE 11-15-1990.

FOR: PROVIDING MEDICAL SERVICES TO CHILDREN, IN CLASS 44 (U.S. CLS. 100 AND 101).

FIRST USE 11-15-1990; IN COMMERCE 11-15-1990.

THE MARK CONSISTS OF STANDARD CHARACTERS WITHOUT CLAIM TO ANY PARTICULAR FONT, STYLE, SIZE, OR COLOR.

SER. NO. 85-404,489, FILED 8-23-2011.

CHARLES L. JENKINS, EXAMINING ATTORNEY



*David J. Kyros*

Director of the United States Patent and Trademark Office

# United States of America

United States Patent and Trademark Office

## MinistryWorks

**Reg. No. 4,134,742**

**Registered May 1, 2012**

**Int. Cl.: 35**

**SERVICE MARK**

**PRINCIPAL REGISTER**

BROTHERHOOD MUTUAL INSURANCE COMPANY (INDIANA CORPORATION)  
6400 BROTHERHOOD WAY  
P.O. BOX 2227  
FT. WAYNE, IN 468012227

FOR: PAYROLL PROCESSING SERVICES; ADMINISTRATION OF BUSINESS PAYROLL FOR OTHERS; BUSINESS CONSULTATION IN THE FIELD OF PAYROLL SERVICES, PAYROLL PREPARATION, AND PAYROLL ADMINISTRATION; BUSINESS ADMINISTRATION CONSULTANCY; BUSINESS RISK MANAGEMENT CONSULTATION, IN CLASS 35 (U.S. CLS. 100, 101 AND 102).

FIRST USE 6-1-2011; IN COMMERCE 6-1-2011.

OWNER OF U.S. REG. NO. 4,035,490.

THE COLOR(S) BLUE AND GOLD IS/ARE CLAIMED AS A FEATURE OF THE MARK.

THE MARK CONSISTS OF THE WORDS "MINISTRYWORKS" IN THE COLORS BLUE AND GOLD. THE "MINISTRY" PORTION OF THE MARK APPEARS IN BLUE AND THE "WORKS" PORTION OF THE MARK APPEARS IN GOLD.

SER. NO. 85-404,491, FILED 8-23-2011.

CHARLES L. JENKINS, EXAMINING ATTORNEY



*David J. Kybas*

Director of the United States Patent and Trademark Office

# United States of America

United States Patent and Trademark Office

## Selah Photography

**Reg. No. 4,134,743**

**Registered May 1, 2012**

**Int. Cl.: 41**

**SERVICE MARK**

**PRINCIPAL REGISTER**

SELAH PHOTOGRAPHY LLC (COLORADO LIMITED LIABILITY COMPANY)  
910 SANTE FE DRIVE UNIT 302  
DENVER, CO 80204

FOR: PHOTOGRAPHY, IN CLASS 41 (U.S. CLS. 100, 101 AND 107).

FIRST USE 10-31-2008; IN COMMERCE 10-31-2008.

THE MARK CONSISTS OF STANDARD CHARACTERS WITHOUT CLAIM TO ANY PARTICULAR FONT, STYLE, SIZE, OR COLOR.

NO CLAIM IS MADE TO THE EXCLUSIVE RIGHT TO USE "PHOTOGRAPHY", APART FROM THE MARK AS SHOWN.

SER. NO. 85-404,563, FILED S.R. 8-23-2011 AM. P.R. 12-16-2011.

STEVEN JACKSON, EXAMINING ATTORNEY



*David J. Kyffers*

Director of the United States Patent and Trademark Office

# United States of America

United States Patent and Trademark Office

# ESSENTIALS

**Reg. No. 4,134,744**

BEAUMONT PRODUCTS, INC. (GEORGIA CORPORATION)  
1560 BIG SHANTY DRIVE  
KENNESAW, GA 30144

**Registered May 1, 2012**

**Int. Cl.: 5**

FOR: TOPICAL OINTMENT, NAMELY, HOT FLASH RELIEF SPRAY, IN CLASS 5 (U.S. CLS. 6, 18, 44, 46, 51 AND 52).

**TRADEMARK**

FIRST USE 8-10-2011; IN COMMERCE 8-10-2011.

**PRINCIPAL REGISTER**

THE MARK CONSISTS OF STANDARD CHARACTERS WITHOUT CLAIM TO ANY PARTICULAR FONT, STYLE, SIZE, OR COLOR.

SER. NO. 85-404,578, FILED 8-23-2011.

ESTHER A. BORSUK, EXAMINING ATTORNEY



*David J. Kyffers*

Director of the United States Patent and Trademark Office

# United States of America

United States Patent and Trademark Office



**Reg. No. 4,134,745**

**Registered May 1, 2012**

**Int. Cl.: 40**

**SERVICE MARK**

**PRINCIPAL REGISTER**

SEQUOIA WASTE MANAGEMENT SOLUTIONS, LLC (DELAWARE LIMITED LIABILITY COMPANY)  
90 BETA DRIVE  
PITTSBURGH, PA 15238

FOR: PROVIDING TECHNICAL INFORMATION IN THE FIELD OF WASTE MANAGEMENT; RECYCLING; WASTE MANAGEMENT; WASTE TREATMENT SERVICES, IN CLASS 40 (U.S. CLS. 100, 103 AND 106).

FIRST USE 8-4-2011; IN COMMERCE 8-4-2011.

NO CLAIM IS MADE TO THE EXCLUSIVE RIGHT TO USE "WASTE MANAGEMENT SOLUTIONS", APART FROM THE MARK AS SHOWN.

THE COLOR(S) GREEN IS/ARE CLAIMED AS A FEATURE OF THE MARK.

THE MARK CONSISTS OF THREE GREEN ARROWS FORMING THE SHAPE OF A TREE, WITH AN ARCED LINE AT THE BASE OF THE TREE SHAPE, WITH THE WORDS "SEQUOIA" IN LARGE ALL CAPITAL LETTERS, IMMEDIATELY BELOW THE TREE SHAPE, WITH THE WORDS "WASTE MANAGEMENT SOLUTIONS" IN SMALLER FONT, CENTERED BELOW THE WORD "SEQUOIA", ALL IN GREEN.

SER. NO. 85-404,582, FILED 8-23-2011.

ESTHER A. BORSUK, EXAMINING ATTORNEY



*David J. Kybas*

Director of the United States Patent and Trademark Office

# United States of America

United States Patent and Trademark Office

# Pub tech

**Reg. No. 4,134,746**

**Registered May 1, 2012**

**Int. Cl.: 38**

**SERVICE MARK**

**PRINCIPAL REGISTER**

LEAVENS MEDIA ASSOCIATES LLC (PENNSYLVANIA LIMITED LIABILITY COMPANY)  
1919 RIGGS RD.  
SOUTH PARK, PA 15129

FOR: PROVIDING ON-LINE LISTSERVICES FOR TRANSMISSION OF MESSAGES AMONG  
COMPUTER USERS CONCERNING BROADCASTING, IN CLASS 38 (U.S. CLS. 100, 101  
AND 104).

FIRST USE 1-1-1987; IN COMMERCE 1-11-1995.

THE MARK CONSISTS OF STANDARD CHARACTERS WITHOUT CLAIM TO ANY PAR-  
TICULAR FONT, STYLE, SIZE, OR COLOR.

NO CLAIM IS MADE TO THE EXCLUSIVE RIGHT TO USE "TECH", APART FROM THE  
MARK AS SHOWN.

SER. NO. 85-404,598, FILED 8-23-2011.

INGRID C. EULIN, EXAMINING ATTORNEY



*David J. Kybas*

Director of the United States Patent and Trademark Office



# United States of America

United States Patent and Trademark Office

## SERVICE GUARANTEED

**Reg. No. 4,134,747**

**Registered May 1, 2012**

**Int. Cl.: 11**

**TRADEMARK**

**PRINCIPAL REGISTER**

WESTINGHOUSE LIGHTING CORPORATION (PENNSYLVANIA CORPORATION)  
12401 MCNULTY ROAD  
PHILADELPHIA, PA 19154

FOR: ELECTRIC LIGHT BULBS; FLUORESCENT ELECTRIC LIGHT BULBS; FLUORESCENT LIGHTING TUBES; HALOGEN LIGHT BULBS; INCANDESCENT LIGHT BULBS; LED LIGHT BULBS; LIGHT BULBS, IN CLASS 11 (U.S. CLS. 13, 21, 23, 31 AND 34).

FIRST USE 3-1-2004; IN COMMERCE 3-1-2004.

THE MARK CONSISTS OF STANDARD CHARACTERS WITHOUT CLAIM TO ANY PARTICULAR FONT, STYLE, SIZE, OR COLOR.

NO CLAIM IS MADE TO THE EXCLUSIVE RIGHT TO USE "GUARANTEED", APART FROM THE MARK AS SHOWN.

SER. NO. 85-404,644, FILED 8-23-2011.

JEFF DEFORD, EXAMINING ATTORNEY



*David J. Kybas*

Director of the United States Patent and Trademark Office

# United States of America

United States Patent and Trademark Office

## BIOEXPÉRIENCE

**Reg. No. 4,134,748**

**Registered May 1, 2012**

**Int. Cl.: 3**

**TRADEMARK**

**PRINCIPAL REGISTER**

MINERAL ORIGIN INC. (CANADA CORPORATION)  
395 DU PARC ST-EUSTACHE  
QUEBEC, CANADA J7R0A3

FOR: MASSAGE PREPARATIONS, NAMELY, OILS, LOTIONS, CREAMS, NON-MEDICATED BALMS, GELS; PERFUME, EAU DE PERFUME OIL FOR PERSONAL USE, SCENTED BODY SPRAY, BODY LOTION, BODY CREAM, HAND CREAM, TOILET SOAP, NON-MEDICATED BATH SALTS, BATH FOAM, BATH OIL, BATH AND SHOWER GEL, TALCUM POWDER, DUSTING POWDER, MAKEUP REMOVER, SKIN CLEANSING SCRUB, FACIAL CLEANER, EYE CREAM, FACIAL CREAM, FACIAL LOTION, FACIAL MASK, FACIAL SKIN TONER, LIP MOISTURIZER, NON-MEDICATED LIP BALM, SKIN LIGHTENER, SUN TANNING GEL, SUN TANNING LOTION, SUN TANNING OIL, SUN TANNING CREAM, SUN TANNING SPRAY, PRE-MOISTENED TOWELETTES CONTAINING SUN SCREEN, LIPSTICK, LIP LINER, LIP GLOSS, FACIAL FOUNDATION, FACIAL POWDER, FACIAL CONCEALER, BLUSH, MASCARA, EYEBROW PENCIL, EYESHADOW, EYE LINER, HAIR SHAMPOO, HAIR CONDITIONER, HAIR GEL, HAIR MOUSSE, HAIR SPRAY, NAIL ENAMEL, NAIL STRENGTHENER, NAIL POLISH BASE COAT, NAIL POLISH TOP COAT, CUTICLE CONDITIONER, IN CLASS 3 (U.S. CLS. 1, 4, 6, 50, 51 AND 52).

FIRST USE 7-1-2010; IN COMMERCE 7-1-2010.

THE MARK CONSISTS OF THE WORD "BIOEXPERIENCE" IN CAPITAL LETTERS WITH THE LETTERS "BIO" IN HEAVY SOLID BLACK, THEREAFTER A STYLIZED "E" AND THE REMAINING LETTERS IN BLOCK FORMAT WITH AN ACCENT SYMBOL OVER THE SECOND "E"; UNDERNEATH THE ENTIRE WORD IS A THICK ARCHED UNDERLINE.

SER. NO. 85-404,676, FILED 8-23-2011.

KEVON CHISOLM, EXAMINING ATTORNEY



*David J. Kyros*

Director of the United States Patent and Trademark Office

# United States of America

United States Patent and Trademark Office



**Reg. No. 4,134,749**

**Registered May 1, 2012**

**Int. Cls.: 9, 16, 21, 25  
and 41**

**TRADEMARK**

**SERVICE MARK**

**PRINCIPAL REGISTER**

BLOOM, AKIVAH (UNITED STATES INDIVIDUAL)  
2516 AVENUE W  
BROOKLYN, NY 11229

FOR: REFRIGERATOR MAGNETS, IN CLASS 9 (U.S. CLS. 21, 23, 26, 36 AND 38).

FIRST USE 7-22-2011; IN COMMERCE 8-10-2011.

FOR: DECALS, IN CLASS 16 (U.S. CLS. 2, 5, 22, 23, 29, 37, 38 AND 50).

FIRST USE 7-18-2011; IN COMMERCE 8-5-2011.

FOR: MUGS, IN CLASS 21 (U.S. CLS. 2, 13, 23, 29, 30, 33, 40 AND 50).

FIRST USE 7-15-2011; IN COMMERCE 8-5-2011.

FOR: T-SHIRTS, IN CLASS 25 (U.S. CLS. 22 AND 39).

FIRST USE 6-27-2011; IN COMMERCE 8-5-2011.

FOR: PROVIDING AN INTERACTIVE WEBSITE FEATURING ENTERTAINMENT INFORMATION FOR CHILDREN, INCLUDING BLOGS, ANIMATION, AND NON-DOWNLOADABLE PUBLICATIONS IN THE NATURE OF COMICS VIA A GLOBAL COMPUTER NETWORK, IN CLASS 41 (U.S. CLS. 100, 101 AND 107).

FIRST USE 7-15-2011; IN COMMERCE 8-21-2011.

OWNER OF U.S. REG. NO. 4,056,885.

THE STIPPLING IS A FEATURE OF THE MARK.

THE NAME "BACKSEAT BETTE" IS NOT THE NICKNAME OF A LIVING INDIVIDUAL.

THE MARK CONSISTS OF A DESIGN OF A STYLIZED YOUNG GIRL WITH A STAR ON HER DRESS, PIGTAILS AND BRACES ABOVE THE TEXT "BACKSEAT BETTE". THERE ARE DEVILS HORNS WITH A HALO ABOVE THE LETTER "T" IN THE TERM "BACKSEAT".



*David J. Kyros*

Director of the United States Patent and Trademark Office

**Reg. No. 4,134,749** THERE ARE THREE STARS BESIDE THE LETTER "B" IN "BETTE", AND A HEART WITH CROSS BONES DESIGN WITHIN THE LETTER "B" IN "BETTE".

SER. NO. 85-404,756, FILED 8-23-2011.

ZHALEH DELANEY, EXAMINING ATTORNEY

United States of America  
United States Patent and Trademark Office

# WEEKIDZ

**Reg. No. 4,134,750**

**Registered May 1, 2012**

**Int. Cl.: 28**

**TRADEMARK**

**PRINCIPAL REGISTER**

EVERLAST CLIMBING INDUSTRIES, INC. (DELAWARE CORPORATION)  
1335 MENDOTA HEIGHTS RD  
MENDOTA HEIGHTS, MN 55120

FOR: FITNESS EQUIPMENT, NAMELY, ARTIFICIAL CLIMBING WALLS AND ACCESSORIES THEREFOR, STRETCH BANDS, HAND AND FOOT HOLDS FOR USE IN CONNECTION WITH ARTIFICIAL CLIMBING WALLS, BALANCE BEAMS, HURDLES, AGILITY LADDERS, AGILITY ARCHES, PERSONAL EXERCISE MATS AND POOL NOODLES, IN CLASS 28 (U.S. CLS. 22, 23, 38 AND 50).

FIRST USE 1-13-2006; IN COMMERCE 1-13-2006.

THE MARK CONSISTS OF STANDARD CHARACTERS WITHOUT CLAIM TO ANY PARTICULAR FONT, STYLE, SIZE, OR COLOR.

SER. NO. 85-404,866, FILED 8-23-2011.

ELLEN BURNS, EXAMINING ATTORNEY



*David J. Kyffers*

Director of the United States Patent and Trademark Office

# United States of America

United States Patent and Trademark Office

## INSTITUTE FOR PROFESSIONALS IN TAXATION

**Reg. No. 4,134,751**

**Registered May 1, 2012**

**Int. Cl.: 41**

**SERVICE MARK**

**PRINCIPAL REGISTER**

INSTITUTE FOR PROFESSIONALS IN TAXATION (D.C. NON-PROFIT CORPORATION)  
BUILDING 600, SUITE L-2  
1200 ABERNATHY RD. NE  
ATLANTA, GA 30328

FOR: ORGANIZING AND CONDUCTING SEMINARS, SCHOOLS, SYMPOSIA, CONFERENCES AND EDUCATIONAL COURSES AND PROGRAMS IN THE FIELD OF STATE AND LOCAL TAXES, AND VALUE ADDED TAXES, CREDITS AND FINANCIAL INCENTIVES, AND RELATED TAX AND FISCAL MATTERS, IN CLASS 41 (U.S. CLS. 100, 101 AND 107).

FIRST USE 7-2-1997; IN COMMERCE 7-2-1997.

THE MARK CONSISTS OF STANDARD CHARACTERS WITHOUT CLAIM TO ANY PARTICULAR FONT, STYLE, SIZE, OR COLOR.

OWNER OF U.S. REG. NO. 3,025,778.

NO CLAIM IS MADE TO THE EXCLUSIVE RIGHT TO USE "INSTITUTE", APART FROM THE MARK AS SHOWN.

SEC. 2(F).

SER. NO. 85-404,949, FILED 8-23-2011.

WILLIAM P. SHANAHAN, EXAMINING ATTORNEY



*David J. Kybas*

Director of the United States Patent and Trademark Office

# United States of America

United States Patent and Trademark Office

briscola

**Reg. No. 4,134,752**

ZINC RESTAURANT ASSOCIATES LLC (NEVADA LIMITED LIABILITY COMPANY)  
420 LEXINGTON AVENUE SUITE 850  
NEW YORK, NY 10170

**Registered May 1, 2012**

**Int. Cl.: 43**

FOR: RESTAURANT, BAR AND CATERING SERVICES, IN CLASS 43 (U.S. CLS. 100 AND 101).

**SERVICE MARK**

FIRST USE 0-0-2009; IN COMMERCE 0-0-2009.

**PRINCIPAL REGISTER**

THE MARK CONSISTS OF THE WORD "BRISCOLA" IN BURNT ORANGE.

THE COLOR(S) BURNT ORANGE IS/ARE CLAIMED AS A FEATURE OF THE MARK.

SER. NO. 85-405,043, FILED 8-23-2011.

GEORGE LORENZO, EXAMINING ATTORNEY



*David J. Kyffers*

Director of the United States Patent and Trademark Office

# United States of America

United States Patent and Trademark Office

*Edith Sanford*



**Reg. No. 4,134,753**

**Registered May 1, 2012**

**Int. Cl.: 36**

**SERVICE MARK**

**PRINCIPAL REGISTER**

SANFORD (NORTH DAKOTA NON-PROFIT CORPORATION)  
801 BROADWAY N.  
FARGO, ND 58122

FOR: CHARITABLE FUNDRAISING, IN CLASS 36 (U.S. CLS. 100, 101 AND 102).

FIRST USE 8-17-2011; IN COMMERCE 8-17-2011.

THE NAME(S), PORTRAIT(S), AND/OR SIGNATURE(S) SHOWN IN THE MARK DOES NOT IDENTIFY A PARTICULAR LIVING INDIVIDUAL.

THE MARK CONSISTS OF THE WORDS "EDITH SANFORD" IN CURSIVE. LOOPED FROM THE "E" IN "EDITH" IS A RIBBON CONTAINING FIVE STRANDS. THE STRANDS CONTAIN 11 HEXAGON-SHAPED BEADS.

SER. NO. 85-405,049, FILED 8-23-2011.

MICHAEL KEATING, EXAMINING ATTORNEY



*David J. Kybas*

Director of the United States Patent and Trademark Office



# United States of America

United States Patent and Trademark Office



**Reg. No. 4,134,754**

**Registered May 1, 2012**

**Int. Cl.: 36**

**SERVICE MARK**

**PRINCIPAL REGISTER**

SANFORD (NORTH DAKOTA NON-PROFIT CORPORATION)  
801 BROADWAY N.  
FARGO, ND 58122

FOR: CHARITABLE FUNDRAISING, IN CLASS 36 (U.S. CLS. 100, 101 AND 102).

FIRST USE 8-17-2011; IN COMMERCE 8-17-2011.

NO CLAIM IS MADE TO THE EXCLUSIVE RIGHT TO USE "BREAST CANCER", APART FROM THE MARK AS SHOWN.

THE NAME(S), PORTRAIT(S), AND/OR SIGNATURE(S) SHOWN IN THE MARK DOES NOT IDENTIFY A PARTICULAR LIVING INDIVIDUAL.

THE MARK CONSISTS OF THE WORDS "EDITH SANFORD" IN CURSIVE. LOOPED FROM THE "E" IN "EDITH" IS A RIBBON CONTAINING FIVE STRANDS. THE STRANDS CONTAIN 11 HEXAGON-SHAPED BEADS. BELOW THE WORDS "EDITH SANFORD" ARE THE WORDS "BREAST CANCER" IN BLOCK.

SER. NO. 85-405,086, FILED 8-23-2011.

MICHAEL KEATING, EXAMINING ATTORNEY



*David J. Kyffers*

Director of the United States Patent and Trademark Office

# United States of America

United States Patent and Trademark Office

## LAMB TREE AND STUMP

**Reg. No. 4,134,755**

**Registered May 1, 2012**

**Int. Cl.: 44**

**SERVICE MARK**

**PRINCIPAL REGISTER**

LAMB TREE AND STUMP (KENTUCKY LIMITED LIABILITY COMPANY)  
1321 GREENHILL ROAD  
BOWLING GREEN, KY 42103

FOR: TREE AND SHRUB PRUNING AND SHAPING; TREE AND STUMP REMOVAL AND STUMP GRINDING, IN CLASS 44 (U.S. CLS. 100 AND 101).

FIRST USE 0-0-1993; IN COMMERCE 0-0-2000.

THE MARK CONSISTS OF STANDARD CHARACTERS WITHOUT CLAIM TO ANY PARTICULAR FONT, STYLE, SIZE, OR COLOR.

NO CLAIM IS MADE TO THE EXCLUSIVE RIGHT TO USE "TREE AND STUMP", APART FROM THE MARK AS SHOWN.

THE NAME(S), PORTRAIT(S), AND/OR SIGNATURE(S) SHOWN IN THE MARK IDENTIFIES BENJAMIN LAMB, WHOSE CONSENT(S) TO REGISTER IS MADE OF RECORD.

SER. NO. 85-405,142, FILED 8-23-2011.

JASON TURNER, EXAMINING ATTORNEY



*David J. Kybas*

Director of the United States Patent and Trademark Office

United States of America  
United States Patent and Trademark Office

**Promentum**

**Reg. No. 4,134,756**

AVENTUR PARTNERS, LLC (NEW MEXICO LIMITED LIABILITY COMPANY)  
123 EAST MARCY STREET, SUITE 101  
SANTA FE, NM 87501

**Registered May 1, 2012**

**Int. Cl.: 9**

FOR: COMPUTER SOFTWARE FOR MEDICAL CHARTING, IN CLASS 9 (U.S. CLS. 21, 23, 26, 36 AND 38).

**TRADEMARK**

FIRST USE 2-20-2011; IN COMMERCE 2-20-2011.

**PRINCIPAL REGISTER**

THE MARK CONSISTS OF THE STYLIZED LETTERS "PROMENTUM".

SER. NO. 85-405,151, FILED 8-23-2011.

JEFF DEFORD, EXAMINING ATTORNEY



*David J. Kyffers*

Director of the United States Patent and Trademark Office

# United States of America

United States Patent and Trademark Office

## SERVICE LONG LIFE GUARANTEED

**Reg. No. 4,134,757**

**Registered May 1, 2012**

**Int. Cl.: 11**

**TRADEMARK**

**PRINCIPAL REGISTER**

WESTINGHOUSE LIGHTING CORPORATION (PENNSYLVANIA CORPORATION)  
12401 MCNULTY ROAD  
PHILADELPHIA, PA 19154

FOR: ELECTRIC LIGHT BULBS; FLUORESCENT ELECTRIC LIGHT BULBS; FLUORESCENT LIGHTING TUBES; HALOGEN LIGHT BULBS; INCANDESCENT LIGHT BULBS; LED LIGHT BULBS; LIGHT BULBS, IN CLASS 11 (U.S. CLS. 13, 21, 23, 31 AND 34).

FIRST USE 3-1-2004; IN COMMERCE 3-1-2004.

THE MARK CONSISTS OF STANDARD CHARACTERS WITHOUT CLAIM TO ANY PARTICULAR FONT, STYLE, SIZE, OR COLOR.

NO CLAIM IS MADE TO THE EXCLUSIVE RIGHT TO USE "LONG LIFE GUARANTEED", APART FROM THE MARK AS SHOWN.

SER. NO. 85-405,153, FILED 8-23-2011.

JEFF DEFORD, EXAMINING ATTORNEY



*David J. Kyffers*

Director of the United States Patent and Trademark Office

# United States of America

United States Patent and Trademark Office

## FLORIDA PADDLEBOARD ADVENTURES

**Reg. No. 4,134,758**

FLORIDA PADDLEBOARD ADVENTURES, INC. (FLORIDA CORPORATION)  
9617 SW SHARON ST  
HOBE SOUND, FL 33455

**Registered May 1, 2012**

**Int. Cl.: 35**

FOR: RETAIL STORE SERVICES FEATURING PADDLEBOARDS, IN CLASS 35 (U.S. CLS. 100, 101 AND 102).

**SERVICE MARK**

FIRST USE 2-1-2011; IN COMMERCE 6-7-2011.

**PRINCIPAL REGISTER**

THE MARK CONSISTS OF STANDARD CHARACTERS WITHOUT CLAIM TO ANY PARTICULAR FONT, STYLE, SIZE, OR COLOR.

NO CLAIM IS MADE TO THE EXCLUSIVE RIGHT TO USE "FLORIDA PADDLEBOARD", APART FROM THE MARK AS SHOWN.

SER. NO. 85-405,408, FILED 8-24-2011.

EDWARD NELSON, EXAMINING ATTORNEY



*David J. Kyffers*

Director of the United States Patent and Trademark Office

# United States of America

United States Patent and Trademark Office



**Reg. No. 4,134,759**

**Registered May 1, 2012**

**Int. Cl.: 45**

**SERVICE MARK**

**PRINCIPAL REGISTER**

SINGLE PARENT LINK, LLC (OHIO LIMITED LIABILITY COMPANY)  
3982 POWELL ROAD SUITE 178  
POWELL, OH 43065

FOR: INTERNET BASED SOCIAL NETWORKING SERVICES FOR SINGLE PARENTS, IN CLASS 45 (U.S. CLS. 100 AND 101).

FIRST USE 7-26-2011; IN COMMERCE 7-26-2011.

NO CLAIM IS MADE TO THE EXCLUSIVE RIGHT TO USE "SINGLE PARENT LINK", APART FROM THE MARK AS SHOWN.

THE COLOR(S) BROWN, BLUE, RUST, GREEN AND PINK IS/ARE CLAIMED AS A FEATURE OF THE MARK.

THE MARK CONSISTS OF THE WORDS "SINGLE PARENT" AND THE TRUNKS AND BRANCHES OF THE TREES WITH SPOTS OF 1 TREE TOP APPEARING IN BROWN, THE WORD "LINK" AND A TREE TOP APPEARING IN BLUE, A TREE TOP APPEARING IN RUST, 2 TREE TOPS APPEARING IN GREEN AND CIRCLES ON A TREE TOP APPEARING IN PINK.

SER. NO. 85-405,443, FILED 8-24-2011.

NICHOLAS COLEMAN, EXAMINING ATTORNEY



*David J. Kybas*

Director of the United States Patent and Trademark Office

# United States of America

United States Patent and Trademark Office

## DR CONTRACTORS

**Reg. No. 4,134,760**

**Registered May 1, 2012**

**Int. Cl.: 37**

**SERVICE MARK**

**PRINCIPAL REGISTER**

DR CONTRACTORS, LLC (INDIANA LIMITED LIABILITY COMPANY)  
7860 INDIAN LAKE ROAD  
INDIANAPOLIS, IN 46236

FOR: BUILDING CONSTRUCTION, REMODELING AND REPAIR, IN CLASS 37 (U.S. CLS. 100, 103 AND 106).

FIRST USE 8-15-2011; IN COMMERCE 8-15-2011.

THE MARK CONSISTS OF STANDARD CHARACTERS WITHOUT CLAIM TO ANY PARTICULAR FONT, STYLE, SIZE, OR COLOR.

NO CLAIM IS MADE TO THE EXCLUSIVE RIGHT TO USE "CONTRACTORS", APART FROM THE MARK AS SHOWN.

SER. NO. 85-405,473, FILED 8-24-2011.

RONALD MCMORROW, EXAMINING ATTORNEY



*David J. Kyffers*

Director of the United States Patent and Trademark Office

# United States of America

United States Patent and Trademark Office



**Reg. No. 4,134,761**

**Registered May 1, 2012**

**Int. Cl.: 36**

**SERVICE MARK**

**PRINCIPAL REGISTER**

BUCKINGHAM ASSET MANAGEMENT LLC (DELAWARE LIMITED LIABILITY COMPANY)  
SUITE 900  
8182 MARYLAND AVE.  
ST. LOUIS, MO 63105

FOR: TURNKEY FINANCIAL ASSET MANAGEMENT SERVICES TO OTHERS, IN CLASS  
36 (U.S. CLS. 100, 101 AND 102).

FIRST USE 4-19-2011; IN COMMERCE 4-19-2011.

NO CLAIM IS MADE TO THE EXCLUSIVE RIGHT TO USE "ADVISOR SERVICES", APART  
FROM THE MARK AS SHOWN.

THE MARK CONSISTS OF CIRCLES WITH TWO BREAKS WHERE THE WORD "BAM" IS  
AT THE ENDING OF THE INNER CIRCLE; AND THE WORDS "ADVISOR SERVICES" IS  
AT THE ENDING OF THE OUTER CIRCLE.

SER. NO. 85-405,492, FILED 8-24-2011.

KARANENDRA S. CHHINA, EXAMINING ATTORNEY



*David J. Kybas*

Director of the United States Patent and Trademark Office



United States of America  
United States Patent and Trademark Office

# CREMIEUX

**Reg. No. 4,134,762**

**Registered May 1, 2012**

**Int. Cl.: 25**

**TRADEMARK**

**PRINCIPAL REGISTER**

CREMIEUX, STEPHANE (FRANCE INDIVIDUAL)  
C/O PATCHWORK USA INC.  
166 MERCER STREET, SUITE 6A  
NEW YORK, NY 10012

FOR: CLOTHING, NAMELY, SHIRTS, BLOUSES, T-SHIRTS, SWEATERS, SHORTS, PANTS, JEANS, COATS, JACKETS, DRESSES, SKIRTS, SWIMWEAR, LOUNGEWEAR, NECKWEAR, SCARVES, HEADWEAR, HOSIERY, IN CLASS 25 (U.S. CLS. 22 AND 39).

FIRST USE 3-0-2009; IN COMMERCE 3-0-2009.

THE MARK CONSISTS OF STANDARD CHARACTERS WITHOUT CLAIM TO ANY PARTICULAR FONT, STYLE, SIZE, OR COLOR.

OWNER OF U.S. REG. NOS. 3,339,239, 3,367,426, AND 3,567,749.

SEC. 2(F).

SER. NO. 85-405,496, FILED 8-24-2011.

ROBIN CHOSID, EXAMINING ATTORNEY



*David J. Kybas*

Director of the United States Patent and Trademark Office

# United States of America

United States Patent and Trademark Office



**Reg. No. 4,134,763**

**Registered May 1, 2012**

**Int. Cl.: 9**

**TRADEMARK**

**PRINCIPAL REGISTER**

PERCONA, INC. (WASHINGTON CORPORATION)  
#179  
550-M RITCHIE HIGHWAY  
SEVERNA PARK, MD 21146

FOR: DOWNLOADABLE COMPUTER SOFTWARE FOR USE IN DATABASE MANAGEMENT AND APPLICATION DEVELOPMENT, IN CLASS 9 (U.S. CLS. 21, 23, 26, 36 AND 38).

FIRST USE 12-16-2008; IN COMMERCE 12-16-2008.

OWNER OF U.S. REG. NO. 3,733,062.

NO CLAIM IS MADE TO THE EXCLUSIVE RIGHT TO USE "SERVER", APART FROM THE MARK AS SHOWN.

THE MARK CONSISTS OF A JAGUAR DESIGN ON A CIRCLE NEXT TO THE WORDS "PERCONA SERVER".

SER. NO. 85-405,520, FILED 8-24-2011.

KATINA MISTER, EXAMINING ATTORNEY



*David J. Kybas*

Director of the United States Patent and Trademark Office

# United States of America

United States Patent and Trademark Office

## PPAI TurboTest

**Reg. No. 4,134,764**

**Registered May 1, 2012**

**Int. Cl.: 45**

**SERVICE MARK**

**PRINCIPAL REGISTER**

PROMOTIONAL PRODUCTS ASSOCIATION INTERNATIONAL (D.C. CORPORATION)  
3125 SKYWAY CIRCLE NORTH  
IRVING, TX 75038

FOR: PROVIDING ONLINE INFORMATION CONCERNING PRODUCT SAFETY ANALYSIS,  
IN CLASS 45 (U.S. CLS. 100 AND 101).

FIRST USE 7-22-2011; IN COMMERCE 8-10-2011.

THE MARK CONSISTS OF STANDARD CHARACTERS WITHOUT CLAIM TO ANY PAR-  
TICULAR FONT, STYLE, SIZE, OR COLOR.

OWNER OF U.S. REG. NOS. 3,961,750, 3,961,752 AND OTHERS.

SER. NO. 85-405,522, FILED 8-24-2011.

DARRYL SPRUILL, EXAMINING ATTORNEY



*David J. Kyros*

Director of the United States Patent and Trademark Office

# United States of America

United States Patent and Trademark Office



**Reg. No. 4,134,765**

**Registered May 1, 2012**

**Int. Cl.: 30**

**TRADEMARK**

**PRINCIPAL REGISTER**

TWO BELLES SOUTHERN POUND CAKES, LLC (VIRGINIA LIMITED LIABILITY COMPANY)  
5100 27TH STREET NORTH  
ARLINGTON, VA 222071744

FOR: CAKES, IN CLASS 30 (U.S. CL. 46).

FIRST USE 11-11-2009; IN COMMERCE 11-11-2009.

NO CLAIM IS MADE TO THE EXCLUSIVE RIGHT TO USE "SOUTHERN POUND CAKES", APART FROM THE MARK AS SHOWN.

THE MARK CONSISTS OF TWO WOMEN DEPICTED HOLDING A CAKE WITH STEAM RISING ABOVE AND A DOTTED OVAL IN THE BACKGROUND AND THE WORDS "TWO BELLES" IN CURSIVE WRITING ABOVE THE DESIGN WITH TWO CURVED LINES NEAR THE LETTERS "T" AND "B", AND THE WORDS "SOUTHERN POUND CAKES" IN BLOCK LETTERS UNDER THE DESIGN.

SER. NO. 85-405,525, FILED 8-24-2011.

TINA MAI, EXAMINING ATTORNEY



*David J. Kybas*

Director of the United States Patent and Trademark Office

# United States of America

United States Patent and Trademark Office



**Reg. No. 4,134,766**

**Registered May 1, 2012**

**Int. Cl.: 35**

**SERVICE MARK**

**PRINCIPAL REGISTER**

MYHOMETOWNBRONXVILLE, LLC (NEW YORK LIMITED LIABILITY COMPANY), DBA  
MYHOMETOWNSTORES.COM  
55 PRESCOTT AVENUE  
BRONXVILLE, NY 10708

FOR: COMPUTERIZED ON-LINE RETAIL STORE SERVICES FEATURING A WIDE VARIETY OF CONSUMER GOODS OF LOCAL MERCHANTS; MARKETING SERVICES, NAMELY, RETAIL STORE SERVICES FEATURING A WIDE VARIETY OF CONSUMER GOODS OF LOCAL MERCHANTS; ON-LINE RETAIL STORE SERVICES FEATURING A WIDE VARIETY OF CONSUMER GOODS OF OTHERS; RETAIL STORE AND ON-LINE RETAIL STORE SERVICES FEATURING LOCAL FASHION, APPAREL, HOME GOODS AND LOCAL PRODUCTS; RETAIL STORE SERVICES FEATURING A WIDE VARIETY OF CONSUMER GOODS OF OTHERS, IN CLASS 35 (U.S. CLS. 100, 101 AND 102).

FIRST USE 7-27-2011; IN COMMERCE 7-27-2011.

NO CLAIM IS MADE TO THE EXCLUSIVE RIGHT TO USE "THE BEST LOCAL STORES ONLINE", APART FROM THE MARK AS SHOWN.

THE COLOR(S) GREEN, BROWN, BLUE, WHITE AND GRAY IS/ARE CLAIMED AS A FEATURE OF THE MARK.

THE MARK CONSISTS OF A GREEN SHOPPING BAG WITH BROWN HANDLES PLACED ABOVE A BLUE BAR, WITH THE WORDING, "MYHOMETOWNSTORES.COM TO THE RIGHT, WITH THE LETTERS "MYHO" IN THE COLOR BLUE, LINED IN WHITE PLACED ON THE UPPER PORTION OF THE GREEN SHOPPING BAG, WITH THE LETTERS, "MET-OWNSTORES COM" IN THE COLOR BLUE, WITH A GREEN CIRCLE REPRESENTING THE DOT BEFORE "COM", WITH THE WORDING, "THE BEST LOCAL STORES ONLINE" BELOW IN GREEN, ON A WHITE BACKGROUND, WITH THREE SLANTED BARS IN DIFFERENT SHADES OF GRAY IN THE RIGHT CORNER OF THE WHITE BACKGROUND.

SER. NO. 85-405,527, FILED 8-24-2011.

ODESSA BIBBINS, EXAMINING ATTORNEY



*David J. Kappas*

Director of the United States Patent and Trademark Office

# United States of America

United States Patent and Trademark Office

## PPAI Promotional Products TurboTest

**Reg. No. 4,134,767**

**Registered May 1, 2012**

**Int. Cl.: 45**

**SERVICE MARK**

**PRINCIPAL REGISTER**

PROMOTIONAL PRODUCTS ASSOCIATION INTERNATIONAL (D.C. CORPORATION)  
3125 SKYWAY CIRCLE NORTH  
IRVING, TX 75038

FOR: PROVIDING ONLINE INFORMATION CONCERNING CONSUMER PRODUCT SAFETY  
AND ANALYSIS, IN CLASS 45 (U.S. CLS. 100 AND 101).

FIRST USE 8-18-2011; IN COMMERCE 8-18-2011.

THE MARK CONSISTS OF STANDARD CHARACTERS WITHOUT CLAIM TO ANY PAR-  
TICULAR FONT, STYLE, SIZE, OR COLOR.

OWNER OF U.S. REG. NOS. 3,961,750, 3,961,752 AND OTHERS.

NO CLAIM IS MADE TO THE EXCLUSIVE RIGHT TO USE "PROMOTIONAL PRODUCTS",  
APART FROM THE MARK AS SHOWN.

SER. NO. 85-405,535, FILED 8-24-2011.

DARRYL SPRUILL, EXAMINING ATTORNEY



*David J. Kyffers*

Director of the United States Patent and Trademark Office

# United States of America

United States Patent and Trademark Office

## A Product Safety Roadmap

**Reg. No. 4,134,768**

**Registered May 1, 2012**

**Int. Cl.: 45**

**SERVICE MARK**

**PRINCIPAL REGISTER**

PROMOTIONAL PRODUCTS ASSOCIATION INTERNATIONAL (D.C. CORPORATION)  
3125 SKYWAY CIRCLE NORTH  
IRVING, TX 75038

FOR: PROVIDING ONLINE CONSUMER INFORMATION CONCERNING PRODUCT SAFETY ANALYSIS, IN CLASS 45 (U.S. CLS. 100 AND 101).

FIRST USE 8-18-2011; IN COMMERCE 8-18-2011.

THE MARK CONSISTS OF STANDARD CHARACTERS WITHOUT CLAIM TO ANY PARTICULAR FONT, STYLE, SIZE, OR COLOR.

NO CLAIM IS MADE TO THE EXCLUSIVE RIGHT TO USE "PRODUCT SAFETY", APART FROM THE MARK AS SHOWN.

SER. NO. 85-405,543, FILED 8-24-2011.

DARRYL SPRUILL, EXAMINING ATTORNEY



*David J. Kyros*

Director of the United States Patent and Trademark Office

# United States of America

United States Patent and Trademark Office

## Track's End Restaurant

**Reg. No. 4,134,769**

**Registered May 1, 2012**

**Int. Cl.: 43**

**SERVICE MARK**

**PRINCIPAL REGISTER**

MOTEL SLEEPERS, INC. (MINNESOTA CORPORATION)  
101 MORGAN KEEGAN DR, STE B  
LITTLE ROCK, AR 722022212

FOR: RESTAURANT SERVICES, IN CLASS 43 (U.S. CLS. 100 AND 101).

FIRST USE 9-30-1980; IN COMMERCE 9-30-1980.

THE MARK CONSISTS OF STANDARD CHARACTERS WITHOUT CLAIM TO ANY PARTICULAR FONT, STYLE, SIZE, OR COLOR.

NO CLAIM IS MADE TO THE EXCLUSIVE RIGHT TO USE "RESTAURANT", APART FROM THE MARK AS SHOWN.

SER. NO. 85-405,612, FILED 8-24-2011.

MARIA-VICTORIA SUAREZ, EXAMINING ATTORNEY



*David J. Kybas*

Director of the United States Patent and Trademark Office



# United States of America

United States Patent and Trademark Office

## Gragg Advertising

**Reg. No. 4,134,770**

**Registered May 1, 2012**

**Int. Cl.: 35**

**SERVICE MARK**

**PRINCIPAL REGISTER**

GRAGG ADVERTISING (MISSOURI CORPORATION)  
450 EAST 4TH ST., STE 100  
KANSAS CITY, MO 64106

FOR: ADVERTISING AGENCIES SPECIALIZING IN ONLINE TECHNOLOGY AND LEAD MANAGEMENT FOR DIRECT RESPONSE CLIENTS; BUSINESS-TO-BUSINESS DIRECT MARKETING SERVICES, IN CLASS 35 (U.S. CLS. 100, 101 AND 102).

FIRST USE 10-22-1992; IN COMMERCE 10-22-1992.

THE MARK CONSISTS OF STANDARD CHARACTERS WITHOUT CLAIM TO ANY PARTICULAR FONT, STYLE, SIZE, OR COLOR.

NO CLAIM IS MADE TO THE EXCLUSIVE RIGHT TO USE "ADVERTISING", APART FROM THE MARK AS SHOWN.

SEC. 2(F).

SER. NO. 85-405,636, FILED 8-24-2011.

JUDITH HELFMAN, EXAMINING ATTORNEY



*David J. Kyros*

Director of the United States Patent and Trademark Office

# United States of America

United States Patent and Trademark Office



**Reg. No. 4,134,771**

**Registered May 1, 2012**

**Int. Cl.: 11**

**TRADEMARK**

**PRINCIPAL REGISTER**

AIR DEVISER INDUSTRIAL CO., LTD. (TAIWAN CORPORATION)  
1FL., NO. 932, LINSEN RD.  
WUFENG DISTRICT  
TAICHUNG CITY, TAIWAN 413

FOR: AIR CONDITIONERS FOR VEHICLES; AIR-CONDITIONING, AIR COOLING AND VENTILATION APPARATUS AND INSTRUMENTS; DRYING APPARATUS FOR USE IN HEATING, VENTILATION SYSTEMS, AIR CONDITIONING SYSTEMS AND REFRIGERATION SYSTEMS; FANS FOR AIR CONDITIONING APPARATUS; FIREPLACES; GAS SCRUBBERS; HEATING INSTALLATIONS; HUMIDIFIERS; INDUSTRIAL DRYERS FOR HEATING AND DEHUMIDIFYING; INTERIOR ENVIRONMENT CONTROL SYSTEM FOR COMMERCIAL BUILDINGS, NAMELY, HEATERS, VENTILATORS AND HUMIDIFIERS ALL SOLD AS A UNIT; IONISATION APPARATUS FOR THE TREATMENT OF AIR; LABORATORY VENTILATION HOODS; VENTILATING EXHAUST FANS; VENTILATING FANS FOR COMMERCIAL AND INDUSTRIAL USE; VENTILATION HOODS, IN CLASS 11 (U.S. CLS. 13, 21, 23, 31 AND 34).

FIRST USE 4-1-2007; IN COMMERCE 4-1-2007.

NO CLAIM IS MADE TO THE EXCLUSIVE RIGHT TO USE "AIR", APART FROM THE MARK AS SHOWN.

THE MARK CONSISTS OF THE WORDING "AIR DEVISER" BELOW THE DESIGN OF TWO CONCENTRIC CIRCLES WITH THE STYLIZED LETTERS "AD" IN THE CENTER OF THE CIRCLES AND LINES EXTENDING BETWEEN THE TWO CIRCLES ALL THE WAY AROUND.

SER. NO. 85-405,661, FILED 8-24-2011.

SANDRA BUJA, EXAMINING ATTORNEY



*David J. Kybas*

Director of the United States Patent and Trademark Office

# United States of America

United States Patent and Trademark Office

# crystal fresh

**Reg. No. 4,134,772**

**Registered May 1, 2012**

**Int. Cl.: 1**

**TRADEMARK**

**PRINCIPAL REGISTER**

BECK, JIM (UNITED STATES INDIVIDUAL), DBA OLD SUMMIT FOREST PRODUCTS  
22217 OLD SANTA CRUZ HWY  
LOS GATOS, CA 95033

FOR: UNPROCESSED POLYMERS USED TO PRESERVE FRESHNESS OF PLANTS, TREES  
OR FLOWERS, IN CLASS 1 (U.S. CLS. 1, 5, 6, 10, 26 AND 46).

FIRST USE 6-0-2011; IN COMMERCE 7-15-2011.

THE MARK CONSISTS OF STANDARD CHARACTERS WITHOUT CLAIM TO ANY PAR-  
TICULAR FONT, STYLE, SIZE, OR COLOR.

NO CLAIM IS MADE TO THE EXCLUSIVE RIGHT TO USE "FRESH", APART FROM THE  
MARK AS SHOWN.

SER. NO. 85-405,673, FILED 8-24-2011.

KATHERINE E. HALMEN, EXAMINING ATTORNEY



*David J. Kybas*

Director of the United States Patent and Trademark Office

# United States of America

United States Patent and Trademark Office

## goodie two sleeves

**Reg. No. 4,134,773**

**Registered May 1, 2012**

**Int. Cl.: 25**

**TRADEMARK**

**PRINCIPAL REGISTER**

HOLD THIS INC. (CALIFORNIA CORPORATION), DBA GOODIE TWO SLEEVES  
JASON HALLOCK AND GABRIEL CONNOR  
9400 LURLINE AVENUE, SUITE C  
CHATSWORTH, CA 91311

FOR: CLOTHING, NAMELY, T-SHIRTS, LONG SLEEVE SHIRTS, TANK TOPS, SWEAT-SHIRTS, SWEATPANTS, SWEATERS, JACKETS, PANTS, SHORTS, DRESSES, SKIRTS, PAJAMAS, SWIMSUITS, UNDERWEAR, SOCKS, SCARVES, BASEBALL CAPS, STOCKING CAPS, HEADBANDS, GLOVES AND MITTENS, IN CLASS 25 (U.S. CLS. 22 AND 39).

FIRST USE 10-15-2002; IN COMMERCE 1-8-2003.

THE MARK CONSISTS OF STANDARD CHARACTERS WITHOUT CLAIM TO ANY PARTICULAR FONT, STYLE, SIZE, OR COLOR.

SER. NO. 85-405,689, FILED 8-24-2011.

CURTIS FRENCH, EXAMINING ATTORNEY



*David J. Kyffers*

Director of the United States Patent and Trademark Office

# United States of America

United States Patent and Trademark Office



**Reg. No. 4,134,774**

**Registered May 1, 2012**

**Int. Cl.: 3**

**TRADEMARK**

**PRINCIPAL REGISTER**

TARA COOPER (UNITED STATES INDIVIDUAL)  
2425 FRANK ST  
EUREKA, CA 95501

FOR: ORGANIC BEAUTY CREAMS; ORGANIC BEAUTY LOTIONS; ORGANIC BODY BUTTER; ORGANIC BODY CREAMS, IN CLASS 3 (U.S. CLS. 1, 4, 6, 50, 51 AND 52).

FIRST USE 10-1-2000; IN COMMERCE 11-18-2003.

NO CLAIM IS MADE TO THE EXCLUSIVE RIGHT TO USE "ORGANICS", APART FROM THE MARK AS SHOWN.

THE MARK CONSISTS OF THE WORDING "OHANA ORGANICS" APPEARING ABOVE A DESIGN OF A STICK FIGURE WITH A TRIANGLE IN THE CENTER.

THE ENGLISH TRANSLATION OF THE WORD "OHANA" IN THE MARK IS "FAMILY".

SER. NO. 85-405,770, FILED 8-24-2011.

ELIZABETH KAJUBI, EXAMINING ATTORNEY



*David J. Kybas*

Director of the United States Patent and Trademark Office

# United States of America

United States Patent and Trademark Office

## Colorplay Design

**Reg. No. 4,134,775**

**Registered May 1, 2012**

**Int. Cl.: 42**

**SERVICE MARK**

**PRINCIPAL REGISTER**

WOODWARD, ROSEMARIE (UNITED STATES INDIVIDUAL)  
1004 S. 2480 E.  
SPANISH FORK, UT 84660

FOR: COMMERCIAL ART DESIGN; COMPUTER AIDED GRAPHIC DESIGN; COMPUTER GRAPHICS DESIGN SERVICES; COMPUTER WEBSITE DESIGN; GRAPHIC ART DESIGN; GRAPHIC DESIGN; GRAPHIC DESIGN SERVICES, IN CLASS 42 (U.S. CLS. 100 AND 101).

FIRST USE 3-14-2008; IN COMMERCE 3-14-2008.

THE MARK CONSISTS OF STANDARD CHARACTERS WITHOUT CLAIM TO ANY PARTICULAR FONT, STYLE, SIZE, OR COLOR.

NO CLAIM IS MADE TO THE EXCLUSIVE RIGHT TO USE "DESIGN", APART FROM THE MARK AS SHOWN.

SER. NO. 85-405,777, FILED 8-24-2011.

ALICIA COLLINS, EXAMINING ATTORNEY



*David J. Kybas*

Director of the United States Patent and Trademark Office

# United States of America

United States Patent and Trademark Office



**Reg. No. 4,134,776**

**Registered May 1, 2012**

**Int. Cl.: 30**

**TRADEMARK**

**PRINCIPAL REGISTER**

PRODUCTOS UVAVIÑA, S.A. DE C.V. (MEXICO SOCIEDAD ANONIMA (SA DE CV)))  
CARLOS L. GRACIDAS, 1140 FRACC. EL COLLI  
ZAPOPAN, JALISCO, MEXICO 45070

FOR: EXTRACTS USED AS FLAVORING; VANILLA; VANILLA FLAVORINGS, IN CLASS  
30 (U.S. CL. 46).

FIRST USE 12-31-1979; IN COMMERCE 12-31-1979.

OWNER OF U.S. REG. NOS. 3,108,920, 3,221,947, AND 3,895,386.

THE COLOR(S) RED, GREEN, LIGHT GREEN, WHITE, ORANGE IS/ARE CLAIMED AS A  
FEATURE OF THE MARK.

THE MARK CONSISTS OF A RED RECTANGLE CONTAINING THE WORD "MOLINA" IN  
WHITE, OUTLINED IN WHITE OVER A GREEN RECTANGLE ALSO OUTLINED IN WHITE,  
ALL OUTLINED IN LIGHT GREEN WITH AN ORANGE BORDER.

SER. NO. 85-405,785, FILED 8-24-2011.

ANN E. SAPPENFIELD, EXAMINING ATTORNEY



*David J. Kybas*

Director of the United States Patent and Trademark Office

# United States of America

United States Patent and Trademark Office



**Reg. No. 4,134,777**

HEPBURN, KATHARINE (UNITED STATES INDIVIDUAL)  
8825 ASHTON CT  
KNOXVILLE, TN 37923

**Registered May 1, 2012**

**Int. Cl.: 18**

FOR: PURSES, TOTE BAGS, MULTI-PURPOSE PURSES, CLUTCHES, WRIST MOUNTED PURSES, WALLETS, RUCK SACKS, KNAP SACKS, AND MESSENGER BAGS MADE FROM SUSTAINABLE, ORGANIC, RECYCLED, AND/OR NATURAL FABRICS, FIBERS AND MATERIALS, IN CLASS 18 (U.S. CLS. 1, 2, 3, 22 AND 41).

**TRADEMARK**

**PRINCIPAL REGISTER**

FIRST USE 6-28-2008; IN COMMERCE 8-3-2011.

NO CLAIM IS MADE TO THE EXCLUSIVE RIGHT TO USE "SACK", APART FROM THE MARK AS SHOWN.

THE MARK CONSISTS OF A SQUIRREL WITH THE STYLIZED TEXT "SQUIRREL SACK".

SER. NO. 85-405,801, FILED 8-24-2011.

COLLEEN KEARNEY, EXAMINING ATTORNEY



*David J. Kyffers*

Director of the United States Patent and Trademark Office



# United States of America

United States Patent and Trademark Office

## JONATHAN PAUL

**Reg. No. 4,134,778**

**Registered May 1, 2012**

**Int. Cl.: 9**

**TRADEMARK**

**PRINCIPAL REGISTER**

LAVA LIMITED COMPANY HONG KONG (HONG KONG CORPORATION)  
1604 WING HING INDUSTRIAL BUILDING  
83-93 CHAI WON KOK STREET TSUEN WAN, N.T  
HONG KONG, HONG KONG

FOR: CASES FOR EYEGLASSES AND SUNGLASSES; EYEWEAR, NAMELY, SUNGLASSES TO BE WORN WITH EYEGLASSES; SUNGLASSES; SUNGLASSES AND SPECTACLES, IN CLASS 9 (U.S. CLS. 21, 23, 26, 36 AND 38).

FIRST USE 3-1-1998; IN COMMERCE 3-1-1998.

THE MARK CONSISTS OF STANDARD CHARACTERS WITHOUT CLAIM TO ANY PARTICULAR FONT, STYLE, SIZE, OR COLOR.

THE NAME(S), PORTRAIT(S), AND/OR SIGNATURE(S) SHOWN IN THE MARK DOES NOT IDENTIFY A PARTICULAR LIVING INDIVIDUAL.

SER. NO. 85-405,806, FILED 8-24-2011.

JUDITH HELFMAN, EXAMINING ATTORNEY



*David J. Kyjars*

Director of the United States Patent and Trademark Office

# United States of America

United States Patent and Trademark Office

# PREDIC.TV

**Reg. No. 4,134,779**

**Registered May 1, 2012**

**Int. Cl.: 35**

**SERVICE MARK**

**PRINCIPAL REGISTER**

PRIME VISIBILITY MEDIA GROUP (DELAWARE CORPORATION), DBA PV MEDIA GROUP  
SUITE 2913  
60 E. 42ND STREET  
NEW YORK, NY 101652900

FOR: ADVERTISING, MARKETING AND DISSEMINATION OF ADVERTISING MATTER SERVICES, NAMELY, PROMOTING THE GOODS, SERVICES, BRAND IDENTITY AND COMMERCIAL INFORMATION AND NEWS OF THIRD PARTIES THROUGH DIGITAL, MOBILE AND ON-LINE MEDIUM, IN CLASS 35 (U.S. CLS. 100, 101 AND 102).

FIRST USE 8-22-2011; IN COMMERCE 8-22-2011.

THE MARK CONSISTS OF STANDARD CHARACTERS WITHOUT CLAIM TO ANY PARTICULAR FONT, STYLE, SIZE, OR COLOR.

SER. NO. 85-405,890, FILED 8-24-2011.

AMY C. KEAN, EXAMINING ATTORNEY



*David J. Kappas*

Director of the United States Patent and Trademark Office

# United States of America

United States Patent and Trademark Office

## Portrait Stories

**Reg. No. 4,134,780**

**Registered May 1, 2012**

**Int. Cl.: 41**

**SERVICE MARK**

**PRINCIPAL REGISTER**

PORTRAIT STORIES (ALABAMA SOLE PROPRIETORSHIP)  
3841 ISABEL WAY W  
3841 ISABEL WAY W  
MOBILE, AL 36693

FOR: DIGITAL IMAGING SERVICES; PHOTOGRAPHY; PHOTOGRAPHY SERVICES;  
PORTRAIT PAINTING SERVICES, IN CLASS 41 (U.S. CLS. 100, 101 AND 107).

FIRST USE 10-1-1996; IN COMMERCE 10-1-1996.

THE MARK CONSISTS OF STANDARD CHARACTERS WITHOUT CLAIM TO ANY PAR-  
TICULAR FONT, STYLE, SIZE, OR COLOR.

NO CLAIM IS MADE TO THE EXCLUSIVE RIGHT TO USE "PORTRAIT", APART FROM  
THE MARK AS SHOWN.

SER. NO. 85-405,893, FILED 8-24-2011.

AMY C. KEAN, EXAMINING ATTORNEY



*David J. Kybas*

Director of the United States Patent and Trademark Office

# United States of America

United States Patent and Trademark Office



**MIDSTATE**  
LAMP LLC

**Reg. No. 4,134,781**

SCHROCK, SAMUEL F (UNITED STATES INDIVIDUAL), DBA MIDSTATE LAMP  
169 E CR 200 N  
ARTHUR, IL 61911

**Registered May 1, 2012**

**Int. Cl.: 11**

FOR: GAS LAMPS; GLOBES FOR LAMPS; LAMP REFLECTORS; LAMP SHADES; SPARK  
IGNITERS FOR GAS APPLIANCES, IN CLASS 11 (U.S. CLS. 13, 21, 23, 31 AND 34).

**TRADEMARK**

FIRST USE 7-1-2006; IN COMMERCE 7-1-2006.

**PRINCIPAL REGISTER**

NO CLAIM IS MADE TO THE EXCLUSIVE RIGHT TO USE "LAMP LLC", APART FROM  
THE MARK AS SHOWN.

THE COLOR(S) BLUE, BLACK AND WHITE IS/ARE CLAIMED AS A FEATURE OF THE  
MARK.

THE MARK CONSISTS OF A WHITE AND BLUE FLAME, WHICH IS SET INSIDE A BLACK  
CIRCLE, THE BLACK CIRCLE IS RIMMED IN A BLUE CIRCLE, WHICH IS THEN RIMMED  
IN A WHITE CIRCLE, WHICH IS FINALLY RIMMED IN A THIN BLACK CIRCLE. WRITTEN  
UNDERNEATH THE FLAME AND CIRCLE, IS THE WORD "MIDSTATE" IN BLACK FONT,  
THE WORDS "LAMP LLC" IS IN BLUE FONT AND IS WRITTEN BENEATH THE WORD  
"MIDSTATE".

SER. NO. 85-405,906, FILED 8-24-2011.

AMY C. KEAN, EXAMINING ATTORNEY



*David J. Kappas*

Director of the United States Patent and Trademark Office

# United States of America

United States Patent and Trademark Office

# TL CARE

**Reg. No. 4,134,782**

**Registered May 1, 2012**

**Int. Cls.: 3, 24 and 25**

**TRADEMARK**

**PRINCIPAL REGISTER**

TL CARE, INC. (CALIFORNIA CORPORATION)  
2881 SEVENTEEN MILE DRIVE  
PEBBLE BEACH, CA 93953

FOR: ALL PURPOSE COTTON SWABS FOR PERSONAL USE; COTTON BALLS FOR COSMETIC PURPOSES; COTTON SWABS FOR COSMETIC PURPOSES, IN CLASS 3 (U.S. CLS. 1, 4, 6, 50, 51 AND 52).

FIRST USE 7-1-2006; IN COMMERCE 7-1-2006.

FOR: BABY BLANKETS; BED BLANKETS; BED SHEETS OF PAPER; BED SKIRTS; BLANKET THROWS; COMFORTERS; CRIB BUMPER PADS; CRIB BUMPERS; FITTED BED SHEETS; FLAT BED SHEETS; HOODED TOWELS; MATTRESS PADS; PLASTIC TABLE COVERS; SHEET SETS; WASH CLOTHS, IN CLASS 24 (U.S. CLS. 42 AND 50).

FIRST USE 6-1-2004; IN COMMERCE 6-1-2004.

FOR: BOOTIES; CAPS; CLOTH BIBS; CLOTH DIAPERS; INFANT DIAPER COVERS; MITTENS; UNDERWEAR, IN CLASS 25 (U.S. CLS. 22 AND 39).

FIRST USE 11-5-1985; IN COMMERCE 11-5-1985.

THE MARK CONSISTS OF THE LETTERS "TL" AND THE WORD "CARE". THE LETTER "C" IN "CARE" IS REPRESENTED IN THE STYLE OF A HEART.

SER. NO. 85-405,982, FILED 8-24-2011.

GISELLE AGOSTO, EXAMINING ATTORNEY



*David J. Kyjars*

Director of the United States Patent and Trademark Office

# United States of America

United States Patent and Trademark Office



**Reg. No. 4,134,783**

**Registered May 1, 2012**

**Int. Cl.: 36**

**SERVICE MARK**

**PRINCIPAL REGISTER**

THE PETER AND PATRICIA GRUBER FOUNDATION (DELAWARE NON-PROFIT CORPORATION)  
140 W 57TH STREET SUITE 10C  
NEW YORK, NY 10019

FOR: AWARDING MONETARY PRIZES IN THE FIELDS OF COSMOLOGY, GENETICS, NEUROSCIENCES, SOCIAL JUSTICE AND WOMEN'S RIGHTS, IN CLASS 36 (U.S. CLS. 100, 101 AND 102).

FIRST USE 0-0-2007; IN COMMERCE 0-0-2007.

OWNER OF U.S. REG. NOS. 4,059,181, 4,059,184 AND OTHERS.

THE MARK CONSISTS OF AN ABSTRACT SPHERE.

SER. NO. 85-406,002, FILED 8-24-2011.

MAUREEN DALL, EXAMINING ATTORNEY



*David J. Kybas*

Director of the United States Patent and Trademark Office

# United States of America

United States Patent and Trademark Office



**GRUBER**  
FOUNDATION

**Reg. No. 4,134,784**

**Registered May 1, 2012**

**Int. Cl.: 36**

**SERVICE MARK**

**PRINCIPAL REGISTER**

THE PETER AND PATRICIA GRUBER FOUNDATION (DELAWARE NON-PROFIT CORPORATION)  
140 W 57TH STREET SUITE 10C  
NEW YORK, NY 10019

FOR: AWARDING MONETARY PRIZES IN THE FIELDS OF COSMOLOGY, GENETICS, NEUROSCIENCES, SOCIAL JUSTICE AND WOMEN'S RIGHTS, IN CLASS 36 (U.S. CLS. 100, 101 AND 102).

FIRST USE 0-0-2007; IN COMMERCE 0-0-2007.

OWNER OF U.S. REG. NOS. 4,059,181, 4,059,184 AND OTHERS.

NO CLAIM IS MADE TO THE EXCLUSIVE RIGHT TO USE "FOUNDATION", APART FROM THE MARK AS SHOWN.

THE MARK CONSISTS OF AN ABSTRACT SPHERE AND ITS SHADOW TO THE LEFT OF THE WORDING "GRUBER FOUNDATION."

SER. NO. 85-406,019, FILED 8-24-2011.

MAUREEN DALL, EXAMINING ATTORNEY



*David J. Kyjars*

Director of the United States Patent and Trademark Office

# United States of America

United States Patent and Trademark Office

## LOGO ON THE GOGO

**Reg. No. 4,134,785**

**Registered May 1, 2012**

**Int. Cl.: 20**

**TRADEMARK**

**PRINCIPAL REGISTER**

O'NEILL, LYNDIA (UNITED STATES INDIVIDUAL)  
16731 GREENBRIER ROAD  
LAKE OSWEGO, OR 97034 AND

GEROT, DIANE (UNITED STATES INDIVIDUAL)  
17585 TREETOP WAY  
LAKE OSWEGO, OR 97034

FOR: THREE DIMENSIONAL DECORATIVE PLASTIC ORNAMENTS FOR ATTACHMENT TO CAR GRILLS, IN CLASS 20 (U.S. CLS. 2, 13, 22, 25, 32 AND 50).

FIRST USE 4-18-2011; IN COMMERCE 4-18-2011.

THE MARK CONSISTS OF STANDARD CHARACTERS WITHOUT CLAIM TO ANY PARTICULAR FONT, STYLE, SIZE, OR COLOR.

SER. NO. 85-406,053, FILED 8-24-2011.

GISELLE AGOSTO, EXAMINING ATTORNEY



*David J. Kyffers*

Director of the United States Patent and Trademark Office



# United States of America

United States Patent and Trademark Office

SN\*WShack

**Reg. No. 4,134,786**

SURESOURCE LLC (CONNECTICUT LIMITED LIABILITY COMPANY)  
20 CONSTITUTION BOULEVARD, SOUTH  
SHELTON, CT 06484

**Registered May 1, 2012**

**Int. Cl.: 35**

FOR: COMPUTERIZED ON-LINE RETAIL STORE SERVICES IN THE FIELD OF SKIING  
MERCHANDISE AND ACCESSORIES, IN CLASS 35 (U.S. CLS. 100, 101 AND 102).

**SERVICE MARK**

FIRST USE 2-9-1998; IN COMMERCE 3-16-1998.

**PRINCIPAL REGISTER**

THE MARK CONSISTS OF THE STYLIZED WORDS "SNOWSHACK", WITH A SNOWFLAKE  
IN PLACE OF THE "O".

SER. NO. 85-406,066, FILED 8-24-2011.

H. M. FISHER, EXAMINING ATTORNEY



*David J. Kyffers*

Director of the United States Patent and Trademark Office

# United States of America

United States Patent and Trademark Office

## INNOVATIVE DINING GROUP

**Reg. No. 4,134,787**

**Registered May 1, 2012**

**Int. Cl.: 43**

**SERVICE MARK**

**PRINCIPAL REGISTER**

INNOVATIVE DINING GROUP, LLC (CALIFORNIA LIMITED LIABILITY COMPANY)  
9200 SUNSET BLVD., SUITE 650  
WEST HOLLYWOOD, CA 90069

FOR: CATERING SERVICES; RESTAURANT AND BAR SERVICES; RESTAURANT AND CAFE SERVICES; RESTAURANTS, IN CLASS 43 (U.S. CLS. 100 AND 101).

FIRST USE 10-3-2003; IN COMMERCE 10-3-2003.

THE MARK CONSISTS OF STANDARD CHARACTERS WITHOUT CLAIM TO ANY PARTICULAR FONT, STYLE, SIZE, OR COLOR.

OWNER OF U.S. REG. NO. 2,989,046.

NO CLAIM IS MADE TO THE EXCLUSIVE RIGHT TO USE "DINING GROUP", APART FROM THE MARK AS SHOWN.

SER. NO. 85-406,069, FILED 8-24-2011.

MARK T. MULLEN, EXAMINING ATTORNEY



*David J. Kybas*

Director of the United States Patent and Trademark Office

# United States of America

United States Patent and Trademark Office

# UPREP

**Reg. No. 4,134,788**

**Registered May 1, 2012**

**Int. Cl.: 3**

**TRADEMARK**

**PRINCIPAL REGISTER**

UCOAT IT AMERICA, LLC (MICHIGAN LIMITED LIABILITY COMPANY)  
1911 BELLAIRE AVENUE  
ROYAL OAK, MI 48067

FOR: CLEANING COMPOUNDS FOR USE ON CONCRETE, WOOD, AND OTHER STABLE  
SUBSTRATE SURFACES, IN CLASS 3 (U.S. CLS. 1, 4, 6, 50, 51 AND 52).

FIRST USE 1-31-2006; IN COMMERCE 1-31-2006.

THE MARK CONSISTS OF STANDARD CHARACTERS WITHOUT CLAIM TO ANY PAR-  
TICULAR FONT, STYLE, SIZE, OR COLOR.

SER. NO. 85-406,076, FILED 8-24-2011.

DOUGLAS LEE, EXAMINING ATTORNEY



*David J. Kyfos*

Director of the United States Patent and Trademark Office

# United States of America

United States Patent and Trademark Office

# SWELLEX

**Reg. No. 4,134,789**

**Registered May 1, 2012**

**Int. Cl.: 1**

**TRADEMARK**

**PRINCIPAL REGISTER**

MICRO CARE CORPORATION (CONNECTICUT CORPORATION)  
595 JOHN DOWNEY DRIVE  
NEW BRITAIN, CT 06051

FOR: CHEMICAL PREPARATIONS, NAMELY, SOLVENTS AND AGENTS WHICH CAUSE RUBBER, SILICONE AND ELASTOMERS TO SWELL, IN CLASS 1 (U.S. CLS. 1, 5, 6, 10, 26 AND 46).

FIRST USE 2-8-2011; IN COMMERCE 2-8-2011.

THE MARK CONSISTS OF STANDARD CHARACTERS WITHOUT CLAIM TO ANY PARTICULAR FONT, STYLE, SIZE, OR COLOR.

SER. NO. 85-406,084, FILED 8-24-2011.

H. M. FISHER, EXAMINING ATTORNEY



*David J. Kyffers*

Director of the United States Patent and Trademark Office

# United States of America

United States Patent and Trademark Office

# kvees'

**Reg. No. 4,134,790**

**Registered May 1, 2012**

**Int. Cl.: 28**

**TRADEMARK**

**PRINCIPAL REGISTER**

MORNING STAR SPORTS, LLC (WISCONSIN LIMITED LIABILITY COMPANY)  
660 PINE TERRACE  
SLINGER, WI 53086

FOR: FISHING HOOKS, IN CLASS 28 (U.S. CLS. 22, 23, 38 AND 50).

FIRST USE 6-21-2011; IN COMMERCE 6-21-2011.

THE MARK CONSISTS OF STANDARD CHARACTERS WITHOUT CLAIM TO ANY PARTICULAR FONT, STYLE, SIZE, OR COLOR.

SER. NO. 85-406,086, FILED 8-24-2011.

GISELLE AGOSTO, EXAMINING ATTORNEY



*David J. Kybas*

Director of the United States Patent and Trademark Office

# United States of America

United States Patent and Trademark Office

## Show Me the Mani

**Reg. No. 4,134,791**

MAZER, RACHEL B (UNITED STATES INDIVIDUAL)  
320 E 65TH ST. APT. 318  
NEW YORK, NY 10065

**Registered May 1, 2012**

**Int. Cl.: 41**

FOR: ON-LINE JOURNALS, NAMELY, BLOGS FEATURING NAIL POLISH, IN CLASS 41  
(U.S. CLS. 100, 101 AND 107).

**SERVICE MARK**

FIRST USE 5-1-2010; IN COMMERCE 5-1-2010.

**PRINCIPAL REGISTER**

THE MARK CONSISTS OF STANDARD CHARACTERS WITHOUT CLAIM TO ANY PARTICULAR FONT, STYLE, SIZE, OR COLOR.

NO CLAIM IS MADE TO THE EXCLUSIVE RIGHT TO USE "MANI", APART FROM THE MARK AS SHOWN.

SER. NO. 85-406,087, FILED 8-24-2011.

H. M. FISHER, EXAMINING ATTORNEY



*David J. Kybas*

Director of the United States Patent and Trademark Office

# United States of America

United States Patent and Trademark Office

# GLICO

**Reg. No. 4,134,792**

**Registered May 1, 2012**

**Int. Cl.: 30**

**TRADEMARK**

**PRINCIPAL REGISTER**

EZAKI GLICO KABUSHIKI KAISHA (JAPAN CORPORATION)  
6-5, UTAJIMA 4-CHOME, NISHIYODOGAWA-KU  
OSAKA, JAPAN

FOR: BISCUITS; CANDY; CHEWING GUM; CHOCOLATE; CRACKERS; PRETZELS, IN  
CLASS 30 (U.S. CL. 46).

FIRST USE 12-31-1971; IN COMMERCE 12-31-1990.

THE MARK CONSISTS OF STANDARD CHARACTERS WITHOUT CLAIM TO ANY PAR-  
TICULAR FONT, STYLE, SIZE, OR COLOR.

OWNER OF U.S. REG. NOS. 1,227,927, 1,777,365 AND OTHERS.

SER. NO. 85-406,093, FILED 8-24-2011.

JAMES A. RAUEN, EXAMINING ATTORNEY



*David J. Kyros*

Director of the United States Patent and Trademark Office

# United States of America

United States Patent and Trademark Office

## Stellar Conquest

**Reg. No. 4,134,793**

**Registered May 1, 2012**

**Int. Cl.: 9**

**TRADEMARK**

**PRINCIPAL REGISTER**

TONSTAD, C SHAUN (UNITED STATES INDIVIDUAL)  
112 CYPRESS POINT DRIVE  
SPRINGFIELD, IL 62704

FOR: COMPUTER GAME SOFTWARE; COMPUTER GAME SOFTWARE FOR PERSONAL COMPUTERS AND HOME VIDEO GAME CONSOLES; COMPUTER GAME SOFTWARE FOR USE ON MOBILE AND CELLULAR PHONES, IN CLASS 9 (U.S. CLS. 21, 23, 26, 36 AND 38).

FIRST USE 8-1-2011; IN COMMERCE 8-1-2011.

THE MARK CONSISTS OF STANDARD CHARACTERS WITHOUT CLAIM TO ANY PARTICULAR FONT, STYLE, SIZE, OR COLOR.

SER. NO. 85-406,096, FILED 8-24-2011.

JAMES A. RAUEN, EXAMINING ATTORNEY



*David J. Kyffers*

Director of the United States Patent and Trademark Office



# United States of America

United States Patent and Trademark Office

# UDEGREASE

**Reg. No. 4,134,794**

UCOAT IT AMERICA, LLC (MICHIGAN LIMITED LIABILITY COMPANY)  
1911 BELLAIRE AVENUE  
ROYAL OAK, MI 48067

**Registered May 1, 2012**

**Int. Cl.: 3**

FOR: CLEANING COMPOUNDS FOR USE ON CONCRETE, WOOD, AND OTHER STABLE  
SUBSTRATE SURFACES, IN CLASS 3 (U.S. CLS. 1, 4, 6, 50, 51 AND 52).

**TRADEMARK**

FIRST USE 1-31-2004; IN COMMERCE 1-31-2004.

**PRINCIPAL REGISTER**

THE MARK CONSISTS OF STANDARD CHARACTERS WITHOUT CLAIM TO ANY PAR-  
TICULAR FONT, STYLE, SIZE, OR COLOR.

SER. NO. 85-406,106, FILED 8-24-2011.

DOUGLAS LEE, EXAMINING ATTORNEY



*David J. Kyffers*

Director of the United States Patent and Trademark Office

# United States of America

United States Patent and Trademark Office

## Ethics for Life

**Reg. No. 4,134,795**

**Registered May 1, 2012**

**Int. Cl.: 41**

**SERVICE MARK**

**PRINCIPAL REGISTER**

DECATUR PROFESSIONAL DEVELOPMENT, LLC (TEXAS LIMITED LIABILITY COMPANY), DBA PDHENGINEER.COM  
17350 STATE HIGHWAY 249 SUITE 140  
HOUSTON, TX 77064

FOR: CONTINUING EDUCATION SERVICES, NAMELY, PROVIDING LIVE AND ON-LINE CONTINUING PROFESSIONAL EDUCATION SEMINARS IN THE FIELD OF ENGINEERING, IN CLASS 41 (U.S. CLS. 100, 101 AND 107).

FIRST USE 8-22-2011; IN COMMERCE 8-22-2011.

THE MARK CONSISTS OF STANDARD CHARACTERS WITHOUT CLAIM TO ANY PARTICULAR FONT, STYLE, SIZE, OR COLOR.

NO CLAIM IS MADE TO THE EXCLUSIVE RIGHT TO USE "ETHICS", APART FROM THE MARK AS SHOWN.

SER. NO. 85-406,112, FILED 8-24-2011.

H. M. FISHER, EXAMINING ATTORNEY



*David J. Kyffers*

Director of the United States Patent and Trademark Office

# United States of America

United States Patent and Trademark Office

## Sweaty Sundays

**Reg. No. 4,134,796**

**Registered May 1, 2012**

**Int. Cl.: 41**

**SERVICE MARK**

**PRINCIPAL REGISTER**

THE SWEAT SPOT (CALIFORNIA LIMITED LIABILITY COMPANY)  
3327 SUNSET BLVD.  
LOS ANGELES, CA 90026

FOR: DANCE INSTRUCTION, IN CLASS 41 (U.S. CLS. 100, 101 AND 107).

FIRST USE 5-1-2008; IN COMMERCE 5-1-2008.

THE MARK CONSISTS OF STANDARD CHARACTERS WITHOUT CLAIM TO ANY PARTICULAR FONT, STYLE, SIZE, OR COLOR.

SER. NO. 85-406,119, FILED 8-24-2011.

MARK T. MULLEN, EXAMINING ATTORNEY



*David J. Kyffers*

Director of the United States Patent and Trademark Office

# United States of America

United States Patent and Trademark Office

## SPUR HAPPENINGS

**Reg. No. 4,134,797**

**Registered May 1, 2012**

**Int. Cl.: 41**

**SERVICE MARK**

**PRINCIPAL REGISTER**

SPUR HAPPENINGS, LLC (CALIFORNIA LIMITED LIABILITY COMPANY)  
2800 SAND HILL ROAD, SUITE 170  
MENLO PARK, CA 94025

FOR: SOCIAL CLUB SERVICES, NAMELY, ARRANGING, ORGANIZING, AND HOSTING SOCIAL EVENTS, GET-TOGETHERS, AND PARTIES FOR CLUB MEMBERS; SPECIAL EVENT PLANNING FOR SOCIAL ENTERTAINMENT PURPOSES, IN CLASS 41 (U.S. CLS. 100, 101 AND 107).

FIRST USE 5-1-2009; IN COMMERCE 5-1-2009.

THE MARK CONSISTS OF STANDARD CHARACTERS WITHOUT CLAIM TO ANY PARTICULAR FONT, STYLE, SIZE, OR COLOR.

NO CLAIM IS MADE TO THE EXCLUSIVE RIGHT TO USE "HAPPENINGS", APART FROM THE MARK AS SHOWN.

SER. NO. 85-406,123, FILED 8-24-2011.

JUDITH HELFMAN, EXAMINING ATTORNEY



*David J. Kyffers*

Director of the United States Patent and Trademark Office

# United States of America

United States Patent and Trademark Office

# BHOLT

**Reg. No. 4,134,798**

**Registered May 1, 2012**

**Int. Cl.: 35**

**SERVICE MARK**

**PRINCIPAL REGISTER**

INTECARE, INC. (INDIANA CORPORATION)  
SUITE 325  
8604 ALLISONVILLE ROAD  
INDIANAPOLIS, IN 46250

FOR: PROVIDING AN ON-LINE DIRECTORY INFORMATION SERVICE FEATURING INFORMATION REGARDING BEHAVIORAL HEALTH CARE PROVIDERS, IN CLASS 35 (U.S. CLS. 100, 101 AND 102).

FIRST USE 3-9-2011; IN COMMERCE 3-9-2011.

THE MARK CONSISTS OF STANDARD CHARACTERS WITHOUT CLAIM TO ANY PARTICULAR FONT, STYLE, SIZE, OR COLOR.

SER. NO. 85-406,146, FILED 8-24-2011.

MARGARET POWER, EXAMINING ATTORNEY



*David J. Kybas*

Director of the United States Patent and Trademark Office

# United States of America

United States Patent and Trademark Office

# Vintage Evil

**Reg. No. 4,134,799**

**Registered May 1, 2012**

**Int. Cl.: 25**

**TRADEMARK**

**PRINCIPAL REGISTER**

STORM DESIGN INC. (CANADA CORPORATION)  
SUITE 355  
2211 - 19 STREET NE  
CALGARY, CANADA T2E4Y5

FOR: CLOTHING, NAMELY, T-SHIRTS, TANK TOPS, SHIRTS, JERSEY, WORK SHIRTS, DINNER SHIRTS, BOWLING SHIRTS, JACKETS, COATS, DRESSES, VESTS, PANTS, SHORTS, BOARD SHORTS, HATS, CAPS, VISORS, BEANIES, DRESS SHIRTS, BLOUSES, SWEATSHIRTS, SKIRTS, SOCKS, UNDERWEAR, AND BELTS, IN CLASS 25 (U.S. CLS. 22 AND 39).

FIRST USE 6-0-2006; IN COMMERCE 8-0-2006.

THE MARK CONSISTS OF STANDARD CHARACTERS WITHOUT CLAIM TO ANY PARTICULAR FONT, STYLE, SIZE, OR COLOR.

NO CLAIM IS MADE TO THE EXCLUSIVE RIGHT TO USE "VINTAGE", APART FROM THE MARK AS SHOWN.

SER. NO. 85-406,151, FILED 8-24-2011.

JUDITH HELFMAN, EXAMINING ATTORNEY



*David J. Kyffers*

Director of the United States Patent and Trademark Office

# United States of America

United States Patent and Trademark Office

# UPATCH

**Reg. No. 4,134,800**

UCOAT IT AMERICA, LLC (MICHIGAN LIMITED LIABILITY COMPANY)  
1911 BELLAIRE  
ROYAL OAK, MI 48067

**Registered May 1, 2012**

**Int. Cl.: 2**

FOR: EPOXY COATING FOR USE ON CONCRETE, WOOD, AND OTHER STABLE SUBSTRATE SURFACES, IN CLASS 2 (U.S. CLS. 6, 11 AND 16).

**TRADEMARK**

FIRST USE 1-31-2002; IN COMMERCE 1-31-2002.

**PRINCIPAL REGISTER**

THE MARK CONSISTS OF STANDARD CHARACTERS WITHOUT CLAIM TO ANY PARTICULAR FONT, STYLE, SIZE, OR COLOR.

SER. NO. 85-406,194, FILED 8-24-2011.

DOUGLAS LEE, EXAMINING ATTORNEY



*David J. Kyffers*

Director of the United States Patent and Trademark Office

# United States of America

United States Patent and Trademark Office

## FURNITURE OUTLET WORLD

**Reg. No. 4,134,801**

FURNITURE OUTLET WORLD, INC. (SOUTH CAROLINA CORPORATION)  
730 MAIN STREET #313  
NORTH MYRTLE BEACH, SC 29582

**Registered May 1, 2012**

**Int. Cl.: 35**

FOR: ON-LINE RETAIL STORE SERVICES FEATURING FURNITURE, IN CLASS 35 (U.S. CLS. 100, 101 AND 102).

**SERVICE MARK**

FIRST USE 2-0-2008; IN COMMERCE 2-0-2008.

**PRINCIPAL REGISTER**

NO CLAIM IS MADE TO THE EXCLUSIVE RIGHT TO USE "FURNITURE OUTLET", APART FROM THE MARK AS SHOWN.

SER. NO. 85-406,214, FILED 8-24-2011.

KATHLEEN LORENZO, EXAMINING ATTORNEY



*David J. Kybas*

Director of the United States Patent and Trademark Office



# United States of America

United States Patent and Trademark Office

# UROCK

**Reg. No. 4,134,802**

**Registered May 1, 2012**

**Int. Cl.: 2**

**TRADEMARK**

**PRINCIPAL REGISTER**

UCOAT IT AMERICA, LLC (MICHIGAN LIMITED LIABILITY COMPANY)  
1911 BELLAIRE  
ROYAL OAK, MI 48067

FOR: PROTECTIVE COATINGS AND COMPOUNDS FOR USE ON CONCRETE, WOOD,  
AND OTHER STABLE SUBSTRATE SURFACES, IN CLASS 2 (U.S. CLS. 6, 11 AND 16).

FIRST USE 1-31-2003; IN COMMERCE 1-31-2003.

THE MARK CONSISTS OF STANDARD CHARACTERS WITHOUT CLAIM TO ANY PAR-  
TICULAR FONT, STYLE, SIZE, OR COLOR.

SER. NO. 85-406,234, FILED 8-24-2011.

DOUGLAS LEE, EXAMINING ATTORNEY



*David J. Kyffers*

Director of the United States Patent and Trademark Office

# United States of America

United States Patent and Trademark Office

# UGLAZE

**Reg. No. 4,134,803**

**Registered May 1, 2012**

**Int. Cl.: 2**

**TRADEMARK**

**PRINCIPAL REGISTER**

UCOAT IT AMERICA, LLC (MICHIGAN LIMITED LIABILITY COMPANY)  
1911 BELLAIRE  
ROYAL OAK, MI 48067

FOR: PROTECTIVE COATINGS AND COMPOUNDS FOR USE ON CONCRETE, WOOD,  
AND OTHER STABLE SUBSTRATE SURFACES, IN CLASS 2 (U.S. CLS. 6, 11 AND 16).

FIRST USE 1-31-2001; IN COMMERCE 1-31-2001.

THE MARK CONSISTS OF STANDARD CHARACTERS WITHOUT CLAIM TO ANY PAR-  
TICULAR FONT, STYLE, SIZE, OR COLOR.

SER. NO. 85-406,260, FILED 8-24-2011.

DOUGLAS LEE, EXAMINING ATTORNEY



*David J. Kyffers*

Director of the United States Patent and Trademark Office

# United States of America

United States Patent and Trademark Office

## MDT PERSONNEL

**Reg. No. 4,134,804**

**Registered May 1, 2012**

**Int. Cl.: 35**

**SERVICE MARK**

**PRINCIPAL REGISTER**

MDT PERSONNEL, LLC (PENNSYLVANIA LIMITED LIABILITY COMPANY)  
17757 US 19 NORTH, SUITE 660  
CLEARWATER, FL 33764

FOR: EMPLOYMENT AGENCY SERVICES, NAMELY, FILLING THE TEMPORARY AND PERMANENT STAFFING NEEDS OF BUSINESSES; EMPLOYMENT STAFFING IN THE FIELD OF CONSTRUCTION, LIGHT INDUSTRIAL, DISASTER RECOVERY, HOSPITALITY AND EVENT STAFFING; PROFESSIONAL STAFFING AND RECRUITING SERVICES; PROVIDING AN EMPLOYER WITH CANDIDATES OR POTENTIAL EMPLOYEES TO FILL TEMPORARY, CONTRACT AND PERMANENT POSITIONS; TEMPORARY PERSONNEL SERVICES, IN CLASS 35 (U.S. CLS. 100, 101 AND 102).

FIRST USE 8-1-2010; IN COMMERCE 8-1-2010.

THE MARK CONSISTS OF STANDARD CHARACTERS WITHOUT CLAIM TO ANY PARTICULAR FONT, STYLE, SIZE, OR COLOR.

NO CLAIM IS MADE TO THE EXCLUSIVE RIGHT TO USE "PERSONNEL", APART FROM THE MARK AS SHOWN.

SER. NO. 85-406,285, FILED 8-24-2011.

MICHELE SWAIN, EXAMINING ATTORNEY



*David J. Kyffers*

Director of the United States Patent and Trademark Office

# United States of America

United States Patent and Trademark Office



**Reg. No. 4,134,805**

**Registered May 1, 2012**

**Int. Cl.: 35**

**SERVICE MARK**

**PRINCIPAL REGISTER**

MDT PERSONNEL, LLC (PENNSYLVANIA LIMITED LIABILITY COMPANY)  
17757 US 19 NORTH, SUITE 660  
CLEARWATER, FL 33764

FOR: EMPLOYMENT AGENCY SERVICES, NAMELY, FILLING THE TEMPORARY AND PERMANENT STAFFING NEEDS OF BUSINESSES; EMPLOYMENT STAFFING IN THE FIELD OF CONSTRUCTION, LIGHT INDUSTRIAL, DISASTER RECOVERY, HOSPITALITY AND EVENT STAFFING; PROFESSIONAL STAFFING AND RECRUITING SERVICES; PROVIDING AN EMPLOYER WITH CANDIDATES OR POTENTIAL EMPLOYEES TO FILL TEMPORARY, CONTRACT AND PERMANENT POSITIONS; TEMPORARY PERSONNEL SERVICES, IN CLASS 35 (U.S. CLS. 100, 101 AND 102).

FIRST USE 8-1-2010; IN COMMERCE 8-1-2010.

NO CLAIM IS MADE TO THE EXCLUSIVE RIGHT TO USE "PERSONNEL", APART FROM THE MARK AS SHOWN.

THE MARK CONSISTS OF A CIRCULAR LOGO WITH A HUMAN ALIKE SILHOUETTE INSIDE THE CIRCLE, NEXT TO THE LOGO THE THREE LETTERS "MDT" AND BENEATH, THE WORD "PERSONNEL".

SER. NO. 85-406,339, FILED 8-24-2011.

MICHELE SWAIN, EXAMINING ATTORNEY



*David J. Kyjars*

Director of the United States Patent and Trademark Office

# United States of America

United States Patent and Trademark Office

## Real ICE-EAZE

**Reg. No. 4,134,806**

**Registered May 1, 2012**

**Int. Cl.: 10**

**TRADEMARK**

**PRINCIPAL REGISTER**

ANRO INC (TEXAS CORPORATION)  
2919 CLIFF POINT  
SPICEWOOD, TX 78669

FOR: MEDICAL ICE PACKS, IN CLASS 10 (U.S. CLS. 26, 39 AND 44).

FIRST USE 6-9-2011; IN COMMERCE 6-9-2011.

THE MARK CONSISTS OF STANDARD CHARACTERS WITHOUT CLAIM TO ANY PARTICULAR FONT, STYLE, SIZE, OR COLOR.

NO CLAIM IS MADE TO THE EXCLUSIVE RIGHT TO USE "REAL", APART FROM THE MARK AS SHOWN.

SER. NO. 85-406,379, FILED 8-24-2011.

REBECCA POVARCHUK, EXAMINING ATTORNEY



*David J. Kyffers*

Director of the United States Patent and Trademark Office

# United States of America

United States Patent and Trademark Office



**Reg. No. 4,134,807**

**Registered May 1, 2012**

**Int. Cl.: 45**

**SERVICE MARK**

**PRINCIPAL REGISTER**

GIFT BASKETS AND DREAMS, INC. (NEVADA CORPORATION)  
1412 SUNBLUSH LANE  
LAS VEGAS, NV 89117

FOR: PREPARATION OF CUSTOMIZED GIFT BASKETS WITH SELECTED ITEMS REGARDING A PARTICULAR OCCASION OR THEME, IN CLASS 45 (U.S. CLS. 100 AND 101).

FIRST USE 6-15-2008; IN COMMERCE 6-15-2008.

NO CLAIM IS MADE TO THE EXCLUSIVE RIGHT TO USE "GIFT BASKETS", APART FROM THE MARK AS SHOWN.

THE MARK CONSISTS OF THE DESIGN OF A GIFT BASKET WRAPPED WITH RIBBON AND BOW AND CONTAINING A SLEEPING CRESCENT MOON WITH THE LETTERS "ZZZZ" EMANATING FROM THE MOON'S MOUTH. TO THE LEFT OF THE MOON CARICATURE THERE APPEARS A GIFT BOX DISPLAYING A RIBBON AND BOW. THE STYLIZED WORDING "GIFT BASKETS & DREAMS" APPEARS AS THE UPPER PORTION OF THE HANDLE OF A GIFT BASKET. BENEATH THE HANDLE APPEAR THREE SHOOTING STAR DESIGNS AND NINE STATIONARY STAR DESIGNS.

SER. NO. 85-406,478, FILED 8-24-2011.

GEOFFREY FOSDICK, EXAMINING ATTORNEY



*David J. Kyros*

Director of the United States Patent and Trademark Office

# United States of America

## United States Patent and Trademark Office

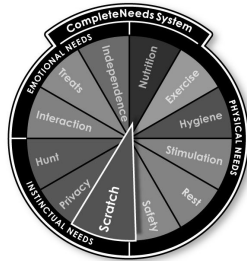

**Reg. No. 4,134,808**

**Registered May 1, 2012**

**Int. Cl.: 20**

**TRADEMARK**

**PRINCIPAL REGISTER**

WORLDWISE, INC. (CALIFORNIA CORPORATION)  
160 MITCHELL BOULEVARD  
SAN RAFAEL, CA 94903

FOR: CAT SCRATCHING PADS AND POSTS AND REPLACEMENT PADS THEREFOR, IN CLASS 20 (U.S. CLS. 2, 13, 22, 25, 32 AND 50).

FIRST USE 7-16-2004; IN COMMERCE 7-16-2004.

OWNER OF U.S. REG. NOS. 3,275,734 AND 3,857,569.

NO CLAIM IS MADE TO THE EXCLUSIVE RIGHT TO USE "SYSTEM" AND "PHYSICAL NEEDS INSTINCTUAL NEEDS EMOTIONAL NEEDS NUTRITION EXERCISE HYGIENE STIMULATION REST SAFETY SCRATCH PRIVACY HUNT INTERACTION TREATS INDEPENDENCE", APART FROM THE MARK AS SHOWN.

THE MARK CONSISTS OF A PIE CHART COMPRISED OF TWELVE PIECES FEATURING THE WORDING "NUTRITION," "EXERCISE," "HYGIENE," "STIMULATION," "REST," "SAFETY," "SCRATCH," "PRIVACY," "HUNT," "INTERACTION," "TREATS," AND "INDEPENDENCE." ALL PIE PIECES ARE SIZED EQUALLY WITH THE EXCEPTION OF THE PIECE OF THE PIE CONTAINING THE WORD "SCRATCH" WHICH IS LARGER THAN AND ELEVATED ABOVE THE OTHER ELEVEN PIECES OF THE PIE. THE PIE CHART CONSISTS OF A BORDER CONTAINING THE WORDING "PHYSICAL NEEDS," "INSTINCTUAL NEEDS," AND "EMOTIONAL NEEDS." THE WORDING "COMPLETENEEDS SYSTEM" IS SET IN THE OUTER MOST BORDER AT THE TOP OF THE PIE CHART.

SER. NO. 85-406,506, FILED 8-24-2011.

BARNEY CHARLON, EXAMINING ATTORNEY



*David J. Kyros*

Director of the United States Patent and Trademark Office

# United States of America

United States Patent and Trademark Office

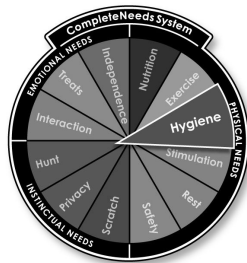

**Reg. No. 4,134,809**

**Registered May 1, 2012**

**Int. Cl.: 21**

**TRADEMARK**

**PRINCIPAL REGISTER**

WORLDWISE, INC. (CALIFORNIA CORPORATION)  
160 MITCHELL BOULEVARD  
SAN RAFAEL, CA 94903

FOR: PET LITTER BOX LINERS, IN CLASS 21 (U.S. CLS. 2, 13, 23, 29, 30, 33, 40 AND 50).

FIRST USE 4-3-2009; IN COMMERCE 4-3-2009.

OWNER OF U.S. REG. NOS. 3,275,734 AND 3,857,569.

NO CLAIM IS MADE TO THE EXCLUSIVE RIGHT TO USE "SYSTEM" AND "PHYSICAL NEEDS INSTINCTUAL NEEDS EMOTIONAL NEEDS NUTRITION EXERCISE HYGIENE STIMULATION REST SAFETY SCRATCH PRIVACY HUNT INTERACTION TREATS INDEPENDENCE", APART FROM THE MARK AS SHOWN.

THE MARK CONSISTS OF A PIE CHART COMPRISED OF TWELVE PIECES FEATURING THE WORDING "NUTRITION," "EXERCISE," "HYGIENE," "STIMULATION," "REST," "SAFETY," "SCRATCH," "PRIVACY," "HUNT," "INTERACTION," "TREATS," AND "INDEPENDENCE." ALL PIE PIECES ARE SIZED EQUALLY WITH THE EXCEPTION OF THE PIECE OF THE PIE CONTAINING THE WORD "HYGIENE" WHICH IS LARGER THAN AND ELEVATED ABOVE THE OTHER ELEVEN PIECES OF THE PIE. THE PIE CHART CONSISTS OF A BORDER CONTAINING THE WORDING "PHYSICAL NEEDS," "INSTINCTUAL NEEDS," AND "EMOTIONAL NEEDS." THE WORDING "COMPLETENEEDS SYSTEM" IS SET IN THE OUTER MOST BORDER AT THE TOP OF THE PIE CHART.

SER. NO. 85-406,522, FILED 8-24-2011.

BARNEY CHARLON, EXAMINING ATTORNEY



*David J. Kyros*

Director of the United States Patent and Trademark Office



# United States of America

United States Patent and Trademark Office

# BE NIMBL

**Reg. No. 4,134,810**

**Registered May 1, 2012**

**Int. Cl.: 42**

**SERVICE MARK**

**PRINCIPAL REGISTER**

NIMBL LLC (COLORADO LIMITED LIABILITY COMPANY)  
13914 JACKSON STREET  
THORNTON, CO 80602

FOR: IT CONSULTING SERVICES, IN CLASS 42 (U.S. CLS. 100 AND 101).

FIRST USE 1-0-2009; IN COMMERCE 1-0-2009.

THE MARK CONSISTS OF STANDARD CHARACTERS WITHOUT CLAIM TO ANY PARTICULAR FONT, STYLE, SIZE, OR COLOR.

OWNER OF U.S. REG. NO. 4,032,407.

SER. NO. 85-406,526, FILED 8-24-2011.

JENNIFER WILLISTON, EXAMINING ATTORNEY



*David J. Kyffers*

Director of the United States Patent and Trademark Office

# United States of America

United States Patent and Trademark Office

## Certified Criminal Investigator, CCI

**Reg. No. 4,134,811**

THE ROBERT L. O'BLOCK REVOCABLE TRUST (MISSOURI TRUST)  
2750 EAST SUNSHINE  
SPRINGFIELD, MO 65804

**Registered May 1, 2012**

**Int. Cl.: 42**

FOR: TESTING, ANALYSIS, AND EVALUATION FOR THE PURPOSE OF CERTIFICATION  
IN THE FIELD OF CRIMINAL INVESTIGATION, IN CLASS 42 (U.S. CLS. 100 AND 101).

**SERVICE MARK**

FIRST USE 8-24-2011; IN COMMERCE 8-24-2011.

**PRINCIPAL REGISTER**

THE MARK CONSISTS OF STANDARD CHARACTERS WITHOUT CLAIM TO ANY PAR-  
TICULAR FONT, STYLE, SIZE, OR COLOR.

NO CLAIM IS MADE TO THE EXCLUSIVE RIGHT TO USE "CERTIFIED CRIMINAL IN-  
VESTIGATOR", APART FROM THE MARK AS SHOWN.

SER. NO. 85-406,534, FILED 8-24-2011.

JEFFREY LOOK, EXAMINING ATTORNEY



*David J. Kyffers*

Director of the United States Patent and Trademark Office

# United States of America

United States Patent and Trademark Office

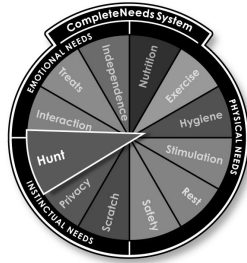

**Reg. No. 4,134,812**

**Registered May 1, 2012**

**Int. Cl.: 28**

**TRADEMARK**

**PRINCIPAL REGISTER**

WORLDWISE, INC. (CALIFORNIA CORPORATION)  
160 MITCHELL BOULEVARD  
SAN RAFAEL, CA 94903

FOR: PET TOYS, IN CLASS 28 (U.S. CLS. 22, 23, 38 AND 50).

FIRST USE 3-15-2006; IN COMMERCE 3-15-2006.

OWNER OF U.S. REG. NOS. 3,275,734 AND 3,857,569.

NO CLAIM IS MADE TO THE EXCLUSIVE RIGHT TO USE "SYSTEM" AND "PHYSICAL NEEDS INSTINCTUAL NEEDS EMOTIONAL NEEDS NUTRITION EXERCISE HYGIENE STIMULATION REST SAFETY SCRATCH PRIVACY HUNT INTERACTION TREATS INDEPENDENCE", APART FROM THE MARK AS SHOWN.

THE MARK CONSISTS OF A PIE CHART COMPRISED OF TWELVE PIECES FEATURING THE WORDING "NUTRITION," "EXERCISE," "HYGIENE," "STIMULATION," "REST," "SAFETY," "SCRATCH," "PRIVACY," "HUNT," "INTERACTION," "TREATS," AND "INDEPENDENCE." ALL PIE PIECES ARE SIZED EQUALLY WITH THE EXCEPTION OF THE PIECE OF THE PIE CONTAINING THE WORD "HUNT" WHICH IS LARGER THAN AND ELEVATED ABOVE THE OTHER ELEVEN PIECES OF THE PIE. THE PIE CHART CONSISTS OF A BORDER CONTAINING THE WORDING "PHYSICAL NEEDS," "INSTINCTUAL NEEDS," AND "EMOTIONAL NEEDS." THE WORDING "COMPLETENEEEDS SYSTEM" IS SET IN THE OUTER MOST BORDER AT THE TOP OF THE PIE CHART.

SER. NO. 85-406,535, FILED 8-24-2011.

BARNEY CHARLON, EXAMINING ATTORNEY



*David J. Kyros*

Director of the United States Patent and Trademark Office

# United States of America

## United States Patent and Trademark Office

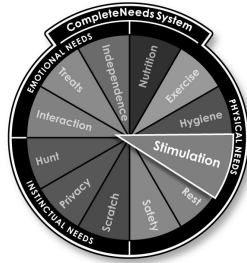

**Reg. No. 4,134,813**

**Registered May 1, 2012**

**Int. Cl.: 31**

**TRADEMARK**

**PRINCIPAL REGISTER**

WORLDWISE, INC. (CALIFORNIA CORPORATION)  
160 MITCHELL BOULEVARD  
SAN RAFAEL, CA 94903

FOR: CATNIP, IN CLASS 31 (U.S. CLS. 1 AND 46).

FIRST USE 7-16-2004; IN COMMERCE 7-16-2004.

OWNER OF U.S. REG. NOS. 3,275,734 AND 3,857,569.

NO CLAIM IS MADE TO THE EXCLUSIVE RIGHT TO USE "SYSTEM" AND "PHYSICAL NEEDS INSTINCTUAL NEEDS EMOTIONAL NEEDS NUTRITION EXERCISE HYGIENE STIMULATION REST SAFETY SCRATCH PRIVACY HUNT INTERACTION TREATS INDEPENDENCE", APART FROM THE MARK AS SHOWN.

THE MARK CONSISTS OF A PIE CHART COMPRISED OF TWELVE PIECES FEATURING THE WORDING "NUTRITION," "EXERCISE," "HYGIENE," "STIMULATION," "REST," "SAFETY," "SCRATCH," "PRIVACY," "HUNT," "INTERACTION," "TREATS," AND "INDEPENDENCE." ALL PIE PIECES ARE SIZED EQUALLY WITH THE EXCEPTION OF THE PIECE OF THE PIE CONTAINING THE WORD "STIMULATION" WHICH IS LARGER THAN AND ELEVATED ABOVE THE OTHER ELEVEN PIECES OF THE PIE. THE PIE CHART CONSISTS OF A BORDER CONTAINING THE WORDING "PHYSICAL NEEDS," "INSTINCTUAL NEEDS," AND "EMOTIONAL NEEDS." THE WORDING "COMPLETENEDS SYSTEM" IS SET IN THE OUTER MOST BORDER AT THE TOP OF THE PIE CHART.

SER. NO. 85-406,540, FILED 8-24-2011.

BARNEY CHARLON, EXAMINING ATTORNEY



*David J. Kyros*

Director of the United States Patent and Trademark Office

# United States of America

## United States Patent and Trademark Office

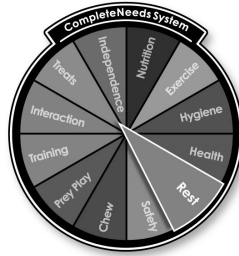

**Reg. No. 4,134,814**

**Registered May 1, 2012**

**Int. Cl.: 20**

**TRADEMARK**

**PRINCIPAL REGISTER**

WORLDWISE, INC. (CALIFORNIA CORPORATION)  
160 MITCHELL BOULEVARD  
SAN RAFAEL, CA 94903

FOR: PET BEDS, IN CLASS 20 (U.S. CLS. 2, 13, 22, 25, 32 AND 50).

FIRST USE 7-26-2006; IN COMMERCE 7-26-2006.

OWNER OF U.S. REG. NOS. 3,275,734 AND 3,857,569.

NO CLAIM IS MADE TO THE EXCLUSIVE RIGHT TO USE "SYSTEM" AND "PHYSICAL NEEDS INSTINCTUAL NEEDS EMOTIONAL NEEDS NUTRITION EXERCISE HYGIENE STIMULATION REST SAFETY SCRATCH PRIVACY HUNT INTERACTION TREATS INDEPENDENCE", APART FROM THE MARK AS SHOWN.

THE MARK CONSISTS OF A PIE CHART COMPRISED OF TWELVE PIECES FEATURING THE WORDING "NUTRITION," "EXERCISE," "HYGIENE," "STIMULATION," "REST," "SAFETY," "SCRATCH," "PRIVACY," "HUNT," "INTERACTION," "TREATS," AND "INDEPENDENCE." ALL PIE PIECES ARE SIZED EQUALLY WITH THE EXCEPTION OF THE PIECE OF THE PIE CONTAINING THE WORD "REST" WHICH IS LARGER THAN AND ELEVATED ABOVE THE OTHER ELEVEN PIECES OF THE PIE. THE PIE CHART CONSISTS OF A BORDER CONTAINING THE WORDING "PHYSICAL NEEDS," "INSTINCTUAL NEEDS," AND "EMOTIONAL NEEDS." THE WORDING "COMPLETENEEDS SYSTEM" IS SET IN THE OUTER MOST BORDER AT THE TOP OF THE PIE CHART.

SER. NO. 85-406,550, FILED 8-24-2011.

BARNEY CHARLON, EXAMINING ATTORNEY



*David J. Kyjars*

Director of the United States Patent and Trademark Office

# United States of America

United States Patent and Trademark Office

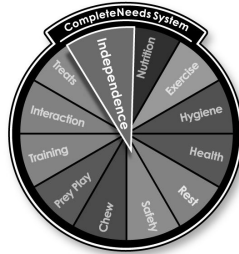

**Reg. No. 4,134,815**

**Registered May 1, 2012**

**Int. Cl.: 28**

**TRADEMARK**

**PRINCIPAL REGISTER**

WORLDWISE, INC. (CALIFORNIA CORPORATION)  
160 MITCHELL BOULEVARD  
SAN RAFAEL, CA 94903

FOR: PET TOYS, IN CLASS 28 (U.S. CLS. 22, 23, 38 AND 50).

FIRST USE 4-9-2008; IN COMMERCE 4-9-2008.

OWNER OF U.S. REG. NOS. 3,275,734 AND 3,857,569.

NO CLAIM IS MADE TO THE EXCLUSIVE RIGHT TO USE "SYSTEM" AND "NUTRITION EXERCISE HYGIENE HEALTH REST SAFETY CHEW PREY PLAY TRAINING INTERACTION TREATS INDEPENDENCE", APART FROM THE MARK AS SHOWN.

THE MARK CONSISTS OF A PIE CHART COMPRISED OF TWELVE PIECES FEATURING THE WORDING "NUTRITION," "EXERCISE," "HYGIENE," "HEALTH," "REST," "SAFETY," "CHEW," "PREY PLAY," "TRAINING," "INTERACTION," "TREATS," AND "INDEPENDENCE." ALL PIE PIECES ARE SIZED EQUALLY WITH THE EXCEPTION OF THE PIECE OF THE PIE CONTAINING THE WORD "INDEPENDENCE" WHICH IS LARGER THAN AND ELEVATED ABOVE THE OTHER ELEVEN PIECES OF THE PIE. THE WORDING "COMPLETENEEDS SYSTEM" IS SET IN THE BORDER AT THE TOP OF THE PIE CHART.

SER. NO. 85-406,575, FILED 8-24-2011.

BARNEY CHARLON, EXAMINING ATTORNEY



*David J. Kyjars*

Director of the United States Patent and Trademark Office

# United States of America

United States Patent and Trademark Office

## healincomfort.com

**Reg. No. 4,134,816**

**Registered May 1, 2012**

**Int. Cl.: 10**

**TRADEMARK**

**PRINCIPAL REGISTER**

MATHEWS, CHERIE (UNITED STATES INDIVIDUAL)  
7529 HARLOW DR  
AUSTIN, TX 78739

FOR: MEDICAL APPAREL USED FOR POST-OPERATIVE UPPER EXTREMITY SURGERIES, NAMELY, SHIRTS WITH HOOK AND LOOP FASTENERS UP THE MIDDLE FOR EASY DRESSING, WITH INTERNAL POCKETS TO HOLD SURGICAL DRAINS , IN CLASS 10 (U.S. CLS. 26, 39 AND 44).

FIRST USE 1-0-2009; IN COMMERCE 4-0-2009.

THE MARK CONSISTS OF STANDARD CHARACTERS WITHOUT CLAIM TO ANY PARTICULAR FONT, STYLE, SIZE, OR COLOR.

SER. NO. 85-406,578, FILED 8-24-2011.

BILL DAWE, EXAMINING ATTORNEY



*David J. Kyffers*

Director of the United States Patent and Trademark Office

# United States of America

United States Patent and Trademark Office

## Septic System Saver

**Reg. No. 4,134,817**

**Registered May 1, 2012**

**Int. Cl.: 11**

**TRADEMARK**

**PRINCIPAL REGISTER**

KARL K. HOLT (UNITED STATES INDIVIDUAL)  
N78 W29098 FLYNN ROAD  
HARTLAND, WI 53029

FOR: BIOLOGICAL CONTACTOR FOR TREATMENT OF SEWAGE AND DRAINAGE WATER; BIOREACTOR FOR USE IN THE TREATMENT OF WASTEWATER; WASTE WATER PURIFICATION APPARATUS, INSTALLATIONS AND TANKS , IN CLASS 11 (U.S. CLS. 13, 21, 23, 31 AND 34).

FIRST USE 8-24-2011; IN COMMERCE 8-24-2011.

THE MARK CONSISTS OF STANDARD CHARACTERS WITHOUT CLAIM TO ANY PARTICULAR FONT, STYLE, SIZE, OR COLOR.

NO CLAIM IS MADE TO THE EXCLUSIVE RIGHT TO USE "SEPTIC SYSTEM", APART FROM THE MARK AS SHOWN.

SER. NO. 85-406,635, FILED 8-24-2011.

JANET LEE, EXAMINING ATTORNEY



*David J. Kyffers*

Director of the United States Patent and Trademark Office



# United States of America

United States Patent and Trademark Office



**Reg. No. 4,134,818**

**Registered May 1, 2012**

**Int. Cl.: 28**

**TRADEMARK**

**PRINCIPAL REGISTER**

APS AIRGUN LIMITED (HONG KONG LIMITED LIABILITY COMPANY)  
UNIT B, 22/F, RICHWEALTH INDUSTRIAL BLDG  
77 WANG LUNG STREET  
TSUEN WAN, HONG KONG

FOR: TOY PISTOLS; TOY AIR PISTOLS; WATER PISTOLS; TOY AEROSOL ACTUATOR GUNS; TOY HARPOON GUNS; TOY GUNS; PAINTBALL GUNS; SPORTING APPARATUS, NAMELY, AMMUNITION FOR PAINTBALL GUNS; SPORTING APPARATUS, NAMELY, PAINTBALL GUNS; PAINTBALL MARKERS; PAINTBALL PISTOLS; PAINTBALL RIFLES; MARKER FLAGS FOR USE IN SPORTS AND ATHLETICS, IN CLASS 28 (U.S. CLS. 22, 23, 38 AND 50).

FIRST USE 6-1-2011; IN COMMERCE 6-1-2011.

THE MARK CONSISTS OF VARIOUS GEOMETRIC SHAPES. AT THE CENTER OF THE MARK IS AN INNER CONVEX TRIANGLE, WITH ITS LINES EXTENDING AND OVERLAPPING AT EACH VERTEX TO CREATE THREE CURVED QUADRILATERALS, AND THE INNER TRIANGLE AND THREE QUADRILATERAL DESIGNS ARE WITHIN AN OUTER CONVEX TRIANGLE. THE MARK APPEARS ON A SHADED BACKGROUND TO EMPHASIZE THE DETAILS OF THE VARIOUS GEOMETRIC SHAPES.

SER. NO. 85-406,678, FILED 8-25-2011.

JUDITH HELFMAN, EXAMINING ATTORNEY



*David J. Kybas*

Director of the United States Patent and Trademark Office

# United States of America

United States Patent and Trademark Office



**Reg. No. 4,134,819**

**Registered May 1, 2012**

**Int. Cl.: 2**

**TRADEMARK**

**PRINCIPAL REGISTER**

DAVID TAI-AN CHEN (TAIWAN INDIVIDUAL)  
9F-5 NO.760 SEC.4 BADE RD.  
TAIPEI, TAIWAN 105

FOR: INK JET PRINTER INK, IN CLASS 2 (U.S. CLS. 6, 11 AND 16).

FIRST USE 8-8-2011; IN COMMERCE 8-8-2011.

THE MARK CONSISTS OF THE STYLIZED WORDING "INKFINITY" WITH THE "INK" PORTION IN WHITE AND THE "FINITY" PORTION IN GREEN WITH A GREEN OVAL AROUND THE "INK" PORTION AND WITH THREE LIGHT GREEN OVALS TO THE UPPER LEFT OF THE MARK DESCENDING AND WITH THE SECOND ONE DOWN BEING SMALLER THAN THE TOP ONE AND THE THIRD ONE DOWN BEING SMALLER THAN THE SECOND ONE.

THE COLOR(S) GREEN AND WHITE IS/ARE CLAIMED AS A FEATURE OF THE MARK.

SER. NO. 85-406,715, FILED 8-25-2011.

KELLEY WELLS, EXAMINING ATTORNEY



*David J. Kybas*

Director of the United States Patent and Trademark Office

# United States of America

United States Patent and Trademark Office



## BEVERLY HILLS FILM FESTIVAL

**Reg. No. 4,134,820**

**Registered May 1, 2012**

**Int. Cls.: 25 and 41**

**TRADEMARK**

**SERVICE MARK**

**PRINCIPAL REGISTER**

BEVERLY HILLS FILM FESTIVAL (CALIFORNIA CORPORATION)  
9663 SANTA MONICA BLVD UNIT 777  
BEVERLY HILLS, CA 90210

FOR: SHIRTS AND CAPS, IN CLASS 25 (U.S. CLS. 22 AND 39).

FIRST USE 10-1-2004; IN COMMERCE 10-1-2004.

FOR: ENTERTAINMENT SERVICES, NAMELY, CONDUCTING A SERIES OF FILM FESTIVALS, IN CLASS 41 (U.S. CLS. 100, 101 AND 107).

FIRST USE 12-9-2002; IN COMMERCE 12-9-2002.

NO CLAIM IS MADE TO THE EXCLUSIVE RIGHT TO USE "FILM FESTIVAL", APART FROM THE MARK AS SHOWN.

THE MARK CONSISTS OF THE WORDS "BEVERLY HILLS" ABOVE A LINE WITH A BREAK IN THE MIDDLE AND THE WORDS "FILM FESTIVAL" DIRECTLY BELOW THE SAME LINE WITH A BRANCH TO THE LEFT OF THE WORDS, FURTHER COMPRISED OF A SHAFT WITH ELEVEN LEAVES PROTRUDING FROM THE LEFT AND RIGHT SIDES OF THE SHAFT IN AN ALTERNATING FASHION.

SEC. 2(F).

SER. NO. 85-406,782, FILED 8-25-2011.

EDWARD FENNESSY, EXAMINING ATTORNEY



*David J. Kyros*

Director of the United States Patent and Trademark Office

# United States of America

United States Patent and Trademark Office



**FARM**  
*to*  
**CLUB**  
LOCALLY  
GROWN

**Reg. No. 4,134,821**

**Registered May 1, 2012**

**Int. Cl.: 31**

**TRADEMARK**

**PRINCIPAL REGISTER**

STRATHMORE PARTNERS, LP (DELAWARE LIMITED PARTNERSHIP)  
214 NORTH MAIN STREET  
CONCORD, NH 033021415

FOR: FRESH VEGETABLES, NAMELY, CUCUMBERS, YELLOW SQUASH, ZUCCHINI SQUASH AND TOMATOES, IN CLASS 31 (U.S. CLS. 1 AND 46).

FIRST USE 6-24-2011; IN COMMERCE 6-24-2011.

NO CLAIM IS MADE TO THE EXCLUSIVE RIGHT TO USE "LOCALLY GROWN", APART FROM THE MARK AS SHOWN.

THE MARK CONSISTS OF A DRAWING OF A FARMER RIDING A TRACTOR WITH A BARN AND BARBED WIRE FENCE IN THE BACKGROUND. THIS DRAWING IS PLACED TO THE LEFT OF THE WORDS IN DESCENDING AND CENTERED ORDER: "FARM TO CLUB LOCALLY GROWN".

SER. NO. 85-406,845, FILED 8-25-2011.

JOHN WILKE, EXAMINING ATTORNEY



*David J. Kyffers*

Director of the United States Patent and Trademark Office

# United States of America

United States Patent and Trademark Office

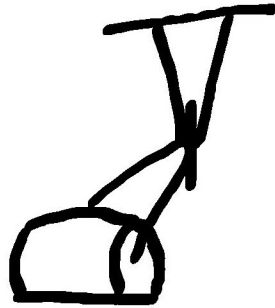

**Reg. No. 4,134,822**

**Registered May 1, 2012**

**Int. Cl.: 25**

**TRADEMARK**

**PRINCIPAL REGISTER**

HENRY, STEVEN (UNITED STATES INDIVIDUAL)  
17384 RIVA RIDGE DRIVE  
MORENO VALLEY, CA 92555

FOR: HATS; JACKETS; PANTS; SHIRTS; SHOES; SWEAT SHIRTS; UNDERGARMENTS;  
WRISTBANDS, IN CLASS 25 (U.S. CLS. 22 AND 39).

FIRST USE 1-20-2006; IN COMMERCE 2-25-2007.

THE MARK CONSISTS OF AN ABSTRACT DESIGN OF A SCOOTER.

SER. NO. 85-406,852, FILED 8-25-2011.

LANA PHAM, EXAMINING ATTORNEY



*David J. Kybas*

Director of the United States Patent and Trademark Office

# United States of America

United States Patent and Trademark Office

# IWF

**Reg. No. 4,134,823**

**Registered May 1, 2012**

**Int. Cls.: 35 and 41**

**SERVICE MARK**

**PRINCIPAL REGISTER**

INTERNATIONAL WOMEN'S FORUM (D.C. CORPORATION)  
2120 L STREET, N.W., SUITE 460  
WASHINGTON, DC 20037

FOR: ASSOCIATION SERVICES, NAMELY, PROMOTING BUSINESS, POLITICS, EDUCATION, AND EXECUTIVE MANAGEMENT LEADERSHIP AND THE INTEREST OF WOMEN IN THE AFOREMENTIONED FIELDS; ARRANGING AND CONDUCTING BUSINESS CONFERENCES ON ISSUES RELATING TO LEADERSHIP AND WOMEN'S LEADERSHIP IN BUSINESS, POLITICS, AND EDUCATION; BUSINESS NETWORKING AND COLLABORATION SERVICES, NAMELY, FACILITATING PEER TO PEER EXCHANGES OF IDEAS AND INFORMATION AMONG FUTURE LEADERS AND WOMEN; CHARITABLE SERVICES, NAMELY, ORGANIZING AND DEVELOPING PROJECTS TO SUPPORT FUTURE LEADERS AND WOMEN IN BUSINESS, POLITICS, EDUCATION, AND EXECUTIVE MANAGEMENT; PROVIDING BUSINESS INFORMATION AND BUSINESS RESEARCH ABOUT FUTURE LEADERS AND WOMEN IN BUSINESS, POLITICS, EDUCATION, AND EXECUTIVE MANAGEMENT, IN CLASS 35 (U.S. CLS. 100, 101 AND 102).

FIRST USE 0-0-1990; IN COMMERCE 0-0-1990.

FOR: EDUCATIONAL SERVICES, NAMELY, CONDUCTING CONFERENCES, SEMINARS, WORKSHOPS, AND DISCUSSION GROUPS RELATING TO LEADERSHIP AND WOMEN'S LEADERSHIP IN BUSINESS, POLITICS, EDUCATION, AND EXECUTIVE MANAGEMENT; PROVIDING ONE-ON-ONE MENTORING TO SUPPORT FUTURE LEADERS AND WOMEN IN BUSINESS, POLITICS, EDUCATION, AND EXECUTIVE MANAGEMENT, IN CLASS 41 (U.S. CLS. 100, 101 AND 107).

FIRST USE 0-0-1990; IN COMMERCE 0-0-1990.

THE MARK CONSISTS OF STANDARD CHARACTERS WITHOUT CLAIM TO ANY PARTICULAR FONT, STYLE, SIZE, OR COLOR.

SER. NO. 85-406,910, FILED 8-25-2011.

KEVIN DINALLO, EXAMINING ATTORNEY



*David J. Kyros*

Director of the United States Patent and Trademark Office

# United States of America

United States Patent and Trademark Office



**Reg. No. 4,134,824**

**Registered May 1, 2012**

**Int. Cls.: 35, 41, 43, 44  
and 45**

**SERVICE MARK**

**PRINCIPAL REGISTER**

WOMEN AGAINST ABUSE, INC. (PENNSYLVANIA NON-PROFIT CORPORATION)  
100 SOUTH BROAD STREET, SUITE 1341  
PHILADELPHIA, PA 19110

FOR: CHARITABLE SERVICES FOR VICTIMS OF DOMESTIC VIOLENCE AND THEIR FAMILIES, NAMELY, PUBLIC POLICY ADVOCACY TO PROMOTE PUBLIC AWARENESS OF DOMESTIC VIOLENCE AND CHANGE LEGISLATION AND COMMUNITY RESPONSE TO PREVENT DOMESTIC VIOLENCE, IN CLASS 35 (U.S. CLS. 100, 101 AND 102).

FIRST USE 0-0-1976; IN COMMERCE 0-0-1976.

FOR: CHARITABLE SERVICES FOR THE PUBLIC, NAMELY, COMMUNITY EDUCATION TO PREVENT DOMESTIC VIOLENCE IN THE NATURE OF CLASSES AND SEMINARS; CHARITABLE SERVICES FOR VICTIMS OF DOMESTIC VIOLENCE AND THEIR FAMILIES, NAMELY, TRAINING OF OTHERS ABOUT DOMESTIC VIOLENCE ISSUES; AFTER SCHOOL AND SUMMER PROGRAMS FOR CHILDREN, IN CLASS 41 (U.S. CLS. 100, 101 AND 107).

FIRST USE 0-0-1976; IN COMMERCE 0-0-1976.

FOR: CHARITABLE SERVICES FOR VICTIMS OF DOMESTIC VIOLENCE AND THEIR FAMILIES, NAMELY, EMERGENCY SHELTER SERVICES, LONGTERM HOUSING SERVICES, IN CLASS 43 (U.S. CLS. 100 AND 101).

FIRST USE 0-0-1976; IN COMMERCE 0-0-1976.

FOR: CHARITABLE SERVICES FOR VICTIMS OF DOMESTIC VIOLENCE AND THEIR FAMILIES, NAMELY, BEHAVIORAL HEALTH COUNSELING SERVICES, IN CLASS 44 (U.S. CLS. 100 AND 101).

FIRST USE 0-0-1976; IN COMMERCE 0-0-1976.

FOR: CHARITABLE SERVICES FOR VICTIMS OF DOMESTIC VIOLENCE AND THEIR FAMILIES, NAMELY, COUNSELING AND INTERVENTION SERVICES IN THE NATURE OF PROVIDING PERSONAL SUPPORT SERVICES FOR VICTIMS AND FAMILY OF VICTIMS NAMELY EMOTIONAL COUNSELING AND EMOTIONAL SUPPORT SERVICES; CHARITABLE SERVICES FOR VICTIMS OF DOMESTIC VIOLENCE AND THEIR FAMILIES,



*David J. Kyjars*

Director of the United States Patent and Trademark Office

**Reg. No. 4,134,824** NAMELY, LEGAL SERVICES AND DOMESTIC VIOLENCE HOTLINE SERVICES, IN CLASS 45 (U.S. CLS. 100 AND 101).

FIRST USE 0-0-1976; IN COMMERCE 0-0-1976.

OWNER OF U.S. REG. NOS. 4,000,956 AND 4,000,957.

THE COLOR(S) PURPLE AND WHITE IS/ARE CLAIMED AS A FEATURE OF THE MARK.

THE MARK CONSISTS OF A DEPICTION OF A PROFILE OF A FACE IN PURPLE AND A PROFILE OF A FACE IN WHITE WHICH FADES INTO A PURPLE BANNER. BELOW THE BANNER ARE THE WORDS "WOMEN AGAINST ABUSE" IN PURPLE. BELOW THE WORDS "WOMEN AGAINST ABUSE" IS A PURPLE LINE. BELOW THE PURPLE LINE ARE THE WORDS "ADVOCACY IN ACTION" IN PURPLE.

SEC. 2(F) AS TO "WOMEN AGAINST ABUSE".

SER. NO. 85-406,918, FILED 8-25-2011.

NICHOLAS COLEMAN, EXAMINING ATTORNEY



# United States of America

United States Patent and Trademark Office

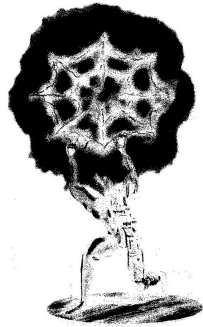

**Reg. No. 4,134,825**

**Registered May 1, 2012**

**Int. Cl.: 42**

**SERVICE MARK**

**PRINCIPAL REGISTER**

VIRUAL IT BY DESIGN, LLC (CALIFORNIA LIMITED LIABILITY COMPANY)  
6247 OCHO RIOS DRIVE  
SAN JOSE, CA 95123

FOR: COMPUTER SECURITY CONSULTANCY; CONSULTING IN THE FIELD OF IT PROJECT MANAGEMENT; DESIGN FOR OTHERS IN THE FIELD OF INFORMATION TECHNOLOGY SYSTEMS; IT CONSULTING SERVICES; IT INTEGRATION SERVICES, IN CLASS 42 (U.S. CLS. 100 AND 101).

FIRST USE 1-1-1995; IN COMMERCE 1-1-1995.

THE MARK CONSISTS OF A DESIGN OF A STYLIZED HUMAN FIGURE RAISING A LARGE CLOUD-LIKE SHAPE ABOVE ITS HEAD LIKE ATLAS. INSIDE THE CLOUD SHAPE THERE ARE RADIATING LINES CONNECTED LIKE A SPIDER WEB.

SER. NO. 85-406,925, FILED 8-25-2011.

CORY BOONE, EXAMINING ATTORNEY



*David J. Kybas*

Director of the United States Patent and Trademark Office

# United States of America

United States Patent and Trademark Office

# DYNEPO

**Reg. No. 4,134,826**

**Registered May 1, 2012**

**Int. Cl.: 5**

**TRADEMARK**

**PRINCIPAL REGISTER**

HOECHST GMBH (FED REP GERMANY CORPORATION)  
BRÜNINGSTRASSE 50  
FRANKFURT AM MAIN, FED REP GERMANY 65926

FOR: PHARMACEUTICAL PREPARATIONS FOR THE TREATMENT OF BLOOD DISORDERS AND CARDIOVASCULAR DISEASES, IN CLASS 5 (U.S. CLS. 6, 18, 44, 46, 51 AND 52).

THE MARK CONSISTS OF STANDARD CHARACTERS WITHOUT CLAIM TO ANY PARTICULAR FONT, STYLE, SIZE, OR COLOR.

OWNER OF FED REP GERMANY REG. NO. 30010356, DATED 4-11-2000, RENEWED AS REG. NO. 30010356.5, DATED 3-1-2010, EXPIRES 2-29-2020.

OWNER OF U.S. REG. NO. 2,984,421.

SER. NO. 85-406,932, FILED 8-25-2011.

CORY BOONE, EXAMINING ATTORNEY



*David J. Kybas*

Director of the United States Patent and Trademark Office

# United States of America

United States Patent and Trademark Office



**Reg. No. 4,134,827**

**Registered May 1, 2012**

**Int. Cl.: 41**

**SERVICE MARK**

**PRINCIPAL REGISTER**

GOLF IN SCHOOLS, LLC (TEXAS LIMITED LIABILITY COMPANY)  
429 CROOKED CRK.  
BUDA, TX 78610

FOR: SPORTS INSTRUCTION SERVICES, IN CLASS 41 (U.S. CLS. 100, 101 AND 107).

FIRST USE 2-1-2010; IN COMMERCE 3-1-2010.

NO CLAIM IS MADE TO THE EXCLUSIVE RIGHT TO USE "GOLF IN SCHOOLS", APART FROM THE MARK AS SHOWN.

THE MARK CONSISTS OF AN APPLE ON THE LEFT SIDE OF THE WORDS, THE WORD "GOLF" ON THE TOP LINE, WITH A GOLF BALL DESIGN FOR THE "O", AND THE WORDS "IN SCHOOLS" WRITTEN UNDERNEATH "GOLF".

SER. NO. 85-406,986, FILED 8-25-2011.

MARK SHINER, EXAMINING ATTORNEY



*David J. Kybas*

Director of the United States Patent and Trademark Office

United States of America  
United States Patent and Trademark Office

COVERYS

**Reg. No. 4,134,828**

**Registered May 1, 2012**

**Int. Cl.: 36**

**SERVICE MARK**

**PRINCIPAL REGISTER**

MEDICAL PROFESSIONAL MUTUAL INSURANCE COMPANY (MASSACHUSETTS CORPORATION)  
101 ARCH STREET  
BOSTON, MA 02110

FOR: UNDERWRITING PROFESSIONAL LIABILITY INSURANCE; UNDERWRITING LIABILITY INSURANCE FOR HEALTH CARE PROVIDERS; INSURANCE ADMINISTRATION SERVICES; INSURANCE ACTUARIAL SERVICES; ASSESSING INSURANCE CLAIMS; INSURANCE CLAIMS PROCESSING SERVICES; FINANCIAL RISK MANAGEMENT; INSURANCE AGENCY AND BROKERAGE SERVICES; CONSULTING AND INFORMATION CONCERNING INSURANCE, IN CLASS 36 (U.S. CLS. 100, 101 AND 102).

FIRST USE 7-25-2011; IN COMMERCE 7-25-2011.

OWNER OF U.S. REG. NO. 4,057,736.

THE MARK CONSISTS OF THE WORD "COVERYS" IN STYLIZED LETTERS.

SER. NO. 85-406,991, FILED 8-25-2011.

JULIE WATSON, EXAMINING ATTORNEY



*David J. Kyffers*

Director of the United States Patent and Trademark Office

# United States of America

United States Patent and Trademark Office

## TMACS INC DISCOVER PERFORMANCE

**Reg. No. 4,134,829**

**Registered May 1, 2012**

**Int. Cl.: 41**

**SERVICE MARK**

**PRINCIPAL REGISTER**

TMACS INC (NORTH CAROLINA CORPORATION)  
65 BEAVER LANE  
PINEHURST, NC 28374

FOR: TRAINING SERVICES IN THE FIELD OF FIREARM OPERATION, COMBAT, AND MILITARY AND LAW ENFORCEMENT STRATEGY, IN CLASS 41 (U.S. CLS. 100, 101 AND 107).

FIRST USE 6-1-2010; IN COMMERCE 6-1-2010.

THE MARK CONSISTS OF STANDARD CHARACTERS WITHOUT CLAIM TO ANY PARTICULAR FONT, STYLE, SIZE, OR COLOR.

NO CLAIM IS MADE TO THE EXCLUSIVE RIGHT TO USE "INC" AND "PERFORMANCE", APART FROM THE MARK AS SHOWN.

SER. NO. 85-407,011, FILED 8-25-2011.

NAKIA HENRY, EXAMINING ATTORNEY



*David J. Kybas*

Director of the United States Patent and Trademark Office

# United States of America

United States Patent and Trademark Office

# AMERiDENT

**Reg. No. 4,134,830**

**Registered May 1, 2012**

**Int. Cl.: 36**

**SERVICE MARK**

**PRINCIPAL REGISTER**

AMERIDENT (NEW JERSEY LIMITED LIABILITY COMPANY)  
110 AVIGNON ROAD  
MONROE, NJ 08831

FOR: FINANCING SERVICES, NAMELY, PROVIDING FINANCING FOR THE PRACTICES OF DENTISTS, AND PROVIDING FINANCING TO PATIENTS THROUGH THEIR DOCTORS AND DENTISTS FOR CARE RECEIVED, IN CLASS 36 (U.S. CLS. 100, 101 AND 102).

FIRST USE 10-2-2010; IN COMMERCE 10-2-2010.

THE MARK CONSISTS OF STANDARD CHARACTERS WITHOUT CLAIM TO ANY PARTICULAR FONT, STYLE, SIZE, OR COLOR.

OWNER OF U.S. REG. NO. 3,970,144.

SER. NO. 85-407,025, FILED 8-25-2011.

DOUGLAS LEE, EXAMINING ATTORNEY



*David J. Kyffers*

Director of the United States Patent and Trademark Office

# United States of America

United States Patent and Trademark Office

The logo for "Coco Bolos" features the words "Coco Bolos" in a highly decorative, cursive script. Below the text is a stylized silhouette of a chili pepper, which is part of the trademark.

**Reg. No. 4,134,831**

**Registered May 1, 2012**

**Int. Cl.: 43**

**SERVICE MARK**

**PRINCIPAL REGISTER**

COCO BOLOS, INC. (KANSAS CORPORATION)  
1227 BLUEMONT AVE.  
MANHATTAN, KS 66502

FOR: RESTAURANT AND CATERING SERVICES, IN CLASS 43 (U.S. CLS. 100 AND 101).

FIRST USE 10-1-1998; IN COMMERCE 10-1-1998.

THE MARK CONSISTS OF THE WORDS "COCO BOLOS" IN FANCIFUL LETTERS WITH A CHILI PEPPER BELOW.

SER. NO. 85-407,058, FILED 8-25-2011.

JULIE WATSON, EXAMINING ATTORNEY



*David J. Kybas*

Director of the United States Patent and Trademark Office

United States of America  
United States Patent and Trademark Office



**Reg. No. 4,134,832**

HEALTHSUN HEALTH PLANS, INC. (FLORIDA CORPORATION)  
1205 SOUTHWEST 37TH AVENUE, 2ND FLOOR  
MIAMI, FL 33135

**Registered May 1, 2012**

**Int. Cl.: 44**

FOR: PROVIDING COMPREHENSIVE HEALTH CARE SERVICES IN THE NATURE OF A HEALTH MAINTENANCE ORGANIZATION, IN CLASS 44 (U.S. CLS. 100 AND 101).

**SERVICE MARK**

FIRST USE 8-0-2003; IN COMMERCE 8-0-2003.

**PRINCIPAL REGISTER**

NO CLAIM IS MADE TO THE EXCLUSIVE RIGHT TO USE "HEALTH PLANS", APART FROM THE MARK AS SHOWN.

THE MARK CONSISTS OF THE LITERAL ELEMENTS "HEALTHSUN HEALTH PLANS" WITH AN OPAQUE CRESCENT MOON SHAPE ARCHING OVER A PORTION OF THE SECOND "H" AND THE LETTERS "SUN" IN "HEALTHSUN". THE WORD "HEALTHSUN" IS UNDERLINED, AND THE PHRASE "HEALTH PLANS" APPEARS JUST BELOW IT IN SMALLER FONT.

SER. NO. 85-407,161, FILED 8-25-2011.

CIMMERIAN COLEMAN, EXAMINING ATTORNEY



*David J. Kyros*

Director of the United States Patent and Trademark Office



# United States of America

United States Patent and Trademark Office

## HEALTHSUN HEALTH PLANS

**Reg. No. 4,134,833**

HEALTHSUN HEALTH PLANS, INC. (FLORIDA CORPORATION)  
1205 SOUTHWEST 37TH AVENUE, 2ND FLOOR  
MIAMI, FL 33135

**Registered May 1, 2012**

**Int. Cl.: 44**

FOR: PROVIDING COMPREHENSIVE HEALTH CARE SERVICES IN THE NATURE OF A HEALTH MAINTENANCE ORGANIZATION, IN CLASS 44 (U.S. CLS. 100 AND 101).

**SERVICE MARK**

FIRST USE 8-0-2003; IN COMMERCE 8-0-2003.

**PRINCIPAL REGISTER**

THE MARK CONSISTS OF STANDARD CHARACTERS WITHOUT CLAIM TO ANY PARTICULAR FONT, STYLE, SIZE, OR COLOR.

NO CLAIM IS MADE TO THE EXCLUSIVE RIGHT TO USE "HEALTH PLANS", APART FROM THE MARK AS SHOWN.

SER. NO. 85-407,176, FILED 8-25-2011.

CIMMERIAN COLEMAN, EXAMINING ATTORNEY



*David J. Kyffers*

Director of the United States Patent and Trademark Office

# United States of America

United States Patent and Trademark Office

## TOOLS FOR LIFE

**Reg. No. 4,134,834**

**Registered May 1, 2012**

**Int. Cl.: 37**

**SERVICE MARK**

**PRINCIPAL REGISTER**

JOHN MEZZALINGUA ASSOCIATES, INC. (DELAWARE CORPORATION), DBA PPC  
LEGAL DEPARTMENT  
6176 E. MOLLOY RD.  
EAST SYRACUSE, NY 13057

FOR: TOOL AUDITING SERVICES IN THE NATURE OF INSPECTING TOOLS FOR WEAR-AND-TEAR AND FOR DEFECTS; INSTALLATION, MAINTENANCE, REPAIR AND REPLACEMENT OF TOOLS AND TOOL PARTS, IN CLASS 37 (U.S. CLS. 100, 103 AND 106).

FIRST USE 7-0-2009; IN COMMERCE 7-0-2009.

THE MARK CONSISTS OF STANDARD CHARACTERS WITHOUT CLAIM TO ANY PARTICULAR FONT, STYLE, SIZE, OR COLOR.

NO CLAIM IS MADE TO THE EXCLUSIVE RIGHT TO USE "TOOLS", APART FROM THE MARK AS SHOWN.

SER. NO. 85-407,182, FILED 8-25-2011.

ERNEST SHOSHO, EXAMINING ATTORNEY



*David J. Kybas*

Director of the United States Patent and Trademark Office

# United States of America

United States Patent and Trademark Office

## ANGER CLASS ONLINE

**Reg. No. 4,134,835**

**Registered May 1, 2012**

**Int. Cl.: 41**

**SERVICE MARK**

**PRINCIPAL REGISTER**

AJ NOVICK GROUP MARRIAGE & FAMILY THERAPIST (CALIFORNIA CORPORATION)  
2830 CHATEAU WAY  
LAGUNA BEACH, CA 92651

FOR: EDUCATIONAL SERVICES, NAMELY, PROVIDING ON-LINE CLASSES IN THE  
FIELD OF ANGER MANAGEMENT, IN CLASS 41 (U.S. CLS. 100, 101 AND 107).

FIRST USE 8-22-2006; IN COMMERCE 8-22-2006.

THE MARK CONSISTS OF STANDARD CHARACTERS WITHOUT CLAIM TO ANY PAR-  
TICULAR FONT, STYLE, SIZE, OR COLOR.

OWNER OF U.S. REG. NO. 3,678,112.

NO CLAIM IS MADE TO THE EXCLUSIVE RIGHT TO USE "CLASS ONLINE", APART  
FROM THE MARK AS SHOWN.

SEC. 2(F).

SER. NO. 85-407,197, FILED 8-25-2011.

DAVID C. REIHNER, EXAMINING ATTORNEY



*David J. Kybas*

Director of the United States Patent and Trademark Office

**United States of America**  
United States Patent and Trademark Office

# SURGPRO

**Reg. No. 4,134,836**

PORTER, BILL (UNITED STATES INDIVIDUAL)  
5809 DEPARTURE DRIVE, SUITE 106  
RALEIGH, NC 27616

**Registered May 1, 2012**

**Int. Cl.: 35**

FOR: RETAIL STORE SERVICES IN THE FIELD OF VASCULAR AND INTERVENTIONAL MEDICAL DEVICES, IN CLASS 35 (U.S. CLS. 100, 101 AND 102).

**SERVICE MARK**

FIRST USE 3-8-2000; IN COMMERCE 11-15-2001.

**PRINCIPAL REGISTER**

THE MARK CONSISTS OF STANDARD CHARACTERS WITHOUT CLAIM TO ANY PARTICULAR FONT, STYLE, SIZE, OR COLOR.

SER. NO. 85-407,210, FILED 8-25-2011.

CIMMERIAN COLEMAN, EXAMINING ATTORNEY



*David J. Kyffers*

Director of the United States Patent and Trademark Office

# United States of America

United States Patent and Trademark Office

# Evology

**Reg. No. 4,134,837**

**Registered May 1, 2012**

**Int. Cl.: 38**

**SERVICE MARK**

**PRINCIPAL REGISTER**

EVOLGY, LLC (FLORIDA LIMITED LIABILITY COMPANY)  
240 N. WASHINGTON BLVD, SUITE 700  
SARASOTA, FL 34236

FOR: STREAMING OF AUDIO MATERIAL ON THE INTERNET; STREAMING OF VIDEO MATERIAL ON THE INTERNET; STREAMING OF DIGITAL MEDIA CONTENT FOR OTHERS VIA THE INTERNET , IN CLASS 38 (U.S. CLS. 100, 101 AND 104).

FIRST USE 5-1-2011; IN COMMERCE 5-1-2011.

THE MARK CONSISTS OF STANDARD CHARACTERS WITHOUT CLAIM TO ANY PARTICULAR FONT, STYLE, SIZE, OR COLOR.

SER. NO. 85-407,235, FILED 8-25-2011.

SUE LAWRENCE, EXAMINING ATTORNEY



*David J. Kyffers*

Director of the United States Patent and Trademark Office

# United States of America

United States Patent and Trademark Office

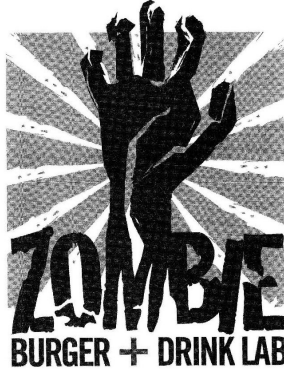

**Reg. No. 4,134,838**

**Registered May 1, 2012**

**Int. Cl.: 43**

**SERVICE MARK**

**PRINCIPAL REGISTER**

ZB RESTAURANT GROUP, LLC (IOWA LIMITED LIABILITY COMPANY)  
SUITE 300  
200 10TH STREET  
DES MOINES, IA 50309

FOR: CARRY-OUT RESTAURANTS; RESTAURANT AND BAR SERVICES; RESTAURANT AND CATERING SERVICES; SELF SERVICE RESTAURANTS, IN CLASS 43 (U.S. CLS. 100 AND 101).

FIRST USE 8-20-2011; IN COMMERCE 8-20-2011.

NO CLAIM IS MADE TO THE EXCLUSIVE RIGHT TO USE "BURGER + DRINK", APART FROM THE MARK AS SHOWN.

THE MARK CONSISTS OF A HAND AND WRIST REACHING UP FROM THE WORDS "ZOMBIE BURGER + DRINK LAB" IN FRONT OF A FRACTURED BACKGROUND. THE HAND, WRIST AND THE WORD "ZOMBIE" HAVE A RAGGED APPEARANCE.

SER. NO. 85-407,392, FILED 8-25-2011.

LAURIE KAUFMAN, EXAMINING ATTORNEY



*David J. Kyros*

Director of the United States Patent and Trademark Office

# United States of America

United States Patent and Trademark Office

# MaxID

**Reg. No. 4,134,839**

**Registered May 1, 2012**

**Int. Cl.: 9**

**TRADEMARK**

**PRINCIPAL REGISTER**

MAXID CORP. (DELAWARE CORPORATION)  
1775 WIEHHLE AVE SUITE 104  
RESTON, VA 20190

FOR: PORTABLE AND HAND-HELD COMPUTERS; PORTABLE AND HAND-HELD COMPUTERS FOR IDENTITY DETERMINATION VERIFICATION AND VALIDATION AND ACCESS MANAGEMENT AND PERIMETER CONTROL OF BUILDINGS AND SURROUNDING AREAS; SCANNERS AND PORTABLE SCANNERS; COMPUTER SOFTWARE FOR OPERATING THE AFOREMENTIONED GOODS, IN CLASS 9 (U.S. CLS. 21, 23, 26, 36 AND 38).

FIRST USE 6-0-2007; IN COMMERCE 6-0-2007.

THE MARK CONSISTS OF STANDARD CHARACTERS WITHOUT CLAIM TO ANY PARTICULAR FONT, STYLE, SIZE, OR COLOR.

SER. NO. 85-407,439, FILED 8-25-2011.

DAVID YONTEF, EXAMINING ATTORNEY



*David J. Kyffers*

Director of the United States Patent and Trademark Office

# United States of America

United States Patent and Trademark Office

## Bashed Burgers

**Reg. No. 4,134,840**

**Registered May 1, 2012**

**Int. Cl.: 43**

**SERVICE MARK**

**PRINCIPAL REGISTER**

ZB RESTAURANT GROUP, LLC (IOWA LIMITED LIABILITY COMPANY)  
SUITE 300  
200 10TH STREET  
DES MOINES, IA 50309

FOR: CARRY-OUT RESTAURANTS; RESTAURANT AND BAR SERVICES; RESTAURANT AND CATERING SERVICES; SELF SERVICE RESTAURANTS, IN CLASS 43 (U.S. CLS. 100 AND 101).

FIRST USE 8-20-2011; IN COMMERCE 8-20-2011.

THE MARK CONSISTS OF STANDARD CHARACTERS WITHOUT CLAIM TO ANY PARTICULAR FONT, STYLE, SIZE, OR COLOR.

NO CLAIM IS MADE TO THE EXCLUSIVE RIGHT TO USE "BURGERS", APART FROM THE MARK AS SHOWN.

SER. NO. 85-407,443, FILED 8-25-2011.

LAURIE KAUFMAN, EXAMINING ATTORNEY



*David J. Kyffers*

Director of the United States Patent and Trademark Office



# United States of America

United States Patent and Trademark Office

# COBALT

**Reg. No. 4,134,841**

**Registered May 1, 2012**

**Int. Cl.: 9**

**TRADEMARK**

**PRINCIPAL REGISTER**

COBALT DIGITAL, INC. (ILLINOIS CORPORATION)  
2406 EAST UNIVERSITY AVENUE  
URBANA, IL 61801

FOR: ELECTRONIC BROADCAST DEVICES, NAMELY, VIDEO AND AUDIO INTERFACES, SIGNAL CONVERTERS, DISTRIBUTION AMPLIFIERS, ANALOG COMPONENT ENCODERS, AND AUDIO-VIDEO DELAY TESTERS, IN CLASS 9 (U.S. CLS. 21, 23, 26, 36 AND 38).

FIRST USE 4-10-1998; IN COMMERCE 4-10-1998.

THE MARK CONSISTS OF STANDARD CHARACTERS WITHOUT CLAIM TO ANY PARTICULAR FONT, STYLE, SIZE, OR COLOR.

SER. NO. 85-407,514, FILED 8-25-2011.

PAUL E. FAHRENKOPF, EXAMINING ATTORNEY



*David J. Kybas*

Director of the United States Patent and Trademark Office

# United States of America

United States Patent and Trademark Office



**Reg. No. 4,134,842**

**Registered May 1, 2012**

**Int. Cl.: 35**

**SERVICE MARK**

**PRINCIPAL REGISTER**

TRI STATE DOMESTIC, INC. (PENNSYLVANIA CORPORATION)  
208 VANDERMARK DRIVE  
MILFORD, PA 18337

FOR: EMPLOYMENT AGENCY SERVICES, NAMELY, FILLING THE TEMPORARY AND PERMANENT STAFFING NEEDS OF BUSINESSES; EMPLOYMENT HIRING, RECRUITING, PLACEMENT, STAFFING AND CAREER NETWORKING SERVICES; EMPLOYMENT STAFFING IN THE FIELD OF DOMESTIC STAFFING; PROFESSIONAL STAFFING AND RECRUITING SERVICES, IN CLASS 35 (U.S. CLS. 100, 101 AND 102).

FIRST USE 1-1-2005; IN COMMERCE 4-26-2005.

NO CLAIM IS MADE TO THE EXCLUSIVE RIGHT TO USE "TRISTATE DOMESTIC", APART FROM THE MARK AS SHOWN.

THE COLOR(S) BLUE AND GREY IS/ARE CLAIMED AS A FEATURE OF THE MARK.

THE MARK CONSISTS OF A BLUE BOX WITH A GREY FLEUR-DE-LIS LOCATED WITHIN THE BLUE BOX, WITH THE WORDING "TRI STATE DOMESTIC" IN BLUE LOCATED BENEATH THE BOX.

SER. NO. 85-407,613, FILED 8-25-2011.

JAY FLOWERS, EXAMINING ATTORNEY



*David J. Kybas*

Director of the United States Patent and Trademark Office

# United States of America

United States Patent and Trademark Office



**Reg. No. 4,134,843**

**Registered May 1, 2012**

**Int. Cl.: 37**

**SERVICE MARK**

**PRINCIPAL REGISTER**

TRASH CLEANUP, INC. (CALIFORNIA CORPORATION)  
3020 BILLINGS STREET  
AURORA, CO 80011

FOR: TRASH COLLECTION, IN CLASS 37 (U.S. CLS. 100, 103 AND 106).

FIRST USE 7-1-2011; IN COMMERCE 7-1-2011.

NO CLAIM IS MADE TO THE EXCLUSIVE RIGHT TO USE "TRASH CLEANUP" , APART FROM THE MARK AS SHOWN.

THE MARK CONSISTS OF THE STYLIZED WORDING "TRASH CLEANUP" AND AN IMAGE OF A PERSON HOLDING A BROOM SWEEPING TO THE RIGHT OF THE WORDING.

SER. NO. 85-407,675, FILED 8-25-2011.

LESLIE RICHARDS, EXAMINING ATTORNEY



*David J. Kybas*

Director of the United States Patent and Trademark Office

# United States of America

United States Patent and Trademark Office

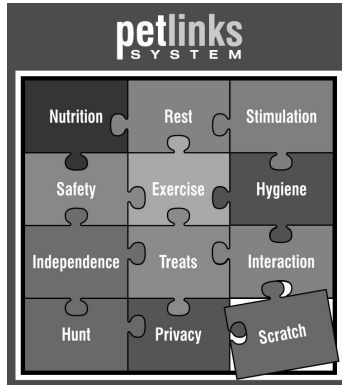

**Reg. No. 4,134,844**

**Registered May 1, 2012**

**Int. Cl.: 20**

**TRADEMARK**

**PRINCIPAL REGISTER**

WORLDWISE, INC. (CALIFORNIA CORPORATION)  
160 MITCHELL BOULEVARD  
SAN RAFAEL, CA 94903

FOR: CAT SCRATCHING PADS AND POSTS AND REPLACEMENT PADS THEREFOR, IN CLASS 20 (U.S. CLS. 2, 13, 22, 25, 32 AND 50).

FIRST USE 12-9-2005; IN COMMERCE 12-9-2005.

OWNER OF U.S. REG. NOS. 3,683,440 AND 3,857,569.

NO CLAIM IS MADE TO THE EXCLUSIVE RIGHT TO USE "SYSTEM" AND "NUTRITION REST STIMULATION SAFETY EXERCISE HYGIENE INDEPENDENCE TREATS INTERACTION HUNT PRIVACY SCRATCH", APART FROM THE MARK AS SHOWN.

THE MARK CONSISTS OF THE WORDING "PETLINKS SYSTEM" SET ABOVE A STYLIZED DEPICTION OF A PUZZLE MADE UP OF TWELVE PIECES, WITH THE WORDING "NUTRITION," "REST," "STIMULATION," "SAFETY," "EXERCISE," "HYGIENE," "INDEPENDENCE," "TREATS," "INTERACTION," "HUNT," "PRIVACY," AND "SCRATCH" SET INSIDE THE PIECES. THE BOTTOM RIGHT PUZZLE PIECE WITH THE WORD "SCRATCH" INSIDE IT IS TILTED SLIGHTLY TO THE LEFT SETTING IT APART FROM THE OTHER ELEVEN PUZZLE PIECES.

SER. NO. 85-407,696, FILED 8-25-2011.

BARNEY CHARLON, EXAMINING ATTORNEY



*David J. Kyros*

Director of the United States Patent and Trademark Office

# United States of America

United States Patent and Trademark Office

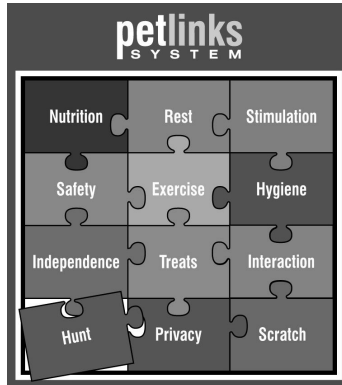

**Reg. No. 4,134,845**

**Registered May 1, 2012**

**Int. Cl.: 28**

**TRADEMARK**

**PRINCIPAL REGISTER**

WORLDWISE, INC. (CALIFORNIA CORPORATION)  
160 MITCHELL BOULEVARD  
SAN RAFAEL, CA 94903

FOR: PET TOYS, IN CLASS 28 (U.S. CLS. 22, 23, 38 AND 50).

FIRST USE 9-23-2005; IN COMMERCE 9-23-2005.

OWNER OF U.S. REG. NOS. 3,683,440 AND 3,857,569.

NO CLAIM IS MADE TO THE EXCLUSIVE RIGHT TO USE "SYSTEM" AND "NUTRITION REST STIMULATION SAFETY EXERCISE HYGIENE INDEPENDENCE TREATS INTERACTION HUNT PRIVACY SCRATCH", APART FROM THE MARK AS SHOWN.

THE MARK CONSISTS OF THE WORDING "PETLINKS SYSTEM" SET ABOVE A STYLIZED DEPICTION OF A PUZZLE MADE UP OF TWELVE PIECES, WITH THE WORDING "NUTRITION," "REST," "STIMULATION," "SAFETY," "EXERCISE," "HYGIENE," "INDEPENDENCE," "TREATS," "INTERACTION," "HUNT," "PRIVACY," AND "SCRATCH" SET INSIDE THE PIECES. THE BOTTOM LEFT PUZZLE PIECE WITH THE WORD "HUNT" INSIDE IT IS TILTED SLIGHTLY TO THE LEFT SETTING IT APART FROM THE OTHER ELEVEN PUZZLE PIECES.

SER. NO. 85-407,710, FILED 8-25-2011.

BARNEY CHARLON, EXAMINING ATTORNEY



*David J. Kyros*

Director of the United States Patent and Trademark Office

# United States of America

United States Patent and Trademark Office

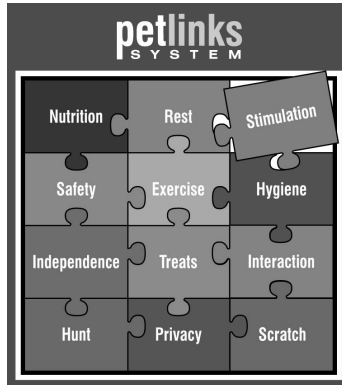

**Reg. No. 4,134,846**

**Registered May 1, 2012**

**Int. Cl.: 31**

**TRADEMARK**

**PRINCIPAL REGISTER**

WORLDWISE, INC. (CALIFORNIA CORPORATION)  
160 MITCHELL BOULEVARD  
SAN RAFAEL, CA 94903

FOR: CATNIP, IN CLASS 31 (U.S. CLS. 1 AND 46).

FIRST USE 3-18-2008; IN COMMERCE 3-18-2008.

OWNER OF U.S. REG. NOS. 3,683,440 AND 3,857,569.

NO CLAIM IS MADE TO THE EXCLUSIVE RIGHT TO USE "SYSTEM" AND "NUTRITION REST STIMULATION SAFETY EXERCISE HYGIENE INDEPENDENCE TREATS INTERACTION HUNT PRIVACY SCRATCH", APART FROM THE MARK AS SHOWN.

THE MARK CONSISTS OF THE WORDING "PETLINKS SYSTEM" SET ABOVE A STYLIZED DEPICTION OF A PUZZLE MADE UP OF TWELVE PIECES, WITH THE WORDING "NUTRITION," "REST," "STIMULATION," "SAFETY," "EXERCISE," "HYGIENE," "INDEPENDENCE," "TREATS," "INTERACTION," "HUNT," "PRIVACY," AND "SCRATCH" SET INSIDE THE PIECES. THE TOP RIGHT PUZZLE PIECE WITH THE WORD "STIMULATION" INSIDE IT IS TILTED SLIGHTLY TO THE LEFT SETTING IT APART FROM THE OTHER ELEVEN PUZZLE PIECES.

SER. NO. 85-407,717, FILED 8-25-2011.

BARNEY CHARLON, EXAMINING ATTORNEY



*David J. Kyjars*

Director of the United States Patent and Trademark Office

# United States of America

## United States Patent and Trademark Office



**Reg. No. 4,134,847**

**Registered May 1, 2012**

**Int. Cl.: 41**

**SERVICE MARK**

**PRINCIPAL REGISTER**

FINAO CAPITAL PARTNERS LLC. (OHIO LIMITED LIABILITY COMPANY)  
8020 MARIETTA RD. SE  
BREMEN, OH 43107

FOR: ON-LINE JOURNALS, NAMELY, BLOGS FEATURING THE SUBJECT OF SELF SUFFICIENT LIVING, WILDERNESS AND URBAN SURVIVAL; PROVIDING CURRENT EVENT NEWS AND INFORMATION VIA A GLOBAL COMPUTER NETWORK, IN CLASS 41 (U.S. CLS. 100, 101 AND 107).

FIRST USE 1-1-2011; IN COMMERCE 2-1-2011.

THE MARK CONSISTS OF A GLOBE SURROUNDED BY A COMPASS POINTS DESIGN WITH A FLAMING TORCH HAVING THE LETTERS "OSS" WRITTEN VERTICALLY ON THE HANDLE OVERLAYING THE THREE ARROWS AT THE BASE

SER. NO. 85-407,795, FILED 8-25-2011.

BARBARA BROWN, EXAMINING ATTORNEY



*David J. Kyffers*

Director of the United States Patent and Trademark Office

# United States of America

United States Patent and Trademark Office

## SMOOTHAIR DEFLECTOR

**Reg. No. 4,134,848**

**Registered May 1, 2012**

**Int. Cl.: 11**

**TRADEMARK**

**PRINCIPAL REGISTER**

U.S. SUNLIGHT CORP. (NEVADA CORPORATION)  
SUITE 110  
932 TAHOE BLVD.  
INCLINE VILLAGE, CA 89451

FOR: APPARATUS FOR VENTILATING, NAMELY, VENTILATING EXHAUST FANS, IN CLASS 11 (U.S. CLS. 13, 21, 23, 31 AND 34).

FIRST USE 7-12-2011; IN COMMERCE 7-20-2011.

THE MARK CONSISTS OF STANDARD CHARACTERS WITHOUT CLAIM TO ANY PARTICULAR FONT, STYLE, SIZE, OR COLOR.

NO CLAIM IS MADE TO THE EXCLUSIVE RIGHT TO USE "DEFLECTOR", APART FROM THE MARK AS SHOWN.

SER. NO. 85-407,824, FILED 8-25-2011.

ANGELA M. MICHELI, EXAMINING ATTORNEY



*David J. Kybas*

Director of the United States Patent and Trademark Office



# United States of America

United States Patent and Trademark Office

# PNK Elephant

**Reg. No. 4,134,849**

**Registered May 1, 2012**

**Int. Cl.: 35**

**SERVICE MARK**

**PRINCIPAL REGISTER**

PNK ELEPHANT, LLC (DELAWARE LIMITED LIABILITY COMPANY)  
C/O CHRISTOPHER J. CABOTT, ESQ.  
1 LIBERTY PLACE, 1650 MARKET ST, 56TH FL  
PHILADELPHIA, PA 19103

FOR: RETAIL ACCESSORY BOUTIQUES FEATURING RINGS, EARRINGS, NECKLACES,  
BRACELETS AND CARRYING BAGS FOR RINGS, EARRINGS, NECKLACES AND  
BRACELETS, IN CLASS 35 (U.S. CLS. 100, 101 AND 102).

FIRST USE 6-2-2010; IN COMMERCE 6-2-2010.

THE MARK CONSISTS OF STANDARD CHARACTERS WITHOUT CLAIM TO ANY PAR-  
TICULAR FONT, STYLE, SIZE, OR COLOR.

SER. NO. 85-407,826, FILED 8-25-2011.

ANGELA M. MICHELI, EXAMINING ATTORNEY



*David J. Kyffers*

Director of the United States Patent and Trademark Office

# United States of America

United States Patent and Trademark Office



**Reg. No. 4,134,850**

**Registered May 1, 2012**

**Int. Cl.: 25**

**TRADEMARK**

**PRINCIPAL REGISTER**

OBOZ FOOTWEAR LLC (WYOMING LIMITED LIABILITY COMPANY)  
411 W. MENDENHALL  
BOZEMAN, MT 59715

FOR: FOOTWEAR, IN CLASS 25 (U.S. CLS. 22 AND 39).

FIRST USE 2-1-2008; IN COMMERCE 2-1-2008.

OWNER OF U.S. REG. NO. 3,584,471.

THE MARK CONSISTS OF THE WORD "OBOZ" SURROUNDED BY AN OVAL WITH AN ACCENT OVER THE SECOND "O" AND WITH THE FIRST "O" ADJOINING THE OVAL.

SER. NO. 85-407,840, FILED 8-25-2011.

CHRISTOPHER SIDOTI, EXAMINING ATTORNEY



*David J. Kyffers*

Director of the United States Patent and Trademark Office

# United States of America

United States Patent and Trademark Office



**Reg. No. 4,134,851**

**Registered May 1, 2012**

**Int. Cl.: 30**

**TRADEMARK**

**PRINCIPAL REGISTER**

RDE, LLC (WASHINGTON LIMITED LIABILITY COMPANY), DBA WP COFFEE CO.  
SUITE 201  
110 W. DAYTON STREET  
EDMONDS, WA 98020

FOR: COFFEE, IN CLASS 30 (U.S. CL. 46).

FIRST USE 5-10-2010; IN COMMERCE 5-10-2010.

NO CLAIM IS MADE TO THE EXCLUSIVE RIGHT TO USE "VIENNA COFFEE HOUSE",  
APART FROM THE MARK AS SHOWN.

THE MARK CONSISTS OF THE WORDS "VIENNA COFFEE HOUSE" WITH A CANDELABRA  
DESIGN ABOVE IT AND A BACKGROUND DESIGN FEATURING CURVED DESIGNS,  
DOTS AND FLORAL LIKE DESIGNS.

SER. NO. 85-407,850, FILED 8-25-2011.

REBECCA EISINGER, EXAMINING ATTORNEY



*David J. Kybas*

Director of the United States Patent and Trademark Office

# United States of America

United States Patent and Trademark Office



**Reg. No. 4,134,852**

**Registered May 1, 2012**

**Int. Cl.: 30**

**TRADEMARK**

**PRINCIPAL REGISTER**

RDE, LLC (WASHINGTON LIMITED LIABILITY COMPANY), DBA WP COFFEE CO.  
SUITE 201  
110 W. DAYTON STREET  
EDMONDS, WA 98020

FOR: COFFEE, IN CLASS 30 (U.S. CL. 46).

FIRST USE 5-10-2010; IN COMMERCE 5-10-2010.

THE MARK CONSISTS OF THE WORD "SORRENTO" IN LOWER CASE CURSIVE SCRIPT WITH A "T" EXTENDED VERTICALLY TO TWICE THE HEIGHT OF THE OTHER LETTERS OVER A DESIGN THAT RESEMBLES A WING PATTERN WITH TWO HORIZONTAL LINES NEAR THE TOP. THE RECTANGULAR SHAPE OF THE BACKGROUND IN THE DRAWING IS NOT A FEATURE OF THE MARK.

SER. NO. 85-407,891, FILED 8-25-2011.

REBECCA EISINGER, EXAMINING ATTORNEY



*David J. Kybas*

Director of the United States Patent and Trademark Office

# United States of America

United States Patent and Trademark Office



**Reg. No. 4,134,853**

**Registered May 1, 2012**

**Int. Cl.: 9**

**TRADEMARK**

**PRINCIPAL REGISTER**

THE STATE BAR OF CALIFORNIA (CALIFORNIA PUBLIC CORPORATION)  
180 HOWARD STREET  
SAN FRANCISCO, CA 941051639

FOR: DOWNLOADABLE ELECTRONIC PUBLICATIONS IN THE NATURE OF JOURNALS  
IN THE FIELD OF REAL PROPERTY LAW, IN CLASS 9 (U.S. CLS. 21, 23, 26, 36 AND 38).

FIRST USE 12-31-1997; IN COMMERCE 12-31-1997.

OWNER OF U.S. REG. NO. 2,984,949.

NO CLAIM IS MADE TO THE EXCLUSIVE RIGHT TO USE "JOURNAL", APART FROM  
THE MARK AS SHOWN.

THE MARK CONSISTS OF THE WORDING "CALIFORNIA REAL PROPERTY JOURNAL"  
IN WHITE LETTERING AGAINST A STYLIZED RENDERING OF A SKYLINE SILHOUETTE.

SEC. 2(F) AS TO "CALIFORNIA REAL PROPERTY JOURNAL".

SER. NO. 85-407,938, FILED 8-26-2011.

MARIA-VICTORIA SUAREZ, EXAMINING ATTORNEY



*David J. Kybas*

Director of the United States Patent and Trademark Office

# United States of America

United States Patent and Trademark Office

## THE ART INSTITUTE OF TENNESSEE

**Reg. No. 4,134,854**

EDUCATION MANAGEMENT LLC (DELAWARE LIMITED LIABILITY COMPANY)  
210 SIXTH AVENUE  
PITTSBURGH, PA 15222

**Registered May 1, 2012**

**Int. Cl.: 41**

FOR: EDUCATION SERVICES, NAMELY, OFFERING COURSES OF INSTRUCTION AT THE POST SECONDARY LEVEL, IN CLASS 41 (U.S. CLS. 100, 101 AND 107).

**SERVICE MARK**

FIRST USE 8-7-2006; IN COMMERCE 8-7-2006.

**PRINCIPAL REGISTER**

THE MARK CONSISTS OF STANDARD CHARACTERS WITHOUT CLAIM TO ANY PARTICULAR FONT, STYLE, SIZE, OR COLOR.

OWNER OF U.S. REG. NOS. 1,602,968, 3,172,636 AND OTHERS.

NO CLAIM IS MADE TO THE EXCLUSIVE RIGHT TO USE "ART INSTITUTE", APART FROM THE MARK AS SHOWN.

SEC. 2(F).

SER. NO. 85-407,995, FILED 8-26-2011.

HAI-LY LAM, EXAMINING ATTORNEY



*David J. Kyros*

Director of the United States Patent and Trademark Office

# United States of America

United States Patent and Trademark Office



**Reg. No. 4,134,855**

**Registered May 1, 2012**

**Int. Cl.: 36**

**SERVICE MARK**

**PRINCIPAL REGISTER**

PARK AND REFER INC. (COLORADO CORPORATION)  
11001 W. 120TH AVE. #451  
BROOMFIELD, CO 80021

FOR: REAL ESTATE AGENCIES; REAL ESTATE BROKERAGE, IN CLASS 36 (U.S. CLS. 100, 101 AND 102).

FIRST USE 4-30-2010; IN COMMERCE 4-30-2010.

NO CLAIM IS MADE TO THE EXCLUSIVE RIGHT TO USE "REFERRAL AGENT BROKERAGE", APART FROM THE MARK AS SHOWN.

THE COLOR(S) BLUE, WHITE, GRAY, GREEN AND ORANGE IS/ARE CLAIMED AS A FEATURE OF THE MARK.

THE MARK CONSISTS OF A STYLIZED DESIGN OF A GRAY AND WHITE CIRCLE. WITHIN THE CIRCLE IS A STYLIZED DESIGN OF A HOUSE, CONSISTING OF FOUR WHITE SQUARES AND A TRIANGLE. UNDERNEATH THE GRAY AND WHITE CIRCLE IS A GREEN LEAF. BELOW THE DESIGN ELEMENT ARE THE TERMS "PARK AND REFER". THE TERM "PARK" IS IN BLUE, THE TERM "AND" IS IN GRAY, AND THE TERM "REFER" IS IN GREEN. BELOW "PARK AND REFER" ARE THE STYLIZED TERMS "REFERRAL AGENT BROKERAGE" IN ORANGE.

SER. NO. 85-407,997, FILED 8-26-2011.

MARGERY A. TIERNEY, EXAMINING ATTORNEY



*David J. Kybas*

Director of the United States Patent and Trademark Office

United States of America  
United States Patent and Trademark Office



**Reg. No. 4,134,856**

MINISPLITWAREHOUSE.COM INC. (FLORIDA CORPORATION)  
18120 BIRDWATER DRIVE  
TAMPA, FL 33647

**Registered May 1, 2012**

**Int. Cl.: 35**

FOR: WHOLESALE AND RETAIL STORE SERVICES FEATURING HEATING AND AIR COOLING EQUIPMENT, IN CLASS 35 (U.S. CLS. 100, 101 AND 102).

**SERVICE MARK**

FIRST USE 8-8-2010; IN COMMERCE 8-8-2010.

**PRINCIPAL REGISTER**

NO CLAIM IS MADE TO THE EXCLUSIVE RIGHT TO USE "MINISPLIT WAREHOUSE", APART FROM THE MARK AS SHOWN.

THE MARK CONSISTS OF THE WORDING "MINISPLIT" FOLLOWED BY THE WORDING "WAREHOUSE" UNDERNEATH. A DESIGN OF TWO STRAIGHT HORIZONTAL BANDS APPEAR UNDERNEATH THE WORDING "WAREHOUSE" AND EXTEND INTO TWO CURVED BANDS THAT CURVE OVER THE FIRST THREE LETTERS IN THE WORDING "MINISPLIT".

SER. NO. 85-408,003, FILED 8-26-2011.

HAI-LY LAM, EXAMINING ATTORNEY



*David J. Kybas*

Director of the United States Patent and Trademark Office



# United States of America

United States Patent and Trademark Office



**Reg. No. 4,134,857**

**Registered May 1, 2012**

**Int. Cl.: 35**

**SERVICE MARK**

**PRINCIPAL REGISTER**

WATERMARK RESEARCH PARTNERS, INC (INDIANA CORPORATION)  
8123 CASTLETON ROAD  
INDIANAPOLIS, IN 46250

FOR: BUSINESS SUPPORT SERVICES, NAMELY, BUSINESS CONSULTING TO FREELAN-  
CERS, START-UPS, EXISTING BUSINESSES AND NON-PROFIT ORGANIZATIONS, IN  
CLASS 35 (U.S. CLS. 100, 101 AND 102).

FIRST USE 5-1-2011; IN COMMERCE 5-1-2011.

NO CLAIM IS MADE TO THE EXCLUSIVE RIGHT TO USE "MEDICAL", APART FROM  
THE MARK AS SHOWN.

THE MARK CONSISTS OF A STYLIZED PEGASUS WITH TWO LINES OF TEXT BELOW.  
LINE ONE IS THE STYLIZED TEXT "STEELHORSE". LINE TWO IS "MEDICAL".

SER. NO. 85-408,024, FILED 8-26-2011.

JAMES STEIN, EXAMINING ATTORNEY



*David J. Kybas*

Director of the United States Patent and Trademark Office

# United States of America

United States Patent and Trademark Office

## LIGHT 'N GO BONFIRE

**Reg. No. 4,134,858**

**Registered May 1, 2012**

**Int. Cl.: 4**

**TRADEMARK**

**PRINCIPAL REGISTER**

ESSAY GROUP LLC (NEW JERSEY LIMITED LIABILITY COMPANY)  
352 LAKEVIEW DRIVE WYCKOFF  
WYCKOFF, NJ 07481

FOR: ARTIFICIAL FIREPLACE LOGS; WOOD LOGS FOR FUEL; FIREPLACE LOGS, IN CLASS 4 (U.S. CLS. 1, 6 AND 15).

FIRST USE 8-24-2011; IN COMMERCE 8-24-2011.

THE MARK CONSISTS OF STANDARD CHARACTERS WITHOUT CLAIM TO ANY PARTICULAR FONT, STYLE, SIZE, OR COLOR.

OWNER OF U.S. REG. NOS. 3,224,973 AND 3,879,816.

NO CLAIM IS MADE TO THE EXCLUSIVE RIGHT TO USE "BONFIRE", APART FROM THE MARK AS SHOWN.

SER. NO. 85-408,034, FILED 8-26-2011.

MICHELE SWAIN, EXAMINING ATTORNEY



*David J. Kybas*

Director of the United States Patent and Trademark Office

# United States of America

United States Patent and Trademark Office

# Awia Warrior

**Reg. No. 4,134,859**

**Registered May 1, 2012**

**Int. Cl.: 9**

**TRADEMARK**

**PRINCIPAL REGISTER**

AWIATECH CORPORATION (TEXAS CORPORATION)  
11713 JOLLYVILLE ROAD  
AUSTIN, TX 78759

FOR: ELECTRONIC DEVICES THAT FORM A WIRELESS SENSOR NETWORK, NAMELY, COMPUTER HARDWARE ASSOCIATED FIRMWARE AND SOFTWARE THAT RETRIEVE, MEASURE, OR DETECT A PARAMETER, VARIABLE, OR ANY MEASURABLE CONDITION, DETECTABLE EVENT, OR INFORMATION, WHERE EACH DEVICE CAN TRANSMIT VIA WIRED CONNECTIONS OR RADIO WAVES INFORMATION ABOUT THE RETRIEVED, MEASURED, OR DETECTED VALUE TO AT LEAST ONE OTHER DEVICE, IN CLASS 9 (U.S. CLS. 21, 23, 26, 36 AND 38).

FIRST USE 4-20-2010; IN COMMERCE 4-20-2010.

THE MARK CONSISTS OF STANDARD CHARACTERS WITHOUT CLAIM TO ANY PARTICULAR FONT, STYLE, SIZE, OR COLOR.

OWNER OF U.S. REG. NO. 3,984,657.

SER. NO. 85-408,094, FILED 8-26-2011.

CHRISIE B. KING, EXAMINING ATTORNEY



*David J. Kyffers*

Director of the United States Patent and Trademark Office

# United States of America

United States Patent and Trademark Office

## SIMPLE T-SHIRTS FOR COMPLEX CREATURES

**Reg. No. 4,134,860**

**Registered May 1, 2012**

**Int. Cls.: 18 and 25**

**TRADEMARK**

**PRINCIPAL REGISTER**

PUPPY & BEAN, LLC (MICHIGAN LIMITED LIABILITY COMPANY)  
3500 GERTRUDE STREET  
DEARBORN, MI 48124

FOR: TOTE BAGS, IN CLASS 18 (U.S. CLS. 1, 2, 3, 22 AND 41).

FIRST USE 11-0-2010; IN COMMERCE 11-0-2010.

FOR: ONE-PIECE GARMENTS FOR CHILDREN; T-SHIRTS, IN CLASS 25 (U.S. CLS. 22 AND 39).

FIRST USE 11-0-2010; IN COMMERCE 11-0-2010.

THE MARK CONSISTS OF STANDARD CHARACTERS WITHOUT CLAIM TO ANY PARTICULAR FONT, STYLE, SIZE, OR COLOR.

SER. NO. 85-408,106, FILED 8-26-2011.

MATTHEW MCDOWELL, EXAMINING ATTORNEY



*David J. Kybas*

Director of the United States Patent and Trademark Office

# United States of America

United States Patent and Trademark Office



## RED MOUNTAIN

**Reg. No. 4,134,861**

**Registered May 1, 2012**

**Int. Cls.: 35 and 36**

**SERVICE MARK**

**PRINCIPAL REGISTER**

RED MOUNTAIN CAPITAL PARTNERS LLC (DELAWARE LIMITED LIABILITY COMPANY)  
SUITE 925  
10100 SANTA MONICA BLVD  
LOS ANGELES, CA 90067

FOR: BUSINESS SUCCESSION PLANNING; INFORMATION AND CONSULTANCY SERVICES ON THE TOPIC OF BUSINESS SUCCESSION PLANNING, IN CLASS 35 (U.S. CLS. 100, 101 AND 102).

FIRST USE 10-31-2006; IN COMMERCE 10-31-2006.

FOR: INVESTMENT MANAGEMENT; FINANCIAL CONSULTING AND ADVISING IN THE FIELD OF MERGERS AND ACQUISITIONS; FINANCIAL PLANNING AND INVESTMENT ADVISORY SERVICES; FINANCIAL SERVICES, NAMELY, WEALTH MANAGEMENT SERVICES, IN CLASS 36 (U.S. CLS. 100, 101 AND 102).

FIRST USE 10-31-2006; IN COMMERCE 10-31-2006.

THE MARK CONSISTS OF THE WORDS "RED MOUNTAIN" IN STYLIZED FONT WITH A RED MOUNTAIN PEAK DESIGN OVER THE "AIN" PORTION OF THE WORD "MOUNTAIN". THE COLORS WHITE AND BLACK ARE INTENDED AS BACKGROUND, OUTLINING, SHADING AND/OR TRANSPARENT AREA AND ARE NOT PART OF THE MARK.

THE COLOR(S) RED IS/ARE CLAIMED AS A FEATURE OF THE MARK.

SER. NO. 85-408,229, FILED 8-26-2011.

ERNEST SHOSHO, EXAMINING ATTORNEY



*David J. Kyffers*

Director of the United States Patent and Trademark Office

# United States of America

United States Patent and Trademark Office

## Hands Of Light Ministry

**Reg. No. 4,134,862**

**Registered May 1, 2012**

**Int. Cl.: 44**

**SERVICE MARK**

**PRINCIPAL REGISTER**

LINDA M MORRIS (UNITED STATES INDIVIDUAL)  
9626 KARMONT AVENUE  
SOUTH GATE, CA 90280

FOR: PROVIDING WELLNESS SERVICES, NAMELY, PERSONAL ASSESSMENTS, PERSONALIZED ROUTINES, MAINTENANCE SCHEDULES, AND COUNSELING, IN CLASS 44 (U.S. CLS. 100 AND 101).

FIRST USE 6-14-2011; IN COMMERCE 6-14-2011.

THE MARK CONSISTS OF STANDARD CHARACTERS WITHOUT CLAIM TO ANY PARTICULAR FONT, STYLE, SIZE, OR COLOR.

NO CLAIM IS MADE TO THE EXCLUSIVE RIGHT TO USE "MINISTRY", APART FROM THE MARK AS SHOWN.

SER. NO. 85-408,323, FILED 8-26-2011.

ALEXANDER L. POWERS, EXAMINING ATTORNEY



*David J. Kyros*

Director of the United States Patent and Trademark Office

# United States of America

United States Patent and Trademark Office

# TouchTalk

**Reg. No. 4,134,863**

**Registered May 1, 2012**

**Int. Cl.: 9**

**TRADEMARK**

**PRINCIPAL REGISTER**

LINGGRAPHICARE AMERICA, INC. (CALIFORNIA CORPORATION), AKA LINGGRAPHICA  
103 CARNEGIE CENTER, SUITE 204  
PRINCETON, NJ 08540

FOR: COMPREHENSIVE COMPUTER BASED-SYSTEM, NAMELY, COMPUTER HARDWARE  
AND SOFTWARE FOR CREATING COMMUNICATION ABILITY ON BEHALF OF PERSONS  
WITH SPEECH DISABILITIES, IN CLASS 9 (U.S. CLS. 21, 23, 26, 36 AND 38).

FIRST USE 1-1-2011; IN COMMERCE 8-1-2011.

THE MARK CONSISTS OF STANDARD CHARACTERS WITHOUT CLAIM TO ANY PAR-  
TICULAR FONT, STYLE, SIZE, OR COLOR.

SER. NO. 85-408,333, FILED 8-26-2011.

JESSICA A. POWERS, EXAMINING ATTORNEY



*David J. Kyffers*

Director of the United States Patent and Trademark Office

# United States of America

United States Patent and Trademark Office

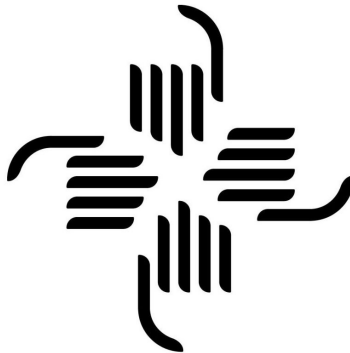

**Reg. No. 4,134,864**

**Registered May 1, 2012**

**Int. Cl.: 35**

**SERVICE MARK**

**PRINCIPAL REGISTER**

WORLD RELIEF CORPORATION OF NATIONAL ASSOCIATION OF EVANGELICALS  
(DELAWARE CHARITABLE, NON-PROFIT CORPORATION)  
7 EAST BALTIMORE STREET  
BALTIMORE, MD 21202

FOR: CHARITABLE SERVICES, NAMELY, ORGANIZING AND DEVELOPING PROJECTS THAT AIM TO IMPROVE THE LIVES OF UNDERPRIVILEGED AND IMPOVERISHED PEOPLE AND JOB PLACEMENT SERVICES FOR UNDERPRIVILEGED AND IMPOVERISHED PEOPLE; PROMOTING PUBLIC AWARENESS ABOUT POVERTY, IN CLASS 35 (U.S. CLS. 100, 101 AND 102).

FIRST USE 9-18-2010; IN COMMERCE 9-18-2010.

OWNER OF U.S. REG. NOS. 2,251,349, 2,270,515, AND 3,981,610.

THE MARK CONSISTS OF FOUR STYLIZED HAND SYMBOLS THAT CREATE A PINWHEEL DESIGN.

SER. NO. 85-408,384, FILED 8-26-2011.

DAVID YONTEF, EXAMINING ATTORNEY



*David J. Kyffers*

Director of the United States Patent and Trademark Office



# United States of America

United States Patent and Trademark Office

# TracyLocke

**Reg. No. 4,134,865**

**Registered May 1, 2012**

**Int. Cl.: 35**

**SERVICE MARK**

**PRINCIPAL REGISTER**

TLP INC. (DELAWARE CORPORATION)  
1999 BRYAN STREET, SUITE 2800  
DALLAS, TX 75201

FOR: ADVERTISING AGENCY SERVICES; BUSINESS MARKETING CONSULTING SERVICES IN THE FIELD OF SHOPPER MARKETING, AND SHOPPER AND CONSUMER BEHAVIOR; BUSINESS MARKETING CONSULTING IN THE FIELD OF BRAND CREATION, BRAND DEVELOPMENT AND BRAND MARKETING; MARKET RESEARCH AND ANALYSIS SERVICES; ADVERTISING AND MARKETING SERVICES THROUGH DIGITAL AND ONLINE INTERACTIVE MEDIUM; PUBLIC RELATIONS SERVICES; SALES PROMOTION SERVICES; CUSTOMER RELATIONSHIP MANAGEMENT; MARKETING COMMUNICATIONS SERVICES, NAMELY, PROVIDING CUSTOMIZED COMMUNICATION PROGRAMS TO HELP BUSINESSES PROMOTE AND MARKET THEIR PRODUCTS AND SERVICES; PROVIDING MARKETING AND PROMOTION OF SPECIAL EVENTS; ARRANGING AND CONDUCTING MARKETING PROMOTIONAL EVENTS FOR OTHERS, IN CLASS 35 (U.S. CLS. 100, 101 AND 102).

FIRST USE 0-0-1913; IN COMMERCE 0-0-1913.

THE MARK CONSISTS OF STANDARD CHARACTERS WITHOUT CLAIM TO ANY PARTICULAR FONT, STYLE, SIZE, OR COLOR.

THE NAME "TRACY LOCKE" DOES NOT IDENTIFY A LIVING INDIVIDUAL.

SER. NO. 85-408,402, FILED 8-26-2011.

BRIAN CALLAGHAN, EXAMINING ATTORNEY



*David J. Kyros*

Director of the United States Patent and Trademark Office

# United States of America

United States Patent and Trademark Office

## STAND/FOR THE VULNERABLE

**Reg. No. 4,134,866**

**Registered May 1, 2012**

**Int. Cl.: 35**

**SERVICE MARK**

**PRINCIPAL REGISTER**

WORLD RELIEF CORPORATION OF NATIONAL ASSOCIATION OF EVANGELICALS  
(DELAWARE CHARITABLE, NON-PROFIT CORPORATION)  
7 EAST BALTIMORE STREET  
BALTIMORE, MD 21202

FOR: CHARITABLE SERVICES, NAMELY, ORGANIZING AND DEVELOPING PROJECTS THAT AIM TO IMPROVE THE LIVES OF UNDERPRIVILEGED AND IMPOVERISHED PEOPLE AND JOB PLACEMENT SERVICES FOR UNDERPRIVILEGED AND IMPOVERISHED PEOPLE; PROMOTING PUBLIC AWARENESS ABOUT POVERTY, IN CLASS 35 (U.S. CLS. 100, 101 AND 102).

FIRST USE 9-18-2010; IN COMMERCE 9-18-2010.

OWNER OF U.S. REG. NO. 3,981,627.

THE MARK CONSISTS OF THE WORDS "STAND/FOR THE VULNERABLE" IN A STYLIZED FORMAT WITH AN UPSIDE DOWN "V" FOR THE "A" IN "STAND".

SER. NO. 85-408,440, FILED 8-26-2011.

DAVID YONTEF, EXAMINING ATTORNEY



*David J. Kyffers*

Director of the United States Patent and Trademark Office

# United States of America

United States Patent and Trademark Office

## STITES & HARBISON<sub>PLLC</sub>

A T T O R N E Y S

**Reg. No. 4,134,867**

**Registered May 1, 2012**

**Int. Cl.: 45**

**SERVICE MARK**

**PRINCIPAL REGISTER**

STITES & HARBISON PLLC (KENTUCKY PROFESSIONAL LIMITED LIABILITY COMPANY)  
400 WEST MARKET STREET  
SUITE 1800  
LOUISVILLE, KY 402023352

FOR: LEGAL SERVICES, IN CLASS 45 (U.S. CLS. 100 AND 101).

FIRST USE 11-0-2000; IN COMMERCE 11-0-2000.

NO CLAIM IS MADE TO THE EXCLUSIVE RIGHT TO USE "PLLC" AND "ATTORNEYS",  
APART FROM THE MARK AS SHOWN.

THE COLOR(S) BLUE AND GRAY IS/ARE CLAIMED AS A FEATURE OF THE MARK.

THE MARK CONSISTS OF THE WORDS "STITES & HARBISON PLLC" IN STYLIZED FONT  
WITH THE WORDS "STITES", "HARBISON" AND "PLLC" COLORED BLUE AND WITH  
THE AMPERSAND COLORED GRAY ABOVE A THICK LINE WHICH IS COLORED BLUE  
IN A SECTION IN THE CENTER OF THE LINE AND WHICH IS OTHERWISE COLORED  
GRAY AND WHICH IS ABOVE THE WORD "ATTORNEYS" COLORED BLUE AND IN A  
STYLIZED FONT.

SER. NO. 85-408,468, FILED 8-26-2011.

YAT SYE, LEE, EXAMINING ATTORNEY



*David J. Kyjars*

Director of the United States Patent and Trademark Office

# United States of America

United States Patent and Trademark Office

## WASEDA FARMS

**Reg. No. 4,134,868**

**Registered May 1, 2012**

**Int. Cls.: 29 and 31**

**TRADEMARK**

**PRINCIPAL REGISTER**

WASEDA FARM, LLC (WISCONSIN LIMITED LIABILITY COMPANY)  
PO BOX 22074  
GREEN BAY, WI 54305

FOR: MEATS AND PROCESSED MEAT PRODUCTS, IN CLASS 29 (U.S. CL. 46).

FIRST USE 12-16-2008; IN COMMERCE 7-28-2010.

FOR: LIVESTOCK, IN CLASS 31 (U.S. CLS. 1 AND 46).

FIRST USE 10-14-2009; IN COMMERCE 10-14-2009.

THE MARK CONSISTS OF STANDARD CHARACTERS WITHOUT CLAIM TO ANY PARTICULAR FONT, STYLE, SIZE, OR COLOR.

NO CLAIM IS MADE TO THE EXCLUSIVE RIGHT TO USE "FARMS", APART FROM THE MARK AS SHOWN.

SER. NO. 85-408,498, FILED 8-26-2011.

DEIRDRE ROBERTSON, EXAMINING ATTORNEY



*David J. Kyffers*

Director of the United States Patent and Trademark Office

# United States of America

United States Patent and Trademark Office

# Fresh Leaf

**Reg. No. 4,134,869**

**Registered May 1, 2012**

**Int. Cl.: 30**

**TRADEMARK**

**PRINCIPAL REGISTER**

GLOBAL ORGANIX, INC. (TEXAS CORPORATION)  
8601 COBBLESTONE  
AUSTIN, TX 78735

FOR: BLACK TEA; CHAI TEA; COFFEE AND TEA; GREEN TEA; HERB TEA; JAPANESE GREEN TEA; OOLONG TEA; TEA; TEA BAGS; TEA FOR INFUSIONS; TEA-BASED BEVERAGES, IN CLASS 30 (U.S. CL. 46).

FIRST USE 7-25-2011; IN COMMERCE 7-25-2011.

THE MARK CONSISTS OF STANDARD CHARACTERS WITHOUT CLAIM TO ANY PARTICULAR FONT, STYLE, SIZE, OR COLOR.

NO CLAIM IS MADE TO THE EXCLUSIVE RIGHT TO USE "LEAF", APART FROM THE MARK AS SHOWN.

SER. NO. 85-408,589, FILED 8-26-2011.

HEATHER THOMPSON, EXAMINING ATTORNEY



*David J. Kybas*

Director of the United States Patent and Trademark Office

# United States of America

United States Patent and Trademark Office

# Kaitei

**Reg. No. 4,134,870**

**Registered May 1, 2012**

**Int. Cl.: 25**

**TRADEMARK**

**PRINCIPAL REGISTER**

HOFFMAN, KATHERAN (UNITED STATES INDIVIDUAL)  
87 CINNAMON TEAL  
ALISO VIEJO, CA 92656

FOR: BOTTOMS; DRESSES; JACKETS; PANTS; SHIRTS; TOPS, IN CLASS 25 (U.S. CLS. 22 AND 39).

FIRST USE 8-1-2011; IN COMMERCE 8-1-2011.

THE MARK CONSISTS OF STANDARD CHARACTERS WITHOUT CLAIM TO ANY PARTICULAR FONT, STYLE, SIZE, OR COLOR.

SER. NO. 85-408,598, FILED 8-26-2011.

HEATHER THOMPSON, EXAMINING ATTORNEY



*David J. Kybas*

Director of the United States Patent and Trademark Office

# United States of America

United States Patent and Trademark Office

## POWERED BY RURAL

**Reg. No. 4,134,871**

**Registered May 1, 2012**

**Int. Cl.: 35**

**SERVICE MARK**

**PRINCIPAL REGISTER**

RURAL DEVELOPMENT INITIATIVES, INC. (OREGON CORPORATION)  
2620 RIVER ROAD  
SUITE 205  
EUGENE, OR 97404

FOR: CHARITABLE SERVICES, NAMELY, PROMOTING PUBLIC AWARENESS IN RURAL COMMUNITIES ABOUT ECONOMIC DEVELOPMENT, LEADERSHIP TRAINING, AND LEADERSHIP OPPORTUNITIES , IN CLASS 35 (U.S. CLS. 100, 101 AND 102).

FIRST USE 1-1-2001; IN COMMERCE 6-24-2011.

THE MARK CONSISTS OF STANDARD CHARACTERS WITHOUT CLAIM TO ANY PARTICULAR FONT, STYLE, SIZE, OR COLOR.

SER. NO. 85-408,601, FILED 8-26-2011.

SUNG IN, EXAMINING ATTORNEY



*David J. Kyffers*

Director of the United States Patent and Trademark Office

# United States of America

United States Patent and Trademark Office

## MOTHER'S CHOICE

**Reg. No. 4,134,872**

**Registered May 1, 2012**

**Int. Cl.: 33**

**TRADEMARK**

**PRINCIPAL REGISTER**

NEVADA COUNTY WINE GUILD, INC. (CALIFORNIA CORPORATION)  
11372 WINTER MOON WAY  
NEVADA CITY, CA 95959

FOR: WINES, IN CLASS 33 (U.S. CLS. 47 AND 49).

FIRST USE 7-8-2011; IN COMMERCE 7-8-2011.

THE MARK CONSISTS OF STANDARD CHARACTERS WITHOUT CLAIM TO ANY PARTICULAR FONT, STYLE, SIZE, OR COLOR.

SER. NO. 85-408,622, FILED 8-26-2011.

BENJAMIN OKEKE, EXAMINING ATTORNEY



*David J. Kybas*

Director of the United States Patent and Trademark Office



**United States of America**  
United States Patent and Trademark Office

# OBESTRIM

**Reg. No. 4,134,873**

**Registered May 1, 2012**

**Int. Cl.: 5**

**TRADEMARK**

**PRINCIPAL REGISTER**

PE LABS, INC. (OKLAHOMA CORPORATION)  
6409 S. WESTERN AVE.  
OKLAHOMA CITY, OK 73139

FOR: DIETARY SUPPLEMENTS, IN CLASS 5 (U.S. CLS. 6, 18, 44, 46, 51 AND 52).

FIRST USE 4-1-2011; IN COMMERCE 4-12-2011.

THE MARK CONSISTS OF STANDARD CHARACTERS WITHOUT CLAIM TO ANY PARTICULAR FONT, STYLE, SIZE, OR COLOR.

SER. NO. 85-408,629, FILED 8-26-2011.

SUNG IN, EXAMINING ATTORNEY



*David J. Kyffers*

Director of the United States Patent and Trademark Office

# United States of America

United States Patent and Trademark Office

## HEARTSWORK WINERY

**Reg. No. 4,134,874**

NEVADA COUNTY WINE GUILD, INC. (CALIFORNIA CORPORATION)  
11372 WINTER MOON WAY  
NEVADA CITY, CA 95959

**Registered May 1, 2012**

**Int. Cl.: 33**

FOR: WINES, IN CLASS 33 (U.S. CLS. 47 AND 49).

**TRADEMARK**

FIRST USE 8-9-2005; IN COMMERCE 8-9-2005.

**PRINCIPAL REGISTER**

THE MARK CONSISTS OF STANDARD CHARACTERS WITHOUT CLAIM TO ANY PARTICULAR FONT, STYLE, SIZE, OR COLOR.

NO CLAIM IS MADE TO THE EXCLUSIVE RIGHT TO USE "WINERY", APART FROM THE MARK AS SHOWN.

SER. NO. 85-408,634, FILED 8-26-2011.

BENJAMIN OKEKE, EXAMINING ATTORNEY



*David J. Kyffers*

Director of the United States Patent and Trademark Office

# United States of America

United States Patent and Trademark Office

# WELL READ

**Reg. No. 4,134,875**

**Registered May 1, 2012**

**Int. Cl.: 33**

**TRADEMARK**

**PRINCIPAL REGISTER**

NEVADA COUNTY WINE GUILD, INC. (CALIFORNIA CORPORATION)  
11372 WINTER MOON WAY  
NEVADA CITY, CA 95959

FOR: WINES, IN CLASS 33 (U.S. CLS. 47 AND 49).

FIRST USE 8-9-2005; IN COMMERCE 8-9-2005.

THE MARK CONSISTS OF STANDARD CHARACTERS WITHOUT CLAIM TO ANY PARTICULAR FONT, STYLE, SIZE, OR COLOR.

SER. NO. 85-408,650, FILED 8-26-2011.

BENJAMIN OKEKE, EXAMINING ATTORNEY



*David J. Kybas*

Director of the United States Patent and Trademark Office

# United States of America

United States Patent and Trademark Office

## EL SABOR DE MIAMI

**Reg. No. 4,134,876**

S D I FOODS LLC (FLORIDA LIMITED LIABILITY COMPANY)  
3501 NW 67 STREET  
MIAMI, FL 33147

**Registered May 1, 2012**

**Int. Cl.: 30**

FOR: SEASONINGS, SPICES, DRIED CHILI PEPPERS FOR USE AS A SEASONING, PROCESSED HERBS, SAUCES, CANDY, IN CLASS 30 (U.S. CL. 46).

**TRADEMARK**

FIRST USE 1-25-2008; IN COMMERCE 1-25-2008.

**PRINCIPAL REGISTER**

THE MARK CONSISTS OF STANDARD CHARACTERS WITHOUT CLAIM TO ANY PARTICULAR FONT, STYLE, SIZE, OR COLOR.

NO CLAIM IS MADE TO THE EXCLUSIVE RIGHT TO USE "MIAMI", APART FROM THE MARK AS SHOWN.

THE ENGLISH TRANSLATION OF "EL SABOR DE MIAMI" IN THE MARK IS "THE FLAVOR OF MIAMI".

SER. NO. 85-408,652, FILED 8-26-2011.

WENDY GOODMAN, EXAMINING ATTORNEY



*David J. Kybas*

Director of the United States Patent and Trademark Office

# United States of America

United States Patent and Trademark Office

# TRASHY

**Reg. No. 4,134,877**

NATURAL HOUSE (ILLINOIS LIMITED LIABILITY COMPANY)  
3820 OHIO AVENUE, SUITE 10  
ST. CHARLES, IL 60174

**Registered May 1, 2012**

**Int. Cl.: 5**

FOR: TRASH CAN DEODORIZER WITH SCRUBBING ACTION, IN CLASS 5 (U.S. CLS. 6, 18, 44, 46, 51 AND 52).

**TRADEMARK**

FIRST USE 4-7-2011; IN COMMERCE 4-7-2011.

**PRINCIPAL REGISTER**

THE MARK CONSISTS OF STANDARD CHARACTERS WITHOUT CLAIM TO ANY PARTICULAR FONT, STYLE, SIZE, OR COLOR.

SER. NO. 85-408,661, FILED 8-26-2011.

TRICIA SONNEBORN, EXAMINING ATTORNEY



*David J. Kyffers*

Director of the United States Patent and Trademark Office

# United States of America

United States Patent and Trademark Office



**Reg. No. 4,134,878**

**Registered May 1, 2012**

**Int. Cl.: 9**

**TRADEMARK**

**PRINCIPAL REGISTER**

RZ MASK LLC (MINNESOTA LIMITED LIABILITY COMPANY)  
949 RIVAGE LN  
BURNSVILLE, MN 55306

FOR: DUST MASKS, IN CLASS 9 (U.S. CLS. 21, 23, 26, 36 AND 38).

FIRST USE 2-15-2011; IN COMMERCE 2-15-2011.

NO CLAIM IS MADE TO THE EXCLUSIVE RIGHT TO USE "MASK", APART FROM THE MARK AS SHOWN.

THE STIPPLING IS FOR SHADING PURPOSES ONLY.

THE MARK CONSISTS OF AN OVAL WITH A SPIRAL-LIKE BORDER THAT CONTAINS THE STYLIZED TEXT "RZ" TO THE LEFT OF THE STYLIZED TEXT "MASK".

SER. NO. 85-408,663, FILED 8-26-2011.

CHARLOTTE CORWIN, EXAMINING ATTORNEY



*David J. Kybas*

Director of the United States Patent and Trademark Office

# United States of America

United States Patent and Trademark Office

# FAT SPOON

**Reg. No. 4,134,879**

**Registered May 1, 2012**

**Int. Cl.: 43**

**SERVICE MARK**

**PRINCIPAL REGISTER**

PASSION PROJECT DINING 2, LLC (CALIFORNIA LIMITED LIABILITY COMPANY), DBA  
FAT SPOON  
329 E 1ST STREET  
LOS ANGELES, CA 90012

FOR: RESTAURANT SERVICES, IN CLASS 43 (U.S. CLS. 100 AND 101).

FIRST USE 8-15-2011; IN COMMERCE 8-15-2011.

THE MARK CONSISTS OF STANDARD CHARACTERS WITHOUT CLAIM TO ANY PARTICULAR FONT, STYLE, SIZE, OR COLOR.

SER. NO. 85-408,676, FILED 8-26-2011.

TRICIA SONNEBORN, EXAMINING ATTORNEY



*David J. Kyffers*

Director of the United States Patent and Trademark Office

# United States of America

United States Patent and Trademark Office



**Reg. No. 4,134,880**

**Registered May 1, 2012**

**Int. Cl.: 41**

**SERVICE MARK**

**PRINCIPAL REGISTER**

COASTAL BEND GUIDES ASSOCIATION (CBGA) (TEXAS UNINCORPORATED TRADE ASSOCIATION- 501(C)6)  
P. O. BOX 1571  
ARANSAS PASS, TX 78335

FOR: ENTERTAINMENT IN THE NATURE OF SPECIAL EVENTS, NAMELY, FISHING TOURNAMENTS, IN CLASS 41 (U.S. CLS. 100, 101 AND 107).

FIRST USE 9-10-2007; IN COMMERCE 9-10-2007.

THE MARK CONSISTS OF THE STYLIZED TEXT "SALTWATER SWEETIES" WITH "SALTWATER" SLIGHTLY HIGHER THAN "SWEETIES". BETWEEN THE WORDS IS A MERMAID SEATED ON A FISHING HOOK HOLDING A FISHING POLE.

SER. NO. 85-408,677, FILED 8-26-2011.

TRICIA SONNEBORN, EXAMINING ATTORNEY



*David J. Kyros*

Director of the United States Patent and Trademark Office



# United States of America

United States Patent and Trademark Office



**Reg. No. 4,134,881**

**Registered May 1, 2012**

**Int. Cl.: 41**

**SERVICE MARK**

**PRINCIPAL REGISTER**

COGNITO COMICS, LLC (CALIFORNIA LIMITED LIABILITY COMPANY)  
3375 17TH STREET, #201  
SAN FRANCISCO, CA 94110

FOR: DIGITAL VIDEO, AUDIO, AND MULTIMEDIA PUBLISHING SERVICES; PUBLISHING OF BOOKS, E-BOOKS, AUDIO BOOKS, MUSIC AND ILLUSTRATIONS, IN CLASS 41 (U.S. CLS. 100, 101 AND 107).

FIRST USE 1-8-2010; IN COMMERCE 1-8-2010.

THE MARK CONSISTS OF A MAN WEARING A MINER HAT WITH A HEADLAMP SHINING.

SER. NO. 85-408,682, FILED 8-26-2011.

MARY ROSSMAN, EXAMINING ATTORNEY



*David J. Kyffers*

Director of the United States Patent and Trademark Office

United States of America  
United States Patent and Trademark Office

READY. SET. \$  
DOUGH!

**Reg. No. 4,134,882**

**Registered May 1, 2012**

**Int. Cl.: 36**

**SERVICE MARK**

**PRINCIPAL REGISTER**

READY SET DOUGH, LLC. (TEXAS LIMITED LIABILITY COMPANY)  
SUITE 2900  
350 N. SAINT PAUL ST.  
DALLAS, TX 75201

FOR: CHARITABLE FUNDRAISING SERVICES, IN CLASS 36 (U.S. CLS. 100, 101 AND 102).

FIRST USE 7-1-2010; IN COMMERCE 7-1-2010.

THE MARK CONSISTS OF THE PHRASE "READY. SET." IN A STYLIZED FORMAT DISPOSED ABOVE THE WORD "DOUGH" IN ANOTHER STYLIZED FORMAT, ALL OF WHICH IS TO THE LEFT OF AN EXCLAMATION POINT HAVING A DOLLAR SIGN DISPOSED UPON AN UPPER PORTION THEREOF.

SER. NO. 85-408,689, FILED 8-26-2011.

TRICIA SONNEBORN, EXAMINING ATTORNEY



*David J. Kyffers*

Director of the United States Patent and Trademark Office

# United States of America

United States Patent and Trademark Office

## BioTHAD

**Reg. No. 4,134,883**

**Registered May 1, 2012**

**Int. Cl.: 42**

**SERVICE MARK**

**PRINCIPAL REGISTER**

KNOWLEDGE BASED SYSTEMS, INC. (TEXAS CORPORATION)  
1408 UNIVERSITY DRIVE EAST  
COLLEGE STATION, TX 77840

FOR: PROVIDING A WEBSITE FEATURING TEMPORARY USE OF NON-DOWNLOADABLE SOFTWARE IN THE FIELD OF SURVEILLANCE, ANALYSIS, AND REPORTING TO PROVIDE SITUATIONAL AWARENESS INTO THE OCCURRENCE AND STATUS OF DISEASE AND BIOLOGICAL EVENTS OF NATIONAL AND GLOBAL IMPORTANCE ACROSS THE WORLD, IN CLASS 42 (U.S. CLS. 100 AND 101).

FIRST USE 5-3-2011; IN COMMERCE 5-3-2011.

THE MARK CONSISTS OF THE LETTERS "BIOTHAD" PRESENTED IN STYLIZED FORM.

SER. NO. 85-408,710, FILED 8-26-2011.

ANGELA DUONG, EXAMINING ATTORNEY



*David J. Kyjars*

Director of the United States Patent and Trademark Office

# United States of America

United States Patent and Trademark Office

## CLOSET RICH

**Reg. No. 4,134,884**

**Registered May 1, 2012**

**Int. Cl.: 35**

**SERVICE MARK**

**PRINCIPAL REGISTER**

ELIZABETH KOTT (UNITED STATES INDIVIDUAL)  
8391 BEVERLY BLVD., #561  
LOS ANGELES, CA 90048

FOR: ON-LINE RETAIL CONSIGNMENT STORES FEATURING CLOTHING, FOOTWEAR, HANDBAGS, BELTS, JEWELRY AND HAIR ACCESSORIES, NAMELY, HEADBANDS, IN CLASS 35 (U.S. CLS. 100, 101 AND 102).

FIRST USE 5-2-2011; IN COMMERCE 8-8-2011.

THE MARK CONSISTS OF STANDARD CHARACTERS WITHOUT CLAIM TO ANY PARTICULAR FONT, STYLE, SIZE, OR COLOR.

SER. NO. 85-408,729, FILED 8-26-2011.

WILLIAM BRECKENFELD, EXAMINING ATTORNEY



*David J. Kyffers*

Director of the United States Patent and Trademark Office

# United States of America

United States Patent and Trademark Office

# N2WIN

**Reg. No. 4,134,885**

**Registered May 1, 2012**

**Int. Cl.: 14**

**TRADEMARK**

**PRINCIPAL REGISTER**

RICH, NED (UNITED STATES INDIVIDUAL)  
1167 CANAAN RD  
COLUMBIA, TN 38401

FOR: WATCHES; NECKLACES: JEWELRY, IN CLASS 14 (U.S. CLS. 2, 27, 28 AND 50).

FIRST USE 8-1-2011; IN COMMERCE 8-10-2011.

THE MARK CONSISTS OF STANDARD CHARACTERS WITHOUT CLAIM TO ANY PARTICULAR FONT, STYLE, SIZE, OR COLOR.

SER. NO. 85-408,736, FILED 8-26-2011.

ROBIN CHOSID, EXAMINING ATTORNEY



*David J. Kyffers*

Director of the United States Patent and Trademark Office

# United States of America

United States Patent and Trademark Office

## UKE CAN CHANGE THE WORLD

**Reg. No. 4,134,886**

**Registered May 1, 2012**

**Int. Cl.: 15**

**TRADEMARK**

**PRINCIPAL REGISTER**

FLEA MARKET MUSIC, INC. (CALIFORNIA CORPORATION)  
22 PRATT ROAD  
CLINTON, CT 06413

FOR: MUSICAL INSTRUMENTS; UKULELES, IN CLASS 15 (U.S. CLS. 2, 21 AND 36).

FIRST USE 7-1-1999; IN COMMERCE 7-1-1999.

THE MARK CONSISTS OF STANDARD CHARACTERS WITHOUT CLAIM TO ANY PARTICULAR FONT, STYLE, SIZE, OR COLOR.

SER. NO. 85-408,759, FILED 8-26-2011.

WON TEAK OH, EXAMINING ATTORNEY



*David J. Kyffers*

Director of the United States Patent and Trademark Office

# United States of America

United States Patent and Trademark Office

# WHAK SAK

**Reg. No. 4,134,887**

**Registered May 1, 2012**

**Int. Cl.: 28**

**TRADEMARK**

**PRINCIPAL REGISTER**

HJC I, LLC (NEVADA LIMITED LIABILITY COMPANY), DBA WHAK SAK  
4022 VIA DANA AVE.  
LAS VEGAS, NV 891414128

FOR: BAGS SPECIALLY ADAPTED FOR SPORTS EQUIPMENT, IN CLASS 28 (U.S. CLS. 22, 23, 38 AND 50).

FIRST USE 6-1-2008; IN COMMERCE 6-1-2008.

THE MARK CONSISTS OF STANDARD CHARACTERS WITHOUT CLAIM TO ANY PARTICULAR FONT, STYLE, SIZE, OR COLOR.

NO CLAIM IS MADE TO THE EXCLUSIVE RIGHT TO USE "SACK", APART FROM THE MARK AS SHOWN.

SER. NO. 85-408,766, FILED 8-26-2011.

THOMAS MANOR, EXAMINING ATTORNEY



*David J. Kyros*

Director of the United States Patent and Trademark Office

# United States of America

United States Patent and Trademark Office

# WHAK SAK

**Reg. No. 4,134,888**

**Registered May 1, 2012**

**Int. Cl.: 18**

**TRADEMARK**

**PRINCIPAL REGISTER**

HJC I, LLC (NEVADA LIMITED LIABILITY COMPANY), DBA WHAK SAK  
4022 VIA DANA AVE.  
LAS VEGAS, NV 891414128

FOR: ALL-PURPOSE CARRYING BAGS, IN CLASS 18 (U.S. CLS. 1, 2, 3, 22 AND 41).

FIRST USE 6-1-2008; IN COMMERCE 6-1-2008.

THE MARK CONSISTS OF STANDARD CHARACTERS WITHOUT CLAIM TO ANY PARTICULAR FONT, STYLE, SIZE, OR COLOR.

NO CLAIM IS MADE TO THE EXCLUSIVE RIGHT TO USE "SACK", APART FROM THE MARK AS SHOWN.

SER. NO. 85-408,779, FILED 8-26-2011.

THOMAS MANOR, EXAMINING ATTORNEY



*David J. Kyffers*

Director of the United States Patent and Trademark Office



# United States of America

United States Patent and Trademark Office



**Reg. No. 4,134,889**

**Registered May 1, 2012**

**Int. Cl.: 41**

**SERVICE MARK**

**PRINCIPAL REGISTER**

PETER LIK IP COMPANY, LLC (NEVADA LIMITED LIABILITY COMPANY)  
6625 W. BADURA AVENUE  
LAS VEGAS, NV 89118

FOR: ART EXHIBITIONS; PHOTOGRAPHY, IN CLASS 41 (U.S. CLS. 100, 101 AND 107).

FIRST USE 3-31-2010; IN COMMERCE 3-31-2010.

OWNER OF U.S. REG. NO. 3,048,088.

THE MARK CONSISTS OF THE WORD "LIK" VERTICALLY CONTAINED INSIDE A SQUARE.

SER. NO. 85-408,815, FILED 8-26-2011.

SOPHIA S. KIM, EXAMINING ATTORNEY



*David J. Kyffers*

Director of the United States Patent and Trademark Office

# United States of America

United States Patent and Trademark Office

# LIK

**Reg. No. 4,134,890**

**Registered May 1, 2012**

**Int. Cl.: 16**

**TRADEMARK**

**PRINCIPAL REGISTER**

PETER LIK IP COMPANY, LLC (NEVADA LIMITED LIABILITY COMPANY)  
6625 W. BADURA AVENUE  
LAS VEGAS, NV 89118

FOR: PHOTOGRAPHIC PRINTS, POSTERS, POSTCARDS, AND NON-FICTION BOOKS  
CONTAINING PHOTOGRAPHS, IN CLASS 16 (U.S. CLS. 2, 5, 22, 23, 29, 37, 38 AND 50).

FIRST USE 5-31-2003; IN COMMERCE 5-31-2003.

THE MARK CONSISTS OF STANDARD CHARACTERS WITHOUT CLAIM TO ANY PAR-  
TICULAR FONT, STYLE, SIZE, OR COLOR.

OWNER OF U.S. REG. NO. 3,048,088.

SER. NO. 85-408,817, FILED 8-26-2011.

SOPHIA S. KIM, EXAMINING ATTORNEY



*David J. Kybas*

Director of the United States Patent and Trademark Office

# United States of America

United States Patent and Trademark Office

# LIK

**Reg. No. 4,134,891**

**Registered May 1, 2012**

**Int. Cl.: 41**

**SERVICE MARK**

**PRINCIPAL REGISTER**

PETER LIK IP COMPANY, LLC (NEVADA LIMITED LIABILITY COMPANY)  
6625 W. BADURA AVENUE  
LAS VEGAS, NV 89118

FOR: ART EXHIBITIONS; PHOTOGRAPHY, IN CLASS 41 (U.S. CLS. 100, 101 AND 107).

FIRST USE 5-31-2003; IN COMMERCE 5-31-2003.

THE MARK CONSISTS OF STANDARD CHARACTERS WITHOUT CLAIM TO ANY PARTICULAR FONT, STYLE, SIZE, OR COLOR.

OWNER OF U.S. REG. NO. 3,048,088.

SER. NO. 85-408,823, FILED 8-26-2011.

SOPHIA S. KIM, EXAMINING ATTORNEY



*David J. Kybas*

Director of the United States Patent and Trademark Office

# United States of America

United States Patent and Trademark Office

# EXPOSED

**Reg. No. 4,134,892**

PETER LIK IP COMPANY, LLC (NEVADA LIMITED LIABILITY COMPANY)  
6625 W. BADURA AVENUE  
LAS VEGAS, NV 89118

**Registered May 1, 2012**

**Int. Cl.: 41**

FOR: ON-LINE JOURNALS, NAMELY, BLOGS FEATURING PHOTOGRAPHY, ENTERTAINMENT, AND GENERAL INTEREST MATTERS, IN CLASS 41 (U.S. CLS. 100, 101 AND 107).

**SERVICE MARK**

FIRST USE 1-28-2011; IN COMMERCE 1-28-2011.

**PRINCIPAL REGISTER**

THE MARK CONSISTS OF STANDARD CHARACTERS WITHOUT CLAIM TO ANY PARTICULAR FONT, STYLE, SIZE, OR COLOR.

SER. NO. 85-408,824, FILED 8-26-2011.

SOPHIA S. KIM, EXAMINING ATTORNEY



*David J. Kybas*

Director of the United States Patent and Trademark Office

# United States of America

United States Patent and Trademark Office

# EXPOSED

**Reg. No. 4,134,893**

**Registered May 1, 2012**

**Int. Cl.: 41**

**SERVICE MARK**

**PRINCIPAL REGISTER**

PETER LIK IP COMPANY, LLC (NEVADA LIMITED LIABILITY COMPANY)  
6625 W. BADURA AVENUE  
LAS VEGAS, NV 89118

FOR: ON-LINE JOURNALS, NAMELY, BLOGS FEATURING PHOTOGRAPHY, ENTERTAINMENT, AND GENERAL INTEREST MATTERS, IN CLASS 41 (U.S. CLS. 100, 101 AND 107).

FIRST USE 1-28-2011; IN COMMERCE 1-28-2011.

THE MARK CONSISTS OF THE WORD "EXPOSED" WITH THE "X" CONTAINED IN A 3 DIMENSIONAL SQUARE.

SER. NO. 85-408,825, FILED 8-26-2011.

SOPHIA S. KIM, EXAMINING ATTORNEY



*David J. Kybas*

Director of the United States Patent and Trademark Office

# United States of America

United States Patent and Trademark Office



**Reg. No. 4,134,894**

**Registered May 1, 2012**

**Int. Cl.: 38**

**SERVICE MARK**

**PRINCIPAL REGISTER**

PETER LIK IP COMPANY, LLC (NEVADA LIMITED LIABILITY COMPANY)  
6625 W. BADURA AVENUE  
LAS VEGAS, NV 89118

FOR: PROVIDING ONLINE CHAT ROOMS AND ELECTRONIC BULLETIN BOARDS FOR REGISTERED USERS FOR TRANSMISSION OF MESSAGES CONCERNING PHOTOGRAPHY AND SOCIAL NETWORKING , IN CLASS 38 (U.S. CLS. 100, 101 AND 104).

FIRST USE 1-28-2011; IN COMMERCE 1-28-2011.

THE MARK CONSISTS OF THE LETTER "X" CONTAINED IN A 3 DIMENSIONAL SQUARE.

SER. NO. 85-408,826, FILED 8-26-2011.

SOPHIA S. KIM, EXAMINING ATTORNEY



*David J. Kybas*

Director of the United States Patent and Trademark Office

# United States of America

United States Patent and Trademark Office



**Reg. No. 4,134,895**

**Registered May 1, 2012**

**Int. Cl.: 41**

**SERVICE MARK**

**PRINCIPAL REGISTER**

PETER LIK IP COMPANY, LLC (NEVADA LIMITED LIABILITY COMPANY)  
6625 W. BADURA AVENUE  
LAS VEGAS, NV 89118

FOR: ON-LINE JOURNALS, NAMELY, BLOGS FEATURING PHOTOGRAPHY, ENTERTAINMENT, AND GENERAL INTEREST MATTERS, IN CLASS 41 (U.S. CLS. 100, 101 AND 107).

FIRST USE 1-28-2011; IN COMMERCE 1-28-2011.

THE MARK CONSISTS OF THE LETTER "X" CONTAINED IN A 3 DIMENSIONAL SQUARE.

SER. NO. 85-408,827, FILED 8-26-2011.

SOPHIA S. KIM, EXAMINING ATTORNEY



*David J. Kybas*

Director of the United States Patent and Trademark Office

# United States of America

United States Patent and Trademark Office

iStarGLOBAL

**Reg. No. 4,134,896**

**Registered May 1, 2012**

**Int. Cl.: 9**

**TRADEMARK**

**PRINCIPAL REGISTER**

WANG, KUO AN (UNITED STATES INDIVIDUAL)  
727 PHILLIPS DRIVE  
CITY OF INDUSTRY, CA 91748

FOR: COMPUTER CABLES, COMPUTER HARDWARE, COMPUTER NETWORKING HARDWARE, AND COMPUTER PERIPHERALS, IN CLASS 9 (U.S. CLS. 21, 23, 26, 36 AND 38).

FIRST USE 3-1-2011; IN COMMERCE 3-1-2011.

THE MARK CONSISTS OF "ISTARGLBAL" IN STYLIZED FORM AND A GLOBE SKETCH SYMBOLIZES THE LETTER "O" WHICH IS PLACED BETWEEN THE LETTERS "L" AND "B" AND IS CONNECTED TO THE LETTER "B". THE LETTERS "I", "T", "A", AND "R" ARE IN LOWER CASE, THE LETTER "S", "G", "L", "B", "A", AND "L" ARE IN UPPER CASE.

SER. NO. 85-408,828, FILED 8-26-2011.

SHARON MEIER, EXAMINING ATTORNEY



*David J. Kyffers*

Director of the United States Patent and Trademark Office



# United States of America

United States Patent and Trademark Office



## incloudcounsel

**Reg. No. 4,134,897**

**Registered May 1, 2012**

**Int. Cl.: 45**

**SERVICE MARK**

**PRINCIPAL REGISTER**

DOCUMENT SERVICES, LLC (CALIFORNIA LIMITED LIABILITY COMPANY)  
1360 STEVENSON STREET  
SAN FRANCISCO, CA 94103

FOR: LEGAL SERVICES, IN CLASS 45 (U.S. CLS. 100 AND 101).

FIRST USE 3-27-2011; IN COMMERCE 3-27-2011.

THE MARK CONSISTS OF THE WORD "INCLOUDCOUNSEL" STYLIZED BELOW AN IMAGE OF A SHEET OF PAPER, FOLDED AT THE TOP LEFT CORNER, CONTAINED WITHIN A CLOUD.

SER. NO. 85-408,852, FILED 8-26-2011.

SOPHIA S. KIM, EXAMINING ATTORNEY



*David J. Kybas*

Director of the United States Patent and Trademark Office

# United States of America

United States Patent and Trademark Office

# Kan Lun

**Reg. No. 4,134,898**

**Registered May 1, 2012**

**Int. Cl.: 25**

**TRADEMARK**

**PRINCIPAL REGISTER**

GARY L PIFER (UNITED STATES INDIVIDUAL)  
2356 CADDIE CT  
OCEANSIDE, CA 92056

FOR: JEANS; T-SHIRTS, IN CLASS 25 (U.S. CLS. 22 AND 39).

FIRST USE 8-8-2011; IN COMMERCE 8-8-2011.

THE MARK CONSISTS OF STANDARD CHARACTERS WITHOUT CLAIM TO ANY PARTICULAR FONT, STYLE, SIZE, OR COLOR.

THE NAME(S), PORTRAIT(S), AND/OR SIGNATURE(S) SHOWN IN THE MARK DOES NOT IDENTIFY A PARTICULAR LIVING INDIVIDUAL.

SER. NO. 85-408,860, FILED 8-27-2011.

JOHN DWYER, EXAMINING ATTORNEY



*David J. Kyffers*

Director of the United States Patent and Trademark Office

# United States of America

United States Patent and Trademark Office

## THAT'S HOW WE ROLL

**Reg. No. 4,134,899**

**Registered May 1, 2012**

**Int. Cl.: 37**

**SERVICE MARK**

**PRINCIPAL REGISTER**

WALLACE, LARRY (UNITED STATES INDIVIDUAL)  
30949 KNOLL COURT  
LEWES, DE 19958

FOR: CUSTOM AND DECORATIVE PAINTING SERVICES; DECORATIVE PAINTING SERVICES; DRYWALL AND PAINTING CONTRACTOR SERVICES; PAINTING CONTRACTOR SERVICES, IN CLASS 37 (U.S. CLS. 100, 103 AND 106).

FIRST USE 1-11-2007; IN COMMERCE 1-11-2007.

THE MARK CONSISTS OF STANDARD CHARACTERS WITHOUT CLAIM TO ANY PARTICULAR FONT, STYLE, SIZE, OR COLOR.

SER. NO. 85-408,869, FILED 8-27-2011.

JENNIFER DIXON, EXAMINING ATTORNEY



*David J. Kybas*

Director of the United States Patent and Trademark Office

United States of America  
United States Patent and Trademark Office

**FR**

**Reg. No. 4,134,900**

**Registered May 1, 2012**

**Int. Cl.: 42**

**SERVICE MARK**

**PRINCIPAL REGISTER**

FRANK, RICHARD (UNITED STATES INDIVIDUAL)  
401 23RD ST. S  
FARGO, ND 58103

FOR: CONSULTING IN THE FIELD OF CONFIGURATION MANAGEMENT FOR COMPUTER  
HARDWARE AND SOFTWARE, IN CLASS 42 (U.S. CLS. 100 AND 101).

FIRST USE 10-1-2004; IN COMMERCE 10-1-2004.

THE MARK CONSISTS OF AN "F" AND AN "R", WITH THE "F" FLIPPED IN THE HORIZONTAL PLANE, SO THAT IT IS BACKWARDS. THE BACKWARDS "F" AND THE "R" ARE CONNECTED AT THE TOP AND BOTTOM OF THEIR SPINES TO FORM A SINGLE SYMBOL. THE FONT USED IS COPPERPLATE GOTHIC BOLD.

SER. NO. 85-408,892, FILED 8-27-2011.

Laurie Kaufman, Examining Attorney



*David J. Kybas*

Director of the United States Patent and Trademark Office

# United States of America

United States Patent and Trademark Office



**Reg. No. 4,134,901**

**Registered May 1, 2012**

**Int. Cl.: 18**

**TRADEMARK**

**PRINCIPAL REGISTER**

BUNCH BAGS (FLORIDA LIMITED LIABILITY COMPANY)  
2840 W. BAY DR. #140  
BELLEAIR BLUFFS, FL 33770

FOR: REUSABLE TEXTILE PRODUCE BAGS TO CARRY PRODUCE FROM GROCERY STORES AND FARMER'S MARKETS, IN CLASS 18 (U.S. CLS. 1, 2, 3, 22 AND 41).

FIRST USE 1-1-2011; IN COMMERCE 8-25-2011.

NO CLAIM IS MADE TO THE EXCLUSIVE RIGHT TO USE "BAGS", APART FROM THE MARK AS SHOWN.

THE COLOR(S) YELLOW, PINK, GREEN, ORANGE, BROWN, RED, PURPLE, WHITE, BLUE, AND BLACK IS/ARE CLAIMED AS A FEATURE OF THE MARK.

THE MARK CONSISTS OF THE WORDING "BUNCH BAGS" AND A DESIGN ELEMENT COMPRISING FRUIT AND VEGETABLES FEATURING CARTOON FACES. THE COLOR YELLOW APPEARS IN "BUNCH BAGS", THE CELERY STALK, THE BANANA, AND TOP OF THE TOMATO. THE COLOR PINK APPEARS IN THE WATERMELON. THE COLOR GREEN APPEARS IN THE WATERMELON, THE LETTUCE, THE TOP OF THE CARROT, AND THE TOP OF THE CELERY. THE COLOR ORANGE APPEARS IN THE CARROT. THE COLOR BROWN APPEARS IN THE POTATO. THE COLOR RED APPEARS IN THE TOMATO. THE COLOR PURPLE APPEARS IN THE BACKGROUND OF THE MARK. THE COLOR WHITE APPEARS IN THE ONION AND IN ALL OF THE CARTOON EYES. THE COLOR BLUE APPEARS IN THE CARTOON EYES. THE COLOR BLACK OUTLINES THE WORDING AND DESIGN ELEMENTS AND APPEARS IN THE WATERMELON PITS, IN THE CARTOON EYES AND MOUTHS, IN THE POTATO, AND IN THE BACKGROUND OF THE MARK.

SER. NO. 85-408,893, FILED 8-27-2011.

Laurie Kaufman, Examining Attorney



*David J. Kybas*

Director of the United States Patent and Trademark Office

# United States of America

United States Patent and Trademark Office

## Credit Repair Doctor

**Reg. No. 4,134,902**

**Registered May 1, 2012**

**Int. Cl.: 9**

**TRADEMARK**

**PRINCIPAL REGISTER**

FORMIDABLE PUBLISHING GROUP LLC (ARIZONA LIMITED LIABILITY COMPANY)  
7024 S 30TH STREET  
PHOENIX, AZ 85042

FOR: DIGITAL MATERIALS, NAMELY, DOWNLOADABLE ELECTRONIC BOOKS,  
WORKBOOKS, AND VIDEO RECORDINGS FEATURING THE SUBJECT OF CREDIT REPAIR  
, IN CLASS 9 (U.S. CLS. 21, 23, 26, 36 AND 38).

FIRST USE 2-1-2010; IN COMMERCE 10-14-2010.

THE MARK CONSISTS OF STANDARD CHARACTERS WITHOUT CLAIM TO ANY PAR-  
TICULAR FONT, STYLE, SIZE, OR COLOR.

NO CLAIM IS MADE TO THE EXCLUSIVE RIGHT TO USE "CREDIT REPAIR", APART  
FROM THE MARK AS SHOWN.

SER. NO. 85-408,897, FILED 8-27-2011.

MARK T. MULLEN, EXAMINING ATTORNEY



*David J. Kybas*

Director of the United States Patent and Trademark Office

# United States of America

United States Patent and Trademark Office

# Kendall Day

**Reg. No. 4,134,903**

**Registered May 1, 2012**

**Int. Cl.: 41**

**SERVICE MARK**

**PRINCIPAL REGISTER**

EATON, KENDALL L (UNITED STATES INDIVIDUAL), AKA KENDALL DAY  
16410 MARYLAND ST  
SOUTHFIELD, MI 48076

FOR: ENTERTAINMENT IN THE NATURE OF LIVE PERFORMANCES BY A SINGER SONGWRITER; ENTERTAINMENT SERVICES IN THE NATURE OF LIVE MUSICAL PERFORMANCES; ENTERTAINMENT SERVICES IN THE NATURE OF RECORDING, PRODUCTION AND POST-PRODUCTION SERVICES IN THE FIELD OF MUSIC; ENTERTAINMENT, NAMELY, LIVE MUSIC CONCERTS, IN CLASS 41 (U.S. CLS. 100, 101 AND 107).

FIRST USE 6-1-2006; IN COMMERCE 6-1-2006.

THE MARK CONSISTS OF STANDARD CHARACTERS WITHOUT CLAIM TO ANY PARTICULAR FONT, STYLE, SIZE, OR COLOR.

THE NAME(S), PORTRAIT(S), AND/OR SIGNATURE(S) SHOWN IN THE MARK IDENTIFIES "KENDALL L EATON", WHOSE CONSENT(S) TO REGISTER IS MADE OF RECORD.

SER. NO. 85-408,911, FILED 8-27-2011.

HELENE LIWINSKI, EXAMINING ATTORNEY



*David J. Kyros*

Director of the United States Patent and Trademark Office

# United States of America

United States Patent and Trademark Office



**Reg. No. 4,134,904**

**Registered May 1, 2012**

**Int. Cl.: 3**

**TRADEMARK**

**PRINCIPAL REGISTER**

SUPER CONTAGIOUS (ILLINOIS CORPORATION)  
1416 FLORENCE AVENUE  
EVANSTON, IL 60201

FOR: CLEANING, WASHING AND POLISHING PREPARATIONS, IN CLASS 3 (U.S. CLS. 1, 4, 6, 50, 51 AND 52).

FIRST USE 4-1-2011; IN COMMERCE 7-1-2011.

NO CLAIM IS MADE TO THE EXCLUSIVE RIGHT TO USE "SCRATCH PROTECTOR", APART FROM THE MARK AS SHOWN.

THE STIPPLING IS FOR SHADING PURPOSES ONLY.

THE MARK CONSISTS OF THE SHAPE OF A SHIELD. THERE IS A HORIZONTAL BAR RUNNING THROUGH THE MIDDLE OF THE SHIELD THAT HOLDS THE WORDS "SCRATCH PROTECTOR". THE SHIELD HOLDS A VERTICAL STRIPE THAT RUNS FROM THE TOP OF THE SHIELD TO THE BOTTOM OF THE SHIELD. THE HORIZONTAL BAR FADES OUT ON ITS FURTHEST ENDS.

SER. NO. 85-408,913, FILED 8-27-2011.

ALAIN LAPTER, EXAMINING ATTORNEY



*David J. Kyffers*

Director of the United States Patent and Trademark Office



# United States of America

United States Patent and Trademark Office

# life is primo

**Reg. No. 4,134,905**

MCMILLIN, MAUI M.P. (UNITED STATES INDIVIDUAL)  
126 HINAU ST.  
LAHAINA, HI 96761

**Registered May 1, 2012**

**Int. Cl.: 25**

FOR: HATS; HOODED SWEAT SHIRTS; RASH GUARDS; SHORTS; SWEAT SHIRTS; SWIM SUITS; T-SHIRTS, IN CLASS 25 (U.S. CLS. 22 AND 39).

**TRADEMARK**

FIRST USE 4-13-2011; IN COMMERCE 4-13-2011.

**PRINCIPAL REGISTER**

THE MARK CONSISTS OF STANDARD CHARACTERS WITHOUT CLAIM TO ANY PARTICULAR FONT, STYLE, SIZE, OR COLOR.

SER. NO. 85-408,914, FILED 8-27-2011.

INGA ERVIN, EXAMINING ATTORNEY



*David J. Kyffers*

Director of the United States Patent and Trademark Office

# United States of America

United States Patent and Trademark Office

## Crêpe Expectations

**Reg. No. 4,134,906**

**Registered May 1, 2012**

**Int. Cl.: 43**

**SERVICE MARK**

**PRINCIPAL REGISTER**

CREPE EXPECTATIONS LLC (NEVADA LIMITED LIABILITY COMPANY)  
#339  
2657 WINDMILL PKWY.  
HENDERSON, NV 89074

FOR: RESTAURANT SERVICES, IN CLASS 43 (U.S. CLS. 100 AND 101).

FIRST USE 11-15-2010; IN COMMERCE 11-20-2010.

THE MARK CONSISTS OF STANDARD CHARACTERS WITHOUT CLAIM TO ANY PARTICULAR FONT, STYLE, SIZE, OR COLOR.

NO CLAIM IS MADE TO THE EXCLUSIVE RIGHT TO USE "CREPE", APART FROM THE MARK AS SHOWN.

SER. NO. 85-408,924, FILED 8-27-2011.

JOHN DWYER, EXAMINING ATTORNEY



*David J. Kyffers*

Director of the United States Patent and Trademark Office

# United States of America

United States Patent and Trademark Office

## SENSORY PLAYGROUND

**Reg. No. 4,134,907**

**Registered May 1, 2012**

**Int. Cls.: 35 and 41**

**SERVICE MARK**

**PRINCIPAL REGISTER**

DERVAL, DIANA (FRANCE INDIVIDUAL)  
CARVALHOM2002@YAHOO.COM  
KEIZERSGRACHT 44F  
AMSTERDAM, NETHERLANDS

FOR: BUSINESS MARKETING SERVICES, MARKETING PLAN DEVELOPMENT; MARKET SEGMENTATION CONSULTATION; MARKET RESEARCH SERVICES, NAMELY, CONSUMER MARKETING CONSULTANCY SERVICES PARTICULARLY SPECIALIZING IN THE USE OF SENSORY PERCEPTION ANALYSIS THAT IDENTIFY SENSORY PROPERTIES OF PRODUCTS FOR THE UNDERSTANDING AND PREDICTING OF CONSUMERS, BUSINESSES, AND MARKET TRENDS AND ACTIONS, TO AID IN MAXIMIZING THE DEVELOPMENT OF MARKETING PLANS FOR NEW PRODUCTS AND SERVICES; PROMOTION OF GOODS AND SERVICES OF OTHERS, IN CLASS 35 (U.S. CLS. 100, 101 AND 102).

FIRST USE 12-10-2010; IN COMMERCE 3-16-2011.

FOR: EDUCATION SERVICES, NAMELY, CONDUCTING SEMINARS, CONFERENCES, LECTURES AND EDUCATIONAL PRESENTATIONS RELATING TO MARKETING ON THE TOPICS OF SENSORY PERCEPTION ANALYSIS THAT IDENTIFY SENSORY PROPERTIES OF PRODUCTS FOR RECOGNIZING CONSUMER'S EXPERIENCE, BEHAVIOR AND ACCEPTANCE, BUSINESSES, AND MARKET TRENDS AND ACTIONS; PROVIDING ONLINE NON-DOWNLOADABLE NEWSLETTERS IN THE FIELD OF MARKETING SPECIFICALLY RELATED TO SENSORY PERCEPTION ANALYSIS THAT IDENTIFY SENSORY PROPERTIES OF PRODUCTS FOR CONSUMER ACCEPTANCE, BUSINESSES, AND MARKET TRENDS AND ACTIONS; LIFE COACHING SERVICES IN THE FIELD OF PROFESSIONAL AND PERSONAL DEVELOPMENT BASED ON SENSORY PERCEPTION PROFILES, IN CLASS 41 (U.S. CLS. 100, 101 AND 107).

FIRST USE 12-10-2010; IN COMMERCE 3-16-2011.

THE MARK CONSISTS OF STANDARD CHARACTERS WITHOUT CLAIM TO ANY PARTICULAR FONT, STYLE, SIZE, OR COLOR.

NO CLAIM IS MADE TO THE EXCLUSIVE RIGHT TO USE "SENSORY", APART FROM THE MARK AS SHOWN.

SER. NO. 85-408,926, FILED 8-27-2011.



*David J. Kyjars*

Director of the United States Patent and Trademark Office

**Reg. No. 4,134,907** COLLEEN KEARNEY, EXAMINING ATTORNEY

# United States of America

United States Patent and Trademark Office

## Joe Cotten's Barbecue

**Reg. No. 4,134,908**

**Registered May 1, 2012**

**Int. Cl.: 43**

**SERVICE MARK**

**PRINCIPAL REGISTER**

COTTEN'S BARBECUE, INC. (TEXAS CORPORATION)  
P.O. BOX 1029  
ROBSTOWN, TX 78380

FOR: RESTAURANT AND CATERING SERVICES, IN CLASS 43 (U.S. CLS. 100 AND 101).

FIRST USE 12-1-1947; IN COMMERCE 12-1-1947.

THE MARK CONSISTS OF STANDARD CHARACTERS WITHOUT CLAIM TO ANY PARTICULAR FONT, STYLE, SIZE, OR COLOR.

NO CLAIM IS MADE TO THE EXCLUSIVE RIGHT TO USE "BARBECUE", APART FROM THE MARK AS SHOWN.

THE NAME "JOE COTTEN" DOES NOT IDENTIFY A PARTICULAR LIVING INDIVIDUAL.

SER. NO. 85-408,928, FILED 8-27-2011.

JOHN DWYER, EXAMINING ATTORNEY



*David J. Kyffers*

Director of the United States Patent and Trademark Office

# United States of America

United States Patent and Trademark Office

# Dent Poppers

**Reg. No. 4,134,909**

**Registered May 1, 2012**

**Int. Cl.: 37**

**SERVICE MARK**

**PRINCIPAL REGISTER**

DENT POPPERS, LLC (TEXAS LIMITED LIABILITY COMPANY)  
P.O. BOX 700476  
DALLAS, TX 75370

FOR: AUTOMOBILE BODY REPAIR, NAMELY, PAINT DENT REPAIR SERVICES FOR VEHICLES, IN CLASS 37 (U.S. CLS. 100, 103 AND 106).

FIRST USE 1-0-1991; IN COMMERCE 1-0-1991.

THE MARK CONSISTS OF STANDARD CHARACTERS WITHOUT CLAIM TO ANY PARTICULAR FONT, STYLE, SIZE, OR COLOR.

NO CLAIM IS MADE TO THE EXCLUSIVE RIGHT TO USE "DENT", APART FROM THE MARK AS SHOWN.

SER. NO. 85-408,936, FILED 8-27-2011.

SCOTT BIBB, EXAMINING ATTORNEY



*David J. Kybas*

Director of the United States Patent and Trademark Office

# United States of America

United States Patent and Trademark Office

## SENSORY GEOMAP

**Reg. No. 4,134,910**

**Registered May 1, 2012**

**Int. Cls.: 35 and 41**

**SERVICE MARK**

**PRINCIPAL REGISTER**

DERVAL, DIANA (FRANCE INDIVIDUAL)  
KEIZERSGRACHT 44F  
AMSTERDAM, NETHERLANDS

FOR: BUSINESS MARKETING SERVICES, MARKETING PLAN DEVELOPMENT; MARKET SEGMENTATION CONSULTATION; MARKET RESEARCH SERVICES, NAMELY, CONSUMER MARKETING CONSULTANCY SERVICES PARTICULARLY SPECIALIZING IN THE GEOGRAPHIC DISTRIBUTION OF PROFILES RELATING TO SENSORY PERCEPTIONS BROKEN DOWN BY DEGREES OF CAPABILITIES THAT ALLOWS CUSTOMERS TO RECOGNIZE REGIONAL CONSUMER'S EXPERIENCE AND BEHAVIORS FOR THE UNDERSTANDING AND PREDICTING OF CONSUMERS, BUSINESSES, AND MARKET TRENDS AND ACTIONS, TO AID IN MAXIMIZING THE DEVELOPMENT OF MARKETING PLANS FOR NEW PRODUCTS AND SERVICES; PROMOTION OF GOODS AND SERVICES OF OTHERS, IN CLASS 35 (U.S. CLS. 100, 101 AND 102).

FIRST USE 6-9-2010; IN COMMERCE 7-14-2010.

FOR: EDUCATION SERVICES, NAMELY, CONDUCTING SEMINARS, CONFERENCES, LECTURES AND EDUCATIONAL PRESENTATIONS RELATING TO MARKETING ON THE TOPICS OF GEOGRAPHIC DISTRIBUTION OF SENSORY PERCEPTION PROFILES FOR CONSUMER ACCEPTANCE, TRENDS AND BEHAVIORS, BUSINESSES, AND MARKET TRENDS AND ACTIONS; PROVIDING ONLINE NON-DOWNLOADABLE NEWSLETTERS IN THE FIELD OF MARKETING SPECIFICALLY RELATED TO THE GEOGRAPHIC DISTRIBUTION OF SENSORY PERCEPTION PROFILES AS A GUIDE TO CONSUMER'S EXPERIENCES, BEHAVIORS AND ACCEPTANCE, BUSINESSES, AND MARKET TRENDS AND ACTIONS; LIFE COACHING SERVICES IN THE FIELD OF PROFESSIONAL AND PERSONAL DEVELOPMENT BASED ON GEOGRAPHICALLY LOCALIZED SENSORY PERCEPTION PROFILES, IN CLASS 41 (U.S. CLS. 100, 101 AND 107).

FIRST USE 6-9-2010; IN COMMERCE 7-14-2010.

THE MARK CONSISTS OF STANDARD CHARACTERS WITHOUT CLAIM TO ANY PARTICULAR FONT, STYLE, SIZE, OR COLOR.

NO CLAIM IS MADE TO THE EXCLUSIVE RIGHT TO USE "SENSORY" , APART FROM THE MARK AS SHOWN.



*David J. Kyjars*

Director of the United States Patent and Trademark Office

**Reg. No. 4,134,910** SER. NO. 85-408,942, FILED 8-27-2011.

COLLEEN KEARNEY, EXAMINING ATTORNEY



United States of America  
United States Patent and Trademark Office

# BeautyJoint

**Reg. No. 4,134,911**

LEE, BRIAN (UNITED STATES INDIVIDUAL)  
681 S BRONSON AVE.  
LOS ANGELES, CA 90005

**Registered May 1, 2012**

**Int. Cl.: 35**

FOR: ON-LINE RETAIL STORE SERVICES FEATURING COSMETICS, IN CLASS 35 (U.S. CLS. 100, 101 AND 102).

**SERVICE MARK**

FIRST USE 11-1-2010; IN COMMERCE 11-1-2010.

**PRINCIPAL REGISTER**

THE MARK CONSISTS OF STANDARD CHARACTERS WITHOUT CLAIM TO ANY PARTICULAR FONT, STYLE, SIZE, OR COLOR.

SER. NO. 85-408,949, FILED 8-27-2011.

REBECCA POVARCHUK, EXAMINING ATTORNEY



*David J. Kyros*

Director of the United States Patent and Trademark Office

# United States of America

United States Patent and Trademark Office

# POWER+ HL

**Reg. No. 4,134,912**

**Registered May 1, 2012**

**Int. Cl.: 5**

**TRADEMARK**

**PRINCIPAL REGISTER**

HEALTHYLIFE INC. (NEW YORK CORPORATION)  
2149 79TH STREET  
BROOKLYN, NY 11214

FOR: HOMEOPATHIC SUPPLEMENTS, IN CLASS 5 (U.S. CLS. 6, 18, 44, 46, 51 AND 52).

FIRST USE 6-11-2010; IN COMMERCE 6-11-2010.

THE MARK CONSISTS OF STANDARD CHARACTERS WITHOUT CLAIM TO ANY PARTICULAR FONT, STYLE, SIZE, OR COLOR.

SER. NO. 85-408,952, FILED 8-27-2011.

REBECCA POVARCHUK, EXAMINING ATTORNEY



*David J. Kyffers*

Director of the United States Patent and Trademark Office

# United States of America

United States Patent and Trademark Office



**Reg. No. 4,134,913**

**Registered May 1, 2012**

**Int. Cl.: 30**

**TRADEMARK**

**PRINCIPAL REGISTER**

GRAND POINTE ENTERPRISE INC (ILLINOIS CORPORATION), DBA GRAND GOURMET  
MARKET  
27710 S STONEY ISLAND AVE  
CRETE, IL 60417

FOR: CHICKEN WING SAUCE, IN CLASS 30 (U.S. CL. 46).

FIRST USE 8-25-2011; IN COMMERCE 8-25-2011.

THE MARK CONSISTS OF OVAL SHAPE WITH BLACK BACKGROUND WITH THE WORD "SHAZAM" IN RED FONT ARCHED ONTO THE BACKGROUND WITH A RED SQUIGGLY "S" STYLE DESIGN.

THE COLOR(S) BLACK, RED IS/ARE CLAIMED AS A FEATURE OF THE MARK.

SER. NO. 85-408,953, FILED 8-27-2011.

REBECCA POVARCHUK, EXAMINING ATTORNEY



*David J. Kybas*

Director of the United States Patent and Trademark Office

**United States of America**  
United States Patent and Trademark Office

**chicBoom**

**Reg. No. 4,134,914**

CHICBLVD INC (CALIFORNIA CORPORATION), DBA CHICBUDS  
1487 POINSETTIA AVE #125  
VISTA, CA 92587

**Registered May 1, 2012**

**Int. Cl.: 9**

FOR: AUDIO SPEAKERS, IN CLASS 9 (U.S. CLS. 21, 23, 26, 36 AND 38).

**TRADEMARK**

FIRST USE 3-1-2010; IN COMMERCE 6-1-2010.

**PRINCIPAL REGISTER**

THE MARK CONSISTS OF STANDARD CHARACTERS WITHOUT CLAIM TO ANY PARTICULAR FONT, STYLE, SIZE, OR COLOR.

SER. NO. 85-408,962, FILED 8-27-2011.

MARTHA FROMM, EXAMINING ATTORNEY



*David J. Kyffers*

Director of the United States Patent and Trademark Office

# United States of America

United States Patent and Trademark Office

# RockBoom

**Reg. No. 4,134,915**

**Registered May 1, 2012**

**Int. Cl.: 9**

**TRADEMARK**

**PRINCIPAL REGISTER**

CHICBLVD INC (CALIFORNIA CORPORATION), DBA ROCKBUDS  
1487 POINSETTIA AVE #125  
VISTA, CA 92081

FOR: AUDIO SPEAKERS, IN CLASS 9 (U.S. CLS. 21, 23, 26, 36 AND 38).

FIRST USE 3-1-2010; IN COMMERCE 6-1-2010.

THE MARK CONSISTS OF STANDARD CHARACTERS WITHOUT CLAIM TO ANY PARTICULAR FONT, STYLE, SIZE, OR COLOR.

SER. NO. 85-408,965, FILED 8-27-2011.

MARTHA FROMM, EXAMINING ATTORNEY



*David J. Kyffers*

Director of the United States Patent and Trademark Office

# United States of America

United States Patent and Trademark Office

# Black Saga

**Reg. No. 4,134,916**

**Registered May 1, 2012**

**Int. Cl.: 41**

**SERVICE MARK**

**PRINCIPAL REGISTER**

CHRISTIAN, CHARLES M. (UNITED STATES INDIVIDUAL)  
3025 JOHN BERNARD DRIVE  
ELLCOTT CITY, MD 21042

FOR: EDUCATIONAL SERVICES, NAMELY, PROVIDING CLASSES, SEMINARS AND CONFERENCES IN THE FIELD OF SOCIAL STUDIES, HISTORY, ECONOMICS, AND GEOGRAPHY, IN CLASS 41 (U.S. CLS. 100, 101 AND 107).

FIRST USE 9-30-1992; IN COMMERCE 9-30-1992.

THE MARK CONSISTS OF STANDARD CHARACTERS WITHOUT CLAIM TO ANY PARTICULAR FONT, STYLE, SIZE, OR COLOR.

NO CLAIM IS MADE TO THE EXCLUSIVE RIGHT TO USE "BLACK", APART FROM THE MARK AS SHOWN.

SER. NO. 85-408,971, FILED 8-27-2011.

CAROLYN CATALDO, EXAMINING ATTORNEY



*David J. Kyjars*

Director of the United States Patent and Trademark Office

# United States of America

United States Patent and Trademark Office



**Reg. No. 4,134,917**

**Registered May 1, 2012**

**Int. Cl.: 45**

**SERVICE MARK**

**PRINCIPAL REGISTER**

DANIEL S. GONZALEZ (TEXAS SOLE PROPRIETORSHIP)  
1216 MONTANA AVE.  
EL PASO, TX 79902

FOR: LEGAL SERVICES, IN CLASS 45 (U.S. CLS. 100 AND 101).

FIRST USE 1-1-2011; IN COMMERCE 1-1-2011.

THE MARK CONSISTS OF THE LETTER "G" WITH A PICTURE OF A GAVEL IN THE MIDDLE OF THE LETTER.

SER. NO. 85-408,999, FILED 8-27-2011.

TRACY CROSS, EXAMINING ATTORNEY



*David J. Kyffers*

Director of the United States Patent and Trademark Office

**United States of America**  
United States Patent and Trademark Office

# FALLZONE

**Reg. No. 4,134,918**

**Registered May 1, 2012**

**Int. Cl.: 37**

**SERVICE MARK**

**PRINCIPAL REGISTER**

FALLZONE SAFETY SURFACING, LLC (OHIO LIMITED LIABILITY COMPANY)  
1839 CANDLEWOOD DRIVE  
AVON, OH 44011

FOR: INSTALLATION OF RECREATIONAL EQUIPMENT AND SURFACING, IN CLASS 37  
(U.S. CLS. 100, 103 AND 106).

FIRST USE 4-1-2010; IN COMMERCE 4-1-2010.

THE MARK CONSISTS OF STANDARD CHARACTERS WITHOUT CLAIM TO ANY PARTICULAR FONT, STYLE, SIZE, OR COLOR.

SER. NO. 85-409,008, FILED 8-27-2011.

TRACY CROSS, EXAMINING ATTORNEY



*David J. Kyffers*

Director of the United States Patent and Trademark Office



# United States of America

United States Patent and Trademark Office

## dominion energy solutions

**Reg. No. 4,134,919**

**Registered May 1, 2012**

**Int. Cl.: 39**

**SERVICE MARK**

**PRINCIPAL REGISTER**

DOMINION RESOURCES, INC. (VIRGINIA CORPORATION)  
120 TREDEGAR STREET  
RICHMOND, VA 23219

FOR: DISTRIBUTION AND TRANSMISSION OF ELECTRICITY, IN CLASS 39 (U.S. CLS. 100 AND 105).

FIRST USE 10-30-2009; IN COMMERCE 10-30-2009.

THE MARK CONSISTS OF STANDARD CHARACTERS WITHOUT CLAIM TO ANY PARTICULAR FONT, STYLE, SIZE, OR COLOR.

OWNER OF U.S. REG. NOS. 2,096,938, 2,601,969 AND OTHERS.

NO CLAIM IS MADE TO THE EXCLUSIVE RIGHT TO USE "ENERGY SOLUTIONS", APART FROM THE MARK AS SHOWN.

SER. NO. 85-409,013, FILED 8-27-2011.

EUGENIA MARTIN, EXAMINING ATTORNEY



*David J. Kybas*

Director of the United States Patent and Trademark Office

# United States of America

United States Patent and Trademark Office

## ACADEMIC SWAGGER

**Reg. No. 4,134,920**

**Registered May 1, 2012**

**Int. Cl.: 25**

**TRADEMARK**

**PRINCIPAL REGISTER**

SCHOLAR-BALLER I.M.A.G.E., LLC (ARIZONA LIMITED LIABILITY COMPANY), AKA  
SCHOLAR-BALLER  
12773 LEXINGTON SUMMIT STREET  
ORLANDO, FL 32828

FOR: ATHLETIC APPAREL, NAMELY, SHIRTS, PANTS, JACKETS, FOOTWEAR, HATS  
AND CAPS, ATHLETIC UNIFORMS, IN CLASS 25 (U.S. CLS. 22 AND 39).

FIRST USE 10-1-2009; IN COMMERCE 10-1-2009.

THE MARK CONSISTS OF STANDARD CHARACTERS WITHOUT CLAIM TO ANY PAR-  
TICULAR FONT, STYLE, SIZE, OR COLOR.

SER. NO. 85-409,046, FILED 8-27-2011.

DAWN FELDMAN, EXAMINING ATTORNEY



*David J. Kyjars*

Director of the United States Patent and Trademark Office

# United States of America

United States Patent and Trademark Office

## Pawz That Refresh

**Reg. No. 4,134,921**

ENSEMBLE GROUP (MISSOURI LIMITED LIABILITY COMPANY)  
1916 NW FAWN DR  
BLUE SPRINGS, MO 64015

**Registered May 1, 2012**

**Int. Cl.: 21**

FOR: COFFEE CUPS, TEA CUPS AND MUGS, IN CLASS 21 (U.S. CLS. 2, 13, 23, 29, 30, 33, 40 AND 50).

**TRADEMARK**

FIRST USE 6-1-2011; IN COMMERCE 6-1-2011.

**PRINCIPAL REGISTER**

THE MARK CONSISTS OF STANDARD CHARACTERS WITHOUT CLAIM TO ANY PARTICULAR FONT, STYLE, SIZE, OR COLOR.

SER. NO. 85-409,111, FILED 8-28-2011.

JACLYN KIDWELL WALKER, EXAMINING ATTORNEY



*David J. Kyffers*

Director of the United States Patent and Trademark Office

# United States of America

United States Patent and Trademark Office

# Le Cuvier

**Reg. No. 4,134,922**

**Registered May 1, 2012**

**Int. Cl.: 33**

**TRADEMARK**

**PRINCIPAL REGISTER**

MUNCH & FOX (CALIFORNIA CORPORATION)  
3333 VINE HILL LANE  
PASO ROBLES, CA 93446

FOR: WINE, IN CLASS 33 (U.S. CLS. 47 AND 49).

FIRST USE 9-24-2004; IN COMMERCE 4-26-2006.

THE MARK CONSISTS OF STANDARD CHARACTERS WITHOUT CLAIM TO ANY PARTICULAR FONT, STYLE, SIZE, OR COLOR.

THE ENGLISH TRANSLATION OF "LE CUVIER" IN THE MARK IS "THE TUB".

SER. NO. 85-409,126, FILED 8-28-2011.

SCOTT BIBB, EXAMINING ATTORNEY



*David J. Kybas*

Director of the United States Patent and Trademark Office

# United States of America

United States Patent and Trademark Office

# Mr. Gripper

**Reg. No. 4,134,923**

**Registered May 1, 2012**

**Int. Cl.: 12**

**TRADEMARK**

**PRINCIPAL REGISTER**

STICKY GELZ INC. (NEW YORK CORPORATION), DBA MR. GRIPPER  
5 KRAMER CT.  
OAKHURST, NJ 07755

FOR: ANTI SLIP MATERIAL IN THE FORM OF MATS THAT ADHERE TO THE INTERIOR SURFACE OF A VEHICLE TO HOLD DIFFERENT OBJECTS, IN CLASS 12 (U.S. CLS. 19, 21, 23, 31, 35 AND 44).

FIRST USE 2-17-2010; IN COMMERCE 3-25-2011.

THE MARK CONSISTS OF STANDARD CHARACTERS WITHOUT CLAIM TO ANY PARTICULAR FONT, STYLE, SIZE, OR COLOR.

NO CLAIM IS MADE TO THE EXCLUSIVE RIGHT TO USE "GRIPPER", APART FROM THE MARK AS SHOWN.

SER. NO. 85-409,130, FILED 8-28-2011.

DOMINICK J. SALEMI, EXAMINING ATTORNEY



*David J. Kyffers*

Director of the United States Patent and Trademark Office

# United States of America

United States Patent and Trademark Office

# DecaDome

**Reg. No. 4,134,924**

**Registered May 1, 2012**

**Int. Cl.: 19**

**TRADEMARK**

**PRINCIPAL REGISTER**

ERIC BARCLAY LIPSON (MICHIGAN SOLE PROPRIETORSHIP), DBA NEWHOUSE  
RESEARCH AND DESIGN  
1318 ROSEWOOD STREET  
ANN ARBOR, MI 481046229

FOR: BUILDING MATERIALS, NAMELY, COMPOSITE PANELS COMPOSED PRIMARILY OF NONMETAL MATERIALS; MULTILAYER PANELS OF PLASTIC FOR USE IN BUILDING; NON METALLIC TRANSPORTABLE BUILDINGS; NON-METAL ANIMAL SHELTERS; NON-METAL FIRE-RESISTANT BOARDS AND PANELS FOR CONSTRUCTION; NON-METAL ROOFING PANELS; NON-METAL SHELTER STRUCTURES; NON-METAL STORAGE SHEDS; NON-METAL STRUCTURES FOR DISASTER RELIEF, TEMPORARY HOUSING, STORAGE, PORTABLE FIELD HOSPITALS, PORTABLE OFFICES, SHELTER, MILITARY USE, HUMANITARIAN ASSISTANCE, REFUGEE HOUSING, GREENHOUSES, DISPLAYS AND EXHIBITS; NON-METAL WATER-RESISTANT BOARDS AND PANELS FOR CONSTRUCTION; NON-METALLIC TRANSPORTABLE BUILDINGS; PORTABLE NON-METAL BUILDINGS; PORTABLE NON-METAL STRUCTURES TO PROVIDE TEMPORARY PRIVACY FOR CHANGING AND TOILET PURPOSES; PREFABRICATED HOUSES; PREFABRICATED NON-METAL BUILDINGS; PREFABRICATED, NON-METAL STORAGE SHEDS; REINFORCING MATERIALS NOT OF METAL FOR BUILDING PURPOSES, IN CLASS 19 (U.S. CLS. 1, 12, 33 AND 50).

FIRST USE 8-0-1997; IN COMMERCE 1-0-1998.

THE MARK CONSISTS OF STANDARD CHARACTERS WITHOUT CLAIM TO ANY PARTICULAR FONT, STYLE, SIZE, OR COLOR.

SER. NO. 85-409,134, FILED 8-28-2011.

DOMINICK J. SALEMI, EXAMINING ATTORNEY



*David J. Kyros*

Director of the United States Patent and Trademark Office

# United States of America

United States Patent and Trademark Office

# MAKH2OPAK

**Reg. No. 4,134,925**

**Registered May 1, 2012**

**Int. Cl.: 21**

**TRADEMARK**

**PRINCIPAL REGISTER**

CANDICE MAKOWSKI (UNITED STATES INDIVIDUAL)  
PO BOX 2669  
26394 U.S. HIGHWAY 70, G  
RUIDOSO DOWNS, CO 88346

FOR: PERSONAL FLUID HYDRATION SYSTEMS COMPRISING A FLUID RESERVOIR, A DELIVERY TUBE, A MOUTHPIECE AND A CARRYING PACK, IN CLASS 21 (U.S. CLS. 2, 13, 23, 29, 30, 33, 40 AND 50).

FIRST USE 4-13-2011; IN COMMERCE 4-13-2011.

THE MARK CONSISTS OF STANDARD CHARACTERS WITHOUT CLAIM TO ANY PARTICULAR FONT, STYLE, SIZE, OR COLOR.

SER. NO. 85-409,147, FILED 8-28-2011.

DOMINICK J. SALEMI, EXAMINING ATTORNEY



*David J. Kybas*

Director of the United States Patent and Trademark Office

# United States of America

United States Patent and Trademark Office

## CHIDVILASANANDA

**Reg. No. 4,134,926**

**Registered May 1, 2012**

**Int. Cls.: 9, 16 and 45**

**TRADEMARK**

**SERVICE MARK**

**PRINCIPAL REGISTER**

SYDA FOUNDATION (NEW YORK NON-PROFIT CORPORATION)  
INTELLECTUAL PROPERTY DEPARTMENT  
371 BRICKMAN ROAD  
SOUTH FALLSBURG, NY 12779

FOR: MUSICAL SOUND RECORDINGS, AUDIO RECORDINGS, CDS AND TAPES, AUDIOVISUAL RECORDINGS, PRE-RECORDED DVDS AND VIDEOTAPES ALL IN THE FIELD OF SPIRITUAL AND RELIGIOUS DEVELOPMENT, IN CLASS 9 (U.S. CLS. 21, 23, 26, 36 AND 38).

FIRST USE 7-0-1983; IN COMMERCE 7-0-1983.

FOR: PRINTED MATTER, NAMELY, BOOKS, BOOKS SERIES, PHOTOGRAPHS, PAMPHLETS AND PRINTED INSTRUCTIONAL AND TEACHING MATERIALS ALL IN THE FIELD OF SPIRITUAL AND RELIGIOUS DEVELOPMENT, IN CLASS 16 (U.S. CLS. 2, 5, 22, 23, 29, 37, 38 AND 50).

FIRST USE 7-0-1983; IN COMMERCE 7-0-1983.

FOR: PROVIDING A WEBSITE AND SPIRITUAL RETREATS IN THE FIELD OF SPIRITUAL AND RELIGIOUS DEVELOPMENT, IN CLASS 45 (U.S. CLS. 100 AND 101).

FIRST USE 7-0-1983; IN COMMERCE 7-0-1983.

THE MARK CONSISTS OF STANDARD CHARACTERS WITHOUT CLAIM TO ANY PARTICULAR FONT, STYLE, SIZE, OR COLOR.

OWNER OF U.S. REG. NO. 1,431,529.

THE NAME(S), PORTRAIT(S), AND/OR SIGNATURE(S) SHOWN IN THE MARK IDENTIFIES SWAMI "CHIDVILASANANDA", WHOSE CONSENT(S) TO REGISTER IS MADE OF RECORD.

SER. NO. 85-409,149, FILED 8-28-2011.

DOMINICK J. SALEMI, EXAMINING ATTORNEY



*David J. Kyffers*

Director of the United States Patent and Trademark Office



# United States of America

United States Patent and Trademark Office

# STASH

**Reg. No. 4,134,927**

**Registered May 1, 2012**

**Int. Cl.: 35**

**SERVICE MARK**

**PRINCIPAL REGISTER**

STASH LLC (OKLAHOMA LIMITED LIABILITY COMPANY)  
412 E. MAIN ST.  
NORMAN, OK 73071

FOR: RETAIL STORE AND ON-LINE RETAIL STORE SERVICES FEATURING VINTAGE, NEW AND UTILITARIAN HOUSEWARES AND GIFTS COMPRISED OF DOMESTIC GOODS AND HOUSEWARES, IN CLASS 35 (U.S. CLS. 100, 101 AND 102).

FIRST USE 6-24-2010; IN COMMERCE 6-24-2010.

THE MARK CONSISTS OF STANDARD CHARACTERS WITHOUT CLAIM TO ANY PARTICULAR FONT, STYLE, SIZE, OR COLOR.

SER. NO. 85-409,152, FILED 8-28-2011.

JUDITH HELFMAN, EXAMINING ATTORNEY



*David J. Kyros*

Director of the United States Patent and Trademark Office

# United States of America

United States Patent and Trademark Office

# prettier

**Reg. No. 4,134,928**

**Registered May 1, 2012**

**Int. Cl.: 25**

**TRADEMARK**

**PRINCIPAL REGISTER**

LUNAIRE, INC. (NEW YORK CORPORATION)  
20 WEST 36 STREET  
NEW YORK, NY 10018

FOR: BOTTOMS; BRAS; LADIES' UNDERWEAR; LINGERIE; SHAPEWEAR, NAMELY, GIRDLES, BODYSUITS, BOTTOMS; SLEEPWEAR; SWIMWEAR; UNDERWEAR; WOMEN'S CLOTHING, NAMELY, SHIRTS, DRESSES, SKIRTS, BLOUSES , IN CLASS 25 (U.S. CLS. 22 AND 39).

FIRST USE 12-1-2002; IN COMMERCE 12-1-2002.

THE MARK CONSISTS OF STANDARD CHARACTERS WITHOUT CLAIM TO ANY PARTICULAR FONT, STYLE, SIZE, OR COLOR.

SER. NO. 85-409,154, FILED 8-28-2011.

JUDITH HELFMAN, EXAMINING ATTORNEY



*David J. Kybas*

Director of the United States Patent and Trademark Office

# United States of America

United States Patent and Trademark Office

# Weaponite

**Reg. No. 4,134,929**

**Registered May 1, 2012**

**Int. Cl.: 42**

**SERVICE MARK**

**PRINCIPAL REGISTER**

WHITE BRANCH (NEW YORK LIMITED LIABILITY COMPANY)  
360  
132 E 43RD ST  
NEW YORK, NY 100174019

FOR: PROVIDING A WEB SITE FEATURING TECHNOLOGY THAT ENABLES USERS TO PUBLISH, READ, DOWNLOAD, SHARE, SELL BUY AND COMMENT ON DIGITAL MEDIA, NAMELY, GRAPHICS, TEXT, VIDEO, SOUND, ANIMATION, MUSIC AND VIRTUAL REALITY, IN CLASS 42 (U.S. CLS. 100 AND 101).

FIRST USE 6-17-2007; IN COMMERCE 8-28-2011.

THE MARK CONSISTS OF STANDARD CHARACTERS WITHOUT CLAIM TO ANY PARTICULAR FONT, STYLE, SIZE, OR COLOR.

SER. NO. 85-409,158, FILED 8-28-2011.

WILLIAM ROSSMAN, EXAMINING ATTORNEY



*David J. Kyffers*

Director of the United States Patent and Trademark Office

# United States of America

United States Patent and Trademark Office

## JUST PAWN IT

**Reg. No. 4,134,930**

**Registered May 1, 2012**

**Int. Cl.: 36**

**SERVICE MARK**

**PRINCIPAL REGISTER**

JUST PAWN IT, INC. (CALIFORNIA CORPORATION)  
4030 TYLER ST.  
RIVERSIDE, CA 92503

FOR: PAWN BROKERAGE; PAWN SHOPS, IN CLASS 36 (U.S. CLS. 100, 101 AND 102).

FIRST USE 12-31-1996; IN COMMERCE 12-31-1999.

THE MARK CONSISTS OF STANDARD CHARACTERS WITHOUT CLAIM TO ANY PARTICULAR FONT, STYLE, SIZE, OR COLOR.

SER. NO. 85-409,165, FILED 8-28-2011.

BILL DAWE, EXAMINING ATTORNEY



*David J. Kybas*

Director of the United States Patent and Trademark Office

# United States of America

United States Patent and Trademark Office

# Paw-Made

**Reg. No. 4,134,931**

**Registered May 1, 2012**

**Int. Cls.: 30 and 31**

**TRADEMARK**

**PRINCIPAL REGISTER**

ZRIP, INC. (CALIFORNIA CORPORATION)  
8194 LAURELMONT DRIVE  
LOS ANGELES, CA 90046

FOR: FROZEN CONFECTIONS; FROZEN YOGURT, IN CLASS 30 (U.S. CL. 46).

FIRST USE 8-1-2011; IN COMMERCE 8-1-2011.

FOR: DOG TREATS, IN CLASS 31 (U.S. CLS. 1 AND 46).

FIRST USE 8-1-2011; IN COMMERCE 8-1-2011.

THE MARK CONSISTS OF STANDARD CHARACTERS WITHOUT CLAIM TO ANY PARTICULAR FONT, STYLE, SIZE, OR COLOR.

SER. NO. 85-409,172, FILED 8-28-2011.

RONALD AIKENS, EXAMINING ATTORNEY



*David J. Kybas*

Director of the United States Patent and Trademark Office

# United States of America

United States Patent and Trademark Office

# KYR

**Reg. No. 4,134,932**

**Registered May 1, 2012**

**Int. Cl.: 36**

**SERVICE MARK**

**PRINCIPAL REGISTER**

KYR FINANCIAL SERVICES (CALIFORNIA LIMITED LIABILITY COMPANY), AKA KYR CREDIT  
4283 SILVERADO DR  
THOUSAND OAKS, CA 91360

FOR: BUSINESS CREDIT REPORTING SERVICES; BUSINESS CREDIT VERIFICATION SERVICES; CREDIT AGENCIES; CREDIT CONSULTATION; CREDIT INQUIRY AND CONSULTATION; CREDIT RATING SERVICES; CREDIT REPORTING SERVICES; CREDIT RISK MANAGEMENT; CREDIT SCORING SERVICES; EVALUATION OF THE CREDIT WORTHINESS OF COMPANIES AND PRIVATE INDIVIDUALS; FINANCIAL CREDIT SCORING SERVICES; FINANCIAL SERVICES, NAMELY, CREDIT AGENCIES FEATURING CREDIT PROCESSING, NAMELY, CREDIT CHECKING, CREDIT ANALYZING, AND FINANCIAL REPORTING SERVICES, IN CLASS 36 (U.S. CLS. 100, 101 AND 102).

FIRST USE 5-10-2011; IN COMMERCE 5-10-2011.

THE MARK CONSISTS OF STANDARD CHARACTERS WITHOUT CLAIM TO ANY PARTICULAR FONT, STYLE, SIZE, OR COLOR.

SER. NO. 85-409,183, FILED S.R. 8-28-2011 AM. P.R. 12-15-2011.

RONALD AIKENS, EXAMINING ATTORNEY



*David J. Kyros*

Director of the United States Patent and Trademark Office

# United States of America

United States Patent and Trademark Office

## Natasha Club

**Reg. No. 4,134,933**

**Registered May 1, 2012**

**Int. Cl.: 45**

**SERVICE MARK**

**PRINCIPAL REGISTER**

1ST INTERNATIONAL LTD. (ST.KITTS-NEVIS CORPORATION)  
PO BOX 642, MAIN STREET  
CHARLESTOWN, NEVIS, ST.KITTS-NEVIS

FOR: COMPUTER DATING SERVICES; DATING SERVICES; DATING SERVICES, NAMELY, PROVIDING AN ON-LINE COMPUTER DATABASE FEATURING SINGLE PEOPLE INTERESTED IN MEETING OTHER SINGLE PEOPLE; INTERNET BASED SOCIAL NETWORKING, INTRODUCTION, AND DATING SERVICES; INTERNET-BASED DATING, SOCIAL INTRODUCTION AND SOCIAL NETWORKING SERVICES; MARRIAGE PARTNER INTRODUCTION OR DATING SERVICES, IN CLASS 45 (U.S. CLS. 100 AND 101).

FIRST USE 9-30-1997; IN COMMERCE 9-30-1997.

THE MARK CONSISTS OF STANDARD CHARACTERS WITHOUT CLAIM TO ANY PARTICULAR FONT, STYLE, SIZE, OR COLOR.

NO CLAIM IS MADE TO THE EXCLUSIVE RIGHT TO USE "CLUB", APART FROM THE MARK AS SHOWN.

SER. NO. 85-409,190, FILED 8-28-2011.

COLLEEN KEARNEY, EXAMINING ATTORNEY



*David J. Kyros*

Director of the United States Patent and Trademark Office

# United States of America

United States Patent and Trademark Office

# fitco

**Reg. No. 4,134,934**

**Registered May 1, 2012**

**Int. Cl.: 35**

**SERVICE MARK**

**PRINCIPAL REGISTER**

FITCO-CONSULTING PTE. LTD. (SINGAPORE CORPORATION)  
ROBINSON TOWERS  
30 ROBINSON ROAD, #03-01B  
SINGAPORE, SINGAPORE 048546

FOR: BUSINESS MANAGEMENT CONSULTANCY; BUSINESS MANAGEMENT AND ORGANIZATION CONSULTANCY; BUSINESS ORGANIZATION CONSULTANCY; PROFESSIONAL BUSINESS CONSULTANCY; EMPLOYMENT AGENCY; PERSONNEL MANAGEMENT CONSULTANCY; PERSONNEL RECRUITMENT, IN CLASS 35 (U.S. CLS. 100, 101 AND 102).

FIRST USE 11-12-2010; IN COMMERCE 11-12-2010.

THE MARK CONSISTS OF STYLIZED LOWER CASE WORD "FITCO".

SER. NO. 85-409,219, FILED 8-29-2011.

RUDY R. SINGLETON, EXAMINING ATTORNEY



*David J. Kybas*

Director of the United States Patent and Trademark Office



# United States of America

United States Patent and Trademark Office

# FITCO

**Reg. No. 4,134,935**

**Registered May 1, 2012**

**Int. Cl.: 35**

**SERVICE MARK**

**PRINCIPAL REGISTER**

FITCO-CONSULTING PTE. LTD. (SINGAPORE CORPORATION)  
ROBINSON TOWERS  
30 ROBINSON ROAD, #03-01B  
SINGAPORE, SINGAPORE 048546

FOR: BUSINESS MANAGEMENT CONSULTANCY; BUSINESS MANAGEMENT AND ORGANIZATION CONSULTANCY; BUSINESS ORGANIZATION CONSULTANCY; PROFESSIONAL BUSINESS CONSULTANCY; EMPLOYMENT AGENCY; PERSONNEL MANAGEMENT CONSULTANCY; PERSONNEL RECRUITMENT, IN CLASS 35 (U.S. CLS. 100, 101 AND 102).

FIRST USE 11-12-2010; IN COMMERCE 11-12-2010.

THE MARK CONSISTS OF STANDARD CHARACTERS WITHOUT CLAIM TO ANY PARTICULAR FONT, STYLE, SIZE, OR COLOR.

SER. NO. 85-409,220, FILED 8-29-2011.

RUDY R. SINGLETON, EXAMINING ATTORNEY



*David J. Kyffers*

Director of the United States Patent and Trademark Office

# United States of America

United States Patent and Trademark Office

# Noom

**Reg. No. 4,134,936**

**Registered May 1, 2012**

**Int. Cl.: 9**

**TRADEMARK**

**PRINCIPAL REGISTER**

WORKSMART LABS, INC. (DELAWARE CORPORATION)  
530 WEST 25TH STREET, SUITE 502  
NEW YORK, NY 10001

FOR: COMPUTER APPLICATION SOFTWARE FOR MOBILE PHONES, TABLET COMPUTERS, PORTABLE MEDIA PLAYERS, AND HANDHELD COMPUTERS, NAMELY, SOFTWARE FOR SETTING AND TRACKING HEALTH, FITNESS OR WEIGHT LOSS GOALS OF USERS, IN CLASS 9 (U.S. CLS. 21, 23, 26, 36 AND 38).

FIRST USE 5-4-2011; IN COMMERCE 5-4-2011.

THE MARK CONSISTS OF STANDARD CHARACTERS WITHOUT CLAIM TO ANY PARTICULAR FONT, STYLE, SIZE, OR COLOR.

SER. NO. 85-409,232, FILED 8-29-2011.

DAVID TOOLEY, EXAMINING ATTORNEY



*David J. Kyffers*

Director of the United States Patent and Trademark Office

# United States of America

United States Patent and Trademark Office



**Reg. No. 4,134,937**

**Registered May 1, 2012**

**COLLECTIVE  
MEMBERSHIP**

**PRINCIPAL REGISTER**

IRON WARRIORS MOTORCYCLE CLUB CRUE'D PIGS CENTRAL IOWA CHAPTER INC.  
(IOWA NON-PROFIT CORPORATION)  
P.O. BOX 1844  
DES MOINES, IA 50305

FOR: INDICATING MEMBERSHIP IN AN ORGANIZATION OF INDIVIDUALS SUPPORTING  
MOTORCYCLE RIDERS AND OWNERS FOR USE BY MEMBER CHAPTERS , IN CLASS  
200 (U.S. CL. 200).

FIRST USE 11-1-1999; IN COMMERCE 11-1-1999.

THE MARK CONSISTS OF A CARICATURE OF A WILD PIG INSIDE A CIRCULAR RING  
OF BARBWIRE WITH THE WORDS CRUE'D PIGS ABOVE THE WILD PIG WHICH IS INSIDE  
ANOTHER CIRCULAR RING.

SER. NO. 85-409,253, FILED 8-29-2011.

HEATHER BIDDULPH, EXAMINING ATTORNEY



*David J. Kybas*

Director of the United States Patent and Trademark Office

# United States of America

United States Patent and Trademark Office

# Deepbox

**Reg. No. 4,134,938**

HI-FIVE PRODUCTS DEVELOPING CO., LTD. (TAIWAN CORPORATION)  
1F., NO.236, YATAN RD., DAYA DIST.  
TAICHUNG CITY, TAIWAN

**Registered May 1, 2012**

**Int. Cl.: 8**

FOR: HAND TOOLS, NAMELY, WRENCHES, SOCKET WRENCHES, BOX WRENCHES  
AND RATCHET WRENCHES, IN CLASS 8 (U.S. CLS. 23, 28 AND 44).

**TRADEMARK**

FIRST USE 8-22-2011; IN COMMERCE 8-22-2011.

**PRINCIPAL REGISTER**

THE MARK CONSISTS OF STANDARD CHARACTERS WITHOUT CLAIM TO ANY PAR-  
TICULAR FONT, STYLE, SIZE, OR COLOR.

SER. NO. 85-409,263, FILED 8-29-2011.

ANDREA HACK, EXAMINING ATTORNEY



*David J. Kyffers*

Director of the United States Patent and Trademark Office

# United States of America

United States Patent and Trademark Office

## IOWA CULINARY INSTITUTE

**Reg. No. 4,134,939**

**Registered May 1, 2012**

**Int. Cl.: 41**

**SERVICE MARK**

**PRINCIPAL REGISTER**

DES MOINES AREA COMMUNITY COLLEGE (IOWA NON-PROFIT CORPORATION)  
2006 SOUTH ANKENY BLVD.  
ANKENY, IA 50023

FOR: EDUCATING AT UNIVERSITY OR COLLEGES; EDUCATIONAL SERVICES, NAMELY, PROVIDING COURSES OF INSTRUCTION AT THE COLLEGE LEVEL, IN CLASS 41 (U.S. CLS. 100, 101 AND 107).

FIRST USE 1-24-2006; IN COMMERCE 1-24-2006.

THE MARK CONSISTS OF STANDARD CHARACTERS WITHOUT CLAIM TO ANY PARTICULAR FONT, STYLE, SIZE, OR COLOR.

OWNER OF U.S. REG. NOS. 3,161,171 AND 3,185,112.

NO CLAIM IS MADE TO THE EXCLUSIVE RIGHT TO USE "CULINARY INSTITUTE", APART FROM THE MARK AS SHOWN.

SEC. 2(F).

SER. NO. 85-409,280, FILED 8-29-2011.

LEIGH CAROLINE CASE, EXAMINING ATTORNEY



*David J. Kyffers*

Director of the United States Patent and Trademark Office

# United States of America

United States Patent and Trademark Office

## ZUZU WATCH

**Reg. No. 4,134,940**

**Registered May 1, 2012**

**Int. Cl.: 35**

**SERVICE MARK**

**PRINCIPAL REGISTER**

DIRECTORY PUBLISHING SERVICES, INC. (MISSOURI CORPORATION)  
SUITE 220  
16640 CHESTERFIELD GROVE ROAD  
CHESTERFIELD, MO 63005

FOR: ADVERTISING AND PUBLICITY SERVICES, NAMELY, PROMOTING THE GOODS, SERVICES, BRAND IDENTITY AND COMMERCIAL INFORMATION AND NEWS OF THIRD PARTIES THROUGH PRINT, AUDIO, VIDEO, DIGITAL AND ON-LINE MEDIUM; INFORMATION, ADVISORY AND CONSULTANCY SERVICES RELATING TO BUSINESS AND MANAGEMENT OR BUSINESS ADMINISTRATION, INCLUDING SUCH SERVICES PROVIDED ON LINE OR VIA THE INTERNET; ONLINE MEDIA MONITORING SERVICES USING COMPUTER SOFTWARE TO AUTOMATICALLY MONITOR INTERNET WEBSITES AND ONLINE PUBLICATIONS FOR CUSTOMER-SPECIFIED TOPICS AND TO CAPTURE RELEVANT CONTENT ON THOSE TOPICS, AND PROVIDING DOCUMENTATION AND ANALYSIS OF THAT ONLINE CONTENT TO OTHERS FOR BUSINESS PURPOSES, IN CLASS 35 (U.S. CLS. 100, 101 AND 102).

FIRST USE 1-1-2011; IN COMMERCE 1-1-2011.

THE MARK CONSISTS OF STANDARD CHARACTERS WITHOUT CLAIM TO ANY PARTICULAR FONT, STYLE, SIZE, OR COLOR.

NO CLAIM IS MADE TO THE EXCLUSIVE RIGHT TO USE "WATCH", APART FROM THE MARK AS SHOWN.

SER. NO. 85-409,306, FILED 8-29-2011.

KATHERINE E. HALMEN, EXAMINING ATTORNEY



*David J. Kyffers*

Director of the United States Patent and Trademark Office

# United States of America

United States Patent and Trademark Office

# PRESTONE

**Reg. No. 4,134,941**

**Registered May 1, 2012**

**Int. Cl.: 1**

**TRADEMARK**

**PRINCIPAL REGISTER**

PRESTONE PRODUCTS CORPORATION (DELAWARE CORPORATION)  
39 OLD RIDGEBURY ROAD  
DANBURY, CT 06810

FOR: FUEL INJECTION CLEANER CHEMICAL ADDITIVE, IN CLASS 1 (U.S. CLS. 1, 5, 6, 10, 26 AND 46).

FIRST USE 10-6-1999; IN COMMERCE 10-6-1999.

THE MARK CONSISTS OF STANDARD CHARACTERS WITHOUT CLAIM TO ANY PARTICULAR FONT, STYLE, SIZE, OR COLOR.

OWNER OF U.S. REG. NOS. 181,657, 590,698 AND OTHERS.

SER. NO. 85-409,312, FILED 8-29-2011.

CAROLYN CATALDO, EXAMINING ATTORNEY



*David J. Kybas*

Director of the United States Patent and Trademark Office

# United States of America

United States Patent and Trademark Office

## A MESSAGE FOR THE SOLE

**Reg. No. 4,134,942**

**Registered May 1, 2012**

**Int. Cl.: 25**

**TRADEMARK**

**PRINCIPAL REGISTER**

POLLOCK, HARRIS (UNITED STATES INDIVIDUAL)  
3350 SW 15 STREET  
DEERFIELD BEACH, FL 33442

FOR: ADULT NOVELTY GAG CLOTHING ITEM, NAMELY, SOCKS; ANKLE SOCKS; ANKLETS; ANTI-PERSPIRANT SOCKS; COMPRESSION GARMENTS FOR ATHLETIC OR OTHER NON-MEDICAL USE, NAMELY, SOCKS; INSOLES; INSOLES FOR FOOTWEAR; JACKETS AND SOCKS; JAPANESE STYLE SOCKS (TABI COVERS); JAPANESE STYLE SOCKS (TABI); MEN'S DRESS SOCKS; MEN'S SOCKS; NON-SLIP SOCKS; PAPER SHOES USED WHEN GOING THROUGH METAL DETECTORS TO KEEP FEET AND SOCKS CLEAN; SLIPPER SOCKS; SOCK SUSPENDERS; SOCKS; SOCKS AND STOCKINGS; THERMAL SOCKS; WATER SOCKS; WOOLLEN SOCKS, IN CLASS 25 (U.S. CLS. 22 AND 39).

FIRST USE 1-1-2011; IN COMMERCE 1-20-2011.

THE MARK CONSISTS OF STANDARD CHARACTERS WITHOUT CLAIM TO ANY PARTICULAR FONT, STYLE, SIZE, OR COLOR.

SER. NO. 85-409,319, FILED 8-29-2011.

CAROLYN CATALDO, EXAMINING ATTORNEY



*David J. Kyros*

Director of the United States Patent and Trademark Office



# United States of America

United States Patent and Trademark Office

## IOWA CULINARY INSTITUTE

**Reg. No. 4,134,943**

**Registered May 1, 2012**

**Int. Cl.: 41**

**SERVICE MARK**

**PRINCIPAL REGISTER**

DES MOINES AREA COMMUNITY COLLEGE (IOWA NON-PROFIT CORPORATION)  
2006 SOUTH ANKENY BLVD.  
ANKENY, IA 50023

FOR: EDUCATING AT UNIVERSITY OR COLLEGES; EDUCATIONAL SERVICES, NAMELY,  
PROVIDING COURSES OF INSTRUCTION AT THE COLLEGE LEVEL, IN CLASS 41 (U.S.  
CLS. 100, 101 AND 107).

FIRST USE 1-24-2006; IN COMMERCE 1-24-2006.

OWNER OF U.S. REG. NOS. 3,161,171 AND 3,185,112.

NO CLAIM IS MADE TO THE EXCLUSIVE RIGHT TO USE "CULINARY INSTITUTE",  
APART FROM THE MARK AS SHOWN.

THE MARK CONSISTS OF THE WORDS "IOWA CULINARY INSTITUTE" IN STYLIZED  
TYPE.

SEC. 2(F).

SER. NO. 85-409,330, FILED 8-29-2011.

LEIGH CAROLINE CASE, EXAMINING ATTORNEY



*David J. Kyros*

Director of the United States Patent and Trademark Office

# United States of America

United States Patent and Trademark Office

# SAFMUNE

**Reg. No. 4,134,944**

**Registered May 1, 2012**

**Int. Cl.: 31**

**TRADEMARK**

**PRINCIPAL REGISTER**

LESAFFRE ET COMPAGNIE (FRANCE CORPORATION)  
41, RUE ETIENNE MARCEL  
PARIS, FRANCE 75001

FOR: ANIMAL FEED ADDITIVES FOR NONNUTRITIONAL PURPOSES FOR USE AS AN INGREDIENT; YEAST EXTRACTS FOR USE AS AN INGREDIENT IN ANIMAL FEED, IN CLASS 31 (U.S. CLS. 1 AND 46).

FIRST USE 7-18-2011; IN COMMERCE 7-18-2011.

THE MARK CONSISTS OF STANDARD CHARACTERS WITHOUT CLAIM TO ANY PARTICULAR FONT, STYLE, SIZE, OR COLOR.

OWNER OF U.S. REG. NO. 2,711,517.

SER. NO. 85-409,338, FILED 8-29-2011.

BARBARA RUTLAND, EXAMINING ATTORNEY



*David J. Kybas*

Director of the United States Patent and Trademark Office

# United States of America

United States Patent and Trademark Office

# MR. FITZ

**Reg. No. 4,134,945**

MAINE SALT COMPANY (MAINE CORPORATION)  
677 COLBROOK ROAD  
HERMON, ME 04401

**Registered May 1, 2012**

**Int. Cl.: 1**

FOR: CHEMICAL PREPARATIONS FOR MELTING SNOW AND ICE, IN CLASS 1 (U.S. CLS. 1, 5, 6, 10, 26 AND 46).

**TRADEMARK**

FIRST USE 12-15-1998; IN COMMERCE 1-15-1999.

**PRINCIPAL REGISTER**

THE MARK CONSISTS OF STANDARD CHARACTERS WITHOUT CLAIM TO ANY PARTICULAR FONT, STYLE, SIZE, OR COLOR.

SER. NO. 85-409,339, FILED 8-29-2011.

CARYN GLASSER, EXAMINING ATTORNEY



*David J. Kybas*

Director of the United States Patent and Trademark Office

# United States of America

United States Patent and Trademark Office

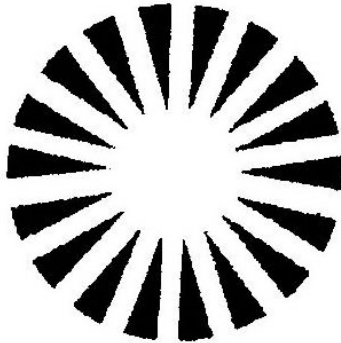

**Reg. No. 4,134,946**

**Registered May 1, 2012**

**Int. Cls.: 37 and 39**

**SERVICE MARK**

**PRINCIPAL REGISTER**

CHAMPION ENERGY CORPORATION (DELAWARE CORPORATION)  
ONE RADISSON PLAZA, SUITE 801  
NEW ROCHELLE, NY 10801

FOR: INSTALLATION, REPAIR AND MAINTENANCE OF HEATING EQUIPMENT; OIL BURNER AND BOILER REGULATION AND REPAIR SERVICES; HVAC CONTRACTING SERVICES, NAMELY, INSTALLATION, MAINTENANCE AND REPAIR OF HVAC SYSTEMS, IN CLASS 37 (U.S. CLS. 100, 103 AND 106).

FIRST USE 12-31-1986; IN COMMERCE 12-31-1986.

FOR: FUEL DELIVERY SERVICES FEATURING HEATING OIL, IN CLASS 39 (U.S. CLS. 100 AND 105).

FIRST USE 12-31-1986; IN COMMERCE 12-31-1986.

THE MARK CONSISTS OF A SUNBURST.

SER. NO. 85-409,341, FILED 8-29-2011.

KATHERINE CHANG, EXAMINING ATTORNEY



*David J. Kybas*

Director of the United States Patent and Trademark Office

# United States of America

United States Patent and Trademark Office

# T.I.P.

**Reg. No. 4,134,947**

**Registered May 1, 2012**

**Int. Cl.: 35**

**SERVICE MARK**

**PRINCIPAL REGISTER**

GLOBAL TEL\*LINK CORPORATION (DELAWARE CORPORATION)  
2609 CAMERON STREET  
MOBILE, AL 36607

FOR: ARRANGING AND CONDUCTING INCENTIVE REWARD PROGRAMS TO PROMOTE THE SALE OF TELECOMMUNICATIONS, MONITORING, DATABASE MANAGEMENT, AND FINANCIAL SOFTWARE AND SERVICES FOR CORRECTIONAL INSTITUTIONS, IN CLASS 35 (U.S. CLS. 100, 101 AND 102).

FIRST USE 9-30-2009; IN COMMERCE 9-30-2009.

THE MARK CONSISTS OF STANDARD CHARACTERS WITHOUT CLAIM TO ANY PARTICULAR FONT, STYLE, SIZE, OR COLOR.

SER. NO. 85-409,346, FILED 8-29-2011.

REGINA DRUMMOND, EXAMINING ATTORNEY



*David J. Kyffers*

Director of the United States Patent and Trademark Office

# United States of America

United States Patent and Trademark Office

# SILK SERICA

**Reg. No. 4,134,948**

KREINIK MFG CO INC (WEST VIRGINIA CORPORATION)  
1708 GIHON RD  
PARKERSBURG, WV 26101

**Registered May 1, 2012**

**Int. Cl.: 23**

FOR: EMBROIDERY THREAD; EMBROIDERY THREAD AND YARN; SILK THREAD; SILK THREADS AND YARNS; SILK YARN; THREAD FOR TEXTILE USE; THREADS AND YARNS; TWISTED SILK THREAD AND YARN; YARNS AND THREADS FOR TEXTILE USE; ALL OF THE FOREGOING MADE OF SILK, IN CLASS 23 (U.S. CL. 43).

**TRADEMARK**

**PRINCIPAL REGISTER**

FIRST USE 9-20-1997; IN COMMERCE 9-20-1997.

THE MARK CONSISTS OF STANDARD CHARACTERS WITHOUT CLAIM TO ANY PARTICULAR FONT, STYLE, SIZE, OR COLOR.

NO CLAIM IS MADE TO THE EXCLUSIVE RIGHT TO USE "SILK", APART FROM THE MARK AS SHOWN.

THE WORDING "SERICA" HAS NO MEANING IN A FOREIGN LANGUAGE.

SER. NO. 85-409,353, FILED 8-29-2011.

REBECCA POVARCHUK, EXAMINING ATTORNEY



*David J. Kyros*

Director of the United States Patent and Trademark Office

# United States of America

United States Patent and Trademark Office

## CUSTOMSHAPEPROS

**Reg. No. 4,134,949**

**Registered May 1, 2012**

**Int. Cl.: 35**

**SERVICE MARK**

**PRINCIPAL REGISTER**

ACCUCUT, LLC (NEBRASKA LIMITED LIABILITY COMPANY)  
1035 EAST DODGE STREET  
FREMONT, NE 68025

FOR: ONLINE RETAIL STORE AND WHOLESALE STORE SERVICES FOR QUILTING SUPPLIES AND ACCESSORIES, NAMELY CUTTING EQUIPMENT AND DIES, PATTERNS AND ANCILLARY PRODUCTS; MAIL ORDER CATALOG SERVICES FOR QUILTING SUPPLIES AND ACCESSORIES, NAMELY CUTTING EQUIPMENT AND DIES, PATTERNS AND ANCILLARY PRODUCTS, IN CLASS 35 (U.S. CLS. 100, 101 AND 102).

FIRST USE 11-8-2010; IN COMMERCE 11-8-2010.

THE MARK CONSISTS OF STANDARD CHARACTERS WITHOUT CLAIM TO ANY PARTICULAR FONT, STYLE, SIZE, OR COLOR.

SER. NO. 85-409,359, FILED 8-29-2011.

CARRIE GENOVESE, EXAMINING ATTORNEY



*David J. Kybas*

Director of the United States Patent and Trademark Office

# United States of America

United States Patent and Trademark Office

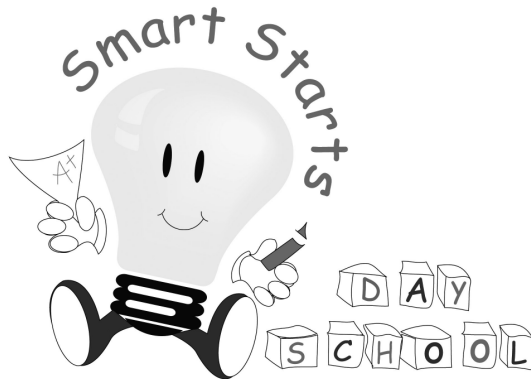

**Reg. No. 4,134,950**

**Registered May 1, 2012**

**Int. Cl.: 41**

**SERVICE MARK**

**PRINCIPAL REGISTER**

SMART STARTS DAY SCHOOL, INC. (FLORIDA CORPORATION)  
7990 SW 117TH AVENUE, SUITE 210  
MIAMI, FL 33183

FOR: EDUCATIONAL AND CHILDCARE SERVICES IN THE NATURE OF PRE-SCHOOLS,  
IN CLASS 41 (U.S. CLS. 100, 101 AND 107).

FIRST USE 6-18-2002; IN COMMERCE 7-30-2002.

NO CLAIM IS MADE TO THE EXCLUSIVE RIGHT TO USE "DAY SCHOOL", APART FROM  
THE MARK AS SHOWN.

THE MARK CONSISTS OF ANTHROPOMORPHIC LIGHT BULB CHARACTER, WHICH IN  
ONE HAND IS HOLDING AN "A+" PAPER AND IN THE OTHER HAND IS HOLDING A  
PENCIL, WITH "SMART STARTS" LETTERS ARCHING ABOVE THE CHARACTER, AND  
THE WORDS "DAY SCHOOL" ARE SPELLED OUT IN CAPITALIZED LETTERS, APPEARING  
IN CHILDREN'S BLOCKS ON THE LOWER RIGHT-HAND SIDE OF THE CHARACTER.

SER. NO. 85-409,366, FILED 8-29-2011.

HELENE LIWINSKI, EXAMINING ATTORNEY



*David J. Kyjars*

Director of the United States Patent and Trademark Office



# United States of America

United States Patent and Trademark Office

# SLATE

**Reg. No. 4,134,951**

**Registered May 1, 2012**

**Int. Cl.: 42**

**SERVICE MARK**

**PRINCIPAL REGISTER**

TECHNOLUTIONS, INC. (DELAWARE CORPORATION)  
234 CHURCH ST 15TH FL  
NEW HAVEN, CT 06510

FOR: COMPUTER SERVICES, NAMELY, ACTING AS AN APPLICATION SERVICE PROVIDER IN THE FIELD OF KNOWLEDGE MANAGEMENT TO HOST COMPUTER APPLICATION SOFTWARE FOR THE PURPOSE OF SEARCHING AND RETRIEVING INFORMATION FROM DATABASES AND COMPUTER NETWORKS, IN CLASS 42 (U.S. CLS. 100 AND 101).

FIRST USE 5-1-2004; IN COMMERCE 5-1-2004.

THE MARK CONSISTS OF STANDARD CHARACTERS WITHOUT CLAIM TO ANY PARTICULAR FONT, STYLE, SIZE, OR COLOR.

SER. NO. 85-409,370, FILED 8-29-2011.

HELENE LIWINSKI, EXAMINING ATTORNEY



*David J. Kybas*

Director of the United States Patent and Trademark Office

# United States of America

United States Patent and Trademark Office

## EFFORTS TO OUTCOMES

**Reg. No. 4,134,952**

**Registered May 1, 2012**

**Int. Cl.: 42**

**SERVICE MARK**

**PRINCIPAL REGISTER**

SOCIAL SOLUTIONS GLOBAL, INC. (DELAWARE CORPORATION)  
SUITE 100  
425 WILLIAMS CIRCLE  
BALTIMORE, MD 21220

FOR: COMPUTER SERVICE, NAMELY, ACTING AS AN APPLICATION SERVICE PROVIDER IN THE FIELD OF KNOWLEDGE MANAGEMENT TO HOST COMPUTER APPLICATION SOFTWARE FOR CREATING SEARCHABLE DATABASES OF INFORMATION AND DATA AND FOR RECORDING, MONITORING, RETRIEVING, AND REPORTING DATA ON ANY USER DEFINED PERFORMANCE OUTCOMES FOR USE IN HUMAN SERVICES DELIVERY; SOFTWARE AS A SERVICE (SAAS) SERVICES, NAMELY, HOSTING SOFTWARE FOR USE BY OTHERS FOR CREATING SEARCHABLE DATABASES OF INFORMATION AND DATA AND FOR RECORDING, MONITORING, RETRIEVING, AND REPORTING DATA ON ANY USER DEFINED PERFORMANCE OUTCOMES FOR USE IN HUMAN SERVICES DELIVERY, IN CLASS 42 (U.S. CLS. 100 AND 101).

FIRST USE 7-11-2000; IN COMMERCE 7-11-2000.

THE MARK CONSISTS OF STANDARD CHARACTERS WITHOUT CLAIM TO ANY PARTICULAR FONT, STYLE, SIZE, OR COLOR.

OWNER OF U.S. REG. NO. 2,915,818.

SER. NO. 85-409,378, FILED 8-29-2011.

CARRIE GENOVESE, EXAMINING ATTORNEY



*David J. Kybas*

Director of the United States Patent and Trademark Office

# United States of America

United States Patent and Trademark Office

# Tabbit

**Reg. No. 4,134,953**

**Registered May 1, 2012**

**Int. Cl.: 42**

**SERVICE MARK**

**PRINCIPAL REGISTER**

TABBIT (CALIFORNIA CORPORATION)  
APT. 713  
727 W. 7TH ST.  
LOS ANGELES, CA 90017

FOR: PROVIDING TEMPORARY USE OF ON-LINE NON-DOWNLOADABLE SOFTWARE FOR USE IN KEEPING TRACK OF DEBTS AND SHARED PAYMENTS, IN CLASS 42 (U.S. CLS. 100 AND 101).

FIRST USE 7-1-2011; IN COMMERCE 7-1-2011.

THE MARK CONSISTS OF STANDARD CHARACTERS WITHOUT CLAIM TO ANY PARTICULAR FONT, STYLE, SIZE, OR COLOR.

SER. NO. 85-409,387, FILED 8-29-2011.

CHRISTOPHER BUONGIORNO, EXAMINING ATTORNEY



*David J. Kybas*

Director of the United States Patent and Trademark Office

# United States of America

United States Patent and Trademark Office

## CLASSIC AMERICAN IRON

**Reg. No. 4,134,954**

**Registered May 1, 2012**

**Int. Cl.: 25**

**TRADEMARK**

**PRINCIPAL REGISTER**

TAM COMMUNICATIONS, INC. (CONNECTICUT CORPORATION)  
1010 SUMMER STREET  
STAMFORD, CT 06905

FOR: T-SHIRTS, IN CLASS 25 (U.S. CLS. 22 AND 39).

FIRST USE 5-31-2010; IN COMMERCE 5-31-2010.

THE MARK CONSISTS OF STANDARD CHARACTERS WITHOUT CLAIM TO ANY PARTICULAR FONT, STYLE, SIZE, OR COLOR.

OWNER OF U.S. REG. NOS. 3,199,486 AND 3,276,345.

NO CLAIM IS MADE TO THE EXCLUSIVE RIGHT TO USE "AMERICAN", APART FROM THE MARK AS SHOWN.

SER. NO. 85-409,412, FILED 8-29-2011.

VIVIAN MICZNIK FIRST, EXAMINING ATTORNEY



*David J. Kybas*

Director of the United States Patent and Trademark Office

# United States of America

United States Patent and Trademark Office

# emitips

**Reg. No. 4,134,955**

**Registered May 1, 2012**

**Int. Cl.: 24**

**TRADEMARK**

**PRINCIPAL REGISTER**

EMITIPS, LLC (ILLINOIS LIMITED LIABILITY COMPANY)  
3100 NORTH ST. LOUIS, SUITE 2F  
CHICAGO, IL 60618

FOR: ADHESIVE FABRIC FOR APPLICATION BY HEAT, IN CLASS 24 (U.S. CLS. 42 AND 50).

FIRST USE 11-17-2010; IN COMMERCE 11-17-2010.

THE MARK CONSISTS OF STANDARD CHARACTERS WITHOUT CLAIM TO ANY PARTICULAR FONT, STYLE, SIZE, OR COLOR.

SER. NO. 85-409,418, FILED 8-29-2011.

JULIE GUTTADAURO, EXAMINING ATTORNEY



*David J. Kybas*

Director of the United States Patent and Trademark Office

# United States of America

United States Patent and Trademark Office

# TRANSAMIN

**Reg. No. 4,134,956**

**Registered May 1, 2012**

**Int. Cl.: 5**

**TRADEMARK**

**PRINCIPAL REGISTER**

DAIICHI SANKYO COMPANY, LIMITED (JAPAN CORPORATION)  
CHUO-KU  
3-5-1, NIHONBASHI HONCHO  
TOKYO, JAPAN 103-8426

FOR: PHARMACEUTICAL PREPARATIONS, NAMELY, ANTIPLASMINIC PREPARATION,  
IN CLASS 5 (U.S. CLS. 6, 18, 44, 46, 51 AND 52).

THE MARK CONSISTS OF STANDARD CHARACTERS WITHOUT CLAIM TO ANY PAR-  
TICULAR FONT, STYLE, SIZE, OR COLOR.

OWNER OF JAPAN REG. NO. 2022449, DATED 2-22-1988, EXPIRES 2-22-2018.

OWNER OF U.S. REG. NO. 2,998,501.

SER. NO. 85-409,419, FILED 8-29-2011.

BARBARA GAYNOR, EXAMINING ATTORNEY



*David J. Kybas*

Director of the United States Patent and Trademark Office

# United States of America

United States Patent and Trademark Office

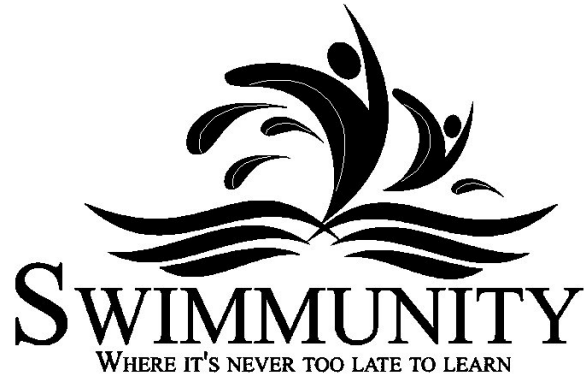

**Reg. No. 4,134,957**

**Registered May 1, 2012**

**Int. Cls.: 38 and 41**

**SERVICE MARK**

**PRINCIPAL REGISTER**

RODRIGUEZ, LARISSA (UNITED STATES INDIVIDUAL)  
18394 CATTAIL COURT  
EDEN PRAIRIE, MN 55346

FOR: PROVIDING AN ON-LINE FORUM FOR DISCUSSION OF SWIMMING, IN CLASS 38 (U.S. CLS. 100, 101 AND 104).

FIRST USE 8-10-2011; IN COMMERCE 8-10-2011.

FOR: PROVIDING A WEBSITE FEATURING INFORMATION IN THE FIELD OF SWIMMING AND LEARNING HOW TO SWIM; ON-LINE JOURNALS, NAMELY, BLOGS FEATURING THE SUBJECT OF SWIMMING, IN CLASS 41 (U.S. CLS. 100, 101 AND 107).

FIRST USE 8-10-2011; IN COMMERCE 8-10-2011.

THE MARK CONSISTS OF AN ABSTRACT DESIGN REPRESENTING WAVES AND TWO PEOPLE COMING OUT OF THE WATER OVER THE STYLIZED WORD "SWIMMUNITY"; UNDERNEATH IS THE STYLIZED WORDING "WHERE IT'S NEVER TOO LATE TO LEARN".

SER. NO. 85-409,422, FILED 8-29-2011.

JULIE GUTTADAURO, EXAMINING ATTORNEY



*David J. Kybas*

Director of the United States Patent and Trademark Office

**United States of America**  
United States Patent and Trademark Office

# BootDazzles

**Reg. No. 4,134,958**

**Registered May 1, 2012**

**Int. Cl.: 25**

**TRADEMARK**

**PRINCIPAL REGISTER**

MARLENE KNIGHT SPECIAL EVENTS, INC. (KENTUCKY CORPORATION), DBA  
BOOTDAZZLES  
9109 NOTTINGHAM PARKWAY  
LOUISVILLE, KY 402225029

FOR: BOOT ACCESSORIES, NAMELY, FITTED DECORATIVE COVERS FOR BOOTS, IN  
CLASS 25 (U.S. CLS. 22 AND 39).

FIRST USE 8-25-2011; IN COMMERCE 8-26-2011.

THE MARK CONSISTS OF STANDARD CHARACTERS WITHOUT CLAIM TO ANY PAR-  
TICULAR FONT, STYLE, SIZE, OR COLOR.

SER. NO. 85-409,444, FILED 8-29-2011.

KARANENDRA S. CHHINA, EXAMINING ATTORNEY



*David J. Kybas*

Director of the United States Patent and Trademark Office



# United States of America

United States Patent and Trademark Office

## Motivational Firewood

**Reg. No. 4,134,959**

**Registered May 1, 2012**

**Int. Cl.: 16**

**TRADEMARK**

**PRINCIPAL REGISTER**

STEPHEN GAMLIN (UNITED STATES INDIVIDUAL)  
65 FLINTLOCK FARM ROAD  
DUNBARTON, NH 03046

FOR: PAPERWEIGHTS, IN CLASS 16 (U.S. CLS. 2, 5, 22, 23, 29, 37, 38 AND 50).

FIRST USE 8-15-2011; IN COMMERCE 8-15-2011.

THE MARK CONSISTS OF STANDARD CHARACTERS WITHOUT CLAIM TO ANY PARTICULAR FONT, STYLE, SIZE, OR COLOR.

SER. NO. 85-409,450, FILED 8-29-2011.

KATHRYN COWARD, EXAMINING ATTORNEY



*David J. Kyffers*

Director of the United States Patent and Trademark Office

# United States of America

United States Patent and Trademark Office

## INNER PERSPECTIVE WORKSHOP

**Reg. No. 4,134,960**

**Registered May 1, 2012**

**Int. Cl.: 41**

**SERVICE MARK**

**PRINCIPAL REGISTER**

CARROLL, DAVID M (UNITED STATES INDIVIDUAL)  
6550 WETHEROLE ST. APT# 4G  
REGO PARK, NY 11374 AND

CARROLL, ALLISON J (UNITED STATES INDIVIDUAL)  
6550 WETHEROLE ST. APT# 4G  
REGO PARK, NY 11374

FOR: EDUCATIONAL SERVICES, NAMELY, PROVIDING ON-LINE PHOTOGRAPHIC, AUDIO, VIDEO AND PROSE PRESENTATIONS FEATURING EDUCATIONAL INFORMATION IN THE FIELD OF ART-RELATED SELF-EXPRESSION, DRAWING, PAINTING, TATTOOING, DIGITAL ART, AND USING TOOLS AND METHODS FOR FURTHERING ARTISTIC EXPRESSION AND DEVELOPMENT, IN CLASS 41 (U.S. CLS. 100, 101 AND 107).

FIRST USE 8-25-2011; IN COMMERCE 8-25-2011.

THE MARK CONSISTS OF STANDARD CHARACTERS WITHOUT CLAIM TO ANY PARTICULAR FONT, STYLE, SIZE, OR COLOR.

NO CLAIM IS MADE TO THE EXCLUSIVE RIGHT TO USE "WORKSHOP", APART FROM THE MARK AS SHOWN.

SER. NO. 85-409,454, FILED 8-29-2011.

MARILYN IZZI, EXAMINING ATTORNEY



*David J. Kybas*

Director of the United States Patent and Trademark Office

# United States of America

United States Patent and Trademark Office



**Reg. No. 4,134,961**

**Registered May 1, 2012**

**Int. Cl.: 36**

**SERVICE MARK**

**PRINCIPAL REGISTER**

SWIPE FOR CHANGE, LLC (GEORGIA LIMITED LIABILITY COMPANY)  
SUITE 1-310  
3715 NORTHSIDE PARKWAY  
ATLANTA, GA 30327

FOR: CHARGE CARD AND CREDIT CARD SERVICES; CHARITABLE FUNDRAISING SERVICES BY MEANS OF ENABLING OTHERS TO DONATE A PORTION OF CREDIT CARD AND CHARGE CARD TRANSACTION FEES AND PROCESSING FEES TO CHARITABLE ORGANIZATIONS AND CAUSES; CREDIT CARD PAYMENT PROCESSING SERVICES; CREDIT CARD TRANSACTION PROCESSING SERVICES; PAYMENT PROCESSING SERVICES, NAMELY, CREDIT CARD AND DEBIT CARD TRANSACTION PROCESSING SERVICES, IN CLASS 36 (U.S. CLS. 100, 101 AND 102).

FIRST USE 5-30-2011; IN COMMERCE 7-26-2011.

THE MARK CONSISTS OF TWO COMPLEMENTARY ARCUATE SHAPES FORMING A PARTIAL OUTLINE OF A STYLISTIC "S" CHARACTER.

SER. NO. 85-409,457, FILED 8-29-2011.

ZHALEH DELANEY, EXAMINING ATTORNEY



*David J. Kyffers*

Director of the United States Patent and Trademark Office

# United States of America

United States Patent and Trademark Office

## INNER PERSPECTIVE WORKSHOP

**Reg. No. 4,134,962**

**Registered May 1, 2012**

**Int. Cl.: 9**

**TRADEMARK**

**PRINCIPAL REGISTER**

CARROLL, DAVID M (UNITED STATES INDIVIDUAL)  
6550 WETHEROLE ST. APT# 4G  
REGO PARK, NY 11374 AND

CARROLL, ALLISON J (UNITED STATES INDIVIDUAL)  
6550 WETHEROLE ST. APT# 4G  
REGO PARK, NY 11374

FOR: AUDIO AND VIDEO RECORDINGS FEATURING INSTRUCTION AND INFORMATION IN THE FIELDS OF DRAWING, PAINTING, TATTOOING OR DIGITAL ART; DVDS FEATURING INSTRUCTION AND INFORMATION IN THE FIELDS OF DRAWING, PAINTING, TATTOOING OR DIGITAL ART, IN CLASS 9 (U.S. CLS. 21, 23, 26, 36 AND 38).

FIRST USE 8-25-2011; IN COMMERCE 8-25-2011.

THE MARK CONSISTS OF STANDARD CHARACTERS WITHOUT CLAIM TO ANY PARTICULAR FONT, STYLE, SIZE, OR COLOR.

NO CLAIM IS MADE TO THE EXCLUSIVE RIGHT TO USE "WORKSHOP", APART FROM THE MARK AS SHOWN.

SER. NO. 85-409,459, FILED 8-29-2011.

MARILYN IZZI, EXAMINING ATTORNEY



*David J. Kybas*

Director of the United States Patent and Trademark Office

# United States of America

United States Patent and Trademark Office

## FUNCHISYCAL

**Reg. No. 4,134,963**

**Registered May 1, 2012**

**Int. Cl.: 41**

**SERVICE MARK**

**PRINCIPAL REGISTER**

ANDREW BERLER (UNITED STATES INDIVIDUAL)  
61 DEVON LANE  
MARSTONS MILLS, MA 02648

FOR: CONSULTING SERVICES IN THE FIELDS OF FITNESS AND EXERCISE; PERSONAL FITNESS TRAINING SERVICES AND CONSULTANCY; PHYSICAL FITNESS TRAINING SERVICES, IN CLASS 41 (U.S. CLS. 100, 101 AND 107).

FIRST USE 6-0-2010; IN COMMERCE 6-0-2010.

THE MARK CONSISTS OF STANDARD CHARACTERS WITHOUT CLAIM TO ANY PARTICULAR FONT, STYLE, SIZE, OR COLOR.

SER. NO. 85-409,465, FILED 8-29-2011.

JUDITH HELFMAN, EXAMINING ATTORNEY



*David J. Kyros*

Director of the United States Patent and Trademark Office

# United States of America

United States Patent and Trademark Office

## Make Time for Nothing

**Reg. No. 4,134,964**

**Registered May 1, 2012**

**Int. Cl.: 41**

**SERVICE MARK**

**PRINCIPAL REGISTER**

KIMBERLY L. COLEGROVE (UNITED STATES INDIVIDUAL), DBA MAKE TIME FOR NOTHING  
16021 S BRADLEY DR  
OLATHE, KS 66062

FOR: PROVIDING LIFE COACHING CONSULTATION IN THE MENTAL, EMOTIONAL AND SPIRITUAL WELLNESS FIELDS; PROVIDING INSTRUCTIONAL CLASSES IN THE FIELDS OF STRESS REDUCTION MEDITATION AND MENTAL, EMOTIONAL, SPIRITUAL WELLNESS, IN CLASS 41 (U.S. CLS. 100, 101 AND 107).

FIRST USE 3-1-2006; IN COMMERCE 3-24-2011.

THE MARK CONSISTS OF STANDARD CHARACTERS WITHOUT CLAIM TO ANY PARTICULAR FONT, STYLE, SIZE, OR COLOR.

SER. NO. 85-409,467, FILED 8-29-2011.

JUDITH HELFMAN, EXAMINING ATTORNEY



*David J. Kyffers*

Director of the United States Patent and Trademark Office

**United States of America**  
United States Patent and Trademark Office

**SANEXAS**

**Reg. No. 4,134,965**

**Registered May 1, 2012**

**Int. Cl.: 10**

**TRADEMARK**

**PRINCIPAL REGISTER**

SANEXAS CORPORATION (NEVADA CORPORATION)  
SUITE B-121  
3111 S. VALLEY VIEW BLVD.  
LAS VEGAS, NV 89102

FOR: MEDICAL DEVICES, NAMELY, ELECTRONIC NEURO-MUSCULAR STIMULATORS,  
AND INTEGRAL NEUROPATHY PAIN AND NERVE STIMULATING ACCESSORY DEVICES  
SOLD AS COMPONENT PARTS THEREFOR, IN CLASS 10 (U.S. CLS. 26, 39 AND 44).

FIRST USE 1-30-2003; IN COMMERCE 1-30-2003.

THE MARK CONSISTS OF STANDARD CHARACTERS WITHOUT CLAIM TO ANY PAR-  
TICULAR FONT, STYLE, SIZE, OR COLOR.

THE WORDING "SANEXAS" HAS NO MEANING IN A FOREIGN LANGUAGE.

SER. NO. 85-409,469, FILED 8-29-2011.

JUDITH HELFMAN, EXAMINING ATTORNEY



*David J. Kyffers*

Director of the United States Patent and Trademark Office

# United States of America

United States Patent and Trademark Office

## RICH FLY GEE\$

**Reg. No. 4,134,966**

**Registered May 1, 2012**

**Int. Cl.: 25**

**TRADEMARK**

**PRINCIPAL REGISTER**

KARL JORDAN (UNITED STATES INDIVIDUAL)  
91-50 195TH ST.  
HOLLIS, NY 11423

FOR: T-SHIRTS, IN CLASS 25 (U.S. CLS. 22 AND 39).

FIRST USE 8-3-2011; IN COMMERCE 8-3-2011.

THE MARK CONSISTS OF STANDARD CHARACTERS WITHOUT CLAIM TO ANY PARTICULAR FONT, STYLE, SIZE, OR COLOR.

SER. NO. 85-409,478, FILED 8-29-2011.

FRANK LATTUCA, EXAMINING ATTORNEY



*David J. Kybas*

Director of the United States Patent and Trademark Office



# United States of America

United States Patent and Trademark Office

## PARADISE ENERGY SOLUTIONS

**Reg. No. 4,134,967**

**Registered May 1, 2012**

**Int. Cl.: 37**

**SERVICE MARK**

**PRINCIPAL REGISTER**

PARADISE ENERGY SOLUTIONS LLC (PENNSYLVANIA LIMITED LIABILITY COMPANY)  
5292 LINCOLN HIGHWAY  
GAP, PA 17527

FOR: INSTALLATION OF RENEWABLE ENERGY GENERATION EQUIPMENT, IN CLASS  
37 (U.S. CLS. 100, 103 AND 106).

FIRST USE 1-1-2009; IN COMMERCE 1-1-2009.

THE MARK CONSISTS OF STANDARD CHARACTERS WITHOUT CLAIM TO ANY PAR-  
TICULAR FONT, STYLE, SIZE, OR COLOR.

NO CLAIM IS MADE TO THE EXCLUSIVE RIGHT TO USE "ENERGY SOLUTIONS", APART  
FROM THE MARK AS SHOWN.

SER. NO. 85-409,487, FILED 8-29-2011.

WILLIAM ROSSMAN, EXAMINING ATTORNEY



*David J. Kyffers*

Director of the United States Patent and Trademark Office

# United States of America

United States Patent and Trademark Office

# FLUO-8

**Reg. No. 4,134,968**

AAT BIOQUEST, INC. (CALIFORNIA CORPORATION)  
923 THOMPSON PLACE  
SUNNYVALE, CA 94085

**Registered May 1, 2012**

**Int. Cl.: 1**

FOR: ASSAYS AND CHEMICAL REAGENTS FOR NON-MEDICAL PURPOSES, NAMELY,  
FOR USE IN DETECTING CALCIUM, IN CLASS 1 (U.S. CLS. 1, 5, 6, 10, 26 AND 46).

**TRADEMARK**

FIRST USE 6-12-2007; IN COMMERCE 6-12-2007.

**PRINCIPAL REGISTER**

THE MARK CONSISTS OF STANDARD CHARACTERS WITHOUT CLAIM TO ANY PARTICULAR FONT, STYLE, SIZE, OR COLOR.

SER. NO. 85-409,493, FILED 8-29-2011.

HANNO RITTNER, EXAMINING ATTORNEY



*David J. Kybas*

Director of the United States Patent and Trademark Office

# United States of America

United States Patent and Trademark Office

## Journal of Academic Ophthalmology

**Reg. No. 4,134,969**

**Registered May 1, 2012**

**Int. Cl.: 16**

**TRADEMARK**

**PRINCIPAL REGISTER**

FREE EDUCATIONAL PUBLICATIONS INTERNATIONAL, INC (MARYLAND CORPORATION)  
941 25TH AVENUE, #101  
CORALVILLE, IA 52241

FOR: JOURNALS CONCERNING TOPICS IN OPHTHALMOLOGY, ORIGINAL EDUCATION RESEARCH, LITERATURE REVIEWS, AND EDITORIAL, HISTORICAL, OR POLICY PERSPECTIVES, IN CLASS 16 (U.S. CLS. 2, 5, 22, 23, 29, 37, 38 AND 50).

FIRST USE 1-23-2006; IN COMMERCE 1-23-2006.

THE MARK CONSISTS OF STANDARD CHARACTERS WITHOUT CLAIM TO ANY PARTICULAR FONT, STYLE, SIZE, OR COLOR.

OWNER OF U.S. REG. NO. 3,697,297.

NO CLAIM IS MADE TO THE EXCLUSIVE RIGHT TO USE "JOURNAL", APART FROM THE MARK AS SHOWN.

SEC. 2(F).

SER. NO. 85-409,509, FILED 8-29-2011.

AMY HELLA, EXAMINING ATTORNEY



*David J. Kyffers*

Director of the United States Patent and Trademark Office

# United States of America

United States Patent and Trademark Office

## PRE-VIEW Cholangiography

**Reg. No. 4,134,970**

NASHVILLE SURGICAL INSTRUMENTS (TENNESSEE LIMITED LIABILITY COMPANY)  
2005 KUMAR LANE  
SPRINGFIELD, TN 37172

**Registered May 1, 2012**

**Int. Cl.: 10**

FOR: CHOLANGIOGRAPHY CATHETERS FOR USE IN GALLBLADDER SURGERY, IN CLASS 10 (U.S. CLS. 26, 39 AND 44).

**TRADEMARK**

FIRST USE 3-1-1999; IN COMMERCE 3-1-1999.

**PRINCIPAL REGISTER**

THE MARK CONSISTS OF STANDARD CHARACTERS WITHOUT CLAIM TO ANY PARTICULAR FONT, STYLE, SIZE, OR COLOR.

OWNER OF U.S. REG. NO. 4,001,103.

NO CLAIM IS MADE TO THE EXCLUSIVE RIGHT TO USE "CHOLANGIOGRAPHY", APART FROM THE MARK AS SHOWN.

SER. NO. 85-409,514, FILED 8-29-2011.

JACLYN KIDWELL WALKER, EXAMINING ATTORNEY



*David J. Kyffers*

Director of the United States Patent and Trademark Office

# United States of America

United States Patent and Trademark Office

# SIMGL

**Reg. No. 4,134,971**

**Registered May 1, 2012**

**Int. Cl.: 9**

**TRADEMARK**

**PRINCIPAL REGISTER**

QUANTUM3D, INC. (CALIFORNIA CORPORATION)  
5400 HELLYER AVE  
SAN JOSE, CA 95138

FOR: COMPUTER SOFTWARE, NAMELY AN APPLICATIONS PROGRAMMING INTERFACE FOR 3D GRAPHICS APPLICATIONS, IN CLASS 9 (U.S. CLS. 21, 23, 26, 36 AND 38).

FIRST USE 0-0-1997; IN COMMERCE 0-0-1997.

THE MARK CONSISTS OF STANDARD CHARACTERS WITHOUT CLAIM TO ANY PARTICULAR FONT, STYLE, SIZE, OR COLOR.

SER. NO. 85-409,527, FILED 8-29-2011.

KHANH LE, EXAMINING ATTORNEY



*David J. Kybas*

Director of the United States Patent and Trademark Office

United States of America  
United States Patent and Trademark Office

# TALKTRAC

**Reg. No. 4,134,972**

**Registered May 1, 2012**

**Int. Cl.: 42**

**SERVICE MARK**

**PRINCIPAL REGISTER**

THE MECO GROUP, LLC (GEORGIA LIMITED LIABILITY COMPANY)  
826 CARRIAGE LANE  
WAYCROSS, GA 31503

FOR: PROVIDING TEMPORARY USE OF NON-DOWNLOADABLE EDUCATION MANAGEMENT SOFTWARE, NAMELY, SOFTWARE FOR MANAGING STUDENT PERFORMANCE DATA, IN CLASS 42 (U.S. CLS. 100 AND 101).

FIRST USE 5-24-2011; IN COMMERCE 7-8-2011.

THE MARK CONSISTS OF STANDARD CHARACTERS WITHOUT CLAIM TO ANY PARTICULAR FONT, STYLE, SIZE, OR COLOR.

SER. NO. 85-409,541, FILED 8-29-2011.

NICHOLAS COLEMAN, EXAMINING ATTORNEY



*David J. Kybas*

Director of the United States Patent and Trademark Office

# United States of America

United States Patent and Trademark Office

## The Ultimate Journey

**Reg. No. 4,134,973**

**Registered May 1, 2012**

**Int. Cls.: 16 and 41**

**TRADEMARK**

**SERVICE MARK**

**PRINCIPAL REGISTER**

CHRIST-LIFE MINISTRIES, INC. (IOWA CORPORATION)  
P.O. BOX 3841  
DES MOINES, IA 50323

FOR: EDUCATIONAL BOOKS DEALING WITH CHRISTIAN SUBJECTS, IN CLASS 16 (U.S. CLS. 2, 5, 22, 23, 29, 37, 38 AND 50).

FIRST USE 9-1-2009; IN COMMERCE 9-1-2009.

FOR: CONDUCTING EDUCATIONAL MEETINGS AND SEMINARS FOR PASTORS AND CHURCH LEADERS TO ENABLE THEM TO TEACH EDUCATIONAL CLASSES DEALING WITH CHRISTIAN SUBJECTS, IN CLASS 41 (U.S. CLS. 100, 101 AND 107).

FIRST USE 9-1-2009; IN COMMERCE 9-1-2009.

THE MARK CONSISTS OF STANDARD CHARACTERS WITHOUT CLAIM TO ANY PARTICULAR FONT, STYLE, SIZE, OR COLOR.

SER. NO. 85-409,542, FILED 8-29-2011.

HOWARD SMIGA, EXAMINING ATTORNEY



*David J. Kybas*

Director of the United States Patent and Trademark Office

# United States of America

United States Patent and Trademark Office



# Talktrac

**Reg. No. 4,134,974**

**Registered May 1, 2012**

**Int. Cl.: 42**

**SERVICE MARK**

**PRINCIPAL REGISTER**

THE MECO GROUP, LLC (GEORGIA LIMITED LIABILITY COMPANY)  
826 CARRIAGE LANE  
WAYCROSS, GA 31503

FOR: PROVIDING TEMPORARY USE OF NON-DOWNLOADABLE EDUCATION MANAGEMENT SOFTWARE, NAMELY, SOFTWARE FOR MANAGING STUDENT PERFORMANCE DATA, IN CLASS 42 (U.S. CLS. 100 AND 101).

FIRST USE 5-24-2011; IN COMMERCE 7-8-2011.

THE MARK CONSISTS OF THE WORD "TALKTRAC" HAVING A PAIR OF TEXT BUBBLES WITH ONE OF THE TEXT BUBBLES HAVING BUBBLES ON TOP OF IT.

SER. NO. 85-409,551, FILED 8-29-2011.

NICHOLAS COLEMAN, EXAMINING ATTORNEY



*David J. Kyffers*

Director of the United States Patent and Trademark Office



# United States of America

United States Patent and Trademark Office

## Pink Up Cape

**Reg. No. 4,134,975**

**Registered May 1, 2012**

**Int. Cl.: 35**

**SERVICE MARK**

**PRINCIPAL REGISTER**

SAINT FRANCIS MEDICAL CENTER (MISSOURI CORPORATION)  
211 SAINT FRANCIS DRIVE  
CAPE GIRARDEAU, MO 63703

FOR: PROMOTING PUBLIC AWARENESS OF THE NEED FOR RESEARCH, EDUCATION AND OTHER ACTIVITIES RELATING TO BREAST CANCER, IN CLASS 35 (U.S. CLS. 100, 101 AND 102).

FIRST USE 10-1-2010; IN COMMERCE 10-1-2010.

THE MARK CONSISTS OF STANDARD CHARACTERS WITHOUT CLAIM TO ANY PARTICULAR FONT, STYLE, SIZE, OR COLOR.

SER. NO. 85-409,552, FILED 8-29-2011.

MICHAEL KEATING, EXAMINING ATTORNEY



*David J. Kyffers*

Director of the United States Patent and Trademark Office

# United States of America

United States Patent and Trademark Office

# INFLUVAC

**Reg. No. 4,134,976**

**Registered May 1, 2012**

**Int. Cl.: 5**

**TRADEMARK**

**PRINCIPAL REGISTER**

ABBOTT BIOLOGICALS B.V. (NETHERLANDS BESLOTEN VENNOOTSCHAP (B.V.))  
C.J. VAN HOUTENLAAN 36  
WEESP, NETHERLANDS 1381CP

FOR: PHARMACEUTICAL PREPARATIONS AND SUBSTANCES, NAMELY, INFLUENZA VACCINES FOR HUMAN USE, IN CLASS 5 (U.S. CLS. 6, 18, 44, 46, 51 AND 52).

THE MARK CONSISTS OF STANDARD CHARACTERS WITHOUT CLAIM TO ANY PARTICULAR FONT, STYLE, SIZE, OR COLOR.

OWNER OF ERPN CMNTY TM OFC REG. NO. 002287498, DATED 9-11-2003, EXPIRES 7-5-2021.

OWNER OF U.S. REG. NOS. 3,021,123, 3,663,811 AND OTHERS.

SER. NO. 85-409,557, FILED 8-29-2011.

SCOTT BIBB, EXAMINING ATTORNEY



*David J. Kybas*

Director of the United States Patent and Trademark Office

# United States of America

United States Patent and Trademark Office

## RDM Server

**Reg. No. 4,134,977**

**Registered May 1, 2012**

**Int. Cl.: 9**

**TRADEMARK**

**PRINCIPAL REGISTER**

RAIMA INC. (DELAWARE CORPORATION)  
720 THIRD AVENUE, SUITE 1100  
SEATTLE, WA 98104

FOR: COMPUTER SOFTWARE FOR DATABASE MANAGEMENT; COMPUTER SOFTWARE FOR DEVELOPING OTHER SOFTWARE PROGRAMS; COMPUTER UTILITY SOFTWARE; AND INSTRUCTION MANUALS THEREFOR, SOLD AS A UNIT, IN CLASS 9 (U.S. CLS. 21, 23, 26, 36 AND 38).

FIRST USE 12-21-2001; IN COMMERCE 12-21-2001.

THE MARK CONSISTS OF STANDARD CHARACTERS WITHOUT CLAIM TO ANY PARTICULAR FONT, STYLE, SIZE, OR COLOR.

OWNER OF U.S. REG. NOS. 3,064,272 AND 3,899,597.

NO CLAIM IS MADE TO THE EXCLUSIVE RIGHT TO USE "SERVER", APART FROM THE MARK AS SHOWN.

SER. NO. 85-409,570, FILED 8-29-2011.

AMY HELLA, EXAMINING ATTORNEY



*David J. Kyffers*

Director of the United States Patent and Trademark Office

# United States of America

United States Patent and Trademark Office

## SUPER CHARGED GREENS BLEND

**Reg. No. 4,134,978**

**Registered May 1, 2012**

**Int. Cl.: 5**

**TRADEMARK**

**PRINCIPAL REGISTER**

DAVID KIRSCH WELLNESS CO., INC. (NEW YORK CORPORATION)  
210 FIFTH AVENUE  
NEW YORK, NY 10010

FOR: DIETARY SUPPLEMENTS; POWDERED PROTEIN NUTRITIONAL SUPPLEMENT DRINK MIX; APPETITE SUPPRESSANTS; AND VITAMIN SUPPLEMENTS, IN CLASS 5 (U.S. CLS. 6, 18, 44, 46, 51 AND 52).

FIRST USE 10-28-2009; IN COMMERCE 10-28-2009.

THE MARK CONSISTS OF STANDARD CHARACTERS WITHOUT CLAIM TO ANY PARTICULAR FONT, STYLE, SIZE, OR COLOR.

NO CLAIM IS MADE TO THE EXCLUSIVE RIGHT TO USE "GREENS BLEND", APART FROM THE MARK AS SHOWN.

SER. NO. 85-409,572, FILED 8-29-2011.

JAY FLOWERS, EXAMINING ATTORNEY



*David J. Kyros*

Director of the United States Patent and Trademark Office

# United States of America

United States Patent and Trademark Office



SECURITY WISE. BRAND SMART.

**Reg. No. 4,134,979**

**Registered May 1, 2012**

**Int. Cl.: 45**

**SERVICE MARK**

**PRINCIPAL REGISTER**

DOCUMENT SECURITY SYSTEMS, INC. (NEW YORK CORPORATION)  
SUITE 1525  
28 EAST MAIN STREET  
ROCHESTER, NY 14614

FOR: CONSULTING SERVICES, NAMELY, CONSULTATION IN THE FIELDS OF PRODUCT AND DOCUMENT AUTHENTICATION AND TRACKING, AND BRAND MONITORING AND PROTECTION, TO PROTECT AGAINST COUNTERFEITING, TAMPERING, AND DIVERSION, AND TO ENSURE THE INTEGRITY OF GENUINE PRODUCTS AND DOCUMENTS, IN CLASS 45 (U.S. CLS. 100 AND 101).

FIRST USE 6-1-2011; IN COMMERCE 6-1-2011.

THE MARK CONSISTS OF A CUBE SHOWN IN A PERSPECTIVE VIEW SURROUNDED BY THREE CHEVRONS TO THE RIGHT OF THE LETTERS "DSS" IN SLIGHTLY STYLIZED FORM ABOVE THE WORDS "SECURITY WISE. BRAND SMART."

SER. NO. 85-409,580, FILED 8-29-2011.

JACLYN KIDWELL WALKER, EXAMINING ATTORNEY



*David J. Kyffers*

Director of the United States Patent and Trademark Office

# United States of America

United States Patent and Trademark Office

## SPIRIT FINGERZ

**Reg. No. 4,134,980**

TERESA DENHAM (UNITED STATES INDIVIDUAL)

**Registered May 1, 2012**

P.O. BOX 6507  
VIRGINIA BEACH, VA 23456

**Int. Cl.: 25**

FOR: GLOVES, HAVING POM POMS, BELLS, OR LIGHT SOURCES ATTACHED TO THE TIPS OF THE GLOVE FINGERS, IN CLASS 25 (U.S. CLS. 22 AND 39).

**TRADEMARK**

FIRST USE 5-6-2008; IN COMMERCE 5-6-2008.

**PRINCIPAL REGISTER**

THE MARK CONSISTS OF STANDARD CHARACTERS WITHOUT CLAIM TO ANY PARTICULAR FONT, STYLE, SIZE, OR COLOR.

SER. NO. 85-409,585, FILED 8-29-2011.

JESSICA FATHY, EXAMINING ATTORNEY



*David J. Kybas*

Director of the United States Patent and Trademark Office

# United States of America

United States Patent and Trademark Office

# METABOLYS

**Reg. No. 4,134,981**

**Registered May 1, 2012**

**Int. Cls.: 5 and 31**

**TRADEMARK**

**PRINCIPAL REGISTER**

H.J. BAKER & BRO., INC. (DELAWARE CORPORATION)  
228 SAUGATUCK AVENUE  
WESTPORT, CT 06880

FOR: ANIMAL FEED SUPPLEMENTS; NON-MEDICATED ADDITIVES FOR ANIMAL FEED FOR USE AS NUTRITIONAL SUPPLEMENTS, IN CLASS 5 (U.S. CLS. 6, 18, 44, 46, 51 AND 52).

FIRST USE 4-23-2010; IN COMMERCE 4-23-2010.

FOR: ADDITIVES FOR ANIMAL FEED, NOT FOR MEDICAL PURPOSES; NON-MEDICATED ADDITIVES FOR ANIMAL FEED, IN CLASS 31 (U.S. CLS. 1 AND 46).

FIRST USE 4-23-2010; IN COMMERCE 4-23-2010.

THE MARK CONSISTS OF STANDARD CHARACTERS WITHOUT CLAIM TO ANY PARTICULAR FONT, STYLE, SIZE, OR COLOR.

OWNER OF U.S. REG. NO. 3,873,622.

SER. NO. 85-409,599, FILED 8-29-2011.

DAWN HAN, EXAMINING ATTORNEY



*David J. Kyros*

Director of the United States Patent and Trademark Office

# United States of America

United States Patent and Trademark Office

## Dispatches from the Wildlands

**Reg. No. 4,134,982**

RICHARDS, PAUL (UNITED STATES INDIVIDUAL)  
30 BROWNS GULCH ROAD  
BOULDER, MT 596329709

**Registered May 1, 2012**

**Int. Cl.: 41**

FOR: ON-LINE JOURNALS, NAMELY, BLOGS FEATURING ENTERTAINMENT NEWS, IN CLASS 41 (U.S. CLS. 100, 101 AND 107).

**SERVICE MARK**

FIRST USE 1-1-1968; IN COMMERCE 1-1-1968.

**PRINCIPAL REGISTER**

THE MARK CONSISTS OF STANDARD CHARACTERS WITHOUT CLAIM TO ANY PARTICULAR FONT, STYLE, SIZE, OR COLOR.

SER. NO. 85-409,607, FILED 8-29-2011.

JACLYN KIDWELL WALKER, EXAMINING ATTORNEY



*David J. Kybas*

Director of the United States Patent and Trademark Office



# United States of America

United States Patent and Trademark Office

## SHALLOWRAIDER

**Reg. No. 4,134,983**

**Registered May 1, 2012**

**Int. Cl.: 28**

**TRADEMARK**

**PRINCIPAL REGISTER**

JOE BUCHER (UNITED STATES INDIVIDUAL), DBA JOE BUCHER OUTDOORS  
P.O. BOX 1105  
3359 HIGHWAY 70 EAST  
EAGLE RIVER, WI 54521

FOR: FISHING LURES; FISHING TACKLE, IN CLASS 28 (U.S. CLS. 22, 23, 38 AND 50).

FIRST USE 12-4-1991; IN COMMERCE 12-4-1991.

THE MARK CONSISTS OF STANDARD CHARACTERS WITHOUT CLAIM TO ANY PARTICULAR FONT, STYLE, SIZE, OR COLOR.

SER. NO. 85-409,618, FILED 8-29-2011.

ANDREA K. NADELMAN, EXAMINING ATTORNEY



*David J. Kyffers*

Director of the United States Patent and Trademark Office

# United States of America

United States Patent and Trademark Office

**HOFFMAN**

**Reg. No. 4,134,984**

**Registered May 1, 2012**

**Int. Cl.: 35**

**SERVICE MARK**

**PRINCIPAL REGISTER**

CHAMPION ENERGY CORPORATION (DELAWARE CORPORATION)  
ONE RADISSON PLAZA, SUITE 801  
NEW ROCHELLE, NY 10801

FOR: CONDUCTING ENERGY AUDITS OF RESIDENTIAL HOMES FOR THE PURPOSE OF IMPROVING ENERGY EFFICIENCY, IN CLASS 35 (U.S. CLS. 100, 101 AND 102).

FIRST USE 2-1-2010; IN COMMERCE 2-1-2010.

THE MARK CONSISTS OF THE WORD "HOFFMAN" WITH THE LETTER "O" AS A SUN-BURST.

SER. NO. 85-409,622, FILED 8-29-2011.

KATHERINE CHANG, EXAMINING ATTORNEY



*David J. Kybas*

Director of the United States Patent and Trademark Office

# United States of America

United States Patent and Trademark Office

# Vortex

**Reg. No. 4,134,985**

**Registered May 1, 2012**

**Int. Cl.: 30**

**TRADEMARK**

**PRINCIPAL REGISTER**

CHILLERS FRANCHISE, INC. (INDIANA CORPORATION)  
7007 HIGHPOINT CIRCLE  
SELLERSBURG, IN 47172

FOR: ICE CREAM AND FROZEN YOGURT CONTAINING FRUIT, CANDY, NUTS, COOKIES,  
IN CLASS 30 (U.S. CL. 46).

FIRST USE 8-27-2011; IN COMMERCE 8-27-2011.

THE MARK CONSISTS OF STANDARD CHARACTERS WITHOUT CLAIM TO ANY PAR-  
TICULAR FONT, STYLE, SIZE, OR COLOR.

SER. NO. 85-409,643, FILED 8-29-2011.

GEOFFREY FOSDICK, EXAMINING ATTORNEY



*David J. Kybas*

Director of the United States Patent and Trademark Office

# United States of America

United States Patent and Trademark Office

# WasteRec

**Reg. No. 4,134,986**

WASTEREC SERVICES INC. (TEXAS CORPORATION)  
3440 S. GROVE ST.  
FT.WORTH, TX 76115

**Registered May 1, 2012**

**Int. Cl.: 40**

FOR: RECYCLING; RECYCLING OF WASTE; WASTE MANAGEMENT, IN CLASS 40 (U.S. CLS. 100, 103 AND 106).

**SERVICE MARK**

FIRST USE 7-5-2011; IN COMMERCE 7-5-2011.

**PRINCIPAL REGISTER**

THE MARK CONSISTS OF STANDARD CHARACTERS WITHOUT CLAIM TO ANY PARTICULAR FONT, STYLE, SIZE, OR COLOR.

SER. NO. 85-409,654, FILED 8-29-2011.

ANDREA HACK, EXAMINING ATTORNEY



*David J. Kybas*

Director of the United States Patent and Trademark Office

# United States of America

United States Patent and Trademark Office

## ZONA VERDE

**Reg. No. 4,134,987**

**Registered May 1, 2012**

**Int. Cl.: 3**

**TRADEMARK**

**PRINCIPAL REGISTER**

MILLER, EARL (UNITED STATES INDIVIDUAL)  
11249 NORTH 74TH STREET  
SCOTTSDALE, AZ 85260

FOR: COSMETICS, HAIR SHAMPOOS, HAIR CONDITIONERS, SUN TAN LOTIONS, SUN SCREEN LOTIONS, FACE CREAMS, HAND AND BODY CREAMS, EYE CREAMS, SKIN MOISTURIZERS, BODY BUTTER, NON-MEDICATED SUNBURN RELIEF LOTIONS, FACIAL AND BODY CLEANSERS, SHAVING GELS, SHOWER GELS, BODY BRONZERS, NECK LINE SKIN CREAMS, BATH OILS, MASSAGE OILS, IN CLASS 3 (U.S. CLS. 1, 4, 6, 50, 51 AND 52).

FIRST USE 6-30-2008; IN COMMERCE 6-30-2008.

THE MARK CONSISTS OF STANDARD CHARACTERS WITHOUT CLAIM TO ANY PARTICULAR FONT, STYLE, SIZE, OR COLOR.

THE ENGLISH TRANSLATION OF "ZONA VERDE" IS "GREEN ZONE".

SER. NO. 85-409,660, FILED 8-29-2011.

ANDREA K. NADELMAN, EXAMINING ATTORNEY



*David J. Kyros*

Director of the United States Patent and Trademark Office

# United States of America

United States Patent and Trademark Office

## MH the Verb

**Reg. No. 4,134,988**

**Registered May 1, 2012**

**Int. Cl.: 41**

**SERVICE MARK**

**PRINCIPAL REGISTER**

HARRIS, MARCUS (UNITED STATES INDIVIDUAL)  
345 CHRISITAN ST.  
PHILADELPHIA, PA 19147

FOR: ENTERTAINMENT, NAMELY, LIVE PERFORMANCES BY A MUSICAL BAND;  
MULTIMEDIA ENTERTAINMENT SERVICES IN THE NATURE OF RECORDING, PRODUC-  
TION AND POST-PRODUCTION SERVICES IN THE FIELDS OF MUSIC, VIDEO, AND  
FILMS, IN CLASS 41 (U.S. CLS. 100, 101 AND 107).

FIRST USE 8-1-2003; IN COMMERCE 8-1-2005.

THE MARK CONSISTS OF STANDARD CHARACTERS WITHOUT CLAIM TO ANY PAR-  
TICULAR FONT, STYLE, SIZE, OR COLOR.

SER. NO. 85-409,668, FILED 8-29-2011.

RONALD DELGIZZI, EXAMINING ATTORNEY



*David J. Kyffers*

Director of the United States Patent and Trademark Office

# United States of America

United States Patent and Trademark Office

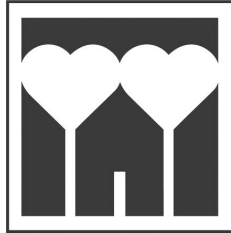

## HOME HEALTH CARE MANAGEMENT, INC.

**Reg. No. 4,134,989**

**Registered May 1, 2012**

**Int. Cl.: 44**

**SERVICE MARK**

**PRINCIPAL REGISTER**

HOME HEALTH CARE MANAGEMENT, INC. (PENNSYLVANIA NON-PROFIT CORPORATION)  
1170 BERKSHIRE BOULEVARD  
WYOMISSING, PA 19610

FOR: HOME HEALTH CARE SERVICES, HOSPICE SERVICES, IN CLASS 44 (U.S. CLS. 100 AND 101).

FIRST USE 8-15-2011; IN COMMERCE 8-15-2011.

NO CLAIM IS MADE TO THE EXCLUSIVE RIGHT TO USE "HOME HEALTH CARE MANAGEMENT, INC.", APART FROM THE MARK AS SHOWN.

THE MARK CONSISTS OF A STYLIZED DESIGN OF A HOUSE AND HEART-SHAPED TREES WITH A RECTANGULAR BORDER AND THE WORDS "HOME HEALTH CARE MANAGEMENT, INC." BENEATH THE DESIGN.

SER. NO. 85-409,679, FILED 8-29-2011.

ANGELA DUONG, EXAMINING ATTORNEY



*David J. Kyffers*

Director of the United States Patent and Trademark Office

# United States of America

United States Patent and Trademark Office

## SEIKO PERFAS PRESTIGE

**Reg. No. 4,134,990**

**Registered May 1, 2012**

**Int. Cl.: 9**

**TRADEMARK**

**PRINCIPAL REGISTER**

SEIKO HOLDINGS KABUSHIKI KAISHA (JAPAN CORPORATION), TA SEIKO HOLDINGS CORPORATION  
5-11, GINZA 4-CHOME, CHUO-KU  
TOKYO, JAPAN

FOR: EYEGLASSES, SUNGLASSES, LENSES FOR EYEGLASSES AND SUNGLASSES AND PARTS FOR EYEGLASSES AND SUNGLASSES, NAMELY, FRAMES AND PINCE-NEZ , IN CLASS 9 (U.S. CLS. 21, 23, 26, 36 AND 38).

FIRST USE 4-30-2011; IN COMMERCE 4-30-2011.

THE MARK CONSISTS OF STANDARD CHARACTERS WITHOUT CLAIM TO ANY PARTICULAR FONT, STYLE, SIZE, OR COLOR.

OWNER OF U.S. REG. NOS. 1,417,292, 1,981,520, AND 3,336,901.

SER. NO. 85-409,685, FILED 8-29-2011.

HOWARD B. LEVINE, EXAMINING ATTORNEY



*David J. Kyros*

Director of the United States Patent and Trademark Office



# United States of America

United States Patent and Trademark Office

# LEDGECUT33

**Reg. No. 4,134,991**

ELDORADO STONE OPERATIONS, LLC (UTAH LIMITED LIABILITY COMPANY)  
10653 S. RIVER FRONT PARKWAY, SUITE 300  
SOUTH JORDAN, UT 84095

**Registered May 1, 2012**

**Int. Cl.: 19**

FOR: BUILDING PRODUCTS, NAMELY, SYNTHETIC, ARTIFICIAL, MANUFACTURED  
AND REFORMED STONES, IN CLASS 19 (U.S. CLS. 1, 12, 33 AND 50).

**TRADEMARK**

FIRST USE 4-13-2011; IN COMMERCE 4-13-2011.

**PRINCIPAL REGISTER**

THE MARK CONSISTS OF STANDARD CHARACTERS WITHOUT CLAIM TO ANY PAR-  
TICULAR FONT, STYLE, SIZE, OR COLOR.

SER. NO. 85-409,702, FILED 8-29-2011.

JESSICA A. POWERS, EXAMINING ATTORNEY



*David J. Kyffers*

Director of the United States Patent and Trademark Office

# United States of America

United States Patent and Trademark Office

## PostureDesks

**Reg. No. 4,134,992**

**Registered May 1, 2012**

**Int. Cl.: 20**

**TRADEMARK**

**PRINCIPAL REGISTER**

REO-SMART, LLC. (CALIFORNIA LIMITED LIABILITY COMPANY)  
2126 S. GREEN PRIVADO  
ONTARIO, CA 91761

FOR: CABINETS; COMPUTER FURNITURE; FURNITURE MADE FROM STEEL TUBING; FURNITURE MADE FROM WOOD OR SUBSTITUTES FOR WOOD; FURNITURE PARTS, NAMELY, CHAIR LEGS, TABLE LEAVES, ARM RESTS, TABLE WRIST RESTS, TILTING DESK TOPS, AIR CUSHIONED TABLE TILT RELEASES, BACKPACK HANGERS, PULL-OUT ORGANIZATION DRAWERS, WIRE MANAGEMENT COMPARTMENTS, SIT-TO-LOCK WHEELS, MEMORY FOAM PADDING, MESH PADDING, MOBILE FILING CABINETS, GLASS DESKTOPS, GLASS BOOKSHELVES, FREE-MOVING-CASTER-WHEELS, FIFTH CASTER WHEELS FOR MOBILE FILING CABINETS; FURNITURE PRIMARILY OF METAL, NAMELY, SHELVING, COMPUTER DESKS, ADJUSTABLE DESKS, HEIGHT ADJUSTABLE FURNITURE; LIVING ROOM FURNITURE; METAL FURNITURE; OFFICE FURNITURE; RESIDENTIAL AND COMMERCIAL FURNITURE; SCHOOL FURNITURE; SEATS; TABLES, TELEVISION STANDS, AND TELEVISION MOUNTS, IN CLASS 20 (U.S. CLS. 2, 13, 22, 25, 32 AND 50).

FIRST USE 2-20-2011; IN COMMERCE 2-20-2011.

THE MARK CONSISTS OF STANDARD CHARACTERS WITHOUT CLAIM TO ANY PARTICULAR FONT, STYLE, SIZE, OR COLOR.

SER. NO. 85-409,706, FILED 8-29-2011.

SUSAN STIGLITZ, EXAMINING ATTORNEY



*David J. Kyros*

Director of the United States Patent and Trademark Office

# United States of America

United States Patent and Trademark Office

# LENS

**Reg. No. 4,134,993**

**Registered May 1, 2012**

**Int. Cl.: 7**

**TRADEMARK**

**PRINCIPAL REGISTER**

SANDIA CORPORATION (DELAWARE CORPORATION)  
M/S 0161  
P.O. BOX 5800  
ALBUQUERQUE, NM 87185

FOR: MECHANICAL MACHINE TO MANUFACTURE CUSTOM PARTS AND MOLDS FROM STREAMS OF POWDERS, IN CLASS 7 (U.S. CLS. 13, 19, 21, 23, 31, 34 AND 35).

FIRST USE 8-9-1996; IN COMMERCE 8-9-1996.

THE MARK CONSISTS OF STANDARD CHARACTERS WITHOUT CLAIM TO ANY PARTICULAR FONT, STYLE, SIZE, OR COLOR.

SER. NO. 85-409,708, FILED 8-29-2011.

SUSAN STIGLITZ, EXAMINING ATTORNEY



*David J. Kybas*

Director of the United States Patent and Trademark Office

# United States of America

United States Patent and Trademark Office

WHEN YOU THINK ADVOCACY,  
THINK OF US

**Reg. No. 4,134,994**

**Registered May 1, 2012**

**Int. Cl.: 45**

**SERVICE MARK**

**PRINCIPAL REGISTER**

SALAR ATRIZADEH (UNITED STATES INDIVIDUAL), DBA LAW OFFICES OF SALAR  
ATRIZADEH  
9701 WILSHIRE BLVD., 10TH FLOOR  
BEVERLY HILLS, CA 90212

FOR: LEGAL SERVICES, IN CLASS 45 (U.S. CLS. 100 AND 101).

FIRST USE 2-0-2009; IN COMMERCE 2-0-2009.

THE MARK CONSISTS OF STANDARD CHARACTERS WITHOUT CLAIM TO ANY PAR-  
TICULAR FONT, STYLE, SIZE, OR COLOR.

SER. NO. 85-409,736, FILED 8-29-2011.

ALAIN LAPTER, EXAMINING ATTORNEY



*David J. Kybas*

Director of the United States Patent and Trademark Office

# United States of America

United States Patent and Trademark Office

## JOKER'S WILD

**Reg. No. 4,134,995**

**Registered May 1, 2012**

**Int. Cl.: 13**

**TRADEMARK**

**PRINCIPAL REGISTER**

B.J. ALAN COMPANY (OHIO CORPORATION)  
555 MARTIN LUTHER KING, JR. BLVD.  
YOUNGSTOWN, OH 44502

FOR: FIREWORKS, IN CLASS 13 (U.S. CLS. 2 AND 9).

FIRST USE 5-11-2010; IN COMMERCE 5-11-2010.

THE MARK CONSISTS OF STANDARD CHARACTERS WITHOUT CLAIM TO ANY PARTICULAR FONT, STYLE, SIZE, OR COLOR.

SER. NO. 85-409,745, FILED 8-29-2011.

BRENDAN REGAN, EXAMINING ATTORNEY



*David J. Kybas*

Director of the United States Patent and Trademark Office

# United States of America

United States Patent and Trademark Office

## SMART MEASUREMENT

**Reg. No. 4,134,996**

**Registered May 1, 2012**

**Int. Cl.: 42**

**SERVICE MARK**

**PRINCIPAL REGISTER**

INGENIX, INC. (DELAWARE CORPORATION)  
13625 TECHNOLOGY DRIVE  
EDEN PRAIRIE, MN 55344

FOR: DATA AUTOMATION AND COLLECTION SERVICE USING PROPRIETARY SOFTWARE TO EVALUATE, ANALYZE AND COLLECT DATA IN THE HEALTH CARE INDUSTRY; PROVIDING ONLINE NON-DOWNLOADABLE SOFTWARE FOR USE IN COLLECTING, REVIEWING AND ANALYZING HEALTH DATA AND INFORMATION, MEDICAL EXPENSE DATA AND INFORMATION, AND HEALTH OUTCOME DATA AND INFORMATION; PROVIDING ONLINE NON-DOWNLOADABLE SOFTWARE FOR COLLECTION, STORAGE, ANALYSIS, SCORING, EVALUATION AND REPORTING OF SURVEY RESULTS CONCERNING HEALTH AND WELL-BEING INFORMATION AND DATA, IN CLASS 42 (U.S. CLS. 100 AND 101).

FIRST USE 0-0-2007; IN COMMERCE 0-0-2007.

THE MARK CONSISTS OF STANDARD CHARACTERS WITHOUT CLAIM TO ANY PARTICULAR FONT, STYLE, SIZE, OR COLOR.

SER. NO. 85-409,751, FILED 8-29-2011.

FLORENTINA BLANDU, EXAMINING ATTORNEY



*David J. Kybas*

Director of the United States Patent and Trademark Office

# United States of America

United States Patent and Trademark Office

# NACOLAH.COM

**Reg. No. 4,134,997**

**Registered May 1, 2012**

**Int. Cl.: 36**

**SERVICE MARK**

**PRINCIPAL REGISTER**

NORTH AMERICAN COMPANY FOR LIFE AND HEALTH INSURANCE (IOWA CORPORATION)  
525 W. VAN BUREN  
CHICAGO, IL 60607

FOR: INSURANCE SERVICES, NAMELY, UNDERWRITING, ISSUING AND ADMINISTRATION OF LIFE INSURANCE; UNDERWRITING, ISSUANCE AND ADMINISTRATION OF ANNUITIES, IN CLASS 36 (U.S. CLS. 100, 101 AND 102).

FIRST USE 12-31-1998; IN COMMERCE 12-31-1998.

THE MARK CONSISTS OF STANDARD CHARACTERS WITHOUT CLAIM TO ANY PARTICULAR FONT, STYLE, SIZE, OR COLOR.

OWNER OF U.S. REG. NOS. 779,638, 2,539,804, AND 2,808,138.

SER. NO. 85-409,753, FILED 8-29-2011.

JOHN GARTNER, EXAMINING ATTORNEY



*David J. Kybas*

Director of the United States Patent and Trademark Office

# United States of America

United States Patent and Trademark Office



**Reg. No. 4,134,998**

**Registered May 1, 2012**

**Int. Cl.: 36**

**SERVICE MARK**

**PRINCIPAL REGISTER**

YORK TRADITIONS BANK (PENNSYLVANIA CHARTERED FINANCIAL INSTITUTION)  
235 ST. CHARLES WAY  
YORK, PA 17402

FOR: BANKING SERVICES, IN CLASS 36 (U.S. CLS. 100, 101 AND 102).

FIRST USE 0-0-2002; IN COMMERCE 7-0-2004.

THE MARK CONSISTS OF THREE STYLIZED WHEAT STALKS ANGLING UPWARDLY AND OBLIQUELY TO THE RIGHT, SUPERIMPOSED ON AND EXTENDING BEYOND THE CIRCUMFERENCE OF A SHADED CIRCLE.

SER. NO. 85-409,765, FILED 8-29-2011.

MATTHEW MCDOWELL, EXAMINING ATTORNEY



*David J. Kybas*

Director of the United States Patent and Trademark Office



# United States of America

United States Patent and Trademark Office

***my  
supply  
≡ buy***

**Reg. No. 4,134,999**

**Registered May 1, 2012**

**Int. Cl.: 35**

**SERVICE MARK**

**PRINCIPAL REGISTER**

SOPHIA GLOBAL, LLC (KANSAS LIMITED LIABILITY COMPANY)  
1705 HASKELL AVENUE, SUITE A  
LAWRENCE, KS 66044

FOR: ONLINE RETAIL STORE SERVICES FEATURING PRINTING SUPPLIES, NAMELY FILLED INK AND TONER CARTRIDGES FOR COMPUTER PRINTERS, FAX MACHINES AND PHOTOCOPY MACHINES, IN CLASS 35 (U.S. CLS. 100, 101 AND 102).

FIRST USE 2-28-2011; IN COMMERCE 2-28-2011.

THE MARK CONSISTS OF THE WORDS "MY SUPPLY BUY" IN LOWERCASE LETTERS WITH A THREE-LINE DESIGN BEFORE THE WORD "BUY".

SER. NO. 85-409,770, FILED 8-29-2011.

SHAILA SETTLES, EXAMINING ATTORNEY



*David J. Kyffers*

Director of the United States Patent and Trademark Office

# United States of America

United States Patent and Trademark Office

# ¡Chevere!

**Reg. No. 4,135,000**

**Registered May 1, 2012**

**Int. Cl.: 30**

**TRADEMARK**

**PRINCIPAL REGISTER**

RICELAND FOODS, INC. (ARKANSAS CORPORATION)  
2120 SOUTH PARK AVENUE  
STUTTGART, AR 72160

FOR: RICE, IN CLASS 30 (U.S. CL. 46).

FIRST USE 12-31-1994; IN COMMERCE 12-31-1994.

THE MARK CONSISTS OF STANDARD CHARACTERS WITHOUT CLAIM TO ANY PARTICULAR FONT, STYLE, SIZE, OR COLOR.

SER. NO. 85-409,772, FILED 8-29-2011.

SARA BENJAMIN, EXAMINING ATTORNEY



*David J. Kyffers*

Director of the United States Patent and Trademark Office

# United States of America

United States Patent and Trademark Office

*Eyemusement*

**Reg. No. 4,135,001**

**Registered May 1, 2012**

**Int. Cl.: 9**

**TRADEMARK**

**PRINCIPAL REGISTER**

EYEMUSEMENT, LLC (MINNESOTA LIMITED LIABILITY COMPANY)  
1516 W 25TH ST  
MINNEAPOLIS, MN 55405

FOR: CASES FOR EYEGLASSES AND SUNGLASSES; CHAINS FOR EYEGLASSES; CORRECTIVE GLASSES; EYE GLASS CASES; EYE GLASS CHAINS; EYE GLASS CORDS; EYE GLASSES; EYEGLOSS CASES; EYEGLOSS CHAINS; EYEGLOSS CHAINS AND CORDS; EYEGLOSS CORDS; EYEGLOSS FRAMES; EYEGLOSS RETAINING CORDS; EYEGASSES; EYEWEAR, NAMELY, SUNGLASSES, EYEGASSES AND OPHTHALMIC FRAMES AND CASES THEREFOR; READING EYEGASSES; READING GLASSES, IN CLASS 9 (U.S. CLS. 21, 23, 26, 36 AND 38).

FIRST USE 1-17-2011; IN COMMERCE 1-17-2011.

THE MARK CONSISTS OF A WHIMSICAL CALLIGRAPHIC WORD "EYEMUSEMENT" UNDERSCORED BY STRAIGHT LINE STARTING TO THE RIGHT OF THE "Y" AND ENDING AT THE "T" IN "EYEMUSEMENT". AT THE END, THE LINE CURVES UP AND AROUND TO BECOME THE RIGHT TEMPLE OF A PAIR OF SMALL OLD FASHIONED WIRE RIM GLASSES.

SER. NO. 85-409,794, FILED 8-29-2011.

EMILY CHUO, EXAMINING ATTORNEY



*David J. Kybas*

Director of the United States Patent and Trademark Office

# United States of America

United States Patent and Trademark Office

## SPY-RO MANIA

**Reg. No. 4,135,002**

**Registered May 1, 2012**

**Int. Cl.: 13**

**TRADEMARK**

**PRINCIPAL REGISTER**

B.J. ALAN COMPANY (OHIO CORPORATION)  
555 MARTIN LUTHER KING, JR. BLVD.  
YOUNGSTOWN, OH 445021102

FOR: FIREWORKS, IN CLASS 13 (U.S. CLS. 2 AND 9).

FIRST USE 5-11-2010; IN COMMERCE 5-11-2010.

THE MARK CONSISTS OF STANDARD CHARACTERS WITHOUT CLAIM TO ANY PARTICULAR FONT, STYLE, SIZE, OR COLOR.

SER. NO. 85-409,795, FILED 8-29-2011.

BRENDAN REGAN, EXAMINING ATTORNEY



*David J. Kybas*

Director of the United States Patent and Trademark Office

# United States of America

United States Patent and Trademark Office



**Reg. No. 4,135,003**

**Registered May 1, 2012**

**Int. Cls.: 9 and 16**

**TRADEMARK**

**PRINCIPAL REGISTER**

AMG INTERNATIONAL (NEW JERSEY CORPORATION)  
6815 SHALLOWFORD ROAD  
CHATTANOOGA, TN 37422

FOR: DIGITAL MEDIA, NAMELY, CDS, CASSETTES, CD-ROMS AND DVDS FEATURING AUDIO RECORDINGS OF THE BIBLE IN ENGLISH, THE NEW TESTAMENT IN GREEK, AND OTHER WORKS OF A RELIGIOUS NATURE.; AUDIO DISCS FEATURING THE BIBLE IN ENGLISH, THE NEW TESTAMENT IN GREEK AND OTHER WORKS OF A RELIGIOUS NATURE; ELECTRONIC PUBLICATIONS, NAMELY, BOOKS FEATURING RELIGION RECORDED ON COMPUTER MEDIA; DVDS FEATURING ADVERTISEMENTS AND TRAINING VIDEOS FOR BIBLE STUDY CLASSES AND WORKSHOPS, AND CLASSES AND WORKSHOPS FEATURING OTHER PUBLICATIONS OF A RELIGIOUS NATURE; DIGITAL MEDIA, NAMELY, VIDEO AND AUDIO FILES ON DVD AND DOWNLOADABLE VIDEO AND AUDIO FILES FEATURING ADVERTISEMENTS AND TRAINING FOR BIBLE STUDY CLASSES AND WORKSHOPS, AND CLASSES AND WORKSHOPS FEATURING OTHER PUBLICATIONS OF A RELIGIOUS NATURE; PRERECORDED AUDIO CASSETTES FEATURING THE BIBLE AND STUDY HELPS FOR LEARNING THE KOINE GREEK LANGUAGE, THE LANGUAGE IN WHICH THE NEW TESTAMENT OF THE BIBLE WAS WRITTEN, IN CLASS 9 (U.S. CLS. 21, 23, 26, 36 AND 38).

FIRST USE 4-30-2001; IN COMMERCE 4-30-2001.

FOR: NON-FICTION BOOKS ON A VARIETY OF TOPICS; PUBLICATIONS, NAMELY, BIBLES AND BOOKS IN THE FIELDS OF THEOLOGY, BIBLICAL LANGUAGES, BIBLE COMMENTARIES, CHRISTIAN LIVING, CHURCH HISTORY, BIBLE STUDIES, BIBLE REFERENCE, RELIGIOUS FICTION, AND OTHER BOOKS OF A RELIGIOUS NATURE, IN CLASS 16 (U.S. CLS. 2, 5, 22, 23, 29, 37, 38 AND 50).

FIRST USE 3-11-1997; IN COMMERCE 3-11-1997.

OWNER OF U.S. REG. NO. 1,448,430.

NO CLAIM IS MADE TO THE EXCLUSIVE RIGHT TO USE "PUBLISHERS", APART FROM THE MARK AS SHOWN.

THE MARK CONSISTS OF A SYMBOL COMPRISING A REPRESENTATION OF AN OPEN BOOK SUPERIMPOSED ON A REPRESENTATION OF A GLOBE, WITH THREE STALKS



*David J. Kyffers*

Director of the United States Patent and Trademark Office

**Reg. No. 4,135,003** OF WHEAT EXTENDING UPWARDLY FROM THE CENTER OF THE BOOK LOCATED ABOVE THE TERM "AMG" AND ABOVE THE WORD "PUBLISHERS".

SER. NO. 85-409,804, FILED 8-29-2011.

EMILY CHUO, EXAMINING ATTORNEY

# United States of America

United States Patent and Trademark Office



**Reg. No. 4,135,004**

**Registered May 1, 2012**

**Int. Cls.: 9 and 16**

**TRADEMARK**

**PRINCIPAL REGISTER**

AMG INTERNATIONAL (NEW JERSEY CORPORATION)  
6815 SHALLOWFORD ROAD  
CHATTANOOGA, TN 37422

FOR: DIGITAL MEDIA, NAMELY, CDS, CASSETTES, CD-ROMS AND DVDS FEATURING AUDIO RECORDINGS OF THE BIBLE IN ENGLISH, THE NEW TESTAMENT IN GREEK, AND OTHER WORKS OF A RELIGIOUS NATURE. ELECTRONIC PUBLICATIONS, NAMELY, BOOKS FEATURING RELIGION RECORDED ON COMPUTER MEDIA; DIGITAL MEDIA, NAMELY, VIDEO AND AUDIO FILES ON DVD AND DOWNLOADABLE VIDEO AND AUDIO FILES FEATURING ADVERTISEMENTS AND TRAINING FOR BIBLE STUDY CLASSES AND WORKSHOPS, AND CLASSES AND WORKSHOPS FEATURING OTHER PUBLICATIONS OF A RELIGIOUS NATURE; PRERECORDED AUDIO CASSETTES FEATURING THE BIBLE AND STUDY HELPS FOR LEARNING THE KOINE GREEK LANGUAGE, THE LANGUAGE IN WHICH THE NEW TESTAMENT OF THE BIBLE WAS WRITTEN; DOWNLOADABLE ELECTRONIC PUBLICATIONS IN THE NATURE OF BOOKS IN THE FIELD OF RELIGION, IN CLASS 9 (U.S. CLS. 21, 23, 26, 36 AND 38).

FIRST USE 4-30-2001; IN COMMERCE 4-30-2001.

FOR: NON-FICTION BOOKS ON A VARIETY OF TOPICS; PUBLICATIONS, NAMELY, BIBLES AND BOOKS IN THE FIELDS OF THEOLOGY, BIBLICAL LANGUAGES, BIBLE COMMENTARIES, CHRISTIAN LIVING, CHURCH HISTORY, BIBLE STUDIES, BIBLE REFERENCE; RELIGIOUS FICTION, AND OTHER BOOKS OF A RELIGIOUS NATURE, IN CLASS 16 (U.S. CLS. 2, 5, 22, 23, 29, 37, 38 AND 50).

FIRST USE 6-10-1999; IN COMMERCE 6-10-1999.

OWNER OF U.S. REG. NO. 1,448,430.

NO CLAIM IS MADE TO THE EXCLUSIVE RIGHT TO USE "PUBLISHERS", APART FROM THE MARK AS SHOWN.

THE MARK CONSISTS OF A SYMBOL COMPRISING A REPRESENTATION OF AN OPEN BOOK SUPERIMPOSED ON A REPRESENTATION OF A GLOBE, WITH THREE STALKS OF WHEAT EXTENDING UPWARDLY FROM THE CENTER OF THE BOOK LOCATED TO THE LEFT OF THE PHRASE "AMG PUBLISHERS".



*David J. Kybas*

Director of the United States Patent and Trademark Office

**Reg. No. 4,135,004** SER. NO. 85-409,808, FILED 8-29-2011.

EMILY CHUO, EXAMINING ATTORNEY



# United States of America

United States Patent and Trademark Office

## PIRATES VOYAGE

**Reg. No. 4,135,005**

WORLD CHOICE INVESTMENTS, LLC (TENNESSEE LIMITED LIABILITY COMPANY)  
P.O. BOX 58  
PIGEON FORGE, TN 378680058

**Registered May 1, 2012**

**Int. Cl.: 30**

FOR: FRUIT FLAVORED POWDER PACKAGED IN A TUBULAR CONTAINER TO BE EATEN AS A CONFECTIONERY, IN CLASS 30 (U.S. CL. 46).

**TRADEMARK**

FIRST USE 6-1-2011; IN COMMERCE 6-1-2011.

**PRINCIPAL REGISTER**

THE MARK CONSISTS OF STANDARD CHARACTERS WITHOUT CLAIM TO ANY PARTICULAR FONT, STYLE, SIZE, OR COLOR.

SER. NO. 85-409,812, FILED 8-29-2011.

HEATHER THOMPSON, EXAMINING ATTORNEY



*David J. Kybas*

Director of the United States Patent and Trademark Office

# United States of America

United States Patent and Trademark Office

# DRIVEWARE

**Reg. No. 4,135,006**

**Registered May 1, 2012**

**Int. Cl.: 9**

**TRADEMARK**

**PRINCIPAL REGISTER**

BARTA-SCHOENEWALD, INC. (CALIFORNIA CORPORATION), DBA ADVANCED MOTION CONTROLS  
3805 CALLE TECATE  
CAMARILLO, CA 93012

FOR: COMPUTER SOFTWARE FOR CONFIGURATION, SETUP, DIAGNOSTICS AND TROUBLESHOOTING OF SERVO DRIVES THAT MAY BE DOWNLOADED FROM A GLOBAL COMPUTER NETWORK, IN CLASS 9 (U.S. CLS. 21, 23, 26, 36 AND 38).

FIRST USE 9-3-1999; IN COMMERCE 9-3-1999.

THE MARK CONSISTS OF STANDARD CHARACTERS WITHOUT CLAIM TO ANY PARTICULAR FONT, STYLE, SIZE, OR COLOR.

SER. NO. 85-409,814, FILED 8-29-2011.

MEGHAN REINHART, EXAMINING ATTORNEY



*David J. Kybas*

Director of the United States Patent and Trademark Office

# United States of America

United States Patent and Trademark Office

# Joan Pillow

**Reg. No. 4,135,007**

**Registered May 1, 2012**

**Int. Cl.: 35**

**SERVICE MARK**

**PRINCIPAL REGISTER**

PILLOW, JOAN (UNITED STATES INDIVIDUAL)  
99 WEST PACES FERRY NW  
ATLANTA, GA 30305

FOR: RETAIL STORE SERVICES FEATURING BRIDAL GOWNS, EVENING GOWNS, BRIDESMAIDS DRESSES, VEILS AND BRIDAL ACCESSORIES, IN CLASS 35 (U.S. CLS. 100, 101 AND 102).

FIRST USE 4-1-1989; IN COMMERCE 4-1-1989.

THE MARK CONSISTS OF STANDARD CHARACTERS WITHOUT CLAIM TO ANY PARTICULAR FONT, STYLE, SIZE, OR COLOR.

THE NAME SHOWN IN THE MARK IDENTIFIES A LIVING INDIVIDUAL WHOSE CONSENT IS OF RECORD.

SER. NO. 85-409,825, FILED 8-29-2011.

MARY ROSSMAN, EXAMINING ATTORNEY



*David J. Kyros*

Director of the United States Patent and Trademark Office

# United States of America

United States Patent and Trademark Office

## CLOSER STILL

**Reg. No. 4,135,008**

BROWN, CHRISTY (UNITED STATES INDIVIDUAL)  
9050 CAROTHERS PARKWAY, STE. 11  
FRANKLIN, TN 370676301

**Registered May 1, 2012**

**Int. Cl.: 41**

FOR: LIVE PERFORMANCES BY A MUSICAL GROUP, IN CLASS 41 (U.S. CLS. 100, 101 AND 107).

**SERVICE MARK**

FIRST USE 7-26-2000; IN COMMERCE 12-21-2002.

**PRINCIPAL REGISTER**

THE MARK CONSISTS OF STANDARD CHARACTERS WITHOUT CLAIM TO ANY PARTICULAR FONT, STYLE, SIZE, OR COLOR.

SER. NO. 85-409,832, FILED 8-29-2011.

MARY ROSSMAN, EXAMINING ATTORNEY



*David J. Kybas*

Director of the United States Patent and Trademark Office

# United States of America

United States Patent and Trademark Office

# OCEAN PALS

**Reg. No. 4,135,009**

**Registered May 1, 2012**

**Int. Cl.: 21**

**TRADEMARK**

**PRINCIPAL REGISTER**

YOUNG PS ACQUISITIONS, LLC (DELAWARE LIMITED LIABILITY COMPANY)  
744 TRADEMARK CIRCLE  
CORONA, CA 92879

FOR: DENTAL FLOSS AND TOOTHBRUSHES, IN CLASS 21 (U.S. CLS. 2, 13, 23, 29, 30, 33, 40 AND 50).

FIRST USE 7-0-2011; IN COMMERCE 7-0-2011.

THE MARK CONSISTS OF STANDARD CHARACTERS WITHOUT CLAIM TO ANY PARTICULAR FONT, STYLE, SIZE, OR COLOR.

SER. NO. 85-409,842, FILED 8-29-2011.

ANTHONY RINKER, EXAMINING ATTORNEY



*David J. Kyffers*

Director of the United States Patent and Trademark Office

# United States of America

United States Patent and Trademark Office

## PIRATES VOYAGE

**Reg. No. 4,135,010**

**Registered May 1, 2012**

**Int. Cl.: 29**

**TRADEMARK**

**PRINCIPAL REGISTER**

WORLD CHOICE INVESTMENTS, LLC (TENNESSEE LIMITED LIABILITY COMPANY)  
P.O. BOX 58  
PIGEON FORGE, TN 378680058

FOR: MIXES FOR MAKING SOUP, IN CLASS 29 (U.S. CL. 46).

FIRST USE 6-1-2011; IN COMMERCE 6-1-2011.

THE MARK CONSISTS OF STANDARD CHARACTERS WITHOUT CLAIM TO ANY PARTICULAR FONT, STYLE, SIZE, OR COLOR.

SER. NO. 85-409,859, FILED 8-29-2011.

HEATHER THOMPSON, EXAMINING ATTORNEY



*David J. Kybas*

Director of the United States Patent and Trademark Office

# United States of America

United States Patent and Trademark Office

## PIRATES VOYAGE

**Reg. No. 4,135,011**

**Registered May 1, 2012**

**Int. Cl.: 9**

**TRADEMARK**

**PRINCIPAL REGISTER**

WORLD CHOICE INVESTMENTS, LLC (TENNESSEE LIMITED LIABILITY COMPANY)  
P.O. BOX 58  
PIGEON FORGE, TN 378680058

FOR: DECORATIVE MAGNETS, IN CLASS 9 (U.S. CLS. 21, 23, 26, 36 AND 38).

FIRST USE 6-1-2011; IN COMMERCE 6-1-2011.

THE MARK CONSISTS OF STANDARD CHARACTERS WITHOUT CLAIM TO ANY PARTICULAR FONT, STYLE, SIZE, OR COLOR.

SER. NO. 85-409,893, FILED 8-29-2011.

HEATHER THOMPSON, EXAMINING ATTORNEY



*David J. Kyffers*

Director of the United States Patent and Trademark Office

# United States of America

United States Patent and Trademark Office

## SEAL TIGHT

**Reg. No. 4,135,012**

**Registered May 1, 2012**

**Int. Cl.: 10**

**TRADEMARK**

**PRINCIPAL REGISTER**

BROWN MEDICAL INDUSTRIES (IOWA CORPORATION)  
1300 LUNDBERG DRIVE WEST  
SPIRIT LAKE, IA 513607246

FOR: COVER DEVICE FOR THE PROTECTION OF ORTHOPEDIC CASTS FROM WATER DAMAGE IN A SHOWER OR THE LIKE, IN CLASS 10 (U.S. CLS. 26, 39 AND 44).

FIRST USE 3-15-1989; IN COMMERCE 3-15-1989.

THE MARK CONSISTS OF STANDARD CHARACTERS WITHOUT CLAIM TO ANY PARTICULAR FONT, STYLE, SIZE, OR COLOR.

OWNER OF U.S. REG. NO. 1,676,669.

SER. NO. 85-409,898, FILED 8-29-2011.

YAT SYE, LEE, EXAMINING ATTORNEY



*David J. Kybas*

Director of the United States Patent and Trademark Office



# United States of America

United States Patent and Trademark Office

# MTAPI

**Reg. No. 4,135,013**

**Registered May 1, 2012**

**Int. Cl.: 42**

**SERVICE MARK**

**PRINCIPAL REGISTER**

MULTICORE ASSOCIATION (CALIFORNIA NON-PROFIT CORPORATION)  
4354 TOWN CENTER BLVD., #114-200  
EL DORADO HILLS, CA 95762

FOR: PROVIDING INFORMATION IN THE FIELDS OF TECHNOLOGY AND SOFTWARE  
DEVELOPMENT VIA AN ON-LINE WEBSITE, IN CLASS 42 (U.S. CLS. 100 AND 101).

FIRST USE 12-5-2007; IN COMMERCE 12-5-2007.

THE MARK CONSISTS OF STANDARD CHARACTERS WITHOUT CLAIM TO ANY PAR-  
TICULAR FONT, STYLE, SIZE, OR COLOR.

SER. NO. 85-409,910, FILED 8-29-2011.

JILL PRATER, EXAMINING ATTORNEY



*David J. Kyffers*

Director of the United States Patent and Trademark Office

# United States of America

United States Patent and Trademark Office

# MRAPI

**Reg. No. 4,135,014**

**Registered May 1, 2012**

**Int. Cl.: 42**

**SERVICE MARK**

**PRINCIPAL REGISTER**

MULTICORE ASSOCIATION (CALIFORNIA NON-PROFIT CORPORATION)  
4354 TOWN CENTER BLVD., #114-200  
EL DORADO HILLS, CA 95762

FOR: PROVIDING INFORMATION IN THE FIELDS OF TECHNOLOGY AND SOFTWARE DEVELOPMENT VIA AN ON-LINE WEBSITE, IN CLASS 42 (U.S. CLS. 100 AND 101).

FIRST USE 10-23-2007; IN COMMERCE 7-15-2008.

THE MARK CONSISTS OF STANDARD CHARACTERS WITHOUT CLAIM TO ANY PARTICULAR FONT, STYLE, SIZE, OR COLOR.

SER. NO. 85-409,915, FILED 8-29-2011.

JILL PRATER, EXAMINING ATTORNEY



*David J. Kyffers*

Director of the United States Patent and Trademark Office

# United States of America

United States Patent and Trademark Office

# MCAPI

**Reg. No. 4,135,015**

**Registered May 1, 2012**

**Int. Cl.: 42**

**SERVICE MARK**

**PRINCIPAL REGISTER**

MULTICORE ASSOCIATION (CALIFORNIA NON-PROFIT CORPORATION)  
4354 TOWN CENTER BLVD., #114-200  
EL DORADO HILLS, CA 95762

FOR: PROVIDING INFORMATION IN THE FIELDS OF TECHNOLOGY AND SOFTWARE DEVELOPMENT VIA AN ON-LINE WEBSITE, IN CLASS 42 (U.S. CLS. 100 AND 101).

FIRST USE 6-29-2006; IN COMMERCE 4-1-2008.

THE MARK CONSISTS OF STANDARD CHARACTERS WITHOUT CLAIM TO ANY PARTICULAR FONT, STYLE, SIZE, OR COLOR.

SER. NO. 85-409,918, FILED 8-29-2011.

JILL PRATER, EXAMINING ATTORNEY



*David J. Kyffers*

Director of the United States Patent and Trademark Office

# United States of America

United States Patent and Trademark Office

## CCI Building Restoration & Waterproofing

**Reg. No. 4,135,016**

**Registered May 1, 2012**

**Int. Cl.: 37**

**SERVICE MARK**

**PRINCIPAL REGISTER**

CCI CONSTRUCTION, INC. (NEW HAMPSHIRE CORPORATION)  
14 LAFAYETTE ROAD, PO BOX 695  
NORTH HAMPTON, NH 03862

FOR: BASEMENT WATERPROOFING; BUILDING RESTORATION, IN CLASS 37 (U.S. CLS. 100, 103 AND 106).

FIRST USE 12-31-2004; IN COMMERCE 12-31-2004.

THE MARK CONSISTS OF STANDARD CHARACTERS WITHOUT CLAIM TO ANY PARTICULAR FONT, STYLE, SIZE, OR COLOR.

NO CLAIM IS MADE TO THE EXCLUSIVE RIGHT TO USE "BUILDING RESTORATION & WATERPROOFING", APART FROM THE MARK AS SHOWN.

SER. NO. 85-409,952, FILED 8-29-2011.

ANGELA DUONG, EXAMINING ATTORNEY



*David J. Kyffers*

Director of the United States Patent and Trademark Office

# United States of America

United States Patent and Trademark Office

## MELT MASTER

**Reg. No. 4,135,017**

MAINE SALT COMPANY (MAINE CORPORATION)  
677 COLBROOK ROAD  
HERMON, ME 04401

**Registered May 1, 2012**

**Int. Cl.: 1**

FOR: CHEMICAL PREPARATIONS FOR MELTING SNOW AND ICE, IN CLASS 1 (U.S. CLS. 1, 5, 6, 10, 26 AND 46).

**TRADEMARK**

FIRST USE 9-15-2009; IN COMMERCE 9-15-2009.

**PRINCIPAL REGISTER**

THE MARK CONSISTS OF STANDARD CHARACTERS WITHOUT CLAIM TO ANY PARTICULAR FONT, STYLE, SIZE, OR COLOR.

NO CLAIM IS MADE TO THE EXCLUSIVE RIGHT TO USE "MELT", APART FROM THE MARK AS SHOWN.

SER. NO. 85-409,973, FILED 8-29-2011.

CARYN GLASSER, EXAMINING ATTORNEY



*David J. Kybas*

Director of the United States Patent and Trademark Office

# United States of America

United States Patent and Trademark Office

# chimpsy<sup>®</sup>

**Reg. No. 4,135,018**

**Registered May 1, 2012**

**Int. Cl.: 41**

**SERVICE MARK**

**PRINCIPAL REGISTER**

CHIMPSY, LLC (COLORADO LIMITED LIABILITY COMPANY)  
1E  
1620 MARKET STREET  
DENVER, CO 80202

FOR: EDUCATIONAL SERVICES, NAMELY, PROVIDING ONLINE PHOTOGRAPHY INSTRUCTION, IN CLASS 41 (U.S. CLS. 100, 101 AND 107).

FIRST USE 11-1-2010; IN COMMERCE 11-1-2010.

THE MARK CONSISTS OF THE STYLIZED TEXT "CHIMPSY" WITH A PLAY BUTTON AT THE END OF THE TEXT.

SER. NO. 85-409,985, FILED 8-29-2011.

TRACY CROSS, EXAMINING ATTORNEY



*David J. Kyros*

Director of the United States Patent and Trademark Office

# United States of America

United States Patent and Trademark Office

*Sweet Bohemian Life*

**Reg. No. 4,135,019**

**Registered May 1, 2012**

**Int. Cl.: 25**

**TRADEMARK**

**PRINCIPAL REGISTER**

GREENWALD, KATHRYN (UNITED STATES INDIVIDUAL)  
5721 ANCHOR BAY WAY  
ELK GROVE, CA 95758

FOR: SHIRTS; T-SHIRTS, IN CLASS 25 (U.S. CLS. 22 AND 39).

FIRST USE 8-9-2010; IN COMMERCE 8-9-2010.

THE MARK CONSISTS OF THE STYLIZED TEXT "SWEET BOHEMIAN LIFE" WITH A SUN OVER THE STYLIZED TEXT.

SER. NO. 85-409,989, FILED 8-29-2011.

TRACY CROSS, EXAMINING ATTORNEY



*David J. Kyffers*

Director of the United States Patent and Trademark Office

# United States of America

United States Patent and Trademark Office



**Reg. No. 4,135,020**

**Registered May 1, 2012**

**Int. Cl.: 44**

**SERVICE MARK**

**PRINCIPAL REGISTER**

CIAO BELLA MEDICAL SPA & VEIN CLINIC, P.L.C. (ARIZONA LIMITED LIABILITY COMPANY), DBA CIAO BELLA MEDICAL SPA & VEIN CLINIC  
2310 WEST RAY ROAD  
CHANDLER, AZ 85224

FOR: COSMETIC AND PLASTIC SURGERY; COSMETIC AND PLASTIC SURGERY, NAMELY, A MINIMALLY INVASIVE FACE/NECK LIFT DONE UNDER LOCAL ANESTHESIA; COSMETIC FACE CARE SERVICES; COSMETIC SERVICES, NAMELY, NON-PERMANENT HAIR REMOVAL; COSMETIC SKIN CARE SERVICES; FACIAL TREATMENT SERVICES, NAMELY, COSMETIC PEELS; NON-INVASIVE COSMETIC MEDICAL PROCEDURES, IN CLASS 44 (U.S. CLS. 100 AND 101).

FIRST USE 1-1-2008; IN COMMERCE 1-1-2008.

NO CLAIM IS MADE TO THE EXCLUSIVE RIGHT TO USE "MEDICAL SPA & VEIN CLINIC", APART FROM THE MARK AS SHOWN.

THE MARK CONSISTS OF THE WORDS "CIAO BELLA" ITALICIZED, LARGE PRINT AND IN LOWER CASE; IN BETWEEN THE WORDS "CIAO" AND "BELLA" IS THE OUTLINE OF A WOMAN WITH HER RIGHT ARM EXTENDED STRAIGHT OVER HER HEAD AND HER LEFT ARM EXTENDED AT A DOWNWARD ANGLE; BENEATH THE OUTLINE OF THE WOMAN ARE WHAT APPEAR TO BE TWO CONCENTRIC CIRCLES WHERE THE BOTTOM TWO-THIRDS OF THE SMALLER CIRCLE IS VISIBLE AND THE RIGHT HALF OF THE LARGER CIRCLE IS VISIBLE; THE WORDS "MEDICAL SPA & VEIN CLINIC" APPEAR BENEATH THE WORD "BELLA" AND ARE IN LOWER CASE AND SMALLER PRINT THAN THAT USED FOR "CIAO BELLA".

THE ENGLISH TRANSLATION OF CIAO BELLA IN THE MARK IS HELLO BEAUTIFUL.

SER. NO. 85-410,001, FILED 8-29-2011.

NORA BUCHANAN WILL, EXAMINING ATTORNEY



*David J. Kyros*

Director of the United States Patent and Trademark Office



**United States of America**  
United States Patent and Trademark Office

# SKYLOFTS

**Reg. No. 4,135,021**

**Registered May 1, 2012**

**Int. Cl.: 44**

**SERVICE MARK**

**PRINCIPAL REGISTER**

MGM RESORTS INTERNATIONAL (DELAWARE CORPORATION)  
3600 LAS VEGAS BOULEVARD SOUTH  
LAS VEGAS, NV 89109

FOR: HEALTH SPA SERVICES FOR HEALTH AND WELLNESS OF THE BODY AND SPIRIT, NAMELY, PROVIDING MASSAGE, FACIAL AND BODY TREATMENT SERVICES, COSMETIC BODY CARE SERVICES, IN CLASS 44 (U.S. CLS. 100 AND 101).

FIRST USE 11-8-2004; IN COMMERCE 11-8-2004.

THE MARK CONSISTS OF STANDARD CHARACTERS WITHOUT CLAIM TO ANY PARTICULAR FONT, STYLE, SIZE, OR COLOR.

OWNER OF U.S. REG. NOS. 3,669,355, 3,822,759 AND OTHERS.

SER. NO. 85-410,022, FILED 8-29-2011.

JULIE GUTTADAURO, EXAMINING ATTORNEY



*David J. Kyffers*

Director of the United States Patent and Trademark Office

# United States of America

United States Patent and Trademark Office

# MINUTE@MAN

**Reg. No. 4,135,022**

**Registered May 1, 2012**

**Int. Cl.: 9**

**TRADEMARK**

**PRINCIPAL REGISTER**

PARA SYSTEMS, INC. (TEXAS CORPORATION)  
1455 LEMAY DRIVE  
CARROLLTON, TX 75007

FOR: ELECTRICAL POWER SUPPLIES, IN CLASS 9 (U.S. CLS. 21, 23, 26, 36 AND 38).

FIRST USE 5-1-1989; IN COMMERCE 5-1-1989.

OWNER OF U.S. REG. NO. 1,713,342.

THE MARK CONSISTS OF THE WORDING "MINUTEMAN" AND A STYLIZED ELECTRICAL SOCKET BETWEEN THE WORDS "MINUTE" AND "MAN".

SER. NO. 85-410,028, FILED 8-29-2011.

CARYN GLASSER, EXAMINING ATTORNEY



*David J. Kyffers*

Director of the United States Patent and Trademark Office

# United States of America

United States Patent and Trademark Office

## W.O.S.-RESISTANCE

**Reg. No. 4,135,023**

**Registered May 1, 2012**

**Int. Cls.: 18 and 25**

**TRADEMARK**

**PRINCIPAL REGISTER**

COLOMER INVESTMENT LIMITED (HONG KONG CORPORATION)  
UNIT #1707,17/F, W TOWER SHUN TAK CENTER  
#168-200CONNAUGHT RD., HONG KONG

FOR: TANNED LEATHER, HANDBAGS, LUGGAGE, PURSES, WALLETS, LEATHER FOR FURNITURE, LEATHER STRAPS, LEATHER BAGS AND WALLETS, ANIMAL SKINS AND HIDES, FUR PELTS, HARNESS FOR HORSE, IN CLASS 18 (U.S. CLS. 1, 2, 3, 22 AND 41).

FIRST USE 2-1-2011; IN COMMERCE 2-1-2011.

FOR: FOOTWEAR, SHOES, BOOTS, BELTS FOR CLOTHING, INFANT SLEEPERS, GLOVES AS CLOTHING, HATS, SCARVES, SOCKS, WEDDING DRESSES, WEDDING GOWNS AND VEILS, IN CLASS 25 (U.S. CLS. 22 AND 39).

FIRST USE 2-1-2011; IN COMMERCE 2-1-2011.

THE MARK CONSISTS OF STANDARD CHARACTERS WITHOUT CLAIM TO ANY PARTICULAR FONT, STYLE, SIZE, OR COLOR.

SER. NO. 85-410,040, FILED 8-29-2011.

JULIE GUTTADAURO, EXAMINING ATTORNEY



*David J. Kyros*

Director of the United States Patent and Trademark Office

# United States of America

United States Patent and Trademark Office



SKYLOFTS

**Reg. No. 4,135,024**

**Registered May 1, 2012**

**Int. Cl.: 44**

**SERVICE MARK**

**PRINCIPAL REGISTER**

MGM RESORTS INTERNATIONAL (DELAWARE CORPORATION)  
3600 LAS VEGAS BOULEVARD SOUTH  
LAS VEGAS, NV 89109

FOR: HEALTH SPA SERVICES FOR HEALTH AND WELLNESS OF THE BODY AND SPIRIT, NAMELY, PROVIDING MASSAGE, FACIAL AND BODY TREATMENT SERVICES, COSMETIC BODY CARE SERVICES, IN CLASS 44 (U.S. CLS. 100 AND 101).

FIRST USE 11-8-2004; IN COMMERCE 11-8-2004.

OWNER OF U.S. REG. NOS. 3,669,355, 3,822,759 AND OTHERS.

THE MARK CONSISTS OF A VERTICAL RECTANGLE WITH TWO VERTICAL AND TWO HORIZONTAL LINES THAT MEET INSIDE THE RECTANGLE FORMING TWO 90 DEGREE ANGLES AND THE WORD "SKYLOFTS" BELOW THE RECTANGLE.

SER. NO. 85-410,042, FILED 8-29-2011.

JULIE GUTTADAURO, EXAMINING ATTORNEY



*David J. Kyffers*

Director of the United States Patent and Trademark Office

# United States of America

United States Patent and Trademark Office

## PUSH, POSE, PRINT

**Reg. No. 4,135,025**

**Registered May 1, 2012**

**Int. Cl.: 9**

**TRADEMARK**

**PRINCIPAL REGISTER**

MOJO ENTERTAINMENT, LLC (ILLINOIS LIMITED LIABILITY COMPANY)  
650 W GRAND AVE - SUITE 312  
ELMHURST, IL 60126

FOR: VIDEO AND PHOTOGRAPHIC EQUIPMENT AND SERVICES, NAMELY, CUSTOMIZABLE PORTABLE VIDEO AND/OR PHOTO BOOTHS AND INTERACTIVE PHOTO KIOSKS FOR CAPTURING, PRINTING AND UPLOADING DIGITAL IMAGES FOR FUTURE USE, IN CLASS 9 (U.S. CLS. 21, 23, 26, 36 AND 38).

FIRST USE 1-3-2011; IN COMMERCE 1-3-2011.

THE MARK CONSISTS OF STANDARD CHARACTERS WITHOUT CLAIM TO ANY PARTICULAR FONT, STYLE, SIZE, OR COLOR.

SER. NO. 85-410,061, FILED 8-29-2011.

NAPOLEON SHARMA, EXAMINING ATTORNEY



*David J. Kyffers*

Director of the United States Patent and Trademark Office

# United States of America

United States Patent and Trademark Office

## SMART DESIGN: THE ART OF SPLINTING

**Reg. No. 4,135,026**

**Registered May 1, 2012**

**Int. Cl.: 41**

**SERVICE MARK**

**PRINCIPAL REGISTER**

HOSPITAL FOR SPECIAL SURGERY (NEW YORK NON-PROFIT CORPORATION)  
535 EAST 70TH STREET  
NEW YORK, NY 10021

FOR: EDUCATIONAL SERVICES, NAMELY, CONDUCTING WORKSHOPS IN THE FIELD OF TREATMENT OF BONES AND JOINTS AND DISTRIBUTION OF TRAINING MATERIALS IN CONNECTION THEREWITH, IN CLASS 41 (U.S. CLS. 100, 101 AND 107).

FIRST USE 9-0-2009; IN COMMERCE 9-0-2009.

THE MARK CONSISTS OF STANDARD CHARACTERS WITHOUT CLAIM TO ANY PARTICULAR FONT, STYLE, SIZE, OR COLOR.

NO CLAIM IS MADE TO THE EXCLUSIVE RIGHT TO USE "SPLINTING", APART FROM THE MARK AS SHOWN.

SER. NO. 85-410,063, FILED 8-29-2011.

JAMES LOVELACE, EXAMINING ATTORNEY



*David J. Kyffers*

Director of the United States Patent and Trademark Office

# United States of America

United States Patent and Trademark Office

# Slim FX

**Reg. No. 4,135,027**

**Registered May 1, 2012**

**Int. Cl.: 5**

**TRADEMARK**

**PRINCIPAL REGISTER**

RESEARCH ENERGY SUPPLEMENTS, LLC (ARIZONA LIMITED LIABILITY COMPANY)  
2245 W. UNIVERSITY DR., SUITE 5  
TEMPE, AZ 85281

FOR: DIETARY AND NUTRITIONAL SUPPLEMENTS USED FOR WEIGHT LOSS, IN CLASS  
5 (U.S. CLS. 6, 18, 44, 46, 51 AND 52).

FIRST USE 8-22-2011; IN COMMERCE 8-22-2011.

THE MARK CONSISTS OF STANDARD CHARACTERS WITHOUT CLAIM TO ANY PAR-  
TICULAR FONT, STYLE, SIZE, OR COLOR.

SER. NO. 85-410,066, FILED 8-29-2011.

NORA BUCHANAN WILL, EXAMINING ATTORNEY



*David J. Kybas*

Director of the United States Patent and Trademark Office

# United States of America

United States Patent and Trademark Office

## SAFE SHEATH ULTRA

**Reg. No. 4,135,028**

**Registered May 1, 2012**

**Int. Cl.: 10**

**TRADEMARK**

**PRINCIPAL REGISTER**

PRESSURE PRODUCTS MEDICAL SUPPLIES INC. (WYOMING CORPORATION)  
49 VIA ALICIA  
SANTA BARBARA, CA 93108

FOR: MEDICAL INTRODUCERS, IN CLASS 10 (U.S. CLS. 26, 39 AND 44).

FIRST USE 2-15-2008; IN COMMERCE 2-15-2008.

THE MARK CONSISTS OF STANDARD CHARACTERS WITHOUT CLAIM TO ANY PARTICULAR FONT, STYLE, SIZE, OR COLOR.

OWNER OF U.S. REG. NOS. 1,932,263, 2,644,239, AND 3,133,575.

NO CLAIM IS MADE TO THE EXCLUSIVE RIGHT TO USE "SHEATH", APART FROM THE MARK AS SHOWN.

SER. NO. 85-410,073, FILED 8-29-2011.

JEFFERY COWARD, EXAMINING ATTORNEY



*David J. Kyros*

Director of the United States Patent and Trademark Office



# United States of America

United States Patent and Trademark Office

## SAFE SHEATH ULTRA LITE

**Reg. No. 4,135,029**

**Registered May 1, 2012**

**Int. Cl.: 10**

**TRADEMARK**

**PRINCIPAL REGISTER**

PRESSURE PRODUCTS MEDICAL SUPPLIES INC. (WYOMING CORPORATION)  
49 VIA ALICIA  
SANTA BARBARA, CA 93108

FOR: MEDICAL INTRODUCERS, IN CLASS 10 (U.S. CLS. 26, 39 AND 44).

FIRST USE 11-9-2009; IN COMMERCE 11-9-2009.

THE MARK CONSISTS OF STANDARD CHARACTERS WITHOUT CLAIM TO ANY PARTICULAR FONT, STYLE, SIZE, OR COLOR.

OWNER OF U.S. REG. NOS. 1,932,263, 2,644,239, AND 3,133,575.

NO CLAIM IS MADE TO THE EXCLUSIVE RIGHT TO USE "SHEATH" OR "LITE", APART FROM THE MARK AS SHOWN.

SER. NO. 85-410,075, FILED 8-29-2011.

JEFFERY COWARD, EXAMINING ATTORNEY



*David J. Kyros*

Director of the United States Patent and Trademark Office

# United States of America

United States Patent and Trademark Office

# Win-Skin

**Reg. No. 4,135,030**

**Registered May 1, 2012**

**Int. Cl.: 9**

**TRADEMARK**

**PRINCIPAL REGISTER**

WTL (USA) FUND, INC. (CALIFORNIA CORPORATION)  
20265 VALLEY BLVD. SUITE R  
WALNUT, CA 91789

FOR: CASES FOR MOBILE PHONES; CELL PHONE CASES; CELL PHONE COVERS; FITTED PLASTIC FILMS KNOWN AS SKINS FOR COVERING AND PROTECTING ELECTRONIC APPARATUS, NAMELY, CELLULAR PHONES; PROTECTIVE COVERS AND CASES FOR CELL PHONES, LAPTOPS AND PORTABLE MEDIA PLAYERS, IN CLASS 9 (U.S. CLS. 21, 23, 26, 36 AND 38).

FIRST USE 8-16-2011; IN COMMERCE 8-16-2011.

THE MARK CONSISTS OF STANDARD CHARACTERS WITHOUT CLAIM TO ANY PARTICULAR FONT, STYLE, SIZE, OR COLOR.

SER. NO. 85-410,081, FILED 8-29-2011.

SCOTT BIBB, EXAMINING ATTORNEY



*David J. Kyffers*

Director of the United States Patent and Trademark Office

# United States of America

United States Patent and Trademark Office

## CELLADVANTAGE

**Reg. No. 4,135,031**

**Registered May 1, 2012**

**Int. Cl.: 10**

**TRADEMARK**

**PRINCIPAL REGISTER**

CBR SYSTEMS, INC. (CALIFORNIA CORPORATION)  
1200 BAYHILL DRIVE, SUITE 301  
SAN BRUNO, CA 94066

FOR: UMBILICAL CORD BLOOD AND CORD TISSUE COLLECTION KITS COMPRISED OF STERILE COLLECTION BAGS, TRANSFER TUBING, BLOOD DRAW NEEDLES, NEEDLE SAFETY GUARDS, BLOOD COLLECTION VIALS, TISSUE COLLECTION CONTAINERS, RETURN PACKAGING AND SHIPPING SUPPLIES, AND PRINTED PATIENT AND HEALTHCARE PROVIDER INSTRUCTIONS, IN CLASS 10 (U.S. CLS. 26, 39 AND 44).

FIRST USE 3-1-2010; IN COMMERCE 3-1-2010.

THE MARK CONSISTS OF STANDARD CHARACTERS WITHOUT CLAIM TO ANY PARTICULAR FONT, STYLE, SIZE, OR COLOR.

OWNER OF U.S. REG. NO. 3,323,230.

SER. NO. 85-410,084, FILED 8-29-2011.

DOMINIC FATHY, EXAMINING ATTORNEY



*David J. Kyffers*

Director of the United States Patent and Trademark Office

# United States of America

United States Patent and Trademark Office



**Reg. No. 4,135,032**

**Registered May 1, 2012**

**Int. Cl.: 35**

**SERVICE MARK**

**PRINCIPAL REGISTER**

HIRE PRIME INC. (ILLINOIS CORPORATION)  
6154 NORTH MAPLEWOOD AVENUE  
CHICAGO, IL 60659

FOR: PROFESSIONAL STAFFING AND RECRUITING SERVICES, IN CLASS 35 (U.S. CLS. 100, 101 AND 102).

FIRST USE 7-1-2011; IN COMMERCE 7-1-2011.

THE MARK CONSISTS OF THE LITERAL ELEMENT "HIRE PRIME" ALIGNED VERTICALLY WITH THE "I" IN "HIRE" AND "PRIME" REPRESENTED BY A SINGLE HUMAN FIGURE.

SER. NO. 85-410,093, FILED 8-29-2011.

JEFFERY COWARD, EXAMINING ATTORNEY



*David J. Kybas*

Director of the United States Patent and Trademark Office

# United States of America

United States Patent and Trademark Office

# torrentprivacy

**Reg. No. 4,135,033**

**Registered May 1, 2012**

**Int. Cls.: 9 and 42**

**TRADEMARK**

**SERVICE MARK**

**PRINCIPAL REGISTER**

DARTON SOFTWARE (SEYCHELLES CORPORATION)  
103 SHAM PENG TONG PLAZA, VICTORIA  
MAHE, SEYCHELLES

FOR: DOWNLOADABLE COMPUTER SOFTWARE FOR DATA TRANSMISSION IN FILE SHARING FIELD; DOWNLOADABLE SOFTWARE FOR DATA ENCRYPTION IN FILE SHARING FIELD, IN CLASS 9 (U.S. CLS. 21, 23, 26, 36 AND 38).

FIRST USE 11-7-2007; IN COMMERCE 11-7-2007.

FOR: PROVIDING A WEBSITE FEATURING TECHNOLOGY THAT ENABLES USERS TO SURF OTHER WEBSITES ANONYMOUSLY, IN CLASS 42 (U.S. CLS. 100 AND 101).

FIRST USE 11-7-2007; IN COMMERCE 11-7-2007.

THE MARK CONSISTS OF STANDARD CHARACTERS WITHOUT CLAIM TO ANY PARTICULAR FONT, STYLE, SIZE, OR COLOR.

SER. NO. 85-410,150, FILED 8-30-2011.

ARETHA SOMERVILLE, EXAMINING ATTORNEY



*David J. Kyros*

Director of the United States Patent and Trademark Office

# United States of America

United States Patent and Trademark Office

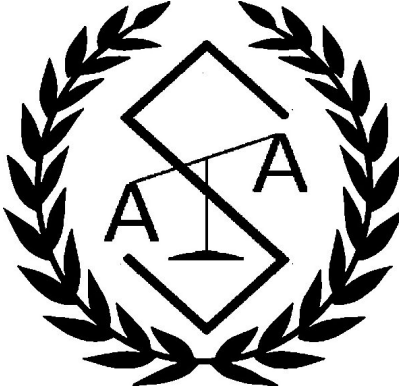

**Reg. No. 4,135,034**

**Registered May 1, 2012**

**Int. Cl.: 45**

**SERVICE MARK**

**PRINCIPAL REGISTER**

AYDIN, SEVAN ABRAHAM (UNITED STATES INDIVIDUAL)  
216-17 48TH AVENUE 2C  
BAYSIDE, NY 11364

FOR: ATTORNEY SERVICES, IN CLASS 45 (U.S. CLS. 100 AND 101).

FIRST USE 8-30-2011; IN COMMERCE 8-30-2011.

THE MARK CONSISTS OF A WREATH CREATING A BORDER THAT CIRCUMSCRIBES A LARGE LETTER "S" AND A SCALE, WHEREIN SAID SCALE IS SUPERIMPOSED ON SAID "S", AND WHEREIN THE TRAYS OF SAID SCALE ARE EACH IN THE FORM OF THE LETTER "A", AND WHEREIN SAID "A" SHAPED TRAYS LIE IN OPPOSING SEMICIRCULAR REGIONS BETWEEN SAID WREATH AND SAID "S".

SER. NO. 85-410,174, FILED 8-30-2011.

JEFFERY COWARD, EXAMINING ATTORNEY



*David J. Kyffers*

Director of the United States Patent and Trademark Office

# United States of America

United States Patent and Trademark Office

# talkoclock

**Reg. No. 4,135,035**

**Registered May 1, 2012**

**Int. Cl.: 45**

**SERVICE MARK**

**PRINCIPAL REGISTER**

KISTENEV, ALEXEY (RUSSIAN FED. INDIVIDUAL)  
SOVETSKAYA ST. 73-19  
TOMSK, RUSSIAN FED.

FOR: ON-LINE SOCIAL NETWORKING SERVICES; ONLINE SOCIAL NETWORKING SERVICES THROUGH WHICH PARTICIPANTS MAY CREATE ALARMS, NAMELY, REQUESTS FOR WAKE-UP CALLS FROM ANOTHER RECIPIENTS AT SPECIFIED TIME; ONLINE SOCIAL NETWORKING SERVICES THROUGH WHICH PARTICIPANTS MAY FULFILL REQUESTS OF OTHER PARTICIPANTS TO MAKE ALARM CALLS TO THEM AT SPECIFIED TIME, IN CLASS 45 (U.S. CLS. 100 AND 101).

FIRST USE 7-11-2011; IN COMMERCE 7-11-2011.

THE MARK CONSISTS OF STANDARD CHARACTERS WITHOUT CLAIM TO ANY PARTICULAR FONT, STYLE, SIZE, OR COLOR.

SER. NO. 85-410,194, FILED 8-30-2011.

SUSAN RICHARDS, EXAMINING ATTORNEY



*David J. Kybas*

Director of the United States Patent and Trademark Office

# United States of America

United States Patent and Trademark Office

# talko'clock

**Reg. No. 4,135,036**

**Registered May 1, 2012**

**Int. Cl.: 45**

**SERVICE MARK**

**PRINCIPAL REGISTER**

KISTENEV, ALEXEY (RUSSIAN FED. INDIVIDUAL)  
SOVETSKAYA ST. 73-19  
TOMSK, RUSSIAN FED.

FOR: ON-LINE SOCIAL NETWORKING SERVICES; ONLINE SOCIAL NETWORKING SERVICES THROUGH WHICH PARTICIPANTS MAY CREATE ALARMS, NAMELY, REQUESTS FOR WAKE-UP CALLS FROM ANOTHER RECIPIENTS AT SPECIFIED TIME; ONLINE SOCIAL NETWORKING SERVICES THROUGH WHICH PARTICIPANTS MAY FULFILL REQUESTS OF OTHER PARTICIPANTS TO MAKE ALARM CALLS TO THEM AT SPECIFIED TIME, IN CLASS 45 (U.S. CLS. 100 AND 101).

FIRST USE 7-11-2011; IN COMMERCE 7-11-2011.

THE MARK CONSISTS OF STANDARD CHARACTERS WITHOUT CLAIM TO ANY PARTICULAR FONT, STYLE, SIZE, OR COLOR.

SER. NO. 85-410,195, FILED 8-30-2011.

SUSAN RICHARDS, EXAMINING ATTORNEY



*David J. Kyros*

Director of the United States Patent and Trademark Office



# United States of America

United States Patent and Trademark Office

# talk clock

**Reg. No. 4,135,037**

**Registered May 1, 2012**

**Int. Cl.: 45**

**SERVICE MARK**

**PRINCIPAL REGISTER**

KISTENEV, ALEXEY (RUSSIAN FED. INDIVIDUAL)  
SOVETSKAYA ST. 73-19  
TOMSK, RUSSIAN FED.

FOR: ON-LINE SOCIAL NETWORKING SERVICES; ONLINE SOCIAL NETWORKING SERVICES THROUGH WHICH PARTICIPANTS MAY CREATE ALARMS, NAMELY, REQUESTS FOR WAKE-UP CALLS FROM ANOTHER RECIPIENTS AT SPECIFIED TIME; ONLINE SOCIAL NETWORKING SERVICES THROUGH WHICH PARTICIPANTS MAY FULFILL REQUESTS OF OTHER PARTICIPANTS TO MAKE ALARM CALLS TO THEM AT SPECIFIED TIME, IN CLASS 45 (U.S. CLS. 100 AND 101).

FIRST USE 7-11-2011; IN COMMERCE 7-11-2011.

THE MARK CONSISTS OF A WORD "TALK", A STYLIZED LETTER "O" THAT LOOKS LIKE A CLOCK SHOWING "9:00", AN APOSTROPHE AFTER THE LETTER "O" THAT MARKS TOP RIGHT SIDE OF THE LETTER "O", AND THE WORD "CLOCK".

SER. NO. 85-410,197, FILED 8-30-2011.

SUSAN RICHARDS, EXAMINING ATTORNEY



*David J. Kyjars*

Director of the United States Patent and Trademark Office

# United States of America

United States Patent and Trademark Office



**Reg. No. 4,135,038**

**Registered May 1, 2012**

**Int. Cl.: 41**

**SERVICE MARK**

**PRINCIPAL REGISTER**

INTERGROOM, INC. (NEW JERSEY CORPORATION)  
76 CAROL DRIVE  
DEDHAM, MA 02020

FOR: ORGANIZING AND CONDUCTING EXHIBITS, DEMONSTRATIONS, WORKSHOPS, SEMINARS, CLASSES AND COMPETITIONS IN THE FIELD OF PET CARE AND GROOMING, IN CLASS 41 (U.S. CLS. 100, 101 AND 107).

FIRST USE 4-30-1985; IN COMMERCE 4-24-1993.

THE MARK CONSISTS OF THE WORD "INTERGROOM" IN STYLIZED FONT BETWEEN TWO HORIZONTAL LINES. ABOVE THE LINE APPEAR THREE SILHOUETTES OF DOGS AND BENEATH APPEARS THE BOTTOM HALF OF A GLOBE.

SER. NO. 85-410,204, FILED 8-30-2011.

AMY KELLY, EXAMINING ATTORNEY



*David J. Kyffers*

Director of the United States Patent and Trademark Office

# United States of America

United States Patent and Trademark Office

## CROWN JEWEL

**Reg. No. 4,135,039**

**Registered May 1, 2012**

**Int. Cl.: 13**

**TRADEMARK**

**PRINCIPAL REGISTER**

B.J. ALAN COMPANY (OHIO CORPORATION)  
555 MARTIN LUTHER KING, JR. BLVD.  
YOUNGSTOWN, OH 445021102

FOR: FIREWORKS, IN CLASS 13 (U.S. CLS. 2 AND 9).

FIRST USE 5-11-2010; IN COMMERCE 5-11-2010.

THE MARK CONSISTS OF STANDARD CHARACTERS WITHOUT CLAIM TO ANY PARTICULAR FONT, STYLE, SIZE, OR COLOR.

SER. NO. 85-410,205, FILED 8-30-2011.

BRENDAN REGAN, EXAMINING ATTORNEY



*David J. Kybas*

Director of the United States Patent and Trademark Office

# United States of America

United States Patent and Trademark Office



**Reg. No. 4,135,040**

**Registered May 1, 2012**

**Int. Cl.: 9**

SHENZHEN DINGCHENGCHANG ELECTRON SCIENCE AND TECHNOLOGY CO., LTD.  
(CHINA CORPORATION)  
F3,BAOZHUANYUAN 1#,NO.182 BULAN ROAD  
SHANGLILANG, NANWAN, LONGGANG  
SHENZHEN CITY, CHINA 518000

**TRADEMARK**

**PRINCIPAL REGISTER**

FOR: BATTERIES; BATTERIES AND BATTERY CHARGERS; BATTERIES AND BATTERY CHARGERS FOR INTRAVENOUS FLUID DELIVERY APPARATUS; BATTERY CHARGERS; CELL PHONE BATTERY CHARGERS; CELL PHONE BATTERY CHARGERS FOR USE IN VEHICLES; CHARGERS FOR BATTERIES; CHARGERS FOR ELECTRIC BATTERIES; CORDLESS TELEPHONES; DIGITAL TELEPHONES; ELECTRIC SHAVER CHARGERS; EMERGENCY AUTO KITS COMPRISED OF A HAND HELD SPOTLIGHT AND BATTERY CHARGER; MOTORCYCLE CHARGER FAULT DETECTOR, IN CLASS 9 (U.S. CLS. 21, 23, 26, 36 AND 38).

FIRST USE 2-8-2011; IN COMMERCE 5-18-2011.

THE MARK CONSISTS OF THE WORDING "D8" IN STYLIZED FORM.

SER. NO. 85-410,206, FILED 8-30-2011.

AMY KELLY, EXAMINING ATTORNEY



*David J. Kyros*

Director of the United States Patent and Trademark Office

# United States of America

United States Patent and Trademark Office

## NIGHT OWL

**Reg. No. 4,135,041**

**Registered May 1, 2012**

**Int. Cl.: 13**

**TRADEMARK**

**PRINCIPAL REGISTER**

B.J. ALAN COMPANY (OHIO CORPORATION)  
555 MARTIN LUTHER KING, JR. BLVD.  
YOUNGSTOWN, OH 445021102

FOR: FIREWORKS, IN CLASS 13 (U.S. CLS. 2 AND 9).

FIRST USE 3-26-2010; IN COMMERCE 3-26-2010.

THE MARK CONSISTS OF STANDARD CHARACTERS WITHOUT CLAIM TO ANY PARTICULAR FONT, STYLE, SIZE, OR COLOR.

SER. NO. 85-410,212, FILED 8-30-2011.

BRENDAN REGAN, EXAMINING ATTORNEY



*David J. Kybas*

Director of the United States Patent and Trademark Office

# United States of America

United States Patent and Trademark Office

## BGMICROSE

**Reg. No. 4,135,042**

**Registered May 1, 2012**

**Int. Cl.: 9**

**TRADEMARK**

**PRINCIPAL REGISTER**

BRAINDA (INTERNATIONAL) HOLDINGS CO., LIMITED (HONG KONG CORPORATION)  
FLAT/RM C,15/F  
UNIONWAY COMM CTR,283 QUEEN'S RD  
CENTRAL, HONG KONG

FOR: BATTERIES; CHARGERS FOR BATTERIES; COMPUTER KEYBOARDS; COMPUTER PERIPHERAL DEVICES; DIGITAL CAMERAS; ELECTRIC DOOR CLOSING SYSTEM; ELECTRIC DOOR OPENERS AND CLOSERS; ELECTRICAL PLUGS AND SOCKETS; ELECTRICAL WIRES; ELECTRONIC ANTI-THEFT SYSTEM COMPRISED OF A BAR CODE SCANNER THAT ALLOWS MANUFACTURERS TO TEMPORARILY DISABLE ELECTRONIC GOODS DURING THE MANUFACTURING PROCESS AND ALLOWS RETAILERS TO ENABLE SUCH GOODS UPON RECEIVING THE PURCHASE PRICE FOR THE GOODS; FACSIMILE MACHINES; FLUORESCENT SCREENS; GALVANIC BATTERIES; HEADPHONES; LAPTOP COMPUTERS; LOUDSPEAKER CABINETS; PORTABLE TELEPHONES; SATELLITE NAVIGATIONAL SYSTEM, NAMELY, A GLOBAL POSITIONING SYSTEM (GPS); SEMI-CONDUCTORS; SOLAR BATTERIES; WALKIE-TALKIES, IN CLASS 9 (U.S. CLS. 21, 23, 26, 36 AND 38).

FIRST USE 2-3-2010; IN COMMERCE 12-28-2010.

THE MARK CONSISTS OF THE WORDING "BGMICROSE" IN STYLIZED FORM.

THE WORDING "BGMICROSE" HAS NO MEANING IN A FOREIGN LANGUAGE.

SER. NO. 85-410,223, FILED 8-30-2011.

DAWN HAN, EXAMINING ATTORNEY



*David J. Kyffers*

Director of the United States Patent and Trademark Office

# United States of America

United States Patent and Trademark Office

# PROPS

**Reg. No. 4,135,043**

**Registered May 1, 2012**

**Int. Cl.: 9**

**TRADEMARK**

**PRINCIPAL REGISTER**

PC TREASURES, INC. (MICHIGAN CORPORATION)  
1795 N. LAPEER ROAD  
OXFORD, MI 48371

FOR: TABLET COMPUTER CASES, IN CLASS 9 (U.S. CLS. 21, 23, 26, 36 AND 38).

FIRST USE 8-0-2011; IN COMMERCE 8-0-2011.

THE MARK CONSISTS OF STANDARD CHARACTERS WITHOUT CLAIM TO ANY PARTICULAR FONT, STYLE, SIZE, OR COLOR.

SER. NO. 85-410,227, FILED 8-30-2011.

LINDA ESTRADA, EXAMINING ATTORNEY



*David J. Kyffers*

Director of the United States Patent and Trademark Office

# United States of America

## United States Patent and Trademark Office

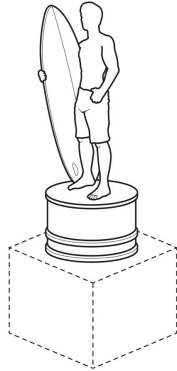

**Reg. No. 4,135,044**

**Registered May 1, 2012**

**Int. Cl.: 3**

**TRADEMARK**

**PRINCIPAL REGISTER**

ABERCROMBIE & FITCH TRADING CO. (OHIO CORPORATION)  
ATTN: JACOB KRAMER, SENIOR LEGAL COUNSEL  
NEW ALBANY, OH 43054

FOR: COLOGNE; FRAGRANCES FOR PERSONAL USE, IN CLASS 3 (U.S. CLS. 1, 4, 6, 50, 51 AND 52).

FIRST USE 10-15-2011; IN COMMERCE 10-15-2011.

THE MARK CONSISTS OF THREE DIMENSIONAL TRADE DRESS IN THE NATURE OF PRODUCT PACKAGING FEATURING A MAN IN SHORTS HOLDING A SURFBOARD. THE MAN STANDS ON A CIRCULAR PEDESTAL. THE BROKEN LINES ARE INCLUDED TO SHOW PLACEMENT AND ARE NOT A PART OF THE MARK.

SER. NO. 85-410,233, FILED 8-30-2011.

LINDA ORNDORFF, EXAMINING ATTORNEY



*David J. Kybas*

Director of the United States Patent and Trademark Office



# United States of America

United States Patent and Trademark Office

## Sounding Circles

**Reg. No. 4,135,045**

**Registered May 1, 2012**

**Int. Cl.: 41**

**SERVICE MARK**

**PRINCIPAL REGISTER**

SOUNDING CIRCLES, LLC (COLORADO LIMITED LIABILITY COMPANY)  
7860 S. HUDSON ST.  
CENTENNIAL, CO 80122

FOR: EDUCATIONAL SERVICES, NAMELY, CONDUCTING CLASSES, WORKSHOPS, INTENSIVES AND RETREATS IN THE FIELD OF EMITTING AND PRODUCING VOCAL AND INSTRUMENTAL SOUNDS AND DISTRIBUTION OF PRINTED MATERIALS IN CONNECTION THEREWITH IN HARD COPY OR ELECTRONIC FORMAT ON THE SAME TOPICS, IN CLASS 41 (U.S. CLS. 100, 101 AND 107).

FIRST USE 10-15-2009; IN COMMERCE 10-15-2009.

THE MARK CONSISTS OF STANDARD CHARACTERS WITHOUT CLAIM TO ANY PARTICULAR FONT, STYLE, SIZE, OR COLOR.

SER. NO. 85-410,240, FILED 8-30-2011.

KATHERINE E. HALMEN, EXAMINING ATTORNEY



*David J. Kyffers*

Director of the United States Patent and Trademark Office

# United States of America

United States Patent and Trademark Office

## Ankida Ridge Vineyards

**Reg. No. 4,135,046**

**Registered May 1, 2012**

**Int. Cl.: 33**

**TRADEMARK**

**PRINCIPAL REGISTER**

CHRISTINE W. VROOMAN (UNITED STATES INDIVIDUAL)  
1304 FRANKLIN CREEK RD.  
AMHERST, VA 24521 AND

DENNIS L. VROOMAN (UNITED STATES INDIVIDUAL)  
1304 FRANKLIN CREEK RD.  
AMHERST, VA 24521

FOR: WINE, IN CLASS 33 (U.S. CLS. 47 AND 49).

FIRST USE 7-3-2011; IN COMMERCE 7-15-2011.

THE MARK CONSISTS OF STANDARD CHARACTERS WITHOUT CLAIM TO ANY PARTICULAR FONT, STYLE, SIZE, OR COLOR.

NO CLAIM IS MADE TO THE EXCLUSIVE RIGHT TO USE "VINEYARDS", APART FROM THE MARK AS SHOWN.

THE ENGLISH TRANSLATION OF "ANKIDA" IN THE MARK IS "JOINING".

SER. NO. 85-410,241, FILED 8-30-2011.

KATHERINE E. HALMEN, EXAMINING ATTORNEY



*David J. Kyffers*

Director of the United States Patent and Trademark Office

# United States of America

United States Patent and Trademark Office

## BGMICROSE

**Reg. No. 4,135,047**

**Registered May 1, 2012**

**Int. Cl.: 18**

**TRADEMARK**

**PRINCIPAL REGISTER**

BRAINDA (INTERNATIONAL) HOLDINGS CO., LIMITED (HONG KONG CORPORATION)  
FLAT/RM C,15/F  
UNIONWAY COMM CTR,283 QUEEN'S RD  
CENTRAL, HONG KONG

FOR: BACKPACKS; BAGS FOR PACKAGING OF LEATHER; BRIEFCASES; CARD WAL-  
LETS; HANDBAGS; IMITATION LEATHER; LEATHER FOR FURNITURE; LEATHER KEY  
CASES; LEATHER LEASHES; LEATHER OR LEATHER-BOARD BOXES; LEATHER STRAPS;  
LEATHER, UNWROUGHT OR SEMI-WROUGHT; POCKET WALLETS; PURSES; TOOL  
BAGS SOLD EMPTY; TRAVEL BAGGAGE; TRAVEL CASES; UNFITTED VANITY CASES;  
VALISES; WHEELED SHOPPING BAGS, IN CLASS 18 (U.S. CLS. 1, 2, 3, 22 AND 41).

FIRST USE 2-3-2010; IN COMMERCE 12-28-2010.

THE MARK CONSISTS OF THE WORDING "BGMICROSE" IN STYLIZED FORM.

THE WORDING "BGMICROSE" HAS NO MEANING IN A FOREIGN LANGUAGE.

SER. NO. 85-410,251, FILED 8-30-2011.

DAWN HAN, EXAMINING ATTORNEY



*David J. Kyffers*

Director of the United States Patent and Trademark Office

# United States of America

United States Patent and Trademark Office

## BROTHER'S KEEPER

**Reg. No. 4,135,048**

**Registered May 1, 2012**

**Int. Cl.: 35**

**SERVICE MARK**

**PRINCIPAL REGISTER**

ALPHA PHI ALPHA FRATERNITY, INC. (D.C. CORPORATION)  
2313 ST. PAUL ST.  
BALTIMORE, MD 212185211

FOR: CHARITABLE SERVICES, NAMELY, ORGANIZING AND CONDUCTING VOLUNTEER PROGRAMS AND COMMUNITY SERVICE PROJECTS, IN CLASS 35 (U.S. CLS. 100, 101 AND 102).

FIRST USE 3-0-2002; IN COMMERCE 3-0-2002.

THE MARK CONSISTS OF STANDARD CHARACTERS WITHOUT CLAIM TO ANY PARTICULAR FONT, STYLE, SIZE, OR COLOR.

SER. NO. 85-410,259, FILED 8-30-2011.

JENNIFER VASQUEZ, EXAMINING ATTORNEY



*David J. Kybas*

Director of the United States Patent and Trademark Office

# United States of America

United States Patent and Trademark Office

## Feather Couture

**Reg. No. 4,135,049**

**Registered May 1, 2012**

**Int. Cl.: 26**

**TRADEMARK**

**PRINCIPAL REGISTER**

HOWARD, LESLIE (UNITED STATES INDIVIDUAL), DBA FEATHER COUTURE  
14620 UINTA STREET  
THORNTON, CO 80602

FOR: HAIR EXTENSIONS, IN CLASS 26 (U.S. CLS. 37, 39, 40, 42 AND 50).

FIRST USE 1-15-2011; IN COMMERCE 1-15-2011.

THE MARK CONSISTS OF STANDARD CHARACTERS WITHOUT CLAIM TO ANY PARTICULAR FONT, STYLE, SIZE, OR COLOR.

NO CLAIM IS MADE TO THE EXCLUSIVE RIGHT TO USE "FEATHER", APART FROM THE MARK AS SHOWN.

SER. NO. 85-410,261, FILED 8-30-2011.

JENNIFER VASQUEZ, EXAMINING ATTORNEY



*David J. Kyffers*

Director of the United States Patent and Trademark Office

# United States of America

United States Patent and Trademark Office

## INTELLI-PACK

**Reg. No. 4,135,050**

**Registered May 1, 2012**

**Int. Cl.: 9**

**TRADEMARK**

**PRINCIPAL REGISTER**

SPACE INFORMATION LABORATORIES, LLC (CALIFORNIA LIMITED LIABILITY COMPANY)  
2260 S. MEREDITH LANE  
SANTA MARIA, CA 93455

FOR: SCALABLE, INTERCHANGEABLE MODULES INCORPORATING BATTERIES WITH ASSOCIATED MICROPROCESSORS FOR AEROSPACE AND AVIONICS APPLICATIONS, IN CLASS 9 (U.S. CLS. 21, 23, 26, 36 AND 38).

FIRST USE 0-0-2008; IN COMMERCE 0-0-2008.

THE MARK CONSISTS OF STANDARD CHARACTERS WITHOUT CLAIM TO ANY PARTICULAR FONT, STYLE, SIZE, OR COLOR.

SER. NO. 85-410,284, FILED 8-30-2011.

CHRISTOPHER SIDOTI, EXAMINING ATTORNEY



*David J. Kyffers*

Director of the United States Patent and Trademark Office

# United States of America

United States Patent and Trademark Office

## ANIMAL HEALTH INSTITUTE

**Reg. No. 4,135,051**

**Registered May 1, 2012**

**Int. Cl.: 35**

**SERVICE MARK**

**PRINCIPAL REGISTER**

ANIMAL HEALTH INSTITUTE (IOWA CORPORATION)  
1325 G STREET, NW, SUITE 700  
WASHINGTON, DC 20005

FOR: ASSOCIATION SERVICES, NAMELY, PROMOTING THE INTERESTS OF MANUFACTURERS OF VETERINARY HEALTH PRODUCTS; PROMOTING PUBLIC AWARENESS OF THE DISCOVERY, DEVELOPMENT AND APPROVAL OF MEDICINES AND OTHER PRODUCTS THAT PROMOTE VETERINARY HEALTH, IN CLASS 35 (U.S. CLS. 100, 101 AND 102).

FIRST USE 0-0-1941; IN COMMERCE 0-0-1941.

THE MARK CONSISTS OF STANDARD CHARACTERS WITHOUT CLAIM TO ANY PARTICULAR FONT, STYLE, SIZE, OR COLOR.

NO CLAIM IS MADE TO THE EXCLUSIVE RIGHT TO USE "INSTITUTE", APART FROM THE MARK AS SHOWN.

SEC. 2(F).

SER. NO. 85-410,288, FILED 8-30-2011.

AMY KELLY, EXAMINING ATTORNEY



*David J. Kybas*

Director of the United States Patent and Trademark Office

# United States of America

United States Patent and Trademark Office

# saltbox

**Reg. No. 4,135,052**

**Registered May 1, 2012**

**Int. Cl.: 25**

**TRADEMARK**

**PRINCIPAL REGISTER**

SALTBOX (NEW YORK CORPORATION)  
APARTMENT #7  
168 ELIZABETH STREET  
NEW YORK, NY 10012

FOR: SWIM WEAR ; MEN'S CLOTHING, NAMELY, SWIM SHORTS, PANTS, SHIRTS,  
JACKETS, IN CLASS 25 (U.S. CLS. 22 AND 39).

FIRST USE 5-25-2007; IN COMMERCE 5-25-2007.

THE MARK CONSISTS OF STANDARD CHARACTERS WITHOUT CLAIM TO ANY PAR-  
TICULAR FONT, STYLE, SIZE, OR COLOR.

SER. NO. 85-410,302, FILED 8-30-2011.

ANDREA HACK, EXAMINING ATTORNEY



*David J. Kybas*

Director of the United States Patent and Trademark Office



# United States of America

United States Patent and Trademark Office

## PUMPKIN POPPERS

**Reg. No. 4,135,053**

**Registered May 1, 2012**

**Int. Cl.: 13**

**TRADEMARK**

**PRINCIPAL REGISTER**

B.J. ALAN COMPANY (OHIO CORPORATION)  
555 MARTIN LUTHER KING, JR. BLVD.  
YOUNGSTOWN, OH 445021102

FOR: FIREWORKS, IN CLASS 13 (U.S. CLS. 2 AND 9).

FIRST USE 8-3-2009; IN COMMERCE 10-2-2009.

THE MARK CONSISTS OF STANDARD CHARACTERS WITHOUT CLAIM TO ANY PARTICULAR FONT, STYLE, SIZE, OR COLOR.

SER. NO. 85-410,317, FILED 8-30-2011.

BRENDAN REGAN, EXAMINING ATTORNEY



*David J. Kybas*

Director of the United States Patent and Trademark Office

# United States of America

United States Patent and Trademark Office

## PASSPORT TO NUTRITION

**Reg. No. 4,135,054**

AHOLD LICENSING SARL (SWITZERLAND LIMITED LIABILITY COMPANY)  
2 RUE JEAN-PETITOT  
GENEVA, SWITZERLAND 1204

**Registered May 1, 2012**

**Int. Cl.: 41**

FOR: PROVIDING AN ONLINE EDUCATIONAL PROGRAM IN THE FIELD OF WELLNESS,  
PHYSICAL FITNESS AND A HEALTHY DIET, IN CLASS 41 (U.S. CLS. 100, 101 AND 107).

**SERVICE MARK**

FIRST USE 9-9-2010; IN COMMERCE 9-9-2010.

**PRINCIPAL REGISTER**

THE MARK CONSISTS OF STANDARD CHARACTERS WITHOUT CLAIM TO ANY PAR-  
TICULAR FONT, STYLE, SIZE, OR COLOR.

OWNER OF U.S. REG. NO. 4,008,677.

NO CLAIM IS MADE TO THE EXCLUSIVE RIGHT TO USE "NUTRITION", APART FROM  
THE MARK AS SHOWN.

SER. NO. 85-410,325, FILED 8-30-2011.

KELLY BOULTON, EXAMINING ATTORNEY



*David J. Kybas*

Director of the United States Patent and Trademark Office

# United States of America

United States Patent and Trademark Office



**Reg. No. 4,135,055**

LIVING RICH MEDIA LLC (NEW JERSEY LIMITED LIABILITY COMPANY)  
11 MONMOUTH COURT  
LIVINGSTON, NJ 07039

**Registered May 1, 2012**

**Int. Cl.: 35**

FOR: PROMOTING THE GOODS AND SERVICES OF OTHERS BY PROVIDING A WEBSITE FEATURING COUPONS, REBATES, PRICE-COMPARISON INFORMATION, PRODUCT REVIEWS, LINKS TO THE RETAIL WEBSITES OF OTHERS, AND DISCOUNT INFORMATION, IN CLASS 35 (U.S. CLS. 100, 101 AND 102).

**SERVICE MARK**

**PRINCIPAL REGISTER**

FIRST USE 4-1-2009; IN COMMERCE 4-1-2009.

NO CLAIM IS MADE TO THE EXCLUSIVE RIGHT TO USE "COUPONS", APART FROM THE MARK AS SHOWN.

THE MARK CONSISTS OF AN IMAGE OF AN OPEN WALLET WITH DOLLAR BILLS INSIDE. TO THE RIGHT IS THE STYLIZED TEXT "LIVING RICH WITH COUPONS".

SER. NO. 85-410,329, FILED 8-30-2011.

KELLY BOULTON, EXAMINING ATTORNEY



*David J. Kybas*

Director of the United States Patent and Trademark Office

# United States of America

United States Patent and Trademark Office

## ATHLETICO PHYSICAL THERAPY

**Reg. No. 4,135,056**

**Registered May 1, 2012**

**Int. Cls.: 41 and 44**

**SERVICE MARK**

**PRINCIPAL REGISTER**

ATHLETICO, LTD. (ILLINOIS CORPORATION)  
625 ENTERPRISE DRIVE  
OAK BROOK, IL 60523

FOR: PROVISION OF PHYSICAL FITNESS PROGRAMS, FACILITIES, INSTRUCTION, CONSULTATION, AND PERSONAL TRAINING; PROVISION OF PHYSICAL FITNESS INSTRUCTION IN THE FIELDS OF PERFORMANCE ENHANCEMENT, ENDURANCE, GOLF FITNESS, WOMEN'S HEALTH, AND SPINE CONTROL, IN CLASS 41 (U.S. CLS. 100, 101 AND 107).

FIRST USE 6-4-2010; IN COMMERCE 6-4-2010.

FOR: SPORTS MEDICINE THERAPY AND PHYSICAL THERAPY SERVICES, NAMELY, PHYSICAL THERAPY, OCCUPATIONAL THERAPY, AND MASSAGE THERAPY; PHYSICAL REHABILITATION SERVICES, INCLUDING IN THE FIELDS OF, ORTHOPEDIC REHABILITATION, WORK REHABILITATION, AND PERFORMING ARTS REHABILITATION, IN CLASS 44 (U.S. CLS. 100 AND 101).

FIRST USE 6-4-2010; IN COMMERCE 6-4-2010.

THE MARK CONSISTS OF STANDARD CHARACTERS WITHOUT CLAIM TO ANY PARTICULAR FONT, STYLE, SIZE, OR COLOR.

OWNER OF U.S. REG. NOS. 2,264,119, 2,277,136 AND OTHERS.

NO CLAIM IS MADE TO THE EXCLUSIVE RIGHT TO USE "PHYSICAL THERAPY", APART FROM THE MARK AS SHOWN.

SEC. 2(F) AS TO ATHLETICO.

SER. NO. 85-410,336, FILED 8-30-2011.

KELLY BOULTON, EXAMINING ATTORNEY



*David J. Kyppas*

Director of the United States Patent and Trademark Office

# United States of America

United States Patent and Trademark Office

## PLAY 2 RAISE

**Reg. No. 4,135,057**

**Registered May 1, 2012**

**Int. Cl.: 36**

**SERVICE MARK**

**PRINCIPAL REGISTER**

STORM CITY ENTERTAINMENT, INC. (NEW JERSEY CORPORATION)  
700 LIBERTY PLACE  
SICKLERVILLE, NJ 08081

FOR: CHARITABLE FUNDRAISING SERVICES BY MEANS OF SELLING VIDEO GAMES TO RAISE FUNDS, IN CLASS 36 (U.S. CLS. 100, 101 AND 102).

FIRST USE 7-1-2011; IN COMMERCE 8-1-2011.

THE MARK CONSISTS OF STANDARD CHARACTERS WITHOUT CLAIM TO ANY PARTICULAR FONT, STYLE, SIZE, OR COLOR.

SER. NO. 85-410,348, FILED 8-30-2011.

MICHAEL LITZAU, EXAMINING ATTORNEY



*David J. Kyffers*

Director of the United States Patent and Trademark Office

# United States of America

United States Patent and Trademark Office

## SCRUFFY DUCK

**Reg. No. 4,135,058**

**Registered May 1, 2012**

**Int. Cl.: 37**

**SERVICE MARK**

**PRINCIPAL REGISTER**

SCRUFFY DUCK, INC. (NORTH CAROLINA CORPORATION)  
1202 LAURA VILLAGE DRIVE  
APEX, NC 27523

FOR: CAR WASH SERVICES, IN CLASS 37 (U.S. CLS. 100, 103 AND 106).

FIRST USE 8-28-2003; IN COMMERCE 8-28-2003.

THE MARK CONSISTS OF STANDARD CHARACTERS WITHOUT CLAIM TO ANY PARTICULAR FONT, STYLE, SIZE, OR COLOR.

SER. NO. 85-410,362, FILED 8-30-2011.

NORA BUCHANAN WILL, EXAMINING ATTORNEY



*David J. Kybas*

Director of the United States Patent and Trademark Office

# United States of America

United States Patent and Trademark Office

# Tessora

**Reg. No. 4,135,059**

**Registered May 1, 2012**

**Int. Cl.: 33**

**TRADEMARK**

**PRINCIPAL REGISTER**

VERIANO FINE FOODS & SPIRITS, LTD. (OHIO LIMITED LIABILITY COMPANY)  
SUITE A  
9798 KARMAR COURT  
NEW ALBANY, OH 43054

FOR: ORIGINAL ITALIAN RECIPE LIQUEUR, IN CLASS 33 (U.S. CLS. 47 AND 49).

FIRST USE 1-1-2011; IN COMMERCE 1-1-2011.

THE MARK CONSISTS OF STANDARD CHARACTERS WITHOUT CLAIM TO ANY PARTICULAR FONT, STYLE, SIZE, OR COLOR.

SER. NO. 85-410,376, FILED 8-30-2011.

LAURIE MAYES, EXAMINING ATTORNEY



*David J. Kyffers*

Director of the United States Patent and Trademark Office

# United States of America

United States Patent and Trademark Office

## EVERYONE LOVES FLYING!

**Reg. No. 4,135,060**

**Registered May 1, 2012**

**Int. Cl.: 35**

**SERVICE MARK**

**PRINCIPAL REGISTER**

HORNE, MARK J. (UNITED STATES INDIVIDUAL)  
4810 NE 18TH TERRACE  
FT. LAUDERDALE, FL 33308

FOR: ON-LINE RETAIL STORE SERVICES FEATURING GENERAL AVIATION PRODUCTS AND TRAVEL-RELATED GOODS, NAMELY, CLOTHING AND APPAREL, HEADSETS, TRAVEL BAGS, AND GARMENT BAGS FOR TRAVEL; PROVIDING CONSUMER INFORMATION IN THE FIELD OF GENERAL AVIATION PRODUCTS AND TRAVEL-RELATED GOODS, IN CLASS 35 (U.S. CLS. 100, 101 AND 102).

FIRST USE 8-23-2011; IN COMMERCE 8-26-2011.

THE MARK CONSISTS OF STANDARD CHARACTERS WITHOUT CLAIM TO ANY PARTICULAR FONT, STYLE, SIZE, OR COLOR.

SER. NO. 85-410,385, FILED 8-30-2011.

KAELIE KUNG, EXAMINING ATTORNEY



*David J. Kyffers*

Director of the United States Patent and Trademark Office



# United States of America

United States Patent and Trademark Office

# AfroRomance

**Reg. No. 4,135,061**

CHELLAUL CORPORATION (NEVADA CORPORATION)  
1135 TERMINAL WAY, SUITE 209  
RENO, NV 89502

**Registered May 1, 2012**

**Int. Cl.: 45**

FOR: INTERRACIAL DATING SERVICES, NAMELY, PROVIDING AN ON-LINE COMPUTER DATABASE FEATURING SINGLE PEOPLE, IN CLASS 45 (U.S. CLS. 100 AND 101).

**SERVICE MARK**

FIRST USE 5-17-2003; IN COMMERCE 5-17-2003.

**PRINCIPAL REGISTER**

THE MARK CONSISTS OF STANDARD CHARACTERS WITHOUT CLAIM TO ANY PARTICULAR FONT, STYLE, SIZE, OR COLOR.

SER. NO. 85-410,386, FILED 8-30-2011.

KAELIE KUNG, EXAMINING ATTORNEY



*David J. Kappas*

Director of the United States Patent and Trademark Office

# United States of America

United States Patent and Trademark Office

## ON-LINE VENTURES

**Reg. No. 4,135,062**

**Registered May 1, 2012**

**Int. Cls.: 35 and 36**

**SERVICE MARK**

**PRINCIPAL REGISTER**

ON-LINE VENTURES, INC. (FLORIDA CORPORATION)  
14504 MARSH ISLAND LN  
JACKSONVILLE BEACH, FL 32250

FOR: GENERAL BUSINESS CONSULTING SERVICES, IN CLASS 35 (U.S. CLS. 100, 101 AND 102).

FIRST USE 6-26-1995; IN COMMERCE 7-12-1995.

FOR: VENTURE CAPITAL CONSULTING SERVICES, IN CLASS 36 (U.S. CLS. 100, 101 AND 102).

FIRST USE 6-26-1995; IN COMMERCE 7-12-1995.

THE MARK CONSISTS OF STANDARD CHARACTERS WITHOUT CLAIM TO ANY PARTICULAR FONT, STYLE, SIZE, OR COLOR.

NO CLAIM IS MADE TO THE EXCLUSIVE RIGHT TO USE "ON-LINE", APART FROM THE MARK AS SHOWN.

SEC. 2(F).

SER. NO. 85-410,387, FILED 8-30-2011.

KAELIE KUNG, EXAMINING ATTORNEY



*David J. Kybas*

Director of the United States Patent and Trademark Office

# United States of America

United States Patent and Trademark Office

## SOCIAL FORTRESS

**Reg. No. 4,135,063**

**Registered May 1, 2012**

**Int. Cl.: 9**

**TRADEMARK**

**PRINCIPAL REGISTER**

SOCIAL FORTRESS OPERATING PARTNERS, LLC (GEORGIA LIMITED LIABILITY COMPANY)  
3350 PEACHTREE RD., SUITE 1140  
ATLANTA, GA 30326

FOR: COMPUTER SOFTWARE FOR ENCRYPTION; MOBILE DEVICE SOFTWARE FOR ENCRYPTION, IN CLASS 9 (U.S. CLS. 21, 23, 26, 36 AND 38).

FIRST USE 6-0-2011; IN COMMERCE 6-0-2011.

THE MARK CONSISTS OF STANDARD CHARACTERS WITHOUT CLAIM TO ANY PARTICULAR FONT, STYLE, SIZE, OR COLOR.

SER. NO. 85-410,390, FILED 8-30-2011.

KAELIE KUNG, EXAMINING ATTORNEY



*David J. Kybas*

Director of the United States Patent and Trademark Office

# United States of America

United States Patent and Trademark Office

# LOVE\*

**Reg. No. 4,135,064**

**Registered May 1, 2012**

**Int. Cls.: 32, 35 and 41**

**TRADEMARK**

**SERVICE MARK**

**PRINCIPAL REGISTER**

ORGANIC AVENUE, LLC (NEW YORK LIMITED LIABILITY COMPANY)  
116 SUFFOLK STREET  
NEW YORK, NY 10002

FOR: COCONUT MILK; COCONUT WATER; COCONUT-BASED BEVERAGES; MILK OF ALMONDS FOR BEVERAGE; PREPARED ENTREES CONSISTING OF FRUIT DRINKS AND FRUIT JUICES, FRUIT-BASED BEVERAGES, NON-ALCOHOLIC BEVERAGES CONTAINING FRUIT JUICES, NON-ALCOHOLIC FRUIT EXTRACTS USED IN THE PREPARATION OF BEVERAGES, NON-ALCOHOLIC FRUIT JUICE BEVERAGES, VEGETABLE JUICES, VEGETABLE-FRUIT JUICES AND SMOOTHIES; SMOOTHIES; VEGETABLE JUICES, IN CLASS 32 (U.S. CLS. 45, 46 AND 48).

FIRST USE 6-30-1999; IN COMMERCE 6-30-1999.

FOR: RETAIL STORES FEATURING RAW, ORGANIC AND VEGAN PREPARED FOOD AND JUICES, IN CLASS 35 (U.S. CLS. 100, 101 AND 102).

FIRST USE 6-30-1999; IN COMMERCE 6-30-1999.

FOR: EDUCATIONAL SERVICES, NAMELY, CONDUCTING SEMINARS, WORKSHOPS AND CLASSES IN THE FIELD OF NUTRITION, HEALTH, WELL-BEING AND FOOD PREPARATION, IN CLASS 41 (U.S. CLS. 100, 101 AND 107).

FIRST USE 6-30-1999; IN COMMERCE 6-30-1999.

THE MARK CONSISTS OF STANDARD CHARACTERS WITHOUT CLAIM TO ANY PARTICULAR FONT, STYLE, SIZE, OR COLOR.

SER. NO. 85-410,415, FILED 8-30-2011.

PAUL MORENO, EXAMINING ATTORNEY



*David J. Kyros*

Director of the United States Patent and Trademark Office

# United States of America

United States Patent and Trademark Office



**Reg. No. 4,135,065**

**Registered May 1, 2012**

**Int. Cls.: 29, 30, 32 and 35**

**TRADEMARK**

**SERVICE MARK**

**PRINCIPAL REGISTER**

ORGANIC AVENUE, LLC (NEW YORK LIMITED LIABILITY COMPANY)  
116 SUFFOLK STREET  
NEW YORK, NY 10002

FOR: CHEESE SUBSTITUTES; CHEESE, NAMELY, MACADEMIA CHEESE, CASHEW SCALLION CREAM CHEESE; DIPS; FALAFEL; NUT-BASED MILK; NUT-BASED SNACK FOODS; ORGANIC NUT AND SEED-BASED SNACK BARS; PROCESSED EDIBLE SEEDS; PROCESSED NUTS; PROCESSED PUMPKIN SEEDS; PROCESSED SUNFLOWER SEEDS; PROCESSED, EDIBLE SEAWEED; SALADS, NAMELY, VEGETABLE SALADS; SNACK MIX CONSISTING OF PRIMARILY OF PROCESSED NUTS, SEEDS, DRIED FRUIT AND ALSO INCLUDING CHOCOLATE; SOUPS; VEGETABLE CHIPS; VEGETABLE-BASED RAW FOOD BARS; PREPARED VEGETABLE-BASED ENTREES, IN CLASS 29 (U.S. CL. 46).

FIRST USE 6-30-1999; IN COMMERCE 6-30-1999.

FOR: CHOCOLATE; FLAN; GRAIN-BASED CHIPS; GRAIN-BASED FOOD BEVERAGES; LASAGNA; MACAROONS; PASTA; PUDDINGS; TAPIOCA, IN CLASS 30 (U.S. CL. 46).

FIRST USE 6-30-1999; IN COMMERCE 6-30-1999.

FOR: BOTTLED ARTESIAN WATER; COCONUT MILK; COCONUT WATER; COCONUT-BASED BEVERAGES; MILK OF ALMONDS FOR BEVERAGE; PREPARED ENTREES CONSISTING OF FRUIT DRINKS AND FRUIT JUICES, FRUIT-BASED BEVERAGES, NON-ALCOHOLIC BEVERAGES CONTAINING FRUIT JUICES, NON-ALCOHOLIC FRUIT EXTRACTS USED IN THE PREPARATION OF BEVERAGES, NON-ALCOHOLIC FRUIT JUICE BEVERAGES, VEGETABLE JUICES, VEGETABLE-FRUIT JUICES AND SMOOTHIES; SMOOTHIES; VEGETABLE JUICES, IN CLASS 32 (U.S. CLS. 45, 46 AND 48).

FIRST USE 6-30-1999; IN COMMERCE 6-30-1999.

FOR: RETAIL STORES FEATURING RAW, ORGANIC AND VEGAN PREPARED FOOD AND JUICES, IN CLASS 35 (U.S. CLS. 100, 101 AND 102).

FIRST USE 6-30-1999; IN COMMERCE 6-30-1999.



*David J. Kappas*

Director of the United States Patent and Trademark Office

**Reg. No. 4,135,065** THE MARK CONSISTS OF THE LETTERS "O" AND "A" WITHOUT THE CROSS AND A HORIZONTAL RULE INSIDE A CIRCLE.

SER. NO. 85-410,421, FILED 8-30-2011.

PAUL MORENO, EXAMINING ATTORNEY

# United States of America

United States Patent and Trademark Office

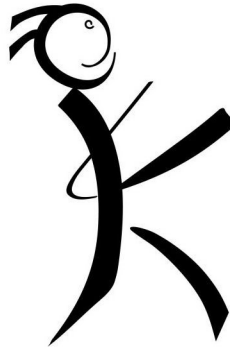

**Reg. No. 4,135,066**

**Registered May 1, 2012**

**Int. Cl.: 25**

**TRADEMARK**

**PRINCIPAL REGISTER**

CROOKED HUMAN, INC. (CALIFORNIA CORPORATION)  
12230 EL CAMINO REAL, SUITE 130  
SAN DIEGO, CA 92130

FOR: CLOTHING, NAMELY, DRESSES, SKIRTS, SHIRTS, SHORTS, PANTS, SWEATSHIRTS, SWEATPANTS, JACKETS, HATS, CAPS, VISORS, SHOES, SANDALS, UNDERWEAR, SOCKS AND BELTS, IN CLASS 25 (U.S. CLS. 22 AND 39).

FIRST USE 3-16-2011; IN COMMERCE 3-16-2011.

THE MARK CONSISTS OF THE GRAPHIC REPRESENTATION OF A HUMAN FIGURE.

SER. NO. 85-410,441, FILED 8-30-2011.

ANNE E. GUSTASON, EXAMINING ATTORNEY



*David J. Kyffers*

Director of the United States Patent and Trademark Office

# United States of America

United States Patent and Trademark Office

# buygüd

**Reg. No. 4,135,067**

**Registered May 1, 2012**

**Int. Cl.: 35**

**SERVICE MARK**

**PRINCIPAL REGISTER**

BUYGUD, INC. (TEXAS CORPORATION)  
1013 LAKEWOOD HILLS TERRACE  
AUSTIN, TX 78732

FOR: PROMOTING THE GOODS AND SERVICES OF OTHERS BY PROVIDING A WEBSITE FEATURING COUPONS, REBATES, DONATIONS, PRICE-COMPARISON INFORMATION, PRODUCT REVIEWS, LINKS TO THE RETAIL WEBSITES OF OTHERS, AND DISCOUNT INFORMATION, IN CLASS 35 (U.S. CLS. 100, 101 AND 102).

FIRST USE 4-11-2011; IN COMMERCE 4-11-2011.

THE MARK CONSISTS OF THE TEXT "BUYGÜD" IN LOWER CASE LETTERS, WITH THE "U" IN "GUD" REPRESENTED BY A GRAPHICALLY PRODUCED IMAGE OF A U SUCH THAT IT APPEARS TO BE MADE BY HAND AS WITH A BRUSH. OVER THE GRAPHICALLY PRODUCED U MENTIONED IS AN UMLAUT DRAWN OF THE SAME DESIGN STYLE SUCH THAT THE COMBINATION OF THE TWO DESIGN ELEMENTS PRODUCES A SMILING FACE.

SER. NO. 85-410,455, FILED 8-30-2011.

KYLE PEETE, EXAMINING ATTORNEY



*David J. Kyros*

Director of the United States Patent and Trademark Office



# United States of America

United States Patent and Trademark Office

# **r1 rehabfirst**

**Reg. No. 4,135,068**

**Registered May 1, 2012**

**Int. Cl.: 44**

**SERVICE MARK**

**PRINCIPAL REGISTER**

LOBB, KELLY (UNITED STATES INDIVIDUAL)  
1600 JOSEPH DRIVE  
BRYAN, TX 77802 AND

LOBB, KASEY (UNITED STATES INDIVIDUAL)  
1600 JOSEPH DRIVE  
BRYAN, TX 77802

FOR: PHYSICAL REHABILITATION AND WEIGHT LOSS SERVICES, IN CLASS 44 (U.S. CLS. 100 AND 101).

FIRST USE 11-1-2010; IN COMMERCE 11-1-2010.

THE MARK CONSISTS OF THE TEXT "R1" LOCATED TO THE LEFT (IN HORIZONTAL CONFIGURATION) OF THE TEXT "REHABFIRST". THE NEGATIVE SPACE BETWEEN THE "R" AND "1" IS DESIGNED TO MAKE A CROSS. "R1 REHABFIRST" IS IN ALL LOWERCASE AND IN A SPECIFIC FONT AND SIZE, AND "FIRST" IS MORE BOLD THAN "REHAB". ALL FONT IS MUSEO SLAB.

SER. NO. 85-410,459, FILED 8-30-2011.

SCOTT BIBB, EXAMINING ATTORNEY



*David J. Kyros*

Director of the United States Patent and Trademark Office

# United States of America

United States Patent and Trademark Office

## ROCKLEDGE ASSOCIATES

**Reg. No. 4,135,069**

**Registered May 1, 2012**

**Int. Cls.: 35 and 36**

**SERVICE MARK**

**PRINCIPAL REGISTER**

LUIS P. BUHLER (CALIFORNIA SOLE PROPRIETORSHIP), DBA ROCKLEDGE ASSOCIATES  
21908 ALMADEN AVENUE  
CUPERTINO, CA 950142861

FOR: ACCOUNTING SERVICES; TAX CONSULTING AND ADVISORY SERVICES; MERGER, ACQUISITION AND DIVESTITURE CONSULTING AND ADVISORY SERVICES; BUSINESS MANAGEMENT AND BUSINESS CONSULTING AND ADVISORY SERVICES, IN CLASS 35 (U.S. CLS. 100, 101 AND 102).

FIRST USE 12-23-2004; IN COMMERCE 12-23-2004.

FOR: FINANCIAL CONSULTING, MANAGEMENT AND ANALYSIS SERVICES FOR ENTERPRISES, IN CLASS 36 (U.S. CLS. 100, 101 AND 102).

FIRST USE 12-23-2004; IN COMMERCE 12-23-2004.

THE MARK CONSISTS OF STANDARD CHARACTERS WITHOUT CLAIM TO ANY PARTICULAR FONT, STYLE, SIZE, OR COLOR.

NO CLAIM IS MADE TO THE EXCLUSIVE RIGHT TO USE "ASSOCIATES" , APART FROM THE MARK AS SHOWN.

SER. NO. 85-410,463, FILED 8-30-2011.

GRETTA YAO, EXAMINING ATTORNEY



*David J. Kyros*

Director of the United States Patent and Trademark Office

# United States of America

United States Patent and Trademark Office

# Revizzit

**Reg. No. 4,135,070**

**Registered May 1, 2012**

**Int. Cl.: 42**

**SERVICE MARK**

**PRINCIPAL REGISTER**

REVIZZIT LLC (CALIFORNIA LIMITED LIABILITY COMPANY)  
SUITE 168  
530 S. LAKE AVE.  
PASADENA, CA 91101

FOR: PLATFORM AS A SERVICE (PAAS) FEATURING COMPUTER SOFTWARE PLATFORMS FOR THE PRODUCTION, MONETIZATION, AND DISTRIBUTION OF DIGITAL CONTENT, IN CLASS 42 (U.S. CLS. 100 AND 101).

FIRST USE 6-5-2010; IN COMMERCE 7-5-2010.

THE MARK CONSISTS OF STANDARD CHARACTERS WITHOUT CLAIM TO ANY PARTICULAR FONT, STYLE, SIZE, OR COLOR.

SER. NO. 85-410,465, FILED 8-30-2011.

GRETТА YAO, EXAMINING ATTORNEY



*David J. Kybas*

Director of the United States Patent and Trademark Office

# United States of America

United States Patent and Trademark Office



**Reg. No. 4,135,071**

**Registered May 1, 2012**

**Int. Cl.: 42**

**SERVICE MARK**

**PRINCIPAL REGISTER**

COONING, CHRISTOPHER (UNITED STATES INDIVIDUAL)  
1129 6TH ST.  
MONTEREY, CA 93940

FOR: GRAPHIC DESIGN; WEBSITE DEVELOPMENT FOR OTHERS, IN CLASS 42 (U.S. CLS. 100 AND 101).

FIRST USE 11-1-2010; IN COMMERCE 11-1-2010.

THE MARK CONSISTS OF A DEEP SEA ANGLER FISH BEARING ITS TEETH, AND THE TEXT "DEEPWATER" ON THE RIGHT OF THE FISH.

SER. NO. 85-410,471, FILED 8-30-2011.

LESLIE RICHARDS, EXAMINING ATTORNEY



*David J. Kybas*

Director of the United States Patent and Trademark Office

# United States of America

United States Patent and Trademark Office

## Professional U

**Reg. No. 4,135,072**

**Registered May 1, 2012**

**Int. Cl.: 35**

**SERVICE MARK**

**PRINCIPAL REGISTER**

PROFESSIONAL U (GEORGIA CORPORATION)  
#335  
8343 ROSWELL ROAD  
ATLANTA, GA 30350

FOR: CAREER DEVELOPMENT CONSULTANT SERVICES, IN CLASS 35 (U.S. CLS. 100, 101 AND 102).

FIRST USE 8-20-2008; IN COMMERCE 1-5-2011.

THE MARK CONSISTS OF STANDARD CHARACTERS WITHOUT CLAIM TO ANY PARTICULAR FONT, STYLE, SIZE, OR COLOR.

SER. NO. 85-410,480, FILED 8-30-2011.

JOHN DALIER, EXAMINING ATTORNEY



*David J. Kyffers*

Director of the United States Patent and Trademark Office

# United States of America

United States Patent and Trademark Office

# Karma Elixir

**Reg. No. 4,135,073**

KARMACEUTICALS, LLC (COLORADO LIMITED LIABILITY COMPANY)  
4 S SANTA FE DRIVE  
DENVER, CO 80223

**Registered May 1, 2012**

**Int. Cl.: 32**

FOR: SOFT DRINKS, IN CLASS 32 (U.S. CLS. 45, 46 AND 48).

**TRADEMARK**

FIRST USE 11-1-2010; IN COMMERCE 11-1-2010.

**PRINCIPAL REGISTER**

THE MARK CONSISTS OF STANDARD CHARACTERS WITHOUT CLAIM TO ANY PARTICULAR FONT, STYLE, SIZE, OR COLOR.

SER. NO. 85-410,486, FILED 8-30-2011.

MARTHA SANTOMARTINO, EXAMINING ATTORNEY



*David J. Kyffers*

Director of the United States Patent and Trademark Office

# United States of America

United States Patent and Trademark Office

## Paranormal Quest

**Reg. No. 4,135,074**

**Registered May 1, 2012**

**Int. Cl.: 41**

**SERVICE MARK**

**PRINCIPAL REGISTER**

PARANORMAL QUEST (WEST VIRGINIA PARTNERSHIP)  
RR2 BOX 277-2  
MOUNDSVILLE, WV 26041

FOR: ENTERTAINMENT SERVICES, NAMELY, AN ON-GOING SERIES FEATURING A PARANORMAL INVESTIGATION DOCUMENTARY PROVIDED THROUGH SATELLITE TELEVISION, CABLE TELEVISION, AND GLOBAL COMPUTER NETWORK; ENTERTAINMENT, NAMELY, A CONTINUING PARANORMAL INVESTIGATION DOCUMENTARY SHOW BROADCAST OVER TELEVISION, SATELLITE, AUDIO, AND VIDEO MEDIA; ENTERTAINMENT, NAMELY, PRODUCTION OF A TELEVISION SHOW, IN CLASS 41 (U.S. CLS. 100, 101 AND 107).

FIRST USE 9-18-2010; IN COMMERCE 12-1-2010.

THE MARK CONSISTS OF STANDARD CHARACTERS WITHOUT CLAIM TO ANY PARTICULAR FONT, STYLE, SIZE, OR COLOR.

NO CLAIM IS MADE TO THE EXCLUSIVE RIGHT TO USE "PARANORMAL", APART FROM THE MARK AS SHOWN.

SER. NO. 85-410,494, FILED 8-30-2011.

LAURIE KAUFMAN, EXAMINING ATTORNEY



*David J. Kyros*

Director of the United States Patent and Trademark Office

# United States of America

United States Patent and Trademark Office

## PRISMATIC POWDERS

**Reg. No. 4,135,075**

**Registered May 1, 2012**

**Int. Cl.: 2**

**TRADEMARK**

**PRINCIPAL REGISTER**

NIC INDUSTRIES, INC. (OREGON CORPORATION)  
7050 6TH STREET  
WHITE CITY, OR 97503

FOR: COATINGS IN THE NATURE OF DECORATIVE AND PROTECTIVE POWDER COATINGS FOR EXTERIOR AND INTERIOR USE ON METAL, WOOD, AND CERAMICS, IN CLASS 2 (U.S. CLS. 6, 11 AND 16).

FIRST USE 1-1-1987; IN COMMERCE 1-1-1987.

THE MARK CONSISTS OF STANDARD CHARACTERS WITHOUT CLAIM TO ANY PARTICULAR FONT, STYLE, SIZE, OR COLOR.

OWNER OF U.S. REG. NO. 2,988,500.

NO CLAIM IS MADE TO THE EXCLUSIVE RIGHT TO USE "POWDERS", APART FROM THE MARK AS SHOWN.

SER. NO. 85-410,495, FILED 8-30-2011.

LAURIE KAUFMAN, EXAMINING ATTORNEY



*David J. Kyfos*

Director of the United States Patent and Trademark Office



# United States of America

United States Patent and Trademark Office

## Brush with Greatness

**Reg. No. 4,135,076**

**Registered May 1, 2012**

**Int. Cl.: 16**

**TRADEMARK**

**PRINCIPAL REGISTER**

WORLDWISE EDUCATION, INC. (DELAWARE CORPORATION)  
235 E. BROADWAY  
8TH FLOOR  
LONG BEACH, CA 90802

FOR: GREETING CARDS, IN CLASS 16 (U.S. CLS. 2, 5, 22, 23, 29, 37, 38 AND 50).

FIRST USE 1-1-2011; IN COMMERCE 6-15-2011.

THE MARK CONSISTS OF STANDARD CHARACTERS WITHOUT CLAIM TO ANY PARTICULAR FONT, STYLE, SIZE, OR COLOR.

SER. NO. 85-410,502, FILED 8-30-2011.

LINDA MICKLEBURGH, EXAMINING ATTORNEY



*David J. Kyffers*

Director of the United States Patent and Trademark Office

# United States of America

United States Patent and Trademark Office



**SAY NO TO LOW!**

**Reg. No. 4,135,077**

**Registered May 1, 2012**

**Int. Cl.: 9**

**TRADEMARK**

**PRINCIPAL REGISTER**

JPM NETWORKS, LLC (TEXAS LIMITED LIABILITY COMPANY), DBA KWIKBOOST  
4819 WOODALL STREET  
DALLAS, TX 75257

FOR: ELECTRONIC DOCKING AND CHARGING STATIONS COMPRISING COMPUTER  
HARDWARE AND PERIPHERALS FOR USE IN CHARGING MOBILE DEVICES, IN CLASS  
9 (U.S. CLS. 21, 23, 26, 36 AND 38).

FIRST USE 2-25-2011; IN COMMERCE 2-25-2011.

THE MARK CONSISTS OF THE WORDS "SAY NO TO LOW!" BELOW THE IMAGE OF A  
CIRCLE WITH A DIAGONAL LINE OVER A BATTERY.

SER. NO. 85-410,524, FILED 8-30-2011.

JUDITH HELFMAN, EXAMINING ATTORNEY



*David J. Kybas*

Director of the United States Patent and Trademark Office

# United States of America

United States Patent and Trademark Office

## Screw You, We're From Texas

**Reg. No. 4,135,078**

**Registered May 1, 2012**

**Int. Cls.: 16, 21 and 25**

**TRADEMARK**

**PRINCIPAL REGISTER**

WYLIeworld MUSIC, LLC (TEXAS LIMITED LIABILITY COMPANY)  
P.O. BOX 2706  
WIMBERLY, TX 78676

FOR: BUMPER STICKERS, IN CLASS 16 (U.S. CLS. 2, 5, 22, 23, 29, 37, 38 AND 50).

FIRST USE 4-1-2003; IN COMMERCE 4-1-2003.

FOR: INSULATED CONTAINERS FOR BEVERAGE CANS FOR DOMESTIC USE, IN CLASS 21 (U.S. CLS. 2, 13, 23, 29, 30, 33, 40 AND 50).

FIRST USE 4-1-2003; IN COMMERCE 4-1-2003.

FOR: BASEBALL CAPS AND HATS; TEE SHIRTS, IN CLASS 25 (U.S. CLS. 22 AND 39).

FIRST USE 4-1-2003; IN COMMERCE 4-1-2003.

THE MARK CONSISTS OF STANDARD CHARACTERS WITHOUT CLAIM TO ANY PARTICULAR FONT, STYLE, SIZE, OR COLOR.

SER. NO. 85-410,528, FILED 8-30-2011.

BRIAN NEVILLE, EXAMINING ATTORNEY



*David J. Kybas*

Director of the United States Patent and Trademark Office

# United States of America

United States Patent and Trademark Office

## BONECUTTERS

**Reg. No. 4,135,079**

**Registered May 1, 2012**

**Int. Cl.: 14**

**TRADEMARK**

**PRINCIPAL REGISTER**

BONECUTTER, JOHN ERIC (UNITED STATES INDIVIDUAL), DBA BONECUTTERS  
PO BOX 3118  
DURANGO, CO 81302

FOR: JEWELRY, IN CLASS 14 (U.S. CLS. 2, 27, 28 AND 50).

FIRST USE 7-1-2011; IN COMMERCE 7-1-2011.

THE MARK CONSISTS OF STANDARD CHARACTERS WITHOUT CLAIM TO ANY PARTICULAR FONT, STYLE, SIZE, OR COLOR.

SER. NO. 85-410,534, FILED 8-30-2011.

JUDITH HELFMAN, EXAMINING ATTORNEY



*David J. Kyffers*

Director of the United States Patent and Trademark Office

# United States of America

United States Patent and Trademark Office

# DFS

**Reg. No. 4,135,080**

**Registered May 1, 2012**

**Int. Cl.: 7**

**TRADEMARK**

**PRINCIPAL REGISTER**

IDEAL MANUFACTURING & SALES CORPORATION (WISCONSIN CORPORATION)  
4607 DOVETAIL DRIVE  
MADISON, WI 53704

FOR: PACKAGING MACHINES, NAMELY, LIQUID CONTAINER FILLERS, IN CLASS 7  
(U.S. CLS. 13, 19, 21, 23, 31, 34 AND 35).

FIRST USE 6-0-2009; IN COMMERCE 6-0-2009.

THE MARK CONSISTS OF STANDARD CHARACTERS WITHOUT CLAIM TO ANY PARTICULAR FONT, STYLE, SIZE, OR COLOR.

SER. NO. 85-410,537, FILED 8-30-2011.

JUDITH HELFMAN, EXAMINING ATTORNEY



*David J. Kyffers*

Director of the United States Patent and Trademark Office

# United States of America

United States Patent and Trademark Office

## Who's Your Favorite Uncle?

**Reg. No. 4,135,081**

RATTRAY, NAKIA (UNITED STATES INDIVIDUAL)  
2040 BRUCKNER BLVD.  
BRONX, NY 10473

**Registered May 1, 2012**

**Int. Cl.: 41**

FOR: ENTERTAINMENT IN THE NATURE OF MAGIC SHOWS, IN CLASS 41 (U.S. CLS. 100, 101 AND 107).

**SERVICE MARK**

FIRST USE 9-1-1998; IN COMMERCE 10-1-2009.

**PRINCIPAL REGISTER**

THE MARK CONSISTS OF STANDARD CHARACTERS WITHOUT CLAIM TO ANY PARTICULAR FONT, STYLE, SIZE, OR COLOR.

SER. NO. 85-410,554, FILED 8-30-2011.

LAURIE KAUFMAN, EXAMINING ATTORNEY



*David J. Kyffers*

Director of the United States Patent and Trademark Office

# United States of America

United States Patent and Trademark Office

# DRUTHERS

**Reg. No. 4,135,082**

**Registered May 1, 2012**

**Int. Cl.: 33**

**TRADEMARK**

**PRINCIPAL REGISTER**

STE. MICHELLE WINE ESTATES LTD. (WASHINGTON CORPORATION)  
ONE STIMSON LANE  
WOODINVILLE, WA 98072

FOR: WINE, IN CLASS 33 (U.S. CLS. 47 AND 49).

FIRST USE 3-24-2011; IN COMMERCE 6-6-2011.

THE MARK CONSISTS OF STANDARD CHARACTERS WITHOUT CLAIM TO ANY PARTICULAR FONT, STYLE, SIZE, OR COLOR.

SER. NO. 85-410,577, FILED 8-30-2011.

MARC LEIPZIG, EXAMINING ATTORNEY



*David J. Kybas*

Director of the United States Patent and Trademark Office

# United States of America

United States Patent and Trademark Office



**PACIFIC POWER**  
RENEWABLES, INC

**Reg. No. 4,135,083**

**Registered May 1, 2012**

**Int. Cl.: 37**

**SERVICE MARK**

**PRINCIPAL REGISTER**

PACIFIC POWER RENEWABLES, INC. (NEVADA CORPORATION)  
12970 EARHART AVE.  
AUBURN, CA 95602

FOR: INSTALLATION AND MAINTENANCE OF SOLAR ENERGY BASED POWER PLANTS;  
CONSTRUCTION SERVICES, NAMELY, PLANNING, LAYING OUT AND CUSTOM CON-  
STRUCTION OF SOLAR POWER PLANT SUPPORT STRUCTURES; SOLAR POWER PLANT  
CONSTRUCTION, IN CLASS 37 (U.S. CLS. 100, 103 AND 106).

FIRST USE 8-0-2003; IN COMMERCE 8-0-2003.

OWNER OF U.S. REG. NO. 3,790,059.

NO CLAIM IS MADE TO THE EXCLUSIVE RIGHT TO USE "POWER, RENEWABLES, INC",  
APART FROM THE MARK AS SHOWN.

THE MARK CONSISTS OF THE STYLIZED WORDS PACIFIC POWER ABOVE THE WORDS  
RENEWABLES, INC JUSTIFIED RIGHT IN STYLIZED FONT. TO THE LEFT OF THE WORDS  
IS A STYLIZED DRAWING OF A CIRCLE FORMED WITH ELECTRIC BOLTS.

SER. NO. 85-410,578, FILED 8-30-2011.

FRANK LATTUCA, EXAMINING ATTORNEY



*David J. Kybas*

Director of the United States Patent and Trademark Office



# United States of America

United States Patent and Trademark Office

## WELCOMING TRANSPLANT FAMILIES HOME.

**Reg. No. 4,135,084**

**Registered May 1, 2012**

**Int. Cl.: 43**

**SERVICE MARK**

**PRINCIPAL REGISTER**

GREATER DELAWARE VALLEY SOCIETY OF TRANSPLANT SURGEONS  
(PENNSYLVANIA NON-PROFIT CORPORATION)  
401 N. THIRD STREET  
PHILADELPHIA, PA 19123

FOR: ARRANGING TEMPORARY HOUSING ACCOMMODATIONS; PROVIDING TEMPORARY HOUSING ACCOMMODATIONS, IN CLASS 43 (U.S. CLS. 100 AND 101).

FIRST USE 11-0-2009; IN COMMERCE 11-0-2009.

THE MARK CONSISTS OF STANDARD CHARACTERS WITHOUT CLAIM TO ANY PARTICULAR FONT, STYLE, SIZE, OR COLOR.

SER. NO. 85-410,581, FILED 8-30-2011.

FLORENTINA BLANDU, EXAMINING ATTORNEY



*David J. Kyjars*

Director of the United States Patent and Trademark Office

# United States of America

United States Patent and Trademark Office

# SENTIRIS

**Reg. No. 4,135,085**

**Registered May 1, 2012**

**Int. Cl.: 9**

**TRADEMARK**

**PRINCIPAL REGISTER**

QUANTUM3D, INC. (CALIFORNIA CORPORATION)  
5400 HELLYER AVE  
SAN JOSE, CA 95138

FOR: COMPUTER HARDWARE AND SOFTWARE, NAMELY, EMBEDDED GRAPHICS MODULES USED IN COMMERCIAL AND MILITARY GROUND VEHICLES AND AIRCRAFT AND MARITIME DISPLAYS, IN CLASS 9 (U.S. CLS. 21, 23, 26, 36 AND 38).

FIRST USE 2-19-2002; IN COMMERCE 2-19-2002.

THE MARK CONSISTS OF STANDARD CHARACTERS WITHOUT CLAIM TO ANY PARTICULAR FONT, STYLE, SIZE, OR COLOR.

SER. NO. 85-410,582, FILED 8-30-2011.

KHANH LE, EXAMINING ATTORNEY



*David J. Kyffers*

Director of the United States Patent and Trademark Office

# United States of America

United States Patent and Trademark Office

## INDEPENDENCE FROM HUNGER

**Reg. No. 4,135,086**

**Registered May 1, 2012**

**Int. Cl.: 35**

**SERVICE MARK**

**PRINCIPAL REGISTER**

GROCERY OUTLET INC. (CALIFORNIA CORPORATION)  
2000 FIFTH STREET  
BERKELEY, CA 94710

FOR: CHARITABLE SERVICES, NAMELY, ORGANIZING AND CONDUCTING FOOD DRIVES FOR FOOD BANKS, IN CLASS 35 (U.S. CLS. 100, 101 AND 102).

FIRST USE 6-8-2011; IN COMMERCE 6-8-2011.

THE MARK CONSISTS OF STANDARD CHARACTERS WITHOUT CLAIM TO ANY PARTICULAR FONT, STYLE, SIZE, OR COLOR.

SER. NO. 85-410,590, FILED 8-30-2011.

RENEE MCCRAY, EXAMINING ATTORNEY



*David J. Kybas*

Director of the United States Patent and Trademark Office

# United States of America

United States Patent and Trademark Office

## IN THE SPHERE

**Reg. No. 4,135,087**

**Registered May 1, 2012**

**Int. Cl.: 41**

**SERVICE MARK**

**PRINCIPAL REGISTER**

PHTHISIS DIAGNOSTICS, INC. (DELAWARE CORPORATION)  
705 DALE AVENUE  
CHARLOTTESVILLE, VA 22903

FOR: ON-LINE JOURNALS, NAMELY, BLOGS FEATURING CONTENT IN THE FIELD OF SCIENCE AND MEDICINE, IN CLASS 41 (U.S. CLS. 100, 101 AND 107).

FIRST USE 7-11-2011; IN COMMERCE 7-11-2011.

THE MARK CONSISTS OF STANDARD CHARACTERS WITHOUT CLAIM TO ANY PARTICULAR FONT, STYLE, SIZE, OR COLOR.

SER. NO. 85-410,595, FILED 8-30-2011.

ANNE E. GUSTASON, EXAMINING ATTORNEY



*David J. Kyffers*

Director of the United States Patent and Trademark Office

# United States of America

United States Patent and Trademark Office

## INDEPENDENCE FROM HUNGER

**Reg. No. 4,135,088**

**Registered May 1, 2012**

**Int. Cl.: 36**

**SERVICE MARK**

**PRINCIPAL REGISTER**

GROCERY OUTLET INC. (CALIFORNIA CORPORATION)  
2000 FIFTH STREET  
BERKELEY, CA 94710

FOR: CHARITABLE FUNDRAISING SERVICES ON BEHALF OF FOOD BANKS, IN CLASS 36 (U.S. CLS. 100, 101 AND 102).

FIRST USE 6-8-2011; IN COMMERCE 6-8-2011.

THE MARK CONSISTS OF STANDARD CHARACTERS WITHOUT CLAIM TO ANY PARTICULAR FONT, STYLE, SIZE, OR COLOR.

SER. NO. 85-410,597, FILED 8-30-2011.

RENEE MCCRAY, EXAMINING ATTORNEY



*David J. Kybas*

Director of the United States Patent and Trademark Office

# United States of America

United States Patent and Trademark Office

# SPARTAN

**Reg. No. 4,135,089**

HARTMANN USA, INC. (SOUTH CAROLINA CORPORATION)  
481 LAKESHORE PARKWAY  
ROCK HILL, SC 29730

**Registered May 1, 2012**

**Int. Cl.: 5**

FOR: INCONTINENCE PANTS FOR ADULTS, IN CLASS 5 (U.S. CLS. 6, 18, 44, 46, 51 AND 52).

**TRADEMARK**

FIRST USE 12-31-2008; IN COMMERCE 12-31-2008.

**PRINCIPAL REGISTER**

THE MARK CONSISTS OF STANDARD CHARACTERS WITHOUT CLAIM TO ANY PARTICULAR FONT, STYLE, SIZE, OR COLOR.

OWNER OF U.S. REG. NO. 2,997,400.

SER. NO. 85-410,615, FILED 8-30-2011.

LINDA MICKLEBURGH, EXAMINING ATTORNEY



*David J. Kybas*

Director of the United States Patent and Trademark Office

United States of America  
United States Patent and Trademark Office

Remodo  
MY ROOM MY DESIGN

**Reg. No. 4,135,090**

**Registered May 1, 2012**

**Int. Cls.: 35 and 42**

**SERVICE MARK**

**PRINCIPAL REGISTER**

WHITNEY DESIGN GROUP, LLC (DELAWARE LIMITED LIABILITY COMPANY)  
2001 KIRBY DRIVE, SUITE 603  
HOUSTON, TX 77019

FOR: ON-LINE RETAIL STORE SERVICES FEATURING FURNITURE AND INTERIOR DESIGN ACCESSORIES; RETAIL FURNITURE STORES; RETAIL STORE SERVICES FEATURING FURNITURE AND INTERIOR DESIGN ACCESSORIES, IN CLASS 35 (U.S. CLS. 100, 101 AND 102).

FIRST USE 8-1-2011; IN COMMERCE 8-1-2011.

FOR: DESIGN OF INTERIOR DECOR; DESIGN OF SPECIALTY INTERIOR AND EXTERIOR ENVIRONMENT SETTINGS; FURNITURE DESIGN SERVICES; INTERIOR DECORATING; INTERIOR DECORATION CONSULTATION; INTERIOR DESIGN SERVICES; INTERIOR DESIGN SERVICES INCLUDING SPACE PLANNING, FURNITURE SELECTION, MATERIAL AND SURFACE SELECTION; INTERIOR STYLING SERVICES, IN CLASS 42 (U.S. CLS. 100 AND 101).

FIRST USE 8-1-2011; IN COMMERCE 8-1-2011.

THE MARK CONSISTS OF THE WORD "REMODO" IN STYLIZED, CURSIVE LETTERING, WITH THE PHRASE "MY ROOM MY DESIGN" BENEATH IT.

SER. NO. 85-410,622, FILED 8-30-2011.

SHAILA SETTLES, EXAMINING ATTORNEY



*David J. Kyros*

Director of the United States Patent and Trademark Office

# United States of America

United States Patent and Trademark Office

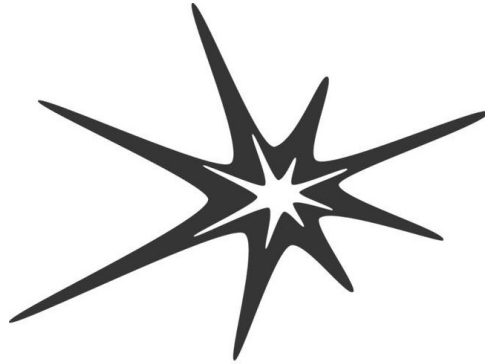

**Reg. No. 4,135,091**

**Registered May 1, 2012**

**Int. Cls.: 35 and 41**

**SERVICE MARK**

**PRINCIPAL REGISTER**

SPARKSPACE, LTD. (OHIO LIMITED LIABILITY COMPANY)  
300 MARCONI BOULEVARD, SUITE 206  
COLUMBUS, OH 43215

FOR: PROVIDING FACILITIES FOR BUSINESS AND NONPROFIT MEETINGS, IN CLASS 35 (U.S. CLS. 100, 101 AND 102).

FIRST USE 12-1-1999; IN COMMERCE 12-1-1999.

FOR: CONDUCTING CLASSES, WORKSHOPS AND SEMINARS AND DISTRIBUTING COURSE MATERIALS THEREWITH IN THE FIELDS OF TEAMWORK AND PERSONAL SKILL DEVELOPMENT; PROVIDING FACILITIES FOR WORKSHOPS AND SEMINARS, IN CLASS 41 (U.S. CLS. 100, 101 AND 107).

FIRST USE 12-1-1999; IN COMMERCE 12-1-1999.

OWNER OF U.S. REG. NO. 3,123,456.

THE MARK CONSISTS OF A MISCELLANEOUS DESIGN DEPICTING A SPARK WITH EIGHT POINTS OF VARYING LENGTHS WITH THE SAME SPARK DESIGN IN THE MIDDLE.

SER. NO. 85-410,642, FILED 8-30-2011.

BERNICE MIDDLETON, EXAMINING ATTORNEY



*David J. Kybas*

Director of the United States Patent and Trademark Office



# United States of America

United States Patent and Trademark Office



**Dondlinger**  
CONSTRUCTION

**Reg. No. 4,135,092**

**Registered May 1, 2012**

**Int. Cl.: 37**

**SERVICE MARK**

**PRINCIPAL REGISTER**

DONDLINGER & SONS CONSTRUCTION CO., INC. (KANSAS CORPORATION)  
2656 S. SHERIDAN  
P.O. BOX 398  
WICHITA, KS 67201

FOR: GENERAL CONSTRUCTION CONTRACTING, IN CLASS 37 (U.S. CLS. 100, 103 AND 106).

FIRST USE 2-9-2011; IN COMMERCE 2-9-2011.

OWNER OF U.S. REG. NO. 2,130,067.

THE COLOR(S) BLACK, YELLOW, AND GRAY IS/ARE CLAIMED AS A FEATURE OF THE MARK.

NO CLAIM IS MADE TO THE EXCLUSIVE RIGHT TO USE "CONSTRUCTION", APART FROM THE MARK AS SHOWN.

THE MARK IS MADE UP OF A "D" WITH BLACK AND YELLOW STRIPES THAT EMULATE CONSTRUCTION STRIPES. TO THE RIGHT OF THE "D" IS THE WORD "DONDLINGER" IN BLACK. STACKED UNDERNEATH "DONDLINGER" IS "CONSTRUCTION" WHICH IS SMALLER AND PLACED IN BETWEEN THE "D" AND THE "G" IN "DONDLINGER". "CONSTRUCTION" IS IN GRAY.

SER. NO. 85-410,660, FILED 8-30-2011.

FLORENTINA BLANDU, EXAMINING ATTORNEY



*David J. Kybas*

Director of the United States Patent and Trademark Office

# United States of America

United States Patent and Trademark Office

# NETTALON

**Reg. No. 4,135,093**

**Registered May 1, 2012**

**Int. Cl.: 9**

**TRADEMARK**

**PRINCIPAL REGISTER**

NETTALON SECURITY SYSTEMS, INCORPORATED (VIRGINIA CORPORATION)  
3324 BOURBON STREET  
FREDERICKSBURG, VA 22408

FOR: FIRE AND SECURITY ALARM AND ALARM MONITORING SYSTEMS, IN CLASS 9  
(U.S. CLS. 21, 23, 26, 36 AND 38).

FIRST USE 7-31-2004; IN COMMERCE 7-31-2004.

THE MARK CONSISTS OF STANDARD CHARACTERS WITHOUT CLAIM TO ANY PARTICULAR FONT, STYLE, SIZE, OR COLOR.

SER. NO. 85-410,661, FILED 8-30-2011.

RUDY R. SINGLETON, EXAMINING ATTORNEY



*David J. Kyffers*

Director of the United States Patent and Trademark Office

# United States of America

United States Patent and Trademark Office



**Reg. No. 4,135,094**

**Registered May 1, 2012**

**Int. Cl.: 9**

**TRADEMARK**

**PRINCIPAL REGISTER**

NETTALON SECURITY SYSTEMS, INCORPORATED (VIRGINIA CORPORATION)  
3324 BOURBON STREET  
FREDERICKSBURG, VA 22408

FOR: FIRE AND SECURITY ALARM AND ALARM MONITORING SYSTEMS, IN CLASS 9  
(U.S. CLS. 21, 23, 26, 36 AND 38).

FIRST USE 7-31-2004; IN COMMERCE 7-31-2004.

THE MARK CONSISTS OF THE WORD NETTALON WITH A HALF CIRCLE ABOVE THE  
"ALON" CONTAINING A BIRD IN A LANDING POSE WITH TALONS OUTSTRETCHED.

SER. NO. 85-410,669, FILED 8-30-2011.

RUDY R. SINGLETON, EXAMINING ATTORNEY



*David J. Kyffers*

Director of the United States Patent and Trademark Office

# United States of America

United States Patent and Trademark Office



**Reg. No. 4,135,095**

**Registered May 1, 2012**

**Int. Cl.: 35**

**SERVICE MARK**

**PRINCIPAL REGISTER**

TRIANGLECABLES.COM, LLC (FLORIDA LIMITED LIABILITY COMPANY)  
1969 S. ALAFAYA TRAIL  
ORLANDO, FL 32828

FOR: PROMOTING THE GOODS AND SERVICES OF OTHERS BY PROVIDING A WEBSITE DISTRIBUTING ELECTRONIC COMPONENTS; PROVIDING A SEARCHABLE ONLINE ADVERTISING WEBSITE AND INFORMATIONAL GUIDE FEATURING THE GOODS AND SERVICES OF OTHER VENDORS VIA THE INTERNET IN THE FIELD OF ELECTRONIC COMPONENTS; PROVIDING AN INTERNET WEBSITE PORTAL FEATURING PROMOTION AND ADVERTISING FOR HOME SERVICE PROVIDERS AND PRODUCT MANUFACTURERS, IN CLASS 35 (U.S. CLS. 100, 101 AND 102).

FIRST USE 7-10-1999; IN COMMERCE 7-10-1999.

NO CLAIM IS MADE TO THE EXCLUSIVE RIGHT TO USE "CABLES", APART FROM THE MARK AS SHOWN.

THE MARK CONSISTS OF THE CAPITALIZED AND STYLIZED WORD "TRIANGLE" ABOVE THE CAPITALIZED WORD "CABLES" WITH A DEPICTION OF AN ELECTRONIC CONNECTOR/CABLE.

SER. NO. 85-410,684, FILED 8-30-2011.

ROSELLE HERRERA, EXAMINING ATTORNEY



*David J. Kybas*

Director of the United States Patent and Trademark Office

# United States of America

United States Patent and Trademark Office

**HEMOPTYSIS**

**Reg. No. 4,135,096**

**Registered May 1, 2012**

**Int. Cl.: 41**

**SERVICE MARK**

**PRINCIPAL REGISTER**

MURASHITA MASAKI (JAPAN INDIVIDUAL), AKA HEMOPTYSIS  
APT 208  
242 S BECK AVE  
TEMPE, AZ 85281

FOR: ENTERTAINMENT SERVICES IN THE NATURE OF LIVE MUSICAL PERFORMANCES,  
IN CLASS 41 (U.S. CLS. 100, 101 AND 107).

FIRST USE 9-4-2009; IN COMMERCE 9-4-2009.

THE MARK CONSISTS OF THE STYLIZED WORDING "HEMOPTYSIS" APPEARING IN  
THE COLOR RED WITH A BLACK OUTLINE. IN BETWEEN THE RED LETTERING IN THE  
MARK AND THE BLACK OUTLINE IS A WHITE BORDER SURROUNDING THE TERM  
"HEMOPTYSIS".

THE COLOR(S) RED, WHITE, AND BLACK IS/ARE CLAIMED AS A FEATURE OF THE  
MARK.

SER. NO. 85-410,690, FILED 8-30-2011.

MICHAEL WEBSTER, EXAMINING ATTORNEY



*David J. Kyros*

Director of the United States Patent and Trademark Office

# United States of America

United States Patent and Trademark Office

# intelliVOL

**Reg. No. 4,135,097**

**Registered May 1, 2012**

**Int. Cl.: 42**

**SERVICE MARK**

**PRINCIPAL REGISTER**

FIVE FOR A DOLLAR, LLC (TEXAS LIMITED LIABILITY COMPANY)  
P. O. BOX 613  
COPPELL, TX 75019

FOR: PROVIDING TEMPORARY USE OF ON-LINE NON-DOWNLOADABLE COMPUTER SOFTWARE THAT TRACKS VOLUNTEER HOURS AND ACTIVITIES, MANAGES VOLUNTEER PROJECTS AND MEASURES IMPACT ON THE COMMUNITY, IN CLASS 42 (U.S. CLS. 100 AND 101).

FIRST USE 12-0-2008; IN COMMERCE 12-0-2008.

THE MARK CONSISTS OF STANDARD CHARACTERS WITHOUT CLAIM TO ANY PARTICULAR FONT, STYLE, SIZE, OR COLOR.

SER. NO. 85-410,695, FILED 8-30-2011.

EVELYN BRADLEY, EXAMINING ATTORNEY



*David J. Kyros*

Director of the United States Patent and Trademark Office

# United States of America

United States Patent and Trademark Office

# Glamamom

**Reg. No. 4,135,098**

JAS CAPITAL, LLC (DELAWARE LIMITED LIABILITY COMPANY)  
19C TROLLEY SQUARE  
WILMINGTON, DE 19806

**Registered May 1, 2012**

**Int. Cl.: 41**

FOR: ON-LINE JOURNALS, NAMELY, BLOGS FEATURING INFORMATION AND ADVICE ABOUT FASHION, FITNESS, LIFESTYLE, CITY-LIVING, MOTHERHOOD, PARENTING, CHILDREN AND REVIEWS OF PRODUCTS FOR WOMEN, MOTHERS, PARENTS AND CHILDREN, IN CLASS 41 (U.S. CLS. 100, 101 AND 107).

**SERVICE MARK**

**PRINCIPAL REGISTER**

FIRST USE 4-19-2010; IN COMMERCE 5-24-2010.

THE MARK CONSISTS OF STANDARD CHARACTERS WITHOUT CLAIM TO ANY PARTICULAR FONT, STYLE, SIZE, OR COLOR.

SER. NO. 85-410,699, FILED 8-30-2011.

WENDY GOODMAN, EXAMINING ATTORNEY



*David J. Kybas*

Director of the United States Patent and Trademark Office

# United States of America

United States Patent and Trademark Office

# x2VOL

**Reg. No. 4,135,099**

**Registered May 1, 2012**

**Int. Cl.: 42**

**SERVICE MARK**

**PRINCIPAL REGISTER**

FIVE FOR A DOLLAR, LLC (TEXAS LIMITED LIABILITY COMPANY)  
P. O. BOX 613  
COPPELL, TX 75019

FOR: PROVIDING TEMPORARY USE OF ON-LINE NON-DOWNLOADABLE COMPUTER SOFTWARE THAT TRACKS VOLUNTEER HOURS AND ACTIVITIES, MANAGES VOLUNTEER PROJECTS AND MEASURES IMPACT ON THE COMMUNITY, IN CLASS 42 (U.S. CLS. 100 AND 101).

FIRST USE 12-0-2008; IN COMMERCE 12-0-2008.

THE MARK CONSISTS OF STANDARD CHARACTERS WITHOUT CLAIM TO ANY PARTICULAR FONT, STYLE, SIZE, OR COLOR.

SER. NO. 85-410,712, FILED 8-30-2011.

EVELYN BRADLEY, EXAMINING ATTORNEY



*David J. Kybas*

Director of the United States Patent and Trademark Office



# United States of America

United States Patent and Trademark Office

## Every Hour Counts!

**Reg. No. 4,135,100**

**Registered May 1, 2012**

**Int. Cl.: 42**

**SERVICE MARK**

**PRINCIPAL REGISTER**

FIVE FOR A DOLLAR, LLC (TEXAS LIMITED LIABILITY COMPANY)  
P. O. BOX 613  
COPPELL, TX 75019

FOR: PROVIDING TEMPORARY USE OF ON-LINE NON-DOWNLOADABLE COMPUTER SOFTWARE THAT TRACKS VOLUNTEER HOURS AND ACTIVITIES, MANAGES VOLUNTEER PROJECTS AND MEASURES IMPACT ON THE COMMUNITY, IN CLASS 42 (U.S. CLS. 100 AND 101).

FIRST USE 12-0-2008; IN COMMERCE 12-0-2008.

THE MARK CONSISTS OF STANDARD CHARACTERS WITHOUT CLAIM TO ANY PARTICULAR FONT, STYLE, SIZE, OR COLOR.

SER. NO. 85-410,727, FILED 8-30-2011.

EVELYN BRADLEY, EXAMINING ATTORNEY



*David J. Kyjars*

Director of the United States Patent and Trademark Office

# United States of America

United States Patent and Trademark Office

## SUPREME TENDER

**Reg. No. 4,135,101**

**Registered May 1, 2012**

**Int. Cl.: 29**

**TRADEMARK**

**PRINCIPAL REGISTER**

TYSON FRESH MEATS, INC. (DELAWARE CORPORATION)  
2200 DON TYSON PARKWAY  
SPRINGDALE, AR 72762

FOR: MEAT, IN CLASS 29 (U.S. CL. 46).

FIRST USE 2-1-1998; IN COMMERCE 2-1-1998.

THE MARK CONSISTS OF STANDARD CHARACTERS WITHOUT CLAIM TO ANY PARTICULAR FONT, STYLE, SIZE, OR COLOR.

OWNER OF U.S. REG. NO. 2,306,706.

SEC. 2(F).

SER. NO. 85-410,740, FILED 8-30-2011.

FLORENTINA BLANDU, EXAMINING ATTORNEY



*David J. Kybas*

Director of the United States Patent and Trademark Office

# United States of America

United States Patent and Trademark Office

# MyStage

**Reg. No. 4,135,102**

**Registered May 1, 2012**

**Int. Cl.: 9**

**TRADEMARK**

**PRINCIPAL REGISTER**

PONDANET INC (CALIFORNIA CORPORATION), DBA US KARAOKE  
1179 N PATT ST.  
ANAHEIM, CA 92801

FOR: KARAOKE PLAYERS, IN CLASS 9 (U.S. CLS. 21, 23, 26, 36 AND 38).

FIRST USE 8-30-2011; IN COMMERCE 8-30-2011.

THE MARK CONSISTS OF STANDARD CHARACTERS WITHOUT CLAIM TO ANY PARTICULAR FONT, STYLE, SIZE, OR COLOR.

SER. NO. 85-410,742, FILED 8-30-2011.

FLORENTINA BLANDU, EXAMINING ATTORNEY



*David J. Kybas*

Director of the United States Patent and Trademark Office

# United States of America

United States Patent and Trademark Office

# IntraCrete

**Reg. No. 4,135,103**

**Registered May 1, 2012**

**Int. Cl.: 37**

**SERVICE MARK**

**PRINCIPAL REGISTER**

LIPAN, ANDREA (UNITED STATES INDIVIDUAL)  
13411 W CITRUS CT.  
LITCHFIELD PARK, AZ 85340

FOR: DECORATIVE CONCRETE COATING INSTALLATION SERVICES, NAMELY, INSTALLATION AND APPLICATION OF ACRYLIC LACE, ACRYLIC OVERLAYS, ACID STAINING, EPOXY FLOORING, STAMPED OVERLAYING, AND REMOVAL OF EXISTING OVERLAYS, IN CLASS 37 (U.S. CLS. 100, 103 AND 106).

FIRST USE 7-16-2006; IN COMMERCE 7-16-2006.

THE MARK CONSISTS OF STANDARD CHARACTERS WITHOUT CLAIM TO ANY PARTICULAR FONT, STYLE, SIZE, OR COLOR.

SER. NO. 85-410,744, FILED 8-30-2011.

FLORENTINA BLANDU, EXAMINING ATTORNEY



*David J. Kyffers*

Director of the United States Patent and Trademark Office

# United States of America

United States Patent and Trademark Office

# UnitedHire

**Reg. No. 4,135,104**

AMERICAREERS LLC (MICHIGAN LIMITED LIABILITY COMPANY)  
PO BOX 21126  
LANSING, MI 48909

**Registered May 1, 2012**

**Int. Cl.: 35**

FOR: EMPLOYMENT ADVERTISING, RECRUITING, STAFFING AND CAREER NETWORKING SERVICES, IN CLASS 35 (U.S. CLS. 100, 101 AND 102).

**SERVICE MARK**

FIRST USE 8-30-2011; IN COMMERCE 8-30-2011.

**PRINCIPAL REGISTER**

THE MARK CONSISTS OF STANDARD CHARACTERS WITHOUT CLAIM TO ANY PARTICULAR FONT, STYLE, SIZE, OR COLOR.

SER. NO. 85-410,749, FILED 8-30-2011.

BARNEY CHARLON, EXAMINING ATTORNEY



*David J. Kyffers*

Director of the United States Patent and Trademark Office

# United States of America

United States Patent and Trademark Office



Good health. Good business. Great schools.

**Reg. No. 4,135,105**

**Registered May 1, 2012**

**Int. Cl.: 36**

**SERVICE MARK**

**PRINCIPAL REGISTER**

MICHIGAN EDUCATION SPECIAL SERVICES ASSOCIATION (MICHIGAN CORPORATION)  
1475 KENDALE BLVD.  
EAST LANSING, MI 48823

FOR: HEALTH INSURANCE ADMINISTRATION, BROKERAGE AND UNDERWRITING  
FOR EDUCATIONAL EMPLOYEES, IN CLASS 36 (U.S. CLS. 100, 101 AND 102).

FIRST USE 9-7-2010; IN COMMERCE 9-7-2010.

OWNER OF U.S. REG. NOS. 2,708,651, 2,787,100, AND 2,986,733.

THE MARK CONSISTS OF THE STYLIZED WORDING "MESSA GOOD HEALTH. GOOD  
BUSINESS. GREAT SCHOOLS." AND THE DESIGN OF THREE STICK FIGURES HOLDING  
HANDS AND FORMING A CIRCLE. THE DESIGN APPEARS TO THE LEFT OF THE WORD  
"MESSA" AND THE WORDING "GOOD HEALTH. GOOD BUSINESS. GREAT SCHOOLS."  
APPEARS IN SMALLER TYPE BELOW.

SER. NO. 85-410,750, FILED 8-30-2011.

JERI J. FICKES, EXAMINING ATTORNEY



*David J. Kybas*

Director of the United States Patent and Trademark Office

# United States of America

United States Patent and Trademark Office

# Vive Mobile

**Reg. No. 4,135,106**

**Registered May 1, 2012**

**Int. Cl.: 38**

**SERVICE MARK**

**PRINCIPAL REGISTER**

RMR ENTERPRISES LLC (FLORIDA LIMITED LIABILITY COMPANY)  
#318  
16850-122 COLLINS AVE  
SUNNY ISLE, FL 33160

FOR: TELECOMMUNICATION SERVICES, NAMELY, PROVIDING INTERNET ACCESS VIA BROADBAND OPTICAL OR WIRELESS NETWORKS; TELECOMMUNICATION SERVICES, NAMELY, WIRELESS TELEPHONE SERVICES, IN CLASS 38 (U.S. CLS. 100, 101 AND 104).

FIRST USE 1-1-2008; IN COMMERCE 3-1-2011.

THE MARK CONSISTS OF STANDARD CHARACTERS WITHOUT CLAIM TO ANY PARTICULAR FONT, STYLE, SIZE, OR COLOR.

NO CLAIM IS MADE TO THE EXCLUSIVE RIGHT TO USE "MOBILE", APART FROM THE MARK AS SHOWN.

SER. NO. 85-410,786, FILED 8-30-2011.

ESTHER BELENKER, EXAMINING ATTORNEY



*David J. Kyffers*

Director of the United States Patent and Trademark Office

# United States of America

United States Patent and Trademark Office

## Project Engage!

**Reg. No. 4,135,107**

**Registered May 1, 2012**

**Int. Cl.: 41**

**SERVICE MARK**

**PRINCIPAL REGISTER**

MASSACHUSETTS ACADEMY OF SCIENCES CORPORATION (MASSACHUSETTS CORPORATION)  
611 N. PLEASANT STREET  
AMHERST, MA 01003

FOR: PROVIDING SCIENCE EDUCATIONAL MENTORING SERVICES AND PROGRAMS, IN CLASS 41 (U.S. CLS. 100, 101 AND 107).

FIRST USE 8-25-2011; IN COMMERCE 8-25-2011.

THE MARK CONSISTS OF STANDARD CHARACTERS WITHOUT CLAIM TO ANY PARTICULAR FONT, STYLE, SIZE, OR COLOR.

NO CLAIM IS MADE TO THE EXCLUSIVE RIGHT TO USE "PROJECT", APART FROM THE MARK AS SHOWN.

SER. NO. 85-410,799, FILED 8-30-2011.

CHERYL CLAYTON, EXAMINING ATTORNEY



*David J. Kybas*

Director of the United States Patent and Trademark Office



# United States of America

United States Patent and Trademark Office

# روتانا خليجية

**Reg. No. 4,135,108**

**Registered May 1, 2012**

**Int. Cl.: 38**

**SERVICE MARK**

**PRINCIPAL REGISTER**

ROTANA AUDIO VISUAL CO. (SAUDI ARABIA COMPANY)  
P.O. BOX 1  
RIYADH 11321, SAUDI ARABIA

FOR: TELECOMMUNICATION SERVICES, NAMELY, TELEVISION BROADCASTING SERVICES, RADIO BROADCASTING SERVICES AND SATELLITE TRANSMISSION, IN CLASS 38 (U.S. CLS. 100, 101 AND 104).

OWNER OF JORDAN REG. NO. 97029, DATED 9-24-2008, EXPIRES 11-27-2017.

THE NON-LATIN CHARACTERS IN THE MARK TRANSLITERATE TO "ROTANA KHALI-GIYAH" AND THIS MEANS "THE BEAUTIFUL AND THE TASTY GULF" IN ENGLISH.

NO CLAIM IS MADE TO THE EXCLUSIVE RIGHT TO USE THE NON-LATIN CHARACTERS THAT TRANSLITERATE TO GULF, APART FROM THE MARK AS SHOWN.

THE MARK CONSISTS OF NON-LATIN CHARACTERS.

SER. NO. 85-410,803, FILED 8-30-2011.

ARETHA SOMERVILLE, EXAMINING ATTORNEY



*David J. Kypos*

Director of the United States Patent and Trademark Office

# United States of America

United States Patent and Trademark Office

# Garads

**Reg. No. 4,135,109**

**Registered May 1, 2012**

**Int. Cl.: 35**

**SERVICE MARK**

**PRINCIPAL REGISTER**

GONZALEZ, JOSE LUIS, MR. (UNITED STATES INDIVIDUAL)  
534 SAN ANTONIO AVE.  
CORAL GABLES, FL 33146

FOR: ADVERTISING SERVICES, IN CLASS 35 (U.S. CLS. 100, 101 AND 102).

FIRST USE 1-15-2011; IN COMMERCE 6-1-2011.

THE MARK CONSISTS OF STANDARD CHARACTERS WITHOUT CLAIM TO ANY PARTICULAR FONT, STYLE, SIZE, OR COLOR.

SER. NO. 85-410,804, FILED 8-30-2011.

CHERYL CLAYTON, EXAMINING ATTORNEY



*David J. Kybas*

Director of the United States Patent and Trademark Office

# United States of America

United States Patent and Trademark Office

## GO BIG OR GO HOME.

**Reg. No. 4,135,110**

**Registered May 1, 2012**

**Int. Cl.: 41**

**SERVICE MARK**

**PRINCIPAL REGISTER**

REGAL ENTERTAINMENT GROUP (DELAWARE CORPORATION)  
7132 REGAL LANE  
KNOXVILLE, TN 37918

FOR: MOVIE THEATER SERVICES, IN CLASS 41 (U.S. CLS. 100, 101 AND 107).

FIRST USE 7-15-2011; IN COMMERCE 7-15-2011.

THE MARK CONSISTS OF STANDARD CHARACTERS WITHOUT CLAIM TO ANY PARTICULAR FONT, STYLE, SIZE, OR COLOR.

SER. NO. 85-410,832, FILED 8-30-2011.

SUNG IN, EXAMINING ATTORNEY



*David J. Kybas*

Director of the United States Patent and Trademark Office

# United States of America

United States Patent and Trademark Office

# Salon Red

**Reg. No. 4,135,111**

**Registered May 1, 2012**

**Int. Cl.: 44**

**SERVICE MARK**

**PRINCIPAL REGISTER**

SALON RED INC. (GEORGIA CORPORATION)  
1642 N. DEKALB AVE.  
ATLANTA, GA 30307

FOR: BEAUTY SPA SERVICES, NAMELY, COSMETIC BODY CARE; HAIR SALON SERVICES, IN CLASS 44 (U.S. CLS. 100 AND 101).

FIRST USE 1-1-1999; IN COMMERCE 1-1-1999.

THE MARK CONSISTS OF STANDARD CHARACTERS WITHOUT CLAIM TO ANY PARTICULAR FONT, STYLE, SIZE, OR COLOR.

NO CLAIM IS MADE TO THE EXCLUSIVE RIGHT TO USE "SALON", APART FROM THE MARK AS SHOWN.

SER. NO. 85-410,833, FILED 8-30-2011.

WENDY GOODMAN, EXAMINING ATTORNEY



*David J. Kybas*

Director of the United States Patent and Trademark Office

# United States of America

United States Patent and Trademark Office

## CLIQUORSTORE

**Reg. No. 4,135,112**

**Registered May 1, 2012**

**Int. Cl.: 35**

**SERVICE MARK**

**PRINCIPAL REGISTER**

CLIQUORSTORE, INC. (MINNESOTA CORPORATION)  
909 FIRETHORNE TRAIL  
JORDAN, MN 55352

FOR: PROMOTING THE GOODS AND SERVICES OF OTHERS IN THE FIELD OF RETAIL LIQUOR STORES BY PROVIDING A COMMUNITY-DRIVEN WEBSITE, DISTRIBUTING COUPONS, AND PROVIDING HYPERLINKS TO WEBSITES OF OTHER, IN CLASS 35 (U.S. CLS. 100, 101 AND 102).

FIRST USE 4-1-2011; IN COMMERCE 8-1-2011.

THE MARK CONSISTS OF THE STYLIZED TEXT "CLIQUORSTORE" IN WHICH THE LETTER "R" IS REVERSED.

SER. NO. 85-410,835, FILED 8-30-2011.

WENDY GOODMAN, EXAMINING ATTORNEY



*David J. Kybas*

Director of the United States Patent and Trademark Office

# United States of America

United States Patent and Trademark Office

## ReVenture Park

**Reg. No. 4,135,113**

**Registered May 1, 2012**

**Int. Cl.: 37**

**SERVICE MARK**

**PRINCIPAL REGISTER**

REVENTURE PARK INVESTMENTS I, LLC (NORTH CAROLINA LIMITED LIABILITY COMPANY)  
5320 OLD PINEVILLE ROAD  
CHARLOTTE, NC 28217

FOR: REAL ESTATE DEVELOPMENT, IN CLASS 37 (U.S. CLS. 100, 103 AND 106).

FIRST USE 10-1-2009; IN COMMERCE 10-1-2009.

THE MARK CONSISTS OF STANDARD CHARACTERS WITHOUT CLAIM TO ANY PARTICULAR FONT, STYLE, SIZE, OR COLOR.

SER. NO. 85-410,842, FILED 8-30-2011.

SUNG IN, EXAMINING ATTORNEY



*David J. Kyffers*

Director of the United States Patent and Trademark Office

# United States of America

United States Patent and Trademark Office

## A POWERFUL COMBINATION OF LEGAL AND BUSINESS ACUMEN

**Reg. No. 4,135,114**

**Registered May 1, 2012**

**Int. Cl.: 45**

**SERVICE MARK**

**PRINCIPAL REGISTER**

MITCHELL MILLER, A PROFESSIONAL CORPORATION (CALIFORNIA CORPORATION),  
DBA MILLER LAW GROUP, P.C.  
260 SHERIDAN AVENUE, SUITE 208  
PALO ALTO, CA 94306

FOR: LEGAL SERVICES, IN CLASS 45 (U.S. CLS. 100 AND 101).

FIRST USE 9-21-2007; IN COMMERCE 9-21-2007.

THE MARK CONSISTS OF STANDARD CHARACTERS WITHOUT CLAIM TO ANY PARTICULAR FONT, STYLE, SIZE, OR COLOR.

SER. NO. 85-410,851, FILED 8-30-2011.

CHERYL CLAYTON, EXAMINING ATTORNEY



*David J. Kybas*

Director of the United States Patent and Trademark Office

# United States of America

United States Patent and Trademark Office

## OPCLOUD.COM

**Reg. No. 4,135,115**

**Registered May 1, 2012**

**Int. Cl.: 42**

**SERVICE MARK**

**PRINCIPAL REGISTER**

CYBERCOM INC (HAWAII CORPORATION)  
PO BOX 240596  
HONOLULU, HI 96824

FOR: CLOUD COMPUTING FEATURING SOFTWARE FOR USE IN DATABASE MANAGEMENT, WEB APPLICATIONS, ELECTRONIC EMAIL, DOCUMENT STORAGE, AND INTRANET DEVELOPMENT; COMPUTER SERVICES, NAMELY, CLOUD HOSTING PROVIDER SERVICES; COMPUTER SERVICES, NAMELY, INTEGRATION OF PRIVATE AND PUBLIC CLOUD COMPUTING ENVIRONMENTS; CONSULTING SERVICES IN THE FIELD OF CLOUD COMPUTING; TECHNICAL CONSULTING SERVICES IN THE FIELDS OF DATA-CENTER ARCHITECTURE, PUBLIC AND PRIVATE CLOUD COMPUTING SOLUTIONS, AND EVALUATION AND IMPLEMENTATION OF INTERNET TECHNOLOGY AND SERVICES; TECHNICAL SUPPORT SERVICES, NAMELY, REMOTE AND ON-SITE INFRASTRUCTURE MANAGEMENT SERVICES FOR MONITORING, ADMINISTRATION AND MANAGEMENT OF PUBLIC AND PRIVATE CLOUD COMPUTING IT AND APPLICATION SYSTEMS, IN CLASS 42 (U.S. CLS. 100 AND 101).

FIRST USE 10-29-2010; IN COMMERCE 7-16-2011.

THE MARK CONSISTS OF STANDARD CHARACTERS WITHOUT CLAIM TO ANY PARTICULAR FONT, STYLE, SIZE, OR COLOR.

SER. NO. 85-410,861, FILED 8-30-2011.

ALEXANDER L. POWERS, EXAMINING ATTORNEY



*David J. Kyffers*

Director of the United States Patent and Trademark Office



# United States of America

United States Patent and Trademark Office

## Back On Track Plan

**Reg. No. 4,135,116**

**Registered May 1, 2012**

**Int. Cl.: 36**

**SERVICE MARK**

**PRINCIPAL REGISTER**

VAUGHT, CAROLYN (UNITED STATES INDIVIDUAL)  
1065 S ALLANTE PL.  
BOISE, ID 83709 AND

HYMAS, CLINT (UNITED STATES INDIVIDUAL)  
1065 S ALLANTE PL.  
BOISE, ID 83709

FOR: FINANCIAL CONSULTING IN THE FIELD OF REAL ESTATE NOTE BROKERAGE;  
REAL ESTATE AGENCIES , IN CLASS 36 (U.S. CLS. 100, 101 AND 102).

FIRST USE 3-19-2011; IN COMMERCE 3-19-2011.

THE MARK CONSISTS OF STANDARD CHARACTERS WITHOUT CLAIM TO ANY PARTICULAR FONT, STYLE, SIZE, OR COLOR.

SER. NO. 85-410,865, FILED 8-30-2011.

CHERYL CLAYTON, EXAMINING ATTORNEY



*David J. Kybas*

Director of the United States Patent and Trademark Office

# United States of America

United States Patent and Trademark Office

# NO-TRACE

**Reg. No. 4,135,117**

**Registered May 1, 2012**

**Int. Cl.: 10**

**TRADEMARK**

**PRINCIPAL REGISTER**

YOUNG DENTAL MANUFACTURING I, LLC (MISSOURI CORPORATION)  
13705 SHORELINE CT. EAST  
EARTH CITY, MO 63045

FOR: ORTHODONTIC APPLIANCES, IN CLASS 10 (U.S. CLS. 26, 39 AND 44).

FIRST USE 12-3-2010; IN COMMERCE 12-3-2010.

THE MARK CONSISTS OF STANDARD CHARACTERS WITHOUT CLAIM TO ANY PARTICULAR FONT, STYLE, SIZE, OR COLOR.

SER. NO. 85-410,900, FILED 8-30-2011.

ANGELA DUONG, EXAMINING ATTORNEY



*David J. Kybas*

Director of the United States Patent and Trademark Office

# United States of America

United States Patent and Trademark Office

# GRUNTS

**Reg. No. 4,135,118**

**Registered May 1, 2012**

**Int. Cl.: 25**

**TRADEMARK**

**PRINCIPAL REGISTER**

GRUNTS, LLC (ALABAMA LIMITED LIABILITY COMPANY)  
1662 CREEKSTONE CT.  
BIRMINGHAM, AL 35243

FOR: UNDERWEAR, IN CLASS 25 (U.S. CLS. 22 AND 39).

FIRST USE 6-1-2009; IN COMMERCE 8-18-2011.

THE MARK CONSISTS OF STANDARD CHARACTERS WITHOUT CLAIM TO ANY PARTICULAR FONT, STYLE, SIZE, OR COLOR.

SER. NO. 85-410,912, FILED 8-30-2011.

SKYE YOUNG, EXAMINING ATTORNEY



*David J. Kyffers*

Director of the United States Patent and Trademark Office

# United States of America

United States Patent and Trademark Office

# Bandor Sports

**Reg. No. 4,135,119**

**Registered May 1, 2012**

**Int. Cl.: 42**

**SERVICE MARK**

**PRINCIPAL REGISTER**

BANDY, TYLER (UNITED STATES INDIVIDUAL), DBA BANDOR SPORTS  
5213 CHASTAIN DR NE  
ATLANTA, GA 30342

FOR: COMPUTER SERVICES, NAMELY, CREATING AN ON-LINE COMMUNITY FOR REGISTERED USERS TO PARTICIPATE IN DISCUSSIONS, GET FEEDBACK FROM THEIR PEERS, FORM VIRTUAL COMMUNITIES, AND ENGAGE IN SOCIAL NETWORKING SERVICES IN THE FIELD OF FINDING AND ORGANIZING LOCAL ACTIVITIES, IN CLASS 42 (U.S. CLS. 100 AND 101).

FIRST USE 8-6-2011; IN COMMERCE 8-6-2011.

THE MARK CONSISTS OF STANDARD CHARACTERS WITHOUT CLAIM TO ANY PARTICULAR FONT, STYLE, SIZE, OR COLOR.

NO CLAIM IS MADE TO THE EXCLUSIVE RIGHT TO USE "SPORTS", APART FROM THE MARK AS SHOWN.

SER. NO. 85-410,919, FILED 8-30-2011.

WENDY GOODMAN, EXAMINING ATTORNEY



*David J. Kyros*

Director of the United States Patent and Trademark Office

# United States of America

United States Patent and Trademark Office

## TRUEPOINT LASER SCANNING

**Reg. No. 4,135,120**

**Registered May 1, 2012**

**Int. Cl.: 42**

**SERVICE MARK**

**PRINCIPAL REGISTER**

TRUEPOINT LASER SCANNING, LLC (OHIO LIMITED LIABILITY COMPANY)  
SUITE E-1  
6800 WEST CENTRAL AVENUE  
TOLEDO, OH 43617

FOR: LASER SCANNING FOR THE PURPOSE OF CAPTURING THREE-DIMENSIONAL DATA ON BUILDINGS, STRUCTURES, ROADS, LANDSCAPES, AND SPACES, IN CLASS 42 (U.S. CLS. 100 AND 101).

FIRST USE 8-0-2011; IN COMMERCE 8-0-2011.

THE MARK CONSISTS OF STANDARD CHARACTERS WITHOUT CLAIM TO ANY PARTICULAR FONT, STYLE, SIZE, OR COLOR.

NO CLAIM IS MADE TO THE EXCLUSIVE RIGHT TO USE "LASER SCANNING", APART FROM THE MARK AS SHOWN.

SER. NO. 85-410,921, FILED 8-30-2011.

WENDY GOODMAN, EXAMINING ATTORNEY



*David J. Kyffers*

Director of the United States Patent and Trademark Office

# United States of America

United States Patent and Trademark Office

## Curls Just Want To Have Fun

**Reg. No. 4,135,121**

**Registered May 1, 2012**

**Int. Cl.: 44**

**SERVICE MARK**

**PRINCIPAL REGISTER**

CURLS JUST WANT TO HAVE FUN LLC (DELAWARE LIMITED LIABILITY COMPANY)  
W/K INCORPORATING SERVICES, INC.  
3500 SOUTH DUPONT HIGHWAY  
DOVER, DE 19901

FOR: BEAUTY ANALYSIS TO DETERMINE COSMETICS THAT ARE BEST SUITED TO PARTICULAR INDIVIDUALS; BEAUTY CONSULTATION SERVICES; BEAUTY CONSULTATION SERVICES IN THE SELECTION AND USE OF COSMETICS, FRAGRANCES, BEAUTY AIDS, PERSONAL CARE PRODUCTS, AND BATH, BODY AND BEAUTY PRODUCTS; BEAUTY SALON SERVICES; CONSULTATION SERVICES IN THE FIELD OF MAKE-UP, NAMELY, ON-LINE MAKEUP CONSULTATION SERVICES AND IN-PERSON MAKEUP CONSULTATION AND APPLICATION SERVICES; HAIR COLOR SALON SERVICES; HAIR COLOURING SERVICES; HAIR CUTTING; HAIR CUTTING SERVICES; HAIR SALON SERVICES; HAIR SALON SERVICES, NAMELY, HAIR CUTTING, STYLING, COLORING, AND HAIR EXTENSION SERVICES; HAIR SALON SERVICES, NAMELY, TREATMENTS TO PROTECT HAIR FROM EFFECTS OF EXPOSURE TO SUNLIGHT, HEAT, HUMIDITY AND CHLORINATED WATER; HAIR STYLING; HYGIENIC AND BEAUTY CARE; MEDICAL, HYGIENIC AND BEAUTY CARE; PROVIDING INFORMATION ABOUT BEAUTY; PROVIDING INFORMATION IN THE FIELD OF HAIR STYLING; PROVIDING NEWS AND INFORMATION IN THE FIELD OF PERSONAL BEAUTY; PROVIDING ON-SITE BEAUTY SERVICES, NAMELY, HAIR STYLING AND MAKE-UP APPLICATION SERVICES , IN CLASS 44 (U.S. CLS. 100 AND 101).

FIRST USE 6-1-2011; IN COMMERCE 6-1-2011.

THE MARK CONSISTS OF STANDARD CHARACTERS WITHOUT CLAIM TO ANY PARTICULAR FONT, STYLE, SIZE, OR COLOR.

SER. NO. 85-410,943, FILED 8-30-2011.

SHARON MEIER, EXAMINING ATTORNEY



*David J. Kyffers*

Director of the United States Patent and Trademark Office

# United States of America

United States Patent and Trademark Office

## DRIFT BUSTER

**Reg. No. 4,135,122**

**Registered May 1, 2012**

**Int. Cl.: 7**

**TRADEMARK**

**PRINCIPAL REGISTER**

D & G WELDING INC. (NEW YORK CORPORATION)  
249 HERTEL AVENUE  
BUFFALO, NY 14207

FOR: SNOW PLOWS, IN CLASS 7 (U.S. CLS. 13, 19, 21, 23, 31, 34 AND 35).

FIRST USE 0-0-1999; IN COMMERCE 0-0-1999.

THE MARK CONSISTS OF STANDARD CHARACTERS WITHOUT CLAIM TO ANY PARTICULAR FONT, STYLE, SIZE, OR COLOR.

SER. NO. 85-410,946, FILED 8-30-2011.

DOUGLAS LEE, EXAMINING ATTORNEY



*David J. Kyffers*

Director of the United States Patent and Trademark Office

# United States of America

United States Patent and Trademark Office

# CIPHERPOINT

**Reg. No. 4,135,123**

**Registered May 1, 2012**

**Int. Cl.: 9**

**TRADEMARK**

**PRINCIPAL REGISTER**

CIPHERPOINT SOFTWARE, INC. (DELAWARE CORPORATION)  
28 MOUNTAIN PINE DRIVE  
LITTLETON, CO 80127

FOR: COMPUTER SOFTWARE FOR ENCRYPTION, IN CLASS 9 (U.S. CLS. 21, 23, 26, 36 AND 38).

FIRST USE 7-20-2010; IN COMMERCE 1-21-2011.

THE MARK CONSISTS OF STANDARD CHARACTERS WITHOUT CLAIM TO ANY PARTICULAR FONT, STYLE, SIZE, OR COLOR.

SER. NO. 85-410,950, FILED 8-30-2011.

DOUGLAS LEE, EXAMINING ATTORNEY



*David J. Kyffers*

Director of the United States Patent and Trademark Office



# United States of America

United States Patent and Trademark Office

## JAMES MITCHELL

**Reg. No. 4,135,124**

**Registered May 1, 2012**

**Int. Cl.: 33**

**TRADEMARK**

**PRINCIPAL REGISTER**

A. V. BRAND, INC. (DELAWARE CORPORATION)  
SUITE 340  
509 SOUTH EXETER STREET  
BALTIMORE, MD 21202

FOR: WINES, IN CLASS 33 (U.S. CLS. 47 AND 49).

FIRST USE 6-22-2011; IN COMMERCE 6-22-2011.

THE MARK CONSISTS OF STANDARD CHARACTERS WITHOUT CLAIM TO ANY PARTICULAR FONT, STYLE, SIZE, OR COLOR.

THE NAME(S), PORTRAIT(S), AND/OR SIGNATURE(S) SHOWN IN THE MARK DOES NOT IDENTIFY A PARTICULAR LIVING INDIVIDUAL.

SER. NO. 85-410,970, FILED 8-30-2011.

THEODORE MCBRIDE, EXAMINING ATTORNEY



*David J. Kyffers*

Director of the United States Patent and Trademark Office

# United States of America

United States Patent and Trademark Office

**BæB**  
Blue Ever Blue

**Reg. No. 4,135,125**

**Registered May 1, 2012**

**Int. Cl.: 9**

**TRADEMARK**

**PRINCIPAL REGISTER**

BLUE EVER BLUE LLC (DELAWARE LIMITED LIABILITY COMPANY)  
2412 MINNESOTA AVE., S.E., SUITE 301  
WASHINGTON, DC 20020

FOR: AUDIO HEADPHONES; EARPHONES AND HEADPHONES; MUSIC HEADPHONES,  
IN CLASS 9 (U.S. CLS. 21, 23, 26, 36 AND 38).

FIRST USE 6-3-2011; IN COMMERCE 6-3-2011.

THE MARK CONSISTS OF THE TEXT BLUE EVER BLUE BELOW STYLIZED LETTERING  
CONSISTING OF THE LETTERS B, E, E, B WITH THE FIRST TWO LETTERS REVERSED.

SER. NO. 85-410,988, FILED 8-30-2011.

ANNE FARRELL, EXAMINING ATTORNEY



*David J. Kybas*

Director of the United States Patent and Trademark Office

# United States of America

United States Patent and Trademark Office

# BRIGHT

**Reg. No. 4,135,126**

**Registered May 1, 2012**

**Int. Cls.: 37 and 40**

**SERVICE MARK**

**PRINCIPAL REGISTER**

BRIGHT DISPOSAL SERVICES, LLC (MISSOURI LIMITED LIABILITY COMPANY)  
3908 RIVER RD.  
ST. JOSEPH, MO 64505

FOR: TRASH COLLECTION, IN CLASS 37 (U.S. CLS. 100, 103 AND 106).

FIRST USE 6-23-2011; IN COMMERCE 6-23-2011.

FOR: RECYCLING OF WASTE AND RUBBISH , IN CLASS 40 (U.S. CLS. 100, 103 AND 106).

FIRST USE 6-23-2011; IN COMMERCE 6-23-2011.

THE MARK CONSISTS OF STANDARD CHARACTERS WITHOUT CLAIM TO ANY PARTICULAR FONT, STYLE, SIZE, OR COLOR.

SER. NO. 85-411,008, FILED 8-30-2011.

THEODORE MCBRIDE, EXAMINING ATTORNEY



*David J. Kybas*

Director of the United States Patent and Trademark Office

# United States of America

United States Patent and Trademark Office

## PRODUCTIONPLUS

**Reg. No. 4,135,127**

**Registered May 1, 2012**

**Int. Cl.: 9**

**TRADEMARK**

**PRINCIPAL REGISTER**

CONTROL MICROSYSTEMS INC. (CANADA CORPORATION)  
48 STEACIE DRIVE  
KANATA, ONTARIO, CANADA K2K2A9

FOR: INTEGRATED HARDWARE AND SOFTWARE USED IN THE OIL AND GAS INDUSTRY TO MONITOR AND CONTROL FLOW RATE AT THE WELLHEAD, IN CLASS 9 (U.S. CLS. 21, 23, 26, 36 AND 38).

FIRST USE 8-18-2010; IN COMMERCE 8-18-2010.

THE MARK CONSISTS OF STANDARD CHARACTERS WITHOUT CLAIM TO ANY PARTICULAR FONT, STYLE, SIZE, OR COLOR.

PRIORITY CLAIMED UNDER SEC. 44(D) ON CANADA APPLICATION NO. 1517199, FILED 3-1-2011.

SER. NO. 85-411,009, FILED 8-30-2011.

THEODORE MCBRIDE, EXAMINING ATTORNEY



*David J. Kybas*

Director of the United States Patent and Trademark Office

# United States of America

United States Patent and Trademark Office

# FotodioX

**Reg. No. 4,135,128**

**Registered May 1, 2012**

**Int. Cl.: 9**

**TRADEMARK**

**PRINCIPAL REGISTER**

FOTODIOX, INC. (ILLINOIS CORPORATION)  
3805 HAWTHORN CT.  
WAUKEGAN, IL 60087

FOR: ADAPTER RINGS FOR ATTACHING OBJECTIVES ON CAMERAS; BAGS FOR CAMERAS AND PHOTOGRAPHIC EQUIPMENT; CAMERA FILTERS; COLLAPSIBLE LIGHT DIRECTORS AND DIFFUSERS FOR USE WITH PHOTOGRAPHIC LIGHTING EQUIPMENT FOR PROFESSIONAL AND HIGH-END PHOTOGRAPHY; ELECTRICAL LIGHTS FOR USE IN PROFESSIONAL QUALITY PHOTOGRAPHY; LENS FILTERS; LENS HOODS; LIGHT DIRECTORS AND PHOTOGRAPHIC LIGHTING TENTS, ALL FOR USE WITH PHOTOGRAPHIC LIGHTING EQUIPMENT FOR PROFESSIONAL AND HIGH-END PHOTOGRAPHY; LIGHTING DEVICES FOR TAKING PICTURES; LIGHTS FOR USE ON VIDEO CAMERAS; PORTABLE PHOTOGRAPHY EQUIPMENT, NAMELY, REFLECTORS, TRIPODS, LIGHT STANDS AND SUPPORTS AND BAGS SPECIALLY ADAPTED FOR THESE GOODS; SHUTTER RELEASES; STROBE LIGHT APPARATUS FOR USE IN PROFESSIONAL QUALITY PHOTOGRAPHY, IN CLASS 9 (U.S. CLS. 21, 23, 26, 36 AND 38).

FIRST USE 6-1-2004; IN COMMERCE 6-1-2004.

THE MARK CONSISTS OF STANDARD CHARACTERS WITHOUT CLAIM TO ANY PARTICULAR FONT, STYLE, SIZE, OR COLOR.

SER. NO. 85-411,031, FILED 8-30-2011.

ELLEN PERKINS, EXAMINING ATTORNEY



*David J. Kybas*

Director of the United States Patent and Trademark Office

# United States of America

United States Patent and Trademark Office

## Transformation One

**Reg. No. 4,135,129**

**Registered May 1, 2012**

**Int. Cl.: 44**

**SERVICE MARK**

**PRINCIPAL REGISTER**

TRANSFORMATION ONE, LLC (VERMONT LIMITED LIABILITY COMPANY)  
SUITE C2  
20 WEST CANAL ST.  
WINOOSKI, VT 05404

FOR: WELLNESS AND HEALTH-RELATED CONSULTING SERVICES, IN CLASS 44 (U.S. CLS. 100 AND 101).

FIRST USE 2-0-2006; IN COMMERCE 8-0-2007.

THE MARK CONSISTS OF STANDARD CHARACTERS WITHOUT CLAIM TO ANY PARTICULAR FONT, STYLE, SIZE, OR COLOR.

SER. NO. 85-411,038, FILED 8-30-2011.

HEATHER THOMPSON, EXAMINING ATTORNEY



*David J. Kyffers*

Director of the United States Patent and Trademark Office

# United States of America

United States Patent and Trademark Office

Your good health is our  
business

**Reg. No. 4,135,130**

**Registered May 1, 2012**

**Int. Cl.: 36**

**SERVICE MARK**

**PRINCIPAL REGISTER**

DOWNEY, JAMES S. (UNITED STATES INDIVIDUAL)  
2103 TRUXTUN RD.  
SAN DIEGO, CA 92106

FOR: ADVISORY SERVICES IN THE FIELD OF EMPLOYEE BENEFITS FOR GROUP HEALTHCARE AND BUSINESS INSURANCE OFFERED TO EMPLOYEES IN ADDITION TO STANDARD BENEFITS SUCH AS MEDICAL, DENTAL, LIFE INSURANCE INCLUDING SHORT TERM DISABILITY, LONG TERM DISABILITY, CANCER INSURANCE, ACCIDENTAL DEATH AND DISMEMBERMENT; INSURANCE AGENCIES; INSURANCE AGENCY AND BROKERAGE, IN CLASS 36 (U.S. CLS. 100, 101 AND 102).

FIRST USE 8-1-2011; IN COMMERCE 8-1-2011.

THE MARK CONSISTS OF STANDARD CHARACTERS WITHOUT CLAIM TO ANY PARTICULAR FONT, STYLE, SIZE, OR COLOR.

SER. NO. 85-411,043, FILED 8-30-2011.

HEATHER THOMPSON, EXAMINING ATTORNEY



*David J. Kybas*

Director of the United States Patent and Trademark Office

# United States of America

United States Patent and Trademark Office

## Love Has Come

**Reg. No. 4,135,131**

**Registered May 1, 2012**

**Int. Cl.: 36**

**SERVICE MARK**

**PRINCIPAL REGISTER**

LOVE HAS COME (MONTANA CORPORATION)  
16191 HIGHLAND DR  
FLORENCE, MT 59833

FOR: PROVIDING GRANTS FOR ADOPTION COSTS, IN CLASS 36 (U.S. CLS. 100, 101 AND 102).

FIRST USE 5-1-2011; IN COMMERCE 7-1-2011.

THE MARK CONSISTS OF STANDARD CHARACTERS WITHOUT CLAIM TO ANY PARTICULAR FONT, STYLE, SIZE, OR COLOR.

SER. NO. 85-411,059, FILED 8-30-2011.

ALEXANDER L. POWERS, EXAMINING ATTORNEY



*David J. Kybas*

Director of the United States Patent and Trademark Office



# United States of America

United States Patent and Trademark Office

# THUUZ

**Reg. No. 4,135,132**

**Registered May 1, 2012**

**Int. Cl.: 35**

**SERVICE MARK**

**PRINCIPAL REGISTER**

THUUZ, INC. (DELAWARE CORPORATION)  
438 ADDISON AVENUE  
PALO ALTO, CA 94301

FOR: ADVERTISING AND MARKETING SERVICES, NAMELY, PROMOTING THE GOODS AND SERVICES OF OTHERS, IN CLASS 35 (U.S. CLS. 100, 101 AND 102).

FIRST USE 9-8-2010; IN COMMERCE 9-8-2010.

THE MARK CONSISTS OF STANDARD CHARACTERS WITHOUT CLAIM TO ANY PARTICULAR FONT, STYLE, SIZE, OR COLOR.

SER. NO. 85-411,069, FILED 8-30-2011.

KAELIE KUNG, EXAMINING ATTORNEY



*David J. Kappas*

Director of the United States Patent and Trademark Office

United States of America  
United States Patent and Trademark Office

nopalito

**Reg. No. 4,135,133**

**Registered May 1, 2012**

**Int. Cl.: 43**

**SERVICE MARK**

**PRINCIPAL REGISTER**

NOPALITO LLC (CALIFORNIA LIMITED LIABILITY COMPANY)  
306 BRODERICK STREET  
SAN FRANCISCO, CA 941172275

FOR: RESTAURANT SERVICES, INCLUDING SIT-DOWN SERVICE OF FOOD AND TAKE-OUT RESTAURANT SERVICES; CATERING SERVICES, IN CLASS 43 (U.S. CLS. 100 AND 101).

FIRST USE 2-0-2009; IN COMMERCE 2-0-2009.

THE MARK CONSISTS OF THE WORD "NOPALITO" IN STYLIZED LETTERING.

THE ENGLISH TRANSLATION OF "NOPALITO" IN THE MARK IS THE DIMINUTIVE FORM OF "NOPAL" A CACTUS OF THE GENUS NOPALEA.

SER. NO. 85-411,078, FILED 8-30-2011.

NAAKWAMA ANKRAH, EXAMINING ATTORNEY



*David J. Kyros*

Director of the United States Patent and Trademark Office

# United States of America

United States Patent and Trademark Office

## Tri-Bio Solutions Inc.

**Reg. No. 4,135,134**

**Registered May 1, 2012**

**Int. Cl.: 35**

**SERVICE MARK**

**PRINCIPAL REGISTER**

TRI-BIO SOLUTIONS INC. (NEW YORK CORPORATION)  
306 APPLEWOOD COURT  
PORT JEFFERSON STATION, NY 11776

FOR: ON-LINE RETAIL STORE SERVICES FEATURING SAFETY, PRODUCTION AND MAINTENANCE SUPPLIES; RETAIL STORE AND ON-LINE RETAIL STORE SERVICES FEATURING SAFETY, PRODUCTION AND MAINTENANCE SUPPLIES; RETAIL STORE SERVICES FEATURING SAFETY, PRODUCTION AND MAINTENANCE SUPPLIES; WHOLESALE STORE SERVICES FEATURING SAFETY, PRODUCTION AND MAINTENANCE SUPPLIES AND RETAIL STORE SERVICES FEATURING SAFETY, PRODUCTION AND MAINTENANCE SUPPLIES, IN CLASS 35 (U.S. CLS. 100, 101 AND 102).

FIRST USE 3-1-2011; IN COMMERCE 3-1-2011.

THE MARK CONSISTS OF STANDARD CHARACTERS WITHOUT CLAIM TO ANY PARTICULAR FONT, STYLE, SIZE, OR COLOR.

NO CLAIM IS MADE TO THE EXCLUSIVE RIGHT TO USE "INC.", APART FROM THE MARK AS SHOWN.

SER. NO. 85-411,079, FILED 8-30-2011.

NAAKWAMA ANKRAH, EXAMINING ATTORNEY



*David J. Kyros*

Director of the United States Patent and Trademark Office

# United States of America

United States Patent and Trademark Office



**Reg. No. 4,135,135**

**Registered May 1, 2012**

**Int. Cl.: 9**

**TRADEMARK**

**PRINCIPAL REGISTER**

RND POWER SOLUTIONS, INC. (CALIFORNIA CORPORATION)  
530 LOS ANGELES AVENUE, #115-313  
MOORPARK, CA 93021

FOR: BATTERIES AND BATTERY CHARGERS; BATTERY CHARGERS; CARRYING CASES, HOLDERS, PROTECTIVE CASES AND STANDS FEATURING POWER SUPPLY CONNECTORS, ADAPTORS, SPEAKERS AND BATTERY CHARGING DEVICES, SPECIALLY ADAPTED FOR USE WITH HANDHELD DIGITAL ELECTRONIC DEVICES; CELL PHONE BATTERY CHARGERS; CELL PHONE BATTERY CHARGERS FOR USE IN VEHICLES; CELLULAR TELEPHONE APPARATUSES; CONNECTION CABLES; DESK OR CAR MOUNTED UNITS INCORPORATING A LOUDSPEAKER TO ALLOW A TELEPHONE HANDSET TO BE USED HANDS-FREE; ELECTRICAL INTERCONNECT CABLES; ELECTRONIC EQUIPMENT, NAMELY, TRANSFORMERS, BALUNS, CABLES USED IN CONNECTION WITH COMPUTERS, COMPUTER PERIPHERAL DEVICES, TELEVISIONS, AUDIO-VIDEO EQUIPMENT, CLOSED-CIRCUIT TV EQUIPMENT AND TELECOMMUNICATION EQUIPMENT; FITTED PLASTIC FILMS KNOWN AS SKINS FOR COVERING AND PROVIDING A SCRATCH PROOF BARRIER OR PROTECTION FOR ELECTRONIC DEVICES, NAMELY, MP3 PLAYERS, MOBILE TELEPHONES, SMART TELEPHONES, DIGITAL CAMERAS, GLOBAL POSITIONING SYSTEMS AND PERSONAL DIGITAL ASSISTANTS; RECHARGEABLE ELECTRIC BATTERIES; USB CABLES; VIDEO CABLES, IN CLASS 9 (U.S. CLS. 21, 23, 26, 36 AND 38).

FIRST USE 1-1-2011; IN COMMERCE 1-1-2011.

NO CLAIM IS MADE TO THE EXCLUSIVE RIGHT TO USE "POWER", APART FROM THE MARK AS SHOWN.

THE MARK CONSISTS OF THE LITERAL ELEMENTS COMPOSED OF THE STYLIZED LETTERS "RND" OVER THE WORDS: "POWER SOLUTIONS" BRACKETED ON THE LEFT BY A NARROW PARENTHESIS ARC, AND BRACKETED ON THE RIGHT BY A THICKER PARENTHESIS ARC, WHICH WHEN SUCH ARCS ARE COMBINED TOGETHER, GIVE THE APPEARANCE OF AN ELLIPSE SURROUNDING THE LITERAL ELEMENTS.

SER. NO. 85-411,089, FILED 8-30-2011.

SUSAN RICHARDS, EXAMINING ATTORNEY



*David J. Kyros*

Director of the United States Patent and Trademark Office

# United States of America

United States Patent and Trademark Office

## THE INSIDE COUP

**Reg. No. 4,135,136**

**Registered May 1, 2012**

**Int. Cl.: 35**

**SERVICE MARK**

**PRINCIPAL REGISTER**

SLIMAN, DAVID, J (UNITED STATES INDIVIDUAL)  
4702 NORTH 32ND STREET  
PHOENIX, AZ 85018

FOR: ADVERTISING SERVICES, IN CLASS 35 (U.S. CLS. 100, 101 AND 102).

FIRST USE 6-1-2011; IN COMMERCE 6-1-2011.

THE MARK CONSISTS OF STANDARD CHARACTERS WITHOUT CLAIM TO ANY PARTICULAR FONT, STYLE, SIZE, OR COLOR.

SER. NO. 85-411,090, FILED 8-30-2011.

SUSAN RICHARDS, EXAMINING ATTORNEY



*David J. Kyffers*

Director of the United States Patent and Trademark Office

# United States of America

United States Patent and Trademark Office

# THUUZ

**Reg. No. 4,135,137**

**Registered May 1, 2012**

**Int. Cl.: 42**

**SERVICE MARK**

**PRINCIPAL REGISTER**

THUUZ, INC. (DELAWARE CORPORATION)  
438 ADDISON AVENUE  
PALO ALTO, CA 94301

FOR: APPLICATION SERVICE PROVIDER FEATURING APPLICATION PROGRAMMING INTERFACE (API) SOFTWARE FOR INTEGRATION OF DATA CONTENT INTO WEBSITES; APPLICATION SERVICE PROVIDER FEATURING APPLICATION PROGRAMMING INTERFACE (API) SOFTWARE FOR INTEGRATION OF INFORMATION AND DATA CONTENT INTO WEBSITES, SOCIAL MEDIA PLATFORMS AND OTHER ELECTRONIC MEDIA, NAMELY, SPORTS AND SPORTS TEAM INFORMATION AND STATISTICS, ATHLETE INFORMATION AND STATISTICS, SPORT TEAM AND ATHLETE RANKINGS, SPORT TEAM AND ATHLETE PERFORMANCE AND POPULARITY RANKINGS, SPORTING GAME SCHEDULES AND BROADCASTS, AND SPORTING GAME SUMMARIES, IN CLASS 42 (U.S. CLS. 100 AND 101).

FIRST USE 3-1-2011; IN COMMERCE 3-1-2011.

THE MARK CONSISTS OF STANDARD CHARACTERS WITHOUT CLAIM TO ANY PARTICULAR FONT, STYLE, SIZE, OR COLOR.

SER. NO. 85-411,091, FILED 8-30-2011.

KAELIE KUNG, EXAMINING ATTORNEY



*David J. Kyros*

Director of the United States Patent and Trademark Office

# United States of America

United States Patent and Trademark Office

# HEALTHSTEP

**Reg. No. 4,135,138**

**Registered May 1, 2012**

**Int. Cl.: 20**

**TRADEMARK**

**PRINCIPAL REGISTER**

GINACOR, INC. (DELAWARE CORPORATION)  
513 31ST AVENUE  
SEATTLE, WA 98122

FOR: TOILET FOOT STOOL, IN CLASS 20 (U.S. CLS. 2, 13, 22, 25, 32 AND 50).

FIRST USE 5-10-2004; IN COMMERCE 5-19-2004.

THE MARK CONSISTS OF STANDARD CHARACTERS WITHOUT CLAIM TO ANY PARTICULAR FONT, STYLE, SIZE, OR COLOR.

SER. NO. 85-411,097, FILED 8-30-2011.

BERNICE MIDDLETON, EXAMINING ATTORNEY



*David J. Kyffers*

Director of the United States Patent and Trademark Office

# United States of America

United States Patent and Trademark Office

# THUUZ

**Reg. No. 4,135,139**

**Registered May 1, 2012**

**Int. Cl.: 41**

**SERVICE MARK**

**PRINCIPAL REGISTER**

THUUZ, INC. (DELAWARE CORPORATION)  
438 ADDISON AVENUE  
PALO ALTO, CA 94301

FOR: PROVIDING A WEBSITE FEATURING SPORTS AND SPORTS TEAM INFORMATION AND STATISTICS, ATHLETE INFORMATION AND STATISTICS, SPORT TEAM AND ATHLETE RANKINGS, SPORT TEAM AND ATHLETE PERFORMANCE AND POPULARITY RANKINGS, SPORTING GAME SCHEDULES AND BROADCASTS, SPORTING GAME SUMMARIES; ON-LINE JOURNALS, NAMELY, BLOGS FEATURING SPORTS AND ATHLETE AND SPORTS TEAM INFORMATION, IN CLASS 41 (U.S. CLS. 100, 101 AND 107).

FIRST USE 9-8-2010; IN COMMERCE 9-8-2010.

THE MARK CONSISTS OF STANDARD CHARACTERS WITHOUT CLAIM TO ANY PARTICULAR FONT, STYLE, SIZE, OR COLOR.

SER. NO. 85-411,101, FILED 8-30-2011.

KAELIE KUNG, EXAMINING ATTORNEY



*David J. Kybas*

Director of the United States Patent and Trademark Office



# United States of America

United States Patent and Trademark Office

**EDGE UP** 

**Reg. No. 4,135,140**

**Registered May 1, 2012**

**Int. Cl.: 44**

**SERVICE MARK**

**PRINCIPAL REGISTER**

SOUDER, JR., PERCY D. (UNITED STATES INDIVIDUAL)  
8717 S. 3RD AVENUE  
INGLEWOOD, CA 90305

FOR: SHOPPING MALL KIOSKS FOR PROVIDING MEN'S BARBER SERVICES, IN CLASS 44 (U.S. CLS. 100 AND 101).

FIRST USE 1-1-2011; IN COMMERCE 3-1-2011.

THE MARK CONSISTS OF ALL CAPITAL LETTERS IN STENCIL FONT SPELLING TWO DIFFERENT WORDS, "EDGE UP". THE WORD "UP" IS ELEVATED SLIGHTLY HIGHER THAN THE WORD "EDGE". A PAIR OF LONG AND THIN HAIR CUTTING SCISSORS ARE DIRECTLY ABOVE THE WORD "UP" AND THE SCISSORS' HANDLE CURVES SLIGHTLY AROUND THE LETTER "P" IN THE WORD "UP". THE FINGER HOLES IN THE SCISSORS HANDLE ARE EQUALLY ROUND AND ONE HAS A SMALL PROTRUSION EXTENDING OUTWARD.

SER. NO. 85-411,102, FILED 8-30-2011.

KAELIE KUNG, EXAMINING ATTORNEY



*David J. Kyffers*

Director of the United States Patent and Trademark Office

# United States of America

United States Patent and Trademark Office

# NGS-PLUS

**Reg. No. 4,135,141**

MEDICAL NEUROGENETICS (GEORGIA LIMITED LIABILITY COMPANY)  
5424 GLENRIDGE DRIVE  
ATLANTA, GA 30342

**Registered May 1, 2012**

**Int. Cl.: 44**

FOR: GENETIC TESTING FOR MEDICAL PURPOSES, IN CLASS 44 (U.S. CLS. 100 AND 101).

**SERVICE MARK**

FIRST USE 8-16-2011; IN COMMERCE 8-16-2011.

**PRINCIPAL REGISTER**

THE MARK CONSISTS OF STANDARD CHARACTERS WITHOUT CLAIM TO ANY PARTICULAR FONT, STYLE, SIZE, OR COLOR.

SER. NO. 85-411,105, FILED 8-30-2011.

ROBIN CHOSID, EXAMINING ATTORNEY



*David J. Kyffers*

Director of the United States Patent and Trademark Office

# United States of America

United States Patent and Trademark Office

# SHEVKOFF

**Reg. No. 4,135,142**

**Registered May 1, 2012**

**Int. Cl.: 33**

**TRADEMARK**

**PRINCIPAL REGISTER**

SPIRIT GROUP, INC. (ILLINOIS CORPORATION)  
3 MONTCLAIR COURT  
CARY, IL 60013

FOR: VODKA, IN CLASS 33 (U.S. CLS. 47 AND 49).

FIRST USE 6-0-2011; IN COMMERCE 6-0-2011.

THE MARK CONSISTS OF STANDARD CHARACTERS WITHOUT CLAIM TO ANY PARTICULAR FONT, STYLE, SIZE, OR COLOR.

SER. NO. 85-411,114, FILED 8-30-2011.

GRETTA YAO, EXAMINING ATTORNEY



*David J. Kybas*

Director of the United States Patent and Trademark Office

# United States of America

United States Patent and Trademark Office

# Huntin' Chix

**Reg. No. 4,135,143**

FISHIN' CHIX, LLC (FLORIDA LIMITED LIABILITY COMPANY)  
362 GULF BREEZE PKWY # 141  
GULF BREEZE, FL 32561

**Registered May 1, 2012**

**Int. Cl.: 25**

FOR: CLOTHING, NAMELY, SHIRTS, HATS AND SWEATSHIRTS, IN CLASS 25 (U.S. CLS. 22 AND 39).

**TRADEMARK**

FIRST USE 8-30-2011; IN COMMERCE 8-30-2011.

**PRINCIPAL REGISTER**

THE MARK CONSISTS OF STANDARD CHARACTERS WITHOUT CLAIM TO ANY PARTICULAR FONT, STYLE, SIZE, OR COLOR.

SER. NO. 85-411,124, FILED 8-30-2011.

SUSAN STIGLITZ, EXAMINING ATTORNEY



*David J. Kybas*

Director of the United States Patent and Trademark Office

# United States of America

United States Patent and Trademark Office

# PHYTEL

**Reg. No. 4,135,144**

**Registered May 1, 2012**

**Int. Cl.: 42**

**SERVICE MARK**

**PRINCIPAL REGISTER**

PHYTEL, INC. (TEXAS CORPORATION)  
SUITE 600  
11511 LUNA ROAD  
DALLAS, TX 75234

FOR: PROVIDING ONLINE NON-DOWNLOADABLE COMPUTER SOFTWARE FOR IDENTIFYING, NOTIFYING, TRACKING AND MEASURING PATIENT COMPLIANCE IN THE FIELD OF HEALTH AND DISEASE MANAGEMENT, IN CLASS 42 (U.S. CLS. 100 AND 101).

FIRST USE 7-1-2002; IN COMMERCE 7-1-2002.

THE MARK CONSISTS OF STANDARD CHARACTERS WITHOUT CLAIM TO ANY PARTICULAR FONT, STYLE, SIZE, OR COLOR.

OWNER OF U.S. REG. NOS. 2,241,255, 3,483,962, AND 3,589,829.

SER. NO. 85-411,130, FILED 8-30-2011.

MATTHEW MCDOWELL, EXAMINING ATTORNEY



*David J. Kybas*

Director of the United States Patent and Trademark Office

# United States of America

United States Patent and Trademark Office

# Beer Is Art

**Reg. No. 4,135,145**

**Registered May 1, 2012**

**Int. Cl.: 25**

**TRADEMARK**

**PRINCIPAL REGISTER**

FRANK GLEN JONES (UNITED STATES INDIVIDUAL)  
4909 NAGLE AVE.  
SHERMAN OAKS, CA 91423

FOR: BATHING SUITS; BELTS; DRESSES; HATS; JACKETS; PAJAMAS; PANTS; SHIRTS;  
SHOES; SHORTS; SKIRTS; SOCKS; SWEATSHIRTS; T-SHIRTS; UNDERWEAR, IN CLASS  
25 (U.S. CLS. 22 AND 39).

FIRST USE 8-30-2011; IN COMMERCE 11-1-2011.

THE MARK CONSISTS OF STANDARD CHARACTERS WITHOUT CLAIM TO ANY PAR-  
TICULAR FONT, STYLE, SIZE, OR COLOR.

SER. NO. 85-411,141, FILED 8-30-2011.

KIMBERLY PERRY, EXAMINING ATTORNEY



*David J. Kyffers*

Director of the United States Patent and Trademark Office

# United States of America

United States Patent and Trademark Office

# Crimie

**Reg. No. 4,135,146**

**Registered May 1, 2012**

**Int. Cls.: 18 and 25**

**TRADEMARK**

**PRINCIPAL REGISTER**

HIGHER GROUND USA INC. (CALIFORNIA CORPORATION), DBA GARDEN LOS ANGELES  
UNIT 312  
1550 N. POINSETTIA PL  
LOS ANGELES, CA 900463644

FOR: WALLETS, IN CLASS 18 (U.S. CLS. 1, 2, 3, 22 AND 41).

FIRST USE 1-1-2010; IN COMMERCE 5-23-2011.

FOR: BELTS; FOOTWEAR FOR MEN; MEN'S AND WOMEN'S JACKETS, COATS, TROUSERS,  
VESTS, IN CLASS 25 (U.S. CLS. 22 AND 39).

FIRST USE 1-1-2010; IN COMMERCE 5-23-2011.

THE MARK CONSISTS OF STANDARD CHARACTERS WITHOUT CLAIM TO ANY PAR-  
TICULAR FONT, STYLE, SIZE, OR COLOR.

SER. NO. 85-411,163, FILED 8-30-2011.

CURTIS FRENCH, EXAMINING ATTORNEY



*David J. Kyros*

Director of the United States Patent and Trademark Office

# United States of America

United States Patent and Trademark Office

# MTM

**Reg. No. 4,135,147**

**Registered May 1, 2012**

**Int. Cl.: 1**

**TRADEMARK**

**PRINCIPAL REGISTER**

SPECIALTY FERTILIZER PRODUCTS, LLC (OHIO LIMITED LIABILITY COMPANY)  
SUITE 220  
11550 ASH STREET  
LEAWOOD, KS 66211

FOR: CHEMICAL ADDITIVES FOR FERTILIZERS, IN CLASS 1 (U.S. CLS. 1, 5, 6, 10, 26 AND 46).

FIRST USE 9-0-2010; IN COMMERCE 9-0-2010.

THE MARK CONSISTS OF STANDARD CHARACTERS WITHOUT CLAIM TO ANY PARTICULAR FONT, STYLE, SIZE, OR COLOR.

SER. NO. 85-411,164, FILED 8-30-2011.

STEVEN PEREZ, EXAMINING ATTORNEY



*David J. Kybas*

Director of the United States Patent and Trademark Office



# United States of America

United States Patent and Trademark Office

# Arenal

**Reg. No. 4,135,148**

**Registered May 1, 2012**

**Int. Cl.: 33**

**TRADEMARK**

**PRINCIPAL REGISTER**

SOUTHERN WINE GROUP, LLC (OREGON LIMITED LIABILITY COMPANY)  
550 SW INDUSTRIAL WAY, STE 102  
BEND, OR 97702

FOR: TABLE WINE, IN CLASS 33 (U.S. CLS. 47 AND 49).

FIRST USE 10-18-2007; IN COMMERCE 10-18-2007.

THE MARK CONSISTS OF STANDARD CHARACTERS WITHOUT CLAIM TO ANY PARTICULAR FONT, STYLE, SIZE, OR COLOR.

THE ENGLISH TRANSLATION OF "ARENAL" IN THE MARK IS "SANDY GROUND".

SER. NO. 85-411,172, FILED 8-30-2011.

KELLY CHOE, EXAMINING ATTORNEY



*David J. Kyffers*

Director of the United States Patent and Trademark Office

# United States of America

United States Patent and Trademark Office

# Toyplane

**Reg. No. 4,135,149**

**Registered May 1, 2012**

**Int. Cl.: 25**

**TRADEMARK**

**PRINCIPAL REGISTER**

HIGHER GROUND USA INC. (CALIFORNIA CORPORATION), DBA GARDEN LOS ANGELES  
UNIT 312  
1550 N. POINSETTIA PL  
LOS ANGELES, CA 900463644

FOR: HATS; JACKETS; SHIRTS AND SHORT-SLEEVED SHIRTS; TROUSERS, IN CLASS  
25 (U.S. CLS. 22 AND 39).

FIRST USE 1-1-2010; IN COMMERCE 5-23-2011.

THE MARK CONSISTS OF STANDARD CHARACTERS WITHOUT CLAIM TO ANY PAR-  
TICULAR FONT, STYLE, SIZE, OR COLOR.

SER. NO. 85-411,176, FILED 8-30-2011.

CURTIS FRENCH, EXAMINING ATTORNEY



*David J. Kyros*

Director of the United States Patent and Trademark Office

# United States of America

United States Patent and Trademark Office

# PUPFITS

**Reg. No. 4,135,150**

**Registered May 1, 2012**

**Int. Cls.: 18 and 35**

**TRADEMARK**

**SERVICE MARK**

**PRINCIPAL REGISTER**

DANNER, JENNIFER L (UNITED STATES INDIVIDUAL), DBA PUPFITS  
3268 GOVERNOR DR. SUITE 134  
SAN DIEGO, CA 92122

FOR: PET CLOTHING, IN CLASS 18 (U.S. CLS. 1, 2, 3, 22 AND 41).

FIRST USE 7-26-2011; IN COMMERCE 7-26-2011.

FOR: ON-LINE RETAIL STORE SERVICES FEATURING PET CLOTHING AND ACCESSORIES, IN CLASS 35 (U.S. CLS. 100, 101 AND 102).

FIRST USE 7-26-2011; IN COMMERCE 7-26-2011.

THE MARK CONSISTS OF STANDARD CHARACTERS WITHOUT CLAIM TO ANY PARTICULAR FONT, STYLE, SIZE, OR COLOR.

SER. NO. 85-411,194, FILED 8-30-2011.

CURTIS FRENCH, EXAMINING ATTORNEY



*David J. Kyros*

Director of the United States Patent and Trademark Office

# United States of America

United States Patent and Trademark Office

# ETHERAPI

**Reg. No. 4,135,151**

**Registered May 1, 2012**

**Int. Cl.: 42**

**SERVICE MARK**

**PRINCIPAL REGISTER**

EQUANIMITY, INC. (DELAWARE CORPORATION)  
255 S. RENGSTORFF AVENUE, SUITE 94  
MOUNTAIN VIEW, CA 94040

FOR: PROVIDING A WEBSITE FEATURING SOFTWARE AS A SERVICE (SAAS) SERVICES FEATURING TOOLS FOR MENTAL HEALTH PROVIDER PRACTICE MANAGEMENT, NAMELY, FOR HEALTH RECORDS MANAGEMENT, APPOINTMENT SCHEDULING AND REMINDERS, FOLLOW UP CARE REMINDERS, ASSESSMENT OF PATIENT COMPLIANCE AND PROGRESS, CLINICAL EFFICACY AND OUTCOMES, FOR PROVIDING FEE ESTIMATES, BILLING, PAYMENT PROCESSING, INSURANCE COVERAGE BILLING INTEGRATION, ANALYSIS AND MANAGEMENT, AND FOR MONITORING COMPLIANCE WITH MENTAL HEALTH CARE PRACTICE LICENSING REQUIREMENTS, IN CLASS 42 (U.S. CLS. 100 AND 101).

FIRST USE 1-17-2010; IN COMMERCE 1-17-2010.

THE MARK CONSISTS OF STANDARD CHARACTERS WITHOUT CLAIM TO ANY PARTICULAR FONT, STYLE, SIZE, OR COLOR.

SER. NO. 85-411,221, FILED 8-30-2011.

ALAIN LAPTER, EXAMINING ATTORNEY



*David J. Kybas*

Director of the United States Patent and Trademark Office

# United States of America

United States Patent and Trademark Office

# DeCuzzi

**Reg. No. 4,135,152**

**Registered May 1, 2012**

**Int. Cl.: 12**

**TRADEMARK**

**PRINCIPAL REGISTER**

LOUIS DECUZZI (UNITED STATES INDIVIDUAL)  
900 THEORA DR.  
BRUNSWICK, OH 44212

FOR: TIRES; TIRES FOR VEHICLES, IN CLASS 12 (U.S. CLS. 19, 21, 23, 31, 35 AND 44).

FIRST USE 7-3-2005; IN COMMERCE 7-3-2005.

THE MARK CONSISTS OF STANDARD CHARACTERS WITHOUT CLAIM TO ANY PARTICULAR FONT, STYLE, SIZE, OR COLOR.

OWNER OF U.S. REG. NO. 4,018,355.

SEC. 2(F).

SER. NO. 85-411,229, FILED 8-30-2011.

KEVON CHISOLM, EXAMINING ATTORNEY



*David J. Kybas*

Director of the United States Patent and Trademark Office

# United States of America

United States Patent and Trademark Office

## LongTale Publishing

**Reg. No. 4,135,153**

**Registered May 1, 2012**

**Int. Cls.: 9 and 16**

**TRADEMARK**

**PRINCIPAL REGISTER**

LONG TALE PUBLISHING, LLC (TEXAS LIMITED LIABILITY COMPANY)  
13039 MOSSY RIDGE COVE  
HOUSTON, TX 77041

FOR: AUDIO BOOKS IN THE NATURE OF NOVELS; DIGITAL MEDIA, NAMELY, AUDIO BOOKS FEATURING CHILDREN'S LITERATURE, IN CLASS 9 (U.S. CLS. 21, 23, 26, 36 AND 38).

FIRST USE 5-8-2008; IN COMMERCE 8-1-2008.

FOR: CHILDREN'S BOOKS; SERIES OF FICTION BOOKS; STORY BOOKS, IN CLASS 16 (U.S. CLS. 2, 5, 22, 23, 29, 37, 38 AND 50).

FIRST USE 5-8-2008; IN COMMERCE 7-1-2008.

THE MARK CONSISTS OF STANDARD CHARACTERS WITHOUT CLAIM TO ANY PARTICULAR FONT, STYLE, SIZE, OR COLOR.

NO CLAIM IS MADE TO THE EXCLUSIVE RIGHT TO USE "PUBLISHING", APART FROM THE MARK AS SHOWN.

SER. NO. 85-411,264, FILED 8-30-2011.

JUSTINE D. PARKER, EXAMINING ATTORNEY



*David J. Kybas*

Director of the United States Patent and Trademark Office

# United States of America

United States Patent and Trademark Office

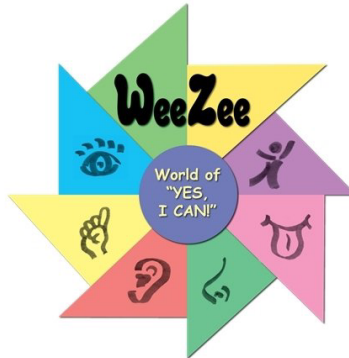

**Reg. No. 4,135,154**

**Registered May 1, 2012**

**Int. Cl.: 41**

**SERVICE MARK**

**PRINCIPAL REGISTER**

WEEZEE LLC (DELAWARE LIMITED LIABILITY COMPANY)  
411 MANVILLE ROAD  
PLEASANTVILLE, NY 10570

FOR: PROVISION OF PLAY FACILITIES FOR CHILDREN AND TEENS WITH AUTISM SPECTRUM DISORDERS; PROVIDING EDUCATIONAL ACTIVITIES IN THE NATURE OF CLASSES FOR CHILDREN AND TEENS WITH AUTISM SPECTRUM DISORDERS FOCUSED ON SENSORY INTEGRATION AND DEVELOPMENT, IN CLASS 41 (U.S. CLS. 100, 101 AND 107).

FIRST USE 6-21-2011; IN COMMERCE 6-21-2011.

THE MARK CONSISTS THE WORDS "WEE ZEE" IN STYLIZED BLACK LETTERING WRITTEN ACROSS THE TWO TOP TRIANGLES OF A MULTI-COLORED PINWHEEL PATTERN OF TRIANGLES INTERSECTING WITH A CENTRAL PURPLE CIRCLE. THE WORDING "WORLD OF "YES, I CAN!"" IS WRITTEN ON THE CENTRAL CIRCLE IN YELLOW. THE TRIANGLES ARE GREEN AND YELLOW AT THE TOP WITH THE WORDS "WEE ZEE" AND MOVING CLOCKWISE, ARE PURPLE WITH A STYLIZED HUMAN STICK FIGURE DESIGN, PINK WITH A HUMAN TONGUE DESIGN, GREEN WITH A HUMAN NOSE DESIGN, ORANGE WITH A HUMAN EAR DESIGN, YELLOW WITH A HUMAN HAND DESIGN WITH THE INDEX FINGER EXTENDED UP, AND BLUE WITH A HUMAN EYE DESIGN.

THE COLOR(S) BLACK, YELLOW, PURPLE, PINK, GREEN, ORANGE, AND BLUE IS/ARE CLAIMED AS A FEATURE OF THE MARK.

SER. NO. 85-411,274, FILED 8-30-2011.

MATTHEW MCDOWELL, EXAMINING ATTORNEY



*David J. Kyros*

Director of the United States Patent and Trademark Office

# United States of America

United States Patent and Trademark Office

# WeeZee

**Reg. No. 4,135,155**

**Registered May 1, 2012**

**Int. Cl.: 41**

**SERVICE MARK**

**PRINCIPAL REGISTER**

WEEZEE LLC (DELAWARE LIMITED LIABILITY COMPANY)  
411 MANVILLE ROAD  
PLEASANTVILLE, NY 10570

FOR: PROVISION OF PLAY FACILITIES FOR CHILDREN AND TEENS WITH AUTISM SPECTRUM DISORDERS; PROVIDING EDUCATIONAL ACTIVITIES IN THE NATURE OF CLASSES FOR CHILDREN AND TEENS WITH AUTISM SPECTRUM DISORDERS FOCUSED ON SENSORY INTEGRATION AND DEVELOPMENT, IN CLASS 41 (U.S. CLS. 100, 101 AND 107).

FIRST USE 6-21-2011; IN COMMERCE 6-21-2011.

THE MARK CONSISTS OF STANDARD CHARACTERS WITHOUT CLAIM TO ANY PARTICULAR FONT, STYLE, SIZE, OR COLOR.

SER. NO. 85-411,277, FILED 8-30-2011.

MATTHEW MCDOWELL, EXAMINING ATTORNEY



*David J. Kybas*

Director of the United States Patent and Trademark Office



# United States of America

United States Patent and Trademark Office

## WORLD OF "YES, I CAN!"

**Reg. No. 4,135,156**

**Registered May 1, 2012**

**Int. Cl.: 41**

**SERVICE MARK**

**PRINCIPAL REGISTER**

WEEZEE LLC (DELAWARE LIMITED LIABILITY COMPANY)  
411 MANVILLE ROAD  
PLEASANTVILLE, NY 10570

FOR: PROVISION OF PLAY FACILITIES FOR CHILDREN AND TEENS WITH AUTISM SPECTRUM DISORDERS; PROVIDING EDUCATIONAL ACTIVITIES IN THE NATURE OF CLASSES FOR CHILDREN AND TEENS WITH AUTISM SPECTRUM DISORDERS FOCUSED ON SENSORY INTEGRATION AND DEVELOPMENT, IN CLASS 41 (U.S. CLS. 100, 101 AND 107).

FIRST USE 6-21-2011; IN COMMERCE 6-21-2011.

THE MARK CONSISTS OF STANDARD CHARACTERS WITHOUT CLAIM TO ANY PARTICULAR FONT, STYLE, SIZE, OR COLOR.

SER. NO. 85-411,278, FILED 8-30-2011.

MATTHEW MCDOWELL, EXAMINING ATTORNEY



*David J. Kyffers*

Director of the United States Patent and Trademark Office

# United States of America

United States Patent and Trademark Office



**Reg. No. 4,135,157**

BBU WORKS, LLC (MISSOURI LIMITED LIABILITY COMPANY), DBA BBU  
1318 N CLEAVER AVE, APT 3F  
CHICAGO, IL 60622

**Registered May 1, 2012**

**Int. Cl.: 41**

FOR: ENTERTAINMENT, NAMELY, LIVE PERFORMANCES BY A MUSICAL BAND, IN CLASS 41 (U.S. CLS. 100, 101 AND 107).

**SERVICE MARK**

FIRST USE 1-12-2009; IN COMMERCE 1-12-2009.

**PRINCIPAL REGISTER**

THE MARK CONSISTS OF THE LETTERS "B" "B" AND "U" WITH AN EXCLAMATION POINT.

SER. NO. 85-411,280, FILED 8-30-2011.

JUSTINE D. PARKER, EXAMINING ATTORNEY



*David J. Kyffers*

Director of the United States Patent and Trademark Office

# United States of America

United States Patent and Trademark Office

## Put A Cork In It

**Reg. No. 4,135,158**

**Registered May 1, 2012**

**Int. Cl.: 33**

**TRADEMARK**

**PRINCIPAL REGISTER**

PUT A CORK IN IT, LLC (OKLAHOMA LIMITED LIABILITY COMPANY), DBA PUT A CORK IN IT  
115 EAST CALIFORNIA, SUITE 103  
OKLAHOMA CITY, OK 73104

FOR: WINE, IN CLASS 33 (U.S. CLS. 47 AND 49).

FIRST USE 3-26-2009; IN COMMERCE 3-26-2009.

THE MARK CONSISTS OF STANDARD CHARACTERS WITHOUT CLAIM TO ANY PARTICULAR FONT, STYLE, SIZE, OR COLOR.

SER. NO. 85-411,293, FILED 8-30-2011.

KATHLEEN KOLACZ, EXAMINING ATTORNEY



*David J. Kybas*

Director of the United States Patent and Trademark Office

# United States of America

United States Patent and Trademark Office

# CALVI

**Reg. No. 4,135,159**

**Registered May 1, 2012**

**Int. Cl.: 6**

**TRADEMARK**

**PRINCIPAL REGISTER**

CALVI S.P.A. (ITALY JOINT STOCK COMPANY)  
VIA IV NOVEMBRE, 2  
MERATE (LECCO), ITALY

FOR: METAL PROFILES, ALLOYS PROFILES AND STEEL PROFILES, DRAWN OR EXTRUDED SEMI-FINISHED ARTICLES OF STEEL OR ITS ALLOYS, IN CLASS 6 (U.S. CLS. 2, 12, 13, 14, 23, 25 AND 50).

FIRST USE 11-27-1974; IN COMMERCE 11-27-1974.

THE MARK CONSISTS OF STANDARD CHARACTERS WITHOUT CLAIM TO ANY PARTICULAR FONT, STYLE, SIZE, OR COLOR.

OWNER OF U.S. REG. NO. 2,982,333.

SEC. 2(F).

SER. NO. 85-411,297, FILED 8-30-2011.

DAVID TAYLOR, EXAMINING ATTORNEY



*David J. Kybas*

Director of the United States Patent and Trademark Office

# United States of America

United States Patent and Trademark Office

## The Dishmaster

**Reg. No. 4,135,160**

**Registered May 1, 2012**

**Int. Cl.: 35**

**SERVICE MARK**

**PRINCIPAL REGISTER**

HAGEN, VANESSA L. (CALIFORNIA SOLE PROPRIETORSHIP), DBA THE DISHMASTER  
8853 ALCOTT STREET APARTMENT 2  
LOS ANGELES, CA 90035

FOR: ADVERTISING AND MARKETING SERVICES PROVIDED BY MEANS OF INDIRECT METHODS OF MARKETING COMMUNICATIONS, NAMELY, SOCIAL MEDIA, SEARCH ENGINE MARKETING, INQUIRY MARKETING, INTERNET MARKETING, MOBILE MARKETING, BLOGGING AND OTHER FORMS OF PASSIVE, SHARABLE OR VIRAL COMMUNICATIONS CHANNELS, IN CLASS 35 (U.S. CLS. 100, 101 AND 102).

FIRST USE 8-1-2010; IN COMMERCE 8-15-2010.

THE MARK CONSISTS OF STANDARD CHARACTERS WITHOUT CLAIM TO ANY PARTICULAR FONT, STYLE, SIZE, OR COLOR.

SER. NO. 85-411,307, FILED 8-31-2011.

MARIA-VICTORIA SUAREZ, EXAMINING ATTORNEY



*David J. Kybas*

Director of the United States Patent and Trademark Office

# United States of America

United States Patent and Trademark Office

## IT'S UP TO ME TO BE DRUG FREE

**Reg. No. 4,135,161**

NATIONAL FAMILY PARTNERSHIP (FLORIDA CORPORATION)  
2490 CORAL WAY  
MIAMI, FL 33145

**Registered May 1, 2012**

**Int. Cl.: 35**

FOR: PROMOTING PUBLIC AWARENESS OF THE NEED FOR DRUG ABUSE PREVENTION,  
IN CLASS 35 (U.S. CLS. 100, 101 AND 102).

**SERVICE MARK**

FIRST USE 2-8-2011; IN COMMERCE 2-8-2011.

**PRINCIPAL REGISTER**

THE MARK CONSISTS OF STANDARD CHARACTERS WITHOUT CLAIM TO ANY PAR-  
TICULAR FONT, STYLE, SIZE, OR COLOR.

SER. NO. 85-411,309, FILED 8-31-2011.

MARIA-VICTORIA SUAREZ, EXAMINING ATTORNEY



*David J. Kybas*

Director of the United States Patent and Trademark Office

# United States of America

United States Patent and Trademark Office

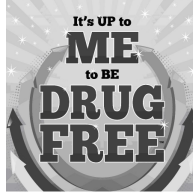

**Reg. No. 4,135,162**

NATIONAL FAMILY PARTNERSHIP (FLORIDA CORPORATION)  
2490 CORAL WAY  
MIAMI, FL 33145

**Registered May 1, 2012**

**Int. Cl.: 35**

FOR: PROMOTING PUBLIC AWARENESS OF THE NEED FOR DRUG ABUSE PREVENTION,  
IN CLASS 35 (U.S. CLS. 100, 101 AND 102).

**SERVICE MARK**

FIRST USE 2-8-2011; IN COMMERCE 2-8-2011.

**PRINCIPAL REGISTER**

THE MARK CONSISTS OF THE WORDS "IT'S UP TO ME TO BE DRUG FREE" WITH THE WORDS "UP" "ME" "BE" "DRUG" AND "FREE" IN ALL CAPS, WITH THE WORDS DESCENDING DOWN THE PAGE: "IT'S UP TO" ABOVE "ME" ABOVE "TO BE" ABOVE "DRUG FREE", WITH THE WORDS "ME" AND "DRUG FREE" IN LARGER FONT THAN THE OTHER WORDS, WITH ALL THE WORDS ENCIRCLED BY ARROWS IN DESCENDING ORDER OF WIDER AND SHORTER CIRCUMFERENCE, IN VARYING SHADES, AND THE WHOLE IMAGE DEPICTED AS BEING IN THE CENTER WITH RAYS OF LIGHT EMANATING FROM THE CENTER, AND SPARKLING STARS INTERSPERSED AMONG THE RAYS.

SER. NO. 85-411,311, FILED 8-31-2011.

MARIA-VICTORIA SUAREZ, EXAMINING ATTORNEY



*David J. Kyros*

Director of the United States Patent and Trademark Office

# United States of America

United States Patent and Trademark Office

## 1st Class Collection

**Reg. No. 4,135,163**

**Registered May 1, 2012**

**Int. Cl.: 16**

**TRADEMARK**

**PRINCIPAL REGISTER**

1ST CLASS COLLECTION, LLC (MASSACHUSETTS LIMITED LIABILITY COMPANY)  
23 JOSEPHINE AVENUE  
METHUEN, MA 01844

FOR: SPORTS TRADING CARDS, IN CLASS 16 (U.S. CLS. 2, 5, 22, 23, 29, 37, 38 AND 50).

FIRST USE 8-27-2011; IN COMMERCE 8-27-2011.

THE MARK CONSISTS OF STANDARD CHARACTERS WITHOUT CLAIM TO ANY PARTICULAR FONT, STYLE, SIZE, OR COLOR.

NO CLAIM IS MADE TO THE EXCLUSIVE RIGHT TO USE "COLLECTION", APART FROM THE MARK AS SHOWN.

SER. NO. 85-411,314, FILED 8-31-2011.

HOWARD B. LEVINE, EXAMINING ATTORNEY



*David J. Kyffers*

Director of the United States Patent and Trademark Office



# United States of America

United States Patent and Trademark Office

## Lovesdelicious...

**Reg. No. 4,135,164**

**Registered May 1, 2012**

**Int. Cl.: 45**

**SERVICE MARK**

**PRINCIPAL REGISTER**

SHAHERAH LOVE WHITE (UNITED STATES INDIVIDUAL)  
31858 CASTAIC ROAD, SUITE 145  
CASTAIC, CA 91384

FOR: PRIVATE CHEF SERVICES, IN CLASS 45 (U.S. CLS. 100 AND 101).

FIRST USE 1-1-2008; IN COMMERCE 1-1-2008.

THE MARK CONSISTS OF STANDARD CHARACTERS WITHOUT CLAIM TO ANY PARTICULAR FONT, STYLE, SIZE, OR COLOR.

SER. NO. 85-411,318, FILED 8-31-2011.

JENNIFER DIXON, EXAMINING ATTORNEY



*David J. Kybas*

Director of the United States Patent and Trademark Office

# United States of America

United States Patent and Trademark Office

XOX

**Reg. No. 4,135,165**

**Registered May 1, 2012**

**Int. Cl.: 9**

**TRADEMARK**

**PRINCIPAL REGISTER**

SHENZHEN XOX ELECTRONICS CO., LTD. (CHINA CORPORATION)  
SOUTH SEC.,4/F ANZHILONG FACTORY BLOCK 1  
LONGHUA STREET, BAO'AN DISTRICT  
SHENZHEN, CHINA

FOR: ACOUSTIC CONDUITS; BATTERY CHARGERS; BLANK INTEGRATED CIRCUIT CARDS; CABINETS FOR LOUDSPEAKERS; COMPUTER PERIPHERAL DEVICES; COMPUTERS; ELECTRONIC CARD READERS; ELECTRONIC POCKET TRANSLATORS; GALVANIC BATTERIES; HEADPHONES; HORNS FOR LOUDSPEAKERS; MEGAPHONES; PERSONAL STEREOS; SOUND CARDS; SOUND RECORDING APPARATUS; SOUND TRANSMITTING APPARATUS, IN CLASS 9 (U.S. CLS. 21, 23, 26, 36 AND 38).

FIRST USE 7-4-2011; IN COMMERCE 7-4-2011.

THE MARK CONSISTS OF STYLIZED WORD XOX.

SER. NO. 85-411,339, FILED 8-31-2011.

ANNE E. GUSTASON, EXAMINING ATTORNEY



*David J. Kybas*

Director of the United States Patent and Trademark Office

# United States of America

United States Patent and Trademark Office

# HAOBO

**Reg. No. 4,135,166**

**Registered May 1, 2012**

**Int. Cl.: 28**

**TRADEMARK**

**PRINCIPAL REGISTER**

ZHEJIANG HOPE SPORTS EQUIPMENT CO., LTD. (CHINA LIMITED COMPANY (LTD.))  
NO.19, HARDWARE ROAD  
TONGQIN INDUSTRIAL ZONE, WUYI  
ZHEJIANG PROVINCE, CHINA

FOR: APPARATUS FOR ELECTRONIC GAMES OTHER THAN THOSE ADAPTED FOR USE WITH AN EXTERNAL DISPLAY SCREEN OR MONITOR; BALLS FOR GAMES; BATTING GLOVES; BODY-BUILDING APPARATUS; BOWS FOR ARCHERY; CAMOUFLAGE SCREENS; CHRISTMAS TREES OF SYNTHETIC MATERIAL; ELECTRONIC GAMES OTHER THAN THOSE ADAPTED FOR USE WITH TELEVISION RECEIVERS ONLY; EXERCISE EQUIPMENT, NAMELY, STATIONARY CYCLES; EXERCISE MACHINES; FISHING RODS; FITNESS MACHINES AND EQUIPMENT, NAMELY, WEIGHTS, TREADMILLS, ROWING MACHINES, STAIR STEPPING MACHINES, RESISTANCE MACHINES, STATIONARY CYCLES; GAMING EQUIPMENT, NAMELY, PLAYING CARDS, CHIPS, GAMING TABLES AND GAMING CLOTHS; GYMNAS TIC APPARATUS; HANG GLIDERS; INFANT TOYS; INFLATABLE SWIMMING POOLS; MANUALLY-OPERATED EXERCISE EQUIPMENT FOR PHYSICAL FITNESS PURPOSES; STATIONARY EXERCISE BICYCLES, IN CLASS 28 (U.S. CLS. 22, 23, 38 AND 50).

FIRST USE 7-7-2011; IN COMMERCE 7-7-2011.

THE MARK CONSISTS OF THE STYLIZED WORD "HAOBO" WHERE THE HORIZONTAL LINE IN THE LETTER A IS OMITTED.

THE WORDING "HAOBO" HAS NO MEANING IN A FOREIGN LANGUAGE.

SER. NO. 85-411,342, FILED 8-31-2011.

MIDGE BUTLER, EXAMINING ATTORNEY



*David J. Kyros*

Director of the United States Patent and Trademark Office

# United States of America

United States Patent and Trademark Office

**MAGICSHINE**

**Reg. No. 4,135,167**

**Registered May 1, 2012**

**Int. Cl.: 11**

**TRADEMARK**

**PRINCIPAL REGISTER**

SHENZHEN MINJUN ELECTRONIC CO., LTD (CHINA LIMITED LIABILITY COMPANY)  
3/F, BUILDING D, HUALI INDUSTRIAL ZONE  
28 BAOAN DISTRICT  
SHENZHEN, CHINA

FOR: AIR CONDITIONING APPARATUS; AIR CONDITIONING UNITS; COOKING OVENS;  
ELECTRIC RADIATORS; ELECTRIC TORCHES FOR LIGHTING; HEAT ACCUMULATORS;  
LIGHTING TUBES; LIGHTS FOR VEHICLES; SEARCHLIGHTS; WATER PURIFICATION  
UNITS, IN CLASS 11 (U.S. CLS. 13, 21, 23, 31 AND 34).

FIRST USE 12-14-2009; IN COMMERCE 2-8-2011.

THE MARK CONSISTS OF THE LETTERS OF "MAGICSHINE" WITH TWO PITCH ARCS  
ON THE TOP OF LETTERS "AGICSHINE".

SER. NO. 85-411,349, FILED 8-31-2011.

AMY KERTGATE, EXAMINING ATTORNEY



*David J. Kyffers*

Director of the United States Patent and Trademark Office

# United States of America

United States Patent and Trademark Office

# Mocdei

**Reg. No. 4,135,168**

**Registered May 1, 2012**

**Int. Cl.: 30**

**TRADEMARK**

**PRINCIPAL REGISTER**

CHEN FENG (CHINA INDIVIDUAL)  
RM.502,BLD E2, SHIGANG GUOJI GONGYU  
NO.192, XINGANG EAST ROAD  
HAIZHU, GUANGZHOU, CHINA

FOR: BREAD; CEREAL BASED SNACK FOOD; COFFEE; FARINACEOUS FOOD PASTES FOR HUMAN CONSUMPTION; HONEY; ICE CREAM; NOODLES; PASTRIES; RICE; SEASONINGS; SOYA FLOUR; SUGAR; SUSHI; SWEETMEATS; TEA, IN CLASS 30 (U.S. CL. 46).

FIRST USE 9-18-2008; IN COMMERCE 10-28-2010.

THE MARK CONSISTS OF THE LETTERS OF "MOCDEI" IN CURSIVE WRITING.

SER. NO. 85-411,356, FILED 8-31-2011.

MIDGE BUTLER, EXAMINING ATTORNEY



*David J. Kyffers*

Director of the United States Patent and Trademark Office

# United States of America

United States Patent and Trademark Office

## HONEST ENTERTAINING

**Reg. No. 4,135,169**

**Registered May 1, 2012**

**Int. Cl.: 41**

**SERVICE MARK**

**PRINCIPAL REGISTER**

LEITE'S CULINARIA, INC. (NEW YORK CORPORATION)  
174 WEST 76TH STREET, 13G  
NEW YORK, NY 10023

FOR: PROVIDING ON-LINE, NON-DOWNLOADABLE PUBLICATIONS IN THE NATURE OF NEWSLETTERS IN THE FIELD OF COOKING AND RECIPES, IN CLASS 41 (U.S. CLS. 100, 101 AND 107).

FIRST USE 6-1-2011; IN COMMERCE 6-1-2011.

THE MARK CONSISTS OF STANDARD CHARACTERS WITHOUT CLAIM TO ANY PARTICULAR FONT, STYLE, SIZE, OR COLOR.

NO CLAIM IS MADE TO THE EXCLUSIVE RIGHT TO USE "ENTERTAINING", APART FROM THE MARK AS SHOWN.

SER. NO. 85-411,366, FILED 8-31-2011.

PAUL E. FAHRENKOPF, EXAMINING ATTORNEY



*David J. Kyffers*

Director of the United States Patent and Trademark Office

# United States of America

United States Patent and Trademark Office

# PENTHOUSE

**Reg. No. 4,135,170**

**Registered May 1, 2012**

**Int. Cl.: 4**

**TRADEMARK**

**PRINCIPAL REGISTER**

GENERAL MEDIA COMMUNICATIONS, INC. (NEW YORK CORPORATION)  
6800 BROKEN SOUND PKWY, SUITE 100  
BOCA RATON, FL 33487

FOR: CANDLES; KITS CONTAINING CANDLES, IN CLASS 4 (U.S. CLS. 1, 6 AND 15).

FIRST USE 0-0-1998; IN COMMERCE 0-0-1998.

THE MARK CONSISTS OF STANDARD CHARACTERS WITHOUT CLAIM TO ANY PARTICULAR FONT, STYLE, SIZE, OR COLOR.

OWNER OF U.S. REG. NOS. 2,435,702, 3,007,070 AND OTHERS.

SER. NO. 85-411,383, FILED 8-31-2011.

JEFF DEFORD, EXAMINING ATTORNEY



*David J. Kyffers*

Director of the United States Patent and Trademark Office

# United States of America

United States Patent and Trademark Office

# GLOFISH

**Reg. No. 4,135,171**

**Registered May 1, 2012**

**Int. Cls.: 18 and 25**

**TRADEMARK**

**PRINCIPAL REGISTER**

YORKTOWN TECHNOLOGIES, L.P. (TEXAS LIMITED PARTNERSHIP)  
C/O REGISTERED AGENT SOLUTIONS, INC.  
515 CONGRESS AVENUE, SUITE 2300  
AUSTIN, TX 78701

FOR: TOTE BAGS, IN CLASS 18 (U.S. CLS. 1, 2, 3, 22 AND 41).

FIRST USE 12-5-2010; IN COMMERCE 12-5-2010.

FOR: T-SHIRTS, IN CLASS 25 (U.S. CLS. 22 AND 39).

FIRST USE 2-2-2011; IN COMMERCE 2-2-2011.

THE MARK CONSISTS OF STANDARD CHARACTERS WITHOUT CLAIM TO ANY PARTICULAR FONT, STYLE, SIZE, OR COLOR.

SER. NO. 85-411,394, FILED 8-31-2011.

DEBORAH LOBO, EXAMINING ATTORNEY



*David J. Kybas*

Director of the United States Patent and Trademark Office



# United States of America

United States Patent and Trademark Office

# ClickSafe

**Reg. No. 4,135,172**

**Registered May 1, 2012**

**Int. Cl.: 42**

**SERVICE MARK**

**PRINCIPAL REGISTER**

LUCENTE, DANIEL G (UNITED STATES INDIVIDUAL)  
PO BOX 810  
487 FEDERAL RD 2ND FL  
BROOKFIELD, CT 06804

FOR: RECORDING DATA FOR OTHERS ON OPTICAL, DIGITAL AND MAGNETIC MEDIA  
FOR ELECTRONIC STORAGE, IN CLASS 42 (U.S. CLS. 100 AND 101).

FIRST USE 1-1-2008; IN COMMERCE 1-1-2008.

THE MARK CONSISTS OF STANDARD CHARACTERS WITHOUT CLAIM TO ANY PAR-  
TICULAR FONT, STYLE, SIZE, OR COLOR.

SER. NO. 85-411,423, FILED 8-31-2011.

MARK T. MULLEN, EXAMINING ATTORNEY



*David J. Kybas*

Director of the United States Patent and Trademark Office

# United States of America

United States Patent and Trademark Office



**Reg. No. 4,135,173**

**Registered May 1, 2012**

**Int. Cl.: 37**

**SERVICE MARK**

**PRINCIPAL REGISTER**

LOETSCHER, JOLENE (UNITED STATES INDIVIDUAL)  
8611 W GRINN PLACE  
SIOUX FALLS, SD 57106

FOR: PET WASTE REMOVAL SERVICES, IN CLASS 37 (U.S. CLS. 100, 103 AND 106).

FIRST USE 10-1-2007; IN COMMERCE 1-15-2008.

THE MARK CONSISTS OF THE STYLIZED WORDS "DOOGOODERS". AN IMAGE OF A PILE OF POO WITH A HALO ABOVE.

SER. NO. 85-411,440, FILED 8-31-2011.

ELI HELLMAN, EXAMINING ATTORNEY



*David J. Kybas*

Director of the United States Patent and Trademark Office

# United States of America

United States Patent and Trademark Office

## Best Hookers In Town

**Reg. No. 4,135,174**

**Registered May 1, 2012**

**Int. Cl.: 39**

**SERVICE MARK**

**PRINCIPAL REGISTER**

FLORIDA KEYS TOWING INC. (FLORIDA CORPORATION)  
1600 OVERSEAS HIGHWAY  
MARATHON, FL 33050

FOR: EMERGENCY AUTO OR TRUCK TOWING, IN CLASS 39 (U.S. CLS. 100 AND 105).

FIRST USE 1-1-1997; IN COMMERCE 1-1-1997.

THE MARK CONSISTS OF STANDARD CHARACTERS WITHOUT CLAIM TO ANY PARTICULAR FONT, STYLE, SIZE, OR COLOR.

SER. NO. 85-411,445, FILED 8-31-2011.

LINDA MICKLEBURGH, EXAMINING ATTORNEY



*David J. Kyffers*

Director of the United States Patent and Trademark Office

# United States of America

United States Patent and Trademark Office

"After physical therapy -  
there is pilates"

**Reg. No. 4,135,175**

**Registered May 1, 2012**

**Int. Cl.: 41**

**SERVICE MARK**

**PRINCIPAL REGISTER**

THE PILATES STUDIO LLC (NEW JERSEY LIMITED LIABILITY COMPANY)  
APT 417  
2700 ATLANTIC AVE  
LONGPORT, NJ 08403

FOR: PROVIDING FITNESS AND EXERCISE STUDIO SERVICES, NAMELY, PILATES INSTRUCTION AND TRAINING, IN CLASS 41 (U.S. CLS. 100, 101 AND 107).

FIRST USE 4-1-2010; IN COMMERCE 4-1-2010.

THE MARK CONSISTS OF STANDARD CHARACTERS WITHOUT CLAIM TO ANY PARTICULAR FONT, STYLE, SIZE, OR COLOR.

SER. NO. 85-411,448, FILED 8-31-2011.

LINDA MICKLEBURGH, EXAMINING ATTORNEY



*David J. Kybas*

Director of the United States Patent and Trademark Office

# United States of America

United States Patent and Trademark Office

# Glamour FX

**Reg. No. 4,135,176**

**Registered May 1, 2012**

**Int. Cls.: 2 and 21**

**TRADEMARK**

**PRINCIPAL REGISTER**

HOWES, ANNIE (ARIZONA SOLE PROPRIETORSHIP), DBA ANNIE HOWES KEEPSAKES  
14175 W INDIAN SCHOOL RD STE B4#115  
GOODYEAR, AZ 85395

FOR: GLAZES, IN CLASS 2 (U.S. CLS. 6, 11 AND 16).

FIRST USE 8-1-2011; IN COMMERCE 8-15-2011.

FOR: GLASS FOR DECORATIVE PURPOSES, NAMELY, SEA GLASS, IN CLASS 21 (U.S. CLS. 2, 13, 23, 29, 30, 33, 40 AND 50).

FIRST USE 8-1-2011; IN COMMERCE 8-15-2011.

THE MARK CONSISTS OF STANDARD CHARACTERS WITHOUT CLAIM TO ANY PARTICULAR FONT, STYLE, SIZE, OR COLOR.

SER. NO. 85-411,452, FILED 8-31-2011.

DEZMONA MIZELLE, EXAMINING ATTORNEY



*David J. Kyffers*

Director of the United States Patent and Trademark Office

# United States of America

United States Patent and Trademark Office

# SAAMS

**Reg. No. 4,135,177**

**Registered May 1, 2012**

**Int. Cl.: 42**

**SERVICE MARK**

**PRINCIPAL REGISTER**

AMERICAN ASSOCIATION OF AIRPORT EXECUTIVES INC. (ILLINOIS NOT-FOR-PROFIT CORPORATION)  
601 MADISON STREET  
ALEXANDRIA, VA 22314

FOR: SOFTWARE AS A SERVICE (SAAS) FEATURING SOFTWARE THAT PROVIDES SPATIAL INFORMATION MAPPING OF AREAS AND FEATURES OF VARIOUS DEFINED AREAS, SUCH AS TRANSPORTATION HUBS LIKE AVIATION FACILITIES, ROADWAYS, AND RAILWAY SYSTEMS, FOR ASSET MANAGEMENT AND MAINTENANCE, SECURITY, REPORTING, DATA COLLECTION, SPACE PLANNING AND DESIGN, AND DATA ANALYSIS FUNCTIONS, IN CLASS 42 (U.S. CLS. 100 AND 101).

FIRST USE 4-1-2011; IN COMMERCE 4-1-2011.

THE MARK CONSISTS OF STANDARD CHARACTERS WITHOUT CLAIM TO ANY PARTICULAR FONT, STYLE, SIZE, OR COLOR.

SER. NO. 85-411,478, FILED 8-31-2011.

WILLIAM ROSSMAN, EXAMINING ATTORNEY



*David J. Kyffers*

Director of the United States Patent and Trademark Office

# United States of America

United States Patent and Trademark Office

**PURE**  
HYPERCLEANING

**Reg. No. 4,135,178**

**Registered May 1, 2012**

**Int. Cl.: 37**

**SERVICE MARK**

**PRINCIPAL REGISTER**

PURE, LLC (FLORIDA LIMITED LIABILITY COMPANY)  
SUITE 130  
10385 IRONWOOD RD.  
PALM BEACH GARDENS, FL 33410

FOR: CLEANING OF COMMERCIAL PREMISES; CLEANING OF RESIDENTIAL HOUSES,  
IN CLASS 37 (U.S. CLS. 100, 103 AND 106).

FIRST USE 1-15-2010; IN COMMERCE 1-15-2010.

THE MARK CONSISTS OF THE TEXT "PURE" ON TOP WITH THE "U" DESIGNED IN THE  
SHAPE OF A WATER DROP, AND THE TEXT "HYPERCLEANING" BELOW.

SER. NO. 85-411,479, FILED 8-31-2011.

REGINA DRUMMOND, EXAMINING ATTORNEY



*David J. Kybas*

Director of the United States Patent and Trademark Office

# United States of America

United States Patent and Trademark Office



**Reg. No. 4,135,179**

**Registered May 1, 2012**

**Int. Cl.: 36**

**SERVICE MARK**

**PRINCIPAL REGISTER**

OMO CHILD FOUNDATION (CALIFORNIA NON-PROFIT CORPORATION)  
P.O. BOX 2387  
RANCHO SANTA FE, CA 92067

FOR: CHARITABLE FUNDRAISING, IN CLASS 36 (U.S. CLS. 100, 101 AND 102).

FIRST USE 4-0-2011; IN COMMERCE 4-0-2011.

THE MARK CONSISTS OF A DESIGN OF A HAND.

SER. NO. 85-411,489, FILED 8-31-2011.

KHANH LE, EXAMINING ATTORNEY



*David J. Kybas*

Director of the United States Patent and Trademark Office



# United States of America

United States Patent and Trademark Office

# Sour Girls

**Reg. No. 4,135,180**

**Registered May 1, 2012**

**Int. Cls.: 14 and 25**

**TRADEMARK**

**PRINCIPAL REGISTER**

FORTY FREE (DELAWARE LIMITED LIABILITY COMPANY)  
APT. 404  
1725 W. NORTH AVE.  
CHICAGO, IL 60622

FOR: JEWELRY, IN CLASS 14 (U.S. CLS. 2, 27, 28 AND 50).

FIRST USE 1-7-2011; IN COMMERCE 1-7-2011.

FOR: HATS; SCARVES; T-SHIRTS, IN CLASS 25 (U.S. CLS. 22 AND 39).

FIRST USE 1-7-2011; IN COMMERCE 1-7-2011.

THE MARK CONSISTS OF STANDARD CHARACTERS WITHOUT CLAIM TO ANY PARTICULAR FONT, STYLE, SIZE, OR COLOR.

SER. NO. 85-411,490, FILED 8-31-2011.

APRIL HESIK, EXAMINING ATTORNEY



*David J. Kybas*

Director of the United States Patent and Trademark Office

# United States of America

United States Patent and Trademark Office

## OMG...THEY DON'T SLIP!

**Reg. No. 4,135,181**

**Registered May 1, 2012**

**Int. Cl.: 25**

**TRADEMARK**

**PRINCIPAL REGISTER**

SWEATY BANDS LLC (OHIO LIMITED LIABILITY COMPANY)  
4650 WILMER COURT  
CINCINNATI, OH 45226

FOR: ATHLETIC HEADBANDS, IN CLASS 25 (U.S. CLS. 22 AND 39).

FIRST USE 3-1-2009; IN COMMERCE 3-1-2009.

THE MARK CONSISTS OF STANDARD CHARACTERS WITHOUT CLAIM TO ANY PARTICULAR FONT, STYLE, SIZE, OR COLOR.

SER. NO. 85-411,506, FILED 8-31-2011.

WILLIAM ROSSMAN, EXAMINING ATTORNEY



*David J. Kyros*

Director of the United States Patent and Trademark Office

# United States of America

United States Patent and Trademark Office

## CENT\$IBLE MARKETING

**Reg. No. 4,135,182**

**Registered May 1, 2012**

**Int. Cl.: 35**

**SERVICE MARK**

**PRINCIPAL REGISTER**

PRO/PHASE MARKETING, INC. (MINNESOTA CORPORATION)  
6554 EDENVALE BOULEVARD  
EDEN PRAIRIE, MN 553462502

FOR: MARKETING SERVICES, NAMELY, PROVIDING PHYSICAL AND DIGITAL BUSINESS MARKETING SERVICES, INCLUDING PROVIDING MARKETING SERVICES VIA A WORLDWIDE GLOBAL COMPUTER NETWORK; AND LOYALTY AND MEMBERSHIP PROGRAM MARKETING SERVICES, IN CLASS 35 (U.S. CLS. 100, 101 AND 102).

FIRST USE 12-21-2010; IN COMMERCE 12-21-2010.

THE MARK CONSISTS OF STANDARD CHARACTERS WITHOUT CLAIM TO ANY PARTICULAR FONT, STYLE, SIZE, OR COLOR.

NO CLAIM IS MADE TO THE EXCLUSIVE RIGHT TO USE "MARKETING", APART FROM THE MARK AS SHOWN.

SER. NO. 85-411,507, FILED 8-31-2011.

MIDGE BUTLER, EXAMINING ATTORNEY



*David J. Kyffers*

Director of the United States Patent and Trademark Office

# United States of America

United States Patent and Trademark Office

# silhouPETte

**Reg. No. 4,135,183**

**Registered May 1, 2012**

**Int. Cl.: 14**

**TRADEMARK**

**PRINCIPAL REGISTER**

SILHOUPETTE, LLC (CALIFORNIA LIMITED LIABILITY COMPANY)  
SUITE 203  
1350 ABBOT KINNEY BOULEVARD  
VENICE, CA 90291

FOR: JEWELRY, IN CLASS 14 (U.S. CLS. 2, 27, 28 AND 50).

FIRST USE 12-1-2008; IN COMMERCE 12-1-2008.

THE MARK CONSISTS OF STANDARD CHARACTERS WITHOUT CLAIM TO ANY PARTICULAR FONT, STYLE, SIZE, OR COLOR.

SER. NO. 85-411,531, FILED 8-31-2011.

RENEE MCCRAY, EXAMINING ATTORNEY



*David J. Kybas*

Director of the United States Patent and Trademark Office

# United States of America

United States Patent and Trademark Office

## Eastern Engineered Wood Products

**Reg. No. 4,135,184**

**Registered May 1, 2012**

**Int. Cl.: 35**

**SERVICE MARK**

**PRINCIPAL REGISTER**

EASTERN ENGINEERED WOOD PRODUCTS, INC. (PENNSYLVANIA CORPORATION)  
1245 EASTON ROAD  
BETHLEHEM, PA 18015

FOR: WHOLESALE DISTRIBUTORSHIPS FEATURING ENGINEERED WOOD PRODUCTS, NAMELY, I-JOISTS, LAMINATED VENEER LUMBER, GLUED LAMINATED TIMBERS, AND BOARDS IN THE NATURE OF RIMBOARDS, LAMINATED STUDS AND TRIMMABLE-END TRUSSES, IN CLASS 35 (U.S. CLS. 100, 101 AND 102).

FIRST USE 1-1-1998; IN COMMERCE 1-1-1998.

THE MARK CONSISTS OF STANDARD CHARACTERS WITHOUT CLAIM TO ANY PARTICULAR FONT, STYLE, SIZE, OR COLOR.

NO CLAIM IS MADE TO THE EXCLUSIVE RIGHT TO USE "ENGINEERED WOOD PRODUCTS", APART FROM THE MARK AS SHOWN.

SER. NO. 85-411,532, FILED 8-31-2011.

DORITT L. CARROLL, EXAMINING ATTORNEY



*David J. Kyros*

Director of the United States Patent and Trademark Office

# United States of America

United States Patent and Trademark Office

DON'T LET LOVE PASS YOU BY

**Reg. No. 4,135,185**

**Registered May 1, 2012**

**Int. Cl.: 45**

**SERVICE MARK**

**PRINCIPAL REGISTER**

CAROLANN MERRITT-MUNSON (UNITED STATES INDIVIDUAL)  
7855 CANYON LAKE CIRCLE  
ORLANDO, FL 32835 AND

CHRISTOPHER MUNSON (UNITED STATES INDIVIDUAL)  
7855 CANYON LAKE CIRCLE  
ORLANDO, FL 32835

FOR: COMPUTER DATING SERVICES; DATING SERVICES; DATING SERVICES, NAMELY, PROVIDING AN ON-LINE COMPUTER DATABASE FEATURING SINGLE PEOPLE INTERESTED IN MEETING OTHER SINGLE PEOPLE; INTERNET-BASED DATING, SOCIAL INTRODUCTION AND SOCIAL NETWORKING SERVICES; PROVIDING A WEB SITE FEATURING INFORMATION AND CONTENT IN THE FIELDS OF PERSONAL RELATIONSHIPS, DATING AND FASHION; VIDEO DATING SERVICES; WEB SITE SERVICES FEATURING ON-LINE DATING CLUB, IN CLASS 45 (U.S. CLS. 100 AND 101).

FIRST USE 7-14-2011; IN COMMERCE 7-14-2011.

THE MARK CONSISTS OF STANDARD CHARACTERS WITHOUT CLAIM TO ANY PARTICULAR FONT, STYLE, SIZE, OR COLOR.

SER. NO. 85-411,545, FILED 8-31-2011.

JENNIFER WILLISTON, EXAMINING ATTORNEY



*David J. Kybas*

Director of the United States Patent and Trademark Office

# United States of America

United States Patent and Trademark Office

## Circa Real Estate

**Reg. No. 4,135,186**

**Registered May 1, 2012**

**Int. Cl.: 36**

**SERVICE MARK**

**PRINCIPAL REGISTER**

CIRCA REAL ESTATE (TEXAS LIMITED LIABILITY COMPANY)  
1127 WINSTON ST.  
HOUSTON, TX 77009

FOR: REAL ESTATE BROKERAGE, IN CLASS 36 (U.S. CLS. 100, 101 AND 102).

FIRST USE 3-15-2011; IN COMMERCE 3-15-2011.

THE MARK CONSISTS OF STANDARD CHARACTERS WITHOUT CLAIM TO ANY PARTICULAR FONT, STYLE, SIZE, OR COLOR.

NO CLAIM IS MADE TO THE EXCLUSIVE RIGHT TO USE "REAL ESTATE", APART FROM THE MARK AS SHOWN.

SER. NO. 85-411,574, FILED 8-31-2011.

JILL PRATER, EXAMINING ATTORNEY



*David J. Kybas*

Director of the United States Patent and Trademark Office

# United States of America

United States Patent and Trademark Office

## New Taste Today

**Reg. No. 4,135,187**

**Registered May 1, 2012**

**Int. Cl.: 41**

**SERVICE MARK**

**PRINCIPAL REGISTER**

V MARKETING & MEDIA INC (KANSAS CORPORATION)  
3522 N LAKE RIDGE CT.  
WICHITA, KS 67205

FOR: ENTERTAINMENT, NAMELY, A CONTINUING FOOD, WINE, COOKING, AND DINING SHOW BROADCAST OVER TELEVISION, RADIO, AND INTERNET, IN CLASS 41 (U.S. CLS. 100, 101 AND 107).

FIRST USE 7-23-2011; IN COMMERCE 7-23-2011.

THE MARK CONSISTS OF STANDARD CHARACTERS WITHOUT CLAIM TO ANY PARTICULAR FONT, STYLE, SIZE, OR COLOR.

SER. NO. 85-411,577, FILED 8-31-2011.

JILL PRATER, EXAMINING ATTORNEY



*David J. Kyffers*

Director of the United States Patent and Trademark Office



# United States of America

United States Patent and Trademark Office



**Reg. No. 4,135,188**

**Registered May 1, 2012**

**Int. Cl.: 25**

**TRADEMARK**

**PRINCIPAL REGISTER**

DECO TEASE (TEXAS PARTNERSHIP)  
APT. 2  
1707 NASSAU ST.  
EDINBURG, TX 78541

FOR: CLOTHING, NAMELY, T-SHIRTS, TANK TOPS, DRESSES, CORSETS, BUSTIERS, SUITS, JEANS, BOLEROS, JACKETS, VESTS, GLOVES, AND HATS DECORATED WITH ORIGINAL ARTWORK FROM VARIOUS ARTISTS, IN CLASS 25 (U.S. CLS. 22 AND 39).

FIRST USE 6-0-2011; IN COMMERCE 6-20-2011.

THE MARK CONSISTS OF A CIRCULAR ICON WITH SYMMETRICAL DETAIL ATTACHED TO THE BASE OF THE CIRCLE. WITHIN THE CIRCLE IS A STRIPED BACKGROUND AND A WOMAN'S FACE WITH HAIR AND FEATHERS ON THE TOP OF HER HEAD. BELOW THE ICON IN A ROUGHLY SKETCHED RECTANGLE WITH THE WORD "DECO" IN CAPITAL LETTERS IN AN ART DECO STYLE FONT, AND THE WORD "TEASE" IN CAPITAL LETTERS WITHIN THE CURVE OF THE LETTER "C".

SER. NO. 85-411,580, FILED 8-31-2011.

JILL PRATER, EXAMINING ATTORNEY



*David J. Kyffers*

Director of the United States Patent and Trademark Office

# United States of America

United States Patent and Trademark Office

# BILL'S BUS

**Reg. No. 4,135,189**

**Registered May 1, 2012**

**Int. Cl.: 39**

**SERVICE MARK**

**PRINCIPAL REGISTER**

CRAIG C. JENKINS (UNITED STATES INDIVIDUAL)  
415 W. GUTIERREZ, SUITE 17  
SANTA BARBARA, CA 93101

FOR: TRANSPORTATION OF PASSENGERS AND/OR GOODS BY BUS, IN CLASS 39 (U.S. CLS. 100 AND 105).

FIRST USE 0-0-1991; IN COMMERCE 0-0-1991.

THE MARK CONSISTS OF STANDARD CHARACTERS WITHOUT CLAIM TO ANY PARTICULAR FONT, STYLE, SIZE, OR COLOR.

NO CLAIM IS MADE TO THE EXCLUSIVE RIGHT TO USE "BUS", APART FROM THE MARK AS SHOWN.

SER. NO. 85-411,581, FILED 8-31-2011.

HOWARD SMIGA, EXAMINING ATTORNEY



*David J. Kybas*

Director of the United States Patent and Trademark Office

# United States of America

United States Patent and Trademark Office

## #RunChat Be There, or Be Running

**Reg. No. 4,135,190**

**Registered May 1, 2012**

**Int. Cl.: 45**

**SERVICE MARK**

**PRINCIPAL REGISTER**

#RUNCHAT (NEW YORK PARTNERSHIP)  
P.O. BOX 1367  
BEDFORD, VA 24523

FOR: ON-LINE SOCIAL NETWORKING SERVICES, IN CLASS 45 (U.S. CLS. 100 AND 101).

FIRST USE 6-1-2010; IN COMMERCE 6-1-2010.

THE MARK CONSISTS OF STANDARD CHARACTERS WITHOUT CLAIM TO ANY PARTICULAR FONT, STYLE, SIZE, OR COLOR.

SER. NO. 85-411,606, FILED 8-31-2011.

PATRICIA EVANKO, EXAMINING ATTORNEY



*David J. Kyjars*

Director of the United States Patent and Trademark Office

# United States of America

United States Patent and Trademark Office

## BUY RIGHT & BUY SAFE!

**Reg. No. 4,135,191**

**Registered May 1, 2012**

**Int. Cls.: 9 and 36**

**TRADEMARK**

**SERVICE MARK**

**PRINCIPAL REGISTER**

CARD LIMITED CORP (FLORIDA CORPORATION)  
5255 N EDGEWOOD DR, SUITE 225  
PROVO, UT 84604

FOR: MAGNETICALLY ENCODED DEBIT CARDS, IN CLASS 9 (U.S. CLS. 21, 23, 26, 36 AND 38).

FIRST USE 5-1-2011; IN COMMERCE 8-15-2011.

FOR: DEBIT CARD SERVICES, IN CLASS 36 (U.S. CLS. 100, 101 AND 102).

FIRST USE 5-1-2011; IN COMMERCE 8-15-2011.

THE MARK CONSISTS OF STANDARD CHARACTERS WITHOUT CLAIM TO ANY PARTICULAR FONT, STYLE, SIZE, OR COLOR.

SER. NO. 85-411,651, FILED 8-31-2011.

CURTIS FRENCH, EXAMINING ATTORNEY



*David J. Kybas*

Director of the United States Patent and Trademark Office

# United States of America

United States Patent and Trademark Office

## HAND IN HAND

**Reg. No. 4,135,192**

**Registered May 1, 2012**

**Int. Cl.: 35**

**SERVICE MARK**

**PRINCIPAL REGISTER**

MEDIMETRIX GROUP, INC. (OHIO CORPORATION)  
2424 NORTH FEDERAL HIGHWAY, SUITE 100  
BOCA RATON, FL 33431

FOR: PROMOTING PUBLIC AWARENESS OF THE NEED FOR CANCER SCREENINGS;  
ADVERTISING AND MARKETING SERVICES, IN CLASS 35 (U.S. CLS. 100, 101 AND 102).

FIRST USE 8-15-2011; IN COMMERCE 8-15-2011.

THE MARK CONSISTS OF STANDARD CHARACTERS WITHOUT CLAIM TO ANY PARTICULAR FONT, STYLE, SIZE, OR COLOR.

SER. NO. 85-411,673, FILED 8-31-2011.

HANNO RITTNER, EXAMINING ATTORNEY



*David J. Kyffers*

Director of the United States Patent and Trademark Office

# United States of America

United States Patent and Trademark Office

# DRILLAUD

**Reg. No. 4,135,193**

**Registered May 1, 2012**

**Int. Cl.: 33**

**TRADEMARK**

**PRINCIPAL REGISTER**

PAGES VEDRENNE (FRANCE CORPORATION)  
DISTILLERIE DE LA VERVEINE DU VELAY  
Z.I. DE BLAVOZY  
43700, FRANCE SAINTGERM

FOR: ALCOHOLIC BEVERAGES EXCEPT BEER, IN CLASS 33 (U.S. CLS. 47 AND 49).

FIRST USE 10-30-1969; IN COMMERCE 8-8-1983.

THE MARK CONSISTS OF STANDARD CHARACTERS WITHOUT CLAIM TO ANY PARTICULAR FONT, STYLE, SIZE, OR COLOR.

OWNER OF U.S. REG. NO. 1,647,007.

SER. NO. 85-411,686, FILED 8-31-2011.

JOHN E. MICHOS, EXAMINING ATTORNEY



*David J. Kyros*

Director of the United States Patent and Trademark Office

# United States of America

United States Patent and Trademark Office

# JESTMASTER

**Reg. No. 4,135,194**

**Registered May 1, 2012**

**Int. Cls.: 35 and 41**

**SERVICE MARK**

**PRINCIPAL REGISTER**

JON KOONS (UNITED STATES INDIVIDUAL), DBA JESTMASTER  
434 TENAFLY ROAD  
ENGLEWOOD, NJ 07631

FOR: RETAIL STORE AND ON-LINE RETAIL STORE SERVICES FEATURING JUGGLING PRODUCTS, PUZZLES, GAMES, COSTUMES AND PUPPETS, IN CLASS 35 (U.S. CLS. 100, 101 AND 102).

FIRST USE 7-27-1995; IN COMMERCE 7-27-1995.

FOR: ENTERTAINMENT IN THE NATURE OF LIVE PERFORMANCES BY MAGICIANS, COMEDIANS, AND LIVE THEATRICAL PERFORMANCES, IN CLASS 41 (U.S. CLS. 100, 101 AND 107).

FIRST USE 7-27-1995; IN COMMERCE 7-27-1995.

THE MARK CONSISTS OF STANDARD CHARACTERS WITHOUT CLAIM TO ANY PARTICULAR FONT, STYLE, SIZE, OR COLOR.

SER. NO. 85-411,689, FILED 8-31-2011.

JOHN E. MICHOS, EXAMINING ATTORNEY



*David J. Kyffers*

Director of the United States Patent and Trademark Office

# United States of America

United States Patent and Trademark Office



**Reg. No. 4,135,195**

**Registered May 1, 2012**

**Int. Cl.: 35**

**SERVICE MARK**

**PRINCIPAL REGISTER**

EASTERN ENGINEERED WOOD PRODUCTS, INC. (PENNSYLVANIA CORPORATION)  
1245 EASTON ROAD  
BETHLEHEM, PA 18015

FOR: WHOLE DISTRIBUTORSHIPS FEATURING ENGINEERED WOOD PRODUCTS, NAMELY, I-JOISTS, LAMINATED VENEER LUMBER, GLUED LAMINATED TIMBERS, AND BOARD IN THE NATURE OF RIMBOARDS, LAMINATED STUDS, AND TRIMMABLE-END TRUSSES, IN CLASS 35 (U.S. CLS. 100, 101 AND 102).

FIRST USE 10-26-2004; IN COMMERCE 10-26-2004.

NO CLAIM IS MADE TO THE EXCLUSIVE RIGHT TO USE "ENGINEERED WOOD PRODUCTS", APART FROM THE MARK AS SHOWN.

THE COLOR(S) GREEN, GRAY, BLACK AND WHITE IS/ARE CLAIMED AS A FEATURE OF THE MARK.

THE MARK CONSISTS OF A BLACK OUTLINE CREATING A TILTED SQUARE WITH ROUNDED EDGES WITH GRAY SHADING ALONG THE LEFT SIDE. THE BACKGROUND INSIDE THE TILTED SQUARE OUTLINE IS WHITE. ON THE WHITE BACKGROUND IN THE UPPER CENTER OF THE TILTED SQUARE OUTLINE IS A GREEN STYLIZED LETTER "E" IN BLOCK FONT FEATURING AN ARROW IN THE CENTER OF THE LETTER "E" WITH GRAY SHADING TO THE LEFT OF THE LETTER "E" AND TO THE LEFT OF THE ARROWHEAD. THE STYLIZED LETTER "E" IS LOCATED IN THE CENTER OF FOUR GREEN RIGHT ANGLES FORMING A TILTED SQUARE AROUND THE STYLIZED LETTER "E". THE TOP GREEN RIGHT ANGLE HAS GRAY SHADING TO THE OUTER LEFT EDGE AND THE INNER RIGHT SIDE, THE RIGHT GREEN RIGHT ANGLE HAS GRAY SHADING THROUGH ITS FULL INNER EDGE, THE BOTTOM GREEN RIGHT ANGLE HAS GRAY SHADING TO THE OUTER LEFT SIDE AND INNER RIGHT SIDE, THE LEFT GREEN RIGHT ANGLE HAS GRAY SHADING THROUGH ITS FULL OUTER EDGE. IN THE LOWER LEFT OF THE BLACK TILTED SQUARE OUTLINE IS A RECTANGLE WITH ROUNDED BOTTOM CORNERS WITH A BLACK BACKGROUND AND THE WORD "EASTERN" THEREIN IN WHITE. IN THE LOWER RIGHT OF THE BLACK TILTED SQUARE OUTLINE IS A RECTANGLE WITH A ROUNDED BOTTOM RIGHT CORNER WITH A GREEN BACKGROUND. THE WORDS "ENGINEERED", "WOOD", AND "PRODUCTS" ARE IN THE GREEN RECTANGLE IN WHITE AND ARE PLACED IN DECENDING ORDER.



*David J. Kybas*

Director of the United States Patent and Trademark Office



**Reg. No. 4,135,195** SER. NO. 85-411,732, FILED 8-31-2011.

DORITT L. CARROLL, EXAMINING ATTORNEY

# United States of America

United States Patent and Trademark Office

## uhaulcarshare

---

.com

**Reg. No. 4,135,196**

**Registered May 1, 2012**

**Int. Cl.: 39**

**SERVICE MARK**

**PRINCIPAL REGISTER**

U-HAUL INTERNATIONAL, INC (NEVADA CORPORATION)  
2727 NORTH CENTRAL AVENUE  
PHOENIX, AZ 85004

FOR: MOTOR VEHICLE RENTAL SERVICES, IN CLASS 39 (U.S. CLS. 100 AND 105).

FIRST USE 8-12-2011; IN COMMERCE 8-12-2011.

OWNER OF U.S. REG. NOS. 795,733, 3,648,101 AND OTHERS.

THE MARK CONSISTS OF THE LETTERS "UHAULCARSHARE" ABOVE A LINE THAT ENDS WITH ".COM".

SER. NO. 85-411,748, FILED 8-31-2011.

DORITT L. CARROLL, EXAMINING ATTORNEY



*David J. Kybas*

Director of the United States Patent and Trademark Office

# United States of America

United States Patent and Trademark Office

# INNOSCALE

**Reg. No. 4,135,197**

**Registered May 1, 2012**

**Int. Cl.: 42**

**SERVICE MARK**

**PRINCIPAL REGISTER**

INNOVATIVE SCALING TECHNOLOGIES INC. (WYOMING CORPORATION)  
93 S. JACKSON ST. #31077  
SEATTLE, WA 98104

FOR: HOSTING OF DIGITAL CONTENT ON THE INTERNET; HOSTING OF WEB SITES;  
HOSTING THE WEB SITES OF OTHERS ON A COMPUTER SERVER FOR A GLOBAL  
COMPUTER NETWORK; HOSTING WEBSITES ON THE INTERNET; MAINTENANCE OF  
WEBSITES AND HOSTING ON-LINE WEB FACILITIES FOR OTHERS; WEB SITE HOSTING  
SERVICES, IN CLASS 42 (U.S. CLS. 100 AND 101).

FIRST USE 6-28-2011; IN COMMERCE 6-28-2011.

THE MARK CONSISTS OF STANDARD CHARACTERS WITHOUT CLAIM TO ANY PAR-  
TICULAR FONT, STYLE, SIZE, OR COLOR.

SER. NO. 85-411,757, FILED 8-31-2011.

DAVID YONTEF, EXAMINING ATTORNEY



*David J. Kyffers*

Director of the United States Patent and Trademark Office

# United States of America

United States Patent and Trademark Office

## DR. MICHAEL GRAY

**Reg. No. 4,135,198**

**Registered May 1, 2012**

**Int. Cl.: 44**

**SERVICE MARK**

**PRINCIPAL REGISTER**

GRAY, MICHAEL W. (UNITED STATES INDIVIDUAL)  
6635 DALY RD.  
WEST BLOOMFIELD, MI 48322

FOR: MEDICAL CONSULTATIONS; COSMETIC AND PLASTIC SURGERY SERVICES; INVASIVE, NONINVASIVE, AND MINIMALLY INVASIVE COSMETIC AND AESTHETIC SURGERY SERVICES; RECONSTRUCTIVE SURGERY SERVICES; MEDICAL SPA AND AESTHETIC SALON SERVICES; SKIN CARE SERVICES; LASER SURGERY SERVICES; MASSAGE THERAPY, IN CLASS 44 (U.S. CLS. 100 AND 101).

FIRST USE 12-31-1997; IN COMMERCE 12-31-1997.

THE MARK CONSISTS OF STANDARD CHARACTERS WITHOUT CLAIM TO ANY PARTICULAR FONT, STYLE, SIZE, OR COLOR.

NO CLAIM IS MADE TO THE EXCLUSIVE RIGHT TO USE "DR.", APART FROM THE MARK AS SHOWN.

THE NAME(S), PORTRAIT(S), AND/OR SIGNATURE(S) SHOWN IN THE MARK IDENTIFIES DR. MICHAEL W. GRAY, WHOSE CONSENT(S) TO REGISTER IS MADE OF RECORD.

SER. NO. 85-411,760, FILED 8-31-2011.

MICHELE SWAIN, EXAMINING ATTORNEY



*David J. Kyjars*

Director of the United States Patent and Trademark Office

# United States of America

United States Patent and Trademark Office

## UHAULCARSHARE.COM

**Reg. No. 4,135,199**

**Registered May 1, 2012**

**Int. Cl.: 39**

**SERVICE MARK**

**PRINCIPAL REGISTER**

U-HAUL INTERNATIONAL, INC (NEVADA CORPORATION)  
2727 NORTH CENTRAL AVENUE  
PHOENIX, AZ 85004

FOR: MOTOR VEHICLE RENTAL SERVICES, IN CLASS 39 (U.S. CLS. 100 AND 105).

FIRST USE 8-12-2011; IN COMMERCE 8-12-2011.

THE MARK CONSISTS OF STANDARD CHARACTERS WITHOUT CLAIM TO ANY PARTICULAR FONT, STYLE, SIZE, OR COLOR.

OWNER OF U.S. REG. NOS. 795,733, 3,648,101 AND OTHERS.

SER. NO. 85-411,771, FILED 8-31-2011.

DORITT L. CARROLL, EXAMINING ATTORNEY



*David J. Kyffers*

Director of the United States Patent and Trademark Office

# United States of America

United States Patent and Trademark Office

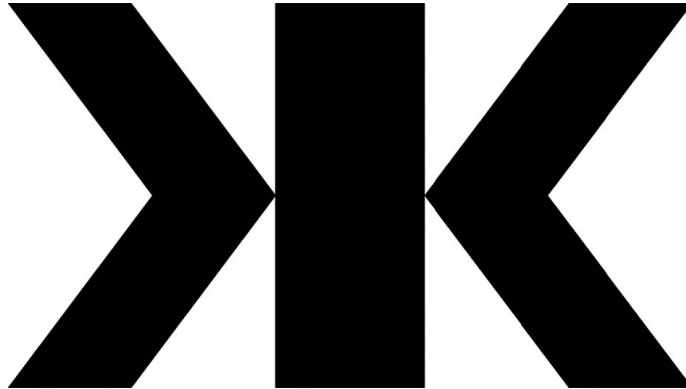

**Reg. No. 4,135,200**

**Registered May 1, 2012**

**Int. Cl.: 25**

**TRADEMARK**

**PRINCIPAL REGISTER**

KEEPIN IT KOOL LLC (MICHIGAN LIMITED LIABILITY COMPANY)  
16172 FENMORE  
DETROIT, MI 48235

FOR: APPAREL FOR DANCERS, NAMELY, TEE SHIRTS, SWEATSHIRTS, PANTS, LEGGINGS, SHORTS AND JACKETS; ATHLETIC APPAREL, NAMELY, SHIRTS, PANTS, JACKETS, FOOTWEAR, HATS AND CAPS, ATHLETIC UNIFORMS, IN CLASS 25 (U.S. CLS. 22 AND 39).

FIRST USE 2-27-2010; IN COMMERCE 3-25-2010.

THE MARK CONSISTS OF A BACKWARD "K", AN UPPER-CASE "I", AND A NORMAL "K", WHICH ARE THE INITIALS FOR "KEEPIN IT KOOL". AN ARROW POINTING TO THE RIGHT, A RECTANGLE, AND AN ARROW POINTING TO THE LEFT WAS USED TO CREATE THIS LOGO.

SER. NO. 85-411,774, FILED 8-31-2011.

BARBARA A. GOLD, EXAMINING ATTORNEY



*David J. Kybas*

Director of the United States Patent and Trademark Office

# United States of America

United States Patent and Trademark Office

DR. MICHAEL W. GRAY, D.O.

**Reg. No. 4,135,201**

**Registered May 1, 2012**

**Int. Cl.: 44**

**SERVICE MARK**

**PRINCIPAL REGISTER**

GRAY, MICHAEL W. (UNITED STATES INDIVIDUAL)  
6635 DALY RD.  
WEST BLOOMFIELD, MI 48322

FOR: MEDICAL CONSULTATIONS; COSMETIC AND PLASTIC SURGERY SERVICES; INVASIVE, NONINVASIVE, AND MINIMALLY INVASIVE COSMETIC AND AESTHETIC SURGERY SERVICES; RECONSTRUCTIVE SURGERY SERVICES; MEDICAL SPA AND AESTHETIC SALON SERVICES; SKIN CARE SERVICES; LASER SURGERY SERVICES; MASSAGE THERAPY, IN CLASS 44 (U.S. CLS. 100 AND 101).

FIRST USE 12-31-1997; IN COMMERCE 12-31-1997.

THE MARK CONSISTS OF STANDARD CHARACTERS WITHOUT CLAIM TO ANY PARTICULAR FONT, STYLE, SIZE, OR COLOR.

NO CLAIM IS MADE TO THE EXCLUSIVE RIGHT TO USE "DR." AND "D.O.", APART FROM THE MARK AS SHOWN.

THE NAME(S), PORTRAIT(S), AND/OR SIGNATURE(S) SHOWN IN THE MARK IDENTIFIES DR. MICHAEL W. GRAY, WHOSE CONSENT(S) TO REGISTER IS MADE OF RECORD.

SER. NO. 85-411,793, FILED 8-31-2011.

MICHELE SWAIN, EXAMINING ATTORNEY



*David J. Kyjars*

Director of the United States Patent and Trademark Office

# United States of America

United States Patent and Trademark Office



**Eastern**  
ENGINEERED  
WOOD PRODUCTS

**Reg. No. 4,135,202**

**Registered May 1, 2012**

**Int. Cl.: 35**

**SERVICE MARK**

**PRINCIPAL REGISTER**

EASTERN ENGINEERED WOOD PRODUCTS, INC. (PENNSYLVANIA CORPORATION)  
1245 EASTON ROAD  
BETHLEHEM, PA 18015

FOR: WHOLESALE DISTRIBUTORSHIPS FEATURING ENGINEERED WOOD PRODUCTS, NAMELY, I-JOISTS, LAMINATED VENEER LUMBER, GLUED LAMINATED TIMBERS, AND BOARDS IN THE NATURE OF RIMBOARDS, LAMINATED STUDS, AND TRIMMABLE-END TRUSSES, IN CLASS 35 (U.S. CLS. 100, 101 AND 102).

FIRST USE 10-26-2004; IN COMMERCE 10-26-2004.

NO CLAIM IS MADE TO THE EXCLUSIVE RIGHT TO USE "ENGINEERED WOOD PRODUCTS", APART FROM THE MARK AS SHOWN.

THE COLOR(S) WHITE, GREEN, GRAY, AND BLACK IS/ARE CLAIMED AS A FEATURE OF THE MARK.

THE MARK CONSISTS OF A GREEN STYLIZED LETTER "E" IN BLOCK FONT FEATURING AN ARROW IN THE CENTER OF THE LETTER "E" WITH GRAY SHADING TO THE LEFT OF THE LETTER "E" AND TO THE LEFT OF THE ARROW HEAD. THE STYLIZED LETTER "E" IS LOCATED IN THE CENTER OF FOUR GREEN RIGHT ANGLES FORMING A TILTED SQUARE AROUND THE STYLIZED LETTER "E". THE TOP GREEN RIGHT ANGLE HAS GRAY SHADING TO THE OUTER LEFT AND INNER RIGHT SIDE, THE RIGHT GREEN RIGHT ANGLE HAS GRAY SHADING THROUGH ITS FULL INNER EDGE, THE BOTTOM GREEN RIGHT ANGLE HAS GRAY SHADING TO THE OUTER LEFT SIDE AND INNER RIGHT SIDE, THE LEFT GREEN RIGHT ANGLE HAS GRAY SHADING THROUGH ITS FULL OUTER EDGE. THE WORDS "EASTERN ENGINEERED WOOD PRODUCTS" ARE IN BLACK TO THE RIGHT OF THE STYLIZED "E". THE WORD "EASTERN" IS ABOVE THE WORD "ENGINEERED" WHICH IS ABOVE THE WORDS "WOOD PRODUCTS". THE OUTLINE OF THE LETTER "E" AND THE AREAS INSIDE THE GREEN DIAMOND ARE WHITE.



SER. NO. 85-411,804, FILED 8-31-2011.

*David J. Kyffers*

DORITT L. CARROLL, EXAMINING ATTORNEY



# United States of America

United States Patent and Trademark Office

## TAKE CONTROL OF YOUR HEALTH

**Reg. No. 4,135,203**

**Registered May 1, 2012**

**Int. Cl.: 44**

**SERVICE MARK**

**PRINCIPAL REGISTER**

ANY TEST FRANCHISING, INC. (GEORGIA CORPORATION)  
SUITE 401, ROOM 299  
10945 STATE BRIDGE RD  
ALPHARETTA, GA 30022

FOR: MEDICAL TESTING OF URINE, BLOOD, HAIR FOLLICLES AND BREATH, IN CLASS  
44 (U.S. CLS. 100 AND 101).

FIRST USE 10-1-2007; IN COMMERCE 10-1-2007.

THE MARK CONSISTS OF STANDARD CHARACTERS WITHOUT CLAIM TO ANY PAR-  
TICULAR FONT, STYLE, SIZE, OR COLOR.

SER. NO. 85-411,832, FILED 8-31-2011.

SAMUEL E. SHARPER JR., EXAMINING ATTORNEY



*David J. Kyffers*

Director of the United States Patent and Trademark Office

# United States of America

United States Patent and Trademark Office

NO INSURANCE? NO PROBLEM!

**Reg. No. 4,135,204**

**Registered May 1, 2012**

**Int. Cl.: 44**

**SERVICE MARK**

**PRINCIPAL REGISTER**

ANY TEST FRANCHISING, INC. (GEORGIA CORPORATION)  
SUITE 401, ROOM 299  
10945 STATE BRIDGE RD  
ALPHARETTA, GA 30022

FOR: MEDICAL TESTING OF URINE, BLOOD, HAIR FOLLICLES AND BREATH, IN CLASS  
44 (U.S. CLS. 100 AND 101).

FIRST USE 10-1-2007; IN COMMERCE 10-1-2007.

THE MARK CONSISTS OF STANDARD CHARACTERS WITHOUT CLAIM TO ANY PAR-  
TICULAR FONT, STYLE, SIZE, OR COLOR.

SER. NO. 85-411,857, FILED 8-31-2011.

SAMUEL E. SHARPER JR., EXAMINING ATTORNEY



*David J. Kybas*

Director of the United States Patent and Trademark Office

# United States of America

United States Patent and Trademark Office

## COMALI FOODS

**Reg. No. 4,135,205**

**Registered May 1, 2012**

**Int. Cl.: 35**

**SERVICE MARK**

**PRINCIPAL REGISTER**

COMALI FOODS, INC (CALIFORNIA CORPORATION)  
27375 VIA INDUSTRIA  
TEMECULA, CA 92590

FOR: WHOLESALE FOOD DISTRIBUTORSHIP SERVICES; ON-LINE RETAIL STORE SERVICES FEATURING FOOD PRODUCTS; MAIL ORDER SERVICES FEATURING FOOD PRODUCTS, IN CLASS 35 (U.S. CLS. 100, 101 AND 102).

FIRST USE 5-6-2010; IN COMMERCE 5-6-2010.

THE MARK CONSISTS OF STANDARD CHARACTERS WITHOUT CLAIM TO ANY PARTICULAR FONT, STYLE, SIZE, OR COLOR.

OWNER OF U.S. REG. NO. 3,894,709.

NO CLAIM IS MADE TO THE EXCLUSIVE RIGHT TO USE "FOODS", APART FROM THE MARK AS SHOWN.

SER. NO. 85-411,861, FILED 8-31-2011.

SAMUEL E. SHARPER JR., EXAMINING ATTORNEY



*David J. Kypos*

Director of the United States Patent and Trademark Office

# United States of America

United States Patent and Trademark Office

# DWK

**Reg. No. 4,135,206**

**Registered May 1, 2012**

**Int. Cl.: 20**

**TRADEMARK**

**PRINCIPAL REGISTER**

DWK ENTERPRISES (CALIFORNIA CORPORATION)  
1250 EAST BELMONT STREET  
ONTARIO, CA 91761

FOR: FIGURINES OF POLYRESIN, IN CLASS 20 (U.S. CLS. 2, 13, 22, 25, 32 AND 50).

FIRST USE 2-2-1999; IN COMMERCE 2-2-1999.

THE MARK CONSISTS OF STANDARD CHARACTERS WITHOUT CLAIM TO ANY PARTICULAR FONT, STYLE, SIZE, OR COLOR.

SER. NO. 85-411,875, FILED 8-31-2011.

CHARLOTTE CORWIN, EXAMINING ATTORNEY



*David J. Kybas*

Director of the United States Patent and Trademark Office

# United States of America

United States Patent and Trademark Office



**Reg. No. 4,135,207**

**Registered May 1, 2012**

**CERTIFICATION MARK**

**PRINCIPAL REGISTER**

COMMERCIAL VEHICLE SAFETY ALLIANCE (D.C. CORPORATION)  
6303 IVY LANE, SUITE 310  
GREENBELT, MD 207706319

FOR: COMMERCIAL MOTOR VEHICLES, IN CLASS A (U.S. CL. A).

FIRST USE 0-0-2005; IN COMMERCE 0-0-2005.

NO CLAIM IS MADE TO THE EXCLUSIVE RIGHT TO USE "ALLIANCE" , APART FROM THE MARK AS SHOWN.

THE MARK CONSISTS OF THE LETTERS "CVSA" WITH THE LETTER "V" IN THE FORM OF A CHECKMARK, UNDER A DESIGN OF A GLOBE, WITH THE WORDING "COMMERCIAL VEHICLE SAFETY ALLIANCE" IN AN ARCH OVER THE GLOBE.

THE CERTIFICATION MARK IS USED BY AUTHORIZED PERSONS TO CERTIFY THAT THEIR GOODS MEET STANDARDS FOR CERTAIN SAFETY ITEMS, WHICH STANDARDS ARE BASED UPON FEDERAL HIGHWAY ADMINISTRATION CRITERIA.

SEC. 2(F) AS TO "COMMERCIAL VEHICLE SAFETY ALLIANCE" .

SER. NO. 85-411,904, FILED 8-31-2011.

ALEXANDER L. POWERS, EXAMINING ATTORNEY



*David J. Kybas*

Director of the United States Patent and Trademark Office

# United States of America

United States Patent and Trademark Office

# JERKY MATE

**Reg. No. 4,135,208**

LEE JAMES (UNITED STATES INDIVIDUAL)  
1400 N 12TH STREET  
BISMARCK, ND 58504

**Registered May 1, 2012**

**Int. Cl.: 21**

FOR: CARVING BOARDS; CUTTING BOARDS, IN CLASS 21 (U.S. CLS. 2, 13, 23, 29, 30, 33, 40 AND 50).

**TRADEMARK**

FIRST USE 5-12-2011; IN COMMERCE 5-12-2011.

**PRINCIPAL REGISTER**

THE MARK CONSISTS OF STANDARD CHARACTERS WITHOUT CLAIM TO ANY PARTICULAR FONT, STYLE, SIZE, OR COLOR.

SER. NO. 85-411,920, FILED 8-31-2011.

ROBIN CHOSID, EXAMINING ATTORNEY



*David J. Kyros*

Director of the United States Patent and Trademark Office

# United States of America

United States Patent and Trademark Office



**Reg. No. 4,135,209**

**Registered May 1, 2012**

**Int. Cl.: 35**

**SERVICE MARK**

**PRINCIPAL REGISTER**

CITY OF MIAMI BEACH (FLORIDA MUNICIPAL CORPORATION)  
1700 CONVENTION CENTER DR.  
MIAMI BEACH, FL 33139

FOR: PROMOTING ARTS AND CULTURAL AFFAIRS IN MIAMI BEACH, FL, IN CLASS 35  
(U.S. CLS. 100, 101 AND 102).

FIRST USE 8-1-2005; IN COMMERCE 8-1-2005.

THE MARK CONSISTS OF A SAILBOAT AND CIRCLE IN AGAINST A HALF CIRCLE ON  
TOP OF A HALF CIRCLE OF STRIPED LINES.

SER. NO. 85-411,922, FILED 8-31-2011.

ROBIN CHOSID, EXAMINING ATTORNEY



*David J. Kyffers*

Director of the United States Patent and Trademark Office

# United States of America

United States Patent and Trademark Office

## SB STRONGBOND

**Reg. No. 4,135,210**

**Registered May 1, 2012**

**Int. Cl.: 1**

**TRADEMARK**

**PRINCIPAL REGISTER**

STRONG INDUSTRIES, INC. (PENNSYLVANIA CORPORATION)  
P.O. BOX 108  
NORTHUMBERLAND, PA 17857

FOR: CHEMICAL SOLUTION SPRAYED ON ACRYLIC SURFACE OF SPAS. HOT TUBS AND POOLS TO PREVENT DAMAGE TO ACRYLIC SURFACE, IN CLASS 1 (U.S. CLS. 1, 5, 6, 10, 26 AND 46).

FIRST USE 4-29-2010; IN COMMERCE 4-29-2010.

THE MARK CONSISTS OF STANDARD CHARACTERS WITHOUT CLAIM TO ANY PARTICULAR FONT, STYLE, SIZE, OR COLOR.

SER. NO. 85-411,928, FILED 8-31-2011.

NAPOLEON SHARMA, EXAMINING ATTORNEY



*David J. Kyffers*

Director of the United States Patent and Trademark Office



**United States of America**  
United States Patent and Trademark Office

**CORBEIL**

**Reg. No. 4,135,211**

**Registered May 1, 2012**

**Int. Cl.: 12**

**TRADEMARK**

**PRINCIPAL REGISTER**

COLLINS BUS CORPORATION (KANSAS CORPORATION)  
415 W. 6TH  
SOUTH HUTCHINSON, KS 675042946

FOR: BUSES, IN CLASS 12 (U.S. CLS. 19, 21, 23, 31, 35 AND 44).

FIRST USE 11-1-2008; IN COMMERCE 11-1-2008.

THE MARK CONSISTS OF STANDARD CHARACTERS WITHOUT CLAIM TO ANY PARTICULAR FONT, STYLE, SIZE, OR COLOR.

OWNER OF U.S. REG. NO. 2,533,332.

SER. NO. 85-411,948, FILED 8-31-2011.

CURTIS FRENCH, EXAMINING ATTORNEY



*David J. Kybas*

Director of the United States Patent and Trademark Office

United States of America  
United States Patent and Trademark Office

# BUYRIGHT

**Reg. No. 4,135,212**

CARD LIMITED CORP (FLORIDA CORPORATION)  
5255 N EDGEWOOD DR, SUITE 225  
PROVO, UT 84604

**Registered May 1, 2012**

**Int. Cls.: 9 and 36**

FOR: MAGNETICALLY ENCODED DEBIT CARDS, IN CLASS 9 (U.S. CLS. 21, 23, 26, 36 AND 38).

**TRADEMARK**

FIRST USE 5-1-2011; IN COMMERCE 8-15-2011.

**SERVICE MARK**

FOR: DEBIT CARD SERVICES, IN CLASS 36 (U.S. CLS. 100, 101 AND 102).

**PRINCIPAL REGISTER**

FIRST USE 5-1-2011; IN COMMERCE 8-15-2011.

THE MARK CONSISTS OF STANDARD CHARACTERS WITHOUT CLAIM TO ANY PARTICULAR FONT, STYLE, SIZE, OR COLOR.

SER. NO. 85-411,956, FILED 8-31-2011.

CURTIS FRENCH, EXAMINING ATTORNEY



*David J. Kybas*

Director of the United States Patent and Trademark Office

# United States of America

United States Patent and Trademark Office

# Ignition

**Reg. No. 4,135,213**

**Registered May 1, 2012**

**Int. Cl.: 41**

**SERVICE MARK**

**PRINCIPAL REGISTER**

FOCUS TRAINING, INC. (WISCONSIN CORPORATION), FORMERLY FOCUS TRAINING, LLC.  
531 S WATER STREET  
MILWAUKEE, WI 53204

FOR: EDUCATIONAL SERVICES, NAMELY, CONDUCTING PROGRAMS IN THE FIELD OF STUDENT MENTORSHIP AND LEADERSHIP PROGRAMS RELATED TO TRANSITION BETWEEN EDUCATIONAL LEVELS, IN CLASS 41 (U.S. CLS. 100, 101 AND 107).

FIRST USE 6-1-2005; IN COMMERCE 4-1-2006.

THE MARK CONSISTS OF STANDARD CHARACTERS WITHOUT CLAIM TO ANY PARTICULAR FONT, STYLE, SIZE, OR COLOR.

SER. NO. 85-411,958, FILED 8-31-2011.

SHAUNIA CARLYLE, EXAMINING ATTORNEY



*David J. Kybas*

Director of the United States Patent and Trademark Office

# United States of America

United States Patent and Trademark Office

# SeqWright

**Reg. No. 4,135,214**

**Registered May 1, 2012**

**Int. Cl.: 42**

**SERVICE MARK**

**PRINCIPAL REGISTER**

SEQWRIGHT, INC. (TEXAS CORPORATION)  
2575 WEST BELLFORT ST., SUITE 2001  
HOUSTON, TX 77054

FOR: DNA ANALYSIS SERVICES; DNA SCREENING FOR SCIENTIFIC RESEARCH PURPOSES; GENOTYPING SERVICES FOR RESEARCH OR ANALYSIS PURPOSES; PROVIDING MEDICAL AND SCIENTIFIC RESEARCH INFORMATION IN THE FIELDS OF PHARMACEUTICALS AND GENETICS, IN CLASS 42 (U.S. CLS. 100 AND 101).

FIRST USE 1-1-1995; IN COMMERCE 1-1-1995.

THE MARK CONSISTS OF STANDARD CHARACTERS WITHOUT CLAIM TO ANY PARTICULAR FONT, STYLE, SIZE, OR COLOR.

SER. NO. 85-411,960, FILED 8-31-2011.

SHAUNIA CARLYLE, EXAMINING ATTORNEY



*David J. Kybas*

Director of the United States Patent and Trademark Office

# United States of America

United States Patent and Trademark Office

# PROCLIP

**Reg. No. 4,135,215**

**Registered May 1, 2012**

**Int. Cl.: 9**

**TRADEMARK**

**PRINCIPAL REGISTER**

PROCLIP USA, INC. (ILLINOIS CORPORATION)  
SUITE A  
750 TOWER ROAD  
MUNDELEIN, IL 60060

FOR: DEVICES AND ACCESSORIES FOR MOUNTING MOBILE ELECTRONIC DEVICES IN A VEHICLE, NAMELY, DEVICES FOR MOUNTING MOBILE PHONES, SMART PHONES, GPS NAVIGATION DEVICES, PERSONAL DIGITAL ASSISTANTS, SATELLITE RADIOS, TWO-WAY RADIOS, MOBILE COMPUTERS, ELECTRONIC TABLET DEVICES, AND MUSIC PLAYERS, NAMELY, DEVICE MOUNTS, DOCKS, CLIPS, BRACKETS, CRADLES, HOLDERS, TILT AND SWIVEL MOUNTS; HOLDERS WITH BATTERY CHARGERS; HOLDERS WITH BATTERY CHARGER AND CIGARETTE LIGHTER ADAPTER; BATTERY CHARGERS WITH A CONNECTOR TO PLUG INTO A MOBILE ELECTRONIC DEVICE; CONNECTING WIRES AND CABLES FOR CONNECTION TO ELECTRIC CURRENT SOURCES FOR ELECTRONIC MOBILE DEVICES; EXTENSION PLATES FOR MOUNTING MULTIPLE ELECTRONIC DEVICES TO THE SAME DEVICE HOLDER; ADAPTERS FOR ENABLING MOUNTING AN ELECTRONIC DEVICE IN A DEVICE HOLDER; AND ACCESSORIES FOR THE FOREGOING, IN CLASS 9 (U.S. CLS. 21, 23, 26, 36 AND 38).

FIRST USE 12-9-1996; IN COMMERCE 12-9-1996.

THE MARK CONSISTS OF STANDARD CHARACTERS WITHOUT CLAIM TO ANY PARTICULAR FONT, STYLE, SIZE, OR COLOR.

OWNER OF U.S. REG. NO. 3,343,378.

SER. NO. 85-411,983, FILED 8-31-2011.

DARRYL SPRUILL, EXAMINING ATTORNEY



*David J. Kyros*

Director of the United States Patent and Trademark Office

# United States of America

United States Patent and Trademark Office

## POWER. PAIR. PLAY.

**Reg. No. 4,135,216**

**Registered May 1, 2012**

**Int. Cl.: 9**

**TRADEMARK**

**PRINCIPAL REGISTER**

BIG BLUE AUDIO LLC (NEW HAMPSHIRE LIMITED LIABILITY COMPANY), DBA BIG  
BLUE AUDIO  
ONE INNOVATION WAY  
MERRIMACK, NH 03054

FOR: AUDIO SPEAKERS, IN CLASS 9 (U.S. CLS. 21, 23, 26, 36 AND 38).

FIRST USE 10-30-2011; IN COMMERCE 10-30-2011.

THE MARK CONSISTS OF STANDARD CHARACTERS WITHOUT CLAIM TO ANY PAR-  
TICULAR FONT, STYLE, SIZE, OR COLOR.

SER. NO. 85-411,990, FILED 8-31-2011.

CARYN GLASSER, EXAMINING ATTORNEY



*David J. Kyffers*

Director of the United States Patent and Trademark Office

# United States of America

United States Patent and Trademark Office

# SkimGard

**Reg. No. 4,135,217**

PARABIT SYSTEMS, INC. (NEW YORK CORPORATION)  
35 DEBEVOISE AVE.  
ROOSEVELT, NY 11575

**Registered May 1, 2012**

**Int. Cl.: 9**

FOR: CARD READERS FOR MAGNETICALLY ENCODED CARDS, IN CLASS 9 (U.S. CLS. 21, 23, 26, 36 AND 38).

**TRADEMARK**

FIRST USE 1-0-2011; IN COMMERCE 8-31-2011.

**PRINCIPAL REGISTER**

THE MARK CONSISTS OF STANDARD CHARACTERS WITHOUT CLAIM TO ANY PARTICULAR FONT, STYLE, SIZE, OR COLOR.

SER. NO. 85-411,996, FILED 8-31-2011.

TINA BROWN, EXAMINING ATTORNEY



*David J. Kybas*

Director of the United States Patent and Trademark Office

# United States of America

United States Patent and Trademark Office

# MDR

**Reg. No. 4,135,218**

**Registered May 1, 2012**

**Int. Cl.: 5**

**TRADEMARK**

**PRINCIPAL REGISTER**

MDR FITNESS CORP. (FLORIDA CORPORATION)  
14101 NW 4TH STREET  
SUNRISE, FL 33325

FOR: DIETARY AND NUTRITIONAL SUPPLEMENTS; VITAMIN SUPPLEMENTS, IN CLASS 5 (U.S. CLS. 6, 18, 44, 46, 51 AND 52).

FIRST USE 7-21-1983; IN COMMERCE 7-21-1983.

THE MARK CONSISTS OF STANDARD CHARACTERS WITHOUT CLAIM TO ANY PARTICULAR FONT, STYLE, SIZE, OR COLOR.

SER. NO. 85-412,015, FILED 8-31-2011.

WILLIAM BRECKENFELD, EXAMINING ATTORNEY



*David J. Kyffers*

Director of the United States Patent and Trademark Office



# United States of America

United States Patent and Trademark Office

# PLUSfoam

**Reg. No. 4,135,219**

**Registered May 1, 2012**

**Int. Cl.: 17**

**TRADEMARK**

**PRINCIPAL REGISTER**

PLUSFOAM COMPOUND TECHNOLOGIES LLC (CALIFORNIA LIMITED LIABILITY COMPANY)  
1510 CANTERA AVENUE  
SANTA BARBARA, CA 93110

FOR: POLYMER RESIN MATERIAL FOR USE IN THE MANUFACTURE OF FOOTWEAR, CLOTHING, SUNGLASSES, LUGGAGE, LUGGAGE STRAPS, WATCHBANDS, GOGGLES, KNEEPADS, KNEELERS, TOYS, SPORTING GOODS AND PROTECTIVE WEAR, IN CLASS 17 (U.S. CLS. 1, 5, 12, 13, 35 AND 50).

FIRST USE 1-0-2010; IN COMMERCE 1-0-2010.

THE MARK CONSISTS OF THE WORD "PLUS" IN UPPERCASE CYAN BLUE LETTERS; THE WORD "FOAM" AND LOWERCASE BLACK LETTER.

THE COLOR(S) CYAN BLUE AND BLACK IS/ARE CLAIMED AS A FEATURE OF THE MARK.

SER. NO. 85-412,029, FILED 8-31-2011.

CARYN GLASSER, EXAMINING ATTORNEY



*David J. Kyffers*

Director of the United States Patent and Trademark Office

# United States of America

United States Patent and Trademark Office



**Reg. No. 4,135,220**

**Registered May 1, 2012**

**Int. Cl.: 9**

**TRADEMARK**

**PRINCIPAL REGISTER**

TSI POWER CORP. (ILLINOIS CORPORATION)  
1103 WEST PIERCE AVENUE  
ANTIGO, WI 544093103

FOR: PULSE WIDTH MODULATING VOLTAGE REGULATORS, UNINTERRUPTIBLE ELECTRICAL POWER SUPPLY SYSTEMS, DC TO AC POWER INVERTERS , IN CLASS 9 (U.S. CLS. 21, 23, 26, 36 AND 38).

FIRST USE 1-1-1998; IN COMMERCE 1-1-1998.

THE MARK CONSISTS OF THE CAPITAL LETTER "T" WITH A SUPERPOSED STYLIZED SINE WAVE.

SER. NO. 85-412,032, FILED 8-31-2011.

RONALD MCMORROW, EXAMINING ATTORNEY



*David J. Kybas*

Director of the United States Patent and Trademark Office

# United States of America

United States Patent and Trademark Office

## GOLD SERIES

**Reg. No. 4,135,221**

**Registered May 1, 2012**

**Int. Cl.: 28**

**TRADEMARK**

**PRINCIPAL REGISTER**

TRUE TEMPER SPORTS, INC. (DELAWARE CORPORATION)  
SUITE 200  
8275 TOURNAMENT DRIVE  
MEMPHIS, TN 38125

FOR: GOLF CLUB SHAFTS, IN CLASS 28 (U.S. CLS. 22, 23, 38 AND 50).

FIRST USE 7-0-2006; IN COMMERCE 7-0-2006.

THE MARK CONSISTS OF STANDARD CHARACTERS WITHOUT CLAIM TO ANY PARTICULAR FONT, STYLE, SIZE, OR COLOR.

OWNER OF U.S. REG. NOS. 1,298,940, 2,613,789 AND OTHERS.

NO CLAIM IS MADE TO THE EXCLUSIVE RIGHT TO USE "SERIES", APART FROM THE MARK AS SHOWN.

SER. NO. 85-412,038, FILED 8-31-2011.

JOHN SCHUYLER YARD, EXAMINING ATTORNEY



*David J. Kybas*

Director of the United States Patent and Trademark Office

# United States of America

United States Patent and Trademark Office

## WORLD SCREEN

**Reg. No. 4,135,222**

WSN, INC. (NEW YORK CORPORATION)  
1123 BROADWAY, SUITE 1207  
NEW YORK, NY 10010

**Registered May 1, 2012**

**Int. Cl.: 16**

FOR: MAGAZINES FEATURING NEWS AND INFORMATION FOR THE MEDIA BUSINESS;  
PRINTED PERIODICALS IN THE FIELD OF INTERNATIONAL MEDIA, TELEVISION AND  
FILM PRODUCTION AND DISTRIBUTION, IN CLASS 16 (U.S. CLS. 2, 5, 22, 23, 29, 37, 38  
AND 50).

**TRADEMARK**

**PRINCIPAL REGISTER**

FIRST USE 4-1-2005; IN COMMERCE 4-1-2005.

THE MARK CONSISTS OF STANDARD CHARACTERS WITHOUT CLAIM TO ANY PAR-  
TICULAR FONT, STYLE, SIZE, OR COLOR.

SER. NO. 85-412,063, FILED 8-31-2011.

CHARLOTTE CORWIN, EXAMINING ATTORNEY



*David J. Kybas*

Director of the United States Patent and Trademark Office

# United States of America

United States Patent and Trademark Office



**Reg. No. 4,135,223**

**Registered May 1, 2012**

**Int. Cl.: 41**

**SERVICE MARK**

**PRINCIPAL REGISTER**

FITZHUGH, AUGUSTA (UNITED STATES INDIVIDUAL)  
1152 RIVA RIDGE DR  
FALLS, VA 22066

FOR: ARRANGING AND CONDUCTING SPECIAL EVENTS FOR SOCIAL ENTERTAINMENT PURPOSES; PARTY AND WEDDING PLANNING AND COORDINATION SERVICES, IN CLASS 41 (U.S. CLS. 100, 101 AND 107).

FIRST USE 11-1-2010; IN COMMERCE 11-1-2010.

NO CLAIM IS MADE TO THE EXCLUSIVE RIGHT TO USE "EVENT STUDIO", APART FROM THE MARK AS SHOWN.

THE MARK CONSISTS OF THE WORDING "VOILÀ! EVENT STUDIO" IN STYLIZED LETTERING, APPEARING INSIDE AN ANTIQUE STYLE OVAL SHAPED FRAME.

SER. NO. 85-412,086, FILED 8-31-2011.

WENDY GOODMAN, EXAMINING ATTORNEY



*David J. Kybas*

Director of the United States Patent and Trademark Office

# United States of America

United States Patent and Trademark Office

## THE HORTON GROUP

**Reg. No. 4,135,224**

**Registered May 1, 2012**

**Int. Cl.: 36**

**SERVICE MARK**

**PRINCIPAL REGISTER**

THE HORTON GROUP, INC. (ILLINOIS CORPORATION)  
10320 ORLAND PARKWAY  
ORLAND PARK, IL 60467

FOR: INSURANCE AGENCY SERVICES IN THE FIELDS OF HOME, ACCIDENT, FIRE, LIFE, WORKMEN'S COMPENSATION, COMMERCIAL AND PERSONAL UMBRELLAS, HEALTH, DISABILITY AND DENTAL INSURANCE; INSURANCE ADMINISTRATION, CONSULTING AND RISK MANAGEMENT SERVICES REGARDING ALL TYPES OF INSURANCE AND RELATED PRODUCTS, NAMELY, CLAIMS MANAGEMENT, SAFETY AND LOSS CONTROL CONSULTING, AND EMPLOYEE BENEFITS, IN CLASS 36 (U.S. CLS. 100, 101 AND 102).

FIRST USE 5-0-1999; IN COMMERCE 5-0-1999.

THE MARK CONSISTS OF STANDARD CHARACTERS WITHOUT CLAIM TO ANY PARTICULAR FONT, STYLE, SIZE, OR COLOR.

OWNER OF U.S. REG. NOS. 2,468,593 AND 2,588,268.

NO CLAIM IS MADE TO THE EXCLUSIVE RIGHT TO USE "GROUP", APART FROM THE MARK AS SHOWN.

SEC. 2(F).

SER. NO. 85-412,097, FILED 8-31-2011.

JESSICA A. POWERS, EXAMINING ATTORNEY



*David J. Kybas*

Director of the United States Patent and Trademark Office

# United States of America

United States Patent and Trademark Office

## STERLING MIST

**Reg. No. 4,135,225**

**Registered May 1, 2012**

**Int. Cl.: 34**

**TRADEMARK**

**PRINCIPAL REGISTER**

LEEVER, ERIC (UNITED STATES INDIVIDUAL)  
3580 SW COCO PALM DR  
PALM CITY, FL 34990

FOR: ELECTRONIC CIGARETTES, IN CLASS 34 (U.S. CLS. 2, 8, 9 AND 17).

FIRST USE 12-15-2009; IN COMMERCE 12-15-2009.

THE MARK CONSISTS OF STANDARD CHARACTERS WITHOUT CLAIM TO ANY PARTICULAR FONT, STYLE, SIZE, OR COLOR.

SER. NO. 85-412,105, FILED 8-31-2011.

KIMBERLY FRYE, EXAMINING ATTORNEY



*David J. Kyffers*

Director of the United States Patent and Trademark Office

# United States of America

United States Patent and Trademark Office

The logo consists of the letters "ILC" in a bold, sans-serif font. A stylized lightning bolt is superimposed over the letters, starting from the top right and striking the letter "C".

**Reg. No. 4,135,226**

TSI POWER CORP. (ILLINOIS CORPORATION)  
1103 WEST PIERCE AVENUE  
ANTIGO, WI 544093103

**Registered May 1, 2012**

**Int. Cl.: 9**

FOR: ISOLATING ELECTRICAL POWER LINE CONDITIONERS, IN CLASS 9 (U.S. CLS. 21, 23, 26, 36 AND 38).

**TRADEMARK**

FIRST USE 1-5-1998; IN COMMERCE 1-5-1998.

**PRINCIPAL REGISTER**

THE MARK CONSISTS OF THE LETTERS "ILC" WITH A SUPERPOSED LIGHTNING BOLT.

SER. NO. 85-412,112, FILED 8-31-2011.

RONALD MCMORROW, EXAMINING ATTORNEY



*David J. Kyffers*

Director of the United States Patent and Trademark Office



# United States of America

United States Patent and Trademark Office

## TWO HEARTED

**Reg. No. 4,135,227**

**Registered May 1, 2012**

**Int. Cls.: 16, 20, 21, 25  
and 32**

**TRADEMARK**

**PRINCIPAL REGISTER**

BELL'S BREWERY, INC. (MICHIGAN CORPORATION)  
8938 KRUM AVENUE  
GALESBURG, MI 49053

FOR: PAPER GOODS, NAMELY, POSTERS, STICKERS, PRINTED NOVELTY BEER LABELS;  
PAPER MATERIALS AND PRINTED MATTER, NAMELY, POSTERS, STICKERS, PRINTED  
NOVELTY BEER LABELS, IN CLASS 16 (U.S. CLS. 2, 5, 22, 23, 29, 37, 38 AND 50).

FIRST USE 8-7-1989; IN COMMERCE 8-7-1989.

FOR: NONMETAL TAPS FOR KEGS; NONMETAL TAP GLOBES FOR KEGS, IN CLASS 20  
(U.S. CLS. 2, 13, 22, 25, 32 AND 50).

FIRST USE 8-7-1989; IN COMMERCE 8-7-1989.

FOR: BEVERAGE GLASSWARE; BOTTLE OPENER, IN CLASS 21 (U.S. CLS. 2, 13, 23, 29,  
30, 33, 40 AND 50).

FIRST USE 8-7-1989; IN COMMERCE 8-7-1989.

FOR: CLOTHING, NAMELY, T-SHIRTS; HATS, IN CLASS 25 (U.S. CLS. 22 AND 39).

FIRST USE 8-7-1989; IN COMMERCE 8-7-1989.

FOR: BEER; ALE; MALT LIQUOR, IN CLASS 32 (U.S. CLS. 45, 46 AND 48).

FIRST USE 8-7-1989; IN COMMERCE 8-7-1989.

THE MARK CONSISTS OF STANDARD CHARACTERS WITHOUT CLAIM TO ANY PAR-  
TICULAR FONT, STYLE, SIZE, OR COLOR.

OWNER OF U.S. REG. NO. 2,963,844.

SER. NO. 85-412,136, FILED 8-31-2011.

DANIEL BRODY, EXAMINING ATTORNEY



*David J. Kyffers*

Director of the United States Patent and Trademark Office

United States of America  
United States Patent and Trademark Office

wagenwerks

**Reg. No. 4,135,228**

CRANE, MATTHEW (UNITED STATES INDIVIDUAL)  
520 ROCK DRIVE  
CHESAPEAKE, VA 23323

**Registered May 1, 2012**

**Int. Cl.: 9**

FOR: AUDIO AND VIDEO RECORDINGS FEATURING AUTOMOTIVE ENTHUSIAST LIFESTYLE AND VEHICLES, IN CLASS 9 (U.S. CLS. 21, 23, 26, 36 AND 38).

**TRADEMARK**

FIRST USE 12-1-2004; IN COMMERCE 10-1-2007.

**PRINCIPAL REGISTER**

THE MARK CONSISTS OF STANDARD CHARACTERS WITHOUT CLAIM TO ANY PARTICULAR FONT, STYLE, SIZE, OR COLOR.

SER. NO. 85-412,156, FILED 8-31-2011.

TINA MAI, EXAMINING ATTORNEY



*David J. Kyffers*

Director of the United States Patent and Trademark Office

# United States of America

United States Patent and Trademark Office

# DEALVILLE

**Reg. No. 4,135,229**

**Registered May 1, 2012**

**Int. Cl.: 35**

**SERVICE MARK**

**PRINCIPAL REGISTER**

DEALVILLE USA, INC. (TENNESSEE CORPORATION)  
STE 110  
3505 ADKISSON DR.  
CLEVELAND, TN 37312

FOR: PROVIDING INFORMATION ABOUT AND MAKING REFERRALS IN THE FIELD OF CONSUMER PRODUCTS AND SERVICES FOR RETAIL SERVICES CONCERNING PRODUCTS, SERVICES, EVENTS, ACTIVITIES, ATTRACTIONS AND FACILITIES IN PARTICULAR GEOGRAPHIC LOCATIONS; PROVIDING MARKETING AND PROMOTION OF SPECIAL EVENTS; ADVERTISING AND PROMOTIONAL SERVICES; PROMOTING THE GOODS AND SERVICES OF OTHERS VIA A GLOBAL COMPUTER NETWORK; PROMOTING THE GOODS AND SERVICES OF OTHERS, NAMELY, PROVIDING INFORMATION REGARDING DISCOUNTS, COUPONS, REBATES, VOUCHERS, AND SPECIAL OFFERS FOR THE GOODS AND SERVICES OF OTHERS, IN CLASS 35 (U.S. CLS. 100, 101 AND 102).

FIRST USE 3-7-2011; IN COMMERCE 3-22-2011.

THE MARK CONSISTS OF STANDARD CHARACTERS WITHOUT CLAIM TO ANY PARTICULAR FONT, STYLE, SIZE, OR COLOR.

SER. NO. 85-412,178, FILED 8-31-2011.

ALEXANDER L. POWERS, EXAMINING ATTORNEY



*David J. Kyffers*

Director of the United States Patent and Trademark Office

# United States of America

United States Patent and Trademark Office



**Reg. No. 4,135,230**

**Registered May 1, 2012**

**Int. Cl.: 25**

**TRADEMARK**

**PRINCIPAL REGISTER**

MILES TO GO, LLC (ARIZONA SOLE PROPRIETORSHIP)  
1318 W MULBERRY DR  
PHOENIX, AZ 85013

FOR: WEARABLE GARMENTS AND CLOTHING, NAMELY, SHIRTS, IN CLASS 25 (U.S. CLS. 22 AND 39).

FIRST USE 12-2-2010; IN COMMERCE 1-1-2011.

THE MARK CONSISTS OF A BOOK WITH A QUILL PIERCING THE CENTER.

SEC. 2(F).

SER. NO. 85-412,193, FILED 8-31-2011.

FRANK LATTUCA, EXAMINING ATTORNEY



*David J. Kyffers*

Director of the United States Patent and Trademark Office

# United States of America

United States Patent and Trademark Office

## Ditch Parrots Unlimited

**Reg. No. 4,135,231**

**Registered May 1, 2012**

**Int. Cl.: 25**

**TRADEMARK**

**PRINCIPAL REGISTER**

HOCUM, SCOTT (UNITED STATES INDIVIDUAL)  
5178 LEXINGTON CT SE  
PRIOR LAKE, MN 55372

FOR: CLOTHING, NAMELY, HATS, T-SHIRTS, SWEATSHIRTS, JACKETS, BASEBALL CAPS, STOCKING CAPS, PANTS, SHORTS, TANK SHIRTS, GLOVES, AND VESTS, IN CLASS 25 (U.S. CLS. 22 AND 39).

FIRST USE 5-7-2007; IN COMMERCE 5-7-2007.

THE MARK CONSISTS OF STANDARD CHARACTERS WITHOUT CLAIM TO ANY PARTICULAR FONT, STYLE, SIZE, OR COLOR.

SER. NO. 85-412,212, FILED 8-31-2011.

KAREN SEVERSON, EXAMINING ATTORNEY



*David J. Kybas*

Director of the United States Patent and Trademark Office

# United States of America

United States Patent and Trademark Office

# Coquette

**Reg. No. 4,135,232**

**Registered May 1, 2012**

**Int. Cl.: 41**

**SERVICE MARK**

**PRINCIPAL REGISTER**

BONILLA-ESPADA, DORIMAR (UNITED STATES INDIVIDUAL)  
4566 FLAMING RIDGE TRL.  
LAS VEGAS, NV 89147

FOR: EDUCATION SERVICES, NAMELY, PROVIDING CLASSES IN THE FIELD OF DANCING; ENTERTAINMENT SERVICES, NAMELY, ARRANGING AND CONDUCTING SHOWS IN THE FIELD OF DANCE; ARRANGING AND CONDUCTING LIVE PERFORMANCES FEATURING DANCE; ENTERTAINMENT IN THE NATURE OF DANCE PERFORMANCES; CHOREOGRAPHY SERVICES FOR OTHERS, IN CLASS 41 (U.S. CLS. 100, 101 AND 107).

FIRST USE 12-27-2007; IN COMMERCE 10-12-2008.

THE MARK CONSISTS OF STANDARD CHARACTERS WITHOUT CLAIM TO ANY PARTICULAR FONT, STYLE, SIZE, OR COLOR.

SER. NO. 85-412,223, FILED 8-31-2011.

KAREN SEVERSON, EXAMINING ATTORNEY



*David J. Kybas*

Director of the United States Patent and Trademark Office

# United States of America

United States Patent and Trademark Office

## CAVE CREEK CHILI BEER

**Reg. No. 4,135,233**

**Registered May 1, 2012**

**Int. Cl.: 32**

**TRADEMARK**

**PRINCIPAL REGISTER**

CERVECERIA MEXICANA, S. DE R.L. DE C.V. (MEXICO CORPORATION)  
COL. INDUSTRIAL  
BLVD. MORELOS NO. 750-B  
TECATE, B.C., MEXICO C.P.21430

FOR: BEER, IN CLASS 32 (U.S. CLS. 45, 46 AND 48).

FIRST USE 12-31-1990; IN COMMERCE 12-31-1990.

THE MARK CONSISTS OF STANDARD CHARACTERS WITHOUT CLAIM TO ANY PARTICULAR FONT, STYLE, SIZE, OR COLOR.

NO CLAIM IS MADE TO THE EXCLUSIVE RIGHT TO USE "CHILI BEER", APART FROM THE MARK AS SHOWN.

SER. NO. 85-412,240, FILED 8-31-2011.

ALICE BENMAMAN, EXAMINING ATTORNEY



*David J. Kybas*

Director of the United States Patent and Trademark Office

# United States of America

United States Patent and Trademark Office

# RED PIG

**Reg. No. 4,135,234**

**Registered May 1, 2012**

**Int. Cl.: 32**

**TRADEMARK**

**PRINCIPAL REGISTER**

CERVECERIA MEXICANA, S. DE R.L. DE C.V. (MEXICO CORPORATION)  
COL. INDUSTRIAL  
BLVD. MORELOS NO. 750-B  
TECATE, B.C., MEXICO C.P.21430

FOR: ALE; BEER, IN CLASS 32 (U.S. CLS. 45, 46 AND 48).

FIRST USE 1-10-2007; IN COMMERCE 1-10-2007.

THE MARK CONSISTS OF STANDARD CHARACTERS WITHOUT CLAIM TO ANY PARTICULAR FONT, STYLE, SIZE, OR COLOR.

SER. NO. 85-412,257, FILED 8-31-2011.

ALICE BENMAMAN, EXAMINING ATTORNEY



*David J. Kybas*

Director of the United States Patent and Trademark Office



# United States of America

United States Patent and Trademark Office

# EXCESS

**Reg. No. 4,135,235**

**Registered May 1, 2012**

**Int. Cl.: 15**

**TRADEMARK**

**PRINCIPAL REGISTER**

VIGIER, PATRICE (FRANCE INDIVIDUAL)  
100T ROUTE D'EVRY  
MAROLLES EN HUREPOIX, FRANCE 91630

FOR: MUSICAL INSTRUMENTS, IN CLASS 15 (U.S. CLS. 2, 21 AND 36).

FIRST USE 6-0-2001; IN COMMERCE 6-0-2001.

THE MARK CONSISTS OF STANDARD CHARACTERS WITHOUT CLAIM TO ANY PARTICULAR FONT, STYLE, SIZE, OR COLOR.

SER. NO. 85-412,259, FILED 8-31-2011.

ALICE BENMAMAN, EXAMINING ATTORNEY



*David J. Kybas*

Director of the United States Patent and Trademark Office

# United States of America

United States Patent and Trademark Office

# OARSMAN

**Reg. No. 4,135,236**

**Registered May 1, 2012**

**Int. Cls.: 20 and 32**

**TRADEMARK**

**PRINCIPAL REGISTER**

BELL'S BREWERY, INC. (MICHIGAN CORPORATION)  
8938 KRUM AVENUE  
GALESBURG, MI 49053

FOR: NONMETAL TAPS FOR KEGS; NONMETAL TAP GLOBES FOR KEGS, IN CLASS 20  
(U.S. CLS. 2, 13, 22, 25, 32 AND 50).

FIRST USE 10-31-2008; IN COMMERCE 3-20-2009.

FOR: BEER; ALE; MALT LIQUOR, IN CLASS 32 (U.S. CLS. 45, 46 AND 48).

FIRST USE 10-31-2008; IN COMMERCE 3-20-2009.

THE MARK CONSISTS OF STANDARD CHARACTERS WITHOUT CLAIM TO ANY PARTICULAR FONT, STYLE, SIZE, OR COLOR.

SER. NO. 85-412,279, FILED 8-31-2011.

DANIEL BRODY, EXAMINING ATTORNEY



*David J. Kybas*

Director of the United States Patent and Trademark Office

# United States of America

United States Patent and Trademark Office

VRP

**Reg. No. 4,135,237**

TSI POWER CORP. (ILLINOIS CORPORATION)  
1103 WEST PIERCE AVENUE  
ANTIGO, WI 544093103

**Registered May 1, 2012**

**Int. Cl.: 9**

FOR: PULSE WIDTH MODULATING VOLTAGE REGULATORS, IN CLASS 9 (U.S. CLS. 21, 23, 26, 36 AND 38).

**TRADEMARK**

FIRST USE 1-1-2002; IN COMMERCE 1-1-2002.

**PRINCIPAL REGISTER**

THE MARK CONSISTS OF THE LETTERS "VRP" WITH A SUPERPOSED LIGHTNING BOLT.

SER. NO. 85-412,309, FILED 8-31-2011.

RONALD MCMORROW, EXAMINING ATTORNEY



*David J. Kyffers*

Director of the United States Patent and Trademark Office

# United States of America

United States Patent and Trademark Office

## Wealth Off Wall Street

**Reg. No. 4,135,238**

**Registered May 1, 2012**

**Int. Cl.: 36**

**SERVICE MARK**

**PRINCIPAL REGISTER**

WEALTH OFF WALL STREET, LLC (FLORIDA LIMITED LIABILITY COMPANY)  
SUITE 207  
100 MAIN STREET  
SAFETY HARBOR, FL 34695

FOR: CAPITAL INVESTMENT CONSULTING; EQUITY CAPITAL INVESTMENT; FINANCIAL AND INVESTMENT SERVICES, NAMELY, ASSET AND INVESTMENT ACQUISITION, CONSULTATION, ADVISORY AND DEVELOPMENT; FINANCIAL ASSET MANAGEMENT; FINANCIAL PLANNING AND INVESTMENT ADVISORY SERVICES; FINANCIAL PLANNING CONSULTATION; FINANCIAL PLANNING FOR RETIREMENT; INVESTMENT ADVICE; INVESTMENT CONSULTATION; PROVIDING INFORMATION AND ADVICE IN THE FIELD OF FINANCE, FINANCIAL INVESTMENTS, FINANCIAL VALUATIONS, AND THE FINANCIAL ASPECTS OF RETIREMENT, IN CLASS 36 (U.S. CLS. 100, 101 AND 102).

FIRST USE 12-1-2008; IN COMMERCE 12-1-2008.

THE MARK CONSISTS OF STANDARD CHARACTERS WITHOUT CLAIM TO ANY PARTICULAR FONT, STYLE, SIZE, OR COLOR.

SER. NO. 85-412,310, FILED 8-31-2011.

CHARLES L. JENKINS, EXAMINING ATTORNEY



*David J. Kybas*

Director of the United States Patent and Trademark Office

# United States of America

United States Patent and Trademark Office

# VRx

**Reg. No. 4,135,239**

**Registered May 1, 2012**

**Int. Cl.: 9**

**TRADEMARK**

**PRINCIPAL REGISTER**

TSI POWER CORP. (ILLINOIS CORPORATION)  
1103 WEST PIERCE AVENUE  
ANTIGI, WI 544093103

FOR: PULSE WIDTH MODULATING VOLTAGE REGULATORS, IN CLASS 9 (U.S. CLS. 21, 23, 26, 36 AND 38).

FIRST USE 1-1-2002; IN COMMERCE 1-1-2002.

THE MARK CONSISTS OF THE LETTERS "VRX" WITH A SUPERPOSED LIGHTNING BOLT.

SER. NO. 85-412,317, FILED 8-31-2011.

RONALD MCMORROW, EXAMINING ATTORNEY



*David J. Kybas*

Director of the United States Patent and Trademark Office

# United States of America

United States Patent and Trademark Office

## Four Marks

**Reg. No. 4,135,240**

**Registered May 1, 2012**

**Int. Cl.: 20**

**TRADEMARK**

**PRINCIPAL REGISTER**

FOUR MARKS INC. (KENTUCKY CORPORATION)  
435 OXFORD PL  
LOUISVILLE, KY 40207

FOR: OUTDOOR FURNITURE, IN CLASS 20 (U.S. CLS. 2, 13, 22, 25, 32 AND 50).

FIRST USE 10-1-2010; IN COMMERCE 10-1-2010.

THE MARK CONSISTS OF STANDARD CHARACTERS WITHOUT CLAIM TO ANY PARTICULAR FONT, STYLE, SIZE, OR COLOR.

SER. NO. 85-412,320, FILED 8-31-2011.

RONALD MCMORROW, EXAMINING ATTORNEY



*David J. Kyffers*

Director of the United States Patent and Trademark Office

**United States of America**  
United States Patent and Trademark Office

# Itchy Paws

**Reg. No. 4,135,241**

**Registered May 1, 2012**

**Int. Cl.: 43**

**SERVICE MARK**

**PRINCIPAL REGISTER**

ITCHY PAWS, INC. (CALIFORNIA CORPORATION)  
1213 EAST 8TH STREET  
LONG BEACH, CA 90813

FOR: PET DAY CARE SERVICES, IN CLASS 43 (U.S. CLS. 100 AND 101).

FIRST USE 1-1-2009; IN COMMERCE 1-1-2009.

THE MARK CONSISTS OF STANDARD CHARACTERS WITHOUT CLAIM TO ANY PARTICULAR FONT, STYLE, SIZE, OR COLOR.

SER. NO. 85-412,332, FILED 8-31-2011.

LAURIE MAYES, EXAMINING ATTORNEY



*David J. Kyros*

Director of the United States Patent and Trademark Office

# United States of America

United States Patent and Trademark Office

# GRABTOWN

**Reg. No. 4,135,242**

**Registered May 1, 2012**

**Int. Cl.: 12**

**TRADEMARK**

**PRINCIPAL REGISTER**

GRABTOWN, INC. (CALIFORNIA CORPORATION)  
2720 AIELLO DRIVE, SUITE B  
SAN JOSE, CA 95111

FOR: LAND VEHICLES AND STRUCTURAL PARTS THEREFOR, IN CLASS 12 (U.S. CLS. 19, 21, 23, 31, 35 AND 44).

FIRST USE 11-2-2010; IN COMMERCE 11-2-2010.

THE MARK CONSISTS OF STANDARD CHARACTERS WITHOUT CLAIM TO ANY PARTICULAR FONT, STYLE, SIZE, OR COLOR.

SER. NO. 85-412,334, FILED 8-31-2011.

WENDY GOODMAN, EXAMINING ATTORNEY



*David J. Kybas*

Director of the United States Patent and Trademark Office



# United States of America

United States Patent and Trademark Office

# XINV

**Reg. No. 4,135,243**

**Registered May 1, 2012**

**Int. Cl.: 9**

**TRADEMARK**

**PRINCIPAL REGISTER**

TSI POWER CORP. (ILLINOIS CORPORATION)  
1103 WEST PIERCE AVENUE  
ANTIGO, WI 544093103

FOR: DC TO AC POWER INVERTERS, IN CLASS 9 (U.S. CLS. 21, 23, 26, 36 AND 38).

FIRST USE 1-1-2006; IN COMMERCE 1-1-2006.

THE MARK CONSISTS OF THE LETTERS "XINV" WITH A SUPERPOSED LIGHTNING BOLT.

SER. NO. 85-412,341, FILED 8-31-2011.

RONALD MCMORROW, EXAMINING ATTORNEY



*David J. Kyffers*

Director of the United States Patent and Trademark Office

# United States of America

United States Patent and Trademark Office

## LITTLE FUTURE

**Reg. No. 4,135,244**

**Registered May 1, 2012**

**Int. Cl.: 35**

**SERVICE MARK**

**PRINCIPAL REGISTER**

RITCHIE, DAVID (UNITED STATES INDIVIDUAL)  
3072 GLEN OAK AVE N  
CLEARWATER, FL 33759

FOR: PROMOTING PUBLIC AWARENESS IN SUPPORT OF PRO-LIFE BELIEFS, IN CLASS 35 (U.S. CLS. 100, 101 AND 102).

FIRST USE 1-20-2011; IN COMMERCE 7-6-2011.

THE MARK CONSISTS OF STANDARD CHARACTERS WITHOUT CLAIM TO ANY PARTICULAR FONT, STYLE, SIZE, OR COLOR.

SER. NO. 85-412,342, FILED 8-31-2011.

JESSICA A. POWERS, EXAMINING ATTORNEY



*David J. Kybas*

Director of the United States Patent and Trademark Office

# United States of America

United States Patent and Trademark Office

## HEAVY BREATHING

**Reg. No. 4,135,245**

GLOVE MUSIC, LLP (MARYLAND LIMITED PARTNERSHIP)  
8104 LIONS CREST WAY  
LAYTONSVILLE, MD 20879

**Registered May 1, 2012**

**Int. Cl.: 41**

FOR: ENTERTAINMENT SERVICES IN THE NATURE OF LIVE MUSICAL PERFORMANCES,  
IN CLASS 41 (U.S. CLS. 100, 101 AND 107).

**SERVICE MARK**

FIRST USE 6-17-2011; IN COMMERCE 8-5-2011.

**PRINCIPAL REGISTER**

THE MARK CONSISTS OF STANDARD CHARACTERS WITHOUT CLAIM TO ANY PARTICULAR FONT, STYLE, SIZE, OR COLOR.

SER. NO. 85-412,347, FILED 8-31-2011.

JOSETTE BEVERLY, EXAMINING ATTORNEY



*David J. Kybas*

Director of the United States Patent and Trademark Office

# United States of America

United States Patent and Trademark Office



**Reg. No. 4,135,246**

**Registered May 1, 2012**

**Int. Cl.: 35**

**SERVICE MARK**

**PRINCIPAL REGISTER**

SOLES, JEREMY WAYNE (UNITED STATES INDIVIDUAL)  
3012 SILVERBUSH COURT  
RICHMOND, VA 23228

FOR: CHARITABLE SERVICES, NAMELY, ORGANIZING, DEVELOPING AND PARTICIPATING IN PROJECTS AND EVENTS THAT FEATURE EXTREME FEATS OF PHYSICAL AND MENTAL ENDURANCE TO PROMOTE AND RAISE AWARENESS OF THE SACRIFICES MADE BY VETERANS AND WOUNDED WARRIORS, IN CLASS 35 (U.S. CLS. 100, 101 AND 102).

FIRST USE 8-0-2009; IN COMMERCE 8-0-2009.

THE MARK CONSISTS OF THE STYLIZED WORD "TEAM" TO THE LEFT OF THE WORD "X T.R.E.M.E." IN STYLIZED FONT. THE LETTER "X" IS LARGER THAN THE LETTERS "T.R.E.M.E." AND IS BEHIND A DRAWING OF THE HEAD OF A HUMAN WEARING A GAS MASK. THERE IS AN UNEVEN SOLID LINE BELOW THE LETTERS "T.R.E.M.E." AND BELOW THE LINE ARE THE STYLIZED WORDS "TRAIN. REHABILITATE. EMPOWER. MOTIVATE. ENDURE.".

SER. NO. 85-412,351, FILED 8-31-2011.

JOSETTE BEVERLY, EXAMINING ATTORNEY



*David J. Kybas*

Director of the United States Patent and Trademark Office

# United States of America

United States Patent and Trademark Office

# SoftJAM

**Reg. No. 4,135,247**

**Registered May 1, 2012**

**Int. Cl.: 31**

**TRADEMARK**

**PRINCIPAL REGISTER**

LOWE, MATTHEW SNYDER (UNITED STATES INDIVIDUAL)  
655 SHOWERS LANE  
MARTINSBURG, WV 25403

FOR: MULCH, IN CLASS 31 (U.S. CLS. 1 AND 46).

FIRST USE 8-31-2011; IN COMMERCE 8-31-2011.

THE MARK CONSISTS OF STANDARD CHARACTERS WITHOUT CLAIM TO ANY PARTICULAR FONT, STYLE, SIZE, OR COLOR.

SER. NO. 85-412,367, FILED 8-31-2011.

NICHOLAS ALTREE, EXAMINING ATTORNEY



*David J. Kybas*

Director of the United States Patent and Trademark Office

# United States of America

United States Patent and Trademark Office

## MAKING MEMORIES TOGETHER

**Reg. No. 4,135,248**

**Registered May 1, 2012**

**Int. Cl.: 28**

**TRADEMARK**

**PRINCIPAL REGISTER**

GENCO INTERNATIONAL, INC. (D.C. CORPORATION)  
10225 MONTGOMERY AVENUE  
KENSINGTON, MD 20895

FOR: BOARD GAMES; EQUIPMENT SOLD AS A UNIT FOR PLAYING BOARD GAMES,  
IN CLASS 28 (U.S. CLS. 22, 23, 38 AND 50).

FIRST USE 9-1-1999; IN COMMERCE 9-1-1999.

THE MARK CONSISTS OF STANDARD CHARACTERS WITHOUT CLAIM TO ANY PAR-  
TICULAR FONT, STYLE, SIZE, OR COLOR.

SER. NO. 85-412,370, FILED 8-31-2011.

DAVID ELTON, EXAMINING ATTORNEY



*David J. Kybas*

Director of the United States Patent and Trademark Office

# United States of America

United States Patent and Trademark Office

# SHARKTOBER

**Reg. No. 4,135,249**

**Registered May 1, 2012**

**Int. Cl.: 35**

**SERVICE MARK**

**PRINCIPAL REGISTER**

MCGUIRE, DAVID (UNITED STATES INDIVIDUAL)  
454 BOLINAS RD  
FAIRFAX, CA 94930

FOR: PUBLIC ADVOCACY TO PROMOTE AWARENESS OF SHARK AND OCEAN CONSERVATION; PROMOTING PUBLIC AWARENESS OF THE NEED FOR SHARK AND OCEAN CONSERVATION, IN CLASS 35 (U.S. CLS. 100, 101 AND 102).

FIRST USE 8-1-2009; IN COMMERCE 8-1-2009.

THE MARK CONSISTS OF STANDARD CHARACTERS WITHOUT CLAIM TO ANY PARTICULAR FONT, STYLE, SIZE, OR COLOR.

SER. NO. 85-412,374, FILED 8-31-2011.

NAPOLEON SHARMA, EXAMINING ATTORNEY



*David J. Kyffers*

Director of the United States Patent and Trademark Office

# United States of America

United States Patent and Trademark Office

## MEDICI MINT

**Reg. No. 4,135,250**

**Registered May 1, 2012**

**Int. Cl.: 30**

**TRADEMARK**

**PRINCIPAL REGISTER**

ROSENSTOCK, DALE RICE (UNITED STATES INDIVIDUAL)  
1749 SHADY CREST PLACE  
EL CAJON, CA 92020

FOR: CHOCOLATE, IN CLASS 30 (U.S. CL. 46).

FIRST USE 8-1-1998; IN COMMERCE 10-10-1998.

THE MARK CONSISTS OF STANDARD CHARACTERS WITHOUT CLAIM TO ANY PARTICULAR FONT, STYLE, SIZE, OR COLOR.

NO CLAIM IS MADE TO THE EXCLUSIVE RIGHT TO USE "MINT", APART FROM THE MARK AS SHOWN.

SEC. 2(F) AS TO "MEDICI".

SER. NO. 85-412,377, FILED 8-31-2011.

RUDY R. SINGLETON, EXAMINING ATTORNEY



*David J. Kyffers*

Director of the United States Patent and Trademark Office



# United States of America

United States Patent and Trademark Office

## MAD ABOUT MAHJ

**Reg. No. 4,135,251**

**Registered May 1, 2012**

**Int. Cl.: 30**

**TRADEMARK**

**PRINCIPAL REGISTER**

ROSENSTOCK, DALE RICE (UNITED STATES INDIVIDUAL)  
1749 SHADY CREST PLACE  
EL CAJON, CA 92020

FOR: CHOCOLATE, IN CLASS 30 (U.S. CL. 46).

FIRST USE 8-10-1998; IN COMMERCE 10-10-1998.

THE MARK CONSISTS OF STANDARD CHARACTERS WITHOUT CLAIM TO ANY PARTICULAR FONT, STYLE, SIZE, OR COLOR.

SER. NO. 85-412,381, FILED 8-31-2011.

RUDY R. SINGLETON, EXAMINING ATTORNEY



*David J. Kyffers*

Director of the United States Patent and Trademark Office

# United States of America

United States Patent and Trademark Office

## SocialMediaPlus

**Reg. No. 4,135,252**

**Registered May 1, 2012**

**Int. Cl.: 41**

**SERVICE MARK**

**PRINCIPAL REGISTER**

HUMAN CAPITAL SOLUTIONS, LLC (PENNSYLVANIA LIMITED LIABILITY COMPANY)  
4 WEST PRESCOTT ALLEY  
WEST CHESTER, PA 19382

FOR: ARRANGING AND CONDUCTING EDUCATIONAL CONFERENCES; EDUCATION SERVICES, NAMELY, PROVIDING SEMINARS IN THE FIELD OF SOCIAL MEDIA, MOBILE TECHNOLOGIES, AND WEB DEVELOPMENT; TRAINING SERVICES IN THE FIELD OF SOCIAL MEDIA, MOBILE TECHNOLOGIES, REPUTATION MANAGEMENT, WEB DEVELOPMENT AND SOCIAL TECHNOLOGIES AND SOCIAL MEDIA BEST PRACTICES, IN CLASS 41 (U.S. CLS. 100, 101 AND 107).

FIRST USE 2-1-2010; IN COMMERCE 2-1-2010.

THE MARK CONSISTS OF STANDARD CHARACTERS WITHOUT CLAIM TO ANY PARTICULAR FONT, STYLE, SIZE, OR COLOR.

SER. NO. 85-412,388, FILED 8-31-2011.

ASMAT KHAN, EXAMINING ATTORNEY



*David J. Kyffers*

Director of the United States Patent and Trademark Office

# United States of America

United States Patent and Trademark Office

## Wine and Palette

**Reg. No. 4,135,253**

**Registered May 1, 2012**

**Int. Cl.: 41**

**SERVICE MARK**

**PRINCIPAL REGISTER**

HASLEY, AARON (UNITED STATES INDIVIDUAL)  
209 SW 140TH TERR  
OKLAHOMA CITY, OK 73170 AND

ENSIGN, MARIE (UNITED STATES INDIVIDUAL)  
209 SW 140TH TERR  
OKLAHOMA CITY, OK 73170

FOR: INSTRUCTION IN THE FIELD OF PAINTING ART, IN CLASS 41 (U.S. CLS. 100, 101 AND 107).

FIRST USE 8-22-2011; IN COMMERCE 8-22-2011.

THE MARK CONSISTS OF STANDARD CHARACTERS WITHOUT CLAIM TO ANY PARTICULAR FONT, STYLE, SIZE, OR COLOR.

SER. NO. 85-412,391, FILED 8-31-2011.

SUE LAWRENCE, EXAMINING ATTORNEY



*David J. Kyros*

Director of the United States Patent and Trademark Office

# United States of America

United States Patent and Trademark Office

# FUSION

**Reg. No. 4,135,254**

**Registered May 1, 2012**

**Int. Cl.: 15**

**TRADEMARK**

**PRINCIPAL REGISTER**

FUSION PRODUCTS LIMITED (UNITED KINGDOM PRIVATE LIMITED COMPANY)  
164A SCHOLLS LANE  
SCHOLLS, CLECKHEATON  
WEST YORKSHIRE, UNITED KINGDOM BD166LX

FOR: BAGS, CASES AND HOLDALLS FOR USE WITH MUSICAL INSTRUMENTS, IN CLASS 15 (U.S. CLS. 2, 21 AND 36).

THE MARK CONSISTS OF STANDARD CHARACTERS WITHOUT CLAIM TO ANY PARTICULAR FONT, STYLE, SIZE, OR COLOR.

OWNER OF UNITED KINGDOM REG. NO. 006813497, DATED 12-23-2008, EXPIRES 4-8-2018.

SER. NO. 85-412,412, FILED 8-31-2011.

NAPOLEON SHARMA, EXAMINING ATTORNEY



*David J. Kyffers*

Director of the United States Patent and Trademark Office

**United States of America**  
United States Patent and Trademark Office

# SKYLOFTS

**Reg. No. 4,135,255**

**Registered May 1, 2012**

**Int. Cl.: 45**

**SERVICE MARK**

**PRINCIPAL REGISTER**

MGM RESORTS INTERNATIONAL (DELAWARE CORPORATION)  
3600 LAS VEGAS BOULEVARD SOUTH  
LAS VEGAS, NV 89109

FOR: HOTEL CONCIERGE SERVICES, IN CLASS 45 (U.S. CLS. 100 AND 101).

FIRST USE 11-8-2004; IN COMMERCE 11-8-2004.

THE MARK CONSISTS OF STANDARD CHARACTERS WITHOUT CLAIM TO ANY PARTICULAR FONT, STYLE, SIZE, OR COLOR.

OWNER OF U.S. REG. NOS. 3,669,355, 3,822,759 AND OTHERS.

SER. NO. 85-412,413, FILED 8-31-2011.

JULIE GUTTADAURO, EXAMINING ATTORNEY



*David J. Kybas*

Director of the United States Patent and Trademark Office

# United States of America

United States Patent and Trademark Office

## THE ASSOCIATION OF BONE AND JOINT SURGEONS

**Reg. No. 4,135,256**

**Registered May 1, 2012**

**Int. Cls.: 35 and 41**

**SERVICE MARK**

**PRINCIPAL REGISTER**

THE ASSOCIATION OF BONE AND JOINT SURGEONS (OKLAHOMA CORPORATION)  
6300 NORTH RIVER ROAD, SUITE 605  
ROSEMONT, IL 60018

FOR: ASSOCIATION SERVICES, NAMELY, PROMOTING THE INTERESTS OF ORTHOPAEDIC SURGEONS, IN CLASS 35 (U.S. CLS. 100, 101 AND 102).

FIRST USE 0-0-1954; IN COMMERCE 0-0-1954.

FOR: EDUCATIONAL SERVICES, NAMELY, CONDUCTING SEMINARS, CONFERENCES, AND WORKSHOPS IN THE FIELD OF ORTHOPAEDIC CARE AND SURGERY; AND PROVIDING AWARDS FOR THE DEMONSTRATION OF EXCELLENCE IN MUSCULOSKELETAL RESEARCH, IN CLASS 41 (U.S. CLS. 100, 101 AND 107).

FIRST USE 0-0-1954; IN COMMERCE 0-0-1954.

THE MARK CONSISTS OF STANDARD CHARACTERS WITHOUT CLAIM TO ANY PARTICULAR FONT, STYLE, SIZE, OR COLOR.

OWNER OF U.S. REG. NOS. 2,575,216 AND 2,729,220.

SEC. 2(F).

SER. NO. 85-412,419, FILED 8-31-2011.

ROBIN CHOSID, EXAMINING ATTORNEY



*David J. Kybas*

Director of the United States Patent and Trademark Office

**United States of America**  
United States Patent and Trademark Office

# KÖR FÖRCE

**Reg. No. 4,135,257**

**Registered May 1, 2012**

**Int. Cl.: 5**

**TRADEMARK**

**PRINCIPAL REGISTER**

VITALITY RESEARCH LABS (NEVADA LIMITED LIABILITY COMPANY)  
8820 W. RUSSELL RD SUITE 110  
LAS VEGAS, NV 89148

FOR: DIETARY AND NUTRITIONAL SUPPLEMENTS; DIETARY AND NUTRITIONAL SUPPLEMENTS FOR ENDURANCE SPORTS, IN CLASS 5 (U.S. CLS. 6, 18, 44, 46, 51 AND 52).

FIRST USE 4-1-2011; IN COMMERCE 6-11-2011.

THE MARK CONSISTS OF STANDARD CHARACTERS WITHOUT CLAIM TO ANY PARTICULAR FONT, STYLE, SIZE, OR COLOR.

SER. NO. 85-412,435, FILED 8-31-2011.

KATHERINE STOIDES, EXAMINING ATTORNEY



*David J. Kyffers*

Director of the United States Patent and Trademark Office

# United States of America

United States Patent and Trademark Office

## GLOBAL YODEL

**Reg. No. 4,135,258**

**Registered May 1, 2012**

**Int. Cl.: 41**

**SERVICE MARK**

**PRINCIPAL REGISTER**

GLOBAL YODEL LLC (WASHINGTON LIMITED LIABILITY COMPANY)  
6426 WARREN ST.  
ANACORTES, WA 98221

FOR: ENTERTAINMENT SERVICES, NAMELY, PROVIDING A WEB SITE FEATURING PHOTOGRAPHIC, VIDEO AND PROSE PRESENTATIONS FEATURING TRAVEL DESTINATIONS FROM THE PERSPECTIVE OF LOCAL PHOTOGRAPHERS, WRITERS, ARTISTIC CREATORS, AND OTHER LOCALS, IN CLASS 41 (U.S. CLS. 100, 101 AND 107).

FIRST USE 2-1-2011; IN COMMERCE 8-8-2011.

THE MARK CONSISTS OF STANDARD CHARACTERS WITHOUT CLAIM TO ANY PARTICULAR FONT, STYLE, SIZE, OR COLOR.

SER. NO. 85-412,437, FILED 8-31-2011.

KATHERINE STOIDES, EXAMINING ATTORNEY



*David J. Kybas*

Director of the United States Patent and Trademark Office



# United States of America

United States Patent and Trademark Office

## NĀ HŌKŪ HANO HANO

**Reg. No. 4,135,259**

**Registered May 1, 2012**

**Int. Cl.: 41**

**SERVICE MARK**

**PRINCIPAL REGISTER**

HAWAII ACADEMY OF RECORDING ARTS (HAWAII CORPORATION)  
P.O. BOX 821  
HONOLULU, HI 96808

FOR: EDUCATIONAL SERVICES, NAMELY, PROVIDING INCENTIVES TO PEOPLE TO DEMONSTRATE EXCELLENCE IN THE FIELD OF MUSIC AND VIDEO ARTS AND SCIENCES THROUGH THE ISSUANCE OF AWARDS; ENTERTAINMENT SERVICES, NAMELY, LIVE PERFORMANCES BY MUSICAL ARTISTS AND MUSICAL GROUPS; ENTERTAINMENT IN THE NATURE OF TELEVISED MUSIC AWARDS PROGRAMS; AN ANNUAL AWARDS PROGRAM FOR THE PRESENTATION OF AWARDS IN RECOGNITION OF DISTINGUISHED ACHIEVEMENT IN THE FIELD OF MUSIC, IN CLASS 41 (U.S. CLS. 100, 101 AND 107).

FIRST USE 8-14-1978; IN COMMERCE 8-14-1978.

THE MARK CONSISTS OF STANDARD CHARACTERS WITHOUT CLAIM TO ANY PARTICULAR FONT, STYLE, SIZE, OR COLOR.

THE ENGLISH TRANSLATION OF NA HOKU HANO HANO IN THE MARK IS STARS OF DISTINCTION.

SER. NO. 85-412,460, FILED 8-31-2011.

NORA BUCHANAN WILL, EXAMINING ATTORNEY



*David J. Kyros*

Director of the United States Patent and Trademark Office

# United States of America

United States Patent and Trademark Office

## NĀ HŌKŪ HANO HANO

**Reg. No. 4,135,260**

**Registered May 1, 2012**

**Int. Cl.: 35**

**SERVICE MARK**

**PRINCIPAL REGISTER**

HAWAII ACADEMY OF RECORDING ARTS (HAWAII CORPORATION)  
P.O. BOX 821  
HONOLULU, HI 96808

FOR: ASSOCIATION SERVICES, NAMELY, PROMOTING ARTISTIC PROGRESS AND ACHIEVEMENT IN THE FIELD OF RECORDING ARTS AND SCIENCES, IN CLASS 35 (U.S. CLS. 100, 101 AND 102).

FIRST USE 8-14-1978; IN COMMERCE 8-14-1978.

THE MARK CONSISTS OF STANDARD CHARACTERS WITHOUT CLAIM TO ANY PARTICULAR FONT, STYLE, SIZE, OR COLOR.

THE ENGLISH TRANSLATION OF "NA HOKU HANO HANO" IN THE MARK IS "STARS OF DISTINCTION".

SER. NO. 85-412,469, FILED 8-31-2011.

NORA BUCHANAN WILL, EXAMINING ATTORNEY



*David J. Kyjars*

Director of the United States Patent and Trademark Office

# United States of America

United States Patent and Trademark Office

# SigEp

**Reg. No. 4,135,261**

**Registered May 1, 2012**

**Int. Cl.: 35**

**SERVICE MARK**

**PRINCIPAL REGISTER**

SIGMA PHI EPSILON FRATERNITY (VIRGINIA CORPORATION)  
P.O. BOX 1901  
RICHMOND, VA 23218

FOR: ASSOCIATION SERVICES, NAMELY, ORGANIZING CHAPTERS OF A FRATERNITY AND PROMOTING THE INTERESTS OF THE MEMBERS THEREOF, IN CLASS 35 (U.S. CLS. 100, 101 AND 102).

FIRST USE 12-31-1996; IN COMMERCE 12-31-1996.

THE MARK CONSISTS OF STANDARD CHARACTERS WITHOUT CLAIM TO ANY PARTICULAR FONT, STYLE, SIZE, OR COLOR.

OWNER OF U.S. REG. NO. 2,552,331.

SER. NO. 85-412,488, FILED 8-31-2011.

JOHN DWYER, EXAMINING ATTORNEY



*David J. Kyffers*

Director of the United States Patent and Trademark Office

# United States of America

United States Patent and Trademark Office



# MyWorkout

**Reg. No. 4,135,262**

**Registered May 1, 2012**

**Int. Cl.: 9**

**TRADEMARK**

**PRINCIPAL REGISTER**

LEVYTAM, SHALOM (CANADA INDIVIDUAL)  
1301-520 TALBOT ST  
LONDON, CANADA N6A-6K4

FOR: COMPUTER SOFTWARE FOR THE ONLINE AND OFFLINE TRACKING OF A PERSON'S PHYSICAL FITNESS LEVEL AND EXERCISE ROUTINE, IN CLASS 9 (U.S. CLS. 21, 23, 26, 36 AND 38).

FIRST USE 3-14-2009; IN COMMERCE 3-14-2009.

THE MARK CONSISTS OF THE TERM 'MYWORKOUT' ALONG WITH A LOGO WHICH GRAPHICALLY DEPICTS THE SILHOUETTE OF A BODY BUILDER FLEXING HIS BICEPS WITH HIS ARMS ABOVE HIS HEAD.

SER. NO. 85-412,499, FILED 8-31-2011.

JOHN DWYER, EXAMINING ATTORNEY



*David J. Kyffers*

Director of the United States Patent and Trademark Office

# United States of America

United States Patent and Trademark Office

# EVO

**Reg. No. 4,135,263**

**Registered May 1, 2012**

**Int. Cl.: 20**

**TRADEMARK**

**PRINCIPAL REGISTER**

AYA KITCHENS AND BATHS LTD. (CANADA CORPORATION)  
1551 CATERPILLAR ROAD  
MISSISSAGA, ONTARIO, CANADA L4X2Z6

FOR: CABINETS, NAMELY, BATHROOM, BEDROOM, DINING ROOM AND KITCHEN CABINETS, INCLUDING CABINETS, COUNTERS, COUNTERTOPS FOR USE IN BATHROOMS AND KITCHENS, MODULAR CABINETS UNITS FOR USE IN BATHROOMS, BEDROOMS, DINING ROOMS, KITCHENS, HALLWAYS, LIVING ROOMS, AND WORKROOMS, IN CLASS 20 (U.S. CLS. 2, 13, 22, 25, 32 AND 50).

FIRST USE 5-19-2008; IN COMMERCE 5-19-2008.

THE MARK CONSISTS OF STANDARD CHARACTERS WITHOUT CLAIM TO ANY PARTICULAR FONT, STYLE, SIZE, OR COLOR.

OWNER OF CANADA REG. NO. TMA755,020, DATED 12-10-2009, EXPIRES 12-10-2024.

OWNER OF U.S. REG. NO. 3,991,455.

SER. NO. 85-412,511, FILED 8-31-2011.

COLLEEN KEARNEY, EXAMINING ATTORNEY



*David J. Kybas*

Director of the United States Patent and Trademark Office

# United States of America

United States Patent and Trademark Office

## WE TURN ON THE COMFORT

**Reg. No. 4,135,264**

**Registered May 1, 2012**

**Int. Cl.: 37**

**SERVICE MARK**

**PRINCIPAL REGISTER**

SYNAPSE, LLC (PENNSYLVANIA LIMITED LIABILITY COMPANY)  
2950 OLD TREE DRIVE  
LANCASTER, PA 17603

FOR: INSTALLATION, MAINTENANCE AND REPAIR OF HVAC UNITS AND PLUMBING,  
IN CLASS 37 (U.S. CLS. 100, 103 AND 106).

FIRST USE 5-0-2010; IN COMMERCE 5-0-2010.

THE MARK CONSISTS OF STANDARD CHARACTERS WITHOUT CLAIM TO ANY PAR-  
TICULAR FONT, STYLE, SIZE, OR COLOR.

SER. NO. 85-412,516, FILED 8-31-2011.

HEATHER THOMPSON, EXAMINING ATTORNEY



*David J. Kybas*

Director of the United States Patent and Trademark Office

# United States of America

United States Patent and Trademark Office

## KERATINOLOGY

**Reg. No. 4,135,265**

**Registered May 1, 2012**

**Int. Cl.: 3**

**TRADEMARK**

**PRINCIPAL REGISTER**

PARAWEST, LLC (NEW YORK LIMITED LIABILITY COMPANY)  
41 MERCEDES WAY UNIT 34  
EDGEWOOD, NY 11717

FOR: HAIR BLEACHES; HAIR BLEACHING PREPARATIONS; HAIR CARE CREAMS; HAIR CARE LOTIONS; HAIR CARE PREPARATIONS; HAIR CLEANING PREPARATIONS; HAIR CONDITIONERS; HAIR CREAMS; HAIR CURLING PREPARATIONS; HAIR GELS; HAIR GLAZE; HAIR LOTIONS; HAIR MOUSSES; HAIR NOURISHERS; HAIR POMADES; HAIR RELAXERS; HAIR RELAXING PREPARATIONS; HAIR REMOVING CREAM; HAIR RINSES; HAIR SHAMPOOS AND CONDITIONERS; HAIR SPRAYS AND HAIR GELS; HAIR STRAIGHTENING PREPARATIONS; HAIR STYLING FIXATIVE IN THE NATURE OF HAIR WAX; HAIR STYLING GEL; HAIR STYLING PREPARATIONS; HAIR STYLING SPRAY; HAIR TONICS; HAIR WAVING LOTION; HAIR WAVING PREPARATIONS; HAIR WAX, IN CLASS 3 (U.S. CLS. 1, 4, 6, 50, 51 AND 52).

FIRST USE 10-0-2009; IN COMMERCE 10-0-2009.

THE MARK CONSISTS OF STANDARD CHARACTERS WITHOUT CLAIM TO ANY PARTICULAR FONT, STYLE, SIZE, OR COLOR.

SER. NO. 85-412,531, FILED 8-31-2011.

REGINA DRUMMOND, EXAMINING ATTORNEY



*David J. Kyros*

Director of the United States Patent and Trademark Office

# United States of America

United States Patent and Trademark Office

## THE COLLECTORS TABLE

**Reg. No. 4,135,266**

**Registered May 1, 2012**

**Int. Cl.: 35**

**SERVICE MARK**

**PRINCIPAL REGISTER**

THE SORTING TABLE, LLC (DELAWARE LIMITED LIABILITY COMPANY)  
1700 2ND STREET, SUITE 380  
NAPA, CA 94559

FOR: ONLINE RETAIL STORE SERVICES FEATURING ALCOHOLIC BEVERAGES, IN CLASS 35 (U.S. CLS. 100, 101 AND 102).

FIRST USE 10-0-2008; IN COMMERCE 10-0-2008.

THE MARK CONSISTS OF STANDARD CHARACTERS WITHOUT CLAIM TO ANY PARTICULAR FONT, STYLE, SIZE, OR COLOR.

SER. NO. 85-412,557, FILED 9-1-2011.

KEVIN DINALLO, EXAMINING ATTORNEY



*David J. Kybas*

Director of the United States Patent and Trademark Office



# United States of America

United States Patent and Trademark Office

# SkinnSonic

**Reg. No. 4,135,267**

SKINN COSMETICS, LLC (CALIFORNIA LIMITED LIABILITY COMPANY)  
4733 TORRANCE BLVD., #974  
TORRANCE, CA 90503

**Registered May 1, 2012**

**Int. Cl.: 21**

FOR: POWER-OPERATED BRUSH USED TO CLEAN AND EXFOLIATE THE SKIN, IN CLASS 21 (U.S. CLS. 2, 13, 23, 29, 30, 33, 40 AND 50).

**TRADEMARK**

FIRST USE 10-1-2009; IN COMMERCE 2-4-2010.

**PRINCIPAL REGISTER**

THE MARK CONSISTS OF STANDARD CHARACTERS WITHOUT CLAIM TO ANY PARTICULAR FONT, STYLE, SIZE, OR COLOR.

SER. NO. 85-412,559, FILED 9-1-2011.

WILLIAM ROSSMAN, EXAMINING ATTORNEY



*David J. Kyros*

Director of the United States Patent and Trademark Office

# United States of America

United States Patent and Trademark Office

## Winning with CPAs

**Reg. No. 4,135,268**

**Registered May 1, 2012**

**Int. Cl.: 41**

**SERVICE MARK**

**PRINCIPAL REGISTER**

ADVISORS EDGE MARKETING INC. (MISSOURI CORPORATION)  
BLDG. 1, STE.400  
1000 W. NIFONG BLVD.  
COLUMBIA, MO 65203

FOR: EDUCATIONAL SERVICES, NAMELY, CONDUCTING WEBINARS AND LIVE OR PRE-RECORDED TRAINING EVENTS IN THE FIELD OF BUSINESS DEVELOPMENT FOR INSURANCE AGENTS AND FINANCIAL ADVISORS THROUGH PARTNERING WITH CPAS AND DISTRIBUTION OF EDUCATIONAL MATERIALS IN CONNECTION THEREWITH, IN CLASS 41 (U.S. CLS. 100, 101 AND 107).

FIRST USE 2-1-2010; IN COMMERCE 2-1-2010.

THE MARK CONSISTS OF STANDARD CHARACTERS WITHOUT CLAIM TO ANY PARTICULAR FONT, STYLE, SIZE, OR COLOR.

NO CLAIM IS MADE TO THE EXCLUSIVE RIGHT TO USE "CPAS", APART FROM THE MARK AS SHOWN.

SER. NO. 85-412,560, FILED 9-1-2011.

ODESSA BIBBINS, EXAMINING ATTORNEY



*David J. Kyffers*

Director of the United States Patent and Trademark Office

**United States of America**  
United States Patent and Trademark Office

# POLARIO

**Reg. No. 4,135,269**

**Registered May 1, 2012**

**Int. Cl.: 7**

**TRADEMARK**

**PRINCIPAL REGISTER**

TECHNOLOGICAL AQUATIC ASSOCIATED MANUFACTURING, INC. (CALIFORNIA CORPORATION), AKA TAAM, INC.  
1011 AVENIDA ACASO  
CAMARILLO, CA 93012

FOR: AQUARIUM PUMPS; ELECTRICAL WATER PUMPS FOR AQUARIUM, SPAS, IN CLASS 7 (U.S. CLS. 13, 19, 21, 23, 31, 34 AND 35).

FIRST USE 2-7-2008; IN COMMERCE 2-7-2008.

THE MARK CONSISTS OF STANDARD CHARACTERS WITHOUT CLAIM TO ANY PARTICULAR FONT, STYLE, SIZE, OR COLOR.

SER. NO. 85-412,561, FILED 9-1-2011.

RAUL CORDOVA, EXAMINING ATTORNEY



*David J. Kyffers*

Director of the United States Patent and Trademark Office

# United States of America

United States Patent and Trademark Office

# EYEDEAL.LY

**Reg. No. 4,135,270**

**Registered May 1, 2012**

**Int. Cl.: 35**

**SERVICE MARK**

**PRINCIPAL REGISTER**

OPTOSEO INC. (CANADA CORPORATION)  
55 DOUGLAS CRES.  
TORONTO, CANADA M4W2E6

FOR: PROMOTING THE GOODS AND SERVICES OF OTHERS BY PROVIDING A WEBSITE FEATURING VOUCHERS, PRODUCT INFORMATION, PRODUCT REVIEWS, LINKS TO THE RETAIL WEBSITES OF OTHERS, AND DISCOUNT INFORMATION, IN CLASS 35 (U.S. CLS. 100, 101 AND 102).

FIRST USE 4-13-2011; IN COMMERCE 5-9-2011.

THE MARK CONSISTS OF STANDARD CHARACTERS WITHOUT CLAIM TO ANY PARTICULAR FONT, STYLE, SIZE, OR COLOR.

SER. NO. 85-412,583, FILED 9-1-2011.

LINDA ORNDORFF, EXAMINING ATTORNEY



*David J. Kybas*

Director of the United States Patent and Trademark Office

# United States of America

United States Patent and Trademark Office

## RODDY RANCH

**Reg. No. 4,135,271**

RODDY, JACK T. (UNITED STATES INDIVIDUAL)  
5601 CHADBOURNE ROAD  
BRENTWOOD, CA 94513

**Registered May 1, 2012**

**Int. Cl.: 25**

FOR: CLOTHING, NAMELY, TOPS, BOTTOMS, SHIRTS, PANTS, HATS, SOCKS, IN CLASS 25 (U.S. CLS. 22 AND 39).

**TRADEMARK**

FIRST USE 11-1-2000; IN COMMERCE 11-2-2000.

**PRINCIPAL REGISTER**

THE MARK CONSISTS OF STANDARD CHARACTERS WITHOUT CLAIM TO ANY PARTICULAR FONT, STYLE, SIZE, OR COLOR.

SER. NO. 85-412,586, FILED 9-1-2011.

JAY FLOWERS, EXAMINING ATTORNEY



*David J. Kyffers*

Director of the United States Patent and Trademark Office

# United States of America

United States Patent and Trademark Office

# NOCTUASTAR

**Reg. No. 4,135,272**

PESTOV ILYA ALEXANDROVICH (RUSSIAN FED. INDIVIDUAL)  
S/T STROITEL'-1, SOLNECHNAYA ST., 7  
PRIOZERSK, RUSSIAN FED.

**Registered May 1, 2012**

**Int. Cl.: 41**

FOR: ENTERTAINMENT SERVICES, NAMELY, PROVIDING ON-LINE COMPUTER GAMES,  
IN CLASS 41 (U.S. CLS. 100, 101 AND 107).

**SERVICE MARK**

FIRST USE 3-4-2011; IN COMMERCE 3-4-2011.

**PRINCIPAL REGISTER**

THE MARK CONSISTS OF STANDARD CHARACTERS WITHOUT CLAIM TO ANY PAR-  
TICULAR FONT, STYLE, SIZE, OR COLOR.

THE ENGLISH TRANSLATION OF NOCTUA IN THE MARK IS OWL.

SER. NO. 85-412,593, FILED 9-1-2011.

SANJEEV VOHRA, EXAMINING ATTORNEY



*David J. Kyros*

Director of the United States Patent and Trademark Office

# United States of America

United States Patent and Trademark Office



**Reg. No. 4,135,273**

**Registered May 1, 2012**

**Int. Cl.: 25**

**TRADEMARK**

**PRINCIPAL REGISTER**

ELLZWEAR LLC (PENNSYLVANIA LIMITED LIABILITY COMPANY)  
868 WINSTON ST  
HATFIELD, PA 19440

FOR: BERMUDA SHORTS, IN CLASS 25 (U.S. CLS. 22 AND 39).

FIRST USE 1-1-2011; IN COMMERCE 8-8-2011.

THE MARK CONSISTS OF LOWER CASE "E", TWO UPPER CASE "L'S" AND A LOWER CASE "Z".

SER. NO. 85-412,600, FILED 9-1-2011.

GEORGE LORENZO, EXAMINING ATTORNEY



*David J. Kyffers*

Director of the United States Patent and Trademark Office

# United States of America

United States Patent and Trademark Office

We fight so you don't have  
to.

**Reg. No. 4,135,274**

**Registered May 1, 2012**

**Int. Cl.: 45**

**SERVICE MARK**

**PRINCIPAL REGISTER**

JAMES M. ROANE III (UNITED STATES INDIVIDUAL), DBA ROANE LAW  
107 LINDLEY ROAD  
GREENSBORO, NC 27410

FOR: ATTORNEY SERVICES, IN CLASS 45 (U.S. CLS. 100 AND 101).

FIRST USE 8-31-2011; IN COMMERCE 8-31-2011.

THE MARK CONSISTS OF STANDARD CHARACTERS WITHOUT CLAIM TO ANY PARTICULAR FONT, STYLE, SIZE, OR COLOR.

SER. NO. 85-412,605, FILED 9-1-2011.

ALYSSA STEEL, EXAMINING ATTORNEY



*David J. Kyffers*

Director of the United States Patent and Trademark Office



# United States of America

United States Patent and Trademark Office

## REAL FRESH. REAL FAST.

**Reg. No. 4,135,275**

**Registered May 1, 2012**

**Int. Cls.: 35 and 43**

**SERVICE MARK**

**PRINCIPAL REGISTER**

TWO FARMS, INC. (MARYLAND CORPORATION), TA ROYAL FARMS  
3611 ROLAND AVENUE  
BALTIMORE, MD 21211

FOR: CONVENIENCE STORES FEATURING CONVENIENCE STORE ITEMS AND GASOLINE, IN CLASS 35 (U.S. CLS. 100, 101 AND 102).

FIRST USE 8-0-2000; IN COMMERCE 8-0-2000.

FOR: RESTAURANT SERVICES, INCLUDING SIT-DOWN AND TAKE-OUT RESTAURANT SERVICES, FAST FOOD RESTAURANTS AND SNACKBARS THROUGH CONVENIENCE STORES, IN CLASS 43 (U.S. CLS. 100 AND 101).

FIRST USE 8-0-2000; IN COMMERCE 8-0-2000.

THE MARK CONSISTS OF STANDARD CHARACTERS WITHOUT CLAIM TO ANY PARTICULAR FONT, STYLE, SIZE, OR COLOR.

SER. NO. 85-412,607, FILED 9-1-2011.

KEVIN CORWIN, EXAMINING ATTORNEY



*David J. Kybas*

Director of the United States Patent and Trademark Office

# United States of America

United States Patent and Trademark Office

# DillyWacker!

**Reg. No. 4,135,276**

**Registered May 1, 2012**

**Int. Cl.: 28**

**TRADEMARK**

**PRINCIPAL REGISTER**

DILL & ASSOC., INC. (MINNESOTA CORPORATION)  
11798 253RD AVENUE  
ZIMMERMAN, MN 55398

FOR: FISHING LURES, IN CLASS 28 (U.S. CLS. 22, 23, 38 AND 50).

FIRST USE 6-1-2011; IN COMMERCE 6-1-2011.

THE MARK CONSISTS OF STANDARD CHARACTERS WITHOUT CLAIM TO ANY PARTICULAR FONT, STYLE, SIZE, OR COLOR.

SER. NO. 85-412,616, FILED 9-1-2011.

SCOTT BIBB, EXAMINING ATTORNEY



*David J. Kyffers*

Director of the United States Patent and Trademark Office

# United States of America

United States Patent and Trademark Office

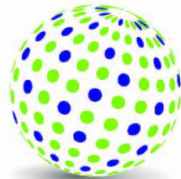

EARTHSHAPER

**Reg. No. 4,135,277**

**Registered May 1, 2012**

**Int. Cl.: 9**

**TRADEMARK**

**PRINCIPAL REGISTER**

EARTH EYE, LLC (FLORIDA LIMITED LIABILITY COMPANY)  
3680 AVALON PARK BLVD EAST, SUITE 200  
ORLANDO, FL 32828

FOR: COMPUTER SOFTWARE FOR USE IN CONNECTION WITH THE VIEWING, MANIPULATION AND ANALYSIS OF LIDAR (LIGHT DETECTION AND RANGING) DATA, IN CLASS 9 (U.S. CLS. 21, 23, 26, 36 AND 38).

FIRST USE 8-31-2011; IN COMMERCE 8-31-2011.

THE MARK CONSISTS OF THE COINED WORD MARK EARTHSHAPER IN STYLIZED FORMAT BELOW A CIRCULAR GLOBE DESIGN. THE CIRCULAR GLOBE DESIGN CONTAINS A SERIES OF COLORED CIRCLES. THE GLOBE DESIGN IS WHITE. THE WORD COMPONENT "EARTH" AND SOME OF THE CIRCLE DESIGN PLACED IN THE GLOBE ARE BLUE. THE WORD COMPONENT "SHAPER" IS GREY. SOME OF THE CIRCLE DESIGNS PLACED IN THE GLOBE DESIGN ARE GREEN.

THE COLOR(S) BLUE, GREY, GREEN AND WHITE IS/ARE CLAIMED AS A FEATURE OF THE MARK.

SER. NO. 85-412,623, FILED 9-1-2011.

AMY KELLY, EXAMINING ATTORNEY



*David J. Kybas*

Director of the United States Patent and Trademark Office

# United States of America

United States Patent and Trademark Office

## POWER BLACKJACK

**Reg. No. 4,135,278**

**Registered May 1, 2012**

**Int. Cl.: 41**

**SERVICE MARK**

**PRINCIPAL REGISTER**

HALL, GEOFF (UNITED KINGDOM INDIVIDUAL)  
323 HASLUCKS GREEN ROAD  
SHIRLEY, SOLIHULL WMID, UNITED KINGDOM B902NF

FOR: LEASING OF CASINO GAMES; PROVIDING A GAME OF CHANCE IN A CASINO,  
NAMELY A CARD GAME, IN CLASS 41 (U.S. CLS. 100, 101 AND 107).

FIRST USE 3-4-2011; IN COMMERCE 3-4-2011.

THE MARK CONSISTS OF STANDARD CHARACTERS WITHOUT CLAIM TO ANY PAR-  
TICULAR FONT, STYLE, SIZE, OR COLOR.

NO CLAIM IS MADE TO THE EXCLUSIVE RIGHT TO USE "BLACKJACK", APART FROM  
THE MARK AS SHOWN.

SER. NO. 85-412,629, FILED 9-1-2011.

KATHRYN COWARD, EXAMINING ATTORNEY



*David J. Kyros*

Director of the United States Patent and Trademark Office

# United States of America

United States Patent and Trademark Office

# CampusLogic

**Reg. No. 4,135,279**

**Registered May 1, 2012**

**Int. Cl.: 35**

**SERVICE MARK**

**PRINCIPAL REGISTER**

CAMPUSLOGIC, INC. (DELAWARE CORPORATION)  
SUITE D-1600  
3600 E. UNIVERSITY  
PHOENIX, AZ 85034

FOR: CONSULTING SERVICES IN THE FIELD OF HIGHER EDUCATION ADMINISTRATION; MARKETING CONSULTING, IN CLASS 35 (U.S. CLS. 100, 101 AND 102).

FIRST USE 6-1-2009; IN COMMERCE 6-1-2009.

THE MARK CONSISTS OF STANDARD CHARACTERS WITHOUT CLAIM TO ANY PARTICULAR FONT, STYLE, SIZE, OR COLOR.

SER. NO. 85-412,652, FILED 9-1-2011.

BARBARA BROWN, EXAMINING ATTORNEY



*David J. Kybas*

Director of the United States Patent and Trademark Office

# United States of America

United States Patent and Trademark Office

*Capresso*

**Reg. No. 4,135,280**

JURA ELEKTROAPPARATE AG (SWITZERLAND SOCIÉTÉ ANONYME (SA))  
KAFFEEWELTSTRASSE 10  
NIEDERBUCHSITEN, SWITZERLAND 4626

**Registered May 1, 2012**

**Int. Cl.: 11**

FOR: ELECTRIC ESPRESSO COFFEE MACHINES, IN CLASS 11 (U.S. CLS. 13, 21, 23, 31 AND 34).

**TRADEMARK**

FIRST USE 11-0-2008; IN COMMERCE 11-0-2008.

**PRINCIPAL REGISTER**

OWNER OF U.S. REG. NOS. 2,899,587 AND 4,013,583.

THE MARK CONSISTS OF "CAPRESSO" IN SCRIPT FORM.

SER. NO. 85-412,666, FILED 9-1-2011.

SHAILA SETTLES, EXAMINING ATTORNEY



*David J. Kyffers*

Director of the United States Patent and Trademark Office

# United States of America

United States Patent and Trademark Office

# ZENXYTH

**Reg. No. 4,135,281**

**Registered May 1, 2012**

**Int. Cl.: 25**

**TRADEMARK**

**PRINCIPAL REGISTER**

AKINS ASHLYN ELIZABETH (UNITED STATES INDIVIDUAL), DBA ZENXYTH  
3867 MAHOGANY ST.  
WEST COVINA, CA 91792

FOR: BATHING COSTUMES FOR WOMEN; COATS FOR MEN AND WOMEN; CREW NECK SWEATERS; FOOTWEAR FOR MEN; FOOTWEAR FOR MEN AND WOMEN; HEAD SCARVES; HOODED SWEATSHIRTS FOR MEN AND WOMEN; KNIT BOTTOMS; KNIT DRESSES; KNIT JACKETS; KNIT SHIRTS; KNIT SKIRTS; LEOTARDS AND TIGHTS FOR WOMEN, MEN AND CHILDREN OF NYLON, COTTON OR OTHER TEXTILE FIBERS; MEN'S AND WOMEN'S JACKETS, COATS, TROUSERS, VESTS; MEN'S DRESS SOCKS; MEN'S SOCKS; MEN'S SUITS; MEN'S SUITS, WOMEN'S SUITS; MEN'S UNDERWEAR; SCARVES; SHORT-SLEEVED OR LONG-SLEEVED T-SHIRTS; SHOULDER SCARVES; SILK SCARVES; SOCKS; SOCKS AND STOCKINGS; SWEATERS; SWEATSHIRTS FOR MEN AND WOMEN; T-SHIRTS; T-SHIRTS FOR WOMEN; V-NECK SWEATERS; WOMEN'S CLOTHING, NAMELY, SHIRTS, DRESSES, SKIRTS, BLOUSES; WOMEN'S HATS AND HOODS; WOMEN'S SHOES; WOMEN'S UNDERWEAR, IN CLASS 25 (U.S. CLS. 22 AND 39).

FIRST USE 6-15-2011; IN COMMERCE 6-15-2011.

THE MARK CONSISTS OF STANDARD CHARACTERS WITHOUT CLAIM TO ANY PARTICULAR FONT, STYLE, SIZE, OR COLOR.

SER. NO. 85-412,673, FILED 9-1-2011.

DAVID YONTEF, EXAMINING ATTORNEY



*David J. Kyffers*

Director of the United States Patent and Trademark Office

# United States of America

United States Patent and Trademark Office

**POWERSMART**

**Reg. No. 4,135,282**

AMERISUN INC (ILLINOIS CORPORATION)  
465 PARKCHESTER ROAD  
BUFFALO GROVE, IL 60089

**Registered May 1, 2012**

**Int. Cl.: 7**

FOR: ELECTRIC CHAIN SAWS; LAWN MOWERS; POWER OPERATED BLOWERS; POWER-OPERATED GRASS/WEED TRIMMERS; POWER-OPERATED LAWN AND GARDEN TILLERS; SNOW THROWERS, IN CLASS 7 (U.S. CLS. 13, 19, 21, 23, 31, 34 AND 35).

**TRADEMARK**

FIRST USE 1-2-2011; IN COMMERCE 1-2-2011.

**PRINCIPAL REGISTER**

THE MARK CONSISTS OF THE LITERAL ELEMENT "POWER SMART" WITH A MOUNTAIN PEAK ABOVE AND IN THE MIDDLE OF THE LETTERS "R" AND "S".

SER. NO. 85-412,728, FILED 9-1-2011.

MARIA-VICTORIA SUAREZ, EXAMINING ATTORNEY



*David J. Kybas*

Director of the United States Patent and Trademark Office



# United States of America

United States Patent and Trademark Office

# protoTx

**Reg. No. 4,135,283**

**Registered May 1, 2012**

**Int. Cl.: 9**

**TRADEMARK**

**PRINCIPAL REGISTER**

POLYPHASE MICROWAVE, INC. (INDIANA CORPORATION)  
1111 W. 17TH ST., STE 200  
BLOOMINGTON, IN 47404

FOR: RADIO FREQUENCY GENERATORS FOR SUPPLYING RADIO-FREQUENCY ENERGY,  
IN CLASS 9 (U.S. CLS. 21, 23, 26, 36 AND 38).

FIRST USE 8-1-2011; IN COMMERCE 8-1-2011.

THE MARK CONSISTS OF STANDARD CHARACTERS WITHOUT CLAIM TO ANY PAR-  
TICULAR FONT, STYLE, SIZE, OR COLOR.

SER. NO. 85-412,780, FILED 9-1-2011.

ELLEN B. AWRICH, EXAMINING ATTORNEY



*David J. Kybas*

Director of the United States Patent and Trademark Office

# United States of America

United States Patent and Trademark Office

## Leading the way to a healthier future

**Reg. No. 4,135,284**

ANDROSCOGGIN VALLEY HOSPITAL, INC. (NEW HAMPSHIRE CORPORATION)  
59 PAGE HILL ROAD  
BERLIN, NH 03570

**Registered May 1, 2012**

**Int. Cl.: 44**

FOR: HOSPITAL SERVICES FOR PERSONS WITH PHYSICAL AND/OR COGNITIVE DIS-  
ABILITIES OR IMPAIRMENTS; HOSPITALS, IN CLASS 44 (U.S. CLS. 100 AND 101).

**SERVICE MARK**

FIRST USE 10-15-2009; IN COMMERCE 10-15-2009.

**PRINCIPAL REGISTER**

THE MARK CONSISTS OF STANDARD CHARACTERS WITHOUT CLAIM TO ANY PAR-  
TICULAR FONT, STYLE, SIZE, OR COLOR.

SER. NO. 85-412,792, FILED 9-1-2011.

JUDITH HELFMAN, EXAMINING ATTORNEY



*David J. Kyffers*

Director of the United States Patent and Trademark Office

# United States of America

United States Patent and Trademark Office



**Reg. No. 4,135,285**

**Registered May 1, 2012**

**Int. Cl.: 35**

**SERVICE MARK**

**PRINCIPAL REGISTER**

HEAT EXCHANGER SALES AND ENGINEERING CO., LLC (WISCONSIN LIMITED LIABILITY COMPANY), DBA HESECO  
N1102 29TH AVENUE  
BERLIN, WI 54923

FOR: INDEPENDENT SALES REPRESENTATIVES IN THE FIELD OF INDUSTRIAL HEAT TRANSFER AND POLLUTION CONTROL EQUIPMENT, IN CLASS 35 (U.S. CLS. 100, 101 AND 102).

FIRST USE 0-0-1972; IN COMMERCE 0-0-1972.

THE MARK CONSISTS OF THE STYLIZED WORD HESECO CENTERED INSIDE AN OVAL.

SER. NO. 85-412,794, FILED 9-1-2011.

JULIE WATSON, EXAMINING ATTORNEY



*David J. Kyffers*

Director of the United States Patent and Trademark Office

# United States of America

United States Patent and Trademark Office

## Joshua Tree Rock Climbing School

**Reg. No. 4,135,286**

**Registered May 1, 2012**

**Int. Cl.: 41**

**SERVICE MARK**

**PRINCIPAL REGISTER**

MARK B. BOWLING (UNITED STATES INDIVIDUAL), DBA JOSHUA TREE ROCK  
CLIMBING SCHOOL  
HCR BOX 3034  
JOSHUA TREE, CA 92252

FOR: EDUCATION SERVICES, NAMELY, PROVIDING CLASSES AND INDIVIDUAL IN-  
STRUCTION IN THE FIELD OF ROCK CLIMBING; GUIDED TOURS OF ROCK FORMATIONS  
FOR ROCK CLIMBING AND DESERT HIKING DESTINATIONS, IN CLASS 41 (U.S. CLS.  
100, 101 AND 107).

FIRST USE 8-0-1993; IN COMMERCE 8-0-1993.

THE MARK CONSISTS OF STANDARD CHARACTERS WITHOUT CLAIM TO ANY PAR-  
TICULAR FONT, STYLE, SIZE, OR COLOR.

NO CLAIM IS MADE TO THE EXCLUSIVE RIGHT TO USE "ROCK CLIMBING SCHOOL",  
APART FROM THE MARK AS SHOWN.

SEC. 2(F).

SER. NO. 85-412,807, FILED 9-1-2011.

JOHN E. MICHOS, EXAMINING ATTORNEY



*David J. Kybas*

Director of the United States Patent and Trademark Office

# United States of America

United States Patent and Trademark Office

## PUTTING THE CUSTOM BACK IN CUSTOMER

**Reg. No. 4,135,287**

**Registered May 1, 2012**

**Int. Cls.: 35 and 36**

**SERVICE MARK**

**PRINCIPAL REGISTER**

FEDERATED MUTUAL INSURANCE COMPANY (MINNESOTA CORPORATION)  
121 EAST PARK SQUARE  
OWATONNA, MN 55060

FOR: BUSINESS RISK MANAGEMENT, IN CLASS 35 (U.S. CLS. 100, 101 AND 102).

FIRST USE 7-1-2011; IN COMMERCE 7-1-2011.

FOR: FINANCIAL RISK MANAGEMENT; INSURANCE UNDERWRITING FOR ALL TYPES  
OF INSURANCE, IN CLASS 36 (U.S. CLS. 100, 101 AND 102).

FIRST USE 7-1-2011; IN COMMERCE 7-1-2011.

THE MARK CONSISTS OF STANDARD CHARACTERS WITHOUT CLAIM TO ANY PAR-  
TICULAR FONT, STYLE, SIZE, OR COLOR.

SER. NO. 85-412,828, FILED 9-1-2011.

NELSON SNYDER, EXAMINING ATTORNEY



*David J. Kybas*

Director of the United States Patent and Trademark Office

# United States of America

United States Patent and Trademark Office

# SimplySunlight

**Reg. No. 4,135,288**

KLEINSASSER, JOHN M (UNITED STATES INDIVIDUAL)  
1304 SUMMIT ST  
YANKTON, SD 57078

**Registered May 1, 2012**

**Int. Cl.: 4**

FOR: RENEWABLE ENERGY, NAMELY, SOLAR ENERGY, WIND ENERGY AND GEOTHERMAL ENERGY, IN CLASS 4 (U.S. CLS. 1, 6 AND 15).

**TRADEMARK**

FIRST USE 7-3-2011; IN COMMERCE 8-19-2011.

**PRINCIPAL REGISTER**

THE MARK CONSISTS OF THE WORDING "SIMPLYSUNLIGHT" IN RED USING THE FONT EAST MARKET NF.

THE COLOR(S) RED IS/ARE CLAIMED AS A FEATURE OF THE MARK.

SER. NO. 85-412,835, FILED 9-1-2011.

JOHN DALIER, EXAMINING ATTORNEY



*David J. Kyffers*

Director of the United States Patent and Trademark Office

# United States of America

United States Patent and Trademark Office

# Bijoulee

**Reg. No. 4,135,289**

**Registered May 1, 2012**

**Int. Cl.: 14**

**TRADEMARK**

**PRINCIPAL REGISTER**

SAY DESIGNS, LLC (NORTH CAROLINA LIMITED LIABILITY COMPANY)  
4100 CARMEL ROAD, SUITE B-120  
CHARLOTTE, NC 28226

FOR: JEWELRY, IN CLASS 14 (U.S. CLS. 2, 27, 28 AND 50).

FIRST USE 3-1-2010; IN COMMERCE 3-1-2010.

THE MARK CONSISTS OF STANDARD CHARACTERS WITHOUT CLAIM TO ANY PARTICULAR FONT, STYLE, SIZE, OR COLOR.

SER. NO. 85-412,866, FILED 9-1-2011.

PAUL E. FAHRENKOPF, EXAMINING ATTORNEY



*David J. Kyffers*

Director of the United States Patent and Trademark Office

# United States of America

United States Patent and Trademark Office

## ADVERTICKETS

**Reg. No. 4,135,290**

**Registered May 1, 2012**

**Int. Cl.: 35**

**SERVICE MARK**

**PRINCIPAL REGISTER**

ADVERTICKETS LLC (CALIFORNIA LIMITED LIABILITY COMPANY)  
SUITE 600  
50 FIRST STREET  
SAN FRANCISCO, CA 94105

FOR: ADVERTISING SERVICES, NAMELY, DISSEMINATING ADVERTISING OF OTHERS IN CHECK CASHING LOCATIONS AND IN PARKING FACILITIES INCLUDING ON VALET PARKING TICKETS, SELF-PARK TICKETS, AND OTHER FORMS OF PRINTED MATERIALS THAT CAN DISPLAY ADVERTISING, IN CLASS 35 (U.S. CLS. 100, 101 AND 102).

FIRST USE 2-28-1998; IN COMMERCE 2-28-1998.

THE MARK CONSISTS OF STANDARD CHARACTERS WITHOUT CLAIM TO ANY PARTICULAR FONT, STYLE, SIZE, OR COLOR.

SER. NO. 85-412,874, FILED 9-1-2011.

KATHLEEN M. VANSTON, EXAMINING ATTORNEY



*David J. Kyffers*

Director of the United States Patent and Trademark Office



# United States of America

United States Patent and Trademark Office



**Reg. No. 4,135,291**

**Registered May 1, 2012**

**Int. Cl.: 43**

**SERVICE MARK**

**PRINCIPAL REGISTER**

JIN HUR (UNITED STATES INDIVIDUAL), DBA CRAZY OTTO'S DINER  
41008 43RD STREET WEST  
PALMDALE, CA 93551

FOR: RESTAURANT SERVICES, IN CLASS 43 (U.S. CLS. 100 AND 101).

FIRST USE 0-0-1990; IN COMMERCE 0-0-1990.

NO CLAIM IS MADE TO THE EXCLUSIVE RIGHT TO USE "DINER", APART FROM THE MARK AS SHOWN.

THE NAME(S), PORTRAIT(S), AND/OR SIGNATURE(S) SHOWN IN THE MARK DOES NOT IDENTIFY A PARTICULAR LIVING INDIVIDUAL.

THE MARK CONSISTS OF A DRAWING OF A STEAM POWERED TRAIN LOCOMOTIVE WITH COAL CAR AND AN ENGINEER WEARING A CHEF'S HAT. INSIDE A CARRIER FORMED BY SMOKE FROM THE STEAM ENGINE ARE THE STYLIZED WORDS CRAZY OTTO'S AND THE WORD DINER APPEARS IN STYLIZED FONT ON THE COAL CAR.

SER. NO. 85-412,890, FILED 9-1-2011.

SAMUEL E. SHARPER JR., EXAMINING ATTORNEY



*David J. Kybas*

Director of the United States Patent and Trademark Office

# United States of America

United States Patent and Trademark Office

# GILLIG

**Reg. No. 4,135,292**

**Registered May 1, 2012**

**Int. Cl.: 12**

**TRADEMARK**

**PRINCIPAL REGISTER**

GILLIG LLC (CALIFORNIA LIMITED LIABILITY COMPANY)  
25800 CLAWITER ROAD  
HAYWARD, CA 94545

FOR: BUSES; BUSES AND STRUCTURAL PARTS THEREFOR; TROLLEY BUSES; TROLLEYS, IN CLASS 12 (U.S. CLS. 19, 21, 23, 31, 35 AND 44).

FIRST USE 1-1-1920; IN COMMERCE 1-1-1920.

THE MARK CONSISTS OF STANDARD CHARACTERS WITHOUT CLAIM TO ANY PARTICULAR FONT, STYLE, SIZE, OR COLOR.

SEC. 2(F).

SER. NO. 85-412,912, FILED 9-1-2011.

JOHN SCHUYLER YARD, EXAMINING ATTORNEY



*David J. Kybas*

Director of the United States Patent and Trademark Office

# United States of America

United States Patent and Trademark Office

# MRS. MAC'S

**Reg. No. 4,135,293**

**Registered May 1, 2012**

**Int. Cl.: 29**

**TRADEMARK**

**PRINCIPAL REGISTER**

GREENBAX ENTERPRISES, INC. (SOUTH CAROLINA CORPORATION)  
176 CROGHAN SPUR ROAD, SUITE 400  
CHARLESTON, SC 29407

FOR: SOUTHERN FRIED CHICKEN, IN CLASS 29 (U.S. CL. 46).

FIRST USE 6-30-1991; IN COMMERCE 6-30-1991.

THE MARK CONSISTS OF STANDARD CHARACTERS WITHOUT CLAIM TO ANY PARTICULAR FONT, STYLE, SIZE, OR COLOR.

SER. NO. 85-412,928, FILED 9-1-2011.

ESTHER BELENKER, EXAMINING ATTORNEY



*David J. Kyffers*

Director of the United States Patent and Trademark Office

# United States of America

United States Patent and Trademark Office

# ECOMEND

**Reg. No. 4,135,294**

**Registered May 1, 2012**

**Int. Cl.: 1**

**TRADEMARK**

**PRINCIPAL REGISTER**

GLOBAL CONSULTING, LTD. (MICHIGAN DOMESTIC PROFIT CORPORATION), DBA  
GLOBAL ENVIRONMENTAL, LLC  
7042 VALLEYBROOK  
WEST BLOOMFIELD, MI 48322

FOR: CHEMICAL PREPARATIONS FOR USE IN ABSORBING FUEL, WASTE AND TOXIC  
CONTAMINANTS, IN CLASS 1 (U.S. CLS. 1, 5, 6, 10, 26 AND 46).

FIRST USE 4-0-2010; IN COMMERCE 6-0-2011.

THE MARK CONSISTS OF STANDARD CHARACTERS WITHOUT CLAIM TO ANY PAR-  
TICULAR FONT, STYLE, SIZE, OR COLOR.

SER. NO. 85-412,951, FILED 9-1-2011.

REGINA DRUMMOND, EXAMINING ATTORNEY



*David J. Kybas*

Director of the United States Patent and Trademark Office

# United States of America

United States Patent and Trademark Office

## BEET HUNGER

**Reg. No. 4,135,295**

**Registered May 1, 2012**

**Int. Cls.: 35 and 43**

**SERVICE MARK**

**PRINCIPAL REGISTER**

PHILABUNDANCE (PENNSYLVANIA NON-PROFIT CORPORATION)  
P.O. BOX 37555  
3616 GALLOWAY STREET  
PHILADELPHIA, PA 19148

FOR: CHARITABLE SERVICES, NAMELY, COORDINATION OF THE PROCUREMENT AND DISTRIBUTION OF FOOD DONATIONS FROM INDIVIDUALS, MANUFACTURERS, WHOLESALERS, RETAILERS AND GOVERNMENT AGENCIES TO ORGANIZATIONS PROVIDING FREE FOOD TO NEEDY PEOPLE; CHARITABLE PROCUREMENT SERVICES, NAMELY, PURCHASING FOOD FOR OTHERS; CHARITABLE DISTRIBUTORSHIP SERVICES IN THE FIELD OF FOOD; CHARITABLE RETAIL STORE FEATURING FOOD AT A DISCOUNT FOR NEEDY PEOPLE; ASSOCIATION SERVICES, NAMELY, PROMOTING THE INTERESTS OF PEOPLE RENDERING FINANCIAL, PLANNING AND SUPERVISORY ASSISTANCE TO SOCIAL SERVICE ORGANIZATIONS, IN CLASS 35 (U.S. CLS. 100, 101 AND 102).

FIRST USE 6-1-2011; IN COMMERCE 6-1-2011.

FOR: CHARITABLE SERVICES, NAMELY, PROVIDING FOOD TO THOSE IN NEED; PROVIDING NON-MEDICAL ASSISTED LIVING IN THE NATURE OF FOOD PREPARATION, IN CLASS 43 (U.S. CLS. 100 AND 101).

FIRST USE 6-1-2011; IN COMMERCE 6-1-2011.

THE MARK CONSISTS OF STANDARD CHARACTERS WITHOUT CLAIM TO ANY PARTICULAR FONT, STYLE, SIZE, OR COLOR.

NO CLAIM IS MADE TO THE EXCLUSIVE RIGHT TO USE "HUNGER", APART FROM THE MARK AS SHOWN.

SER. NO. 85-413,000, FILED 9-1-2011.

JOHN KELLY, EXAMINING ATTORNEY



*David J. Kyros*

Director of the United States Patent and Trademark Office

# United States of America

United States Patent and Trademark Office

## PIXSURE PERFECT

**Reg. No. 4,135,296**

**Registered May 1, 2012**

**Int. Cl.: 35**

**SERVICE MARK**

**PRINCIPAL REGISTER**

ORTHO TECHNOLOGY, INC. (FLORIDA CORPORATION)  
17401 COMMERCE PARK BLVD.  
TAMPA, FL 33647

FOR: ELECTRONIC CATALOG SERVICES FEATURING CLINICAL PHOTOGRAPHY SUPPLIES DIRECTED TO DENTAL PROFESSIONALS; MAIL ORDER CATALOG SERVICES FEATURING CLINICAL PHOTOGRAPHY SUPPLIES DIRECTED TO DENTAL PROFESSIONALS, IN CLASS 35 (U.S. CLS. 100, 101 AND 102).

FIRST USE 6-1-2010; IN COMMERCE 6-1-2010.

THE MARK CONSISTS OF STANDARD CHARACTERS WITHOUT CLAIM TO ANY PARTICULAR FONT, STYLE, SIZE, OR COLOR.

SER. NO. 85-413,002, FILED 9-1-2011.

JOHN KELLY, EXAMINING ATTORNEY



*David J. Kybas*

Director of the United States Patent and Trademark Office

# United States of America

United States Patent and Trademark Office

# GCS

**Reg. No. 4,135,297**

GCS DISTRIBUTION AND LICENSING, LLC (GEORGIA LIMITED LIABILITY COMPANY)  
4750 WHITESTONE WAY  
SUWANEE, GEORGIA 30024, GA 30024

**Registered May 1, 2012**

**Int. Cl.: 44**

FOR: LANDSCAPE SERVICES, NAMELY, APPLICATION OF TOPICAL COLORANT AND PRESERVATIVE TO PINE STRAW AND MULCH, IN CLASS 44 (U.S. CLS. 100 AND 101).

**SERVICE MARK**

FIRST USE 8-2-2006; IN COMMERCE 8-2-2006.

**PRINCIPAL REGISTER**

THE MARK CONSISTS OF STANDARD CHARACTERS WITHOUT CLAIM TO ANY PARTICULAR FONT, STYLE, SIZE, OR COLOR.

SER. NO. 85-413,026, FILED 9-1-2011.

TINA BROWN, EXAMINING ATTORNEY



*David J. Kybas*

Director of the United States Patent and Trademark Office

# United States of America

United States Patent and Trademark Office

# OpDemand

**Reg. No. 4,135,298**

**Registered May 1, 2012**

**Int. Cl.: 42**

**SERVICE MARK**

**PRINCIPAL REGISTER**

OPDEMAND LLC (COLORADO LIMITED LIABILITY COMPANY)  
4450 ARAPAHOE AVE., SUITE 100  
BOULDER, CO 80303

FOR: PROVIDING ON-LINE NON-DOWNLOADABLE COMPUTER SOFTWARE FOR DE-  
PLOYMENT AND MANAGEMENT OF CLOUD COMPUTING INFRASTRUCTURE, IN CLASS  
42 (U.S. CLS. 100 AND 101).

FIRST USE 6-7-2011; IN COMMERCE 6-7-2011.

THE MARK CONSISTS OF STANDARD CHARACTERS WITHOUT CLAIM TO ANY PAR-  
TICULAR FONT, STYLE, SIZE, OR COLOR.

SER. NO. 85-413,027, FILED 9-1-2011.

DANNEAN HETZEL, EXAMINING ATTORNEY



*David J. Kyffers*

Director of the United States Patent and Trademark Office



# United States of America

United States Patent and Trademark Office



**Reg. No. 4,135,299**

**Registered May 1, 2012**

**Int. Cl.: 42**

**SERVICE MARK**

**PRINCIPAL REGISTER**

SCRIBBLE PRESS, INC. (CALIFORNIA CORPORATION)  
1834 ROSCOMARE ROAD  
LOS ANGELES, CA 90077

FOR: PROVIDING A WEB-BASED SERVICE FEATURING TECHNOLOGY THAT ENABLES USERS TO MANAGE THE PRODUCTION AND PUBLICATION OF ELECTRONIC BOOKS (E-BOOKS), HARD AND SOFTCOVER BOOKS AND RELATED DIGITAL CONTENT AND OFFER THEM FOR SALE TO THE GENERAL PUBLIC, IN CLASS 42 (U.S. CLS. 100 AND 101).

FIRST USE 6-15-2011; IN COMMERCE 6-15-2011.

THE MARK CONSISTS OF A SCRIBBLE IN QUOTES IN A CIRCLE.

SER. NO. 85-413,029, FILED 9-1-2011.

JESSICA FATHY, EXAMINING ATTORNEY



*David J. Kyffers*

Director of the United States Patent and Trademark Office

# United States of America

United States Patent and Trademark Office



**Reg. No. 4,135,300**

**Registered May 1, 2012**

**Int. Cl.: 41**

**SERVICE MARK**

**PRINCIPAL REGISTER**

SCRIBBLE PRESS, INC. (CALIFORNIA CORPORATION)  
1834 ROSCOMARE ROAD  
LOS ANGELES, CA 90077

FOR: ENTERTAINMENT SERVICES, NAMELY, PROVIDING USE OF FACILITIES, SUPPLIES AND EQUIPMENT TO ALLOW CUSTOMERS TO WRITE, ILLUSTRATE AND PUBLISH BOOKS FOR CHILDREN; "DO IT YOURSELF" PUBLISHING OF BOOKS FOR CHILDREN; ORGANIZING AND CONDUCTING PARTIES TO CREATE INSTANT CHILDREN'S BOOKS; EDUCATIONAL SERVICES, NAMELY, OFFERING WORKSHOPS, CLASSES, AFTER-SCHOOL PROGRAMS AND CAMP PROGRAMS ON WRITING AND ILLUSTRATION OF BOOKS; ONLINE ELECTRONIC PUBLISHING OF BOOKS, IN CLASS 41 (U.S. CLS. 100, 101 AND 107).

FIRST USE 6-15-2011; IN COMMERCE 6-15-2011.

THE MARK CONSISTS OF A SCRIBBLE IN QUOTES IN A CIRCLE.

SER. NO. 85-413,041, FILED 9-1-2011.

JESSICA FATHY, EXAMINING ATTORNEY



*David J. Kybas*

Director of the United States Patent and Trademark Office

# United States of America

United States Patent and Trademark Office

# OpDemand

**Reg. No. 4,135,301**

**Registered May 1, 2012**

**Int. Cl.: 42**

**SERVICE MARK**

**PRINCIPAL REGISTER**

OPDEMAND LLC (COLORADO LIMITED LIABILITY COMPANY)  
4450 ARAPAHOE AVE., SUITE 100  
BOULDER, CO 80303

FOR: PROVIDING ON-LINE NON-DOWNLOADABLE COMPUTER SOFTWARE FOR DE-  
PLOYMENT AND MANAGEMENT OF CLOUD COMPUTING INFRASTRUCTURE, IN CLASS  
42 (U.S. CLS. 100 AND 101).

FIRST USE 6-7-2011; IN COMMERCE 6-7-2011.

THE MARK CONSISTS OF A STYLIZED IMAGE OF A CLOUD AND THE WORD "OPDE-  
MAND".

SER. NO. 85-413,050, FILED 9-1-2011.

DANNEAN HETZEL, EXAMINING ATTORNEY



*David J. Kyffers*

Director of the United States Patent and Trademark Office

# United States of America

United States Patent and Trademark Office



**Reg. No. 4,135,302**

**Registered May 1, 2012**

**Int. Cl.: 42**

**SERVICE MARK**

**PRINCIPAL REGISTER**

OPDEMAND LLC (COLORADO LIMITED LIABILITY COMPANY)  
4450 ARAPAHOE AVE., SUITE 100  
BOULDER, CO 80303

FOR: PROVIDING ON-LINE NON-DOWNLOADABLE COMPUTER SOFTWARE FOR DE-  
PLOYMENT AND MANAGEMENT OF CLOUD COMPUTING INFRASTRUCTURE, IN CLASS  
42 (U.S. CLS. 100 AND 101).

FIRST USE 6-7-2011; IN COMMERCE 6-7-2011.

THE MARK CONSISTS OF A STYLIZED DRAWING OF A CLOUD.

SER. NO. 85-413,061, FILED 9-1-2011.

DANNEAN HETZEL, EXAMINING ATTORNEY



*David J. Kybas*

Director of the United States Patent and Trademark Office

# United States of America

United States Patent and Trademark Office

# POWERTRON

**Reg. No. 4,135,303**

**Registered May 1, 2012**

**Int. Cl.: 9**

**TRADEMARK**

**PRINCIPAL REGISTER**

TROJAN BATTERY COMPANY (CALIFORNIA CORPORATION)  
12380 CLARK STREET  
SANTA FE SPRINGS, CA 90670

FOR: LEAD-ACID BATTERIES, IN CLASS 9 (U.S. CLS. 21, 23, 26, 36 AND 38).

FIRST USE 6-0-1986; IN COMMERCE 6-0-1986.

THE MARK CONSISTS OF STANDARD CHARACTERS WITHOUT CLAIM TO ANY PARTICULAR FONT, STYLE, SIZE, OR COLOR.

OWNER OF U.S. REG. NOS. 1,559,637, 1,975,544, AND 2,076,626.

SER. NO. 85-413,076, FILED 9-1-2011.

BENJAMIN OKEKE, EXAMINING ATTORNEY



*David J. Kyffers*

Director of the United States Patent and Trademark Office

# United States of America

United States Patent and Trademark Office

## BUILDING ON BRIGHT IDEAS

**Reg. No. 4,135,304**

**Registered May 1, 2012**

**Int. Cl.: 42**

**SERVICE MARK**

**PRINCIPAL REGISTER**

MOVAIC, INC. (WASHINGTON CORPORATION), AKA MOVAIC  
4917 EVERGREEN WAY, SUITE 400  
EVERETT, WA 982032828

FOR: INDUSTRIAL DESIGN SERVICES, IN CLASS 42 (U.S. CLS. 100 AND 101).

FIRST USE 8-29-2008; IN COMMERCE 8-29-2008.

THE MARK CONSISTS OF STANDARD CHARACTERS WITHOUT CLAIM TO ANY PARTICULAR FONT, STYLE, SIZE, OR COLOR.

SER. NO. 85-413,108, FILED 9-1-2011.

JANICE KIM, EXAMINING ATTORNEY



*David J. Kybas*

Director of the United States Patent and Trademark Office

# United States of America

United States Patent and Trademark Office

## REHABSTUDIO

**Reg. No. 4,135,305**

**Registered May 1, 2012**

**Int. Cl.: 35**

**SERVICE MARK**

**PRINCIPAL REGISTER**

REHABSTUDIO LIMITED (NORTHERN IRELAND LIMITED COMPANY (LTD.))  
UNIT 12, 8 CROMAC AVE  
ORMEAU BUSINESS PARK  
BELFAST, NORTHERN IRELAND BT72JA

FOR: PROVIDING AND DISSEMINATING ADVERTISING AND BRANDED CONTENT, NAMELY INTEGRATING THE BRANDS OF OTHERS INTO THE CONTENT OF VARIOUS MEDIA PROGRAMMING AND DEVELOPING CONTENT BUILT AROUND BRANDS IN ALL MEDIA TECHNOLOGIES; DEVELOPMENT OF MARKETING STRATEGIES, CONCEPTS AND TACTICS, NAMELY, AUDIENCE DEVELOPMENT, BRAND AWARENESS, ONLINE COMMUNITY BUILDING AND DIGITAL WORD OF MOUTH COMMUNICATIONS; ADVERTISING AND MARKETING SERVICES PROVIDED BY MEANS OF INDIRECT METHODS OF MARKETING COMMUNICATIONS, NAMELY, SOCIAL MEDIA, SEARCH ENGINE MARKETING, INQUIRY MARKETING, INTERNET MARKETING, MOBILE MARKETING, BLOGGING AND OTHER FORMS OF PASSIVE, SHARABLE OR VIRAL COMMUNICATIONS CHANNELS; BRANDING SERVICES, NAMELY, CONSULTING, DEVELOPMENT, MANAGEMENT AND MARKETING OF BRANDS FOR BUSINESSES, IN CLASS 35 (U.S. CLS. 100, 101 AND 102).

FIRST USE 4-6-2005; IN COMMERCE 5-8-2008.

THE MARK CONSISTS OF STANDARD CHARACTERS WITHOUT CLAIM TO ANY PARTICULAR FONT, STYLE, SIZE, OR COLOR.

SER. NO. 85-413,172, FILED 9-1-2011.

SKYE YOUNG, EXAMINING ATTORNEY



*David J. Kyros*

Director of the United States Patent and Trademark Office

# United States of America

United States Patent and Trademark Office

## REHABSTUDIO

**Reg. No. 4,135,306**

**Registered May 1, 2012**

**Int. Cl.: 41**

**SERVICE MARK**

**PRINCIPAL REGISTER**

REHABSTUDIO LIMITED (NORTHERN IRELAND LIMITED COMPANY (LTD.))  
UNIT 12, 8 CROMAC AVE  
ORMEAU BUSINESS PARK  
BELFAST, NORTHERN IRELAND BT72JA

FOR: MULTIMEDIA ENTERTAINMENT SERVICES IN THE NATURE OF DEVELOPMENT,  
PRODUCTION AND POST-PRODUCTION SERVICES IN THE FIELDS OF VIDEO AND  
FILMS, IN CLASS 41 (U.S. CLS. 100, 101 AND 107).

FIRST USE 4-6-2005; IN COMMERCE 5-8-2008.

THE MARK CONSISTS OF STANDARD CHARACTERS WITHOUT CLAIM TO ANY PAR-  
TICULAR FONT, STYLE, SIZE, OR COLOR.

SER. NO. 85-413,175, FILED 9-1-2011.

SKYE YOUNG, EXAMINING ATTORNEY



*David J. Kyffers*

Director of the United States Patent and Trademark Office



# United States of America

United States Patent and Trademark Office

## REHABSTUDIO

**Reg. No. 4,135,307**

**Registered May 1, 2012**

**Int. Cl.: 42**

**SERVICE MARK**

**PRINCIPAL REGISTER**

REHABSTUDIO LIMITED (NORTHERN IRELAND LIMITED COMPANY (LTD.))  
UNIT 12, 8 CROMAC AVE  
ORMEAU BUSINESS PARK  
BELFAST, NORTHERN IRELAND BT72JA

FOR: GRAPHIC ART DESIGN AND GRAPHIC ILLUSTRATION FOR OTHERS; COMPUTER GRAPHICS DESIGN SERVICES; CREATION OF WEB SITES FOR OTHERS , IN CLASS 42 (U.S. CLS. 100 AND 101).

FIRST USE 4-6-2005; IN COMMERCE 5-8-2008.

THE MARK CONSISTS OF STANDARD CHARACTERS WITHOUT CLAIM TO ANY PARTICULAR FONT, STYLE, SIZE, OR COLOR.

SER. NO. 85-413,179, FILED 9-1-2011.

SKYE YOUNG, EXAMINING ATTORNEY



*David J. Kyffers*

Director of the United States Patent and Trademark Office

# United States of America

United States Patent and Trademark Office

# ASPIRE

**Reg. No. 4,135,308**

**Registered May 1, 2012**

**Int. Cl.: 9**

**TRADEMARK**

**PRINCIPAL REGISTER**

SUN BAN FASHIONS (NEW YORK CORPORATION)  
600 FOURTH AVENUE  
BROOKLYN, NY 11215

FOR: EYEGLASSES, SUNGLASSES, MAGNIFYING GLASSES, EYEGLASS FRAMES, EYEGLASS LENSES; EYEWEAR ACCESSORIES, NAMELY, CASES AND CHAINS, IN CLASS 9 (U.S. CLS. 21, 23, 26, 36 AND 38).

FIRST USE 9-1-2011; IN COMMERCE 9-1-2011.

THE MARK CONSISTS OF STANDARD CHARACTERS WITHOUT CLAIM TO ANY PARTICULAR FONT, STYLE, SIZE, OR COLOR.

SER. NO. 85-413,196, FILED 9-1-2011.

SKYE YOUNG, EXAMINING ATTORNEY



*David J. Kybas*

Director of the United States Patent and Trademark Office

# United States of America

United States Patent and Trademark Office

## *It's the new nightlife*

**Reg. No. 4,135,309**

**Registered May 1, 2012**

**Int. Cl.: 41**

**SERVICE MARK**

**PRINCIPAL REGISTER**

FERMATA FITNESS LLC (ILLINOIS LIMITED LIABILITY COMPANY)  
129 KENLOCH AVENUE  
LIBERTYVILLE, IL 60048

FOR: ARRANGING AND CONDUCTING NIGHTCLUB ENTERTAINMENT EVENTS;  
PHYSICAL FITNESS CONDITIONING CLASSES, IN CLASS 41 (U.S. CLS. 100, 101 AND  
107).

FIRST USE 4-7-2011; IN COMMERCE 4-7-2011.

THE MARK CONSISTS OF THE STYLIZED TEXT "IT'S THE NEW NIGHTLIFE".

SER. NO. 85-413,216, FILED 9-1-2011.

C. DIONNE CLYBURN, EXAMINING ATTORNEY



*David J. Kyffers*

Director of the United States Patent and Trademark Office

# United States of America

United States Patent and Trademark Office

# WSA

**Reg. No. 4,135,310**

**Registered May 1, 2012**

**Int. Cl.: 41**

**SERVICE MARK**

**PRINCIPAL REGISTER**

WORLDWIDE SPIRIT ASSOCIATION, L.L.C. (LOUISIANA LIMITED LIABILITY COMPANY)  
14141 AIRLINE HWY., BLDG. 3, STE. D  
BATON ROUGE, LA 70817

FOR: CONDUCTING AND ORGANIZING CHEERLEADING AND DANCE TRAINING CAMPS,  
CLINICS, WORKSHOPS, AND COMPETITIONS; PROVIDING CHEERLEADING AND DANCE  
TRAINING AND INSTRUCTION, IN CLASS 41 (U.S. CLS. 100, 101 AND 107).

FIRST USE 7-0-1997; IN COMMERCE 7-0-1997.

THE MARK CONSISTS OF STANDARD CHARACTERS WITHOUT CLAIM TO ANY PAR-  
TICULAR FONT, STYLE, SIZE, OR COLOR.

SER. NO. 85-413,228, FILED 9-1-2011.

ELIZABETH KAJUBI, EXAMINING ATTORNEY



*David J. Kybas*

Director of the United States Patent and Trademark Office

# United States of America

United States Patent and Trademark Office

# IJM

**Reg. No. 4,135,311**

**Registered May 1, 2012**

**Int. Cl.: 36**

**SERVICE MARK**

**PRINCIPAL REGISTER**

INTERNATIONAL JUSTICE MISSION (VIRGINIA NON-PROFIT CORPORATION)  
P.O. BOX 58147  
WASHINGTON, DC 20037

FOR: CHARITABLE FUNDRAISING SERVICES, IN CLASS 36 (U.S. CLS. 100, 101 AND 102).

FIRST USE 10-0-2000; IN COMMERCE 10-0-2000.

THE MARK CONSISTS OF STANDARD CHARACTERS WITHOUT CLAIM TO ANY PARTICULAR FONT, STYLE, SIZE, OR COLOR.

SER. NO. 85-413,253, FILED 9-1-2011.

ANDREA BUTLER, EXAMINING ATTORNEY



*David J. Kyffers*

Director of the United States Patent and Trademark Office

# United States of America

United States Patent and Trademark Office

# TACTICS

**Reg. No. 4,135,312**

**Registered May 1, 2012**

**Int. Cl.: 9**

**TRADEMARK**

**PRINCIPAL REGISTER**

SIEMENS INDUSTRY, INC. (DELAWARE CORPORATION)  
3333 OLD MILTON PARKWAY  
ALPHARETTA, GA 30005

FOR: COMPUTER SOFTWARE FOR CONNECTING, SETTING UP, CONFIGURING AND OPERATING INTEGRATED TRAFFIC CONTROL SYSTEMS, IN CLASS 9 (U.S. CLS. 21, 23, 26, 36 AND 38).

FIRST USE 11-27-2007; IN COMMERCE 11-27-2007.

THE MARK CONSISTS OF STANDARD CHARACTERS WITHOUT CLAIM TO ANY PARTICULAR FONT, STYLE, SIZE, OR COLOR.

SER. NO. 85-413,255, FILED 9-1-2011.

JEFFERY COWARD, EXAMINING ATTORNEY



*David J. Kybas*

Director of the United States Patent and Trademark Office

# United States of America

United States Patent and Trademark Office

## House of Lounge

**Reg. No. 4,135,313**

**Registered May 1, 2012**

**Int. Cl.: 35**

**SERVICE MARK**

**PRINCIPAL REGISTER**

FOXYWOODS, L.L.C. (LOUISIANA LIMITED LIABILITY COMPANY), DBA HOUSE OF LOUNGE  
2044 MAGAZINE STREET  
NEW ORLEANS, LA 70130

FOR: RETAIL LINGERIE, UNDERGARMENTS, ROBES, BATH ROBES, KIMONOS, SMOKING JACKETS AND SARIS, PAJAMAS, TEDDIES AND NIGHTGOWNS, GARTERS AND GARTER BELTS, STOCKINGS AND PANTY HOSE, SLIPPERS, BRAS, PANTIES, GLOVES, SCARVES, SHAWLS, HATS AND FEATHER BOAS, SLIPS AND CAMISOLES, CORSETS AND BUSTIERS, ANGEL WINGS AND FAIRY WINGS, CAPES AND MASKS, PURSES AND HANDBAGS, HAIR ORNAMENTS, FUR HANDCUFFS, LADIES DRESSES, WOMEN'S SWIMWEAR, FANS, AND CIGARETTE HOLDERS STORES, IN CLASS 35 (U.S. CLS. 100, 101 AND 102).

FIRST USE 6-24-1999; IN COMMERCE 6-24-1999.

THE MARK CONSISTS OF STANDARD CHARACTERS WITHOUT CLAIM TO ANY PARTICULAR FONT, STYLE, SIZE, OR COLOR.

SER. NO. 85-413,256, FILED 9-1-2011.

HEATHER THOMPSON, EXAMINING ATTORNEY



*David J. Kypos*

Director of the United States Patent and Trademark Office

# United States of America

United States Patent and Trademark Office

# IJM

**Reg. No. 4,135,314**

**Registered May 1, 2012**

**Int. Cl.: 38**

**SERVICE MARK**

**PRINCIPAL REGISTER**

INTERNATIONAL JUSTICE MISSION (VIRGINIA NON-PROFIT CORPORATION)  
P.O. BOX 58147  
WASHINGTON, DC 20037

FOR: STREAMING OF AUDIOVISUAL MATERIAL VIA A GLOBAL COMPUTER NETWORK IN THE FIELDS OF JUSTICE, HUMAN RIGHTS, CHRISTIANITY, SPIRITUALITY, RELIGION, AND SEEKING JUSTICE FOR VICTIMS OF CHILD EXPLOITATION, SLAVERY, SEXUAL EXPLOITATION, HUMAN TRAFFICKING, AND OTHER FORMS OF VIOLENT OPPRESSION; PROVIDING ONLINE FORUMS FOR USERS FOR TRANSMISSION AND THE SHARING OF NEWS AND INFORMATION CONCERNING JUSTICE, HUMAN RIGHTS, CHRISTIANITY, SPIRITUALITY, RELIGION, AND SEEKING JUSTICE FOR VICTIMS OF CHILD EXPLOITATION, SLAVERY, SEXUAL EXPLOITATION, HUMAN TRAFFICKING, AND OTHER FORMS OF VIOLENT OPPRESSION, IN CLASS 38 (U.S. CLS. 100, 101 AND 104).

FIRST USE 3-0-2000; IN COMMERCE 3-0-2000.

THE MARK CONSISTS OF STANDARD CHARACTERS WITHOUT CLAIM TO ANY PARTICULAR FONT, STYLE, SIZE, OR COLOR.

SER. NO. 85-413,272, FILED 9-1-2011.

ANDREA BUTLER, EXAMINING ATTORNEY



*David J. Kybas*

Director of the United States Patent and Trademark Office



# United States of America

United States Patent and Trademark Office

## HALLOWEEN BAG OF TRICKS

**Reg. No. 4,135,315**

**Registered May 1, 2012**

**Int. Cl.: 13**

**TRADEMARK**

**PRINCIPAL REGISTER**

B.J. ALAN COMPANY (OHIO CORPORATION)  
555 MARTIN LUTHER KING, JR. BLVD.  
YOUNGSTOWN, OH 445021102

FOR: FIREWORKS, IN CLASS 13 (U.S. CLS. 2 AND 9).

FIRST USE 9-18-2009; IN COMMERCE 10-2-2009.

THE MARK CONSISTS OF STANDARD CHARACTERS WITHOUT CLAIM TO ANY PARTICULAR FONT, STYLE, SIZE, OR COLOR.

SER. NO. 85-413,276, FILED 9-1-2011.

BRENDAN REGAN, EXAMINING ATTORNEY



*David J. Kybas*

Director of the United States Patent and Trademark Office

# United States of America

United States Patent and Trademark Office



**Reg. No. 4,135,316**

**Registered May 1, 2012**

**Int. Cls.: 41 and 43**

**SERVICE MARK**

**PRINCIPAL REGISTER**

FLY LOW, INC. (FLORIDA CORPORATION), DBA KING OF DIAMONDS  
17800 NE 5TH AVE.  
MIAMI, FL 33162

FOR: NIGHT CLUB SERVICES, IN CLASS 41 (U.S. CLS. 100, 101 AND 107).

FIRST USE 11-24-2008; IN COMMERCE 11-24-2008.

FOR: BAR AND COCKTAIL LOUNGE SERVICES , IN CLASS 43 (U.S. CLS. 100 AND 101).

FIRST USE 11-24-2008; IN COMMERCE 11-24-2008.

THE MARK CONSISTS OF THE WORDS KING OF DIAMONDS APPEARING WITHIN THE DESIGN OF A SHIELD, BENEATH THE IMAGE OF A DIAMOND, WHICH APPEARS BENEATH THE IMAGE OF A CROWN, ALL OF WHICH APPEARS BETWEEN TWO LIONS, ALL AGAINST A FILIGREE DESIGN BACKGROUND.

SER. NO. 85-413,306, FILED 9-1-2011.

CHERYL CLAYTON, EXAMINING ATTORNEY



*David J. Kybas*

Director of the United States Patent and Trademark Office

# United States of America

United States Patent and Trademark Office

## AFTER ALL, ISN'T IT YOUR MONEY?

**Reg. No. 4,135,317**

**Registered May 1, 2012**

**Int. Cl.: 45**

**SERVICE MARK**

**PRINCIPAL REGISTER**

DALE L. BUCHANAN & ASSOCIATES, P.C. (TENNESSEE PROFESSIONAL CORPORATION)  
SUITE 160  
232 EAST 11TH STREET  
CHATTANOOGA, TN 37402

FOR: PROVISION OF LEGAL SERVICES AND ADVICE IN THE AREA OF DISABILITY  
AND/OR SOCIAL SECURITY LAW, IN CLASS 45 (U.S. CLS. 100 AND 101).

FIRST USE 7-1-2004; IN COMMERCE 7-1-2004.

THE MARK CONSISTS OF STANDARD CHARACTERS WITHOUT CLAIM TO ANY PAR-  
TICULAR FONT, STYLE, SIZE, OR COLOR.

SER. NO. 85-413,321, FILED 9-1-2011.

ANDREW RHIM, EXAMINING ATTORNEY



*David J. Kyffers*

Director of the United States Patent and Trademark Office

# United States of America

United States Patent and Trademark Office

## AMERICAN ADOPTIONS

**Reg. No. 4,135,318**

**Registered May 1, 2012**

**Int. Cl.: 45**

**SERVICE MARK**

**PRINCIPAL REGISTER**

AMERICAN ADOPTIONS, INC. (KANSAS NON-PROFIT CORPORATION)  
9101 W. 110TH STREET, STE. 200  
OVERLAND PARK, KS 66210

FOR: ADOPTION AGENCY; ADOPTION PLACEMENT; ADOPTION COUNSELING;  
PROVIDING A WEBSITE FEATURING INFORMATION ON UNPLANNED PREGNANCIES  
AND ADOPTION , IN CLASS 45 (U.S. CLS. 100 AND 101).

FIRST USE 6-1-1993; IN COMMERCE 6-1-1993.

THE MARK CONSISTS OF STANDARD CHARACTERS WITHOUT CLAIM TO ANY PAR-  
TICULAR FONT, STYLE, SIZE, OR COLOR.

NO CLAIM IS MADE TO THE EXCLUSIVE RIGHT TO USE "ADOPTIONS", APART FROM  
THE MARK AS SHOWN.

SEC. 2(F) AS TO "AMERICAN".

SER. NO. 85-413,359, FILED 9-1-2011.

JOHN HWANG, EXAMINING ATTORNEY



*David J. Kyffers*

Director of the United States Patent and Trademark Office

# United States of America

United States Patent and Trademark Office

## AMERICAN ADOPTIONS AMERICA'S ADOPTION AGENCY

**Reg. No. 4,135,319**

**Registered May 1, 2012**

**Int. Cl.: 45**

**SERVICE MARK**

**PRINCIPAL REGISTER**

AMERICAN ADOPTIONS, INC. (KANSAS NON-PROFIT CORPORATION)  
9101 W. 110TH STREET, STE. 200  
OVERLAND PARK, KS 66210

FOR: ADOPTION AGENCY; ADOPTION PLACEMENT; ADOPTION COUNSELING;  
PROVIDING A WEBSITE FEATURING INFORMATION ON UNPLANNED PREGNANCIES  
AND ADOPTION, IN CLASS 45 (U.S. CLS. 100 AND 101).

FIRST USE 6-1-1993; IN COMMERCE 6-1-1993.

THE MARK CONSISTS OF STANDARD CHARACTERS WITHOUT CLAIM TO ANY PAR-  
TICULAR FONT, STYLE, SIZE, OR COLOR.

NO CLAIM IS MADE TO THE EXCLUSIVE RIGHT TO USE "ADOPTIONS" AND "ADOPTION  
AGENCY", APART FROM THE MARK AS SHOWN.

SEC. 2(F) AS TO "AMERICAN" AND "AMERICA'S".

SER. NO. 85-413,374, FILED 9-1-2011.

JOHN HWANG, EXAMINING ATTORNEY



*David J. Kybas*

Director of the United States Patent and Trademark Office

# United States of America

United States Patent and Trademark Office

# WHTZ UP!

**Reg. No. 4,135,320**

**Registered May 1, 2012**

**Int. Cl.: 32**

**TRADEMARK**

**PRINCIPAL REGISTER**

WHTZ! UP, LLC (TEXAS LIMITED LIABILITY COMPANY)  
235 SANDPEBBLE DRIVE  
THE WOODLANDS, TX 77381

FOR: FRUIT FLAVORED SOFT DRINKS; SOFT DRINKS, NAMELY, SODAS, IN CLASS 32  
(U.S. CLS. 45, 46 AND 48).

FIRST USE 8-19-2011; IN COMMERCE 8-19-2011.

THE MARK CONSISTS OF STANDARD CHARACTERS WITHOUT CLAIM TO ANY PARTICULAR FONT, STYLE, SIZE, OR COLOR.

SER. NO. 85-413,386, FILED 9-1-2011.

DOUGLAS LEE, EXAMINING ATTORNEY



*David J. Kybas*

Director of the United States Patent and Trademark Office

# United States of America

United States Patent and Trademark Office

## Leaving Lasting Imprints

**Reg. No. 4,135,321**

**Registered May 1, 2012**

**Int. Cl.: 41**

**SERVICE MARK**

**PRINCIPAL REGISTER**

BAKER, ELAINE (UNITED STATES INDIVIDUAL)  
#401  
22287 MULHOLLAND HIGHWAY  
CALABASAS, CA 91302

FOR: LIFE COACHING SERVICES IN THE FIELD OF MAINTAINING AN ADDICTION FREE LIFESTYLE AND SUPPORT FOR FAMILIES OF THE ADDICTED CLIENT, IN CLASS 41 (U.S. CLS. 100, 101 AND 107).

FIRST USE 9-1-2011; IN COMMERCE 9-1-2011.

THE MARK CONSISTS OF STANDARD CHARACTERS WITHOUT CLAIM TO ANY PARTICULAR FONT, STYLE, SIZE, OR COLOR.

SER. NO. 85-413,389, FILED 9-1-2011.

CHERYL CLAYTON, EXAMINING ATTORNEY



*David J. Kybas*

Director of the United States Patent and Trademark Office

# United States of America

United States Patent and Trademark Office



**Reg. No. 4,135,322**

**Registered May 1, 2012**

**Int. Cl.: 34**

**TRADEMARK**

**PRINCIPAL REGISTER**

CUMMINGS ENTERPRISES INC. (CANADA CORPORATION)  
126 MALCOLM ROAD, UNIT #9  
GUELPH, CANADA N1K1J1

FOR: SMOKING ARTICLES, NAMELY, SMOKING PIPES AND PIPE CASES, IN CLASS 34  
(U.S. CLS. 2, 8, 9 AND 17).

FIRST USE 6-15-2009; IN COMMERCE 7-0-2010.

THE MARK CONSISTS OF LETTER H INCLUDING A DEPICTION OF A CROWN THERE-  
ABOVE.

SER. NO. 85-413,443, FILED 9-1-2011.

DANIEL BRODY, EXAMINING ATTORNEY



*David J. Kybas*

Director of the United States Patent and Trademark Office



# United States of America

United States Patent and Trademark Office

## HARPUTS OWN

**Reg. No. 4,135,323**

HARPUT'S SAN FRANCISCO, LLC (CALIFORNIA LIMITED LIABILITY COMPANY)  
109 GEARY STREET  
SAN FRANCISCO, CA 94108

**Registered May 1, 2012**

**Int. Cl.: 25**

FOR: WOMEN'S CLOTHING, NAMELY, JACKETS, DRESSES, TOPS, PANTS, SWEATERS,  
SKIRTS, VESTS, IN CLASS 25 (U.S. CLS. 22 AND 39).

**TRADEMARK**

FIRST USE 2-7-2007; IN COMMERCE 2-7-2007.

**PRINCIPAL REGISTER**

THE MARK CONSISTS OF STANDARD CHARACTERS WITHOUT CLAIM TO ANY PAR-  
TICULAR FONT, STYLE, SIZE, OR COLOR.

SER. NO. 85-413,446, FILED 9-1-2011.

TINA BROWN, EXAMINING ATTORNEY



*David J. Kyffers*

Director of the United States Patent and Trademark Office

# United States of America

United States Patent and Trademark Office



**Reg. No. 4,135,324**

**Registered May 1, 2012**

**Int. Cl.: 29**

**TRADEMARK**

**PRINCIPAL REGISTER**

IBE BUSINESS ENTERPRISE AG (SWITZERLAND CORPORATION)  
BAARERSTRASSE 86  
ZUG 6300, SWITZERLAND

FOR: MILK, IN CLASS 29 (U.S. CL. 46).

FIRST USE 6-20-2011; IN COMMERCE 6-20-2011.

OWNER OF U.S. REG. NOS. 2,703,415, 3,380,947 AND OTHERS.

THE MARK CONSISTS OF THE STYLIZED WORD "BORDEN" BENEATH A STYLIZED COW HEAD SET AGAINST A DAISY, WHICH FEATURES THE WORD "ELSIE" ON ONE PETAL. THE COW IS WEARING A DAISY FLOWER NECKLACE.

SER. NO. 85-413,453, FILED 9-1-2011.

ELI HELLMAN, EXAMINING ATTORNEY



*David J. Kybas*

Director of the United States Patent and Trademark Office

# United States of America

United States Patent and Trademark Office

## Youfit Health Clubs

**Reg. No. 4,135,325**

**Registered May 1, 2012**

**Int. Cl.: 41**

**SERVICE MARK**

**PRINCIPAL REGISTER**

YOU FIT, INC. (FLORIDA CORPORATION)  
2300 W SAMPLE RD., SUITE 208  
POMPANO, FL 33073

FOR: GYMNASIUM SERVICES; PROVIDING EXERCISE AND FITNESS FACILITIES;  
PROVIDING INSTRUCTION IN EXERCISE AND FITNESS, IN CLASS 41 (U.S. CLS. 100, 101  
AND 107).

FIRST USE 1-1-2008; IN COMMERCE 1-1-2008.

THE MARK CONSISTS OF STANDARD CHARACTERS WITHOUT CLAIM TO ANY PAR-  
TICULAR FONT, STYLE, SIZE, OR COLOR.

OWNER OF U.S. REG. NO. 3,683,711.

NO CLAIM IS MADE TO THE EXCLUSIVE RIGHT TO USE "HEALTH CLUBS", APART  
FROM THE MARK AS SHOWN.

SER. NO. 85-413,462, FILED 9-1-2011.

KEVIN CORWIN, EXAMINING ATTORNEY



*David J. Kyffers*

Director of the United States Patent and Trademark Office

# United States of America

United States Patent and Trademark Office

## Touchpoint Real Estate

**Reg. No. 4,135,326**

**Registered May 1, 2012**

**Int. Cl.: 36**

**SERVICE MARK**

**PRINCIPAL REGISTER**

TOUCHPOINT REAL ESTATE INC. (TEXAS CORPORATION)  
9310 SUMMER SKY DRIVE  
AUSTIN, TX 78736

FOR: REAL ESTATE BROKERAGE, IN CLASS 36 (U.S. CLS. 100, 101 AND 102).

FIRST USE 4-1-2011; IN COMMERCE 4-1-2011.

THE MARK CONSISTS OF STANDARD CHARACTERS WITHOUT CLAIM TO ANY PARTICULAR FONT, STYLE, SIZE, OR COLOR.

NO CLAIM IS MADE TO THE EXCLUSIVE RIGHT TO USE "REAL ESTATE", APART FROM THE MARK AS SHOWN.

SER. NO. 85-413,466, FILED 9-1-2011.

DAVID TAYLOR, EXAMINING ATTORNEY



*David J. Kybas*

Director of the United States Patent and Trademark Office

# United States of America

United States Patent and Trademark Office



**Reg. No. 4,135,327**

**Registered May 1, 2012**

**Int. Cl.: 35**

**SERVICE MARK**

**PRINCIPAL REGISTER**

LEO BURNETT COMPANY, INC. (DELAWARE CORPORATION)  
35 W. WACKER DRIVE  
CHICAGO, IL 60601

FOR: ADVERTISING AGENCY SERVICES, IN CLASS 35 (U.S. CLS. 100, 101 AND 102).

FIRST USE 9-1-2011; IN COMMERCE 9-1-2011.

THE MARK CONSISTS OF THE LETTER S TOUCHING THE NUMBER 2 TOUCHING THE LETTER S IN STYLIZED FORMAT WITH THE WORDS SPECIALIST-TO-SPECIALIST BELOW.

SER. NO. 85-413,483, FILED 9-1-2011.

INGA ERVIN, EXAMINING ATTORNEY



*David J. Kybas*

Director of the United States Patent and Trademark Office

# United States of America

United States Patent and Trademark Office

# HYALITE

**Reg. No. 4,135,328**

**Registered May 1, 2012**

**Int. Cls.: 18 and 20**

**TRADEMARK**

**PRINCIPAL REGISTER**

HYALITE OUTDOOR GROUP, INC. (MONTANA CORPORATION)  
2134 INDUSTRIAL DRIVE  
BOZEMAN, MT 59715

FOR: BACKPACKS AND LUMBAR PACKS; CARRY BAGS, NAMELY, ALL PURPOSE CARRYING BAGS, MESSENGER BAGS, TRAVEL BAGS; DUFFLE BAGS; POUCHES MADE OF TEXTILE, CLOTH, AND PLASTIC; STUFF SACKS, IN CLASS 18 (U.S. CLS. 1, 2, 3, 22 AND 41).

FIRST USE 8-4-2011; IN COMMERCE 8-4-2011.

FOR: CAMPING FURNITURE, NAMELY, CAMP CHAIRS, TABLES; SLEEPING BAG PADS, SLEEPING BAGS, PILLOWS, IN CLASS 20 (U.S. CLS. 2, 13, 22, 25, 32 AND 50).

FIRST USE 8-4-2011; IN COMMERCE 8-4-2011.

THE MARK CONSISTS OF STANDARD CHARACTERS WITHOUT CLAIM TO ANY PARTICULAR FONT, STYLE, SIZE, OR COLOR.

SER. NO. 85-413,484, FILED 9-1-2011.

SHARON MEIER, EXAMINING ATTORNEY



*David J. Kyros*

Director of the United States Patent and Trademark Office

# United States of America

United States Patent and Trademark Office

# Big Deal Girl

**Reg. No. 4,135,329**

**Registered May 1, 2012**

**Int. Cl.: 35**

**SERVICE MARK**

**PRINCIPAL REGISTER**

BIG DEAL GIRL, LLC (ARIZONA LIMITED LIABILITY COMPANY)  
14114 W. FIELDINGS FRY  
SURPRISE, AZ 85374

FOR: ADVERTISING AND PROMOTIONAL SERVICES; PROMOTING THE GOODS AND SERVICES OF OTHERS BY PROVIDING A WEB SITE FEATURING COUPONS, REBATES, PRODUCT REVIEWS, LINKS TO THE RETAIL WEB SITES OF OTHERS, AND DISCOUNT INFORMATION, IN CLASS 35 (U.S. CLS. 100, 101 AND 102).

FIRST USE 4-1-2010; IN COMMERCE 4-1-2010.

THE MARK CONSISTS OF STANDARD CHARACTERS WITHOUT CLAIM TO ANY PARTICULAR FONT, STYLE, SIZE, OR COLOR.

SER. NO. 85-413,486, FILED 9-1-2011.

DAVID MURRAY, EXAMINING ATTORNEY



*David J. Kypos*

Director of the United States Patent and Trademark Office

# United States of America

United States Patent and Trademark Office

## DISCOVER THE BORDEN DIFFERENCE

**Reg. No. 4,135,330**

**Registered May 1, 2012**

**Int. Cl.: 29**

**TRADEMARK**

**PRINCIPAL REGISTER**

IBE BUSINESS ENTERPRISE AG (SWITZERLAND CORPORATION)  
BAARERSTRASSE 86  
ZUG, SWITZERLAND 6300

FOR: DAIRY PRODUCTS EXCLUDING ICE CREAM, ICE MILK AND FROZEN YOGURT;  
MILK, IN CLASS 29 (U.S. CL. 46).

FIRST USE 6-20-2011; IN COMMERCE 6-20-2011.

THE MARK CONSISTS OF STANDARD CHARACTERS WITHOUT CLAIM TO ANY PAR-  
TICULAR FONT, STYLE, SIZE, OR COLOR.

OWNER OF U.S. REG. NOS. 921,370, 2,715,645 AND OTHERS.

SER. NO. 85-413,487, FILED 9-1-2011.

ELI HELLMAN, EXAMINING ATTORNEY



*David J. Kybas*

Director of the United States Patent and Trademark Office



# United States of America

United States Patent and Trademark Office

 SoftJAM

**Reg. No. 4,135,331**

**Registered May 1, 2012**

**Int. Cl.: 31**

**TRADEMARK**

**PRINCIPAL REGISTER**

LOWE, MATTHEW SNYDER (UNITED STATES INDIVIDUAL)  
655 SHOWERS LANE  
MARTINSBURG, WV 25403

FOR: MULCH, IN CLASS 31 (U.S. CLS. 1 AND 46).

FIRST USE 8-31-2011; IN COMMERCE 8-31-2011.

THE MARK CONSISTS OF A BARE FOOTPRINT AND LEAF WITH THE STYLIZED WORDING "SOFTJAM".

SER. NO. 85-413,497, FILED 9-1-2011.

NICHOLAS ALTREE, EXAMINING ATTORNEY



*David J. Kybas*

Director of the United States Patent and Trademark Office

# United States of America

United States Patent and Trademark Office

WE CARE ABOUT OKLAHOMA.  
WE CARE ABOUT YOU.

**Reg. No. 4,135,332**

**Registered May 1, 2012**

**Int. Cl.: 36**

**SERVICE MARK**

**PRINCIPAL REGISTER**

BANK7 (OKLAHOMA STATE BANKING CORPORATION)  
1039 N.W. 63RD STREET  
OKLAHOMA CITY, OK 73116

FOR: BANKING SERVICES, IN CLASS 36 (U.S. CLS. 100, 101 AND 102).

FIRST USE 1-30-2011; IN COMMERCE 1-30-2011.

THE MARK CONSISTS OF STANDARD CHARACTERS WITHOUT CLAIM TO ANY PARTICULAR FONT, STYLE, SIZE, OR COLOR.

SER. NO. 85-413,499, FILED 9-1-2011.

ELLEN PERKINS, EXAMINING ATTORNEY



*David J. Kybas*

Director of the United States Patent and Trademark Office

# United States of America

United States Patent and Trademark Office

## SOLACE PER AQUA

**Reg. No. 4,135,333**

**Registered May 1, 2012**

**Int. Cl.: 24**

**TRADEMARK**

**PRINCIPAL REGISTER**

DUNN, SUSAN C. (UNITED STATES INDIVIDUAL)  
P.O. BOX 1086  
6436 VIA NARANJAL  
RANCHO SANTA FE, CA 92067

FOR: TOWELS, IN CLASS 24 (U.S. CLS. 42 AND 50).

FIRST USE 4-2-1999; IN COMMERCE 4-2-1999.

THE MARK CONSISTS OF STANDARD CHARACTERS WITHOUT CLAIM TO ANY PARTICULAR FONT, STYLE, SIZE, OR COLOR.

OWNER OF U.S. REG. NOS. 2,684,212 AND 3,079,993.

SER. NO. 85-413,526, FILED 9-1-2011.

DAVID MURRAY, EXAMINING ATTORNEY



*David J. Kyros*

Director of the United States Patent and Trademark Office

# United States of America

United States Patent and Trademark Office

# approvee

**Reg. No. 4,135,334**

**Registered May 1, 2012**

**Int. Cl.: 35**

**SERVICE MARK**

**PRINCIPAL REGISTER**

SOKAPP INC. (DELAWARE CORPORATION), DBA APPROVEE  
30 WALL ST.  
SEATTLE, WA 98121

FOR: ADVERTISEMENT VIA MOBILE PHONE NETWORKS; ADVERTISING AND MARKETING SERVICES PROVIDED BY MEANS OF INDIRECT METHODS OF MARKETING COMMUNICATIONS, NAMELY, SOCIAL MEDIA, SEARCH ENGINE MARKETING, INQUIRY MARKETING, INTERNET MARKETING, MOBILE MARKETING, BLOGGING AND OTHER FORMS OF PASSIVE, SHARABLE OR VIRAL COMMUNICATIONS CHANNELS; ELECTRONIC COMMERCE SERVICES, NAMELY, PROVIDING INFORMATION ABOUT PRODUCTS VIA TELECOMMUNICATION NETWORKS FOR ADVERTISING AND SALES PURPOSES; ON-LINE ADVERTISING ON COMPUTER COMMUNICATION NETWORKS; PROVIDING A WEBSITE FOR USERS WITH SPECIFIC INFORMED RECOMMENDATIONS OF SPECIFIC CONSUMER PRODUCTS AND SERVICES VALIDATED BY THE USERS' INPUTTED PREFERENCES AND SOCIAL NETWORK; PROVIDING RATINGS VIA A GLOBAL COMPUTER NETWORK FOR HOME PRODUCTS AND SERVICES RECOMMENDED BY CONSUMERS, IN CLASS 35 (U.S. CLS. 100, 101 AND 102).

FIRST USE 8-22-2011; IN COMMERCE 9-1-2011.

THE MARK CONSISTS OF STANDARD CHARACTERS WITHOUT CLAIM TO ANY PARTICULAR FONT, STYLE, SIZE, OR COLOR.

SER. NO. 85-413,549, FILED 9-1-2011.

CAROLYN CATALDO, EXAMINING ATTORNEY



*David J. Kyjars*

Director of the United States Patent and Trademark Office

# United States of America

United States Patent and Trademark Office

# GASKET

**Reg. No. 4,135,335**

**Registered May 1, 2012**

**Int. Cl.: 9**

**TRADEMARK**

**PRINCIPAL REGISTER**

KEN WILSON (UNITED STATES INDIVIDUAL)  
3639 MIDWAY DR., STE. B242  
SAN DIEGO, CA 92110

FOR: EYEGLASSES AND SUNGLASSES; EYEGLOSS AND SUNGLASS REPLACEMENT LENSES AND PARTS AND ACCESSORIES THEREFOR, NAMELY, FRAMES, EARSTEMS AND NOSE PIECES; EYEGLOSS CASES; EYEGLOSS CHAINS, STRAPS AND CHORDS, IN CLASS 9 (U.S. CLS. 21, 23, 26, 36 AND 38).

FIRST USE 2-0-2008; IN COMMERCE 2-0-2008.

THE MARK CONSISTS OF STANDARD CHARACTERS WITHOUT CLAIM TO ANY PARTICULAR FONT, STYLE, SIZE, OR COLOR.

SER. NO. 85-413,571, FILED 9-1-2011.

ALICE BENMAMAN, EXAMINING ATTORNEY



*David J. Kyros*

Director of the United States Patent and Trademark Office

# United States of America

United States Patent and Trademark Office

## EXPECT RESULTS!

**Reg. No. 4,135,336**

PCA REALTY, INC. (NEW YORK CORPORATION)  
29-17 FRANCIS LEWIS BLVD.  
FLUSHING, NY 11358

**Registered May 1, 2012**

**Int. Cl.: 36**

FOR: REAL ESTATE AGENCIES, REAL ESTATE BROKERAGE, IN CLASS 36 (U.S. CLS. 100, 101 AND 102).

**SERVICE MARK**

FIRST USE 4-1-1999; IN COMMERCE 4-1-1999.

**PRINCIPAL REGISTER**

THE MARK CONSISTS OF STANDARD CHARACTERS WITHOUT CLAIM TO ANY PARTICULAR FONT, STYLE, SIZE, OR COLOR.

SER. NO. 85-413,572, FILED 9-1-2011.

INGA ERVIN, EXAMINING ATTORNEY



*David J. Kyffers*

Director of the United States Patent and Trademark Office

# United States of America

United States Patent and Trademark Office

## ARCHITECTS TOUCH

**Reg. No. 4,135,337**

**Registered May 1, 2012**

**Int. Cl.: 35**

**SERVICE MARK**

**PRINCIPAL REGISTER**

BERMAN, RICHARD WAYNE (UNITED STATES INDIVIDUAL)  
75 WINDOM STREET  
WHITE PLAINS, NY 10607

FOR: ON-LINE RETAIL STORE SERVICES FEATURING GIFTS, IN CLASS 35 (U.S. CLS. 100, 101 AND 102).

FIRST USE 7-27-1999; IN COMMERCE 10-14-1999.

THE MARK CONSISTS OF STANDARD CHARACTERS WITHOUT CLAIM TO ANY PARTICULAR FONT, STYLE, SIZE, OR COLOR.

OWNER OF U.S. REG. NO. 2,843,271.

SER. NO. 85-413,625, FILED 9-1-2011.

DEZMONA MIZELLE, EXAMINING ATTORNEY



*David J. Kybas*

Director of the United States Patent and Trademark Office

# United States of America

United States Patent and Trademark Office

# outofpawn.com

**Reg. No. 4,135,338**

**Registered May 1, 2012**

**Int. Cl.: 35**

**SERVICE MARK**

**PRINCIPAL REGISTER**

CASHNETPLUS, INC. (CALIFORNIA CORPORATION)  
369 N. FAIRFAX, SUITE #5  
LOS ANGELES, CA 90036

FOR: ON-LINE RETAIL STORE SERVICES FEATURING JEWELRY, ELECTRONICS, AND OTHER GOODS OF THIRD PARTY PAWN SHOPS AND WHOLESALERS, IN CLASS 35 (U.S. CLS. 100, 101 AND 102).

FIRST USE 9-27-2009; IN COMMERCE 9-27-2009.

THE MARK CONSISTS OF STANDARD CHARACTERS WITHOUT CLAIM TO ANY PARTICULAR FONT, STYLE, SIZE, OR COLOR.

SER. NO. 85-413,634, FILED 9-1-2011.

HELENE LIWINSKI, EXAMINING ATTORNEY



*David J. Kyffers*

Director of the United States Patent and Trademark Office



# United States of America

United States Patent and Trademark Office

# SEIO

**Reg. No. 4,135,339**

**Registered May 1, 2012**

**Int. Cl.: 7**

**TRADEMARK**

**PRINCIPAL REGISTER**

TECHNOLOGICAL AQUATIC ASSOCIATED MANUFACTURING, INC. (CALIFORNIA CORPORATION), AKA TAAM, INC.  
1011 AVENIDA ACASO  
CAMARILLO, CA 93012

FOR: AQUARIUM PUMPS; ELECTRICAL WATER PUMPS FOR AQUARIUM, SPAS, IN CLASS 7 (U.S. CLS. 13, 19, 21, 23, 31, 34 AND 35).

FIRST USE 1-11-2004; IN COMMERCE 1-11-2004.

THE MARK CONSISTS OF STANDARD CHARACTERS WITHOUT CLAIM TO ANY PARTICULAR FONT, STYLE, SIZE, OR COLOR.

SER. NO. 85-413,664, FILED 9-1-2011.

RAUL CORDOVA, EXAMINING ATTORNEY



*David J. Kybas*

Director of the United States Patent and Trademark Office

# United States of America

United States Patent and Trademark Office

# AMEDICA

**Reg. No. 4,135,340**

**Registered May 1, 2012**

**Int. Cl.: 5**

**TRADEMARK**

**PRINCIPAL REGISTER**

AMEDICA BIOTECH, INC. (CALIFORNIA CORPORATION)  
SUITE K  
28301 INDUSTRIAL BLVD.  
HAYWARD, CA 94545

FOR: PROFESSIONAL USE IMMUNODIAGNOSTIC TEST KITS COMPRISED PRIMARILY OF REAGENTS FOR CLINICAL MEDICAL USE, NAMELY, FOR DRUG ABUSE TESTING, INFECTIOUS DISEASE TESTING, TUMOR MARKER AND OTHER DISEASE MARKER TESTING, AND FOR THE DETECTION OF HORMONE LEVELS SUCH AS CHORIONIC GONADOTROPIN, LUTEINIZING HORMONE AND FOLLICLE STIMULATING HORMONE, IN CLASS 5 (U.S. CLS. 6, 18, 44, 46, 51 AND 52).

FIRST USE 3-15-2004; IN COMMERCE 3-15-2004.

THE MARK CONSISTS OF STANDARD CHARACTERS WITHOUT CLAIM TO ANY PARTICULAR FONT, STYLE, SIZE, OR COLOR.

SER. NO. 85-413,674, FILED 9-2-2011.

DAVID ELTON, EXAMINING ATTORNEY



*David J. Kyros*

Director of the United States Patent and Trademark Office

# United States of America

United States Patent and Trademark Office

# Learn Naked

**Reg. No. 4,135,341**

**Registered May 1, 2012**

**Int. Cl.: 16**

**TRADEMARK**

**PRINCIPAL REGISTER**

JACKSON, TAYDAMA S. (UNITED STATES INDIVIDUAL)  
4692 CHIEF JOSEPH CIRCLE  
DOUGLASVILLE, GA 30135

FOR: PRINTED EDUCATIONAL MATERIALS IN THE FIELD OF STATISTICAL LITERACY, MIDI SUSTAIN LITERACY, CIVIL RIGHTS LITERACY, IN CLASS 16 (U.S. CLS. 2, 5, 22, 23, 29, 37, 38 AND 50).

FIRST USE 10-4-2009; IN COMMERCE 10-4-2009.

THE MARK CONSISTS OF STANDARD CHARACTERS WITHOUT CLAIM TO ANY PARTICULAR FONT, STYLE, SIZE, OR COLOR.

SER. NO. 85-413,682, FILED 9-2-2011.

CHRIS WELLS, EXAMINING ATTORNEY



*David J. Kyffers*

Director of the United States Patent and Trademark Office

# United States of America

United States Patent and Trademark Office

# Zerosplash

**Reg. No. 4,135,342**

**Registered May 1, 2012**

**Int. Cls.: 12 and 21**

**TRADEMARK**

**PRINCIPAL REGISTER**

INVISCID DESIGN, INC. (CALIFORNIA CORPORATION)  
3231 CADDEN CT  
SAN DIEGO, CA 92117

FOR: AERO-DYNAMIC FAIRINGS FOR VEHICLES; BICYCLE WATER BOTTLE CAGES; WATER BOTTLE HOLDERS FOR BICYCLES, IN CLASS 12 (U.S. CLS. 19, 21, 23, 31, 35 AND 44).

FIRST USE 5-25-2011; IN COMMERCE 8-31-2011.

FOR: EMPTY WATER BOTTLES FOR BICYCLES; PERSONAL FLUID HYDRATION SYSTEMS COMPRISING A FLUID RESERVOIR, A DELIVERY TUBE, A MOUTHPIECE AND A CARRYING PACK, IN CLASS 21 (U.S. CLS. 2, 13, 23, 29, 30, 33, 40 AND 50).

FIRST USE 5-25-2011; IN COMMERCE 8-31-2011.

THE MARK CONSISTS OF STANDARD CHARACTERS WITHOUT CLAIM TO ANY PARTICULAR FONT, STYLE, SIZE, OR COLOR.

SER. NO. 85-413,683, FILED 9-2-2011.

CHRIS WELLS, EXAMINING ATTORNEY



*David J. Kybas*

Director of the United States Patent and Trademark Office

# United States of America

United States Patent and Trademark Office

# SILVER KEY

**Reg. No. 4,135,343**

**Registered May 1, 2012**

**Int. Cl.: 36**

**SERVICE MARK**

**PRINCIPAL REGISTER**

SILVER KEY REALTY, LLC (ARIZONA LIMITED LIABILITY COMPANY), DBA SILVER  
KEY REALTY  
SUITE 107  
3240 E. UNION HILLS DRIVE  
PHOENIX, AZ 85050

FOR: REAL ESTATE BROKERAGE, IN CLASS 36 (U.S. CLS. 100, 101 AND 102).

FIRST USE 6-10-2011; IN COMMERCE 7-17-2011.

THE MARK CONSISTS OF STANDARD CHARACTERS WITHOUT CLAIM TO ANY PARTICULAR FONT, STYLE, SIZE, OR COLOR.

SER. NO. 85-413,685, FILED 9-2-2011.

CHRIS WELLS, EXAMINING ATTORNEY



*David J. Kybas*

Director of the United States Patent and Trademark Office

# United States of America

United States Patent and Trademark Office

## CoolPencilCase.com

**Reg. No. 4,135,344**

COOL PENCIL CASE LLC (CALIFORNIA LIMITED LIABILITY COMPANY)  
17264 RACHELS WAY  
CHINO HILLS, CA 91709

**Registered May 1, 2012**

**Int. Cl.: 35**

FOR: ON-LINE RETAIL STORE SERVICES FEATURING PENCIL CASES AND SCHOOL SUPPLIES, IN CLASS 35 (U.S. CLS. 100, 101 AND 102).

**SERVICE MARK**

FIRST USE 4-15-2010; IN COMMERCE 7-7-2010.

**PRINCIPAL REGISTER**

THE MARK CONSISTS OF STANDARD CHARACTERS WITHOUT CLAIM TO ANY PARTICULAR FONT, STYLE, SIZE, OR COLOR.

SER. NO. 85-413,686, FILED 9-2-2011.

CHRIS WELLS, EXAMINING ATTORNEY



*David J. Kybas*

Director of the United States Patent and Trademark Office

# United States of America

United States Patent and Trademark Office

# SHOEBREEZE

**Reg. No. 4,135,345**

**Registered May 1, 2012**

**Int. Cl.: 35**

**SERVICE MARK**

**PRINCIPAL REGISTER**

SYLVESTER, LEONNA (UNITED STATES INDIVIDUAL)  
3RD FL  
2818 ALBEMARLE RD  
BROOKLYN, NY 11226

FOR: ON-LINE RETAIL STORE SERVICES FEATURING FOOTWEAR, IN CLASS 35 (U.S. CLS. 100, 101 AND 102).

FIRST USE 4-2-2006; IN COMMERCE 9-1-2011.

THE MARK CONSISTS OF STANDARD CHARACTERS WITHOUT CLAIM TO ANY PARTICULAR FONT, STYLE, SIZE, OR COLOR.

SER. NO. 85-413,727, FILED 9-2-2011.

SHAILA SETTLES, EXAMINING ATTORNEY



*David J. Kybas*

Director of the United States Patent and Trademark Office

# United States of America

United States Patent and Trademark Office



**Reg. No. 4,135,346**

**Registered May 1, 2012**

**Int. Cl.: 36**

**SERVICE MARK**

**PRINCIPAL REGISTER**

KEMPER CORPORATION (DELAWARE CORPORATION)  
ONE EAST WACKER DRIVE  
CHICAGO, IL 60601

FOR: INSURANCE UNDERWRITING SERVICES IN THE FIELDS OF LIFE, HEALTH, ACCIDENT, PROPERTY AND CASUALTY INSURANCE, IN CLASS 36 (U.S. CLS. 100, 101 AND 102).

FIRST USE 8-25-2011; IN COMMERCE 8-25-2011.

THE MARK CONSISTS OF TWO TRIANGLES CREATING THE IMPRESSION OF THE LETTER "K", THE LOWER TRIANGLE HAVING A GOLD COLOR AND THE UPPER TRIANGLE HAVING BROWN ON THE LEFT SIDE OF THE UPPER TRIANGLE AND GRADUATING TO GOLD ON THE RIGHT SIDE OF THE UPPER TRIANGLE.

THE COLOR(S) GOLD AND BROWN IS/ARE CLAIMED AS A FEATURE OF THE MARK.

SER. NO. 85-413,773, FILED 9-2-2011.

PAUL MORENO, EXAMINING ATTORNEY



*David J. Kybas*

Director of the United States Patent and Trademark Office



# United States of America

United States Patent and Trademark Office



**Reg. No. 4,135,347**

**Registered May 1, 2012**

**Int. Cl.: 29**

**TRADEMARK**

**PRINCIPAL REGISTER**

MALONEY SEAFOOD CORPORATION (MASSACHUSETTS CORPORATION)  
350 COPELAND STREET  
QUINCY, MA 02169

FOR: EDIBLE FISH, NAMELY, FROZEN COD AND COD LOINS, FLOUNDER, SOLE,  
HADDOCK AND HADDOCK LOINS, IN CLASS 29 (U.S. CL. 46).

FIRST USE 12-1-1979; IN COMMERCE 12-1-1979.

THE MARK CONSISTS OF A DRAWING OF A BIRD.

SER. NO. 85-413,781, FILED 9-2-2011.

GEORGE LORENZO, EXAMINING ATTORNEY



*David J. Kyffers*

Director of the United States Patent and Trademark Office

# United States of America

United States Patent and Trademark Office

## CHAMBER OF SPARKS

**Reg. No. 4,135,348**

**Registered May 1, 2012**

**Int. Cl.: 13**

**TRADEMARK**

**PRINCIPAL REGISTER**

B.J. ALAN COMPANY (OHIO CORPORATION)  
555 MARTIN LUTHER KING, JR. BLVD.  
YOUNGSTOWN, OH 445021102

FOR: FIREWORKS, IN CLASS 13 (U.S. CLS. 2 AND 9).

FIRST USE 1-1-2010; IN COMMERCE 3-26-2010.

THE MARK CONSISTS OF STANDARD CHARACTERS WITHOUT CLAIM TO ANY PARTICULAR FONT, STYLE, SIZE, OR COLOR.

SER. NO. 85-413,792, FILED 9-2-2011.

BRENDAN REGAN, EXAMINING ATTORNEY



*David J. Kybas*

Director of the United States Patent and Trademark Office

# United States of America

United States Patent and Trademark Office

## The Stall Seat

**Reg. No. 4,135,349**

**Registered May 1, 2012**

**Int. Cl.: 41**

**SERVICE MARK**

**PRINCIPAL REGISTER**

ROBINSON, MILLER (UNITED STATES INDIVIDUAL)  
88 NEARWATER LANE  
DARIEN, CT 06820 AND

MICHAILIDIS, PANAYIOTIS (UNITED STATES INDIVIDUAL)  
88 NEARWATER LANE  
DARIEN, CT 06820

FOR: PROVIDING ON-LINE NON-DOWNLOADABLE NEWSPAPERS , IN CLASS 41 (U.S. CLS. 100, 101 AND 107).

FIRST USE 7-1-2011; IN COMMERCE 7-1-2011.

THE MARK CONSISTS OF STANDARD CHARACTERS WITHOUT CLAIM TO ANY PARTICULAR FONT, STYLE, SIZE, OR COLOR.

SER. NO. 85-413,793, FILED 9-2-2011.

DORITT L. CARROLL, EXAMINING ATTORNEY



*David J. Kyros*

Director of the United States Patent and Trademark Office

**United States of America**  
United States Patent and Trademark Office

# ECONO-ZIP

**Reg. No. 4,135,350**

**Registered May 1, 2012**

**Int. Cl.: 16**

**TRADEMARK**

**PRINCIPAL REGISTER**

ACTION BAG COMPANY (ILLINOIS CORPORATION)  
PURCHASING DEPARTMENT  
1001 ENTRY DRIVE  
BENSENVILLE, IL 60106

FOR: GENERAL PURPOSE PLASTIC BAGS, IN CLASS 16 (U.S. CLS. 2, 5, 22, 23, 29, 37, 38 AND 50).

FIRST USE 5-1-1997; IN COMMERCE 5-1-1997.

THE MARK CONSISTS OF STANDARD CHARACTERS WITHOUT CLAIM TO ANY PARTICULAR FONT, STYLE, SIZE, OR COLOR.

SER. NO. 85-413,807, FILED 9-2-2011.

HEATHER THOMPSON, EXAMINING ATTORNEY



*David J. Kyffers*

Director of the United States Patent and Trademark Office

# United States of America

United States Patent and Trademark Office

## CELEBRATION

**Reg. No. 4,135,351**

**Registered May 1, 2012**

**Int. Cl.: 13**

**TRADEMARK**

**PRINCIPAL REGISTER**

B.J. ALAN COMPANY (OHIO CORPORATION)  
555 MARTIN LUTHER KING, JR. BLVD.  
YOUNGSTOWN, OH 445021102

FOR: FIREWORKS, IN CLASS 13 (U.S. CLS. 2 AND 9).

FIRST USE 1-1-2010; IN COMMERCE 3-26-2010.

THE MARK CONSISTS OF STANDARD CHARACTERS WITHOUT CLAIM TO ANY PARTICULAR FONT, STYLE, SIZE, OR COLOR.

SER. NO. 85-413,818, FILED 9-2-2011.

BRENDAN REGAN, EXAMINING ATTORNEY



*David J. Kybas*

Director of the United States Patent and Trademark Office

# United States of America

United States Patent and Trademark Office

# VIP FALO

**Reg. No. 4,135,352**

VIP FALO, LLC (OHIO LIMITED LIABILITY COMPANY)  
3603 FOREST PARK DRIVE  
CINCINNATI, OH 45229

**Registered May 1, 2012**

**Int. Cl.: 35**

FOR: ON-LINE RETAIL STORE SERVICES FEATURING PERSONAL HOLIDAY GIFT ITEMS, JEWELRY, CANDLES, MUGS, KEYRINGS, IN CLASS 35 (U.S. CLS. 100, 101 AND 102).

**SERVICE MARK**

FIRST USE 12-1-2007; IN COMMERCE 2-1-2008.

**PRINCIPAL REGISTER**

THE MARK CONSISTS OF STANDARD CHARACTERS WITHOUT CLAIM TO ANY PARTICULAR FONT, STYLE, SIZE, OR COLOR.

SER. NO. 85-413,860, FILED 9-2-2011.

RONALD MCMORROW, EXAMINING ATTORNEY



*David J. Kyffers*

Director of the United States Patent and Trademark Office

# United States of America

United States Patent and Trademark Office

# TECHSTARS

**Reg. No. 4,135,353**

**Registered May 1, 2012**

**Int. Cl.: 41**

**SERVICE MARK**

**PRINCIPAL REGISTER**

TECHSTARS CENTRAL LLC (DELAWARE LIMITED LIABILITY COMPANY)  
1375 WALNUT STREET, SUITE 010  
BOULDER, CO 80302

FOR: EDUCATION AND ENTERTAINMENT SERVICES, NAMELY, CONTINUING PROGRAMS IN THE FIELD OF BUSINESS, BUSINESS GROWTH, BUSINESS MANAGEMENT, BUSINESS DEVELOPMENT AND BUSINESS START-UPS ACCESSIBLE BY TELEVISION, SATELLITE, CABLE, AND INTERNET, IN CLASS 41 (U.S. CLS. 100, 101 AND 107).

FIRST USE 5-31-2009; IN COMMERCE 5-31-2009.

THE MARK CONSISTS OF STANDARD CHARACTERS WITHOUT CLAIM TO ANY PARTICULAR FONT, STYLE, SIZE, OR COLOR.

OWNER OF U.S. REG. NO. 3,741,647.

SER. NO. 85-413,876, FILED 9-2-2011.

ANTHONY RINKER, EXAMINING ATTORNEY



*David J. Kyffers*

Director of the United States Patent and Trademark Office

# United States of America

United States Patent and Trademark Office

# PaxBox

**Reg. No. 4,135,354**

**Registered May 1, 2012**

**Int. Cl.: 42**

**SERVICE MARK**

**PRINCIPAL REGISTER**

HEALTHY-IT (GEORGIA LIMITED LIABILITY COMPANY)  
2005 PRINCE AVE  
ATHENS, GA 30606

FOR: SOFTWARE AS A SERVICE (SAAS) SERVICES FEATURING SOFTWARE FOR VIEWING, SENDING, RECEIVING, STORING, RETRIEVING, AND MANIPULATING DICOM IMAGES TO ULTRASOUND, CT, MRI, X-RAY, X-RAY ANGIOGRAPHY AND NUCLEAR SCAN IMAGES, FOR THE PACS AND TELE-RADIOLOGY FIELDS, IN CLASS 42 (U.S. CLS. 100 AND 101).

FIRST USE 3-1-2007; IN COMMERCE 3-1-2007.

THE MARK CONSISTS OF STANDARD CHARACTERS WITHOUT CLAIM TO ANY PARTICULAR FONT, STYLE, SIZE, OR COLOR.

SER. NO. 85-413,922, FILED 9-2-2011.

ANTHONY RINKER, EXAMINING ATTORNEY



*David J. Kybas*

Director of the United States Patent and Trademark Office



# United States of America

United States Patent and Trademark Office

## Circle of Life

**Reg. No. 4,135,355**

JAHNKE, ROGER (UNITED STATES INDIVIDUAL)  
243 PEBBLE BEACH  
GOLETA, CA 93117

**Registered May 1, 2012**

**Int. Cl.: 41**

FOR: PROFESSIONAL COACHING SERVICES IN THE FIELD OF HEALTH AND WELLNESS,  
IN CLASS 41 (U.S. CLS. 100, 101 AND 107).

**SERVICE MARK**

FIRST USE 1-1-1985; IN COMMERCE 1-1-1985.

**PRINCIPAL REGISTER**

THE MARK CONSISTS OF STANDARD CHARACTERS WITHOUT CLAIM TO ANY PARTICULAR FONT, STYLE, SIZE, OR COLOR.

SER. NO. 85-413,948, FILED 9-2-2011.

KEVON CHISOLM, EXAMINING ATTORNEY



*David J. Kybas*

Director of the United States Patent and Trademark Office

# United States of America

United States Patent and Trademark Office

# LUCID

**Reg. No. 4,135,356**

**Registered May 1, 2012**

**Int. Cl.: 20**

**TRADEMARK**

**PRINCIPAL REGISTER**

MALOUF MARKETING, INC. (UTAH CORPORATION), DBA MALOUF FINE LINENS  
1189 WEST 1700 NORTH  
LOGAN, UT 84321

FOR: MATTRESSES, IN CLASS 20 (U.S. CLS. 2, 13, 22, 25, 32 AND 50).

FIRST USE 1-10-2011; IN COMMERCE 1-10-2011.

THE MARK CONSISTS OF STANDARD CHARACTERS WITHOUT CLAIM TO ANY PARTICULAR FONT, STYLE, SIZE, OR COLOR.

SER. NO. 85-413,954, FILED 9-2-2011.

KEVON CHISOLM, EXAMINING ATTORNEY



*David J. Kybas*

Director of the United States Patent and Trademark Office

# United States of America

United States Patent and Trademark Office

## Intuitive Intelligence

**Reg. No. 4,135,357**

**Registered May 1, 2012**

**Int. Cl.: 41**

**SERVICE MARK**

**PRINCIPAL REGISTER**

GREGOROWICZ, PAULA (UNITED STATES INDIVIDUAL)  
66 WHETHERSFIELD CIRCLE  
TELFORD, PA 18969

FOR: EDUCATION SERVICES, NAMELY, PROVIDING WORKSHOPS IN THE FIELD OF CAREER SUCCESS, BUSINESS SUCCESS, AND PERSONAL DEVELOPMENT; PROFESSIONAL COACHING SERVICES IN THE FIELD OF CAREER SUCCESS, BUSINESS SUCCESS, AND PERSONAL DEVELOPMENT; TRAINING SERVICES IN THE FIELD OF CAREER SUCCESS, BUSINESS SUCCESS, AND PERSONAL DEVELOPMENT, IN CLASS 41 (U.S. CLS. 100, 101 AND 107).

FIRST USE 12-1-2010; IN COMMERCE 2-0-2011.

THE MARK CONSISTS OF STANDARD CHARACTERS WITHOUT CLAIM TO ANY PARTICULAR FONT, STYLE, SIZE, OR COLOR.

SER. NO. 85-413,963, FILED 9-2-2011.

RONALD AIKENS, EXAMINING ATTORNEY



*David J. Kyros*

Director of the United States Patent and Trademark Office

# United States of America

United States Patent and Trademark Office

# LearningTimes

**Reg. No. 4,135,358**

**Registered May 1, 2012**

**Int. Cl.: 42**

**SERVICE MARK**

**PRINCIPAL REGISTER**

LEARNINGTIMES, LLC (NEW YORK LIMITED LIABILITY COMPANY)  
1106  
450 7TH AVENUE  
NEW YORK, NY 10123

FOR: COMPUTER SOFTWARE CONSULTATION SERVICES, NAMELY, PROVIDING RECOMMENDATION OF A SOFTWARE AS IT PERTAINS TO ONLINE CONFERENCES, WEBCASTS, PODCASTS AND ONLINE LEARNING EXPERIENCES, IN CLASS 42 (U.S. CLS. 100 AND 101).

FIRST USE 1-1-2002; IN COMMERCE 1-1-2002.

THE MARK CONSISTS OF STANDARD CHARACTERS WITHOUT CLAIM TO ANY PARTICULAR FONT, STYLE, SIZE, OR COLOR.

SER. NO. 85-413,970, FILED 9-2-2011.

RONALD AIKENS, EXAMINING ATTORNEY



*David J. Kyffers*

Director of the United States Patent and Trademark Office

# United States of America

United States Patent and Trademark Office



**Reg. No. 4,135,359**

**Registered May 1, 2012**

**Int. Cl.: 41**

**SERVICE MARK**

**PRINCIPAL REGISTER**

DJ BOOTH LLC (NEW YORK LIMITED LIABILITY COMPANY)  
3L  
587 17TH ST  
BROOKLYN, NY 11218

FOR: ENTERTAINMENT SERVICES, NAMELY, PROVIDING A WEBSITE FEATURING NEWS, EVENTS, REVIEWS, INTERVIEWS AND RELATED ENTERTAINMENT INFORMATION IN THE FIELD OF MUSIC, IN CLASS 41 (U.S. CLS. 100, 101 AND 107).

FIRST USE 3-15-2003; IN COMMERCE 4-15-2003.

THE MARK CONSISTS OF A DJ USING 2 TURNTABLES AND THE STYLIZED TEXT "DJ-BOOTH".

SER. NO. 85-413,976, FILED 9-2-2011.

RONALD AIKENS, EXAMINING ATTORNEY



*David J. Kyffers*

Director of the United States Patent and Trademark Office

# United States of America

United States Patent and Trademark Office



**Reg. No. 4,135,360**

**Registered May 1, 2012**

**Int. Cl.: 41**

**SERVICE MARK**

**PRINCIPAL REGISTER**

ADAMS, KATHERINE (UNITED STATES INDIVIDUAL), DBA THE READING PANDA  
5811 S 152ND PLACE, APT 212  
TUKWILA, WA 98188

FOR: ON-LINE JOURNALS, NAMELY, BLOGS FEATURING BOOK REVIEWS; WRITTEN  
TEXT EDITING, IN CLASS 41 (U.S. CLS. 100, 101 AND 107).

FIRST USE 8-1-2011; IN COMMERCE 8-1-2011.

THE MARK CONSISTS OF A PURPLE OVAL CONTAINING THE IMAGE OF A BLACK  
AND WHITE PANDA BEAR. THE PANDA APPEARS TO BE READING A GREEN BOOK  
WITH GRAY PAGES THAT IT IS HOLDING. THERE IS A PURPLE BOOKMARK EMERGING  
FROM THE TOP OF THE BOOK AND RUNNING DOWN THE BACK COVER. THE SPINE  
OF THE BOOK DISPLAYS THE RED UNDERLINED WORDS THE READING PANDA.

THE COLOR(S) PURPLE, BLACK, WHITE, GREEN, RED AND GRAY IS/ARE CLAIMED  
AS A FEATURE OF THE MARK.

SER. NO. 85-414,000, FILED 9-2-2011.

H. M. FISHER, EXAMINING ATTORNEY



*David J. Kybas*

Director of the United States Patent and Trademark Office

# United States of America

United States Patent and Trademark Office

# Limp Wick

**Reg. No. 4,135,361**

LIMP WICK, L.L.C. (MISSOURI LIMITED LIABILITY COMPANY)  
717 EAST 18TH STREET  
KEARNEY, MO 64060

**Registered May 1, 2012**

**Int. Cl.: 35**

FOR: ON-LINE RETAIL STORE SERVICES FEATURING CANDLES AND CANDLE WARMERS, IN CLASS 35 (U.S. CLS. 100, 101 AND 102).

**SERVICE MARK**

FIRST USE 9-1-2011; IN COMMERCE 9-1-2011.

**PRINCIPAL REGISTER**

THE MARK CONSISTS OF STANDARD CHARACTERS WITHOUT CLAIM TO ANY PARTICULAR FONT, STYLE, SIZE, OR COLOR.

SER. NO. 85-414,090, FILED 9-2-2011.

C. DIONNE CLYBURN, EXAMINING ATTORNEY



*David J. Kybas*

Director of the United States Patent and Trademark Office

# United States of America

United States Patent and Trademark Office

# ABOUT.ME

**Reg. No. 4,135,362**

**Registered May 1, 2012**

**Int. Cl.: 45**

**SERVICE MARK**

**PRINCIPAL REGISTER**

ABOUT.ME, INC. (DELAWARE CORPORATION)  
C/O TRUE VENTURES, PIER 38  
THE EMBARCADERO  
SAN FRANCISCO, CA 94107

FOR: ONLINE SOCIAL NETWORKING SERVICES, IN CLASS 45 (U.S. CLS. 100 AND 101).

FIRST USE 12-16-2010; IN COMMERCE 12-16-2010.

THE MARK CONSISTS OF STANDARD CHARACTERS WITHOUT CLAIM TO ANY PARTICULAR FONT, STYLE, SIZE, OR COLOR.

SER. NO. 85-414,093, FILED 9-2-2011.

ANGELA M. MICHELI, EXAMINING ATTORNEY



*David J. Kyffers*

Director of the United States Patent and Trademark Office



# United States of America

United States Patent and Trademark Office

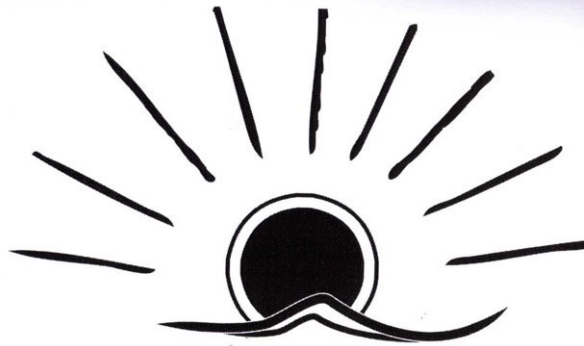

**Reg. No. 4,135,363**

**Registered May 1, 2012**

**Int. Cl.: 44**

**SERVICE MARK**

**PRINCIPAL REGISTER**

NATIONAL ALLERGY, ASTHMA AND URTICARIA CENTERS OF CHARLESTON, P.A.  
(SOUTH CAROLINA CORPORATION)  
9165 UNIVERSITY BLVD.  
CHARLESTON, SC 29406

FOR: MEDICAL SERVICES, NAMELY, TREATMENT OF ALLERGIC AND IMMUNOLOGICAL DISEASES, IN CLASS 44 (U.S. CLS. 100 AND 101).

FIRST USE 9-1-2011; IN COMMERCE 9-1-2011.

THE MARK CONSISTS OF A RISING SUN WITH RAYS OVER A WAVE OF WATER.

SER. NO. 85-414,099, FILED 9-2-2011.

KATINA MISTER, EXAMINING ATTORNEY



*David J. Kyffers*

Director of the United States Patent and Trademark Office

# United States of America

United States Patent and Trademark Office

# NCGR

**Reg. No. 4,135,364**

**Registered May 1, 2012**

**Int. Cl.: 42**

NATIONAL CENTER FOR GENOME RESOURCES (NEW MEXICO CORPORATION), AKA  
NCGR  
BRAD ROSS  
2935 RODEO PARK DRIVE EAST  
SANTA FE, NM 87505

**SERVICE MARK**

FOR: SCIENTIFIC RESEARCH IN THE FIELD OF GENETICS, IN CLASS 42 (U.S. CLS. 100 AND 101).

**PRINCIPAL REGISTER**

FIRST USE 1-1-1997; IN COMMERCE 1-1-1997.

THE MARK CONSISTS OF STANDARD CHARACTERS WITHOUT CLAIM TO ANY PARTICULAR FONT, STYLE, SIZE, OR COLOR.

SER. NO. 85-414,107, FILED 9-2-2011.

NANCY CLARKE, EXAMINING ATTORNEY



*David J. Kyffers*

Director of the United States Patent and Trademark Office

# United States of America

United States Patent and Trademark Office

# ABOUT.ME

**Reg. No. 4,135,365**

**Registered May 1, 2012**

**Int. Cl.: 42**

**SERVICE MARK**

**PRINCIPAL REGISTER**

ABOUT.ME, INC. (DELAWARE CORPORATION)  
C/O TRUE VENTURES, PIER 38  
THE EMBARCADERO  
SAN FRANCISCO, CA 94107

FOR: PROVIDING A WEBSITE THAT GIVES USERS THE ABILITY TO CREATE CUSTOMIZED WEB PAGES FEATURING USER-DEFINED PROFILES; PROVIDING TEMPORARY USE OF ONLINE, NON-DOWNLOADABLE SOFTWARE FOR USE IN AGGREGATING SOCIAL MEDIA CONTENT AND PROFILES, IN CLASS 42 (U.S. CLS. 100 AND 101).

FIRST USE 12-16-2010; IN COMMERCE 12-16-2010.

THE MARK CONSISTS OF STANDARD CHARACTERS WITHOUT CLAIM TO ANY PARTICULAR FONT, STYLE, SIZE, OR COLOR.

SER. NO. 85-414,115, FILED 9-2-2011.

ANGELA M. MICHELI, EXAMINING ATTORNEY



*David J. Kybas*

Director of the United States Patent and Trademark Office

# United States of America

United States Patent and Trademark Office

# SYMPHONY

**Reg. No. 4,135,366**

LOVEY DOVEY PLUS, INC. (CALIFORNIA CORPORATION), DBA SYMPHONY  
1822 E. 41ST PLACE  
LOS ANGELES, CA 90058

**Registered May 1, 2012**

**Int. Cl.: 25**

FOR: DRESSES; EVENING DRESSES; JUMPER DRESSES; KNIT DRESSES; SKIRTS AND DRESSES, IN CLASS 25 (U.S. CLS. 22 AND 39).

**TRADEMARK**

FIRST USE 1-1-2009; IN COMMERCE 1-1-2009.

**PRINCIPAL REGISTER**

THE MARK CONSISTS OF STANDARD CHARACTERS WITHOUT CLAIM TO ANY PARTICULAR FONT, STYLE, SIZE, OR COLOR.

SER. NO. 85-414,158, FILED 9-2-2011.

LUCY ARANT, EXAMINING ATTORNEY



*David J. Kybas*

Director of the United States Patent and Trademark Office

# United States of America

United States Patent and Trademark Office

## WE RISE IN THE FALL

**Reg. No. 4,135,367**

**Registered May 1, 2012**

**Int. Cl.: 41**

**SERVICE MARK**

**PRINCIPAL REGISTER**

WASHINGTON LOCAL SCHOOL DISTRICT BOARD OF EDUCATION (OHIO POLITICAL  
SUBDIVISION)  
3505 WEST LINCOLNSHIRE BOULEVARD  
TOLEDO, OH 43606

FOR: EDUCATION SERVICES, NAMELY, PROVIDING KINDERGARTEN THROUGH 12TH  
GRADE (K-12) CLASSROOM INSTRUCTION, IN CLASS 41 (U.S. CLS. 100, 101 AND 107).

FIRST USE 8-26-2011; IN COMMERCE 8-26-2011.

THE MARK CONSISTS OF STANDARD CHARACTERS WITHOUT CLAIM TO ANY PAR-  
TICULAR FONT, STYLE, SIZE, OR COLOR.

SER. NO. 85-414,176, FILED 9-2-2011.

CHARLOTTE CORWIN, EXAMINING ATTORNEY



*David J. Kyffers*

Director of the United States Patent and Trademark Office

# United States of America

United States Patent and Trademark Office



**Reg. No. 4,135,368**

**Registered May 1, 2012**

**Int. Cl.: 41**

**SERVICE MARK**

**PRINCIPAL REGISTER**

PROVO BEACH RESORT, L.L.C. (UTAH LIMITED LIABILITY COMPANY)  
86 NORTH UNIVERSITY AVENUE  
SUITE 700  
PROVO, UT 84601

FOR: ENTERTAINMENT SERVICES, NAMELY, PROVIDING A MINIATURE CROQUET GAME, IN CLASS 41 (U.S. CLS. 100, 101 AND 107).

FIRST USE 1-14-2011; IN COMMERCE 1-14-2011.

NO CLAIM IS MADE TO THE EXCLUSIVE RIGHT TO USE "MINIATURE CROQUET", APART FROM THE MARK AS SHOWN.

THE COLOR(S) RED, BROWN, BLACK AND WHITE IS/ARE CLAIMED AS A FEATURE OF THE MARK.

THE MARK CONSISTS OF THE WORD IN RED "MINIATURE" WITH THE IMAGE OF A BROWN CROQUET MALLET BEHIND THE LETTER "M" AND THE WORD "CROQUET" WITH THE LETTERS "C", "R", "Q", "U", "E" AND "T" IN BLACK AND THE LETTER "O" IN RED WITH THREE WHITE HORIZONTAL LINES RUNNING THROUGH THE CENTER OF THE LETTER "O".

SER. NO. 85-414,184, FILED 9-2-2011.

ANGELA DUONG, EXAMINING ATTORNEY



*David J. Kybas*

Director of the United States Patent and Trademark Office

# United States of America

United States Patent and Trademark Office

# BUNK

**Reg. No. 4,135,369**

**Registered May 1, 2012**

**Int. Cl.: 43**

**SERVICE MARK**

**PRINCIPAL REGISTER**

BUNK BAR, INC. (OREGON CORPORATION)  
625 SE. MORRISON STREET  
PORTLAND, OR 97214

FOR: BAR SERVICES; CATERING SERVICES; RESTAURANT SERVICES, IN CLASS 43  
(U.S. CLS. 100 AND 101).

FIRST USE 11-30-2008; IN COMMERCE 11-30-2008.

THE MARK CONSISTS OF STANDARD CHARACTERS WITHOUT CLAIM TO ANY PARTICULAR FONT, STYLE, SIZE, OR COLOR.

SER. NO. 85-414,205, FILED 9-2-2011.

KATHLEEN KOLACZ, EXAMINING ATTORNEY



*David J. Kybas*

Director of the United States Patent and Trademark Office

# United States of America

United States Patent and Trademark Office

## LOCA LOCA NOCHE

**Reg. No. 4,135,370**

**Registered May 1, 2012**

**Int. Cl.: 33**

**TRADEMARK**

**PRINCIPAL REGISTER**

SARGSYAN, HENRIK (UNITED STATES INDIVIDUAL)  
4062 VERDUGO ROAD  
LOS ANGELES, CA 90065

FOR: TEQUILA, IN CLASS 33 (U.S. CLS. 47 AND 49).

FIRST USE 5-0-2011; IN COMMERCE 5-0-2011.

THE MARK CONSISTS OF STANDARD CHARACTERS WITHOUT CLAIM TO ANY PARTICULAR FONT, STYLE, SIZE, OR COLOR.

THE ENGLISH TRANSLATION OF "LOCA LOCA NOCHE" IN THE MARK IS "CRAZY CRAZY NIGHT".

SER. NO. 85-414,243, FILED 9-2-2011.

JOHN WILKE, EXAMINING ATTORNEY



*David J. Kyffers*

Director of the United States Patent and Trademark Office



# United States of America

United States Patent and Trademark Office

## AROMACARD

**Reg. No. 4,135,371**

**Registered May 1, 2012**

**Int. Cls.: 35 and 36**

**SERVICE MARK**

**PRINCIPAL REGISTER**

SHEFA FRANCHISES, LTD. (ISRAEL LIMITED COMPANY (LTD.))  
7 HA'SOLELA ST.  
BEIT-SHEMESH, ISRAEL

FOR: PROVIDING INCENTIVE AWARD PROGRAMS FOR CUSTOMERS AND EMPLOYEES THROUGH THE DISTRIBUTION OF PREPAID STORED VALUE CARDS FOR THE PURPOSE OF PROMOTING AND REWARDING LOYALTY, IN CLASS 35 (U.S. CLS. 100, 101 AND 102).

FIRST USE 12-31-2007; IN COMMERCE 12-31-2007.

FOR: PROVIDING STORED VALUE CARD SERVICES, IN CLASS 36 (U.S. CLS. 100, 101 AND 102).

FIRST USE 12-31-2007; IN COMMERCE 12-31-2007.

THE MARK CONSISTS OF STANDARD CHARACTERS WITHOUT CLAIM TO ANY PARTICULAR FONT, STYLE, SIZE, OR COLOR.

SER. NO. 85-414,249, FILED 9-2-2011.

IRA J. GOODSaid, EXAMINING ATTORNEY



*David J. Kybas*

Director of the United States Patent and Trademark Office

# United States of America

United States Patent and Trademark Office

# 3SX

**Reg. No. 4,135,372**

**Registered May 1, 2012**

**Int. Cls.: 35 and 37**

**SERVICE MARK**

**PRINCIPAL REGISTER**

3SX PERFORMANCE AUTOMOTIVE, INC. (NORTH CAROLINA CORPORATION)  
4494 RACEWAY DRIVE  
CONCORD, NC 28027

FOR: ON-LINE RETAIL STORE SERVICES FEATURING AUTOMOTIVE PARTS, IN CLASS 35 (U.S. CLS. 100, 101 AND 102).

FIRST USE 0-0-2001; IN COMMERCE 0-0-2001.

FOR: AUTOMOTIVE MAINTENANCE AND REPAIR; AUTOMOTIVE MAINTENANCE SERVICES, NAMELY, AUTOMOTIVE UPGRADING, IN CLASS 37 (U.S. CLS. 100, 103 AND 106).

FIRST USE 0-0-2001; IN COMMERCE 0-0-2001.

THE MARK CONSISTS OF STANDARD CHARACTERS WITHOUT CLAIM TO ANY PARTICULAR FONT, STYLE, SIZE, OR COLOR.

SER. NO. 85-414,251, FILED 9-2-2011.

HELENE LIWINSKI, EXAMINING ATTORNEY



*David J. Kybas*

Director of the United States Patent and Trademark Office

# United States of America

United States Patent and Trademark Office

## GOTCHA! YOGURT

**Reg. No. 4,135,373**

**Registered May 1, 2012**

**Int. Cl.: 30**

**TRADEMARK**

**PRINCIPAL REGISTER**

GOTCHA FRANCHISING LLC (COLORADO LIMITED LIABILITY COMPANY)  
11153 S. PARKER ROAD, UNIT K  
PARKER, CO 80134

FOR: FROZEN YOGURT, FROZEN YOGURT CAKES, PIES AND OTHER CONFECTIONS,  
FROZEN YOGURT COMBINED WITH FRUIT, NUTS AND OTHER TOPPINGS, IN CLASS  
30 (U.S. CL. 46).

FIRST USE 12-2-2010; IN COMMERCE 12-2-2010.

THE MARK CONSISTS OF STANDARD CHARACTERS WITHOUT CLAIM TO ANY PAR-  
TICULAR FONT, STYLE, SIZE, OR COLOR.

NO CLAIM IS MADE TO THE EXCLUSIVE RIGHT TO USE "YOGURT", APART FROM THE  
MARK AS SHOWN.

SER. NO. 85-414,256, FILED 9-2-2011.

DORITT L. CARROLL, EXAMINING ATTORNEY



*David J. Kyros*

Director of the United States Patent and Trademark Office

# United States of America

United States Patent and Trademark Office

## Stellar Corpses

**Reg. No. 4,135,374**

**Registered May 1, 2012**

**Int. Cl.: 41**

**SERVICE MARK**

**PRINCIPAL REGISTER**

STELLAR CORPSES, LLC (NEVADA LIMITED LIABILITY COMPANY)  
95 HWY 50, #104-PB 7172  
STATELINE, NV 89449

FOR: COMPOSITION OF MUSIC FOR OTHERS; ENTERTAINMENT IN THE NATURE OF VISUAL AND AUDIO PERFORMANCES BY A BAND; ENTERTAINMENT IN THE NATURE OF VISUAL AND AUDIO PERFORMANCES, AND MUSICAL, VARIETY, NEWS AND COMEDY SHOWS; ENTERTAINMENT IN THE NATURE OF VISUAL AND AUDIO PERFORMANCES, NAMELY, MUSICAL BAND, ROCK GROUP, GYMNASTIC, DANCE, AND BALLET PERFORMANCES; ENTERTAINMENT IN THE NATURE OF LIVE MUSICAL PERFORMANCES; ENTERTAINMENT SERVICES BY A MUSICAL ARTIST AND PRODUCER, NAMELY, MUSICAL COMPOSITION FOR OTHERS AND PRODUCTION OF MUSICAL SOUND RECORDINGS; ENTERTAINMENT SERVICES IN THE NATURE OF LIVE MUSICAL PERFORMANCES; ENTERTAINMENT SERVICES IN THE NATURE OF PRESENTING LIVE MUSICAL PERFORMANCES; ENTERTAINMENT SERVICES IN THE NATURE OF RECORDING, PRODUCTION AND POST-PRODUCTION SERVICES IN THE FIELD OF MUSIC; ENTERTAINMENT SERVICES IN THE NATURE OF MUSICAL PERFORMANCES; ENTERTAINMENT SERVICES, NAMELY, NON-DOWNLOADABLE RINGTONES, PRE-RECORDED MUSIC, AND GRAPHICS PRESENTED TO MOBILE COMMUNICATIONS DEVICES VIA A GLOBAL COMPUTER NETWORK AND WIRELESS NETWORKS; ENTERTAINMENT SERVICES, NAMELY, PROVIDING A WEB SITE FEATURING NON-DOWNLOADABLE MUSICAL PERFORMANCES, MUSICAL VIDEOS, RELATED FILM CLIPS, PHOTOGRAPHS, AND OTHER MULTIMEDIA MATERIALS FEATURING RECORDING ARTISTS; ENTERTAINMENT SERVICES, NAMELY, PROVIDING NON-DOWNLOADABLE PLAYBACK OF MUSIC VIA GLOBAL COMMUNICATIONS NETWORKS; ENTERTAINMENT, NAMELY, LIVE MUSIC CONCERTS; ENTERTAINMENT, NAMELY, LIVE PERFORMANCES BY A MUSICAL BAND; LIVE PERFORMANCES BY A MUSICAL GROUP; MUSIC COMPOSITION AND TRANSCRIPTION FOR OTHERS; MUSIC COMPOSITION FOR OTHERS; MUSIC PRODUCTION SERVICES; MUSIC PUBLISHING SERVICES; MUSIC VIDEO PRODUCTION; PRODUCTION OF MUSICAL SOUND RECORDING; PRODUCTION OF MUSICAL VIDEOS; PRODUCTION OF SOUND AND MUSIC VIDEO RECORDINGS; PROVISION OF INFORMATION RELATING TO LIVE PERFORMANCES, ROAD SHOWS, LIVE STAGE EVENTS, THEATRICAL PERFORMANCES, LIVE MUSIC CONCERTS AND AUDIENCE PARTICIPATION IN SUCH EVENTS; PROVISION OF INFORMATION RELATING TO MUSIC, IN CLASS 41 (U.S. CLS. 100, 101 AND 107).



*David J. Kappas*

Director of the United States Patent and Trademark Office

FIRST USE 6-1-2007; IN COMMERCE 6-1-2007.

**Reg. No. 4,135,374** THE MARK CONSISTS OF STANDARD CHARACTERS WITHOUT CLAIM TO ANY PARTICULAR FONT, STYLE, SIZE, OR COLOR.

SER. NO. 85-414,267, FILED 9-2-2011.

SCOTT BIBB, EXAMINING ATTORNEY

# United States of America

United States Patent and Trademark Office

## ATTENTIONAL

**Reg. No. 4,135,375**

**Registered May 1, 2012**

**Int. Cl.: 35**

**SERVICE MARK**

**PRINCIPAL REGISTER**

ATTENTION, INC (CALIFORNIA CORPORATION)  
11620 WILSHIRE BLVD, SUITE 900  
LOS ANGELES, CA 90025

FOR: ASSISTANCE, ADVICE AND CONSULTANCY WITH REGARD TO BUSINESS PLANNING, BUSINESS ANALYSIS, BUSINESS MANAGEMENT AND BUSINESS ORGANIZATION RELATING TO PURCHASING FUNCTIONS; ASSISTANCE, ADVISORY SERVICES AND CONSULTANCY WITH REGARD TO BUSINESS PLANNING, BUSINESS ANALYSIS, BUSINESS MANAGEMENT, BUSINESS ORGANIZATION, MARKETING AND CUSTOMER ANALYSIS; BRAND IMAGERY CONSULTING SERVICES; BUSINESS ADVISORY SERVICES, CONSULTANCY AND INFORMATION; BUSINESS CONSULTATION AND MANAGEMENT REGARDING MARKETING ACTIVITIES AND LAUNCHING OF NEW PRODUCTS; PROVIDING CONSUMER INFORMATION SERVICES AND MAKING REFERRALS IN THE FIELD OF ENTERTAINMENT SERVICES FOR PRODUCTS, SERVICES, EVENTS, ACTIVITIES, FACILITIES AND LOCATIONS, IN CLASS 35 (U.S. CLS. 100, 101 AND 102).

FIRST USE 1-1-2008; IN COMMERCE 1-20-2008.

THE MARK CONSISTS OF STANDARD CHARACTERS WITHOUT CLAIM TO ANY PARTICULAR FONT, STYLE, SIZE, OR COLOR.

SER. NO. 85-414,270, FILED 9-2-2011.

DORITT L. CARROLL, EXAMINING ATTORNEY



*David J. Kyffers*

Director of the United States Patent and Trademark Office

# United States of America

United States Patent and Trademark Office



**Reg. No. 4,135,376**

**Registered May 1, 2012**

**Int. Cl.: 3**

**TRADEMARK**

**PRINCIPAL REGISTER**

COSMOS CORPORATION (MISSOURI CORPORATION)  
103 ENTERPRISE DR.  
WENTZVILLE, MO 63385

FOR: STAIN REMOVING PREPARATIONS WITH DEODORIZERS; PET STAIN REMOVERS;  
CARPET AND FLOOR CLEANING PREPARATIONS WITH DEODORIZERS, IN CLASS 3  
(U.S. CLS. 1, 4, 6, 50, 51 AND 52).

FIRST USE 8-0-2011; IN COMMERCE 8-0-2011.

NO CLAIM IS MADE TO THE EXCLUSIVE RIGHT TO USE "HABIT BREAKER", APART  
FROM THE MARK AS SHOWN.

THE MARK CONSISTS OF THE LETTERS "HB" AND THE WORD "HABITBREAKER"  
WITHIN A STYLIZED STOP SIGN.

SER. NO. 85-414,271, FILED 9-2-2011.

BERNICE MIDDLETON, EXAMINING ATTORNEY



*David J. Kyffers*

Director of the United States Patent and Trademark Office

# United States of America

United States Patent and Trademark Office

## Dally in the Alley

**Reg. No. 4,135,377**

**Registered May 1, 2012**

**Int. Cl.: 41**

**SERVICE MARK**

**PRINCIPAL REGISTER**

NORTH CASS COMMUNITY UNION (MICHIGAN CORPORATION)  
4632 SECOND  
DETROIT, MI 48201

FOR: ENTERTAINMENT SERVICES, NAMELY, CONDUCTING FAIRS; ORGANIZATION OF EVENTS FOR CULTURAL PURPOSES; ORGANIZING CULTURAL AND ARTS EVENTS, IN CLASS 41 (U.S. CLS. 100, 101 AND 107).

FIRST USE 8-1-1982; IN COMMERCE 8-1-1982.

THE MARK CONSISTS OF STANDARD CHARACTERS WITHOUT CLAIM TO ANY PARTICULAR FONT, STYLE, SIZE, OR COLOR.

SER. NO. 85-414,293, FILED 9-2-2011.

JENNIFER DIXON, EXAMINING ATTORNEY



*David J. Kybas*

Director of the United States Patent and Trademark Office



# United States of America

United States Patent and Trademark Office

# ICE AROMA

**Reg. No. 4,135,378**

**Registered May 1, 2012**

**Int. Cls.: 29 and 30**

**TRADEMARK**

**PRINCIPAL REGISTER**

SHEFA FRANCHISES, LTD. (ISRAEL LIMITED COMPANY (LTD.))  
7 HA'SOLELA ST.  
BEIT-SHEMESH, ISRAEL

FOR: MILK-BASED BEVERAGE CONTAINING COFFEE, IN CLASS 29 (U.S. CL. 46).

FIRST USE 12-31-1994; IN COMMERCE 12-31-1994.

FOR: BEVERAGES MADE OF COFFEE; COFFEE-BASED BEVERAGES, IN CLASS 30 (U.S. CL. 46).

FIRST USE 12-31-1994; IN COMMERCE 12-31-1994.

THE MARK CONSISTS OF STANDARD CHARACTERS WITHOUT CLAIM TO ANY PARTICULAR FONT, STYLE, SIZE, OR COLOR.

OWNER OF U.S. REG. NOS. 3,314,329, 3,314,330, AND 3,862,503.

NO CLAIM IS MADE TO THE EXCLUSIVE RIGHT TO USE "ICE", APART FROM THE MARK AS SHOWN.

SER. NO. 85-414,303, FILED 9-2-2011.

IRA J. GOODSID, EXAMINING ATTORNEY



*David J. Kyros*

Director of the United States Patent and Trademark Office

# United States of America

United States Patent and Trademark Office

## JAN'S Jewels of the Sea

**Reg. No. 4,135,379**

DAWKINS, JANET HARDY (UNITED STATES INDIVIDUAL)  
5199 VIA MALAGUENA  
OCEANSIDE, CA 92057

**Registered May 1, 2012**

**Int. Cl.: 14**

FOR: JEWELRY; NECKLACES; WOMEN'S JEWELRY, IN CLASS 14 (U.S. CLS. 2, 27, 28 AND 50).

**TRADEMARK**

FIRST USE 8-23-2011; IN COMMERCE 8-23-2011.

**PRINCIPAL REGISTER**

THE MARK CONSISTS OF STANDARD CHARACTERS WITHOUT CLAIM TO ANY PARTICULAR FONT, STYLE, SIZE, OR COLOR.

NO CLAIM IS MADE TO THE EXCLUSIVE RIGHT TO USE "JEWELS", APART FROM THE MARK AS SHOWN.

SER. NO. 85-414,306, FILED 9-2-2011.

SCOTT BIBB, EXAMINING ATTORNEY



*David J. Kyffers*

Director of the United States Patent and Trademark Office

# United States of America

United States Patent and Trademark Office

## THE FLIGHT CREW

**Reg. No. 4,135,380**

**Registered May 1, 2012**

**Int. Cls.: 41 and 42**

**SERVICE MARK**

**PRINCIPAL REGISTER**

DUNCAN, LLC (DELAWARE LIMITED LIABILITY COMPANY)  
200 INDUSTRIAL PARKWAY  
CHAGRIN FALLS, OH 44022

FOR: TRAINING SERVICES IN THE FIELD OF COMPUTERS AND CLOUD COMPUTING,  
IN CLASS 41 (U.S. CLS. 100, 101 AND 107).

FIRST USE 9-1-2011; IN COMMERCE 9-1-2011.

FOR: CLOUD COMPUTING FEATURING SOFTWARE FOR USE IN FACILITATION OF IT NETWORKING, TELECOMPUTING COLLABORATION, HUMAN RESOURCES SCHEDULING AND MANAGEMENT, MEDICAL CASE MANAGEMENT AND DATA STORAGE; TECHNOLOGICAL PLANNING AND CONSULTING SERVICES IN THE FIELD OF REMOTELY HOSTED, NON-DOWNLOADABLE COMPUTER SOFTWARE, NAMELY, COMPUTING ENVIRONMENTS, OPERATING SYSTEMS, APPLICATIONS, AND DATA MANAGEMENT SOFTWARE AS WELL AS IT PROCESS; CLOUD COMPUTING ARCHITECTURE, IN CLASS 42 (U.S. CLS. 100 AND 101).

FIRST USE 9-1-2011; IN COMMERCE 9-1-2011.

THE MARK CONSISTS OF STANDARD CHARACTERS WITHOUT CLAIM TO ANY PARTICULAR FONT, STYLE, SIZE, OR COLOR.

SER. NO. 85-414,319, FILED 9-2-2011.

LINDA POWELL, EXAMINING ATTORNEY



*David J. Kyjars*

Director of the United States Patent and Trademark Office

# United States of America

United States Patent and Trademark Office

## The Red Thread

**Reg. No. 4,135,381**

ROSS-NASH, KATHRYN (UNITED STATES INDIVIDUAL)  
50 DALE AVENUE  
ALLENDALE, NJ 07401

**Registered May 1, 2012**

**Int. Cl.: 41**

FOR: CONDUCTING WORKSHOPS AND SEMINARS IN PHYSICAL FITNESS.; WORKSHOPS AND SEMINARS IN THE FIELD OF PILATES, IN CLASS 41 (U.S. CLS. 100, 101 AND 107).

**SERVICE MARK**

FIRST USE 5-1-2010; IN COMMERCE 5-1-2010.

**PRINCIPAL REGISTER**

THE MARK CONSISTS OF STANDARD CHARACTERS WITHOUT CLAIM TO ANY PARTICULAR FONT, STYLE, SIZE, OR COLOR.

SER. NO. 85-414,361, FILED 9-2-2011.

STEVEN PEREZ, EXAMINING ATTORNEY



*David J. Kyffers*

Director of the United States Patent and Trademark Office

# United States of America

United States Patent and Trademark Office

## GOTCHA YOGURT

**Reg. No. 4,135,382**

**Registered May 1, 2012**

**Int. Cl.: 43**

**SERVICE MARK**

**PRINCIPAL REGISTER**

GOTCHA FRANCHISING LLC (COLORADO LIMITED LIABILITY COMPANY)  
11153 S. PARKER ROAD, UNIT K  
PARKER, CO 80134

FOR: RESTAURANTS FEATURING FROZEN YOGURT AND OTHER CONFECTIONS, IN CLASS 43 (U.S. CLS. 100 AND 101).

FIRST USE 12-2-2010; IN COMMERCE 12-2-2010.

THE MARK CONSISTS OF STANDARD CHARACTERS WITHOUT CLAIM TO ANY PARTICULAR FONT, STYLE, SIZE, OR COLOR.

NO CLAIM IS MADE TO THE EXCLUSIVE RIGHT TO USE "YOGURT", APART FROM THE MARK AS SHOWN.

SER. NO. 85-414,369, FILED 9-2-2011.

DORITT L. CARROLL, EXAMINING ATTORNEY



*David J. Kybas*

Director of the United States Patent and Trademark Office

# United States of America

United States Patent and Trademark Office

# ENSYS

**Reg. No. 4,135,383**

**Registered May 1, 2012**

**Int. Cl.: 41**

**SERVICE MARK**

**PRINCIPAL REGISTER**

ASGARALI, FAISAL (UNITED STATES INDIVIDUAL)  
1546 HUNTERS STAND RUN  
OVIEDO, FL 32765

FOR: EDUCATION AND ENTERTAINMENT SERVICES, NAMELY, ENGINEERING TRAINING SERVICES, ENGINEERING LICENSE EXAM TRAINING PROGRAMS, ENGINEERING TUTORING SERVICES, CONTINUING PROFESSIONAL ENGINEERING EDUCATION, IN CLASS 41 (U.S. CLS. 100, 101 AND 107).

FIRST USE 12-1-1989; IN COMMERCE 12-1-1989.

THE MARK CONSISTS OF STANDARD CHARACTERS WITHOUT CLAIM TO ANY PARTICULAR FONT, STYLE, SIZE, OR COLOR.

SER. NO. 85-414,383, FILED 9-2-2011.

ANGELA DUONG, EXAMINING ATTORNEY



*David J. Kyffers*

Director of the United States Patent and Trademark Office

# United States of America

United States Patent and Trademark Office

## DEFY ORDINARY

**Reg. No. 4,135,384**

ASPEN CHAMBER RESORT ASSOCIATION (COLORADO NON-PROFIT ASSOCIATION)  
425 RIO GRANDE PL.  
ASPEN, CO 81611

**Registered May 1, 2012**

**Int. Cl.: 35**

FOR: PROMOTING TOURISM IN AND AROUND THE ASPEN, COLORADO GEOGRAPHIC AREA, IN CLASS 35 (U.S. CLS. 100, 101 AND 102).

**SERVICE MARK**

FIRST USE 6-0-2011; IN COMMERCE 6-0-2011.

**PRINCIPAL REGISTER**

THE MARK CONSISTS OF STANDARD CHARACTERS WITHOUT CLAIM TO ANY PARTICULAR FONT, STYLE, SIZE, OR COLOR.

SER. NO. 85-414,390, FILED 9-2-2011.

JUDITH HELFMAN, EXAMINING ATTORNEY



*David J. Kybas*

Director of the United States Patent and Trademark Office

# United States of America

United States Patent and Trademark Office

# Avalon LARP

**Reg. No. 4,135,385**

AVALON LARP, LLC (VIRGINIA LIMITED LIABILITY COMPANY)  
138 E. MEADOWLAND LANE  
STERLING, VA 20164

**Registered May 1, 2012**

**Int. Cl.: 41**

FOR: ENTERTAINMENT IN THE NATURE OF CONDUCTING ROLE-PLAYING GAMES,  
IN CLASS 41 (U.S. CLS. 100, 101 AND 107).

**SERVICE MARK**

FIRST USE 8-1-1997; IN COMMERCE 8-1-1997.

**PRINCIPAL REGISTER**

THE MARK CONSISTS OF STANDARD CHARACTERS WITHOUT CLAIM TO ANY PARTICULAR FONT, STYLE, SIZE, OR COLOR.

NO CLAIM IS MADE TO THE EXCLUSIVE RIGHT TO USE "LARP", APART FROM THE MARK AS SHOWN.

SER. NO. 85-414,395, FILED 9-2-2011.

MARK SHINER, EXAMINING ATTORNEY



*David J. Kybas*

Director of the United States Patent and Trademark Office



# United States of America

United States Patent and Trademark Office

# BLUESHIP

**Reg. No. 4,135,386**

**Registered May 1, 2012**

**Int. Cl.: 42**

**SERVICE MARK**

**PRINCIPAL REGISTER**

BLUE-GRACE I.P. LLC (FLORIDA LIMITED LIABILITY COMPANY)  
2846 S. FALKENBURG RD.  
RIVERVIEW, FL 33578

FOR: PROVIDING TEMPORARY USE OF A WEB-BASED SOFTWARE APPLICATION FOR PLACING SHIPPING ORDERS, TRACKING SHIPMENTS, AND REQUESTING STATUS UPDATES REGARDING SHIPMENTS, IN CLASS 42 (U.S. CLS. 100 AND 101).

FIRST USE 2-0-2009; IN COMMERCE 2-0-2009.

THE MARK CONSISTS OF STANDARD CHARACTERS WITHOUT CLAIM TO ANY PARTICULAR FONT, STYLE, SIZE, OR COLOR.

SER. NO. 85-414,401, FILED 9-2-2011.

JOHN WILKE, EXAMINING ATTORNEY



*David J. Kyffers*

Director of the United States Patent and Trademark Office

# United States of America

United States Patent and Trademark Office

# SideBox

**Reg. No. 4,135,387**

**Registered May 1, 2012**

**Int. Cl.: 42**

**SERVICE MARK**

**PRINCIPAL REGISTER**

HARKNESS, BARRY (UNITED STATES INDIVIDUAL)  
7257 E. NATHAN ST.  
MESA, AZ 85207

FOR: SOFTWARE AS A SERVICE (SAAS) SERVICES FEATURING SOFTWARE FOR SALES STAFF TO MANAGE ESTIMATES, INVOICES, AND WORK ORDERS WHILE IN THE FIELD, IN CLASS 42 (U.S. CLS. 100 AND 101).

FIRST USE 10-15-2010; IN COMMERCE 11-1-2010.

THE MARK CONSISTS OF STANDARD CHARACTERS WITHOUT CLAIM TO ANY PARTICULAR FONT, STYLE, SIZE, OR COLOR.

SER. NO. 85-414,403, FILED 9-2-2011.

IRA J. GOODSaid, EXAMINING ATTORNEY



*David J. Kybas*

Director of the United States Patent and Trademark Office

# United States of America

United States Patent and Trademark Office



**Reg. No. 4,135,388**

**Registered May 1, 2012**

**Int. Cl.: 42**

**SERVICE MARK**

**PRINCIPAL REGISTER**

BLUE-GRACE I.P. LLC (FLORIDA LIMITED LIABILITY COMPANY)  
2846 S. FALKENBURG RD.  
RIVERVIEW, FL 33578

FOR: PROVIDING TEMPORARY USE OF A WEB-BASED SOFTWARE APPLICATION FOR PLACING SHIPPING ORDERS, TRACKING SHIPMENTS, AND REQUESTING STATUS UPDATES REGARDING SHIPMENTS, IN CLASS 42 (U.S. CLS. 100 AND 101).

FIRST USE 12-0-2010; IN COMMERCE 12-0-2010.

THE MARK CONSISTS OF THE WORD "BLUESHIP" TO THE RIGHT OF AN ABSTRACT DESIGN CONSISTING OF A SEMICIRCLE PARTIALLY INTERSECTED BY A TRIANGULAR FIGURE.

SER. NO. 85-414,412, FILED 9-2-2011.

JOHN WILKE, EXAMINING ATTORNEY



*David J. Kybas*

Director of the United States Patent and Trademark Office

# United States of America

United States Patent and Trademark Office

# EPSOMHOL

**Reg. No. 4,135,389**

**Registered May 1, 2012**

**Int. Cl.: 5**

**TRADEMARK**

**PRINCIPAL REGISTER**

J.E. INGRAM, LLC (ARKANSAS LIMITED LIABILITY COMPANY), DBA NATURE'S BEST PRODUCTS, LLC  
1782 LATHAM ST.  
MEMPHIS, TN 381066206

FOR: RUBBING COMPOUND FOR MEDICAL AND/OR THERAPEUTIC USE, IN CLASS 5 (U.S. CLS. 6, 18, 44, 46, 51 AND 52).

FIRST USE 9-12-2003; IN COMMERCE 9-12-2003.

THE MARK CONSISTS OF STANDARD CHARACTERS WITHOUT CLAIM TO ANY PARTICULAR FONT, STYLE, SIZE, OR COLOR.

SER. NO. 85-414,418, FILED 9-2-2011.

SUE LAWRENCE, EXAMINING ATTORNEY



*David J. Kybas*

Director of the United States Patent and Trademark Office

# United States of America

United States Patent and Trademark Office

## If you... Then I can...

**Reg. No. 4,135,390**

**Registered May 1, 2012**

**Int. Cl.: 16**

**TRADEMARK**

**PRINCIPAL REGISTER**

PAPE, TAMARA (UNITED STATES INDIVIDUAL)  
PO BOX 246  
1020 MOON CIRCLE  
MILFORD, KS 66514

FOR: ADHESIVE NOTE PADS; ADHESIVE NOTE PAPER; BINDERS; DAY PLANNERS;  
DRY ERASE WRITING BOARDS AND WRITING SURFACES; LOOSE LEAF BINDERS;  
LOOSE LEAF PAPER; MAGNETIC BOARDS; MEMO PADS; NOTEBOOK PAPER; NOTE-  
BOOKS; NOTEPADS; PENS, IN CLASS 16 (U.S. CLS. 2, 5, 22, 23, 29, 37, 38 AND 50).

FIRST USE 1-30-2011; IN COMMERCE 8-9-2011.

THE MARK CONSISTS OF STANDARD CHARACTERS WITHOUT CLAIM TO ANY PAR-  
TICULAR FONT, STYLE, SIZE, OR COLOR.

SER. NO. 85-414,432, FILED 9-2-2011.

JOHN DWYER, EXAMINING ATTORNEY



*David J. Kyffers*

Director of the United States Patent and Trademark Office

# United States of America

United States Patent and Trademark Office

## SWAMP THING

**Reg. No. 4,135,391**

**Registered May 1, 2012**

**Int. Cl.: 32**

**TRADEMARK**

**PRINCIPAL REGISTER**

SWAMP BEVERAGES LLC (TEXAS LIMITED LIABILITY COMPANY)  
9 JAMIE COURT  
TROPHY CLUB, TX 76262

FOR: NON-ALCOHOLIC BEVERAGES CONTAINING FRUIT JUICES, IN CLASS 32 (U.S. CLS. 45, 46 AND 48).

FIRST USE 7-1-2008; IN COMMERCE 7-1-2008.

THE MARK CONSISTS OF STANDARD CHARACTERS WITHOUT CLAIM TO ANY PARTICULAR FONT, STYLE, SIZE, OR COLOR.

SER. NO. 85-414,440, FILED 9-2-2011.

MIDGE BUTLER, EXAMINING ATTORNEY



*David J. Kybas*

Director of the United States Patent and Trademark Office

# United States of America

United States Patent and Trademark Office

# STEAMBLADE

**Reg. No. 4,135,392**

**Registered May 1, 2012**

**Int. Cl.: 7**

**TRADEMARK**

**PRINCIPAL REGISTER**

JIFFY STEAMER COMPANY, LLC (TENNESSEE LIMITED LIABILITY COMPANY),  
FORMERLY JIFFY STEAMER COMPANY  
P.O. BOX 869  
UNION CITY, TN 382810869

FOR: STEAM CLEANING MACHINES FOR REMOVING FILMS, TINTING, STICKERS, AND  
DECALS FROM SURFACES , IN CLASS 7 (U.S. CLS. 13, 19, 21, 23, 31, 34 AND 35).

FIRST USE 9-6-2011; IN COMMERCE 9-6-2011.

THE MARK CONSISTS OF STANDARD CHARACTERS WITHOUT CLAIM TO ANY PAR-  
TICULAR FONT, STYLE, SIZE, OR COLOR.

SER. NO. 85-414,454, FILED 9-2-2011.

JENNIFER MARTIN, EXAMINING ATTORNEY



*David J. Kybas*

Director of the United States Patent and Trademark Office

# United States of America

United States Patent and Trademark Office

# NORTHSTAR

**Reg. No. 4,135,393**

**Registered May 1, 2012**

**Int. Cl.: 42**

**SERVICE MARK**

**PRINCIPAL REGISTER**

DUNCAN, LLC (DELAWARE LIMITED LIABILITY COMPANY)  
200 INDUSTRIAL PARKWAY  
CHAGRIN FALLS, OH 44022

FOR: CLOUD COMPUTING FEATURING SOFTWARE FOR USE WITH MOBILE PHONES AND PORTABLE COMPUTING DEVICES, NAMELY, SOFTWARE FOR PLANNING, SCHEDULING AND SENDING REMINDERS TO ENHANCE PRODUCTIVITY IN EDUCATIONAL AND PROFESSIONAL SETTINGS, IN CLASS 42 (U.S. CLS. 100 AND 101).

FIRST USE 9-2-2011; IN COMMERCE 9-2-2011.

THE MARK CONSISTS OF STANDARD CHARACTERS WITHOUT CLAIM TO ANY PARTICULAR FONT, STYLE, SIZE, OR COLOR.

SER. NO. 85-414,469, FILED 9-2-2011.

LINDA POWELL, EXAMINING ATTORNEY



*David J. Kyffers*

Director of the United States Patent and Trademark Office



# United States of America

United States Patent and Trademark Office

## NORTHSTAR: NAVIGATION FOR LIFE

**Reg. No. 4,135,394**

**Registered May 1, 2012**

**Int. Cl.: 42**

**SERVICE MARK**

**PRINCIPAL REGISTER**

DUNCAN, LLC (DELAWARE LIMITED LIABILITY COMPANY)  
200 INDUSTRIAL PARKWAY  
CHAGRIN FALLS, OH 44022

FOR: CLOUD COMPUTING FEATURING SOFTWARE FOR USE WITH MOBILE PHONES AND PORTABLE COMPUTING DEVICES, NAMELY, SOFTWARE FOR PLANNING, SCHEDULING AND SENDING REMINDERS TO ENHANCE PRODUCTIVITY IN EDUCATIONAL AND PROFESSIONAL SETTINGS, IN CLASS 42 (U.S. CLS. 100 AND 101).

FIRST USE 9-2-2011; IN COMMERCE 9-2-2011.

THE MARK CONSISTS OF STANDARD CHARACTERS WITHOUT CLAIM TO ANY PARTICULAR FONT, STYLE, SIZE, OR COLOR.

SER. NO. 85-414,475, FILED 9-2-2011.

LINDA POWELL, EXAMINING ATTORNEY



*David J. Kybas*

Director of the United States Patent and Trademark Office

# United States of America

United States Patent and Trademark Office

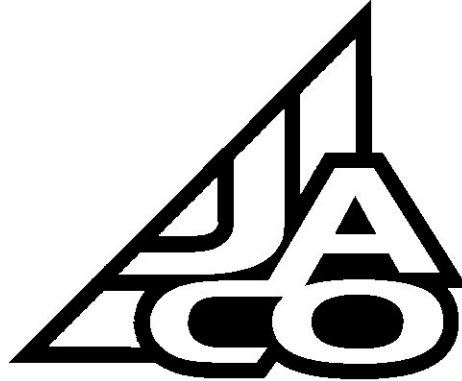

**Reg. No. 4,135,395**

**Registered May 1, 2012**

**Int. Cl.: 37**

**SERVICE MARK**

**PRINCIPAL REGISTER**

JACO GENERAL CONTRACTORS, INC. (TEXAS CORPORATION)  
509 GILES RD., STE. A  
EL PASO, TX 79915

FOR: BUILDING CONSTRUCTION; BUILDING CONSTRUCTION AND REPAIR; BUILDING CONSTRUCTION SERVICES; BUILDING CONSTRUCTION, REMODELING AND REPAIR; GENERAL BUILDING CONTRACTOR SERVICES; GENERAL CONSTRUCTION CONTRACTING, IN CLASS 37 (U.S. CLS. 100, 103 AND 106).

FIRST USE 5-0-2001; IN COMMERCE 5-0-2001.

THE MARK CONSISTS OF A TRIANGLE AROUND THE TERM "JACO" WITH THE LETTERS "JA" SHOWN ABOVE THE LETTERS "CO".

SER. NO. 85-414,476, FILED 9-2-2011.

JENNIFER DIXON, EXAMINING ATTORNEY



*David J. Kybas*

Director of the United States Patent and Trademark Office

# United States of America

United States Patent and Trademark Office



**Reg. No. 4,135,396**

**Registered May 1, 2012**

**Int. Cl.: 41**

**SERVICE MARK**

**PRINCIPAL REGISTER**

VARIANT EVENTS LLC (VIRGINIA LIMITED LIABILITY COMPANY)  
3450 KILBURN CIRCLE #832  
RICHMOND, VA 23233

FOR: ENTERTAINMENT AND EDUCATIONAL SERVICES, NAMELY, CONDUCTING WINE TASTINGS, EDUCATIONAL CLASSES AND LECTURES THAT ALSO FEATURE LUNCHEAS AND DINNERS, SYMPOSIUMS, SEMINARS, CLASSES, CONFERENCES AND WORKSHOPS IN THE FIELD OF THE ENOLOGY AND VINICULTURE, IN CLASS 41 (U.S. CLS. 100, 101 AND 107).

FIRST USE 1-1-2010; IN COMMERCE 1-1-2010.

THE MARK CONSISTS OF A CIRCLE CONTAINING A BIRD WITH SPREAD WINGS AND HEAD LOOKING TO THE SIDE AND A WINE GLASS IN FRONT OF THE BIRD WITH ITS BASE OVERLYING AND EXTENDING BEYOND THE CIRCLE.

SER. NO. 85-414,484, FILED 9-2-2011.

APRIL ROACH, EXAMINING ATTORNEY



*David J. Kybas*

Director of the United States Patent and Trademark Office

# United States of America

United States Patent and Trademark Office



**Reg. No. 4,135,397**

**Registered May 1, 2012**

**Int. Cl.: 41**

**SERVICE MARK**

**PRINCIPAL REGISTER**

VARIANT EVENTS LLC (VIRGINIA LIMITED LIABILITY COMPANY)  
3450 KILBURN CIRCLE #832  
RICHMOND, VA 23233

FOR: ENTERTAINMENT AND EDUCATIONAL SERVICES, NAMELY, CONDUCTING WINE TASTINGS, EDUCATIONAL CLASSES AND LECTURES THAT ALSO FEATURE LUNCHEAS AND DINNERS, SYMPOSIUMS, SEMINARS, CLASSES, CONFERENCES AND WORKSHOPS IN THE FIELD OF THE ENOLOGY AND VINICULTURE, IN CLASS 41 (U.S. CLS. 100, 101 AND 107).

FIRST USE 8-18-2011; IN COMMERCE 8-18-2011.

THE MARK CONSISTS OF AN INVERTED TRIANGLE DEFINED BY SIX OVERLAPPING CIRCLES, ONE AT THE APEX, TWO IN THE MIDDLE, THREE IN THE TOP LAYER, WITH THE TOP THREE CIRCLES BEING CUT OFF TO DEFINE AN INVERTED ARC.

SER. NO. 85-414,495, FILED 9-2-2011.

APRIL ROACH, EXAMINING ATTORNEY



*David J. Kybas*

Director of the United States Patent and Trademark Office

# United States of America

United States Patent and Trademark Office

## INDIAN FIG OFFERINGS

**Reg. No. 4,135,398**

**Registered May 1, 2012**

**Int. Cl.: 30**

**TRADEMARK**

**PRINCIPAL REGISTER**

INDIAN FIG OFFERINGS, LLC (TEXAS LIMITED LIABILITY COMPANY)  
P.O. BOX 1884  
AUSTIN, TX 78767

FOR: SALSA, IN CLASS 30 (U.S. CL. 46).

FIRST USE 6-0-2011; IN COMMERCE 8-0-2011.

THE MARK CONSISTS OF STANDARD CHARACTERS WITHOUT CLAIM TO ANY PARTICULAR FONT, STYLE, SIZE, OR COLOR.

NO CLAIM IS MADE TO THE EXCLUSIVE RIGHT TO USE "INDIAN FIG", APART FROM THE MARK AS SHOWN.

SER. NO. 85-414,503, FILED 9-2-2011.

BILL DAWE, EXAMINING ATTORNEY



*David J. Kyffers*

Director of the United States Patent and Trademark Office

# United States of America

United States Patent and Trademark Office

## DERMAFLAGE

**Reg. No. 4,135,399**

**Registered May 1, 2012**

**Int. Cl.: 3**

**TRADEMARK**

**PRINCIPAL REGISTER**

SILICONE ARTS LABORATORIES (TENNESSEE LIMITED LIABILITY COMPANY)  
6 WEST G.E. PATTERSON AVE  
MEMPHIS, TN 38103

FOR: COSMETICS, IN CLASS 3 (U.S. CLS. 1, 4, 6, 50, 51 AND 52).

FIRST USE 8-15-2007; IN COMMERCE 10-11-2007.

THE MARK CONSISTS OF STANDARD CHARACTERS WITHOUT CLAIM TO ANY PARTICULAR FONT, STYLE, SIZE, OR COLOR.

SER. NO. 85-414,508, FILED 9-2-2011.

MARIA-VICTORIA SUAREZ, EXAMINING ATTORNEY



*David J. Kybas*

Director of the United States Patent and Trademark Office

# United States of America

United States Patent and Trademark Office

## FROZEN ROPE

**Reg. No. 4,135,400**

**Registered May 1, 2012**

**Int. Cl.: 14**

**TRADEMARK**

**PRINCIPAL REGISTER**

GAMEWEAR, INC. (DELAWARE CORPORATION)  
70 HUDSON STREET, SECOND FLOOR  
HOBOKEN, NJ 07030

FOR: NECKLACES AND BRACELETS, IN CLASS 14 (U.S. CLS. 2, 27, 28 AND 50).

FIRST USE 9-0-2009; IN COMMERCE 9-0-2009.

THE MARK CONSISTS OF STANDARD CHARACTERS WITHOUT CLAIM TO ANY PARTICULAR FONT, STYLE, SIZE, OR COLOR.

SER. NO. 85-414,509, FILED 9-2-2011.

SANJEEV VOHRA, EXAMINING ATTORNEY



*David J. Kyffers*

Director of the United States Patent and Trademark Office

# United States of America

United States Patent and Trademark Office

# CAUSEGEAR

**Reg. No. 4,135,401**

**Registered May 1, 2012**

**Int. Cls.: 9 and 18**

**TRADEMARK**

**PRINCIPAL REGISTER**

MOVEMENT 121 LLC (ILLINOIS LIMITED LIABILITY COMPANY)  
324 PRINCETON LANE  
GLENVIEW, IL 60026

FOR: COVERS FOR ELECTRONIC READERS, TABLETS, SMART PHONES, CELL PHONES, MP3 PLAYERS, AND LAPTOP COMPUTERS; CARRYING CASES, BACKPACKS, AND MESSENGER BAGS ESPECIALLY ADAPTED FOR HOLDING OR CARRYING ELECTRONIC READERS, TABLETS, SMART PHONES, CELL PHONES, MP3 PLAYERS, AND LAPTOP COMPUTERS; COMPUTER BAGS, IN CLASS 9 (U.S. CLS. 21, 23, 26, 36 AND 38).

FIRST USE 8-26-2011; IN COMMERCE 8-26-2011.

FOR: LUGGAGE; BACKPACKS; BAGS, NAMELY, MESSENGER BAGS, DUFFEL BAGS, BOOK BAGS, SPORTS BAGS, BUM BAGS, WALLETS AND HANDBAGS, IN CLASS 18 (U.S. CLS. 1, 2, 3, 22 AND 41).

FIRST USE 8-26-2011; IN COMMERCE 8-26-2011.

THE MARK CONSISTS OF STANDARD CHARACTERS WITHOUT CLAIM TO ANY PARTICULAR FONT, STYLE, SIZE, OR COLOR.

SER. NO. 85-414,521, FILED 9-2-2011.

SHARON MEIER, EXAMINING ATTORNEY



*David J. Kyjars*

Director of the United States Patent and Trademark Office



# United States of America

United States Patent and Trademark Office

# BBD

**Reg. No. 4,135,402**

**Registered May 1, 2012**

**Int. Cl.: 35**

**SERVICE MARK**

**PRINCIPAL REGISTER**

BUSINESS BY DEMAND LLC (NEW HAMPSHIRE LIMITED LIABILITY COMPANY)  
SUITE 2B  
ONE CROSSWOODS PATH BLVD.  
MERRIMACK, NH 03054

FOR: APPOINTMENT SCHEDULING SERVICES; BUSINESS SERVICES, NAMELY, TRACKING AND MONITORING OF CALLS FOR OTHERS IN RESPONSE TO ADVERTISING ADS; CONDUCTING BUSINESS AND MARKET RESEARCH SURVEYS; CONSUMER SURVEY SERVICES; PROVIDING DEMAND CREATION AND LEAD GENERATION ACTIVITIES AND SERVICES, IN CLASS 35 (U.S. CLS. 100, 101 AND 102).

FIRST USE 3-9-2007; IN COMMERCE 3-14-2010.

THE MARK CONSISTS OF STANDARD CHARACTERS WITHOUT CLAIM TO ANY PARTICULAR FONT, STYLE, SIZE, OR COLOR.

SER. NO. 85-414,522, FILED 9-2-2011.

JIM RINGLE, EXAMINING ATTORNEY



*David J. Kyffers*

Director of the United States Patent and Trademark Office

# United States of America

United States Patent and Trademark Office

## Inventing Profit

**Reg. No. 4,135,403**

DONOGHUE, JOSEPH (UNITED STATES INDIVIDUAL)  
11956 BERNARDO PLAZA DRIVE, SUITE 216  
SAN DIEGO, CA 92128

**Registered May 1, 2012**

**Int. Cl.: 41**

FOR: ENTERTAINMENT SERVICES IN THE NATURE OF AN ON-GOING REALITY BASED TELEVISION PROGRAM, IN CLASS 41 (U.S. CLS. 100, 101 AND 107).

**SERVICE MARK**

FIRST USE 8-20-2010; IN COMMERCE 8-11-2011.

**PRINCIPAL REGISTER**

THE MARK CONSISTS OF STANDARD CHARACTERS WITHOUT CLAIM TO ANY PARTICULAR FONT, STYLE, SIZE, OR COLOR.

SER. NO. 85-414,524, FILED 9-2-2011.

STEVEN R. FINE, EXAMINING ATTORNEY



*David J. Kybas*

Director of the United States Patent and Trademark Office

# United States of America

United States Patent and Trademark Office



**Reg. No. 4,135,404**

**Registered May 1, 2012**

**Int. Cls.: 9, 14 and 20**

**TRADEMARK**

**PRINCIPAL REGISTER**

GAMEWEAR, INC. (DELAWARE CORPORATION)  
70 HUDSON STREET, SECOND FLOOR  
HOBOKEN, NJ 07030

FOR: PROTECTIVE CASES FOR CELL PHONES, PDAS, AND TABLET COMPUTERS, IN CLASS 9 (U.S. CLS. 21, 23, 26, 36 AND 38).

FIRST USE 9-0-2009; IN COMMERCE 9-0-2009.

FOR: NECKLACES AND BRACELETS, IN CLASS 14 (U.S. CLS. 2, 27, 28 AND 50).

FIRST USE 6-0-2004; IN COMMERCE 6-0-2004.

FOR: NON-METAL KEY CHAINS, IN CLASS 20 (U.S. CLS. 2, 13, 22, 25, 32 AND 50).

FIRST USE 5-0-2005; IN COMMERCE 5-0-2005.

THE MARK CONSISTS OF A STYLIZED "W".

SER. NO. 85-414,526, FILED 9-2-2011.

SANJEEV VOHRA, EXAMINING ATTORNEY



*David J. Kybas*

Director of the United States Patent and Trademark Office

# United States of America

United States Patent and Trademark Office

# JACO

**Reg. No. 4,135,405**

**Registered May 1, 2012**

**Int. Cl.: 37**

**SERVICE MARK**

**PRINCIPAL REGISTER**

JACO GENERAL CONTRACTORS, INC. (TEXAS CORPORATION)  
509 GILES RD., STE. A  
EL PASO, TX 79915

FOR: BUILDING CONSTRUCTION; BUILDING CONSTRUCTION AND REPAIR; BUILDING CONSTRUCTION SERVICES; BUILDING CONSTRUCTION, REMODELING AND REPAIR; GENERAL BUILDING CONTRACTOR SERVICES; GENERAL CONSTRUCTION CONTRACTING, IN CLASS 37 (U.S. CLS. 100, 103 AND 106).

FIRST USE 5-0-2001; IN COMMERCE 5-0-2001.

THE MARK CONSISTS OF STANDARD CHARACTERS WITHOUT CLAIM TO ANY PARTICULAR FONT, STYLE, SIZE, OR COLOR.

SER. NO. 85-414,530, FILED 9-2-2011.

JENNIFER DIXON, EXAMINING ATTORNEY



*David J. Kybas*

Director of the United States Patent and Trademark Office

# United States of America

United States Patent and Trademark Office

## COMMAND CONSOLE

**Reg. No. 4,135,406**

**Registered May 1, 2012**

**Int. Cl.: 9**

**TRADEMARK**

**PRINCIPAL REGISTER**

AFFYMETRIX, INC. (DELAWARE CORPORATION)  
3420 CENTRAL EXPRESSWAY  
SANTA ANA, CA 95051

FOR: COMPUTER PROGRAMS, NAMELY, OPERATING SYSTEM PROGRAMS FOR USE WITH GENETIC AND GENOMIC ANALYSIS EQUIPMENT, IN CLASS 9 (U.S. CLS. 21, 23, 26, 36 AND 38).

FIRST USE 8-31-2006; IN COMMERCE 8-31-2006.

THE MARK CONSISTS OF STANDARD CHARACTERS WITHOUT CLAIM TO ANY PARTICULAR FONT, STYLE, SIZE, OR COLOR.

OWNER OF U.S. REG. NO. 3,289,228.

SEC. 2(F).

SER. NO. 85-414,534, FILED 9-2-2011.

VIVIAN MICZNIK FIRST, EXAMINING ATTORNEY



*David J. Kyffers*

Director of the United States Patent and Trademark Office

# United States of America

United States Patent and Trademark Office

# GAMEWEAR

**Reg. No. 4,135,407**

**Registered May 1, 2012**

**Int. Cls.: 9, 14 and 20**

**TRADEMARK**

**PRINCIPAL REGISTER**

GAMEWEAR, INC. (DELAWARE CORPORATION)  
70 HUDSON STREET, SECOND FLOOR  
HOBOKEN, NJ 07030

FOR: PROTECTIVE CASES FOR CELL PHONES, PDAS, AND TABLET COMPUTERS, IN CLASS 9 (U.S. CLS. 21, 23, 26, 36 AND 38).

FIRST USE 9-0-2009; IN COMMERCE 9-0-2009.

FOR: NECKLACES AND BRACELETS, IN CLASS 14 (U.S. CLS. 2, 27, 28 AND 50).

FIRST USE 6-0-2004; IN COMMERCE 6-0-2004.

FOR: NON-METAL KEY CHAINS, IN CLASS 20 (U.S. CLS. 2, 13, 22, 25, 32 AND 50).

FIRST USE 5-0-2005; IN COMMERCE 5-0-2005.

THE MARK CONSISTS OF STANDARD CHARACTERS WITHOUT CLAIM TO ANY PARTICULAR FONT, STYLE, SIZE, OR COLOR.

SER. NO. 85-414,538, FILED 9-2-2011.

SANJEEV VOHRA, EXAMINING ATTORNEY



*David J. Kyros*

Director of the United States Patent and Trademark Office

# United States of America

United States Patent and Trademark Office

## THE DIAMOND OF OUR INDUSTRY

**Reg. No. 4,135,408**

**Registered May 1, 2012**

**Int. Cl.: 35**

**SERVICE MARK**

**PRINCIPAL REGISTER**

BUSINESS BY DEMAND LLC (NEW HAMPSHIRE LIMITED LIABILITY COMPANY)  
SUITE 2B  
ONE CROSSWOODS PATH BLVD.  
MERRIMACK, NH 03054

FOR: APPOINTMENT SCHEDULING SERVICES; BUSINESS SERVICES, NAMELY, TRACKING AND MONITORING OF CALLS FOR OTHERS IN RESPONSE TO ADVERTISING ADS; CONDUCTING BUSINESS AND MARKET RESEARCH SURVEYS; CONSUMER SURVEY SERVICES; PROVIDING DEMAND CREATION AND LEAD GENERATION ACTIVITIES AND SERVICES, IN CLASS 35 (U.S. CLS. 100, 101 AND 102).

FIRST USE 8-29-2011; IN COMMERCE 8-29-2011.

THE MARK CONSISTS OF STANDARD CHARACTERS WITHOUT CLAIM TO ANY PARTICULAR FONT, STYLE, SIZE, OR COLOR.

SER. NO. 85-414,546, FILED 9-2-2011.

JIM RINGLE, EXAMINING ATTORNEY



*David J. Kyffers*

Director of the United States Patent and Trademark Office

# United States of America

United States Patent and Trademark Office

## WEAR THE GAME

**Reg. No. 4,135,409**

**Registered May 1, 2012**

**Int. Cls.: 9, 14 and 20**

**TRADEMARK**

**PRINCIPAL REGISTER**

GAMEWEAR, INC. (DELAWARE CORPORATION)  
70 HUDSON STREET, SECOND FLOOR  
HOBOKEN, NJ 07030

FOR: PROTECTIVE CASES FOR CELL PHONES, PDAS, AND TABLET COMPUTERS, IN CLASS 9 (U.S. CLS. 21, 23, 26, 36 AND 38).

FIRST USE 9-0-2009; IN COMMERCE 9-0-2009.

FOR: NECKLACES AND BRACELETS, IN CLASS 14 (U.S. CLS. 2, 27, 28 AND 50).

FIRST USE 6-0-2004; IN COMMERCE 6-0-2004.

FOR: NON-METAL KEY CHAINS, IN CLASS 20 (U.S. CLS. 2, 13, 22, 25, 32 AND 50).

FIRST USE 5-0-2005; IN COMMERCE 5-0-2005.

THE MARK CONSISTS OF STANDARD CHARACTERS WITHOUT CLAIM TO ANY PARTICULAR FONT, STYLE, SIZE, OR COLOR.

SER. NO. 85-414,550, FILED 9-2-2011.

SANJEEV VOHRA, EXAMINING ATTORNEY



*David J. Kyros*

Director of the United States Patent and Trademark Office



# United States of America

United States Patent and Trademark Office

## MATT BERNSON

**Reg. No. 4,135,410**

**Registered May 1, 2012**

**Int. Cls.: 14, 18 and 25**

**TRADEMARK**

**PRINCIPAL REGISTER**

MATT BERNSON DESIGN, LLC (NEW YORK LIMITED LIABILITY COMPANY)  
434 GREENWICH STREET  
NEW YORK, NY 10013

FOR: JEWELRY, IN CLASS 14 (U.S. CLS. 2, 27, 28 AND 50).

FIRST USE 1-31-2008; IN COMMERCE 1-31-2008.

FOR: CLUTCHES; HANDBAGS , IN CLASS 18 (U.S. CLS. 1, 2, 3, 22 AND 41).

FIRST USE 1-31-2009; IN COMMERCE 1-31-2009.

FOR: SANDALS; SHOES, IN CLASS 25 (U.S. CLS. 22 AND 39).

FIRST USE 9-1-2004; IN COMMERCE 10-1-2004.

THE MARK CONSISTS OF STANDARD CHARACTERS WITHOUT CLAIM TO ANY PARTICULAR FONT, STYLE, SIZE, OR COLOR.

OWNER OF U.S. REG. NO. 3,070,506.

THE NAME(S), PORTRAIT(S), AND/OR SIGNATURE(S) SHOWN IN THE MARK DOES NOT IDENTIFY A PARTICULAR LIVING INDIVIDUAL.

SER. NO. 85-414,598, FILED 9-2-2011.

SANJEEV VOHRA, EXAMINING ATTORNEY



*David J. Kyros*

Director of the United States Patent and Trademark Office

# United States of America

United States Patent and Trademark Office

**RK**  **Co.**  

---

**JEWELERS**  

---

*A Fine Jewelry Store With A Purpose*

**Reg. No. 4,135,411**

**Registered May 1, 2012**

**Int. Cl.: 35**

**SERVICE MARK**

**PRINCIPAL REGISTER**

REZA, INC. (GEORGIA CORPORATION)  
5188 MCGINNIS FERRY ROAD  
ALPHARETTA, GA 30005

FOR: RETAIL STORE SERVICES AND ONLINE RETAIL STORE SERVICES FEATURING JEWELRY AND WATCHES, IN CLASS 35 (U.S. CLS. 100, 101 AND 102).

FIRST USE 1-1-2011; IN COMMERCE 1-1-2011.

NO CLAIM IS MADE TO THE EXCLUSIVE RIGHT TO USE "CO." AND "JEWELERS", APART FROM THE MARK AS SHOWN.

THE MARK CONSISTS OF THE LETTERS "RK", FOLLOWED BY A RIBBON AND THE LETTERS "CO.", UNDER WHICH IS THE WORD "JEWELERS", UNDER WHICH IS THE PHRASE "A FINE JEWELRY STORE WITH A PURPOSE".

SER. NO. 85-414,600, FILED 9-2-2011.

REBECCA SMITH, EXAMINING ATTORNEY



*David J. Kybas*

Director of the United States Patent and Trademark Office

# United States of America

United States Patent and Trademark Office

# TERO

**Reg. No. 4,135,412**

**Registered May 1, 2012**

**Int. Cl.: 32**

**TRADEMARK**

**PRINCIPAL REGISTER**

PATEL, RAMAN (UNITED STATES INDIVIDUAL)  
P.O. BOX 8130  
JERSEY CITY, NJ 07308 AND

PATEL, RAVIN (UNITED STATES INDIVIDUAL)  
16 WALDO AVENUE  
JERSEY CITY, NJ 07306

FOR: COCONUT JUICE; COCONUT WATER; COCONUT-BASED BEVERAGES; FRUIT DRINKS AND FRUIT JUICES; HERBAL JUICES; MIXED FRUIT JUICE; VEGETABLE JUICES; VEGETABLE-FRUIT JUICES, IN CLASS 32 (U.S. CLS. 45, 46 AND 48).

FIRST USE 2-1-2008; IN COMMERCE 2-1-2008.

THE MARK CONSISTS OF STANDARD CHARACTERS WITHOUT CLAIM TO ANY PARTICULAR FONT, STYLE, SIZE, OR COLOR.

OWNER OF U.S. REG. NO. 4,008,983.

SER. NO. 85-414,604, FILED 9-2-2011.

MATTHEW PAPPAS, EXAMINING ATTORNEY



*David J. Kappas*

Director of the United States Patent and Trademark Office

# United States of America

United States Patent and Trademark Office

## The Face of Temptress

**Reg. No. 4,135,413**

**Registered May 1, 2012**

**Int. Cl.: 41**

**SERVICE MARK**

**PRINCIPAL REGISTER**

TEMPTRESS FASHION (CALIFORNIA PARTNERSHIP)  
1918 BACON STREET  
SAN DIEGO, CA 92107

FOR: ENTERTAINMENT IN THE NATURE OF BEAUTY PAGEANTS, IN CLASS 41 (U.S. CLS. 100, 101 AND 107).

FIRST USE 1-1-2010; IN COMMERCE 1-1-2010.

THE MARK CONSISTS OF STANDARD CHARACTERS WITHOUT CLAIM TO ANY PARTICULAR FONT, STYLE, SIZE, OR COLOR.

SER. NO. 85-414,613, FILED 9-2-2011.

DAWN FELDMAN, EXAMINING ATTORNEY



*David J. Kyffers*

Director of the United States Patent and Trademark Office

# United States of America

United States Patent and Trademark Office

# inforistec

**Reg. No. 4,135,414**

**Registered May 1, 2012**

**Int. Cl.: 42**

**SERVICE MARK**

**PRINCIPAL REGISTER**

INFORISTEC CONSULTING LLC (MARYLAND LIMITED LIABILITY COMPANY), DBA  
INFORISTEC  
155 GIBBS STREET, SUITE 516  
ROCKVILLE, MD 20850

FOR: COMPUTER CONSULTATION, IN CLASS 42 (U.S. CLS. 100 AND 101).

FIRST USE 5-1-2009; IN COMMERCE 5-1-2009.

THE MARK CONSISTS OF "INFORISTEC" AS ONE WORD WITH COLORING AS FOLLOWS:  
"INFO" (TURQUOISE), "RIS" (GREEN), AND "TEC" (TURQUOISE).

THE COLOR(S) TURQUOISE AND GREEN IS/ARE CLAIMED AS A FEATURE OF THE  
MARK.

SER. NO. 85-414,629, FILED 9-2-2011.

MICHAEL SOUDERS, EXAMINING ATTORNEY



*David J. Kybas*

Director of the United States Patent and Trademark Office

# United States of America

United States Patent and Trademark Office

# A.B. Elfelt

**Reg. No. 4,135,415**

**Registered May 1, 2012**

**Int. Cl.: 25**

**TRADEMARK**

**PRINCIPAL REGISTER**

PIFER, GARY L. (UNITED STATES INDIVIDUAL)  
2356 CADDIE CT  
OCEANSIDE, CA 92056

FOR: JEANS, T-SHIRTS, IN CLASS 25 (U.S. CLS. 22 AND 39).

FIRST USE 6-1-1873; IN COMMERCE 8-15-2011.

THE MARK CONSISTS OF STANDARD CHARACTERS WITHOUT CLAIM TO ANY PARTICULAR FONT, STYLE, SIZE, OR COLOR.

THE NAME(S), PORTRAIT(S), AND/OR SIGNATURE(S) SHOWN IN THE MARK DOES NOT IDENTIFY A PARTICULAR LIVING INDIVIDUAL.

SER. NO. 85-414,644, FILED 9-2-2011.

MATTHEW PAPPAS, EXAMINING ATTORNEY



*David J. Kappas*

Director of the United States Patent and Trademark Office

# United States of America

United States Patent and Trademark Office



**Reg. No. 4,135,416**

**Registered May 1, 2012**

**Int. Cl.: 9**

**TRADEMARK**

**PRINCIPAL REGISTER**

ESI AUDIOTECHNIK GMBH (FED REP GERMANY LIMITED LIABILITY COMPANY)  
BRENNERSTRASSE 48  
71229 LEONBERG, FED REP GERMANY

FOR: DIGITAL AUDIO PERIPHERALS AND INTERFACES, NAMELY, DIGITAL AUDIO CONVERTERS, SOUND MIXERS, PRE AMPLIFIERS AND AUDIO SIGNAL PROCESSORS; LOUD SPEAKERS, IN CLASS 9 (U.S. CLS. 21, 23, 26, 36 AND 38).

FIRST USE 1-18-2007; IN COMMERCE 1-18-2007.

OWNER OF U.S. REG. NO. 4,030,584.

THE MARK CONSISTS OF THE LITERAL ELEMENT "ESI" REPRESENTED IN STYLIZED FONT WHEREIN IT FORMS A DESIGN SUPERIMPOSED UPON A CARRIER BACKGROUND.

THE WORDING "ESI" HAS NO MEANING IN A FOREIGN LANGUAGE.

SER. NO. 85-414,646, FILED 9-2-2011.

MATTHEW EINSTEIN, EXAMINING ATTORNEY



*David J. Kybas*

Director of the United States Patent and Trademark Office

# United States of America

United States Patent and Trademark Office

# Cakebee

**Reg. No. 4,135,417**

**Registered May 1, 2012**

**Int. Cl.: 40**

**SERVICE MARK**

**PRINCIPAL REGISTER**

KWOK, SALLY S (UNITED STATES INDIVIDUAL)  
13503 JEB STUART SQ.  
CENTREVILLE, VA 20120

FOR: BAKERY SERVICES, NAMELY, THE MANUFACTURE OF BAKERY PRODUCTS TO ORDER AND/OR SPECIFICATION OF OTHERS; CUSTOM CAKE DECORATING SERVICES; CUSTOM COOKIE DECORATING SERVICES, IN CLASS 40 (U.S. CLS. 100, 103 AND 106).

FIRST USE 10-3-2008; IN COMMERCE 10-3-2008.

THE MARK CONSISTS OF STANDARD CHARACTERS WITHOUT CLAIM TO ANY PARTICULAR FONT, STYLE, SIZE, OR COLOR.

SER. NO. 85-414,682, FILED 9-2-2011.

SUNG IN, EXAMINING ATTORNEY



*David J. Kybas*

Director of the United States Patent and Trademark Office



**United States of America**  
**United States Patent and Trademark Office**

**EVOFLEX**

**Reg. No. 4,135,418**

**Registered May 1, 2012**

**Int. Cl.: 10**

**TRADEMARK**

**PRINCIPAL REGISTER**

BODYPOINT, INC. (WASHINGTON CORPORATION)  
SUITE 300  
558 FIRST AVENUE S  
SEATTLE, WA 98104

FOR: BELTS SPECIFICALLY ADAPTED FOR MEDICAL USE OR FOR USE BY PHYSICALLY INJURED OR HANDICAPPED PERSONS, IN CLASS 10 (U.S. CLS. 26, 39 AND 44).

FIRST USE 9-2-2011; IN COMMERCE 9-2-2011.

THE MARK CONSISTS OF STANDARD CHARACTERS WITHOUT CLAIM TO ANY PARTICULAR FONT, STYLE, SIZE, OR COLOR.

SER. NO. 85-414,710, FILED 9-2-2011.

ROBIN MITTLER, EXAMINING ATTORNEY



*David J. Kyffers*

Director of the United States Patent and Trademark Office

# United States of America

United States Patent and Trademark Office

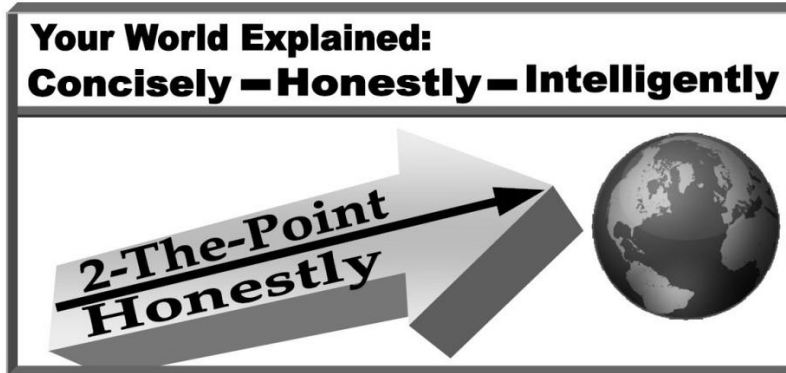

**Reg. No. 4,135,419**

**Registered May 1, 2012**

**Int. Cl.: 16**

**TRADEMARK**

**PRINCIPAL REGISTER**

NATHAN, ALLAN (UNITED STATES INDIVIDUAL)  
# 4243  
848 N. RAINBOW BLVD.  
LAS VEGAS, NV 89107

FOR: SERIES OF FICTION AND NON-FICTION BOOKS ON A VARIETY OF TOPICS, IN CLASS 16 (U.S. CLS. 2, 5, 22, 23, 29, 37, 38 AND 50).

FIRST USE 9-1-2011; IN COMMERCE 9-1-2011.

THE MARK CONSISTS OF A LARGE ARROW THAT SLOPES UPWARDS (FROM LEFT TO RIGHT), AND POINTS DIRECTLY INTO AN IMAGE OF THE EARTH AS A GLOBE. THIS LARGE ARROW IS SHADED AT THE BOTTOM, TO CONVEY THE ARROW AS BEING 3 DIMENSIONAL. THIS LARGE ARROW IS DIVIDED INTO AN UPPER HALF AND A LOWER HALF (BISECTED) BY A PARALLEL, THIN, BLACK, 2 DIMENSIONAL ARROW. THE WORDS "2-THE-POINT" ARE DEPICTED ON TOP OF THIS THINNER, TWO DIMENSIONAL ARROW. THE WORD "HONESTLY" IS DEPICTED BELOW THIS THINNER, TWO DIMENSIONAL ARROW. BOTH OF THE LARGE AND SMALLER ARROWS POINT DIRECTLY TO AN IMAGE DEPICTING A GLOBE OF THE EARTH. THE IMAGE OF THE EARTH SHOWS THE NORTH AND SOUTH ATLANTIC OCEAN IN THE CENTER. THE NORTH POLE APPEARS AT THE TOP OF THE EARTH IMAGE. NORTH AND SOUTH AMERICA APPEAR AT THE LEFT SIDE OF THE EARTH IMAGE. EUROPE AND AFRICA APPEAR ON THE RIGHT SIDE OF THE EARTH IMAGE. ABOVE THE IMAGES OF THE TWO ARROWS AND THE GLOBE OF THE EARTH, THE WORDS "YOUR WORLD EXPLAINED: CONCISELY - HONESTLY - INTELLIGENTLY" APPEAR. THESE WORDS ARE SEPARATED FROM THE 2 ARROWS AND THE EARTH GLOBE BY A HORIZONTAL SEPARATOR. THE HORIZONTAL SEPARATOR HAS SHADING TO CREATE A 3 DIMENSIONAL APPEARANCE. THE 2 ARROWS, THE EARTH GLOBE IMAGE, AND THE WORDS "2-THE-POINT", "HONESTLY", AND "YOUR WORLD EXPLAINED: CONCISELY - HONESTLY - INTELLIGENTLY" ARE SURROUNDED AND ENCASED TOGETHER BY A RECTANGULAR BOUNDARY. THIS RECTANGULAR BOUNDARY HAS SHADING TO CREATE A 3 DIMENSIONAL APPEARANCE.



*David J. Kappas*

SER. NO. 85-414,738, FILED 9-3-2011.

DANNEAN HETZEL, EXAMINING ATTORNEY

# United States of America

United States Patent and Trademark Office

# JPR

**Reg. No. 4,135,420**

J PUBLIC RELATIONS, INC. (CALIFORNIA CORPORATION)  
1125 WEST OLIVE STREET SUITE C  
SAN DIEGO, CA 92103

**Registered May 1, 2012**

**Int. Cl.: 35**

FOR: PUBLIC RELATIONS; PUBLICITY AGENTS, IN CLASS 35 (U.S. CLS. 100, 101 AND 102).

**SERVICE MARK**

FIRST USE 2-23-2005; IN COMMERCE 2-23-2005.

**PRINCIPAL REGISTER**

THE MARK CONSISTS OF STANDARD CHARACTERS WITHOUT CLAIM TO ANY PARTICULAR FONT, STYLE, SIZE, OR COLOR.

SER. NO. 85-414,825, FILED 9-3-2011.

MARTHA FROMM, EXAMINING ATTORNEY



*David J. Kybas*

Director of the United States Patent and Trademark Office

# United States of America

United States Patent and Trademark Office

# Seedsy Rolls

**Reg. No. 4,135,421**

**Registered May 1, 2012**

**Int. Cl.: 31**

**TRADEMARK**

**PRINCIPAL REGISTER**

THE SILLY PARROT, LLC (MINNESOTA LIMITED LIABILITY COMPANY)  
20941 RENDOVA ST. NE  
EAST BETHEL, MN 550114601

FOR: BIRD TREATS, IN CLASS 31 (U.S. CLS. 1 AND 46).

FIRST USE 9-1-2009; IN COMMERCE 9-1-2009.

THE MARK CONSISTS OF STANDARD CHARACTERS WITHOUT CLAIM TO ANY PARTICULAR FONT, STYLE, SIZE, OR COLOR.

NO CLAIM IS MADE TO THE EXCLUSIVE RIGHT TO USE "ROLLS", APART FROM THE MARK AS SHOWN.

SER. NO. 85-414,831, FILED 9-3-2011.

MARTHA FROMM, EXAMINING ATTORNEY



*David J. Kyffers*

Director of the United States Patent and Trademark Office

# United States of America

United States Patent and Trademark Office

## THE CHOCOCEUTICAL WAY OF LIFE

**Reg. No. 4,135,422**

**Registered May 1, 2012**

**Int. Cl.: 30**

**TRADEMARK**

**PRINCIPAL REGISTER**

LOPEZ, NGUYEN S. (CUBA INDIVIDUAL)  
155 OAK HILL DRIVE  
SARASOTA, FL 34232 AND

ALMEIDA, DELSYS (CUBA INDIVIDUAL)  
155 OAK HILL DRIVE  
SARASOTA, FL 34232 AND

MIKELL, WILLIAM J. (UNITED STATES INDIVIDUAL)  
6097 COCOS DRIVE  
FT. MYERS, FL 33908

FOR: CANDY; CHOCOLATES CONTAINING NUTRIENTS, IN CLASS 30 (U.S. CL. 46).

FIRST USE 10-1-2010; IN COMMERCE 10-1-2010.

THE MARK CONSISTS OF STANDARD CHARACTERS WITHOUT CLAIM TO ANY PARTICULAR FONT, STYLE, SIZE, OR COLOR.

SER. NO. 85-414,868, FILED 9-4-2011.

JILL PRATER, EXAMINING ATTORNEY



*David J. Kybas*

Director of the United States Patent and Trademark Office

United States of America  
United States Patent and Trademark Office

**HOOTAD**

**Reg. No. 4,135,423**

**Registered May 1, 2012**

**Int. Cl.: 35**

**SERVICE MARK**

**PRINCIPAL REGISTER**

HOOTAD LLC (MISSOURI LIMITED LIABILITY COMPANY)  
SUITE 117  
36 FOUR SEASONS CENTER  
CHESTERFIELD, MO 63017

FOR: PREPARING AND PLACING ADVERTISEMENTS FOR OTHERS; PROMOTING THE GOODS AND SERVICES OF OTHERS BY MEANS OF DISTRIBUTING ADVERTISING ON THE INTERNET; PROMOTING THE GOODS AND SERVICES OF OTHERS BY PROVIDING A WEBSITE FEATURING ADVERTISEMENTS FOR LOCAL BUSINESSES AND HYPERTEXT LINKS TO THE WEBSITES OF OTHERS, IN CLASS 35 (U.S. CLS. 100, 101 AND 102).

FIRST USE 5-0-2011; IN COMMERCE 5-0-2011.

THE MARK CONSISTS OF THE WORD HOOTAD WITH THE "OO" STYLIZED TO LOOK LIKE AN OWL'S EYES AND FACE.

SER. NO. 85-414,872, FILED 9-4-2011.

KATHRYN COWARD, EXAMINING ATTORNEY



*David J. Kyffers*

Director of the United States Patent and Trademark Office

# United States of America

United States Patent and Trademark Office

## THE LIBERATOR

**Reg. No. 4,135,424**

**Registered May 1, 2012**

**Int. Cl.: 32**

**TRADEMARK**

**PRINCIPAL REGISTER**

SHORT'S BREWING COMPANY (MICHIGAN CORPORATION)  
121 N BRIDGE ST, P.O. BOX 1230  
BELLAIRE, MI 49615

FOR: BEER, ALE AND LAGER, IN CLASS 32 (U.S. CLS. 45, 46 AND 48).

FIRST USE 12-15-2008; IN COMMERCE 12-15-2008.

THE MARK CONSISTS OF STANDARD CHARACTERS WITHOUT CLAIM TO ANY PARTICULAR FONT, STYLE, SIZE, OR COLOR.

NO CLAIM IS MADE TO THE EXCLUSIVE RIGHT TO USE "THE", APART FROM THE MARK AS SHOWN.

SER. NO. 85-414,879, FILED 9-4-2011.

SAIMA MAKHDOOM, EXAMINING ATTORNEY



*David J. Kybas*

Director of the United States Patent and Trademark Office

# United States of America

United States Patent and Trademark Office

## Song of the Spine BoneToner

**Reg. No. 4,135,425**

**Registered May 1, 2012**

**Int. Cl.: 10**

**TRADEMARK**

**PRINCIPAL REGISTER**

JUNE LESLIE WIEDER (UNITED STATES INDIVIDUAL)  
131 S. GOLD CANYON STREET  
RIDGECREST, CA 93555

FOR: VIBROMASSAGE DEVICES, IN CLASS 10 (U.S. CLS. 26, 39 AND 44).

FIRST USE 6-3-2011; IN COMMERCE 8-19-2011.

THE MARK CONSISTS OF STANDARD CHARACTERS WITHOUT CLAIM TO ANY PARTICULAR FONT, STYLE, SIZE, OR COLOR.

SER. NO. 85-414,886, FILED 9-4-2011.

KAREN BRACEY, EXAMINING ATTORNEY



*David J. Kyffers*

Director of the United States Patent and Trademark Office



# United States of America

United States Patent and Trademark Office

## Care is There

**Reg. No. 4,135,426**

**Registered May 1, 2012**

**Int. Cl.: 45**

**SERVICE MARK**

**PRINCIPAL REGISTER**

SOURCEFUL ENTERPRISES, INC. (VIRGINIA CORPORATION), DBA CARE IS THERE  
785 PEWTER CT. #308  
CHARLOTTESVILLE, VA 22911

FOR: IN-HOME SUPPORT SERVICES TO SENIOR PERSONS, NAMELY, GERIATRIC CARE  
MANAGEMENT SERVICES IN THE NATURE OF THE COORDINATION OF NECESSARY  
SERVICES AND PERSONAL CARE FOR OLDER INDIVIDUALS, IN CLASS 45 (U.S. CLS.  
100 AND 101).

FIRST USE 10-9-2007; IN COMMERCE 2-14-2008.

THE MARK CONSISTS OF STANDARD CHARACTERS WITHOUT CLAIM TO ANY PAR-  
TICULAR FONT, STYLE, SIZE, OR COLOR.

OWNER OF U.S. REG. NO. 3,989,710.

SER. NO. 85-414,891, FILED 9-4-2011.

JIM RINGLE, EXAMINING ATTORNEY



*David J. Kyffers*

Director of the United States Patent and Trademark Office

# United States of America

United States Patent and Trademark Office

## Cville Seniors

**Reg. No. 4,135,427**

**Registered May 1, 2012**

**Int. Cl.: 45**

**SERVICE MARK**

**PRINCIPAL REGISTER**

SOURCEFUL ENTERPRISES, INC. (VIRGINIA CORPORATION), DBA CARE IS THERE  
ATTENTION: ELIZABETH SWIDER  
785 PEWTER CT #308  
CHARLOTTESVILLE, VA 22911

FOR: INTERNET-BASED SOCIAL NETWORKING SERVICES, IN CLASS 45 (U.S. CLS. 100  
AND 101).

FIRST USE 11-6-2009; IN COMMERCE 11-6-2009.

THE MARK CONSISTS OF STANDARD CHARACTERS WITHOUT CLAIM TO ANY PAR-  
TICULAR FONT, STYLE, SIZE, OR COLOR.

NO CLAIM IS MADE TO THE EXCLUSIVE RIGHT TO USE "SENIORS", APART FROM THE  
MARK AS SHOWN.

SER. NO. 85-414,896, FILED 9-4-2011.

JIM RINGLE, EXAMINING ATTORNEY



*David J. Kyffers*

Director of the United States Patent and Trademark Office

# United States of America

United States Patent and Trademark Office

## DIVA WITH A FORK

**Reg. No. 4,135,428**

**Registered May 1, 2012**

**Int. Cl.: 41**

**SERVICE MARK**

**PRINCIPAL REGISTER**

DIVA WITH A FORK, L.L.C. (FLORIDA LIMITED LIABILITY COMPANY)  
15003 OTTO ROAD  
TAMPA, FL 33624

FOR: ON-LINE JOURNALS, NAMELY, BLOGS FEATURING EVENT PLANNING AND DESIGN, WEDDINGS, FOOD, RECIPES, TRAVEL, SHOPPING AND FASHION; PARTY AND WEDDING PLANNING, COORDINATION AND CONSULTATION SERVICES, IN CLASS 41 (U.S. CLS. 100, 101 AND 107).

FIRST USE 4-14-2010; IN COMMERCE 4-14-2010.

THE MARK CONSISTS OF STANDARD CHARACTERS WITHOUT CLAIM TO ANY PARTICULAR FONT, STYLE, SIZE, OR COLOR.

SER. NO. 85-414,911, FILED 9-4-2011.

MICHAEL SOUDERS, EXAMINING ATTORNEY



*David J. Kyffers*

Director of the United States Patent and Trademark Office

# United States of America

United States Patent and Trademark Office

# Vitopian

**Reg. No. 4,135,429**

**Registered May 1, 2012**

**Int. Cl.: 42**

**SERVICE MARK**

**PRINCIPAL REGISTER**

VITOPIAN LLC (WYOMING LIMITED LIABILITY COMPANY)  
SUITE 4090  
2510 WARREN AVENUE  
CHEYENNE, WY 82001

FOR: CONSULTING SERVICES IN THE FIELD OF SEARCH ENGINE OPTIMIZATION;  
DESIGN, CREATION, HOSTING, MAINTENANCE OF WEBSITES FOR OTHERS; GRAPHIC  
DESIGN, IN CLASS 42 (U.S. CLS. 100 AND 101).

FIRST USE 6-3-2011; IN COMMERCE 6-3-2011.

THE MARK CONSISTS OF STANDARD CHARACTERS WITHOUT CLAIM TO ANY PAR-  
TICULAR FONT, STYLE, SIZE, OR COLOR.

SER. NO. 85-414,924, FILED 9-4-2011.

DAVID YONTEF, EXAMINING ATTORNEY



*David J. Kyffers*

Director of the United States Patent and Trademark Office

# United States of America

United States Patent and Trademark Office

# Bottrum

**Reg. No. 4,135,430**

**Registered May 1, 2012**

**Int. Cl.: 15**

**TRADEMARK**

**PRINCIPAL REGISTER**

KUROKI, KAZ (UNITED STATES INDIVIDUAL)  
2640 HAMPSHIRE AVENUE S  
SAINT LOUIS PARK, MN 55426

FOR: MUSICAL INSTRUMENTS, IN CLASS 15 (U.S. CLS. 2, 21 AND 36).

FIRST USE 6-2-2011; IN COMMERCE 6-2-2011.

THE MARK CONSISTS OF STANDARD CHARACTERS WITHOUT CLAIM TO ANY PARTICULAR FONT, STYLE, SIZE, OR COLOR.

SER. NO. 85-414,925, FILED 9-4-2011.

PAUL MORENO, EXAMINING ATTORNEY



*David J. Kybas*

Director of the United States Patent and Trademark Office

# United States of America

United States Patent and Trademark Office

# WE INVENTED COOL

**Reg. No. 4,135,431**

STUDEBAKER DRIVERS CLUB INC. (NEW YORK CORPORATION)  
13981 71ST AVENUE NORTH  
MAPLE GROVE, MN 55311

**Registered May 1, 2012**

**Int. Cl.: 35**

FOR: CLUB SERVICES, NAMELY, PROMOTING THE INTERESTS OF STUDEBAKER VEHICLE DRIVERS, IN CLASS 35 (U.S. CLS. 100, 101 AND 102).

**SERVICE MARK**

FIRST USE 9-1-2010; IN COMMERCE 9-1-2010.

**PRINCIPAL REGISTER**

THE MARK CONSISTS OF THE THREE WORDS WE INVENTED COOL WITH WORD COOL OVERLAPPING THE BOTTOM OF THE OTHER TWO WORDS.

SER. NO. 85-414,929, FILED 9-4-2011.

WILLIAM JACKSON, EXAMINING ATTORNEY



*David J. Kyffers*

Director of the United States Patent and Trademark Office

# United States of America

United States Patent and Trademark Office

## THE DIEN THOAI ONG GIA NOEL

**Reg. No. 4,135,432**

DELUXE TELECOM LLC (CALIFORNIA LIMITED LIABILITY COMPANY)  
14922 MORAN ST, SUITE B  
WESTMINSTER, CA 92683

**Registered May 1, 2012**

**Int. Cl.: 16**

FOR: TELEPHONE CALLING CARDS, NOT MAGNETICALLY ENCODED, IN CLASS 16  
(U.S. CLS. 2, 5, 22, 23, 29, 37, 38 AND 50).

**TRADEMARK**

FIRST USE 10-1-2010; IN COMMERCE 10-1-2010.

**PRINCIPAL REGISTER**

THE MARK CONSISTS OF STANDARD CHARACTERS WITHOUT CLAIM TO ANY PARTICULAR FONT, STYLE, SIZE, OR COLOR.

NO CLAIM IS MADE TO THE EXCLUSIVE RIGHT TO USE "THE DIEN THOAI", APART FROM THE MARK AS SHOWN.

THE ENGLISH TRANSLATION OF "THE DIEN THOAI ONG GIA NOEL" IN THE MARK IS "FATHER NOEL PHONE CARD".

SER. NO. 85-414,940, FILED 9-4-2011.

SANI KHOURI, EXAMINING ATTORNEY



*David J. Kyros*

Director of the United States Patent and Trademark Office

# United States of America

United States Patent and Trademark Office

## CREATIVE GYM

**Reg. No. 4,135,433**

**Registered May 1, 2012**

**Int. Cl.: 16**

**TRADEMARK**

**PRINCIPAL REGISTER**

HAWTHORNE, GRACE (UNITED STATES INDIVIDUAL)  
28 MIRABEL AVENUE  
MILL VALLEY, CA 94941

FOR: A SERIES OF BOOKS, WRITTEN ARTICLES, HANDOUTS AND WORKSHEETS IN THE FIELD OF CREATIVITY AND DESIGN THINKING, IN CLASS 16 (U.S. CLS. 2, 5, 22, 23, 29, 37, 38 AND 50).

FIRST USE 9-15-2009; IN COMMERCE 11-5-2009.

THE MARK CONSISTS OF STANDARD CHARACTERS WITHOUT CLAIM TO ANY PARTICULAR FONT, STYLE, SIZE, OR COLOR.

NO CLAIM IS MADE TO THE EXCLUSIVE RIGHT TO USE "CREATIVE", APART FROM THE MARK AS SHOWN.

SER. NO. 85-414,947, FILED 9-4-2011.

TASHIA BUNCH, EXAMINING ATTORNEY



*David J. Kybas*

Director of the United States Patent and Trademark Office



# United States of America

United States Patent and Trademark Office

**Zammex**

**Reg. No. 4,135,434**

**Registered May 1, 2012**

**Int. Cl.: 1**

**TRADEMARK**

**PRINCIPAL REGISTER**

HAINAN ZHONGXIN CHEMICAL CO., LTD. (CHINA LIMITED LIABILITY COMPANY)  
HAINAN MANDARIN HOTEL  
NO.18, WENHUA ROAD  
HAIKOU, HAINAN, CHINA

FOR: ADHESIVES FOR INDUSTRIAL PURPOSES; AGAR-AGAR; AMMONIA FOR INDUSTRIAL PURPOSES; ANHYDRIDES; ANTIMONY OXIDES; ARTIFICIAL SWEETENERS; CHEMICAL PRODUCTS FOR THE FRESH-KEEPING AND PRESERVING OF FOOD; CHEMICALS FOR FERMENTING WINE; EPOXY RESINS; FERTILIZERS AND MANURES; FIRE RETARDANT CHEMICALS; GELATINE GLUE; POLYURETHANE; SODIUM BICARBONATE; TITANIUM OXIDES; WATER PURIFYING CHEMICALS FOR SWIMMING POOLS, IN CLASS 1 (U.S. CLS. 1, 5, 6, 10, 26 AND 46).

FIRST USE 7-19-2008; IN COMMERCE 7-19-2008.

THE MARK CONSISTS OF STYLIZED WORD "ZAMMEX".

SER. NO. 85-414,949, FILED 9-5-2011.

APRIL HESIK, EXAMINING ATTORNEY



*David J. Kyfos*

Director of the United States Patent and Trademark Office

# United States of America

United States Patent and Trademark Office

# Fantom Works

**Reg. No. 4,135,435**

SHORT, DANIEL R (UNITED STATES INDIVIDUAL)  
2400 HAMPTON BLVD  
NORFOLK, VA 23517

**Registered May 1, 2012**

**Int. Cl.: 37**

FOR: RESTORATION IN THE FIELD OF ANTIQUE CARS, IN CLASS 37 (U.S. CLS. 100, 103 AND 106).

**SERVICE MARK**

FIRST USE 4-0-2010; IN COMMERCE 4-0-2010.

**PRINCIPAL REGISTER**

THE MARK CONSISTS OF STANDARD CHARACTERS WITHOUT CLAIM TO ANY PARTICULAR FONT, STYLE, SIZE, OR COLOR.

SER. NO. 85-414,983, FILED 9-5-2011.

KYLE PEETE, EXAMINING ATTORNEY



*David J. Kyffers*

Director of the United States Patent and Trademark Office

# United States of America

United States Patent and Trademark Office

## FIRE ROAD CYCLING

**Reg. No. 4,135,436**

MULTISPORTS.COM, LLC (CALIFORNIA LIMITED LIABILITY COMPANY)  
P.O. BOX 235150  
ENCINITAS, CA 92024

**Registered May 1, 2012**

**Int. Cl.: 41**

FOR: ENTERTAINMENT SERVICES, NAMELY, ARRANGING AND CONDUCTING ATHLETIC COMPETITIONS, IN CLASS 41 (U.S. CLS. 100, 101 AND 107).

**SERVICE MARK**

FIRST USE 3-1-2011; IN COMMERCE 3-1-2011.

**PRINCIPAL REGISTER**

THE MARK CONSISTS OF STANDARD CHARACTERS WITHOUT CLAIM TO ANY PARTICULAR FONT, STYLE, SIZE, OR COLOR.

NO CLAIM IS MADE TO THE EXCLUSIVE RIGHT TO USE "CYCLING", APART FROM THE MARK AS SHOWN.

SER. NO. 85-414,990, FILED 9-5-2011.

JAY FLOWERS, EXAMINING ATTORNEY



*David J. Kybas*

Director of the United States Patent and Trademark Office

# United States of America

United States Patent and Trademark Office



**Pensacola  
International Airport**

**Reg. No. 4,135,437**

**Registered May 1, 2012**

**Int. Cl.: 39**

**SERVICE MARK**

**PRINCIPAL REGISTER**

CITY OF PENSACOLA, FLORIDA (FLORIDA MUNICIPAL CORPORATION)  
222 W. MAIN STREET  
PENSACOLA, FL 32521

FOR: AIRPORT SERVICES, IN CLASS 39 (U.S. CLS. 100 AND 105).

FIRST USE 11-9-2011; IN COMMERCE 11-9-2011.

OWNER OF U.S. REG. NO. 3,725,342.

NO CLAIM IS MADE TO THE EXCLUSIVE RIGHT TO USE "PENSACOLA INTERNATIONAL AIRPORT", APART FROM THE MARK AS SHOWN.

THE MARK CONSISTS OF THE WORDS "PENSACOLA INTERNATIONAL AIRPORT" AND A CIRCLE IN THREE SEGMENTS WITH A TRIANGLE ABOVE IT.

SER. NO. 85-415,005, FILED 9-5-2011.

JESSICA FATHY, EXAMINING ATTORNEY



*David J. Kybas*

Director of the United States Patent and Trademark Office

# United States of America

United States Patent and Trademark Office

# PHATWARE

**Reg. No. 4,135,438**

**Registered May 1, 2012**

**Int. Cl.: 9**

**TRADEMARK**

**PRINCIPAL REGISTER**

PHATWARE CORPORATION (DELAWARE CORPORATION)  
530 SHOWERS DRIVE, SUITE 7, #333  
MOUNTAIN VIEW, CA 94040

FOR: COMPUTER APPLICATION SOFTWARE FOR HANDHELD COMPUTERS, PERSONAL COMPUTERS AND MOBILE PHONES, NAMELY, SOFTWARE FOR HANDWRITING RECOGNITION AND CONVERSION, WORD PROCESSING, LANGUAGE TRANSLATION, SPELL CHECKING, DATABASE BROWSING AND MANAGEMENT, NETWORK ACCESS AND INTERNET ACCESS; DOWNLOADABLE SOFTWARE FOR HANDHELD COMPUTERS, PERSONAL COMPUTERS AND MOBILE PHONES, NAMELY, SOFTWARE FOR HANDWRITING RECOGNITION AND CONVERSION, WORD PROCESSING, LANGUAGE TRANSLATION, SPELL CHECKING, DATABASE BROWSING AND MANAGEMENT, NETWORK ACCESS AND INTERNET ACCESS, IN CLASS 9 (U.S. CLS. 21, 23, 26, 36 AND 38).

FIRST USE 11-30-1997; IN COMMERCE 11-30-1997.

THE MARK CONSISTS OF STANDARD CHARACTERS WITHOUT CLAIM TO ANY PARTICULAR FONT, STYLE, SIZE, OR COLOR.

SER. NO. 85-415,018, FILED 9-5-2011.

ELIZABETH HUGHITT, EXAMINING ATTORNEY



*David J. Kyros*

Director of the United States Patent and Trademark Office

# United States of America

United States Patent and Trademark Office

# BODY BY D

**Reg. No. 4,135,439**

**Registered May 1, 2012**

**Int. Cl.: 41**

**SERVICE MARK**

**PRINCIPAL REGISTER**

BODY BY D, INC (VIRGINIA CORPORATION)  
106 N. CONSTITUTION DR.  
YORKTOWN, VA 23692

FOR: PERSONAL FITNESS TRAINING SERVICES AND CONSULTANCY; ATHLETIC TRAINING SERVICES; EDUCATIONAL AND ENTERTAINMENT SERVICES, NAMELY, PROVIDING MOTIVATIONAL SPEAKING SERVICES IN THE FIELD OF PHYSICAL FITNESS, IN CLASS 41 (U.S. CLS. 100, 101 AND 107).

FIRST USE 2-17-2009; IN COMMERCE 2-17-2009.

THE MARK CONSISTS OF STANDARD CHARACTERS WITHOUT CLAIM TO ANY PARTICULAR FONT, STYLE, SIZE, OR COLOR.

SER. NO. 85-415,019, FILED 9-5-2011.

ELIZABETH HUGHITT, EXAMINING ATTORNEY



*David J. Kyros*

Director of the United States Patent and Trademark Office

# United States of America

United States Patent and Trademark Office

# WRITEPAD

**Reg. No. 4,135,440**

**Registered May 1, 2012**

**Int. Cl.: 9**

**TRADEMARK**

**PRINCIPAL REGISTER**

PHATWARE CORPORATION (DELAWARE CORPORATION)  
530 SHOWERS DRIVE, SUITE 7, #333  
MOUNTAIN VIEW, CA 94040

FOR: COMPUTER APPLICATION SOFTWARE FOR HANDHELD COMPUTERS AND MOBILE PHONES, NAMELY, SOFTWARE FOR HANDWRITING RECOGNITION AND CONVERSION; DOWNLOADABLE COMPUTER SOFTWARE FOR HANDHELD COMPUTERS, PERSONAL COMPUTERS AND MOBILE PHONES, NAMELY, FOR HANDWRITING RECOGNITION AND CONVERSION, IN CLASS 9 (U.S. CLS. 21, 23, 26, 36 AND 38).

FIRST USE 12-31-2005; IN COMMERCE 12-31-2005.

THE MARK CONSISTS OF STANDARD CHARACTERS WITHOUT CLAIM TO ANY PARTICULAR FONT, STYLE, SIZE, OR COLOR.

SER. NO. 85-415,025, FILED 9-5-2011.

ELIZABETH HUGHITT, EXAMINING ATTORNEY



*David J. Kyffers*

Director of the United States Patent and Trademark Office

# United States of America

United States Patent and Trademark Office

## PIRATES VOYAGE

**Reg. No. 4,135,441**

**Registered May 1, 2012**

**Int. Cl.: 14**

**TRADEMARK**

**PRINCIPAL REGISTER**

WORLD CHOICE INVESTMENTS, LLC (TENNESSEE LIMITED LIABILITY COMPANY)  
P.O. BOX 58  
PIGEON FORGE, TN 378680058

FOR: EARRINGS; NECKLACES, IN CLASS 14 (U.S. CLS. 2, 27, 28 AND 50).

FIRST USE 6-1-2011; IN COMMERCE 6-1-2011.

THE MARK CONSISTS OF STANDARD CHARACTERS WITHOUT CLAIM TO ANY PARTICULAR FONT, STYLE, SIZE, OR COLOR.

SER. NO. 85-415,064, FILED 9-5-2011.

HEATHER THOMPSON, EXAMINING ATTORNEY



*David J. Kyffers*

Director of the United States Patent and Trademark Office



# United States of America

United States Patent and Trademark Office

## MOBILITY VAN SALES

**Reg. No. 4,135,442**

**Registered May 1, 2012**

**Int. Cl.: 35**

**SERVICE MARK**

**PRINCIPAL REGISTER**

DIGI ADS PTY LTD (AUSTRALIA PROPRIETARY LIMITED COMPANY (P/L OR PTY. LTD.))  
SUITE 202 - 147 PIRIE STREET  
ADELAIDE, AUSTRALIA

FOR: ADVERTISING, ON-LINE ADVERTISING ON A COMPUTER NETWORK FOR THE PURPOSE OF 3RD PARTIES PERSONS OR ORGANISATIONS TO BUY AND OR SELL WHEELCHAIR ACCESSIBLE VEHICLES, HANDICAP ACCESSIBLE MOTORCYCLES, HANDICAP ACCESSIBLE TRUCKS, HANDICAP AIDS, HANDICAP DEVICES AND RELATES HANDICAP EQUIPMENT FOR THE CARER OR INDIVIDUAL OF PHYSICALLY CHALLENGED, ELDERLY PERSONS OR HANDICAPPED PERSONS, IN CLASS 35 (U.S. CLS. 100, 101 AND 102).

FIRST USE 1-7-2006; IN COMMERCE 1-7-2006.

THE MARK CONSISTS OF STANDARD CHARACTERS WITHOUT CLAIM TO ANY PARTICULAR FONT, STYLE, SIZE, OR COLOR.

SEC. 2(F).

SER. NO. 85-415,074, FILED 9-5-2011.

KELLY TRUSILO, EXAMINING ATTORNEY



*David J. Kybas*

Director of the United States Patent and Trademark Office

# United States of America

United States Patent and Trademark Office

## DEBUTANTE BIKER

**Reg. No. 4,135,443**

SOUTHWICK, MARCIA (UNITED STATES INDIVIDUAL)  
303 E. BERGER ST.  
SANTA FE, NM 87505

**Registered May 1, 2012**

**Int. Cl.: 14**

FOR: JEWELRY; NECKLACES; BRACELETS; RINGS; PEARLS; SILVER; GOLD, IN CLASS 14 (U.S. CLS. 2, 27, 28 AND 50).

**TRADEMARK**

FIRST USE 2-4-2011; IN COMMERCE 2-4-2011.

**PRINCIPAL REGISTER**

THE MARK CONSISTS OF STANDARD CHARACTERS WITHOUT CLAIM TO ANY PARTICULAR FONT, STYLE, SIZE, OR COLOR.

SER. NO. 85-415,081, FILED 9-5-2011.

KELLY TRUSILO, EXAMINING ATTORNEY



*David J. Kyffers*

Director of the United States Patent and Trademark Office

# United States of America

United States Patent and Trademark Office

## Nature's Eraser

**Reg. No. 4,135,444**

**Registered May 1, 2012**

**Int. Cl.: 3**

**TRADEMARK**

**PRINCIPAL REGISTER**

KNOCKOUT INDUSTRIES LLC. (NEW YORK LIMITED LIABILITY COMPANY)  
3RD FLOOR  
4306 THIRD AVENUE  
BROOKLYN, NY 11232 AND

DANIEL, TONYA J (UNITED STATES INDIVIDUAL)  
3RD FLOOR  
4306 THIRD AVENUE  
BROOKLYN, NY 11232

FOR: AROMATIC BODY CARE PRODUCTS, NAMELY, BODY LOTION, SHOWER GEL, CUTICLE CREAM, SHAMPOO, CONDITIONER, NON-MEDICATED LIP BALM, SOAP, BODY POLISH, BODY AND FOOT SCRUB AND NON-MEDICATED FOOT CREAM, IN CLASS 3 (U.S. CLS. 1, 4, 6, 50, 51 AND 52).

FIRST USE 1-1-2010; IN COMMERCE 9-1-2011.

THE MARK CONSISTS OF STANDARD CHARACTERS WITHOUT CLAIM TO ANY PARTICULAR FONT, STYLE, SIZE, OR COLOR.

SER. NO. 85-415,086, FILED 9-5-2011.

ANDREW RHIM, EXAMINING ATTORNEY



*David J. Kyffers*

Director of the United States Patent and Trademark Office

# United States of America

United States Patent and Trademark Office



**Reg. No. 4,135,445**

**Registered May 1, 2012**

**Int. Cl.: 35**

**SERVICE MARK**

**PRINCIPAL REGISTER**

WARKOCZESKI, BRIAN R (UNITED STATES INDIVIDUAL)  
7664 BAY TREE DRIVE  
YPSILANTI, MI 48197

FOR: PROVIDING A WEBSITE PROMOTING RECREATION AND TOURISM IN MICHIGAN,  
IN CLASS 35 (U.S. CLS. 100, 101 AND 102).

FIRST USE 1-1-2011; IN COMMERCE 6-1-2011.

NO CLAIM IS MADE TO THE EXCLUSIVE RIGHT TO USE "MICHIGAN" OR THE  
PICTORIAL REPRESENTATION OF THE STATE OF MICHIGAN, APART FROM THE MARK  
AS SHOWN.

THE COLOR(S) BLACK, WHITE, BLUE AND GRAY IS/ARE CLAIMED AS A FEATURE OF  
THE MARK.

THE MARK CONSISTS OF THE FOLLOWING: THE DESIGN OF A WHITE EYE WITH  
BLACK LASHES AND A BLUE AND BLACK IRIS. THE PUPIL IS BLACK AND GRAY AND  
CONTAINS A GRAY OUTLINE OF THE STATE OF MICHIGAN. TO THE RIGHT IS THE  
WORDING "EYE" IN BLACK, A BLACK CIRCLE CONTAINING "ON" IN WHITE, AND  
"MICHIGAN" IN BLACK.

SER. NO. 85-415,090, FILED 9-5-2011.

REBECCA POVARCHUK, EXAMINING ATTORNEY



*David J. Kybas*

Director of the United States Patent and Trademark Office

# United States of America

United States Patent and Trademark Office

# BITACO

**Reg. No. 4,135,446**

**Registered May 1, 2012**

**Int. Cl.: 30**

**TRADEMARK**

**PRINCIPAL REGISTER**

AGRICOLA HIMALAYA SA (COLOMBIA SOCIEDAD ANONIMA (SA))  
CL 15 # 31A-19 BOD 3  
YUMBO, VALLE, COLOMBIA

FOR: BEVERAGES MADE OF TEA; BEVERAGES WITH A TEA BASE; BLACK TEA; COFFEE AND COFFEE SUBSTITUTES; COFFEE AND TEA; COFFEE SUBSTITUTES; DRIED HERBS; FLAVOURINGS OF TEA; GREEN TEA; HERB TEA; HERBAL FLAVOURINGS FOR MAKING BEVERAGES; HERBAL FOOD BEVERAGES; HERBAL INFUSIONS; HERBAL TEA; ICED TEA; INSTANT TEA; LIME TEA; MIXES IN THE NATURE OF CONCENTRATES, SYRUPS OR POWDERS USED IN THE PREPARATION OF TEA BASED BEVERAGES; PROCESSED HERBS; TEA; TEA BAGS; TEA EXTRACTS; TEA FOR INFUSIONS; TEA PODS; TEA SUBSTITUTES; TEA-BASED BEVERAGES; TEA-BASED BEVERAGES WITH FRUIT FLAVORING, IN CLASS 30 (U.S. CL. 46).

THE MARK CONSISTS OF STANDARD CHARACTERS WITHOUT CLAIM TO ANY PARTICULAR FONT, STYLE, SIZE, OR COLOR.

OWNER OF COLOMBIA REG. NO. 415902, DATED 12-17-2010, EXPIRES 12-17-2020.

THE WORDING BITACO HAS NO MEANING IN A FOREIGN LANGUAGE.

SER. NO. 85-415,098, FILED 9-5-2011.

JACQUELINE A. LAVINE, EXAMINING ATTORNEY



*David J. Kyros*

Director of the United States Patent and Trademark Office

# United States of America

United States Patent and Trademark Office

## Neighborhood Corkboard

**Reg. No. 4,135,447**

NEIGHBORHOOD CORKBOARD (PENNSYLVANIA LIMITED LIABILITY COMPANY)  
2295 CHESTNUT HILL ROAD  
POTTSTOWN, PA 19465

**Registered May 1, 2012**

**Int. Cl.: 35**

FOR: ADVERTISING ON THE INTERNET FOR OTHERS, IN CLASS 35 (U.S. CLS. 100, 101 AND 102).

**SERVICE MARK**

FIRST USE 5-1-2011; IN COMMERCE 5-1-2011.

**PRINCIPAL REGISTER**

THE MARK CONSISTS OF STANDARD CHARACTERS WITHOUT CLAIM TO ANY PARTICULAR FONT, STYLE, SIZE, OR COLOR.

SER. NO. 85-415,114, FILED 9-5-2011.

MICHAEL SOUDERS, EXAMINING ATTORNEY



*David J. Kyffers*

Director of the United States Patent and Trademark Office

# United States of America

United States Patent and Trademark Office

# SHONGEAR

**Reg. No. 4,135,448**

**Registered May 1, 2012**

**Int. Cl.: 18**

**TRADEMARK**

**PRINCIPAL REGISTER**

REFLECTIONS OF LIGHT, INC. (FLORIDA CORPORATION)  
6601 NW FOURTH COURT  
PLANTATION, FL 33317

FOR: ANIMAL HARNESSSES, IN CLASS 18 (U.S. CLS. 1, 2, 3, 22 AND 41).

FIRST USE 7-1-2011; IN COMMERCE 7-1-2011.

THE MARK CONSISTS OF STANDARD CHARACTERS WITHOUT CLAIM TO ANY PARTICULAR FONT, STYLE, SIZE, OR COLOR.

SER. NO. 85-415,116, FILED 9-5-2011.

MARK SPARACINO, EXAMINING ATTORNEY



*David J. Kyffers*

Director of the United States Patent and Trademark Office

# United States of America

United States Patent and Trademark Office

Your first resource for  
the legal world!

**Reg. No. 4,135,449**

**Registered May 1, 2012**

**Int. Cl.: 16**

**TRADEMARK**

**PRINCIPAL REGISTER**

BAES, INC. (CALIFORNIA CORPORATION), DBA LEGAL FRANCA PUBLISHING  
22729 WATERS DRIVE  
CRESTLINE, CA 92325

FOR: EDUCATIONAL PUBLICATIONS, NAMELY, NON-FICTION BOOKS, GUIDES, MANUALS, BOOKLETS, PAMPHLETS, DOCUMENTS, FORMS AND HANDOUTS IN THE FIELDS OF LAW , IN CLASS 16 (U.S. CLS. 2, 5, 22, 23, 29, 37, 38 AND 50).

FIRST USE 6-1-2011; IN COMMERCE 6-1-2011.

THE MARK CONSISTS OF STANDARD CHARACTERS WITHOUT CLAIM TO ANY PARTICULAR FONT, STYLE, SIZE, OR COLOR.

SER. NO. 85-415,122, FILED 9-5-2011.

HEATHER THOMPSON, EXAMINING ATTORNEY



*David J. Kybas*

Director of the United States Patent and Trademark Office



# United States of America

United States Patent and Trademark Office

## CLUMSYPLUSH

**Reg. No. 4,135,450**

**Registered May 1, 2012**

**Int. Cl.: 28**

**TRADEMARK**

**PRINCIPAL REGISTER**

CHHIV, CORIANE (CANADA INDIVIDUAL)  
4227 RUE RENE-GOUPIL  
MONTREAL, CANADA H1Z1W5

FOR: STUFFED AND PLUSH TOYS, IN CLASS 28 (U.S. CLS. 22, 23, 38 AND 50).

FIRST USE 10-8-2010; IN COMMERCE 10-8-2010.

THE MARK CONSISTS OF STANDARD CHARACTERS WITHOUT CLAIM TO ANY PARTICULAR FONT, STYLE, SIZE, OR COLOR.

SER. NO. 85-415,128, FILED 9-5-2011.

JUDITH HELFMAN, EXAMINING ATTORNEY



*David J. Kyros*

Director of the United States Patent and Trademark Office

# United States of America

United States Patent and Trademark Office



**Reg. No. 4,135,451**

**Registered May 1, 2012**

**Int. Cl.: 41**

**SERVICE MARK**

**PRINCIPAL REGISTER**

THE JEWISH MOTHER, INC. (VIRGINIA CORPORATION)  
320 GRANBY STREET  
NORFOLK, VA 23510

FOR: ENTERTAINMENT SERVICES IN THE NATURE OF PRESENTING LIVE MUSICAL PERFORMANCES; PROVISION OF INFORMATION RELATING TO LIVE ENTERTAINMENT, IN CLASS 41 (U.S. CLS. 100, 101 AND 107).

FIRST USE 9-5-1975; IN COMMERCE 3-5-1976.

THE MARK CONSISTS OF WOMAN WITH BAG OF GROCERIES AT HER FEET.

SER. NO. 85-415,207, FILED 9-6-2011.

NAAKWAMA ANKRAH, EXAMINING ATTORNEY



*David J. Kyffers*

Director of the United States Patent and Trademark Office

# United States of America

United States Patent and Trademark Office

## THE JEWISH MOTHER

**Reg. No. 4,135,452**

**Registered May 1, 2012**

**Int. Cl.: 41**

**SERVICE MARK**

**PRINCIPAL REGISTER**

THE JEWISH MOTHER, INC. (VIRGINIA CORPORATION)  
320 GRANBY STREET  
NORFOLK, VA 23510

FOR: ENTERTAINMENT SERVICES IN THE NATURE OF PRESENTING LIVE MUSICAL PERFORMANCES; PROVISION OF INFORMATION RELATING TO LIVE ENTERTAINMENT, IN CLASS 41 (U.S. CLS. 100, 101 AND 107).

FIRST USE 9-5-1975; IN COMMERCE 3-5-1976.

THE MARK CONSISTS OF STANDARD CHARACTERS WITHOUT CLAIM TO ANY PARTICULAR FONT, STYLE, SIZE, OR COLOR.

OWNER OF U.S. REG. NOS. 1,131,505 AND 1,598,787.

SER. NO. 85-415,219, FILED 9-6-2011.

NAAKWAMA ANKRAH, EXAMINING ATTORNEY



*David J. Kyffers*

Director of the United States Patent and Trademark Office

# United States of America

United States Patent and Trademark Office



**Reg. No. 4,135,453**

**Registered May 1, 2012**

**Int. Cl.: 43**

**SERVICE MARK**

**PRINCIPAL REGISTER**

THE JEWISH MOTHER, INC. (VIRGINIA CORPORATION)  
320 GRANBY STREET  
NORFOLK, VA 23510

FOR: RESTAURANT, BAR AND CATERING SERVICES, IN CLASS 43 (U.S. CLS. 100 AND 101).

FIRST USE 9-5-1975; IN COMMERCE 3-5-1976.

THE MARK CONSISTS OF WOMAN WITH A BAG OF GROCERIES AT HER FEET.

SER. NO. 85-415,221, FILED 9-6-2011.

NAAKWAMA ANKRAH, EXAMINING ATTORNEY



*David J. Kyfos*

Director of the United States Patent and Trademark Office

# United States of America

United States Patent and Trademark Office



**Reg. No. 4,135,454**

**Registered May 1, 2012**

**Int. Cl.: 41**

**SERVICE MARK**

**PRINCIPAL REGISTER**

FITCH, DONALD MARDEN (UNITED STATES INDIVIDUAL)  
20 WEYBURN ROAD  
SCARSDALE, NY 10583

FOR: EDUCATION SERVICES, NAMELY, PROVIDING ON-LINE JOB SKILLS TRAINING, VIA E-LEARNING CLASSES, IN THE FIELD OF COMPUTER/INTERNET OFFICE SKILLS, IN CLASS 41 (U.S. CLS. 100, 101 AND 107).

FIRST USE 6-22-2011; IN COMMERCE 8-10-2011.

THE MARK CONSISTS OF THE TEXT "CYBILITY" IN A STYLIZED FONT IN BLACK AND WHITE ON THE WHITE SCREEN OF A BLACK LAPTOP/NOTEBOOK COMPUTER WITH WHITE KEYS AND GRAY SHADING THAT IS PARTIALLY OBSTRUCTING A BLUE PUZZLE PIECE OUTLINED IN BLACK WITH HEAVY OUTLINES SUPERIMPOSED ON A YELLOW SUN WITH RAYS.

THE COLOR(S) BLUE, YELLOW, BLACK, WHITE AND GRAY IS/ARE CLAIMED AS A FEATURE OF THE MARK.

SER. NO. 85-415,307, FILED 9-6-2011.

LINDA ORNDORFF, EXAMINING ATTORNEY



*David J. Kyros*

Director of the United States Patent and Trademark Office

# United States of America

United States Patent and Trademark Office



**Reg. No. 4,135,455**

ASAP ACCOUNTING AND PAYROLL, INC. (COLORADO CORPORATION)  
PO BOX 2710  
TELLURIDE, CO 81435

**Registered May 1, 2012**

**Int. Cl.: 35**

FOR: ACCOUNTING, BOOKKEEPING, PAYROLL, NAMELY, PAYROLL PROCESSING SERVICES, ALL FOR BUSINESSES, NON-PROFIT ORGANIZATIONS, GOVERNMENTAL ENTITIES, AND OWNERS ASSOCIATIONS, IN CLASS 35 (U.S. CLS. 100, 101 AND 102).

**SERVICE MARK**

FIRST USE 6-1-2004; IN COMMERCE 6-1-2004.

**PRINCIPAL REGISTER**

THE MARK CONSISTS OF THE LETTERS "A","S","A","P" IN WHITE INSIDE A BLACK BOX WITH A RED LINE EXTENDING HORIZONTALLY ACROSS THE ENTIRE MARK. NO CLAIM IS MADE TO BACKGROUND COLOR.

THE COLOR(S) WHITE, BLACK AND RED IS/ARE CLAIMED AS A FEATURE OF THE MARK.

SER. NO. 85-415,359, FILED 9-6-2011.

LEIGH CAROLINE CASE, EXAMINING ATTORNEY



*David J. Kyffers*

Director of the United States Patent and Trademark Office

# United States of America

United States Patent and Trademark Office

# ThermaDivide

**Reg. No. 4,135,456**

**Registered May 1, 2012**

**Int. Cl.: 19**

**TRADEMARK**

**PRINCIPAL REGISTER**

US DAYLIGHTING, LLC (KENTUCKY LIMITED LIABILITY COMPANY)  
813 CLAY STREET  
BOWLING GREEN, KY 42101

FOR: INSULATED GLASS, IN CLASS 19 (U.S. CLS. 1, 12, 33 AND 50).

FIRST USE 8-4-2011; IN COMMERCE 8-11-2011.

THE MARK CONSISTS OF STANDARD CHARACTERS WITHOUT CLAIM TO ANY PARTICULAR FONT, STYLE, SIZE, OR COLOR.

SER. NO. 85-415,534, FILED 9-6-2011.

YAT SYE, LEE, EXAMINING ATTORNEY



*David J. Kyffers*

Director of the United States Patent and Trademark Office

# United States of America

United States Patent and Trademark Office



**Reg. No. 4,135,457**

**Registered May 1, 2012**

**Int. Cl.: 44**

**SERVICE MARK**

**PRINCIPAL REGISTER**

CHRISTEL B. D'AGOSTINO, LLC (NEW YORK LIMITED LIABILITY COMPANY)  
310 WEST 72 STREET  
NEW YORK, NY 10023

FOR: ENERGY HEALING SERVICES, NAMELY, STRESS MANAGEMENT AND STRESS REDUCTION COUNSELING FOR INDIVIDUALS TO ENHANCE THEIR LIVES, IN CLASS 44 (U.S. CLS. 100 AND 101).

FIRST USE 1-15-1992; IN COMMERCE 1-15-1992.

THE STIPLING IS FOR SHADING PURPOSES ONLY.

THE MARK CONSISTS OF AN ABSTRACT DESIGN ON THE LEFT WITH THE STYLIZED TEXT "UVT VIBRATION OF LIFE".

SER. NO. 85-415,562, FILED 9-6-2011.

JORDAN BAKER, EXAMINING ATTORNEY



*David J. Kyffers*

Director of the United States Patent and Trademark Office



# United States of America

United States Patent and Trademark Office



**Reg. No. 4,135,458**

U.S. SEEDS, LLC (ARKANSAS LIMITED LIABILITY COMPANY)  
2528 ALEXANDER DR.  
JONESBORO, AR 724017175

**Registered May 1, 2012**

**Int. Cl.: 31**

FOR: AGRICULTURAL SEEDS, IN CLASS 31 (U.S. CLS. 1 AND 46).

**TRADEMARK**

FIRST USE 3-1-2008; IN COMMERCE 3-1-2008.

**PRINCIPAL REGISTER**

THE MARK CONSISTS OF THE WORD "HALO" WITH A HALO IN PERSPECTIVE ABOVE THE LETTER "A" WITH STYLIZED FLAMES RISING VERTICALLY THEREABOVE.

SER. NO. 85-415,650, FILED 9-6-2011.

VIVIAN MICZNIK FIRST, EXAMINING ATTORNEY



*David J. Kybas*

Director of the United States Patent and Trademark Office

# United States of America

United States Patent and Trademark Office

## COUPON SNOB

**Reg. No. 4,135,459**

**Registered May 1, 2012**

**Int. Cl.: 35**

**SERVICE MARK**

**PRINCIPAL REGISTER**

THE COUPON SNOB, INC. (INDIANA CORPORATION)  
33 W. LAWRIN BLVD.  
TERRE HAUTE, IN 47803

FOR: PROMOTING THE GOODS OF OTHERS, NAMELY, PROVIDING INFORMATION REGARDING DISCOUNTS, COUPONS, REBATES, VOUCHERS AND SPECIAL OFFERS FOR THE GOODS OF OTHERS, IN CLASS 35 (U.S. CLS. 100, 101 AND 102).

FIRST USE 11-17-2010; IN COMMERCE 11-17-2010.

THE MARK CONSISTS OF STANDARD CHARACTERS WITHOUT CLAIM TO ANY PARTICULAR FONT, STYLE, SIZE, OR COLOR.

NO CLAIM IS MADE TO THE EXCLUSIVE RIGHT TO USE "COUPON", APART FROM THE MARK AS SHOWN.

SER. NO. 85-415,657, FILED 9-6-2011.

AMY HELLA, EXAMINING ATTORNEY



*David J. Kyffers*

Director of the United States Patent and Trademark Office

# United States of America

United States Patent and Trademark Office

let the spirit move you

**Reg. No. 4,135,460**

**Registered May 1, 2012**

**Int. Cl.: 25**

**TRADEMARK**

**PRINCIPAL REGISTER**

JIWA UNLIMITED (WASHINGTON LIMITED LIABILITY COMPANY)  
1328 N JACKSON AVE  
TACOMA, WA 98406

FOR: SURF WEAR; WEARABLE GARMENTS AND CLOTHING, NAMELY, SHIRTS, IN CLASS 25 (U.S. CLS. 22 AND 39).

FIRST USE 1-1-2011; IN COMMERCE 3-1-2011.

THE MARK CONSISTS OF STANDARD CHARACTERS WITHOUT CLAIM TO ANY PARTICULAR FONT, STYLE, SIZE, OR COLOR.

SER. NO. 85-415,700, FILED 9-6-2011.

MARY ROSSMAN, EXAMINING ATTORNEY



*David J. Kyffers*

Director of the United States Patent and Trademark Office

# United States of America

United States Patent and Trademark Office

# ODAPRA

**Reg. No. 4,135,461**

**Registered May 1, 2012**

**Int. Cl.: 5**

**TRADEMARK**

**PRINCIPAL REGISTER**

CELGENE CORPORATION (DELAWARE CORPORATION)  
86 MORRIS AVENUE  
SUMMIT, NJ 07901

FOR: PHARMACEUTICAL PREPARATIONS FOR THE TREATMENT OF IMMUNE SYSTEM RELATED DISEASES AND DISORDERS, IN CLASS 5 (U.S. CLS. 6, 18, 44, 46, 51 AND 52).

THE MARK CONSISTS OF STANDARD CHARACTERS WITHOUT CLAIM TO ANY PARTICULAR FONT, STYLE, SIZE, OR COLOR.

PRIORITY CLAIMED UNDER SEC. 44(D) ON SWITZERLAND APPLICATION NO. 59902/2011, FILED 8-31-2011, REG. NO. 619759, DATED 8-31-2011, EXPIRES 8-31-2021.

THE WORDING "ODAPRA" HAS NO MEANING IN A FOREIGN LANGUAGE.

SER. NO. 85-415,717, FILED 9-6-2011.

TASNEEM HUSSAIN, EXAMINING ATTORNEY



*David J. Kybas*

Director of the United States Patent and Trademark Office

# United States of America

United States Patent and Trademark Office

# HALO

**Reg. No. 4,135,462**

**Registered May 1, 2012**

**Int. Cl.: 31**

**TRADEMARK**

**PRINCIPAL REGISTER**

U.S. SEEDS, LLC (ARKANSAS LIMITED LIABILITY COMPANY)  
2528 ALEXANDER DR.  
JONESBORO, AR 724017175

FOR: AGRICULTURAL SEEDS, IN CLASS 31 (U.S. CLS. 1 AND 46).

FIRST USE 3-1-2008; IN COMMERCE 3-1-2008.

THE MARK CONSISTS OF STANDARD CHARACTERS WITHOUT CLAIM TO ANY PARTICULAR FONT, STYLE, SIZE, OR COLOR.

SER. NO. 85-415,728, FILED 9-6-2011.

VIVIAN MICZNIK FIRST, EXAMINING ATTORNEY



*David J. Kyffers*

Director of the United States Patent and Trademark Office

# United States of America

United States Patent and Trademark Office

# ROCO

**Reg. No. 4,135,463**

**Registered May 1, 2012**

**Int. Cl.: 41**

**SERVICE MARK**

**PRINCIPAL REGISTER**

RIVER OAKS CHAMBER ORCHESTRA (TEXAS NON-PROFIT CORPORATION)  
3733-1 WESTHEIMER RD. #1029  
HOUSTON, TX 77027

FOR: ENTERTAINMENT IN THE NATURE OF ORCHESTRA AND CHAMBER PERFORMANCES, IN CLASS 41 (U.S. CLS. 100, 101 AND 107).

FIRST USE 12-1-2005; IN COMMERCE 12-1-2005.

THE MARK CONSISTS OF STANDARD CHARACTERS WITHOUT CLAIM TO ANY PARTICULAR FONT, STYLE, SIZE, OR COLOR.

SER. NO. 85-415,741, FILED 9-6-2011.

VIVIAN MICZNIK FIRST, EXAMINING ATTORNEY



*David J. Kybas*

Director of the United States Patent and Trademark Office

# United States of America

United States Patent and Trademark Office

# PAZNEO

**Reg. No. 4,135,464**

**Registered May 1, 2012**

**Int. Cl.: 5**

**TRADEMARK**

**PRINCIPAL REGISTER**

CELGENE CORPORATION (DELAWARE CORPORATION)  
86 MORRIS AVENUE  
SUMMIT, NJ 07901

FOR: PHARMACEUTICAL PREPARATIONS FOR THE TREATMENT OF IMMUNE SYSTEM RELATED DISEASES AND DISORDERS, IN CLASS 5 (U.S. CLS. 6, 18, 44, 46, 51 AND 52).

THE MARK CONSISTS OF STANDARD CHARACTERS WITHOUT CLAIM TO ANY PARTICULAR FONT, STYLE, SIZE, OR COLOR.

PRIORITY CLAIMED UNDER SEC. 44(D) ON SWITZERLAND APPLICATION NO. 59904/2011, FILED 8-31-2011, REG. NO. 619761, DATED 8-31-2011, EXPIRES 8-31-2021.

THE WORDING "PAZNEO" HAS NO MEANING IN A FOREIGN LANGUAGE.

SER. NO. 85-415,773, FILED 9-6-2011.

TASNEEM HUSSAIN, EXAMINING ATTORNEY



*David J. Kybas*

Director of the United States Patent and Trademark Office

# United States of America

United States Patent and Trademark Office

# BODAPRA

**Reg. No. 4,135,465**

**Registered May 1, 2012**

**Int. Cl.: 5**

**TRADEMARK**

**PRINCIPAL REGISTER**

CELGENE CORPORATION (DELAWARE CORPORATION)  
86 MORRIS AVENUE  
SUMMIT, NJ 07901

FOR: PHARMACEUTICAL PREPARATIONS FOR THE TREATMENT OF IMMUNE SYSTEM RELATED DISEASES AND DISORDERS, IN CLASS 5 (U.S. CLS. 6, 18, 44, 46, 51 AND 52).

THE MARK CONSISTS OF STANDARD CHARACTERS WITHOUT CLAIM TO ANY PARTICULAR FONT, STYLE, SIZE, OR COLOR.

PRIORITY CLAIMED UNDER SEC. 44(D) ON SWITZERLAND APPLICATION NO. 59905/2011, FILED 8-31-2011, REG. NO. 619762, DATED 8-31-2011, EXPIRES 8-31-2021.

THE WORDING "BODAPRA" HAS NO MEANING IN A FOREIGN LANGUAGE.

SER. NO. 85-415,796, FILED 9-6-2011.

TASNEEM HUSSAIN, EXAMINING ATTORNEY



*David J. Kybas*

Director of the United States Patent and Trademark Office



# United States of America

United States Patent and Trademark Office



**Reg. No. 4,135,466**

**Registered May 1, 2012**

**Int. Cl.: 9**

**TRADEMARK**

**PRINCIPAL REGISTER**

V3 SYSTEMS, INC. (NEVADA CORPORATION)  
6405 S. 3000 E., 2ND FL  
SALT LAKE CITY, UT 84098

FOR: COMPUTER HARDWARE AND SOFTWARE FOR OPTIMIZING VIRTUAL DESKTOPS AND VIRTUAL DESKTOP MANAGEMENT SERVICES, IN CLASS 9 (U.S. CLS. 21, 23, 26, 36 AND 38).

FIRST USE 8-29-2010; IN COMMERCE 8-29-2010.

THE MARK CONSISTS OF THE LETTER "V" AND THE NUMBER "3".

SER. NO. 85-415,840, FILED 9-6-2011.

JENNY PARK, EXAMINING ATTORNEY



*David J. Kyffers*

Director of the United States Patent and Trademark Office

# United States of America

United States Patent and Trademark Office

## EDISON 2 FAVORED BY PHYSICS

**Reg. No. 4,135,467**

**Registered May 1, 2012**

**Int. Cl.: 42**

**SERVICE MARK**

**PRINCIPAL REGISTER**

EDISON 2, LLC (VIRGINIA LIMITED LIABILITY COMPANY)  
108 2ND STREET, SW. SUITE 2  
CHARLOTTESVILLE, VA 22902

FOR: AUTOMOTIVE DESIGN SERVICES, IN CLASS 42 (U.S. CLS. 100 AND 101).

FIRST USE 1-11-2010; IN COMMERCE 1-11-2010.

THE MARK CONSISTS OF STANDARD CHARACTERS WITHOUT CLAIM TO ANY PARTICULAR FONT, STYLE, SIZE, OR COLOR.

SER. NO. 85-415,870, FILED 9-6-2011.

ELI HELLMAN, EXAMINING ATTORNEY



*David J. Kyffers*

Director of the United States Patent and Trademark Office

# United States of America

United States Patent and Trademark Office

## Condex

**Reg. No. 4,135,468**

**Registered May 1, 2012**

**Int. Cl.: 10**

**TRADEMARK**

**PRINCIPAL REGISTER**

ASF GROUP (NETHERLANDS CORPORATION)  
PO BOX 4179  
ARNHEM, NETHERLANDS 6803ED

FOR: CONDOMS, IN CLASS 10 (U.S. CLS. 26, 39 AND 44).

THE MARK CONSISTS OF STANDARD CHARACTERS WITHOUT CLAIM TO ANY PARTICULAR FONT, STYLE, SIZE, OR COLOR.

OWNER OF ERPN CMNTY TM OFC REG. NO. 002190502, DATED 2-10-2003, RENEWED AS REG. NO. 002190502, DATED 3-13-2011, EXPIRES 4-25-2021.

SER. NO. 85-415,892, FILED 9-6-2011.

SKYE YOUNG, EXAMINING ATTORNEY



*David J. Kyffers*

Director of the United States Patent and Trademark Office

# United States of America

United States Patent and Trademark Office



**REDKNIGHT**  
M A R K E T I N G

**Reg. No. 4,135,469**

**Registered May 1, 2012**

**Int. Cls.: 35 and 42**

**SERVICE MARK**

**PRINCIPAL REGISTER**

REDKNIGHT MARKETING INC (PENNSYLVANIA CORPORATION)  
FIRST FLOOR  
430 SCWHENKSVILLE RD.  
SCWHENKSVILLE, PA 19473

FOR: MARKETING CONSULTING; MARKETING STRATEGY CONSULTING; BUSINESS CONSULTING AND INFORMATION SERVICES; PAY PER CLICK (PPC) ADVERTISING MANAGEMENT SERVICES; FRANCHISING, NAMELY, CONSULTATION AND ASSISTANCE IN BUSINESS MANAGEMENT, ORGANIZATION AND PROMOTION, IN CLASS 35 (U.S. CLS. 100, 101 AND 102).

FIRST USE 1-1-2006; IN COMMERCE 1-1-2006.

FOR: DESIGN OF HOME PAGES AND WEB SITES; COMPUTER SERVICES, NAMELY, SEARCH ENGINE OPTIMIZATION; GRAPHIC DESIGN SERVICES, IN CLASS 42 (U.S. CLS. 100 AND 101).

FIRST USE 1-1-2006; IN COMMERCE 1-1-2006.

NO CLAIM IS MADE TO THE EXCLUSIVE RIGHT TO USE "MARKETING" , APART FROM THE MARK AS SHOWN.

THE MARK CONSISTS OF THE STYLIZED TEXT "REDKNIGHT" ABOVE THE STYLIZED TEXT "MARKETING". TO THE LEFT OF THE TEXT IS AN IMAGE OF A HORSE'S HEAD, VERY SIMILAR TO A CLASSIC KNIGHT FROM A CHESS SET.

SER. NO. 85-415,952, FILED 9-6-2011.

SUSAN RICHARDS, EXAMINING ATTORNEY



*David J. Kybas*

Director of the United States Patent and Trademark Office

# United States of America

United States Patent and Trademark Office

## Your California Law Firm

**Reg. No. 4,135,470**

**Registered May 1, 2012**

**Int. Cl.: 45**

**SERVICE MARK**

**PRINCIPAL REGISTER**

WALSWORTH FRANKLIN BEVINS & MCCALL, LLP (CALIFORNIA LIMITED PARTNERSHIP)  
ONE CITY BOULEVARD WEST, 5TH FLOOR  
ORANGE, CA 92868

FOR: LEGAL SERVICES, IN CLASS 45 (U.S. CLS. 100 AND 101).

FIRST USE 8-12-2011; IN COMMERCE 8-12-2011.

THE MARK CONSISTS OF STANDARD CHARACTERS WITHOUT CLAIM TO ANY PARTICULAR FONT, STYLE, SIZE, OR COLOR.

NO CLAIM IS MADE TO THE EXCLUSIVE RIGHT TO USE "CALIFORNIA LAW FIRM", APART FROM THE MARK AS SHOWN.

SER. NO. 85-415,968, FILED 9-6-2011.

CARYN GLASSER, EXAMINING ATTORNEY



*David J. Kybas*

Director of the United States Patent and Trademark Office

# United States of America

United States Patent and Trademark Office

## SACRED FLOW

**Reg. No. 4,135,471**

MEJIA, MARJORY (UNITED STATES INDIVIDUAL)  
12455 SW 93 TERR T-210  
MIAMI, FL 33186

**Registered May 1, 2012**

**Int. Cl.: 42**

FOR: CONSULTING SERVICES IN THE FIELD OF FENG SHUI DESIGN, IN CLASS 42 (U.S. CLS. 100 AND 101).

**SERVICE MARK**

FIRST USE 11-0-2009; IN COMMERCE 11-0-2009.

**PRINCIPAL REGISTER**

THE MARK CONSISTS OF STANDARD CHARACTERS WITHOUT CLAIM TO ANY PARTICULAR FONT, STYLE, SIZE, OR COLOR.

SER. NO. 85-415,993, FILED 9-6-2011.

KEVON CHISOLM, EXAMINING ATTORNEY



*David J. Kyffers*

Director of the United States Patent and Trademark Office

# United States of America

United States Patent and Trademark Office

## Floradornments

**Reg. No. 4,135,472**

MILLER, HEATHER (CANADA INDIVIDUAL)  
3814 SHOAL CREEK COURT  
AUGUSTA, GA 30907

**Registered May 1, 2012**

**Int. Cl.: 42**

FOR: CUSTOM DESIGN OF FLORAL CLOTHING AND ACCESSORIES BASED ON PERSONAL SELECTIONS MADE BY THE CUSTOMER, IN CLASS 42 (U.S. CLS. 100 AND 101).

**SERVICE MARK**

FIRST USE 2-28-2011; IN COMMERCE 2-28-2011.

**PRINCIPAL REGISTER**

THE MARK CONSISTS OF STANDARD CHARACTERS WITHOUT CLAIM TO ANY PARTICULAR FONT, STYLE, SIZE, OR COLOR.

SER. NO. 85-415,994, FILED 9-6-2011.

KEVON CHISOLM, EXAMINING ATTORNEY



*David J. Kyffers*

Director of the United States Patent and Trademark Office

# United States of America

United States Patent and Trademark Office



**Reg. No. 4,135,473**

**Registered May 1, 2012**

**Int. Cl.: 9**

**TRADEMARK**

**PRINCIPAL REGISTER**

DIGITAL LIVING NETWORK ALLIANCE (OREGON NON-PROFIT CORPORATION)  
STE 250  
4000 KRUSE WAY PLACE, BLDG 2  
LAKE OSWEGO, OR 97035

FOR: COMPUTER HARDWARE; COMPUTER PERIPHERAL EQUIPMENT; COMPUTERS; NOTEBOOK PERSONAL COMPUTERS; PERSONAL COMPUTERS (PCS); LAPTOP COMPUTERS; TABLET COMPUTERS; MOBILE MEDIA TABLETS; COMPUTER STORAGE DEVICES, NAMELY, HIGH-SPEED STORAGE SUBSYSTEMS FOR STORAGE AND BACKUP OF ELECTRONIC DATA EITHER LOCALLY OR VIA A TELECOMMUNICATIONS NETWORK; TELEVISIONS; STEREOS; HOME THEATER SYSTEMS, NAMELY, HOME THEATER RECEIVERS AND AUDIO AMPLIFIERS; AUDIO SPEAKERS, AMPLIFIERS AND DISPLAY FOR HOME THEATER ADAPTED FOR CD/DVD/VCR/MP3/ OPTICAL AND MAGNETO-OPTICAL DISC PLAYERS AND PRERECORDED COMPUTER DATA MEDIA; COMPUTER MONITORS; WIRELESS MONITORS; TV MONITORS; VIDEO MONITORS; COMPUTER GAME CONSOLES FOR USE WITH AN EXTERNAL DISPLAY SCREEN OR MONITOR; VIDEO GAME CONSOLES FOR USE WITH AN EXTERNAL DISPLAY SCREEN OR MONITOR; VIDEO GAME MACHINES FOR USE WITH TELEVISIONS; AUDIO/VIDEO RECEIVERS; VIDEO DISPLAYS; REMOTE SPEAKERS FOR MUSIC; DIGITAL CAMERAS; CAMCORDERS; PERSONAL DIGITAL ASSISTANTS (PDAS); PRINTERS; COMPUTER PRINTERS; PHOTOGRAPH PRINTERS; CELL PHONES; MOBILE PHONES; PORTABLE MUSIC PLAYERS; MOBILE PHONES AND MOBILE MEDIA TABLETS DESIGNED FOR REVIEWING MULTIMEDIA CONTENT; CD/DVD/VCR/MP3/OPTICAL AND MAGNETO-OPTICAL DISC PLAYERS AND RECORDERS; DIGITAL NETWORKING EQUIPMENT, NAMELY, SERVER, ROUTER, GATEWAY, CABLE OR WIRELESS NETWORK, SOFTWARE, COMMUNICATIONS DEVICE INTERFACES; DIGITAL PHOTO FRAMES; SET-TOP BOXES; APPLIANCES WITH INTEGRATED DIGITAL NETWORKING CAPABILITIES FOR STORING AND SHARING DIGITAL CONTENT ON A HOME COMPUTER NETWORK; COMPUTER SOFTWARE FOR SHARING, RETRIEVING, VIEWING AND CONTROLLING PICTURES, MOVIES, DIGITAL MEDIA AND MUSIC FILES BETWEEN MOBILE DEVICES AND HOME ENTERTAINMENT DEVICES; RADIOS INCORPORATING CLOCKS; VIDEO DISK PLAYERS; MODEMS; FACSIMILE MACHINES; SCANNERS; SATELLITE TELEVISION SYSTEMS, SATELLITE RADIO; DIGITAL VIDEO RECORDERS; AUDIO TAPE RECORDERS; AUDIO-VIDEO RECEIVERS; CABLE TV CONVERTERS; DIGITAL ENTERTAINMENT SYSTEMS FOR WATCHING, STORING, AND SHARING DIGITAL CONTENT ON A HOME COMPUTER NETWORK; VIDEO PROJECTORS; MULTIMEDIA PROJECTORS, IN CLASS 9 (U.S. CLS. 21, 23, 26, 36 AND 38).



*David J. Kybas*

Director of the United States Patent and Trademark Office



**Reg. No. 4,135,473** FIRST USE 3-0-2007; IN COMMERCE 3-0-2007.

OWNER OF U.S. REG. NOS. 3,613,833 AND 3,676,147.

THE MARK CONSISTS OF A STYLIZED DISC DESIGN.

SER. NO. 85-416,003, FILED 9-6-2011.

KEVON CHISOLM, EXAMINING ATTORNEY

# United States of America

United States Patent and Trademark Office



**SHILOH**  
UNIVERSITY

**Reg. No. 4,135,474**

**Registered May 1, 2012**

**Int. Cl.: 25**

**TRADEMARK**

**PRINCIPAL REGISTER**

SHILOH UNIVERSITY (IOWA CORPORATION)  
100 SHILOH DRIVE  
KALONA, IA 52247

FOR: JACKETS; POLO SHIRTS; SHIRTS, IN CLASS 25 (U.S. CLS. 22 AND 39).

FIRST USE 7-8-2011; IN COMMERCE 7-8-2011.

OWNER OF U.S. REG. NOS. 3,725,322, 3,725,324, AND 3,733,804.

THE MARK CONSISTS OF A CIRCLE WITH A STARBURST DESIGN ABOVE THE WORD "SHILOH" ABOVE THE WORD "UNIVERSITY".

SER. NO. 85-416,146, FILED 9-6-2011.

MARK SHINER, EXAMINING ATTORNEY



*David J. Kyffers*

Director of the United States Patent and Trademark Office

# United States of America

United States Patent and Trademark Office



**Reg. No. 4,135,475**

**Registered May 1, 2012**

**Int. Cl.: 21**

**TRADEMARK**

**PRINCIPAL REGISTER**

BEIJING HONGJIAN CREATIVE TRADING CO., LTD. (CHINA CORPORATION)  
XUANWU DISTRICT  
NO. 14 MALIANDAO ROAD  
BEIJING, CHINA

FOR: TEA SERVICES; TEA KETTLES; TEA SETS; TEA STRAINERS; TEA INFUSERS; NON-ELECTRIC TEA POTS; COFFEE CUPS, TEA CUPS AND MUGS; TEA CANISTERS; EARTHENWARE MUGS; PORCELAIN MUGS, IN CLASS 21 (U.S. CLS. 2, 13, 23, 29, 30, 33, 40 AND 50).

FIRST USE 10-21-2008; IN COMMERCE 8-5-2011.

THE MARK CONSISTS OF A STYLIZED CHINESE CHARACTER, BENEATH WHICH ARE TWO CHINESE CHARACTERS AND THEIR TRANSLITERATION "HONG JIAN".

THE NON-LATIN CHARACTERS IN THE MARK TRANSLITERATE TO "HONG JIAN" AND THIS MEANS "GREAT BUILD" IN ENGLISH.

THE ENGLISH TRANSLATION OF THE WORD "HONG JIAN" IN THE MARK IS "GREAT BUILD".

SER. NO. 85-416,565, FILED 9-7-2011.

REGINA DRUMMOND, EXAMINING ATTORNEY



*David J. Kybas*

Director of the United States Patent and Trademark Office

# United States of America

United States Patent and Trademark Office

## PERSPECTIVES ON CLINICAL RISK MANAGEMENT

**Reg. No. 4,135,476**

**Registered May 1, 2012**

**Int. Cl.: 16**

**TRADEMARK**

**PRINCIPAL REGISTER**

MEDICAL PROFESSIONAL MUTUAL INSURANCE COMPANY (MASSACHUSETTS CORPORATION)  
101 ARCH STREET  
BOSTON, MA 02110

FOR: NEWSLETTERS IN THE FIELD OF HEALTH CARE AND RISK MANAGEMENT; PRINTED EDUCATIONAL MATERIALS IN THE FIELD OF HEALTH CARE AND RISK MANAGEMENT, IN CLASS 16 (U.S. CLS. 2, 5, 22, 23, 29, 37, 38 AND 50).

FIRST USE 6-0-1998; IN COMMERCE 6-0-1998.

THE MARK CONSISTS OF STANDARD CHARACTERS WITHOUT CLAIM TO ANY PARTICULAR FONT, STYLE, SIZE, OR COLOR.

NO CLAIM IS MADE TO THE EXCLUSIVE RIGHT TO USE "RISK MANAGEMENT", APART FROM THE MARK AS SHOWN.

SEC. 2(F).

SER. NO. 85-416,875, FILED 9-7-2011.

JULIE WATSON, EXAMINING ATTORNEY



*David J. Kyffers*

Director of the United States Patent and Trademark Office

# United States of America

United States Patent and Trademark Office

# VIRALHEAT

**Reg. No. 4,135,477**

**Registered May 1, 2012**

**Int. Cl.: 35**

**SERVICE MARK**

**PRINCIPAL REGISTER**

VIRALHEAT, INC. (DELAWARE CORPORATION)  
1510 FASHION ISLAND BOULEVARD, SUITE 260  
SAN MATEO, CA 94404

FOR: BUSINESS ANALYSIS AND CONSULTING SERVICES, NAMELY, TRACKING AND ANALYZING SOCIAL MEDIA, WEB SITES AND APPLICATIONS OF OTHERS TO PROVIDE BUSINESS INFORMATION REGARDING RESEARCH, STRATEGY, INSIGHT, INTELLIGENCE, OPTIMIZATION, MARKETING, SALES, OPERATION, AND PRODUCT DESIGN, PARTICULARLY SPECIALIZING IN THE USE OF ANALYTIC AND STATISTIC MODELS FOR THE UNDERSTANDING AND PREDICTING INTENT OF CONSUMERS, BUSINESSES, AND MARKET TRENDS AND ACTIONS IN THE FIELD OF SOCIAL MEDIA, CUSTOMER RELATIONSHIP, REPUTATION AND BRAND MANAGEMENT; CONSULTING SERVICES IN THE FIELD OF INTERNET AND SOCIAL MEDIA MARKETING, IN CLASS 35 (U.S. CLS. 100, 101 AND 102).

FIRST USE 5-0-2009; IN COMMERCE 7-0-2009.

THE MARK CONSISTS OF STANDARD CHARACTERS WITHOUT CLAIM TO ANY PARTICULAR FONT, STYLE, SIZE, OR COLOR.

SER. NO. 85-416,965, FILED 9-7-2011.

SUSAN RICHARDS, EXAMINING ATTORNEY



*David J. Kyros*

Director of the United States Patent and Trademark Office

# United States of America

United States Patent and Trademark Office

## Freedom Benefits

**Reg. No. 4,135,478**

**Registered May 1, 2012**

**Int. Cl.: 35**

**SERVICE MARK**

**PRINCIPAL REGISTER**

NOVAK, TONY (UNITED STATES INDIVIDUAL), DBA FREEDOM BENEFITS  
183 BAYVIEW ROAD  
NEWPORT, PA 19004

FOR: PROVIDING HEALTH INSURANCE EXCHANGES IN THE NATURE OF A MARKET-PLACE THAT OFFERS PURCHASERS OF HEALTH INSURANCE A VARIETY OF PLANS FROM DIFFERENT INSURANCE PROVIDERS, IN CLASS 35 (U.S. CLS. 100, 101 AND 102).

FIRST USE 4-15-1997; IN COMMERCE 4-15-1997.

THE MARK CONSISTS OF STANDARD CHARACTERS WITHOUT CLAIM TO ANY PARTICULAR FONT, STYLE, SIZE, OR COLOR.

NO CLAIM IS MADE TO THE EXCLUSIVE RIGHT TO USE "BENEFITS", APART FROM THE MARK AS SHOWN.

SER. NO. 85-416,972, FILED 9-7-2011.

SUSAN RICHARDS, EXAMINING ATTORNEY



*David J. Kyjars*

Director of the United States Patent and Trademark Office

# United States of America

United States Patent and Trademark Office

# ProcurDirect

**Reg. No. 4,135,479**

**Registered May 1, 2012**

**Int. Cl.: 35**

**SERVICE MARK**

**PRINCIPAL REGISTER**

TELWORX COMMUNICATIONS, LLC (NORTH CAROLINA LIMITED LIABILITY COMPANY)  
239 WELCOME CENTER ROAD  
LEXINGTON, NC 27295

FOR: IMPORT AGENCY SERVICES IN THE FIELD OF TELECOMMUNICATIONS EQUIPMENT, IN CLASS 35 (U.S. CLS. 100, 101 AND 102).

FIRST USE 10-0-2007; IN COMMERCE 10-0-2007.

THE MARK CONSISTS OF STANDARD CHARACTERS WITHOUT CLAIM TO ANY PARTICULAR FONT, STYLE, SIZE, OR COLOR.

SER. NO. 85-417,988, FILED 9-8-2011.

LINDA POWELL, EXAMINING ATTORNEY



*David J. Kyffers*

Director of the United States Patent and Trademark Office

# United States of America

United States Patent and Trademark Office

# TrustWorkz

**Reg. No. 4,135,480**

**Registered May 1, 2012**

**Int. Cl.: 35**

**SERVICE MARK**

**PRINCIPAL REGISTER**

TRUSTWORKZ, INC. (GEORGIA CORPORATION)  
2449 TOWNE LAKE PARKWAY  
WOODSTOCK, GA 30189

FOR: ADVERTISING AND MARKETING SERVICES PROVIDED BY MEANS OF INDIRECT METHODS OF MARKETING COMMUNICATIONS, NAMELY, SOCIAL MEDIA, SEARCH ENGINE MARKETING, INQUIRY MARKETING, INTERNET MARKETING, MOBILE MARKETING, BLOGGING AND OTHER FORMS OF PASSIVE, SHARABLE OR VIRAL COMMUNICATIONS CHANNELS, IN CLASS 35 (U.S. CLS. 100, 101 AND 102).

FIRST USE 9-1-2011; IN COMMERCE 9-6-2011.

NO CLAIM IS MADE TO THE EXCLUSIVE RIGHT TO USE "1/16", APART FROM THE MARK AS SHOWN.

THE MARK CONSISTS OF THE WORDING "TRUSTWORKZ" WHEREIN THE LETTER "O" IS DEPICTED AS A MECHANICAL GEAR DESIGN WITH THE FRACTION "1/16" CENTERED INSIDE THE GEAR DESIGN.

SER. NO. 85-418,490, FILED 9-9-2011.

KELLY CHOE, EXAMINING ATTORNEY



*David J. Kyros*

Director of the United States Patent and Trademark Office



# United States of America

United States Patent and Trademark Office

# eListening

**Reg. No. 4,135,481**

**Registered May 1, 2012**

**Int. Cls.: 35 and 42**

**SERVICE MARK**

**PRINCIPAL REGISTER**

PENTON MEDIA, INC. (DELAWARE CORPORATION)  
249 WEST 17TH STREET  
NEW YORK, NY 10011

FOR: ADVERTISING AND MARKETING CONSULTANCY IN THE FIELDS OF SOCIAL NETWORKING AND SOCIAL MEDIA; ADVERTISING AND MARKETING SERVICES IN THE FIELDS OF SOCIAL NETWORKING AND SOCIAL MEDIA PROVIDED BY MEANS OF INDIRECT METHODS OF MARKETING COMMUNICATIONS, NAMELY, SOCIAL MEDIA, SEARCH ENGINE MARKETING, INQUIRY MARKETING, INTERNET MARKETING, MOBILE MARKETING, BLOGGING AND OTHER FORMS OF PASSIVE, SHARABLE OR VIRAL COMMUNICATIONS CHANNELS; ADVERTISING AND MARKETING SERVICES IN THE FIELDS OF SOCIAL NETWORKING AND SOCIAL MEDIA, NAMELY, PROMOTING THE GOODS AND SERVICES OF OTHERS; ANALYSIS OF MARKET RESEARCH DATA AND STATISTICS IN THE FIELDS OF SOCIAL NETWORKING AND SOCIAL MEDIA; ASSISTANCE, ADVISORY SERVICES AND CONSULTANCY IN THE FIELDS OF SOCIAL NETWORKING AND SOCIAL MEDIA WITH REGARD TO BUSINESS PLANNING, BUSINESS ANALYSIS, BUSINESS MANAGEMENT, BUSINESS ORGANIZATION, MARKETING AND CUSTOMER ANALYSIS; BUSINESS MANAGEMENT CONSULTING IN THE FIELD OF SOCIAL NETWORKING AND SOCIAL MEDIA WITH RELATION TO STRATEGY, MARKETING, SALES, OPERATION, PRODUCT DESIGN PARTICULARLY SPECIALIZING IN THE USE OF ANALYTIC AND STATISTIC MODELS FOR THE UNDERSTANDING AND PREDICTING OF CONSUMERS, BUSINESSES, AND MARKET TRENDS AND ACTIONS; BUSINESS MARKETING AND DIRECT MAIL CONSULTING SERVICES IN THE FIELDS OF SOCIAL NETWORKING AND SOCIAL MEDIA; BUSINESS MARKETING SERVICES IN THE FIELDS OF SOCIAL NETWORKING AND SOCIAL MEDIA; BUSINESS MONITORING AND CONSULTING SERVICES IN THE FIELDS OF SOCIAL NETWORKING AND SOCIAL MEDIA, NAMELY, TRACKING WEB SITES AND APPLICATIONS OF OTHERS TO PROVIDE STRATEGY, INSIGHT, MARKETING, SALES, OPERATION, PRODUCT DESIGN, PARTICULARLY SPECIALIZING IN THE USE OF ANALYTIC AND STATISTIC MODELS FOR THE UNDERSTANDING AND PREDICTING OF CONSUMERS, BUSINESSES, AND MARKET TRENDS AND ACTIONS; BUSINESS TO BUSINESS DIRECT MARKETING SERVICES IN THE FIELDS OF SOCIAL NETWORKING AND SOCIAL MEDIA; COMPUTERIZED MARKET RESEARCH SERVICES IN THE FIELDS OF SOCIAL NETWORKING AND SOCIAL MEDIA; CONSULTING SERVICES IN THE FIELD OF INTERNET MARKETING; DIRECT MARKETING CONSULTING SERVICES IN THE FIELDS OF SOCIAL NETWORKING AND SOCIAL MEDIA; MARKET ANALYSIS AND RESEARCH SERVICES IN THE FIELDS OF SOCIAL NETWORKING AND SOCIAL MEDIA; MARKET RESEARCH AND MARKET INTELLIGENCE



*David J. Kyffers*

Director of the United States Patent and Trademark Office

**Reg. No. 4,135,481** SERVICES IN THE FIELDS OF SOCIAL NETWORKING AND SOCIAL MEDIA; MARKET RESEARCH CONSULTATION IN THE FIELDS OF SOCIAL NETWORKING AND SOCIAL MEDIA; MARKETING ANALYSIS SERVICES IN THE FIELDS OF SOCIAL NETWORKING AND SOCIAL MEDIA; MARKETING AND CONSULTING SERVICES IN THE FIELD OF PROMOTING AND TRACKING THE GOODS, SERVICES, AND BRANDS OF OTHERS THROUGH ALL PUBLIC COMMUNICATION MEANS, PARTICULARLY SPECIALIZING IN THE USE OF MOBILE, SOCIAL, AND PRINT MEDIA TO DRIVE CONSUMER INTEREST, ENGAGEMENT AND ACTION; ON-LINE ADVERTISING AND MARKETING SERVICES IN THE FIELDS OF SOCIAL NETWORKING AND SOCIAL MEDIA; PROVIDING A WEBSITE FEATURING INFORMATION ON MULTI-LEVEL MARKETING BUSINESS SERVICES IN THE FIELDS OF SOCIAL NETWORKING AND SOCIAL MEDIA; PROVIDING DEMAND CREATION AND LEAD GENERATION ACTIVITIES AND SERVICES IN THE FIELDS OF SOCIAL NETWORKING AND SOCIAL MEDIA; PROVIDING INFORMATION IN THE FIELD OF MARKETING AND ON-LINE MARKETING MEDIA VIA THE INTERNET IN THE FIELDS OF SOCIAL NETWORKING AND SOCIAL MEDIA; SOCIAL MEDIA STRATEGY AND MARKETING CONSULTANCY FOCUSING ON HELPING CLIENTS CREATE AND EXTEND THEIR PRODUCT AND BRAND STRATEGIES BY BUILDING VIRALLY ENGAGING MARKETING SOLUTIONS, IN CLASS 35 (U.S. CLS. 100, 101 AND 102).

FIRST USE 7-0-2011; IN COMMERCE 7-0-2011.

FOR: CONSULTATION SERVICES IN THE FIELD OF SEARCH ENGINE OPTIMIZATION; WEBSITE DEVELOPMENT FOR OTHERS, IN CLASS 42 (U.S. CLS. 100 AND 101).

FIRST USE 7-0-2011; IN COMMERCE 7-0-2011.

THE MARK CONSISTS OF STANDARD CHARACTERS WITHOUT CLAIM TO ANY PARTICULAR FONT, STYLE, SIZE, OR COLOR.

SER. NO. 85-418,777, FILED 9-9-2011.

SUSAN STIGLITZ, EXAMINING ATTORNEY

# United States of America

United States Patent and Trademark Office

# Lowdel

**Reg. No. 4,135,482**

**Registered May 1, 2012**

**Int. Cl.: 42**

**SERVICE MARK**

**PRINCIPAL REGISTER**

LOWDEL INC. (NEW JERSEY CORPORATION)  
37 RIDGE ROAD  
GLEN ROCK, NJ 07452

FOR: COMPUTER SOFTWARE DEVELOPMENT, DEVELOPMENT OF WIRELESS COMPUTER NETWORKS, AND DATABASE DEVELOPMENT SERVICES, FOR THE PURPOSES OF AUTOMATING PRINTERS, SCANNERS, AND INDUSTRIAL CONTROLS FOR ENTERPRISE MOBILITY AND DATA COLLECTION, IN CLASS 42 (U.S. CLS. 100 AND 101).

FIRST USE 12-28-2009; IN COMMERCE 12-28-2009.

THE MARK CONSISTS OF STANDARD CHARACTERS WITHOUT CLAIM TO ANY PARTICULAR FONT, STYLE, SIZE, OR COLOR.

SER. NO. 85-419,474, FILED 9-9-2011.

TEJBIR SINGH, EXAMINING ATTORNEY



*David J. Kybas*

Director of the United States Patent and Trademark Office

# United States of America

United States Patent and Trademark Office

# S.E.T.

**Reg. No. 4,135,483**

**Registered May 1, 2012**

**Int. Cl.: 8**

**TRADEMARK**

**PRINCIPAL REGISTER**

DASCO PRO, INC (ILLINOIS CORPORATION)  
340 BLACKHAWK PARK AVE.  
ROCKFORD, IL 61104

FOR: HAND-OPERATED TOOLS, NAMELY, AXES, PICKS, SLEDGE HAMMERS, PRY BARS, FORCIBLE ENTRY BARS, WRECKING BARS, CROW BARS, PINCH BARS, PIKE POLES, PIKE POLE HOOKS, FORCIBLE ENTRY TOOLS, NAMELY, RAMS, BREACH BARS, BOLT CUTTERS, AXE HANDLES, SLEDGE HAMMER HANDLES, IN CLASS 8 (U.S. CLS. 23, 28 AND 44).

FIRST USE 5-23-2010; IN COMMERCE 8-30-2010.

THE MARK CONSISTS OF STANDARD CHARACTERS WITHOUT CLAIM TO ANY PARTICULAR FONT, STYLE, SIZE, OR COLOR.

SER. NO. 85-419,916, FILED 9-12-2011.

BRENDAN REGAN, EXAMINING ATTORNEY



*David J. Kyffers*

Director of the United States Patent and Trademark Office

# United States of America

United States Patent and Trademark Office



**Reg. No. 4,135,484**

**Registered May 1, 2012**

**Int. Cl.: 43**

**SERVICE MARK**

**PRINCIPAL REGISTER**

BARBWIRE MCGUIRE'S BODACIOUS BBQ (NEW MEXICO CORPORATION)  
2422 SUNSHINE RD SW  
ALBUQUERQUE, NM 87105

FOR: PROVIDING OF FOOD AND DRINK VIA A MOBILE TRUCK, IN CLASS 43 (U.S. CLS. 100 AND 101).

FIRST USE 6-1-2009; IN COMMERCE 6-1-2009.

NO CLAIM IS MADE TO THE EXCLUSIVE RIGHT TO USE "BBQ", APART FROM THE MARK AS SHOWN.

THE MARK CONSISTS OF A CIRCULAR DESIGN WITH A BULL SILHOUETTE. THE STYLIZED TEXT "BARBWIRE MCGUIRE'S" IS ON THE TOP. THE STYLIZED TEXT "BODACIOUS" AT THE BOTTOM AND THE STYLIZED TEXT "BBQ" IN THE MIDDLE.

SER. NO. 85-420,160, FILED 9-12-2011.

FRANK LATTUCA, EXAMINING ATTORNEY



*David J. Kybas*

Director of the United States Patent and Trademark Office

# United States of America

United States Patent and Trademark Office

## ORANGE-A-TANG

**Reg. No. 4,135,485**

**Registered May 1, 2012**

**Int. Cl.: 30**

**TRADEMARK**

**PRINCIPAL REGISTER**

SAVORY FOODS, INC. (MICHIGAN CORPORATION)  
900 HYNES AVENUE SW  
GRAND RAPIDS, MI 49501

FOR: COOKIE DOUGH, IN CLASS 30 (U.S. CL. 46).

FIRST USE 8-15-2011; IN COMMERCE 8-15-2011.

THE MARK CONSISTS OF STANDARD CHARACTERS WITHOUT CLAIM TO ANY PARTICULAR FONT, STYLE, SIZE, OR COLOR.

NO CLAIM IS MADE TO THE EXCLUSIVE RIGHT TO USE "ORANGE", APART FROM THE MARK AS SHOWN.

SER. NO. 85-420,162, FILED 9-12-2011.

MICHAEL ENGEL, EXAMINING ATTORNEY



*David J. Kybas*

Director of the United States Patent and Trademark Office

# United States of America

United States Patent and Trademark Office

## CLEAR EFFECTS

**Reg. No. 4,135,486**

**Registered May 1, 2012**

**Int. Cls.: 3 and 5**

**TRADEMARK**

**PRINCIPAL REGISTER**

PRODUCT QUEST MANUFACTURING, LLC (FLORIDA LIMITED LIABILITY COMPANY)  
330 CARSWELL AVENUE  
HOLLY HILL, FL 32117

FOR: NON-MEDICATED SKIN CARE PREPARATIONS; LOTIONS AND MOISTURIZERS  
CONTAINING SPF, ANTI-AGING CREAM, IN CLASS 3 (U.S. CLS. 1, 4, 6, 50, 51 AND 52).

FIRST USE 7-18-2003; IN COMMERCE 7-18-2003.

FOR: ACNE TREATMENT PREPARATIONS; MEDICATED FACIAL CLEANSERS; MEDICATED SKIN CARE PREPARATIONS, IN CLASS 5 (U.S. CLS. 6, 18, 44, 46, 51 AND 52).

FIRST USE 7-18-2003; IN COMMERCE 7-18-2003.

THE MARK CONSISTS OF STANDARD CHARACTERS WITHOUT CLAIM TO ANY PARTICULAR FONT, STYLE, SIZE, OR COLOR.

NO CLAIM IS MADE TO THE EXCLUSIVE RIGHT TO USE "CLEAR", APART FROM THE MARK AS SHOWN.

SER. NO. 85-420,165, FILED 9-12-2011.

DAWN FELDMAN, EXAMINING ATTORNEY



*David J. Kyros*

Director of the United States Patent and Trademark Office

# United States of America

United States Patent and Trademark Office

# WetlandMod

**Reg. No. 4,135,487**

**Registered May 1, 2012**

**Int. Cl.: 11**

**TRADEMARK**

**PRINCIPAL REGISTER**

MODULAR WETLAND SYSTEMS, INC. (CALIFORNIA CORPORATION)  
2972 SAN LUIS REY ROAD  
OCEANSIDE, CA 92054

FOR: WATER FILTRATION SYSTEMS COMPRISED OF A SERIES OF FILTERS MADE OF FIBER FOR FILTERING STORM RUN-OFF WATER; STORM WATER FILTRATION SYSTEMS, NAMELY, EXTERNAL FILTERING DEVICE FOR USE IN A LOCAL CONTAINMENT AREA FOR REMOVING OIL AND OTHER CONTAMINANTS FROM STORM DRAIN EFFLUENT AS IT EXITS STORM WATER SYSTEMS; STORM WATER FILTERING UNITS FEATURING NON-METAL FILTERING BOOMS AND TENDRILS USED TO REDUCE BACTERIA AND HYDROCARBONS IN STANDING WATER; FILTERS FOR FLUIDS, NAMELY, FOR WATER AND AREA-WATER SOLUTIONS; STORM WATER FILTRATION SYSTEMS, NAMELY, EXTERNAL FILTERING DEVICE FOR USE IN A LOCAL CONTAINMENT AREA FOR REMOVING OIL AND OTHER CONTAMINANTS FROM STORM DRAIN EFFLUENT AS IT EXITS STORM WATER SYSTEMS, IN CLASS 11 (U.S. CLS. 13, 21, 23, 31 AND 34).

FIRST USE 9-7-2011; IN COMMERCE 9-7-2011.

THE MARK CONSISTS OF STANDARD CHARACTERS WITHOUT CLAIM TO ANY PARTICULAR FONT, STYLE, SIZE, OR COLOR.

SER. NO. 85-420,292, FILED 9-12-2011.

LAURIE MAYES, EXAMINING ATTORNEY



*David J. Kyros*

Director of the United States Patent and Trademark Office



# United States of America

United States Patent and Trademark Office

## STRIKE CONSTRUCTION, LLC

**Reg. No. 4,135,488**

**Registered May 1, 2012**

**Int. Cl.: 37**

**SERVICE MARK**

**PRINCIPAL REGISTER**

STRIKE, LLC (TEXAS LIMITED LIABILITY COMPANY)  
831 CROSSBRIDGE DR.  
SPRING, TX 77373

FOR: PIPELINE CONSTRUCTION, MAINTENANCE, AND REPAIR SERVICES FOR THE OIL AND GAS INDUSTRY, IN CLASS 37 (U.S. CLS. 100, 103 AND 106).

FIRST USE 3-0-2003; IN COMMERCE 3-0-2003.

THE MARK CONSISTS OF STANDARD CHARACTERS WITHOUT CLAIM TO ANY PARTICULAR FONT, STYLE, SIZE, OR COLOR.

OWNER OF U.S. REG. NO. 3,434,733.

NO CLAIM IS MADE TO THE EXCLUSIVE RIGHT TO USE "CONSTRUCTION, LLC", APART FROM THE MARK AS SHOWN.

SER. NO. 85-420,489, FILED 9-12-2011.

MICHAEL ENGEL, EXAMINING ATTORNEY



*David J. Kybas*

Director of the United States Patent and Trademark Office

# United States of America

United States Patent and Trademark Office

## SEE THE WORLD FROM THE INSIDE

**Reg. No. 4,135,489**

**Registered May 1, 2012**

**Int. Cl.: 39**

**SERVICE MARK**

**PRINCIPAL REGISTER**

TRAFALGAR TOURS WEST, INC. (CALIFORNIA CORPORATION)  
801 E. KATELLA AVENUE  
ANAHEIM, CA 92805

FOR: TRAVEL SERVICES, NAMELY, ORGANIZING, ARRANGING AND OPERATING ESCORTED TOURS, IN CLASS 39 (U.S. CLS. 100 AND 105).

FIRST USE 9-9-2011; IN COMMERCE 9-9-2011.

THE MARK CONSISTS OF STANDARD CHARACTERS WITHOUT CLAIM TO ANY PARTICULAR FONT, STYLE, SIZE, OR COLOR.

SER. NO. 85-420,703, FILED 9-12-2011.

NANCY CLARKE, EXAMINING ATTORNEY



*David J. Kybas*

Director of the United States Patent and Trademark Office

# United States of America

United States Patent and Trademark Office

## HSS SPINE AND SPORT

**Reg. No. 4,135,490**

**Registered May 1, 2012**

**Int. Cls.: 41 and 44**

**SERVICE MARK**

**PRINCIPAL REGISTER**

HOSPITAL FOR SPECIAL SURGERY (NEW YORK NON-PROFIT CORPORATION)  
535 EAST 70TH STREET  
NEW YORK, NY 10021

FOR: PHYSICAL FITNESS TRAINING SERVICES; PERSONAL FITNESS TRAINING SERVICES AND CONSULTANCY; SPORTS TRAINING SERVICES; SPORTS PERFORMANCE ENHANCEMENT TRAINING SERVICES, IN CLASS 41 (U.S. CLS. 100, 101 AND 107).

FIRST USE 9-6-2011; IN COMMERCE 9-6-2011.

FOR: PHYSICAL REHABILITATION AND PHYSICAL THERAPY SERVICES; MASSAGE THERAPY SERVICES; MASSAGES, IN CLASS 44 (U.S. CLS. 100 AND 101).

FIRST USE 9-6-2011; IN COMMERCE 9-6-2011.

THE MARK CONSISTS OF STANDARD CHARACTERS WITHOUT CLAIM TO ANY PARTICULAR FONT, STYLE, SIZE, OR COLOR.

OWNER OF U.S. REG. NO. 1,838,935.

NO CLAIM IS MADE TO THE EXCLUSIVE RIGHT TO USE "SPINE AND SPORT" , APART FROM THE MARK AS SHOWN.

SER. NO. 85-420,836, FILED 9-12-2011.

JAMES LOVELACE, EXAMINING ATTORNEY



*David J. Kybas*

Director of the United States Patent and Trademark Office

# United States of America

United States Patent and Trademark Office

## CSI Global-Fleet

**Reg. No. 4,135,491**

**Registered May 1, 2012**

**Int. Cls.: 35 and 36**

**SERVICE MARK**

**PRINCIPAL REGISTER**

CSI ENTERPRISES, INC. (FLORIDA CORPORATION)  
SUITE 300  
3301 BONITA BEACH RD.  
BONITA SPRINGS, FL 34134

FOR: PROVIDING FUEL MANAGEMENT SERVICES IN THE FIELD OF AVIATION, COMMERCIAL TRUCKING, AND COMMERCIAL VEHICLES, IN CLASS 35 (U.S. CLS. 100, 101 AND 102).

FIRST USE 8-8-2011; IN COMMERCE 8-8-2011.

FOR: CREDIT CARD SERVICES, IN CLASS 36 (U.S. CLS. 100, 101 AND 102).

FIRST USE 8-8-2011; IN COMMERCE 8-8-2011.

THE MARK CONSISTS OF STANDARD CHARACTERS WITHOUT CLAIM TO ANY PARTICULAR FONT, STYLE, SIZE, OR COLOR.

NO CLAIM IS MADE TO THE EXCLUSIVE RIGHT TO USE "GLOBAL-FLEET", APART FROM THE MARK AS SHOWN.

SER. NO. 85-421,012, FILED 9-13-2011.

ELLEN BURNS, EXAMINING ATTORNEY



*David J. Kybas*

Director of the United States Patent and Trademark Office

# United States of America

United States Patent and Trademark Office



Corporate Spending Innovations

**Reg. No. 4,135,492**

**Registered May 1, 2012**

**Int. Cls.: 35 and 36**

**SERVICE MARK**

**PRINCIPAL REGISTER**

CSI ENTERPRISES, INC. (FLORIDA CORPORATION)  
SUITE 300  
3301 BONITA BEACH RD.  
BONITA SPRINGS, FL 34134

FOR: PROVIDING FUEL MANAGEMENT SERVICES IN THE FIELD OF AVIATION, COMMERCIAL TRUCKING AND COMMERCIAL VEHICLES, IN CLASS 35 (U.S. CLS. 100, 101 AND 102).

FIRST USE 2-28-2011; IN COMMERCE 2-28-2011.

FOR: CREDIT CARD SERVICES, IN CLASS 36 (U.S. CLS. 100, 101 AND 102).

FIRST USE 2-28-2011; IN COMMERCE 2-28-2011.

NO CLAIM IS MADE TO THE EXCLUSIVE RIGHT TO USE "CORPORATE SPENDING", APART FROM THE MARK AS SHOWN.

THE MARK CONSISTS OF THE LETTERS "CSI" WITH A TRIANGLE OVER THE "I" AND AN ARROW IN AN ORBITAL SHAPE GOING THROUGH THE LETTERS ALL HAVING THE WORDS "CORPORATE SPENDING INNOVATIONS" WRITTEN BELOW.

SER. NO. 85-421,228, FILED 9-13-2011.

ELLEN BURNS, EXAMINING ATTORNEY



*David J. Kybas*

Director of the United States Patent and Trademark Office

# United States of America

## United States Patent and Trademark Office

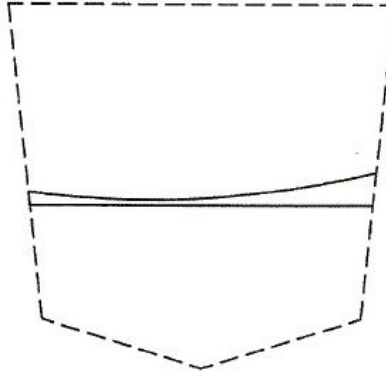

**Reg. No. 4,135,493**

**Registered May 1, 2012**

**Int. Cl.: 25**

**TRADEMARK**

**PRINCIPAL REGISTER**

ABERCROMBIE & FITCH TRADING CO. (OHIO CORPORATION)  
ATTN: JACOB KRAMER, SENIOR LEGAL COUNSEL  
6301 FITCH PATH  
NEW ALBANY, OH 43054

FOR: BOTTOMS, IN CLASS 25 (U.S. CLS. 22 AND 39).

FIRST USE 7-14-2004; IN COMMERCE 7-14-2004.

THE MARK CONSISTS OF A STITCHING DESIGN COMPRISED OF TWO LINES RUNNING HORIZONTALLY ACROSS THE CENTER OF A POCKET. THE LOWER LINE RUNS STRAIGHT ACROSS THE POCKET. THE UPPER LINE CURVES DOWNWARD, FROM LEFT TO RIGHT, TOWARD THE LOWER LINE AND THEN, APPROXIMATELY ONE THIRD OF THE WAY ACROSS THE POCKET, CURVES UPWARD AS IT CONTINUES TO THE RIGHT SIDE OF THE POCKET. THE TWO LINES COME CLOSE TO TOUCHING, BUT DO NOT TOUCH. THE DOTTED LINE AROUND THE MARK REPRESENTS THE SHAPE OF THE POCKET, WHICH IS NOT CLAIMED AS A FEATURE OF THE MARK.

SEC. 2(F).

SER. NO. 85-421,315, FILED 9-13-2011.

LINDA ORNDORFF, EXAMINING ATTORNEY



*David J. Kybas*

Director of the United States Patent and Trademark Office

# United States of America

United States Patent and Trademark Office

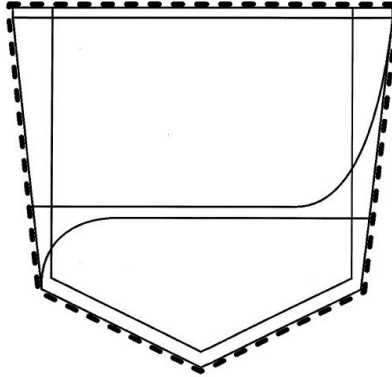

**Reg. No. 4,135,494**

**Registered May 1, 2012**

**Int. Cl.: 25**

**TRADEMARK**

**PRINCIPAL REGISTER**

ABERCROMBIE & FITCH TRADING CO. (OHIO CORPORATION)  
6301 FITCH PATH  
NEW ALBANY, OH 43054

FOR: BOTTOMS, IN CLASS 25 (U.S. CLS. 22 AND 39).

FIRST USE 4-20-2003; IN COMMERCE 4-20-2003.

THE MARK CONSISTS OF A STITCHING DESIGN COMPRISED OF TWO STRAIGHT LINES THAT EACH CURVE AT ONE END. THE DOTTED LINE AROUND THE MARK REPRESENTS THE SHAPE OF THE POCKET, WHICH IS NOT CLAIMED AS A FEATURE OF THE MARK.

SEC. 2(F).

SER. NO. 85-421,318, FILED 9-13-2011.

LINDA ORNDORFF, EXAMINING ATTORNEY



*David J. Kybas*

Director of the United States Patent and Trademark Office

# United States of America

United States Patent and Trademark Office

# RU6YSIX

**Reg. No. 4,135,495**

MORRIS, ANGELA L. (UNITED STATES INDIVIDUAL)  
1310 W. PARMER LANE #1603  
AUSTIN, TX 78727

**Registered May 1, 2012**

**Int. Cl.: 14**

FOR: JEWELRY PRODUCT LINE, NAMELY, NECKLACES, BRACELETS AND EARRINGS,  
IN CLASS 14 (U.S. CLS. 2, 27, 28 AND 50).

**TRADEMARK**

FIRST USE 9-1-2010; IN COMMERCE 10-18-2010.

**PRINCIPAL REGISTER**

THE MARK CONSISTS OF STANDARD CHARACTERS WITHOUT CLAIM TO ANY PAR-  
TICULAR FONT, STYLE, SIZE, OR COLOR.

SER. NO. 85-421,342, FILED 9-13-2011.

ANNE MADDEN, EXAMINING ATTORNEY



*David J. Kybas*

Director of the United States Patent and Trademark Office



# United States of America

United States Patent and Trademark Office

## FIGHT THE SILENCE

**Reg. No. 4,135,496**

**Registered May 1, 2012**

**Int. Cl.: 9**

**TRADEMARK**

**PRINCIPAL REGISTER**

BIG BLUE AUDIO LLC (NEW HAMPSHIRE LIMITED LIABILITY COMPANY), DBA BIG BLUE AUDIO  
ONE INNOVATION WAY  
MERRIMACK, NH 03054

FOR: AUDIO SPEAKERS, IN CLASS 9 (U.S. CLS. 21, 23, 26, 36 AND 38).

FIRST USE 10-30-2011; IN COMMERCE 10-30-2011.

THE MARK CONSISTS OF STANDARD CHARACTERS WITHOUT CLAIM TO ANY PARTICULAR FONT, STYLE, SIZE, OR COLOR.

SER. NO. 85-421,452, FILED 9-13-2011.

CARYN GLASSER, EXAMINING ATTORNEY



*David J. Kyffers*

Director of the United States Patent and Trademark Office

# United States of America

United States Patent and Trademark Office

# SOY

**Reg. No. 4,135,497**

**Registered May 1, 2012**

**Int. Cls.: 16, 36 and 38**

**TRADEMARK**

**SERVICE MARK**

**PRINCIPAL REGISTER**

IDT TELECOM, INC. (DELAWARE CORPORATION)  
550 BROAD STREET  
NEWARK, NJ 07102

FOR: PREPAID TELEPHONE CALLING CARDS, NOT MAGNETICALLY ENCODED, IN CLASS 16 (U.S. CLS. 2, 5, 22, 23, 29, 37, 38 AND 50).

FIRST USE 8-1-2011; IN COMMERCE 8-1-2011.

FOR: PREPAID TELEPHONE CALLING CARD AND TELEPHONE DEBIT CARD SERVICES, IN CLASS 36 (U.S. CLS. 100, 101 AND 102).

FIRST USE 8-1-2011; IN COMMERCE 8-1-2011.

FOR: TELEPHONE TELECOMMUNICATIONS SERVICES PROVIDED VIA PREPAID TELEPHONE CALLING CARDS, IN CLASS 38 (U.S. CLS. 100, 101 AND 104).

FIRST USE 8-1-2011; IN COMMERCE 8-1-2011.

THE MARK CONSISTS OF STANDARD CHARACTERS WITHOUT CLAIM TO ANY PARTICULAR FONT, STYLE, SIZE, OR COLOR.

THE ENGLISH TRANSLATION OF "SOY" IN THE MARK IS "I AM".

SER. NO. 85-421,744, FILED 9-13-2011.

EDWARD FENNESSY, EXAMINING ATTORNEY



*David J. Kyros*

Director of the United States Patent and Trademark Office

# United States of America

United States Patent and Trademark Office

# AUTO BALM

**Reg. No. 4,135,498**

**Registered May 1, 2012**

**Int. Cl.: 3**

**TRADEMARK**

**PRINCIPAL REGISTER**

AUTO BALM, LLC (WEST VIRGINIA LIMITED LIABILITY COMPANY)  
78 HUNTING HILLS DR.  
CHARLESTON, WV 25311

FOR: ADHESIVE REMOVERS; ALL-PURPOSE CLEANERS; AUTOMOBILE CARPET AND UPHOLSTERY CLEANING PREPARATIONS; AUTOMOBILE CLEANERS; AUTOMOBILE POLISH; AUTOMOBILE POLISHES; AUTOMOBILE TIRE CLEANING AND POLISHING PREPARATIONS; AUTOMOBILE WAX; AUTOMOBILE, TIRE, GLASS AND WHEEL CLEANING PREPARATIONS; DETERGENTS FOR AUTOMOBILES; FRAGRANCES FOR AUTOMOBILES; GLASS CLEANERS; INDUSTRIAL SOAP; PET STAIN REMOVERS; PREPARATIONS FOR CLEANING, PROTECTING AND PRESERVING VEHICLE SURFACES; STAIN REMOVERS, IN CLASS 3 (U.S. CLS. 1, 4, 6, 50, 51 AND 52).

FIRST USE 10-31-2004; IN COMMERCE 10-31-2004.

THE MARK CONSISTS OF STANDARD CHARACTERS WITHOUT CLAIM TO ANY PARTICULAR FONT, STYLE, SIZE, OR COLOR.

NO CLAIM IS MADE TO THE EXCLUSIVE RIGHT TO USE "AUTO", APART FROM THE MARK AS SHOWN.

SER. NO. 85-421,749, FILED 9-13-2011.

LUCY ARANT, EXAMINING ATTORNEY



*David J. Kyros*

Director of the United States Patent and Trademark Office

# United States of America

United States Patent and Trademark Office

# QUICKSTER

**Reg. No. 4,135,499**

**Registered May 1, 2012**

**Int. Cl.: 28**

**TRADEMARK**

**PRINCIPAL REGISTER**

PRO PERFORMANCE SPORTS, L.L.C. (CALIFORNIA LIMITED LIABILITY COMPANY)  
SUITE 130  
5823 NEWTON DRIVE  
CARLSBAD, CA 92008

FOR: SPORTS TRAINING EQUIPMENT, NAMELY, QUICK-ASSEMBLY PORTABLE MULTI-SPORT PRACTICE NETS, IN CLASS 28 (U.S. CLS. 22, 23, 38 AND 50).

FIRST USE 9-13-2011; IN COMMERCE 9-13-2011.

THE MARK CONSISTS OF STANDARD CHARACTERS WITHOUT CLAIM TO ANY PARTICULAR FONT, STYLE, SIZE, OR COLOR.

SER. NO. 85-421,781, FILED 9-13-2011.

GISELLE AGOSTO, EXAMINING ATTORNEY



*David J. Kyffers*

Director of the United States Patent and Trademark Office

# United States of America

United States Patent and Trademark Office

# GUYLINER

**Reg. No. 4,135,500**

**Registered May 1, 2012**

**Int. Cl.: 3**

**TRADEMARK**

**PRINCIPAL REGISTER**

TISH & SNOOKY'S N.Y.C. INC. (NEW YORK CORPORATION)  
4TH FLOOR  
21-07 BORDEN AVENUE  
LONG ISLAND CITY, NY 11101

FOR: COSMETIC PENCILS, IN CLASS 3 (U.S. CLS. 1, 4, 6, 50, 51 AND 52).

FIRST USE 3-1-2000; IN COMMERCE 3-1-2000.

THE MARK CONSISTS OF STANDARD CHARACTERS WITHOUT CLAIM TO ANY PARTICULAR FONT, STYLE, SIZE, OR COLOR.

SER. NO. 85-421,990, FILED 9-14-2011.

SKYE YOUNG, EXAMINING ATTORNEY



*David J. Kybas*

Director of the United States Patent and Trademark Office

# United States of America

United States Patent and Trademark Office

## SANT'ANDREA

**Reg. No. 4,135,501**

**Registered May 1, 2012**

**Int. Cl.: 21**

**TRADEMARK**

**PRINCIPAL REGISTER**

ONEIDA LTD. (DELAWARE CORPORATION)  
163-181 KENWOOD AVENUE  
ONEIDA, NY 13421

FOR: DINNERWARE, NAMELY, CUPS, SAUCERS, PLATES, PLATTERS, BOWLS, SERVING  
PIECES, IN CLASS 21 (U.S. CLS. 2, 13, 23, 29, 30, 33, 40 AND 50).

FIRST USE 9-17-2001; IN COMMERCE 9-17-2001.

THE MARK CONSISTS OF STANDARD CHARACTERS WITHOUT CLAIM TO ANY PAR-  
TICULAR FONT, STYLE, SIZE, OR COLOR.

OWNER OF U.S. REG. NOS. 2,469,654, 2,668,370 AND OTHERS.

THE ENGLISH TRANSLATION OF "SANT' ANDREA" IS "SAINT ANDREA" .

SER. NO. 85-422,102, FILED 9-14-2011.

LINDA ESTRADA, EXAMINING ATTORNEY



*David J. Kybas*

Director of the United States Patent and Trademark Office

# United States of America

United States Patent and Trademark Office

# ESPACE

**Reg. No. 4,135,502**

**Registered May 1, 2012**

**Int. Cl.: 25**

**TRADEMARK**

**PRINCIPAL REGISTER**

CLERMA (FRANCE SOCIÉTÉ PAR ACTIONS SIMPLIFIÉE (SAS))  
RUE PIERRE CURIE  
ROMANS-SUR-ISERE, FRANCE 26100

FOR: DRESS SHOES, IN CLASS 25 (U.S. CLS. 22 AND 39).

FIRST USE 0-0-1994; IN COMMERCE 0-0-1994.

THE MARK CONSISTS OF STANDARD CHARACTERS WITHOUT CLAIM TO ANY PARTICULAR FONT, STYLE, SIZE, OR COLOR.

THE ENGLISH TRANSLATION OF THE WORD "ESPACE" IN THE MARK IS "SPACE".

SER. NO. 85-422,755, FILED 9-14-2011.

SUNG IN, EXAMINING ATTORNEY



*David J. Kyfos*

Director of the United States Patent and Trademark Office

# United States of America

United States Patent and Trademark Office

# TIO NACHO

**Reg. No. 4,135,503**

GENOMMA LAB INTERNACIONAL, S.A.B. DE C.V. (MEXICO CORPORATION)  
DURANGO 332 - 102 ROMA  
MEXICO, D.F., MEXICO 06700

**Registered May 1, 2012**

**Int. Cl.: 3**

FOR: SOAPS, SHAMPOOS, CONDITIONERS, AND BODY LOTIONS, IN CLASS 3 (U.S. CLS. 1, 4, 6, 50, 51 AND 52).

**TRADEMARK**

FIRST USE 9-13-2011; IN COMMERCE 9-13-2011.

**PRINCIPAL REGISTER**

THE MARK CONSISTS OF STANDARD CHARACTERS WITHOUT CLAIM TO ANY PARTICULAR FONT, STYLE, SIZE, OR COLOR.

OWNER OF U.S. REG. NO. 1,129,434.

THE ENGLISH TRANSLATION OF "TIO NACHO" IN THE MARK IS "UNCLE IGNACIO" ('NACHO' BEING A NICKNAME FOR 'IGNACIO').

SER. NO. 85-422,756, FILED 9-14-2011.

ARETHA SOMERVILLE, EXAMINING ATTORNEY



*David J. Kyffers*

Director of the United States Patent and Trademark Office



# United States of America

United States Patent and Trademark Office



**Reg. No. 4,135,504**

HAUMEA S.R.L. (ITALY LIMITED LIABILITY COMPANY)  
VIA XIII NOVEMBRE 56  
47122 FORLI (FC), ITALY

**Registered May 1, 2012**

**Int. Cl.: 7**

FOR: PLANETARY GEAR MOTORS AND PLANETARY GEAR REDUCERS AS PARTS OF MACHINES, IN CLASS 7 (U.S. CLS. 13, 19, 21, 23, 31, 34 AND 35).

**TRADEMARK**

FIRST USE 8-31-2011; IN COMMERCE 8-31-2011.

**PRINCIPAL REGISTER**

THE MARK CONSISTS OF THE WORD "HAUMEA" IN LOWER CASE LETTERS TO THE LEFT OF WHICH ARE THREE PARTIAL CIRCULAR DESIGNS MEANT TO RESEMBLE A PROPELLER.

SER. NO. 85-422,814, FILED 9-14-2011.

AHSEN KHAN, EXAMINING ATTORNEY



*David J. Kybas*

Director of the United States Patent and Trademark Office

# United States of America

United States Patent and Trademark Office

# VOICEWORKS

**Reg. No. 4,135,505**

**Registered May 1, 2012**

**Int. Cl.: 38**

**SERVICE MARK**

**PRINCIPAL REGISTER**

VOICEWORKS INCORPORATED (TEXAS CORPORATION)  
5339 MAGDELENA DR  
AUSTIN, TX 78735

FOR: CELLULAR TELEPHONE SERVICES, IN CLASS 38 (U.S. CLS. 100, 101 AND 104).

FIRST USE 5-25-2011; IN COMMERCE 5-25-2011.

THE MARK CONSISTS OF THE WORD "VOICEWORKS" WITH THE SECOND "O" IN THE WORD SUBSTITUTED WITH THE VOICEWORKS LOGO, WHICH IS A FIGURE COMPRISING TWO CONCENTRIC CIRCULAR SHAPES, DESCRIBED FURTHER AS FOLLOWS. THE OUTER SHAPE APPEARS AS A NEARLY COMPLETE CIRCLE EXTENDING FROM THE EIGHT O'CLOCK POSITION AROUND TO THE SEVEN O'CLOCK POSITION, WITH TWO LINES EXTENDING OUTWARD FROM THOSE POINTS TO FORM TWO LEGS OF AN ISOSCELES TRIANGLE THAT JOIN TOGETHER AT A POINT THAT IS APPROXIMATELY THE SAME DISTANCE FROM THE MID-POINT OF THE LINE CONSTITUTING THE OUTER CIRCULAR SHAPE AS SUCH MID-POINT IS FROM THE CENTER OF THE CIRCLE, AND WITH THE LEGS OF THE TRIANGLE EXTENDING AT APPROXIMATELY SIXTY DEGREE ANGLES FROM AN IMAGINARY TANGENT TO THE CIRCULAR SHAPE THAT CONSTITUTES THE BASE OF THE TRIANGLE, WITH THE POINT OF TANGENCY LOCATED HALFWAY BETWEEN THE SEVEN AND EIGHT O'CLOCK POSITIONS. THE SECOND SHAPE IS A SEMICIRCLE LOCATED WITHIN, BUT NOT ATTACHED TO, THE FIRST SHAPE, COMPRISING A LINE OF EQUAL THICKNESS AS THE OUTER SHAPE EXTENDING FROM THE THREE O'CLOCK TO THE NINE O'CLOCK POSITION. THE THICKNESSES OF THE LINES OF BOTH THE OUTER AND INNER SHAPES ARE APPROXIMATELY ONE FOURTH (1/4TH) OF THE RADIUS OF THE OUTER CIRCULAR SHAPE AS MEASURED FROM THE CENTER-POINT TO THE OUTER EDGE OF THE CIRCLE. THE OVERALL FIGURE RESEMBLES A CIRCULAR, EYE-LESS, "SMILEY-FACE" CARTOON QUOTE BUBBLE WITH THE POINT OF THE BUBBLE EXTENDING DOWNWARDS FROM THE LOWER LEFT QUADRANT.



SER. NO. 85-423,034, FILED 9-14-2011.

*David J. Kyros*

VIVIAN MICZNIK FIRST, EXAMINING ATTORNEY

# United States of America

United States Patent and Trademark Office

## I'm Not A Pretender!

**Reg. No. 4,135,506**

**Registered May 1, 2012**

**Int. Cl.: 25**

**TRADEMARK**

**PRINCIPAL REGISTER**

TIMOTHY L WILKS (UNITED STATES INDIVIDUAL)  
2B  
621 EAST 105TH STREET  
BROOKLYN, NY 11236

FOR: ATHLETIC APPAREL, NAMELY, SHIRTS, PANTS, JACKETS, FOOTWEAR, HATS AND CAPS, ATHLETIC UNIFORMS; T-SHIRTS, IN CLASS 25 (U.S. CLS. 22 AND 39).

FIRST USE 12-15-2005; IN COMMERCE 4-28-2006.

THE MARK CONSISTS OF STANDARD CHARACTERS WITHOUT CLAIM TO ANY PARTICULAR FONT, STYLE, SIZE, OR COLOR.

SER. NO. 85-423,051, FILED 9-14-2011.

EMILY CHUO, EXAMINING ATTORNEY



*David J. Kyffers*

Director of the United States Patent and Trademark Office

# United States of America

United States Patent and Trademark Office



**Reg. No. 4,135,507**

**Registered May 1, 2012**

**Int. Cls.: 35, 36 and 41**

**SERVICE MARK**

**PRINCIPAL REGISTER**

AMERICAREERS LLC (MICHIGAN LIMITED LIABILITY COMPANY)  
PO BOX 21126  
LANSING, MI 48909

FOR: PERSONNEL PLACEMENT AND RECRUITMENT; PROVIDING AN ON-LINE SEARCHABLE DATABASE FEATURING EMPLOYMENT OPPORTUNITIES; PROVIDING EMPLOYMENT INFORMATION; RECRUITMENT OF STUDENTS FOR HIGHER EDUCATION INSTITUTIONS, IN CLASS 35 (U.S. CLS. 100, 101 AND 102).

FIRST USE 9-27-2005; IN COMMERCE 9-27-2005.

FOR: PROVIDING AN ON-LINE SEARCHABLE DATABASE FEATURING EDUCATION GRANTS, IN CLASS 36 (U.S. CLS. 100, 101 AND 102).

FIRST USE 4-18-2009; IN COMMERCE 4-18-2009.

FOR: PROVIDING A WEB SITE THAT FEATURES INFORMATION ABOUT ONLINE HIGHER EDUCATION RESOURCES; PROVIDING INFORMATION ABOUT EDUCATION, IN CLASS 41 (U.S. CLS. 100, 101 AND 107).

FIRST USE 4-18-2009; IN COMMERCE 4-18-2009.

OWNER OF U.S. REG. NOS. 3,669,347 AND 3,970,697.

THE MARK CONSISTS OF THE WORD "AMERICAREERS" AND AN "A" SHAPED ARCH CROSSING OVER A "C" SHAPED CURVE.

SER. NO. 85-423,168, FILED 9-15-2011.

BARNEY CHARLON, EXAMINING ATTORNEY



*David J. Kybas*

Director of the United States Patent and Trademark Office

# United States of America

United States Patent and Trademark Office

## THE WEDGE

**Reg. No. 4,135,508**

**Registered May 1, 2012**

**Int. Cl.: 9**

**TRADEMARK**

**PRINCIPAL REGISTER**

ENFOTRACEGPS INC (TENNESSEE CORPORATION)  
2035 LAKESIDE CENTRE WAY  
KNOXVILLE, TN 37922

FOR: VEHICLE TRACKING DEVICES COMPRISED OF CELLULAR RADIO MODULES, COMPUTER SOFTWARE AND COMPUTER HARDWARE, SENSORS, TRANSMITTERS, RECEIVERS AND GLOBAL POSITIONING SATELLITE RECEIVERS, ALL FOR USE IN CONNECTION WITH VEHICLE TRACKING, VEHICLE MONITORING AND ANTI-THEFT VEHICLE ALARMS, IN CLASS 9 (U.S. CLS. 21, 23, 26, 36 AND 38).

FIRST USE 3-3-2010; IN COMMERCE 3-3-2010.

THE MARK CONSISTS OF STANDARD CHARACTERS WITHOUT CLAIM TO ANY PARTICULAR FONT, STYLE, SIZE, OR COLOR.

SER. NO. 85-423,187, FILED 9-15-2011.

JERI J. FICKES, EXAMINING ATTORNEY



*David J. Kyffers*

Director of the United States Patent and Trademark Office

**United States of America**  
United States Patent and Trademark Office

# IRONTAG

**Reg. No. 4,135,509**

**Registered May 1, 2012**

**Int. Cl.: 9**

**TRADEMARK**

**PRINCIPAL REGISTER**

STID (FRANCE SOCIÉTÉ ANONYME (SA))  
20 PARC D' ACTIVITÉS DES PRADEAUX  
13850 GREASQUE, FRANCE

FOR: DATA PROCESSING EQUIPMENT FOR CONTACTLESS IDENTIFICATION OF ASSETS,  
IN CLASS 9 (U.S. CLS. 21, 23, 26, 36 AND 38).

THE MARK CONSISTS OF STANDARD CHARACTERS WITHOUT CLAIM TO ANY PAR-  
TICULAR FONT, STYLE, SIZE, OR COLOR.

PRIORITY CLAIMED UNDER SEC. 44(D) ON FRANCE APPLICATION NO. 113815080,  
FILED 3-17-2011, REG. NO. 113815080, DATED 3-17-2011, EXPIRES 3-17-2021.

SER. NO. 85-423,808, FILED 9-15-2011.

REGINA DRUMMOND, EXAMINING ATTORNEY



*David J. Kybas*

Director of the United States Patent and Trademark Office

# United States of America

United States Patent and Trademark Office



**Reg. No. 4,135,510**

**Registered May 1, 2012**

**Int. Cl.: 30**

**TRADEMARK**

**PRINCIPAL REGISTER**

ANASTASIA CONFECTIONS, INC. (FLORIDA CORPORATION)  
1815 CYPRESS LAKE DRIVE  
ORLANDO, FL 32837

FOR: CANDY; CHOCOLATE COVERED COCONUT CONFECTION, IN CLASS 30 (U.S. CL. 46).

FIRST USE 9-14-2011; IN COMMERCE 9-14-2011.

NO CLAIM IS MADE TO THE EXCLUSIVE RIGHT TO USE "COCO BITES" , APART FROM THE MARK AS SHOWN.

THE COLOR(S) BROWN, WHITE, GRAY, ORANGE, BLUE, BLACK AND GREEN IS/ARE CLAIMED AS A FEATURE OF THE MARK.

THE MARK CONSISTS OF THE STYLIZED WORD "COCO" IN WHITE, GRAY, BROWN AND ORANGE APPEARING ABOVE THE STYLIZED WORD "BITES" IN ORANGE AND BLUE. THE SECOND "O" IN "COCO" IS DRAWN TO LOOK LIKE A CHOCOLATE COVERED COCONUT CANDY IN BROWN, WHITE AND ORANGE WITH FOUR GREEN AND BLACK LEAVES APPEARING UNDERNEATH THE CANDY.

SER. NO. 85-424,184, FILED 9-15-2011.

BRIDGETT SMITH, EXAMINING ATTORNEY



*David J. Kyros*

Director of the United States Patent and Trademark Office

# United States of America

United States Patent and Trademark Office

## VSX SEXY SPORT

**Reg. No. 4,135,511**

**Registered May 1, 2012**

**Int. Cls.: 18, 25 and 28**

**TRADEMARK**

**PRINCIPAL REGISTER**

VICTORIA'S SECRET STORES BRAND MANAGEMENT, INC. (OHIO CORPORATION)  
5 LIMITED PARKWAY EAST  
REYNOLDSBURG, OH 43068

FOR: GYM BAG, IN CLASS 18 (U.S. CLS. 1, 2, 3, 22 AND 41).

FIRST USE 8-10-2011; IN COMMERCE 8-10-2011.

FOR: TEE SHIRTS, SHORTS, CAPRIS, PANTS, TIGHTS, HALTER BRAS, SPORTS BRAS,  
TANK TOPS, IN CLASS 25 (U.S. CLS. 22 AND 39).

FIRST USE 8-10-2011; IN COMMERCE 8-10-2011.

FOR: YOGA MAT, IN CLASS 28 (U.S. CLS. 22, 23, 38 AND 50).

FIRST USE 8-10-2011; IN COMMERCE 8-10-2011.

THE MARK CONSISTS OF STANDARD CHARACTERS WITHOUT CLAIM TO ANY PARTICULAR FONT, STYLE, SIZE, OR COLOR.

OWNER OF U.S. REG. NOS. 3,455,138, 3,963,363 AND OTHERS.

NO CLAIM IS MADE TO THE EXCLUSIVE RIGHT TO USE "SPORT" , APART FROM THE MARK AS SHOWN.

SER. NO. 85-424,299, FILED 9-16-2011.

BRIDGETT SMITH, EXAMINING ATTORNEY



*David J. Kyros*

Director of the United States Patent and Trademark Office



# United States of America

United States Patent and Trademark Office

# BackBone

**Reg. No. 4,135,512**

**Registered May 1, 2012**

**Int. Cl.: 10**

**TRADEMARK**

**PRINCIPAL REGISTER**

CASE MEDICAL (NEW JERSEY CORPORATION)  
19 EMPIRE BOULEVARD  
SOUTH HACKENSACK, NJ 07606

FOR: BRACKETS ESPECIALLY ADAPTED FOR AND SOLD WITH MEDICAL CASES, USED FOR SUPPORTING MEDICAL INSTRUMENTS ON A STERILIZATION TRAY, IN CLASS 10 (U.S. CLS. 26, 39 AND 44).

FIRST USE 4-13-1999; IN COMMERCE 4-13-1999.

THE MARK CONSISTS OF STANDARD CHARACTERS WITHOUT CLAIM TO ANY PARTICULAR FONT, STYLE, SIZE, OR COLOR.

SER. NO. 85-424,388, FILED 9-16-2011.

CHARISMA HAMPTON, EXAMINING ATTORNEY



*David J. Kyros*

Director of the United States Patent and Trademark Office

# United States of America

United States Patent and Trademark Office



**Reg. No. 4,135,513**

**Registered May 1, 2012**

**Int. Cl.: 25**

**TRADEMARK**

**PRINCIPAL REGISTER**

ACTERVIS GMBH (SWITZERLAND LIMITED LIABILITY COMPANY)  
LINDENHOF/DORFSTRASSE 38  
PRV PROVIDES TREUHANDGESELLSCHAFT  
BAAR/ZUG, SWITZERLAND 6341

FOR: BRAS, IN CLASS 25 (U.S. CLS. 22 AND 39).

FIRST USE 8-14-2011; IN COMMERCE 8-14-2011.

PRIORITY CLAIMED UNDER SEC. 44(D) ON ERPN CMNTY TM OFC APPLICATION NO.  
009934291, FILED 5-2-2011.

NO CLAIM IS MADE TO THE EXCLUSIVE RIGHT TO USE "BRA", APART FROM THE  
MARK AS SHOWN.

THE MARK CONSISTS OF A FLOWER DESIGN AND STEM LOCATED TO THE LEFT AND  
UNDERNEATH THE TERMS "COMFORTISSE BRA".

SER. NO. 85-424,537, FILED 9-16-2011.

CHRISIE B. KING, EXAMINING ATTORNEY



*David J. Kybas*

Director of the United States Patent and Trademark Office

# United States of America

United States Patent and Trademark Office

## OMMEGEDDON

**Reg. No. 4,135,514**

**Registered May 1, 2012**

**Int. Cl.: 32**

**TRADEMARK**

**PRINCIPAL REGISTER**

BROUWERIJ BELAME, LTD. (NEW YORK CORPORATION)  
656 COUNTY HIGHWAY 33  
COOPERSTOWN, NY 13326

FOR: ALES, IN CLASS 32 (U.S. CLS. 45, 46 AND 48).

FIRST USE 7-1-2007; IN COMMERCE 7-1-2007.

THE MARK CONSISTS OF STANDARD CHARACTERS WITHOUT CLAIM TO ANY PARTICULAR FONT, STYLE, SIZE, OR COLOR.

OWNER OF U.S. REG. NOS. 2,196,429 AND 3,801,046.

SER. NO. 85-425,117, FILED 9-16-2011.

TEJBIR SINGH, EXAMINING ATTORNEY



*David J. Kybas*

Director of the United States Patent and Trademark Office

# United States of America

United States Patent and Trademark Office

## School Rider

**Reg. No. 4,135,515**

**Registered May 1, 2012**

**Int. Cl.: 25**

**TRADEMARK**

**PRINCIPAL REGISTER**

LEUNG, WOON HUNG (HONG KONG INDIVIDUAL)  
925 CANADA COURT  
CITY OF INDUSTRY, CA 91748

FOR: FOOTWEAR, NAMELY, SHOES, IN CLASS 25 (U.S. CLS. 22 AND 39).

FIRST USE 7-1-2007; IN COMMERCE 7-1-2007.

THE MARK CONSISTS OF THE WORDS "SCHOOL RIDER" IN STYLIZED FORM.

SER. NO. 85-425,154, FILED 9-16-2011.

KARANENDRA S. CHHINA, EXAMINING ATTORNEY



*David J. Kybas*

Director of the United States Patent and Trademark Office

# United States of America

United States Patent and Trademark Office



**Reg. No. 4,135,516**

**Registered May 1, 2012**

**Int. Cl.: 45**

**SERVICE MARK**

**PRINCIPAL REGISTER**

ACTS MINISTRIES INTERNATIONAL, INC. (CALIFORNIA CORPORATION)  
2536 W. WOODLAND DRIVE  
ANAHEIM, CA 92801

FOR: CHRISTIAN MINISTRY SERVICES, IN CLASS 45 (U.S. CLS. 100 AND 101).

FIRST USE 1-1-2002; IN COMMERCE 6-1-2002.

THE MARK CONSISTS OF THE LETTERS "AMI" IN BLACK UPPERCASE, AND THE "I" IS DOTTED IN RED, WITH A RED HALO (AT AN ANGLE) SOMEWHAT SURROUNDING THE LETTERS "M" AND "I".

THE COLOR(S) BLACK AND RED IS/ARE CLAIMED AS A FEATURE OF THE MARK.

SER. NO. 85-425,278, FILED 9-16-2011.

AMY KELLY, EXAMINING ATTORNEY



*David J. Kyffers*

Director of the United States Patent and Trademark Office

# United States of America

United States Patent and Trademark Office

# NIATROX

**Reg. No. 4,135,517**

**Registered May 1, 2012**

**Int. Cl.: 40**

**SERVICE MARK**

**PRINCIPAL REGISTER**

NIATROX, INC. (FLORIDA CORPORATION), DBA NIATROX  
1787 AUBURN LAKES DR  
ROCKLEDGE, FL 32955

FOR: TECHNICAL CONSULTING SERVICES IN THE FIELD OF WASTE MANAGEMENT,  
IN CLASS 40 (U.S. CLS. 100, 103 AND 106).

FIRST USE 3-7-2005; IN COMMERCE 1-31-2009.

THE MARK CONSISTS OF STANDARD CHARACTERS WITHOUT CLAIM TO ANY PAR-  
TICULAR FONT, STYLE, SIZE, OR COLOR.

SER. NO. 85-425,965, FILED 9-19-2011.

TASNEEM HUSSAIN, EXAMINING ATTORNEY



*David J. Kybas*

Director of the United States Patent and Trademark Office

# United States of America

United States Patent and Trademark Office



**Reg. No. 4,135,518**

**Registered May 1, 2012**

**Int. Cl.: 36**

**SERVICE MARK**

**PRINCIPAL REGISTER**

FUND FOR INVESTIGATIVE JOURNALISM, INC. (D.C. NON-PROFIT ORGANIZATION)  
SUITE 350  
1023 15TH STREET NW  
WASHINGTON, DC 20005

FOR: PROVIDING GRANTS TO FREELANCE REPORTERS, AUTHORS AND NON-PROFIT NEWS ORGANIZATIONS TO FACILITATE THE PUBLICATION OF STORIES, BROADCASTS AND BOOKS, IN CLASS 36 (U.S. CLS. 100, 101 AND 102).

FIRST USE 10-15-2010; IN COMMERCE 10-15-2010.

THE MARK CONSISTS OF THE LETTERS "FIJ", WITH THE "I" STYLIZED AS A PEN, INSIDE A SQUARE.

SER. NO. 85-426,027, FILED 9-19-2011.

WILLIAM ROSSMAN, EXAMINING ATTORNEY



*David J. Kybas*

Director of the United States Patent and Trademark Office

# United States of America

United States Patent and Trademark Office

## 5 TOWERS ON UNIVERSAL CITYWALK

**Reg. No. 4,135,519**

**Registered May 1, 2012**

**Int. Cl.: 41**

**SERVICE MARK**

**PRINCIPAL REGISTER**

UNIVERSAL CITY STUDIOS LLC (DELAWARE LIMITED LIABILITY COMPANY)  
100 UNIVERSAL CITY PLAZA  
UNIVERSAL CITY, CA 91608

FOR: ORGANIZING AND PROVIDING FACILITIES FOR ENTERTAINMENT EVENTS, SPECIFICALLY MUSICAL CONCERTS, PERFORMING ARTS ACTIVITIES, CULTURAL EVENTS AND OTHER LIVE ENTERTAINMENT PERFORMANCES, IN CLASS 41 (U.S. CLS. 100, 101 AND 107).

FIRST USE 7-1-2011; IN COMMERCE 7-1-2011.

THE MARK CONSISTS OF STANDARD CHARACTERS WITHOUT CLAIM TO ANY PARTICULAR FONT, STYLE, SIZE, OR COLOR.

OWNER OF U.S. REG. NOS. 1,849,592, 1,903,781 AND OTHERS.

SER. NO. 85-426,525, FILED 9-19-2011.

FLORENTINA BLANDU, EXAMINING ATTORNEY



*David J. Kyffers*

Director of the United States Patent and Trademark Office



# United States of America

United States Patent and Trademark Office

## LOVE'S ULTIMATE EXPRESSION

**Reg. No. 4,135,520**

ROSY BLUE JEWELRY INC. (NEW YORK CORPORATION)  
595 FIFTH AVENUE, 12TH FLOOR  
NEW YORK, NY 10017

**Registered May 1, 2012**

**Int. Cl.: 14**

FOR: JEWELRY; DIAMONDS; PRECIOUS AND SEMI PRECIOUS STONES, IN CLASS 14  
(U.S. CLS. 2, 27, 28 AND 50).

**TRADEMARK**

FIRST USE 11-15-2011; IN COMMERCE 11-15-2011.

**PRINCIPAL REGISTER**

THE MARK CONSISTS OF STANDARD CHARACTERS WITHOUT CLAIM TO ANY PARTICULAR FONT, STYLE, SIZE, OR COLOR.

SER. NO. 85-427,135, FILED 9-20-2011.

NAKIA HENRY, EXAMINING ATTORNEY



*David J. Kybas*

Director of the United States Patent and Trademark Office

# United States of America

United States Patent and Trademark Office

## CHECK ARMOR

**Reg. No. 4,135,521**

**Registered May 1, 2012**

**Int. Cl.: 45**

**SERVICE MARK**

**PRINCIPAL REGISTER**

CHECKS IN THE MAIL, INC. (DELAWARE CORPORATION)  
2435 GOODWIN LANE  
NEW BRAUNFELS, TX 78135

FOR: FRAUD AND IDENTITY THEFT PROTECTION SERVICES, IN CLASS 45 (U.S. CLS. 100 AND 101).

FIRST USE 5-31-2011; IN COMMERCE 5-31-2011.

THE MARK CONSISTS OF STANDARD CHARACTERS WITHOUT CLAIM TO ANY PARTICULAR FONT, STYLE, SIZE, OR COLOR.

NO CLAIM IS MADE TO THE EXCLUSIVE RIGHT TO USE "CHECK", APART FROM THE MARK AS SHOWN.

SER. NO. 85-427,548, FILED 9-20-2011.

ASMAT KHAN, EXAMINING ATTORNEY



*David J. Kybas*

Director of the United States Patent and Trademark Office

# United States of America

United States Patent and Trademark Office

# Fireprime

**Reg. No. 4,135,522**

GUPTA, LAXMI C (UNITED STATES INDIVIDUAL)  
2852 MAINWAY DRIVE  
LOS ALAMITOS, CA 90720

**Registered May 1, 2012**

**Int. Cl.: 2**

FOR: CLEAR AND PIGMENTED COATINGS USED IN THE NATURE OF PAINT, IN CLASS 2 (U.S. CLS. 6, 11 AND 16).

**TRADEMARK**

FIRST USE 9-1-2011; IN COMMERCE 9-6-2011.

**PRINCIPAL REGISTER**

THE MARK CONSISTS OF STANDARD CHARACTERS WITHOUT CLAIM TO ANY PARTICULAR FONT, STYLE, SIZE, OR COLOR.

SER. NO. 85-427,599, FILED 9-20-2011.

RUSS HERMAN, EXAMINING ATTORNEY



*David J. Kyros*

Director of the United States Patent and Trademark Office

# United States of America

United States Patent and Trademark Office

# Ecotar

**Reg. No. 4,135,523**

**Registered May 1, 2012**

**Int. Cl.: 2**

**TRADEMARK**

**PRINCIPAL REGISTER**

GUPTA, LAXMI C (UNITED STATES INDIVIDUAL)  
2852 MAINWAY DRIVE  
LOS ALAMITOS, CA 90720

FOR: CLEAR AND PIGMENTED COATINGS USED IN THE NATURE OF PAINT, IN CLASS  
2 (U.S. CLS. 6, 11 AND 16).

FIRST USE 9-1-2011; IN COMMERCE 9-9-2011.

THE MARK CONSISTS OF STANDARD CHARACTERS WITHOUT CLAIM TO ANY PAR-  
TICULAR FONT, STYLE, SIZE, OR COLOR.

SER. NO. 85-427,607, FILED 9-20-2011.

RUSS HERMAN, EXAMINING ATTORNEY



*David J. Kybas*

Director of the United States Patent and Trademark Office

# United States of America

United States Patent and Trademark Office

## 1-800 JUNKREFUND GET CASH FROM YOUR TRASH

**Reg. No. 4,135,524**

**Registered May 1, 2012**

**Int. Cl.: 39**

**SERVICE MARK**

**PRINCIPAL REGISTER**

COOK, ALAN J. (MARYLAND LIMITED LIABILITY COMPANY), DBA 1-800-JUNK-REFUND,  
LLC  
9 PARSIPPANY COURT  
NORTH POTOMAC, MD 20878

FOR: JUNK, TRASH AND DEBRIS REMOVAL, IN CLASS 39 (U.S. CLS. 100 AND 105).

FIRST USE 9-1-2008; IN COMMERCE 9-1-2008.

THE MARK CONSISTS OF STANDARD CHARACTERS WITHOUT CLAIM TO ANY PARTICULAR FONT, STYLE, SIZE, OR COLOR.

NO CLAIM IS MADE TO THE EXCLUSIVE RIGHT TO USE "1-800", APART FROM THE MARK AS SHOWN.

SER. NO. 85-427,682, FILED 9-20-2011.

DANIEL CAPSHAW, EXAMINING ATTORNEY



*David J. Kybas*

Director of the United States Patent and Trademark Office

# United States of America

United States Patent and Trademark Office

Around  
the Clock  
Home Care

**Reg. No. 4,135,525**

**Registered May 1, 2012**

**Int. Cl.: 44**

**SERVICE MARK**

**PRINCIPAL REGISTER**

AROUND THE CLOCK HOMECARE GROUP, LLC (MINNESOTA LIMITED LIABILITY COMPANY)  
2257 LOUISIANA AVENUE SOUTH  
ST. LOUIS PARK, MN 55426

FOR: HOME HEALTH CARE SERVICES, IN CLASS 44 (U.S. CLS. 100 AND 101).

FIRST USE 7-1-1998; IN COMMERCE 7-1-1998.

NO CLAIM IS MADE TO THE EXCLUSIVE RIGHT TO USE "AROUND THE CLOCK HOME CARE", APART FROM THE MARK AS SHOWN.

THE COLOR(S) TEAL AND PINK IS/ARE CLAIMED AS A FEATURE OF THE MARK.

THE MARK CONSISTS OF THE WORDING "AROUND THE CLOCK" IN TEAL WITH A PINK CLOCK FACE SERVING AS THE LETTER "O" IN "AROUND" AND A PINK CLOCK STAND SERVING AS THE LETTER "L" IN "CLOCK", ALL OF WHICH IS ABOVE THE WORDS "HOME CARE" IN TEAL.

SER. NO. 85-427,712, FILED 9-20-2011.

AMY KELLY, EXAMINING ATTORNEY



*David J. Kyros*

Director of the United States Patent and Trademark Office

# United States of America

United States Patent and Trademark Office

## FRESH PRODUCE. FRESH PRICES.

**Reg. No. 4,135,526**

**Registered May 1, 2012**

**Int. Cl.: 35**

**SERVICE MARK**

**PRINCIPAL REGISTER**

SUPERVALU INC. (DELAWARE CORPORATION)  
LEGAL DEPARTMENT  
7075 FLYING CLOUD DRIVE  
EDEN PRAIRIE, MN 55344

FOR: RETAIL GROCERY STORE SERVICES, IN CLASS 35 (U.S. CLS. 100, 101 AND 102).

FIRST USE 9-15-2011; IN COMMERCE 9-15-2011.

THE MARK CONSISTS OF STANDARD CHARACTERS WITHOUT CLAIM TO ANY PARTICULAR FONT, STYLE, SIZE, OR COLOR.

SER. NO. 85-427,816, FILED 9-21-2011.

MARK SPARACINO, EXAMINING ATTORNEY



*David J. Kybas*

Director of the United States Patent and Trademark Office

# United States of America

United States Patent and Trademark Office

# PRO-ARC

**Reg. No. 4,135,527**

**Registered May 1, 2012**

**Int. Cl.: 6**

**TRADEMARK**

**PRINCIPAL REGISTER**

MASTER-HALCO, INC. (CALIFORNIA CORPORATION)  
1321 GREENWAY DRIVE, SUITE 5  
IRVING, CA 750382504

FOR: ORNAMENTAL METAL FENCING, METAL FENCE GATES, AND METAL FENCING COMPONENTS, NAMELY, BRACKETS, IN CLASS 6 (U.S. CLS. 2, 12, 13, 14, 23, 25 AND 50).

FIRST USE 0-0-1996; IN COMMERCE 0-0-1996.

THE MARK CONSISTS OF STANDARD CHARACTERS WITHOUT CLAIM TO ANY PARTICULAR FONT, STYLE, SIZE, OR COLOR.

SER. NO. 85-428,110, FILED 9-21-2011.

WENDY JUN, EXAMINING ATTORNEY



*David J. Kyffers*

Director of the United States Patent and Trademark Office



# United States of America

United States Patent and Trademark Office

## Provata Bioactives

**Reg. No. 4,135,528**

**Registered May 1, 2012**

**Int. Cl.: 5**

**TRADEMARK**

**PRINCIPAL REGISTER**

NUTRI-BODIES, L.L.C. (IOWA LIMITED LIABILITY COMPANY)  
STE 4  
14858 W RIDGE LN  
DUBUQUE, IA 52003

FOR: DIETARY AND NUTRITIONAL SUPPLEMENTS, IN CLASS 5 (U.S. CLS. 6, 18, 44, 46, 51 AND 52).

FIRST USE 12-6-2010; IN COMMERCE 12-6-2010.

THE MARK CONSISTS OF STANDARD CHARACTERS WITHOUT CLAIM TO ANY PARTICULAR FONT, STYLE, SIZE, OR COLOR.

NO CLAIM IS MADE TO THE EXCLUSIVE RIGHT TO USE "BIOACTIVES", APART FROM THE MARK AS SHOWN.

SER. NO. 85-428,263, FILED 9-21-2011.

TEJBIR SINGH, EXAMINING ATTORNEY



*David J. Kyros*

Director of the United States Patent and Trademark Office

# United States of America

United States Patent and Trademark Office

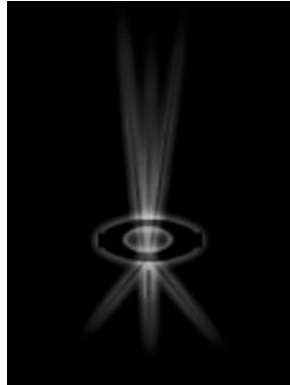

**Reg. No. 4,135,529**

**Registered May 1, 2012**

**Int. Cl.: 41**

**SERVICE MARK**

**PRINCIPAL REGISTER**

CARROLL, DAVID M (UNITED STATES INDIVIDUAL)  
6550 WETHEROLE ST. APT# 4G  
REGO PARK, NY 11374 AND

CARROLL, ALLISON J (UNITED STATES INDIVIDUAL)  
6550 WETHEROLE ST. APT# 4G  
REGO PARK, NY 11374

FOR: EDUCATION SERVICES, NAMELY, PROVIDING ON-LINE PHOTOGRAPHIC, AUDIO, VIDEO AND PROSE PRESENTATIONS FEATURING EDUCATIONAL INFORMATION IN THE FIELD OF ART-RELATED SELF-EXPRESSION, DRAWING, PAINTING, TATTOOING, DIGITAL ART, AND USING TOOLS AND METHODS FOR FURTHERING ARTISTIC EXPRESSION AND DEVELOPMENT, IN CLASS 41 (U.S. CLS. 100, 101 AND 107).

FIRST USE 8-0-2011; IN COMMERCE 8-0-2011.

THE MARK CONSISTS OF A MISCELLANEOUS DESIGN WITH AN OVAL SHAPE AND THREE REFRACTING LIGHT ELEMENTS.

SER. NO. 85-428,300, FILED 9-21-2011.

MARILYN IZZI, EXAMINING ATTORNEY



*David J. Kybas*

Director of the United States Patent and Trademark Office

# United States of America

United States Patent and Trademark Office

# Alltuition

**Reg. No. 4,135,530**

**Registered May 1, 2012**

**Int. Cl.: 36**

**SERVICE MARK**

**PRINCIPAL REGISTER**

EDULENDER, INC. (ILLINOIS CORPORATION)  
825 N. MICHIGAN AVE, SUITE 3100  
CHICAGO, IL 60611

FOR: CHARITABLE FUNDRAISING SERVICES, NAMELY, RAISING FUNDS FOR COLLEGE EDUCATION COSTS; COLLEGE COUNSELING SERVICES, NAMELY, ASSISTING STUDENTS IN APPLYING FOR SCHOLARSHIPS AND FINANCIAL AID; PROVIDING STUDENT LOAN INFORMATION; STUDENT LOAN SERVICES, IN CLASS 36 (U.S. CLS. 100, 101 AND 102).

FIRST USE 9-16-2011; IN COMMERCE 9-16-2011.

THE MARK CONSISTS OF STANDARD CHARACTERS WITHOUT CLAIM TO ANY PARTICULAR FONT, STYLE, SIZE, OR COLOR.

SER. NO. 85-428,374, FILED 9-21-2011.

KIMBERLY FRYE, EXAMINING ATTORNEY



*David J. Kyffers*

Director of the United States Patent and Trademark Office

# United States of America

United States Patent and Trademark Office

## TOUGH PROJECTS INNOVATIVE SOLUTIONS

**Reg. No. 4,135,531**

**Registered May 1, 2012**

**Int. Cl.: 37**

**SERVICE MARK**

**PRINCIPAL REGISTER**

CLYDE COMPANIES, INC. (UTAH CORPORATION)  
730 NORTH 1500 WEST  
OREM, UT 84057

FOR: ASPHALT PAVING CONTRACTOR SERVICES; CONSTRUCTION, REPAIR, MAINTENANCE AND RENOVATION SERVICES FOR COMMERCIAL, INDUSTRIAL, GOVERNMENT AND UTILITY BUILDINGS; INSTALLATION OF DOORS, GARAGE DOORS, GARAGE DOOR OPENERS, INSULATION, WINDOWS, ROOFING AND DECKING; PAVING CONTRACTOR SERVICES; ROAD PAVING; EXCAVATION SERVICES; EARTHWORKS CONSTRUCTION; MASONRY; LAND DEVELOPMENT AND CONSTRUCTION SERVICES IN THE NATURE OF SITE WORK, NAMELY, GRADING, CLEARING, CUTTING AND PATCHING ASPHALT AND CONCRETE, PLACEMENT AND COMPACTION OF ROCK, SAND, DIRT, ASPHALT, AND CONCRETE; AND CONCRETE CONSTRUCTION; RENTAL OF HAND AND POWER TOOLS, IN CLASS 37 (U.S. CLS. 100, 103 AND 106).

FIRST USE 9-18-2007; IN COMMERCE 9-18-2007.

THE MARK CONSISTS OF STANDARD CHARACTERS WITHOUT CLAIM TO ANY PARTICULAR FONT, STYLE, SIZE, OR COLOR.

SER. NO. 85-428,521, FILED 9-21-2011.

BARBARA GAYNOR, EXAMINING ATTORNEY



*David J. Kyros*

Director of the United States Patent and Trademark Office

# United States of America

United States Patent and Trademark Office

# 2HOT4U

**Reg. No. 4,135,532**

**Registered May 1, 2012**

**Int. Cl.: 25**

**TRADEMARK**

**PRINCIPAL REGISTER**

SASHAY SOURCING LLC (FLORIDA LIMITED LIABILITY COMPANY), DBA 2HOT4U  
8904 TROPICAL COURT  
FORT MYERS, FL 339089244

FOR: A-SHIRTS; BERMUDA SHORTS; BLOUSES; BOXER BRIEFS; BOXER SHORTS; BUTTON DOWN SHIRTS; CAMOUFLAGE SHIRTS; CREW NECK SWEATERS; CREW NECKS; FLEECE PULLOVERS; FLEECE TOPS; GYM SHORTS; MOCK TURTLE-NECK SWEATERS; OPEN-NECKED SHIRTS; PANTIES, SHORTS AND BRIEFS; SHORT-SLEEVED OR LONG-SLEEVED T-SHIRTS; SLEEVES WORN SEPARATE AND APART FROM BLOUSES, SHIRTS AND OTHER TOPS; WOMEN'S CLOTHING, NAMELY, SHIRTS, DRESSES, SKIRTS, BLOUSES, IN CLASS 25 (U.S. CLS. 22 AND 39).

FIRST USE 9-1-2011; IN COMMERCE 9-1-2011.

THE MARK CONSISTS OF STANDARD CHARACTERS WITHOUT CLAIM TO ANY PARTICULAR FONT, STYLE, SIZE, OR COLOR.

SER. NO. 85-428,577, FILED 9-21-2011.

KATHLEEN LORENZO, EXAMINING ATTORNEY



*David J. Kyffers*

Director of the United States Patent and Trademark Office

United States of America  
United States Patent and Trademark Office

THE STUDIOS  
★★★★ at ★★★★★  
*Paramount*

**Reg. No. 4,135,533**

**Registered May 1, 2012**

**Int. Cls.: 37, 40, 41 and 42**

**SERVICE MARK**

**PRINCIPAL REGISTER**

PARAMOUNT PICTURES CORPORATION (DELAWARE CORPORATION)  
5555 MELROSE AVENUE  
HOLLYWOOD, CA 90038

FOR: CARPENTRY SERVICES, PAINTING SERVICES, AND RENTAL OF CONSTRUCTION AND BUILDING EQUIPMENT, ALL FOR THE PURPOSES OF MOTION PICTURE, FILM, VIDEO, TELEVISION, AND MULTIMEDIA PRODUCTION, IN CLASS 37 (U.S. CLS. 100, 103 AND 106).

FIRST USE 3-31-2009; IN COMMERCE 3-31-2009.

FOR: CUSTOM FABRICATION OF MODELS, SETS AND PROPS FOR MOTION PICTURE, FILM, VIDEO, TELEVISION, AND MULTIMEDIA PRODUCTION; FILM PROCESSING AND PHOTOFINISHING, IN CLASS 40 (U.S. CLS. 100, 103 AND 106).

FIRST USE 3-31-2009; IN COMMERCE 3-31-2009.

FOR: ENTERTAINMENT SERVICES IN THE NATURE OF DEVELOPMENT, CREATION, PRODUCTION AND POST-PRODUCTION SERVICES FOR MULTIMEDIA ENTERTAINMENT CONTENT; PRODUCTION OF SPECIAL EFFECTS INCLUDING MODEL-MAKING SERVICES AND RELATED PHYSICAL PRODUCTION ELEMENTS FOR USE IN MOTION PICTURES; GUIDED TOURS OF MOTION PICTURE STUDIOS; RENTAL OF FACILITIES AND EQUIPMENT FOR MOTION PICTURE, FILM, VIDEO, TELEVISION, AND MULTIMEDIA PRODUCTION, NAMELY, STUDIOS, SETS, DRESSING ROOMS; CONDUCTING AND PROVIDING FACILITIES FOR SPECIAL EVENTS FOR SOCIAL ENTERTAINMENT PURPOSES, IN CLASS 41 (U.S. CLS. 100, 101 AND 107).

FIRST USE 3-31-2009; IN COMMERCE 3-31-2009.

FOR: DESIGN OF MODELS, SETS AND PROPS FOR MOTION PICTURE, FILM, VIDEO, TELEVISION, AND MULTIMEDIA PRODUCTION; SPECIAL EFFECTS DESIGN SERVICES; GRAPHIC DESIGN SERVICES, IN CLASS 42 (U.S. CLS. 100 AND 101).

FIRST USE 3-31-2009; IN COMMERCE 3-31-2009.

OWNER OF U.S. REG. NOS. 103,248, 2,683,224 AND OTHERS.



*David J. Kyjars*

Director of the United States Patent and Trademark Office

**Reg. No. 4,135,533** NO CLAIM IS MADE TO THE EXCLUSIVE RIGHT TO USE "STUDIOS", APART FROM THE MARK AS SHOWN.

THE MARK CONSISTS OF THE STYLIZED WORDS "THE STUDIOS AT PARAMOUNT", WITH FOUR STARS ON EITHER SIDE OF THE WORD "AT".

SER. NO. 85-428,670, FILED 9-21-2011.

KHANH LE, EXAMINING ATTORNEY

# United States of America

United States Patent and Trademark Office

**d**ynamic  
! h o u g h t

**Reg. No. 4,135,534**

**Registered May 1, 2012**

**Int. Cl.: 9**

**TRADEMARK**

**PRINCIPAL REGISTER**

DOUGLAS A. BROWN (UNITED STATES INDIVIDUAL)  
11445 CINDER CONE COURT  
TRUCKEE, CA 96161

FOR: COMPUTER SOFTWARE FOR TRAINING IN COMPUTER SKILLS, LIFE SKILLS, GAMES INVOLVING MENTAL AND STRATEGIC SKILLS, AND ACADEMIC, SPORTS AND BUSINESS SKILLS, IN CLASS 9 (U.S. CLS. 21, 23, 26, 36 AND 38).

FIRST USE 7-1-2002; IN COMMERCE 7-1-2002.

THE MARK CONSISTS OF THE STYLIZED WORD "DYNAMIC" ABOVE THE STYLIZED WORD "THOUGHT". THE FIRST "T" IN "THOUGHT" APPEARS AS AN EXCLAMATION POINT AND THE CROSS OF THE "T" IS INCORPORATED INTO THE STYLIZED FONT THAT FORMS THE "D" IN "DYNAMIC".

SER. NO. 85-428,685, FILED 9-21-2011.

TARAH HARDY, EXAMINING ATTORNEY



*David J. Kyffers*

Director of the United States Patent and Trademark Office



# United States of America

United States Patent and Trademark Office



**Reg. No. 4,135,535**

**Registered May 1, 2012**

**Int. Cls.: 35, 39, 40, 41  
and 42**

**SERVICE MARK**

**PRINCIPAL REGISTER**

PARAMOUNT PICTURES CORPORATION (DELAWARE CORPORATION)  
5555 MELROSE AVENUE  
HOLLYWOOD, CA 90038

FOR: RETAIL STORE SERVICES, NAMELY, PROVIDING TOOLS AND OTHER MATERIALS AND EQUIPMENT FOR THE FABRICATION OF MODELS, SETS AND PROPS FOR USE IN MOTION PICTURE, FILM, VIDEO, TELEVISION, AND MULTIMEDIA PRODUCTION, IN CLASS 35 (U.S. CLS. 100, 101 AND 102).

FIRST USE 8-12-2011; IN COMMERCE 8-12-2011.

FOR: TRANSPORTATION SERVICES, NAMELY, DELIVERING CAMERA, LIGHTING, GRIP, AND POWER GENERATOR EQUIPMENT FOR MOTION PICTURE, FILM, VIDEO, TELEVISION, AND MULTIMEDIA PRODUCTION, IN CLASS 39 (U.S. CLS. 100 AND 105).

FIRST USE 8-12-2011; IN COMMERCE 8-12-2011.

FOR: RENTAL OF ELECTRIC POWER GENERATORS FOR USE IN MOTION PICTURE, FILM, VIDEO, TELEVISION, AND MULTIMEDIA PRODUCTION, IN CLASS 40 (U.S. CLS. 100, 103 AND 106).

FIRST USE 8-12-2011; IN COMMERCE 8-12-2011.

FOR: RENTAL OF STAGE AND MOVIE EQUIPMENT, NAMELY, CAMERA EQUIPMENT, LIGHTING EQUIPMENT AND GRIP EQUIPMENT; ENTERTAINMENT MEDIA PRODUCTION SERVICES FOR MOTION PICTURE, FILM, VIDEO, TELEVISION, AND MULTIMEDIA PRODUCTION, IN CLASS 41 (U.S. CLS. 100, 101 AND 107).

FIRST USE 8-12-2011; IN COMMERCE 8-12-2011.

FOR: LIGHTING DESIGN AND TECHNOLOGY SPECIFICATION SERVICES PERTAINING TO TEMPORARY ENTERTAINMENT APPLICATIONS IN THE NATURE OF MOTION PICTURE, FILM, VIDEO, TELEVISION, AND MULTIMEDIA PRODUCTION, IN CLASS 42 (U.S. CLS. 100 AND 101).

FIRST USE 8-12-2011; IN COMMERCE 8-12-2011.



*David J. Kybas*

Director of the United States Patent and Trademark Office

**Reg. No. 4,135,535** OWNER OF U.S. REG. NOS. 103,248, 2,736,878 AND OTHERS.

NO CLAIM IS MADE TO THE EXCLUSIVE RIGHT TO USE "ON LOCATION", APART FROM THE MARK AS SHOWN.

THE MARK CONSISTS OF THE STYLIZED WORDS "PARAMOUNT ON LOCATION", WITH THREE STARS TO THE LEFT OF "ON LOCATION", ALL BENEATH A FIVE-SHADOW MOUNTAIN WHICH IS ENCLOSED IN A DARK INCOMPLETE CIRCLE AND SURROUNDED BY AN ARC OF STARS.

SER. NO. 85-428,758, FILED 9-21-2011.

KHANH LE, EXAMINING ATTORNEY

# United States of America

United States Patent and Trademark Office

# LVP

**Reg. No. 4,135,536**

**Registered May 1, 2012**

**Int. Cl.: 36**

**SERVICE MARK**

**PRINCIPAL REGISTER**

BUCK CONSULTANTS, LLC (DELAWARE LIMITED LIABILITY COMPANY)  
ONE PENNSYLVANIA PLAZA, 29TH FLOOR  
NEW YORK, NY 10119

FOR: FINANCIAL CONSULTATION IN THE FIELD OF PENSION PLANS, IN CLASS 36  
(U.S. CLS. 100, 101 AND 102).

FIRST USE 9-20-2011; IN COMMERCE 9-20-2011.

THE MARK CONSISTS OF STANDARD CHARACTERS WITHOUT CLAIM TO ANY PARTICULAR FONT, STYLE, SIZE, OR COLOR.

SER. NO. 85-428,905, FILED 9-22-2011.

KAREN SEVERSON, EXAMINING ATTORNEY



*David J. Kybas*

Director of the United States Patent and Trademark Office

# United States of America

United States Patent and Trademark Office

# LO MAX

**Reg. No. 4,135,537**

**Registered May 1, 2012**

**Int. Cl.: 9**

**TRADEMARK**

**PRINCIPAL REGISTER**

PEAVEY ELECTRONICS CORPORATION (DELAWARE CORPORATION)  
5022 HARTLEY PEAVEY DRIVE  
MERIDIAN, MS 39305

FOR: LOUDSPEAKERS, IN CLASS 9 (U.S. CLS. 21, 23, 26, 36 AND 38).

FIRST USE 1-23-2004; IN COMMERCE 1-23-2004.

THE MARK CONSISTS OF STANDARD CHARACTERS WITHOUT CLAIM TO ANY PARTICULAR FONT, STYLE, SIZE, OR COLOR.

SER. NO. 85-430,377, FILED 9-23-2011.

REBECCA SMITH, EXAMINING ATTORNEY



*David J. Kyffers*

Director of the United States Patent and Trademark Office

# United States of America

United States Patent and Trademark Office



**Reg. No. 4,135,538**

**Registered May 1, 2012**

**Int. Cl.: 20**

**TRADEMARK**

**PRINCIPAL REGISTER**

DR. SEUSS ENTERPRISES, L.P. (CALIFORNIA LIMITED PARTNERSHIP)  
C/O KARL ZOBELL, ESQ. DLA PIPER LLP (US)  
1200 PROSPECT STREET, SUITE 575  
LA JOLLA, CA 920373610

FOR: VINYL APPLIQUÉS FOR ATTACHMENT TO WALLS OR OTHER SOLID SURFACES,  
IN CLASS 20 (U.S. CLS. 2, 13, 22, 25, 32 AND 50).

FIRST USE 7-0-2011; IN COMMERCE 7-0-2011.

OWNER OF U.S. REG. NOS. 3,701,165, 3,891,351 AND OTHERS.

THE NAME "DR. SEUSS" DOES NOT IDENTIFY A LIVING INDIVIDUAL.

THE MARK CONSISTS OF THE WORDING "DR. SEUSS" INSIDE A BEAN SHAPE.

SER. NO. 85-430,645, FILED 9-23-2011.

SUE LAWRENCE, EXAMINING ATTORNEY



*David J. Kybas*

Director of the United States Patent and Trademark Office

# United States of America

United States Patent and Trademark Office

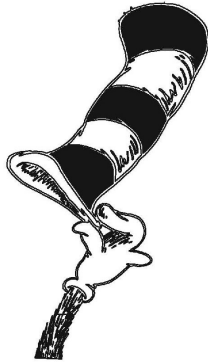

**Reg. No. 4,135,539**

**Registered May 1, 2012**

**Int. Cl.: 21**

**TRADEMARK**

**PRINCIPAL REGISTER**

DR. SEUSS ENTERPRISES, L.P. (CALIFORNIA LIMITED PARTNERSHIP)  
C/O KARL ZOBELL, ESQ. DLA PIPER LLP (US)  
1200 PROSPECT STREET, SUITE 575  
LA JOLLA, CA 920373610

FOR: PLATES, BOWLS, BEVERAGE GLASSWARE, IN CLASS 21 (U.S. CLS. 2, 13, 23, 29, 30, 33, 40 AND 50).

FIRST USE 9-21-2011; IN COMMERCE 9-21-2011.

OWNER OF U.S. REG. NOS. 2,373,215, 3,528,417 AND OTHERS.

THE MARK CONSISTS OF A STOVE PIPE HAT WITH FIVE STRIPES AND A GLOVED HAND HOLDING THE HAT.

SER. NO. 85-430,901, FILED 9-23-2011.

SUE LAWRENCE, EXAMINING ATTORNEY



*David J. Kybas*

Director of the United States Patent and Trademark Office

# United States of America

United States Patent and Trademark Office



**Reg. No. 4,135,540**

**Registered May 1, 2012**

**Int. Cl.: 11**

**TRADEMARK**

**PRINCIPAL REGISTER**

RECLAIM FILTERS & SYSTEMS, INC. (NORTH CAROLINA CORPORATION)  
1129 HIDDEN HILLS DR.  
WAKE FOREST, NC 27587

FOR: WATER FILTERS; INDUSTRIAL WATER FILTERS; WATER FILTRATION SYSTEMS COMPRISED PRIMARILY OF WATER PUMPS, WATER FILTERS AND PUMP AND FILTER CONTROLS FOR USE IN TURNING ON AND OFF WATER PUMPS AND VALVES USED IN WATER FILTRATION SYSTEMS AND SOLD AS A COMPONENT PART THEREFOR; OZONE GENERATORS, IN THE NATURE OF OZONE SANITIZERS FOR WATER PURIFICATION AND ODOR CONTROL OF WATER; WATER PURIFICATION UNITS; WATER RECYCLING EQUIPMENT, NAMELY, FILTERING UNITS FOR WATER RECLAMATION, IN CLASS 11 (U.S. CLS. 13, 21, 23, 31 AND 34).

FIRST USE 7-15-2002; IN COMMERCE 2-10-2003.

NO CLAIM IS MADE TO THE EXCLUSIVE RIGHT TO USE "THE RECYCLING SYMBOL" , APART FROM THE MARK AS SHOWN.

THE COLOR(S) BLUE IS/ARE CLAIMED AS A FEATURE OF THE MARK.

THE MARK CONSISTS OF A BLUE RECYCLING SYMBOL WITH A BLUE WATER DROP IN THE CENTER.

SER. NO. 85-430,905, FILED 9-23-2011.

SHANNON TWOHIG, EXAMINING ATTORNEY



*David J. Kybas*

Director of the United States Patent and Trademark Office

# United States of America

United States Patent and Trademark Office

# RAM

**Reg. No. 4,135,541**

**Registered May 1, 2012**

**Int. Cl.: 28**

**TRADEMARK**

**PRINCIPAL REGISTER**

TSA STORES, INC. (DELAWARE CORPORATION)  
1050 WEST HAMPDEN AVENUE  
ENGLEWOOD, CO 80110

FOR: GOLF CLUBS, GOLF BAGS, GOLF BALLS, GOLF BAG TRAVEL COVERS, NON-MOTORIZED GOLF BAG PULL CARTS, AND GOLF GLOVES, IN CLASS 28 (U.S. CLS. 22, 23, 38 AND 50).

FIRST USE 8-0-1999; IN COMMERCE 8-0-1999.

THE MARK CONSISTS OF STANDARD CHARACTERS WITHOUT CLAIM TO ANY PARTICULAR FONT, STYLE, SIZE, OR COLOR.

OWNER OF U.S. REG. NOS. 1,089,318, 3,686,636 AND OTHERS.

SER. NO. 85-431,566, FILED 9-26-2011.

NANCY CLARKE, EXAMINING ATTORNEY



*David J. Kybas*

Director of the United States Patent and Trademark Office



# United States of America

United States Patent and Trademark Office

## TJX REWARDS SMART. STYLISH. REWARDING.

**Reg. No. 4,135,542**

**Registered May 1, 2012**

**Int. Cl.: 36**

**SERVICE MARK**

**PRINCIPAL REGISTER**

THE TJX COMPANIES, INC. (DELAWARE CORPORATION)  
770 COCHITUATE ROAD  
FRAMINGHAM, MA 01701

FOR: CREDIT CARD SERVICES, DEBIT CARD SERVICES, AND FINANCIAL TRANSACTION CARD SERVICES, IN CLASS 36 (U.S. CLS. 100, 101 AND 102).

FIRST USE 7-1-2011; IN COMMERCE 7-1-2011.

THE MARK CONSISTS OF STANDARD CHARACTERS WITHOUT CLAIM TO ANY PARTICULAR FONT, STYLE, SIZE, OR COLOR.

OWNER OF U.S. REG. NOS. 2,117,444, 3,356,884 AND OTHERS.

NO CLAIM IS MADE TO THE EXCLUSIVE RIGHT TO USE "REWARDS", APART FROM THE MARK AS SHOWN.

SER. NO. 85-431,624, FILED 9-26-2011.

GRETTA YAO, EXAMINING ATTORNEY



*David J. Kybas*

Director of the United States Patent and Trademark Office

# United States of America

United States Patent and Trademark Office

# Platinet

**Reg. No. 4,135,543**

**Registered May 1, 2012**

**Int. Cl.: 6**

**TRADEMARK**

**PRINCIPAL REGISTER**

UNITED PRECIOUS METAL REFINING, INC. (NEW YORK CORPORATION)  
2781 TOWNLINE ROAD  
ALDEN, NY 14004

FOR: METAL ALLOY FOR FURTHER MANUFACTURING, NAMELY, A STERLING SILVER ALLOY, IN CLASS 6 (U.S. CLS. 2, 12, 13, 14, 23, 25 AND 50).

FIRST USE 6-23-2011; IN COMMERCE 7-13-2011.

THE MARK CONSISTS OF STANDARD CHARACTERS WITHOUT CLAIM TO ANY PARTICULAR FONT, STYLE, SIZE, OR COLOR.

SER. NO. 85-431,805, FILED 9-26-2011.

ALYSSA STEEL, EXAMINING ATTORNEY



*David J. Kybas*

Director of the United States Patent and Trademark Office

# United States of America

United States Patent and Trademark Office

# ZIGARETTES

**Reg. No. 4,135,544**

**Registered May 1, 2012**

**Int. Cl.: 34**

**TRADEMARK**

**PRINCIPAL REGISTER**

NORTH ATLANTIC OPERATING COMPANY, INC. (DELAWARE CORPORATION)  
5201 INTERCHANGE WAY  
LOUISVILLE, KY 40229

FOR: CIGARETTE CASES, IN CLASS 34 (U.S. CLS. 2, 8, 9 AND 17).

FIRST USE 10-17-2011; IN COMMERCE 10-17-2011.

THE MARK CONSISTS OF STANDARD CHARACTERS WITHOUT CLAIM TO ANY PARTICULAR FONT, STYLE, SIZE, OR COLOR.

SER. NO. 85-431,822, FILED 9-26-2011.

ANDREA HACK, EXAMINING ATTORNEY



*David J. Kyffers*

Director of the United States Patent and Trademark Office

# United States of America

United States Patent and Trademark Office

## TRIBALOGIST

**Reg. No. 4,135,545**

**Registered May 1, 2012**

**Int. Cl.: 41**

**SERVICE MARK**

**PRINCIPAL REGISTER**

CARROLL, DAVID M (UNITED STATES INDIVIDUAL)  
6550 WETHEROLE ST. APT# 4G  
REGO PARK, NY 11374 AND

CARROLL, ALLISON J (UNITED STATES INDIVIDUAL)  
6550 WETHEROLE ST. APT# 4G  
REGO PARK, NY 11374

FOR: EDUCATIONAL SERVICES, NAMELY, PROVIDING ON-LINE PHOTOGRAPHIC, AUDIO, VIDEO AND PROSE PRESENTATIONS FEATURING EDUCATIONAL INFORMATION IN THE FIELD OF ART-RELATED SELF-EXPRESSION, DRAWING, PAINTING, TATTOOING, DIGITAL ART, AND USING TOOLS AND METHODS FOR FURTHERING ARTISTIC EXPRESSION AND DEVELOPMENT, IN CLASS 41 (U.S. CLS. 100, 101 AND 107).

FIRST USE 9-21-2011; IN COMMERCE 9-21-2011.

THE MARK CONSISTS OF STANDARD CHARACTERS WITHOUT CLAIM TO ANY PARTICULAR FONT, STYLE, SIZE, OR COLOR.

SER. NO. 85-431,963, FILED 9-26-2011.

MARILYN IZZI, EXAMINING ATTORNEY



*David J. Kybas*

Director of the United States Patent and Trademark Office

# United States of America

United States Patent and Trademark Office

# VASYLI

**Reg. No. 4,135,546**

**Registered May 1, 2012**

**Int. Cl.: 10**

**TRADEMARK**

**PRINCIPAL REGISTER**

FREEHAVEN INVESTMENTS LTD. (ST.KITTS-NEVIS CORPORATION)  
NISBETTS CHAMBERS, P.O. BOX 517  
CHARLESTOWN, ST.KITTS-NEVIS

FOR: ORTHOPEDIC FOOTWEAR, IN CLASS 10 (U.S. CLS. 26, 39 AND 44).

FIRST USE 5-20-2010; IN COMMERCE 5-20-2010.

THE MARK CONSISTS OF STANDARD CHARACTERS WITHOUT CLAIM TO ANY PARTICULAR FONT, STYLE, SIZE, OR COLOR.

OWNER OF U.S. REG. NOS. 2,727,758 AND 3,925,852.

SER. NO. 85-432,552, FILED 9-27-2011.

LINDA POWELL, EXAMINING ATTORNEY



*David J. Kyffers*

Director of the United States Patent and Trademark Office

# United States of America

United States Patent and Trademark Office

# FAST 2000CT

**Reg. No. 4,135,547**

**Registered May 1, 2012**

**Int. Cl.: 35**

**SERVICE MARK**

**PRINCIPAL REGISTER**

FASTENAL IP COMPANY (MINNESOTA CORPORATION)  
2001 THEURER BLVD.  
WINONA, MN 55987

FOR: MOBILE VENDING SERVICES IN THE FIELDS OF MAINTENANCE, REPAIR AND OPERATION SUPPLIES AND OFFICE SUPPLIES, IN CLASS 35 (U.S. CLS. 100, 101 AND 102).

FIRST USE 5-1-2011; IN COMMERCE 5-1-2011.

THE MARK CONSISTS OF STANDARD CHARACTERS WITHOUT CLAIM TO ANY PARTICULAR FONT, STYLE, SIZE, OR COLOR.

OWNER OF U.S. REG. NO. 4,005,696.

SER. NO. 85-432,764, FILED 9-27-2011.

KIM SAITO, EXAMINING ATTORNEY



*David J. Kyffers*

Director of the United States Patent and Trademark Office

# United States of America

United States Patent and Trademark Office

# FAST 4000CT

**Reg. No. 4,135,548**

**Registered May 1, 2012**

**Int. Cl.: 35**

**SERVICE MARK**

**PRINCIPAL REGISTER**

FASTENAL IP COMPANY (MINNESOTA CORPORATION)  
2001 THEURER BLVD.  
WINONA, MN 55987

FOR: MOBILE VENDING SERVICES IN THE FIELDS OF MAINTENANCE, REPAIR AND OPERATION SUPPLIES AND OFFICE SUPPLIES, IN CLASS 35 (U.S. CLS. 100, 101 AND 102).

FIRST USE 5-1-2011; IN COMMERCE 5-1-2011.

THE MARK CONSISTS OF STANDARD CHARACTERS WITHOUT CLAIM TO ANY PARTICULAR FONT, STYLE, SIZE, OR COLOR.

OWNER OF U.S. REG. NO. 4,005,696.

SER. NO. 85-432,767, FILED 9-27-2011.

KIM SAITO, EXAMINING ATTORNEY



*David J. Kyffers*

Director of the United States Patent and Trademark Office

# United States of America

United States Patent and Trademark Office

# FAST 5000

**Reg. No. 4,135,549**

**Registered May 1, 2012**

**Int. Cl.: 35**

**SERVICE MARK**

**PRINCIPAL REGISTER**

FASTENAL IP COMPANY (MINNESOTA CORPORATION)  
2001 THEURER BLVD.  
WINONA, MN 55987

FOR: MOBILE VENDING SERVICES IN THE FIELDS OF MAINTENANCE, REPAIR AND OPERATION SUPPLIES AND OFFICE SUPPLIES, IN CLASS 35 (U.S. CLS. 100, 101 AND 102).

FIRST USE 12-1-2010; IN COMMERCE 12-1-2010.

THE MARK CONSISTS OF STANDARD CHARACTERS WITHOUT CLAIM TO ANY PARTICULAR FONT, STYLE, SIZE, OR COLOR.

OWNER OF U.S. REG. NO. 4,005,696.

SER. NO. 85-432,774, FILED 9-27-2011.

KIM SAITO, EXAMINING ATTORNEY



*David J. Kybas*

Director of the United States Patent and Trademark Office



# United States of America

United States Patent and Trademark Office

# BriteBrace

**Reg. No. 4,135,550**

**Registered May 1, 2012**

**Int. Cl.: 44**

**SERVICE MARK**

**PRINCIPAL REGISTER**

WAUGH, JR., DR. ROBERT L. (UNITED STATES INDIVIDUAL)  
1091 BROOKVIEW DRIVE  
ATHENS, GA 30606

FOR: ORTHODONTIC SERVICES, IN CLASS 44 (U.S. CLS. 100 AND 101).

FIRST USE 9-1-2008; IN COMMERCE 9-1-2008.

THE MARK CONSISTS OF STANDARD CHARACTERS WITHOUT CLAIM TO ANY PARTICULAR FONT, STYLE, SIZE, OR COLOR.

SER. NO. 85-432,985, FILED 9-27-2011.

AMY KERTGATE, EXAMINING ATTORNEY



*David J. Kybas*

Director of the United States Patent and Trademark Office

United States of America  
United States Patent and Trademark Office

KOYKER

**Reg. No. 4,135,551**

**Registered May 1, 2012**

**Int. Cl.: 12**

**TRADEMARK**

**PRINCIPAL REGISTER**

SIOUX STEEL COMPANY (DELAWARE CORPORATION), DBA KOYKER  
MANUFACTURING  
196 1/2 E. 6TH ST  
SIOUX FALLS, SD 571011265

FOR: TRANSPORT TRAILERS FOR HANDLING OF HAY; AND TRANSPORT TRAILERS  
WITH ATTACHMENTS, NAMELY, LOADING ARM FOR HANDLING OF BALES , IN CLASS  
12 (U.S. CLS. 19, 21, 23, 31, 35 AND 44).

FIRST USE 8-0-2008; IN COMMERCE 8-0-2008.

THE MARK CONSISTS OF STANDARD CHARACTERS WITHOUT CLAIM TO ANY PAR-  
TICULAR FONT, STYLE, SIZE, OR COLOR.

OWNER OF U.S. REG. NO. 1,769,713.

SER. NO. 85-433,333, FILED 9-27-2011.

JOHN E. MICHOS, EXAMINING ATTORNEY



*David J. Kyffers*

Director of the United States Patent and Trademark Office

# United States of America

United States Patent and Trademark Office

The Heart is the hub of  
all sacred places. Go  
there and roam.

**Reg. No. 4,135,552**

**Registered May 1, 2012**

**Int. Cl.: 41**

**SERVICE MARK**

**PRINCIPAL REGISTER**

SYDA FOUNDATION (NEW YORK NON-PROFIT CORPORATION)  
INTELLECTUAL PROPERTY DEPARTMENT  
371 BRICKMAN ROAD  
SOUTH FALLSBURG, NY 12779

FOR: EDUCATIONAL SERVICES, NAMELY, LECTURES AND COURSES IN THE FIELD OF SPIRITUAL AND RELIGIOUS DEVELOPMENT, IN CLASS 41 (U.S. CLS. 100, 101 AND 107).

FIRST USE 9-2-2011; IN COMMERCE 9-2-2011.

THE MARK CONSISTS OF STANDARD CHARACTERS WITHOUT CLAIM TO ANY PARTICULAR FONT, STYLE, SIZE, OR COLOR.

SER. NO. 85-433,696, FILED 9-28-2011.

DOMINICK J. SALEMI, EXAMINING ATTORNEY



*David J. Kybas*

Director of the United States Patent and Trademark Office

# United States of America

United States Patent and Trademark Office



**Reg. No. 4,135,553**

**Registered May 1, 2012**

**Int. Cl.: 36**

**SERVICE MARK**

**PRINCIPAL REGISTER**

DISCOVER FINANCIAL SERVICES (DELAWARE CORPORATION)  
2500 LAKE COOK ROAD  
RIVERWOODS, IL 60015

FOR: FINANCIAL SERVICES, NAMELY, PROVIDING PAYMENT SERVICES IN THE NATURE OF REDEMPTION OF DISCOUNTS, REWARD POINTS, AND/OR OTHER INCENTIVES GENERATED IN CONNECTION WITH ONE OR MORE LOYALTY AND/OR REWARDS PROGRAMS, VIA A GLOBAL COMMUNICATIONS NETWORK, MOBILE PHONE, CONTACTLESS DEVICE OR AT A RETAIL STORE LOCATION, IN CLASS 36 (U.S. CLS. 100, 101 AND 102).

FIRST USE 10-5-2011; IN COMMERCE 10-5-2011.

OWNER OF U.S. REG. NO. 1,538,444.

THE COLOR(S) WHITE AND ORANGE IS/ARE CLAIMED AS A FEATURE OF THE MARK.

NO CLAIM IS MADE TO THE EXCLUSIVE RIGHT TO USE "PAY WITH CASHBACK", APART FROM THE MARK AS SHOWN.

THE MARK CONSISTS OF THE WORDS "PAY WITH CASHBACK BONUS" IN STYLIZED WHITE LETTERS CONTAINED IN A REPRESENTATION OF AN ORANGE TAG.

SER. NO. 85-434,239, FILED 9-28-2011.

SHARON MEIER, EXAMINING ATTORNEY



*David J. Kyjars*

Director of the United States Patent and Trademark Office

# United States of America

United States Patent and Trademark Office

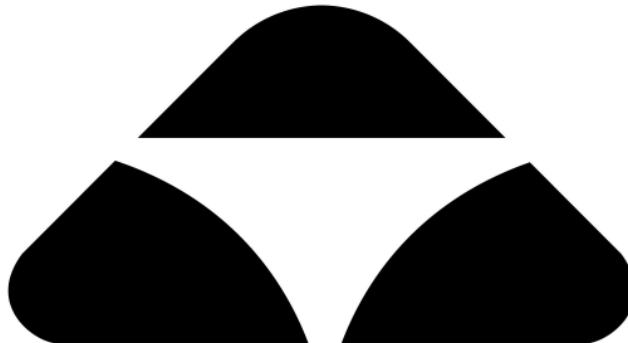

**Reg. No. 4,135,554**

**Registered May 1, 2012**

**Int. Cls.: 9 and 25**

**TRADEMARK**

**PRINCIPAL REGISTER**

WILSON, KEN (UNITED STATES INDIVIDUAL)  
3639 MIDWAY DR., STE. B242  
SAN DIEGO, CA 92110

FOR: EYEGLASSES, SUNGLASSES AND SPORT GOGGLES; EYEGLASS, SUNGLASS AND SPORTS GOGGLE REPLACEMENT LENSES AND PARTS AND ACCESSORIES THEREFOR, NAMELY, FRAMES, EARSTEMS AND NOSE PIECES, EYEGLASS, SUNGLASS AND SPORT GOGGLE CASES, CHAINS, STRAPS AND CHORDS, IN CLASS 9 (U.S. CLS. 21, 23, 26, 36 AND 38).

FIRST USE 2-25-2002; IN COMMERCE 2-25-2002.

FOR: CLOTHING, NAMELY, T-SHIRTS, SWEATSHIRTS, BEACH-WEAR, BLOUSES, SPORTS SHIRTS, JERSEYS, SWIMWEAR, SWIMTRUNKS, SHORTS, UNDERWEAR, SHIRTS, PANTS, RACING PANTS, JEANS, VESTS, JACKETS, WETSUITS, SWEATERS, PULLOVERS, COATS, SWEATPANTS, HEADWEAR, NAMELY, HATS, CAPS, VISORS, IN CLASS 25 (U.S. CLS. 22 AND 39).

FIRST USE 1-21-2002; IN COMMERCE 1-21-2002.

THE MARK CONSISTS OF A TRIANGULAR SHAPE, MADE UP OF FOUR TRIANGULAR SHAPES.

SER. NO. 85-434,273, FILED 9-28-2011.

ALICE BENMAMAN, EXAMINING ATTORNEY



*David J. Kybas*

Director of the United States Patent and Trademark Office

# United States of America

United States Patent and Trademark Office

## ARROYOS CRISTALINOS

**Reg. No. 4,135,555**

**Registered May 1, 2012**

**Int. Cl.: 5**

**TRADEMARK**

**PRINCIPAL REGISTER**

S. C. JOHNSON & SON, INC. (WISCONSIN CORPORATION)  
1525 HOWE STREET  
RACINE, WI 53403

FOR: CARPET AND ROOM DEODORIZERS; DEODORIZER FOR AIR, FABRIC AND UP-  
HOLSTERY, IN CLASS 5 (U.S. CLS. 6, 18, 44, 46, 51 AND 52).

FIRST USE 9-5-2011; IN COMMERCE 9-5-2011.

THE MARK CONSISTS OF STANDARD CHARACTERS WITHOUT CLAIM TO ANY PAR-  
TICULAR FONT, STYLE, SIZE, OR COLOR.

OWNER OF U.S. REG. NO. 3,822,422.

THE ENGLISH TRANSLATION OF "ARROYOS CRISTALINOS" IN THE MARK IS "CRYS-  
TALLINE STREAMS".

SER. NO. 85-434,473, FILED 9-28-2011.

SARA BENJAMIN, EXAMINING ATTORNEY



*David J. Kyffers*

Director of the United States Patent and Trademark Office

# United States of America

United States Patent and Trademark Office

## M&M'S MAKES RACE DAY MORE FUN

**Reg. No. 4,135,556**

**Registered May 1, 2012**

**Int. Cl.: 30**

**TRADEMARK**

**PRINCIPAL REGISTER**

MARS, INCORPORATED (DELAWARE CORPORATION)  
6885 ELM STREET  
MCLEAN, VA 221013883

FOR: CONFECTIONERY, NAMELY, CANDY, IN CLASS 30 (U.S. CL. 46).

FIRST USE 7-31-2011; IN COMMERCE 7-31-2011.

THE MARK CONSISTS OF STANDARD CHARACTERS WITHOUT CLAIM TO ANY PARTICULAR FONT, STYLE, SIZE, OR COLOR.

OWNER OF U.S. REG. NOS. 396,914, 1,774,366, AND 3,161,319.

SER. NO. 85-435,710, FILED 9-29-2011.

BRIAN NEVILLE, EXAMINING ATTORNEY



*David J. Kyffers*

Director of the United States Patent and Trademark Office

# United States of America

United States Patent and Trademark Office

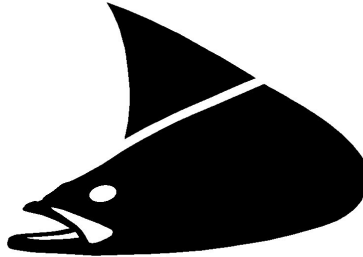

**Reg. No. 4,135,557**

**Registered May 1, 2012**

**Int. Cl.: 25**

**TRADEMARK**

**PRINCIPAL REGISTER**

TACKLE THE DREAM, INC. (FLORIDA CORPORATION)  
7818 CHASE MEADOWS DR. W  
JACKSONVILLE, FL 32256

FOR: POLO SHIRTS; TEE SHIRTS, IN CLASS 25 (U.S. CLS. 22 AND 39).

FIRST USE 9-1-2010; IN COMMERCE 7-1-2011.

THE MARK CONSISTS OF A FISH WITH THE TAIL TURNED BACK TO ITS LEFT.

SER. NO. 85-435,814, FILED 9-29-2011.

JEFFERY COWARD, EXAMINING ATTORNEY



*David J. Kybas*

Director of the United States Patent and Trademark Office



# United States of America

United States Patent and Trademark Office



**Reg. No. 4,135,558**

**Registered May 1, 2012**

**Int. Cl.: 8**

**TRADEMARK**

**PRINCIPAL REGISTER**

SUNBEAM PRODUCTS, INC. (DELAWARE CORPORATION)  
2381 NW EXECUTIVE CENTER DRIVE  
BOCA RATON, FL 33431

FOR: ELECTRIC HAIR CLIPPERS AND TRIMMERS FOR HUMAN USE, IN CLASS 8 (U.S. CLS. 23, 28 AND 44).

FIRST USE 10-31-2010; IN COMMERCE 10-31-2010.

THE MARK CONSISTS OF THE LITERAL ELEMENT "ROCKER" IN A STYLIZED FONT, WITH THE FIRST LETTER "R" IN THE LITERAL ELEMENT OVERLAID WITH CALIGRAPHIC SWIRLS, SCROLLS AND SPIRALS.

SER. NO. 85-436,113, FILED 9-30-2011.

JULIE GUTTADAURO, EXAMINING ATTORNEY



*David J. Kybas*

Director of the United States Patent and Trademark Office

# United States of America

United States Patent and Trademark Office

# Tarthane

**Reg. No. 4,135,559**

**Registered May 1, 2012**

**Int. Cl.: 2**

**TRADEMARK**

**PRINCIPAL REGISTER**

GUPTA, LAXMI C (UNITED STATES INDIVIDUAL)  
2852 MAINWAY DRIVE  
LOS ALAMITOS, CA 90720

FOR: CLEAR AND PIGMENTED COATINGS USED IN THE NATURE OF PAINT, IN CLASS 2 (U.S. CLS. 6, 11 AND 16).

FIRST USE 9-16-2011; IN COMMERCE 9-20-2011.

THE MARK CONSISTS OF STANDARD CHARACTERS WITHOUT CLAIM TO ANY PARTICULAR FONT, STYLE, SIZE, OR COLOR.

SER. NO. 85-436,269, FILED 9-30-2011.

RUSS HERMAN, EXAMINING ATTORNEY



*David J. Kybas*

Director of the United States Patent and Trademark Office

# United States of America

United States Patent and Trademark Office



**Reg. No. 4,135,560**

**Registered May 1, 2012**

**Int. Cl.: 26**

**TRADEMARK**

**PRINCIPAL REGISTER**

TV WINNERS, INC. (NEW JERSEY CORPORATION)  
21 MADISON PLAZA, SUITE 400  
MADISON, NJ 07940

FOR: HAIR ACCESSORIES, NAMELY, FEATHERS THAT ATTACH TO HAIR USING A TETHER LINE AND FEATHER EXTENSIONS, AND FEATHER EXTENSIONS WITH CLIPS; HAIR EXTENSIONS; HAIR ORNAMENTS NOT OF PRECIOUS METAL, IN CLASS 26 (U.S. CLS. 37, 39, 40, 42 AND 50).

FIRST USE 6-20-2011; IN COMMERCE 6-20-2011.

NO CLAIM IS MADE TO THE EXCLUSIVE RIGHT TO USE "SNAP-ON FEATHERS", APART FROM THE MARK AS SHOWN.

THE MARK CONSISTS OF THE STYLIZED WORDS "SNAP-ON" IN PRINTED LETTERS, ABOVE THE WORD "FEATHERS" IN CURSIVE STYLE, AND HAVING A DESIGN FEATURING TWO FEATHERS TIED TOGETHER WITH A TETHER LINE. ALL OF THE WORDING IN THE MARK IS DOUBLE-OUTLINED.

SER. NO. 85-436,683, FILED 9-30-2011.

TRACY WHITTAKER-BROWN, EXAMINING ATTORNEY



*David J. Kyffers*

Director of the United States Patent and Trademark Office

# United States of America

United States Patent and Trademark Office

# Add On Mat

**Reg. No. 4,135,561**

ROSS-NASH, KATHRYN (UNITED STATES INDIVIDUAL)  
50 DALE AVENUE  
ALLENDALE, NJ 07401

**Registered May 1, 2012**

**Int. Cl.: 41**

FOR: PROVIDING FITNESS AND EXERCISE STUDIO SERVICES, NAMELY, PILATES INSTRUCTION AND TRAINING, IN CLASS 41 (U.S. CLS. 100, 101 AND 107).

**SERVICE MARK**

FIRST USE 8-1-2008; IN COMMERCE 8-1-2008.

**PRINCIPAL REGISTER**

THE MARK CONSISTS OF STANDARD CHARACTERS WITHOUT CLAIM TO ANY PARTICULAR FONT, STYLE, SIZE, OR COLOR.

SER. NO. 85-437,296, FILED 10-2-2011.

STEVEN PEREZ, EXAMINING ATTORNEY



*David J. Kyros*

Director of the United States Patent and Trademark Office

# United States of America

United States Patent and Trademark Office

# FOURSIES

**Reg. No. 4,135,562**

**Registered May 1, 2012**

**Int. Cl.: 43**

**SERVICE MARK**

**PRINCIPAL REGISTER**

SEVEN HAPPINESS, LLC (WASHINGTON LIMITED LIABILITY COMPANY)  
1526 E. INTERLAKEN BLVD.  
SEATTLE, WA 98112

FOR: RESTAURANT SERVICES, IN CLASS 43 (U.S. CLS. 100 AND 101).

FIRST USE 9-20-2011; IN COMMERCE 10-5-2011.

THE MARK CONSISTS OF STANDARD CHARACTERS WITHOUT CLAIM TO ANY PARTICULAR FONT, STYLE, SIZE, OR COLOR.

SER. NO. 85-438,257, FILED 10-3-2011.

HOWARD B. LEVINE, EXAMINING ATTORNEY



*David J. Kyros*

Director of the United States Patent and Trademark Office

# United States of America

United States Patent and Trademark Office

# FXBOSS

**Reg. No. 4,135,563**

**Registered May 1, 2012**

**Int. Cl.: 36**

**SERVICE MARK**

**PRINCIPAL REGISTER**

FIRST NATIONAL INNOVATION BROKERS (NEW ZEALAND LIMITED LIABILITY COMPANY)  
PLAZA LEVEL, 41 SHORTLAND STREET  
AUCKLAND, NEW ZEALAND 1010

FOR: FINANCIAL EVALUATION, TRACKING, ANALYSIS, FORECASTING, CONSULTANCY, ADVISORY AND RESEARCH SERVICES RELATING TO SECURITIES AND OTHER FINANCIAL INSTRUMENTS; FINANCIAL FORECASTING, IN CLASS 36 (U.S. CLS. 100, 101 AND 102).

FIRST USE 1-31-2009; IN COMMERCE 1-31-2009.

THE MARK CONSISTS OF STANDARD CHARACTERS WITHOUT CLAIM TO ANY PARTICULAR FONT, STYLE, SIZE, OR COLOR.

SER. NO. 85-438,424, FILED 10-4-2011.

LESLEY LAMOTHE, EXAMINING ATTORNEY



*David J. Kyffers*

Director of the United States Patent and Trademark Office

# United States of America

United States Patent and Trademark Office

## SINGING WATER

**Reg. No. 4,135,564**

TENNESSEE SINGING WATER LLC (TENNESSEE LIMITED LIABILITY COMPANY)  
1008 17TH AVENUE S  
NASHVILLE, TN 37212

**Registered May 1, 2012**

**Int. Cl.: 32**

FOR: BOTTLED WATER; BOTTLED FLAVORED WATER, IN CLASS 32 (U.S. CLS. 45, 46 AND 48).

**TRADEMARK**

FIRST USE 9-24-2011; IN COMMERCE 9-24-2011.

**PRINCIPAL REGISTER**

THE MARK CONSISTS OF STANDARD CHARACTERS WITHOUT CLAIM TO ANY PARTICULAR FONT, STYLE, SIZE, OR COLOR.

NO CLAIM IS MADE TO THE EXCLUSIVE RIGHT TO USE "WATER", APART FROM THE MARK AS SHOWN.

SER. NO. 85-438,476, FILED 10-4-2011.

JUDITH HELFMAN, EXAMINING ATTORNEY



*David J. Kyffers*

Director of the United States Patent and Trademark Office

# United States of America

United States Patent and Trademark Office

## BLOOMBERG GOVERNMENT

**Reg. No. 4,135,565**

**Registered May 1, 2012**

**Int. Cl.: 35**

**SERVICE MARK**

**PRINCIPAL REGISTER**

BLOOMBERG FINANCE ONE L.P. (DELAWARE LIMITED PARTNERSHIP)  
731 LEXINGTON AVENUE  
NEW YORK, NY 10022

FOR: PROVIDING A WEBSITE FEATURING INFORMATION IN THE FIELDS OF GOVERNMENT AFFAIRS AND BUSINESS, IN CLASS 35 (U.S. CLS. 100, 101 AND 102).

FIRST USE 7-8-2010; IN COMMERCE 7-8-2010.

THE MARK CONSISTS OF STANDARD CHARACTERS WITHOUT CLAIM TO ANY PARTICULAR FONT, STYLE, SIZE, OR COLOR.

OWNER OF U.S. REG. NOS. 2,045,947, 2,591,609 AND OTHERS.

NO CLAIM IS MADE TO THE EXCLUSIVE RIGHT TO USE "GOVERNMENT", APART FROM THE MARK AS SHOWN.

SEC. 2(F) AS TO "BLOOMBERG".

SER. NO. 85-438,863, FILED 10-4-2011.

JOHN E. MICHOS, EXAMINING ATTORNEY



*David J. Kyros*

Director of the United States Patent and Trademark Office



# United States of America

United States Patent and Trademark Office

## LIVE WITHOUT COMPROMISE

**Reg. No. 4,135,566**

DAVID FRANCIS FURNITURE CORP. (FLORIDA CORPORATION)  
3990 US HIGHWAY ONE  
VERO BEACH, FL 32960

**Registered May 1, 2012**

**Int. Cl.: 35**

FOR: WHOLESALE AND RETAIL STORE SERVICES FEATURING FURNITURE, IN CLASS 35 (U.S. CLS. 100, 101 AND 102).

**SERVICE MARK**

FIRST USE 1-31-2006; IN COMMERCE 1-31-2006.

**PRINCIPAL REGISTER**

THE MARK CONSISTS OF STANDARD CHARACTERS WITHOUT CLAIM TO ANY PARTICULAR FONT, STYLE, SIZE, OR COLOR.

SER. NO. 85-439,126, FILED 10-4-2011.

KIMBERLY PERRY, EXAMINING ATTORNEY



*David J. Kybas*

Director of the United States Patent and Trademark Office

# United States of America

United States Patent and Trademark Office

# Alltech

**Reg. No. 4,135,567**

**Registered May 1, 2012**

**Int. Cl.: 29**

**TRADEMARK**

**PRINCIPAL REGISTER**

ALLTECH, INC. (KENTUCKY CORPORATION)  
3031 CATNIP HILL PIKE  
NICHOLASVILLE, KY 40356

FOR: MEAT, IN CLASS 29 (U.S. CL. 46).

FIRST USE 6-19-2010; IN COMMERCE 7-7-2010.

OWNER OF U.S. REG. NOS. 2,268,156, 4,028,757 AND OTHERS.

THE MARK CONSISTS OF "ALLTECH" IN STYLIZED FORM.

SER. NO. 85-439,640, FILED 10-5-2011.

RUDY R. SINGLETON, EXAMINING ATTORNEY



*David J. Kyffers*

Director of the United States Patent and Trademark Office

# United States of America

United States Patent and Trademark Office



**Reg. No. 4,135,568**

**Registered May 1, 2012**

**Int. Cl.: 9**

**TRADEMARK**

**PRINCIPAL REGISTER**

ENFOTRACEGPS INC (TENNESSEE CORPORATION)  
SUITE 125  
2035 LAKESIDE CENTRE WAY  
KNOXVILLE, TN 37922

FOR: VEHICLE TRACKING DEVICES COMPRISED OF CELLULAR RADIO MODULES, COMPUTER SOFTWARE AND COMPUTER HARDWARE, SENSORS, TRANSMITTERS, RECEIVERS AND GLOBAL POSITIONING SATELLITE RECEIVERS, ALL FOR USE IN CONNECTION WITH VEHICLE TRACKING, VEHICLE MONITORING AND ANTI-THEFT VEHICLE ALARMS, IN CLASS 9 (U.S. CLS. 21, 23, 26, 36 AND 38).

FIRST USE 9-2-2011; IN COMMERCE 9-2-2011.

OWNER OF U.S. REG. NO. 3,866,889.

THE COLOR(S) BLACK, GRAY AND BLUE IS/ARE CLAIMED AS A FEATURE OF THE MARK.

NO CLAIM IS MADE TO THE EXCLUSIVE RIGHT TO USE "AFFORDABLE GPS TRACKING", APART FROM THE MARK AS SHOWN.

THE MARK CONSISTS OF THE WORD "ENFOTRACE", WHEREIN THE "ENF" AND "TRACE" PORTIONS ARE FORMED OF BLACK STYLIZED LETTERS OUTLINED IN GRAY AND THE "O" PORTION COMPRISES A BLUE SPHERE OUTLINED IN GRAY, WITH GRAY SWOOSH DESIGNS DISPOSED ABOVE AND BELOW THE BLUE SPHERE, AND THE PHRASE "AFFORDABLE GPS TRACKING" IN BLACK BLOCK LETTERS DISPOSED BELOW THE "TRACE" PORTION.

SER. NO. 85-439,697, FILED 10-5-2011.

JERI J. FICKES, EXAMINING ATTORNEY



*David J. Kybas*

Director of the United States Patent and Trademark Office

# United States of America

United States Patent and Trademark Office

## TOUCH DOWN. MOVE UP.

**Reg. No. 4,135,569**

**Registered May 1, 2012**

**Int. Cl.: 35**

**SERVICE MARK**

**PRINCIPAL REGISTER**

SIGNATURE FLIGHT SUPPORT UK REGIONS LIMITED (UNITED KINGDOM CORPORATION)  
20 BALDERTON STREET  
LONDON, UNITED KINGDOM W1K6TL

FOR: ADMINISTRATION OF A CONSUMER LOYALTY PROGRAM DESIGNED TO PROMOTE INCREASED VISIT TO FIXED BASE OPERATION (FBO) AVIATION FACILITIES BY MEMBERS BY OFFERING ESCALATING BENEFITS, NAMELY, GUARANTEED CREW CARS, PREFERRED RAMP PARKING, PRIORITY DAYTIME HANGARAGE, GROUND POWER UNIT (GPU) STARTUP DISCOUNTS, AND COMPLIMENTARY RENTAL CAR MEMBERSHIP AS PERCENTAGE OF VISITS INCREASE, IN CLASS 35 (U.S. CLS. 100, 101 AND 102).

FIRST USE 1-25-2010; IN COMMERCE 1-25-2010.

THE MARK CONSISTS OF STANDARD CHARACTERS WITHOUT CLAIM TO ANY PARTICULAR FONT, STYLE, SIZE, OR COLOR.

SER. NO. 85-439,803, FILED 10-5-2011.

BARBARA RUTLAND, EXAMINING ATTORNEY



*David J. Kyros*

Director of the United States Patent and Trademark Office

# United States of America

United States Patent and Trademark Office

## GRAND ENTERTAINER

**Reg. No. 4,135,570**

**Registered May 1, 2012**

**Int. Cl.: 12**

**TRADEMARK**

**PRINCIPAL REGISTER**

PREMIER MARINE, INC. (MINNESOTA CORPORATION)  
26612 FALLBROOK AVENUE  
WYOMING, MN 55092

FOR: PONTOON BOATS, IN CLASS 12 (U.S. CLS. 19, 21, 23, 31, 35 AND 44).

FIRST USE 8-13-2011; IN COMMERCE 8-13-2011.

THE MARK CONSISTS OF STANDARD CHARACTERS WITHOUT CLAIM TO ANY PARTICULAR FONT, STYLE, SIZE, OR COLOR.

SER. NO. 85-440,724, FILED 10-6-2011.

BARBARA RUTLAND, EXAMINING ATTORNEY



*David J. Kybas*

Director of the United States Patent and Trademark Office

# United States of America

United States Patent and Trademark Office

# CO-ACTIVE

**Reg. No. 4,135,571**

**Registered May 1, 2012**

**Int. Cl.: 41**

**SERVICE MARK**

**PRINCIPAL REGISTER**

THE COACHES TRAINING INSTITUTE (CALIFORNIA CORPORATION)  
4000 CIVIC CENTER DRIVE, STE 500  
SAN RAFAEL, CA 94903

FOR: EDUCATIONAL AND TRAINING SERVICES IN THE FIELD OF PROFESSIONAL COACHING AND LEADERSHIP DEVELOPMENT; NAMELY CONDUCTING GROUP AND PRIVATE SEMINARS, COURSES, WORKSHOPS, AND RETREATS IN THE FIELD OF PROFESSIONAL COACHING AND LEADERSHIP DEVELOPMENT; PROVIDING TRAINING OF PROFESSIONAL COACHES FOR CERTIFICATIONS IN THE FIELD OF PROFESSIONAL COACHING, IN CLASS 41 (U.S. CLS. 100, 101 AND 107).

FIRST USE 10-1-1997; IN COMMERCE 1-0-2008.

THE MARK CONSISTS OF STANDARD CHARACTERS WITHOUT CLAIM TO ANY PARTICULAR FONT, STYLE, SIZE, OR COLOR.

OWNER OF U.S. REG. NOS. 2,680,023, 2,706,272, AND 3,120,151.

SER. NO. 85-443,294, FILED 10-10-2011.

VIVIAN MICZNIK FIRST, EXAMINING ATTORNEY



*David J. Kyffers*

Director of the United States Patent and Trademark Office

# United States of America

United States Patent and Trademark Office



**Reg. No. 4,135,572**

**Registered May 1, 2012**

**Int. Cl.: 9**

**TRADEMARK**

**PRINCIPAL REGISTER**

UNIVERSAL CITY STUDIOS LLC (DELAWARE LIMITED LIABILITY COMPANY)  
BLDG. 1280/6TH FLOOR  
100 UNIVERSAL CITY PLAZA  
UNIVERSAL CITY, CA 91608

FOR: DIGITAL MEDIA, NAMELY, PRE-RECORDED DVD'S, DOWNLOADABLE AUDIO AND VIDEO RECORDINGS, AND CDS ALL FEATURING AND PROMOTING MOTION PICTURE FILMS AND TELEVISION PROGRAMS IN THE COMEDY, DRAMA, ROMANCE, FANTASY, SCIENCE FICTION, HORROR, MYSTERY, ACTION, ADVENTURE AND ANIMATION GENRES; MUSICAL SOUND RECORDINGS, IN CLASS 9 (U.S. CLS. 21, 23, 26, 36 AND 38).

FIRST USE 0-0-1997; IN COMMERCE 0-0-1997.

OWNER OF U.S. REG. NOS. 2,438,538 AND 2,519,493.

THE MARK CONSISTS OF THE LITERAL ELEMENT "UNIVERSAL" CENTERED OVER AN IMAGE OF A GLOBE.

SER. NO. 85-443,402, FILED 10-10-2011.

FLORENTINA BLANDU, EXAMINING ATTORNEY



*David J. Kybas*

Director of the United States Patent and Trademark Office

# United States of America

United States Patent and Trademark Office

# PROTENZA

**Reg. No. 4,135,573**

**Registered May 1, 2012**

**Int. Cl.: 31**

**TRADEMARK**

**PRINCIPAL REGISTER**

FARMERS FEED MILL, INC. (KENTUCKY CORPORATION)  
251 W. LOUDON AVENUE  
LEXINGTON, KY 405081273

FOR: HORSE FEED, IN CLASS 31 (U.S. CLS. 1 AND 46).

FIRST USE 11-10-2011; IN COMMERCE 11-10-2011.

THE MARK CONSISTS OF STANDARD CHARACTERS WITHOUT CLAIM TO ANY PARTICULAR FONT, STYLE, SIZE, OR COLOR.

SER. NO. 85-445,507, FILED 10-12-2011.

ELLEN B. AWRICH, EXAMINING ATTORNEY



*David J. Kyffers*

Director of the United States Patent and Trademark Office



# United States of America

United States Patent and Trademark Office

## BJ'S TODO EN CUANTO A AHORROS

**Reg. No. 4,135,574**

**Registered May 1, 2012**

**Int. Cl.: 35**

**SERVICE MARK**

**PRINCIPAL REGISTER**

STRATHMORE PARTNERS, LP (DELAWARE LIMITED PARTNERSHIP)  
214 NORTH MAIN STREET  
CONCORD, NH 033021415

FOR: RETAIL FOOD AND GENERAL MERCHANDISE CLUB BUYING SERVICES OFFERED  
TO CUSTOMERS OF A RELATED COMPANY, IN CLASS 35 (U.S. CLS. 100, 101 AND 102).

FIRST USE 2-1-2011; IN COMMERCE 2-1-2011.

THE MARK CONSISTS OF STANDARD CHARACTERS WITHOUT CLAIM TO ANY PAR-  
TICULAR FONT, STYLE, SIZE, OR COLOR.

OWNER OF U.S. REG. NOS. 1,643,993, 1,751,720 AND OTHERS.

THE ENGLISH TRANSLATION OF "TODO EN CUANTO A AHORROS" IN THE MARK IS  
"IT'S ALL ABOUT SAVINGS".

SER. NO. 85-446,342, FILED 10-13-2011.

JOHN WILKE, EXAMINING ATTORNEY



*David J. Kybas*

Director of the United States Patent and Trademark Office

**United States of America**  
United States Patent and Trademark Office

# BATCAVE

**Reg. No. 4,135,575**

DC COMICS (NEW YORK PARTNERSHIP)  
1700 BROADWAY  
NEW YORK, NY 10019

**Registered May 1, 2012**

**Int. Cl.: 28**

FOR: PLAY SETS FOR ACTION FIGURES, ACTION FIGURES, TOY VEHICLES AND TOY FURNITURE, IN CLASS 28 (U.S. CLS. 22, 23, 38 AND 50).

**TRADEMARK**

FIRST USE 0-0-2007; IN COMMERCE 0-0-2007.

**PRINCIPAL REGISTER**

THE MARK CONSISTS OF STANDARD CHARACTERS WITHOUT CLAIM TO ANY PARTICULAR FONT, STYLE, SIZE, OR COLOR.

SER. NO. 85-446,715, FILED 10-13-2011.

SCOTT BIBB, EXAMINING ATTORNEY



*David J. Kybas*

Director of the United States Patent and Trademark Office

**United States of America**  
United States Patent and Trademark Office

**POLAROID**

**Reg. No. 4,135,576**

**Registered May 1, 2012**

**Int. Cl.: 1**

**TRADEMARK**

**PRINCIPAL REGISTER**

PLR IP HOLDINGS, LLC (DELAWARE LIMITED LIABILITY COMPANY)  
4350 BAKER ROAD  
MINNETONKA, MN 55343

FOR: PHOTOGRAPHIC PAPER, UNEXPOSED PHOTOGRAPHIC FILM, SENSITIZED SELF-DEVELOPING PHOTOGRAPHIC FILM, IN CLASS 1 (U.S. CLS. 1, 5, 6, 10, 26 AND 46).

FIRST USE 0-0-2010; IN COMMERCE 0-0-2010.

THE MARK CONSISTS OF STANDARD CHARACTERS WITHOUT CLAIM TO ANY PARTICULAR FONT, STYLE, SIZE, OR COLOR.

OWNER OF U.S. REG. NOS. 579,986, 3,112,549 AND OTHERS.

SER. NO. 85-447,972, FILED 10-14-2011.

THEODORE MCBRIDE, EXAMINING ATTORNEY



*David J. Kybas*

Director of the United States Patent and Trademark Office

# United States of America

United States Patent and Trademark Office



**Reg. No. 4,135,577**

**Registered May 1, 2012**

**Int. Cl.: 7**

**TRADEMARK**

**PRINCIPAL REGISTER**

ZHEJIANG YONGYUAN VALVE CO., LTD. (CHINA LIMITED COMPANY (LTD.))  
DONGCHENG STREET, SUXI INDUSTRIAL ZONE  
YONGKANG CITY  
ZHEJIANG PROVINCE, CHINA

FOR: BACK PRESSURE VALVES AS PARTS OF MACHINES; COMPRESSED AIR MACHINE COMPONENTS, NAMELY, CYLINDERS, VALVES AND AIR GRIPS; FLUID POWER COMPONENT KIT FOR MACHINE CONTROL COMPRISING PUMPS AND VALVES; HYDRAULIC CONTROLS FOR MACHINES, MOTORS AND ENGINES; HYDRAULIC PUMPS; HYDRAULIC VALVE ACTUATORS; PNEUMATIC CONTROLS FOR MACHINES, MOTORS AND ENGINES; PNEUMATIC VALVE ACTUATORS; VALVES BEING PARTS OF MACHINES, IN CLASS 7 (U.S. CLS. 13, 19, 21, 23, 31, 34 AND 35).

FIRST USE 12-10-2008; IN COMMERCE 5-17-2011.

THE MARK CONSISTS OF AN OVAL DESIGN WITH THREE LETTERS "YVC" INSIDE.

SER. NO. 85-449,446, FILED 10-18-2011.

EUGENIA MARTIN, EXAMINING ATTORNEY



*David J. Kybas*

Director of the United States Patent and Trademark Office

# United States of America

United States Patent and Trademark Office

Design. Analyze. Optimize.  
Implement.

**Reg. No. 4,135,578**

EPI ENGINEERING, INC. (TEXAS CORPORATION)  
9801 WESTHEIMER SUITE 1070  
HOUSTON, TX 77042

**Registered May 1, 2012**

**Int. Cl.: 42**

FOR: ARCHITECTURAL AND ENGINEERING SERVICES, IN CLASS 42 (U.S. CLS. 100 AND 101).

**SERVICE MARK**

FIRST USE 2-1-2011; IN COMMERCE 2-1-2011.

**PRINCIPAL REGISTER**

THE MARK CONSISTS OF STANDARD CHARACTERS WITHOUT CLAIM TO ANY PARTICULAR FONT, STYLE, SIZE, OR COLOR.

SER. NO. 85-449,884, FILED 10-18-2011.

CAROLINE WOOD, EXAMINING ATTORNEY



*David J. Kybas*

Director of the United States Patent and Trademark Office

# United States of America

United States Patent and Trademark Office

## AN UMBRELLA FOR A DIFFERENT KIND OF BAD DAY

**Reg. No. 4,135,579**

**Registered May 1, 2012**

**Int. Cl.: 45**

**SERVICE MARK**

**PRINCIPAL REGISTER**

BLACK UMBRELLA, LLC (DELAWARE LIMITED LIABILITY COMPANY)  
590 MADISON AVENUE, 21ST FLOOR  
NEW YORK, NY 10022

FOR: PERSONAL EMERGENCY AND SAFETY PLANNING SERVICES, NAMELY, CREATING EMERGENCY AND SAFETY PLANS FOR INDIVIDUALS IN THE EVENT OF NATURAL OR MAN-MADE DISASTERS, IN CLASS 45 (U.S. CLS. 100 AND 101).

FIRST USE 9-0-2011; IN COMMERCE 9-0-2011.

THE MARK CONSISTS OF STANDARD CHARACTERS WITHOUT CLAIM TO ANY PARTICULAR FONT, STYLE, SIZE, OR COLOR.

OWNER OF U.S. REG. NO. 3,861,915.

SER. NO. 85-450,326, FILED 10-18-2011.

ANDREW RHIM, EXAMINING ATTORNEY



*David J. Kybas*

Director of the United States Patent and Trademark Office

# United States of America

United States Patent and Trademark Office

# E/SP

**Reg. No. 4,135,580**

**Registered May 1, 2012**

**Int. Cl.: 45**

**SERVICE MARK**

**PRINCIPAL REGISTER**

BLACK UMBRELLA, LLC (DELAWARE LIMITED LIABILITY COMPANY)  
590 MADISON AVENUE, 21ST FLOOR  
NEW YORK, NY 10022

FOR: PERSONAL EMERGENCY AND SAFETY PLANNING SERVICES, NAMELY, CREATING EMERGENCY AND SAFETY PLANS FOR INDIVIDUALS IN THE EVENT OF NATURAL OR MAN-MADE DISASTERS, IN CLASS 45 (U.S. CLS. 100 AND 101).

FIRST USE 9-0-2011; IN COMMERCE 9-0-2011.

THE MARK CONSISTS OF STANDARD CHARACTERS WITHOUT CLAIM TO ANY PARTICULAR FONT, STYLE, SIZE, OR COLOR.

SER. NO. 85-450,333, FILED 10-18-2011.

ANDREW RHIM, EXAMINING ATTORNEY



*David J. Kybas*

Director of the United States Patent and Trademark Office

# United States of America

United States Patent and Trademark Office

# SolutionScan

**Reg. No. 4,135,581**

**Registered May 1, 2012**

**Int. Cl.: 35**

**SERVICE MARK**

**PRINCIPAL REGISTER**

HAGGIN MARKETING, INC. (CALIFORNIA CORPORATION), DBA SOLUTIONSET  
100 SHORELINE HWY A200  
MILL VALLEY, CA 94941

FOR: MARKETING AND ADVERTISING CONSULTING FOR OTHERS; STRATEGIC  
MARKETING PLANNING AND MARKETING DATA ANALYSIS OF THE RESULTS;  
MARKET RESEARCH SERVICES , IN CLASS 35 (U.S. CLS. 100, 101 AND 102).

FIRST USE 5-26-2011; IN COMMERCE 5-26-2011.

THE MARK CONSISTS OF STANDARD CHARACTERS WITHOUT CLAIM TO ANY PAR-  
TICULAR FONT, STYLE, SIZE, OR COLOR.

SER. NO. 85-450,422, FILED 10-18-2011.

MATTHEW MCDOWELL, EXAMINING ATTORNEY



*David J. Kyros*

Director of the United States Patent and Trademark Office



# United States of America

United States Patent and Trademark Office

## CLINICAL ONCOLOGY NEWS

**Reg. No. 4,135,582**

**Registered May 1, 2012**

**Int. Cls.: 16 and 41**

THE MCMAHON GROUP LIMITED PARTNERSHIP (CONNECTICUT LIMITED PARTNERSHIP)  
8TH FLOOR  
545 WEST 45TH STREET  
NEW YORK, NY 10036

**TRADEMARK**

FOR: PRINTED PERIODICALS FOR ONCOLOGISTS AND OTHERS ON THE SUBJECT OF TREATING CANCER PATIENTS, IN CLASS 16 (U.S. CLS. 2, 5, 22, 23, 29, 37, 38 AND 50).

**SERVICE MARK**

FIRST USE 9-30-2006; IN COMMERCE 9-30-2006.

**PRINCIPAL REGISTER**

FOR: PROVIDING AN ON-LINE PUBLICATION IN THE NATURE OF PERIODICALS FOR ONCOLOGISTS AND OTHERS ON THE SUBJECT OF TREATING CANCER PATIENTS, IN CLASS 41 (U.S. CLS. 100, 101 AND 107).

FIRST USE 9-30-2006; IN COMMERCE 9-30-2006.

THE MARK CONSISTS OF STANDARD CHARACTERS WITHOUT CLAIM TO ANY PARTICULAR FONT, STYLE, SIZE, OR COLOR.

OWNER OF U.S. REG. NO. 3,354,511.

NO CLAIM IS MADE TO THE EXCLUSIVE RIGHT TO USE "NEWS", APART FROM THE MARK AS SHOWN.

SEC. 2(F).

SER. NO. 85-451,722, FILED 10-20-2011.

JEFFERY COWARD, EXAMINING ATTORNEY



*David J. Kybas*

Director of the United States Patent and Trademark Office

# United States of America

United States Patent and Trademark Office

# RUMPEDIA

**Reg. No. 4,135,583**

**Registered May 1, 2012**

**Int. Cl.: 9**

**TRADEMARK**

**PRINCIPAL REGISTER**

DIAGEO NORTH AMERICA, INC. (CONNECTICUT CORPORATION)  
801 MAIN AVENUE  
NORWALK, CT 06851

FOR: COMPUTER APPLICATION SOFTWARE FOR WIRELESS DEVICES, COMPUTERS, HANDHELD COMPUTERS AND TABLETS, NAMELY, SOFTWARE FOR USE IN THE CREATION OF ALCOHOLIC DRINK RECIPES , IN CLASS 9 (U.S. CLS. 21, 23, 26, 36 AND 38).

FIRST USE 2-28-2011; IN COMMERCE 2-28-2011.

THE MARK CONSISTS OF STANDARD CHARACTERS WITHOUT CLAIM TO ANY PARTICULAR FONT, STYLE, SIZE, OR COLOR.

SER. NO. 85-452,178, FILED 10-20-2011.

CHERYL CLAYTON, EXAMINING ATTORNEY



*David J. Kybas*

Director of the United States Patent and Trademark Office

# United States of America

United States Patent and Trademark Office

## ASTHMA CLINICAL RESEARCH CENTERS (ACRC)

**Reg. No. 4,135,584**

AMERICAN LUNG ASSOCIATION (MAINE CORPORATION)  
1301 PENNSYLVANIA AVENUE NW, SUITE 800  
WASHINGTON, DC 20004

**Registered May 1, 2012**

**Int. Cl.: 42**

FOR: CONDUCTING RESEARCH AND CLINICAL TRIALS RELATING TO ASTHMA, IN CLASS 42 (U.S. CLS. 100 AND 101).

**SERVICE MARK**

FIRST USE 0-0-1999; IN COMMERCE 0-0-1999.

**PRINCIPAL REGISTER**

THE MARK CONSISTS OF STANDARD CHARACTERS WITHOUT CLAIM TO ANY PARTICULAR FONT, STYLE, SIZE, OR COLOR.

NO CLAIM IS MADE TO THE EXCLUSIVE RIGHT TO USE "CLINICAL RESEARCH CENTERS", APART FROM THE MARK AS SHOWN.

SEC. 2(F).

SER. NO. 85-452,940, FILED 10-21-2011.

TIMOTHY FINNEGAN, EXAMINING ATTORNEY



*David J. Kybas*

Director of the United States Patent and Trademark Office

# United States of America

United States Patent and Trademark Office

## SPINEFRONTIER

**Reg. No. 4,135,585**

**Registered May 1, 2012**

**Int. Cl.: 5**

**TRADEMARK**

**PRINCIPAL REGISTER**

SPINEFRONTIER, INC. (DELAWARE CORPORATION)  
500 CUMMINGS CENTER, SUITE 3500  
BEVERLY, MA 01915

FOR: BONE GROWTH MEDIA CONSISTING OF BIOLOGICAL MATERIALS FOR MEDICAL PURPOSES; HUMAN ALLOGRAFT BONE AND TISSUE, IN CLASS 5 (U.S. CLS. 6, 18, 44, 46, 51 AND 52).

FIRST USE 2-28-2009; IN COMMERCE 2-28-2009.

THE MARK CONSISTS OF STANDARD CHARACTERS WITHOUT CLAIM TO ANY PARTICULAR FONT, STYLE, SIZE, OR COLOR.

SER. NO. 85-453,075, FILED 10-21-2011.

MATTHEW KLINE, EXAMINING ATTORNEY



*David J. Kyffers*

Director of the United States Patent and Trademark Office

# United States of America

United States Patent and Trademark Office

# SHAFTFIT

**Reg. No. 4,135,586**

**Registered May 1, 2012**

**Int. Cl.: 35**

**SERVICE MARK**

**PRINCIPAL REGISTER**

TRUE TEMPER SPORTS, INC. (DELAWARE CORPORATION)  
SUITE 200  
8275 TOURNAMENT DRIVE  
MEMPHIS, TN 38125

FOR: ONLINE PROVISION OF INFORMATION AND ADVICE TO CONSUMERS REGARDING THE SELECTION OF GOLF CLUB SHAFTS TO BE PURCHASED, IN CLASS 35 (U.S. CLS. 100, 101 AND 102).

FIRST USE 7-0-2002; IN COMMERCE 7-0-2002.

THE MARK CONSISTS OF STANDARD CHARACTERS WITHOUT CLAIM TO ANY PARTICULAR FONT, STYLE, SIZE, OR COLOR.

SER. NO. 85-455,162, FILED 10-25-2011.

JOHN SCHUYLER YARD, EXAMINING ATTORNEY



*David J. Kyros*

Director of the United States Patent and Trademark Office

# United States of America

United States Patent and Trademark Office

## Hope Elephants

**Reg. No. 4,135,587**

**Registered May 1, 2012**

**Int. Cl.: 35**

**SERVICE MARK**

**PRINCIPAL REGISTER**

HOPE ELEPHANTS INC. (MAINE CORPORATION)  
P.O. BOX 293  
ROCKPORT, ME 04856

FOR: CHARITABLE SERVICES, NAMELY, PROMOTING AND RAISING PUBLIC AWARENESS ABOUT AND OPERATE A CARE AND REHABILITATION FACILITY FOR AGING RETIRED CIRCUS ELEPHANTS, IN CLASS 35 (U.S. CLS. 100, 101 AND 102).

FIRST USE 6-1-2011; IN COMMERCE 6-1-2011.

THE MARK CONSISTS OF STANDARD CHARACTERS WITHOUT CLAIM TO ANY PARTICULAR FONT, STYLE, SIZE, OR COLOR.

NO CLAIM IS MADE TO THE EXCLUSIVE RIGHT TO USE "ELEPHANTS", APART FROM THE MARK AS SHOWN.

SER. NO. 85-455,537, FILED 10-25-2011.

DARRYL SPRUILL, EXAMINING ATTORNEY



*David J. Kyffers*

Director of the United States Patent and Trademark Office

# United States of America

United States Patent and Trademark Office

# Dig for Life

**Reg. No. 4,135,588**

**Registered May 1, 2012**

**Int. Cl.: 36**

**SERVICE MARK**

**PRINCIPAL REGISTER**

SAINT FRANCIS MEDICAL CENTER (MISSOURI CORPORATION)  
211 ST. FRANCIS DRIVE  
CAPE GIRARDEAU, MO 63701

FOR: FUNDRAISING SERVICES, NAMELY, RAISING FUNDS TO EDUCATE WOMEN ABOUT EARLY BREAST CANCER DETECTION AND TO PROVIDE MAMMOGRAMS , IN CLASS 36 (U.S. CLS. 100, 101 AND 102).

FIRST USE 1-31-2001; IN COMMERCE 1-31-2001.

THE MARK CONSISTS OF STANDARD CHARACTERS WITHOUT CLAIM TO ANY PARTICULAR FONT, STYLE, SIZE, OR COLOR.

SER. NO. 85-455,655, FILED S.R. 10-25-2011 AM. P.R. 12-19-2011.

MICHAEL KEATING, EXAMINING ATTORNEY



*David J. Kybas*

Director of the United States Patent and Trademark Office

# United States of America

United States Patent and Trademark Office

# WROX

**Reg. No. 4,135,589**

**Registered May 1, 2012**

**Int. Cls.: 16 and 41**

**TRADEMARK**

**SERVICE MARK**

**PRINCIPAL REGISTER**

JOHN WILEY & SONS, INC. (NEW YORK CORPORATION)  
LEGAL DEPARTMENT  
111 RIVER STREET  
HOBOKEN, NJ 07030

FOR: PRINTED MATTER, NAMELY, BOOKS, BOOKLETS, CATALOGS, INFORMATIONAL BROCHURES AND PAMPHLETS IN THE FIELD OF BUSINESS AND GENERAL COMPUTER REFERENCE, IN CLASS 16 (U.S. CLS. 2, 5, 22, 23, 29, 37, 38 AND 50).

FIRST USE 1-1-2000; IN COMMERCE 1-1-2000.

FOR: PROVIDING A WEBSITE FEATURING NON-DOWNLOADABLE PUBLICATIONS, NAMELY, BOOKS, CATALOGS, INFORMATIONAL BROCHURES AND PAMPHLETS IN THE FIELD OF BUSINESS AND GENERAL COMPUTER REFERENCE, IN CLASS 41 (U.S. CLS. 100, 101 AND 107).

FIRST USE 1-1-2000; IN COMMERCE 1-1-2000.

THE MARK CONSISTS OF STANDARD CHARACTERS WITHOUT CLAIM TO ANY PARTICULAR FONT, STYLE, SIZE, OR COLOR.

OWNER OF U.S. REG. NOS. 2,468,822 AND 2,477,094.

SER. NO. 85-456,562, FILED 10-26-2011.

B. PARADEWELAI, EXAMINING ATTORNEY



*David J. Kybas*

Director of the United States Patent and Trademark Office



# United States of America

United States Patent and Trademark Office



**Reg. No. 4,135,590**

**Registered May 1, 2012**

**Int. Cl.: 35**

**SERVICE MARK**

**PRINCIPAL REGISTER**

KOH, HYUN-LIM (REPUBLIC OF KOREA INDIVIDUAL)  
2605 SIGMA TOWER,  
7-19 SHINCHEON-DONG, SONGPA-GU,  
SEOUL, REPUBLIC OF KOREA

FOR: DISTRIBUTORSHIP SERVICES IN THE FIELD OF CLOTHING, GROCERIES, COSMETICS, PERFUMES, SPORTING GOODS, AND HOME APPLIANCES; ON-LINE RETAIL STORE SERVICES FEATURING CLOTHING, GROCERIES, COSMETICS, PERFUMES, SPORTING GOODS, AND HOME APPLIANCES; RETAIL STORES FEATURING CLOTHING, GROCERIES, COSMETICS, PERFUMES, SPORTING GOODS, AND HOME APPLIANCES; WHOLESALE STORES FEATURING CLOTHING, GROCERIES, COSMETICS, PERFUMES, SPORTING GOODS, AND HOME APPLIANCES, IN CLASS 35 (U.S. CLS. 100, 101 AND 102).

OWNER OF REPUBLIC OF KOREA REG. NO. 41-0210621, DATED 5-19-2011, EXPIRES 5-19-2021.

THE COLOR(S) BLACK, GRAY, AND RED IS/ARE CLAIMED AS A FEATURE OF THE MARK.

NO CLAIM IS MADE TO THE EXCLUSIVE RIGHT TO USE "BEST" , APART FROM THE MARK AS SHOWN.

THE MARK CONSISTS OF THE WORD "BEST" IN LARGE, BLACK BOLD FOLLOWED BY A GRAY SQUARE HAVING A LETTER "K" PLACED TOP LEFT AND A LETTER "Q" PLACED BOTTOM RIGHT IN RED, THE SQUARE BEING FOLLOWED BY "ING" ON TOP RIGHT IN BLACK AND "UEEN" ON BOTTOM RIGHT IN BLACK, EACH IN SMALLER BOLD WHERE THE COLOR WHITE REPRESENTS BACKGROUND AND IS NOT CLAIMED AS A COLOR FEATURE OF THE MARK.

SER. NO. 85-456,698, FILED 10-26-2011.

GRETТА YAO, EXAMINING ATTORNEY



*David J. Kyffers*

Director of the United States Patent and Trademark Office

# United States of America

United States Patent and Trademark Office

# LatinoLicious

**Reg. No. 4,135,591**

**Registered May 1, 2012**

**Int. Cl.: 45**

**SERVICE MARK**

**PRINCIPAL REGISTER**

CHELLAUL CORPORATION (NEVADA CORPORATION)  
1135 TERMINAL WAY, SUITE 209  
RENO, NV 89502

FOR: INTERRACIAL DATING SERVICES, NAMELY, PROVIDING AN ON-LINE COMPUTER DATABASE FEATURING SINGLE PEOPLE INTERESTED IN MEETING OTHER SINGLE PEOPLE, IN CLASS 45 (U.S. CLS. 100 AND 101).

FIRST USE 12-18-2010; IN COMMERCE 12-18-2010.

THE MARK CONSISTS OF STANDARD CHARACTERS WITHOUT CLAIM TO ANY PARTICULAR FONT, STYLE, SIZE, OR COLOR.

SER. NO. 85-456,723, FILED 10-26-2011.

KAELIE KUNG, EXAMINING ATTORNEY



*David J. Kyros*

Director of the United States Patent and Trademark Office

# United States of America

United States Patent and Trademark Office

# TemptAsian

**Reg. No. 4,135,592**

**Registered May 1, 2012**

**Int. Cl.: 45**

**SERVICE MARK**

**PRINCIPAL REGISTER**

CHELLAUL CORPORATION (NEVADA CORPORATION)  
1135 TERMINAL WAY, SUITE 209  
RENO, NV 89502

FOR: INTERRACIAL DATING SERVICES, NAMELY, PROVIDING AN ON-LINE COMPUTER DATABASE FEATURING SINGLE PEOPLE INTERESTED IN MEETING OTHER SINGLE PEOPLE, IN CLASS 45 (U.S. CLS. 100 AND 101).

FIRST USE 12-18-2010; IN COMMERCE 12-18-2010.

THE MARK CONSISTS OF STANDARD CHARACTERS WITHOUT CLAIM TO ANY PARTICULAR FONT, STYLE, SIZE, OR COLOR.

SER. NO. 85-456,755, FILED 10-26-2011.

KAELIE KUNG, EXAMINING ATTORNEY



*David J. Kyros*

Director of the United States Patent and Trademark Office

United States of America  
United States Patent and Trademark Office

**TruSlate**  
**"THE AFFORDABLE GENUINE SLATE"**

**Reg. No. 4,135,593**

BUILDING MATERIALS INVESTMENT CORPORATION (DELAWARE CORPORATION)  
2600 SINGLETON BLVD.  
DALLAS, TX 75212

**Registered May 1, 2012**

**Int. Cl.: 19**

FOR: ROOFING SLATES; NON-METAL ROOF VENTS FOR VENTILATION IN RESIDENTIAL OR COMMERCIAL BUILDINGS, IN CLASS 19 (U.S. CLS. 1, 12, 33 AND 50).

**TRADEMARK**

FIRST USE 9-30-2008; IN COMMERCE 9-30-2008.

**PRINCIPAL REGISTER**

NO CLAIM IS MADE TO THE EXCLUSIVE RIGHT TO USE "GENUINE SLATE", APART FROM THE MARK AS SHOWN.

THE MARK CONSISTS OF THE WORD "TRUSLATE", WITH THE "T" APPEARING IN A RECTANGLE, ON TOP OF THE PHRASE "THE AFFORDABLE GENUINE SLATE" IN QUOTES WITH THE WORD "AFFORDABLE" UNDERLINED.

SER. NO. 85-456,857, FILED 10-26-2011.

MEGHAN REINHART, EXAMINING ATTORNEY



*David J. Kybas*

Director of the United States Patent and Trademark Office

United States of America  
United States Patent and Trademark Office

# Bonnie

**Reg. No. 4,135,594**

**Registered May 1, 2012**

**Int. Cls.: 1 and 31**

**TRADEMARK**

**PRINCIPAL REGISTER**

BONNIE PLANTS, INC. (ALABAMA CORPORATION)  
1729 HIGHWAY 223  
UNION SPRINGS, AL 36089

FOR: PLANT FOOD, IN CLASS 1 (U.S. CLS. 1, 5, 6, 10, 26 AND 46).

FIRST USE 12-0-2009; IN COMMERCE 12-0-2009.

FOR: LIVE PLANTS, NAMELY, VEGETABLE, FRUIT, FLOWER, AND HERB PLANTS, IN CLASS 31 (U.S. CLS. 1 AND 46).

FIRST USE 1-0-2007; IN COMMERCE 1-0-2007.

OWNER OF U.S. REG. NOS. 3,465,918, 3,465,919, AND 3,479,204.

THE MARK CONSISTS OF THE WORD "BONNIE" IN A SPECIALIZED DESIGN.

SER. NO. 85-457,626, FILED 10-27-2011.

JILL PRATER, EXAMINING ATTORNEY



*David J. Kyffers*

Director of the United States Patent and Trademark Office

# United States of America

United States Patent and Trademark Office



**Reg. No. 4,135,595**

**Registered May 1, 2012**

**Int. Cl.: 35**

**SERVICE MARK**

**PRINCIPAL REGISTER**

RESEARCH NOW LIMITED (UNITED KINGDOM CORPORATION)  
ELIZABETH HOUSE, 39 YORK ROAD  
LONDON, UNITED KINGDOM SE17NQ

FOR: CONDUCTING, PROCESSING AND ANALYZING BUSINESS, MARKET AND PUBLIC OPINION RESEARCH SURVEYS; ORGANIZATION AND MANAGEMENT OF FOCUS GROUPS, PANEL GROUPS, AND ONLINE OPINION PANEL PARTICIPANTS; PROMOTING THE GOODS AND SERVICES OF OTHERS THROUGH THE ADMINISTRATION OF LOYALTY INCENTIVE AWARD PROGRAMS; PROMOTING LOYALTY FOR PARTICIPATION VIA ONLINE COMPUTER NETWORK SERVICES BY INCENTIVE AWARDS TO SUBSCRIBERS, IN CLASS 35 (U.S. CLS. 100, 101 AND 102).

FIRST USE 9-19-2011; IN COMMERCE 9-19-2011.

PRIORITY CLAIMED UNDER SEC. 44(D) ON UNITED KINGDOM APPLICATION NO. 2580109, FILED 5-3-2011, REG. NO. 2580109, DATED 8-5-2011, EXPIRES 5-3-2021.

THE MARK CONSISTS OF A RECTANGULAR SHAPED SPEECH BALLOON, CONTAINING A STAR IN THE CENTER OF THE SPEECH BALLOON.

SER. NO. 85-457,687, FILED 10-27-2011.

VERNA BETH RIRIE, EXAMINING ATTORNEY



*David J. Kybas*

Director of the United States Patent and Trademark Office

# United States of America

United States Patent and Trademark Office

## UNIVERSITY TOWERS SAN DIEGO STATE UNIVERSITY

**Reg. No. 4,135,596**

AZTEC SHOPS, LTD. (CALIFORNIA CORPORATION)  
SAN DIEGO STATE UNIVERSITY  
SAN DIEGO, CA 921821701

**Registered May 1, 2012**

**Int. Cl.: 43**

FOR: PROVIDING TEMPORARY HOUSING ACCOMMODATIONS; RESTAURANT AND CATERING SERVICES, IN CLASS 43 (U.S. CLS. 100 AND 101).

**SERVICE MARK**

FIRST USE 11-21-2001; IN COMMERCE 11-21-2001.

**PRINCIPAL REGISTER**

THE MARK CONSISTS OF STANDARD CHARACTERS WITHOUT CLAIM TO ANY PARTICULAR FONT, STYLE, SIZE, OR COLOR.

NO CLAIM IS MADE TO THE EXCLUSIVE RIGHT TO USE "UNIVERSITY TOWERS" OR "STATE UNIVERSITY", APART FROM THE MARK AS SHOWN.

SEC. 2(F).

SER. NO. 85-457,816, FILED 10-27-2011.

AMY KERTGATE, EXAMINING ATTORNEY



*David J. Kybas*

Director of the United States Patent and Trademark Office

# United States of America

United States Patent and Trademark Office



**Reg. No. 4,135,597**

**Registered May 1, 2012**

**Int. Cl.: 36**

**SERVICE MARK**

**PRINCIPAL REGISTER**

CHAMPION COLLEGE SERVICES, INC. (ARIZONA CORPORATION)  
4600 SOUTH MILL AVENUE, SUITE 180  
TEMPE, AZ 85285

FOR: CREDIT AND LOAN SERVICES; STUDENT LOAN SERVICES; FINANCING AND LOAN SERVICES; LOAN MANAGEMENT SERVICES; FINANCIAL SERVICES, NAMELY, LOAN DEFAULT MITIGATION SERVICES; AND LOAN SERVICES, NAMELY, STUDENT LOAN DEFAULT MITIGATION SERVICES, IN CLASS 36 (U.S. CLS. 100, 101 AND 102).

FIRST USE 3-1-2009; IN COMMERCE 3-1-2009.

THE MARK CONSISTS OF TORCH WITH FLAMES.

SER. NO. 85-457,948, FILED 10-27-2011.

TOBY BULLOFF, EXAMINING ATTORNEY



*David J. Kybas*

Director of the United States Patent and Trademark Office



# United States of America

United States Patent and Trademark Office



**Reg. No. 4,135,598**

**Registered May 1, 2012**

**Int. Cl.: 42**

**SERVICE MARK**

**PRINCIPAL REGISTER**

CHAMPION COLLEGE SERVICES, INC. (ARIZONA CORPORATION)  
4600 SOUTH MILL AVENUE, SUITE 180  
TEMPE, AZ 85285

FOR: CLOUD COMPUTING FEATURING SOFTWARE FOR LOAN MANAGEMENT SERVICES; CLOUD COMPUTING FEATURING SOFTWARE FOR FINANCIAL SERVICES, NAMELY, LOAN DEFAULT MITIGATION SERVICES; PROVIDING A WEBSITE FEATURING NON-DOWNLOADABLE SOFTWARE FOR LOAN MANAGEMENT SERVICES; AND PROVIDING TEMPORARY USE OF ON-LINE NON-DOWNLOADABLE SOFTWARE FOR LOAN SERVICES, NAMELY, LOAN MANAGEMENT SERVICES, IN CLASS 42 (U.S. CLS. 100 AND 101).

FIRST USE 10-10-2011; IN COMMERCE 10-10-2011.

THE MARK CONSISTS OF TORCH WITH FLAMES.

SER. NO. 85-458,167, FILED 10-27-2011.

TOBY BULLOFF, EXAMINING ATTORNEY



*David J. Kyffers*

Director of the United States Patent and Trademark Office

# United States of America

United States Patent and Trademark Office

# ALLIANCE

**Reg. No. 4,135,599**

**Registered May 1, 2012**

**Int. Cl.: 42**

**SERVICE MARK**

**PRINCIPAL REGISTER**

CHAMPION COLLEGE SERVICES, INC. (ARIZONA CORPORATION)  
4600 SOUTH MILL AVENUE, SUITE 180  
TEMPE, AZ 85285

FOR: CLOUD COMPUTING FEATURING SOFTWARE FOR LOAN MANAGEMENT SERVICES; CLOUD COMPUTING FEATURING SOFTWARE FOR FINANCIAL SERVICES, NAMELY, LOAN DEFAULT MITIGATION SERVICES; PROVIDING A WEBSITE FEATURING NON-DOWNLOADABLE SOFTWARE FOR LOAN MANAGEMENT SERVICES; AND PROVIDING TEMPORARY USE OF ON-LINE NON-DOWNLOADABLE SOFTWARE FOR LOAN SERVICES, NAMELY, LOAN MANAGEMENT SERVICES, IN CLASS 42 (U.S. CLS. 100 AND 101).

FIRST USE 10-10-2011; IN COMMERCE 10-10-2011.

THE MARK CONSISTS OF STANDARD CHARACTERS WITHOUT CLAIM TO ANY PARTICULAR FONT, STYLE, SIZE, OR COLOR.

SER. NO. 85-458,201, FILED 10-27-2011.

TOBY BULLOFF, EXAMINING ATTORNEY



*David J. Kyffers*

Director of the United States Patent and Trademark Office

# United States of America

United States Patent and Trademark Office

# CLR

## Septic System Treatment

**Reg. No. 4,135,600**

**Registered May 1, 2012**

**Int. Cl.: 3**

**TRADEMARK**

**PRINCIPAL REGISTER**

JELMAR, LLC (ILLINOIS LIMITED LIABILITY COMPANY)  
5550 W. TOUHY AVE.  
SKOKIE, IL 60077

FOR: CLEANING PREPARATIONS COMPRISED OF CHEMICAL COMPOSITIONS FOR REMOVING DEPOSIT BUILDUPS FROM SEPTIC RETAINING TANKS, IN CLASS 3 (U.S. CLS. 1, 4, 6, 50, 51 AND 52).

FIRST USE 1-0-2005; IN COMMERCE 1-0-2005.

OWNER OF U.S. REG. NOS. 2,049,978, 3,093,728 AND OTHERS.

NO CLAIM IS MADE TO THE EXCLUSIVE RIGHT TO USE "SEPTIC SYSTEM TREATMENT", APART FROM THE MARK AS SHOWN.

THE MARK CONSISTS OF THE LETTERS "CLR" POSITIONED ABOVE THE WORDS "SEPTIC SYSTEM TREATMENT".

SER. NO. 85-459,151, FILED 10-28-2011.

COLLEEN DOMBROW, EXAMINING ATTORNEY



*David J. Kybas*

Director of the United States Patent and Trademark Office

# United States of America

United States Patent and Trademark Office



**Reg. No. 4,135,601**

**Registered May 1, 2012**

**Int. Cls.: 9 and 28**

**TRADEMARK**

**PRINCIPAL REGISTER**

DISCOVERY BAY GAMES, INC. (DELAWARE CORPORATION)  
206 FIRST AVENUE S., SUITE 310  
SEATTLE, WA 98104

FOR: INTERACTIVE GAME SOFTWARE FOR MOBILE DEVICES, IN CLASS 9 (U.S. CLS. 21, 23, 26, 36 AND 38).

FIRST USE 7-1-2010; IN COMMERCE 7-1-2010.

FOR: BOARD GAMES, IN CLASS 28 (U.S. CLS. 22, 23, 38 AND 50).

FIRST USE 7-1-2010; IN COMMERCE 7-1-2010.

THE MARK CONSISTS OF A SQUARE WITH ROUNDED CORNERS, INSIDE OF WHICH IS A SMALLER SQUARE WITH ROUNDED CORNERS AND TILTED TO THE LEFT. OVERLAPPING THE BORDERS OF BOTH SQUARES ARE THREE CIRCLES, ONE LOCATED AT THE TOP OF THE DESIGN, ONE LOCATED AT THE LEFT OF THE DESIGN, AND ONE LOCATED AT THE RIGHT OF THE DESIGN. THE SQUARES ARE BOTH BLUE. THE TOP CIRCLE IS RED, THE LEFT CIRCLE IS YELLOW, AND THE RIGHT CIRCLE IS GREEN. THE BORDERS OF ALL OF THE SHAPES ARE OUTLINED IN WHITE.

THE COLOR(S) RED, YELLOW, GREEN, BLUE, AND WHITE IS/ARE CLAIMED AS A FEATURE OF THE MARK.

SER. NO. 85-459,219, FILED 10-28-2011.

LEIGH LOWRY, EXAMINING ATTORNEY



*David J. Kybas*

Director of the United States Patent and Trademark Office

# United States of America

United States Patent and Trademark Office

# *Auston*

**Reg. No. 4,135,602**

**Registered May 1, 2012**

**Int. Cl.: 25**

**TRADEMARK**

**PRINCIPAL REGISTER**

LEUNG, WOON HUNG (HONG KONG INDIVIDUAL)  
INFO@AMIGASHOES.COM  
2647 ABETO AVE.  
ROWLAND HEIGHTS, CA 91748

FOR: FOOTWEAR, NAMELY SHOES, IN CLASS 25 (U.S. CLS. 22 AND 39).

FIRST USE 9-1-2010; IN COMMERCE 9-1-2010.

THE MARK CONSISTS OF THE WORD "AUSTON" IN A STYLIZED FORM.

SER. NO. 85-459,568, FILED 10-28-2011.

KARANENDRA S. CHHINA, EXAMINING ATTORNEY



*David J. Kybas*

Director of the United States Patent and Trademark Office

# United States of America

United States Patent and Trademark Office

## SOVEREIGN

**Reg. No. 4,135,603**

**Registered May 1, 2012**

**Int. Cl.: 9**

**TRADEMARK**

**PRINCIPAL REGISTER**

NETFINANCE SOLUTIONS, INC. (DELAWARE CORPORATION)  
STE. 525  
235 E. BROADWAY  
LONG BEACH, CA 90802

FOR: DOWNLOADABLE COMPUTER SOFTWARE USED TO MANAGE, ANALYZE, RETRIEVE, MONITOR, MAINTAIN, REPORT ON, STRUCTURE, MODEL, FORECAST, PRESENT AND DISPLAY DATA AND INFORMATION FROM COMPUTER DATABASES AND THE INTERNET, AND FOR THE DEVELOPMENT, ANALYSIS, MANAGEMENT, INTEGRATION, DEPLOYMENT AND MAINTENANCE OF COMPUTER SOFTWARE; COMPUTER SOFTWARE FOR CONTROLLING AND MANAGING ACCESS SERVER APPLICATIONS, DATABASE SOFTWARE, BUSINESS INTELLIGENCE SOFTWARE, INTERNET AND INTRANET PORTAL SOFTWARE, DATA WAREHOUSING SOFTWARE, CONTENT MANAGEMENT SOFTWARE, ONLINE TRAINING SOFTWARE, TELEPHONY SOFTWARE, FAX MESSAGING SOFTWARE, ELECTRONIC MAIL SOFTWARE, SCHEDULING SOFTWARE, WIRELESS COMMUNICATIONS SOFTWARE, AND VOICE ENABLEMENT SOFTWARE; COMPUTER SOFTWARE APPLICATIONS IN THE FIELDS OF ANALYSIS AND MANAGEMENT OF FINANCIAL TRANSACTIONS, ASSET MANAGEMENT, LENDING OPERATIONS, LOAN MANAGEMENT, PORTFOLIO MANAGEMENT, BUSINESS RISK MANAGEMENT, FINANCIAL SERVICES, ENTERPRISE AND RESOURCE PLANNING; AND INSTRUCTIONAL MANUALS SOLD AS A UNIT, IN CLASS 9 (U.S. CLS. 21, 23, 26, 36 AND 38).

FIRST USE 5-1-2010; IN COMMERCE 6-1-2010.

THE MARK CONSISTS OF STANDARD CHARACTERS WITHOUT CLAIM TO ANY PARTICULAR FONT, STYLE, SIZE, OR COLOR.

SER. NO. 85-459,940, FILED 10-31-2011.

JILL PRATER, EXAMINING ATTORNEY



*David J. Kyros*

Director of the United States Patent and Trademark Office

# United States of America

United States Patent and Trademark Office



**Reg. No. 4,135,604**

**Registered May 1, 2012**

**Int. Cl.: 41**

**SERVICE MARK**

**PRINCIPAL REGISTER**

INSTITUTE OF ELECTRICAL AND ELECTRONICS ENGINEERS, INC., THE (NEW YORK CORPORATION)  
445 HOES LANE  
PISCATAWAY, NJ 08855

FOR: EDUCATIONAL SERVICES, NAMELY, DEVELOPING, ARRANGING, AND CONDUCTING CONFERENCES, SYMPOSIA, WORKSHOPS, AND LECTURES, ALL IN THE FIELD OF SCIENTIFIC AND ELECTRICAL ENGINEERING AND SIGNAL PROCESSING, AND DISTRIBUTING COURSE MATERIALS IN CONNECTION THEREWITH, IN CLASS 41 (U.S. CLS. 100, 101 AND 107).

FIRST USE 6-30-2000; IN COMMERCE 6-30-2000.

OWNER OF U.S. REG. NOS. 1,770,511, 2,862,848 AND OTHERS.

NO CLAIM IS MADE TO THE EXCLUSIVE RIGHT TO USE "SIGNAL PROCESSING SOCIETY", APART FROM THE MARK AS SHOWN.

THE MARK CONSISTS OF A HORIZONTAL LINE, ON THE LEFTMOST EDGE OF WHICH, ABOVE THE LINE, ARE THE STYLIZED LETTERS "IEEE". BELOW THE LINE, ALSO ON THE LEFTMOST SIDE, ARE THE STYLIZED WORDS "SIGNAL PROCESSING SOCIETY," TO THE RIGHT OF WHICH IS A STYLIZED WAVE PARTIALLY REPRESENTED BY A SINGLE LINE, PARTIALLY REPRESENTED BY A BAR PATTERN.

SER. NO. 85-460,799, FILED 10-31-2011.

MARK SHINER, EXAMINING ATTORNEY



*David J. Kybas*

Director of the United States Patent and Trademark Office

# United States of America

United States Patent and Trademark Office

# DART

**Reg. No. 4,135,605**

**Registered May 1, 2012**

**Int. Cl.: 9**

**TRADEMARK**

**PRINCIPAL REGISTER**

NYSE GROUP, INC. (DELAWARE CORPORATION)  
11 WALL STREET  
NEW YORK, NY 10005

FOR: COMPUTER SOFTWARE FOR MONITORING, ANALYZING, MANAGING, AND CREATING REPORTS ON USAGE OF VENDOR PROVIDED DATA SERVICES AND FOR CONTROLLING USER AND APPLICATION ACCESS TO VENDOR PROVIDED DATA SERVICES FOR USE IN THE FINANCIAL AND SECURITIES FIELDS, IN CLASS 9 (U.S. CLS. 21, 23, 26, 36 AND 38).

FIRST USE 12-31-1998; IN COMMERCE 12-31-1998.

THE MARK CONSISTS OF STANDARD CHARACTERS WITHOUT CLAIM TO ANY PARTICULAR FONT, STYLE, SIZE, OR COLOR.

SER. NO. 85-460,803, FILED 10-31-2011.

CHRISIE B. KING, EXAMINING ATTORNEY



*David J. Kyjars*

Director of the United States Patent and Trademark Office



# United States of America

United States Patent and Trademark Office

# WELLPAD

**Reg. No. 4,135,606**

**Registered May 1, 2012**

**Int. Cl.: 9**

**TRADEMARK**

**PRINCIPAL REGISTER**

SCHLUMBERGER TECHNOLOGY CORPORATION (TEXAS CORPORATION)  
5599 SAN FELIPE  
SUITE 100  
HOUSTON, TX 77056

FOR: MOBILE TABLET DEVICE LOADED WITH SOFTWARE APPLICATIONS IN THE  
FIELD OF OIL AND GAS EXPLORATION AND PRODUCTION, IN CLASS 9 (U.S. CLS. 21,  
23, 26, 36 AND 38).

FIRST USE 6-1-2011; IN COMMERCE 6-1-2011.

THE MARK CONSISTS OF STANDARD CHARACTERS WITHOUT CLAIM TO ANY PAR-  
TICULAR FONT, STYLE, SIZE, OR COLOR.

SER. NO. 85-461,089, FILED 11-1-2011.

FLORENTINA BLANDU, EXAMINING ATTORNEY



*David J. Kybas*

Director of the United States Patent and Trademark Office

# United States of America

United States Patent and Trademark Office

# We-Skin

**Reg. No. 4,135,607**

**Registered May 1, 2012**

**Int. Cl.: 9**

**TRADEMARK**

**PRINCIPAL REGISTER**

WTL (USA) FUND, INC. (CALIFORNIA CORPORATION)  
20265 VALLEY BLVD., SUITE R  
WALNUT, CA 91789

FOR: CASES FOR MOBILE PHONES; CELL PHONE CASES; CELL PHONE COVERS; FITTED PLASTIC FILMS KNOWN AS SKINS FOR COVERING AND PROTECTING ELECTRONIC APPARATUS, NAMELY, CELLULAR PHONES; PROTECTIVE COVERS AND CASES FOR CELL PHONES, LAPTOPS AND PORTABLE MEDIA PLAYERS, IN CLASS 9 (U.S. CLS. 21, 23, 26, 36 AND 38).

FIRST USE 8-16-2011; IN COMMERCE 8-16-2011.

THE MARK CONSISTS OF STANDARD CHARACTERS WITHOUT CLAIM TO ANY PARTICULAR FONT, STYLE, SIZE, OR COLOR.

SER. NO. 85-461,359, FILED 11-1-2011.

SCOTT BIBB, EXAMINING ATTORNEY



*David J. Kybas*

Director of the United States Patent and Trademark Office

# United States of America

United States Patent and Trademark Office

# ESENSUAL

**Reg. No. 4,135,608**

CALIFORNIA EXOTIC NOVELTIES, LLC (CALIFORNIA LIMITED LIABILITY COMPANY)  
14235 RAMONA AVENUE  
CHINO, CA 917105751

**Registered May 1, 2012**

**Int. Cl.: 10**

FOR: ADULT SEXUAL STIMULATION AIDS, NAMELY, VIBRATORS AND MASSAGE DEVICES, IN CLASS 10 (U.S. CLS. 26, 39 AND 44).

**TRADEMARK**

FIRST USE 7-8-2011; IN COMMERCE 10-25-2011.

**PRINCIPAL REGISTER**

THE MARK CONSISTS OF STANDARD CHARACTERS WITHOUT CLAIM TO ANY PARTICULAR FONT, STYLE, SIZE, OR COLOR.

SER. NO. 85-462,123, FILED 11-2-2011.

WILLIAM BRECKENFELD, EXAMINING ATTORNEY



*David J. Kyffers*

Director of the United States Patent and Trademark Office

# United States of America

United States Patent and Trademark Office

# iPERFORM

**Reg. No. 4,135,609**

**Registered May 1, 2012**

**Int. Cl.: 20**

**TRADEMARK**

**PRINCIPAL REGISTER**

GUARD MASTER INC. (NEW YORK CORPORATION)  
SUITE 101  
110 BI-COUNTY BLVD.  
FARMINGDALE, NY 11735

FOR: MATTRESSES, IN CLASS 20 (U.S. CLS. 2, 13, 22, 25, 32 AND 50).

FIRST USE 11-1-2011; IN COMMERCE 11-1-2011.

THE MARK CONSISTS OF STANDARD CHARACTERS WITHOUT CLAIM TO ANY PARTICULAR FONT, STYLE, SIZE, OR COLOR.

SER. NO. 85-462,147, FILED 11-2-2011.

TASNEEM HUSSAIN, EXAMINING ATTORNEY



*David J. Kybas*

Director of the United States Patent and Trademark Office

# United States of America

United States Patent and Trademark Office

# di-soric

**Reg. No. 4,135,610**

**Registered May 1, 2012**

**Int. Cl.: 11**

**TRADEMARK**

**PRINCIPAL REGISTER**

DI-SORIC GMBH & CO. KG (FED REP GERMANY GMBH & CO. KG)  
STEINBEISSTRASSE 6  
URBACH, FED REP GERMANY 73660

FOR: LAMPS; LED (LIGHT EMITTING DIODE) LIGHTING FIXTURES; LED (LIGHT EMITTING DIODES) LIGHTING FIXTURES FOR USE IN DISPLAY, COMMERCIAL, INDUSTRIAL, RESIDENTIAL, AND ARCHITECTURAL ACCENT LIGHTING APPLICATIONS; LED LIGHT ASSEMBLIES FOR STREET LIGHTS, SIGNS, COMMERCIAL LIGHTING, AUTOMOBILES, BUILDINGS, AND OTHER ARCHITECTURAL USES; LED LIGHT BULBS; SPOTLIGHTS, IN CLASS 11 (U.S. CLS. 13, 21, 23, 31 AND 34).

THE MARK CONSISTS OF STANDARD CHARACTERS WITHOUT CLAIM TO ANY PARTICULAR FONT, STYLE, SIZE, OR COLOR.

OWNER OF ERPN CMNTY TM OFC REG. NO. 008819211, DATED 7-13-2010, EXPIRES 1-19-2020.

OWNER OF U.S. REG. NO. 1,494,020.

SER. NO. 85-462,259, FILED 11-2-2011.

AISHA CLARKE, EXAMINING ATTORNEY



*David J. Kybas*

Director of the United States Patent and Trademark Office

# United States of America

United States Patent and Trademark Office

# EAT NATIVE

**Reg. No. 4,135,611**

**Registered May 1, 2012**

**Int. Cl.: 30**

**TRADEMARK**

**PRINCIPAL REGISTER**

INDIAN FIG OFFERINGS, LLC (TEXAS LIMITED LIABILITY COMPANY)  
P.O. BOX 1884  
AUSTIN, TX 78767

FOR: SALSA, IN CLASS 30 (U.S. CL. 46).

FIRST USE 8-0-2011; IN COMMERCE 8-0-2011.

THE MARK CONSISTS OF STANDARD CHARACTERS WITHOUT CLAIM TO ANY PARTICULAR FONT, STYLE, SIZE, OR COLOR.

SER. NO. 85-462,294, FILED 11-2-2011.

BILL DAWE, EXAMINING ATTORNEY



*David J. Kyffers*

Director of the United States Patent and Trademark Office

# United States of America

United States Patent and Trademark Office

## JDATE WALKING

**Reg. No. 4,135,612**

**Registered May 1, 2012**

**Int. Cl.: 41**

**SERVICE MARK**

**PRINCIPAL REGISTER**

SPARK NETWORKS USA, LLC (DELAWARE LIMITED LIABILITY COMPANY)  
SUITE 800  
8383 WILSHIRE BLVD.  
BEVERLY HILLS, CA 90211

FOR: ENTERTAINMENT SERVICES, NAMELY, PROVIDING ON-GOING WEBISODES FEATURING COMEDY AND COMMENTARY ON ONLINE DATING, RELATIONSHIPS, FRIENDSHIPS AND PERSONAL INTRODUCTIONS, IN CLASS 41 (U.S. CLS. 100, 101 AND 107).

FIRST USE 11-1-2010; IN COMMERCE 11-1-2010.

THE MARK CONSISTS OF STANDARD CHARACTERS WITHOUT CLAIM TO ANY PARTICULAR FONT, STYLE, SIZE, OR COLOR.

OWNER OF U.S. REG. NOS. 2,420,967, 3,786,158 AND OTHERS.

SER. NO. 85-462,408, FILED 11-2-2011.

SHAILA SETTLES, EXAMINING ATTORNEY



*David J. Kyffers*

Director of the United States Patent and Trademark Office

# United States of America

United States Patent and Trademark Office

## STUDIO LIQUID LINER

**Reg. No. 4,135,613**

**Registered May 1, 2012**

**Int. Cl.: 3**

**TRADEMARK**

**PRINCIPAL REGISTER**

NYX, LOS ANGELES INC. (CALIFORNIA CORPORATION)  
2230 S. TUBEWAY AVENUE  
COMMERCE, CA 90040

FOR: EYELINER, IN CLASS 3 (U.S. CLS. 1, 4, 6, 50, 51 AND 52).

FIRST USE 6-30-2011; IN COMMERCE 6-30-2011.

THE MARK CONSISTS OF STANDARD CHARACTERS WITHOUT CLAIM TO ANY PARTICULAR FONT, STYLE, SIZE, OR COLOR.

NO CLAIM IS MADE TO THE EXCLUSIVE RIGHT TO USE "LIQUID LINER", APART FROM THE MARK AS SHOWN.

SER. NO. 85-462,601, FILED 11-2-2011.

MATTHEW MCDOWELL, EXAMINING ATTORNEY



*David J. Kyffers*

Director of the United States Patent and Trademark Office



# United States of America

United States Patent and Trademark Office

## LE GRAND CRU

**Reg. No. 4,135,614**

**Registered May 1, 2012**

**Int. Cl.: 3**

**TRADEMARK**

**PRINCIPAL REGISTER**

DAVI LUXURY BRAND GROUP, INC. (NEVADA CORPORATION)  
9426 DAYTON WAY  
BEVERLY HILLS, CA 90210

FOR: SKIN CARE PRODUCTS, NAMELY, LIP BALMS, EYE CREAMS, FACIAL SCRUBS, BODY SCRUBS, FACIAL MOISTURIZERS, BODY MOISTURIZERS AND FACIAL MASQUES, IN CLASS 3 (U.S. CLS. 1, 4, 6, 50, 51 AND 52).

FIRST USE 3-0-2006; IN COMMERCE 3-0-2006.

THE MARK CONSISTS OF STANDARD CHARACTERS WITHOUT CLAIM TO ANY PARTICULAR FONT, STYLE, SIZE, OR COLOR.

THE ENGLISH TRANSLATION OF "LE GRAND CRU" IN THE MARK IS "THE GREAT GROWTH".

SER. NO. 85-462,875, FILED 11-2-2011.

BERNICE MIDDLETON, EXAMINING ATTORNEY



*David J. Kyros*

Director of the United States Patent and Trademark Office

# United States of America

United States Patent and Trademark Office

# Java Joy

**Reg. No. 4,135,615**

**Registered May 1, 2012**

**Int. Cl.: 30**

**TRADEMARK**

**PRINCIPAL REGISTER**

GLOBAL ORGANIX, INC. (TEXAS CORPORATION)  
8601 COBBLESTONE  
AUSTIN, TX 78735

FOR: COFFEE; COFFEE; COFFEE AND ARTIFICIAL COFFEE; COFFEE BEANS; COFFEE-BASED BEVERAGE CONTAINING MILK; GROUND COFFEE BEANS, IN CLASS 30 (U.S. CL. 46).

FIRST USE 11-1-2011; IN COMMERCE 11-1-2011.

THE MARK CONSISTS OF STANDARD CHARACTERS WITHOUT CLAIM TO ANY PARTICULAR FONT, STYLE, SIZE, OR COLOR.

NO CLAIM IS MADE TO THE EXCLUSIVE RIGHT TO USE "JAVA", APART FROM THE MARK AS SHOWN.

SER. NO. 85-463,036, FILED 11-2-2011.

HEATHER THOMPSON, EXAMINING ATTORNEY



*David J. Kybas*

Director of the United States Patent and Trademark Office

# United States of America

United States Patent and Trademark Office

## KING KONG 360 3-D

**Reg. No. 4,135,616**

**Registered May 1, 2012**

**Int. Cl.: 6**

**TRADEMARK**

**PRINCIPAL REGISTER**

UNIVERSAL CITY STUDIOS LLC (DELAWARE LIMITED LIABILITY COMPANY)  
100 UNIVERSAL CITY PLAZA  
UNIVERSAL CITY, CA 91608

FOR: METAL KEY RINGS, IN CLASS 6 (U.S. CLS. 2, 12, 13, 14, 23, 25 AND 50).

FIRST USE 7-27-2010; IN COMMERCE 7-27-2010.

THE MARK CONSISTS OF STANDARD CHARACTERS WITHOUT CLAIM TO ANY PARTICULAR FONT, STYLE, SIZE, OR COLOR.

NO CLAIM IS MADE TO THE EXCLUSIVE RIGHT TO USE "3-D", APART FROM THE MARK AS SHOWN.

SER. NO. 85-463,514, FILED 11-3-2011.

FLORENTINA BLANDU, EXAMINING ATTORNEY



*David J. Kyffers*

Director of the United States Patent and Trademark Office

# United States of America

United States Patent and Trademark Office

## KING KONG 360 3-D

**Reg. No. 4,135,617**

**Registered May 1, 2012**

**Int. Cl.: 14**

**TRADEMARK**

**PRINCIPAL REGISTER**

UNIVERSAL CITY STUDIOS LLC (DELAWARE LIMITED LIABILITY COMPANY)  
100 UNIVERSAL CITY PLAZA  
UNIVERSAL CITY, CA 91608

FOR: ORNAMENTAL LAPEL PINS, IN CLASS 14 (U.S. CLS. 2, 27, 28 AND 50).

FIRST USE 7-27-2010; IN COMMERCE 7-27-2010.

THE MARK CONSISTS OF STANDARD CHARACTERS WITHOUT CLAIM TO ANY PARTICULAR FONT, STYLE, SIZE, OR COLOR.

NO CLAIM IS MADE TO THE EXCLUSIVE RIGHT TO USE "3-D", APART FROM THE MARK AS SHOWN.

SER. NO. 85-463,528, FILED 11-3-2011.

FLORENTINA BLANDU, EXAMINING ATTORNEY



*David J. Kyjars*

Director of the United States Patent and Trademark Office

# United States of America

United States Patent and Trademark Office

## KING KONG 360 3-D

**Reg. No. 4,135,618**

**Registered May 1, 2012**

**Int. Cl.: 25**

**TRADEMARK**

**PRINCIPAL REGISTER**

UNIVERSAL CITY STUDIOS LLC (DELAWARE LIMITED LIABILITY COMPANY)  
100 UNIVERSAL CITY STUDIOS  
UNIVERSAL CITY, CA 91608

FOR: T-SHIRTS, IN CLASS 25 (U.S. CLS. 22 AND 39).

FIRST USE 6-18-2010; IN COMMERCE 6-18-2010.

THE MARK CONSISTS OF STANDARD CHARACTERS WITHOUT CLAIM TO ANY PARTICULAR FONT, STYLE, SIZE, OR COLOR.

NO CLAIM IS MADE TO THE EXCLUSIVE RIGHT TO USE "3-D", APART FROM THE MARK AS SHOWN.

SER. NO. 85-463,536, FILED 11-3-2011.

FLORENTINA BLANDU, EXAMINING ATTORNEY



*David J. Kybas*

Director of the United States Patent and Trademark Office

# United States of America

United States Patent and Trademark Office

## KING KONG 360 3-D

**Reg. No. 4,135,619**

**Registered May 1, 2012**

**Int. Cl.: 21**

**TRADEMARK**

**PRINCIPAL REGISTER**

UNIVERSAL CITY STUDIOS LLC (DELAWARE LIMITED LIABILITY COMPANY)  
100 UNIVERSAL CITY PLAZA  
UNIVERSAL CITY, CA 91608

FOR: DRINKING GLASSES, NAMELY, TUMBLERS; MUGS; PLASTIC WATER BOTTLES  
SOLD EMPTY; SHOT GLASSES, IN CLASS 21 (U.S. CLS. 2, 13, 23, 29, 30, 33, 40 AND 50).

FIRST USE 6-19-2010; IN COMMERCE 6-19-2010.

THE MARK CONSISTS OF STANDARD CHARACTERS WITHOUT CLAIM TO ANY PAR-  
TICULAR FONT, STYLE, SIZE, OR COLOR.

NO CLAIM IS MADE TO THE EXCLUSIVE RIGHT TO USE "3-D", APART FROM THE  
MARK AS SHOWN.

SER. NO. 85-463,576, FILED 11-3-2011.

FLORENTINA BLANDU, EXAMINING ATTORNEY



*David J. Kybas*

Director of the United States Patent and Trademark Office

# United States of America

United States Patent and Trademark Office

## NASHVILLE SINGING WATER

**Reg. No. 4,135,620**

TENNESSEE SINGING WATER LLC (TENNESSEE LIMITED LIABILITY COMPANY)  
1008 17TH AVENUE S  
NASHVILLE, TN 37212

**Registered May 1, 2012**

**Int. Cl.: 32**

FOR: BOTTLED WATER; BOTTLED FLAVORED WATER, IN CLASS 32 (U.S. CLS. 45, 46 AND 48).

**TRADEMARK**

FIRST USE 8-27-2011; IN COMMERCE 8-27-2011.

**PRINCIPAL REGISTER**

THE MARK CONSISTS OF STANDARD CHARACTERS WITHOUT CLAIM TO ANY PARTICULAR FONT, STYLE, SIZE, OR COLOR.

NO CLAIM IS MADE TO THE EXCLUSIVE RIGHT TO USE "NASHVILLE" AND "WATER", APART FROM THE MARK AS SHOWN.

SER. NO. 85-463,997, FILED 11-3-2011.

JUDITH HELFMAN, EXAMINING ATTORNEY



*David J. Kyffers*

Director of the United States Patent and Trademark Office

# United States of America

United States Patent and Trademark Office

## EXCLUSIVE ACCESS AT VIP PRICES

**Reg. No. 4,135,621**

**Registered May 1, 2012**

**Int. Cl.: 35**

**SERVICE MARK**

**PRINCIPAL REGISTER**

AMERICAN MEDICAL MEDIA, INC. (CALIFORNIA CORPORATION)  
SUITE 230  
16520 BAKE PARKWAY  
IRVINE, CA 92618

FOR: PROMOTING THE GOODS AND SERVICES OF OTHERS BY PROVIDING A WEBSITE FEATURING COUPONS, REBATES, PRICE-COMPARISON INFORMATION, PRODUCT REVIEWS, LINKS TO THE RETAIL WEBSITES OF OTHERS, AND DISCOUNT INFORMATION, IN CLASS 35 (U.S. CLS. 100, 101 AND 102).

FIRST USE 11-2-2011; IN COMMERCE 11-2-2011.

THE MARK CONSISTS OF STANDARD CHARACTERS WITHOUT CLAIM TO ANY PARTICULAR FONT, STYLE, SIZE, OR COLOR.

SER. NO. 85-464,089, FILED 11-3-2011.

DEZMONA MIZELLE, EXAMINING ATTORNEY



*David J. Kyffers*

Director of the United States Patent and Trademark Office



# United States of America

United States Patent and Trademark Office

# HELLFIRE

**Reg. No. 4,135,622**

KEN WILSON (UNITED STATES INDIVIDUAL)  
3639 MIDWAY DR., STE. B242  
SAN DIEGO, CA 92110

**Registered May 1, 2012**

**Int. Cl.: 9**

FOR: EYEGLASSES AND SUNGLASSES; EYEGLOSS AND SUNGLASS LENSES; EYEGLOSS AND SUNGLASS REPLACEMENT LENSES AND PARTS AND ACCESSORIES THEREFOR, NAMELY, FRAMES, EARSTEMS AND NOSE PIECES; EYEGLOSS CASES; EYEGLOSS CHAINS, STRAPS AND CHORDS, IN CLASS 9 (U.S. CLS. 21, 23, 26, 36 AND 38).

**TRADEMARK**

**PRINCIPAL REGISTER**

FIRST USE 1-15-2007; IN COMMERCE 1-15-2007.

THE MARK CONSISTS OF STANDARD CHARACTERS WITHOUT CLAIM TO ANY PARTICULAR FONT, STYLE, SIZE, OR COLOR.

SER. NO. 85-464,102, FILED 11-3-2011.

ALICE BENMAMAN, EXAMINING ATTORNEY



*David J. Kyros*

Director of the United States Patent and Trademark Office

# United States of America

United States Patent and Trademark Office

## MAGNUM DS

**Reg. No. 4,135,623**

**Registered May 1, 2012**

**Int. Cl.: 9**

**TRADEMARK**

**PRINCIPAL REGISTER**

EATON CORPORATION (OHIO CORPORATION)  
1111 SUPERIOR AVENUE  
CLEVELAND, OH 44114

FOR: LOW VOLTAGE SWITCHGEAR, IN CLASS 9 (U.S. CLS. 21, 23, 26, 36 AND 38).

FIRST USE 12-1-1998; IN COMMERCE 12-1-1998.

THE MARK CONSISTS OF STANDARD CHARACTERS WITHOUT CLAIM TO ANY PARTICULAR FONT, STYLE, SIZE, OR COLOR.

OWNER OF U.S. REG. NO. 2,502,835.

SER. NO. 85-464,306, FILED 11-4-2011.

MARILYN IZZI, EXAMINING ATTORNEY



*David J. Kyffers*

Director of the United States Patent and Trademark Office

# United States of America

United States Patent and Trademark Office

## REACH RADAR

**Reg. No. 4,135,624**

**Registered May 1, 2012**

**Int. Cl.: 42**

**SERVICE MARK**

**PRINCIPAL REGISTER**

BULLHORN, INC. (DELAWARE CORPORATION)  
5TH FLOOR  
33-41 FARNSWORTH STREET  
BOSTON, MA 02110

FOR: PROVIDING TEMPORARY USE OF ON-LINE DOWNLOADABLE SOFTWARE FOR USE BY HIRING MANAGERS AND RECRUITERS FOR MONITORING AND COLLECTING INFORMATION FROM SOCIAL NETWORKS TO FIND POSSIBLE CANDIDATES, IN CLASS 42 (U.S. CLS. 100 AND 101).

FIRST USE 2-7-2011; IN COMMERCE 2-7-2011.

THE MARK CONSISTS OF STANDARD CHARACTERS WITHOUT CLAIM TO ANY PARTICULAR FONT, STYLE, SIZE, OR COLOR.

SER. NO. 85-464,367, FILED 11-4-2011.

MARIA-VICTORIA SUAREZ, EXAMINING ATTORNEY



*David J. Kybas*

Director of the United States Patent and Trademark Office

# United States of America

United States Patent and Trademark Office

# WPS

**Reg. No. 4,135,625**

JOHN MEZZALINGUA ASSOCIATES, INC. (DELAWARE CORPORATION), DBA PPC  
6176 E. MOLLOY RD.  
EAST SYRACUSE, NY 13057

**Registered May 1, 2012**

**Int. Cl.: 17**

FOR: INSULATING COVERS FOR CONNECTION CABLES; INSULATING COVERS FOR  
CABLE CONNECTORS, IN CLASS 17 (U.S. CLS. 1, 5, 12, 13, 35 AND 50).

**TRADEMARK**

FIRST USE 9-0-2010; IN COMMERCE 9-0-2010.

**PRINCIPAL REGISTER**

THE MARK CONSISTS OF STANDARD CHARACTERS WITHOUT CLAIM TO ANY PAR-  
TICULAR FONT, STYLE, SIZE, OR COLOR.

SER. NO. 85-464,488, FILED 11-4-2011.

ERNEST SHOSHO, EXAMINING ATTORNEY



*David J. Kyffers*

Director of the United States Patent and Trademark Office

# United States of America

United States Patent and Trademark Office

## LIVE LIFE LIKE A SONG

**Reg. No. 4,135,626**

**Registered May 1, 2012**

**Int. Cl.: 25**

**TRADEMARK**

**PRINCIPAL REGISTER**

MARGARITAVILLE ENTERPRISES, LLC (DELAWARE LIMITED LIABILITY COMPANY)  
256 WORTH AVENUE, SUITE Q-R  
PALM BEACH, FL 33480

FOR: SHIRTS AND HEADWEAR, IN CLASS 25 (U.S. CLS. 22 AND 39).

FIRST USE 3-3-2010; IN COMMERCE 3-3-2010.

THE MARK CONSISTS OF STANDARD CHARACTERS WITHOUT CLAIM TO ANY PARTICULAR FONT, STYLE, SIZE, OR COLOR.

SER. NO. 85-465,130, FILED 11-4-2011.

HANNO RITTNER, EXAMINING ATTORNEY



*David J. Kyffers*

Director of the United States Patent and Trademark Office

# United States of America

United States Patent and Trademark Office

## LIVE LIFE LIKE A SONG

**Reg. No. 4,135,627**

**Registered May 1, 2012**

**Int. Cl.: 35**

**SERVICE MARK**

**PRINCIPAL REGISTER**

MARGARITAVILLE ENTERPRISES, LLC (DELAWARE LIMITED LIABILITY COMPANY)  
256 WORTH AVENUE, SUITE Q-R  
PALM BEACH, FL 33480

FOR: RETAIL STORES FEATURING A WIDE ARRAY OF MERCHANDISE IN THE NATURE OF NOVELTY ITEMS, SOUVENIRS, CLOTHING, HEADWEAR, BOOKS, RECORDINGS, BEVERAGeware, AND PRINTED MATERIALS, IN CLASS 35 (U.S. CLS. 100, 101 AND 102).

FIRST USE 7-31-2011; IN COMMERCE 7-31-2011.

THE MARK CONSISTS OF STANDARD CHARACTERS WITHOUT CLAIM TO ANY PARTICULAR FONT, STYLE, SIZE, OR COLOR.

SER. NO. 85-465,131, FILED 11-4-2011.

HANNO RITTNER, EXAMINING ATTORNEY



*David J. Kyffers*

Director of the United States Patent and Trademark Office

# United States of America

United States Patent and Trademark Office

## STEELTON TECH

**Reg. No. 4,135,628**

**Registered May 1, 2012**

**Int. Cl.: 9**

**TRADEMARK**

**PRINCIPAL REGISTER**

OLLIE'S BARGAIN OUTLET, INC. (PENNSYLVANIA CORPORATION)  
SUITE 1  
6295 ALLENTOWN BOULEVARD  
HARRISBURG, PA 17112

FOR: CAMERA CASES; CARRYING CASES FOR LAPTOP COMPUTERS, TABLETS AND MOBILE TELEPHONES; EARPHONES AND HEADPHONES; MOBILE TELEPHONE CASES AND ACCESSORIES; PROTECTIVE SLEEVES FOR LAPTOP COMPUTERS AND TABLETS; SCREEN PROTECTORS FOR LAPTOP COMPUTERS, TABLETS, COMPUTER MONITORS AND MOBILE TELEPHONES, IN CLASS 9 (U.S. CLS. 21, 23, 26, 36 AND 38).

FIRST USE 9-16-2011; IN COMMERCE 9-16-2011.

THE MARK CONSISTS OF STANDARD CHARACTERS WITHOUT CLAIM TO ANY PARTICULAR FONT, STYLE, SIZE, OR COLOR.

OWNER OF U.S. REG. NO. 3,056,652.

NO CLAIM IS MADE TO THE EXCLUSIVE RIGHT TO USE "TECH", APART FROM THE MARK AS SHOWN.

SEC. 2(F) AS TO "STEELTON".

SER. NO. 85-465,772, FILED 11-7-2011.

MIDGE BUTLER, EXAMINING ATTORNEY



*David J. Kyffers*

Director of the United States Patent and Trademark Office

# United States of America

United States Patent and Trademark Office



**Reg. No. 4,135,629**

**Registered May 1, 2012**

**Int. Cls.: 9 and 11**

**TRADEMARK**

**PRINCIPAL REGISTER**

WANGS ALLIANCE CORP. (NEW YORK CORPORATION), DBA WAC LIGHTING  
615 SOUTH STREET  
GARDEN CITY, NY 11530

FOR: ELECTRICAL LIGHTING CONNECTORS; TRANSFORMERS; POWER SUPPLIES;  
ELECTRIC LIGHT DIMMERS; POWER CORDS; LEAD WIRES; ELECTRICAL LIGHTING  
INTERCONNECTION CABLES; ELECTRIC CABLES, WIRES, CONDUCTORS AND CON-  
NECTION FITTINGS THEREFOR, IN CLASS 9 (U.S. CLS. 21, 23, 26, 36 AND 38).

FIRST USE 10-31-2008; IN COMMERCE 10-31-2008.

FOR: LAMPS AND PARTS THEREFOR; ELECTRIC LIGHTING FIXTURES AND PARTS  
THEREFOR, IN CLASS 11 (U.S. CLS. 13, 21, 23, 31 AND 34).

FIRST USE 10-31-2008; IN COMMERCE 10-31-2008.

OWNER OF U.S. REG. NOS. 1,707,981, 3,217,287, AND 3,349,790.

THE MARK CONSISTS OF A STYLIZED "W" IN A BOX.

SER. NO. 85-466,212, FILED 11-7-2011.

EUGENIA MARTIN, EXAMINING ATTORNEY



*David J. Kybas*

Director of the United States Patent and Trademark Office



# United States of America

United States Patent and Trademark Office

# Too big to fail.

**Reg. No. 4,135,630**

**Registered May 1, 2012**

**Int. Cl.: 36**

**SERVICE MARK**

**PRINCIPAL REGISTER**

CALVERT INVESTMENTS, INC. (DELAWARE CORPORATION), FORMERLY CALVERT GROUP, LTD.  
4550 MONTGOMERY AVE.  
BETHESDA, MD 20814

FOR: INVESTMENT ADVISORY SERVICES, IN CLASS 36 (U.S. CLS. 100, 101 AND 102).

FIRST USE 10-2-2011; IN COMMERCE 10-2-2011.

THE MARK CONSISTS OF STANDARD CHARACTERS WITHOUT CLAIM TO ANY PARTICULAR FONT, STYLE, SIZE, OR COLOR.

SER. NO. 85-466,222, FILED 11-7-2011.

BARBARA GAYNOR, EXAMINING ATTORNEY



*David J. Kybas*

Director of the United States Patent and Trademark Office

# United States of America

United States Patent and Trademark Office

# RADIOGRIPS

**Reg. No. 4,135,631**

**Registered May 1, 2012**

**Int. Cl.: 9**

**TRADEMARK**

**PRINCIPAL REGISTER**

KLEIN ELECTRONICS, INC. (CALIFORNIA CORPORATION)  
349 N. VINEWOOD STREET  
ESCONDIDO, CA 92029

FOR: SILICON CASES FOR TWO-WAY COMMUNICATION DEVICES, IN CLASS 9 (U.S. CLS. 21, 23, 26, 36 AND 38).

FIRST USE 11-2-2011; IN COMMERCE 11-2-2011.

THE MARK CONSISTS OF STANDARD CHARACTERS WITHOUT CLAIM TO ANY PARTICULAR FONT, STYLE, SIZE, OR COLOR.

SER. NO. 85-466,259, FILED 11-7-2011.

JEFF DEFORD, EXAMINING ATTORNEY



*David J. Kybas*

Director of the United States Patent and Trademark Office

# United States of America

United States Patent and Trademark Office

# PLEX PICKS

**Reg. No. 4,135,632**

**Registered May 1, 2012**

**Int. Cl.: 15**

**TRADEMARK**

**PRINCIPAL REGISTER**

EVERLY MUSIC COMPANY, INC. (CALIFORNIA CORPORATION)  
7303 ATOLL AVE.  
NORTH HOLLYWOOD, CA 91605

FOR: GUITAR PICKS, IN CLASS 15 (U.S. CLS. 2, 21 AND 36).

FIRST USE 11-1-2011; IN COMMERCE 11-1-2011.

THE MARK CONSISTS OF STANDARD CHARACTERS WITHOUT CLAIM TO ANY PARTICULAR FONT, STYLE, SIZE, OR COLOR.

NO CLAIM IS MADE TO THE EXCLUSIVE RIGHT TO USE "PICKS", APART FROM THE MARK AS SHOWN.

SER. NO. 85-466,465, FILED 11-7-2011.

WARREN L. OLANDRIA, EXAMINING ATTORNEY



*David J. Kyffers*

Director of the United States Patent and Trademark Office

# United States of America

United States Patent and Trademark Office

# JAY JDIZZY

**Reg. No. 4,135,633**

**Registered May 1, 2012**

**Int. Cl.: 28**

**TRADEMARK**

**PRINCIPAL REGISTER**

PRETTY UGLY, LLC (DELAWARE LIMITED LIABILITY COMPANY)  
45 FERNWOOD AVENUE  
EDISON, NJ 08837 AND

HORVATH, DAVID (UNITED STATES INDIVIDUAL)  
45 FERNWOOD AVENUE  
EDISON, NJ 08837 AND

KIM, SUN-MIN (REPUBLIC OF KOREA INDIVIDUAL)  
45 FERNWOOD AVENUE  
EDISON, NJ 08837

FOR: STUFFED AND PLUSH TOYS, IN CLASS 28 (U.S. CLS. 22, 23, 38 AND 50).

FIRST USE 10-15-2011; IN COMMERCE 10-15-2011.

THE MARK CONSISTS OF STANDARD CHARACTERS WITHOUT CLAIM TO ANY PARTICULAR FONT, STYLE, SIZE, OR COLOR.

THE NAME(S), PORTRAIT(S), AND/OR SIGNATURE(S) SHOWN IN THE MARK DOES NOT IDENTIFY A PARTICULAR LIVING INDIVIDUAL.

SER. NO. 85-467,042, FILED 11-8-2011.

JOHN KELLY, EXAMINING ATTORNEY



*David J. Kybas*

Director of the United States Patent and Trademark Office

# United States of America

United States Patent and Trademark Office

# JAYBERRY

**Reg. No. 4,135,634**

**Registered May 1, 2012**

**Int. Cl.: 28**

**TRADEMARK**

**PRINCIPAL REGISTER**

PRETTY UGLY, LLC (DELAWARE LIMITED LIABILITY COMPANY)  
45 FERNWOOD AVENUE  
EDISON, NJ 08837 AND

HORVATH, DAVID (UNITED STATES INDIVIDUAL)  
45 FERNWOOD AVENUE  
EDISON, NJ 08837 AND

KIM, SUN-MIN (REPUBLIC OF KOREA INDIVIDUAL)  
45 FERNWOOD AVENUE  
EDISON, NJ 08837

FOR: STUFFED AND PLUSH TOYS, IN CLASS 28 (U.S. CLS. 22, 23, 38 AND 50).

FIRST USE 10-15-2011; IN COMMERCE 10-15-2011.

THE MARK CONSISTS OF STANDARD CHARACTERS WITHOUT CLAIM TO ANY PARTICULAR FONT, STYLE, SIZE, OR COLOR.

THE NAME(S), PORTRAIT(S), AND/OR SIGNATURE(S) SHOWN IN THE MARK DOES NOT IDENTIFY A PARTICULAR LIVING INDIVIDUAL.

SER. NO. 85-467,068, FILED 11-8-2011.

JOHN KELLY, EXAMINING ATTORNEY



*David J. Kybas*

Director of the United States Patent and Trademark Office

# United States of America

United States Patent and Trademark Office

## TO LIVING IN GOOD COMPANY

**Reg. No. 4,135,635**

**Registered May 1, 2012**

**Int. Cl.: 33**

**TRADEMARK**

**PRINCIPAL REGISTER**

BACARDI & COMPANY LIMITED (LIECHTENSTEIN CORPORATION)  
AEULESTRASSE 5  
VADUZ, LIECHTENSTEIN FL-9490

FOR: VODKA, IN CLASS 33 (U.S. CLS. 47 AND 49).

FIRST USE 11-0-2010; IN COMMERCE 11-0-2010.

THE MARK CONSISTS OF STANDARD CHARACTERS WITHOUT CLAIM TO ANY PARTICULAR FONT, STYLE, SIZE, OR COLOR.

SER. NO. 85-467,207, FILED 11-8-2011.

ROBIN CHOSID, EXAMINING ATTORNEY



*David J. Kyffers*

Director of the United States Patent and Trademark Office

# United States of America

United States Patent and Trademark Office

# SUNLINE

**Reg. No. 4,135,636**

**Registered May 1, 2012**

**Int. Cl.: 22**

**TRADEMARK**

**PRINCIPAL REGISTER**

HOUSEHOLD ESSENTIALS, LLC (MISSOURI LIMITED LIABILITY COMPANY)  
5895 N. LINDBERGH BLVD.  
HAZELWOOD, MO 63042

FOR: RETRACTABLE CLOTHESLINES, IN CLASS 22 (U.S. CLS. 1, 2, 7, 19, 22, 42 AND 50).

FIRST USE 11-0-1959; IN COMMERCE 11-0-1959.

THE MARK CONSISTS OF STANDARD CHARACTERS WITHOUT CLAIM TO ANY PARTICULAR FONT, STYLE, SIZE, OR COLOR.

SER. NO. 85-467,548, FILED 11-8-2011.

JEFFERY COWARD, EXAMINING ATTORNEY



*David J. Kyros*

Director of the United States Patent and Trademark Office

# United States of America

United States Patent and Trademark Office

## BIOFOUNDATION-G

**Reg. No. 4,135,637**

**Registered May 1, 2012**

**Int. Cl.: 5**

**TRADEMARK**

**PRINCIPAL REGISTER**

NATURAL FACTORS NUTRITIONAL PRODUCTS LTD. (CANADA CORPORATION)  
1550 UNITED BOULEVARD  
COQUITLAM, BC, CANADA V3K6Y2

FOR: DIETARY AND NUTRITIONAL SUPPLEMENTS; DIETARY FOOD SUPPLEMENTS;  
HEALTH FOOD SUPPLEMENTS; HERBAL SUPPLEMENTS; MINERAL SUPPLEMENTS;  
NUTRACEUTICALS FOR USE AS A DIETARY SUPPLEMENT; VITAMIN SUPPLEMENTS,  
IN CLASS 5 (U.S. CLS. 6, 18, 44, 46, 51 AND 52).

FIRST USE 4-15-2011; IN COMMERCE 4-15-2011.

THE MARK CONSISTS OF STANDARD CHARACTERS WITHOUT CLAIM TO ANY PAR-  
TICULAR FONT, STYLE, SIZE, OR COLOR.

SER. NO. 85-467,553, FILED 11-8-2011.

NAPOLEON SHARMA, EXAMINING ATTORNEY



*David J. Kybas*

Director of the United States Patent and Trademark Office



# United States of America

United States Patent and Trademark Office

# CLEAR-HM

**Reg. No. 4,135,638**

**Registered May 1, 2012**

**Int. Cl.: 5**

**TRADEMARK**

**PRINCIPAL REGISTER**

NATURAL FACTORS NUTRITIONAL PRODUCTS LTD. (CANADA CORPORATION)  
1550 UNITED BOULEVARD  
COQUITLAM, BC, CANADA V3K6Y2

FOR: DIETARY AND NUTRITIONAL SUPPLEMENTS; DIETARY FIBER AS AN ADDITIVE FOR FOOD PRODUCTS; DIETARY FOOD SUPPLEMENTS; HERBAL SUPPLEMENTS; VITAMIN AND MINERAL SUPPLEMENTS, IN CLASS 5 (U.S. CLS. 6, 18, 44, 46, 51 AND 52).

FIRST USE 5-18-2011; IN COMMERCE 6-1-2011.

THE MARK CONSISTS OF STANDARD CHARACTERS WITHOUT CLAIM TO ANY PARTICULAR FONT, STYLE, SIZE, OR COLOR.

OWNER OF U.S. REG. NOS. 2,570,247 AND 2,747,810.

SER. NO. 85-467,580, FILED 11-8-2011.

NAPOLEON SHARMA, EXAMINING ATTORNEY



*David J. Kyros*

Director of the United States Patent and Trademark Office

# United States of America

United States Patent and Trademark Office

# UGLYDOLL

**Reg. No. 4,135,639**

**Registered May 1, 2012**

**Int. Cl.: 14**

**TRADEMARK**

**PRINCIPAL REGISTER**

PRETTY UGLY, LLC (DELAWARE LIMITED LIABILITY COMPANY)  
45 FERNWOOD AVENUE  
EDISON, NJ 08837 AND

HORVATH, DAVID (UNITED STATES INDIVIDUAL)  
45 FERNWOOD AVENUE  
EDISON, NJ 08837 AND

KIM, SUN-MIN (REPUBLIC OF KOREA INDIVIDUAL)  
45 FERNWOOD AVENUE  
EDISON, NJ 08837

FOR: WATCHES, CLOCKS, ALARM CLOCKS, MEDALS USED AS AWARDS, IN CLASS 14 (U.S. CLS. 2, 27, 28 AND 50).

FIRST USE 12-31-2010; IN COMMERCE 12-31-2010.

THE MARK CONSISTS OF STANDARD CHARACTERS WITHOUT CLAIM TO ANY PARTICULAR FONT, STYLE, SIZE, OR COLOR.

OWNER OF U.S. REG. NOS. 3,136,659, 3,974,740 AND OTHERS.

SER. NO. 85-468,380, FILED 11-9-2011.

JOHN KELLY, EXAMINING ATTORNEY



*David J. Kyros*

Director of the United States Patent and Trademark Office

# United States of America

United States Patent and Trademark Office

## PACIFIC STREAM PUPPY

**Reg. No. 4,135,640**

**Registered May 1, 2012**

**Int. Cl.: 31**

**TRADEMARK**

**PRINCIPAL REGISTER**

SCHELL & KAMPETER, INC. (MISSOURI CORPORATION)  
103 NORTH OLIVE STREET  
META, MO 65058

FOR: DOG FOOD, IN CLASS 31 (U.S. CLS. 1 AND 46).

FIRST USE 11-7-2011; IN COMMERCE 11-7-2011.

THE MARK CONSISTS OF STANDARD CHARACTERS WITHOUT CLAIM TO ANY PARTICULAR FONT, STYLE, SIZE, OR COLOR.

OWNER OF U.S. REG. NO. 3,831,858.

NO CLAIM IS MADE TO THE EXCLUSIVE RIGHT TO USE "PUPPY", APART FROM THE MARK AS SHOWN.

SER. NO. 85-468,596, FILED 11-9-2011.

ARETHA SOMERVILLE, EXAMINING ATTORNEY



*David J. Kybas*

Director of the United States Patent and Trademark Office

# United States of America

United States Patent and Trademark Office

# BAT

**Reg. No. 4,135,641**

**Registered May 1, 2012**

**Int. Cl.: 41**

**SERVICE MARK**

**PRINCIPAL REGISTER**

BLOOMBERG FINANCE ONE L.P. (DELAWARE LIMITED PARTNERSHIP)  
731 LEXINGTON AVENUE  
NEW YORK, NY 10022

FOR: PREPARING, ADMINISTERING, AND SCORING STANDARDIZED TESTS IN THE FINANCIAL AND BUSINESS FIELDS, IN CLASS 41 (U.S. CLS. 100, 101 AND 107).

FIRST USE 11-1-2010; IN COMMERCE 11-1-2010.

THE MARK CONSISTS OF STANDARD CHARACTERS WITHOUT CLAIM TO ANY PARTICULAR FONT, STYLE, SIZE, OR COLOR.

SER. NO. 85-468,619, FILED 11-9-2011.

JOHN E. MICHOS, EXAMINING ATTORNEY



*David J. Kyffers*

Director of the United States Patent and Trademark Office

# United States of America

United States Patent and Trademark Office

# BMART

**Reg. No. 4,135,642**

BLOOMBERG FINANCE ONE L.P. (DELAWARE LIMITED PARTNERSHIP)  
731 LEXINGTON AVENUE  
NEW YORK, NY 10022

**Registered May 1, 2012**

**Int. Cl.: 35**

FOR: ON-LINE RETAIL STORE SERVICES FEATURING FINANCIAL AND BUSINESS INFORMATION, IN CLASS 35 (U.S. CLS. 100, 101 AND 102).

**SERVICE MARK**

FIRST USE 12-31-2010; IN COMMERCE 12-31-2010.

**PRINCIPAL REGISTER**

THE MARK CONSISTS OF STANDARD CHARACTERS WITHOUT CLAIM TO ANY PARTICULAR FONT, STYLE, SIZE, OR COLOR.

SER. NO. 85-468,658, FILED 11-9-2011.

JOHN E. MICHOS, EXAMINING ATTORNEY



*David J. Kybas*

Director of the United States Patent and Trademark Office

# United States of America

United States Patent and Trademark Office

*Jonathan  Bentley*

**Reg. No. 4,135,643**

MERSHO, JOHN (UNITED STATES INDIVIDUAL)  
300 ENZO DR.  
SAN JOSE, CA 95138

**Registered May 1, 2012**

**Int. Cl.: 25**

FOR: SHOES; SOCKS; T-SHIRTS, IN CLASS 25 (U.S. CLS. 22 AND 39).

**TRADEMARK**

FIRST USE 2-1-2011; IN COMMERCE 2-1-2011.

**PRINCIPAL REGISTER**

THE NAME(S), PORTRAIT(S), AND/OR SIGNATURE(S) SHOWN IN THE MARK DOES NOT IDENTIFY A PARTICULAR LIVING INDIVIDUAL.

THE MARK CONSISTS OF THE STYLIZED TEXT "JB" COMBINED AS ONE SYMBOL, AND EMBEDDED WITHIN THE SHAPE OF STYLIZED WINGS. ON THE LEFT SIDE OF THE SYMBOL "JB" IS THE STYLIZED TEXT "JONATHAN" AND ON THE RIGHT SIDE IS THE STYLIZED TEXT "BENTLEY".

SER. NO. 85-468,839, FILED 11-9-2011.

WILLIAM BRECKENFELD, EXAMINING ATTORNEY



*David J. Kybas*

Director of the United States Patent and Trademark Office

# United States of America

United States Patent and Trademark Office

## EAT YOUR ENERGY

**Reg. No. 4,135,644**

**Registered May 1, 2012**

**Int. Cl.: 29**

**TRADEMARK**

**PRINCIPAL REGISTER**

JOHN B. SANFILIPPO & SON, INC. (DELAWARE CORPORATION)  
1703 N. RANDALL ROAD  
ELGIN, IL 601237820

FOR: POTATO CHIPS, IN CLASS 29 (U.S. CL. 46).

FIRST USE 7-22-2011; IN COMMERCE 7-22-2011.

THE MARK CONSISTS OF STANDARD CHARACTERS WITHOUT CLAIM TO ANY PARTICULAR FONT, STYLE, SIZE, OR COLOR.

OWNER OF U.S. REG. NO. 3,974,717.

SER. NO. 85-469,721, FILED 11-10-2011.

DAVID TAYLOR, EXAMINING ATTORNEY



*David J. Kyffers*

Director of the United States Patent and Trademark Office

# United States of America

United States Patent and Trademark Office

# Talkapella

**Reg. No. 4,135,645**

**Registered May 1, 2012**

**Int. Cl.: 9**

**TRADEMARK**

**PRINCIPAL REGISTER**

KHUSH INC. (DELAWARE CORPORATION)  
358 ANGIER AVE NE  
ATLANTA, GA 30312

FOR: COMPUTER GAME SOFTWARE; COMPUTER GAME SOFTWARE FOR USE ON MOBILE AND CELLULAR PHONES, IN CLASS 9 (U.S. CLS. 21, 23, 26, 36 AND 38).

FIRST USE 8-18-2011; IN COMMERCE 10-13-2011.

THE MARK CONSISTS OF STANDARD CHARACTERS WITHOUT CLAIM TO ANY PARTICULAR FONT, STYLE, SIZE, OR COLOR.

SER. NO. 85-470,654, FILED 11-11-2011.

JOHN DWYER, EXAMINING ATTORNEY



*David J. Kyffers*

Director of the United States Patent and Trademark Office



# United States of America

United States Patent and Trademark Office

# MultiCal

**Reg. No. 4,135,646**

**Registered May 1, 2012**

**Int. Cl.: 9**

**TRADEMARK**

**PRINCIPAL REGISTER**

WEATHERFORD/LAMB, INC. (TEXAS CORPORATION)  
515 POST OAK BLVD.  
515 POST OAK BLVD.  
HOUSTON, TX 77027

FOR: A MULTI-CHANNEL CALIPER TOOL COMPRISING OF CALIPER ARMS, SENSORS, ODOMETER WHEELS AND A DATA STORAGE SYSTEM, FOR OIL AND GAS PIPELINE INSPECTION PURPOSES , IN CLASS 9 (U.S. CLS. 21, 23, 26, 36 AND 38).

FIRST USE 4-19-2004; IN COMMERCE 4-19-2004.

THE MARK CONSISTS OF STANDARD CHARACTERS WITHOUT CLAIM TO ANY PARTICULAR FONT, STYLE, SIZE, OR COLOR.

SER. NO. 85-471,590, FILED 11-14-2011.

FRED CARL, EXAMINING ATTORNEY



*David J. Kyffers*

Director of the United States Patent and Trademark Office

# United States of America

United States Patent and Trademark Office

## Pink Up Jackson

**Reg. No. 4,135,647**

**Registered May 1, 2012**

**Int. Cl.: 35**

**SERVICE MARK**

**PRINCIPAL REGISTER**

SAINT FRANCIS MEDICAL CENTER (MISSOURI CORPORATION)  
211 ST. FRANCIS DRIVE  
CAPE GIRARDEAU, MO 63701

FOR: PROMOTING PUBLIC AWARENESS OF BREAST CANCER, IN CLASS 35 (U.S. CLS. 100, 101 AND 102).

FIRST USE 9-26-2011; IN COMMERCE 9-26-2011.

THE MARK CONSISTS OF STANDARD CHARACTERS WITHOUT CLAIM TO ANY PARTICULAR FONT, STYLE, SIZE, OR COLOR.

NO CLAIM IS MADE TO THE EXCLUSIVE RIGHT TO USE "JACKSON", APART FROM THE MARK AS SHOWN.

SER. NO. 85-471,715, FILED 11-14-2011.

MICHAEL KEATING, EXAMINING ATTORNEY



*David J. Kybas*

Director of the United States Patent and Trademark Office

# United States of America

United States Patent and Trademark Office

## Pink Up Bluff

**Reg. No. 4,135,648**

**Registered May 1, 2012**

**Int. Cl.: 35**

**SERVICE MARK**

**PRINCIPAL REGISTER**

SAINT FRANCIS MEDICAL CENTER (MISSOURI CORPORATION)  
211 ST. FRANCIS DRIVE  
CAPE GIRARDEAU, MO 63701

FOR: PROMOTING PUBLIC AWARENESS OF BREAST CANCER, IN CLASS 35 (U.S. CLS. 100, 101 AND 102).

FIRST USE 10-1-2011; IN COMMERCE 10-1-2011.

THE MARK CONSISTS OF STANDARD CHARACTERS WITHOUT CLAIM TO ANY PARTICULAR FONT, STYLE, SIZE, OR COLOR.

SER. NO. 85-471,722, FILED 11-14-2011.

MICHAEL KEATING, EXAMINING ATTORNEY



*David J. Kybas*

Director of the United States Patent and Trademark Office

# United States of America

United States Patent and Trademark Office



**Reg. No. 4,135,649**

**Registered May 1, 2012**

**Int. Cl.: 25**

**TRADEMARK**

**PRINCIPAL REGISTER**

A. G. S. OF HANOVER INCORPORATED (VIRGINIA CORPORATION)  
11234 AIR PARK ROAD  
ASHLAND, VA 23005

FOR: FLIP FLOPS, IN CLASS 25 (U.S. CLS. 22 AND 39).

FIRST USE 10-1-2011, THE MARK WAS FIRST USED ANYWHERE IN A DIFFERENT FORM OTHER THAN THAT SOUGHT TO BE REGISTERED AT LEAST AS EARLY AS 09/28/1993; IN COMMERCE 11-1-2011, THE MARK WAS FIRST USED IN COMMERCE IN A DIFFERENT FORM OTHER THAN THAT SOUGHT TO BE REGISTERED AT LEAST AS EARLY AS 12/04/1991.

OWNER OF U.S. REG. NO. 1,872,572.

THE MARK CONSISTS OF THE WORDING "CUDAS" UNDER A SHAPE SIGNIFYING FIVE TOES IN A SANDAL.

SER. NO. 85-471,858, FILED 11-14-2011.

JEAN IM, EXAMINING ATTORNEY



*David J. Kyffers*

Director of the United States Patent and Trademark Office

# United States of America

United States Patent and Trademark Office

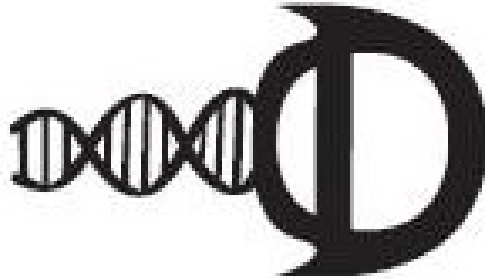

**Reg. No. 4,135,650**

**Registered May 1, 2012**

**Int. Cls.: 18 and 25**

**TRADEMARK**

**PRINCIPAL REGISTER**

LONZA WALKERSVILLE, INC. (DELAWARE CORPORATION)  
8830 BIGGS FORD ROAD  
WALKERSVILLE, MD 217930127

FOR: TOTE BAGS, IN CLASS 18 (U.S. CLS. 1, 2, 3, 22 AND 41).

FIRST USE 4-0-2009; IN COMMERCE 4-0-2009.

FOR: HATS, IN CLASS 25 (U.S. CLS. 22 AND 39).

FIRST USE 8-0-2011; IN COMMERCE 8-0-2011.

THE MARK CONSISTS OF STYLIZED HORSESHOE CRAB WITH A DNA HELIX FOR A TAIL.

SER. NO. 85-471,906, FILED 11-14-2011.

JOHN WILKE, EXAMINING ATTORNEY



*David J. Kybas*

Director of the United States Patent and Trademark Office

# United States of America

United States Patent and Trademark Office

# Banish

**Reg. No. 4,135,651**

**Registered May 1, 2012**

**Int. Cl.: 5**

**TRADEMARK**

**PRINCIPAL REGISTER**

RUN IT CONSULTING, LLC (NEVADA LIMITED LIABILITY COMPANY)  
B200  
704 HWY 71 WEST  
BASTROP, TX 78602

FOR: DIETARY FOOD SUPPLEMENTS, IN CLASS 5 (U.S. CLS. 6, 18, 44, 46, 51 AND 52).

FIRST USE 9-1-2011; IN COMMERCE 9-1-2011.

THE MARK CONSISTS OF STANDARD CHARACTERS WITHOUT CLAIM TO ANY PARTICULAR FONT, STYLE, SIZE, OR COLOR.

SER. NO. 85-472,410, FILED 11-14-2011.

JOHN HWANG, EXAMINING ATTORNEY



*David J. Kyffers*

Director of the United States Patent and Trademark Office

# United States of America

United States Patent and Trademark Office

## AEROPALOOZA

**Reg. No. 4,135,652**

HORNE, MARK J. (UNITED STATES INDIVIDUAL)  
4810 NE 18TH TERRACE  
FT. LAUDERDALE, FL 33308

**Registered May 1, 2012**

**Int. Cl.: 41**

FOR: ENTERTAINMENT IN THE NATURE OF AIR SHOWS AND CUSTOMER EVENTS, NAMELY, LIVE MUSICAL PERFORMANCES, IN CLASS 41 (U.S. CLS. 100, 101 AND 107).

**SERVICE MARK**

FIRST USE 3-17-2010; IN COMMERCE 11-16-2011.

**PRINCIPAL REGISTER**

THE MARK CONSISTS OF STANDARD CHARACTERS WITHOUT CLAIM TO ANY PARTICULAR FONT, STYLE, SIZE, OR COLOR.

SER. NO. 85-474,340, FILED 11-16-2011.

KAELIE KUNG, EXAMINING ATTORNEY



*David J. Kybas*

Director of the United States Patent and Trademark Office

# United States of America

United States Patent and Trademark Office

# Rompo

**Reg. No. 4,135,653**

**Registered May 1, 2012**

**Int. Cl.: 32**

**TRADEMARK**

**PRINCIPAL REGISTER**

JACKALOPE BREWING COMPANY, LLC (TENNESSEE LIMITED LIABILITY COMPANY)  
701 8TH AVENUE SOUTH  
NASHVILLE, TN 37203

FOR: ALE; ALES; BEER; BEER, ALE, LAGER, STOUT AND PORTER; BEERS, IN CLASS  
32 (U.S. CLS. 45, 46 AND 48).

FIRST USE 5-21-2011; IN COMMERCE 5-21-2011.

THE MARK CONSISTS OF STANDARD CHARACTERS WITHOUT CLAIM TO ANY PAR-  
TICULAR FONT, STYLE, SIZE, OR COLOR.

SER. NO. 85-475,499, FILED 11-17-2011.

SKYE YOUNG, EXAMINING ATTORNEY



*David J. Kybas*

Director of the United States Patent and Trademark Office



# United States of America

United States Patent and Trademark Office



**Reg. No. 4,135,654**

**Registered May 1, 2012**

**Int. Cl.: 41**

**SERVICE MARK**

**PRINCIPAL REGISTER**

WEEZEE LLC (DELAWARE LIMITED LIABILITY COMPANY)  
411 MANVILLE ROAD  
PLEASANTVILLE, NY 10570

FOR: PROVISION OF PLAY FACILITIES FOR CHILDREN AND TEENS WITH AUTISM SPECTRUM DISORDERS; PROVIDING EDUCATIONAL ACTIVITIES IN THE NATURE OF CLASSES FOR CHILDREN AND TEENS WITH AUTISM SPECTRUM DISORDERS FOCUSED ON SENSORY INTEGRATION AND DEVELOPMENT, IN CLASS 41 (U.S. CLS. 100, 101 AND 107).

FIRST USE 10-12-2011; IN COMMERCE 11-17-2011.

THE MARK CONSISTS THE WORDS "WEE ZEE" IN STYLIZED BLACK LETTERING WRITTEN ACROSS THE TWO TOP TRIANGLES OF A MULTI-COLORED PINWHEEL PATTERN OF TRIANGLES INTERSECTING WITH A CENTRAL PURPLE CIRCLE. THE WORDING "WORLD OF "YES, I CAN!" IS WRITTEN ON THE CENTRAL CIRCLE IN YELLOW. THE TRIANGLES ARE GREEN AND YELLOW AT THE TOP WITH THE WORDS "WEE ZEE" AND MOVING CLOCKWISE, ARE BLUE WITH A STYLIZED HUMAN EYE DESIGN, PINK WITH A HUMAN TONGUE DESIGN, GREEN WITH A HUMAN NOSE DESIGN, ORANGE WITH A HUMAN EAR DESIGN, YELLOW WITH A HUMAN HAND DESIGN WITH THE INDEX FINGER EXTENDED UP, AND PURPLE WITH HUMAN STICK FIGURE DESIGN.

THE COLOR(S) BLACK, YELLOW, PURPLE, PINK, GREEN, ORANGE, AND BLUE IS/ARE CLAIMED AS A FEATURE OF THE MARK.

SER. NO. 85-478,135, FILED 11-21-2011.

MATTHEW MCDOWELL, EXAMINING ATTORNEY



*David J. Kybas*

Director of the United States Patent and Trademark Office

# United States of America

United States Patent and Trademark Office

## WHITTAKER CONTROLS

**Reg. No. 4,135,655**

**Registered May 1, 2012**

**Int. Cls.: 7 and 9**

**TRADEMARK**

**PRINCIPAL REGISTER**

WHITTAKER CORPORATION (DELAWARE CORPORATION)  
ERIC LARDIERE, ESQ. C/O MEGGITT USA INC.  
1955 NORTH SURVEYOR AVENUE  
SIMI VALLEY, CA 930633386

FOR: MECHANICALLY OPERATED AIRCRAFT FLUID CONTROL VALVES, REGULATORS AND STRUCTURAL COMPONENTS THEREOF, IN CLASS 7 (U.S. CLS. 13, 19, 21, 23, 31, 34 AND 35).

FIRST USE 2-17-1978; IN COMMERCE 2-17-1978.

FOR: ELECTRICALLY OPERATED AIRCRAFT FLUID CONTROL VALVES, REGULATORS AND STRUCTURAL COMPONENTS THEREOF, IN CLASS 9 (U.S. CLS. 21, 23, 26, 36 AND 38).

FIRST USE 2-17-1978; IN COMMERCE 2-17-1978.

THE MARK CONSISTS OF STANDARD CHARACTERS WITHOUT CLAIM TO ANY PARTICULAR FONT, STYLE, SIZE, OR COLOR.

OWNER OF U.S. REG. NOS. 871,081 AND 1,150,214.

NO CLAIM IS MADE TO THE EXCLUSIVE RIGHT TO USE "CONTROLS", APART FROM THE MARK AS SHOWN.

SEC. 2(F).

SER. NO. 85-481,121, FILED 11-27-2011.

KIMBERLY PERRY, EXAMINING ATTORNEY



*David J. Kypos*

Director of the United States Patent and Trademark Office

# United States of America

United States Patent and Trademark Office



**Reg. No. 4,135,656**

**Registered May 1, 2012**

**Int. Cl.: 30**

**TRADEMARK**

**PRINCIPAL REGISTER**

WILLIAMS, CHERYL (UNITED STATES INDIVIDUAL), DBA 4SEASONS GOURMET FOODS GROUP  
250 PROSPECT ST., SUITE 805  
EAST ORANGE, NJ 07017

FOR: HERBAL FOOD BEVERAGES, IN CLASS 30 (U.S. CL. 46).

FIRST USE 6-1-2009; IN COMMERCE 1-1-2011.

THE MARK CONSISTS OF A STYLIZED EMBRACING FAMILY UNIT IN ORANGE RED COMPRISING A FATHER WITH A WHITE MOUTH, MOTHER AND BABY, ALL WITH ORANGE GOLD FACES WITHIN AN INNER BLACK CIRCLE, THE INNER CIRCLE ENCLOSED BY TRIANGULAR ELEMENTS IN ROYAL BLUE DEFINING A FIVE-POINTED STAR SHAPE AROUND THE INNER CIRCLE, AND AN OUTER CIRCLE IN YELLOW ENCLOSING THE STAR SHAPE. FIVE SMALL, TURQUOISE BLUE CIRCLES ARE POSITIONED AROUND THE STAR SHAPE AND WITHIN AN OUTER BLACK CIRCLE. ONE SMALL, WHITE FOUR-POINTED STAR IS POSITIONED TO THE UPPER LEFT OF THE FAMILY AND ANOTHER SMALL, WHITE FOUR-POINTED STAR IS POSITIONED TO THE LOWER RIGHT OF THE FAMILY.

THE COLOR(S) YELLOW, ROYAL BLUE, TURQUOISE BLUE, ORANGE RED, ORANGE GOLD, BLACK AND WHITE IS/ARE CLAIMED AS A FEATURE OF THE MARK.

SER. NO. 85-481,504, FILED 11-28-2011.

SKYE YOUNG, EXAMINING ATTORNEY



*David J. Kyffers*

Director of the United States Patent and Trademark Office

# United States of America

United States Patent and Trademark Office

LIVE TO THE FULLEST BREW  
TO THE FULLEST

**Reg. No. 4,135,657**

HOPUNION, L.L.C. (WASHINGTON LIMITED LIABILITY COMPANY)  
203 DIVISION STREET  
YAKIMA, WA 98902

**Registered May 1, 2012**

**Int. Cl.: 32**

FOR: PROCESSED HOPS, NAMELY, PELLETIZED HOPS, IN CLASS 32 (U.S. CLS. 45, 46 AND 48).

**TRADEMARK**

FIRST USE 11-1-2010; IN COMMERCE 12-16-2010.

**PRINCIPAL REGISTER**

THE MARK CONSISTS OF STANDARD CHARACTERS WITHOUT CLAIM TO ANY PARTICULAR FONT, STYLE, SIZE, OR COLOR.

SER. NO. 85-482,856, FILED 11-29-2011.

SEAN CROWLEY, EXAMINING ATTORNEY



*David J. Kybas*

Director of the United States Patent and Trademark Office

# United States of America

United States Patent and Trademark Office

# SEA TEA

**Reg. No. 4,135,658**

**Registered May 1, 2012**

**Int. Cl.: 41**

**SERVICE MARK**

**PRINCIPAL REGISTER**

SEA TEA IMPROV, LLC (CONNECTICUT LIMITED LIABILITY COMPANY)  
21 TEMPLE STREET  
HARTFORD, CT 06103

FOR: ENTERTAINMENT SERVICES, NAMELY, THE PROVISION OF LIVE SHOWS AND FILMED PERFORMANCES FEATURING IMPROVISATIONAL AND SCRIPTED COMEDY; EDUCATION SERVICES, NAMELY, PROVIDING TRAINING IN THE FIELDS OF THEATER, COMEDY, AND GENERAL PRESENTATION SKILLS, IN CLASS 41 (U.S. CLS. 100, 101 AND 107).

FIRST USE 4-1-2009; IN COMMERCE 4-2-2009.

THE MARK CONSISTS OF STANDARD CHARACTERS WITHOUT CLAIM TO ANY PARTICULAR FONT, STYLE, SIZE, OR COLOR.

SER. NO. 85-484,514, FILED 12-1-2011.

DARRYL SPRUILL, EXAMINING ATTORNEY



*David J. Kyffers*

Director of the United States Patent and Trademark Office

# United States of America

United States Patent and Trademark Office



**Reg. No. 4,135,659**

**Registered May 1, 2012**

**Int. Cl.: 41**

**SERVICE MARK**

**PRINCIPAL REGISTER**

WEISS, PHILLIP W. (UNITED STATES INDIVIDUAL)  
19 WEST 34TH STREET, PENTHOUSE  
NEW YORK, NY 10001

FOR: DIRECTION OR PRESENTATION OF PLAYS; ENTERTAINMENT IN THE NATURE OF THEATER PRODUCTIONS, IN CLASS 41 (U.S. CLS. 100, 101 AND 107).

FIRST USE 5-18-2006; IN COMMERCE 5-18-2006.

NO CLAIM IS MADE TO THE EXCLUSIVE RIGHT TO USE "LITERARY WORKS", APART FROM THE MARK AS SHOWN.

THE COLOR(S) BLUE AND BLACK IS/ARE CLAIMED AS A FEATURE OF THE MARK.

THE MARK CONSISTS OF A STYLIZED LETTER "P" WITH AN ARROW FORMING THE END OF THE "P", IN BLUE, THE WORD "PHIL'S" IN BLACK AND "LITERARY WORKS" IN BLUE.

SER. NO. 85-487,907, FILED 12-6-2011.

EUGENIA MARTIN, EXAMINING ATTORNEY



*David J. Kybas*

Director of the United States Patent and Trademark Office

United States of America  
United States Patent and Trademark Office

eON

**Reg. No. 4,135,660**

SUNBEAM PRODUCTS, INC. (DELAWARE CORPORATION)  
2381 EXECUTIVE CENTER DRIVE  
BOCA RATON, FL 33431

**Registered May 1, 2012**

**Int. Cl.: 8**

FOR: CLIPPERS AND TRIMMERS FOR HUMAN USE, IN CLASS 8 (U.S. CLS. 23, 28 AND 44).

**TRADEMARK**

FIRST USE 10-31-2011; IN COMMERCE 10-31-2011.

**PRINCIPAL REGISTER**

THE MARK CONSISTS OF THE LITERAL ELEMENT "EON" WITH THE LETTER "E" IN LOWER CASE AND THE LETTERS "O" AND "N" CAPITALIZED AND WITH THE BOTTOM OF THE LETTER "E" EXTENDING INTO THE LETTER "O".

SER. NO. 85-489,115, FILED 12-7-2011.

JULIE GUTTADAURO, EXAMINING ATTORNEY



*David J. Kybas*

Director of the United States Patent and Trademark Office

# United States of America

United States Patent and Trademark Office

# JUICE

**Reg. No. 4,135,661**

**Registered May 1, 2012**

**Int. Cl.: 8**

**TRADEMARK**

**PRINCIPAL REGISTER**

SUNBEAM PRODUCTS, INC. (DELAWARE CORPORATION)  
2381 EXECUTIVE CENTER DRIVE  
BOCA RATON, FL 33431

FOR: CLIPPERS AND TRIMMERS FOR HUMAN USE, IN CLASS 8 (U.S. CLS. 23, 28 AND 44).

FIRST USE 10-31-2011; IN COMMERCE 10-31-2011.

THE MARK CONSISTS OF THE STYLIZED LITERAL ELEMENT "JUICE" HAVING A PLUS SYMBOL REPLACING THE "DOT" ABOVE THE LETTER "I" IN THE LITERAL ELEMENT.

SER. NO. 85-489,129, FILED 12-7-2011.

JULIE GUTTADAURO, EXAMINING ATTORNEY



*David J. Kybas*

Director of the United States Patent and Trademark Office



# United States of America

United States Patent and Trademark Office

## SMARTER FROM ANY ANGLE

**Reg. No. 4,135,662**

**Registered May 1, 2012**

**Int. Cl.: 35**

**SERVICE MARK**

**PRINCIPAL REGISTER**

THE GREATER RALEIGH CHAMBER OF COMMERCE (NORTH CAROLINA  
NOT-FOR-PROFIT CORPORATION)  
800 S. SALISBURY ST.  
RALEIGH, NC 27601

FOR: CHAMBER OF COMMERCE SERVICES, NAMELY, PROMOTING BUSINESS AND  
INDUSTRY IN THE WAKE COUNTY, NORTH CAROLINA AREA; PROMOTING ECONOMIC  
DEVELOPMENT AND COMMERCIAL GROWTH IN THE WAKE COUNTY, NORTH CARO-  
LINA AREA, IN CLASS 35 (U.S. CLS. 100, 101 AND 102).

FIRST USE 9-17-2011; IN COMMERCE 9-17-2011.

THE MARK CONSISTS OF STANDARD CHARACTERS WITHOUT CLAIM TO ANY PAR-  
TICULAR FONT, STYLE, SIZE, OR COLOR.

SER. NO. 85-491,640, FILED 12-9-2011.

SANDRA BUJA, EXAMINING ATTORNEY



*David J. Kyffers*

Director of the United States Patent and Trademark Office

# United States of America

United States Patent and Trademark Office

# CALLIDUS

**Reg. No. 4,135,663**

**Registered May 1, 2012**

**Int. Cl.: 42**

**SERVICE MARK**

**PRINCIPAL REGISTER**

CALLIDUS SOFTWARE INC. (DELAWARE CORPORATION)  
6200 STONERIDGE MALL ROAD  
PLEASANTON, CA 94588

FOR: PROVIDING TEMPORARY USE OF ON-LINE NON-DOWNLOADABLE SOFTWARE TO STORE, MANAGE, TRACK, ANALYZE, AND REPORT DATA IN THE FIELD OF MARKETING, PROMOTION, SALES, CUSTOMER INFORMATION, CUSTOMER RELATIONSHIP MANAGEMENT, SALES SUPPORT AND EMPLOYEE EFFICIENCY; PROVIDING TEMPORARY USE OF ON-LINE NONDOWNLOADABLE SOFTWARE TO FACILITATE COMMUNICATING AMONG PEER PROFESSIONALS IN THE ADVERTISING, MARKETING AND BUSINESS SERVICES FIELDS, AND FOR CUSTOMIZING COMPUTER APPLICATION USER INTERFACES; COMPUTER SERVICES, NAMELY, DESIGNING, DEVELOPING, AND MAINTAINING COMPUTER SOFTWARE APPLICATIONS FOR OTHERS AND CONSULTING SERVICES RELATED THERETO; PROVIDING TEMPORARY USE OF ONLINE NON-DOWNLOADABLE COMPUTER SOFTWARE APPLICATION DEVELOPMENT TOOLS AND PROGRAMMING LANGUAGE FOR USE IN DEVELOPING, ANALYZING, CODING, CHECKING, AND CONTROLLING OTHER COMPUTER SOFTWARE; PROVIDING TEMPORARY USE OF ONLINE NONDOWNLOADABLE COMPUTER SOFTWARE THAT IMPLEMENTS A PROCEDURAL AND OBJECT-ORIENTED PROGRAMMING LANGUAGE; ONLINE HOSTED COMPUTER SERVICES, NAMELY, DESIGNING, DEVELOPING, CUSTOMIZING, AND MAINTAINING COMPUTER SOFTWARE APPLICATIONS FOR OTHERS; AND CONSULTING SERVICES RELATED THERETO , IN CLASS 42 (U.S. CLS. 100 AND 101).

FIRST USE 5-31-2006; IN COMMERCE 5-31-2006.

THE MARK CONSISTS OF STANDARD CHARACTERS WITHOUT CLAIM TO ANY PARTICULAR FONT, STYLE, SIZE, OR COLOR.

OWNER OF U.S. REG. NOS. 2,451,479 AND 3,375,117.

SER. NO. 85-492,789, FILED 12-12-2011.

JOHN DALIER, EXAMINING ATTORNEY



*David J. Kyffers*

Director of the United States Patent and Trademark Office

# United States of America

United States Patent and Trademark Office

## LUXURY ECO

**Reg. No. 4,135,664**

**Registered May 1, 2012**

**Int. Cl.: 3**

**TRADEMARK**

**PRINCIPAL REGISTER**

LOUDERMILK, INC. (CALIFORNIA CORPORATION)  
7119 W. SUNSET BOULEVARD #301  
LOS ANGELES, CA 90046

FOR: SKINCARE AND BATH AND BODY CARE PRODUCTS, NAMELY, SKIN CLEANSERS  
AND BODY CLEANSERS, IN CLASS 3 (U.S. CLS. 1, 4, 6, 50, 51 AND 52).

FIRST USE 6-5-2010; IN COMMERCE 6-5-2010.

THE MARK CONSISTS OF STANDARD CHARACTERS WITHOUT CLAIM TO ANY PAR-  
TICULAR FONT, STYLE, SIZE, OR COLOR.

OWNER OF U.S. REG. NOS. 3,169,886 AND 3,420,791.

SER. NO. 85-975,014, FILED 5-18-2010.

ROBERT STRUCK, EXAMINING ATTORNEY



*David J. Kyffers*

Director of the United States Patent and Trademark Office

# United States of America

United States Patent and Trademark Office

## LIQUIDITYCONNECT

**Reg. No. 4,135,665**

**Registered May 1, 2012**

**Int. Cl.: 42**

**SERVICE MARK**

**PRINCIPAL REGISTER**

SMART TRADE TECHNOLOGIES (FRANCE SOCIEDAD ANONIMA (SA))  
140 RUE DU FAUBOURG SAINT HONORÉ  
PARIS, FRANCE 75008

FOR: DESIGN, DEVELOPMENT, MAINTENANCE, RENTAL, UPDATING OF SOFTWARE;  
COMPUTER SOFTWARE CONSULTING, IN CLASS 42 (U.S. CLS. 100 AND 101).

FIRST USE 8-1-2009; IN COMMERCE 8-1-2009.

THE MARK CONSISTS OF STANDARD CHARACTERS WITHOUT CLAIM TO ANY PAR-  
TICULAR FONT, STYLE, SIZE, OR COLOR.

OWNER OF U.S. REG. NOS. 3,676,607 AND 3,767,533.

SER. NO. 85-976,018, FILED 8-20-2010.

MICHAEL ENGEL, EXAMINING ATTORNEY



*David J. Kybas*

Director of the United States Patent and Trademark Office

# United States of America

United States Patent and Trademark Office

# BAHP

**Reg. No. 4,135,666**

**Registered May 1, 2012**

**Int. Cls.: 35 and 45**

**SERVICE MARK**

**PRINCIPAL REGISTER**

SOCIETY OF CHEMICAL MANUFACTURERS AND AFFILIATES, INC. (NEW YORK  
NON-PROFIT CORPORATION), AKA SOCMA  
SUITE 700  
1850 M STREET NW  
WASHINGTON, D.C., DC 20036

FOR: PROVIDING INFORMATION TO CONSUMERS ABOUT THE COMPOSITION AND  
ENVIRONMENTAL IMPACT OF BABY AND ADULT HYGIENE PRODUCTS, IN CLASS 35  
(U.S. CLS. 100, 101 AND 102).

FIRST USE 6-17-2010; IN COMMERCE 6-17-2010.

FOR: PROVIDING INFORMATION TO CONSUMERS ABOUT THE SAFETY OF BABY AND  
ADULT HYGIENE PRODUCTS, IN CLASS 45 (U.S. CLS. 100 AND 101).

FIRST USE 6-17-2010; IN COMMERCE 6-17-2010.

THE MARK CONSISTS OF STANDARD CHARACTERS WITHOUT CLAIM TO ANY PAR-  
TICULAR FONT, STYLE, SIZE, OR COLOR.

SER. NO. 85-976,025, FILED 7-29-2010.

FLORENTINA BLANDU, EXAMINING ATTORNEY



*David J. Kybas*

Director of the United States Patent and Trademark Office

**United States of America**  
**United States Patent and Trademark Office**

**BAHP**

**Reg. No. 4,135,667**

**Registered May 1, 2012**

**Int. Cls.: 35 and 45**

SOCIETY OF CHEMICAL MANUFACTURERS AND AFFILIATES, INC. (NEW YORK  
NON-PROFIT CORPORATION), AKA SOCMA  
SUITE 700  
1850 M STREET NW  
WASHINGTON, D.C., DC 20036

**SERVICE MARK**

FOR: PROVIDING INFORMATION TO CONSUMERS ABOUT THE COMPOSITION AND  
ENVIRONMENTAL IMPACT OF BABY AND ADULT HYGIENE PRODUCTS, IN CLASS 35  
(U.S. CLS. 100, 101 AND 102).

**PRINCIPAL REGISTER**

FIRST USE 6-17-2010; IN COMMERCE 6-17-2010.

FOR: PROVIDING INFORMATION TO CONSUMERS ABOUT THE SAFETY OF BABY AND  
ADULT HYGIENE PRODUCTS, IN CLASS 45 (U.S. CLS. 100 AND 101).

FIRST USE 6-17-2010; IN COMMERCE 6-17-2010.

THE MARK CONSISTS OF THE STYLIZED LETTERS "BAHP" AND A HORIZONTAL  
SWOOSH DESIGN IN THE BACKGROUND BEHIND THE LETTERS.

SER. NO. 85-976,042, FILED 7-29-2010.

FLORENTINA BLANDU, EXAMINING ATTORNEY



*David J. Kybas*

Director of the United States Patent and Trademark Office

# United States of America

United States Patent and Trademark Office

# GRANGE

**Reg. No. 4,135,668**

**Registered May 1, 2012**

**Int. Cl.: 14**

**TRADEMARK**

**PRINCIPAL REGISTER**

NATIONAL GRANGE OF THE ORDER OF PATRONS OF HUSBANDRY (D.C. NON-PROFIT CORPORATION)  
1616 H STREET NW  
WASHINGTON, DC 20006

FOR: JEWELRY; ORNAMENTAL PINS, IN CLASS 14 (U.S. CLS. 2, 27, 28 AND 50).

FIRST USE 0-0-1898; IN COMMERCE 0-0-1898.

THE MARK CONSISTS OF STANDARD CHARACTERS WITHOUT CLAIM TO ANY PARTICULAR FONT, STYLE, SIZE, OR COLOR.

OWNER OF U.S. REG. NOS. 1,817,894, 3,792,978 AND OTHERS.

SER. NO. 85-976,056, FILED 10-19-2010.

Laurie Kaufman, Examining Attorney



*David J. Kyros*

Director of the United States Patent and Trademark Office

# United States of America

United States Patent and Trademark Office

## MUTUAL MOBILE

**Reg. No. 4,135,669**

**Registered May 1, 2012**

**Int. Cl.: 42**

**SERVICE MARK**

**PRINCIPAL REGISTER**

MUTUAL MOBILE, INC. (DELAWARE CORPORATION)  
1709 RIO GRANDE ST.  
AUSTIN, TX 78701

FOR: CONSULTING, DESIGN, AND SOFTWARE DEVELOPMENT SERVICES FOR CONSUMER AND ENTERPRISE MOBILE SOFTWARE APPLICATIONS AND MOBILE SOLUTIONS, IN CLASS 42 (U.S. CLS. 100 AND 101).

FIRST USE 4-9-2009; IN COMMERCE 4-9-2009.

THE MARK CONSISTS OF STANDARD CHARACTERS WITHOUT CLAIM TO ANY PARTICULAR FONT, STYLE, SIZE, OR COLOR.

NO CLAIM IS MADE TO THE EXCLUSIVE RIGHT TO USE "MOBILE", APART FROM THE MARK AS SHOWN.

SER. NO. 85-976,102, FILED 1-26-2011.

KAELIE KUNG, EXAMINING ATTORNEY



*David J. Kybas*

Director of the United States Patent and Trademark Office



# United States of America

United States Patent and Trademark Office

## OLD WORLD

**Reg. No. 4,135,670**

**Registered May 1, 2012**

**Int. Cl.: 21**

**TRADEMARK**

**PRINCIPAL REGISTER**

TEMP-TATIONS LLC (DELAWARE LIMITED LIABILITY COMPANY)  
180 GORDON DRIVE  
SUITE 102  
EXTON, PA 19341

FOR: KITCHEN ITEMS, NAMELY, NON-ELECTRIC KITCHEN CONTAINERS NOT MADE OF PRECIOUS METAL AND BAKEWARE, BREAD BOXES; SPICE HOLDERS, NAMELY, SPICE RACKS; SPICE SHAKERS, BUTTER DISHES, RECIPES BOXES, KITCHEN UTENSILS, NAMELY, SPATULAS, SERVING SPOONS, MEAT SERVING FORKS, PASTA SERVING FORKS; COUNTERTOP HOLDER FOR PAPER TOWELS, IN CLASS 21 (U.S. CLS. 2, 13, 23, 29, 30, 33, 40 AND 50).

FIRST USE 12-0-2007; IN COMMERCE 12-0-2007.

THE MARK CONSISTS OF STANDARD CHARACTERS WITHOUT CLAIM TO ANY PARTICULAR FONT, STYLE, SIZE, OR COLOR.

SER. NO. 85-976,107, FILED 9-3-2010.

EVELYN BRADLEY, EXAMINING ATTORNEY



*David J. Kyffers*

Director of the United States Patent and Trademark Office

# United States of America

United States Patent and Trademark Office

# GREEN OX

**Reg. No. 4,135,671**

**Registered May 1, 2012**

**Int. Cl.: 20**

**TRADEMARK**

**PRINCIPAL REGISTER**

SHANDON VALLEY TRANSPORT SOLUTIONS USA, LLC (COLORADO LIMITED LIABILITY COMPANY)  
P.O. BOX 466  
FRANKTOWN, CO 80116

FOR: NON-METAL PALLETS AND NON-METAL CONTAINERS FOR STORAGE OR TRANSPORT; ALL OF THE AFOREMENTIONED GOODS MADE FROM ENVIRONMENTALLY FRIENDLY MATERIALS, IN CLASS 20 (U.S. CLS. 2, 13, 22, 25, 32 AND 50).

FIRST USE 12-16-2010; IN COMMERCE 1-24-2011.

THE MARK CONSISTS OF STANDARD CHARACTERS WITHOUT CLAIM TO ANY PARTICULAR FONT, STYLE, SIZE, OR COLOR.

NO CLAIM IS MADE TO THE EXCLUSIVE RIGHT TO USE "GREEN", APART FROM THE MARK AS SHOWN.

SER. NO. 85-976,518, FILED 2-9-2011.

SCOTT BIBB, EXAMINING ATTORNEY



*David J. Kyffers*

Director of the United States Patent and Trademark Office

# United States of America

United States Patent and Trademark Office

## PSYCH-CESS

**Reg. No. 4,135,672**

**Registered May 1, 2012**

**Int. Cl.: 41**

**SERVICE MARK**

**PRINCIPAL REGISTER**

DONNELLY, THOMAS M. (UNITED STATES INDIVIDUAL)  
896 ALLWOOD ROAD  
CLIFTON, NJ 07012

FOR: EDUCATIONAL SERVICES, NAMELY, PROVIDING COURSES OF INSTRUCTION AT THE COLLEGE LEVEL AND DISTRIBUTING COURSE MATERIAL IN CONNECTION THEREWITH, IN CLASS 41 (U.S. CLS. 100, 101 AND 107).

FIRST USE 2-7-2012; IN COMMERCE 2-7-2012.

THE MARK CONSISTS OF STANDARD CHARACTERS WITHOUT CLAIM TO ANY PARTICULAR FONT, STYLE, SIZE, OR COLOR.

SN 76-634,126, FILED 3-24-2005.

JEAN IM, EXAMINING ATTORNEY



*David J. Kybas*

Director of the United States Patent and Trademark Office

# United States of America

United States Patent and Trademark Office

# SBP

**Reg. No. 4,135,673**

**Registered May 1, 2012**

**Int. Cl.: 7**

**TRADEMARK**

**PRINCIPAL REGISTER**

ATOTECH DEUTSCHLAND GMBH (FED REP GERMANY CORPORATION)  
ERASMUSSTRASSE 20  
BERLIN, FED REP GERMANY 10553

FOR: MACHINES FOR USE IN SURFACE TREATMENT OF METALS, POLYMERS AND SEMICONDUCTORS; MACHINES FOR GALVANIZING ELECTRICAL COMPONENTS; MACHINES FOR MANUFACTURE OF ELECTRONIC COMPONENTS, NAMELY, SEMICONDUCTORS, PRINTED CIRCUIT BOARDS, WAFER, LEAD FRAMES AND CONNECTORS, IN CLASS 7 (U.S. CLS. 13, 19, 21, 23, 31, 34 AND 35).

FIRST USE 8-10-2010; IN COMMERCE 8-10-2010.

THE MARK CONSISTS OF STANDARD CHARACTERS WITHOUT CLAIM TO ANY PARTICULAR FONT, STYLE, SIZE, OR COLOR.

OWNER OF FED REP GERMANY REG. NO. 30740557.5, DATED 9-4-2007, EXPIRES 6-30-2017.

THE WORDING "SBP" HAS NO MEANING IN A FOREIGN LANGUAGE.

SN 76-683,131, FILED 10-19-2007.

ESTHER A. BORSUK, EXAMINING ATTORNEY



*David J. Kyjars*

Director of the United States Patent and Trademark Office

# United States of America

United States Patent and Trademark Office

# ZABALATTE

**Reg. No. 4,135,674**

**Registered May 1, 2012**

**Int. Cl.: 30**

**TRADEMARK**

**PRINCIPAL REGISTER**

RUVIO, MARIA L. (UNITED STATES INDIVIDUAL)  
13-11 145TH PLACE  
WHITESTONE, NY 11357

FOR: COFFEE-BASED BEVERAGES CONTAINING MILK, TO BE SERVED HOT OR COLD,  
IN CLASS 30 (U.S. CL. 46).

FIRST USE 1-7-2012; IN COMMERCE 2-12-2012.

THE MARK CONSISTS OF STANDARD CHARACTERS WITHOUT CLAIM TO ANY PAR-  
TICULAR FONT, STYLE, SIZE, OR COLOR.

SN 76-687,496, FILED 3-7-2008.

TRACY WHITTAKER-BROWN, EXAMINING ATTORNEY



*David J. Kyffers*

Director of the United States Patent and Trademark Office

# United States of America

United States Patent and Trademark Office

# ASPEN

**Reg. No. 4,135,675**

**Registered May 1, 2012**

**Int. Cl.: 29**

**TRADEMARK**

**PRINCIPAL REGISTER**

HI-PRO FOODS OF IOWA, CORP. (TEXAS CORPORATION)  
207 1/2 W WATER ST STE 1A  
DECORAH, IA 521010277

FOR: FRESH, FROZEN AND COOKED POULTRY AND POULTRY PARTS, IN CLASS 29  
(U.S. CL. 46).

FIRST USE 6-1-2011; IN COMMERCE 6-1-2011.

THE MARK CONSISTS OF STANDARD CHARACTERS WITHOUT CLAIM TO ANY PARTICULAR FONT, STYLE, SIZE, OR COLOR.

SN 76-695,133, FILED 1-5-2009.

DAVID TAYLOR, EXAMINING ATTORNEY



*David J. Kyffers*

Director of the United States Patent and Trademark Office

**United States of America**  
United States Patent and Trademark Office

# ARCTIC

**Reg. No. 4,135,676**

OKANAGAN SPECIALTY FRUITS INC. (CANADA CORPORATION)  
P.O. BOX 1533  
SUMMERLAND, BRITISH COLUMBIA, CANADA V0H 1Z0

**Registered May 1, 2012**

**Int. Cl.: 31**

FOR: BIOENGINEERED AND GENETICALLY ENGINEERED NON-BROWNING FRESH APPLES, IN CLASS 31 (U.S. CLS. 1 AND 46).

**TRADEMARK**

FIRST USE 12-5-2011; IN COMMERCE 12-5-2011.

**PRINCIPAL REGISTER**

THE MARK CONSISTS OF STANDARD CHARACTERS WITHOUT CLAIM TO ANY PARTICULAR FONT, STYLE, SIZE, OR COLOR.

SN 76-696,904, FILED 4-16-2009.

TINA BROWN, EXAMINING ATTORNEY



*David J. Kybas*

Director of the United States Patent and Trademark Office

# United States of America

United States Patent and Trademark Office



**Reg. No. 4,135,677**

**Registered May 1, 2012**

**Int. Cl.: 31**

**TRADEMARK**

**PRINCIPAL REGISTER**

OKANAGAN SPECIALTY FRUITS INC. (CANADA CORPORATION)  
P.O. BOX 1533  
SUMMERLAND, BRITISH COLUMBIA, CANADA V0H 1Z0

FOR: BIOENGINEERED AND GENETICALLY ENGINEERED NON-BROWNING FRESH  
APPLES, IN CLASS 31 (U.S. CLS. 1 AND 46).

FIRST USE 12-5-2011; IN COMMERCE 12-5-2011.

THE MARK CONSISTS OF A PARTIAL APPLE, SLICED IN HALF, WITH A SNOWFLAKE  
AROUND THE APPLE CORE CENTERED ABOVE THE WORD "ARCTIC".

SN 76-696,905, FILED 4-16-2009.

TINA BROWN, EXAMINING ATTORNEY



*David J. Kybas*

Director of the United States Patent and Trademark Office



# United States of America

United States Patent and Trademark Office

## OPTIONS BY CATALINA

**Reg. No. 4,135,678**

**Registered May 1, 2012**

**Int. Cl.: 25**

**TRADEMARK**

**PRINCIPAL REGISTER**

IN MOCEAN GROUP L.L.C. (NEW YORK LIMITED LIABILITY COMPANY)  
501 7TH AVENUE, 12TH FLOOR  
NEW YORK, NY 10018

FOR: CLOTHING, NAMELY, BATHING SUITS, SWIMWEAR, SWIM DRESSES, COVER DRESSES, TOPS, AND BOARD SHORTS; AND BODYWEAR, NAMELY, TIGHTS, BODY-SUITS, LEOTARDS, BIKE SHORTS, BRA TOPS, LEGGINGS, BIKETARDS, UNITARDS, T-SHIRTS, SWEATSHIRTS, SWEATPANTS, TANK TOPS, SHORTS, JOGGING SUITS, ATHLETIC SHOES, SOCKS, HATS, HEADBANDS, AND UNDERWEAR, IN CLASS 25 (U.S. CLS. 22 AND 39).

FIRST USE 12-15-2011; IN COMMERCE 12-15-2011.

THE MARK CONSISTS OF STANDARD CHARACTERS WITHOUT CLAIM TO ANY PARTICULAR FONT, STYLE, SIZE, OR COLOR.

OWNER OF U.S. REG. NOS. 819,551, 3,584,747, AND OTHERS.

SN 76-697,264, FILED 5-6-2009.

TASNEEM HUSSAIN, EXAMINING ATTORNEY



*David J. Kyffers*

Director of the United States Patent and Trademark Office

# United States of America

United States Patent and Trademark Office



**Reg. No. 4,135,679**

**Registered May 1, 2012**

**Int. Cl.: 35**

**SERVICE MARK**

**PRINCIPAL REGISTER**

MUWVAKKIL, LARRY H. (UNITED STATES INDIVIDUAL)  
905 SERO ESTATES DRIVE  
FORT WASHINGTON, MD 20744

FOR: PROMOTING, IN YOUNG CHILDREN, PUBLIC AWARENESS OF THE IMPORTANCE OF RECYCLING, NOT WASTING NATURAL RESOURCES, AND NOT LITTERING, IN CLASS 35 (U.S. CLS. 100, 101 AND 102).

FIRST USE 2-23-2011; IN COMMERCE 9-14-2011.

THE MARK CONSISTS OF A TRASH CAN WITH A LIGHT GREEN BODY, DARK GREEN TOP MADE OUT OF A TRASH BAG, DARK GREEN ARMS WITH WHITE HANDS OUTLINED IN BLACK, WHITE LEGS OUTLINED IN BLACK WITH DARK GREEN AND BLACK FEET, WITH YELLOW AND RED TRASH IN THE BAG IN ITS TOP, THE WORDS "MR. GREEN" IN WHITE ACROSS THE TOP OF THE CAN WHERE IT IS WRAPPED BY THE BAG, AND A FACE ON THE CAN WITH A WHITE MOUTH OUTLINED IN BLACK, RED TONGUE, BLACK MARKS FOR DIMPLES, WHITE EYES OUTLINED IN BLACK WITH BLACK PUPILS; AND WITH A WORD BALLOON OUTLINED IN DARK GREEN EMANATED FROM THE MOUTH, CONTAINING THE WORDS "HEY KIDS" IN RED, "MR. GREEN SAYS" IN DARK GREEN, "PUT IT IN THE TRASH CAN!" IN BLACK, AND ALSO CONTAINING A VARIETY OF MUSICAL NOTES IN LIGHT GREEN; WITH THE REMAINDER OF THE MARK APPEARING ON A TRANSPARENT BACKGROUND REPRESENTED BY THE COLOR WHITE.

THE COLOR(S) RED, YELLOW, LIGHT GREEN, DARK GREEN, BLACK, AND WHITE IS/ARE CLAIMED AS A FEATURE OF THE MARK.

SN 76-702,628, FILED 4-26-2010.

CHRISTINE COOPER, EXAMINING ATTORNEY



*David J. Kybas*

Director of the United States Patent and Trademark Office

# United States of America

United States Patent and Trademark Office

## CUSTOMATIC ADJUSTABLE BEDZ

**Reg. No. 4,135,680**

PPJ, LLC (MASSACHUSETTS LLC)  
2 CARSHA DRIVE  
NATICK, MA 01760

**Registered May 1, 2012**

**Int. Cls.: 20 and 35**

FOR: BEDS, IN CLASS 20 (U.S. CLS. 2, 13, 22, 25, 32 AND 50).

**TRADEMARK**

FIRST USE 5-28-2010; IN COMMERCE 5-28-2010.

**SERVICE MARK**

FOR: RETAIL STORE SERVICES FEATURING BEDS , IN CLASS 35 (U.S. CLS. 100, 101 AND 102).

**PRINCIPAL REGISTER**

FIRST USE 5-28-2010; IN COMMERCE 5-28-2010.

THE MARK CONSISTS OF STANDARD CHARACTERS WITHOUT CLAIM TO ANY PARTICULAR FONT, STYLE, SIZE, OR COLOR.

NO CLAIM IS MADE TO THE EXCLUSIVE RIGHT TO USE "ADJUSTABLE BEDS", APART FROM THE MARK AS SHOWN.

SN 76-703,202, FILED 6-1-2010.

THOMAS MANOR, EXAMINING ATTORNEY



*David J. Kyros*

Director of the United States Patent and Trademark Office

# United States of America

United States Patent and Trademark Office

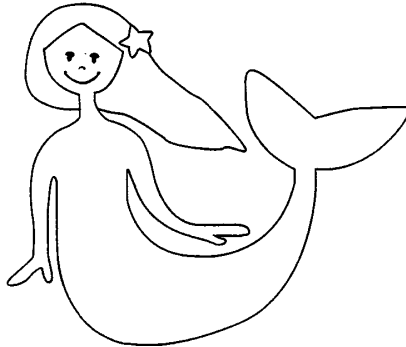

**Reg. No. 4,135,681**

**Registered May 1, 2012**

**Int. Cl.: 25**

**TRADEMARK**

**PRINCIPAL REGISTER**

88 TEES HAWAII, INC. (HAWAII CORPORATION)  
725 KAPIOLANI BOULEVARD, SUITE C-110  
HONOLULU, HI 96813

FOR: CLOTHING, NAMELY, T-SHIRTS, IN CLASS 25 (U.S. CLS. 22 AND 39).

FIRST USE 1-30-2012; IN COMMERCE 1-30-2012.

THE MARK CONSISTS OF A REPRESENTATION OF A MERMAID FEATURING A FIVE POINT STAR IN HER HAIR.

SN 76-704,054, FILED 8-9-2010.

LINDA ESTRADA, EXAMINING ATTORNEY



*David J. Kyffers*

Director of the United States Patent and Trademark Office

# United States of America

United States Patent and Trademark Office

## MONOCLONE

**Reg. No. 4,135,682**

**Registered May 1, 2012**

**Int. Cl.: 33**

**TRADEMARK**

**PRINCIPAL REGISTER**

TENACITY WINES, LLC (CALIFORNIA LIMITED LIABILITY COMPANY)  
405 EAST D STREET, SUITE 116  
PETALUMA, CA 94952

FOR: WINE, IN CLASS 33 (U.S. CLS. 47 AND 49).

FIRST USE 11-18-2011; IN COMMERCE 11-18-2011.

THE MARK CONSISTS OF STANDARD CHARACTERS WITHOUT CLAIM TO ANY PARTICULAR FONT, STYLE, SIZE, OR COLOR.

SN 76-704,087, FILED 8-12-2010.

ELISSA GARBER KON, EXAMINING ATTORNEY



*David J. Kybas*

Director of the United States Patent and Trademark Office

# United States of America

United States Patent and Trademark Office



**Reg. No. 4,135,683**

**Registered May 1, 2012**

**Int. Cl.: 45**

**SERVICE MARK**

**PRINCIPAL REGISTER**

STEVE HARVEY (UNITED STATES INDIVIDUAL)  
3565 PIEDMONT AVENUE, STE. 105  
ATLANTIC, GA 30305 AND

RICKY ANDERSON (UNITED STATES INDIVIDUAL)  
7322 S. W. FRWY., STE. 2010  
HOUSTON, TX 77074 AND

RUSHION MCDONALD (UNITED STATES INDIVIDUAL)  
1202 TUMBURY OAK LANE  
HOUSTON, TX 77055

FOR: DATING AND MATCHMAKING SERVICES, IN CLASS 45 (U.S. CLS. 100 AND 101).

FIRST USE 11-19-2009; IN COMMERCE 1-10-2010.

OWNER OF U.S. REG. NO. 3,875,238.

THE COLOR(S) BLACK, WHITE AND RED IS/ARE CLAIMED AS A FEATURE OF THE MARK.

THE WORD "LOCATE" APPEARS IN BLACK ON TOP OF THE WORD "LOVE" IN BLACK WITH A RED HEART DESIGN IN PLACE OF THE LETTER "V" AND A BLACK MAGNIFYING LENS WITH THE LENS HAVING THE WORD "YOUR" IN RED WRITTEN ACROSS IT IN PLACE OF THE LETTER "O" IN THE WORD "LOCATE", THE WORD "YOUR" HAS A WHITE BACKGROUND.

SN 76-704,904, FILED 10-15-2010.

ZACHARY BELLO, EXAMINING ATTORNEY



*David J. Kybas*

Director of the United States Patent and Trademark Office

# United States of America

United States Patent and Trademark Office

## IT'S A WONDERFUL LIFE

**Reg. No. 4,135,684**

**Registered May 1, 2012**

**Int. Cl.: 5**

**TRADEMARK**

**PRINCIPAL REGISTER**

OLDE GRANDDAD INDUSTRIES, INC. (NEW JERSEY CORPORATION)  
160 PASSAIC AVENUE  
BLDG. 31B  
KEARNY, NJ 07032

FOR: FRAGRANCE PRODUCTS FOR LAND VEHICLES, AIRCRAFT, MARINE CRAFT, PERSONAL, COMMERCIAL, INDUSTRIAL AND HOME USE, NAMELY, AIR FRESHENERS, IN CLASS 5 (U.S. CLS. 6, 18, 44, 46, 51 AND 52).

FIRST USE 8-19-2011; IN COMMERCE 8-19-2011.

THE MARK CONSISTS OF STANDARD CHARACTERS WITHOUT CLAIM TO ANY PARTICULAR FONT, STYLE, SIZE, OR COLOR.

SN 76-705,083, FILED 10-27-2010.

DAVID I, EXAMINING ATTORNEY



*David J. Kyffers*

Director of the United States Patent and Trademark Office

# United States of America

United States Patent and Trademark Office

## PRESTIGE UNITY COLLECTION

**Reg. No. 4,135,685**

**Registered May 1, 2012**

**Int. Cl.: 14**

PRESTIGE JEWELRY INTERNATIONAL, INC (NEW YORK CORPORATION)  
529 FIFTH AVENUE  
17TH FLOOR  
NEW YORK, NY 10017

FOR: JEWELRY, IN CLASS 14 (U.S. CLS. 2, 27, 28 AND 50).

**TRADEMARK**

FIRST USE 2-0-2011; IN COMMERCE 2-0-2011.

**PRINCIPAL REGISTER**

THE MARK CONSISTS OF STANDARD CHARACTERS WITHOUT CLAIM TO ANY PARTICULAR FONT, STYLE, SIZE, OR COLOR.

NO CLAIM IS MADE TO THE EXCLUSIVE RIGHT TO USE "COLLECTION", APART FROM THE MARK AS SHOWN.

SN 76-706,070, FILED 1-20-2011.

MICHAEL WIENER, EXAMINING ATTORNEY



*David J. Kybas*

Director of the United States Patent and Trademark Office



# United States of America

United States Patent and Trademark Office

## INSTA-GRIP

**Reg. No. 4,135,686**

**Registered May 1, 2012**

**Int. Cl.: 12**

**TRADEMARK**

**PRINCIPAL REGISTER**

E&B GIFTWARD, LLC (DELAWARE CORPORATION)  
4 EXECUTIVE PLAZA  
YONKERS, NY 10701

FOR: AUTOMOTIVE ACCESSORY, NAMELY, A VISOR ORGANIZER, IN CLASS 12 (U.S. CLS. 19, 21, 23, 31, 35 AND 44).

FIRST USE 8-31-2011; IN COMMERCE 8-31-2011.

THE MARK CONSISTS OF STANDARD CHARACTERS WITHOUT CLAIM TO ANY PARTICULAR FONT, STYLE, SIZE, OR COLOR.

SN 76-706,332, FILED 2-8-2011.

GRETTA YAO, EXAMINING ATTORNEY



*David J. Kybas*

Director of the United States Patent and Trademark Office

# United States of America

United States Patent and Trademark Office

## **RuggedJet**

**Reg. No. 4,135,687**

**Registered May 1, 2012**

**Int. Cl.: 9**

**TRADEMARK**

**PRINCIPAL REGISTER**

BROTHER INDUSTRIES, LTD. (JAPAN CORPORATION)  
15-1 NAESHIRO-CHO  
MIZUHO-KU  
NAGOYA-SHI 467-8561, JAPAN

FOR: COMPUTER, MOBILE, AND THERMAL PRINTERS; COMPUTER SOFTWARE FOR PROCESSING DIGITAL IMAGES AND DATA, FOR USE WITH PRINTERS; PRE-RECORDED ELECTRONIC AND DIGITAL MEDIA FEATURING COMPUTER SOFTWARE FOR PROCESSING DIGITAL IMAGES AND DATA, FOR USE WITH PRINTERS, IN CLASS 9 (U.S. CLS. 21, 23, 26, 36 AND 38).

FIRST USE 1-1-2012; IN COMMERCE 1-1-2012.

NO CLAIM IS MADE TO THE EXCLUSIVE RIGHT TO USE "JET", APART FROM THE MARK AS SHOWN.

SN 76-706,825, FILED 3-15-2011.

BENJAMIN OKEKE, EXAMINING ATTORNEY



*David J. Kyros*

Director of the United States Patent and Trademark Office

# United States of America

United States Patent and Trademark Office

# heart2soul

**Reg. No. 4,135,688**

**Registered May 1, 2012**

**Int. Cls.: 38 and 45**

**SERVICE MARK**

**PRINCIPAL REGISTER**

HEART2SOUL (NEW JERSEY LIMITED LIABILITY COMPANY)  
7 RED ROAD  
CHATHAM, NJ 07928

FOR: PROVIDING AN ONLINE FORUM AND CHAT ROOM FOR TRANSMISSION OF MESSAGES AMONG USERS IN THE FIELD OF FUNERALS, IN CLASS 38 (U.S. CLS. 100, 101 AND 104).

FIRST USE 8-15-2011; IN COMMERCE 8-15-2011.

FOR: PROVIDING AN INTERNET WEBSITE PORTAL FEATURING INFORMATION ON FUNERAL ARRANGEMENT SERVICES, IN CLASS 45 (U.S. CLS. 100 AND 101).

FIRST USE 8-15-2011; IN COMMERCE 8-15-2011.

THE MARK CONSISTS OF THE STYLIZED ELEMENTS "HEART2SOUL" WHERE THE TERMS "HEART" AND "SOUL" ARE IN THE COLOR BROWN AND THE NUMERAL "2" IS BLUE.

THE COLOR(S) BROWN AND BLUE IS/ARE CLAIMED AS A FEATURE OF THE MARK.

SN 76-707,133, FILED 4-6-2011.

CHRISTOPHER BUONGIORNO, EXAMINING ATTORNEY



*David J. Kybas*

Director of the United States Patent and Trademark Office

# United States of America

United States Patent and Trademark Office



*The* **HAMILTON**

**Reg. No. 4,135,689**

**Registered May 1, 2012**

**Int. Cls.: 41 and 43**

**SERVICE MARK**

**PRINCIPAL REGISTER**

CLYDE'S INVESTMENT CORPORATION (DELAWARE CORPORATION)  
3236 M STREET, NW  
WASHINGTON, DC 20007

FOR: ENTERTAINMENT SERVICES, NAMELY, LIVE MUSICAL PERFORMANCES, IN CLASS 41 (U.S. CLS. 100, 101 AND 107).

FIRST USE 12-18-2011; IN COMMERCE 12-18-2011.

FOR: RESTAURANT, CATERING AND BAR SERVICES, IN CLASS 43 (U.S. CLS. 100 AND 101).

FIRST USE 12-18-2011; IN COMMERCE 12-18-2011.

THE MARK CONSISTS OF THE WORDS "THE HAMILTON" IN STYLIZED FONT BENEATH A STYLIZED IMAGE OF ALEXANDER "HAMILTON" WEARING SUNGLASSES INSIDE OF AN OVAL SHAPE

SN 76-707,353, FILED 4-20-2011.

ERNEST SHOSHO, EXAMINING ATTORNEY



*David J. Kybas*

Director of the United States Patent and Trademark Office

# United States of America

United States Patent and Trademark Office

## OUTBACK THUNDA

**Reg. No. 4,135,690**

BEAR FOOT, INC. (ILLINOIS CORPORATION)  
651 WEST STATE ROAD 2  
WESTVILLE, IN 46391

**Registered May 1, 2012**

**Int. Cl.: 41**

FOR: ENTERTAINMENT SERVICES IN THE NATURE OF CUSTOMIZED TRUCK STUNT SHOWS, IN CLASS 41 (U.S. CLS. 100, 101 AND 107).

**SERVICE MARK**

FIRST USE 3-0-2011; IN COMMERCE 3-0-2011.

**PRINCIPAL REGISTER**

THE MARK CONSISTS OF STANDARD CHARACTERS WITHOUT CLAIM TO ANY PARTICULAR FONT, STYLE, SIZE, OR COLOR.

SN 76-707,517, FILED 5-6-2011.

LINDA E. BLOHM, EXAMINING ATTORNEY



*David J. Kybas*

Director of the United States Patent and Trademark Office

# United States of America

United States Patent and Trademark Office

## FEEL GOODS

**Reg. No. 4,135,691**

**Registered May 1, 2012**

**Int. Cl.: 35**

**SERVICE MARK**

**PRINCIPAL REGISTER**

FLECK, MICHAEL (UNITED STATES INDIVIDUAL)  
1412 SUMMIT AVENUE  
TOMS RIVER, NJ 08753

FOR: RETAIL STORE SERVICES WITHIN A PAINT STORE FEATURING HOME DECORATING ITEMS TO COMPLIMENT A REPAINTING, IN CLASS 35 (U.S. CLS. 100, 101 AND 102).

FIRST USE 10-6-2011; IN COMMERCE 10-6-2011.

THE MARK CONSISTS OF STANDARD CHARACTERS WITHOUT CLAIM TO ANY PARTICULAR FONT, STYLE, SIZE, OR COLOR.

SN 76-707,757, FILED 5-27-2011.

SKYE YOUNG, EXAMINING ATTORNEY



*David J. Kybas*

Director of the United States Patent and Trademark Office

# United States of America

United States Patent and Trademark Office

## NUTRITIOUS PLANET

**Reg. No. 4,135,692**

**Registered May 1, 2012**

**Int. Cl.: 30**

**TRADEMARK**

**PRINCIPAL REGISTER**

NUTRITIOUS PLANET, LLC (MISSOURI LIMITED LIABILITY COMPANY)  
1213 BELLEVUE AVENUE  
ST. LOUIS, MO 63117

FOR: PASTRY MIXES AND MIXES FOR BAKERY GOODS, IN CLASS 30 (U.S. CL. 46).

FIRST USE 6-1-2010; IN COMMERCE 6-1-2010.

NO CLAIM IS MADE TO THE EXCLUSIVE RIGHT TO USE "NUTRITIOUS", APART FROM THE MARK AS SHOWN.

SN 76-708,028, FILED 6-17-2011.

APRIL HESIK, EXAMINING ATTORNEY



*David J. Kyffers*

Director of the United States Patent and Trademark Office

# United States of America

United States Patent and Trademark Office

## GRILL SMITH

**Reg. No. 4,135,693**

**Registered May 1, 2012**

**Int. Cl.: 11**

**TRADEMARK**

**PRINCIPAL REGISTER**

RANKAM (CHINA) MANUFACTURING CO., LTD. (HONG KONG CORPORATION)  
18F NEW LEE WAH CENTRE  
88 TOKWAWAN ROAD  
KOWLOON, HONG KONG

FOR: OUTDOOR GAS AND CHARCOAL GRILLS AND FISH AND DEEP TURKEY FRYERS,  
IN CLASS 11 (U.S. CLS. 13, 21, 23, 31 AND 34).

FIRST USE 11-15-2011; IN COMMERCE 11-15-2011.

THE MARK CONSISTS OF STANDARD CHARACTERS WITHOUT CLAIM TO ANY PAR-  
TICULAR FONT, STYLE, SIZE, OR COLOR.

NO CLAIM IS MADE TO THE EXCLUSIVE RIGHT TO USE "GRILL", APART FROM THE  
MARK AS SHOWN.

SN 76-708,296, FILED 7-11-2011.

DAVID HOFFMAN, EXAMINING ATTORNEY



*David J. Kyffers*

Director of the United States Patent and Trademark Office



# United States of America

United States Patent and Trademark Office

# PHAG

**Reg. No. 4,135,694**

**Registered May 1, 2012**

**Int. Cl.: 25**

**TRADEMARK**

**PRINCIPAL REGISTER**

LISA L. WRIGHT (UNITED STATES INDIVIDUAL)  
10 VENETIAN WAY, SUITE 1105  
MIAMI BEACH, FL 33139

FOR: HATS; JACKETS; PANTS; SHIRTS; SHOES; SHORTS; T-SHIRTS; TIES; UNDERWEAR,  
IN CLASS 25 (U.S. CLS. 22 AND 39).

FIRST USE 6-30-2009; IN COMMERCE 1-31-2011.

THE MARK CONSISTS OF STANDARD CHARACTERS WITHOUT CLAIM TO ANY PAR-  
TICULAR FONT, STYLE, SIZE, OR COLOR.

SN 77-022,538, FILED 10-17-2006.

JOHN DALIER, EXAMINING ATTORNEY



*David J. Kybas*

Director of the United States Patent and Trademark Office

# United States of America

United States Patent and Trademark Office

# MULTIPOINT

**Reg. No. 4,135,695**

BAE SYSTEMS INFORMATION SOLUTIONS INC. (VIRGINIA CORPORATION)  
4075 WILSON BOULEVARD  
ARLINGTON, VA 22203

**Registered May 1, 2012**

**Int. Cl.: 9**

FOR: COMPUTER SOFTWARE IN THE FIELD OF IMAGING, NAMELY, TERRAIN AND FEATURE MAPPING, IN CLASS 9 (U.S. CLS. 21, 23, 26, 36 AND 38).

**TRADEMARK**

FIRST USE 0-0-2002; IN COMMERCE 0-0-2002.

**PRINCIPAL REGISTER**

THE MARK CONSISTS OF STANDARD CHARACTERS WITHOUT CLAIM TO ANY PARTICULAR FONT, STYLE, SIZE, OR COLOR.

SN 77-057,646, FILED 12-5-2006.

LINDA MICKLEBURGH, EXAMINING ATTORNEY



*David J. Kyffers*

Director of the United States Patent and Trademark Office

# United States of America

United States Patent and Trademark Office

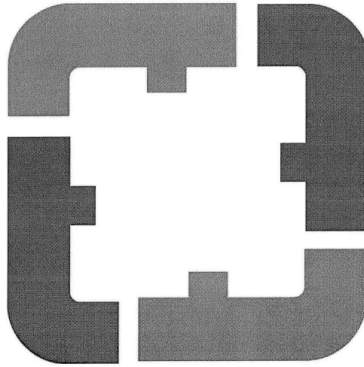

**Reg. No. 4,135,696**

**Registered May 1, 2012**

**Int. Cls.: 7 and 12**

**TRADEMARK**

**PRINCIPAL REGISTER**

TECTRAN MFG. INC. (NEW YORK CORPORATION)  
330 GREENE STREET  
BUFFALO, NY 14206

FOR: MUFFLER CLAMPS, IN CLASS 7 (U.S. CLS. 13, 19, 21, 23, 31, 34 AND 35).

FIRST USE 12-31-1989; IN COMMERCE 12-31-1989.

FOR: PNEUMATIC, HYDRAULIC, ELECTRONIC AND ELECTRICAL ORIGINAL EQUIPMENT FOR USE ON TRUCKS, TRACTORS, TRAILERS, OFF ROAD VEHICLES, AUTOMOTIVE VEHICLES, MARINE AND RAIL, NAMELY, BRAKES, BRAKE HARDWARE FOR VEHICLES, NAMELY, CONTROL VALVES, BRAKE CHAMBERS, CLEVIS ASSEMBLIES, DIAPHRAGMS, AUTOMATIC AND MANUAL SLACK ADJUSTERS, BRAKE STROKE INDICATORS, AIR DISTRIBUTION FITTINGS, AIR COIL PRODUCTS FOR CONNECTION FROM TRACTOR TO TRAILER, AIR BRAKE CONNECTION COUPLINGS; HORNS; UNDER-CARRIAGE SPRING ASSEMBLIES, NAMELY, SUSPENSION SPRINGS FOR MOTOR CARS; RUBBER AIR BRAKE HOSE AND ASSEMBLIES USED TO PROVIDE FLEXIBLE AIR CONNECTION FROM FRAME TO AXLE OR BETWEEN TRACTOR AND TRAILER; A RESERVOIR OF ACCUMULATED AIR SUPPLY INPUTTED BY AIR COMPRESSOR AND OUTPUT TO AIR ACTUATED DEVICES, NAMELY, AIR PUMPS FOR AUTOMOBILES; BACK UP ALARMS FOR SAFETY SOUND WARNING FOR VEHICLES IN REVERSE; AIR BRAKE HOSE CONNECTOR FOR USE ON TRUCKS, TRAILERS, TRACTORS, AND AUTOMOTIVE VEHICLES; ELECTRICAL CABLE ASSEMBLY PROVIDING POWER BETWEEN THE TRACTOR AND TRAILER FOR BRAKING, LIGHTS AND ACCESSORIES, NAMELY, LAND VEHICLE PARTS IN THE NATURE OF WIRE HARNESSSES, NAMELY, WIRES, TERMINALS AND CONNECTORS BUNDLED TOGETHER TO TRANSMIT ELECTRIC POWER AND SIGNALS BETWEEN A TRACTOR AND A TRAILER, IN CLASS 12 (U.S. CLS. 19, 21, 23, 31, 35 AND 44).

FIRST USE 12-31-1989; IN COMMERCE 12-31-1989.

THE STIPLING IS FOR SHADING PURPOSES ONLY.

THE MARK CONSISTS OF SQUARE WITH DECORATIVE BORDER.

SN 77-063,437, FILED 12-13-2006.



*David J. Kyros*

Director of the United States Patent and Trademark Office

**Reg. No. 4,135,696** MATTHEW EINSTEIN, EXAMINING ATTORNEY

# United States of America

United States Patent and Trademark Office

# CAMELBAK

**Reg. No. 4,135,697**

**Registered May 1, 2012**

**Int. Cls.: 9 and 25**

**TRADEMARK**

**PRINCIPAL REGISTER**

CAMELBAK PRODUCTS, LLC (DELAWARE LIMITED LIABILITY COMPANY)  
2000 S. MCDOWELL, SUITE 200  
PETALUMA, CA 94954

FOR: PROTECTIVE CLOTHING; PROTECTIVE WORK GLOVES; PROTECTIVE GLOVES FOR INDUSTRIAL AND MILITARY USE; FIRE-RESISTANT GLOVES, IN CLASS 9 (U.S. CLS. 21, 23, 26, 36 AND 38).

FIRST USE 8-31-2011; IN COMMERCE 8-31-2011.

FOR: CLOTHING AND SPORTSWEAR, NAMELY, SHIRTS, GLOVES, VESTS, BASELAYER TOPS, CYCLING GARMENTS, NAMELY, SHIRTS AND CYCLISTS' JERSEYS, IN CLASS 25 (U.S. CLS. 22 AND 39).

FIRST USE 8-31-2011; IN COMMERCE 8-31-2011.

THE MARK CONSISTS OF STANDARD CHARACTERS WITHOUT CLAIM TO ANY PARTICULAR FONT, STYLE, SIZE, OR COLOR.

OWNER OF U.S. REG. NOS. 1,576,430, 2,098,505, AND 3,184,821.

SN 77-067,406, FILED 12-19-2006.

WILLIAM ROSSMAN, EXAMINING ATTORNEY



*David J. Kyros*

Director of the United States Patent and Trademark Office

# United States of America

United States Patent and Trademark Office

## I WANT MY EXPLOSIVE

**Reg. No. 4,135,698**

EXPLOSIVE PRODUCTIONS LTD. (CANADA CORPORATION)

**Registered May 1, 2012**

#600, 4911 - 51ST STREET  
RED DEER, ALBERTA, CANADA T4N6V4

**Int. Cls.: 16, 21, 25, and 35**

FOR: CALENDARS; POSTERS; POSTCARDS; GREETING CARDS; PRINTS, NAMELY, PHOTOGRAPHIC PRINTS; STICKERS; DECALS; STICK-ON TATTOOS; COASTERS, NAMELY, COASTERS MADE OF PAPER; BOOKMARKS; PLACE MATS, NAMELY, PAPER PLACE MATS; MAGAZINES CONCERNING PHOTOGRAPHY, IMAGING AND THE VISUAL ARTS, IN CLASS 16 (U.S. CLS. 2, 5, 22, 23, 29, 37, 38 AND 50).

**TRADEMARK**

**SERVICE MARK**

FIRST USE 9-30-2009; IN COMMERCE 7-30-2010.

**PRINCIPAL REGISTER**

FOR: CUPS; MUGS; TRAVEL MUGS; WATER BOTTLES; DRINKING GLASSES; COASTERS, NAMELY, COASTERS NOT OF PAPER AND NOT BEING TABLE LINEN, IN CLASS 21 (U.S. CLS. 2, 13, 23, 29, 30, 33, 40 AND 50).

FIRST USE 9-30-2009; IN COMMERCE 7-30-2010.

FOR: CLOTHING, NAMELY, T-SHIRTS, GOLF-SHIRTS, SHORTS, SWEATSHIRTS, JACKETS, VESTS, PANTS; BASEBALL CAPS; HATS; TOQUES; VISORS; SHIRTS; CASUAL TOPS WITH LONG AND SHORT SLEEVES; SLEEVELESS SHIRTS; SLEEVELESS TOPS; SWEAT TOPS; COATS; LONG PANTS; TROUSERS; SLACKS; JEANS; OVERALLS; DRESSES; SKIRTS; NIGHTWEAR; BATHROBES; UNDERWEAR; LINGERIE; SOCKS; VESTS; BELTS; BANDANAS, IN CLASS 25 (U.S. CLS. 22 AND 39).

FIRST USE 9-30-2009; IN COMMERCE 7-30-2010.

FOR: RETAIL, WHOLESALE AND INTERNET STORE SERVICES FEATURING CLOTHING, STATIONARY, MAGAZINES, CALENDARS, PHOTOGRAPHIC PRINTS AND POSTCARDS, IN CLASS 35 (U.S. CLS. 100, 101 AND 102).

FIRST USE 9-30-2009; IN COMMERCE 7-30-2010.

THE MARK CONSISTS OF STANDARD CHARACTERS WITHOUT CLAIM TO ANY PARTICULAR FONT, STYLE, SIZE, OR COLOR.



*David J. Kyros*

Director of the United States Patent and Trademark Office

**Reg. No. 4,135,698** PRIORITY CLAIMED UNDER SEC. 44(D) ON CANADA APPLICATION NO. 1321002, FILED 10-23-2006, REG. NO. TMA750,861, DATED 10-22-2009, EXPIRES 10-22-2024.

SN 77-072,157, FILED 12-27-2006.

HENRY S. ZAK, EXAMINING ATTORNEY

# United States of America

United States Patent and Trademark Office

# GMUSIC

**Reg. No. 4,135,699**

**Registered May 1, 2012**

**Int. Cl.: 35**

**SERVICE MARK**

**PRINCIPAL REGISTER**

GUION PARTNERS, INC. (NEW YORK CORPORATION)  
590 MADISON AVENUE  
NEW YORK, NY 10022

FOR: TALENT REPRESENTATION, NAMELY, MARKETING, PROMOTION, AND MANAGEMENT OF PERFORMING ARTISTS AND PROFESSIONALS IN THE MUSIC, FILM, THEATER, AND TELEVISION INDUSTRIES, IN CLASS 35 (U.S. CLS. 100, 101 AND 102).

FIRST USE 7-28-2005; IN COMMERCE 3-22-2007.

THE MARK CONSISTS OF STANDARD CHARACTERS WITHOUT CLAIM TO ANY PARTICULAR FONT, STYLE, SIZE, OR COLOR.

SN 77-077,779, FILED 1-8-2007.

KELLY BOULTON, EXAMINING ATTORNEY



*David J. Kybas*

Director of the United States Patent and Trademark Office



# United States of America

United States Patent and Trademark Office

# NULIFE

**Reg. No. 4,135,700**

**Registered May 1, 2012**

**Int. Cl.: 29**

**TRADEMARK**

**PRINCIPAL REGISTER**

MODERN DAIRIES LTD. (INDIA COMPANY)  
POST OFFICE BOX NO. 3, 136 KM, G.T. ROAD  
KARNAL, INDIA 132-001

FOR: DAIRY-BASED BEVERAGES; DAIRY PRODUCTS EXCLUDING ICE CREAM, ICE MILK AND FROZEN YOGURT, IN CLASS 29 (U.S. CL. 46).

FIRST USE 0-0-2009; IN COMMERCE 0-0-2009.

THE MARK CONSISTS OF STANDARD CHARACTERS WITHOUT CLAIM TO ANY PARTICULAR FONT, STYLE, SIZE, OR COLOR.

SN 77-105,422, FILED 2-12-2007.

ANNE E. GUSTASON, EXAMINING ATTORNEY



*David J. Kybas*

Director of the United States Patent and Trademark Office

# United States of America

United States Patent and Trademark Office

# DYNAMIC

**Reg. No. 4,135,701**

BOSTON SCIENTIFIC SCIMED, INC. (MINNESOTA CORPORATION)  
ONE SCIMED PLACE  
MAPLE GROVE, MN 55311

**Registered May 1, 2012**

**Int. Cl.: 10**

FOR: MEDICAL STENTS NOT FOR VASCULAR APPLICATIONS, IN CLASS 10 (U.S. CLS. 26, 39 AND 44).

**TRADEMARK**

FIRST USE 3-0-2007; IN COMMERCE 3-0-2007.

**PRINCIPAL REGISTER**

THE MARK CONSISTS OF STANDARD CHARACTERS WITHOUT CLAIM TO ANY PARTICULAR FONT, STYLE, SIZE, OR COLOR.

SN 77-129,802, FILED 3-13-2007.

ALYSSA STEEL, EXAMINING ATTORNEY



*David J. Kybas*

Director of the United States Patent and Trademark Office

# United States of America

United States Patent and Trademark Office

## PLATINUM EDGE

**Reg. No. 4,135,702**

**Registered May 1, 2012**

**Int. Cl.: 24**

**TRADEMARK**

**PRINCIPAL REGISTER**

PACIFIC COAST FEATHER COMPANY (WASHINGTON CORPORATION)  
P.O. BOX 80385  
SEATTLE, WA 98108

FOR: FEATURE OF MATTRESS PADS, NAMELY, AN ELASTIC TRIM IN THE NATURE OF AN ELASTIC BAND THAT GRIPS THE MATTRESS, IN CLASS 24 (U.S. CLS. 42 AND 50).

FIRST USE 11-1-2010; IN COMMERCE 11-1-2010.

THE MARK CONSISTS OF STANDARD CHARACTERS WITHOUT CLAIM TO ANY PARTICULAR FONT, STYLE, SIZE, OR COLOR.

SN 77-155,095, FILED 4-12-2007.

DARRYL SPRUILL, EXAMINING ATTORNEY



*David J. Kybas*

Director of the United States Patent and Trademark Office

# United States of America

United States Patent and Trademark Office

## BLACK CHANNEL

**Reg. No. 4,135,703**

**Registered May 1, 2012**

**Int. Cl.: 9**

**TRADEMARK**

**PRINCIPAL REGISTER**

OBJECTIVE INTERFACE SYSTEMS, INC. (DELAWARE CORPORATION)  
SUITE 530  
220 SPRING STREET  
HERNDON, VA 20170

FOR: COMPUTER SOFTWARE USED IN THE FIELD OF COMPUTER NETWORKS AND GATEWAYS FOR DATA TRANSFERS; COMPUTER HARDWARE USED IN THE FIELD OF COMPUTER NETWORKS AND GATEWAYS FOR DATA TRANSFERS; COMPUTER HARDWARE; COMPUTER NETWORK SWITCHES, ROUTERS, HUBS, BRIDGES, FIREWALLS, ETHERNET AND NETWORK REPEATERS; PCMCIA, CARDBUS, PCI, MEMORY CARDS AND BUS CARDS; COMPUTER CHIPS, PROCESSOR CHIPS, AND COMPUTER STORAGE MEDIUM, NAMELY, DISK DRIVES, MEMORY DRIVES, FLASH DRIVES AND SOLID STATE DRIVES; AND OPERATIONAL AND APPLICATION SOFTWARE FOR ALL THE AFORESAID GOODS, IN CLASS 9 (U.S. CLS. 21, 23, 26, 36 AND 38).

FIRST USE 5-20-2007; IN COMMERCE 12-11-2008.

THE MARK CONSISTS OF STANDARD CHARACTERS WITHOUT CLAIM TO ANY PARTICULAR FONT, STYLE, SIZE, OR COLOR.

OWNER OF U.S. REG. NO. 3,541,979.

NO CLAIM IS MADE TO THE EXCLUSIVE RIGHT TO USE "CHANNEL", APART FROM THE MARK AS SHOWN.

SN 77-186,674, FILED 5-22-2007.

SIMON TENG, EXAMINING ATTORNEY



*David J. Kybas*

Director of the United States Patent and Trademark Office

# United States of America

United States Patent and Trademark Office

## NOW IT'S OUR TURN TO ANSWER THE CALL

**Reg. No. 4,135,704**

**Registered May 1, 2012**

**Int. Cl.: 36**

**SERVICE MARK**

**PRINCIPAL REGISTER**

N.Y. POLICE AND FIRE WIDOWS' & CHILDREN'S BENEFIT FUND, INC. (NEW YORK  
NON-PROFIT CORPORATION)  
767 5TH AVENUE  
C/O WEIL, GOTSHAL & MANGES LLP  
NEW YORK, NY 10153

FOR: CHARITABLE FUND RAISING SERVICES, IN CLASS 36 (U.S. CLS. 100, 101 AND  
102).

FIRST USE 10-31-2011; IN COMMERCE 10-31-2011.

THE MARK CONSISTS OF STANDARD CHARACTERS WITHOUT CLAIM TO ANY PAR-  
TICULAR FONT, STYLE, SIZE, OR COLOR.

SN 77-187,416, FILED 5-22-2007.

PAUL E. FAHRENKOPF, EXAMINING ATTORNEY



*David J. Kybas*

Director of the United States Patent and Trademark Office

# United States of America

United States Patent and Trademark Office

# deCODE AF

**Reg. No. 4,135,705**

**Registered May 1, 2012**

**Int. Cl.: 10**

**TRADEMARK**

**PRINCIPAL REGISTER**

DECODE GENETICS EHF (ICELAND CORPORATION)  
IS-101  
STURLUGATA 8  
REYKJAVIK, ICELAND

FOR: BLOOD TESTING APPARATUS, NAMELY, TESTS AND TEST KITS FOR DIAGNOSTIC TESTING FOR ATRIAL FIBRILLATION, IN CLASS 10 (U.S. CLS. 26, 39 AND 44).

FIRST USE 1-1-2011; IN COMMERCE 1-1-2011.

THE MARK CONSISTS OF STANDARD CHARACTERS WITHOUT CLAIM TO ANY PARTICULAR FONT, STYLE, SIZE, OR COLOR.

OWNER OF U.S. REG. NO. 2,606,100.

NO CLAIM IS MADE TO THE EXCLUSIVE RIGHT TO USE "AF", APART FROM THE MARK AS SHOWN.

SN 77-211,805, FILED 6-21-2007.

CHRISIE B. KING, EXAMINING ATTORNEY



*David J. Kyffers*

Director of the United States Patent and Trademark Office

**United States of America**  
United States Patent and Trademark Office

**ARSENAL**

**Reg. No. 4,135,706**

**Registered May 1, 2012**

**Int. Cl.: 33**

**TRADEMARK**

**PRINCIPAL REGISTER**

AUTENTICA TEQUILERA, S.A. DE C.V. (MEXICO CORPORATION)  
MORELOS #285  
COLONIA CENTRO. C.P. 46400  
TEQUILA, JALISCO, MEXICO

FOR: TEQUILA, IN CLASS 33 (U.S. CLS. 47 AND 49).

FIRST USE 12-7-2011; IN COMMERCE 12-7-2011.

THE MARK CONSISTS OF STANDARD CHARACTERS WITHOUT CLAIM TO ANY PARTICULAR FONT, STYLE, SIZE, OR COLOR.

SN 77-216,125, FILED 6-26-2007.

MICHAEL GAAFAR, EXAMINING ATTORNEY



*David J. Kyffers*

Director of the United States Patent and Trademark Office

# United States of America

United States Patent and Trademark Office

## MOVIES. MAGIC. MORE.

**Reg. No. 4,135,707**

**Registered May 1, 2012**

**Int. Cl.: 9**

**TRADEMARK**

**PRINCIPAL REGISTER**

DISNEY ENTERPRISES, INC. (DELAWARE CORPORATION)  
500 SOUTH BUENA VISTA STREET  
BURBANK, CA 91521

FOR: AUDIO AND VISUAL RECORDINGS IN ALL MEDIA FEATURING LIVE-ACTION AND ANIMATED ENTERTAINMENT, IN CLASS 9 (U.S. CLS. 21, 23, 26, 36 AND 38).

FIRST USE 9-30-2007; IN COMMERCE 9-30-2007.

THE MARK CONSISTS OF STANDARD CHARACTERS WITHOUT CLAIM TO ANY PARTICULAR FONT, STYLE, SIZE, OR COLOR.

OWNER OF U.S. REG. NO. 3,151,706.

NO CLAIM IS MADE TO THE EXCLUSIVE RIGHT TO USE "MOVIES", APART FROM THE MARK AS SHOWN.

SN 77-237,775, FILED 7-24-2007.

CHRISTINE COOPER, EXAMINING ATTORNEY



*David J. Kybas*

Director of the United States Patent and Trademark Office



# United States of America

United States Patent and Trademark Office

## TAKE CARE HEALTH

**Reg. No. 4,135,708**

**Registered May 1, 2012**

**Int. Cl.: 44**

**SERVICE MARK**

**PRINCIPAL REGISTER**

TAKE CARE HEALTH SYSTEMS, LLC (DELAWARE LIMITED LIABILITY COMPANY)  
SUITE 1400  
EIGHT TOWER BRIDGE, 161 WASHINGTON ST.  
CONSHOHOCKEN, PA 19428

FOR: MANAGED HEALTH CARE SERVICES, NAMELY, PROVIDING MEDICAL AND PHARMACEUTICAL CONSULTATION, PERFORMING DIAGNOSIS AND TREATMENT OF DISEASES, MEDICAL TESTING, AND PROVIDING HEALTH CARE INFORMATION BY PHONE AND THE INTERNET; MEDICAL CLINICS AND MOBILE MEDICAL CLINICS, IN CLASS 44 (U.S. CLS. 100 AND 101).

FIRST USE 7-0-2006; IN COMMERCE 7-0-2006.

THE MARK CONSISTS OF STANDARD CHARACTERS WITHOUT CLAIM TO ANY PARTICULAR FONT, STYLE, SIZE, OR COLOR.

NO CLAIM IS MADE TO THE EXCLUSIVE RIGHT TO USE "HEALTH", APART FROM THE MARK AS SHOWN.

SN 77-257,066, FILED 8-16-2007.

LEIGH CAROLINE CASE, EXAMINING ATTORNEY



*David J. Kyros*

Director of the United States Patent and Trademark Office

# United States of America

United States Patent and Trademark Office

# LIVE LARGE

**Reg. No. 4,135,709**

**Registered May 1, 2012**

**Int. Cl.: 25**

**TRADEMARK**

**PRINCIPAL REGISTER**

CIM/H&H RETAIL, LP (CALIFORNIA LIMITED PARTNERSHIP)  
6922 HOLLYWOOD BLVD.  
SUITE 900  
LOS ANGELES, CA 90028

FOR: CLOTHING, NAMELY, SHIRTS AND SHORTS, IN CLASS 25 (U.S. CLS. 22 AND 39).

FIRST USE 1-26-2012; IN COMMERCE 1-26-2012.

THE MARK CONSISTS OF STANDARD CHARACTERS WITHOUT CLAIM TO ANY PARTICULAR FONT, STYLE, SIZE, OR COLOR.

SN 77-271,861, FILED 9-5-2007.

HOWARD B. LEVINE, EXAMINING ATTORNEY



*David J. Kyffers*

Director of the United States Patent and Trademark Office

# United States of America

United States Patent and Trademark Office

# Schott

**Reg. No. 4,135,710**

**Registered May 1, 2012**

**Int. Cl.: 15**

**TRADEMARK**

**PRINCIPAL REGISTER**

WILLIAM S EVERITT (UNITED STATES INDIVIDUAL)  
5106 KELSEY ROAD  
DALLAS, TX 75229

FOR: CARRYING CASES FOR MUSICAL INSTRUMENTS; MUSICAL INSTRUMENTS;  
WOODWIND INSTRUMENTS; BASSOON; BASSOONS; OBOES, IN CLASS 15 (U.S. CLS.  
2, 21 AND 36).

FIRST USE 10-1-2007; IN COMMERCE 10-1-2007.

THE MARK CONSISTS OF STANDARD CHARACTERS WITHOUT CLAIM TO ANY PAR-  
TICULAR FONT, STYLE, SIZE, OR COLOR.

SN 77-287,268, FILED 9-24-2007.

AISHA CLARKE, EXAMINING ATTORNEY



*David J. Kybas*

Director of the United States Patent and Trademark Office

# United States of America

United States Patent and Trademark Office

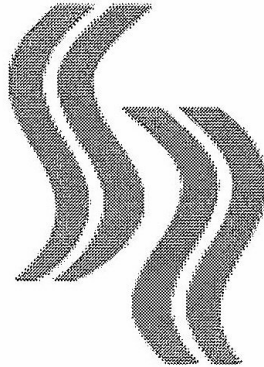

**Reg. No. 4,135,711**

**Registered May 1, 2012**

**Int. Cl.: 25**

**TRADEMARK**

**PRINCIPAL REGISTER**

LEDUC, GINETTE (CANADA INDIVIDUAL)  
297 CITE DES JEUNES BLVD.  
ST-CLET, QUEBEC, CANADA J0P1S0

FOR: WOMEN'S PLUS-SIZE SPORTSWEAR, NAMELY, PANTS, SPORT PANTS, SKI PANTS, SNOW PANTS, CAPRI PANTS, CARGO PANTS, JOGGING PANTS, NON-DISPOSABLE CLOTH TRAINING PANTS, STRETCH PANTS, YOGA PANTS, WIND PANTS, SHORTS, T-SHIRTS, POLO SHIRTS, SPORT SHIRTS, SPORT JERSEYS, ATHLETIC UNIFORMS, SKIRTS AND DRESSES, SKORTS, TOPS, BERMUDA SHORTS, JACKETS, SPORTS JACKETS, SKI JACKETS, SHELL JACKETS, REVERSIBLE JACKETS, FUR JACKETS, COATS, SPORT COATS, FUR COATS, PARKAS, SKI BIBS, FUR STOLEES, FUR CLOAKS, FUR COLLARS, RAINWEAR, WIND JACKETS, WATERPROOF JACKETS AND PANTS, IN CLASS 25 (U.S. CLS. 22 AND 39).

FIRST USE 11-0-2011; IN COMMERCE 11-0-2011.

THE MARK CONSISTS OF TWO WAVY LINES.

SN 77-300,019, FILED 10-9-2007.

EDWARD FENNESSY, EXAMINING ATTORNEY



*David J. Kyffers*

Director of the United States Patent and Trademark Office

# United States of America

United States Patent and Trademark Office

## MOISTUREGUARD

**Reg. No. 4,135,712**

**Registered May 1, 2012**

**Int. Cl.: 31**

**TRADEMARK**

**PRINCIPAL REGISTER**

OMS INVESTMENTS, INC. (DELAWARE CORPORATION)  
10250 CONSTELLATION BLVD. SUITE 2800  
LOS ANGELES, CA 90067

FOR: PEAT MOSS; SOIL CONTAINING FERTILIZER, IN CLASS 31 (U.S. CLS. 1 AND 46).

FIRST USE 5-31-2009; IN COMMERCE 5-31-2009.

THE MARK CONSISTS OF STANDARD CHARACTERS WITHOUT CLAIM TO ANY PARTICULAR FONT, STYLE, SIZE, OR COLOR.

SN 77-322,575, FILED 11-6-2007.

THOMAS MANOR, EXAMINING ATTORNEY



*David J. Kyros*

Director of the United States Patent and Trademark Office

# United States of America

United States Patent and Trademark Office

# Z77

**Reg. No. 4,135,713**

**Registered May 1, 2012**

**Int. Cl.: 9**

**TRADEMARK**

**PRINCIPAL REGISTER**

CYAN OPTICS, INC. (DELAWARE CORPORATION)  
1383 N. MCDOWELL BLVD., SUITE 300  
PETALUMA, CA 94954

FOR: COMPUTER HARDWARE, NAMELY, COMPUTER NETWORKING HARDWARE; ROUTERS; COMMUNICATIONS SERVERS; WIRELESS NETWORK REPEATERS AND EXTENDERS; NETWORK ACCESS SERVER HARDWARE; PERIPHERAL COMPONENT INTERFACE (PCI) HARDWARE; VPN (VIRTUAL PRIVATE NETWORK) HARDWARE; WAN (WIDE AREA NETWORK) HARDWARE; LAN (LOCAL AREA NETWORK) HARDWARE; WIRELESS ACCESS POINT (WAP) DEVICES; GATEWAY ROUTERS IN THE NATURE OF COMPUTER CONTROL HARDWARE, IN CLASS 9 (U.S. CLS. 21, 23, 26, 36 AND 38).

FIRST USE 11-0-2008; IN COMMERCE 11-0-2008.

THE MARK CONSISTS OF STANDARD CHARACTERS WITHOUT CLAIM TO ANY PARTICULAR FONT, STYLE, SIZE, OR COLOR.

SN 77-340,112, FILED 11-29-2007.

BARBARA GAYNOR, EXAMINING ATTORNEY



*David J. Kyffers*

Director of the United States Patent and Trademark Office

# United States of America

United States Patent and Trademark Office

# T.I.P.

**Reg. No. 4,135,714**

BRIDGESTONE CORPORATION (JAPAN CORPORATION)  
TODA BUILDING 9F, 7-1, KYOBASHI 1-CHOME  
CHUO-KU, TOKYO, JAPAN 104-0031

**Registered May 1, 2012**

**Int. Cl.: 12**

FOR: VEHICLE TIRE COMPONENTS IN THE NATURE OF BEADS, IN CLASS 12 (U.S. CLS. 19, 21, 23, 31, 35 AND 44).

**TRADEMARK**

FIRST USE 3-22-2011; IN COMMERCE 3-22-2011.

**PRINCIPAL REGISTER**

THE MARK CONSISTS OF STANDARD CHARACTERS WITHOUT CLAIM TO ANY PARTICULAR FONT, STYLE, SIZE, OR COLOR.

SN 77-353,483, FILED 12-17-2007.

DAYNA BROWNE, EXAMINING ATTORNEY



*David J. Kyffers*

Director of the United States Patent and Trademark Office

# United States of America

United States Patent and Trademark Office

# DONG LONG

**Reg. No. 4,135,715**

**Registered May 1, 2012**

**Int. Cl.: 35**

**SERVICE MARK**

**PRINCIPAL REGISTER**

SCHMITZ, PHILIP J. (UNITED STATES INDIVIDUAL)  
11710 OLD GEORGETOWN ROAD; UNIT 1406  
ROCKVILLE, MD 20852

FOR: ONLINE RETAIL STORE SERVICES FEATURING CLOTHING AND ACCESSORIES,  
IN CLASS 35 (U.S. CLS. 100, 101 AND 102).

FIRST USE 2-24-2012; IN COMMERCE 2-24-2012.

THE MARK CONSISTS OF STANDARD CHARACTERS WITHOUT CLAIM TO ANY PAR-  
TICULAR FONT, STYLE, SIZE, OR COLOR.

THE FOREIGN WORDING IN THE MARK TRANSLATES INTO ENGLISH AS UNDERSTAND-  
ING OF THE DRAGON.

SN 77-354,798, FILED 12-18-2007.

JOHN GARTNER, EXAMINING ATTORNEY



*David J. Kybas*

Director of the United States Patent and Trademark Office



# United States of America

United States Patent and Trademark Office

# DONG LONG

**Reg. No. 4,135,716**

**Registered May 1, 2012**

**Int. Cl.: 25**

**TRADEMARK**

**PRINCIPAL REGISTER**

PHILIP J. SCHMITZ (UNITED STATES INDIVIDUAL)  
11710 OLD GEORGETOWN ROAD; UNIT 1406  
ROCKVILLE, MD 20852

FOR: CLOTHING, NAMELY, T-SHIRTS, IN CLASS 25 (U.S. CLS. 22 AND 39).

FIRST USE 1-14-2012; IN COMMERCE 1-14-2012.

THE MARK CONSISTS OF STANDARD CHARACTERS WITHOUT CLAIM TO ANY PARTICULAR FONT, STYLE, SIZE, OR COLOR.

THE FOREIGN WORDING IN THE MARK TRANSLATES INTO ENGLISH AS UNDERSTANDING OF THE DRAGON.

SN 77-354,801, FILED 12-18-2007.

JOHN GARTNER, EXAMINING ATTORNEY



*David J. Kyffers*

Director of the United States Patent and Trademark Office

# United States of America

United States Patent and Trademark Office

## DON'T FOUL OUT

**Reg. No. 4,135,717**

**Registered May 1, 2012**

**Int. Cl.: 41**

**SERVICE MARK**

**PRINCIPAL REGISTER**

PREMIER BASKETBALL LEAGUE, INC. (ILLINOIS CORPORATION)  
SUITE 200  
4958 WEST IRVING PARK ROAD  
CHICAGO, IL 60641

FOR: ENTERTAINMENT AND EDUCATIONAL SERVICES IN THE NATURE OF ONGOING TELEVISION AND RADIO PROGRAMS IN THE FIELD OF BASKETBALL AND RENDERING LIVE BASKETBALL GAMES AND BASKETBALL EXHIBITIONS; THE PRODUCTION AND DISTRIBUTION OF RADIO AND TELEVISION BROADCASTS OF BASKETBALL GAMES, BASKETBALL EVENTS AND PROGRAMS IN THE FIELD OF BASKETBALL; CONDUCTING AND ARRANGING BASKETBALL CLINICS AND CAMPS, COACHES CLINICS AND CAMPS, DANCE TEAM CLINICS AND CAMPS AND BASKETBALL EVENTS; ENTERTAINMENT SERVICES IN THE NATURE OF PERSONAL APPEARANCES BY A COSTUMED MASCOT OR DANCE TEAM AT BASKETBALL GAMES AND EXHIBITIONS, CLINICS, CAMPS, PROMOTIONS, AND OTHER BASKETBALL-RELATED EVENTS, SPECIAL EVENTS AND PARTIES; FAN CLUB SERVICES; ENTERTAINMENT SERVICES, NAMELY, PROVIDING A WEBSITE FEATURING THE FOLLOWING NON-DOWNLOADABLE CONTENT; TELEVISION HIGHLIGHTS, INTERACTIVE TELEVISION HIGHLIGHTS, VIDEO RECORDINGS, VIDEO STREAM RECORDINGS, INTERACTIVE VIDEO HIGHLIGHT SELECTIONS, RADIO PROGRAMS, RADIO HIGHLIGHTS, AND AUDIO RECORDINGS IN THE FIELD OF BASKETBALL, BASKETBALL NEWS IN THE NATURE OF INFORMATION, STATISTICS, AND TRIVIA ABOUT BASKETBALL, ON-LINE NON-DOWNLOADABLE COMPUTER GAMES, NAMELY, VIDEO GAMES, INTERACTIVE VIDEO GAMES, ACTION SKILL GAMES, ARCADE GAMES, ADULTS' AND CHILDREN'S PARTY GAMES, BOARD GAMES, PUZZLES, AND TRIVIA GAMES; PUBLISHING NON-DOWNLOADABLE ON-LINE MAGAZINES, GUIDES, NEWSLETTERS, COLORING BOOKS, AND GAME SCHEDULES IN THE FIELD OF BASKETBALL OVER THE INTERNET; PROVIDING AN ONLINE COMPUTER DATABASE IN THE FIELD OF BASKETBALL, IN CLASS 41 (U.S. CLS. 100, 101 AND 107).



FIRST USE 2-0-2012; IN COMMERCE 2-0-2012.

THE MARK CONSISTS OF STANDARD CHARACTERS WITHOUT CLAIM TO ANY PARTICULAR FONT, STYLE, SIZE, OR COLOR.

*David J. Kypas*

SN 77-357,290, FILED 12-20-2007.

MATTHEW KLINE, EXAMINING ATTORNEY

# United States of America

United States Patent and Trademark Office



**Reg. No. 4,135,718**

**Registered May 1, 2012**

**Int. Cl.: 25**

**TRADEMARK**

**PRINCIPAL REGISTER**

KROON, NICLAS (SWEDEN INDIVIDUAL)  
5800 WOODWAY DR. #433  
HOUSTON, TX 77057

FOR: CAPS; TOPS; KNIT SHIRTS; POLO SHIRTS; SHORT-SLEEVED OR LONG-SLEEVED T-SHIRTS; SWEAT SHIRTS; T-SHIRTS; TEE SHIRTS, IN CLASS 25 (U.S. CLS. 22 AND 39).

FIRST USE 3-14-2005; IN COMMERCE 2-2-2012.

THE MARK CONSISTS OF A STYLIZED HUMAN FACE IN PROFILE WITH ARM EXTENDED OUT IN FRONT AND ELBOW BENT UPWARD AND HAND POINTING BACK TOWARD FACE IN COBRA-LIKE FASHION, ABOVE THE WORD "VICT"! AND TO THE RIGHT OF A GROUPING OF LINES INDICATING A MOTION OF THE HAND TOWARD THE FACE.

THERE IS NO ENGLISH TRANSLATION FOR "VICT" IN THE MARK.

SN 77-359,534, FILED 12-26-2007.

ELISSA GARBER KON, EXAMINING ATTORNEY



*David J. Kybas*

Director of the United States Patent and Trademark Office

# United States of America

United States Patent and Trademark Office



**Reg. No. 4,135,719**

**Registered May 1, 2012**

**Int. Cl.: 7**

**TRADEMARK**

**PRINCIPAL REGISTER**

SOLAROAD TECHNOLOGIES INC. (MARYLAND CORPORATION)  
7 BIDEFORD COURT  
PARKVILLE, MD 21234

FOR: SOLAR POWERED ELECTRICITY GENERATORS THAT HAVE THE ABILITY TO STORE ENERGY, IN CLASS 7 (U.S. CLS. 13, 19, 21, 23, 31, 34 AND 35).

FIRST USE 4-14-2011; IN COMMERCE 4-14-2011.

THE MARK CONSISTS OF THE WORDS "ELECTRAWALL" WITH A STAR SHAPE TO THE LEFT OF THE WORDS.

SN 77-363,083, FILED 1-3-2008.

MARGERY A. TIERNEY, EXAMINING ATTORNEY



*David J. Kyffers*

Director of the United States Patent and Trademark Office

# United States of America

United States Patent and Trademark Office

## ELECTRAWALL

**Reg. No. 4,135,720**

**Registered May 1, 2012**

**Int. Cl.: 7**

**TRADEMARK**

**PRINCIPAL REGISTER**

SOLAROAD TECHNOLOGIES INC. (MARYLAND CORPORATION)  
7 BIDEFORD COURT  
PARKVILLE, MD 21234

FOR: SOLAR POWERED ELECTRICITY GENERATORS THAT HAVE THE ABILITY TO STORE ENERGY, IN CLASS 7 (U.S. CLS. 13, 19, 21, 23, 31, 34 AND 35).

FIRST USE 4-14-2011; IN COMMERCE 4-14-2011.

THE MARK CONSISTS OF STANDARD CHARACTERS WITHOUT CLAIM TO ANY PARTICULAR FONT, STYLE, SIZE, OR COLOR.

SN 77-363,334, FILED 1-3-2008.

MARGERY A. TIERNEY, EXAMINING ATTORNEY



*David J. Kybas*

Director of the United States Patent and Trademark Office

# United States of America

United States Patent and Trademark Office



**Reg. No. 4,135,721**

**Registered May 1, 2012**

**Int. Cl.: 42**

**SERVICE MARK**

**PRINCIPAL REGISTER**

SCIENCE APPLICATIONS INTERNATIONAL CORPORATION (DELAWARE CORPORATION)  
1710 SAIC DRIVE  
MCLEAN, VA 22102

FOR: PROVIDING ONLINE, NON-DOWNLOADABLE DECISION SUPPORT APPLICATION SOFTWARE FOR USE BY ANALYSTS, DECISION MAKERS, STRATEGISTS, AND OPERATIONAL PLANNERS IN STRATEGIC PLANNING, ANALYSIS, AND EVALUATION OF DATA ISSUES, EVENTS, UNCONTROLLED VARIABLES, AND OTHER SIGNIFICANT FACTORS IN A WIDE RANGE OF FIELDS, IN CLASS 42 (U.S. CLS. 100 AND 101).

FIRST USE 2-10-2012; IN COMMERCE 2-10-2012.

THE MARK CONSISTS OF THE WORD "DESIGNS" WITH THE DESIGN OF A ROOK TO THE LEFT OF THE WORD.

SN 77-365,585, FILED 1-7-2008.

LINDA LAVACHE, EXAMINING ATTORNEY



*David J. Kybas*

Director of the United States Patent and Trademark Office

# United States of America

United States Patent and Trademark Office

# SELECTSHIFT

**Reg. No. 4,135,722**

**Registered May 1, 2012**

**Int. Cl.: 12**

**TRADEMARK**

**PRINCIPAL REGISTER**

FORD MOTOR COMPANY (DELAWARE CORPORATION)  
ONE AMERICAN ROAD  
DEARBORN, MI 48126

FOR: TRANSMISSIONS FOR AUTOMOBILES, TRUCKS, VANS, AND SPORT-UTILITY VEHICLES, SOLD AS A COMPONENT OF SUCH VEHICLES, IN CLASS 12 (U.S. CLS. 19, 21, 23, 31, 35 AND 44).

FIRST USE 9-30-2009; IN COMMERCE 9-30-2009.

THE MARK CONSISTS OF STANDARD CHARACTERS WITHOUT CLAIM TO ANY PARTICULAR FONT, STYLE, SIZE, OR COLOR.

SN 77-365,650, FILED 1-7-2008.

REBECCA GILBERT, EXAMINING ATTORNEY



*David J. Kyffers*

Director of the United States Patent and Trademark Office

# United States of America

United States Patent and Trademark Office

## STUDIO ASSETS

**Reg. No. 4,135,723**

**Registered May 1, 2012**

**Int. Cl.: 9**

**TRADEMARK**

**PRINCIPAL REGISTER**

HARLOCKER, CHRISTOPHER R. (UNITED STATES INDIVIDUAL)  
P.O. BOX 604  
LAKE FOREST, IL 60045

FOR: PORTABLE PHOTOGRAPHY EQUIPMENT, NAMELY, PHOTOGRAPHY LIGHT STANDS, LIGHT REFLECTORS, LIGHTING, FLASH UNITS, FLASH POWER PACKS, IN CLASS 9 (U.S. CLS. 21, 23, 26, 36 AND 38).

FIRST USE 11-30-2010; IN COMMERCE 11-30-2010.

THE MARK CONSISTS OF STANDARD CHARACTERS WITHOUT CLAIM TO ANY PARTICULAR FONT, STYLE, SIZE, OR COLOR.

NO CLAIM IS MADE TO THE EXCLUSIVE RIGHT TO USE "STUDIO", APART FROM THE MARK AS SHOWN.

SN 77-368,536, FILED 1-10-2008.

HELENE LIWINSKI, EXAMINING ATTORNEY



*David J. Kyros*

Director of the United States Patent and Trademark Office



# United States of America

United States Patent and Trademark Office

# ECO SELECT

**Reg. No. 4,135,724**

**Registered May 1, 2012**

**Int. Cls.: 7, 9, and 11**

**TRADEMARK**

**PRINCIPAL REGISTER**

PENTAIR WATER POOL AND SPA, INC. (DELAWARE CORPORATION)  
1620 HAWKINS AVENUE  
SANFORD, NC 27330

FOR: WATER PUMPS AND AUTOMATIC POOL CLEANERS FOR RESIDENTIAL AND COMMERCIAL SWIMMING POOLS, SPAS AND WATER PARKS, IN CLASS 7 (U.S. CLS. 13, 19, 21, 23, 31, 34 AND 35).

FIRST USE 9-1-2010; IN COMMERCE 9-1-2010.

FOR: ELECTRICAL CONTROL UNITS FOR CONTROLLING THE OPERATION OF POOL AND SPA LIGHTS, HEATERS, AND PUMPS, IN CLASS 9 (U.S. CLS. 21, 23, 26, 36 AND 38).

FIRST USE 9-1-2010; IN COMMERCE 9-1-2010.

FOR: AUTOMATIC CHLORINE GENERATORS FOR RESIDENTIAL AND COMMERCIAL SWIMMING POOLS, SPAS AND WATER PARKS; UNDERWATER POOL AND SPA LIGHTS; WATER HEATERS, HEAT PUMPS, AND WATER FILTERS FOR RESIDENTIAL AND COMMERCIAL SWIMMING POOLS, SPAS AND WATER PARKS, IN CLASS 11 (U.S. CLS. 13, 21, 23, 31 AND 34).

FIRST USE 9-15-2011; IN COMMERCE 9-15-2011.

THE MARK CONSISTS OF STANDARD CHARACTERS WITHOUT CLAIM TO ANY PARTICULAR FONT, STYLE, SIZE, OR COLOR.

SN 77-369,300, FILED 1-11-2008.

ANTHONY RINKER, EXAMINING ATTORNEY



*David J. Kybas*

Director of the United States Patent and Trademark Office

# United States of America

United States Patent and Trademark Office

## AEROVALBRUNA

**Reg. No. 4,135,725**

ACCIAIERIE VALBRUNA S.P.A (ITALY SOCIETÀ PER AZIONI (SPA))  
VIALE DELLA SCIENZA 25  
VICENZA, ITALY 36100

**Registered May 1, 2012**

**Int. Cl.: 6**

FOR: STEEL, STAINLESS STEEL, NICKEL AND TITANIUM ALLOYS FOR THE AEROSPACE INDUSTRY, IN CLASS 6 (U.S. CLS. 2, 12, 13, 14, 23, 25 AND 50).

**TRADEMARK**

FIRST USE 7-12-2011; IN COMMERCE 7-12-2011.

**PRINCIPAL REGISTER**

THE MARK CONSISTS OF STANDARD CHARACTERS WITHOUT CLAIM TO ANY PARTICULAR FONT, STYLE, SIZE, OR COLOR.

SN 77-370,853, FILED 1-14-2008.

DAVID MURRAY, EXAMINING ATTORNEY



*David J. Kyfos*

Director of the United States Patent and Trademark Office

# United States of America

United States Patent and Trademark Office



**Reg. No. 4,135,726**

HALL WINES, LLC (TEXAS LIMITED LIABILITY COMPANY)  
401 ST. HELENA HIGHWAY SOUTH  
ST. HELENA, CA 94574

**Registered May 1, 2012**

**Int. Cl.: 21**

FOR: WINE GLASSES, CORKSCREWS, IN CLASS 21 (U.S. CLS. 2, 13, 23, 29, 30, 33, 40 AND 50).

**TRADEMARK**

FIRST USE 8-4-2009; IN COMMERCE 8-4-2009.

**PRINCIPAL REGISTER**

THE MARK CONSISTS OF A SERIES OF WAVY INTERSECTING LINES IN A THREE BY THREE GRID.

SN 77-371,500, FILED 1-14-2008.

HAI-LY LAM, EXAMINING ATTORNEY



*David J. Kybas*

Director of the United States Patent and Trademark Office

# United States of America

United States Patent and Trademark Office

## GEOSCIENTISTS WITHOUT BORDERS

**Reg. No. 4,135,727**

**Registered May 1, 2012**

**Int. Cls.: 16 and 41**

**TRADEMARK**

**SERVICE MARK**

**PRINCIPAL REGISTER**

SEG FOUNDATION (OKLAHOMA CORPORATION)  
8801 SOUTH YALE AVENUE  
TULSA, OK 741373575

FOR: PRINTED PUBLICATIONS, NAMELY, TECHNICAL PUBLICATIONS AND GENERAL INTEREST PUBLICATIONS IN THE NATURE OF ACADEMIC PAPERS, JOURNALS, REPORTS, ARTICLES, NEWS BULLETINS, MAGAZINES, BOOKS, NEWSPAPERS, PRESS RELEASES, DOSSIERS, PRINTED CHARTS, PRINTED TABLES, GUIDES, MANUALS, PAMPHLETS, LEAFLETS AND NEWSLETTERS IN THE FIELD OF GEOSCIENCE, IN CLASS 16 (U.S. CLS. 2, 5, 22, 23, 29, 37, 38 AND 50).

FIRST USE 10-0-2010; IN COMMERCE 10-0-2010.

FOR: PROVIDING ON-LINE PUBLICATIONS, NAMELY, TECHNICAL PUBLICATIONS AND GENERAL INTEREST PUBLICATIONS IN THE NATURE OF ACADEMIC PAPERS, JOURNALS, REPORTS, ARTICLES, NEWS BULLETINS, MAGAZINES, BOOKS, NEWSPAPERS, PRESS RELEASES, DOSSIERS, CHARTS, TABLES, GUIDES, MANUALS, PAMPHLETS, LEAFLETS AND NEWSLETTERS IN THE FIELD OF GEOSCIENCE, IN CLASS 41 (U.S. CLS. 100, 101 AND 107).

FIRST USE 9-0-2011; IN COMMERCE 9-0-2011.

THE MARK CONSISTS OF STANDARD CHARACTERS WITHOUT CLAIM TO ANY PARTICULAR FONT, STYLE, SIZE, OR COLOR.

NO CLAIM IS MADE TO THE EXCLUSIVE RIGHT TO USE "GEOSCIENTISTS", APART FROM THE MARK AS SHOWN.

SN 77-378,868, FILED 1-23-2008.

NAAKWAMA ANKRAH, EXAMINING ATTORNEY



*David J. Kyros*

Director of the United States Patent and Trademark Office

# United States of America

United States Patent and Trademark Office

## GAC LATE SHIFT

**Reg. No. 4,135,728**

**Registered May 1, 2012**

**Int. Cl.: 41**

**SERVICE MARK**

**PRINCIPAL REGISTER**

SCRIPPS NETWORKS, LLC (DELAWARE LIMITED LIABILITY COMPANY)  
9721 SHERRILL BOULEVARD  
KNOXVILLE, TN 37932

FOR: ENTERTAINMENT SERVICES, NAMELY, PRODUCTION OF TELEVISION PROGRAMS FEATURING MUSIC, WITH SUCH SERVICES BEING DELIVERED BY WAY OF TELECOMMUNICATIONS TECHNOLOGY, IN CLASS 41 (U.S. CLS. 100, 101 AND 107).

FIRST USE 2-17-2009; IN COMMERCE 2-17-2009.

THE MARK CONSISTS OF STANDARD CHARACTERS WITHOUT CLAIM TO ANY PARTICULAR FONT, STYLE, SIZE, OR COLOR.

OWNER OF U.S. REG. NOS. 2,577,654, 3,285,052, AND 3,285,053.

NO CLAIM IS MADE TO THE EXCLUSIVE RIGHT TO USE "LATE SHIFT", APART FROM THE MARK AS SHOWN.

SN 77-380,757, FILED 1-25-2008.

LINDA ESTRADA, EXAMINING ATTORNEY



*David J. Kyffers*

Director of the United States Patent and Trademark Office

# United States of America

United States Patent and Trademark Office

## TRINA TURK RESIDENTIAL

**Reg. No. 4,135,729**

**Registered May 1, 2012**

**Int. Cl.: 35**

**SERVICE MARK**

**PRINCIPAL REGISTER**

L2T, INC (CALIFORNIA CORPORATION)  
3025 W. MISSION ROAD  
ALHAMBRA, CA 91803

FOR: RETAIL STORE SERVICES FEATURING FABRIC BED PRODUCTS, FURNITURE, PATIOWARE, KITCHENWARE, HOME ACCESSORIES, NAMELY, LAMPS, PICTURE FRAMES, MIRRORS, INTERIOR DECORATING BOOKS, GIFT ITEMS; ONLINE RETAIL STORE SERVICES FEATURING FABRIC BED PRODUCTS, HOME ACCESSORIES, NAMELY, INTERIOR DECORATING BOOKS, GIFT ITEMS, IN CLASS 35 (U.S. CLS. 100, 101 AND 102).

FIRST USE 4-25-2008; IN COMMERCE 3-30-2009.

THE MARK CONSISTS OF STANDARD CHARACTERS WITHOUT CLAIM TO ANY PARTICULAR FONT, STYLE, SIZE, OR COLOR.

OWNER OF U.S. REG. NOS. 2,055,613, 3,310,042, AND 3,405,208.

NO CLAIM IS MADE TO THE EXCLUSIVE RIGHT TO USE "RESIDENTIAL", APART FROM THE MARK AS SHOWN.

THE NAME "TRINA TURK" IDENTIFIES A LIVING INDIVIDUAL WHOSE CONSENT IS OF RECORD.

SN 77-384,825, FILED 1-30-2008.

SIMON TENG, EXAMINING ATTORNEY



*David J. Kyffers*

Director of the United States Patent and Trademark Office

# United States of America

United States Patent and Trademark Office

## Bare Naked Honey

**Reg. No. 4,135,730**

**Registered May 1, 2012**

**Int. Cl.: 30**

**TRADEMARK**

**PRINCIPAL REGISTER**

GUIETTE, DEBORAH E (UNITED STATES INDIVIDUAL), DBA TATTER, DEBORAH E,  
10111 HEEREN ST  
WESTON, WI 54476

FOR: HONEY, IN CLASS 30 (U.S. CL. 46).

FIRST USE 1-1-2000; IN COMMERCE 1-1-2000.

THE MARK CONSISTS OF STANDARD CHARACTERS WITHOUT CLAIM TO ANY PARTICULAR FONT, STYLE, SIZE, OR COLOR.

NO CLAIM IS MADE TO THE EXCLUSIVE RIGHT TO USE "HONEY", APART FROM THE MARK AS SHOWN.

SN 77-387,555, FILED 2-4-2008.

GRETТА YAO, EXAMINING ATTORNEY



*David J. Kyffers*

Director of the United States Patent and Trademark Office

# United States of America

United States Patent and Trademark Office

## TATA COMMUNICATIONS

**Reg. No. 4,135,731**

**Registered May 1, 2012**

**Int. Cls.: 37, 38, and 42**

**SERVICE MARK**

**PRINCIPAL REGISTER**

TATA SONS LIMITED (INDIA COMPANY)  
BOMBAY HOUSE, 24  
HOMI MODY STREET  
MUMBAI, INDIA 400001

FOR: CONSTRUCTION, INSTALLATION AND MAINTENANCE OF FIBER OPTIC TELECOMMUNICATIONS NETWORKS, TECHNICAL FACILITIES, IN CLASS 37 (U.S. CLS. 100, 103 AND 106).

FIRST USE 12-31-2008; IN COMMERCE 12-31-2008.

FOR: COMMUNICATIONS SERVICES, NAMELY, LOCAL AND LONG DISTANCE TRANSMISSION OF VOICE, VIDEO AND DATA VIA FIBER OPTIC NETWORKS; PROVIDING MULTIPLE USERS ACCESS TO GLOBAL COMPUTER NETWORK; AND VOICE OVER INTERNET PROTOCOL (VOIP) SERVICES, IN CLASS 38 (U.S. CLS. 100, 101 AND 104).

FIRST USE 12-31-2008; IN COMMERCE 12-31-2008.

FOR: SCIENTIFIC RESEARCH AND DEVELOPMENT; INDUSTRIAL RESEARCH IN THE FIELD OF TELECOMMUNICATIONS; COMPUTER SERVICES FOR FACILITATING COMPUTERIZED COMMUNICATIONS, NAMELY, PROVIDING TECHNICAL SUPPORT SERVICES, NAMELY, MONITORING OF NETWORK SYSTEMS, HOSTING ONLINE WEB SITE FOR OTHERS TO DISPLAY THEIR PRODUCTS OR SERVICES; COMPUTER PROGRAMMING SERVICES; APPLICATION SERVICE PROVIDER (ASP), NAMELY, HOSTING OF COMPUTER SOFTWARE APPLICATIONS OF OTHERS, IN CLASS 42 (U.S. CLS. 100 AND 101).

FIRST USE 12-31-2008; IN COMMERCE 12-31-2008.

THE MARK CONSISTS OF STANDARD CHARACTERS WITHOUT CLAIM TO ANY PARTICULAR FONT, STYLE, SIZE, OR COLOR.

OWNER OF U.S. REG. NOS. 2,814,916, 2,824,913, AND 2,929,070.

NO CLAIM IS MADE TO THE EXCLUSIVE RIGHT TO USE "COMMUNICATIONS", APART FROM THE MARK AS SHOWN.



*David J. Kappas*

Director of the United States Patent and Trademark Office



**Reg. No. 4,135,731** SN 77-389,690, FILED 2-6-2008.

STEVEN JACKSON, EXAMINING ATTORNEY

# United States of America

United States Patent and Trademark Office

## BLACK AMETHYST

**Reg. No. 4,135,732**

**Registered May 1, 2012**

**Int. Cls.: 3 and 4**

**TRADEMARK**

**PRINCIPAL REGISTER**

BATH & BODY WORKS BRAND MANAGEMENT, INC. (DELAWARE CORPORATION)  
5 LIMITED PARKWAY EAST  
REYNOLDSBURG, OH 43068

FOR: PERSONAL CARE PRODUCTS, NAMELY, BODY BUTTER FOR COSMETIC PURPOSES, BODY CREAM, BODY GEL, BODY LOTION, BODY MIST, BODY SCRUB, BODY SMOOTHER LOTION, BODY SOAP, BODY SPLASH, BODY WASH, BUBBLE BATH, COLOGNE, CREAM BODY WASH, CREAM SKIN CLEANSER, ESSENTIAL OILS, FACE CLEANSER, FACE LOTION, FACE SCRUB, FACE SOAP, FACE WASH, FOAM BATH, HAND BALM, HAND CLEANSING SPRAY, HAND CREAM, HAND EXFOLIATOR, HAND LOTION, HAND RENEWER LOTION, HAND SOAP, HAND WASH, PERFUME, PERFUME OILS, SCENTED LINEN SPRAY, REFILLS FOR ELECTRIC ROOM FRAGRANCE DISPENSERS, ROOM FRAGRANCE SPRAY, SHOWER CREAM, SHOWER FOAM, SHOWER GEL, SHOWER SCRUB, IN CLASS 3 (U.S. CLS. 1, 4, 6, 50, 51 AND 52).

FIRST USE 9-0-2009; IN COMMERCE 9-0-2009.

FOR: CANDLES, IN CLASS 4 (U.S. CLS. 1, 6 AND 15).

FIRST USE 9-0-2009; IN COMMERCE 9-0-2009.

THE MARK CONSISTS OF STANDARD CHARACTERS WITHOUT CLAIM TO ANY PARTICULAR FONT, STYLE, SIZE, OR COLOR.

SN 77-392,205, FILED 2-8-2008.

ANNE E. GUSTASON, EXAMINING ATTORNEY



*David J. Kyros*

Director of the United States Patent and Trademark Office

# United States of America

United States Patent and Trademark Office

# CELIXSYS

**Reg. No. 4,135,733**

BIO MATRIX RESEARCH INC. (JAPAN CORPORATION)  
105 HIGASHIFUKAI, NAGAREYAMA-SHI  
CHIBA, JAPAN

**Registered May 1, 2012**

**Int. Cl.: 40**

FOR: MANUFACTURING SERVICES FOR OTHERS IN THE FIELD OF PHARMACEUTICALS  
AND CHEMICALS, IN CLASS 40 (U.S. CLS. 100, 103 AND 106).

**SERVICE MARK**

FIRST USE 12-11-2007; IN COMMERCE 3-18-2008.

**PRINCIPAL REGISTER**

THE MARK CONSISTS OF STANDARD CHARACTERS WITHOUT CLAIM TO ANY PAR-  
TICULAR FONT, STYLE, SIZE, OR COLOR.

SN 77-397,066, FILED 2-14-2008.

MICHAEL KEATING, EXAMINING ATTORNEY



*David J. Kybas*

Director of the United States Patent and Trademark Office

# United States of America

United States Patent and Trademark Office

## WATCH THIS

**Reg. No. 4,135,734**

**Registered May 1, 2012**

**Int. Cl.: 41**

**SERVICE MARK**

**PRINCIPAL REGISTER**

TV GUIDE ENTERTAINMENT GROUP, LLC (CALIFORNIA CORPORATION)  
1800 NORTH HIGHLAND AVENUE  
LOS ANGELES, CA 90028

FOR: PROVIDING ENTERTAINMENT INFORMATION CONCERNING A TELEVISION PROGRAM VIA A GLOBAL COMPUTER NETWORK, IN CLASS 41 (U.S. CLS. 100, 101 AND 107).

FIRST USE 9-1-2010; IN COMMERCE 9-1-2010.

THE MARK CONSISTS OF STANDARD CHARACTERS WITHOUT CLAIM TO ANY PARTICULAR FONT, STYLE, SIZE, OR COLOR.

SN 77-400,388, FILED 2-19-2008.

KELLEY WELLS, EXAMINING ATTORNEY



*David J. Kybas*

Director of the United States Patent and Trademark Office

# United States of America

United States Patent and Trademark Office

## DESTINATION MISSOURI

**Reg. No. 4,135,735**

**Registered May 1, 2012**

**Int. Cl.: 16**

**TRADEMARK**

**PRINCIPAL REGISTER**

SHOW-ME PUBLISHING, INC. (MISSOURI CORPORATION)  
2049 WYANDOTTE  
KANSAS CITY, MO 64108

FOR: PRINTED PERIODICALS AND MAGAZINES FEATURING INFORMATION ON BUSINESS AND ECONOMIC DEVELOPMENT, IN CLASS 16 (U.S. CLS. 2, 5, 22, 23, 29, 37, 38 AND 50).

FIRST USE 3-17-2012; IN COMMERCE 3-17-2012.

THE MARK CONSISTS OF STANDARD CHARACTERS WITHOUT CLAIM TO ANY PARTICULAR FONT, STYLE, SIZE, OR COLOR.

NO CLAIM IS MADE TO THE EXCLUSIVE RIGHT TO USE "MISSOURI", APART FROM THE MARK AS SHOWN.

SN 77-416,377, FILED 3-7-2008.

JORDAN BAKER, EXAMINING ATTORNEY



*David J. Kyros*

Director of the United States Patent and Trademark Office

# United States of America

United States Patent and Trademark Office

## DESTINATION KANSAS

**Reg. No. 4,135,736**

**Registered May 1, 2012**

**Int. Cl.: 16**

**TRADEMARK**

**PRINCIPAL REGISTER**

SHOW-ME PUBLISHING, INC. (MISSOURI CORPORATION)  
2049 WYANDOTTE  
KANSAS CITY, MO 64108

FOR: PRINTED PERIODICALS AND MAGAZINES FEATURING INFORMATION ON BUSINESS AND ECONOMIC DEVELOPMENT, IN CLASS 16 (U.S. CLS. 2, 5, 22, 23, 29, 37, 38 AND 50).

FIRST USE 3-17-2012; IN COMMERCE 3-17-2012.

THE MARK CONSISTS OF STANDARD CHARACTERS WITHOUT CLAIM TO ANY PARTICULAR FONT, STYLE, SIZE, OR COLOR.

NO CLAIM IS MADE TO THE EXCLUSIVE RIGHT TO USE "KANSAS", APART FROM THE MARK AS SHOWN.

SN 77-416,406, FILED 3-7-2008.

JORDAN BAKER, EXAMINING ATTORNEY



*David J. Kyros*

Director of the United States Patent and Trademark Office

# United States of America

United States Patent and Trademark Office

## ANGELS ON MY PILLOW

**Reg. No. 4,135,737**

**Registered May 1, 2012**

**Int. Cls.: 20, 24, and 25**

CARDINAL HOUSE PRODUCTIONS, INC. (TEXAS CORPORATION), DBA ANGELS ON MY PILLOW,  
8726 CR 853  
MCKINNEY, TX 75071

FOR: PILLOWS, IN CLASS 20 (U.S. CLS. 2, 13, 22, 25, 32 AND 50).

**TRADEMARK**

FIRST USE 10-24-2011; IN COMMERCE 10-24-2011.

**PRINCIPAL REGISTER**

FOR: BED LINEN, NAMELY, PILLOW CASES, PILLOW TOPPERS, POCKETS FOR PILLOW CASES, SHEETS, AND COMFORTERS, IN CLASS 24 (U.S. CLS. 42 AND 50).

FIRST USE 10-24-2011; IN COMMERCE 10-24-2011.

FOR: CLOTHING, NAMELY, T-SHIRTS, SLEEP WEAR, AND HATS, IN CLASS 25 (U.S. CLS. 22 AND 39).

FIRST USE 10-24-2011; IN COMMERCE 10-24-2011.

THE MARK CONSISTS OF STANDARD CHARACTERS WITHOUT CLAIM TO ANY PARTICULAR FONT, STYLE, SIZE, OR COLOR.

SN 77-421,290, FILED 3-13-2008.

SHAILA SETTLES, EXAMINING ATTORNEY



*David J. Kybas*

Director of the United States Patent and Trademark Office

United States of America  
United States Patent and Trademark Office

CONWAY

**Reg. No. 4,135,738**

**Registered May 1, 2012**

**Int. Cl.: 33**

**TRADEMARK**

**PRINCIPAL REGISTER**

CONWAY VINEYARDS, INC. (CALIFORNIA CORPORATION)  
1034 MILL STREET  
SAN LUIS OBISPO, CA 93401

FOR: WINES, IN CLASS 33 (U.S. CLS. 47 AND 49).

FIRST USE 0-0-2008; IN COMMERCE 0-0-2008.

THE MARK CONSISTS OF STANDARD CHARACTERS WITHOUT CLAIM TO ANY PARTICULAR FONT, STYLE, SIZE, OR COLOR.

SN 77-424,676, FILED 3-18-2008.

KATHERINE CONNOLLY, EXAMINING ATTORNEY



*David J. Kybas*

Director of the United States Patent and Trademark Office



# United States of America

United States Patent and Trademark Office

# WIRED

**Reg. No. 4,135,739**

**Registered May 1, 2012**

**Int. Cls.: 35 and 42**

**SERVICE MARK**

**PRINCIPAL REGISTER**

ADVANCE MAGAZINE PUBLISHERS INC. (NEW YORK CORPORATION)  
FOUR TIMES SQUARE  
NEW YORK, NY 10036

FOR: PROVIDING INFORMATION ABOUT BUSINESS AND POLITICS VIA A GLOBAL COMPUTER NETWORK, DIGITAL NETWORKS, WIRELESS NETWORKS, IN CLASS 35 (U.S. CLS. 100, 101 AND 102).

FIRST USE 6-1-1992; IN COMMERCE 6-1-1992.

FOR: PROVIDING INFORMATION ABOUT TECHNOLOGY, ELECTRONICS AND SCIENCE VIA ELECTRONIC AND DIGITAL NETWORKS, IN CLASS 42 (U.S. CLS. 100 AND 101).

FIRST USE 6-1-1992; IN COMMERCE 6-1-1992.

SN 77-465,833, FILED 5-5-2008.

MARK RADEMACHER, EXAMINING ATTORNEY



*David J. Kybas*

Director of the United States Patent and Trademark Office

# United States of America

United States Patent and Trademark Office

## STUDIO DECOR

**Reg. No. 4,135,740**

**Registered May 1, 2012**

**Int. Cl.: 16**

**TRADEMARK**

**PRINCIPAL REGISTER**

MICHAELS STORES PROCUREMENT COMPANY, INC. (DELAWARE CORPORATION)  
8000 BENT BRANCH DRIVE  
IRVING, TX 75063

FOR: PAPER GOODS AND PRINTED MATERIALS, NAMELY, PAPER MATS, MAT BOARDS, PRE-FRAMED AND UNFRAMED POSTERS, ART PRINTS, EASELS, IN CLASS 16 (U.S. CLS. 2, 5, 22, 23, 29, 37, 38 AND 50).

FIRST USE 5-0-2009; IN COMMERCE 5-0-2009.

THE MARK CONSISTS OF STANDARD CHARACTERS WITHOUT CLAIM TO ANY PARTICULAR FONT, STYLE, SIZE, OR COLOR.

NO CLAIM IS MADE TO THE EXCLUSIVE RIGHT TO USE "DECOR", APART FROM THE MARK AS SHOWN.

SN 77-470,451, FILED 5-9-2008.

SUSAN STIGLITZ, EXAMINING ATTORNEY



*David J. Kyjars*

Director of the United States Patent and Trademark Office

# United States of America

United States Patent and Trademark Office

## STUDIO DECOR

**Reg. No. 4,135,741**

**Registered May 1, 2012**

**Int. Cl.: 20**

**TRADEMARK**

**PRINCIPAL REGISTER**

MICHAELS STORES PROCUREMENT COMPANY, INC. (DELAWARE CORPORATION)  
8000 BENT BRANCH DRIVE  
IRVING, TX 75063

FOR: PICTURE FRAMES; PICTURE FRAMING MATERIALS, NAMELY, WALL FRAMES FOR THE DISPLAY OF POSTERS, ART PRINTS, LITHOGRAPHIC PRINTS, PAINTINGS, AND PHOTOGRAPHS; DISPLAY CASES, IN CLASS 20 (U.S. CLS. 2, 13, 22, 25, 32 AND 50).

FIRST USE 5-0-2010; IN COMMERCE 5-0-2010.

THE MARK CONSISTS OF STANDARD CHARACTERS WITHOUT CLAIM TO ANY PARTICULAR FONT, STYLE, SIZE, OR COLOR.

NO CLAIM IS MADE TO THE EXCLUSIVE RIGHT TO USE "DECOR", APART FROM THE MARK AS SHOWN.

SN 77-470,453, FILED 5-9-2008.

SUSAN STIGLITZ, EXAMINING ATTORNEY



*David J. Kyffers*

Director of the United States Patent and Trademark Office

# United States of America

United States Patent and Trademark Office

# MORE

**Reg. No. 4,135,742**

**Registered May 1, 2012**

**Int. Cl.: 25**

**TRADEMARK**

**PRINCIPAL REGISTER**

MORE CUPCAKES, LLC (ILLINOIS LIMITED LIABILITY COMPANY)  
311 S. WACKER DRIVE, #4190  
CHICAGO, IL 60606

FOR: T-SHIRTS, IN CLASS 25 (U.S. CLS. 22 AND 39).

FIRST USE 1-5-2012; IN COMMERCE 1-5-2012.

THE MARK CONSISTS OF STANDARD CHARACTERS WITHOUT CLAIM TO ANY PARTICULAR FONT, STYLE, SIZE, OR COLOR.

SN 77-475,480, FILED 5-15-2008.

ERNEST SHOSHO, EXAMINING ATTORNEY



*David J. Kybas*

Director of the United States Patent and Trademark Office

# United States of America

United States Patent and Trademark Office

# Nimbuzz!

**Reg. No. 4,135,743**

**Registered May 1, 2012**

**Int. Cl.: 38**

**SERVICE MARK**

**PRINCIPAL REGISTER**

NIMBUZZ B.V. (NETHERLANDS CORPORATION)  
RIVIUM BOULEVARD 301  
CAPELLE AAN DEN IJSSEL, NETHERLANDS 2909LK

FOR: COMMUNICATION SERVICES, NAMELY, TRANSMISSION OF VOICE, AUDIO, VISUAL IMAGES, AUDIO-VISUAL CONTENT, VIDEO, TEXT, AND DATA BY TELECOMMUNICATIONS NETWORKS, WIRELESS COMMUNICATION NETWORKS, THE INTERNET, INFORMATION SERVICES NETWORKS AND DATA NETWORKS; INTERNET TELEPHONY AND VIDEO-CONFERENCING SERVICES; PROVIDING EMAIL AND INSTANT MESSAGING SERVICES; VOICE OVER INTERNET PROTOCOL (VOIP) SERVICES; COMMUNICATIONS BY TELEPHONE; MOBILE TELEPHONE COMMUNICATION, IN CLASS 38 (U.S. CLS. 100, 101 AND 104).

FIRST USE 8-31-2006; IN COMMERCE 8-31-2006.

THE MARK CONSISTS OF THE WORD "NIMBUZZ" WITH SOLID LETTERS APPEARING ON DIFFERENT LEVELS RATHER THAN ON A HORIZONTAL LINE. AN EXCLAMATION POINT FOLLOWS THE WORD.

SN 77-478,894, FILED 5-20-2008.

STEVEN JACKSON, EXAMINING ATTORNEY



*David J. Kyffers*

Director of the United States Patent and Trademark Office

# United States of America

United States Patent and Trademark Office

# Nimbuzz!

**Reg. No. 4,135,744**

**Registered May 1, 2012**

**Int. Cl.: 9**

**TRADEMARK**

**PRINCIPAL REGISTER**

NIMBUZZ B.V. (NETHERLANDS CORPORATION)  
RIVIUM BOULEVARD 301  
CAPELLE AAN DEN IJSSEL, NETHERLANDS 2909LK

FOR: COMPUTER SOFTWARE THAT ENABLES COMMUNICATION VIA VOICE TRANSMISSION, INSTANT MESSAGING, CHAT, VOICE OVER INTERNET PROTOCOL (VOIP), WIRELESS VOICE OVER INTERNET PROTOCOL (WVOIP), VOICE OVER INSTANT MESSAGE (VOIM) AND WIRELESS VOICE OVER INSTANT MESSAGE (WVOIM); DOWNLOADABLE COMPUTER SOFTWARE THAT ENABLES COMMUNICATION VIA VOICE TRANSMISSION, INSTANT MESSAGING, CHAT, VOIP, WVOIP, VOIM AND WVOIM; COMMUNICATIONS SOFTWARE FOR CONNECTING COMPUTER NETWORK USERS; COMPUTER APPLICATION SOFTWARE FOR MOBILE PHONES; COMPUTER SOFTWARE FOR COMMUNICATING WITH USERS OF HAND-HELD COMPUTERS; COMPUTER SOFTWARE FOR WIRELESS CONTENT DELIVERY; COMPUTER SOFTWARE TO ENABLE THE TRANSMISSION OF PHOTOGRAPHS TO MOBILE TELEPHONES; COMPUTER TELEPHONY SOFTWARE; COMPUTER SOFTWARE AND HARDWARE FOR TRANSMISSION OF VOICE, DATA AND VIDEO; COMPUTER SOFTWARE FOR USE IN TELECOMMUNICATIONS FOR ROUTING VOIP APPLICATIONS, VOICE, DATA AND VIDEO TRANSMISSION, AND INSTANT MESSAGING SERVICES OVER WIRELINE, WIRELESS AND CELLULAR COMMUNICATION NETWORKS; COMPUTER SOFTWARE FOR USE IN TELECOMMUNICATIONS FOR CONTROLLING VOIP APPLICATIONS, VOICE, DATA AND VIDEO TRANSMISSION, AND INSTANT MESSAGING SERVICES OVER WIRELINE, WIRELESS AND CELLULAR COMMUNICATION NETWORKS; DOWNLOADABLE RING TONES, MUSIC, AND GRAPHICS VIA THE INTERNET AND WIRELESS DEVICES, IN CLASS 9 (U.S. CLS. 21, 23, 26, 36 AND 38).



FIRST USE 8-31-2006; IN COMMERCE 8-31-2006.

THE MARK CONSISTS OF THE WORD "NIMBUZZ" WITH SOLID LETTERS APPEARING ON DIFFERENT LEVELS RATHER THAN ON A HORIZONTAL LINE. AN EXCLAMATION POINT FOLLOWS THE WORD.

SN 77-478,900, FILED 5-20-2008.

STEVEN JACKSON, EXAMINING ATTORNEY

*David J. Kyros*

Director of the United States Patent and Trademark Office

# United States of America

United States Patent and Trademark Office

## STUDIO HIS & HERS

**Reg. No. 4,135,745**

**Registered May 1, 2012**

**Int. Cl.: 14**

**TRADEMARK**

**PRINCIPAL REGISTER**

HOBBY LOBBY STORES, INC. (OKLAHOMA CORPORATION)  
7707 SOUTHWEST 44TH STREET  
OKLAHOMA CITY, OK 73179

FOR: JEWELRY, IN CLASS 14 (U.S. CLS. 2, 27, 28 AND 50).

FIRST USE 7-1-2010; IN COMMERCE 8-26-2010.

THE MARK CONSISTS OF STANDARD CHARACTERS WITHOUT CLAIM TO ANY PARTICULAR FONT, STYLE, SIZE, OR COLOR.

SN 77-480,266, FILED 5-21-2008.

DANNEAN HETZEL, EXAMINING ATTORNEY



*David J. Kybas*

Director of the United States Patent and Trademark Office

# United States of America

United States Patent and Trademark Office



**Reg. No. 4,135,746**

**Registered May 1, 2012**

**Int. Cl.: 41**

**SERVICE MARK**

**PRINCIPAL REGISTER**

PUSSYCAT DOLLS, LLC (DELAWARE LIMITED LIABILITY COMPANY)  
UMG RECORDINGS, INC.  
2220 COLORADO AVENUE  
SANTA MONICA, CA 90404

FOR: PRODUCTION AND PUBLISHING OF MUSIC; PROVIDING ONLINE ENTERTAINMENT, NAMELY, NON-DOWNLOADABLE SOUND AND VIDEO RECORDINGS IN THE FIELD OF MUSIC AND MUSIC BASED ENTERTAINMENT; ENTERTAINMENT SERVICES, NAMELY, PROVIDING ONLINE NON-DOWNLOADABLE PRERECORDED MUSICAL SOUND AND VIDEO RECORDINGS VIA A GLOBAL COMPUTER NETWORK; AUDIO AND SOUND RECORDING AND PRODUCTION; ENTERTAINMENT IN THE NATURE OF LIVE CONCERTS AND PERFORMANCES BY MUSICAL ARTISTS AND GROUPS; ENTERTAINMENT SERVICES, NAMELY, PERSONAL APPEARANCES BY MUSICAL GROUPS, MUSICAL ARTISTS AND CELEBRITIES; ENTERTAINMENT SERVICES IN THE NATURE OF PERFORMANCES RENDERED BY MUSICAL ARTISTS THROUGH THE MEDIUM OF TELEVISION, RADIO, AND ONLINE NON-DOWNLOADABLE AUDIO AND VIDEO RECORDINGS; ENTERTAINMENT SERVICES, NAMELY, PERFORMANCES BY MUSICAL ARTISTS RENDERED LIVE AND RECORDED FOR FUTURE DISTRIBUTION; ENTERTAINMENT SERVICES, NAMELY, PROVIDING A WEB SITE FEATURING NON-DOWNLOADABLE MUSICAL PERFORMANCES, MUSICAL VIDEOS, RELATED FILM CLIPS, PHOTOGRAPHS, AND OTHER MULTIMEDIA MATERIALS; ENTERTAINMENT SERVICES, NAMELY, PROVIDING ON-LINE REVIEWS OF MUSIC, MUSICAL ARTISTS AND MUSIC VIDEOS; ENTERTAINMENT SERVICES, NAMELY, PROVIDING PRERECORDED NON-DOWNLOADABLE MUSIC, INFORMATION IN THE FIELD OF MUSIC, AND COMMENTARY AND ARTICLES ABOUT MUSIC, ALL ON-LINE VIA A GLOBAL COMPUTER NETWORK; ENTERTAINMENT SERVICES NAMELY, LIVE, TELEVISED AND MOVIE APPEARANCES BY A PROFESSIONAL ENTERTAINER; ORGANIZING EXHIBITIONS FOR ENTERTAINMENT PURPOSES FEATURING MUSIC AND THE ARTS; AND PUBLISHING OF WEB MAGAZINES, IN CLASS 41 (U.S. CLS. 100, 101 AND 107).



FIRST USE 9-30-2004; IN COMMERCE 9-30-2004.

THE MARK CONSISTS OF THE WORDS "PUSSYCAT DOLLS" WITHIN A HEART, WITH THE WORD "PUSSYCAT" PLACED ON A BANNER DISPLAYED ACROSS THE UPPER PART OF THE HEART, THE WORD "DOLLS" DISPLAYED ON THE HEART UNDER THE BANNER AND AN ORNAMENTAL DESIGN ON THE TOP OF THE HEART.

*David J. Kybas*

Director of the United States Patent and Trademark Office



**Reg. No. 4,135,746** SN 77-480,598, FILED 5-21-2008.

ANN E. SAPPENFIELD, EXAMINING ATTORNEY

# United States of America

United States Patent and Trademark Office

# GUT CARE

**Reg. No. 4,135,747**

**Registered May 1, 2012**

**Int. Cl.: 5**

**TRADEMARK**

**PRINCIPAL REGISTER**

NATREN INC. (CALIFORNIA CORPORATION)  
3105 WILLOW LANE  
WESTLAKE VILLAGE, CA 91361

FOR: DIETARY SUPPLEMENTS, IN CLASS 5 (U.S. CLS. 6, 18, 44, 46, 51 AND 52).

FIRST USE 1-30-2012; IN COMMERCE 1-30-2012.

THE MARK CONSISTS OF STANDARD CHARACTERS WITHOUT CLAIM TO ANY PARTICULAR FONT, STYLE, SIZE, OR COLOR.

NO CLAIM IS MADE TO THE EXCLUSIVE RIGHT TO USE "GUT", APART FROM THE MARK AS SHOWN.

SN 77-484,501, FILED 5-27-2008.

BARBARA BROWN, EXAMINING ATTORNEY



*David J. Kybas*

Director of the United States Patent and Trademark Office

# United States of America

United States Patent and Trademark Office



**Reg. No. 4,135,748**

**Registered May 1, 2012**

**Int. Cl.: 16**

**TRADEMARK**

**PRINCIPAL REGISTER**

BIG FISH GAMES, INC. (WASHINGTON CORPORATION)  
SUITE 200  
333 ELLIOTT AVENUE WEST  
SEATTLE, WA 98119

FOR: PRINTED MATTER, NAMELY, COMPUTER GAME INSTRUCTION MANUALS AND INSERTS; PRINTED USER MANUALS AND INSTRUCTIONAL GUIDE BOOKS FOR ONLINE COMPUTER GAMES, COMPUTER SOFTWARE GAMES, VIDEO GAMES AND ELECTRONIC GAME SOFTWARE; PRINTED PUBLICATIONS, NAMELY, BOOKS IN THE FIELD OF COMPUTER GAMES AND VIDEO GAMES, IN CLASS 16 (U.S. CLS. 2, 5, 22, 23, 29, 37, 38 AND 50).

FIRST USE 9-0-2006; IN COMMERCE 9-0-2006.

OWNER OF U.S. REG. NOS. 3,158,277, 3,158,278, AND 3,419,177.

THE MARK CONSISTS OF A DESIGN OF A BADGE WITH THE STYLIZED WORDS "MYSTERY CASE FILES", "MCF", AND "TO SEEK & SOLVE" ON IT.

SN 77-491,151, FILED 6-4-2008.

LIEF MARTIN, EXAMINING ATTORNEY



*David J. Kyffers*

Director of the United States Patent and Trademark Office

# United States of America

United States Patent and Trademark Office

# KOVIO

**Reg. No. 4,135,749**

**Registered May 1, 2012**

**Int. Cl.: 9**

**TRADEMARK**

**PRINCIPAL REGISTER**

KOVIO, INC. (DELAWARE CORPORATION)  
233 S. HILLVIEW DRIVE  
MILPITAS, CA 95035

FOR: ELECTRONIC AND SCIENTIFIC APPARATUS AND INSTRUMENTS, NAMELY, GRAVURE PRINTERS, OFFSET PRINTERS, SCREEN PRINTERS, LITHOGRAPHY PRINTERS, FLEXOGRAPHIC PRINTERS, LASER PRINTERS, ELECTRICAL SENSORS FOR TEMPERATURE, HUMIDITY, AND PRESSURE, LIGHT SENSING; DIODES; CIRCUIT BOARDS; MEMORY DEVICES FOR MANUFACTURING ELECTRONIC COMPONENTS, SEMICONDUCTOR COMPONENTS; LIGHT EMITTING DIODES; ELECTRICAL RESISTANCE HEATING WIRES AND ELECTRICAL CONTROLLERS THEREFOR; COMPUTER PRINTERS; INK JET PRINTERS; ELECTROSTATIC EMISSION CONTROL DEVICES, NAMELY, ELECTROSTATIC PRECIPITATORS FOR REDUCING PARTICULATE EMISSION IN INDUSTRIAL APPLICATIONS; COMPUTER SOFTWARE FOR CONTROLLING ELECTRONIC SENSORS, OPERATING CHIP CARD READERS, PROGRAMMING RADIO FREQUENCY IDENTIFICATION (RFID) DEVICES, ELECTRIC LUMINESCENT DISPLAY PANELS, ORGANIC LIGHT EMITTED DIODE (OLED) DISPLAYS, ELECTROPHORETIC DISPLAYS, ELECTRIC SIGNS, LUMINOUS SIGNS, SENSOR CHIPS FOR SCIENTIFIC USE, LIQUID LEVEL SENSORS, GAS SENSORS FOR MEASURING GAS CONCENTRATION, PROXIMITY SENSORS, PRESSURE SENSORS, TEMPERATURE SENSORS, HUMIDITY SENSORS, PHOTOVOLTAIC CELLS, SOLAR CELLS, ELECTRODES; RADIO FREQUENCY IDENTIFICATION (RFID) INTEGRATED CIRCUITS; RADIO FREQUENCY IDENTIFICATION (RFID) CARD, TAGS, LABELS, AND TICKETS; RADIO FREQUENCY IDENTIFICATION (RFID) READERS; CHIP CARD READERS; PRINTED INTEGRATED CIRCUITS; INTEGRATED CIRCUITS; RADIO FREQUENCY IDENTIFICATION (RFID) CHIPS WITH ATTACHED ANTENNA, IN CLASS 9 (U.S. CLS. 21, 23, 26, 36 AND 38).

FIRST USE 11-8-2011; IN COMMERCE 11-8-2011.

THE MARK CONSISTS OF STANDARD CHARACTERS WITHOUT CLAIM TO ANY PARTICULAR FONT, STYLE, SIZE, OR COLOR.

SN 77-492,300, FILED 6-5-2008.

Laurie Kaufman, Examining Attorney



*David J. Kyros*

Director of the United States Patent and Trademark Office

# United States of America

United States Patent and Trademark Office



**Reg. No. 4,135,750**

**Registered May 1, 2012**

**Int. Cl.: 16**

**TRADEMARK**

**PRINCIPAL REGISTER**

EAST WEST PUBLISHING, LLC (NEBRASKA LIMITED LIABILITY COMPANY)  
SUITE 3700 FIRST NATIONAL TOWER  
1601 DODGE STREET  
OMAHA, NE 68102

FOR: PRINTED EDUCATIONAL MATERIALS FOR BUSINESS OWNERS, NAMELY, SCORECARDS, HANDBOOKS, WORKBOOK MODULES COMPRISED OF WORKBOOKS AND REFERENCE BOOKS IN THE FIELD OF BUSINESS, ROADMAPS, NEWSLETTERS, REPORT CARDS, NAMELY, PRINTED REPORTS, AND FORMS, ALL OF THE AFOREMENTIONED IN THE FIELD OF BUSINESS OWNER TRANSITION PLANNING AND BUSINESS EXIT PLANNING, IN CLASS 16 (U.S. CLS. 2, 5, 22, 23, 29, 37, 38 AND 50).

FIRST USE 10-1-2008; IN COMMERCE 10-1-2008.

THE MARK CONSISTS OF THE WORDS "THE NEXT STEP" DISPLAYED IN A STAGGERED MANNER NEXT TO AN IMAGE OF STAIRS AND SUN BEAMS.

SN 77-496,455, FILED 6-11-2008.

KATINA MISTER, EXAMINING ATTORNEY



*David J. Kybas*

Director of the United States Patent and Trademark Office

# United States of America

United States Patent and Trademark Office

iQprep

**Reg. No. 4,135,751**

BIZNIZINSY TZ.COM INC (NEW YORK CORPORATION)  
166-05 HIGHLAND AVE.  
JAMAICA ESTATES, NY 11432

**Registered May 1, 2012**

**Int. Cl.: 41**

FOR: EDUCATION SERVICES, NAMELY, PROVIDING CLASSES AND TESTS VIA A GLOBAL COMPUTER NETWORK IN THE FIELD OF MATH, READING, LANGUAGE ARTS, SPELLING, SOCIAL STUDIES, SCIENCE, HISTORY, MUSIC, FINANCES, ENGLISH AND FOREIGN LANGUAGES, IN CLASS 41 (U.S. CLS. 100, 101 AND 107).

**SERVICE MARK**

**PRINCIPAL REGISTER**

FIRST USE 12-19-2011; IN COMMERCE 12-19-2011.

THE MARK CONSISTS OF THE WORD IQPREP WITH A MORTAR BOARD GRADUATION HAT ABOVE THE "Q".

SN 77-497,415, FILED 6-12-2008.

NAKIA HENRY, EXAMINING ATTORNEY



*David J. Kyffers*

Director of the United States Patent and Trademark Office

# United States of America

United States Patent and Trademark Office

## IT'S WHO YOU ARE THAT MAKES US WHO WE ARE

**Reg. No. 4,135,752**

**Registered May 1, 2012**

**Int. Cls.: 16 and 35**

**TRADEMARK**

**SERVICE MARK**

**PRINCIPAL REGISTER**

TIM HORTONS USA INC. (DELAWARE CORPORATION)  
4150 TULLER ROAD  
SUITE 236  
DUBLIN, OH 43017

FOR: PRINTED TRAINING AND RESOURCE MATERIALS IN THE FIELD OF EMPLOYEE RECRUITMENT, NAMELY, JOB OUTLINES AND INFORMATION TRAINING MANUALS, BOOKLETS, PAMPHLETS, IN CLASS 16 (U.S. CLS. 2, 5, 22, 23, 29, 37, 38 AND 50).

FIRST USE 1-25-2012; IN COMMERCE 1-25-2012.

FOR: EMPLOYEE RECRUITMENT AND PLACEMENT SERVICES FOR FRANCHISEES, IN CLASS 35 (U.S. CLS. 100, 101 AND 102).

FIRST USE 5-20-2008; IN COMMERCE 5-29-2008.

THE MARK CONSISTS OF STANDARD CHARACTERS WITHOUT CLAIM TO ANY PARTICULAR FONT, STYLE, SIZE, OR COLOR.

SN 77-499,041, FILED 6-13-2008.

CHERYL CLAYTON, EXAMINING ATTORNEY



*David J. Kybas*

Director of the United States Patent and Trademark Office

# United States of America

United States Patent and Trademark Office

The sound in your head,  
now at your fingertips

**Reg. No. 4,135,753**

BAER AMPLIFICATION LLC (CALIFORNIA LIMITED LIABILITY COMPANY)  
36427 NICKEL ST.  
PALMDALE, CA 93550

**Registered May 1, 2012**

**Int. Cl.: 9**

FOR: GUITAR AMPLIFIERS, IN CLASS 9 (U.S. CLS. 21, 23, 26, 36 AND 38).

**TRADEMARK**

FIRST USE 12-11-2009; IN COMMERCE 10-6-2011.

**PRINCIPAL REGISTER**

THE MARK CONSISTS OF STANDARD CHARACTERS WITHOUT CLAIM TO ANY PARTICULAR FONT, STYLE, SIZE, OR COLOR.

SN 77-501,345, FILED 6-17-2008.

STEVEN JACKSON, EXAMINING ATTORNEY



*David J. Kyfos*

Director of the United States Patent and Trademark Office



# United States of America

United States Patent and Trademark Office

## THIEVES OF PROFIT

**Reg. No. 4,135,754**

STEVE RINKENBERGER (UNITED STATES INDIVIDUAL)  
4802 EAST RAY ROAD  
PHOENIX, AZ 85044

**Registered May 1, 2012**

**Int. Cl.: 16**

FOR: BOOKS IN THE FIELD OF BUSINESS MANAGEMENT, IN CLASS 16 (U.S. CLS. 2, 5, 22, 23, 29, 37, 38 AND 50).

**TRADEMARK**

FIRST USE 2-10-2012; IN COMMERCE 2-10-2012.

**PRINCIPAL REGISTER**

THE MARK CONSISTS OF STANDARD CHARACTERS WITHOUT CLAIM TO ANY PARTICULAR FONT, STYLE, SIZE, OR COLOR.

NO CLAIM IS MADE TO THE EXCLUSIVE RIGHT TO USE "PROFIT", APART FROM THE MARK AS SHOWN.

SN 77-504,584, FILED 6-20-2008.

LINDA M. KING, EXAMINING ATTORNEY



*David J. Kybas*

Director of the United States Patent and Trademark Office

United States of America  
United States Patent and Trademark Office

# HEIDISKIS

**Reg. No. 4,135,755**

HEIDISKIS (SWITZERLAND CORPORATION)  
ROUTE DE GLION 43  
MONTREAUX 1820, SWITZERLAND

**Registered May 1, 2012**

**Int. Cl.: 9**

FOR: SKI GOGGLES AND SPORTS HELMETS, IN CLASS 9 (U.S. CLS. 21, 23, 26, 36 AND 38).

**TRADEMARK**

FIRST USE 12-0-2007; IN COMMERCE 12-0-2007.

**PRINCIPAL REGISTER**

THE MARK CONSISTS OF STANDARD CHARACTERS WITHOUT CLAIM TO ANY PARTICULAR FONT, STYLE, SIZE, OR COLOR.

SN 77-508,198, FILED 6-25-2008.

GIANCARLO CASTRO, EXAMINING ATTORNEY



*David J. Kybas*

Director of the United States Patent and Trademark Office

# United States of America

United States Patent and Trademark Office



**Reg. No. 4,135,756**

KOLO LLC (DELAWARE LIMITED LIABILITY COMPANY)  
241 ASYLUM STREET  
HARTFORD, CT 06103

**Registered May 1, 2012**

**Int. Cl.: 9**

FOR: LAPTOP CARRYING CASES; LAPTOP SLEEVE IN THE NATURE OF A PADDED COVER FOR CARRYING LAPTOPS, IN CLASS 9 (U.S. CLS. 21, 23, 26, 36 AND 38).

**TRADEMARK**

FIRST USE 2-7-2012; IN COMMERCE 2-7-2012.

**PRINCIPAL REGISTER**

OWNER OF U.S. REG. NOS. 2,356,171, 2,480,117, AND 3,307,673.

THE COLOR(S) BLUE, ORANGE AND WHITE IS/ARE CLAIMED AS A FEATURE OF THE MARK.

THE MARK CONSISTS OF ADJACENT BLOCKS, WITH THE LEFT BLOCK IN THE COLOR BLUE AND THE RIGHT BLOCK IN THE COLOR ORANGE, AND THE WORD "KOLO" IN THE COLOR WHITE WRITTEN ACROSS THE BLOCKS.

SN 77-508,711, FILED 6-26-2008.

JEFFERY COWARD, EXAMINING ATTORNEY



*David J. Kyffers*

Director of the United States Patent and Trademark Office

# United States of America

United States Patent and Trademark Office

## DELIGHTFUL BAZAAR

**Reg. No. 4,135,757**

**Registered May 1, 2012**

**Int. Cl.: 35**

**SERVICE MARK**

**PRINCIPAL REGISTER**

VINTAGE FOOD CORPORATION (NEW YORK CORPORATION)  
4-19TH STREET, BUILDING 2B  
BROOKLYN, NY 11232

FOR: RETAIL STORE SERVICES FEATURING SPECIALTY FOODS, IN CLASS 35 (U.S. CLS. 100, 101 AND 102).

FIRST USE 1-3-2012; IN COMMERCE 1-3-2012.

THE MARK CONSISTS OF STANDARD CHARACTERS WITHOUT CLAIM TO ANY PARTICULAR FONT, STYLE, SIZE, OR COLOR.

NO CLAIM IS MADE TO THE EXCLUSIVE RIGHT TO USE "BAZAAR", APART FROM THE MARK AS SHOWN.

SN 77-510,729, FILED 6-29-2008.

KHANH LE, EXAMINING ATTORNEY



*David J. Kybas*

Director of the United States Patent and Trademark Office

# United States of America

United States Patent and Trademark Office

## ROCK STAR BABY

**Reg. No. 4,135,758**

**Registered May 1, 2012**

**Int. Cl.: 20**

**TRADEMARK**

**PRINCIPAL REGISTER**

TORRES, TICO (UNITED STATES INDIVIDUAL)  
C/O DOROTHY WEBER, 111 W.57TH ST., #1120  
NEW YORK, NY 10019

FOR: BABY BOLSTERS; BABY BOUNCERS; BABY CHANGING MATS; BABY CHANGING TABLES; BABY HEAD SUPPORT CUSHIONS; BABY WALKERS; CRIBS; HIGH CHAIRS FOR BABIES; PLAYPENS FOR BABIES; PORTABLE BABY BATH SEATS FOR USE IN BATH TUBS, IN CLASS 20 (U.S. CLS. 2, 13, 22, 25, 32 AND 50).

FIRST USE 7-2-2009; IN COMMERCE 7-2-2009.

THE MARK CONSISTS OF STANDARD CHARACTERS WITHOUT CLAIM TO ANY PARTICULAR FONT, STYLE, SIZE, OR COLOR.

OWNER OF U.S. REG. NOS. 2,940,309, 3,097,013, AND 3,182,153.

NO CLAIM IS MADE TO THE EXCLUSIVE RIGHT TO USE "BABY", APART FROM THE MARK AS SHOWN.

SN 77-519,432, FILED 7-10-2008.

LINDA M. KING, EXAMINING ATTORNEY



*David J. Kyros*

Director of the United States Patent and Trademark Office

# United States of America

United States Patent and Trademark Office

## ROCK STAR BABY

**Reg. No. 4,135,759**

**Registered May 1, 2012**

**Int. Cl.: 24**

**TRADEMARK**

**PRINCIPAL REGISTER**

TORRES, TICO (UNITED STATES INDIVIDUAL)  
C/O DOROTHY WEBER, 111 W.57TH ST., #1120  
NEW YORK, NY 10019

FOR: COT TIDIES, NAMELY, FABRIC ORGANIZERS TO HANG ON SIDE OF CRIB, COMFORTERS, QUILTS, CRIB BUMPERS, BED SHEETS, CRIB BED SHEETS, PILLOWCASES, PILLOW SHAMS, DUST RUFFLES, TEXTILE WALL HANGINGS, FABRIC VALANCES, BED BLANKETS, PILLOW CRIB BUMPERS MADE OF FABRIC OR CLOTH, DIAPER STACKERS MADE OF FABRIC, IN CLASS 24 (U.S. CLS. 42 AND 50).

FIRST USE 2-13-2012; IN COMMERCE 2-13-2012.

THE MARK CONSISTS OF STANDARD CHARACTERS WITHOUT CLAIM TO ANY PARTICULAR FONT, STYLE, SIZE, OR COLOR.

OWNER OF U.S. REG. NOS. 2,940,309, 3,097,013, AND 3,182,153.

NO CLAIM IS MADE TO THE EXCLUSIVE RIGHT TO USE "BABY", APART FROM THE MARK AS SHOWN.

SN 77-519,436, FILED 7-10-2008.

LINDA M. KING, EXAMINING ATTORNEY



*David J. Kybas*

Director of the United States Patent and Trademark Office

# United States of America

United States Patent and Trademark Office

## ELECTROCRAFT AXIALPOWER

**Reg. No. 4,135,760**

**Registered May 1, 2012**

**Int. Cl.: 7**

**TRADEMARK**

**PRINCIPAL REGISTER**

ELECTROCRAFT, INC. (DELAWARE CORPORATION)  
1 PROGRESS DRIVE  
DOVER, NH 03820

FOR: LINEAR ACTUATORS, IN CLASS 7 (U.S. CLS. 13, 19, 21, 23, 31, 34 AND 35).

FIRST USE 2-24-2012; IN COMMERCE 2-24-2012.

THE MARK CONSISTS OF STANDARD CHARACTERS WITHOUT CLAIM TO ANY PARTICULAR FONT, STYLE, SIZE, OR COLOR.

OWNER OF U.S. REG. NOS. 1,572,910, 2,752,092, AND 2,758,207.

SN 77-521,120, FILED 7-14-2008.

SAMUEL E. SHARPER JR., EXAMINING ATTORNEY



*David J. Kyffers*

Director of the United States Patent and Trademark Office

# United States of America

United States Patent and Trademark Office

## ELECTROCRAFT SOLIDPOWER

**Reg. No. 4,135,761**

**Registered May 1, 2012**

**Int. Cl.: 7**

**TRADEMARK**

**PRINCIPAL REGISTER**

ELECTROCRAFT, INC. (DELAWARE CORPORATION)  
1 PROGRESS DRIVE  
DOVER, NH 03820

FOR: AC MOTORS, AC GEAR MOTORS, OTHER THAN FOR LAND VEHICLES, IN CLASS  
7 (U.S. CLS. 13, 19, 21, 23, 31, 34 AND 35).

FIRST USE 2-28-2012; IN COMMERCE 2-28-2012.

THE MARK CONSISTS OF STANDARD CHARACTERS WITHOUT CLAIM TO ANY PAR-  
TICULAR FONT, STYLE, SIZE, OR COLOR.

OWNER OF U.S. REG. NOS. 1,572,910, 2,752,092, AND 2,758,207.

SN 77-521,127, FILED 7-14-2008.

SAMUEL E. SHARPER JR., EXAMINING ATTORNEY



*David J. Kybas*

Director of the United States Patent and Trademark Office



# United States of America

United States Patent and Trademark Office

# LumenScript

**Reg. No. 4,135,762**

TELELUMEN LLC (CALIFORNIA LIMITED LIABILITY COMPANY)  
P.O. BOX 3163  
SARATOGA, CA 950701163

**Registered May 1, 2012**

**Int. Cl.: 9**

FOR: DOWNLOADABLE SOFTWARE FOR CONTROLLING THE OPERATION OF A LIGHTING DEVICE, IN CLASS 9 (U.S. CLS. 21, 23, 26, 36 AND 38).

**TRADEMARK**

FIRST USE 3-7-2012; IN COMMERCE 3-7-2012.

**PRINCIPAL REGISTER**

THE MARK CONSISTS OF STANDARD CHARACTERS WITHOUT CLAIM TO ANY PARTICULAR FONT, STYLE, SIZE, OR COLOR.

SN 77-526,067, FILED 7-18-2008.

APRIL ROACH, EXAMINING ATTORNEY



*David J. Kyffers*

Director of the United States Patent and Trademark Office

# United States of America

United States Patent and Trademark Office

# BODYLAMP

**Reg. No. 4,135,763**

BARKER, PAUL (UNITED STATES INDIVIDUAL)  
6155 SOUTH ONEIDA WAY  
CENTENNIAL, CO 80111

**Registered May 1, 2012**

**Int. Cl.: 9**

FOR: SAFETY EQUIPMENT, NAMELY, STRAPS WITH ILLUMINATION CAPABILITIES WORN TO ENHANCE VISIBILITY, IN CLASS 9 (U.S. CLS. 21, 23, 26, 36 AND 38).

**TRADEMARK**

FIRST USE 3-1-2012; IN COMMERCE 3-1-2012.

**PRINCIPAL REGISTER**

THE MARK CONSISTS OF STANDARD CHARACTERS WITHOUT CLAIM TO ANY PARTICULAR FONT, STYLE, SIZE, OR COLOR.

SN 77-526,329, FILED 7-18-2008.

JOHN WILKE, EXAMINING ATTORNEY



*David J. Kybas*

Director of the United States Patent and Trademark Office

# United States of America

United States Patent and Trademark Office

## ACOUSTIC PLANET TOUR

**Reg. No. 4,135,764**

**Registered May 1, 2012**

**Int. Cl.: 25**

**TRADEMARK**

**PRINCIPAL REGISTER**

BÈLA FLECK PRODUCTIONS, INC. (TENNESSEE CORPORATION)  
9111 SUNSET BLVD., ATTN: K. PALS  
LOS ANGELES, CA 90069

FOR: CLOTHING, NAMELY, SHIRTS, T-SHIRTS AND TOPS, IN CLASS 25 (U.S. CLS. 22 AND 39).

FIRST USE 6-23-2006; IN COMMERCE 6-27-2006.

THE MARK CONSISTS OF STANDARD CHARACTERS WITHOUT CLAIM TO ANY PARTICULAR FONT, STYLE, SIZE, OR COLOR.

OWNER OF U.S. REG. NO. 3,042,811.

NO CLAIM IS MADE TO THE EXCLUSIVE RIGHT TO USE "TOUR", APART FROM THE MARK AS SHOWN.

SN 77-527,676, FILED 7-21-2008.

MICHAEL TANNER, EXAMINING ATTORNEY



*David J. Kyffers*

Director of the United States Patent and Trademark Office

# United States of America

United States Patent and Trademark Office

# IGAG

**Reg. No. 4,135,765**

**Registered May 1, 2012**

**Int. Cl.: 10**

**TRADEMARK**

**PRINCIPAL REGISTER**

PHENOMENAL CONCEPTS, INC. (NEW YORK CORPORATION)  
SUITE 19X  
400 CENTRAL PARK WEST  
NEW YORK, NY 10025

FOR: TONGUE SCRAPER, NAMELY, TONGUE CLEANER, IN CLASS 10 (U.S. CLS. 26, 39 AND 44).

FIRST USE 2-17-2012; IN COMMERCE 2-17-2012.

THE MARK CONSISTS OF STANDARD CHARACTERS WITHOUT CLAIM TO ANY PARTICULAR FONT, STYLE, SIZE, OR COLOR.

SN 77-528,143, FILED 7-22-2008.

TINA MAI, EXAMINING ATTORNEY



*David J. Kybas*

Director of the United States Patent and Trademark Office

# United States of America

United States Patent and Trademark Office

# GROM

**Reg. No. 4,135,766**

**Registered May 1, 2012**

**Int. Cl.: 3**

**TRADEMARK**

**PRINCIPAL REGISTER**

SCHAFFER, RICKY (UNITED STATES INDIVIDUAL)  
3245 PRODUCTION AVE. #D  
OCEANSIDE, CA 92058

FOR: SUN BLOCK; SUN SCREEN, IN CLASS 3 (U.S. CLS. 1, 4, 6, 50, 51 AND 52).

FIRST USE 2-20-2012; IN COMMERCE 2-20-2012.

THE MARK CONSISTS OF STANDARD CHARACTERS WITHOUT CLAIM TO ANY PARTICULAR FONT, STYLE, SIZE, OR COLOR.

OWNER OF U.S. REG. NOS. 2,464,765 AND 3,388,560.

SN 77-529,450, FILED 7-23-2008.

SIMON TENG, EXAMINING ATTORNEY



*David J. Kybas*

Director of the United States Patent and Trademark Office

# United States of America

United States Patent and Trademark Office

## LUCKY WINNER

**Reg. No. 4,135,767**

**Registered May 1, 2012**

**Int. Cl.: 9**

**TRADEMARK**

**PRINCIPAL REGISTER**

GRAND PRODUCTS, INC. (ILLINOIS CORPORATION)  
1757 S. WINTHROP DRIVE  
DES PLAINES, IL 60018

FOR: GAMING DEVICES, NAMELY, SLOT MACHINES WITH OR WITHOUT VIDEO OUTPUT; AND AMUSEMENT APPARATUS, NAMELY, VIDEO GAME MACHINES FOR USE WITH EXTERNAL DISPLAY SCREEN OR MONITOR, IN CLASS 9 (U.S. CLS. 21, 23, 26, 36 AND 38).

FIRST USE 7-21-2011; IN COMMERCE 7-21-2011.

THE MARK CONSISTS OF STANDARD CHARACTERS WITHOUT CLAIM TO ANY PARTICULAR FONT, STYLE, SIZE, OR COLOR.

SN 77-530,523, FILED 7-24-2008.

WILLIAM ROSSMAN, EXAMINING ATTORNEY



*David J. Kyffers*

Director of the United States Patent and Trademark Office

# United States of America

United States Patent and Trademark Office

## TRIUMPH OVER ADVERSITY

**Reg. No. 4,135,768**

**Registered May 1, 2012**

**Int. Cl.: 25**

**TRADEMARK**

**PRINCIPAL REGISTER**

CAREY, BRIAN FRANCIS (UNITED STATES INDIVIDUAL)  
310 TYBURN PLACE  
DANVILLE, CA 94526

FOR: SHIRTS; T-SHIRTS, IN CLASS 25 (U.S. CLS. 22 AND 39).

FIRST USE 3-7-2012; IN COMMERCE 3-7-2012.

THE MARK CONSISTS OF STANDARD CHARACTERS WITHOUT CLAIM TO ANY PARTICULAR FONT, STYLE, SIZE, OR COLOR.

SN 77-531,521, FILED 7-25-2008.

MATTHEW KLINE, EXAMINING ATTORNEY



*David J. Kyffers*

Director of the United States Patent and Trademark Office

# United States of America

United States Patent and Trademark Office

## Bloomin' Tuckers

**Reg. No. 4,135,769**

**Registered May 1, 2012**

**Int. Cl.: 43**

**SERVICE MARK**

**PRINCIPAL REGISTER**

CREATIVE ENTERPRISES UNLIMITED, LLC (MICHIGAN LIMITED LIABILITY COMPANY)  
46882 JANS DRIVE  
CHESTERFIELD, MI 48047

FOR: RESTAURANT SERVICES, IN CLASS 43 (U.S. CLS. 100 AND 101).

FIRST USE 3-12-2012; IN COMMERCE 3-12-2012.

THE MARK CONSISTS OF STANDARD CHARACTERS WITHOUT CLAIM TO ANY PARTICULAR FONT, STYLE, SIZE, OR COLOR.

SN 77-535,675, FILED 7-31-2008.

GEORGE LORENZO, EXAMINING ATTORNEY



*David J. Kybas*

Director of the United States Patent and Trademark Office



# United States of America

United States Patent and Trademark Office

# LAPPY

**Reg. No. 4,135,770**

**Registered May 1, 2012**

**Int. Cl.: 21**

**TRADEMARK**

**PRINCIPAL REGISTER**

MEDIALORE LLC (CONNECTICUT LIMITED LIABILITY COMPANY)  
1771 POST ROAD EAST #314  
WESTPORT, CT 06880

FOR: FEEDING VESSELS FOR PETS, IN CLASS 21 (U.S. CLS. 2, 13, 23, 29, 30, 33, 40 AND 50).

FIRST USE 3-14-2012; IN COMMERCE 3-14-2012.

THE MARK CONSISTS OF STANDARD CHARACTERS WITHOUT CLAIM TO ANY PARTICULAR FONT, STYLE, SIZE, OR COLOR.

SN 77-537,973, FILED 8-4-2008.

ALEX KEAM, EXAMINING ATTORNEY



*David J. Kybas*

Director of the United States Patent and Trademark Office

# United States of America

United States Patent and Trademark Office

# XPRESIDENT

**Reg. No. 4,135,771**

**Registered May 1, 2012**

**Int. Cls.: 42 and 44**

**SERVICE MARK**

**PRINCIPAL REGISTER**

IMMATICS BIOTECHNOLOGIES GMBH (FED REP GERMANY GESELLSCHAFT MIT  
BESCHRÄNKTER HAFTUNG (GMBH))  
PAUL-EHRLICH-STRASSE 15  
TUEBINGEN, FED REP GERMANY 72076

FOR: MEDICAL RESEARCH SERVICES, NAMELY, CONDUCTING CLINICAL TRIALS FOR  
OTHERS IN THE FIELDS OF CANCER , IN CLASS 42 (U.S. CLS. 100 AND 101).

FIRST USE 8-0-2011; IN COMMERCE 8-0-2011.

FOR: MEDICAL TESTING SERVICES; MEDICAL SERVICES, NAMELY, DIAGNOSIS AND  
TREATMENT OF CANCER, IN CLASS 44 (U.S. CLS. 100 AND 101).

FIRST USE 2-1-2012; IN COMMERCE 2-1-2012.

THE MARK CONSISTS OF STANDARD CHARACTERS WITHOUT CLAIM TO ANY PAR-  
TICULAR FONT, STYLE, SIZE, OR COLOR.

SN 77-539,153, FILED 8-5-2008.

MATTHEW KLINE, EXAMINING ATTORNEY



*David J. Kyffers*

Director of the United States Patent and Trademark Office

# United States of America

United States Patent and Trademark Office

## HAND ON YOUR HEART

**Reg. No. 4,135,772**

**Registered May 1, 2012**

**Int. Cl.: 14**

**TRADEMARK**

**PRINCIPAL REGISTER**

JEMERC, INC. (NEW YORK CORPORATION)  
P.O. BOX 383  
HUNTINGTON, NY 11743

FOR: JEWELRY, IN CLASS 14 (U.S. CLS. 2, 27, 28 AND 50).

FIRST USE 9-0-2011; IN COMMERCE 9-0-2011.

THE MARK CONSISTS OF STANDARD CHARACTERS WITHOUT CLAIM TO ANY PARTICULAR FONT, STYLE, SIZE, OR COLOR.

SN 77-539,727, FILED 8-5-2008.

SIMON TENG, EXAMINING ATTORNEY



*David J. Kybas*

Director of the United States Patent and Trademark Office

# United States of America

United States Patent and Trademark Office



**Reg. No. 4,135,773**

**Registered May 1, 2012**

**Int. Cl.: 16**

**TRADEMARK**

**PRINCIPAL REGISTER**

SANDERS & ASSOCIATES, INC. (WASHINGTON CORPORATION)  
11616 NE 30TH PLACE  
BELLEVUE, WA 98005

FOR: BABIES' DIAPERS OF PAPER; DISPOSABLE DIAPERS, IN CLASS 16 (U.S. CLS. 2, 5, 22, 23, 29, 37, 38 AND 50).

FIRST USE 1-17-2012; IN COMMERCE 1-17-2012.

NO CLAIM IS MADE TO THE EXCLUSIVE RIGHT TO USE "DIAPER", APART FROM THE MARK AS SHOWN.

THE MARK CONSISTS OF "DIAPER ON-THE-GO" ABOVE A MOTHER KANGAROO WITH A BABY KANGAROO IN HER POUCH.

SN 77-540,735, FILED 8-6-2008.

KATHRYN COWARD, EXAMINING ATTORNEY



*David J. Kybas*

Director of the United States Patent and Trademark Office

# United States of America

United States Patent and Trademark Office

# HUWA-SAN

**Reg. No. 4,135,774**

**Registered May 1, 2012**

**Int. Cls.: 1 and 5**

**TRADEMARK**

**PRINCIPAL REGISTER**

ROAM CHEMIE BVBA (BELGIUM BESLOTEN VENNOOTSCHAP MET BEPERKTE  
AANSPRAKELIJKHEID (BVBA))  
INDUSTRIEZONE CENTRUM ZUID 2053  
HOUTHALEN LIMBURG, BELGIUM B-3530

FOR: CHEMICALS FOR TREATING AND CLARIFYING WATER, NAMELY, WASTE WATER  
TREATMENT CHEMICALS FOR INDUSTRIAL USE AND WATER TREATMENT CHEMICALS  
FOR USE IN SWIMMING POOLS AND SPAS, IN CLASS 1 (U.S. CLS. 1, 5, 6, 10, 26 AND 46).

FIRST USE 8-1-1995; IN COMMERCE 6-6-2011.

FOR: DISINFECTANTS FOR WATER, IN CLASS 5 (U.S. CLS. 6, 18, 44, 46, 51 AND 52).

FIRST USE 8-1-1995; IN COMMERCE 6-6-2011.

THE MARK CONSISTS OF STANDARD CHARACTERS WITHOUT CLAIM TO ANY PAR-  
TICULAR FONT, STYLE, SIZE, OR COLOR.

THE WORDING "HUWA-SAN" HAS NO MEANING IN A FOREIGN LANGUAGE.

SN 77-546,725, FILED 8-14-2008.

APRIL HESIK, EXAMINING ATTORNEY



*David J. Kypos*

Director of the United States Patent and Trademark Office

# United States of America

United States Patent and Trademark Office

# CHEETAH

**Reg. No. 4,135,775**

**Registered May 1, 2012**

**Int. Cl.: 1**

**TRADEMARK**

**PRINCIPAL REGISTER**

ROMAN DECORATING PRODUCTS LLC (ILLINOIS LIMITED LIABILITY COMPANY)  
824 STATE STREET  
CALUMET CITY, IL 60409

FOR: WALLPAPER REMOVING PREPARATIONS, IN CLASS 1 (U.S. CLS. 1, 5, 6, 10, 26 AND 46).

FIRST USE 3-19-2012; IN COMMERCE 3-19-2012.

THE MARK CONSISTS OF STANDARD CHARACTERS WITHOUT CLAIM TO ANY PARTICULAR FONT, STYLE, SIZE, OR COLOR.

SN 77-546,881, FILED 8-14-2008.

NICHOLAS ALTREE, EXAMINING ATTORNEY



*David J. Kyffers*

Director of the United States Patent and Trademark Office

# United States of America

United States Patent and Trademark Office

# VERGANIC

**Reg. No. 4,135,776**

**Registered May 1, 2012**

**Int. Cl.: 3**

**TRADEMARK**

**PRINCIPAL REGISTER**

BIOCOS CO., LTD. (REPUBLIC OF KOREA CORPORATION)  
1F., SAMBO BLDG. 92-6, SAMSEONG-DONG  
GANGNAM-GU, SEOUL, REPUBLIC OF KOREA

FOR: LIQUID SOAP, BATH SOAP, SHAVING SOAP, COSMETIC SOAP IN SOLID FORM, SHAMPOOS, SHAMPOOS FOR BABIES, SOAP IN THE FORM OF SHEET, HAND CLEANER, HAND CLEANING PREPARATIONS, PERFUMED SOAP, HAIR RINSES, COSMETIC SOAPS, BABY OILS, BABY POWDERS, PERFUMED POWDER, SHOWER AND BATH GEL, SHOWER GELS, SHOWER CREAM, SHOWER AND BATH FOAM, SHAVING LOTION, SHAVING CREAM, SKIN CLEANSER, COSMETIC PREPARATIONS FOR SKIN CARE, COSMETIC CREAMS FOR SKIN CARE, HAND LOTIONS, HAIR CONDITIONERS, COSMETIC BATH POWDER, OILS FOR COSMETIC PURPOSES, IN CLASS 3 (U.S. CLS. 1, 4, 6, 50, 51 AND 52).

FIRST USE 8-12-2010; IN COMMERCE 10-14-2011.

THE MARK CONSISTS OF STANDARD CHARACTERS WITHOUT CLAIM TO ANY PARTICULAR FONT, STYLE, SIZE, OR COLOR.

SN 77-550,175, FILED 8-19-2008.

ROBIN CHOSID, EXAMINING ATTORNEY



*David J. Kyffers*

Director of the United States Patent and Trademark Office

# United States of America

United States Patent and Trademark Office



**Reg. No. 4,135,777**

**Registered May 1, 2012**

**Int. Cls.: 16, 35, 42, 44,  
and 45**

**TRADEMARK**

**SERVICE MARK**

**PRINCIPAL REGISTER**

HUMANA INC. (DELAWARE CORPORATION)  
500 WEST MAIN STREET  
LOUISVILLE, KY 40202

FOR: PRINTED REPORTS AND PRINTED VISUALS, NAMELY, INFORMATION GRAPHICS PROVIDING STATEWIDE, MARKET AREA, PAYER, HOSPITAL, AND PHYSICIAN MEASUREMENTS ON OUTCOMES, QUALITY, MORTALITY, INFECTIONS, COMPLICATIONS, UTILIZATION, AND PRICE FOR USE BY THIRD PARTY PAYERS, HOSPITALS, PHYSICIANS, HEALTHCARE ORGANIZATIONS, INSURANCE COMPANIES, HMOS, EMPLOYERS, LEGAL COUNSEL, THE MEDIA, GOVERNMENT ENTITIES AND CONSUMERS, IN CLASS 16 (U.S. CLS. 2, 5, 22, 23, 29, 37, 38 AND 50).

FIRST USE 7-31-2008; IN COMMERCE 7-31-2008.

FOR: CONSULTING SERVICES RELATED TO MEDICAL COST MANAGEMENT; MANAGEMENT SERVICES OF A BUSINESS NATURE FOR CLINICAL TRIALS IN THE FIELD OF INVESTIGATIONAL DRUGS; DATA COMPILATION AND ANALYSIS IN THE FIELD OF HEALTHCARE MANAGEMENT, NAMELY, CONDUCTING PHARMACOECONOMICS, HEALTH ECONOMICS AND STATISTICAL RESEARCH FOR BUSINESS PURPOSES; COMPUTERIZED DATABASE MANAGEMENT AND DATA PROCESSING SERVICES IN THE FIELDS OF HEALTHCARE, PHARMACEUTICALS, PHARMACOGENOMIC, BIOTECHNICAL, AND MEDICAL PRODUCTS AND DEVICES; COMPUTERIZED DATABASE MANAGEMENT AND DATA PROCESSING SERVICES IN THE FIELDS OF HEALTHCARE, PHARMACEUTICALS, PHARMACOGENOMIC, BIOTECHNICAL, AND MEDICAL PRODUCTS AND DEVICES; BUSINESS CONSULTING SERVICES IN THE FIELDS OF HEALTHCARE, PHARMACEUTICALS, PHARMACOGENOMIC, BIOTECHNICAL, AND MEDICAL PRODUCTS AND DEVICES; SUPPLY CHAIN MANAGEMENT, NAMELY, TRACKING AND MANAGEMENT OF CLINICAL TRIAL SUPPLIES AND RESEARCH MATERIALS USED IN SUCH; PROVIDING STATISTICAL INFORMATION AND ANALYSIS VIA COMPUTER FOR USE WITH CLINICAL TRIAL DATA FOR BUSINESS PURPOSES; BUSINESS CONSULTATION SERVICES FOR THE HEALTHCARE INDUSTRY; BUSINESS CONSULTING IN THE FIELD OF CLINICAL AND HEALTH ECONOMIC RESEARCH SERVICES FOR HEALTHCARE COMPANIES; PREPARING STATISTICAL BUSINESS REPORTS RESULTING FROM CLINICAL TRIALS AND LABORATORY DATA ANALYSIS; CONSULTATION IN THE FIELD OF PATIENT RECRUITMENT; DATA PREPARATION FOR BUSINESS PURPOSES, NAMELY, PREPARATION OF MEDICAL AND SCIENTIFIC DATA FOR USE



*David J. Kyjars*

Director of the United States Patent and Trademark Office



**Reg. No. 4,135,777** BY INSURANCE COMPANIES AND THIRD PARTY MEDICAL REIMBURSEMENT ORGANIZATIONS, IN CLASS 35 (U.S. CLS. 100, 101 AND 102).

FIRST USE 7-31-2008; IN COMMERCE 7-31-2008.

FOR: MEDICAL AND SCIENTIFIC RESEARCH, DATA COLLECTION AND ANALYSIS IN THE NATURE OF CLINICAL RESEARCH AND CONDUCTING CLINICAL TRIALS IN THE FIELDS OF HEALTHCARE, MEDICAL CARE AND PHARMACEUTICALS; SCIENTIFIC RESEARCH IN THE FIELD OF GENERAL HEALTH AND MEDICAL AND SCIENTIFIC RESEARCH, NAMELY, CONDUCTING CLINICAL TRIALS BY PROVIDING CLINICAL INDICATORS CALCULATED USING MEDICAL CLAIMS DATA THAT ARE USED TO MEASURE QUALITY OF MEDICAL CARE; COMPILATION AND ANALYSIS IN THE FIELD OF SCIENTIFIC AND MEDICAL RESEARCH, NAMELY, CONDUCTING PHARMACOECONOMICS, HEALTH ECONOMICS, MEDICAL LABORATORY DATA ANALYSIS, AND STATISTICAL MEDICAL RESEARCH; PHARMACEUTICAL DEVELOPMENT SERVICES IN THE FIELDS OF MOLECULAR MEDICINE; HEALTHCARE, NAMELY, SCIENTIFIC RESEARCH CONSULTING FOR IMPROVED CLINICAL TRIAL DESIGN; MEDICAL RESEARCH THAT ANALYZES DATA TO IDENTIFY PATTERNS ACROSS PATIENT GROUPS OR DISEASE PROGRESSION; PHARMACEUTICAL DEVELOPMENT, NAMELY, DESIGN, RESEARCH AND DEVELOPMENT OF DRUGS, PHARMACEUTICALS AND MEDICINES FOR OTHERS; CLINICAL DEVELOPMENT SERVICES FOR OTHERS, NAMELY, RESEARCH AND CONSULTATION IN THE FIELDS OF PHARMACEUTICAL DRUG DEVELOPMENT AND CLINICAL TRIAL DESIGN; MEDICAL LABORATORY DATA ANALYSIS, CLINICAL DIAGNOSIS RESEARCH AND DIAGNOSTIC TESTING RESEARCH; PREPARATION OF REPORTS AND RESEARCH CONCERNING DEVELOPMENT OF MEDICINES, PHARMACEUTICALS, GENETICS, BIOLOGY, BIOTECHNOLOGY AND PHARMACEUTICAL DRUGS; CONSULTING SERVICES IN THE FIELDS OF PHARMACEUTICALS RESEARCH, AND BIOTECHNOLOGY FIELDS; PROVIDING AN ON-LINE DATABASE IN THE FIELD OF MEDICAL, PHARMACEUTICAL, AND BIOTECHNICAL RESEARCH AND ANALYSIS; MANAGEMENT SERVICES OF A SCIENTIFIC AND TECHNICAL NATURE FOR CLINICAL TRIALS IN THE FIELD OF INVESTIGATIONAL DRUGS, NAMELY, CONDUCTING CLINICAL PROTOCOLS AND TRIALS FOR OTHERS; CONSULTING SERVICES REGARDING SCIENTIFIC ASPECTS OF CLINICAL TRIALS OF INVESTIGATIONAL DRUGS, NAMELY, ADVISING OTHERS ON CONDUCTING CLINICAL PROTOCOLS AND TRIALS; TECHNICAL WRITING FOR OTHERS OF CLINICAL TRIAL REPORTS; RESEARCH AND CONSULTATION IN THE CLINICAL MEDICAL FIELD, NAMELY, RESEARCH AND ANALYSIS PROVIDED TO HEALTHCARE PROVIDERS, SUPPLIERS OF MEDICAL DEVICES AND PHARMACEUTICAL PRODUCTS, AND SUPPLIERS OF MEDICAL SOFTWARE AND MEDICAL INFORMATION MANAGEMENT SERVICES; MEDICAL QUALITY EVALUATION SERVICES, NAMELY, PROVIDING DATA COLLECTION, ANALYSIS, AND REPORTING SERVICES FOR PATIENT DATA, CLINICAL INFORMATION, TREATMENT OPTIONS AND TREATMENT SUCCESS FOR THE MEDICAL INDUSTRY; PROVIDING AN ON-LINE COMPUTER DATABASE IN THE FIELD OF HEALTHCARE, NAMELY, HEALTH AND PRODUCTIVITY RESEARCH AND ANALYSIS; ASSESSMENT SURVEYS FOR HEALTH AND MEDICAL PURPOSES, NAMELY, IN RESEARCH CONCERNING MEDICINES, PHARMACEUTICALS, GENETICS, BIOLOGY, BIOTECHNOLOGY AND DRUGS; QUALITY EVALUATION SERVICES, NAMELY, SURVEYING PATIENTS TO ASSESS QUALITY OF LIFE, BURDEN OF DISEASE AND OVERALL SATISFACTION WITH ACCESS TO MEDICAL CARE TO DETERMINE SERVICE QUALITY FOR THE MEDICAL INDUSTRY, IN CLASS 42 (U.S. CLS. 100 AND 101).

FIRST USE 7-31-2008; IN COMMERCE 7-31-2008.

FOR: CONSULTATION IN THE FIELD OF DRUG USE TESTING SERVICES; CONSULTATION IN THE FIELD OF HEALTHCARE; PROVIDING PHARMACEUTICAL ADVICE; PROVIDING AN INTERACTIVE ON-LINE COMPUTER DATABASE IN THE FIELD OF MEDICAL DIAGNOSTICS, IN CLASS 44 (U.S. CLS. 100 AND 101).

**Reg. No. 4,135,777** FIRST USE 7-31-2008; IN COMMERCE 7-31-2008.

FOR: CONSULTING SERVICES IN THE FIELD OF RESEARCH AND ANALYSIS OF DRUG PRESCRIPTION AND ASSOCIATED DATA, NAMELY, REGULATORY COMPLIANCE CONSULTING AS IT APPLIES TO PRESCRIPTION DRUG SAMPLING, IN CLASS 45 (U.S. CLS. 100 AND 101).

FIRST USE 7-31-2008; IN COMMERCE 7-31-2008.

OWNER OF U.S. REG. NO. 2,573,663.

THE MARK CONSISTS OF THREE STYLIZED CURVED TRIANGLES SURROUNDING A CENTRAL POINT, EACH WITH A CONCAVE INNER SURFACE.

SN 77-551,152, FILED 8-20-2008.

NAKIA HENRY, EXAMINING ATTORNEY

# United States of America

## United States Patent and Trademark Office



**Reg. No. 4,135,778**

**Registered May 1, 2012**

**Int. Cls.: 16, 35, 42, 44,  
and 45**

**TRADEMARK**

**SERVICE MARK**

**PRINCIPAL REGISTER**

HUMANA INC. (DELAWARE CORPORATION)  
500 WEST MAIN STREET  
LOUISVILLE, KY 40202

FOR: PRINTED REPORTS AND PRINTED VISUALS, NAMELY, INFORMATION GRAPHICS PROVIDING STATEWIDE, MARKET AREA, PAYER, HOSPITAL, AND PHYSICIAN MEASUREMENTS ON OUTCOMES, QUALITY, MORTALITY, INFECTIONS, COMPLICATIONS, UTILIZATION, AND PRICE FOR USE BY THIRD PARTY PAYERS, HOSPITALS, PHYSICIANS, HEALTHCARE ORGANIZATIONS, INSURANCE COMPANIES, HMOS, EMPLOYERS, LEGAL COUNSEL, THE MEDIA, GOVERNMENT ENTITIES AND CONSUMERS, IN CLASS 16 (U.S. CLS. 2, 5, 22, 23, 29, 37, 38 AND 50).

FIRST USE 7-31-2008; IN COMMERCE 7-31-2008.

FOR: CONSULTING SERVICES RELATED TO MEDICAL COST MANAGEMENT; MANAGEMENT SERVICES OF A BUSINESS NATURE FOR CLINICAL TRIALS IN THE FIELD OF INVESTIGATIONAL DRUGS; DATA COMPILATION AND ANALYSIS IN THE FIELD OF HEALTHCARE MANAGEMENT, NAMELY, CONDUCTING PHARMACOECONOMICS, HEALTH ECONOMICS AND STATISTICAL RESEARCH FOR BUSINESS PURPOSES; COMPUTERIZED DATABASE MANAGEMENT AND DATA PROCESSING SERVICES IN THE FIELDS OF HEALTHCARE, PHARMACEUTICALS, PHARMACOGENOMIC, BIOTECHNICAL, AND MEDICAL PRODUCTS AND DEVICES; COMPUTERIZED DATABASE MANAGEMENT AND DATA PROCESSING SERVICES IN THE FIELDS OF HEALTHCARE, PHARMACEUTICALS, PHARMACOGENOMIC, BIOTECHNICAL, AND MEDICAL PRODUCTS AND DEVICES; BUSINESS CONSULTING SERVICES IN THE FIELDS OF HEALTHCARE, PHARMACEUTICALS, PHARMACOGENOMIC, BIOTECHNICAL, AND MEDICAL PRODUCTS AND DEVICES; SUPPLY CHAIN MANAGEMENT, NAMELY, TRACKING AND MANAGEMENT OF CLINICAL TRIAL SUPPLIES AND RESEARCH MATERIALS USED IN SUCH; PROVIDING STATISTICAL INFORMATION AND ANALYSIS VIA COMPUTER FOR USE WITH CLINICAL TRIAL DATA FOR BUSINESS PURPOSES; BUSINESS CONSULTATION SERVICES FOR THE HEALTHCARE INDUSTRY; BUSINESS CONSULTING IN THE FIELD OF CLINICAL AND HEALTH ECONOMIC RESEARCH SERVICES FOR HEALTHCARE COMPANIES; PREPARING STATISTICAL BUSINESS REPORTS RESULTING FROM CLINICAL TRIALS AND LABORATORY DATA ANALYSIS; CONSULTATION IN THE FIELD OF PATIENT RECRUITMENT; DATA PREPARATION FOR BUSINESS PURPOSES, NAMELY, PREPARATION OF MEDICAL AND SCIENTIFIC DATA FOR USE



*David J. Kyjars*

Director of the United States Patent and Trademark Office

**Reg. No. 4,135,778** BY INSURANCE COMPANIES AND THIRD PARTY MEDICAL REIMBURSEMENT ORGANIZATIONS, IN CLASS 35 (U.S. CLS. 100, 101 AND 102).

FIRST USE 7-31-2008; IN COMMERCE 7-31-2008.

FOR: MEDICAL AND SCIENTIFIC RESEARCH, DATA COLLECTION AND ANALYSIS IN THE NATURE OF CLINICAL RESEARCH AND CONDUCTING CLINICAL TRIALS IN THE FIELDS OF HEALTHCARE, MEDICAL CARE AND PHARMACEUTICALS; SCIENTIFIC RESEARCH IN THE FIELD OF GENERAL HEALTH AND MEDICAL AND SCIENTIFIC RESEARCH, NAMELY, CONDUCTING CLINICAL TRIALS BY PROVIDING CLINICAL INDICATORS CALCULATED USING MEDICAL CLAIMS DATA THAT ARE USED TO MEASURE QUALITY OF MEDICAL CARE; COMPILATION AND ANALYSIS IN THE FIELD OF SCIENTIFIC AND MEDICAL RESEARCH, NAMELY, CONDUCTING PHARMACOECONOMICS, HEALTH ECONOMICS, MEDICAL LABORATORY DATA ANALYSIS, AND STATISTICAL MEDICAL RESEARCH; PHARMACEUTICAL DEVELOPMENT SERVICES IN THE FIELDS OF MOLECULAR MEDICINE; HEALTHCARE, NAMELY, SCIENTIFIC RESEARCH CONSULTING FOR IMPROVED CLINICAL TRIAL DESIGN; MEDICAL RESEARCH THAT ANALYZES DATA TO IDENTIFY PATTERNS ACROSS PATIENT GROUPS OR DISEASE PROGRESSION; PHARMACEUTICAL DEVELOPMENT, NAMELY, DESIGN, RESEARCH AND DEVELOPMENT OF DRUGS, PHARMACEUTICALS AND MEDICINES FOR OTHERS; CLINICAL DEVELOPMENT SERVICES FOR OTHERS, NAMELY, RESEARCH AND CONSULTATION IN THE FIELDS OF PHARMACEUTICAL DRUG DEVELOPMENT AND CLINICAL TRIAL DESIGN; MEDICAL LABORATORY DATA ANALYSIS, CLINICAL DIAGNOSIS RESEARCH AND DIAGNOSTIC TESTING RESEARCH; PREPARATION OF REPORTS AND RESEARCH CONCERNING DEVELOPMENT OF MEDICINES, PHARMACEUTICALS, GENETICS, BIOLOGY, BIOTECHNOLOGY AND PHARMACEUTICAL DRUGS; CONSULTING SERVICES IN THE FIELDS OF PHARMACEUTICALS RESEARCH, AND BIOTECHNOLOGY FIELDS; PROVIDING AN ON-LINE DATABASE IN THE FIELD OF MEDICAL, PHARMACEUTICAL, AND BIOTECHNICAL RESEARCH AND ANALYSIS; MANAGEMENT SERVICES OF A SCIENTIFIC AND TECHNICAL NATURE FOR CLINICAL TRIALS IN THE FIELD OF INVESTIGATIONAL DRUGS, NAMELY, CONDUCTING CLINICAL PROTOCOLS AND TRIALS FOR OTHERS; CONSULTING SERVICES REGARDING SCIENTIFIC ASPECTS OF CLINICAL TRIALS OF INVESTIGATIONAL DRUGS, NAMELY, ADVISING OTHERS ON CONDUCTING CLINICAL PROTOCOLS AND TRIALS; TECHNICAL WRITING FOR OTHERS OF CLINICAL TRIAL REPORTS; RESEARCH AND CONSULTATION IN THE CLINICAL MEDICAL FIELD, NAMELY, RESEARCH AND ANALYSIS PROVIDED TO HEALTHCARE PROVIDERS, SUPPLIERS OF MEDICAL DEVICES AND PHARMACEUTICAL PRODUCTS, AND SUPPLIERS OF MEDICAL SOFTWARE AND MEDICAL INFORMATION MANAGEMENT SERVICES; MEDICAL QUALITY EVALUATION SERVICES, NAMELY, PROVIDING DATA COLLECTION, ANALYSIS, AND REPORTING SERVICES FOR PATIENT DATA, CLINICAL INFORMATION, TREATMENT OPTIONS AND TREATMENT SUCCESS FOR THE MEDICAL INDUSTRY; PROVIDING AN ON-LINE COMPUTER DATABASE IN THE FIELD OF HEALTHCARE, NAMELY, HEALTH AND PRODUCTIVITY RESEARCH AND ANALYSIS; ASSESSMENT SURVEYS FOR HEALTH AND MEDICAL PURPOSES, NAMELY, IN RESEARCH CONCERNING MEDICINES, PHARMACEUTICALS, GENETICS, BIOLOGY, BIOTECHNOLOGY AND DRUGS; QUALITY EVALUATION SERVICES, NAMELY, SURVEYING PATIENTS TO ASSESS QUALITY OF LIFE, BURDEN OF DISEASE AND OVERALL SATISFACTION WITH ACCESS TO MEDICAL CARE TO DETERMINE SERVICE QUALITY FOR THE MEDICAL INDUSTRY, IN CLASS 42 (U.S. CLS. 100 AND 101).

FIRST USE 7-31-2008; IN COMMERCE 7-31-2008.

FOR: CONSULTATION IN THE FIELD OF DRUG USE TESTING SERVICES; CONSULTATION IN THE FIELD OF HEALTHCARE; PROVIDING PHARMACEUTICAL ADVICE; PROVIDING AN INTERACTIVE ON-LINE COMPUTER DATABASE IN THE FIELD OF MEDICAL DIAGNOSTICS, IN CLASS 44 (U.S. CLS. 100 AND 101).

**Reg. No. 4,135,778** FIRST USE 7-31-2008; IN COMMERCE 7-31-2008.

FOR: CONSULTING SERVICES IN THE FIELD OF RESEARCH AND ANALYSIS OF DRUG PRESCRIPTION AND ASSOCIATED DATA, NAMELY, REGULATORY COMPLIANCE CONSULTING AS IT APPLIES TO PRESCRIPTION DRUG SAMPLING, IN CLASS 45 (U.S. CLS. 100 AND 101).

FIRST USE 7-31-2008; IN COMMERCE 7-31-2008.

OWNER OF U.S. REG. NO. 2,573,663.

THE COLOR(S) BLUE, GREEN, AND TEAL IS/ARE CLAIMED AS A FEATURE OF THE MARK.

THE MARK CONSISTS OF THREE STYLIZED CURVED TRIANGLES SURROUNDING A CENTRAL POINT, EACH WITH A CONCAVE INNER SURFACE; ONE OF THE TRIANGLES IS BLUE, ONE GREEN, AND ONE TEAL.

SN 77-551,231, FILED 8-20-2008.

NAKIA HENRY, EXAMINING ATTORNEY

# United States of America

United States Patent and Trademark Office

*Paletta*



**Reg. No. 4,135,779**

**Registered May 1, 2012**

**Int. Cl.: 14**

**TRADEMARK**

**PRINCIPAL REGISTER**

PALETTA JEWELRY, LLC (CALIFORNIA LIMITED LIABILITY COMPANY)  
SUITE 105-224  
6965 EL CAMINO REAL  
CARLSBAD, CA 92009

FOR: JEWELRY, IN CLASS 14 (U.S. CLS. 2, 27, 28 AND 50).

FIRST USE 10-0-2007; IN COMMERCE 10-0-2007.

THE MARK CONSISTS OF THE WORD "PALETTA" WHERE THE LETTER "L" IS REPRESENTED BY A SPADE DEVICE.

THE ENGLISH TRANSLATION OF "PALETTA" IN THE MARK IS "LITTLE SHOVEL".

SN 77-553,988, FILED 8-22-2008.

ALEX KEAM, EXAMINING ATTORNEY



*David J. Kybas*

Director of the United States Patent and Trademark Office

# United States of America

United States Patent and Trademark Office

# JOYBAR

**Reg. No. 4,135,780**

**Registered May 1, 2012**

**Int. Cl.: 12**

**TRADEMARK**

**PRINCIPAL REGISTER**

FLOWERS, MICHAEL (UNITED STATES INDIVIDUAL)  
2 SHANNON LANE  
MANTUA, NJ 08051

FOR: STEERING ASSEMBLIES COMPRISING HANDLE BARS FOR DUAL-MOTOR ELECTRIC VEHICLES, ELECTRIC WHEELCHAIRS, FLOOR-SCRUBBERS AND ELECTRIC CARS, IN CLASS 12 (U.S. CLS. 19, 21, 23, 31, 35 AND 44).

FIRST USE 3-3-2011; IN COMMERCE 2-17-2012.

THE MARK CONSISTS OF STANDARD CHARACTERS WITHOUT CLAIM TO ANY PARTICULAR FONT, STYLE, SIZE, OR COLOR.

SN 77-554,187, FILED 8-23-2008.

RONALD AIKENS, EXAMINING ATTORNEY



*David J. Kyffers*

Director of the United States Patent and Trademark Office

# United States of America

United States Patent and Trademark Office

# MT

**Reg. No. 4,135,781**

**Registered May 1, 2012**

**Int. Cl.: 7**

**TRADEMARK**

**PRINCIPAL REGISTER**

ALLIED GATOR, INC. (OHIO CORPORATION)  
2100 POLAND AVENUE  
YOUNGSTOWN, OH 44502

FOR: HYDRAULICALLY POWERED MATERIAL PROCESSING AND HANDLING ATTACHMENTS IN THE NATURE OF QUICK-CHANGE CRACKER TEETH JAW SETS, QUICK-CHANGE CRUSHER TEETH JAW SETS AND QUICK-CHANGE SHEAR JAW SETS, AND QUICK-CHANGE MAGNETIC EXTENSION HANDLER FOR EXCAVATORS, THE FOREGOING EQUIPMENT TYPICALLY USED IN THE RECYCLING, DEMOLITION AND CONSTRUCTION INDUSTRIES, IN CLASS 7 (U.S. CLS. 13, 19, 21, 23, 31, 34 AND 35).

FIRST USE 6-11-2002; IN COMMERCE 6-11-2002.

THE MARK CONSISTS OF STANDARD CHARACTERS WITHOUT CLAIM TO ANY PARTICULAR FONT, STYLE, SIZE, OR COLOR.

SN 77-554,823, FILED 8-25-2008.

MAYUR VAGHANI, EXAMINING ATTORNEY



*David J. Kyffers*

Director of the United States Patent and Trademark Office



# United States of America

United States Patent and Trademark Office

## TASTE THE TRUTH

**Reg. No. 4,135,782**

**Registered May 1, 2012**

**Int. Cl.: 43**

**SERVICE MARK**

**PRINCIPAL REGISTER**

RED MANGO, INC. (TEXAS CORPORATION)  
SUITE 18  
2811 MCKINNEY AVENUE  
DALLAS, TX 75204

FOR: SERVING OF FOOD AND DRINK/BEVERAGES AT RESTAURANTS, CAFES AND DRINK BARS; RESTAURANT, CAFE, DRINK AND YOGURT BAR SERVICES, IN CLASS 43 (U.S. CLS. 100 AND 101).

FIRST USE 8-1-2009; IN COMMERCE 8-1-2009.

THE MARK CONSISTS OF STANDARD CHARACTERS WITHOUT CLAIM TO ANY PARTICULAR FONT, STYLE, SIZE, OR COLOR.

SN 77-558,084, FILED 8-28-2008.

JILL C. ALT, EXAMINING ATTORNEY



*David J. Kyffers*

Director of the United States Patent and Trademark Office

# United States of America

United States Patent and Trademark Office



**Reg. No. 4,135,783**

**Registered May 1, 2012**

**Int. Cl.: 25**

**TRADEMARK**

**PRINCIPAL REGISTER**

CAMPBELL, DAVID (UNITED STATES INDIVIDUAL)  
70 BANK STREET, APT. 3R  
NEW YORK, NY 10014

FOR: CLOTHING, NAMELY, SHIRTS, IN CLASS 25 (U.S. CLS. 22 AND 39).

FIRST USE 1-17-2012; IN COMMERCE 1-17-2012.

THE MARK CONSISTS OF THE LETTER "H".

SN 77-558,087, FILED 8-28-2008.

KATHY DE JONGE, EXAMINING ATTORNEY



*David J. Kyffers*

Director of the United States Patent and Trademark Office

# United States of America

United States Patent and Trademark Office

## ALL AMERICAN MONITORING

**Reg. No. 4,135,784**

**Registered May 1, 2012**

**Int. Cl.: 45**

**SERVICE MARK**

**PRINCIPAL REGISTER**

ALARM SPECIALIST CORPORATION (FLORIDA CORPORATION), DBA ALL AMERICAN MONITORING,  
1375 NORTH EAST AVENUE  
SARASOTA, FL 34237

FOR: ALARM MONITORING, IN CLASS 45 (U.S. CLS. 100 AND 101).

FIRST USE 7-25-1997; IN COMMERCE 7-25-1997.

NO CLAIM IS MADE TO THE EXCLUSIVE RIGHT TO USE "MONITORING", APART FROM THE MARK AS SHOWN.

SN 77-563,083, FILED 9-5-2008.

MARK PILARO, EXAMINING ATTORNEY



*David J. Kyffers*

Director of the United States Patent and Trademark Office

# United States of America

United States Patent and Trademark Office

## MARGARITAVILLE

**Reg. No. 4,135,785**

**Registered May 1, 2012**

**Int. Cl.: 43**

**SERVICE MARK**

**PRINCIPAL REGISTER**

MARGARITAVILLE ENTERPRISES, LLC (DELAWARE LIMITED LIABILITY COMPANY)  
256 WORTH AVENUE, SUITE Q-R  
PALM BEACH, FL 33480

FOR: RESORT HOTELS, IN CLASS 43 (U.S. CLS. 100 AND 101).

FIRST USE 6-28-2010; IN COMMERCE 6-28-2010.

THE MARK CONSISTS OF STANDARD CHARACTERS WITHOUT CLAIM TO ANY PARTICULAR FONT, STYLE, SIZE, OR COLOR.

OWNER OF U.S. REG. NOS. 1,642,132, 2,082,231, AND OTHERS.

SN 77-569,980, FILED 9-15-2008.

WILLIAM BRECKENFELD, EXAMINING ATTORNEY



*David J. Kybas*

Director of the United States Patent and Trademark Office

# United States of America

United States Patent and Trademark Office

# Zen Do

**Reg. No. 4,135,786**

**Registered May 1, 2012**

**Int. Cl.: 28**

**TRADEMARK**

**PRINCIPAL REGISTER**

LINDROTH, HOLLY J (UNITED STATES INDIVIDUAL)  
5071 HOWARD AVE  
LOS ALAMITOS, CA 90720 AND

JOHNSTON, CINNAMON P (UNITED STATES INDIVIDUAL)  
5071 HOWARD AVE  
LOS ALAMITOS, CA 90720

FOR: MINIATURE DESKTOP CLAY SCULPTURE TOY, IN CLASS 28 (U.S. CLS. 22, 23, 38 AND 50).

FIRST USE 11-21-2006; IN COMMERCE 11-17-2011.

THE MARK CONSISTS OF STANDARD CHARACTERS WITHOUT CLAIM TO ANY PARTICULAR FONT, STYLE, SIZE, OR COLOR.

SN 77-573,568, FILED 9-18-2008.

EDWARD NELSON, EXAMINING ATTORNEY



*David J. Kyfos*

Director of the United States Patent and Trademark Office

# United States of America

United States Patent and Trademark Office

# SUAVECITO

**Reg. No. 4,135,787**

**Registered May 1, 2012**

**Int. Cl.: 33**

**TRADEMARK**

**PRINCIPAL REGISTER**

BLUE AGAVE IMPORTERS INC (INDIANA CORPORATION)  
8306 REEF COURT  
INDIANAPOLIS, IN 46236

FOR: TEQUILA, IN CLASS 33 (U.S. CLS. 47 AND 49).

FIRST USE 10-1-2011; IN COMMERCE 10-1-2011.

THE MARK CONSISTS OF STANDARD CHARACTERS WITHOUT CLAIM TO ANY PARTICULAR FONT, STYLE, SIZE, OR COLOR.

THE ENGLISH TRANSLATION OF "SUAVECITO" IN THE MARK IS NOT HARSH OR STERN.

SN 77-575,821, FILED 9-22-2008.

ARETHA SOMERVILLE, EXAMINING ATTORNEY



*David J. Kyros*

Director of the United States Patent and Trademark Office

# United States of America

United States Patent and Trademark Office

# INTHINC

**Reg. No. 4,135,788**

**Registered May 1, 2012**

**Int. Cls.: 9, 41, 42, and  
45**

**TRADEMARK**

**SERVICE MARK**

**PRINCIPAL REGISTER**

INTHINC TECHNOLOGY SOLUTIONS, INC. (DELAWARE CORPORATION)  
SUITE 100  
4225 WEST LAKE PARK BOULEVARD  
WEST VALLEY CITY, UT 84120

FOR: EVENT DATA RECORDERS; COMPUTER HARDWARE AND SOFTWARE FOR RECORDING, MONITORING AND ANALYSIS OF DATA RELATING TO VEHICLE INFORMATION, DRIVER BEHAVIOR, VEHICLE LOCATION INFORMATION AND EVENTS OCCURRING DURING VEHICLE OPERATION AND TRANSFER OF SAME BETWEEN COMPUTERS AND ON-BOARD VEHICLE INFORMATION RECORDING DEVICE; SOFTWARE FOR MONITORING AND EVALUATING DRIVER BEHAVIORS AND VEHICLE PERFORMANCE AND EFFICIENCY AND FOR USE IN PROCESSING AND ASSESSING RISK FACTORS, RISK INDEXES AND SCORES ASSOCIATED WITH DRIVER BEHAVIOR OR FLEET MANAGEMENT; COMPUTER HARDWARE AND SOFTWARE FOR ACCESSING DRIVER PERFORMANCE DATA AND INFORMATION GENERATED BY DRIVERS OF VEHICLES AND MONITORING VEHICLES WHEN DRIVER BEHAVIOR EXCEEDS OR MEETS PRE-PROGRAMMED PARAMETERS RELATED TO VEHICLE OPERATION; COMPUTER HARDWARE AND SOFTWARE FOR SENDING REAL TIME ALERTS VIA SATELLITE, WIRELESS AND CELLULAR TRANSMISSION NOTIFYING OF CHANGE IN STATUS OF DRIVER BEHAVIOR WHICH EXCEEDS OR MEETS PRE-PROGRAMMED PARAMETERS; HARDWARE AND SOFTWARE FOR IN-CAR TELEPHONE CALLING; VEHICLE SAFETY EQUIPMENT AND HARDWARE, NAMELY, 24 HOUR EMERGENCY ASSISTANCE UNIT COMPRISED OF A CELLULAR TELEPHONE, COMPUTER HARDWARE AND COMPUTER SOFTWARE FOR USE IN TRANSMITTING VOICE MESSAGES AND DATA, AND FOR USE IN TRANSMITTING EMERGENCY ALERTS, VEHICLE LOCATION AND OTHER DATA RELEVANT TO PROVIDING VEHICLE OR EMERGENCY SERVICES, IN CLASS 9 (U.S. CLS. 21, 23, 26, 36 AND 38).

FIRST USE 1-0-2008; IN COMMERCE 1-0-2008.

FOR: PROVIDING DRIVER SAFETY EDUCATION TO INDIVIDUALS AND COMPANIES, NAMELY, PROVIDING GROUP AND INDIVIDUAL INSTRUCTION IN THE FIELD OF DRIVER SAFETY FEATURING IN-VEHICLE FEEDBACK SYSTEMS AND DRIVING PERFORMANCE MANAGEMENT; PROVIDING DRIVER SAFETY TRAINING FEATURING USE OF ON-BOARD HARDWARE AND SOFTWARE TO RECOVER, ANALYZE, AND ASSESS DRIVER PERFORMANCE, RISK FACTORS AND EVENTS OCCURRING DURING VEHICLE OPERATION; EDUCATIONAL SERVICES, NAMELY, CONDUCTING CLASSES, SEMINARS,



*David J. Kybas*

Director of the United States Patent and Trademark Office

**Reg. No. 4,135,788** AND WORKSHOPS IN THE FIELD OF MOTOR VEHICLE SAFETY, DRIVER SAFETY AND SAFE DRIVING; DRIVER SAFETY TRAINING; VEHICLE DRIVING INSTRUCTION, NAMELY, DRIVING INSTRUCTION FOR LAND VEHICLES, IN CLASS 41 (U.S. CLS. 100, 101 AND 107).

FIRST USE 1-0-2008; IN COMMERCE 1-0-2008.

FOR: PROCESSING DATA AND INFORMATION, NAMELY, INTERPRETING COLLECTED AUDIO, VIDEO, TEXT AND DIGITAL CONTENT RECEIVED FROM ON-BOARD VEHICLE COMPUTER SYSTEM RELATED TO DRIVER BEHAVIOR AND HABITS, VEHICLE INFORMATION, ROAD CONDITIONS AND WEATHER CONDITIONS AND ANALYSIS OF SUCH DATA AND INFORMATION FOR REPORTING AND STORAGE IN A DATABASE; PROVIDING TEMPORARY USE OF ONLINE NON-DOWNLOADABLE SOFTWARE FOR CUSTOMERS TO REMOTELY ACCESS INFORMATION AND DATA RELATED TO DRIVING HABITS AND BEHAVIOR OF AN OPERATOR OF A PARTICULAR VEHICLE, TECHNICAL AND MECHANICAL OPERATING INFORMATION OF THE VEHICLE, ROAD CONDITIONS AND WEATHER CONDITIONS AND TO MANAGE, ADMINISTER, MODIFY AND CONTROL PARAMETERS FOR COLLECTION OF DATA AND INFORMATION FROM ON-BOARD VEHICLE COMPUTER SYSTEM, IN CLASS 42 (U.S. CLS. 100 AND 101).

FIRST USE 1-0-2008; IN COMMERCE 1-0-2008.

FOR: PROVIDING A DATABASE OF DRIVER BEHAVIOR ESTABLISHING A DRIVER RISK INDEX AND DRIVER RISK SCORES FOR THE PURPOSE OF IMPROVING DRIVER SAFETY AND REDUCING RISKY DRIVER BEHAVIOR, IN CLASS 45 (U.S. CLS. 100 AND 101).

FIRST USE 1-0-2008; IN COMMERCE 1-0-2008.

THE MARK CONSISTS OF STANDARD CHARACTERS WITHOUT CLAIM TO ANY PARTICULAR FONT, STYLE, SIZE, OR COLOR.

SN 77-576,517, FILED 9-23-2008.

ELLEN PERKINS, EXAMINING ATTORNEY



# United States of America

United States Patent and Trademark Office

# DOLLYWOOD

**Reg. No. 4,135,789**

**Registered May 1, 2012**

**Int. Cl.: 41**

**SERVICE MARK**

**PRINCIPAL REGISTER**

THE DOLLYWOOD COMPANY (TENNESSEE JOINT VENTURE)  
1020 DOLLYWOOD LANE  
PIGEON FORGE, TN 37863

FOR: ENTERTAINMENT SERVICES, NAMELY, DINNER SHOWS AND LIVE MUSICAL, DANCE, COMEDY, MAGIC, AND THEATRICAL PERFORMANCES, IN CLASS 41 (U.S. CLS. 100, 101 AND 107).

FIRST USE 5-2-1986; IN COMMERCE 5-2-1986.

THE MARK CONSISTS OF STANDARD CHARACTERS WITHOUT CLAIM TO ANY PARTICULAR FONT, STYLE, SIZE, OR COLOR.

OWNER OF U.S. REG. NOS. 1,420,192, 1,430,622, AND OTHERS.

SN 77-579,774, FILED 9-26-2008.

DOMINIC J. FERRAIUOLO, EXAMINING ATTORNEY



*David J. Kyffers*

Director of the United States Patent and Trademark Office

# United States of America

United States Patent and Trademark Office

## WAVERLEY HILLS

**Reg. No. 4,135,790**

**Registered May 1, 2012**

**Int. Cl.: 33**

**TRADEMARK**

**PRINCIPAL REGISTER**

WAVERLEY HILL WINES (PTY) LIMITED (SOUTH AFRICA COMPANY)  
R46, TULBAGH/CERES ROADS, WAVERLEY  
WESTERN CAPE, SOUTH AFRICA

FOR: ALCOHOLIC BEVERAGES EXCEPT BEERS, NAMELY, WINES, IN CLASS 33 (U.S. CLS. 47 AND 49).

FIRST USE 10-1-2004; IN COMMERCE 1-30-2012.

THE MARK CONSISTS OF STANDARD CHARACTERS WITHOUT CLAIM TO ANY PARTICULAR FONT, STYLE, SIZE, OR COLOR.

SN 77-582,337, FILED 9-30-2008.

AMY C. KEAN, EXAMINING ATTORNEY



*David J. Kappas*

Director of the United States Patent and Trademark Office

# United States of America

United States Patent and Trademark Office



**Reg. No. 4,135,791**

**Registered May 1, 2012**

**Int. Cls.: 9 and 41**

**TRADEMARK**

**SERVICE MARK**

**PRINCIPAL REGISTER**

NGH JAPAN CO., LTD. (JAPAN CORPORATION)  
6-4, TSUKIJI 5-CHOME, CHUO-KU  
TOKYO, JAPAN 104-8439

FOR: DOWNLOADABLE ELECTRONIC PUBLICATIONS IN THE FIELD OF NATURAL GAS-HYDRATES, IN CLASS 9 (U.S. CLS. 21, 23, 26, 36 AND 38).

FIRST USE 4-0-2007; IN COMMERCE 3-6-2009.

FOR: PUBLISHING ELECTRONIC PUBLICATIONS, IN CLASS 41 (U.S. CLS. 100, 101 AND 107).

FIRST USE 4-0-2007; IN COMMERCE 3-6-2009.

NO CLAIM IS MADE TO THE EXCLUSIVE RIGHT TO USE "NGH JAPAN", APART FROM THE MARK AS SHOWN.

THE COLOR(S) RED AND BLUE IS/ARE CLAIMED AS A FEATURE OF THE MARK.

THE MARK CONSISTS OF THE WORDS "NGH JAPAN" IN RED LOCATED IN THE CENTER OF TWO OVERLAPPING ELLIPSES, THE LONG AXES OF THE ELLIPSES HAVING DIFFERENT LENGTHS WITH EACH LONG AXIS ORIENTED FROM 2:00 O'CLOCK TO 8:00 O'CLOCK AND EACH HAVING A SHORT AXIS OF THE SAME LENGTH. THE PORTION FORMED BETWEEN THE TWO ELLIPSES AT THE 2:00 O'CLOCK POSITION BEING COLORED RED AND THE PORTION FORMED BETWEEN THE TWO ELLIPSES AT THE 8:00 O'CLOCK POSITION BEING COLORED BLUE.

SN 77-587,866, FILED 10-7-2008.

AMEEN IMAM, EXAMINING ATTORNEY



*David J. Kybas*

Director of the United States Patent and Trademark Office

# United States of America

United States Patent and Trademark Office

# WAYS SMART

**Reg. No. 4,135,792**

**Registered May 1, 2012**

**Int. Cls.: 9, 41, 42, and  
45**

**TRADEMARK**

**SERVICE MARK**

**PRINCIPAL REGISTER**

INTHINC TECHNOLOGY SOLUTIONS, INC. (DELAWARE CORPORATION)  
SUITE 100  
4225 WEST LAKE PARK BOULEVARD  
WEST VALLEY CITY, UT 84120

FOR: EVENT DATA RECORDERS; COMPUTER HARDWARE AND SOFTWARE FOR RECORDING, MONITORING AND ANALYSIS OF DATA RELATING TO VEHICLE INFORMATION, DRIVER BEHAVIOR, VEHICLE LOCATION INFORMATION AND EVENTS OCCURRING DURING VEHICLE OPERATION AND TRANSFER OF SAME BETWEEN COMPUTERS AND ON-BOARD VEHICLE INFORMATION RECORDING DEVICE; SOFTWARE FOR MONITORING AND EVALUATING DRIVER BEHAVIORS AND VEHICLE PERFORMANCE AND EFFICIENCY AND FOR USE IN PROCESSING AND ASSESSING RISK FACTORS, RISK INDEXES AND SCORES ASSOCIATED WITH DRIVER BEHAVIOR OR FLEET MANAGEMENT; COMPUTER HARDWARE AND SOFTWARE FOR ACCESSING DRIVER PERFORMANCE DATA AND INFORMATION GENERATED BY DRIVERS OF VEHICLES AND MONITORING VEHICLES WHEN DRIVER BEHAVIOR EXCEEDS OR MEETS PRE-PROGRAMMED PARAMETERS RELATED TO VEHICLE OPERATION; COMPUTER HARDWARE AND SOFTWARE FOR SENDING REAL TIME ALERTS VIA SATELLITE, WIRELESS AND CELLULAR TRANSMISSION NOTIFYING OF CHANGE IN STATUS OF DRIVER BEHAVIOR WHICH EXCEEDS OR MEETS PRE-PROGRAMMED PARAMETERS; HARDWARE AND SOFTWARE FOR IN-CAR TELEPHONE CALLING; VEHICLE SAFETY EQUIPMENT AND HARDWARE, NAMELY, 24 HOUR EMERGENCY ASSISTANCE UNIT COMPRISED OF A CELLULAR TELEPHONE, COMPUTER HARDWARE AND COMPUTER SOFTWARE FOR USE IN TRANSMITTING VOICE MESSAGES AND DATA, AND FOR USE IN TRANSMITTING EMERGENCY ALERTS, VEHICLE LOCATION AND OTHER DATA RELEVANT TO PROVIDING VEHICLE OR EMERGENCY SERVICES, IN CLASS 9 (U.S. CLS. 21, 23, 26, 36 AND 38).

FIRST USE 5-0-2004; IN COMMERCE 5-0-2004.

FOR: PROVIDING DRIVER SAFETY EDUCATION TO INDIVIDUALS AND COMPANIES, NAMELY, PROVIDING GROUP AND INDIVIDUAL INSTRUCTION IN THE FIELD OF DRIVER SAFETY FEATURING IN-VEHICLE FEEDBACK SYSTEMS AND DRIVING PERFORMANCE MANAGEMENT; PROVIDING DRIVER SAFETY TRAINING FEATURING USE OF ON-BOARD HARDWARE AND SOFTWARE TO RECOVER, ANALYZE, AND ASSESS DRIVER PERFORMANCE, RISK FACTORS AND EVENTS OCCURRING DURING VEHICLE OPERATION; EDUCATIONAL SERVICES, NAMELY, CONDUCTING CLASSES, SEMINARS,



*David J. Kybas*

Director of the United States Patent and Trademark Office

**Reg. No. 4,135,792** AND WORKSHOPS IN THE FIELD OF MOTOR VEHICLE SAFETY, DRIVER SAFETY AND SAFE DRIVING; DRIVER SAFETY TRAINING; VEHICLE DRIVING INSTRUCTION, NAMELY, DRIVING INSTRUCTION FOR LAND VEHICLES, IN CLASS 41 (U.S. CLS. 100, 101 AND 107).

FIRST USE 5-0-2004; IN COMMERCE 5-0-2004.

FOR: PROCESSING DATA AND INFORMATION, NAMELY, INTERPRETING COLLECTED AUDIO, VIDEO, TEXT AND DIGITAL CONTENT RECEIVED FROM ON-BOARD VEHICLE COMPUTER SYSTEM RELATED TO DRIVER BEHAVIOR AND HABITS, VEHICLE INFORMATION, ROAD CONDITIONS AND WEATHER CONDITIONS AND ANALYSIS OF SUCH DATA AND INFORMATION FOR REPORTING AND STORAGE IN A DATABASE; PROVIDING TEMPORARY USE OF ONLINE NON-DOWNLOADABLE SOFTWARE FOR CUSTOMERS TO REMOTELY ACCESS INFORMATION AND DATA RELATED TO DRIVING HABITS AND BEHAVIOR OF AN OPERATOR OF A PARTICULAR VEHICLE, TECHNICAL AND MECHANICAL OPERATING INFORMATION OF THE VEHICLE, ROAD CONDITIONS AND WEATHER CONDITIONS AND TO MANAGE, ADMINISTER, MODIFY AND CONTROL PARAMETERS FOR COLLECTION OF DATA AND INFORMATION FROM ON-BOARD VEHICLE COMPUTER SYSTEM, IN CLASS 42 (U.S. CLS. 100 AND 101).

FIRST USE 5-0-2004; IN COMMERCE 5-0-2004.

FOR: PROVIDING A DATABASE OF DRIVER BEHAVIOR ESTABLISHING A DRIVER RISK INDEX AND DRIVER RISK SCORES FOR THE PURPOSE OF IMPROVING DRIVER SAFETY AND REDUCING RISKY DRIVER BEHAVIOR, IN CLASS 45 (U.S. CLS. 100 AND 101).

FIRST USE 5-0-2004; IN COMMERCE 5-0-2004.

THE MARK CONSISTS OF STANDARD CHARACTERS WITHOUT CLAIM TO ANY PARTICULAR FONT, STYLE, SIZE, OR COLOR.

SN 77-588,210, FILED 10-8-2008.

ELLEN PERKINS, EXAMINING ATTORNEY

# United States of America

United States Patent and Trademark Office

## FilmNation Entertainment

**Reg. No. 4,135,793**

**Registered May 1, 2012**

**Int. Cl.: 41**

**SERVICE MARK**

**PRINCIPAL REGISTER**

FILMNATION MANAGEMENT LLC (DELAWARE LIMITED LIABILITY COMPANY)  
150 WEST 22ND ST, 9TH FLOOR  
NEW YORK, NY 10011

FOR: PROVIDING AN INTERNET WEBSITE CONTAINING REFERENCE MATERIAL ON FILMS, ACTORS, DIRECTORS, BACKGROUND ON FILMS AND OTHER INFORMATION ABOUT THE FILM INDUSTRY, AND ENTERTAINMENT NEWS; PRODUCTION OF AUDIO AND VIDEO RECORDINGS ON A WIDE VARIETY OF THEMES, IN CLASS 41 (U.S. CLS. 100, 101 AND 107).

FIRST USE 2-0-2010; IN COMMERCE 2-0-2010.

THE MARK CONSISTS OF STANDARD CHARACTERS WITHOUT CLAIM TO ANY PARTICULAR FONT, STYLE, SIZE, OR COLOR.

NO CLAIM IS MADE TO THE EXCLUSIVE RIGHT TO USE "ENTERTAINMENT", APART FROM THE MARK AS SHOWN.

SN 77-605,195, FILED 10-31-2008.

ASMAT KHAN, EXAMINING ATTORNEY



*David J. Kypos*

Director of the United States Patent and Trademark Office

# United States of America

United States Patent and Trademark Office

## CHICAGO BOOTH

The University of Chicago Booth School of Business

**Reg. No. 4,135,794**

**Registered May 1, 2012**

**Int. Cl.: 18**

**TRADEMARK**

**PRINCIPAL REGISTER**

UNIVERSITY OF CHICAGO, THE (ILLINOIS NOT-FOR-PROFIT CORPORATION)  
5801 ELLIS AVENUE  
CHICAGO, IL 60637

FOR: TOTE BAGS, BOOK BAGS, BRIEFCASES, IN CLASS 18 (U.S. CLS. 1, 2, 3, 22 AND 41).

FIRST USE 1-0-2009; IN COMMERCE 1-0-2009.

OWNER OF U.S. REG. NOS. 1,876,527 AND 2,668,437.

NO CLAIM IS MADE TO THE EXCLUSIVE RIGHT TO USE "CHICAGO", APART FROM THE MARK AS SHOWN.

THE MARK CONSISTS OF THE WORDS "CHICAGO BOOTH" TOGETHER WITH A DESIGN AND THE WORDS "THE UNIVERSITY OF CHICAGO BOOTH SCHOOL OF BUSINESS".

SN 77-609,374, FILED 11-6-2008.

MICHELE SWAIN, EXAMINING ATTORNEY



*David J. Kyjars*

Director of the United States Patent and Trademark Office

# United States of America

United States Patent and Trademark Office

# GRIPEN

**Reg. No. 4,135,795**

**Registered May 1, 2012**

**Int. Cls.: 7, 9, 12, 25, 28,  
and 41**

SAAB-BAE SYSTEMS GRIPEN AKTIEBOLAG (SWEDEN CORPORATION)  
C/O SAAB AB  
LINKÖPING, SWEDEN S58188

FOR: (BASED ON 44(E)) MOTORS AND ENGINES FOR AIRCRAFT, TRANSMISSION GEAR BOXES FOR AIRCRAFT, IN CLASS 7 (U.S. CLS. 13, 19, 21, 23, 31, 34 AND 35).

FOR: (BASED ON 44(E)) RADAR, STEERING AND NAVIGATION EQUIPMENT, NAMELY, AN ONBOARD COMPUTER FOR AIRCRAFT COMPRISING A GLOBAL POSITIONING SYSTEM, RADIO RECEIVERS, ANTENNAS, DISPLAY MONITORS, COMPUTER HARDWARE AND COMPUTER OPERATING SOFTWARE, IN CLASS 9 (U.S. CLS. 21, 23, 26, 36 AND 38).

**TRADEMARK**

**SERVICE MARK**

**PRINCIPAL REGISTER**

FOR: (BASED ON 44(E)) MILITARY AIRPLANES AND HELICOPTERS, IN CLASS 12 (U.S. CLS. 19, 21, 23, 31, 35 AND 44).

FOR: (BASED ON USE IN COMMERCE) CAPS, JACKETS, SWEATERS, AND T-SHIRTS, IN CLASS 25 (U.S. CLS. 22 AND 39).

FIRST USE 2-25-1997; IN COMMERCE 2-25-1997.

FOR: (BASED ON 44(E)) GAMES, PLAYTHINGS, TOYS, GYMNAS TIC AND SPORTING ARTICLES, NAMELY, GOLF BALLS, GOLF BAGS, GOLF GLOVES AND GOLF CLUBS, IN CLASS 28 (U.S. CLS. 22, 23, 38 AND 50).

FOR: (BASED ON USE IN COMMERCE) PRACTICAL TRAINING AND EDUCATION IN THE NATURE OF CLASSES, CONFERENCES, SEMINARS, SYMPOSIUMS, WORKSHOPS AND LECTURES, IN THE FIELD OF MILITARY AIRCRAFT, IN CLASS 41 (U.S. CLS. 100, 101 AND 107).

FIRST USE 2-25-1997; IN COMMERCE 2-25-1997.

THE MARK CONSISTS OF STANDARD CHARACTERS WITHOUT CLAIM TO ANY PARTICULAR FONT, STYLE, SIZE, OR COLOR.

PRIORITY CLAIMED UNDER SEC. 44(D) ON SWEDEN APPLICATION NO. 2008/09999, FILED 10-31-2008, REG. NO. 403845, DATED 5-22-2009, EXPIRES 5-22-2019.



*David J. Kyros*

Director of the United States Patent and Trademark Office



**Reg. No. 4,135,795** THE ENGLISH TRANSLATION OF "GRIPEN" IN THE MARK IS "GRIFFIN".

SN 77-614,665, FILED 11-14-2008.

SUNG IN, EXAMINING ATTORNEY

# United States of America

United States Patent and Trademark Office



**Reg. No. 4,135,796**

**Registered May 1, 2012**

**Int. Cls.: 35 and 42**

**SERVICE MARK**

**PRINCIPAL REGISTER**

M-I L.L.C. (DELAWARE LIMITED LIABILITY COMPANY)  
5950 NORTH COURSE DRIVE  
HOUSTON, TX 77072

FOR: LOGISTICS MANAGEMENT SERVICES PROVIDED AT SPECIALLY EQUIPPED OIL AND GAS DRILLING, EXPLORATION AND PRODUCTION FACILITIES, IN CLASS 35 (U.S. CLS. 100, 101 AND 102).

FIRST USE 1-1-2009; IN COMMERCE 1-1-2009.

FOR: TECHNICAL CONSULTING SERVICES PROVIDED AT SPECIALLY EQUIPPED OIL AND GAS DRILLING, EXPLORATION AND PRODUCTION FACILITIES, NAMELY, EVALUATION AND MEASUREMENT OF DRILLING FLUID ISSUES, EVALUATION OF ENVIRONMENTAL IMPACT AND DESIGN AND IMPLEMENTATION OF WELLBORE PRODUCTIVITY SOLUTIONS, IN CLASS 42 (U.S. CLS. 100 AND 101).

FIRST USE 1-1-2009; IN COMMERCE 1-1-2009.

NO CLAIM IS MADE TO THE EXCLUSIVE RIGHT TO USE "DEEP WATER EQUIPPED", APART FROM THE MARK AS SHOWN.

THE MARK CONSISTS OF A SHIELD DEVICE WITH THE WORDS "DEEP WATER EQUIPPED" WITH A PROMINENT LETTER "A" IN THE WORD "WATER" WITH A WAVY LINE PRESENTED ACROSS THE PROMINENT LETTER "A".

SN 77-616,489, FILED 11-18-2008.

DAVID ELTON, EXAMINING ATTORNEY



*David J. Kybas*

Director of the United States Patent and Trademark Office

# United States of America

United States Patent and Trademark Office



**Reg. No. 4,135,797**

**Registered May 1, 2012**

**Int. Cl.: 42**

**SERVICE MARK**

**PRINCIPAL REGISTER**

M-I L.L.C. (DELAWARE LIMITED LIABILITY COMPANY)  
5950 NORTH COURSE DRIVE  
HOUSTON, TX 77002

FOR: ENGINEERING SERVICES, NAMELY, ENGINEERING IN THE FIELD OF OIL AND GAS DRILLING, EXPLORATION AND PRODUCTION, IN CLASS 42 (U.S. CLS. 100 AND 101).

FIRST USE 8-1-2010; IN COMMERCE 8-1-2010.

NO CLAIM IS MADE TO THE EXCLUSIVE RIGHT TO USE "DEEP WATER CERTIFIED", APART FROM THE MARK AS SHOWN.

THE MARK CONSISTS OF A SHIELD DEVICE WITH THE WORDS "DEEP WATER CERTIFIED" WITH A PROMINENT LETTER "A" IN THE WORD "WATER" WITH A WAVY LINE PRESENTED ACROSS THE PROMINENT LETTER "A".

SN 77-616,505, FILED 11-18-2008.

DAVID ELTON, EXAMINING ATTORNEY



*David J. Kyros*

Director of the United States Patent and Trademark Office

# United States of America

United States Patent and Trademark Office

# MatteFX

**Reg. No. 4,135,798**

**Registered May 1, 2012**

**Int. Cl.: 2**

**TRADEMARK**

**PRINCIPAL REGISTER**

EXOPACK, LLC (DELAWARE LIMITED LIABILITY COMPANY)  
3070 SOUTHPORT ROAD  
SPARTANBURG, SC 29302

FOR: LACQUERS; COATINGS FOR USE ON PACKAGING; LACQUERS FOR USE ON PACKAGING; TWO-PART LACQUER SYSTEM COMPRISING A FIRST COATING HAVING CHEMICAL HYDROXYL GROUPS AND A SECOND COATING NOT HAVING CHEMICAL HYDROXYL GROUPS THAT USES FLEXOGRAPHIC PRINTING TO PRODUCE A FLEXIBLE PACKAGE SURFACE UTILIZING BOTH MATTE AND GLOSS FINISHES, IN CLASS 2 (U.S. CLS. 6, 11 AND 16).

FIRST USE 1-20-2009; IN COMMERCE 1-20-2009.

THE MARK CONSISTS OF STANDARD CHARACTERS WITHOUT CLAIM TO ANY PARTICULAR FONT, STYLE, SIZE, OR COLOR.

SN 77-624,246, FILED 12-1-2008.

LINDA ESTRADA, EXAMINING ATTORNEY



*David J. Kyros*

Director of the United States Patent and Trademark Office

# United States of America

United States Patent and Trademark Office

## ULTIMATE CHIROCARE

**Reg. No. 4,135,799**

**Registered May 1, 2012**

**Int. Cl.: 44**

**SERVICE MARK**

**PRINCIPAL REGISTER**

CAMMISA, PERRY A. (UNITED STATES INDIVIDUAL)  
3590 HOBSON RD, SUITE 301  
WOODRIDGE, IL 60517

FOR: CHIROPRACTIC SERVICES, IN CLASS 44 (U.S. CLS. 100 AND 101).

FIRST USE 9-0-2008; IN COMMERCE 9-0-2008.

THE MARK CONSISTS OF STANDARD CHARACTERS WITHOUT CLAIM TO ANY PARTICULAR FONT, STYLE, SIZE, OR COLOR.

SN 77-629,047, FILED 12-8-2008.

LINDSEY RUBIN, EXAMINING ATTORNEY



*David J. Kyffers*

Director of the United States Patent and Trademark Office

# United States of America

United States Patent and Trademark Office



**Reg. No. 4,135,800**

**Registered May 1, 2012**

**Int. Cl.: 44**

**SERVICE MARK**

**PRINCIPAL REGISTER**

CAMMISA, PERRY A. (UNITED STATES INDIVIDUAL)  
3590 HOBSON RD, SUITE 301  
WOODRIDGE, IL 60517

FOR: CHIROPRACTIC SERVICES, IN CLASS 44 (U.S. CLS. 100 AND 101).

FIRST USE 9-0-2008; IN COMMERCE 9-0-2008.

THE MARK CONSISTS OF THE IMAGE OF A CIRCLE OVER A CURVED BAND, WITH THE TERMS "ULTIMATE CHIROCARE" APPEARING BELOW THE FOREGOING.

SN 77-629,048, FILED 12-8-2008.

LINDSEY RUBIN, EXAMINING ATTORNEY



*David J. Kybas*

Director of the United States Patent and Trademark Office

# United States of America

United States Patent and Trademark Office

# Asensia

**Reg. No. 4,135,801**

**Registered May 1, 2012**

**Int. Cl.: 5**

**TRADEMARK**

**PRINCIPAL REGISTER**

DAILY WELLNESS COMPANY (CALIFORNIA CORPORATION)  
1946 YOUNG STREET #360  
HONOLULU, HI 96826

FOR: DIETARY AND NUTRITIONAL SUPPLEMENTS, IN CLASS 5 (U.S. CLS. 6, 18, 44, 46, 51 AND 52).

FIRST USE 12-8-2011; IN COMMERCE 12-8-2011.

THE MARK CONSISTS OF STANDARD CHARACTERS WITHOUT CLAIM TO ANY PARTICULAR FONT, STYLE, SIZE, OR COLOR.

SN 77-632,659, FILED 12-14-2008.

TRACY CROSS, EXAMINING ATTORNEY



*David J. Kyros*

Director of the United States Patent and Trademark Office

# United States of America

United States Patent and Trademark Office

# Conceiva

**Reg. No. 4,135,802**

**Registered May 1, 2012**

**Int. Cl.: 5**

**TRADEMARK**

**PRINCIPAL REGISTER**

DAILY WELLNESS COMPANY (CALIFORNIA CORPORATION)  
1946 YOUNG STREET #360  
HONOLULU, HI 96826

FOR: DIETARY AND NUTRITIONAL SUPPLEMENTS, IN CLASS 5 (U.S. CLS. 6, 18, 44, 46, 51 AND 52).

FIRST USE 12-8-2011; IN COMMERCE 12-8-2011.

THE MARK CONSISTS OF STANDARD CHARACTERS WITHOUT CLAIM TO ANY PARTICULAR FONT, STYLE, SIZE, OR COLOR.

SN 77-632,660, FILED 12-14-2008.

TRACY CROSS, EXAMINING ATTORNEY



*David J. Kyros*

Director of the United States Patent and Trademark Office



# United States of America

United States Patent and Trademark Office

# FABRI SPAN

**Reg. No. 4,135,803**

FABRI TRAK SYSTEMS, INC. (NEW JERSEY CORPORATION)  
2553 ROUTE 130 SOUTH SUITE 2  
CRANBURY, NJ 08512

**Registered May 1, 2012**

**Int. Cl.: 27**

FOR: FABRIC WALL COVERINGS FOR USE WITH TRACKS ATTACHED TO WALLS, IN CLASS 27 (U.S. CLS. 19, 20, 37, 42 AND 50).

**TRADEMARK**

FIRST USE 8-24-2009; IN COMMERCE 8-24-2009.

**PRINCIPAL REGISTER**

THE MARK CONSISTS OF STANDARD CHARACTERS WITHOUT CLAIM TO ANY PARTICULAR FONT, STYLE, SIZE, OR COLOR.

SN 77-636,150, FILED 12-18-2008.

JULIE VEPPUMTHARA, EXAMINING ATTORNEY



*David J. Kyffers*

Director of the United States Patent and Trademark Office

# United States of America

United States Patent and Trademark Office

## FRUITION BAR

**Reg. No. 4,135,804**

**Registered May 1, 2012**

**Int. Cl.: 29**

**TRADEMARK**

**PRINCIPAL REGISTER**

PRO VENTURES, LLC (UTAH LIMITED LIABILITY COMPANY)  
1910 PROSPECTOR AVENUE, SUITE 302  
PARK CITY, UT 84068

FOR: FRUIT-BASED ORGANIC FOOD BARS; FRUIT-BASED SNACK FOOD, IN CLASS 29  
(U.S. CL. 46).

FIRST USE 2-3-2012; IN COMMERCE 2-3-2012.

THE MARK CONSISTS OF STANDARD CHARACTERS WITHOUT CLAIM TO ANY PARTICULAR FONT, STYLE, SIZE, OR COLOR.

NO CLAIM IS MADE TO THE EXCLUSIVE RIGHT TO USE "BAR", APART FROM THE MARK AS SHOWN.

SN 77-638,570, FILED 12-23-2008.

RUSS HERMAN, EXAMINING ATTORNEY



*David J. Kybas*

Director of the United States Patent and Trademark Office

# United States of America

United States Patent and Trademark Office



**Reg. No. 4,135,805**

**Registered May 1, 2012**

**Int. Cl.: 41**

**SERVICE MARK**

**PRINCIPAL REGISTER**

KILLINGSWORTH PARTNERS, INC. (CALIFORNIA CORPORATION)  
4569 LAKE FOREST DRIVE  
LOOMIS, CA 95650

FOR: ENTERTAINMENT SERVICES, NAMELY, RECREATIONAL SPORTS ARENA FACILITIES FOR SKATEBOARDING AND INLINE SKATING, SKATE PARK FACILITIES FOR SKATEBOARDING AND INLINE SKATING, COMPETITIONS IN THE FIELD OF SKATEBOARDING AND INLINE SKATING, ENTERTAINMENT IN THE NATURE OF SKATEBOARDING AND INLINE SKATING PERFORMANCES AND EXHIBITIONS, RENTAL OF SKATEBOARDING AND INLINE SKATING EQUIPMENT, IN CLASS 41 (U.S. CLS. 100, 101 AND 107).

FIRST USE 3-14-2009; IN COMMERCE 3-14-2009.

NO CLAIM IS MADE TO THE EXCLUSIVE RIGHT TO USE "INDOOR SKATEPARK", APART FROM THE MARK AS SHOWN.

THE MARK CONSISTS OF THE UPPERCASE LETTERS "EP", FOLLOWED BY A LOWER CASE LETTER "I", FOLLOWED BY AN UPPERCASE, REVERSED LETTER "C", ALL SURROUNDED BY AN OVAL BORDER AND ATOP THE WORDS "INDOOR SKATEPARK".

SN 77-639,910, FILED 12-24-2008.

FONG HSU, EXAMINING ATTORNEY



*David J. Kybas*

Director of the United States Patent and Trademark Office

# United States of America

United States Patent and Trademark Office

# PLANEDECK

**Reg. No. 4,135,806**

**Registered May 1, 2012**

**Int. Cl.: 9**

**TRADEMARK**

**PRINCIPAL REGISTER**

GULFSTREAM AEROSPACE CORPORATION (GEORGIA CORPORATION)  
500 GULFSTREAM ROAD  
SAVANNAH, GA 31407

FOR: AIRCRAFT AVIONICS SYSTEMS CONSISTING OF COMPUTER HARDWARE AND COMPUTER SOFTWARE FOR AIRPLANE COMMUNICATION, AIRPLANE NAVIGATION AND IMPROVED SITUATIONAL AWARENESS OF AIRPORTS, WEATHER, AIR TRAFFIC AND TERRAIN; INTEGRATED PILOTS' PRIMARY FLIGHT DISPLAYS AND MULTIFUNCTION DISPLAYS, ALL SOLD AS A COMPONENT OF AN AIRPLANE, IN CLASS 9 (U.S. CLS. 21, 23, 26, 36 AND 38).

FIRST USE 6-30-2009; IN COMMERCE 6-30-2009.

THE MARK CONSISTS OF STANDARD CHARACTERS WITHOUT CLAIM TO ANY PARTICULAR FONT, STYLE, SIZE, OR COLOR.

SN 77-647,762, FILED 1-12-2009.

JAMES A. RAUEN, EXAMINING ATTORNEY



*David J. Kyffers*

Director of the United States Patent and Trademark Office

# United States of America

United States Patent and Trademark Office

## MEMBER'S MARK FINEST

**Reg. No. 4,135,807**

**Registered May 1, 2012**

**Int. Cl.: 30**

**TRADEMARK**

**PRINCIPAL REGISTER**

WAL-MART STORES, INC. (DELAWARE CORPORATION)  
702 S.W. 8TH ST.  
BENTONVILLE, AR 727160520

FOR: COFFEE, IN CLASS 30 (U.S. CL. 46).

FIRST USE 1-0-2009; IN COMMERCE 1-0-2009.

THE MARK CONSISTS OF STANDARD CHARACTERS WITHOUT CLAIM TO ANY PARTICULAR FONT, STYLE, SIZE, OR COLOR.

OWNER OF U.S. REG. NOS. 2,579,036, 2,601,390, AND OTHERS.

NO CLAIM IS MADE TO THE EXCLUSIVE RIGHT TO USE "FINEST", APART FROM THE MARK AS SHOWN.

SN 77-652,398, FILED 1-20-2009.

MICHAEL WEBSTER, EXAMINING ATTORNEY



*David J. Kybas*

Director of the United States Patent and Trademark Office

# United States of America

United States Patent and Trademark Office

## LIFE ON TOP

**Reg. No. 4,135,808**

**Registered May 1, 2012**

**Int. Cl.: 16**

**TRADEMARK**

**PRINCIPAL REGISTER**

GENERAL MEDIA COMMUNICATIONS, INC. (NEW YORK CORPORATION)  
6800 BROKEN SOUND PARKWAY NW, SUITE 100  
BOCA RATON, FL 33487

FOR: BOOKS IN THE FIELD OF ADULT ENTERTAINMENT AND EROTICA, IN CLASS 16  
(U.S. CLS. 2, 5, 22, 23, 29, 37, 38 AND 50).

FIRST USE 0-0-2009; IN COMMERCE 0-0-2009.

THE MARK CONSISTS OF STANDARD CHARACTERS WITHOUT CLAIM TO ANY PARTICULAR FONT, STYLE, SIZE, OR COLOR.

OWNER OF U.S. REG. NOS. 3,436,911 AND 4,094,055.

SN 77-653,907, FILED 1-21-2009.

Laurie Kaufman, Examining Attorney



*David J. Kybas*

Director of the United States Patent and Trademark Office

# United States of America

United States Patent and Trademark Office

# RECLAIM

**Reg. No. 4,135,809**

**Registered May 1, 2012**

**Int. Cl.: 10**

**TRADEMARK**

**PRINCIPAL REGISTER**

DEPUY, INC. (DELAWARE CORPORATION)  
700 ORTHOPAEDIC DRIVE  
WARSAW, IN 46581

FOR: ORTHOPAEDIC JOINT IMPLANTS; SURGICAL INSTRUMENTS FOR USE WITH  
ORTHOPAEDIC JOINT IMPLANTS, IN CLASS 10 (U.S. CLS. 26, 39 AND 44).

FIRST USE 11-0-2011; IN COMMERCE 11-0-2011.

THE MARK CONSISTS OF STANDARD CHARACTERS WITHOUT CLAIM TO ANY PAR-  
TICULAR FONT, STYLE, SIZE, OR COLOR.

SN 77-653,977, FILED 1-21-2009.

AMY C. KEAN, EXAMINING ATTORNEY



*David J. Kappas*

Director of the United States Patent and Trademark Office

# United States of America

United States Patent and Trademark Office

## ROYAL C POP

**Reg. No. 4,135,810**

**Registered May 1, 2012**

**Int. Cl.: 41**

**SERVICE MARK**

**PRINCIPAL REGISTER**

LITEMAN, GODNI AMIR (ISRAEL INDIVIDUAL)  
115 EAST 57TH STREET SUITE 520  
NEW YORK, NY 10122

FOR: ENTERTAINMENT IN THE NATURE OF ORCHESTRA PERFORMANCES; ENTERTAINMENT IN THE NATURE OF VISUAL AND AUDIO PERFORMANCES, NAMELY, MUSICAL BAND, ROCK GROUP, GYMNASTIC, DANCE, AND BALLET PERFORMANCES; ENTERTAINMENT SERVICES IN THE NATURE OF LIVE MUSICAL PERFORMANCES; ENTERTAINMENT SERVICES, NAMELY, PROVIDING A WEB SITE FEATURING PHOTOGRAPHIC, AUDIO, VIDEO AND PROSE PRESENTATIONS FEATURING MUSIC AND DANCE PERFORMANCE; ENTERTAINMENT SERVICES, NAMELY, PROVIDING A WEB SITE FEATURING MUSICAL PERFORMANCES, MUSICAL VIDEOS, RELATED FILM CLIPS, PHOTOGRAPHS, AND OTHER MULTIMEDIA MATERIALS FEATURING MUSIC AND DANCE PERFORMANCES; ENTERTAINMENT SERVICES, NAMELY, PROVIDING PRERECORDED MUSIC, INFORMATION IN THE FIELD OF MUSIC, AND COMMENTARY AND ARTICLES ABOUT MUSIC, ALL ON-LINE VIA A GLOBAL COMPUTER NETWORK; ENTERTAINMENT, NAMELY, LIVE PERFORMANCES BY A MUSICAL BAND; ENTERTAINMENT, NAMELY, PRODUCTION OF CDS, DVDS, AUDIO AND VIDEO, IN CLASS 41 (U.S. CLS. 100, 101 AND 107).

FIRST USE 1-1-2010; IN COMMERCE 1-1-2011.

THE MARK CONSISTS OF STANDARD CHARACTERS WITHOUT CLAIM TO ANY PARTICULAR FONT, STYLE, SIZE, OR COLOR.

SN 77-655,644, FILED 1-23-2009.

MEGHAN REINHART, EXAMINING ATTORNEY



*David J. Kyros*

Director of the United States Patent and Trademark Office



# United States of America

United States Patent and Trademark Office



**Reg. No. 4,135,811**

**Registered May 1, 2012**

**Int. Cl.: 35**

**SERVICE MARK**

**PRINCIPAL REGISTER**

GLENN, GERALD (UNITED STATES INDIVIDUAL)  
618 5TH STREET  
VALLEJO, CA 94590 AND

SIMON, PARISH (UNITED STATES INDIVIDUAL)  
618 5TH STREET  
VALLEJO, CA 94590

FOR: CLUB SERVICES, NAMELY, PROMOTING THE INTERESTS OF MOTORCYCLE RIDING, IN CLASS 35 (U.S. CLS. 100, 101 AND 102).

FIRST USE 9-1-2006; IN COMMERCE 7-20-2007.

NO CLAIM IS MADE TO THE EXCLUSIVE RIGHT TO USE "CALIFORNIA 80 WEST RIDERS MC", APART FROM THE MARK AS SHOWN.

THE MARK CONSISTS OF THE WORD "CALIFORNIA" OVER A LINE OVER THE TERM "80 WEST" IN THE DESIGN OF STREET SIGN. BELOW THE DESIGN OF A STREET SIGN APPEARS THE WORDING "RIDERS MC" INSIDE A CONCENTRIC RECTANGLE.

SN 77-658,750, FILED 1-28-2009.

MICHAEL WIENER, EXAMINING ATTORNEY



*David J. Kybas*

Director of the United States Patent and Trademark Office

# United States of America

United States Patent and Trademark Office

# WAVE

**Reg. No. 4,135,812**

**Registered May 1, 2012**

**Int. Cl.: 9**

**TRADEMARK**

**PRINCIPAL REGISTER**

GLORY LTD. (JAPAN CORPORATION)  
3-1, SHIMOTENO 1-CHOME  
HIMEJI-SHI, HYOGO-KEN, JAPAN

FOR: MONEY COUNTING AND SORTING MACHINES; MONEY COUNTING AND SORTING MACHINES EQUIPPED WITH SAFETY CASHBOXES; CASH DEPOSITOR MACHINES; CASH DISPENSERS; MONEY HANDLING MACHINES FOR CASHIER/VAULT, NAMELY, MONEY HANDLING MACHINES FOR COUNTING, SORTING, DISPENSING AND PROCESSING COINS, CHECKS, OR BANKNOTES FOR USE BY CASHIERS AND THAT ARE PLACED IN VAULTS; CASH AND/OR CHECK MANAGEMENT SYSTEMS COMPRISED OF COMPUTER HARDWARE, COMPUTER PROGRAMS USED FOR CASH AND/OR CHECK MANAGEMENT, AND MONEY COUNTING AND SORTING MACHINES; MONEY EXCHANGERS; COIN COUNTING AND WRAPPING/PACKING MACHINES; BANKNOTE STRAPPING MACHINES, NAMELY, MACHINES FOR COUNTING AND STRAPPING TOGETHER PREDETERMINED VALUES OF BANKNOTES; CASH SETTLEMENT SYSTEM COMPRISED OF COMPUTER HARDWARE, COMPUTER PROGRAMS USED FOR CASH ACCOUNTING AND SETTLEMENT, AND CASH RECEIVING/DISPENSING APPARATUS; BANKNOTE COUNTING MACHINES; COUNTERFEIT FALSE COIN DETECTING MACHINES; BANKNOTE CHECKERS IN THE NATURE OF BANKNOTE RECOGNITION MACHINES FOR DETECTING COUNTERFEIT NOTES; SORTING MACHINES FOR FITNESS OF BANKNOTES, NAMELY, AUTOMATED PAPER MONEY SORTING MACHINES; CASH DISPENSING MACHINES; CASH DEPOSIT AND/OR DISPENSING MACHINES; COIN COUNTING MACHINES; CHECK DEPOSIT MACHINES; COMPUTER SOFTWARE FOR CASH AND/OR CHECK MANAGEMENT, IN CLASS 9 (U.S. CLS. 21, 23, 26, 36 AND 38).



FIRST USE 10-0-1997; IN COMMERCE 7-19-2011.

THE MARK CONSISTS OF STANDARD CHARACTERS WITHOUT CLAIM TO ANY PARTICULAR FONT, STYLE, SIZE, OR COLOR.

SN 77-660,324, FILED 1-30-2009.

AMEEN IMAM, EXAMINING ATTORNEY

*David J. Kybas*

Director of the United States Patent and Trademark Office

# United States of America

United States Patent and Trademark Office

## L. & C. HARDTMUTH

**Reg. No. 4,135,813**

**Registered May 1, 2012**

**Int. Cl.: 16**

**TRADEMARK**

**PRINCIPAL REGISTER**

CHARTPAK, INC. (DELAWARE CORPORATION)  
510 BROAD HOLLOW ROAD, STE. 205  
MELVILLE, NY 11747

FOR: FINE WRITING INSTRUMENTS, IN CLASS 16 (U.S. CLS. 2, 5, 22, 23, 29, 37, 38 AND 50).

FIRST USE 2-22-2012; IN COMMERCE 2-22-2012.

THE MARK CONSISTS OF STANDARD CHARACTERS WITHOUT CLAIM TO ANY PARTICULAR FONT, STYLE, SIZE, OR COLOR.

OWNER OF U.S. REG. NOS. 504,631, 3,151,716, AND 3,159,431.

SN 77-664,207, FILED 2-5-2009.

MATTHEW PAPPAS, EXAMINING ATTORNEY



*David J. Kyffers*

Director of the United States Patent and Trademark Office

# United States of America

United States Patent and Trademark Office

## FROM MY HEART 2 YOU

**Reg. No. 4,135,814**

BOXER, LESTER (UNITED STATES INDIVIDUAL)  
448 SPALDING DRIVE  
BEVERLY HILLS, CA 90212

**Registered May 1, 2012**

**Int. Cl.: 16**

FOR: GIFT BOXES WITH PRERECORDED MUSIC AND RECORDABLE PERSONALIZED MESSAGE, IN CLASS 16 (U.S. CLS. 2, 5, 22, 23, 29, 37, 38 AND 50).

**TRADEMARK**

FIRST USE 12-15-2011; IN COMMERCE 12-15-2011.

**PRINCIPAL REGISTER**

THE MARK CONSISTS OF STANDARD CHARACTERS WITHOUT CLAIM TO ANY PARTICULAR FONT, STYLE, SIZE, OR COLOR.

SN 77-664,578, FILED 2-5-2009.

ELLEN PERKINS, EXAMINING ATTORNEY



*David J. Kybas*

Director of the United States Patent and Trademark Office

# United States of America

United States Patent and Trademark Office



**Reg. No. 4,135,815**

**Registered May 1, 2012**

**Int. Cls.: 35 and 36**

**SERVICE MARK**

**PRINCIPAL REGISTER**

UNIVERSITY ACCOUNTING SERVICE, LLC (WISCONSIN LIMITED LIABILITY COMPANY)  
PO BOX 510955  
2520 SOUTH 170TH STREET  
NEW BERLIN, WI 53151

FOR: ACCOUNTS RECEIVABLE MANAGEMENT SERVICES, IN CLASS 35 (U.S. CLS. 100, 101 AND 102).

FIRST USE 3-0-2009; IN COMMERCE 3-0-2009.

FOR: DEBT RECOVERY AND COLLECTION SERVICES, IN CLASS 36 (U.S. CLS. 100, 101 AND 102).

FIRST USE 3-0-2009; IN COMMERCE 3-0-2009.

NO CLAIM IS MADE TO THE EXCLUSIVE RIGHT TO USE "UNIVERSITY ACCOUNTING SERVICE, LLC", APART FROM THE MARK AS SHOWN.

THE MARK CONSISTS OF WORDS "UAS UNIVERSITY ACCOUNTING SERVICE, LLC" WITH A STYLIZED STAR SHAPE BEHIND THE LETTER "U" IN THE WORD "UAS".

SN 77-668,916, FILED 2-12-2009.

MICHAEL ENGEL, EXAMINING ATTORNEY



*David J. Kybas*

Director of the United States Patent and Trademark Office

# United States of America

United States Patent and Trademark Office

## POWERED BY POPCORN

**Reg. No. 4,135,816**

**Registered May 1, 2012**

**Int. Cl.: 36**

**SERVICE MARK**

**PRINCIPAL REGISTER**

WEAVER POPCORN COMPANY, INC. (INDIANA CORPORATION)  
SUITE 100  
14470 BERGEN BLVD.  
NOBLESVILLE, IN 46060

FOR: CHARITABLE FUNDRAISING SERVICES, NAMELY, ASSISTING OTHERS IN RAISING MONEY THROUGH THE SALE OF POPCORN AND POPCORN BASED SNACK PRODUCTS, IN CLASS 36 (U.S. CLS. 100, 101 AND 102).

FIRST USE 6-0-2009; IN COMMERCE 6-0-2009.

THE MARK CONSISTS OF STANDARD CHARACTERS WITHOUT CLAIM TO ANY PARTICULAR FONT, STYLE, SIZE, OR COLOR.

NO CLAIM IS MADE TO THE EXCLUSIVE RIGHT TO USE "POPCORN", APART FROM THE MARK AS SHOWN.

SN 77-674,143, FILED 2-19-2009.

ANDREW LEASER, EXAMINING ATTORNEY



*David J. Kyros*

Director of the United States Patent and Trademark Office

# United States of America

United States Patent and Trademark Office



**Reg. No. 4,135,817**

**Registered May 1, 2012**

**Int. Cl.: 21**

**TRADEMARK**

**PRINCIPAL REGISTER**

PAMELA MCCREARY (UNITED STATES INDIVIDUAL)  
2261 NORTH 68TH STREET  
WAUWATOSA, WI 53213

FOR: MUGS, IN CLASS 21 (U.S. CLS. 2, 13, 23, 29, 30, 33, 40 AND 50).

FIRST USE 1-1-2011; IN COMMERCE 1-1-2011.

THE MARK CONSISTS OF THE SYMBOL FOR THE WORD "AT" AND THE SYMBOL FOR THE WORD "PEACE".

SN 77-674,589, FILED 2-20-2009.

RENEE SERVANCE, EXAMINING ATTORNEY



*David J. Kybas*

Director of the United States Patent and Trademark Office

# United States of America

United States Patent and Trademark Office

# Sports Kitten

**Reg. No. 4,135,818**

**Registered May 1, 2012**

**Int. Cl.: 25**

**TRADEMARK**

**PRINCIPAL REGISTER**

STRONG, ANGELA M. (UNITED STATES INDIVIDUAL)  
3030 BRISBANE DRIVE  
MOUNT JULIET, TN 37122

FOR: ATHLETIC APPAREL, NAMELY, SHIRTS, PANTS, JACKETS, FOOTWEAR, HATS AND CAPS, ATHLETIC UNIFORMS; ATHLETIC SHOES; BEACH SHOES; BELTS; CANVAS SHOES; CHILDREN'S AND INFANTS' CLOTH BIBS; COATS FOR MEN AND WOMEN; CORSETS; FOOTWEAR FOR WOMEN; HOODS; INFANT AND TODDLER ONE PIECE CLOTHING; JERSEYS; TOPS; WOMEN'S SHOES; WOMEN'S UNDERWEAR, IN CLASS 25 (U.S. CLS. 22 AND 39).

FIRST USE 7-21-2011; IN COMMERCE 7-21-2011.

THE MARK CONSISTS OF STANDARD CHARACTERS WITHOUT CLAIM TO ANY PARTICULAR FONT, STYLE, SIZE, OR COLOR.

NO CLAIM IS MADE TO THE EXCLUSIVE RIGHT TO USE "SPORTS", APART FROM THE MARK AS SHOWN.

SN 77-677,068, FILED 2-24-2009.

ROBERT STRUCK, EXAMINING ATTORNEY



*David J. Kyros*

Director of the United States Patent and Trademark Office



**United States of America**  
United States Patent and Trademark Office

# PRIMAX

**Reg. No. 4,135,819**

**Registered May 1, 2012**

**Int. Cl.: 9**

**TRADEMARK**

**PRINCIPAL REGISTER**

MINE SAFETY APPLIANCES COMPANY (PENNSYLVANIA CORPORATION)  
1000 CRANBERRY WOODS DRIVE  
CRANBERRY TOWNSHIP, PA 16066

FOR: GAS MONITORS FOR INDICATING OXYGEN, COMBUSTIBLE GASES OR TOXIC GASES, AND PARTS THEREFOR, IN CLASS 9 (U.S. CLS. 21, 23, 26, 36 AND 38).

FIRST USE 11-21-2011; IN COMMERCE 11-21-2011.

THE MARK CONSISTS OF STANDARD CHARACTERS WITHOUT CLAIM TO ANY PARTICULAR FONT, STYLE, SIZE, OR COLOR.

SN 77-677,808, FILED 2-25-2009.

PRISCILLA MILTON, EXAMINING ATTORNEY



*David J. Kybas*

Director of the United States Patent and Trademark Office

# United States of America

United States Patent and Trademark Office

## SMOOTH TOUCH

**Reg. No. 4,135,820**

**Registered May 1, 2012**

**Int. Cl.: 8**

**TRADEMARK**

**PRINCIPAL REGISTER**

PACE SHAVE, INC. (CALIFORNIA CORPORATION)  
2199 BRITANIA BOULEVARD  
SAN DIEGO, CA 92154

FOR: RAZORS AND RAZOR BLADES, IN CLASS 8 (U.S. CLS. 23, 28 AND 44).

FIRST USE 3-8-2012; IN COMMERCE 3-8-2012.

THE MARK CONSISTS OF STANDARD CHARACTERS WITHOUT CLAIM TO ANY PARTICULAR FONT, STYLE, SIZE, OR COLOR.

SN 77-678,525, FILED 2-25-2009.

ESTHER BELENKER, EXAMINING ATTORNEY



*David J. Kyffers*

Director of the United States Patent and Trademark Office

# United States of America

United States Patent and Trademark Office

## ROAD WARRIOR

**Reg. No. 4,135,821**

**Registered May 1, 2012**

**Int. Cl.: 33**

**TRADEMARK**

**PRINCIPAL REGISTER**

SAN ANTONIO WINERY, INC. (CALIFORNIA CORPORATION)  
737 LAMAR STREET  
LOS ANGELES, CA 90031

FOR: WINES, IN CLASS 33 (U.S. CLS. 47 AND 49).

FIRST USE 2-29-2012; IN COMMERCE 2-29-2012.

THE MARK CONSISTS OF STANDARD CHARACTERS WITHOUT CLAIM TO ANY PARTICULAR FONT, STYLE, SIZE, OR COLOR.

SN 77-681,664, FILED 3-2-2009.

CARYN GLASSER, EXAMINING ATTORNEY



*David J. Kybas*

Director of the United States Patent and Trademark Office

# United States of America

United States Patent and Trademark Office

## STRATEGICFUSION

**Reg. No. 4,135,822**

**Registered May 1, 2012**

**Int. Cl.: 36**

**SERVICE MARK**

**PRINCIPAL REGISTER**

EMAT CAPITAL MANAGEMENT, INC. (CALIFORNIA CORPORATION)  
7474 N. FIGUEROA ST., SUITE A  
LOS ANGELES, CA 90041

FOR: BUSINESS MANAGEMENT AND CONSULTATION; INVESTMENT SERVICES, NAMELY, ASSET ACQUISITION, CONSULTATION, DEVELOPMENT AND MANAGEMENT SERVICES, IN CLASS 36 (U.S. CLS. 100, 101 AND 102).

FIRST USE 2-23-2012; IN COMMERCE 2-23-2012.

THE MARK CONSISTS OF STANDARD CHARACTERS WITHOUT CLAIM TO ANY PARTICULAR FONT, STYLE, SIZE, OR COLOR.

SN 77-685,238, FILED 3-6-2009.

KATHRYN COWARD, EXAMINING ATTORNEY



*David J. Kyros*

Director of the United States Patent and Trademark Office

# United States of America

United States Patent and Trademark Office

*SeaWing*

**Reg. No. 4,135,823**

SEAWING BOATS, LLC (WASHINGTON LIMITED LIABILITY COMPANY)  
920 CATHY CT SE  
TUMWATER, WA 98501

**Registered May 1, 2012**

**Int. Cl.: 12**

FOR: BOATS, NAMELY, FULL SIZE BOATS NOT CAPABLE OF BEING CARRIED ON A VEHICLE RACK, IN CLASS 12 (U.S. CLS. 19, 21, 23, 31, 35 AND 44).

**TRADEMARK**

FIRST USE 4-14-2010; IN COMMERCE 4-14-2010.

**PRINCIPAL REGISTER**

THE MARK CONSISTS OF THE WORD "SEAWING" STYLIZED.

SN 77-688,335, FILED 3-11-2009.

JASON TURNER, EXAMINING ATTORNEY



*David J. Kybas*

Director of the United States Patent and Trademark Office

# United States of America

United States Patent and Trademark Office

# BODYSUIT

**Reg. No. 4,135,824**

**Registered May 1, 2012**

**Int. Cl.: 3**

**TRADEMARK**

**PRINCIPAL REGISTER**

GABRIELLE STUDIO, INC. (NEW YORK CORPORATION)  
550 SEVENTH AVENUE  
NEW YORK, NY 10018

FOR: NON-MEDICATED SKIN CARE PREPARATION, NAMELY, BODY MIST; NON-MEDICATED SKIN CARE PREPARATIONS, IN CLASS 3 (U.S. CLS. 1, 4, 6, 50, 51 AND 52).

FIRST USE 2-28-2011; IN COMMERCE 2-28-2011.

THE MARK CONSISTS OF STANDARD CHARACTERS WITHOUT CLAIM TO ANY PARTICULAR FONT, STYLE, SIZE, OR COLOR.

SN 77-688,651, FILED 3-11-2009.

CAROLINE WOOD, EXAMINING ATTORNEY



*David J. Kybas*

Director of the United States Patent and Trademark Office

# United States of America

United States Patent and Trademark Office



**Reg. No. 4,135,825**

**Registered May 1, 2012**

**Int. Cl.: 9**

**TRADEMARK**

**PRINCIPAL REGISTER**

UNDER ARMOUR, INC. (MARYLAND CORPORATION)  
1020 HULL STREET  
BALTIMORE, MD 21230

FOR: EYEWEAR; GOGGLES FOR SPORTS, IN CLASS 9 (U.S. CLS. 21, 23, 26, 36 AND 38).

FIRST USE 4-10-2006; IN COMMERCE 4-10-2006.

OWNER OF U.S. REG. NOS. 2,509,632, 2,951,069, AND OTHERS.

THE MARK CONSISTS OF A STYLIZED LETTER "U" VERTICALLY OVERLAPPING A STYLIZED LETTER "A".

SN 77-690,675, FILED 3-13-2009.

BILL DAWE, EXAMINING ATTORNEY



*David J. Kyffers*

Director of the United States Patent and Trademark Office

# United States of America

United States Patent and Trademark Office

## UNDER ARMOUR

**Reg. No. 4,135,826**

**Registered May 1, 2012**

**Int. Cl.: 9**

**TRADEMARK**

**PRINCIPAL REGISTER**

UNDER ARMOUR, INC. (MARYLAND CORPORATION)  
1020 HULL STREET  
BALTIMORE, MD 21230

FOR: EYEWEAR; GOGGLES FOR SPORTS, IN CLASS 9 (U.S. CLS. 21, 23, 26, 36 AND 38).

FIRST USE 4-10-2006; IN COMMERCE 4-10-2006.

THE MARK CONSISTS OF STANDARD CHARACTERS WITHOUT CLAIM TO ANY PARTICULAR FONT, STYLE, SIZE, OR COLOR.

OWNER OF U.S. REG. NOS. 2,279,668, 3,501,773, AND OTHERS.

SN 77-690,683, FILED 3-13-2009.

BILL DAWE, EXAMINING ATTORNEY



*David J. Kybas*

Director of the United States Patent and Trademark Office



# United States of America

United States Patent and Trademark Office



**Reg. No. 4,135,827**

**Registered May 1, 2012**

**Int. Cls.: 6 and 17**

**TRADEMARK**

**PRINCIPAL REGISTER**

HOLDING SOPREMA (FRANCE LIMITED LIABILITY COMPANY)  
14, RUE DE SAINT-NAZAIRE  
STRASBOURG 67100, FRANCE 67100

FOR: CONSTRUCTION MATERIALS FOR RESIDENTIAL AND COMMERCIAL SOUND-PROOFING USES, NAMELY, METAL ANCHORING SYSTEM FOR CEILINGS COMPRISED OF LIGHTWEIGHT STEEL METAL FURRINGS AND LIGHTWEIGHT STEEL METAL ANCHORS, IN CLASS 6 (U.S. CLS. 2, 12, 13, 14, 23, 25 AND 50).

FIRST USE 10-1-2010; IN COMMERCE 12-1-2008.

FOR: CONSTRUCTION MATERIALS, NAMELY, NON-METAL SUB-FLOOR SOUNDPROOFING POLYETHYLENE MEMBRANE AND POLYMER MEMBRANE COATED WITH RUBBER GRANULES FOR RESIDENTIAL AND COMMERCIAL USE, CONSTRUCTION MATERIALS IN THE NATURE OF ARCHITECTURAL ACOUSTIC PRODUCTS, NAMELY, A NON-METAL SUB-FLOOR SOUND ABSORBING AND DIFFUSING MEMBRANE FOR COMMERCIAL AND RESIDENTIAL USE; ACOUSTIC INSULATION FOR USE IN AND ON WALLS AND CEILINGS IN THE RESIDENTIAL AND COMMERCIAL CONSTRUCTION AND RENOVATION INDUSTRIES; ACOUSTICAL INSULATION FOR BUILDINGS; SOUNDPROOFING PANELS USED TO SOUNDPROOF TUBS, SPAS, WHIRLPOOL BATHS, THERAPEUTIC BATHS AND SHOWERS, IN CLASS 17 (U.S. CLS. 1, 5, 12, 13, 35 AND 50).

FIRST USE 10-1-2010; IN COMMERCE 12-1-2008.

PRIORITY CLAIMED UNDER SEC. 44(D) ON CANADA APPLICATION NO. 1427986, FILED 2-6-2009, REG. NO. TMA764378, DATED 4-19-2010, EXPIRES 4-19-2025.

NO CLAIM IS MADE TO THE EXCLUSIVE RIGHT TO USE "SOUND", APART FROM THE MARK AS SHOWN.

THE MARK CONSISTS OF A WAVE DESIGN INTERRUPTED BY A STYLIZED VERSION OF THE WORDING "RESISTOSOUND".

THE WORDING "RESISTO" HAS NO MEANING IN A FOREIGN LANGUAGE.

SN 77-702,171, FILED 3-30-2009.



*David J. Kyros*

Director of the United States Patent and Trademark Office

**Reg. No. 4,135,827** SUSAN RICHARDS, EXAMINING ATTORNEY

# United States of America

United States Patent and Trademark Office

## RESISTOSOUND

**Reg. No. 4,135,828**

**Registered May 1, 2012**

**Int. Cls.: 6 and 17**

**TRADEMARK**

**PRINCIPAL REGISTER**

HOLDING SOPREMA (FRANCE LIMITED RESPONSIBILITY CORPORATION)  
14, RUE DE SAINT-NAZAIRE  
STRASBOURG, FRANCE 67100

FOR: CONSTRUCTION MATERIALS FOR RESIDENTIAL AND COMMERCIAL SOUND-PROOFING USES, NAMELY, METAL ANCHORING SYSTEM FOR CEILINGS COMPRISED OF LIGHTWEIGHT STEEL METAL FURRINGS AND LIGHTWEIGHT STEEL METAL ANCHORS, IN CLASS 6 (U.S. CLS. 2, 12, 13, 14, 23, 25 AND 50).

FIRST USE 10-1-2010; IN COMMERCE 12-1-2008.

FOR: CONSTRUCTION MATERIALS, NAMELY, NON-METAL SUB-FLOOR SOUNDPROOFING POLYETHYLENE MEMBRANE AND POLYMER MEMBRANE COATED WITH RUBBER GRANULES FOR RESIDENTIAL AND COMMERCIAL USE, CONSTRUCTION MATERIALS IN THE NATURE OF ARCHITECTURAL ACOUSTIC PRODUCTS, NAMELY, A NON-METAL SUB-FLOOR SOUND ABSORBING AND DIFFUSING MEMBRANE FOR COMMERCIAL AND RESIDENTIAL USE; ACOUSTIC INSULATION FOR USE IN AND ON WALLS AND CEILINGS IN THE RESIDENTIAL AND COMMERCIAL CONSTRUCTION AND RENOVATION INDUSTRIES; ACOUSTICAL INSULATION FOR BUILDINGS; SOUNDPROOFING PANELS USED TO SOUNDPROOF TUBS, SPAS, WHIRLPOOL BATHS, THERAPEUTIC BATHS AND SHOWERS, IN CLASS 17 (U.S. CLS. 1, 5, 12, 13, 35 AND 50).

FIRST USE 10-1-2010; IN COMMERCE 12-1-2008.

THE MARK CONSISTS OF STANDARD CHARACTERS WITHOUT CLAIM TO ANY PARTICULAR FONT, STYLE, SIZE, OR COLOR.

OWNER OF CANADA REG. NO. TMA764377, DATED 4-19-2010, EXPIRES 4-19-2025.

SN 77-702,206, FILED 3-30-2009.

SUSAN RICHARDS, EXAMINING ATTORNEY



*David J. Kyros*

Director of the United States Patent and Trademark Office

# United States of America

United States Patent and Trademark Office

## BORED TO DEATH

**Reg. No. 4,135,829**

**Registered May 1, 2012**

**Int. Cl.: 9**

**TRADEMARK**

**PRINCIPAL REGISTER**

HOME BOX OFFICE, INC. (NEW YORK CORPORATION)  
1100 AVENUE OF THE AMERICAS  
NEW YORK, NY 10036

FOR: PRERECORDED AUDIO CD FEATURING MUSIC, DRAMA AND COMEDY RELATED TO AN ONGOING COMEDY SERIES; MAGNIFYING GLASSES, IN CLASS 9 (U.S. CLS. 21, 23, 26, 36 AND 38).

FIRST USE 9-21-2010; IN COMMERCE 9-21-2010.

THE MARK CONSISTS OF STANDARD CHARACTERS WITHOUT CLAIM TO ANY PARTICULAR FONT, STYLE, SIZE, OR COLOR.

SN 77-706,542, FILED 4-3-2009.

STEVEN R. FINE, EXAMINING ATTORNEY



*David J. Kybas*

Director of the United States Patent and Trademark Office

# United States of America

United States Patent and Trademark Office

# QS Solar

**Reg. No. 4,135,830**

**Registered May 1, 2012**

**Int. Cl.: 9**

NANTONG QIANGSHENG PHOTOVOLTAIC TECHNOLOGY CO., LTD. (CHINA CORPORATION)  
NORTH SIDE, JIA LING JIANG ROAD  
RUDONG ECONOMIC TECHN DEVELOPMENT ZONE  
RUDONG COUNTY, NANTONG, JIANGSU, CHINA 226400

**TRADEMARK**

**PRINCIPAL REGISTER**

FOR: ACCUMULATORS; ACCUMULATORS AND BATTERIES; ELECTRIC ACCUMULATORS; ELECTRONIC AND OPTICAL COMMUNICATIONS INSTRUMENTS AND COMPONENTS, NAMELY, CABLE TELEVISION TRANSMITTERS; ELECTRONIC AND OPTICAL COMMUNICATIONS INSTRUMENTS AND COMPONENTS, NAMELY, COMMUNICATION LINK TESTERS FOR TESTING COMMUNICATION LINKS; ELECTRONIC AND OPTICAL COMMUNICATIONS INSTRUMENTS AND COMPONENTS, NAMELY, DIGITAL TRANSMITTERS; ELECTRONIC AND OPTICAL COMMUNICATIONS INSTRUMENTS AND COMPONENTS, NAMELY, OPTICAL DATA LINKS; ELECTRONIC AND OPTICAL COMMUNICATIONS INSTRUMENTS AND COMPONENTS, NAMELY, OPTICAL RECEIVERS; ELECTRONIC AND OPTICAL COMMUNICATIONS INSTRUMENTS AND COMPONENTS, NAMELY, OPTICAL TRANSCEIVERS; ELECTRONIC AND OPTICAL COMMUNICATIONS INSTRUMENTS AND COMPONENTS, NAMELY, OPTICAL TRANSMITTERS; RECHARGERS FOR ELECTRIC ACCUMULATORS; SOLAR BATTERIES; SOLAR CELLS, IN CLASS 9 (U.S. CLS. 21, 23, 26, 36 AND 38).

FIRST USE 6-1-2008; IN COMMERCE 6-1-2008.

THE MARK CONSISTS OF STANDARD CHARACTERS WITHOUT CLAIM TO ANY PARTICULAR FONT, STYLE, SIZE, OR COLOR.

NO CLAIM IS MADE TO THE EXCLUSIVE RIGHT TO USE "SOLAR", APART FROM THE MARK AS SHOWN.

SN 77-707,004, FILED 4-4-2009.

DANNEAN HETZEL, EXAMINING ATTORNEY



*David J. Kyffers*

Director of the United States Patent and Trademark Office

# United States of America

United States Patent and Trademark Office

# GEDHARMA

**Reg. No. 4,135,831**

**Registered May 1, 2012**

**Int. Cl.: 35**

**SERVICE MARK**

**PRINCIPAL REGISTER**

CAPITALES DHARMA, SA DE CV SOFOM ENR (MEXICO COMPANY)  
2184 PTE. INT. 101 CONSTITUCION OBSIPADO  
MONTERREY, NUEVO LEON, MEXICO 64060

FOR: BUSINESS CONSULTING SERVICES, NAMELY, PROVIDING ASSISTANCE IN DEVELOPMENT OF BUSINESS STRATEGIES; BUSINESS OPERATIONS MANAGEMENT SERVICES; PROVIDING BUSINESS MANAGEMENT SERVICES FOR COMPANIES THAT PROVIDE FOOD; AND PROVIDING BUSINESS MANAGEMENT SERVICES FOR COMPANIES THAT PROVIDE ENERGY, IN CLASS 35 (U.S. CLS. 100, 101 AND 102).

FIRST USE 6-20-2011; IN COMMERCE 6-20-2011.

THE MARK CONSISTS OF STANDARD CHARACTERS WITHOUT CLAIM TO ANY PARTICULAR FONT, STYLE, SIZE, OR COLOR.

SN 77-714,573, FILED 4-15-2009.

MICHAEL WEBSTER, EXAMINING ATTORNEY



*David J. Kyffers*

Director of the United States Patent and Trademark Office

# United States of America

United States Patent and Trademark Office

## ROCKFIN AMERICAS

**Reg. No. 4,135,832**

**Registered May 1, 2012**

**Int. Cl.: 7**

**TRADEMARK**

**PRINCIPAL REGISTER**

HELGESEN INDUSTRIES, INC. (WISCONSIN CORPORATION)  
7261 HIGHWAY 60 WEST  
HARTFORD, WI 53027

FOR: HYDRAULIC COMPONENT PARTS FOR POWER TRANSMISSIONS, CONTROL SYSTEMS AND INDUSTRIAL OIL FILTRATION SYSTEMS, NAMELY, HYDRAULIC TURBINES, HYDRAULIC VALVE ACTUATORS, HYDRAULIC CONTROLS FOR MACHINES, MOTORS AND ENGINES, AND HYDRAULIC LUBE, OIL UNIT, AND GAS UNIT CONTROLS FOR STEAM TURBINE ENGINES AND TURBINES, ALL EXCLUDING VEHICLE HYDRAULIC SYSTEMS, IN CLASS 7 (U.S. CLS. 13, 19, 21, 23, 31, 34 AND 35).

FIRST USE 12-1-2010; IN COMMERCE 12-1-2010.

THE MARK CONSISTS OF STANDARD CHARACTERS WITHOUT CLAIM TO ANY PARTICULAR FONT, STYLE, SIZE, OR COLOR.

NO CLAIM IS MADE TO THE EXCLUSIVE RIGHT TO USE "AMERICAS", APART FROM THE MARK AS SHOWN.

SN 77-726,896, FILED 5-1-2009.

MAYUR VAGHANI, EXAMINING ATTORNEY



*David J. Kyros*

Director of the United States Patent and Trademark Office

# United States of America

United States Patent and Trademark Office

## Meals on Heels

**Reg. No. 4,135,833**

**Registered May 1, 2012**

**Int. Cls.: 16, 41, and 43**

**TRADEMARK**

**SERVICE MARK**

**PRINCIPAL REGISTER**

KOBRIN, MINDY B. (UNITED STATES INDIVIDUAL), AKA MEALS ON HEELS,  
SUITE 9J  
277 WEST 10TH STREET  
NEW YORK, NY 10014

FOR: A SERIES OF BOOKS AND WRITTEN ARTICLES IN THE FIELD OF HOME ENTERTAINING, HOSPITALITY, COOKING, MIXOLOGY, SOCIALIZING, HOSTING, DINNER PARTIES, IN CLASS 16 (U.S. CLS. 2, 5, 22, 23, 29, 37, 38 AND 50).

FIRST USE 4-20-2009; IN COMMERCE 7-29-2009.

FOR: EDUCATIONAL SERVICES, NAMELY, CONDUCTING PROGRAMS IN THE FIELD OF HOME ENTERTAINING, HOSPITALITY, COOKING, MIXOLOGY, SOCIALIZING, HOSTING, DINNER PARTIES, IN CLASS 41 (U.S. CLS. 100, 101 AND 107).

FIRST USE 4-20-2009; IN COMMERCE 7-29-2009.

FOR: SERVING FOOD AND DRINKS, IN CLASS 43 (U.S. CLS. 100 AND 101).

FIRST USE 3-1-2007; IN COMMERCE 7-29-2009.

THE MARK CONSISTS OF STANDARD CHARACTERS WITHOUT CLAIM TO ANY PARTICULAR FONT, STYLE, SIZE, OR COLOR.

SN 77-727,407, FILED 5-1-2009.

DANNEAN HETZEL, EXAMINING ATTORNEY



*David J. Kyros*

Director of the United States Patent and Trademark Office



# United States of America

United States Patent and Trademark Office

## Mindy's Meals on Heels

**Reg. No. 4,135,834**

**Registered May 1, 2012**

**Int. Cls.: 16 and 43**

**TRADEMARK**

**SERVICE MARK**

**PRINCIPAL REGISTER**

KOBRIN, MINDY B. (UNITED STATES INDIVIDUAL), AKA MINDY'S MEALS ON HEELS,  
SUITE 9J  
277 WEST 10TH STREET  
NEW YORK, NY 10014

FOR: A SERIES OF BOOKS AND WRITTEN ARTICLES IN THE FIELD OF HOME ENTERTAINING, HOSPITALITY, COOKING, MIXOLOGY, SOCIALIZING, HOSTING, DINNER PARTIES, IN CLASS 16 (U.S. CLS. 2, 5, 22, 23, 29, 37, 38 AND 50).

FIRST USE 4-20-2009; IN COMMERCE 7-29-2009.

FOR: SERVING FOOD AND DRINKS, IN CLASS 43 (U.S. CLS. 100 AND 101).

FIRST USE 4-1-2007; IN COMMERCE 7-29-2009.

THE MARK CONSISTS OF STANDARD CHARACTERS WITHOUT CLAIM TO ANY PARTICULAR FONT, STYLE, SIZE, OR COLOR.

SN 77-727,432, FILED 5-1-2009.

DANNEAN HETZEL, EXAMINING ATTORNEY



*David J. Kypos*

Director of the United States Patent and Trademark Office

# United States of America

United States Patent and Trademark Office



**Reg. No. 4,135,835**

**Registered May 1, 2012**

**Int. Cl.: 12**

**TRADEMARK**

**PRINCIPAL REGISTER**

KNEAL HOLDINGS, INC. (MARYLAND CORPORATION)  
5000 TUXEDO ROAD  
HYATTSVILLE, MD 20781

FOR: STRUCTURAL PARTS FOR TRUCKS, IN CLASS 12 (U.S. CLS. 19, 21, 23, 31, 35 AND 44).

FIRST USE 8-0-2009; IN COMMERCE 8-0-2009.

THE MARK CONSISTS OF THE WORDS "K2 PEAK PERFORMANCE" IN STYLIZED FONT AND A STYLIZED DESIGN OF AN EAGLE AND TWO MOUNTAIN PEAKS.

SN 77-728,901, FILED 5-5-2009.

TOBY BULLOFF, EXAMINING ATTORNEY



*David J. Kyffers*

Director of the United States Patent and Trademark Office

# United States of America

United States Patent and Trademark Office

## STREETLIGHT CLOTHING

**Reg. No. 4,135,836**

MIKE TONCHE (UNITED STATES INDIVIDUAL)  
1606 PINON PINE DR.  
PFLUGERVILLE, TX 78660

**Registered May 1, 2012**

**Int. Cl.: 25**

FOR: CLOTHING, NAMELY, T-SHIRTS, SWEATSHIRTS, SHIRTS, HATS, JACKETS, AND CAPS, IN CLASS 25 (U.S. CLS. 22 AND 39).

**TRADEMARK**

FIRST USE 2-2-2012; IN COMMERCE 2-2-2012.

**PRINCIPAL REGISTER**

THE MARK CONSISTS OF STANDARD CHARACTERS WITHOUT CLAIM TO ANY PARTICULAR FONT, STYLE, SIZE, OR COLOR.

NO CLAIM IS MADE TO THE EXCLUSIVE RIGHT TO USE "CLOTHING", APART FROM THE MARK AS SHOWN.

SN 77-730,883, FILED 5-6-2009.

DAVID TOOLEY, EXAMINING ATTORNEY



*David J. Kyffers*

Director of the United States Patent and Trademark Office

# United States of America

United States Patent and Trademark Office

## *charles* SCHWAB ADVISOR SERVICES

**Reg. No. 4,135,837**

**Registered May 1, 2012**

**Int. Cls.: 16, 35, 36, 41,  
and 42**

CHARLES SCHWAB & CO., INC. (CALIFORNIA CORPORATION)  
211 MAIN STREET  
SAN FRANCISCO, CA 94105

FOR: PRINTED MATERIAL, NAMELY, LEAFLETS, BROCHURES, AND PAMPHLETS IN THE FIELD OF INVESTMENTS, IN CLASS 16 (U.S. CLS. 2, 5, 22, 23, 29, 37, 38 AND 50).

FIRST USE 1-0-2010; IN COMMERCE 1-0-2010.

**TRADEMARK**

**SERVICE MARK**

**PRINCIPAL REGISTER**

FOR: PROVIDING NEWS, INFORMATION, RESEARCH, AND ANALYSIS IN THE FIELDS OF BUSINESS, CURRENT BUSINESS EVENTS, NAMELY, FEDERAL REGULATORY AND LEGISLATIVE CHANGES, GLOBAL ECONOMIC TRENDS AND ECONOMIC OUTLOOK, GOVERNMENT, NAMELY, ECONOMICS; PROVIDING AN ON-LINE COMPUTER DATABASE IN THE FIELDS OF BUSINESS, CURRENT BUSINESS EVENTS, NAMELY, FEDERAL REGULATORY AND LEGISLATIVE CHANGES, GLOBAL ECONOMIC TRENDS AND ECONOMIC OUTLOOK. PROVIDING INFORMATION AND ANALYSIS IN THE FIELDS OF ECONOMICS, AND BUSINESS BY ONLINE MEANS; BUSINESS CONSULTING SERVICES IN THE FIELDS OF HUMAN CAPITAL, BUSINESS AND STRATEGY PLANNING, MARKETING AND BUSINESS DEVELOPMENT, TRANSITION SERVICES FOR FINANCIAL ADVISORS, OPERATIONS SUPPORT, AND COMPLIANCE RESOURCES, IN CLASS 35 (U.S. CLS. 100, 101 AND 102).

FIRST USE 11-0-2009; IN COMMERCE 11-0-2009.

FOR: PROVIDING FINANCIAL AND INVESTMENT INFORMATION TO INVESTORS FOR USE IN THE TRADING AND ANALYSIS OF INVESTMENTS, FINANCES AND FINANCIAL PLANNING, VIA A GLOBAL COMPUTER NETWORK; PROVIDING NEWS IN THE FIELD OF FINANCE AND INVESTMENTS FOR USE BY INVESTORS IN THE TRADING AND ANALYSIS OF INVESTMENTS, FINANCES AND FINANCIAL PLANNING, VIA A GLOBAL COMPUTER NETWORK; PROVIDING FINANCIAL AND INVESTMENT RESEARCH DATA TO INVESTORS FOR USE IN THE TRADING AND ANALYSIS OF INVESTMENTS, FINANCES AND FINANCIAL PLANNING, VIA A GLOBAL COMPUTER NETWORK; PROVIDING DATABASES IN THE FIELD OF FINANCE AND INVESTMENT FOR USE BY INVESTORS IN THE TRADING AND ANALYSIS OF INVESTMENTS, FINANCES AND FINANCIAL PLANNING, VIA A GLOBAL COMPUTER NETWORK; BROKERAGE SERVICES AND INVESTMENT SERVICES PROVIDED ELECTRONICALLY AND VIA GLOBAL INFORMATION NETWORKS, NAMELY, ELECTRONIC TRADING IN SECURITIES, STOCKS,



*David J. Kyros*

Director of the United States Patent and Trademark Office

**Reg. No. 4,135,837** BONDS, MUTUAL FUNDS, MONEY MARKET FUNDS, COMMODITIES, FUTURES, OPTIONS, AND INDICES OF ANY OF THEM; BROKERAGE SERVICES IN THE FIELDS OF SECURITIES, STOCKS, BONDS, MUTUAL FUNDS, MANAGED ACCOUNTS, STRUCTURED PRODUCTS, ALTERNATIVE INVESTMENTS, CASH PRODUCTS, MONEY MARKET FUNDS, COMMODITIES, FUTURES, OPTIONS, AND INDICES OF ANY OF THEM; SECURITIES BROKERAGE ACCOUNT SERVICES NAMELY, AN INTEREST BEARING FEATURE FOR CASH BETWEEN INVESTMENTS, ACCESS TO CASH, AND MARGIN LOANS; BANKING SERVICES; DEBIT CARD SERVICES; BILL PAYMENT SERVICES; PROVIDING INFORMATION SERVICES IN THE FIELD OF INVESTMENT ACCOUNTS; FINANCIAL ADMINISTRATION OF RETIREMENT PLANS; TRUST SERVICES, NAMELY, TRUST COMPANY CUSTODY SERVICES; INSURANCE BROKERAGE SERVICES; CASH MANAGEMENT ACCOUNT SERVICES. FIXED INCOME INVESTMENT SERVICES, NAMELY, PROVIDING FINANCIAL TRADING SERVICES AND FINANCIAL INFORMATION IN THE FIELD OF FIXED INCOME INVESTMENT PRODUCTS; ELECTRONIC FUND TRANSFER SERVICES; SEPARATELY MANAGED ACCOUNT AND STRUCTURED FINANCIAL PRODUCT SERVICES, NAMELY, BROKERAGE OF STRUCTURED PRODUCTS, NAMELY, STRUCTURED CDS, PRINCIPAL PROTECTED NOTES, BUFFERED NOTES, RETURN ENHANCED NOTES, REVERSE CONVERTIBLES, AND HEDGING AND MONETIZATION STRATEGIES FOR CONCENTRATED EQUITY POSITIONS; PROVIDING FINANCIAL INFORMATION AND BROKERAGE SERVICES RELATING TO THIRD PARTY BANK STRUCTURED INVESTMENT PRODUCTS, NAMELY, PRINCIPAL PROTECTED NOTES, BUFFERED AND LEVERAGED NOTES, STRUCTURED CERTIFICATES OF DEPOSIT AND RATE NOTES; PROVIDING INFORMATION AND FINANCIAL ANALYSIS IN THE FIELDS OF FINANCE, INVESTMENT, FINANCIAL PLANNING, AND INVESTMENT STRATEGY; PROVIDING NEWS, INFORMATION, RESEARCH, AND ANALYSIS IN THE FIELDS OF INVESTING, FINANCE, FINANCIAL PLANNING, AND CURRENT FINANCIAL EVENTS, NAMELY, MACRO AND MICROECONOMIC TRENDS, MERGERS AND ACQUISITIONS AND BANK FAILURES; PROVIDING AN ON-LINE COMPUTER DATABASE IN THE FIELDS OF INVESTING, FINANCE, FINANCIAL PLANNING, AND CURRENT FINANCIAL EVENTS, NAMELY, MACRO AND MICROECONOMIC TRENDS, MERGERS AND ACQUISITIONS AND BANK FAILURES; BROKERAGE SERVICES IN THE FIELDS OF SECURITIES, STOCKS, BONDS, MUTUAL FUNDS, MONEY MARKET FUNDS, COMMODITIES, FUTURES, OPTIONS, AND INDICES OF ANY OF THEM, PROVIDED ELECTRONICALLY AND VIA GLOBAL INFORMATION NETWORKS; PROVIDING INFORMATION AND ANALYSIS IN THE FIELDS OF FINANCE, INVESTMENT, FINANCIAL PLANNING, AND INVESTMENT STRATEGY BY ONLINE MEANS; PROVIDING ON-LINE COMPUTER DATABASES FEATURING PERSONAL FINANCIAL INFORMATION ABOUT FINANCIAL PORTFOLIO ACCOUNTS, IN CLASS 36 (U.S. CLS. 100, 101 AND 102).

FIRST USE 11-0-2009; IN COMMERCE 11-0-2009.

FOR: EDUCATIONAL SERVICES, NAMELY, CONDUCTING SEMINARS, CONFERENCES, LECTURES, CLASSES, SYMPOSIUMS AND WORKSHOPS IN THE FIELDS OF INVESTMENT, FINANCE, ECONOMICS, BUSINESS, FINANCIAL PLANNING, PORTFOLIO MANAGEMENT, RETIREMENT PLANNING, MONEY MANAGEMENT, INVESTMENT STRATEGY, ASSET ALLOCATION, AND PRACTICE MANAGEMENT AND TECHNOLOGY; PROVIDING ONLINE PUBLICATIONS IN THE NATURE OF EMAIL NEWSLETTERS AND WEB-BASED MATERIALS, NAMELY, WEB-BASED NEWSLETTER IN THE FIELDS OF INVESTMENT, FINANCE, ECONOMICS, BUSINESS, FINANCIAL PLANNING, PORTFOLIO MANAGEMENT, RETIREMENT PLANNING, MONEY MANAGEMENT, INVESTMENT STRATEGY, ASSET ALLOCATION, PRACTICE MANAGEMENT AND TECHNOLOGY; AND ENTERTAINMENT SERVICES, NAMELY, PROVIDING WEBCASTS IN THE FIELDS OF INVESTMENT, FINANCE, ECONOMICS, BUSINESS, FINANCIAL PLANNING, PORTFOLIO MANAGEMENT, RETIREMENT PLANNING, MONEY MANAGEMENT, INVESTMENT STRATEGY, ASSET ALLOCATION, PRACTICE MANAGEMENT AND TECHNOLOGY, IN CLASS 41 (U.S. CLS. 100, 101 AND 107).

FIRST USE 11-0-2009; IN COMMERCE 11-0-2009.

**Reg. No. 4,135,837** FOR: TECHNOLOGY CONSULTATION SERVICES, NAMELY, CONSULTING SERVICES FOR ASSISTING INVESTMENT ADVISORS IN SELECTING, IMPLEMENTING AND ADOPTING TECHNOLOGIES, NAMELY, COMPUTER HARDWARE AND SOFTWARE, FOR THE PROVISION OF FINANCIAL SERVICES; PROVIDING TEMPORARY USE OF ON-LINE NON-DOWNLOADABLE SOFTWARE TOOLS FOR PERFORMING INVESTMENT PORTFOLIO TRANSACTIONS, TRADING, ACCOUNTING, ALLOCATION, REPORTING, DOWNLOADING FINANCIAL ACCOUNT DATA, DATA MANAGEMENT, PERFORMING RESEARCH, AND PERFORMANCE AND TRANSACTION TRACKING; PROVIDING TEMPORARY USE OF ON-LINE NON-DOWNLOADABLE SOFTWARE TOOLS FOR TRACKING AND COMPARING PERFORMANCE OF FINANCIAL PRODUCTS AND FOR RESEARCH INFORMATION REGARDING INDUSTRY, SECTOR AND SECURITY FINANCIAL ANALYSES AND RATINGS, IN CLASS 42 (U.S. CLS. 100 AND 101).

FIRST USE 11-0-2009; IN COMMERCE 11-0-2009.

OWNER OF U.S. REG. NOS. 2,491,729, 3,611,542, AND OTHERS.

NO CLAIM IS MADE TO THE EXCLUSIVE RIGHT TO USE "ADVISOR SERVICES", APART FROM THE MARK AS SHOWN.

THE NAME "CHARLES SCHWAB" IDENTIFIES A LIVING INDIVIDUAL WHOSE CONSENT IS OF RECORD.

THE MARK CONSISTS OF THE WORDS "CHARLES SCHWAB" IN STYLIZED LETTERS OVER THE WORDS "ADVISOR SERVICES".

SN 77-732,510, FILED 5-8-2009.

BILL DAWE, EXAMINING ATTORNEY

# United States of America

United States Patent and Trademark Office

# LFL

**Reg. No. 4,135,838**

**Registered May 1, 2012**

**Int. Cl.: 35**

**SERVICE MARK**

**PRINCIPAL REGISTER**

FOOT LOCKER RETAIL, INC. (NEW YORK CORPORATION)  
112 WEST 34TH STREET  
NEW YORK, NY 10120

FOR: ON-LINE RETAIL STORE SERVICES FEATURING CLOTHING, FOOTWEAR AND HEADGEAR; RETAIL CLOTHING STORES; RETAIL STORE AND ON-LINE RETAIL STORE SERVICES FEATURING CLOTHING, FOOTWEAR AND HEADGEAR; RETAIL STORE SERVICES FEATURING CLOTHING, FOOTWEAR AND HEADGEAR, IN CLASS 35 (U.S. CLS. 100, 101 AND 102).

FIRST USE 11-1-2008; IN COMMERCE 11-1-2008.

THE MARK CONSISTS OF STANDARD CHARACTERS WITHOUT CLAIM TO ANY PARTICULAR FONT, STYLE, SIZE, OR COLOR.

SN 77-741,338, FILED 5-20-2009.

NICHOLAS ALTREE, EXAMINING ATTORNEY



*David J. Kybas*

Director of the United States Patent and Trademark Office

# United States of America

United States Patent and Trademark Office

# 9X9

**Reg. No. 4,135,839**

**Registered May 1, 2012**

**Int. Cl.: 35**

**SERVICE MARK**

**PRINCIPAL REGISTER**

PURPLECOMM, INC. (DELAWARE CORPORATION)  
2620 AUGUSTINE DR., SUITE 100  
SANTA CLARA, CA 95054

FOR: ONLINE RETAIL STORE SERVICES IN THE FIELD OF ENTERTAINMENT FEATURING DOWNLOADABLE MUSIC, ELECTRONIC GAMES, MOVIES, AND TELEVISION PROGRAMS, IN CLASS 35 (U.S. CLS. 100, 101 AND 102).

FIRST USE 1-1-2012; IN COMMERCE 1-1-2012.

THE MARK CONSISTS OF STANDARD CHARACTERS WITHOUT CLAIM TO ANY PARTICULAR FONT, STYLE, SIZE, OR COLOR.

SN 77-746,218, FILED 5-28-2009.

DAWN FELDMAN, EXAMINING ATTORNEY



*David J. Kyros*

Director of the United States Patent and Trademark Office



# United States of America

United States Patent and Trademark Office



**Reg. No. 4,135,840**

**Registered May 1, 2012**

**Int. Cl.: 11**

**TRADEMARK**

**PRINCIPAL REGISTER**

SEARS BRANDS, LLC (ILLINOIS LIMITED LIABILITY COMPANY)  
3333 BEVERLY ROAD  
HOFFMAN ESTATES, IL 60179

FOR: LCD PANELS SOLD AS COMPONENT PARTS OF REFRIGERATORS AND FREEZERS  
FEATURING NOTIFICATIONS THAT ALERT OWNERS TO RESET OR REPLACE A FILTER  
, IN CLASS 11 (U.S. CLS. 13, 21, 23, 31 AND 34).

FIRST USE 9-0-2009; IN COMMERCE 9-0-2009.

THE MARK CONSISTS OF A STYLIZED FILTER BOTTLE DESIGN WITH TWO ARROWS  
ROTATING CLOCKWISE.

SN 77-753,415, FILED 6-5-2009.

HAI-LY LAM, EXAMINING ATTORNEY



*David J. Kybas*

Director of the United States Patent and Trademark Office

# United States of America

United States Patent and Trademark Office



**Reg. No. 4,135,841**

**Registered May 1, 2012**

**Int. Cl.: 11**

**TRADEMARK**

**PRINCIPAL REGISTER**

SEARS BRANDS, LLC (ILLINOIS LIMITED LIABILITY COMPANY)  
3333 BEVERLY ROAD  
HOFFMAN ESTATES, IL 60179

FOR: LCD PANELS SOLD AS COMPONENT PARTS OF REFRIGERATORS AND FREEZERS  
FEATURING NOTIFICATIONS THAT ALERT OWNERS TO RESET OR REPLACE A FILTER  
, IN CLASS 11 (U.S. CLS. 13, 21, 23, 31 AND 34).

FIRST USE 9-0-2009; IN COMMERCE 9-0-2009.

THE MARK CONSISTS OF A STYLIZED FILTER BOTTLE WITH A CHECK MARK EN-  
CLOSED IN A CIRCLE.

SN 77-753,435, FILED 6-5-2009.

HAI-LY LAM, EXAMINING ATTORNEY



*David J. Kybas*

Director of the United States Patent and Trademark Office

# United States of America

United States Patent and Trademark Office

## 340B. Simplified.

**Reg. No. 4,135,842**

**Registered May 1, 2012**

**Int. Cl.: 35**

**SERVICE MARK**

**PRINCIPAL REGISTER**

SUNRX, LLC (DELAWARE LIMITED LIABILITY COMPANY)  
3260 TILLMAN DRIVE  
SUITE 75  
BENSALEM, PA 19020

FOR: BUSINESS CONSULTING SERVICES, NAMELY, OPERATIONS MANAGEMENT SERVICES, MANAGING THE FLOW OF INVENTORY, INFORMATION AND PAYMENTS BETWEEN HEALTH CENTERS, PHARMACIES, WHOLESALERS AND INSURANCE COMPANIES, IN CLASS 35 (U.S. CLS. 100, 101 AND 102).

FIRST USE 3-15-2009; IN COMMERCE 3-15-2009.

THE MARK CONSISTS OF STANDARD CHARACTERS WITHOUT CLAIM TO ANY PARTICULAR FONT, STYLE, SIZE, OR COLOR.

NO CLAIM IS MADE TO THE EXCLUSIVE RIGHT TO USE "340B", APART FROM THE MARK AS SHOWN.

SN 77-756,020, FILED 6-10-2009.

JOHN SCHUYLER YARD, EXAMINING ATTORNEY



*David J. Kyffers*

Director of the United States Patent and Trademark Office

# United States of America

United States Patent and Trademark Office



**Reg. No. 4,135,843**  
**Registered May 1, 2012**  
**Int. Cls.: 1 and 9**

JAYTEE BIOSCIENCES LIMITED (UNITED KINGDOM LIMITED LIABILITY COMPANY),  
DBA JAYTEE BIOSCIENCES LIMITED,  
171-173 JOHN WILSON BUSINESS PARK  
WHITSTABLE KENT, UNITED KINGDOM

**TRADEMARK**

FOR: CHEMICALS, NAMELY, BUFFER AND STANDARD SOLUTIONS USED IN ANALYTICAL CHEMISTRY, IN CLASS 1 (U.S. CLS. 1, 5, 6, 10, 26 AND 46).

**PRINCIPAL REGISTER**

FIRST USE 3-0-2011; IN COMMERCE 3-0-2011.

FOR: APPARATUS FOR AUTOMATIC CHROMATOGRAPHY; PHARMACEUTICAL AND SCIENTIFIC RESEARCH EQUIPMENT FOR USE IN MASS SPECTROMETERS; SCIENTIFIC APPARATUS, NAMELY, SPECTROMETERS AND PARTS AND FITTINGS THEREFOR, IN CLASS 9 (U.S. CLS. 21, 23, 26, 36 AND 38).

FIRST USE 3-0-2011; IN COMMERCE 3-0-2011.

THE MARK CONSISTS OF AN INCOMPLETE GREEK OMEGA CHARACTER IN THE COLOR RED ON A WHITE BACKGROUND. THE TERM "KROMEGE" IS SUPERIMPOSED ACROSS THE GREEK CHARACTER CAUSING A BREAK ON EITHER SIDE. THE LETTER "K" OF THE TERM "KROMEGE" APPEARS IN THE COLOR RED AND THE LETTERING "ROMEGE" OF THE TERM "KROMEGE" APPEARS IN THE COLOR DARK GRAY.

THE COLOR(S) RED, DARK GRAY AND WHITE IS/ARE CLAIMED AS A FEATURE OF THE MARK.

SN 77-756,942, FILED 6-11-2009.

ZHALEH DELANEY, EXAMINING ATTORNEY



*David J. Kypos*

Director of the United States Patent and Trademark Office

# United States of America

United States Patent and Trademark Office

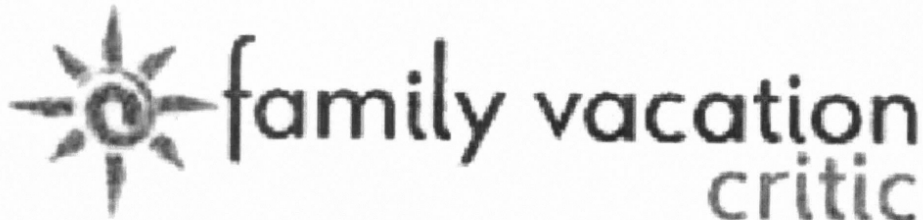

**Reg. No. 4,135,844**

**Registered May 1, 2012**

**Int. Cls.: 38, 39, 41, and 43**

THE INDEPENDENT TRAVELER, INC. (NEW JERSEY CORPORATION)  
7 TREE FARM ROAD, SUITE 202  
PENNINGTON, NJ 08534

FOR: PROVIDING ON-LINE ELECTRONIC BULLETIN BOARDS, CHAT ROOMS AND FORUMS FOR TRANSMISSION OF MESSAGES AMONG COMPUTER USERS IN THE FIELD OF TRAVEL, IN CLASS 38 (U.S. CLS. 100, 101 AND 104).

**SERVICE MARK**

FIRST USE 2-4-2011; IN COMMERCE 2-4-2011.

**PRINCIPAL REGISTER**

FOR: TRAVEL INFORMATION SERVICES; PROVIDING AN ON-LINE COMPUTER DATABASE IN THE FIELD OF TRAVEL INFORMATION SERVICES; PROVIDING REVIEWS OF TRAVEL SERVICE PROVIDERS VIA A GLOBAL COMPUTER NETWORK, IN CLASS 39 (U.S. CLS. 100 AND 105).

FIRST USE 2-4-2011; IN COMMERCE 2-4-2011.

FOR: PROVIDING ON-LINE NEWSLETTERS RELATING TO TRAVEL SERVICE PROVIDERS, TRAVEL DESTINATIONS, HOTEL ACCOMMODATIONS AND LOCAL ATTRACTIONS, IN CLASS 41 (U.S. CLS. 100, 101 AND 107).

FIRST USE 10-24-2011; IN COMMERCE 10-24-2011.

FOR: PROVIDING TRAVEL LODGING INFORMATION SERVICES; PROVIDING REVIEWS OF HOTEL ACCOMMODATIONS VIA A GLOBAL COMPUTER NETWORK; PROVIDING AN ON-LINE COMPUTER DATABASE IN THE FIELD OF TRAVEL LODGING INFORMATION AND HOTEL ACCOMMODATIONS, IN CLASS 43 (U.S. CLS. 100 AND 101).

FIRST USE 2-4-2011; IN COMMERCE 2-4-2011.

NO CLAIM IS MADE TO THE EXCLUSIVE RIGHT TO USE "FAMILY VACATION CRITIC", APART FROM THE MARK AS SHOWN.

THE MARK CONSISTS OF A STYLIZED IMAGE OF A SUN APPEARING TO THE LEFT OF THE LITERAL ELEMENTS "FAMILY VACATION" WHICH IS ABOVE "CRITIC.COM".



*David J. Kyros*

Director of the United States Patent and Trademark Office

SN 77-757,873, FILED 6-11-2009.

**Reg. No. 4,135,844** ANTHONY RINKER, EXAMINING ATTORNEY

# United States of America

United States Patent and Trademark Office



**Reg. No. 4,135,845**

**Registered May 1, 2012**

**Int. Cls.: 9 and 42**

**TRADEMARK**

**SERVICE MARK**

**PRINCIPAL REGISTER**

MUELLER INTERNATIONAL, INC. (DELAWARE CORPORATION)  
SUITE 1200  
1200 ABERNATHY ROAD  
ATLANTA, GA 30328

FOR: COMPUTER NETWORKS CONSISTING OF TRANSCEIVERS, SENSORS, COMPUTER SERVERS AND ACCOMPANYING SOFTWARE USED BY UTILITY PROVIDERS TO TRACK UTILITY USAGE, DETECT LEAKS, PINPOINT OUTAGES AND PROVIDE UPDATES ON SERVICE RESTORATION, IN CLASS 9 (U.S. CLS. 21, 23, 26, 36 AND 38).

FIRST USE 11-0-2009; IN COMMERCE 11-0-2009.

FOR: HOSTING AN ONLINE WEBSITE USED BY UTILITY PROVIDERS TO TRACK UTILITY USAGE, DETECT LEAKS, PINPOINT OUTAGES AND PROVIDE UPDATES ON SERVICE RESTORATION, IN CLASS 42 (U.S. CLS. 100 AND 101).

FIRST USE 11-0-2009; IN COMMERCE 11-0-2009.

THE MARK CONSISTS OF THE LETTERS "M", "I", "N", "E", "T" IN STYLIZED TEXT ENCOMPASSED BY A RECTANGULAR ROUNDED-CORNER BOX, WITH THREE CURVED LINES EMANATING FROM THE "DOT" OF THE LOWER-CASE "I" IN A TRIANGULAR SHAPE.

SN 77-760,077, FILED 6-15-2009.

WARREN L. OLANDRIA, EXAMINING ATTORNEY



*David J. Kybas*

Director of the United States Patent and Trademark Office

# United States of America

United States Patent and Trademark Office

## FARR'S FRESH

**Reg. No. 4,135,846**

FARR'S FRESH, INC. (UTAH CORPORATION)  
2575 SOUTH 300 WEST  
SALT LAKE CITY, UT 84115

**Registered May 1, 2012**

**Int. Cl.: 35**

FOR: RETAIL FROZEN DESSERT STORE SERVICES, IN CLASS 35 (U.S. CLS. 100, 101 AND 102).

**SERVICE MARK**

FIRST USE 8-15-2009; IN COMMERCE 8-15-2009.

**PRINCIPAL REGISTER**

THE MARK CONSISTS OF STANDARD CHARACTERS WITHOUT CLAIM TO ANY PARTICULAR FONT, STYLE, SIZE, OR COLOR.

NO CLAIM IS MADE TO THE EXCLUSIVE RIGHT TO USE "FRESH", APART FROM THE MARK AS SHOWN.

SN 77-762,425, FILED 6-17-2009.

MICHAEL WIENER, EXAMINING ATTORNEY



*David J. Kyros*

Director of the United States Patent and Trademark Office



# United States of America

United States Patent and Trademark Office

## THE FRESH BEAT BAND

**Reg. No. 4,135,847**

**Registered May 1, 2012**

**Int. Cl.: 9**

**TRADEMARK**

**PRINCIPAL REGISTER**

VIACOM INTERNATIONAL INC. (DELAWARE CORPORATION)  
1515 BROADWAY  
C/O DIANE MANTARING  
NEW YORK, NY 10036

FOR: THEATRICAL OR MUSICAL SOUND RECORDINGS; THEATRICAL OR MUSICAL VIDEO RECORDINGS, LASER DISCS AND DIGITAL VIDEO DISCS/DIGITAL VERSATILE DISCS ("DVD") FEATURING TELEVISION PROGRAMS AND THEATRICAL OR MUSICAL VIDEO RECORDINGS; VIDEO GAME MACHINES FOR USE WITH TELEVISION, AUDIO OUTPUT GAME MACHINES FOR USE WITH TELEVISION, VIDEO GAME CARTRIDGES, VIDEO GAMES RECORDED ON CD-ROM FOR USE IN FREESTANDING VIDEO GAME MACHINES; AND COMPUTER PRODUCTS, NAMELY, GAME CARTRIDGES FOR COMPUTER VIDEO GAMES AND VIDEO OUTPUT GAME MACHINES AND INSTRUCTIONAL MATERIALS SOLD AS A UNIT, COMPUTER GAME CASSETTES, COMPUTER GAME TAPES AND MANUALS SOLD AS A UNIT; DOWNLOADABLE WIRELESS GAME SOFTWARE; DOWNLOADABLE WIRELESS ENTERTAINMENT SOFTWARE, NAMELY, THEATRICAL OR MUSICAL VIDEO RECORDINGS; DOWNLOADABLE IMAGES RELATED TO A CHILDREN'S TELEVISION PROGRAM; AND COMPUTER SOFTWARE FOR USE IN THE DESIGN, DEVELOPMENT AND EXECUTION OF WIRELESS GAME AND ENTERTAINMENT PROGRAMS AND APPLICATIONS; SUNGLASSES, IN CLASS 9 (U.S. CLS. 21, 23, 26, 36 AND 38).

FIRST USE 1-31-2012; IN COMMERCE 1-31-2012.

THE MARK CONSISTS OF STANDARD CHARACTERS WITHOUT CLAIM TO ANY PARTICULAR FONT, STYLE, SIZE, OR COLOR.

NO CLAIM IS MADE TO THE EXCLUSIVE RIGHT TO USE "BAND", APART FROM THE MARK AS SHOWN.

SN 77-763,398, FILED 6-18-2009.

ROBIN CHOSID, EXAMINING ATTORNEY



*David J. Kyffers*

Director of the United States Patent and Trademark Office

# United States of America

United States Patent and Trademark Office

# AVIDASPORTS

**Reg. No. 4,135,848**

**Registered May 1, 2012**

**Int. Cl.: 9**

**TRADEMARK**

**PRINCIPAL REGISTER**

AVIDASPORTS LLC (MICHIGAN LIMITED LIABILITY COMPANY)  
20844 HARPER AVENUE  
HARPER WOODS, MI 48225

FOR: ATHLETIC ELECTRONIC MONITORS AND POSITION RECORDING SYSTEMS,  
ALONG WITH ASSOCIATED SOFTWARE THAT PROVIDES USER FEEDBACK ON THE  
ATHLETE'S PERFORMANCE , IN CLASS 9 (U.S. CLS. 21, 23, 26, 36 AND 38).

FIRST USE 7-0-2010; IN COMMERCE 7-0-2010.

THE MARK CONSISTS OF STANDARD CHARACTERS WITHOUT CLAIM TO ANY PAR-  
TICULAR FONT, STYLE, SIZE, OR COLOR.

SN 77-766,111, FILED 6-23-2009.

ANN E. SAPPENFIELD, EXAMINING ATTORNEY



*David J. Kyffers*

Director of the United States Patent and Trademark Office

# United States of America

United States Patent and Trademark Office



**Reg. No. 4,135,849**

**Registered May 1, 2012**

**Int. Cl.: 16**

CONSEJO DE PROMOCION TURISTICA DE MEXICO. S.A. DE C.V. (MEXICO SOCIEDAD ANONIMA (SA DE CV))  
VIADUCTO MIGUEL ALEMÁN NO. 105  
PISO 2, COLONIA ESCANDÓN, C.P.  
DELEGACIÓN MIGUEL HIDA, MEXICO 11800

**TRADEMARK**

**PRINCIPAL REGISTER**

FOR: PAPER, CARDBOARD AND GOODS MADE FROM THESE MATERIALS, NAMELY, FLAGS OF PAPER, WRITING PADS, BOXES OF CARDBOARD OR PAPER, SCHOOL BOOKS; DRAWING PADS; WRITING PAPER; PAPER BAGS FOR PACKAGING; PRINTED MATERIALS, NAMELY, ALMANACS, ATLASES, CALENDARS, TEAR-OFF CALENDARS, GRAPHIC PRINTS, NEWSPAPERS, POSTCARDS, POSTERS; PHOTOGRAPHS; STATIONERY; OFFICE REQUISITES, NAMELY, PAPER CUTTERS, STICKERS AND TRANSFERS, PENS, PENCILS; PRINTED INSTRUCTIONAL AND TEACHING MATERIAL IN THE FIELD OF HISTORY AND GEOGRAPHY, NAMELY, HISTORICAL SECTIONS FOR TEACHING PURPOSES, HANDBOOKS, AND GEOGRAPHICAL MAPS; PLASTIC BAGS FOR PACKAGING MAGAZINES, MANUALS, NEWSPAPERS, PAMPHLETS AND CALENDARS IN THE FIELD OF TOURISM, IN CLASS 16 (U.S. CLS. 2, 5, 22, 23, 29, 37, 38 AND 50).

FIRST USE 4-0-2005; IN COMMERCE 4-0-2005.

NO CLAIM IS MADE TO THE EXCLUSIVE RIGHT TO USE "MEXICO", APART FROM THE MARK AS SHOWN.

THE MARK CONSISTS OF THE WORD "MEXICO" IN STYLIZED FORM.

SN 77-769,158, FILED 6-26-2009.

WENDY JUN, EXAMINING ATTORNEY



*David J. Kyffers*

Director of the United States Patent and Trademark Office

# United States of America

United States Patent and Trademark Office



**Reg. No. 4,135,850**

**Registered May 1, 2012**

**Int. Cls.: 35 and 36**

**SERVICE MARK**

**PRINCIPAL REGISTER**

EMAT CAPITAL MANAGEMENT, INC. (CALIFORNIA CORPORATION)  
7474 N. FIGUEROA STREET, SUITE A  
LOS ANGELES, CA 90041

FOR: BUSINESS MANAGEMENT FOR OTHERS; BUSINESS CONSULTATION SERVICES, BUSINESS DEVELOPMENT SERVICES, NAMELY, PROVIDING START-UP ACTIVITIES FOR BUSINESSES OF OTHERS, IN CLASS 35 (U.S. CLS. 100, 101 AND 102).

FIRST USE 2-23-2012; IN COMMERCE 2-23-2012.

FOR: CAPITAL INVESTMENT SERVICES, IN CLASS 36 (U.S. CLS. 100, 101 AND 102).

FIRST USE 2-23-2012; IN COMMERCE 2-23-2012.

THE MARK CONSISTS OF THE STYLIZED LETTERS "EM", NAMELY, A GREEN LETTER "E" WITH VERTICAL STRIPES AND AN "M" WHICH IS GREY EXCEPT THE LOWER RIGHT CORNER WHICH IS RED. THE LETTER "E" OVERLAPS THE FIRST LEG OF THE LETTER "M".

THE COLOR(S) GREEN, RED AND GREY IS/ARE CLAIMED AS A FEATURE OF THE MARK.

SN 77-779,830, FILED 7-13-2009.

BRENDAN REGAN, EXAMINING ATTORNEY



*David J. Kybas*

Director of the United States Patent and Trademark Office

# United States of America

United States Patent and Trademark Office

# MEGADECK

**Reg. No. 4,135,851**

**Registered May 1, 2012**

**Int. Cl.: 7**

**TRADEMARK**

**PRINCIPAL REGISTER**

JLG INDUSTRIES, INC. (PENNSYLVANIA CORPORATION)  
1 JLG DRIVE  
MCCONNELLSBURG, PA 17233

FOR: AERIAL WORK PLATFORMS, IN CLASS 7 (U.S. CLS. 13, 19, 21, 23, 31, 34 AND 35).

FIRST USE 2-21-2012; IN COMMERCE 2-21-2012.

THE MARK CONSISTS OF STANDARD CHARACTERS WITHOUT CLAIM TO ANY PARTICULAR FONT, STYLE, SIZE, OR COLOR.

OWNER OF U.S. REG. NO. 2,675,558.

SN 77-779,905, FILED 7-13-2009.

KIMBERLY PERRY, EXAMINING ATTORNEY



*David J. Kybas*

Director of the United States Patent and Trademark Office

# United States of America

United States Patent and Trademark Office

## MARTHA STEWART LIVING

**Reg. No. 4,135,852**

**Registered May 1, 2012**

**Int. Cl.: 8**

**TRADEMARK**

**PRINCIPAL REGISTER**

MARTHA STEWART LIVING OMNIMEDIA, INC. (DELAWARE CORPORATION)  
601 WEST 26TH STREET, 10TH FLOOR  
NEW YORK, NY 100011101

FOR: GARDENING TOOLS, NAMELY, PRUNERS, SHEARS, TROWELS, MANUALLY OPERATED CULTIVATORS, WEEDERS IN THE NATURE OF WEED CUTTERS, WEED DIGGERS AND WEEDING FORKS, TRANSPLANTERS AND PRUNING SAWS; GARDENING KITS COMPRISED MAINLY OF GARDENING TOOLS, NAMELY, PRUNERS, SHEARS, TROWELS, CULTIVATORS, WEED CUTTERS, WEED DIGGERS, WEEDING FORKS, TRANSPLANTERS, AND PRUNING SAWS, POTS AND SEEDS, IN CLASS 8 (U.S. CLS. 23, 28 AND 44).

FIRST USE 2-1-2010; IN COMMERCE 2-1-2010.

THE MARK CONSISTS OF STANDARD CHARACTERS WITHOUT CLAIM TO ANY PARTICULAR FONT, STYLE, SIZE, OR COLOR.

OWNER OF U.S. REG. NOS. 2,708,561, 2,951,948, AND OTHERS.

THE NAME "MARTHA STEWART" IN THE MARK IDENTIFIES A LIVING INDIVIDUAL WHOSE CONSENT IS OF RECORD.

SN 77-780,975, FILED 7-14-2009.

DOMINIC FATHY, EXAMINING ATTORNEY



*David J. Kyffers*

Director of the United States Patent and Trademark Office

# United States of America

United States Patent and Trademark Office

## 5 A Day, The Healthy Way

**Reg. No. 4,135,853**

**Registered May 1, 2012**

**Int. Cls.: 41 and 44**

**SERVICE MARK**

**PRINCIPAL REGISTER**

AMERICAN SPECIALLY HEALTH INCORPORATED (DELAWARE CORPORATION)  
10221 WATERIDGE CIRCEL  
SAN DIEGO, CA 92121

FOR: ENTERTAINMENT SERVICES, NAMELY, CONTEST AND INCENTIVE AWARD PROGRAMS DESIGNED TO REWARD PROGRAM PARTICIPANTS WHO EXERCISE, MAKE HEALTHY EATING CHOICES, AND ENGAGE IN OTHER HEALTH-PROMOTING ACTIVITIES, IN CLASS 41 (U.S. CLS. 100, 101 AND 107).

FIRST USE 7-15-2009; IN COMMERCE 2-23-2011.

FOR: PROVIDING A WEB SITE FEATURING INFORMATION ON HEALTH AND NUTRITION; HEALTH CARE SERVICES, NAMELY, WELLNESS PROGRAMS; PROVIDING ASSISTANCE, FITNESS EVALUATION AND CONSULTATION TO CORPORATE CLIENTS TO HELP THEIR EMPLOYEES MAKE HEALTH, WELLNESS AND NUTRITIONAL CHANGES IN THEIR DAILY LIVING TO IMPROVE HEALTH, IN CLASS 44 (U.S. CLS. 100 AND 101).

FIRST USE 7-15-2009; IN COMMERCE 2-23-2011.

THE MARK CONSISTS OF STANDARD CHARACTERS WITHOUT CLAIM TO ANY PARTICULAR FONT, STYLE, SIZE, OR COLOR.

SN 77-781,617, FILED 7-15-2009.

MARC LEIPZIG, EXAMINING ATTORNEY



*David J. Kyros*

Director of the United States Patent and Trademark Office

# United States of America

United States Patent and Trademark Office

## MYPORTFOLIO

**Reg. No. 4,135,854**

**Registered May 1, 2012**

**Int. Cl.: 44**

**SERVICE MARK**

**PRINCIPAL REGISTER**

UNIVERSITY OF MARYLAND MEDICAL SYSTEM CORPORATION (MARYLAND  
NON-PROFIT CORPORATION)  
110 S. PACA STREET  
BALTIMORE, MD 21201

FOR: MAINTAINING AND PROVIDING PATIENT MEDICAL RECORDS AND INFORMATION  
VIA AN ELECTRONIC INTERACTIVE SYSTEM TO PATIENTS, PRACTITIONERS AND  
RESEARCHERS, IN CLASS 44 (U.S. CLS. 100 AND 101).

FIRST USE 1-1-2010; IN COMMERCE 1-1-2010.

THE MARK CONSISTS OF STANDARD CHARACTERS WITHOUT CLAIM TO ANY PAR-  
TICULAR FONT, STYLE, SIZE, OR COLOR.

SN 77-784,004, FILED 7-17-2009.

WILLIAM ROSSMAN, EXAMINING ATTORNEY



*David J. Kyros*

Director of the United States Patent and Trademark Office



# United States of America

United States Patent and Trademark Office



**Reg. No. 4,135,855**

**Registered May 1, 2012**

**Int. Cl.: 33**

**TRADEMARK**

**PRINCIPAL REGISTER**

WHEELER WINERY, INC. (CALIFORNIA CORPORATION)  
1791 OLIVET ROAD  
SANTA ROSA, CA 95401

FOR: WINE, IN CLASS 33 (U.S. CLS. 47 AND 49).

FIRST USE 10-7-2011; IN COMMERCE 10-7-2011.

OWNER OF U.S. REG. NO. 1,119,391.

THE LINING IS A FEATURE OF THE MARK AND DOES NOT INDICATE COLOR.

THE MARK CONSISTS OF A COAT OF ARMS BEARING A MANTLING WITH HELM AND CORONET RESTING ABOVE A SHIELD, CONTAINED WITHIN THE SHIELD IS AN ARM HOLDING A SWORD THAT IS PLACED ABOVE A CROWN, BELOW THE SHIELD IS A BANNER CONTAINING THE WORD "HARASZTHY".

THE WORDING "HARASZTHY" HAS NO MEANING IN A FOREIGN LANGUAGE.

SN 77-788,406, FILED 7-23-2009.

LOURDES AYALA, EXAMINING ATTORNEY



*David J. Kyffers*

Director of the United States Patent and Trademark Office

# United States of America

United States Patent and Trademark Office

# ARAYA

**Reg. No. 4,135,856**

**Registered May 1, 2012**

**Int. Cl.: 11**

**TRADEMARK**

**PRINCIPAL REGISTER**

HERST VENTURES, INC. (CALIFORNIA CORPORATION)  
2047 FOURTH STREET  
BERKELEY, CA 94710

FOR: LED (LIGHT EMITTING DIODE) LIGHTING FIXTURES, IN CLASS 11 (U.S. CLS. 13, 21, 23, 31 AND 34).

FIRST USE 1-11-2012; IN COMMERCE 1-11-2012.

THE MARK CONSISTS OF STANDARD CHARACTERS WITHOUT CLAIM TO ANY PARTICULAR FONT, STYLE, SIZE, OR COLOR.

SN 77-788,428, FILED 7-23-2009.

MICHAEL KEATING, EXAMINING ATTORNEY



*David J. Kyros*

Director of the United States Patent and Trademark Office

# United States of America

United States Patent and Trademark Office

## London Young Designers Connection

**Reg. No. 4,135,857**

**Registered May 1, 2012**

**Int. Cl.: 18**

**TRADEMARK**

**PRINCIPAL REGISTER**

CHEN, YONGJING (UNITED KINGDOM INDIVIDUAL)  
12 LARCH GARDENS  
MANCHESTER, M88BJ, UNITED KINGDOM

FOR: ARTICLES MADE WHOLLY OR PRINCIPALLY OF LEATHER OR IMITATION LEATHER, NAMELY, HANDBAGS, HANDBAGS, HOLDALLS, SHOULDER BAGS, PURSES, KEY-CASES, PURSES, TRAVELLING BAGS, WALLETS, BRIEFCASES, GARMENT BAGS FOR TRAVEL, CREDIT CARD HOLDERS, HOLDALLS AND SHOULDER BAGS, IN CLASS 18 (U.S. CLS. 1, 2, 3, 22 AND 41).

FIRST USE 6-1-2005; IN COMMERCE 6-1-2005.

THE MARK CONSISTS OF STANDARD CHARACTERS WITHOUT CLAIM TO ANY PARTICULAR FONT, STYLE, SIZE, OR COLOR.

NO CLAIM IS MADE TO THE EXCLUSIVE RIGHT TO USE "LONDON YOUNG DESIGNERS", APART FROM THE MARK AS SHOWN.

SN 77-789,699, FILED 7-26-2009.

SOPHIA S. KIM, EXAMINING ATTORNEY



*David J. Kybas*

Director of the United States Patent and Trademark Office

# United States of America

United States Patent and Trademark Office

## LOVERLONGER

**Reg. No. 4,135,858**

SHELLIAN CORPORATION (COLORADO CORPORATION)  
42415 DEERFOOT LANE  
STEAMBOAT SPRINGS, CO 80487

**Registered May 1, 2012**

**Int. Cl.: 20**

FOR: MASSAGE TABLES, MASSAGE BENCHES, AND MASSAGE CUSHIONS, IN CLASS 20 (U.S. CLS. 2, 13, 22, 25, 32 AND 50).

**TRADEMARK**

FIRST USE 10-10-2011; IN COMMERCE 10-10-2011.

**PRINCIPAL REGISTER**

THE MARK CONSISTS OF STANDARD CHARACTERS WITHOUT CLAIM TO ANY PARTICULAR FONT, STYLE, SIZE, OR COLOR.

SN 77-798,094, FILED 8-5-2009.

KATHLEEN M. VANSTON, EXAMINING ATTORNEY



*David J. Kybas*

Director of the United States Patent and Trademark Office

# United States of America

United States Patent and Trademark Office

## ARAYA LIGHTING

**Reg. No. 4,135,859**

**Registered May 1, 2012**

**Int. Cl.: 11**

**TRADEMARK**

**PRINCIPAL REGISTER**

HERST VENTURES, INC. (CALIFORNIA CORPORATION)  
2027 FOURTH STREET  
BERKELEY, CA 94710

FOR: LED (LIGHT EMITTING DIODE) LIGHTING FIXTURES, IN CLASS 11 (U.S. CLS. 13, 21, 23, 31 AND 34).

FIRST USE 1-11-2012; IN COMMERCE 1-11-2012.

THE MARK CONSISTS OF STANDARD CHARACTERS WITHOUT CLAIM TO ANY PARTICULAR FONT, STYLE, SIZE, OR COLOR.

NO CLAIM IS MADE TO THE EXCLUSIVE RIGHT TO USE "LIGHTING", APART FROM THE MARK AS SHOWN.

SN 77-800,062, FILED 8-7-2009.

MICHAEL KEATING, EXAMINING ATTORNEY



*David J. Kybas*

Director of the United States Patent and Trademark Office

# United States of America

United States Patent and Trademark Office

## GRANDBOOK

**Reg. No. 4,135,860**

**Registered May 1, 2012**

**Int. Cl.: 41**

**SERVICE MARK**

**PRINCIPAL REGISTER**

SEARCHING FOR VALUES, LLC (OHIO LIMITED LIABILITY COMPANY)  
23611 CHAGRIN BOULEVARD  
BEACHWOOD, OH 44122

FOR: EDUCATIONAL SERVICES, NAMELY, CONDUCTING LIVE AND ONLINE CLASSES, WORKSHOPS, AND SEMINARS, TO TEACH VALUES THROUGH THE TELLING OF THEIR INTERGENERATIONAL STORIES; EDUCATIONAL AND ENTERTAINMENT SERVICES, NAMELY, PROVIDING LIVE AND ONLINE MOTIVATIONAL AND EDUCATIONAL SPEAKERS IN THE FIELD OF CHARACTER DEVELOPMENT, VALUES; EDUCATIONAL SERVICES, NAMELY, CONDUCTING LIVE AND ONLINE PROGRAMS IN THE FIELD OF CHARACTER DEVELOPMENT THROUGH INTERGENERATIONAL INTERACTION; EDUCATIONAL SERVICES, NAMELY, CONDUCTING LIVE AND ONLINE WORKSHOPS AND CLASSES IN THE FIELD OF CHARACTER DEVELOPMENT THROUGH INTERGENERATIONAL INTERACTION AND DISTRIBUTING COURSE BOOK MATERIALS IN CONNECTION THEREWITH, IN CLASS 41 (U.S. CLS. 100, 101 AND 107).

FIRST USE 2-9-2012; IN COMMERCE 2-9-2012.

THE MARK CONSISTS OF STANDARD CHARACTERS WITHOUT CLAIM TO ANY PARTICULAR FONT, STYLE, SIZE, OR COLOR.

SN 77-800,598, FILED 8-10-2009.

JEFF DEFORD, EXAMINING ATTORNEY



*David J. Kybas*

Director of the United States Patent and Trademark Office

# United States of America

United States Patent and Trademark Office

## FREE RANGE HUMAN

**Reg. No. 4,135,861**

**Registered May 1, 2012**

**Int. Cl.: 41**

**SERVICE MARK**

**PRINCIPAL REGISTER**

APPEL, CAROLYN (UNITED STATES INDIVIDUAL)  
25 W. 120TH ST  
#GRD FLR  
NEW YORK, NY 10027

FOR: TRAINING SERVICES IN THE FIELD OF MOTOR SKILL DEVELOPMENT, IN CLASS 41 (U.S. CLS. 100, 101 AND 107).

FIRST USE 11-6-2011; IN COMMERCE 11-6-2011.

THE MARK CONSISTS OF STANDARD CHARACTERS WITHOUT CLAIM TO ANY PARTICULAR FONT, STYLE, SIZE, OR COLOR.

SN 77-807,976, FILED 8-19-2009.

TINA MAI, EXAMINING ATTORNEY



*David J. Kybas*

Director of the United States Patent and Trademark Office

# United States of America

United States Patent and Trademark Office

# VEGEFLUX

**Reg. No. 4,135,862**

**Registered May 1, 2012**

**Int. Cl.: 19**

**TRADEMARK**

**PRINCIPAL REGISTER**

COLAS (FRANCE SOCIÉTÉ ANONYME (SA))  
7, PLACE RENÉ CLAIR  
BOULOGNE BILLANCOURT, FRANCE 92100

FOR: NON-METALLIC BUILDING MATERIALS IN THE FORM OF A PLANT-BASED BINDER OR AN ASPHALT-BASED BINDER FOR USE IN THE CONSTRUCTION, MAINTAINING, STABILIZING, RESURFACING OF ROADS, ROAD AND MOTORWAY SURFACES, PATHS FOR BICYCLES AND SIMILAR TRAFFIC, IN CLASS 19 (U.S. CLS. 1, 12, 33 AND 50).

FIRST USE 6-0-2005; IN COMMERCE 6-0-2010.

THE MARK CONSISTS OF STANDARD CHARACTERS WITHOUT CLAIM TO ANY PARTICULAR FONT, STYLE, SIZE, OR COLOR.

SN 77-808,818, FILED 8-20-2009.

INGA ERVIN, EXAMINING ATTORNEY



*David J. Kybas*

Director of the United States Patent and Trademark Office



# United States of America

United States Patent and Trademark Office

## METALOCALYPSE

**Reg. No. 4,135,863**

**Registered May 1, 2012**

**Int. Cl.: 25**

**TRADEMARK**

**PRINCIPAL REGISTER**

THE CARTOON NETWORK, INC. (DELAWARE CORPORATION)  
1050 TECHWOOD DRIVE, NW  
ATLANTA, GA 30318

FOR: ATHLETIC FOOTWEAR AND APPAREL, NAMELY, HOODED SWEATSHIRTS AND TERRY CLOTH WRISTBANDS, IN CLASS 25 (U.S. CLS. 22 AND 39).

FIRST USE 4-1-2007; IN COMMERCE 4-1-2007.

THE MARK CONSISTS OF STANDARD CHARACTERS WITHOUT CLAIM TO ANY PARTICULAR FONT, STYLE, SIZE, OR COLOR.

OWNER OF U.S. REG. NOS. 3,266,453, 3,589,136, AND OTHERS.

SN 77-809,262, FILED 8-20-2009.

ANNE FARRELL, EXAMINING ATTORNEY



*David J. Kyros*

Director of the United States Patent and Trademark Office

# United States of America

United States Patent and Trademark Office

## BROW RAISERS

**Reg. No. 4,135,864**

**Registered May 1, 2012**

**Int. Cl.: 28**

**TRADEMARK**

**PRINCIPAL REGISTER**

JAKKS PACIFIC, INC. (NEW YORK CORPORATION)  
22619 PACIFIC COAST HIGHWAY  
MALIBU, NY 90265

FOR: COSTUME MASKS; FACE MASKS; TOY AND NOVELTY FACE MASKS; TOY MASKS,  
IN CLASS 28 (U.S. CLS. 22, 23, 38 AND 50).

FIRST USE 10-30-2010; IN COMMERCE 10-28-2011.

THE MARK CONSISTS OF STANDARD CHARACTERS WITHOUT CLAIM TO ANY PAR-  
TICULAR FONT, STYLE, SIZE, OR COLOR.

SN 77-810,564, FILED 8-21-2009.

ELLEN PERKINS, EXAMINING ATTORNEY



*David J. Kybas*

Director of the United States Patent and Trademark Office

# United States of America

United States Patent and Trademark Office

## THE HOPELINE

**Reg. No. 4,135,865**

**Registered May 1, 2012**

**Int. Cls.: 38, 41, and 45**

**SERVICE MARK**

**PRINCIPAL REGISTER**

THE SHEPHERD'S CALL (TENNESSEE CORPORATION)  
220 TOWN CENTER PARKWAY  
SPRING HILL, TN 37174

FOR: PROVIDING TRANSMISSION OF MESSAGES AMONG WEBSITE USERS IN THE FIELD OF SELF-HELP AND MENTORING, IN CLASS 38 (U.S. CLS. 100, 101 AND 104).

FIRST USE 4-29-2002; IN COMMERCE 4-29-2002.

FOR: PERSONAL LIFE COACHING AND MENTORING SERVICES IN THE FIELD OF SELF-HELP AND PERSONAL EMPOWERMENT PROVIDED VIA TELEPHONE, IN CLASS 41 (U.S. CLS. 100, 101 AND 107).

FIRST USE 10-31-1991; IN COMMERCE 10-31-1991.

FOR: PROVIDING THROUGH THE TELEPHONE INFORMATION IN THE FIELD OF SELF-HELP AND PERSONAL EMPOWERMENT, IN CLASS 45 (U.S. CLS. 100 AND 101).

FIRST USE 10-31-1991; IN COMMERCE 10-31-1991.

THE MARK CONSISTS OF STANDARD CHARACTERS WITHOUT CLAIM TO ANY PARTICULAR FONT, STYLE, SIZE, OR COLOR.

SN 77-813,202, FILED 8-26-2009.

DAVID C. REIHNER, EXAMINING ATTORNEY



*David J. Kybas*

Director of the United States Patent and Trademark Office

# United States of America

United States Patent and Trademark Office

## CINEPHOTOGRAPHY

**Reg. No. 4,135,866**

RED.COM, INC. (WASHINGTON CORPORATION)  
20291 VALENCIA CIR.  
LAKE FOREST, CA 92630

**Registered May 1, 2012**

**Int. Cl.: 41**

FOR: ENTERTAINMENT SERVICES, NAMELY, RECORDING, PRODUCTION AND POST-PRODUCTION SERVICES IN THE FIELDS OF VIDEO AND FILMS, IN CLASS 41 (U.S. CLS. 100, 101 AND 107).

**SERVICE MARK**

FIRST USE 9-17-2009; IN COMMERCE 9-17-2009.

**PRINCIPAL REGISTER**

THE MARK CONSISTS OF STANDARD CHARACTERS WITHOUT CLAIM TO ANY PARTICULAR FONT, STYLE, SIZE, OR COLOR.

SN 77-813,987, FILED 8-27-2009.

JOHN DWYER, EXAMINING ATTORNEY



*David J. Kybas*

Director of the United States Patent and Trademark Office

# United States of America

United States Patent and Trademark Office

# XPRESSVIEW

**Reg. No. 4,135,867**

**Registered May 1, 2012**

**Int. Cl.: 9**

**TRADEMARK**

**PRINCIPAL REGISTER**

ANALOG DEVICES, INC. (MASSACHUSETTS CORPORATION)  
ONE TECHNOLOGY WAY  
NORWOOD, MA 02062

FOR: HIGH DEFINITION MULTIMEDIA INTERFACE DEVICES FOR HOME ENTERTAINMENT SYSTEMS, NAMELY, CONNECTORS; HIGH DEFINITION MULTIMEDIA INTERFACE CABLES; WIRELESS EXTENDERS, PLUG ADAPTERS, OPTICAL CABLES, ELECTRONIC VIDEO CONTROLLERS, COMPUTER HARDWARE, NAMELY, WIRELESS NETWORK HIGH DEFINITION MULTIMEDIA INTERFACE EXTENDERS AND REPEATERS, IN CLASS 9 (U.S. CLS. 21, 23, 26, 36 AND 38).

FIRST USE 9-29-2009; IN COMMERCE 9-29-2009.

THE MARK CONSISTS OF STANDARD CHARACTERS WITHOUT CLAIM TO ANY PARTICULAR FONT, STYLE, SIZE, OR COLOR.

SN 77-817,576, FILED 9-1-2009.

CHRISIE B. KING, EXAMINING ATTORNEY



*David J. Kyros*

Director of the United States Patent and Trademark Office

# United States of America

United States Patent and Trademark Office



**Reg. No. 4,135,868**

**Registered May 1, 2012**

**Int. Cl.: 35**

**SERVICE MARK**

**PRINCIPAL REGISTER**

TELLBOB INC. (CANADA CORPORATION)  
250 VILLAIRE AVENUE  
WINDSOR, ONTARIO, CANADA N8S2J2

FOR: PLANNING, PREPARING, CONDUCTING AND MANAGING CUSTOMER SATISFACTION SURVEYS AND MARKET RESEARCH SURVEYS AND POLLS FOR OTHERS, AND COMPILING, ANALYZING AND PUBLISHING THE RESULTS OF SAID SURVEYS; ADVERTISING THE GOODS AND SERVICES OF OTHERS ONLINE AND ON SCREENS LOCATED IN KIOSKS LOCATED IN SHOPPING MALLS, STORES AND RESTAURANTS; PROVIDING AN INTERACTIVE WEBSITE FOR MEMBERS INTERESTED IN PARTICIPATING IN CUSTOMER SATISFACTION SURVEYS AND MARKET RESEARCH SURVEYS AND POLLS; COMPILING, MANAGING, UPDATING AND ANALYZING MARKET RESEARCH DATA AND INFORMATION FOR OTHERS; PROMOTING THE GOODS AND SERVICES OF OTHERS BY ADMINISTERING INCENTIVE REWARDS PROGRAMS FEATURING COUPONS AND REWARDS FOR PARTICIPATING IN CUSTOMER SATISFACTION SURVEYS AND MARKET RESEARCH SURVEYS AND POLLS FOR OTHERS; THE PROVISION OF AN INTERACTIVE WEBSITE TO PERMIT MEMBERS WHO PARTICIPATE IN CUSTOMER SATISFACTION SURVEYS AND MARKET RESEARCH SURVEYS AND POLLS AND WHO RECEIVE REWARDS AS A RESULT OF SUCH PARTICIPATION, TO POST AND TRADE THEIR REWARDS AND COUPONS WITH OTHER MEMBERS, IN CLASS 35 (U.S. CLS. 100, 101 AND 102).

FIRST USE 3-31-2009; IN COMMERCE 10-11-2011.

THE MARK CONSISTS OF THE WORDS "TELLBOB" WITH "TELL" PRESENTED IN A CONVERSATION BUBBLE DESIGN AND "BOB" PRESENTED IN A CONTRASTING COLOR WITH THE WORDS "BE HEARD.GET STUFF" UNDERNEATH AND IN A SMALLER TYPEFACE.

SN 77-825,414, FILED 9-12-2009.

ANN E. SAPPENFIELD, EXAMINING ATTORNEY



*David J. Kyros*

Director of the United States Patent and Trademark Office

# United States of America

United States Patent and Trademark Office

*Achilles*  *Comfort*

**Reg. No. 4,135,869**

**Registered May 1, 2012**

**Int. Cl.: 25**

**TRADEMARK**

**PRINCIPAL REGISTER**

ACHILLES COMFORT, LLC (FLORIDA LIMITED LIABILITY COMPANY)  
2871 NORTH OCEAN BLVD., R-360  
BOCA RATON, FL 33431

FOR: CLOTHING, NAMELY, HOSIERY, SOCKS AND STOCKINGS, IN CLASS 25 (U.S. CLS. 22 AND 39).

FIRST USE 3-0-2011; IN COMMERCE 3-0-2011.

NO CLAIM IS MADE TO THE EXCLUSIVE RIGHT TO USE "COMFORT", APART FROM THE MARK AS SHOWN.

THE COLOR(S) BLUE AND AQUA IS/ARE CLAIMED AS A FEATURE OF THE MARK.

THE MARK CONSISTS OF THE STYLIZED WORD "ACHILLES" IN THE COLOR BLUE, FOLLOWED BY A STYLIZED DESIGN OF AN INCOMPLETE HUMAN FOOT IN THE COLOR AQUA, FOLLOWED BY THE STYLIZED WORD "COMFORT" IN THE COLOR BLUE. THE COLOR WHITE REPRESENTS BACKGROUND, OUTLINING, SHADING AND/OR TRANSPARENT AREAS AND IS NOT PART OF THE MARK.

SN 77-826,595, FILED 9-15-2009.

ADA HAN, EXAMINING ATTORNEY



*David J. Kyros*

Director of the United States Patent and Trademark Office

# United States of America

United States Patent and Trademark Office

*flash*  
**GUARD**

**Reg. No. 4,135,870**

**Registered May 1, 2012**

**Int. Cls.: 24 and 25**

**TRADEMARK**

**PRINCIPAL REGISTER**

RED WING SHOE COMPANY, INC. (MINNESOTA CORPORATION)  
RIVERFRONT CENTRE, 314 MAIN STREET  
RED WING, MN 55066

FOR: FIRE RETARDANT FABRIC FOR THE MANUFACTURE OF WORKWEAR, IN CLASS 24 (U.S. CLS. 42 AND 50).

FIRST USE 1-0-2010; IN COMMERCE 1-0-2010.

FOR: FABRIC SOLD AS AN INTEGRAL COMPONENT OF FINISHED CLOTHING ITEMS, NAMELY, JACKETS, SHIRTS AND HEADWEAR, IN CLASS 25 (U.S. CLS. 22 AND 39).

FIRST USE 1-0-2010; IN COMMERCE 1-0-2010.

THE MARK CONSISTS OF THE WORD "FLASHGUARD" AND A FANCIFUL FLAME DESIGN.

SN 77-828,058, FILED 9-16-2009.

RONALD MCMORROW, EXAMINING ATTORNEY



*David J. Kyros*

Director of the United States Patent and Trademark Office



# United States of America

United States Patent and Trademark Office

# Verbatim

**Reg. No. 4,135,871**

**Registered May 1, 2012**

**Int. Cls.: 1, 3, 9, 16, and 21**

VERBATIM AMERICAS LLC (DELAWARE LIMITED LIABILITY COMPANY)  
1200 W.T. HARRIS BOULEVARD  
CHARLOTTE, NC 28262

FOR: PHOTOGRAPHIC PAPER, IN CLASS 1 (U.S. CLS. 1, 5, 6, 10, 26 AND 46).

FIRST USE 1-1-2007; IN COMMERCE 1-1-2007.

**TRADEMARK**

**PRINCIPAL REGISTER**

FOR: CLEANING PREPARATIONS; DISPOSABLE WIPES IMPREGNATED WITH CLEANING COMPOUNDS FOR USE ON MAGNETIC AND OPTICAL DISKS, IN CLASS 3 (U.S. CLS. 1, 4, 6, 50, 51 AND 52).

FIRST USE 1-1-2007; IN COMMERCE 1-1-2007.

FOR: AUDIO AND VIDEO RECORDING AND REPRODUCTION MACHINES, NAMELY, VIDEO DISC RECORDERS AND PLAYERS; BLANK RECORDING MEDIA, NAMELY, FLOPPY DISKS, CDS, DVDS, HD DVDS, OPTICAL DISKS, AND MAGNETO-OPTICAL DISKS; ELECTRONIC AND MAGNETIC CARD READERS; COMPACT DISC RECORDERS AND PLAYERS; COMPUTER HARDWARE; COMPUTER PERIPHERALS; COMPUTER AND OPTICAL DISK DRIVES FOR WRITING DATA ONTO RECORDING MEDIA; COMPUTER DISK DRIVES; DESKTOP HARD DRIVES FOR COMPUTERS; NAS DESKTOP HARD DRIVES FOR COMPUTERS; KEYBOARDS; LASER PRINTER TONER CARTRIDGES; MEMORY CARDS; COMPUTER MICE; PORTABLE HARD DRIVES FOR COMPUTERS; OPTICAL DISK DRIVES; OPTICAL AND MAGNETO-OPTICAL DISC PLAYERS AND RECORDERS FOR AUDIO, VIDEO AND COMPUTER DATA; DVD AND CD STORAGE CASES; AUDIO TAPE STORAGE CASES; USB ADAPTERS; USB CABLES; USB DRIVES; USB HUBS, IN CLASS 9 (U.S. CLS. 21, 23, 26, 36 AND 38).

FIRST USE 1-1-2007; IN COMMERCE 1-1-2007.

FOR: PAPER FOR PRINTING PHOTOGRAPHS, IN CLASS 16 (U.S. CLS. 2, 5, 22, 23, 29, 37, 38 AND 50).

FIRST USE 1-1-2007; IN COMMERCE 1-1-2007.

FOR: CLEANING CLOTHS, IN CLASS 21 (U.S. CLS. 2, 13, 23, 29, 30, 33, 40 AND 50).



*David J. Kyros*

Director of the United States Patent and Trademark Office

**Reg. No. 4,135,871** FIRST USE 1-1-2007; IN COMMERCE 1-1-2007.

OWNER OF U.S. REG. NOS. 1,675,734, 1,930,778, AND 2,765,962.

THE MARK CONSISTS OF THE WORD "VERBATIM" NEXT TO A STYLIZED "V" IN A SQUARE BOX.

SN 77-828,513, FILED 9-17-2009.

DAVID TOOLEY, EXAMINING ATTORNEY

# United States of America

United States Patent and Trademark Office

# FORTUNOFF

**Reg. No. 4,135,872**

**Registered May 1, 2012**

**Int. Cls.: 6, 11, 18, 20,  
and 35**

**TRADEMARK**

**SERVICE MARK**

**PRINCIPAL REGISTER**

FORTUNOFF BRANDS, LLC (DELAWARE LIMITED LIABILITY COMPANY)  
SUITE 303  
100 QUENTIN ROOSEVELT BLVD.  
GARDEN CITY, NY 11530

FOR: METAL MAILBOXES; DECORATIVE METAL MAILBOX COVERS, IN CLASS 6 (U.S. CLS. 2, 12, 13, 14, 23, 25 AND 50).

FIRST USE 3-31-2010; IN COMMERCE 3-31-2010.

FOR: GAS GRILLS; CHARCOAL GRILLS; OUTDOOR PATIO AND GARDEN HEATERS, NAMELY, CHIMENEAS, FIREPLACES, PORTABLE FIREPLACES, FIRE RINGS, FIRE BOWLS AND GAS PATIO BURNERS; OUTDOOR LIGHTING FIXTURES; ELECTRIC HOLIDAY AND CHRISTMAS LIGHTS FOR INDOOR AND OUTDOOR USE; OUTDOOR LIGHTED HOLIDAY AND CHRISTMAS ORNAMENTS, IN CLASS 11 (U.S. CLS. 13, 21, 23, 31 AND 34).

FIRST USE 3-31-2010; IN COMMERCE 3-31-2010.

FOR: PATIO ACCESSORIES, NAMELY, PATIO UMBRELLAS, IN CLASS 18 (U.S. CLS. 1, 2, 3, 22 AND 41).

FIRST USE 3-31-2010; IN COMMERCE 3-31-2010.

FOR: OUTDOOR AND PATIO FURNITURE; OUTDOOR AND PATIO ACCESSORIES, NAMELY, FITTED FABRIC FURNITURE COVERS, CHAIR PADS, SEAT CUSHIONS AND PILLOWS; NON-METAL MAILBOXES; DECORATIVE NON-METAL MAILBOX COVERS; HOLIDAY ORNAMENTS OF PLASTIC HAVING HOLIDAY-THEMED SHAPES NOT FOR USE AS TREE ORNAMENTS, IN CLASS 20 (U.S. CLS. 2, 13, 22, 25, 32 AND 50).

FIRST USE 3-31-2010; IN COMMERCE 3-31-2010.

FOR: RETAIL AND ONLINE STORE SERVICES FEATURING OUTDOOR AND PATIO FURNITURE, OUTDOOR AND PATIO ACCESSORIES, OUTDOOR GRILLS AND HEATERS, OUTDOOR LIGHTING FIXTURES, PEST AND INSECT CONTROL DEVICES, MAILBOXES AND MAILBOX COVERS, DINNERWARE, TABLEWARE, BEVERAGeware, FLATWARE, UTENSILS, SERVING TRAYS, CANDLE HOLDERS, KITCHEN, TABLE AND BATH LINENS,



*David J. Kyros*

Director of the United States Patent and Trademark Office

**Reg. No. 4,135,872** BARBECUE ACCESSORIES, PICNIC ACCESSORIES, SWIMMING POOL ACCESSORIES, RUGS, FANS AND GARDEN DÉCOR, HOLIDAY AND CHRISTMAS THEMED MERCHANDISE, NAMELY, ORNAMENTS AND DECORATIONS, LIGHTS, ARTIFICIAL TREES, GARLANDS AND WREATHS, TREE SKIRTS, TREE STANDS, IN CLASS 35 (U.S. CLS. 100, 101 AND 102).

FIRST USE 3-31-2010; IN COMMERCE 3-31-2010.

THE MARK CONSISTS OF STANDARD CHARACTERS WITHOUT CLAIM TO ANY PARTICULAR FONT, STYLE, SIZE, OR COLOR.

SEC. 2(F).

OWNER OF U.S. REG. NOS. 1,044,488, 1,420,819, AND 1,634,537.

SN 77-828,872, FILED 9-17-2009.

STEVEN PEREZ, EXAMINING ATTORNEY

# United States of America

United States Patent and Trademark Office



**Reg. No. 4,135,873**

**Registered May 1, 2012**

**Int. Cls.: 36 and 41**

**SERVICE MARK**

**PRINCIPAL REGISTER**

HUNTSVILLE AREA ASSOCIATION OF REALTORS, INC. (ALABAMA CORPORATION)  
535 MONROE ST. NW  
HUNTSVILLE, AL 35801

FOR: REAL ESTATE INFORMATION SERVICES, NAMELY, PROVIDING MULTIPLE PROPERTY LISTING INFORMATION TO MEMBERS AND PROVIDING MULTIPLE PROPERTY LISTING INFORMATION ONLINE, IN CLASS 36 (U.S. CLS. 100, 101 AND 102).

FIRST USE 10-15-2010; IN COMMERCE 10-15-2010.

FOR: PROVIDING EDUCATIONAL INFORMATION IN THE FIELD OF REAL ESTATE TO MEMBERS, NAMELY, DEVELOPING AND DISSEMINATING REAL ESTATE EDUCATIONAL MATERIALS AND CONDUCTING REAL ESTATE SEMINARS FOR MEMBERS, IN CLASS 41 (U.S. CLS. 100, 101 AND 107).

FIRST USE 10-15-2010; IN COMMERCE 10-15-2010.

OWNER OF U.S. REG. NOS. 3,746,186 AND 3,833,478.

NO CLAIM IS MADE TO THE EXCLUSIVE RIGHT TO USE "HUNTSVILLE AREA ASSOCIATION", APART FROM THE MARK AS SHOWN.

THE MARK CONSISTS OF A CIRCLE HAVING AN IMAGE OF A HOUSE WITHIN THE CIRCLE, THE ACRONYM "HAAR" TO THE SIDE OF THE CIRCLE AND THE WORDS "HUNTSVILLE AREA ASSOCIATION OF REALTORS" BELOW THE CIRCLE AND THE ACRONYM.

SN 77-828,892, FILED 9-17-2009.

JOHN DALIER, EXAMINING ATTORNEY



*David J. Kybas*

Director of the United States Patent and Trademark Office

# United States of America

United States Patent and Trademark Office

## Valley Bank of Nevada

**Reg. No. 4,135,874**

BANK OF NORTH LAS VEGAS (NEVADA CORPORATION)  
6385 SIMMONS STREET  
NORTH LAS VEGAS, NV 89031

**Registered May 1, 2012**

**Int. Cl.: 36**

FOR: BANKING; BANKING AND FINANCING SERVICES; BANKING SERVICES, IN CLASS 36 (U.S. CLS. 100, 101 AND 102).

**SERVICE MARK**

FIRST USE 8-3-2011; IN COMMERCE 8-3-2011.

**PRINCIPAL REGISTER**

THE MARK CONSISTS OF STANDARD CHARACTERS WITHOUT CLAIM TO ANY PARTICULAR FONT, STYLE, SIZE, OR COLOR.

NO CLAIM IS MADE TO THE EXCLUSIVE RIGHT TO USE "BANK OF NEVADA", APART FROM THE MARK AS SHOWN.

SN 77-831,184, FILED 9-21-2009.

MEGHAN REINHART, EXAMINING ATTORNEY



*David J. Kyffers*

Director of the United States Patent and Trademark Office

# United States of America

United States Patent and Trademark Office



## MON D VIN

Demystifying French Wine

**Reg. No. 4,135,875**

**Registered May 1, 2012**

**Int. Cl.: 35**

**SERVICE MARK**

**PRINCIPAL REGISTER**

MON D VIN (FRANCE SOCIÉTÉ À RESPONSABILITÉ LIMITÉE (SARL))  
12 RUE VIVIENNE  
PARIS, FRANCE

FOR: COMMERCIAL INFORMATION IN THE FIELD OF WINE; COMPUTERIZED ON-LINE ORDERING SERVICES IN THE FIELD OF WINE; COMPUTERIZED ON-LINE RETAIL STORE SERVICES IN THE FIELD OF WINE; DISTRIBUTORSHIP SERVICES IN THE FIELD OF WINE; DISTRIBUTORSHIPS IN THE FIELD OF WINE; ON-LINE RETAIL STORE SERVICES FEATURING WINE; OPERATING AN ON-LINE SHOPPING SITE IN THE FIELD OF WINE; PROVIDING A WEBSITE USED TO PLACE ON-LINE COMMERCIAL ORDERS IN THE FIELD OF WINE; PROVIDING CONSUMER INFORMATION AND RELATED NEWS IN THE FIELD OF WINE; PROVIDING CONSUMER INFORMATION IN THE FIELD OF WINE; RETAIL STORE AND ON-LINE RETAIL STORE SERVICES FEATURING WINE; WHOLESALE AND RETAIL STORE SERVICES FEATURING WINE; WHOLESALE DISTRIBUTORSHIPS FEATURING WINE; WHOLESALE ORDERING SERVICES IN THE FIELD OF WINE, IN CLASS 35 (U.S. CLS. 100, 101 AND 102).

FIRST USE 5-21-2011; IN COMMERCE 5-21-2011.

OWNER OF FRANCE REG. NO. 3646936, DATED 5-6-2009, EXPIRES 5-6-2019.

NO CLAIM IS MADE TO THE EXCLUSIVE RIGHT TO USE "VIN" AND "FRENCH WINE", APART FROM THE MARK AS SHOWN.

THE MARK CONSISTS OF FIVE INTERLOCKING DROPS OF LIQUID THREE UPWARD FACING ON THE BOTTOM AND 2 DOWNWARD FACING ON THE TOP. BELOW THE DROPS IS THE WORDING "MON D VIN" IN LARGE CAPITAL LETTERS. BELOW THAT IS THE WORDING "DEMYSTIFYING FRENCH WINE" IN SMALLER TYPE.

THE ENGLISH TRANSLATION OF "MON" AND "VIN" IN THE MARK IS "MY" AND "WINE".

SN 77-832,672, FILED 9-23-2009.

MICHAEL WEBSTER, EXAMINING ATTORNEY



*David J. Kyffers*

Director of the United States Patent and Trademark Office

# United States of America

United States Patent and Trademark Office

**Antioxidant Nutrient 100% Natural**



## **Biotiquin**

**Reg. No. 4,135,876**

**Registered May 1, 2012**

**Int. Cl.: 5**

**TRADEMARK**

**PRINCIPAL REGISTER**

JUAN ALFONSO URBINA GARCIA (MEXICO INDIVIDUAL)  
ANDADOR UNO #224 COLONIA BANOBRAS  
LA PAZ, B.C.S., MEXICO 23080 AND

MANUEL URBINA GARCIA (UNITED STATES INDIVIDUAL)  
6968 BOLADO DR  
SAN JOSE, CA 95119

FOR: ALL NATURAL DIETARY FOOD SUPPLEMENTS WHICH CONTAIN ANTIOXIDANTS AND NON-TOXIC RESIDUES, IN CLASS 5 (U.S. CLS. 6, 18, 44, 46, 51 AND 52).

FIRST USE 1-1-2011; IN COMMERCE 1-1-2011.

NO CLAIM IS MADE TO THE EXCLUSIVE RIGHT TO USE "ANTIOXIDANT NUTRIENT 100% NATURAL HEALTH 100% NATURAL NON TOXIC RESIDUES", APART FROM THE MARK AS SHOWN.

THE COLOR(S) RED, GREEN AND GOLD IS/ARE CLAIMED AS A FEATURE OF THE MARK.

THE MARK CONSISTS OF THE FOLLOWING: THE WORDING "ANTIOXIDANT NUTRIENT 100% NATURAL" AND "BIOTIQUIN" IN RED, THE WORDING "HEALTH 100% NATURAL T-3 NON TOXIC RESIDUES" IN GOLD AND THE DESIGN OF AN OVAL GLOBE WITH MERIDIANS AND TREES AROUND ITS BORDER IN GREEN.

THE WORDING "BIOTIQUIN" HAS NO MEANING IN A FOREIGN LANGUAGE.

SN 77-833,550, FILED 9-23-2009.

JOHN SCHUYLER YARD, EXAMINING ATTORNEY



*David J. Kypos*

Director of the United States Patent and Trademark Office



# United States of America

United States Patent and Trademark Office

## It Is What It R

**Reg. No. 4,135,877**

**Registered May 1, 2012**

**Int. Cl.: 16**

**TRADEMARK**

**PRINCIPAL REGISTER**

RICHARDSON, DAVID (UNITED STATES INDIVIDUAL)  
2609 CAMILLE DR.  
LEWISVILLE, TX 75056

FOR: ART PRINTS; POSTERS, IN CLASS 16 (U.S. CLS. 2, 5, 22, 23, 29, 37, 38 AND 50).

FIRST USE 1-0-2010; IN COMMERCE 1-0-2010.

THE MARK CONSISTS OF STANDARD CHARACTERS WITHOUT CLAIM TO ANY PARTICULAR FONT, STYLE, SIZE, OR COLOR.

SN 77-841,229, FILED 10-5-2009.

ANDREW RHIM, EXAMINING ATTORNEY



*David J. Kyffers*

Director of the United States Patent and Trademark Office

# United States of America

United States Patent and Trademark Office

# BLACKBOX

**Reg. No. 4,135,878**

**Registered May 1, 2012**

**Int. Cl.: 9**

**TRADEMARK**

**PRINCIPAL REGISTER**

AIRSHOWBUZZ L.L.C. D.B.A. BLACKBOX (TEXAS LIMITED LIABILITY COMPANY)  
1375 ENCLAVE PARKWAY  
HOUSTON, TX 77077

FOR: COMPUTER SOFTWARE THAT PROVIDES A MODULAR, CUSTOMIZABLE, ADAPTIVE, AND INTERACTIVE GRAPHICAL USER INTERFACE FOR ORGANIZING, DISPLAYING, PUBLISHING, SORTING, TRANSMITTING, MANIPULATING SHARING, DISCUSSING, VIEWING AND CREATING CUSTOM LAYOUTS OF PUBLISHED AND USER-GENERATED DATA, INFORMATION AND MULTIMEDIA CONTENT; DOWNLOADABLE SOFTWARE THAT ALLOWS USERS TO UTILIZE VOICE/VIDEO OVER INTERNET PROTOCOL (VOIP) APPLICATIONS, IN CLASS 9 (U.S. CLS. 21, 23, 26, 36 AND 38).

FIRST USE 6-15-2010; IN COMMERCE 1-20-2011.

THE MARK CONSISTS OF STANDARD CHARACTERS WITHOUT CLAIM TO ANY PARTICULAR FONT, STYLE, SIZE, OR COLOR.

SN 77-842,987, FILED 10-6-2009.

WON TEAK OH, EXAMINING ATTORNEY



*David J. Kyros*

Director of the United States Patent and Trademark Office

**United States of America**  
United States Patent and Trademark Office

# HARDCORE

**Reg. No. 4,135,879**

**Registered May 1, 2012**

**Int. Cl.: 12**

**TRADEMARK**

**PRINCIPAL REGISTER**

TIRE MART, INC. (MISSOURI CORPORATION)  
1815 LOCUST STREET  
ST. LOUIS, MO 63105

FOR: TIRES, IN CLASS 12 (U.S. CLS. 19, 21, 23, 31, 35 AND 44).

FIRST USE 12-21-2011; IN COMMERCE 12-21-2011.

THE MARK CONSISTS OF STANDARD CHARACTERS WITHOUT CLAIM TO ANY PARTICULAR FONT, STYLE, SIZE, OR COLOR.

SN 77-844,797, FILED 10-8-2009.

ELISSA GARBER KON, EXAMINING ATTORNEY



*David J. Kyffers*

Director of the United States Patent and Trademark Office

# United States of America

United States Patent and Trademark Office

## TWIST EDUCATION

**Reg. No. 4,135,880**

**Registered May 1, 2012**

**Int. Cls.: 9 and 41**

**TRADEMARK**

**SERVICE MARK**

**PRINCIPAL REGISTER**

TWIST EDUCATION, LLC (TEXAS LIMITED LIABILITY COMPANY)  
14402 BLANCO ROAD, SUITE 100  
SAN ANTONIO, TX 78216

FOR: EDUCATIONAL COMPUTER GAME SOFTWARE; DOWNLOADABLE EDUCATIONAL  
COMPUTER GAME SOFTWARE, IN CLASS 9 (U.S. CLS. 21, 23, 26, 36 AND 38).

FIRST USE 1-31-2011; IN COMMERCE 1-31-2011.

FOR: PROVIDING TEMPORARY USE OF ONLINE AND NON-DOWNLOADABLE EDUCA-  
TIONAL COMPUTER GAME SOFTWARE, IN CLASS 41 (U.S. CLS. 100, 101 AND 107).

FIRST USE 1-31-2011; IN COMMERCE 1-31-2011.

THE MARK CONSISTS OF STANDARD CHARACTERS WITHOUT CLAIM TO ANY PAR-  
TICULAR FONT, STYLE, SIZE, OR COLOR.

NO CLAIM IS MADE TO THE EXCLUSIVE RIGHT TO USE "EDUCATION", APART FROM  
THE MARK AS SHOWN.

SN 77-845,680, FILED 10-9-2009.

AMY C. KEAN, EXAMINING ATTORNEY



*David J. Kappas*

Director of the United States Patent and Trademark Office

# United States of America

United States Patent and Trademark Office



**Reg. No. 4,135,881**

**Registered May 1, 2012**

**Int. Cl.: 25**

**TRADEMARK**

**PRINCIPAL REGISTER**

MCCOY, TRAVIS D. (UNITED STATES INDIVIDUAL), DBA HAPPY FIGHTER,  
313 DOCKSIDE DR  
SLIDELL, LA 70461

FOR: ATHLETIC APPAREL, NAMELY, SHIRTS, PANTS, JACKETS, FOOTWEAR, HATS AND CAPS, ATHLETIC UNIFORMS; BOARD SHORTS; BODY SHIRTS; BOXER SHORTS; BOXING SHORTS; GLOVES; GLOVES AS CLOTHING; GLOVES FOR PERSONAL HAND CONDITIONING USE; GYM PANTS; GYM SHORTS; HAT BANDS; HATS; HOODED SWEAT SHIRTS; JOGGING PANTS; LONG-SLEEVED SHIRTS; LOUNGE PANTS; NIGHT SHIRTS; RUGBY SHIRTS; RUGBY SHORTS; SHIRTS AND SHORT-SLEEVED SHIRTS; SHORT-SLEEVED OR LONG-SLEEVED T-SHIRTS; SHORT-SLEEVED SHIRTS; SHORTS; SMALL HATS; SPORT SHIRTS; SPORTS PANTS; SPORTS SHIRTS; SPORTS SHIRTS WITH SHORT SLEEVES; STRETCH PANTS; SWEAT PANTS; SWEAT SHIRTS; SWEAT SHORTS; T-SHIRTS; TEE SHIRTS, IN CLASS 25 (U.S. CLS. 22 AND 39).

FIRST USE 11-10-2009; IN COMMERCE 11-24-2009.

NO CLAIM IS MADE TO THE EXCLUSIVE RIGHT TO USE ".COM", APART FROM THE MARK AS SHOWN.

THE COLOR(S) YELLOW, BLACK, WHITE AND GRAY IS/ARE CLAIMED AS A FEATURE OF THE MARK.



THE MARK CONSISTS OF THE WORDING "HAPPY FIGHTER .COM" POSITIONED BENEATH A SMILEY FACE DESIGN HAVING A BLACK EYE AND HANDS IN BOXING GLOVES. THE COLORS YELLOW, BLACK, WHITE AND GRAY ARE CLAIMED AS FEATURES OF THE MARK. THE MARK CONSISTS OF THE FOLLOWING: A YELLOW SMILEY FACE DESIGN AND YELLOW FINGERS AND PALMS OF BOXING GLOVES. THE COLOR YELLOW ALSO APPEARS IN A MISCELLANEOUS DESIGN IN THE BACKGROUND OF THE WORDING "HAPPY FIGHTER .COM". THE COLOR BLACK APPEARS ON THE EYELID, PUPILS OF THE EYES, OUTLINING SMILEY FACE, OUTLINING FOR EYES AND FOR DESIGN OF THE SMILE, ON THE DESIGN OF THE GLOVES AND OUTLINE OF FINGERS AND IN THE WORDING "HAPPY FIGHTER .COM". THE COLOR WHITE APPEARS IN THE EYES AND ON BOXING GLOVES AND THE COLOR GRAY APPEARS IN THE IRISES OF THE EYES.

*David J. Kyjars*

Director of the United States Patent and Trademark Office

THE WORDING "HAPPY FIGHTER" HAS NO MEANING IN A FOREIGN LANGUAGE.

**Reg. No. 4,135,881** SN 77-846,274, FILED 10-12-2009.

KAREN BRACEY, EXAMINING ATTORNEY

# United States of America

United States Patent and Trademark Office

# 340Beyond

**Reg. No. 4,135,882**

**Registered May 1, 2012**

**Int. Cl.: 35**

**SERVICE MARK**

**PRINCIPAL REGISTER**

AMERICAN HEALTH CARE ADMINISTRATIVE SERVICES, INC. (CALIFORNIA CORPORATION), AKA AMERICAN HEALTH CARE (AHC),  
2217 PLAZA DRIVE, SUITE 100  
ROCKLIN, CA 95765

FOR: CONSULTING SERVICES, NAMELY, TO EMPLOYERS, COMMUNITY ORGANIZATIONS, BROKERS AND BENEFICIARIES, RELATED TO CONSUMER INFORMATION REGARDING HEALTH CARE PLAN OPTIONS, PRODUCTS AND PROGRAMS IN THE FIELD OF MANAGED CARE AND STATE AND FEDERAL MEDICAL CARE PROGRAMS, IN CLASS 35 (U.S. CLS. 100, 101 AND 102).

FIRST USE 7-15-2010; IN COMMERCE 7-15-2010.

THE MARK CONSISTS OF STANDARD CHARACTERS WITHOUT CLAIM TO ANY PARTICULAR FONT, STYLE, SIZE, OR COLOR.

SN 77-846,509, FILED 10-12-2009.

KAREN SEVERSON, EXAMINING ATTORNEY



*David J. Kyros*

Director of the United States Patent and Trademark Office

# United States of America

United States Patent and Trademark Office

## ENVI CACHEPOT COLLECTION

**Reg. No. 4,135,883**

**Registered May 1, 2012**

**Int. Cl.: 16**

**TRADEMARK**

**PRINCIPAL REGISTER**

THE JOHN HENRY COMPANY, A MULTI PACKAGING SOLUTIONS COMPANY (MICHIGAN CORPORATION)  
5800 W. GRAND RIVER AVENUE  
LANSING, MI 48901

FOR: FOLDABLE PLANT PAPER PACKAGING CONTAINER, IN CLASS 16 (U.S. CLS. 2, 5, 22, 23, 29, 37, 38 AND 50).

FIRST USE 9-30-2009; IN COMMERCE 9-30-2009.

THE MARK CONSISTS OF STANDARD CHARACTERS WITHOUT CLAIM TO ANY PARTICULAR FONT, STYLE, SIZE, OR COLOR.

NO CLAIM IS MADE TO THE EXCLUSIVE RIGHT TO USE "CACHEPOT COLLECTION", APART FROM THE MARK AS SHOWN.

SN 77-852,410, FILED 10-20-2009.

WILLIAM VERHOSEK, EXAMINING ATTORNEY



*David J. Kyros*

Director of the United States Patent and Trademark Office



# United States of America

United States Patent and Trademark Office

# twilight

**Reg. No. 4,135,884**

**Registered May 1, 2012**

**Int. Cl.: 22**

**TRADEMARK**

**PRINCIPAL REGISTER**

SUMMIT ENTERTAINMENT, LLC (DELAWARE LIMITED LIABILITY COMPANY)  
1630 STEWART STREET, SUITE 120  
SANTA MONICA, CA 90404

FOR: LANYARDS FOR HOLDING KEY CHAINS, KEY FOBS, EYEWEAR, PORTABLE ELECTRONIC DEVICES, BADGES, IDENTIFICATION CARDS, BOTTLES AND CONTAINERS, LIPSTICKS, PENS, KEYS, CHARMS AND WHISTLES; MULTI-PURPOSE CLOTH BAGS, IN CLASS 22 (U.S. CLS. 1, 2, 7, 19, 22, 42 AND 50).

FIRST USE 6-30-2008; IN COMMERCE 6-30-2008.

THE MARK CONSISTS OF THE WORD "TWILIGHT" IN A STYLIZED FONT.

SN 77-852,757, FILED 10-20-2009.

ESTHER BELENKER, EXAMINING ATTORNEY



*David J. Kybas*

Director of the United States Patent and Trademark Office

# United States of America

United States Patent and Trademark Office

## NARROW GATE WELLNESS

**Reg. No. 4,135,885**

**Registered May 1, 2012**

**Int. Cl.: 41**

**SERVICE MARK**

**PRINCIPAL REGISTER**

BROSKA COMMUNICATIONS, LLC (MISSOURI LIMITED LIABILITY COMPANY)  
908 NATCHEZ DR.  
ST. CHARLES, MO 63303

FOR: PERSONAL COACHING SERVICES IN THE FIELD OF HEALTH, WELLNESS, AND FITNESS; ENTERTAINMENT AND EDUCATIONAL SERVICES, NAMELY, ORGANIZING AND CONDUCTING COURSES AND WORKSHOPS IN THE FIELD OF HEALTH, WELLNESS, AND FITNESS, IN CLASS 41 (U.S. CLS. 100, 101 AND 107).

FIRST USE 2-0-2011; IN COMMERCE 2-0-2011.

THE MARK CONSISTS OF STANDARD CHARACTERS WITHOUT CLAIM TO ANY PARTICULAR FONT, STYLE, SIZE, OR COLOR.

NO CLAIM IS MADE TO THE EXCLUSIVE RIGHT TO USE "WELLNESS", APART FROM THE MARK AS SHOWN.

SN 77-864,192, FILED 11-3-2009.

KATHLEEN LORENZO, EXAMINING ATTORNEY



*David J. Kyros*

Director of the United States Patent and Trademark Office

# United States of America

United States Patent and Trademark Office

# EYEVIP

**Reg. No. 4,135,886**

NOVARTIS AG (SWITZERLAND CORPORATION)  
CH-4002  
BASEL, SWITZERLAND

**Registered May 1, 2012**

**Int. Cl.: 44**

FOR: DOCTOR'S APPOINTMENT REMINDER SERVICES; PROVIDING HEALTH INFORMATION, IN CLASS 44 (U.S. CLS. 100 AND 101).

**SERVICE MARK**

FIRST USE 2-28-2010; IN COMMERCE 2-28-2010.

**PRINCIPAL REGISTER**

THE MARK CONSISTS OF STANDARD CHARACTERS WITHOUT CLAIM TO ANY PARTICULAR FONT, STYLE, SIZE, OR COLOR.

SN 77-864,584, FILED 11-4-2009.

STEPHANIE ALI, EXAMINING ATTORNEY



*David J. Kybas*

Director of the United States Patent and Trademark Office

# United States of America

United States Patent and Trademark Office

## WHY PRAY FOR A MIRACLE WHEN YOU CAN WEAR ONE

**Reg. No. 4,135,887**

**Registered May 1, 2012**

**Int. Cl.: 25**

**TRADEMARK**

**PRINCIPAL REGISTER**

A & H SPORTSWEAR CO., INC. (PENNSYLVANIA CORPORATION)  
110 COMMERCE WAY  
STOCKERTOWN, PA 18083

FOR: APPAREL, NAMELY, JEANS, SKIRTS, TOPS, DRESSES AND SPORTSWEAR, NAMELY, TOPS, BOTTOMS, SHORTS, PANTS, SHIRTS, AND BLOUSES, IN CLASS 25 (U.S. CLS. 22 AND 39).

FIRST USE 12-12-2011; IN COMMERCE 12-12-2011.

THE MARK CONSISTS OF STANDARD CHARACTERS WITHOUT CLAIM TO ANY PARTICULAR FONT, STYLE, SIZE, OR COLOR.

OWNER OF U.S. REG. NO. 2,636,869.

SN 77-864,791, FILED 11-4-2009.

STEVEN R. FINE, EXAMINING ATTORNEY



*David J. Kyffers*

Director of the United States Patent and Trademark Office

# United States of America

United States Patent and Trademark Office

## VOYANTFLOW

**Reg. No. 4,135,888**

**Registered May 1, 2012**

**Int. Cl.: 9**

**TRADEMARK**

**PRINCIPAL REGISTER**

VOYANT HEALTH, INC. (DELAWARE CORPORATION)  
SUITE 250  
5575 STERRETT PLACE  
COLUMBIA, MD 21044

FOR: SOFTWARE FOR SECURELY ROUTING CLINICAL INFORMATION, NAMELY, IMAGES FOR INSTANT DISPLAY AT THE POINT OF CLINICAL CARE, IN CLASS 9 (U.S. CLS. 21, 23, 26, 36 AND 38).

FIRST USE 10-0-2010; IN COMMERCE 10-0-2010.

THE MARK CONSISTS OF STANDARD CHARACTERS WITHOUT CLAIM TO ANY PARTICULAR FONT, STYLE, SIZE, OR COLOR.

SN 77-867,095, FILED 11-6-2009.

JEFF DEFORD, EXAMINING ATTORNEY



*David J. Kybas*

Director of the United States Patent and Trademark Office

# United States of America

United States Patent and Trademark Office

DEEP Xcav

**Reg. No. 4,135,889**

**Registered May 1, 2012**

**Int. Cl.: 9**

**TRADEMARK**

**PRINCIPAL REGISTER**

CE.A.S. S.R.L. CENTRO DI ANALISI STRUTTURALE (ITALY LIMITED LIABILITY COMPANY)  
VIALE GIUSTINIANO, 10  
MILAN, ITALY 20129 AND

DEEP EXCAVATION LLC (NEW YORK LIMITED LIABILITY COMPANY)  
#188  
30-62 STEINWAY STREET  
ASTORIA, NY 11103

FOR: SOFTWARE PROGRAM THAT PERFORMS ENGINEERING ANALYSIS AND DESIGN OF DEEP EXCAVATIONS, NAMELY, OF VERTICAL WALL STRUCTURES THAT RETAIN EARTH, GROUND WATER AND ADJACENT STRUCTURES, IN CLASS 9 (U.S. CLS. 21, 23, 26, 36 AND 38).

FIRST USE 9-30-2011; IN COMMERCE 10-31-2011.

PRIORITY CLAIMED UNDER SEC. 44(D) ON ITALY APPLICATION NO. MI2009C01013, FILED 10-20-2009, REG. NO. 1386181, DATED 12-9-2010, EXPIRES 10-20-2019.

THE COLOR(S) RED AND BLUE IS/ARE CLAIMED AS A FEATURE OF THE MARK.

THE MARK CONSISTS OF THE WORD "DEEP" IN BLUE IN A STYLIZED FONT NEXT TO THE WORD "XCAV" IN RED IN A STYLIZED FONT.

SN 77-869,204, FILED 11-10-2009.

MATTHEW PAPPAS, EXAMINING ATTORNEY



*David J. Kypas*

Director of the United States Patent and Trademark Office

# United States of America

United States Patent and Trademark Office

eco  que

**Reg. No. 4,135,890**

**Registered May 1, 2012**

**Int. Cls.: 11 and 21**

**TRADEMARK**

**PRINCIPAL REGISTER**

DIRECT GLOBAL SALES, INC. (WASHINGTON CORPORATION)  
628 S BRANDON STREET  
SEATTLE, WA 98108

FOR: BAKING OVENS; BARBECUE GRILLS; BARBECUE SMOKER ACCESSORIES, NAMELY, CONVECTION PLATES; BARBECUE SMOKERS; BARBECUES; BARBECUES AND GRILLS; CHARCOAL GRILLS; FOLDING PORTABLE CHARCOAL, PROPANE AND GAS FIRED BARBECUES, STOVES, AND GRILLS; FOLDING PORTABLE OVENS; GAS GRILLS; GRILL ACCESSORIES, NAMELY, WARMING TRAYS; PORTABLE STOVES; SOLID FUEL BURNING STOVES; WOOD BURNING STOVES, IN CLASS 11 (U.S. CLS. 13, 21, 23, 31 AND 34).

FIRST USE 5-10-2011; IN COMMERCE 5-10-2011.

FOR: CAMPING GRILLS; COOKING PANS; COOKING UTENSILS, NAMELY, GRILLS; COOKING UTENSILS, NAMELY, GRILL COVERS; COOKING UTENSILS, NAMELY, WIRE BASKETS; WOOD COOKING PLANKS FOR USE IN GRILLING, IN CLASS 21 (U.S. CLS. 2, 13, 23, 29, 30, 33, 40 AND 50).

FIRST USE 5-10-2011; IN COMMERCE 5-10-2011.

THE MARK CONSISTS OF A TREE WITH A SHADOW AT THE CENTER OF A RECYCLING SYMBOL, BETWEEN THE WORDS "ECO" AND "QUE".

SN 77-886,905, FILED 12-4-2009.

H. M. FISHER, EXAMINING ATTORNEY



*David J. Kyros*

Director of the United States Patent and Trademark Office

# United States of America

United States Patent and Trademark Office



**COLOR**  
the human race

**Reg. No. 4,135,891**

**Registered May 1, 2012**

**Int. Cl.: 25**

**TRADEMARK**

**PRINCIPAL REGISTER**

SCALF, STEPHEN A. (UNITED STATES INDIVIDUAL)  
282 MARE CREEK ROAD  
STANVILLE, KY 41659

FOR: ATHLETIC APPAREL, NAMELY, SHIRTS, PANTS, JACKETS, FOOTWEAR, HATS AND CAPS, ATHLETIC UNIFORMS; BODY SHIRTS; BUTTON-FRONT ALOHA SHIRTS; CAMOUFLAGE SHIRTS; CAMP SHIRTS; CLOTHING FOR ATHLETIC USE, NAMELY, PADDED SHIRTS; DRESS SHIRTS; FISHING SHIRTS; GOLF PANTS, SHIRTS AND SKIRTS; GOLF SHIRTS; HOODED SWEAT SHIRTS; HUNTING SHIRTS; KNIT SHIRTS; LONG-SLEEVED SHIRTS; MOISTURE-WICKING SPORTS SHIRTS; NIGHT SHIRTS; OPEN-NECKED SHIRTS; OVER SHIRTS; PIQUE SHIRTS; POLO SHIRTS; RUGBY SHIRTS; SCIENTIFIC AND TECHNOLOGICAL APPAREL, NAMELY, SHIRTS, PANTS, JACKETS, FOOTWEAR, HATS AND CAPS, UNIFORMS; SHIRT FRONTS; SHIRT YOKES; SHIRTS; SHIRTS AND SHORT-SLEEVED SHIRTS; SHIRTS FOR INFANTS, BABIES, TODDLERS AND CHILDREN; SHIRTS FOR SUITS; SHORT-SLEEVED OR LONG-SLEEVED T-SHIRTS; SHORT-SLEEVED SHIRTS; SLEEP SHIRTS; SPORT SHIRTS; SPORTS SHIRTS; SPORTS SHIRTS WITH SHORT SLEEVES; SWEAT SHIRTS; T-SHIRTS; TEE SHIRTS; TRIATHLON CLOTHING, NAMELY, TRIATHLON TIGHTS, TRIATHLON SHORTS, TRIATHLON SINGLET, TRIATHLON SHIRTS, TRIATHLON SUITS; TURTLE NECK SHIRTS; WEARABLE GARMENTS AND CLOTHING, NAMELY, SHIRTS; WIND SHIRTS; YOGA SHIRTS, IN CLASS 25 (U.S. CLS. 22 AND 39).

FIRST USE 12-31-2009; IN COMMERCE 2-1-2011.



THE MARK CONSISTS OF THE WORD, "COLOR" WITH THE LETTERS APPEARING IN BROWN, PINK, BLACK, YELLOW AND RED, ABOVE THE WORDS, "THE HUMAN RACE" IN BLACK, TO THE RIGHT OF THE WORDS, "CHRIST ONLY LOVES ONE RACE THE HUMAN RACE", IN BLUE CURVED AROUND THE TOP AND BOTTOM OF THE DESIGN OF A BLUE SINGLE LINE CIRCLE WITH THE DESIGN OF FIVE HANDS INSIDE THE CIRCLE IN BROWN, YELLOW, BLACK, RED AND PINK, WITH DASHES IN THE SAME COLORS SEPARATING THE HANDS, SURROUNDING THE DESIGN OF A GLOBE WITH BLUE OCEANS AND WHITE CONTINENTS.

*David J. Kappas*

THE COLOR(S) BROWN, PINK, BLACK, YELLOW, RED, BLUE AND WHITE IS/ARE CLAIMED AS A FEATURE OF THE MARK.

Director of the United States Patent and Trademark Office

SN 77-889,358, FILED 12-9-2009.



**Reg. No. 4,135,891** BARBARA A. GOLD, EXAMINING ATTORNEY

# United States of America

United States Patent and Trademark Office

## ALISTER MACKENZIE

**Reg. No. 4,135,892**

**Registered May 1, 2012**

**Int. Cl.: 28**

**TRADEMARK**

**PRINCIPAL REGISTER**

PAPCZUN, EDMUND (UNITED STATES INDIVIDUAL)  
2910 N. POWERS ST. #316  
COLORADO SPRINGS, CO 80922

FOR: GOLF EQUIPMENT, NAMELY, GOLF CLUBS, IN CLASS 28 (U.S. CLS. 22, 23, 38 AND 50).

FIRST USE 1-1-2011; IN COMMERCE 1-1-2011.

THE MARK CONSISTS OF STANDARD CHARACTERS WITHOUT CLAIM TO ANY PARTICULAR FONT, STYLE, SIZE, OR COLOR.

OWNER OF U.S. REG. NOS. 2,782,282 AND 3,174,410.

"ALISTER MACKENZIE" DOES NOT IDENTIFY A LIVING INDIVIDUAL.

SN 77-890,712, FILED 12-10-2009.

NAPOLEON SHARMA, EXAMINING ATTORNEY



*David J. Kybas*

Director of the United States Patent and Trademark Office

# United States of America

United States Patent and Trademark Office

## PARKWOOD PICTURES

**Reg. No. 4,135,893**

**Registered May 1, 2012**

**Int. Cl.: 9**

**TRADEMARK**

**PRINCIPAL REGISTER**

BEYONCE, INC. (TEXAS CORPORATION), DBA PARKWOOD PICTURES,  
C/O REED SMITH LLP  
599 LEXINGTON AVENUE  
NEW YORK, NY 10022

FOR: PRE-RECORDED COMPACT DISCS AND DVDS, ALL FEATURING ENTERTAINMENT IN THE NATURE OF MOTION PICTURES FEATURING PRE-RECORDED LIVE CONCERT FOOTAGE OF AUDIO, VISUAL AND DRAMATIC PERFORMANCES AND MUSIC, AND MOTION PICTURES IN THE FIELD OF DRAMA; DOWNLOADABLE IMAGES HELD IN ELECTRONIC FORMAT, NAMELY, DOWNLOADABLE ELECTRONIC PHOTOGRAPHS RELATED TO ENTERTAINMENT, AND DOWNLOADABLE MOTION PICTURES FEATURING PRE-RECORDED LIVE CONCERT FOOTAGE OF AUDIO, VISUAL AND DRAMATIC PERFORMANCES, MOTION PICTURES IN THE FIELD OF DRAMA, AND DIGITAL MUSIC DOWNLOADABLE FROM THE INTERNET, ALL DOWNLOADABLE VIA A GLOBAL COMPUTER NETWORK AND FEATURING CONTENT FROM OR RELATING TO ENTERTAINMENT IN THE NATURE OF MOTION PICTURES AND MUSIC; PRE-RECORDED ELECTRONIC STORAGE AND DIGITAL COMPUTER STORAGE MEDIA FEATURING ELECTRONIC PHOTOGRAPHS, MOTION PICTURES FEATURING PRE-RECORDED LIVE CONCERT FOOTAGE OF AUDIO, VISUAL AND DRAMATIC PERFORMANCES, MUSIC AND GRAPHICS, AND MOTION PICTURES IN THE FIELD OF DRAMA, ALL RELATED TO ENTERTAINMENT; DIGITAL MEDIA, NAMELY, DOWNLOADABLE PRE-RECORDED AUDIO, VIDEO, TEXT AND COMPUTER GRAPHICS ALL FEATURING CONTENT FROM OR RELATING TO ENTERTAINMENT IN THE NATURE OF MOTION PICTURES FEATURING PRE-RECORDED LIVE CONCERT FOOTAGE OF AUDIO, VISUAL AND DRAMATIC PERFORMANCES, MUSIC AND GRAPHICS, AND MOTION PICTURES IN THE FIELD OF DRAMA AND MUSIC, AND CAPABLE OF BEING HELD IN ELECTRONIC PERSONAL COMPUTERS AND HANDHELD WIRELESS DEVICES, IN CLASS 9 (U.S. CLS. 21, 23, 26, 36 AND 38).



FIRST USE 3-10-2009; IN COMMERCE 3-10-2009.

THE MARK CONSISTS OF STANDARD CHARACTERS WITHOUT CLAIM TO ANY PARTICULAR FONT, STYLE, SIZE, OR COLOR.

*David J. Kybas*

OWNER OF U.S. REG. NO. 3,755,725.

**Reg. No. 4,135,893** NO CLAIM IS MADE TO THE EXCLUSIVE RIGHT TO USE "PICTURES", APART FROM THE MARK AS SHOWN.

SN 77-893,856, FILED 12-15-2009.

ANDREA HACK, EXAMINING ATTORNEY

# United States of America

United States Patent and Trademark Office

## BRIAN SCHAD

**Reg. No. 4,135,894**

SCHAD COMMODITY FUTURES & OPTIONS TRADING, INC. (NEVADA CORPORATION)  
1230 S. HIGBEE AVE.  
IDAHO FALLS, ID 834045355

**Registered May 1, 2012**

**Int. Cl.: 36**

FOR: FINANCIAL CONSULTING IN THE FIELD OF SECURITIES TRADING, IN CLASS 36  
(U.S. CLS. 100, 101 AND 102).

**SERVICE MARK**

FIRST USE 1-11-2012; IN COMMERCE 1-11-2012.

**PRINCIPAL REGISTER**

THE MARK CONSISTS OF STANDARD CHARACTERS WITHOUT CLAIM TO ANY PARTICULAR FONT, STYLE, SIZE, OR COLOR.

THE NAME(S), PORTRAIT(S), AND/OR SIGNATURE(S) SHOWN IN THE MARK IDENTIFIES "BRIAN SCHAD", WHOSE CONSENT(S) TO REGISTER IS MADE OF RECORD.

SN 77-894,600, FILED S.R. 12-16-2009; AM. P.R. 9-24-2010.

MARIA-VICTORIA SUAREZ, EXAMINING ATTORNEY



*David J. Kybas*

Director of the United States Patent and Trademark Office

# United States of America

United States Patent and Trademark Office

## BIG BUDDHA

**Reg. No. 4,135,895**

**Registered May 1, 2012**

**Int. Cl.: 25**

**TRADEMARK**

**PRINCIPAL REGISTER**

BIG BUDDHA, INC. (CALIFORNIA CORPORATION)  
52-16 BARNETT AVENUE  
LONG ISLAND CITY, NY 11104

FOR: CLOTHING AND CLOTHING ACCESSORIES, NAMELY, TOPS, BOTTOMS, JACKETS, COATS, CAPES, PONCHOS, DRESSES, COVERALLS, VESTS, BATHING SUITS, BELTS, WRIST BANDS, SUSPENDERS, SCARVES, GLOVES, MITTENS, EAR MUFFS, MUFFS, WRAPS, LEGWEAR, NAMELY, PANTYHOSE, STOCKINGS, LEGGINGS, LEGWARMERS, TIGHTS; SOCKS, LINGERIE, UNDERGARMENTS, SLEEPWEAR; FOOTWEAR; HEADWEAR, IN CLASS 25 (U.S. CLS. 22 AND 39).

FIRST USE 9-1-2010; IN COMMERCE 9-1-2010.

THE MARK CONSISTS OF STANDARD CHARACTERS WITHOUT CLAIM TO ANY PARTICULAR FONT, STYLE, SIZE, OR COLOR.

SN 77-895,455, FILED 12-17-2009.

FONG HSU, EXAMINING ATTORNEY



*David J. Kyros*

Director of the United States Patent and Trademark Office

# United States of America

United States Patent and Trademark Office

# EXO

**Reg. No. 4,135,896**

**Registered May 1, 2012**

**Int. Cl.: 9**

**TRADEMARK**

**PRINCIPAL REGISTER**

PLATFORM G, INC. (DELAWARE CORPORATION)  
9570 W. PICO BLVD., THIRD FLOOR  
LOS ANGELES, CA 90035

FOR: COMPUTER GAME SOFTWARE FOR MOBILE COMMUNICATION DEVICES, IN CLASS 9 (U.S. CLS. 21, 23, 26, 36 AND 38).

FIRST USE 4-0-2010; IN COMMERCE 4-0-2010.

THE MARK CONSISTS OF STANDARD CHARACTERS WITHOUT CLAIM TO ANY PARTICULAR FONT, STYLE, SIZE, OR COLOR.

SN 77-895,605, FILED 12-17-2009.

DORITT L. CARROLL, EXAMINING ATTORNEY



*David J. Kybas*

Director of the United States Patent and Trademark Office

# United States of America

United States Patent and Trademark Office

## DESIGN WORKS NASHVILLE

**Reg. No. 4,135,897**

**Registered May 1, 2012**

**Int. Cls.: 35 and 40**

**SERVICE MARK**

**PRINCIPAL REGISTER**

DESIGN WORKS (DELAWARE CORPORATION)  
218 RIVER HILLS DRIVE  
NASHVILLE, TN 37210

FOR: RETAIL AND WHOLESALE DISTRIBUTORSHIP SERVICES FEATURING COUNTER-TOPS, IN CLASS 35 (U.S. CLS. 100, 101 AND 102).

FIRST USE 8-1-2009; IN COMMERCE 8-1-2009.

FOR: CUSTOM FABRICATION OF COUNTERTOPS TO WHOLESALE AND RETAIL CUSTOMERS, IN CLASS 40 (U.S. CLS. 100, 103 AND 106).

FIRST USE 8-1-2009; IN COMMERCE 8-1-2009.

THE MARK CONSISTS OF STANDARD CHARACTERS WITHOUT CLAIM TO ANY PARTICULAR FONT, STYLE, SIZE, OR COLOR.

NO CLAIM IS MADE TO THE EXCLUSIVE RIGHT TO USE "DESIGN" AND "NASHVILLE", APART FROM THE MARK AS SHOWN.

SN 77-897,201, FILED 12-18-2009.

KELLY BOULTON, EXAMINING ATTORNEY



*David J. Kyros*

Director of the United States Patent and Trademark Office



# United States of America

United States Patent and Trademark Office

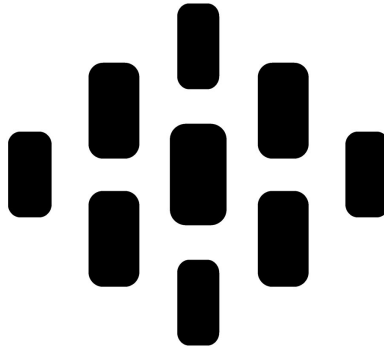

**Reg. No. 4,135,898**

**Registered May 1, 2012**

**Int. Cls.: 35, 36, 37, 38,  
39, 41, and 45**

**SERVICE MARK**

**PRINCIPAL REGISTER**

DONLEN CORPORATION (ILLINOIS CORPORATION)  
2315 SANDERS ROAD  
NORTHBROOK, IL 60062

FOR: BUSINESS MANAGEMENT SERVICES IN THE FIELD OF ADMINISTRATION OF VEHICLE FLEET MANAGEMENT; LOCATING AND PROCURING OF NEW AND PRE-OWNED VEHICLES AVAILABLE FOR PURCHASE OR LEASE FOR OTHERS; FLEET VEHICLE ACQUISITION SERVICES FOR OTHERS; PROVIDING ASSISTANCE IN RE-MARKETING OF FLEET VEHICLES FOR OTHERS; ARRANGING THE TRANSPORT OF FLEET VEHICLES FOR OTHERS; BUSINESS CONSULTATION IN THE FIELD OF VEHICLE INFORMATION SERVICES, NAMELY, BUSINESS CONSULTATION IN THE FIELD OF TELEMATICS AND GPS TECHNOLOGY USED TO TRACK DRIVER AND VEHICLE ACTIONS; PROVIDING TRACKING SERVICES AND INFORMATION CONCERNING TRACKING OF ASSETS IN TRANSIT, NAMELY, VEHICLES, TRAILERS, DRIVERS, CARGO AND DELIVERY CONTAINERS; BUSINESS CONSULTATION SERVICES IN THE FIELD OF FLEET MANAGEMENT, NAMELY, DETERMINING STRATEGIC METHODS FOR MINIMIZING FLEET COSTS; ADMINISTRATIVE PROCESSING OF STATE VEHICULAR REGISTRATION AND TITLE TRANSFERS FOR OTHERS; ADMINISTRATIVE PROCESSING OF CORRECTIONS TO VEHICULAR TITLES; ADMINISTRATIVE PROCESSING OF DOCUMENTS TO ASSIST OTHERS IN OBTAINING DUPLICATE VEHICULAR TITLES; ADMINISTRATIVE PROCESSING AND PREPARATION OF VEHICULAR TITLE TRANSFER APPLICATIONS IN CONNECTION WITH VEHICLE ACQUISITIONS AND REALES FOR OTHERS; ADMINISTRATIVE PROCESSING OF COMMERCIAL VEHICLE REGISTRATION RENEWALS AND LICENSE RENEWALS FOR OTHERS; PROVIDING DATA COLLECTION SERVICES, NAMELY, REPORTING ON VEHICLE FUEL CONSUMPTION AND PREPARING CUSTOMIZED REPORTS FROM SAID DATA TO ASSIST FLEET VEHICLE OPERATORS IN REDUCING FLEET VEHICLE CONSUMPTION FOR BUSINESS PURPOSES, IN CLASS 35 (U.S. CLS. 100, 101 AND 102).

FIRST USE 1-0-2010; IN COMMERCE 1-0-2010.

FOR: FLEET VEHICLE LEASE FINANCING; PROVIDING FINANCING ON VEHICLE MAINTENANCE, REPAIR AND FUEL PURCHASES; PROVIDING FINANCING OF OTHER COMMERCIAL FLEET VEHICLE ACTIVITIES, NAMELY, FINANCING VEHICLE TRANSPORTATION COSTS AND COMMERCIAL VEHICLE ACQUISITION COSTS; PROVIDING FINANCING OF VEHICLE APPRAISALS, IN CLASS 36 (U.S. CLS. 100, 101 AND 102).



*David J. Kybas*

Director of the United States Patent and Trademark Office

**Reg. No. 4,135,898** FIRST USE 1-0-2010; IN COMMERCE 1-0-2010.

FOR: FLEET VEHICLE MAINTENANCE, REPAIRS AND REFUELING SERVICES; FLEET VEHICLE MAINTENANCE AND REPAIR CONSULTATION, NAMELY, ADMINISTERING VEHICLE REPAIR AND MAINTENANCE SERVICES FOR OTHERS; PROVIDING DATA COLLECTION SERVICES, NAMELY, REPORTING ON VEHICLE MAINTENANCE DATA AND REPAIR COSTS AND PREPARING CUSTOMIZED REPORTS FROM SAID DATA, IN CLASS 37 (U.S. CLS. 100, 103 AND 106).

FIRST USE 1-0-2010; IN COMMERCE 1-0-2010.

FOR: RENTAL OF TELEMATICS AND GPS EQUIPMENT, IN CLASS 38 (U.S. CLS. 100, 101 AND 104).

FIRST USE 1-0-2010; IN COMMERCE 1-0-2010.

FOR: CORPORATE FLEET-RELATED VEHICLE LEASING; LEASING OF MOTOR VEHICLES, IN CLASS 39 (U.S. CLS. 100 AND 105).

FIRST USE 1-0-2010; IN COMMERCE 1-0-2010.

FOR: FLEET VEHICLE DRIVER ENVIRONMENTAL AND SAFETY TRAINING, IN CLASS 41 (U.S. CLS. 100, 101 AND 107).

FIRST USE 1-0-2010; IN COMMERCE 1-0-2010.

FOR: ACCIDENT INVESTIGATIONS, NAMELY, PREPARATION OF ACCIDENT REPORTS FOR OTHERS, IN CLASS 45 (U.S. CLS. 100 AND 101).

FIRST USE 1-0-2010; IN COMMERCE 1-0-2010.

THE MARK CONSISTS OF BRICK SHAPES ARRANGED TO FORM A DIAMOND PATTERN.

SN 77-898,089, FILED 12-21-2009.

SALLY SHIH, EXAMINING ATTORNEY

# United States of America

United States Patent and Trademark Office



**DONLEN**

**Reg. No. 4,135,899**

**Registered May 1, 2012**

**Int. Cls.: 35, 36, 37, 38,  
39, 41, and 45**

**SERVICE MARK**

**PRINCIPAL REGISTER**

DONLEN CORPORATION (ILLINOIS CORPORATION)  
2315 SANDERS ROAD  
NORTHBROOK, IL 60062

FOR: BUSINESS MANAGEMENT SERVICES IN THE FIELD OF ADMINISTRATION OF VEHICLE FLEET MANAGEMENT; LOCATING AND PROCURING OF NEW AND PRE-OWNED VEHICLES AVAILABLE FOR PURCHASE OR LEASE FOR OTHERS; FLEET VEHICLE ACQUISITION SERVICES FOR OTHERS; PROVIDING ASSISTANCE IN RE-MARKETING OF FLEET VEHICLES FOR OTHERS; ARRANGING THE TRANSPORT OF FLEET VEHICLES FOR OTHERS; BUSINESS CONSULTATION IN THE FIELD OF VEHICLE INFORMATION SERVICES, NAMELY, BUSINESS CONSULTATION IN THE FIELD OF TELEMATICS AND GPS TECHNOLOGY USED TO TRACK DRIVER AND VEHICLE ACTIONS; PROVIDING TRACKING SERVICES AND INFORMATION CONCERNING TRACKING OF ASSETS IN TRANSIT, NAMELY, VEHICLES, TRAILERS, DRIVERS, CARGO AND DELIVERY CONTAINERS; BUSINESS CONSULTATION SERVICES IN THE FIELD OF FLEET MANAGEMENT, NAMELY, DETERMINING STRATEGIC METHODS FOR MINIMIZING FLEET COSTS; ADMINISTRATIVE PROCESSING OF STATE VEHICULAR REGISTRATION AND TITLE TRANSFERS FOR OTHERS; ADMINISTRATIVE PROCESSING OF CORRECTIONS TO VEHICULAR TITLES; ADMINISTRATIVE PROCESSING OF DOCUMENTS TO ASSIST OTHERS IN OBTAINING DUPLICATE VEHICULAR TITLES; ADMINISTRATIVE PROCESSING AND PREPARATION OF VEHICULAR TITLE TRANSFER APPLICATIONS IN CONNECTION WITH VEHICLE ACQUISITIONS AND REALES FOR OTHERS; ADMINISTRATIVE PROCESSING OF COMMERCIAL VEHICLE REGISTRATION RENEWALS AND LICENSE RENEWALS FOR OTHERS; PROVIDING DATA COLLECTION SERVICES, NAMELY, REPORTING ON VEHICLE FUEL CONSUMPTION AND PREPARING CUSTOMIZED REPORTS FROM SAID DATA TO ASSIST FLEET VEHICLE OPERATORS IN REDUCING FLEET VEHICLE CONSUMPTION FOR BUSINESS PURPOSES, IN CLASS 35 (U.S. CLS. 100, 101 AND 102).

FIRST USE 1-0-2010; IN COMMERCE 1-0-2010.

FOR: FLEET VEHICLE LEASE FINANCING; PROVIDING FINANCING ON VEHICLE MAINTENANCE, REPAIR AND FUEL PURCHASES; PROVIDING FINANCING OF OTHER COMMERCIAL FLEET VEHICLE ACTIVITIES, NAMELY, FINANCING VEHICLE TRANSPORTATION COSTS AND COMMERCIAL VEHICLE ACQUISITION COSTS; PROVIDING FINANCING OF VEHICLE APPRAISALS, IN CLASS 36 (U.S. CLS. 100, 101 AND 102).



*David J. Kappas*

Director of the United States Patent and Trademark Office

**Reg. No. 4,135,899** FIRST USE 1-0-2010; IN COMMERCE 1-0-2010.

FOR: FLEET VEHICLE MAINTENANCE, REPAIRS AND REFUELING SERVICES; FLEET VEHICLE MAINTENANCE AND REPAIR CONSULTATION, NAMELY, ADMINISTERING VEHICLE REPAIR AND MAINTENANCE SERVICES FOR OTHERS; PROVIDING DATA COLLECTION SERVICES, NAMELY, REPORTING ON VEHICLE MAINTENANCE DATA AND REPAIR COSTS AND PREPARING CUSTOMIZED REPORTS FROM SAID DATA, IN CLASS 37 (U.S. CLS. 100, 103 AND 106).

FIRST USE 1-0-2010; IN COMMERCE 1-0-2010.

FOR: RENTAL OF TELEMATICS AND GPS EQUIPMENT, IN CLASS 38 (U.S. CLS. 100, 101 AND 104).

FIRST USE 1-0-2010; IN COMMERCE 1-0-2010.

FOR: CORPORATE FLEET-RELATED VEHICLE LEASING; LEASING OF MOTOR VEHICLES, IN CLASS 39 (U.S. CLS. 100 AND 105).

FIRST USE 1-0-2010; IN COMMERCE 1-0-2010.

FOR: FLEET VEHICLE DRIVER ENVIRONMENTAL AND SAFETY TRAINING, IN CLASS 41 (U.S. CLS. 100, 101 AND 107).

FIRST USE 1-0-2010; IN COMMERCE 1-0-2010.

FOR: ACCIDENT INVESTIGATIONS, NAMELY, PREPARATION OF ACCIDENT REPORTS FOR OTHERS, IN CLASS 45 (U.S. CLS. 100 AND 101).

FIRST USE 1-0-2010; IN COMMERCE 1-0-2010.

OWNER OF U.S. REG. NOS. 3,033,780, 3,673,999, AND 3,680,850.

THE MARK CONSISTS OF BRICK SHAPES ARRANGED TO FORM A DIAMOND PATTERN TO THE LEFT OF THE TERM "DONLEN".

SN 77-898,107, FILED 12-21-2009.

SALLY SHIH, EXAMINING ATTORNEY

# United States of America

United States Patent and Trademark Office

IDEAS. FOCUS. SOLUTIONS.

**Reg. No. 4,135,900**

**Registered May 1, 2012**

**Int. Cls.: 35, 36, 37, 38,  
39, 41, and 45**

**SERVICE MARK**

**PRINCIPAL REGISTER**

DONLEN CORPORATION (ILLINOIS CORPORATION)  
2315 SANDERS ROAD  
NORTHBROOK, IL 60062

FOR: BUSINESS MANAGEMENT SERVICES IN THE FIELD OF ADMINISTRATION OF VEHICLE FLEET MANAGEMENT; LOCATING AND PROCURING OF NEW AND PRE-OWNED VEHICLES AVAILABLE FOR PURCHASE OR LEASE FOR OTHERS; FLEET VEHICLE ACQUISITION SERVICES FOR OTHERS; PROVIDING ASSISTANCE IN RE-MARKETING OF FLEET VEHICLES FOR OTHERS; ARRANGING THE TRANSPORT OF FLEET VEHICLES FOR OTHERS; BUSINESS CONSULTATION IN THE FIELD OF VEHICLE INFORMATION SERVICES, NAMELY, BUSINESS CONSULTATION IN THE FIELD OF TELEMATICS AND GPS TECHNOLOGY USED TO TRACK DRIVER AND VEHICLE ACTIONS; PROVIDING TRACKING SERVICES AND INFORMATION CONCERNING TRACKING OF ASSETS IN TRANSIT, NAMELY, VEHICLES, TRAILERS, DRIVERS, CARGO AND DELIVERY CONTAINERS; BUSINESS CONSULTATION SERVICES IN THE FIELD OF FLEET MANAGEMENT, NAMELY, DETERMINING STRATEGIC METHODS FOR MINIMIZING FLEET COSTS; ADMINISTRATIVE PROCESSING OF STATE VEHICULAR REGISTRATION AND TITLE TRANSFERS FOR OTHERS; ADMINISTRATIVE PROCESSING OF CORRECTIONS TO VEHICULAR TITLES; ADMINISTRATIVE PROCESSING OF DOCUMENTS TO ASSIST OTHERS IN OBTAINING DUPLICATE VEHICULAR TITLES; ADMINISTRATIVE PROCESSING AND PREPARATION OF VEHICULAR TITLE TRANSFER APPLICATIONS IN CONNECTION WITH VEHICLE ACQUISITIONS AND REALES FOR OTHERS; ADMINISTRATIVE PROCESSING OF COMMERCIAL VEHICLE REGISTRATION RENEWALS AND LICENSE RENEWALS FOR OTHERS; PROVIDING DATA COLLECTION SERVICES, NAMELY, REPORTING ON VEHICLE FUEL CONSUMPTION AND PREPARING CUSTOMIZED REPORTS FROM SAID DATA TO ASSIST FLEET VEHICLE OPERATORS IN REDUCING FLEET VEHICLE CONSUMPTION FOR BUSINESS PURPOSES, IN CLASS 35 (U.S. CLS. 100, 101 AND 102).

FIRST USE 1-0-2010; IN COMMERCE 1-0-2010.

FOR: FLEET VEHICLE LEASE FINANCING; PROVIDING FINANCING ON VEHICLE MAINTENANCE, REPAIR AND FUEL PURCHASES; PROVIDING FINANCING OF OTHER COMMERCIAL FLEET VEHICLE ACTIVITIES, NAMELY, FINANCING VEHICLE TRANSPORTATION COSTS AND COMMERCIAL VEHICLE ACQUISITION COSTS; PROVIDING FINANCING OF VEHICLE APPRAISALS, IN CLASS 36 (U.S. CLS. 100, 101 AND 102).



*David J. Kybas*

Director of the United States Patent and Trademark Office

**Reg. No. 4,135,900** FIRST USE 1-0-2010; IN COMMERCE 1-0-2010.

FOR: FLEET VEHICLE MAINTENANCE, REPAIRS AND REFUELING SERVICES; FLEET VEHICLE MAINTENANCE AND REPAIR CONSULTATION, NAMELY, ADMINISTERING VEHICLE REPAIR AND MAINTENANCE SERVICES FOR OTHERS; PROVIDING DATA COLLECTION SERVICES, NAMELY, REPORTING ON VEHICLE MAINTENANCE DATA AND REPAIR COSTS AND PREPARING CUSTOMIZED REPORTS FROM SAID DATA, IN CLASS 37 (U.S. CLS. 100, 103 AND 106).

FIRST USE 1-0-2010; IN COMMERCE 1-0-2010.

FOR: RENTAL OF TELEMATICS AND GPS EQUIPMENT, IN CLASS 38 (U.S. CLS. 100, 101 AND 104).

FIRST USE 1-0-2010; IN COMMERCE 1-0-2010.

FOR: CORPORATE FLEET-RELATED VEHICLE LEASING; LEASING OF MOTOR VEHICLES, IN CLASS 39 (U.S. CLS. 100 AND 105).

FIRST USE 1-0-2010; IN COMMERCE 1-0-2010.

FOR: FLEET VEHICLE DRIVER ENVIRONMENTAL AND SAFETY TRAINING, IN CLASS 41 (U.S. CLS. 100, 101 AND 107).

FIRST USE 1-0-2010; IN COMMERCE 1-0-2010.

FOR: ACCIDENT INVESTIGATIONS, NAMELY, PREPARATION OF ACCIDENT REPORTS FOR OTHERS, IN CLASS 45 (U.S. CLS. 100 AND 101).

FIRST USE 1-0-2010; IN COMMERCE 1-0-2010.

THE MARK CONSISTS OF STANDARD CHARACTERS WITHOUT CLAIM TO ANY PARTICULAR FONT, STYLE, SIZE, OR COLOR.

SN 77-898,374, FILED 12-21-2009.

SALLY SHIH, EXAMINING ATTORNEY

# United States of America

United States Patent and Trademark Office



**Reg. No. 4,135,901**

**Registered May 1, 2012**

**Int. Cls.: 9, 41, and 45**

**TRADEMARK**

**SERVICE MARK**

**PRINCIPAL REGISTER**

GLU MOBILE INC. (DELAWARE CORPORATION)  
45 FREMONT STREET, SUITE 2800  
SAN FRANCISCO, CA 94105

FOR: COMPUTER GAME SOFTWARE; ELECTRONIC GAME SOFTWARE; ELECTRONIC GAME SOFTWARE FOR CELLULAR TELEPHONES, ELECTRONIC GAME SOFTWARE FOR HANDHELD ELECTRONIC DEVICES; ELECTRONIC GAME SOFTWARE FOR WIRELESS DEVICES; DOWNLOADABLE ELECTRONIC GAME SOFTWARE FOR USE WITH SOCIAL NETWORKING APPLICATIONS AND ON SOCIAL NETWORKING WEBSITES, IN CLASS 9 (U.S. CLS. 21, 23, 26, 36 AND 38).

FIRST USE 8-19-2010; IN COMMERCE 8-19-2010.

FOR: ENTERTAINMENT SERVICES, NAMELY, PROVIDING ON-LINE COMPUTER GAMES; ENTERTAINMENT SERVICES, NAMELY, PROVIDING ON-LINE COMPUTER GAMES FOR SOCIAL NETWORKING APPLICATIONS AND ON SOCIAL NETWORKING WEBSITES; MULTIMEDIA PUBLISHING OF GAMES, PROVIDING A COMPUTER GAME THAT MAY BE ACCESSED NETWORK-WIDE BY NETWORK USERS, PROVIDING INFORMATION ON-LINE RELATING TO COMPUTER GAMES AND COMPUTER ENHANCEMENTS FOR GAMES, IN CLASS 41 (U.S. CLS. 100, 101 AND 107).

FIRST USE 8-19-2010; IN COMMERCE 8-19-2010.

FOR: SOCIAL NETWORKING SERVICES PROVIDED ONLINE AND VIA MOBILE AND HANDHELD ELECTRONIC DEVICES, IN CLASS 45 (U.S. CLS. 100 AND 101).

FIRST USE 1-1-2011; IN COMMERCE 1-1-2011.

OWNER OF U.S. REG. NO. 3,205,267.

THE MARK CONSISTS OF A STYLIZED LOWERCASE "G" THAT ALSO APPEARS TO BE A CREATURE WITH EYES.

SN 77-899,196, FILED 12-22-2009.

TARA PATE, EXAMINING ATTORNEY



*David J. Kybas*

Director of the United States Patent and Trademark Office

# United States of America

United States Patent and Trademark Office

## SMALL DOSES

**Reg. No. 4,135,902**

**Registered May 1, 2012**

**Int. Cls.: 16 and 44**

**TRADEMARK**

**SERVICE MARK**

**PRINCIPAL REGISTER**

INTEGRATIVE HEALTH CARE, P.C. (ARIZONA CORPORATION)  
9200 E. RAIN TREE DR., SUITE 100  
SCOTTSDALE, AZ 85260

FOR: PUBLICATIONS, NAMELY, BROCHURES AND BOOKLETS IN THE FIELD HEALTH CARE, NUTRITION AND ALTERNATIVE MEDICINE, IN CLASS 16 (U.S. CLS. 2, 5, 22, 23, 29, 37, 38 AND 50).

FIRST USE 9-0-2009; IN COMMERCE 9-0-2009.

FOR: PROVIDING A WEB SITE FEATURING INFORMATION ON HEALTH, NUTRITION AND ALTERNATIVE MEDICINE, IN CLASS 44 (U.S. CLS. 100 AND 101).

FIRST USE 9-0-2009; IN COMMERCE 9-0-2009.

THE MARK CONSISTS OF STANDARD CHARACTERS WITHOUT CLAIM TO ANY PARTICULAR FONT, STYLE, SIZE, OR COLOR.

SN 77-899,204, FILED 12-22-2009.

C. DIONNE CLYBURN, EXAMINING ATTORNEY



*David J. Kybas*

Director of the United States Patent and Trademark Office



# United States of America

United States Patent and Trademark Office

## THE ORTHO CLUB

**Reg. No. 4,135,903**

**Registered May 1, 2012**

**Int. Cls.: 5 and 10**

**TRADEMARK**

**PRINCIPAL REGISTER**

G & H WIRE COMPANY, INC. (DELAWARE CORPORATION)  
2165 EARLYWOOD DR.  
FRANKLIN, IN 46131

FOR: ORTHODONTIC COMPOSITIONS, NAMELY, DENTAL PATIENT WAX, DENTAL UTILITY WAX; BONDING MATERIALS, CEMENTS, ADHESIVES, METAL AND PLASTIC PRIMERS, ALUMINUM OXIDE, ARTIC SPRAY, STONES AND PLASTERS, ALGINATE FLAVORING ALL FOR DENTAL PURPOSES; HOME CARE KIT COMPRISED OF CARRYING POUCH CONTAINING ORTHODONTIC WAX, FLOSS THREADERS, DENTAL FLOSS, TOOTHBRUSHES, TIMER, SPIRAL BRUSH, MOUTH MIRROR AND DISCLOSING TABLETS, SURVIVAL KIT COMPRISED OF CARRYING POUCH CONTAINING ORTHODONTIC WAX, FLOSS THREADERS, DENTAL FLOSS, TOOTHBRUSHES, TIMER, SPIRAL BRUSH, AND MOUTH MIRROR, IN CLASS 5 (U.S. CLS. 6, 18, 44, 46, 51 AND 52).

FIRST USE 0-0-1992; IN COMMERCE 0-0-1992.

FOR: ORTHODONTIC APPLIANCES, NAMELY, ORTHODONTIC BRACKETS; DENTAL MOLAR AND BICUSPID BANDS; BUCCAL TUBES, LINGUAL BUTTONS, CLEATS, LINGUAL SHEATHS; ORTHODONTIC ARCHWIRES; DENTAL INSTRUMENTS, NAMELY, PREFORMED LIGATURE TIES, KOBAYASHI HOOKS, SPOOLED LIGATURE WIRE; DENTAL INSTRUMENTS, NAMELY, PALATAL BARS, BALL CLASPS, SILVER SOLDER, ARCH HOOKS, CRIMPABLE STOPS; DENTAL INSTRUMENTS AND ACCESSORIES, NAMELY, RETAINER CASES ELASTIC STORAGE KEY RINGS, DISPENSERS, PLIER RACKS; DENTAL INSTRUMENTS AND DEVICES, NAMELY, ELASTOMERIC CHAIN, THREADS, ARCH SLEEVES, SEPARATORS; DENTAL EQUIPMENT, NAMELY, INTRAORAL LATEX ELASTIC BANDS, EXTRAORAL LATEX ELASTIC BANDS, NON-LATEX ELASTIC BANDS; DENTAL EQUIPMENT, NAMELY, DEMONSTRATION MODELS; DENTAL DEVICES, NAMELY, EXPANSION SCREWS; DENTAL PRODUCTS, NAMELY, LIP PROTECTORS, MOUTHGUARDS; DENTAL INSTRUMENTS, NAMELY, ORTHODONTIC CUTTERS AND HAND INSTRUMENTS, NAMELY, BITE STICKS; DENTAL EQUIPMENT, NAMELY, BONDING BRUSHES; DENTAL EQUIPMENT, NAMELY, CHEEK AND TONGUE RETRACTORS; DENTAL EQUIPMENT, NAMELY, PHOTOGRAPHIC MIRRORS, EXAM MIRRORS; DENTAL EQUIPMENT, NAMELY, STAINLESS STEEL AND DISPOSABLE IMPRESSION TRAYS; ORTHODONTIC DRY FIELD EVACUATION KITS, NAMELY, RETRACTORS FOR RETRACTING SOFT TISSUE AND SUCTION DEVICES FOR REMOVING SALIVA IN THE ORAL CAVITY; DENTAL EQUIPMENT, NAMELY, DIAMOND DISKS, LIGHTENING STRIPS; DENTAL DEVICES, NAMELY, EXTRAORAL ORTHODONTIC HEADGEAR, CER-



*David J. Kyjars*

Director of the United States Patent and Trademark Office

**Reg. No. 4,135,903** VICAL NECKPADS, HIGHPULL HEADCAPS, FACEBOWS, SAFETY MODULES, HEADGEAR STORAGE CASES; DENTAL DEVICES, NAMELY, MIXING PADS, MIXING SPATULAS AND KNIVES, MIXING BOWLS; ORTHODONTIC AND DENTAL APPLIANCES, NAMELY, STAINLESS STEEL PREFORMED LIGATURES AND SPOOLED LIGATURE WIRE, CRIMPABLE BALL HOOKS, ROTATION WEDGES, POWER THREAD, PROTECTIVE TUBING, ELASTOMERIC PATIENT TIES, ELASTIC PLACERS, WIRE MARKERS, LABIAL ARCHES, ADAMS CLASPS; DENTAL EQUIPMENT, NAMELY, TOOTH TIMERS, DISPOSABLE TONGUE BLOCKS, HEALTH CARE KIT COMPRISED OF CARRYING POUCH CONTAINING BRACKET TRAYS, DAPPING DISHES, SPATULAS, BIO HAZARD BAGS, EVACUATOR SCREENS, ORTHODONTIC MODEL STORAGE BOXES, DEBUBBLER, SHARPS CONTAINERS, TOOTHBRUSH, TIMER, INTERDENTAL BRUSH, ORTHODONTIC WAX, FLOSS THREADERS, DENTAL FLOSS AND MOUTH MIRROR, INTERPROXIMAL BRUSHES, SPONGE DISPENSERS, COTTON ROLL HOLDER, GLOVE RACKS, NAPKIN CHAINS AND CLIPS, SAFETY GLASSES; DENTAL INSTRUMENTS, NAMELY, DRY TIPS, DRY ANGLES, BITE STICKS, DIGITAL CALIPERS, SWIVEL SAFETY KEYS, MAGNIFIERS, IN CLASS 10 (U.S. CLS. 26, 39 AND 44).

FIRST USE 0-0-1992; IN COMMERCE 0-0-1992.

THE MARK CONSISTS OF STANDARD CHARACTERS WITHOUT CLAIM TO ANY PARTICULAR FONT, STYLE, SIZE, OR COLOR.

NO CLAIM IS MADE TO THE EXCLUSIVE RIGHT TO USE "ORTHO", APART FROM THE MARK AS SHOWN.

SN 77-899,397, FILED 12-22-2009.

DOMINIC J. FERRAIUOLO, EXAMINING ATTORNEY

# United States of America

United States Patent and Trademark Office



**Reg. No. 4,135,904**

**Registered May 1, 2012**

**Int. Cl.: 18**

**TRADEMARK**

**PRINCIPAL REGISTER**

COLEMAN, CONNIE K. (UNITED STATES INDIVIDUAL)  
1636 FOX SPRINGS CIRCLE  
THOUSAND OAKS, CA 91320

FOR: DOG CLOTHING; DOG COLLARS; PET ACCESSORIES, NAMELY, SPECIALLY DESIGNED CANVAS, VINYL OR LEATHER BAGS ATTACHED TO ANIMAL LEASHES FOR HOLDING SMALL ITEMS SUCH AS KEYS, CREDIT CARDS, MONEY OR DISPOSABLE BAGS FOR DISPOSING OF PET WASTE, IN CLASS 18 (U.S. CLS. 1, 2, 3, 22 AND 41).

FIRST USE 9-1-2010; IN COMMERCE 1-15-2012.

NO CLAIM IS MADE TO THE EXCLUSIVE RIGHT TO USE "DOG", APART FROM THE MARK AS SHOWN.

THE MARK CONSISTS OF A SILHOUETTE OF A STANDING DOG WEARING A COLLAR, ON EACH SIDE OF THE STACKED PHRASE "COMFORT DOG". THE DOGS ARE MIRROR IMAGES OF EACH OTHER, WITH THEIR HEADS AT THE LEVEL OF THE WORD "COMFORT" AND THEIR FEET AT THE LEVEL OF THE WORD "DOG".

SN 77-900,903, FILED 12-24-2009.

GRETCHEN ULRICH, EXAMINING ATTORNEY



*David J. Kyffers*

Director of the United States Patent and Trademark Office

# United States of America

United States Patent and Trademark Office

## MAISON D'ESPRIT

**Reg. No. 4,135,905**

**Registered May 1, 2012**

**Int. Cl.: 41**

**SERVICE MARK**

**PRINCIPAL REGISTER**

NOMENUS QUARTERLY, INC. (MINNESOTA CORPORATION), DBA MAISONDESPRIT,  
8713 WALTON OAKS DRIVE  
BLOOMINGTON, MN 55438

FOR: PHOTOGRAPHY SERVICES; CONSULTING SERVICES IN THE FIELD OF PHOTOGRAPHY; AND PHOTOGRAPHIC COMPOSITION SERVICES FOR OTHERS, IN CLASS 41 (U.S. CLS. 100, 101 AND 107).

FIRST USE 2-29-2012; IN COMMERCE 2-29-2012.

THE MARK CONSISTS OF STANDARD CHARACTERS WITHOUT CLAIM TO ANY PARTICULAR FONT, STYLE, SIZE, OR COLOR.

THE ENGLISH TRANSLATION OF "MAISON D'ESPRIT" IN THE MARK IS HOUSE OF SPIRIT.

SN 77-901,952, FILED 12-29-2009.

ALICE BENMAMAN, EXAMINING ATTORNEY



*David J. Kyros*

Director of the United States Patent and Trademark Office

# United States of America

United States Patent and Trademark Office

## MASTERCARD PAY WITH REWARDS

**Reg. No. 4,135,906**

**Registered May 1, 2012**

**Int. Cl.: 35**

**SERVICE MARK**

**PRINCIPAL REGISTER**

MASTERCARD INTERNATIONAL INCORPORATED (DELAWARE CORPORATION)  
2000 PURCHASE STREET  
PURCHASE, NY 10577

FOR: PROMOTING THE GOODS AND SERVICES OF OTHERS BY MEANS OF COUPONS, DISCOUNTS, REWARD POINTS, AIRLINE MILES WHICH CAN BE REDEEMED FOR THE GOODS OF OTHERS EITHER IN CONNECTION WITH A PURCHASE MADE VIA A GLOBAL COMMUNICATIONS NETWORK, MOBILE PHONE, WIRELESS DEVICE OR AT A RETAIL STORE LOCATION, IN CLASS 35 (U.S. CLS. 100, 101 AND 102).

FIRST USE 5-3-2010; IN COMMERCE 5-3-2010.

THE MARK CONSISTS OF STANDARD CHARACTERS WITHOUT CLAIM TO ANY PARTICULAR FONT, STYLE, SIZE, OR COLOR.

OWNER OF U.S. REG. NOS. 1,186,117, 2,168,736, AND OTHERS.

SN 77-902,172, FILED 12-29-2009.

GINA HAYES, EXAMINING ATTORNEY



*David J. Kybas*

Director of the United States Patent and Trademark Office

# United States of America

United States Patent and Trademark Office

# INNUENDO

**Reg. No. 4,135,907**

**Registered May 1, 2012**

**Int. Cl.: 3**

**TRADEMARK**

**PRINCIPAL REGISTER**

Y.Z.Y. INC (FLORIDA CORPORATION)  
6300 NW 72ND AVENUE  
MIAMI, FL 33166

FOR: COLOGNES, PERFUMES AND COSMETICS; EAU DE TOILETTE AND EAU DE COLOGNE; PERFUMES AND COLOGNES; PERFUMES, EAU DE COLOGNES AND AFTER-SHAVES, IN CLASS 3 (U.S. CLS. 1, 4, 6, 50, 51 AND 52).

FIRST USE 11-21-2011; IN COMMERCE 11-21-2011.

THE MARK CONSISTS OF STANDARD CHARACTERS WITHOUT CLAIM TO ANY PARTICULAR FONT, STYLE, SIZE, OR COLOR.

SN 77-902,611, FILED 12-30-2009.

GRETTA YAO, EXAMINING ATTORNEY



*David J. Kybas*

Director of the United States Patent and Trademark Office

# United States of America

United States Patent and Trademark Office

Dream big. Work hard. Live  
simply. Give back.

**Reg. No. 4,135,908**

KIM KAUER (UNITED STATES INDIVIDUAL)  
3222-D POST WOODS DRIVE  
ATLANTA, GA 30339

**Registered May 1, 2012**

**Int. Cl.: 35**

FOR: ADVERTISING AND MARKETING, IN CLASS 35 (U.S. CLS. 100, 101 AND 102).

**SERVICE MARK**

FIRST USE 11-15-2011; IN COMMERCE 11-15-2011.

**PRINCIPAL REGISTER**

THE MARK CONSISTS OF STANDARD CHARACTERS WITHOUT CLAIM TO ANY PARTICULAR FONT, STYLE, SIZE, OR COLOR.

SN 77-903,923, FILED 1-2-2010.

ESTHER BELENKER, EXAMINING ATTORNEY



*David J. Kyffers*

Director of the United States Patent and Trademark Office

# United States of America

United States Patent and Trademark Office



**Reg. No. 4,135,909**

**Registered May 1, 2012**

**Int. Cls.: 35, 42, and 45**

DAON HOLDINGS LIMITED (CAYMAN ISLANDS LIMITED COMPANY (LTD.))  
PO BOX 1787, ONE CAPITAL PLACE  
GT, GRAND CAYMAN, CAYMAN ISLANDS

FOR: EMPLOYMENT VERIFICATION, IN CLASS 35 (U.S. CLS. 100, 101 AND 102).

FIRST USE 4-29-2010; IN COMMERCE 4-29-2010.

**SERVICE MARK**

FOR: COMPUTER SOFTWARE DESIGN FOR OTHERS; COMPUTER SOFTWARE AND DATABASE DEVELOPMENT; COMPUTER PROGRAMMING FOR OTHERS; COMPUTER SOFTWARE CONSULTATION; INSTALLATION AND MAINTENANCE OF COMPUTER SOFTWARE; CONSULTANCY IN THE FIELD OF INFORMATION TECHNOLOGY; PERSONAL IDENTIFICATION VERIFICATION SERVICES, NAMELY, BIOMETRIC CAPTURE, BIOAUTHENTICATION, BIOMETRIC AUTHENTICATION, AND FINGERPRINT, IRIS, VOICE, FACE, HAND AND SIGNATURE RECOGNITION; PROVIDING AUTHENTICATION AND IDENTIFICATION TECHNOLOGY SERVICES; AND UPDATING OF COMPUTER SOFTWARE RELATING TO COMPUTER SECURITY AND USER AUTHENTICATION AND IDENTIFICATION, IN CLASS 42 (U.S. CLS. 100 AND 101).

FIRST USE 4-29-2010; IN COMMERCE 4-29-2010.

**PRINCIPAL REGISTER**

FOR: PROVIDING USER AUTHENTICATION AND IDENTIFICATION SERVICES USING BIOMETRIC FEATURES AND PERSONAL IDENTIFICATION DATA STORED ON A COMPUTER NETWORK; PROVIDING ONLINE INFORMATION IN THE FIELDS OF IDENTITY MANAGEMENT, DATA THEFT, IDENTITY THEFT, USER AUTHENTICATION, BIOMETRICS AND BIOAUTHENTICATION; PROVIDING AUTHENTICATION AND IDENTIFICATION TECHNOLOGY SERVICES USING BIOMETRIC FEATURES FOR STORAGE ON A COMPUTER NETWORK; AND PROVIDING COMPUTER RELATED SECURITY AND PRIVACY SERVICES, NAMELY, USER IDENTIFICATION AND AUTHENTICATION SERVICES, IN CLASS 45 (U.S. CLS. 100 AND 101).

FIRST USE 4-29-2010; IN COMMERCE 4-29-2010.



*David J. Kybas*

OWNER OF U.S. REG. NOS. 2,785,410 AND 2,807,756.

THE COLOR(S) YELLOW IS/ARE CLAIMED AS A FEATURE OF THE MARK.



**Reg. No. 4,135,909** NO CLAIM IS MADE TO THE EXCLUSIVE RIGHT TO USE "TRUSTED IDENTITY SERVICES", APART FROM THE MARK AS SHOWN.

THE MARK CONSISTS OF A YELLOW STYLIZED LETTER "X" FOLLOWED BY THE WORDS "DAON" AND "TRUSTED IDENTITY SERVICES".

SN 77-907,578, FILED 1-8-2010.

C. DIONNE CLYBURN, EXAMINING ATTORNEY

# United States of America

United States Patent and Trademark Office

# I taste great

**Reg. No. 4,135,910**

**Registered May 1, 2012**

**Int. Cl.: 35**

**SERVICE MARK**

**PRINCIPAL REGISTER**

MICHELE CHANDLER (UNITED STATES INDIVIDUAL)  
908 PEGGY LANE  
MENLO PARK, CA 94025

FOR: ADVERTISING SERVICES, IN CLASS 35 (U.S. CLS. 100, 101 AND 102).

FIRST USE 11-15-2006; IN COMMERCE 3-10-2010.

THE MARK CONSISTS OF STANDARD CHARACTERS WITHOUT CLAIM TO ANY PARTICULAR FONT, STYLE, SIZE, OR COLOR.

SN 77-908,461, FILED 1-9-2010.

PRISCILLA MILTON, EXAMINING ATTORNEY



*David J. Kyffers*

Director of the United States Patent and Trademark Office

# United States of America

United States Patent and Trademark Office

"GET BREAD OR DIE HUNGRY"

**Reg. No. 4,135,911**

SEJOUR, CLIFF (UNITED STATES INDIVIDUAL)  
110 SOUTH 29TH STREET  
WYANDANCH, NY 11798

**Registered May 1, 2012**

**Int. Cl.: 25**

FOR: FOOTWEAR; HEADWEAR; HOODED SWEAT SHIRTS; JACKETS; SCARVES; SHIRTS;  
SWEAT SHIRTS; T-SHIRTS; UNDERWEAR, IN CLASS 25 (U.S. CLS. 22 AND 39).

**TRADEMARK**

FIRST USE 8-8-2010; IN COMMERCE 10-19-2010.

**PRINCIPAL REGISTER**

THE MARK CONSISTS OF STANDARD CHARACTERS WITHOUT CLAIM TO ANY PARTICULAR FONT, STYLE, SIZE, OR COLOR.

SN 77-909,851, FILED 1-12-2010.

THOMAS MANOR, EXAMINING ATTORNEY



*David J. Kyros*

Director of the United States Patent and Trademark Office

# United States of America

United States Patent and Trademark Office

## KNOW + GROW

**Reg. No. 4,135,912**

WYLIE, CYNTHIA (UNITED STATES INDIVIDUAL)  
2404 PACIFIC AVENUE  
VENICE, CA 90291

**Registered May 1, 2012**

**Int. Cl.: 41**

FOR: ENTERTAINMENT, NAMELY, A CONTINUING CHILDREN'S SHOW BROADCAST OVER TELEVISION, SATELLITE, AUDIO, AND VIDEO MEDIA; TELEVISION SHOW PRODUCTION, IN CLASS 41 (U.S. CLS. 100, 101 AND 107).

**SERVICE MARK**

FIRST USE 12-24-2010; IN COMMERCE 12-24-2010.

**PRINCIPAL REGISTER**

THE MARK CONSISTS OF STANDARD CHARACTERS WITHOUT CLAIM TO ANY PARTICULAR FONT, STYLE, SIZE, OR COLOR.

SN 77-909,874, FILED 1-12-2010.

RONALD DELGIZZI, EXAMINING ATTORNEY



*David J. Kybas*

Director of the United States Patent and Trademark Office

# United States of America

United States Patent and Trademark Office

# RaceLace

**Reg. No. 4,135,913**

**Registered May 1, 2012**

**Int. Cl.: 25**

**TRADEMARK**

**PRINCIPAL REGISTER**

LIFESTYLE BRANDS CORPORATION (CANADA CORPORATION)  
C/O COLLECTIVE LICENSING INT'L, LLC  
800 ENGLEWOOD PARKWAY, SUITE C200  
ENGLEWOOD, CO 80110

FOR: SNOWBOARD BOOTS, SKI AND SNOWBOARD SHOES AND PARTS THEREOF,  
NAMELY, LACING MECHANISM THAT AUTOMATICALLY TIGHTENS OR LOOSENS  
LACES, IN CLASS 25 (U.S. CLS. 22 AND 39).

FIRST USE 11-1-2009; IN COMMERCE 9-1-2010.

THE MARK CONSISTS OF STANDARD CHARACTERS WITHOUT CLAIM TO ANY PAR-  
TICULAR FONT, STYLE, SIZE, OR COLOR.

SN 77-910,825, FILED 1-13-2010.

MATTHEW MCDOWELL, EXAMINING ATTORNEY



*David J. Kybas*

Director of the United States Patent and Trademark Office

# United States of America

United States Patent and Trademark Office



**Reg. No. 4,135,914**

**Registered May 1, 2012**

**Int. Cls.: 29 and 30**

**TRADEMARK**

**PRINCIPAL REGISTER**

SALADWORKS L.L.C. (DELAWARE LIMITED LIABILITY COMPANY)  
161 WASHINGTON STREET, SUITE 300  
CONSHOHOCKEN, PA 19428

FOR: FOOD, NAMELY, VEGETABLE SALADS, FRUIT SALADS, GARDEN SALADS AND SIDE DISHES IN THE NATURE OF PREPARED MEALS CONSISTING PRIMARILY OF VEGETABLES AND MEATS , IN CLASS 29 (U.S. CL. 46).

FIRST USE 1-1-2012; IN COMMERCE 1-1-2012.

FOR: FOOD, NAMELY, SALAD DRESSINGS, SANDWICHES, DOUGH-ENROBED FOODS CONSISTING OF A DOUGH-BASED WRAPPER WITH FILLINGS CONSISTING PRIMARILY OF VEGETABLES, MEATS, CHEESES AND PASTAS; SIDE DISHES IN THE NATURE OF PREPARED MEALS CONSISTING PRIMARILY OF PASTAS, IN CLASS 30 (U.S. CL. 46).

FIRST USE 1-1-2012; IN COMMERCE 1-1-2012.

NO CLAIM IS MADE TO THE EXCLUSIVE RIGHT TO USE "NUTRITION" , APART FROM THE MARK AS SHOWN.

THE MARK CONSISTS OF THE WORDS "TRUE NUTRITION" IN A SUN DESIGN.

SN 77-911,200, FILED 1-13-2010.

TINA MAI, EXAMINING ATTORNEY



*David J. Kyros*

Director of the United States Patent and Trademark Office

# United States of America

United States Patent and Trademark Office



**Reg. No. 4,135,915**

**Registered May 1, 2012**

**Int. Cl.: 30**

**TRADEMARK**

**PRINCIPAL REGISTER**

CUPS LJ, INC. (CALIFORNIA CORPORATION), DBA CUPS,  
7857 GIRARD AVENUE  
LA JOLLA, CA 92037

FOR: BAKED GOODS, NAMELY, CUPCAKES, IN CLASS 30 (U.S. CL. 46).

FIRST USE 11-30-2009; IN COMMERCE 11-30-2009.

THE MARK CONSISTS OF A CUPCAKE WEARING HEADPHONES WITH THE HEADPHONE CORD EXTENDING DOWNWARD, BENDING TO THE RIGHT, AND SPELLING OUT THE WORD "CUPS" BENEATH THE CUPCAKE, WITH A HEADPHONE CONNECTOR EXTENDING OFF OF THE CORD AFTER THE LETTER "S" AND POINTING DOWNWARD.

SN 77-911,612, FILED 1-14-2010.

JUDITH HELFMAN, EXAMINING ATTORNEY



*David J. Kybas*

Director of the United States Patent and Trademark Office

# United States of America

United States Patent and Trademark Office

# Amplitude iQ

**Reg. No. 4,135,916**

**Registered May 1, 2012**

**Int. Cl.: 9**

**TRADEMARK**

**PRINCIPAL REGISTER**

HOYA CORPORATION (JAPAN CORPORATION)  
7-5, NAKA-OCHIAI 2-CHOME, SHINJUKU-KU  
TOKYO, JAPAN 161-0032

FOR: SPECTACLE LENSES AND SPECTACLES, IN CLASS 9 (U.S. CLS. 21, 23, 26, 36 AND 38).

FIRST USE 12-5-2011; IN COMMERCE 12-5-2011.

THE MARK CONSISTS OF STANDARD CHARACTERS WITHOUT CLAIM TO ANY PARTICULAR FONT, STYLE, SIZE, OR COLOR.

OWNER OF U.S. REG. NO. 3,052,803.

SN 77-912,012, FILED 1-14-2010.

SAMUEL E. SHARPER JR., EXAMINING ATTORNEY



*David J. Kyros*

Director of the United States Patent and Trademark Office



# United States of America

United States Patent and Trademark Office

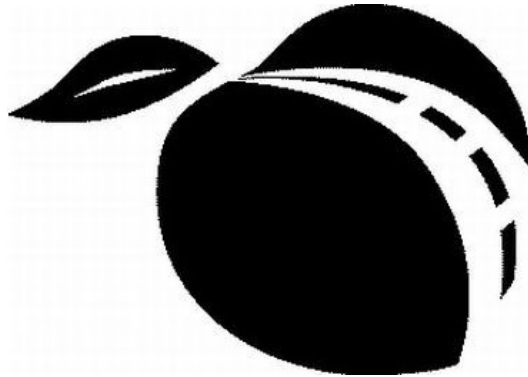

# PEACH PASS

**Reg. No. 4,135,917**

**Registered May 1, 2012**

**Int. Cl.: 9**

**TRADEMARK**

**PRINCIPAL REGISTER**

STATE ROAD AND TOLLWAY AUTHORITY (GEORGIA A BODY CORPORATE AND  
POLITIC AND AN INSTRUMENTALITY AND PUBLIC CORPORATION)  
FOURTH FLOOR  
47 TRINITY AVENUE  
ATLANTA, GA 30334

FOR: TRANSPONDERS, IN CLASS 9 (U.S. CLS. 21, 23, 26, 36 AND 38).

FIRST USE 4-20-2011; IN COMMERCE 4-20-2011.

NO CLAIM IS MADE TO THE EXCLUSIVE RIGHT TO USE "PASS", APART FROM THE  
MARK AS SHOWN.

THE MARK CONSISTS OF THE WORDS "PEACH PASS" TO THE RIGHT OF A STYLIZED  
"PEACH" CONTAINING A HIGHWAY DESIGN THROUGH ITS MIDDLE .

SN 77-912,875, FILED 1-15-2010.

TEJBIR SINGH, EXAMINING ATTORNEY



*David J. Kybas*

Director of the United States Patent and Trademark Office

# United States of America

United States Patent and Trademark Office

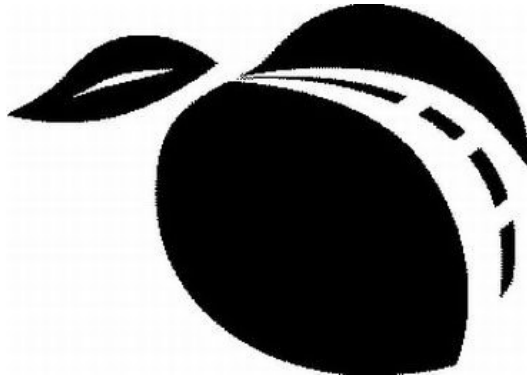

**PEACH  
PASS**  
*Keep Moving.*

**Reg. No. 4,135,918**

**Registered May 1, 2012**

**Int. Cl.: 9**

STATE ROAD AND TOLLWAY AUTHORITY (GEORGIA BODY CORPORATE AND POLITIC  
AND AN INSTRUMENTALITY AND PUBLIC CORPORATION)  
FOURTH FLOOR  
47 TRINITY AVENUE  
ATLANTA, GA 30334

**TRADEMARK**

FOR: TRANSPONDERS, IN CLASS 9 (U.S. CLS. 21, 23, 26, 36 AND 38).

**PRINCIPAL REGISTER**

FIRST USE 4-20-2011; IN COMMERCE 4-20-2011.

NO CLAIM IS MADE TO THE EXCLUSIVE RIGHT TO USE "PASS", APART FROM THE  
MARK AS SHOWN.

THE MARK CONSISTS OF THE WORDS "PEACH PASS KEEP MOVING." TO THE RIGHT  
OF A STYLIZED "PEACH" CONTAINING A HIGHWAY DESIGN THROUGH ITS MIDDLE.

SN 77-912,877, FILED 1-15-2010.

TEJBIR SINGH, EXAMINING ATTORNEY



*David J. Kybas*

Director of the United States Patent and Trademark Office

# United States of America

United States Patent and Trademark Office

錦珍

KUM CHUN

**Reg. No. 4,135,919**

**Registered May 1, 2012**

**Int. Cl.: 30**

**TRADEMARK**

**PRINCIPAL REGISTER**

LEE KUM KEE COMPANY LIMITED (HONG KONG CORPORATION)  
TAI PO INDUSTRIAL ESTATE  
2-4 DAI FAT STREET  
TAI PO, NEW TERRITORIES, HONG KONG

FOR: SAUCES AND CONDIMENTS, NAMELY, OYSTER SAUCE AND OYSTER FLAVORED SAUCE; SAUCES AND CONDIMENTS, NAMELY, READY-MADE SAUCES, PREPARATIONS OR CONCENTRATES FOR MAKING SAUCES, COOKING SAUCES, ORIENTAL COOKING SAUCES, SAUCES FOR MARINATING FOOD, STIR FRY SAUCE, DIPPING SAUCE, SOY SAUCES, CURRY SAUCE, COCONUT FLAVORED CURRY SAUCE, TERIYAKI SAUCE, CHILI SAUCE, HOT AND SPICY SAUCE, CHINESE BARBECUE SAUCE, SWEET AND SOUR SAUCE, GARLIC SAUCE AND PASTE, GINGER SAUCE AND PASTE, SESAME SAUCE, PEANUT FLAVORED SAUCE, PEANUT SAUCE, BEAN SAUCE AND PASTE, BLACK BEAN SAUCE AND PASTE, SOY BEAN SAUCE AND PASTE, BLACK PEPPER SAUCE, KOREAN BARBECUE SAUCE, LEMONGRASS SAUCE, SATAY SAUCE; VINEGAR; SEASONINGS; MINCED GARLIC FOR USE AS SEASONING; MINCED GINGER FOR USE AS SEASONING; SPICES AND MARINADES, IN CLASS 30 (U.S. CL. 46).

FIRST USE 11-1-2009; IN COMMERCE 11-1-2009.

OWNER OF U.S. REG. NOS. 2,171,765, 3,604,826, AND 3,761,970.

THE NON-LATIN CHARACTERS IN THE MARK TRANSLITERATE TO "KUM" AND "CHUN" AND THIS MEANS TAPESTRY AND RARE OR PRECIOUS, RESPECTIVELY, IN ENGLISH.

THE MARK CONSISTS OF THE WORDING "KUM CHUN" UNDERNEATH THE CHINESE CHARACTERS THAT TRANSLITERATE TO "KUM CHUN".

SN 77-913,001, FILED 1-15-2010.

ANDREW LEASER, EXAMINING ATTORNEY



*David J. Kyros*

Director of the United States Patent and Trademark Office

# United States of America

United States Patent and Trademark Office

# ADCETRIS

**Reg. No. 4,135,920**

SEATTLE GENETICS, INC. (DELAWARE CORPORATION)  
21823 30TH DRIVE S.E.  
BOTHELL, WA 98021

**Registered May 1, 2012**

**Int. Cl.: 5**

FOR: PHARMACEUTICAL PREPARATIONS FOR THE PREVENTION AND TREATMENT OF DISORDERS OF THE IMMUNE SYSTEM; PHARMACEUTICAL PREPARATIONS FOR THE TREATMENT OF CANCER; PHARMACEUTICAL PREPARATIONS FOR USE IN ONCOLOGY, IN CLASS 5 (U.S. CLS. 6, 18, 44, 46, 51 AND 52).

**TRADEMARK**

**PRINCIPAL REGISTER**

FIRST USE 8-22-2011; IN COMMERCE 8-22-2011.

THE MARK CONSISTS OF STANDARD CHARACTERS WITHOUT CLAIM TO ANY PARTICULAR FONT, STYLE, SIZE, OR COLOR.

THE WORDING "ADCETRIS" HAS NO MEANING IN A FOREIGN LANGUAGE.

SN 77-913,312, FILED 1-15-2010.

JAMES STEIN, EXAMINING ATTORNEY



*David J. Kyros*

Director of the United States Patent and Trademark Office

# United States of America

United States Patent and Trademark Office

# FRESH-TIPS

**Reg. No. 4,135,921**

MAX HUNTER, LLC (FLORIDA LIMITED LIABILITY COMPANY)  
3178 FAIRWAY CIRCLE  
DAVIE, FL 33328

**Registered May 1, 2012**

**Int. Cl.: 21**

FOR: ORAL HYGIENE PRODUCTS, NAMELY, TOOTH CLEANSING STICKS, IN CLASS 21 (U.S. CLS. 2, 13, 23, 29, 30, 33, 40 AND 50).

**TRADEMARK**

FIRST USE 1-28-2012; IN COMMERCE 1-28-2012.

**PRINCIPAL REGISTER**

THE MARK CONSISTS OF STANDARD CHARACTERS WITHOUT CLAIM TO ANY PARTICULAR FONT, STYLE, SIZE, OR COLOR.

SN 77-913,867, FILED 1-18-2010.

ERIN FALK, EXAMINING ATTORNEY



*David J. Kybas*

Director of the United States Patent and Trademark Office

# United States of America

United States Patent and Trademark Office

## Evil Artisan

**Reg. No. 4,135,922**

**Registered May 1, 2012**

**Int. Cl.: 25**

**TRADEMARK**

**PRINCIPAL REGISTER**

DUSTIN SNOOK (NEVADA LIMITED LIABILITY COMPANY), DBA EVIL ARTISAN,  
9811 W CHARLESTON BLVD 2-769  
LAS VEGAS, NV 89117

FOR: A-SHIRTS; ADULT NOVELTY GAG CLOTHING ITEM, NAMELY, SOCKS; ANKLE SOCKS; ANKLETS; APPAREL FOR DANCERS, NAMELY, TEE SHIRTS, SWEATSHIRTS, PANTS, LEGGINGS, SHORTS AND JACKETS; ATHLETIC APPAREL, NAMELY, SHIRTS, PANTS, JACKETS, FOOTWEAR, HATS AND CAPS, ATHLETIC UNIFORMS; BALLOON PANTS; BATHING COSTUMES FOR WOMEN; BEACH SHOES; BELTS MADE OF LEATHER; BELTS MADE OUT OF CLOTH; BELTS OF TEXTILE; BOAT SHOES; BODY SHIRTS; BOWLING SHOES; BOXING SHOES; BUTTON-FRONT ALOHA SHIRTS; CAMOUFLAGE PANTS; CANVAS SHOES; CAPRI PANTS; CARGO PANTS; CLIMBING SHOES; COATS FOR MEN AND WOMEN; CYCLING SHOES; DANCE SHOES; DECK-SHOES; DENIMS; DRIVERS; FOOTBALL SHOES; FOOTWEAR FOR MEN AND WOMEN; FOOTWEAR FOR WOMEN; GOLF PANTS, SHIRTS AND SKIRTS; GOLF SHIRTS; GOLF SHOES; GYM PANTS; GYMNASTIC SHOES; HANDBALL SHOES; HAT BANDS; HATS; HEAD SCARVES; HOODED SWEAT SHIRTS; INFANTS' SHOES AND BOOTS; JACKETS AND SOCKS; JEANS; JOGGING PANTS; KNIT SHIRTS; LEATHER BELTS; LEATHER PANTS; LEATHER SHOES; LEISURE SHOES; LEOTARDS AND TIGHTS FOR WOMEN, MEN AND CHILDREN OF NYLON, COTTON OR OTHER TEXTILE FIBERS; LONG-SLEEVED SHIRTS; LOUNGE PANTS; MEN'S AND WOMEN'S JACKETS, COATS, TROUSERS, VESTS; MEN'S DRESS SOCKS; MEN'S SOCKS; MOUNTAINEERING SHOES; NIGHT SHIRTS; OPEN-NECKED SHIRTS; OVER SHIRTS; PANTS; PARTY HATS; PETTI-PANTS; PIQUE SHIRTS; POLO SHIRTS; RIDING SHOES; RUBBER SHOES; RUGBY SHIRTS; RUGBY SHOES; RUNNING SHOES; SANDALS AND BEACH SHOES; SCARVES; SHIRTS AND SHORT-SLEEVED SHIRTS; SHIRTS FOR INFANTS, BABIES, TODDLERS AND CHILDREN; SHIRTS FOR SUITS; SHOE SOLES; SHOES; SHORT-SLEEVED OR LONG-SLEEVED T-SHIRTS; SHORT-SLEEVED SHIRTS; SHOULDER SCARVES; SILK SCARVES; SKI AND SNOWBOARD SHOES AND PARTS THEREOF; SKI PANTS; SKIING SHOES; SKIRTS; SKIRTS AND DRESSES; SLEEP PANTS; SLEEP SHIRTS; SLIPPER SOCKS; SMALL HATS; SNOW PANTS; SNOWBOARD PANTS; SOCCER SHOES; SOCKS; SOCKS AND STOCKINGS; SPORT SHIRTS; SPORTS PANTS; SPORTS SHIRTS; SPORTS SHIRTS WITH SHORT SLEEVES; STRETCH PANTS; SWEAT PANTS; SWEAT SHIRTS; SWIMWEAR; T-SHIRTS; TAP PANTS; TAP SHOES; TEE SHIRTS; TENNIS SHOES; THERMAL SOCKS; TOBOGGAN HATS, PANTS AND CAPS; TRACK AND FIELD SHOES; TRACK PANTS; TRAINING SHOES; TURTLE NECK SHIRTS; VOLLEYBALL SHOES; WATER SOCKS; WATERPROOF JACKETS AND PANTS; WEARABLE GARMENTS AND CLOTHING, NAMELY, SHIRTS; WIND PANTS; WOMEN'S HATS AND HOODS; WO-



*David J. Kybas*

Director of the United States Patent and Trademark Office

**Reg. No. 4,135,922** MEN'S SHOES; WOMEN'S TOPS, NAMELY, CAMIS; WOMEN'S UNDERWEAR; WOOLLEN SOCKS; WORK SHOES AND BOOTS; YOGA PANTS; YOGA SHIRTS, IN CLASS 25 (U.S. CLS. 22 AND 39).

FIRST USE 8-1-2010; IN COMMERCE 1-1-2010.

THE MARK CONSISTS OF STANDARD CHARACTERS WITHOUT CLAIM TO ANY PARTICULAR FONT, STYLE, SIZE, OR COLOR.

SN 77-914,213, FILED 1-18-2010.

PATRICIA EVANKO, EXAMINING ATTORNEY

# United States of America

United States Patent and Trademark Office

# TAUNT

**Reg. No. 4,135,923**

**Registered May 1, 2012**

**Int. Cl.: 3**

**TRADEMARK**

**PRINCIPAL REGISTER**

CHAZANAS, CARINA (UNITED STATES INDIVIDUAL)  
C/O MARC J. KESTEN, PL  
9220 NW 72ND STREET  
PARKLAND, FL 33067

FOR: FRAGRANCES; FRAGRANCES AND PERFUMERY; FRAGRANCES FOR PERSONAL USE; PERFUME, IN CLASS 3 (U.S. CLS. 1, 4, 6, 50, 51 AND 52).

FIRST USE 11-0-2010; IN COMMERCE 11-0-2010.

THE MARK CONSISTS OF STANDARD CHARACTERS WITHOUT CLAIM TO ANY PARTICULAR FONT, STYLE, SIZE, OR COLOR.

SN 77-916,206, FILED 1-20-2010.

RICHARD WHITE, EXAMINING ATTORNEY



*David J. Kybas*

Director of the United States Patent and Trademark Office



# United States of America

United States Patent and Trademark Office

# FLEXplace

**Reg. No. 4,135,924**

**Registered May 1, 2012**

**Int. Cl.: 38**

**SERVICE MARK**

**PRINCIPAL REGISTER**

JOHNSON & JOHNSON (NEW JERSEY CORPORATION)  
ONE JOHNSON & JOHNSON PLAZA  
NEW BRUNSWICK, NJ 089337001

FOR: PROVIDING ACCESS AND CONNECTIVITY TO WORK NETWORKS OF OTHERS  
WHEN OFF-SITE, IN CLASS 38 (U.S. CLS. 100, 101 AND 104).

FIRST USE 12-0-2009; IN COMMERCE 12-0-2009.

NO CLAIM IS MADE TO THE EXCLUSIVE RIGHT TO USE "FLEXPLACE", APART FROM  
THE MARK AS SHOWN.

THE MARK CONSISTS OF THE STYLIZED WORD "FLEXPLACE".

SN 77-916,541, FILED 1-21-2010.

FRANK LATTUCA, EXAMINING ATTORNEY



*David J. Kyffers*

Director of the United States Patent and Trademark Office

# United States of America

United States Patent and Trademark Office

## THE SMART SOLUTION.

**Reg. No. 4,135,925**

**Registered May 1, 2012**

**Int. Cl.: 37**

**SERVICE MARK**

**PRINCIPAL REGISTER**

ROLLINS, INC. (DELAWARE CORPORATION)  
2170 PIEDMONT ROAD, NE  
ATLANTA, GA 30324

FOR: PEST CONTROL SERVICES, IN CLASS 37 (U.S. CLS. 100, 103 AND 106).

FIRST USE 6-0-2006; IN COMMERCE 6-0-2006.

THE MARK CONSISTS OF STANDARD CHARACTERS WITHOUT CLAIM TO ANY PARTICULAR FONT, STYLE, SIZE, OR COLOR.

NO CLAIM IS MADE TO THE EXCLUSIVE RIGHT TO USE "SOLUTION", APART FROM THE MARK AS SHOWN.

SN 77-917,070, FILED 1-21-2010.

SIMON TENG, EXAMINING ATTORNEY



*David J. Kyffers*

Director of the United States Patent and Trademark Office

# United States of America

United States Patent and Trademark Office

# ORBIT AF

**Reg. No. 4,135,926**

**Registered May 1, 2012**

**Int. Cls.: 16 and 44**

**TRADEMARK**

**SERVICE MARK**

**PRINCIPAL REGISTER**

JOHNSON & JOHNSON (NEW JERSEY CORPORATION)  
ONE JOHNSON & JOHNSON PLAZA  
NEW BRUNSWICK, NJ 089337001

FOR: PRINTED MATERIALS, NAMELY, PAMPHLETS, FLYERS AND BROCHURES, RELATING TO A REGISTRY FOR PATIENTS WITH ATRIAL FIBRILLATION, IN CLASS 16 (U.S. CLS. 2, 5, 22, 23, 29, 37, 38 AND 50).

FIRST USE 2-7-2010; IN COMMERCE 3-21-2011.

FOR: MEDICAL INFORMATION FOR HEALTH CARE PROVIDERS AND PATIENTS CONCERNING ATRIAL FIBRILLATION, IN CLASS 44 (U.S. CLS. 100 AND 101).

FIRST USE 2-7-2010; IN COMMERCE 3-21-2011.

NO CLAIM IS MADE TO THE EXCLUSIVE RIGHT TO USE "AF", APART FROM THE MARK AS SHOWN.

THE MARK CONSISTS OF THE STYLIZED PHRASE "ORBIT AF" FOLLOWED BY A TRIANGLE WITH THE DESIGN OF A PLANET WITH A RING AROUND IT.

SN 77-917,649, FILED 1-22-2010.

WILLIAM ROSSMAN, EXAMINING ATTORNEY



*David J. Kyros*

Director of the United States Patent and Trademark Office

# United States of America

United States Patent and Trademark Office



**Reg. No. 4,135,927**

**Registered May 1, 2012**

**Int. Cl.: 35**

**SERVICE MARK**

**PRINCIPAL REGISTER**

GIGANETWORKS, INC. (DELAWARE CORPORATION)  
7510 MIAMI VIEW DR  
NORTH BAY VILLAGE, FL 33141

FOR: VALUE-ADDED RESELLER SERVICES, NAMELY, DISTRIBUTORSHIP SERVICES FEATURING COMPUTER SECURITY AND INFORMATION TECHNOLOGY PRODUCTS, IN CLASS 35 (U.S. CLS. 100, 101 AND 102).

FIRST USE 3-23-2010; IN COMMERCE 3-23-2010.

NO CLAIM IS MADE TO THE EXCLUSIVE RIGHT TO USE "NETWORKS", APART FROM THE MARK AS SHOWN.

THE COLOR(S) OLIVE GREEN, BLUE AND WHITE IS/ARE CLAIMED AS A FEATURE OF THE MARK.

THE MARK CONSISTS OF THE WORDING "GIGA" IN BLUE FOLLOWED UNDERNEATH BY THE WORDING "NETWORKS" IN OLIVE GREEN. ON TOP OF THE WORDING IS A DESIGN OF A BLUE AND WHITE SPHERE AGAINST A BLUE STARBURST AND TWO CURVED OLIVE GREEN AND WHITE BANDS EMANATING FROM THE SAME SPHERE.

SN 77-920,744, FILED 1-26-2010.

HAI-LY LAM, EXAMINING ATTORNEY



*David J. Kybas*

Director of the United States Patent and Trademark Office

# United States of America

United States Patent and Trademark Office

## FRESH AND CRUSTY

**Reg. No. 4,135,928**

**Registered May 1, 2012**

**Int. Cl.: 17**

**TRADEMARK**

**PRINCIPAL REGISTER**

NOW PLASTICS, INC. (MASSACHUSETTS CORPORATION)  
136 DENSLOW ROAD  
EAST LONGMEADOW, MA 01028

FOR: PLASTIC FILMS USED AS PACKAGING FOR FOOD, IN CLASS 17 (U.S. CLS. 1, 5, 12, 13, 35 AND 50).

FIRST USE 4-30-2011; IN COMMERCE 4-30-2011.

THE MARK CONSISTS OF STANDARD CHARACTERS WITHOUT CLAIM TO ANY PARTICULAR FONT, STYLE, SIZE, OR COLOR.

SN 77-923,947, FILED 1-29-2010.

LINDA E. BLOHM, EXAMINING ATTORNEY



*David J. Kyffers*

Director of the United States Patent and Trademark Office

# United States of America

United States Patent and Trademark Office



**Reg. No. 4,135,929**  
**Registered May 1, 2012**

INTEL CORPORATION (DELAWARE CORPORATION)  
2200 MISSION COLLEGE BOULEVARD  
SANTA CLARA, CA 950528119

**Int. Cl.: 9**

FOR: COMPUTER CHIPSETS, INTEGRATED CIRCUITS; COMPUTER HARDWARE FOR PROVIDING AND ENHANCING THE OVERALL MANAGEMENT OF COMPUTER APPLICATIONS; COMPUTER HARDWARE FOR PROVIDING AND ENHANCING DATA PROTECTION, SECURITY OF COMPUTERS, COMPUTER NETWORKS AND COMPUTER SOFTWARE; SOFTWARE FOR MANAGING SECURITY OF COMPUTER HARDWARE, SYSTEMS SOFTWARE, APPLICATIONS SOFTWARE AND ELECTRONICALLY STORED DATA, IN CLASS 9 (U.S. CLS. 21, 23, 26, 36 AND 38).

**TRADEMARK**

**PRINCIPAL REGISTER**

FIRST USE 12-0-2008; IN COMMERCE 12-0-2008.

THE MARK CONSISTS OF THE DESIGN OF A HAND REACHING INTO A PARTIALLY OPENED LAPTOP COMPUTER RESEMBLING THE JAWS OF A CROCODILE, ALL INSIDE THE SHAPE OF A TRIANGULAR WARNING SIGN.

SN 77-925,343, FILED 2-1-2010.

CHARISMA HAMPTON, EXAMINING ATTORNEY



*David J. Kyjars*

Director of the United States Patent and Trademark Office

# United States of America

United States Patent and Trademark Office

# AASAN

**Reg. No. 4,135,930**

**Registered May 1, 2012**

**Int. Cls.: 29 and 30**

**TRADEMARK**

**PRINCIPAL REGISTER**

CALTEX TRADING, INC. (COLORADO CORPORATION)  
9045-A ETON AVENUE  
CANOGA PARK, CA 91304

FOR: BEEF STEW; CANNED COOKED MEAT; CANNED FRUITS; CANNED FRUITS AND VEGETABLES; CANNED TOMATOES; CANNED VEGETABLES; COOKED FRUITS AND VEGETABLES; COOKED VEGETABLES; CUT FRUITS; CUT VEGETABLES; DEHYDRATED FRUIT SNACKS; DRIED DATES; DRIED FRUIT MIXES; DRIED FRUIT-BASED SNACKS; DRIED FRUITS; DRIED VEGETABLES; DRINKABLE SOUPS; FRUIT LEATHERS; FRUIT PASTE; FRUIT PEEL; FRUIT PUREES; INSTANT OR PRE-COOKED SOUP; INSTANT OR PRE-COOKED STEW; LUNCHEON MEATS; PICKLED VEGETABLES; PICKLES; PREPARED MEAT; PRESERVED, DRIED AND COOKED FRUIT AND VEGETABLES; PRESERVED, DRIED, COOKED AND GRILLED VEGETABLES; PROCESSED GARLIC; SLICED FRUITS; SLICED VEGETABLES; SOUP MIXES; SOUPS; SOUPS AND PREPARATIONS FOR MAKING SOUPS; SPICY PICKLES; STEWS; TOMATO PASTE; WHEY, IN CLASS 29 (U.S. CL. 46).

FIRST USE 10-10-1979; IN COMMERCE 10-10-1979.

FOR: DESSERT PUDDINGS; EDIBLE SPICES; FLAVORING SYRUP; MOLASSES; MOLASSES SYRUP; RICE; RICE PUDDING; RICE-BASED PUDDING DESSERT (ARROZ CON LECHE); SPICES, IN CLASS 30 (U.S. CL. 46).

FIRST USE 10-10-1979; IN COMMERCE 10-10-1979.

THE MARK CONSISTS OF STANDARD CHARACTERS WITHOUT CLAIM TO ANY PARTICULAR FONT, STYLE, SIZE, OR COLOR.

OWNER OF U.S. REG. NO. 1,546,604.

THE ENGLISH TRANSLATION OF "AASAN" IN THE MARK IS EASY.

SN 77-926,279, FILED 2-2-2010.

KAREN BRACEY, EXAMINING ATTORNEY



*David J. Kyros*

Director of the United States Patent and Trademark Office

# United States of America

United States Patent and Trademark Office

## WE'RE GLAD YOU'RE HERE!

**Reg. No. 4,135,931**

**Registered May 1, 2012**

**Int. Cls.: 41 and 45**

**SERVICE MARK**

**PRINCIPAL REGISTER**

WE'RE GLAD YOU'RE HERE! (OREGON CORPORATION)  
15610 SE BYBEE DRIVE  
PORTLAND, OR 97236

FOR: CHARITABLE OUTREACH SERVICES, NAMELY, PROVIDING COMPANIONSHIP THROUGH LIVE MUSICAL PRESENTATION TO THE ELDERLY, DISABLED AND OTHERS RESIDING IN NURSING HOMES, ASSISTED CARE FACILITIES AND OTHER INSTITUTIONS, IN CLASS 41 (U.S. CLS. 100, 101 AND 107).

FIRST USE 9-1-2010; IN COMMERCE 9-1-2010.

FOR: CHARITABLE OUTREACH SERVICES PROVIDING COUNSELING SERVICES TO THE ELDERLY, DISABLED AND OTHERS RESIDING IN NURSING HOMES, ASSISTED CARE FACILITIES AND OTHER INSTITUTIONS, NAMELY, CHRISTIAN MINISTRY, RELIGIOUS AND SPIRITUAL PRAYER SERVICES, COMPANIONSHIP TO ALLEVIATE LONELINESS AND ADVANCE THE CHRISTIAN FAITH, IN CLASS 45 (U.S. CLS. 100 AND 101).

FIRST USE 9-1-2010; IN COMMERCE 9-1-2010.

THE MARK CONSISTS OF STANDARD CHARACTERS WITHOUT CLAIM TO ANY PARTICULAR FONT, STYLE, SIZE, OR COLOR.

SN 77-926,325, FILED 2-2-2010.

GINA FINK, EXAMINING ATTORNEY



*David J. Kybas*

Director of the United States Patent and Trademark Office



# United States of America

United States Patent and Trademark Office

# C-SADDLE

**Reg. No. 4,135,932**

**Registered May 1, 2012**

**Int. Cl.: 6**

**TRADEMARK**

**PRINCIPAL REGISTER**

CLEMENT, TIMOTHY EDWARD (LOUISIANA LIMITED LIABILITY COMPANY), DBA  
C-SADDLE LLC,  
1031 MARY ROAD  
NEW IBERIA, LA 70560

FOR: PIPE SHOE NON-METALLIC SUPPORTS AND SLIDING PAD FOR USE BETWEEN  
PIPE AND PIPE SUPPORT, IN CLASS 6 (U.S. CLS. 2, 12, 13, 14, 23, 25 AND 50).

FIRST USE 2-3-2010; IN COMMERCE 2-3-2010.

THE MARK CONSISTS OF STANDARD CHARACTERS WITHOUT CLAIM TO ANY PAR-  
TICULAR FONT, STYLE, SIZE, OR COLOR.

SN 77-927,174, FILED 2-3-2010.

THOMAS MANOR, EXAMINING ATTORNEY



*David J. Kyros*

Director of the United States Patent and Trademark Office

# United States of America

United States Patent and Trademark Office

*goFresh*

**Reg. No. 4,135,933**

**Registered May 1, 2012**

**Int. Cl.: 30**

**TRADEMARK**

**PRINCIPAL REGISTER**

SKIES INTERNATIONAL LLC (FLORIDA LIMITED LIABILITY COMPANY)  
2875 NE 191 STREET SUITE 800  
MIAMI, FL 33180

FOR: BUBBLE GUM; CHEWING GUM, IN CLASS 30 (U.S. CL. 46).

FIRST USE 7-26-2011; IN COMMERCE 7-26-2011.

THE MARK CONSISTS OF THE WORDS "GO FRESH" IN STYLIZED LETTERS AND APPEARING UNDERLINED.

SN 77-929,979, FILED 2-7-2010.

STEVEN R. FINE, EXAMINING ATTORNEY



*David J. Kyros*

Director of the United States Patent and Trademark Office

# United States of America

United States Patent and Trademark Office

## PARENT FURTHER

**Reg. No. 4,135,934**

**Registered May 1, 2012**

**Int. Cl.: 35**

**SERVICE MARK**

**PRINCIPAL REGISTER**

SEARCH INSTITUTE (MINNESOTA NON-PROFIT CORPORATION)  
SUITE 125  
615 FIRST AVENUE NE  
MINNEAPOLIS, MN 554132254

FOR: ONLINE RETAIL STORE SERVICES FEATURING EDUCATIONAL MATERIALS ABOUT PARENTING, NAMELY, PARENTING BOOKS, PAMPHLETS, SOFTWARE, MULTIMEDIA PRODUCTS AND RELATED MATERIALS, NAMELY, POSTERS, BUTTONS AND STICKERS, IN CLASS 35 (U.S. CLS. 100, 101 AND 102).

FIRST USE 2-22-2012; IN COMMERCE 2-22-2012.

THE MARK CONSISTS OF STANDARD CHARACTERS WITHOUT CLAIM TO ANY PARTICULAR FONT, STYLE, SIZE, OR COLOR.

NO CLAIM IS MADE TO THE EXCLUSIVE RIGHT TO USE "PARENT", APART FROM THE MARK AS SHOWN.

SN 77-930,466, FILED 2-8-2010.

YAT SYE, LEE, EXAMINING ATTORNEY



*David J. Kyffers*

Director of the United States Patent and Trademark Office

# United States of America

United States Patent and Trademark Office

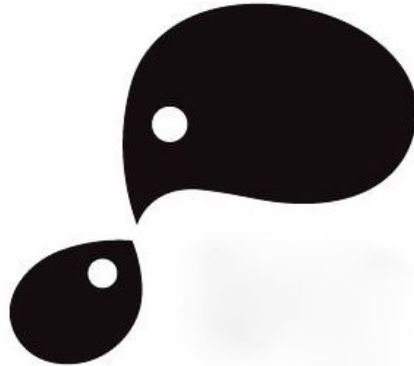

**Reg. No. 4,135,935**

**Registered May 1, 2012**

**Int. Cl.: 35**

**SERVICE MARK**

**PRINCIPAL REGISTER**

SEARCH INSTITUTE (MINNESOTA NON-PROFIT CORPORATION)  
SUITE 125  
615 FIRST AVENUE NE  
MINNEAPOLIS, MN 554132254

FOR: ONLINE RETAIL STORE SERVICES FEATURING EDUCATIONAL MATERIALS ABOUT PARENTING, NAMELY, PARENTING BOOKS, PAMPHLETS, SOFTWARE, MULTIMEDIA PRODUCTS AND RELATED MATERIALS, NAMELY, POSTERS, BUTTONS AND STICKERS, IN CLASS 35 (U.S. CLS. 100, 101 AND 102).

FIRST USE 2-22-2012; IN COMMERCE 2-22-2012.

THE MARK CONSISTS OF TWO STYLIZED BIRDLIKE FIGURES, WITH THE LARGER ONE DENOTING A PARENT ATTENDING TO ITS CHILD, WHICH IS DENOTED BY THE SMALLER FIGURE.

SN 77-931,016, FILED 2-8-2010.

YAT SYE, LEE, EXAMINING ATTORNEY



*David J. Kyffers*

Director of the United States Patent and Trademark Office

# United States of America

United States Patent and Trademark Office

## TEXAS BIOALLIANCE

**Reg. No. 4,135,936**

**Registered May 1, 2012**

**Int. Cl.: 35**

**SERVICE MARK**

**PRINCIPAL REGISTER**

BIOHOUSTON, INC. (TEXAS CORPORATION)  
SUITE 100  
2555 HOLLY HALL ST.  
HOUSTON, TX 77054

FOR: ASSOCIATION SERVICES, NAMELY, PROMOTING TECHNOLOGY TRANSFER AND RESEARCH COMMERCIALIZATION TO ACHIEVE ADVANCES IN THE FIELDS OF LIFE SCIENCE AND BIOTECHNOLOGY; BUSINESS MEETING PLANNING, IN CLASS 35 (U.S. CLS. 100, 101 AND 102).

FIRST USE 12-0-2010; IN COMMERCE 12-0-2010.

THE MARK CONSISTS OF STANDARD CHARACTERS WITHOUT CLAIM TO ANY PARTICULAR FONT, STYLE, SIZE, OR COLOR.

NO CLAIM IS MADE TO THE EXCLUSIVE RIGHT TO USE "TEXAS", APART FROM THE MARK AS SHOWN.

SN 77-931,435, FILED 2-9-2010.

TINA BROWN, EXAMINING ATTORNEY



*David J. Kybas*

Director of the United States Patent and Trademark Office

# United States of America

United States Patent and Trademark Office

## Ultra Nu-Straw

**Reg. No. 4,135,937**

AMTURF ENTERPRISES, LLC (MICHIGAN LIMITED LIABILITY COMPANY)  
4000 E. 7TH AVENUE  
GARY, IN 46403

**Registered May 1, 2012**

**Int. Cl.: 31**

FOR: MIXTURE CONSISTING OF MULCH AND FERTILIZER SOLD AS A UNIT TO REPAIR LAWNS, IN CLASS 31 (U.S. CLS. 1 AND 46).

**TRADEMARK**

FIRST USE 2-28-2010; IN COMMERCE 4-1-2010.

**PRINCIPAL REGISTER**

THE MARK CONSISTS OF STANDARD CHARACTERS WITHOUT CLAIM TO ANY PARTICULAR FONT, STYLE, SIZE, OR COLOR.

NO CLAIM IS MADE TO THE EXCLUSIVE RIGHT TO USE "ULTRA", APART FROM THE MARK AS SHOWN.

SN 77-931,851, FILED 2-9-2010.

SANI KHOURI, EXAMINING ATTORNEY



*David J. Kybas*

Director of the United States Patent and Trademark Office

# United States of America

United States Patent and Trademark Office

# LMM

**Reg. No. 4,135,938**

**Registered May 1, 2012**

**Int. Cls.: 18 and 25**

**TRADEMARK**

**PRINCIPAL REGISTER**

MISS MATCHED, INC. (DELAWARE CORPORATION)  
307 7TH AVENUE, SUITE 501  
NEW YORK, NY 10001

FOR: BAGS, NAMELY, MESSENGER BAGS, TOTE BAGS, WRISTLET BAGS, BOOK BAGS, DRAWSTRING BAGS, SLING BAGS, HANDBAGS, COSMETIC BAGS SOLD EMPTY; DUFFEL BAGS, BACKPACKS; PURSES, CHANGE PURSES, WALLETS; POUCHES, NAMELY, FABRIC POUCHES, DRAWSTRING POUCHES, POUCHES FOR HOLDING KEYS, MAKE-UP AND OTHER PERSONAL ITEMS; LUGGAGE, LUGGAGE TAGS, IN CLASS 18 (U.S. CLS. 1, 2, 3, 22 AND 41).

FIRST USE 9-17-2010; IN COMMERCE 9-17-2010.

FOR: CLOTHING, NAMELY, JACKETS, SWEATSHIRTS, SWEATERS, HOSIERY, PAJAMAS, UNDERWEAR, TANK TOPS, SHIRTS, SKIRTS, DRESSES, LEG WARMERS, ARM WARMERS, LEGGINGS, ONE-PIECE GARMENTS FOR INFANTS, KIMONOS, CLOTH COVERALLS; PANTS, SHORTS; HEADWEAR; FOOTWEAR; ACCESSORIES, NAMELY, SCARVES, GLOVES, MITTENS, IN CLASS 25 (U.S. CLS. 22 AND 39).

FIRST USE 9-17-2010; IN COMMERCE 9-17-2010.

THE MARK CONSISTS OF STANDARD CHARACTERS WITHOUT CLAIM TO ANY PARTICULAR FONT, STYLE, SIZE, OR COLOR.

SN 77-932,957, FILED 2-10-2010.

DOMINIC J. FERRAIUOLO, EXAMINING ATTORNEY



*David J. Kybas*

Director of the United States Patent and Trademark Office

# United States of America

United States Patent and Trademark Office

# Webtoys

**Reg. No. 4,135,939**

**Registered May 1, 2012**

**Int. Cl.: 28**

**TRADEMARK**

**PRINCIPAL REGISTER**

GROOVY TOYS LLC (FLORIDA LIMITED LIABILITY COMPANY), DBA GROOYI,  
563 NW MERCANTILE PLACE  
PORT ST LUCIE, FL 34953

FOR: TOYS, NAMELY, RADIO CONTROL VEHICLES, INFRARED BEAM CONTROL VEHICLES, FREE WHEEL VEHICLES, FRICTION WHEEL VEHICLES, PULL BACK VEHICLES, TOY VEHICLE RACE TRACKS, DOLLS AND ANY ELECTRONIC ACTION TOY THAT EMITS SOUND AND LIGHT ALL CONTAINING A CARD WITH A CODE THAT ALLOWS USERS TO PLAY ONLINE DIGITAL OR VIRTUAL GAMES, SOLD AS A UNIT, IN CLASS 28 (U.S. CLS. 22, 23, 38 AND 50).

FIRST USE 5-17-2010; IN COMMERCE 6-30-2011.

THE MARK CONSISTS OF STANDARD CHARACTERS WITHOUT CLAIM TO ANY PARTICULAR FONT, STYLE, SIZE, OR COLOR.

SN 77-933,363, FILED 2-11-2010.

KAREN BRACEY, EXAMINING ATTORNEY



*David J. Kybas*

Director of the United States Patent and Trademark Office



# United States of America

United States Patent and Trademark Office

# ORTUSTECH

**Reg. No. 4,135,940**

**Registered May 1, 2012**

**Int. Cl.: 9**

**TRADEMARK**

**PRINCIPAL REGISTER**

TOPPAN INSATSU KABUSHIKI KAISHA (JAPAN CORPORATION), DBA TOPPAN PRINTING CO., LTD.,  
5-1, TAITO 1-CHOME, TAITO-KU  
TOKYO, JAPAN

FOR: ELECTRONIC MACHINES, APPARATUS AND THEIR PARTS, NAMELY, LIQUID CRYSTAL DISPLAY MONITORS, COLOR FILTERS FOR LIQUID CRYSTAL DISPLAYS, LIQUID CRYSTAL DISPLAYS AND THEIR PARTS; ORGANIC ELECTROLUMINESCENCE DISPLAYS AND THEIR PARTS; ELECTRONIC PAPERS AND THEIR PARTS; ELECTROPHORETIC DISPLAY DEVICE; ORGANIC ELECTROLUMINESCENCE DISPLAY DEVICE; LIQUID CRYSTAL DISPLAY DEVICE; TWIST BALL DISPLAY DEVICE; POWDER TRANSFER DISPLAY DEVICE; THERMAL DISPLAY DEVICE; ELECTRODEPOSITION DISPLAY DEVICE; ACTUATED FILM DISPLAY DEVICE; ELECTROCHROMIC DISPLAY DEVICE; ELECTROWETTING DISPLAY DEVICE; OPTICAL INTERFEROMETRY DISPLAY DEVICE; MAGNETIC THERMAL DISPLAY DEVICE; THIN-FILM TRANSISTORS FOR LIQUID CRYSTAL DISPLAYS; THIN-FILM TRANSISTORS FOR ORGANIC ELECTROLUMINESCENCE DISPLAYS; TOUCH PANELS AND THEIR PARTS, IN CLASS 9 (U.S. CLS. 21, 23, 26, 36 AND 38).

FIRST USE 4-1-2010; IN COMMERCE 4-1-2010.

THE MARK CONSISTS OF STANDARD CHARACTERS WITHOUT CLAIM TO ANY PARTICULAR FONT, STYLE, SIZE, OR COLOR.

SN 77-933,737, FILED 2-11-2010.

JOHN WILKE, EXAMINING ATTORNEY



*David J. Kyros*

Director of the United States Patent and Trademark Office

# United States of America

United States Patent and Trademark Office



**Reg. No. 4,135,941**

**Registered May 1, 2012**

**Int. Cl.: 16**

**TRADEMARK**

**PRINCIPAL REGISTER**

VIACOM INTERNATIONAL INC. (DELAWARE CORPORATION)  
1515 BROADWAY  
NEW YORK, NY 10036

FOR: PRINTED MATTER, NAMELY, NOTE PAPER AND LOOSE LEAF PAPER, DECALS, STICKERS, TRADING CARDS, NOTE CARDS, POSTERS, FOLDERS, CALENDARS, STATIONERY WRITING PAPER AND ENVELOPES, ARTS AND CRAFT PAINT KITS; NOTEBOOKS; BLANK JOURNALS; ADDRESS BOOKS; DIARIES; SCHOOL SUPPLIES, NAMELY, SCHOOL BOXES MADE OF CARDBOARD; PENCILS; PENS, PEN AND PENCIL CASES AND HOLDERS, ERASERS, PENCIL SHARPENERS, MARKERS, AND DRAWING RULERS; GIFT WRAPPING PAPER; PAPER PARTY DECORATIONS; PARTY PAPER BAGS, IN CLASS 16 (U.S. CLS. 2, 5, 22, 23, 29, 37, 38 AND 50).

FIRST USE 6-15-2010; IN COMMERCE 6-15-2010.

OWNER OF U.S. REG. NOS. 1,400,277 AND 1,401,139.

SN 77-933,791, FILED 2-11-2010.

MICHAEL WEBSTER, EXAMINING ATTORNEY



*David J. Kybas*

Director of the United States Patent and Trademark Office

# United States of America

United States Patent and Trademark Office



**Reg. No. 4,135,942**

**Registered May 1, 2012**

**Int. Cl.: 6**

**TRADEMARK**

**PRINCIPAL REGISTER**

WORDLOCK, INC. (CALIFORNIA CORPORATION)  
2855 KIFER ROAD, SUITE 105  
SANTA CLARA, CA 95051

FOR: METAL COMBINATION LOCKS; METAL PADLOCKS; METAL BICYCLES LOCKS;  
METAL LUGGAGE LOCKS; METAL COMPUTER AND LAPTOP LOCKS; METAL LOCKS  
FOR LOCKERS; METAL BACKPACK LOCKS, IN CLASS 6 (U.S. CLS. 2, 12, 13, 14, 23, 25  
AND 50).

FIRST USE 2-23-2012; IN COMMERCE 2-23-2012.

THE MARK CONSISTS OF A CAPITAL LETTER "L" SUPERIMPOSED ON A CAPITAL  
LETTER "W".

SN 77-935,110, FILED 2-12-2010.

BARBARA BROWN, EXAMINING ATTORNEY



*David J. Kyffers*

Director of the United States Patent and Trademark Office

# United States of America

United States Patent and Trademark Office

## Learning 360° Framework

**Reg. No. 4,135,943**

**Registered May 1, 2012**

**Int. Cl.: 41**

**SERVICE MARK**

**PRINCIPAL REGISTER**

SCHOOL IMPROVEMENT NETWORK, INC. (UTAH CORPORATION)  
32 W. CENTER STREET  
MIDVALE, UT 84047

FOR: EDUCATION SERVICES, NAMELY, PROVIDING ONLINE AND LIVE TRAINING IN THE FORM OF CLASSES, SEMINARS, CONFERENCES, PERSONAL COACHING SESSIONS, AND WORKSHOPS TO EDUCATORS IN THE FIELD OF SYSTEMIC LEARNING THEORIES FOR THE PURPOSE OF INCREASING TEACHER AND ADMINISTRATOR EFFECTIVENESS AND IMPROVING STUDENT ACHIEVEMENT, AND DISTRIBUTION OF PRINTED AND/OR ONLINE MATERIALS IN CONNECTION THEREWITH IN HARD COPY AND/OR ELECTRONIC FORMAT ON THE SAME TOPICS, IN CLASS 41 (U.S. CLS. 100, 101 AND 107).

FIRST USE 7-0-2010; IN COMMERCE 7-0-2010.

THE MARK CONSISTS OF STANDARD CHARACTERS WITHOUT CLAIM TO ANY PARTICULAR FONT, STYLE, SIZE, OR COLOR.

NO CLAIM IS MADE TO THE EXCLUSIVE RIGHT TO USE "LEARNING", APART FROM THE MARK AS SHOWN.

SN 77-937,234, FILED 2-17-2010.

ROBERT C. CLARK JR., EXAMINING ATTORNEY



*David J. Kyros*

Director of the United States Patent and Trademark Office

# United States of America

United States Patent and Trademark Office

# Iofina

**Reg. No. 4,135,944**

**Registered May 1, 2012**

**Int. Cl.: 5**

**TRADEMARK**

**PRINCIPAL REGISTER**

IOFINA NATURAL GAS, INC. (COLORADO CORPORATION)  
8480 EAST ORCHARD ROAD, SUITE 3600  
GREENWOOD VILLAGE, CO 80111

FOR: IODINE, IN CLASS 5 (U.S. CLS. 6, 18, 44, 46, 51 AND 52).

FIRST USE 12-15-2009; IN COMMERCE 12-15-2009.

THE MARK CONSISTS OF STANDARD CHARACTERS WITHOUT CLAIM TO ANY PARTICULAR FONT, STYLE, SIZE, OR COLOR.

SN 77-937,758, FILED 2-17-2010.

KEVON CHISOLM, EXAMINING ATTORNEY



*David J. Kybas*

Director of the United States Patent and Trademark Office

# United States of America

United States Patent and Trademark Office

# COMFORT-U

**Reg. No. 4,135,945**

**Registered May 1, 2012**

**Int. Cl.: 25**

**TRADEMARK**

**PRINCIPAL REGISTER**

HBI BRANDED APPAREL ENTERPRISES, LLC (DELAWARE LIMITED LIABILITY COMPANY)  
1000 EAST HANES MILL ROAD  
WINSTON-SALEM, NC 27105

FOR: COMPONENTS OF A BRA, NAMELY, THE BACK AND STRAPS, IN CLASS 25 (U.S. CLS. 22 AND 39).

FIRST USE 11-30-2009; IN COMMERCE 11-30-2009.

THE MARK CONSISTS OF STANDARD CHARACTERS WITHOUT CLAIM TO ANY PARTICULAR FONT, STYLE, SIZE, OR COLOR.

SN 77-938,506, FILED 2-18-2010.

NAKIA HENRY, EXAMINING ATTORNEY



*David J. Kybas*

Director of the United States Patent and Trademark Office

# United States of America

United States Patent and Trademark Office



**Reg. No. 4,135,946**

**Registered May 1, 2012**

**Int. Cls.: 35, 36, and 37**

**SERVICE MARK**

**PRINCIPAL REGISTER**

CARHELP, LLC (OREGON LIMITED LIABILITY COMPANY)  
8105 IRVINE CENTER DRIVE, SUITE 900  
IRVINE, CA 92618

FOR: PROVIDING AN ONLINE BUSINESS DIRECTORY FEATURING SERVICE PROVIDERS IN THE FIELDS OF AUTOMOTIVE REPAIR SERVICES, TOWING SERVICES, COLLISION REPAIRS, GLASS REPAIRS, TIRE REPAIRS AND REPLACEMENTS, DETAILING SERVICES, RENTAL SERVICES, MECHANICAL REPAIRS, EMERGENCY ROAD ASSISTANCE, AUTOMOTIVE MAINTENANCE SERVICES, TAXI SERVICES, AUTO PARTS RETAILERS AND AUTOMOBILE INSURANCE COMPANIES; ADVERTISING AND BUSINESS SERVICES, NAMELY, PROVIDING AN ONLINE WEBSITE WHERE ADVERTISERS CAN INTERACT WITH USERS FOR ADVERTISING AND PROMOTING KNOWLEDGE ABOUT PRODUCTS AND SERVICES ON BEHALF OF THEMSELVES AND OTHERS, AND FOR EVALUATING AND RATING THE SAME, ALL THE FOREGOING RELEVANT TO AUTOMOTIVE REPAIR, MAINTENANCE AND INSURANCE SERVICES; PROVIDING INFORMATION PERTAINING TO PURCHASING AN AUTOMOBILE; PROVIDING ONLINE INFORMATION FEATURING TIPS AND INFORMATION ON PURCHASING NEW AND USED CAR PURCHASES; PROVIDING ONLINE INFORMATION FEATURING TIPS AND INFORMATION ON FUEL CONSUMPTION AND USAGE CONSERVATION TO IMPROVE ENERGY EFFICIENCY, IN CLASS 35 (U.S. CLS. 100, 101 AND 102).

FIRST USE 12-21-2000; IN COMMERCE 1-1-2010.



FOR: PROVIDING ONLINE INFORMATION FEATURING TIPS AND INFORMATION ON FINANCING NEW AND USED CAR PURCHASES; PROVIDING ONLINE INFORMATION FEATURING TIPS AND INFORMATION ON AUTOMOBILE INSURANCE; PROVIDING INFORMATION REGARDING FINANCING AND INSURING AN AUTOMOBILE, IN CLASS 36 (U.S. CLS. 100, 101 AND 102).

FIRST USE 8-16-2010; IN COMMERCE 8-16-2010.

FOR: PROVIDING INFORMATION REGARDING THE REPAIR AND MAINTENANCE OF AUTOMOBILES; PROVIDING ONLINE INFORMATION FEATURING TIPS AND INFORMATION ON AUTO MAINTENANCE AND TIRE MAINTENANCE, IN CLASS 37 (U.S. CLS. 100, 103 AND 106).

FIRST USE 12-21-2000; IN COMMERCE 1-1-2010.

*David J. Kappas*

Director of the United States Patent and Trademark Office

**Reg. No. 4,135,946** NO CLAIM IS MADE TO THE EXCLUSIVE RIGHT TO USE "1-800", APART FROM THE MARK AS SHOWN.

THE COLOR(S) BLUE, ORANGE, BLACK AND WHITE IS/ARE CLAIMED AS A FEATURE OF THE MARK.

THE MARK CONSISTS OF THE NUMBERS "1-800" IN ORANGE ABOVE THE WORD "CARHELP" IN LOWER CASE BLUE LETTERS; THE LETTERS OF THE WORD "CAR" ARE THINNER THAN THE LETTERS OF THE WORD "HELP"; A PERIOD AND THE LETTERS "COM" APPEAR BELOW THE "P" IN "HELP"; AN ORANGE CARTOON CAR WITH BLUE BLACK AND WHITE EYES, ORANGE AND WHITE MOUTH BLACK TIRES WITH ORANGE AND WHITE RIMS, BLACK WINDOWS AND A BLACK SHADOW BENEATH THE CAR.

SN 77-938,805, FILED 2-18-2010.

PRISCILLA MILTON, EXAMINING ATTORNEY



# United States of America

United States Patent and Trademark Office

# Mego

**Reg. No. 4,135,947**

**Registered May 1, 2012**

**Int. Cls.: 35, 36, and 37**

**SERVICE MARK**

**PRINCIPAL REGISTER**

CARHELP, LLC (OREGON LIMITED LIABILITY COMPANY)  
8105 IRVINE CENTER DRIVE, SUITE 900  
IRVINE, CA 92618

FOR: PROVIDING AN ONLINE BUSINESS DIRECTORY FEATURING SERVICE PROVIDERS IN THE FIELDS OF AUTOMOTIVE REPAIR SERVICES, TOWING SERVICES, COLLISION REPAIRS, GLASS REPAIRS, TIRE REPAIRS AND REPLACEMENTS, DETAILING SERVICES, RENTAL SERVICES, MECHANICAL REPAIRS, EMERGENCY ROAD ASSISTANCE, AUTOMOTIVE MAINTENANCE SERVICES, TAXI SERVICES, AUTO PARTS RETAILERS AND AUTOMOBILE INSURANCE COMPANIES; ADVERTISING AND BUSINESS SERVICES, NAMELY, PROVIDING AN ONLINE WEBSITE WHERE ADVERTISERS CAN INTERACT WITH USERS FOR ADVERTISING AND PROMOTING KNOWLEDGE ABOUT PRODUCTS AND SERVICES ON BEHALF OF THEMSELVES AND OTHERS, AND FOR EVALUATING AND RATING THE SAME, ALL THE FOREGOING RELEVANT TO AUTOMOTIVE REPAIR, MAINTENANCE AND INSURANCE SERVICES; PROVIDING INFORMATION PERTAINING TO PURCHASING AN AUTOMOBILE; PROVIDING ONLINE INFORMATION FEATURING TIPS AND INFORMATION ON PURCHASING NEW AND USED CAR PURCHASES; PROVIDING ONLINE INFORMATION FEATURING TIPS AND INFORMATION ON FUEL CONSUMPTION AND USAGE CONSERVATION TO IMPROVE ENERGY EFFICIENCY, IN CLASS 35 (U.S. CLS. 100, 101 AND 102).

FIRST USE 1-1-2010; IN COMMERCE 1-1-2010.



FOR: PROVIDING ONLINE INFORMATION FEATURING TIPS AND INFORMATION ON FINANCING NEW AND USED CAR PURCHASES; PROVIDING ONLINE INFORMATION FEATURING TIPS AND INFORMATION ON AUTOMOBILE INSURANCE; PROVIDING INFORMATION REGARDING FINANCING AND INSURING AN AUTOMOBILE, IN CLASS 36 (U.S. CLS. 100, 101 AND 102).

FIRST USE 8-16-2010; IN COMMERCE 8-16-2010.

FOR: PROVIDING ONLINE INFORMATION FEATURING TIPS AND INFORMATION ON AUTO MAINTENANCE AND TIRE MAINTENANCE; PROVIDING INFORMATION REGARDING THE REPAIR AND MAINTENANCE OF AUTOMOBILES, IN CLASS 37 (U.S. CLS. 100, 103 AND 106).

FIRST USE 1-1-2010; IN COMMERCE 1-1-2010.

*David J. Kybas*

Director of the United States Patent and Trademark Office

**Reg. No. 4,135,947** THE MARK CONSISTS OF STANDARD CHARACTERS WITHOUT CLAIM TO ANY PARTICULAR FONT, STYLE, SIZE, OR COLOR.

SN 77-938,835, FILED 2-18-2010.

PRISCILLA MILTON, EXAMINING ATTORNEY

# United States of America

United States Patent and Trademark Office

# DIAMSKIN

**Reg. No. 4,135,948**

**Registered May 1, 2012**

**Int. Cl.: 3**

**TRADEMARK**

**PRINCIPAL REGISTER**

MARY COHR (FRANCE SOCIETE PAR ACTIONS SIMPLIFIEE)  
1 RUE DE LA PAIX  
PARIS, FRANCE 75002

FOR: COSMETIC CREAMS FOR SKIN CARE; COSMETICS; FACE AND BODY CREAMS;  
HAND CREAMS; HAND LOTIONS; LIP BALM; LIP CREAM; NON-MEDICATED LIP CARE  
PREPARATIONS; NON-MEDICATED LIP PROTECTORS, IN CLASS 3 (U.S. CLS. 1, 4, 6, 50,  
51 AND 52).

FIRST USE 0-0-2011; IN COMMERCE 2-9-2012.

THE MARK CONSISTS OF STANDARD CHARACTERS WITHOUT CLAIM TO ANY PAR-  
TICULAR FONT, STYLE, SIZE, OR COLOR.

OWNER OF U.S. REG. NO. 3,438,300.

SN 77-940,113, FILED 2-19-2010.

MARY BOAGNI, EXAMINING ATTORNEY



*David J. Kyros*

Director of the United States Patent and Trademark Office

# United States of America

United States Patent and Trademark Office

## EVAN BOURNE

**Reg. No. 4,135,949**

**Registered May 1, 2012**

**Int. Cl.: 25**

**TRADEMARK**

**PRINCIPAL REGISTER**

WORLD WRESTLING ENTERTAINMENT, INC. (DELAWARE CORPORATION)  
1241 EAST MAIN STREET  
STAMFORD, CT 06902

FOR: CLOTHING, NAMELY, TOPS, JACKETS, BOTTOMS, UNDERWEAR, PAJAMAS;  
FOOTWEAR, NAMELY, SHOES, SNEAKERS, SLIPPERS; HEADWEAR, NAMELY, HATS,  
IN CLASS 25 (U.S. CLS. 22 AND 39).

FIRST USE 6-4-2009; IN COMMERCE 6-4-2009.

THE MARK CONSISTS OF STANDARD CHARACTERS WITHOUT CLAIM TO ANY PAR-  
TICULAR FONT, STYLE, SIZE, OR COLOR.

THE NAME(S), PORTRAIT(S), AND/OR SIGNATURE(S) SHOWN IN THE MARK DOES NOT  
IDENTIFY A PARTICULAR LIVING INDIVIDUAL.

SN 77-940,886, FILED 2-21-2010.

JOHN HWANG, EXAMINING ATTORNEY



*David J. Kybas*

Director of the United States Patent and Trademark Office

# United States of America

United States Patent and Trademark Office

# HOT BOMB

**Reg. No. 4,135,950**

**Registered May 1, 2012**

**Int. Cl.: 28**

**TRADEMARK**

**PRINCIPAL REGISTER**

PAT ACQUISITION, LLC (DELAWARE LIMITED LIABILITY COMPANY)  
SUITE 1225  
3100 WEST END  
NASHVILLE, TN 37238

FOR: HUNTING EQUIPMENT, NAMELY, SCENT DISPENSER FOR THE DISPERSAL OF SCENT LURES FOR HUNTING, IN CLASS 28 (U.S. CLS. 22, 23, 38 AND 50).

FIRST USE 6-15-2009; IN COMMERCE 6-15-2009.

THE MARK CONSISTS OF STANDARD CHARACTERS WITHOUT CLAIM TO ANY PARTICULAR FONT, STYLE, SIZE, OR COLOR.

SN 77-941,282, FILED 2-22-2010.

DAVID HOFFMAN, EXAMINING ATTORNEY



*David J. Kyffers*

Director of the United States Patent and Trademark Office

# United States of America

United States Patent and Trademark Office

## NATURE'S ALOE

**Reg. No. 4,135,951**

**Registered May 1, 2012**

**Int. Cl.: 32**

**TRADEMARK**

**PRINCIPAL REGISTER**

VANTAGE BRANDS, LLC (TEXAS LIMITED LIABILITY COMPANY)  
4871 SHARP STREET  
DALLAS, TX 75247

FOR: ALOE DRINKS, IN CLASS 32 (U.S. CLS. 45, 46 AND 48).

FIRST USE 1-16-2012; IN COMMERCE 1-16-2012.

THE MARK CONSISTS OF STANDARD CHARACTERS WITHOUT CLAIM TO ANY PARTICULAR FONT, STYLE, SIZE, OR COLOR.

NO CLAIM IS MADE TO THE EXCLUSIVE RIGHT TO USE "ALOE", APART FROM THE MARK AS SHOWN.

SN 77-941,348, FILED 2-22-2010.

JANICE L. MCMORROW, EXAMINING ATTORNEY



*David J. Kyffers*

Director of the United States Patent and Trademark Office

# United States of America

United States Patent and Trademark Office

## The Ultimate Wingman

**Reg. No. 4,135,952**

**Registered May 1, 2012**

**Int. Cl.: 41**

**SERVICE MARK**

**PRINCIPAL REGISTER**

WINGMAN ENTERPRISES, INC. (GEORGIA CORPORATION)  
2636 POPLAR LAKE TRAIL  
ATLANTA, GA 30360

FOR: CONDUCTING WORKSHOPS AND SEMINARS IN PERSONAL AWARENESS; CONDUCTING WORKSHOPS AND SEMINARS IN SELF AWARENESS; CONTINUING EDUCATION SERVICES, NAMELY, PROVIDING LIVE AND ON-LINE CONTINUING PROFESSIONAL EDUCATION SEMINARS IN THE FIELD OF TEAM BUILDING, TEAMWORK, SELF-IMPROVEMENT, INTERPERSONAL SKILLS, IMPROVING BUSINESS ORGANIZATIONS AND WORKPLACE PERFORMANCE, INTERPERSONAL RELATIONSHIPS AND SKILLS IN THE WORKPLACE, CUSTOMER RELATIONSHIP MANAGEMENT, SALES EXECUTION, BUSINESS MANAGEMENT SKILLS, LEADERSHIP, PEAK PERFORMANCE AND DISTRIBUTING COURSE MATERIALS IN CONNECTION THEREWITH. CUSTOM WRITING SERVICES; EDUCATIONAL AND ENTERTAINMENT SERVICES, NAMELY, PROVIDING MOTIVATIONAL AND EDUCATIONAL SPEAKERS IN THE FIELD OF SELF- AND PERSONAL IMPROVEMENT; EDUCATIONAL SERVICES, NAMELY, CONDUCTING SEMINARS, LECTURES, TELESEMINARS, TELECLASSES, AND WORKSHOPS IN PERSONAL AWARENESS; LIFE COACHING SERVICES IN THE FIELD OF HEALTH AND FITNESS, BUSINESS, PERSONAL AND PROFESSIONAL RELATIONSHIPS, TEAMWORK, SELF-IMPROVEMENT, INTERPERSONAL RELATIONSHIPS, AND PERSONAL DEVELOPMENT. PERSONAL COACHING SERVICES IN THE FIELD OF TEAM BUILDING, TEAMWORK, SELF-IMPROVEMENT, INTERPERSONAL SKILLS, IMPROVING BUSINESS ORGANIZATIONS AND WORKPLACE PERFORMANCE, INTERPERSONAL RELATIONSHIPS AND SKILLS IN THE WORKPLACE, CUSTOMER RELATIONSHIP MANAGEMENT, SALES EXECUTION, BUSINESS MANAGEMENT SKILLS, LEADERSHIP, AND PEAK PERFORMANCE, IN CLASS 41 (U.S. CLS. 100, 101 AND 107).



FIRST USE 8-1-2010; IN COMMERCE 2-1-2011.

THE MARK CONSISTS OF STANDARD CHARACTERS WITHOUT CLAIM TO ANY PARTICULAR FONT, STYLE, SIZE, OR COLOR.

OWNER OF U.S. REG. NOS. 3,105,680, 3,652,339, AND 3,743,296.

SN 77-942,074, FILED 2-23-2010.

APRIL HESIK, EXAMINING ATTORNEY

*David J. Kyros*

Director of the United States Patent and Trademark Office

# United States of America

United States Patent and Trademark Office

## MIRACLESHAPER

**Reg. No. 4,135,953**

**Registered May 1, 2012**

**Int. Cl.: 25**

**TRADEMARK**

**PRINCIPAL REGISTER**

A & H SPORTSWEAR CO., INC. (PENNSYLVANIA CORPORATION)  
110 COMMERCE WAY  
STOCKERTOWN, PA 18083

FOR: SWIMWEAR; JEANS; ACTIVEWEAR, NAMELY, SHORTS, PANTS, SHIRTS AND TOPS; AND SPORTSWEAR, NAMELY, SHORTS, PANTS, SHIRTS AND TOPS, IN CLASS 25 (U.S. CLS. 22 AND 39).

FIRST USE 11-18-2011; IN COMMERCE 11-18-2011.

THE MARK CONSISTS OF STANDARD CHARACTERS WITHOUT CLAIM TO ANY PARTICULAR FONT, STYLE, SIZE, OR COLOR.

OWNER OF U.S. REG. NOS. 2,631,990, 3,503,007, AND OTHERS.

SN 77-942,116, FILED 2-23-2010.

KAPIL BHANOT, EXAMINING ATTORNEY



*David J. Kybas*

Director of the United States Patent and Trademark Office



# United States of America

United States Patent and Trademark Office

# MEDIBUS.X

**Reg. No. 4,135,954**

**Registered May 1, 2012**

**Int. Cl.: 10**

**TRADEMARK**

**PRINCIPAL REGISTER**

DRAEGER MEDICAL GMBH (FED REP GERMANY CORPORATION)  
MOISLINGER ALLEE 53-55  
LUBECK, FED REP GERMANY 23558

FOR: MEDICAL INSTRUMENTS AND APPARATUS, NAMELY, RESPIRATORS FOR ARTIFICIAL RESPIRATION AND ANESTHESIA MACHINES, IN CLASS 10 (U.S. CLS. 26, 39 AND 44).

FIRST USE 11-26-2010; IN COMMERCE 12-2-2010.

THE MARK CONSISTS OF STANDARD CHARACTERS WITHOUT CLAIM TO ANY PARTICULAR FONT, STYLE, SIZE, OR COLOR.

PRIORITY CLAIMED UNDER SEC. 44(D) ON ERPN CMNTY TM OFC APPLICATION NO. 008858078, FILED 2-4-2010.

SN 77-943,308, FILED 2-24-2010.

TINA MAI, EXAMINING ATTORNEY



*David J. Kyffers*

Director of the United States Patent and Trademark Office

# United States of America

United States Patent and Trademark Office

# Sure-Melt

**Reg. No. 4,135,955**

**Registered May 1, 2012**

**Int. Cl.: 1**

**TRADEMARK**

**PRINCIPAL REGISTER**

CP INDUSTRIES CORPORATION UTAH 560 N 500 W SALT LAKE CITY UTAH 84116 (UTAH CORPORATION)  
560 N 500 W  
SALT LAKE CITY, UT 84116

FOR: CHEMICAL PREPARATIONS FOR MELTING SNOW AND ICE NOT SOLD IN GROCERY, DRUG, AND CONVENIENCE STORES, IN CLASS 1 (U.S. CLS. 1, 5, 6, 10, 26 AND 46).

FIRST USE 1-1-2010; IN COMMERCE 1-1-2012.

THE MARK CONSISTS OF STANDARD CHARACTERS WITHOUT CLAIM TO ANY PARTICULAR FONT, STYLE, SIZE, OR COLOR.

SN 77-944,019, FILED 2-24-2010.

LINDA POWELL, EXAMINING ATTORNEY



*David J. Kyffers*

Director of the United States Patent and Trademark Office

# United States of America

United States Patent and Trademark Office

# LEADRIGHT

**Reg. No. 4,135,956**

**Registered May 1, 2012**

**Int. Cl.: 35**

MEDISYNC MIDWEST LIMITED LIABILITY COMPANY (OHIO LIMITED LIABILITY COMPANY)  
SUITE A  
4700 SMITH ROAD  
CINCINNATI, OH 45212

**SERVICE MARK**

**PRINCIPAL REGISTER**

FOR: LEADERSHIP DEVELOPMENT FOR PHYSICIANS AND PHYSICIAN GROUP PRACTICES; ORGANIZATIONAL DEVELOPMENT FOR PHYSICIANS AND PHYSICIAN GROUP PRACTICES, NAMELY, PROVIDING START-UP SUPPORT FOR BUSINESSES OF OTHERS, SUPPORT IN THE IMPROVEMENT OF BUSINESS AND OPERATIONAL PROCESSES AND OF MEDICAL SERVICES, AND SUPPORT IN MARKETING TO AND SERVING MEDICAL PATIENTS; HEALTH-CARE MANAGEMENT SERVICES, NAMELY, PROVIDING PRACTICE ORGANIZATION, MANAGEMENT AND ADMINISTRATIVE SUPPORT SERVICES TO PHYSICIAN GROUP PRACTICES; AND PUBLIC RELATIONS FOR PHYSICIAN PRACTICES, IN CLASS 35 (U.S. CLS. 100, 101 AND 102).

FIRST USE 3-4-2010; IN COMMERCE 3-4-2010.

THE MARK CONSISTS OF STANDARD CHARACTERS WITHOUT CLAIM TO ANY PARTICULAR FONT, STYLE, SIZE, OR COLOR.

SN 77-944,047, FILED 2-24-2010.

SANI KHOURI, EXAMINING ATTORNEY



*David J. Kyffers*

Director of the United States Patent and Trademark Office

# United States of America

United States Patent and Trademark Office

# PolySpan

**Reg. No. 4,135,957**

CDP INDUSTRIES LLC (PENNSYLVANIA LIMITED LIABILITY COMPANY)  
400 UNITY ST  
LATROBE, PA 15650

**Registered May 1, 2012**

**Int. Cl.: 6**

FOR: POLYMER COATED METAL DECKING, IN CLASS 6 (U.S. CLS. 2, 12, 13, 14, 23, 25 AND 50).

**TRADEMARK**

FIRST USE 12-2-2011; IN COMMERCE 12-2-2011.

**PRINCIPAL REGISTER**

THE MARK CONSISTS OF STANDARD CHARACTERS WITHOUT CLAIM TO ANY PARTICULAR FONT, STYLE, SIZE, OR COLOR.

SN 77-944,473, FILED 2-25-2010.

KELLEY WELLS, EXAMINING ATTORNEY



*David J. Kyffers*

Director of the United States Patent and Trademark Office

# United States of America

United States Patent and Trademark Office

## TRUEWIND PRESS

**Reg. No. 4,135,958**

**Registered May 1, 2012**

**Int. Cl.: 41**

**SERVICE MARK**

**PRINCIPAL REGISTER**

ALL WEATHER FRIEND, LLC (VIRGINIA LIMITED LIABILITY COMPANY)  
4495 OLDFIELDS ROAD  
FREE UNION, VA 22940

FOR: BOOK PUBLISHING; ONLINE ELECTRONIC PUBLISHING OF BOOKS AND PERIODICALS; PUBLISHING OF BOOKS AND REVIEWS; PUBLISHING OF ELECTRONIC PUBLICATIONS, IN CLASS 41 (U.S. CLS. 100, 101 AND 107).

FIRST USE 8-29-2011; IN COMMERCE 9-9-2011.

THE MARK CONSISTS OF STANDARD CHARACTERS WITHOUT CLAIM TO ANY PARTICULAR FONT, STYLE, SIZE, OR COLOR.

NO CLAIM IS MADE TO THE EXCLUSIVE RIGHT TO USE "PRESS", APART FROM THE MARK AS SHOWN.

SN 77-944,484, FILED 2-25-2010.

TRACY CROSS, EXAMINING ATTORNEY



*David J. Kyros*

Director of the United States Patent and Trademark Office

# United States of America

United States Patent and Trademark Office



**Reg. No. 4,135,959**

**Registered May 1, 2012**

**Int. Cl.: 25**

**TRADEMARK**

**PRINCIPAL REGISTER**

TE AMO LLC (DELAWARE LIMITED LIABILITY COMPANY)  
8700 REX ROAD  
PICO RIVERA, CA 90660

FOR: DRESSES; JACKETS; JEANS; LEGGINGS; PANTS; SHIRTS; SHORTS; SKIRTS;  
SWEATERS; TOPS, IN CLASS 25 (U.S. CLS. 22 AND 39).

FIRST USE 3-31-2011; IN COMMERCE 3-31-2011.

THE MARK CONSISTS OF THE SCRIPT WORDS "TE AMO" WITH PART OF THE WORD  
"AMO" PLACED OVER A HEART.

THE ENGLISH TRANSLATION OF THE WORDS "TE AMO" IN THE MARK IS I LOVE YOU.

SN 77-944,848, FILED 2-25-2010.

B. PARADEWELAI, EXAMINING ATTORNEY



*David J. Kybas*

Director of the United States Patent and Trademark Office

# United States of America

United States Patent and Trademark Office

## AMADEUS ONE

**Reg. No. 4,135,960**

**Registered May 1, 2012**

**Int. Cl.: 9**

**TRADEMARK**

**PRINCIPAL REGISTER**

AMADEUS NORTH AMERICA, INC. (DELAWARE CORPORATION)  
9250 NW 36TH STREET  
MIAMI, FL 33178

FOR: COMPUTER SYSTEMS, COMPRISED OF COMPUTERS, COMPUTER PERIPHERALS, MONITORS, AND SOFTWARE IN THE FIELD OF TRAVEL AGENCY OPERATIONS, TRAVEL BUSINESS MANAGEMENT, PASSENGER TRANSPORT, AND PLANNING BUSINESS AND LEISURE TRAVEL TOURS AND ARRANGEMENTS, IN CLASS 9 (U.S. CLS. 21, 23, 26, 36 AND 38).

FIRST USE 8-4-2010; IN COMMERCE 8-4-2010.

THE MARK CONSISTS OF STANDARD CHARACTERS WITHOUT CLAIM TO ANY PARTICULAR FONT, STYLE, SIZE, OR COLOR.

SN 77-945,214, FILED 2-25-2010.

BARBARA A. GOLD, EXAMINING ATTORNEY



*David J. Kyffers*

Director of the United States Patent and Trademark Office

# United States of America

United States Patent and Trademark Office

## Executive Fusion

**Reg. No. 4,135,961**

**Registered May 1, 2012**

**Int. Cl.: 41**

**SERVICE MARK**

**PRINCIPAL REGISTER**

EXECUTIVE FUSION, INC. (VIRGINIA CORPORATION)  
703 JUNIPER DRIVE  
NEWPORT NEWS, VA 23601

FOR: EXECUTIVE TRAINING SERVICES, NAMELY, PROVIDING MATERIALS AND CONDUCTING SEMINARS, WORKSHOPS, AND CONFERENCES TO TRAIN OTHERS IN THE SKILLS NECESSARY TO BE A SUCCESSFUL EXECUTIVE; ARRANGING PEER DISCUSSION GROUP MEETINGS IN THE FIELD OF BUSINESS; PERSONAL COACHING SERVICES IN THE FIELD OF BUSINESS CONSULTATION AND EXECUTIVE TRAINING; ARRANGING AND CONDUCTING EXHIBITIONS, SEMINARS, WORKSHOPS AND CONFERENCES IN THE FIELD OF BUSINESS CONSULTATION AND EXECUTIVE TRAINING; MULTIMEDIA PRODUCTION AND PROGRAMMING, NAMELY, AUDIO-VISUAL PRESENTATIONS AND DISPLAYS FOR TRAINING, IN CLASS 41 (U.S. CLS. 100, 101 AND 107).

FIRST USE 2-15-2011; IN COMMERCE 2-15-2011.

THE MARK CONSISTS OF STANDARD CHARACTERS WITHOUT CLAIM TO ANY PARTICULAR FONT, STYLE, SIZE, OR COLOR.

NO CLAIM IS MADE TO THE EXCLUSIVE RIGHT TO USE "EXECUTIVE", APART FROM THE MARK AS SHOWN.

SN 77-946,649, FILED 2-27-2010.

RAUL CORDOVA, EXAMINING ATTORNEY



*David J. Kyffers*

Director of the United States Patent and Trademark Office



# United States of America

United States Patent and Trademark Office

# PPS

**Reg. No. 4,135,962**

**Registered May 1, 2012**

**Int. Cl.: 9**

**TRADEMARK**

**PRINCIPAL REGISTER**

WORLD CURRENCY TRADERS, LLC (FLORIDA CORPORATION)  
1112 WESTON ROAD, STE. 217  
FORT LAUDERDALE, FL 33326

FOR: COMPUTER SOFTWARE FOR CREATING SPREADSHEETS TO ASSIST FOREIGN EXCHANGE TRADERS TO IDENTIFY AND EVALUATE TRADING STRATEGIES THAT MAY BE DOWNLOADED FROM A GLOBAL COMPUTER NETWORK, IN CLASS 9 (U.S. CLS. 21, 23, 26, 36 AND 38).

FIRST USE 11-0-2010; IN COMMERCE 11-0-2010.

THE MARK CONSISTS OF STANDARD CHARACTERS WITHOUT CLAIM TO ANY PARTICULAR FONT, STYLE, SIZE, OR COLOR.

SN 77-946,934, FILED 3-1-2010.

JEAN IM, EXAMINING ATTORNEY



*David J. Kybas*

Director of the United States Patent and Trademark Office

# United States of America

United States Patent and Trademark Office

## BOWLING BALL MATTRESS

**Reg. No. 4,135,963**

**Registered May 1, 2012**

**Int. Cl.: 20**

**TRADEMARK**

**PRINCIPAL REGISTER**

DREAMWELL, LTD. (NEVADA LIMITED LIABILITY COMPANY)  
2215-B RENAISSANCE DRIVE  
SUITE 12  
LAS VEGAS, NV 89119

FOR: MATTRESSES AND BOX SPRINGS, IN CLASS 20 (U.S. CLS. 2, 13, 22, 25, 32 AND 50).

FIRST USE 11-1-2011; IN COMMERCE 11-1-2011.

THE MARK CONSISTS OF STANDARD CHARACTERS WITHOUT CLAIM TO ANY PARTICULAR FONT, STYLE, SIZE, OR COLOR.

NO CLAIM IS MADE TO THE EXCLUSIVE RIGHT TO USE "MATTRESS", APART FROM THE MARK AS SHOWN.

SN 77-947,261, FILED 3-1-2010.

TRACY CROSS, EXAMINING ATTORNEY



*David J. Kyffers*

Director of the United States Patent and Trademark Office

# United States of America

United States Patent and Trademark Office

## PEACE OF MIND . . . DURING UNCERTAIN TIMES

**Reg. No. 4,135,964**

**Registered May 1, 2012**

**Int. Cl.: 37**

**SERVICE MARK**

**PRINCIPAL REGISTER**

DELTA ASSET MANAGEMENT, LLC (COLORADO LIMITED LIABILITY COMPANY)  
5535 W. 56TH AVENUE, UNIT 104  
ARVADA, CO 80002

FOR: FIRE AND WATER DAMAGE RESTORATION AND NATURAL DISASTER RECOVERY SERVICES IN THE NATURE OF BUILDING CLEAN-UP AND REPAIR, AND BUILDING RECONSTRUCTION SERVICES; DISASTER RESTORATION SERVICES, NAMELY, RESTORING BUILDING EXTERIORS, INTERIORS, CARPET AND FURNISHINGS DAMAGED BY FIRE, FLOOD, AND OTHER DISASTERS; HOME AND BUILDING REPAIR; HOME AND BUILDING REPAIR CONSULTING, IN CLASS 37 (U.S. CLS. 100, 103 AND 106).

FIRST USE 1-18-2012; IN COMMERCE 1-18-2012.

THE MARK CONSISTS OF STANDARD CHARACTERS WITHOUT CLAIM TO ANY PARTICULAR FONT, STYLE, SIZE, OR COLOR.

OWNER OF U.S. REG. NO. 3,216,483.

SN 77-947,651, FILED 3-1-2010.

ALEX KEAM, EXAMINING ATTORNEY



*David J. Kybas*

Director of the United States Patent and Trademark Office

# United States of America

United States Patent and Trademark Office

# RESURE

**Reg. No. 4,135,965**

**Registered May 1, 2012**

**Int. Cl.: 5**

**TRADEMARK**

**PRINCIPAL REGISTER**

OCULAR THERAPEUTIX, INC. (DELAWARE CORPORATION)  
SUITE 101  
36 CROSBY DRIVE  
BEDFORD, MA 01730

FOR: OCULAR SURGICAL BANDAGE FOR MEDICAL OR VETERINARY USE; OCULAR SEALANT IN THE NATURE OF A PLIABLE, SELF-ADHESIVE DRESSING MADE OF A SYNTHETIC HYDROGEL USED TO CLOSE WOUNDS AND INCISIONS IN THE EYE, FOR MEDICAL OR VETERINARY USE; MEDICAL AND VETERINARY ADHESIVES FOR TREATING OCULAR WOUNDS, IN CLASS 5 (U.S. CLS. 6, 18, 44, 46, 51 AND 52).

FIRST USE 1-26-2011; IN COMMERCE 3-12-2012.

THE MARK CONSISTS OF STANDARD CHARACTERS WITHOUT CLAIM TO ANY PARTICULAR FONT, STYLE, SIZE, OR COLOR.

SN 77-947,666, FILED 3-1-2010.

ALEX KEAM, EXAMINING ATTORNEY



*David J. Kyros*

Director of the United States Patent and Trademark Office

# United States of America

United States Patent and Trademark Office

# BETTERAVIA

**Reg. No. 4,135,966**

**Registered May 1, 2012**

**Int. Cl.: 33**

**TRADEMARK**

**PRINCIPAL REGISTER**

CIRCLE VISION, LLC (DELAWARE LIMITED LIABILITY COMPANY)  
1006 SEGOVIA CIRCLE  
PLACENTIA, CA 92870

FOR: ALCOHOLIC BEVERAGES EXCEPT BEERS, IN CLASS 33 (U.S. CLS. 47 AND 49).

FIRST USE 3-21-2012; IN COMMERCE 3-21-2012.

THE MARK CONSISTS OF STANDARD CHARACTERS WITHOUT CLAIM TO ANY PARTICULAR FONT, STYLE, SIZE, OR COLOR.

SN 77-948,039, FILED 3-2-2010.

SANJEEV VOHRA, EXAMINING ATTORNEY



*David J. Kybas*

Director of the United States Patent and Trademark Office

# United States of America

United States Patent and Trademark Office

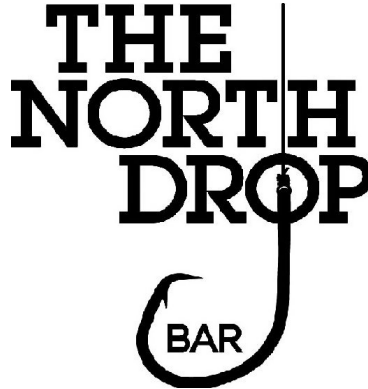

**Reg. No. 4,135,967**

**Registered May 1, 2012**

**Int. Cl.: 25**

**TRADEMARK**

**PRINCIPAL REGISTER**

PROM QUEEN-II, LLC (FLORIDA LIMITED LIABILITY COMPANY)  
400 PENSACOLA BEACH BOULEVARD  
PENSACOLA, FL 33056

FOR: CLOTHING, NAMELY, SHIRTS, SWEATSHIRTS, JACKETS, OUTERWEAR, NAMELY, WIND RESISTANT JACKETS, SWEATERS, HEADWEAR, IN CLASS 25 (U.S. CLS. 22 AND 39).

FIRST USE 7-31-2011; IN COMMERCE 7-31-2011.

THE MARK CONSISTS OF THE STACKED WORDS "THE NORTH DROP BAR" WITH A FISHING LINE AND J-HOOK STARTING TO THE RIGHT OF "THE", EXTENDING BETWEEN THE LETTERS "T" AND "H" OF "NORTH", THROUGH THE "O" IN "DROP", AND CURVING AROUND THE WORD "BAR".

SN 77-948,749, FILED 3-2-2010.

H. M. FISHER, EXAMINING ATTORNEY



*David J. Kyffers*

Director of the United States Patent and Trademark Office

# United States of America

United States Patent and Trademark Office

# Palladium

**Reg. No. 4,135,968**

**Registered May 1, 2012**

**Int. Cl.: 5**

**TRADEMARK**

**PRINCIPAL REGISTER**

SYNGENTA PARTICIPATIONS AG (SWITZERLAND CORPORATION)  
SCHWARZWALDALLEE 215  
BASEL, SWITZERLAND

FOR: TURF AND ORNAMENTAL FUNGICIDE FOR AGRICULTURAL AND COMMERCIAL  
USE, IN CLASS 5 (U.S. CLS. 6, 18, 44, 46, 51 AND 52).

FIRST USE 8-31-2010; IN COMMERCE 8-31-2010.

THE MARK CONSISTS OF STANDARD CHARACTERS WITHOUT CLAIM TO ANY PAR-  
TICULAR FONT, STYLE, SIZE, OR COLOR.

SN 77-949,620, FILED 3-3-2010.

SUNG IN, EXAMINING ATTORNEY



*David J. Kybas*

Director of the United States Patent and Trademark Office

# United States of America

United States Patent and Trademark Office

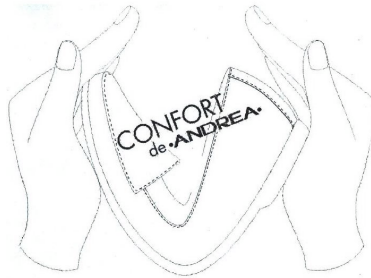

**Reg. No. 4,135,969**

**Registered May 1, 2012**

**Int. Cl.: 16**

**TRADEMARK**

**PRINCIPAL REGISTER**

GRUPO ANDREA S.A. DE C.V. (MEXICO CORPORATION)  
BOULEVARD JUAN ALONSO DE TORRES  
NO. 106, FRACC. SAN JERONIMO  
LEON, GUANAJUATO, MEXICO

FOR: ADVERTISING PAMPHLETS; BROCHURES ABOUT FOOTWEAR AND SHOES; CARDBOARD BOXES; CARDBOARD HANG TAGS; CATALOGS IN THE FIELD OF FOOTWEAR AND SHOES; PAPER; PAPER BAGS; PHOTOGRAPHS; PLASTIC BAGS FOR PACKAGING; POSTERS; PRINTED ADVERTISING BOARDS OF PAPER OR CARDBOARD; PRINTS; STICKERS, IN CLASS 16 (U.S. CLS. 2, 5, 22, 23, 29, 37, 38 AND 50).

FIRST USE 4-30-2011; IN COMMERCE 4-30-2011.

THE NAME(S), PORTRAIT(S), AND/OR SIGNATURE(S) SHOWN IN THE MARK DOES NOT IDENTIFY A PARTICULAR LIVING INDIVIDUAL.

THE MARK CONSISTS OF THE WORDS "CONFORT DE ANDREA" IN STYLIZED LETTERS POSITIONED DIAGONALLY OVER A DESIGN CONSISTING OF TWO HANDS BENDING A SHOE.

THE ENGLISH TRANSLATION OF "CONFORT DE ANDREA" IN THE MARK IS COMFORT OF ANDREA.

SN 77-949,908, FILED 3-3-2010.

BARBARA RUTLAND, EXAMINING ATTORNEY



*David J. Kybas*

Director of the United States Patent and Trademark Office



# United States of America

United States Patent and Trademark Office

# CONFORT

de •ANDREA•

**Reg. No. 4,135,970**

**Registered May 1, 2012**

**Int. Cl.: 16**

**TRADEMARK**

**PRINCIPAL REGISTER**

GRUPO ANDREA S.A. DE C.V. (MEXICO CORPORATION)  
BOULEVARD JUAN ALONSO DE TORRES  
LEON, GUANAJUATO, MEXICO

FOR: ADVERTISING PAMPHLETS; BROCHURES ABOUT FOOTWEAR AND SHOES;  
CARDBOARD BOXES; CATALOGS IN THE FIELD OF FOOTWEAR AND SHOES; POSTERS;  
PRINTS , IN CLASS 16 (U.S. CLS. 2, 5, 22, 23, 29, 37, 38 AND 50).

FIRST USE 4-30-2011; IN COMMERCE 4-30-2011.

THE NAME(S), PORTRAIT(S), AND/OR SIGNATURE(S) SHOWN IN THE MARK DOES NOT  
IDENTIFY A PARTICULAR LIVING INDIVIDUAL.

THE MARK CONSISTS OF THE WORDS "CONFORT DE ANDREA" IN STYLIZED LETTERS.  
THE WORD "ANDREA" APPEARS BETWEEN TWO DOTS.

THE ENGLISH TRANSLATION OF "CONFORT DE ANDREA" IN THE MARK IS COMFORT  
OF ANDREA.

SN 77-949,936, FILED 3-3-2010.

BARBARA RUTLAND, EXAMINING ATTORNEY



*David J. Kyffers*

Director of the United States Patent and Trademark Office

# United States of America

United States Patent and Trademark Office

## CIRQUE BERZERK

**Reg. No. 4,135,971**

**Registered May 1, 2012**

**Int. Cls.: 9 and 25**

**TRADEMARK**

**PRINCIPAL REGISTER**

CIRQUE BERZERK HOLDINGS, LLC (CALIFORNIA LIMITED LIABILITY COMPANY)  
5850 WEST 3RD STREET, #219  
LOS ANGELES, CA 90036

FOR: PRE-RECORDED MEDIA FOR THE STORAGE AND REPRODUCTION OF SOUND AND VIDEO, FEATURING MUSIC AND/OR THEATRICAL PERFORMANCES, NAMELY, COMPACT DISKS, IN CLASS 9 (U.S. CLS. 21, 23, 26, 36 AND 38).

FIRST USE 7-7-2011; IN COMMERCE 7-7-2011.

FOR: CLOTHING, NAMELY, T-SHIRTS, SWEATSHIRTS, CAPS, IN CLASS 25 (U.S. CLS. 22 AND 39).

FIRST USE 7-7-2011; IN COMMERCE 7-7-2011.

THE MARK CONSISTS OF STANDARD CHARACTERS WITHOUT CLAIM TO ANY PARTICULAR FONT, STYLE, SIZE, OR COLOR.

THE ENGLISH TRANSLATION OF "CIRQUE" IN THE MARK IS "CIRCUS".

SN 77-951,180, FILED 3-4-2010.

C. DIONNE CLYBURN, EXAMINING ATTORNEY



*David J. Kypos*

Director of the United States Patent and Trademark Office

# United States of America

United States Patent and Trademark Office

## GOLDEN AGE

**Reg. No. 4,135,972**

**Registered May 1, 2012**

**Int. Cl.: 9**

**TRADEMARK**

**PRINCIPAL REGISTER**

WMS GAMING INC. (DELAWARE CORPORATION)  
800 SOUTH NORTHPOINT BOULEVARD  
WAUKEGAN, IL 60085

FOR: COMPONENTS FOR GAMING MACHINES THAT GENERATE OR DISPLAY WAGER OUTCOMES, NAMELY, CONTROLLERS, DISPLAYS, BUTTON PANELS, BOLSTERS, ELECTRICAL WIRING, AND COMPUTER HARDWARE AND SOFTWARE ASSOCIATED THEREWITH; GAMING MACHINES, NAMELY, DEVICES WHICH ACCEPT A WAGER; GAMING SOFTWARE THAT GENERATES OR DISPLAYS WAGER OUTCOMES OF GAMING MACHINES, IN CLASS 9 (U.S. CLS. 21, 23, 26, 36 AND 38).

FIRST USE 9-16-2011; IN COMMERCE 9-16-2011.

THE MARK CONSISTS OF STANDARD CHARACTERS WITHOUT CLAIM TO ANY PARTICULAR FONT, STYLE, SIZE, OR COLOR.

SN 77-952,837, FILED 3-8-2010.

MARIA-VICTORIA SUAREZ, EXAMINING ATTORNEY



*David J. Kyffers*

Director of the United States Patent and Trademark Office

# United States of America

United States Patent and Trademark Office

## JAVIA BY ARAMARK

**Reg. No. 4,135,973**

**Registered May 1, 2012**

**Int. Cl.: 43**

**SERVICE MARK**

**PRINCIPAL REGISTER**

ARAMARK CORPORATION (DELAWARE CORPORATION)  
1101 MARKET STREET, 29TH FLOOR  
PHILADELPHIA, PA 19107

FOR: RESTAURANT SERVICES; CONTRACT FOOD SERVICES, IN CLASS 43 (U.S. CLS. 100 AND 101).

FIRST USE 12-6-2010; IN COMMERCE 12-6-2010.

THE MARK CONSISTS OF STANDARD CHARACTERS WITHOUT CLAIM TO ANY PARTICULAR FONT, STYLE, SIZE, OR COLOR.

OWNER OF U.S. REG. NOS. 1,941,467, 2,014,184, AND 3,674,313.

SN 77-953,590, FILED 3-8-2010.

GEORGE LORENZO, EXAMINING ATTORNEY



*David J. Kybas*

Director of the United States Patent and Trademark Office

# United States of America

United States Patent and Trademark Office

## FRIENDS WITH BENEFITS

**Reg. No. 4,135,974**

**Registered May 1, 2012**

**Int. Cl.: 9**

**TRADEMARK**

**PRINCIPAL REGISTER**

TWENTIETH CENTURY FOX FILM CORPORATION (DELAWARE CORPORATION)  
10201 WEST PICO BOULEVARD  
LOS ANGELES, CA 90035

FOR: DOWNLOADABLE AUDIO AND VIDEO RECORDINGS FEATURING COMEDY;  
DOWNLOADABLE TELEVISION SHOWS AND VIDEO RECORDINGS FEATURING COMEDY , IN CLASS 9 (U.S. CLS. 21, 23, 26, 36 AND 38).

FIRST USE 8-6-2011; IN COMMERCE 8-6-2011.

THE MARK CONSISTS OF STANDARD CHARACTERS WITHOUT CLAIM TO ANY PARTICULAR FONT, STYLE, SIZE, OR COLOR.

SN 77-953,648, FILED 3-8-2010.

KATHRYN COWARD, EXAMINING ATTORNEY



*David J. Kyros*

Director of the United States Patent and Trademark Office

# United States of America

United States Patent and Trademark Office

# COMMAND

**Reg. No. 4,135,975**

**Registered May 1, 2012**

**Int. Cls.: 6, 20, and 21**

3M COMPANY (DELAWARE CORPORATION)  
220-9E-01  
3M CENTER, 2501 HUDSON ROAD  
ST. PAUL, MN 55144

FOR: METAL HOOKS, IN CLASS 6 (U.S. CLS. 2, 12, 13, 14, 23, 25 AND 50).

**TRADEMARK**

FIRST USE 12-31-2006; IN COMMERCE 12-31-2006.

**PRINCIPAL REGISTER**

FOR: PLASTIC HOOKS; PLASTIC CORD CLIPS AND BUNDLERS, NAMELY, PLASTIC CLIPS FOR ORGANIZING, HANGING, AND BUNDLING WIRES AND CORDS; PLASTIC DECORATING CLIPS, NAMELY, PLASTIC CLIPS FOR HANGING PHOTOS, PICTURES, PRINTS, PAPERS, AND DECORATIONS; PLASTIC SPRING CLIPS FOR CLIPPING PHOTOS, PICTURES, PRINTS, PAPERS, AND DECORATIONS; MIRRORS FOR HOUSEHOLD USE; PLASTIC ORGANIZERS, NAMELY, PLASTIC BINS; PLASTIC KEY HOLDERS; PLASTIC SHELVES; PLASTIC PICTURE-HANGING HOOK, IN CLASS 20 (U.S. CLS. 2, 13, 22, 25, 32 AND 50).

FIRST USE 7-15-1996; IN COMMERCE 7-15-1996.

FOR: WALL CADDIES; SOAP DISHES; SHOWER CADDIES; PLASTIC CONTAINERS FOR HOUSEHOLD USE; PLASTIC CADDIES FOR HOUSEHOLD AND DOMESTIC USE, IN CLASS 21 (U.S. CLS. 2, 13, 23, 29, 30, 33, 40 AND 50).

FIRST USE 12-31-2004; IN COMMERCE 12-31-2004.

THE MARK CONSISTS OF STANDARD CHARACTERS WITHOUT CLAIM TO ANY PARTICULAR FONT, STYLE, SIZE, OR COLOR.

OWNER OF U.S. REG. NOS. 2,079,851, 2,729,051, AND 2,847,839.

SN 77-954,077, FILED 3-9-2010.

MATTHEW EINSTEIN, EXAMINING ATTORNEY



*David J. Kyros*

Director of the United States Patent and Trademark Office

# United States of America

United States Patent and Trademark Office

# GUMOUT

**Reg. No. 4,135,976**

**Registered May 1, 2012**

**Int. Cls.: 1 and 3**

**TRADEMARK**

**PRINCIPAL REGISTER**

ILLINOIS TOOL WORKS INC. (DELAWARE CORPORATION)  
3600 WEST LAKE AVENUE  
GLENVIEW, IL 60026

FOR: BRAKE FLUID; POWER STEERING FLUID; RADIATOR FLUSH; TRANSMISSION FLUID, IN CLASS 1 (U.S. CLS. 1, 5, 6, 10, 26 AND 46).

FIRST USE 12-31-2006; IN COMMERCE 12-31-2006.

FOR: AUTOMOBILE CLEANERS, IN CLASS 3 (U.S. CLS. 1, 4, 6, 50, 51 AND 52).

FIRST USE 12-31-2006; IN COMMERCE 12-31-2006.

THE MARK CONSISTS OF STANDARD CHARACTERS WITHOUT CLAIM TO ANY PARTICULAR FONT, STYLE, SIZE, OR COLOR.

OWNER OF U.S. REG. NOS. 1,064,196, 2,945,055, AND OTHERS.

SN 77-954,293, FILED 3-9-2010.

JIM RINGLE, EXAMINING ATTORNEY



*David J. Kybas*

Director of the United States Patent and Trademark Office

# United States of America

United States Patent and Trademark Office



**Reg. No. 4,135,977**

**Registered May 1, 2012**

**Int. Cl.: 44**

**SERVICE MARK**

**PRINCIPAL REGISTER**

HAPNER, EDIE R. (UNITED STATES INDIVIDUAL)  
1808 PEMBERTON PLACE  
MARIETTA, GA 30062 AND

HAPNER, HOWARD (UNITED STATES INDIVIDUAL)  
1808 PEMBERTON PLACE  
MARIETTA, GA 30062

FOR: MEDICAL CONSULTING AND SERVICES IN HEAD AND NECK CANCER AND MEDICAL SCREENING, NAMELY, ORAL, HEAD AND NECK CANCER SCREENINGS, IN CLASS 44 (U.S. CLS. 100 AND 101).

FIRST USE 9-3-2010; IN COMMERCE 9-3-2010.

NO CLAIM IS MADE TO THE EXCLUSIVE RIGHT TO USE "SCREENING", APART FROM THE MARK AS SHOWN.

THE COLOR(S) BLACK, GRAY, WHITE, RED, BLUE, AND YELLOW IS/ARE CLAIMED AS A FEATURE OF THE MARK.

THE MARK CONSISTS OF A STYLIZED LOGO FEATURING THE PHRASE "THE SCREENING P.I.T. STOP"; BLACK AND WHITE FLAGS ON EITHER SIDE; "P.I.T. STOP" IN YELLOW FONT ON BLACK BACKGROUND WITH A WHITE AND A RED BORDER; "P.I.T." IS LAID OVER A GRAY CIRCLE THAT HAS A WHITE BORDER AND A BLUE BORDER. "THE SCREENING" IS IN RED.

SN 77-956,597, FILED 3-11-2010.

ELLEN PERKINS, EXAMINING ATTORNEY



*David J. Kybas*

Director of the United States Patent and Trademark Office



# United States of America

United States Patent and Trademark Office

# FILMULA

**Reg. No. 4,135,978**

**Registered May 1, 2012**

**Int. Cls.: 9 and 41**

**TRADEMARK**

**SERVICE MARK**

**PRINCIPAL REGISTER**

STUDIO SOLUTIONS GROUP, INC. (CALIFORNIA CORPORATION)  
183 NORTH CRESCENT DRIVE  
BEVERLY HILLS, CA 90210

FOR: PRE-RECORDED DVDS, HIGH DEFINITION DIGITAL DISCS FEATURING DRAMA, COMEDY, ACTION, IN CLASS 9 (U.S. CLS. 21, 23, 26, 36 AND 38).

FIRST USE 3-23-2010; IN COMMERCE 3-23-2010.

FOR: PRODUCTION OF MOTION PICTURE FILMS; PRODUCTION OF MOVIES, IN CLASS 41 (U.S. CLS. 100, 101 AND 107).

FIRST USE 3-23-2010; IN COMMERCE 3-23-2010.

THE MARK CONSISTS OF STANDARD CHARACTERS WITHOUT CLAIM TO ANY PARTICULAR FONT, STYLE, SIZE, OR COLOR.

SN 77-958,282, FILED 3-12-2010.

JAY FLOWERS, EXAMINING ATTORNEY



*David J. Kyros*

Director of the United States Patent and Trademark Office

# United States of America

United States Patent and Trademark Office

## INTRINSIC-ID

**Reg. No. 4,135,979**

**Registered May 1, 2012**

**Int. Cl.: 42**

**SERVICE MARK**

**PRINCIPAL REGISTER**

INTRINSIC ID B.V. (NETHERLANDS CORPORATION)  
HIGH TECH CAMPUS 9  
EINDHOVEN, NETHERLANDS 5656AE

FOR: PRODUCT DEVELOPMENT IN THE FIELD OF ELECTRONIC LOCKS, ELECTRONIC KEY CARDS AND ELECTRONIC KEY CARD READERS, ENCODING APPARATUS FOR ELECTRONIC KEY CARDS, MAGNETIC ENCODED KEY CARDS, ENCODED ELECTRONIC CHIP CARDS, ENCODED ELECTRONIC SMART CARDS, NAMELY, ENCODED ELECTRONIC SMART CARDS FOR USE IN CONTROLLING PRODUCTION PROCESSES; DESIGN AND DEVELOPMENT OF COMPUTER SOFTWARE AND HARDWARE FOR STORAGE OF KEYS TO SECURE SEMICONDUCTOR PRODUCTS AGAINST CLONING, TAMPERING, THEFT-OF-SERVICE AND REVERSE ENGINEERING, IN CLASS 42 (U.S. CLS. 100 AND 101).

FIRST USE 10-10-2008; IN COMMERCE 10-10-2008.

THE MARK CONSISTS OF STANDARD CHARACTERS WITHOUT CLAIM TO ANY PARTICULAR FONT, STYLE, SIZE, OR COLOR.

NO CLAIM IS MADE TO THE EXCLUSIVE RIGHT TO USE "ID", APART FROM THE MARK AS SHOWN.

SN 77-958,777, FILED 3-15-2010.

COLLEEN KEARNEY, EXAMINING ATTORNEY



*David J. Kyjars*

Director of the United States Patent and Trademark Office

United States of America  
United States Patent and Trademark Office

*frontier*  
science

**Reg. No. 4,135,980**

**Registered May 1, 2012**

**Int. Cls.: 35 and 42**

**SERVICE MARK**

**PRINCIPAL REGISTER**

FRONTIER SCIENCE & TECHNOLOGY RESEARCH FOUNDATION, INC. (NEW YORK  
NON-PROFIT CORPORATION)  
900 COMMONWEALTH AVENUE  
BOSTON, MA 02215

FOR: COMPILATION AND PROVISION OF STATISTICAL AND BIOSTATISTICAL INFORMATION, IN CLASS 35 (U.S. CLS. 100, 101 AND 102).

FIRST USE 3-0-2010; IN COMMERCE 3-0-2010.

FOR: MEDICAL AND SCIENTIFIC RESEARCH, NAMELY, CONDUCTING CLINICAL TRIALS; CLINICAL TRIAL DESIGN SERVICES; DATA ANALYSIS IN THE FIELD OF BIOMEDICAL STUDIES; STATISTICAL ANALYSIS IN THE FIELD OF BIOMEDICAL STUDIES; BIOSTATISTICAL ANALYSIS, IN CLASS 42 (U.S. CLS. 100 AND 101).

FIRST USE 3-0-2010; IN COMMERCE 3-0-2010.

NO CLAIM IS MADE TO THE EXCLUSIVE RIGHT TO USE "SCIENCE", APART FROM THE MARK AS SHOWN.

THE COLOR(S) BLUE AND DARK GRAY IS/ARE CLAIMED AS A FEATURE OF THE MARK.

THE MARK CONSISTS OF THE WORD "FRONTIER" IN THE COLOR BLUE IN STYLIZED LETTERING WITH THE "F" IN "FRONTIER" SPANNING FROM THE TOP OF THE MARK TO THE BOTTOM OF THE MARK, AND THE WORD "SCIENCE" IN THE COLOR DARK GRAY IN STYLIZED LETTERING PLACED BELOW "FRONTIER".

SN 77-960,276, FILED 3-16-2010.

ANNE E. GUSTASON, EXAMINING ATTORNEY



*David J. Kybas*

Director of the United States Patent and Trademark Office

# United States of America

United States Patent and Trademark Office

## YOU BETTER BELIEVE IT!

**Reg. No. 4,135,981**

DRIVETIME SALES AND FINANCE CORPORATION (ARIZONA CORPORATION)  
4020 EAST INDIAN SCHOOL ROAD  
PHOENIX, AZ 85018

**Registered May 1, 2012**

**Int. Cls.: 36 and 37**

FOR: PROVIDING BENEFITS IN THE NATURE OF CUSTOMER SERVICE PACKAGES, NAMELY, PROVIDING LIMITED WARRANTY AND EXTENDED LIMITED WARRANTY CONTRACTS FOR AUTOMOBILES MANUFACTURED BY OTHERS, IN CLASS 36 (U.S. CLS. 100, 101 AND 102).

**SERVICE MARK**

**PRINCIPAL REGISTER**

FIRST USE 8-23-2010; IN COMMERCE 8-23-2010.

FOR: PROVIDING BENEFITS IN THE NATURE OF CUSTOMER SERVICE PACKAGES, NAMELY, AUTOMOBILE FREE OIL CHANGE SERVICES; AND PROVIDING BENEFITS IN THE NATURE OF CUSTOMER SERVICE PACKAGES, NAMELY, RESPONDING TO CALLS FOR ROADSIDE ASSISTANCE, FLAT TIRE CHANGING, EMERGENCY FUEL SUPPLYING AND BATTERY JUMP STARTING, IN CLASS 37 (U.S. CLS. 100, 103 AND 106).

FIRST USE 8-23-2010; IN COMMERCE 8-23-2010.

THE MARK CONSISTS OF STANDARD CHARACTERS WITHOUT CLAIM TO ANY PARTICULAR FONT, STYLE, SIZE, OR COLOR.

SN 77-960,691, FILED 3-17-2010.

C. DIONNE CLYBURN, EXAMINING ATTORNEY



*David J. Kyros*

Director of the United States Patent and Trademark Office

# United States of America

United States Patent and Trademark Office

# NANOTROPIC

**Reg. No. 4,135,982**

**Registered May 1, 2012**

**Int. Cl.: 9**

**TRADEMARK**

**PRINCIPAL REGISTER**

NANOTROPIC S.A. (GREECE CORPORATION)  
SOROU 12 MAROUSSI  
ATHENS, GREECE GR15125

FOR: COMPUTER AIDED DESIGN SOFTWARE FOR USE IN THE DESIGN OF ANALOG AND DIGITAL INTEGRATED CIRCUITS AND SYSTEMS, IN CLASS 9 (U.S. CLS. 21, 23, 26, 36 AND 38).

FIRST USE 2-6-2012; IN COMMERCE 2-6-2012.

THE MARK CONSISTS OF STANDARD CHARACTERS WITHOUT CLAIM TO ANY PARTICULAR FONT, STYLE, SIZE, OR COLOR.

SN 77-961,169, FILED 3-17-2010.

JOHN LINCOSKI, EXAMINING ATTORNEY



*David J. Kyffers*

Director of the United States Patent and Trademark Office

# United States of America

United States Patent and Trademark Office

# OJO

**Reg. No. 4,135,983**

**Registered May 1, 2012**

**Int. Cls.: 5 and 32**

**TRADEMARK**

**PRINCIPAL REGISTER**

INSIGHTFUL DEVELOPMENTS, LLC (NEW YORK LIMITED LIABILITY COMPANY)  
254 FRANKEL BLVD.  
MERRICK, NY 11566

FOR: DIETARY SUPPLEMENTAL DRINKS IN THE NATURE OF VITAMIN AND MINERAL BEVERAGES; NUTRITIONAL SUPPLEMENTS; VITAMIN FORTIFIED BEVERAGES , IN CLASS 5 (U.S. CLS. 6, 18, 44, 46, 51 AND 52).

FIRST USE 3-0-2011; IN COMMERCE 3-0-2011.

FOR: DRINKING WATER WITH VITAMINS; NON-ALCOHOLIC BEVERAGES CONTAINING FRUIT JUICES, IN CLASS 32 (U.S. CLS. 45, 46 AND 48).

FIRST USE 3-0-2011; IN COMMERCE 3-0-2011.

THE MARK CONSISTS OF STANDARD CHARACTERS WITHOUT CLAIM TO ANY PARTICULAR FONT, STYLE, SIZE, OR COLOR.

SN 77-961,291, FILED 3-17-2010.

KAREN K. BUSH, EXAMINING ATTORNEY



*David J. Kybas*

Director of the United States Patent and Trademark Office

# United States of America

United States Patent and Trademark Office

# DAGGER GT

**Reg. No. 4,135,984**

**Registered May 1, 2012**

**Int. Cl.: 12**

**TRADEMARK**

**PRINCIPAL REGISTER**

GTR-XS RACING, LLC (FLORIDA LIMITED LIABILITY COMPANY)  
#207  
POMPANO BEACH, FL 33062

FOR: VEHICLES, NAMELY, SPORTS CARS AND RACING CARS, IN CLASS 12 (U.S. CLS. 19, 21, 23, 31, 35 AND 44).

FIRST USE 2-28-2010; IN COMMERCE 3-7-2010.

THE MARK CONSISTS OF STANDARD CHARACTERS WITHOUT CLAIM TO ANY PARTICULAR FONT, STYLE, SIZE, OR COLOR.

NO CLAIM IS MADE TO THE EXCLUSIVE RIGHT TO USE "GT", APART FROM THE MARK AS SHOWN.

SN 77-964,063, FILED 3-20-2010.

ALICIA COLLINS, EXAMINING ATTORNEY



*David J. Kybas*

Director of the United States Patent and Trademark Office

# United States of America

United States Patent and Trademark Office

## 1099 Movement

**Reg. No. 4,135,985**

**Registered May 1, 2012**

**COLLECTIVE  
MEMBERSHIP**

**PRINCIPAL REGISTER**

LANDSCIENCES, LLC (GEORGIA LIMITED LIABILITY COMPANY)  
4497 WINDSOR OAKS DRIVE  
MARIETTA, GA 30066

FOR: INDICATING MEMBERSHIP IN A SOCIAL GROUP WHICH IS FOCUSED ON INDIVIDUAL RESPONSIBILITY FOR EMPLOYERS AND EMPLOYEES WHICH WILL ALLOW FOR DEVELOPMENT AND GROWTH OF PRIVATE CONTRACTORS WORKING UNDER 1099 STATUS BY NETWORKING TOGETHER TO SOLVE COMMON PROBLEMS AND ADDRESS COMMON CONCERNS IN OUR CHANGING WORKPLACES, IN CLASS 200 (U.S. CL. 200).

FIRST USE 12-20-2011; IN COMMERCE 12-20-2011.

THE MARK CONSISTS OF STANDARD CHARACTERS WITHOUT CLAIM TO ANY PARTICULAR FONT, STYLE, SIZE, OR COLOR.

NO CLAIM IS MADE TO THE EXCLUSIVE RIGHT TO USE "1099", APART FROM THE MARK AS SHOWN.

SN 77-964,471, FILED 3-22-2010.

SUNG IN, EXAMINING ATTORNEY



*David J. Kyros*

Director of the United States Patent and Trademark Office



# United States of America

United States Patent and Trademark Office

# P.H.D.

**Reg. No. 4,135,986**

**Registered May 1, 2012**

**Int. Cl.: 35**

**SERVICE MARK**

**PRINCIPAL REGISTER**

ENTERPRISE FINANCIAL GROUP, INC. (TEXAS CORPORATION)  
122 W. CARPERNTER FREEWAY; 6TH FLOOR  
IRVING, TX 75039

FOR: PERSONNEL PLACEMENT AND RECRUITMENT SERVICES PROVIDED TO AUTOMOTIVE DEALERSHIPS; EMPLOYMENT HIRING, RECRUITING, PLACEMENT, STAFFING AND CAREER NETWORKING SERVICES PROVIDED TO AUTOMOTIVE DEALERSHIPS, IN CLASS 35 (U.S. CLS. 100, 101 AND 102).

FIRST USE 9-29-2011; IN COMMERCE 9-29-2011.

THE MARK CONSISTS OF STANDARD CHARACTERS WITHOUT CLAIM TO ANY PARTICULAR FONT, STYLE, SIZE, OR COLOR.

SN 77-966,926, FILED 3-24-2010.

KELLY BOULTON, EXAMINING ATTORNEY



*David J. Kyffers*

Director of the United States Patent and Trademark Office

# United States of America

United States Patent and Trademark Office

# METLOCK

**Reg. No. 4,135,987**

**Registered May 1, 2012**

**Int. Cls.: 1 and 5**

**TRADEMARK**

**PRINCIPAL REGISTER**

VALENT U.S.A. CORPORATION (CALIFORNIA CORPORATION)  
1600 RIVIERA AVENUE, STE. 200  
WALNUT CREEK, CA 945968025

FOR: CHEMICAL PREPARATIONS FOR USE IN AGRICULTURE, HORTICULTURE AND FORESTRY, NAMELY, CHEMICAL PREPARATIONS FOR THE TREATMENT OF SEEDS, IN CLASS 1 (U.S. CLS. 1, 5, 6, 10, 26 AND 46).

FIRST USE 12-27-2011; IN COMMERCE 12-27-2011.

FOR: FUNGICIDES, IN CLASS 5 (U.S. CLS. 6, 18, 44, 46, 51 AND 52).

FIRST USE 12-27-2011; IN COMMERCE 12-27-2011.

THE MARK CONSISTS OF STANDARD CHARACTERS WITHOUT CLAIM TO ANY PARTICULAR FONT, STYLE, SIZE, OR COLOR.

SN 77-967,617, FILED 3-24-2010.

JEAN IM, EXAMINING ATTORNEY



*David J. Kyros*

Director of the United States Patent and Trademark Office

# United States of America

United States Patent and Trademark Office

## AUTUMNCRISP

**Reg. No. 4,135,988**

**Registered May 1, 2012**

**Int. Cl.: 31**

**TRADEMARK**

**PRINCIPAL REGISTER**

SUN WORLD INTERNATIONAL, LLC (DELAWARE LIMITED LIABILITY COMPANY)  
16350 DRIVER ROAD  
BAKERSFIELD, CA 93308

FOR: FRUITS, NAMELY, FRESH GRAPES, IN CLASS 31 (U.S. CLS. 1 AND 46).

FIRST USE 3-2-2012; IN COMMERCE 3-2-2012.

THE MARK CONSISTS OF STANDARD CHARACTERS WITHOUT CLAIM TO ANY PARTICULAR FONT, STYLE, SIZE, OR COLOR.

SN 77-967,751, FILED 3-24-2010.

MARCIE MILONE, EXAMINING ATTORNEY



*David J. Kybas*

Director of the United States Patent and Trademark Office

# United States of America

United States Patent and Trademark Office

# NEVERDEAD

**Reg. No. 4,135,989**

**Registered May 1, 2012**

**Int. Cls.: 9 and 41**

**TRADEMARK**

**SERVICE MARK**

**PRINCIPAL REGISTER**

KONAMI DIGITAL ENTERTAINMENT CO., LTD. (JAPAN CORPORATION)  
9-7-2, AKASAKA, MINATO-KU  
TOKYO, JAPAN

FOR: VIDEO GAME SOFTWARE; VIDEO GAME PROGRAMS; COMPUTER GAME SOFTWARE; COMPUTER GAME PROGRAMS; ELECTRONIC GAME PROGRAMS , IN CLASS 9 (U.S. CLS. 21, 23, 26, 36 AND 38).

FIRST USE 1-31-2012; IN COMMERCE 1-31-2012.

FOR: ENTERTAINMENT SERVICES, NAMELY, PROVIDING ONLINE COMPUTER GAMES ACCESSIBLE VIA VIDEO GAME MACHINES; PROVIDING ONLINE COMPUTER GAMES VIA NETWORK BETWEEN COMMUNICATIONS NETWORKS AND COMPUTERS; PROVIDING INFORMATION TO GAME PLAYERS ABOUT THE RANKING OF THEIR SCORES OF GAMES THROUGH THE WEB SITES; PROVIDING INFORMATION, IMAGES, MUSIC AND/OR SOUND REGARDING GAMES, IN CLASS 41 (U.S. CLS. 100, 101 AND 107).

FIRST USE 1-31-2012; IN COMMERCE 1-31-2012.

THE MARK CONSISTS OF STANDARD CHARACTERS WITHOUT CLAIM TO ANY PARTICULAR FONT, STYLE, SIZE, OR COLOR.

SN 77-968,774, FILED 3-25-2010.

LINDSEY RUBIN, EXAMINING ATTORNEY



*David J. Kyros*

Director of the United States Patent and Trademark Office

# United States of America

United States Patent and Trademark Office



*Moving the world...one click at a time*

**Reg. No. 4,135,990**

**Registered May 1, 2012**

**Int. Cl.: 35**

**SERVICE MARK**

**PRINCIPAL REGISTER**

SIGNATURE LISTINGS LLC (ILLINOIS LIMITED LIABILITY COMPANY)  
2416 DURANGO LANE  
NAPERVILLE, IL 60564

FOR: ADVERTISING OF COMMERCIAL OR RESIDENTIAL REAL ESTATE; REAL ESTATE MARKETING SERVICES, NAMELY, ON-LINE SERVICES FEATURING PICTURES, VIDEOS AND TOURS OF RESIDENTIAL AND COMMERCIAL REAL ESTATE PROPERTIES, IN CLASS 35 (U.S. CLS. 100, 101 AND 102).

FIRST USE 3-20-2011; IN COMMERCE 3-20-2011.

THE MARK CONSISTS OF THE STYLIZED TEXT "SL MOVING THE WORLD...ONE CLICK AT A TIME" WITH A PEN OVER THE LETTER "SL".

SN 77-970,068, FILED 3-26-2010.

JACLYN KIDWELL WALKER, EXAMINING ATTORNEY



*David J. Kybas*

Director of the United States Patent and Trademark Office

# United States of America

United States Patent and Trademark Office



**Reg. No. 4,135,991**

**Registered May 1, 2012**

**Int. Cls.: 35, 38, 41, and 45**

**SERVICE MARK**

**PRINCIPAL REGISTER**

WISHB LLC (FLORIDA LIMITED LIABILITY COMPANY)  
1785 N.E. 123RD STREET  
NORTH MIAMI, FL 33181

FOR: ONLINE RETAIL STORE SERVICES FEATURING TOYS, GAMES, CHILDREN'S PRODUCTS, EDUCATIONAL PRODUCTS, AND GENERAL CONSUMER MERCHANDISE , IN CLASS 35 (U.S. CLS. 100, 101 AND 102).

FIRST USE 12-8-2010; IN COMMERCE 12-8-2010.

FOR: PROVIDING ONLINE CHAT ROOMS AND ELECTRONIC BULLETIN BOARDS WITH PARENTAL CONTROLS FOR TRANSMISSION OF MESSAGES AND ELECTRONIC MAIL AMONG USERS IN THE FIELDS OF GENERAL INTEREST AND EDUCATION, IN CLASS 38 (U.S. CLS. 100, 101 AND 104).

FIRST USE 12-8-2010; IN COMMERCE 12-8-2010.

FOR: ONLINE JOURNALS, NAMELY, BLOGS FEATURING INTERNET SAFETY ISSUES AND TIPS, CHILDREN'S ISSUES, PARENTING ISSUES, AND PRIMARY AND SECONDARY EDUCATION ISSUES, IN CLASS 41 (U.S. CLS. 100, 101 AND 107).

FIRST USE 12-8-2010; IN COMMERCE 12-8-2010.

FOR: PROVIDING A SOCIAL NETWORKING WEBSITE FOR ENTERTAINMENT PURPOSES AND FOR DISCUSSION OF PRIMARY AND SECONDARY EDUCATION ISSUES, IN CLASS 45 (U.S. CLS. 100 AND 101).

FIRST USE 12-8-2010; IN COMMERCE 12-8-2010.

THE MARK CONSISTS OF A CARTOON CHARACTER WITH NO NOSE AND FLOPPY EARS, POSED LIKE IT'S STANDING AND WAVING AND WEARING A SHIRT WITH THE WORD "GLOBWORLD" DISPLAYED.

SN 77-981,584, FILED 7-17-2009.

JASON BLAIR, EXAMINING ATTORNEY



*David J. Kyros*

Director of the United States Patent and Trademark Office

# United States of America

United States Patent and Trademark Office

## BABYSITTING MAMA

**Reg. No. 4,135,992**

**Registered May 1, 2012**

**Int. Cls.: 9 and 28**

**TRADEMARK**

**PRINCIPAL REGISTER**

COOKING MAMA LIMITED (CHINA CORPORATION)  
5F 113 ARGYLE STREET; ROOM 501; MONGKOK  
KOWLOON, HONG KONG, CHINA

FOR: ACCESSORIES FOR CONSUMER GAME CONSOLES ADAPTED FOR USE WITH AN EXTERNAL DISPLAY, SCREEN OR MONITOR, NAMELY, VIDEO GAME SOFTWARE, VIDEO GAME CARTRIDGES, AND VIDEO DISKS, IN CLASS 9 (U.S. CLS. 21, 23, 26, 36 AND 38).

FIRST USE 11-5-2010; IN COMMERCE 11-5-2010.

FOR: HAND-HELD GAMES WITH LIQUID CRYSTAL DISPLAYS AND PLUSH TOYS, IN CLASS 28 (U.S. CLS. 22, 23, 38 AND 50).

FIRST USE 11-5-2010; IN COMMERCE 11-5-2010.

THE MARK CONSISTS OF STANDARD CHARACTERS WITHOUT CLAIM TO ANY PARTICULAR FONT, STYLE, SIZE, OR COLOR.

NO CLAIM IS MADE TO THE EXCLUSIVE RIGHT TO USE "BABYSITTING", APART FROM THE MARK AS SHOWN.

SN 77-982,640, FILED 4-16-2009.

JEAN IM, EXAMINING ATTORNEY



*David J. Kyros*

Director of the United States Patent and Trademark Office

# United States of America

United States Patent and Trademark Office

## CRAFTING MAMA

**Reg. No. 4,135,993**

**Registered May 1, 2012**

**Int. Cls.: 9 and 28**

**TRADEMARK**

**PRINCIPAL REGISTER**

COOKING MAMA LIMITED (CHINA CORPORATION)  
ROOM 501, 5F 113 ARGYLE STREET, MONGKOK  
KOWLOON, HONG KONG, CHINA

FOR: ACCESSORIES FOR CONSUMER GAME CONSOLES ADAPTED FOR USE WITH AN EXTERNAL DISPLAY, SCREEN OR MONITOR, NAMELY, VIDEO GAME SOFTWARE, VIDEO GAME CARTRIDGES, AND VIDEO DISKS, IN CLASS 9 (U.S. CLS. 21, 23, 26, 36 AND 38).

FIRST USE 10-19-2010; IN COMMERCE 10-19-2010.

FOR: HAND-HELD GAMES WITH LIQUID CRYSTAL DISPLAYS, IN CLASS 28 (U.S. CLS. 22, 23, 38 AND 50).

FIRST USE 10-19-2010; IN COMMERCE 10-19-2010.

THE MARK CONSISTS OF STANDARD CHARACTERS WITHOUT CLAIM TO ANY PARTICULAR FONT, STYLE, SIZE, OR COLOR.

SN 77-982,649, FILED 3-11-2009.

JEAN IM, EXAMINING ATTORNEY



*David J. Kybas*

Director of the United States Patent and Trademark Office



# United States of America

United States Patent and Trademark Office

## JOHN CARTER OF MARS

**Reg. No. 4,135,994**

**Registered May 1, 2012**

**Int. Cl.: 28**

**TRADEMARK**

**PRINCIPAL REGISTER**

EDGAR RICE BURROUGHS, INC. (CALIFORNIA CORPORATION)  
18354 VENTURA BOULEVARD  
TARZANA, CA 91357

FOR: FANTASY CHARACTER TOYS AND COLLECTABLE TOY FIGURES, IN CLASS 28  
(U.S. CLS. 22, 23, 38 AND 50).

FIRST USE 12-1-2011; IN COMMERCE 12-1-2011.

THE MARK CONSISTS OF STANDARD CHARACTERS WITHOUT CLAIM TO ANY PARTICULAR FONT, STYLE, SIZE, OR COLOR.

THE NAME(S), PORTRAIT(S), AND/OR SIGNATURE(S) SHOWN IN THE MARK DOES NOT IDENTIFY A PARTICULAR LIVING INDIVIDUAL.

SN 77-982,839, FILED 8-24-2007.

CHARISMA HAMPTON, EXAMINING ATTORNEY



*David J. Kybas*

Director of the United States Patent and Trademark Office

# United States of America

United States Patent and Trademark Office

## PLAQUE-ZAPPER

**Reg. No. 4,135,995**

**Registered May 1, 2012**

**Int. Cl.: 5**

**TRADEMARK**

**PRINCIPAL REGISTER**

GULF COAST NUTRITIONALS, INC. (FLORIDA CORPORATION)  
6166 TAYLOR ROAD, SUITE 103  
NAPLES, FL 34109

FOR: PET DENTAL PRODUCTS, NAMELY, TEETH CLEANING PET TREATS AND SNACKS FOR EXERCISING JAW MUSCLES AND TEETH CLEANING; MEDICATED PET DENTAL PRODUCTS, NAMELY, DENTAL TREATS, AND RINSES AND PHARMACEUTICAL PRODUCTS FOR ANIMAL DENTAL CARE; INGESTIBLE PET DENTAL PRODUCTS, NAMELY, INGESTIBLE MULTI-VITAMINS AND LIQUIDS FOR DENTAL CARE; PET PRODUCTS, NAMELY, MEDICATED SKIN CARE PREPARATIONS, NAMELY, CLEANSERS; PET PRODUCTS, NAMELY, VITAMIN SUPPLEMENT IN TABLET FORM FOR USE IN MAKING AN EFFERVESCENT BEVERAGE WHEN ADDED TO WATER, IN CLASS 5 (U.S. CLS. 6, 18, 44, 46, 51 AND 52).

FIRST USE 1-10-2008; IN COMMERCE 7-1-2008.

THE MARK CONSISTS OF STANDARD CHARACTERS WITHOUT CLAIM TO ANY PARTICULAR FONT, STYLE, SIZE, OR COLOR.

SN 77-982,918, FILED 1-8-2008.

JENNIFER DIXON, EXAMINING ATTORNEY



*David J. Kypos*

Director of the United States Patent and Trademark Office

# United States of America

United States Patent and Trademark Office

## COYOTE UGLY

**Reg. No. 4,135,996**

**Registered May 1, 2012**

**Int. Cl.: 33**

**TRADEMARK**

**PRINCIPAL REGISTER**

UGLY, INC. (NEW YORK CORPORATION)  
2640 US ROUTE 9W  
CORNWALL, NY 12518

FOR: ALCOHOLIC BEVERAGE PRODUCED FROM A BREWED MALT BASE WITH NATURAL FLAVORS; ALCOHOLIC BEVERAGES EXCEPT BEERS; DISTILLED SPIRITS; LIQUOR; WHISKEY, IN CLASS 33 (U.S. CLS. 47 AND 49).

FIRST USE 3-13-2012; IN COMMERCE 3-13-2012.

THE MARK CONSISTS OF STANDARD CHARACTERS WITHOUT CLAIM TO ANY PARTICULAR FONT, STYLE, SIZE, OR COLOR.

SN 77-982,985, FILED 1-13-2010.

ZHALEH DELANEY, EXAMINING ATTORNEY



*David J. Kybas*

Director of the United States Patent and Trademark Office

# United States of America

United States Patent and Trademark Office

# AQUAPLEX

**Reg. No. 4,135,997**

**Registered May 1, 2012**

**Int. Cls.: 5 and 29**

**TRADEMARK**

**PRINCIPAL REGISTER**

CONNELLY, A. SCOTT (UNITED STATES INDIVIDUAL)  
1137 DOLPHIN TERRACE  
CORONA DEL MAR, CA 92625

FOR: DIETARY AND NUTRITIONAL SUPPLEMENTS; FOOD SUPPLEMENTS; FOOD SUPPLEMENTS, NAMELY, ANTI-OXIDANTS; MEAL REPLACEMENT AND DIETARY SUPPLEMENT DRINK MIXES; NUTRITIONAL DRINK MIX FOR USE AS A MEAL REPLACEMENT; POWDERED NUTRITIONAL SUPPLEMENT DRINK MIX, IN CLASS 5 (U.S. CLS. 6, 18, 44, 46, 51 AND 52).

FIRST USE 11-0-2011; IN COMMERCE 11-0-2011.

FOR: MILK POWDER AND WHEY POWDER, IN CLASS 29 (U.S. CL. 46).

FIRST USE 11-0-2011; IN COMMERCE 11-0-2011.

THE MARK CONSISTS OF STANDARD CHARACTERS WITHOUT CLAIM TO ANY PARTICULAR FONT, STYLE, SIZE, OR COLOR.

SN 77-982,991, FILED 10-31-2008.

DAWN FELDMAN, EXAMINING ATTORNEY



*David J. Kyros*

Director of the United States Patent and Trademark Office

# United States of America

United States Patent and Trademark Office

## LIVING TRADITIONS

**Reg. No. 4,135,998**

**Registered May 1, 2012**

**Int. Cls.: 4, 6, 11, 16, 20,  
21, 24, and 27**

FRED'S CAPITAL MANAGEMENT COMPANY (DELAWARE CORPORATION)  
SUITE 200  
103 FOULK ROAD  
WILMINGTON, DE 19803

FOR: TABLE TOP DÉCOR, NAMELY, TEA CANDLES FOR FRAGRANCE LAMPS, IN CLASS 4 (U.S. CLS. 1, 6 AND 15).

**TRADEMARK**

FIRST USE 2-28-2011; IN COMMERCE 2-28-2011.

**PRINCIPAL REGISTER**

FOR: FIGURINES OF COMMON METAL, IN CLASS 6 (U.S. CLS. 2, 12, 13, 14, 23, 25 AND 50).

FIRST USE 10-31-2009; IN COMMERCE 10-31-2009.

FOR: FRAGRANCE DISPENSING UNITS FEATURING A LAMP AND TEA CANDLES; ELECTRIC LAMPS, NAMELY, UPLIGHTS, BUFFET LAMPS, TABLE LAMPS AND FLOOR LAMPS, IN CLASS 11 (U.S. CLS. 13, 21, 23, 31 AND 34).

FIRST USE 1-0-2009; IN COMMERCE 1-0-2009.

FOR: WALL DÉCOR, NAMELY, FRAMED CANVAS WALL DÉCOR AND FRAMED ART PRINTS, IN CLASS 16 (U.S. CLS. 2, 5, 22, 23, 29, 37, 38 AND 50).

FIRST USE 1-0-2009; IN COMMERCE 1-0-2009.

FOR: FURNITURE, NAMELY, KITCHEN DINETTE SETS, BAKER'S RACK, END TABLES, BUFFET TABLES, ENTERTAINMENT CENTERS, OTTOMANS, CHEVAL MIRRORS, COMPUTER DESKS, ARMOIRES, CONSOLE TABLES, ACCENT TABLES, COFFEE TABLES; WALL DÉCOR, NAMELY, WALL PLAQUES MADE OF WOOD; PHOTO FRAMES; INDOOR MINI-BLINDS; SHOWER CURTAIN HOOKS; CLOTHES HANGERS; METAL PHOTO FRAMES; DRAPERY HARDWARE, NAMELY, TRAVERSE RODS, CURTAIN RODS, POLES, CURTAIN RINGS, CURTAIN HOOKS, FINIALS, IN CLASS 20 (U.S. CLS. 2, 13, 22, 25, 32 AND 50).

FIRST USE 1-0-2009; IN COMMERCE 1-0-2009.



*David J. Kybas*

Director of the United States Patent and Trademark Office

**Reg. No. 4,135,998** FOR: DECORATIVE CERAMIC PLATES SOLD WITH DISPLAY STANDS IN THE NATURE OF AN EASEL; CERAMIC, GLASS AND PORCELAIN FIGURINES; DECORATIVE METAL PLATES SOLD WITH DISPLAY STANDS IN THE NATURE OF AN EASEL; FABRIC-COVERED STORAGE CONTAINERS FOR DOMESTIC USE; CERAMIC VASES; BATH ACCESSORY SETS CONSISTING OF, NAMELY, TOOTHBRUSH HOLDERS, TRASH CONTAINERS, SOAP DISHES, DISPENSERS FOR FACIAL TISSUES, CUP HOLDERS; HOUSEWARES, NAMELY, BEVERAGeware, DINNERWARE; PANTRYWARE, NAMELY, AIR-TIGHT CONTAINERS, AND CANISTER SETS, ALL SOLD EMPTY; PAPER TOWEL HOLDERS; BAKEWARE; COOKWARE, NAMELY, CASSEROLE DISHES, COOKING POTS, FRY PANS, SKILLETS, SAUCE PANS, ENAMEL BAKEWARE AND BAKEWARE SETS; KITCHEN GADGETS, NAMELY, UTILITY POTS AND PANS, SERVING SPOONS, SLOTTED SPOONS, MIXING SPOONS, BASTING SPOONS, KITCHEN LADLES, SERVING LADLES; SINKWARE, NAMELY, DISH DRYING RACKS; METAL CANDLE HOLDERS, METAL VASES, IN CLASS 21 (U.S. CLS. 2, 13, 23, 29, 30, 33, 40 AND 50).

FIRST USE 1-0-2009; IN COMMERCE 1-0-2009.

FOR: COMFORTERS, COMFORTER SETS, BED BLANKETS; BED SHEETS AND BED SHEET SETS; MATTRESS PADS; BED PILLOWS; CURTAINS; KITCHEN TOWELS; TABLECLOTHS NOT OF PAPER; TEXTILE NAPKINS; BATH TOWELS; WASHCLOTHS; SHOWER CURTAINS, IN CLASS 24 (U.S. CLS. 42 AND 50).

FIRST USE 1-0-2009; IN COMMERCE 1-0-2009.

FOR: BATH RUGS AND BATH RUG SETS; DOOR MATS; SCATTER RUGS; ROOM SIZE RUGS, IN CLASS 27 (U.S. CLS. 19, 20, 37, 42 AND 50).

FIRST USE 12-31-2011; IN COMMERCE 12-31-2011.

THE MARK CONSISTS OF STANDARD CHARACTERS WITHOUT CLAIM TO ANY PARTICULAR FONT, STYLE, SIZE, OR COLOR.

SN 77-983,010, FILED 12-4-2009.

KARANENDRA S. CHHINA, EXAMINING ATTORNEY

# United States of America

United States Patent and Trademark Office

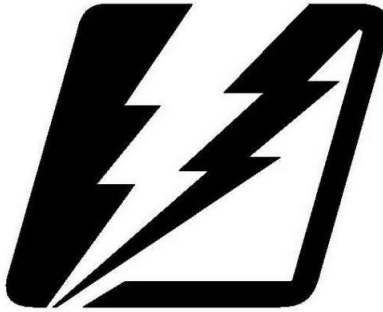

**Reg. No. 4,135,999**

**Registered May 1, 2012**

**Int. Cl.: 25**

**TRADEMARK**

**PRINCIPAL REGISTER**

SEARS BRANDS, LLC (ILLINOIS LIMITED LIABILITY COMPANY)  
3333 BEVERLY ROAD  
HOFFMAN ESTATES, IL 60179

FOR: APPAREL, NAMELY, TOPS, BOTTOMS, SHIRTS, SWEATERS, PANTS, JEANS, SHORTS, JACKETS, COATS, SWIMWEAR; CLOTHING ACCESSORIES, NAMELY, SOCKS, HATS, BELTS, IN CLASS 25 (U.S. CLS. 22 AND 39).

FIRST USE 7-0-2010; IN COMMERCE 7-0-2010.

THE MARK CONSISTS OF A STYLIZED IMAGE OF A LIGHTNING BOLT.

SN 77-983,023, FILED 2-9-2010.

BRIAN PINO, EXAMINING ATTORNEY



*David J. Kyffers*

Director of the United States Patent and Trademark Office

# United States of America

United States Patent and Trademark Office

## FAMILY GOURMET

**Reg. No. 4,136,000**

**Registered May 1, 2012**

**Int. Cls.: 29 and 32**

**TRADEMARK**

**PRINCIPAL REGISTER**

FAMILY DOLLAR STORES OF MICHIGAN, INC. (MICHIGAN CORPORATION)  
10401 OLD MONROE ROAD  
MATTHEWS, NC 28105

FOR: CANNED FRUITS AND CANNED VEGETABLES; CANNED MEAT; PROCESSED NUTS; MEAT JUICES, IN CLASS 29 (U.S. CL. 46).

FIRST USE 2-1-2012; IN COMMERCE 2-1-2012.

FOR: FRUIT AND VEGETABLE JUICES, IN CLASS 32 (U.S. CLS. 45, 46 AND 48).

FIRST USE 7-31-2011; IN COMMERCE 7-31-2011.

THE MARK CONSISTS OF STANDARD CHARACTERS WITHOUT CLAIM TO ANY PARTICULAR FONT, STYLE, SIZE, OR COLOR.

NO CLAIM IS MADE TO THE EXCLUSIVE RIGHT TO USE "GOURMET", APART FROM THE MARK AS SHOWN.

SN 77-983,031, FILED 1-16-2009.

BRENDAN MCCAULEY, EXAMINING ATTORNEY



*David J. Kybas*

Director of the United States Patent and Trademark Office



# United States of America

United States Patent and Trademark Office

## SOUND2SOUND

**Reg. No. 4,136,001**

**Registered May 1, 2012**

**Int. Cl.: 9**

**TRADEMARK**

**PRINCIPAL REGISTER**

SOUNDHOUND, INC. (DELAWARE CORPORATION)  
1731 TECHNOLOGY DRIVE, SUITE 700  
SAN JOSE, CA 95110

FOR: SEARCH ENGINE SOFTWARE; SOFTWARE FOR SEARCHING VIA TEXT, SOUND, SPEECH, AND MUSICAL QUERIES; SOFTWARE IN THE FIELDS OF SOUND RECOGNITION, SPEECH RECOGNITION, AND MUSIC RECOGNITION, IN CLASS 9 (U.S. CLS. 21, 23, 26, 36 AND 38).

FIRST USE 10-0-2009; IN COMMERCE 10-0-2009.

THE MARK CONSISTS OF STANDARD CHARACTERS WITHOUT CLAIM TO ANY PARTICULAR FONT, STYLE, SIZE, OR COLOR.

SN 77-983,032, FILED 3-27-2009.

PAUL E. FAHRENKOPF, EXAMINING ATTORNEY



*David J. Kyffers*

Director of the United States Patent and Trademark Office

# United States of America

United States Patent and Trademark Office

## BRINGING THE "GIFT" BACK TO GIFT CARDS

**Reg. No. 4,136,002**

**Registered May 1, 2012**

**Int. Cl.: 16**

**TRADEMARK**

**PRINCIPAL REGISTER**

GIFT CARD IMPRESSIONS, LLC (KANSAS LIMITED LIABILITY COMPANY)  
14717 FARLEY STREET  
OVERLAND PARK, KS 66221

FOR: GIFT CARDS, PAPER GIFT CARD HOLDERS, PAPER HOLDERS SPECIALLY ADAPTED FOR HOLDING GIFT CARDS, GIFT PACKAGING MADE OF PAPER, GIFT CARD PACKAGING MADE OF PAPER, ENVELOPES, CARDBOARD PACKAGING, PACKAGING CONTAINERS OF PAPER, PAPER POUCHES FOR PACKAGING, PAPER BAGS, PAPER GIFT BAGS, PAPER GIFT BAGS FOR WINE, BOXES OF PAPER OR CARDBOARD, MUSICAL GREETING CARDS, IN CLASS 16 (U.S. CLS. 2, 5, 22, 23, 29, 37, 38 AND 50).

FIRST USE 11-1-2011; IN COMMERCE 11-1-2011.

THE MARK CONSISTS OF STANDARD CHARACTERS WITHOUT CLAIM TO ANY PARTICULAR FONT, STYLE, SIZE, OR COLOR.

SN 77-983,045, FILED 3-7-2010.

TINA L. SNAPP, EXAMINING ATTORNEY



*David J. Kybas*

Director of the United States Patent and Trademark Office

# United States of America

United States Patent and Trademark Office

# APEC

**Reg. No. 4,136,003**

**Registered May 1, 2012**

**Int. Cl.: 41**

**SERVICE MARK**

**PRINCIPAL REGISTER**

CPC PROPERTIES, INC. (DELAWARE CORPORATION)  
SUITE 202  
103 FOULK ROAD  
WILMINGTON, DE 19803

FOR: ENTERTAINMENT SERVICES, NAMELY, PROVIDING ONLINE ELECTRONIC GAMES, VIDEO GAMES AND COMPUTER GAMES; ENTERTAINMENT SERVICES, NAMELY, PROVIDING TEMPORARY USE OF NON-DOWNLOADABLE INTERACTIVE GAMES, ELECTRONIC GAMES, COMPUTER GAMES AND VIDEO GAMES; VIDEO ARCADE SERVICES, IN CLASS 41 (U.S. CLS. 100, 101 AND 107).

FIRST USE 11-17-2009; IN COMMERCE 11-17-2009.

THE MARK CONSISTS OF STANDARD CHARACTERS WITHOUT CLAIM TO ANY PARTICULAR FONT, STYLE, SIZE, OR COLOR.

SN 77-983,080, FILED 10-21-2009.

MARC LEIPZIG, EXAMINING ATTORNEY



*David J. Kybas*

Director of the United States Patent and Trademark Office

# United States of America

United States Patent and Trademark Office

## ECHO

**Reg. No. 4,136,004**

THE ECHO DESIGN GROUP, INC. (NEW YORK CORPORATION)  
10 EAST 40TH STREET  
NEW YORK, NY 10016

**Registered May 1, 2012**

**Int. Cl.: 35**

FOR: RETAIL STORE SERVICES FEATURING FURNITURE, HOUSEHOLD FURNISHINGS AND LINENS, HOUSEWARES, LUGGAGE AND LEATHER ACCESSORIES, CLOTHING, GLASSWARE AND DINNERWARE, IN CLASS 35 (U.S. CLS. 100, 101 AND 102).

**SERVICE MARK**

FIRST USE 6-2-2006; IN COMMERCE 6-2-2006.

**PRINCIPAL REGISTER**

OWNER OF U.S. REG. NOS. 246,934, 2,646,159, AND OTHERS.

SN 78-235,430, FILED 4-8-2003.

WILLIAM BRECKENFELD, EXAMINING ATTORNEY



*David J. Kyffers*

Director of the United States Patent and Trademark Office

# United States of America

United States Patent and Trademark Office

## PARAGON CITY

**Reg. No. 4,136,005**

**Registered May 1, 2012**

**Int. Cl.: 41**

**SERVICE MARK**

**PRINCIPAL REGISTER**

NCSoft CORPORATION (REPUBLIC OF KOREA CORPORATION)  
OKSAN BUILDING  
157-33, SAMSUNG-DONG, GANGNAM-GU  
SEOUL, REPUBLIC OF KOREA 135090

FOR: PROVIDING ENTERTAINMENT IN THE NATURE OF ELECTRONIC GAMES, AND MULTIPLAYER ELECTRONIC GAMING, AND MULTIPLAYER GAME COMPETITIONS, ALL BY MEANS OF ELECTRONIC COMMUNICATIONS NETWORKS, IN CLASS 41 (U.S. CLS. 100, 101 AND 107).

FIRST USE 12-0-2003; IN COMMERCE 12-0-2003.

SN 78-287,591, FILED 8-14-2003.

RAUL CORDOVA, EXAMINING ATTORNEY



*David J. Kyffers*

Director of the United States Patent and Trademark Office

# United States of America

United States Patent and Trademark Office

# DUALIT

**Reg. No. 4,136,006**

**Registered May 1, 2012**

**Int. Cls.: 6, 7, 9, 11, and 21**

DUALIT LIMITED (UNITED KINGDOM COMPANY)  
COUNTY OAK WAY CRAWLEY  
WEST SUSSEX, UNITED KINGDOM RH11 7ST

FOR: METAL BOTTLE STOPPERS, IN CLASS 6 (U.S. CLS. 2, 12, 13, 14, 23, 25 AND 50).

FIRST USE 0-0-2005; IN COMMERCE 0-0-2005.

**TRADEMARK**

**PRINCIPAL REGISTER**

FOR: HOUSEHOLD OR KITCHEN UTENSILS NOT OF PRECIOUS METALS OR COATED THEREWITH, NAMELY, ELECTRIC MINI CHOPPERS, ELECTRIC HAND HELD MIXERS, ELECTRIC HAND HELD FOOD BLENDERS, ELECTRIC FOOD BLENDERS, IN CLASS 7 (U.S. CLS. 13, 19, 21, 23, 31, 34 AND 35).

FIRST USE 0-0-2005; IN COMMERCE 0-0-2005.

FOR: HOUSE HOLD ITEMS NOT OF PRECIOUS METALS OR COATED THEREWITH, NAMELY, WEIGHING SCALES, IN CLASS 9 (U.S. CLS. 21, 23, 26, 36 AND 38).

FIRST USE 0-0-2005; IN COMMERCE 0-0-2005.

FOR: HOUSEHOLD OR KITCHEN UTENSILS NOT OF PRECIOUS METALS OR COATED THEREWITH, NAMELY, ELECTRIC TOASTERS, ELECTRIC TEA KETTLES, ELECTRIC SOUP KETTLES, ELECTRIC COFFEE PERCOLATORS, ELECTRIC MINI COOKING OVENS, IN CLASS 11 (U.S. CLS. 13, 21, 23, 31 AND 34).

FIRST USE 0-0-1945; IN COMMERCE 0-0-1945.

FOR: HOUSEHOLD OR KITCHEN UTENSILS NOT OF PRECIOUS METALS OR COATED THEREWITH, NAMELY, CORK SCREWS, IN CLASS 21 (U.S. CLS. 2, 13, 23, 29, 30, 33, 40 AND 50).

FIRST USE 0-0-2005; IN COMMERCE 0-0-2005.

THE MARK CONSISTS OF STANDARD CHARACTERS WITHOUT CLAIM TO ANY PARTICULAR FONT, STYLE, SIZE, OR COLOR.

SN 78-350,777, FILED 1-12-2004.



*David J. Kyros*

Director of the United States Patent and Trademark Office

**Reg. No. 4,136,006** RUSS HERMAN, EXAMINING ATTORNEY

# United States of America

United States Patent and Trademark Office

## TAKE CARE HEALTH SYSTEMS

**Reg. No. 4,136,007**

**Registered May 1, 2012**

**Int. Cl.: 44**

**SERVICE MARK**

**PRINCIPAL REGISTER**

TAKE CARE HEALTH SYSTEMS, LLC (DELAWARE LIMITED LIABILITY COMPANY)  
EIGHT TOWER BRIDGE, 161 WASHINGTON ST.  
SUITE 1400  
CONSHOHOCKEN, PA 19428

FOR: MANAGED HEALTH CARE SERVICES, NAMELY, PROVIDING MEDICAL AND PHARMACEUTICAL CONSULTATION, PERFORMING DIAGNOSIS AND TREATMENT OF DISEASES, MEDICAL TESTING, AND PROVIDING HEALTH CARE INFORMATION BY PHONE AND THE INTERNET; MEDICAL CLINICS; AND MOBILE HEALTH CARE CENTERS, IN CLASS 44 (U.S. CLS. 100 AND 101).

FIRST USE 0-0-2005; IN COMMERCE 0-0-2005.

THE MARK CONSISTS OF STANDARD CHARACTERS WITHOUT CLAIM TO ANY PARTICULAR FONT, STYLE, SIZE, OR COLOR.

NO CLAIM IS MADE TO THE EXCLUSIVE RIGHT TO USE "HEALTH SYSTEMS", APART FROM THE MARK AS SHOWN.

SN 78-508,075, FILED 10-29-2004.

DAVID MURRAY, EXAMINING ATTORNEY



*David J. Kyros*

Director of the United States Patent and Trademark Office



# United States of America

United States Patent and Trademark Office

## CENTRALCASTS

**Reg. No. 4,136,008**

**Registered May 1, 2012**

**Int. Cl.: 41**

**SERVICE MARK**

**PRINCIPAL REGISTER**

BIERMANN PRODUCTIONS LLC (KANSAS LIMITED LIABILITY COMPANY)  
601 N. BROADMOOR  
WICHITA, KS 67206

FOR: ENTERTAINMENT SERVICES, NAMELY, PRODUCTION OF AUDIO AND VIDEO PROGRAMS DELIVERED VIA TELEVISION, AUDIO AND VIDEO MEDIA, IN CLASS 41 (U.S. CLS. 100, 101 AND 107).

FIRST USE 3-19-2010; IN COMMERCE 3-19-2010.

THE MARK CONSISTS OF STANDARD CHARACTERS WITHOUT CLAIM TO ANY PARTICULAR FONT, STYLE, SIZE, OR COLOR.

SN 78-795,885, FILED 1-20-2006.

DAVID C. REIHNER, EXAMINING ATTORNEY



*David J. Kyffers*

Director of the United States Patent and Trademark Office

# United States of America

United States Patent and Trademark Office

# EPITECT

**Reg. No. 4,136,009**

**Registered May 1, 2012**

**Int. Cl.: 5**

**TRADEMARK**

**PRINCIPAL REGISTER**

QIAGEN GMBH (FED REP GERMANY GMBH)  
1, QIAGEN STR.  
HILDEN, FED REP GERMANY 40724

FOR: CHEMICALS AND BIOCHEMICALS FOR MEDICAL AND VETERINARY MEDICAL PURPOSES, NAMELY, NUCLEIC ACIDS, ENZYMES, POLYMERASES, REAGENTS FOR STAINING OR MARKING, MOLECULAR PROBES AND BUFFERS USED IN CHEMISTRY, BIOLOGY, AND BIOCHEMISTRY; CHEMICALS AND BIOCHEMICALS FOR MEDICAL AND VETERINARY MEDICAL PURPOSES, NAMELY, AQUEOUS AND NONAQUEOUS SOLUTIONS OF ALCOHOLS AND SALTS; CHEMICALS AND BIOCHEMICALS FOR MEDICAL AND VETERINARY MEDICAL PURPOSES, NAMELY, DISTILLED AND PURIFIED WATER; CHEMICALS AND BIOCHEMICALS FOR MEDICAL AND VETERINARY MEDICAL PURPOSES, NAMELY, SILICA POWDER, GRANULATE AND GEL; CHEMICALS AND BIOCHEMICALS FOR MEDICAL AND VETERINARY MEDICAL PURPOSES, NAMELY, CHEMICALS FOR USE WITH SEPARATION COLUMNS FOR SEPARATION, ANALYSIS AND PURIFICATION OF BIOLOGICAL AND BIOCHEMICAL COMPOUNDS; CHEMICALS AND BIOCHEMICALS FOR MEDICAL AND VETERINARY MEDICAL PURPOSES, NAMELY, REAGENTS AND SOLVENTS FOR MARKING, SEPARATION, ISOLATION, PURIFICATION, AMPLIFICATION AND ANALYSIS OF BIOPOLYMERS; AND KITS OF CHEMICALS AND BIOCHEMICALS FOR MEDICAL AND VETERINARY MEDICAL PURPOSES CONTAINING THE AFORESAID GOODS, IN CLASS 5 (U.S. CLS. 6, 18, 44, 46, 51 AND 52).

FIRST USE 1-0-2011; IN COMMERCE 1-0-2011.

THE MARK CONSISTS OF STANDARD CHARACTERS WITHOUT CLAIM TO ANY PARTICULAR FONT, STYLE, SIZE, OR COLOR.

PRIORITY CLAIMED UNDER SEC. 44(D) ON FED REP GERMANY APPLICATION NO. 30554692.9/0, FILED 9-13-2005, REG. NO. 30554692, DATED 1-19-2006, EXPIRES 9-30-2015.

SN 78-832,975, FILED 3-9-2006.

ALICIA COLLINS, EXAMINING ATTORNEY



*David J. Kypos*

Director of the United States Patent and Trademark Office

# United States of America

United States Patent and Trademark Office

## YASSIE GAMALI

**Reg. No. 4,136,010**

SABERZADEH, ROYA (UNITED STATES INDIVIDUAL)  
9514-12 RESEDA BOULEVARD  
NORTHRIDGE, CA 91324

**Registered May 1, 2012**

**Int. Cl.: 25**

FOR: CLOTHING, NAMELY, SHIRTS, T-SHIRTS, TANK TOPS, UNDERSHIRTS, NIGHT SHIRTS, SWEATERS, SWEATSHIRTS, JACKETS, COATS, PANTS, SHORTS, UNDERWEAR, BRIEFS, SWEATPANTS, SKIRTS, JOGGING SUITS, HEADWEAR, NAMELY, CAPS AND VISORS, IN CLASS 25 (U.S. CLS. 22 AND 39).

**TRADEMARK**

**PRINCIPAL REGISTER**

FIRST USE 6-30-2007; IN COMMERCE 6-30-2007.

THE MARK CONSISTS OF STANDARD CHARACTERS WITHOUT CLAIM TO ANY PARTICULAR FONT, STYLE, SIZE, OR COLOR.

THE NAME(S), PORTRAIT(S), AND/OR SIGNATURE(S) SHOWN IN THE MARK DOES NOT IDENTIFY A PARTICULAR LIVING INDIVIDUAL.

SN 78-910,599, FILED 6-16-2006.

LESLEY LAMOTHE, EXAMINING ATTORNEY



*David J. Kyros*

Director of the United States Patent and Trademark Office

# United States of America

United States Patent and Trademark Office

## XTREME BEAUTY

**Reg. No. 4,136,011**

**Registered May 1, 2012**

**Int. Cl.: 3**

**TRADEMARK**

**PRINCIPAL REGISTER**

XTREME LASHES, LLC (TEXAS LIMITED LIABILITY COMPANY)  
24127 WEST HARDY ROAD, SUITE C  
SPRING, TX 77373

FOR: COSMETICS, NAMELY, CREAMS, GELS, MILKS, POWDERS, AND LOTIONS FOR THE FACE, BODY, AND HANDS; MAKE-UP PRODUCTS, NAMELY, MASCARA, EYE LINER, EYE SHADOW, EYEBROW PENCIL, EYELASH EXTENSIONS, ARTIFICIAL EYELASHES, ADHESIVES FOR FALSE EYELASHES AND EYELASH EXTENSIONS, LIPSTICKS, NAIL POLISH, BLUSH, FOUNDATION CREAMS AND POWDER; BODY DEODORANTS; SUN CARE PREPARATIONS, NAMELY, TANNING AND AFTER SUN MILKS, GELS, AND OILS; ESSENTIAL OILS FOR PERSONAL USE; GELS, SPRAYS, AND BALMS FOR HAIR STYLING AND HAIR CARE; HAIR LACQUERS, SHAMPOOS, CONDITIONERS, TREATMENTS, SERUMS, MASQUES AND MOUSSE FOR THE HAIR, IN CLASS 3 (U.S. CLS. 1, 4, 6, 50, 51 AND 52).

FIRST USE 6-28-2011; IN COMMERCE 6-28-2011.

THE MARK CONSISTS OF STANDARD CHARACTERS WITHOUT CLAIM TO ANY PARTICULAR FONT, STYLE, SIZE, OR COLOR.

NO CLAIM IS MADE TO THE EXCLUSIVE RIGHT TO USE "BEAUTY", APART FROM THE MARK AS SHOWN.

SN 78-914,879, FILED 6-22-2006.

PAM WILLIS, EXAMINING ATTORNEY



*David J. Kyros*

Director of the United States Patent and Trademark Office

# United States of America

United States Patent and Trademark Office

## HEALTHYNATION

**Reg. No. 4,136,012**

**Registered May 1, 2012**

**Int. Cl.: 41**

**SERVICE MARK**

**PRINCIPAL REGISTER**

HEALTHINATION, INC. (DELAWARE CORPORATION)  
SUITE 6E  
35 EAST 21ST STREET  
NEW YORK, NY 10010

FOR: ENTERTAINMENT, NAMELY, PRODUCTION OF A CONTINUING EDUCATIONAL SERIES IN THE FIELD OF CONSUMER HEALTHCARE BROADCAST OVER VIDEO MEDIA, IN CLASS 41 (U.S. CLS. 100, 101 AND 107).

FIRST USE 2-9-2012; IN COMMERCE 2-9-2012.

THE MARK CONSISTS OF STANDARD CHARACTERS WITHOUT CLAIM TO ANY PARTICULAR FONT, STYLE, SIZE, OR COLOR.

SN 78-920,736, FILED 6-30-2006.

ALEX KEAM, EXAMINING ATTORNEY



*David J. Kybas*

Director of the United States Patent and Trademark Office

# United States of America

United States Patent and Trademark Office

## HEALTHYNATION

**Reg. No. 4,136,013**

**Registered May 1, 2012**

**Int. Cl.: 44**

**SERVICE MARK**

**PRINCIPAL REGISTER**

HEALTHINATION, INC. (DELAWARE CORPORATION)  
SUITE 6E  
35 EAST 21ST STREET  
NEW YORK, NY 10010

FOR: PROVIDING HEALTHCARE INFORMATION VIA THE INTERNET, IN CLASS 44 (U.S. CLS. 100 AND 101).

FIRST USE 2-9-2012; IN COMMERCE 2-9-2012.

THE MARK CONSISTS OF STANDARD CHARACTERS WITHOUT CLAIM TO ANY PARTICULAR FONT, STYLE, SIZE, OR COLOR.

SN 78-920,744, FILED 6-30-2006.

ALEX KEAM, EXAMINING ATTORNEY



*David J. Kybas*

Director of the United States Patent and Trademark Office

# United States of America

United States Patent and Trademark Office

## ASK AMERICA'S TOP DOCTORS

**Reg. No. 4,136,014**

CASTLE CONNOLLY MEDICAL, LTD (DELAWARE CORPORATION)  
42 WEST 24TH STREET  
NEW YORK, NY 10010

**Registered May 1, 2012**

**Int. Cl.: 44**

FOR: PROVIDING MEDICAL INFORMATION VIA THE INTERNET, IN CLASS 44 (U.S. CLS. 100 AND 101).

**SERVICE MARK**

FIRST USE 2-16-2012; IN COMMERCE 2-16-2012.

**PRINCIPAL REGISTER**

THE MARK CONSISTS OF STANDARD CHARACTERS WITHOUT CLAIM TO ANY PARTICULAR FONT, STYLE, SIZE, OR COLOR.

SEC. 2(F) AS TO "AMERICA'S TOP DOCTORS".

OWNER OF U.S. REG. NOS. 2,448,548, 2,530,961, AND 3,375,239.

SN 78-949,872, FILED 8-10-2006.

PAULA MAHONEY, EXAMINING ATTORNEY



*David J. Kybas*

Director of the United States Patent and Trademark Office

# United States of America

United States Patent and Trademark Office

# ENCORE

**Reg. No. 4,136,015**

**Registered May 1, 2012**

**Int. Cl.: 41**

**SERVICE MARK**

**PRINCIPAL REGISTER**

WYNN RESORTS HOLDINGS, LLC (NEVADA LIMITED LIABILITY COMPANY)  
3131 LAS VEGAS BOULEVARD SOUTH  
LAS VEGAS, NV 89109

FOR: ENTERTAINMENT IN THE NATURE OF THEATER PRODUCTIONS, LIVE MUSIC CONCERTS, VISUAL AND AUDIO PERFORMANCES, VARIETY, AND COMEDY SHOWS; ENTERTAINMENT SERVICES, NAMELY, ORGANIZING COMMUNITY FESTIVALS FEATURING A VARIETY OF ACTIVITIES, NAMELY, ART EXHIBITIONS, AND LIVE MUSIC CONCERTS; MOVIE THEATERS; CABARETS; NIGHT CLUB SERVICES; FIGURE SALONS; ARRANGING AND CONDUCTING GOLF COMPETITIONS, ENTERTAINMENT IN THE NATURE OF GOLF TOURNAMENTS, GOLF COURSES, AND GOLF CLUB SERVICES; HEALTH CLUB SERVICES, NAMELY, PROVIDING FACILITIES FOR RECREATION ACTIVITIES; PROVIDING FACILITIES FOR TOURNAMENTS, NAMELY, POKER; SPECIAL EVENT PLANNING, IN CLASS 41 (U.S. CLS. 100, 101 AND 107).

FIRST USE 12-22-2008; IN COMMERCE 12-22-2008.

THE MARK CONSISTS OF STANDARD CHARACTERS WITHOUT CLAIM TO ANY PARTICULAR FONT, STYLE, SIZE, OR COLOR.

SN 78-979,145, FILED 8-17-2006.

CHERYL CLAYTON, EXAMINING ATTORNEY



*David J. Kyffers*

Director of the United States Patent and Trademark Office



# United States of America

United States Patent and Trademark Office

# uWrite

**Reg. No. 4,136,016**

**Registered May 1, 2012**

**Int. Cl.: 9**

**TRADEMARK**

**PRINCIPAL REGISTER**

MONA LISA SOUND, INC. (NEW YORK CORPORATION)  
TWO MARINERS COVE  
EDGEWATER, NJ 07020

FOR: COMPUTER APPLICATION SOFTWARE FOR WIRELESS AND ELECTRONIC MOBILE AND HANDHELD DEVICES FOR CREATING AND SENDING MESSAGES, IN CLASS 9 (U.S. CLS. 21, 23, 26, 36 AND 38).

FIRST USE 4-23-2010; IN COMMERCE 4-23-2010.

THE MARK CONSISTS OF STANDARD CHARACTERS WITHOUT CLAIM TO ANY PARTICULAR FONT, STYLE, SIZE, OR COLOR.

SN 85-000,850, FILED 3-29-2010.

ROBIN CHOSID, EXAMINING ATTORNEY



*David J. Kyffers*

Director of the United States Patent and Trademark Office

# United States of America

United States Patent and Trademark Office

## TRANSFORMING RESOURCES

**Reg. No. 4,136,017**

**Registered May 1, 2012**

**Int. Cl.: 16**

**TRADEMARK**

**PRINCIPAL REGISTER**

BARTON, RUTH HALEY (UNITED STATES INDIVIDUAL)  
1600 SOMERSET LANE  
WHEATON, IL 60189

FOR: PRINTED EDUCATIONAL MATERIALS IN THE FIELD OF SPIRITUAL FORMATION AND LEADERSHIP SKILLS FOR RELIGIOUS LEADERS, BOTH CLERGY AND LAY; PRINTED MATERIALS, NAMELY, CURRICULA IN THE FIELD OF SPIRITUAL FORMATION AND LEADERSHIP SKILLS FOR RELIGIOUS LEADERS, BOTH CLERGY AND LAY; PRINTED TRAINING MATERIALS IN THE FIELD OF SPIRITUAL FORMATION AND LEADERSHIP SKILLS FOR RELIGIOUS LEADERS, BOTH CLERGY AND LAY, IN CLASS 16 (U.S. CLS. 2, 5, 22, 23, 29, 37, 38 AND 50).

FIRST USE 11-11-2010; IN COMMERCE 11-11-2010.

THE MARK CONSISTS OF STANDARD CHARACTERS WITHOUT CLAIM TO ANY PARTICULAR FONT, STYLE, SIZE, OR COLOR.

OWNER OF U.S. REG. NOS. 3,067,497 AND 3,746,433.

NO CLAIM IS MADE TO THE EXCLUSIVE RIGHT TO USE "RESOURCES", APART FROM THE MARK AS SHOWN.

SN 85-002,673, FILED 3-31-2010.

WANDA KAY PRICE, EXAMINING ATTORNEY



*David J. Kyffers*

Director of the United States Patent and Trademark Office

# United States of America

United States Patent and Trademark Office

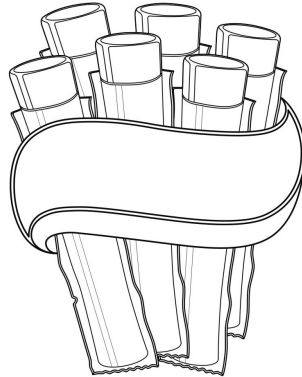

**Reg. No. 4,136,018**

**Registered May 1, 2012**

**Int. Cl.: 30**

**TRADEMARK**

**PRINCIPAL REGISTER**

THE JEL SERT CO. (ILLINOIS CORPORATION)  
HIGHWAY 59 AND CONDE STREET  
WEST CHICAGO, IL 60185

FOR: FROZEN CONFECTIONS, NAMELY, FREEZER BARS, IN CLASS 30 (U.S. CL. 46).

FIRST USE 3-1-2005; IN COMMERCE 3-1-2005.

THE MARK CONSISTS OF STANDING ICE POPS WITH A RIBBON AROUND THEM.

SN 85-005,063, FILED 4-2-2010.

ROBERT C. CLARK JR., EXAMINING ATTORNEY



*David J. Kybas*

Director of the United States Patent and Trademark Office

# United States of America

United States Patent and Trademark Office

## SOKU THE CRUISER

**Reg. No. 4,136,019**

**Registered May 1, 2012**

**Int. Cl.: 28**

**TRADEMARK**

**PRINCIPAL REGISTER**

HASBRO, INC. (RHODE ISLAND CORPORATION)  
1027 NEWPORT AVENUE  
PAWTUCKET, RI 02862

FOR: TOY VEHICLES AND ACCESSORIES FOR USE THEREWITH, IN CLASS 28 (U.S. CLS. 22, 23, 38 AND 50).

FIRST USE 7-8-2011; IN COMMERCE 7-8-2011.

THE MARK CONSISTS OF STANDARD CHARACTERS WITHOUT CLAIM TO ANY PARTICULAR FONT, STYLE, SIZE, OR COLOR.

NO CLAIM IS MADE TO THE EXCLUSIVE RIGHT TO USE "CRUISER", APART FROM THE MARK AS SHOWN.

SN 85-005,990, FILED 4-5-2010.

JENNY PARK, EXAMINING ATTORNEY



*David J. Kybas*

Director of the United States Patent and Trademark Office

# United States of America

United States Patent and Trademark Office

## BIGGS THE MONSTER TRUCK

**Reg. No. 4,136,020**

**Registered May 1, 2012**

**Int. Cl.: 28**

**TRADEMARK**

**PRINCIPAL REGISTER**

HASBRO, INC. (RHODE ISLAND CORPORATION)  
1027 NEWPORT AVENUE  
PAWTUCKET, RI 02862

FOR: TOY VEHICLES AND ACCESSORIES FOR USE THEREWITH, IN CLASS 28 (U.S. CLS. 22, 23, 38 AND 50).

FIRST USE 4-27-2010; IN COMMERCE 4-27-2010.

THE MARK CONSISTS OF STANDARD CHARACTERS WITHOUT CLAIM TO ANY PARTICULAR FONT, STYLE, SIZE, OR COLOR.

NO CLAIM IS MADE TO THE EXCLUSIVE RIGHT TO USE "MONSTER TRUCK", APART FROM THE MARK AS SHOWN.

SN 85-005,993, FILED 4-5-2010.

JENNY PARK, EXAMINING ATTORNEY



*David J. Kyffers*

Director of the United States Patent and Trademark Office

# United States of America

United States Patent and Trademark Office



**Reg. No. 4,136,021**

**Registered May 1, 2012**

**Int. Cls.: 7 and 12**

**TRADEMARK**

**PRINCIPAL REGISTER**

GENERAL MOTORS LLC (DELAWARE LIMITED LIABILITY COMPANY)  
300 RENAISSANCE CENTER  
DETROIT, MI 482653000

FOR: AUTOMOTIVE ENGINE PARTS SOLD AS AN INTEGRAL PART OF MOTOR LAND PASSENGER VEHICLES DESIGNED TO REDUCE CO2 EMISSIONS AND INCREASE FUEL ECONOMY, NAMELY, ROCKER ARMS AND ELECTRONIC FUEL INJECTION MODULES, IN CLASS 7 (U.S. CLS. 13, 19, 21, 23, 31, 34 AND 35).

FIRST USE 12-12-2010; IN COMMERCE 12-12-2010.

FOR: AUTOMOTIVE PARTS AND COMPONENTS SOLD AS AN INTEGRAL PART OF A MOTOR LAND PASSENGER VEHICLE DESIGNED TO REDUCE CO2 EMISSIONS AND INCREASE FUEL ECONOMY, NAMELY, ENGINE, TRANSMISSION, SUSPENSION SYSTEMS, DRIVE SHAFTS, AND AERODYNAMIC AUTOMOTIVE BODY PANELS, IN CLASS 12 (U.S. CLS. 19, 21, 23, 31, 35 AND 44).

FIRST USE 12-12-2010; IN COMMERCE 12-12-2010.

NO CLAIM IS MADE TO THE EXCLUSIVE RIGHT TO USE "ECO", APART FROM THE MARK AS SHOWN.

THE MARK CONSISTS OF THE WORD, "ECO", INSIDE THE DESIGN OF CONCENTRIC RECTANGLES WITH A CURVED HORIZONTAL LINE ABOVE THE WORD AND INTERSECTING THE LEFT SIDE OF THE RECTANGLE DESIGN.

SN 85-007,980, FILED 4-7-2010.

BARBARA A. GOLD, EXAMINING ATTORNEY



*David J. Kybas*

Director of the United States Patent and Trademark Office

# United States of America

United States Patent and Trademark Office

## TRANSFORMERS PRIME

**Reg. No. 4,136,022**

**Registered May 1, 2012**

**Int. Cls.: 28 and 41**

**TRADEMARK**

**SERVICE MARK**

**PRINCIPAL REGISTER**

HASBRO, INC. (RHODE ISLAND CORPORATION)  
1027 NEWPORT AVENUE  
PAWTUCKET, RI 02862

FOR: TOY ACTION FIGURES; TOY VEHICLES; TOY ROBOTS CONVERTIBLE INTO OTHER VISUAL TOY FORMS, IN CLASS 28 (U.S. CLS. 22, 23, 38 AND 50).

FIRST USE 7-20-2011; IN COMMERCE 7-20-2011.

FOR: ENTERTAINMENT SERVICES, NAMELY, AN ON-GOING ANIMATED TELEVISION SERIES IN THE FIELD OF CHILDREN'S ENTERTAINMENT, IN CLASS 41 (U.S. CLS. 100, 101 AND 107).

FIRST USE 11-26-2010; IN COMMERCE 11-26-2010.

THE MARK CONSISTS OF STANDARD CHARACTERS WITHOUT CLAIM TO ANY PARTICULAR FONT, STYLE, SIZE, OR COLOR.

OWNER OF U.S. REG. NOS. 1,348,237, 2,900,471, AND OTHERS.

SN 85-008,156, FILED 4-7-2010.

ANDREW RHIM, EXAMINING ATTORNEY



*David J. Kybas*

Director of the United States Patent and Trademark Office

# United States of America

United States Patent and Trademark Office



**Reg. No. 4,136,023**

**Registered May 1, 2012**

**Int. Cls.: 16, 35, and 40**

OPENSOFTECHNOLOGIES, LLC (CALIFORNIA LIMITED LIABILITY COMPANY)  
2601 MAIN STREET, SUITE 1200  
IRVINE, CA 92614

FOR: BUSINESS CARDS; COLOR PRINTS; GRAPHIC PRINTS AND REPRESENTATIONS  
, IN CLASS 16 (U.S. CLS. 2, 5, 22, 23, 29, 37, 38 AND 50).

**TRADEMARK**

FIRST USE 12-17-2009; IN COMMERCE 12-17-2009.

**SERVICE MARK**

FOR: BUSINESS CARD DESIGN SERVICES; ON-LINE ORDERING SERVICES FEATURING  
BUSINESS CARDS, IN CLASS 35 (U.S. CLS. 100, 101 AND 102).

**PRINCIPAL REGISTER**

FIRST USE 12-17-2009; IN COMMERCE 12-17-2009.

FOR: DESIGN PRINTING FOR OTHERS; IMPRINTING MESSAGES ON T-SHIRTS; PRINTING  
OF ADVERTISING MATTER; STATIONERY PRINTING SERVICES, IN CLASS 40 (U.S. CLS.  
100, 103 AND 106).

FIRST USE 12-17-2009; IN COMMERCE 12-17-2009.

NO CLAIM IS MADE TO THE EXCLUSIVE RIGHT TO USE "BUDGET PRINTS", APART  
FROM THE MARK AS SHOWN.

THE COLOR(S) GREY, BLUE, PINK AND YELLOW IS/ARE CLAIMED AS A FEATURE OF  
THE MARK.

THE MARK CONSISTS OF THE WORDS "BUDGET PRINTS" IN GREY STYLIZED FONT,  
WITH A BLUE CIRCLE DOTTING THE LETTER "I" IN THE WORD "PRINTS" AND A PINK  
CIRCLE AND A YELLOW CIRCLE NEXT TO THE BLUE CIRCLE.

SN 85-008,539, FILED 4-7-2010.

DANIEL CAPSHAW, EXAMINING ATTORNEY



*David J. Kyffers*

Director of the United States Patent and Trademark Office



# United States of America

United States Patent and Trademark Office

## Innovative Cutlery

**Reg. No. 4,136,024**

**Registered May 1, 2012**

**Int. Cl.: 8**

**TRADEMARK**

**PRINCIPAL REGISTER**

MYTYM CO. (COLORADO CORPORATION), DBA ORADINE,  
PO BOX 3155  
GILLETTE, WY 82717

FOR: CUTLERY, NAMELY, FORKS, KNIVES AND SPOONS; DISPOSABLE TABLEWARE,  
NAMELY, KNIVES, FORKS AND SPOONS; DISPOSABLE TABLEWARE, NAMELY, SPOONS;  
FORKS, IN CLASS 8 (U.S. CLS. 23, 28 AND 44).

FIRST USE 7-18-2011; IN COMMERCE 7-18-2011.

THE MARK CONSISTS OF STANDARD CHARACTERS WITHOUT CLAIM TO ANY PAR-  
TICULAR FONT, STYLE, SIZE, OR COLOR.

NO CLAIM IS MADE TO THE EXCLUSIVE RIGHT TO USE "CUTLERY", APART FROM  
THE MARK AS SHOWN.

SN 85-010,518, FILED 4-9-2010.

COLLEEN DOMBROW, EXAMINING ATTORNEY



*David J. Kyros*

Director of the United States Patent and Trademark Office

# United States of America

United States Patent and Trademark Office



**Reg. No. 4,136,025**

**Registered May 1, 2012**

**Int. Cl.: 16**

**TRADEMARK**

**PRINCIPAL REGISTER**

STEPHANIE R. DAWKINS INTERNATIONAL, INC. (NORTH CAROLINA CORPORATION)  
10829 GREEN HERON COURT  
CHARLOTTE, NC 28278

FOR: EDUCATIONAL PUBLICATIONS, NAMELY, BOOKS IN THE FIELDS OF BUSINESS CONSULTING, IN CLASS 16 (U.S. CLS. 2, 5, 22, 23, 29, 37, 38 AND 50).

FIRST USE 6-1-2010; IN COMMERCE 6-1-2010.

THE NAME(S), PORTRAIT(S), AND/OR SIGNATURE(S) SHOWN IN THE MARK IDENTIFIES "STEPHANIE R. DAWKINS", WHOSE CONSENT(S) TO REGISTER IS MADE OF RECORD.

THE MARK CONSISTS OF A HEAD SHOT OF A WOMAN DRINKING COFFEE IN AN URBAN SETTING. THE BACKGROUND BEHIND THE HEAD-SHOT CONTAINS SEVERAL-STORIED BUILDINGS. DIRECTLY UNDERNEATH THE WOMAN AND THE BUILDINGS, THE WORDS "CORPORATE COFFEE" APPEAR.

SN 85-010,782, FILED 4-9-2010.

APRIL HESIK, EXAMINING ATTORNEY



*David J. Kybas*

Director of the United States Patent and Trademark Office

# United States of America

United States Patent and Trademark Office

# E-SPRAYER

**Reg. No. 4,136,026**

**Registered May 1, 2012**

**Int. Cl.: 7**

**TRADEMARK**

**PRINCIPAL REGISTER**

MIDWEST INDUSTRIAL SUPPLY, INC. (OHIO CORPORATION)  
1101 3RD STREET, S. E.  
CANTON, OH 447073230

FOR: POWER-OPERATED SELF-CONTAINED VEHICLE MOUNTED SPRAYER SYSTEMS COMPRISED OF NOZZLES, HOSES, STORAGE TANKS AND CONTROL VALVES FOR SPRAYING DUST CONTROL PREPARATIONS FOR THE PURPOSES OF DUST SUPPRESSION, IN CLASS 7 (U.S. CLS. 13, 19, 21, 23, 31, 34 AND 35).

FIRST USE 4-30-2004; IN COMMERCE 4-30-2004.

THE MARK CONSISTS OF STANDARD CHARACTERS WITHOUT CLAIM TO ANY PARTICULAR FONT, STYLE, SIZE, OR COLOR.

SN 85-012,839, FILED 4-13-2010.

ANNE FARRELL, EXAMINING ATTORNEY



*David J. Kyffers*

Director of the United States Patent and Trademark Office

# United States of America

United States Patent and Trademark Office



**Reg. No. 4,136,027**

**Registered May 1, 2012**

**Int. Cl.: 31**

**TRADEMARK**

**PRINCIPAL REGISTER**

CAUDILL SEED AND WAREHOUSE COMPANY, INC. (KENTUCKY CORPORATION)  
1402 W. MAIN STREET  
LOUISVILLE, KY 40203

FOR: AGRICULTURAL AND HORTICULTURAL PRODUCTS, NAMELY, GRASS SEEDS, CORN SEEDS, FIELD SEEDS, FRUIT AND VEGETABLE SEEDS, IN CLASS 31 (U.S. CLS. 1 AND 46).

FIRST USE 8-1-2011; IN COMMERCE 8-1-2011.

NO CLAIM IS MADE TO THE EXCLUSIVE RIGHT TO USE "SEED", APART FROM THE MARK AS SHOWN.

THE MARK CONSISTS OF A CIRCLE CONTAINING THE WORD "SAFETY" IN STYLIZED FONT WITH THE WORD "SEED" IN STYLIZED FONT BEGINNING BELOW THE LETTERS "ETY" IN THE WORD "SAFETY". THERE IS A CHECKMARK CENTERED BELOW THE WORDING.

SN 85-013,779, FILED 4-14-2010.

TINA BROWN, EXAMINING ATTORNEY



*David J. Kybas*

Director of the United States Patent and Trademark Office

# United States of America

United States Patent and Trademark Office



coolhotyoga...  
it's cool to be HOT

**Reg. No. 4,136,028**

COPLAND, MICHELLE L (UNITED STATES INDIVIDUAL)  
130 FIFTH AVENUE  
NORWOOD, NJ 07648

**Registered May 1, 2012**

**Int. Cls.: 25, 28, and 41**

FOR: APPAREL FOR DANCERS, NAMELY, TEE SHIRTS, SWEATSHIRTS, PANTS, LEGGINGS, SHORTS AND JACKETS; ATHLETIC APPAREL, NAMELY, SHIRTS, PANTS, JACKETS, FOOTWEAR, HATS AND CAPS, ATHLETIC UNIFORMS, IN CLASS 25 (U.S. CLS. 22 AND 39).

**TRADEMARK**

**SERVICE MARK**

FIRST USE 6-20-2009; IN COMMERCE 6-20-2009.

**PRINCIPAL REGISTER**

FOR: EXERCISE BALLS; PERSONAL EXERCISE MATS, IN CLASS 28 (U.S. CLS. 22, 23, 38 AND 50).

FIRST USE 6-20-2009; IN COMMERCE 6-20-2009.

FOR: YOGA INSTRUCTION; CONSULTING SERVICES IN THE FIELDS OF FITNESS AND EXERCISE; HEALTH CLUB SERVICES, NAMELY, PROVIDING INSTRUCTION AND EQUIPMENT IN THE FIELD OF PHYSICAL EXERCISE; PHYSICAL FITNESS STUDIO SERVICES, NAMELY, PROVIDING EXERCISE CLASSES, BODY SCULPTING CLASSES, AND GROUP FITNESS CLASSES; PHYSICAL FITNESS STUDIO SERVICES, NAMELY, PROVIDING GROUP EXERCISE INSTRUCTION, EQUIPMENT, AND FACILITIES; PROVIDING A WEB SITE FEATURING INFORMATION ON EXERCISE AND FITNESS; PROVIDING A WEBSITE FEATURING INFORMATION ON EXERCISE AND FITNESS; PROVIDING A WEBSITE FEATURING ONLINE SPORTS TRAINING AND TRAINING ADVICE AND THE RECORDING OF TRAINING AND WORKOUTS; PROVIDING AN ON-LINE COMPUTER DATABASE FEATURING INFORMATION REGARDING EXERCISE AND FITNESS; PROVIDING AN ON-LINE COMPUTER DATABASE FEATURING INFORMATION REGARDING EXERCISE AND FITNESS BEFORE AND AFTER PREGNANCY; PROVIDING ANIMAL EXERCISE SERVICES; PROVIDING ASSISTANCE, PERSONAL TRAINING AND PHYSICAL FITNESS CONSULTATION TO CORPORATE CLIENTS TO HELP THEIR EMPLOYEES MAKE PHYSICAL FITNESS, STRENGTH, CONDITIONING, AND EXERCISE ALTERATIONS IN THEIR DAILY LIVING; PROVIDING ASSISTANCE, PERSONAL TRAINING AND PHYSICAL FITNESS CONSULTATION TO INDIVIDUALS TO HELP THEM MAKE PHYSICAL FITNESS, STRENGTH, CONDITIONING, AND EXERCISE IMPROVEMENT IN THEIR DAILY LIVING; PROVIDING CLASSES, WORKSHOPS, SEMINARS AND CAMPS IN THE FIELDS OF FITNESS, EXERCISE, BOXING, KICK BOXING AND MIXED MARTIAL



*David J. Kyros*

Director of the United States Patent and Trademark Office

**Reg. No. 4,136,028** ARTS; PROVIDING FITNESS AND EXERCISE FACILITIES; PROVIDING FITNESS AND EXERCISE STUDIO SERVICES, NAMELY, PILATES INSTRUCTION AND TRAINING; PROVIDING GENERAL FITNESS AND MIXED MARTIAL ARTS FACILITIES THAT REQUIRE MEMBERSHIPS AND ARE FOCUSED IN THE FIELDS OF GENERAL FITNESS, EXERCISE, AND MIXED MARTIAL ARTS; PROVIDING INFORMATION IN THE FIELD OF EXERCISE TRAINING; PROVIDING INFORMATION ON PHYSICAL EXERCISE, IN CLASS 41 (U.S. CLS. 100, 101 AND 107).

FIRST USE 6-20-2009; IN COMMERCE 6-20-2009.

THE MARK CONSISTS OF THE IMAGE OF A SUN IN ORANGE AND YELLOW, THE WORDING "COOLHOTYOGA..."IN RED, THE WORDING "ITS COOL TO BE HOT" IN BLACK, THE COLOR WHITE REPRESENTS BACKGROUND AREAS AND IS NOT A PART OF THE MARK.

THE COLOR(S) RED, ORANGE, YELLOW, AND BLACK IS/ARE CLAIMED AS A FEATURE OF THE MARK.

SN 85-015,378, FILED 4-15-2010.

CARRIE GENOVESE, EXAMINING ATTORNEY

# United States of America

United States Patent and Trademark Office

## FIRE SAFETY HOUSE

**Reg. No. 4,136,029**

**Registered May 1, 2012**

**Int. Cls.: 9 and 20**

**TRADEMARK**

**PRINCIPAL REGISTER**

SCHERBA INDUSTRIES, INC. (OHIO CORPORATION)  
2880 INTERSTATE PARKWAY  
THE SCHERBA BUILDING  
BRUNSWICK, OH 44212

FOR: PROTECTION AND SAFETY APPARATUS, NAMELY, INFLATABLE FIRE SAFETY TEACHING DEVICES, IN CLASS 9 (U.S. CLS. 21, 23, 26, 36 AND 38).

FIRST USE 1-1-2012; IN COMMERCE 1-1-2012.

FOR: HOT AND COLD AIR INFLATABLE ADVERTISING BALLOONS NOT FOR TRANSPORT OF PASSENGERS, IN CLASS 20 (U.S. CLS. 2, 13, 22, 25, 32 AND 50).

FIRST USE 1-1-2012; IN COMMERCE 1-1-2012.

THE MARK CONSISTS OF STANDARD CHARACTERS WITHOUT CLAIM TO ANY PARTICULAR FONT, STYLE, SIZE, OR COLOR.

NO CLAIM IS MADE TO THE EXCLUSIVE RIGHT TO USE "FIRE SAFETY", APART FROM THE MARK AS SHOWN.

SN 85-018,208, FILED 4-20-2010.

KAPIL BHANOT, EXAMINING ATTORNEY



*David J. Kyros*

Director of the United States Patent and Trademark Office

# United States of America

United States Patent and Trademark Office



**Reg. No. 4,136,030**

**Registered May 1, 2012**

**Int. Cl.: 25**

**TRADEMARK**

**PRINCIPAL REGISTER**

KASSANDRA NEARY (UNITED STATES INDIVIDUAL)  
P.O. BOX 249  
COTATI, CA 94931

FOR: APPAREL, NAMELY, T-SHIRTS, SWEATSHIRTS, HEADWEAR, JACKETS, SHIRTS, DRESSES, IN CLASS 25 (U.S. CLS. 22 AND 39).

FIRST USE 1-31-2012; IN COMMERCE 1-31-2012.

THE MARK CONSISTS OF TWO INTERTWINED BLACK SNAKES, THE UPPER PORTION OF THEIR BODIES FORMING A HEART AND THEIR HEADS BEING WHITE. THE SNAKES ARE FLANKED BY A PAIR OF FLOWERS WITH BLACK STEMS WOUND AROUND THE SNAKES AND RED PETALS. RED HEARTS APPEAR TO FALL DOWNWARD FROM THE SNAKES' OPEN MOUTHS. THE WORDS "HOLLYWOOD HEARTBREAKER" APPEAR OVER THE SNAKE'S MIDSECTIONS. "HOLLYWOOD" IS IN RED, WITH A BLACK BORDER, "HEARTBREAKER" IS IN BLACK.

THE COLOR(S) RED, BLACK AND WHITE IS/ARE CLAIMED AS A FEATURE OF THE MARK.

SN 85-018,410, FILED 4-20-2010.

STEVEN R. FINE, EXAMINING ATTORNEY



*David J. Kybas*

Director of the United States Patent and Trademark Office



# United States of America

United States Patent and Trademark Office

## MISSION BLUE

**Reg. No. 4,136,031**

**Registered May 1, 2012**

**Int. Cl.: 9**

**TRADEMARK**

**PRINCIPAL REGISTER**

DEEP SEARCH INC. (CALIFORNIA CORPORATION), DBA DEEP SEARCH FOUNDATION,  
2470 MARINER SQUARE LOOP  
ALAMEDA, CA 94501

FOR: PRE-RECORDED DVDS FEATURING INFORMATION REGARDING THE ENVIRONMENT, SCIENCE AND TECHNOLOGY, EXPLORATION, AND CONSERVATION; DOWNLOADABLE VIDEO RECORDINGS FEATURING INFORMATION REGARDING THE ENVIRONMENT, SCIENCE AND TECHNOLOGY, EXPLORATION, AND CONSERVATION, IN CLASS 9 (U.S. CLS. 21, 23, 26, 36 AND 38).

FIRST USE 2-21-2012; IN COMMERCE 2-21-2012.

THE MARK CONSISTS OF STANDARD CHARACTERS WITHOUT CLAIM TO ANY PARTICULAR FONT, STYLE, SIZE, OR COLOR.

SN 85-019,366, FILED 4-21-2010.

THOMAS MANOR, EXAMINING ATTORNEY



*David J. Kyffers*

Director of the United States Patent and Trademark Office

# United States of America

United States Patent and Trademark Office

# eOSphere

**Reg. No. 4,136,032**

**Registered May 1, 2012**

**Int. Cl.: 42**

**SERVICE MARK**

**PRINCIPAL REGISTER**

ENTERPRISE TECHNOLOGY ASSOCIATES, LLC (ILLINOIS LIMITED LIABILITY COMPANY)  
3816 MILLER DRIVE  
GLENVIEW, IL 60026

FOR: COMPUTER SERVICE, NAMELY, ACTING AS AN APPLICATION SERVICE PROVIDER IN THE FIELD OF INFORMATION MANAGEMENT TO HOST COMPUTER APPLICATION SOFTWARE FOR THE PURPOSE OF PROVIDING GENERAL-PURPOSE COMPUTING SERVICES TO SMALL BUSINESSES IN THE NATURE OF WORD PROCESSING, DATABASE MANAGEMENT, OFFICE AUTOMATION, ORDER PROCESSING AND INVENTORY MANAGEMENT, IN CLASS 42 (U.S. CLS. 100 AND 101).

FIRST USE 8-1-2010; IN COMMERCE 8-1-2010.

THE MARK CONSISTS OF THE WORDING "EOSPHERE" WITH A CURVED BAND STRETCHING FROM THE TOP OF THE LETTER "S" TO THE END OF THE WORDING.

SN 85-022,569, FILED 4-25-2010.

SETH A. RAPPAPORT, EXAMINING ATTORNEY



*David J. Kyffers*

Director of the United States Patent and Trademark Office

# United States of America

United States Patent and Trademark Office

## BANG!! CAFFEINATED ICE CREAM

**Reg. No. 4,136,033**

**Registered May 1, 2012**

**Int. Cl.: 30**

**TRADEMARK**

**PRINCIPAL REGISTER**

OSMANSKI, JOHN M (UNITED STATES INDIVIDUAL)  
P.O. BOX 511485  
MILWAUKEE, WI 53203

FOR: CAFFEINATED ICE CREAM, IN CLASS 30 (U.S. CL. 46).

FIRST USE 2-20-2011; IN COMMERCE 2-20-2011.

THE MARK CONSISTS OF STANDARD CHARACTERS WITHOUT CLAIM TO ANY PARTICULAR FONT, STYLE, SIZE, OR COLOR.

NO CLAIM IS MADE TO THE EXCLUSIVE RIGHT TO USE NO CLAIM IS MADE TO THE EXCLUSIVE RIGHT TO USE "CAFFEINATED ICE CREAM" APART FROM THE MARK AS SHOWN., APART FROM THE MARK AS SHOWN.

SN 85-022,627, FILED 4-25-2010.

CHRISTOPHER BUONGIORNO, EXAMINING ATTORNEY



*David J. Kyros*

Director of the United States Patent and Trademark Office

# United States of America

## United States Patent and Trademark Office



**Reg. No. 4,136,034**

**Registered May 1, 2012**

**Int. Cls.: 9, 16, and 45**

**TRADEMARK**

**SERVICE MARK**

**PRINCIPAL REGISTER**

CAIL, MARY MCDANIEL (UNITED STATES INDIVIDUAL)  
4495 OLDFIELDS ROAD  
FREE UNION, VA 22940

FOR: ELECTRONIC PUBLICATIONS, NAMELY, NON-FICTION BOOKS, BOOKLETS, GUIDES, MANUALS, PAMPHLETS AND BROCHURES, IN THE FIELD OF HELPING PEOPLE MAINTAIN SUPPORTIVE RELATIONSHIPS WITH FRIENDS WHO ARE DEALING WITH DIFFICULT EMOTIONAL, PSYCHOLOGICAL AND MEDICAL PROBLEMS, CONDITIONS, AND CIRCUMSTANCES RECORDED ON DIGITAL MEDIA, NAMELY, COMPACT DISCS, DIGITAL VIDEO DISCS, AUDIO AND VIDEO CASSETTES AND DOWNLOADABLE FILES, IN CLASS 9 (U.S. CLS. 21, 23, 26, 36 AND 38).

FIRST USE 8-29-2011; IN COMMERCE 12-16-2011.

FOR: NON-FICTION BOOKS AND OTHER PRINTED MATTER, NAMELY, BOOKLETS, GUIDES, MANUALS, PAMPHLETS AND BROCHURES, IN THE FIELD OF HELPING PEOPLE MAINTAIN SUPPORTIVE RELATIONSHIPS WITH FRIENDS WHO ARE DEALING WITH DIFFICULT EMOTIONAL, PSYCHOLOGICAL AND MEDICAL PROBLEMS, CONDITIONS, AND CIRCUMSTANCES, IN CLASS 16 (U.S. CLS. 2, 5, 22, 23, 29, 37, 38 AND 50).

FIRST USE 8-29-2011; IN COMMERCE 9-9-2011.

FOR: PROVIDING INFORMATION VIA AN INTERACTIVE WEB SITE REGARDING MAINTAINING SUPPORTIVE INTERPERSONAL RELATIONSHIPS WITH FRIENDS WHO ARE DEALING WITH DIFFICULT EMOTIONAL, PSYCHOLOGICAL OR MEDICAL PROBLEMS, CONDITIONS, OR CIRCUMSTANCES; PROVIDING AN INTERACTIVE WEB SITE FEATURING INFORMATION AND CONSULTATION REGARDING HELPING PEOPLE MAINTAIN SUPPORTIVE RELATIONSHIPS WITH FRIENDS WHO ARE DEALING WITH DIFFICULT EMOTIONAL, PSYCHOLOGICAL OR MEDICAL PROBLEMS, CONDITIONS, OR CIRCUMSTANCES, IN CLASS 45 (U.S. CLS. 100 AND 101).

FIRST USE 8-29-2011; IN COMMERCE 9-9-2011.

THE MARK CONSISTS OF A MAN AND A WOMAN WALKING TOGETHER UNDER AN UMBRELLA.

SN 85-022,896, FILED 4-26-2010.



*David J. Kyffers*

Director of the United States Patent and Trademark Office

**Reg. No. 4,136,034** RAUL CORDOVA, EXAMINING ATTORNEY

# United States of America

United States Patent and Trademark Office

## Books to help friends be friends when it matters most

**Reg. No. 4,136,035**

**Registered May 1, 2012**

**Int. Cl.: 45**

**SERVICE MARK**

**PRINCIPAL REGISTER**

CAIL, MARY MCDANIEL (UNITED STATES INDIVIDUAL)  
4495 OLDFIELDS ROAD  
FREE UNION, VA 22940

FOR: PROVIDING INFORMATION VIA AN INTERACTIVE WEB SITE REGARDING MAINTAINING SUPPORTIVE INTERPERSONAL RELATIONSHIPS WITH FRIENDS WHO ARE DEALING WITH DIFFICULT EMOTIONAL, PSYCHOLOGICAL OR MEDICAL PROBLEMS, CONDITIONS, OR CIRCUMSTANCES; PROVIDING AN INTERACTIVE WEB SITE FEATURING EDUCATIONAL INFORMATION REGARDING HELPING PEOPLE MAINTAIN SUPPORTIVE RELATIONSHIPS WITH FRIENDS WHO ARE DEALING WITH DIFFICULT EMOTIONAL, PSYCHOLOGICAL OR MEDICAL PROBLEMS, CONDITIONS, OR CIRCUMSTANCES, IN CLASS 45 (U.S. CLS. 100 AND 101).

FIRST USE 8-29-2011; IN COMMERCE 9-9-2011.

THE MARK CONSISTS OF STANDARD CHARACTERS WITHOUT CLAIM TO ANY PARTICULAR FONT, STYLE, SIZE, OR COLOR.

SN 85-022,900, FILED 4-26-2010.

RAUL CORDOVA, EXAMINING ATTORNEY



*David J. Kybas*

Director of the United States Patent and Trademark Office

# United States of America

United States Patent and Trademark Office

**rocket**  
**boost**  
w i r e l e s s

**Reg. No. 4,136,036**

**Registered May 1, 2012**

**Int. Cl.: 9**

**TRADEMARK**

**PRINCIPAL REGISTER**

BBY SOLUTIONS, INC. (MINNESOTA CORPORATION)  
7601 PENN AVENUE SOUTH  
RICHFIELD, MN 55423

FOR: WIRELESS CONTENT DISTRIBUTION SYSTEMS FOR USE IN CONSUMER ELECTRONICS, PERSONAL COMPUTERS AND COMPUTER PERIPHERALS COMPRISING COMPUTER CHIPSETS, HARDWARE, AND SOFTWARE FOR WIRELESSLY TRANSMITTING OR RECEIVING AUDIO OR MULTIMEDIA CONTENT AND CONTROLLING PLAYBACK OF THAT CONTENT, IN CLASS 9 (U.S. CLS. 21, 23, 26, 36 AND 38).

FIRST USE 1-23-2012; IN COMMERCE 1-23-2012.

OWNER OF U.S. REG. NO. 3,788,696.

NO CLAIM IS MADE TO THE EXCLUSIVE RIGHT TO USE "WIRELESS", APART FROM THE MARK AS SHOWN.

THE MARK CONSISTS OF THREE CURVED LINES OF DIFFERENT LENGTHS TO THE LEFT OF "BOOST" REPRESENTING STYLIZED RADIO WAVES.

SN 85-023,278, FILED 4-26-2010.

SOPHIA S. KIM, EXAMINING ATTORNEY



*David J. Kyros*

Director of the United States Patent and Trademark Office

# United States of America

United States Patent and Trademark Office

## SPEED STACK PUMPED N.O.

**Reg. No. 4,136,037**

**Registered May 1, 2012**

**Int. Cl.: 5**

**TRADEMARK**

**PRINCIPAL REGISTER**

ON OPTIMUM NUTRITION LIMITED (IRELAND LIMITED COMPANY (LTD.))  
GLANBIA HOUSE  
KILKENNY CITY, IRELAND

FOR: POWDERED NUTRITIONAL SUPPLEMENT DRINK MIX, IN CLASS 5 (U.S. CLS. 6, 18, 44, 46, 51 AND 52).

FIRST USE 3-2-2012; IN COMMERCE 3-2-2012.

THE MARK CONSISTS OF STANDARD CHARACTERS WITHOUT CLAIM TO ANY PARTICULAR FONT, STYLE, SIZE, OR COLOR.

OWNER OF U.S. REG. NOS. 2,867,016 AND 3,138,060.

NO CLAIM IS MADE TO THE EXCLUSIVE RIGHT TO USE "STACK" AND "N.O.", APART FROM THE MARK AS SHOWN.

SN 85-024,109, FILED 4-27-2010.

MICHAEL ENGEL, EXAMINING ATTORNEY



*David J. Kyros*

Director of the United States Patent and Trademark Office



# United States of America

United States Patent and Trademark Office

# VISIONLINK

**Reg. No. 4,136,038**

**Registered May 1, 2012**

**Int. Cl.: 42**

**SERVICE MARK**

**PRINCIPAL REGISTER**

TRIMBLE NAVIGATION LIMITED (CALIFORNIA CORPORATION)  
935 STEWART DRIVE  
SUNNYVALE, CA 94085

FOR: PROVIDING ON-LINE NON-DOWNLOADABLE SOFTWARE FOR USE IN TRACKING, MONITORING AND MANAGING FIELD ASSETS, INCLUDING, BUT NOT LIMITED TO, VEHICLES, CONSTRUCTION AND AGRICULTURAL EQUIPMENT, OVER COMPUTER NETWORKS, INTRANETS AND THE INTERNET; PROVIDING ON-LINE NON-DOWNLOADABLE SOFTWARE FOR USE IN TRACKING COSTS ASSOCIATED WITH FIELD ASSETS, INCLUDING, BUT NOT LIMITED TO, CONSTRUCTION PAVING, QUARRY, MINING, FORESTRY, WASTE EQUIPMENT, TRACTORS, COMBINES, AND MOTORIZED VEHICLES, FOR THE PURPOSE OF GENERATING COST ESTIMATES AND BIDS; PROVIDING ON-LINE NON-DOWNLOADABLE SOFTWARE FOR USE IN REMOTELY SECURING CONSTRUCTION EQUIPMENT AND VEHICLES FROM UNAUTHORIZED OR HAZARDOUS USE, AND FOR USE IN PREVENTING COLLISIONS BETWEEN CONSTRUCTION EQUIPMENT AND VEHICLES, AND PREVENTING CONTACT BETWEEN CONSTRUCTION EQUIPMENT AND VEHICLES AND UNDERGROUND UTILITIES, IN CLASS 42 (U.S. CLS. 100 AND 101).

FIRST USE 9-0-2010; IN COMMERCE 9-0-2010.

THE MARK CONSISTS OF STANDARD CHARACTERS WITHOUT CLAIM TO ANY PARTICULAR FONT, STYLE, SIZE, OR COLOR.

SN 85-024,377, FILED 4-27-2010.

LIEF MARTIN, EXAMINING ATTORNEY



*David J. Kyffers*

Director of the United States Patent and Trademark Office

# United States of America

United States Patent and Trademark Office

# CaliBabi

**Reg. No. 4,136,039**

**Registered May 1, 2012**

**Int. Cls.: 25 and 40**

**TRADEMARK**

**SERVICE MARK**

**PRINCIPAL REGISTER**

MAHAFFEY, CATHIALEEN M (UNITED STATES JOINT APPLICANT)  
1041 PALOMINO RD  
1041 PALOMINO RD  
SANTA BARBARA, CA 93105 AND

SOTO, ELLIOT D (UNITED STATES JOINT APPLICANT)  
1041 PALOMINO RD  
SANTA BARBARA, CA 93015

FOR: A-SHIRTS; ATHLETIC APPAREL, NAMELY, SHIRTS, PANTS, JACKETS, FOOTWEAR, HATS AND CAPS, ATHLETIC UNIFORMS; BABY BIBS NOT OF PAPER; BABY BODYSUITS; BABY BOTTOMS; BABY BUNTING; BABY DOLL PYJAMAS; BABY LAYETTES FOR CLOTHING; BABY TOPS; BATHING COSTUMES FOR WOMEN; BATHING SUITS FOR MEN; BODY SHIRTS; CHILDREN'S AND INFANT'S APPAREL, NAMELY, JUMPERS, OVERALL SLEEPWEAR, PAJAMAS, ROMPERS AND ONE-PIECE GARMENTS; CHILDREN'S AND INFANTS' CLOTH BIBS; CHILDREN'S CLOTH EATING BIBS; CHILDREN'S HEADWEAR; COSTUMES FOR USE IN CHILDREN'S DRESS UP PLAY; HATS FOR INFANTS, BABIES, TODDLERS AND CHILDREN; HOODED SWEAT SHIRTS; MOISTURE-WICKING SPORTS SHIRTS; OVER SHIRTS; PIQUE SHIRTS; PLASTIC BABY BIBS; SHIRTS; SHIRTS AND SHORT-SLEEVED SHIRTS; SHIRTS FOR INFANTS, BABIES, TODDLERS AND CHILDREN; SHORT-SLEEVED OR LONG-SLEEVED T-SHIRTS; T-SHIRTS; TEE SHIRTS; WEARABLE GARMENTS AND CLOTHING, NAMELY, SHIRTS; WIND SHIRTS, IN CLASS 25 (U.S. CLS. 22 AND 39).

FIRST USE 7-0-2011; IN COMMERCE 7-0-2011.

FOR: CUSTOM IMPRINTING OF CLOTHING AND FABRIC WITH DECORATIVE DESIGNS; EMBOSsing SERVICES, NAMELY, EMBOSsing WORDS, DESIGNS OR IMAGES ON CLOTHING AND FABRIC; EMBROIDERING; EMBROIDERY; IMPRINTING MESSAGES ON T-SHIRTS; IMPRINTING MESSAGES ON WEARING APPAREL, ACCESSORIES AND MUGS; SCREEN PRINTING; SILK SCREEN PAINTING; SILK SCREEN PRINTING, IN CLASS 40 (U.S. CLS. 100, 103 AND 106).

FIRST USE 7-0-2011; IN COMMERCE 7-0-2011.

THE MARK CONSISTS OF THE WORDING "CALIBABI" IN STYLIZED FONT.



*David J. Kyros*

Director of the United States Patent and Trademark Office

**Reg. No. 4,136,039** SN 85-024,852, FILED 4-28-2010.

KEVON CHISOLM, EXAMINING ATTORNEY

# United States of America

United States Patent and Trademark Office

# ALTRU

**Reg. No. 4,136,040**

**Registered May 1, 2012**

**Int. Cls.: 41 and 42**

**SERVICE MARK**

**PRINCIPAL REGISTER**

BLACKBAUD, INC. (DELAWARE CORPORATION)  
2000 DANIEL ISLAND DRIVE  
CHARLESTON, SC 294927541

FOR: PROVIDING TRAINING FOR AN ONLINE NON-DOWNLOADABLE CUSTOMER RELATIONSHIP MANAGEMENT (CRM) SOFTWARE AND SOFTWARE PLATFORM FOR USE BY CHARITABLE, NONPROFIT, FUNDRAISING, AND EDUCATIONAL ORGANIZATIONS IN CREATING AND MANAGING RELATIONSHIPS WITH DONORS, PROSPECTIVE DONORS, MEMBERS, AND VOLUNTEERS, IN MARKETING, IN SOLICITING CONTRIBUTIONS, AND IN ORGANIZING AND MANAGING FUNDRAISING EVENTS, IN CLASS 41 (U.S. CLS. 100, 101 AND 107).

FIRST USE 5-19-2010; IN COMMERCE 5-19-2010.

FOR: ONLINE NON-DOWNLOADABLE CUSTOMER RELATIONSHIP MANAGEMENT (CRM) SOFTWARE AND SOFTWARE PLATFORM FOR USE BY CHARITABLE, NONPROFIT, FUNDRAISING, AND EDUCATIONAL ORGANIZATIONS IN CREATING AND MANAGING RELATIONSHIPS WITH DONORS, PROSPECTIVE DONORS, MEMBERS, AND VOLUNTEERS, IN MARKETING, IN SOLICITING CONTRIBUTIONS, AND IN ORGANIZING AND MANAGING FUNDRAISING EVENTS; AND PROVIDING SOFTWARE IMPLEMENTATION, SOFTWARE CONSULTING, AND SOFTWARE CUSTOMIZATION FOR AN ONLINE NON-DOWNLOADABLE CUSTOMER RELATIONSHIP MANAGEMENT (CRM) SOFTWARE AND SOFTWARE PLATFORM FOR USE BY CHARITABLE, NONPROFIT, FUNDRAISING, AND EDUCATIONAL ORGANIZATIONS IN CREATING AND MANAGING RELATIONSHIPS WITH DONORS, PROSPECTIVE DONORS, MEMBERS, AND VOLUNTEERS, IN MARKETING, IN SOLICITING CONTRIBUTIONS, AND IN ORGANIZING AND MANAGING FUNDRAISING EVENTS, IN CLASS 42 (U.S. CLS. 100 AND 101).

FIRST USE 5-19-2010; IN COMMERCE 5-19-2010.

THE MARK CONSISTS OF STANDARD CHARACTERS WITHOUT CLAIM TO ANY PARTICULAR FONT, STYLE, SIZE, OR COLOR.

SN 85-027,042, FILED 4-30-2010.

BRENDAN REGAN, EXAMINING ATTORNEY



*David J. Kyros*

Director of the United States Patent and Trademark Office

# United States of America

United States Patent and Trademark Office

## Raul Perez y Richard Perez RP+RP

**Reg. No. 4,136,041**

**Registered May 1, 2012**

**Int. Cl.: 33**

**TRADEMARK**

**PRINCIPAL REGISTER**

OLE IMPORTS LLC (NEW YORK LIMITED LIABILITY COMPANY), AKA OLE,  
SUITE 405  
NEW ROCHELLE, NY 10801

FOR: WINE, IN CLASS 33 (U.S. CLS. 47 AND 49).

FIRST USE 2-8-2012; IN COMMERCE 2-8-2012.

THE MARK CONSISTS OF STANDARD CHARACTERS WITHOUT CLAIM TO ANY PARTICULAR FONT, STYLE, SIZE, OR COLOR.

THE NAME(S), PORTRAIT(S), AND/OR SIGNATURE(S) SHOWN IN THE MARK IDENTIFIES "RAUL PEREZ AND RICHARD PEREZ", WHOSE CONSENT(S) TO REGISTER IS MADE OF RECORD.

THE ENGLISH TRANSLATION OF THE WORD "Y" IN THE MARK IS "AND".

SN 85-028,082, FILED 5-1-2010.

AMY KERTGATE, EXAMINING ATTORNEY



*David J. Kyros*

Director of the United States Patent and Trademark Office

# United States of America

United States Patent and Trademark Office

# DCN

**Reg. No. 4,136,042**

**Registered May 1, 2012**

**Int. Cl.: 36**

**SERVICE MARK**

**PRINCIPAL REGISTER**

THE BANK OF NEW YORK MELLON CORPORATION (DELAWARE CORPORATION)  
ONE WALL STREET  
15TH FLOOR  
NEW YORK, NY 10286

FOR: FINANCIAL SERVICES, NAMELY, PROVIDING DERIVATIVES COLLATERAL AND MARGIN MANAGEMENT AND ADMINISTRATIVE SERVICES TO INSTITUTIONAL CLIENTS VIA A GLOBAL COMMUNICATION NETWORK, IN CLASS 36 (U.S. CLS. 100, 101 AND 102).

FIRST USE 2-17-2009; IN COMMERCE 2-17-2009.

THE MARK CONSISTS OF STANDARD CHARACTERS WITHOUT CLAIM TO ANY PARTICULAR FONT, STYLE, SIZE, OR COLOR.

SN 85-029,608, FILED 5-4-2010.

DEIRDRE ROBERTSON, EXAMINING ATTORNEY



*David J. Kyffers*

Director of the United States Patent and Trademark Office

# United States of America

United States Patent and Trademark Office

## FRESH INFUSIONS

**Reg. No. 4,136,043**

**Registered May 1, 2012**

**Int. Cl.: 3**

**TRADEMARK**

**PRINCIPAL REGISTER**

COLGATE-PALMOLIVE COMPANY (DELAWARE CORPORATION)  
300 PARK AVENUE  
NEW YORK, NY 10022

FOR: DEODORANTS AND ANTIPERSPIRANTS FOR PERSONAL USE, IN CLASS 3 (U.S. CLS. 1, 4, 6, 50, 51 AND 52).

FIRST USE 8-1-2010; IN COMMERCE 8-1-2010.

THE MARK CONSISTS OF STANDARD CHARACTERS WITHOUT CLAIM TO ANY PARTICULAR FONT, STYLE, SIZE, OR COLOR.

OWNER OF U.S. REG. NO. 3,006,450.

SN 85-029,813, FILED 5-4-2010.

MARK SHINER, EXAMINING ATTORNEY



*David J. Kybas*

Director of the United States Patent and Trademark Office

# United States of America

United States Patent and Trademark Office

## MEDICAID FAST

**Reg. No. 4,136,044**

**Registered May 1, 2012**

**Int. Cl.: 42**

**SERVICE MARK**

**PRINCIPAL REGISTER**

BENEFIT INNOVATIONS LLC (ILLINOIS LIMITED LIABILITY COMPANY)  
400 SKOKIE BLVD, STE 380  
NORTHBROOK, IL 60062

FOR: PROVIDING TEMPORARY USE OF A WEB-BASED SOFTWARE APPLICATION FOR THE PREPARATION, PROCESSING, TRACKING AND MANAGEMENT OF MEDICAID AND VETERAN'S ADMINISTRATION BENEFIT APPLICATIONS, IN CLASS 42 (U.S. CLS. 100 AND 101).

FIRST USE 1-2-2012; IN COMMERCE 1-2-2012.

THE MARK CONSISTS OF STANDARD CHARACTERS WITHOUT CLAIM TO ANY PARTICULAR FONT, STYLE, SIZE, OR COLOR.

NO CLAIM IS MADE TO THE EXCLUSIVE RIGHT TO USE "MEDICAID", APART FROM THE MARK AS SHOWN.

SN 85-032,790, FILED 5-7-2010.

BARNEY CHARLON, EXAMINING ATTORNEY



*David J. Kybas*

Director of the United States Patent and Trademark Office



# United States of America

United States Patent and Trademark Office



**Reg. No. 4,136,045**

**Registered May 1, 2012**

**Int. Cls.: 20 and 24**

**TRADEMARK**

**PRINCIPAL REGISTER**

SEALY TECHNOLOGY LLC (NORTH CAROLINA LIMITED LIABILITY COMPANY)  
ONE OFFICE PARKWAY  
TRINITY, NC 27370

FOR: MATTRESSES AND PILLOWS, IN CLASS 20 (U.S. CLS. 2, 13, 22, 25, 32 AND 50).

FIRST USE 12-1-2009; IN COMMERCE 2-1-2010.

FOR: BEDDING, NAMELY, COMFORTERS, SHEETS AND MATTRESS PADS, IN CLASS 24 (U.S. CLS. 42 AND 50).

FIRST USE 12-1-2009; IN COMMERCE 2-1-2010.

THE MARK CONSISTS OF TWO CURVED LINES.

SN 85-033,224, FILED 5-7-2010.

JOHN DWYER, EXAMINING ATTORNEY



*David J. Kyffers*

Director of the United States Patent and Trademark Office

# United States of America

United States Patent and Trademark Office

## Grow n' Show Puzzle Buddy

**Reg. No. 4,136,046**

AMKIDS INCORPORATED (NEBRASKA CORPORATION)  
2116 VIKING ROAD  
GRAND ISLAND, NE 68803

**Registered May 1, 2012**

**Int. Cl.: 20**

FOR: SHELVING RACK IN THE SHAPE OF INTERLOCKED PUZZLE PIECES FOR STORING AND HANGING OBJECTS ON THE SHELVES OF PROTRUDING PUZZLE EDGES AND ALSO FEATURING A GROWTH CHART FOR THE PURPOSE OF MEASURING CHILDREN'S GROWTH, IN CLASS 20 (U.S. CLS. 2, 13, 22, 25, 32 AND 50).

**TRADEMARK**

**PRINCIPAL REGISTER**

FIRST USE 4-18-2009; IN COMMERCE 4-18-2009.

THE MARK CONSISTS OF STANDARD CHARACTERS WITHOUT CLAIM TO ANY PARTICULAR FONT, STYLE, SIZE, OR COLOR.

NO CLAIM IS MADE TO THE EXCLUSIVE RIGHT TO USE "PUZZLE", APART FROM THE MARK AS SHOWN.

SN 85-033,537, FILED 5-7-2010.

GRETТА YAO, EXAMINING ATTORNEY



*David J. Kyros*

Director of the United States Patent and Trademark Office

# United States of America

United States Patent and Trademark Office

## NO JERKS ALLOWED

**Reg. No. 4,136,047**

CONNECTRIA CORPORATION (MISSOURI CORPORATION)  
10845 OLIVE BOULEVARD, SUITE 300  
ST. LOUIS, MO 63141

**Registered May 1, 2012**

**Int. Cls.: 37, 38, and 42**

FOR: TECHNICAL SUPPORT SERVICES, NAMELY, TROUBLESHOOTING IN THE NATURE OF DIAGNOSIS OF PROBLEMS OF VIRTUAL COMPUTING ENVIRONMENTS AND THEIR CORE COMPONENTS, NAMELY, COMPUTER HARDWARE, NETWORKING HARDWARE, AND SECURITY HARDWARE, IN CLASS 37 (U.S. CLS. 100, 103 AND 106).

**SERVICE MARK**

**PRINCIPAL REGISTER**

FIRST USE 1-31-2012; IN COMMERCE 1-31-2012.

FOR: PROVIDING MULTIPLE-USER ACCESS TO A GLOBAL COMPUTER INFORMATION NETWORK; PROVIDING ACCESS TO VIRTUAL COMPUTING RESOURCES NAMELY, COMPUTER PROGRAMS IN DATA NETWORKS, HOSTED OPERATING SYSTEMS IN THE NATURE OF PROGRAMS IN DATA NETWORKS AND COMPUTER APPLICATIONS IN THE NATURE OF PROGRAMS IN DATA NETWORKS; COMPUTER SERVICES, NAMELY, PROVIDING ACCESS TO VIRTUAL COMPUTING ENVIRONMENTS OF VARIABLE CAPACITY, CONSISTING OF VIRTUALIZED COMPUTER HARDWARE, COMPUTER SOFTWARE, INTERNET CONNECTIVITY, COMPUTER AND NETWORK SECURITY, AND DATA STORAGE FACILITIES THROUGH A GLOBAL COMPUTER NETWORK AND ORGANIZATIONAL NETWORKS, IN CLASS 38 (U.S. CLS. 100, 101 AND 104).

FIRST USE 1-31-2012; IN COMMERCE 1-31-2012.

FOR: HOSTING WEBSITES, DATA, DIGITAL CONTENT, AND SOFTWARE APPLICATIONS OF OTHERS ON COMPUTERS CONNECTED TO A GLOBAL COMPUTER NETWORK OR OTHER NETWORKS; TECHNICAL SUPPORT SERVICES, NAMELY, MANAGING, MONITORING, CONSULTING AND TROUBLESHOOTING IN THE NATURE OF DIAGNOSIS OF PROBLEMS IN COMPUTER SERVERS, WEBSITES, DATA, DIGITAL CONTENT, AND SOFTWARE APPLICATIONS OF OTHERS ON GLOBAL COMPUTER NETWORK OR OTHER NETWORKS; TECHNICAL SUPPORT SERVICES, NAMELY, TROUBLESHOOTING IN THE NATURE OF DIAGNOSIS OF PROBLEMS AND DAILY OPERATIONAL SUPPORT OF VIRTUAL COMPUTING ENVIRONMENTS AND THEIR CORE COMPONENTS, NAMELY, COMPUTER SOFTWARE, INTERNET BANDWIDTH, NETWORKING SOFTWARE, SECURITY SOFTWARE, AND DATA STORAGE SYSTEMS; COMPUTER SERVICES, NAMELY, INSTALLATION OF BUSINESS APPLICATION SOFTWARE VIA ELECTRONIC COMMUNICATIONS NETWORKS; CREATING AND MAINTAINING CUSTOM WEB SITES FOR OTHERS;



*David J. Kybas*

Director of the United States Patent and Trademark Office

**Reg. No. 4,136,047** CUSTOM COMPUTER SOFTWARE DESIGN FOR OTHERS; COMPUTER CONSULTING SERVICES IN THE FIELDS OF INFORMATION TECHNOLOGY, SOFTWARE DEVELOPMENT, AND INTEGRATION OF COMPUTER NETWORKS, IN CLASS 42 (U.S. CLS. 100 AND 101).

FIRST USE 1-31-2012; IN COMMERCE 1-31-2012.

THE MARK CONSISTS OF STANDARD CHARACTERS WITHOUT CLAIM TO ANY PARTICULAR FONT, STYLE, SIZE, OR COLOR.

SN 85-034,425, FILED 5-10-2010.

FRED CARL, EXAMINING ATTORNEY

# United States of America

United States Patent and Trademark Office

# FLUIDPOST

**Reg. No. 4,136,048**

**Registered May 1, 2012**

**Int. Cl.: 25**

**TRADEMARK**

**PRINCIPAL REGISTER**

MONTRAIL CORPORATION (OREGON CORPORATION)  
14375 NW SCIENCE PARK DRIVE  
PORTLAND, OR 97229

FOR: FOOTWEAR, IN CLASS 25 (U.S. CLS. 22 AND 39).

FIRST USE 5-31-2011; IN COMMERCE 5-31-2011.

THE MARK CONSISTS OF STANDARD CHARACTERS WITHOUT CLAIM TO ANY PARTICULAR FONT, STYLE, SIZE, OR COLOR.

SN 85-034,518, FILED 5-10-2010.

TARA PATE, EXAMINING ATTORNEY



*David J. Kyffers*

Director of the United States Patent and Trademark Office

# United States of America

United States Patent and Trademark Office

# IE

**Reg. No. 4,136,049**

**Registered May 1, 2012**

**Int. Cls.: 1 and 9**

**TRADEMARK**

**PRINCIPAL REGISTER**

DAICEL CORPORATION (JAPAN CORPORATION)  
3-4-5, UMEDA, KITA-KU  
OSAKA-SHI, OSAKA, JAPAN

FOR: PACKING MATERIALS FOR USE IN LIQUID CHROMATOGRAPHY COLUMNS, IN CLASS 1 (U.S. CLS. 1, 5, 6, 10, 26 AND 46).

FIRST USE 1-1-2012; IN COMMERCE 1-1-2012.

FOR: LIQUID CHROMATOGRAPHY COLUMNS, IN CLASS 9 (U.S. CLS. 21, 23, 26, 36 AND 38).

FIRST USE 1-1-2012; IN COMMERCE 1-1-2012.

THE MARK CONSISTS OF STANDARD CHARACTERS WITHOUT CLAIM TO ANY PARTICULAR FONT, STYLE, SIZE, OR COLOR.

SN 85-036,386, FILED 5-12-2010.

DOMINIC J. FERRAIUOLO, EXAMINING ATTORNEY



*David J. Kyros*

Director of the United States Patent and Trademark Office

# United States of America

United States Patent and Trademark Office

## EAST COAST BADBOYZ & BADGIRLZ MOTORCYCLE CLUB

**Reg. No. 4,136,050**

**Registered May 1, 2012**

**Int. Cl.: 25**

**TRADEMARK**

**PRINCIPAL REGISTER**

JOHNSON, DAVID (UNITED STATES INDIVIDUAL)  
254 CLARK STREET  
HILLSIDE, NJ 07205

FOR: T SHIRTS, VESTS, IN CLASS 25 (U.S. CLS. 22 AND 39).

FIRST USE 7-2-2000; IN COMMERCE 7-2-2000.

THE MARK CONSISTS OF STANDARD CHARACTERS WITHOUT CLAIM TO ANY PARTICULAR FONT, STYLE, SIZE, OR COLOR.

NO CLAIM IS MADE TO THE EXCLUSIVE RIGHT TO USE "EAST COAST", APART FROM THE MARK AS SHOWN.

SN 85-036,469, FILED 5-12-2010.

ROBIN MITTLER, EXAMINING ATTORNEY



*David J. Kyffers*

Director of the United States Patent and Trademark Office

# United States of America

United States Patent and Trademark Office



**Reg. No. 4,136,051**

**Registered May 1, 2012**

**Int. Cl.: 3**

**TRADEMARK**

**PRINCIPAL REGISTER**

WELDON, HEATHERLEIGH (UNITED STATES INDIVIDUAL), DBA PEACE OF SOAP COMPANY,  
6732 SW 196TH AVENUE  
ALOHA, OR 97007

FOR: AROMATIC BODY CARE PRODUCTS, NAMELY, BODY LOTION, SHOWER GEL, CUTICLE CREAM, SHAMPOO, CONDITIONER, NON-MEDICATED LIP BALM, SOAP, BODY POLISH, BODY AND FOOT SCRUB AND NON-MEDICATED FOOT CREAM; BAR SOAP; BATH SOAPS; HAND SOAPS; LAUNDRY SOAP; LIQUID BATH SOAPS; LIQUID SOAP; LIQUID SOAPS; LIQUID SOAPS FOR HANDS AND FACE; LIQUID SOAPS FOR HANDS, FACE AND BODY; NATURAL COCOA BUTTER BASED PERSONAL CARE PRODUCTS, NAMELY, BODY LOTION, SHOWER GEL, SOAP, BODY POLISH, BODY AND FOOT SCRUB AND NON-MEDICATED SKIN CREAMS; SHAVING SOAP; SHAVING SOAPS; SKIN SOAP; SOAPS FOR BODY CARE; SOAPS FOR HOUSEHOLD USE; SOAPS FOR PERSONAL USE, IN CLASS 3 (U.S. CLS. 1, 4, 6, 50, 51 AND 52).

FIRST USE 1-1-2000; IN COMMERCE 5-25-2006.

NO CLAIM IS MADE TO THE EXCLUSIVE RIGHT TO USE "COMPANY", APART FROM THE MARK AS SHOWN.

THE COLOR(S) YELLOW, WHITE, BLUE, RED, ORANGE AND GRAY IS/ARE CLAIMED AS A FEATURE OF THE MARK.

THE MARK CONSISTS OF A BLUE CIRCLE WITH THE YELLOW WORDING "PEACE OF SOAP COMPANY" OUTLINED IN BLUE WITH GRAY SHADING. THE WORDING APPEARS AROUND THE EDGE OF THE CIRCLE. INSIDE THE CIRCLE APPEARS A WHITE AND GRAY DAISY WITH A RED, ORANGE AND YELLOW CENTER CONTAINING A BLUE PEACE SIGN OUTLINED IN YELLOW.

SN 85-037,868, FILED 5-13-2010.

ROBERT STRUCK, EXAMINING ATTORNEY



*David J. Kyffers*

Director of the United States Patent and Trademark Office



# United States of America

United States Patent and Trademark Office

# NORPACM3

**Reg. No. 4,136,052**

NORPAC LLC (MINNESOTA LIMITED LIABILITY COMPANY)  
22400 INDUSTRIAL BLVD.  
ROGERS, MN 55374

**Registered May 1, 2012**

**Int. Cl.: 22**

FOR: TENT ACCESSORIES IN THE NATURE OF FABRIC TENT LINERS FOR USE IN EXTREME WEATHER, IN CLASS 22 (U.S. CLS. 1, 2, 7, 19, 22, 42 AND 50).

**TRADEMARK**

FIRST USE 1-1-2011; IN COMMERCE 1-1-2011.

**PRINCIPAL REGISTER**

THE MARK CONSISTS OF STANDARD CHARACTERS WITHOUT CLAIM TO ANY PARTICULAR FONT, STYLE, SIZE, OR COLOR.

SN 85-038,546, FILED 5-14-2010.

FRED CARL, EXAMINING ATTORNEY



*David J. Kyffers*

Director of the United States Patent and Trademark Office

# United States of America

United States Patent and Trademark Office

## SOLUTIONS FOR LIFE'S TRANSITIONS

**Reg. No. 4,136,053**

**Registered May 1, 2012**

**Int. Cls.: 36 and 45**

**SERVICE MARK**

**PRINCIPAL REGISTER**

SPANO, STEPHEN J. (UNITED STATES INDIVIDUAL), DBA LAW OFFICES OF SPANO & DAWICKI,  
P.O. BOX 1345  
SAUGUS, MA 01906

FOR: FINANCIAL CONSULTING; FINANCIAL PLANNING; FINANCIAL PLANNING CONSULTATION, IN CLASS 36 (U.S. CLS. 100, 101 AND 102).

FIRST USE 3-1-2004; IN COMMERCE 5-12-2010.

FOR: LEGAL SERVICES, IN CLASS 45 (U.S. CLS. 100 AND 101).

FIRST USE 3-1-2004; IN COMMERCE 5-12-2010.

THE MARK CONSISTS OF STANDARD CHARACTERS WITHOUT CLAIM TO ANY PARTICULAR FONT, STYLE, SIZE, OR COLOR.

SN 85-040,102, FILED 5-17-2010.

JEFF DEFORD, EXAMINING ATTORNEY



*David J. Kybas*

Director of the United States Patent and Trademark Office

# United States of America

United States Patent and Trademark Office

## SANDHILL CAFÉ

**Reg. No. 4,136,054**

**Registered May 1, 2012**

**Int. Cls.: 25 and 43**

**TRADEMARK**

**SERVICE MARK**

**PRINCIPAL REGISTER**

GUN LAKE TRIBAL GAMING AUTHORITY (UNITED STATES FEDERALLY-RECOGNIZED INDIAN TRIBE)  
1743 142ND AVENUE, SUITE 3  
DORR, MI 49323

FOR: WEARING APPAREL, NAMELY, SHIRTS, T-SHIRTS, IN CLASS 25 (U.S. CLS. 22 AND 39).

FIRST USE 12-1-2010; IN COMMERCE 12-1-2010.

FOR: RESTAURANT, BAR AND COCKTAIL LOUNGE SERVICES, IN CLASS 43 (U.S. CLS. 100 AND 101).

FIRST USE 2-6-2011; IN COMMERCE 2-6-2011.

THE MARK CONSISTS OF STANDARD CHARACTERS WITHOUT CLAIM TO ANY PARTICULAR FONT, STYLE, SIZE, OR COLOR.

NO CLAIM IS MADE TO THE EXCLUSIVE RIGHT TO USE "CAFÉ", APART FROM THE MARK AS SHOWN.

SN 85-042,109, FILED 5-18-2010.

KATHY DE JONGE, EXAMINING ATTORNEY



*David J. Kyros*

Director of the United States Patent and Trademark Office

# United States of America

United States Patent and Trademark Office



**Reg. No. 4,136,055**

**Registered May 1, 2012**

**Int. Cl.: 12**

**TRADEMARK**

**PRINCIPAL REGISTER**

ASIA SEIKO COMPOSITE MATERIAL CO., LTD. (TAIWAN CORPORATION)  
TANZIH TOWNSHIP  
1F., NO. 27, SHENGLI RD.  
TAICHUNG COUNTY, TAIWAN 427

FOR: BICYCLES AND BICYCLE PARTS, NAMELY, BELLS, BRAKES, BRAKE SHOES, CHAINS, FENDERS, FORKS, FRAMES, FRONT FORK JOINTS, GEARS, HANDLE BARS, HANDLE BAR ENDS, HANDLE BAR GRIPS, BICYCLE GRIP TAPE, HANDLE BAR STEMS, HORNS, KICKSTANDS, PEDALS, SADDLE COVERS, SADDLES, SEAT POSTS, SPROCKETS, WATER BOTTLE CAGES, WHEELS; BICYCLE STANDS; BICYCLE PUMPS; BICYCLE TRAINING WHEELS; FRAMES FOR LUGGAGE CARRIERS FOR BICYCLES; SUSPENSION SYSTEMS FOR BICYCLES; WHEEL HUBS FOR BICYCLES; TRICYCLES, IN CLASS 12 (U.S. CLS. 19, 21, 23, 31, 35 AND 44).

FIRST USE 1-24-2010; IN COMMERCE 1-24-2010.

THE MARK CONSISTS OF A TOP VIEW OF A PYRAMID DESIGN BRACKETED BY TWO CURVED LINES.

SN 85-042,592, FILED 5-19-2010.

TIMOTHY FINNEGAN, EXAMINING ATTORNEY



*David J. Kybas*

Director of the United States Patent and Trademark Office

# United States of America

United States Patent and Trademark Office

## TORREGROSSA

**Reg. No. 4,136,056**

**Registered May 1, 2012**

**Int. Cl.: 18**

**TRADEMARK**

**PRINCIPAL REGISTER**

TORREGROSSA, LTD. (NEW YORK CORPORATION)  
1305 79TH STREET  
BROOKLYN, NY 11228

FOR: HANDBAGS AND PURSES, IN CLASS 18 (U.S. CLS. 1, 2, 3, 22 AND 41).

FIRST USE 5-20-2011; IN COMMERCE 5-20-2011.

THE MARK CONSISTS OF STANDARD CHARACTERS WITHOUT CLAIM TO ANY PARTICULAR FONT, STYLE, SIZE, OR COLOR.

SN 85-043,035, FILED 5-19-2010.

CAROLINE WOOD, EXAMINING ATTORNEY



*David J. Kyffers*

Director of the United States Patent and Trademark Office

# United States of America

United States Patent and Trademark Office

## COLOUR ET AL

**Reg. No. 4,136,057**

**Registered May 1, 2012**

**Int. Cl.: 2**

**TRADEMARK**

**PRINCIPAL REGISTER**

COLOUR ET AL (ARIZONA LIMITED LIABILITY COMPANY), DBA AQUADYE LLC,  
3004 W. WELDON AVE.  
PHOENIX, AZ 85017

FOR: COLORANTS, PAINTS AND DYES FOR GENERAL INDUSTRIAL USE, IN CLASS 2  
(U.S. CLS. 6, 11 AND 16).

FIRST USE 9-1-2010; IN COMMERCE 9-1-2010.

THE MARK CONSISTS OF STANDARD CHARACTERS WITHOUT CLAIM TO ANY PAR-  
TICULAR FONT, STYLE, SIZE, OR COLOR.

NO CLAIM IS MADE TO THE EXCLUSIVE RIGHT TO USE "COLOUR", APART FROM THE  
MARK AS SHOWN.

SN 85-044,132, FILED 5-20-2010.

ANNE MADDEN, EXAMINING ATTORNEY



*David J. Kyffers*

Director of the United States Patent and Trademark Office

# United States of America

United States Patent and Trademark Office



**Reg. No. 4,136,058**

**Registered May 1, 2012**

**Int. Cl.: 18**

**TRADEMARK**

**PRINCIPAL REGISTER**

TORREGROSSA, LTD. (NEW YORK CORPORATION)  
1305 79TH STREET  
BROOKLYN, NY 11228

FOR: HANDBAGS AND PURSES, IN CLASS 18 (U.S. CLS. 1, 2, 3, 22 AND 41).

FIRST USE 5-20-2011; IN COMMERCE 5-20-2011.

THE MARK CONSISTS OF AN OVAL, INSIDE OF WHICH IS THE SHADOW DESIGN OF A BIRD ATOP THE SHADOW DESIGN OF A CASTLE AND FLANKED BY THREE STARS ON EITHER SIDE, AND ON THE OUTSIDE OF WHICH APPEARS A SHADOW VINE DESIGN ON EITHER SIDE OF THE OVAL.

SN 85-044,856, FILED 5-21-2010.

CAROLINE WOOD, EXAMINING ATTORNEY



*David J. Kybas*

Director of the United States Patent and Trademark Office

# United States of America

United States Patent and Trademark Office

## EMERGING SKIN CARE

**Reg. No. 4,136,059**

**Registered May 1, 2012**

**Int. Cl.: 3**

**TRADEMARK**

**PRINCIPAL REGISTER**

VLB RESEARCH GROUP, INC (NEW YORK CORPORATION)  
UNIT 2  
10 CHARLES ST  
PLEASANT VALLEY, NY 12569

FOR: NON-MEDICATED SKIN CARE PREPARATIONS, IN CLASS 3 (U.S. CLS. 1, 4, 6, 50, 51 AND 52).

FIRST USE 1-1-2011; IN COMMERCE 4-1-2011.

THE MARK CONSISTS OF STANDARD CHARACTERS WITHOUT CLAIM TO ANY PARTICULAR FONT, STYLE, SIZE, OR COLOR.

NO CLAIM IS MADE TO THE EXCLUSIVE RIGHT TO USE "SKIN CARE", APART FROM THE MARK AS SHOWN.

SN 85-045,011, FILED 5-21-2010.

DAWN HAN, EXAMINING ATTORNEY



*David J. Kyros*

Director of the United States Patent and Trademark Office



# United States of America

United States Patent and Trademark Office

## BIG FORK LITTLE FORK

**Reg. No. 4,136,060**

**Registered May 1, 2012**

**Int. Cls.: 9 and 43**

**TRADEMARK**

**SERVICE MARK**

**PRINCIPAL REGISTER**

KRAFT FOODS GLOBAL BRANDS LLC (DELAWARE LIMITED LIABILITY COMPANY)  
THREE LAKES DRIVE  
NORTHFIELD, IL 60093

FOR: DOWNLOADABLE MOBILE SOFTWARE AND DIGITAL APPLICATIONS FOR ACCESSING RECIPE, FOOD, AND NUTRITION INFORMATION, IN CLASS 9 (U.S. CLS. 21, 23, 26, 36 AND 38).

FIRST USE 9-1-2010; IN COMMERCE 9-1-2010.

FOR: PROVIDING INFORMATION ABOUT RECIPES, FOOD PREPARATION, AND COOKING VIA MOBILE AND DIGITAL SERVICE, IN CLASS 43 (U.S. CLS. 100 AND 101).

FIRST USE 9-1-2010; IN COMMERCE 9-1-2010.

THE MARK CONSISTS OF STANDARD CHARACTERS WITHOUT CLAIM TO ANY PARTICULAR FONT, STYLE, SIZE, OR COLOR.

SN 85-046,967, FILED 5-25-2010.

PAUL E. FAHRENKOPF, EXAMINING ATTORNEY



*David J. Kybas*

Director of the United States Patent and Trademark Office

# United States of America

United States Patent and Trademark Office

## VIÑA ALCANTA

**Reg. No. 4,136,061**

**Registered May 1, 2012**

**Int. Cl.: 33**

**TRADEMARK**

**PRINCIPAL REGISTER**

BODEGAS COOPERATIVAS DE ALICANTE, COOP. V. (SPAIN SOCIEDAD COOPERATIVA)  
AUTOVIA ALICANTE-MADRID KM 39  
PETRER (ALICANTE), SPAIN E-03610

FOR: WINES, IN CLASS 33 (U.S. CLS. 47 AND 49).

FIRST USE 12-23-2008; IN COMMERCE 12-23-2008.

THE MARK CONSISTS OF STANDARD CHARACTERS WITHOUT CLAIM TO ANY PARTICULAR FONT, STYLE, SIZE, OR COLOR.

OWNER OF ERPN CMNTY TM OFC REG. NO. 1796366, DATED 8-7-2000, RENEWED AS REG. NO. 1796366, EXPIRES 7-8-2020.

NO CLAIM IS MADE TO THE EXCLUSIVE RIGHT TO USE "VIÑA", APART FROM THE MARK AS SHOWN.

THE ENGLISH TRANSLATION OF "VIÑA" IN THE MARK IS "VINEYARD".

SN 85-048,821, FILED 5-26-2010.

EVELYN BRADLEY, EXAMINING ATTORNEY



*David J. Kyros*

Director of the United States Patent and Trademark Office

# United States of America

United States Patent and Trademark Office

# IC42

**Reg. No. 4,136,062**

**Registered May 1, 2012**

**Int. Cls.: 42 and 44**

**SERVICE MARK**

**PRINCIPAL REGISTER**

THE REGENTS OF THE UNIVERSITY OF COLORADO (COLORADO CORPORATION)  
1800 GRANT STREET, 8TH FLOOR  
DENVER, CO 80203

FOR: MEDICAL AND SCIENTIFIC RESEARCH IN THE FIELDS OF BIOTECHNOLOGY, PHARMACEUTICAL DEVELOPMENT AND CLINICAL MEDICINE; RESEARCH AND DEVELOPMENT OF TECHNOLOGY IN THE FIELDS OF BIOTECHNOLOGY, PHARMACEUTICAL DEVELOPMENT AND CLINICAL MEDICINE; DIAGNOSTIC SERVICES IN THE FIELDS OF LIQUID CHROMATOGRAPHY MASS SPECTROMETRY, HIGH-PERFORMANCE LIQUID CHROMATOGRAPHY, GAS CHROMATOGRAPHY- MASS SPECTROMETRY, NUCLEAR MAGNETIC RESONANCE SPECTROSCOPY, IMMUNO-ASSAYS AND PROTEIN ARRAY AND CHIP TECHNOLOGIES, IN CLASS 42 (U.S. CLS. 100 AND 101).

FIRST USE 1-1-2011; IN COMMERCE 1-1-2011.

FOR: MEDICAL TESTING FOR DIAGNOSTIC OR TREATMENT PURPOSES; CONSULTING SERVICES IN THE FIELDS OF DIAGNOSTIC MEDICAL TESTING AND NUTRITION, IN CLASS 44 (U.S. CLS. 100 AND 101).

FIRST USE 1-1-2011; IN COMMERCE 1-1-2011.

THE MARK CONSISTS OF STANDARD CHARACTERS WITHOUT CLAIM TO ANY PARTICULAR FONT, STYLE, SIZE, OR COLOR.

SN 85-049,101, FILED 5-27-2010.

ROSELLE HERRERA, EXAMINING ATTORNEY



*David J. Kybas*

Director of the United States Patent and Trademark Office

# United States of America

United States Patent and Trademark Office

# REDI TOP

**Reg. No. 4,136,063**

**Registered May 1, 2012**

**Int. Cl.: 20**

**TRADEMARK**

**PRINCIPAL REGISTER**

MYDEATION, LLC (KANSAS LIMITED LIABILITY COMPANY)  
23826 WEST 69TH TERRACE  
SHAWNEE, KS 66226

FOR: TABLES, NAMELY, FOLDING EXTENDERS FOR TABLETOPS, COUNTERTOPS, WORKSTATIONS, DESKS, WORK SURFACES AND WORKSHOP BENCHES, IN CLASS 20 (U.S. CLS. 2, 13, 22, 25, 32 AND 50).

FIRST USE 9-23-2011; IN COMMERCE 9-23-2011.

THE MARK CONSISTS OF STANDARD CHARACTERS WITHOUT CLAIM TO ANY PARTICULAR FONT, STYLE, SIZE, OR COLOR.

NO CLAIM IS MADE TO THE EXCLUSIVE RIGHT TO USE "TOP", APART FROM THE MARK AS SHOWN.

SN 85-050,672, FILED 5-28-2010.

ELIZABETH HUGHITT, EXAMINING ATTORNEY



*David J. Kyffers*

Director of the United States Patent and Trademark Office

# United States of America

United States Patent and Trademark Office



**Reg. No. 4,136,064**

**Registered May 1, 2012**

**Int. Cl.: 12**

**TRADEMARK**

**PRINCIPAL REGISTER**

CHANGSHA MEIHUA AUTOMOBILE MANUFACTURING CO. LTD. (CHINA LIMITED LIABILITY COMPANY)  
JIANGBEI TOWN  
CHANGSHA, HUNAN, CHINA

FOR: AIRPLANES; ALL-TERRAIN VEHICLES; ANTI-SKID CHAINS FOR VEHICLES; BOATS; FUNICULAR RAILCARS; LOCOMOTIVES; MOTOR CYCLES; MOTORIZED LUGGAGE CARTS; MOTORS FOR LAND VEHICLES; SLEIGHS; TIRES, IN CLASS 12 (U.S. CLS. 19, 21, 23, 31, 35 AND 44).

FIRST USE 12-11-2010; IN COMMERCE 12-11-2010.

THE MARK CONSISTS OF AN ELLIPSE WHICH CONTAINS A STYLIZED REPRESENTATION OF THE TAIL AND FIN OF A FISH.

SN 85-051,280, FILED 5-31-2010.

JOHN KELLY, EXAMINING ATTORNEY



*David J. Kybas*

Director of the United States Patent and Trademark Office

# United States of America

United States Patent and Trademark Office

## EV SOLUTIONS

**Reg. No. 4,136,065**

**Registered May 1, 2012**

**Int. Cl.: 37**

**SERVICE MARK**

**PRINCIPAL REGISTER**

AEROVIRONMENT, INC. (DELAWARE CORPORATION)  
181 W. HUNTINGTON DR., SUITE 202  
MONROVIA, CA 91016

FOR: REPAIR SERVICES FOR RESIDENTIAL AND COMMERCIAL ELECTRIC VEHICLE BATTERY CHARGING STATIONS; ELECTRICAL CONTRACTING SERVICES; BUILDING SITE ASSESSMENT FOR ELECTRIC VEHICLE BATTERY CHARGING, NAMELY, INSTALLATION, DIAGNOSTICS, REPAIR, AND REMOVAL. INSTALLATION SERVICES IN THE FIELD OF RESIDENTIAL AND COMMERCIAL ELECTRIC VEHICLE BATTERY CHARGING STATIONS. SERVICES ASSOCIATED WITH RESIDENTIAL AND COMMERCIAL ELECTRIC VEHICLE BATTERY CHARGING STATIONS, NAMELY, ON-SITE TESTING OF BATTERY CHARGING STATIONS, REPLACEMENT OF BATTERY CHARGING STATIONS, OFF-SITE DIAGNOSTICS AND REPAIR OF BATTERY CHARGING STATIONS, IN CLASS 37 (U.S. CLS. 100, 103 AND 106).

FIRST USE 6-14-2010; IN COMMERCE 6-14-2010.

THE MARK CONSISTS OF STANDARD CHARACTERS WITHOUT CLAIM TO ANY PARTICULAR FONT, STYLE, SIZE, OR COLOR.

NO CLAIM IS MADE TO THE EXCLUSIVE RIGHT TO USE "EV", APART FROM THE MARK AS SHOWN.

SN 85-053,179, FILED 6-2-2010.

RONALD AIKENS, EXAMINING ATTORNEY



*David J. Kypos*

Director of the United States Patent and Trademark Office

# United States of America

United States Patent and Trademark Office

## UNISOM NATURAL NIGHTS

**Reg. No. 4,136,066**

**Registered May 1, 2012**

**Int. Cl.: 5**

**TRADEMARK**

**PRINCIPAL REGISTER**

CHATTEM, INC. (TENNESSEE CORPORATION)  
1715 WEST 38TH STREET  
CHATTANOOGA, TN 37409

FOR: PHARMACEUTICAL SLEEP AID PREPARATIONS; FOOD, NUTRITIONAL AND DIETARY SUPPLEMENTS, IN CLASS 5 (U.S. CLS. 6, 18, 44, 46, 51 AND 52).

FIRST USE 12-5-2011; IN COMMERCE 12-5-2011.

THE MARK CONSISTS OF STANDARD CHARACTERS WITHOUT CLAIM TO ANY PARTICULAR FONT, STYLE, SIZE, OR COLOR.

OWNER OF U.S. REG. NOS. 1,115,938, 1,843,461, AND 2,327,125.

SN 85-053,720, FILED 6-3-2010.

LINDA LAVACHE, EXAMINING ATTORNEY



*David J. Kyjars*

Director of the United States Patent and Trademark Office

# United States of America

United States Patent and Trademark Office

## MALIBU GOLD

**Reg. No. 4,136,067**

CREATIVE LABORATORIES, INC. (MINNESOTA CORPORATION)  
1325 EAGANDALE COURT, SUITE 110  
EAGAN, MN 55121

**Registered May 1, 2012**

**Int. Cl.: 3**

FOR: SKIN CARE PRODUCTS, NAMELY, TANNING LOTIONS AND SKIN MOISTURIZERS,  
IN CLASS 3 (U.S. CLS. 1, 4, 6, 50, 51 AND 52).

**TRADEMARK**

FIRST USE 2-15-2012; IN COMMERCE 2-15-2012.

**PRINCIPAL REGISTER**

THE MARK CONSISTS OF STANDARD CHARACTERS WITHOUT CLAIM TO ANY PAR-  
TICULAR FONT, STYLE, SIZE, OR COLOR.

OWNER OF U.S. REG. NOS. 2,001,298 AND 3,598,994.

SN 85-053,888, FILED 6-3-2010.

TRACY FLETCHER, EXAMINING ATTORNEY



*David J. Kybas*

Director of the United States Patent and Trademark Office



# United States of America

United States Patent and Trademark Office

## FULL BOOST TECHNOLOGY

**Reg. No. 4,136,068**

**Registered May 1, 2012**

**Int. Cl.: 3**

**TRADEMARK**

**PRINCIPAL REGISTER**

L'OREAL USA CREATIVE, INC. (DELAWARE CORPORATION)  
575 FIFTH AVENUE  
NEW YORK, NY 10017

FOR: A COMBINATION OF INGREDIENTS SOLD AS A COMPONENT PART OF HAIR CARE AND HAIR STYLING PREPARATIONS, IN CLASS 3 (U.S. CLS. 1, 4, 6, 50, 51 AND 52).

FIRST USE 8-1-2011; IN COMMERCE 8-1-2011.

THE MARK CONSISTS OF STANDARD CHARACTERS WITHOUT CLAIM TO ANY PARTICULAR FONT, STYLE, SIZE, OR COLOR.

OWNER OF U.S. REG. NO. 2,701,338.

NO CLAIM IS MADE TO THE EXCLUSIVE RIGHT TO USE "TECHNOLOGY", APART FROM THE MARK AS SHOWN.

SN 85-054,580, FILED 6-4-2010.

JOHN HWANG, EXAMINING ATTORNEY



*David J. Kyros*

Director of the United States Patent and Trademark Office

# United States of America

United States Patent and Trademark Office

# KISS

**Reg. No. 4,136,069**

**Registered May 1, 2012**

**Int. Cl.: 11**

**TRADEMARK**

**PRINCIPAL REGISTER**

KISS NAIL PRODUCTS, INC. (NEW YORK CORPORATION)  
57 SEAVIEW BLVD.  
PORT WASHINGTON, NY 11050

FOR: HAIR DRYERS, IN CLASS 11 (U.S. CLS. 13, 21, 23, 31 AND 34).

FIRST USE 2-28-2012; IN COMMERCE 2-28-2012.

THE MARK CONSISTS OF STANDARD CHARACTERS WITHOUT CLAIM TO ANY PARTICULAR FONT, STYLE, SIZE, OR COLOR.

SN 85-054,707, FILED 6-4-2010.

KARANENDRA S. CHHINA, EXAMINING ATTORNEY



*David J. Kyffers*

Director of the United States Patent and Trademark Office

# United States of America

United States Patent and Trademark Office

# YOURTURN

**Reg. No. 4,136,070**

**Registered May 1, 2012**

**Int. Cl.: 41**

**SERVICE MARK**

**PRINCIPAL REGISTER**

YOURTURN, INC. (VIRGINIA CORPORATION)  
900 NORTH STUART STREET, APT. 1009  
ARLINGTON, VA 22203

FOR: PROVIDING EDUCATIONAL MENTORING SERVICES AND PROGRAMS IN THE FIELD OF CAREER COUNSELING, COACHING AND GUIDANCE BETWEEN INDIVIDUALS AND PROFESSIONALS; PROVIDING A WEBSITE FEATURING INFORMATION ON MENTORING PROGRAMS AND CAREER COUNSELING, COACHING AND GUIDANCE, IN CLASS 41 (U.S. CLS. 100, 101 AND 107).

FIRST USE 1-23-2012; IN COMMERCE 1-23-2012.

THE MARK CONSISTS OF STANDARD CHARACTERS WITHOUT CLAIM TO ANY PARTICULAR FONT, STYLE, SIZE, OR COLOR.

SN 85-054,800, FILED 6-4-2010.

GINA HAYES, EXAMINING ATTORNEY



*David J. Kyffers*

Director of the United States Patent and Trademark Office

# United States of America

United States Patent and Trademark Office

## IRONSHORE INTERNATIONAL

**Reg. No. 4,136,071**

**Registered May 1, 2012**

**Int. Cl.: 36**

**SERVICE MARK**

**PRINCIPAL REGISTER**

IRONSHORE INC. (CAYMAN ISLANDS CORPORATION)  
P.O. BOX 2681  
CENTURY YARD, CRICKET SQUARE HUTCHINS DR  
GEORGE TOWN, CAYMAN ISLANDS

FOR: INSURANCE UNDERWRITING SERVICES IN THE FIELDS OF FIDELITY AND CRIME, COMPUTER CRIME, PROFESSIONAL INDEMNITY, DIRECTORS' AND OFFICERS' FIDUCIARY LIABILITY, UNAUTHORISED TRADING, TRANSACTION WARRANTY, CARGO, TERRORISM, MEDICAL MALPRACTICE, ACCIDENT AND HEALTH, AVIATION WAR, MARINE WAR, MARINE LIABILITY, CASUALTY, PROPERTY, FINE ART, SPECIE, JEWELRY, CASH IN TRANSIT, EXCESS INVESTORS' INSURANCE, MARINE HULL, AVIATION HULL, CREDIT, CONTRACT FRUSTRATION, CONFISCATION AND EXPROPRIATION, ENVIRONMENTAL CASUALTY, KIDNAP AND RANSOM, TRUSTEE LIABILITY, CLASSIC CAR, MOTOR SPORTS, EVENT CONTINGENCY, CANCELLATION AND ABANDONMENT, AND TAX LIABILITY, PROTECTION AND INDEMNITY, IN CLASS 36 (U.S. CLS. 100, 101 AND 102).

FIRST USE 10-1-2011; IN COMMERCE 10-1-2011.

THE MARK CONSISTS OF STANDARD CHARACTERS WITHOUT CLAIM TO ANY PARTICULAR FONT, STYLE, SIZE, OR COLOR.

OWNER OF U.S. REG. NOS. 3,340,749, 3,686,448, AND OTHERS.

NO CLAIM IS MADE TO THE EXCLUSIVE RIGHT TO USE "INTERNATIONAL", APART FROM THE MARK AS SHOWN.

SN 85-054,919, FILED 6-4-2010.

STEVEN R. FINE, EXAMINING ATTORNEY



*David J. Kybas*

Director of the United States Patent and Trademark Office

# United States of America

United States Patent and Trademark Office

# DRAUMUR

**Reg. No. 4,136,072**

**Registered May 1, 2012**

**Int. Cl.: 3**

**TRADEMARK**

**PRINCIPAL REGISTER**

JAFRA COSMETICS INTERNATIONAL, INC. (DELAWARE CORPORATION)  
2451 TOWNSGATE ROAD  
WESTLAKE VILLAGE, CA 91361

FOR: FRAGRANCES, IN CLASS 3 (U.S. CLS. 1, 4, 6, 50, 51 AND 52).

FIRST USE 10-15-2010; IN COMMERCE 10-15-2010.

THE MARK CONSISTS OF STANDARD CHARACTERS WITHOUT CLAIM TO ANY PARTICULAR FONT, STYLE, SIZE, OR COLOR.

THE ENGLISH TRANSLATION OF THE WORD "DRAUMUR" IN THE MARK IS DREAM.

SN 85-057,411, FILED 6-8-2010.

KAPIL BHANOT, EXAMINING ATTORNEY



*David J. Kyffers*

Director of the United States Patent and Trademark Office

# United States of America

United States Patent and Trademark Office



**Reg. No. 4,136,073**

**Registered May 1, 2012**

**Int. Cls.: 41, 43, and 45**

**SERVICE MARK**

**PRINCIPAL REGISTER**

EXCELLENT SERVICES FOR YOU, LLC/BEATRICE E. ALLEN (GEORGIA LIMITED LIABILITY COMPANY)  
P.O. BOX 716  
FAYETTEVILLE, GA 30214

FOR: CONSULTATION SERVICES, IN THE FIELD OF SPECIAL EVENT PLANNING FOR SOCIAL ENTERTAINMENT PURPOSES; CONSULTATION SERVICES, NAMELY, ARRANGING AND CONDUCTING WORKSHOPS AND SEMINARS IN THE FIELD OF CONCIERGE AND HOTEL SERVICE; EDUCATIONAL SERVICES, NAMELY, PROVIDING LIVE AND ON-LINE LECTURES AND CLASSES IN THE FIELD OF CUSTOMER SERVICE, BUSINESS DEVELOPMENT AND PERSONAL MOTIVATION; SPECIAL EVENT PLANNING FOR SOCIAL ENTERTAINMENT PURPOSES, IN CLASS 41 (U.S. CLS. 100, 101 AND 107).

FIRST USE 3-12-2011; IN COMMERCE 3-12-2011.

FOR: HOTEL ACCOMMODATION SERVICES, IN CLASS 43 (U.S. CLS. 100 AND 101).

FIRST USE 3-12-2011; IN COMMERCE 3-12-2011.

FOR: PERSONAL CONCIERGE SERVICES FOR OTHERS, NAMELY, MAKING REQUESTED PERSONAL ARRANGEMENTS, RESERVATIONS, RUNNING ERRANDS AND PROVIDING CUSTOMER SPECIFIC INFORMATION TO MEET INDIVIDUAL NEEDS, ALL RENDERED IN BUSINESS ESTABLISHMENTS, OFFICE BUILDINGS, HOTELS AND RESIDENTIAL COMPLEXES AND HOMES; PERSONAL ASSISTANT SERVICES FOR OTHERS (NON MEDICAL) IN THE NATURE OF PLANNING, ORGANIZING, COORDINATING, ARRANGING AND ASSISTING INDIVIDUALS TO PERFORM DAILY TASKS; BABY SITTING AND PET SITTING SERVICES, IN CLASS 45 (U.S. CLS. 100 AND 101).

FIRST USE 3-12-2011; IN COMMERCE 3-12-2011.

NO CLAIM IS MADE TO THE EXCLUSIVE RIGHT TO USE "LLC", APART FROM THE MARK AS SHOWN.

THE COLOR(S) BLUE, GOLD AND WHITE IS/ARE CLAIMED AS A FEATURE OF THE MARK.



*David J. Kyjars*

Director of the United States Patent and Trademark Office

**Reg. No. 4,136,073** THE MARK CONSISTS OF THE WORDING "ES WE TAKE THE RUSH OUT OF YOUR HOURS!" "EXCELLENT SERVICES FOR YOU! LLC", WRITTEN IN A HIGHLY STYLIZED FORM. THE LETTERS "ES" APPEAR IN THE COLOR WHITE INSIDE OF A GOLD SEMI-CIRCLE; THE WORDS IN THE PHRASE "WE TAKE THE RUSH OUT OF YOUR HOURS!" APPEAR IN THE COLOR BLUE WITH THE EXCEPTION OF THE TERM "RUSH" WHICH APPEARS IN GOLD; THE WORDS "EXCELLENT SERVICES" APPEAR IN BLUE, THE WORDING "FOR YOU!" APPEARS IN THE COLOR GOLD, WITH THE ACRONYM "LLC" APPEARING IN THE COLOR BLUE.

SN 85-058,830, FILED 6-9-2010.

RICHARD WHITE, EXAMINING ATTORNEY

# United States of America

United States Patent and Trademark Office

# MEGAPRESS

**Reg. No. 4,136,074**

**Registered May 1, 2012**

**Int. Cls.: 6, 7, and 11**

**TRADEMARK**

**PRINCIPAL REGISTER**

VIEGA GMBH & CO. KG (FED REP GERMANY CORPORATION)  
VIEGA PLATZ 1  
57439 ATTENDORN, FED REP GERMANY

FOR: ELBOWS OF METAL FOR PIPES; METAL PIPE COUPLINGS AND JOINTS; METAL PIPE CONNECTORS; METAL PIPE FITTINGS; METAL VALVES NOT BEING PARTS OF MACHINES, IN CLASS 6 (U.S. CLS. 2, 12, 13, 14, 23, 25 AND 50).

FIRST USE 2-2-2012; IN COMMERCE 2-2-2012.

FOR: MACHINE TOOLS, NAMELY, JAWS FOR USE IN THE PRECISION CLAMPING OF WORK PIECES; MACHINE TOOLS, NAMELY, JAWS FOR USE IN THE PRECISION CLAMPING OF WORK PIECES IN THE NATURE OF PIPELINE CONNECTORS, IN CLASS 7 (U.S. CLS. 13, 19, 21, 23, 31, 34 AND 35).

FIRST USE 2-2-2012; IN COMMERCE 2-2-2012.

FOR: PLUMBING FITTINGS, NAMELY, COUPLINGS, ELBOWS, TEES, ADAPTERS, PLUGS AND VALVES FOR USE IN HEATING, COOLING, COMPRESSED AIR, GAS AND LIQUID GAS INSTALLATIONS IN RESIDENTIAL, COMMERCIAL AND INDUSTRIAL BUILDINGS AND FOR MARITIME INSTALLATIONS, IN CLASS 11 (U.S. CLS. 13, 21, 23, 31 AND 34).

FIRST USE 2-2-2012; IN COMMERCE 2-2-2012.

THE MARK CONSISTS OF STANDARD CHARACTERS WITHOUT CLAIM TO ANY PARTICULAR FONT, STYLE, SIZE, OR COLOR.

OWNER OF ERPN CMNTY TM OFC REG. NO. 009100249, DATED 10-26-2010, EXPIRES 10-26-2020.

SN 85-059,202, FILED 6-10-2010.

CHRISTINE COOPER, EXAMINING ATTORNEY



*David J. Kypos*

Director of the United States Patent and Trademark Office



# United States of America

United States Patent and Trademark Office

# REloadit

**Reg. No. 4,136,075**

**Registered May 1, 2012**

**Int. Cl.: 36**

**SERVICE MARK**

**PRINCIPAL REGISTER**

BLACKHAWK NETWORK, INC. (ARIZONA CORPORATION)  
5918 STONERIDGE MALL ROAD  
PLEASANTON, CA 94588

FOR: RELOADABLE PREPAID CARD SERVICES, NAMELY, ELECTRONIC PROCESSING AND TRANSMISSION OF ELECTRONIC PAYMENTS TO TRANSFER VALUE AND VALUE EQUIVALENTS, NAMELY, POINTS, MINUTES, AND CREDITS, TO PREPAID CARDS OR MOBILE DEVICES OR ACCOUNTS FROM OTHER PREPAID CARDS OR MOBILE DEVICES OR ACCOUNTS; AND FINANCIAL SERVICES, NAMELY, FACILITATING ELECTRONIC FUNDS TRANSFER, VALUE TRANSFER AND VALUE EQUIVALENT TRANSFER, NAMELY, POINTS, MINUTES, AND CREDITS TO PLASTIC CARDS, OTHER ACCESS DEVICES OR ACCOUNTS FROM OTHER PLASTIC CARDS, OTHER ACCESS DEVICES OR ACCOUNTS; AND VALUE EXCHANGE SERVICES, NAMELY, SECURE ELECTRONIC CASH TRANSACTIONS TO FACILITATE ELECTRONIC COMMERCE, IN CLASS 36 (U.S. CLS. 100, 101 AND 102).

FIRST USE 7-0-2011; IN COMMERCE 7-0-2011.

THE MARK CONSISTS OF A CAPITALIZED "RE" WITH LOWER CASE STYLIZED "L" AND LOWER CASE "OADIT".

SN 85-059,859, FILED 6-10-2010.

CAROLYN CATALDO, EXAMINING ATTORNEY



*David J. Kybas*

Director of the United States Patent and Trademark Office

# United States of America

United States Patent and Trademark Office



**Reg. No. 4,136,076**

**Registered May 1, 2012**

**Int. Cls.: 4 and 21**

**TRADEMARK**

**PRINCIPAL REGISTER**

JANCZ-URBAN, VELYA (UNITED STATES INDIVIDUAL)  
785 MAIN STREET NORTH  
WOODBURY, CT 06798

FOR: CANDLES, IN CLASS 4 (U.S. CLS. 1, 6 AND 15).

FIRST USE 12-0-2010; IN COMMERCE 12-0-2010.

FOR: WINE GLASSES, MUGS , IN CLASS 21 (U.S. CLS. 2, 13, 23, 29, 30, 33, 40 AND 50).

FIRST USE 12-0-2010; IN COMMERCE 12-0-2010.

THE MARK CONSISTS OF A BIRD WITH A FANCIFUL DESIGN ON A BRANCH OVER THE WORDS "CHICA PEEPS".

THE ENGLISH TRANSLATION OF "CHICA" IN THE MARK IS GIRL.

SN 85-060,451, FILED 6-11-2010.

KATHY DE JONGE, EXAMINING ATTORNEY



*David J. Kybas*

Director of the United States Patent and Trademark Office

# United States of America

United States Patent and Trademark Office

# INFUSION+

**Reg. No. 4,136,077**

**Registered May 1, 2012**

**Int. Cl.: 21**

**TRADEMARK**

**PRINCIPAL REGISTER**

DIVERSIFIED GLOBAL TECHNOLOGIES, LLC (DELAWARE LIMITED LIABILITY COMPANY)  
128 SINGLETON STREET  
WOONSOCKET, RI 02895

FOR: BATH SPONGES; FOAM BATH SPONGES; FACIAL CLEANSING SPONGES; FOAM FACIAL CLEANSING SPONGES; FACIAL SPONGES FOR APPLYING MAKE-UP; FOAM FACIAL SPONGES FOR APPLYING MAKE-UP, IN CLASS 21 (U.S. CLS. 2, 13, 23, 29, 30, 33, 40 AND 50).

FIRST USE 1-30-2012; IN COMMERCE 1-30-2012.

THE MARK CONSISTS OF STANDARD CHARACTERS WITHOUT CLAIM TO ANY PARTICULAR FONT, STYLE, SIZE, OR COLOR.

SN 85-060,464, FILED 6-11-2010.

KATHERINE CHANG, EXAMINING ATTORNEY



*David J. Kybas*

Director of the United States Patent and Trademark Office

# United States of America

United States Patent and Trademark Office

## ACCU TECHNOLOGY

**Reg. No. 4,136,078**

**Registered May 1, 2012**

**Int. Cl.: 9**

**TRADEMARK**

**PRINCIPAL REGISTER**

ETYMOTIC RESEARCH, INC. (ILLINOIS CORPORATION)  
61 MARTIN LANE  
ELK GROVE, IL 60007

FOR: EARPHONE ACCESSORIES, NAMELY, EARPHONE CUSHIONS, EARPHONE PADS, CORD MANAGEMENT SYSTEMS, EARPHONE CASES, AND EARPHONE EXTENSION CORDS; EARPHONES, IN CLASS 9 (U.S. CLS. 21, 23, 26, 36 AND 38).

FIRST USE 6-1-2010; IN COMMERCE 6-1-2010.

THE MARK CONSISTS OF STANDARD CHARACTERS WITHOUT CLAIM TO ANY PARTICULAR FONT, STYLE, SIZE, OR COLOR.

NO CLAIM IS MADE TO THE EXCLUSIVE RIGHT TO USE "TECHNOLOGY", APART FROM THE MARK AS SHOWN.

SN 85-061,035, FILED 6-11-2010.

LINDA MICKLEBURGH, EXAMINING ATTORNEY



*David J. Kybas*

Director of the United States Patent and Trademark Office

# United States of America

United States Patent and Trademark Office



**Reg. No. 4,136,079**

**Registered May 1, 2012**

**Int. Cls.: 40 and 42**

**SERVICE MARK**

**PRINCIPAL REGISTER**

AERONAUTICAL SYSTEMS, INCORPORATED (VIRGINIA CORPORATION)  
43671 TRADE CENTER PLACE, SUITE 100  
STERLING, VA 20166

FOR: MANUFACTURING SERVICES FOR OTHERS IN THE FIELD OF AIRCRAFT PARTS AND ACCESSORIES, IN CLASS 40 (U.S. CLS. 100, 103 AND 106).

FIRST USE 3-14-2010; IN COMMERCE 3-14-2010.

FOR: ENGINEERING; DESIGN OF AIRCRAFT PARTS AND ACCESSORIES FOR OTHERS IN THE FIELD OF ENGINEERING; CUSTOM DESIGN AND ENGINEERING IN THE FIELD OF AIRCRAFT PARTS AND ACCESSORIES, IN CLASS 42 (U.S. CLS. 100 AND 101).

FIRST USE 3-14-2010; IN COMMERCE 3-14-2010.

THE MARK CONSISTS OF A RECTANGLE DIVIDED INTO THREE SMALLER HORIZONTALLY ARRANGED RECTANGLES; THE RECTANGLE ON THE LEFT CONTAINS A STYLIZED IMAGE OF AN AIRPLANE; THE RECTANGLE IN THE CENTER CONTAINS A STYLIZED IMAGE OF A HELICOPTER; THE RECTANGLE ON THE RIGHT CONTAINS A STYLIZED IMAGE OF A TARGET WITH CROSSHAIRS.

SN 85-061,309, FILED 6-12-2010.

DAVID ELTON, EXAMINING ATTORNEY



*David J. Kyros*

Director of the United States Patent and Trademark Office

# United States of America

United States Patent and Trademark Office

The logo features a stylized letter 'T' with a leaf-like shape extending from its right side. To the right of the 'T' is the word 'gauze' in a lowercase, cursive font.

**Reg. No. 4,136,080**

**Registered May 1, 2012**

**Int. Cl.: 5**

**TRADEMARK**

**PRINCIPAL REGISTER**

T GAUZE COMPANY, L.L.C. (ARIZONA LIMITED LIABILITY COMPANY)  
1445 E BROADWAY RD, #109  
TEMPE, AZ 85282

FOR: GAUZE FOR DRESSINGS, IN CLASS 5 (U.S. CLS. 6, 18, 44, 46, 51 AND 52).

FIRST USE 3-2-2011; IN COMMERCE 3-2-2011.

NO CLAIM IS MADE TO THE EXCLUSIVE RIGHT TO USE "TEA GAUZE", APART FROM THE MARK AS SHOWN.

THE MARK CONSISTS OF A LETTER "T" WITH "T" HAVING A LEAF OFF THE RIGHT SIDE AND THE WORD "GAUZE" AS SHOWN IN THE MARK.

SN 85-063,579, FILED 6-15-2010.

ASMAT KHAN, EXAMINING ATTORNEY



*David J. Kyffers*

Director of the United States Patent and Trademark Office

# United States of America

United States Patent and Trademark Office

# KINETISOL

**Reg. No. 4,136,081**

**Registered May 1, 2012**

**Int. Cl.: 42**

**SERVICE MARK**

**PRINCIPAL REGISTER**

DISPERSOL TECHNOLOGIES, LLC (TEXAS LIMITED LIABILITY COMPANY)  
SUITE 500  
9442 CAPITAL OF TEXAS HWY N, PLAZA 1  
AUSTIN, TX 78759

FOR: PHARMACEUTICAL RESEARCH AND DEVELOPMENT; PHARMACEUTICAL RESEARCH SERVICES, IN CLASS 42 (U.S. CLS. 100 AND 101).

FIRST USE 11-16-2008; IN COMMERCE 11-16-2008.

THE MARK CONSISTS OF STANDARD CHARACTERS WITHOUT CLAIM TO ANY PARTICULAR FONT, STYLE, SIZE, OR COLOR.

SN 85-063,837, FILED 6-15-2010.

CHRISTINE COOPER, EXAMINING ATTORNEY



*David J. Kybas*

Director of the United States Patent and Trademark Office

# United States of America

United States Patent and Trademark Office

## VOICES IN ADVOCACY

**Reg. No. 4,136,082**

**Registered May 1, 2012**

**Int. Cls.: 16 and 35**

**TRADEMARK**

**SERVICE MARK**

**PRINCIPAL REGISTER**

REVENT, LLC (CALIFORNIA LIMITED LIABILITY COMPANY)  
5209 BROOKFIELD CIRCLE  
ROCKLIN, CA 95677

FOR: PUBLICATIONS, NAMELY, BOOKS AND HAND-OUTS IN THE FIELDS OF ADVOCACY AND THE POWER OF ACTIVE CITIZENSHIP THROUGH ADVOCACY AFFECTING CHANGE OF POLITICAL AND SOCIAL ISSUES, IN CLASS 16 (U.S. CLS. 2, 5, 22, 23, 29, 37, 38 AND 50).

FIRST USE 3-12-2012; IN COMMERCE 3-12-2012.

FOR: PROMOTING PUBLIC AWARENESS OF THE POWER OF ACTIVE CITIZENSHIP THROUGH ADVOCACY IN RELATION TO JOBS, INDUSTRY, AND BROADER COMMUNITY, IN CLASS 35 (U.S. CLS. 100, 101 AND 102).

FIRST USE 4-2-2010; IN COMMERCE 4-2-2010.

THE MARK CONSISTS OF STANDARD CHARACTERS WITHOUT CLAIM TO ANY PARTICULAR FONT, STYLE, SIZE, OR COLOR.

NO CLAIM IS MADE TO THE EXCLUSIVE RIGHT TO USE "ADVOCACY", APART FROM THE MARK AS SHOWN.

SN 85-064,112, FILED 6-16-2010.

LINDA ORNDORFF, EXAMINING ATTORNEY



*David J. Kyros*

Director of the United States Patent and Trademark Office



# United States of America

United States Patent and Trademark Office

# SIALITE

**Reg. No. 4,136,083**

**Registered May 1, 2012**

**Int. Cl.: 19**

**TRADEMARK**

**PRINCIPAL REGISTER**

INTEPLAST GROUP, LTD. (TEXAS LIMITED PARTNERSHIP)  
9 PEACH TREE HILL ROAD  
LIVINGSTON, NJ 07039

FOR: NON-METALLIC CONSTRUCTION MATERIALS FOR NON-REFRACTORY AMBIENT-TEMPERATURE APPLICATIONS, NAMELY, MINERAL-BASED CEMENTITIOUS MATERIALS FOR USE AS CEMENT; BUILDING MATERIALS MADE FROM MINERAL-BASED CEMENTITIOUS MATERIALS FOR NON-REFRACTORY AMBIENT-TEMPERATURE APPLICATIONS, NAMELY, BLOCKS, BRICKS, PAVERS, IN CLASS 19 (U.S. CLS. 1, 12, 33 AND 50).

FIRST USE 11-0-2011; IN COMMERCE 11-0-2011.

THE MARK CONSISTS OF STANDARD CHARACTERS WITHOUT CLAIM TO ANY PARTICULAR FONT, STYLE, SIZE, OR COLOR.

SN 85-065,047, FILED 6-17-2010.

LINDA ESTRADA, EXAMINING ATTORNEY



*David J. Kyros*

Director of the United States Patent and Trademark Office

# United States of America

United States Patent and Trademark Office

## QUICK GUIDE

**Reg. No. 4,136,084**

**Registered May 1, 2012**

**Int. Cl.: 16**

**TRADEMARK**

**PRINCIPAL REGISTER**

MORRIS VISITOR PUBLICATIONS, LLC (GEORGIA LIMITED LIABILITY COMPANY)  
725 BROAD STREET  
AUGUSTA, GA 30901

FOR: PUBLICATIONS, NAMELY, BOOKS AND PAMPHLETS CONTAINING INFORMATION OF INTEREST TO TOURISTS, TRAVELERS, HOTEL GUESTS AND THE LIKE, IN THE FIELDS OF ENTERTAINMENT, SPORTS, SHOPPING, DINING, TOURS AND TRAVEL IN VARIOUS CITIES, IN CLASS 16 (U.S. CLS. 2, 5, 22, 23, 29, 37, 38 AND 50).

FIRST USE 12-0-1991; IN COMMERCE 12-0-1992.

THE MARK CONSISTS OF STANDARD CHARACTERS WITHOUT CLAIM TO ANY PARTICULAR FONT, STYLE, SIZE, OR COLOR.

NO CLAIM IS MADE TO THE EXCLUSIVE RIGHT TO USE "GUIDE", APART FROM THE MARK AS SHOWN.

SN 85-065,081, FILED 6-17-2010.

RICHARD WHITE, EXAMINING ATTORNEY



*David J. Kyffers*

Director of the United States Patent and Trademark Office

# United States of America

United States Patent and Trademark Office

## Connecting People to Petcare

**Reg. No. 4,136,085**

**Registered May 1, 2012**

**Int. Cl.: 35**

**SERVICE MARK**

**PRINCIPAL REGISTER**

PETLINE LLC (CALIFORNIA LIMITED LIABILITY COMPANY)  
STE 1710  
5777 W. CENTURY BLVD  
LOS ANGELES, CA 90045

FOR: REFERRALS IN THE FIELD OF DIRECTING PET OWNERS TO BREED SPECIFIC PET PRODUCTS AND SERVICE PROVIDERS BY MEANS OF TELEPHONE AND THE INTERNET, IN CLASS 35 (U.S. CLS. 100, 101 AND 102).

FIRST USE 2-19-2010; IN COMMERCE 2-19-2010.

THE MARK CONSISTS OF STANDARD CHARACTERS WITHOUT CLAIM TO ANY PARTICULAR FONT, STYLE, SIZE, OR COLOR.

SN 85-066,416, FILED 6-18-2010.

KAREN K. BUSH, EXAMINING ATTORNEY



*David J. Kyffers*

Director of the United States Patent and Trademark Office

# United States of America

United States Patent and Trademark Office

## ONESTOPOMAHA.COM

**Reg. No. 4,136,086**

**Registered May 1, 2012**

**Int. Cl.: 35**

**SERVICE MARK**

**PRINCIPAL REGISTER**

VALLA, JUSTIN (UNITED STATES INDIVIDUAL)  
7905 NORTH 155TH STREET  
BENNINGTON, NE 68007

FOR: PROVIDING A SEARCHABLE ONLINE MARKETING AND ADVERTISING WEBSITE AND INFORMATIONAL GUIDE FEATURING THE GOODS AND SERVICES OF OTHERS VIA THE INTERNET IN THE FIELD OF PRODUCTS PRODUCED IN THE CITY OF OMAHA NEBRASKA, SERVICES ORIGINATING OR BASED IN THE CITY OF NEBRASKA, AND EVENTS, ACTIVITIES AND ATTRACTIONS IN THE CITY OF OMAHA, NEBRASKA AS WELL AS FACILITIES AVAILABLE IN THE CITY OF OMAHA, NEBRASKA, NAMELY, CONVENTION, CONCERT FACILITIES, SPORTS FACILITIES AND THEATER FACILITIES, IN CLASS 35 (U.S. CLS. 100, 101 AND 102).

FIRST USE 8-31-2009; IN COMMERCE 6-17-2010.

THE MARK CONSISTS OF STANDARD CHARACTERS WITHOUT CLAIM TO ANY PARTICULAR FONT, STYLE, SIZE, OR COLOR.

SN 85-066,749, FILED 6-18-2010.

EDWARD FENNESSY, EXAMINING ATTORNEY



*David J. Kyffers*

Director of the United States Patent and Trademark Office

# United States of America

United States Patent and Trademark Office



**Reg. No. 4,136,087**

**Registered May 1, 2012**

**Int. Cl.: 5**

**TRADEMARK**

**PRINCIPAL REGISTER**

LYF HOLDINGS INC. (DELAWARE CORPORATION)  
510 EVERNIA STREET  
WEST PALM BEACH, FL 33401

FOR: DIETARY AND NUTRITIONAL SUPPLEMENTS; DIETARY BEVERAGE SUPPLEMENTS FOR HUMAN CONSUMPTION IN LIQUID AND DRY MIX FORM FOR THERAPEUTIC PURPOSES; DIETARY FOOD SUPPLEMENTS; NUTRACEUTICALS FOR USE AS A DIETARY SUPPLEMENT, IN CLASS 5 (U.S. CLS. 6, 18, 44, 46, 51 AND 52).

FIRST USE 6-21-2010; IN COMMERCE 6-21-2010.

THE MARK CONSISTS OF A STYLIZED CIRCLE BROKEN BY WHITE BANDS INTO IRREGULAR PIECES IN THE COLORS RED, BLUE, YELLOW, GREEN AND GRAY.

THE COLOR(S) RED, BLUE, YELLOW, GREEN, GRAY AND WHITE IS/ARE CLAIMED AS A FEATURE OF THE MARK.

SN 85-066,825, FILED 6-18-2010.

REBECCA EISINGER, EXAMINING ATTORNEY



*David J. Kybas*

Director of the United States Patent and Trademark Office

# United States of America

## United States Patent and Trademark Office

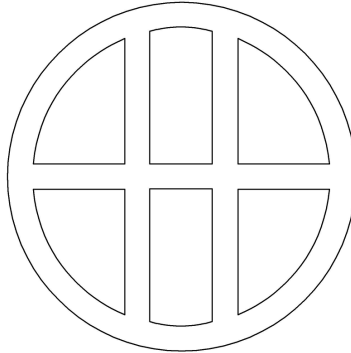

**Reg. No. 4,136,088**

**Registered May 1, 2012**

**Int. Cls.: 9, 18, and 25**

**TRADEMARK**

**PRINCIPAL REGISTER**

HUGO BOSS TRADE MARK MANAGEMENT GMBH & CO. KG (FED REP GERMANY  
GMBH & CO. KG)  
DIESELSTRASSE 12  
METZINGEN, FED REP GERMANY 72555

FOR: EYEWEAR, NAMELY, EYEGASSES AND SUNGLASSES AND PARTS THEREOF,  
IN CLASS 9 (U.S. CLS. 21, 23, 26, 36 AND 38).

FIRST USE 0-0-2010; IN COMMERCE 0-0-2010.

FOR: LEATHER GOODS AND GOODS MADE OF IMITATION LEATHER, NAMELY, TRUNKS  
AND SUITCASES, LUGGAGE, DOCUMENT CASES, BUSINESS CASES, TRAVEL CASES,  
BRIEF CASES, ATTACHÉ CASES, PURSES, BILLFOLDS, WALLETS AND KEY CASES;  
BAGS, GARMENT BAGS FOR TRAVEL, CARRY-ON BAGS, SHOULDER BAGS, HANDBAGS,  
TRAVEL BAGS, ALL-PURPOSE SPORTS BAGS, GYM BAGS, ATHLETIC BAGS, TOTE  
BAGS, CLUTCH BAGS, DUFFEL BAGS, BEACH BAGS, SHOE BAGS FOR TRAVEL, TOI-  
LETRY AND COSMETIC BAGS SOLD EMPTY, SHOPPING BAGS, KNAPSACKS, BACK-  
PACKS; UMBRELLAS, IN CLASS 18 (U.S. CLS. 1, 2, 3, 22 AND 41).

FIRST USE 0-0-2010; IN COMMERCE 0-0-2010.

FOR: CLOTHING AND ACCESSORIES, NAMELY, BEACHWEAR, BLOUSES, BODY SUITS,  
BRAS, BUSTIERS, COATS, CUMMERBUNDS AND SASHES, DRESSES, EXERCISE SUITS,  
FOUNDATION GARMENTS, GOWNS, INFANTWEAR, JACKETS, JEANS, HOSIERY,  
LINGERIE, LOUNGEWEAR, NECKWEAR, PANTS, RAINWEAR, ROBES, SHIRTS, SHORTS,  
SKIRTS, SKI WEAR, SLEEPWEAR, SLIPS, SUITS, SWEATERS, SWEAT SUITS, TENNIS  
WEAR, TUXEDOS, UNDERCLOTHES, UNDER GARMENTS, VESTS; SOCKS AND  
STOCKINGS; HEADWEAR; UNDERWEAR; NIGHTWEAR; SWIMWEAR; BATHROBES;  
BELTS; SHAWLS; NECKWEAR; SCARVES, POCKET KERCHIEFS; TIES; GLOVES; FOOT-  
WEAR, IN CLASS 25 (U.S. CLS. 22 AND 39).

FIRST USE 0-0-2010; IN COMMERCE 0-0-2010.

THE MARK CONSISTS OF A CIRCLE THAT CONTAINS A DOUBLE LINE BISECTING THE  
CIRCLE HORIZONTALLY. THERE ARE TWO DOUBLE-LINE LINES BISECTING THE  
HORIZONTALLY DIVIDING THE CIRCLE INTO SIX SPACES. THE DESIGN IS INTENDED  
TO BE A STYLIZED "HB".



*David J. Kybas*

Director of the United States Patent and Trademark Office

**Reg. No. 4,136,088** SN 85-067,658, FILED 6-21-2010.

DAWN FELDMAN, EXAMINING ATTORNEY

# United States of America

United States Patent and Trademark Office

## Fairweather Press

**Reg. No. 4,136,089**

**Registered May 1, 2012**

**Int. Cls.: 25 and 40**

**TRADEMARK**

**SERVICE MARK**

**PRINCIPAL REGISTER**

FAIRWEATHER PRESS LLC (OREGON LIMITED LIABILITY COMPANY)  
3932 SE LIEBE STREET  
PORTLAND, OR 97202

FOR: CLOTHING, NAMELY, T-SHIRTS, SWEATSHIRTS, HOODED SWEATSHIRTS, IN CLASS 25 (U.S. CLS. 22 AND 39).

FIRST USE 12-22-2010; IN COMMERCE 12-22-2010.

FOR: PRINTING SERVICES, NAMELY, SCREEN PRINTING, CUSTOM IMPRINTING OF CLOTHING, IN CLASS 40 (U.S. CLS. 100, 103 AND 106).

FIRST USE 12-22-2010; IN COMMERCE 12-22-2010.

THE MARK CONSISTS OF STANDARD CHARACTERS WITHOUT CLAIM TO ANY PARTICULAR FONT, STYLE, SIZE, OR COLOR.

NO CLAIM IS MADE TO THE EXCLUSIVE RIGHT TO USE "PRESS", APART FROM THE MARK AS SHOWN.

SN 85-067,859, FILED 6-21-2010.

ANNE E. GUSTASON, EXAMINING ATTORNEY



*David J. Kyros*

Director of the United States Patent and Trademark Office



# United States of America

United States Patent and Trademark Office

## CAREAWARE STAFFLINK

**Reg. No. 4,136,090**

**Registered May 1, 2012**

**Int. Cl.: 9**

**TRADEMARK**

**PRINCIPAL REGISTER**

CERNER INNOVATION, INC. (DELAWARE CORPORATION)  
13725 W. 109TH ST., SUITE 101  
LENEXA, KS 66215

FOR: COMPUTER SOFTWARE AND DEVICES FOR USE IN THE HEALTHCARE FIELD, NAMELY, COMPUTER HARDWARE AND DATA ACQUISITION AND INTEGRATION SOFTWARE FOR MANAGING, STORING, ANALYZING, MAINTAINING, PROCESSING, STRUCTURING, REVIEWING, BUILDING, EDITING, DISTRIBUTING, COMMUNICATING, ORGANIZING, SHARING, REFERENCING, MONITORING AND INTEGRATING HEALTHCARE INFORMATION, AND RELATED USER MANUALS SOLD AS A UNIT THEREWITH, IN CLASS 9 (U.S. CLS. 21, 23, 26, 36 AND 38).

FIRST USE 12-31-2010; IN COMMERCE 12-31-2010.

THE MARK CONSISTS OF STANDARD CHARACTERS WITHOUT CLAIM TO ANY PARTICULAR FONT, STYLE, SIZE, OR COLOR.

OWNER OF U.S. REG. NO. 3,529,177.

SN 85-069,390, FILED 6-23-2010.

BRENDAN REGAN, EXAMINING ATTORNEY



*David J. Kyffers*

Director of the United States Patent and Trademark Office

# United States of America

United States Patent and Trademark Office

## SOLUTE CARBON MICROSPHERES

**Reg. No. 4,136,091**

**Registered May 1, 2012**

**Int. Cl.: 1**

**TRADEMARK**

**PRINCIPAL REGISTER**

SOLUTE, LLC (DELAWARE LIMITED LIABILITY COMPANY)  
10536 LEXINGTON DRIVE  
KNOXVILLE, TN 37932

FOR: SMALL, HOLLOW BALLOONS OF CARBON FOR CREATING COMPOSITE MATERIALS TO BE USED IN SCIENCE AND IN THE SEMICONDUCTOR, AEROSPACE, AVIONIC, DEFENSE, AND OTHER HIGHER TEMPERATURE PROCESSING INDUSTRIES, IN CLASS 1 (U.S. CLS. 1, 5, 6, 10, 26 AND 46).

FIRST USE 7-28-2011; IN COMMERCE 7-28-2011.

THE MARK CONSISTS OF STANDARD CHARACTERS WITHOUT CLAIM TO ANY PARTICULAR FONT, STYLE, SIZE, OR COLOR.

NO CLAIM IS MADE TO THE EXCLUSIVE RIGHT TO USE "CARBON MICROSPHERES", APART FROM THE MARK AS SHOWN.

SN 85-070,421, FILED 6-24-2010.

THOMAS MANOR, EXAMINING ATTORNEY



*David J. Kyros*

Director of the United States Patent and Trademark Office

# United States of America

United States Patent and Trademark Office



**Reg. No. 4,136,092**

**Registered May 1, 2012**

**Int. Cl.: 10**

**TRADEMARK**

**PRINCIPAL REGISTER**

ORTHOTICS WEST, INC. (MASSACHUSETTS CORPORATION)  
3455 MAIN STREET  
SPRINGFIELD, MA 01107

FOR: MEDICAL SUPPORT PRODUCTS, NAMELY, BREAST PROSTHESES; MASTECTOMY BRAS FOR MEDICAL AND COSMETIC PURPOSES, IN CLASS 10 (U.S. CLS. 26, 39 AND 44).

FIRST USE 2-1-2006; IN COMMERCE 2-1-2006.

NO CLAIM IS MADE TO THE EXCLUSIVE RIGHT TO USE "BOUTIQUE AND GIFTS", APART FROM THE MARK AS SHOWN.

THE MARK CONSISTS OF THE WORDS "THE PINK PETAL BOUTIQUE AND GIFTS" IN A STYLIZED FONT. TO THE LEFT OF THE WORDING IS A DESIGN OF A RIBBON HAVING A MULTI-PETAL FLOWER SUPERIMPOSED THEREON.

SN 85-070,738, FILED 6-24-2010.

ERNEST SHOSHO, EXAMINING ATTORNEY



*David J. Kybas*

Director of the United States Patent and Trademark Office

# United States of America

United States Patent and Trademark Office

## THE PINK PETAL BOUTIQUE AND GIFTS

**Reg. No. 4,136,093**

**Registered May 1, 2012**

**Int. Cl.: 10**

**TRADEMARK**

**PRINCIPAL REGISTER**

ORTHOTICS WEST, INC. (MASSACHUSETTS CORPORATION)  
3455 MAIN STREET  
SPRINGFIELD, MA 01107

FOR: MEDICAL SUPPORT PRODUCTS, NAMELY, BREAST PROSTHESES; MASTECTOMY BRAS FOR MEDICAL AND COSMETIC PURPOSES, IN CLASS 10 (U.S. CLS. 26, 39 AND 44).

FIRST USE 2-1-2006; IN COMMERCE 2-1-2006.

THE MARK CONSISTS OF STANDARD CHARACTERS WITHOUT CLAIM TO ANY PARTICULAR FONT, STYLE, SIZE, OR COLOR.

NO CLAIM IS MADE TO THE EXCLUSIVE RIGHT TO USE "BOUTIQUE AND GIFTS", APART FROM THE MARK AS SHOWN.

SN 85-070,768, FILED 6-24-2010.

ERNEST SHOSHO, EXAMINING ATTORNEY



*David J. Kyros*

Director of the United States Patent and Trademark Office

# United States of America

United States Patent and Trademark Office



**Reg. No. 4,136,094**

**Registered May 1, 2012**

**Int. Cl.: 43**

**SERVICE MARK**

**PRINCIPAL REGISTER**

STEAK N SHAKE LLC (INDIANA LIMITED LIABILITY COMPANY)  
500 CENTURY BUILDING  
36 SOUTH PENNSYLVANIA STREET  
INDIANAPOLIS, IN 46204

FOR: RESTAURANT SERVICES, IN CLASS 43 (U.S. CLS. 100 AND 101).

FIRST USE 11-30-2010; IN COMMERCE 11-30-2010.

OWNER OF U.S. REG. NOS. 649,868, 2,233,542, AND OTHERS.

SEC. 2(F) AS TO "FAMOUS FOR STEAKBURGERS".

THE MARK CONSISTS OF A DESIGN OF AN ANIMATED CHARACTER HAVING A BODY IN THE SHAPE OF A MILKSHAKE WEARING MITTENS WITH THE LOGO "STEAK 'N SHAKE FAMOUS FOR STEAKBURGERS" WITHIN A CIRCULAR SHAPE WITH WINGS ON ONE MITTEN. THE WORD "SHAKER" IS POSITIONED NEXT TO THE BODY, REPRESENTING THE NAME OF THE CHARACTER.

SN 85-071,152, FILED 6-24-2010.

BARBARA RUTLAND, EXAMINING ATTORNEY



*David J. Kyffers*

Director of the United States Patent and Trademark Office

# United States of America

United States Patent and Trademark Office

## INDIAN PRINCESS HAIR

**Reg. No. 4,136,095**

**Registered May 1, 2012**

**Int. Cl.: 26**

**TRADEMARK**

**PRINCIPAL REGISTER**

INDIAN PRINCESS HAIR (PENNSYLVANIA CORPORATION)  
5704 NORTH CAMAC STREET  
PHILADELPHIA, PA 19141

FOR: HAIR EXTENSIONS AND WIGS, IN CLASS 26 (U.S. CLS. 37, 39, 40, 42 AND 50).

FIRST USE 1-25-2012; IN COMMERCE 1-25-2012.

THE MARK CONSISTS OF STANDARD CHARACTERS WITHOUT CLAIM TO ANY PARTICULAR FONT, STYLE, SIZE, OR COLOR.

NO CLAIM IS MADE TO THE EXCLUSIVE RIGHT TO USE "INDIAN" AND "HAIR", APART FROM THE MARK AS SHOWN.

SN 85-071,364, FILED 6-25-2010.

KATHLEEN M. VANSTON, EXAMINING ATTORNEY



*David J. Kyffers*

Director of the United States Patent and Trademark Office

# United States of America

United States Patent and Trademark Office

# CIUS

**Reg. No. 4,136,096**

**Registered May 1, 2012**

**Int. Cl.: 9**

**TRADEMARK**

**PRINCIPAL REGISTER**

CISCO TECHNOLOGY, INC. (CALIFORNIA CORPORATION)  
170 WEST TASMAN DRIVE  
SAN JOSE, CA 95134

FOR: COMPUTER HARDWARE; TELEPHONES; HANDHELD COMPUTERS; COMMUNICATIONS SOFTWARE FOR CONNECTING COMPUTERS AND HAND-HELD COMPUTERS; SOFTWARE THAT FACILITATES VIDEO AND VOICE COMMUNICATIONS BETWEEN PARTIES; MOBILE ELECTRONIC DEVICES, NAMELY, CELLULAR HANDSETS AND HAND-HELD COMPUTERS FOR AUDIO AND VIDEO CONFERENCING, UTILIZING ELECTRONIC MAIL, INSTANT MESSAGING AND TRANSMITTING OTHER DIGITAL DATA; OPERATING SYSTEM PROGRAMS; DATA SYNCHRONIZATION PROGRAMS; DOCKING STATIONS, IN CLASS 9 (U.S. CLS. 21, 23, 26, 36 AND 38).

FIRST USE 8-31-2011; IN COMMERCE 8-31-2011.

THE MARK CONSISTS OF STANDARD CHARACTERS WITHOUT CLAIM TO ANY PARTICULAR FONT, STYLE, SIZE, OR COLOR.

SN 85-073,376, FILED 6-28-2010.

TEJBIR SINGH, EXAMINING ATTORNEY



*David J. Kybas*

Director of the United States Patent and Trademark Office

# United States of America

United States Patent and Trademark Office

# BRA-HA-HA

**Reg. No. 4,136,097**

**Registered May 1, 2012**

**Int. Cl.: 25**

**TRADEMARK**

**PRINCIPAL REGISTER**

CHESAPEAKE HOSPITAL AUTHORITY (VIRGINIA POLITICAL SUBDIVISION)  
736 BATTLEFIELD BOULEVARD  
NORTH CHESAPEAKE, VA 23320

FOR: (BASED ON USE IN COMMERCE) CLOTHING, NAMELY, T-SHIRTS, BRAS, BRASSIERES, FLIP FLOPS, SCARVES, TIES, HATS, BOXER SHORTS, IN CLASS 25 (U.S. CLS. 22 AND 39).

FIRST USE 6-30-2008; IN COMMERCE 6-30-2008.

THE MARK CONSISTS OF STANDARD CHARACTERS WITHOUT CLAIM TO ANY PARTICULAR FONT, STYLE, SIZE, OR COLOR.

OWNER OF U.S. REG. NO. 3,786,527.

SN 85-073,501, FILED 6-29-2010.

WON TEAK OH, EXAMINING ATTORNEY



*David J. Kyffers*

Director of the United States Patent and Trademark Office



# United States of America

United States Patent and Trademark Office

## ARISTAS McG

**Reg. No. 4,136,098**

ARISTAS MCCGLOBAL CORPORATION (MASSACHUSETTS CORPORATION)  
508 WASHINGTON STREET  
QUINCY, MA 02169

**Registered May 1, 2012**

**Int. Cl.: 35**

FOR: IMPORT AND EXPORT AGENCY SERVICES, IN CLASS 35 (U.S. CLS. 100, 101 AND 102).

**SERVICE MARK**

FIRST USE 7-8-2011; IN COMMERCE 7-8-2011.

**PRINCIPAL REGISTER**

THE MARK CONSISTS OF STANDARD CHARACTERS WITHOUT CLAIM TO ANY PARTICULAR FONT, STYLE, SIZE, OR COLOR.

SN 85-073,527, FILED 6-29-2010.

EVELYN BRADLEY, EXAMINING ATTORNEY



*David J. Kybas*

Director of the United States Patent and Trademark Office

# United States of America

United States Patent and Trademark Office

# IdentiTrain

**Reg. No. 4,136,099**

**Registered May 1, 2012**

**Int. Cl.: 35**

**SERVICE MARK**

**PRINCIPAL REGISTER**

PROFILES INTERNATIONAL, INC. (TEXAS CORPORATION)  
4525 LAKE SHORE DRIVE  
WACO, TX 76710

FOR: PERSONNEL MANAGEMENT SERVICES, NAMELY, EMPLOYEE EVALUATION, ASSESSMENT, AND TESTING TO DETERMINE EMPLOYMENT SKILLS, IN CLASS 35 (U.S. CLS. 100, 101 AND 102).

FIRST USE 10-27-2009; IN COMMERCE 10-27-2009.

THE MARK CONSISTS OF STANDARD CHARACTERS WITHOUT CLAIM TO ANY PARTICULAR FONT, STYLE, SIZE, OR COLOR.

SN 85-074,449, FILED 6-30-2010.

JAY BESCH, EXAMINING ATTORNEY



*David J. Kyffers*

Director of the United States Patent and Trademark Office

# United States of America

United States Patent and Trademark Office

## Pathway Connect

**Reg. No. 4,136,100**

**Registered May 1, 2012**

**Int. Cl.: 35**

**SERVICE MARK**

**PRINCIPAL REGISTER**

PROFILES INTERNATIONAL, INC. (TEXAS CORPORATION)  
4525 LAKE SHORE DRIVE  
WACO, TX 76710

FOR: PERSONNEL MANAGEMENT SERVICES, NAMELY, EMPLOYEE EVALUATION, ASSESSMENT, AND TESTING TO DETERMINE EMPLOYMENT SKILLS, IN CLASS 35 (U.S. CLS. 100, 101 AND 102).

FIRST USE 1-0-2010; IN COMMERCE 1-0-2010.

THE MARK CONSISTS OF STANDARD CHARACTERS WITHOUT CLAIM TO ANY PARTICULAR FONT, STYLE, SIZE, OR COLOR.

OWNER OF U.S. REG. NOS. 3,722,813, 3,722,815, AND OTHERS.

SN 85-074,451, FILED 6-30-2010.

JAY BESCH, EXAMINING ATTORNEY



*David J. Kyros*

Director of the United States Patent and Trademark Office

# United States of America

United States Patent and Trademark Office



**Reg. No. 4,136,101**

**Registered May 1, 2012**

**Int. Cl.: 30**

**TRADEMARK**

**PRINCIPAL REGISTER**

B-HOPPY LTD (OHIO LIMITED LIABILITY COMPANY)  
6372 STRUTHERS ROAD  
LOWELLVILLE, OH 44436

FOR: CANDY, IN CLASS 30 (U.S. CL. 46).

FIRST USE 10-1-2010; IN COMMERCE 12-29-2010.

NO CLAIM IS MADE TO THE EXCLUSIVE RIGHT TO USE "THE ORIGINAL HOP CANDY",  
APART FROM THE MARK AS SHOWN.

THE MARK CONSISTS OF THE TEXT "B-HOPPY THE ORIGINAL HOP CANDY" PLACED  
AROUND THE EDGE OF A CIRCLE. IN BETWEEN THE WORDS "B-HOPPY" AND "THE  
ORIGINAL HOP CANDY" ARE TWO HOPS, ONE ON EACH SIDE OF THE CIRCLE. INSIDE  
THE CIRCLE IS A DESIGN OF A BEAR, BEE, AND HOP CONE.

SN 85-074,728, FILED 6-30-2010.

JENNIFER VASQUEZ, EXAMINING ATTORNEY



*David J. Kybas*

Director of the United States Patent and Trademark Office

United States of America  
United States Patent and Trademark Office

# PREMAIR

**Reg. No. 4,136,102**

**Registered May 1, 2012**

**Int. Cls.: 29 and 30**

**TRADEMARK**

**PRINCIPAL REGISTER**

PREMAIR HOSPITALITY GROUP, LLC (FLORIDA LIMITED LIABILITY COMPANY)  
6910 N.W. 12TH STREET  
MIAMI, FL 33126

FOR: FRUIT AND VEGETABLE SALADS, GARDEN SALADS, SALADS EXCEPT MACARONI,  
AND PASTA SALAD; CUT FRUITS ARRANGED IN FRUIT CUPS, IN CLASS 29 (U.S. CL.  
46).

FIRST USE 1-1-2011; IN COMMERCE 1-1-2011.

FOR: PREPARED SANDWICHES; PASTA SALAD, MACARONI SALAD, RICE SALAD, IN  
CLASS 30 (U.S. CL. 46).

FIRST USE 1-1-2011; IN COMMERCE 1-1-2011.

THE MARK CONSISTS OF STANDARD CHARACTERS WITHOUT CLAIM TO ANY PAR-  
TICULAR FONT, STYLE, SIZE, OR COLOR.

OWNER OF U.S. REG. NOS. 3,687,435 AND 3,842,027.

SN 85-075,128, FILED 6-30-2010.

ROBIN MITTLER, EXAMINING ATTORNEY



*David J. Kybas*

Director of the United States Patent and Trademark Office

# United States of America

United States Patent and Trademark Office

## Everyone Counts

**Reg. No. 4,136,103**

**Registered May 1, 2012**

**Int. Cl.: 9**

**TRADEMARK**

**PRINCIPAL REGISTER**

HARTMANN, JACK (UNITED STATES INDIVIDUAL), DBA HOP 2 IT MUSIC,  
8449 BARDMOOR PLACE  
LARGO, FL 33777 AND

HARTMANN, LISA (UNITED STATES INDIVIDUAL), DBA HOP 2 IT MUSIC,  
8449 BARDMOOR PLACE  
LARGO, FL 33777

FOR: PRERECORDED CDS AND DVDS FEATURING CHILDREN'S EDUCATIONAL MATERIAL FOR TEACHING MATH SKILLS, IN CLASS 9 (U.S. CLS. 21, 23, 26, 36 AND 38).

FIRST USE 8-16-2011; IN COMMERCE 8-16-2011.

THE MARK CONSISTS OF STANDARD CHARACTERS WITHOUT CLAIM TO ANY PARTICULAR FONT, STYLE, SIZE, OR COLOR.

SN 85-075,350, FILED 6-30-2010.

AMY KERTGATE, EXAMINING ATTORNEY



*David J. Kyffers*

Director of the United States Patent and Trademark Office

# United States of America

United States Patent and Trademark Office

## BIG GREEN ZERO

**Reg. No. 4,136,104**

**Registered May 1, 2012**

**Int. Cl.: 35**

**SERVICE MARK**

**PRINCIPAL REGISTER**

BIG GREEN ZERO, LLC (ARIZONA LIMITED LIABILITY COMPANY)  
1741 W. ROSE GARDEN LN., STE. 1  
PHOENIX, AZ 85027

FOR: CONSULTING AND ADVISORY SERVICES IN THE FIELDS OF ENERGY CONSERVATION AND ENERGY EFFICIENCY FOR COMMERCIAL, INSTITUTIONAL AND RESIDENTIAL BUILDINGS, AND REDUCING ENERGY COST; PROVISION OF ENERGY AUDITING SERVICES; PROVISION OF INFORMATION, ADVICE AND CONSULTANCY IN RELATION TO ENERGY EFFICIENCY, IN CLASS 35 (U.S. CLS. 100, 101 AND 102).

FIRST USE 2-19-2010; IN COMMERCE 5-20-2011.

THE MARK CONSISTS OF STANDARD CHARACTERS WITHOUT CLAIM TO ANY PARTICULAR FONT, STYLE, SIZE, OR COLOR.

NO CLAIM IS MADE TO THE EXCLUSIVE RIGHT TO USE "GREEN", APART FROM THE MARK AS SHOWN.

SN 85-075,410, FILED 6-30-2010.

REBECCA SMITH, EXAMINING ATTORNEY



*David J. Kyffers*

Director of the United States Patent and Trademark Office

# United States of America

United States Patent and Trademark Office



**Reg. No. 4,136,105**

**Registered May 1, 2012**

**Int. Cl.: 28**

**TRADEMARK**

**PRINCIPAL REGISTER**

WILD 52 PRODUCTIONS, INC. (CALIFORNIA CORPORATION)  
10504 CHESTERFIELD COURT  
BAKERSFIELD, CA 93311

FOR: CARD GAMES, IN CLASS 28 (U.S. CLS. 22, 23, 38 AND 50).

FIRST USE 2-1-2012; IN COMMERCE 2-1-2012.

THE MARK CONSISTS OF THE STYLIZED TEXT "WILD 52" OVER FOUR ACES AND A JOKER CARD.

SN 85-075,740, FILED 7-1-2010.

BRIAN CALLAGHAN, EXAMINING ATTORNEY



*David J. Kyffers*

Director of the United States Patent and Trademark Office



# United States of America

United States Patent and Trademark Office

## diversityDNA

**Reg. No. 4,136,106**

**Registered May 1, 2012**

**Int. Cl.: 41**

**SERVICE MARK**

**PRINCIPAL REGISTER**

DIVERSITYDNA LLC (DELAWARE LIMITED LIABILITY COMPANY)  
1992 COMMERCE STREET  
SUITE 27  
YORKTOWN HEIGHTS, NY 10598

FOR: EDUCATIONAL SERVICES, NAMELY, CONDUCTING COURSES AND SEMINARS IN LIVE AND WEB-BASED FORMAT, ON-SITE AND PRE-RECORDED ONLINE, FEATURING TRAINING IN THE FIELDS OF CULTURAL DIVERSITY, COMMUNICATION AND COMPETENCY, AND DISTRIBUTION OF TRAINING MATERIALS IN CONNECTION THEREWITH, IN CLASS 41 (U.S. CLS. 100, 101 AND 107).

FIRST USE 7-1-2010; IN COMMERCE 1-2-2012.

THE MARK CONSISTS OF STANDARD CHARACTERS WITHOUT CLAIM TO ANY PARTICULAR FONT, STYLE, SIZE, OR COLOR.

SN 85-075,916, FILED 7-1-2010.

PAM WILLIS, EXAMINING ATTORNEY



*David J. Kybas*

Director of the United States Patent and Trademark Office

# United States of America

United States Patent and Trademark Office

## NICOLE HENRY

**Reg. No. 4,136,107**

**Registered May 1, 2012**

**Int. Cl.: 25**

**TRADEMARK**

**PRINCIPAL REGISTER**

HENRY, NICOLE (UNITED STATES INDIVIDUAL)  
P.O. BOX 192011  
MIAMI BEACH, FL 33119

FOR: CLOTHING, NAMELY, SHIRTS, T-SHIRTS, IN CLASS 25 (U.S. CLS. 22 AND 39).

FIRST USE 2-16-2012; IN COMMERCE 2-16-2012.

THE MARK CONSISTS OF STANDARD CHARACTERS WITHOUT CLAIM TO ANY PARTICULAR FONT, STYLE, SIZE, OR COLOR.

THE NAME "NICOLE HENRY" IDENTIFIES A LIVING INDIVIDUAL WHOSE CONSENT IS OF RECORD.

SN 85-075,929, FILED 7-1-2010.

EMILY CHUO, EXAMINING ATTORNEY



*David J. Kyffers*

Director of the United States Patent and Trademark Office

# United States of America

United States Patent and Trademark Office



**Reg. No. 4,136,108**

**Registered May 1, 2012**

**Int. Cl.: 25**

**TRADEMARK**

**PRINCIPAL REGISTER**

GOLDEN STATE WARRIORS, LLC (CALIFORNIA LIMITED LIABILITY COMPANY)  
1011 BROADWAY  
OAKLAND, CA 94607

FOR: CLOTHING, NAMELY, HOSIERY, FOOTWEAR, BASKETBALL SHOES, BASKETBALL SNEAKERS, T-SHIRTS, SHIRTS, POLO SHIRTS, SWEATSHIRTS, SWEATPANTS, PANTS, TANK TOPS, JERSEYS, SHORTS, PAJAMAS, SPORT SHIRTS, RUGBY SHIRTS, SWEATERS, BELTS, TIES, NIGHTSHIRTS, HATS, CAPS, VISORS, WARM-UP SUITS, WARM-UP PANTS, WARM-UP TOPS/SHOOTING SHIRTS, JACKETS, WIND RESISTANT JACKETS, PARKAS, COATS, BABY BIBS NOT OF PAPER, HEAD BANDS, WRIST BANDS, APRONS, UNDERGARMENTS, BOXER SHORTS, SLACKS, EAR MUFFS, GLOVES, MITTENS, SCARVES, WOVEN AND KNIT SHIRTS, JERSEY DRESSES, DRESSES, CHEERLEADING DRESSES AND UNIFORMS, SWIM WEAR, BATHING SUITS, SWIMSUITS, BIKINIS, TANKINIS, SWIM TRUNKS, BATHING TRUNKS, BOARD SHORTS, WET SUITS, BEACH COVER-UPS, BATHING SUIT COVER-UPS, BATHING SUIT WRAPS, SANDALS, BEACH SANDALS, BEACH HATS, SUN VISORS, SWIM CAPS, BATHING CAPS, NOVELTY HEADWEAR WITH ATTACHED WIGS, IN CLASS 25 (U.S. CLS. 22 AND 39).

FIRST USE 8-10-2010; IN COMMERCE 8-10-2010.

NO CLAIM IS MADE TO THE EXCLUSIVE RIGHT TO USE "SF", APART FROM THE MARK AS SHOWN.

THE MARK CONSISTS OF A STYLIZED DESIGN OF A BASKETBALL APPEARING WITHIN A CIRCLE AND WITH STYLIZED LETTERS.

SN 85-076,036, FILED 7-1-2010.

BARBARA BROWN, EXAMINING ATTORNEY



*David J. Kyjars*

Director of the United States Patent and Trademark Office

# United States of America

United States Patent and Trademark Office



**Reg. No. 4,136,109**

**Registered May 1, 2012**

**Int. Cl.: 9**

**TRADEMARK**

**PRINCIPAL REGISTER**

GOLDEN STATE WARRIORS, LLC (CALIFORNIA LIMITED LIABILITY COMPANY)  
1011 BROADWAY  
OAKLAND, CA 94607

FOR: AUDIO RECORDINGS AND VIDEO RECORDINGS FEATURING ENTERTAINMENT AND INFORMATION IN THE FIELD OF BASKETBALL; AUDIO DISCS, VIDEO DISCS, COMPUTER LASER DISCS, PRE-RECORDED AUDIO AND VIDEO CASSETTES, PRE-RECORDED AUDIO AND VIDEO TAPES, PRE-RECORDED COMPACT DISCS, PRE-RECORDED COMPUTER LASER DISCS, ALL FEATURING ENTERTAINMENT AND INFORMATION RELATED TO BASKETBALL; COMPUTER ACCESSORIES, NAMELY, MOUSE PADS, MICE, DISC CASES, COMPUTER CARRY-ON CASES, KEYBOARD WRIST PADS, COMPUTER MONITOR CARDBOARD FRAMES, ALL RELATED TO BASKETBALL; COMPUTER PROGRAMS FOR VIEWING INFORMATION, STATISTICS OR TRIVIA ABOUT BASKETBALL; COMPUTER SOFTWARE, NAMELY, SCREEN SAVERS FEATURING BASKETBALL THEMES, COMPUTER SOFTWARE TO ACCESS AND VIEW COMPUTER WALLPAPER, COMPUTER BROWSERS, COMPUTER SKINS AND COMPUTER CURSORS; COMPUTER GAME SOFTWARE; VIDEO GAME SOFTWARE, VIDEO GAME CARTRIDGES AND VIDEO GAME MACHINES AND VIDEO GAME HAND HELD CONTROLLERS FOR USE WITH TELEVISIONS; WIRELESS TELEPHONES; RADIOS, TELEPHONES, AND CELL PHONE ACCESSORIES, NAMELY, FACE PLATES AND CELL PHONE COVERS; VIDEO MONITORS, COMPUTER MONITORS, BINOCULARS; SUNGLASSES; EYEGLASS FRAMES; EYEWEAR STRAPS AND CHAINS; EYEGLASS AND SUNGLASS CASES; MAGNETS; DISPOSABLE CAMERAS; CREDIT CARDS AND PRE-PAID TELEPHONE CALLING CARDS MAGNETICALLY ENCODED, DOWNLOADABLE VIDEO RECORDINGS, VIDEO STREAM RECORDINGS, AND AUDIO RECORDINGS IN THE FIELD OF BASKETBALL PROVIDED OVER THE INTERNET; DOWNLOADABLE COMPUTER SOFTWARE FOR VIEWING DATABASES OF INFORMATION, STATISTICAL INFORMATION, TRIVIA, POLLING INFORMATION, AND INTERACTIVE POLLING IN THE FIELD OF BASKETBALL PROVIDED OVER THE INTERNET; DOWNLOADABLE COMPUTER GAME SOFTWARE; DOWNLOADABLE VIDEO GAME PROGRAMS, INTERACTIVE VIDEO GAMES AND TRIVIA GAME SOFTWARE PROVIDED OVER THE INTERNET; DOWNLOADABLE COMPUTER SOFTWARE FOR USE AS SCREENSAVERS, WALLPAPER, BROWSERS, SKINS, AVATARS AND CURSORS OVER THE INTERNET; DOWNLOADABLE ELECTRONIC PUBLICATIONS IN THE NATURE OF MAGAZINES, NEWSLETTERS, COLORING BOOKS, GAME SCHEDULES ALL IN THE FIELD OF BASKETBALL PROVIDED OVER THE INTERNET; DOWNLOADABLE CATALOGS PROVIDED OVER THE INTERNET FEATURING AN ARRAY OF BASKETBALL-



*David J. Kybas*

Director of the United States Patent and Trademark Office

**Reg. No. 4,136,109** THEMED PRODUCTS; DOWNLOADABLE GREETING CARDS PROVIDED OVER THE INTERNET, IN CLASS 9 (U.S. CLS. 21, 23, 26, 36 AND 38).

FIRST USE 8-10-2010; IN COMMERCE 8-10-2010.

NO CLAIM IS MADE TO THE EXCLUSIVE RIGHT TO USE "SF", APART FROM THE MARK AS SHOWN.

THE MARK CONSISTS OF A STYLIZED DESIGN OF A BASKETBALL APPEARING WITHIN A CIRCLE AND WITH STYLIZED LETTERS.

SN 85-076,096, FILED 7-1-2010.

BARBARA BROWN, EXAMINING ATTORNEY

# United States of America

United States Patent and Trademark Office

# access2go

**Reg. No. 4,136,110**

**Registered May 1, 2012**

**Int. Cl.: 38**

**SERVICE MARK**

**PRINCIPAL REGISTER**

MAIN STREET BROADBAND, LLC (GEORGIA LIMITED LIABILITY COMPANY)  
SUITE 300  
3780 MANSELL ROAD  
ALPHARETTA, GA 30022

FOR: TELECOMMUNICATIONS SERVICES, NAMELY, MOBILE BROADBAND COMMUNICATION SERVICES AND PROVISION OF HIGH SPEED INTERNET ACCESS, IN CLASS 38 (U.S. CLS. 100, 101 AND 104).

FIRST USE 2-6-2010; IN COMMERCE 8-19-2010.

THE MARK CONSISTS OF THE WORD "ACCESS", WITH A NUMBER "2" ON THE INSIDE OF A CIRCLE NEXT TO IT. THE WORD "GO" IS NEXT TO THE CIRCLE.

SN 85-076,278, FILED 7-1-2010.

KATHERINE CHANG, EXAMINING ATTORNEY



*David J. Kybas*

Director of the United States Patent and Trademark Office

# United States of America

United States Patent and Trademark Office

## APEX FITNESS

**Reg. No. 4,136,111**

**Registered May 1, 2012**

**Int. Cl.: 35**

**SERVICE MARK**

**PRINCIPAL REGISTER**

24 HOUR FITNESS USA, INC. (CALIFORNIA CORPORATION)  
12647 ALCOSTA BLVD., 5TH FL  
SAN RAMON, CA 94583

FOR: ONLINE RETAIL STORE SERVICES AND DISTRIBUTORSHIP SERVICES FEATURING SPORTS, FITNESS, NUTRITIONAL AND WEIGHT MANAGEMENT EDUCATIONAL MATERIALS, EQUIPMENT AND ACCESSORIES FOR USE IN CONNECTION WITH FITNESS AND EXERCISE ACTIVITIES, INCLUDING STABILITY BALLS, WEIGHTS, MEDICINE BALLS, KETTLE BALLS, TRAINING AND RESISTANCE BANDS, YOGA MATS, EXERCISE MATS, IN CLASS 35 (U.S. CLS. 100, 101 AND 102).

FIRST USE 0-0-1994; IN COMMERCE 0-0-1994.

THE MARK CONSISTS OF STANDARD CHARACTERS WITHOUT CLAIM TO ANY PARTICULAR FONT, STYLE, SIZE, OR COLOR.

OWNER OF U.S. REG. NOS. 2,701,627, 2,703,428, AND 2,936,205.

NO CLAIM IS MADE TO THE EXCLUSIVE RIGHT TO USE "FITNESS", APART FROM THE MARK AS SHOWN.

SN 85-076,566, FILED 7-1-2010.

BENJAMIN OKEKE, EXAMINING ATTORNEY



*David J. Kyros*

Director of the United States Patent and Trademark Office

# United States of America

United States Patent and Trademark Office

## RECYCLING REDEFINED

**Reg. No. 4,136,112**

**Registered May 1, 2012**

**Int. Cls.: 37 and 40**

**SERVICE MARK**

**PRINCIPAL REGISTER**

SA RECYCLING LLC (DELAWARE LIMITED LIABILITY COMPANY)  
3200 E. FRONTERA STREET  
ANAHEIM, CA 92806

FOR: DISMANTLING AND DEMOLITION OF BUILDINGS AND INDUSTRIAL PLANTS, IN CLASS 37 (U.S. CLS. 100, 103 AND 106).

FIRST USE 2-28-2010; IN COMMERCE 2-28-2010.

FOR: RECYCLING SERVICES; DISMANTLING AND RECYCLING OF METALS, PLASTICS, EQUIPMENT, MACHINERY, APPLIANCES, ELECTRONICS, FIXTURES, AUTOMOBILES AND TIRES; DEMOLITION SERVICES; RECYCLING OF GREEN WASTE, NAMELY, VEGETATION AND PLANT MATTER, GARDENING AND LANDSCAPING TRIMMINGS, AND WOOD WASTE, IN CLASS 40 (U.S. CLS. 100, 103 AND 106).

FIRST USE 2-28-2010; IN COMMERCE 2-28-2010.

THE MARK CONSISTS OF STANDARD CHARACTERS WITHOUT CLAIM TO ANY PARTICULAR FONT, STYLE, SIZE, OR COLOR.

NO CLAIM IS MADE TO THE EXCLUSIVE RIGHT TO USE "RECYCLING", APART FROM THE MARK AS SHOWN.

SN 85-077,021, FILED 7-2-2010.

CHARISMA HAMPTON, EXAMINING ATTORNEY



*David J. Kyros*

Director of the United States Patent and Trademark Office



**United States of America**  
United States Patent and Trademark Office

# BATWOLF

**Reg. No. 4,136,113**

**Registered May 1, 2012**

**Int. Cl.: 9**

**TRADEMARK**

**PRINCIPAL REGISTER**

OAKLEY, INC. (WASHINGTON CORPORATION)  
ONE ICON  
FOOTHILL RANCH, CA 92610

FOR: PROTECTIVE EYEWEAR, NAMELY, SPECTACLES, PRESCRIPTION EYEWEAR, ANTI GLARE GLASSES AND SUNGLASSES AND THEIR PARTS AND ACCESSORIES, NAMELY, REPLACEMENT LENSES, FRAMES, EAR STEMS, AND NOSE PIECES; CASES SPECIALLY ADAPTED FOR SPECTACLES AND SUNGLASSES AND THEIR PARTS AND ACCESSORIES, IN CLASS 9 (U.S. CLS. 21, 23, 26, 36 AND 38).

FIRST USE 11-30-2010; IN COMMERCE 11-30-2010.

THE MARK CONSISTS OF STANDARD CHARACTERS WITHOUT CLAIM TO ANY PARTICULAR FONT, STYLE, SIZE, OR COLOR.

SN 85-077,579, FILED 7-2-2010.

LINDA LAVACHE, EXAMINING ATTORNEY



*David J. Kyffers*

Director of the United States Patent and Trademark Office

**United States of America**  
United States Patent and Trademark Office

# INSIDIOUS

**Reg. No. 4,136,114**

**Registered May 1, 2012**

**Int. Cl.: 25**

**TRADEMARK**

**PRINCIPAL REGISTER**

MASSEY, JAMES (UNITED STATES INDIVIDUAL)  
715 MARINE #8  
BOULDER, CO 80302

FOR: CLOTHING, NAMELY, TOPS, BOTTOMS, UNDERWEAR, FOOTWEAR, HEADWEAR, DRESSES, JACKETS, COATS, BELTS, NECKWEAR, BEACHWEAR, AND SLEEPWEAR, IN CLASS 25 (U.S. CLS. 22 AND 39).

FIRST USE 1-22-2010; IN COMMERCE 12-29-2011.

THE MARK CONSISTS OF STANDARD CHARACTERS WITHOUT CLAIM TO ANY PARTICULAR FONT, STYLE, SIZE, OR COLOR.

SN 85-077,699, FILED 7-3-2010.

RICHARD WHITE, EXAMINING ATTORNEY



*David J. Kybas*

Director of the United States Patent and Trademark Office

# United States of America

United States Patent and Trademark Office

## BROT-SINFONIE

**Reg. No. 4,136,115**

**Registered May 1, 2012**

**Int. Cl.: 30**

**TRADEMARK**

**PRINCIPAL REGISTER**

MACK, NATALIE (FED REP GERMANY INDIVIDUAL)  
BIRNTORWEG 5  
BOPFINGEN, FED REP GERMANY 73441

FOR: BREAD, FRENCH BREAD, WHOLE WHEAT BREAD, IN CLASS 30 (U.S. CL. 46).

FIRST USE 10-30-2010; IN COMMERCE 10-30-2010.

THE MARK CONSISTS OF STANDARD CHARACTERS WITHOUT CLAIM TO ANY PARTICULAR FONT, STYLE, SIZE, OR COLOR.

THE ENGLISH TRANSLATION OF THE WORDS "BROT-SINFONIE" IN THE MARK IS BREAD-SYMPHONY.

SN 85-077,726, FILED 7-3-2010.

EVELYN BRADLEY, EXAMINING ATTORNEY



*David J. Kybas*

Director of the United States Patent and Trademark Office

# United States of America

United States Patent and Trademark Office

# STAR PAK

**Reg. No. 4,136,116**

**Registered May 1, 2012**

**Int. Cl.: 6**

**TRADEMARK**

**PRINCIPAL REGISTER**

AMISTCO SEPARATION PRODUCTS, INC. (TEXAS CORPORATION)  
P.O. BOX 1550  
ALVIN, TX 77512

FOR: RANDOM COLUMN PACKING MADE OF METAL FOR USE IN ABSORPTION, STRIPPING, DISTILLATION, FRACTIONATION AND HEAT TRANSFER APPLICATIONS FOR REFINERIES AND CHEMICAL PLANTS, IN CLASS 6 (U.S. CLS. 2, 12, 13, 14, 23, 25 AND 50).

FIRST USE 7-0-2010; IN COMMERCE 7-0-2010.

THE MARK CONSISTS OF STANDARD CHARACTERS WITHOUT CLAIM TO ANY PARTICULAR FONT, STYLE, SIZE, OR COLOR.

NO CLAIM IS MADE TO THE EXCLUSIVE RIGHT TO USE "PACK", APART FROM THE MARK AS SHOWN.

SN 85-078,013, FILED 7-5-2010.

TEJBIR SINGH, EXAMINING ATTORNEY



*David J. Kypos*

Director of the United States Patent and Trademark Office

# United States of America

United States Patent and Trademark Office

# SECURISYNC

**Reg. No. 4,136,117**

**Registered May 1, 2012**

**Int. Cl.: 42**

**SERVICE MARK**

**PRINCIPAL REGISTER**

INTERMEDIA.NET, INC. (DELAWARE CORPORATION)  
156 WEST 56TH STREET, SUITE 1601  
NEW YORK, NY 10019

FOR: COMPUTER SERVICES, NAMELY, ACTING AS AN APPLICATION SERVICE PROVIDER IN THE FIELD OF ENTERPRISE FILE SHARING ACROSS MULTIPLE COMPUTERS, IN CLASS 42 (U.S. CLS. 100 AND 101).

FIRST USE 2-16-2010; IN COMMERCE 2-16-2010.

THE MARK CONSISTS OF STANDARD CHARACTERS WITHOUT CLAIM TO ANY PARTICULAR FONT, STYLE, SIZE, OR COLOR.

SN 85-078,195, FILED 7-6-2010.

KIM MONINGHOFF, EXAMINING ATTORNEY



*David J. Kybas*

Director of the United States Patent and Trademark Office

# United States of America

United States Patent and Trademark Office

# USERPILOT

**Reg. No. 4,136,118**

**Registered May 1, 2012**

**Int. Cls.: 38 and 42**

**SERVICE MARK**

**PRINCIPAL REGISTER**

INTERMEDIA.NET, INC. (DELAWARE CORPORATION)  
156 WEST 56TH STREET, SUITE 1601  
NEW YORK, NY 10019

FOR: PROVIDING ACCESS TO SOFTWARE APPLICATIONS, COMPUTER SERVER APPLICATIONS, AND WEB SITES OF OTHERS HOSTED ON COMPUTER SERVERS ACCESSIBLE VIA A GLOBAL COMPUTER NETWORK, IN CLASS 38 (U.S. CLS. 100, 101 AND 104).

FIRST USE 11-11-2008; IN COMMERCE 11-11-2008.

FOR: HOSTING THE WEB SITES OF OTHERS ON A COMPUTER SERVER FOR A GLOBAL COMPUTER NETWORK; HOSTING SOFTWARE APPLICATIONS FOR OTHERS ON A COMPUTER SERVER FOR A GLOBAL COMPUTER NETWORK; APPLICATION SERVICE PROVIDER FEATURING SOFTWARE FOR USE IN REMOTELY MANAGING SOFTWARE APPLICATIONS, COMPUTER APPLICATIONS, AND WEBSITES STORED ON A HOST COMPUTER, IN CLASS 42 (U.S. CLS. 100 AND 101).

FIRST USE 11-11-2008; IN COMMERCE 11-11-2008.

THE MARK CONSISTS OF STANDARD CHARACTERS WITHOUT CLAIM TO ANY PARTICULAR FONT, STYLE, SIZE, OR COLOR.

OWNER OF U.S. REG. NOS. 3,401,543 AND 3,625,427.

SN 85-078,202, FILED 7-6-2010.

KIM MONINGHOFF, EXAMINING ATTORNEY



*David J. Kyros*

Director of the United States Patent and Trademark Office

# United States of America

United States Patent and Trademark Office

# DOXIMITY

**Reg. No. 4,136,119**

**Registered May 1, 2012**

**Int. Cl.: 42**

**SERVICE MARK**

**PRINCIPAL REGISTER**

DOXIMITY, INC. (DELAWARE CORPORATION)  
218 COMMONS LANE  
FOSTER CITY, CA 94404

FOR: COMPUTER SERVICES, NAMELY, CREATING AN ONLINE COMMUNITY TO ALLOW PHYSICIANS AND OTHER MEDICAL PROFESSIONALS TO COMMUNICATE VIA SOCIAL NETWORKING, IN CLASS 42 (U.S. CLS. 100 AND 101).

FIRST USE 9-29-2010; IN COMMERCE 9-29-2010.

THE MARK CONSISTS OF STANDARD CHARACTERS WITHOUT CLAIM TO ANY PARTICULAR FONT, STYLE, SIZE, OR COLOR.

SN 85-078,474, FILED 7-6-2010.

GINA HAYES, EXAMINING ATTORNEY



*David J. Kyros*

Director of the United States Patent and Trademark Office

# United States of America

United States Patent and Trademark Office

## THIS IS MY STORY (AND I'M STICKING TO IT)

**Reg. No. 4,136,120**

**Registered May 1, 2012**

**Int. Cl.: 9**

**TRADEMARK**

**PRINCIPAL REGISTER**

COMPANY 5, LLC (NEW JERSEY LIMITED LIABILITY COMPANY)  
11 WEST END ROAD  
TOTOWA, NJ 07512

FOR: INTERACTIVE COMPUTER GAME SOFTWARE FOR HANDHELD ELECTRONIC  
DEVICES, IN CLASS 9 (U.S. CLS. 21, 23, 26, 36 AND 38).

FIRST USE 6-3-2011; IN COMMERCE 6-3-2010.

THE MARK CONSISTS OF STANDARD CHARACTERS WITHOUT CLAIM TO ANY PAR-  
TICULAR FONT, STYLE, SIZE, OR COLOR.

SN 85-078,631, FILED 7-6-2010.

AISHA CLARKE, EXAMINING ATTORNEY



*David J. Kybas*

Director of the United States Patent and Trademark Office



# United States of America

United States Patent and Trademark Office

# GOT PETS?

**Reg. No. 4,136,121**

**Registered May 1, 2012**

**Int. Cl.: 35**

**SERVICE MARK**

**PRINCIPAL REGISTER**

PETLINE LLC (CALIFORNIA LIMITED LIABILITY COMPANY)  
STE 1710  
5777 W. CENTURY BLVD  
LOS ANGELES, CA 90045

FOR: REFERRALS IN THE FIELD OF DIRECTING PET OWNERS TO BREED SPECIFIC PET PRODUCTS AND SERVICE PROVIDERS BY MEANS OF TELEPHONE AND THE INTERNET, IN CLASS 35 (U.S. CLS. 100, 101 AND 102).

FIRST USE 2-19-2010; IN COMMERCE 2-19-2010.

THE MARK CONSISTS OF STANDARD CHARACTERS WITHOUT CLAIM TO ANY PARTICULAR FONT, STYLE, SIZE, OR COLOR.

OWNER OF U.S. REG. NO. 3,804,634.

SN 85-079,154, FILED 7-7-2010.

KAREN K. BUSH, EXAMINING ATTORNEY



*David J. Kybas*

Director of the United States Patent and Trademark Office

# United States of America

United States Patent and Trademark Office



**Reg. No. 4,136,122**

**Registered May 1, 2012**

**Int. Cl.: 22**

**TRADEMARK**

**PRINCIPAL REGISTER**

MOHAWK CARPET DISTRIBUTION, INC. (DELAWARE CORPORATION)  
P.O. BOX 800  
MISTY YOUNG - LEGAL DEPT  
CHATSWORTH, GA 30705

FOR: SYNTHETIC FIBERS AND FILAMENTS FOR USE IN THE MANUFACTURE OF FABRICS, TEXTILES, YARNS, AND CARPETS, IN CLASS 22 (U.S. CLS. 1, 2, 7, 19, 22, 42 AND 50).

FIRST USE 10-12-2010; IN COMMERCE 10-12-2010.

OWNER OF U.S. REG. NO. 2,940,718.

NO CLAIM IS MADE TO THE EXCLUSIVE RIGHT TO USE "EXTRA SOFT" AND "PREMIUM SOFT PET FIBER MADE WITH 100% RECYCLED BOTTLES" AS WELL AS THE INTERNATIONAL RECYCLING SYMBOL, APART FROM THE MARK AS SHOWN.

THE MARK CONSISTS OF THE STYLIZED WORDING "EVERSTRAND" APPEARING ABOVE THE STYLIZED WORDING "XTRASOFT" ALL OF WHICH APPEAR ON TOP OF A STYLIZED LOWER CASE LETTER "E". BELOW THE TERM "XTRASOFT" APPEARS THE STYLIZED WORDING "PREMIUM SOFT PET FIBER MADE WITH 100% RECYCLED BOTTLES". TO THE RIGHT OF THE WORDING "EVERSTRAND" APPEARS THE DEPICTION OF THE INTERNATIONAL RECYCLING SYMBOL.

SN 85-079,190, FILED 7-7-2010.

MICHAEL TANNER, EXAMINING ATTORNEY



*David J. Kybas*

Director of the United States Patent and Trademark Office

# United States of America

United States Patent and Trademark Office

**permaSTRAND**  
XtraSoft

**Reg. No. 4,136,123**

**Registered May 1, 2012**

**Int. Cl.: 22**

**TRADEMARK**

**PRINCIPAL REGISTER**

MOHAWK CARPET DISTRIBUTION, INC. (DELAWARE CORPORATION)  
P.O. BOX 800  
MISTY YOUNG - LEGAL DEPT  
CHATSWORTH, GA 30705

FOR: SYNTHETIC FIBERS AND FILAMENTS FOR USE IN THE MANUFACTURE OF FABRICS, TEXTILES, YARNS, AND CARPETS, IN CLASS 22 (U.S. CLS. 1, 2, 7, 19, 22, 42 AND 50).

FIRST USE 10-12-2010; IN COMMERCE 10-12-2010.

OWNER OF U.S. REG. NO. 2,893,923.

NO CLAIM IS MADE TO THE EXCLUSIVE RIGHT TO USE "EXTRA SOFT", APART FROM THE MARK AS SHOWN.

THE MARK CONSISTS OF THE STYLIZED WORDING "PERMASTRAND" APPEARING ABOVE THE STYLIZED WORDING "XTRASOFT" ALL OF WHICH APPEAR ON TOP OF A STYLIZED LETTER "P".

SN 85-079,241, FILED 7-7-2010.

MICHAEL TANNER, EXAMINING ATTORNEY



*David J. Kybas*

Director of the United States Patent and Trademark Office

# United States of America

United States Patent and Trademark Office

**ROOD-SINEMA**

**Reg. No. 4,136,124**

ALEXANDER, JAMES DOUGLAS (UNITED STATES INDIVIDUAL)  
268 PRESIDENT STREET  
SADDLE BROOK, NJ 07663

**Registered May 1, 2012**

**Int. Cl.: 35**

FOR: ON-LINE PROMOTION OF COMPUTER NETWORKS AND WEBSITES, IN CLASS 35  
(U.S. CLS. 100, 101 AND 102).

**SERVICE MARK**

FIRST USE 6-30-2010; IN COMMERCE 6-30-2010.

**PRINCIPAL REGISTER**

THE STIPPLING IS A FEATURE OF THE MARK AND DOES NOT INDICATE COLOR.

THE MARK CONSISTS OF THE WORDING "ROOD-SINEMA" WITH THE SECOND "O" IN  
THE WORDING "ROOD" REPLACED BY A SKULL DESIGN. LINES ARE SHOWN EMAN-  
ATING FROM ALL OF THE LETTERING IN THE MARK AND THE SKULL DESIGN.

THE ENGLISH TRANSLATION OF THE WORD "SINEMA" IN THE MARK IS "CINEMA".

SN 85-079,383, FILED 7-7-2010.

CHRISTOPHER LAW, EXAMINING ATTORNEY



*David J. Kyros*

Director of the United States Patent and Trademark Office

# United States of America

United States Patent and Trademark Office

# BYOS

**Reg. No. 4,136,125**

**Registered May 1, 2012**

**Int. Cls.: 21 and 35**

**TRADEMARK**

**SERVICE MARK**

**PRINCIPAL REGISTER**

KLEAN KANTEEN, INC. (CALIFORNIA CORPORATION)  
4345 HEDSTROM WAY  
CHICO, CA 95973

FOR: REUSABLE STAINLESS STEEL BEVERAGE CONTAINERS SOLD EMPTY, IN CLASS 21 (U.S. CLS. 2, 13, 23, 29, 30, 33, 40 AND 50).

FIRST USE 11-15-2011; IN COMMERCE 11-15-2011.

FOR: PROMOTING PUBLIC AWARENESS OF ENVIRONMENTAL ISSUES, ENVIRONMENTAL SUSTAINABILITY AND HEALTH-RELATED ISSUES THROUGH SPONSORSHIP OF ENTERTAINMENT, SPORTING AND CULTURAL EVENTS, IN CLASS 35 (U.S. CLS. 100, 101 AND 102).

FIRST USE 11-15-2011; IN COMMERCE 11-15-2011.

THE MARK CONSISTS OF STANDARD CHARACTERS WITHOUT CLAIM TO ANY PARTICULAR FONT, STYLE, SIZE, OR COLOR.

SN 85-079,688, FILED 7-7-2010.

TEJBIR SINGH, EXAMINING ATTORNEY



*David J. Kybas*

Director of the United States Patent and Trademark Office

# United States of America

United States Patent and Trademark Office



**Reg. No. 4,136,126**

**Registered May 1, 2012**

**Int. Cl.: 39**

**SERVICE MARK**

**PRINCIPAL REGISTER**

NEW JERSEY TRANSIT CORPORATION (NEW JERSEY CORPORATION), AKA N.J. TRANSIT,  
ONE PENN PLAZA EAST  
NEWARK, NJ 071052246

FOR: TRAVEL INFORMATION SERVICES AND TRAVEL SERVICES, NAMELY, TRANSPORTATION OF PASSENGERS BY RAIL AND BUS TO DESTINATIONS THROUGHOUT NEW JERSEY, NEW YORK AND PENNSYLVANIA, IN CLASS 39 (U.S. CLS. 100 AND 105).

FIRST USE 9-7-2010; IN COMMERCE 9-7-2010.

NO CLAIM IS MADE TO THE EXCLUSIVE RIGHT TO USE "COMMUTE", APART FROM THE MARK AS SHOWN.

THE COLOR(S) BLUE AND RED IS/ARE CLAIMED AS A FEATURE OF THE MARK.

THE MARK CONSISTS OF A BLUE HAND FORMED IN THE SHAPE OF A FIST WITH THE INDEX FINGER EXTENDING UPWARD IN FRONT OF A PAIR OF PARTIALLY OPENED RED LIPS. TO THE LEFT OF THE HAND IS THE WORD "QUIET" IN RED AND BELOW AND TO THE LEFT OF THE HAND IS THE WORD "COMMUTE" WITH THE LETTERS "COM" IN BLUE AND THE LETTERS "MUTE" IN RED.

SN 85-080,374, FILED 7-8-2010.

LESLIE RICHARDS, EXAMINING ATTORNEY



*David J. Kyffers*

Director of the United States Patent and Trademark Office

United States of America  
United States Patent and Trademark Office

RAY-MAX

**Reg. No. 4,136,127**

NEXTRONEX INC. (OHIO CORPORATION)  
4400 MOLINE MARTIN ROAD  
MILLBURY, OH 43447

**Registered May 1, 2012**

**Int. Cl.: 9**

FOR: INVERTER SYSTEMS COMPRISING INVERTERS, ROW BOXES, NAMELY, JUNCTION BOXES, AND BUS BARS, IN CLASS 9 (U.S. CLS. 21, 23, 26, 36 AND 38).

**TRADEMARK**

FIRST USE 12-10-2010; IN COMMERCE 12-10-2010.

**PRINCIPAL REGISTER**

THE MARK CONSISTS OF STANDARD CHARACTERS WITHOUT CLAIM TO ANY PARTICULAR FONT, STYLE, SIZE, OR COLOR.

SN 85-080,607, FILED 7-8-2010.

MARK RADEMACHER, EXAMINING ATTORNEY



*David J. Kybas*

Director of the United States Patent and Trademark Office

# United States of America

United States Patent and Trademark Office

## LORENZO DONNA

**Reg. No. 4,136,128**

**Registered May 1, 2012**

**Int. Cl.: 25**

**TRADEMARK**

**PRINCIPAL REGISTER**

ECHO LAKE INDUSTRIES, LTD. (NEW YORK CORPORATION)  
85A MARCUS DRIVE  
MELVILLE, NY 11747

FOR: CLOTHING, NAMELY, SHIRTS AND PANTS, IN CLASS 25 (U.S. CLS. 22 AND 39).

FIRST USE 0-0-2003; IN COMMERCE 0-0-2003.

THE MARK CONSISTS OF STANDARD CHARACTERS WITHOUT CLAIM TO ANY PARTICULAR FONT, STYLE, SIZE, OR COLOR.

OWNER OF U.S. REG. NOS. 2,370,118 AND 3,306,234.

NO CLAIM IS MADE TO THE EXCLUSIVE RIGHT TO USE "DONNA", APART FROM THE MARK AS SHOWN.

THE NAME(S), PORTRAIT(S), AND/OR SIGNATURE(S) SHOWN IN THE MARK DOES NOT IDENTIFY A PARTICULAR LIVING INDIVIDUAL.

THE ENGLISH TRANSLATION OF "DONNA" IN THE MARK IS "WOMEN".

SN 85-080,659, FILED 7-8-2010.

MARK SHINER, EXAMINING ATTORNEY



*David J. Kyffers*

Director of the United States Patent and Trademark Office



# United States of America

United States Patent and Trademark Office

## TD WEALTH

**Reg. No. 4,136,129**

**Registered May 1, 2012**

**Int. Cl.: 36**

**SERVICE MARK**

**PRINCIPAL REGISTER**

THE TORONTO-DOMINION BANK (CANADA CHARTERED BANK)  
12TH FLOOR 66 WELLINGTON STREET  
TORONTO-DOMINION TOWER  
TORONTO, CANADA M5K1A2

FOR: FINANCIAL SERVICES, NAMELY, WEALTH MANAGEMENT SERVICES, FINANCIAL ASSET MANAGEMENT SERVICES, BANKING SERVICES, ESTATE TRUST MANAGEMENT SERVICES; CREDIT SERVICES, NAMELY, CREDIT CARD SERVICES, MORTGAGE LENDING AND LOAN FINANCING; DEPOSIT SERVICES, NAMELY, DEBIT CARD SERVICES AND CASH AND SECURITIES DEPOSIT SERVICES; INSURANCE SERVICES, NAMELY, INSURANCE AGENCY BROKERAGE SERVICES AND INSURANCE CONSULTATION, IN CLASS 36 (U.S. CLS. 100, 101 AND 102).

FIRST USE 1-12-2012; IN COMMERCE 1-12-2012.

THE MARK CONSISTS OF STANDARD CHARACTERS WITHOUT CLAIM TO ANY PARTICULAR FONT, STYLE, SIZE, OR COLOR.

OWNER OF U.S. REG. NOS. 3,041,170, 3,854,367, AND OTHERS.

NO CLAIM IS MADE TO THE EXCLUSIVE RIGHT TO USE "WEALTH", APART FROM THE MARK AS SHOWN.

SN 85-080,671, FILED 7-8-2010.

KATHERINE E. HALMEN, EXAMINING ATTORNEY



*David J. Kybas*

Director of the United States Patent and Trademark Office

# United States of America

United States Patent and Trademark Office

## ORGANIC HARVEST

**Reg. No. 4,136,130**

**Registered May 1, 2012**

**Int. Cls.: 3 and 5**

**TRADEMARK**

**PRINCIPAL REGISTER**

JOHNSON & JOHNSON (NEW JERSEY CORPORATION)  
ONE JOHNSON & JOHNSON PLAZA  
NEW BRUNSWICK, NJ 089337001

FOR: ORGANIC HAIR CARE PREPARATIONS, NAMELY, SHAMPOO; ORGANIC BODY CARE PREPARATIONS, NAMELY, BODY WASH AND BODY LOTION; NON-MEDICATED ORGANIC SKIN CARE PREPARATIONS, IN CLASS 3 (U.S. CLS. 1, 4, 6, 50, 51 AND 52).

FIRST USE 12-6-2011; IN COMMERCE 12-6-2011.

FOR: MEDICATED ORGANIC SKIN CARE PREPARATIONS; MEDICATED ORGANIC DIAPER RASH CREAM, IN CLASS 5 (U.S. CLS. 6, 18, 44, 46, 51 AND 52).

FIRST USE 12-6-2011; IN COMMERCE 12-6-2011.

THE MARK CONSISTS OF STANDARD CHARACTERS WITHOUT CLAIM TO ANY PARTICULAR FONT, STYLE, SIZE, OR COLOR.

NO CLAIM IS MADE TO THE EXCLUSIVE RIGHT TO USE "ORGANIC", APART FROM THE MARK AS SHOWN.

SN 85-080,953, FILED 7-9-2010.

ROBIN MITTLER, EXAMINING ATTORNEY



*David J. Kyffers*

Director of the United States Patent and Trademark Office

# United States of America

United States Patent and Trademark Office

## IN-REL PROPERTIES

**Reg. No. 4,136,131**

**Registered May 1, 2012**

**Int. Cls.: 36 and 37**

**SERVICE MARK**

**PRINCIPAL REGISTER**

IN-REL PROPERTIES, INC. (FLORIDA CORPORATION)  
2328 10TH AVE. NORTH  
SUITE 401  
LAKE WORTH, FL 33461

FOR: ACQUISITION, MANAGEMENT AND LEASING OF REAL ESTATE, IN CLASS 36  
(U.S. CLS. 100, 101 AND 102).

FIRST USE 3-0-2010; IN COMMERCE 3-0-2010.

FOR: DEVELOPMENT OF REAL ESTATE, IN CLASS 37 (U.S. CLS. 100, 103 AND 106).

FIRST USE 3-0-2010; IN COMMERCE 3-0-2010.

THE MARK CONSISTS OF STANDARD CHARACTERS WITHOUT CLAIM TO ANY PARTICULAR FONT, STYLE, SIZE, OR COLOR.

NO CLAIM IS MADE TO THE EXCLUSIVE RIGHT TO USE "PROPERTIES", APART FROM THE MARK AS SHOWN.

SN 85-081,143, FILED 7-9-2010.

SANI KHOURI, EXAMINING ATTORNEY



*David J. Kybas*

Director of the United States Patent and Trademark Office

# United States of America

United States Patent and Trademark Office

## RAWDADDY FOODS

**Reg. No. 4,136,132**

**Registered May 1, 2012**

**Int. Cls.: 30 and 43**

**TRADEMARK**

**SERVICE MARK**

**PRINCIPAL REGISTER**

RAWDADDY FOODS, INC. (CALIFORNIA CORPORATION)  
1145 CLEVELAND STREET  
REDWOOD CITY, CA 94061

FOR: EDIBLE CONES MADE OF FLAXSEED FOR HOLDING VARIOUS FOOD ITEMS;  
EDIBLE CONES MADE OF FLAXSEED FILLED WITH VEGAN FOOD ITEMS, IN CLASS  
30 (U.S. CL. 46).

FIRST USE 2-0-2007; IN COMMERCE 2-0-2007.

FOR: PROVIDING OF FOOD AND DRINK, IN CLASS 43 (U.S. CLS. 100 AND 101).

FIRST USE 2-0-2007; IN COMMERCE 2-0-2007.

THE MARK CONSISTS OF STANDARD CHARACTERS WITHOUT CLAIM TO ANY PAR-  
TICULAR FONT, STYLE, SIZE, OR COLOR.

NO CLAIM IS MADE TO THE EXCLUSIVE RIGHT TO USE "FOODS", APART FROM THE  
MARK AS SHOWN.

SN 85-081,517, FILED 7-9-2010.

LINDSEY RUBIN, EXAMINING ATTORNEY



*David J. Kyros*

Director of the United States Patent and Trademark Office

# United States of America

United States Patent and Trademark Office

# RAWDADDY

**Reg. No. 4,136,133**

**Registered May 1, 2012**

**Int. Cls.: 30 and 43**

**TRADEMARK**

**SERVICE MARK**

**PRINCIPAL REGISTER**

RAWDADDY FOODS, INC. (CALIFORNIA CORPORATION)  
1145 CLEVELAND STREET  
REDWOOD CITY, CA 94061

FOR: EDIBLE CONES MADE OF FLAXSEED FOR HOLDING VARIOUS FOOD ITEMS;  
EDIBLE CONES MADE OF FLAXSEED FILLED WITH VEGAN FOOD ITEMS, IN CLASS  
30 (U.S. CL. 46).

FIRST USE 2-0-2007; IN COMMERCE 2-0-2007.

FOR: PROVIDING OF FOOD AND DRINK, IN CLASS 43 (U.S. CLS. 100 AND 101).

FIRST USE 2-0-2007; IN COMMERCE 2-0-2007.

THE MARK CONSISTS OF STANDARD CHARACTERS WITHOUT CLAIM TO ANY PAR-  
TICULAR FONT, STYLE, SIZE, OR COLOR.

SN 85-081,631, FILED 7-9-2010.

LINDSEY RUBIN, EXAMINING ATTORNEY



*David J. Kyros*

Director of the United States Patent and Trademark Office

# United States of America

United States Patent and Trademark Office

## EVE'S APPLE

**Reg. No. 4,136,134**

**Registered May 1, 2012**

**Int. Cl.: 35**

**SERVICE MARK**

**PRINCIPAL REGISTER**

TURNER PERCY, LLC (LOUISIANA LIMITED LIABILITY COMPANY)  
BUILDING A, SUITE 2  
4469 PERKINS ROAD  
BATON ROUGE, LA 70808

FOR: ON-LINE RETAIL STORE SERVICES FEATURING LADIES CLOTHING, JEWELRY,  
HANDBAGS, SHOES, AND ACCESSORIES, IN CLASS 35 (U.S. CLS. 100, 101 AND 102).

FIRST USE 9-1-2010; IN COMMERCE 9-1-2010.

THE MARK CONSISTS OF STANDARD CHARACTERS WITHOUT CLAIM TO ANY PAR-  
TICULAR FONT, STYLE, SIZE, OR COLOR.

SN 85-081,677, FILED 7-9-2010.

MARK T. MULLEN, EXAMINING ATTORNEY



*David J. Kybas*

Director of the United States Patent and Trademark Office

# United States of America

United States Patent and Trademark Office

# evesapple.com

**Reg. No. 4,136,135**

**Registered May 1, 2012**

**Int. Cl.: 35**

**SERVICE MARK**

**PRINCIPAL REGISTER**

TURNER PERCY, LLC (LOUISIANA LIMITED LIABILITY COMPANY)  
BUILDING A, SUITE 2  
4469 PERKINS ROAD  
BATON ROUGE, LA 70808

FOR: ON-LINE RETAIL STORE SERVICES FEATURING LADIES CLOTHING, JEWELRY,  
HANDBAGS, SHOES, AND ACCESSORIES, IN CLASS 35 (U.S. CLS. 100, 101 AND 102).

FIRST USE 9-1-2010; IN COMMERCE 9-1-2010.

THE MARK CONSISTS OF STANDARD CHARACTERS WITHOUT CLAIM TO ANY PAR-  
TICULAR FONT, STYLE, SIZE, OR COLOR.

SN 85-081,682, FILED 7-9-2010.

MARK T. MULLEN, EXAMINING ATTORNEY



*David J. Kybas*

Director of the United States Patent and Trademark Office

# United States of America

United States Patent and Trademark Office



**Reg. No. 4,136,136**

**Registered May 1, 2012**

**Int. Cl.: 9**

**TRADEMARK**

**PRINCIPAL REGISTER**

PCT INTERNATIONAL, INC. (NEVADA CORPORATION)  
2260 WEST BROADWAY ROAD  
MESA, AZ 852021898

FOR: CABLE, SATELLITE, FIBER OPTIC AND TELECOMMUNICATIONS PRODUCTS AND COMPONENTS, NAMELY, COAXIAL CONNECTORS, TELECOMMUNICATIONS CONNECTIVITY MODULES IN THE NATURE OF ELECTRIC PLUG CONNECTORS, SIGNAL SPLITTERS FOR ELECTRONIC TELECOMMUNICATIONS APPARATUS, ELECTRICAL TERMINAL BLOCKS FOR TELECOMMUNICATIONS CONNECTIONS, POWER ADAPTERS FOR TELECOMMUNICATIONS AND ENCLOSURES SPECIFICALLY DESIGNED FOR TELECOMMUNICATIONS ELECTRICAL CONNECTION CABLES; COAXIAL CABLE CONNECTORS; ELECTRICAL POWER DEVICES IN THE NATURE OF TAPS; ELECTRICAL POWER SUPPLIES AND ELECTRICAL POWER DISTRIBUTION UNITS, IN CLASS 9 (U.S. CLS. 21, 23, 26, 36 AND 38).

FIRST USE 12-1-2005; IN COMMERCE 12-1-2005.

THE MARK CONSISTS OF THE LETTERING "DSM" AND AN ARCHED LIGHTNING BOLT DESIGN ABOVE THE LETTERING.

SN 85-081,803, FILED 7-9-2010.

COLLEEN KEARNEY, EXAMINING ATTORNEY



*David J. Kybas*

Director of the United States Patent and Trademark Office



# United States of America

United States Patent and Trademark Office

# GASSER

**Reg. No. 4,136,137**

**Registered May 1, 2012**

**Int. Cls.: 12 and 35**

**TRADEMARK**

**SERVICE MARK**

**PRINCIPAL REGISTER**

JUSTIN JAYE (UNITED STATES INDIVIDUAL)  
40983 CORTE LA FONDA  
INDIO, CA 92203

FOR: AERIAL BILLBOARDS AND AERIAL BANNER TOWING EQUIPMENT, NAMELY, HITCHES, RELEASES, PICK-UP GATES, RODS, RIGGING LINES, HOOKS, CHUTES, POLES, SAFETY LINKS, TAPE, MAST ASSEMBLIES, CLIPS AND CONNECTORS AND USER MANUALS SOLD THEREWITH, IN CLASS 12 (U.S. CLS. 19, 21, 23, 31, 35 AND 44).

FIRST USE 7-9-2010; IN COMMERCE 7-9-2010.

FOR: PROVIDING ADVERTISING SPACE ON AERIAL BANNERS AND AERIAL BILLBOARDS, IN CLASS 35 (U.S. CLS. 100, 101 AND 102).

FIRST USE 7-9-2010; IN COMMERCE 7-9-2010.

THE MARK CONSISTS OF STANDARD CHARACTERS WITHOUT CLAIM TO ANY PARTICULAR FONT, STYLE, SIZE, OR COLOR.

SN 85-081,835, FILED 7-9-2010.

EDWARD NELSON, EXAMINING ATTORNEY



*David J. Kyros*

Director of the United States Patent and Trademark Office

# United States of America

United States Patent and Trademark Office



**Reg. No. 4,136,138**

**Registered May 1, 2012**

**Int. Cl.: 7**

**TRADEMARK**

**PRINCIPAL REGISTER**

ENGINEERING & RESEARCH ASSOCIATES, INC. (ARIZONA CORPORATION)  
100 N. TUCSON BOULEVARD  
TUCSON, AZ 85716

FOR: POWER TOOLS, NAMELY, ELECTROMECHANICAL HAND HELD OR FIXED LOCATION INSTRUMENTS FOR FORMING, WELDING AND EXTRUDING CATHETERS AND CATHETER TIPS USED IN INVASIVE MEDICAL PROCEDURES, IN CLASS 7 (U.S. CLS. 13, 19, 21, 23, 31, 34 AND 35).

FIRST USE 5-31-2011; IN COMMERCE 5-31-2011.

THE MARK CONSISTS OF THE TERM "VANTE" IN COMBINATION WITH A LOGO CONSISTING OF THE LETTER "V" PARTIALLY ENCLOSED WITHIN A LARGER "V" HAVING A ROUNDED TAIL EXTENDING FROM ONE ARM.

THE ENGLISH TRANSLATION OF THE WORD "VANTE" IN THE MARK IS "PRAISE".

SN 85-082,475, FILED 7-12-2010.

TOBY BULLOFF, EXAMINING ATTORNEY



*David J. Kyros*

Director of the United States Patent and Trademark Office

# United States of America

United States Patent and Trademark Office

# CHASKA

**Reg. No. 4,136,139**

**Registered May 1, 2012**

**Int. Cl.: 43**

**SERVICE MARK**

**PRINCIPAL REGISTER**

FLAVOURS LLC (NEW YORK LIMITED LIABILITY COMPANY)  
826 NEWARK AVENUE  
JERSEY CITY, NJ 07306

FOR: RESTAURANT AND BAR SERVICES, INCLUDING RESTAURANT CARRYOUT SERVICES, IN CLASS 43 (U.S. CLS. 100 AND 101).

FIRST USE 5-4-2011; IN COMMERCE 5-4-2011.

THE MARK CONSISTS OF STANDARD CHARACTERS WITHOUT CLAIM TO ANY PARTICULAR FONT, STYLE, SIZE, OR COLOR.

SN 85-082,613, FILED 7-12-2010.

TEJBIR SINGH, EXAMINING ATTORNEY



*David J. Kybas*

Director of the United States Patent and Trademark Office

# United States of America

United States Patent and Trademark Office

## CONFIGURE YOUR LIFE

**Reg. No. 4,136,140**

**Registered May 1, 2012**

**Int. Cl.: 11**

**TRADEMARK**

**PRINCIPAL REGISTER**

LIGHTHOUSE IMPORT COMPANY (TEXAS CORPORATION)  
4430 SIMONTON ROAD  
DALLAS, TX 75244

FOR: ELECTRICAL LIGHTING PRODUCTS, NAMELY, LAMPS, IN CLASS 11 (U.S. CLS. 13, 21, 23, 31 AND 34).

FIRST USE 1-4-2011; IN COMMERCE 1-4-2011.

THE MARK CONSISTS OF STANDARD CHARACTERS WITHOUT CLAIM TO ANY PARTICULAR FONT, STYLE, SIZE, OR COLOR.

SN 85-082,734, FILED 7-12-2010.

JOHN GARTNER, EXAMINING ATTORNEY



*David J. Kybas*

Director of the United States Patent and Trademark Office

# United States of America

United States Patent and Trademark Office

# BENDER

**Reg. No. 4,136,141**

**Registered May 1, 2012**

**Int. Cls.: 37 and 40**

**SERVICE MARK**

**PRINCIPAL REGISTER**

VERNON MACHINE CORP. (CALIFORNIA CORPORATION)  
849 JACKSON STREET  
BENICIA, CA 94510

FOR: REPAIR AND MAINTENANCE SERVICES FOR ROTATING MACHINERY, RECIPROCATING MACHINERY, GAS TURBINES, STEAM TURBINES, HYDRO TURBINES, CONVERTING ROLLS, REEL DRUMS, COMPRESSORS, STEEL-INDUSTRY PROCESS ROLLS, ROTORS FOR TURBINES AND COMPRESSORS, PRINT CYLINDERS, PUMPS, EXTRUDERS, GEAR BOXES, REFINERS, SUCTION-PRESS ROLLS, HYDRAULIC CYLINDERS, CALENDAR ROLLS, FOOD-INDUSTRY EQUIPMENT, PAPER ROLLS, AND CONVEYORS, IN CLASS 37 (U.S. CLS. 100, 103 AND 106).

FIRST USE 12-31-1946; IN COMMERCE 12-31-1946.

FOR: MACHINE SHOP SERVICES, NAMELY, MACHINING PARTS FOR OTHERS; TREATMENT OF METAL, NAMELY, THERMAL SPRAY COATING AND METALIZING , IN CLASS 40 (U.S. CLS. 100, 103 AND 106).

FIRST USE 12-31-1946; IN COMMERCE 12-31-1946.

THE MARK CONSISTS OF STANDARD CHARACTERS WITHOUT CLAIM TO ANY PARTICULAR FONT, STYLE, SIZE, OR COLOR.

SN 85-082,927, FILED 7-12-2010.

RENEE MCCRAY, EXAMINING ATTORNEY



*David J. Kyros*

Director of the United States Patent and Trademark Office

# United States of America

## United States Patent and Trademark Office

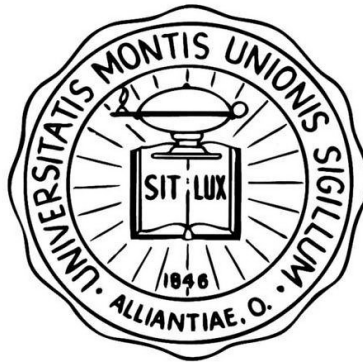

**Reg. No. 4,136,142**

**Registered May 1, 2012**

**Int. Cls.: 25 and 41**

**TRADEMARK**

**SERVICE MARK**

**PRINCIPAL REGISTER**

UNIVERSITY OF MOUNT UNION (OHIO NON-PROFIT CORPORATION)  
1972 CLARK AVENUE  
ALLIANCE, OH 446013929

FOR: CLOTHING, NAMELY, CAPS, HATS, T-SHIRTS, SWEATSHIRTS, SLACKS, PANTS, SOCKS, UNDERGARMENTS, COATS, JACKETS AND WIND RESISTANT JACKETS , IN CLASS 25 (U.S. CLS. 22 AND 39).

FIRST USE 8-1-2010; IN COMMERCE 8-1-2010.

FOR: ARRANGING AND CONDUCTING ATHLETIC COMPETITIONS; EDUCATIONAL SERVICES, NAMELY, PROVIDING COLLEGE LEVEL UNDERGRADUATE AND GRADUATE INSTRUCTION, DISTRIBUTING COURSE MATERIALS IN CONNECTION THEREWITH; EDUCATIONAL SERVICES, NAMELY, CONDUCTING CLASSES, SEMINARS, LECTURES, AND WORKSHOPS IN THE FIELD OF ART, BIOLOGY, CHEMISTRY, COMMUNICATIONS, COMPUTER SCIENCE AND INFORMATION SYSTEMS, ECONOMICS, ACCOUNTING, BUSINESS ADMINISTRATION, EDUCATION, ENGLISH, FOREIGN LANGUAGES, GEOLOGY, HISTORY, HUMAN PERFORMANCE, SPORTS MANAGEMENT, MATHEMATICS, MUSIC, PHILOSOPHY, RELIGIOUS STUDIES, PHYSICS, ASTRONOMY, POLITICAL SCIENCE, PSYCHOLOGY, SOCIOLOGY AND THEATER; ENTERTAINMENT SERVICES IN THE NATURE OF SPORTING EVENTS, IN CLASS 41 (U.S. CLS. 100, 101 AND 107).

FIRST USE 8-1-2010; IN COMMERCE 8-1-2010.

NO CLAIM IS MADE TO THE EXCLUSIVE RIGHT TO USE "UNIVERSITATIS", "ALLIANTIAE", "O" AND "1846" , APART FROM THE MARK AS SHOWN.

THE MARK CONSISTS OF THE STYLIZED WORDS "UNIVERSITATIS MONTIS UNIONIS SIGILLUM ALLIANTIAE, O." FEATURED IN A STYLIZED CIRCULAR PATTERN SURROUNDING A STYLIZED LAMP SITTING ATOP A STYLIZED BOOK FEATURING THE STYLIZED WORDS "SIT LUX" WITH THE YEAR "1846" BELOW THE BOOK AND STYLIZED RAYS EMANATING FROM THE BOOK TO THE CIRCLE'S EDGE.

THE ENGLISH TRANSLATION OF "UNIVERSITATIS MONTIS UNIONIS SIGILLUM ALLIANTIAE, O. SIT LUX" IN THE MARK IS "UNIVERSITY OF MOUNT UNION ALLIANCE, OHIO LET THERE BE LIGHT".



*David J. Kappas*

Director of the United States Patent and Trademark Office

**Reg. No. 4,136,142** SN 85-083,070, FILED 7-13-2010.

ALICE BENMAMAN, EXAMINING ATTORNEY

# United States of America

United States Patent and Trademark Office

# TILBURG

**Reg. No. 4,136,143**

**Registered May 1, 2012**

**Int. Cl.: 18**

**TRADEMARK**

**PRINCIPAL REGISTER**

SAMSONITE IP HOLDINGS S.À R.L. (LUXEMBOURG PRIVATE LIMITED LIABILITY COMPANY)  
13-15 AVENUE DE LA LIBERTÉ  
LUXEMBOURG, LUXEMBOURG L1931

FOR: ALL PURPOSE CARRYING BAGS, BACKPACKS, TRAVELING BAGS, KNAPSACKS, SHOULDER BAGS, BOOK BAGS, IN CLASS 18 (U.S. CLS. 1, 2, 3, 22 AND 41).

FIRST USE 6-30-2011; IN COMMERCE 6-30-2011.

THE MARK CONSISTS OF STANDARD CHARACTERS WITHOUT CLAIM TO ANY PARTICULAR FONT, STYLE, SIZE, OR COLOR.

SN 85-083,388, FILED 7-13-2010.

DAVID TAYLOR, EXAMINING ATTORNEY



*David J. Kyros*

Director of the United States Patent and Trademark Office



# United States of America

United States Patent and Trademark Office

## THE NEW ENGLANDER EDITION

**Reg. No. 4,136,144**

**Registered May 1, 2012**

**Int. Cls.: 7, 9, and 19**

**TRADEMARK**

**PRINCIPAL REGISTER**

GEN CONN LLC (NEW HAMPSHIRE LIMITED LIABILITY COMPANY)  
80 ROUTE 125, P.O. BOX 471  
BARRINGTON, NH 03825

FOR: PORTABLE ELECTRIC GENERATORS; GENERATOR HOUSING ENCLOSURES, IN CLASS 7 (U.S. CLS. 13, 19, 21, 23, 31, 34 AND 35).

FIRST USE 4-26-2010; IN COMMERCE 4-26-2010.

FOR: ELECTRIC TRANSFER SWITCHES, IN CLASS 9 (U.S. CLS. 21, 23, 26, 36 AND 38).

FIRST USE 4-26-2010; IN COMMERCE 4-26-2010.

FOR: CONCRETE GENERATOR PADS UPON WHICH GENERATORS WILL BE SITUATED, IN CLASS 19 (U.S. CLS. 1, 12, 33 AND 50).

FIRST USE 4-26-2010; IN COMMERCE 4-26-2010.

THE MARK CONSISTS OF STANDARD CHARACTERS WITHOUT CLAIM TO ANY PARTICULAR FONT, STYLE, SIZE, OR COLOR.

OWNER OF U.S. REG. NO. 3,352,127.

NO CLAIM IS MADE TO THE EXCLUSIVE RIGHT TO USE "EDITION", APART FROM THE MARK AS SHOWN.

SN 85-083,426, FILED 7-13-2010.

TARAH HARDY, EXAMINING ATTORNEY



*David J. Kypos*

Director of the United States Patent and Trademark Office

# United States of America

United States Patent and Trademark Office

## SPARKLE LIKE NO OTHER

**Reg. No. 4,136,145**

**Registered May 1, 2012**

**Int. Cl.: 33**

**TRADEMARK**

**PRINCIPAL REGISTER**

KOBRAND CORPORATION (NEW YORK CORPORATION)  
1 MANHATTANVILLE ROAD, 4TH FLOOR  
PURCHASE, NY 10577

FOR: WINE, IN CLASS 33 (U.S. CLS. 47 AND 49).

FIRST USE 6-0-2011; IN COMMERCE 6-0-2011.

THE MARK CONSISTS OF STANDARD CHARACTERS WITHOUT CLAIM TO ANY PARTICULAR FONT, STYLE, SIZE, OR COLOR.

SN 85-083,461, FILED 7-13-2010.

LINDA E. BLOHM, EXAMINING ATTORNEY



*David J. Kybas*

Director of the United States Patent and Trademark Office

# United States of America

United States Patent and Trademark Office

# 3DCC

**Reg. No. 4,136,146**

**Registered May 1, 2012**

**Int. Cl.: 41**

**SERVICE MARK**

**PRINCIPAL REGISTER**

MARLY BERGERUD (UNITED STATES INDIVIDUAL)  
527 DESERT HOLLY DRIVE  
PALM DESERT, CA 92211

FOR: EDUCATIONAL SERVICES, NAMELY, CONDUCTING ONLINE AND OFFLINE CLASSES IN THE FIELD OF 3D OBJECTS, MODULES, APPLICATIONS AND CONTENT DELIVERED VIA COMPUTER NETWORKS, TELEVISIONS, MOBILE PHONES, APPLICATIONS, AND OTHER MOBILE DEVICES, IN CLASS 41 (U.S. CLS. 100, 101 AND 107).

FIRST USE 5-1-2011; IN COMMERCE 5-1-2011.

THE MARK CONSISTS OF STANDARD CHARACTERS WITHOUT CLAIM TO ANY PARTICULAR FONT, STYLE, SIZE, OR COLOR.

SN 85-083,986, FILED 7-14-2010.

DAWN HAN, EXAMINING ATTORNEY



*David J. Kyros*

Director of the United States Patent and Trademark Office

# United States of America

United States Patent and Trademark Office

## CONTOUR CURVES DENIM COLLECTION

**Reg. No. 4,136,147**

**Registered May 1, 2012**

**Int. Cl.: 25**

**TRADEMARK**

**PRINCIPAL REGISTER**

GLOBAL TRADEMARKS, INC. (NEVADA CORPORATION)  
110 COMMERCE WAY  
STOCKERTOWN, PA 18083

FOR: JEANS, IN CLASS 25 (U.S. CLS. 22 AND 39).

FIRST USE 8-26-2011; IN COMMERCE 8-26-2011.

THE MARK CONSISTS OF STANDARD CHARACTERS WITHOUT CLAIM TO ANY PARTICULAR FONT, STYLE, SIZE, OR COLOR.

NO CLAIM IS MADE TO THE EXCLUSIVE RIGHT TO USE "CONTOUR" OR "DENIM COLLECTION", APART FROM THE MARK AS SHOWN.

SN 85-084,332, FILED 7-14-2010.

DANIEL CAPSHAW, EXAMINING ATTORNEY



*David J. Kyros*

Director of the United States Patent and Trademark Office

# United States of America

United States Patent and Trademark Office



**Reg. No. 4,136,148**

**Registered May 1, 2012**

**Int. Cl.: 25**

**TRADEMARK**

**PRINCIPAL REGISTER**

CITY OF CHICAGO (ILLINOIS MUNICIPAL CORPORATION)  
CITY HALL, 121 NORTH LASALLE ST., RM 600  
CHICAGO, IL 60602

FOR: T-SHIRTS, JERSEYS, SWEATSHIRTS, HATS AND JACKETS, IN CLASS 25 (U.S. CLS. 22 AND 39).

FIRST USE 12-1-2009; IN COMMERCE 12-1-2009.

OWNER OF U.S. REG. NO. 4,018,201.

NO CLAIM IS MADE TO THE EXCLUSIVE RIGHT TO USE "CHICAGO" AND "DEPARTMENT OF AVIATION", APART FROM THE MARK AS SHOWN.

THE MARK CONSISTS OF THE WORD "CHICAGO" ABOVE THE LETTERS "CDA", AND THE WORDS "DEPARTMENT OF AVIATION" BELOW THE LETTERS "CDA", AND AN AIRPLANE APPEARS NEXT TO THE WORD "CHICAGO" AND ABOVE THE LETTER "A" IN THE LETTERS "CDA", AND A JET STREAM IS SHOWN IN ASCENDING DUAL CURVED LINES FROM BEGINNING IN FRONT OF THE LETTERS "CDA" AND RUNNING THROUGH THE LETTERS "CD" TO THE REAR OF THE AIRPLANE.

SN 85-084,591, FILED 7-14-2010.

JAMES STEIN, EXAMINING ATTORNEY



*David J. Kyros*

Director of the United States Patent and Trademark Office

# United States of America

United States Patent and Trademark Office

# MAXX12

**Reg. No. 4,136,149**

**Registered May 1, 2012**

**Int. Cls.: 25 and 41**

**TRADEMARK**

**SERVICE MARK**

**PRINCIPAL REGISTER**

THOMAS MICHAEL RIDDLE (UNITED STATES INDIVIDUAL)  
5669 SNELL AVENUE #357  
SAN JOSE, CA 95123

FOR: CLOTHING AS MERCHANDISE AND FAN ARTICLES, NAMELY, T-SHIRTS, TOPS, SHIRTS, AND HEADWEAR, NAMELY, HATS, CAPS, IN CLASS 25 (U.S. CLS. 22 AND 39).

FIRST USE 5-31-2010; IN COMMERCE 9-30-2010.

FOR: ENTERTAINMENT SERVICES, NAMELY, LIVE MUSICAL CONCERTS AND CONCERT TOURS; MUSIC PUBLISHING SERVICES; MUSIC FAN CLUB SERVICES; PROVIDING AN ON-LINE COMPUTER DATABASE FEATURING PRERECORDED MUSIC, MUSICAL PERFORMANCES, MUSIC VIDEOS, MUSIC VIDEO CLIPS, MUSIC FILMS, AND MULTIMEDIA MATERIALS FEATURING MUSIC; PROVIDING AN ON-LINE COMPUTER DATABASE FEATURING ENTERTAINMENT INFORMATION ABOUT A MUSICAL BAND, NAMELY, GRAPHICS, DATA, NEWS, REVIEWS, PHOTOGRAPHS, TOUR SCHEDULES, TRAVEL SCHEDULES, MUSICAL PERFORMANCE SCHEDULES, SCHEDULED RELEASE DATES FOR AUDIO, VIDEO AND DIGITAL RECORDINGS, MULTI-MEDIA SOFTWARE, COLLECTIBLE GOODS AND PRINTED MATTER, IN CLASS 41 (U.S. CLS. 100, 101 AND 107).

FIRST USE 5-31-2010; IN COMMERCE 9-30-2010.

THE MARK CONSISTS OF STANDARD CHARACTERS WITHOUT CLAIM TO ANY PARTICULAR FONT, STYLE, SIZE, OR COLOR.

SN 85-084,784, FILED 7-14-2010.

PATRICIA EVANKO, EXAMINING ATTORNEY



*David J. Kybas*

Director of the United States Patent and Trademark Office

# United States of America

United States Patent and Trademark Office



**Reg. No. 4,136,150**

**Registered May 1, 2012**

**Int. Cl.: 3**

**TRADEMARK**

**PRINCIPAL REGISTER**

ALTERNA HOLDINGS CORP. (DELAWARE CORPORATION)  
SUITE 1300  
2029 CENTURY PARK EAST  
CENTURY CITY, CA 90067

FOR: HAIR CARE PREPARATIONS, IN CLASS 3 (U.S. CLS. 1, 4, 6, 50, 51 AND 52).

FIRST USE 10-29-2010; IN COMMERCE 10-29-2010.

NO CLAIM IS MADE TO THE EXCLUSIVE RIGHT TO USE "STYLING", APART FROM THE MARK AS SHOWN.

THE MARK CONSISTS OF THE WORDS "STYLING COCKTAILS" WITHIN A CIRCLE.

SN 85-084,867, FILED 7-14-2010.

DAVID HOFFMAN, EXAMINING ATTORNEY



*David J. Kyffers*

Director of the United States Patent and Trademark Office

# United States of America

United States Patent and Trademark Office



**M A T E R I O N**

**Reg. No. 4,136,151**

**Registered May 1, 2012**

**Int. Cl.: 1**

**TRADEMARK**

**PRINCIPAL REGISTER**

MATERION CORPORATION (OHIO CORPORATION)  
6070 PARKLAND BLVD.  
MAYFIELD HEIGHTS, OH 44124

FOR: CERAMIC POWDERS USED IN MANUFACTURING; CHEMICALS FOR USE IN INDUSTRY AND SCIENCE; COATINGS USED IN THE MANUFACTURE OF PRINTED CIRCUIT BOARDS; MATERIALS, NAMELY, INDUSTRIAL ADHESIVES FOR USE IN SPUTTERING COATINGS ONTO FLEXIBLE OR RIGID CONTINUOUS SUBSTRATES, IN CLASS 1 (U.S. CLS. 1, 5, 6, 10, 26 AND 46).

FIRST USE 3-0-2011; IN COMMERCE 3-0-2011.

OWNER OF U.S. REG. NOS. 3,800,055, 3,815,000, AND OTHERS.

THE MARK CONSISTS OF THE WORD "MATERION" WITH A STYLIZED LETTER "M" FORMED BY GEOMETRIC SHAPES UPON A SQUARE ABOVE THE WORD "MATERION".

SN 85-085,042, FILED 7-15-2010.

EDWARD NELSON, EXAMINING ATTORNEY



*David J. Kyfos*

Director of the United States Patent and Trademark Office



# United States of America

United States Patent and Trademark Office



**MATERION**

**Reg. No. 4,136,152**

**Registered May 1, 2012**

**Int. Cl.: 6**

**TRADEMARK**

**PRINCIPAL REGISTER**

MATERION CORPORATION (OHIO CORPORATION)  
6070 PARKLAND BLVD.  
MAYFIELD HEIGHTS, OH 44124

FOR: METAL ALLOYS FOR FURTHER MANUFACTURING; METAL SPUTTERING TARGETS; METAL ALLOYS FOR USE IN THE MANUFACTURING OF METAL SPUTTERING TARGETS; AND BRAZING ALLOYS, IN CLASS 6 (U.S. CLS. 2, 12, 13, 14, 23, 25 AND 50).

FIRST USE 3-0-2011; IN COMMERCE 3-0-2011.

OWNER OF U.S. REG. NOS. 3,800,055, 3,815,000, AND OTHERS.

THE MARK CONSISTS OF THE WORD "MATERION" WITH A STYLIZED "M" ABOVE THE WORD "MATERION".

SN 85-085,046, FILED 7-15-2010.

EDWARD NELSON, EXAMINING ATTORNEY



*David J. Kybas*

Director of the United States Patent and Trademark Office

# United States of America

United States Patent and Trademark Office



**MATERION**

**Reg. No. 4,136,153**

**Registered May 1, 2012**

**Int. Cl.: 9**

**TRADEMARK**

**PRINCIPAL REGISTER**

MATERION CORPORATION (OHIO CORPORATION)  
6070 PARKLAND BLVD.  
MAYFIELD HEIGHTS, OH 44124

FOR: PRINTED CIRCUITS, IN CLASS 9 (U.S. CLS. 21, 23, 26, 36 AND 38).

FIRST USE 3-0-2011; IN COMMERCE 3-0-2011.

OWNER OF U.S. REG. NOS. 3,800,055, 3,815,000, AND OTHERS.

THE MARK CONSISTS OF THE WORD "MATERION" WITH A STYLIZED LETTER "M" FORMED BY GEOMETRIC SHAPES UPON A SQUARE ABOVE THE WORD "MATERION".

SN 85-085,048, FILED 7-15-2010.

EDWARD NELSON, EXAMINING ATTORNEY



*David J. Kyffers*

Director of the United States Patent and Trademark Office

# United States of America

United States Patent and Trademark Office



**MATERION**

**Reg. No. 4,136,154**

**Registered May 1, 2012**

**Int. Cl.: 14**

**TRADEMARK**

**PRINCIPAL REGISTER**

MATERION CORPORATION (OHIO CORPORATION)  
6070 PARKLAND BLVD.  
MAYFIELD HEIGHTS, OH 44124

FOR: PRECIOUS METALS AND ALLOYS THEREOF AND PROCESSED OR SEMI-PROCESSED PRECIOUS METALS, IN CLASS 14 (U.S. CLS. 2, 27, 28 AND 50).

FIRST USE 3-0-2011; IN COMMERCE 3-0-2011.

OWNER OF U.S. REG. NOS. 3,800,055, 3,815,000, AND OTHERS.

THE MARK CONSISTS OF THE WORD "MATERION" WITH A STYLIZED LETTER "M" FORMED BY GEOMETRIC SHAPES UPON A SQUARE ABOVE THE WORD "MATERION".

SN 85-085,052, FILED 7-15-2010.

EDWARD NELSON, EXAMINING ATTORNEY



*David J. Kybas*

Director of the United States Patent and Trademark Office

# United States of America

United States Patent and Trademark Office

# SALTY DOG

**Reg. No. 4,136,155**

**Registered May 1, 2012**

**Int. Cls.: 32 and 33**

**TRADEMARK**

**PRINCIPAL REGISTER**

JAKE DOG, LLC (SOUTH CAROLINA LIMITED LIABILITY COMPANY)  
224 SOUTH SEA PINES DRIVE  
HILTON HEAD ISLAND, SC 29928

FOR: BEER, ALE, LAGER, PORTER AND STOUT, IN CLASS 32 (U.S. CLS. 45, 46 AND 48).

FIRST USE 5-1-2010; IN COMMERCE 5-1-2010.

FOR: WINE , IN CLASS 33 (U.S. CLS. 47 AND 49).

FIRST USE 5-1-2010; IN COMMERCE 5-1-2010.

THE MARK CONSISTS OF STANDARD CHARACTERS WITHOUT CLAIM TO ANY PARTICULAR FONT, STYLE, SIZE, OR COLOR.

OWNER OF U.S. REG. NOS. 1,676,258, 2,544,843, AND 3,243,621.

SN 85-085,079, FILED 7-15-2010.

PRISCILLA MILTON, EXAMINING ATTORNEY



*David J. Kyjars*

Director of the United States Patent and Trademark Office

# United States of America

United States Patent and Trademark Office



**Reg. No. 4,136,156**

**Registered May 1, 2012**

**Int. Cl.: 9**

**TRADEMARK**

**PRINCIPAL REGISTER**

ELECTRICAL SUCCESS SYSTEMS, INC. (FLORIDA CORPORATION)  
36150 E. SPRING LAKE BLVD  
FRUITLAND PARK, FL 34731

FOR: COMPUTER SOFTWARE FOR DESKTOP COMPUTERS, MOBILE COMPUTERS, MOBILE PHONES AND TABLETS, NAMELY, SOFTWARE FOR THE CONSTRUCTION CONTRACTING INDUSTRY FOR ESTIMATION, SCHEDULING, CUSTOMER MANAGEMENT, MAINTENANCE AND REPAIR OF ELECTRICAL SYSTEMS; COMPUTER PROGRAMS IN THE CONSTRUCTION CONTRACTING INDUSTRY FOR ESTIMATION, MAINTENANCE AND REPAIR OF ELECTRICAL SYSTEMS, AND FOR USE AS A SPREAD SHEET, IN CLASS 9 (U.S. CLS. 21, 23, 26, 36 AND 38).

FIRST USE 9-26-2010; IN COMMERCE 9-26-2010.

NO CLAIM IS MADE TO THE EXCLUSIVE RIGHT TO USE "ELECTRICAL" AND "SYSTEMS, INC.", APART FROM THE MARK AS SHOWN.

THE COLOR(S) BLACK, GRAY, GOLD, RED AND WHITE IS/ARE CLAIMED AS A FEATURE OF THE MARK.

THE MARK CONSISTS OF THE LETTERS "ES" SHADED BLACK TO GRAY AND PLACED IN A GOLD CIRCLE WITH BLACK TO GRAY SHADING ON THE BORDER. THE NUMBER "2", IS IN RED FADING TO WHITE, IN SUPERSCRIPT ATOP THE BORDER OF THE CIRCLE. AN OUTER GOLD BAND ENCOMPASSES THE MARK, LEADING TO THE WORDS "ELECTRICAL SUCCESS SYSTEMS, INC." IN THE COLOR GRAY ON THE LEFT SIDE OF THE DRAWING.

SN 85-085,529, FILED 7-15-2010.

B. PARADEWELAI, EXAMINING ATTORNEY



*David J. Kybas*

Director of the United States Patent and Trademark Office

# United States of America

United States Patent and Trademark Office



**Reg. No. 4,136,157**

GRINBERG, SAM H. (UNITED STATES INDIVIDUAL)  
23 CENTER DR.  
MANALAPAN, NJ 07726

**Registered May 1, 2012**

**Int. Cl.: 16**

FOR: COMIC BOOKS, IN CLASS 16 (U.S. CLS. 2, 5, 22, 23, 29, 37, 38 AND 50).

**TRADEMARK**

FIRST USE 7-22-2011; IN COMMERCE 7-22-2011.

**PRINCIPAL REGISTER**

THE MARK CONSISTS OF THE NAME "RUBBER BANDO" IMAGE CONTAINS A BLUE LETTER "R" THAT REVEALS A PROTRUDING ELONGATED OR STRETCH ARM WITH BEIGE HAND AGAINST A YELLOW CIRCLE. THE REMAINING LETTERS ARE ALL RED IN COLOR.

THE COLOR(S) RED, YELLOW, BLUE, BEIGE IS/ARE CLAIMED AS A FEATURE OF THE MARK.

SN 85-085,877, FILED 7-15-2010.

PAM WILLIS, EXAMINING ATTORNEY



*David J. Kyffers*

Director of the United States Patent and Trademark Office

# United States of America

United States Patent and Trademark Office

## ADVANTAGE BAIT COMPANY

**Reg. No. 4,136,158**

**Registered May 1, 2012**

**Int. Cl.: 25**

**TRADEMARK**

**PRINCIPAL REGISTER**

ADVANTAGE BAIT COMPANY (ILLINOIS LIMITED LIABILITY COMPANY)  
2450 AMERICAN LANE  
ELK GROVE VILLAGE, IL 60007

FOR: APPAREL, NAMELY, SHIRTS, GOLF SHIRTS, T-SHIRTS, SWEATSHIRTS, SHORTS, PANTS, HATS, BASEBALL CAPS, PULLOVERS, JACKETS, IN CLASS 25 (U.S. CLS. 22 AND 39).

FIRST USE 1-26-2011; IN COMMERCE 1-26-2011.

THE MARK CONSISTS OF STANDARD CHARACTERS WITHOUT CLAIM TO ANY PARTICULAR FONT, STYLE, SIZE, OR COLOR.

NO CLAIM IS MADE TO THE EXCLUSIVE RIGHT TO USE "BAIT COMPANY", APART FROM THE MARK AS SHOWN.

SN 85-086,651, FILED 7-16-2010.

WILLIAM P. SHANAHAN, EXAMINING ATTORNEY



*David J. Kybas*

Director of the United States Patent and Trademark Office

# United States of America

United States Patent and Trademark Office

## THE ENERGY OF NATURE

**Reg. No. 4,136,159**

**Registered May 1, 2012**

**Int. Cls.: 1, 40, and 42**

**TRADEMARK**

**SERVICE MARK**

**PRINCIPAL REGISTER**

VERENIUM CORPORATION (DELAWARE CORPORATION)  
4955 DIRECTORS PLACE  
SAN DIEGO, CA 92121

FOR: BIOACTIVE MOLECULES AND ENZYMES FOR RESEARCH, MANUFACTURING, AGRICULTURAL, INDUSTRIAL AND SCIENTIFIC USE IN THE BIOFUEL, ETHANOL, CHEMICAL, PHARMACEUTICAL, BIOTECHNOLOGY, AGRICULTURAL, ALCOHOL AND FOOD PREPARATION INDUSTRIES; ENZYMES FOR THE CONVERSION OF CELLULOSIC BIOMASS TO FUEL ETHANOL; ENZYMES USED FOR THE TREATMENT, REFINING AND/OR PURIFICATION OF VEGETABLE OILS; CHEMICALS FOR USE IN IMPROVING AND INCREASING RECOVERY OF GAS AND OIL IN DRILLING OPERATIONS; ENZYMES FOR USE IN CREATING FLAVORS AND FRAGRANCES; ENZYMES FOR USE IN THE PULP AND PAPER INDUSTRIES; ENZYMES FOR USE IN THE TEXTILE INDUSTRY , IN CLASS 1 (U.S. CLS. 1, 5, 6, 10, 26 AND 46).

FIRST USE 10-0-2011; IN COMMERCE 10-0-2011.

FOR: PROCESSING AND TREATMENT OF CHEMICAL REAGENTS, NAMELY, CONVERSION OF TARGETED SUBSTRATES BY TREATMENT WITH ENZYME SYSTEMS, IN CLASS 40 (U.S. CLS. 100, 103 AND 106).

FIRST USE 9-0-2010; IN COMMERCE 9-0-2010.

FOR: RESEARCH AND DEVELOPMENT SERVICES REGARDING NEW PRODUCTS AND PROCESSES FOR THIRD PARTIES IN THE FIELD OF BIOTECHNOLOGY; PROVIDING SERVICES, NAMELY, DISCOVERY, EVOLUTION AND OPTIMIZATION SERVICES TO THIRD PARTIES FOR BIOLOGICAL SEQUENCES, NUCLEIC ACIDS, ENZYMES, ANTIBODIES, AND POLYPEPTIDES IN THE BIOTECHNOLOGY, BIOFUEL, ETHANOL, INDUSTRIAL, AGRICULTURAL AND PHARMACEUTICAL FIELDS, IN CLASS 42 (U.S. CLS. 100 AND 101).

FIRST USE 9-0-2010; IN COMMERCE 9-0-2010.

THE MARK CONSISTS OF STANDARD CHARACTERS WITHOUT CLAIM TO ANY PARTICULAR FONT, STYLE, SIZE, OR COLOR.

SN 85-086,994, FILED 7-16-2010.



*David J. Kyros*

Director of the United States Patent and Trademark Office



**Reg. No. 4,136,159** SEAN CROWLEY, EXAMINING ATTORNEY

# United States of America

United States Patent and Trademark Office

# 3PLUS

**Reg. No. 4,136,160**

**Registered May 1, 2012**

**Int. Cl.: 7**

**TRADEMARK**

**PRINCIPAL REGISTER**

NEXTWAY LLC (OHIO LIMITED LIABILITY COMPANY)  
1308 U.S. HIGHWAY 50 - 100  
MILFORD, OH 45150

FOR: POWER TOOLS, NAMELY, POWER NAILERS, POWER STAPLERS, AIR COMPRESSORS, GAS COMPRESSORS, ELECTRIC COMPRESSORS, GAS OPERATED POWER GENERATORS, PORTABLE ELECTRIC POWER GENERATORS, GAS-POWERED WATER PUMPS FOR USE IN CONSTRUCTION SITES, IN CLASS 7 (U.S. CLS. 13, 19, 21, 23, 31, 34 AND 35).

FIRST USE 9-2-2011; IN COMMERCE 9-2-2011.

THE MARK CONSISTS OF STANDARD CHARACTERS WITHOUT CLAIM TO ANY PARTICULAR FONT, STYLE, SIZE, OR COLOR.

SN 85-087,346, FILED 7-19-2010.

CHRISTINA SOBRAL, EXAMINING ATTORNEY



*David J. Kybas*

Director of the United States Patent and Trademark Office

# United States of America

United States Patent and Trademark Office

## FIRST STREET COALITION BUILDER

**Reg. No. 4,136,161**

**Registered May 1, 2012**

**Int. Cl.: 35**

**SERVICE MARK**

**PRINCIPAL REGISTER**

SAGE PUBLICATIONS, INC. (DELAWARE CORPORATION)  
2455 TELLER ROAD  
THOUSAND OAKS, CA 91320

FOR: PROVIDING INFORMATION AND RESEARCH DIRECTORIES FOR CONSULTATION, COUNSELING AND RESEARCH PURPOSES IN THE NATURE OF PROVIDING AN ONLINE DIRECTORY INFORMATION SERVICE FEATURING INFORMATION REGARDING GOVERNMENTS, LEGISLATURES AND POLITICS; ONLINE COMPUTER DATABASE FEATURING GOVERNMENT AFFAIRS, POLITICAL ISSUES, AND INFORMATION ABOUT LEGISLATIVE DEVELOPMENTS AS IT RELATES TO BUSINESSES, THE FOREGOING FOR CONSULTATION, COUNSELING AND RESEARCH PURPOSES; PROVIDING INFORMATION AND NEWS IN THE FIELD OF POLITICAL ISSUES, POLITICAL ELECTIONS AND GOVERNMENT AFFAIRS; PROVIDING INFORMATION AND NEWS ON LEGISLATIVE DEVELOPMENTS AS THEY RELATE TO AND CAN IMPACT BUSINESS, IN CLASS 35 (U.S. CLS. 100, 101 AND 102).

FIRST USE 4-0-2011; IN COMMERCE 4-0-2011.

THE MARK CONSISTS OF STANDARD CHARACTERS WITHOUT CLAIM TO ANY PARTICULAR FONT, STYLE, SIZE, OR COLOR.

NO CLAIM IS MADE TO THE EXCLUSIVE RIGHT TO USE "COALITION", APART FROM THE MARK AS SHOWN.

SN 85-087,662, FILED 7-19-2010.

LAURIE MAYES, EXAMINING ATTORNEY



*David J. Kybas*

Director of the United States Patent and Trademark Office

# United States of America

United States Patent and Trademark Office



**Reg. No. 4,136,162**

**Registered May 1, 2012**

**Int. Cl.: 41**

**SERVICE MARK**

**PRINCIPAL REGISTER**

CARTAGENA ENTERTAINMENT & MANAGEMENT, LLC. (NEW JERSEY LIMITED LIABILITY COMPANY)  
904 23RD STREET  
UNION CITY, NJ 07087

FOR: ENTERTAINMENT SERVICES IN THE NATURE OF LIVE MUSICAL PERFORMANCES BY PERFORMERS FROM PUERTO RICO, IN CLASS 41 (U.S. CLS. 100, 101 AND 107).

FIRST USE 2-1-2011; IN COMMERCE 2-1-2011.

NO CLAIM IS MADE TO THE EXCLUSIVE RIGHT TO USE "PUERTO RICO", APART FROM THE MARK AS SHOWN.

THE COLOR(S) BLACK, RED, WHITE, BLUE AND GOLD IS/ARE CLAIMED AS A FEATURE OF THE MARK.

THE MARK CONSISTS OF 14 SMALL GOLD STARS WITH WHITE CIRCLES BORDERING A LARGE GOLD CIRCLE WITH GOLD LINES EMANATING OUTWARD. THE CENTER CIRCLE CONTAINS A GOLD HELIX ON A BLACK AND GOLD BORDER. THE CENTER CIRCLE CONTAINS A LIGHT GOLD AND BLACK WORLD MAP WITH SIX SHOOTING GOLD STARS AND A GOLD BANNER. A LARGE RED, WHITE AND BLUE STAR IS CENTRALLY LOCATED INSIDE THE CIRCLE BORDER AND EXTENDS OUTSIDE OF THE CIRCLE BORDER WHICH ALSO CONTAINS A WHITE STAR. THE STYLIZED WORDING "PUERTO RICO ALL STARS" APPEARS ON THE TOP IN SHADES OF GOLD. ALL THE ELEMENTS APPEAR ON A BLACK BACKGROUND.

SN 85-087,800, FILED 7-19-2010.

BRENDAN MCCAULEY, EXAMINING ATTORNEY



*David J. Kybas*

Director of the United States Patent and Trademark Office

# United States of America

United States Patent and Trademark Office

# KidOneders

**Reg. No. 4,136,163**

**Registered May 1, 2012**

**Int. Cl.: 25**

**TRADEMARK**

**PRINCIPAL REGISTER**

MALANTONIO, CARLA R. (UNITED STATES INDIVIDUAL)  
PO BOX 1014  
FOGELSVILLE, PA 18051 AND

RIEMER, FRANCES JULIA (UNITED STATES INDIVIDUAL)  
3300 N. ADRIANNE WAY  
FLAGSTAFF, AZ 86004

FOR: INFANT AND TODDLER ONE PIECE CLOTHING, IN CLASS 25 (U.S. CLS. 22 AND 39).

FIRST USE 2-15-2012; IN COMMERCE 2-15-2012.

THE MARK CONSISTS OF STANDARD CHARACTERS WITHOUT CLAIM TO ANY PARTICULAR FONT, STYLE, SIZE, OR COLOR.

SN 85-087,821, FILED 7-19-2010.

BILL DAWE, EXAMINING ATTORNEY



*David J. Kyros*

Director of the United States Patent and Trademark Office

# United States of America

United States Patent and Trademark Office

## SIMPLY CRANBERRY

**Reg. No. 4,136,164**

**Registered May 1, 2012**

**Int. Cl.: 32**

**TRADEMARK**

**PRINCIPAL REGISTER**

SIMPLY ORANGE JUICE COMPANY (FLORIDA CORPORATION)  
2659 ORANGE AVENUE  
APOPKA, FL 32703

FOR: FRUIT DRINKS AND FRUIT JUICES, IN CLASS 32 (U.S. CLS. 45, 46 AND 48).

FIRST USE 1-23-2012; IN COMMERCE 1-23-2012.

THE MARK CONSISTS OF STANDARD CHARACTERS WITHOUT CLAIM TO ANY PARTICULAR FONT, STYLE, SIZE, OR COLOR.

OWNER OF U.S. REG. NOS. 2,692,046, 3,410,211, AND OTHERS.

NO CLAIM IS MADE TO THE EXCLUSIVE RIGHT TO USE "CRANBERRY", APART FROM THE MARK AS SHOWN.

SN 85-088,704, FILED 7-20-2010.

JEFF DEFORD, EXAMINING ATTORNEY



*David J. Kybas*

Director of the United States Patent and Trademark Office

# United States of America

United States Patent and Trademark Office

## JUNGLE JUNCTION

**Reg. No. 4,136,165**

**Registered May 1, 2012**

**Int. Cl.: 28**

**TRADEMARK**

**PRINCIPAL REGISTER**

DISNEY ENTERPRISES, INC. (DELAWARE CORPORATION)  
500 SOUTH BUENA VISTA STREET  
BURBANK, CA 91521

FOR: TOY ACTION FIGURES AND ACCESSORIES THEREFOR; TOY VEHICLES; TOY FIGURES, IN CLASS 28 (U.S. CLS. 22, 23, 38 AND 50).

FIRST USE 10-31-2011; IN COMMERCE 10-31-2011.

THE MARK CONSISTS OF STANDARD CHARACTERS WITHOUT CLAIM TO ANY PARTICULAR FONT, STYLE, SIZE, OR COLOR.

OWNER OF U.S. REG. NO. 3,785,125.

SN 85-089,058, FILED 7-20-2010.

SANI KHOURI, EXAMINING ATTORNEY



*David J. Kybas*

Director of the United States Patent and Trademark Office

# United States of America

United States Patent and Trademark Office

# MAXCOR

**Reg. No. 4,136,166**

PCC CHEMAX, INC. (DELAWARE CORPORATION)  
30 OLD AUGUST ROAD  
PIEDMONT, SC 29356

**Registered May 1, 2012**

**Int. Cl.: 1**

FOR: CHEMICAL RUST PREVENTION ADDITIVES, IN CLASS 1 (U.S. CLS. 1, 5, 6, 10, 26 AND 46).

**TRADEMARK**

FIRST USE 5-8-2010; IN COMMERCE 5-8-2010.

**PRINCIPAL REGISTER**

THE MARK CONSISTS OF STANDARD CHARACTERS WITHOUT CLAIM TO ANY PARTICULAR FONT, STYLE, SIZE, OR COLOR.

SN 85-089,494, FILED 7-21-2010.

JUDITH HELFMAN, EXAMINING ATTORNEY



*David J. Kybas*

Director of the United States Patent and Trademark Office



# United States of America

United States Patent and Trademark Office



**Reg. No. 4,136,167**

**Registered May 1, 2012**

**Int. Cl.: 12**

**TRADEMARK**

**PRINCIPAL REGISTER**

BE AEROSPACE, INC. (DELAWARE CORPORATION)  
1400 CORPORATE CENTER WAY  
WELLINGTON, FL 33414

FOR: AIRCRAFT PASSENGER SEATS, IN CLASS 12 (U.S. CLS. 19, 21, 23, 31, 35 AND 44).

FIRST USE 1-0-2010; IN COMMERCE 1-0-2010.

OWNER OF U.S. REG. NO. 3,794,591.

THE MARK CONSISTS OF THE CAPITALIZED WORD "PINNACLE" POSITIONED BELOW AN ARCH. THE ARCH EXTENDS SLIGHTLY BEYOND THE BEGINNING AND END OF THE WORD AND HAS A SOLID CIRCLE AT ITS APEX.

SN 85-089,496, FILED 7-21-2010.

JUDITH HELFMAN, EXAMINING ATTORNEY



*David J. Kyffers*

Director of the United States Patent and Trademark Office

# United States of America

United States Patent and Trademark Office

More loans. Less time. No  
bull.

**Reg. No. 4,136,168**

**Registered May 1, 2012**

**Int. Cls.: 36 and 45**

**SERVICE MARK**

**PRINCIPAL REGISTER**

AVENUE 365 LENDER SERVICES, LLC (PENNSYLVANIA LIMITED LIABILITY COMPANY),  
DBA AVENUE 365 ABSTRACT,  
SUITE 440  
PLYMOUTH MEETING, PA 19462

FOR: INSURANCE AGENCY SERVICES FEATURING REAL ESTATE TITLE INSURANCE,  
IN CLASS 36 (U.S. CLS. 100, 101 AND 102).

FIRST USE 4-15-2011; IN COMMERCE 4-15-2011.

FOR: CLOSING SERVICES FOR REAL ESTATE REFINANCE PURCHASES AND MORTGAGE  
LOAN TRANSACTIONS, IN CLASS 45 (U.S. CLS. 100 AND 101).

FIRST USE 4-15-2011; IN COMMERCE 4-15-2011.

THE MARK CONSISTS OF STANDARD CHARACTERS WITHOUT CLAIM TO ANY PAR-  
TICULAR FONT, STYLE, SIZE, OR COLOR.

SN 85-089,541, FILED 7-21-2010.

SEAN CROWLEY, EXAMINING ATTORNEY



*David J. Kybas*

Director of the United States Patent and Trademark Office

# United States of America

United States Patent and Trademark Office

## GREEN QUEST

**Reg. No. 4,136,169**

**Registered May 1, 2012**

**Int. Cl.: 3**

**TRADEMARK**

**PRINCIPAL REGISTER**

ECOQUIP, INC. (INDIANA CORPORATION)  
3020 DIEGO DRIVE  
EVANSVILLE, IN 47715

FOR: ALL PURPOSE CLEANING PREPARATIONS; ALL PURPOSE CLEANERS, DEGREASING PREPARATIONS FOR GENERAL USE AND CLEANING AGENTS FOR CLEANING SURFACES, ALL OF THE FOREGOING PROTECT AND CAUSE LESS HARM TO HUMAN HEALTH, INCLUDING OCCUPANTS AND CUSTODIAL WORKERS, AND THE ENVIRONMENT AS COMPARED TO COMPETING PRODUCTS AND SERVICES, REDUCE TOXIC MATERIALS AND SUBSTANCES, AND REDUCE DISPOSAL COSTS INCLUDING TRANSPORTATION FOR DISPOSAL, IN CLASS 3 (U.S. CLS. 1, 4, 6, 50, 51 AND 52).

FIRST USE 1-1-2011; IN COMMERCE 1-1-2011.

THE MARK CONSISTS OF STANDARD CHARACTERS WITHOUT CLAIM TO ANY PARTICULAR FONT, STYLE, SIZE, OR COLOR.

NO CLAIM IS MADE TO THE EXCLUSIVE RIGHT TO USE "GREEN" , APART FROM THE MARK AS SHOWN.

SN 85-090,262, FILED 7-22-2010.

MICHAEL WEBSTER, EXAMINING ATTORNEY



*David J. Kypos*

Director of the United States Patent and Trademark Office

# United States of America

United States Patent and Trademark Office



**AFFINAGE**

**Reg. No. 4,136,170**

**Registered May 1, 2012**

**Int. Cls.: 29, 35, and 43**

**TRADEMARK**

**SERVICE MARK**

**PRINCIPAL REGISTER**

SCHRATTER FOODS INCORPORATED (DELAWARE CORPORATION)  
149 NEW DUTCH LANE  
FAIRFIELD, NJ 07004

FOR: CHEESE, IN CLASS 29 (U.S. CL. 46).

FIRST USE 11-5-2010; IN COMMERCE 11-5-2010.

FOR: RETAIL CHEESE STORES; ON-LINE RETAIL STORE SERVICES FEATURING CHEESE,  
IN CLASS 35 (U.S. CLS. 100, 101 AND 102).

FIRST USE 11-5-2010; IN COMMERCE 11-5-2010.

FOR: CATERING, IN CLASS 43 (U.S. CLS. 100 AND 101).

FIRST USE 11-5-2010; IN COMMERCE 11-5-2010.

NO CLAIM IS MADE TO THE EXCLUSIVE RIGHT TO USE "AFFINAGE" FOR INTERNA-  
TIONAL CLASS 29, APART FROM THE MARK AS SHOWN.

THE MARK CONSISTS OF A STYLIZED "A" ABOVE THE WORD "AFFINAGE".

SN 85-090,480, FILED 7-22-2010.

ROBIN MITTLER, EXAMINING ATTORNEY

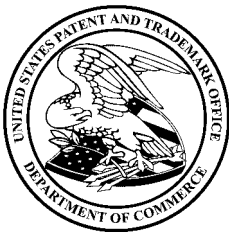

*David J. Kybas*

Director of the United States Patent and Trademark Office

# United States of America

United States Patent and Trademark Office

# TOZZ

**Reg. No. 4,136,171**

**Registered May 1, 2012**

**Int. Cl.: 28**

**TRADEMARK**

**PRINCIPAL REGISTER**

INDIAN INDUSTRIES, INC. (INDIANA CORPORATION)  
817 MAXWELL AVENUE, P.O. BOX 889  
EVANSVILLE, IN 47706

FOR: SPORT BALLS, IN CLASS 28 (U.S. CLS. 22, 23, 38 AND 50).

FIRST USE 1-0-2012; IN COMMERCE 1-0-2012.

THE MARK CONSISTS OF STANDARD CHARACTERS WITHOUT CLAIM TO ANY PARTICULAR FONT, STYLE, SIZE, OR COLOR.

SN 85-090,599, FILED 7-22-2010.

DAWN FELDMAN, EXAMINING ATTORNEY



*David J. Kyffers*

Director of the United States Patent and Trademark Office

# United States of America

United States Patent and Trademark Office

## GO OUT AND PLAY

**Reg. No. 4,136,172**

**Registered May 1, 2012**

**Int. Cl.: 28**

**TRADEMARK**

**PRINCIPAL REGISTER**

INDIAN INDUSTRIES, INC. (INDIANA CORPORATION)  
817 MAXWELL AVENUE, P.O. BOX 889  
EVANSVILLE, IN 47706

FOR: OUTDOOR ACTIVITY GAMES IN THE NATURE OF TARGET GAMES, ACTION SKILL GAMES, AND PADDLE BALL GAMES; BALLS FOR GAMES, IN CLASS 28 (U.S. CLS. 22, 23, 38 AND 50).

FIRST USE 1-0-2012; IN COMMERCE 1-0-2012.

THE MARK CONSISTS OF STANDARD CHARACTERS WITHOUT CLAIM TO ANY PARTICULAR FONT, STYLE, SIZE, OR COLOR.

SN 85-090,606, FILED 7-22-2010.

DAWN FELDMAN, EXAMINING ATTORNEY



*David J. Kyffers*

Director of the United States Patent and Trademark Office

# United States of America

United States Patent and Trademark Office

# UROLIS

**Reg. No. 4,136,173**

PHARMAOUEST INDUSTRIES (FRANCE SOCIÉTÁ IN ACCOMANDITA SEMPLICE (SAS))  
ACTIPOLE 2

**Registered May 1, 2012**

MINIAC MORVAN, FRANCE 35540

**Int. Cl.: 10**

FOR: URINALS, NOTABLY MALE URINALS, IN THE NATURE OF VESSELS FOR MEDICAL PURPOSES, IN CLASS 10 (U.S. CLS. 26, 39 AND 44).

**TRADEMARK**

FIRST USE 12-31-2001; IN COMMERCE 12-31-2001.

**PRINCIPAL REGISTER**

THE MARK CONSISTS OF STANDARD CHARACTERS WITHOUT CLAIM TO ANY PARTICULAR FONT, STYLE, SIZE, OR COLOR.

SN 85-090,770, FILED 7-22-2010.

ALLISON HOLTZ, EXAMINING ATTORNEY



*David J. Kybas*

Director of the United States Patent and Trademark Office

# United States of America

United States Patent and Trademark Office

# MYSTIC

**Reg. No. 4,136,174**

**Registered May 1, 2012**

**Int. Cl.: 16**

**TRADEMARK**

**PRINCIPAL REGISTER**

DISNEY ENTERPRISES, INC. (DELAWARE CORPORATION)  
500 SOUTH BUENA VISTA STREET  
BURBANK, CA 91521

FOR: PRINTED MATERIALS AND PUBLICATIONS, NAMELY, COMIC BOOKS, IN CLASS 16 (U.S. CLS. 2, 5, 22, 23, 29, 37, 38 AND 50).

FIRST USE 7-6-2011; IN COMMERCE 7-6-2011.

THE MARK CONSISTS OF STANDARD CHARACTERS WITHOUT CLAIM TO ANY PARTICULAR FONT, STYLE, SIZE, OR COLOR.

SN 85-091,071, FILED 7-22-2010.

BILL DAWE, EXAMINING ATTORNEY



*David J. Kyros*

Director of the United States Patent and Trademark Office



# United States of America

United States Patent and Trademark Office

# RUSE

**Reg. No. 4,136,175**

**Registered May 1, 2012**

**Int. Cl.: 16**

**TRADEMARK**

**PRINCIPAL REGISTER**

DISNEY ENTERPRISES, INC. (DELAWARE CORPORATION)  
500 SOUTH BUENA VISTA STREET  
BURBANK, CA 91521

FOR: PRINTED MATERIALS AND PUBLICATIONS, NAMELY, COMIC BOOKS, IN CLASS 16 (U.S. CLS. 2, 5, 22, 23, 29, 37, 38 AND 50).

FIRST USE 3-16-2011; IN COMMERCE 3-16-2011.

THE MARK CONSISTS OF STANDARD CHARACTERS WITHOUT CLAIM TO ANY PARTICULAR FONT, STYLE, SIZE, OR COLOR.

SN 85-091,074, FILED 7-22-2010.

BILL DAWE, EXAMINING ATTORNEY



*David J. Kybas*

Director of the United States Patent and Trademark Office

# United States of America

United States Patent and Trademark Office

## PENDANT OF ETERNAL LIGHT

**Reg. No. 4,136,176**

**Registered May 1, 2012**

**Int. Cls.: 16 and 21**

**TRADEMARK**

**PRINCIPAL REGISTER**

DEMARAY, LINDA (UNITED STATES INDIVIDUAL)  
6431 YARROW STREET  
ARVADA, CO 80004

FOR: BOOKS, PAMPHLETS AND PRINTED EDUCATIONAL AND TRAINING MATERIALS  
IN THE FIELD OF SPIRITUAL HEALING, IN CLASS 16 (U.S. CLS. 2, 5, 22, 23, 29, 37, 38  
AND 50).

FIRST USE 8-4-2010; IN COMMERCE 8-4-2010.

FOR: SEMIWORKED UNWROUGHT GLASS PRODUCTS, NAMELY, GLASS SPHERES AND  
FIGURINES, IN CLASS 21 (U.S. CLS. 2, 13, 23, 29, 30, 33, 40 AND 50).

FIRST USE 2-15-2011; IN COMMERCE 2-15-2011.

THE MARK CONSISTS OF STANDARD CHARACTERS WITHOUT CLAIM TO ANY PAR-  
TICULAR FONT, STYLE, SIZE, OR COLOR.

SN 85-091,600, FILED 7-23-2010.

SUNG IN, EXAMINING ATTORNEY



*David J. Kyfos*

Director of the United States Patent and Trademark Office

# United States of America

United States Patent and Trademark Office

# G•D

**Reg. No. 4,136,177**

**Registered May 1, 2012**

**Int. Cl.: 16**

**TRADEMARK**

**PRINCIPAL REGISTER**

BAAL SHEM TOV FOUNDATION (OHIO NON-PROFIT ORGANIZATION)  
SUITE 220  
21625 CHAGRIN BLVD.  
CLEVELAND, OH 44122

FOR: PUBLICATIONS, NAMELY, BOOKS AND NEWSLETTERS IN THE FIELDS OF HASSIDIC LORE, HASSIDIC TEACHINGS, JEWISH RELIGION, JEWISH MYSTICISM AND HASSIDIC STORIES, IN CLASS 16 (U.S. CLS. 2, 5, 22, 23, 29, 37, 38 AND 50).

FIRST USE 2-16-2012; IN COMMERCE 2-16-2012.

THE MARK CONSISTS OF THE LETTER "G", FOLLOWED BY A DOT IN THE CENTER, FOLLOWED BY THE LETTER "D".

SEC. 2(F).

SN 85-091,618, FILED 7-23-2010.

ANNE E. GUSTASON, EXAMINING ATTORNEY



*David J. Kybas*

Director of the United States Patent and Trademark Office

# United States of America

United States Patent and Trademark Office

# SANGUINATE

**Reg. No. 4,136,178**

**Registered May 1, 2012**

**Int. Cl.: 5**

**TRADEMARK**

**PRINCIPAL REGISTER**

PROLONG PHARMACEUTICALS, INC. (DELAWARE CORPORATION)  
300 B CORPORATE COURT  
SOUTH PLAINFIELD, NJ 07080

FOR: BLOOD SUBSTITUTES FOR VETERINARY AND HUMAN USE, IN CLASS 5 (U.S. CLS. 6, 18, 44, 46, 51 AND 52).

FIRST USE 6-1-2010; IN COMMERCE 6-1-2010.

OWNER OF U.S. REG. NO. 2,981,467.

THE COLOR(S) BLACK, RED AND WHITE IS/ARE CLAIMED AS A FEATURE OF THE MARK.

THE MARK CONSISTS OF THE WORD "SANGUINATE" IN BLACK WITH A RED AND WHITE COLOR DROPLET FORMING THE LETTER "U".

SN 85-091,803, FILED 7-23-2010.

RONALD DELGIZZI, EXAMINING ATTORNEY



*David J. Kyffers*

Director of the United States Patent and Trademark Office

# United States of America

United States Patent and Trademark Office

## WINGED ASSASSIN

**Reg. No. 4,136,179**

O'CONNOR, MICHAEL (UNITED STATES INDIVIDUAL)  
103 LEXINGTON DR.  
CLAYMONT, DE 19703

**Registered May 1, 2012**

**Int. Cl.: 41**

FOR: ENTERTAINMENT SERVICES, NAMELY, LIVE PERFORMANCES BY A MUSICAL GROUP, IN CLASS 41 (U.S. CLS. 100, 101 AND 107).

**SERVICE MARK**

FIRST USE 2-17-2012; IN COMMERCE 2-17-2012.

**PRINCIPAL REGISTER**

THE MARK CONSISTS OF STANDARD CHARACTERS WITHOUT CLAIM TO ANY PARTICULAR FONT, STYLE, SIZE, OR COLOR.

SN 85-092,401, FILED 7-26-2010.

ANDREW LEASER, EXAMINING ATTORNEY



*David J. Kybas*

Director of the United States Patent and Trademark Office

# United States of America

United States Patent and Trademark Office

## COLOSSAL REELS

**Reg. No. 4,136,180**

**Registered May 1, 2012**

**Int. Cl.: 9**

**TRADEMARK**

**PRINCIPAL REGISTER**

WMS GAMING INC. (DELAWARE CORPORATION)  
800 SOUTH NORTHPOINT BOULEVARD  
WAUKEGAN, IL 60085

FOR: COMPONENTS FOR GAMING MACHINES THAT GENERATE OR DISPLAY WAGER OUTCOMES, NAMELY, CONTROLLERS, DISPLAYS, BUTTON PANELS, BOLSTERS, ELECTRICAL WIRING, AND COMPUTER HARDWARE AND SOFTWARE ASSOCIATED THEREWITH; GAMING MACHINES, NAMELY, DEVICES WHICH ACCEPT A WAGER; GAMING SOFTWARE THAT GENERATES OR DISPLAYS WAGER OUTCOMES OF GAMING MACHINES, IN CLASS 9 (U.S. CLS. 21, 23, 26, 36 AND 38).

FIRST USE 11-16-2010; IN COMMERCE 11-16-2010.

THE MARK CONSISTS OF STANDARD CHARACTERS WITHOUT CLAIM TO ANY PARTICULAR FONT, STYLE, SIZE, OR COLOR.

OWNER OF U.S. REG. NO. 3,262,135.

NO CLAIM IS MADE TO THE EXCLUSIVE RIGHT TO USE "REELS", APART FROM THE MARK AS SHOWN.

SN 85-092,566, FILED 7-26-2010.

JASON BLAIR, EXAMINING ATTORNEY



*David J. Kyffers*

Director of the United States Patent and Trademark Office

# United States of America

United States Patent and Trademark Office

## TOOLS NOT TOYS

**Reg. No. 4,136,181**

**Registered May 1, 2012**

**Int. Cl.: 11**

**TRADEMARK**

**PRINCIPAL REGISTER**

STREAMLIGHT, INC. (DELAWARE CORPORATION)  
30 EAGLEVILLE ROAD  
EAGLEVILLE, PA 19403

FOR: FLASHLIGHTS AND PARTS THEREFOR, IN CLASS 11 (U.S. CLS. 13, 21, 23, 31 AND 34).

FIRST USE 2-9-2012; IN COMMERCE 2-9-2012.

THE MARK CONSISTS OF STANDARD CHARACTERS WITHOUT CLAIM TO ANY PARTICULAR FONT, STYLE, SIZE, OR COLOR.

NO CLAIM IS MADE TO THE EXCLUSIVE RIGHT TO USE "TOOLS", APART FROM THE MARK AS SHOWN.

SN 85-092,744, FILED 7-26-2010.

GINA HAYES, EXAMINING ATTORNEY



*David J. Kybas*

Director of the United States Patent and Trademark Office

# United States of America

United States Patent and Trademark Office

## BEYOND BREAKING BREAD

**Reg. No. 4,136,182**

**Registered May 1, 2012**

**Int. Cl.: 45**

**SERVICE MARK**

**PRINCIPAL REGISTER**

JEANNE WHITMAN (UNITED STATES INDIVIDUAL)  
18615 RO BRIDGE CT.  
CHESTERFIELD, MO 63005

FOR: RELIGIOUS AND SPIRITUAL SERVICES, NAMELY, ORGANIZING AND CONDUCTING FELLOWSHIP MEETINGS AND EVENTS HAVING CHRISTIAN THEMES FOR WOMEN; RELIGIOUS AND SPIRITUAL SERVICES, NAMELY, ORGANIZING AND CONDUCTING FELLOWSHIP MEETINGS AND EVENTS INVOLVING COOKING-RELATED ACTIVITIES AND HAVING CHRISTIAN THEMES FOR WOMEN, IN CLASS 45 (U.S. CLS. 100 AND 101).

FIRST USE 8-24-2011; IN COMMERCE 8-24-2011.

THE MARK CONSISTS OF STANDARD CHARACTERS WITHOUT CLAIM TO ANY PARTICULAR FONT, STYLE, SIZE, OR COLOR.

SN 85-092,753, FILED 7-26-2010.

ESTHER A. BORSUK, EXAMINING ATTORNEY



*David J. Kybas*

Director of the United States Patent and Trademark Office



# United States of America

United States Patent and Trademark Office



**Reg. No. 4,136,183**

**Registered May 1, 2012**

**Int. Cl.: 16**

**TRADEMARK**

**PRINCIPAL REGISTER**

CATTO CREATIONS, LLC (WISCONSIN LIMITED LIABILITY COMPANY)  
3125 CRUSADE LANE  
GREEN BAY, WI 54313

FOR: CHILDREN'S BOOKS, COLORING BOOKS, FRAMED ART PRINTS, ART PRINTS,  
AND ART PICTURES, IN CLASS 16 (U.S. CLS. 2, 5, 22, 23, 29, 37, 38 AND 50).

FIRST USE 12-31-2011; IN COMMERCE 1-12-2012.

THE MARK CONSISTS OF THE WORD "BELLA", WHEREIN THE "B" APPEARS AS A DRAGON TAIL, WITH THE MAIN PART OF THE LETTER BEING COLORED IN BLUE, DARK GREEN AND LIGHT GREEN, AND WHEREIN THE TAIL FURTHER EXTENDS FROM THE "B" AND APPEARS AS SCALES ON A DRAGON TAIL COLORED IN BLUE, LIGHT BLUE, DARK GREEN, LIGHT GREEN, YELLOW GREEN, RED, ORANGE, AND YELLOW, AND WHEREIN THE END OF THE TAIL IS A DIAMOND-SHAPED JEWEL COLORED IN BLUE AND WHITE WITH SPECKS OF ORANGE, YELLOW AND YELLOW GREEN THEREIN; AND WHEREIN THE "ELLA" ARE IN SMALLER CURSIVE BLUE LETTERS.

THE COLOR(S) BLUE, LIGHT BLUE, DARK GREEN, LIGHT GREEN, YELLOW GREEN, RED, ORANGE, YELLOW, AND WHITE IS/ARE CLAIMED AS A FEATURE OF THE MARK.

THE ENGLISH TRANSLATION OF "BELLA" IN THE MARK IS BEAUTIFUL.

SN 85-092,862, FILED 7-26-2010.

MARK RADEMACHER, EXAMINING ATTORNEY



*David J. Kybas*

Director of the United States Patent and Trademark Office

# United States of America

United States Patent and Trademark Office

## FOR LIFE'S HEADACHES

**Reg. No. 4,136,184**

NOVARTIS AG (SWITZERLAND AKTIENGESELLSCHAFT)  
CH 4002  
BASEL, SWITZERLAND

**Registered May 1, 2012**

**Int. Cl.: 5**

FOR: PHARMACEUTICAL PREPARATIONS, NAMELY, ANALGESICS, IN CLASS 5 (U.S. CLS. 6, 18, 44, 46, 51 AND 52).

**TRADEMARK**

FIRST USE 10-1-2011; IN COMMERCE 10-1-2011.

**PRINCIPAL REGISTER**

THE MARK CONSISTS OF STANDARD CHARACTERS WITHOUT CLAIM TO ANY PARTICULAR FONT, STYLE, SIZE, OR COLOR.

SN 85-093,020, FILED 7-26-2010.

LEIGH CAROLINE CASE, EXAMINING ATTORNEY



*David J. Kyffers*

Director of the United States Patent and Trademark Office

# United States of America

United States Patent and Trademark Office



**Reg. No. 4,136,185**

**Registered May 1, 2012**

**Int. Cls.: 37 and 42**

**SERVICE MARK**

**PRINCIPAL REGISTER**

PALONE, ROXANE (UNITED STATES INDIVIDUAL)  
139 JOHNSON ROAD  
WAYNESBURG, PA 15370 AND

PALONE, VINCENT (UNITED STATES INDIVIDUAL)  
139 JOHNSON ROAD  
WAYNESBURG, PA 15370

FOR: PROVIDING A WEBSITE FEATURING INFORMATION IN THE FIELD OF AIRCRAFT MAINTENANCE, IN CLASS 37 (U.S. CLS. 100, 103 AND 106).

FIRST USE 8-7-2010; IN COMMERCE 8-7-2010.

FOR: PROVIDING A WEBSITE FEATURING TECHNOLOGICAL INFORMATION IN THE TECHNOLOGY FIELD OF AIRCRAFT AND SMOKE SYSTEMS, IN CLASS 42 (U.S. CLS. 100 AND 101).

FIRST USE 8-7-2009; IN COMMERCE 8-7-2009.

NO CLAIM IS MADE TO THE EXCLUSIVE RIGHT TO USE "SMOKE OIL", APART FROM THE MARK AS SHOWN.

THE COLOR(S) BROWN, DARK BROWN, TAN, GREY, DARK GREY, GREEN, LIGHT GREEN, WHITE, BLACK, BLUE, AND LIGHT BLUE IS/ARE CLAIMED AS A FEATURE OF THE MARK.

THE MARK CONSISTS OF A STYLIZED DESIGN OF A BROWN AND DARK BROWN DOG GIVING A THUMB UP SIGN, WITH A GREY AND DARK GREY NOSE AND WITH WHITE, LIGHT GREY, BLACK, AND GREEN EYES, AND LIGHT GREY, BLACK, AND WHITE TEETH, WEARING A DARK BROWN, WHITE, AND TAN PILOT OUTFIT AND A GREEN HAT WITH A BLACK AIRPLANE ON IT AND GREY AND DARK GREY SHOES SMOKING A DARK BROWN AND LIGHT GREY CIGAR WITH WHITE SMOKE WITH A BLACK OUTLINE, WITH A FOOT ON A CAN OF BLUE AND LIGHT BLUE SMOKE OIL WITH A LIGHT BLUE DROP OF OIL DRIPPING FROM THE TOP, AND WITH A LIGHT GREEN CIRCLE IN THE BACKGROUND. THE WORDS "SMOKE HOUND" APPEAR IN STYLIZED WHITE FONT WITH LIGHT BROWN OUTLINING BELOW THE DESIGN, AND THE WORDS "SMOKE OIL" APPEAR IN STYLIZED WHITE FONT ON THE CAN.



*David J. Kybas*

Director of the United States Patent and Trademark Office

**Reg. No. 4,136,185** SN 85-093,312, FILED 7-26-2010.

CHRISTINE MARTIN, EXAMINING ATTORNEY

# United States of America

United States Patent and Trademark Office

# GYM NUT

**Reg. No. 4,136,186**

**Registered May 1, 2012**

**Int. Cl.: 25**

**TRADEMARK**

**PRINCIPAL REGISTER**

RANDLE, VARIEST (UNITED STATES INDIVIDUAL)  
1320 WELLSLEY COURT  
MOBILE, AL 36695

FOR: CLOTHING AND ATHLETIC APPAREL, NAMELY, SHORTS, TANK TOPS, JACKETS, HOODED SHIRTS AND SWEATSHIRTS, T-SHIRTS, AND HEADWEAR, IN CLASS 25 (U.S. CLS. 22 AND 39).

FIRST USE 12-15-2011; IN COMMERCE 12-15-2011.

THE MARK CONSISTS OF STANDARD CHARACTERS WITHOUT CLAIM TO ANY PARTICULAR FONT, STYLE, SIZE, OR COLOR.

NO CLAIM IS MADE TO THE EXCLUSIVE RIGHT TO USE "GYM", APART FROM THE MARK AS SHOWN.

SN 85-093,493, FILED 7-27-2010.

KATHLEEN M. VANSTON, EXAMINING ATTORNEY



*David J. Kyros*

Director of the United States Patent and Trademark Office

# United States of America

United States Patent and Trademark Office

## Home Remedy Plus

**Reg. No. 4,136,187**

**Registered May 1, 2012**

**Int. Cls.: 3 and 5**

**TRADEMARK**

**PRINCIPAL REGISTER**

UNITED INDUSTRIES CORPORATION (DELAWARE CORPORATION)  
1 RIDER TRAIL PLAZA  
ST. LOUIS, MO 63045

FOR: CLEANING PREPARATIONS; ALL-PURPOSE CLEANERS; STAIN REMOVERS; STAIN REMOVING PREPARATIONS; CARPET CLEANERS; PET ODOR REMOVERS; SHOWER TILE AND TUB CLEANER; GLASS CLEANER; DEGREASING PREPARATIONS, NAMELY, CLEANING AND DEGREASING PREPARATIONS FOR HOUSEHOLD AND INDUSTRIAL USE, NOT USED IN THE MANUFACTURING PROCESS; UPHOLSTERY CLEANERS; CLEANERS FOR USE ON STAINLESS STEEL; CARPET SHAMPOO, IN CLASS 3 (U.S. CLS. 1, 4, 6, 50, 51 AND 52).

FIRST USE 12-31-2010; IN COMMERCE 12-31-2010.

FOR: CARPET DEODORIZERS; CARPET FRESHENERS AND ODOR ELIMINATORS, IN CLASS 5 (U.S. CLS. 6, 18, 44, 46, 51 AND 52).

FIRST USE 12-31-2010; IN COMMERCE 12-31-2010.

THE MARK CONSISTS OF STANDARD CHARACTERS WITHOUT CLAIM TO ANY PARTICULAR FONT, STYLE, SIZE, OR COLOR.

SN 85-093,786, FILED 7-27-2010.

ANDREW RHIM, EXAMINING ATTORNEY



*David J. Kyffers*

Director of the United States Patent and Trademark Office

# United States of America

United States Patent and Trademark Office

## LUMINIZING MAGIC POWDER

**Reg. No. 4,136,188**

**Registered May 1, 2012**

**Int. Cl.: 3**

**TRADEMARK**

**PRINCIPAL REGISTER**

SHISEIDO COMPANY, LTD. (JAPAN CORPORATION)  
7-5-5 GINZA, CHUO-KU  
TOKYO, JAPAN 104-8010

FOR: TITANIUM DIOXIDE, POLYMETHYL METHACRYLATE AND MICA, SOLD AS AN INTEGRATED COMPONENT OF MAKEUP AND COSMETICS, IN CLASS 3 (U.S. CLS. 1, 4, 6, 50, 51 AND 52).

FIRST USE 2-2-2011; IN COMMERCE 2-2-2011.

THE MARK CONSISTS OF STANDARD CHARACTERS WITHOUT CLAIM TO ANY PARTICULAR FONT, STYLE, SIZE, OR COLOR.

OWNER OF U.S. REG. NOS. 2,919,987 AND 3,811,708.

NO CLAIM IS MADE TO THE EXCLUSIVE RIGHT TO USE "POWDER", APART FROM THE MARK AS SHOWN.

SN 85-093,903, FILED 7-27-2010.

LEIGH LOWRY, EXAMINING ATTORNEY



*David J. Kyffers*

Director of the United States Patent and Trademark Office

# United States of America

United States Patent and Trademark Office

## AGENCIES DEMAND IT. LEVEL 3 DELIVERS IT.

**Reg. No. 4,136,189**

**Registered May 1, 2012**

**Int. Cl.: 38**

**SERVICE MARK**

**PRINCIPAL REGISTER**

LEVEL 3 COMMUNICATIONS, LLC (DELAWARE CORPORATION)  
1025 ELDORADO BLVD.  
BROOMFIELD, CO 80021

FOR: COMMUNICATIONS SERVICES, NAMELY, PROVIDING NETWORK ACCESS POINTS THROUGH WHICH INFORMATION ON THE GLOBAL COMPUTER INFORMATION NETWORK PASSES FROM ONE GLOBAL COMPUTER INFORMATION NETWORK SERVICE PROVIDER TO ANOTHER; COMMUNICATIONS SERVICES, NAMELY, TRANSMISSION OF INFORMATION FROM ONE GLOBAL COMPUTER INFORMATION NETWORK SERVICE PROVIDER TO ANOTHER; TELECOMMUNICATIONS SERVICES, NAMELY, VOICE TELEPHONY LOCAL AND LONG DISTANCE SERVICES, VOICE MAIL SERVICES, FACSIMILE SERVICES, AND DATA TRANSMISSION SERVICES VIA A FIBER OPTIC NETWORK; TELECOMMUNICATIONS SERVICES, NAMELY, TRANSMISSION OF VOICE, VIDEO AND DATA VIA ELECTRONIC MEANS; TELECOMMUNICATIONS GATEWAY SERVICES; PROVIDING MULTIPLE USER ACCESS TO A GLOBAL COMPUTER INFORMATION NETWORK; PROVIDING FACILITIES AND EQUIPMENT FOR TELECOMMUNICATIONS SERVICES; LEASING OF TELECOMMUNICATIONS LINES AND EQUIPMENT; ELECTRONIC STREAMING OF AUDIO AND VIDEO DATA AND IMAGES ON THE INTERNET OR AN INTRANET; TRANSMISSION AND DELIVERY OF AUDIO AND VIDEO MESSAGES AND IMAGES ON THE INTERNET OR AN INTRANET; TELEVISION TRANSMISSION SERVICES AND SATELLITE TRANSMISSION SERVICES, IN CLASS 38 (U.S. CLS. 100, 101 AND 104).

FIRST USE 12-0-2010; IN COMMERCE 12-0-2010.

THE MARK CONSISTS OF STANDARD CHARACTERS WITHOUT CLAIM TO ANY PARTICULAR FONT, STYLE, SIZE, OR COLOR.

OWNER OF U.S. REG. NOS. 2,400,493, 2,586,143, AND 3,698,129.

SN 85-094,068, FILED 7-27-2010.

MARTHA FROMM, EXAMINING ATTORNEY



*David J. Kyros*

Director of the United States Patent and Trademark Office



# United States of America

United States Patent and Trademark Office



University of  
**Strathclyde**  
USA Foundation

**Reg. No. 4,136,190**

**Registered May 1, 2012**

**Int. Cl.: 36**

**SERVICE MARK**

**PRINCIPAL REGISTER**

UNIVERSITY OF STRATHCLYDE (SCOTLAND CHARITABLE CORPORATION)  
MCCANCE BUILDING  
16 RICHMOND STREET  
GLASGOW G1 1XQ, UNITED KINGDOM

FOR: CHARITABLE FUNDRAISING SERVICES, NAMELY, ORGANIZING AND CONDUCTING FUNDRAISING EVENTS IN RELATION TO EDUCATION; CHARITABLE FUNDRAISING, IN CLASS 36 (U.S. CLS. 100, 101 AND 102).

FIRST USE 7-29-2011; IN COMMERCE 7-29-2011.

NO CLAIM IS MADE TO THE EXCLUSIVE RIGHT TO USE "UNIVERSITY OF STRATHCLYDE USA FOUNDATION", APART FROM THE MARK AS SHOWN.

THE MARK CONSISTS OF THE WORDING "UNIVERSITY OF STRATHCLYDE USA FOUNDATION" WITH A CREST CONTAINING SECTIONS OF DESIGNS FEATURING TWO BOOKS SEPARATED BY A SQUIGGLY LINE ABOVE AN "X" WITH A CROWN ABOVE THE TOP PORTION OF THE "X" WITH A BROKEN UP LINE DESCENDING FROM THE BOTTOM OF THE CROWN AND THREE FIVE-POINTED GEOMETRIC SHAPES, ONE SHAPE IN EACH REMAINING SPACE OF THE "X".

SN 85-095,088, FILED 7-28-2010.

COURTNEY ALVAREZ, EXAMINING ATTORNEY



*David J. Kyjars*

Director of the United States Patent and Trademark Office

# United States of America

United States Patent and Trademark Office

## INTUITIVE MOTION

**Reg. No. 4,136,191**

**Registered May 1, 2012**

**Int. Cl.: 12**

**TRADEMARK**

**PRINCIPAL REGISTER**

INTUITIVE MOTION, INC. (CALIFORNIA CORPORATION)  
SUITE 716  
2202 S. FIGUEROA  
LOS ANGELES, CA 90007

FOR: VEHICLES, NAMELY, ELECTRONICALLY MOTORIZED SKATEBOARDS, IN CLASS 12 (U.S. CLS. 19, 21, 23, 31, 35 AND 44).

FIRST USE 1-11-2012; IN COMMERCE 1-11-2012.

THE MARK CONSISTS OF STANDARD CHARACTERS WITHOUT CLAIM TO ANY PARTICULAR FONT, STYLE, SIZE, OR COLOR.

SN 85-095,136, FILED 7-28-2010.

LAURIE MAYES, EXAMINING ATTORNEY



*David J. Kyffers*

Director of the United States Patent and Trademark Office

# United States of America

United States Patent and Trademark Office

# ZBOARD

**Reg. No. 4,136,192**

**Registered May 1, 2012**

**Int. Cl.: 12**

**TRADEMARK**

**PRINCIPAL REGISTER**

INTUITIVE MOTION, INC. (CALIFORNIA CORPORATION)  
SUITE 716  
2202 S. FIGUEROA  
LOS ANGELES, CA 90007

FOR: VEHICLES, NAMELY, ELECTRONICALLY MOTORIZED SKATEBOARDS, IN CLASS 12 (U.S. CLS. 19, 21, 23, 31, 35 AND 44).

FIRST USE 1-11-2012; IN COMMERCE 1-11-2012.

THE MARK CONSISTS OF STANDARD CHARACTERS WITHOUT CLAIM TO ANY PARTICULAR FONT, STYLE, SIZE, OR COLOR.

SN 85-095,155, FILED 7-28-2010.

LAURIE MAYES, EXAMINING ATTORNEY



*David J. Kyffers*

Director of the United States Patent and Trademark Office

# United States of America

United States Patent and Trademark Office

## SURPRISINGLY CREATIVE BUSINESS PEOPLE

**Reg. No. 4,136,193**

**Registered May 1, 2012**

**Int. Cl.: 35**

**SERVICE MARK**

**PRINCIPAL REGISTER**

BECKER HARRIS AND CO LLC (NEW YORK LIMITED LIABILITY COMPANY)  
SUITE 5  
72 1/2 IVING PLACE  
NEW YORK, NY 10003

FOR: ADVERTISING AND BUSINESS SERVICES, NAMELY, BUSINESS MANAGEMENT CONSULTING TO OTHER BUSINESS AND INDIVIDUALS IN THE INDUSTRY, IN CLASS 35 (U.S. CLS. 100, 101 AND 102).

FIRST USE 5-25-2010; IN COMMERCE 7-28-2010.

THE MARK CONSISTS OF STANDARD CHARACTERS WITHOUT CLAIM TO ANY PARTICULAR FONT, STYLE, SIZE, OR COLOR.

SN 85-095,467, FILED 7-29-2010.

BRIDGETT SMITH, EXAMINING ATTORNEY



*David J. Kyffers*

Director of the United States Patent and Trademark Office

# United States of America

United States Patent and Trademark Office



**Reg. No. 4,136,194**

**Registered May 1, 2012**

**Int. Cl.: 34**

**TRADEMARK**

**PRINCIPAL REGISTER**

WHY NOT (B.V.I.) CO., LIMITED (BR. VIRGIN ISLANDS LIMITED LIABILITY COMPANY)  
OFFSHORE INCORPORATIONS CENTRE  
P.O. BOX 957  
ROAD TOWN, TORTOLA, BR. VIRGIN ISLANDS

FOR: CIGARETTES; TOBACCO; HERBS FOR SMOKING; CIGARS; MOUTHPIECES FOR  
CIGARETTE HOLDERS; TOBACCO PIPES; ASHTRAYS, NOT OF PRECIOUS METAL, FOR  
SMOKERS; MATCHES; CIGARETTE LIGHTERS FOR SMOKERS; CIGARETTE FILTERS,  
IN CLASS 34 (U.S. CLS. 2, 8, 9 AND 17).

FIRST USE 1-1-2011; IN COMMERCE 1-1-2011.

THE MARK CONSISTS OF WORDING "YNOT" WITH A SHADED CIRCLE BEHIND THE  
WORD "NOT" AND A RECTANGULAR CARRIER BEHIND THE ENTIRE MARK.

SN 85-095,470, FILED 7-29-2010.

BRIDGETT SMITH, EXAMINING ATTORNEY



*David J. Kybas*

Director of the United States Patent and Trademark Office

# United States of America

United States Patent and Trademark Office

## MORE DRIVEN

**Reg. No. 4,136,195**

**Registered May 1, 2012**

**Int. Cl.: 37**

**SERVICE MARK**

**PRINCIPAL REGISTER**

THE GOODYEAR TIRE & RUBBER COMPANY (OHIO CORPORATION)  
1144 EAST MARKET STREET  
AKRON, OH 443160001

FOR: VEHICLE MAINTENANCE AND REPAIR, IN CLASS 37 (U.S. CLS. 100, 103 AND 106).

FIRST USE 4-4-2011; IN COMMERCE 4-4-2011.

THE MARK CONSISTS OF STANDARD CHARACTERS WITHOUT CLAIM TO ANY PARTICULAR FONT, STYLE, SIZE, OR COLOR.

SN 85-095,642, FILED 7-29-2010.

AMY KERTGATE, EXAMINING ATTORNEY



*David J. Kyffers*

Director of the United States Patent and Trademark Office

# United States of America

United States Patent and Trademark Office



**Reg. No. 4,136,196**

**Registered May 1, 2012**

**Int. Cl.: 35**

**SERVICE MARK**

**PRINCIPAL REGISTER**

JOHN W. GASPARINI, INC. (TEXAS CORPORATION)  
P.O. BOX 121554  
FORT WORTH, TX 76121

FOR: MAIL ORDER CATALOG SERVICES FEATURING PLUMBING, HEATING, AND ELECTRICAL PARTS; WHOLESALE DISTRIBUTORSHIPS FEATURING PLUMBING, HEATING, AND ELECTRICAL PARTS; ONLINE WHOLESALE STORE SERVICES FEATURING PLUMBING, HEATING, AND ELECTRICAL PARTS, IN CLASS 35 (U.S. CLS. 100, 101 AND 102).

FIRST USE 4-30-2010; IN COMMERCE 4-30-2010.

OWNER OF U.S. REG. NOS. 2,039,030 AND 3,675,889.

THE COLOR(S) BLUE AND WHITE IS/ARE CLAIMED AS A FEATURE OF THE MARK.

NO CLAIM IS MADE TO THE EXCLUSIVE RIGHT TO USE "MRO", APART FROM THE MARK AS SHOWN.

THE MARK CONSISTS OF A WHITE RECTANGLE WITH A BLUE BORDER. A SMALLER BLUE RECTANGLE IS POSITIONED WITHIN THE WHITE RECTANGLE AND THE WORD "MARK'S" IN THE COLOR WHITE IS PLACED IN THE MIDDLE OF THE BLUE RECTANGLE. THE PHRASE "WWW.MARKSMRO.COM" IN THE COLOR WHITE IS POSITIONED WITHIN THE BLUE RECTANGLE, BELOW THE WORD "MARK'S". THE LETTERS "M", "R", AND "O" IN THE COLOR BLUE ARE POSITIONED ON TOP OF ONE ANOTHER WITHIN THE WHITE RECTANGLE AND TO THE RIGHT OF THE BLUE RECTANGLE.

SN 85-095,675, FILED 7-29-2010.

STEVEN JACKSON, EXAMINING ATTORNEY



*David J. Kybas*

Director of the United States Patent and Trademark Office

# United States of America

United States Patent and Trademark Office



**Reg. No. 4,136,197**

**Registered May 1, 2012**

**Int. Cl.: 5**

**TRADEMARK**

**PRINCIPAL REGISTER**

BLUE EARTH LABS, LLC (DELAWARE LIMITED LIABILITY COMPANY)  
5055 WEST PATRICK LANE, SUITE 102  
LAS VEGAS, NV 89118

FOR: BIOCIDES, GERMICIDES, BACTERICIDES, VIRUCIDES, AND FUNGICIDES; BIOCIDES FOR DISINFECTING WATER SUPPLY SYSTEMS; BIOCIDES FOR DISINFECTING HARD SURFACES, IN CLASS 5 (U.S. CLS. 6, 18, 44, 46, 51 AND 52).

FIRST USE 1-25-2012; IN COMMERCE 1-25-2012.

THE MARK CONSISTS OF A CIRCULAR SHAPE BEING DARKER BLUE AT THE PERIPHERY AND TRANSITIONING IN GRADIENT FASHION TO LIGHTER BLUE AT AN UPPER LEFT CENTRAL PORTION THEREOF, WITH A SUPERIMPOSED WAVY WHITE SHAPE EXTENDING AND PROGRESSIVELY INCREASING IN WIDTH FROM AN UPPER LEFT CENTRAL PERIPHERAL POINT OF THE CIRCULAR SHAPE THROUGH THE MAJORITY OF THE LOWER RIGHT QUADRANT OF THE CIRCULAR SHAPE.

THE COLOR(S) BLUE AND WHITE IS/ARE CLAIMED AS A FEATURE OF THE MARK.

SN 85-095,860, FILED 7-29-2010.

SAIMA MAKHDOOM, EXAMINING ATTORNEY



*David J. Kyros*

Director of the United States Patent and Trademark Office



# United States of America

United States Patent and Trademark Office

# VG-MAX

**Reg. No. 4,136,198**

**Registered May 1, 2012**

**Int. Cl.: 8**

**TRADEMARK**

**PRINCIPAL REGISTER**

KAI U.S.A., LTD. (OREGON CORPORATION), DBA KERSHAW KNIVES,  
18600 SOUTHWEST TETON AVENUE  
TUALATIN, OR 97062

FOR: KNIVES AND KITCHEN CUTLERY, IN CLASS 8 (U.S. CLS. 23, 28 AND 44).

FIRST USE 11-0-2011; IN COMMERCE 1-0-2012.

THE MARK CONSISTS OF STANDARD CHARACTERS WITHOUT CLAIM TO ANY PARTICULAR FONT, STYLE, SIZE, OR COLOR.

SN 85-096,095, FILED 7-29-2010.

AMEEN IMAM, EXAMINING ATTORNEY



*David J. Kyffers*

Director of the United States Patent and Trademark Office

# United States of America

United States Patent and Trademark Office

## PANAMA JACK

**Reg. No. 4,136,199**

**Registered May 1, 2012**

**Int. Cl.: 11**

**TRADEMARK**

**PRINCIPAL REGISTER**

PANAMA JACK INTERNATIONAL, INC. (FLORIDA CORPORATION)  
230 ERNESTINE STREET  
ORLANDO, FL 32801

FOR: LAMPS, LAMP SHADES, CEILING FANS AND CANDLE LANTERNS, IN CLASS 11  
(U.S. CLS. 13, 21, 23, 31 AND 34).

FIRST USE 2-22-2012; IN COMMERCE 2-22-2012.

THE MARK CONSISTS OF STANDARD CHARACTERS WITHOUT CLAIM TO ANY PARTICULAR FONT, STYLE, SIZE, OR COLOR.

OWNER OF U.S. REG. NOS. 1,325,935, 1,354,252, AND OTHERS.

SN 85-096,520, FILED 7-30-2010.

JOHN HWANG, EXAMINING ATTORNEY



*David J. Kybas*

Director of the United States Patent and Trademark Office

# United States of America

United States Patent and Trademark Office

## Russell World Cap Index

**Reg. No. 4,136,200**

**Registered May 1, 2012**

**Int. Cls.: 9, 16, 35, and 36**

**TRADEMARK**

**SERVICE MARK**

**PRINCIPAL REGISTER**

FRANK RUSSELL COMPANY (WASHINGTON CORPORATION)  
1301 SECOND AVENUE, 18TH FLOOR  
SEATTLE, WA 98101

FOR: DOWNLOADABLE ELECTRONIC PUBLICATIONS, NAMELY, PUBLICATIONS IN THE NATURE OF LISTINGS OF INVESTMENT SECURITIES AND AN INDEX BASED ON SECURITIES VALUES; AND FINANCIAL PUBLICATIONS, NAMELY, FACT SHEETS, INFORMATIONAL BROCHURES, AND REPORTS RELATING TO INVESTMENT SECURITIES AND AN INDEX OF SECURITIES VALUES; DOWNLOADABLE ELECTRONIC DATA FILES RELATING TO AN INDEX OF SECURITIES VALUES; ELECTRONIC, MAGNETIC, OPTICAL AND OTHER MACHINE-READABLE MEDIA, NAMELY, COMPACT DISKS AND MAGNETIC DISKS CONTAINING/FEATURING FINANCIAL INFORMATION FOR USE IN THE FINANCIAL AND INVESTMENT FIELDS; DOWNLOADABLE VIDEO RECORDINGS, NAMELY, VIDEO RECORDINGS IN THE FINANCIAL AND INVESTMENT FIELDS, IN CLASS 9 (U.S. CLS. 21, 23, 26, 36 AND 38).

FIRST USE 10-1-2010; IN COMMERCE 10-1-2010.

FOR: PRINTED MATTER, NAMELY, LISTINGS OF INVESTMENT SECURITIES AND AN INDEX BASED ON SECURITIES VALUES; PRINTED FINANCIAL PUBLICATIONS, NAMELY, FACTSHEETS, INFORMATIONAL BROCHURES, AND REPORTS RELATING TO INVESTMENT SECURITIES AND AN INDEX OF SECURITIES VALUES, IN CLASS 16 (U.S. CLS. 2, 5, 22, 23, 29, 37, 38 AND 50).

FIRST USE 11-11-2011; IN COMMERCE 11-11-2011.

FOR: PROVIDING AND UPDATING AN INDEX BASED ON SECURITIES VALUES FOR OTHERS AND PROVIDING RULES AS TO THE MAKEUP OF THE INDEX, IN CLASS 35 (U.S. CLS. 100, 101 AND 102).

FIRST USE 10-1-2010; IN COMMERCE 10-1-2010.

FOR: FINANCIAL SERVICES IN THE NATURE OF AN INVESTMENT SECURITY; FINANCIAL CONSULTING SERVICES; PROVIDING FINANCIAL INFORMATION BY ELECTRONIC MEANS; AND PROVIDING ON-LINE FINANCIAL CALCULATORS, IN CLASS 36 (U.S. CLS. 100, 101 AND 102).



*David J. Kyjars*

Director of the United States Patent and Trademark Office

**Reg. No. 4,136,200** FIRST USE 10-1-2010; IN COMMERCE 10-1-2010.

THE MARK CONSISTS OF STANDARD CHARACTERS WITHOUT CLAIM TO ANY PARTICULAR FONT, STYLE, SIZE, OR COLOR.

OWNER OF U.S. REG. NOS. 1,576,348, 3,792,722, AND OTHERS.

NO CLAIM IS MADE TO THE EXCLUSIVE RIGHT TO USE "CAP INDEX", APART FROM THE MARK AS SHOWN.

SN 85-096,856, FILED 7-30-2010.

JANICE L. MCMORROW, EXAMINING ATTORNEY

# United States of America

United States Patent and Trademark Office

## 3D MAXIMUM BARRIER

**Reg. No. 4,136,201**

**Registered May 1, 2012**

**Int. Cl.: 10**

**TRADEMARK**

**PRINCIPAL REGISTER**

FLEXICATH LTD (ISRAEL CORPORATION)  
CALIFORNIA BUILDING, STE. 107  
120 YIGAL ALON STREET  
TEL AVIV 67443, ISRAEL

FOR: CATHETERS; MEDICINAL CATHETERS; CATHETERS AND PARTS AND FITTINGS THEREFOR; INFUSION AND INJECTION DEVICES FOR ADMINISTERING DRUGS; MEDICAL GUIDEWIRES AND PARTS AND FITTINGS THEREFOR; MEDICAL DEVICES TO TREAT INTRAVASCULAR SITES; MEDICAL INTRODUCERS; MEDICAL TUBING FOR DRAINAGE, TRANSFUSION OR ADMINISTERING DRUGS, IN CLASS 10 (U.S. CLS. 26, 39 AND 44).

FIRST USE 3-1-2008; IN COMMERCE 3-1-2008.

THE MARK CONSISTS OF STANDARD CHARACTERS WITHOUT CLAIM TO ANY PARTICULAR FONT, STYLE, SIZE, OR COLOR.

SN 85-097,472, FILED 7-31-2010.

IRA J. GOODSaid, EXAMINING ATTORNEY



*David J. Kybas*

Director of the United States Patent and Trademark Office

# United States of America

United States Patent and Trademark Office

# MIDTERM

**Reg. No. 4,136,202**

**Registered May 1, 2012**

**Int. Cl.: 10**

**TRADEMARK**

**PRINCIPAL REGISTER**

FLEXICATH LTD (ISRAEL CORPORATION)  
CALIFORNIA BUILDING, STE. 107  
120 YIGAL ALON STREET  
TEL AVIV 67443, ISRAEL

FOR: CATHETERS; MEDICINAL CATHETERS; CATHETERS AND PARTS AND FITTINGS THEREFOR; INFUSION AND INJECTION DEVICES FOR ADMINISTERING DRUGS; MEDICAL GUIDEWIRES AND PARTS AND FITTINGS THEREFOR; MEDICAL DEVICES TO TREAT INTRAVASCULAR SITES; MEDICAL INTRODUCERS; MEDICAL TUBING FOR DRAINAGE, TRANSFUSION OR ADMINISTERING DRUGS, IN CLASS 10 (U.S. CLS. 26, 39 AND 44).

FIRST USE 2-22-2012; IN COMMERCE 2-22-2012.

THE MARK CONSISTS OF STANDARD CHARACTERS WITHOUT CLAIM TO ANY PARTICULAR FONT, STYLE, SIZE, OR COLOR.

SN 85-097,474, FILED 7-31-2010.

IRA J. GOODSaid, EXAMINING ATTORNEY



*David J. Kybas*

Director of the United States Patent and Trademark Office

# United States of America

United States Patent and Trademark Office



**Reg. No. 4,136,203**

**Registered May 1, 2012**

**Int. Cl.: 28**

**TRADEMARK**

**PRINCIPAL REGISTER**

ARATIK, LLC (DELAWARE LIMITED LIABILITY COMPANY)  
1707 PORT MANLEIGH CIRCLE  
NEWPORT BEACH, CA 92660

FOR: BODY-TRAINING APPARATUS; SNOWBOARDS, IN CLASS 28 (U.S. CLS. 22, 23, 38 AND 50).

FIRST USE 11-15-2010; IN COMMERCE 11-15-2010.

THE MARK CONSISTS OF THE STYLIZED DEPICTION OF A MODIFIED LETTER "A" INSIDE OF A CIRCLE.

SN 85-098,089, FILED 8-2-2010.

COLLEEN DOMBROW, EXAMINING ATTORNEY



*David J. Kybas*

Director of the United States Patent and Trademark Office

# United States of America

United States Patent and Trademark Office

## RANDOM ACTS OF CULTURE

**Reg. No. 4,136,204**

**Registered May 1, 2012**

**Int. Cl.: 41**

**SERVICE MARK**

**PRINCIPAL REGISTER**

JOHN S. AND JAMES L. KNIGHT FOUNDATION (FLORIDA NON-PROFIT ORGANIZATION)  
SUITE 3300  
200 SOUTH BISCAYNE BLVD.  
MIAMI, FL 331312349

FOR: ENTERTAINMENT SERVICES IN THE NATURE OF LIVE PERFORMANCES OF  
CLASSICAL MUSIC, DANCE, THEATRE, AND OPERA, IN CLASS 41 (U.S. CLS. 100, 101  
AND 107).

FIRST USE 5-14-2010; IN COMMERCE 5-14-2010.

THE MARK CONSISTS OF STANDARD CHARACTERS WITHOUT CLAIM TO ANY PAR-  
TICULAR FONT, STYLE, SIZE, OR COLOR.

SN 85-098,149, FILED 8-2-2010.

JACLYN KIDWELL WALKER, EXAMINING ATTORNEY



*David J. Kybas*

Director of the United States Patent and Trademark Office



# United States of America

United States Patent and Trademark Office

## RANDOM ACT OF CULTURE

**Reg. No. 4,136,205**

**Registered May 1, 2012**

**Int. Cl.: 41**

**SERVICE MARK**

**PRINCIPAL REGISTER**

JOHN S. AND JAMES L. KNIGHT FOUNDATION (FLORIDA NON-PROFIT ORGANIZATION)  
SUITE 3300  
200 SOUTH BISCAYNE BLVD.  
MIAMI, FL 331312349

FOR: ENTERTAINMENT SERVICES IN THE NATURE OF LIVE PERFORMANCES OF  
CLASSICAL MUSIC, DANCE, THEATRE, AND OPERA, IN CLASS 41 (U.S. CLS. 100, 101  
AND 107).

FIRST USE 5-14-2010; IN COMMERCE 5-14-2010.

THE MARK CONSISTS OF STANDARD CHARACTERS WITHOUT CLAIM TO ANY PAR-  
TICULAR FONT, STYLE, SIZE, OR COLOR.

SN 85-098,153, FILED 8-2-2010.

JACLYN KIDWELL WALKER, EXAMINING ATTORNEY



*David J. Kybas*

Director of the United States Patent and Trademark Office

# United States of America

United States Patent and Trademark Office

## TEMPLE OF ZOOM MOTORSPORTS

**Reg. No. 4,136,206**

**Registered May 1, 2012**

**Int. Cl.: 35**

**SERVICE MARK**

**PRINCIPAL REGISTER**

LANGLEY, WILLIAM (UNITED STATES INDIVIDUAL)  
14555 DUSTY MILLER CT  
HUGHESVILLE, MD 20637

FOR: AUTOMOBILE DEALERSHIPS; RETAIL AUTOMOBILE PARTS AND ACCESSORIES STORES; RETAIL STORES FEATURING AUTOMOTIVE MEMORABILIA, IN CLASS 35 (U.S. CLS. 100, 101 AND 102).

FIRST USE 2-25-1999; IN COMMERCE 2-25-1999.

THE MARK CONSISTS OF STANDARD CHARACTERS WITHOUT CLAIM TO ANY PARTICULAR FONT, STYLE, SIZE, OR COLOR.

NO CLAIM IS MADE TO THE EXCLUSIVE RIGHT TO USE "MOTORSPORTS", APART FROM THE MARK AS SHOWN.

SN 85-098,873, FILED 8-3-2010.

AMEEN IMAM, EXAMINING ATTORNEY



*David J. Kyffers*

Director of the United States Patent and Trademark Office

# United States of America

United States Patent and Trademark Office

## GES SHOW ON THE GO

**Reg. No. 4,136,207**

**Registered May 1, 2012**

**Int. Cl.: 38**

**SERVICE MARK**

**PRINCIPAL REGISTER**

GLOBAL EXPERIENCE SPECIALISTS, INC. (NEVADA CORPORATION)  
950 GRIER DRIVE  
LAS VEGAS, NV 89119

FOR: WIRELESS COMMUNICATION SERVICES, NAMELY, TRANSMISSION OF TRADE SHOW INFORMATION BY ELECTRONIC COMMUNICATIONS NETWORKS TO MOBILE PHONES THAT IS OTHERWISE AVAILABLE FROM PRINTED TRADE SHOW INFORMATION PACKETS, IN CLASS 38 (U.S. CLS. 100, 101 AND 104).

FIRST USE 11-18-2010, THE MARK WAS FIRST USED ANYWHERE IN A DIFFERENT FORM OTHER THAN THAT SOUGHT TO BE REGISTERED AT LEAST AS EARLY AS 02/27/1974; IN COMMERCE 11-18-2010, THE MARK WAS FIRST USED IN COMMERCE IN A DIFFERENT FORM OTHER THAN THAT SOUGHT TO BE REGISTERED AT LEAST AS EARLY AS 02/27/1974.

THE MARK CONSISTS OF STANDARD CHARACTERS WITHOUT CLAIM TO ANY PARTICULAR FONT, STYLE, SIZE, OR COLOR.

OWNER OF U.S. REG. NOS. 1,153,404, 3,043,326, AND OTHERS.

SN 85-098,978, FILED 8-3-2010.

ALYSSA STEEL, EXAMINING ATTORNEY



*David J. Kybas*

Director of the United States Patent and Trademark Office

# United States of America

United States Patent and Trademark Office

## Twist and Shout

**Reg. No. 4,136,208**

**Registered May 1, 2012**

**Int. Cl.: 9**

**TRADEMARK**

**PRINCIPAL REGISTER**

DIAMOND GAME ENTERPRISES (CALIFORNIA CORPORATION)  
9340 PENFIELD AVENUE  
CHATSWORTH, CA 91311

FOR: GAMING EQUIPMENT, NAMELY, ELECTRONIC GAMING MACHINES AND GAMING MACHINES WITH VIDEO OUTPUT, IN CLASS 9 (U.S. CLS. 21, 23, 26, 36 AND 38).

FIRST USE 5-3-2011; IN COMMERCE 6-1-2011.

THE MARK CONSISTS OF STANDARD CHARACTERS WITHOUT CLAIM TO ANY PARTICULAR FONT, STYLE, SIZE, OR COLOR.

SN 85-099,467, FILED 8-3-2010.

AMEEN IMAM, EXAMINING ATTORNEY



*David J. Kybas*

Director of the United States Patent and Trademark Office

# United States of America

United States Patent and Trademark Office

## TRADECURRENTS

**Reg. No. 4,136,209**

**Registered May 1, 2012**

**Int. Cl.: 42**

**SERVICE MARK**

**PRINCIPAL REGISTER**

CADUCEUS PARTNERS, LLC (FLORIDA LIMITED LIABILITY COMPANY)  
SUITE 403  
3000 NE 30TH PLACE  
FORT LAUDERDALE, FL 33306

FOR: PROVIDING A WEBSITE FEATURING NEWS, ANALYSIS, COMMENTARY AND DATA, NAMELY, BUSINESS NEWS, ANALYSIS, COMMENTARY AND BUSINESS DATA, IN THE FIELDS OF GLOBAL COMMERCE, INTERNATIONAL TRADE, SUPPLY CHAIN MANAGEMENT AND LOGISTICS; PROVIDING INFORMATION AND DATA, NAMELY, BUSINESS INFORMATION AND BUSINESS DATA, IN THE FIELDS OF GLOBAL COMMERCE, INTERNATIONAL TRADE, SUPPLY CHAIN MANAGEMENT AND LOGISTICS, IN CLASS 42 (U.S. CLS. 100 AND 101).

FIRST USE 10-24-2011; IN COMMERCE 10-24-2011.

THE MARK CONSISTS OF STANDARD CHARACTERS WITHOUT CLAIM TO ANY PARTICULAR FONT, STYLE, SIZE, OR COLOR.

SN 85-099,967, FILED 8-4-2010.

ERNEST SHOSHO, EXAMINING ATTORNEY



*David J. Kypos*

Director of the United States Patent and Trademark Office

# United States of America

United States Patent and Trademark Office

## THE MARKSMAN

**Reg. No. 4,136,210**

GERRY CLARKE (CANADA INDIVIDUAL)  
572 BARTON STREET EAST  
STONEY CREEK, CANADA L8E5N3

**Registered May 1, 2012**

**Int. Cl.: 9**

FOR: SURVEYING INSTRUMENTS, IN CLASS 9 (U.S. CLS. 21, 23, 26, 36 AND 38).

**TRADEMARK**

FIRST USE 12-2-2011; IN COMMERCE 12-2-2011.

**PRINCIPAL REGISTER**

THE MARK CONSISTS OF STANDARD CHARACTERS WITHOUT CLAIM TO ANY PARTICULAR FONT, STYLE, SIZE, OR COLOR.

SN 85-101,114, FILED 8-5-2010.

PRISCILLA MILTON, EXAMINING ATTORNEY



*David J. Kybas*

Director of the United States Patent and Trademark Office

# United States of America

United States Patent and Trademark Office

# SPRINTSCAPE

**Reg. No. 4,136,211**

**Registered May 1, 2012**

**Int. Cl.: 27**

**TRADEMARK**

**PRINCIPAL REGISTER**

INTEGRATED TURF SOLUTIONS, LLC (DELAWARE LIMITED LIABILITY COMPANY)  
799 INDUSTRIAL BLVD.  
CHATSWORTH, GA 307052021

FOR: ARTIFICIAL TURF, IN CLASS 27 (U.S. CLS. 19, 20, 37, 42 AND 50).

FIRST USE 4-1-2011; IN COMMERCE 4-1-2011.

THE MARK CONSISTS OF STANDARD CHARACTERS WITHOUT CLAIM TO ANY PARTICULAR FONT, STYLE, SIZE, OR COLOR.

SN 85-101,221, FILED 8-5-2010.

PRISCILLA MILTON, EXAMINING ATTORNEY



*David J. Kybas*

Director of the United States Patent and Trademark Office

# United States of America

United States Patent and Trademark Office

# ALIUNDE

**Reg. No. 4,136,212**

**Registered May 1, 2012**

**Int. Cls.: 35 and 42**

**SERVICE MARK**

**PRINCIPAL REGISTER**

ALIUNDE LLC (DELAWARE LIMITED LIABILITY COMPANY)  
1550 N. CLEVELAND AVE.  
CHICAGO, IL 60610

FOR: INTERNET WEBSITE THAT ALLOWS LEGAL SERVICES PROVIDERS TO OBTAIN POTENTIAL CLIENT LEADS AND PROSPECTIVE CLIENT INFORMATION ABOUT CONSUMERS OF LEGAL SERVICES AND THEIR MATTERS AND ALLOWS CONSUMERS OF LEGAL SERVICES TO OBTAIN PROPOSALS FROM LEGAL SERVICES PROVIDERS INTERESTED IN THEIR MATTERS; PROVIDING BUSINESS AND MARKET INFORMATION RELATING TO THE LEGAL SERVICES INDUSTRY, IN CLASS 35 (U.S. CLS. 100, 101 AND 102).

FIRST USE 5-24-2011; IN COMMERCE 5-24-2011.

FOR: COMPUTER SERVICES, NAMELY, PROVIDING, HOSTING AND MAINTAINING ONLINE WEB FACILITIES AND TECHNOLOGY PLATFORM FOR THE EXCHANGE OF INFORMATION BETWEEN LEGAL SERVICES PROVIDERS AND CONSUMERS OF LEGAL SERVICES; PROVIDING SEARCH ENGINES FOR OBTAINING INFORMATION REGARDING LEGAL SERVICES PROVIDERS, IN CLASS 42 (U.S. CLS. 100 AND 101).

FIRST USE 5-24-2011; IN COMMERCE 5-24-2011.

THE MARK CONSISTS OF STANDARD CHARACTERS WITHOUT CLAIM TO ANY PARTICULAR FONT, STYLE, SIZE, OR COLOR.

SN 85-101,433, FILED 8-5-2010.

KATHY DE JONGE, EXAMINING ATTORNEY



*David J. Kyjars*

Director of the United States Patent and Trademark Office



# United States of America

United States Patent and Trademark Office

# SPORTSENSE

**Reg. No. 4,136,213**

MINNTECH CORPORATION (MINNESOTA CORPORATION)  
14605 28TH AVENUE NORTH  
MINNEAPOLIS, MN 55447

**Registered May 1, 2012**

**Int. Cl.: 5**

FOR: ANTIMICROBIAL DEODORIZING SPRAY FOR USE ON FABRIC, SPORTS EQUIPMENT  
AND GYM EQUIPMENT, IN CLASS 5 (U.S. CLS. 6, 18, 44, 46, 51 AND 52).

**TRADEMARK**

FIRST USE 12-17-2010; IN COMMERCE 12-17-2010.

**PRINCIPAL REGISTER**

THE MARK CONSISTS OF STANDARD CHARACTERS WITHOUT CLAIM TO ANY PAR-  
TICULAR FONT, STYLE, SIZE, OR COLOR.

SN 85-101,663, FILED 8-6-2010.

PAULA MAHONEY, EXAMINING ATTORNEY



*David J. Kybas*

Director of the United States Patent and Trademark Office

# United States of America

United States Patent and Trademark Office

## CANTON HARVESTER INN

**Reg. No. 4,136,214**

**Registered May 1, 2012**

**Int. Cl.: 43**

**SERVICE MARK**

**PRINCIPAL REGISTER**

CGI REAL ESTATE HOLDINGS, LLC (INDIANA LIMITED LIABILITY COMPANY)  
P.O. BOX 1608  
750 DANIELS WAY  
BLOOMINGTON, IN 47402

FOR: HOTEL SERVICES, IN CLASS 43 (U.S. CLS. 100 AND 101).

FIRST USE 10-1-2011; IN COMMERCE 10-1-2011.

THE MARK CONSISTS OF STANDARD CHARACTERS WITHOUT CLAIM TO ANY PARTICULAR FONT, STYLE, SIZE, OR COLOR.

NO CLAIM IS MADE TO THE EXCLUSIVE RIGHT TO USE "CANTON" AND "INN", APART FROM THE MARK AS SHOWN.

SN 85-101,732, FILED 8-6-2010.

MICHELLE DUBOIS, EXAMINING ATTORNEY



*David J. Kyffers*

Director of the United States Patent and Trademark Office

# United States of America

United States Patent and Trademark Office

## TURNINGPOINT

**Reg. No. 4,136,215**

**Registered May 1, 2012**

**Int. Cls.: 18 and 25**

**TRADEMARK**

**PRINCIPAL REGISTER**

EMTURN, LLC (DELAWARE LIMITED LIABILITY COMPANY)  
1909 K STREET, NW, NINTH FLOOR  
C/O VORYS, SATER, SEYMOUR AND PEASE LLP  
WASHINGTON, DC 20006

FOR: BACKPACKS, IN CLASS 18 (U.S. CLS. 1, 2, 3, 22 AND 41).

FIRST USE 12-15-2011; IN COMMERCE 12-15-2011.

FOR: CAPS; FOOTWEAR; HATS; JACKETS; PANTS; SHIRTS; SHORTS; SOCKS; TANK  
TOPS, IN CLASS 25 (U.S. CLS. 22 AND 39).

FIRST USE 12-15-2011; IN COMMERCE 12-15-2011.

THE MARK CONSISTS OF STANDARD CHARACTERS WITHOUT CLAIM TO ANY PAR-  
TICULAR FONT, STYLE, SIZE, OR COLOR.

SN 85-101,865, FILED 8-6-2010.

SUNG IN, EXAMINING ATTORNEY



*David J. Kybas*

Director of the United States Patent and Trademark Office

# United States of America

United States Patent and Trademark Office



**DYLAN'S CANDY BAR**

**Reg. No. 4,136,216**

**Registered May 1, 2012**

**Int. Cls.: 12, 16, 21, and 28**

DYLAN'S CANDYBAR LLC (DELAWARE LIMITED LIABILITY COMPANY)  
315 EAST 62ND ST 6TH FL  
NEW YORK, NY 10021

FOR: BABY STROLLERS AND RAIN COVERS, IN CLASS 12 (U.S. CLS. 19, 21, 23, 31, 35 AND 44).

FIRST USE 4-0-2011; IN COMMERCE 4-0-2011.

**TRADEMARK**

**PRINCIPAL REGISTER**

FOR: PAPER GIFT TAGS; GIFT BAGS; PAPER GIFT WRAPPING RIBBONS; GIFT WRAP PAPER; GREETING CARDS; BLANK NOTE CARDS; OCCASION SPECIFIC NOTE CARDS; NOTE PADS; DIE-CUT NOTE PADS; STATIONERY SETS, NAMELY, PENS, PAPER AND ENVELOPES; STATIONERY; PAPER NAPKINS; AGENDAS; CALENDARS; PENS; PENCILS; PENCIL SHARPENERS; PHOTO ALBUMS; BLANK JOURNALS; NOTE PAPER; EASELS; CHALK BOARDS; SCRAPBOOKING KITS, NAMELY, SCRAP BOOKS, PAPER, GLUE, AND MARKERS, IN CLASS 16 (U.S. CLS. 2, 5, 22, 23, 29, 37, 38 AND 50).

FIRST USE 2-0-2011; IN COMMERCE 2-0-2011.

FOR: PAPER PLATES; PAPER CUPS; DRINKING MUGS; DRINKING CUPS, IN CLASS 21 (U.S. CLS. 2, 13, 23, 29, 30, 33, 40 AND 50).

FIRST USE 2-0-2011; IN COMMERCE 2-0-2011.

FOR: TOYS AND PLAYTHINGS, NAMELY, PLUSH TOYS; PLAYING CARDS; PAPER PARTY HATS, IN CLASS 28 (U.S. CLS. 22, 23, 38 AND 50).

FIRST USE 2-0-2011; IN COMMERCE 2-0-2011.

OWNER OF U.S. REG. NOS. 2,776,343, 2,795,395, AND 3,627,968.

THE MARK CONSISTS OF A LOGO SHOWING A LOLLYPOP, AN ICE CREAM CONE, A GIFT PACKAGE, AND A MARTINI GLASS, ALONG WITH THE WORDS "DYLAN'S CANDY BAR".

SN 85-101,927, FILED 8-6-2010.



*David J. Kybas*

Director of the United States Patent and Trademark Office

**Reg. No. 4,136,216** BRENDAN MCCAULEY, EXAMINING ATTORNEY

# United States of America

United States Patent and Trademark Office

## HIGH AFFINITY

**Reg. No. 4,136,217**

**Registered May 1, 2012**

**Int. Cl.: 3**

**TRADEMARK**

**PRINCIPAL REGISTER**

THE PROCTER & GAMBLE COMPANY (OHIO CORPORATION)  
ONE PROCTER & GAMBLE PLAZA  
CINCINNATI, OH 45202

FOR: FLOOR FINISHING PREPARATIONS, FOR PROFESSIONAL AND INDUSTRIAL USE,  
IN CLASS 3 (U.S. CLS. 1, 4, 6, 50, 51 AND 52).

FIRST USE 3-14-2011; IN COMMERCE 3-14-2011.

THE MARK CONSISTS OF STANDARD CHARACTERS WITHOUT CLAIM TO ANY PAR-  
TICULAR FONT, STYLE, SIZE, OR COLOR.

SN 85-103,023, FILED 8-9-2010.

EDWARD NELSON, EXAMINING ATTORNEY



*David J. Kybas*

Director of the United States Patent and Trademark Office

# United States of America

United States Patent and Trademark Office

## GRAND OPENING

**Reg. No. 4,136,218**

THE PROCTER & GAMBLE COMPANY (OHIO CORPORATION)  
ONE PROCTER & GAMBLE PLAZA  
CINCINNATI, OH 45202

**Registered May 1, 2012**

**Int. Cl.: 3**

FOR: FLOOR FINISHING PREPARATIONS, FOR PROFESSIONAL AND INDUSTRIAL USE,  
IN CLASS 3 (U.S. CLS. 1, 4, 6, 50, 51 AND 52).

**TRADEMARK**

FIRST USE 3-14-2011; IN COMMERCE 3-14-2011.

**PRINCIPAL REGISTER**

THE MARK CONSISTS OF STANDARD CHARACTERS WITHOUT CLAIM TO ANY PARTICULAR FONT, STYLE, SIZE, OR COLOR.

SN 85-103,027, FILED 8-9-2010.

EDWARD NELSON, EXAMINING ATTORNEY



*David J. Kybas*

Director of the United States Patent and Trademark Office

# United States of America

United States Patent and Trademark Office

## NEW DIRECTIONS

**Reg. No. 4,136,219**

THE PROCTER & GAMBLE COMPANY (OHIO CORPORATION)  
ONE PROCTER & GAMBLE PLAZA  
CINCINNATI, OH 45202

**Registered May 1, 2012**

**Int. Cl.: 3**

FOR: FLOOR FINISHING PREPARATIONS, FOR PROFESSIONAL AND INDUSTRIAL USE,  
IN CLASS 3 (U.S. CLS. 1, 4, 6, 50, 51 AND 52).

**TRADEMARK**

FIRST USE 3-14-2011; IN COMMERCE 3-14-2011.

**PRINCIPAL REGISTER**

THE MARK CONSISTS OF STANDARD CHARACTERS WITHOUT CLAIM TO ANY PARTICULAR FONT, STYLE, SIZE, OR COLOR.

SN 85-103,133, FILED 8-9-2010.

EDWARD NELSON, EXAMINING ATTORNEY



*David J. Kybas*

Director of the United States Patent and Trademark Office



# United States of America

United States Patent and Trademark Office

# BEDTASTIC

**Reg. No. 4,136,220**

**Registered May 1, 2012**

**Int. Cl.: 24**

**TRADEMARK**

**PRINCIPAL REGISTER**

PEM-AMERICA, INC. (NEW YORK CORPORATION)  
SUITE 200  
230 FIFTH AVENUE  
NEW YORK, NY 10001

FOR: TEXTILE GOODS, NAMELY, QUILTS, COMFORTERS, COMFORTER CASES, COVERLETS, DUVETS, BED BLANKETS, BLANKET THROWS, BED SPREADS, BED SHEETS, BED SKIRTS, PILLOW CASES, PILLOW SHAMS, DUST RUFFLES, CURTAINS, DRAPERIES, FABRIC VALANCES, CURTAIN TIEBACKS IN THE NATURE OF TEXTILE CURTAIN HOLDERS, CURTAIN PANELS, TOWELS AND SHOWER CURTAINS, IN CLASS 24 (U.S. CLS. 42 AND 50).

FIRST USE 12-1-2010; IN COMMERCE 12-1-2010.

THE MARK CONSISTS OF STANDARD CHARACTERS WITHOUT CLAIM TO ANY PARTICULAR FONT, STYLE, SIZE, OR COLOR.

SN 85-103,380, FILED 8-9-2010.

MICHAEL KEATING, EXAMINING ATTORNEY



*David J. Kyros*

Director of the United States Patent and Trademark Office

# United States of America

United States Patent and Trademark Office

# Nowa One

**Reg. No. 4,136,221**

NOWA TECHNOLOGY, INC. (KANSAS CORPORATION)  
5250 WEST 94TH TERRACE  
PRAIRIE VILLAGE, KS 66207

**Registered May 1, 2012**

**Int. Cl.: 40**

FOR: WASTE WATER TREATMENT SERVICES FOR RECOVERING USABLE PRODUCTS FROM WASTE WATER SLUDGE, IN CLASS 40 (U.S. CLS. 100, 103 AND 106).

**SERVICE MARK**

FIRST USE 5-30-2011; IN COMMERCE 5-30-2011.

**PRINCIPAL REGISTER**

THE MARK CONSISTS OF STANDARD CHARACTERS WITHOUT CLAIM TO ANY PARTICULAR FONT, STYLE, SIZE, OR COLOR.

SN 85-103,388, FILED 8-9-2010.

B. PARADEWELAI, EXAMINING ATTORNEY



*David J. Kyros*

Director of the United States Patent and Trademark Office

# United States of America

United States Patent and Trademark Office



# AKSHUL

**Reg. No. 4,136,222**

WILLIAMS, STEPHEN L. (UNITED STATES INDIVIDUAL)  
9311 S WENTWORTH AVE.  
CHICAGO, IL 60620

**Registered May 1, 2012**

**Int. Cl.: 25**

FOR: WEARABLE GARMENTS AND CLOTHING, NAMELY, SHIRTS, IN CLASS 25 (U.S. CLS. 22 AND 39).

**TRADEMARK**

FIRST USE 3-1-2010; IN COMMERCE 6-13-2010.

**PRINCIPAL REGISTER**

THE MARK CONSISTS OF A DEPICTION OF AN EYE AND THE LETTERS "AKSHUL", WHICH IS AN ALTERNATE SPELLING OF ACTUAL.

SN 85-103,681, FILED 8-10-2010.

WILLIAM BRECKENFELD, EXAMINING ATTORNEY



*David J. Kyffers*

Director of the United States Patent and Trademark Office

# United States of America

United States Patent and Trademark Office

## FASHIONTHATFITS

**Reg. No. 4,136,223**

**Registered May 1, 2012**

**Int. Cl.: 35**

**SERVICE MARK**

**PRINCIPAL REGISTER**

VANITY SHOP OF GRAND FORKS, INC. (NORTH DAKOTA CORPORATION)  
1001 NORTH 25TH STREET  
FARGO, ND 58102

FOR: ON-LINE RETAIL STORE SERVICES FEATURING PERFUME, IN CLASS 35 (U.S. CLS. 100, 101 AND 102).

FIRST USE 11-28-2011; IN COMMERCE 11-28-2011.

THE MARK CONSISTS OF STANDARD CHARACTERS WITHOUT CLAIM TO ANY PARTICULAR FONT, STYLE, SIZE, OR COLOR.

OWNER OF U.S. REG. NO. 3,153,310.

SN 85-104,841, FILED 8-11-2010.

AISHA SALEM, EXAMINING ATTORNEY



*David J. Kybas*

Director of the United States Patent and Trademark Office

# United States of America

United States Patent and Trademark Office

## MILLION DOLLAR CONTRACTOR

**Reg. No. 4,136,224**

**Registered May 1, 2012**

**Int. Cl.: 41**

**SERVICE MARK**

**PRINCIPAL REGISTER**

SCRIPPS NETWORKS, LLC (DELAWARE LIMITED LIABILITY COMPANY)  
9721 SHERRILL BOULEVARD  
KNOXVILLE, TN 37932

FOR: EDUCATIONAL AND ENTERTAINMENT SERVICES, NAMELY, A CONTINUING PROGRAM ABOUT INTERIOR DESIGN AND DECORATING, ARCHITECTURE AND HOME DESIGN, HOME IMPROVEMENT, AND HOME RENOVATION, ACCESSIBLE BY RADIO, TELEVISION, CABLE, FIBER OPTIC NETWORKS, WIRELESS NETWORKS, SATELLITE, AUDIO VIDEO, AND COMPUTER NETWORKS, IN CLASS 41 (U.S. CLS. 100, 101 AND 107).

FIRST USE 10-16-2011; IN COMMERCE 10-16-2011.

THE MARK CONSISTS OF STANDARD CHARACTERS WITHOUT CLAIM TO ANY PARTICULAR FONT, STYLE, SIZE, OR COLOR.

NO CLAIM IS MADE TO THE EXCLUSIVE RIGHT TO USE "CONTRACTOR", APART FROM THE MARK AS SHOWN.

SN 85-105,273, FILED 8-11-2010.

MARK SHINER, EXAMINING ATTORNEY



*David J. Kyffers*

Director of the United States Patent and Trademark Office

# United States of America

United States Patent and Trademark Office

**MED**  **SHIELD**

**Reg. No. 4,136,225**

**Registered May 1, 2012**

**Int. Cl.: 44**

**SERVICE MARK**

**PRINCIPAL REGISTER**

CLINICAL REFERENCE LABORATORY, INC. (KANSAS CORPORATION)  
8433 QUIVIRA ROAD  
LENEXA, KS 66215

FOR: DRUG USE TESTING SERVICES, IN CLASS 44 (U.S. CLS. 100 AND 101).

FIRST USE 8-3-2011; IN COMMERCE 8-3-2011.

THE MARK CONSISTS OF THE WORDS "MED SHIELD" WITH TWO CURVED LINES BETWEEN THE TWO WORDS.

SN 85-106,383, FILED 8-12-2010.

PAULA MAHONEY, EXAMINING ATTORNEY



*David J. Kyros*

Director of the United States Patent and Trademark Office

# United States of America

United States Patent and Trademark Office

## WEALTH OF ORAL HEALTH

**Reg. No. 4,136,226**

**Registered May 1, 2012**

**Int. Cls.: 3, 5, 16, and 44**

**TRADEMARK**

**SERVICE MARK**

**PRINCIPAL REGISTER**

GLAXOSMITHKLINE LLC (DELAWARE LIMITED LIABILITY COMPANY)  
CORPORATION SERVICE COMPANY  
2711 CENTERVILLE ROAD, SUITE 400  
WILMINGTON, DE 19808

FOR: TOOTHPASTE, DENTURE CLEANSERS , IN CLASS 3 (U.S. CLS. 1, 4, 6, 50, 51 AND 52).

FIRST USE 5-9-2011; IN COMMERCE 5-9-2011.

FOR: ANTIBACTERIAL, ENZYMATIC ORAL CARE PREPARATIONS, NAMELY, MEDICATED TOOTHPASTE; DENTURE ADHESIVES, NAMELY, CREAMS FOR HOLDING FALSE TEETH; PHARMACEUTICAL PREPARATIONS FOR WOUND HEALING, IN CLASS 5 (U.S. CLS. 6, 18, 44, 46, 51 AND 52).

FIRST USE 5-9-2011; IN COMMERCE 5-9-2011.

FOR: PRINTED MATERIALS, NAMELY, NEWSLETTERS, BROCHURES, LEAFLETS IN THE FIELD OF ORAL HEALTH , IN CLASS 16 (U.S. CLS. 2, 5, 22, 23, 29, 37, 38 AND 50).

FIRST USE 5-9-2011; IN COMMERCE 5-9-2011.

FOR: PROVIDING ONLINE MEDICAL INFORMATION SERVICES IN THE FIELD OF ORAL HEALTH, IN CLASS 44 (U.S. CLS. 100 AND 101).

FIRST USE 5-9-2011; IN COMMERCE 5-9-2011.

THE MARK CONSISTS OF STANDARD CHARACTERS WITHOUT CLAIM TO ANY PARTICULAR FONT, STYLE, SIZE, OR COLOR.

NO CLAIM IS MADE TO THE EXCLUSIVE RIGHT TO USE "ORAL HEALTH", APART FROM THE MARK AS SHOWN.

SN 85-107,220, FILED 8-13-2010.

RAUL CORDOVA, EXAMINING ATTORNEY



*David J. Kyros*

Director of the United States Patent and Trademark Office

# United States of America

United States Patent and Trademark Office

# VUE

**Reg. No. 4,136,227**

**Registered May 1, 2012**

**Int. Cl.: 10**

**TRADEMARK**

**PRINCIPAL REGISTER**

C. R. BARD, INC. (NEW JERSEY CORPORATION)  
730 CENTRAL AVENUE  
MURRAY HILL, NJ 07974

FOR: MEDICAL DEVICES AND APPARATUS, NAMELY, SURGICAL IMPLANTS IN THE NATURE OF IMPLANTABLE PORTS, AND PARTS AND FITTINGS THEREFOR, IN CLASS 10 (U.S. CLS. 26, 39 AND 44).

FIRST USE 9-21-2010; IN COMMERCE 9-21-2010.

THE MARK CONSISTS OF STANDARD CHARACTERS WITHOUT CLAIM TO ANY PARTICULAR FONT, STYLE, SIZE, OR COLOR.

SN 85-108,509, FILED 8-16-2010.

TRACY FLETCHER, EXAMINING ATTORNEY



*David J. Kybas*

Director of the United States Patent and Trademark Office



# United States of America

United States Patent and Trademark Office

# RADCARE

**Reg. No. 4,136,228**

**Registered May 1, 2012**

**Int. Cls.: 37 and 42**

**SERVICE MARK**

**PRINCIPAL REGISTER**

RAD DATA COMMUNICATIONS LTD. (ISRAEL CORPORATION)  
24 RAOUL WALLENBERG STREET  
TEL AVIV, ISRAEL 69719

FOR: MAINTENANCE, REPAIR, AND INSTALLATION OF COMPUTER HARDWARE, MULTIPLEXERS, MODEMS, PSEUDOWIRE GATEWAYS, CARRIER ETHERNET ACCESS EQUIPMENT WORKING IN CONJUNCTION AS AN INTEGRATED SYSTEM FOR THE TRANSPORT AND AGGREGATION OF DATA, VOICE AND FIBER AND COPPER INFRASTRUCTURE, ANTENNAS FOR WIRELESS COMMUNICATIONS APPARATUS, TRANSCIEVERS, ASYNCHRONOUS TRANSFER MODE NETWORK TERMINATION UNITS AND MULTISERVICE ACCESS CONCENTRATORS, ETHERNET BRIDGE, INTERNET PROTOCOL ROUTERS, PRODUCTS THAT ENABLES TRANSPORT OF NON-INTERNET PROTOCOL TRAFFIC OVER AN INTERNET PROTOCOL-BASED NETWORK, ROUTERS, MODEMS, SWITCHES FOR VOICE AND DATA AND PACKET SWITCHING, CONVERTERS, SHARING DEVICES, HUBS, REPEATERS, BRIDGES, ROUTERS, CONNECTORS, PATCH PANELS, TERMINAL SERVERS, MONITORING AND TEST, EQUIPMENT, VIDEOCONFERENCING EQUIPMENT, VIDEO GATEWAYS FOR LAN VIDEOCONFERENCING, VIDEO INTERFACE UNITS, VIDEO STATIONS, VIDEO INTERFACE CARDS; COMPUTER NETWORK SECURITY HARDWARE, LOCAL AREA NETWORKS CONSISTING OF MODULAR INTELLIGENT HUBS, MODEM ELIMINATORS, MODEM SHARERS, PRINTER SHARERS, PORT SHARERS, SYNCHRONOUS INTERFACE CONVERTERS, ASYNCHRONOUS-TO-SYNCHRONOUS CONVERTERS, SERIAL/PARALLEL CONVERTERS, INTERFACE CONVERTERS, FIBER OPTIC CONVERTERS, DATA COMPRESSORS, NAMELY, DATA COMMUNICATION EQUIPMENT CONNECTED BETWEEN COMPUTERS AND MODEMS TO COMPRESS DATA, CARRIER CONTROL SIMULATORS, TERMINAL ADAPTORS, TAIL END ADAPTORS, POWER SUPPLY ADAPTORS, LIGHTING ARRESTORS, LOOP GENERATORS, DATA/VOICE SEPARATORS, SPOOLERS, REMOTE ACCESS SWITCHES, TRUNK ACCESSERS AND DIAGNOSTIC TESTING APPARATUSES FOR USE WITH THE ABOVE; TECHNICAL SUPPORT, NAMELY, TROUBLESHOOTING IN THE NATURE OF THE REPAIR OF COMPUTER HARDWARE, IN CLASS 37 (U.S. CLS. 100, 103 AND 106).



FIRST USE 10-31-2010; IN COMMERCE 10-31-2010.

*David J. Kyjars*

Director of the United States Patent and Trademark Office

FOR: MAINTENANCE, REPAIR, AND INSTALLATION OF COMPUTER SOFTWARE; TECHNICAL SUPPORT, NAMELY, TROUBLESHOOTING IN THE NATURE OF DIAGNOSING COMPUTER HARDWARE AND SOFTWARE PROBLEMS, IN CLASS 42 (U.S. CLS. 100 AND 101).

**Reg. No. 4,136,228** FIRST USE 10-31-2010; IN COMMERCE 10-31-2010.

THE MARK CONSISTS OF STANDARD CHARACTERS WITHOUT CLAIM TO ANY PARTICULAR FONT, STYLE, SIZE, OR COLOR.

SN 85-108,661, FILED 8-16-2010.

KAREN K. BUSH, EXAMINING ATTORNEY

# United States of America

United States Patent and Trademark Office

## LEADER HOSE

**Reg. No. 4,136,229**

TEKNOR APEX COMPANY (DELAWARE CORPORATION)  
505 CENTRAL AVE.  
PAWTUCKET, RI 02861

**Registered May 1, 2012**

**Int. Cl.: 17**

FOR: GARDEN HOSES; WATERING HOSES, IN CLASS 17 (U.S. CLS. 1, 5, 12, 13, 35 AND 50).

**TRADEMARK**

FIRST USE 5-31-2010; IN COMMERCE 5-31-2010.

**PRINCIPAL REGISTER**

THE MARK CONSISTS OF STANDARD CHARACTERS WITHOUT CLAIM TO ANY PARTICULAR FONT, STYLE, SIZE, OR COLOR.

NO CLAIM IS MADE TO THE EXCLUSIVE RIGHT TO USE "HOSE", APART FROM THE MARK AS SHOWN.

SN 85-108,887, FILED 8-17-2010.

JANICE KIM, EXAMINING ATTORNEY



*David J. Kyffers*

Director of the United States Patent and Trademark Office

# United States of America

United States Patent and Trademark Office

## Nancy and Christine's

**Reg. No. 4,136,230**

**Registered May 1, 2012**

**Int. Cl.: 30**

**TRADEMARK**

**PRINCIPAL REGISTER**

PRICE SPECIALTY FOODS, LLC (SOUTH CAROLINA LIMITED LIABILITY COMPANY)  
100-3 FORUM DRIVE  
COLUMBIA, SC 29229

FOR: SALAD DRESSINGS, IN CLASS 30 (U.S. CL. 46).

FIRST USE 4-1-2011; IN COMMERCE 4-1-2011.

THE MARK CONSISTS OF STANDARD CHARACTERS WITHOUT CLAIM TO ANY PARTICULAR FONT, STYLE, SIZE, OR COLOR.

THE NAME(S), PORTRAIT(S), AND/OR SIGNATURE(S) SHOWN IN THE MARK IDENTIFIES "NANCY PRICE", WHOSE CONSENT(S) TO REGISTER IS MADE OF RECORD.

SN 85-108,953, FILED 8-17-2010.

ANDREA HACK, EXAMINING ATTORNEY



*David J. Kyffers*

Director of the United States Patent and Trademark Office

# United States of America

United States Patent and Trademark Office

Q1<sup>ST</sup>

**Reg. No. 4,136,231**

**Registered May 1, 2012**

**Int. Cl.: 25**

**TRADEMARK**

**PRINCIPAL REGISTER**

RICHARD BAGAY (UNITED STATES INDIVIDUAL)  
984 EAST BADILLO ST. SUITE E  
COVINA, CA 91724

FOR: HATS; HOODED SWEAT SHIRTS; JACKETS; PANTS; SHORTS; SOCKS; SWEAT SHIRTS; T-SHIRTS; TANK TOPS; UNDERWEAR, IN CLASS 25 (U.S. CLS. 22 AND 39).

FIRST USE 8-18-2010; IN COMMERCE 5-1-2011.

THE MARK CONSISTS OF THE PHRASE "Q1<sup>ST</sup>" IN STYLIZED FONT.

SN 85-110,268, FILED 8-18-2010.

AMY ALFIERI, EXAMINING ATTORNEY



*David J. Kyffers*

Director of the United States Patent and Trademark Office

# United States of America

United States Patent and Trademark Office

## LUXURY FROM POLAND

**Reg. No. 4,136,232**

**Registered May 1, 2012**

**Int. Cl.: 33**

**TRADEMARK**

**PRINCIPAL REGISTER**

PRAVDA INTERNATIONAL INCORPORATED (DELAWARE CORPORATION)  
1105 N. MARKET STREET, SUITE 1144  
WILMINGTON, DE 19801

FOR: ALCOHOLIC BEVERAGES EXCEPT BEERS ALL FROM POLAND, IN CLASS 33 (U.S. CLS. 47 AND 49).

FIRST USE 6-12-2011; IN COMMERCE 6-12-2011.

THE MARK CONSISTS OF STANDARD CHARACTERS WITHOUT CLAIM TO ANY PARTICULAR FONT, STYLE, SIZE, OR COLOR.

NO CLAIM IS MADE TO THE EXCLUSIVE RIGHT TO USE "POLAND", APART FROM THE MARK AS SHOWN.

SN 85-110,387, FILED 8-18-2010.

JOHN HWANG, EXAMINING ATTORNEY



*David J. Kybas*

Director of the United States Patent and Trademark Office

# United States of America

United States Patent and Trademark Office

## DEAD RELATIVES

**Reg. No. 4,136,233**

**Registered May 1, 2012**

**Int. Cl.: 41**

**SERVICE MARK**

**PRINCIPAL REGISTER**

DAVID G STUCKEN (UNITED STATES INDIVIDUAL)  
C/O MCLANE & WONG  
11135 WEDDINGTON ST, #424  
N HOLLYWOOD, CA 91601

FOR: ENTERTAINMENT SERVICES, NAMELY, LIVE PERFORMANCES BY A MUSICAL GROUP, IN CLASS 41 (U.S. CLS. 100, 101 AND 107).

FIRST USE 8-19-2010; IN COMMERCE 8-19-2010.

THE MARK CONSISTS OF STANDARD CHARACTERS WITHOUT CLAIM TO ANY PARTICULAR FONT, STYLE, SIZE, OR COLOR.

SN 85-110,835, FILED 8-18-2010.

BERYL GARDNER, EXAMINING ATTORNEY



*David J. Kybas*

Director of the United States Patent and Trademark Office

# United States of America

United States Patent and Trademark Office

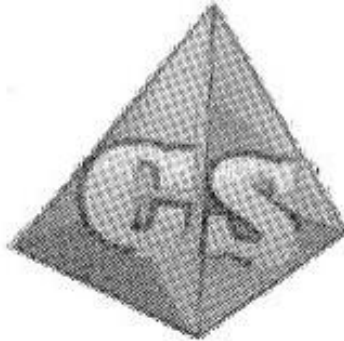

**Reg. No. 4,136,234**

**Registered May 1, 2012**

**Int. Cl.: 10**

**TRADEMARK**

**PRINCIPAL REGISTER**

RYMED TECHNOLOGIES, INC. (DELAWARE CORPORATION)  
137 THIRD AVENUE NORTH  
FRANKLIN, TN 37064

FOR: MEDICAL DEVICES, NAMELY, INTRAVENOUS CONNECTORS, IN CLASS 10 (U.S. CLS. 26, 39 AND 44).

FIRST USE 3-14-2012; IN COMMERCE 3-14-2012.

THE MARK CONSISTS OF A PYRAMID WITH THE LETTERS "C" AND "S" OVERLYING THE PYRAMID WITHIN THE IMAGE OF THE PYRAMID.

SN 85-111,764, FILED 8-19-2010.

AMEEN IMAM, EXAMINING ATTORNEY



*David J. Kyffers*

Director of the United States Patent and Trademark Office



# United States of America

United States Patent and Trademark Office



**Reg. No. 4,136,235**

**Registered May 1, 2012**

**Int. Cl.: 25**

**TRADEMARK**

**PRINCIPAL REGISTER**

CLARK, BENJAMIN D. (UNITED STATES INDIVIDUAL)  
2604 EL GRECO DRIVE  
MODESTO, CA 95354

FOR: ATHLETIC APPAREL, NAMELY, SHIRTS, PANTS, JACKETS, FOOTWEAR, HATS AND CAPS, ATHLETIC UNIFORMS; BOARD SHORTS; BUTTON DOWN SHIRTS; HATS; HOODED PULLOVERS; HOODED SWEAT SHIRTS; RASH GUARDS; SHIRTS FOR INFANTS, BABIES, TODDLERS AND CHILDREN; T-SHIRTS; TANK TOPS, IN CLASS 25 (U.S. CLS. 22 AND 39).

FIRST USE 2-5-2011; IN COMMERCE 2-5-2011.

THE MARK CONSISTS OF TWO BACK TO BACK LETTER "F'S" DRAWN AS A SKULL COMPLETING THE WORDS "FORCED 2 FINISH" WITH THE WORD "FORCED" APPEARING BACKWARDS. THE NUMBER "2" APPEARS IN THE MIDDLE OF THE WORDS.

SN 85-111,786, FILED 8-19-2010.

COURTNEY ALVAREZ, EXAMINING ATTORNEY



*David J. Kybas*

Director of the United States Patent and Trademark Office

# United States of America

United States Patent and Trademark Office

# OH!PEN

**Reg. No. 4,136,236**

**Registered May 1, 2012**

**Int. Cl.: 35**

**SERVICE MARK**

**PRINCIPAL REGISTER**

BISSON, PAOLA PORRINI (UNITED STATES INDIVIDUAL)  
1215 LA MIRADA STREET  
LAGUNA BEACH, CA 92651

FOR: PROMOTING PUBLIC AWARENESS OF ART AND LITERATURE, IN CLASS 35 (U.S. CLS. 100, 101 AND 102).

FIRST USE 11-1-2010; IN COMMERCE 11-1-2010.

THE MARK CONSISTS OF STANDARD CHARACTERS WITHOUT CLAIM TO ANY PARTICULAR FONT, STYLE, SIZE, OR COLOR.

SN 85-111,803, FILED 8-19-2010.

LESLIE RICHARDS, EXAMINING ATTORNEY



*David J. Kyffers*

Director of the United States Patent and Trademark Office

# United States of America

United States Patent and Trademark Office

# LUV U ZOO

**Reg. No. 4,136,237**

**Registered May 1, 2012**

**Int. Cls.: 16 and 18**

**TRADEMARK**

**PRINCIPAL REGISTER**

MATTEL, INC. (DELAWARE CORPORATION)  
M1-1518  
333 CONTINENTAL BOULEVARD  
EL SEGUNDO, CA 90245

FOR: MEMORY BOOKS, IN CLASS 16 (U.S. CLS. 2, 5, 22, 23, 29, 37, 38 AND 50).

FIRST USE 5-19-2011; IN COMMERCE 5-19-2011.

FOR: DIAPER BAGS; DIAPER TOTE BAGS, IN CLASS 18 (U.S. CLS. 1, 2, 3, 22 AND 41).

FIRST USE 5-19-2011; IN COMMERCE 5-19-2011.

THE MARK CONSISTS OF STANDARD CHARACTERS WITHOUT CLAIM TO ANY PARTICULAR FONT, STYLE, SIZE, OR COLOR.

SN 85-112,087, FILED 8-20-2010.

SKYE YOUNG, EXAMINING ATTORNEY



*David J. Kybas*

Director of the United States Patent and Trademark Office

# United States of America

United States Patent and Trademark Office

# HEALTHY YOU

**Reg. No. 4,136,238**

1.800.VENDING (UTAH CORPORATION)  
520 NORTH KAYS DRIVE  
KAYSVILLE, UT 84037

**Registered May 1, 2012**

**Int. Cl.: 35**

FOR: PROCESSING TELEPHONE, INTERNET AND ELECTRONIC INQUIRIES REGARDING  
ADVERTISED GOODS AND SERVICES, IN CLASS 35 (U.S. CLS. 100, 101 AND 102).

**SERVICE MARK**

FIRST USE 12-0-2010; IN COMMERCE 12-0-2010.

**PRINCIPAL REGISTER**

THE MARK CONSISTS OF STANDARD CHARACTERS WITHOUT CLAIM TO ANY PAR-  
TICULAR FONT, STYLE, SIZE, OR COLOR.

SN 85-112,319, FILED 8-20-2010.

BERYL GARDNER, EXAMINING ATTORNEY



*David J. Kyffers*

Director of the United States Patent and Trademark Office

# United States of America

United States Patent and Trademark Office

## POWERWORKS

**Reg. No. 4,136,239**

**Registered May 1, 2012**

**Int. Cl.: 7**

SUNRISE GLOBAL MARKETING LLC (NORTH CAROLINA LIMITED LIABILITY COMPANY)  
SUITE 9A  
224 ROLLING HILL ROAD  
MOORESVILLE, NC 28117

**TRADEMARK**

**PRINCIPAL REGISTER**

FOR: AIR COMPRESSORS; ELECTRICITY GENERATORS; ENGINES AND MOTORS FOR THE GENERATION OF ELECTRICITY; MACHINES FOR CLEANING SURFACES USING HIGH PRESSURE WATER, IN CLASS 7 (U.S. CLS. 13, 19, 21, 23, 31, 34 AND 35).

FIRST USE 10-0-2011; IN COMMERCE 10-0-2011.

THE MARK CONSISTS OF STANDARD CHARACTERS WITHOUT CLAIM TO ANY PARTICULAR FONT, STYLE, SIZE, OR COLOR.

SN 85-112,363, FILED 8-20-2010.

CHRIS WELLS, EXAMINING ATTORNEY



*David J. Kyffers*

Director of the United States Patent and Trademark Office

# United States of America

United States Patent and Trademark Office

## AMERICAN BADASS

**Reg. No. 4,136,240**

**Registered May 1, 2012**

**Int. Cl.: 32**

**TRADEMARK**

**PRINCIPAL REGISTER**

RITCHIE, ROBERT (UNITED STATES INDIVIDUAL)  
P.O. BOX 1230  
CLARKSTON, MI 48347

FOR: BEER, IN CLASS 32 (U.S. CLS. 45, 46 AND 48).

FIRST USE 7-17-2009; IN COMMERCE 7-17-2009.

THE MARK CONSISTS OF STANDARD CHARACTERS WITHOUT CLAIM TO ANY PARTICULAR FONT, STYLE, SIZE, OR COLOR.

OWNER OF U.S. REG. NOS. 2,957,012, 3,411,662, AND OTHERS.

NO CLAIM IS MADE TO THE EXCLUSIVE RIGHT TO USE "AMERICAN", APART FROM THE MARK AS SHOWN.

SN 85-112,740, FILED 8-20-2010.

ANDREA HACK, EXAMINING ATTORNEY



*David J. Kyffers*

Director of the United States Patent and Trademark Office

# United States of America

United States Patent and Trademark Office

## BOOK COUNTRY

**Reg. No. 4,136,241**

**Registered May 1, 2012**

**Int. Cls.: 35 and 42**

**SERVICE MARK**

**PRINCIPAL REGISTER**

BOOK COUNTRY LLC (DELAWARE LIMITED LIABILITY COMPANY)  
375 HUDSON STREET  
NEW YORK, NY 10014

FOR: ON-LINE RETAIL STORE SERVICES FEATURING BOOKS, IN CLASS 35 (U.S. CLS. 100, 101 AND 102).

FIRST USE 12-14-2011; IN COMMERCE 12-14-2011.

FOR: COMPUTER SERVICES, NAMELY, CREATING AN ON-LINE VIRTUAL COMMUNITY FOR AUTHORS, READERS, AND MEMBERS OF THE PUBLISHING INDUSTRY TO UPLOAD THEIR WRITING, READ AND REVIEW THE WRITING OF OTHER USERS, GET FEEDBACK FROM THEIR PEERS, PARTICIPATE IN DISCUSSIONS AND CONTESTS, UPLOAD AND SHARE THEIR PERSONAL PROFILES, ENGAGE IN SOCIAL NETWORKING, AND READ INTERVIEWS OF AND ARTICLES BY PUBLISHING INDUSTRY PROFESSIONALS, IN CLASS 42 (U.S. CLS. 100 AND 101).

FIRST USE 5-2-2011; IN COMMERCE 5-2-2011.

THE MARK CONSISTS OF STANDARD CHARACTERS WITHOUT CLAIM TO ANY PARTICULAR FONT, STYLE, SIZE, OR COLOR.

NO CLAIM IS MADE TO THE EXCLUSIVE RIGHT TO USE "BOOK", APART FROM THE MARK AS SHOWN.

SN 85-113,405, FILED 8-23-2010.

WILLIAM BRECKENFELD, EXAMINING ATTORNEY



*David J. Kybas*

Director of the United States Patent and Trademark Office

# United States of America

United States Patent and Trademark Office

# SWAGCICLE

**Reg. No. 4,136,242**

SIENNA LLC (DELAWARE LIMITED LIABILITY COMPANY)  
540 NW UNIVERSITY BLVD.  
PORT ST. LUCIE, FL 34986

**Registered May 1, 2012**

**Int. Cl.: 11**

FOR: ELECTRIC HOLIDAY LIGHT SETS, ELECTRIC LIGHTS FOR CHRISTMAS TREES;  
ELECTRIC LIGHT BULB SETS, IN CLASS 11 (U.S. CLS. 13, 21, 23, 31 AND 34).

**TRADEMARK**

FIRST USE 6-30-2011; IN COMMERCE 6-30-2011.

**PRINCIPAL REGISTER**

THE MARK CONSISTS OF STANDARD CHARACTERS WITHOUT CLAIM TO ANY PARTICULAR FONT, STYLE, SIZE, OR COLOR.

SN 85-113,696, FILED 8-23-2010.

JANICE KIM, EXAMINING ATTORNEY



*David J. Kyffers*

Director of the United States Patent and Trademark Office



# United States of America

United States Patent and Trademark Office



**Reg. No. 4,136,243**

**Registered May 1, 2012**

**Int. Cl.: 20**

**TRADEMARK**

**PRINCIPAL REGISTER**

LOUISVILLE LADDER INC. (DELAWARE CORPORATION)  
7765 NATIONAL TURNPIKE, UNIT 190  
LOUISVILLE, KY 40214

FOR: NON-METAL LADDER ACCESSORIES, NAMELY, A PLASTIC HANDLE WITH NON-SKID SURFACE, FOR USE ON AND ATTACHMENT TO LADDERS, IN CLASS 20 (U.S. CLS. 2, 13, 22, 25, 32 AND 50).

FIRST USE 1-0-2011; IN COMMERCE 1-0-2011.

NO CLAIM IS MADE TO THE EXCLUSIVE RIGHT TO USE "GRIP", APART FROM THE MARK AS SHOWN.

THE COLOR(S) YELLOW AND BLACK IS/ARE CLAIMED AS A FEATURE OF THE MARK.

THE MARK CONSISTS OF A WEDGE-SHAPED DESIGN HAVING AN OUTER, TREAD-SHAPED OUTLINE IN BLACK, A MIDDLE, WEDGE-SHAPED OUTLINE IN YELLOW AND AN INNER WEDGE SHAPE IN BLACK AND CONTAINING THE WORD "PRO" IN YELLOW STYLIZED LETTERING WITH BLACK SPECKS DIRECTLY ABOVE THE WORD "GRIP" IN YELLOW STYLIZED LETTERING WITH BLACK SPECKS.

SN 85-113,792, FILED 8-23-2010.

KATHERINE CHANG, EXAMINING ATTORNEY



*David J. Kybas*

Director of the United States Patent and Trademark Office

# United States of America

United States Patent and Trademark Office

# Gulfstyle

**Reg. No. 4,136,244**

**Registered May 1, 2012**

**Int. Cl.: 25**

**TRADEMARK**

**PRINCIPAL REGISTER**

GULFSTYLE INC. (FLORIDA CORPORATION)  
715 SAILFISH DE  
FORT WALTON BEACH, FL 32548

FOR: BLOUSES; HATS; JACKETS; JEANS; PANTS; SHIRTS; SHOES; SHORTS; SKIRTS;  
SWEAT SHIRTS; SWEATERS; TIES, IN CLASS 25 (U.S. CLS. 22 AND 39).

FIRST USE 1-1-2011; IN COMMERCE 12-15-2011.

THE MARK CONSISTS OF STANDARD CHARACTERS WITHOUT CLAIM TO ANY PAR-  
TICULAR FONT, STYLE, SIZE, OR COLOR.

SN 85-113,878, FILED 8-23-2010.

REBECCA EISINGER, EXAMINING ATTORNEY



*David J. Kybas*

Director of the United States Patent and Trademark Office

# United States of America

United States Patent and Trademark Office

# CORTEX

**Reg. No. 4,136,245**

**Registered May 1, 2012**

**Int. Cl.: 9**

**TRADEMARK**

**PRINCIPAL REGISTER**

PLASMA-THERM LLC (FLORIDA LIMITED LIABILITY COMPANY)  
10050 16TH STREET NORTH  
ST. PETERSBURG, FL 33716

FOR: SOFTWARE FOR CONTROLLING PLASMA ETCHING AND PLASMA DEPOSITION MACHINES USED IN THE FABRICATION OF SEMICONDUCTOR DEVICES AND RELATED ELECTRONIC COMPONENTS , IN CLASS 9 (U.S. CLS. 21, 23, 26, 36 AND 38).

FIRST USE 7-7-2011; IN COMMERCE 7-7-2011.

THE MARK CONSISTS OF STANDARD CHARACTERS WITHOUT CLAIM TO ANY PARTICULAR FONT, STYLE, SIZE, OR COLOR.

SN 85-114,111, FILED 8-23-2010.

C. DIONNE CLYBURN, EXAMINING ATTORNEY



*David J. Kyros*

Director of the United States Patent and Trademark Office

# United States of America

United States Patent and Trademark Office

# AVESTAR

**Reg. No. 4,136,246**

**Registered May 1, 2012**

**Int. Cl.: 42**

**SERVICE MARK**

**PRINCIPAL REGISTER**

U. S. DEPARTMENT OF ENERGY (UNITED STATES FEDERAL AGENCY)  
GC-62, 6F-067  
1000 INDEPENDENCE AVENUE, SW  
WASHINGTON, DC 20585

FOR: PROVIDING SCIENTIFIC RESEARCH FACILITIES, NAMELY, A RESEARCH CENTER EQUIPPED WITH SCIENTIFIC EQUIPMENT IN THE NATURE OF A POWER GENERATION SIMULATOR COMPLETE WITH CARBON CAPTURE COMPONENTS, IN CLASS 42 (U.S. CLS. 100 AND 101).

FIRST USE 4-30-2011; IN COMMERCE 4-30-2011.

THE MARK CONSISTS OF STANDARD CHARACTERS WITHOUT CLAIM TO ANY PARTICULAR FONT, STYLE, SIZE, OR COLOR.

SN 85-114,721, FILED 8-24-2010.

KEVIN CORWIN, EXAMINING ATTORNEY



*David J. Kyffers*

Director of the United States Patent and Trademark Office

# United States of America

United States Patent and Trademark Office

# EnergyPoint

**Reg. No. 4,136,247**

**Registered May 1, 2012**

**Int. Cl.: 35**

**SERVICE MARK**

**PRINCIPAL REGISTER**

CONNECTING POINT MARKETING GROUP, INC. (NEW HAMPSHIRE CORPORATION)  
56 DOW LANE  
RYE, NH 03870

FOR: BUSINESS SERVICES IN THE NATURE OF ARRANGING AND CONDUCTING MARKETING PROMOTIONAL EVENTS FOR OTHERS AMONG VENDORS AND CUSTOMERS BOTH IN PERSON AND VIA THE INTERNET; PROVIDING STRATEGIC BUSINESS MARKETING SERVICES RELATING TO SUCH EVENTS AND MARKETING, PROMOTING THE SALE OF GOODS AND SERVICES OF OTHER CORPORATIONS, PARTNERSHIPS OR INDIVIDUALS BY AND THROUGH THE MEANS OF THE ARRANGING VARIOUS EVENTS, NAMELY, PREPARING AND DISTRIBUTING INDUSTRY-DEFINING AND EDUCATIONAL CONTENT PROMOTIONAL MATERIALS, PROMOTIONAL NEWSLETTERS, ADVERTISING BROCHURES AND OTHER PRINTED MARKETING MATERIAL, AND ARRANGING AND CONDUCTING MARKETING PROMOTIONAL EVENTS WITH SELECT AND GUARANTEED AUDIENCES AND PRE-QUALIFIED PRIVATE APPOINTMENTS, IN CLASS 35 (U.S. CLS. 100, 101 AND 102).

FIRST USE 3-15-2011; IN COMMERCE 3-15-2011.

THE MARK CONSISTS OF STANDARD CHARACTERS WITHOUT CLAIM TO ANY PARTICULAR FONT, STYLE, SIZE, OR COLOR.

OWNER OF U.S. REG. NOS. 3,189,767, 3,354,988, AND OTHERS.

SN 85-115,461, FILED 8-25-2010.

ANN E. SAPPENFIELD, EXAMINING ATTORNEY



*David J. Kyros*

Director of the United States Patent and Trademark Office

# United States of America

United States Patent and Trademark Office

# HotelPoint

**Reg. No. 4,136,248**

**Registered May 1, 2012**

**Int. Cl.: 35**

**SERVICE MARK**

**PRINCIPAL REGISTER**

CONNECTING POINT MARKETING GROUP, INC. (NEW HAMPSHIRE CORPORATION)  
56 DOW LANE  
RYE, NH 03870

FOR: BUSINESS SERVICES IN THE NATURE OF ARRANGING AND CONDUCTING MARKETING PROMOTIONAL EVENTS FOR OTHERS AMONG VENDORS AND CUSTOMERS BOTH IN PERSON AND VIA THE INTERNET; PROVIDING STRATEGIC BUSINESS MARKETING SERVICES RELATING TO SUCH EVENTS AND MARKETING, PROMOTING THE SALE OF GOODS AND SERVICES OF OTHER CORPORATIONS, PARTNERSHIPS OR INDIVIDUALS BY AND THROUGH THE MEANS OF THE ARRANGING VARIOUS EVENTS, NAMELY, PREPARING AND DISTRIBUTING INDUSTRY-DEFINING AND EDUCATIONAL CONTENT PROMOTIONAL MATERIALS, PROMOTIONAL NEWSLETTERS, ADVERTISING BROCHURES AND OTHER PRINTED MARKETING MATERIAL, AND ARRANGING AND CONDUCTING MARKETING PROMOTIONAL EVENTS WITH SELECT AND GUARANTEED AUDIENCES AND PRE-QUALIFIED PRIVATE APPOINTMENTS, IN CLASS 35 (U.S. CLS. 100, 101 AND 102).

FIRST USE 10-18-2011; IN COMMERCE 10-18-2011.

THE MARK CONSISTS OF STANDARD CHARACTERS WITHOUT CLAIM TO ANY PARTICULAR FONT, STYLE, SIZE, OR COLOR.

OWNER OF U.S. REG. NOS. 3,189,767, 3,354,988, AND OTHERS.

SN 85-115,470, FILED 8-25-2010.

ANN E. SAPPENFIELD, EXAMINING ATTORNEY



*David J. Kyros*

Director of the United States Patent and Trademark Office

# United States of America

United States Patent and Trademark Office

## ENTENMANN'S

**Reg. No. 4,136,249**

**Registered May 1, 2012**

**Int. Cl.: 16**

**TRADEMARK**

**PRINCIPAL REGISTER**

OROGRAIN BAKERIES PRODUCTS, INC. (DELAWARE CORPORATION)  
255 BUSINESS CENTER DRIVE  
HORSHAM, PA 19044

FOR: BOOKS IN THE FIELD OF COOKING, IN CLASS 16 (U.S. CLS. 2, 5, 22, 23, 29, 37, 38 AND 50).

FIRST USE 8-15-2011; IN COMMERCE 8-15-2011.

THE MARK CONSISTS OF STANDARD CHARACTERS WITHOUT CLAIM TO ANY PARTICULAR FONT, STYLE, SIZE, OR COLOR.

SEC. 2(F).

OWNER OF U.S. REG. NOS. 976,025, 3,799,046, AND OTHERS.

SN 85-119,430, FILED 8-31-2010.

TEJBIR SINGH, EXAMINING ATTORNEY



*David J. Kybas*

Director of the United States Patent and Trademark Office

# United States of America

United States Patent and Trademark Office

# Dualchek

**Reg. No. 4,136,250**

**Registered May 1, 2012**

**Int. Cl.: 9**

**TRADEMARK**

**PRINCIPAL REGISTER**

ASSOCIATED RESEARCH, INC. (ILLINOIS CORPORATION)  
13860 WEST LAUREL DRIVE  
LAKE FOREST, IL 60045

FOR: ELECTRICAL AND ELECTRONIC INSTRUMENTS FOR MEASURING AND TESTING THE PERFORMANCE, STRENGTH AND EFFICIENCY OF ELECTRONIC AND/OR ELECTRICAL PRODUCTS, IN CLASS 9 (U.S. CLS. 21, 23, 26, 36 AND 38).

FIRST USE 1-1-2012; IN COMMERCE 1-1-2012.

THE MARK CONSISTS OF STANDARD CHARACTERS WITHOUT CLAIM TO ANY PARTICULAR FONT, STYLE, SIZE, OR COLOR.

SN 85-119,692, FILED 8-31-2010.

BARBARA GAYNOR, EXAMINING ATTORNEY



*David J. Kyffers*

Director of the United States Patent and Trademark Office



# United States of America

United States Patent and Trademark Office

## The Truth about Ugly Women

**Reg. No. 4,136,251**

**Registered May 1, 2012**

**Int. Cl.: 16**

**TRADEMARK**

**PRINCIPAL REGISTER**

GORDON, LAKIA (UNITED STATES INDIVIDUAL)  
PO BOX 1292  
NEWPORT NEWS, VA 23601

FOR: A SERIES OF BOOKS, WRITTEN ARTICLES, HANDOUTS AND WORKSHEETS IN THE FIELD OF SELF AND PERSONAL DEVELOPMENT AND IMPROVEMENT, IN CLASS 16 (U.S. CLS. 2, 5, 22, 23, 29, 37, 38 AND 50).

FIRST USE 9-2-2011; IN COMMERCE 9-2-2011.

THE MARK CONSISTS OF STANDARD CHARACTERS WITHOUT CLAIM TO ANY PARTICULAR FONT, STYLE, SIZE, OR COLOR.

SN 85-120,384, FILED 8-31-2010.

KIM SAITO, EXAMINING ATTORNEY



*David J. Kyffers*

Director of the United States Patent and Trademark Office

# United States of America

United States Patent and Trademark Office

## MOLEHILL MANIA

**Reg. No. 4,136,252**

**Registered May 1, 2012**

**Int. Cl.: 28**

**TRADEMARK**

**PRINCIPAL REGISTER**

MATTEL, INC. (DELAWARE CORPORATION)  
M1-1518  
333 CONTINENTAL BOULEVARD  
EL SEGUNDO, CA 90245

FOR: PARLOR GAMES; ACTION SKILL GAMES, IN CLASS 28 (U.S. CLS. 22, 23, 38 AND 50).

FIRST USE 5-18-2011; IN COMMERCE 5-18-2011.

THE MARK CONSISTS OF STANDARD CHARACTERS WITHOUT CLAIM TO ANY PARTICULAR FONT, STYLE, SIZE, OR COLOR.

SN 85-121,189, FILED 9-1-2010.

ROBIN CHOSID, EXAMINING ATTORNEY



*David J. Kyffers*

Director of the United States Patent and Trademark Office

# United States of America

United States Patent and Trademark Office

## YOGA JELLIES

**Reg. No. 4,136,253**

**Registered May 1, 2012**

**Int. Cl.: 28**

**TRADEMARK**

**PRINCIPAL REGISTER**

JAROWENKO, ANITA L. (UNITED STATES INDIVIDUAL)  
156 N. SCHOOL LANE  
LANCASTER, PA 17603 AND

JAROWENKO, MARK V. (UNITED STATES INDIVIDUAL)  
156 N. SCHOOL LANE  
LANCASTER, PA 17603

FOR: CUSHIONING PADS; NAMELY, HAND, KNEE, ELBOW, FOOT, HEAD AND HIP PADS  
FOR USE DURING YOGA EXERCISES, IN CLASS 28 (U.S. CLS. 22, 23, 38 AND 50).

FIRST USE 9-2-2011; IN COMMERCE 9-22-2011.

THE MARK CONSISTS OF STANDARD CHARACTERS WITHOUT CLAIM TO ANY PARTICULAR FONT, STYLE, SIZE, OR COLOR.

NO CLAIM IS MADE TO THE EXCLUSIVE RIGHT TO USE "YOGA", APART FROM THE MARK AS SHOWN.

SN 85-121,287, FILED 9-1-2010.

SUSAN RICHARDS, EXAMINING ATTORNEY



*David J. Kybas*

Director of the United States Patent and Trademark Office

# United States of America

United States Patent and Trademark Office

## FISHERMAN'S LANDING

**Reg. No. 4,136,254**

**Registered May 1, 2012**

**Int. Cl.: 43**

**SERVICE MARK**

**PRINCIPAL REGISTER**

FISHERMAN'S MARKET & GRILL MANAGEMENT, INC. (CALIFORNIA CORPORATION)  
SUITE B  
590 SOUTH OLEANDER ROAD  
PALM SPRINGS, CA 92264

FOR: RESTAURANT SERVICES; TAKE-OUT RESTAURANT SERVICES, IN CLASS 43 (U.S. CLS. 100 AND 101).

FIRST USE 11-5-2009; IN COMMERCE 12-1-2011.

THE MARK CONSISTS OF STANDARD CHARACTERS WITHOUT CLAIM TO ANY PARTICULAR FONT, STYLE, SIZE, OR COLOR.

SN 85-121,312, FILED 9-1-2010.

JEFFREY LOOK, EXAMINING ATTORNEY



*David J. Kybas*

Director of the United States Patent and Trademark Office

# United States of America

United States Patent and Trademark Office



**Reg. No. 4,136,255**

**Registered May 1, 2012**

**Int. Cl.: 30**

**TRADEMARK**

**PRINCIPAL REGISTER**

BAZZINI BAKERY LLC (NEW YORK LIMITED LIABILITY COMPANY)  
200 FOOD CENTER DRIVE  
BRONX, NY 10474

FOR: CHOCOLATE CANDY BARS, IN CLASS 30 (U.S. CL. 46).

FIRST USE 6-22-2010; IN COMMERCE 6-22-2010.

NO CLAIM IS MADE TO THE EXCLUSIVE RIGHT TO USE "HANUKKAH" AND THE REPRESENTATION OF A MENORAH, APART FROM THE MARK AS SHOWN.

THE MARK CONSISTS OF A MENORAH DESIGN WITHIN AN OVAL SHAPED DESIGN. EACH SIDE OF THE OVAL IS BORDERED BY SCROLL AND LEAF DESIGNS. CENTERED AT THE TOP OF THE MARK IS THE STACKED WORDING "HAPPY HANUKKAH". ACROSS THE BOTTOM OF THE OVAL IS A BANNER WITH THE WORD "SHALOM" WITHIN THE BORDER.

SN 85-121,444, FILED 9-2-2010.

PAULA MAHONEY, EXAMINING ATTORNEY



*David J. Kybas*

Director of the United States Patent and Trademark Office

# United States of America

United States Patent and Trademark Office

## SWIVEL+ STEERING SYSTEM

**Reg. No. 4,136,256**

**Registered May 1, 2012**

**Int. Cl.: 7**

**TRADEMARK**

**PRINCIPAL REGISTER**

SEARS BRANDS, LLC (ILLINOIS LIMITED LIABILITY COMPANY)  
3333 BEVERLY ROAD  
HOFFMAN ESTATES, IL 60179

FOR: VACUUM CLEANERS, IN CLASS 7 (U.S. CLS. 13, 19, 21, 23, 31, 34 AND 35).

FIRST USE 12-0-2010; IN COMMERCE 12-0-2010.

THE MARK CONSISTS OF STANDARD CHARACTERS WITHOUT CLAIM TO ANY PARTICULAR FONT, STYLE, SIZE, OR COLOR.

NO CLAIM IS MADE TO THE EXCLUSIVE RIGHT TO USE "SWIVEL" AND "STEERING SYSTEM", APART FROM THE MARK AS SHOWN.

SN 85-121,993, FILED 9-2-2010.

JOHN HWANG, EXAMINING ATTORNEY



*David J. Kyffers*

Director of the United States Patent and Trademark Office

# United States of America

United States Patent and Trademark Office

## RECIRC READY

**Reg. No. 4,136,257**

**Registered May 1, 2012**

**Int. Cl.: 31**

**TRADEMARK**

**PRINCIPAL REGISTER**

MOORE-CLARK USA, INC. (WASHINGTON CORPORATION)  
1140 INDUSTRIAL WAY  
LONGVIEW, WA 98632

FOR: FISH FOOD, IN CLASS 31 (U.S. CLS. 1 AND 46).

FIRST USE 11-1-2011; IN COMMERCE 11-1-2011.

THE MARK CONSISTS OF STANDARD CHARACTERS WITHOUT CLAIM TO ANY PARTICULAR FONT, STYLE, SIZE, OR COLOR.

SN 85-122,000, FILED 9-2-2010.

RONALD DELGIZZI, EXAMINING ATTORNEY



*David J. Kybas*

Director of the United States Patent and Trademark Office

**United States of America**  
United States Patent and Trademark Office

# COMFORT

**Reg. No. 4,136,258**

R & D MEDICAL PRODUCTS, INC. (CALIFORNIA CORPORATION)  
20492 CRESCENT BAY DRIVE, BLDG. 106  
LAKE FOREST, CA 92630

**Registered May 1, 2012**

**Int. Cl.: 5**

FOR: HYDROGEL FOR MEDICAL PURPOSES, IN CLASS 5 (U.S. CLS. 6, 18, 44, 46, 51 AND 52).

**TRADEMARK**

FIRST USE 10-4-2000; IN COMMERCE 10-4-2000.

**PRINCIPAL REGISTER**

THE MARK CONSISTS OF STANDARD CHARACTERS WITHOUT CLAIM TO ANY PARTICULAR FONT, STYLE, SIZE, OR COLOR.

SN 85-122,316, FILED 9-2-2010.

KEVON CHISOLM, EXAMINING ATTORNEY



*David J. Kyffers*

Director of the United States Patent and Trademark Office



# United States of America

United States Patent and Trademark Office

# LANSUN

**Reg. No. 4,136,259**

**Registered May 1, 2012**

**Int. Cl.: 5**

DH NUTRACEUTICALS LLC (NEW JERSEY LIMITED LIABILITY COMPANY), DBA DH NUTRACEUTICALS LLC,  
19 WINTERGREEN AVENUE EAST  
SHI.XIAOWEI508@GMAIL.COM  
EDISON, NJ 08820

**TRADEMARK**

FOR: DIETARY AND NUTRITIONAL SUPPLEMENTS, IN CLASS 5 (U.S. CLS. 6, 18, 44, 46, 51 AND 52).

**PRINCIPAL REGISTER**

FIRST USE 6-1-2011; IN COMMERCE 6-1-2011.

THE MARK CONSISTS OF STANDARD CHARACTERS WITHOUT CLAIM TO ANY PARTICULAR FONT, STYLE, SIZE, OR COLOR.

SN 85-124,061, FILED 9-7-2010.

CHRISTINE COOPER, EXAMINING ATTORNEY



*David J. Kybas*

Director of the United States Patent and Trademark Office

# United States of America

United States Patent and Trademark Office

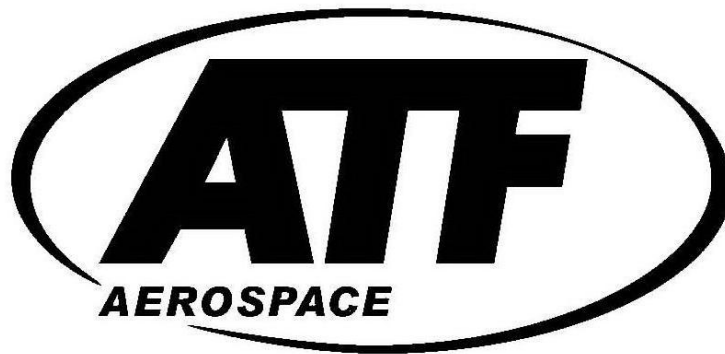

**Reg. No. 4,136,260**

**Registered May 1, 2012**

**Int. Cl.: 6**

**TRADEMARK**

**PRINCIPAL REGISTER**

ATF, INC. (DELAWARE CORPORATION)  
3550 WEST PRATT AVENUE  
LINCOLNWOOD, IL 60712

FOR: METAL FASTENERS FOR COMMERCIAL AND INDUSTRIAL USE, NAMELY, METAL THREADED FASTENERS, BOLTS, AND SCREWS, IN CLASS 6 (U.S. CLS. 2, 12, 13, 14, 23, 25 AND 50).

FIRST USE 2-9-2012; IN COMMERCE 2-9-2012.

OWNER OF U.S. REG. NOS. 2,031,367, 3,056,207, AND 3,670,813.

NO CLAIM IS MADE TO THE EXCLUSIVE RIGHT TO USE "AEROSPACE", APART FROM THE MARK AS SHOWN.

THE MARK CONSISTS OF THE WORDS "ATF AEROSPACE" INSIDE AN OVAL DESIGN.

SN 85-124,068, FILED 9-7-2010.

CHRISTINE COOPER, EXAMINING ATTORNEY



*David J. Kyros*

Director of the United States Patent and Trademark Office

# United States of America

United States Patent and Trademark Office

## DETROIT SHAKER

**Reg. No. 4,136,261**

DETROIT CITY DISCOUNTS LLC (MICHIGAN LIMITED LIABILITY COMPANY)  
5780 JOHN R. RD  
TROY, MI 48085

**Registered May 1, 2012**

**Int. Cl.: 12**

FOR: LAND MOTOR VEHICLES, NAMELY, CARS, IN CLASS 12 (U.S. CLS. 19, 21, 23, 31, 35 AND 44).

**TRADEMARK**

FIRST USE 2-18-2011; IN COMMERCE 2-18-2011.

**PRINCIPAL REGISTER**

THE MARK CONSISTS OF STANDARD CHARACTERS WITHOUT CLAIM TO ANY PARTICULAR FONT, STYLE, SIZE, OR COLOR.

NO CLAIM IS MADE TO THE EXCLUSIVE RIGHT TO USE "DETROIT", APART FROM THE MARK AS SHOWN.

SN 85-124,347, FILED 9-7-2010.

ERNEST SHOSHO, EXAMINING ATTORNEY



*David J. Kyffers*

Director of the United States Patent and Trademark Office

# United States of America

United States Patent and Trademark Office

## ALAN WEISS'S FRIDAY WRAP

**Reg. No. 4,136,262**

**Registered May 1, 2012**

**Int. Cls.: 38 and 41**

**SERVICE MARK**

**PRINCIPAL REGISTER**

SUMMIT CONSULTING GROUP, INC. (NEW JERSEY CORPORATION)  
85 BRISAS CIRCLE  
EAST GREENWICH, RI 02818

FOR: STREAMING OF AUDIO AND VIDEO MATERIALS VIA THE INTERNET IN THE FIELD OF BUSINESS CONSULTING AND BUSINESS MARKETING, IN CLASS 38 (U.S. CLS. 100, 101 AND 104).

FIRST USE 3-31-2011; IN COMMERCE 3-31-2011.

FOR: EDUCATIONAL SERVICES, NAMELY, CONDUCTING CLASSES, SEMINARS OR WORKSHOPS IN THE FIELD OF BUSINESS CONSULTING AND BUSINESS MARKETING; AND DISTRIBUTING COURSE MATERIALS IN CONNECTION THEREWITH, IN CLASS 41 (U.S. CLS. 100, 101 AND 107).

FIRST USE 3-31-2011; IN COMMERCE 3-31-2011.

THE MARK CONSISTS OF STANDARD CHARACTERS WITHOUT CLAIM TO ANY PARTICULAR FONT, STYLE, SIZE, OR COLOR.

OWNER OF U.S. REG. NO. 3,875,607.

NO CLAIM IS MADE TO THE EXCLUSIVE RIGHT TO USE "FRIDAY WRAP", APART FROM THE MARK AS SHOWN.

THE NAME "ALAN WEISS" IDENTIFIES A LIVING INDIVIDUAL WHOSE CONSENT IS OF RECORD.

SN 85-124,992, FILED 9-8-2010.

HEATHER BIDDULPH, EXAMINING ATTORNEY



*David J. Kybas*

Director of the United States Patent and Trademark Office

# United States of America

United States Patent and Trademark Office

## EXPERIENCE RETAIL SUCCESS

**Reg. No. 4,136,263**

**Registered May 1, 2012**

**Int. Cls.: 39 and 40**

**SERVICE MARK**

**PRINCIPAL REGISTER**

INTERNATIONAL PAPER COMPANY (NEW YORK CORPORATION)  
6400 POPLAR AVENUE  
MEMPHIS, TN 38197

FOR: PACKING ARTICLES FOR TRANSPORTATION; STORAGE AND TRANSPORTATION OF PACKAGES BY AIR, RAIL, SHIP OR TRUCK, IN CLASS 39 (U.S. CLS. 100 AND 105).

FIRST USE 6-30-2010; IN COMMERCE 6-30-2010.

FOR: ASSEMBLY OF PRODUCTS FOR OTHERS, NAMELY, DISPLAYS AND PACKAGING, CORRUGATED POINT OF PURCHASE DISPLAY UNITS FOR MERCHANDISING PRODUCTS AND CARDBOARD AND CORRUGATED CONTAINERS, BOXES AND TRAYS, PREFORMED AND UNASSEMBLED CARDBOARD AND CORRUGATED CONTAINERS, BOXES AND TRAYS, CORRUGATED BULK CONTAINERS, IN CLASS 40 (U.S. CLS. 100, 103 AND 106).

FIRST USE 6-30-2010; IN COMMERCE 6-30-2010.

THE MARK CONSISTS OF STANDARD CHARACTERS WITHOUT CLAIM TO ANY PARTICULAR FONT, STYLE, SIZE, OR COLOR.

SN 85-125,070, FILED 9-8-2010.

DEZMONA MIZELLE, EXAMINING ATTORNEY



*David J. Kybas*

Director of the United States Patent and Trademark Office

# United States of America

United States Patent and Trademark Office

## THE GRASS SEED PEOPLE

**Reg. No. 4,136,264**

**Registered May 1, 2012**

**Int. Cl.: 31**

**TRADEMARK**

**PRINCIPAL REGISTER**

PENNINGTON SEED, INC. OF NEBRASKA (NEBRASKA CORPORATION)  
P.O. BOX 290  
MADISON, GA 30650

FOR: GRASS SEED FOR RESIDENTIAL AND COMMERCIAL USE; LAWN SEED FOR RESIDENTIAL AND COMMERCIAL USE; GRASS SOD; CLOVER SEED FOR AGRICULTURAL USE; VEGETABLE SEED; WILD GAME PRODUCTS, NAMELY, SEED AND FEED; FORAGE PRODUCTS, NAMELY, FORAGE GRASS SEED AND CLOVER SEED; BIRD FEED; BIRD FEED WITH ADDED NUTRIENTS, VITAMINS AND MINERALS; BIRD FEED WITH NUTRIENT SOLUTION CONTAINING MINERALS AND VITAMINS FOR HUMMING BIRDS; WILD ANIMAL FEED; PACKAGED WILDFLOWER SEED; PACKAGED FLOWER SEED; PACKAGED VEGETABLE SEED; AGRICULTURAL PLANT SEED; MULCH; LAWN PATCH KITS COMPRISING SEED, FERTILIZER AND MULCH; COMBINATION GRASS SEEDING PRODUCT CONTAINING MULCH, SEED AND FERTILIZER, IN CLASS 31 (U.S. CLS. 1 AND 46).

FIRST USE 2-0-2011; IN COMMERCE 2-0-2011.

THE MARK CONSISTS OF STANDARD CHARACTERS WITHOUT CLAIM TO ANY PARTICULAR FONT, STYLE, SIZE, OR COLOR.

NO CLAIM IS MADE TO THE EXCLUSIVE RIGHT TO USE "GRASS SEED", APART FROM THE MARK AS SHOWN.

SN 85-126,172, FILED 9-9-2010.

TRACY CROSS, EXAMINING ATTORNEY



*David J. Kyffers*

Director of the United States Patent and Trademark Office

# United States of America

United States Patent and Trademark Office

# ELITEC

**Reg. No. 4,136,265**

**Registered May 1, 2012**

**Int. Cl.: 1**

**TRADEMARK**

**PRINCIPAL REGISTER**

CALGON CARBON CORPORATION (DELAWARE CORPORATION)  
500 CALGON CARBON DRIVE  
PITTSBURGH, PA 15205

FOR: ACTIVATED CARBON FOR USE IN ULTRACAPACITORS, IN CLASS 1 (U.S. CLS. 1, 5, 6, 10, 26 AND 46).

FIRST USE 3-11-2011; IN COMMERCE 3-11-2011.

THE MARK CONSISTS OF STANDARD CHARACTERS WITHOUT CLAIM TO ANY PARTICULAR FONT, STYLE, SIZE, OR COLOR.

SN 85-126,654, FILED 9-10-2010.

HANNO RITTNER, EXAMINING ATTORNEY



*David J. Kyffers*

Director of the United States Patent and Trademark Office

# United States of America

United States Patent and Trademark Office

## THE POWER OF CARBON

**Reg. No. 4,136,266**

**Registered May 1, 2012**

**Int. Cl.: 1**

**TRADEMARK**

**PRINCIPAL REGISTER**

CALGON CARBON CORPORATION (DELAWARE CORPORATION)  
500 CALGON CARBON DRIVE  
PITTSBURGH, PA 15205

FOR: ACTIVATED CARBON FOR USE IN ULTRACAPACITORS, IN CLASS 1 (U.S. CLS. 1, 5, 6, 10, 26 AND 46).

FIRST USE 3-11-2011; IN COMMERCE 3-11-2011.

THE MARK CONSISTS OF STANDARD CHARACTERS WITHOUT CLAIM TO ANY PARTICULAR FONT, STYLE, SIZE, OR COLOR.

NO CLAIM IS MADE TO THE EXCLUSIVE RIGHT TO USE "CARBON", APART FROM THE MARK AS SHOWN.

SN 85-126,690, FILED 9-10-2010.

HANNO RITTNER, EXAMINING ATTORNEY



*David J. Kyffers*

Director of the United States Patent and Trademark Office



# United States of America

United States Patent and Trademark Office



## NATIONAL Home Sleep Testing

**Reg. No. 4,136,267**

**Registered May 1, 2012**

**Int. Cl.: 44**

**SERVICE MARK**

**PRINCIPAL REGISTER**

NEVADA SLEEP DIAGNOSTICS, INC. (NEVADA CORPORATION)  
SUITE B  
62 N. PECOS  
HENDERSON, NV 89074

FOR: MEDICAL SERVICES FOR THE TESTING, DIAGNOSIS AND TREATMENT OF SLEEP DISORDERS, IN CLASS 44 (U.S. CLS. 100 AND 101).

FIRST USE 2-25-2011; IN COMMERCE 2-25-2011.

NO CLAIM IS MADE TO THE EXCLUSIVE RIGHT TO USE "NATIONAL HOME SLEEP TESTING", APART FROM THE MARK AS SHOWN.

THE MARK CONSISTS OF A RENDERING OF A HOUSE WITH A EEG TRACING POSITIONED HORIZONTALLY ABOVE IT AND THE WORDS "NATIONAL HOME SLEEP TESTING" TO THE RIGHT.

SN 85-128,009, FILED 9-13-2010.

REBECCA EISINGER, EXAMINING ATTORNEY



*David J. Kyjars*

Director of the United States Patent and Trademark Office

# United States of America

United States Patent and Trademark Office

## WILD HORSES

**Reg. No. 4,136,268**

**Registered May 1, 2012**

**Int. Cl.: 9**

**TRADEMARK**

**PRINCIPAL REGISTER**

IGT (NEVADA CORPORATION)  
9295 PROTOTYPE DRIVE  
RENO, NV 895218986

FOR: GAMING MACHINES, NAMELY, DEVICES WHICH ACCEPT A WAGER, IN CLASS 9 (U.S. CLS. 21, 23, 26, 36 AND 38).

FIRST USE 1-13-2012; IN COMMERCE 2-3-2012.

THE MARK CONSISTS OF STANDARD CHARACTERS WITHOUT CLAIM TO ANY PARTICULAR FONT, STYLE, SIZE, OR COLOR.

SN 85-130,944, FILED 9-16-2010.

JIM RINGLE, EXAMINING ATTORNEY



*David J. Kybas*

Director of the United States Patent and Trademark Office

# United States of America

United States Patent and Trademark Office

# AGCELERATE

**Reg. No. 4,136,269**

**Registered May 1, 2012**

**Int. Cl.: 35**

**SERVICE MARK**

**PRINCIPAL REGISTER**

AGDATA, L.P. (DELAWARE LIMITED PARTNERSHIP)  
SUITE 300  
2100 REXFORD ROAD  
CHARLOTTE, NC 28211

FOR: DATA COMPILATION AND MANAGEMENT SERVICES FOR THE AGRICULTURAL INDUSTRY, NAMELY, COORDINATING EXECUTION AND PERFORMANCE OF AGREEMENTS BETWEEN AGRICULTURAL ENTITIES, NAMELY, SEED PRODUCERS/SELLERS, GROWERS/FARMERS, RETAIL COMPANIES, AND COLLECTION, PROCESSING, STORAGE AND REPORTING OF TRANSACTION INFORMATION, NAMELY, CONSUMPTION, INVENTORY, ROYALTIES, ACCRUALS, SALES, AND COMPLIANCE, IN CLASS 35 (U.S. CLS. 100, 101 AND 102).

FIRST USE 1-0-2012; IN COMMERCE 1-0-2012.

THE MARK CONSISTS OF STANDARD CHARACTERS WITHOUT CLAIM TO ANY PARTICULAR FONT, STYLE, SIZE, OR COLOR.

SN 85-131,255, FILED 9-16-2010.

PAUL E. FAHRENKOPF, EXAMINING ATTORNEY



*David J. Kypos*

Director of the United States Patent and Trademark Office

# United States of America

United States Patent and Trademark Office

## HUNTINGTON GARAGE

**Reg. No. 4,136,270**

GONZALEZ, EDGAR (UNITED STATES INDIVIDUAL)  
6552 OXFORD DRIVE  
HUNTINGTON BEACH, CA 92647

**Registered May 1, 2012**

**Int. Cl.: 25**

FOR: READY-MADE CLOTHING, NAMELY, T SHIRTS, HATS, SWEATERS, JACKETS, IN CLASS 25 (U.S. CLS. 22 AND 39).

**TRADEMARK**

FIRST USE 3-30-2011; IN COMMERCE 3-30-2011.

**PRINCIPAL REGISTER**

THE MARK CONSISTS OF STANDARD CHARACTERS WITHOUT CLAIM TO ANY PARTICULAR FONT, STYLE, SIZE, OR COLOR.

SN 85-131,790, FILED 9-17-2010.

KATHLEEN LORENZO, EXAMINING ATTORNEY



*David J. Kybas*

Director of the United States Patent and Trademark Office

# United States of America

United States Patent and Trademark Office

## ULTIMATE CONSTRUCT COLLECTION

**Reg. No. 4,136,271**

**Registered May 1, 2012**

**Int. Cl.: 28**

**TRADEMARK**

**PRINCIPAL REGISTER**

MATTEL, INC. (DELAWARE CORPORATION)  
M1-1518  
333 CONTINENTAL BOULEVARD  
EL SEGUNDO, CA 90245

FOR: TOY ACTION FIGURES AND ACCESSORIES THEREFOR; TOY WEAPONS AND ACCESSORIES THEREFOR, IN CLASS 28 (U.S. CLS. 22, 23, 38 AND 50).

FIRST USE 6-20-2011; IN COMMERCE 6-20-2011.

THE MARK CONSISTS OF STANDARD CHARACTERS WITHOUT CLAIM TO ANY PARTICULAR FONT, STYLE, SIZE, OR COLOR.

NO CLAIM IS MADE TO THE EXCLUSIVE RIGHT TO USE "ULTIMATE" AND "COLLECTION", APART FROM THE MARK AS SHOWN.

SN 85-131,984, FILED 9-17-2010.

RAUL CORDOVA, EXAMINING ATTORNEY



*David J. Kyros*

Director of the United States Patent and Trademark Office

# United States of America

United States Patent and Trademark Office

# MAG-D

**Reg. No. 4,136,272**

**Registered May 1, 2012**

**Int. Cl.: 13**

**TRADEMARK**

**PRINCIPAL REGISTER**

WILLIAM D. MARCONI (UNITED STATES INDIVIDUAL)  
2831 TUSCARORA ROAD  
ERIEVILLE, NY 13061

FOR: CARTRIDGE CASES; EXPLOSIVE CARTRIDGES; INCENDIARY CARTRIDGES; RE-LEASING APPARATUS FOR GRENADES, BOMBS, AND THE LIKE, IN CLASS 13 (U.S. CLS. 2 AND 9).

FIRST USE 2-28-2011; IN COMMERCE 2-28-2011.

THE MARK CONSISTS OF STANDARD CHARACTERS WITHOUT CLAIM TO ANY PARTICULAR FONT, STYLE, SIZE, OR COLOR.

SN 85-132,824, FILED 9-18-2010.

LAURIE MAYES, EXAMINING ATTORNEY



*David J. Kybas*

Director of the United States Patent and Trademark Office

# United States of America

United States Patent and Trademark Office



**Reg. No. 4,136,273**

**Registered May 1, 2012**

**Int. Cl.: 24**

**TRADEMARK**

**PRINCIPAL REGISTER**

YANG HAIGUANG (CHINA INDIVIDUAL)  
ROOM 202, 69-5 BAIYANG STREET, NINGBO  
ZHEJIANG PROVINCE, CHINA

FOR: FABRICS FOR TEXTILE USE; NON-WOVEN FABRICS; TEXTILE WALL HANGINGS; TOWELS; BED COVERS; CURTAINS; TABLECLOTHS, NOT OF PAPER; TABLE LINEN, NAMELY, COASTERS; NET CURTAINS; WASHING MITTS, IN CLASS 24 (U.S. CLS. 42 AND 50).

FIRST USE 3-7-2011; IN COMMERCE 3-7-2011.

THE TERM "RAMA ROSE" IN THE MARK DOES NOT IDENTIFY A LIVING INDIVIDUAL.

THE NON-LATIN CHARACTERS IN THE MARK TRANSLITERATE TO "ROU RUI" AND THIS MEANS "GENTLENESS LUCKY" IN ENGLISH.

THE MARK CONSISTS OF THE LETTERS "RR" IN LARGE FONT NEXT TO EACH OTHER WITH THE FIRST "R" FACING BACKWARDS, BENEATH THE LETTERS "RR" AND IN SMALLER FONT IS THE WORDING "RAMA ROSE", BENEATH THAT ARE TWO CHINESE CHARACTERS WITH A HORIZONTAL LINE ON THE LEFT AND RIGHT OF THE CHARACTERS. THE CHINESE CHARACTERS TRANSLITERATE AS "ROU RUI", AND THIS TRANSLATES AS "GENTLENESS LUCKY". BENEATH THE CHINESE CHARACTERS ARE FIVE STARS LINED UP HORIZONTALLY AND WITH A SINGLE HORIZONTAL LINE BENEATH THEM.

THE ENGLISH TRANSLATION OF "ROU RUI" IN THE MARK IS "GENTLENESS LUCKY".

SN 85-133,056, FILED 9-19-2010.

JOHN DWYER, EXAMINING ATTORNEY



*David J. Kyros*

Director of the United States Patent and Trademark Office

# United States of America

United States Patent and Trademark Office

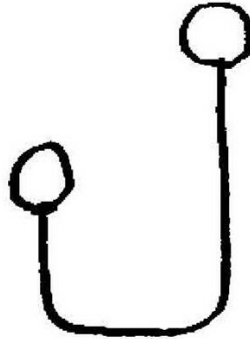

**Reg. No. 4,136,274**

**Registered May 1, 2012**

**Int. Cl.: 16**

**TRADEMARK**

**PRINCIPAL REGISTER**

LAWRENCE, BRUCE (UNITED STATES INDIVIDUAL)  
78 BIG TREE DR.  
ALTURAS, CA 96101

FOR: POSTERS, IN CLASS 16 (U.S. CLS. 2, 5, 22, 23, 29, 37, 38 AND 50).

FIRST USE 9-1-2011; IN COMMERCE 9-1-2011.

THE MARK CONSISTS OF A LINE WITH A CIRCLE AT EACH END IN THE SHAPE OF AN UNEVEN SQUARED OFF "U".

SN 85-133,386, FILED 9-20-2010.

HOWARD B. LEVINE, EXAMINING ATTORNEY



*David J. Kybas*

Director of the United States Patent and Trademark Office



# United States of America

United States Patent and Trademark Office

## SCIENCE SIMPLIFIED

**Reg. No. 4,136,275**

**Registered May 1, 2012**

**Int. Cls.: 1 and 2**

**TRADEMARK**

**PRINCIPAL REGISTER**

THE VALSPAR CORPORATION (DELAWARE CORPORATION)  
P.O. BOX 1461  
MINNEAPOLIS, MN 55440

FOR: ARTIFICIAL RESINS, SYNTHETIC RESINS AND POLYMERS FOR USE IN THE MANUFACTURE OF PAINTS AND SURFACE COATINGS, IN CLASS 1 (U.S. CLS. 1, 5, 6, 10, 26 AND 46).

FIRST USE 4-0-2011; IN COMMERCE 4-0-2011.

FOR: RAW NATURAL RESINS AND NATURAL RESINS FOR USE IN THE MANUFACTURE OF PAINTS AND SURFACE COATINGS; PAINTS, IN CLASS 2 (U.S. CLS. 6, 11 AND 16).

FIRST USE 4-0-2011; IN COMMERCE 4-0-2011.

THE MARK CONSISTS OF STANDARD CHARACTERS WITHOUT CLAIM TO ANY PARTICULAR FONT, STYLE, SIZE, OR COLOR.

SN 85-133,458, FILED 9-20-2010.

ERNEST SHOSHO, EXAMINING ATTORNEY



*David J. Kyfos*

Director of the United States Patent and Trademark Office

# United States of America

United States Patent and Trademark Office

# THEO

**Reg. No. 4,136,276**

**Registered May 1, 2012**

**Int. Cls.: 9 and 41**

**TRADEMARK**

**SERVICE MARK**

**PRINCIPAL REGISTER**

SAI INDUSTRIES (CALIFORNIA CORPORATION)  
631 ALLEN AVENUE  
GLENDALE, CA 91201

FOR: DIGITAL MEDIA, NAMELY, DVD AND DOWNLOADABLE AUDIO AND VIDEO RECORDINGS FEATURING CHILDREN'S CARTOONS, IN CLASS 9 (U.S. CLS. 21, 23, 26, 36 AND 38).

FIRST USE 12-1-2010; IN COMMERCE 12-1-2010.

FOR: RELIGIOUS INSTRUCTION SERVICES RENDERED BY PROVIDING CHRISTIAN CARTOONS FOR CHILDREN ONLINE, IN CLASS 41 (U.S. CLS. 100, 101 AND 107).

FIRST USE 12-13-2008; IN COMMERCE 12-13-2008.

THE MARK CONSISTS OF STANDARD CHARACTERS WITHOUT CLAIM TO ANY PARTICULAR FONT, STYLE, SIZE, OR COLOR.

OWNER OF U.S. REG. NO. 3,743,876.

SN 85-133,608, FILED 9-20-2010.

CHARLES L. JENKINS, EXAMINING ATTORNEY



*David J. Kybas*

Director of the United States Patent and Trademark Office

# United States of America

United States Patent and Trademark Office

# Humog

**Reg. No. 4,136,277**

**Registered May 1, 2012**

**Int. Cl.: 16**

**TRADEMARK**

**PRINCIPAL REGISTER**

CLOSE, RALPH (UNITED STATES INDIVIDUAL)  
195 DEER RIDGE LANE  
SEQUIM, WA 98382

FOR: PRINTED CERTIFICATES, IN CLASS 16 (U.S. CLS. 2, 5, 22, 23, 29, 37, 38 AND 50).

FIRST USE 7-3-2011; IN COMMERCE 7-3-2011.

THE MARK CONSISTS OF STANDARD CHARACTERS WITHOUT CLAIM TO ANY PARTICULAR FONT, STYLE, SIZE, OR COLOR.

SN 85-134,003, FILED 9-20-2010.

HOWARD SMIGA, EXAMINING ATTORNEY



*David J. Kybas*

Director of the United States Patent and Trademark Office

# United States of America

United States Patent and Trademark Office

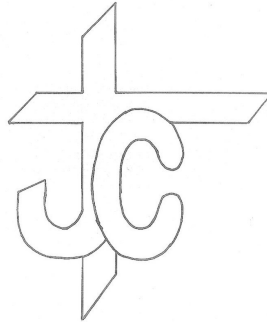

**Reg. No. 4,136,278**

**Registered May 1, 2012**

**Int. Cl.: 25**

**TRADEMARK**

**PRINCIPAL REGISTER**

GEORGE J. ROSADO (UNITED STATES INDIVIDUAL)  
5804 FARR OAK DRIVE  
PLANO, TX 75093

FOR: BASEBALL CAPS AND HATS; JACKETS; PANTS; SHORTS; TEE SHIRTS; WEARABLE  
GARMENTS AND CLOTHING, NAMELY, SHIRTS, IN CLASS 25 (U.S. CLS. 22 AND 39).

FIRST USE 8-24-2010; IN COMMERCE 3-22-2011.

OWNER OF U.S. REG. NO. 4,075,079.

THE MARK CONSISTS OF THE STYLIZED LETTERS OF "T", "J", AND "C".

SN 85-134,777, FILED 9-21-2010.

CHRISTOPHER BUONGIORNO, EXAMINING ATTORNEY



*David J. Kybas*

Director of the United States Patent and Trademark Office

**United States of America**  
United States Patent and Trademark Office

# LEADOFF

**Reg. No. 4,136,279**

**Registered May 1, 2012**

**Int. Cl.: 5**

**TRADEMARK**

**PRINCIPAL REGISTER**

E. I. DU PONT DE NEMOURS AND COMPANY (DELAWARE CORPORATION)  
1007 MARKET STREET  
WILMINGTON, DE 19898

FOR: HERBICIDES FOR AGRICULTURAL USE, IN CLASS 5 (U.S. CLS. 6, 18, 44, 46, 51 AND 52).

FIRST USE 10-25-2011; IN COMMERCE 10-25-2011.

THE MARK CONSISTS OF STANDARD CHARACTERS WITHOUT CLAIM TO ANY PARTICULAR FONT, STYLE, SIZE, OR COLOR.

SN 85-135,168, FILED 9-22-2010.

EMILY CHUO, EXAMINING ATTORNEY



*David J. Kybas*

Director of the United States Patent and Trademark Office

# United States of America

United States Patent and Trademark Office

# THE CLAW

**Reg. No. 4,136,280**

**Registered May 1, 2012**

**Int. Cl.: 21**

**TRADEMARK**

**PRINCIPAL REGISTER**

AP&G CO., INC. (NEW YORK CORPORATION)  
170 53RD STREET  
BROOKLYN, NY 10165

FOR: RODENT TRAPS, IN CLASS 21 (U.S. CLS. 2, 13, 23, 29, 30, 33, 40 AND 50).

FIRST USE 10-15-2010; IN COMMERCE 10-15-2010.

THE MARK CONSISTS OF STANDARD CHARACTERS WITHOUT CLAIM TO ANY PARTICULAR FONT, STYLE, SIZE, OR COLOR.

SN 85-135,409, FILED 9-22-2010.

JOHN GARTNER, EXAMINING ATTORNEY



*David J. Kyffers*

Director of the United States Patent and Trademark Office

# United States of America

United States Patent and Trademark Office

## DUBBEL CANNON

**Reg. No. 4,136,281**

**Registered May 1, 2012**

**Int. Cl.: 32**

**TRADEMARK**

**PRINCIPAL REGISTER**

CLIPPER CITY BREWING COMPANY, L.P. (MARYLAND LIMITED PARTNERSHIP)  
SUITE B  
4615 HOLLINS FERRY ROAD  
BALTIMORE, MD 21227

FOR: BEVERAGES, NAMELY, BEERS, ALES, AND MALT LIQUORS, IN CLASS 32 (U.S. CLS. 45, 46 AND 48).

FIRST USE 4-1-2011; IN COMMERCE 4-1-2011.

THE MARK CONSISTS OF STANDARD CHARACTERS WITHOUT CLAIM TO ANY PARTICULAR FONT, STYLE, SIZE, OR COLOR.

OWNER OF U.S. REG. NO. 3,184,936.

NO CLAIM IS MADE TO THE EXCLUSIVE RIGHT TO USE "DUBBEL", APART FROM THE MARK AS SHOWN.

SN 85-135,417, FILED 9-22-2010.

RON FAIRBANKS, EXAMINING ATTORNEY



*David J. Kybas*

Director of the United States Patent and Trademark Office

# United States of America

United States Patent and Trademark Office



**Reg. No. 4,136,282**

**Registered May 1, 2012**

**Int. Cl.: 25**

**TRADEMARK**

**PRINCIPAL REGISTER**

BOLAJI BARBER (UNITED STATES INDIVIDUAL), DBA HOTSTYLE MUSIC,  
2554 SAGE DRIVE  
KISSIMMEE, FL 34758

FOR: APPAREL FOR DANCERS, NAMELY, TEE SHIRTS, SWEATSHIRTS, PANTS, LEG-  
GINGS, SHORTS AND JACKETS; ATHLETIC APPAREL, NAMELY, SHIRTS, PANTS,  
JACKETS, FOOTWEAR, HATS AND CAPS, ATHLETIC UNIFORMS; BASEBALL CAPS AND  
HATS; CAMP SHIRTS; EYESHADES; HATS; HEADBANDS FOR CLOTHING; HOODS;  
JACKETS; NIGHT SHIRTS, IN CLASS 25 (U.S. CLS. 22 AND 39).

FIRST USE 12-7-2010; IN COMMERCE 12-7-2010.

THE MARK CONSISTS OF A STYLIZED LETTER "B".

SN 85-137,042, FILED 9-23-2010.

PAM WILLIS, EXAMINING ATTORNEY



*David J. Kybas*

Director of the United States Patent and Trademark Office



# United States of America

United States Patent and Trademark Office

# YOOMI

**Reg. No. 4,136,283**

DISCOVERY BAY GAMES, INC. (DELAWARE CORPORATION)  
1000 N. NORTHLAKE WAY  
SEATTLE, WA 98103

**Registered May 1, 2012**

**Int. Cl.: 9**

FOR: INTERACTIVE GAME SOFTWARE FOR MOBILE DEVICES, IN CLASS 9 (U.S. CLS. 21, 23, 26, 36 AND 38).

**TRADEMARK**

FIRST USE 12-1-2010; IN COMMERCE 12-1-2010.

**PRINCIPAL REGISTER**

THE MARK CONSISTS OF STANDARD CHARACTERS WITHOUT CLAIM TO ANY PARTICULAR FONT, STYLE, SIZE, OR COLOR.

SN 85-137,111, FILED 9-23-2010.

FRANK LATTUCA, EXAMINING ATTORNEY



*David J. Kybas*

Director of the United States Patent and Trademark Office

# United States of America

United States Patent and Trademark Office

## THE BON MARCHE'

**Reg. No. 4,136,284**

**Registered May 1, 2012**

**Int. Cl.: 35**

**SERVICE MARK**

**PRINCIPAL REGISTER**

STRATEGIC MARKS, LLC (CALIFORNIA LIMITED LIABILITY COMPANY)  
47 OCEAN HEIGHTS DRIVE  
NEWPORT COAST, CA 92657

FOR: RETAIL DEPARTMENT STORE AND ON-LINE RETAIL DEPARTMENT STORE SERVICES; RETAIL AND ON-LINE RETAIL CLOTHING BOUTIQUES; RETAIL AND ON-LINE RETAIL CLOTHING STORES; RETAIL AND ON-LINE RETAIL APPAREL STORES; RETAIL AND ON-LINE RETAIL STORE SERVICES FEATURING CLOTHING AND FASHION ACCESSORIES, IN CLASS 35 (U.S. CLS. 100, 101 AND 102).

FIRST USE 5-1-2011; IN COMMERCE 5-1-2011.

THE MARK CONSISTS OF STANDARD CHARACTERS WITHOUT CLAIM TO ANY PARTICULAR FONT, STYLE, SIZE, OR COLOR.

THE ENGLISH TRANSLATION OF "BON MARCHE" IS "GOOD MARKET".

SN 85-137,193, FILED 9-24-2010.

GRETТА YAO, EXAMINING ATTORNEY



*David J. Kybas*

Director of the United States Patent and Trademark Office

# United States of America

United States Patent and Trademark Office



**Reg. No. 4,136,285**

**Registered May 1, 2012**

**Int. Cl.: 42**

**SERVICE MARK**

**PRINCIPAL REGISTER**

PROTON COLLABORATIVE GROUP (DELAWARE CORPORATION)  
420 NORTH WALNUT STREET  
BLOOMINGTON, IN 47404

FOR: MEDICAL RESEARCH IN THE FIELD OF CANCER TREATMENT USING PROTON RADIATION THERAPY, IN CLASS 42 (U.S. CLS. 100 AND 101).

FIRST USE 11-20-2010; IN COMMERCE 11-20-2010.

NO CLAIM IS MADE TO THE EXCLUSIVE RIGHT TO USE "PROTON COLLABORATIVE GROUP", APART FROM THE MARK AS SHOWN.

THE COLOR(S) ROYAL BLUE, ROBIN'S EGG BLUE, LAVENDER, DENIM BLUE AND TEAL IS/ARE CLAIMED AS A FEATURE OF THE MARK.

THE MARK CONSISTS OF THE LETTERS "PCG" IN ROYAL BLUE AND THE WORDING "PROTON COLLABORATIVE GROUP" BELOW THE LETTERS ALSO IN ROYAL BLUE. THE "C" CHARACTER IN "PCG" IS A STYLIZED HYDROGEN ATOM, AND CONSISTS OF TWO ELEMENTS: THE PATH OF THE ELECTRON, WHICH MAKES THE LETTER "C", AND A CIRCLE WITHIN THE LETTER "C", REPRESENTING THE PROTON. THE CIRCLE HAS GRADIENT COLORS OF ROYAL BLUE, ROBIN'S EGG BLUE, LAVENDER, DENIM BLUE AND TEAL.

SN 85-137,378, FILED 9-24-2010.

ESTHER A. BORSUK, EXAMINING ATTORNEY



*David J. Kyjars*

Director of the United States Patent and Trademark Office

# United States of America

United States Patent and Trademark Office

## JAGUAR MIST

**Reg. No. 4,136,286**

**Registered May 1, 2012**

**Int. Cl.: 9**

**TRADEMARK**

**PRINCIPAL REGISTER**

ARISTOCRAT TECHNOLOGIES AUSTRALIA PTY LTD. (AUSTRALIA CORPORATION)  
BUILDING A, PINNACLE OFFICE PARK  
85 EPPING ROAD  
NORTH RYDE, NSW, AUSTRALIA 2113

FOR: ELECTRONIC GAMING MACHINES, NAMELY, DEVICES WHICH ACCEPT A WAGER,  
IN CLASS 9 (U.S. CLS. 21, 23, 26, 36 AND 38).

FIRST USE 2-1-2011; IN COMMERCE 2-1-2011.

THE MARK CONSISTS OF STANDARD CHARACTERS WITHOUT CLAIM TO ANY PAR-  
TICULAR FONT, STYLE, SIZE, OR COLOR.

SN 85-137,449, FILED 9-24-2010.

ANTHONY RINKER, EXAMINING ATTORNEY



*David J. Kybas*

Director of the United States Patent and Trademark Office

# United States of America

United States Patent and Trademark Office

## THE MOST FLEXIBLE SELECTION ASSISTANT

**Reg. No. 4,136,287**

**Registered May 1, 2012**

**Int. Cl.: 9**

**TRADEMARK**

**PRINCIPAL REGISTER**

SEEGRID CORPORATION (DELAWARE CORPORATION)  
216 RIDC PARK WEST DRIVE  
PITTSBURGH, PA 15275

FOR: COMPONENTS FOR INDUSTRIAL MOBILE ROBOTS SOLD AS A KIT PRIMARILY COMPOSED OF A VISION GUIDED NAVIGATION DEVICE HAVING STEREO CAMERAS, COMPUTER HARDWARE AND COMPUTER SOFTWARE FOR CREATING A 3-D REPRESENTATION OF THE ENVIRONMENT SCANNED BY THE STEREO CAMERAS, COMPUTER SOFTWARE AND COMPUTER HARDWARE TO POWER AND GUIDE THE ROBOT, AND A GRAPHICAL OPERATOR INTERFACE, NAMELY, A KEYBOARD AND A COLOR VGA DISPLAY SCREEN, IN CLASS 9 (U.S. CLS. 21, 23, 26, 36 AND 38).

FIRST USE 9-0-2010; IN COMMERCE 9-0-2010.

THE MARK CONSISTS OF STANDARD CHARACTERS WITHOUT CLAIM TO ANY PARTICULAR FONT, STYLE, SIZE, OR COLOR.

SN 85-137,756, FILED 9-24-2010.

KAREN K. BUSH, EXAMINING ATTORNEY



*David J. Kyros*

Director of the United States Patent and Trademark Office

# United States of America

United States Patent and Trademark Office

## Return to Performance

**Reg. No. 4,136,288**

SANFORD HEALTH (SOUTH DAKOTA NON-PROFIT CORPORATION)  
1305 W. 18TH ST.  
SIOUX FALLS, SD 571175039

**Registered May 1, 2012**

**Int. Cl.: 44**

FOR: HEALTH CARE SERVICES, NAMELY, ORTHOPEDICS AND SPORTS MEDICINE, IN CLASS 44 (U.S. CLS. 100 AND 101).

**SERVICE MARK**

FIRST USE 2-0-2011; IN COMMERCE 2-0-2011.

**PRINCIPAL REGISTER**

THE MARK CONSISTS OF STANDARD CHARACTERS WITHOUT CLAIM TO ANY PARTICULAR FONT, STYLE, SIZE, OR COLOR.

SN 85-137,842, FILED 9-24-2010.

REBECCA EISINGER, EXAMINING ATTORNEY



*David J. Kyros*

Director of the United States Patent and Trademark Office

# United States of America

United States Patent and Trademark Office

## GAMER NEXT DOOR

**Reg. No. 4,136,289**

**Registered May 1, 2012**

**Int. Cl.: 41**

**SERVICE MARK**

**PRINCIPAL REGISTER**

PLAYBOY ENTERPRISES INTERNATIONAL, INC. (DELAWARE CORPORATION)  
680 NORTH LAKE SHORE DRIVE  
CHICAGO, IL 60611

FOR: ENTERTAINMENT SERVICES, NAMELY, AN ON-GOING SERIES FEATURING A FEMALE HOST CONDUCTING INTERVIEWS IN THE FIELD OF GAMING, PREVIEWING VIDEO GAMES, TESTING VIDEO GAMES AND REVIEWING VIDEO GAMES PROVIDED THROUGH MULTIPLE FORMS OF TRANSMISSION MEDIA ENTERTAINMENT SERVICES, NAMELY, PROVIDING A WEB SITE FEATURING PHOTOGRAPHIC, AUDIO, VIDEO AND PROSE PRESENTATIONS FEATURING GAMING AND ENTERTAINMENT TOPICS; ENTERTAINMENT SERVICES, NAMELY, PROVIDING ON-GOING WEBISODES FEATURING A FEMALE HOST CONDUCTING INTERVIEWS IN THE FIELD OF GAMING, PREVIEWING VIDEO GAMES, TESTING VIDEO GAMES AND REVIEWING VIDEO GAMES VIA A GLOBAL COMPUTER NETWORK; ENTERTAINMENT SERVICES, NAMELY, PROVIDING ON-LINE REVIEWS OF VIDEO GAMES; ENTERTAINMENT SERVICES, NAMELY, PROVIDING WEBCASTS IN THE FIELD OF GAMING; ENTERTAINMENT SERVICES, NAMELY, THE PROVISION OF CONTINUING VIDEOS AND TELEVISION SHOWS FEATURING GAMING AND ENTERTAINMENT TOPICS DELIVERED BY MULTIPLE FORMS OF TRANSMISSION MEDIA; ENTERTAINMENT, NAMELY, A CONTINUING TELEVISION SHOW BROADCAST OVER MULTIPLE FORMS OF TRANSMISSION MEDIA, IN CLASS 41 (U.S. CLS. 100, 101 AND 107).

FIRST USE 7-13-2010; IN COMMERCE 7-13-2010.

THE MARK CONSISTS OF STANDARD CHARACTERS WITHOUT CLAIM TO ANY PARTICULAR FONT, STYLE, SIZE, OR COLOR.

SN 85-138,082, FILED 9-24-2010.

RONALD MCMORROW, EXAMINING ATTORNEY



*David J. Kyros*

Director of the United States Patent and Trademark Office

# United States of America

United States Patent and Trademark Office

## GAMER NEXT DOOR

**Reg. No. 4,136,290**

**Registered May 1, 2012**

**Int. Cl.: 9**

**TRADEMARK**

**PRINCIPAL REGISTER**

PLAYBOY ENTERPRISES INTERNATIONAL, INC. (DELAWARE CORPORATION)  
680 NORTH LAKE SHORE DRIVE  
CHICAGO, IL 60611

FOR: VIDEO RECORDINGS FEATURING GAMING AND ENTERTAINMENT TOPICS, IN  
CLASS 9 (U.S. CLS. 21, 23, 26, 36 AND 38).

FIRST USE 7-13-2010; IN COMMERCE 7-13-2010.

THE MARK CONSISTS OF STANDARD CHARACTERS WITHOUT CLAIM TO ANY PAR-  
TICULAR FONT, STYLE, SIZE, OR COLOR.

SN 85-138,097, FILED 9-24-2010.

RONALD MCMORROW, EXAMINING ATTORNEY



*David J. Kybas*

Director of the United States Patent and Trademark Office



# United States of America

United States Patent and Trademark Office



**Reg. No. 4,136,291**

**Registered May 1, 2012**

**Int. Cl.: 31**

**TRADEMARK**

**PRINCIPAL REGISTER**

TOP LINE SEEDS LLC (COLORADO LIMITED LIABILITY COMPANY)  
8915 W. 80TH DR.  
ARVADA, CO 80005

FOR: FLOWER SEEDS; HERB SEEDS FOR PLANTING; SEEDS FOR FLOWERS; VEGETABLE SEEDS FOR PLANTING, NONE OF THE FOREGOING BEING RELATED TO CHRYSANTHEMUMS, BLUE MARBLE TREES OR EGGPLANTS, IN CLASS 31 (U.S. CLS. 1 AND 46).

FIRST USE 5-20-2011; IN COMMERCE 12-15-2011.

NO CLAIM IS MADE TO THE EXCLUSIVE RIGHT TO USE "SEEDS", APART FROM THE MARK AS SHOWN.

THE COLOR(S) LIGHT BLUE, DARK BLUE AND GREEN IS/ARE CLAIMED AS A FEATURE OF THE MARK.

THE MARK CONSISTS OF THE WORDS "BLUE MARBLE SEEDS" WITH "BLUE" IN LIGHT BLUE AND "MARBLE SEEDS" IN DARK BLUE, COMBINED WITH A RENDERING OF THE EARTH WHICH IS DARK BLUE AT THE BOTTOM AND LIGHT BLUE AT THE TOP SURROUNDED BY A GREEN VINE. THE WHITE IN THE MARK IS BACKGROUND AREA WHICH IS NOT A PART OF THE MARK.

SN 85-138,282, FILED 9-25-2010.

REBECCA GILBERT, EXAMINING ATTORNEY



*David J. Kybas*

Director of the United States Patent and Trademark Office

# United States of America

United States Patent and Trademark Office

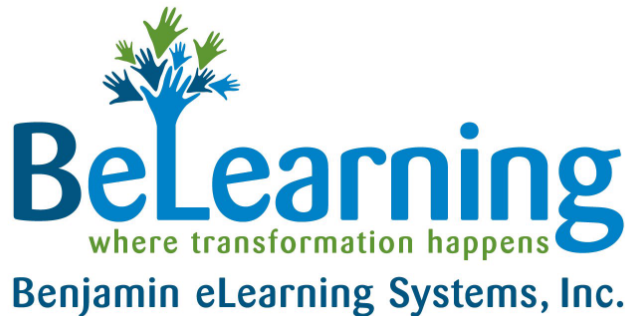

**Reg. No. 4,136,292**

**Registered May 1, 2012**

**Int. Cl.: 41**

**SERVICE MARK**

**PRINCIPAL REGISTER**

M L BENJAMIN ENTERPRISES, INC. (NEW YORK CORPORATION), DBA BENJAMIN ENTERPRISES,  
192 TOWER DRIVE  
MIDDLETOWN, NY 10941

FOR: EDUCATION SERVICES, NAMELY, PROVIDING CAREER RE-TRAINING VIA ON-LINE, CLASSROOM, SEMINAR AND CONFERENCE IN THE FIELDS OF COMPREHENSIVE GENERAL CAREER ADVANCEMENT AND BUSINESS KNOWLEDGE, IN CLASS 41 (U.S. CLS. 100, 101 AND 107).

FIRST USE 6-30-2010; IN COMMERCE 9-30-2010.

NO CLAIM IS MADE TO THE EXCLUSIVE RIGHT TO USE "ELEARNING SYSTEMS, INC.", APART FROM THE MARK AS SHOWN.

THE COLOR(S) DARK BLUE, LIGHT BLUE, GREEN IS/ARE CLAIMED AS A FEATURE OF THE MARK.

THE MARK CONSISTS OF THE LITERAL ELEMENTS "BELEARNING", "WHERE TRANSFORMATION HAPPENS" AND "BENJAMIN ELEARNING SYSTEMS, INC.". THE LETTER "B" IN "BELEARNING" IS IN DARK BLUE WITH THE REMAINING LETTERS IN LIGHT BLUE. "WHERE TRANSFORMATION HAPPENS" IS IN GREEN. "BENJAMIN ELEARNING SYSTEMS, INC." IS IN DARK BLUE. THE LETTER "L" IN "BELEARNING" HAS ITS UPPER PORTION STYLIZED INTO A DESIGN OF MULTIPLE GREEN, DARK BLUE AND LIGHT BLUE COLORED HANDS.

SN 85-138,941, FILED 9-27-2010.

JORDAN BAKER, EXAMINING ATTORNEY



*David J. Kybas*

Director of the United States Patent and Trademark Office

# United States of America

United States Patent and Trademark Office

untold news

**Reg. No. 4,136,293**

UNTOLD NEWS (NEW YORK NOT-FOR-PROFIT CORPORATION)  
900 FIFTH AVENUE, 2A  
NEW YORK, NY 10021

**Registered May 1, 2012**

**Int. Cl.: 35**

FOR: PROMOTING PUBLIC AWARENESS OF HUMANITARIAN EFFORTS IN THE MIDDLE EAST, IN CLASS 35 (U.S. CLS. 100, 101 AND 102).

**SERVICE MARK**

FIRST USE 10-23-2010; IN COMMERCE 10-23-2010.

**PRINCIPAL REGISTER**

THE MARK CONSISTS OF THE WORDS "UNTOLD NEWS". THE WORD "UNTOLD" APPEARS IN THE COLOR BLACK; THE WORD "NEWS" APPEARS IN THE COLOR WHITE IN A BLACK RECTANGLE.

SN 85-139,016, FILED 9-27-2010.

MIDGE BUTLER, EXAMINING ATTORNEY



*David J. Kybas*

Director of the United States Patent and Trademark Office

# United States of America

United States Patent and Trademark Office

## CROQUETAS ISLAS CANARIAS

**Reg. No. 4,136,294**

**Registered May 1, 2012**

**Int. Cl.: 29**

**TRADEMARK**

**PRINCIPAL REGISTER**

ANDRADE, NANCY (UNITED STATES INDIVIDUAL)  
14040 S.W. 22ND STREET  
MIAMI, FL 33175

FOR: HAM CROQUETTES, CHICKEN CROQUETTES, FISH CROQUETTES, SPINACH AND CHEESE CROQUETTES, MEAT CROQUETTES, CHORIZO CROQUETTES, IN CLASS 29 (U.S. CL. 46).

FIRST USE 12-31-2006; IN COMMERCE 12-31-2006.

THE MARK CONSISTS OF STANDARD CHARACTERS WITHOUT CLAIM TO ANY PARTICULAR FONT, STYLE, SIZE, OR COLOR.

OWNER OF U.S. REG. NO. 3,164,036.

NO CLAIM IS MADE TO THE EXCLUSIVE RIGHT TO USE "CROQUETAS", APART FROM THE MARK AS SHOWN.

THE ENGLISH TRANSLATION OF "CROQUETAS ISLAS CANARIAS" IN THE MARK IS "CANARY ISLANDS CROQUETTES".

SN 85-139,017, FILED 9-27-2010.

LINDA LAVACHE, EXAMINING ATTORNEY



*David J. Kybas*

Director of the United States Patent and Trademark Office

# United States of America

United States Patent and Trademark Office

## RoboteX Avatars

**Reg. No. 4,136,295**

**Registered May 1, 2012**

**Int. Cls.: 9, 12, and 28**

**TRADEMARK**

**PRINCIPAL REGISTER**

ROBOTEX INC. (DELAWARE CORPORATION)  
1400 PAGE MILL ROAD, SUITE 100  
PALO ALTO, CA 94304

FOR: MANIPULATORS FOR THE REMOTE OPERATION OF ROBOTIC ARMS FOR NON-INDUSTRIAL USE; ROBOTS FOR PERSONAL OR HOBBY USE; ROBOTS FOR PERSONAL, EDUCATIONAL AND HOBBY USE AND STRUCTURAL PARTS THEREFOR; TACTICAL ROBOTS FOR NON-INDUSTRIAL USE, IN CLASS 9 (U.S. CLS. 21, 23, 26, 36 AND 38).

FIRST USE 9-30-2009; IN COMMERCE 3-1-2011.

FOR: REMOTELY CONTROLLED LAND VEHICLE; ROBOTIC TRANSPORT VEHICLES FOR NON-INDUSTRIAL USE, IN CLASS 12 (U.S. CLS. 19, 21, 23, 31, 35 AND 44).

FIRST USE 9-30-2009; IN COMMERCE 3-1-2011.

FOR: REMOTE CONTROL TOYS, NAMELY, WEAPONIZED SMALL GROUND VEHICLES, IN CLASS 28 (U.S. CLS. 22, 23, 38 AND 50).

FIRST USE 9-30-2009; IN COMMERCE 3-1-2011.

THE MARK CONSISTS OF STANDARD CHARACTERS WITHOUT CLAIM TO ANY PARTICULAR FONT, STYLE, SIZE, OR COLOR.

OWNER OF U.S. REG. NOS. 3,452,763, 3,583,335, AND 3,704,195.

SN 85-140,537, FILED 9-29-2010.

ZHALEH DELANEY, EXAMINING ATTORNEY



*David J. Kyros*

Director of the United States Patent and Trademark Office

# United States of America

United States Patent and Trademark Office

## BOYS TOWN SAME DAY PEDIATRICS

**Reg. No. 4,136,296**

**Registered May 1, 2012**

**Int. Cl.: 44**

**SERVICE MARK**

**PRINCIPAL REGISTER**

FATHER FLANAGAN'S BOYS' HOME (NEBRASKA CORPORATION)  
14100 CRAWFORD STREET  
BOYS TOWN, NE 68010

FOR: MEDICAL SERVICES, NAMELY, HOSPITAL AND MEDICAL CLINIC SERVICES IN THE FIELD OF GENERAL PEDIATRICS; PROVIDING MEDICAL INFORMATION IN THE FIELD OF GENERAL PEDIATRICS, IN CLASS 44 (U.S. CLS. 100 AND 101).

FIRST USE 9-1-2010; IN COMMERCE 9-1-2010.

THE MARK CONSISTS OF STANDARD CHARACTERS WITHOUT CLAIM TO ANY PARTICULAR FONT, STYLE, SIZE, OR COLOR.

OWNER OF U.S. REG. NOS. 1,075,701, 2,019,149, AND OTHERS.

NO CLAIM IS MADE TO THE EXCLUSIVE RIGHT TO USE "SAME DAY PEDIATRICS", APART FROM THE MARK AS SHOWN.

SN 85-141,852, FILED 9-30-2010.

KATHLEEN M. VANSTON, EXAMINING ATTORNEY



*David J. Kybas*

Director of the United States Patent and Trademark Office

# United States of America

United States Patent and Trademark Office

## FRUMTHEURTH

**Reg. No. 4,136,297**

**Registered May 1, 2012**

**Int. Cl.: 25**

**TRADEMARK**

**PRINCIPAL REGISTER**

FRUMTHEURTH, LLC (VIRGINIA LIMITED LIABILITY COMPANY)  
4748 WORMLEYS LANE  
MECHANICSVILLE, VA 23116

FOR: SHIRTS AND HATS, IN CLASS 25 (U.S. CLS. 22 AND 39).

FIRST USE 4-0-2010; IN COMMERCE 4-0-2010.

THE MARK CONSISTS OF STANDARD CHARACTERS WITHOUT CLAIM TO ANY PARTICULAR FONT, STYLE, SIZE, OR COLOR.

SN 85-142,200, FILED 9-30-2010.

MARK SPARACINO, EXAMINING ATTORNEY



*David J. Kybas*

Director of the United States Patent and Trademark Office

# United States of America

United States Patent and Trademark Office



**Reg. No. 4,136,298**

**Registered May 1, 2012**

**Int. Cl.: 45**

**SERVICE MARK**

**PRINCIPAL REGISTER**

FIREWATCH SECURITY CONSULTANTS, INC. (INDIANA CORPORATION)  
4151 KEENELAND CIRCLE  
PLAINFIELD, IN 46168

FOR: SECURITY SERVICES FOR THE PROTECTION OF PROPERTY AND INDIVIDUALS; CONSULTATION ON INDIVIDUAL AND PROPERTY SECURITY ISSUES, SECURITY MONITORING OF INDIVIDUALS AND PROPERTY; SECURITY SERVICES FOR CONTROLLING ADMISSION TO BUILDINGS AND PUBLIC PLACES; NIGHT WATCHMAN SERVICES; SURVEILLANCE OF PROPERTY AND INDIVIDUALS; AND BODYGUARD SERVICES, IN CLASS 45 (U.S. CLS. 100 AND 101).

FIRST USE 6-1-2009; IN COMMERCE 6-1-2009.

NO CLAIM IS MADE TO THE EXCLUSIVE RIGHT TO USE "SECURITY CONSULTANTS, INC.", APART FROM THE MARK AS SHOWN.

THE MARK CONSISTS OF A PAIR OF WINGS WITH A HALO IN THE CENTER WITH THE WORDS "FIREWATCH SECURITY CONSULTANTS, INC." DIRECTLY BELOW.

SN 85-142,232, FILED 9-30-2010.

JAY FLOWERS, EXAMINING ATTORNEY



*David J. Kyffers*

Director of the United States Patent and Trademark Office



United States of America  
United States Patent and Trademark Office

Double  
Wick

**Reg. No. 4,136,299**

**Registered May 1, 2012**

**Int. Cl.: 4**

**TRADEMARK**

**PRINCIPAL REGISTER**

LAMPLIGHT FARMS INCORPORATED (WISCONSIN CORPORATION)  
4900 N. LILLY ROAD  
MENOMONEE FALLS, WI 53051

FOR: PATIO TORCHES FEATURING FLAME ENHANCING TECHNOLOGY, IN CLASS 4  
(U.S. CLS. 1, 6 AND 15).

FIRST USE 1-1-2012; IN COMMERCE 1-1-2012.

NO CLAIM IS MADE TO THE EXCLUSIVE RIGHT TO USE "DOUBLE WICK", APART  
FROM THE MARK AS SHOWN.

THE MARK CONSISTS OF THE STYLIZED WORDING "DOUBLE" ABOVE THE STYLIZED  
WORDING "WICK" WITH THE REPRESENTATION OF TWO FLAME ELEMENTS APPEAR-  
ING OVER THE LOWER CASE "I".

SN 85-142,246, FILED 9-30-2010.

TASNEEM HUSSAIN, EXAMINING ATTORNEY



*David J. Kybas*

Director of the United States Patent and Trademark Office

# United States of America

United States Patent and Trademark Office

bon appétit  
**CAFÉ**

**Reg. No. 4,136,300**

**Registered May 1, 2012**

**Int. Cl.: 43**

**SERVICE MARK**

**PRINCIPAL REGISTER**

ADVANCE MAGAZINE PUBLISHERS INC. (NEW YORK CORPORATION)  
4 TIMES SQUARE  
NEW YORK, NY 10036

FOR: RESTAURANT AND CAFE SERVICES, IN CLASS 43 (U.S. CLS. 100 AND 101).

FIRST USE 9-30-2009; IN COMMERCE 9-30-2009.

OWNER OF U.S. REG. NOS. 653,791 AND 2,773,320.

NO CLAIM IS MADE TO THE EXCLUSIVE RIGHT TO USE "CAFÉ", APART FROM THE MARK AS SHOWN.

THE ENGLISH TRANSLATION OF "BON APPETIT" IN THE MARK IS "GOOD APPETITE".

SN 85-142,323, FILED 9-30-2010.

SIMON TENG, EXAMINING ATTORNEY



*David J. Kyros*

Director of the United States Patent and Trademark Office

# United States of America

United States Patent and Trademark Office

## SKEO SOLUTIONS

**Reg. No. 4,136,301**

SKEO SOLUTIONS, INC. (VIRGINIA CORPORATION)  
921 SECOND STREET SE  
CHARLOTTESVILLE, VA 22902

**Registered May 1, 2012**

**Int. Cls.: 35, 39, and 42**

FOR: CONSULTING SERVICES IN THE FIELDS OF ECONOMICS AND ENERGY, IN CLASS 35 (U.S. CLS. 100, 101 AND 102).

**SERVICE MARK**

FIRST USE 2-8-2012; IN COMMERCE 2-8-2012.

**PRINCIPAL REGISTER**

FOR: CONSULTING SERVICES IN THE FIELDS OF TRANSPORTATION AND GEOGRAPHIC INFORMATION, NAMELY, SUCH SERVICES FOCUSED ON TRANSPORTATION INFRA-STRUCTURE IMPROVEMENT, IN CLASS 39 (U.S. CLS. 100 AND 105).

FIRST USE 2-8-2012; IN COMMERCE 2-8-2012.

FOR: CONSULTING SERVICES IN THE FIELDS OF ENVIRONMENTAL ASSESSMENT AND PLANNING, AND LAND USE PLANNING AND DESIGN, IN CLASS 42 (U.S. CLS. 100 AND 101).

FIRST USE 2-8-2012; IN COMMERCE 2-8-2012.

THE MARK CONSISTS OF STANDARD CHARACTERS WITHOUT CLAIM TO ANY PARTICULAR FONT, STYLE, SIZE, OR COLOR.

NO CLAIM IS MADE TO THE EXCLUSIVE RIGHT TO USE "SOLUTIONS", APART FROM THE MARK AS SHOWN.

SN 85-142,458, FILED 9-30-2010.

INGA ERVIN, EXAMINING ATTORNEY



*David J. Kybas*

Director of the United States Patent and Trademark Office

# United States of America

United States Patent and Trademark Office

## COMPASSIONATE CARE

**Reg. No. 4,136,302**

**Registered May 1, 2012**

**Int. Cl.: 36**

**SERVICE MARK**

**PRINCIPAL REGISTER**

STANCORP FINANCIAL GROUP, INC. (OREGON CORPORATION)  
1100 SW SIXTH AVENUE  
PORTLAND, OR 97204

FOR: UNDERWRITING OF INSURANCE, NAMELY, DISABILITY AND DISABILITY INCOME INSURANCE BY PROVIDING INSURANCE BENEFITS TO REPLACE LOST INCOME OF INDIVIDUALS CARING FOR FAMILY MEMBERS; ADMINISTRATION OF DISABILITY AND DISABILITY INCOME INSURANCE CLAIMS, NAMELY, PROVIDING INSURANCE BENEFITS TO REPLACE LOST INCOME OF INDIVIDUALS CARING FOR FAMILY MEMBERS, IN CLASS 36 (U.S. CLS. 100, 101 AND 102).

FIRST USE 11-30-2010; IN COMMERCE 11-30-2010.

THE MARK CONSISTS OF STANDARD CHARACTERS WITHOUT CLAIM TO ANY PARTICULAR FONT, STYLE, SIZE, OR COLOR.

NO CLAIM IS MADE TO THE EXCLUSIVE RIGHT TO USE "CARE", APART FROM THE MARK AS SHOWN.

SN 85-142,563, FILED 9-30-2010.

KAPIL BHANOT, EXAMINING ATTORNEY



*David J. Kybas*

Director of the United States Patent and Trademark Office

# United States of America

United States Patent and Trademark Office

## COMPASSIONATE CARE BENEFIT

**Reg. No. 4,136,303**

**Registered May 1, 2012**

**Int. Cl.: 36**

**SERVICE MARK**

**PRINCIPAL REGISTER**

STANCORP FINANCIAL GROUP, INC. (OREGON CORPORATION)  
1100 SW SIXTH AVENUE  
PORTLAND, OR 97204

FOR: UNDERWRITING OF INSURANCE, NAMELY, DISABILITY AND DISABILITY INCOME INSURANCE BY PROVIDING INSURANCE BENEFITS TO REPLACE LOST INCOME OF INDIVIDUALS CARING FOR FAMILY MEMBERS; ADMINISTRATION OF DISABILITY AND DISABILITY INCOME INSURANCE CLAIMS, NAMELY, PROVIDING INSURANCE BENEFITS TO REPLACE LOST INCOME OF INDIVIDUALS CARING FOR FAMILY MEMBERS, IN CLASS 36 (U.S. CLS. 100, 101 AND 102).

FIRST USE 11-30-2010; IN COMMERCE 11-30-2010.

THE MARK CONSISTS OF STANDARD CHARACTERS WITHOUT CLAIM TO ANY PARTICULAR FONT, STYLE, SIZE, OR COLOR.

NO CLAIM IS MADE TO THE EXCLUSIVE RIGHT TO USE "CARE BENEFIT", APART FROM THE MARK AS SHOWN.

SN 85-142,568, FILED 9-30-2010.

KAPIL BHANOT, EXAMINING ATTORNEY



*David J. Kybas*

Director of the United States Patent and Trademark Office

# United States of America

United States Patent and Trademark Office

# HORSESHOE

**Reg. No. 4,136,304**

**Registered May 1, 2012**

**Int. Cl.: 34**

**TRADEMARK**

**PRINCIPAL REGISTER**

IP, LLC (KENTUCKY LIMITED LIABILITY COMPANY)  
200 PROGRESS DRIVE  
RUSSELL SPRINGS, KY 42642

FOR: TOBACCO; CIGARS; CIGARETTES; PIPE TOBACCO, IN CLASS 34 (U.S. CLS. 2, 8, 9 AND 17).

FIRST USE 1-31-2012; IN COMMERCE 1-31-2012.

THE MARK CONSISTS OF STANDARD CHARACTERS WITHOUT CLAIM TO ANY PARTICULAR FONT, STYLE, SIZE, OR COLOR.

SN 85-142,829, FILED 10-1-2010.

ELISSA GARBER KON, EXAMINING ATTORNEY



*David J. Kybas*

Director of the United States Patent and Trademark Office

# United States of America

United States Patent and Trademark Office

# PenFibe

**Reg. No. 4,136,305**

**Registered May 1, 2012**

**Int. Cl.: 30**

**TRADEMARK**

**PRINCIPAL REGISTER**

PENFORD PRODUCTS CO. (DELAWARE CORPORATION), DBA PENFORD FOOD  
INGREDIENTS,  
7094 SOUTH REVERE PARKWAY  
CENTENNIAL, CO 80112

FOR: FOOD STARCH; STARCH FOR USE IN MANUFACTURING FOOD, IN CLASS 30 (U.S.  
CL. 46).

FIRST USE 2-20-2012; IN COMMERCE 2-20-2012.

THE MARK CONSISTS OF STANDARD CHARACTERS WITHOUT CLAIM TO ANY PAR-  
TICULAR FONT, STYLE, SIZE, OR COLOR.

SN 85-143,529, FILED 10-1-2010.

KIMBERLY PERRY, EXAMINING ATTORNEY



*David J. Kybas*

Director of the United States Patent and Trademark Office

# United States of America

United States Patent and Trademark Office

## MARK STENGLER

**Reg. No. 4,136,306**

STENGLER VISION, INC. (CALIFORNIA CORPORATION)  
894 ANTILLA WAY  
SAN MARCOS, CA 92078

**Registered May 1, 2012**

**Int. Cls.: 5, 9, 16, 41, and 44**

FOR: NUTRITIONAL PRODUCTS, NAMELY, NUTRITIONAL SUPPLEMENTS , IN CLASS 5 (U.S. CLS. 6, 18, 44, 46, 51 AND 52).

FIRST USE 10-31-1995; IN COMMERCE 8-31-2010.

**TRADEMARK**

FOR: PRE-RECORDED CDS FEATURING INFORMATION ON HEALTH AND NUTRITION AND HOLISTIC MEDICINE, IN CLASS 9 (U.S. CLS. 21, 23, 26, 36 AND 38).

**SERVICE MARK**

**PRINCIPAL REGISTER**

FIRST USE 10-31-1995; IN COMMERCE 8-29-2011.

FOR: PUBLICATIONS, NAMELY, BOOKS AND NEWSLETTERS IN THE FIELDS OF HEALTH AND NUTRITION AND HOLISTIC MEDICINE, IN CLASS 16 (U.S. CLS. 2, 5, 22, 23, 29, 37, 38 AND 50).

FIRST USE 10-31-1995; IN COMMERCE 8-29-2011.

FOR: EDUCATIONAL SERVICES, NAMELY, A CONTINUING PROGRAM PROVIDING INFORMATION ABOUT HEALTH AND NUTRITIONAL AND HOLISTIC MEDICINE AND PROVIDING HOLISTIC MEDICAL INFORMATION ABOUT NUTRITIONAL PRODUCTS AND SUPPLEMENTS ACCESSIBLE BY RADIO, TELEVISION, SATELLITE, AUDIO, VIDEO AND COMPUTER NETWORKS, IN CLASS 41 (U.S. CLS. 100, 101 AND 107).

FIRST USE 10-31-1995; IN COMMERCE 1-31-1997.

FOR: PROVIDING INFORMATION ABOUT HEALTH AND NUTRITIONAL AND HOLISTIC MEDICINE; PROVIDING HOLISTIC MEDICAL INFORMATION ABOUT NUTRITIONAL PRODUCTS AND SUPPLEMENTS, IN CLASS 44 (U.S. CLS. 100 AND 101).

FIRST USE 10-31-1995; IN COMMERCE 1-31-1997.

THE MARK CONSISTS OF STANDARD CHARACTERS WITHOUT CLAIM TO ANY PARTICULAR FONT, STYLE, SIZE, OR COLOR.



*David J. Kybas*

Director of the United States Patent and Trademark Office



**Reg. No. 4,136,306** THE NAME "MARK STENGLER" IDENTIFIES A LIVING INDIVIDUAL WHOSE CONSENT IS OF RECORD.

SN 85-143,746, FILED 10-2-2010.

ANDREW RHIM, EXAMINING ATTORNEY

# United States of America

United States Patent and Trademark Office

## THE NEW CENTER FOR WORLD TRADE

**Reg. No. 4,136,307**

**Registered May 1, 2012**

**Int. Cls.: 35 and 42**

**SERVICE MARK**

**PRINCIPAL REGISTER**

FLATWORLD SOLUTIONS INC. (DELAWARE CORPORATION)  
116 VILLAGE BOULEVARD  
SUITE 200  
PRINCETON, NJ 08540

FOR: ON-LINE BUSINESS NETWORKING SERVICES; BUSINESS SERVICES, NAMELY, COMBINED STRATEGIC GOODS OR SERVICES SOURCING, IN CLASS 35 (U.S. CLS. 100, 101 AND 102).

FIRST USE 10-10-2010; IN COMMERCE 10-10-2010.

FOR: SOFTWARE AS A SERVICE (SAAS) SERVICES FEATURING SOFTWARE FOR BUSINESS NETWORKING AND GOODS OR SERVICES SOURCING, IN CLASS 42 (U.S. CLS. 100 AND 101).

FIRST USE 10-10-2010; IN COMMERCE 10-10-2010.

THE MARK CONSISTS OF STANDARD CHARACTERS WITHOUT CLAIM TO ANY PARTICULAR FONT, STYLE, SIZE, OR COLOR.

NO CLAIM IS MADE TO THE EXCLUSIVE RIGHT TO USE "CENTER FOR WORLD TRADE", APART FROM THE MARK AS SHOWN.

SN 85-144,949, FILED 10-5-2010.

WILLIAM BRECKENFELD, EXAMINING ATTORNEY



*David J. Kyros*

Director of the United States Patent and Trademark Office

# United States of America

United States Patent and Trademark Office



**Reg. No. 4,136,308**

**Registered May 1, 2012**

**Int. Cls.: 9 and 42**

**TRADEMARK**

**SERVICE MARK**

**PRINCIPAL REGISTER**

NUVOLOCITY (CALIFORNIA LIMITED LIABILITY COMPANY)  
250 SOCO DRIVE  
FULLERTON, CA 92832

FOR: DOWNLOADABLE SOFTWARE IN THE NATURE OF A MOBILE APPLICATION FOR THE REAL ESTATE INDUSTRY TO CALCULATE EFFECTIVE REAL ESTATE RENTS, FOR REAL ESTATE RENT QUOTES, FOR WAREHOUSING OF REAL ESTATE DEAL RENTAL DATA AND ANALYTICS, FOR TRACKING EFFECTIVE RENTAL QUOTES BETWEEN INTERNAL AND EXTERNAL PARTIES, AND FOR INTERFACING REAL ESTATE PROPERTY AND RENTAL DATA BETWEEN THIRD PARTY INFORMATION SYSTEMS, IN CLASS 9 (U.S. CLS. 21, 23, 26, 36 AND 38).

FIRST USE 1-1-2010; IN COMMERCE 1-1-2010.

FOR: PROVIDING ON-LINE NON-DOWNLOADABLE SOFTWARE FOR THE REAL ESTATE INDUSTRY TO CALCULATE EFFECTIVE REAL ESTATE RENTS, FOR REAL ESTATE RENT QUOTES, FOR WAREHOUSING OF REAL ESTATE DEAL RENTAL DATA AND ANALYTICS, FOR TRACKING EFFECTIVE RENTAL QUOTES BETWEEN INTERNAL AND EXTERNAL PARTIES, AND FOR INTERFACING REAL ESTATE PROPERTY AND RENTAL DATA BETWEEN THIRD PARTY INFORMATION SYSTEMS, IN CLASS 42 (U.S. CLS. 100 AND 101).

FIRST USE 1-1-2010; IN COMMERCE 1-1-2010.

NO CLAIM IS MADE TO THE EXCLUSIVE RIGHT TO USE "BLEND", APART FROM THE MARK AS SHOWN.

THE MARK CONSISTS OF A BLENDER WITH NUMBERS AND DOLLAR SIGNS GOING INTO TO BE BLENDED AND THE WORD "RATEBLEND" LOCATED TO THE RIGHT OF IT.

SN 85-145,650, FILED 10-5-2010.

DEIRDRE ROBERTSON, EXAMINING ATTORNEY



*David J. Kyjars*

Director of the United States Patent and Trademark Office

# United States of America

United States Patent and Trademark Office

# WHOA

WHAT'S HAPPENING W/ ORIGINAL ARTISTS

**Reg. No. 4,136,309**

**Registered May 1, 2012**

**Int. Cl.: 16**

**TRADEMARK**

**PRINCIPAL REGISTER**

WHOA MEDIA GROUP LLC (FLORIDA LIMITED LIABILITY COMPANY)  
14744 YELLOW PINE LANE  
CLERMONT, FL 34711

FOR: GENERAL FEATURE MAGAZINE IN THE FIELD OF THE ARTS; GENERAL FEATURE MAGAZINES; MAGAZINES IN THE FIELD OF THE ARTS, IN CLASS 16 (U.S. CLS. 2, 5, 22, 23, 29, 37, 38 AND 50).

FIRST USE 8-1-2010; IN COMMERCE 3-1-2011.

SN 85-145,906, FILED 10-6-2010.

KAREN K. BUSH, EXAMINING ATTORNEY



*David J. Kybas*

Director of the United States Patent and Trademark Office

# United States of America

United States Patent and Trademark Office



**Reg. No. 4,136,310**

**Registered May 1, 2012**

**Int. Cls.: 35 and 36**

**SERVICE MARK**

**PRINCIPAL REGISTER**

NATIONAL COMPREHENSIVE CANCER NETWORK, INC. (DELAWARE CORPORATION)  
275 COMMERCE DR. SUITE 300  
FORT WASHINGTON, PA 19034

FOR: ADMINISTRATION AND MANAGEMENT OF GRANTS FOR EDUCATION AND RESEARCH, IN CLASS 35 (U.S. CLS. 100, 101 AND 102).

FIRST USE 2-9-2011; IN COMMERCE 2-9-2011.

FOR: CHARITABLE FUNDRAISING SERVICES, IN CLASS 36 (U.S. CLS. 100, 101 AND 102).

FIRST USE 2-9-2011; IN COMMERCE 2-9-2011.

OWNER OF U.S. REG. NOS. 2,052,732, 3,444,990, AND OTHERS.

SEC. 2(F) AS TO "NATIONAL COMPREHENSIVE CANCER NETWORK".

NO CLAIM IS MADE TO THE EXCLUSIVE RIGHT TO USE "FOUNDATION", APART FROM THE MARK AS SHOWN.

THE MARK CONSISTS OF THE LITERAL ELEMENT "NCCN NATIONAL COMPREHENSIVE CANCER NETWORK FOUNDATION GUIDING TREATMENT, CHANGING LIVES" IN A STYLIZED FONT AND A DESIGN THAT CONSISTS OF A BOX. THE WORDING "NCCN" APPEARS IN THE BOX.

SN 85-145,962, FILED 10-6-2010.

RENEE MCCRAY, EXAMINING ATTORNEY



*David J. Kybas*

Director of the United States Patent and Trademark Office

# United States of America

United States Patent and Trademark Office

## BOO BOO KIDS

**Reg. No. 4,136,311**

**Registered May 1, 2012**

**Int. Cl.: 25**

**TRADEMARK**

**PRINCIPAL REGISTER**

ANDJESKI, THERESE (UNITED STATES INDIVIDUAL)  
7806 SOUTHTON DR  
PARMA, OH 44129

FOR: CLOTHING, NAMELY, T-SHIRTS, IN CLASS 25 (U.S. CLS. 22 AND 39).

FIRST USE 10-25-2011; IN COMMERCE 10-25-2011.

THE MARK CONSISTS OF STANDARD CHARACTERS WITHOUT CLAIM TO ANY PARTICULAR FONT, STYLE, SIZE, OR COLOR.

NO CLAIM IS MADE TO THE EXCLUSIVE RIGHT TO USE "KIDS", APART FROM THE MARK AS SHOWN.

SN 85-146,905, FILED 10-7-2010.

RONALD MCMORROW, EXAMINING ATTORNEY



*David J. Kyffers*

Director of the United States Patent and Trademark Office

# United States of America

United States Patent and Trademark Office

## HIGHLANDS BENCH

**Reg. No. 4,136,312**

**Registered May 1, 2012**

**Int. Cl.: 33**

**TRADEMARK**

**PRINCIPAL REGISTER**

J. LOHR WINERY CORPORATION (CALIFORNIA CORPORATION)  
1000 LENZEN AVENUE  
SAN JOSE, CA 95126

FOR: WINE, IN CLASS 33 (U.S. CLS. 47 AND 49).

FIRST USE 3-6-2012; IN COMMERCE 3-6-2012.

THE MARK CONSISTS OF STANDARD CHARACTERS WITHOUT CLAIM TO ANY PARTICULAR FONT, STYLE, SIZE, OR COLOR.

SN 85-147,685, FILED 10-7-2010.

KHANH LE, EXAMINING ATTORNEY



*David J. Kybas*

Director of the United States Patent and Trademark Office

**United States of America**  
United States Patent and Trademark Office

**SALONA**

**Reg. No. 4,136,313**

**Registered May 1, 2012**

**Int. Cl.: 30**

**TRADEMARK**

**PRINCIPAL REGISTER**

ICL PERFORMANCE PRODUCTS LP (DELAWARE LIMITED PARTNERSHIP)  
622 EMERSON ROAD  
SAINT LOUIS, MO 63141

FOR: SALT, IN CLASS 30 (U.S. CL. 46).

FIRST USE 2-3-2012; IN COMMERCE 2-3-2012.

THE MARK CONSISTS OF STANDARD CHARACTERS WITHOUT CLAIM TO ANY PARTICULAR FONT, STYLE, SIZE, OR COLOR.

SN 85-148,297, FILED 10-8-2010.

LEIGH CAROLINE CASE, EXAMINING ATTORNEY



*David J. Kyfos*

Director of the United States Patent and Trademark Office



# United States of America

United States Patent and Trademark Office



**Reg. No. 4,136,314**

**Registered May 1, 2012**

**Int. Cl.: 33**

**TRADEMARK**

**PRINCIPAL REGISTER**

TEQUILERA RH, SA DE CV (MEXICO CORPORATION), DBA TEQUILERA RH, SA DE CV,  
COLMENA 1224, COLONIA MERCADO DE ABASTOS  
GUADALAJARA, JALISCO, MEXICO 44530

FOR: TEQUILA, IN CLASS 33 (U.S. CLS. 47 AND 49).

FIRST USE 9-5-2011; IN COMMERCE 9-26-2011.

THE MARK CONSISTS OF AN AGAVE PLANT IN THE SHAPE OF A HEART ABOVE THE  
WORDING "PASIÓN SECRETA".

THE ENGLISH TRANSLATION OF "PASION SECRETA" IN THE MARK IS "SECRET PAS-  
SION".

SN 85-148,578, FILED 10-8-2010.

JUSTINE D. PARKER, EXAMINING ATTORNEY



*David J. Kybas*

Director of the United States Patent and Trademark Office

# United States of America

United States Patent and Trademark Office

# VANCL

**Reg. No. 4,136,315**

**Registered May 1, 2012**

**Int. Cls.: 18, 25, and 35**

**TRADEMARK**

**SERVICE MARK**

**PRINCIPAL REGISTER**

VANCL (BEIJING) TECHNOLOGY CO., LTD. (CHINA LIMITED LIABILITY COMPANY)  
8TH FLOOR, NO. 2 FUFENG ROAD  
FENGTAI DISTRICT  
BEIJING, CHINA

FOR: ANIMAL SKINS; PURSES; SCHOOL BAGS; REUSABLE SHOPPING BAGS; HAND-BAGS; IMITATION LEATHER; UMBRELLAS; WALKING STICKS; SADDLERY; VALISES; POCKET WALLETS; ATTACHÉ CASES; UNFITTED VANITY CASES, IN CLASS 18 (U.S. CLS. 1, 2, 3, 22 AND 41).

FIRST USE 7-1-2007; IN COMMERCE 8-25-2010.

FOR: LAYETTES; SWIMSUITS; RAINCOATS; FOOTBALL SHOES; FOOTWEAR; HEADWEAR, NAMELY, CAPS; HOSIERY; GLOVES; NECKTIES; GIRDLES; SHOWER CAPS; SHIRTS; TROUSERS; SINGLET; TOPCOATS; OUTER CLOTHING, NAMELY, OVERCOATS; TEE-SHIRTS; SUITS; FUR COATS AND JACKETS; FUR HATS; FUR STOLE; JACKETS; CAMISOLES; UNDERWEAR; PAJAMAS; BRASSIERES; SLIPPERS; SANDALS; SPORTS SHOES; SCARVES; SHAWLS, IN CLASS 25 (U.S. CLS. 22 AND 39).

FIRST USE 7-1-2007; IN COMMERCE 8-25-2010.

FOR: ADVERTISING SERVICES; ONLINE RETAIL STORE SERVICES FEATURING CLOTHING FOR MEN, WOMEN, BABIES, AND CHILDREN, FOOTWEAR, OUTDOOR AND SPORTS GEAR, SUCH AS TENTS, YOGA MATS, YOGA BAGS, WATER BOTTLES, HATS, SLEEPING BAGS, BACKPACKS, BRAS, UNDERWEAR, PAJAMAS, SOCKS, BAGS, SUCH AS SUITCASES, HANDBAGS, AND WALLETS, APPAREL, JEWELRY, AND FASHION ACCESSORIES, SUCH AS GLASSES, EARRING, SCARVES, AND TIES; PROVIDING BUSINESS MARKETING INFORMATION; ADVERTISING AND PROMOTION SERVICES, NAMELY, PROMOTING THE SELLING OF GOODS AND SERVICES OF OTHERS THROUGH THE INTERNET; PROCUREMENT SERVICES, NAMELY, PURCHASING APPAREL ITEMS FOR OTHER BUSINESSES; PERSONNEL MANAGEMENT CONSULTATION; RELOCATION SERVICES FOR BUSINESSES, IN CLASS 35 (U.S. CLS. 100, 101 AND 102).

FIRST USE 7-1-2007; IN COMMERCE 8-25-2010.

THE MARK CONSISTS OF STANDARD CHARACTERS WITHOUT CLAIM TO ANY PARTICULAR FONT, STYLE, SIZE, OR COLOR.



*David J. Kyros*

Director of the United States Patent and Trademark Office

**Reg. No. 4,136,315** SN 85-149,716, FILED 10-11-2010.

INGA ERVIN, EXAMINING ATTORNEY

# United States of America

United States Patent and Trademark Office

DEDICATED TO BRINGING  
SMILES TO OUR COMMUNITY

**Reg. No. 4,136,316**

**Registered May 1, 2012**

**Int. Cl.: 44**

**SERVICE MARK**

**PRINCIPAL REGISTER**

WILLOW WALK FAMILY DENTISTRY (FLORIDA CORPORATION), DBA TIOGA DENTAL ASSOCIATES,  
13005 SW 1ST ROAD, STE 233  
JONESVILLE, FL 32669

FOR: COSMETIC DENTISTRY; DENTISTRY; ORTHODONTIC SERVICES, IN CLASS 44 (U.S. CLS. 100 AND 101).

FIRST USE 3-1-2008; IN COMMERCE 3-1-2008.

THE MARK CONSISTS OF STANDARD CHARACTERS WITHOUT CLAIM TO ANY PARTICULAR FONT, STYLE, SIZE, OR COLOR.

SN 85-151,316, FILED 10-13-2010.

DAVID H. STINE, EXAMINING ATTORNEY



*David J. Kyffers*

Director of the United States Patent and Trademark Office

# United States of America

United States Patent and Trademark Office

## DESIGNS FOR LIFE

**Reg. No. 4,136,317**

**Registered May 1, 2012**

**Int. Cl.: 21**

**TRADEMARK**

**PRINCIPAL REGISTER**

WESTERN INDUSTRIES, INC. (KANSAS CORPORATION)  
FIRST AND B STREET  
STROTHER FIELD INDUSTRIAL PARK  
WINFIELD, KS 67156

FOR: PLASTIC STORAGE CONTAINERS FOR HOUSEHOLD OR DOMESTIC USE IN CONNECTION WITH LAWN AND GARDEN AND CAMPING AND HIKING EQUIPMENT, IN CLASS 21 (U.S. CLS. 2, 13, 23, 29, 30, 33, 40 AND 50).

FIRST USE 2-15-2011; IN COMMERCE 2-15-2011.

THE MARK CONSISTS OF STANDARD CHARACTERS WITHOUT CLAIM TO ANY PARTICULAR FONT, STYLE, SIZE, OR COLOR.

SN 85-151,479, FILED 10-13-2010.

ELIZABETH HUGHITT, EXAMINING ATTORNEY



*David J. Kyffers*

Director of the United States Patent and Trademark Office

# United States of America

United States Patent and Trademark Office

## STYLEWORKS

**Reg. No. 4,136,318**

**Registered May 1, 2012**

**Int. Cl.: 21**

**TRADEMARK**

**PRINCIPAL REGISTER**

WESTERN INDUSTRIES, INC. (KANSAS CORPORATION)  
FIRST & B STREET  
STROTHER FIELD INDUSTRIAL PARK  
WINFIELD, KS 67156

FOR: PLASTIC STORAGE CONTAINERS FOR HOUSEHOLD OR DOMESTIC USE IN CONNECTION WITH LAWN AND GARDEN AND CAMPING AND HIKING EQUIPMENT, IN CLASS 21 (U.S. CLS. 2, 13, 23, 29, 30, 33, 40 AND 50).

FIRST USE 2-15-2011; IN COMMERCE 2-15-2011.

THE MARK CONSISTS OF STANDARD CHARACTERS WITHOUT CLAIM TO ANY PARTICULAR FONT, STYLE, SIZE, OR COLOR.

SN 85-151,485, FILED 10-13-2010.

ELIZABETH HUGHITT, EXAMINING ATTORNEY



*David J. Kyffers*

Director of the United States Patent and Trademark Office

# United States of America

United States Patent and Trademark Office

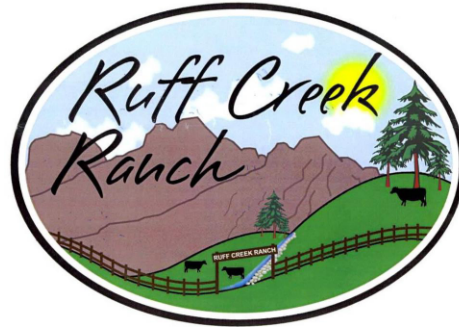

**Reg. No. 4,136,319**

**Registered May 1, 2012**

**Int. Cl.: 29**

**TRADEMARK**

**PRINCIPAL REGISTER**

MAID-RITE STEAK CO., INC. (PENNSYLVANIA CORPORATION)  
105 KEYSTONE INDUSTRIAL PARK  
DUNMORE, PA 18512

FOR: MEAT, NAMELY, RAW AND FULLY COOKED AND SEASONED BEEF, IN CLASS 29 (U.S. CL. 46).

FIRST USE 12-21-2011; IN COMMERCE 12-21-2011.

NO CLAIM IS MADE TO THE EXCLUSIVE RIGHT TO USE "RANCH", APART FROM THE MARK AS SHOWN.

THE COLOR(S) GREEN, BLUE, BROWN, YELLOW BLACK AND WHITE IS/ARE CLAIMED AS A FEATURE OF THE MARK.

THE MARK CONSISTS OF THE WORDING "RUFF CREEK RANCH" IN BLACK, AND A SCENE OF BROWN MOUNTAINS, GREEN HILLS OUTLINED IN BLACK, BLACK COWS, GREEN AND BROWN TREES, A BROWN FENCE AND SIGN WITH THE WORDING "RUFF CREEK RANCH" IN WHITE, A BLUE STREAM WITH A WHITE ROCK EDGE, A BLUE SKY WITH WHITE CLOUDS AND A YELLOW SUN, ALL ENCLOSED WITHIN A BLACK OVAL WITH A WHITE INTERIOR BORDER.

SN 85-151,635, FILED 10-13-2010.

APRIL ROACH, EXAMINING ATTORNEY



*David J. Kybas*

Director of the United States Patent and Trademark Office

# United States of America

United States Patent and Trademark Office

# BLOODLINE

**Reg. No. 4,136,320**

**Registered May 1, 2012**

**Int. Cl.: 13**

**TRADEMARK**

**PRINCIPAL REGISTER**

PLASTIC INDUSTRIES (TENNESSEE CORPORATION)  
213 DENNIS ST  
ATHENS, TN 37303

FOR: BULLETS, IN CLASS 13 (U.S. CLS. 2 AND 9).

FIRST USE 10-0-2010; IN COMMERCE 10-0-2010.

THE MARK CONSISTS OF STANDARD CHARACTERS WITHOUT CLAIM TO ANY PARTICULAR FONT, STYLE, SIZE, OR COLOR.

SN 85-151,837, FILED 10-13-2010.

YAT SYE, LEE, EXAMINING ATTORNEY



*David J. Kyffers*

Director of the United States Patent and Trademark Office



# United States of America

United States Patent and Trademark Office

## WRATH OF ASHARDALON

**Reg. No. 4,136,321**

**Registered May 1, 2012**

**Int. Cl.: 28**

**TRADEMARK**

**PRINCIPAL REGISTER**

WIZARDS OF THE COAST LLC (DELAWARE LIMITED LIABILITY COMPANY)  
1027 NEWPORT AVENUE  
PAWTUCKET, RI 02862

FOR: TOYS, GAMES AND PLAYTHINGS, NAMELY, BOARD GAMES AND EQUIPMENT  
SOLD AS A UNIT FOR PLAYING BOARD GAMES, IN CLASS 28 (U.S. CLS. 22, 23, 38 AND  
50).

FIRST USE 2-11-2011; IN COMMERCE 2-11-2011.

THE MARK CONSISTS OF STANDARD CHARACTERS WITHOUT CLAIM TO ANY PAR-  
TICULAR FONT, STYLE, SIZE, OR COLOR.

SN 85-151,885, FILED 10-13-2010.

GINA FINK, EXAMINING ATTORNEY



*David J. Kyffers*

Director of the United States Patent and Trademark Office

# United States of America

United States Patent and Trademark Office

# Perfect Torc

**Reg. No. 4,136,322**

**Registered May 1, 2012**

**Int. Cl.: 9**

**TRADEMARK**

**PRINCIPAL REGISTER**

PAINLESS PERFORMANCE PRODUCTS OF TEXAS, LLC (TEXAS LIMITED LIABILITY COMPANY)  
2501 LUDELLE  
FORT WORTH, TX 76105

FOR: PROGRAMMED CIRCUIT BOARDS USED IN THE FUNCTIONAL OPERATION OF AN ELECTRONIC AUTOMOBILE TRANSMISSION, IN CLASS 9 (U.S. CLS. 21, 23, 26, 36 AND 38).

FIRST USE 6-23-2011; IN COMMERCE 6-23-2011.

THE MARK CONSISTS OF STANDARD CHARACTERS WITHOUT CLAIM TO ANY PARTICULAR FONT, STYLE, SIZE, OR COLOR.

NO CLAIM IS MADE TO THE EXCLUSIVE RIGHT TO USE "TORQUE", APART FROM THE MARK AS SHOWN.

SN 85-152,035, FILED 10-13-2010.

TINA MAI, EXAMINING ATTORNEY



*David J. Kybas*

Director of the United States Patent and Trademark Office

# United States of America

United States Patent and Trademark Office

## TURBOFLAME

**Reg. No. 4,136,323**

**Registered May 1, 2012**

**Int. Cl.: 4**

**TRADEMARK**

**PRINCIPAL REGISTER**

PETER J. WYCKOFF (UNITED STATES INDIVIDUAL), DBA BEST OF THE WEST TWO TREES PRODUCTS,  
10945 WHITEGATE AVE.  
SUNLAND, CA 91040

FOR: GAS FIRE STARTERS AS FUEL FOR COOKING, FOR BARBEQUES, FOR CAMPFIRES, FOR CHARCOAL, AND FOR FIREPLACES, IN CLASS 4 (U.S. CLS. 1, 6 AND 15).

FIRST USE 6-4-2010; IN COMMERCE 6-4-2010.

THE MARK CONSISTS OF STANDARD CHARACTERS WITHOUT CLAIM TO ANY PARTICULAR FONT, STYLE, SIZE, OR COLOR.

SN 85-152,733, FILED 10-14-2010.

ANDREW LEASER, EXAMINING ATTORNEY



*David J. Kyffers*

Director of the United States Patent and Trademark Office

# United States of America

United States Patent and Trademark Office

## PLUM PUBLIC RELATIONS

**Reg. No. 4,136,324**

**Registered May 1, 2012**

**Int. Cl.: 35**

**SERVICE MARK**

**PRINCIPAL REGISTER**

THOMAS, SIMONE (UNITED STATES INDIVIDUAL)  
44B MEADOWBROOK PLACE  
MAPLEWOOD, NJ 07040

FOR: PUBLIC RELATIONS, IN CLASS 35 (U.S. CLS. 100, 101 AND 102).

FIRST USE 2-1-2012; IN COMMERCE 2-1-2012.

THE MARK CONSISTS OF STANDARD CHARACTERS WITHOUT CLAIM TO ANY PARTICULAR FONT, STYLE, SIZE, OR COLOR.

NO CLAIM IS MADE TO THE EXCLUSIVE RIGHT TO USE "PUBLIC RELATIONS", APART FROM THE MARK AS SHOWN.

SN 85-153,314, FILED 10-15-2010.

REBECCA SMITH, EXAMINING ATTORNEY



*David J. Kybas*

Director of the United States Patent and Trademark Office

# United States of America

United States Patent and Trademark Office

## 24/7 COACHING

**Reg. No. 4,136,325**

**Registered May 1, 2012**

**Int. Cls.: 16 and 41**

**TRADEMARK**

**SERVICE MARK**

**PRINCIPAL REGISTER**

COLLEAGUE CONSULTING, LLC (MARYLAND LIMITED LIABILITY COMPANY)  
7500 GREENWAY CIRCLE DRIVE SUITE 200  
GREENBELT, MD 20770

FOR: PRINTED EDUCATIONAL MATERIALS IN THE FIELD OF BUSINESS COACHING, MENTORING, AND TRAINING IN CAREER COUNSELING, IN CLASS 16 (U.S. CLS. 2, 5, 22, 23, 29, 37, 38 AND 50).

FIRST USE 1-0-2011; IN COMMERCE 1-0-2011.

FOR: EDUCATION SERVICES, NAMELY, PROVIDING CLASSES IN THE FIELDS OF BUSINESS COACHING, MENTORING, AND TRAINING IN CAREER COUNSELING, IN CLASS 41 (U.S. CLS. 100, 101 AND 107).

FIRST USE 1-0-2011; IN COMMERCE 1-0-2011.

THE MARK CONSISTS OF STANDARD CHARACTERS WITHOUT CLAIM TO ANY PARTICULAR FONT, STYLE, SIZE, OR COLOR.

NO CLAIM IS MADE TO THE EXCLUSIVE RIGHT TO USE "COACHING", APART FROM THE MARK AS SHOWN.

SN 85-154,035, FILED 10-15-2010.

B. PARADEWELAI, EXAMINING ATTORNEY



*David J. Kybas*

Director of the United States Patent and Trademark Office

# United States of America

United States Patent and Trademark Office

# CloudMotion

**Reg. No. 4,136,326**

**Registered May 1, 2012**

**Int. Cl.: 42**

**SERVICE MARK**

**PRINCIPAL REGISTER**

AFORE SOLUTIONS INC. (CANADA CORPORATION)  
2680 QUEENSVIEW DR., SUITE 150  
OTTAWA, CANADA K2B8J9

FOR: CLOUD COMPUTING FEATURING SOFTWARE FOR MOVING VIRTUAL MACHINES INTO INFRASTRUCTURE AS A SERVICE (IAAS) ENVIRONMENTS IN A PRIVATE, PUBLIC OR HYBRID CLOUD ENVIRONMENT; TECHNICAL SUPPORT SERVICES, NAMELY, MIGRATION OF DATACENTER, SERVER AND DATABASE APPLICATIONS; COMPUTER SERVICES, NAMELY, REMOTE AND ON-SITE MANAGEMENT OF THE INFORMATION TECHNOLOGY CLOUD COMPUTING SYSTEMS OF OTHERS, IN CLASS 42 (U.S. CLS. 100 AND 101).

FIRST USE 4-1-2010; IN COMMERCE 8-31-2010.

THE MARK CONSISTS OF STANDARD CHARACTERS WITHOUT CLAIM TO ANY PARTICULAR FONT, STYLE, SIZE, OR COLOR.

SN 85-154,896, FILED 10-18-2010.

ANNE E. GUSTASON, EXAMINING ATTORNEY



*David J. Kyros*

Director of the United States Patent and Trademark Office

# United States of America

United States Patent and Trademark Office

# PACA

**Reg. No. 4,136,327**

**Registered May 1, 2012**

**Int. Cl.: 35**

**SERVICE MARK**

**PRINCIPAL REGISTER**

ROBERT E. PURCELL (UNITED STATES INDIVIDUAL)  
5204 HARVEST HILL DRIVE  
JAMESVILLE, NY 13078

FOR: RETAIL STORE SERVICES, AND ON-LINE RETAIL STORE SERVICES, FEATURING COLOGNES, PERFUMES, COSMETICS, NON-MEDICATED SKIN LOTIONS, CLOTHING, CLOTHING ACCESSORIES, AND BEDDING, IN CLASS 35 (U.S. CLS. 100, 101 AND 102).

FIRST USE 5-2-2011; IN COMMERCE 5-2-2011.

THE MARK CONSISTS OF STANDARD CHARACTERS WITHOUT CLAIM TO ANY PARTICULAR FONT, STYLE, SIZE, OR COLOR.

SN 85-155,198, FILED 10-18-2010.

MARC LEIPZIG, EXAMINING ATTORNEY



*David J. Kybas*

Director of the United States Patent and Trademark Office

# United States of America

United States Patent and Trademark Office



**Reg. No. 4,136,328**

**Registered May 1, 2012**

**Int. Cl.: 35**

**SERVICE MARK**

**PRINCIPAL REGISTER**

PET PLANET LTD. (CANADA CORPORATION)  
11550 - 40TH STREET S.E.  
CALGARY, ALBERTA, CANADA T2Z4V6

FOR: FRANCHISE SERVICES, NAMELY, OFFERING TECHNICAL AND BUSINESS MANAGEMENT ASSISTANCE IN THE ESTABLISHMENT AND OPERATION OF A RETAIL PET SUPPLY STORE, IN CLASS 35 (U.S. CLS. 100, 101 AND 102).

FIRST USE 8-28-1996; IN COMMERCE 4-4-2011.

NO CLAIM IS MADE TO THE EXCLUSIVE RIGHT TO USE "PET", APART FROM THE MARK AS SHOWN.

THE MARK CONSISTS OF THE WORD "PET" WITH A PICTURE OF A GLOBE WITH THE WORD "PLANET" INSIDE THE GLOBE AND ON THE RIGHT SIDE OF THE GLOBE ARE THREE LARGE BLACK CIRCLES. THE GLOBE AND THREE CIRCLES FORM THE IMAGE OF A PAW PRINT.

SN 85-155,361, FILED 10-18-2010.

ROSELLE HERRERA, EXAMINING ATTORNEY



*David J. Kyros*

Director of the United States Patent and Trademark Office



# United States of America

United States Patent and Trademark Office



**HITEC | LA**  
POWER YOUR PRACTICE

**Reg. No. 4,136,329**

**Registered May 1, 2012**

**Int. Cls.: 35, 37, 41, and 42**

**SERVICE MARK**

**PRINCIPAL REGISTER**

LOCAL INITIATIVE HEALTH AUTHORITY FOR LOS ANGELES COUNTY (CALIFORNIA PUBLIC AGENCY)  
555 WEST FIFTH STREET, 29TH FLOOR  
LOS ANGELES, CA 90013

FOR: BUSINESS MANAGEMENT CONSULTING, STRATEGIC PLANNING AND BUSINESS ADVISORY SERVICES IN THE FIELD OF ELECTRONIC HEALTHCARE INFORMATION SYSTEMS; PURCHASING AND PROCUREMENT SERVICES, NAMELY, PROCURING OF CONTRACTS FOR OTHERS FOR THE PURCHASE OF GOODS AND SERVICES IN THE FIELD OF ELECTRONIC HEALTHCARE INFORMATION SYSTEMS AND THE DESIGN OF GROUP PURCHASING PLANS FOR GOODS AND SERVICES IN THE FIELD OF ELECTRONIC HEALTHCARE INFORMATION SYSTEMS; PUBLIC ADVOCACY TO PROMOTE THE AWARENESS OF THE IMPORTANCE OF EFFECTIVE IMPLEMENTATION AND USE OF ELECTRONIC HEALTHCARE INFORMATION SYSTEMS; TECHNICAL SUPPORT SERVICES, NAMELY, TECHNICAL ADVICE CONCERNING THE PURCHASE OF ELECTRONIC HEALTHCARE INFORMATION SYSTEMS, IN CLASS 35 (U.S. CLS. 100, 101 AND 102).

FIRST USE 12-1-2009; IN COMMERCE 6-1-2010.

FOR: TECHNICAL SUPPORT SERVICES, NAMELY, TECHNICAL ADVICE CONCERNING THE INSTALLATION, REPAIR, UPGRADING, AND MAINTENANCE OF ELECTRONIC HEALTHCARE INFORMATION SYSTEMS, IN CLASS 37 (U.S. CLS. 100, 103 AND 106).

FIRST USE 12-1-2009; IN COMMERCE 6-1-2010.

FOR: EDUCATIONAL SERVICES, NAMELY, DEVELOPING, ARRANGING, AND CONDUCTING EDUCATIONAL CONFERENCES AND PROGRAMS IN THE FIELD OF ELECTRONIC HEALTHCARE INFORMATION SYSTEMS; AND PROVIDING EDUCATIONAL INFORMATION IN THE FIELD OF ELECTRONIC HEALTHCARE INFORMATION SYSTEMS, IN CLASS 41 (U.S. CLS. 100, 101 AND 107).

FIRST USE 12-1-2009; IN COMMERCE 6-1-2010.

FOR: TECHNICAL SUPPORT SERVICES, NAMELY, TECHNICAL ADVICE CONCERNING THE DESIGN OF ELECTRONIC HEALTHCARE INFORMATION SYSTEMS; TECHNICAL SUPPORT SERVICES, NAMELY, TECHNICAL ADVICE CONCERNING THE PURCHASE OF ELECTRONIC HEALTHCARE INFORMATION SYSTEMS; TECHNICAL SUPPORT



*David J. Kyffers*

Director of the United States Patent and Trademark Office

**Reg. No. 4,136,329** SERVICES, NAMELY, TECHNICAL ADVICE CONCERNING THE OPERATION OF ELECTRONIC HEALTHCARE INFORMATION SYSTEMS; PROVIDING TECHNICAL INFORMATION IN THE FIELD OF ELECTRONIC HEALTHCARE INFORMATION SYSTEMS, IN CLASS 42 (U.S. CLS. 100 AND 101).

FIRST USE 12-1-2009; IN COMMERCE 6-1-2010.

NO CLAIM IS MADE TO THE EXCLUSIVE RIGHT TO USE "LA", APART FROM THE MARK AS SHOWN.

THE MARK CONSISTS OF THE DESIGN ELEMENT IN THE FORM OF A FANCIFUL STETHOSCOPE WHERE THE CHESTPIECE IS REPLACED BY A POWER PLUG WHICH EXTENDS THROUGH AN OPENING IN A SURROUNDING CIRCLE.

SN 85-156,427, FILED 10-19-2010.

ALLISON HOLTZ, EXAMINING ATTORNEY

# United States of America

United States Patent and Trademark Office

# DAYSTRIP

**Reg. No. 4,136,330**

DAYTON PROGRESS CORPORATION (OHIO CORPORATION)  
500 PROGRESS ROAD, P.O. BOX 39  
DAYTON, OH 454490039

**Registered May 1, 2012**

**Int. Cl.: 7**

FOR: MACHINE PARTS, NAMELY, STRIPPERS, FOR USE IN STAMPING MACHINES, IN CLASS 7 (U.S. CLS. 13, 19, 21, 23, 31, 34 AND 35).

**TRADEMARK**

FIRST USE 6-15-2011; IN COMMERCE 6-15-2011.

**PRINCIPAL REGISTER**

THE MARK CONSISTS OF STANDARD CHARACTERS WITHOUT CLAIM TO ANY PARTICULAR FONT, STYLE, SIZE, OR COLOR.

SN 85-157,117, FILED 10-20-2010.

TEJBIR SINGH, EXAMINING ATTORNEY



*David J. Kyros*

Director of the United States Patent and Trademark Office

# United States of America

United States Patent and Trademark Office

## CUSTOM CLASSIC

**Reg. No. 4,136,331**

**Registered May 1, 2012**

**Int. Cl.: 11**

**TRADEMARK**

**PRINCIPAL REGISTER**

CONAIR CORPORATION (DELAWARE CORPORATION)  
ONE CUMMINGS POINT ROAD  
STAMFORD, CT 06902

FOR: ELECTRIC TOASTER OVENS, IN CLASS 11 (U.S. CLS. 13, 21, 23, 31 AND 34).

FIRST USE 10-30-2010; IN COMMERCE 10-30-2010.

THE MARK CONSISTS OF STANDARD CHARACTERS WITHOUT CLAIM TO ANY PARTICULAR FONT, STYLE, SIZE, OR COLOR.

SN 85-157,350, FILED 10-20-2010.

JAMES GRIFFIN, EXAMINING ATTORNEY



*David J. Kyffers*

Director of the United States Patent and Trademark Office

# United States of America

United States Patent and Trademark Office

# NTRO

**Reg. No. 4,136,332**

**Registered May 1, 2012**

**Int. Cl.: 9**

**TRADEMARK**

**PRINCIPAL REGISTER**

NPROGRESS, INC. (DELAWARE CORPORATION)  
P.O. BOX 491727  
LOS ANGELES, CA 90049

FOR: DOWNLOADABLE SOFTWARE IN THE FIELD OF SOCIAL NETWORKING FOR MOBILE TELEPHONES, SMART PHONES AND MOBILE DEVICES THAT PERMIT USERS WITH COMMON INTERESTS TO MEET EACH OTHER; DOWNLOADABLE SOFTWARE IN THE FIELD OF SOCIAL NETWORKING FOR PRE-INSTALLATION IN MOBILE TELEPHONES, SMART PHONES AND MOBILE DEVICES TO PERMIT USERS WITH COMMON INTERESTS TO MEET EACH OTHER, IN CLASS 9 (U.S. CLS. 21, 23, 26, 36 AND 38).

FIRST USE 8-17-2011; IN COMMERCE 8-17-2011.

THE MARK CONSISTS OF STANDARD CHARACTERS WITHOUT CLAIM TO ANY PARTICULAR FONT, STYLE, SIZE, OR COLOR.

SN 85-157,395, FILED 10-20-2010.

BARBARA A. GOLD, EXAMINING ATTORNEY



*David J. Kyffers*

Director of the United States Patent and Trademark Office

# United States of America

United States Patent and Trademark Office

# NTRO

**Reg. No. 4,136,333**

**Registered May 1, 2012**

**Int. Cl.: 45**

**SERVICE MARK**

**PRINCIPAL REGISTER**

NPROGRESS, INC. (DELAWARE CORPORATION)  
P.O. BOX 491727  
LOS ANGELES, CA 90049

FOR: PROVIDING SOCIAL NETWORKING SERVICES VIA THE INTERNET, MOBILE TELEPHONES, MOBILE DEVICES, AND MOBILE PHONE NETWORKS, IN CLASS 45 (U.S. CLS. 100 AND 101).

FIRST USE 8-17-2011; IN COMMERCE 8-17-2011.

THE MARK CONSISTS OF STANDARD CHARACTERS WITHOUT CLAIM TO ANY PARTICULAR FONT, STYLE, SIZE, OR COLOR.

SN 85-157,399, FILED 10-20-2010.

BARBARA A. GOLD, EXAMINING ATTORNEY



*David J. Kybas*

Director of the United States Patent and Trademark Office

# United States of America

United States Patent and Trademark Office

## NOVALINX SYSTEMS

**Reg. No. 4,136,334**

**Registered May 1, 2012**

**Int. Cl.: 9**

**TRADEMARK**

**PRINCIPAL REGISTER**

LINXBERG TECHNOLOGY (SOUTH CAROLINA LIMITED LIABILITY COMPANY)  
7271-A INVESTMENT DRIVE  
NORTH CHARLESTON, SC 29418

FOR: COMPUTER SOFTWARE FOR LABOR MANAGEMENT AND TIME KEEPING;  
LOCKING/UNLOCKING DOORS AND CONTROLLING ALARMS; CALCULATING OF  
LABOR OUTPUT AND EFFICIENCY, IN CLASS 9 (U.S. CLS. 21, 23, 26, 36 AND 38).

FIRST USE 7-21-2011; IN COMMERCE 7-21-2011.

THE MARK CONSISTS OF STANDARD CHARACTERS WITHOUT CLAIM TO ANY PAR-  
TICULAR FONT, STYLE, SIZE, OR COLOR.

NO CLAIM IS MADE TO THE EXCLUSIVE RIGHT TO USE "SYSTEMS", APART FROM  
THE MARK AS SHOWN.

SN 85-157,570, FILED 10-20-2010.

LESLIE RICHARDS, EXAMINING ATTORNEY



*David J. Kyffers*

Director of the United States Patent and Trademark Office

# United States of America

United States Patent and Trademark Office



**Reg. No. 4,136,335**

**Registered May 1, 2012**

**Int. Cls.: 35, 39, and 42**

**SERVICE MARK**

**PRINCIPAL REGISTER**

SKEO SOLUTIONS, INC. (VIRGINIA CORPORATION)  
921 SECOND STREET SE  
CHARLOTTESVILLE, VA 22902

FOR: CONSULTING SERVICES IN THE FIELDS OF ECONOMICS AND ENERGY, IN CLASS 35 (U.S. CLS. 100, 101 AND 102).

FIRST USE 2-8-2012; IN COMMERCE 2-8-2012.

FOR: CONSULTING SERVICES IN THE FIELDS OF TRANSPORTATION AND GEOGRAPHIC INFORMATION, NAMELY, SUCH SERVICES FOCUSED ON TRANSPORTATION INFRA-STRUCTURE IMPROVEMENT, IN CLASS 39 (U.S. CLS. 100 AND 105).

FIRST USE 2-8-2012; IN COMMERCE 2-8-2012.

FOR: CONSULTING SERVICES IN THE FIELDS OF ENVIRONMENTAL ASSESSMENT AND PLANNING, AND LAND USE PLANNING AND DESIGN, IN CLASS 42 (U.S. CLS. 100 AND 101).

FIRST USE 2-8-2012; IN COMMERCE 2-8-2012.

NO CLAIM IS MADE TO THE EXCLUSIVE RIGHT TO USE "SOLUTIONS", APART FROM THE MARK AS SHOWN.

THE MARK CONSISTS OF A STYLIZED LETTER "S" AND THE WORDS "SKEO SOLUTIONS".

SN 85-157,994, FILED 10-21-2010.

INGA ERVIN, EXAMINING ATTORNEY

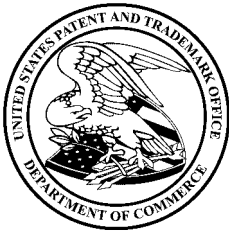

*David J. Kybas*

Director of the United States Patent and Trademark Office



# United States of America

United States Patent and Trademark Office

# INSPECT

**Reg. No. 4,136,336**

**Registered May 1, 2012**

**Int. Cl.: 9**

**TRADEMARK**

**PRINCIPAL REGISTER**

CODEWARE, INC. (TEXAS CORPORATION)  
5224 STATION WAY  
SARASOTA, FL 34233

FOR: COMPUTER SOFTWARE, NAMELY, SOFTWARE TO STORE POST-CONSTRUCTION INSPECTION DATA IN THE NATURE OF WALL THICKNESS MEASUREMENTS, TEXT DESCRIPTIONS AND IMAGES FILES OBTAINED FROM A PHYSICAL INSPECTION AND CALCULATE RETIREMENT/REPAIR AND INSPECTION DATES IN ACCORDANCE WITH STANDARDS PUBLISHED BY THE AMERICAN PETROLEUM INSTITUTE AND THE AMERICAN SOCIETY OF MECHANICAL ENGINEERS FOR PRESSURE VESSEL AND HEAT EXCHANGERS, IN CLASS 9 (U.S. CLS. 21, 23, 26, 36 AND 38).

FIRST USE 2-23-2012; IN COMMERCE 2-23-2012.

THE MARK CONSISTS OF STANDARD CHARACTERS WITHOUT CLAIM TO ANY PARTICULAR FONT, STYLE, SIZE, OR COLOR.

SN 85-158,217, FILED 10-21-2010.

CHRISTOPHER BUONGIORNO, EXAMINING ATTORNEY



*David J. Kyros*

Director of the United States Patent and Trademark Office

# United States of America

United States Patent and Trademark Office

# InnoPick

**Reg. No. 4,136,337**

**Registered May 1, 2012**

**Int. Cls.: 7 and 9**

**TRADEMARK**

**PRINCIPAL REGISTER**

3584925 CANADA INC. (CANADA CORPORATION), DBA DRL SYSTEMS,  
245 LABROSSE AVENUE  
POINTE-CLAIRE, QUEBEC, CANADA H9R1A3

FOR: MATERIAL HANDLING MACHINES, NAMELY, DEPALLETIZERS, PALLETIZERS, SINGULATORS, AND CRANES; AUTOMATED CASE AND LAYER STORAGE AND RETRIEVAL SYSTEMS CONSISTING OF CRANES, RACKING, SHELVING, CASE ELEVATORS AND LAYER ELEVATORS; CASE ACCUMULATION, REPLENISHMENT, DISPENSING, SEQUENCING AND CONVEYING MACHINERY; AUTOMATED ORDER FULFILLMENT SYSTEMS CONSISTING OF DEPALLETIZERS, SINGULATORS, CRANES, RACKING, SHELVING, CASE ELEVATORS, LAYER ELEVATORS, CONVEYORS, CASE DISPENSERS, MERGES, SWITCHES, AND PALLETIZERS, IN CLASS 7 (U.S. CLS. 13, 19, 21, 23, 31, 34 AND 35).

FIRST USE 1-1-2011; IN COMMERCE 2-10-2012.

FOR: COMPUTER SOFTWARE TO COLLECT REAL-TIME DATA, TO DIRECT AND MANAGE AUTOMATED MATERIAL HANDLING EQUIPMENT AND PERSONNEL WITHIN A WAREHOUSE, AND TO PROVIDE USER INTERFACES FOR OPERATIONS, MANAGEMENT, DIAGNOSTICS, MONITORING AND CONTROL; COMPUTER SOFTWARE TO CREATE PALLETIZING INSTRUCTIONS TO GUIDE PALLETIZERS IN ASSEMBLING MIXED CASE ORDERS, IN CLASS 9 (U.S. CLS. 21, 23, 26, 36 AND 38).

FIRST USE 1-1-2011; IN COMMERCE 2-10-2012.

THE MARK CONSISTS OF STANDARD CHARACTERS WITHOUT CLAIM TO ANY PARTICULAR FONT, STYLE, SIZE, OR COLOR.

SN 85-159,202, FILED 10-22-2010.

DOMINIC FATHY, EXAMINING ATTORNEY



*David J. Kyros*

Director of the United States Patent and Trademark Office

# United States of America

United States Patent and Trademark Office



**Reg. No. 4,136,338**

**Registered May 1, 2012**

**Int. Cl.: 9**

**TRADEMARK**

**PRINCIPAL REGISTER**

INGRASYS TECHNOLOGY INC. (TAIWAN CORPORATION)  
21F, 207, FUHSING RD.  
TAOYUAN 33066, TAIWAN

FOR: REMOTE CONTROL APPARATUS FOR DEVICES FOR MONITORING THE ENVIRONMENT; COMPUTER HARDWARE AND SOFTWARE SYSTEM FOR REMOTELY MONITORING ENVIRONMENTAL CONDITIONS AND CONTROLLING DEVICES WITHIN A BUILDING, FACILITY, GROUNDS, OR DESIGNATED SPATIAL AREA; DIGITAL VIDEO PLAYERS AND RECORDERS; NETWORK VIDEO PLAYERS AND RECORDERS; NETWORK CAMERAS; VIDEO SERVERS; VIDEO DECODERS; VIDEO BROADCAST SYSTEMS COMPRISED OF VIDEO PROCESSORS, VIDEO RECEIVERS, VIDEO SCREENS, VIDEO TRANSMISSION APPARATUS, VIDEO MONITORS, VIDEO CABLES, VIDEO CAMERAS, VIDEO CIRCUIT BOARDS, AND VIDEO DISPLAY CARDS; AND SOFTWARE FOR CONTROLLING THE OPERATION OF VIDEO PLAYERS, IN CLASS 9 (U.S. CLS. 21, 23, 26, 36 AND 38).

FIRST USE 8-1-2010; IN COMMERCE 12-8-2010.

THE MARK CONSISTS OF THE WORDING "IMEGE MAGIC IN VISION", WITH A CRESCENT DESIGN ABOVE TWO CIRCLES AND TWO CIRCLES IN THE LETTER "G".

SN 85-160,010, FILED 10-25-2010.

JUSTINE D. PARKER, EXAMINING ATTORNEY



*David J. Kyffers*

Director of the United States Patent and Trademark Office

# United States of America

United States Patent and Trademark Office

## SHAMROCK FOODS FOODSERVICE WAREHOUSE

**Reg. No. 4,136,339**

**Registered May 1, 2012**

**Int. Cl.: 35**

**SERVICE MARK**

**PRINCIPAL REGISTER**

SHAMROCK FOODS COMPANY (ARIZONA CORPORATION)  
3900 E. CAMELBACK ROAD, SUITE 300  
PHOENIX, AZ 85018

FOR: RETAIL AND WHOLESALE STORE SERVICES IN THE FIELD OF GROCERIES AND RESTAURANT SUPPLIES FOR BOTH CONSUMERS AND RESTAURATEURS , IN CLASS 35 (U.S. CLS. 100, 101 AND 102).

FIRST USE 1-0-2011; IN COMMERCE 1-0-2011.

THE MARK CONSISTS OF STANDARD CHARACTERS WITHOUT CLAIM TO ANY PARTICULAR FONT, STYLE, SIZE, OR COLOR.

NO CLAIM IS MADE TO THE EXCLUSIVE RIGHT TO USE "FOODS FOODSERVICE WAREHOUSE", APART FROM THE MARK AS SHOWN.

SN 85-160,224, FILED 10-25-2010.

KEVON CHISOLM, EXAMINING ATTORNEY



*David J. Kyros*

Director of the United States Patent and Trademark Office

# United States of America

United States Patent and Trademark Office

## COMMITTED TO CLEAN

**Reg. No. 4,136,340**

**Registered May 1, 2012**

**Int. Cl.: 40**

**SERVICE MARK**

**PRINCIPAL REGISTER**

BRADFORD SOAP WORKS, INC. (RHODE ISLAND CORPORATION)  
200 PROVIDENCE STREET  
WEST WARWICK, RI 02893

FOR: MANUFACTURE OF GENERAL PRODUCT LINES IN THE FIELDS OF BODY CLEANSING AND BEAUTY CARE PRODUCTS TO THE ORDER AND SPECIFICATION OF OTHERS , IN CLASS 40 (U.S. CLS. 100, 103 AND 106).

FIRST USE 9-30-2011; IN COMMERCE 9-30-2011.

THE MARK CONSISTS OF STANDARD CHARACTERS WITHOUT CLAIM TO ANY PARTICULAR FONT, STYLE, SIZE, OR COLOR.

SN 85-160,606, FILED 10-25-2010.

LINDSEY RUBIN, EXAMINING ATTORNEY



*David J. Kyffers*

Director of the United States Patent and Trademark Office

# United States of America

United States Patent and Trademark Office

LOVE PEOPLE. COOK THEM  
TASTY FOOD.

**Reg. No. 4,136,341**

**Registered May 1, 2012**

**Int. Cl.: 35**

**SERVICE MARK**

**PRINCIPAL REGISTER**

PENZEYS, LTD. (WISCONSIN CORPORATION)  
9300 WEST JANACEK COURT  
BROOKFIELD, WI 53045

FOR: RETAIL STORE AND ONLINE RETAIL STORE SERVICES FEATURING SPICES, SPICE BLENDS, SEASONINGS, PROCESSED HERBS, EXTRACTS USED FOR FLAVORING AND GIFT BOXES FEATURING SPICES, SPICE BLENDS, SEASONINGS, PROCESSED HERBS, EXTRACTS USED FOR FLAVORING; MAIL ORDER CATALOG SERVICES FEATURING SPICES, SPICE BLENDS, SEASONINGS, PROCESSED HERBS, EXTRACTS USED FOR FLAVORING AND GIFT BOXES FEATURING SPICES, SPICE BLENDS, SEASONINGS, PROCESSED HERBS, EXTRACTS USED FOR FLAVORING, IN CLASS 35 (U.S. CLS. 100, 101 AND 102).

FIRST USE 1-1-2010; IN COMMERCE 1-1-2010.

THE MARK CONSISTS OF STANDARD CHARACTERS WITHOUT CLAIM TO ANY PARTICULAR FONT, STYLE, SIZE, OR COLOR.

SN 85-160,643, FILED 10-25-2010.

CHRIS WELLS, EXAMINING ATTORNEY



*David J. Kyffers*

Director of the United States Patent and Trademark Office

# United States of America

United States Patent and Trademark Office

# Tivity

**Reg. No. 4,136,342**

**Registered May 1, 2012**

**Int. Cl.: 42**

**SERVICE MARK**

**PRINCIPAL REGISTER**

GREEN MULES (NEW JERSEY LIMITED LIABILITY COMPANY)  
54 DORTMUNDER DRIVE  
MANALAPAN, NJ 07726

FOR: COMPUTER SERVICES, NAMELY, CREATING AN ON-LINE COMMUNITY FOR REGISTERED USERS TO PARTICIPATE IN COMPETITIONS, SHOWCASE THEIR SKILLS, GET FEEDBACK FROM THEIR PEERS, FORM VIRTUAL COMMUNITIES, ENGAGE IN SOCIAL NETWORKING AND IMPROVE THEIR TALENT; COMPUTER SERVICES, NAMELY, CREATING AN ON-LINE COMMUNITY FOR REGISTERED USERS TO PARTICIPATE IN DISCUSSIONS, GET FEEDBACK FROM THEIR PEERS, FORM VIRTUAL COMMUNITIES, AND ENGAGE IN SOCIAL NETWORKING FEATURING ATHLETIC ACTIVITY, IN CLASS 42 (U.S. CLS. 100 AND 101).

FIRST USE 3-25-2010; IN COMMERCE 3-25-2010.

THE MARK CONSISTS OF STANDARD CHARACTERS WITHOUT CLAIM TO ANY PARTICULAR FONT, STYLE, SIZE, OR COLOR.

SN 85-160,681, FILED 10-25-2010.

SETH A. RAPPAPORT, EXAMINING ATTORNEY



*David J. Kyffers*

Director of the United States Patent and Trademark Office

# United States of America

United States Patent and Trademark Office

# HI!WAY

**Reg. No. 4,136,343**

**Registered May 1, 2012**

**Int. Cl.: 9**

**TRADEMARK**

**PRINCIPAL REGISTER**

4DK TECHNOLOGIES, INC. (DELAWARE CORPORATION)  
520 HERDON PARKWAY, SUITE D  
HERNDON, VA 20170

FOR: COMPUTER APPLICATION SOFTWARE FOR MOBILE PHONES AND WIRELESS DEVICES, NAMELY, SOFTWARE THAT TRANSCRIBES INCOMING TEXT MESSAGES OR EMAILS INTO VOICE MESSAGES, AND OUTGOING VOICE MESSAGE REPLIES INTO TEXTS OR EMAILS, WHEN IT DETERMINES THAT THE USER HAS A WIRELESS DEVICE, HEADSET OR EXTERNAL SPEAKER SYSTEM ENABLED AND IS DRIVING OR RUNNING, IN CLASS 9 (U.S. CLS. 21, 23, 26, 36 AND 38).

FIRST USE 6-22-2011; IN COMMERCE 6-22-2011.

THE MARK CONSISTS OF STANDARD CHARACTERS WITHOUT CLAIM TO ANY PARTICULAR FONT, STYLE, SIZE, OR COLOR.

SN 85-160,939, FILED 10-26-2010.

PAULA MAHONEY, EXAMINING ATTORNEY



*David J. Kyffers*

Director of the United States Patent and Trademark Office



# United States of America

United States Patent and Trademark Office

## TURNING TODAY'S FANS INTO TOMORROW'S STARS

**Reg. No. 4,136,344**

COLUMBIA TRISTAR MARKETING GROUP, INC. (CALIFORNIA CORPORATION)  
10202 W. WASHINGTON BLVD.  
CULVER CITY, CA 90232

**Registered May 1, 2012**

**Int. Cl.: 35**

FOR: ADVERTISING AND MARKETING SERVICES, NAMELY, PROMOTING THE MOTION PICTURES OF OTHERS, IN CLASS 35 (U.S. CLS. 100, 101 AND 102).

**SERVICE MARK**

FIRST USE 11-19-2010; IN COMMERCE 11-19-2010.

**PRINCIPAL REGISTER**

THE MARK CONSISTS OF STANDARD CHARACTERS WITHOUT CLAIM TO ANY PARTICULAR FONT, STYLE, SIZE, OR COLOR.

SN 85-162,108, FILED 10-27-2010.

DAVID HOFFMAN, EXAMINING ATTORNEY



*David J. Kybas*

Director of the United States Patent and Trademark Office

# United States of America

United States Patent and Trademark Office



**Reg. No. 4,136,345**

**Registered May 1, 2012**

**Int. Cl.: 41**

**SERVICE MARK**

**PRINCIPAL REGISTER**

NORMAN, THOMAS (UNITED STATES INDIVIDUAL)  
2808 TRANSIT DRIVE  
KILLEEN, TX 76543

FOR: MUSIC PRODUCTION SERVICES; MUSIC PUBLISHING SERVICES, IN CLASS 41  
(U.S. CLS. 100, 101 AND 107).

FIRST USE 9-0-2011; IN COMMERCE 9-0-2011.

THE MARK CONSISTS OF THE STYLIZED WORDS "OUTKROWD NATION" WITH THE ARTISTIC RENDERING OF A HOODED SWEATSHIRT APPEARING IN THE "O" IN "OUTKROWD".

SN 85-162,157, FILED 10-27-2010.

KAREN K. BUSH, EXAMINING ATTORNEY



*David J. Kybas*

Director of the United States Patent and Trademark Office

# United States of America

United States Patent and Trademark Office

# VIRIDEX

**Reg. No. 4,136,346**

**Registered May 1, 2012**

**Int. Cl.: 5**

**TRADEMARK**

**PRINCIPAL REGISTER**

GASPARI NUTRITION, INC. (NEW JERSEY CORPORATION)  
SUITE 230  
575 PROSPECT STREET  
LAKEWOOD, NJ 08701

FOR: DIETARY AND NUTRITIONAL SUPPLEMENTS, NOT INCLUDING PHARMACEUTICAL PREPARATIONS, IN CLASS 5 (U.S. CLS. 6, 18, 44, 46, 51 AND 52).

FIRST USE 3-1-2011; IN COMMERCE 3-1-2011.

THE MARK CONSISTS OF STANDARD CHARACTERS WITHOUT CLAIM TO ANY PARTICULAR FONT, STYLE, SIZE, OR COLOR.

SN 85-162,215, FILED 10-27-2010.

MICHAEL ENGEL, EXAMINING ATTORNEY



*David J. Kyros*

Director of the United States Patent and Trademark Office

# United States of America

United States Patent and Trademark Office

## ARBONNE essentiäls

**Reg. No. 4,136,347**

**Registered May 1, 2012**

**Int. Cl.: 5**

**TRADEMARK**

**PRINCIPAL REGISTER**

ARBONNE INTERNATIONAL, LLC (DELAWARE LIMITED LIABILITY COMPANY)  
9400 JERONIMO  
IRVINE, CA 92618

FOR: VITAMINS, MINERAL SUPPLEMENTS, NUTRITIONAL SUPPLEMENTS, DIETARY SUPPLEMENTS, FOOD SUPPLEMENTS AND HERBAL SUPPLEMENTS; ENERGY BOOSTING TABLETS; POWDERED NUTRITIONAL SUPPLEMENT DRINK MIX; NUTRITIONAL SUPPLEMENT FOR ELIMINATING TOXINS FROM THE BODY; DIETARY AND NUTRITIONAL SUPPLEMENTS CONTAINING FIBER; HERBAL TEAS FOR USE AS DIETARY SUPPLEMENTS; DIETARY SUPPLEMENTS IN THE NATURE OF NUTRITIONALLY FORTIFIED SOFT CHEWS; DIETARY SUPPLEMENTS WITH CALCIUM IN THE NATURE OF NUTRITIONALLY FORTIFIED SOFT CHEWS, IN CLASS 5 (U.S. CLS. 6, 18, 44, 46, 51 AND 52).

FIRST USE 1-18-2011; IN COMMERCE 1-18-2011.

OWNER OF U.S. REG. NOS. 1,770,981, 3,452,663, AND OTHERS.

NO CLAIM IS MADE TO THE EXCLUSIVE RIGHT TO USE "ESSENTIALS", APART FROM THE MARK AS SHOWN.

THE MARK CONSISTS OF THE STYLIZED WORDING "ARBONNE ESSENTIALS" FEATURING A DESIGN FOR THE LETTER "A" IN "ESSENTIALS".

SN 85-162,340, FILED 10-27-2010.

BERYL GARDNER, EXAMINING ATTORNEY



*David J. Kyros*

Director of the United States Patent and Trademark Office

# United States of America

United States Patent and Trademark Office

# Phone Floatie

**Reg. No. 4,136,348**

**Registered May 1, 2012**

**Int. Cl.: 9**

**TRADEMARK**

**PRINCIPAL REGISTER**

POWELL, JAY H (UNITED STATES INDIVIDUAL), DBA AUCET TECHNOLOGIES,  
10816 RIVER OAKS DR  
FRISCO, TX 75035

FOR: CARRYING CASES SPECIALLY ADAPTED FOR POCKET CALCULATORS AND  
CELLPHONES, IN CLASS 9 (U.S. CLS. 21, 23, 26, 36 AND 38).

FIRST USE 11-1-2010; IN COMMERCE 11-1-2010.

THE MARK CONSISTS OF STANDARD CHARACTERS WITHOUT CLAIM TO ANY PAR-  
TICULAR FONT, STYLE, SIZE, OR COLOR.

NO CLAIM IS MADE TO THE EXCLUSIVE RIGHT TO USE "PHONE", APART FROM THE  
MARK AS SHOWN.

SN 85-163,059, FILED 10-27-2010.

DEIRDRE ROBERTSON, EXAMINING ATTORNEY



*David J. Kybas*

Director of the United States Patent and Trademark Office

# United States of America

United States Patent and Trademark Office

## Right Road Kids!

**Reg. No. 4,136,349**

**Registered May 1, 2012**

**Int. Cl.: 41**

**SERVICE MARK**

**PRINCIPAL REGISTER**

THE DREAM FUND OUTREACH (CALIFORNIA NON-PROFIT CORPORATION), DBA  
RIGHT ROAD KIDS,  
UNIT H  
615 HAZELWOOD WAY  
SIMI VALLEY, CA 93065

FOR: EDUCATIONAL SERVICES, NAMELY, CONDUCTING CLASSES, SEMINARS AND  
WORKSHOPS, IN THE FIELD OF SELF ESTEEM, CHARACTER, AND EDUCATIONAL  
ENRICHMENT FOR CHILDREN AND TEACHERS, AND DISTRIBUTION OF TRAINING  
MATERIALS IN CONNECTION THEREWITH, IN CLASS 41 (U.S. CLS. 100, 101 AND 107).

FIRST USE 11-1-2010; IN COMMERCE 3-1-2011.

THE MARK CONSISTS OF STANDARD CHARACTERS WITHOUT CLAIM TO ANY PAR-  
TICULAR FONT, STYLE, SIZE, OR COLOR.

SN 85-164,597, FILED 10-29-2010.

GIANCARLO CASTRO, EXAMINING ATTORNEY



*David J. Kyffers*

Director of the United States Patent and Trademark Office

# United States of America

United States Patent and Trademark Office

## GOLDILOCKS GUIDE

**Reg. No. 4,136,350**

**Registered May 1, 2012**

**Int. Cls.: 24 and 25**

**TRADEMARK**

**PRINCIPAL REGISTER**

SWADDLEDESIGNS, LLC (WASHINGTON LIMITED LIABILITY COMPANY)  
4612 UNION BAY PLACE NE  
SEATTLE, WA 98105

FOR: BABY BEDDING, NAMELY, BUNDLE BAGS, SWADDLING BLANKETS, CRIB BUMPERS, FITTED CRIB SHEETS, CRIB SKIRTS, CRIB BLANKETS, AND DIAPER CHANGING PAD COVERS NOT OF PAPER; BABY BLANKETS; BED BLANKETS; BLANKET THROWS; CHILDREN'S BLANKETS, IN CLASS 24 (U.S. CLS. 42 AND 50).

FIRST USE 6-0-2011; IN COMMERCE 6-0-2011.

FOR: INFANT WEARABLE BLANKETS, IN CLASS 25 (U.S. CLS. 22 AND 39).

FIRST USE 6-0-2011; IN COMMERCE 6-0-2011.

THE MARK CONSISTS OF STANDARD CHARACTERS WITHOUT CLAIM TO ANY PARTICULAR FONT, STYLE, SIZE, OR COLOR.

SN 85-165,689, FILED 10-31-2010.

BARBARA RUTLAND, EXAMINING ATTORNEY



*David J. Kyros*

Director of the United States Patent and Trademark Office

# United States of America

United States Patent and Trademark Office

# bullman

**Reg. No. 4,136,351**

**Registered May 1, 2012**

**Int. Cl.: 25**

**TRADEMARK**

**PRINCIPAL REGISTER**

WALTERS, SHAWN T. (UNITED STATES INDIVIDUAL)  
10209 WILL ALLMAN ROAD  
GEORGETOWN, OH 45121

FOR: HATS; T-SHIRTS, IN CLASS 25 (U.S. CLS. 22 AND 39).

FIRST USE 2-24-2012; IN COMMERCE 2-24-2012.

THE MARK CONSISTS OF STANDARD CHARACTERS WITHOUT CLAIM TO ANY PARTICULAR FONT, STYLE, SIZE, OR COLOR.

SN 85-165,759, FILED 11-1-2010.

COURTNEY ALVAREZ, EXAMINING ATTORNEY



*David J. Kybas*

Director of the United States Patent and Trademark Office



# United States of America

United States Patent and Trademark Office

# CLOUDPOD

**Reg. No. 4,136,352**

**Registered May 1, 2012**

**Int. Cl.: 37**

**SERVICE MARK**

**PRINCIPAL REGISTER**

CANVAS SYSTEMS, LLC (GEORGIA LIMITED LIABILITY COMPANY)  
3025 NORTHWOODS PARKWAY  
NORCROSS, GA 30071

FOR: INSTALLATION, MAINTENANCE AND REPAIR OF COMPUTER HARDWARE, NONE OF THE FOREGOING RELATED TO PORTABLE AND HANDHELD DIGITAL ELECTRONIC DEVICES AND SOFTWARE THEREFOR FOR RECORDING, ORGANIZING, TRANSMITTING, MANIPULATING, AND REVIEWING TEXT, DATA, AUDIO, IMAGE AND VIDEO FILES, IN CLASS 37 (U.S. CLS. 100, 103 AND 106).

FIRST USE 7-27-2010; IN COMMERCE 7-27-2010.

THE MARK CONSISTS OF STANDARD CHARACTERS WITHOUT CLAIM TO ANY PARTICULAR FONT, STYLE, SIZE, OR COLOR.

SN 85-165,812, FILED 11-1-2010.

LINDSEY RUBIN, EXAMINING ATTORNEY



*David J. Kyffers*

Director of the United States Patent and Trademark Office

# United States of America

United States Patent and Trademark Office

## CABLE MANAGEMENT. YOUR WAY. A CLICK AWAY.

**Reg. No. 4,136,353**

**Registered May 1, 2012**

**Int. Cl.: 35**

**SERVICE MARK**

**PRINCIPAL REGISTER**

CABLEORGANIZER.COM, INC. (FLORIDA CORPORATION)  
6250 NW 27TH WAY  
FORT LAUDERDALE, FL 33309

FOR: ONLINE RETAIL STORE SERVICES FEATURING ACCESSORIES FOR WIRES AND CABLES, NAMELY, CABLE CLIPS, CORD COVERS, SURFACE RACEWAYS, CABLE TIES AND WRAPS, CABLE SLEEVES, IN CLASS 35 (U.S. CLS. 100, 101 AND 102).

FIRST USE 12-1-2010; IN COMMERCE 12-1-2010.

THE MARK CONSISTS OF STANDARD CHARACTERS WITHOUT CLAIM TO ANY PARTICULAR FONT, STYLE, SIZE, OR COLOR.

NO CLAIM IS MADE TO THE EXCLUSIVE RIGHT TO USE "CABLE MANAGEMENT", APART FROM THE MARK AS SHOWN.

SN 85-166,040, FILED 11-1-2010.

JANICE KIM, EXAMINING ATTORNEY



*David J. Kybas*

Director of the United States Patent and Trademark Office

# United States of America

United States Patent and Trademark Office

# VANBOR

**Reg. No. 4,136,354**

TAMBOR LLC (VIRGINIA LIMITED LIABILITY COMPANY)  
PMB 220  
LYNCHBURG, VA 24503

**Registered May 1, 2012**

**Int. Cl.: 18**

FOR: BRIEFCASES; CREDIT CARD CASES; LUGGAGE; MESSENGER BAGS, IN CLASS 18 (U.S. CLS. 1, 2, 3, 22 AND 41).

**TRADEMARK**

FIRST USE 6-1-2011; IN COMMERCE 8-1-2011.

**PRINCIPAL REGISTER**

THE MARK CONSISTS OF STANDARD CHARACTERS WITHOUT CLAIM TO ANY PARTICULAR FONT, STYLE, SIZE, OR COLOR.

SN 85-166,094, FILED 11-1-2010.

BRIDGETT SMITH, EXAMINING ATTORNEY



*David J. Kyros*

Director of the United States Patent and Trademark Office

# United States of America

United States Patent and Trademark Office

## SPEED FREAK

**Reg. No. 4,136,355**

**Registered May 1, 2012**

**Int. Cl.: 28**

**TRADEMARK**

**PRINCIPAL REGISTER**

EASTMAN OUTDOORS, INC. (MICHIGAN CORPORATION)  
3476 EASTMAN DRIVE  
FLUSHING, MI 48433

FOR: ARCHERY ARROWS, IN CLASS 28 (U.S. CLS. 22, 23, 38 AND 50).

FIRST USE 8-31-2010; IN COMMERCE 8-31-2010.

THE MARK CONSISTS OF STANDARD CHARACTERS WITHOUT CLAIM TO ANY PARTICULAR FONT, STYLE, SIZE, OR COLOR.

SN 85-166,209, FILED 11-1-2010.

JAMES LOVELACE, EXAMINING ATTORNEY



*David J. Kybas*

Director of the United States Patent and Trademark Office

# United States of America

United States Patent and Trademark Office

# Ogilvy Noor

**Reg. No. 4,136,356**

**Registered May 1, 2012**

**Int. Cl.: 35**

**SERVICE MARK**

**PRINCIPAL REGISTER**

WPP PROPERTIES (DELAWARE PARTNERSHIP)  
100 PARK AVENUE  
NEW YORK, NY 10017

FOR: BUSINESS MARKETING CONSULTING SERVICES IN THE FIELD OF MARKETING TO MUSLIM CONSUMERS; MARKET RESEARCH AND ANALYSIS IN THE FIELD OF MARKETING TO MUSLIM CONSUMERS; ADVERTISING AGENCY SERVICES TARGETED TO MUSLIM CONSUMERS; BRAND DEVELOPMENT AND BRAND MARKETING SERVICES IN THE FIELD OF MARKETING TO MUSLIM CONSUMERS; PUBLIC RELATIONS SERVICES; MEDIA RESEARCH AND CONSULTATION SERVICES; PLANNING, BUYING AND NEGOTIATING ADVERTISING AND MEDIA SPACE AND MEDIA TIME; ADVERTISING AND PROMOTIONAL SERVICES, NAMELY, PREPARING AND PLACING ADVERTISEMENT FOR OTHERS; INTERACTIVE AND DIGITAL ADVERTISING SERVICES; EMAIL MARKETING; DIRECT MARKETING ADVERTISING SERVICES, IN CLASS 35 (U.S. CLS. 100, 101 AND 102).

FIRST USE 5-0-2010; IN COMMERCE 10-30-2010.

THE MARK CONSISTS OF STANDARD CHARACTERS WITHOUT CLAIM TO ANY PARTICULAR FONT, STYLE, SIZE, OR COLOR.

OWNER OF U.S. REG. NOS. 2,544,073 AND 3,366,964.

THE ENGLISH TRANSLATION OF "NOOR" IN THE MARK IS "LIGHT".

SN 85-166,272, FILED 11-1-2010.

BRIAN NEVILLE, EXAMINING ATTORNEY



*David J. Kybas*

Director of the United States Patent and Trademark Office

# United States of America

United States Patent and Trademark Office

# hosPETality

**Reg. No. 4,136,357**

**Registered May 1, 2012**

**Int. Cl.: 43**

**SERVICE MARK**

**PRINCIPAL REGISTER**

KIMPTON HOTEL & RESTAURANT GROUP, LLC (DELAWARE LIMITED LIABILITY COMPANY)  
SUITE 200  
ATTN: LEILA AHLSTROM, 222 KEARNY STREET  
SAN FRANCISCO, CA 94108

FOR: PET BOARDING SERVICES PROVIDED AS A FEATURE OF HOTEL SERVICES, IN CLASS 43 (U.S. CLS. 100 AND 101).

FIRST USE 7-15-2010; IN COMMERCE 7-15-2010.

THE MARK CONSISTS OF THE WORD "HOSPETALITY" WHERE THE LETTERS "PET" ARE CAPITALIZED.

SN 85-167,861, FILED 11-3-2010.

JACLYN KIDWELL WALKER, EXAMINING ATTORNEY



*David J. Kyffers*

Director of the United States Patent and Trademark Office

# United States of America

United States Patent and Trademark Office

## GRILL ASSURE

**Reg. No. 4,136,358**

**Registered May 1, 2012**

**Int. Cl.: 30**

**TRADEMARK**

**PRINCIPAL REGISTER**

QUALITY INGREDIENTS CORPORATION (MINNESOTA CORPORATION)  
14300 ROSEMOUNT DRIVE  
BURNSVILLE, MN 55306

FOR: DRY INGREDIENTS FOR HUMAN FOOD, NAMELY, ANIMAL OR VEGETABLE FAT POWDER FOR USE IN THE MANUFACTURE OF SEASONINGS, IN CLASS 30 (U.S. CL. 46).

FIRST USE 12-7-2010; IN COMMERCE 12-7-2010.

THE MARK CONSISTS OF STANDARD CHARACTERS WITHOUT CLAIM TO ANY PARTICULAR FONT, STYLE, SIZE, OR COLOR.

NO CLAIM IS MADE TO THE EXCLUSIVE RIGHT TO USE "GRILL", APART FROM THE MARK AS SHOWN.

SN 85-167,985, FILED 11-3-2010.

CAROLINE WOOD, EXAMINING ATTORNEY



*David J. Kyffers*

Director of the United States Patent and Trademark Office

# United States of America

United States Patent and Trademark Office

## TASTE ENDURE

**Reg. No. 4,136,359**

**Registered May 1, 2012**

**Int. Cl.: 30**

**TRADEMARK**

**PRINCIPAL REGISTER**

QUALITY INGREDIENTS CORPORATION (MINNESOTA CORPORATION)  
14300 ROSEMOUNT DRIVE  
BURNSVILLE, MN 55306

FOR: DRY INGREDIENTS FOR HUMAN FOOD, NAMELY, ANIMAL OR VEGETABLE FAT POWDER FOR USE IN THE MANUFACTURE OF BAKING AND FRIED FOOD BATTERS, IN CLASS 30 (U.S. CL. 46).

FIRST USE 3-31-2011; IN COMMERCE 3-31-2011.

THE MARK CONSISTS OF STANDARD CHARACTERS WITHOUT CLAIM TO ANY PARTICULAR FONT, STYLE, SIZE, OR COLOR.

SN 85-167,987, FILED 11-3-2010.

CAROLINE WOOD, EXAMINING ATTORNEY



*David J. Kybas*

Director of the United States Patent and Trademark Office



# United States of America

## United States Patent and Trademark Office



**Reg. No. 4,136,360**

**Registered May 1, 2012**

**Int. Cls.: 21 and 25**

**TRADEMARK**

**PRINCIPAL REGISTER**

JONATHON WYE, L.L.C. (D.C. LIMITED LIABILITY COMPANY)  
723 INDEPENDENCE AVE SE  
WASHINGTON, DC 20003

FOR: COOKWARE, NAMELY, MICROWAVE SAFE PLATES AND OVEN SAFE PLATES; HOUSEHOLD UTENSILS, NAMELY, SPATULAS; TRAYS FOR DOMESTIC PURPOSES; MICROWAVE SAFE BOWLS, OVEN SAFE BOWLS, MIXING BOWLS, AND RINSING BOWLS; KITCHEN LADLES; SERVING LADLES; POTS; PANS; COOKIE SHEETS; WHISKS; NON-ELECTRIC FOOD MIXERS; AND DUTCH OVENS; UTENSILS FOR BARBECUES, NAMELY, FORKS, TONGS, AND TURNERS; HOUSEHOLD UTENSILS, NAMELY, KITCHEN TONGS, IN CLASS 21 (U.S. CLS. 2, 13, 23, 29, 30, 33, 40 AND 50).

FIRST USE 12-1-2011; IN COMMERCE 12-1-2011.

FOR: CLOTHING, NAMELY, SHIRTS; T-SHIRTS; PANTS; SHORTS; SHOES; BELTS; BELTS FOR CLOTHING; BELTS MADE OF LEATHER; BELTS MADE OUT OF CLOTHS; BELTS MADE FROM IMITATION LEATHER; APRONS, IN CLASS 25 (U.S. CLS. 22 AND 39).

FIRST USE 3-8-2009; IN COMMERCE 3-8-2009.

THE MARK CONSISTS OF A SKULL AND CROSSBONES WITH A SPATULA AND WHISK AS THE CROSSBONES AND A CHEF'S HAT ON THE SKULL.

SN 85-168,151, FILED 11-3-2010.

TINA MAI, EXAMINING ATTORNEY



*David J. Kybas*

Director of the United States Patent and Trademark Office

# United States of America

United States Patent and Trademark Office



**Reg. No. 4,136,361**

**Registered May 1, 2012**

**Int. Cls.: 30, 35, 40, and 42**

**TRADEMARK**

**SERVICE MARK**

**PRINCIPAL REGISTER**

DAIRY HOUSE COMPANY (MISSOURI CORPORATION)  
150 LARKIN WILLIAMS INDUSTRIAL COURT  
FENTON, MO 63026

FOR: FLAVORINGS FOR FOODS, FOODSTUFFS AND BEVERAGES; NON-NUTRITIONAL FLAVORING ADDITIVES FOR USE IN FOODS AND BEVERAGES; FOOD ADDITIVES FOR NON-NUTRITIONAL PURPOSES FOR USE AS A FLAVORING; INGREDIENTS FOR CREATING AND ENHANCING THE FEEL, TASTE, AROMA AND TEXTURE OF FOOD, FOODSTUFFS AND BEVERAGES, NAMELY, FOOD STARCH, SUGAR AND OTHER NATURAL SWEETENERS, THICKENING AGENTS FOR FOODSTUFFS FOR USE IN COOKING, WHEAT FLOUR AND FLAVORED GELATINS, IN CLASS 30 (U.S. CL. 46).

FIRST USE 10-1-2010; IN COMMERCE 10-1-2010.

FOR: ADVERTISING AND MARKETING; DEVELOPMENT OF MARKETING STRATEGIES AND CONCEPTS IN THE FIELD OF NEW FLAVORS, FLAVORING PRODUCTS, INGREDIENTS AND COMPOSITIONS THEREOF; CONCEPT AND BRAND DEVELOPMENT IN THE FIELD OF NEW FLAVORS, FLAVORING PRODUCTS, INGREDIENTS AND COMPOSITIONS THEREOF, IN CLASS 35 (U.S. CLS. 100, 101 AND 102).

FIRST USE 10-1-2010; IN COMMERCE 10-1-2010.

FOR: MANUFACTURE OF BEVERAGE CONTAINERS TO THE ORDER AND SPECIFICATION OF OTHERS; FILLING OF BEVERAGE CONTAINERS AS PART OF A MANUFACTURING PROCESS TO THE ORDER AND SPECIFICATION OF OTHERS; TECHNICAL CONSULTATION SERVICES, NAMELY, PROVIDING TECHNICAL ADVICE RELATED TO THE MANUFACTURE OF FOODS, BEVERAGES, FLAVORINGS AND DIETARY SUPPLEMENTS FOR FOODS AND BEVERAGES, IN CLASS 40 (U.S. CLS. 100, 103 AND 106).

FIRST USE 10-1-2010; IN COMMERCE 10-1-2010.

FOR: RESEARCH AND DEVELOPMENT FOR THE FOOD INGREDIENT AND FOOD INDUSTRY; FOOD RESEARCH; RESEARCH AND DEVELOPMENT OF FOOD PRODUCTS, BEVERAGES, FLAVORINGS, EMULSIFIERS, HYDROCOLLOIDS AND OTHER FUNCTIONAL FOOD AND BEVERAGE INGREDIENTS; RESEARCH ON FOOD; TESTING, INSPECTION, OR RESEARCH OF FOODSTUFF; TECHNOLOGY CONSULTATION AND RESEARCH IN THE FIELD OF FLAVORS, COLORANTS, NUTRACEUTICALS, AND FOOD INGREDIENTS;



*David J. Kyros*

Director of the United States Patent and Trademark Office

**Reg. No. 4,136,361** SCIENTIFIC RESEARCH AND DEVELOPMENT; SCIENTIFIC CONSULTATION RELATING TO FOODS AND SCIENTIFIC TESTING OF FOODSTUFF; RESEARCH AND DEVELOPMENT FOR NEW PRODUCTS FOR OTHERS; SCIENTIFIC AND TECHNOLOGICAL SERVICES, NAMELY, SCIENTIFIC CONSULTATION, RESEARCH, ANALYSIS AND SELECTION IN THE FIELD OF FOOD, BEVERAGE AND FLAVORING TECHNOLOGY; SCIENTIFIC AND TECHNOLOGICAL SERVICES, NAMELY, SERVICES FOR THE DESIGN AND DEVELOPMENT OF TECHNOLOGIES AND TECHNICAL COMPONENTS FOR THE FOOD, BEVERAGE AND DRINK PROCESSING AND PRODUCING INDUSTRY; PROFESSIONAL TECHNICAL CONSULTANCY IN RELATION TO THE DEVELOPMENT OF TECHNOLOGIES IN THE FIELDS OF FOOD AND BEVERAGE TECHNOLOGY; SCIENTIFIC CONSULTANCY AND ADVISORY SERVICES RELATING TO THE SCIENTIFIC ANALYSIS AND DEVELOPMENT OF DIETARY SUPPLEMENTS FOR FOOD AND BEVERAGES, IN CLASS 42 (U.S. CLS. 100 AND 101).

FIRST USE 10-1-2010; IN COMMERCE 10-1-2010.

OWNER OF U.S. REG. NO. 2,226,671.

NO CLAIM IS MADE TO THE EXCLUSIVE RIGHT TO USE "DAIRY", APART FROM THE MARK AS SHOWN.

THE MARK CONSISTS OF THE WORD "DAIRY" UNDERLINED FOLLOWED BY A DESIGN OF A BARN AND SILO WITHIN A CIRCLE FOLLOWED BY THE WORD "HOUSE" UNDERLINED.

SN 85-168,476, FILED 11-3-2010.

KRISTIN CARLSON, EXAMINING ATTORNEY

# United States of America

United States Patent and Trademark Office



**Reg. No. 4,136,362**

**Registered May 1, 2012**

**Int. Cl.: 35**

**SERVICE MARK**

**PRINCIPAL REGISTER**

SHELL FOUNDATION (UNITED KINGDOM CORPORATION)  
SHELL CENTRE SE1 7NA  
LONDON, UNITED KINGDOM

FOR: BUSINESS MANAGEMENT ADVICE; BUSINESS PROMOTION SERVICES, NAMELY, IMPLEMENTING BUSINESS PROMOTIONAL AND ADVERTISING CAMPAIGNS FOR BUSINESSES; BUSINESS ASSISTANCE; BUSINESS CONSULTANCY FOR PRODUCT SUPPLY SECURITY, NEW BUSINESS OPPORTUNITIES AND CONSUMER COMMUNICATION; ALL OF THE FOREGOING PROVIDED FOR COTTON GROWERS, MANUFACTURERS AND RETAILERS OF COTTON GOODS, IN CLASS 35 (U.S. CLS. 100, 101 AND 102).

FIRST USE 6-30-2010; IN COMMERCE 6-30-2010.

THE MARK CONSISTS OF THE WORDING "COTTONCONNECT" IN BLUE WITH THE "C" OF "COTTON" AND THE "C" OF "CONNECT" IN CAPITAL LETTERS WHILE THE REMAINING LETTERS ARE IN A LOWER CASE FONT. FOUR CONCENTRIC HALF CIRCLES, EACH HALF CIRCLE A DIFFERENT SHADE OF BLUE, ARE ARRANGED TO RESEMBLE A COTTON BALL AND ARE SITUATED DIRECTLY ABOVE THE WORDING "COTTONCONNECT".

THE COLOR(S) BLUE IS/ARE CLAIMED AS A FEATURE OF THE MARK.

SN 85-168,519, FILED 11-3-2010.

MEGHAN REINHART, EXAMINING ATTORNEY



*David J. Kyjars*

Director of the United States Patent and Trademark Office

# United States of America

United States Patent and Trademark Office

## ABOVEBOARDS

**Reg. No. 4,136,363**

**Registered May 1, 2012**

**Int. Cl.: 42**

**SERVICE MARK**

**PRINCIPAL REGISTER**

ABOVEBOARDS (OHIO LIMITED LIABILITY COMPANY)  
6995 RIEBER ST.  
WORTHINGTON, OH 43085

FOR: GRAPHIC ILLUSTRATION SERVICES FOR OTHERS, NAMELY, PROVIDING STORYBOARD ILLUSTRATIONS TO HELP ADVERTISING AGENCIES SELL THEIR IDEAS TO THEIR CLIENTS ON A CONTRACT BASIS ACCORDING TO CLIENT SPECIFICATIONS, AND PROVIDING CONCEPT ILLUSTRATIONS ON A CONTRACT BASIS ACCORDING TO CLIENT SPECIFICATIONS PRIMARILY FOR ADVERTISING AGENCIES, IN CLASS 42 (U.S. CLS. 100 AND 101).

FIRST USE 12-1-2010; IN COMMERCE 12-1-2010.

THE MARK CONSISTS OF STANDARD CHARACTERS WITHOUT CLAIM TO ANY PARTICULAR FONT, STYLE, SIZE, OR COLOR.

SN 85-168,672, FILED 11-3-2010.

LAURA HAMMEL, EXAMINING ATTORNEY



*David J. Kyffers*

Director of the United States Patent and Trademark Office

# United States of America

United States Patent and Trademark Office

## TREE SPIDER

**Reg. No. 4,136,364**

**Registered May 1, 2012**

**Int. Cl.: 9**

**TRADEMARK**

**PRINCIPAL REGISTER**

SPIDER PRODUCTS, LLC (DELAWARE LIMITED LIABILITY COMPANY)  
110 NORTH PARK DRIVE  
CANNON FALLS, MN 55009

FOR: FALL PROTECTION EQUIPMENT FOR FALL RESTRAINT AND FALL ARREST, NAMELY, HARNESES, VESTS, TREE TETHERS, LINEMAN BELTS, SUSPENSION RELIEF DEVICES, AND CONTROLLED DESCENT DEVICES, IN CLASS 9 (U.S. CLS. 21, 23, 26, 36 AND 38).

FIRST USE 10-15-2010; IN COMMERCE 6-7-2011.

THE MARK CONSISTS OF STANDARD CHARACTERS WITHOUT CLAIM TO ANY PARTICULAR FONT, STYLE, SIZE, OR COLOR.

SN 85-168,840, FILED 11-4-2010.

DORITT L. CARROLL, EXAMINING ATTORNEY



*David J. Kybas*

Director of the United States Patent and Trademark Office

# United States of America

United States Patent and Trademark Office

## TAKING PACKAGING TO A NEW HIGH

**Reg. No. 4,136,365**

NEW HIGH GLASS (FLORIDA CORPORATION)  
12713 S.W. 125TH AVENUE  
MIAMI, FL 33186

**Registered May 1, 2012**

**Int. Cl.: 21**

FOR: GLASS CONTAINERS FOR NAIL POLISH, AND COSMETICS, SOLD EMPTY, IN CLASS 21 (U.S. CLS. 2, 13, 23, 29, 30, 33, 40 AND 50).

**TRADEMARK**

FIRST USE 1-23-2012; IN COMMERCE 1-23-2012.

**PRINCIPAL REGISTER**

THE MARK CONSISTS OF STANDARD CHARACTERS WITHOUT CLAIM TO ANY PARTICULAR FONT, STYLE, SIZE, OR COLOR.

SN 85-168,841, FILED 11-4-2010.

LINDSEY RUBIN, EXAMINING ATTORNEY



*David J. Kybas*

Director of the United States Patent and Trademark Office

# United States of America

United States Patent and Trademark Office

## KEEPING THE WORLD SAFE FROM UGLY PACKAGING

**Reg. No. 4,136,366**

NEW HIGH GLASS (FLORIDA CORPORATION)  
12713 S.W. 125TH AVENUE  
MIAMI, FL 33186

**Registered May 1, 2012**

**Int. Cl.: 21**

FOR: GLASS CONTAINERS FOR NAIL POLISH, AND COSMETICS, SOLD EMPTY, IN CLASS 21 (U.S. CLS. 2, 13, 23, 29, 30, 33, 40 AND 50).

**TRADEMARK**

FIRST USE 1-23-2012; IN COMMERCE 1-23-2012.

**PRINCIPAL REGISTER**

THE MARK CONSISTS OF STANDARD CHARACTERS WITHOUT CLAIM TO ANY PARTICULAR FONT, STYLE, SIZE, OR COLOR.

SN 85-168,856, FILED 11-4-2010.

LINDSEY RUBIN, EXAMINING ATTORNEY



*David J. Kybas*

Director of the United States Patent and Trademark Office



# United States of America

United States Patent and Trademark Office

## BISTRO BOBETTE

**Reg. No. 4,136,367**

**Registered May 1, 2012**

**Int. Cl.: 43**

**SERVICE MARK**

**PRINCIPAL REGISTER**

FRENDY, LLC (VIRGINIA LIMITED LIABILITY COMPANY), DBA BISTRO BOBETTE,  
7 E 2ND STREET  
RICHMOND, VA 23224

FOR: RESTAURANT, BAR AND CATERING SERVICES; TAKE-OUT RESTAURANT SERVICES, IN CLASS 43 (U.S. CLS. 100 AND 101).

FIRST USE 1-0-2011; IN COMMERCE 1-0-2011.

THE MARK CONSISTS OF STANDARD CHARACTERS WITHOUT CLAIM TO ANY PARTICULAR FONT, STYLE, SIZE, OR COLOR.

NO CLAIM IS MADE TO THE EXCLUSIVE RIGHT TO USE "BISTRO", APART FROM THE MARK AS SHOWN.

SN 85-169,375, FILED 11-4-2010.

RENEE MCCRAY, EXAMINING ATTORNEY



*David J. Kybas*

Director of the United States Patent and Trademark Office

# United States of America

United States Patent and Trademark Office

# Medature

**Reg. No. 4,136,368**

**Registered May 1, 2012**

**Int. Cl.: 3**

**TRADEMARK**

**PRINCIPAL REGISTER**

BIO GROUP (CALIFORNIA LIMITED LIABILITY COMPANY)  
13765 LINDAMERE LN  
SAN DIEGO, CA 92128

FOR: BEAUTY SERUMS; BLUSH; BODY LOTION; BODY SCRUB; EXFOLIANT CREAMS; EYE CREAM; EYELINER; EYESHADOW; FOUNDATION; FRAGRANCES; HAND CREAM; LIPSTICK; MASCARA; NAIL CARE PREPARATIONS; NON-MEDICATED LIP CARE PREPARATIONS; PERFUMES; PRESSED FACE POWDER; SKIN CLEANSERS; SKIN MOISTURIZER; SKIN TONERS; SUN-BLOCK LOTIONS, IN CLASS 3 (U.S. CLS. 1, 4, 6, 50, 51 AND 52).

FIRST USE 9-15-2011; IN COMMERCE 9-15-2011.

THE MARK CONSISTS OF STANDARD CHARACTERS WITHOUT CLAIM TO ANY PARTICULAR FONT, STYLE, SIZE, OR COLOR.

SN 85-170,586, FILED 11-5-2010.

JEFFREY LOOK, EXAMINING ATTORNEY



*David J. Kypos*

Director of the United States Patent and Trademark Office

# United States of America

United States Patent and Trademark Office



Green Bay Hand Center  

---

BAYCARE CLINIC

**Reg. No. 4,136,369**

**Registered May 1, 2012**

**Int. Cl.: 44**

**SERVICE MARK**

**PRINCIPAL REGISTER**

BAYCARE HEALTH SYSTEMS LLC (WISCONSIN LIMITED LIABILITY COMPANY)  
164 N. BROADWAY  
GREEN BAY, WI 54303

FOR: HEALTH CARE SERVICES, NAMELY, MEDICAL DIAGNOSIS, PHYSICAL THERAPY, MASSAGE THERAPY AND SURGERY AND MEDICAL TREATMENT FOR HANDS AND OTHER UPPER EXTREMITIES, IN CLASS 44 (U.S. CLS. 100 AND 101).

FIRST USE 9-16-2010; IN COMMERCE 9-16-2010.

OWNER OF U.S. REG. NOS. 2,793,431 AND 2,826,810.

THE COLOR(S) LIGHT GREEN, LIGHT BLUE, TAN, BLACK AND WHITE IS/ARE CLAIMED AS A FEATURE OF THE MARK.

NO CLAIM IS MADE TO THE EXCLUSIVE RIGHT TO USE "GREEN BAY HAND CENTER" AND "CLINIC", APART FROM THE MARK AS SHOWN.

THE MARK CONSISTS OF A LIGHT GREEN CROSS WITH A WHITE BORDER AND A THIN BLACK OUTLINE. WITHIN THE CROSS ARE THREE OVERLAPPING HAND SHAPES, WITH THE TAN HAND BEHIND, THE LIGHT BLUE HAND OVERLAPPING THAT, AND A SMALLER WHITE HAND IN FRONT. TO THE RIGHT OF THIS IS THE WORDING "GREEN BAY HAND CENTER" IN BLACK OVER A BLACK HORIZONTAL LINE, BENEATH WHICH IS THE WORDING "BAYCARE CLINIC" ALSO IN BLACK.

SN 85-170,646, FILED 11-5-2010.

FRED CARL, EXAMINING ATTORNEY



*David J. Kyjars*

Director of the United States Patent and Trademark Office

# United States of America

United States Patent and Trademark Office

# plan4solar

**Reg. No. 4,136,370**

**Registered May 1, 2012**

**Int. Cl.: 9**

**TRADEMARK**

**PRINCIPAL REGISTER**

GASCAD 3D TECHNOLOGIE (AUSTRIA GMBH)  
DURISOLSTR 7  
WELLS, AUSTRIA A-4600

FOR: COMPUTER SOFTWARE FOR 3D CONFIGURATION AND SIMULATION OF THERMODYNAMICS, BIO MASS, POWER STATIONS, AND RENEWABLE ENERGY, IN CLASS 9 (U.S. CLS. 21, 23, 26, 36 AND 38).

FIRST USE 1-1-2009; IN COMMERCE 1-1-2009.

THE MARK CONSISTS OF THE TERM "PLAN4" IN GRAY AND THE TERM "SOLAR" IN BURGUNDY RED.

THE COLOR(S) GRAY AND BURGUNDY RED IS/ARE CLAIMED AS A FEATURE OF THE MARK.

SN 85-170,890, FILED 11-6-2010.

AMY HELLA, EXAMINING ATTORNEY



*David J. Kyffers*

Director of the United States Patent and Trademark Office

# United States of America

United States Patent and Trademark Office

# ICEY-TEK

**Reg. No. 4,136,371**

**Registered May 1, 2012**

**Int. Cl.: 21**

**TRADEMARK**

**PRINCIPAL REGISTER**

ICEY-TEK PTY. LTD. (BANGLADESH CORPORATION)  
4/38 OURIMBAH RD  
TWEED HEADS, NSW, AUSTRALIA

FOR: PORTABLE COOLERS, IN CLASS 21 (U.S. CLS. 2, 13, 23, 29, 30, 33, 40 AND 50).

FIRST USE 10-31-2011; IN COMMERCE 10-31-2011.

THE MARK CONSISTS OF STANDARD CHARACTERS WITHOUT CLAIM TO ANY PARTICULAR FONT, STYLE, SIZE, OR COLOR.

SN 85-170,891, FILED 11-6-2010.

MICHAEL ENGEL, EXAMINING ATTORNEY



*David J. Kyffers*

Director of the United States Patent and Trademark Office

# United States of America

United States Patent and Trademark Office

## THE FOLIO SOCIETY

**Reg. No. 4,136,372**

**Registered May 1, 2012**

**Int. Cls.: 16 and 41**

**TRADEMARK**

**SERVICE MARK**

**PRINCIPAL REGISTER**

THE FOLIO SOCIETY LIMITED (UNITED KINGDOM CORPORATION)  
44 EAGLE STREET  
LONDON, UNITED KINGDOM WC1R4FS

FOR: BOOKS, NAMELY, FICTION BOOKS, CHILDREN'S BOOKS AND NON-FICTION BOOKS IN THE FIELDS OF ART, MUSIC, BIOGRAPHY, FOOD AND WINE, GARDENING, HISTORY, HUMOR, LANGUAGE, MYTHS AND LEGENDS, PHILOSOPHY, POLITICS AND SOCIAL THOUGHT, POETRY, DRAMA, REFERENCE BOOKS, RELIGION, SCIENCE, NATURAL HISTORY, TRAVEL AND EXPLORATION, IN CLASS 16 (U.S. CLS. 2, 5, 22, 23, 29, 37, 38 AND 50).

FIRST USE 0-0-1947; IN COMMERCE 0-0-1986.

FOR: PUBLISHING OF BOOKS, IN CLASS 41 (U.S. CLS. 100, 101 AND 107).

FIRST USE 0-0-1947; IN COMMERCE 0-0-1986.

THE MARK CONSISTS OF STANDARD CHARACTERS WITHOUT CLAIM TO ANY PARTICULAR FONT, STYLE, SIZE, OR COLOR.

SN 85-171,297, FILED 11-8-2010.

JIM RINGLE, EXAMINING ATTORNEY



*David J. Kybas*

Director of the United States Patent and Trademark Office

# United States of America

United States Patent and Trademark Office

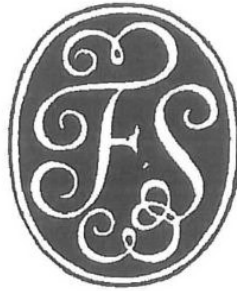

**Reg. No. 4,136,373**

**Registered May 1, 2012**

**Int. Cls.: 16 and 41**

**TRADEMARK**

**SERVICE MARK**

**PRINCIPAL REGISTER**

THE FOLIO SOCIETY LIMITED (UNITED KINGDOM CORPORATION)  
44 EAGLE STREET  
LONDON, UNITED KINGDOM WC1R4FS

FOR: BOOKS, NAMELY, FICTION BOOKS, CHILDREN'S BOOKS AND NON-FICTION BOOKS IN THE FIELDS OF ART, MUSIC, BIOGRAPHY, FOOD AND WINE, GARDENING, HISTORY, HUMOR, LANGUAGE, MYTHS AND LEGENDS, PHILOSOPHY, POLITICS AND SOCIAL THOUGHT, POETRY, DRAMA, REFERENCE BOOKS, RELIGION, SCIENCE, NATURAL HISTORY, TRAVEL AND EXPLORATION, IN CLASS 16 (U.S. CLS. 2, 5, 22, 23, 29, 37, 38 AND 50).

FIRST USE 0-0-1947; IN COMMERCE 0-0-1986.

FOR: PUBLISHING OF BOOKS, IN CLASS 41 (U.S. CLS. 100, 101 AND 107).

FIRST USE 0-0-1947; IN COMMERCE 0-0-1986.

THE MARK CONSISTS OF THE LETTERS "FS" IN STYLIZED PRINT WITHIN AN OVAL DESIGN.

SN 85-171,309, FILED 11-8-2010.

JIM RINGLE, EXAMINING ATTORNEY



*David J. Kybas*

Director of the United States Patent and Trademark Office

# United States of America

United States Patent and Trademark Office

## SOLAR WAVE

**Reg. No. 4,136,374**

HEALEY, ROBERT (UNITED STATES INDIVIDUAL)  
5 MARLENE DRIVE  
WILLIAMSBURG, OH 45176

**Registered May 1, 2012**

**Int. Cl.: 9**

FOR: ELECTRICAL APPARATUS, NAMELY, SOLAR-POWERED BATTERY CHARGERS FOR HANDHELD ELECTRONICS, GAMING DEVICES, LAPTOP COMPUTERS, WIRELESS COMMUNICATION DEVICES, AND OTHER BATTERY OPERATED HANDHELD DEVICES, IN CLASS 9 (U.S. CLS. 21, 23, 26, 36 AND 38).

**TRADEMARK**

**PRINCIPAL REGISTER**

FIRST USE 5-9-2011; IN COMMERCE 12-10-2011.

THE MARK CONSISTS OF STANDARD CHARACTERS WITHOUT CLAIM TO ANY PARTICULAR FONT, STYLE, SIZE, OR COLOR.

NO CLAIM IS MADE TO THE EXCLUSIVE RIGHT TO USE "SOLAR", APART FROM THE MARK AS SHOWN.

SN 85-172,099, FILED 11-9-2010.

MARK SPARACINO, EXAMINING ATTORNEY



*David J. Kyros*

Director of the United States Patent and Trademark Office



# United States of America

United States Patent and Trademark Office

# BOUNCE

**Reg. No. 4,136,375**

**Registered May 1, 2012**

**Int. Cl.: 41**

**SERVICE MARK**

**PRINCIPAL REGISTER**

BOUNCE HOLDINGS, LLC (GEORGIA LIMITED LIABILITY COMPANY)  
600 GALLERIA PARKWAY  
SUITE 1900  
ATLANTA, GA 30339

FOR: ENTERTAINMENT SERVICES IN THE NATURE OF DEVELOPMENT, PRODUCTION, AND DISTRIBUTION OF MOVIES, ON-GOING TELEVISION PROGRAMS, ON-GOING TELEVISION SERIES AND ON-GOING INTERSTITIAL TELEVISION PROGRAM SEGMENTS FEATURING MOVIES AND TELEVISION PROGRAMMING IN THE FIELD OF COMEDY, DRAMA, SPORTS, ACTION, OR ADVENTURE, PROVIDED THROUGH BROADCAST AND CABLE TELEVISION AND VIA GLOBAL COMPUTER NETWORKS; TELEVISION SHOW PRODUCTION SERVICES; DISTRIBUTION OF TELEVISION PROGRAMMING; PROVIDING ON-LINE INFORMATION IN THE FIELD OF ENTERTAINMENT, IN CLASS 41 (U.S. CLS. 100, 101 AND 107).

FIRST USE 9-26-2011; IN COMMERCE 9-26-2011.

THE MARK CONSISTS OF STANDARD CHARACTERS WITHOUT CLAIM TO ANY PARTICULAR FONT, STYLE, SIZE, OR COLOR.

SN 85-172,242, FILED 11-9-2010.

LINDA MICKLEBURGH, EXAMINING ATTORNEY



*David J. Kyros*

Director of the United States Patent and Trademark Office

# United States of America

United States Patent and Trademark Office

# TC3000

**Reg. No. 4,136,376**

**Registered May 1, 2012**

**Int. Cl.: 10**

**TRADEMARK**

**PRINCIPAL REGISTER**

VEINWAVE LIMITED (UNITED KINGDOM CORPORATION)  
NEWLANDS MEDICAL CENTRE  
315 CHORLEY NEW ROAD  
BOLTON, UNITED KINGDOM BL15BP

FOR: MEDICAL DEVICES, NAMELY, ELECTROSURGICAL COAGULATION DEVICES  
USED FOR THE TREATMENT OF VASCULAR BLEMISHES, SPIDER VEINS, SKIN TAGS  
AND OTHER COSMETIC SKIN CONDITIONS, IN CLASS 10 (U.S. CLS. 26, 39 AND 44).

FIRST USE 0-0-2008; IN COMMERCE 0-0-2008.

THE MARK CONSISTS OF STANDARD CHARACTERS WITHOUT CLAIM TO ANY PAR-  
TICULAR FONT, STYLE, SIZE, OR COLOR.

SN 85-173,763, FILED 11-10-2010.

SUNG IN, EXAMINING ATTORNEY



*David J. Kyffers*

Director of the United States Patent and Trademark Office

# United States of America

United States Patent and Trademark Office

## VALUE PRODUCTS BY MAZDA

**Reg. No. 4,136,377**

**Registered May 1, 2012**

**Int. Cls.: 7 and 12**

**TRADEMARK**

**PRINCIPAL REGISTER**

MAZDA MOTOR OF AMERICA, INC. (CALIFORNIA CORPORATION)  
7755 IRVINE CENTER DRIVE  
IRVINE, CA 92618

FOR: WATER PUMPS FOR AUTOMOBILES; TIMING BELT KITS FOR ENGINES FOR AUTOMOBILES, COMPRISING PRIMARILY TIMING BELTS, TIMING BELT TENSIONERS AND TIMING BELT IDLERS, IN CLASS 7 (U.S. CLS. 13, 19, 21, 23, 31, 34 AND 35).

FIRST USE 0-0-2011; IN COMMERCE 0-0-2011.

FOR: BRAKE PADS FOR AUTOMOBILES; BRAKE SHOES FOR AUTOMOBILES; CLUTCH MECHANISMS FOR AUTOMOBILES; AUTOMOBILE WINDSHIELD WIPER BLADES; AUTOMOBILE WINDSHIELD WIPER BLADE INSERTS, IN CLASS 12 (U.S. CLS. 19, 21, 23, 31, 35 AND 44).

FIRST USE 0-0-2011; IN COMMERCE 0-0-2011.

THE MARK CONSISTS OF STANDARD CHARACTERS WITHOUT CLAIM TO ANY PARTICULAR FONT, STYLE, SIZE, OR COLOR.

OWNER OF U.S. REG. NOS. 2,987,176, 3,427,945, AND OTHERS.

NO CLAIM IS MADE TO THE EXCLUSIVE RIGHT TO USE "VALUE PRODUCTS", APART FROM THE MARK AS SHOWN.

SN 85-175,626, FILED 11-12-2010.

SHAUNIA CARLYLE, EXAMINING ATTORNEY



*David J. Kyros*

Director of the United States Patent and Trademark Office

# United States of America

United States Patent and Trademark Office

# CURL SET

**Reg. No. 4,136,378**

**Registered May 1, 2012**

**Int. Cl.: 3**

**TRADEMARK**

**PRINCIPAL REGISTER**

L'OREAL USA CREATIVE, INC. (DELAWARE CORPORATION)  
575 FIFTH AVENUE  
NEW YORK, NY 10017

FOR: HAIR STYLING PREPARATION, IN CLASS 3 (U.S. CLS. 1, 4, 6, 50, 51 AND 52).

FIRST USE 10-0-2011; IN COMMERCE 10-0-2011.

THE MARK CONSISTS OF STANDARD CHARACTERS WITHOUT CLAIM TO ANY PARTICULAR FONT, STYLE, SIZE, OR COLOR.

NO CLAIM IS MADE TO THE EXCLUSIVE RIGHT TO USE "CURL", APART FROM THE MARK AS SHOWN.

SN 85-175,629, FILED 11-12-2010.

JOHN HWANG, EXAMINING ATTORNEY



*David J. Kyffers*

Director of the United States Patent and Trademark Office

# United States of America

United States Patent and Trademark Office

## The Missional Mom

**Reg. No. 4,136,379**

LEE, HELEN (UNITED STATES INDIVIDUAL)  
325 ROWAN CT.  
NAPERVILLE, IL 60540

**Registered May 1, 2012**

**Int. Cl.: 16**

FOR: PRINTED TEACHING MATERIALS IN THE FIELD OF RELIGION, IN CLASS 16 (U.S. CLS. 2, 5, 22, 23, 29, 37, 38 AND 50).

**TRADEMARK**

FIRST USE 1-20-2012; IN COMMERCE 1-20-2012.

**PRINCIPAL REGISTER**

THE MARK CONSISTS OF STANDARD CHARACTERS WITHOUT CLAIM TO ANY PARTICULAR FONT, STYLE, SIZE, OR COLOR.

NO CLAIM IS MADE TO THE EXCLUSIVE RIGHT TO USE "MISSIONAL", APART FROM THE MARK AS SHOWN.

SN 85-176,615, FILED 11-15-2010.

APRIL ROACH, EXAMINING ATTORNEY



*David J. Kyffers*

Director of the United States Patent and Trademark Office

# United States of America

United States Patent and Trademark Office

# ZIPMATES

**Reg. No. 4,136,380**

M&E INNOVATIVE SOLUTIONS LLC (MISSOURI LIMITED LIABILITY COMPANY)  
134 NE TIMBERCREEK CIRCLE  
LEE'S SUMMIT, MO 64086

**Registered May 1, 2012**

**Int. Cl.: 26**

FOR: A CHARM OR TRINKET THAT IS MECHANICALLY ATTACHED TO A ZIPPER PULL,  
IN CLASS 26 (U.S. CLS. 37, 39, 40, 42 AND 50).

**TRADEMARK**

FIRST USE 12-1-2011; IN COMMERCE 12-20-2011.

**PRINCIPAL REGISTER**

THE MARK CONSISTS OF STANDARD CHARACTERS WITHOUT CLAIM TO ANY PAR-  
TICULAR FONT, STYLE, SIZE, OR COLOR.

SN 85-176,647, FILED 11-15-2010.

ANTHONY RINKER, EXAMINING ATTORNEY



*David J. Kybas*

Director of the United States Patent and Trademark Office

# United States of America

United States Patent and Trademark Office

# Laser Logic

**Reg. No. 4,136,381**

**Registered May 1, 2012**

**Int. Cl.: 9**

**TRADEMARK**

**PRINCIPAL REGISTER**

IDEAL IMAGE DEVELOPMENT CORPORATION (FLORIDA CORPORATION)  
4830 W. KENNEDY BLVD. STE. 440  
TAMPA, FL 33609

FOR: COMPUTER SOFTWARE FOR TRACKING AND OPTIMIZING THE PROVISION OF LASER HAIR REMOVAL SERVICES, IN CLASS 9 (U.S. CLS. 21, 23, 26, 36 AND 38).

FIRST USE 11-21-2011; IN COMMERCE 11-21-2011.

THE MARK CONSISTS OF STANDARD CHARACTERS WITHOUT CLAIM TO ANY PARTICULAR FONT, STYLE, SIZE, OR COLOR.

OWNER OF U.S. REG. NOS. 2,829,610, 3,065,163, AND OTHERS.

NO CLAIM IS MADE TO THE EXCLUSIVE RIGHT TO USE "LASER", APART FROM THE MARK AS SHOWN.

SN 85-176,726, FILED 11-15-2010.

LINDA POWELL, EXAMINING ATTORNEY



*David J. Kyffers*

Director of the United States Patent and Trademark Office

# United States of America

United States Patent and Trademark Office



**Reg. No. 4,136,382**

**Registered May 1, 2012**

**Int. Cl.: 10**

**TRADEMARK**

**PRINCIPAL REGISTER**

TRAXX MOBILITY SYSTEMS (MICHIGAN LIMITED LIABILITY COMPANY)  
33750 FREEDOM ROAD  
SUITE A  
FARMINGTON, MI 48335

FOR: INVALID LIFT FOR LIFTING, HANDLING, SUPPORTING AND TRANSPORTING PATIENTS, INVALIDS, AND DISABLED PERSONNEL, IN CLASS 10 (U.S. CLS. 26, 39 AND 44).

FIRST USE 2-9-2010; IN COMMERCE 2-9-2010.

THE MARK CONSISTS OF THE WORD "TRAXX" (COLORED BLUE) WITH THE TOP OF THE LETTER "T" EXTENDING OVER THE REMAINDER OF THE WORD "TRAXX". THREE WAVES (COLORED RED) EXTEND FROM THE TOP LEFT OF THE WORD "TRAXX" TOWARDS THE RIGHT. THREE WAVES (COLORED BLACK) EXTEND FROM THE BOTTOM RIGHT OF THE WORD "TRAXX" TOWARDS THE LEFT.

THE COLOR(S) RED, BLUE AND BLACK IS/ARE CLAIMED AS A FEATURE OF THE MARK.

SN 85-176,842, FILED 11-15-2010.

RAMONA ORTIGA, EXAMINING ATTORNEY



*David J. Kybas*

Director of the United States Patent and Trademark Office



# United States of America

United States Patent and Trademark Office

# eScience3000

**Reg. No. 4,136,383**

**Registered May 1, 2012**

**Int. Cl.: 41**

**SERVICE MARK**

**PRINCIPAL REGISTER**

ACHIEVE3000, INC. (DELAWARE CORPORATION)  
1091 RIVER AVE.  
LAKEWOOD, NJ 08701

FOR: EDUCATIONAL SERVICES, NAMELY, PROVIDING COURSES OF INSTRUCTION VIA THE INTERNET AT THE K-12 LEVEL IN THE FIELD OF SCIENCE, IN CLASS 41 (U.S. CLS. 100, 101 AND 107).

FIRST USE 1-1-2012; IN COMMERCE 1-1-2012.

THE MARK CONSISTS OF STANDARD CHARACTERS WITHOUT CLAIM TO ANY PARTICULAR FONT, STYLE, SIZE, OR COLOR.

OWNER OF U.S. REG. NOS. 3,085,314, 3,289,994, AND OTHERS.

SN 85-177,048, FILED 11-15-2010.

COURTNEY ALVAREZ, EXAMINING ATTORNEY



*David J. Kyffers*

Director of the United States Patent and Trademark Office

# United States of America

United States Patent and Trademark Office

# 4FRONT

**Reg. No. 4,136,384**

**Registered May 1, 2012**

**Int. Cl.: 28**

**TRADEMARK**

**PRINCIPAL REGISTER**

WOODWAY USA, INC. (WISCONSIN CORPORATION)  
W229 N591 FOSTER COURT  
WAUKESHA, WI 53186

FOR: TREADMILLS, IN CLASS 28 (U.S. CLS. 22, 23, 38 AND 50).

FIRST USE 10-26-2011; IN COMMERCE 10-26-2011.

THE MARK CONSISTS OF STANDARD CHARACTERS WITHOUT CLAIM TO ANY PARTICULAR FONT, STYLE, SIZE, OR COLOR.

SN 85-177,088, FILED 11-15-2010.

LESLIE RICHARDS, EXAMINING ATTORNEY



*David J. Kybas*

Director of the United States Patent and Trademark Office

# United States of America

United States Patent and Trademark Office

## ARBONNE ESSENTIALS

**Reg. No. 4,136,385**

**Registered May 1, 2012**

**Int. Cl.: 5**

**TRADEMARK**

**PRINCIPAL REGISTER**

ARBONNE INTERNATIONAL, LLC (DELAWARE LIMITED LIABILITY COMPANY)  
9400 JERONIMO  
IRVINE, CA 92618

FOR: VITAMINS, MINERAL SUPPLEMENTS, NUTRITIONAL SUPPLEMENTS, DIETARY SUPPLEMENTS, FOOD SUPPLEMENTS AND HERBAL SUPPLEMENTS; ENERGY BOOSTING TABLETS; POWDERED NUTRITIONAL SUPPLEMENT DRINK MIX; NUTRITIONAL SUPPLEMENT FOR ELIMINATING TOXINS FROM THE BODY; DIETARY AND NUTRITIONAL SUPPLEMENTS CONTAINING FIBER; HERBAL TEAS FOR USE AS DIETARY SUPPLEMENTS; DIETARY SUPPLEMENTS IN THE NATURE OF NUTRITIONALLY FORTIFIED SOFT CHEWS; DIETARY SUPPLEMENTS WITH CALCIUM IN THE NATURE OF NUTRITIONALLY FORTIFIED SOFT CHEWS, IN CLASS 5 (U.S. CLS. 6, 18, 44, 46, 51 AND 52).

FIRST USE 1-18-2011; IN COMMERCE 1-18-2011.

THE MARK CONSISTS OF STANDARD CHARACTERS WITHOUT CLAIM TO ANY PARTICULAR FONT, STYLE, SIZE, OR COLOR.

OWNER OF U.S. REG. NOS. 1,770,981, 3,218,119, AND OTHERS.

NO CLAIM IS MADE TO THE EXCLUSIVE RIGHT TO USE "ESSENTIALS", APART FROM THE MARK AS SHOWN.

SN 85-177,244, FILED 11-15-2010.

BERYL GARDNER, EXAMINING ATTORNEY



*David J. Kyros*

Director of the United States Patent and Trademark Office

# United States of America

United States Patent and Trademark Office

## HEADWAY EMOTIONAL HEALTH SERVICES

**Reg. No. 4,136,386**

**Registered May 1, 2012**

**Int. Cls.: 44 and 45**

**SERVICE MARK**

**PRINCIPAL REGISTER**

HEADWAY EMOTIONAL HEALTH SERVICES (MINNESOTA CORPORATION)  
6425 NICOLLET AVENUE SOUTH  
RICHFIELD, MN 55423

FOR: PSYCHIATRIC SERVICES; PSYCHIATRIC CONSULTATION AND THERAPY; PROVIDING INFORMATION TO PATIENTS IN THE FIELD OF ADMINISTERING MEDICATIONS; MENTAL HEALTH SERVICES; PROVIDING INFORMATION IN THE FIELD OF PARENTING CONCERNING THE HEALTH OF CHILDREN AND FAMILIES; ANGER MANAGEMENT MENTAL HEALTH THERAPY; YOUTH MENTAL HEALTH COUNSELING ON THE TOPICS OF DEPRESSION AND ANXIETY; YOUTH PSYCHOLOGICAL COUNSELING; FAMILY MENTAL HEALTH COUNSELING ON THE TOPICS OF DEPRESSION AND ANXIETY; FAMILY PSYCHOLOGICAL COUNSELING, IN CLASS 44 (U.S. CLS. 100 AND 101).

FIRST USE 7-1-2011; IN COMMERCE 7-1-2011.

FOR: PROVIDING EMOTIONAL SUPPORT COUNSELING FOR VICTIMS OF BATTERY, ABUSE, AND SEXUAL ABUSE; YOUTH COUNSELING ON THE TOPICS OF INTERPERSONAL RELATIONSHIPS; FAMILY COUNSELING ON THE TOPICS OF INTERPERSONAL RELATIONSHIPS, IN CLASS 45 (U.S. CLS. 100 AND 101).

FIRST USE 7-1-2011; IN COMMERCE 7-1-2011.

THE MARK CONSISTS OF STANDARD CHARACTERS WITHOUT CLAIM TO ANY PARTICULAR FONT, STYLE, SIZE, OR COLOR.

NO CLAIM IS MADE TO THE EXCLUSIVE RIGHT TO USE "EMOTIONAL HEALTH SERVICES", APART FROM THE MARK AS SHOWN.

SN 85-177,549, FILED 11-16-2010.

CORY BOONE, EXAMINING ATTORNEY



*David J. Kyros*

Director of the United States Patent and Trademark Office

# United States of America

United States Patent and Trademark Office

## ZEN MONKEY

**Reg. No. 4,136,387**

**Registered May 1, 2012**

**Int. Cl.: 30**

**TRADEMARK**

**PRINCIPAL REGISTER**

WHOLESOME FOOD SOLUTIONS LLC (CALIFORNIA LIMITED LIABILITY COMPANY)  
415 EAST HARVARD STREET, SUITE 102  
GLENDALE, CA 91205

FOR: READY-TO-EAT CEREAL BASED MEAL CONTAINING OATS, YOGURT AND/OR  
FRUITS, IN CLASS 30 (U.S. CL. 46).

FIRST USE 3-14-2011; IN COMMERCE 3-14-2011.

THE MARK CONSISTS OF STANDARD CHARACTERS WITHOUT CLAIM TO ANY PAR-  
TICULAR FONT, STYLE, SIZE, OR COLOR.

SN 85-178,483, FILED 11-16-2010.

ANTHONY RINKER, EXAMINING ATTORNEY



*David J. Kybas*

Director of the United States Patent and Trademark Office

# United States of America

United States Patent and Trademark Office



**Reg. No. 4,136,388**

**Registered May 1, 2012**

**Int. Cl.: 12**

**TRADEMARK**

**PRINCIPAL REGISTER**

HUFFY CORPORATION (OHIO CORPORATION)  
6551 CENTERVILLE BUSINESS PARKWAY  
CENTERVILLE, OH 45459

FOR: BICYCLES AND STRUCTURAL PARTS THEREOF, IN CLASS 12 (U.S. CLS. 19, 21, 23, 31, 35 AND 44).

FIRST USE 9-1-2011; IN COMMERCE 9-1-2011.

THE MARK CONSISTS OF THE WORD "WICKED" IN A STYLIZED FORMAT WITH THE SECOND "W" IN A LOWERCASE FORMAT CONTAINED IN A TRIANGULAR SHAPE.

SN 85-179,919, FILED 11-18-2010.

SUNG IN, EXAMINING ATTORNEY



*David J. Kybas*

Director of the United States Patent and Trademark Office

# United States of America

United States Patent and Trademark Office



**Reg. No. 4,136,389**

**Registered May 1, 2012**

**Int. Cl.: 25**

**TRADEMARK**

**PRINCIPAL REGISTER**

FLAMM, MEGAN (UNITED STATES INDIVIDUAL)  
2375 COUNTY RD. 220  
MONROE CITY, MO 63456 AND

TALTON, LISA (UNITED STATES INDIVIDUAL)  
2375 COUNTY RD. 220  
MONROE CITY, MO 63456

FOR: CLOTHING AND APPAREL, NAMELY, T-SHIRTS, HOODED SWEATSHIRTS, SWEATSHIRTS, SHIRTS, PANTS, HATS, AND CAPS, IN CLASS 25 (U.S. CLS. 22 AND 39).

FIRST USE 9-30-2010; IN COMMERCE 9-30-2010.

THE NAME(S), PORTRAIT(S), AND/OR SIGNATURE(S) SHOWN IN THE MARK DOES NOT IDENTIFY A PARTICULAR LIVING INDIVIDUAL.

THE MARK CONSISTS OF THE WORDS "J THANG" WITH A STYLIZED CROSS MAKING UP THE LETTER "T".

SN 85-179,922, FILED 11-18-2010.

SUSAN RICHARDS, EXAMINING ATTORNEY



*David J. Kybas*

Director of the United States Patent and Trademark Office

# United States of America

United States Patent and Trademark Office

## MARSHMALLOW

**Reg. No. 4,136,390**

**Registered May 1, 2012**

**Int. Cls.: 16 and 28**

**TRADEMARK**

**PRINCIPAL REGISTER**

LAMRITE WEST, INC. (OHIO CORPORATION)  
PARK 82, 13000 DARICE PARKWAY  
STRONGSVILLE, OH 44149

FOR: MODELING CLAY, IN CLASS 16 (U.S. CLS. 2, 5, 22, 23, 29, 37, 38 AND 50).

FIRST USE 5-0-2011; IN COMMERCE 5-0-2011.

FOR: HOBBY CRAFT KITS COMPRISING MODELING CLAY, DECORATIVE ACCENT  
PIECES AND ASSEMBLY INSTRUCTIONS, SOLD AS A UNIT, IN CLASS 28 (U.S. CLS. 22,  
23, 38 AND 50).

FIRST USE 5-0-2011; IN COMMERCE 5-0-2011.

THE MARK CONSISTS OF STANDARD CHARACTERS WITHOUT CLAIM TO ANY PAR-  
TICULAR FONT, STYLE, SIZE, OR COLOR.

SN 85-180,980, FILED 11-19-2010.

ELISSA GARBER KON, EXAMINING ATTORNEY



*David J. Kybas*

Director of the United States Patent and Trademark Office



# United States of America

United States Patent and Trademark Office

# MUSHROOM

**Reg. No. 4,136,391**

**Registered May 1, 2012**

**Int. Cl.: 17**

**TRADEMARK**

**PRINCIPAL REGISTER**

ECOVATIVE DESIGN LLC (NEW YORK LIMITED LIABILITY COMPANY)  
60 COHOES AVENUE  
GREEN ISLAND, NY 12183

FOR: PACKING AND INSULATION MATERIALS COMPRISED OF PREFABRICATED INSULATION PANELS, INSULATION BLOCKS, ACOUSTICAL INSULATION, AND ACOUSTICAL PANELS FOR FURNITURE, ELECTRONICS, APPLIANCES, HOUSEWARES, MACHINE PARTS, NOVELTY PRODUCTS, FOOD PRODUCTS, GLASSWARE, LABWARE AND EQUIPMENT, IN CLASS 17 (U.S. CLS. 1, 5, 12, 13, 35 AND 50).

FIRST USE 12-15-2011; IN COMMERCE 12-15-2011.

THE MARK CONSISTS OF STANDARD CHARACTERS WITHOUT CLAIM TO ANY PARTICULAR FONT, STYLE, SIZE, OR COLOR.

SN 85-181,537, FILED 11-19-2010.

ARETHA SOMERVILLE, EXAMINING ATTORNEY



*David J. Kyffers*

Director of the United States Patent and Trademark Office

# United States of America

United States Patent and Trademark Office

# B TWEEN

**Reg. No. 4,136,392**

**Registered May 1, 2012**

**Int. Cl.: 28**

**TRADEMARK**

**PRINCIPAL REGISTER**

CREATIVE KIDS FAR EAST INC. (NEW YORK CORPORATION)  
382 ROUTE 59  
SUITE 288,  
MONSEY, NY 10952

FOR: CRAFT AND HOBBY SETS, NAMELY, CRAFT SETS FOR MAKING TOY JEWELRY, CRAFT SETS FOR MAKING TOY COSMETICS, CRAFT SETS CONSISTING OF BEADS, SEQUINS AND STRINGING THREAD , IN CLASS 28 (U.S. CLS. 22, 23, 38 AND 50).

FIRST USE 9-15-2011; IN COMMERCE 9-15-2011.

THE MARK CONSISTS OF STANDARD CHARACTERS WITHOUT CLAIM TO ANY PARTICULAR FONT, STYLE, SIZE, OR COLOR.

SN 85-182,046, FILED 11-22-2010.

KELLEY WELLS, EXAMINING ATTORNEY



*David J. Kybas*

Director of the United States Patent and Trademark Office

# United States of America

United States Patent and Trademark Office

# Quilt Tite

**Reg. No. 4,136,393**

**Registered May 1, 2012**

**Int. Cl.: 24**

**TRADEMARK**

**PRINCIPAL REGISTER**

MALOUF MARKETING, INC. (UTAH CORPORATION), DBA MALOUF FINE LINENS,  
1189 WEST 1700 NORTH  
LOGAN, UT 84321

FOR: QUILTED MATTRESS PAD; QUILTED MATTRESS PROTECTOR, NAMELY, QUILTED  
MATTRESS COVER, IN CLASS 24 (U.S. CLS. 42 AND 50).

FIRST USE 8-12-2011; IN COMMERCE 1-30-2012.

THE MARK CONSISTS OF STANDARD CHARACTERS WITHOUT CLAIM TO ANY PAR-  
TICULAR FONT, STYLE, SIZE, OR COLOR.

NO CLAIM IS MADE TO THE EXCLUSIVE RIGHT TO USE "QUILT", APART FROM THE  
MARK AS SHOWN.

SN 85-182,107, FILED 11-22-2010.

EMILY CHUO, EXAMINING ATTORNEY



*David J. Kybas*

Director of the United States Patent and Trademark Office

# United States of America

United States Patent and Trademark Office

# AMPEGY

**Reg. No. 4,136,394**

**Registered May 1, 2012**

**Int. Cl.: 36**

**SERVICE MARK**

**PRINCIPAL REGISTER**

AMPEGY, L.L.C. (TEXAS LIMITED LIABILITY COMPANY)  
SUITE 100  
2105 CITYWEST BLVD.  
HOUSTON, TX 77042

FOR: ENERGY BROKERAGE SERVICES, NAMELY, PROCURING ELECTRICITY AND NATURAL GAS ENERGY COMMODITIES PURCHASED FROM ELECTRICITY AND NATURAL GAS ENERGY UTILITIES AND FROM OTHER ENERGY PRODUCERS AND ARRANGING FOR THE SUPPLY OF ELECTRICITY AND NATURAL GAS ENERGY COMMODITIES TO A DISTRIBUTION NETWORK FOR ULTIMATE DELIVERY TO CONSUMERS AND BUSINESSES, IN CLASS 36 (U.S. CLS. 100, 101 AND 102).

FIRST USE 2-24-2011; IN COMMERCE 2-24-2011.

THE MARK CONSISTS OF STANDARD CHARACTERS WITHOUT CLAIM TO ANY PARTICULAR FONT, STYLE, SIZE, OR COLOR.

SN 85-182,412, FILED 11-22-2010.

MICHAEL GAAFAR, EXAMINING ATTORNEY



*David J. Kybas*

Director of the United States Patent and Trademark Office

# United States of America

United States Patent and Trademark Office



**Reg. No. 4,136,395**

**Registered May 1, 2012**

**Int. Cl.: 18**

**TRADEMARK**

**PRINCIPAL REGISTER**

PANACAVALLO, LLC (MASSACHUSETTS LIMITED LIABILITY COMPANY)  
42 WINTER STREET, SUITE 7  
PEMBROKE, MA 02359

FOR: BOOTS FOR HORSES, NAMELY, BELL BOOTS AND TURNOUT BOOTS, IN CLASS  
18 (U.S. CLS. 1, 2, 3, 22 AND 41).

FIRST USE 1-10-2011; IN COMMERCE 1-10-2011.

THE MARK CONSISTS OF TWO HORSE HEADS FACING EACH OTHER WITH A STYLIZED  
CROSS IN A CIRCLE AND HORIZONTAL STIRRUP, WITH THE WORD "PANACAVALLO"  
BENEATH THE ENTIRE DESIGN.

THE WORDING "PANACAVALLO" HAS NO MEANING IN A FOREIGN LANGUAGE.

SN 85-182,676, FILED 11-22-2010.

TINA L. SNAPP, EXAMINING ATTORNEY



*David J. Kyffers*

Director of the United States Patent and Trademark Office

# United States of America

United States Patent and Trademark Office

## PANACAVALLO

**Reg. No. 4,136,396**

**Registered May 1, 2012**

**Int. Cl.: 18**

**TRADEMARK**

**PRINCIPAL REGISTER**

PANACAVALLO, LLC (MASSACHUSETTS LIMITED LIABILITY COMPANY)  
42 WINTER STREET, SUITE 7  
PEMBROKE, MA 02359

FOR: BOOTS FOR HORSES, NAMELY, BELL BOOTS AND TURNOUT BOOTS, IN CLASS  
18 (U.S. CLS. 1, 2, 3, 22 AND 41).

FIRST USE 1-10-2011; IN COMMERCE 1-10-2011.

THE MARK CONSISTS OF STANDARD CHARACTERS WITHOUT CLAIM TO ANY PAR-  
TICULAR FONT, STYLE, SIZE, OR COLOR.

THE WORDING "PANACAVALLO" HAS NO MEANING IN A FOREIGN LANGUAGE.

SN 85-182,694, FILED 11-22-2010.

TINA L. SNAPP, EXAMINING ATTORNEY



*David J. Kybas*

Director of the United States Patent and Trademark Office

# United States of America

United States Patent and Trademark Office

## YOUR GO TO GIRL

**Reg. No. 4,136,397**

**Registered May 1, 2012**

**Int. Cl.: 45**

**SERVICE MARK**

**PRINCIPAL REGISTER**

YOUR GO TO GIRL, LLC (GEORGIA LIMITED LIABILITY COMPANY)  
2625 PIEDMONT RD.  
STE 56-276  
ATLANTA, GA 30324

FOR: PERSONAL CONCIERGE SERVICES FOR OTHERS COMPRISING MAKING REQUESTED PERSONAL ARRANGEMENTS AND RESERVATIONS, RUNNING ERRANDS AND PROVIDING CUSTOMER SPECIFIC INFORMATION TO MEET INDIVIDUAL NEEDS, ALL RENDERED IN BUSINESS ESTABLISHMENTS, OFFICE BUILDINGS, HOTELS, RESIDENTIAL COMPLEXES AND HOMES, IN CLASS 45 (U.S. CLS. 100 AND 101).

FIRST USE 11-15-2010; IN COMMERCE 11-15-2010.

THE MARK CONSISTS OF STANDARD CHARACTERS WITHOUT CLAIM TO ANY PARTICULAR FONT, STYLE, SIZE, OR COLOR.

SN 85-182,995, FILED 11-22-2010.

ANGELA DUONG, EXAMINING ATTORNEY



*David J. Kybas*

Director of the United States Patent and Trademark Office

# United States of America

United States Patent and Trademark Office

## ALTA LUNA PHASES

**Reg. No. 4,136,398**

**Registered May 1, 2012**

**Int. Cl.: 33**

**TRADEMARK**

**PRINCIPAL REGISTER**

CAVIT CANTINA VITICOLTORI CONSORZIO CANTINE SOCIALI DEL TRENTO  
SOCIETA' COOPERATIVA (ITALY SOCIETA COOPERATIVA (SC))  
VIA DEL PONTE 31  
TRENTO, ITALY I-38123

FOR: ALCOHOLIC BEVERAGES EXCEPT BEERS, IN CLASS 33 (U.S. CLS. 47 AND 49).

FIRST USE 4-29-2011; IN COMMERCE 6-1-2011.

THE MARK CONSISTS OF STANDARD CHARACTERS WITHOUT CLAIM TO ANY PARTICULAR FONT, STYLE, SIZE, OR COLOR.

THE ENGLISH TRANSLATION OF "ALTA LUNA" IN THE MARK IS "HIGH MOON".

SN 85-183,206, FILED 11-23-2010.

ELIZABETH HUGHITT, EXAMINING ATTORNEY



*David J. Kybas*

Director of the United States Patent and Trademark Office



# United States of America

United States Patent and Trademark Office

## THE RICHARD J. CASEY FOUNDATION

**Reg. No. 4,136,399**

**Registered May 1, 2012**

**Int. Cl.: 36**

**SERVICE MARK**

**PRINCIPAL REGISTER**

THE RICHARD J. CASEY FOUNDATION (NORTH CAROLINA NON-PROFIT CORPORATION)  
30077 BRITT  
CHAPEL HILL, NC 27517

FOR: CHARITABLE FUNDRAISING, IN CLASS 36 (U.S. CLS. 100, 101 AND 102).

FIRST USE 11-15-2011; IN COMMERCE 11-15-2011.

THE MARK CONSISTS OF STANDARD CHARACTERS WITHOUT CLAIM TO ANY PARTICULAR FONT, STYLE, SIZE, OR COLOR.

NO CLAIM IS MADE TO THE EXCLUSIVE RIGHT TO USE "FOUNDATION", APART FROM THE MARK AS SHOWN.

THE NAME "RICHARD J. CASEY" DOES NOT IDENTIFY A LIVING INDIVIDUAL.

SN 85-183,664, FILED 11-23-2010.

MARK PILARO, EXAMINING ATTORNEY



*David J. Kyros*

Director of the United States Patent and Trademark Office

**United States of America**  
United States Patent and Trademark Office

# POPICON

**Reg. No. 4,136,400**

**Registered May 1, 2012**

**Int. Cl.: 9**

**TRADEMARK**

**PRINCIPAL REGISTER**

RUTHERFORD & CHEKENE (CALIFORNIA CORPORATION)  
55 SECOND STREET, SUITE 600  
SAN FRANCISCO, CA 94105

FOR: CAD SOFTWARE, NAMELY, COMPUTER-AIDED DESIGN SOFTWARE AND COMPUTER-AIDED MANAGEMENT SOFTWARE FOR ARCHITECTS, ENGINEERS, AND FACILITIES PLANNERS AND MANAGERS, AND INSTRUCTIONAL MANUALS SOLD TOGETHER AS A UNIT THEREWITH, IN CLASS 9 (U.S. CLS. 21, 23, 26, 36 AND 38).

FIRST USE 12-7-2011; IN COMMERCE 12-7-2011.

THE MARK CONSISTS OF STANDARD CHARACTERS WITHOUT CLAIM TO ANY PARTICULAR FONT, STYLE, SIZE, OR COLOR.

SN 85-185,063, FILED 11-24-2010.

ANNE FARRELL, EXAMINING ATTORNEY



*David J. Kyffers*

Director of the United States Patent and Trademark Office

# United States of America

United States Patent and Trademark Office

# 8X8

**Reg. No. 4,136,401**

**Registered May 1, 2012**

**Int. Cl.: 25**

**TRADEMARK**

**PRINCIPAL REGISTER**

PRIME TIME FASHIONS, LLC (NEW JERSEY LIMITED LIABILITY COMPANY)  
135 WEST 36TH ST. 4TH FLOOR  
NEW YORK, NY 10018

FOR: MEN'S AND WOMEN'S APPAREL AND CLOTHING ACCESSORIES, NAMELY, SHIRTS, PANTS, SHORTS, T-SHIRTS, TANK TOPS, BLOUSES, SKIRTS, SWEATERS, JACKETS, SCARVES, SUITS, UNDERGARMENTS, COATS, GLOVES AND SHOES, IN CLASS 25 (U.S. CLS. 22 AND 39).

FIRST USE 10-5-2011; IN COMMERCE 10-5-2011.

THE MARK CONSISTS OF STANDARD CHARACTERS WITHOUT CLAIM TO ANY PARTICULAR FONT, STYLE, SIZE, OR COLOR.

SN 85-185,395, FILED 11-26-2010.

KARANENDRA S. CHHINA, EXAMINING ATTORNEY



*David J. Kyros*

Director of the United States Patent and Trademark Office

# United States of America

United States Patent and Trademark Office

## Marker Gripper

**Reg. No. 4,136,402**

**Registered May 1, 2012**

**Int. Cl.: 16**

**TRADEMARK**

**PRINCIPAL REGISTER**

WIDDISON, RAY B. (UNITED STATES INDIVIDUAL)  
1016 LANIE LANE  
MOORE, OK 73160

FOR: MARKER CADDIES, IN CLASS 16 (U.S. CLS. 2, 5, 22, 23, 29, 37, 38 AND 50).

FIRST USE 4-1-2011; IN COMMERCE 4-1-2011.

THE MARK CONSISTS OF STANDARD CHARACTERS WITHOUT CLAIM TO ANY PARTICULAR FONT, STYLE, SIZE, OR COLOR.

NO CLAIM IS MADE TO THE EXCLUSIVE RIGHT TO USE "MARKER", APART FROM THE MARK AS SHOWN.

SN 85-185,509, FILED 11-26-2010.

THOMAS MANOR, EXAMINING ATTORNEY



*David J. Kyffers*

Director of the United States Patent and Trademark Office

# United States of America

United States Patent and Trademark Office

# CAMRIELLE

**Reg. No. 4,136,403**

**Registered May 1, 2012**

**Int. Cl.: 15**

**TRADEMARK**

**PRINCIPAL REGISTER**

MATHEW A. MCPHERSON (UNITED STATES INDIVIDUAL)  
ROUTE 2, P.O. 58  
19055 INCLINE ROAD  
NORWALK, WI 54648

FOR: ACOUSTIC GUITARS, IN CLASS 15 (U.S. CLS. 2, 21 AND 36).

FIRST USE 1-13-2011; IN COMMERCE 1-13-2011.

THE MARK CONSISTS OF STANDARD CHARACTERS WITHOUT CLAIM TO ANY PARTICULAR FONT, STYLE, SIZE, OR COLOR.

SN 85-186,231, FILED 11-29-2010.

GEORGE LORENZO, EXAMINING ATTORNEY



*David J. Kybas*

Director of the United States Patent and Trademark Office

# United States of America

United States Patent and Trademark Office

# Drive2Friend

**Reg. No. 4,136,404**

**Registered May 1, 2012**

**Int. Cl.: 38**

**SERVICE MARK**

**PRINCIPAL REGISTER**

DAIMLER AG (FED REP GERMANY CORPORATION)  
MERCEDSSTRASSE 137  
STUTTGART 70327, FED REP GERMANY

FOR: TELEMATIC SERVICES, NAMELY, TELEMATIC SENDING OF A TEXT MESSAGE TO ANYONE WITH A MOBILE PHONE TO OBTAIN THE MOBILE PHONE'S CURRENT LOCATION, AND THEN THE TELEMATIC SENDING OF THIS LOCATION TO THE USER'S IN-VEHICLE NAVIGATION SYSTEM WHICH ENABLES THE VEHICLE TO BE GUIDED TO THE LOCATION OF THE MOBILE PHONE, IN CLASS 38 (U.S. CLS. 100, 101 AND 104).

FIRST USE 3-1-2011; IN COMMERCE 3-1-2011.

THE MARK CONSISTS OF STANDARD CHARACTERS WITHOUT CLAIM TO ANY PARTICULAR FONT, STYLE, SIZE, OR COLOR.

SN 85-186,455, FILED 11-29-2010.

SANJEEV VOHRA, EXAMINING ATTORNEY



*David J. Kybas*

Director of the United States Patent and Trademark Office

# United States of America

United States Patent and Trademark Office

## THE POST BOOT

**Reg. No. 4,136,405**

**Registered May 1, 2012**

**Int. Cl.: 17**

**TRADEMARK**

**PRINCIPAL REGISTER**

KRAY, JAMES (UNITED STATES INDIVIDUAL)  
1565 ORCHARD ROAD  
WHEATON, IL 60189 AND

KRAY, JANE (UNITED STATES INDIVIDUAL)  
1565 ORCHARD ROAD  
WHEATON, IL 60189

FOR: CIRCULAR RUBBER PAD DESIGNED TO ELIMINATE THE NEED FOR TRIMMING GRASS AND WEED GROWTH AROUND FENCE POSTS, MAIL BOX POSTS, AND STREET SIGNS, IN CLASS 17 (U.S. CLS. 1, 5, 12, 13, 35 AND 50).

FIRST USE 4-10-2011; IN COMMERCE 4-10-2011.

THE MARK CONSISTS OF STANDARD CHARACTERS WITHOUT CLAIM TO ANY PARTICULAR FONT, STYLE, SIZE, OR COLOR.

NO CLAIM IS MADE TO THE EXCLUSIVE RIGHT TO USE "POST", APART FROM THE MARK AS SHOWN.

SN 85-186,580, FILED 11-29-2010.

SUNG IN, EXAMINING ATTORNEY



*David J. Kyros*

Director of the United States Patent and Trademark Office

# United States of America

United States Patent and Trademark Office

# PARABOLA

**Reg. No. 4,136,406**

**Registered May 1, 2012**

**Int. Cl.: 32**

**TRADEMARK**

**PRINCIPAL REGISTER**

FIRESTONE WALKER LLC (CALIFORNIA LIMITED LIABILITY COMPANY)  
C/O KOENIG & ASSOCIATES  
920 GARDEN STREET, SUITE A  
SANTA BARBARA, CA 93101

FOR: BEER, IN CLASS 32 (U.S. CLS. 45, 46 AND 48).

FIRST USE 4-1-2008; IN COMMERCE 4-1-2008.

THE MARK CONSISTS OF STANDARD CHARACTERS WITHOUT CLAIM TO ANY PARTICULAR FONT, STYLE, SIZE, OR COLOR.

SN 85-186,689, FILED 11-29-2010.

ROBIN CHOSID, EXAMINING ATTORNEY



*David J. Kyros*

Director of the United States Patent and Trademark Office



# United States of America

United States Patent and Trademark Office

# SKYWORD

**Reg. No. 4,136,407**

**Registered May 1, 2012**

**Int. Cl.: 42**

**SERVICE MARK**

**PRINCIPAL REGISTER**

SKYWORD, INC. (DELAWARE CORPORATION)  
234 CONGRESS STREET, 4TH FLOOR  
BOSTON, MA 02110

FOR: PLATFORM AS A SERVICE (PAAS) FEATURING COMPUTER SOFTWARE PROGRAMS TO MANAGE CONTENT CREATORS AND CONTENT CREATION IN THE FORM OF TEXT, IMAGES, VIDEOS, SOUND AND THE LIKE BASED ON CONSUMER DEMAND FOR SPECIFIC INFORMATION, IN CLASS 42 (U.S. CLS. 100 AND 101).

FIRST USE 12-15-2010; IN COMMERCE 12-15-2010.

THE MARK CONSISTS OF STANDARD CHARACTERS WITHOUT CLAIM TO ANY PARTICULAR FONT, STYLE, SIZE, OR COLOR.

SN 85-186,902, FILED 11-30-2010.

PATRICIA EVANKO, EXAMINING ATTORNEY



*David J. Kyjars*

Director of the United States Patent and Trademark Office

# United States of America

United States Patent and Trademark Office



**Reg. No. 4,136,408**

**Registered May 1, 2012**

**Int. Cls.: 35 and 36**

**SERVICE MARK**

**PRINCIPAL REGISTER**

COVERDELL & COMPANY, INC. (GEORGIA CORPORATION)  
SUITE 1000  
8770 W. BRYN MAWR  
CHICAGO, IL 60631

FOR: MEMBERSHIP CLUB SERVICES PROVIDING DISCOUNTS AND PROCESSING REBATES FOR THE SERVICES OF OTHERS, IN CLASS 35 (U.S. CLS. 100, 101 AND 102).

FIRST USE 1-18-2011; IN COMMERCE 1-18-2011.

FOR: PROVIDING EXTENDED WARRANTIES ON A VARIETY OF CONSUMER GOODS OF OTHERS, NAMELY, JEWELRY, APPLIANCES, ELECTRONICS, FURNITURE, SPORTING GOODS, OFFICE PRODUCTS AND ENTERTAINMENT EQUIPMENT, IN CLASS 36 (U.S. CLS. 100, 101 AND 102).

FIRST USE 1-18-2011; IN COMMERCE 1-18-2011.

THE MARK CONSISTS OF THE WORDS "SHOP-SHIP-PROTECT" NEXT TO AN OPEN BOX WITH A DOLLAR SIGN ON ITS SIDE.

SN 85-187,177, FILED 11-30-2010.

MARGERY A. TIERNEY, EXAMINING ATTORNEY



*David J. Kybas*

Director of the United States Patent and Trademark Office

# United States of America

United States Patent and Trademark Office

## CONCEPT TO COMPLETION

**Reg. No. 4,136,409**

**Registered May 1, 2012**

**Int. Cl.: 11**

**TRADEMARK**

**PRINCIPAL REGISTER**

VICTORY ENERGY OPERATIONS, L.L.C. (DELAWARE LIMITED LIABILITY COMPANY)  
10701 EAST 126TH STREET NORTH  
COLLINSVILLE, OK 74021

FOR: FUEL DELIVERY UNITS FOR STEAM BOILERS; STEAM GENERATORS; WATER TREATMENT UNITS FOR FILTRATION, DEALKINATION AND DEMINERALIZATION; AND PARTS FOR THE AFORESAID GOODS, NAMELY, FUEL INLETS AND FUEL RACKS, INDUSTRIAL FANS, BURNERS, STACK ECONOMIZERS, FUEL GAS RECIRCULATION AND WATER TREATMENT UNITS, DEAERATORS AND HEAT PUMPS, IN CLASS 11 (U.S. CLS. 13, 21, 23, 31 AND 34).

FIRST USE 11-12-2010; IN COMMERCE 11-12-2010.

THE MARK CONSISTS OF STANDARD CHARACTERS WITHOUT CLAIM TO ANY PARTICULAR FONT, STYLE, SIZE, OR COLOR.

SN 85-187,640, FILED 11-30-2010.

JORDAN BAKER, EXAMINING ATTORNEY



*David J. Kyffers*

Director of the United States Patent and Trademark Office

# United States of America

United States Patent and Trademark Office

## FREEDOM TO MOVE, STRENGTH TO STAND!

**Reg. No. 4,136,410**

KOSCHITZKI, AVI M. (UNITED STATES INDIVIDUAL)  
P.O. BOX 323  
WOODMERE, NY 11598

**Registered May 1, 2012**

**Int. Cl.: 25**

FOR: CLOTHING, NAMELY, FOOTWEAR, JACKETS, BELTS, CAPS, SHIRTS, IN CLASS 25 (U.S. CLS. 22 AND 39).

**TRADEMARK**

FIRST USE 11-17-2011; IN COMMERCE 11-17-2011.

**PRINCIPAL REGISTER**

THE MARK CONSISTS OF STANDARD CHARACTERS WITHOUT CLAIM TO ANY PARTICULAR FONT, STYLE, SIZE, OR COLOR.

SN 85-187,898, FILED 12-1-2010.

ALYSSA STEEL, EXAMINING ATTORNEY



*David J. Kybas*

Director of the United States Patent and Trademark Office

# United States of America

United States Patent and Trademark Office

RESULT

PROVEN. PRACTICE. PERFORMANCE.

**Reg. No. 4,136,411**

**Registered May 1, 2012**

**Int. Cl.: 35**

**SERVICE MARK**

**PRINCIPAL REGISTER**

RESULT, LLC (VIRGINIA LIMITED LIABILITY COMPANY)  
10800 MIDLOTHIAN TURNPIKE STE. 265  
RICHMOND, VA 23235

FOR: BUSINESS MANAGEMENT SERVICES, NAMELY, BUSINESS DEVELOPMENT, MANAGEMENT ASSISTANCE, BILLING, EMPLOYMENT RECRUITING, ACCOUNTING, BUDGET CONSULTATION, PREPARING BUSINESS REPORTS, PAYROLL ADMINISTRATION, BUSINESS OVERSIGHT, NAMELY, PROVIDING PRACTICE ORGANIZATION, MANAGEMENT AND ADMINISTRATIVE SUPPORT SERVICES TO MEDICAL PRACTICE GROUPS AND HEALTH CARE PROVIDERS, IN CLASS 35 (U.S. CLS. 100, 101 AND 102).

FIRST USE 2-0-2010; IN COMMERCE 1-0-2011.

THE MARK CONSISTS OF THE WORD "RESULT" WITH A STYLIZED PERCENTAGE SIGN FOR THE "S" AND THE WORDS "PROVEN. PRACTICE. PERFORMANCE" IN SMALLER FONT BENEATH THE "RESULT".

SN 85-188,484, FILED 12-1-2010.

KAREN BRACEY, EXAMINING ATTORNEY



*David J. Kybas*

Director of the United States Patent and Trademark Office

# United States of America

United States Patent and Trademark Office

## Women Rule The Planet

**Reg. No. 4,136,412**

**Registered May 1, 2012**

**Int. Cl.: 25**

**TRADEMARK**

**PRINCIPAL REGISTER**

WOMEN RULE THE PLANET LLC (GEORGIA LIMITED LIABILITY COMPANY)  
963 N CARTER RD  
DECATUR, GA 30030

FOR: CLOTHING, NAMELY, SHIRTS, JACKETS, IN CLASS 25 (U.S. CLS. 22 AND 39).

FIRST USE 9-1-2011; IN COMMERCE 10-22-2011.

THE MARK CONSISTS OF STANDARD CHARACTERS WITHOUT CLAIM TO ANY PARTICULAR FONT, STYLE, SIZE, OR COLOR.

SN 85-189,907, FILED 12-3-2010.

JIM RINGLE, EXAMINING ATTORNEY



*David J. Kyffers*

Director of the United States Patent and Trademark Office

# United States of America

United States Patent and Trademark Office

# NRP

**Reg. No. 4,136,413**

**Registered May 1, 2012**

**Int. Cl.: 35**

**SERVICE MARK**

**PRINCIPAL REGISTER**

NATIONAL REGISTRY OF EMERGENCY MEDICAL TECHNICIANS (OHIO NON-PROFIT CORPORATION)  
6610 BUSCH BOULEVARD  
COLUMBUS, OH 43229

FOR: TESTING SERVICES, NAMELY, CONDUCTING WRITTEN AND PRACTICAL EXAMINATION TESTING TO DETERMINE PROFESSIONAL COMPETENCY OF CANDIDATES FOR THE PRACTICE OF EMERGENCY MEDICAL SERVICES BASED ON ESTABLISHED REQUIREMENTS AND ISSUING A CERTIFICATE TO INDIVIDUALS WHO SATISFY THE ESTABLISHED REQUIREMENTS; MAINTAINING A REGISTRY OF CERTIFIED PRACTITIONERS OF EMERGENCY MEDICAL SERVICES, IN CLASS 35 (U.S. CLS. 100, 101 AND 102).

FIRST USE 1-1-2012; IN COMMERCE 1-1-2012.

THE MARK CONSISTS OF STANDARD CHARACTERS WITHOUT CLAIM TO ANY PARTICULAR FONT, STYLE, SIZE, OR COLOR.

SN 85-190,280, FILED 12-3-2010.

GINA FINK, EXAMINING ATTORNEY



*David J. Kybas*

Director of the United States Patent and Trademark Office

# United States of America

United States Patent and Trademark Office

# NRAEMT

**Reg. No. 4,136,414**

**Registered May 1, 2012**

**Int. Cl.: 35**

**SERVICE MARK**

**PRINCIPAL REGISTER**

NATIONAL REGISTRY OF EMERGENCY MEDICAL TECHNICIANS (OHIO NON-PROFIT CORPORATION)  
6610 BUSCH BOULEVARD  
COLUMBUS, OH 43229

FOR: TESTING SERVICES, NAMELY, CONDUCTING WRITTEN AND PRACTICAL EXAMINATION TESTING TO DETERMINE PROFESSIONAL COMPETENCY OF CANDIDATES FOR THE PRACTICE OF EMERGENCY MEDICAL SERVICES BASED ON ESTABLISHED REQUIREMENTS AND ISSUING A CERTIFICATE TO INDIVIDUALS WHO SATISFY THE ESTABLISHED REQUIREMENTS; MAINTAINING A REGISTRY OF CERTIFIED PRACTITIONERS OF EMERGENCY MEDICAL SERVICES, IN CLASS 35 (U.S. CLS. 100, 101 AND 102).

FIRST USE 1-1-2012; IN COMMERCE 1-1-2012.

THE MARK CONSISTS OF STANDARD CHARACTERS WITHOUT CLAIM TO ANY PARTICULAR FONT, STYLE, SIZE, OR COLOR.

SN 85-190,286, FILED 12-3-2010.

GINA FINK, EXAMINING ATTORNEY



*David J. Kyros*

Director of the United States Patent and Trademark Office



# United States of America

United States Patent and Trademark Office

# NREMR

**Reg. No. 4,136,415**

**Registered May 1, 2012**

**Int. Cl.: 35**

**SERVICE MARK**

**PRINCIPAL REGISTER**

NATIONAL REGISTRY OF EMERGENCY MEDICAL TECHNICIANS (OHIO NON-PROFIT CORPORATION)  
6610 BUSCH BOULEVARD  
COLUMBUS, OH 43229

FOR: TESTING SERVICES, NAMELY, CONDUCTING WRITTEN AND PRACTICAL EXAMINATION TESTING TO DETERMINE PROFESSIONAL COMPETENCY OF CANDIDATES FOR THE PRACTICE OF EMERGENCY MEDICAL SERVICES BASED ON ESTABLISHED REQUIREMENTS AND ISSUING A CERTIFICATE TO INDIVIDUALS WHO SATISFY THE ESTABLISHED REQUIREMENTS; MAINTAINING A REGISTRY OF CERTIFIED PRACTITIONERS OF EMERGENCY MEDICAL SERVICES, IN CLASS 35 (U.S. CLS. 100, 101 AND 102).

FIRST USE 1-1-2012; IN COMMERCE 1-1-2012.

THE MARK CONSISTS OF STANDARD CHARACTERS WITHOUT CLAIM TO ANY PARTICULAR FONT, STYLE, SIZE, OR COLOR.

SN 85-190,295, FILED 12-3-2010.

GINA FINK, EXAMINING ATTORNEY



*David J. Kybas*

Director of the United States Patent and Trademark Office

# United States of America

United States Patent and Trademark Office

# mDAS

**Reg. No. 4,136,416**

**Registered May 1, 2012**

**Int. Cl.: 9**

**TRADEMARK**

**PRINCIPAL REGISTER**

BRAVO TECH INTERNATIONAL LIMITED (HONG KONG LIMITED LIABILITY COMPANY)  
UNIT 713-714, CHEVALIER COMMERCIAL CTR.  
8 WANG HOI ROAD  
KOWLOON BAY, HONG KONG

FOR: MULTI-BAND, MULTI-STANDARDS AND MULTI-CARRIER DISTRIBUTED ANTENNA SYSTEM FOR COMMUNICATIONS DEVICES, THE AFOREMENTIONED COMPRISED OF HOST UNIT, WHICH INCLUDES BASE STATION INTERFACE UNITS, FIBER INTERFACE UNITS, REMOTE CONTROL UNIT AND POWER SUPPLY UNITS; AND COMPRISED OF POINT OF INTERFACE, WHICH INCLUDES COMBINER, DUPLEXER, HIGH POWER ATTENUATOR; AND REMOTE UNIT, WHICH INCLUDES OPTICAL MODULE, DOWNLINK POWER AMPLIFIER, LOW NOISE AMPLIFIER AND DUPLEXER, IN CLASS 9 (U.S. CLS. 21, 23, 26, 36 AND 38).

FIRST USE 2-1-2011; IN COMMERCE 5-1-2011.

THE MARK CONSISTS OF STANDARD CHARACTERS WITHOUT CLAIM TO ANY PARTICULAR FONT, STYLE, SIZE, OR COLOR.

SN 85-190,321, FILED 12-3-2010.

ELI HELLMAN, EXAMINING ATTORNEY



*David J. Kybas*

Director of the United States Patent and Trademark Office

# United States of America

United States Patent and Trademark Office

## TAKE IT EASEL

**Reg. No. 4,136,417**

**Registered May 1, 2012**

**Int. Cl.: 28**

**TRADEMARK**

**PRINCIPAL REGISTER**

BATTAT INCORPORATED (DELAWARE CORPORATION)  
1560 MILITARY TURNPIKE  
PLATTSBURGH, NY 12901

FOR: CHILDREN'S ACTIVITY TABLES CONTAINING MANIPULATIVE TOYS WHICH  
CONVERT TO EASELS, IN CLASS 28 (U.S. CLS. 22, 23, 38 AND 50).

FIRST USE 7-31-2011; IN COMMERCE 7-31-2011.

THE MARK CONSISTS OF STANDARD CHARACTERS WITHOUT CLAIM TO ANY PAR-  
TICULAR FONT, STYLE, SIZE, OR COLOR.

SN 85-190,483, FILED 12-3-2010.

ANTHONY RINKER, EXAMINING ATTORNEY



*David J. Kyffers*

Director of the United States Patent and Trademark Office

# United States of America

United States Patent and Trademark Office

## NETSPACE.COM

**Reg. No. 4,136,418**

**Registered May 1, 2012**

**Int. Cl.: 42**

**SERVICE MARK**

**PRINCIPAL REGISTER**

SITETOOLS, INC. (CALIFORNIA CORPORATION)  
1726 STONER AVE #101  
LOS ANGELES, CA 90025

FOR: APPLICATION SERVICE PROVIDER (ASP) FEATURING SOFTWARE FOR USE FOR WEBSITE DESIGN AND PUBLISHING TO ENABLE POSTING, SHOWING, UPLOADING, DISPLAYING, BLOGGING, SHARING, LINK BUILDING OR OTHERWISE PROVIDING ELECTRONIC MEDIA AND USER GENERATED CONTENT OR INFORMATION OVER THE INTERNET OR OTHER COMMUNICATIONS NETWORK; COMPUTER SERVICE, NAMELY, ACTING AS AN APPLICATION SERVICE PROVIDER IN THE FIELD OF KNOWLEDGE MANAGEMENT TO HOST COMPUTER APPLICATION SOFTWARE FOR SEARCHING AND RETRIEVING INFORMATION FROM DATABASES AND COMPUTER NETWORKS; COMPUTER SERVICE, NAMELY, ACTING AS AN APPLICATION SERVICE PROVIDER IN THE FIELD OF KNOWLEDGE MANAGEMENT TO HOST COMPUTER APPLICATION SOFTWARE FOR THE COLLECTION, EDITING, ORGANIZING, MODIFYING, BOOK MARKING, TRANSMISSION, STORAGE AND SHARING OF DATA AND INFORMATION; COMPUTER SERVICES IN THE NATURE OF CUSTOMIZED WEB PAGES FEATURING USER-DEFINED INFORMATION, PERSONAL PROFILES AND INFORMATION; PROVIDING A WEBSITE THAT GIVES USERS THE ABILITY TO CREATE CUSTOMIZED WEB PAGES FEATURING USER-DEFINED INFORMATION; PROVIDING CUSTOMIZED ON-LINE WEB PAGES FEATURING USER-DEFINED INFORMATION, WHICH INCLUDES SEARCH ENGINES AND ON-LINE WEB LINKS TO OTHER WEB SITES, IN CLASS 42 (U.S. CLS. 100 AND 101).

FIRST USE 9-5-2011; IN COMMERCE 9-5-2011.

THE MARK CONSISTS OF STANDARD CHARACTERS WITHOUT CLAIM TO ANY PARTICULAR FONT, STYLE, SIZE, OR COLOR.

SN 85-190,923, FILED 12-6-2010.

ANGELA DUONG, EXAMINING ATTORNEY



*David J. Kybas*

Director of the United States Patent and Trademark Office

# United States of America

United States Patent and Trademark Office

# CARPEVITA

**Reg. No. 4,136,419**

**Registered May 1, 2012**

**Int. Cls.: 35, 43, and 44**

**SERVICE MARK**

**PRINCIPAL REGISTER**

CARPEVITA, INC. (DELAWARE CORPORATION)  
SUITE 107  
150 MORRISTOWN ROAD  
BERNARDSVILLE, NJ 07924

FOR: RETAIL GROCERY STORE SERVICES; RETAIL STORE AND ON-LINE RETAIL STORE SERVICES FEATURING HEALTH FOODS, NATURAL FOODS, ORGANIC FOODS, GOURMET FOODS, TOXIN-FREE FOODS, ANTIBIOTIC-FREE FOODS, NUTRACEUTICAL FOODS AND NUTRITIONAL SUPPLEMENTS; RETAIL STORE SERVICES FEATURING WINE, LIQUOR AND BEER, IN CLASS 35 (U.S. CLS. 100, 101 AND 102).

FIRST USE 10-1-2010; IN COMMERCE 10-1-2010.

FOR: FOOD PREPARATION SERVICES; FOOD PREPARATION SERVICES FEATURING HEALTHY, PERSONALIZED MEALS MADE TO ORDER FOR DELIVERY OR PICK UP, IN CLASS 43 (U.S. CLS. 100 AND 101).

FIRST USE 10-1-2010; IN COMMERCE 10-1-2010.

FOR: FOOD NUTRITION CONSULTATION; NUTRITION COUNSELING; DIETARY AND NUTRITIONAL GUIDANCE; COUNSELING SERVICES IN THE FIELDS OF HEALTH, NUTRITION AND LIFESTYLE WELLNESS; PROVIDING ASSISTANCE AND CONSULTATION TO INDIVIDUALS TO HELP THEM MAKE HEALTH, WELLNESS AND NUTRITIONAL CHANGES IN THEIR DAILY LIVING TO IMPROVE HEALTH; PROVIDING INFORMATION ABOUT DIETARY SUPPLEMENTS AND NUTRITION; PROVIDING A WEBSITE FEATURING INFORMATION AND ADVICE IN THE FIELDS OF DIET, NUTRITION, WEIGHT LOSS, DIET PLANNING, HEALTH AND LIFESTYLE WELLNESS, IN CLASS 44 (U.S. CLS. 100 AND 101).

FIRST USE 10-1-2010; IN COMMERCE 10-1-2010.

THE MARK CONSISTS OF STANDARD CHARACTERS WITHOUT CLAIM TO ANY PARTICULAR FONT, STYLE, SIZE, OR COLOR.

THE ENGLISH TRANSLATION OF THE WORDS "CARPE VITA" IN THE MARK IS SEIZE LIFE.



*David J. Kyros*

Director of the United States Patent and Trademark Office

**Reg. No. 4,136,419** SN 85-191,243, FILED 12-6-2010.

DAVID TAYLOR, EXAMINING ATTORNEY

# United States of America

United States Patent and Trademark Office



**Reg. No. 4,136,420**

**Registered May 1, 2012**

**Int. Cl.: 25**

**TRADEMARK**

**PRINCIPAL REGISTER**

CAMPBELL, STANLEY (UNITED STATES INDIVIDUAL)  
25590 KALMIA RD  
MORENO VALLEY, CA 92557

FOR: CLOTHING, NAMELY, TSHIRTS, JACKETS, SWEATERS, TANK TOPS, VEST AND HATS, IN CLASS 25 (U.S. CLS. 22 AND 39).

FIRST USE 11-9-2011; IN COMMERCE 11-9-2011.

THE MARK CONSISTS OF A PIG HEAD WITH A STYLIZED HUNDRED DOLLAR BILL ACROSS ITS MOUTH, CENT SIGNS INSIDE OF THE EARS AND TWO DOLLAR SIGNS AS THE EYES.

SN 85-191,826, FILED 12-7-2010.

KELLY CHOE, EXAMINING ATTORNEY



*David J. Kybas*

Director of the United States Patent and Trademark Office

# United States of America

United States Patent and Trademark Office

# RESPITE

**Reg. No. 4,136,421**

REETH DERMATOLOGICS, LLC (NEVADA LIMITED LIABILITY COMPANY)  
1770 GOLD BELT DR.  
RENO, NV 89521

**Registered May 1, 2012**

**Int. Cl.: 3**

FOR: MOISTURIZING CREAM FOR THE RELIEF OF DRY, SCALY SKIN FOR NON-MEDICAL USE, IN CLASS 3 (U.S. CLS. 1, 4, 6, 50, 51 AND 52).

**TRADEMARK**

FIRST USE 2-8-2012; IN COMMERCE 2-8-2012.

**PRINCIPAL REGISTER**

THE MARK CONSISTS OF STANDARD CHARACTERS WITHOUT CLAIM TO ANY PARTICULAR FONT, STYLE, SIZE, OR COLOR.

SN 85-192,643, FILED 12-7-2010.

PAM WILLIS, EXAMINING ATTORNEY



*David J. Kyffers*

Director of the United States Patent and Trademark Office



# United States of America

United States Patent and Trademark Office

## GLIDE RIDE TECHNOLOGY

**Reg. No. 4,136,422**

STRUTMASTERS, LLC (NORTH CAROLINA LIMITED LIABILITY COMPANY)  
PO BOX 3010  
ROXBORO, NC 27573

**Registered May 1, 2012**

**Int. Cl.: 12**

FOR: SUSPENSION SYSTEMS FOR AUTOMOBILES, NAMELY, SHOCK ABSORBERS AND SUSPENSION STRUTS, IN CLASS 12 (U.S. CLS. 19, 21, 23, 31, 35 AND 44).

**TRADEMARK**

FIRST USE 12-15-2011; IN COMMERCE 12-15-2011.

**PRINCIPAL REGISTER**

THE MARK CONSISTS OF STANDARD CHARACTERS WITHOUT CLAIM TO ANY PARTICULAR FONT, STYLE, SIZE, OR COLOR.

NO CLAIM IS MADE TO THE EXCLUSIVE RIGHT TO USE "TECHNOLOGY", APART FROM THE MARK AS SHOWN.

SN 85-192,837, FILED 12-8-2010.

BARBARA A. GOLD, EXAMINING ATTORNEY



*David J. Kybas*

Director of the United States Patent and Trademark Office

# United States of America

United States Patent and Trademark Office



**Reg. No. 4,136,423**

**Registered May 1, 2012**

**Int. Cl.: 9**

**TRADEMARK**

**PRINCIPAL REGISTER**

SANDERA, RENE (UNITED STATES INDIVIDUAL)  
1737 10TH ST  
MANHATTAN BEACH, CA 90266

FOR: ANTI-THEFT DEVICE SPECIALLY ADAPTED FOR USE WITH MOBILE PHONES AND MP3 PLAYERS COMPRISED OF A NON-METAL CORD AND CLIP THAT ATTACHES TO THE MOBILE PHONE OR MP3 PLAYER AND TO A PURSE, BELT LOOP OR OTHER ARTICLE TO PREVENT THE MOBILE PHONE OR MP3 PLAYER FROM BEING LOST OR LEFT BEHIND, IN CLASS 9 (U.S. CLS. 21, 23, 26, 36 AND 38).

FIRST USE 3-1-2010; IN COMMERCE 1-12-2012.

THE MARK CONSISTS OF A LOCK WITH AN "I" SUPERIMPOSED ON TOP. DIRECTLY TO THE RIGHT OF THE LOCK IS THE WORD "KEEP".

SN 85-194,760, FILED 12-10-2010.

JAMES LOVELACE, EXAMINING ATTORNEY



*David J. Kybas*

Director of the United States Patent and Trademark Office

# United States of America

United States Patent and Trademark Office



**Reg. No. 4,136,424**

**Registered May 1, 2012**

**Int. Cl.: 41**

**SERVICE MARK**

**PRINCIPAL REGISTER**

MARCO, ZANETTI (ITALY INDIVIDUAL)  
VIA PASSO DEL BRENNERO 9  
TORINO, ITALY

FOR: EDUCATIONAL SERVICES, NAMELY, CONDUCTING SEMINARS AND COURSES IN THE FIELD OF NUTRITION AND DISTRIBUTION OF COURSE AND EDUCATIONAL MATERIALS IN CONNECTION THEREWITH, IN CLASS 41 (U.S. CLS. 100, 101 AND 107).

FIRST USE 3-23-2011; IN COMMERCE 3-23-2011.

NO CLAIM IS MADE TO THE EXCLUSIVE RIGHT TO USE "NUTRITIONAL COACH", APART FROM THE MARK AS SHOWN.

THE MARK CONSISTS OF THE WORD "NUTRITIONAL" OVERLAPPED TO THE WORD "COACH" AND FLANKED BY A STYLIZED REPRESENTATION OF A SEQUENCE OF DNA.

SN 85-194,791, FILED 12-10-2010.

AISHA CLARKE, EXAMINING ATTORNEY



*David J. Kybas*

Director of the United States Patent and Trademark Office

# United States of America

United States Patent and Trademark Office

## ACCOUNTABLE ANESTHESIA ORGANIZATION

**Reg. No. 4,136,425**

SOMNIA, INC. (NEW YORK CORPORATION)  
10 COMMERCE DRIVE  
NEW ROCHELLE, NY 108015214

**Registered May 1, 2012**

**Int. Cls.: 35 and 44**

FOR: BUSINESS ADMINISTRATION OF MEDICAL SERVICES FOR OTHERS RELATED TO ANESTHESIOLOGY, IN CLASS 35 (U.S. CLS. 100, 101 AND 102).

**SERVICE MARK**

FIRST USE 3-15-2011; IN COMMERCE 3-15-2011.

**PRINCIPAL REGISTER**

FOR: ANESTHESIOLOGY MEDICAL SERVICES, IN CLASS 44 (U.S. CLS. 100 AND 101).

FIRST USE 3-15-2011; IN COMMERCE 3-15-2011.

THE MARK CONSISTS OF STANDARD CHARACTERS WITHOUT CLAIM TO ANY PARTICULAR FONT, STYLE, SIZE, OR COLOR.

NO CLAIM IS MADE TO THE EXCLUSIVE RIGHT TO USE "ANESTHESIA ORGANIZATION", APART FROM THE MARK AS SHOWN.

SN 85-195,053, FILED 12-10-2010.

RAUL CORDOVA, EXAMINING ATTORNEY



*David J. Kybas*

Director of the United States Patent and Trademark Office

# United States of America

United States Patent and Trademark Office

# GOLD STOP

**Reg. No. 4,136,426**

**Registered May 1, 2012**

**Int. Cl.: 35**

**SERVICE MARK**

**PRINCIPAL REGISTER**

TOP HAT, INC. (MINNESOTA CORPORATION)  
108 FIRST AVENUE EAST  
SHAKOPEE, MN 55379

FOR: RETAIL JEWELRY STORE SERVICES FEATURING GOLD AND DIAMOND JEWELRY;  
ON-LINE RETAIL STORE SERVICES FEATURING GOLD AND DIAMOND JEWELRY;  
PROVIDING A WEBSITE FEATURING CONSUMER INFORMATION ABOUT JEWELRY  
BUYING AND SELLING, IN CLASS 35 (U.S. CLS. 100, 101 AND 102).

FIRST USE 3-31-2011; IN COMMERCE 3-31-2011.

THE MARK CONSISTS OF STANDARD CHARACTERS WITHOUT CLAIM TO ANY PARTICULAR FONT, STYLE, SIZE, OR COLOR.

NO CLAIM IS MADE TO THE EXCLUSIVE RIGHT TO USE "GOLD", APART FROM THE MARK AS SHOWN.

SN 85-196,253, FILED 12-13-2010.

ANGELA DUONG, EXAMINING ATTORNEY



*David J. Kyros*

Director of the United States Patent and Trademark Office

# United States of America

United States Patent and Trademark Office

# ethosystem

**Reg. No. 4,136,427**

**Registered May 1, 2012**

**Int. Cl.: 35**

**SERVICE MARK**

**PRINCIPAL REGISTER**

TALLWAVE MEDIA, INC. (DELAWARE CORPORATION)  
C/O WEISS BROWN, PLLC, SUITE 143  
6263 NORTH SCOTTSDALE ROAD  
SCOTTSDALE, AZ 85250

FOR: ANALYZING AND COMPILING DATA FOR MEASURING PERFORMANCE OF OTHER BUSINESSES' DIGITAL MARKETING, IN CLASS 35 (U.S. CLS. 100, 101 AND 102).

FIRST USE 8-31-2011; IN COMMERCE 8-31-2011.

THE MARK CONSISTS OF STANDARD CHARACTERS WITHOUT CLAIM TO ANY PARTICULAR FONT, STYLE, SIZE, OR COLOR.

SN 85-196,305, FILED 12-13-2010.

H. M. FISHER, EXAMINING ATTORNEY



*David J. Kyffers*

Director of the United States Patent and Trademark Office

# United States of America

United States Patent and Trademark Office

# Five Wits

**Reg. No. 4,136,428**

SILVESTER, JOSEPH A (UNITED STATES INDIVIDUAL)  
48 ST MARKS PLACE  
BROOKLYN, NY 11217

**Registered May 1, 2012**

**Int. Cl.: 3**

FOR: BEAUTY CREAMS; HAIR CARE PREPARATIONS; HAIR SHAMPOOS AND CONDITIONERS; HAIR STYLING PREPARATIONS, IN CLASS 3 (U.S. CLS. 1, 4, 6, 50, 51 AND 52).

**TRADEMARK**

FIRST USE 11-30-2011; IN COMMERCE 11-30-2011.

**PRINCIPAL REGISTER**

THE MARK CONSISTS OF STANDARD CHARACTERS WITHOUT CLAIM TO ANY PARTICULAR FONT, STYLE, SIZE, OR COLOR.

SN 85-196,505, FILED 12-13-2010.

JERI J. FICKES, EXAMINING ATTORNEY



*David J. Kybas*

Director of the United States Patent and Trademark Office

# United States of America

United States Patent and Trademark Office



**Reg. No. 4,136,429**

**Registered May 1, 2012**

**Int. Cl.: 35**

**SERVICE MARK**

**PRINCIPAL REGISTER**

AP GAS & ELECTRIC (TX), LLC (TEXAS LIMITED LIABILITY COMPANY), DBA APG&E,  
6161 SAVOY  
SUITE 500  
HOUSTON, TX 77036

FOR: ENERGY MANAGEMENT SERVICES, NAMELY, PROVIDING A SERVICE THAT  
ALLOWS CUSTOMERS TO PURCHASE ENERGY, NAMELY, ELECTRICITY, NATURAL  
GAS AND RENEWABLE ENERGY, AT A FIXED PRICE, IN CLASS 35 (U.S. CLS. 100, 101  
AND 102).

FIRST USE 1-13-2011; IN COMMERCE 1-13-2011.

NO CLAIM IS MADE TO THE EXCLUSIVE RIGHT TO USE "GAS & ELECTRIC", APART  
FROM THE MARK AS SHOWN.

THE COLOR(S) RED, ORANGE, YELLOW, WHITE, BLUE IS/ARE CLAIMED AS A FEATURE  
OF THE MARK.

THE MARK CONSISTS OF A PARTIALLY OBSCURED SUNBURST CONTAINING COLORS  
ORANGE, RED, YELLOW AND WHITE CONTINUING INTO THE LETTERS, "AP" IN BLUE,  
OUTLINED IN ORANGE, FOLLOWED BY THE WORDS "GAS & ELECTRIC" IN ORANGE  
OUTLINED IN BLUE.

SN 85-196,993, FILED 12-14-2010.

MATTHEW MCDOWELL, EXAMINING ATTORNEY



*David J. Kybas*

Director of the United States Patent and Trademark Office



# United States of America

United States Patent and Trademark Office



**Reg. No. 4,136,430**

**Registered May 1, 2012**

**Int. Cl.: 35**

**SERVICE MARK**

**PRINCIPAL REGISTER**

AP GAS & ELECTRIC (TX), LLC (TEXAS LIMITED LIABILITY COMPANY), DBA APG&E,  
SUITE 500  
6161 SAVOY  
HOUSTON, TX 77036

FOR: ENERGY MANAGEMENT SERVICES, NAMELY, PROVIDING A SERVICE THAT  
ALLOWS CUSTOMERS TO PURCHASE ENERGY, NAMELY, ELECTRICITY, NATURAL  
GAS AND RENEWABLE ENERGY, AT A FIXED PRICE, IN CLASS 35 (U.S. CLS. 100, 101  
AND 102).

FIRST USE 1-13-2011; IN COMMERCE 1-13-2011.

NO CLAIM IS MADE TO THE EXCLUSIVE RIGHT TO USE "G & E ENERGY SOLUTIONS",  
APART FROM THE MARK AS SHOWN.

THE COLOR(S) RED, ORANGE, YELLOW, WHITE AND BLUE IS/ARE CLAIMED AS A  
FEATURE OF THE MARK.

THE MARK CONSISTS OF A PARTIALLY OBSCURED SUNBURST CONTAINING COLORS  
ORANGE, RED, YELLOW AND WHITE CONTINUING INTO THE LETTERS "AP" IN BLUE,  
OUTLINED IN ORANGE, FOLLOWED BY THE LETTERS "G&E" IN ORANGE, OUTLINED  
IN BLUE WITH THE WORDS "ENERGY SOLUTIONS" BELOW IN BLUE.

SN 85-196,999, FILED 12-14-2010.

MATTHEW MCDOWELL, EXAMINING ATTORNEY



*David J. Kybas*

Director of the United States Patent and Trademark Office

# United States of America

United States Patent and Trademark Office



**Reg. No. 4,136,431**

**Registered May 1, 2012**

**Int. Cl.: 40**

**SERVICE MARK**

**PRINCIPAL REGISTER**

INK HEALTH, LLC. (WASHINGTON LIMITED LIABILITY COMPANY)  
401 W 1ST AVE. #7  
SPOKANE, WA 99201

FOR: MANUFACTURING SERVICES FOR OTHERS IN THE FIELD OF BANDAGES FOR THE TATTOO INDUSTRY, IN CLASS 40 (U.S. CLS. 100, 103 AND 106).

FIRST USE 9-1-2010; IN COMMERCE 1-25-2011.

NO CLAIM IS MADE TO THE EXCLUSIVE RIGHT TO USE "HEALTH", APART FROM THE MARK AS SHOWN.

THE MARK CONSISTS OF THE STYLIZED TEXT "INK HEALTH".

SN 85-197,240, FILED 12-14-2010.

ADA HAN, EXAMINING ATTORNEY



*David J. Kybas*

Director of the United States Patent and Trademark Office

# United States of America

United States Patent and Trademark Office

# OPACIPRENE

**Reg. No. 4,136,432**

POLY-MED, INC. (SOUTH CAROLINA CORPORATION)  
6309 HWY 187  
ANDERSON, SC 29625

**Registered May 1, 2012**

**Int. Cl.: 10**

FOR: RADIOPAQUE FIBERS FOR USE AS A LOCATING MARKER IN IMPLANTED MEDICAL DEVICES, IN CLASS 10 (U.S. CLS. 26, 39 AND 44).

**TRADEMARK**

FIRST USE 3-22-2011; IN COMMERCE 3-22-2011.

**PRINCIPAL REGISTER**

THE MARK CONSISTS OF STANDARD CHARACTERS WITHOUT CLAIM TO ANY PARTICULAR FONT, STYLE, SIZE, OR COLOR.

OWNER OF U.S. REG. NO. 3,556,338.

SN 85-197,343, FILED 12-14-2010.

MICHAEL ENGEL, EXAMINING ATTORNEY



*David J. Kybas*

Director of the United States Patent and Trademark Office

# United States of America

United States Patent and Trademark Office

# scan my boobies

**Reg. No. 4,136,433**

**Registered May 1, 2012**

**Int. Cl.: 25**

**TRADEMARK**

**PRINCIPAL REGISTER**

MICHELLE BAKARICH (UNITED STATES INDIVIDUAL)  
2331 N TANQUE VERDE PLACE  
TUCSON, AZ 85749

FOR: T-SHIRTS; SLEEP SHIRTS; TANK TOPS; TANK-TOPS, IN CLASS 25 (U.S. CLS. 22 AND 39).

FIRST USE 9-9-2010; IN COMMERCE 9-9-2010.

THE MARK CONSISTS OF STANDARD CHARACTERS WITHOUT CLAIM TO ANY PARTICULAR FONT, STYLE, SIZE, OR COLOR.

SN 85-197,359, FILED 12-14-2010.

MICHAEL KEATING, EXAMINING ATTORNEY



*David J. Kyffers*

Director of the United States Patent and Trademark Office

# United States of America

United States Patent and Trademark Office

# 34

**Reg. No. 4,136,434**

**Registered May 1, 2012**

**Int. Cl.: 12**

**TRADEMARK**

**PRINCIPAL REGISTER**

FOX FACTORY, INC. (CALIFORNIA CORPORATION)  
915 DISK DRIVE  
SCOTTS VALLEY, CA 95066

FOR: VEHICLE PARTS, NAMELY, SHOCK ABSORBERS, IN CLASS 12 (U.S. CLS. 19, 21, 23, 31, 35 AND 44).

FIRST USE 11-15-2010; IN COMMERCE 11-15-2010.

THE MARK CONSISTS OF STANDARD CHARACTERS WITHOUT CLAIM TO ANY PARTICULAR FONT, STYLE, SIZE, OR COLOR.

OWNER OF U.S. REG. NOS. 3,036,706, 3,832,817, AND OTHERS.

SN 85-198,153, FILED 12-15-2010.

BARBARA RUTLAND, EXAMINING ATTORNEY



*David J. Kybas*

Director of the United States Patent and Trademark Office

# United States of America

United States Patent and Trademark Office



**Reg. No. 4,136,435**

**Registered May 1, 2012**

**Int. Cl.: 5**

**TRADEMARK**

**PRINCIPAL REGISTER**

AVENTISUB II INC. (DELAWARE CORPORATION)  
3711 KENNETT PIKE SUITE 200  
GREENVILLE, DE 19807

FOR: PHARMACEUTICAL PREPARATIONS, NAMELY, ANTIHISTAMINES NOT FOR OPHTHALMIC USE, IN CLASS 5 (U.S. CLS. 6, 18, 44, 46, 51 AND 52).

FIRST USE 3-4-2011; IN COMMERCE 3-4-2011.

OWNER OF U.S. REG. NO. 2,067,728.

THE COLOR(S) PURPLE, RED, ORANGE, PINK AND WHITE IS/ARE CLAIMED AS A FEATURE OF THE MARK.

NO CLAIM IS MADE TO THE EXCLUSIVE RIGHT TO USE "24 HOUR", APART FROM THE MARK AS SHOWN.

THE MARK CONSISTS OF A MOSTLY PURPLE COLORED RECTANGLE DESIGN WHERE A PORTION OF THE UPPER RIGHT CORNER OF THE RECTANGLE IS A GRADATION OF RED TO ORANGE AND A PORTION OF THE LOWER LEFT CORNER IS PINK. RIGHT BELOW THE UPPER LEFT CORNER IS THE TERM "ALLEGRA" IN A STYLIZED FONT WHEREIN ALL THE LETTERS IN "ALLEGRA" ARE IN WHITE AND THE LETTER "E" IN "ALLEGRA" IS IN WHITE AND PURPLE. IN THE LOWER RIGHT CORNER IS THE TERM "24 HOUR" IN BLUE NUMBERS AND LETTERS. THE NUMBER "24" IS SUPER-IMPOSED ON A GRAPHIC IMAGE OF A CLOCK ALSO BLUE IN COLOR.

SN 85-198,413, FILED 12-15-2010.

B. PARADEWELAI, EXAMINING ATTORNEY



*David J. Kybas*

Director of the United States Patent and Trademark Office

# United States of America

United States Patent and Trademark Office



**Reg. No. 4,136,436**

**Registered May 1, 2012**

**Int. Cl.: 5**

**TRADEMARK**

**PRINCIPAL REGISTER**

AVENTISUB II INC. (DELAWARE CORPORATION)  
3711 KENNETT PIKE SUITE 200  
GREENVILLE, DE 19807

FOR: PHARMACEUTICAL PREPARATIONS, NAMELY, ANTIHISTAMINES AND DECONGESTANTS NOT FOR OPHTHALMIC USE, IN CLASS 5 (U.S. CLS. 6, 18, 44, 46, 51 AND 52).

FIRST USE 3-4-2011; IN COMMERCE 3-4-2011.

OWNER OF U.S. REG. NO. 2,157,669.

THE COLOR(S) PURPLE, RED, ORANGE, PINK AND WHITE IS/ARE CLAIMED AS A FEATURE OF THE MARK.

NO CLAIM IS MADE TO THE EXCLUSIVE RIGHT TO USE "12 HOUR", APART FROM THE MARK AS SHOWN.

THE MARK CONSISTS OF A MOSTLY PURPLE COLORED RECTANGLE DESIGN WHERE A PORTION OF THE UPPER RIGHT CORNER OF THE RECTANGLE IS A GRADATION OF RED TO ORANGE AND A PORTION OF THE LOWER LEFT CORNER IS PINK. RIGHT BELOW THE UPPER LEFT CORNER IS THE TERM "ALLEGRA-D" IN A STYLIZED FONT WHEREIN ALL THE LETTERS IN "ALLEGRA-D" ARE IN WHITE AND THE LETTER "E" IN "ALLEGRA-D" IS IN WHITE AND PURPLE. IN THE LOWER RIGHT CORNER IS THE TERM "12 HOUR" IN ORANGE NUMBERS AND LETTERS. THE NUMBER "12" IS SUPERIMPOSED ON A GRAPHIC IMAGE OF A CLOCK ALSO ORANGE IN COLOR.

SN 85-198,443, FILED 12-15-2010.

B. PARADEWELAI, EXAMINING ATTORNEY



*David J. Kyffers*

Director of the United States Patent and Trademark Office

# United States of America

United States Patent and Trademark Office

## PLATE PARTNER

**Reg. No. 4,136,437**

**Registered May 1, 2012**

**Int. Cl.: 12**

**TRADEMARK**

**PRINCIPAL REGISTER**

BRADLEY ELLMAN (UNITED STATES INDIVIDUAL)  
3468 FAIRWAY RD.  
OCEANSIDE, NY 11572

FOR: LICENSE PLATE HOLDERS, IN CLASS 12 (U.S. CLS. 19, 21, 23, 31, 35 AND 44).

FIRST USE 11-14-2011; IN COMMERCE 11-14-2011.

THE MARK CONSISTS OF STANDARD CHARACTERS WITHOUT CLAIM TO ANY PARTICULAR FONT, STYLE, SIZE, OR COLOR.

NO CLAIM IS MADE TO THE EXCLUSIVE RIGHT TO USE "PLATE", APART FROM THE MARK AS SHOWN.

SN 85-198,449, FILED 12-15-2010.

TINA MAI, EXAMINING ATTORNEY



*David J. Kyffers*

Director of the United States Patent and Trademark Office



# United States of America

United States Patent and Trademark Office

## BLAST BY COLT 45

**Reg. No. 4,136,438**

PABST BREWING COMPANY (DELAWARE CORPORATION)  
9014 HERITAGE PARKWAY, SUITE 308  
WOODBIDGE, IL 60517

**Registered May 1, 2012**

**Int. Cl.: 33**

FOR: ALCOHOLIC BEVERAGE PRODUCED FROM A BREWED MALT BASE WITH NATURAL FLAVORS, IN CLASS 33 (U.S. CLS. 47 AND 49).

**TRADEMARK**

FIRST USE 3-1-2011; IN COMMERCE 3-1-2011.

**PRINCIPAL REGISTER**

THE MARK CONSISTS OF STANDARD CHARACTERS WITHOUT CLAIM TO ANY PARTICULAR FONT, STYLE, SIZE, OR COLOR.

OWNER OF U.S. REG. NO. 799,986.

SN 85-198,456, FILED 12-15-2010.

ELLEN PERKINS, EXAMINING ATTORNEY



*David J. Kyffers*

Director of the United States Patent and Trademark Office

# United States of America

United States Patent and Trademark Office

## LACTAID FIT & CREAMY

**Reg. No. 4,136,439**

**Registered May 1, 2012**

**Int. Cl.: 29**

**TRADEMARK**

**PRINCIPAL REGISTER**

JOHNSON & JOHNSON (NEW JERSEY CORPORATION)  
ONE JOHNSON & JOHNSON PLAZA  
NEW BRUNSWICK, NJ 089337001

FOR: FLUID MILK, IN CLASS 29 (U.S. CL. 46).

FIRST USE 4-5-2011; IN COMMERCE 4-5-2011.

THE MARK CONSISTS OF STANDARD CHARACTERS WITHOUT CLAIM TO ANY PARTICULAR FONT, STYLE, SIZE, OR COLOR.

OWNER OF U.S. REG. NOS. 1,459,381, 3,760,760, AND OTHERS.

NO CLAIM IS MADE TO THE EXCLUSIVE RIGHT TO USE "CREAMY", APART FROM THE MARK AS SHOWN.

SN 85-199,616, FILED 12-16-2010.

KAREN K. BUSH, EXAMINING ATTORNEY



*David J. Kyffers*

Director of the United States Patent and Trademark Office

# United States of America

United States Patent and Trademark Office

# INSTINCT

**Reg. No. 4,136,440**

**Registered May 1, 2012**

**Int. Cl.: 9**

**TRADEMARK**

**PRINCIPAL REGISTER**

ILLINOIS TOOL WORKS INC. (DELAWARE CORPORATION)  
3600 WEST LAKE AVENUE  
GLENVIEW, IL 60026

FOR: SOFTWARE FOR USE IN THE CONSTRUCTION INDUSTRY, NAMELY, ENGINEERING SOFTWARE FOR DESIGNING, MODELING, SIMULATING, AND ANALYZING CONSTRUCTION PROJECTS; STRUCTURAL AND ARCHITECTURAL DESIGN SOFTWARE; STRUCTURAL AND ARCHITECTURAL DESIGN SOFTWARE TO BE USED FOR MEASURING, SKETCHING AND DRAWING; BUILDING PROJECT MANAGEMENT SOFTWARE FOR SCHEDULING, RESOURCING, BUDGETING AND TRACKING OF CONSTRUCTION PROJECTS; AND COMPUTER AIDED MANUFACTURING SOFTWARE FOR ENGINEERING AND MANUFACTURING APPLICATIONS, IN CLASS 9 (U.S. CLS. 21, 23, 26, 36 AND 38).

FIRST USE 6-3-2011; IN COMMERCE 6-3-2011.

THE MARK CONSISTS OF STANDARD CHARACTERS WITHOUT CLAIM TO ANY PARTICULAR FONT, STYLE, SIZE, OR COLOR.

SN 85-199,633, FILED 12-16-2010.

LESLEY LAMOTHE, EXAMINING ATTORNEY



*David J. Kypos*

Director of the United States Patent and Trademark Office

# United States of America

United States Patent and Trademark Office

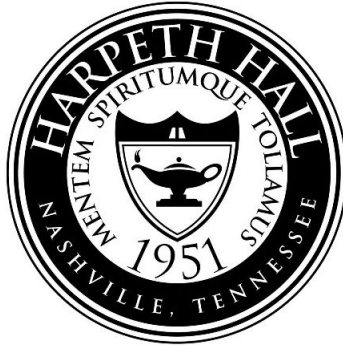

**Reg. No. 4,136,441**

**Registered May 1, 2012**

**Int. Cl.: 41**

**SERVICE MARK**

**PRINCIPAL REGISTER**

HARPETH HALL SCHOOL (THE) (TENNESSEE CORPORATION)  
3801 HOBBS ROAD  
NASHVILLE, TN 37215

FOR: EDUCATIONAL SERVICES IN THE NATURE OF AN INDEPENDENT SCHOOL PROVIDING COURSES OF INSTRUCTION AT THE MIDDLE SCHOOL AND SECONDARY LEVELS, IN CLASS 41 (U.S. CLS. 100, 101 AND 107).

FIRST USE 6-0-1952; IN COMMERCE 6-0-1952.

NO CLAIM IS MADE TO THE EXCLUSIVE RIGHT TO USE "NASHVILLE, TENNESSEE" AND "1951", APART FROM THE MARK AS SHOWN.

THE MARK CONSISTS OF CONCENTRIC RINGS OF VARYING WIDTH INCLUDING THE WORDING "HARPETH HALL NASHVILLE, TENNESSEE" WITHIN THE THIRD RING AND THE WORDING "MENTEM SPIRITUMQUE TOLLAMUS 1951" IN THE CENTER ALONG WITH A SEAL DISPLAYING AN OIL LAMP.

THE ENGLISH TRANSLATION OF THE WORDS "MENTEM SPIRITUMQUE TOLLAMUS" IN THE MARK IS "LET US LIFT UP THE MIND AND SPIRIT".

SN 85-199,829, FILED 12-16-2010.

TINA MAI, EXAMINING ATTORNEY



*David J. Kyjars*

Director of the United States Patent and Trademark Office

# United States of America

United States Patent and Trademark Office



**Reg. No. 4,136,442**

**Registered May 1, 2012**

**Int. Cl.: 34**

BUENA VISTA TOBACCO COMPANY BTF SWITZERLAND SA (SWITZERLAND CORPORATION)  
BUILDING 1A  
RUE DES VIGNERONS P.O. BOX 359  
MORGES, SWITZERLAND 1110

**TRADEMARK**

FOR: CIGARS; TOBACCO, IN CLASS 34 (U.S. CLS. 2, 8, 9 AND 17).

**PRINCIPAL REGISTER**

FIRST USE 2-11-2011; IN COMMERCE 6-27-2011.

NO CLAIM IS MADE TO THE EXCLUSIVE RIGHT TO USE "TOBACCO FACTORY", APART FROM THE MARK AS SHOWN.

THE COLOR(S) BLACK, RED AND SILVER IS/ARE CLAIMED AS A FEATURE OF THE MARK.

THE MARK CONSISTS OF A BLACK DIAMOND SHAPE THAT IS OUTLINED IN RED AND SILVER, WITH THE SILVER OUTLINE FOLLOWING THE SHAPE OF THE DIAMOND AND THE RED OUTLINE INCLUDING LEAF, SWIRL, AND FLEUR-DE-LIS DESIGNS. THE WORDING "BUENA VISTA TOBACCO FACTORY" APPEARS IN THE COLOR SILVER IN THE MIDDLE OF THE BLACK DIAMOND WITH A SILVER CHEVRON WITH THE POINT FACING UP ABOVE THE WORDING AND THE MIRROR IMAGE OF THE CHEVRON APPEARING IN SILVER BELOW THE WORDING; THE TERM "BTF" APPEARS IN SILVER BELOW THE BOTTOM CHEVRON. ABOVE THE TOP CHEVRON IS A SMALL DIAMOND APPEARING BETWEEN TWO VERTICAL DESIGN ELEMENTS, ALL IN THE COLOR SILVER. A SERIES OF BLACK PARTIAL FLOWERS APPEARS BETWEEN THE SILVER AND RED OUTLINES.



THE ENGLISH TRANSLATION OF "BUENA VISTA" IN THE MARK IS "GOOD VIEW".

SN 85-200,417, FILED 12-17-2010.

SUZANNE BLANE, EXAMINING ATTORNEY

*David J. Kyros*

Director of the United States Patent and Trademark Office

# United States of America

United States Patent and Trademark Office

# VizGear

**Reg. No. 4,136,443**

**Registered May 1, 2012**

**Int. Cl.: 9**

**TRADEMARK**

**PRINCIPAL REGISTER**

VIZUSA, LLC (OHIO LIMITED LIABILITY COMPANY)  
35401 EUCLID AVENUE, SUITE 117  
WILLOUGHBY, OH 44094

FOR: REFLECTIVE CLOTHING FOR SAFETY PURPOSES, IN CLASS 9 (U.S. CLS. 21, 23, 26, 36 AND 38).

FIRST USE 2-24-2012; IN COMMERCE 2-24-2012.

THE MARK CONSISTS OF STANDARD CHARACTERS WITHOUT CLAIM TO ANY PARTICULAR FONT, STYLE, SIZE, OR COLOR.

SN 85-201,509, FILED 12-20-2010.

JAY FLOWERS, EXAMINING ATTORNEY



*David J. Kyffers*

Director of the United States Patent and Trademark Office

# United States of America

United States Patent and Trademark Office

## KRUSTEAZ ONE STEP

**Reg. No. 4,136,444**

**Registered May 1, 2012**

**Int. Cl.: 30**

**TRADEMARK**

**PRINCIPAL REGISTER**

CONTINENTAL MILLS, INC. (WASHINGTON CORPORATION)  
P.O. BOX 88176  
SEATTLE, WA 98138

FOR: MIXES FOR BAKERY GOODS; MUFFIN MIXES, IN CLASS 30 (U.S. CL. 46).

FIRST USE 6-30-2011; IN COMMERCE 6-30-2011.

THE MARK CONSISTS OF STANDARD CHARACTERS WITHOUT CLAIM TO ANY PARTICULAR FONT, STYLE, SIZE, OR COLOR.

OWNER OF U.S. REG. NOS. 733,899 AND 2,109,120.

NO CLAIM IS MADE TO THE EXCLUSIVE RIGHT TO USE "ONE STEP", APART FROM THE MARK AS SHOWN.

SN 85-202,309, FILED 12-20-2010.

JENNIFER MARTIN, EXAMINING ATTORNEY



*David J. Kyros*

Director of the United States Patent and Trademark Office

# United States of America

United States Patent and Trademark Office



**Reg. No. 4,136,445**

**Registered May 1, 2012**

**Int. Cl.: 42**

**SERVICE MARK**

**PRINCIPAL REGISTER**

MEDTECH HOLDINGS, INC. (DELAWARE CORPORATION)  
6 CENTURY ROAD  
SOUTH PLAINFIELD, NJ 07080

FOR: PRODUCT DESIGN AND DEVELOPMENT IN THE FIELD OF MEDICAL DEVICES; PRODUCT DEVELOPMENT AND ENGINEERING SERVICES FOR OTHERS; DESIGN AND TESTING FOR NEW PRODUCT DEVELOPMENT; DESIGN AND TESTING OF NEW PRODUCTS FOR OTHERS, IN CLASS 42 (U.S. CLS. 100 AND 101).

FIRST USE 1-13-2012; IN COMMERCE 1-13-2012.

NO CLAIM IS MADE TO THE EXCLUSIVE RIGHT TO USE "MEDICAL", APART FROM THE MARK AS SHOWN.

THE COLOR(S) PURPLE AND GRAY IS/ARE CLAIMED AS A FEATURE OF THE MARK.

THE MARK CONSISTS OF THE WORD "VENTION" GENERALLY IN PURPLE IN CAPS, WITH THE "V" SLANTED TO THE LEFT AND THE "E" APPEARING IN GRAY AS THREE HORIZONTAL LINES. THE WORD "MEDICAL" IS VERTICAL IN GRAY TO THE "N" IN "VENTION". THE WORDS "ADVANCING YOUR INNOVATIONS FOR HEALTH" APPEARS IN GRAY A SMALL FONT UNDERNEATH THE LETTERS "ION" IN "VENTION".

SN 85-202,441, FILED 12-21-2010.

SKYE YOUNG, EXAMINING ATTORNEY



*David J. Kyros*

Director of the United States Patent and Trademark Office



# United States of America

United States Patent and Trademark Office

# PAKNATURAL

**Reg. No. 4,136,446**

**Registered May 1, 2012**

**Int. Cl.: 17**

**TRADEMARK**

**PRINCIPAL REGISTER**

SEALED AIR CORPORATION (US) (DELAWARE CORPORATION)  
200 RIVERFRONT BOULEVARD  
ELMWOOD PARK, NJ 07407

FOR: PACKING AND PACKAGING MATERIALS MADE OF BIODEGRADABLE PLASTIC  
DERIVED FROM GRAIN BASED MATERIALS FOR SHIPPING CONTAINERS, IN CLASS  
17 (U.S. CLS. 1, 5, 12, 13, 35 AND 50).

FIRST USE 1-19-2012; IN COMMERCE 1-19-2012.

THE MARK CONSISTS OF STANDARD CHARACTERS WITHOUT CLAIM TO ANY PAR-  
TICULAR FONT, STYLE, SIZE, OR COLOR.

SN 85-202,446, FILED 12-21-2010.

CHRISTINE COOPER, EXAMINING ATTORNEY



*David J. Kyffers*

Director of the United States Patent and Trademark Office

# United States of America

United States Patent and Trademark Office



**Reg. No. 4,136,447**

**Registered May 1, 2012**

**Int. Cl.: 40**

**SERVICE MARK**

**PRINCIPAL REGISTER**

MEDTECH HOLDINGS, INC. (DELAWARE CORPORATION)  
6 CENTURY ROAD  
SOUTH PLAINFIELD, MA 07080

FOR: ASSEMBLY OF PRODUCTS FOR OTHERS; CUSTOM MANUFACTURE OF MEDICAL DEVICES AND MEDICAL DEVICE COMPONENTS; CONTRACT MANUFACTURING IN THE FIELD OF MEDICAL DEVICES, IN CLASS 40 (U.S. CLS. 100, 103 AND 106).

FIRST USE 1-13-2012; IN COMMERCE 1-13-2012.

NO CLAIM IS MADE TO THE EXCLUSIVE RIGHT TO USE "MEDICAL", APART FROM THE MARK AS SHOWN.

THE COLOR(S) PURPLE AND GRAY IS/ARE CLAIMED AS A FEATURE OF THE MARK.

THE MARK CONSISTS OF THE WORD "VENTION" GENERALLY IN PURPLE IN CAPS, WITH THE "V" SLANTED TO THE LEFT AND THE "E" APPEARING IN GRAY AS THREE HORIZONTAL LINES. THE WORD "MEDICAL" IS VERTICAL IN GRAY TO THE "N" IN "VENTION". THE WORDS "ADVANCING YOUR INNOVATIONS FOR HEALTH" APPEARS IN GRAY A SMALL FONT UNDERNEATH THE LETTERS "ION" IN "VENTION".

SN 85-202,451, FILED 12-21-2010.

SKYE YOUNG, EXAMINING ATTORNEY



*David J. Kyjars*

Director of the United States Patent and Trademark Office

# United States of America

United States Patent and Trademark Office

# JUCINA

**Reg. No. 4,136,448**

**Registered May 1, 2012**

**Int. Cl.: 32**

**TRADEMARK**

**PRINCIPAL REGISTER**

MEHRAN BOTTLERS (PVT.) LTD. (PAKISTAN PRIVATE LIMITED COMPANY)  
C/5-A, S.I.T.E.  
KARACHI-75700, PAKISTAN

FOR: FRUIT DRINKS, IN CLASS 32 (U.S. CLS. 45, 46 AND 48).

FIRST USE 12-9-2011; IN COMMERCE 12-27-2011.

THE MARK CONSISTS OF STANDARD CHARACTERS WITHOUT CLAIM TO ANY PARTICULAR FONT, STYLE, SIZE, OR COLOR.

SN 85-202,522, FILED 12-21-2010.

FLORENTINA BLANDU, EXAMINING ATTORNEY



*David J. Kybas*

Director of the United States Patent and Trademark Office

# United States of America

United States Patent and Trademark Office

## PERFECT FINISH

**Reg. No. 4,136,449**

KSIN LUXEMBOURG III, S.AR.L. (LUXEMBOURG CORPORATION)  
1, RUE DE GLACIS  
L-1628, LUXEMBOURG

**Registered May 1, 2012**

**Int. Cl.: 7**

FOR: SERGERS; SEWING MACHINES, IN CLASS 7 (U.S. CLS. 13, 19, 21, 23, 31, 34 AND 35).

**TRADEMARK**

FIRST USE 3-30-2011; IN COMMERCE 3-30-2011.

**PRINCIPAL REGISTER**

THE MARK CONSISTS OF STANDARD CHARACTERS WITHOUT CLAIM TO ANY PARTICULAR FONT, STYLE, SIZE, OR COLOR.

OWNER OF U.S. REG. NO. 3,912,082.

SN 85-202,796, FILED 12-21-2010.

MARGERY A. TIERNEY, EXAMINING ATTORNEY



*David J. Kybas*

Director of the United States Patent and Trademark Office

# United States of America

United States Patent and Trademark Office



**Reg. No. 4,136,450**

**Registered May 1, 2012**

**Int. Cl.: 38**

**SERVICE MARK**

**PRINCIPAL REGISTER**

ADVANCED PATIENT ADVOCACY, LLC (MARYLAND LIMITED LIABILITY COMPANY)  
SUITE 403  
175 ADMIRAL COCHRANE DRIVE  
ANNAPOLIS, MD 21401

FOR: ELECTRONIC DATA INTERCHANGE SERVICES IN THE FIELD OF HEALTHCARE TRANSACTIONS SUCH AS ENROLLMENT, CLAIMS, ELIGIBILITY, CLAIM STATUS, PRIOR AUTHORIZATIONS AND REFERRALS THAT ALLOW DIRECT TRANSACTION AND PAYMENT COMMUNICATIONS BETWEEN HEALTHCARE PROVIDERS AND PAYERS, IN CLASS 38 (U.S. CLS. 100, 101 AND 104).

FIRST USE 2-15-2011; IN COMMERCE 2-15-2011.

NO CLAIM IS MADE TO THE EXCLUSIVE RIGHT TO USE "PATIENT ADVOCACY", APART FROM THE MARK AS SHOWN.

THE MARK CONSISTS OF A STYLIZED LETTER "A" WITH THE WORDS "ADVANCED PATIENT ADVOCACY" TO THE RIGHT OF THE STYLIZED "A".

SN 85-203,027, FILED 12-21-2010.

BILL DAWE, EXAMINING ATTORNEY



*David J. Kyffers*

Director of the United States Patent and Trademark Office

# United States of America

United States Patent and Trademark Office

# BIGOSO

**Reg. No. 4,136,451**

**Registered May 1, 2012**

**Int. Cl.: 42**

**SERVICE MARK**

**PRINCIPAL REGISTER**

THE HIGH ROCK, LLC (MARYLAND LIMITED LIABILITY COMPANY)  
205 MT. OAK PLACE  
ANNAPOLIS, MD 21409

FOR: COMPUTER SERVICES, NAMELY, CREATING ON-LINE VIRTUAL COMMUNITIES FOR REGISTERED USERS TO ORGANIZE GROUPS AND EVENTS, PARTICIPATE IN DISCUSSIONS, AND ENGAGE IN SOCIAL, BUSINESS AND COMMUNITY NETWORKING; COMPUTER SERVICES, NAMELY, HOSTING ELECTRONIC FACILITIES FOR OTHERS FOR ORGANIZING AND CONDUCTING MEETINGS, EVENTS AND INTERACTIVE DISCUSSIONS VIA COMMUNICATION NETWORKS; APPLICATION SERVICE PROVIDER (ASP) SERVICES, NAMELY, HOSTING COMPUTER SOFTWARE APPLICATIONS OF OTHERS; PROVIDING A WEB SITE FEATURING TECHNOLOGY THAT ENABLES USERS TO UPLOAD AND SHARE VIDEO, PHOTOS, TEXT, GRAPHICS AND DATA, IN CLASS 42 (U.S. CLS. 100 AND 101).

FIRST USE 9-11-2008; IN COMMERCE 1-7-2009.

THE MARK CONSISTS OF STANDARD CHARACTERS WITHOUT CLAIM TO ANY PARTICULAR FONT, STYLE, SIZE, OR COLOR.

SN 85-203,077, FILED 12-21-2010.

DOUGLAS LEE, EXAMINING ATTORNEY



*David J. Kypos*

Director of the United States Patent and Trademark Office

# United States of America

United States Patent and Trademark Office

# GENESIS

**Reg. No. 4,136,452**

**Registered May 1, 2012**

**Int. Cl.: 9**

**TRADEMARK**

**PRINCIPAL REGISTER**

BURKHART, BRANDON (UNITED STATES INDIVIDUAL)  
6619 KERRY LANE  
RIVERSIDE, CA 92509

FOR: BALLASTS FOR HALOGEN LIGHTS, IN CLASS 9 (U.S. CLS. 21, 23, 26, 36 AND 38).

FIRST USE 10-1-2010; IN COMMERCE 8-1-2011.

THE MARK CONSISTS OF STANDARD CHARACTERS WITHOUT CLAIM TO ANY PARTICULAR FONT, STYLE, SIZE, OR COLOR.

SN 85-203,214, FILED 12-21-2010.

C. DIONNE CLYBURN, EXAMINING ATTORNEY



*David J. Kybas*

Director of the United States Patent and Trademark Office

# United States of America

United States Patent and Trademark Office

## FOREVER BRILLIANT

**Reg. No. 4,136,453**

**Registered May 1, 2012**

**Int. Cl.: 14**

**TRADEMARK**

**PRINCIPAL REGISTER**

CHARLES & COLVARD, LTD. (NORTH CAROLINA CORPORATION)  
SUITE A  
300 PERIMETER PARK DRIVE  
MORRISVILLE, NC 27560

FOR: GEMSTONES AND JEWELRY, IN CLASS 14 (U.S. CLS. 2, 27, 28 AND 50).

FIRST USE 1-31-2012; IN COMMERCE 2-1-2012.

THE MARK CONSISTS OF STANDARD CHARACTERS WITHOUT CLAIM TO ANY PARTICULAR FONT, STYLE, SIZE, OR COLOR.

NO CLAIM IS MADE TO THE EXCLUSIVE RIGHT TO USE "BRILLIANT", APART FROM THE MARK AS SHOWN.

SN 85-203,332, FILED 12-21-2010.

TINA BROWN, EXAMINING ATTORNEY



*David J. Kybas*

Director of the United States Patent and Trademark Office



# United States of America

United States Patent and Trademark Office



**Reg. No. 4,136,454**

**Registered May 1, 2012**

**Int. Cl.: 25**

**TRADEMARK**

**PRINCIPAL REGISTER**

YEO, JAMES (UNITED STATES INDIVIDUAL)  
3821 S. SANTA FE AVE.  
VERNON, CA 90058

FOR: DRESSES; JACKETS; KNIT TOPS; SHIRTS; SKIRTS, IN CLASS 25 (U.S. CLS. 22 AND 39).

FIRST USE 8-22-2011; IN COMMERCE 8-22-2011.

NO CLAIM IS MADE TO THE EXCLUSIVE RIGHT TO USE "DESIGN" , APART FROM THE MARK AS SHOWN.

THE MARK CONSISTS OF THE STYLIZED LETTER AND NUMERAL "A3" AND THE TERM "DESIGN" AGAINST A SHADED RECTANGLE DESIGN.

SN 85-204,298, FILED 12-22-2010.

CHRISTOPHER BUONGIORNO, EXAMINING ATTORNEY



*David J. Kybas*

Director of the United States Patent and Trademark Office

# United States of America

United States Patent and Trademark Office

## G-COMMERCE

**Reg. No. 4,136,455**

**Registered May 1, 2012**

**Int. Cl.: 35**

**SERVICE MARK**

**PRINCIPAL REGISTER**

GOOD360 (VIRGINIA NON-STOCK CORPORATION)  
SUITE 6000  
1330 BRADDOCK PLACE  
ALEXANDRIA, VA 22314

FOR: CHARITABLE SERVICES, NAMELY, COORDINATION OF THE PROCUREMENT AND DISTRIBUTION OF GIFT-IN-KIND PRODUCT DONATIONS FROM MANUFACTURERS, WHOLESALERS, RETAILERS, AND GOVERNMENT AGENCIES TO ORGANIZATIONS PROVIDING FREE PRODUCTS TO NEEDY PEOPLE; PROMOTING THE BENEFITS OF MAKING AND RECEIVING NONMONETARY CHARITABLE DONATIONS; ADMINISTERING A PROGRAM OF NONMONETARY CHARITABLE DONATIONS FOR OTHERS TO PROVIDE GIFT-IN-KIND PRODUCT DONATIONS; CONSULTING SERVICES IN THE NATURE OF ASSISTING OTHERS IN ESTABLISHING AND MAINTAINING NONMONETARY CHARITABLE DONATION AND RECEIPT PROGRAMS IN THE FIELD OF GIFT-IN-KIND DONATIONS, IN CLASS 35 (U.S. CLS. 100, 101 AND 102).

FIRST USE 12-4-2010; IN COMMERCE 12-4-2010.

THE MARK CONSISTS OF STANDARD CHARACTERS WITHOUT CLAIM TO ANY PARTICULAR FONT, STYLE, SIZE, OR COLOR.

SN 85-205,898, FILED 12-27-2010.

ANNE MADDEN, EXAMINING ATTORNEY



*David J. Kybas*

Director of the United States Patent and Trademark Office

# United States of America

United States Patent and Trademark Office

## The Glory Be Thine

**Reg. No. 4,136,456**

THE GLORY BE THINE (UTAH CORPORATION)  
497 HAYLEY COURT  
ALPINE, UT 84004

**Registered May 1, 2012**

**Int. Cl.: 41**

FOR: PUBLISHING OF BOOKS, E-BOOKS, AUDIO BOOKS, MUSIC AND ILLUSTRATIONS,  
IN CLASS 41 (U.S. CLS. 100, 101 AND 107).

**SERVICE MARK**

FIRST USE 6-1-2011; IN COMMERCE 6-1-2011.

**PRINCIPAL REGISTER**

THE MARK CONSISTS OF STANDARD CHARACTERS WITHOUT CLAIM TO ANY PAR-  
TICULAR FONT, STYLE, SIZE, OR COLOR.

SN 85-205,983, FILED 12-27-2010.

JACQUELINE A. LAVINE, EXAMINING ATTORNEY



*David J. Kyros*

Director of the United States Patent and Trademark Office

# United States of America

United States Patent and Trademark Office

## THE EXERCISER

**Reg. No. 4,136,457**

**Registered May 1, 2012**

**Int. Cl.: 9**

**TRADEMARK**

**PRINCIPAL REGISTER**

M.P. ELECTRONICS, INC. (FLORIDA CORPORATION)  
2464 VULCAN ROAD  
APOPKA, FL 32703

FOR: ELECTRIC RELAY THAT ALLOWS A SUMP PUMP TO TURN ON AND OFF PERIODICALLY, IN CLASS 9 (U.S. CLS. 21, 23, 26, 36 AND 38).

FIRST USE 12-31-2011; IN COMMERCE 12-31-2011.

THE MARK CONSISTS OF STANDARD CHARACTERS WITHOUT CLAIM TO ANY PARTICULAR FONT, STYLE, SIZE, OR COLOR.

SN 85-206,017, FILED 12-27-2010.

ALICIA COLLINS, EXAMINING ATTORNEY



*David J. Kybas*

Director of the United States Patent and Trademark Office

# United States of America

United States Patent and Trademark Office

## WORLDPINWALL

**Reg. No. 4,136,458**

**Registered May 1, 2012**

**Int. Cl.: 42**

**SERVICE MARK**

**PRINCIPAL REGISTER**

SUSLA, MICHAEL (FED REP GERMANY INDIVIDUAL)  
REDTENBACHERSTRASSE 2  
DORTMUND, NRW, FED REP GERMANY

FOR: HOSTING OF DIGITAL CONTENT ON THE INTERNET, NAMELY, USER-GENERATED CONTENT CONSISTING OF TEXT IMAGES AND VIDEO CONTENT; HOSTING WEBSITES ON THE INTERNET, IN CLASS 42 (U.S. CLS. 100 AND 101).

FIRST USE 10-15-2010; IN COMMERCE 3-3-2011.

THE MARK CONSISTS OF STANDARD CHARACTERS WITHOUT CLAIM TO ANY PARTICULAR FONT, STYLE, SIZE, OR COLOR.

SN 85-206,280, FILED 12-28-2010.

C. DIONNE CLYBURN, EXAMINING ATTORNEY



*David J. Kyros*

Director of the United States Patent and Trademark Office

# United States of America

United States Patent and Trademark Office

## COSMO SPECIALTY FIBERS

**Reg. No. 4,136,459**

**Registered May 1, 2012**

**Int. Cls.: 1 and 17**

**TRADEMARK**

**PRINCIPAL REGISTER**

COSMO SPECIALTY FIBERS, INC. (DELAWARE CORPORATION)  
1701 FIRST STREET  
COSMOPOLIS, WA 98537

FOR: CELLULOSE, UNPROCESSED CELLULOSE ACETATE AND UNPROCESSED VISCOSE, ALL FOR USE IN A VARIETY OF FIELDS, IN CLASS 1 (U.S. CLS. 1, 5, 6, 10, 26 AND 46).

FIRST USE 7-7-2011; IN COMMERCE 7-7-2011.

FOR: SEMI-PROCESSED CELLULOSE ACETATE AND SEMI-PROCESSED VISCOSE, ALL FOR USE IN A VARIETY OF FIELDS, IN CLASS 17 (U.S. CLS. 1, 5, 12, 13, 35 AND 50).

FIRST USE 7-7-2011; IN COMMERCE 7-7-2011.

THE MARK CONSISTS OF STANDARD CHARACTERS WITHOUT CLAIM TO ANY PARTICULAR FONT, STYLE, SIZE, OR COLOR.

NO CLAIM IS MADE TO THE EXCLUSIVE RIGHT TO USE "SPECIALTY FIBERS", APART FROM THE MARK AS SHOWN.

SN 85-206,369, FILED 12-28-2010.

MARK PILARO, EXAMINING ATTORNEY



*David J. Kyros*

Director of the United States Patent and Trademark Office

# United States of America

United States Patent and Trademark Office

# TORCH

**Reg. No. 4,136,460**

**Registered May 1, 2012**

**Int. Cl.: 13**

**TRADEMARK**

**PRINCIPAL REGISTER**

MISSION FIRST TACTICAL LLC (PENNSYLVANIA LIMITED LIABILITY COMPANY)  
780 HAUNTED LANE  
BENSALEM, PA 19020

FOR: FIREARM ATTACHMENTS, NAMELY, AIMING MOUNTS FOR ATTACHING ILLUMINATION DEVICES OR LASER POINTERS TO THE RAIL OF A FIREARM, IN CLASS 13 (U.S. CLS. 2 AND 9).

FIRST USE 5-17-2011; IN COMMERCE 5-17-2011.

THE MARK CONSISTS OF STANDARD CHARACTERS WITHOUT CLAIM TO ANY PARTICULAR FONT, STYLE, SIZE, OR COLOR.

SN 85-206,391, FILED 12-28-2010.

CHRISTOPHER BUONGIORNO, EXAMINING ATTORNEY



*David J. Kybas*

Director of the United States Patent and Trademark Office

# United States of America

United States Patent and Trademark Office

## KAWAI & KIDS

**Reg. No. 4,136,461**

**Registered May 1, 2012**

**Int. Cl.: 25**

**TRADEMARK**

**PRINCIPAL REGISTER**

YU, KA WAI (CHINA INDIVIDUAL)  
ROOM 1102 TOWER 18 LA CITE GREENVILLE  
KAI YIN XIN CHENG LING FENG 18 1102  
ZHONGSHAN GUANGDONG, CHINA 181102

FOR: ATHLETIC FOOTWEAR; BATHING SUITS; DENIM JACKETS; DRESS SUITS; FLIP FLOPS; FOOTWEAR; GOLF SHIRTS; HEADGEAR, NAMELY, HATS AND CAPS; JACKETS; JEANS; KNIT DRESSES; KNIT JACKETS; KNIT SHIRTS; KNIT SKIRTS; KNIT TOPS; KNITTED CAPS; SHIRTS; SPORT SHIRTS; T-SHIRTS, IN CLASS 25 (U.S. CLS. 22 AND 39).

FIRST USE 11-1-2011; IN COMMERCE 11-1-2011.

THE MARK CONSISTS OF STANDARD CHARACTERS WITHOUT CLAIM TO ANY PARTICULAR FONT, STYLE, SIZE, OR COLOR.

NO CLAIM IS MADE TO THE EXCLUSIVE RIGHT TO USE "KIDS", APART FROM THE MARK AS SHOWN.

THE NAME(S), PORTRAIT(S), AND/OR SIGNATURE(S) SHOWN IN THE MARK IDENTIFIES "KA WAI YU", WHOSE CONSENT(S) TO REGISTER IS MADE OF RECORD.

SN 85-206,534, FILED 12-28-2010.

SCOTT BIBB, EXAMINING ATTORNEY



*David J. Kybas*

Director of the United States Patent and Trademark Office



United States of America  
United States Patent and Trademark Office

**TAIFF**  
**FOX iöñ Tc**

**Reg. No. 4,136,462**

**Registered May 1, 2012**

**Int. Cl.: 11**

**TRADEMARK**

**PRINCIPAL REGISTER**

DAIHATSU INDUSTRIA E COMERCIO DE MOVEIS E APARELHOS DOMÉSTICOS LTDA  
(BRAZIL CORPORATION)  
AV. NAÇÕES UNIDAS 21.314  
SÃO PAULO, BRAZIL 04795-000

FOR: HAND-HELD ELECTRIC HAIR DRYERS, IN CLASS 11 (U.S. CLS. 13, 21, 23, 31 AND 34).

FIRST USE 12-28-2010; IN COMMERCE 12-28-2010.

NO CLAIM IS MADE TO THE EXCLUSIVE RIGHT TO USE "ION", APART FROM THE MARK AS SHOWN.

THE MARK CONSISTS OF THE WORD "TAIFF" ABOVE THE WORDS "FOX ION TC" WITH 6 DOTS APPEARING ABOVE THE WORD "ION".

SN 85-206,703, FILED 12-28-2010.

ROBERT C. CLARK JR., EXAMINING ATTORNEY



*David J. Kyffers*

Director of the United States Patent and Trademark Office

# United States of America

United States Patent and Trademark Office

LIVING  
the GIFT



**Reg. No. 4,136,463**

**Registered May 1, 2012**

**Int. Cls.: 14 and 25**

**TRADEMARK**

**PRINCIPAL REGISTER**

JACOB BERRY MINISTRIES, INC. (OKLAHOMA CORPORATION)  
1902 G NORTHWEST  
MIAMI, OK 74354

FOR: JEWELRY, NAMELY, EARRINGS, BRACELETS, NECKLACES, CHAINS, RINGS, LAPEL PINS, TIE TACKS, CUFF LINKS, BROOCHES, PERSONAL CHARMS, PENDANTS, KEY CHAINS, AND JEWELRY PINS FOR USE ON HATS, IN CLASS 14 (U.S. CLS. 2, 27, 28 AND 50).

FIRST USE 1-23-2012; IN COMMERCE 1-25-2012.

FOR: WEARABLE GARMENTS AND CLOTHING, NAMELY, SHIRTS, T-SHIRTS, TANK TOPS, SWEATSHIRTS, OXFORD SHIRTS, POLO SHIRTS, SWEATERS, DRESSES, SKIRTS, BLOUSES, PANTS, JEANS, ATHLETIC PANTS, DRESS SLACKS, SHORTS, COATS, JACKETS, SCARVES, HATS, CAPS, SOCK CAPS, GLOVES, MITTENS, SOCKS, PAJAMAS, BELTS FOR CLOTHING, NECK TIES, SHOES, ATHLETIC SHOES, DRESS SHOES, CASUAL SHOES, AND SLIPPERS, IN CLASS 25 (U.S. CLS. 22 AND 39).

FIRST USE 1-31-2012; IN COMMERCE 1-31-2012.

THE MARK CONSISTS OF THE WORDS "LIVING THE GIFT" IN BLACK WITH A STYLIZED DOVE OUTLINED IN BLACK HOLDING A RED RIBBON ON THE RIGHT SIDE THEREOF.

THE COLOR(S) BLACK AND RED IS/ARE CLAIMED AS A FEATURE OF THE MARK.

SN 85-207,052, FILED 12-29-2010.

CHRIS WELLS, EXAMINING ATTORNEY



*David J. Kyros*

Director of the United States Patent and Trademark Office

# United States of America

United States Patent and Trademark Office



**Reg. No. 4,136,464**

**Registered May 1, 2012**

**Int. Cl.: 25**

**TRADEMARK**

**PRINCIPAL REGISTER**

HECK, JODI L. (UNITED STATES INDIVIDUAL)  
1412 APPLETON CT.  
ARNOLD, MO 63010 AND

HECK, TYLER J. (UNITED STATES INDIVIDUAL)  
1412 APPLETON CT.  
ARNOLD, MO 63010

FOR: CLOTHING, NAMELY, T-SHIRTS, SHIRTS, JACKETS, AND HATS, IN CLASS 25 (U.S. CLS. 22 AND 39).

FIRST USE 12-1-2011; IN COMMERCE 12-1-2011.

THE MARK CONSISTS OF PAIRED CURVED STREAMS FROM LEFT MERGE WITH PAIRED CURVED STREAMS FROM RIGHT AT LOWER ELEVATION TO COMMON ELEVATION AND WORDS "EAST WEST CHEST" STACKED VERTICALLY INTERIORLY OF RIGHT STREAMS, LEFT STREAMS HAVE APPEARANCE SIMILAR TO LETTER "J" AND RIGHT STREAMS HAVE APPEARANCE SIMILAR TO LETTER "L".

SN 85-207,859, FILED 12-30-2010.

MARK SPARACINO, EXAMINING ATTORNEY



*David J. Kyffers*

Director of the United States Patent and Trademark Office

# United States of America

United States Patent and Trademark Office

# IXL DO U?

**Reg. No. 4,136,465**

ELECTROMIN, L.C. (KANSAS LIMITED LIABILITY COMPANY)  
7604A WEDD STREET  
OVERLAND PARK, KS 66204

**Registered May 1, 2012**

**Int. Cl.: 32**

FOR: SPORT DRINKS; AND POWDERS USED IN THE PREPARATION OF SPORTS DRINKS AND BEVERAGES, IN CLASS 32 (U.S. CLS. 45, 46 AND 48).

**TRADEMARK**

FIRST USE 12-0-2010; IN COMMERCE 12-0-2010.

**PRINCIPAL REGISTER**

THE MARK CONSISTS OF STANDARD CHARACTERS WITHOUT CLAIM TO ANY PARTICULAR FONT, STYLE, SIZE, OR COLOR.

OWNER OF U.S. REG. NO. 3,930,043.

SN 85-208,007, FILED 12-30-2010.

SEAN CROWLEY, EXAMINING ATTORNEY



*David J. Kybas*

Director of the United States Patent and Trademark Office

# United States of America

United States Patent and Trademark Office

**plum**  
connecting hearts

**Reg. No. 4,136,466**

**Registered May 1, 2012**

**Int. Cl.: 9**

**TRADEMARK**

**PRINCIPAL REGISTER**

CLC ENTERPRISES, INC (FLORIDA CORPORATION)  
11231 NW 20 STREET # 133  
MIAMI, FL 33172

FOR: ALL-IN-ONE PCS; AUDIO HEADPHONES; CELLULAR PHONES; EARPHONES AND HEADPHONES; HEADPHONES; LOUDSPEAKERS, HEADPHONES, MICROPHONES AND CD PLAYERS; MUSIC HEADPHONES; STEREO HEADPHONES, IN CLASS 9 (U.S. CLS. 21, 23, 26, 36 AND 38).

FIRST USE 4-1-2011; IN COMMERCE 4-1-2011.

THE MARK CONSISTS OF THE WORD "PLUM" IN THE COLOR RED IN LARGER LETTERING THAN THE WORDING "CONNECTING HEARTS" WHICH APPEARS IN THE COLOR BLACK IN SMALL LETTERING, UNDER THE RIGHT SIDE OF THE WORD "PLUM".

THE COLOR(S) RED AND BLACK IS/ARE CLAIMED AS A FEATURE OF THE MARK.

SN 85-208,142, FILED 12-30-2010.

TIMOTHY FINNEGAN, EXAMINING ATTORNEY



*David J. Kyffers*

Director of the United States Patent and Trademark Office

# United States of America

United States Patent and Trademark Office

# latus

**Reg. No. 4,136,467**

**Registered May 1, 2012**

**Int. Cl.: 42**

**SERVICE MARK**

**PRINCIPAL REGISTER**

UBERAN, INC. (ARIZONA CORPORATION)  
12239 S. RUNNING BEAR CT.  
PHOENIX, AZ 85044

FOR: SOFTWARE AS A SERVICE (SAAS) SERVICES FEATURING SOFTWARE FOR SOFTWARE APPLICATION DEVELOPERS, IN CLASS 42 (U.S. CLS. 100 AND 101).

FIRST USE 1-5-2012; IN COMMERCE 1-5-2012.

THE MARK CONSISTS OF STANDARD CHARACTERS WITHOUT CLAIM TO ANY PARTICULAR FONT, STYLE, SIZE, OR COLOR.

THE WORDING "LATUUS" HAS NO MEANING IN A FOREIGN LANGUAGE.

SN 85-208,840, FILED 1-2-2011.

ANNE MADDEN, EXAMINING ATTORNEY



*David J. Kyjars*

Director of the United States Patent and Trademark Office

# United States of America

United States Patent and Trademark Office

## Sanctuary Timber & Wildlife

**Reg. No. 4,136,468**

SANCTUARY TIMBER & WILDLIFE, LLC (ALABAMA LIMITED LIABILITY COMPANY)  
4145 CARMICHAEL ROAD  
MONTGOMERY, AL 36106

**Registered May 1, 2012**

**Int. Cls.: 35, 42, and 44**

FOR: CONSULTING SERVICES IN THE AREAS OF WILDLIFE CONSERVATION AND MANAGEMENT, IN CLASS 35 (U.S. CLS. 100, 101 AND 102).

**SERVICE MARK**

FIRST USE 12-13-2011; IN COMMERCE 12-13-2011.

**PRINCIPAL REGISTER**

FOR: RESEARCH AND DEVELOPMENT OF TREE VARIETIES SUITABLE FOR USE IN WILDLIFE CONSERVATION AND MANAGEMENT EFFORTS, IN CLASS 42 (U.S. CLS. 100 AND 101).

FIRST USE 12-13-2011; IN COMMERCE 12-13-2011.

FOR: TECHNICAL CONSULTATION IN THE FIELDS OF FEEDING AND RAISING BASS FOR RECREATIONAL AND SPORT FISHING PURPOSES, IN CLASS 44 (U.S. CLS. 100 AND 101).

FIRST USE 12-13-2011; IN COMMERCE 12-13-2011.

THE MARK CONSISTS OF STANDARD CHARACTERS WITHOUT CLAIM TO ANY PARTICULAR FONT, STYLE, SIZE, OR COLOR.

NO CLAIM IS MADE TO THE EXCLUSIVE RIGHT TO USE "TIMBER & WILDLIFE", APART FROM THE MARK AS SHOWN.

SN 85-209,226, FILED 1-3-2011.

JULIE WATSON, EXAMINING ATTORNEY



*David J. Kybas*

Director of the United States Patent and Trademark Office

# United States of America

United States Patent and Trademark Office

## MYCAREERCENTER

**Reg. No. 4,136,469**

**Registered May 1, 2012**

**Int. Cl.: 35**

**SERVICE MARK**

**PRINCIPAL REGISTER**

CAREERARC GROUP LLC (DELAWARE LIMITED LIABILITY COMPANY)  
3400 W. OLIVE AVENUE, SUITE 220  
BURBANK, CA 91505

FOR: PROVIDING AN INTERNET WEBSITE PORTAL FEATURING ON-LINE INTERACTIVE EMPLOYMENT COUNSELING AND AN ON-LINE SEARCHABLE DATABASE FEATURING INFORMATION ABOUT EMPLOYMENT AND EMPLOYMENT RECRUITING EVENTS; PROVIDING AN ON-LINE SEARCHABLE DATABASE FEATURING EMPLOYMENT OPPORTUNITIES AND CONTENT ABOUT EMPLOYMENT; PROVIDING EMPLOYMENT INFORMATION; PROVIDING INFORMATION ABOUT EMPLOYMENT COUNSELING; PROVIDING NETWORKING OPPORTUNITIES FOR INDIVIDUALS SEEKING EMPLOYMENT; PROVIDING ON-LINE EMPLOYMENT PLACEMENT SERVICES, NAMELY, MATCHING RESUMES AND POTENTIAL EMPLOYERS VIA A GLOBAL COMPUTER NETWORK, IN CLASS 35 (U.S. CLS. 100, 101 AND 102).

FIRST USE 11-16-2011; IN COMMERCE 11-16-2011.

THE MARK CONSISTS OF STANDARD CHARACTERS WITHOUT CLAIM TO ANY PARTICULAR FONT, STYLE, SIZE, OR COLOR.

SN 85-209,381, FILED 1-3-2011.

NAPOLEON SHARMA, EXAMINING ATTORNEY



*David J. Kyros*

Director of the United States Patent and Trademark Office



# United States of America

United States Patent and Trademark Office



**Reg. No. 4,136,470**

**Registered May 1, 2012**

**Int. Cl.: 35**

**SERVICE MARK**

**PRINCIPAL REGISTER**

SUPPLEMENTSATCOST.COM, LLC (FLORIDA LIMITED LIABILITY COMPANY)  
21551 ARBOR WAY  
BOCA RATON, FL 33433

FOR: ONLINE RETAIL STORE SERVICES FEATURING NUTRITIONAL SUPPLEMENTS,  
VITAMINS AND DIETARY FOODS, IN CLASS 35 (U.S. CLS. 100, 101 AND 102).

FIRST USE 6-30-2011; IN COMMERCE 6-30-2011.

NO CLAIM IS MADE TO THE EXCLUSIVE RIGHT TO USE "SUPPLEMENTSATCOST.COM",  
APART FROM THE MARK AS SHOWN.

THE MARK CONSISTS OF THE STYLIZED WORDS "SUPPLEMENTSATCOST.COM" TO  
THE LEFT OF A STYLIZED DOLLAR SIGN INSIDE A STYLIZED PARALLELOGRAM BOX.

SN 85-209,928, FILED 1-4-2011.

TINA MAI, EXAMINING ATTORNEY



*David J. Kybas*

Director of the United States Patent and Trademark Office

**United States of America**  
United States Patent and Trademark Office

**BAZINGA!**

**Reg. No. 4,136,471**

WARNER BROS. ENTERTAINMENT INC. (DELAWARE CORPORATION)  
4000 WARNER BOULEVARD  
BURBANK, CA 91522

**Registered May 1, 2012**

**Int. Cl.: 21**

FOR: BEVERAGE GLASSWARE, NAMELY, DRINKING GLASSES; LUNCH BOXES, IN CLASS 21 (U.S. CLS. 2, 13, 23, 29, 30, 33, 40 AND 50).

**TRADEMARK**

FIRST USE 3-30-2011; IN COMMERCE 3-30-2011.

**PRINCIPAL REGISTER**

THE MARK CONSISTS OF STANDARD CHARACTERS WITHOUT CLAIM TO ANY PARTICULAR FONT, STYLE, SIZE, OR COLOR.

SN 85-210,262, FILED 1-4-2011.

MARK SPARACINO, EXAMINING ATTORNEY



*David J. Kybas*

Director of the United States Patent and Trademark Office

# United States of America

United States Patent and Trademark Office

# BAZINGA!

**Reg. No. 4,136,472**

WARNER BROS. ENTERTAINMENT INC. (DELAWARE CORPORATION)  
4000 WARNER BOULEVARD  
BURBANK, CA 91522

**Registered May 1, 2012**

**Int. Cl.: 25**

FOR: CLOTHING FOR MEN, WOMEN AND CHILDREN - NAMELY, SHIRTS, T-SHIRTS, SWEATSHIRTS, JACKETS, IN CLASS 25 (U.S. CLS. 22 AND 39).

**TRADEMARK**

FIRST USE 11-10-2010; IN COMMERCE 11-10-2010.

**PRINCIPAL REGISTER**

THE MARK CONSISTS OF STANDARD CHARACTERS WITHOUT CLAIM TO ANY PARTICULAR FONT, STYLE, SIZE, OR COLOR.

SN 85-210,308, FILED 1-4-2011.

MARK SPARACINO, EXAMINING ATTORNEY



*David J. Kyffers*

Director of the United States Patent and Trademark Office

# United States of America

United States Patent and Trademark Office

# CEZZON

**Reg. No. 4,136,473**

**Registered May 1, 2012**

**Int. Cl.: 35**

**SERVICE MARK**

**PRINCIPAL REGISTER**

HAUBEN, MICHAEL R. (UNITED STATES INDIVIDUAL)  
60 KNOLLS CRESCENT, APT 1C  
BRONX, NY 10463

FOR: ADVERTISEMENT FOR OTHERS ON THE INTERNET; ADVERTISING AND BUSINESS SERVICES, NAMELY, SECURING AIRTIME ON ALL FORMS OF MEDIA COMMUNICATIONS STATIONS, SYSTEMS, NETWORKS, AND SERVICES FOR THE PURPOSE OF PROMOTING THE GOODS AND SERVICES OF OTHERS; ADVERTISING AND COMMERCIAL INFORMATION SERVICES, VIA THE INTERNET; ADVERTISING AND MARKETING SERVICES PROVIDED BY MEANS OF INDIRECT METHODS OF MARKETING COMMUNICATIONS, NAMELY, SOCIAL MEDIA, SEARCH ENGINE MARKETING, INQUIRY MARKETING, INTERNET MARKETING, MOBILE MARKETING, BLOGGING AND OTHER FORMS OF PASSIVE, SHARABLE OR VIRAL COMMUNICATIONS CHANNELS; ADVERTISING AND PUBLICITY SERVICES, NAMELY, PROMOTING THE GOODS, SERVICES, BRAND IDENTITY AND COMMERCIAL INFORMATION AND NEWS OF THIRD PARTIES THROUGH PRINT, AUDIO, VIDEO, DIGITAL AND ON-LINE MEDIUM; ADVERTISING ON THE INTERNET FOR OTHERS; ADVERTISING SERVICES, NAMELY, PROMOTING AND MARKETING THE GOODS AND SERVICES OF OTHERS IN THE FIELD OF UPSCALE CHOICES SUCH AS CULTURAL EVENTS, RESTAURANTS, SHOPPING, AND TRAVEL VIA PRINT AND ELECTRONIC MEDIA; ADVERTISING SERVICES, NAMELY, PROMOTING PROPERTIES FOR SALE BY OWNER VIA THE INTERNET; ADVERTISING VIA ELECTRONIC MEDIA AND SPECIFICALLY THE INTERNET; ADVICE AND INFORMATION ABOUT CUSTOMER SERVICES AND PRODUCT MANAGEMENT AND PRICES ON INTERNET SITES IN CONNECTION WITH PURCHASES MADE OVER THE INTERNET; AN INTERACTIVE WEB SITE FOR USERS TO REVIEW AND RATE INTERNET CONTENT, PEOPLE, COMPANIES, PRODUCTS AND/OR SERVICES UTILIZING A SOFTWARE APPLICATION TO AWARD POINTS WHEREBY WEB SITE USERS ARE ELIGIBLE TO EXCHANGE POINTS EARNED FOR PROMOTIONAL ITEMS CONSISTING OF COUPONS, REBATES, DISCOUNTS OR SPECIAL OFFERINGS ON GOODS AND/OR SERVICE PROVIDED BY WEB SITE SPONSORS; BARTER EXCHANGE SERVICES, NAMELY, PROVIDING COMMERCIAL BARTER AND TRADE EXCHANGE OF PRODUCTS AND SERVICES VIA A GLOBAL COMPUTER INFORMATION NETWORK; BUSINESS ADMINISTRATION SERVICES FOR PROCESSING SALES MADE ON THE INTERNET; BUSINESS ADVICE AND COMMERCIAL INFORMATION; BUSINESS ADVICE AND INFORMATION; BUSINESS ADVISORY SERVICES, CONSULTANCY AND INFORMATION; BUSINESS CONSULTING AND INFORMATION SERVICES; BUSINESS CONSULTING, INQUIRIES OR INFORMATION; BUSINESS INFORMATION SERVICES, NAMELY, GATHERING AND REPORTING INFORMATION



*David J. Kyros*

Director of the United States Patent and Trademark Office

**Reg. No. 4,136,473** REGARDING E-MAIL ADDRESSES OF OTHERS THAT ARE MADE AVAILABLE TO OTHER COMPANIES FOR COMMERCIAL PURPOSES; COLLECTION AND SYSTEMATISATION OF INFORMATION INTO COMPUTER DATABASES; COLLECTION OF MARKET RESEARCH INFORMATION; COMMERCIAL INFORMATION AGENCIES; COMMERCIAL INFORMATION AND ADVICE FOR CONSUMERS; COMMERCIAL INFORMATION AND DIRECTORY AGENCY; COMPILATION AND SYSTEMIZATION OF INFORMATION INTO COMPUTER DATABASES; COMPILATION OF ADVERTISEMENTS FOR USE AS WEB PAGES ON THE INTERNET; COMPUTER-ASSISTED BUSINESS INFORMATION AND RESEARCH SERVICES; CONSULTING SERVICES IN THE FIELD OF INTERNET MARKETING; CONSULTING SERVICES, NAMELY, PROVIDING EXPECTANT PARENTS WITH CONSUMER INFORMATION ON ALL TYPES OF BABY PRODUCTS AND SERVICES; COOPERATIVE ADVERTISING AND MARKETING SERVICES BY WAY OF SOLICITATION, CUSTOMER SERVICE AND PROVIDING MARKETING INFORMATION VIA WEB SITES ON A GLOBAL COMPUTER NETWORK; DESIGN OF INTERNET ADVERTISING; DEVELOPMENT, OPERATION AND ADMINISTRATION OF DIGITAL SIGNAGE SYSTEMS AND DIGITAL ADVERTISING SYSTEMS FOR OTHERS, NAMELY, PROVIDING ADVERTISING SPACE BY ELECTRONIC MEANS AND GLOBAL COMPUTER INFORMATION NETWORKS; DISSEMINATION OF ADVERTISING FOR OTHERS VIA AN ON-LINE COMMUNICATIONS NETWORK ON THE INTERNET; DISSEMINATION OF ADVERTISING FOR OTHERS VIA THE INTERNET; ELECTRONIC COMMERCE SERVICES, NAMELY, PROVIDING INFORMATION ABOUT PRODUCTS VIA TELECOMMUNICATION NETWORKS FOR ADVERTISING AND SALES PURPOSES; INFOMEDIARY SERVICES, NAMELY, FACILITATING TRANSACTIONS BETWEEN BUYERS AND SELLERS THROUGH PROVIDING BUYERS WITH INFORMATION ABOUT SELLERS, GOODS, AND/OR SERVICES; INFORMATION AND EXPERT OPINIONS RELATING TO COMPANIES AND BUSINESS; INFORMATION MANAGEMENT SERVICES, NAMELY, SHIPMENT PROCESSING, PREPARING SHIPPING DOCUMENTS AND INVOICES, TRACKING DOCUMENTS, PACKAGES AND FREIGHT OVER COMPUTER NETWORKS, INTRANETS AND INTERNETS; INFORMATION OR ENQUIRIES ON BUSINESS AND MARKETING; INFORMATION SERVICES RELATING TO BUSINESS MATTERS; INFORMATION, ADVISORY AND CONSULTANCY SERVICES RELATING TO BUSINESS AND MANAGEMENT OR BUSINESS ADMINISTRATION, INCLUDING SUCH SERVICES PROVIDED ON LINE OR VIA THE INTERNET; INFORMATION, ADVISORY, CONSULTING, BUSINESS RESEARCH AND PLANNING SERVICES RELATING TO PUBLICITY, MARKETING COMMUNICATIONS, REPUTATION MANAGEMENT OR BUSINESS ADMINISTRATION, INCLUDING SUCH SERVICES PROVIDED ONLINE OR VIA THE INTERNET; INTERNET ADVERTISING SERVICES; MARKETING AND CONSULTING SERVICES IN THE FIELD OF PROMOTING AND TRACKING THE GOODS, SERVICES, AND BRANDS OF OTHERS THROUGH ALL PUBLIC COMMUNICATION MEANS, PARTICULARLY SPECIALIZING IN THE USE OF MOBILE, SOCIAL, AND PRINT MEDIA TO DRIVE CONSUMER INTEREST, ENGAGEMENT AND ACTION; MARKETING SERVICES, NAMELY, PROVIDING INFORMATIONAL WEB PAGES DESIGNED TO GENERATE SALES TRAFFIC VIA HYPERLINKS TO OTHER WEB SITES; MARKETING, ADVERTISING AND PROMOTING THE GOODS AND SERVICES OF OTHERS IN THE FIELD OF TRAVEL AND TOURISM, NAMELY, PROVIDING INFORMATION VIA MAIL AND ELECTRONIC MAIL; MEDIA BUYING ADVICE, NAMELY, ADVISING THE CLIENT HOW MUCH MEDIA TIME, AND AT WHAT TIMES THE CLIENT SHOULD BE PURCHASING ADVERTISING; MEDIA MONITORING SERVICES, NAMELY, MONITORING PRINT MEDIA, TELEVISION, RADIO, AND OTHER MEDIA FOR CUSTOMER-SPECIFIED TOPICS, GATHERING RELEVANT CONTENT ON THOSE TOPICS, AND PROVIDING DOCUMENTATION AND ANALYSIS OF THAT MEDIA CONTENT TO OTHERS FOR BUSINESS PURPOSES; MEDIA PLANNING, NAMELY, ADVISING THE CLIENT ON THE CORRECT TIMES AND STATIONS TO ADVERTISE BASED ON MEDIA ANALYSIS OF THE MARKET FOR THAT MEDIA; MEDIA PRODUCTION LOCATION SCOUTING SERVICES FOR ADVERTISING PURPOSES; MEMBERSHIP CLUB SERVICES, NAMELY, PROVIDING ON-LINE INFORMATION TO MEMBERS IN THE FIELDS OF BRANDING, BUSINESS DEVELOPMENT, BUSINESS MARKETING, AND MARKETING; ON-LINE BUSINESS RESEARCH SERVICE THAT ALLOWS THE USER TO ANALYZE OPINION TRENDS CONTAINED IN DOCUMENTS ON THE INTERNET; ON-LINE POSTING OF REWARDS FOR INFORMATION; ON-LINE

**Reg. No. 4,136,473** TRADING SERVICES IN WHICH SELLER POSTS PRODUCTS TO BE AUCTIONED AND BIDDING IS DONE VIA THE INTERNET; ONLINE MEDIA MONITORING SERVICES USING COMPUTER SOFTWARE TO AUTOMATICALLY MONITOR INTERNET WEBSITES AND ONLINE PUBLICATIONS FOR CUSTOMER-SPECIFIED TOPICS AND TO CAPTURE RELEVANT CONTENT ON THOSE TOPICS, AND PROVIDING DOCUMENTATION AND ANALYSIS OF THAT ONLINE CONTENT TO OTHERS FOR BUSINESS PURPOSES; ORGANISATION OF INTERNET AUCTIONS; ORGANISATION OF PROMOTIONS USING AUDIOVISUAL MEDIA; PREPARATION AND REALIZATION OF MEDIA AND ADVERTISING PLANS AND CONCEPTS; PREPARING ADVERTISEMENTS FOR OTHERS, NAMELY, PREPARING VIDEO ADVERTISING AND PROMOTIONAL VIDEOS FOR COMMERCIAL USE VIA THE INTERNET AND TELEVISION, DIGITAL CABLE AND VIDEO-ON-DEMAND OR DOWNLOAD; PRESENTATION OF GOODS ON COMMUNICATION MEDIA FOR RETAIL PURPOSES; PROMOTING THE CHARITABLE SERVICES OF OTHERS, NAMELY, PROVIDING INDIVIDUALS WITH INFORMATION FOR THE PURPOSE OF MAKING DONATIONS TO CHARITIES; PROMOTING THE GOODS AND SERVICES OF OTHERS BY MEANS OF DISTRIBUTING ADVERTISING ON THE INTERNET; PROMOTING THE GOODS AND SERVICES OF OTHERS BY PROVIDING A COMMUNITY-DRIVEN WEB SITE FEATURING USER-SUBMITTED CONTENT IN THE NATURE OF COUPONS, REBATES, PRICE-COMPARISON INFORMATION, PRODUCT REVIEWS, LINKS TO THE RETAIL WEB SITES OF OTHERS, AND DISCOUNT INFORMATION; PROMOTING THE GOODS AND SERVICES OF OTHERS BY PROVIDING A WEB SITE FEATURING COUPONS, REBATES, PRICE-COMPARISON INFORMATION, PRODUCT REVIEWS, LINKS TO THE RETAIL WEB SITES OF OTHERS, AND DISCOUNT INFORMATION; PROMOTING THE GOODS AND SERVICES OF OTHERS BY PROVIDING A WEBSITE FEATURING COUPONS, REBATES, PRICE-COMPARISON INFORMATION, PRODUCT REVIEWS, LINKS TO THE RETAIL WEBSITES OF OTHERS, AND DISCOUNT INFORMATION; PROMOTING THE GOODS OF OTHERS, NAMELY, PROVIDING INFORMATION REGARDING DISCOUNTS, COUPONS, REBATES, VOUCHERS AND SPECIAL OFFERS FOR THE GOODS OF OTHERS; PROMOTING VISUAL AND PERFORMING ARTS EVENTS BY MEANS OF PROVIDING AN ONLINE EVENTS CALENDAR, ORIGINAL ARTICLES, INTERVIEWS, AND INFORMATION ABOUT ART, ARTISTS AND ARTS EVENTS VIA AN INTERNET WEB SITE, ALL FOR PROMOTIONAL PURPOSES; PROMOTIONAL MARKETING SERVICES USING AUDIOVISUAL MEDIA; PROVIDING A SEARCHABLE ON-LINE ADVERTISING WEBSITE AND GUIDE FEATURING THE GOODS AND SERVICES OF OTHER VENDORS VIA THE INTERNET; PROVIDING A SEARCHABLE ONLINE ADVERTISING GUIDE FEATURING THE GOODS AND SERVICES OF OTHER ON-LINE VENDORS ON THE INTERNET; PROVIDING A SECURED ACCESS DATABASE VIA THE INTERNET THROUGH WHICH DOCUMENTS AND IMAGES CAN BE VIEWED, COPIED, AND PRINTED FOR PURPOSES OF CONDUCTING CORPORATE TRANSACTIONS; PROVIDING A WEB SITE FEATURING BUSINESS INFORMATION IN THE FORM OF AUDIO AND VIDEO INTERVIEWS, TRANSCRIPTS AND OTHER EDUCATIONAL MATERIALS; PROVIDING A WEB SITE FEATURING CONSUMER INFORMATION ON VARIOUS PUBLICATIONS AND PROVIDING HYPERLINKS TO ON-LINE RETAILERS THAT SELL THE PUBLICATIONS; PROVIDING A WEB-BASED SYSTEM AND ONLINE PORTALS IN THE FIELD OF CONSUMER-TO-BUSINESS COMMERCE FOR CONSUMERS TO ENTER, MANAGE AND MODIFY THEIR CONSUMER PREFERENCE INFORMATION FOR USE BY MERCHANTS TO CREATE AND MANAGE OFFERS FOR DELIVERY TO CONSUMERS; PROVIDING A WEBSITE FEATURING INFORMATION FOR CONSUMERS IN THE FIELD OF PET FOOD, PET TREATS AND PET TOYS FOR PARTICULAR PET BREEDS; PROVIDING A WEBSITE FOR USERS WITH SPECIFIC INFORMED RECOMMENDATIONS OF SPECIFIC CONSUMER PRODUCTS AND SERVICES VALIDATED BY THE USERS' INPUTTED PREFERENCES AND SOCIAL NETWORK; PROVIDING ADVERTISING SERVICE TO DISTRIBUTE ADVERTISEMENTS FOR DISPLAY ON INTERNET, NAMELY, IN WEBSITES, SOCIAL CONVERSATIONS OVER THE INTERNET, E-MAILS, MICROBLOGS, BLOGS, ELECTRONIC MESSAGES, INSTANT MESSAGES, TEXT MESSAGES, MULTIMEDIA MESSAGES, SOCIAL NETWORKS, STATUS UPDATES, FORUMS, ELECTRONIC BULLETIN BOARDS; PROVIDING AN INTERACTIVE REAL ESTATE WEBSITE WHICH PROMOTES HOUSING AND APARTMENT PROPERTIES THROUGH OFFERING PROSPECTIVE TENANTS VIDEO WALK THROUGHs, PROPERTY DESCRIPTIONS, TEXT, PRICE, LOCATION,

**Reg. No. 4,136,473** MAPS AND OTHER INFORMATION THAT WOULD BE INFLUENTIAL TO A PROSPECTIVE TENANT IN MAKING A RENTAL DECISION; PROVIDING AN INTERNET WEBSITE PORTAL FEATURING LINKS TO MUSIC-RELATED MERCHANDISE FOR RETAIL PURPOSES; PROVIDING AN INTERNET WEBSITE PORTAL FEATURING PROMOTION AND ADVERTISING FOR HOME SERVICE PROVIDERS AND PRODUCT MANUFACTURERS; PROVIDING AN ON-LINE COMMERCIAL INFORMATION DIRECTORY ON THE INTERNET; PROVIDING AN ON-LINE COMPUTER DATABASE IN THE FIELD OF BUSINESS INFORMATION AND BUSINESS CONTACTS; PROVIDING AN ON-LINE SEARCHABLE DATABASE FEATURING BUSINESS INFORMATION AND BUSINESS CONTACTS; PROVIDING AN ON-LINE SEARCHABLE DATABASE FEATURING USED BOOK BEING OFFERED FOR SALE AND BUYER/SELLER CONTACT INFORMATION; PROVIDING AND RENTAL OF ADVERTISING SPACE ON THE INTERNET; PROVIDING BUSINESS AND COMMERCIAL INFORMATION IN THE FIELD OF BUSINESS TRAVEL MANAGEMENT AND THE BUSINESS TRAVEL INDUSTRY; PROVIDING BUSINESS INFORMATION, ALSO VIA INTERNET, THE CABLE NETWORK OR OTHER FORMS OF DATA TRANSFER; PROVIDING BUSINESS MANAGEMENT INFORMATION IN CONNECTION WITH CONSULTING AND ADVISORY SERVICES IN THE FIELD OF STRATEGIC PLANNING; PROVIDING BUSINESS MARKETING INFORMATION; PROVIDING COMMERCIAL INFORMATION UPDATES ONLINE AND OVER A GLOBAL COMPUTER NETWORK IN THE FIELDS OF BUSINESS, COMMERCE, AND INDUSTRY; PROVIDING CONSULTING SERVICES IN THE FIELD OF FACILITATING THE PLANNING, BUYING, AND SELLING OF MEDIA; PROVIDING CONSUMER INFORMATION SERVICES AND MAKING REFERRALS IN THE FIELD OF ENTERTAINMENT SERVICES FOR PRODUCTS, SERVICES, EVENTS, ACTIVITIES, FACILITIES AND LOCATIONS; PROVIDING CONSUMER PRODUCT INFORMATION VIA THE INTERNET; PROVIDING INFORMATION ABOUT AND MAKING REFERRALS IN THE FIELD OF CONSUMER PRODUCTS AND SERVICES FOR RETAIL SERVICES CONCERNING PRODUCTS, SERVICES, EVENTS, ACTIVITIES, ATTRACTIONS AND FACILITIES IN PARTICULAR GEOGRAPHIC LOCATIONS; PROVIDING INFORMATION ABOUT AUTOMOBILES FOR SALE BY MEANS OF THE INTERNET; PROVIDING INFORMATION ABOUT THE GOODS AND SERVICES OF OTHERS VIA THE GLOBAL COMPUTER NETWORK; PROVIDING INFORMATION AND NEWS IN THE FIELD OF BUSINESS; PROVIDING INFORMATION IN THE FIELD OF MARKETING AND ON-LINE MARKETING MEDIA VIA THE INTERNET; PROVIDING INFORMATION PERTAINING TO PROCUREMENT, BUYING, SELLING AND TENDERING INFORMATION AND OPPORTUNITIES RELATING TO GOODS, SERVICES, AND CONSTRUCTION VIA COMPUTER, COMPUTER NETWORKS, TELEPHONE, THE INTERNET OR ELECTRONIC MAIL; PROVIDING ON-LINE BUSINESS INFORMATION OF OTHERS, NAMELY, ADVERTISEMENTS OR SOLICITATIONS; PROVIDING ON-LINE CONSUMER INFORMATION CONCERNING THE LOCATION OF MOBILE RESTAURANTS; PROVIDING ON-LINE DIRECTORY INFORMATION SERVICES ALSO FEATURING HYPERLINKS TO OTHER WEB SITES; PROVIDING PROMOTIONAL MARKETING SERVICES TO BUSINESSES IN THE BROADBAND AND MEDIA INDUSTRIES; PROVIDING STATISTICAL INFORMATION; PROVISION OF A WEB SITE FEATURING COMMERCIAL INFORMATION ON SHOPPING; PROVISION OF ADVERTISING SPACE BY ELECTRONIC MEANS AND GLOBAL INFORMATION NETWORKS; PROVISION OF BUSINESS INFORMATION VIA GLOBAL COMPUTER NETWORKS; PROVISION OF INFORMATION AND ADVICE TO CONSUMERS REGARDING THE SELECTION OF PRODUCTS AND ITEMS TO BE PURCHASED; PROVISION OF INFORMATION CONCERNING COMMERCIAL SALES; PROVISION OF INFORMATION, ADVICE AND CONSULTANCY IN RELATION TO ENERGY EFFICIENCY; PROVISION OF MARKET RESEARCH INFORMATION; PUBLIC RELATIONS, ADVERTISING AND MARKETING SERVICES FOR THE TOURISM AND CONVENTION INDUSTRY, NAMELY, ORGANIZING AND HOSTING SITE INSPECTIONS AND FAMILIARIZATION TOURS FOR WHOLESALERS, TOUR OPERATORS, TRAVEL AGENTS, MEETING AND INCENTIVE TRAVEL PLANNERS AND TRAVEL MEDIA; SHOPPERS' GUIDE INFORMATION; SHOPPING FACILITATION SERVICES, NAMELY, PROVIDING AN ONLINE COMPARISON-SHOPPING SEARCH ENGINE FOR OBTAINING PURCHASING INFORMATION; SOCIAL MEDIA STRATEGY AND MARKETING CONSULTANCY FOCUSING ON HELPING CLIENTS CREATE AND EXTEND THEIR PRODUCT AND BRAND STRATEGIES BY BUILDING VIRALLY ENGAGING MARKETING SOLU-

**Reg. No. 4,136,473** TIONS; SUBSCRIPTION TO AN INFORMATION MEDIA PACKAGE; THE BRINGING TOGETHER OF CONSUMERS AND PROVIDERS OF A VARIETY OF GOODS AND SERVICES IN THE FIELD OF ATHLETICS FOR COMMERCIAL PURPOSES VIA THE INTERNET; THE BRINGING TOGETHER, FOR THE BENEFIT OF OTHERS, OF A VARIETY OF GOODS AND SERVICES, ENABLING CUSTOMERS TO CONVENIENTLY VIEW AND PURCHASE THOSE GOODS AND SERVICES FROM AN INTERNET WEB SITE PARTICULARLY SPECIALIZING IN THE MARKETING OF THE SALE OF GOODS AND SERVICES OF OTHERS, IN CLASS 35 (U.S. CLS. 100, 101 AND 102).

FIRST USE 5-1-2011; IN COMMERCE 8-1-2011.

THE MARK CONSISTS OF STANDARD CHARACTERS WITHOUT CLAIM TO ANY PARTICULAR FONT, STYLE, SIZE, OR COLOR.

SN 85-210,543, FILED 1-5-2011.

PAM WILLIS, EXAMINING ATTORNEY



# United States of America

United States Patent and Trademark Office

## FIN RECORDS

**Reg. No. 4,136,474**

**Registered May 1, 2012**

**Int. Cl.: 9**

**TRADEMARK**

**PRINCIPAL REGISTER**

FIN RECORDS, LLC (WASHINGTON LIMITED LIABILITY COMPANY)  
5140 BALLARD AVE. NW, SUITE A  
SEATTLE, WA 98107

FOR: DIGITAL MEDIA, NAMELY, CDS, DVDS, DOWNLOADABLE AUDIO FILES, DOWNLOADABLE VIDEO FILES, FEATURING MUSIC, MUSIC VIDEOS AND MUSIC PERFORMANCES; MUSICAL SOUND RECORDINGS; MUSICAL VIDEO RECORDINGS; PHONOGRAPH RECORDS FEATURING MUSIC AND MUSIC PERFORMANCES, IN CLASS 9 (U.S. CLS. 21, 23, 26, 36 AND 38).

FIRST USE 5-31-2011; IN COMMERCE 6-9-2011.

THE MARK CONSISTS OF STANDARD CHARACTERS WITHOUT CLAIM TO ANY PARTICULAR FONT, STYLE, SIZE, OR COLOR.

NO CLAIM IS MADE TO THE EXCLUSIVE RIGHT TO USE "RECORDS", APART FROM THE MARK AS SHOWN.

SN 85-210,945, FILED 1-5-2011.

GISELLE AGOSTO, EXAMINING ATTORNEY



*David J. Kyffers*

Director of the United States Patent and Trademark Office

# United States of America

United States Patent and Trademark Office

## SORGENTE MEDICAL SPA

**Reg. No. 4,136,475**

**Registered May 1, 2012**

**Int. Cl.: 44**

**SERVICE MARK**

**PRINCIPAL REGISTER**

ALL CAPE GYNECOLOGY, LLC (MASSACHUSETTS LIMITED LIABILITY COMPANY)  
1330 PHINNEY'S LANE  
HYANNIS, MA 02601

FOR: HEALTH SPA SERVICES, NAMELY, PROVIDING MASSAGE, FACIAL AND BODY TREATMENT SERVICES, COSMETIC BODY CARE SERVICES, IN CLASS 44 (U.S. CLS. 100 AND 101).

FIRST USE 12-1-2010; IN COMMERCE 12-1-2010.

THE MARK CONSISTS OF STANDARD CHARACTERS WITHOUT CLAIM TO ANY PARTICULAR FONT, STYLE, SIZE, OR COLOR.

NO CLAIM IS MADE TO THE EXCLUSIVE RIGHT TO USE "MEDICAL SPA", APART FROM THE MARK AS SHOWN.

THE ENGLISH TRANSLATION OF THE WORD "SORGENTE" IN THE MARK IS "SOURCE" OR "SPRING".

SN 85-212,040, FILED 1-6-2011.

MICHELLE DUBOIS, EXAMINING ATTORNEY



*David J. Kyffers*

Director of the United States Patent and Trademark Office

# United States of America

United States Patent and Trademark Office



**Reg. No. 4,136,476**

**Registered May 1, 2012**

**Int. Cl.: 11**

**TRADEMARK**

**PRINCIPAL REGISTER**

MATERIAL SUPPLY, INC. (CALIFORNIA CORPORATION), DBA MSI HVAC,  
11700 INDUSTRY AVE.  
FONTANA, CA 92337

FOR: AIR-CONDITIONING APPARATUS AND INSTALLATIONS, IN CLASS 11 (U.S. CLS.  
13, 21, 23, 31 AND 34).

FIRST USE 1-15-2012; IN COMMERCE 1-15-2012.

NO CLAIM IS MADE TO THE EXCLUSIVE RIGHT TO USE "AC", APART FROM THE MARK  
AS SHOWN.

THE MARK CONSISTS OF THE LETTERS "AC" APPEARING ON A RECTANGULAR  
SHAPED BACKGROUND AND THE LETTERS "PRO".

SN 85-212,174, FILED 1-6-2011.

EDWARD NELSON, EXAMINING ATTORNEY



*David J. Kybas*

Director of the United States Patent and Trademark Office

# United States of America

United States Patent and Trademark Office

## Legacy Lacrosse

**Reg. No. 4,136,477**

**Registered May 1, 2012**

**Int. Cl.: 41**

**SERVICE MARK**

**PRINCIPAL REGISTER**

JACKSON II, ROBERT (UNITED STATES INDIVIDUAL)  
1990 LONG HOLLOW LANE  
MILTON, GA 30004 AND

JACKSON, LAUREN (UNITED STATES INDIVIDUAL)  
1990 LONG HOLLOW LANE  
MILTON, GA 30004

FOR: ARRANGING AND CONDUCTING ANNUAL LACROSSE GAMES , IN CLASS 41 (U.S. CLS. 100, 101 AND 107).

FIRST USE 3-29-2007; IN COMMERCE 3-29-2007.

THE MARK CONSISTS OF STANDARD CHARACTERS WITHOUT CLAIM TO ANY PARTICULAR FONT, STYLE, SIZE, OR COLOR.

OWNER OF U.S. REG. NO. 3,872,831.

NO CLAIM IS MADE TO THE EXCLUSIVE RIGHT TO USE "LACROSSE", APART FROM THE MARK AS SHOWN.

SN 85-212,337, FILED 1-6-2011.

TIMOTHY FINNEGAN, EXAMINING ATTORNEY



*David J. Kybas*

Director of the United States Patent and Trademark Office

# United States of America

United States Patent and Trademark Office

## EXOSKELETON

**Reg. No. 4,136,478**

**Registered May 1, 2012**

**Int. Cls.: 26 and 28**

**TRADEMARK**

**PRINCIPAL REGISTER**

INC INTERNATIONAL COMPANY (PENNSYLVANIA CORPORATION)  
143 VIBURNUM DRIVE  
KENNETT SQUARE, PA 19348

FOR: SHOULDER PADS FOR CLOTHING, IN CLASS 26 (U.S. CLS. 37, 39, 40, 42 AND 50).

FIRST USE 2-17-2011; IN COMMERCE 2-17-2011.

FOR: ELBOW PADS FOR ATHLETIC USE; FOOTBALL CHEST PADS; FOOTBALL LEG PADS; FOOTBALL SHOULDER PADS; ICE HOCKEY GOALIE PADS; KARATE KICK PADS; PROTECTIVE PADDING FOR PLAYING FOOTBALL, BASEBALL, HOCKEY, BASKETBALL, TENNIS, LACROSSE, BASKETBALL, KARATE; PROTECTIVE PADDING FOR SKATEBOARDING; PROTECTIVE PADDING FOR SNOWBOARDING; SAFETY PADDING FOR FOOTBALL, BASEBALL, HOCKEY, BASKETBALL, TENNIS, LACROSSE, BASKETBALL, KARATE; SHIN PADS FOR USE IN FOOTBALL, BASEBALL, HOCKEY, BASKETBALL, TENNIS, LACROSSE, BASKETBALL, KARATE; SHOULDER PADS FOR ATHLETIC USE; SOCCER BALL KNEE PADS; TRACTION PADS FOR SURFBOARDS, IN CLASS 28 (U.S. CLS. 22, 23, 38 AND 50).

FIRST USE 2-17-2011; IN COMMERCE 2-17-2011.

THE MARK CONSISTS OF STANDARD CHARACTERS WITHOUT CLAIM TO ANY PARTICULAR FONT, STYLE, SIZE, OR COLOR.

SN 85-212,941, FILED 1-7-2011.

JACQUELINE A. LAVINE, EXAMINING ATTORNEY



*David J. Kyros*

Director of the United States Patent and Trademark Office

# United States of America

United States Patent and Trademark Office



**PRIMESCALES**

**Reg. No. 4,136,479**

**Registered May 1, 2012**

**Int. Cl.: 9**

**TRADEMARK**

**PRINCIPAL REGISTER**

BRYTUN LIGHTING CORP. (CALIFORNIA CORPORATION)  
17850 LONE RANGER TRL  
CHINO HILLS, CA 91709

FOR: WEIGHING EQUIPMENT, NAMELY, SCALES AND BALANCES, IN CLASS 9 (U.S. CLS. 21, 23, 26, 36 AND 38).

FIRST USE 3-8-2011; IN COMMERCE 3-8-2011.

THE MARK CONSISTS OF THE WORDING "PRIMESCALES" WITH "PRIME" IN DARK BLUE AND "SCALES" IN LIGHT BLUE. BELOW THE WORDING IS A BEAM IN GRAY. TO THE LEFT OF "PRIMESCALES" IS THE LETTERING "PS" WITH "P" AND WHITE AND "S" IN LIGHT BLUE ON A DARK BLUE BACKGROUND WITH A WHITE CIRCLE AND GRAY CIRCLE OUTLINE.

THE COLOR(S) DARK BLUE, LIGHT BLUE, WHITE, AND GRAY IS/ARE CLAIMED AS A FEATURE OF THE MARK.

SN 85-213,639, FILED 1-9-2011.

KAPIL BHANOT, EXAMINING ATTORNEY



*David J. Kyffers*

Director of the United States Patent and Trademark Office

# United States of America

United States Patent and Trademark Office

## COUNTRY DANCE

**Reg. No. 4,136,480**

**Registered May 1, 2012**

**Int. Cl.: 9**

**TRADEMARK**

**PRINCIPAL REGISTER**

GAMEMILL ENTERTAINMENT, LLC (MINNESOTA LIMITED LIABILITY COMPANY)  
6600 FRANCE AVENUE SOUTH, SUITE 670  
EDINA, MN 55435

FOR: COMPUTER GAME SOFTWARE, IN CLASS 9 (U.S. CLS. 21, 23, 26, 36 AND 38).

FIRST USE 3-29-2011; IN COMMERCE 3-29-2011.

THE MARK CONSISTS OF STANDARD CHARACTERS WITHOUT CLAIM TO ANY PARTICULAR FONT, STYLE, SIZE, OR COLOR.

SEC. 2(F).

SN 85-213,706, FILED 1-10-2011.

GEOFFREY FOSDICK, EXAMINING ATTORNEY



*David J. Kybas*

Director of the United States Patent and Trademark Office

# United States of America

United States Patent and Trademark Office

## MIND ARMOR

**Reg. No. 4,136,481**

**Registered May 1, 2012**

**Int. Cl.: 9**

**TRADEMARK**

**PRINCIPAL REGISTER**

JERICO VENTURES, LLC (MINNESOTA LIMITED LIABILITY COMPANY)  
1331 COUNTY ROAD D  
ST. PAUL, MN 55109

FOR: DOWNLOADABLE ELECTRONIC PUBLICATIONS IN THE NATURE OF TRAINING GUIDES IN THE FIELD OF PORNOGRAPHY ADDICTION TREATMENT, IN CLASS 9 (U.S. CLS. 21, 23, 26, 36 AND 38).

FIRST USE 8-11-2011; IN COMMERCE 8-11-2011.

THE MARK CONSISTS OF STANDARD CHARACTERS WITHOUT CLAIM TO ANY PARTICULAR FONT, STYLE, SIZE, OR COLOR.

SN 85-213,878, FILED 1-10-2011.

ANNE E. GUSTASON, EXAMINING ATTORNEY



*David J. Kybas*

Director of the United States Patent and Trademark Office



# United States of America

United States Patent and Trademark Office

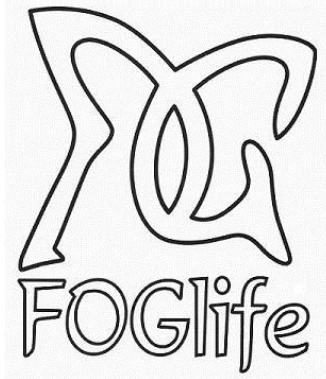

**Reg. No. 4,136,482**

**Registered May 1, 2012**

**Int. Cl.: 25**

**TRADEMARK**

**PRINCIPAL REGISTER**

GORDON, STEVEN ANTHONY (UNITED STATES INDIVIDUAL), DBA FOGLEIFE,  
P.O. BOX 758  
SHAFTER, CA 93263 AND

GORDON, MELISSA DIANE (UNITED STATES INDIVIDUAL), DBA FOGLEIFE,  
P.O. BOX 758  
SHAFTER, CA 93263

FOR: HATS; SPORTS CAPS AND HATS; TOPS; WEARABLE GARMENTS AND CLOTHING, NAMELY, SHIRTS; ADULT NOVELTY GAG CLOTHING ITEM, NAMELY, SOCKS; APPAREL FOR DANCERS, NAMELY, TEE SHIRTS, SWEATSHIRTS, PANTS, LEGGINGS, SHORTS AND JACKETS; ATHLETIC APPAREL, NAMELY, SHIRTS, PANTS, JACKETS, FOOTWEAR, HATS AND CAPS, ATHLETIC UNIFORMS; BABY LAYETTES FOR CLOTHING; BASEBALL CAPS AND HATS; BELTS; BELTS FOR CLOTHING; BELTS MADE OUT OF CLOTH; BIBS NOT OF CLOTH OR PAPER; BOTTOMS; CHEF'S HATS; CHILDREN'S AND INFANT'S APPAREL, NAMELY, JUMPERS, OVERALL SLEEPWEAR, PAJAMAS, ROMPERS AND ONE-PIECE GARMENTS; CHILDREN'S AND INFANTS' APPAREL TREATED WITH FIRE AND HEAT RETARDANTS, NAMELY, JUMPERS, OVERALL SLEEPWEAR, PAJAMAS, ROMPERS AND ONE-PIECE GARMENTS; CHILDREN'S AND INFANTS' CLOTH BIBS; CHILDREN'S CLOTH EATING BIBS; CLOTH BIBS; CLOTH BIBS FOR ADULT DINERS; CLOTH BIBS FOR USE BY SENIOR CITIZENS OR PHYSICALLY- OR MENTALLY-CHALLENGED PERSONS; CLOTH DIAPERS; CLOTHING EXTENSION USED TO EXTEND THE NORMAL SIZE RANGE OF CLOTHING ITEMS TO ACCOMMODATE PREGNANCY SIZE CHANGES; CLOTHING FOR ATHLETIC USE, NAMELY, PADDED ELBOW COMPRESSION SLEEVES BEING PART OF AN ATHLETIC GARMENT; CLOTHING FOR ATHLETIC USE, NAMELY, PADDED PANTS; CLOTHING FOR ATHLETIC USE, NAMELY, PADDED SHIRTS; CLOTHING FOR ATHLETIC USE, NAMELY, PADDED SHORTS; CLOTHING FOR BABIES, TODDLERS AND CHILDREN, TREATED WITH FIRE AND HEAT RETARDANTS, NAMELY, PAJAMAS, JACKETS, SHIRTS, PANTS, JUMPERS; CLOTHING FOR WEAR IN JUDO PRACTICES; CLOTHING FOR WEAR IN WRESTLING GAMES; CLOTHING ITEMS, NAMELY, ADHESIVE POCKETS THAT MAY BE AFFIXED DIRECTLY TO THE BODY AS A DECORATIVE PIECE OF CLOTHING WITH UTILITY; CLOTHING ITEMS, NAMELY, ADHESIVE POCKETS THAT MAY BE AFFIXED DIRECTLY TO THE INSIDE OF CLOTHING FOR STORAGE AND SAFEKEEPING OF PERSONAL ITEMS; CLOTHING SHIELDS, NAMELY, PADS APPLIED TO THE UNDERARMS OF SHIRTS, BLOUSES AND SWEATERS; CLOTHING, NAMELY, ARM WARMERS; CLOTHING, NAMELY, ATHLETIC SLEEVES; CLOTHING, NAMELY, BASE LAYERS; CLOTHING, NAMELY, COWLS AND SMOKE RING

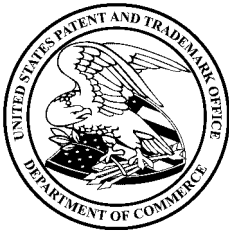

*David J. Kybas*

Director of the United States Patent and Trademark Office

**Reg. No. 4,136,482** SCARVES; CLOTHING, NAMELY, FOLK COSTUMES; CLOTHING, NAMELY, HAND-WARMERS; CLOTHING, NAMELY, KHAKIS; CLOTHING, NAMELY, KNEE WARMERS; CLOTHING, NAMELY, MATERNITY BANDS; CLOTHING, NAMELY, NECK TUBES; CLOTHING, NAMELY, THOBES; CLOTHING, NAMELY, WRAP-AROUNDS; CORSETS; CROSS-COUNTRY MITTENS; DUSTERS; EYESHADES; FOULARDS; FUR HATS; GLOVES AS CLOTHING; GLOVES FOR APPAREL; HAT BANDS; HATS FOR INFANTS, BABIES, TODDLERS AND CHILDREN; HEAD SCARVES; HEADBANDS FOR CLOTHING; HOODS; INFANT AND TODDLER ONE PIECE CLOTHING; INFANT CLOTH DIAPERS; INSERTS SPECIALLY ADAPTED FOR CLOTH DIAPERS MADE OF BAMBOO; INSERTS SPECIALLY ADAPTED FOR CLOTH DIAPERS MADE OF HEMP; INSERTS SPECIALLY ADAPTED FOR CLOTH DIAPERS MADE OF MICROFIBER; JACKETS; JERSEYS; LEATHER BELTS; LEATHER HATS; MANTLES; MITTENS; MITTENS MODIFIED TO COVER THE HAND AND AN ANIMAL LEASH HANDLE OR OTHER LOOP; MUFFLERS; NON-DISPOSABLE CLOTH TRAINING PANTS; OUTDOOR MITTENS; PAPER HATS FOR USE AS CLOTHING ITEMS; PARTS OF CLOTHING, NAMELY, GUSSETS FOR TIGHTS, GUSSETS FOR STOCKINGS, GUSSETS FOR BATHING SUITS, GUSSETS FOR UNDERWEAR, GUSSETS FOR LEOTARDS AND GUSSETS FOR FOOTLETS; PARTS OF CLOTHING, NAMELY, UNDERARM GUSSETS; PARTY HATS; PERSPIRATION ABSORBENT STRAP TO BE USED IN THE BILL OF A HAT; PERSPIRATION ABSORBENT UNDERWEAR CLOTHING; POCKET SQUARES; RAIN HATS; SCARVES; SCIENTIFIC AND TECHNOLOGICAL APPAREL, NAMELY, SHIRTS, PANTS, JACKETS, FOOTWEAR, HATS AND CAPS, UNIFORMS; SEDGE HATS (SUGE-GASA); SHIFTS; SHORT SETS; SHOULDER SCARVES; SHOULDER WRAPS; SHOULDER WRAPS FOR CLOTHING; SILK SCARVES; SMALL HATS; SNOWBOARD MITTENS; SWADDLING CLOTHES; TIES; TOBOGGAN HATS, PANTS AND CAPS; TRAVEL CLOTHING CONTAINED IN A PACKAGE COMPRISING REVERSIBLE JACKETS, PANTS, SKIRTS, TOPS AND A BELT OR SCARF; TRIATHLON CLOTHING, NAMELY, TRIATHLON TIGHTS, TRIATHLON SHORTS, TRIATHLON SINGLETS, TRIATHLON SHIRTS, TRIATHLON SUITS; UNDERARM CLOTHING SHIELDS; VISCOUS GEL POLYMER SOLD AS A COMPONENT OF FINISHED CUSTOM CUSHIONED FOOTWEAR FOR NON-ORTHOPEDIC PURPOSES AND APPAREL; WOMEN'S HATS AND HOODS; WOOLLY HATS; WRAPS , IN CLASS 25 (U.S. CLS. 22 AND 39).

FIRST USE 4-1-2010; IN COMMERCE 4-1-2010.

THE MARK CONSISTS OF THE WORDING "FOGLIFE" IN STYLIZED FORM LOCATED UNDERNEATH A DESIGN ELEMENT OF A BUTTERFLY COMPRISED OF THE LETTERS "F", "O", AND "G".

SN 85-213,986, FILED 1-10-2011.

Laurie Kaufman, Examining Attorney

# United States of America

United States Patent and Trademark Office

## SLEEP NUMBER INNER CIRCLE

**Reg. No. 4,136,483**

**Registered May 1, 2012**

**Int. Cl.: 35**

**SERVICE MARK**

**PRINCIPAL REGISTER**

SELECT COMFORT CORPORATION (MINNESOTA CORPORATION)  
9800 59TH AVENUE NORTH  
PLYMOUTH, MN 55442

FOR: CUSTOMER LOYALTY SERVICES AND CUSTOMER CLUB SERVICES, FOR COMMERCIAL, PROMOTIONAL AND/OR ADVERTISING PURPOSES; PROVIDING INCENTIVE AWARD PROGRAMS AND CUSTOMER LOYALTY AND REWARD PROGRAMS, NAMELY, PROVIDING INCENTIVES AND REWARDS SUCH AS DISCOUNTS, COUPONS, PRE-SALES, EVENTS AND SPECIAL ACCESS TO PRODUCT AND OTHER INFORMATION FOR CUSTOMERS, IN CLASS 35 (U.S. CLS. 100, 101 AND 102).

FIRST USE 3-1-2011; IN COMMERCE 3-1-2011.

THE MARK CONSISTS OF STANDARD CHARACTERS WITHOUT CLAIM TO ANY PARTICULAR FONT, STYLE, SIZE, OR COLOR.

OWNER OF U.S. REG. NOS. 2,641,045, 2,702,762, AND 2,807,432.

SN 85-214,071, FILED 1-10-2011.

KAPIL BHANOT, EXAMINING ATTORNEY



*David J. Kybas*

Director of the United States Patent and Trademark Office

# United States of America

United States Patent and Trademark Office

# REVOLUTION

**Reg. No. 4,136,484**

DENTIST RX, LLC (DELAWARE LIMITED LIABILITY COMPANY)  
14787 NE 95TH STREET  
REDMOND, WA 98052

**Registered May 1, 2012**

**Int. Cls.: 9 and 21**

FOR: ELECTRIC TOOTHBRUSH CHARGER HAVING SANITIZING CAPABILITY, IN CLASS 9 (U.S. CLS. 21, 23, 26, 36 AND 38).

**TRADEMARK**

FIRST USE 6-15-2011; IN COMMERCE 6-15-2011.

**PRINCIPAL REGISTER**

FOR: TOOTHBRUSHES, ELECTRICAL TOOTHBRUSHES, AND TOOTHBRUSH HEADS, IN CLASS 21 (U.S. CLS. 2, 13, 23, 29, 30, 33, 40 AND 50).

FIRST USE 6-15-2011; IN COMMERCE 6-15-2011.

THE MARK CONSISTS OF STANDARD CHARACTERS WITHOUT CLAIM TO ANY PARTICULAR FONT, STYLE, SIZE, OR COLOR.

SN 85-214,241, FILED 1-10-2011.

C. DIONNE CLYBURN, EXAMINING ATTORNEY



*David J. Kyros*

Director of the United States Patent and Trademark Office

# United States of America

United States Patent and Trademark Office

# CREABLE

**Reg. No. 4,136,485**

**Registered May 1, 2012**

**Int. Cls.: 35, 41, and 42**

**SERVICE MARK**

**PRINCIPAL REGISTER**

CREABLE (CALIFORNIA CORPORATION)  
411 SOUTH MAIN STREET, SUITE 307  
LOS ANGELES, CA 90013

FOR: BRANDING SERVICES, NAMELY, CONSULTING, DEVELOPMENT, MANAGEMENT AND MARKETING OF BRANDS FOR BUSINESSES, IN CLASS 35 (U.S. CLS. 100, 101 AND 102).

FIRST USE 1-7-2008; IN COMMERCE 1-7-2008.

FOR: MULTIMEDIA ENTERTAINMENT SERVICES IN THE NATURE OF DEVELOPMENT, PRODUCTION AND POST-PRODUCTION SERVICES IN THE FIELDS OF VIDEO AND FILMS, IN CLASS 41 (U.S. CLS. 100, 101 AND 107).

FIRST USE 1-1-2010; IN COMMERCE 4-1-2010.

FOR: GRAPHIC DESIGN SERVICES; VISUAL DESIGN SERVICES IN THE NATURE OF DESIGNING VISUAL ELEMENTS FOR ON-LINE, BROADCAST, PRINT, OUTDOOR AND OTHER COMMUNICATION MEDIA, IN CLASS 42 (U.S. CLS. 100 AND 101).

FIRST USE 1-7-2008; IN COMMERCE 1-7-2008.

THE MARK CONSISTS OF STANDARD CHARACTERS WITHOUT CLAIM TO ANY PARTICULAR FONT, STYLE, SIZE, OR COLOR.

SN 85-214,254, FILED 1-10-2011.

C. DIONNE CLYBURN, EXAMINING ATTORNEY



*David J. Kyros*

Director of the United States Patent and Trademark Office

# United States of America

United States Patent and Trademark Office

## AUTHENTIC SPORTS MANAGEMENT

**Reg. No. 4,136,486**

**Registered May 1, 2012**

**Int. Cl.: 35**

**SERVICE MARK**

**PRINCIPAL REGISTER**

AUTHENTIC SPORTS MANAGEMENT, LLC (FLORIDA LIMITED LIABILITY COMPANY)  
624 S. MILITARY TRAIL  
DEERFIELD BEACH, FL 33442

FOR: MANAGEMENT, REPRESENTATION AND PROMOTION OF PROFESSIONAL ATHLETES IN ATHLETICS AND ENTERTAINMENT; PROMOTING THE GOODS AND SERVICES OF OTHERS BY ARRANGING FOR SPONSORS AND ENDORSERS TO AFFILIATE THEIR GOODS AND SERVICES WITH ATHLETES, IN CLASS 35 (U.S. CLS. 100, 101 AND 102).

FIRST USE 1-5-2011; IN COMMERCE 1-5-2011.

THE MARK CONSISTS OF STANDARD CHARACTERS WITHOUT CLAIM TO ANY PARTICULAR FONT, STYLE, SIZE, OR COLOR.

NO CLAIM IS MADE TO THE EXCLUSIVE RIGHT TO USE "SPORTS MANAGEMENT", APART FROM THE MARK AS SHOWN.

SN 85-214,381, FILED 1-10-2011.

THOMAS MANOR, EXAMINING ATTORNEY



*David J. Kyros*

Director of the United States Patent and Trademark Office

# United States of America

United States Patent and Trademark Office

## WARNER'S FALL IN LUXE

**Reg. No. 4,136,487**

**Registered May 1, 2012**

**Int. Cl.: 25**

**TRADEMARK**

**PRINCIPAL REGISTER**

WARNACO U.S., INC. (DELAWARE CORPORATION)  
470 WHEELERS FARMS ROAD  
MILFORD, CT 06460

FOR: INTIMATE APPAREL AND FIGURE ENHANCING GARMENTS, NAMELY, BRAS, PANTIES, UNDERWEAR, UNDERPANTS, UNDERGARMENTS, UNDERCLOTHES, LINGERIE, FOUNDATION GARMENTS AND CAMISOLES, IN CLASS 25 (U.S. CLS. 22 AND 39).

FIRST USE 6-15-2011; IN COMMERCE 6-15-2011.

THE MARK CONSISTS OF STANDARD CHARACTERS WITHOUT CLAIM TO ANY PARTICULAR FONT, STYLE, SIZE, OR COLOR.

OWNER OF U.S. REG. NOS. 50,062, 179,292, AND 3,252,372.

NO CLAIM IS MADE TO THE EXCLUSIVE RIGHT TO USE "LUXE", APART FROM THE MARK AS SHOWN.

SN 85-214,626, FILED 1-11-2011.

ARETHA SOMERVILLE, EXAMINING ATTORNEY



*David J. Kyffers*

Director of the United States Patent and Trademark Office

# United States of America

United States Patent and Trademark Office

## ZI XIU TANG

**Reg. No. 4,136,488**

ANDREW M. SAM (UNITED STATES INDIVIDUAL)  
3256 STEVENS AVE.  
ROSEMEAD, CA 91770

**Registered May 1, 2012**

**Int. Cl.: 5**

FOR: DIETARY AND NUTRITIONAL SUPPLEMENTS, IN CLASS 5 (U.S. CLS. 6, 18, 44, 46, 51 AND 52).

**TRADEMARK**

FIRST USE 10-1-2009; IN COMMERCE 10-1-2009.

**PRINCIPAL REGISTER**

THE MARK CONSISTS OF STANDARD CHARACTERS WITHOUT CLAIM TO ANY PARTICULAR FONT, STYLE, SIZE, OR COLOR.

THE ENGLISH TRANSLATION OF "ZI XIU TANG" IN THE MARK IS "ELEGANCE HALL".

SN 85-214,874, FILED 1-11-2011.

THOMAS MANOR, EXAMINING ATTORNEY



*David J. Kybas*

Director of the United States Patent and Trademark Office



# United States of America

United States Patent and Trademark Office

## WORDY WORD

**Reg. No. 4,136,489**

**Registered May 1, 2012**

**Int. Cl.: 28**

**TRADEMARK**

**PRINCIPAL REGISTER**

PONDERING ARMORED VEHICLE LLC (NEW YORK LIMITED LIABILITY COMPANY),  
DBA MOONRACER,  
8 KING EIDER WAY  
TAYLORS, SC 29687

FOR: BOARD GAMES, IN CLASS 28 (U.S. CLS. 22, 23, 38 AND 50).

FIRST USE 1-1-2012; IN COMMERCE 2-1-2012.

THE MARK CONSISTS OF STANDARD CHARACTERS WITHOUT CLAIM TO ANY PARTICULAR FONT, STYLE, SIZE, OR COLOR.

SN 85-215,362, FILED 1-11-2011.

GISELLE AGOSTO, EXAMINING ATTORNEY



*David J. Kyffers*

Director of the United States Patent and Trademark Office

# United States of America

United States Patent and Trademark Office

## MODERNFOLD TRUSS SYSTEM

**Reg. No. 4,136,490**

**Registered May 1, 2012**

**Int. Cls.: 6, 19, and 20**

**TRADEMARK**

**PRINCIPAL REGISTER**

MODERNFOLD, INC. (DELAWARE CORPORATION)  
215 WEST NEW ROAD  
GREENFIELD, IN 46140

FOR: METAL TRUSS SYSTEMS CONSISTING OF TRUSSES AND COMPONENT PARTS THEREOF FOR USE WITH MOVEABLE WALLS, PANELS, AND SPACE DIVIDERS , IN CLASS 6 (U.S. CLS. 2, 12, 13, 14, 23, 25 AND 50).

FIRST USE 4-0-2011; IN COMMERCE 5-1-2011.

FOR: NON-METAL TRUSS SYSTEMS CONSISTING OF TRUSSES AND CLAMPS AND COMPONENT PARTS THEREOF FOR USE WITH MOVEABLE WALLS, PANELS, AND SPACE DIVIDERS, IN CLASS 19 (U.S. CLS. 1, 12, 33 AND 50).

FIRST USE 4-0-2011; IN COMMERCE 5-1-2011.

FOR: MOVEABLE PARTITION WALLS FOR OFFICE AND WORK SPACES, PARTITION PANELS FOR OFFICE AND WORK SPACES, AND OFFICE AND WORK SPACE DIVIDERS AND ROUTING SYSTEMS FOR SAME, SOLD AS A UNIT, COMPRISED OF TRACKS, CABLES, DIVIDING PANELS, PARTITION PANELS, AND COMPONENT PARTS THEREOF, IN CLASS 20 (U.S. CLS. 2, 13, 22, 25, 32 AND 50).

FIRST USE 4-0-2011; IN COMMERCE 5-1-2011.

THE MARK CONSISTS OF STANDARD CHARACTERS WITHOUT CLAIM TO ANY PARTICULAR FONT, STYLE, SIZE, OR COLOR.

OWNER OF U.S. REG. NOS. 671,393, 3,083,546, AND OTHERS.

NO CLAIM IS MADE TO THE EXCLUSIVE RIGHT TO USE "TRUSS SYSTEM", APART FROM THE MARK AS SHOWN.

SN 85-215,631, FILED 1-12-2011.

KARANENDRA S. CHHINA, EXAMINING ATTORNEY



*David J. Kyros*

Director of the United States Patent and Trademark Office

# United States of America

United States Patent and Trademark Office



A Division of Mori Lee LLC

**Reg. No. 4,136,491**

**Registered May 1, 2012**

**Int. Cl.: 25**

**TRADEMARK**

**PRINCIPAL REGISTER**

MORI LEE, LLC (DELAWARE LIMITED LIABILITY COMPANY)  
6101 PARK OF COMMERCE BLVD.  
BOCA RATON, FL 33487

FOR: CLOTHING, NAMELY, DRESSES, IN CLASS 25 (U.S. CLS. 22 AND 39).

FIRST USE 1-31-2011; IN COMMERCE 1-31-2011.

OWNER OF U.S. REG. NOS. 1,869,685, 3,824,031, AND OTHERS.

NO CLAIM IS MADE TO THE EXCLUSIVE RIGHT TO USE "DIVISION" AND "LLC", APART FROM THE MARK AS SHOWN.

THE NAME "MORI LEE" IDENTIFIES A LIVING INDIVIDUAL WHOSE CONSENT IS OF RECORD.

THE MARK CONSISTS OF THE LETTERS "VM" ABOVE THE LETTERS "VM" WHICH APPEAR UPSIDE DOWN AND THE WORDS "A DIVISION OF MORI LEE LLC" APPEARING BELOW.

SN 85-215,987, FILED 1-12-2011.

NAKIA HENRY, EXAMINING ATTORNEY



*David J. Kyffers*

Director of the United States Patent and Trademark Office

# United States of America

United States Patent and Trademark Office

# JEXO

**Reg. No. 4,136,492**

**Registered May 1, 2012**

**Int. Cl.: 35**

**SERVICE MARK**

**PRINCIPAL REGISTER**

SANLAND INVESTMENTS LIMITED (BR. VIRGIN ISLANDS CORPORATION)  
9 KAFKASOU STR. TREPPIDES TOWER  
AGLANTZIAM, NICOSIA, CYPRUS 2112

FOR: ADVERTISING AND MARKETING SERVICES; CONSULTING SERVICES IN THE  
FIELD OF INTERNET MARKETING; ONLINE MARKETING SERVICES, NAMELY, AFFIL-  
IATE MARKETING SERVICES, IN CLASS 35 (U.S. CLS. 100, 101 AND 102).

FIRST USE 11-20-2011; IN COMMERCE 11-20-2011.

THE MARK CONSISTS OF STANDARD CHARACTERS WITHOUT CLAIM TO ANY PAR-  
TICULAR FONT, STYLE, SIZE, OR COLOR.

SN 85-216,738, FILED 1-13-2011.

REBECCA SMITH, EXAMINING ATTORNEY



*David J. Kyros*

Director of the United States Patent and Trademark Office

# United States of America

United States Patent and Trademark Office



**Reg. No. 4,136,493**

**Registered May 1, 2012**

**Int. Cl.: 9**

**TRADEMARK**

**PRINCIPAL REGISTER**

FIN RECORDS, LLC (WASHINGTON LIMITED LIABILITY COMPANY)  
5140 BALLARD AVE. NW, SUITE A  
SEATTLE, WA 98107

FOR: DIGITAL MEDIA, NAMELY, CDS, DVDS, DOWNLOADABLE AUDIO FILES, DOWNLOADABLE VIDEO FILES FEATURING MUSIC, MUSIC VIDEOS AND MUSIC PERFORMANCES; MUSICAL SOUND RECORDINGS; MUSICAL VIDEO RECORDINGS; PHONOGRAPH RECORDS FEATURING MUSIC AND MUSIC PERFORMANCES, IN CLASS 9 (U.S. CLS. 21, 23, 26, 36 AND 38).

FIRST USE 5-31-2011; IN COMMERCE 6-9-2011.

NO CLAIM IS MADE TO THE EXCLUSIVE RIGHT TO USE "RECORDS", APART FROM THE MARK AS SHOWN.

THE MARK CONSISTS OF A SERIES OF CONCENTRIC CIRCLES. THE TERM "RECORDS" APPEARS AT THE BOTTOM. THE TERM "FIN" APPEARS IN THE INNERMOST CIRCLE. THE LETTERS SPELLING "FIN" ARE STYLIZED AND THE BOTTOM OF THE LETTER "F" EXTENDS THROUGH SEVERAL OF THE CIRCLES. THE TOP OF THE LETTER "F" IS STYLIZED TO REPRESENT THE HEAD OF A FISH.

SN 85-216,968, FILED 1-13-2011.

GISELLE AGOSTO, EXAMINING ATTORNEY



*David J. Kyjars*

Director of the United States Patent and Trademark Office

# United States of America

United States Patent and Trademark Office

## WENTE FIRST FAMILY OF CHARDONNAY

**Reg. No. 4,136,494**

**Registered May 1, 2012**

**Int. Cl.: 33**

**TRADEMARK**

**PRINCIPAL REGISTER**

WENTE BROS. (CALIFORNIA CORPORATION)  
5565 TESLA RD  
LIVERMORE, CA 94550

FOR: WINE, IN CLASS 33 (U.S. CLS. 47 AND 49).

FIRST USE 12-13-2011; IN COMMERCE 12-13-2011.

THE MARK CONSISTS OF STANDARD CHARACTERS WITHOUT CLAIM TO ANY PARTICULAR FONT, STYLE, SIZE, OR COLOR.

OWNER OF U.S. REG. NOS. 1,366,981, 2,128,552, AND OTHERS.

NO CLAIM IS MADE TO THE EXCLUSIVE RIGHT TO USE "CHARDONNAY", APART FROM THE MARK AS SHOWN.

SN 85-217,170, FILED 1-13-2011.

LEIGH CAROLINE CASE, EXAMINING ATTORNEY



*David J. Kyffers*

Director of the United States Patent and Trademark Office

# United States of America

United States Patent and Trademark Office



**Reg. No. 4,136,495**

**Registered May 1, 2012**

**Int. Cl.: 14**

**TRADEMARK**

**PRINCIPAL REGISTER**

JEWELRY MARKETING COMPANY, LLC (NEW YORK LIMITED LIABILITY COMPANY)  
500 SEVENTH AVENUE, 12TH FLOOR B  
NEW YORK, NY 10036

FOR: JEWELRY, PRECIOUS GEMSTONES, SEMI-PRECIOUS GEMSTONES; DIAMONDS, CUT-DIAMONDS, WATCHES, JEWELRY WATCHES, HOROLOGICAL AND CHRONOMETRIC INSTRUMENTS AND CASES THEREFOR, IN CLASS 14 (U.S. CLS. 2, 27, 28 AND 50).

FIRST USE 2-7-2011; IN COMMERCE 9-8-2011.

THE MARK CONSISTS OF A MISCELLANEOUS DESIGN THAT RESEMBLES AN ANCHOR WITH AN OPENING IN THE SHAPE OF A HEART IN THE MIDDLE, TOGETHER WITH A HORIZONTAL LINE ON THE TOP OF THE DESIGN AND ANOTHER ON THE BOTTOM OF THE DESIGN.

SN 85-217,824, FILED 1-14-2011.

LEIGH LOWRY, EXAMINING ATTORNEY



*David J. Kybas*

Director of the United States Patent and Trademark Office

# United States of America

United States Patent and Trademark Office

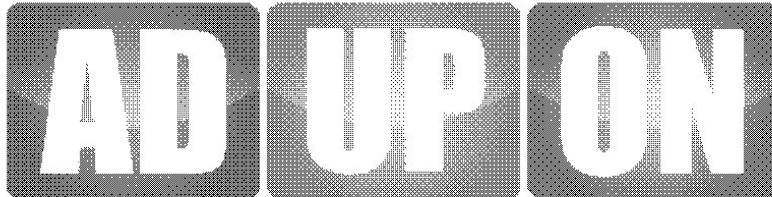

**Reg. No. 4,136,496**

**Registered May 1, 2012**

**Int. Cl.: 35**

**SERVICE MARK**

**PRINCIPAL REGISTER**

ADUPON, INC (DELAWARE CORPORATION)  
9 CRESCENT AVE  
NEWTON, MA 02459

FOR: ADVERTISING SERVICES, NAMELY, PROMOTING THE GOODS AND SERVICES OF OTHERS BY DISTRIBUTING ADVERTISING ON WEB SITES AND MOBILE APPLICATIONS, IN CLASS 35 (U.S. CLS. 100, 101 AND 102).

FIRST USE 1-14-2011; IN COMMERCE 1-20-2011.

NO CLAIM IS MADE TO THE EXCLUSIVE RIGHT TO USE "AD", APART FROM THE MARK AS SHOWN.

THE STIPPLING IS FOR SHADING PURPOSES ONLY.

THE MARK CONSISTS OF THE STYLIZED TEXT "AD UP ON" INSIDE THREE DIFFERENT ROUND SQUARES.

SN 85-218,270, FILED 1-14-2011.

PRISCILLA MILTON, EXAMINING ATTORNEY



*David J. Kybas*

Director of the United States Patent and Trademark Office



# United States of America

United States Patent and Trademark Office

# SALT

**Reg. No. 4,136,497**

**Registered May 1, 2012**

**Int. Cl.: 9**

**TRADEMARK**

**PRINCIPAL REGISTER**

SALT CASES (MAINE CORPORATION)  
90 CARLETON STREET  
PORTLAND, ME 04102

FOR: PROTECTIVE CARRYING CASES FOR CELL PHONES, COMPUTERS, MOBILE PHONES AND PORTABLE ELECTRONIC DEVICES, IN CLASS 9 (U.S. CLS. 21, 23, 26, 36 AND 38).

FIRST USE 5-18-2011; IN COMMERCE 5-18-2011.

THE MARK CONSISTS OF STANDARD CHARACTERS WITHOUT CLAIM TO ANY PARTICULAR FONT, STYLE, SIZE, OR COLOR.

SN 85-219,233, FILED 1-17-2011.

HAI-LY LAM, EXAMINING ATTORNEY



*David J. Kyffers*

Director of the United States Patent and Trademark Office

# United States of America

United States Patent and Trademark Office

## COMPASSIONATE ACTIONS PROJECT

**Reg. No. 4,136,498**

GREEN, KATHERINE M. (UNITED STATES INDIVIDUAL)  
PO BOX 1523  
ERIE, PA 16507

**Registered May 1, 2012**

**Int. Cls.: 43 and 44**

FOR: CHARITABLE SERVICES, NAMELY, PROVIDING FOOD TO NEEDY PERSONS, IN CLASS 43 (U.S. CLS. 100 AND 101).

**SERVICE MARK**

FIRST USE 9-0-2011; IN COMMERCE 9-0-2011.

**PRINCIPAL REGISTER**

FOR: CHARITABLE SERVICES, NAMELY, PROVIDING CARE PACKAGES CONSISTING PRIMARILY OF PERSONAL CARE ITEMS, IN CLASS 44 (U.S. CLS. 100 AND 101).

FIRST USE 9-0-2011; IN COMMERCE 9-0-2011.

THE MARK CONSISTS OF STANDARD CHARACTERS WITHOUT CLAIM TO ANY PARTICULAR FONT, STYLE, SIZE, OR COLOR.

NO CLAIM IS MADE TO THE EXCLUSIVE RIGHT TO USE "PROJECT", APART FROM THE MARK AS SHOWN.

SN 85-219,291, FILED 1-17-2011.

DOMINIC FATHY, EXAMINING ATTORNEY



*David J. Kyros*

Director of the United States Patent and Trademark Office

# United States of America

United States Patent and Trademark Office



**Reg. No. 4,136,499**

**Registered May 1, 2012**

**Int. Cl.: 5**

**TRADEMARK**

**PRINCIPAL REGISTER**

EDGEMONT PHARMACEUTICALS, LLC (NEW JERSEY LIMITED LIABILITY COMPANY)  
88 EAST MAIN STREET, SUITE 506  
MENDHAM, NJ 07945

FOR: PHARMACEUTICAL PREPARATIONS FOR THE TREATMENT OF CENTRAL NERVOUS SYSTEM RELATED DISEASES AND DISORDERS, IN CLASS 5 (U.S. CLS. 6, 18, 44, 46, 51 AND 52).

FIRST USE 1-25-2012; IN COMMERCE 1-25-2012.

THE MARK CONSISTS OF AN "E" DESIGN FORMED BY TWO WHITE HORIZONTAL LINES SUPERIMPOSED ON A BACKGROUND OF THREE ADJOINING TRIANGLES.

SN 85-219,577, FILED 1-18-2011.

KHANH LE, EXAMINING ATTORNEY



*David J. Kyffers*

Director of the United States Patent and Trademark Office

# United States of America

United States Patent and Trademark Office

AMPEGY 

**Reg. No. 4,136,500**

**Registered May 1, 2012**

**Int. Cl.: 36**

**SERVICE MARK**

**PRINCIPAL REGISTER**

AMPEGY, LLC (TEXAS LIMITED LIABILITY COMPANY)  
SUITE 100  
2105 CITYWEST BLVD.  
HOUSTON, TX 77042

FOR: ENERGY BROKERAGE SERVICES, NAMELY, PROCURING ELECTRICITY AND NATURAL GAS ENERGY COMMODITIES PURCHASED FROM ELECTRICITY AND NATURAL GAS ENERGY UTILITIES AND FROM OTHER ENERGY PRODUCERS AND ARRANGING FOR THE SUPPLY OF ELECTRICITY AND NATURAL GAS ENERGY COMMODITIES TO A DISTRIBUTION NETWORK FOR ULTIMATE DELIVERY TO CONSUMERS AND BUSINESSES, IN CLASS 36 (U.S. CLS. 100, 101 AND 102).

FIRST USE 2-24-2011; IN COMMERCE 2-24-2011.

THE MARK CONSISTS OF THE WORD "AMPEGY" IN DISTINCTIVE TYPE WITH A CLUSTER OF LEAVES OVER THE "Y" IN THE WORD MARK.

SN 85-219,832, FILED 1-18-2011.

MICHAEL GAAFAR, EXAMINING ATTORNEY



*David J. Kybas*

Director of the United States Patent and Trademark Office

# United States of America

United States Patent and Trademark Office

# FADERS

**Reg. No. 4,136,501**

V-MODA, LLC (CALIFORNIA LIMITED LIABILITY COMPANY)  
6464 SUNSET BOULEVARD, SUITE 500  
HOLLYWOOD, CA 90028

**Registered May 1, 2012**

**Int. Cl.: 9**

FOR: EAR SAFETY DEVICES, NAMELY, PLUGS AND INSERTS FOR NON-MEDICAL PURPOSES, IN CLASS 9 (U.S. CLS. 21, 23, 26, 36 AND 38).

**TRADEMARK**

FIRST USE 12-1-2011; IN COMMERCE 12-1-2011.

**PRINCIPAL REGISTER**

THE MARK CONSISTS OF STANDARD CHARACTERS WITHOUT CLAIM TO ANY PARTICULAR FONT, STYLE, SIZE, OR COLOR.

SN 85-219,844, FILED 1-18-2011.

MARY CRAWFORD, EXAMINING ATTORNEY



*David J. Kyffers*

Director of the United States Patent and Trademark Office

# United States of America

United States Patent and Trademark Office

## COVER CADDY

**Reg. No. 4,136,502**

**Registered May 1, 2012**

**Int. Cl.: 28**

**TRADEMARK**

**PRINCIPAL REGISTER**

THE COVER CADDY LLC (WISCONSIN LIMITED LIABILITY COMPANY)  
W264 N6577 HILLVIEW DR.  
SUSSEX, WI 53089

FOR: GOLF CLUB COVER HOLDER, IN CLASS 28 (U.S. CLS. 22, 23, 38 AND 50).

FIRST USE 4-1-2011; IN COMMERCE 4-1-2011.

THE MARK CONSISTS OF STANDARD CHARACTERS WITHOUT CLAIM TO ANY PARTICULAR FONT, STYLE, SIZE, OR COLOR.

NO CLAIM IS MADE TO THE EXCLUSIVE RIGHT TO USE "COVER", APART FROM THE MARK AS SHOWN.

SN 85-220,302, FILED 1-18-2011.

JEFF DEFORD, EXAMINING ATTORNEY



*David J. Kyffers*

Director of the United States Patent and Trademark Office

# United States of America

United States Patent and Trademark Office

## ANOMALY WARZONE EARTH

**Reg. No. 4,136,503**

**Registered May 1, 2012**

**Int. Cl.: 9**

**TRADEMARK**

**PRINCIPAL REGISTER**

11 BIT STUDIOS S.A. (POLAND CORPORATION)  
UL. GDANSKA 2, LOKAL 82  
WARSZAWA, POLAND 01-633

FOR: COMPUTER GAME PROGRAMMES DOWNLOADABLE VIA THE INTERNET; COMPUTER GAME PROGRAMS; COMPUTER GAME SOFTWARE; COMPUTER GAME SOFTWARE FOR PERSONAL COMPUTERS AND HOME VIDEO GAME CONSOLES; COMPUTER GAME SOFTWARE FOR USE ON MOBILE AND CELLULAR PHONES; COMPUTER GAME SOFTWARE FOR USE WITH PERSONAL COMPUTERS, HOME VIDEO GAME CONSOLES USED WITH TELEVISIONS AND ARCADE-BASED VIDEO GAME CONSOLES; DOWNLOADABLE COMPUTER GAME PROGRAMS; INTERACTIVE MULTIMEDIA COMPUTER GAME PROGRAM; INTERACTIVE VIDEO GAME PROGRAMS; VIDEO AND COMPUTER GAME PROGRAMS; VIDEO GAME SOFTWARE, IN CLASS 9 (U.S. CLS. 21, 23, 26, 36 AND 38).

FIRST USE 10-14-2010; IN COMMERCE 4-7-2011.

THE MARK CONSISTS OF STANDARD CHARACTERS WITHOUT CLAIM TO ANY PARTICULAR FONT, STYLE, SIZE, OR COLOR.

SN 85-220,598, FILED 1-19-2011.

CARRIE GENOVESE, EXAMINING ATTORNEY



*David J. Kyros*

Director of the United States Patent and Trademark Office

# United States of America

United States Patent and Trademark Office



**Reg. No. 4,136,504**

**Registered May 1, 2012**

**Int. Cl.: 30**

**TRADEMARK**

**PRINCIPAL REGISTER**

CASO LLC (PENNSYLVANIA LIMITED LIABILITY COMPANY)  
279 NANDINA PLACE  
PHILADELPHIA, PA 19116

FOR: COFFEE, IN CLASS 30 (U.S. CL. 46).

FIRST USE 10-26-2010; IN COMMERCE 10-21-2011.

NO CLAIM IS MADE TO THE EXCLUSIVE RIGHT TO USE "BROS" AND "COFFEE ROASTERS", APART FROM THE MARK AS SHOWN.

THE STIPPLING IS FOR SHADING PURPOSES ONLY.

THE MARK CONSISTS OF TWO BOXERS FACING EACH OTHER, HOLDING COFFEE MUGS, WITH (4) STARS ON BOTH SIDES. THE BOXERS ARE ABOVE THE ARCHING TEXT "RIVAL". DIRECTLY BELOW THAT IS THE TEXT "BROS" IN A BANNER. AT THE BOTTOM IS THE TEXT "COFFEE ROASTERS" WITH A STAR SPLITTING THE TWO WORDS.

SN 85-220,958, FILED 1-19-2011.

ZHALEH DELANEY, EXAMINING ATTORNEY



*David J. Kyffers*

Director of the United States Patent and Trademark Office



# United States of America

United States Patent and Trademark Office

## A BETTER WAY TO GET BETTER

**Reg. No. 4,136,505**

**Registered May 1, 2012**

**Int. Cl.: 44**

**SERVICE MARK**

**PRINCIPAL REGISTER**

MEDIG PROPRIETARY HOLDINGS, L.L.C. (FLORIDA LIMITED LIABILITY COMPANY)  
4410 NEWBERRY ROAD, SUITE A-3  
GAINESVILLE, FL 32607

FOR: MEDICAL SERVICES, IN CLASS 44 (U.S. CLS. 100 AND 101).

FIRST USE 12-0-2010; IN COMMERCE 12-0-2010.

THE MARK CONSISTS OF STANDARD CHARACTERS WITHOUT CLAIM TO ANY PARTICULAR FONT, STYLE, SIZE, OR COLOR.

SN 85-220,981, FILED 1-19-2011.

DAVID C. REIHNER, EXAMINING ATTORNEY



*David J. Kyfos*

Director of the United States Patent and Trademark Office

# United States of America

United States Patent and Trademark Office

## FIBER CLAW

**Reg. No. 4,136,506**

**Registered May 1, 2012**

**Int. Cl.: 19**

**TRADEMARK**

**PRINCIPAL REGISTER**

SYSTEM COMPONENTS CORPORATION (WASHINGTON CORPORATION)  
P.O. BOX 2432  
ISSAQUAH, WA 98027

FOR: ROOFING UNDERLAYMENT INCORPORATING A TEXTURED WALKING SURFACE  
FOR STEEP SLOPE ROOFS, IN CLASS 19 (U.S. CLS. 1, 12, 33 AND 50).

FIRST USE 1-31-2011; IN COMMERCE 1-31-2011.

THE MARK CONSISTS OF STANDARD CHARACTERS WITHOUT CLAIM TO ANY PAR-  
TICULAR FONT, STYLE, SIZE, OR COLOR.

SN 85-221,215, FILED 1-19-2011.

ANTHONY RINKER, EXAMINING ATTORNEY



*David J. Kyffers*

Director of the United States Patent and Trademark Office

# United States of America

United States Patent and Trademark Office

## PLUM CRAZY

**Reg. No. 4,136,507**

**Registered May 1, 2012**

**Int. Cl.: 3**

**TRADEMARK**

**PRINCIPAL REGISTER**

MEEKS, MARY (UNITED STATES INDIVIDUAL)  
P.O. BOX 548  
CORONA, CA 92878

FOR: NON-MEDICATED PET CARE PREPARATIONS, NAMELY, SHAMPOOS, IN CLASS 3 (U.S. CLS. 1, 4, 6, 50, 51 AND 52).

FIRST USE 4-0-2011; IN COMMERCE 4-0-2011.

THE MARK CONSISTS OF STANDARD CHARACTERS WITHOUT CLAIM TO ANY PARTICULAR FONT, STYLE, SIZE, OR COLOR.

OWNER OF U.S. REG. NO. 3,794,365.

SN 85-221,459, FILED 1-19-2011.

MICHAEL WEBSTER, EXAMINING ATTORNEY



*David J. Kyros*

Director of the United States Patent and Trademark Office

# United States of America

United States Patent and Trademark Office

# CCRE

**Reg. No. 4,136,508**

**Registered May 1, 2012**

**Int. Cl.: 36**

**SERVICE MARK**

**PRINCIPAL REGISTER**

CANTOR FITZGERALD SECURITIES (NEW YORK PARTNERSHIP)  
110 EAST 59TH STREET  
NEW YORK, NY 10022

FOR: FINANCIAL SERVICES, NAMELY, MONEY LENDING, ORIGINATION OF SUBORDINATED DEBT, SECONDARY MARKET TRANSACTION SERVICES, AND DEBT INVESTMENT SERVICES; COMMERCIAL LENDING SERVICES; BANKING AND FINANCING SERVICES; REAL ESTATE LENDING, INVESTMENT, AND FINANCING SERVICES; MORTGAGE BANKING SERVICES, NAMELY, ORIGINATION, ACQUISITION, SERVICING, AND SECURITIZATION OF MORTGAGE AND MEZZANINE LOANS; FINANCING OF REAL ESTATE DEVELOPMENT PROJECTS; MORTGAGE BANKING, REFINANCING AND LENDING; FINANCIAL INVESTMENT IN THE FIELD OF REAL ESTATE AND INVESTMENT SECURITIES; FINANCIAL ADVISORY, CONSULTANCY AND MANAGEMENT SERVICES; PROVIDING FINANCIAL INFORMATION; PROVIDING INFORMATION IN THE FIELD OF REAL ESTATE AND FINANCIAL INVESTMENTS, IN CLASS 36 (U.S. CLS. 100, 101 AND 102).

FIRST USE 8-13-2010; IN COMMERCE 8-13-2010.

THE MARK CONSISTS OF STANDARD CHARACTERS WITHOUT CLAIM TO ANY PARTICULAR FONT, STYLE, SIZE, OR COLOR.

SN 85-221,596, FILED 1-19-2011.

WARREN L. OLANDRIA, EXAMINING ATTORNEY



*David J. Kyros*

Director of the United States Patent and Trademark Office

# United States of America

United States Patent and Trademark Office

# IZALL

**Reg. No. 4,136,509**

**Registered May 1, 2012**

**Int. Cls.: 9 and 18**

**TRADEMARK**

**PRINCIPAL REGISTER**

CHEIL INDUSTRIES INC. (REPUBLIC OF KOREA CORPORATION)  
290, KONGDAN-DONG  
GUMI, KYONGSANGBUK-DO, REPUBLIC OF KOREA

FOR: BACKPACKS ESPECIALLY ADAPTED FOR HOLDING LAPTOPS; BACKPACKS ESPECIALLY ADAPTED FOR HOLDING LAPTOPS AND NOTEBOOK COMPUTERS; BAGS AND CASES SPECIALLY ADAPTED FOR HOLDING OR CARRYING PORTABLE TELEPHONES AND TELEPHONE EQUIPMENT AND ACCESSORIES; BAGS FOR CAMERAS AND PHOTOGRAPHIC EQUIPMENT; BAGS FOR UNDERWATER CAMERA ENCLOSURES; BAGS SPECIALLY ADAPTED FOR UNDERWATER CAMERA HOUSINGS; BATTERY CASES; BEEPER CARRYING CASES; BRIEFCASES SPECIALLY ADAPTED FOR HOLDING LAPTOP COMPUTERS; CAMERA CASES; CARRYING CASES FOR CELL PHONES; CARRYING CASES FOR MOBILE COMPUTERS; CARRYING CASES SPECIALLY ADAPTED FOR POCKET CALCULATORS AND CELLPHONES; CARRYING CASES, HOLDERS, PROTECTIVE CASES AND STANDS FEATURING POWER SUPPLY CONNECTORS, ADAPTORS, SPEAKERS AND BATTERY CHARGING DEVICES, SPECIALLY ADAPTED FOR USE WITH HANDHELD DIGITAL ELECTRONIC DEVICES; CASES FOR DISKETTES AND COMPACT DISKS; CASES FOR ELECTRONIC DIARIES; CASES FOR MOBILE PHONES; CASES FOR PHOTOGRAPHIC APPARATUS; CASES FOR TELEPHONES; CELL PHONE CASES; COMPUTER BAGS; COMPUTER CARRYING CASES; EARPHONE ACCESSORIES, NAMELY, EARPHONE CUSHIONS, EARPHONE PADS, CORD MANAGEMENT SYSTEMS, EARPHONE CASES, AND EARPHONE EXTENSION CORDS; LAPTOP CARRYING CASES; MESSENGER BAGS ESPECIALLY ADAPTED FOR HOLDING LAPTOPS; MESSENGER BAGS ESPECIALLY ADAPTED FOR HOLDING ELECTRONIC BOOK READERS; MOBILE PHONE STRAPS; NOTEBOOK COMPUTER CARRYING CASES; PLASTIC CASE USED AS A SECURITY DEVICE FOR PROTECTING AND SECURING DVDS AND OTHER MAGNETIC AND ELECTRONIC MEDIA FROM THEFT; PLASTIC CASES SPECIALLY ADAPTED HOLDING COMPACT DISCS, DVDS AND OTHER ELECTRONIC MEDIA; PORTABLE PHOTOGRAPHY EQUIPMENT, NAMELY, REFLECTORS, TRIPODS, LIGHT STANDS AND SUPPORTS AND BAGS SPECIALLY ADAPTED FOR THESE GOODS; PROTECTIVE CARRYING CASES FOR PORTABLE MUSIC PLAYERS, NAMELY, MP3 PLAYERS; PROTECTIVE CARRYING CASES SPECIALLY ADAPTED FOR GLOBAL POSITIONING SYSTEM (GPS) APPARATUS; PROTECTIVE CARRYING CASES SPECIALLY ADAPTED FOR PERSONAL DIGITAL ASSISTANTS (PDA); PROTECTIVE CARRYING CASES SPECIALLY ADAPTED FOR VIDEO GAME CONSOLES FOR USE WITH AN EXTERNAL DISPLAY SCREEN OR MONITOR; PROTECTIVE COVERS AND CASES FOR CELL PHONES, LAPTOPS AND PORTABLE MEDIA PLAYERS; ROLLING CASES ESPECIALLY ADAPTED FOR HOLDING



*David J. Kybas*

Director of the United States Patent and Trademark Office

**Reg. No. 4,136,509** LAPTOPS AND NOTEBOOK COMPUTERS; SPECIALTY HOLSTER FOR CARRYING CELLULAR PHONES, PAGERS, AND/OR PERSONAL DIGITAL ASSISTANTS; STRAPS FOR MOBILE PHONES; WHEELED BACKPACKS ESPECIALLY ADAPTED FOR HOLDING LAPTOPS; WHEELED MESSENGER BAGS ESPECIALLY ADAPTED FOR HOLDING LAPTOPS, IN CLASS 9 (U.S. CLS. 21, 23, 26, 36 AND 38).

FIRST USE 10-15-2011; IN COMMERCE 10-15-2011.

FOR: CALLING CARD CASES; BUSINESS CARD CASES; NAME CARD CASES AND CREDIT CARD CASES; BACK PACKS; RUCKSACKS; TRAVELLING BAGS; TRAVELLING TRUNKS; BRIEF CASES; SUIT CASES; SCHOOL BAGS; HANDBAGS; BOSTON BAGS; UMBRELLAS; PARASOLS; LEATHER STRAPS; ALL-PURPOSE CARRYING BAGS; BABY BACKPACKS; BAGS FOR CLIMBERS IN THE NATURE OF ALL-PURPOSE CARRYING BAGS; CANES AND WALKING STICKS; CARD WALLETS; CARRIERS FOR SUITS, SHIRTS AND DRESSES; COIN PURSES; HIPSACKS; KEY CASES; MESSENGER BAGS; PURSES; SHOULDER BAGS; SPORTS BAGS, WALLETS , IN CLASS 18 (U.S. CLS. 1, 2, 3, 22 AND 41).

FIRST USE 10-15-2011; IN COMMERCE 10-15-2011.

THE MARK CONSISTS OF STANDARD CHARACTERS WITHOUT CLAIM TO ANY PARTICULAR FONT, STYLE, SIZE, OR COLOR.

SN 85-221,752, FILED 1-20-2011.

ZHALEH DELANEY, EXAMINING ATTORNEY

# United States of America

United States Patent and Trademark Office



**Reg. No. 4,136,510**

**Registered May 1, 2012**

**Int. Cls.: 35 and 41**

**SERVICE MARK**

**PRINCIPAL REGISTER**

FLETCHER-GREEN, NICOLE (UNITED STATES INDIVIDUAL)  
8511 VINE MAPLE WAY  
INDIANAPOLIS, IN 46278

FOR: ARRANGING AND CONDUCTING BUSINESS CONFERENCES, IN CLASS 35 (U.S. CLS. 100, 101 AND 102).

FIRST USE 8-1-2005; IN COMMERCE 8-1-2005.

FOR: EDUCATIONAL SERVICES, NAMELY, CONDUCTING CONFERENCES IN THE FIELD OF FEMALE EMPOWERMENT AND ADVANCEMENT AND DISTRIBUTION OF PRINTED MATERIALS IN CONNECTION THEREWITH IN HARD COPY OR ELECTRONIC FORMAT ON THE SAME TOPICS, IN CLASS 41 (U.S. CLS. 100, 101 AND 107).

FIRST USE 8-1-2005; IN COMMERCE 8-1-2005.

THE MARK CONSISTS OF THE STYLIZED TEXT "NO MORE SILLY WOMEN" WITH A DOVE.

SN 85-221,939, FILED 1-20-2011.

MAYUR VAGHANI, EXAMINING ATTORNEY



*David J. Kyros*

Director of the United States Patent and Trademark Office

# United States of America

United States Patent and Trademark Office

# ALPEJSKIE

**Reg. No. 4,136,511**

**Registered May 1, 2012**

**Int. Cl.: 30**

**TRADEMARK**

**PRINCIPAL REGISTER**

LU POLSKA S.A. (POLAND CORPORATION)  
DOMANIEWSKA 49  
02-672 WARSAW, POLAND

FOR: COOKIES, IN CLASS 30 (U.S. CL. 46).

FIRST USE 12-31-1997; IN COMMERCE 12-31-1997.

THE MARK CONSISTS OF STANDARD CHARACTERS WITHOUT CLAIM TO ANY PARTICULAR FONT, STYLE, SIZE, OR COLOR.

THE ENGLISH TRANSLATION OF "ALPEJSKIE" IN THE MARK IS "ALPINE".

SN 85-222,344, FILED 1-20-2011.

JENNIFER MARTIN, EXAMINING ATTORNEY



*David J. Kybas*

Director of the United States Patent and Trademark Office



# United States of America

United States Patent and Trademark Office

# TAU BU

**Reg. No. 4,136,512**

**Registered May 1, 2012**

**Int. Cls.: 25 and 32**

**TRADEMARK**

**PRINCIPAL REGISTER**

PALM DISTRIBUTION INC. (FLORIDA CORPORATION)  
1008 ROYAL ABERDEEN WAY  
ORLANDO, FL 32828

FOR: CLOTHING, NAMELY, SHIRTS, T-SHIRTS, SHORTS, PANTS, SWEATERS, JACKETS,  
IN CLASS 25 (U.S. CLS. 22 AND 39).

FIRST USE 1-1-2011; IN COMMERCE 2-1-2011.

FOR: BEER, IN CLASS 32 (U.S. CLS. 45, 46 AND 48).

FIRST USE 2-1-2010; IN COMMERCE 3-1-2011.

THE MARK CONSISTS OF THE STYLIZED LETTERS "TAU" ABOVE THE STYLIZED  
LETTERS "BU".

THE WORDING "TAUBU" HAS NO MEANING IN A FOREIGN LANGUAGE.

SN 85-222,437, FILED 1-20-2011.

CHRISTINA SOBRAL, EXAMINING ATTORNEY



*David J. Kyffers*

Director of the United States Patent and Trademark Office

United States of America  
United States Patent and Trademark Office

**TAUBU**

**Reg. No. 4,136,513**

**Registered May 1, 2012**

**Int. Cls.: 25 and 32**

**TRADEMARK**

**PRINCIPAL REGISTER**

PALM DISTRIBUTION INC. (FLORIDA CORPORATION)  
1008 ROYAL ABERDEEN WAY  
ORLANDO, FL 32828

FOR: CLOTHING, NAMELY, SHIRTS, T-SHIRTS, SHORTS, PANTS, SWEATERS, JACKETS,  
IN CLASS 25 (U.S. CLS. 22 AND 39).

FIRST USE 1-1-2010; IN COMMERCE 2-1-2010.

FOR: BEER, IN CLASS 32 (U.S. CLS. 45, 46 AND 48).

FIRST USE 1-1-2010; IN COMMERCE 3-1-2011.

THE MARK CONSISTS OF THE STYLIZED LETTERS "TAUBU".

THE WORDING "TAUBU" HAS NO MEANING IN A FOREIGN LANGUAGE.

SN 85-222,444, FILED 1-20-2011.

CHRISTINA SOBRAL, EXAMINING ATTORNEY



*David J. Kybas*

Director of the United States Patent and Trademark Office

# United States of America

United States Patent and Trademark Office



**Reg. No. 4,136,514**

**Registered May 1, 2012**

**Int. Cl.: 29**

**TRADEMARK**

**PRINCIPAL REGISTER**

ARAUCO FOODS S.R.L. (ARGENTINA CORPORATION)  
CERVIÑO 3702, PISO 10  
CIUDAD DE BUENOS AIRES, ARGENTINA

FOR: OLIVE OIL, IN CLASS 29 (U.S. CL. 46).

FIRST USE 9-27-2011; IN COMMERCE 9-27-2011.

THE MARK CONSISTS OF THE TERM "AMARA" IN A FANCIFULLY STYLIZED FONT. POSITIONED ABOVE SAID TERM AMARA IS A SMALL LEAF CRADLING A DROP OF WATER. POSITIONED BELOW SAID TERM "AMARA" IS A THIN LINE WHICH ARCHES IN A DOWNWARD DIRECTION.

SN 85-223,244, FILED 1-21-2011.

JACQUELINE A. LAVINE, EXAMINING ATTORNEY



*David J. Kybas*

Director of the United States Patent and Trademark Office

# United States of America

United States Patent and Trademark Office



**Reg. No. 4,136,515**

**Registered May 1, 2012**

**Int. Cl.: 35**

**SERVICE MARK**

**PRINCIPAL REGISTER**

DLK COMMUNICATIONS, INC. (NEW YORK CORPORATION)  
2606 WATCH HILL DRIVE  
TARRYTOWN, NY 10591

FOR: PROMOTIONAL SERVICES, NAMELY, LAUNCH PARTIES TO INTRODUCE A NEW BOOK, AUTHOR, BOOK PUBLISHER OR RETAILER; ADVERTISING AND PUBLICITY SERVICES, IN CLASS 35 (U.S. CLS. 100, 101 AND 102).

FIRST USE 12-20-2010; IN COMMERCE 12-20-2010.

NO CLAIM IS MADE TO THE EXCLUSIVE RIGHT TO USE "COMMUNICATIONS", APART FROM THE MARK AS SHOWN.

THE MARK CONSISTS OF FOUR SHADED CIRCLES, WITH TWO ABOVE AND TWO BELOW, WITH THE CAPITAL LETTERS, "DLK" TO THE RIGHT OF THE SHADED CIRCLES, AND ALL THE FOREGOING ABOVE THE WORD "COMMUNICATIONS", WITH THE LETTERS "A" "T" LEANING TO THE LEFT AND THE LETTER "S" LEANING TO THE RIGHT IN "COMMUNICATIONS".

SN 85-223,279, FILED 1-21-2011.

ODESSA BIBBINS, EXAMINING ATTORNEY



*David J. Kyffers*

Director of the United States Patent and Trademark Office

# United States of America

United States Patent and Trademark Office

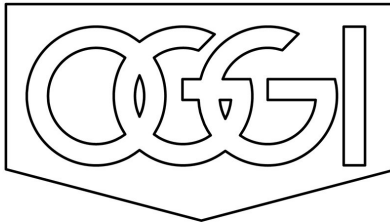

**Reg. No. 4,136,516**

**Registered May 1, 2012**

**Int. Cl.: 25**

**TRADEMARK**

**PRINCIPAL REGISTER**

JUNIOR DE MÉXICO (MEXICO SOCIEDAD ANONIMA (SA DE CV))  
TORRE INTÉLISIS PISO 15 COL. LOMAS ALTAS  
PASEO DE LA REFORMA NO. 2654  
MEXICO CITY, MEXICO 11950

FOR: BELTS, FOOTWEAR, SWIMWEAR, HATS, CAPS, APPAREL AND OUTERWEAR, NAMELY, BATHING SUITS, BATHING TRUNKS, BEACHWEAR, BIKINIS, BLOUSES, BOOTS, PANTS, COATS, DRESSES, GLOVES, HEADWEAR, JACKETS, JEANS, NECKWEAR, PANTS, SANDALS, SCARVES, SHAWLS, SHIRTS, SHOES, SHORTS, SKIRTS, SNEAKERS, SWEAT PANTS, SWEATSHIRTS, T-SHIRTS, TOPS, TANK TOPS, VESTS, IN CLASS 25 (U.S. CLS. 22 AND 39).

FIRST USE 1-3-2012; IN COMMERCE 1-3-2012.

THE MARK CONSISTS OF AN UPSIDE DOWN HORIZONTAL CONVEX POLYGON WITH THE OVERLAPPING LETTERS "OGGI" IN THE CENTER.

THE ENGLISH TRANSLATION OF "OGGI" IN THE MARK IS "TODAY".

SN 85-223,479, FILED 1-21-2011.

ALLISON SCHRODY, EXAMINING ATTORNEY



*David J. Kybas*

Director of the United States Patent and Trademark Office

# United States of America

United States Patent and Trademark Office

## TOMKAT FOUNDATION

**Reg. No. 4,136,517**

**Registered May 1, 2012**

**Int. Cl.: 36**

**SERVICE MARK**

**PRINCIPAL REGISTER**

TOMKAT FOUNDATION (DELAWARE NON-PROFIT CORPORATION)  
ONE MARITIME PLAZA, SUITE 1102  
SAN FRANCISCO, CA 94111

FOR: ACCEPTING AND ADMINISTERING MONETARY CHARITABLE CONTRIBUTIONS; CHARITABLE FOUNDATION SERVICES, NAMELY, PROVIDING FUNDRAISING ACTIVITIES, SUPPLEMENTAL FUNDING, CAPITAL IMPROVEMENT FUNDING, SCHOLARSHIPS AND FINANCIAL ASSISTANCE FOR PROGRAMS AND SERVICES OF OTHERS; CHARITABLE FUNDRAISING, IN CLASS 36 (U.S. CLS. 100, 101 AND 102).

FIRST USE 12-4-2007; IN COMMERCE 12-4-2007.

THE MARK CONSISTS OF STANDARD CHARACTERS WITHOUT CLAIM TO ANY PARTICULAR FONT, STYLE, SIZE, OR COLOR.

NO CLAIM IS MADE TO THE EXCLUSIVE RIGHT TO USE "FOUNDATION", APART FROM THE MARK AS SHOWN.

SN 85-223,641, FILED 1-21-2011.

DAVID YONTEF, EXAMINING ATTORNEY



*David J. Kyffers*

Director of the United States Patent and Trademark Office

# United States of America

United States Patent and Trademark Office

## PURE BY GLOSS

**Reg. No. 4,136,518**

**Registered May 1, 2012**

**Int. Cl.: 3**

**TRADEMARK**

**PRINCIPAL REGISTER**

PURE GLOSS MARKETING, LP (DELAWARE LIMITED PARTNERSHIP)  
5TH FLOOR  
1178 BROADWAY  
NEW YORK, NY 10001

FOR: BATH SOAP; FACIAL SOAP; SKIN SOAP; SHAMPOO; HAIR CONDITIONER; HAIR LOTION; BATH GEL; BODY LOTION, IN CLASS 3 (U.S. CLS. 1, 4, 6, 50, 51 AND 52).

FIRST USE 7-1-2011; IN COMMERCE 7-1-2011.

THE MARK CONSISTS OF STANDARD CHARACTERS WITHOUT CLAIM TO ANY PARTICULAR FONT, STYLE, SIZE, OR COLOR.

NO CLAIM IS MADE TO THE EXCLUSIVE RIGHT TO USE "PURE", APART FROM THE MARK AS SHOWN.

SN 85-223,690, FILED 1-21-2011.

JIM RINGLE, EXAMINING ATTORNEY



*David J. Kybas*

Director of the United States Patent and Trademark Office

# United States of America

United States Patent and Trademark Office

## THREE LITTLE INDIANS

**Reg. No. 4,136,519**

BROWNING SEED INC. (TEXAS CORPORATION)  
3101 S IH 27  
PLAINVIEW, TX 79072

**Registered May 1, 2012**

**Int. Cl.: 31**

FOR: FORAGE SORGHUM HYBRID AND SUDANGRASS SORGHUM HYBRID SEEDS, IN CLASS 31 (U.S. CLS. 1 AND 46).

**TRADEMARK**

FIRST USE 5-2-2011; IN COMMERCE 5-2-2011.

**PRINCIPAL REGISTER**

THE MARK CONSISTS OF STANDARD CHARACTERS WITHOUT CLAIM TO ANY PARTICULAR FONT, STYLE, SIZE, OR COLOR.

SN 85-223,789, FILED 1-22-2011.

ANDREA HACK, EXAMINING ATTORNEY



*David J. Kybas*

Director of the United States Patent and Trademark Office



# United States of America

United States Patent and Trademark Office

# Vibrite

**Reg. No. 4,136,520**

**Registered May 1, 2012**

**Int. Cl.: 3**

**TRADEMARK**

**PRINCIPAL REGISTER**

HERTZ ORAL PRODUCTS LLC (NEW YORK LIMITED LIABILITY COMPANY)  
18 EAST 12TH STREET 1A  
NEW YORK, NY 100034458

FOR: MOISTENED TOOTH POWDER; TEETH WHITENING KIT; TEETH WHITENING STRIPS IMPREGNATED WITH TEETH WHITENING PREPARATIONS; TOOTH BLEACHING PREPARATIONS; TOOTH CLEANING PREPARATIONS; TOOTH GEL; TOOTH PASTE; TOOTH PASTE IN SOFT CAKE; TOOTH POLISHES; TOOTH POWDER; TOOTH POWDERS; TOOTH WHITENERS FOR COSMETIC PURPOSES COMPRISED OF NEUTRAL SODIUM FLUORIDE SUSTAINED RELEASE GEL; TOOTH WHITENING CREAMS; TOOTH WHITENING GELS; TOOTH WHITENING PASTES; TOOTH WHITENING PREPARATIONS, IN CLASS 3 (U.S. CLS. 1, 4, 6, 50, 51 AND 52).

FIRST USE 11-7-2011; IN COMMERCE 11-7-2011.

THE MARK CONSISTS OF STANDARD CHARACTERS WITHOUT CLAIM TO ANY PARTICULAR FONT, STYLE, SIZE, OR COLOR.

SN 85-223,811, FILED 1-22-2011.

JAMES LOVELACE, EXAMINING ATTORNEY



*David J. Kypos*

Director of the United States Patent and Trademark Office

# United States of America

United States Patent and Trademark Office

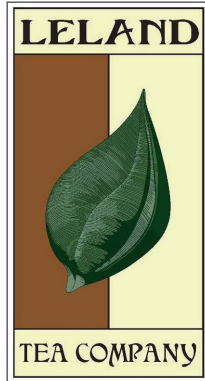

**Reg. No. 4,136,521**

**Registered May 1, 2012**

**Int. Cls.: 18, 30, and 43**

**TRADEMARK**

**SERVICE MARK**

**PRINCIPAL REGISTER**

THE LELAND TEA COMPANY (CALIFORNIA SOLE PROPRIETORSHIP), AKA LELAND TEA COMPANY,  
1416 BUSH STREET  
SAN FRANCISCO, CA 94109

FOR: ALL-PURPOSE CARRYING BAGS; ALL-PURPOSE REUSABLE CARRYING BAGS; CANVAS SHOPPING BAGS; CARRY-ALL BAGS; SHOULDER BAGS; TOTE BAGS, IN CLASS 18 (U.S. CLS. 1, 2, 3, 22 AND 41).

FIRST USE 10-12-2005; IN COMMERCE 10-12-2005.

FOR: BEVERAGES MADE OF TEA; BEVERAGES WITH A TEA BASE; BLACK TEA; CHAI TEA; FRUIT TEAS; GREEN TEA; HERB TEA; HERBAL TEA; ICED TEA; JAPANESE GREEN TEA; OOLONG TEA; TEA; TEA BAGS; TEA FOR INFUSIONS; TEA-BASED BEVERAGES; TEA-BASED BEVERAGES WITH FRUIT FLAVORING, IN CLASS 30 (U.S. CL. 46).

FIRST USE 10-12-2005; IN COMMERCE 10-12-2005.

FOR: TEA BARS; TEA ROOMS , IN CLASS 43 (U.S. CLS. 100 AND 101).

FIRST USE 10-12-2005; IN COMMERCE 10-12-2005.

NO CLAIM IS MADE TO THE EXCLUSIVE RIGHT TO USE "TEA COMPANY", APART FROM THE MARK AS SHOWN.

THE COLOR(S) BROWN, GREEN, DARK GREEN, BLACK, AND LIGHT YELLOW IS/ARE CLAIMED AS A FEATURE OF THE MARK.

THE MARK CONSISTS OF A RECTANGLE MADE UP OF FOUR BLACK LINES. WITHIN THE BLACK RECTANGLE APPEARS THE WORD "LELAND" IN STYLIZED BLACK LETTERS ABOVE A BLACK HORIZONTAL LINE BELOW OF WHICH APPEARS A SINGLE GREEN LEAF. BELOW THE SINGLE GREEN LEAF APPEARS ANOTHER BLACK HORIZONTAL LINE BELOW OF WHICH APPEAR THE WORDS "TEA COMPANY" IN STYLIZED BLACK LETTERS. A CENTER BLACK VERTICAL LINE CONNECTS THE BLACK HORIZONTAL LINE APPEARING BELOW THE WORD "LELAND" AND THE BLACK HORIZONTAL LINE APPEARING ABOVE "TEA COMPANY". THE SINGLE GREEN LEAF LIES ON TOP OF AND INTERRUPTS THE CENTER BLACK VERTICAL LINE. THE COLOR BROWN



*David J. Kyros*

Director of the United States Patent and Trademark Office

**Reg. No. 4,136,521** APPEARS BETWEEN THE BLACK HORIZONTAL LINE APPEARING BELOW THE WORD "LELAND" AND THE BLACK HORIZONTAL LINE APPEARING ABOVE THE WORD "TEA COMPANY" AND TO THE LEFT OF THE CENTER BLACK VERTICAL LINE. THE COLORS GREEN AND DARK GREEN APPEAR IN THE LEAF. THE COLOR BLACK APPEARS IN THE RECTANGLE BORDER, THE HORIZONTAL LINES WITHIN RECTANGLE BORDER, THE CENTER VERTICAL LINE CONNECTING THE HORIZONTAL LINES, AND THE WORDS "LELAND" AND "TEA COMPANY". THE COLOR LIGHT YELLOW APPEARS BETWEEN THE BLACK HORIZONTAL LINE BELOW THE WORD "LELAND" AND THE BLACK HORIZONTAL LINE ABOVE THE WORDS "TEA COMPANY" AND TO THE RIGHT OF THE CENTER BLACK LINE AS WELL AS IN THE BACKGROUND FOR THE WORDS "LELAND" AND "TEA COMPANY".

SN 85-223,876, FILED 1-22-2011.

DANIEL CAPSHAW, EXAMINING ATTORNEY

# United States of America

United States Patent and Trademark Office

## CELL BUCKLE

**Reg. No. 4,136,522**

**Registered May 1, 2012**

**Int. Cl.: 9**

**TRADEMARK**

**PRINCIPAL REGISTER**

BOBBY MUSSELMAN (UNITED STATES INDIVIDUAL), DBA LOCHEW ENTERPRISES,  
SUITE 141 #256  
3820 W. HAPPY VALLEY RD  
GLENDALE, AZ 85310

FOR: HOLDERS SPECIFICALLY DESIGNED FOR MOBILE ELECTRONIC DEVICES IN THE NATURE OF CELLULAR PHONES, MP3 PLAYERS, AND GPS DEVICES; THE AFOREMENTIONED HOLDERS USED TO SECURE THE MOBILE DEVICES TO STRUCTURES SUCH AS CAR, TRUCK, BOAT, GOLF CART, TRACTOR, AND AIRPLANE STEERING WHEELS, SHOPPING CART HANDLES, BICYCLE HANDLES, AND GYM EQUIPMENT, IN CLASS 9 (U.S. CLS. 21, 23, 26, 36 AND 38).

FIRST USE 12-30-2011; IN COMMERCE 12-30-2011.

THE MARK CONSISTS OF STANDARD CHARACTERS WITHOUT CLAIM TO ANY PARTICULAR FONT, STYLE, SIZE, OR COLOR.

NO CLAIM IS MADE TO THE EXCLUSIVE RIGHT TO USE "CELL", APART FROM THE MARK AS SHOWN.

SN 85-223,883, FILED 1-22-2011.

ELI HELLMAN, EXAMINING ATTORNEY



*David J. Kyros*

Director of the United States Patent and Trademark Office

# United States of America

United States Patent and Trademark Office

# BLITZ

**Reg. No. 4,136,523**

**Registered May 1, 2012**

**Int. Cl.: 38**

**SERVICE MARK**

**PRINCIPAL REGISTER**

TRUSTEES OF DARTMOUTH COLLEGE (NEW HAMPSHIRE NON-PROFIT CORPORATION)  
DARTMOUTH COLLEGE  
HANOVER, NH 03755

FOR: ELECTRONIC MAIL AND MESSAGING SERVICES; COMMUNICATIONS SERVICES,  
NAMELY, ELECTRONIC TRANSMISSION OF DATA AND DOCUMENTS, IN CLASS 38  
(U.S. CLS. 100, 101 AND 104).

FIRST USE 5-15-2011; IN COMMERCE 5-15-2011.

THE MARK CONSISTS OF STANDARD CHARACTERS WITHOUT CLAIM TO ANY PAR-  
TICULAR FONT, STYLE, SIZE, OR COLOR.

OWNER OF U.S. REG. NO. 1,841,252.

SN 85-224,479, FILED 1-24-2011.

MARGERY A. TIERNEY, EXAMINING ATTORNEY



*David J. Kybas*

Director of the United States Patent and Trademark Office

# United States of America

United States Patent and Trademark Office

# SPOIL ME

**Reg. No. 4,136,524**

**Registered May 1, 2012**

**Int. Cl.: 45**

**SERVICE MARK**

**PRINCIPAL REGISTER**

SPOILED ONLINE, LLC (DELAWARE LIMITED LIABILITY COMPANY)  
500 OFFICE CENTER DRIVE, SUITE 400  
FORT WASHINGTON, PA 19034

FOR: SOCIAL BOOKMARKING WEBSITE SERVICES FEATURED AS A COMPONENT OF PROVIDING A SOCIAL NETWORKING WEBSITE AT WHICH A USER CAN GIVE GIFTS TO OTHERS , IN CLASS 45 (U.S. CLS. 100 AND 101).

FIRST USE 10-5-2011; IN COMMERCE 10-5-2011.

THE MARK CONSISTS OF STANDARD CHARACTERS WITHOUT CLAIM TO ANY PARTICULAR FONT, STYLE, SIZE, OR COLOR.

SN 85-225,178, FILED 1-25-2011.

HENRY S. ZAK, EXAMINING ATTORNEY



*David J. Kybas*

Director of the United States Patent and Trademark Office

# United States of America

United States Patent and Trademark Office

## SKID ROW VINEYARD

**Reg. No. 4,136,525**

**Registered May 1, 2012**

**Int. Cl.: 33**

**TRADEMARK**

**PRINCIPAL REGISTER**

SARACINA VINEYARDS LLC (CALIFORNIA LIMITED LIABILITY COMPANY)  
P.O. BOX 618  
HOPLAND, CA 95449

FOR: WINE, IN CLASS 33 (U.S. CLS. 47 AND 49).

FIRST USE 10-4-2011; IN COMMERCE 10-14-2011.

THE MARK CONSISTS OF STANDARD CHARACTERS WITHOUT CLAIM TO ANY PARTICULAR FONT, STYLE, SIZE, OR COLOR.

NO CLAIM IS MADE TO THE EXCLUSIVE RIGHT TO USE "VINEYARD", APART FROM THE MARK AS SHOWN.

SN 85-225,400, FILED 1-25-2011.

JUSTINE D. PARKER, EXAMINING ATTORNEY



*David J. Kyffers*

Director of the United States Patent and Trademark Office

# United States of America

United States Patent and Trademark Office

# KING SPOKE

**Reg. No. 4,136,526**

**Registered May 1, 2012**

**Int. Cl.: 12**

**TRADEMARK**

**PRINCIPAL REGISTER**

MIDWEST MOTORCYCLE SUPPLY DISTRIBUTORS CORP. (MISSOURI CORPORATION)  
2100 STATE ROAD Z  
PEVELY, MO 63070

FOR: WHEELS FOR MOTORCYCLES, IN CLASS 12 (U.S. CLS. 19, 21, 23, 31, 35 AND 44).

FIRST USE 6-1-2011; IN COMMERCE 6-1-2011.

THE MARK CONSISTS OF STANDARD CHARACTERS WITHOUT CLAIM TO ANY PARTICULAR FONT, STYLE, SIZE, OR COLOR.

SN 85-225,621, FILED 1-25-2011.

TRACY CROSS, EXAMINING ATTORNEY



*David J. Kyffers*

Director of the United States Patent and Trademark Office



# United States of America

United States Patent and Trademark Office

# genesalud

**Reg. No. 4,136,527**

**Registered May 1, 2012**

**Int. Cl.: 35**

**SERVICE MARK**

**PRINCIPAL REGISTER**

WELLGENOMICS, LLC. (FLORIDA LIMITED LIABILITY COMPANY)  
802 VISTA MEADOWS DRIVE  
WESTON, FL 33327

FOR: BUSINESS SERVICES, NAMELY, INDEPENDENT MEDICAL MANAGEMENT SERVICES FOR SELF-FUNDED MAJOR MEDICAL HEALTH PLANS, IN CLASS 35 (U.S. CLS. 100, 101 AND 102).

FIRST USE 10-10-2011; IN COMMERCE 10-10-2011.

THE MARK CONSISTS OF STANDARD CHARACTERS WITHOUT CLAIM TO ANY PARTICULAR FONT, STYLE, SIZE, OR COLOR.

THE WORDING "GENESALUD" HAS NO MEANING IN A FOREIGN LANGUAGE.

SN 85-225,627, FILED 1-25-2011.

TRACY CROSS, EXAMINING ATTORNEY



*David J. Kyros*

Director of the United States Patent and Trademark Office

# United States of America

United States Patent and Trademark Office

# Poop Professor

**Reg. No. 4,136,528**

**Registered May 1, 2012**

**Int. Cl.: 42**

**SERVICE MARK**

**PRINCIPAL REGISTER**

SUPERIOR SEPTIC SERVICE, LLC (NEW HAMPSHIRE LIMITED LIABILITY COMPANY)  
P.O. BOX 1256  
DERRY, NH 03038

FOR: INSPECTIONS OF SEPTIC SYSTEMS, IN CLASS 42 (U.S. CLS. 100 AND 101).

FIRST USE 3-31-2008; IN COMMERCE 9-7-2011.

THE MARK CONSISTS OF STANDARD CHARACTERS WITHOUT CLAIM TO ANY PARTICULAR FONT, STYLE, SIZE, OR COLOR.

SN 85-225,645, FILED 1-25-2011.

GIANCARLO CASTRO, EXAMINING ATTORNEY



*David J. Kyffers*

Director of the United States Patent and Trademark Office

# United States of America

United States Patent and Trademark Office

## FLEXMANAGE

**Reg. No. 4,136,529**

**Registered May 1, 2012**

**Int. Cl.: 42**

**SERVICE MARK**

**PRINCIPAL REGISTER**

PROJECT LEADERSHIP ASSOCIATES (ILLINOIS CORPORATION)  
SUITE 1200  
120 S. LASALLE STREET  
CHICAGO, IL 60601

FOR: INFORMATION TECHNOLOGY MANAGEMENT SERVICES, NAMELY, COMPUTER SERVICES IN THE NATURE OF REMOTE AND ON-SITE MANAGEMENT OF THE INFORMATION TECHNOLOGY SYSTEMS OF OTHERS AND CONSULTING IN THE FIELD OF INFORMATION TECHNOLOGY; INFORMATION TECHNOLOGY MANAGEMENT SERVICES, NAMELY, INSTALLATION, MAINTENANCE AND REPAIR OF COMPUTER SOFTWARE; INFORMATION TECHNOLOGY MANAGEMENT SERVICES, NAMELY, TECHNICAL SUPPORT IN THE NATURE OF MONITORING OF NETWORK SYSTEMS AND TECHNICAL SUPPORT SERVICES IN THE NATURE OF 24X7 MONITORING OF NETWORK SYSTEMS, SERVERS AND WEB AND DATABASE APPLICATIONS AND NOTIFICATION OF RELATED EVENTS AND ALERTS; INFORMATION TECHNOLOGY MANAGEMENT SERVICES IN THE NATURE OF TECHNICAL SUPPORT SERVICES, NAMELY, TROUBLESHOOTING IN THE NATURE OF DIAGNOSING COMPUTER HARDWARE AND SOFTWARE PROBLEMS AND INSTALLATION, ADMINISTRATION AND TROUBLESHOOTING OF WEB AND DATABASE APPLICATIONS, IN CLASS 42 (U.S. CLS. 100 AND 101).

FIRST USE 2-5-2011; IN COMMERCE 2-5-2011.

THE MARK CONSISTS OF STANDARD CHARACTERS WITHOUT CLAIM TO ANY PARTICULAR FONT, STYLE, SIZE, OR COLOR.

SN 85-225,812, FILED 1-25-2011.

BRENDAN MCCAULEY, EXAMINING ATTORNEY



*David J. Kyros*

Director of the United States Patent and Trademark Office

# United States of America

United States Patent and Trademark Office

# MLGJ

**Reg. No. 4,136,530**

GOLDIE, MICHAEL (UNITED STATES INDIVIDUAL)  
5191 CROFTON AVE  
SOLON, OH 44139

**Registered May 1, 2012**

**Int. Cl.: 14**

FOR: PRECIOUS METALS AND THEIR ALLOYS; JEWELRY, IN CLASS 14 (U.S. CLS. 2, 27, 28 AND 50).

**TRADEMARK**

FIRST USE 5-1-1998; IN COMMERCE 11-1-2011.

**PRINCIPAL REGISTER**

THE MARK CONSISTS OF STANDARD CHARACTERS WITHOUT CLAIM TO ANY PARTICULAR FONT, STYLE, SIZE, OR COLOR.

SN 85-225,910, FILED 1-25-2011.

GISELLE AGOSTO, EXAMINING ATTORNEY



*David J. Kybas*

Director of the United States Patent and Trademark Office

**United States of America**  
United States Patent and Trademark Office

# GENIFUEL

**Reg. No. 4,136,531**

**Registered May 1, 2012**

**Int. Cl.: 42**

**SERVICE MARK**

**PRINCIPAL REGISTER**

GENIFUEL CORPORATION (DELAWARE CORPORATION)  
JAMES R. OYLER  
1873 CARRIGAN CIRCLE  
SALT LAKE CITY, UT 84109

FOR: ENGINEERING SERVICES IN THE FIELD OF PRODUCING FUEL FROM WET BIOMASS MATERIALS, IN CLASS 42 (U.S. CLS. 100 AND 101).

FIRST USE 10-29-2006; IN COMMERCE 6-12-2008.

THE MARK CONSISTS OF STANDARD CHARACTERS WITHOUT CLAIM TO ANY PARTICULAR FONT, STYLE, SIZE, OR COLOR.

SN 85-225,920, FILED 1-25-2011.

DOMINIC FATHY, EXAMINING ATTORNEY



*David J. Kybas*

Director of the United States Patent and Trademark Office

# United States of America

United States Patent and Trademark Office

## CUDDLY BOUTIQUE

**Reg. No. 4,136,532**

**Registered May 1, 2012**

**Int. Cl.: 28**

**TRADEMARK**

**PRINCIPAL REGISTER**

WAL-MART STORES, INC. (DELAWARE CORPORATION)  
702 SW 8TH STREET  
BENTONVILLE, AR 727160520

FOR: TOYS AND PLAY THINGS, NAMELY, PLUSH TOYS, STUFFED TOY ANIMALS, IN CLASS 28 (U.S. CLS. 22, 23, 38 AND 50).

FIRST USE 8-0-2010; IN COMMERCE 8-0-2010.

THE MARK CONSISTS OF STANDARD CHARACTERS WITHOUT CLAIM TO ANY PARTICULAR FONT, STYLE, SIZE, OR COLOR.

SN 85-225,928, FILED 1-25-2011.

WENDY JUN, EXAMINING ATTORNEY



*David J. Kybas*

Director of the United States Patent and Trademark Office

# United States of America

United States Patent and Trademark Office

# GENIFUEL

**Reg. No. 4,136,533**

**Registered May 1, 2012**

**Int. Cl.: 40**

**SERVICE MARK**

**PRINCIPAL REGISTER**

GENIFUEL CORPORATION (DELAWARE CORPORATION)  
1873 CARRIGAN CIRCLE  
SALT LAKE CITY, UT 84109

FOR: PRODUCTION OF ENERGY, IN CLASS 40 (U.S. CLS. 100, 103 AND 106).

FIRST USE 10-29-2006; IN COMMERCE 6-12-2008.

THE MARK CONSISTS OF STANDARD CHARACTERS WITHOUT CLAIM TO ANY PARTICULAR FONT, STYLE, SIZE, OR COLOR.

SN 85-225,929, FILED 1-25-2011.

DOMINIC FATHY, EXAMINING ATTORNEY



*David J. Kybas*

Director of the United States Patent and Trademark Office

# United States of America

United States Patent and Trademark Office

LEGEND BORN IN THE SOUTH.  
RAISED IN A GLASS.

**Reg. No. 4,136,534**

**Registered May 1, 2012**

**Int. Cl.: 32**

**TRADEMARK**

**PRINCIPAL REGISTER**

CAROLINA BEVERAGE CORPORATION (NORTH CAROLINA CORPORATION)  
1413 JAKE ALEXANDER BOULEVARD  
SALISBURY, NC 28415

FOR: SOFT DRINKS, IN CLASS 32 (U.S. CLS. 45, 46 AND 48).

FIRST USE 9-0-2011; IN COMMERCE 9-0-2011.

THE MARK CONSISTS OF STANDARD CHARACTERS WITHOUT CLAIM TO ANY PARTICULAR FONT, STYLE, SIZE, OR COLOR.

SN 85-226,240, FILED 1-26-2011.

JENNIFER MARTIN, EXAMINING ATTORNEY



*David J. Kyffers*

Director of the United States Patent and Trademark Office



# United States of America

United States Patent and Trademark Office



**Reg. No. 4,136,535**

**Registered May 1, 2012**

**Int. Cl.: 44**

**SERVICE MARK**

**PRINCIPAL REGISTER**

ACCESS EYE CENTERS, P.C. (VIRGINIA PROFESSIONAL CORPORATION)  
110 CAMBRIDGE STREET  
FREDERICKSBURG, VA 22405

FOR: FITTING OF CONTACT LENSES; LASER VISION CORRECTION SERVICES; LASER VISION SURGERY SERVICES; TREATMENT OF EYE DISEASES AND CONDITIONS , IN CLASS 44 (U.S. CLS. 100 AND 101).

FIRST USE 1-1-1990; IN COMMERCE 1-1-1990.

NO CLAIM IS MADE TO THE EXCLUSIVE RIGHT TO USE "EYE CENTERS" OR "EYES" OR "OPTICAL", APART FROM THE MARK AS SHOWN.

THE COLOR(S) RED, BLACK AND WHITE IS/ARE CLAIMED AS A FEATURE OF THE MARK.

THE MARK CONSISTS OF A RED TRIANGLE WITH LOWER CASE "E" IN THE COLOR WHITE INSIDE THE TRIANGLE, ATTACHED THERETO IS A RED LINE WITH THE WORDS "THE BEST IN SIGHT INSIDE" IN THE COLOR WHITE; ABOVE THAT ARE THE WORDS "ACCENT ON EYES OPTICAL" AND THE WORDS "ACCESS EYE CENTERS" WITH A HORIZONTAL LINE IN BETWEEN THE PHRASES ALL IN THE COLOR BLACK.

SN 85-226,308, FILED 1-26-2011.

LINDA E. BLOHM, EXAMINING ATTORNEY



*David J. Kyffers*

Director of the United States Patent and Trademark Office

# United States of America

United States Patent and Trademark Office

# CANDYMATIC

**Reg. No. 4,136,536**

MATUSZAK, JULIE M (UNITED STATES INDIVIDUAL)  
2409 COLWOOD RD  
CARO, MI 48723

**Registered May 1, 2012**

**Int. Cl.: 41**

FOR: ENTERTAINMENT IN THE NATURE OF AUTOMOBILE RACES, IN CLASS 41 (U.S. CLS. 100, 101 AND 107).

**SERVICE MARK**

FIRST USE 5-1-2011; IN COMMERCE 10-8-2011.

**PRINCIPAL REGISTER**

THE MARK CONSISTS OF STANDARD CHARACTERS WITHOUT CLAIM TO ANY PARTICULAR FONT, STYLE, SIZE, OR COLOR.

SN 85-226,368, FILED 1-26-2011.

JIM RINGLE, EXAMINING ATTORNEY



*David J. Kyffers*

Director of the United States Patent and Trademark Office

# United States of America

United States Patent and Trademark Office

## Redglare Records

**Reg. No. 4,136,537**

**Registered May 1, 2012**

**Int. Cl.: 9**

**TRADEMARK**

**PRINCIPAL REGISTER**

REDGLARE RECORDS LLC (GEORGIA LIMITED LIABILITY COMPANY)  
1270 CAROLINE ST.  
SUITE D120-303  
ATLANTA, GA 30316

FOR: AUDIO RECORDINGS FEATURING MUSIC; DOWNLOADABLE MP3 FILES AND MP3 RECORDINGS FEATURING MUSIC, IN CLASS 9 (U.S. CLS. 21, 23, 26, 36 AND 38).

FIRST USE 1-26-2011; IN COMMERCE 6-8-2011.

THE MARK CONSISTS OF STANDARD CHARACTERS WITHOUT CLAIM TO ANY PARTICULAR FONT, STYLE, SIZE, OR COLOR.

NO CLAIM IS MADE TO THE EXCLUSIVE RIGHT TO USE "RECORDS", APART FROM THE MARK AS SHOWN.

SN 85-226,457, FILED 1-26-2011.

BRENDAN REGAN, EXAMINING ATTORNEY



*David J. Kybas*

Director of the United States Patent and Trademark Office

# United States of America

United States Patent and Trademark Office

# Wristrictor

**Reg. No. 4,136,538**

LUCAS, MICHAEL (UNITED STATES INDIVIDUAL)  
1308 ELMHURST  
IRVINE, CA 92618

**Registered May 1, 2012**

**Int. Cl.: 28**

FOR: ATHLETIC SPORTING GOODS, NAMELY, ATHLETIC WRIST AND JOINT SUPPORTS,  
IN CLASS 28 (U.S. CLS. 22, 23, 38 AND 50).

**TRADEMARK**

FIRST USE 5-6-2010; IN COMMERCE 1-2-2011.

**PRINCIPAL REGISTER**

THE MARK CONSISTS OF STANDARD CHARACTERS WITHOUT CLAIM TO ANY PAR-  
TICULAR FONT, STYLE, SIZE, OR COLOR.

SN 85-226,653, FILED 1-26-2011.

CAROLINE WOOD, EXAMINING ATTORNEY



*David J. Kyros*

Director of the United States Patent and Trademark Office

# United States of America

United States Patent and Trademark Office



**Reg. No. 4,136,539**

**Registered May 1, 2012**

**Int. Cl.: 41**

**SERVICE MARK**

**PRINCIPAL REGISTER**

CALVERT SCHOOL, INC. (MARYLAND NON-PROFIT CORPORATION)  
105 TUSCANY ROAD  
BALTIMORE, MD 21210

FOR: EDUCATIONAL SERVICES, NAMELY, PROVIDING KINDERGARTEN THROUGH 12TH GRADE COURSES BY MEANS OF HOME INSTRUCTION, IN CLASS 41 (U.S. CLS. 100, 101 AND 107).

FIRST USE 5-31-2007; IN COMMERCE 5-31-2007.

OWNER OF U.S. REG. NOS. 1,593,508 AND 1,596,871.

THE MARK CONSISTS OF THE SILHOUETTE OF A CHILD INSIDE THE SHAPE OF A DIAMOND OVERLAPPING A SQUARE WITH A BORDER.

SN 85-226,744, FILED 1-26-2011.

ELLEN BURNS, EXAMINING ATTORNEY



*David J. Kyffers*

Director of the United States Patent and Trademark Office

# United States of America

United States Patent and Trademark Office

## GARAGE PARTS CHRISTIAN AUDIGIER

**Reg. No. 4,136,540**

**Registered May 1, 2012**

**Int. Cl.: 25**

**TRADEMARK**

**PRINCIPAL REGISTER**

AUDIGIER BRAND MANAGEMENT GROUP, LLC. (CALIFORNIA LIMITED LIABILITY COMPANY)  
8680 HAYDEN PLACE  
CULVER CITY, CA 90232

FOR: CLOTHING, NAMELY, SHIRTS, JACKETS, T-SHIRTS, LONG SLEEVED T-SHIRTS, TANK TOPS, PANTS, SWEAT JACKETS, HOODED SWEATSHIRTS, SWEATERS, BELTS, HEADWEAR, AND FOOTWEAR, IN CLASS 25 (U.S. CLS. 22 AND 39).

FIRST USE 9-23-2009; IN COMMERCE 10-5-2009.

THE MARK CONSISTS OF STANDARD CHARACTERS WITHOUT CLAIM TO ANY PARTICULAR FONT, STYLE, SIZE, OR COLOR.

THE NAME(S), PORTRAIT(S), AND/OR SIGNATURE(S) SHOWN IN THE MARK IDENTIFIES "CHRISTIAN AUDIGIER", WHOSE CONSENT(S) TO REGISTER IS MADE OF RECORD.

SN 85-226,785, FILED 1-26-2011.

RUSS HERMAN, EXAMINING ATTORNEY



*David J. Kyros*

Director of the United States Patent and Trademark Office

# United States of America

United States Patent and Trademark Office

## Beach Buzzard

**Reg. No. 4,136,541**

**Registered May 1, 2012**

**Int. Cl.: 25**

**TRADEMARK**

**PRINCIPAL REGISTER**

STEVEN TODD MCWATERS (UNITED STATES INDIVIDUAL)  
1304 EAST HERNANDEZ  
PENSACOLA, FL 32503 AND

BRADLEY STEVE HARVELL (UNITED STATES INDIVIDUAL)  
2911 ROYAL ISLE DRIVE  
TALLAHASSEE, FL 32312

FOR: CLOTHING, NAMELY, SHIRTS, IN CLASS 25 (U.S. CLS. 22 AND 39).

FIRST USE 8-24-2011; IN COMMERCE 8-24-2011.

THE MARK CONSISTS OF STANDARD CHARACTERS WITHOUT CLAIM TO ANY PARTICULAR FONT, STYLE, SIZE, OR COLOR.

NO CLAIM IS MADE TO THE EXCLUSIVE RIGHT TO USE "BEACH", APART FROM THE MARK AS SHOWN.

SN 85-226,813, FILED 1-26-2011.

KRISTINA MORRIS, EXAMINING ATTORNEY



*David J. Kyffers*

Director of the United States Patent and Trademark Office

# United States of America

United States Patent and Trademark Office



**Reg. No. 4,136,542**

**Registered May 1, 2012**

**Int. Cl.: 43**

**SERVICE MARK**

**PRINCIPAL REGISTER**

ARBY'S IP HOLDER TRUST (DELAWARE BUSINESS TRUST)  
1155 PERIMETER CENTER WEST  
ATLANTA, GA 30338

FOR: RESTAURANT SERVICES, IN CLASS 43 (U.S. CLS. 100 AND 101).

FIRST USE 2-21-2011; IN COMMERCE 2-21-2011.

OWNER OF U.S. REG. NOS. 890,565, 1,081,230, AND OTHERS.

THE MARK CONSISTS OF THE WORD "ARBY'S" INSIDE THE OUTLINE OF A HAT, INTERSECTING WITH THE LEFT SIDE OF A SOLID CIRCULAR SHAPE CONTAINING THE FOUR STACKED WORDS "IT'S, GOOD, MOOD", AND "FOOD".

SN 85-226,826, FILED 1-26-2011.

ANDREA K. NADELMAN, EXAMINING ATTORNEY



*David J. Kybas*

Director of the United States Patent and Trademark Office



# United States of America

United States Patent and Trademark Office

## ENGAGED GUIDANCE, EXCEPTIONAL COUNSEL

**Reg. No. 4,136,543**

**Registered May 1, 2012**

**Int. Cl.: 45**

**SERVICE MARK**

**PRINCIPAL REGISTER**

MILLER NASH LLP (OREGON LIMITED LIABILITY PARTNERSHIP)  
SUITE 3400  
111 S.W. FIFTH AVENUE  
PORTLAND, OR 97204

FOR: LEGAL SERVICES, IN CLASS 45 (U.S. CLS. 100 AND 101).

FIRST USE 4-13-2011; IN COMMERCE 4-13-2011.

THE MARK CONSISTS OF STANDARD CHARACTERS WITHOUT CLAIM TO ANY PARTICULAR FONT, STYLE, SIZE, OR COLOR.

SN 85-227,121, FILED 1-26-2011.

KAELIE KUNG, EXAMINING ATTORNEY



*David J. Kyffers*

Director of the United States Patent and Trademark Office

# United States of America

United States Patent and Trademark Office

## ARMED & FABULOUS

**Reg. No. 4,136,544**

AUSTRALIAN GOLD, LLC (INDIANA LIMITED LIABILITY COMPANY)  
6270 CORPORATE DRIVE  
INDIANAPOLIS, IN 46278

**Registered May 1, 2012**

**Int. Cl.: 3**

FOR: INDOOR AND OUTDOOR NON-MEDICATED SKIN TANNING PREPARATIONS, IN CLASS 3 (U.S. CLS. 1, 4, 6, 50, 51 AND 52).

**TRADEMARK**

FIRST USE 11-1-2011; IN COMMERCE 11-1-2011.

**PRINCIPAL REGISTER**

THE MARK CONSISTS OF STANDARD CHARACTERS WITHOUT CLAIM TO ANY PARTICULAR FONT, STYLE, SIZE, OR COLOR.

SN 85-227,325, FILED 1-27-2011.

NORA BUCHANAN WILL, EXAMINING ATTORNEY



*David J. Kyffers*

Director of the United States Patent and Trademark Office

# United States of America

United States Patent and Trademark Office

## ONE NIGHT STAND

**Reg. No. 4,136,545**

**Registered May 1, 2012**

**Int. Cl.: 3**

**TRADEMARK**

**PRINCIPAL REGISTER**

AUSTRALIAN GOLD, LLC (INDIANA LIMITED LIABILITY COMPANY)  
6270 CORPORATE DRIVE  
INDIANAPOLIS, IN 46278

FOR: INDOOR AND OUTDOOR NON-MEDICATED SKIN TANNING PREPARATIONS, IN CLASS 3 (U.S. CLS. 1, 4, 6, 50, 51 AND 52).

FIRST USE 11-1-2011; IN COMMERCE 11-1-2011.

THE MARK CONSISTS OF STANDARD CHARACTERS WITHOUT CLAIM TO ANY PARTICULAR FONT, STYLE, SIZE, OR COLOR.

SN 85-227,846, FILED 1-27-2011.

DOMINIC J. FERRAIUOLO, EXAMINING ATTORNEY



*David J. Kyffers*

Director of the United States Patent and Trademark Office

# United States of America

United States Patent and Trademark Office

## HOLISTIC HOTTIE

**Reg. No. 4,136,546**

HOLISTIC HOTTIE, INC. (NEW YORK CORPORATION)  
336 CLINTON AVE., #4  
BROOKLYN, NY 11205

**Registered May 1, 2012**

**Int. Cls.: 25 and 41**

FOR: T-SHIRTS, IN CLASS 25 (U.S. CLS. 22 AND 39).

**TRADEMARK**

FIRST USE 2-17-2011; IN COMMERCE 2-17-2011.

**SERVICE MARK**

FOR: CLASSES AND COURSES ON FITNESS, NUTRITION AND WEIGHT LOSS, IN CLASS 41 (U.S. CLS. 100, 101 AND 107).

**PRINCIPAL REGISTER**

FIRST USE 1-1-2012; IN COMMERCE 1-1-2012.

THE MARK CONSISTS OF STANDARD CHARACTERS WITHOUT CLAIM TO ANY PARTICULAR FONT, STYLE, SIZE, OR COLOR.

NO CLAIM IS MADE TO THE EXCLUSIVE RIGHT TO USE "HOLISTIC", APART FROM THE MARK AS SHOWN.

SN 85-227,961, FILED 1-27-2011.

MARGERY A. TIERNEY, EXAMINING ATTORNEY



*David J. Kybas*

Director of the United States Patent and Trademark Office

# United States of America

United States Patent and Trademark Office

# CULTIVATE

**Reg. No. 4,136,547**

WILLIAMS-SONOMA, INC. (DELAWARE CORPORATION)  
3250 VAN NESS AVENUE  
SAN FRANCISCO, CA 94109

**Registered May 1, 2012**

**Int. Cls.: 35, 37, and 42**

FOR: PROVIDING A WEBSITE FEATURING REFERRAL INFORMATION FOR HOME RENOVATIONS, IN CLASS 35 (U.S. CLS. 100, 101 AND 102).

**SERVICE MARK**

FIRST USE 10-19-2011; IN COMMERCE 10-19-2011.

**PRINCIPAL REGISTER**

FOR: PROVIDING A WEBSITE FEATURING INFORMATION ABOUT HOME RENOVATIONS, IN CLASS 37 (U.S. CLS. 100, 103 AND 106).

FIRST USE 10-19-2011; IN COMMERCE 10-19-2011.

FOR: PROVIDING AN INTERACTIVE WEBSITE FEATURING TECHNOLOGY THAT ALLOWS USERS TO UPLOAD, DOWNLOAD, AND SHARE INFORMATION ABOUT HOME RENOVATION; COMPUTER SERVICES, NAMELY, CREATING AN ON-LINE COMMUNITY FOR REGISTERED USERS TO DISTRIBUTE AND EXCHANGE INFORMATION REGARDING HOME RENOVATION, IN CLASS 42 (U.S. CLS. 100 AND 101).

FIRST USE 10-19-2011; IN COMMERCE 10-19-2011.

THE MARK CONSISTS OF STANDARD CHARACTERS WITHOUT CLAIM TO ANY PARTICULAR FONT, STYLE, SIZE, OR COLOR.

SN 85-228,240, FILED 1-27-2011.

CARRIE GENOVESE, EXAMINING ATTORNEY



*David J. Kyros*

Director of the United States Patent and Trademark Office

# United States of America

United States Patent and Trademark Office

## I THINK I CAN

**Reg. No. 4,136,548**

**Registered May 1, 2012**

**Int. Cl.: 9**

**TRADEMARK**

**PRINCIPAL REGISTER**

PENGUIN GROUP (USA) INC. (DELAWARE CORPORATION)  
375 HUDSON STREET  
NEW YORK, NY 10014

FOR: DOWNLOADABLE COMPUTER SOFTWARE FOR USE ON COMPUTERS, WIRELESS DEVICES AND HAND-HELD DEVICES TO READ THE TEXT AND VIEW THE STILL AND ANIMATED PICTURES OF DIGITAL ADAPTATIONS OF CHILDREN'S PICTURE BOOKS, LISTEN TO THEIR AUDIO NARRATIONS AND ACCOMPANYING SOUNDS, AND INTERACT WITH THEIR VISUAL AND AUDIO ELEMENTS, IN CLASS 9 (U.S. CLS. 21, 23, 26, 36 AND 38).

FIRST USE 12-20-2010; IN COMMERCE 12-20-2010.

THE MARK CONSISTS OF STANDARD CHARACTERS WITHOUT CLAIM TO ANY PARTICULAR FONT, STYLE, SIZE, OR COLOR.

OWNER OF U.S. REG. NOS. 2,904,156, 2,915,530, AND 3,351,426.

SN 85-228,594, FILED 1-28-2011.

SALLY SHIH, EXAMINING ATTORNEY



*David J. Kyffers*

Director of the United States Patent and Trademark Office

# United States of America

United States Patent and Trademark Office

# BRENTWOOD

**Reg. No. 4,136,549**

**Registered May 1, 2012**

**Int. Cl.: 11**

**TRADEMARK**

**PRINCIPAL REGISTER**

MANSFIELD PLUMBING PRODUCTS, LLC (DELAWARE LIMITED LIABILITY COMPANY)  
150 FIRST STREET  
PERRYSVILLE, OH 44864

FOR: BATHTUBS; LAVATORIES; SINKS; TOILETS, IN CLASS 11 (U.S. CLS. 13, 21, 23, 31 AND 34).

FIRST USE 6-15-2011; IN COMMERCE 6-15-2011.

THE MARK CONSISTS OF STANDARD CHARACTERS WITHOUT CLAIM TO ANY PARTICULAR FONT, STYLE, SIZE, OR COLOR.

SN 85-228,881, FILED 1-28-2011.

JOHN GARTNER, EXAMINING ATTORNEY



*David J. Kyffers*

Director of the United States Patent and Trademark Office

# United States of America

United States Patent and Trademark Office



**Reg. No. 4,136,550**

**Registered May 1, 2012**

**Int. Cl.: 35**

**SERVICE MARK**

**PRINCIPAL REGISTER**

MINILUXE, INC. (DELAWARE CORPORATION)  
21 HIGHLAND CIRCLE, 2ND FL.  
NEEDHAM, MA 02494

FOR: MAIL ORDER SERVICES, ON-LINE RETAIL STORE SERVICES AND RETAIL STORE SERVICES, ALL FEATURING COSMETICS, TOILETRIES, PERSONAL CARE PRODUCTS, MAKE-UP PRODUCTS, HAIR CARE PRODUCTS, SPA, SKIN, BODY AND BEAUTY CARE PRODUCTS, AND HOME FRAGRANCE PRODUCTS, IN CLASS 35 (U.S. CLS. 100, 101 AND 102).

FIRST USE 4-15-2010; IN COMMERCE 4-15-2010.

OWNER OF U.S. REG. NOS. 3,694,260, 3,779,597, AND 3,779,598.

THE MARK CONSISTS OF STYLIZED PINWHEEL COMPRISING FOUR INTERLOCKING FINGERNAILS.

SN 85-228,995, FILED 1-28-2011.

ANGELA M. MICHELI, EXAMINING ATTORNEY



*David J. Kybas*

Director of the United States Patent and Trademark Office



# United States of America

United States Patent and Trademark Office



**Reg. No. 4,136,551**

**Registered May 1, 2012**

**Int. Cl.: 44**

**SERVICE MARK**

**PRINCIPAL REGISTER**

MINILUXE, INC. (DELAWARE CORPORATION)  
21 HIGHLAND CIRCLE, 2ND FL.  
NEEDHAM, MA 02494

FOR: BEAUTY SALONS; NAIL CARE SALONS; SKIN CARE SALONS; BODY WAXING SERVICES; MANICURE AND PEDICURE SERVICES; HEALTH SPA SERVICES, NAMELY, PROVIDING FACIAL, SKIN AND BODY TREATMENTS AND COSMETIC BODY CARE SERVICES, IN CLASS 44 (U.S. CLS. 100 AND 101).

FIRST USE 4-15-2010; IN COMMERCE 4-15-2010.

OWNER OF U.S. REG. NOS. 3,694,260, 3,779,597, AND 3,779,598.

THE MARK CONSISTS OF STYLIZED PINWHEEL COMPRISING FOUR INTERLOCKING FINGERNAILS.

SN 85-229,014, FILED 1-28-2011.

ANGELA M. MICHELI, EXAMINING ATTORNEY



*David J. Kyros*

Director of the United States Patent and Trademark Office

# United States of America

United States Patent and Trademark Office



**Reg. No. 4,136,552**

MINILUXE, INC. (DELAWARE CORPORATION)  
21 HIGHLAND CIRCLE, 2ND FL.  
NEEDHAM, MA 02494

**Registered May 1, 2012**

**Int. Cl.: 8**

FOR: MANICURE SETS; PEDICURE SETS; MANICURE/PEDICURE IMPLEMENTS, NAMELY,  
NAIL FILES, IN CLASS 8 (U.S. CLS. 23, 28 AND 44).

**TRADEMARK**

FIRST USE 7-7-2009; IN COMMERCE 8-10-2009.

**PRINCIPAL REGISTER**

OWNER OF U.S. REG. NOS. 3,694,260, 3,779,597, AND 3,779,598.

THE MARK CONSISTS OF STYLIZED PINWHEEL COMPRISING FOUR INTERLOCKING  
FINGERNAILS.

SN 85-229,038, FILED 1-28-2011.

ANGELA M. MICHELI, EXAMINING ATTORNEY



*David J. Kybas*

Director of the United States Patent and Trademark Office

# United States of America

United States Patent and Trademark Office

# DVP

**Reg. No. 4,136,553**

VALKRE SOLUTIONS, INC. (DELAWARE CORPORATION)  
560 W. WASHINGTON STREET, SUITE 410  
CHICAGO, IL 60661

**Registered May 1, 2012**

**Int. Cls.: 35, 41, and 42**

FOR: BUSINESS INFORMATION ANALYSIS; BUSINESS MANAGEMENT AND CONSULTING SERVICES, IN CLASS 35 (U.S. CLS. 100, 101 AND 102).

**SERVICE MARK**

FIRST USE 12-19-2008; IN COMMERCE 12-19-2008.

**PRINCIPAL REGISTER**

FOR: BUSINESS TRAINING, IN CLASS 41 (U.S. CLS. 100, 101 AND 107).

FIRST USE 12-19-2008; IN COMMERCE 12-19-2008.

FOR: PROVIDING TEMPORARY USE OF ON-LINE NON-DOWNLOADABLE SOFTWARE FOR USE IN DATA COLLECTION TO PROVIDE STATISTICAL ANALYSIS AND PRODUCE REPORTS TO ENHANCE BOTH THE PERFORMANCE AND PROFITABILITY FOR A BUSINESS AND ITS CUSTOMERS, IN CLASS 42 (U.S. CLS. 100 AND 101).

FIRST USE 12-19-2008; IN COMMERCE 12-19-2008.

THE MARK CONSISTS OF STANDARD CHARACTERS WITHOUT CLAIM TO ANY PARTICULAR FONT, STYLE, SIZE, OR COLOR.

SN 85-229,041, FILED 1-28-2011.

ANGELA M. MICHELI, EXAMINING ATTORNEY



*David J. Kybas*

Director of the United States Patent and Trademark Office

# United States of America

United States Patent and Trademark Office



**Reg. No. 4,136,554**

**Registered May 1, 2012**

**Int. Cl.: 3**

**TRADEMARK**

**PRINCIPAL REGISTER**

MINILUXE, INC. (DELAWARE CORPORATION)  
21 HIGHLAND CIRCLE, 2ND FL  
NEEDHAM, MA 02494

FOR: COSMETICS; BODY AND BEAUTY CARE COSMETICS; COSMETIC CREAMS; COSMETIC CLEANSING CREAMS; COSMETIC CREAMS FOR SKIN CARE; BODY CREAMS; BODY LOTIONS; HAND CREAMS; HAND LOTIONS; NAIL CARE PRODUCTS, NAMELY, NAIL CARE PREPARATIONS, NAIL POLISH, NAIL POLISH BASE COAT, NAIL POLISH TOP COAT, NAIL ENAMEL, NAIL LACQUER, NAIL VARNISH, NAIL GLITTER, NAIL CREAM, NAIL STRENGTHENING AND HARDENING PREPARATIONS, SOAPS FOR FACE, BODY, FEET AND HANDS; BODY AND FACIAL SCRUBS; NON-MEDICATED FOOT CREAM; SKIN MOISTURIZERS; EXFOLIANTS FOR SKIN AND LIPS, IN CLASS 3 (U.S. CLS. 1, 4, 6, 50, 51 AND 52).

FIRST USE 7-31-2010; IN COMMERCE 7-31-2010.

OWNER OF U.S. REG. NOS. 3,694,260, 3,779,597, AND 3,779,598.

THE MARK CONSISTS OF STYLIZED PINWHEEL COMPRISING FOUR INTERLOCKING FINGERNAILS.

SN 85-229,085, FILED 1-28-2011.

ANGELA M. MICHELI, EXAMINING ATTORNEY



*David J. Kybas*

Director of the United States Patent and Trademark Office

# United States of America

United States Patent and Trademark Office



THUNDERHORSE  
ENTERTAINMENT

**Reg. No. 4,136,555**

**Registered May 1, 2012**

**Int. Cl.: 38**

**SERVICE MARK**

**PRINCIPAL REGISTER**

TRUSTEE OF TYREE AND ASSOCIATES TRUST ESTATE (BELIZE TRUST)  
1565 W. MAIN STREET, #208-157  
LEWISVILLE, TX 75067

FOR: INTERNET PROTOCOL TELEVISION (IPTV) TRANSMISSION SERVICES, IN CLASS  
38 (U.S. CLS. 100, 101 AND 104).

FIRST USE 10-1-2010; IN COMMERCE 10-5-2010.

NO CLAIM IS MADE TO THE EXCLUSIVE RIGHT TO USE "ENTERTAINMENT", APART  
FROM THE MARK AS SHOWN.

THE MARK CONSISTS OF A CIRCLE WITH THE HEAD OF A HORSE ALONG THE RIGHT  
CIRCUMFERENCE, WITH A LIGHTNING BOLT DIAGONAL ACROSS THE CIRCLE, OVER  
THE WORDS "THUNDERHORSE ENTERTAINMENT".

SN 85-229,087, FILED 1-28-2011.

DAVID TAYLOR, EXAMINING ATTORNEY



*David J. Kyros*

Director of the United States Patent and Trademark Office

# United States of America

United States Patent and Trademark Office



## HIDDENFJORD

**Reg. No. 4,136,556**

**Registered May 1, 2012**

**Int. Cl.: 29**

**TRADEMARK**

**PRINCIPAL REGISTER**

P/F LUNA (FAROE ISLANDS CORPORATION)  
PO BOX 29  
FO-510 GOTU, FAROE ISLANDS

FOR: FRESH FISH, NAMELY, PREMIUM-FARMED SALMON PACKAGED IN ICE, IN CLASS 29 (U.S. CL. 46).

FIRST USE 3-18-2011; IN COMMERCE 3-18-2011.

THE MARK CONSISTS OF THE WORD-COMBINATION "HIDDENFJORD", WHERE THE COMPONENT "HIDDEN" IS PRESENTED IN A DARK GREEN COLOR AND THE COMPONENT "FJORD" IS PRESENTED IN A RELATIVELY LIGHT GREEN COLOR. CENTRALLY POSITIONED ABOVE THE WORD-COMBINATION, INSIDE A CIRCLE, IS A LIGHT GREEN MOUNTAIN ON THE LEFT THAT IS OVERLAPPED BY A DARK GREEN MOUNTAIN FROM THE RIGHT, WITH A LIGHT BLUE SKY ABOVE AND A DARK BLUE SEA BELOW THE MOUNTAINS.

THE COLOR(S) DARK GREEN, LIGHT GREEN, LIGHT BLUE AND DARK BLUE IS/ARE CLAIMED AS A FEATURE OF THE MARK.

SN 85-229,258, FILED 1-28-2011.

PRISCILLA MILTON, EXAMINING ATTORNEY



*David J. Kybas*

Director of the United States Patent and Trademark Office

# United States of America

United States Patent and Trademark Office

## Balance My Checkbook

**Reg. No. 4,136,557**

**Registered May 1, 2012**

**Int. Cls.: 36 and 41**

**SERVICE MARK**

**PRINCIPAL REGISTER**

STALLINGS, CLARISSA (UNITED STATES INDIVIDUAL)  
STE C-113  
2020 HOWELL MILL RD NW  
ATLANTA, GA 30318

FOR: FINANCIAL COUNSELING SERVICES, NAMELY, HELPING OTHERS BUILD A BETTER WORKING RELATIONSHIP WITH THEIR MONEY IN ALL AREAS OF FINANCE, IN CLASS 36 (U.S. CLS. 100, 101 AND 102).

FIRST USE 1-13-2012; IN COMMERCE 1-13-2012.

FOR: EDUCATIONAL SERVICES, NAMELY, PROVIDING ONLINE SERVICES, INDIVIDUAL SESSIONS, CLASSES, SEMINARS, AND WORKSHOPS IN FINANCIAL AFFAIRS, IN CLASS 41 (U.S. CLS. 100, 101 AND 107).

FIRST USE 1-13-2012; IN COMMERCE 1-20-2012.

THE MARK CONSISTS OF STANDARD CHARACTERS WITHOUT CLAIM TO ANY PARTICULAR FONT, STYLE, SIZE, OR COLOR.

SN 85-229,353, FILED 1-28-2011.

HENRY S. ZAK, EXAMINING ATTORNEY



*David J. Kyros*

Director of the United States Patent and Trademark Office

# United States of America

United States Patent and Trademark Office

I LIKE THAT BOONBOOREE! WE  
LIKE THAT BOONBOOREE! Teal  
Bunbury

**Reg. No. 4,136,558**

BUNBURY, ORTON (UNITED STATES INDIVIDUAL)  
100 WEST TEXAS AVENUE  
WEBSTER, TX 77598

**Registered May 1, 2012**

**Int. Cl.: 25**

FOR: CLOTHING, NAMELY, T-SHIRTS, SWEAT SHIRTS, SWEAT PANTS, JACKETS, IN  
CLASS 25 (U.S. CLS. 22 AND 39).

**TRADEMARK**

FIRST USE 2-1-2012; IN COMMERCE 2-1-2012.

**PRINCIPAL REGISTER**

THE MARK CONSISTS OF STANDARD CHARACTERS WITHOUT CLAIM TO ANY PAR-  
TICULAR FONT, STYLE, SIZE, OR COLOR.

THE NAME(S), PORTRAIT(S), AND/OR SIGNATURE(S) SHOWN IN THE MARK IDENTIFIES  
"TEAL BUNBURY", WHOSE CONSENT(S) TO REGISTER IS MADE OF RECORD.

SN 85-229,409, FILED 1-29-2011.

WILLIAM VERHOSEK, EXAMINING ATTORNEY



*David J. Kybas*

Director of the United States Patent and Trademark Office



# United States of America

United States Patent and Trademark Office

## Powering Growth With Science

**Reg. No. 4,136,559**

**Registered May 1, 2012**

**Int. Cls.: 16 and 41**

**TRADEMARK**

**SERVICE MARK**

**PRINCIPAL REGISTER**

ATP NUTRITION LTD. (CANADA CORPORATION), DBA ATP NUTRITION LTD.,  
1030 GORDON STREET  
GUELPH, ONTARIO, CANADA

FOR: PUBLICATIONS, NAMELY, BROCHURES, INFORMATION SHEETS AND TECHNICAL  
INFORMATION PAMPHLETS IN THE FIELDS OF PLANT NUTRITION, IN CLASS 16 (U.S.  
CLS. 2, 5, 22, 23, 29, 37, 38 AND 50).

FIRST USE 11-1-2011; IN COMMERCE 11-1-2011.

FOR: EDUCATION SERVICES, NAMELY, PROVIDING SEMINARS, LECTURES AND  
CONFERENCES IN THE FIELD OF PLANT NUTRITION, IN CLASS 41 (U.S. CLS. 100, 101  
AND 107).

FIRST USE 2-4-2011; IN COMMERCE 2-4-2011.

THE MARK CONSISTS OF STANDARD CHARACTERS WITHOUT CLAIM TO ANY PAR-  
TICULAR FONT, STYLE, SIZE, OR COLOR.

SN 85-229,883, FILED 1-31-2011.

MARK SPARACINO, EXAMINING ATTORNEY



*David J. Kyffers*

Director of the United States Patent and Trademark Office

# United States of America

United States Patent and Trademark Office

## KWIAT TIARA

**Reg. No. 4,136,560**

**Registered May 1, 2012**

**Int. Cl.: 14**

**TRADEMARK**

**PRINCIPAL REGISTER**

KWIAT, INC. (NEW YORK CORPORATION)  
555 MADISON AVENUE, SUITE 1400  
NEW YORK, NY 10022

FOR: DIAMONDS AND JEWELRY CONTAINING DIAMONDS, IN CLASS 14 (U.S. CLS. 2, 27, 28 AND 50).

FIRST USE 6-1-2008; IN COMMERCE 6-1-2008.

THE MARK CONSISTS OF STANDARD CHARACTERS WITHOUT CLAIM TO ANY PARTICULAR FONT, STYLE, SIZE, OR COLOR.

SEC. 2(F) AS TO "KWIAT".

OWNER OF U.S. REG. NOS. 3,102,850, 3,102,867, AND 3,108,571.

NO CLAIM IS MADE TO THE EXCLUSIVE RIGHT TO USE "TIARA", APART FROM THE MARK AS SHOWN.

SN 85-230,206, FILED 1-31-2011.

DAVID TOOLEY, EXAMINING ATTORNEY



*David J. Kyffers*

Director of the United States Patent and Trademark Office

# United States of America

United States Patent and Trademark Office

# EP

**Reg. No. 4,136,561**

**Registered May 1, 2012**

**Int. Cl.: 29**

**TRADEMARK**

**PRINCIPAL REGISTER**

EPCL USA INC. (DELAWARE CORPORATION)  
107 WALKER DRIVE  
BRAMPTON, ONTARIO, CANADA L6T5K5

FOR: SEAFOOD, IN CLASS 29 (U.S. CL. 46).

FIRST USE 10-22-2011; IN COMMERCE 10-22-2011.

THE MARK CONSISTS OF STANDARD CHARACTERS WITHOUT CLAIM TO ANY PARTICULAR FONT, STYLE, SIZE, OR COLOR.

SN 85-230,257, FILED 1-31-2011.

ELLEN B. AWRICH, EXAMINING ATTORNEY



*David J. Kyros*

Director of the United States Patent and Trademark Office

# United States of America

United States Patent and Trademark Office

# EagleEye

**Reg. No. 4,136,562**

**Registered May 1, 2012**

**Int. Cl.: 9**

**TRADEMARK**

**PRINCIPAL REGISTER**

SHAFFER MANUFACTURING CORP. (OHIO CORPORATION)  
417 EAST WATER STREET  
URBANA, OH 43078

FOR: MACHINE VISION SYSTEMS AND PARTS THEREOF, NAMELY, COMPUTER HARDWARE AND SOFTWARE FOR INSPECTING BAKERY PRODUCTS, IN CLASS 9 (U.S. CLS. 21, 23, 26, 36 AND 38).

FIRST USE 9-30-2010; IN COMMERCE 9-30-2010.

THE MARK CONSISTS OF STANDARD CHARACTERS WITHOUT CLAIM TO ANY PARTICULAR FONT, STYLE, SIZE, OR COLOR.

SN 85-230,394, FILED 1-31-2011.

CARRIE GENOVESE, EXAMINING ATTORNEY



*David J. Kyffers*

Director of the United States Patent and Trademark Office

# United States of America

United States Patent and Trademark Office

## BERTRAND LEVAN

**Reg. No. 4,136,563**

**Registered May 1, 2012**

**Int. Cl.: 33**

**TRADEMARK**

**PRINCIPAL REGISTER**

CALIFORNIA REDWOOD WINES, INC. (CALIFORNIA CORPORATION)  
615 HEALDSBURG AVENUE, SUITE 302  
HEALDSBURG, CA 954015169

FOR: WINE, IN CLASS 33 (U.S. CLS. 47 AND 49).

FIRST USE 8-23-2011; IN COMMERCE 8-23-2011.

THE MARK CONSISTS OF STANDARD CHARACTERS WITHOUT CLAIM TO ANY PARTICULAR FONT, STYLE, SIZE, OR COLOR.

THE NAME(S), PORTRAIT(S), AND/OR SIGNATURE(S) SHOWN IN THE MARK DOES NOT IDENTIFY A PARTICULAR LIVING INDIVIDUAL.

SN 85-230,450, FILED 1-31-2011.

GEORGE LORENZO, EXAMINING ATTORNEY



*David J. Kyffers*

Director of the United States Patent and Trademark Office

# United States of America

United States Patent and Trademark Office

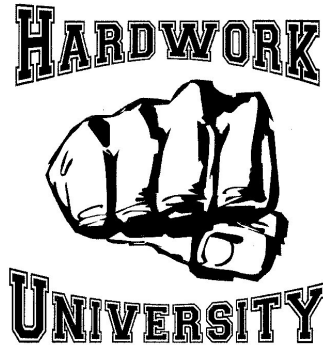

**Reg. No. 4,136,564**

**Registered May 1, 2012**

**Int. Cl.: 25**

**TRADEMARK**

**PRINCIPAL REGISTER**

FOREMAN IV, GEORGE (UNITED STATES INDIVIDUAL)  
29507 MARTELLY WAY  
HUFFMAN, TX 77336

FOR: HEADWEAR; JACKETS; SHIRTS; SWEATPANTS; SWEATSHIRTS, IN CLASS 25 (U.S. CLS. 22 AND 39).

FIRST USE 10-10-2010; IN COMMERCE 11-2-2010.

THE MARK CONSISTS OF "HARDWORK UNIVERSITY" WRITTEN IN BOLD LETTERS WITH AN OUTLINE. THERE IS A DRAWING OF A FIST IN-BETWEEN THE TWO WORDS. THE FIST IS TRANSPARENT WITH AN OUTLINE.

SN 85-230,713, FILED 1-31-2011.

GIANCARLO CASTRO, EXAMINING ATTORNEY



*David J. Kybas*

Director of the United States Patent and Trademark Office

# United States of America

United States Patent and Trademark Office

## Hawaiian Luau

**Reg. No. 4,136,565**

**Registered May 1, 2012**

**Int. Cl.: 9**

**TRADEMARK**

**PRINCIPAL REGISTER**

MULTIMEDIA GAMES, INC. (TEXAS CORPORATION)  
BUILDING B, 4TH FLOOR  
206 WILD BASIN ROAD SOUTH  
AUSTIN, TX 78746

FOR: COMPUTER SOFTWARE AND FIRMWARE FOR GAMES OF CHANCE ON ANY COMPUTERIZED PLATFORM, INCLUDING DEDICATED GAMING CONSOLES, VIDEO BASED SLOT MACHINES, REEL BASED SLOT MACHINES, AND VIDEO LOTTERY TERMINALS; GAMING MACHINES, NAMELY, ELECTRONIC SLOT AND BINGO MACHINES, IN CLASS 9 (U.S. CLS. 21, 23, 26, 36 AND 38).

FIRST USE 10-4-2011; IN COMMERCE 10-4-2011.

THE MARK CONSISTS OF STANDARD CHARACTERS WITHOUT CLAIM TO ANY PARTICULAR FONT, STYLE, SIZE, OR COLOR.

SN 85-231,678, FILED 2-1-2011.

JOHN WILKE, EXAMINING ATTORNEY



*David J. Kyffers*

Director of the United States Patent and Trademark Office

# United States of America

United States Patent and Trademark Office

## PEEK MOBILITY

**Reg. No. 4,136,566**

**Registered May 1, 2012**

**Int. Cl.: 10**

**TRADEMARK**

**PRINCIPAL REGISTER**

ABS CORPORATION (MINNESOTA CORPORATION)  
SUITE 550  
5909 BAKER ROAD  
MINNETONKA, MN 55345

FOR: ORTHOPEDIC JOINT IMPLANTS, IN CLASS 10 (U.S. CLS. 26, 39 AND 44).

FIRST USE 1-11-2011; IN COMMERCE 2-18-2011.

THE MARK CONSISTS OF STANDARD CHARACTERS WITHOUT CLAIM TO ANY PARTICULAR FONT, STYLE, SIZE, OR COLOR.

NO CLAIM IS MADE TO THE EXCLUSIVE RIGHT TO USE "PEEK", APART FROM THE MARK AS SHOWN.

SN 85-231,697, FILED 2-1-2011.

WILLIAM VERHOSEK, EXAMINING ATTORNEY



*David J. Kybas*

Director of the United States Patent and Trademark Office



# United States of America

United States Patent and Trademark Office

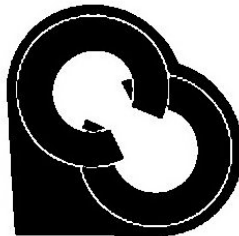

**Reg. No. 4,136,567**

**Registered May 1, 2012**

**Int. Cl.: 35**

**SERVICE MARK**

**PRINCIPAL REGISTER**

COUTURE WITH A CAUSE LLC (CALIFORNIA LIMITED LIABILITY COMPANY)  
8789 AUBURN FOLSOM ROAD, SUITE C-414  
GRANITE BAY, CA 95746

FOR: ON-LINE RETAIL CONSIGNMENT STORES FEATURING HANDBAGS, SHOES,  
CLOTHING, AND ACCESSORIES, IN CLASS 35 (U.S. CLS. 100, 101 AND 102).

FIRST USE 2-28-2011; IN COMMERCE 2-28-2011.

THE MARK CONSISTS OF THE STYLIZED LETTERS "CC" IN THE FORM OF A HEART.

SN 85-231,986, FILED 2-2-2011.

ZACHARY BELLO, EXAMINING ATTORNEY



*David J. Kyffers*

Director of the United States Patent and Trademark Office

# United States of America

United States Patent and Trademark Office

## Bound & Tide

**Reg. No. 4,136,568**

**Registered May 1, 2012**

**Int. Cl.: 25**

**TRADEMARK**

**PRINCIPAL REGISTER**

KASS, MITCHELL (UNITED STATES INDIVIDUAL)  
27 ROOSEVELT RD  
MAPLEWOOD, NJ 07040

FOR: SWIMWEAR, IN CLASS 25 (U.S. CLS. 22 AND 39).

FIRST USE 1-10-2010; IN COMMERCE 12-15-2011.

THE MARK CONSISTS OF STANDARD CHARACTERS WITHOUT CLAIM TO ANY PARTICULAR FONT, STYLE, SIZE, OR COLOR.

SN 85-232,011, FILED 2-2-2011.

APRIL HESIK, EXAMINING ATTORNEY



*David J. Kyffers*

Director of the United States Patent and Trademark Office

# United States of America

United States Patent and Trademark Office



**Reg. No. 4,136,569**

**Registered May 1, 2012**

**Int. Cl.: 35**

**SERVICE MARK**

**PRINCIPAL REGISTER**

MASK, LINDSEY (UNITED STATES INDIVIDUAL)  
#805  
550 14TH ROAD S.  
ARLINGTON, VA 22202

FOR: ASSOCIATION SERVICES, NAMELY, PROMOTING THE INTERESTS OF PROFESSIONAL WOMEN IN THE DISTRICT OF COLUMBIA METROPOLITAN REGION, IN CLASS 35 (U.S. CLS. 100, 101 AND 102).

FIRST USE 4-1-2008; IN COMMERCE 4-1-2010.

NO CLAIM IS MADE TO THE EXCLUSIVE RIGHT TO USE "LADIES DC", APART FROM THE MARK AS SHOWN.

THE STIPPLING IS FOR SHADING PURPOSES ONLY.

THE MARK CONSISTS OF A CIRCLE DESIGN CONTAINING A RAY PATTERN AND AN OUTLINE OF THE DOME OF THE US CAPITOL BUILDING. THE OUTLINE OF THE DOME SITS ABOVE THE WORD "LADIES DC", AND TO THE LEFT OF A DESIGN OF THE WASHINGTON MONUMENT. TO THE LEFT OF THE CIRCULAR DESIGN IS THE SILHOUETTE OF A FEMALE HOLDING A BOOK.

SN 85-232,225, FILED 2-2-2011.

JANICE L. MCMORROW, EXAMINING ATTORNEY



*David J. Kyffers*

Director of the United States Patent and Trademark Office

# United States of America

United States Patent and Trademark Office

## BABY BOUNCE

**Reg. No. 4,136,570**

**Registered May 1, 2012**

**Int. Cl.: 9**

**TRADEMARK**

**PRINCIPAL REGISTER**

DAVID HONL (UNITED STATES INDIVIDUAL)  
2125 FLOYD STREET  
BURBANK, CA 91504

FOR: LIGHT DIRECTORS AND PHOTOGRAPHIC LIGHTING TENTS, ALL FOR USE WITH PHOTOGRAPHIC LIGHTING EQUIPMENT FOR PROFESSIONAL AND HIGH-END PHOTOGRAPHY; LIGHTING DEVICES FOR TAKING PICTURES, IN CLASS 9 (U.S. CLS. 21, 23, 26, 36 AND 38).

FIRST USE 9-1-2011; IN COMMERCE 9-1-2011.

THE MARK CONSISTS OF STANDARD CHARACTERS WITHOUT CLAIM TO ANY PARTICULAR FONT, STYLE, SIZE, OR COLOR.

NO CLAIM IS MADE TO THE EXCLUSIVE RIGHT TO USE "BOUNCE", APART FROM THE MARK AS SHOWN.

SN 85-232,268, FILED 2-2-2011.

KAREN K. BUSH, EXAMINING ATTORNEY



*David J. Kyffers*

Director of the United States Patent and Trademark Office

# United States of America

United States Patent and Trademark Office

## AROMATHERBAL HEALING

**Reg. No. 4,136,571**

**Registered May 1, 2012**

**Int. Cl.: 3**

**TRADEMARK**

**PRINCIPAL REGISTER**

SHANKARA, INC. (COLORADO CORPORATION)  
2401 15TH ST NW  
WASHINGTON, DC 20009

FOR: AFTER-SHAVE LOTIONS; AFTER-SUN LOTIONS; ANTI-AGING CREAMS; ANTI-BACTERIAL SOAP; ASTRINGENTS FOR COSMETIC PURPOSES; BABY OIL; BATH BEADS; BATH CRYSTALS; BATH FOAM; BATH GELS; BATH OIL; BEAUTY MASKS; BLUSH; BODY EMULSIONS; BODY MASKS; BODY OIL; BODY SCRUB; CONCEALERS FOR THE SKIN AND THE BODY; CREAMS FOR CELLULITE REDUCTION; DEODORANTS AND ANTIPERSPIRANTS; ESSENTIAL OILS FOR AROMATHERAPY USE; ESSENTIAL OILS FOR PERSONAL USE; ESSENTIAL OILS FOR USE IN AROMATHERAPY; ESSENTIAL OILS FOR USE IN THE MANUFACTURE OF SCENTED PRODUCTS; EYE CREAM; EYE GELS; EYE MAKE-UP; EYEBROW PENCILS; FACIAL CLEANSERS; FACIAL CONCEALER; FACIAL CREAMS; FACIAL EMULSIONS; FACIAL MAKE-UP; FACIAL MASKS; FACIAL SCRUBS; FOOT DEODORANT SPRAY; FOUNDATION MAKE-UP; HAIR CARE PREPARATIONS; HAND CREAM; INCENSE; LIP BALM; LIP LINER; LIPSTICK; LOTIONS FOR CELLULITE REDUCTION; MAKE-UP; MASCARA; MASSAGE OILS; MOUTHWASH; NON-MEDICATED BATH SALTS; NON-MEDICATED SKIN CARE PREPARATIONS; PERFUME OILS; PUMICE STONES FOR PERSONAL USE; ROOM FRAGRANCES; SCENTED BODY SPRAY; SHAMPOO-CONDITIONERS; SHAVE CREAMS; SHAVING BALM; SHAVING PREPARATIONS; SHOWER GEL; SKIN CONDITIONERS; SKIN MOISTURIZER; SKIN TONERS; SUN SCREEN; SUN-TANNING PREPARATIONS; TOOTH GEL; TOOTH PASTE; TOOTH POLISHES; TOOTH POWDERS, IN CLASS 3 (U.S. CLS. 1, 4, 6, 50, 51 AND 52).

FIRST USE 3-0-2011; IN COMMERCE 3-0-2011.

THE MARK CONSISTS OF STANDARD CHARACTERS WITHOUT CLAIM TO ANY PARTICULAR FONT, STYLE, SIZE, OR COLOR.

SN 85-232,398, FILED 2-2-2011.

KIM MONINGHOFF, EXAMINING ATTORNEY



*David J. Kyffers*

Director of the United States Patent and Trademark Office

# United States of America

United States Patent and Trademark Office

# LVAPOR

**Reg. No. 4,136,572**

**Registered May 1, 2012**

**Int. Cl.: 11**

**TRADEMARK**

**PRINCIPAL REGISTER**

RAB LIGHTING INC. (NEW YORK CORPORATION)  
170 LUDLOW AVENUE  
NORTHVALE, NJ 07647

FOR: ELECTRIC LIGHTING FIXTURES; LED (LIGHT EMITTING DIODE) LIGHTING FIXTURES; LED AND HID LIGHT FIXTURES; LIGHTING FIXTURES, IN CLASS 11 (U.S. CLS. 13, 21, 23, 31 AND 34).

FIRST USE 4-19-2011; IN COMMERCE 4-19-2011.

THE MARK CONSISTS OF STANDARD CHARACTERS WITHOUT CLAIM TO ANY PARTICULAR FONT, STYLE, SIZE, OR COLOR.

SN 85-232,495, FILED 2-2-2011.

JUSTINE D. PARKER, EXAMINING ATTORNEY



*David J. Kyffers*

Director of the United States Patent and Trademark Office

# United States of America

United States Patent and Trademark Office

## POWERING A GREENER FUTURE

**Reg. No. 4,136,573**

**Registered May 1, 2012**

**Int. Cl.: 9**

**TRADEMARK**

**PRINCIPAL REGISTER**

ALPHA AND OMEGA SEMICONDUCTOR INCORPORATED (CALIFORNIA CORPORATION)  
475 OAKMEAD PARKWAY  
SUNNYVALE, CA 94085

FOR: CHIP CARRIERS, NAMELY, SEMICONDUCTOR CHIP HOUSINGS; SEMICONDUCTOR CHIPS; SEMICONDUCTOR DEVICES; SEMICONDUCTOR POWER ELEMENTS; SEMICONDUCTORS; VERY LARGE SCALE INTEGRATION (VLSI) SEMICONDUCTOR INTEGRATED CIRCUITS, IN CLASS 9 (U.S. CLS. 21, 23, 26, 36 AND 38).

FIRST USE 2-2-2011; IN COMMERCE 9-5-2011.

THE MARK CONSISTS OF STANDARD CHARACTERS WITHOUT CLAIM TO ANY PARTICULAR FONT, STYLE, SIZE, OR COLOR.

SN 85-232,558, FILED 2-2-2011.

DANNEAN HETZEL, EXAMINING ATTORNEY



*David J. Kyjars*

Director of the United States Patent and Trademark Office

# United States of America

United States Patent and Trademark Office

# LIFELINE

**Reg. No. 4,136,574**

**Registered May 1, 2012**

**Int. Cl.: 22**

**TRADEMARK**

**PRINCIPAL REGISTER**

MADICO, INC. (MASSACHUSETTS CORPORATION)  
64 INDUSTRIAL PARKWAY  
WOBURN, MA 01801

FOR: RESTRAINT SYSTEM, NAMELY, SYNTHETIC CORDS, FOR SECURING SAFETY WINDOW FILMED GLASS TO WINDOW FRAMES, IN CLASS 22 (U.S. CLS. 1, 2, 7, 19, 22, 42 AND 50).

FIRST USE 11-5-2002; IN COMMERCE 11-5-2002.

THE MARK CONSISTS OF STANDARD CHARACTERS WITHOUT CLAIM TO ANY PARTICULAR FONT, STYLE, SIZE, OR COLOR.

SN 85-232,635, FILED 2-2-2011.

JANICE KIM, EXAMINING ATTORNEY



*David J. Kybas*

Director of the United States Patent and Trademark Office



# United States of America

United States Patent and Trademark Office

# Stallion Spirit

**Reg. No. 4,136,575**

**Registered May 1, 2012**

**Int. Cl.: 9**

**TRADEMARK**

**PRINCIPAL REGISTER**

MULTIMEDIA GAMES, INC. (TEXAS CORPORATION)  
BUILDING B, 4TH FLOOR  
206 WILD BASIN ROAD SOUTH  
AUSTIN, TX 78746

FOR: COMPUTER SOFTWARE AND FIRMWARE FOR GAMES OF CHANCE ON ANY COMPUTERIZED PLATFORM, INCLUDING DEDICATED GAMING CONSOLES, VIDEO BASED SLOT MACHINES, REEL BASED SLOT MACHINES, AND VIDEO LOTTERY TERMINALS; GAMING MACHINES, NAMELY, ELECTRONIC SLOT AND BINGO MACHINES, IN CLASS 9 (U.S. CLS. 21, 23, 26, 36 AND 38).

FIRST USE 10-4-2011; IN COMMERCE 10-4-2011.

THE MARK CONSISTS OF STANDARD CHARACTERS WITHOUT CLAIM TO ANY PARTICULAR FONT, STYLE, SIZE, OR COLOR.

SN 85-232,925, FILED 2-3-2011.

JOHN WILKE, EXAMINING ATTORNEY



*David J. Kyros*

Director of the United States Patent and Trademark Office

# United States of America

United States Patent and Trademark Office

## JOIN US, STAY YOU.

**Reg. No. 4,136,576**

**Registered May 1, 2012**

**Int. Cls.: 35 and 36**

**SERVICE MARK**

**PRINCIPAL REGISTER**

MBO PARTNERS, INC. (VIRGINIA CORPORATION)  
13454 SUNRISE VALLEY DRIVE  
HERNDON, VA 20171

FOR: BUSINESS MANAGEMENT OF INDEPENDENT CONTRACTORS, CONSULTANTS, AND FREELANCE WORKERS FOR OTHERS, NAMELY, BUSINESS RISK ASSESSMENT AND BUSINESS RISK MITIGATION SERVICES, TAX ADVISORY SERVICES REGARDING TAX REGULATION COMPLIANCE, PAYROLL ADMINISTRATION SERVICES, AND INVOICE CONSOLIDATION, APPROVAL, PAYMENT AND MANAGEMENT SERVICES; BUSINESS CONSULTING SERVICES, IN CLASS 35 (U.S. CLS. 100, 101 AND 102).

FIRST USE 6-0-2011; IN COMMERCE 6-0-2011.

FOR: INSURANCE ADMINISTRATION SERVICES; FINANCIAL RISK ASSESSMENT AND FINANCIAL RISK MITIGATION OF INDEPENDENT CONTRACTORS, CONSULTANTS, AND FREELANCE WORKERS FOR OTHERS, IN CLASS 36 (U.S. CLS. 100, 101 AND 102).

FIRST USE 6-0-2011; IN COMMERCE 6-0-2011.

THE MARK CONSISTS OF STANDARD CHARACTERS WITHOUT CLAIM TO ANY PARTICULAR FONT, STYLE, SIZE, OR COLOR.

SN 85-233,125, FILED 2-3-2011.

KATHY DE JONGE, EXAMINING ATTORNEY



*David J. Kyffers*

Director of the United States Patent and Trademark Office

# United States of America

United States Patent and Trademark Office

## MBO ENTERPRISE SOLUTIONS

**Reg. No. 4,136,577**

**Registered May 1, 2012**

**Int. Cls.: 35 and 36**

**SERVICE MARK**

**PRINCIPAL REGISTER**

MBO PARTNERS, INC. (VIRGINIA CORPORATION)  
13454 SUNRISE VALLEY DRIVE  
SUITE 550  
HERNDON, VA 20171

FOR: BUSINESS MANAGEMENT OF INDEPENDENT CONTRACTORS, CONSULTANTS, AND FREELANCE WORKERS FOR OTHERS, NAMELY, BUSINESS RISK ASSESSMENT AND BUSINESS RISK MITIGATION SERVICES, TAX ADVISORY SERVICES REGARDING TAX REGULATION COMPLIANCE, PAYROLL ADMINISTRATION SERVICES, AND INVOICE CONSOLIDATION, APPROVAL, PAYMENT AND MANAGEMENT SERVICES; BUSINESS CONSULTING SERVICES, IN CLASS 35 (U.S. CLS. 100, 101 AND 102).

FIRST USE 6-0-2011; IN COMMERCE 6-0-2011.

FOR: INSURANCE ADMINISTRATION SERVICES; FINANCIAL RISK ASSESSMENT AND FINANCIAL RISK MITIGATION OF INDEPENDENT CONTRACTORS, CONSULTANTS, AND FREELANCE WORKERS FOR OTHERS, IN CLASS 36 (U.S. CLS. 100, 101 AND 102).

FIRST USE 6-0-2011; IN COMMERCE 6-0-2011.

THE MARK CONSISTS OF STANDARD CHARACTERS WITHOUT CLAIM TO ANY PARTICULAR FONT, STYLE, SIZE, OR COLOR.

OWNER OF U.S. REG. NOS. 3,758,217 AND 3,824,128.

NO CLAIM IS MADE TO THE EXCLUSIVE RIGHT TO USE "ENTERPRISE SOLUTIONS", APART FROM THE MARK AS SHOWN.

SN 85-233,131, FILED 2-3-2011.

KATHY DE JONGE, EXAMINING ATTORNEY



*David J. Kybas*

Director of the United States Patent and Trademark Office

# United States of America

United States Patent and Trademark Office

# MAGNETIK

**Reg. No. 4,136,578**

**Registered May 1, 2012**

**Int. Cls.: 35 and 42**

**SERVICE MARK**

**PRINCIPAL REGISTER**

STRONGMAIL SYSTEMS, INC. (DELAWARE CORPORATION)  
1300 ISLAND DRIVE, SUITE 200  
REDWOOD SHORES, CA 940655171

FOR: ADVERTISING, MARKETING AND PROMOTION SERVICES; ADVERTISING AGENCY SERVICES; CONCEPT AND BRAND DEVELOPMENT FOR OTHERS; BRANDING SERVICES, NAMELY, BRAND MANAGEMENT FOR OTHERS; CONSULTING SERVICES IN THE FIELD OF MARKETING; CONSULTING SERVICES IN THE FIELD OF INTERNET MARKETING, NAMELY, EMAIL MARKETING CAMPAIGNS, CUSTOMER RELATIONSHIP MANAGEMENT (CRM), AND SEARCH ENGINE MARKETING (SEM); PROVISION OF MARKET RESEARCH FOR OTHERS; DIRECT MAIL MARKETING SERVICES, IN CLASS 35 (U.S. CLS. 100, 101 AND 102).

FIRST USE 1-1-2005; IN COMMERCE 1-1-2005.

FOR: CONSULTING SERVICES IN THE FIELD OF SEARCH ENGINE OPTIMIZATION (SEO); WEBSITE DESIGN AND IMPLEMENTATION FOR OTHERS; GRAPHIC DESIGN SERVICES; INDUSTRIAL DESIGN SERVICES; DESIGN AND DEVELOPMENT OF MULTIMEDIA PRODUCTS; COMPUTER SOFTWARE CONSULTING AND DESIGN SERVICES; DESIGN, DEVELOPMENT AND CONSULTING SERVICES IN THE FIELD OF SOFTWARE FOR CONTENT MANAGEMENT, IN CLASS 42 (U.S. CLS. 100 AND 101).

FIRST USE 1-1-2005; IN COMMERCE 1-1-2005.

THE MARK CONSISTS OF STANDARD CHARACTERS WITHOUT CLAIM TO ANY PARTICULAR FONT, STYLE, SIZE, OR COLOR.

OWNER OF U.S. REG. NO. 3,493,965.

SN 85-233,237, FILED 2-3-2011.

ZHALEH DELANEY, EXAMINING ATTORNEY



*David J. Kyros*

Director of the United States Patent and Trademark Office

# United States of America

United States Patent and Trademark Office

## TYLER ALEXANDRA

**Reg. No. 4,136,579**

**Registered May 1, 2012**

**Int. Cl.: 18**

**TRADEMARK**

**PRINCIPAL REGISTER**

TYLER ALEXANDRA, LLC (DELAWARE LIMITED LIABILITY COMPANY)  
30 WEST 63RD STREET, SUITE 31J  
NEW YORK, NY 10023

FOR: HANDBAGS, IN CLASS 18 (U.S. CLS. 1, 2, 3, 22 AND 41).

FIRST USE 1-5-2011; IN COMMERCE 1-5-2011.

THE MARK CONSISTS OF STANDARD CHARACTERS WITHOUT CLAIM TO ANY PARTICULAR FONT, STYLE, SIZE, OR COLOR.

THE NAME(S), PORTRAIT(S), AND/OR SIGNATURE(S) SHOWN IN THE MARK IDENTIFIES "TYLER ALEXANDRA" ELLIS, WHOSE CONSENT(S) TO REGISTER IS MADE OF RECORD.

SN 85-233,303, FILED 2-3-2011.

FRANK LATTUCA, EXAMINING ATTORNEY



*David J. Kyffers*

Director of the United States Patent and Trademark Office

# United States of America

United States Patent and Trademark Office

# BREATHE-X

**Reg. No. 4,136,580**

SEASONALLY WELL, LLC (TEXAS LIMITED LIABILITY COMPANY)  
790 ESTATES DRIVE  
COPPER CANYON, TX 75077

**Registered May 1, 2012**

**Int. Cl.: 5**

FOR: DIETARY AND NUTRITIONAL SUPPLEMENTS, IN CLASS 5 (U.S. CLS. 6, 18, 44, 46, 51 AND 52).

**TRADEMARK**

FIRST USE 4-14-2011; IN COMMERCE 4-14-2011.

**PRINCIPAL REGISTER**

THE MARK CONSISTS OF STANDARD CHARACTERS WITHOUT CLAIM TO ANY PARTICULAR FONT, STYLE, SIZE, OR COLOR.

SN 85-233,336, FILED 2-3-2011.

LINDA E. BLOHM, EXAMINING ATTORNEY



*David J. Kybas*

Director of the United States Patent and Trademark Office

# United States of America

United States Patent and Trademark Office

## Rufus and Delilah

**Reg. No. 4,136,581**

JENNIFER SHAFTON (UNITED STATES INDIVIDUAL)  
4166 DIXIE CANYON AVE  
SHERMAN OAKS, CA 91423

**Registered May 1, 2012**

**Int. Cl.: 44**

FOR: PET CARE SERVICES, NAMELY, DOG WALKING, DOG BATHING AND NON-MEDICATED PET GROOMING; PET CARE SERVICES, NAMELY, DOG WALKING, DOG BATHING, NON-MEDICATED PET GROOMING AND IN-HOME MEDICAL CARE, IN CLASS 44 (U.S. CLS. 100 AND 101).

**SERVICE MARK**

**PRINCIPAL REGISTER**

FIRST USE 10-1-2011; IN COMMERCE 10-1-2011.

THE MARK CONSISTS OF STANDARD CHARACTERS WITHOUT CLAIM TO ANY PARTICULAR FONT, STYLE, SIZE, OR COLOR.

SN 85-233,344, FILED 2-3-2011.

STEVEN JACKSON, EXAMINING ATTORNEY



*David J. Kyros*

Director of the United States Patent and Trademark Office

# United States of America

United States Patent and Trademark Office

## BISON JACK'S

**Reg. No. 4,136,582**

**Registered May 1, 2012**

**Int. Cls.: 29 and 43**

**TRADEMARK**

**SERVICE MARK**

**PRINCIPAL REGISTER**

BISON JACKS IP, LLC (DELAWARE LIMITED LIABILITY COMPANY)  
1395 S. PLATTE RIVER DRIVE  
DENVER, CO 80223

FOR: MEAT, IN CLASS 29 (U.S. CL. 46).

FIRST USE 10-13-2011; IN COMMERCE 10-13-2011.

FOR: RESTAURANT SERVICES, NAMELY, PROVIDING OF FOOD AND BEVERAGES FOR CONSUMPTION ON AND OFF THE PREMISES, IN CLASS 43 (U.S. CLS. 100 AND 101).

FIRST USE 10-13-2011; IN COMMERCE 10-13-2011.

THE MARK CONSISTS OF STANDARD CHARACTERS WITHOUT CLAIM TO ANY PARTICULAR FONT, STYLE, SIZE, OR COLOR.

NO CLAIM IS MADE TO THE EXCLUSIVE RIGHT TO USE "BISON", APART FROM THE MARK AS SHOWN.

SN 85-233,394, FILED 2-3-2011.

MAYUR VAGHANI, EXAMINING ATTORNEY



*David J. Kyros*

Director of the United States Patent and Trademark Office



# United States of America

United States Patent and Trademark Office

## THE SOLE OF BRAZIL

**Reg. No. 4,136,583**

**Registered May 1, 2012**

**Int. Cl.: 25**

**TRADEMARK**

**PRINCIPAL REGISTER**

GRENDENE, S.A. (BRAZIL COMPANY)  
AV. PIMENTEL GOMES  
214 BAIRRO EXPECTATIVA SOBRAL  
CE BRAZIL, BRAZIL 62040-050

FOR: FOOTWEAR, IN CLASS 25 (U.S. CLS. 22 AND 39).

FIRST USE 3-27-2011; IN COMMERCE 3-27-2011.

THE MARK CONSISTS OF STANDARD CHARACTERS WITHOUT CLAIM TO ANY PARTICULAR FONT, STYLE, SIZE, OR COLOR.

SN 85-233,450, FILED 2-3-2011.

AISHA CLARKE, EXAMINING ATTORNEY



*David J. Kybas*

Director of the United States Patent and Trademark Office

# United States of America

United States Patent and Trademark Office

## Humble Beginning Publishing

**Reg. No. 4,136,584**

**Registered May 1, 2012**

**Int. Cl.: 41**

**SERVICE MARK**

**PRINCIPAL REGISTER**

MCINTOSH, ALFONZO LEE (UNITED STATES INDIVIDUAL)  
11980 OVERBROOK LN APT#825  
4523 MARTIN LUTHER KING JR. WAY  
HOUSTON, TX 77077

FOR: BOOK PUBLISHING; PUBLISHING OF BOOKS, MAGAZINES, IN CLASS 41 (U.S. CLS. 100, 101 AND 107).

FIRST USE 1-30-2011; IN COMMERCE 1-30-2011.

THE MARK CONSISTS OF STANDARD CHARACTERS WITHOUT CLAIM TO ANY PARTICULAR FONT, STYLE, SIZE, OR COLOR.

NO CLAIM IS MADE TO THE EXCLUSIVE RIGHT TO USE "PUBLISHING", APART FROM THE MARK AS SHOWN.

SN 85-233,945, FILED 2-4-2011.

HENRY S. ZAK, EXAMINING ATTORNEY



*David J. Kyros*

Director of the United States Patent and Trademark Office

# United States of America

United States Patent and Trademark Office

## BUDGET MOBILE

**Reg. No. 4,136,585**

**Registered May 1, 2012**

**Int. Cls.: 9 and 38**

BUDGET PREPAY, INC. (LOUISIANA CORPORATION)  
SUITE 200  
1325 BARKSDALE BLVD  
BOSSIER CITY, LA 71111

FOR: MOBILE PHONES, IN CLASS 9 (U.S. CLS. 21, 23, 26, 36 AND 38).

**TRADEMARK**

FIRST USE 2-0-2011; IN COMMERCE 2-0-2011.

**SERVICE MARK**

FOR: PREPAID MOBILE TELEPHONE SERVICES, IN CLASS 38 (U.S. CLS. 100, 101 AND 104).

**PRINCIPAL REGISTER**

FIRST USE 2-0-2011; IN COMMERCE 2-0-2011.

THE MARK CONSISTS OF STANDARD CHARACTERS WITHOUT CLAIM TO ANY PARTICULAR FONT, STYLE, SIZE, OR COLOR.

OWNER OF U.S. REG. NOS. 3,243,912, 3,573,053, AND 3,573,054.

NO CLAIM IS MADE TO THE EXCLUSIVE RIGHT TO USE "MOBILE", APART FROM THE MARK AS SHOWN.

SN 85-234,028, FILED 2-4-2011.

JANICE L. MCMORROW, EXAMINING ATTORNEY



*David J. Kyros*

Director of the United States Patent and Trademark Office

# United States of America

United States Patent and Trademark Office

# NEXXZR

**Reg. No. 4,136,586**

SAGEMAX BIOCERAMICS, INC. (WASHINGTON CORPORATION)  
104 49TH STREET NW, SUITE 101  
AUBURN, WA 98001

**Registered May 1, 2012**

**Int. Cl.: 5**

FOR: DENTAL CERAMIC BLANKS MADE IN PART OF ZIRCONIUM, IN CLASS 5 (U.S. CLS. 6, 18, 44, 46, 51 AND 52).

**TRADEMARK**

FIRST USE 2-0-2011; IN COMMERCE 2-0-2011.

**PRINCIPAL REGISTER**

THE MARK CONSISTS OF STANDARD CHARACTERS WITHOUT CLAIM TO ANY PARTICULAR FONT, STYLE, SIZE, OR COLOR.

SN 85-234,108, FILED 2-4-2011.

DANIEL CAPSHAW, EXAMINING ATTORNEY



*David J. Kybas*

Director of the United States Patent and Trademark Office

# United States of America

United States Patent and Trademark Office

## CARTAGE NOW

**Reg. No. 4,136,587**

**Registered May 1, 2012**

**Int. Cl.: 42**

**SERVICE MARK**

**PRINCIPAL REGISTER**

CARTAGE NOW, LLC (GEORGIA LIMITED LIABILITY COMPANY)  
SUITE 19  
300 WILLOWBEND ROAD  
PEACHTREE CITY, GA 30269

FOR: PROVIDING ON-LINE NON-DOWNLOADABLE SOFTWARE FOR MANAGEMENT, ACCOUNTING, AND REPORTING FUNCTIONS IN THE FIELD OF FREIGHT TRANSPORTATION AND LOGISTICS , IN CLASS 42 (U.S. CLS. 100 AND 101).

FIRST USE 10-14-2011; IN COMMERCE 10-14-2011.

THE MARK CONSISTS OF STANDARD CHARACTERS WITHOUT CLAIM TO ANY PARTICULAR FONT, STYLE, SIZE, OR COLOR.

NO CLAIM IS MADE TO THE EXCLUSIVE RIGHT TO USE "CARTAGE", APART FROM THE MARK AS SHOWN.

SN 85-234,326, FILED 2-4-2011.

LOURDES AYALA, EXAMINING ATTORNEY



*David J. Kybas*

Director of the United States Patent and Trademark Office

# United States of America

United States Patent and Trademark Office

## CARTAGE: NOW

**Reg. No. 4,136,588**

**Registered May 1, 2012**

**Int. Cl.: 42**

**SERVICE MARK**

**PRINCIPAL REGISTER**

CARTAGE NOW, LLC (GEORGIA LIMITED LIABILITY COMPANY)  
SUITE 19  
300 WILLOWBEND ROAD  
PEACHTREE CITY, GA 30269

FOR: PROVIDING ON-LINE NON-DOWNLOADABLE SOFTWARE FOR MANAGEMENT, ACCOUNTING, AND REPORTING FUNCTIONS IN THE FIELD OF FREIGHT TRANSPORTATION AND LOGISTICS, IN CLASS 42 (U.S. CLS. 100 AND 101).

FIRST USE 10-14-2011; IN COMMERCE 10-14-2011.

NO CLAIM IS MADE TO THE EXCLUSIVE RIGHT TO USE "CARTAGE", APART FROM THE MARK AS SHOWN.

THE MARK CONSISTS OF THE WORDS "CARTAGE NOW" SEPARATED BY THE DESIGN OF A RIGHT-POINTING ARROW THAT CONSISTS OF PARALLEL COLUMNS OF FOUR, THEN TWO, THEN ONE DOTS.

SN 85-234,333, FILED 2-4-2011.

LOURDES AYALA, EXAMINING ATTORNEY



*David J. Kyros*

Director of the United States Patent and Trademark Office

# United States of America

United States Patent and Trademark Office

# BENARI

**Reg. No. 4,136,589**

**Registered May 1, 2012**

**Int. Cl.: 35**

**SERVICE MARK**

**PRINCIPAL REGISTER**

SMOLINSKY, STEVEN (UNITED STATES INDIVIDUAL)  
BOX 197  
BURCHRUNVILLE, PA 19421

FOR: CONSULTING SERVICES IN BUSINESS ORGANIZATION, PLANNING, MANAGEMENT AND MARKETING, IN CLASS 35 (U.S. CLS. 100, 101 AND 102).

FIRST USE 12-31-1982; IN COMMERCE 12-31-1982.

THE MARK CONSISTS OF STANDARD CHARACTERS WITHOUT CLAIM TO ANY PARTICULAR FONT, STYLE, SIZE, OR COLOR.

SN 85-234,373, FILED 2-4-2011.

DOUGLAS LEE, EXAMINING ATTORNEY



*David J. Kybas*

Director of the United States Patent and Trademark Office

# United States of America

United States Patent and Trademark Office

## BROOKESIDE INSIGHT

**Reg. No. 4,136,590**

**Registered May 1, 2012**

**Int. Cl.: 42**

**SERVICE MARK**

**PRINCIPAL REGISTER**

THE BROOKESIDE GROUP, INC. (MASSACHUSETTS CORPORATION)  
524 MAIN STREET  
ACTON, MA 01720

FOR: SOFTWARE AS A SERVICE, NAMELY, ON-LINE NONDOWNLOADABLE SOFTWARE USED TO MEASURE, MANAGE, AND ANALYZE CUSTOMER RELATIONSHIPS, CUSTOMER LOYALTY, AND VALUE, IN CLASS 42 (U.S. CLS. 100 AND 101).

FIRST USE 3-2-2011; IN COMMERCE 3-2-2011.

THE MARK CONSISTS OF STANDARD CHARACTERS WITHOUT CLAIM TO ANY PARTICULAR FONT, STYLE, SIZE, OR COLOR.

SN 85-234,406, FILED 2-4-2011.

JORDAN BAKER, EXAMINING ATTORNEY



*David J. Kyros*

Director of the United States Patent and Trademark Office



# United States of America

United States Patent and Trademark Office

# NICE!

**Reg. No. 4,136,591**

**Registered May 1, 2012**

**Int. Cl.: 20**

**TRADEMARK**

**PRINCIPAL REGISTER**

WALGREEN CO. (ILLINOIS CORPORATION)  
200 WILMOT ROAD  
DEERFIELD, IL 60015

FOR: DRINKING STRAWS, IN CLASS 20 (U.S. CLS. 2, 13, 22, 25, 32 AND 50).

FIRST USE 10-27-2011; IN COMMERCE 10-27-2011.

THE MARK CONSISTS OF STANDARD CHARACTERS WITHOUT CLAIM TO ANY PARTICULAR FONT, STYLE, SIZE, OR COLOR.

SN 85-234,600, FILED 2-4-2011.

JIM RINGLE, EXAMINING ATTORNEY



*David J. Kybas*

Director of the United States Patent and Trademark Office

# United States of America

United States Patent and Trademark Office

6y

**Reg. No. 4,136,592**

**Registered May 1, 2012**

**Int. Cl.: 33**

**TRADEMARK**

**PRINCIPAL REGISTER**

TOPEL, MARCUS (UNITED STATES INDIVIDUAL), DBA TOPEL WINERY,  
P.O. BOX 510  
HOPLAND, CA 95449 AND

TOPEL, DONNIS (UNITED STATES INDIVIDUAL), DBA TOPEL WINERY,  
P.O. BOX 510  
HOPLAND, CA 95449

FOR: WINES, IN CLASS 33 (U.S. CLS. 47 AND 49).

FIRST USE 10-1-2011; IN COMMERCE 10-1-2011.

THE MARK CONSISTS OF STANDARD CHARACTERS WITHOUT CLAIM TO ANY PARTICULAR FONT, STYLE, SIZE, OR COLOR.

SN 85-234,609, FILED 2-4-2011.

MARK SPARACINO, EXAMINING ATTORNEY



*David J. Kybas*

Director of the United States Patent and Trademark Office

# United States of America

United States Patent and Trademark Office

## TownSquare Real Estate Alpha Fund I, L.P.

**Reg. No. 4,136,593**

**Registered May 1, 2012**

**Int. Cl.: 36**

**SERVICE MARK**

**PRINCIPAL REGISTER**

THE TOWNSEND GROUP, INC. (OHIO CORPORATION)  
SKYLIGHT OFFICE TOWER  
1660 WEST 2ND, SUITE 450  
CLEVELAND, OH 44113

FOR: REAL ESTATE FUND INVESTMENT SERVICES, IN CLASS 36 (U.S. CLS. 100, 101 AND 102).

FIRST USE 11-0-2011; IN COMMERCE 11-0-2011.

THE MARK CONSISTS OF STANDARD CHARACTERS WITHOUT CLAIM TO ANY PARTICULAR FONT, STYLE, SIZE, OR COLOR.

NO CLAIM IS MADE TO THE EXCLUSIVE RIGHT TO USE "REAL ESTATE ALPHA FUND I, L.P.", APART FROM THE MARK AS SHOWN.

SN 85-234,630, FILED 2-4-2011.

FONG HSU, EXAMINING ATTORNEY



*David J. Kybas*

Director of the United States Patent and Trademark Office

# United States of America

United States Patent and Trademark Office

## TownSquare Ex-US Real Estate Alpha Fund I, L.P.

**Reg. No. 4,136,594**

**Registered May 1, 2012**

**Int. Cl.: 36**

**SERVICE MARK**

**PRINCIPAL REGISTER**

THE TOWNSEND GROUP, INC. (OHIO CORPORATION)  
SKYLIGHT OFFICE TOWER  
1660 WEST 2ND, SUITE 450  
CLEVELAND, OH 44113

FOR: REAL ESTATE FUND INVESTMENT SERVICES, IN CLASS 36 (U.S. CLS. 100, 101 AND 102).

FIRST USE 11-0-2011; IN COMMERCE 11-0-2011.

THE MARK CONSISTS OF STANDARD CHARACTERS WITHOUT CLAIM TO ANY PARTICULAR FONT, STYLE, SIZE, OR COLOR.

NO CLAIM IS MADE TO THE EXCLUSIVE RIGHT TO USE "EX-US REAL ESTATE ALPHA FUND I, L.P.", APART FROM THE MARK AS SHOWN.

SN 85-234,636, FILED 2-4-2011.

FONG HSU, EXAMINING ATTORNEY



*David J. Kybas*

Director of the United States Patent and Trademark Office

# United States of America

United States Patent and Trademark Office

## TownSquare US Real Estate Alpha Fund I, L.P.

**Reg. No. 4,136,595**

**Registered May 1, 2012**

**Int. Cl.: 36**

**SERVICE MARK**

**PRINCIPAL REGISTER**

THE TOWNSEND GROUP, INC. (OHIO CORPORATION)  
SKYLIGHT OFFICE TOWER  
1660 WEST 2ND, SUITE 450  
CLEVELAND, OH 44113

FOR: REAL ESTATE FUND INVESTMENT SERVICES, IN CLASS 36 (U.S. CLS. 100, 101 AND 102).

FIRST USE 11-0-2011; IN COMMERCE 11-0-2011.

THE MARK CONSISTS OF STANDARD CHARACTERS WITHOUT CLAIM TO ANY PARTICULAR FONT, STYLE, SIZE, OR COLOR.

NO CLAIM IS MADE TO THE EXCLUSIVE RIGHT TO USE "US REAL ESTATE ALPHA FUND I, L.P.", APART FROM THE MARK AS SHOWN.

SN 85-234,640, FILED 2-4-2011.

FONG HSU, EXAMINING ATTORNEY



*David J. Kyros*

Director of the United States Patent and Trademark Office

# United States of America

United States Patent and Trademark Office

## STEAK N SHAKE SIGNATURE

**Reg. No. 4,136,596**

**Registered May 1, 2012**

**Int. Cl.: 43**

**SERVICE MARK**

**PRINCIPAL REGISTER**

STEAK N SHAKE, LLC (INDIANA LIMITED LIABILITY COMPANY)  
500 CENTURY BUILDING  
36 SOUTH PENNSYLVANIA STREET  
INDIANAPOLIS, IN 46204

FOR: RESTAURANT SERVICES, IN CLASS 43 (U.S. CLS. 100 AND 101).

FIRST USE 1-12-2012; IN COMMERCE 1-12-2012.

THE MARK CONSISTS OF STANDARD CHARACTERS WITHOUT CLAIM TO ANY PARTICULAR FONT, STYLE, SIZE, OR COLOR.

OWNER OF U.S. REG. NOS. 843,430, 2,259,584, AND OTHERS.

SN 85-234,686, FILED 2-4-2011.

LESLIE RICHARDS, EXAMINING ATTORNEY



*David J. Kyros*

Director of the United States Patent and Trademark Office

# United States of America

United States Patent and Trademark Office



**Reg. No. 4,136,597**

**Registered May 1, 2012**

**Int. Cl.: 10**

**TRADEMARK**

**PRINCIPAL REGISTER**

MIAMI INSTRUMENTS LLC (FLORIDA LIMITED LIABILITY COMPANY)  
2222 PONCE DE LEON BLVD., SUITE 200  
CORAL GABLES, FL 33134

FOR: SURGICAL DEVICES AND INSTRUMENTS, IN CLASS 10 (U.S. CLS. 26, 39 AND 44).

FIRST USE 1-17-2012; IN COMMERCE 1-19-2012.

NO CLAIM IS MADE TO THE EXCLUSIVE RIGHT TO USE "MIAMI INSTRUMENTS",  
APART FROM THE MARK AS SHOWN.

THE COLOR(S) RED, BLACK AND BLUE IS/ARE CLAIMED AS A FEATURE OF THE  
MARK.

THE MARK CONSISTS OF THE STYLIZED LETTERS "MI" INSIDE A HEART SHAPE WITH  
AN OPENING AT THE TOP AND INTERSECTING LINES AT THE BOTTOM. THE STYLIZED  
WORDS "MIAMI INSTRUMENTS" ARE TO THE RIGHT OF THE HEART DESIGN. THE  
HEART OUTLINE IS IN RED, THE LETTER "M" IS IN BLUE, THE LETTER "I" IS IN BLACK,  
THE WORD "MIAMI" IS IN BLUE, AND THE WORD "INSTRUMENTS" IS IN BLACK.

SN 85-234,708, FILED 2-4-2011.

SANDRA BUJA, EXAMINING ATTORNEY



*David J. Kybas*

Director of the United States Patent and Trademark Office

# United States of America

United States Patent and Trademark Office



**Reg. No. 4,136,598**

**Registered May 1, 2012**

**Int. Cl.: 10**

**TRADEMARK**

**PRINCIPAL REGISTER**

MIAMI INSTRUMENTS LLC (FLORIDA LIMITED LIABILITY COMPANY)  
2222 PONCE DE LEON BLVD., SUITE 200  
CORAL GABLES, FL 33134

FOR: SURGICAL DEVICES AND INSTRUMENTS, IN CLASS 10 (U.S. CLS. 26, 39 AND 44).

FIRST USE 1-17-2012; IN COMMERCE 1-19-2012.

THE MARK CONSISTS OF THE STYLIZED LETTERS "MI" INSIDE A HEART SHAPE WITH AN OPENING AT THE TOP AND INTERSECTING LINES AT THE BOTTOM. THE HEART OUTLINE IS IN RED, THE LETTER "M" IS IN BLUE, AND THE LETTER "I" IS IN BLACK.

THE COLOR(S) RED, BLACK AND BLUE IS/ARE CLAIMED AS A FEATURE OF THE MARK.

SN 85-234,729, FILED 2-4-2011.

SANDRA BUJA, EXAMINING ATTORNEY



*David J. Kyjars*

Director of the United States Patent and Trademark Office



# United States of America

United States Patent and Trademark Office



**Reg. No. 4,136,599**

**Registered May 1, 2012**

**Int. Cl.: 10**

**TRADEMARK**

**PRINCIPAL REGISTER**

MIAMI INSTRUMENTS LLC (FLORIDA LIMITED LIABILITY COMPANY)  
2222 PONCE DE LEON BLVD., SUITE 200  
CORAL GABLES, FL 33134

FOR: SURGICAL DEVICES AND INSTRUMENTS, IN CLASS 10 (U.S. CLS. 26, 39 AND 44).

FIRST USE 1-17-2012; IN COMMERCE 1-19-2012.

NO CLAIM IS MADE TO THE EXCLUSIVE RIGHT TO USE "MIAMI INSTRUMENTS",  
APART FROM THE MARK AS SHOWN.

THE COLOR(S) RED, BLACK AND BLUE IS/ARE CLAIMED AS A FEATURE OF THE  
MARK.

THE MARK CONSISTS OF THE STYLIZED WORDS "MIAMI" AND "INSTRUMENTS" INSIDE  
A HEART SHAPE WITH AN OPENING AT THE TOP AND INTERSECTING LINES AT THE  
BOTTOM. THE WORD "MIAMI" IS ABOVE THE WORD "INSTRUMENTS". THE HEART  
OUTLINE IS IN RED, THE WORD "MIAMI" IS IN BLUE, AND THE WORD "INSTRUMENTS"  
IS IN BLACK.

SN 85-234,770, FILED 2-4-2011.

SANDRA BUJA, EXAMINING ATTORNEY



*David J. Kyffers*

Director of the United States Patent and Trademark Office

# United States of America

United States Patent and Trademark Office

# alterpose

**Reg. No. 4,136,600**

**Registered May 1, 2012**

**Int. Cl.: 42**

**SERVICE MARK**

**PRINCIPAL REGISTER**

CONCEPT AWARE INC. (NEVADA CORPORATION)  
P.O. BOX 1106  
KLAMATH FALLS, OR 97601

FOR: COMPUTER SERVICE, NAMELY, ACTING AS AN APPLICATION SERVICE PROVIDER IN THE FIELD OF INFORMATION MANAGEMENT TO HOST COMPUTER APPLICATION SOFTWARE FOR THE PURPOSE OF COLLECTION, EDITING, ORGANIZING, MODIFYING, BOOK MARKING, TRANSMISSION, STORAGE, SEARCHING, AND SHARING OF DATA AND INFORMATION AND FOR PROVIDING CUSTOMIZED WEB PAGES FEATURING USER-DEFINED INFORMATION, PERSONAL PROFILES, ORGANIZATION PROFILES, DATA, AND INFORMATION, IN CLASS 42 (U.S. CLS. 100 AND 101).

FIRST USE 1-10-2012; IN COMMERCE 1-10-2012.

THE MARK CONSISTS OF STANDARD CHARACTERS WITHOUT CLAIM TO ANY PARTICULAR FONT, STYLE, SIZE, OR COLOR.

SN 85-234,825, FILED 2-4-2011.

TOBY BULLOFF, EXAMINING ATTORNEY



*David J. Kyros*

Director of the United States Patent and Trademark Office

# United States of America

United States Patent and Trademark Office

# BRIGHTPAK

**Reg. No. 4,136,601**

**Registered May 1, 2012**

**Int. Cl.: 20**

**TRADEMARK**

**PRINCIPAL REGISTER**

ADVANCED TECHNOLOGY MATERIALS, INC. (DELAWARE CORPORATION)  
7 COMMERCE DRIVE  
DANBURY, CT 06810

FOR: NON-METALLIC CONTAINERS FOR CHEMICAL FLUIDS AND FLUID DISPENSERS  
CONNECTABLE TO SUCH CONTAINERS FOR USE THEREWITH TO DISPENSE CHEMICAL  
FLUIDS FROM SUCH CONTAINERS ALL FOR INDUSTRIAL USE, IN CLASS 20 (U.S. CLS.  
2, 13, 22, 25, 32 AND 50).

FIRST USE 12-21-2011; IN COMMERCE 12-21-2011.

THE MARK CONSISTS OF STANDARD CHARACTERS WITHOUT CLAIM TO ANY PAR-  
TICULAR FONT, STYLE, SIZE, OR COLOR.

SN 85-235,130, FILED 2-6-2011.

MARK SPARACINO, EXAMINING ATTORNEY



*David J. Kyffers*

Director of the United States Patent and Trademark Office

# United States of America

United States Patent and Trademark Office



**Reg. No. 4,136,602**

**Registered May 1, 2012**

**Int. Cl.: 25**

**TRADEMARK**

**PRINCIPAL REGISTER**

SAND SCRAPPERS LLC (MICHIGAN LIMITED LIABILITY COMPANY)  
44910 ARKONA ROAD  
NEW BOSTON, MI 48164

FOR: SHOES, IN CLASS 25 (U.S. CLS. 22 AND 39).

FIRST USE 8-26-2011; IN COMMERCE 8-26-2011.

THE MARK CONSISTS OF THE PHRASE "SAND SCRAPPERS" IN A DISTINCTIVE FONT WITH THE WORD "SAND" APPEARING ABOVE AND THE WORD "SCRAPPERS" APPEARING BELOW A HAND DRAWN DEPICTION OF A PAIR OF MEN'S SHOES. THE MARK CONTAINS A BORDER CONSISTING OF AN IRREGULAR SERIES OF ZIG ZAG LINES.

SN 85-235,324, FILED 2-7-2011.

WARREN L. OLANDRIA, EXAMINING ATTORNEY



*David J. Kybas*

Director of the United States Patent and Trademark Office

# United States of America

United States Patent and Trademark Office

## EXCELL-LIVING

**Reg. No. 4,136,603**

EX-CELL HOME FASHIONS, INC. (DELAWARE CORPORATION)  
295 FIFTH AVENUE  
NEW YORK, NY 10016

**Registered May 1, 2012**

**Int. Cl.: 35**

FOR: ON-LINE RETAIL STORE SERVICES FEATURING HOME FURNISHING PRODUCTS,  
IN CLASS 35 (U.S. CLS. 100, 101 AND 102).

**SERVICE MARK**

FIRST USE 3-0-2011; IN COMMERCE 3-0-2011.

**PRINCIPAL REGISTER**

THE MARK CONSISTS OF STANDARD CHARACTERS WITHOUT CLAIM TO ANY PARTICULAR FONT, STYLE, SIZE, OR COLOR.

SN 85-235,470, FILED 2-7-2011.

JANICE KIM, EXAMINING ATTORNEY



*David J. Kybas*

Director of the United States Patent and Trademark Office

# United States of America

United States Patent and Trademark Office

## CONSULTING. FROM THE INSIDE OUT.

**Reg. No. 4,136,604**

**Registered May 1, 2012**

**Int. Cl.: 35**

**SERVICE MARK**

**PRINCIPAL REGISTER**

RC MANAGEMENT GROUP LLC (DELAWARE LIMITED LIABILITY COMPANY)  
17101 ARMSTRONG AVENUE  
IRVINE, CA 92614

FOR: TEMPORARY EMPLOYMENT AGENCIES, NAMELY, PROVIDING EXPERIENCED PROFESSIONALS TO CLIENTS FOR DISCRETE PERIODS IN THE FIELD OF MANAGEMENT CONSULTING, ACCOUNTING AND FINANCE, RISK MANAGEMENT AND INTERNAL AUDIT, INFORMATION TECHNOLOGY, HUMAN RESOURCES, LEGAL SERVICES AND SUPPLY CHAIN MANAGEMENT, IN CLASS 35 (U.S. CLS. 100, 101 AND 102).

FIRST USE 1-1-2011; IN COMMERCE 1-1-2011.

THE MARK CONSISTS OF STANDARD CHARACTERS WITHOUT CLAIM TO ANY PARTICULAR FONT, STYLE, SIZE, OR COLOR.

NO CLAIM IS MADE TO THE EXCLUSIVE RIGHT TO USE "CONSULTING", APART FROM THE MARK AS SHOWN.

SN 85-235,632, FILED 2-7-2011.

MAYUR VAGHANI, EXAMINING ATTORNEY



*David J. Kyros*

Director of the United States Patent and Trademark Office

# United States of America

United States Patent and Trademark Office

## CHAMPION SHAPE

**Reg. No. 4,136,605**

**Registered May 1, 2012**

**Int. Cl.: 25**

**TRADEMARK**

**PRINCIPAL REGISTER**

HBI BRANDED APPAREL ENTERPRISES, LLC (DELAWARE LIMITED LIABILITY COMPANY)  
1000 EAST HANES MILL ROAD  
WINSTON-SALEM, NC 27105

FOR: CAPRIS; PANTS; SHORTS; SPORTS BRAS; T-SHIRTS; TANK TOPS; TOPS, IN CLASS 25 (U.S. CLS. 22 AND 39).

FIRST USE 6-24-2011; IN COMMERCE 6-24-2011.

THE MARK CONSISTS OF STANDARD CHARACTERS WITHOUT CLAIM TO ANY PARTICULAR FONT, STYLE, SIZE, OR COLOR.

OWNER OF U.S. REG. NOS. 1,819,014, 1,828,930, AND 1,860,938.

SN 85-235,650, FILED 2-7-2011.

COLLEEN KEARNEY, EXAMINING ATTORNEY



*David J. Kyros*

Director of the United States Patent and Trademark Office

# United States of America

United States Patent and Trademark Office

## COORDINATION

**Reg. No. 4,136,606**

**Registered May 1, 2012**

**Int. Cl.: 16**

**TRADEMARK**

**PRINCIPAL REGISTER**

WANT & NEED, INC. (CALIFORNIA CORPORATION)  
130 PATHWAY  
IRVINE, CA 92618

FOR: INTERIOR DESIGN KITS FOR DO-IT-YOURSELF DESIGNERS CONTAINING PRINTED PLANNING TEMPLATES, COLOR SELECTION SAMPLES, AND FABRIC SWATCHES, IN CLASS 16 (U.S. CLS. 2, 5, 22, 23, 29, 37, 38 AND 50).

FIRST USE 2-1-2012; IN COMMERCE 2-1-2012.

THE MARK CONSISTS OF STANDARD CHARACTERS WITHOUT CLAIM TO ANY PARTICULAR FONT, STYLE, SIZE, OR COLOR.

SN 85-235,906, FILED 2-7-2011.

DANNEAN HETZEL, EXAMINING ATTORNEY



*David J. Kybas*

Director of the United States Patent and Trademark Office



# United States of America

United States Patent and Trademark Office

# NICE!

**Reg. No. 4,136,607**

**Registered May 1, 2012**

**Int. Cl.: 32**

**TRADEMARK**

**PRINCIPAL REGISTER**

WALGREEN CO. (ILLINOIS CORPORATION)  
200 WILMOT ROAD  
DEERFIELD, IL 60015

FOR: SOFT DRINKS; FRUIT JUICES; BOTTLED WATER, IN CLASS 32 (U.S. CLS. 45, 46 AND 48).

FIRST USE 4-28-2011; IN COMMERCE 4-28-2011.

THE MARK CONSISTS OF STANDARD CHARACTERS WITHOUT CLAIM TO ANY PARTICULAR FONT, STYLE, SIZE, OR COLOR.

SN 85-236,021, FILED 2-7-2011.

JIM RINGLE, EXAMINING ATTORNEY



*David J. Kybas*

Director of the United States Patent and Trademark Office

# United States of America

United States Patent and Trademark Office



**Reg. No. 4,136,608**

**Registered May 1, 2012**

**Int. Cl.: 35**

**SERVICE MARK**

**PRINCIPAL REGISTER**

FASTAFF, LLC (COLORADO LIMITED LIABILITY COMPANY)  
6501 S. FIDDLER'S GREEN CIRCLE, SUITE  
GREENWOOD VILLAGE, CO 80111

FOR: EMPLOYMENT AGENCY SERVICES, IN CLASS 35 (U.S. CLS. 100, 101 AND 102).

FIRST USE 3-21-2011; IN COMMERCE 3-21-2011.

OWNER OF U.S. REG. NO. 3,763,205.

THE COLOR(S) YELLOW, ORANGE AND BLUE IS/ARE CLAIMED AS A FEATURE OF THE MARK.

NO CLAIM IS MADE TO THE EXCLUSIVE RIGHT TO USE "TRAVEL NURSING", APART FROM THE MARK AS SHOWN.

THE MARK CONSISTS OF THREE ELONGATED RECTANGLES TO THE LEFT OF THE WORDS. THE COLOR YELLOW APPEARS IN THE SMALLEST RECTANGLE AND THE OTHER TWO RECTANGLES ARE ORANGE. THE COLOR BLUE APPEARS IN STYLIZED WORDING "FASTAFF TRAVEL NURSING".

SN 85-236,073, FILED 2-7-2011.

TASNEEM HUSSAIN, EXAMINING ATTORNEY



*David J. Kybas*

Director of the United States Patent and Trademark Office

**United States of America**  
United States Patent and Trademark Office

**KRUNK**

**Reg. No. 4,136,609**

FELIX IKE (UNITED STATES INDIVIDUAL)  
1165 SOUTH 150 WEST  
OREM, UT 84058

**Registered May 1, 2012**

**Int. Cl.: 9**

FOR: AUDIO HEADPHONES; EARPHONES AND HEADPHONES; MUSIC HEADPHONES;  
STEREO HEADPHONES, IN CLASS 9 (U.S. CLS. 21, 23, 26, 36 AND 38).

**TRADEMARK**

FIRST USE 1-27-2011; IN COMMERCE 4-10-2011.

**PRINCIPAL REGISTER**

THE MARK CONSISTS OF STANDARD CHARACTERS WITHOUT CLAIM TO ANY PAR-  
TICULAR FONT, STYLE, SIZE, OR COLOR.

SN 85-236,085, FILED 2-7-2011.

ESTHER A. BORSUK, EXAMINING ATTORNEY



*David J. Kybas*

Director of the United States Patent and Trademark Office

# United States of America

United States Patent and Trademark Office

## HOMEAWAY SOFTWARE FOR PROFESSIONALS

**Reg. No. 4,136,610**

**Registered May 1, 2012**

**Int. Cl.: 9**

**TRADEMARK**

**PRINCIPAL REGISTER**

HOMEAWAY.COM, INC. (DELAWARE CORPORATION)  
SUITE 300  
1011 W. FIFTH ST.  
AUSTIN, TX 78703

FOR: COMPUTER SOFTWARE FOR USE IN DATABASE CREATION AND MANAGEMENT OF A VACATION RENTAL WEBSITE; COMPUTER SOFTWARE FOR APPLICATION AND DATABASE INTEGRATION; COMPUTER SOFTWARE FOR APPLICATION AND DATABASE DESIGN; COMPUTER SOFTWARE FOR CREATING SEARCHABLE DATABASES OF INFORMATION AND DATA; DOWNLOADABLE SOFTWARE FOR USE IN DATABASE MANAGEMENT ON A VACATION RENTAL WEBSITE; COMPUTER SOFTWARE AND SOFTWARE TOOLS FOR WEBSITE DEVELOPMENT, IN CLASS 9 (U.S. CLS. 21, 23, 26, 36 AND 38).

FIRST USE 1-26-2011; IN COMMERCE 1-26-2011.

THE MARK CONSISTS OF STANDARD CHARACTERS WITHOUT CLAIM TO ANY PARTICULAR FONT, STYLE, SIZE, OR COLOR.

OWNER OF U.S. REG. NOS. 3,385,395, 3,596,175, AND OTHERS.

NO CLAIM IS MADE TO THE EXCLUSIVE RIGHT TO USE "SOFTWARE FOR PROFESSIONALS", APART FROM THE MARK AS SHOWN.

SN 85-236,141, FILED 2-7-2011.

KAPIL BHANOT, EXAMINING ATTORNEY



*David J. Kyros*

Director of the United States Patent and Trademark Office

# United States of America

United States Patent and Trademark Office

# BluePrintJuice

**Reg. No. 4,136,611**

**Registered May 1, 2012**

**Int. Cl.: 32**

**TRADEMARK**

**PRINCIPAL REGISTER**

BLUEPRINTCLEANSE LLC (NEW YORK LIMITED LIABILITY COMPANY)  
135 WEST 29TH STREET  
NEW YORK, NY 10001

FOR: FRUIT BEVERAGES; FRUIT DRINKS AND FRUIT JUICES; NON-ALCOHOLIC FRUIT EXTRACTS USED IN THE PREPARATION OF BEVERAGES; NON-ALCOHOLIC FRUIT JUICE BEVERAGES; PREPARED ENTREES CONSISTING OF FRUIT DRINKS AND FRUIT JUICES, FRUIT-BASED BEVERAGES, NON-ALCOHOLIC BEVERAGES CONTAINING FRUIT JUICES, NON-ALCOHOLIC FRUIT EXTRACTS USED IN THE PREPARATION OF BEVERAGES, NON-ALCOHOLIC FRUIT JUICE BEVERAGES, VEGETABLE JUICES, VEGETABLE-FRUIT JUICES AND SMOOTHIES; VEGETABLE DRINKS; VEGETABLE JUICE; VEGETABLE JUICES; VEGETABLE-FRUIT JUICES, IN CLASS 32 (U.S. CLS. 45, 46 AND 48).

FIRST USE 11-15-2010; IN COMMERCE 12-30-2011.

THE MARK CONSISTS OF STANDARD CHARACTERS WITHOUT CLAIM TO ANY PARTICULAR FONT, STYLE, SIZE, OR COLOR.

OWNER OF U.S. REG. NO. 3,523,499.

SN 85-236,195, FILED 2-7-2011.

ZHALEH DELANEY, EXAMINING ATTORNEY



*David J. Kyros*

Director of the United States Patent and Trademark Office

# United States of America

United States Patent and Trademark Office

## FIRST GEAR ACCOUNT

**Reg. No. 4,136,612**

MICHIGAN FIRST CREDIT UNION (MICHIGAN CREDIT UNION)  
27000 EVERGREEN ROAD  
LATHRUP VILLAGE, MI 48076

**Registered May 1, 2012**

**Int. Cl.: 36**

FOR: CREDIT UNION SERVICES, IN CLASS 36 (U.S. CLS. 100, 101 AND 102).

**SERVICE MARK**

FIRST USE 2-25-2011; IN COMMERCE 2-25-2011.

**PRINCIPAL REGISTER**

THE MARK CONSISTS OF STANDARD CHARACTERS WITHOUT CLAIM TO ANY PARTICULAR FONT, STYLE, SIZE, OR COLOR.

NO CLAIM IS MADE TO THE EXCLUSIVE RIGHT TO USE "ACCOUNT", APART FROM THE MARK AS SHOWN.

SN 85-236,340, FILED 2-8-2011.

PAM WILLIS, EXAMINING ATTORNEY



*David J. Kyffers*

Director of the United States Patent and Trademark Office

# United States of America

United States Patent and Trademark Office

## PERSONAL FREEDOM THROUGH FINANCIAL FREEDOM

**Reg. No. 4,136,613**

**Registered May 1, 2012**

**Int. Cl.: 9**

**TRADEMARK**

**PRINCIPAL REGISTER**

CASEY RESEARCH, LLC (COLORADO LIMITED LIABILITY COMPANY)  
C/O DIANA ETTLINGER  
201 NORTH MILL STREET, SUITE 201  
ASPEN, CO 81611

FOR: DOWNLOADABLE ELECTRONIC NEWSLETTERS IN THE FIELD OF FINANCIAL INVESTMENT, FINANCIAL ANALYSIS, GLOBAL FINANCIAL TRENDS, GEOPOLITICAL ISSUES, NATURAL RESOURCES AND EMERGING INVESTMENT OPPORTUNITIES, IN CLASS 9 (U.S. CLS. 21, 23, 26, 36 AND 38).

FIRST USE 1-26-2012; IN COMMERCE 1-26-2012.

THE MARK CONSISTS OF STANDARD CHARACTERS WITHOUT CLAIM TO ANY PARTICULAR FONT, STYLE, SIZE, OR COLOR.

SN 85-236,416, FILED 2-8-2011.

KATHERINE CONNOLLY, EXAMINING ATTORNEY



*David J. Kyffers*

Director of the United States Patent and Trademark Office

# United States of America

United States Patent and Trademark Office

## PERSONAL FREEDOM THROUGH FINANCIAL FREEDOM

**Reg. No. 4,136,614**

**Registered May 1, 2012**

**Int. Cl.: 41**

**SERVICE MARK**

**PRINCIPAL REGISTER**

CASEY RESEARCH, LLC (COLORADO LIMITED LIABILITY COMPANY)  
C/O DIANA ETTLINGER  
201 NORTH MILL ST., SUITE 201  
ASPEN, CO 81611

FOR: ONLINE PUBLICATIONS, NAMELY, ONLINE NEWSLETTERS IN THE FIELDS OF FINANCIAL INVESTMENT, FINANCIAL ANALYSIS, GLOBAL FINANCIAL TRENDS, GEOPOLITICAL ISSUES, NATURAL RESOURCES AND EMERGING INVESTMENT OPPORTUNITIES, IN CLASS 41 (U.S. CLS. 100, 101 AND 107).

FIRST USE 7-1-2011; IN COMMERCE 7-1-2011.

THE MARK CONSISTS OF STANDARD CHARACTERS WITHOUT CLAIM TO ANY PARTICULAR FONT, STYLE, SIZE, OR COLOR.

SN 85-236,417, FILED 2-8-2011.

KATHERINE CONNOLLY, EXAMINING ATTORNEY



*David J. Kyffers*

Director of the United States Patent and Trademark Office



# United States of America

United States Patent and Trademark Office

## PURE COMFORT

**Reg. No. 4,136,615**

**Registered May 1, 2012**

**Int. Cl.: 24**

**TRADEMARK**

**PRINCIPAL REGISTER**

SNA TEXTILE COMPANY, LLC (DELAWARE LIMITED LIABILITY COMPANY)  
701 GATEWAY BOULEVARD, SUITE 370  
SOUTH SAN FRANCISCO, CA 94080

FOR: BED LINEN; BED SHEETS; FITTED BED SHEETS; FLAT BED SHEETS; MATTRESS  
PADS; PILLOW CASES; SHEET SETS, IN CLASS 24 (U.S. CLS. 42 AND 50).

FIRST USE 1-1-2011; IN COMMERCE 1-1-2011.

THE MARK CONSISTS OF STANDARD CHARACTERS WITHOUT CLAIM TO ANY PAR-  
TICULAR FONT, STYLE, SIZE, OR COLOR.

SN 85-236,638, FILED 2-8-2011.

DOMINIC J. FERRAIUOLO, EXAMINING ATTORNEY



*David J. Kyffers*

Director of the United States Patent and Trademark Office

# United States of America

United States Patent and Trademark Office

# GENEME

**Reg. No. 4,136,616**

**Registered May 1, 2012**

**Int. Cls.: 3 and 5**

**TRADEMARK**

**PRINCIPAL REGISTER**

GENE ME LLC (KENTUCKY LIMITED LIABILITY COMPANY)  
SUITE 1500  
167 WEST MAIN STREET  
LEXINGTON, KY 40507

FOR: COSMETICS AND COSMETIC PREPARATIONS; SERUMS, NAMELY, BEAUTY SERUMS, NON-MEDICATED ANTI-AGING SERUM, NON-MEDICATED FACIAL AND EYE SERUM CONTAINING ANTIOXIDANTS, NON-MEDICATED HAIR SERUMS, NON-MEDICATED SERUMS FOR USE ON LIPS, AND NON-MEDICATED SKIN SERUMS, IN CLASS 3 (U.S. CLS. 1, 4, 6, 50, 51 AND 52).

FIRST USE 9-30-2011; IN COMMERCE 9-30-2011.

FOR: NUTRITIONAL SUPPLEMENTS; VITAMINS, IN CLASS 5 (U.S. CLS. 6, 18, 44, 46, 51 AND 52).

FIRST USE 9-30-2011; IN COMMERCE 9-30-2011.

THE MARK CONSISTS OF STANDARD CHARACTERS WITHOUT CLAIM TO ANY PARTICULAR FONT, STYLE, SIZE, OR COLOR.

SN 85-236,653, FILED 2-8-2011.

DOMINIC J. FERRAIUOLO, EXAMINING ATTORNEY



*David J. Kybas*

Director of the United States Patent and Trademark Office

# United States of America

United States Patent and Trademark Office

# Croneez

**Reg. No. 4,136,617**

**Registered May 1, 2012**

**Int. Cl.: 28**

**TRADEMARK**

**PRINCIPAL REGISTER**

NICNO LLC (PENNSYLVANIA LIMITED LIABILITY COMPANY)  
208 PRIMROSE LANE  
MAPLE GLEN, PA 19002

FOR: COLLECTABLE TOY FIGURES; TOYS, NAMELY, A DISK TO TOSS IN PLAYING A GAME WHEREIN OTHER DISKS ARE FLIPPED AND COLLECTED, IN CLASS 28 (U.S. CLS. 22, 23, 38 AND 50).

FIRST USE 2-13-2011; IN COMMERCE 2-13-2011.

THE MARK CONSISTS OF STANDARD CHARACTERS WITHOUT CLAIM TO ANY PARTICULAR FONT, STYLE, SIZE, OR COLOR.

SN 85-237,135, FILED 2-8-2011.

REBECCA GILBERT, EXAMINING ATTORNEY



*David J. Kyffers*

Director of the United States Patent and Trademark Office

# United States of America

United States Patent and Trademark Office

# PAIRFET

**Reg. No. 4,136,618**

**Registered May 1, 2012**

**Int. Cl.: 9**

**TRADEMARK**

**PRINCIPAL REGISTER**

ALPHA AND OMEGA SEMICONDUCTOR INCORPORATED (CALIFORNIA CORPORATION)  
475 OAKMEAD PARKWAY  
SUNNYVALE, CA 94085

FOR: CHIP CARRIERS, NAMELY, SEMICONDUCTOR CHIP HOUSINGS; SEMICONDUCTOR CHIPS; SEMICONDUCTOR DEVICES; SEMICONDUCTOR POWER ELEMENTS; SEMICONDUCTORS; VERY LARGE SCALE INTEGRATION (VLSI) SEMICONDUCTOR INTEGRATED CIRCUITS, IN CLASS 9 (U.S. CLS. 21, 23, 26, 36 AND 38).

FIRST USE 2-2-2011; IN COMMERCE 9-5-2011.

THE MARK CONSISTS OF STANDARD CHARACTERS WITHOUT CLAIM TO ANY PARTICULAR FONT, STYLE, SIZE, OR COLOR.

SN 85-237,321, FILED 2-8-2011.

DANNEAN HETZEL, EXAMINING ATTORNEY



*David J. Kyjars*

Director of the United States Patent and Trademark Office

# United States of America

United States Patent and Trademark Office

# SUPRALUBE

**Reg. No. 4,136,619**

**Registered May 1, 2012**

**Int. Cl.: 4**

**TRADEMARK**

**PRINCIPAL REGISTER**

ALLIANCE SALES & MARKETING, LLC (PENNSYLVANIA LIMITED LIABILITY COMPANY)  
6 GEOFFREY ROAD  
FAIRLESS HILLS, PA 19030

FOR: LUBRICANTS FOR INDUSTRIAL MACHINERY, IN CLASS 4 (U.S. CLS. 1, 6 AND 15).

FIRST USE 6-6-2011; IN COMMERCE 6-6-2011.

THE MARK CONSISTS OF STANDARD CHARACTERS WITHOUT CLAIM TO ANY PARTICULAR FONT, STYLE, SIZE, OR COLOR.

SN 85-237,504, FILED 2-9-2011.

ELI HELLMAN, EXAMINING ATTORNEY



*David J. Kybas*

Director of the United States Patent and Trademark Office

# United States of America

United States Patent and Trademark Office

uVu

**Reg. No. 4,136,620**

**Registered May 1, 2012**

**Int. Cl.: 20**

**TRADEMARK**

**PRINCIPAL REGISTER**

WEISS, DAVID (UNITED STATES INDIVIDUAL)  
151 N. NOB HILL ROAD, SUITE 233  
PLANTATION, FL 33324

FOR: PLASTIC LIDS, IN CLASS 20 (U.S. CLS. 2, 13, 22, 25, 32 AND 50).

FIRST USE 6-1-2011; IN COMMERCE 6-1-2011.

THE MARK CONSISTS OF STANDARD CHARACTERS WITHOUT CLAIM TO ANY PARTICULAR FONT, STYLE, SIZE, OR COLOR.

SN 85-237,632, FILED 2-9-2011.

GEOFFREY FOSDICK, EXAMINING ATTORNEY



*David J. Kybas*

Director of the United States Patent and Trademark Office

# United States of America

United States Patent and Trademark Office

# ROCKETTE

**Reg. No. 4,136,621**

**Registered May 1, 2012**

**Int. Cl.: 31**

**TRADEMARK**

**PRINCIPAL REGISTER**

AMERINOVA PROPERTIES, LLC (CALIFORNIA LIMITED LIABILITY COMPANY)  
32149 AQUEDUCT ROAD  
BONSALL, CA 92003

FOR: LIVE PLANTS, IN CLASS 31 (U.S. CLS. 1 AND 46).

FIRST USE 4-1-2011; IN COMMERCE 4-1-2011.

THE MARK CONSISTS OF STANDARD CHARACTERS WITHOUT CLAIM TO ANY PARTICULAR FONT, STYLE, SIZE, OR COLOR.

SN 85-237,989, FILED 2-9-2011.

NICHOLAS ALTREE, EXAMINING ATTORNEY



*David J. Kybas*

Director of the United States Patent and Trademark Office

# United States of America

United States Patent and Trademark Office

# SWANKLE

**Reg. No. 4,136,622**

**Registered May 1, 2012**

**Int. Cls.: 10 and 20**

**TRADEMARK**

**PRINCIPAL REGISTER**

LEACHCO, INC. (OKLAHOMA CORPORATION)  
130 E. 10TH STREET  
ADA, OK 74820

FOR: WEDGE SHAPED ELEVATION PILLOW USED ON OR UNDER A MATTRESS TO RAISE THE HEAD OR FOOT OF THE MATTRESS FOR THERAPEUTIC PURPOSES, IN CLASS 10 (U.S. CLS. 26, 39 AND 44).

FIRST USE 2-7-2012; IN COMMERCE 2-7-2012.

FOR: WEDGE SHAPED ELEVATION PILLOW USED ON TOP OF A MATTRESS OR BED TO ELEVATE THE HEAD OR FEET, OR USED UNDER A MATTRESS TO RAISE THE HEAD OR FOOT OF THE MATTRESS, OR AS A STUDY OR READING PILLOW, IN CLASS 20 (U.S. CLS. 2, 13, 22, 25, 32 AND 50).

FIRST USE 2-7-2012; IN COMMERCE 2-7-2012.

THE MARK CONSISTS OF STANDARD CHARACTERS WITHOUT CLAIM TO ANY PARTICULAR FONT, STYLE, SIZE, OR COLOR.

SN 85-238,131, FILED 2-9-2011.

REBECCA SMITH, EXAMINING ATTORNEY



*David J. Kyros*

Director of the United States Patent and Trademark Office



# United States of America

United States Patent and Trademark Office

## TD CHECKING CHECK-UP

**Reg. No. 4,136,623**

**Registered May 1, 2012**

**Int. Cl.: 36**

**SERVICE MARK**

**PRINCIPAL REGISTER**

THE TORONTO-DOMINION BANK (CANADA CHARTERED BANK)  
12TH FLOOR  
66 WELLINGTON STREET  
TORONTO, CANADA M5K1A2

FOR: FINANCIAL ADVISORY SERVICES, IN CLASS 36 (U.S. CLS. 100, 101 AND 102).

FIRST USE 3-20-2011; IN COMMERCE 3-20-2011.

THE MARK CONSISTS OF STANDARD CHARACTERS WITHOUT CLAIM TO ANY PARTICULAR FONT, STYLE, SIZE, OR COLOR.

OWNER OF U.S. REG. NOS. 1,649,009, 3,891,532, AND OTHERS.

NO CLAIM IS MADE TO THE EXCLUSIVE RIGHT TO USE "CHECKING", APART FROM THE MARK AS SHOWN.

SN 85-238,181, FILED 2-9-2011.

TINA L. SNAPP, EXAMINING ATTORNEY



*David J. Kybas*

Director of the United States Patent and Trademark Office

# United States of America

United States Patent and Trademark Office



**Reg. No. 4,136,624**

**Registered May 1, 2012**

**Int. Cl.: 41**

**SERVICE MARK**

**PRINCIPAL REGISTER**

4F INVESTMENTS PTY LIMITED (AUSTRALIA COMPANY)  
SUITE 2, LEVEL 12  
75 ELIZABETH STREET  
SYDNEY, NSW, AUSTRALIA 2000

FOR: GAMBLING SERVICES, INCLUDING OPERATING CASINO GAMES, IN CLASS 41  
(U.S. CLS. 100, 101 AND 107).

FIRST USE 7-31-2011; IN COMMERCE 7-31-2011.

NO CLAIM IS MADE TO THE EXCLUSIVE RIGHT TO USE "KING HIGH POKER", APART  
FROM THE MARK AS SHOWN.

THE COLOR(S) YELLOW, RED AND BLACK IS/ARE CLAIMED AS A FEATURE OF THE  
MARK.

THE MARK CONSISTS OF A SHAPE OF A YELLOW CROWN, THE WORDS "KING HIGH"  
ARE DISPOSED IN BLACK ON THE INSIDE OF THE CROWN, THE WORD "POKER" IS  
LOCATED IN BLACK UNDER THE WORDS "KING HIGH", A RED HEART IS LOCATED  
BETWEEN THE "P" AND THE "O" IN THE WORD "POKER", A BLACK CLUB IS LOCATED  
BETWEEN THE "O" AND THE "K" IN THE WORD "POKER", A RED DIAMOND IS LOCATED  
BETWEEN THE "K" AND THE "E" IN THE WORD "POKER", AND A BLACK SPADE IS  
LOCATED BETWEEN THE "E" AND THE "R" IN THE WORD "POKER", AND A BLACK  
OUTLINE SURROUNDS THE SHAPE OF THE CROWN.

SN 85-238,189, FILED 2-9-2011.

ANDREW LEASER, EXAMINING ATTORNEY



*David J. Kybas*

Director of the United States Patent and Trademark Office

# United States of America

United States Patent and Trademark Office

# OO.COM

**Reg. No. 4,136,625**

**Registered May 1, 2012**

**Int. Cl.: 35**

**SERVICE MARK**

**PRINCIPAL REGISTER**

NEXT JUMP, INC. (DELAWARE CORPORATION)  
261 FIFTH AVENUE, 8TH FLOOR  
NEW YORK, NY 10016

FOR: DEVELOPING, IMPLEMENTING, ADMINISTERING AND SUPERVISING REWARDS, LOYALTY, INCENTIVE AND AFFINITY PROGRAMS FOR BUSINESSES WHO OFFER SUCH PROGRAMS TO OTHERS; DEVELOPING, IMPLEMENTING, ADMINISTERING AND SUPERVISING ADVERTISING AND MARKETING CAMPAIGNS FOR OTHERS, IN CLASS 35 (U.S. CLS. 100, 101 AND 102).

FIRST USE 4-1-2011; IN COMMERCE 4-1-2011.

THE MARK CONSISTS OF STANDARD CHARACTERS WITHOUT CLAIM TO ANY PARTICULAR FONT, STYLE, SIZE, OR COLOR.

SN 85-238,307, FILED 2-9-2011.

SHAUNIA CARLYLE, EXAMINING ATTORNEY



*David J. Kybas*

Director of the United States Patent and Trademark Office

# United States of America

United States Patent and Trademark Office

## We're The Good Guys

**Reg. No. 4,136,626**

**Registered May 1, 2012**

**Int. Cl.: 36**

**SERVICE MARK**

**PRINCIPAL REGISTER**

AURORA PROCESSING, LLC (DELAWARE LIMITED LIABILITY COMPANY)  
43 WASHINGTON DRIVE  
CRANBURY, NJ 08512

FOR: ATM BANKING SERVICES; CASH ADVANCE SERVICES FOR BUSINESSES AND MERCHANTS; CHARGE CARD AND CREDIT CARD SERVICES; CREDIT CARD AND DEBIT CARD SERVICES; CREDIT CARD AND PAYMENT CARD SERVICES; CREDIT CARD AUTHORIZATION SERVICES; CREDIT CARD FACTORING SERVICES; CREDIT CARD PAYMENT PROCESSING SERVICES; CREDIT CARD SERVICES; CREDIT CARD TRANSACTION PROCESSING SERVICES; CREDIT CARD VERIFICATION; ELECTRONIC CREDIT CARD TRANSACTIONS; FINANCIAL ADVISORY AND CONSULTANCY SERVICES; FINANCIAL SERVICES, NAMELY, FUNDING ONLINE CASH ACCOUNTS FROM PREPAID CASH CARDS, BANK ACCOUNTS AND CREDIT CARD ACCOUNTS; PAYMENT PROCESSING SERVICES, NAMELY, CREDIT CARD AND DEBIT CARD TRANSACTION PROCESSING SERVICES, IN CLASS 36 (U.S. CLS. 100, 101 AND 102).

FIRST USE 9-15-2010; IN COMMERCE 1-19-2011.

THE MARK CONSISTS OF STANDARD CHARACTERS WITHOUT CLAIM TO ANY PARTICULAR FONT, STYLE, SIZE, OR COLOR.

SN 85-238,311, FILED 2-9-2011.

NAAKWAMA ANKRAH, EXAMINING ATTORNEY



*David J. Kyffers*

Director of the United States Patent and Trademark Office

# United States of America

United States Patent and Trademark Office

# AURORA

**Reg. No. 4,136,627**

**Registered May 1, 2012**

**Int. Cl.: 36**

**SERVICE MARK**

**PRINCIPAL REGISTER**

AURORA PROCESSING, LLC (DELAWARE LIMITED LIABILITY COMPANY)  
43 WASHINGTON DRIVE  
CRANBURY, NJ 08512

FOR: ATM BANKING SERVICES; CASH ADVANCE SERVICES FOR BUSINESSES AND MERCHANTS; CHARGE CARD AND CREDIT CARD SERVICES; CREDIT CARD AND DEBIT CARD SERVICES; CREDIT CARD AND PAYMENT CARD SERVICES; CREDIT CARD AUTHORIZATION SERVICES; CREDIT CARD FACTORING SERVICES; CREDIT CARD PAYMENT PROCESSING SERVICES; CREDIT CARD SERVICES; CREDIT CARD TRANSACTION PROCESSING SERVICES; CREDIT CARD VERIFICATION; ELECTRONIC CREDIT CARD TRANSACTIONS; FINANCIAL ADVISORY AND CONSULTANCY SERVICES; FINANCIAL SERVICES, NAMELY, FUNDING ONLINE CASH ACCOUNTS FROM PREPAID CASH CARDS, BANK ACCOUNTS AND CREDIT CARD ACCOUNTS; PAYMENT PROCESSING SERVICES, NAMELY, CREDIT CARD AND DEBIT CARD TRANSACTION PROCESSING SERVICES, IN CLASS 36 (U.S. CLS. 100, 101 AND 102).

FIRST USE 9-15-2010; IN COMMERCE 2-8-2011.

THE MARK CONSISTS OF STANDARD CHARACTERS WITHOUT CLAIM TO ANY PARTICULAR FONT, STYLE, SIZE, OR COLOR.

SN 85-238,316, FILED 2-9-2011.

NAAKWAMA ANKRAH, EXAMINING ATTORNEY



*David J. Kyffers*

Director of the United States Patent and Trademark Office

# United States of America

United States Patent and Trademark Office

**TIGHT ♥ TOPZ**

**Reg. No. 4,136,628**

**Registered May 1, 2012**

**Int. Cl.: 25**

**TRADEMARK**

**PRINCIPAL REGISTER**

HILLIARD, DEIRDRE (UNITED STATES INDIVIDUAL)  
1620 N. M.L.KING BLVD.  
TALLAHASSEE, FL 32303

FOR: TIGHTS, IN CLASS 25 (U.S. CLS. 22 AND 39).

FIRST USE 12-23-2008; IN COMMERCE 9-25-2009.

SN 85-238,415, FILED 2-9-2011.

SUSAN STIGLITZ, EXAMINING ATTORNEY

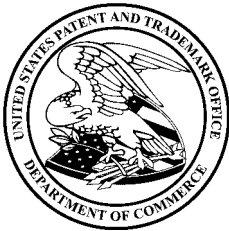

*David J. Kyffers*

Director of the United States Patent and Trademark Office

# United States of America

United States Patent and Trademark Office

# Illustrion

**Reg. No. 4,136,629**

LLEWELLYN, THOMAS (UNITED STATES INDIVIDUAL)  
6347 FARM HILL WAY  
SAN JOSE, CA 95120

**Registered May 1, 2012**

**Int. Cl.: 42**

FOR: GRAPHIC DESIGN SERVICES; GRAPHIC ILLUSTRATION SERVICES FOR OTHERS,  
IN CLASS 42 (U.S. CLS. 100 AND 101).

**SERVICE MARK**

FIRST USE 9-15-2011; IN COMMERCE 9-15-2011.

**PRINCIPAL REGISTER**

THE MARK CONSISTS OF STANDARD CHARACTERS WITHOUT CLAIM TO ANY PAR-  
TICULAR FONT, STYLE, SIZE, OR COLOR.

SN 85-238,927, FILED 2-10-2011.

VERNA BETH RIRIE, EXAMINING ATTORNEY



*David J. Kyffers*

Director of the United States Patent and Trademark Office

# United States of America

United States Patent and Trademark Office

# TXBCARDIO

**Reg. No. 4,136,630**

**Registered May 1, 2012**

**Int. Cl.: 5**

**TRADEMARK**

**PRINCIPAL REGISTER**

CORGENIX MEDICAL CORPORATION (NEVADA CORPORATION)  
11575 MAIN STREET, SUITE 400  
BROOMFIELD, CO 80020

FOR: MEDICAL DIAGNOSTIC TEST KITS CONSISTING PRIMARILY OF REAGENTS AND OTHER CHEMICALS, WHICH DETECT THE PRESENCE OF IMMUNE COMPLEXES IN BODY FLUIDS , IN CLASS 5 (U.S. CLS. 6, 18, 44, 46, 51 AND 52).

FIRST USE 11-16-2011; IN COMMERCE 11-16-2011.

THE MARK CONSISTS OF STANDARD CHARACTERS WITHOUT CLAIM TO ANY PARTICULAR FONT, STYLE, SIZE, OR COLOR.

SN 85-239,282, FILED 2-10-2011.

AMY HELLA, EXAMINING ATTORNEY



*David J. Kybas*

Director of the United States Patent and Trademark Office



# United States of America

United States Patent and Trademark Office

MAKE AN ENTIRE WEEK'S  
WORTH OF HEALTHY  
ALL-NATURAL BABY FOOD... IN  
LESS THAN 5 MINUTES!

**Reg. No. 4,136,631**

**Registered May 1, 2012**

**Int. Cl.: 7**

**TRADEMARK**

**PRINCIPAL REGISTER**

HOMELAND HOUSEWARES, LLC (CALIFORNIA LIMITED LIABILITY COMPANY)  
11755 WILSHIRE BLVD  
SUITE 1200  
LOS ANGELES, CA 90025

FOR: KITCHEN APPLIANCES, NAMELY, ELECTRONIC FOOD BLENDERS, IN CLASS 7  
(U.S. CLS. 13, 19, 21, 23, 31, 34 AND 35).

FIRST USE 9-19-2010; IN COMMERCE 9-19-2010.

THE MARK CONSISTS OF STANDARD CHARACTERS WITHOUT CLAIM TO ANY PARTICULAR FONT, STYLE, SIZE, OR COLOR.

SN 85-239,332, FILED 2-10-2011.

BENJAMIN OKEKE, EXAMINING ATTORNEY



*David J. Kybas*

Director of the United States Patent and Trademark Office

# United States of America

United States Patent and Trademark Office

# VERSY

**Reg. No. 4,136,632**

VERSY PILLOW LLC (TEXAS LIMITED LIABILITY COMPANY)  
PO BOX 162  
GOODRICH, TX 77335

**Registered May 1, 2012**

**Int. Cl.: 20**

FOR: DUAL-PURPOSE CUSHIONS FOR SUPPORTING A FEEDING BOTTLE AND THE HEAD AND NECK OF AN INFANT, IN CLASS 20 (U.S. CLS. 2, 13, 22, 25, 32 AND 50).

**TRADEMARK**

FIRST USE 1-24-2012; IN COMMERCE 1-24-2012.

**PRINCIPAL REGISTER**

THE MARK CONSISTS OF STANDARD CHARACTERS WITHOUT CLAIM TO ANY PARTICULAR FONT, STYLE, SIZE, OR COLOR.

SN 85-239,408, FILED 2-10-2011.

JILL C. ALT, EXAMINING ATTORNEY



*David J. Kybas*

Director of the United States Patent and Trademark Office

# United States of America

United States Patent and Trademark Office



**Reg. No. 4,136,633**

**Registered May 1, 2012**

**Int. Cl.: 12**

**TRADEMARK**

**PRINCIPAL REGISTER**

QIU YAO LIANG (CHINA INDIVIDUAL)  
NO. 115, MA LI XI NEW DISTRICT  
GUAN LAN, SHENZHEN, CHINA

FOR: BICYCLE CHAINS; BICYCLE GEARS; BICYCLE PARTS, NAMELY, HANDLE BARS;  
BICYCLE SADDLES; BICYCLE STANDS; BICYCLES; MOTOR CYCLES; PARTS OF MO-  
TORCYCLES, NAMELY, HANDLE BARS; RIMS FOR BICYCLE WHEELS; TIRES, IN CLASS  
12 (U.S. CLS. 19, 21, 23, 31, 35 AND 44).

FIRST USE 1-4-2006; IN COMMERCE 1-1-2011.

THE MARK CONSISTS OF THE STYLIZED WORD "GUB".

THE WORDING "GUB" HAS NO MEANING IN A FOREIGN LANGUAGE.

SN 85-239,529, FILED 2-10-2011.

MARK SPARACINO, EXAMINING ATTORNEY



*David J. Kybas*

Director of the United States Patent and Trademark Office

# United States of America

United States Patent and Trademark Office

## THE HENRI NOUWEN SPIRITUALITY SERIES

**Reg. No. 4,136,634**

**Registered May 1, 2012**

**Int. Cl.: 9**

**TRADEMARK**

**PRINCIPAL REGISTER**

THE UPPER ROOM (TENNESSEE NON-PROFIT CORPORATION)  
P.O. BOX 340004  
NASHVILLE, TN 372030004

FOR: DOWNLOADABLE ELECTRONIC PUBLICATIONS IN THE NATURE OF BOOKS IN THE FIELD OF CHRISTIANITY, CHRISTIAN, RELIGIOUS AND SPIRITUAL DEVELOPMENT, CHRISTIAN, RELIGIOUS AND SPIRITUAL MINISTRY, CONGREGATIONAL, INSPIRATIONAL AND RELIGIOUS PROGRAMS, DEVOTIONAL TOPICS, PERSONAL DEVELOPMENT, PERSONAL PIETY, PERSONAL TRANSFORMATION, PRAYER, RELIGION, RELIGIOUS CONGREGATIONS, RELIGIOUS EDUCATION, SPIRITUALITY, AND SPIRITUAL GROWTH, IN CLASS 9 (U.S. CLS. 21, 23, 26, 36 AND 38).

FIRST USE 2-1-2011; IN COMMERCE 1-4-2012.

THE MARK CONSISTS OF STANDARD CHARACTERS WITHOUT CLAIM TO ANY PARTICULAR FONT, STYLE, SIZE, OR COLOR.

NO CLAIM IS MADE TO THE EXCLUSIVE RIGHT TO USE "SPIRITUALITY SERIES", APART FROM THE MARK AS SHOWN.

THE NAME(S), PORTRAIT(S), AND/OR SIGNATURE(S) SHOWN IN THE MARK DOES NOT IDENTIFY A PARTICULAR LIVING INDIVIDUAL.

SN 85-239,558, FILED 2-10-2011.

WILLIAM VERHOSEK, EXAMINING ATTORNEY



*David J. Kybas*

Director of the United States Patent and Trademark Office

# United States of America

United States Patent and Trademark Office

## Can you walk the walk

**Reg. No. 4,136,635**

**Registered May 1, 2012**

**Int. Cl.: 42**

**SERVICE MARK**

**PRINCIPAL REGISTER**

DEVSSQUARE INC (NEW JERSEY CORPORATION)  
33, WOODS AVENUE SOUTH, 6TH FLOOR,  
ISELIN,, NJ 08830

FOR: DESIGN OF COMPUTER NETWORKS AND SOFTWARE FOR OTHERS FOR THE TESTING, ASSESSMENT AND CERTIFICATION OF PROFESSIONAL SKILLS; TESTING, ANALYSIS AND EVALUATION OF THE SERVICES OF OTHERS FOR THE PURPOSE OF CERTIFICATION, IN CLASS 42 (U.S. CLS. 100 AND 101).

FIRST USE 10-1-2010; IN COMMERCE 10-1-2010.

THE MARK CONSISTS OF STANDARD CHARACTERS WITHOUT CLAIM TO ANY PARTICULAR FONT, STYLE, SIZE, OR COLOR.

SN 85-239,617, FILED 2-11-2011.

HENRY S. ZAK, EXAMINING ATTORNEY



*David J. Kyffers*

Director of the United States Patent and Trademark Office

# United States of America

United States Patent and Trademark Office

## PURPLE COW ORGANICS

**Reg. No. 4,136,636**

**Registered May 1, 2012**

**Int. Cl.: 1**

**TRADEMARK**

**PRINCIPAL REGISTER**

SYBURG, JAMES (UNITED STATES INDIVIDUAL)  
W360 N8515 BROWN STREET  
OCONOMOWOC, WI 53066

FOR: ORGANIC COMPOST, IN CLASS 1 (U.S. CLS. 1, 5, 6, 10, 26 AND 46).

FIRST USE 2-1-2011; IN COMMERCE 2-1-2011.

THE MARK CONSISTS OF STANDARD CHARACTERS WITHOUT CLAIM TO ANY PARTICULAR FONT, STYLE, SIZE, OR COLOR.

NO CLAIM IS MADE TO THE EXCLUSIVE RIGHT TO USE "ORGANICS", APART FROM THE MARK AS SHOWN.

SN 85-239,629, FILED 2-11-2011.

TINA L. SNAPP, EXAMINING ATTORNEY



*David J. Kyffers*

Director of the United States Patent and Trademark Office

# United States of America

United States Patent and Trademark Office

# FILLOOKIE

**Reg. No. 4,136,637**

**Registered May 1, 2012**

**Int. Cl.: 30**

**TRADEMARK**

**PRINCIPAL REGISTER**

CHUDLEIGH'S LTD. (CANADA CORPORATION)  
8501 CHUDLEIGH WAY  
MILTON, ONTARIO, CANADA L9T0L9

FOR: COOKIES, IN CLASS 30 (U.S. CL. 46).

FIRST USE 3-25-2010; IN COMMERCE 3-25-2010.

THE MARK CONSISTS OF STANDARD CHARACTERS WITHOUT CLAIM TO ANY PARTICULAR FONT, STYLE, SIZE, OR COLOR.

SN 85-239,704, FILED 2-11-2011.

WENDY JUN, EXAMINING ATTORNEY



*David J. Kybas*

Director of the United States Patent and Trademark Office

# United States of America

United States Patent and Trademark Office

## MY FIRST PROJECT

**Reg. No. 4,136,638**

WOODCRAFT SUPPLY, LLC (WEST VIRGINIA LIMITED LIABILITY COMPANY)  
1177 ROSEMAR ROAD  
PARKERSBURG, WV 26012

**Registered May 1, 2012**

**Int. Cl.: 16**

FOR: PRINTED INSTRUCTIONAL, EDUCATIONAL, AND TEACHING MATERIALS IN THE FIELD OF WOODWORKING, IN CLASS 16 (U.S. CLS. 2, 5, 22, 23, 29, 37, 38 AND 50).

**TRADEMARK**

FIRST USE 2-28-2011; IN COMMERCE 2-28-2011.

**PRINCIPAL REGISTER**

THE MARK CONSISTS OF STANDARD CHARACTERS WITHOUT CLAIM TO ANY PARTICULAR FONT, STYLE, SIZE, OR COLOR.

OWNER OF U.S. REG. NO. 2,932,464.

SN 85-239,806, FILED 2-11-2011.

PRISCILLA MILTON, EXAMINING ATTORNEY



*David J. Kybas*

Director of the United States Patent and Trademark Office



# United States of America

United States Patent and Trademark Office

## BDiACCESS

**Reg. No. 4,136,639**

**Registered May 1, 2012**

**Int. Cls.: 35 and 36**

**SERVICE MARK**

**PRINCIPAL REGISTER**

BDI PHARMA, INC. (SOUTH CAROLINA CORPORATION)  
120 RESEARCH DRIVE  
GREENVILLE, SC 29203

FOR: STRATEGIC BUSINESS PLANNING AND CONSULTATION IN THE FIELD OF REIMBURSEMENT SUPPORT FOR PHARMACEUTICAL AND BIOTECHNOLOGY PRODUCTS; ADMINISTERING PHARMACEUTICAL AND BIOTECHNOLOGY REIMBURSEMENT SUPPORT PROGRAMS AND SERVICES, IN CLASS 35 (U.S. CLS. 100, 101 AND 102).

FIRST USE 4-1-2011; IN COMMERCE 4-1-2011.

FOR: STRATEGIC REIMBURSEMENT SUPPORT SERVICES, NAMELY, TELEPHONE HOT LINE COUNSELING FOR PHYSICIANS AND HOSPITALS, OFFERING ADVICE REGARDING CLAIMS AND INSURANCE COVERAGE; STRATEGIC REIMBURSEMENT SUPPORT SERVICES, NAMELY, TELEPHONE HOT LINE COUNSELING FOR PHYSICIANS AND HOSPITALS, OFFERING ADVICE REGARDING BILLING, IN CLASS 36 (U.S. CLS. 100, 101 AND 102).

FIRST USE 4-1-2011; IN COMMERCE 4-1-2011.

THE MARK CONSISTS OF THE TERM "BDIACCESS" INCLUDING A DOT DESIGNS WITHIN THE TERM INCLUDING NEXT TO THE LETTERS "I", "C" AND "S".

SN 85-239,874, FILED 2-11-2011.

MARGERY A. TIERNEY, EXAMINING ATTORNEY



*David J. Kybas*

Director of the United States Patent and Trademark Office

# United States of America

United States Patent and Trademark Office

## BOMGAR BUTTON

**Reg. No. 4,136,640**

**Registered May 1, 2012**

**Int. Cl.: 9**

**TRADEMARK**

**PRINCIPAL REGISTER**

BOMGAR CORPORATION (MISSISSIPPI CORPORATION)  
PARAGON CENTRE, SUITE 300  
578 HIGHLAND COLONY PARKWAY  
RIDGELAND, MS 39157

FOR: COMPUTER SOFTWARE, NAMELY, COMPUTER SOFTWARE FOR USE IN ACCESSING, USING AND CONTROLLING REMOTE COMPUTER SYSTEMS, SOFTWARE AND HANDHELD ELECTRONIC DEVICES; COMPUTER SOFTWARE FOR USE IN MONITORING, DIAGNOSING AND TROUBLESHOOTING REMOTE COMPUTER SYSTEMS AND SOFTWARE; COMPUTER SOFTWARE FOR USE IN ADMINISTERING AND AUDITING COMPUTER SYSTEMS AND SOFTWARE; COMPUTER SOFTWARE FOR USE IN DELIVERING AND DEPLOYING SOFTWARE APPLICATIONS AND DATA OVER THE INTERNET AND/OR TO REMOTE USERS; COMPUTER SOFTWARE FOR USE IN EDUCATING REMOTE USERS CONCERNING THE USE OF COMPUTER SOFTWARE; COMPUTER SOFTWARE FOR USE IN INSTALLING AND UNINSTALLING COMPUTER SOFTWARE, IN CLASS 9 (U.S. CLS. 21, 23, 26, 36 AND 38).

FIRST USE 11-21-2008; IN COMMERCE 11-21-2008.

THE MARK CONSISTS OF STANDARD CHARACTERS WITHOUT CLAIM TO ANY PARTICULAR FONT, STYLE, SIZE, OR COLOR.

OWNER OF U.S. REG. NOS. 3,558,116 AND 3,558,117.

SN 85-240,007, FILED 2-11-2011.

JOHN HWANG, EXAMINING ATTORNEY



*David J. Kyros*

Director of the United States Patent and Trademark Office

# United States of America

United States Patent and Trademark Office

## THE CHOSEN MINT

**Reg. No. 4,136,641**

**Registered May 1, 2012**

**Int. Cl.: 30**

**TRADEMARK**

**PRINCIPAL REGISTER**

CJ GLOBAL, INC. (NEW YORK CORPORATION)  
C/O FRANKFURT KURNIT KLEIN & SELZ PC  
488 MADISON AVENUE  
NEW YORK, NY 10022

FOR: CANDY, NAMELY, MINTS, IN CLASS 30 (U.S. CL. 46).

FIRST USE 12-0-2011; IN COMMERCE 12-0-2011.

THE MARK CONSISTS OF STANDARD CHARACTERS WITHOUT CLAIM TO ANY PARTICULAR FONT, STYLE, SIZE, OR COLOR.

NO CLAIM IS MADE TO THE EXCLUSIVE RIGHT TO USE "MINT", APART FROM THE MARK AS SHOWN.

SN 85-240,366, FILED 2-11-2011.

CHRISTINA SOBRAL, EXAMINING ATTORNEY



*David J. Kybas*

Director of the United States Patent and Trademark Office

# United States of America

United States Patent and Trademark Office

# SuppShot

**Reg. No. 4,136,642**

**Registered May 1, 2012**

**Int. Cl.: 9**

**TRADEMARK**

**PRINCIPAL REGISTER**

SUPLASERVE, CORP (CALIFORNIA CORPORATION)  
SUITE 260  
4125 BLACKHAWK PLAZA CIRCLE  
DANVILLE, CA 94506

FOR: MECHANICAL DEVICES, NAMELY, DISPENSERS OF PRESET PORTIONS OF FLUIDS, SOLID GRANULES AND POWDER FOR DOSING PURPOSES, ALL NOT FOR MEDICAL USE, IN CLASS 9 (U.S. CLS. 21, 23, 26, 36 AND 38).

FIRST USE 5-1-2011; IN COMMERCE 1-1-2012.

THE MARK CONSISTS OF STANDARD CHARACTERS WITHOUT CLAIM TO ANY PARTICULAR FONT, STYLE, SIZE, OR COLOR.

SN 85-240,393, FILED 2-11-2011.

GRETТА YAO, EXAMINING ATTORNEY



*David J. Kybas*

Director of the United States Patent and Trademark Office

# United States of America

United States Patent and Trademark Office

# IDB Access

**Reg. No. 4,136,643**

**Registered May 1, 2012**

**Int. Cl.: 36**

**SERVICE MARK**

**PRINCIPAL REGISTER**

ISRAEL DISCOUNT BANK OF NEW YORK (NEW YORK CORPORATION)  
511 FIFTH AVENUE  
NEW YORK, NY 10017

FOR: BANKING SERVICES, IN CLASS 36 (U.S. CLS. 100, 101 AND 102).

FIRST USE 1-31-2012; IN COMMERCE 1-31-2012.

OWNER OF U.S. REG. NOS. 1,208,988, 2,515,109, AND OTHERS.

THE MARK CONSISTS OF "IDB ACCESS" IN STYLIZED FONT.

SN 85-240,459, FILED 2-11-2011.

TINA BROWN, EXAMINING ATTORNEY



*David J. Kybas*

Director of the United States Patent and Trademark Office

# United States of America

United States Patent and Trademark Office

## SIENTE EL AZUL

**Reg. No. 4,136,644**

**Registered May 1, 2012**

**Int. Cl.: 25**

**TRADEMARK**

**PRINCIPAL REGISTER**

JUNIOR DE MÉXICO (MEXICO SOCIEDAD ANONIMA (SA DE CV))  
TORRE INTÉLISIS PISO 15 COL. LOMAS ALTAS  
PASEO DE LA REFORMA NO. 2654  
MEXICO CITY, MEXICO 11950

FOR: BELTS, FOOTWEAR, SWIMWEAR, HATS, CAPS, APPAREL AND OUTERWEAR, NAMELY, BATHING SUITS, BATHING TRUNKS, BEACHWEAR, BIKINIS, BLOUSES, BOOTS, PANTS, COATS, DRESSES, GLOVES, HEADWEAR, JACKETS, JEANS, NECKWEAR, PANTS, SANDALS, SCARVES, SHAWLS, SHIRTS, SHOES, SHORTS, SKIRTS, SNEAKERS, SWEAT PANTS, SWEATSHIRTS, T-SHIRTS, TOPS, TANK TOPS, VESTS, IN CLASS 25 (U.S. CLS. 22 AND 39).

FIRST USE 1-3-2012; IN COMMERCE 1-3-2012.

THE MARK CONSISTS OF STANDARD CHARACTERS WITHOUT CLAIM TO ANY PARTICULAR FONT, STYLE, SIZE, OR COLOR.

THE ENGLISH TRANSLATION OF "SIENTE EL AZUL" IN THE MARK IS "FEEL THE BLUE".

SN 85-240,545, FILED 2-11-2011.

ALLISON SCHRODY, EXAMINING ATTORNEY



*David J. Kyros*

Director of the United States Patent and Trademark Office

# United States of America

United States Patent and Trademark Office

## Troy & Sons Distillers

**Reg. No. 4,136,645**

**Registered May 1, 2012**

**Int. Cl.: 33**

**TRADEMARK**

**PRINCIPAL REGISTER**

BALL & SONS DISTILLERS, LLC (NORTH CAROLINA LIMITED LIABILITY COMPANY)  
41 HILLTOP ROAD  
ASHEVILLE, NC 288033122

FOR: DISTILLED SPIRITS, IN CLASS 33 (U.S. CLS. 47 AND 49).

FIRST USE 3-15-2010; IN COMMERCE 3-15-2010.

THE MARK CONSISTS OF STANDARD CHARACTERS WITHOUT CLAIM TO ANY PARTICULAR FONT, STYLE, SIZE, OR COLOR.

NO CLAIM IS MADE TO THE EXCLUSIVE RIGHT TO USE "DISTILLERS", APART FROM THE MARK AS SHOWN.

SN 85-240,549, FILED 2-11-2011.

KATHERINE CONNOLLY, EXAMINING ATTORNEY



*David J. Kybas*

Director of the United States Patent and Trademark Office

# United States of America

United States Patent and Trademark Office

# GÜD

**Reg. No. 4,136,646**

**Registered May 1, 2012**

**Int. Cl.: 3**

**TRADEMARK**

**PRINCIPAL REGISTER**

BURT'S BEES, INC. (DELAWARE CORPORATION)  
210 W. PETTIGREW STREET  
DURHAM, NC 27701

FOR: BODY LOTIONS; BODY WASH; HAIR SHAMPOOS AND CONDITIONERS; HAND CREAMS; HAND SOAPS; NON-MEDICATED SKIN CARE PREPARATION, NAMELY, BODY MIST; PERFUME; SHOWER GEL, IN CLASS 3 (U.S. CLS. 1, 4, 6, 50, 51 AND 52).

FIRST USE 11-16-2011; IN COMMERCE 11-16-2011.

THE MARK CONSISTS OF STANDARD CHARACTERS WITHOUT CLAIM TO ANY PARTICULAR FONT, STYLE, SIZE, OR COLOR.

THE WORDING "GÜD" HAS NO MEANING IN A FOREIGN LANGUAGE.

SN 85-240,696, FILED 2-11-2011.

ZACHARY BELLO, EXAMINING ATTORNEY



*David J. Kyffers*

Director of the United States Patent and Trademark Office



# United States of America

United States Patent and Trademark Office



Totes Magoatz

**Reg. No. 4,136,647**

**Registered May 1, 2012**

**Int. Cl.: 33**

**TRADEMARK**

**PRINCIPAL REGISTER**

AMRIS LLC. (COLORADO LIMITED LIABILITY COMPANY)  
6410 SOUTH NEWCASTLE WAY  
AURORA, CO 80016

FOR: BREWED MALT-BASED ALCOHOLIC BEVERAGE IN THE NATURE OF A BEER, IN CLASS 33 (U.S. CLS. 47 AND 49).

FIRST USE 6-1-2011; IN COMMERCE 6-1-2011.

THE MARK CONSISTS OF A STYLIZED "M" AND THE STYLIZED WORDING "TOTES MAGOATZ".

SN 85-240,814, FILED 2-12-2011.

HOWARD B. LEVINE, EXAMINING ATTORNEY



*David J. Kybas*

Director of the United States Patent and Trademark Office

# United States of America

United States Patent and Trademark Office

## PARKING LOOP

**Reg. No. 4,136,648**

**Registered May 1, 2012**

**Int. Cl.: 35**

**SERVICE MARK**

**PRINCIPAL REGISTER**

ACE PARKING MANAGEMENT, INC. (CALIFORNIA CORPORATION)  
645 ASH STREET  
SAN DIEGO, CA 92101

FOR: ON-LINE RETAIL STORE SERVICES FEATURING A WIDE VARIETY OF USED PARKING LOT EQUIPMENT AND USED PARKING LOT EQUIPMENT PARTS, IN CLASS 35 (U.S. CLS. 100, 101 AND 102).

FIRST USE 2-15-2011; IN COMMERCE 2-15-2011.

THE MARK CONSISTS OF STANDARD CHARACTERS WITHOUT CLAIM TO ANY PARTICULAR FONT, STYLE, SIZE, OR COLOR.

NO CLAIM IS MADE TO THE EXCLUSIVE RIGHT TO USE "PARKING", APART FROM THE MARK AS SHOWN.

SN 85-240,865, FILED 2-12-2011.

ANNE FARRELL, EXAMINING ATTORNEY



*David J. Kyros*

Director of the United States Patent and Trademark Office

# United States of America

United States Patent and Trademark Office

## PARKING CONNECTION

**Reg. No. 4,136,649**

**Registered May 1, 2012**

**Int. Cl.: 39**

**SERVICE MARK**

**PRINCIPAL REGISTER**

ACE PARKING MANAGEMENT, INC. (CALIFORNIA CORPORATION)  
645 ASH STREET  
SAN DIEGO, CA 92101

FOR: PROVIDING A WEB SITE ON THE INTERNET FEATURING INFORMATION AND RESERVATIONS FOR PARKING LOTS, VALET PARKING LOTS AND SHUTTLE SERVICES, IN CLASS 39 (U.S. CLS. 100 AND 105).

FIRST USE 1-10-2011; IN COMMERCE 1-10-2011.

THE MARK CONSISTS OF STANDARD CHARACTERS WITHOUT CLAIM TO ANY PARTICULAR FONT, STYLE, SIZE, OR COLOR.

OWNER OF U.S. REG. NO. 3,748,918.

NO CLAIM IS MADE TO THE EXCLUSIVE RIGHT TO USE "PARKING", APART FROM THE MARK AS SHOWN.

SN 85-240,866, FILED 2-12-2011.

ANNE FARRELL, EXAMINING ATTORNEY



*David J. Kybas*

Director of the United States Patent and Trademark Office

# United States of America

United States Patent and Trademark Office

## MYOTONOLOGY

**Reg. No. 4,136,650**

**Registered May 1, 2012**

**Int. Cls.: 10, 41, and 44**

**TRADEMARK**

**SERVICE MARK**

**PRINCIPAL REGISTER**

VAN HORN TRUST (NORTH CAROLINA TRUST)  
2812 SHANDY AVE  
WILMINGTON, NC 28409

FOR: FACIAL TONING MACHINES FOR COSMETIC USE, IN CLASS 10 (U.S. CLS. 26, 39 AND 44).

FIRST USE 2-28-2006; IN COMMERCE 2-28-2006.

FOR: PROVIDING TRAINING, WORKSHOPS, CLASSES AND SEMINARS ON METHODS FOR CONDUCTING FACIAL TONING TREATMENTS USING FACIAL TONING MACHINES, IN CLASS 41 (U.S. CLS. 100, 101 AND 107).

FIRST USE 2-2-1987; IN COMMERCE 2-2-1987.

FOR: PROVIDING FACIAL TONING TREATMENTS USING FACIAL TONING MACHINES, IN CLASS 44 (U.S. CLS. 100 AND 101).

FIRST USE 2-2-1987; IN COMMERCE 2-2-1987.

THE MARK CONSISTS OF STANDARD CHARACTERS WITHOUT CLAIM TO ANY PARTICULAR FONT, STYLE, SIZE, OR COLOR.

OWNER OF U.S. REG. NO. 3,432,728.

SN 85-241,272, FILED 2-14-2011.

CARRIE GENOVESE, EXAMINING ATTORNEY



*David J. Kybas*

Director of the United States Patent and Trademark Office

# United States of America

United States Patent and Trademark Office

# SESWITCH

**Reg. No. 4,136,651**

**Registered May 1, 2012**

**Int. Cl.: 45**

**SERVICE MARK**

**PRINCIPAL REGISTER**

STONEEAGLE SERVICES, INC. (TEXAS CORPORATION)  
SUITE 100  
111 W. SPRING VALLEY ROAD  
RICHARDSON, TX 75081

FOR: FRAUD DETECTION SERVICES FOR ELECTRONIC PROCESSING OF INSURANCE CLAIMS AND PAYMENT DATA, IN CLASS 45 (U.S. CLS. 100 AND 101).

FIRST USE 2-23-2012; IN COMMERCE 2-23-2012.

THE MARK CONSISTS OF STANDARD CHARACTERS WITHOUT CLAIM TO ANY PARTICULAR FONT, STYLE, SIZE, OR COLOR.

SN 85-241,706, FILED 2-14-2011.

SALLY SHIH, EXAMINING ATTORNEY



*David J. Kybas*

Director of the United States Patent and Trademark Office

# United States of America

United States Patent and Trademark Office

## DO YOU KNOW MARSHALLS?

**Reg. No. 4,136,652**

**Registered May 1, 2012**

**Int. Cl.: 35**

**SERVICE MARK**

**PRINCIPAL REGISTER**

MARSHALLS OF NEVADA, INC. (NEVADA CORPORATION)  
4100 EAST LONE MOUNTAIN ROAD  
NORTH LAS VEGAS, NV 89031

FOR: RETAIL DEPARTMENT STORE SERVICES, IN CLASS 35 (U.S. CLS. 100, 101 AND 102).

FIRST USE 3-28-2011; IN COMMERCE 3-28-2011.

THE MARK CONSISTS OF STANDARD CHARACTERS WITHOUT CLAIM TO ANY PARTICULAR FONT, STYLE, SIZE, OR COLOR.

OWNER OF U.S. REG. NOS. 1,978,509, 3,807,045, AND OTHERS.

SN 85-241,752, FILED 2-14-2011.

GENE MACIOL, EXAMINING ATTORNEY



*David J. Kybas*

Director of the United States Patent and Trademark Office

# United States of America

United States Patent and Trademark Office



**Reg. No. 4,136,653**

**Registered May 1, 2012**

**Int. Cl.: 33**

**TRADEMARK**

**PRINCIPAL REGISTER**

MUD HOUSE WINES LIMITED (NEW ZEALAND CORPORATION)  
30 MAXWELL ROAD  
BLENHEIM, NEW ZEALAND 7201

FOR: ALCOHOLIC BEVERAGES EXCEPT BEERS; WINES, IN CLASS 33 (U.S. CLS. 47 AND 49).

FIRST USE 3-1-2011; IN COMMERCE 3-1-2011.

THE MARK CONSISTS OF A STYLIZED "H" SURROUNDED AND ENCOMPASSED BY A STYLIZED "M".

SN 85-241,968, FILED 2-14-2011.

APRIL HESIK, EXAMINING ATTORNEY



*David J. Kybas*

Director of the United States Patent and Trademark Office

# United States of America

United States Patent and Trademark Office

# IMATTRESS

**Reg. No. 4,136,654**

KING KOIL LICENSING COMPANY, INC. (DELAWARE CORPORATION)  
7501 S. QUINCY STREET, SUITE 130  
WILLOWBROOK, IL 605275574

**Registered May 1, 2012**

**Int. Cl.: 20**

FOR: BEDS; BOX SPRINGS; MATTRESSES, IN CLASS 20 (U.S. CLS. 2, 13, 22, 25, 32 AND 50).

**TRADEMARK**

FIRST USE 11-30-2011; IN COMMERCE 11-30-2011.

**PRINCIPAL REGISTER**

THE MARK CONSISTS OF STANDARD CHARACTERS WITHOUT CLAIM TO ANY PARTICULAR FONT, STYLE, SIZE, OR COLOR.

SN 85-242,263, FILED 2-15-2011.

LAURIE KAUFMAN, EXAMINING ATTORNEY



*David J. Kybas*

Director of the United States Patent and Trademark Office



# United States of America

United States Patent and Trademark Office

# Aglaea

**Reg. No. 4,136,655**

**Registered May 1, 2012**

**Int. Cl.: 3**

**TRADEMARK**

**PRINCIPAL REGISTER**

AGLAEUSA, INC. (CALIFORNIA CORPORATION)  
1539 N. CHINA LAKE BLVD., SUITE A  
RIDGECREST, CA 93555

FOR: AROMATIC BODY CARE PRODUCTS, NAMELY, BODY LOTION, SHOWER GEL, CUTICLE CREAM, SHAMPOO, CONDITIONER, NON-MEDICATED LIP BALM, SOAP, BODY POLISH, BODY AND FOOT SCRUB AND NON-MEDICATED FOOT CREAM, IN CLASS 3 (U.S. CLS. 1, 4, 6, 50, 51 AND 52).

FIRST USE 12-1-2011; IN COMMERCE 12-1-2011.

THE MARK CONSISTS OF STANDARD CHARACTERS WITHOUT CLAIM TO ANY PARTICULAR FONT, STYLE, SIZE, OR COLOR.

SN 85-242,428, FILED 2-15-2011.

ALYSSA STEEL, EXAMINING ATTORNEY



*David J. Kyros*

Director of the United States Patent and Trademark Office

# United States of America

United States Patent and Trademark Office



**Reg. No. 4,136,656**

**Registered May 1, 2012**

**Int. Cl.: 31**

**TRADEMARK**

**PRINCIPAL REGISTER**

PFF BRANDS, LLC (FLORIDA LIMITED LIABILITY COMPANY)  
14095 STATE ROAD 7  
DELRAY BEACH, FL 33446

FOR: FRESH PEPPERS, IN CLASS 31 (U.S. CLS. 1 AND 46).

FIRST USE 10-31-2010; IN COMMERCE 10-31-2010.

OWNER OF U.S. REG. NOS. 3,774,607, 3,794,140, AND OTHERS.

THE COLOR(S) BLUE, GREEN, TAN, RED, SILVER, BLACK AND WHITE IS/ARE CLAIMED AS A FEATURE OF THE MARK.

NO CLAIM IS MADE TO THE EXCLUSIVE RIGHT TO USE "FAMILY FARMS" AND "MINI SWEET PEPPERS", APART FROM THE MARK AS SHOWN.

THE MARK CONSISTS OF THE WORDS "PERO FAMILY FARMS" IN STYLIZED FORM WITH THE WORD "PERO" IN RED WITH A WHITE OUTLINE AND THE WORDS "FAMILY FARMS" UNDERNEATH IN WHITE, SAID WORDS SUPERIMPOSED OVER AN OVAL HAVING A WHITE AND BLACK OUTLINE AND AN IMAGE WITHIN THE OVAL COMPRISING GREEN HILLS WITH A TAN COLORED ROAD IN THE MIDDLE AND A BLUE SKY, SAID OVAL BEING PARTIALLY SUPERIMPOSED AT THE BOTTOM PORTION OVER A LARGER BLACK OVAL THAT HAS A SUB-OVAL SHAPE DISPOSED AT ITS LOWER RIGHT BORDER PORTION AND HAVING A SILVER OVAL BORDER LINE SPACED INWARDLY FROM THE EDGE OF THE OVAL AND SUB-OVAL AND THE WORD "SWEET" IN STYLIZED FORM IN WHITE WITH LINES RESEMBLING SPARKLING DISPOSED ON THE UPPER PORTION OF THE "S" IN THE WORD "SWEET" WITH THE WORD "MINI" IN RED DISPOSED PARTIALLY OVER THE UPPER PORTION OF THE "S" IN THE WORD "SWEET" AND THE WORD "PEPPERS" IN RED DISPOSED PARTIALLY OVER THE BOTTOM PORTION OF THE "T" IN THE WORD "SWEET".

SN 85-242,538, FILED 2-15-2011.

DOMINIC J. FERRAIUOLO, EXAMINING ATTORNEY



*David J. Kyros*

Director of the United States Patent and Trademark Office

# United States of America

United States Patent and Trademark Office



**Reg. No. 4,136,657**

**Registered May 1, 2012**

**Int. Cl.: 31**

**TRADEMARK**

**PRINCIPAL REGISTER**

PFF BRANDS, LLC (FLORIDA LIMITED LIABILITY COMPANY)  
14095 STATE ROAD 7  
DELRAY BEACH, FL 33446

FOR: FRESH PEPPERS, IN CLASS 31 (U.S. CLS. 1 AND 46).

FIRST USE 10-31-2010; IN COMMERCE 10-31-2010.

NO CLAIM IS MADE TO THE EXCLUSIVE RIGHT TO USE "SWEET" , APART FROM THE MARK AS SHOWN.

THE MARK CONSISTS OF THE WORD "SWEET" IN STYLIZED FORM WITH LINES RESEMBLING SPARKLING DISPOSED OVER THE UPPER RIGHT PORTION OF THE LETTER "S".

SN 85-242,547, FILED 2-15-2011.

DOMINIC J. FERRAIUOLO, EXAMINING ATTORNEY



*David J. Kyffers*

Director of the United States Patent and Trademark Office

# United States of America

United States Patent and Trademark Office

## LOVE YOUR HEALTH

**Reg. No. 4,136,658**

**Registered May 1, 2012**

**Int. Cl.: 29**

**TRADEMARK**

**PRINCIPAL REGISTER**

LOVE YOUR HEALTH, LLC (MICHIGAN LIMITED LIABILITY COMPANY)  
4760 CATAMOUNT TRAIL NE  
ADA, MI 49301

FOR: SOY-BASED SNACK FOODS, IN CLASS 29 (U.S. CL. 46).

FIRST USE 7-25-2011; IN COMMERCE 7-25-2011.

THE MARK CONSISTS OF STANDARD CHARACTERS WITHOUT CLAIM TO ANY PARTICULAR FONT, STYLE, SIZE, OR COLOR.

SN 85-242,680, FILED 2-15-2011.

DOMINIC J. FERRAIUOLO, EXAMINING ATTORNEY



*David J. Kybas*

Director of the United States Patent and Trademark Office

# United States of America

United States Patent and Trademark Office

## IQ WINDOWS

**Reg. No. 4,136,659**

**Registered May 1, 2012**

**Int. Cl.: 19**

**TRADEMARK**

**PRINCIPAL REGISTER**

IQWINDOWS LLC (DELAWARE LIMITED LIABILITY COMPANY)  
9254 UNITY STREET NW  
COON RAPIDS, MN 55433

FOR: VINYL WINDOWS AND DOORS, IN CLASS 19 (U.S. CLS. 1, 12, 33 AND 50).

FIRST USE 11-15-2011; IN COMMERCE 11-15-2011.

THE MARK CONSISTS OF STANDARD CHARACTERS WITHOUT CLAIM TO ANY PARTICULAR FONT, STYLE, SIZE, OR COLOR.

NO CLAIM IS MADE TO THE EXCLUSIVE RIGHT TO USE "WINDOWS", APART FROM THE MARK AS SHOWN.

SN 85-242,765, FILED 2-15-2011.

KATINA MISTER, EXAMINING ATTORNEY



*David J. Kyffers*

Director of the United States Patent and Trademark Office

# United States of America

United States Patent and Trademark Office

## TUMBLER FAN

**Reg. No. 4,136,660**

**Registered May 1, 2012**

**Int. Cl.: 11**

**TRADEMARK**

**PRINCIPAL REGISTER**

KING OF FANS, INC. (FLORIDA CORPORATION)  
1951 NW 22ND STREET  
FORT LAUDERDALE, FL 33311

FOR: ENVIRONMENTAL CONTROL APPARATUS, NAMELY, PORTABLE ELECTRIC FANS, FIXTURES AND PARTS THEREFOR; FREESTANDING ELECTRIC FANS, FIXTURES AND PARTS THEREFOR; AND ELECTRIC DESK FANS, FIXTURES AND PARTS THEREFOR; ELECTRIC FLOOR FANS AND REPLACEMENT PARTS THEREFOR; ELECTRIC CIRCULATING FANS FOR DOMESTIC AND COMMERCIAL USE; INDOOR AND OUTDOOR CEILING AND WALL SURFACE MOUNTED FANS AND LIGHTS, FIXTURES AND PARTS THEREFOR, IN CLASS 11 (U.S. CLS. 13, 21, 23, 31 AND 34).

FIRST USE 3-22-2011; IN COMMERCE 4-12-2011.

THE MARK CONSISTS OF STANDARD CHARACTERS WITHOUT CLAIM TO ANY PARTICULAR FONT, STYLE, SIZE, OR COLOR.

NO CLAIM IS MADE TO THE EXCLUSIVE RIGHT TO USE "FAN", APART FROM THE MARK AS SHOWN.

SN 85-242,799, FILED 2-15-2011.

JOHN HWANG, EXAMINING ATTORNEY



*David J. Kyros*

Director of the United States Patent and Trademark Office

# United States of America

United States Patent and Trademark Office

## STRESS AWAY

**Reg. No. 4,136,661**

MURDOCK, LUCAS G (UNITED STATES INDIVIDUAL)  
PO BOX 99360  
SAN DIEGO, CA 92169

**Registered May 1, 2012**

**Int. Cl.: 5**

FOR: DIETARY AND NUTRITIONAL SUPPLEMENTS, IN CLASS 5 (U.S. CLS. 6, 18, 44, 46, 51 AND 52).

**TRADEMARK**

FIRST USE 2-15-2011; IN COMMERCE 1-18-2012.

**PRINCIPAL REGISTER**

THE MARK CONSISTS OF STANDARD CHARACTERS WITHOUT CLAIM TO ANY PARTICULAR FONT, STYLE, SIZE, OR COLOR.

SN 85-242,946, FILED 2-15-2011.

JAY BESCH, EXAMINING ATTORNEY



*David J. Kyffers*

Director of the United States Patent and Trademark Office

# United States of America

United States Patent and Trademark Office

## FAITHFUL FRIENDS

**Reg. No. 4,136,662**

**Registered May 1, 2012**

**Int. Cl.: 14**

**TRADEMARK**

**PRINCIPAL REGISTER**

SHARE MEMORIES, LLC (COLORADO LIMITED LIABILITY COMPANY)  
2800 SOUTH UNIVERSITY BOULEVARD, #71  
DENVER, CO 80210

FOR: JEWELRY, IN CLASS 14 (U.S. CLS. 2, 27, 28 AND 50).

FIRST USE 8-0-2011; IN COMMERCE 8-0-2011.

THE MARK CONSISTS OF STANDARD CHARACTERS WITHOUT CLAIM TO ANY PARTICULAR FONT, STYLE, SIZE, OR COLOR.

OWNER OF U.S. REG. NOS. 3,794,077, 3,796,634, AND 3,796,635.

SN 85-243,049, FILED 2-15-2011.

ROBERT C. CLARK JR., EXAMINING ATTORNEY



*David J. Kyffers*

Director of the United States Patent and Trademark Office



# United States of America

United States Patent and Trademark Office

## FAITHFUL FRIENDS

**Reg. No. 4,136,663**

**Registered May 1, 2012**

**Int. Cl.: 18**

**TRADEMARK**

**PRINCIPAL REGISTER**

SHARE MEMORIES, LLC (COLORADO LIMITED LIABILITY COMPANY)  
2800 SOUTH UNIVERSITY BOULEVARD, #71  
DENVER, CO 80210

FOR: ANIMAL CARRIERS; COLLARS FOR PETS; DOG LEASHES; HARNESES, IN CLASS  
18 (U.S. CLS. 1, 2, 3, 22 AND 41).

FIRST USE 8-0-2011; IN COMMERCE 8-0-2011.

THE MARK CONSISTS OF STANDARD CHARACTERS WITHOUT CLAIM TO ANY PAR-  
TICULAR FONT, STYLE, SIZE, OR COLOR.

OWNER OF U.S. REG. NOS. 3,794,077, 3,796,634, AND 3,796,635.

SN 85-243,088, FILED 2-15-2011.

ROBERT C. CLARK JR., EXAMINING ATTORNEY



*David J. Kyros*

Director of the United States Patent and Trademark Office

# United States of America

United States Patent and Trademark Office

## FAITHFUL FRIENDS

**Reg. No. 4,136,664**

**Registered May 1, 2012**

**Int. Cl.: 21**

**TRADEMARK**

**PRINCIPAL REGISTER**

SHARE MEMORIES, LLC (COLORADO LIMITED LIABILITY COMPANY)  
2800 SOUTH UNIVERSITY BOULEVARD, #71  
DENVER, CO 80210

FOR: GROOMING TOOLS FOR PETS, NAMELY, COMBS AND BRUSHES; PET FEEDING AND DRINKING BOWLS, IN CLASS 21 (U.S. CLS. 2, 13, 23, 29, 30, 33, 40 AND 50).

FIRST USE 8-0-2011; IN COMMERCE 8-0-2011.

THE MARK CONSISTS OF STANDARD CHARACTERS WITHOUT CLAIM TO ANY PARTICULAR FONT, STYLE, SIZE, OR COLOR.

OWNER OF U.S. REG. NOS. 3,794,077, 3,796,634, AND 3,796,635.

SN 85-243,103, FILED 2-15-2011.

ROBERT C. CLARK JR., EXAMINING ATTORNEY



*David J. Kybas*

Director of the United States Patent and Trademark Office

# United States of America

United States Patent and Trademark Office

## FAITHFUL FRIENDS

**Reg. No. 4,136,665**

**Registered May 1, 2012**

**Int. Cl.: 28**

**TRADEMARK**

**PRINCIPAL REGISTER**

SHARE MEMORIES, LLC (COLORADO LIMITED LIABILITY COMPANY)  
2800 SOUTH UNIVERSITY BOULEVARD, #71  
DENVER, CO 80210

FOR: PET TOYS; STUFFED TOY ANIMALS; STUFFED TOYS, IN CLASS 28 (U.S. CLS. 22, 23, 38 AND 50).

FIRST USE 8-0-2011; IN COMMERCE 8-0-2011.

THE MARK CONSISTS OF STANDARD CHARACTERS WITHOUT CLAIM TO ANY PARTICULAR FONT, STYLE, SIZE, OR COLOR.

OWNER OF U.S. REG. NOS. 3,794,077, 3,796,634, AND 3,796,635.

SN 85-243,108, FILED 2-15-2011.

ROBERT C. CLARK JR., EXAMINING ATTORNEY



*David J. Kybas*

Director of the United States Patent and Trademark Office

# United States of America

United States Patent and Trademark Office

## CYBERLOCK FLEX SYSTEM

**Reg. No. 4,136,666**

**Registered May 1, 2012**

**Int. Cl.: 9**

**TRADEMARK**

**PRINCIPAL REGISTER**

VIDEX, INC. (OREGON CORPORATION)  
1105 NE CIRCLE BLVD.  
CORVALLIS, OR 97330

FOR: ELECTRONIC READERS AND CONTROLLERS FOR CONTROLLING ACCESS TO PREMISES AND CONTAINERS; RFID READERS; AND ELECTRONIC KEY CABINETS, NAMELY, ELECTRONIC CONTAINERS FOR PROGRAMMING, RECHARGING, AND RETAINING ELECTRONIC KEYS, IN CLASS 9 (U.S. CLS. 21, 23, 26, 36 AND 38).

FIRST USE 4-0-2011; IN COMMERCE 4-0-2011.

THE MARK CONSISTS OF STANDARD CHARACTERS WITHOUT CLAIM TO ANY PARTICULAR FONT, STYLE, SIZE, OR COLOR.

OWNER OF U.S. REG. NO. 3,082,458.

NO CLAIM IS MADE TO THE EXCLUSIVE RIGHT TO USE "SYSTEM", APART FROM THE MARK AS SHOWN.

SN 85-243,142, FILED 2-15-2011.

ANDREA HACK, EXAMINING ATTORNEY



*David J. Kybas*

Director of the United States Patent and Trademark Office

# United States of America

United States Patent and Trademark Office



**Reg. No. 4,136,667**

**Registered May 1, 2012**

**Int. Cl.: 41**

**SERVICE MARK**

**PRINCIPAL REGISTER**

THE SMITH CENTER FOR THE PERFORMING ARTS (NEVADA NON-PROFIT CORPORATION)  
361 SYMPHONY PARK AVENUE  
LAS VEGAS, NV 89106

FOR: ENTERTAINMENT AND EDUCATION SERVICES IN THE NATURE OF LIVE DANCE AND MUSICAL PERFORMANCES; ORGANIZING EXHIBITIONS FOR PROGRAMMING, PRODUCTION AND EDUCATIONAL PURPOSES, ALL IN THE FIELD OF PERFORMING ARTS, IN CLASS 41 (U.S. CLS. 100, 101 AND 107).

FIRST USE 2-0-2009; IN COMMERCE 2-0-2009.

NO CLAIM IS MADE TO THE EXCLUSIVE RIGHT TO USE "CENTER", APART FROM THE MARK AS SHOWN.

THE NAME(S), PORTRAIT(S), AND/OR SIGNATURE(S) SHOWN IN THE MARK IDENTIFIES FRED W. "SMITH", WHOSE CONSENT(S) TO REGISTER IS MADE OF RECORD.

THE MARK CONSISTS OF VERTICAL LINES WHICH ALTERNATE IN WIDTH AND HEIGHT AND COMPRISE A STYLIZED DRAWING OF A TOWER TO THE RIGHT OF WHICH IS THE STYLIZED WORD "THE," WHICH IS OVER THE STYLIZED WORD "SMITH," WHICH IS OVER THE STYLIZED WORD "CENTER," ALL OF WHICH IS RIGHT-JUSTIFIED.

SN 85-243,184, FILED 2-15-2011.

JASON BLAIR, EXAMINING ATTORNEY



*David J. Kyros*

Director of the United States Patent and Trademark Office

# United States of America

United States Patent and Trademark Office



**Reg. No. 4,136,668**

**Registered May 1, 2012**

**Int. Cl.: 43**

**SERVICE MARK**

**PRINCIPAL REGISTER**

THE SMITH CENTER FOR THE PERFORMING ARTS (NEVADA NON-PROFIT CORPORATION)  
361 SYMPHONY PARK AVENUE  
LAS VEGAS, NV 89106

FOR: PROVIDING PAVILIONS, ARENAS, AND COMMUNITY CENTERS FOR PERFORMING ARTS EVENTS; PROVIDING CONFERENCE, MEETING, BANQUET AND EXHIBITION FACILITIES, IN CLASS 43 (U.S. CLS. 100 AND 101).

FIRST USE 7-0-2011; IN COMMERCE 7-0-2011.

NO CLAIM IS MADE TO THE EXCLUSIVE RIGHT TO USE "CENTER", APART FROM THE MARK AS SHOWN.

THE NAME(S), PORTRAIT(S), AND/OR SIGNATURE(S) SHOWN IN THE MARK IDENTIFIES FRED W. SMITH, WHOSE CONSENT(S) TO REGISTER IS MADE OF RECORD.

THE MARK CONSISTS OF VERTICAL LINES WHICH ALTERNATE IN WIDTH AND HEIGHT AND COMPRISE A STYLIZED DRAWING OF A TOWER TO THE RIGHT OF WHICH IS THE STYLIZED WORD "THE," WHICH IS OVER THE STYLIZED WORD "SMITH", WHICH IS OVER THE STYLIZED WORD "CENTER", ALL OF WHICH IS RIGHT-JUSTIFIED.

SN 85-243,192, FILED 2-15-2011.

JASON BLAIR, EXAMINING ATTORNEY



*David J. Kybas*

Director of the United States Patent and Trademark Office

# United States of America

United States Patent and Trademark Office

## Golden Bear Turf

**Reg. No. 4,136,669**

**Registered May 1, 2012**

**Int. Cls.: 27, 37, and 42**

**TRADEMARK**

**SERVICE MARK**

**PRINCIPAL REGISTER**

NICKLAUS COMPANIES, LLC (DELAWARE LIMITED LIABILITY COMPANY)  
SUITE 500  
11780 U.S. HIGHWAY ONE  
NORTH PALM BEACH, FL 33408

FOR: SYNTHETIC TURF USED FOR PUTTING GREENS, DRIVING RANGES, ATHLETIC COURTS, PLAY AREAS, AND RECREATIONAL SURFACES, IN CLASS 27 (U.S. CLS. 19, 20, 37, 42 AND 50).

FIRST USE 12-31-2011; IN COMMERCE 12-31-2011.

FOR: INSTALLATION OF PUTTING GREENS, DRIVING RANGES, ATHLETIC COURTS, PLAY AREAS, AND RECREATIONAL SURFACES, IN CLASS 37 (U.S. CLS. 100, 103 AND 106).

FIRST USE 12-31-2011; IN COMMERCE 12-31-2011.

FOR: DESIGN OF PUTTING GREENS, DRIVING RANGES, ATHLETIC COURTS, PLAY AREAS, AND RECREATIONAL SURFACES, IN CLASS 42 (U.S. CLS. 100 AND 101).

FIRST USE 12-31-2011; IN COMMERCE 12-31-2011.

THE MARK CONSISTS OF STANDARD CHARACTERS WITHOUT CLAIM TO ANY PARTICULAR FONT, STYLE, SIZE, OR COLOR.

OWNER OF U.S. REG. NOS. 1,841,511, 2,097,404, AND OTHERS.

NO CLAIM IS MADE TO THE EXCLUSIVE RIGHT TO USE "TURF", APART FROM THE MARK AS SHOWN.

THE TERMS "GOLDEN BEAR" REFER TO JACK NICKLAUS WHOSE CONSENT IS OF RECORD.

SN 85-243,444, FILED 2-16-2011.

JANICE L. MCMORROW, EXAMINING ATTORNEY



*David J. Kyros*

Director of the United States Patent and Trademark Office

United States of America  
United States Patent and Trademark Office

octane  
LIMITED

**Reg. No. 4,136,670**

**Registered May 1, 2012**

**Int. Cl.: 14**

**TRADEMARK**

**PRINCIPAL REGISTER**

PAN USA, INC. (FLORIDA CORPORATION)  
2450 WEST SAMOPLE ROAD, SUITE 9  
POMPANO BEACH, FL 33073

FOR: WATCHES AND STRAPS FOR WATCHES, IN CLASS 14 (U.S. CLS. 2, 27, 28 AND 50).

FIRST USE 9-0-2011; IN COMMERCE 9-0-2011.

THE MARK CONSISTS OF STANDARD CHARACTERS WITHOUT CLAIM TO ANY PARTICULAR FONT, STYLE, SIZE, OR COLOR.

NO CLAIM IS MADE TO THE EXCLUSIVE RIGHT TO USE "LIMITED", APART FROM THE MARK AS SHOWN.

SN 85-243,603, FILED 2-16-2011.

MICHAEL TANNER, EXAMINING ATTORNEY



*David J. Kyffers*

Director of the United States Patent and Trademark Office



# United States of America

United States Patent and Trademark Office

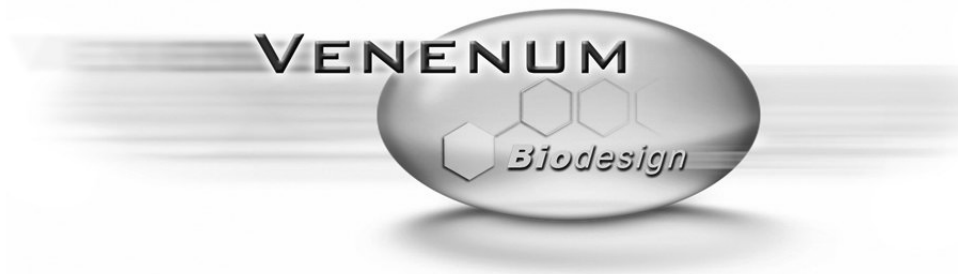

**Reg. No. 4,136,671**

**Registered May 1, 2012**

**Int. Cl.: 42**

**SERVICE MARK**

**PRINCIPAL REGISTER**

VENENUM BIODESIGN, LLC (NEW JERSEY LIMITED LIABILITY COMPANY)  
2439 KUSER ROAD  
HAMILTON, NJ 08690

FOR: DRUG DISCOVERY SERVICES; PHARMACEUTICAL DRUG DEVELOPMENT SERVICES, IN CLASS 42 (U.S. CLS. 100 AND 101).

FIRST USE 2-16-2010; IN COMMERCE 2-16-2011.

NO CLAIM IS MADE TO THE EXCLUSIVE RIGHT TO USE "BIODESIGN", APART FROM THE MARK AS SHOWN.

THE MARK CONSISTS OF THE LITERAL ELEMENTS "VENENUM BIODESIGN" AND A STYLIZED OVAL CONTAINING THE DEPICTION OF A CHEMICAL STRUCTURE; THE LETTERS "NENUM" IN "VENENUM" APPEAR IN FRONT OF THE STYLIZED OVAL AND ABOVE THE CHEMICAL STRUCTURE, THE TERM "BIODESIGN" APPEARS IN FRONT OF THE STYLIZED OVAL AND BELOW THE CHEMICAL STRUCTURE; HORIZONTAL STREAKS APPEAR BEHIND THE LITERAL ELEMENTS AND STYLIZED OVAL.

SN 85-243,752, FILED 2-16-2011.

REBECCA GILBERT, EXAMINING ATTORNEY



*David J. Kyffers*

Director of the United States Patent and Trademark Office

# United States of America

United States Patent and Trademark Office

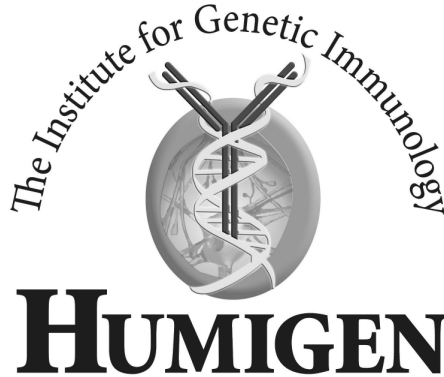

**Reg. No. 4,136,672**

**Registered May 1, 2012**

**Int. Cl.: 42**

**SERVICE MARK**

**PRINCIPAL REGISTER**

HUMIGEN, LLC (NEW JERSEY LIMITED LIABILITY COMPANY)  
2439 KUSER ROAD  
HAMILTON, NJ 08690

FOR: RESEARCH AND DEVELOPMENT IN THE PHARMACEUTICAL AND BIOTECHNOLOGY FIELDS, IN CLASS 42 (U.S. CLS. 100 AND 101).

FIRST USE 2-16-2007; IN COMMERCE 2-16-2011.

NO CLAIM IS MADE TO THE EXCLUSIVE RIGHT TO USE "INSTITUTE FOR GENETIC IMMUNOLOGY", APART FROM THE MARK AS SHOWN.

THE MARK CONSISTS OF THE LITERAL ELEMENTS "THE INSTITUTE FOR GENETIC IMMUNOLOGY HUMIGEN" AND A STYLIZED ELEMENT DEPICTING AN ANTIBODY ENTWINED BY A DNA DOUBLE-HELIX IN FRONT OF AN OVAL DEPICTING A CELL; THE OVAL CONSISTS OF AN OUTER OVAL AND AN INNER OVAL; THE INNER OVAL CONTAINS A DEPICTION OF CELLULAR COMPONENTS; THE LITERAL ELEMENTS "THE INSTITUTE FOR GENETIC IMMUNOLOGY" ARCH ABOVE THE STYLIZED ELEMENT AND THE LITERAL TERM "HUMIGEN" APPEARS BELOW THE STYLIZED ELEMENT.

SN 85-243,847, FILED 2-16-2011.

WILLIAM BRECKENFELD, EXAMINING ATTORNEY



*David J. Kybas*

Director of the United States Patent and Trademark Office

# United States of America

United States Patent and Trademark Office

# HEARLINK

**Reg. No. 4,136,673**

**Registered May 1, 2012**

**Int. Cl.: 35**

**SERVICE MARK**

**PRINCIPAL REGISTER**

OTICON, INC. (CALIFORNIA CORPORATION)  
29 SCHOOLHOUSE ROAD  
SOMERSET, NJ 08873

FOR: REFERRALS IN THE FIELD OF SERVICES TO THE HEARING IMPAIRED; REFERRALS FOR HEARING TESTING; REFERRALS FOR FITTING AND PURCHASE OF HEARING AIDS AND RELATED ACCESSORIES; REFERRALS FOR COUNSELING, THERAPY AND UNDERSTANDING HEARING RELATED ISSUES, IN CLASS 35 (U.S. CLS. 100, 101 AND 102).

FIRST USE 4-13-2011; IN COMMERCE 4-13-2011.

THE MARK CONSISTS OF STANDARD CHARACTERS WITHOUT CLAIM TO ANY PARTICULAR FONT, STYLE, SIZE, OR COLOR.

SN 85-243,887, FILED 2-16-2011.

C. DIONNE CLYBURN, EXAMINING ATTORNEY



*David J. Kyffers*

Director of the United States Patent and Trademark Office

# United States of America

United States Patent and Trademark Office

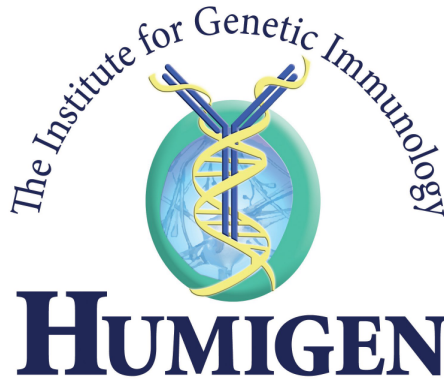

**Reg. No. 4,136,674**

**Registered May 1, 2012**

**Int. Cl.: 42**

**SERVICE MARK**

**PRINCIPAL REGISTER**

HUMIGEN, LLC (NEW JERSEY LIMITED LIABILITY COMPANY)  
2439 KUSER ROAD  
HAMILTON, NJ 08690

FOR: RESEARCH AND DEVELOPMENT IN THE PHARMACEUTICAL AND BIOTECHNOLOGY FIELDS, IN CLASS 42 (U.S. CLS. 100 AND 101).

FIRST USE 2-16-2007; IN COMMERCE 2-16-2011.

NO CLAIM IS MADE TO THE EXCLUSIVE RIGHT TO USE "INSTITUTE FOR GENETIC IMMUNOLOGY", APART FROM THE MARK AS SHOWN.

THE COLOR(S) BLACK, BLUE, GREEN, YELLOW AND VIOLET IS/ARE CLAIMED AS A FEATURE OF THE MARK.

THE MARK CONSISTS OF THE LITERAL ELEMENTS "THE INSTITUTE FOR GENETIC IMMUNOLOGY HUMIGEN" AND A STYLIZED ELEMENT DEPICTING AN ANTIBODY ENTWINED BY A DNA DOUBLE-HELIX IN FRONT OF AN OVAL DEPICTING A CELL; THE OVAL CONSISTS OF AN OUTER OVAL AND AN INNER OVAL; THE INNER OVAL CONTAINS A DEPICTION OF CELLULAR COMPONENTS; THE LITERAL ELEMENTS "THE INSTITUTE FOR GENETIC IMMUNOLOGY" ARCH ABOVE THE STYLIZED ELEMENT AND THE LITERAL TERM "HUMIGEN" APPEARS BELOW THE STYLIZED ELEMENT; THE COLOR BLACK APPEARS IN THE LITERAL ELEMENTS "THE INSTITUTE FOR GENETIC IMMUNOLOGY HUMIGEN"; THE COLOR BLUE APPEARS IN THE DEPICTION OF THE ANTIBODY; THE COLOR YELLOW APPEARS IN THE DEPICTION OF THE DNA DOUBLE-HELIX; THE COLOR GREEN APPEARS IN THE OUTER OVAL; THE COLOR VIOLET APPEARS IN THE INNER OVAL.

SN 85-244,046, FILED 2-16-2011.

WILLIAM BRECKENFELD, EXAMINING ATTORNEY



*David J. Kybas*

Director of the United States Patent and Trademark Office

# United States of America

United States Patent and Trademark Office

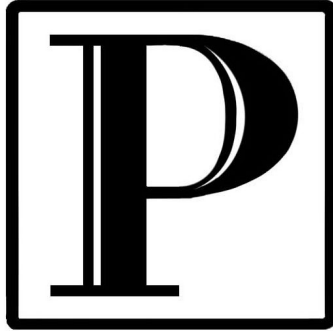

**Reg. No. 4,136,675**

**Registered May 1, 2012**

**Int. Cl.: 41**

**SERVICE MARK**

**PRINCIPAL REGISTER**

THE INTERNATIONAL SOCIETY OF PRIMERUS LAW FIRMS, LTD. (MICHIGAN CORPORATION)  
SUITE 750  
171 MONROE AVENUE NW  
GRAND RAPIDS, MI 49503

FOR: PROVIDING CONTINUING LEGAL EDUCATION SEMINARS AND CONFERENCES AND DISTRIBUTION OF EDUCATIONAL MATERIALS IN CONNECTION THEREWITH, IN CLASS 41 (U.S. CLS. 100, 101 AND 107).

FIRST USE 10-0-2010; IN COMMERCE 10-0-2010.

THE MARK CONSISTS OF A STYLIZED LETTER "P" SET ON A SQUARE BASE.

SN 85-244,055, FILED 2-16-2011.

TINA MAI, EXAMINING ATTORNEY



*David J. Kyffers*

Director of the United States Patent and Trademark Office

# United States of America

United States Patent and Trademark Office

## TEAR-A-SIZE

**Reg. No. 4,136,676**

**Registered May 1, 2012**

**Int. Cl.: 16**

**TRADEMARK**

**PRINCIPAL REGISTER**

SEARS BRANDS, LLC (ILLINOIS LIMITED LIABILITY COMPANY)  
3333 BEVERLY ROAD  
HOFFMAN ESTATES, IL 60179

FOR: PAPER TOWELS, IN CLASS 16 (U.S. CLS. 2, 5, 22, 23, 29, 37, 38 AND 50).

FIRST USE 4-23-2011; IN COMMERCE 4-23-2011.

THE MARK CONSISTS OF STANDARD CHARACTERS WITHOUT CLAIM TO ANY PARTICULAR FONT, STYLE, SIZE, OR COLOR.

SN 85-244,119, FILED 2-16-2011.

STEVEN PEREZ, EXAMINING ATTORNEY



*David J. Kybas*

Director of the United States Patent and Trademark Office

# United States of America

United States Patent and Trademark Office

## SHINE RESPONSIBLY

**Reg. No. 4,136,677**

**Registered May 1, 2012**

**Int. Cl.: 33**

**TRADEMARK**

**PRINCIPAL REGISTER**

OLE SMOKY DISTILLERY, LLC (TENNESSEE LIMITED LIABILITY COMPANY)  
236 E. MAIN ST. #136  
SEVIERVILLE, TN 37862

FOR: ALCOHOLIC BEVERAGES EXCEPT BEERS, IN CLASS 33 (U.S. CLS. 47 AND 49).

FIRST USE 6-28-2011; IN COMMERCE 6-28-2011.

THE MARK CONSISTS OF STANDARD CHARACTERS WITHOUT CLAIM TO ANY PARTICULAR FONT, STYLE, SIZE, OR COLOR.

SN 85-244,125, FILED 2-16-2011.

ELLEN PERKINS, EXAMINING ATTORNEY



*David J. Kyros*

Director of the United States Patent and Trademark Office

# United States of America

United States Patent and Trademark Office

# Orbiez

**Reg. No. 4,136,678**

**Registered May 1, 2012**

**Int. Cl.: 28**

**TRADEMARK**

**PRINCIPAL REGISTER**

FABRIQUE INNOVATIONS, INC. (NEW YORK CORPORATION), DBA SYKEL  
ENTERPRISES,  
48 WEST 38TH STREET, 6TH FLOOR  
NEW YORK, NY 10018

FOR: STUFFED AND PLUSH TOYS; STUFFED DOLLS AND ANIMALS; STUFFED TOY  
ANIMALS; STUFFED TOYS, IN CLASS 28 (U.S. CLS. 22, 23, 38 AND 50).

FIRST USE 12-1-2011; IN COMMERCE 12-1-2011.

THE MARK CONSISTS OF STANDARD CHARACTERS WITHOUT CLAIM TO ANY PAR-  
TICULAR FONT, STYLE, SIZE, OR COLOR.

SN 85-244,571, FILED 2-17-2011.

ALICE BENMAMAN, EXAMINING ATTORNEY



*David J. Kybas*

Director of the United States Patent and Trademark Office



# United States of America

United States Patent and Trademark Office

# CEMBLES

**Reg. No. 4,136,679**

**Registered May 1, 2012**

**Int. Cl.: 9**

**TRADEMARK**

**PRINCIPAL REGISTER**

PREMIER LAB SUPPLY INC. (FLORIDA CORPORATION)  
1982 SW HAYWORTH ST.  
PORT ST. LUCIE, FL 34953

FOR: LABORATORY EQUIPMENT, NAMELY, PRE-ASSEMBLED X-RAY FLUORESCENCE SAMPLE CUPS FOR ANALYZING LIQUID, POWDER AND SOLID SAMPLES, IN CLASS 9 (U.S. CLS. 21, 23, 26, 36 AND 38).

FIRST USE 6-28-2011; IN COMMERCE 6-28-2011.

THE MARK CONSISTS OF STANDARD CHARACTERS WITHOUT CLAIM TO ANY PARTICULAR FONT, STYLE, SIZE, OR COLOR.

SN 85-244,843, FILED 2-17-2011.

ESTHER A. BORSUK, EXAMINING ATTORNEY



*David J. Kybas*

Director of the United States Patent and Trademark Office

# United States of America

United States Patent and Trademark Office

## El Centro, D.F.

**Reg. No. 4,136,680**

**Registered May 1, 2012**

**Int. Cl.: 43**

**SERVICE MARK**

**PRINCIPAL REGISTER**

MODERN MEXICAN RESTAURANTS, INC. (COLORADO CORPORATION)  
1400 LARIMER STREET  
DENVER, CO 80202

FOR: BAR AND RESTAURANT SERVICES, IN CLASS 43 (U.S. CLS. 100 AND 101).

FIRST USE 5-5-2011; IN COMMERCE 5-5-2011.

THE MARK CONSISTS OF STANDARD CHARACTERS WITHOUT CLAIM TO ANY PARTICULAR FONT, STYLE, SIZE, OR COLOR.

NO CLAIM IS MADE TO THE EXCLUSIVE RIGHT TO USE "D.F.", APART FROM THE MARK AS SHOWN.

THE ENGLISH TRANSLATION OF "EL CENTRO" IN THE MARK IS "THE CENTER".

SN 85-245,353, FILED 2-17-2011.

MIDGE BUTLER, EXAMINING ATTORNEY



*David J. Kyffers*

Director of the United States Patent and Trademark Office

United States of America  
United States Patent and Trademark Office

# MIXCHIEF

**Reg. No. 4,136,681**

**Registered May 1, 2012**

**Int. Cl.: 30**

**TRADEMARK**

**PRINCIPAL REGISTER**

KRAFT FOODS GLOBAL BRANDS LLC (DELAWARE LIMITED LIABILITY COMPANY)  
KRAFT FOODS  
THREE LAKES DRIVE  
NORTHFIELD, IL 60093

FOR: FLAVORED AND SWEETENED GELATINS; FLAVORED, SWEETENED GELATIN  
DESSERTS; PUDDINGS, IN CLASS 30 (U.S. CL. 46).

FIRST USE 8-1-2011; IN COMMERCE 8-1-2011.

THE MARK CONSISTS OF STANDARD CHARACTERS WITHOUT CLAIM TO ANY PAR-  
TICULAR FONT, STYLE, SIZE, OR COLOR.

SN 85-245,364, FILED 2-17-2011.

EDWARD FENNESSY, EXAMINING ATTORNEY



*David J. Kyffers*

Director of the United States Patent and Trademark Office

# United States of America

United States Patent and Trademark Office



**Reg. No. 4,136,682**

**Registered May 1, 2012**

**Int. Cl.: 18**

**TRADEMARK**

**PRINCIPAL REGISTER**

TMNAB, LLC (CALIFORNIA LIMITED LIABILITY COMPANY)  
2912 LAFAYETTE AVENUE  
NEWPORT BEACH, CA 92663

FOR: ALL PURPOSE SPORT BAGS; ALL-PURPOSE ATHLETIC BAGS; ALL-PURPOSE CARRYING BAGS; BACK PACKS; BAGS AND HOLDALLS FOR SPORTS CLOTHING; SHOULDER BAGS; WALLETS, IN CLASS 18 (U.S. CLS. 1, 2, 3, 22 AND 41).

FIRST USE 2-6-2008; IN COMMERCE 2-6-2008.

THE MARK CONSISTS OF A STYLIZED LETTER "A".

SN 85-245,392, FILED 2-17-2011.

SUNG IN, EXAMINING ATTORNEY



*David J. Kyffers*

Director of the United States Patent and Trademark Office

# United States of America

United States Patent and Trademark Office



**Reg. No. 4,136,683**

**Registered May 1, 2012**

**Int. Cl.: 41**

**SERVICE MARK**

**PRINCIPAL REGISTER**

OPTUM, INC. (DELAWARE CORPORATION)  
9900 BREN ROAD EAST  
MINNETONKA, MN 55343

FOR: PROVIDING CONTINUING MEDICAL EDUCATION COURSES; EDUCATION SERVICES, NAMELY, CONDUCTING SEMINARS, COURSES, CONFERENCES, AUDIO CONFERENCES, AND ONLINE SEMINARS IN THE FIELDS OF CONTINUING MEDICAL EDUCATION AND HEALTH CARE AND WELL-BEING, AND DISTRIBUTION OF COURSE MATERIALS IN CONNECTION THEREWITH; CONDUCTING CLASSES, WORKSHOPS AND SEMINARS IN THE FIELDS OF HEALTH, WELL-BEING AND NUTRITION VIA THE INTERNET; PROVIDING INFORMATION IN THE FIELD OF PATIENT EDUCATION INFORMATION VIA THE INTERNET; CONDUCTING CLASSES, WORKSHOPS, AND SEMINARS IN THE FIELDS OF DIABETES CONTROL AND PREVENTION, BEHAVIORAL MANAGEMENT, EXERCISE AND NUTRITION; PERSONAL COACHING SERVICES IN THE FIELDS OF DIABETES CONTROL AND PREVENTION, BEHAVIORAL MANAGEMENT, EXERCISE AND NUTRITION, IN CLASS 41 (U.S. CLS. 100, 101 AND 107).

FIRST USE 6-6-2011; IN COMMERCE 6-6-2011.

THE MARK CONSISTS OF THE WORDING "OPTUMHEALTH" AND THE DESIGN OF A CURVED DIAMOND SHAPE WITH SMALLER DIAMOND SHAPES SET WITHIN THE BORDERS OF THE DESIGN.

THE WORDING "OPTUM" HAS NO MEANING IN A FOREIGN LANGUAGE.

SN 85-245,975, FILED 2-18-2011.

SEAN CROWLEY, EXAMINING ATTORNEY



*David J. Kyjars*

Director of the United States Patent and Trademark Office

# United States of America

United States Patent and Trademark Office



**Reg. No. 4,136,684**

**Registered May 1, 2012**

**Int. Cl.: 45**

**SERVICE MARK**

**PRINCIPAL REGISTER**

OPTUM, INC. (DELAWARE CORPORATION)  
9900 BREN ROAD EAST  
MINNETONKA, MN 55343

FOR: HEALTH CARE ADVOCACY SERVICES TO MEMBERS OF HEALTH BENEFIT PLANS; INDIVIDUALIZED HEALTH CARE COORDINATION SERVICES, NAMELY, FACILITATING MEDICAL CARE SERVICES, BEHAVIOR HEALTH SERVICES, AND HEALTH CARE MANAGEMENT, IN CLASS 45 (U.S. CLS. 100 AND 101).

FIRST USE 6-6-2011; IN COMMERCE 6-6-2011.

THE MARK CONSISTS OF THE WORDING "OPTUMHEALTH" AND THE DESIGN OF A CURVED DIAMOND SHAPE WITH SMALLER DIAMOND SHAPES SET WITHIN THE BORDERS OF THE DESIGN.

THE WORDING "OPTUM" HAS NO MEANING IN A FOREIGN LANGUAGE.

SN 85-245,985, FILED 2-18-2011.

SEAN CROWLEY, EXAMINING ATTORNEY



*David J. Kybas*

Director of the United States Patent and Trademark Office

# United States of America

United States Patent and Trademark Office

# PoshGhetto

**Reg. No. 4,136,685**

**Registered May 1, 2012**

**Int. Cl.: 25**

**TRADEMARK**

**PRINCIPAL REGISTER**

KOCH, DEBORAH (UNITED STATES INDIVIDUAL)  
1541 PINWOOD PLACE  
LA HABRA, CA 90631 AND

CADWELL, AUDREY (UNITED STATES INDIVIDUAL)  
1541 PINWOOD PLACE  
LA HABRA, CA 90631

FOR: BOTTOMS; DENIMS; DRESS PANTS; DRESSES; JACKETS; JERSEYS; MEN'S AND WOMEN'S JACKETS, COATS, TROUSERS, VESTS; SHIRTS; SKIRTS; SOCKS; SWEATERS; TIES; TOPS; WEARABLE GARMENTS AND CLOTHING, NAMELY, SHIRTS; WOMEN'S CLOTHING, NAMELY, SHIRTS, DRESSES, SKIRTS, BLOUSES; WRAPS, IN CLASS 25 (U.S. CLS. 22 AND 39).

FIRST USE 12-1-2010; IN COMMERCE 2-1-2011.

THE MARK CONSISTS OF STANDARD CHARACTERS WITHOUT CLAIM TO ANY PARTICULAR FONT, STYLE, SIZE, OR COLOR.

SN 85-246,553, FILED 2-18-2011.

DOUGLAS LEE, EXAMINING ATTORNEY



*David J. Kyffers*

Director of the United States Patent and Trademark Office

# United States of America

United States Patent and Trademark Office

# CoachOasis

**Reg. No. 4,136,686**

**Registered May 1, 2012**

**Int. Cl.: 35**

**SERVICE MARK**

**PRINCIPAL REGISTER**

COACHOASIS INC. (CANADA CORPORATION)  
1270, MONTPELLIER STREET  
LAVAL, CANADA H7E3E2

FOR: ADVERTISING THE SERVICES OF OTHERS VIA WEB PAGES OPTIMIZED FOR ONLINE SEARCH ENGINES; APPOINTMENT SCHEDULING SERVICES; INFOMEDIARY SERVICES, NAMELY, FACILITATING TRANSACTIONS BETWEEN BUYERS AND SELLERS THROUGH PROVIDING BUYERS WITH INFORMATION ABOUT SELLERS, GOODS, AND/OR SERVICES; PROVIDING A WEBSITE FEATURING AN ONLINE MARKETPLACE FOR EXCHANGING GOODS AND SERVICES WITH OTHER USERS; PROVIDING A WEBSITE FOR CONNECTING SELLERS WITH BUYERS, IN CLASS 35 (U.S. CLS. 100, 101 AND 102).

FIRST USE 2-23-2011; IN COMMERCE 2-23-2011.

THE MARK CONSISTS OF STANDARD CHARACTERS WITHOUT CLAIM TO ANY PARTICULAR FONT, STYLE, SIZE, OR COLOR.

SN 85-247,041, FILED 2-20-2011.

TINA MAI, EXAMINING ATTORNEY



*David J. Kyffers*

Director of the United States Patent and Trademark Office



# United States of America

United States Patent and Trademark Office

# SweatBandit

**Reg. No. 4,136,687**

**Registered May 1, 2012**

**Int. Cl.: 25**

**TRADEMARK**

**PRINCIPAL REGISTER**

4 HEADWEAR, LLC (KENTUCKY LIMITED LIABILITY COMPANY)  
501 WILLOWHURST PLACE  
LOUISVILLE, KY 40223

FOR: ATHLETIC APPAREL, NAMELY, HATS AND CAPS; BASEBALL CAPS AND HATS;  
HATS; HEADGEAR, NAMELY, HATS TO BE USED DURING OUTDOOR SPORTING  
EVENTS, INCLUDING GOLF; SPORT CAPS AND HATS , IN CLASS 25 (U.S. CLS. 22 AND  
39).

FIRST USE 2-3-2012; IN COMMERCE 2-3-2012.

THE MARK CONSISTS OF STANDARD CHARACTERS WITHOUT CLAIM TO ANY PAR-  
TICULAR FONT, STYLE, SIZE, OR COLOR.

SN 85-247,368, FILED 2-21-2011.

HENRY S. ZAK, EXAMINING ATTORNEY



*David J. Kyros*

Director of the United States Patent and Trademark Office

# United States of America

United States Patent and Trademark Office



**Reg. No. 4,136,688**

**Registered May 1, 2012**

**Int. Cls.: 35, 36, 38, 41,  
and 42**

**SERVICE MARK**

**PRINCIPAL REGISTER**

GERSON LEHRMAN GROUP, INC. (DELAWARE CORPORATION)  
9TH FLOOR  
850 THIRD AVENUE  
NEW YORK, NY 10022

FOR: RECRUITING THIRD-PARTY EXPERTS FOR OTHERS, IN THE FIELDS OF TECHNOLOGY AND TELECOM, HEALTHCARE AND BIOMEDICAL, ENERGY AND INDUSTRIALS, CONSUMER GOODS AND SERVICES, FINANCIAL AND BUSINESS SERVICES, REAL ESTATE, ACCOUNTING AND LEGAL AND REGULATORY AFFAIRS; BUSINESS CONSULTING AND INFORMATION SERVICES, NAMELY, PROVIDING A PLATFORM FOR EXPERT CONSULTATIONS, CUSTOMS SURVEYS AND OTHER CONSULTING PROJECTS TO INVESTMENT AND BUSINESS LEADERS IN SPECIALIZED INDUSTRY SECTORS, NAMELY, TECHNOLOGY AND TELECOM, HEALTHCARE AND BIOMEDICAL, ENERGY AND INDUSTRIALS, CONSUMER GOODS AND SERVICES, FINANCIAL AND BUSINESS SERVICES, REAL ESTATE, ACCOUNTING AND LEGAL AND REGULATORY AFFAIRS; ON-LINE BUSINESS NETWORKING SERVICES, IN CLASS 35 (U.S. CLS. 100, 101 AND 102).

FIRST USE 5-0-2011; IN COMMERCE 5-0-2011.

FOR: RESEARCH SERVICES FOR THE BUSINESS COMMUNITY IN THE NATURE OF PROVIDING DIRECT CONSULTATION OR BROAD SURVEYS TO A NETWORK OF EXPERT ADVISORS AND INDUSTRY PROFESSIONALS IN SPECIALIZED INDUSTRY SECTORS, NAMELY, TECHNOLOGY AND TELECOM, HEALTHCARE AND BIOMEDICAL, ENERGY AND INDUSTRIALS, CONSUMER GOODS AND SERVICES, FINANCIAL AND BUSINESS SERVICES, REAL ESTATE, ACCOUNTING AND LEGAL AND REGULATORY AFFAIRS; RESEARCH SERVICES FOR THE BUSINESS COMMUNITY IN THE NATURE OF PROVIDING A DATABASE OF INDUSTRY SECTOR REPORTS AND SURVEYS, IN CLASS 36 (U.S. CLS. 100, 101 AND 102).

FIRST USE 5-0-2011; IN COMMERCE 5-0-2011.

FOR: PROVIDING ON-LINE CHAT ROOMS AND ELECTRONIC BULLETIN BOARDS FOR TRANSMISSION OF MESSAGES AMONG USERS IN THE FIELDS OF TECHNOLOGY AND TELECOM, HEALTHCARE AND BIOMEDICAL, ENERGY AND INDUSTRIALS, CONSUMER GOODS AND SERVICES, FINANCIAL AND BUSINESS SERVICES, REAL ESTATE, AC-



*David J. Kybas*

Director of the United States Patent and Trademark Office

**Reg. No. 4,136,688** COUNTING AND LEGAL AND REGULATORY AFFAIRS; PROVIDING ON-LINE CHAT ROOMS FOR SOCIAL NETWORKING, IN CLASS 38 (U.S. CLS. 100, 101 AND 104).

FIRST USE 5-0-2011; IN COMMERCE 5-0-2011.

FOR: EDUCATIONAL SERVICES, NAMELY, THE PRESENTATION OF SEMINARS, LECTURES, AND ROUNDTABLES IN THE FIELDS OF TECHNOLOGY AND TELECOM, HEALTHCARE AND BIOMEDICAL, ENERGY AND INDUSTRIALS, CONSUMER GOODS AND SERVICES, FINANCIAL AND BUSINESS SERVICES, REAL ESTATE, ACCOUNTING AND LEGAL AND REGULATORY AFFAIRS, IN CLASS 41 (U.S. CLS. 100, 101 AND 107).

FIRST USE 5-0-2011; IN COMMERCE 5-0-2011.

FOR: COMPUTER SERVICES, NAMELY, HOSTING ON-LINE WEB FACILITIES FOR OTHERS FOR ORGANIZING ON-LINE MEETINGS, GATHERINGS AND INTERACTIVE DISCUSSIONS, IN CLASS 42 (U.S. CLS. 100 AND 101).

FIRST USE 5-0-2011; IN COMMERCE 5-0-2011.

THE MARK CONSISTS OF THE LETTER "G" WITH A PLUS SIGN ("+") TO THE RIGHT.

SN 85-247,393, FILED 2-21-2011.

ALEXANDER L. POWERS, EXAMINING ATTORNEY

# United States of America

United States Patent and Trademark Office

## GREEN SWEEP

**Reg. No. 4,136,689**

**Registered May 1, 2012**

**Int. Cl.: 7**

**TRADEMARK**

**PRINCIPAL REGISTER**

ZANINI, ARTHUR (UNITED STATES INDIVIDUAL)  
2976 MOJAVE CT  
BLOOMINGTON, CA 92346

FOR: ELECTRIC PARKING LOT SWEEPER, IN CLASS 7 (U.S. CLS. 13, 19, 21, 23, 31, 34 AND 35).

FIRST USE 2-6-2011; IN COMMERCE 2-17-2012.

THE MARK CONSISTS OF STANDARD CHARACTERS WITHOUT CLAIM TO ANY PARTICULAR FONT, STYLE, SIZE, OR COLOR.

NO CLAIM IS MADE TO THE EXCLUSIVE RIGHT TO USE "SWEEP", APART FROM THE MARK AS SHOWN.

SN 85-247,861, FILED 2-22-2011.

ALEXANDER L. POWERS, EXAMINING ATTORNEY



*David J. Kybas*

Director of the United States Patent and Trademark Office

# United States of America

United States Patent and Trademark Office



**Reg. No. 4,136,690**

**Registered May 1, 2012**

**Int. Cls.: 17 and 19**

**TRADEMARK**

**PRINCIPAL REGISTER**

THE QUARTZ CORP USA (DELAWARE CORPORATION)  
100 MANSELL COURT EAST, SUITE 300  
ROSWELL, GA 30076

FOR: MICA, IN CLASS 17 (U.S. CLS. 1, 5, 12, 13, 35 AND 50).

FIRST USE 1-0-2011; IN COMMERCE 1-0-2011.

FOR: FELDSPAR; QUARTZ, IN CLASS 19 (U.S. CLS. 1, 12, 33 AND 50).

FIRST USE 1-0-2011; IN COMMERCE 1-0-2011.

NO CLAIM IS MADE TO THE EXCLUSIVE RIGHT TO USE "QUARTZ CORP", APART FROM THE MARK AS SHOWN.

THE MARK CONSISTS OF A STYLIZED LETTER "Q" WITH THE WORD "THE" TO THE LEFT OF THE STYLIZED "Q" AND THE WORDS "QUARTZ CORP" TO THE RIGHT OF THE STYLIZED "Q".

SN 85-247,934, FILED 2-22-2011.

KEVON CHISOLM, EXAMINING ATTORNEY



*David J. Kybas*

Director of the United States Patent and Trademark Office

# United States of America

United States Patent and Trademark Office

# FireFiber

**Reg. No. 4,136,691**

**Registered May 1, 2012**

**Int. Cl.: 17**

**TRADEMARK**

**PRINCIPAL REGISTER**

L.J.AVALON LLC (FLORIDA LIMITED LIABILITY COMPANY)  
6900 INTERBAY BLVD.  
TAMPA, FL 33616

FOR: SLAG WOOL FOR USE AS A BUILDING INSULATOR, IN CLASS 17 (U.S. CLS. 1, 5, 12, 13, 35 AND 50).

FIRST USE 12-1-2010; IN COMMERCE 12-1-2010.

THE MARK CONSISTS OF STANDARD CHARACTERS WITHOUT CLAIM TO ANY PARTICULAR FONT, STYLE, SIZE, OR COLOR.

SN 85-248,060, FILED 2-22-2011.

JOHN HWANG, EXAMINING ATTORNEY



*David J. Kyffers*

Director of the United States Patent and Trademark Office

# United States of America

United States Patent and Trademark Office

# AMAVEL

**Reg. No. 4,136,692**

**Registered May 1, 2012**

**Int. Cl.: 30**

**TRADEMARK**

**PRINCIPAL REGISTER**

KRAFT FOODS SCHWEIZ HOLDING GMBH (SWITZERLAND LIMITED LIABILITY COMPANY)  
CHOLLERSTRASSE 4  
6301 ZUG, SWITZERLAND

FOR: CHOCOLATE; CHOCOLATE BARS, IN CLASS 30 (U.S. CL. 46).

FIRST USE 2-1-2012; IN COMMERCE 2-1-2012.

THE MARK CONSISTS OF STANDARD CHARACTERS WITHOUT CLAIM TO ANY PARTICULAR FONT, STYLE, SIZE, OR COLOR.

THE ENGLISH TRANSLATION OF "AMAVEL" IN THE MARK IS "LOVELY".

SN 85-248,170, FILED 2-22-2011.

MATTHEW EINSTEIN, EXAMINING ATTORNEY



*David J. Kybas*

Director of the United States Patent and Trademark Office

**United States of America**  
United States Patent and Trademark Office

# LIP SPLASH

**Reg. No. 4,136,693**

**Registered May 1, 2012**

**Int. Cl.: 3**

**TRADEMARK**

**PRINCIPAL REGISTER**

ASPIRE BRANDS, INC. (NEVADA CORPORATION)  
1006 CROCKER ROAD  
WESTLAKE, OH 44115

FOR: COSMETICS; LIP BALMS; LIP GLOSS; LIPSTICKS, IN CLASS 3 (U.S. CLS. 1, 4, 6, 50, 51 AND 52).

FIRST USE 12-1-2011; IN COMMERCE 12-1-2011.

THE MARK CONSISTS OF STANDARD CHARACTERS WITHOUT CLAIM TO ANY PARTICULAR FONT, STYLE, SIZE, OR COLOR.

NO CLAIM IS MADE TO THE EXCLUSIVE RIGHT TO USE "LIP", APART FROM THE MARK AS SHOWN.

SN 85-248,218, FILED 2-22-2011.

CHRISTOPHER BUONGIORNO, EXAMINING ATTORNEY



*David J. Kyffers*

Director of the United States Patent and Trademark Office



# United States of America

United States Patent and Trademark Office

# WEBCX

**Reg. No. 4,136,694**

**Registered May 1, 2012**

**Int. Cl.: 9**

**TRADEMARK**

**PRINCIPAL REGISTER**

EATON CORPORATION (OHIO CORPORATION)  
1111 SUPERIOR AVENUE  
CLEVELAND, OH 44114

FOR: PROJECT MANAGEMENT SOFTWARE TOOL USED BY BUILDING OWNERS, CONTRACTORS, DESIGN ENGINEERS, AND ARCHITECTS THROUGHOUT THE PROCESS OF CONSTRUCTION OF NEW BUILDINGS, IN CLASS 9 (U.S. CLS. 21, 23, 26, 36 AND 38).

FIRST USE 6-17-2008; IN COMMERCE 6-17-2008.

THE MARK CONSISTS OF STANDARD CHARACTERS WITHOUT CLAIM TO ANY PARTICULAR FONT, STYLE, SIZE, OR COLOR.

SN 85-248,252, FILED 2-22-2011.

STEVEN JACKSON, EXAMINING ATTORNEY



*David J. Kyffers*

Director of the United States Patent and Trademark Office

# United States of America

United States Patent and Trademark Office

## I'm An American Not An American't!

**Reg. No. 4,136,695**

NANCY F. TAYLOR (UNITED STATES INDIVIDUAL)  
48 HILL DRIVE  
MILFORD, IA 51351

**Registered May 1, 2012**

**Int. Cl.: 41**

FOR: EDUCATIONAL AND MOTIVATIONAL SERVICES, NAMELY, PROVIDING CLASSES, SEMINARS, WORKSHOPS, TUTORING AND MENTORING IN THE FIELD OF PERSONAL ASSETS, STRENGTHS AND FINANCIAL LIFESTYLE GOALS, IN CLASS 41 (U.S. CLS. 100, 101 AND 107).

**SERVICE MARK**

**PRINCIPAL REGISTER**

FIRST USE 1-15-2012; IN COMMERCE 1-15-2012.

THE MARK CONSISTS OF STANDARD CHARACTERS WITHOUT CLAIM TO ANY PARTICULAR FONT, STYLE, SIZE, OR COLOR.

SN 85-248,441, FILED 2-22-2011.

ANDREW LEASER, EXAMINING ATTORNEY



*David J. Kyffers*

Director of the United States Patent and Trademark Office

# United States of America

United States Patent and Trademark Office

## PLANET WORK

**Reg. No. 4,136,696**

**Registered May 1, 2012**

**Int. Cl.: 9**

**TRADEMARK**

**PRINCIPAL REGISTER**

CAPCOM CO., LTD. (JAPAN CORPORATION)  
3-1-3 UCHIHIRANOMACHI, CHUO-KU  
OSAKA, JAPAN

FOR: COMPUTER GAME SOFTWARE; COMPUTER GAMES IN THE FORM OF CARTRIDGES, CASSETTES, DISCS OR TAPES; VIDEO GAME CARTRIDGES; VIDEO GAME MACHINES FOR USE WITH TELEVISION RECEIVERS; DOWNLOADABLE GAME SOFTWARE; DOWNLOADABLE COMPUTER GAMES; DOWNLOADABLE GAME PROGRAM FOR PLAYING ON MOBILE PHONES; DOWNLOADABLE GAME SOFTWARE FOR PLAYING ON MOBILE PHONES; SCREEN SAVER SOFTWARE AND WALLPAPER SOFTWARE; DOWNLOADABLE SCREEN SAVER SOFTWARE AND WALLPAPER SOFTWARE FOR MOBILE PHONES; DOWNLOADABLE GRAPHICS AND MUSIC VIA A GLOBAL COMPUTER NETWORK; DOWNLOADABLE GRAPHICS, MUSIC AND RING TONES FOR MOBILE PHONES, IN CLASS 9 (U.S. CLS. 21, 23, 26, 36 AND 38).

FIRST USE 3-9-2011; IN COMMERCE 3-9-2011.

THE MARK CONSISTS OF STANDARD CHARACTERS WITHOUT CLAIM TO ANY PARTICULAR FONT, STYLE, SIZE, OR COLOR.

SN 85-248,594, FILED 2-22-2011.

HEATHER THOMPSON, EXAMINING ATTORNEY



*David J. Kyros*

Director of the United States Patent and Trademark Office

# United States of America

United States Patent and Trademark Office

# Pyramid

**Reg. No. 4,136,697**

**Registered May 1, 2012**

**Int. Cl.: 25**

**TRADEMARK**

**PRINCIPAL REGISTER**

BOWLINGBALL.COM, INC. (FLORIDA CORPORATION)  
771 FENTRESS BLVD., SUITE 14  
DAYTONA BEACH, FL 32114

FOR: BOWLING SHOES, IN CLASS 25 (U.S. CLS. 22 AND 39).

FIRST USE 8-5-2011; IN COMMERCE 8-5-2011.

THE MARK CONSISTS OF STANDARD CHARACTERS WITHOUT CLAIM TO ANY PARTICULAR FONT, STYLE, SIZE, OR COLOR.

SN 85-249,182, FILED 2-23-2011.

MARK T. MULLEN, EXAMINING ATTORNEY



*David J. Kyffers*

Director of the United States Patent and Trademark Office

# United States of America

United States Patent and Trademark Office

# Pyramid

**Reg. No. 4,136,698**

**Registered May 1, 2012**

**Int. Cl.: 28**

**TRADEMARK**

**PRINCIPAL REGISTER**

BOWLINGBALL.COM, INC. (FLORIDA CORPORATION)  
771 FENTRESS BLVD., SUITE 14  
DAYTONA BEACH, FL 32114

FOR: BOWLING BAGS; BOWLING BALLS, IN CLASS 28 (U.S. CLS. 22, 23, 38 AND 50).

FIRST USE 8-5-2011; IN COMMERCE 8-5-2011.

THE MARK CONSISTS OF STANDARD CHARACTERS WITHOUT CLAIM TO ANY PARTICULAR FONT, STYLE, SIZE, OR COLOR.

SN 85-249,184, FILED 2-23-2011.

MARK T. MULLEN, EXAMINING ATTORNEY



*David J. Kybas*

Director of the United States Patent and Trademark Office

# United States of America

United States Patent and Trademark Office

## FileLine<sup>♦</sup>ACCESS

Retrievex Online Information Management

**Reg. No. 4,136,699**

**Registered May 1, 2012**

**Int. Cls.: 35, 39, and 42**

**SERVICE MARK**

**PRINCIPAL REGISTER**

RETRIEVEX FINANCING CORP. (DELAWARE CORPORATION)  
4 FIRST AVENUE  
PEABODY, MA 01960

FOR: ELECTRONIC MANAGEMENT OF FILES AND DOCUMENTS THAT ARE IN STORAGE, NAMELY, COMPUTERIZED FILE AND DOCUMENT MANAGEMENT SERVICES; BUSINESS AND FINANCIAL RECORDS MANAGEMENT SERVICES; RECORDS MANAGEMENT SERVICES, NAMELY, DOCUMENT INDEXING FOR OTHERS; INVENTORY MANAGEMENT AND CONTROL SERVICES FOR BUSINESS AND FINANCIAL RECORDS; MAINTENANCE OF BUSINESS RECORDS, NAMELY, INVENTORY MANAGEMENT AND CONTROL SERVICES OF BUSINESS RECORDS AND BUSINESS RECORDS IN THE NATURE OF VITAL RECORDS, COMPUTER DATA, FILMS, MASTER RECORDINGS, AND ARCHIVAL MATERIALS AND RECORDS, IN CLASS 35 (U.S. CLS. 100, 101 AND 102).

FIRST USE 10-6-2010; IN COMMERCE 10-6-2010.

FOR: WAREHOUSING SERVICES, NAMELY, STORAGE, DISTRIBUTION, PICK-UP, AND PACKING FOR SHIPMENT OF RECORDS AND DOCUMENTS FOR OTHERS; DOCUMENT STORAGE SERVICES; ELECTRONIC STORAGE OF FILES AND DOCUMENTS; PHYSICAL STORAGE OF ELECTRONICALLY-STORED DATA OR DOCUMENTS; STORAGE SERVICES FOR ARCHIVING DATABASES, IMAGES AND OTHER ELECTRONIC DATA; DOCUMENT DELIVERY SERVICES, IN CLASS 39 (U.S. CLS. 100 AND 105).

FIRST USE 10-6-2010; IN COMMERCE 10-6-2010.

FOR: ELECTRONIC RETRIEVAL SERVICES FOR FILES AND DOCUMENTS THAT ARE IN STORAGE, NAMELY, COMPUTERIZED FILE AND DOCUMENT RETRIEVAL SERVICES FOR OTHERS, IN CLASS 42 (U.S. CLS. 100 AND 101).

FIRST USE 10-6-2010; IN COMMERCE 10-6-2010.

OWNER OF U.S. REG. NO. 3,670,186.

NO CLAIM IS MADE TO THE EXCLUSIVE RIGHT TO USE "ONLINE INFORMATION MANAGEMENT", APART FROM THE MARK AS SHOWN.



*David J. Kyros*

Director of the United States Patent and Trademark Office

**Reg. No. 4,136,699** THE MARK CONSISTS OF THE WORD "FILELINE" TO THE LEFT OF A DIAMOND WITH THE WORD "ACCESS" TO THE RIGHT OF THE DIAMOND AND ABOVE THE WORDING "RETRIEVEX ONLINE INFORMATION MANAGEMENT".

SN 85-249,203, FILED 2-23-2011.

CHARLES L. JENKINS, EXAMINING ATTORNEY

# United States of America

United States Patent and Trademark Office

## ARCADIAN HARVEST

**Reg. No. 4,136,700**

**Registered May 1, 2012**

**Int. Cl.: 31**

**TRADEMARK**

**PRINCIPAL REGISTER**

MANN PACKING CO., INC. (CALIFORNIA CORPORATION)  
1333 SCHILLING PLACE  
SALINAS, CA 93101

FOR: FRESH VEGETABLES, NAMELY, LETTUCE, IN CLASS 31 (U.S. CLS. 1 AND 46).

FIRST USE 1-31-2011; IN COMMERCE 1-31-2011.

THE MARK CONSISTS OF STANDARD CHARACTERS WITHOUT CLAIM TO ANY PARTICULAR FONT, STYLE, SIZE, OR COLOR.

SN 85-249,361, FILED 2-23-2011.

KATHY DE JONGE, EXAMINING ATTORNEY



*David J. Kyffers*

Director of the United States Patent and Trademark Office



# United States of America

United States Patent and Trademark Office

# VINTACT

**Reg. No. 4,136,701**

VINAPEX, INC. (ILLINOIS CORPORATION)  
411 S. ALBERT STREET  
MOUNT PROSPECT, IL 60056

**Registered May 1, 2012**

**Int. Cl.: 21**

FOR: BOTTLE STOPPERS SPECIALLY ADAPTED FOR USE WITH WINE BOTTLES FOR PRESERVATION OF CONTENTS, IN CLASS 21 (U.S. CLS. 2, 13, 23, 29, 30, 33, 40 AND 50).

**TRADEMARK**

FIRST USE 11-24-2011; IN COMMERCE 4-14-2011.

**PRINCIPAL REGISTER**

THE MARK CONSISTS OF STANDARD CHARACTERS WITHOUT CLAIM TO ANY PARTICULAR FONT, STYLE, SIZE, OR COLOR.

SN 85-249,515, FILED 2-23-2011.

COLLEEN DOMBROW, EXAMINING ATTORNEY



*David J. Kybas*

Director of the United States Patent and Trademark Office

# United States of America

United States Patent and Trademark Office

# SHARPMART

**Reg. No. 4,136,702**

**Registered May 1, 2012**

**Int. Cls.: 35 and 36**

**SERVICE MARK**

**PRINCIPAL REGISTER**

POWELL GROWTH CAPITAL, LLC (GEORGIA LIMITED LIABILITY COMPANY)  
3155 ROSWELL ROAD, SUTE 120  
ATLANTA, GA 30305

FOR: DISCOUNT STORES IN THE FIELD OF GENERAL CONSUMER MERCHANDISE;  
RETAIL DISCOUNT STORE SERVICES IN THE FIELD OF GENERAL CONSUMER MER-  
CHANDISE , IN CLASS 35 (U.S. CLS. 100, 101 AND 102).

FIRST USE 6-26-2011; IN COMMERCE 6-26-2011.

FOR: PAWN SHOPS, IN CLASS 36 (U.S. CLS. 100, 101 AND 102).

FIRST USE 6-26-2011; IN COMMERCE 6-26-2011.

THE MARK CONSISTS OF STANDARD CHARACTERS WITHOUT CLAIM TO ANY PAR-  
TICULAR FONT, STYLE, SIZE, OR COLOR.

SN 85-249,598, FILED 2-23-2011.

PATRICIA EVANKO, EXAMINING ATTORNEY



*David J. Kyros*

Director of the United States Patent and Trademark Office

# United States of America

United States Patent and Trademark Office

# FUELF OAM

**Reg. No. 4,136,703**

**Registered May 1, 2012**

**Int. Cl.: 25**

**TRADEMARK**

**PRINCIPAL REGISTER**

REEBOK INTERNATIONAL LIMITED (UNITED KINGDOM COMPANY)  
11/12 PALL MALL  
LONDON SW1Y 5LU, UNITED KINGDOM

FOR: FOOTWEAR, IN CLASS 25 (U.S. CLS. 22 AND 39).

FIRST USE 8-0-2011; IN COMMERCE 8-0-2011.

THE MARK CONSISTS OF STANDARD CHARACTERS WITHOUT CLAIM TO ANY PARTICULAR FONT, STYLE, SIZE, OR COLOR.

SN 85-249,614, FILED 2-23-2011.

C. DIONNE CLYBURN, EXAMINING ATTORNEY



*David J. Kybas*

Director of the United States Patent and Trademark Office

# United States of America

United States Patent and Trademark Office

## ANSWERS AT WALGREENS

**Reg. No. 4,136,704**

WALGREEN CO. (ILLINOIS CORPORATION)  
200 WILMOT ROAD  
DEERFIELD, IL 60015

**Registered May 1, 2012**

**Int. Cl.: 44**

FOR: PROVIDING HEALTH CARE INFORMATION AND INTERNET-BASED HEALTH CARE INFORMATION SERVICES, IN CLASS 44 (U.S. CLS. 100 AND 101).

**SERVICE MARK**

FIRST USE 3-31-2011; IN COMMERCE 3-31-2011.

**PRINCIPAL REGISTER**

THE MARK CONSISTS OF STANDARD CHARACTERS WITHOUT CLAIM TO ANY PARTICULAR FONT, STYLE, SIZE, OR COLOR.

OWNER OF U.S. REG. NOS. 2,876,500, 3,303,249, AND OTHERS.

SN 85-249,644, FILED 2-23-2011.

WON TEAK OH, EXAMINING ATTORNEY



*David J. Kybas*

Director of the United States Patent and Trademark Office

# United States of America

United States Patent and Trademark Office

## BRAKE AND ENTER

**Reg. No. 4,136,705**

**Registered May 1, 2012**

**Int. Cl.: 12**

**TRADEMARK**

**PRINCIPAL REGISTER**

BRAKE AND ENTER AUTOMOTIVE INC. (CANADA CORPORATION)  
SUITE #3  
335 LAIRD ROAD  
GUELPH, ONTARIO, CANADA N1G4P7

FOR: BRAKE LININGS FOR LAND VEHICLES; BRAKE PADS FOR LAND VEHICLES;  
BRAKE SHOES FOR LAND VEHICLES; BRAKES FOR LAND VEHICLES; DISC BRAKE  
PADS FOR VEHICLES; DISC BRAKES FOR LAND VEHICLES, IN CLASS 12 (U.S. CLS. 19,  
21, 23, 31, 35 AND 44).

FIRST USE 4-6-2011; IN COMMERCE 4-6-2011.

THE MARK CONSISTS OF STANDARD CHARACTERS WITHOUT CLAIM TO ANY PAR-  
TICULAR FONT, STYLE, SIZE, OR COLOR.

SN 85-250,007, FILED 2-23-2011.

JOHN DWYER, EXAMINING ATTORNEY



*David J. Kyffers*

Director of the United States Patent and Trademark Office

# United States of America

United States Patent and Trademark Office

# SILENCER

**Reg. No. 4,136,706**

**Registered May 1, 2012**

**Int. Cl.: 12**

**TRADEMARK**

**PRINCIPAL REGISTER**

BRAKE AND ENTER AUTOMOTIVE INC. (CANADA CORPORATION)  
SUITE #3  
335 LAIRD ROAD  
GUELPH, ONTARIO, CANADA N1G4P7

FOR: BRAKE LININGS FOR LAND VEHICLES; BRAKE PADS FOR LAND VEHICLES;  
BRAKE SHOES FOR LAND VEHICLES; BRAKES FOR LAND VEHICLES; DISC BRAKE  
PADS FOR VEHICLES; DISC BRAKES FOR LAND VEHICLES, IN CLASS 12 (U.S. CLS. 19,  
21, 23, 31, 35 AND 44).

FIRST USE 4-6-2011; IN COMMERCE 4-6-2011.

THE MARK CONSISTS OF STANDARD CHARACTERS WITHOUT CLAIM TO ANY PAR-  
TICULAR FONT, STYLE, SIZE, OR COLOR.

SN 85-250,013, FILED 2-23-2011.

JOHN DWYER, EXAMINING ATTORNEY



*David J. Kyffers*

Director of the United States Patent and Trademark Office

# United States of America

United States Patent and Trademark Office

# Onlyfearone

**Reg. No. 4,136,707**

**Registered May 1, 2012**

**Int. Cl.: 25**

**TRADEMARK**

**PRINCIPAL REGISTER**

LOVETT II, ALLAN (UNITED STATES INDIVIDUAL)  
2736 MAYBROOK HOLLOW LANE  
HOUSTON, TX 77047

FOR: JACKETS; PANTS; SHIRTS; WRISTBANDS, IN CLASS 25 (U.S. CLS. 22 AND 39).

FIRST USE 10-1-2011; IN COMMERCE 11-1-2011.

THE MARK CONSISTS OF STANDARD CHARACTERS WITHOUT CLAIM TO ANY PARTICULAR FONT, STYLE, SIZE, OR COLOR.

SN 85-250,400, FILED 2-24-2011.

DOUGLAS LEE, EXAMINING ATTORNEY



*David J. Kyffers*

Director of the United States Patent and Trademark Office

# United States of America

United States Patent and Trademark Office

## KIDS THESE DAYS

**Reg. No. 4,136,708**

**Registered May 1, 2012**

**Int. Cl.: 9**

**TRADEMARK**

**PRINCIPAL REGISTER**

CUNNINGHAM, PETER (UNITED STATES INDIVIDUAL)  
APT 912  
933 WEST VAN BURAN STREET  
CHICAGO, IL 60607

FOR: DOWNLOADABLE MP3 FILES AND MP3 RECORDINGS FEATURING MUSIC; PRE-RECORDED CDS FEATURING MUSIC; PRE-RECORDED DIGITAL MEDIA FEATURING MUSIC, IN CLASS 9 (U.S. CLS. 21, 23, 26, 36 AND 38).

FIRST USE 1-0-2012; IN COMMERCE 1-0-2012.

THE MARK CONSISTS OF STANDARD CHARACTERS WITHOUT CLAIM TO ANY PARTICULAR FONT, STYLE, SIZE, OR COLOR.

SN 85-250,432, FILED 2-24-2011.

APRIL ROACH, EXAMINING ATTORNEY



*David J. Kybas*

Director of the United States Patent and Trademark Office



# United States of America

United States Patent and Trademark Office

# ELEV8

**Reg. No. 4,136,709**

**Registered May 1, 2012**

**Int. Cl.: 42**

**SERVICE MARK**

**PRINCIPAL REGISTER**

AFFLINK, LLC (DELAWARE LIMITED LIABILITY COMPANY)  
1400 AFFLINK PLACE  
TUSCALOOSA, AL 35406

FOR: PROVIDING A WEB SITE FEATURING TEMPORARY USE OF NON-DOWNLOADABLE SOFTWARE FOR SUPPLY CHAIN MANAGEMENT FOR USE WITH PROCUREMENT AND OPERATION EFFICIENCIES, NAMELY, PRODUCT AND PROCESS SOLUTIONS FOR BUSINESSES, IN CLASS 42 (U.S. CLS. 100 AND 101).

FIRST USE 8-31-2011; IN COMMERCE 8-31-2011.

THE MARK CONSISTS OF STANDARD CHARACTERS WITHOUT CLAIM TO ANY PARTICULAR FONT, STYLE, SIZE, OR COLOR.

SN 85-250,716, FILED 2-24-2011.

ALEXANDER L. POWERS, EXAMINING ATTORNEY



*David J. Kybas*

Director of the United States Patent and Trademark Office

# United States of America

United States Patent and Trademark Office

# GO CART

**Reg. No. 4,136,710**

**Registered May 1, 2012**

**Int. Cl.: 11**

**TRADEMARK**

**PRINCIPAL REGISTER**

THE DELFIELD COMPANY LLC (DELAWARE LIMITED LIABILITY COMPANY)  
SUITE 400  
2711 CENTERVILLE ROAD  
WILMINGTON, DE 19808

FOR: TEMPERATURE CONTROLLED, REFRIGERATED OR HEATED MOBILE UNITS FOR THE STORAGE AND DELIVERY OF FOOD PRODUCTS FEATURING HEATING, REFRIGERATING, FREEZING, PREPARING AND STORING FOOD, IN CLASS 11 (U.S. CLS. 13, 21, 23, 31 AND 34).

FIRST USE 10-0-2011; IN COMMERCE 10-0-2011.

THE MARK CONSISTS OF STANDARD CHARACTERS WITHOUT CLAIM TO ANY PARTICULAR FONT, STYLE, SIZE, OR COLOR.

SN 85-250,829, FILED 2-24-2011.

TASNEEM HUSSAIN, EXAMINING ATTORNEY



*David J. Kyffers*

Director of the United States Patent and Trademark Office

# United States of America

United States Patent and Trademark Office

## UI Integrity Warehouse

**Reg. No. 4,136,711**

**Registered May 1, 2012**

**Int. Cl.: 9**

**TRADEMARK**

**PRINCIPAL REGISTER**

REVENUE SOLUTIONS, INC. (MASSACHUSETTS CORPORATION)  
42 WINTER STREET  
PEMBROKE, MA 02359

FOR: COMPUTER SOFTWARE FOR UNEMPLOYMENT COMPENSATION MANAGEMENT, NAMELY, FOR AUDITING, IDENTIFICATION AND PURSUIT OF NON-COMPLIANCE AND BENEFIT OVERPAYMENT IN CONNECTION WITH UNEMPLOYMENT COMPENSATION, IN CLASS 9 (U.S. CLS. 21, 23, 26, 36 AND 38).

FIRST USE 10-31-2010; IN COMMERCE 10-31-2010.

THE MARK CONSISTS OF STANDARD CHARACTERS WITHOUT CLAIM TO ANY PARTICULAR FONT, STYLE, SIZE, OR COLOR.

SN 85-250,933, FILED 2-24-2011.

MICHAEL WEBSTER, EXAMINING ATTORNEY



*David J. Kyros*

Director of the United States Patent and Trademark Office

# United States of America

United States Patent and Trademark Office



**Reg. No. 4,136,712**

**Registered May 1, 2012**

**Int. Cls.: 32 and 33**

**TRADEMARK**

**PRINCIPAL REGISTER**

MARK ANTHONY INTERNATIONAL SRL (BARBADOS CORPORATION)  
PARKER HOUSE, WILDEY BUSINESS HOUSE  
WILDEY ROAD  
ST. MICHAEL, BARBADOS

FOR: FLAVORED BREWED MALT-BASED ALCOHOLIC BEVERAGES IN THE NATURE OF BEER, IN CLASS 32 (U.S. CLS. 45, 46 AND 48).

FIRST USE 4-17-2011; IN COMMERCE 4-17-2011.

FOR: ALCOHOLIC FLAVORED MALT COOLERS, IN CLASS 33 (U.S. CLS. 47 AND 49).

FIRST USE 4-17-2011; IN COMMERCE 4-17-2011.

THE MARK CONSISTS OF STYLIZED LEAVES FROM A PLANT KNOWN AS "BIRD OF PARADISE". THE MARK IS NOT IN COLOR. THE BLACK IN THE DRAWING IS MEANT TO SHOW BACKGROUND AND IS NOT PART OF THE MARK.

SN 85-251,891, FILED 2-25-2011.

SUZANNE BLANE, EXAMINING ATTORNEY



*David J. Kybas*

Director of the United States Patent and Trademark Office

# United States of America

United States Patent and Trademark Office

## DYNAMIC WORKFLOW

**Reg. No. 4,136,713**

**Registered May 1, 2012**

**Int. Cl.: 35**

**SERVICE MARK**

**PRINCIPAL REGISTER**

CARDINAL LOGISTICS MANAGEMENT CORPORATION (NORTH CAROLINA CORPORATION)  
5333 DAVIDSON HIGHWAY  
CONCORD, NC 28027

FOR: SUPPLY CHAIN MANAGEMENT SERVICES; ARRANGING FOR PICKUP, DELIVERY, STORAGE AND TRANSPORTATION OF FREIGHT VIA GROUND CARRIERS; TRANSPORTATION LOGISTIC SERVICES, NAMELY, ARRANGING THE TRANSPORTATION OF GOODS FOR OTHERS; TRANSPORTATION AND LOGISTICS SERVICES, NAMELY, PLANNING AND SCHEDULING SHIPMENTS FOR USERS OF TRANSPORTATION SERVICES; FREIGHT LOGISTICS MANAGEMENT; TRANSPORTATION LOGISTICS SERVICES, NAMELY, ARRANGING THE TRANSPORTATION OF GOODS FOR OTHERS; TRANSPORTATION LOGISTICS SERVICES, NAMELY, PLANNING AND SCHEDULING SHIPMENTS FOR USERS OF TRANSPORTATION SERVICES, IN CLASS 35 (U.S. CLS. 100, 101 AND 102).

FIRST USE 10-0-2011; IN COMMERCE 10-0-2011.

THE MARK CONSISTS OF STANDARD CHARACTERS WITHOUT CLAIM TO ANY PARTICULAR FONT, STYLE, SIZE, OR COLOR.

NO CLAIM IS MADE TO THE EXCLUSIVE RIGHT TO USE "WORKFLOW", APART FROM THE MARK AS SHOWN.

SN 85-251,922, FILED 2-25-2011.

GINA HAYES, EXAMINING ATTORNEY



*David J. Kyros*

Director of the United States Patent and Trademark Office

# United States of America

United States Patent and Trademark Office

## The Aussie Boys

**Reg. No. 4,136,714**

**Registered May 1, 2012**

**Int. Cl.: 41**

**SERVICE MARK**

**PRINCIPAL REGISTER**

SPOTLIGHT ENTERTAINMENT PRODUCTIONS, INC. (FLORIDA CORPORATION)  
1700 EAST LAS OLAS BLVD, STE 201  
FORT LAUDERDALE, FL 33301

FOR: ENTERTAINMENT SERVICES IN THE NATURE OF LIVE MUSICAL PERFORMANCES,  
IN CLASS 41 (U.S. CLS. 100, 101 AND 107).

FIRST USE 9-7-2011; IN COMMERCE 9-7-2011.

THE MARK CONSISTS OF STANDARD CHARACTERS WITHOUT CLAIM TO ANY PAR-  
TICULAR FONT, STYLE, SIZE, OR COLOR.

SN 85-252,187, FILED 2-25-2011.

TIMOTHY FINNEGAN, EXAMINING ATTORNEY



*David J. Kyffers*

Director of the United States Patent and Trademark Office

# United States of America

United States Patent and Trademark Office

# GREENLINE

**Reg. No. 4,136,715**

**Registered May 1, 2012**

**Int. Cl.: 44**

**SERVICE MARK**

**PRINCIPAL REGISTER**

LIMEADE, INC. (WASHINGTON CORPORATION)  
SUITE 203  
10777 MAIN STREET  
BELLEVUE, WA 98004

FOR: PROVIDING ONLINE HOLISTIC HEALTH, WELL-BEING AND ASSESSMENT SERVICES; PROVIDING INFORMATION REGARDING HEALTH AND WELLNESS; PROVIDING INFORMATION REGARDING SETTING, TRACKING, EVALUATING AND ENCOURAGING DEVELOPMENT GOALS RELATED TO HEALTH AND WELLNESS, IN CLASS 44 (U.S. CLS. 100 AND 101).

FIRST USE 3-2-2011; IN COMMERCE 3-2-2011.

THE MARK CONSISTS OF STANDARD CHARACTERS WITHOUT CLAIM TO ANY PARTICULAR FONT, STYLE, SIZE, OR COLOR.

SN 85-252,250, FILED 2-25-2011.

KEVON CHISOLM, EXAMINING ATTORNEY



*David J. Kyffers*

Director of the United States Patent and Trademark Office

# United States of America

United States Patent and Trademark Office

## HD Unleashed

**Reg. No. 4,136,716**

**Registered May 1, 2012**

**Int. Cl.: 42**

**SERVICE MARK**

**PRINCIPAL REGISTER**

NETWORK OPTIX, INC. (CALIFORNIA CORPORATION)  
1146 NORTH CENTRAL AVENUE, #624  
GLENDALE, CA 91202

FOR: COMPUTER SOFTWARE DEVELOPMENT, IN CLASS 42 (U.S. CLS. 100 AND 101).

FIRST USE 9-14-2011; IN COMMERCE 9-14-2011.

THE MARK CONSISTS OF STANDARD CHARACTERS WITHOUT CLAIM TO ANY PARTICULAR FONT, STYLE, SIZE, OR COLOR.

NO CLAIM IS MADE TO THE EXCLUSIVE RIGHT TO USE "HD", APART FROM THE MARK AS SHOWN.

SN 85-252,720, FILED 2-26-2011.

BARBARA BROWN, EXAMINING ATTORNEY



*David J. Kyffers*

Director of the United States Patent and Trademark Office



# United States of America

United States Patent and Trademark Office

# QT-TV

**Reg. No. 4,136,717**

**Registered May 1, 2012**

**Int. Cl.: 9**

**TRADEMARK**

**PRINCIPAL REGISTER**

FOR YOUR EASE ONLY, INC. (ILLINOIS CORPORATION)  
1301 NORTH DEARBORN PARKWAY  
CHICAGO, IL 60610

FOR: VIDEO RECORDINGS FEATURING ADVERTISEMENTS FOR INNOVATIVE PRODUCTS FOR THE HOME, IN CLASS 9 (U.S. CLS. 21, 23, 26, 36 AND 38).

FIRST USE 3-0-2011; IN COMMERCE 3-0-2011.

THE MARK CONSISTS OF STANDARD CHARACTERS WITHOUT CLAIM TO ANY PARTICULAR FONT, STYLE, SIZE, OR COLOR.

SN 85-253,566, FILED 2-28-2011.

KRISTIN DAHLING, EXAMINING ATTORNEY



*David J. Kybas*

Director of the United States Patent and Trademark Office

# United States of America

United States Patent and Trademark Office



**Reg. No. 4,136,718**

**Registered May 1, 2012**

**Int. Cl.: 41**

**SERVICE MARK**

**PRINCIPAL REGISTER**

GAUGHAN SOUTH LLC (NEVADA LIMITED LIABILITY COMPANY), DBA SOUTH POINT HOTEL AND CASINO,  
C/O BARRY LIEBERMAN  
9777 LAS VEGAS BOULEVARD SOUTH  
LAS VEGAS, NV 89183

FOR: ENTERTAINMENT IN THE NATURE OF CASINO SERVICES, AND LIVE PERFORMANCES BY SINGERS, MUSICIANS, MUSICAL GROUPS AND COMEDIANS, IN CLASS 41 (U.S. CLS. 100, 101 AND 107).

FIRST USE 3-3-2011; IN COMMERCE 3-3-2011.

THE MARK CONSISTS OF THE WORDS "WE YOU MORE" WITH A HEART THAT IS FILLED WITH RED COLOR BETWEEN THE WORDS "WE" AND "YOU". THE LETTER COMPONENTS ARE WHITE. THERE IS A BLACK BACKGROUND FOR BOTH THE LETTERS AND THE HEART THAT IS FILLED WITH RED COLOR.

THE COLOR(S) RED, WHITE, AND BLACK IS/ARE CLAIMED AS A FEATURE OF THE MARK.

SN 85-253,817, FILED 2-28-2011.

KRISTIN CARLSON, EXAMINING ATTORNEY



*David J. Kyffers*

Director of the United States Patent and Trademark Office

# United States of America

United States Patent and Trademark Office

## REPRESENT FRESH FLAG

**Reg. No. 4,136,719**

JIMMY TEES INC (CANADA CORPORATION)  
3209 SOVEREIGN RD  
BURLINGTON, CANADA

**Registered May 1, 2012**

**Int. Cl.: 5**

FOR: AIR FRESHENERS, ABSORBENT BODIES IMPREGNATED WITH A PERFUMED AIR  
DEODORANT, IN CLASS 5 (U.S. CLS. 6, 18, 44, 46, 51 AND 52).

**TRADEMARK**

FIRST USE 12-16-2000; IN COMMERCE 1-17-2001.

**PRINCIPAL REGISTER**

THE MARK CONSISTS OF STANDARD CHARACTERS WITHOUT CLAIM TO ANY PAR-  
TICULAR FONT, STYLE, SIZE, OR COLOR.

SN 85-254,383, FILED 3-1-2011.

KATINA MISTER, EXAMINING ATTORNEY



*David J. Kybas*

Director of the United States Patent and Trademark Office

# United States of America

United States Patent and Trademark Office

The logo for iconnect features a stylized lowercase 'i' with a dot above it. To the right of the 'i' is the word 'connect' in a bold, lowercase sans-serif font. Above the word 'connect' is the word 'CareSource' in a smaller, regular sans-serif font. Two thin horizontal lines are positioned above and below the word 'connect'.

**Reg. No. 4,136,720**

**Registered May 1, 2012**

**Int. Cls.: 35 and 36**

**SERVICE MARK**

**PRINCIPAL REGISTER**

CARESOURCE (OHIO CORPORATION)  
230 NORTH MAIN STREET  
DAYTON, OH 45402

FOR: CONSUMER RESEARCH SERVICES, NAMELY, CONDUCTING BUSINESS SURVEYS AND OUTREACH PROGRAMS TO OBTAIN CONSUMER FEEDBACK, INCLUDING, BUT NOT LIMITED TO CONDUCTING IN PERSON AND ONLINE INTERACTIVE FORUMS, SURVEYS, FOCUS GROUPS AND QUALITY OF SERVICE EVALUATIONS; ADMINISTRATIVE SERVICES FOR THE PUBLIC HEALTH SECTOR, NAMELY, GENERAL ADMINISTRATION OF HEALTH CARE CLINICS FOR OTHERS; HEALTH CARE UTILIZATION AND REVIEW SERVICES, CASE AND MEDICAL MANAGEMENT, NAMELY, HEALTH CARE COST CONTAINMENT, IN CLASS 35 (U.S. CLS. 100, 101 AND 102).

FIRST USE 1-1-2012; IN COMMERCE 1-1-2012.

FOR: ADMINISTRATIVE SERVICES FOR THE PUBLIC HEALTH SECTOR, NAMELY, ADMINISTRATION OF PRE-PAID HEALTH CARE PLANS, HEALTH INSURANCE CLAIMS PROCESSING; PROVIDER RELATIONS, NAMELY, ADMINISTRATION OF PREFERRED PROVIDER PLANS IN THE FIELD OF HEALTH CARE; HEALTH INSURANCE ADMINISTRATION; PROVIDING INFORMATION IN HEALTH INSURANCE MATTERS VIA THE INTERNET AND PROVIDING FINANCIAL CONSULTATION, IN CLASS 36 (U.S. CLS. 100, 101 AND 102).

FIRST USE 1-1-2012; IN COMMERCE 1-1-2012.

OWNER OF U.S. REG. NOS. 2,553,920, 3,651,635, AND OTHERS.

THE MARK CONSISTS OF A STYLIZED LETTER "I" FOLLOWED BY TWO THIN LINES BETWEEN WHICH THE WORD "CONNECT" APPEARS. THE WORD "CARESOURCE" FOLLOWS THE LINE ABOVE THE WORD "CONNECT".

SN 85-254,543, FILED 3-1-2011.

REBECCA EISINGER, EXAMINING ATTORNEY



*David J. Kappas*

Director of the United States Patent and Trademark Office

# United States of America

United States Patent and Trademark Office

# CARESOURCE

**Reg. No. 4,136,721**

**Registered May 1, 2012**

**Int. Cl.: 35**

**SERVICE MARK**

**PRINCIPAL REGISTER**

CARESOURCE (OHIO CORPORATION)  
230 NORTH MAIN STREET  
DAYTON, OH 45402

FOR: CONSUMER RESEARCH SERVICES, NAMELY, CONDUCTING BUSINESS SURVEYS AND OUTREACH PROGRAMS TO OBTAIN CONSUMER FEEDBACK, INCLUDING, BUT NOT LIMITED TO CONDUCTING IN PERSON AND ONLINE INTERACTIVE FORUMS, SURVEYS, FOCUS GROUPS AND QUALITY OF SERVICE EVALUATIONS, IN CLASS 35 (U.S. CLS. 100, 101 AND 102).

FIRST USE 1-1-2012; IN COMMERCE 1-1-2012.

THE MARK CONSISTS OF STANDARD CHARACTERS WITHOUT CLAIM TO ANY PARTICULAR FONT, STYLE, SIZE, OR COLOR.

SN 85-254,549, FILED 3-1-2011.

REBECCA EISINGER, EXAMINING ATTORNEY



*David J. Kybas*

Director of the United States Patent and Trademark Office

# United States of America

United States Patent and Trademark Office

## CARESOURCE ICONNECT

**Reg. No. 4,136,722**

**Registered May 1, 2012**

**Int. Cls.: 35 and 36**

**SERVICE MARK**

**PRINCIPAL REGISTER**

CARESOURCE (OHIO CORPORATION)  
230 NORTH MAIN STREET  
DAYTON, OH 45402

FOR: CONSUMER RESEARCH SERVICES, NAMELY, CONDUCTING BUSINESS SURVEYS AND OUTREACH PROGRAMS TO OBTAIN CONSUMER FEEDBACK, INCLUDING, BUT NOT LIMITED TO CONDUCTING IN PERSON AND ONLINE INTERACTIVE FORUMS, SURVEYS, FOCUS GROUPS AND QUALITY OF SERVICE EVALUATIONS; ADMINISTRATIVE SERVICES FOR THE PUBLIC HEALTH SECTOR, NAMELY, GENERAL ADMINISTRATION OF HEALTH CARE CLINICS FOR OTHERS; HEALTH CARE UTILIZATION AND REVIEW SERVICES, CASE AND MEDICAL MANAGEMENT, NAMELY, HEALTH CARE COST CONTAINMENT, IN CLASS 35 (U.S. CLS. 100, 101 AND 102).

FIRST USE 1-1-2012; IN COMMERCE 1-1-2012.

FOR: ADMINISTRATIVE SERVICES FOR THE PUBLIC HEALTH SECTOR, NAMELY, ADMINISTRATION OF PRE-PAID HEALTH CARE PLANS, HEALTH INSURANCE CLAIMS PROCESSING; PROVIDER RELATIONS, NAMELY, ADMINISTRATION OF PREFERRED PROVIDER PLANS IN THE FIELD OF HEALTH CARE; HEALTH INSURANCE ADMINISTRATION; PROVIDING INFORMATION IN HEALTH INSURANCE MATTERS VIA THE INTERNET AND PROVIDING FINANCIAL CONSULTATION, IN CLASS 36 (U.S. CLS. 100, 101 AND 102).

FIRST USE 1-1-2012; IN COMMERCE 1-1-2012.

THE MARK CONSISTS OF STANDARD CHARACTERS WITHOUT CLAIM TO ANY PARTICULAR FONT, STYLE, SIZE, OR COLOR.

OWNER OF U.S. REG. NOS. 2,553,920, 3,651,635, AND OTHERS.

SN 85-254,554, FILED 3-1-2011.

REBECCA EISINGER, EXAMINING ATTORNEY



*David J. Kyffers*

Director of the United States Patent and Trademark Office

# United States of America

United States Patent and Trademark Office

# SHOP TALK

**Reg. No. 4,136,723**

FLEET WHOLESALE SUPPLY CO., INC. (WISCONSIN CORPORATION)  
1300 SOUTH LYNNDALE DRIVE  
APPLETON, WI 54914

**Registered May 1, 2012**

**Int. Cl.: 35**

FOR: RETAIL STORE SERVICES IN THE FIELD OF HARDWARE, PLUMBING, FARM AND GARDEN, AND AUTOMOTIVE ITEMS, IN CLASS 35 (U.S. CLS. 100, 101 AND 102).

**SERVICE MARK**

FIRST USE 1-24-2012; IN COMMERCE 1-24-2012.

**PRINCIPAL REGISTER**

THE MARK CONSISTS OF STANDARD CHARACTERS WITHOUT CLAIM TO ANY PARTICULAR FONT, STYLE, SIZE, OR COLOR.

SN 85-254,758, FILED 3-1-2011.

KEVIN DINALLO, EXAMINING ATTORNEY



*David J. Kybas*

Director of the United States Patent and Trademark Office

# United States of America

United States Patent and Trademark Office

# Stadia

**Reg. No. 4,136,724**

**Registered May 1, 2012**

**Int. Cl.: 9**

**TRADEMARK**

**PRINCIPAL REGISTER**

EARLYBIRD TECHNOLOGY INC. (DELAWARE CORPORATION)  
2320 N. GAINES ST.  
DAVENPORT, IA 52804

FOR: COMPUTER SOFTWARE FOR ARCHITECTURAL VISUALIZATION, IN CLASS 9 (U.S. CLS. 21, 23, 26, 36 AND 38).

FIRST USE 11-29-2011; IN COMMERCE 11-29-2011.

THE MARK CONSISTS OF STANDARD CHARACTERS WITHOUT CLAIM TO ANY PARTICULAR FONT, STYLE, SIZE, OR COLOR.

SN 85-255,116, FILED 3-1-2011.

SUSAN LESLIE DUBOIS, EXAMINING ATTORNEY



*David J. Kyffers*

Director of the United States Patent and Trademark Office



# United States of America

United States Patent and Trademark Office



**Reg. No. 4,136,725**

**Registered May 1, 2012**

**Int. Cl.: 29**

**TRADEMARK**

**PRINCIPAL REGISTER**

TEAMWELLS INTERNATIONAL INC. (TAIWAN CORPORATION)  
2F, NO.798, GONGYAN RD.  
TAINAN, TAIWAN

FOR: MILK, MILK CURD, LACTIC ACID BACTERIA DRINKS, LACTIC ACID DRINKS, MILK BEVERAGES WITH HIGH MILK CONTENT, RICE MILK FOR USE AS A MILK SUBSTITUTE, SOY MILK, FERMENTED MILK, SOY-BASED FOOD BEVERAGES USED AS A MILK SUBSTITUTE, HONEY SOYMILK, PLANT BASED BEVERAGES USED AS A MILK SUBSTITUTE MADE FROM LOTUS FLOWER SEED POD LIQUIDS, EDIBLE OILS, EDIBLE FATS, OLIVE OILS, VEGETABLE OILS, SOYBEAN OILS FOR COOKING, SALAD OILS, IN CLASS 29 (U.S. CL. 46).

FIRST USE 1-1-2012; IN COMMERCE 1-1-2012.

THE MARK CONSISTS OF A SEMICIRCULAR SHAPE WITH A FLAT BASE HAVING A TARTAN BACKGROUND, TWO CHINESE CHARACTERS, AND THE WORD "NÜLIFE" BELOW THE SEMICIRCULAR SHAPE.

THE NON-LATIN CHARACTERS IN THE MARK TRANSLITERATE TO "SHUN HUO" AND THIS MEANS "LIFE" IN ENGLISH.

THE WORD "NÜLIFE" HAS NO MEANING IN A FOREIGN LANGUAGE.

SN 85-255,211, FILED 3-1-2011.

REBECCA SMITH, EXAMINING ATTORNEY



*David J. Kypos*

Director of the United States Patent and Trademark Office

# United States of America

United States Patent and Trademark Office



**Reg. No. 4,136,726**

**Registered May 1, 2012**

**Int. Cl.: 30**

**TRADEMARK**

**PRINCIPAL REGISTER**

TEAMWELLS INTERNATIONAL INC. (TAIWAN CORPORATION)  
2F, NO.798, GONGYAN RD.  
TAINAN, TAIWAN

FOR: TEAS, TEA EXTRACTS, TEA BAGS, TEA-BASED BEVERAGES, BLACK TEAS, LIME TEAS, OOLONG TEAS, GREEN TEAS, DRIED LONGAN TEAS, MILK TEAS, ROSELLE TEAS, HERBAL JELLY TEAS, CHRYSANTHEMUM TEAS, HERBAL TEA BAGS, JUJUBE TEAS, BEVERAGES MADE WITH COFFEE, COCOAS, CHOCOLATE POWDERS, COFFEE-BASED BEVERAGES, COCOA BASED BEVERAGES, COCOA SPREADS, CHOCOLATE-BASED BEVERAGES WITH MILK, COFFEE-BASED BEVERAGES CONTAINING MILK, COCOA BEVERAGES WITH MILK, RICE AND SEASONING MIXES COMBINED IN UNITARY PACKAGES, OATMEAL, IN CLASS 30 (U.S. CL. 46).

FIRST USE 1-1-2012; IN COMMERCE 1-1-2012.

THE MARK CONSISTS OF A SEMICIRCULAR SHAPE WITH A FLAT BASE HAVING A TARTAN BACKGROUND, TWO CHINESE CHARACTERS, AND THE WORD "NÜLIFE" BELOW THE SEMICIRCULAR SHAPE.

THE NON-LATIN CHARACTERS IN THE MARK TRANSLITERATE TO "SHUN HUO" AND THIS MEANS "LIFE" IN ENGLISH.

THE WORDING "NÜLIFE" HAS NO MEANING IN A FOREIGN LANGUAGE.

SN 85-255,214, FILED 3-1-2011.

REBECCA SMITH, EXAMINING ATTORNEY



*David J. Kyjars*

Director of the United States Patent and Trademark Office

# United States of America

United States Patent and Trademark Office



**Reg. No. 4,136,727**

**Registered May 1, 2012**

**Int. Cl.: 32**

**TRADEMARK**

**PRINCIPAL REGISTER**

TEAMWELLS INTERNATIONAL INC. (TAIWAN CORPORATION)  
2F, NO.798, GONGYAN RD.  
TAINAN, TAIWAN

FOR: BEER, SOFT DRINKS, FRUIT JUICES, MINERAL WATER, ISOTONIC DRINKS, LEMONADES, SOFT DRINKS AND FRUIT DRINKS CONTAINING PLANT EXTRACTS, HERBAL JUICES, VINEGAR-BASED SOFT DRINKS, SOFT DRINKS MADE FROM BIRD'S NEST, SPECIFICALLY, SWALLOW'S NEST, IN CLASS 32 (U.S. CLS. 45, 46 AND 48).

FIRST USE 1-1-2012; IN COMMERCE 1-1-2012.

THE MARK CONSISTS OF A SEMICIRCULAR SHAPE WITH A FLAT BASE HAVING A TARTAN BACKGROUND, TWO CHINESE CHARACTERS, AND THE WORD "NÜLIFE" BELOW THE SEMICIRCULAR SHAPE.

THE NON-LATIN CHARACTERS IN THE MARK TRANSLITERATE TO "SHUN HUO" AND THIS MEANS "LIFE" IN ENGLISH.

THE WORDING "NÜLIFE" HAS NO MEANING IN A FOREIGN LANGUAGE.

SN 85-255,215, FILED 3-1-2011.

REBECCA SMITH, EXAMINING ATTORNEY



*David J. Kybas*

Director of the United States Patent and Trademark Office

# United States of America

United States Patent and Trademark Office

## PRIMAL INSTINCT

**Reg. No. 4,136,728**

AUSTRALIAN GOLD, LLC (INDIANA LIMITED LIABILITY COMPANY)  
6270 CORPORATE DR.  
INDIANAPOLIS, IN 46278

**Registered May 1, 2012**

**Int. Cl.: 3**

FOR: INDOOR AND OUTDOOR NON-MEDICATED SKIN TANNING PREPARATION, IN CLASS 3 (U.S. CLS. 1, 4, 6, 50, 51 AND 52).

**TRADEMARK**

FIRST USE 11-1-2011; IN COMMERCE 11-1-2011.

**PRINCIPAL REGISTER**

THE MARK CONSISTS OF STANDARD CHARACTERS WITHOUT CLAIM TO ANY PARTICULAR FONT, STYLE, SIZE, OR COLOR.

SN 85-255,322, FILED 3-2-2011.

DOMINIC J. FERRAIUOLO, EXAMINING ATTORNEY



*David J. Kyffers*

Director of the United States Patent and Trademark Office

# United States of America

United States Patent and Trademark Office

## SCANDALOUS BEAUTY

**Reg. No. 4,136,729**

AUSTRALIAN GOLD, LLC (INDIANA LIMITED LIABILITY COMPANY)  
6270 CORPORATE DR.  
INDIANAPOLIS, IN 46278

**Registered May 1, 2012**

**Int. Cl.: 3**

FOR: INDOOR AND OUTDOOR NON-MEDICATED SKIN TANNING PREPARATION, IN CLASS 3 (U.S. CLS. 1, 4, 6, 50, 51 AND 52).

**TRADEMARK**

FIRST USE 11-1-2011; IN COMMERCE 11-1-2011.

**PRINCIPAL REGISTER**

THE MARK CONSISTS OF STANDARD CHARACTERS WITHOUT CLAIM TO ANY PARTICULAR FONT, STYLE, SIZE, OR COLOR.

OWNER OF U.S. REG. NOS. 3,276,662 AND 3,949,363.

NO CLAIM IS MADE TO THE EXCLUSIVE RIGHT TO USE "BEAUTY", APART FROM THE MARK AS SHOWN.

SN 85-255,334, FILED 3-2-2011.

JULIE GUTTADAURO, EXAMINING ATTORNEY



*David J. Kyros*

Director of the United States Patent and Trademark Office

# United States of America

United States Patent and Trademark Office

## HD MILLIONAIRE

**Reg. No. 4,136,730**

AUSTRALIAN GOLD, LLC (INDIANA LIMITED LIABILITY COMPANY)  
6270 CORPORATE DR.  
INDIANAPOLIS, IN 46278

**Registered May 1, 2012**

**Int. Cl.: 3**

FOR: INDOOR AND OUTDOOR NON-MEDICATED SKIN TANNING PREPARATION, IN CLASS 3 (U.S. CLS. 1, 4, 6, 50, 51 AND 52).

**TRADEMARK**

FIRST USE 11-1-2011; IN COMMERCE 11-1-2011.

**PRINCIPAL REGISTER**

THE MARK CONSISTS OF STANDARD CHARACTERS WITHOUT CLAIM TO ANY PARTICULAR FONT, STYLE, SIZE, OR COLOR.

SN 85-255,483, FILED 3-2-2011.

JOHN DWYER, EXAMINING ATTORNEY



*David J. Kybas*

Director of the United States Patent and Trademark Office

# United States of America

United States Patent and Trademark Office

## CHICHILUNA INDULGE YOUR PASSION

**Reg. No. 4,136,731**

**Registered May 1, 2012**

**Int. Cls.: 14 and 25**

**TRADEMARK**

**PRINCIPAL REGISTER**

CHICHILUNA LLC (FLORIDA LIMITED LIABILITY COMPANY)  
2225 N.E. 17TH COURT  
FORT LAUDERDALE, FL 33305

FOR: WOMEN'S JEWELRY, IN CLASS 14 (U.S. CLS. 2, 27, 28 AND 50).

FIRST USE 11-10-2011; IN COMMERCE 11-10-2011.

FOR: WOMEN'S CLOTHING, NAMELY, SHIRTS, DRESSES, SKIRTS, BLOUSES, IN CLASS 25 (U.S. CLS. 22 AND 39).

FIRST USE 11-10-2011; IN COMMERCE 11-10-2011.

THE MARK CONSISTS OF STANDARD CHARACTERS WITHOUT CLAIM TO ANY PARTICULAR FONT, STYLE, SIZE, OR COLOR.

SN 85-255,918, FILED 3-2-2011.

ANDREA BUTLER, EXAMINING ATTORNEY



*David J. Kyros*

Director of the United States Patent and Trademark Office

# United States of America

United States Patent and Trademark Office

## PLATINUMHD PROPVID

**Reg. No. 4,136,732**

CLEMENTS, LINDA (AUSTRALIA INDIVIDUAL)  
25B SURFERS AVENUE  
MERMAID WATERS, AUSTRALIA 4218

**Registered May 1, 2012**

**Int. Cl.: 35**

FOR: REAL ESTATE ADVERTISING SERVICES; REAL ESTATE AUCTIONS; REAL ESTATE SALES MANAGEMENT, IN CLASS 35 (U.S. CLS. 100, 101 AND 102).

**SERVICE MARK**

FIRST USE 2-21-2008; IN COMMERCE 2-21-2008.

**PRINCIPAL REGISTER**

THE MARK CONSISTS OF STANDARD CHARACTERS WITHOUT CLAIM TO ANY PARTICULAR FONT, STYLE, SIZE, OR COLOR.

SN 85-256,472, FILED 3-3-2011.

COLLEEN KEARNEY, EXAMINING ATTORNEY



*David J. Kybas*

Director of the United States Patent and Trademark Office



# United States of America

United States Patent and Trademark Office

# CYCLONE

**Reg. No. 4,136,733**

**Registered May 1, 2012**

**Int. Cl.: 7**

**TRADEMARK**

**PRINCIPAL REGISTER**

CONTINENTAL COMMERCIAL PRODUCTS, LLC (DELAWARE LIMITED LIABILITY COMPANY)  
305 ROCK INDUSTRIAL PARK DRIVE  
BRIDGETON, MO 63044

FOR: FLOOR MAINTENANCE PADS FOR USE WITH MACHINES FOR STRIPPING, SCRUBBING, BUFFING AND POLISHING FLOORS, IN CLASS 7 (U.S. CLS. 13, 19, 21, 23, 31, 34 AND 35).

FIRST USE 5-18-2011; IN COMMERCE 5-18-2011.

THE MARK CONSISTS OF STANDARD CHARACTERS WITHOUT CLAIM TO ANY PARTICULAR FONT, STYLE, SIZE, OR COLOR.

SN 85-256,708, FILED 3-3-2011.

STEVEN R. FINE, EXAMINING ATTORNEY



*David J. Kybas*

Director of the United States Patent and Trademark Office

# United States of America

United States Patent and Trademark Office

# Brain Parade

**Reg. No. 4,136,734**

**Registered May 1, 2012**

**Int. Cl.: 9**

**TRADEMARK**

**PRINCIPAL REGISTER**

BRAIN PARADE, LLC (CONNECTICUT LIMITED LIABILITY COMPANY)  
51 BERTMOR DRIVE  
STAMFORD, CT 06905

FOR: COMPUTER APPLICATION SOFTWARE FOR PORTABLE MEDIA PLAYERS, HANDHELD COMPUTERS, TABLET COMPUTERS, MOBILE PHONES, LAPTOP COMPUTERS, DESKTOP COMPUTERS, NAMELY, SOFTWARE FOR MANAGING, CREATING AND DISPLAYING SPECIAL EDUCATION TOOLS AND LESSONS, IN CLASS 9 (U.S. CLS. 21, 23, 26, 36 AND 38).

FIRST USE 1-7-2011; IN COMMERCE 3-9-2011.

THE MARK CONSISTS OF STANDARD CHARACTERS WITHOUT CLAIM TO ANY PARTICULAR FONT, STYLE, SIZE, OR COLOR.

SN 85-257,235, FILED 3-3-2011.

JEFFREY LOOK, EXAMINING ATTORNEY



*David J. Kyffers*

Director of the United States Patent and Trademark Office

# United States of America

United States Patent and Trademark Office

# POOLMARK

**Reg. No. 4,136,735**

**Registered May 1, 2012**

**Int. Cl.: 1**

**TRADEMARK**

**PRINCIPAL REGISTER**

HALOSOURCE, INC. (WASHINGTON CORPORATION)  
1631 - 220TH STREET SE, SUITE 100  
BOTHELL, WA 98021

FOR: WATER TREATMENT CHEMICALS FOR SWIMMING POOLS AND SPAS, IN CLASS  
1 (U.S. CLS. 1, 5, 6, 10, 26 AND 46).

FIRST USE 4-0-2011; IN COMMERCE 1-0-2012.

THE MARK CONSISTS OF STANDARD CHARACTERS WITHOUT CLAIM TO ANY PAR-  
TICULAR FONT, STYLE, SIZE, OR COLOR.

SN 85-257,493, FILED 3-3-2011.

JORDAN BAKER, EXAMINING ATTORNEY



*David J. Kyffers*

Director of the United States Patent and Trademark Office

**United States of America**  
United States Patent and Trademark Office

**ALCOR**

**Reg. No. 4,136,736**

**Registered May 1, 2012**

**Int. Cl.: 10**

**TRADEMARK**

**PRINCIPAL REGISTER**

ALCOR SCIENTIFIC INC. (RHODE ISLAND CORPORATION)  
BUILDING F23, 11 KNIGHT STREET  
WARWICK, RI 02886

FOR: ENTERAL FEEDING PUMPS; ENTERAL FEEDING TUBE SETS; ENTERAL FEEDING BAG SETS; ENTERAL FEEDING TUBE AND BAGS SETS; ENTERAL FEEDING SPIKE SETS; IRRIGATION KITS COMPRISING IRRIGATORS FOR MEDICAL USE AND MEDICAL IRRIGATION TUBING; MEDICAL DIAGNOSTIC INSTRUMENTS FOR THE ANALYSIS OF BODY FLUIDS; HEMATOLOGY ANALYZERS FOR MEDICAL DIAGNOSTIC USES, IN CLASS 10 (U.S. CLS. 26, 39 AND 44).

FIRST USE 4-15-2011; IN COMMERCE 7-27-2011.

THE MARK CONSISTS OF STANDARD CHARACTERS WITHOUT CLAIM TO ANY PARTICULAR FONT, STYLE, SIZE, OR COLOR.

SN 85-257,972, FILED 3-4-2011.

ADA HAN, EXAMINING ATTORNEY



*David J. Kyffers*

Director of the United States Patent and Trademark Office

# United States of America

United States Patent and Trademark Office

# ION

**Reg. No. 4,136,737**

**Registered May 1, 2012**

**Int. Cl.: 34**

**TRADEMARK**

**PRINCIPAL REGISTER**

CIGAR EXPRESS, INC. (FLORIDA CORPORATION)  
360 N.E. 103RD STREET  
MIAMI SHORES, FL 33138

FOR: CIGARS, IN CLASS 34 (U.S. CLS. 2, 8, 9 AND 17).

FIRST USE 7-1-2011; IN COMMERCE 7-1-2011.

THE MARK CONSISTS OF STANDARD CHARACTERS WITHOUT CLAIM TO ANY PARTICULAR FONT, STYLE, SIZE, OR COLOR.

SN 85-258,365, FILED 3-4-2011.

EVELYN BRADLEY, EXAMINING ATTORNEY



*David J. Kyffers*

Director of the United States Patent and Trademark Office

# United States of America

United States Patent and Trademark Office

## Let's Embrace Green in Life

**Reg. No. 4,136,738**

**Registered May 1, 2012**

**Int. Cl.: 9**

**TRADEMARK**

**PRINCIPAL REGISTER**

BLUTRON GROUP (TEXAS LIMITED LIABILITY COMPANY)  
PO BOX 803103  
DALLAS, TX 75380

FOR: CELL PHONE BATTERY CHARGERS; HEADSETS FOR MOBILE TELEPHONES;  
MOBILE TELEPHONE BATTERIES, IN CLASS 9 (U.S. CLS. 21, 23, 26, 36 AND 38).

FIRST USE 12-1-2011; IN COMMERCE 12-1-2011.

THE MARK CONSISTS OF STANDARD CHARACTERS WITHOUT CLAIM TO ANY PARTICULAR FONT, STYLE, SIZE, OR COLOR.

SN 85-258,608, FILED 3-4-2011.

ESTHER A. BORSUK, EXAMINING ATTORNEY



*David J. Kyros*

Director of the United States Patent and Trademark Office

# United States of America

United States Patent and Trademark Office



**Reg. No. 4,136,739**

**Registered May 1, 2012**

**Int. Cl.: 36**

**COLLECTIVE SERVICE  
MARK**

**PRINCIPAL REGISTER**

BEST PARTNERS MORTGAGE COOPERATIVE, INC. (DELAWARE CORPORATION)  
2 CITYPLACE DRIVE, SUITE 30  
ST. LOUIS, MO 63141

FOR: MORTGAGE LENDING; FINANCIAL SERVICES, NAMELY, MORTGAGE ORIGIN-  
ATION AND REFINANCING, IN CLASS 36 (U.S. CLS. 100, 101 AND 102).

FIRST USE 1-5-2011; IN COMMERCE 1-5-2011.

NO CLAIM IS MADE TO THE EXCLUSIVE RIGHT TO USE "HOME MORTGAGE EXPERTS",  
APART FROM THE MARK AS SHOWN.

THE MARK CONSISTS OF THE WORD "LENDRIGHT" AT THE TOP OF A CIRCLE AND  
THE WORDS "HOME MORTGAGE EXPERTS" AT THE BOTTOM OF A CIRCLE WITH THE  
IMAGE OF THE ROOF OF A HOUSE WITH STARS AT THE RIGHT AND LEFT CENTER  
OF THE CIRCLE.

SN 85-258,630, FILED 3-4-2011.

SAIMA MAKHDOOM, EXAMINING ATTORNEY



*David J. Kybas*

Director of the United States Patent and Trademark Office

# United States of America

United States Patent and Trademark Office

# LENDRIGHT

**Reg. No. 4,136,740**

BEST PARTNERS MORTGAGE COOPERATIVE, INC. (DELAWARE CORPORATION)  
2 CITYPLACE DRIVE, SUITE 30  
ST. LOUIS, MO 63141

**Registered May 1, 2012**

**Int. Cl.: 36**

FOR: MORTGAGE LENDING; FINANCIAL SERVICES, NAMELY, MORTGAGE ORIGIN-  
ATION AND REFINANCING, IN CLASS 36 (U.S. CLS. 100, 101 AND 102).

**COLLECTIVE SERVICE  
MARK**

FIRST USE 1-5-2011; IN COMMERCE 1-5-2011.

**PRINCIPAL REGISTER**

THE MARK CONSISTS OF STANDARD CHARACTERS WITHOUT CLAIM TO ANY PAR-  
TICULAR FONT, STYLE, SIZE, OR COLOR.

SN 85-258,640, FILED 3-4-2011.

SAIMA MAKHDOOM, EXAMINING ATTORNEY



*David J. Kybas*

Director of the United States Patent and Trademark Office



# United States of America

United States Patent and Trademark Office

## See.Touch.Learn.

**Reg. No. 4,136,741**

**Registered May 1, 2012**

**Int. Cl.: 9**

**TRADEMARK**

**PRINCIPAL REGISTER**

BRAIN PARADE, LLC (CONNECTICUT LIMITED LIABILITY COMPANY)  
51 BERTMOR DRIVE  
STAMFORD, CT 06905

FOR: COMPUTER APPLICATION SOFTWARE FOR PORTABLE MEDIA PLAYERS, HANDHELD COMPUTERS, TABLET COMPUTERS, MOBILE PHONES, LAPTOP COMPUTERS, DESKTOP COMPUTERS, NAMELY, SOFTWARE FOR MANAGING, CREATING AND DISPLAYING SPECIAL EDUCATION TOOLS AND LESSON, IN CLASS 9 (U.S. CLS. 21, 23, 26, 36 AND 38).

FIRST USE 1-10-2011; IN COMMERCE 3-9-2011.

THE MARK CONSISTS OF STANDARD CHARACTERS WITHOUT CLAIM TO ANY PARTICULAR FONT, STYLE, SIZE, OR COLOR.

SN 85-258,694, FILED 3-4-2011.

JEFFREY LOOK, EXAMINING ATTORNEY



*David J. Kyffers*

Director of the United States Patent and Trademark Office

# United States of America

United States Patent and Trademark Office

## READY REWARDS

**Reg. No. 4,136,742**

**Registered May 1, 2012**

**Int. Cl.: 16**

**TRADEMARK**

**PRINCIPAL REGISTER**

CARSON-DELLOSA PUBLISHING, LLC (DELAWARE LIMITED LIABILITY COMPANY)  
7027 ALBERT PICK ROAD  
GREENSBORO, NC 27409

FOR: PRINTED PAPER CERTIFICATES OF RECOGNITION FOR USE WITH PRE-K AND ELEMENTARY SCHOOL-AGED CHILDREN, IN CLASS 16 (U.S. CLS. 2, 5, 22, 23, 29, 37, 38 AND 50).

FIRST USE 1-31-2012; IN COMMERCE 1-31-2012.

THE MARK CONSISTS OF STANDARD CHARACTERS WITHOUT CLAIM TO ANY PARTICULAR FONT, STYLE, SIZE, OR COLOR.

NO CLAIM IS MADE TO THE EXCLUSIVE RIGHT TO USE "REWARDS", APART FROM THE MARK AS SHOWN.

SN 85-259,120, FILED 3-6-2011.

EDWARD NELSON, EXAMINING ATTORNEY



*David J. Kyffers*

Director of the United States Patent and Trademark Office

# United States of America

United States Patent and Trademark Office

# Crowdperks

**Reg. No. 4,136,743**

**Registered May 1, 2012**

**Int. Cl.: 42**

**SERVICE MARK**

**PRINCIPAL REGISTER**

DISPERSE NETWORKS (DELAWARE LIMITED LIABILITY COMPANY), DBA  
CROWDPERKS,  
15 WALTHAM ST, STE. B606  
BOSTON, MA 02118

FOR: PLATFORM AS A SERVICE (PAAS) FEATURING COMPUTER SOFTWARE PLATFORMS FOR ENABLING TWO OR MORE CONSUMERS TO EFFECTIVELY FORM BUYING AND REWARDS COALITIONS WITH PREFERRED BUSINESS ENTITIES IN THE FIELD OF ONLINE MARKETING, IN CLASS 42 (U.S. CLS. 100 AND 101).

FIRST USE 11-1-2011; IN COMMERCE 1-5-2012.

THE MARK CONSISTS OF STANDARD CHARACTERS WITHOUT CLAIM TO ANY PARTICULAR FONT, STYLE, SIZE, OR COLOR.

SN 85-259,160, FILED 3-6-2011.

KATHERINE E. HALMEN, EXAMINING ATTORNEY



*David J. Kybas*

Director of the United States Patent and Trademark Office

# United States of America

United States Patent and Trademark Office



**Reg. No. 4,136,744**

**Registered May 1, 2012**

**Int. Cl.: 41**

**SERVICE MARK**

**PRINCIPAL REGISTER**

SULTAN CHAUHDRY HABIB (CONNECTICUT LIMITED LIABILITY COMPANY), DBA  
TUTELAGE LLC,  
19 CHARTER OAK DRIVE  
EAST LYME, CT 06333

FOR: COMPUTER EDUCATION TRAINING; COMPUTER EDUCATION TRAINING SERVICES; CONSULTANCY IN THE FIELD OF LEARNING DIFFICULTIES; CONSULTATION IN THE FIELD OF K-12 EDUCATIONAL SYSTEMS; EDUCATING AT SENIOR HIGH SCHOOLS; EDUCATING AT UNIVERSITY OR COLLEGES; EDUCATION SERVICES IN THE NATURE OF COURSES AT THE UNIVERSITY LEVEL; EDUCATION SERVICES, NAMELY, A PROGRAM TO PROMOTE THE USE OF PROPER PUNCTUATION TO SCHOOL AGE CHILDREN; EDUCATION SERVICES, NAMELY, MENTORING IN THE FIELD OF MATH, READING; EDUCATION SERVICES, NAMELY, ONE-ON-ONE MENTORING IN THE FIELD OF MATH, READING; EDUCATION SERVICES, NAMELY, ONE-ON-ONE MENTORING IN THE FIELDS OF MATH, READING; EDUCATION SERVICES, NAMELY, PRE-KINDERGARTEN THROUGH 12TH GRADE CLASSROOM INSTRUCTION, VOCATIONAL INSTRUCTION, MENTORING, TUTORING, CLASSES, SEMINARS AND WORKSHOPS FOR INDIVIDUALS WITH AUTISM AND OTHER DEVELOPMENTAL DISORDERS; EDUCATION SERVICES, NAMELY, PROVIDING PRE-KINDERGARTEN THROUGH 12TH GRADE CLASSROOM INSTRUCTION AT INTERNATIONAL SCHOOLS; EDUCATION SERVICES, NAMELY, PROVIDING TUTORIAL SESSIONS IN THE FIELDS OF MATH, READING; EDUCATION SERVICES, NAMELY, PROVIDING TUTORIAL SESSIONS IN THE FIELDS OF MATH, READING; EDUCATION SERVICES, NAMELY, PROVIDING TUTORING IN THE FIELD OF MATH, READING; EDUCATIONAL EXAMINATION; EDUCATIONAL PROGRAMS, NAMELY, PRE-SCHOOLS; EDUCATIONAL SERVICES, NAMELY, A LEARNING AND INNOVATION CENTER FEATURING FULLY CUSTOMIZED LEADERSHIP, MOTIVATIONAL, EDUCATIONAL, AND BRAINSTORMING TRAINING; EDUCATIONAL SERVICES, NAMELY, CONDUCTING DISTANCE LEARNING INSTRUCTION AT THE PRIMARY AND SECONDARY LEVELS; EDUCATIONAL SERVICES, NAMELY, CONDUCTING DISTANCE LEARNING INSTRUCTION AT THE SECONDARY, COLLEGE AND GRADUATE LEVELS; EDUCATIONAL SERVICES, NAMELY, CONDUCTING DISTANCE LEARNING INSTRUCTION AT THE UNIVERSITY LEVEL; PROVIDING GROUP COACHING AND LEARNING FORUMS IN THE FIELD OF LEADERSHIP DEVELOPMENT, IN CLASS 41 (U.S. CLS. 100, 101 AND 107).



*David J. Kappas*

FIRST USE 5-1-2011; IN COMMERCE 5-1-2011.

**Reg. No. 4,136,744** NO CLAIM IS MADE TO THE EXCLUSIVE RIGHT TO USE "TUTELAGE", APART FROM THE MARK AS SHOWN.

THE COLOR(S) BLUE, BLACK AND WHITE IS/ARE CLAIMED AS A FEATURE OF THE MARK.

THE MARK CONSISTS OF A DESIGN OF A BLUE RIBBON WITH OUTLINING IN THE COLOR BLACK, WITH THE WORD "TUTELAGE" WRITTEN IN THE COLOR WHITE FEATURED INSIDE THE RIBBON AND THE DESIGN OF AN OPEN BOOK APPEARING IN THE COLOR BLUE WITH WHITE AND BLUE PAGES AND A BLUE DOT IN THE MIDDLE OF THE BOOK.

SN 85-259,211, FILED 3-6-2011.

CHARISMA HAMPTON, EXAMINING ATTORNEY

# United States of America

United States Patent and Trademark Office

## PANAMA JACK

**Reg. No. 4,136,745**

PANAMA JACK INTERNATIONAL, INC. (FLORIDA CORPORATION)  
230 ERNESTINE STREET  
ORLANDO, FL 32801

**Registered May 1, 2012**

**Int. Cl.: 24**

FOR: TOWELS; PILLOWCASES; BED AND TABLE LINENS; BED BLANKETS; BLANKET THROWS; DINING LINENS; TEXTILE TABLECLOTHS; PLACE MATS MADE OF TEXTILES; SHOWER CURTAINS; BED SHEETS; BED THROWS; BEDSPREADS; COMFORTERS AND FUTON QUILTS, IN CLASS 24 (U.S. CLS. 42 AND 50).

**TRADEMARK**

**PRINCIPAL REGISTER**

FIRST USE 2-22-2012; IN COMMERCE 2-22-2012.

THE MARK CONSISTS OF STANDARD CHARACTERS WITHOUT CLAIM TO ANY PARTICULAR FONT, STYLE, SIZE, OR COLOR.

THE NAME(S), PORTRAIT(S), AND/OR SIGNATURE(S) SHOWN IN THE MARK DOES NOT IDENTIFY A PARTICULAR LIVING INDIVIDUAL.

SN 85-259,878, FILED 3-7-2011.

B. PARADEWELAI, EXAMINING ATTORNEY



*David J. Kyffers*

Director of the United States Patent and Trademark Office

# United States of America

United States Patent and Trademark Office

# SCOTCHGARD

**Reg. No. 4,136,746**

**Registered May 1, 2012**

**Int. Cl.: 27**

3M COMPANY (DELAWARE CORPORATION)  
220-9E-01  
3M CENTER, 2501 HUDSON ROAD  
ST. PAUL, MN 55144

FOR: CARPET PADDING, IN CLASS 27 (U.S. CLS. 19, 20, 37, 42 AND 50).

**TRADEMARK**

FIRST USE 12-5-2010; IN COMMERCE 12-5-2010.

**PRINCIPAL REGISTER**

THE MARK CONSISTS OF STANDARD CHARACTERS WITHOUT CLAIM TO ANY PARTICULAR FONT, STYLE, SIZE, OR COLOR.

OWNER OF U.S. REG. NOS. 630,698, 1,707,645, AND OTHERS.

SN 85-259,933, FILED 3-7-2011.

BARBARA BROWN, EXAMINING ATTORNEY



*David J. Kyjars*

Director of the United States Patent and Trademark Office

United States of America  
United States Patent and Trademark Office

**TESORO**  
**LOGISTICS**

**Reg. No. 4,136,747**

TESORO CORPORATION (DELAWARE CORPORATION)  
8700 TESORO DRIVE  
SAN ANTONIO, TX 78216

**Registered May 1, 2012**

**Int. Cl.: 39**

FOR: TERMINALLING, STORAGE, AND TRANSPORTATION OF FUEL, LUBRICANTS,  
AND PETROLEUM PRODUCTS; TRUCK HAULING, IN CLASS 39 (U.S. CLS. 100 AND 105).

**SERVICE MARK**

FIRST USE 4-0-2011; IN COMMERCE 4-0-2011.

**PRINCIPAL REGISTER**

OWNER OF U.S. REG. NOS. 2,417,980, 2,473,954, AND OTHERS.

NO CLAIM IS MADE TO THE EXCLUSIVE RIGHT TO USE "LOGISTICS", APART FROM  
THE MARK AS SHOWN.

THE MARK CONSISTS OF THE TERM "TESORO" ABOVE THE TERM "LOGISTICS" AND  
INCLUDES A TWO-PIECE ARCH BEGINNING ABOVE THE LETTER "R" IN THE TERM  
"TESORO" AND ENDING ABOVE THE LETTER "S" IN THE TERM "LOGISTICS".

THE ENGLISH TRANSLATION OF "TESORO" IN THE MARK IS "TREASURE".

SN 85-261,087, FILED 3-8-2011.

SANI KHOURI, EXAMINING ATTORNEY



*David J. Kybas*

Director of the United States Patent and Trademark Office



# United States of America

United States Patent and Trademark Office



**Reg. No. 4,136,748**

**Registered May 1, 2012**

**Int. Cl.: 41**

**SERVICE MARK**

**PRINCIPAL REGISTER**

DEMAND MEDIA, INC. (DELAWARE CORPORATION)  
1299 OCEAN AVENUE  
SANTA MONICA, CA 90401

FOR: PROVIDING ON-LINE PUBLICATIONS IN THE NATURE OF E-ARTICLES FEATURING BEAUTY AND FASHION; PROVIDING ON-LINE VIDEOS FEATURING BEAUTY AND FASHION, IN CLASS 41 (U.S. CLS. 100, 101 AND 107).

FIRST USE 3-15-2011; IN COMMERCE 3-15-2011.

THE MARK CONSISTS OF THE WORD "TYPE" NEXT TO A CAPITAL LETTER "F" WRITTEN IN PAINT STROKES.

SN 85-261,266, FILED 3-8-2011.

EDWARD NELSON, EXAMINING ATTORNEY



*David J. Kybas*

Director of the United States Patent and Trademark Office

# United States of America

United States Patent and Trademark Office



**Reg. No. 4,136,749**

**Registered May 1, 2012**

**Int. Cl.: 42**

**SERVICE MARK**

**PRINCIPAL REGISTER**

DEMAND MEDIA, INC. (DELAWARE CORPORATION)  
1299 OCEAN AVENUE  
SANTA MONICA, CA 90401

FOR: PROVIDING A WEB SITE THAT GIVES COMPUTER USERS THE ABILITY TO UPLOAD AND SHARE ESSAYS AND ARTICLES ON A WIDE VARIETY OF TOPICS AND SUBJECTS; COMPUTER SERVICES, NAMELY, PROVIDING SEARCH ENGINES FOR OBTAINING DATA ON A GLOBAL COMPUTER NETWORK, IN CLASS 42 (U.S. CLS. 100 AND 101).

FIRST USE 3-15-2011; IN COMMERCE 3-15-2011.

THE MARK CONSISTS OF THE WORD "TYPE" NEXT TO A CAPITAL LETTER "F" WRITTEN IN PAINT STROKES.

SN 85-261,314, FILED 3-8-2011.

EDWARD NELSON, EXAMINING ATTORNEY



*David J. Kyffers*

Director of the United States Patent and Trademark Office

# United States of America

United States Patent and Trademark Office

# ConveyStop

**Reg. No. 4,136,750**

INSIGHT AUTOMATION, INC. (KENTUCKY CORPORATION)  
2748 CIRCLEPORT DRIVE  
ERLANGER, KY 41018

**Registered May 1, 2012**

**Int. Cl.: 9**

FOR: INDUSTRIAL AUTOMATION CONTROLS, IN CLASS 9 (U.S. CLS. 21, 23, 26, 36 AND 38).

**TRADEMARK**

FIRST USE 9-1-2011; IN COMMERCE 9-1-2011.

**PRINCIPAL REGISTER**

THE MARK CONSISTS OF STANDARD CHARACTERS WITHOUT CLAIM TO ANY PARTICULAR FONT, STYLE, SIZE, OR COLOR.

SN 85-261,858, FILED 3-9-2011.

SANDRA BUJA, EXAMINING ATTORNEY



*David J. Kyffers*

Director of the United States Patent and Trademark Office

# United States of America

United States Patent and Trademark Office



**Reg. No. 4,136,751**

**Registered May 1, 2012**

**Int. Cl.: 41**

**SERVICE MARK**

**PRINCIPAL REGISTER**

HERNANDEZ, ANGEL A. (UNITED STATES INDIVIDUAL)  
3812 SUGAR CREEK CT.  
PLANT CITY, FL 33563

FOR: ENTERTAINMENT SERVICES IN THE NATURE OF LIVE MUSICAL PERFORMANCES,  
IN CLASS 41 (U.S. CLS. 100, 101 AND 107).

FIRST USE 1-1-2012; IN COMMERCE 2-3-2012.

THE MARK CONSISTS OF A STAR OVERLAID WITH 3 SILHOUETTE OF 3 MEN (MUSICIANS). ON THE TOP THERE IS THE STYLIZED TEXT "ESTRELLAS DE RANCHO".

THE ENGLISH TRANSLATION OF "ESTRELLAS DE RANCHO" IN THE MARK IS "STARS OF RANCH".

SN 85-261,979, FILED 3-9-2011.

DOMINIC J. FERRAIUOLO, EXAMINING ATTORNEY



*David J. Kybas*

Director of the United States Patent and Trademark Office

# United States of America

United States Patent and Trademark Office

# THUNDERVAK

**Reg. No. 4,136,752**

**Registered May 1, 2012**

**Int. Cl.: 7**

**TRADEMARK**

**PRINCIPAL REGISTER**

105766 CANADA INC. (CANADA CORPORATION), DBA MEGAWATT HYDROCULTURE,  
636 ROUTE 364  
MORIN-HEIGHTS, QC, CANADA J0R1H0

FOR: POWER-OPERATED SEPARATORS AND SHREDDERS FOR HERBS AND FLOWERS,  
IN CLASS 7 (U.S. CLS. 13, 19, 21, 23, 31, 34 AND 35).

FIRST USE 6-30-2010; IN COMMERCE 8-29-2011.

THE MARK CONSISTS OF STANDARD CHARACTERS WITHOUT CLAIM TO ANY PAR-  
TICULAR FONT, STYLE, SIZE, OR COLOR.

PRIORITY CLAIMED UNDER SEC. 44(D) ON CANADA APPLICATION NO. 1,516,218, FILED  
2-22-2011.

SN 85-262,052, FILED 3-9-2011.

DAVID HOFFMAN, EXAMINING ATTORNEY



*David J. Kyffers*

Director of the United States Patent and Trademark Office

# United States of America

## United States Patent and Trademark Office



**Reg. No. 4,136,753**

**Registered May 1, 2012**

**Int. Cl.: 45**

**SERVICE MARK**

**PRINCIPAL REGISTER**

PURITY BAPTIST CHURCH AND URBAN CENTER (D.C. NON-PROFIT ORGANIZATION)  
1325 MARYLAND AVENUE, NE  
WASHINGTON, DC 20002

FOR: EVANGELISTIC AND MINISTERIAL SERVICES, IN CLASS 45 (U.S. CLS. 100 AND 101).

FIRST USE 5-15-2011; IN COMMERCE 5-15-2011.

NO CLAIM IS MADE TO THE EXCLUSIVE RIGHT TO USE "BAPTIST CHURCH & URBAN CENTER" AND "ACTS 1:8", APART FROM THE MARK AS SHOWN.

THE STIPPLING IS FOR SHADING PURPOSES ONLY.

THE MARK CONSISTS OF A SHIELD DESIGN WITH THE PHRASE "EMPOWERED BY GOD TO REACH" APPEARING INSIDE THE TOP BAND OF THE SHIELD AND "UPWARD" AND "OUTWARD" APPEARING INSIDE THE BOTTOM BAND OF THE SHIELD. THE WORD INWARD APPEARS BETWEEN THE TERMS "UPWARD" AND "OUTWARD" IN THE CENTER OF THE BOTTOM BAND OF THE SHIELD INSIDE A STYLIZED RIBBON DESIGN. THE WORDS "PURITY BAPTIST CHURCH" APPEARS ABOVE THE DESIGN AND "& URBAN CENTER" APPEARS BELOW THE DESIGN. THE DESIGN CONSISTS OF TWO BIRDS ON EITHER SIDE OF A CROSS. THE CROSS IS SUPERIMPOSED OVER THE SUN, A RIBBON WITH "ACTS 1:8" IS DRAPED OVER THE TOP OF THE CROSS, AND FLOWERS APPEAR AT THE BASE OF THE CROSS. A SET OF PRAYING HANDS APPEARS ON EACH SIDE OF THE FLOWERS AT THE BASE OF THE CROSS. THE ENTIRE DESIGN APPEARS INSIDE THE SHIELD.

SN 85-262,157, FILED 3-9-2011.

ANDREA BUTLER, EXAMINING ATTORNEY



*David J. Kappas*

Director of the United States Patent and Trademark Office

# United States of America

United States Patent and Trademark Office

# Road Iron

**Reg. No. 4,136,754**

**Registered May 1, 2012**

**Int. Cl.: 16**

**TRADEMARK**

**PRINCIPAL REGISTER**

ER ASSETS, LP (DELAWARE LIMITED PARTNERSHIP)  
MDODGE@PAISANOPUB.COM  
2400 LAGUNA DRIVE  
FT. LAUDERDALE, FL 33316

FOR: MAGAZINES IN THE FIELD OF MOTORCYCLES AND MOTORCYCLING, IN CLASS 16 (U.S. CLS. 2, 5, 22, 23, 29, 37, 38 AND 50).

FIRST USE 6-15-2011; IN COMMERCE 8-2-2011.

THE MARK CONSISTS OF STANDARD CHARACTERS WITHOUT CLAIM TO ANY PARTICULAR FONT, STYLE, SIZE, OR COLOR.

SN 85-262,661, FILED 3-9-2011.

LINDA POWELL, EXAMINING ATTORNEY



*David J. Kyffers*

Director of the United States Patent and Trademark Office

# United States of America

United States Patent and Trademark Office



The Neurobehavior Center of Minnesota

**Reg. No. 4,136,755**

**Registered May 1, 2012**

**Int. Cl.: 44**

**SERVICE MARK**

**PRINCIPAL REGISTER**

DANIEL C. HOLLAND (UNITED STATES INDIVIDUAL), DBA THE NEUROBEHAVIOR CENTER OF MINNESOTA,  
4817 DUNBERRY LANE  
EDINA, MN 55435

FOR: OCCUPATIONAL THERAPY SERVICES; PSYCHOLOGICAL ASSESSMENT SERVICES; PSYCHOLOGICAL CONSULTATION; PSYCHOLOGICAL SERVICES, NAMELY, PROVIDING DIAGNOSTIC SERVICES TO CHILDREN WITH SPECIAL NEEDS AND THEIR FAMILIES; PSYCHOLOGICAL SERVICES, NAMELY, PROVIDING THERAPEUTIC SERVICES TO CHILDREN WITH SPECIAL NEEDS AND THEIR FAMILIES; PSYCHOLOGICAL TESTING, IN CLASS 44 (U.S. CLS. 100 AND 101).

FIRST USE 6-1-2011; IN COMMERCE 6-1-2011.

NO CLAIM IS MADE TO THE EXCLUSIVE RIGHT TO USE "THE NEUROBEHAVIOR CENTER OF MINNESOTA", APART FROM THE MARK AS SHOWN.

THE COLOR(S) RED, BLUE, PURPLE, GREY AND GREEN IS/ARE CLAIMED AS A FEATURE OF THE MARK.

THE MARK CONSISTS OF AN INTERNAL SQUARE WITH RED, BLUE, PURPLE, AND GREEN QUADRANTS, EMBEDDED WITHIN A GREY TRIANGLE. A GREY CIRCLE SURROUNDS THE COLORED SQUARE AND OVERLAPS WITH THE TRIANGLE. THE MARK IMAGE IS TO THE IMMEDIATE LEFT OF THE LITERAL ELEMENTS "THE NEUROBEHAVIOR CENTER OF MINNESOTA" APPEARING IN GREY.

SN 85-262,840, FILED 3-9-2011.

KATHERINE E. HALMEN, EXAMINING ATTORNEY



*David J. Kyjars*

Director of the United States Patent and Trademark Office



# United States of America

United States Patent and Trademark Office

## HOME FAVORITE

**Reg. No. 4,136,756**

**Registered May 1, 2012**

**Int. Cl.: 30**

**TRADEMARK**

**PRINCIPAL REGISTER**

RALCORP HOLDINGS, INC. (MISSOURI CORPORATION)  
800 MARKET STREET  
SUITE 2900  
ST. LOUIS, MO 63101

FOR: BREAKFAST CEREALS; OATMEAL, IN CLASS 30 (U.S. CL. 46).

FIRST USE 12-31-2011; IN COMMERCE 12-31-2011.

THE MARK CONSISTS OF STANDARD CHARACTERS WITHOUT CLAIM TO ANY PARTICULAR FONT, STYLE, SIZE, OR COLOR.

SN 85-263,329, FILED 3-10-2011.

SANI KHOURI, EXAMINING ATTORNEY



*David J. Kyffers*

Director of the United States Patent and Trademark Office

# United States of America

United States Patent and Trademark Office

# Cal Power

**Reg. No. 4,136,757**

D & L DISTRIBUTION, LLC (PENNSYLVANIA LIMITED LIABILITY COMPANY)  
2213 LEABROOK ROAD  
LANCASTER, PA 17601

**Registered May 1, 2012**

**Int. Cl.: 1**

FOR: FOLIAR PLANT GROWTH MICRONUTRIENTS FOR AGRICULTURAL CROPS, IN CLASS 1 (U.S. CLS. 1, 5, 6, 10, 26 AND 46).

**TRADEMARK**

FIRST USE 4-4-2011; IN COMMERCE 4-4-2011.

**PRINCIPAL REGISTER**

THE MARK CONSISTS OF STANDARD CHARACTERS WITHOUT CLAIM TO ANY PARTICULAR FONT, STYLE, SIZE, OR COLOR.

NO CLAIM IS MADE TO THE EXCLUSIVE RIGHT TO USE "CAL", APART FROM THE MARK AS SHOWN.

SN 85-263,391, FILED 3-10-2011.

NATALIE POLZER, EXAMINING ATTORNEY



*David J. Kybas*

Director of the United States Patent and Trademark Office

# United States of America

United States Patent and Trademark Office

# Grain Power

**Reg. No. 4,136,758**

D & L DISTRIBUTION, LLC (PENNSYLVANIA LIMITED LIABILITY COMPANY)  
2213 LEABROOK ROAD  
LANCASTER, PA 17601

**Registered May 1, 2012**

**Int. Cl.: 1**

FOR: FOLIAR PLANT GROWTH MICRONUTRIENTS FOR AGRICULTURAL CROPS, IN CLASS 1 (U.S. CLS. 1, 5, 6, 10, 26 AND 46).

**TRADEMARK**

FIRST USE 2-23-2011; IN COMMERCE 2-23-2011.

**PRINCIPAL REGISTER**

THE MARK CONSISTS OF STANDARD CHARACTERS WITHOUT CLAIM TO ANY PARTICULAR FONT, STYLE, SIZE, OR COLOR.

NO CLAIM IS MADE TO THE EXCLUSIVE RIGHT TO USE "GRAIN", APART FROM THE MARK AS SHOWN.

SN 85-263,409, FILED 3-10-2011.

NATALIE POLZER, EXAMINING ATTORNEY



*David J. Kybas*

Director of the United States Patent and Trademark Office

# United States of America

United States Patent and Trademark Office

# Harvest Power

**Reg. No. 4,136,759**

D & L DISTRIBUTION, LLC (PENNSYLVANIA LIMITED LIABILITY COMPANY)  
2213 LEABROOK ROAD  
LANCASTER, PA 17601

**Registered May 1, 2012**

**Int. Cl.: 1**

FOR: FOLIAR PLANT GROWTH MICRONUTRIENTS FOR AGRICULTURAL CROPS, IN CLASS 1 (U.S. CLS. 1, 5, 6, 10, 26 AND 46).

**TRADEMARK**

FIRST USE 4-6-2011; IN COMMERCE 4-6-2011.

**PRINCIPAL REGISTER**

THE MARK CONSISTS OF STANDARD CHARACTERS WITHOUT CLAIM TO ANY PARTICULAR FONT, STYLE, SIZE, OR COLOR.

SN 85-263,423, FILED 3-10-2011.

NATALIE POLZER, EXAMINING ATTORNEY



*David J. Kyffers*

Director of the United States Patent and Trademark Office

# United States of America

United States Patent and Trademark Office

# Micro Power

**Reg. No. 4,136,760**

D & L DISTRIBUTION, LLC (PENNSYLVANIA LIMITED LIABILITY COMPANY)  
2213 LEABROOK ROAD  
LANCASTER, PA 17601

**Registered May 1, 2012**

**Int. Cl.: 1**

FOR: FOLIAR PLANT GROWTH MICRONUTRIENTS FOR AGRICULTURAL CROPS, IN CLASS 1 (U.S. CLS. 1, 5, 6, 10, 26 AND 46).

**TRADEMARK**

FIRST USE 4-11-2011; IN COMMERCE 4-11-2011.

**PRINCIPAL REGISTER**

THE MARK CONSISTS OF STANDARD CHARACTERS WITHOUT CLAIM TO ANY PARTICULAR FONT, STYLE, SIZE, OR COLOR.

SN 85-263,439, FILED 3-10-2011.

NATALIE POLZER, EXAMINING ATTORNEY



*David J. Kyffers*

Director of the United States Patent and Trademark Office

# United States of America

United States Patent and Trademark Office

# Nutri Power

**Reg. No. 4,136,761**

D & L DISTRIBUTION, LLC (PENNSYLVANIA LIMITED LIABILITY COMPANY)  
2213 LEABROOK ROAD  
LANCASTER, PA 17601

**Registered May 1, 2012**

**Int. Cl.: 1**

FOR: FOLIAR PLANT GROWTH MICRONUTRIENTS FOR AGRICULTURAL CROPS, IN CLASS 1 (U.S. CLS. 1, 5, 6, 10, 26 AND 46).

**TRADEMARK**

FIRST USE 3-25-2011; IN COMMERCE 3-25-2011.

**PRINCIPAL REGISTER**

THE MARK CONSISTS OF STANDARD CHARACTERS WITHOUT CLAIM TO ANY PARTICULAR FONT, STYLE, SIZE, OR COLOR.

SN 85-263,461, FILED 3-10-2011.

NATALIE POLZER, EXAMINING ATTORNEY



*David J. Kyffers*

Director of the United States Patent and Trademark Office

# United States of America

United States Patent and Trademark Office

# Sul Power

**Reg. No. 4,136,762**

D & L DISTRIBUTION, LLC (PENNSYLVANIA LIMITED LIABILITY COMPANY)  
2213 LEABROOK ROAD  
LANCASTER, PA 17601

**Registered May 1, 2012**

**Int. Cl.: 1**

FOR: FOLIAR PLANT GROWTH MICRONUTRIENTS FOR AGRICULTURAL CROPS, IN CLASS 1 (U.S. CLS. 1, 5, 6, 10, 26 AND 46).

**TRADEMARK**

FIRST USE 12-28-2011; IN COMMERCE 12-28-2011.

**PRINCIPAL REGISTER**

THE MARK CONSISTS OF STANDARD CHARACTERS WITHOUT CLAIM TO ANY PARTICULAR FONT, STYLE, SIZE, OR COLOR.

NO CLAIM IS MADE TO THE EXCLUSIVE RIGHT TO USE "SUL", APART FROM THE MARK AS SHOWN.

SN 85-263,479, FILED 3-10-2011.

NATALIE POLZER, EXAMINING ATTORNEY



*David J. Kybas*

Director of the United States Patent and Trademark Office

# United States of America

United States Patent and Trademark Office

# SENZARI

**Reg. No. 4,136,763**

**Registered May 1, 2012**

**Int. Cl.: 41**

**SERVICE MARK**

**PRINCIPAL REGISTER**

SENZARI, INC. (DELAWARE CORPORATION)  
601 BRICKELL KEY DRIVE, SUITE 602  
MIAMI, FL 33131

FOR: ENTERTAINMENT SERVICES, NAMELY, PROVIDING NON-DOWNLOADABLE  
PLAYBACK OF MUSIC VIA GLOBAL COMMUNICATIONS NETWORKS, IN CLASS 41  
(U.S. CLS. 100, 101 AND 107).

FIRST USE 11-7-2011; IN COMMERCE 11-7-2011.

THE MARK CONSISTS OF STANDARD CHARACTERS WITHOUT CLAIM TO ANY PAR-  
TICULAR FONT, STYLE, SIZE, OR COLOR.

THE WORDING "SENZARI" HAS NO MEANING IN A FOREIGN LANGUAGE.

SN 85-263,916, FILED 3-10-2011.

HELENE LIWINSKI, EXAMINING ATTORNEY



*David J. Kybas*

Director of the United States Patent and Trademark Office



# United States of America

United States Patent and Trademark Office

## INFINITE HERO

**Reg. No. 4,136,764**

**Registered May 1, 2012**

**Int. Cls.: 9 and 25**

**TRADEMARK**

**PRINCIPAL REGISTER**

INFINITE HERO FOUNDATION (CALIFORNIA FOUNDATION)  
22365 EL TORO ROAD #275  
LAKE FOREST, CA 92630

FOR: PROTECTIVE EYEWEAR, NAMELY, SPECTACLES, PRESCRIPTION EYEWEAR, ANTI GLARE GLASSES AND SUNGLASSES AND THEIR PARTS AND ACCESSORIES, NAMELY, REPLACEMENT LENSES, FRAMES, EARSTEMS, AND NOSE PIECES; CASES SPECIALLY ADAPTED FOR SPECTACLES AND SUNGLASSES AND THEIR PARTS AND ACCESSORIES, IN CLASS 9 (U.S. CLS. 21, 23, 26, 36 AND 38).

FIRST USE 4-5-2011; IN COMMERCE 4-5-2011.

FOR: CLOTHING, NAMELY, T-SHIRTS, BEACH-WEAR, BLOUSES, SPORTS SHIRTS, JERSEYS, SWIMWEAR, SWIMTRUNKS, SHORTS, UNDERWEAR, SHIRTS, PANTS, RACING PANTS, SKI AND SNOWBOARD PANTS AND JACKETS, JEANS, VESTS, JACKETS, WETSUITS, SWEATERS, PULLOVERS, COATS, SWEATPANTS, HEADWEAR, NAMELY, HATS, CAPS, VISORS AND FOOTWEAR, NAMELY, WETSUIT BOOTIES, SHOES, SANDALS, ATHLETIC FOOTWEAR, ALL PURPOSE SPORTS FOOTWEAR, THONGS AND BOOTS, IN CLASS 25 (U.S. CLS. 22 AND 39).

FIRST USE 4-5-2011; IN COMMERCE 4-5-2011.

THE MARK CONSISTS OF STANDARD CHARACTERS WITHOUT CLAIM TO ANY PARTICULAR FONT, STYLE, SIZE, OR COLOR.

SN 85-263,969, FILED 3-10-2011.

WILLIAM BRECKENFELD, EXAMINING ATTORNEY



*David J. Kyros*

Director of the United States Patent and Trademark Office

# United States of America

United States Patent and Trademark Office

## ECONO-TUFF

**Reg. No. 4,136,765**

**Registered May 1, 2012**

**Int. Cl.: 25**

**TRADEMARK**

**PRINCIPAL REGISTER**

REFRIGIWEAR, INC. (GEORGIA CORPORATION)  
54 BREAKSTONE DRIVE  
DAHLONEGA, GA 30533

FOR: INSULATED CLOTHING FOR PROTECTION AT LOW TEMPERATURES, NAMELY, JACKETS, PARKAS, COVERALLS, OVERALLS, PANTS, VESTS, HANDWEAR, HEADWEAR, FOOTWEAR, SOCKS, SWEATSHIRTS, BODY SUITS , IN CLASS 25 (U.S. CLS. 22 AND 39).

FIRST USE 8-1-2010; IN COMMERCE 8-1-2010.

THE MARK CONSISTS OF STANDARD CHARACTERS WITHOUT CLAIM TO ANY PARTICULAR FONT, STYLE, SIZE, OR COLOR.

SN 85-264,319, FILED 3-11-2011.

LINDA ORNDORFF, EXAMINING ATTORNEY



*David J. Kyffers*

Director of the United States Patent and Trademark Office

# United States of America

United States Patent and Trademark Office

# VidaBand

**Reg. No. 4,136,766**

HEALTHPEP LLC. (FLORIDA LIMITED LIABILITY COMPANY), DBA HEALTHPEP LLC.,  
15154 SW 92 TERRACE  
MIAMI, FL 33196

**Registered May 1, 2012**

**Int. Cl.: 14**

FOR: JEWELRY THAT INCORPORATES TECHNOLOGY FOR REBALANCING THE HUMAN ENERGY FIELD, IN CLASS 14 (U.S. CLS. 2, 27, 28 AND 50).

**TRADEMARK**

FIRST USE 11-21-2010; IN COMMERCE 3-14-2011.

**PRINCIPAL REGISTER**

THE MARK CONSISTS OF STANDARD CHARACTERS WITHOUT CLAIM TO ANY PARTICULAR FONT, STYLE, SIZE, OR COLOR.

SN 85-264,476, FILED 3-11-2011.

WILLIAM BRECKENFELD, EXAMINING ATTORNEY



*David J. Kyfos*

Director of the United States Patent and Trademark Office

# United States of America

United States Patent and Trademark Office

## MONSTER MADNESS

**Reg. No. 4,136,767**

**Registered May 1, 2012**

**Int. Cl.: 9**

**TRADEMARK**

**PRINCIPAL REGISTER**

AMI ENTERTAINMENT NETWORK, INC. (DELAWARE CORPORATION)  
155 RITTENHOUSE CIRCLE  
BRISTOL, PA 19007

FOR: COMPUTER AND ELECTRONIC GAME PROGRAMS; COMPUTER AND ELECTRONIC GAME SOFTWARE; DOWNLOADABLE ELECTRONIC GAMES VIA THE INTERNET AND WIRELESS DEVICES , IN CLASS 9 (U.S. CLS. 21, 23, 26, 36 AND 38).

FIRST USE 10-1-2011; IN COMMERCE 10-1-2011.

THE MARK CONSISTS OF STANDARD CHARACTERS WITHOUT CLAIM TO ANY PARTICULAR FONT, STYLE, SIZE, OR COLOR.

OWNER OF U.S. REG. NO. 2,438,660.

SN 85-264,610, FILED 3-11-2011.

WILLIAM ROSSMAN, EXAMINING ATTORNEY



*David J. Kyffers*

Director of the United States Patent and Trademark Office

# United States of America

United States Patent and Trademark Office

# Y it Sucks

**Reg. No. 4,136,768**

**Registered May 1, 2012**

**Int. Cl.: 35**

**SERVICE MARK**

**PRINCIPAL REGISTER**

MASSIVE APE (DELAWARE LIMITED LIABILITY COMPANY)  
15410 BENJAMIN RING ST  
BRANDYWINE, MD 20613

FOR: PROVIDING A WEB SITE WHERE USERS CAN POST RATINGS, REVIEWS AND RECOMMENDATIONS ON PRODUCTS AND SERVICES FOR COMMERCIAL PURPOSES, IN CLASS 35 (U.S. CLS. 100, 101 AND 102).

FIRST USE 9-8-2006; IN COMMERCE 7-25-2011.

THE MARK CONSISTS OF STANDARD CHARACTERS WITHOUT CLAIM TO ANY PARTICULAR FONT, STYLE, SIZE, OR COLOR.

SN 85-265,466, FILED 3-12-2011.

KIM SAITO, EXAMINING ATTORNEY



*David J. Kybas*

Director of the United States Patent and Trademark Office

# United States of America

United States Patent and Trademark Office

## TOBY FARMS

**Reg. No. 4,136,769**

**Registered May 1, 2012**

**Int. Cl.: 29**

**TRADEMARK**

**PRINCIPAL REGISTER**

TOBY FARMS INC. (CALIFORNIA CORPORATION)  
5148 MAYWOOD COURT  
RANCHO CUCAMONGA, CA 91739

FOR: CANDIED NUTS; FLAVORED NUTS; NUT-BASED SNACK FOODS; PROCESSED NUTS; ROASTED NUTS, IN CLASS 29 (U.S. CL. 46).

FIRST USE 2-8-2012; IN COMMERCE 2-8-2012.

THE MARK CONSISTS OF STANDARD CHARACTERS WITHOUT CLAIM TO ANY PARTICULAR FONT, STYLE, SIZE, OR COLOR.

NO CLAIM IS MADE TO THE EXCLUSIVE RIGHT TO USE "FARMS", APART FROM THE MARK AS SHOWN.

SN 85-265,715, FILED 3-14-2011.

KIM MONINGHOFF, EXAMINING ATTORNEY



*David J. Kyffers*

Director of the United States Patent and Trademark Office

# United States of America

United States Patent and Trademark Office

## NSF Reference Standards

**Reg. No. 4,136,770**

**Registered May 1, 2012**

**Int. Cl.: 1**

**TRADEMARK**

**PRINCIPAL REGISTER**

NSF INTERNATIONAL (MICHIGAN CORPORATION)  
789 N. DIXBORO ROAD  
ANN ARBOR, MI 48105

FOR: STANDARDIZED CHEMICAL PREPARATIONS FOR USE IN THE TESTING AND MANUFACTURE OF PHARMACEUTICALS, MEDICINES, AND FOOD, DIETARY AND NUTRITIONAL SUPPLEMENTS, IN CLASS 1 (U.S. CLS. 1, 5, 6, 10, 26 AND 46).

FIRST USE 6-21-2011; IN COMMERCE 6-21-2011.

NO CLAIM IS MADE TO THE EXCLUSIVE RIGHT TO USE "REFERENCE STANDARDS", APART FROM THE MARK AS SHOWN.

THE MARK CONSISTS OF THE TERMS "NSF REFERENCE STANDARDS" INSIDE TWO OVALS, THE LINE OF THE INNER OVAL BEING THINNER THAN THE LINE OF THE OUTER OVAL.

SN 85-265,875, FILED 3-14-2011.

TIMOTHY FINNEGAN, EXAMINING ATTORNEY



*David J. Kyros*

Director of the United States Patent and Trademark Office

# United States of America

United States Patent and Trademark Office

# Farmer Dick

**Reg. No. 4,136,771**

**Registered May 1, 2012**

**Int. Cl.: 44**

**SERVICE MARK**

**PRINCIPAL REGISTER**

RICHARD KITTNER (UNITED STATES INDIVIDUAL), AKA FARMER DICK,  
#590  
IRVINE, CA 92612

FOR: CONTRACT FARMING FOR OTHERS, IN CLASS 44 (U.S. CLS. 100 AND 101).

FIRST USE 6-0-2010; IN COMMERCE 6-0-2010.

THE MARK CONSISTS OF STANDARD CHARACTERS WITHOUT CLAIM TO ANY PARTICULAR FONT, STYLE, SIZE, OR COLOR.

NO CLAIM IS MADE TO THE EXCLUSIVE RIGHT TO USE "FARMER", APART FROM THE MARK AS SHOWN.

SN 85-265,935, FILED 3-14-2011.

ELI HELLMAN, EXAMINING ATTORNEY



*David J. Kyffers*

Director of the United States Patent and Trademark Office



# United States of America

United States Patent and Trademark Office

# PEKY

**Reg. No. 4,136,772**

**Registered May 1, 2012**

**Int. Cl.: 32**

**TRADEMARK**

**PRINCIPAL REGISTER**

ABI DISTRIBUTOR CORPORATION (FLORIDA CORPORATION)  
STE 400  
6303 BLUE LAGOON DRIVE  
MIAMI, FL 33126

FOR: SOFT DRINKS, NAMELY, SODAS, IN CLASS 32 (U.S. CLS. 45, 46 AND 48).

FIRST USE 1-1-2012; IN COMMERCE 1-1-2012.

THE MARK CONSISTS OF STANDARD CHARACTERS WITHOUT CLAIM TO ANY PARTICULAR FONT, STYLE, SIZE, OR COLOR.

THE WORDING "PEKY" HAS NO MEANING IN A FOREIGN LANGUAGE.

SN 85-266,543, FILED 3-14-2011.

CHERYL CLAYTON, EXAMINING ATTORNEY



*David J. Kybas*

Director of the United States Patent and Trademark Office

# United States of America

United States Patent and Trademark Office

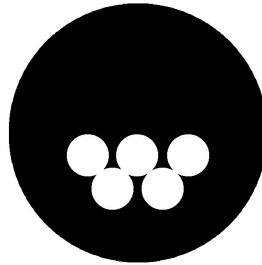

**Reg. No. 4,136,773**

**Registered May 1, 2012**

**Int. Cl.: 11**

**TRADEMARK**

**PRINCIPAL REGISTER**

WINLITE, INC. (CALIFORNIA CORPORATION)  
#1-248  
19745 COLIMA RD.  
ROWLAND HEIGHTS, CA 91748

FOR: FLASHLIGHTS, IN CLASS 11 (U.S. CLS. 13, 21, 23, 31 AND 34).

FIRST USE 1-1-2012; IN COMMERCE 1-1-2012.

THE MARK CONSISTS OF THE LETTER "W", COMPRISED OF FIVE CIRCLES THAT ARE TOUCHING, AND THIS DESIGN ELEMENT IS WITHIN A SHADED CIRCULAR BACKGROUND.

SN 85-266,731, FILED 3-14-2011.

JUDITH HELFMAN, EXAMINING ATTORNEY



*David J. Kybas*

Director of the United States Patent and Trademark Office

# United States of America

United States Patent and Trademark Office

# GROWOLOGY

**Reg. No. 4,136,774**

**Registered May 1, 2012**

**Int. Cl.: 1**

**TRADEMARK**

**PRINCIPAL REGISTER**

DOGGETT & SIMPSON, LLC (RHODE ISLAND LIMITED LIABILITY COMPANY)  
76 KEANE STREET  
PROVIDENCE, RI 02906

FOR: FERTILIZERS, IN CLASS 1 (U.S. CLS. 1, 5, 6, 10, 26 AND 46).

FIRST USE 9-13-2011; IN COMMERCE 9-13-2011.

THE MARK CONSISTS OF STANDARD CHARACTERS WITHOUT CLAIM TO ANY PARTICULAR FONT, STYLE, SIZE, OR COLOR.

SN 85-266,861, FILED 3-15-2011.

BARBARA RUTLAND, EXAMINING ATTORNEY



*David J. Kyffers*

Director of the United States Patent and Trademark Office

# United States of America

United States Patent and Trademark Office

# sponsorgoal

**Reg. No. 4,136,775**

**Registered May 1, 2012**

**Int. Cl.: 36**

**SERVICE MARK**

**PRINCIPAL REGISTER**

BASS ENTERPRISES PRODUCTIONS, LLC (NEW HAMPSHIRE LIMITED LIABILITY COMPANY)  
22 SOUTH BROADWAY  
SALEM, NH 03079

FOR: ON-LINE BUSINESS FUNDRAISING SERVICES, IN CLASS 36 (U.S. CLS. 100, 101 AND 102).

FIRST USE 2-23-2011; IN COMMERCE 2-23-2011.

THE MARK CONSISTS OF STANDARD CHARACTERS WITHOUT CLAIM TO ANY PARTICULAR FONT, STYLE, SIZE, OR COLOR.

SN 85-267,460, FILED 3-15-2011.

BARBARA RUTLAND, EXAMINING ATTORNEY



*David J. Kybas*

Director of the United States Patent and Trademark Office

# United States of America

United States Patent and Trademark Office

## ULTRA TOUCH

**Reg. No. 4,136,776**

CHURCH & DWIGHT CO., INC. (DELAWARE CORPORATION)  
469 NORTH HARRISON STREET LAW DEPARTMENT  
PRINCETON, NJ 08543

**Registered May 1, 2012**

**Int. Cl.: 10**

FOR: ADULT SEXUAL STIMULATION AIDS, NAMELY, PERSONAL VIBRATORS, IN CLASS 10 (U.S. CLS. 26, 39 AND 44).

**TRADEMARK**

FIRST USE 12-9-2011; IN COMMERCE 12-9-2011.

**PRINCIPAL REGISTER**

THE MARK CONSISTS OF STANDARD CHARACTERS WITHOUT CLAIM TO ANY PARTICULAR FONT, STYLE, SIZE, OR COLOR.

SN 85-268,453, FILED 3-16-2011.

ANGELA DUONG, EXAMINING ATTORNEY



*David J. Kybas*

Director of the United States Patent and Trademark Office

# United States of America

United States Patent and Trademark Office

# UNMINED

**Reg. No. 4,136,777**

**Registered May 1, 2012**

**Int. Cl.: 14**

**TRADEMARK**

**PRINCIPAL REGISTER**

FAIR TRADE JEWELLERY COMPANY LTD. (CANADA CORPORATION)  
523 PARLIAMENT STREET  
TORONTO, ONTARIO, CANADA M4X1P3

FOR: JEWELRY, DIAMONDS AND GEMS OBTAINED FROM, AND MANUFACTURED WITH, ECOLOGICALLY FRIENDLY METHODS AND SOURCES; RECYCLED PRECIOUS METALS AND PRECIOUS METAL ALLOYS, IN CLASS 14 (U.S. CLS. 2, 27, 28 AND 50).

FIRST USE 2-1-2011; IN COMMERCE 2-1-2011.

THE MARK CONSISTS OF STANDARD CHARACTERS WITHOUT CLAIM TO ANY PARTICULAR FONT, STYLE, SIZE, OR COLOR.

SN 85-268,697, FILED 3-16-2011.

LEIGH LOWRY, EXAMINING ATTORNEY



*David J. Kyros*

Director of the United States Patent and Trademark Office

# United States of America

United States Patent and Trademark Office

## OPALESCENCE

**Reg. No. 4,136,778**

**Registered May 1, 2012**

**Int. Cl.: 21**

**TRADEMARK**

**PRINCIPAL REGISTER**

ULTRADENT PRODUCTS, INC. (UTAH CORPORATION)  
505 WEST 10200 SOUTH  
SOUTH JORDAN, UT 84095

FOR: TOOTHBRUSHES, IN CLASS 21 (U.S. CLS. 2, 13, 23, 29, 30, 33, 40 AND 50).

FIRST USE 7-1-2003; IN COMMERCE 7-1-2003.

THE MARK CONSISTS OF STANDARD CHARACTERS WITHOUT CLAIM TO ANY PARTICULAR FONT, STYLE, SIZE, OR COLOR.

OWNER OF U.S. REG. NOS. 1,662,181, 1,914,450, AND 2,228,422.

SN 85-268,826, FILED 3-16-2011.

LOURDES AYALA, EXAMINING ATTORNEY



*David J. Kyffers*

Director of the United States Patent and Trademark Office

# United States of America

United States Patent and Trademark Office

## PERFECT DIABETIC CLUB (PDC)

**Reg. No. 4,136,779**

**Registered May 1, 2012**

**Int. Cls.: 41 and 45**

**SERVICE MARK**

**PRINCIPAL REGISTER**

UHS OF DELAWARE, INC. (DELAWARE CORPORATION)  
367 SOUTH GULPH ROAD  
KING OF PRUSSIA, PA 194060958

FOR: EDUCATION SERVICES, NAMELY, PROVIDING CLASSES, SEMINARS AND WORKSHOPS IN THE FIELD OF DIABETES EDUCATION, IN CLASS 41 (U.S. CLS. 100, 101 AND 107).

FIRST USE 4-0-2011; IN COMMERCE 4-0-2011.

FOR: ORGANIZING AND CONDUCTING SUPPORT GROUPS IN THE FIELD OF DIABETIC MEDICAL AND HEALTHCARE ISSUES, IN CLASS 45 (U.S. CLS. 100 AND 101).

FIRST USE 4-0-2011; IN COMMERCE 4-0-2011.

THE MARK CONSISTS OF STANDARD CHARACTERS WITHOUT CLAIM TO ANY PARTICULAR FONT, STYLE, SIZE, OR COLOR.

NO CLAIM IS MADE TO THE EXCLUSIVE RIGHT TO USE "DIABETIC CLUB", APART FROM THE MARK AS SHOWN.

SN 85-269,213, FILED 3-17-2011.

DOUGLAS LEE, EXAMINING ATTORNEY



*David J. Kybas*

Director of the United States Patent and Trademark Office



# United States of America

United States Patent and Trademark Office

## Questeq The Educated Choice

**Reg. No. 4,136,780**

**Registered May 1, 2012**

**Int. Cl.: 42**

**SERVICE MARK**

**PRINCIPAL REGISTER**

QUESTEQ INC. (PENNSYLVANIA CORPORATION)  
420 ROUSER BUILDING 3 LL1  
CORAOPOLIS, PA 15108

FOR: TECHNICAL SUPPORT SERVICES, NAMELY, TROUBLESHOOTING OF COMPUTER SOFTWARE PROBLEMS; DESIGN AND MAINTENANCE OF WEBSITES FOR OTHERS; IT CONSULTING SERVICES; COMPUTER SERVICES, NAMELY, REMOTE AND ON-SITE MANAGEMENT OF THE INFORMATION TECHNOLOGY (IT) SYSTEMS OF OTHERS, IN CLASS 42 (U.S. CLS. 100 AND 101).

FIRST USE 2-8-2011; IN COMMERCE 2-8-2011.

THE MARK CONSISTS OF STANDARD CHARACTERS WITHOUT CLAIM TO ANY PARTICULAR FONT, STYLE, SIZE, OR COLOR.

SN 85-269,425, FILED 3-17-2011.

SOPHIA S. KIM, EXAMINING ATTORNEY



*David J. Kybas*

Director of the United States Patent and Trademark Office

# United States of America

United States Patent and Trademark Office

# PROLINE

**Reg. No. 4,136,781**

**Registered May 1, 2012**

**Int. Cl.: 9**

**TRADEMARK**

**PRINCIPAL REGISTER**

TELSCO INDUSTRIES, INC. (TEXAS CORPORATION), DBA WEATHERMATIC,  
3301 W. KINGSLEY ROAD  
GARLAND, TX 75041

FOR: ELECTRONIC CONTROLLERS, ELECTRONIC VALVES, AND ELECTRONIC SENSORS,  
NAMELY, FOR EXTERIOR LAWN WATERING AND IRRIGATION USES , IN CLASS 9 (U.S.  
CLS. 21, 23, 26, 36 AND 38).

FIRST USE 9-1-2011; IN COMMERCE 9-1-2011.

THE MARK CONSISTS OF STANDARD CHARACTERS WITHOUT CLAIM TO ANY PAR-  
TICULAR FONT, STYLE, SIZE, OR COLOR.

SN 85-269,433, FILED 3-17-2011.

SOPHIA S. KIM, EXAMINING ATTORNEY



*David J. Kybas*

Director of the United States Patent and Trademark Office

# United States of America

United States Patent and Trademark Office



**Reg. No. 4,136,782**

**Registered May 1, 2012**

**Int. Cl.: 30**

**TRADEMARK**

**PRINCIPAL REGISTER**

SCHWAN'S IP, LLC (MINNESOTA LIMITED LIABILITY COMPANY)  
115 W. COLLEGE DRIVE  
MARSHALL, MN 56258

FOR: DOUGH-ENROBED FOODS CONSISTING OF A DOUGH-BASED WRAPPER WITH FILLINGS CONSISTING PRIMARILY OF FRUITS, MEATS, CHEESE, AND SAUCE WITH AND WITHOUT VEGETABLES; ICE CREAM, IN CLASS 30 (U.S. CL. 46).

FIRST USE 1-16-2012; IN COMMERCE 1-16-2012.

OWNER OF U.S. REG. NOS. 786,887, 3,909,148, AND OTHERS.

THE STIPPLING IS A FEATURE OF THE MARK AND DOES NOT INDICATE COLOR.

THE NAME(S), PORTRAIT(S), AND/OR SIGNATURE(S) SHOWN IN THE MARK DOES NOT IDENTIFY A PARTICULAR LIVING INDIVIDUAL.

THE MARK CONSISTS OF A BANNER CONTAINING THE WORDS "MRS. SMITH'S" AND A ROLLING PIN.

SN 85-269,880, FILED 3-17-2011.

RENEE MCCRAY, EXAMINING ATTORNEY



*David J. Kyros*

Director of the United States Patent and Trademark Office

# United States of America

United States Patent and Trademark Office

## SALTYCLAWS

**Reg. No. 4,136,783**

HUNTER, RICHARD (UNITED STATES INDIVIDUAL)  
4 TUCKER PARK  
PEPPERELL, MA 01463

**Registered May 1, 2012**

**Int. Cl.: 43**

FOR: PET BOARDING SERVICES; PET DAY CARE SERVICES, IN CLASS 43 (U.S. CLS. 100 AND 101).

**SERVICE MARK**

FIRST USE 2-7-2012; IN COMMERCE 2-7-2012.

**PRINCIPAL REGISTER**

THE MARK CONSISTS OF STANDARD CHARACTERS WITHOUT CLAIM TO ANY PARTICULAR FONT, STYLE, SIZE, OR COLOR.

SN 85-270,422, FILED 3-18-2011.

WILLIAM VERHOSEK, EXAMINING ATTORNEY



*David J. Kybas*

Director of the United States Patent and Trademark Office

# United States of America

United States Patent and Trademark Office

# ZQUOTE

**Reg. No. 4,136,784**

**Registered May 1, 2012**

**Int. Cl.: 42**

**SERVICE MARK**

**PRINCIPAL REGISTER**

FLEXMASTER CANADA LTD. (CANADA CORPORATION)  
20 EAST PEARCE STREET  
RICHMOND HILL, CANADA L4B1B7

FOR: PROVIDING TEMPORARY USE OF ON-LINE NON-DOWNLOADABLE SOFTWARE FOR DETERMINING MATERIAL NEEDS AND COSTS, AND FOR DEVELOPING CUSTOMER DRAWINGS AND ESTIMATES FOR HEATING AND HEAT GENERATING APPLIANCE VENTING, IN CLASS 42 (U.S. CLS. 100 AND 101).

FIRST USE 6-15-2011; IN COMMERCE 6-15-2011.

THE MARK CONSISTS OF STANDARD CHARACTERS WITHOUT CLAIM TO ANY PARTICULAR FONT, STYLE, SIZE, OR COLOR.

SN 85-271,112, FILED 3-18-2011.

NORA BUCHANAN WILL, EXAMINING ATTORNEY



*David J. Kybas*

Director of the United States Patent and Trademark Office

# United States of America

United States Patent and Trademark Office

## GO ENERGY FOR THE SKIN

**Reg. No. 4,136,785**

**Registered May 1, 2012**

**Int. Cl.: 3**

**TRADEMARK**

**PRINCIPAL REGISTER**

FOOD MARKET MANAGEMENT, INC. (CALIFORNIA CORPORATION)  
215 REINDOLLAR AVENUE  
MARINA, CA 93933

FOR: NON-MEDICATED SKIN CARE PREPARATIONS; SKIN CLEANSERS; SKIN TONER;  
SKIN MOISTURIZER; SKIN CREAMS AND LOTIONS; MOISTURIZING CREAMS; FACE  
AND BODY CREAMS, IN CLASS 3 (U.S. CLS. 1, 4, 6, 50, 51 AND 52).

FIRST USE 4-29-2011; IN COMMERCE 4-29-2011.

THE MARK CONSISTS OF STANDARD CHARACTERS WITHOUT CLAIM TO ANY PAR-  
TICULAR FONT, STYLE, SIZE, OR COLOR.

SN 85-271,320, FILED 3-18-2011.

JUDITH HELFMAN, EXAMINING ATTORNEY



*David J. Kyffers*

Director of the United States Patent and Trademark Office

# United States of America

United States Patent and Trademark Office

## Irish by Intercourse

**Reg. No. 4,136,786**

**Registered May 1, 2012**

**Int. Cls.: 21, 25, and 26**

SCS CONSULTING (INDIANA LIMITED LIABILITY COMPANY), DBA SULLIVAN CONSULTING,  
5867 N. NEW JERSEY STREET  
INDIANAPOLIS, IN 46220

FOR: BEER MUGS, IN CLASS 21 (U.S. CLS. 2, 13, 23, 29, 30, 33, 40 AND 50).

**TRADEMARK**

FIRST USE 12-13-2011; IN COMMERCE 12-13-2011.

**PRINCIPAL REGISTER**

FOR: T-SHIRTS, IN CLASS 25 (U.S. CLS. 22 AND 39).

FIRST USE 9-17-2011; IN COMMERCE 12-13-2011.

FOR: NOVELTY BUTTONS, IN CLASS 26 (U.S. CLS. 37, 39, 40, 42 AND 50).

FIRST USE 12-13-2011; IN COMMERCE 12-13-2011.

THE MARK CONSISTS OF STANDARD CHARACTERS WITHOUT CLAIM TO ANY PARTICULAR FONT, STYLE, SIZE, OR COLOR.

SN 85-271,504, FILED 3-19-2011.

KATINA MISTER, EXAMINING ATTORNEY



*David J. Kyros*

Director of the United States Patent and Trademark Office

# United States of America

United States Patent and Trademark Office

# FREE-FLY

**Reg. No. 4,136,787**

**Registered May 1, 2012**

**Int. Cl.: 28**

**TRADEMARK**

**PRINCIPAL REGISTER**

MEANT-2-MOVE LLC (DELAWARE LIMITED LIABILITY COMPANY)  
UNIT 210  
7751 SOUTHAMPTON TERRACE  
TAMARAC, FL 33321

FOR: HAND HELD UPPER BODY EXERCISE DEVICES, IN CLASS 28 (U.S. CLS. 22, 23, 38 AND 50).

FIRST USE 12-24-2011; IN COMMERCE 12-24-2011.

THE MARK CONSISTS OF STANDARD CHARACTERS WITHOUT CLAIM TO ANY PARTICULAR FONT, STYLE, SIZE, OR COLOR.

SN 85-271,602, FILED 3-19-2011.

RICHARD WHITE, EXAMINING ATTORNEY



*David J. Kybas*

Director of the United States Patent and Trademark Office



United States of America  
United States Patent and Trademark Office

# Hungribles

**Reg. No. 4,136,788**

**Registered May 1, 2012**

**Int. Cl.: 9**

**TRADEMARK**

**PRINCIPAL REGISTER**

FUTUREMARK OY (FINLAND CORPORATION)  
KAPPELITIE 6 C  
ESPOO, FINLAND FI-02200

FOR: ELECTRONIC GAME PROGRAMS; DOWNLOADABLE ELECTRONIC GAME SOFTWARE FOR WIRELESS AND HANDHELD ELECTRONIC DEVICES; COMPUTER AND VIDEO GAME SOFTWARE AND DISCS, IN CLASS 9 (U.S. CLS. 21, 23, 26, 36 AND 38).

FIRST USE 3-18-2011; IN COMMERCE 1-19-2012.

THE MARK CONSISTS OF STANDARD CHARACTERS WITHOUT CLAIM TO ANY PARTICULAR FONT, STYLE, SIZE, OR COLOR.

THE WORD(S) "HUNGRIBLES" HAS NO MEANING IN A FOREIGN LANGUAGE.

SN 85-271,839, FILED 3-21-2011.

MATTHEW MCDOWELL, EXAMINING ATTORNEY



*David J. Kyros*

Director of the United States Patent and Trademark Office

# United States of America

United States Patent and Trademark Office



**Reg. No. 4,136,789**

**Registered May 1, 2012**

**Int. Cls.: 36 and 41**

**SERVICE MARK**

**PRINCIPAL REGISTER**

WATERFOWL CHESAPEAKE INC. (MARYLAND CORPORATION)  
40 SOUTH HARRISON STREET  
EASTON, MD 21601

FOR: CHARITABLE FUNDRAISING SERVICES; CHARITABLE SERVICES, NAMELY, ORGANIZING FUNDRAISING SERVICES AND EVENTS TO RAISE FUNDS FOR WILDLIFE, IN CLASS 36 (U.S. CLS. 100, 101 AND 102).

FIRST USE 8-4-2011; IN COMMERCE 8-4-2011.

FOR: ENTERTAINMENT AND EDUCATION SERVICES, NAMELY, CONDUCTING AN ART FESTIVAL IN THE FIELD OF WILDLIFE CONSERVATION; CONDUCTING ENTERTAINMENT EXHIBITIONS IN THE NATURE OF FINE CRAFTS, ART GALLERIES, CARVING, PHOTOGRAPHY AND SCULPTURE; ENTERTAINMENT IN THE NATURE OF CALLING CONTESTS, LIVE MUSICAL PERFORMANCES, FLY FISHING DEMONSTRATIONS, AND DOG RETRIEVER DEMONSTRATIONS; ORGANIZING COMMUNITY FESTIVALS FEATURING A VARIETY OF ACTIVITIES, NAMELY, ARTISTS GALLERIES AND WORKSHOPS, CARVING AND PAINTING CLASSES, ART AND CRAFTS, PHOTOGRAPHY, SCULPTURE, CALLING CONTESTS, LIVE MUSICAL PERFORMANCES, FLY FISHING DEMONSTRATIONS, FISHING CONTESTS, DOG JUMPING CONTESTS, RETRIEVER DEMONSTRATIONS, DECOY EXHIBITIONS AND WINE TASTINGS, IN CLASS 41 (U.S. CLS. 100, 101 AND 107).

FIRST USE 8-4-2011; IN COMMERCE 8-4-2011.

THE MARK CONSISTS OF TWO WINGED BIRDS IN A FANCIFUL DESIGN.

SN 85-271,948, FILED 3-21-2011.

PAULA MAHONEY, EXAMINING ATTORNEY



*David J. Kybas*

Director of the United States Patent and Trademark Office

# United States of America

United States Patent and Trademark Office

## WATERFOWL CHESAPEAKE

**Reg. No. 4,136,790**

**Registered May 1, 2012**

**Int. Cls.: 36 and 41**

**SERVICE MARK**

**PRINCIPAL REGISTER**

WATERFOWL CHESAPEAKE INC. (MARYLAND CORPORATION)  
40 SOUTH HARRISON STREET  
EASTON, MD 21601

FOR: CHARITABLE FUNDRAISING SERVICES; CHARITABLE SERVICES, NAMELY, ORGANIZING FUNDRAISING SERVICES AND EVENTS TO RAISE FUNDS FOR WILDLIFE CONSERVATION, IN CLASS 36 (U.S. CLS. 100, 101 AND 102).

FIRST USE 8-4-2011; IN COMMERCE 8-4-2011.

FOR: ENTERTAINMENT AND EDUCATION SERVICES, NAMELY, CONDUCTING AN ART FESTIVAL IN THE FIELD OF WILDLIFE CONSERVATION; CONDUCTING ENTERTAINMENT EXHIBITIONS IN THE NATURE OF FINE CRAFTS, ART GALLERIES, CARVING, PHOTOGRAPHY AND SCULPTURE; ENTERTAINMENT IN THE NATURE OF CALLING CONTESTS, LIVE MUSICAL PERFORMANCES, FLY FISHING DEMONSTRATIONS, AND DOG RETRIEVER DEMONSTRATIONS; ORGANIZING COMMUNITY FESTIVALS FEATURING A VARIETY OF ACTIVITIES, NAMELY, ARTISTS GALLERIES AND WORKSHOPS, CARVING AND PAINTING CLASSES, ART AND CRAFTS, PHOTOGRAPHY, SCULPTURE, CALLING CONTESTS, LIVE MUSICAL PERFORMANCES, FLY FISHING DEMONSTRATIONS, FISHING CONTESTS, DOG JUMPING CONTESTS, RETRIEVER DEMONSTRATIONS, DECOY EXHIBITIONS AND WINE TASTINGS, IN CLASS 41 (U.S. CLS. 100, 101 AND 107).

FIRST USE 8-4-2011; IN COMMERCE 8-4-2011.

THE MARK CONSISTS OF STANDARD CHARACTERS WITHOUT CLAIM TO ANY PARTICULAR FONT, STYLE, SIZE, OR COLOR.

OWNER OF U.S. REG. NO. 1,090,472.

NO CLAIM IS MADE TO THE EXCLUSIVE RIGHT TO USE "CHESAPEAKE", APART FROM THE MARK AS SHOWN.

SN 85-271,987, FILED 3-21-2011.

PAULA MAHONEY, EXAMINING ATTORNEY



*David J. Kyros*

Director of the United States Patent and Trademark Office

# United States of America

United States Patent and Trademark Office

# LUMINATE

**Reg. No. 4,136,791**

**Registered May 1, 2012**

**Int. Cls.: 35 and 42**

**SERVICE MARK**

**PRINCIPAL REGISTER**

CONVIO, INC. (DELAWARE CORPORATION)  
SUITE 200  
11400 BURNET ROAD  
AUSTIN, TX 78758

FOR: BUSINESS CONSULTING SERVICES IN THE FIELD OF CONSTITUENT RELATIONSHIP MANAGEMENT PROVIDED TO ORGANIZATIONS ENGAGED IN FUND-RAISING, SPECIAL EVENT AND ADVOCACY ACTIVITIES, IN CLASS 35 (U.S. CLS. 100, 101 AND 102).

FIRST USE 7-25-2011; IN COMMERCE 8-1-2011.

FOR: COMPUTER SOFTWARE CONSULTING SERVICES IN THE FIELDS OF FUND-RAISING, SPECIAL EVENT AND ADVOCACY SOFTWARE; PROVIDING ON-LINE NON-DOWNLOADABLE SOFTWARE FOR CONSTITUENT RELATIONSHIP MANAGEMENT IN THE FIELDS OF FUNDRAISING, SPECIAL EVENT PLANNING AND PUBLIC ADVOCACY; PROVIDING ON-LINE NON-DOWNLOADABLE SOFTWARE FOR CONSTITUENT RELATIONSHIP MANAGEMENT FOR NONPROFIT ORGANIZATIONS AND CHARITIES FOR MANAGING EMAIL COMMUNICATIONS, DESIGNING AND ACTIVATING WEBSITES, MANAGING FINANCIAL DONATIONS, MEASURING AND DISPLAYING FINANCIAL DONATION STATUS, DATA TRACKING, DATA MODELING AND ANALYTICS, GENERATING PROGRESS REPORTS AND WEB CONTENT MANAGEMENT IN THE FIELDS OF FUNDRAISING, SPECIAL EVENT PLANNING AND PUBLIC ADVOCACY, IN CLASS 42 (U.S. CLS. 100 AND 101).

FIRST USE 7-25-2011; IN COMMERCE 8-1-2011.

THE MARK CONSISTS OF STANDARD CHARACTERS WITHOUT CLAIM TO ANY PARTICULAR FONT, STYLE, SIZE, OR COLOR.

SN 85-273,176, FILED 3-22-2011.

KATHERINE E. HALMEN, EXAMINING ATTORNEY



*David J. Kybas*

Director of the United States Patent and Trademark Office

# United States of America

United States Patent and Trademark Office

# JEWELSTAR

**Reg. No. 4,136,792**

**Registered May 1, 2012**

**Int. Cl.: 28**

**TRADEMARK**

**PRINCIPAL REGISTER**

MATTEL, INC. (DELAWARE CORPORATION)  
333 CONTINENTAL BOULEVARD  
M1-1518  
EL SEGUNDO, CA 90245

FOR: TOY ACTION FIGURES AND ACCESSORIES THEREFOR, IN CLASS 28 (U.S. CLS. 22, 23, 38 AND 50).

FIRST USE 1-17-2012; IN COMMERCE 1-17-2012.

THE MARK CONSISTS OF STANDARD CHARACTERS WITHOUT CLAIM TO ANY PARTICULAR FONT, STYLE, SIZE, OR COLOR.

SN 85-273,210, FILED 3-22-2011.

ELISSA GARBER KON, EXAMINING ATTORNEY



*David J. Kybas*

Director of the United States Patent and Trademark Office

# United States of America

United States Patent and Trademark Office

## RS BLUELINE

**Reg. No. 4,136,793**

**Registered May 1, 2012**

**Int. Cl.: 7**

**TRADEMARK**

**PRINCIPAL REGISTER**

RS LINING SYSTEMS, LLC (DELAWARE LIMITED LIABILITY COMPANY)  
105 WOODWINDS INDUSTRIAL COURT  
CARY, NC 27511

FOR: SYSTEM FOR REPAIRING PIPELINES COMPRISED OF VACUUM PUMPS, POWER-OPERATED PIPE CUTTERS, MECHANICAL AND POWER OPERATED CALIBRATION ROLLERS, ELECTRICAL UNITS FOR CONTROLLING THE TEMPERATURE OF THERMOSET RESINS, METAL HOSE FITTINGS, METAL PIPE CONNECTORS, METAL PIPE COUPLINGS, METAL PIPES, THERMOSET RESINS APPLICATORS, LINERS AND THERMOSET RESINS, ALL SOLD AS A UNIT FOR THE REPAIR OR RECONSTRUCTION OF EXISTING CONDUITS, PIPELINES, POTABLE WATER PIPES AND PASSAGEWAYS, IN CLASS 7 (U.S. CLS. 13, 19, 21, 23, 31, 34 AND 35).

FIRST USE 3-31-2009; IN COMMERCE 3-31-2009.

THE MARK CONSISTS OF STANDARD CHARACTERS WITHOUT CLAIM TO ANY PARTICULAR FONT, STYLE, SIZE, OR COLOR.

SN 85-273,362, FILED 3-22-2011.

C. DIONNE CLYBURN, EXAMINING ATTORNEY



*David J. Kypos*

Director of the United States Patent and Trademark Office

# United States of America

United States Patent and Trademark Office

## RS SPRAYLINER

**Reg. No. 4,136,794**

**Registered May 1, 2012**

**Int. Cl.: 37**

**SERVICE MARK**

**PRINCIPAL REGISTER**

RS LINING SYSTEMS, LLC (DELAWARE LIMITED LIABILITY COMPANY)  
105 WOODWINDS INDUSTRIAL COURT  
CARY, NC 27511

FOR: EPOXY-BASED SYSTEMS COMPRISED OF MODIFIED EPOXY RESINS AND HARDENERS FOR THE REPAIR OR CONSTRUCTION OF EXISTING MANHOLES, PIPELINES, TUNNELS AND OTHER BURIED INFRASTRUCTURE BY SPRAY OR SPIN CAST APPLICATION, IN CLASS 37 (U.S. CLS. 100, 103 AND 106).

FIRST USE 11-30-2010; IN COMMERCE 11-30-2010.

THE MARK CONSISTS OF STANDARD CHARACTERS WITHOUT CLAIM TO ANY PARTICULAR FONT, STYLE, SIZE, OR COLOR.

SN 85-273,371, FILED 3-22-2011.

C. DIONNE CLYBURN, EXAMINING ATTORNEY



*David J. Kybas*

Director of the United States Patent and Trademark Office

# United States of America

United States Patent and Trademark Office



**Reg. No. 4,136,795**

**Registered May 1, 2012**

**Int. Cl.: 21**

**TRADEMARK**

**PRINCIPAL REGISTER**

SILVER DRAGON ENTERPRISE, LTD. (CHINA COMPANY)  
610 NATHAN ROAD  
ROOM 1117, HOLLYWOOD PLAZA  
MONGKOK, KOWLOON, CHINA

FOR: WORK GLOVES, IN CLASS 21 (U.S. CLS. 2, 13, 23, 29, 30, 33, 40 AND 50).

FIRST USE 9-10-2011; IN COMMERCE 9-10-2011.

THE MARK CONSISTS OF THE WORDS "THE FLYING ANVIL" IN BLACK WITH ALL CAPITAL LETTERS ABOVE A DISTINCTIVE PICTURE OF AN ANVIL IN BLACK, WHITE AND GRAY WITH DETAILED WINGS ALSO IN BLACK, WHITE AND GRAY ABOVE A BANNER IN BLACK, WHITE AND GRAY WITH THE WORDS "BUILT LIKE THEY USED TO MAKE 'EM." IN DISTINCTIVE GRAY.

THE COLOR(S) BLACK, WHITE AND GRAY IS/ARE CLAIMED AS A FEATURE OF THE MARK.

SN 85-273,971, FILED 3-22-2011.

RAUL CORDOVA, EXAMINING ATTORNEY



*David J. Kybas*

Director of the United States Patent and Trademark Office



# United States of America

United States Patent and Trademark Office

## OMLWORLDWIDE

**Reg. No. 4,136,796**

**Registered May 1, 2012**

**Int. Cl.: 39**

**SERVICE MARK**

**PRINCIPAL REGISTER**

O'HARE-MIDWAY LIMOUSINE SERVICE, INC. (ILLINOIS CORPORATION)  
3000 DUNDEE ROAD, #106  
NORTHBROOK, IL 60062

FOR: LIMOUSINE SERVICES, IN CLASS 39 (U.S. CLS. 100 AND 105).

FIRST USE 1-8-2012; IN COMMERCE 1-8-2012.

THE MARK CONSISTS OF STANDARD CHARACTERS WITHOUT CLAIM TO ANY PARTICULAR FONT, STYLE, SIZE, OR COLOR.

SN 85-274,484, FILED 3-23-2011.

SANI KHOURI, EXAMINING ATTORNEY



*David J. Kybas*

Director of the United States Patent and Trademark Office

# United States of America

United States Patent and Trademark Office

## THE BRUSH MATTERS

**Reg. No. 4,136,797**

**Registered May 1, 2012**

**Int. Cl.: 16**

**TRADEMARK**

**PRINCIPAL REGISTER**

THE SHERWIN-WILLIAMS COMPANY (OHIO CORPORATION)  
101 W. PROSPECT AVENUE  
CLEVELAND, OH 441151075

FOR: PAINT APPLICATORS, IN CLASS 16 (U.S. CLS. 2, 5, 22, 23, 29, 37, 38 AND 50).

FIRST USE 7-5-2011; IN COMMERCE 7-5-2011.

THE MARK CONSISTS OF STANDARD CHARACTERS WITHOUT CLAIM TO ANY PARTICULAR FONT, STYLE, SIZE, OR COLOR.

SN 85-275,299, FILED 3-24-2011.

CHRISTINE COOPER, EXAMINING ATTORNEY



*David J. Kyffers*

Director of the United States Patent and Trademark Office

# United States of America

United States Patent and Trademark Office

) . (

**Reg. No. 4,136,798**

TIMES THREE CLOTHIER, LLC (NEW YORK LIMITED LIABILITY COMPANY)  
561 SEVENTH AVENUE, 12TH FLOOR  
NEW YORK, NY 10018

**Registered May 1, 2012**

**Int. Cl.: 25**

FOR: CLOTHING, NAMELY, DRESSES, SHIRTS, UNDERGARMENTS, LINGERIE, SHORTS,  
HOSIERY AND LEGGINGS, IN CLASS 25 (U.S. CLS. 22 AND 39).

**TRADEMARK**

FIRST USE 4-1-2011; IN COMMERCE 4-1-2011.

**PRINCIPAL REGISTER**

THE MARK CONSISTS OF A SQUARE IN BETWEEN TWO OPEN ENDED PARENTHESIS.

SN 85-275,306, FILED 3-24-2011.

DAVID C. REIHNER, EXAMINING ATTORNEY



*David J. Kybas*

Director of the United States Patent and Trademark Office

# United States of America

United States Patent and Trademark Office



Your child's prescription for  
nutrition • fitness • self esteem

**Reg. No. 4,136,799**

**Registered May 1, 2012**

**Int. Cl.: 44**

**SERVICE MARK**

**PRINCIPAL REGISTER**

CHILDREN'S HOSPITAL OF THE KING'S DAUGHTERS, INC. (VIRGINIA CORPORATION),  
AKA CHKD,  
ATTN.: SHERRI M. MATSON, ESQ., VP/GC  
601 CHILDREN'S LANE  
NORFOLK, VA 23507

FOR: CONSULTING TO INDIVIDUALS AND COMMUNITIES ENGAGED IN GROUP WEIGHT LOSS PROGRAMS; MEDICAL CLINICS; PROVIDING A WEBSITE FEATURING INFORMATION AND ADVICE IN THE FIELDS OF DIET, WEIGHT LOSS, DIET PLANNING AND LIFESTYLE WELLNESS; PROVIDING INFORMATION ON MAINTAINING A HEALTHY LIFESTYLE AND LOSING WEIGHT; PROVIDING WEIGHT LOSS PROGRAM SERVICES; WEIGHT MANAGEMENT SERVICES, NAMELY, PROVIDING WEIGHT LOSS AND/OR WEIGHT MAINTENANCE PROGRAMS; WEIGHT REDUCTION DIET PLANNING AND SUPERVISION, IN CLASS 44 (U.S. CLS. 100 AND 101).

FIRST USE 8-0-2011; IN COMMERCE 8-0-2011.

NO CLAIM IS MADE TO THE EXCLUSIVE RIGHT TO USE "CHILD'S" AND "NUTRITION" AND "FITNESS", APART FROM THE MARK AS SHOWN.

THE MARK CONSISTS OF THE WORD "HEALTHY" WRITTEN ABOVE THE WORD "YOU", THE "O" OF WHICH IS DEPICTED BY A BALL WITH STAR DESIGNS ON IT; THE WORDS "FOR LIFE" WRITTEN BENEATH THE WORD "YOU"; THE LETTERS "CHKD" APPEARING ON DRAWINGS OF THREE CHILDREN'S TOY BLOCKS UNDERNEATH THE WORDS "FOR LIFE" WITH A STYLIZED V-SHAPED DESIGN OF DOTS RISING FROM THE TOY BLOCKS AS HIGH AS THE WORD "HEALTHY" ON THE TOP LEFT AND THE WORD "YOU" ON THE TOP RIGHT; AND THE PHRASE "YOUR CHILD'S PRESCRIPTION FOR NUTRITION FITNESS SELF ESTEEM" APPEARING BENEATH THE TOY BLOCKS.

SN 85-275,362, FILED 3-24-2011.

TIMOTHY FINNEGAN, EXAMINING ATTORNEY



*David J. Kybas*

Director of the United States Patent and Trademark Office

# United States of America

United States Patent and Trademark Office

# FU e=fu8

**Reg. No. 4,136,800**

**Registered May 1, 2012**

**Int. Cl.: 25**

**TRADEMARK**

**PRINCIPAL REGISTER**

WU, FU-SHING (UNITED STATES INDIVIDUAL)  
242 E. 38TH STREET #2C  
NEW YORK, NY 10016

FOR: BELTS; BELTS FOR CLOTHING; BRIEFS; CLOTHING, NAMELY, KHAKIS; GLOVES AS CLOTHING; JACKETS; JERSEYS; KNITTED UNDERWEAR; LADIES' UNDERWEAR; LEATHER BELTS; LONG UNDERWEAR; MEN'S UNDERWEAR; SHOULDER WRAPS; TIES; TOPS; UNDERWEAR; UNDERWEAR, NAMELY, BOY SHORTS; WOMEN'S CLOTHING, NAMELY, SHIRTS, DRESSES, SKIRTS, BLOUSES; WOMEN'S UNDERWEAR, IN CLASS 25 (U.S. CLS. 22 AND 39).

FIRST USE 12-1-2011; IN COMMERCE 12-1-2011.

THE MARK CONSISTS OF STANDARD CHARACTERS WITHOUT CLAIM TO ANY PARTICULAR FONT, STYLE, SIZE, OR COLOR.

THE ENGLISH TRANSLATION OF THE WORD "FU" IN THE MARK IS "LUCK" OR "GOOD FORTUNE".

SN 85-275,390, FILED 3-24-2011.

LESLEY LAMOTHE, EXAMINING ATTORNEY



*David J. Kyjars*

Director of the United States Patent and Trademark Office

# United States of America

United States Patent and Trademark Office

# QUIKWELD

**Reg. No. 4,136,801**

**Registered May 1, 2012**

**Int. Cls.: 1, 6, and 9**

**TRADEMARK**

**PRINCIPAL REGISTER**

AMIDAC GLOBAL, LLC (OHIO LIMITED LIABILITY COMPANY)  
151 INNOVATION DR.  
ELYRIA, OH 44035

FOR: CHEMICALS, CHEMICAL PREPARATIONS, CHEMICAL GASSES, AND SOLDERING FLUXES FOR USE IN WIRED, WIRELESS AND REMOTELY CONTROLLED EXOTHERMIC REACTIONS, WELDING, GROUNDING, AND BONDING, FOR RAIL, CATHODIC PROTECTION, POWER, AND GROUNDING APPLICATIONS, IN CLASS 1 (U.S. CLS. 1, 5, 6, 10, 26 AND 46).

FIRST USE 11-14-2011; IN COMMERCE 11-14-2011.

FOR: METAL HARDWARE, NAMELY, METAL RODS, WIRE, LUG NUTS, THREADED STUDS, MOLDINGS, CABLE JUNCTION SLEEVES FOR FORMING SPLICES AND ANCHORS FOR USE IN WIRED, WIRELESS AND REMOTELY CONTROLLED EXOTHERMIC REACTIONS, WELDING, GROUNDING AND BONDING, FOR RAIL, CATHODIC PROTECTION, POWER, AND GROUNDING APPLICATIONS; CONTAINERS OF METAL FOR CHEMICALS, IN CLASS 6 (U.S. CLS. 2, 12, 13, 14, 23, 25 AND 50).

FIRST USE 11-14-2011; IN COMMERCE 11-14-2011.

FOR: ELECTRODES, ELECTRICAL CONNECTIONS, JUMPERS, ELECTRICAL CABLES, METAL GROUNDING CLAMPS, ELECTRICAL RECEPTACLES, METAL GROUNDING PLATES TO DISSIPATE ELECTRICAL CHARGES, ELECTRICAL TRANSFORMERS, WELDING TORCHES, SAFETY HELMETS, DUST MASKS FOR USE IN WIRED, WIRELESS AND REMOTELY CONTROLLED EXOTHERMIC REACTIONS, WELDING, GROUNDING AND BONDING, FOR RAIL, CATHODIC PROTECTION, POWER, AND GROUNDING APPLICATIONS, IN CLASS 9 (U.S. CLS. 21, 23, 26, 36 AND 38).

FIRST USE 11-14-2011; IN COMMERCE 11-14-2011.

THE MARK CONSISTS OF STANDARD CHARACTERS WITHOUT CLAIM TO ANY PARTICULAR FONT, STYLE, SIZE, OR COLOR.

SN 85-275,712, FILED 3-24-2011.

KAPIL BHANOT, EXAMINING ATTORNEY



*David J. Kyros*

Director of the United States Patent and Trademark Office

# United States of America

United States Patent and Trademark Office

## STARBOARD VALUE

**Reg. No. 4,136,802**

**Registered May 1, 2012**

**Int. Cl.: 36**

**SERVICE MARK**

**PRINCIPAL REGISTER**

STARBOARD VALUE LP (DELAWARE LIMITED PARTNERSHIP)  
3RD FLOOR  
830 THIRD AVENUE  
NEW YORK, NY 10022

FOR: FINANCIAL SERVICES, NAMELY, ASSET MANAGEMENT SERVICES, INVESTMENT MANAGEMENT SERVICES AND INVESTMENT ADVISORY SERVICES, IN CLASS 36 (U.S. CLS. 100, 101 AND 102).

FIRST USE 3-31-2011; IN COMMERCE 3-31-2011.

THE MARK CONSISTS OF STANDARD CHARACTERS WITHOUT CLAIM TO ANY PARTICULAR FONT, STYLE, SIZE, OR COLOR.

NO CLAIM IS MADE TO THE EXCLUSIVE RIGHT TO USE "VALUE", APART FROM THE MARK AS SHOWN.

SN 85-277,298, FILED 3-25-2011.

MICHAEL W. BAIRD, EXAMINING ATTORNEY



*David J. Kyros*

Director of the United States Patent and Trademark Office

# United States of America

United States Patent and Trademark Office



## STARBOARD VALUE

**Reg. No. 4,136,803**

**Registered May 1, 2012**

**Int. Cl.: 36**

**SERVICE MARK**

**PRINCIPAL REGISTER**

STARBOARD VALUE LP (DELAWARE LIMITED PARTNERSHIP)  
3RD FLOOR  
830 THIRD AVENUE  
NEW YORK, NY 10022

FOR: FINANCIAL SERVICES, NAMELY, ASSET MANAGEMENT SERVICES, INVESTMENT MANAGEMENT SERVICES AND INVESTMENT ADVISORY SERVICES, IN CLASS 36 (U.S. CLS. 100, 101 AND 102).

FIRST USE 3-31-2011; IN COMMERCE 3-31-2011.

NO CLAIM IS MADE TO THE EXCLUSIVE RIGHT TO USE "VALUE", APART FROM THE MARK AS SHOWN.

THE MARK CONSISTS OF THE WORDS "STARBOARD VALUE" ON TOP OF THREE CIRCLES INTERSECTING BENEATH THE LETTER "V".

SN 85-277,307, FILED 3-25-2011.

MICHAEL W. BAIRD, EXAMINING ATTORNEY



*David J. Kybas*

Director of the United States Patent and Trademark Office



# United States of America

United States Patent and Trademark Office

# SHINE

**Reg. No. 4,136,804**

**Registered May 1, 2012**

**Int. Cl.: 4**

**TRADEMARK**

**PRINCIPAL REGISTER**

GRECO PRODUCTS, INC. (NEW YORK CORPORATION)  
350 VANDERBILT MOTOR PARKWAY  
HAUPPAUGE, NY 11788

FOR: CANDLES; PERFUMED CANDLES; SCENTED CANDLES, IN CLASS 4 (U.S. CLS. 1, 6 AND 15).

FIRST USE 8-31-2011; IN COMMERCE 8-31-2011.

THE MARK CONSISTS OF STANDARD CHARACTERS WITHOUT CLAIM TO ANY PARTICULAR FONT, STYLE, SIZE, OR COLOR.

SN 85-277,869, FILED 3-26-2011.

LAURIE KAUFMAN, EXAMINING ATTORNEY



*David J. Kybas*

Director of the United States Patent and Trademark Office

# United States of America

United States Patent and Trademark Office

# I've Got Bugs

**Reg. No. 4,136,805**

**Registered May 1, 2012**

**Int. Cl.: 28**

**TRADEMARK**

**PRINCIPAL REGISTER**

OLSON, SHANNON J. (UNITED STATES INDIVIDUAL)  
P.O. BOX 295  
ELMER, OK 73539

FOR: FISHING FLIES, IN CLASS 28 (U.S. CLS. 22, 23, 38 AND 50).

FIRST USE 10-4-2011; IN COMMERCE 10-20-2011.

THE MARK CONSISTS OF STANDARD CHARACTERS WITHOUT CLAIM TO ANY PARTICULAR FONT, STYLE, SIZE, OR COLOR.

SN 85-277,875, FILED 3-26-2011.

GILBERT SWIFT, EXAMINING ATTORNEY



*David J. Kyffers*

Director of the United States Patent and Trademark Office

# United States of America

United States Patent and Trademark Office

## LIVE YOUR FIRE

**Reg. No. 4,136,806**

**Registered May 1, 2012**

**Int. Cl.: 4**

**TRADEMARK**

**PRINCIPAL REGISTER**

GRECO PRODUCTS, INC. (NEW YORK CORPORATION)  
350 VANDERBILT MOTOR PARKWAY  
HAUPPAUGE, NY 11788

FOR: CANDLES; PERFUMED CANDLES; SCENTED CANDLES, IN CLASS 4 (U.S. CLS. 1, 6 AND 15).

FIRST USE 8-31-2011; IN COMMERCE 8-31-2011.

THE MARK CONSISTS OF STANDARD CHARACTERS WITHOUT CLAIM TO ANY PARTICULAR FONT, STYLE, SIZE, OR COLOR.

SN 85-277,926, FILED 3-26-2011.

LAURIE KAUFMAN, EXAMINING ATTORNEY



*David J. Kybas*

Director of the United States Patent and Trademark Office

# United States of America

United States Patent and Trademark Office



**Reg. No. 4,136,807**

**Registered May 1, 2012**

**Int. Cl.: 20**

**TRADEMARK**

**PRINCIPAL REGISTER**

BERRYMAN-KENT, ELIZABETH (UNITED STATES INDIVIDUAL), DBA DECORATIVE WALLS & CREATIVE ARTS LLC,  
1518 JACQUELIN STREET  
RICHMOND, VA 232206010

FOR: END TABLES; OTTOMAN SEATS; OTTOMANS, IN CLASS 20 (U.S. CLS. 2, 13, 22, 25, 32 AND 50).

FIRST USE 3-9-2011; IN COMMERCE 3-9-2011.

THE MARK CONSISTS OF THE TERM "E3" AND THE LESS-THAN SIGN IN STYLIZED FORM.

SN 85-277,959, FILED 3-26-2011.

TARA PATE, EXAMINING ATTORNEY



*David J. Kyffers*

Director of the United States Patent and Trademark Office

# United States of America

United States Patent and Trademark Office

## Broke Dick's Surfboards

**Reg. No. 4,136,808**

**Registered May 1, 2012**

**Int. Cls.: 25 and 28**

**TRADEMARK**

**PRINCIPAL REGISTER**

HELMER, STEVEN D. (UNITED STATES INDIVIDUAL), DBA BROKE DICK'S SURFBOARDS,  
9 MISNERS TR.  
ORMOND BEACH, FL 32174

FOR: PROTECTIVE NECK AND ARM GUARDS MADE OF NEOPRENE OR OTHER MATERIALS TO PREVENT WETSUIT CHAFING; SHORT-SLEEVED OR LONG-SLEEVED T-SHIRTS; SURF WEAR; SWIM WEAR; SWIM WEAR FOR GENTLEMEN AND LADIES; T-SHIRTS; WETSUITS; WETSUITS FOR WATER-SKIING, IN CLASS 25 (U.S. CLS. 22 AND 39).

FIRST USE 9-1-2011; IN COMMERCE 10-1-2011.

FOR: LEASHES FOR SURFBOARDS; PADDLE SURFBOARDS; PADDLES FOR USE WITH SURFBOARDS; SURFBOARD LEASHES; SURFBOARD TRACTION PADS; SURFBOARD WAX; SURFBOARDS; TRACTION PADS FOR SURFBOARDS, IN CLASS 28 (U.S. CLS. 22, 23, 38 AND 50).

FIRST USE 9-1-2011; IN COMMERCE 10-1-2011.

THE MARK CONSISTS OF STANDARD CHARACTERS WITHOUT CLAIM TO ANY PARTICULAR FONT, STYLE, SIZE, OR COLOR.

NO CLAIM IS MADE TO THE EXCLUSIVE RIGHT TO USE "SURFBOARDS", APART FROM THE MARK AS SHOWN.

SN 85-278,508, FILED 3-28-2011.

JUSTINE D. PARKER, EXAMINING ATTORNEY



*David J. Kyros*

Director of the United States Patent and Trademark Office

# United States of America

United States Patent and Trademark Office

## SOAK 'N SPLASH

**Reg. No. 4,136,809**

**Registered May 1, 2012**

**Int. Cl.: 28**

**TRADEMARK**

**PRINCIPAL REGISTER**

LITTLE KIDS, INC. (RHODE ISLAND CORPORATION)  
1015 NEWMAN AVENUE  
SEEKONK, MA 02771

FOR: WATER TOYS; WATER SLIDES; WATER SHOOTING TOYS; TOY WATER SPRINKLERS; SWIMMING POOL TOYS, TOY BALLOONS; PUMPS FOR INFLATING TOY BALLOONS; PADDLE BALLS; PADDLES FOR USE IN PADDLE BALL GAMES; BATS FOR GAMES; BALLS FOR GAMES, IN CLASS 28 (U.S. CLS. 22, 23, 38 AND 50).

FIRST USE 2-1-2012; IN COMMERCE 2-1-2012.

THE MARK CONSISTS OF STANDARD CHARACTERS WITHOUT CLAIM TO ANY PARTICULAR FONT, STYLE, SIZE, OR COLOR.

SN 85-279,375, FILED 3-29-2011.

GENE MACIOL, EXAMINING ATTORNEY



*David J. Kyffers*

Director of the United States Patent and Trademark Office

# United States of America

United States Patent and Trademark Office

## Two Old Guys

**Reg. No. 4,136,810**

**Registered May 1, 2012**

**Int. Cl.: 43**

**SERVICE MARK**

**PRINCIPAL REGISTER**

TWO OLD GUYS, INC. (NORTH CAROLINA CORPORATION)  
129 BELL POINTE  
SNEADS FERRY, NC 28460

FOR: RESTAURANT SERVICES, IN CLASS 43 (U.S. CLS. 100 AND 101).

FIRST USE 1-27-2012; IN COMMERCE 1-27-2012.

THE MARK CONSISTS OF STANDARD CHARACTERS WITHOUT CLAIM TO ANY PARTICULAR FONT, STYLE, SIZE, OR COLOR.

SN 85-279,858, FILED 3-29-2011.

JEFFREY LOOK, EXAMINING ATTORNEY



*David J. Kybas*

Director of the United States Patent and Trademark Office

# United States of America

United States Patent and Trademark Office

## STRONGHOLD

**Reg. No. 4,136,811**

**Registered May 1, 2012**

**Int. Cl.: 7**

**TRADEMARK**

**PRINCIPAL REGISTER**

FASTENAL IP COMPANY (MINNESOTA CORPORATION)  
2001 THEURER BLVD.  
WINONA, MN 55987

FOR: POWER TRANSMISSION PRODUCTS, NAMELY, COGGED BELTS, V-BELTS, RADIAL BEARINGS, TAPERED BEARINGS, PILLOW BLOCK BEARINGS, FLANGED BEARINGS, INSERT BEARINGS, RETAINING RINGS, E-CLIPS, SNAP RINGS, SHAFT COLLARS, ROLLER AND DRIVE CHAIN, BRONZE BEARINGS AND BUSHINGS; HVAC MOTORS, BLOWER MOTORS, IN CLASS 7 (U.S. CLS. 13, 19, 21, 23, 31, 34 AND 35).

FIRST USE 12-31-2011; IN COMMERCE 12-31-2011.

THE MARK CONSISTS OF STANDARD CHARACTERS WITHOUT CLAIM TO ANY PARTICULAR FONT, STYLE, SIZE, OR COLOR.

SN 85-279,939, FILED 3-29-2011.

GIANCARLO CASTRO, EXAMINING ATTORNEY



*David J. Kybas*

Director of the United States Patent and Trademark Office



# United States of America

United States Patent and Trademark Office

***XTREME SPIN***

**Reg. No. 4,136,812**

**Registered May 1, 2012**

**Int. Cl.: 28**

**TRADEMARK**

**PRINCIPAL REGISTER**

GLOD, DAVID (UNITED STATES INDIVIDUAL)  
1301 PIERSON DRIVE  
BATAVIA, IL 60510

FOR: GOLF CLUBS AND COMPONENTS THEREOF, NAMELY, GOLF CLUB HEADS, GOLF CLUB SHAFTS AND HAND GRIPS FOR GOLF CLUBS, IN CLASS 28 (U.S. CLS. 22, 23, 38 AND 50).

FIRST USE 8-1-2007; IN COMMERCE 8-1-2007.

NO CLAIM IS MADE TO THE EXCLUSIVE RIGHT TO USE "SPIN", APART FROM THE MARK AS SHOWN.

THE MARK CONSISTS OF STYLIZED MARK "XTREME SPIN".

SN 85-280,030, FILED 3-29-2011.

ALLISON HOLTZ, EXAMINING ATTORNEY



*David J. Kybas*

Director of the United States Patent and Trademark Office

# United States of America

United States Patent and Trademark Office

# KNIGHT

**Reg. No. 4,136,813**

**Registered May 1, 2012**

**Int. Cls.: 7 and 12**

**TRADEMARK**

**PRINCIPAL REGISTER**

KEITH HUBER, INC. (MISSISSIPPI CORPORATION)  
14220 HWY 49N  
GULFPORT, MS 39503

FOR: INDUSTRIAL VACUUM LOADING MACHINES AND HIGH PRESSURE WATER JETTING MACHINES FOR LOADING, TRANSPORTING, HANDLING, AND HYDRO-EXCAVATING OF DRY, LIQUID, SOLID, SEMI SOLID, SLUDGE AND HAZARDOUS WASTE MATERIAL, IN CLASS 7 (U.S. CLS. 13, 19, 21, 23, 31, 34 AND 35).

FIRST USE 6-23-2011; IN COMMERCE 6-23-2011.

FOR: TRUCKS EQUIPPED WITH VACUUM LOADING EQUIPMENT AND HIGH PRESSURE AND WATER JETTING MACHINES FOR LOADING, TRANSPORTING, HANDLING, AND HYDRO-EXCAVATING OF DRY, LIQUID, SOLID, SEMI SOLID, SLUDGE AND HAZARDOUS WASTE MATERIAL, IN CLASS 12 (U.S. CLS. 19, 21, 23, 31, 35 AND 44).

FIRST USE 6-23-2011; IN COMMERCE 6-23-2011.

THE MARK CONSISTS OF STANDARD CHARACTERS WITHOUT CLAIM TO ANY PARTICULAR FONT, STYLE, SIZE, OR COLOR.

SN 85-280,432, FILED 3-29-2011.

ALICIA COLLINS, EXAMINING ATTORNEY



*David J. Kyjars*

Director of the United States Patent and Trademark Office

# United States of America

United States Patent and Trademark Office



**Reg. No. 4,136,814**

**Registered May 1, 2012**

**Int. Cl.: 35**

**SERVICE MARK**

**PRINCIPAL REGISTER**

CANCER RECOVERY FOUNDATION INTERNATIONAL, INC. (PENNSYLVANIA CORPORATION)  
6380 FLANK DRIVE, SUITE 400  
HARRISBURG, PA 17112

FOR: CHARITABLE SERVICES, NAMELY, PROMOTING PUBLIC AWARENESS OF THE IMPORTANCE OF VITAMIN D IN PREVENTING, FIGHTING, TREATING, AND RECOVERING FROM CANCER, IN CLASS 35 (U.S. CLS. 100, 101 AND 102).

FIRST USE 10-1-2011; IN COMMERCE 10-1-2011.

NO CLAIM IS MADE TO THE EXCLUSIVE RIGHT TO USE "NATIONAL VITAMIN D AWARENESS MONTH", APART FROM THE MARK AS SHOWN.

THE COLOR(S) WHITE, YELLOW AND GREY IS/ARE CLAIMED AS A FEATURE OF THE MARK.

THE MARK CONSISTS OF A RISING YELLOW SUN WITH THE LITERAL ELEMENT "NATIONAL VITAMIN D" IN WHITE LETTERS SET AGAINST THE SUN AND THE LITERAL ELEMENT "AWARENESS MONTH" IN GREY LETTERS BELOW THE SUN.

SN 85-280,878, FILED 3-30-2011.

JOHN E. MICHOS, EXAMINING ATTORNEY



*David J. Kybas*

Director of the United States Patent and Trademark Office

# United States of America

United States Patent and Trademark Office

## INSTANT COLOR RENEWAL

**Reg. No. 4,136,815**

HAIRMARKER LLC (DELAWARE LIMITED LIABILITY COMPANY)  
620 CAMINO RANCHEROS  
SANTA FE, NM 87505

**Registered May 1, 2012**

**Int. Cl.: 3**

FOR: HAIR CARE PREPARATIONS, NAMELY, HAIR SHAMPOOS, HAIR CONDITIONERS,  
HAIR COLORING PREPARATIONS, IN CLASS 3 (U.S. CLS. 1, 4, 6, 50, 51 AND 52).

**TRADEMARK**

FIRST USE 7-31-2011; IN COMMERCE 7-31-2011.

**PRINCIPAL REGISTER**

THE MARK CONSISTS OF STANDARD CHARACTERS WITHOUT CLAIM TO ANY PARTICULAR FONT, STYLE, SIZE, OR COLOR.

NO CLAIM IS MADE TO THE EXCLUSIVE RIGHT TO USE "COLOR RENEWAL", APART FROM THE MARK AS SHOWN.

SN 85-280,882, FILED 3-30-2011.

LINDSEY RUBIN, EXAMINING ATTORNEY



*David J. Kybas*

Director of the United States Patent and Trademark Office

# United States of America

United States Patent and Trademark Office

# Sophistikitty

**Reg. No. 4,136,816**

**Registered May 1, 2012**

**Int. Cl.: 26**

**TRADEMARK**

**PRINCIPAL REGISTER**

CWH INTERNATIONAL, LLC (TEXAS LIMITED LIABILITY COMPANY)  
6333 E. MOCKINGBIRD LN #147-847  
DALLAS, TX 75214

FOR: BARRETTES; BROOCHES; BUCKLES OF PRECIOUS METAL; CLAM CLIPS FOR HAIR; HAIR ACCESSORIES, NAMELY, CLAW CLIPS; HAIR ACCESSORIES, NAMELY, HAIR STICKS; HAIR ACCESSORIES, NAMELY, JAW CLIPS; HAIR ACCESSORIES, NAMELY, PLASTIC STYLING INSERTS THAT CREATE HEIGHT AND VOLUME ON THE CROWN OF THE HEAD; HAIR ACCESSORIES, NAMELY, SNAP CLIPS; HAIR ACCESSORIES, NAMELY, TWISTERS; HAIR BANDS; HAIR BARRETTES; HAIR BOWS; HAIR CLAMPS; HAIR CLIPS; HAIR ELASTICS; HAIR PINS; HAIR RIBBONS; HAIR RODS; HAIR SCRUNCHIES; HAIR SLIDES; PONYTAIL HOLDERS AND HAIR RIBBONS; RUBBER BANDS FOR HAIR, IN CLASS 26 (U.S. CLS. 37, 39, 40, 42 AND 50).

FIRST USE 2-3-2006; IN COMMERCE 9-24-2011.

THE MARK CONSISTS OF STANDARD CHARACTERS WITHOUT CLAIM TO ANY PARTICULAR FONT, STYLE, SIZE, OR COLOR.

SN 85-281,775, FILED 3-30-2011.

CHRIS WELLS, EXAMINING ATTORNEY



*David J. Kyros*

Director of the United States Patent and Trademark Office

# United States of America

United States Patent and Trademark Office

# MISO



**Reg. No. 4,136,817**

**Registered May 1, 2012**

**Int. Cls.: 35, 36, and 39**

**SERVICE MARK**

**PRINCIPAL REGISTER**

MIDWEST INDEPENDENT TRANSMISSION SYSTEM OPERATOR, INC. (DELAWARE CORPORATION)  
720 CITY CENTER DRIVE  
CARMEL, IN 46032

FOR: BUSINESS ADMINISTRATION, BUSINESS MANAGEMENT AND OPERATION OF THE TRANSMISSION AND DISTRIBUTION OF BULK ELECTRICITY; ARRANGING AND CONDUCTING WHOLESALE SALES FOR OTHERS OF BULK ELECTRICITY, IN CLASS 35 (U.S. CLS. 100, 101 AND 102).

FIRST USE 6-7-2011; IN COMMERCE 6-7-2011.

FOR: BROKERAGE SERVICES IN THE FIELD OF POWER AND ENERGY TRADING MARKETS, IN CLASS 36 (U.S. CLS. 100, 101 AND 102).

FIRST USE 6-7-2011; IN COMMERCE 6-7-2011.

FOR: UTILITY SERVICES, NAMELY, TRANSMISSION AND DISTRIBUTION OF BULK ELECTRICITY, IN CLASS 39 (U.S. CLS. 100 AND 105).

FIRST USE 6-7-2011; IN COMMERCE 6-7-2011.

OWNER OF U.S. REG. NOS. 3,067,216 AND 3,616,899.

THE COLOR(S) BLUE, GREEN, WHITE AND BLACK IS/ARE CLAIMED AS A FEATURE OF THE MARK.

THE MARK CONSISTS OF "MISO" WITH A CIRCLE DESIGN REPLACING THE LETTER "O". THE LETTERS "M", "I", "S" APPEAR IN BLACK. THE CIRCLE DESIGN CONSISTS OF A WHITE SUN ON A HORIZON WITH A BLUE SKY AND DIAGONAL WHITE LINES CURVING AND DECREASING IN SIZE TO ILLUSTRATE A GRID ACROSS THE GREEN EARTH.

SN 85-282,027, FILED 3-31-2011.

ANDREA BUTLER, EXAMINING ATTORNEY



*David J. Kybas*

Director of the United States Patent and Trademark Office

# United States of America

United States Patent and Trademark Office

## KYKO GLOBAL

**Reg. No. 4,136,818**

**Registered May 1, 2012**

**Int. Cl.: 36**

**SERVICE MARK**

**PRINCIPAL REGISTER**

KYKO GLOBAL INC. (CANADA CORPORATION)  
2 FINLEY ROAD  
BRAMPTON, CANADA L6T1A9

FOR: FINANCING SERVICES, IN CLASS 36 (U.S. CLS. 100, 101 AND 102).

FIRST USE 1-1-2010; IN COMMERCE 1-1-2010.

THE MARK CONSISTS OF STANDARD CHARACTERS WITHOUT CLAIM TO ANY PARTICULAR FONT, STYLE, SIZE, OR COLOR.

PRIORITY CLAIMED UNDER SEC. 44(D) ON CANADA APPLICATION NO. 1521707, FILED 3-21-2011.

NO CLAIM IS MADE TO THE EXCLUSIVE RIGHT TO USE "GLOBAL", APART FROM THE MARK AS SHOWN.

SN 85-282,048, FILED 3-31-2011.

ALICE BENMAMAN, EXAMINING ATTORNEY



*David J. Kyfos*

Director of the United States Patent and Trademark Office

# United States of America

United States Patent and Trademark Office

# Playshop!

**Reg. No. 4,136,819**

**Registered May 1, 2012**

**Int. Cl.: 41**

**SERVICE MARK**

**PRINCIPAL REGISTER**

YOUNG, KAREN (UNITED STATES INDIVIDUAL)  
1735 YORK AVENUE, SUITE 34C  
NEW YORK, NY 10128

FOR: EDUCATIONAL SERVICES, NAMELY, CONDUCTING CLASSES, SEMINARS, CONFERENCES, WORKSHOPS, RETREATS, CAMPS AND FIELD TRIPS IN THE FIELD OF COMMUNICATIONS, POETRY, ART, MUSIC, GAME PLAYING AND ENGAGING WITH AND UNDERSTANDING PEOPLE WITH SPECIAL NEEDS AND DISTRIBUTION OF TRAINING MATERIAL IN CONNECTION THEREWITH, IN CLASS 41 (U.S. CLS. 100, 101 AND 107).

FIRST USE 4-4-2011; IN COMMERCE 6-4-2011.

THE MARK CONSISTS OF STANDARD CHARACTERS WITHOUT CLAIM TO ANY PARTICULAR FONT, STYLE, SIZE, OR COLOR.

SN 85-282,051, FILED 3-31-2011.

KATHERINE STOIDES, EXAMINING ATTORNEY



*David J. Kybas*

Director of the United States Patent and Trademark Office



# United States of America

United States Patent and Trademark Office

# DABBLE

**Reg. No. 4,136,820**

**Registered May 1, 2012**

**Int. Cls.: 9 and 28**

**TRADEMARK**

**PRINCIPAL REGISTER**

INI, LLC (MARYLAND LIMITED LIABILITY COMPANY)  
7112 CYPRESS HILL DRIVE  
GAITHERSBURG, MD 20879

FOR: COMPUTER GAME SOFTWARE; COMPUTER GAME SOFTWARE FOR USE ON MOBILE AND CELLULAR PHONES; COMPUTER SOFTWARE PLATFORMS FOR SOCIAL GAMING AND WORD GAME THAT MAY BE ACCESSED VIA THE INTERNET, COMPUTERS AND WIRELESS DEVICES; DOWNLOADABLE WORD GAME WITH TIMER AND LETTERED AND POINT TILES VIA THE INTERNET AND WIRELESS DEVICES; ELECTRONIC GAME SOFTWARE FOR WIRELESS DEVICES, IN CLASS 9 (U.S. CLS. 21, 23, 26, 36 AND 38).

FIRST USE 9-15-2010; IN COMMERCE 9-15-2010.

FOR: BOARD GAMES; EQUIPMENT SOLD AS A UNIT FOR PLAYING BOARD GAMES, IN CLASS 28 (U.S. CLS. 22, 23, 38 AND 50).

FIRST USE 9-15-2010; IN COMMERCE 9-15-2010.

THE MARK CONSISTS OF STANDARD CHARACTERS WITHOUT CLAIM TO ANY PARTICULAR FONT, STYLE, SIZE, OR COLOR.

SN 85-282,515, FILED 3-31-2011.

JASON TURNER, EXAMINING ATTORNEY



*David J. Kybas*

Director of the United States Patent and Trademark Office

# United States of America

United States Patent and Trademark Office

# Q CLAY

**Reg. No. 4,136,821**

**Registered May 1, 2012**

**Int. Cl.: 33**

**TRADEMARK**

**PRINCIPAL REGISTER**

VINAS BISQUERTT LIMITADA (CHILE LIMITED LIABILITY COMPANY)  
OFICINA 201 CIUDAD EMPRESARIAL  
AVENIDA DEL CÓNDROR SUR 590, HEUCHURABA  
SANTIAGO, CHILE

FOR: ALCOHOLIC BEVERAGES EXCEPT BEER, IN CLASS 33 (U.S. CLS. 47 AND 49).

FIRST USE 12-31-2011; IN COMMERCE 12-31-2011.

THE MARK CONSISTS OF STANDARD CHARACTERS WITHOUT CLAIM TO ANY PARTICULAR FONT, STYLE, SIZE, OR COLOR.

OWNER OF CHILE REG. NO. 868311, DATED 11-30-2009, EXPIRES 11-30-2019.

SN 85-283,697, FILED 4-1-2011.

DAVID TAYLOR, EXAMINING ATTORNEY



*David J. Kyfos*

Director of the United States Patent and Trademark Office

# United States of America

United States Patent and Trademark Office



## PATIENT SAFE SYRINGE

**Reg. No. 4,136,822**

**Registered May 1, 2012**

**Int. Cl.: 10**

**TRADEMARK**

**PRINCIPAL REGISTER**

RETRACTABLE TECHNOLOGIES, INC. (TEXAS CORPORATION)  
511 LOBO LANE  
LITTLE ELM, TX 75068

FOR: SYRINGES FOR MEDICAL USE, NAMELY, NEEDLELESS THERAPEUTIC SYRINGES HAVING A LUER CONNECTOR ATTACHABLE TO AN INTRAVENOUS FLUID DELIVERY SYSTEM AND A FORWARDLY EXTENDING AND OUTWARDLY INCLINED GUIDE STRUCTURE FACILITATING THE ATTACHMENT, IN CLASS 10 (U.S. CLS. 26, 39 AND 44).

FIRST USE 6-25-2010; IN COMMERCE 6-25-2010.

OWNER OF U.S. REG. NO. 3,732,661.

NO CLAIM IS MADE TO THE EXCLUSIVE RIGHT TO USE "PATIENT" AND "SYRINGE", APART FROM THE MARK AS SHOWN.

THE MARK CONSISTS OF STYLIZED DESIGN OF THE END OF A SYRINGE CONTAINED WITHIN A BOX AND THE WORDING "PATIENT SAFE SYRINGE" TO THE LEFT OF THE DESIGN.

SN 85-283,764, FILED 4-1-2011.

REGINA DRUMMOND, EXAMINING ATTORNEY



*David J. Kybas*

Director of the United States Patent and Trademark Office

# United States of America

United States Patent and Trademark Office

# QuickFarm

**Reg. No. 4,136,823**

**Registered May 1, 2012**

**Int. Cl.: 36**

**SERVICE MARK**

**PRINCIPAL REGISTER**

LISTINGBOOK, LLC (NORTH CAROLINA LIMITED LIABILITY COMPANY)  
123 SOUTH ELM STREET  
GREENSBORO, NC 27401

FOR: PROVIDING ON-LINE INFORMATION IN THE FIELD OF REAL ESTATE, IN CLASS  
36 (U.S. CLS. 100, 101 AND 102).

FIRST USE 5-5-2011; IN COMMERCE 5-5-2011.

THE MARK CONSISTS OF STANDARD CHARACTERS WITHOUT CLAIM TO ANY PAR-  
TICULAR FONT, STYLE, SIZE, OR COLOR.

SN 85-284,009, FILED 4-1-2011.

GIANCARLO CASTRO, EXAMINING ATTORNEY



*David J. Kybas*

Director of the United States Patent and Trademark Office

# United States of America

United States Patent and Trademark Office

## HERCESSORIES

**Reg. No. 4,136,824**

**Registered May 1, 2012**

**Int. Cl.: 35**

**SERVICE MARK**

**PRINCIPAL REGISTER**

S & S WISDOM, INC. (MISSOURI CORPORATION)  
124 NORTH 10TH ST.  
POPLAR BLUFF, MO 63901

FOR: ON-LINE RETAIL STORE SERVICES FEATURING HANDBAGS, PURSES, JEWELRY, CLOTHING, AND FASHION ACCESSORIES; RETAIL STORE SERVICES FEATURING HANDBAGS, PURSES, JEWELRY, CLOTHING, AND FASHION ACCESSORIES, IN CLASS 35 (U.S. CLS. 100, 101 AND 102).

FIRST USE 2-20-2012; IN COMMERCE 2-20-2012.

THE MARK CONSISTS OF STANDARD CHARACTERS WITHOUT CLAIM TO ANY PARTICULAR FONT, STYLE, SIZE, OR COLOR.

SN 85-284,688, FILED 4-3-2011.

NICHOLAS ALTREE, EXAMINING ATTORNEY



*David J. Kybas*

Director of the United States Patent and Trademark Office

United States of America  
United States Patent and Trademark Office

# BluePrintBar

**Reg. No. 4,136,825**

**Registered May 1, 2012**

**Int. Cl.: 29**

**TRADEMARK**

**PRINCIPAL REGISTER**

BLUEPRINTCLEANSE LLC (NEW YORK LIMITED LIABILITY COMPANY)  
135 WEST 29TH STREET, SUITE 701  
NEW YORK, NY 10011

FOR: FRUIT-BASED ORGANIC FOOD BARS, ALSO CONTAINING NUTS; FRUIT-BASED  
RAW FOOD BARS, IN CLASS 29 (U.S. CL. 46).

FIRST USE 12-9-2010; IN COMMERCE 10-25-2011.

THE MARK CONSISTS OF STANDARD CHARACTERS WITHOUT CLAIM TO ANY PAR-  
TICULAR FONT, STYLE, SIZE, OR COLOR.

OWNER OF U.S. REG. NO. 3,523,499.

SN 85-285,001, FILED 4-4-2011.

ZHALEH DELANEY, EXAMINING ATTORNEY



*David J. Kybas*

Director of the United States Patent and Trademark Office

# United States of America

United States Patent and Trademark Office

## Kitcheninterventions

**Reg. No. 4,136,826**

**Registered May 1, 2012**

**Int. Cl.: 37**

**SERVICE MARK**

**PRINCIPAL REGISTER**

MARC COAN DESIGNS (NEW MEXICO LIMITED LIABILITY COMPANY), DBA  
MARCCOAN DESIGNS,  
3301 MENAUL BLVD. NE SUITE 28  
ALBUQUERQUE, NM 87107

FOR: CONSTRUCTION CONSULTATION, IN CLASS 37 (U.S. CLS. 100, 103 AND 106).

FIRST USE 8-4-2011; IN COMMERCE 8-4-2011.

THE MARK CONSISTS OF STANDARD CHARACTERS WITHOUT CLAIM TO ANY PARTICULAR FONT, STYLE, SIZE, OR COLOR.

SN 85-285,275, FILED 4-4-2011.

NATALIE POLZER, EXAMINING ATTORNEY



*David J. Kyffers*

Director of the United States Patent and Trademark Office

# United States of America

United States Patent and Trademark Office

# KUYA

**Reg. No. 4,136,827**

**Registered May 1, 2012**

**Int. Cl.: 28**

**TRADEMARK**

**PRINCIPAL REGISTER**

PRO LOOK SPORTS (UTAH CORPORATION)  
#304  
37 EAST CENTER STREET  
PROVO, UT 84604

FOR: BAGS SPECIALLY ADAPTED FOR SPORTS EQUIPMENT, IN CLASS 28 (U.S. CLS. 22, 23, 38 AND 50).

FIRST USE 7-15-2009; IN COMMERCE 7-15-2009.

THE MARK CONSISTS OF STANDARD CHARACTERS WITHOUT CLAIM TO ANY PARTICULAR FONT, STYLE, SIZE, OR COLOR.

OWNER OF U.S. REG. NO. 3,756,765.

THE ENGLISH TRANSLATION OF "KUYA" IN THE MARK IS BIG BROTHER.

SN 85-285,284, FILED 4-4-2011.

CIMMERIAN COLEMAN, EXAMINING ATTORNEY



*David J. Kyfos*

Director of the United States Patent and Trademark Office



# United States of America

United States Patent and Trademark Office

# TUNDRA

**Reg. No. 4,136,828**

**Registered May 1, 2012**

**Int. Cl.: 7**

**TRADEMARK**

**PRINCIPAL REGISTER**

TUNDRA EQUIPMENT COMPANY (DELAWARE CORPORATION)  
C/O SNR REGISTERED AGENT SERVICES  
4520 MAIN ST., SUITE 1100  
KANSAS CITY, MO 64111

FOR: FLOOR CLEANING MACHINES; FLOOR MACHINES FOR BUFFING, BURNISHING, POLISHING, SCRUBBING AND STRIPPING; DRYING MACHINES FOR CARPETS AND FLOORS, IN CLASS 7 (U.S. CLS. 13, 19, 21, 23, 31, 34 AND 35).

FIRST USE 9-30-2011; IN COMMERCE 9-30-2011.

THE MARK CONSISTS OF STANDARD CHARACTERS WITHOUT CLAIM TO ANY PARTICULAR FONT, STYLE, SIZE, OR COLOR.

SN 85-286,524, FILED 4-5-2011.

JULIE GUTTADAURO, EXAMINING ATTORNEY



*David J. Kybas*

Director of the United States Patent and Trademark Office

# United States of America

United States Patent and Trademark Office

**propane360** 

**Reg. No. 4,136,829**

**Registered May 1, 2012**

**Int. Cl.: 35**

**SERVICE MARK**

**PRINCIPAL REGISTER**

PROPANE360 LLC (CALIFORNIA LIMITED LIABILITY COMPANY)  
PO BOX 1237  
BRENTWOOD, CA 94513

FOR: ON-LINE RETAIL STORE SERVICES FEATURING PROPANE AND RELATED PROPANE PRODUCTS SUCH AS GRILLS AND PATIO HEATERS, IN CLASS 35 (U.S. CLS. 100, 101 AND 102).

FIRST USE 2-18-2012; IN COMMERCE 2-18-2012.

NO CLAIM IS MADE TO THE EXCLUSIVE RIGHT TO USE "PROPANE", APART FROM THE MARK AS SHOWN.

THE MARK CONSISTS OF THE LETTERS "P", "R", "O", "P", "A", "N", "E", IN SUCCESSION; IMMEDIATELY FOLLOWED BY THE NUMBERS "3", "6", "0" IN SUCCESSION AND FORMING THE STYLIZED TEXT "PROPANE360". A HALF -CIRCLE ORIGINATES BETWEEN THE "E" AND "3", PASSES UNDER THE "3" AND "6", CONTINUES TO CURVE UNTIL PASSING THROUGH THE MIDDLE OF THE "0", TERMINATING AT NEARLY THE SAME HEIGHT AS THE FURTHEST RIGHT "FLAME" TIP. THE "FLAME" PORTION OF THE LOGO APPEARS TO FLOAT MAINLY ABOVE THE "0"; HOWEVER, THE LEFT EDGE OF THE FLAME APPEARS OVER THE RIGHT EDGE OF THE "6" AS WELL. THE "FLAME" CONSISTS OF 4 FLAME TIPS.

SN 85-286,756, FILED 4-5-2011.

C. DIONNE CLYBURN, EXAMINING ATTORNEY



*David J. Kybas*

Director of the United States Patent and Trademark Office

# United States of America

United States Patent and Trademark Office

## HEMO-SURGE

**Reg. No. 4,136,830**

**Registered May 1, 2012**

**Int. Cl.: 5**

**TRADEMARK**

**PRINCIPAL REGISTER**

MEDICAL RESEARCH INSTITUTE (CALIFORNIA CORPORATION)  
21411 PRAIRIE STREET  
CHATSWORTH, CA 91311

FOR: DIETARY SUPPLEMENTS, IN CLASS 5 (U.S. CLS. 6, 18, 44, 46, 51 AND 52).

FIRST USE 5-27-2011; IN COMMERCE 5-27-2011.

THE MARK CONSISTS OF STANDARD CHARACTERS WITHOUT CLAIM TO ANY PARTICULAR FONT, STYLE, SIZE, OR COLOR.

SN 85-287,104, FILED 4-5-2011.

LEIGH LOWRY, EXAMINING ATTORNEY



*David J. Kyffers*

Director of the United States Patent and Trademark Office

# United States of America

United States Patent and Trademark Office

## ALADDIN TRADING NETWORK

**Reg. No. 4,136,831**

**Registered May 1, 2012**

**Int. Cls.: 36 and 42**

**SERVICE MARK**

**PRINCIPAL REGISTER**

BLACKROCK, INC. (DELAWARE CORPORATION)  
40 EAST 52ND STREET  
NEW YORK, NY 10022

FOR: PROVIDING FINANCIAL RISK MANAGEMENT SERVICES; FINANCIAL MANAGEMENT SERVICES AND SECURITIES TRADING; FINANCIAL RESEARCH; FINANCIAL ANALYSIS AND CONSULTING; FINANCIAL INFORMATION, IN CLASS 36 (U.S. CLS. 100, 101 AND 102).

FIRST USE 9-1-2011; IN COMMERCE 9-1-2011.

FOR: TEMPORARY USE OF ONLINE NON-DOWNLOADABLE COMPUTER SOFTWARE FOR USE BY OTHERS IN PROVIDING FINANCIAL SERVICES, NAMELY, FINANCIAL INFORMATION, FINANCIAL MANAGEMENT, SECURITIES TRADING, INVESTMENT MANAGEMENT, AND TRADING FINANCIAL INSTRUMENTS VIA AN ONLINE TRADING PLATFORM; PROVIDING A TRADING PLATFORM FOR PLACING AND EXECUTING ORDERS TO PURCHASE OR SELL SECURITIES, OPTIONS, FUTURES, FOREIGN EXCHANGE AND OTHER FINANCIAL INSTRUMENTS, IN CLASS 42 (U.S. CLS. 100 AND 101).

FIRST USE 9-1-2011; IN COMMERCE 9-1-2011.

THE MARK CONSISTS OF STANDARD CHARACTERS WITHOUT CLAIM TO ANY PARTICULAR FONT, STYLE, SIZE, OR COLOR.

OWNER OF U.S. REG. NO. 2,639,018.

NO CLAIM IS MADE TO THE EXCLUSIVE RIGHT TO USE "TRADING NETWORK", APART FROM THE MARK AS SHOWN.

SN 85-287,156, FILED 4-5-2011.

MARY I. SPARROW, EXAMINING ATTORNEY



*David J. Kyffers*

Director of the United States Patent and Trademark Office

# United States of America

United States Patent and Trademark Office



**Reg. No. 4,136,832**

**Registered May 1, 2012**

**Int. Cl.: 33**

**TRADEMARK**

**PRINCIPAL REGISTER**

CHENG YUSHAN (CHINA INDIVIDUAL)  
16TH GROUP, 7TH COMMUNITY, JINGYU STREET  
XINFU DISTRICT, FUSHUN CITY  
LIAONING PROVINCE, CHINA

FOR: ALCOHOLIC BEVERAGES EXCEPT BEERS; ALCOHOLIC EXTRACTS; ALCOHOLIC FRUIT EXTRACTS; APERITIFS; ARAK; COOKING WINE; DISTILLED SPIRITS; DISTILLED SPIRITS OF RICE (AWAMORI); SPIRITS; WINE, IN CLASS 33 (U.S. CLS. 47 AND 49).

FIRST USE 10-6-2010; IN COMMERCE 10-6-2011.

THE MARK CONSISTS OF A RECTANGLE DESIGN WITH ROUND CORNERS, WITH A BROKEN VERTICAL LINE AND A CIRCLE DESIGN IN THE MIDDLE OF THE RECTANGLE.

SN 85-287,310, FILED 4-6-2011.

REBECCA EISINGER, EXAMINING ATTORNEY



*David J. Kybas*

Director of the United States Patent and Trademark Office

# United States of America

United States Patent and Trademark Office

## KENTUCKY CHOICE

**Reg. No. 4,136,833**

**Registered May 1, 2012**

**Int. Cl.: 34**

**TRADEMARK**

**PRINCIPAL REGISTER**

HERITAGE TOBACCO GROUP, LLC (KENTUCKY LIMITED LIABILITY COMPANY)  
1660 HARRODSBURG ROAD  
PERRYVILLE, KY 40468

FOR: PIPE TOBACCO, IN CLASS 34 (U.S. CLS. 2, 8, 9 AND 17).

FIRST USE 6-28-2011; IN COMMERCE 6-28-2011.

THE MARK CONSISTS OF STANDARD CHARACTERS WITHOUT CLAIM TO ANY PARTICULAR FONT, STYLE, SIZE, OR COLOR.

NO CLAIM IS MADE TO THE EXCLUSIVE RIGHT TO USE "KENTUCKY", APART FROM THE MARK AS SHOWN.

SN 85-287,780, FILED 4-6-2011.

MIDGE BUTLER, EXAMINING ATTORNEY



*David J. Kyffers*

Director of the United States Patent and Trademark Office

# United States of America

United States Patent and Trademark Office

## BEAR ESSENTIALS

**Reg. No. 4,136,834**

WOLK, PETER C. (UNITED STATES INDIVIDUAL)  
10398 63RD AVENUE NORTH  
SEMINOLE, FL 33772

**Registered May 1, 2012**

**Int. Cl.: 6**

FOR: METAL CAGE FOR PROTECTING WILDLIFE FEEDER FROM DAMAGE, IN CLASS 6 (U.S. CLS. 2, 12, 13, 14, 23, 25 AND 50).

**TRADEMARK**

FIRST USE 12-5-2011; IN COMMERCE 12-5-2011.

**PRINCIPAL REGISTER**

THE MARK CONSISTS OF STANDARD CHARACTERS WITHOUT CLAIM TO ANY PARTICULAR FONT, STYLE, SIZE, OR COLOR.

NO CLAIM IS MADE TO THE EXCLUSIVE RIGHT TO USE "BEAR", APART FROM THE MARK AS SHOWN.

SN 85-287,923, FILED 4-6-2011.

JACLYN KIDWELL WALKER, EXAMINING ATTORNEY



*David J. Kyffers*

Director of the United States Patent and Trademark Office

# United States of America

United States Patent and Trademark Office

# YARD

**Reg. No. 4,136,835**

**Registered May 1, 2012**

**Int. Cl.: 36**

**SERVICE MARK**

**PRINCIPAL REGISTER**

THE TORONTO-DOMINION BANK (CANADA CHARTERED BANK)  
12TH FLOOR TORONTO-DOMINION TOWER  
66 WELLINGTON STREET  
TORONTO, CANADA M5K1A2

FOR: EQUIPMENT FINANCING SERVICES; CREDIT CARD SERVICES, IN CLASS 36 (U.S. CLS. 100, 101 AND 102).

FIRST USE 10-27-2011; IN COMMERCE 10-27-2011.

THE MARK CONSISTS OF STANDARD CHARACTERS WITHOUT CLAIM TO ANY PARTICULAR FONT, STYLE, SIZE, OR COLOR.

SN 85-288,037, FILED 4-6-2011.

TINA L. SNAPP, EXAMINING ATTORNEY



*David J. Kybas*

Director of the United States Patent and Trademark Office



# United States of America

United States Patent and Trademark Office

# STEELHOUSE

**Reg. No. 4,136,836**

**Registered May 1, 2012**

**Int. Cl.: 35**

**SERVICE MARK**

**PRINCIPAL REGISTER**

STEEL HOUSE, INC. (DELAWARE CORPORATION)  
5870 W. JEFFERSON BLVD., SUITE F  
LOS ANGELES, CA 90016

FOR: INTERNET ADVERTISING SERVICES; DESIGN OF INTERNET ADVERTISING; AD SERVING, NAMELY, PLACING ADVERTISEMENTS ON WEBSITES FOR OTHERS USING SPECIALIZED COMPUTER SOFTWARE; PREPARATION OF CUSTOM ADVERTISEMENTS FOR OTHERS; PREPARING AND PLACING ADVERTISEMENTS FOR OTHERS; SERVICES TO DETERMINE THE AUDIENCE AFFECTED BY ADVERTISEMENTS; MARKETING SERVICES, NAMELY, CONDUCTING CONSUMER TRACKING BEHAVIOR RESEARCH AND CONSUMER TREND ANALYSIS; DESIGN OF INTERNET ADVERTISING BASED ON BEHAVIOR OF INTERNET USERS, IN CLASS 35 (U.S. CLS. 100, 101 AND 102).

FIRST USE 5-0-2009; IN COMMERCE 5-0-2009.

THE MARK CONSISTS OF STANDARD CHARACTERS WITHOUT CLAIM TO ANY PARTICULAR FONT, STYLE, SIZE, OR COLOR.

SN 85-288,243, FILED 4-6-2011.

KELLY BOULTON, EXAMINING ATTORNEY



*David J. Kyros*

Director of the United States Patent and Trademark Office

# United States of America

United States Patent and Trademark Office

## DOUBLE DUTY

**Reg. No. 4,136,837**

**Registered May 1, 2012**

**Int. Cl.: 39**

**SERVICE MARK**

**PRINCIPAL REGISTER**

DOUBLE DUTY PORTABLE STORAGE AND MOVERS, LLC (SOUTH DAKOTA LIMITED LIABILITY COMPANY)  
12870 WEST PLEASANT VALLEY DRIVE  
ABERDEEN, SD 57401

FOR: MOVING AND STORAGE SERVICES, NAMELY, RENTAL, STORAGE, DELIVERY AND PICKUP OF PORTABLE STORAGE UNITS, IN CLASS 39 (U.S. CLS. 100 AND 105).

FIRST USE 3-4-2011; IN COMMERCE 3-4-2011.

THE MARK CONSISTS OF STANDARD CHARACTERS WITHOUT CLAIM TO ANY PARTICULAR FONT, STYLE, SIZE, OR COLOR.

SN 85-289,324, FILED 4-7-2011.

TINA L. SNAPP, EXAMINING ATTORNEY



*David J. Kyffers*

Director of the United States Patent and Trademark Office

# United States of America

United States Patent and Trademark Office



**Reg. No. 4,136,838**

**Registered May 1, 2012**

**Int. Cls.: 16, 25, 28, and 41**

WICHITA WINGS INDOOR SOCCER, LLC (KANSAS LIMITED LIABILITY COMPANY)  
10500 E. BERKELEY SQUARE PKWY, STE. 100  
WICHITA, KS 67206

FOR: POSTERS; STICKERS; TRADING CARDS; SPORTS PROGRAMS; PRINTED EVENT ADMISSION TICKETS, IN CLASS 16 (U.S. CLS. 2, 5, 22, 23, 29, 37, 38 AND 50).

FIRST USE 6-1-2011; IN COMMERCE 6-1-2011.

**TRADEMARK**

FOR: T-SHIRTS; SHIRTS; FLEECE TOPS; JERSEYS; HATS; SWEAT SUITS; JACKETS; SWEATSHIRTS, IN CLASS 25 (U.S. CLS. 22 AND 39).

**SERVICE MARK**

**PRINCIPAL REGISTER**

FIRST USE 6-1-2011; IN COMMERCE 6-1-2011.

FOR: SOCCER BALL REPLICAS, IN CLASS 28 (U.S. CLS. 22, 23, 38 AND 50).

FIRST USE 6-1-2011; IN COMMERCE 6-1-2011.

FOR: ENTERTAINMENT SERVICES, NAMELY, ORGANIZING, CONDUCTING, AND STAGING PROFESSIONAL SOCCER GAMES AND EXHIBITIONS, SOCCER CLINICS AND TOURNAMENTS, SOCCER SKILLS DEVELOPMENT PROGRAMS AND CLINICS; PROVIDING A WEBSITE CONTAINING INFORMATION RELATING TO THE SPORT OF SOCCER, INCLUDING TEAM INFORMATION, PLAYER STATISTICS, AND NEWS, IN CLASS 41 (U.S. CLS. 100, 101 AND 107).

FIRST USE 6-1-2011; IN COMMERCE 6-1-2011.

NO CLAIM IS MADE TO THE EXCLUSIVE RIGHT TO USE "WICHITA", APART FROM THE MARK AS SHOWN.

THE MARK CONSISTS OF THE DESIGN OF A SHIELD WITH THE STYLIZED WORDS "WICHITA WINGS" AT THE TOP, THE DESIGN OF PHOENIX IN THE STYLE OF THE LETTER "W" BELOW THE WORDS "WICHITA WINGS", AND A SOCCER BALL BELOW THE PHOENIX DESIGN.

SN 85-289,410, FILED 4-7-2011.



*David J. Kybas*

Director of the United States Patent and Trademark Office

**Reg. No. 4,136,838** GINA HAYES, EXAMINING ATTORNEY

# United States of America

United States Patent and Trademark Office

## FUEL THE FUTURE

**Reg. No. 4,136,839**

**Registered May 1, 2012**

**Int. Cl.: 41**

**SERVICE MARK**

**PRINCIPAL REGISTER**

PROMETHEUS GLOBAL MEDIA, LLC (DELAWARE LIMITED LIABILITY COMPANY)  
770 BROADWAY  
NEW YORK, NY 100039595

FOR: PROVIDING INFORMATION IN THE FIELD OF FILM, TV, MUSIC AND ENTERTAINMENT VIA A GLOBAL COMPUTER NETWORK, IN CLASS 41 (U.S. CLS. 100, 101 AND 107).

FIRST USE 4-14-2011; IN COMMERCE 4-14-2011.

THE MARK CONSISTS OF STANDARD CHARACTERS WITHOUT CLAIM TO ANY PARTICULAR FONT, STYLE, SIZE, OR COLOR.

SN 85-289,935, FILED 4-8-2011.

SEAN CROWLEY, EXAMINING ATTORNEY



*David J. Kyffers*

Director of the United States Patent and Trademark Office

# United States of America

United States Patent and Trademark Office

# WORXRITE

**Reg. No. 4,136,840**

**Registered May 1, 2012**

**Int. Cls.: 9 and 42**

**TRADEMARK**

**SERVICE MARK**

**PRINCIPAL REGISTER**

ATLANTIC AMERICAN CORPORATION (GEORGIA CORPORATION)  
4370 PEACHTREE ROAD, NE  
ATLANTA, GA 30319

FOR: COMPUTER HARDWARE AND SOFTWARE, FOR USE WITH ENROLLING PARTICIPANTS IN BENEFITS PACKAGES, GROUP INSURANCE, 401(K), MEDICAL INSURANCE, DENTAL INSURANCE, SHORT-TERM CARE INSURANCE, DISABILITY INSURANCE, HEALTH INSURANCE, MEDICARE SUPPLEMENT INSURANCE, PAYROLL INSURANCE, FOR RECEIVING, PROCESSING, TRANSMITTING AND DISPLAYING DATA, IN CLASS 9 (U.S. CLS. 21, 23, 26, 36 AND 38).

FIRST USE 12-30-2011; IN COMMERCE 12-30-2011.

FOR: PROVIDING TEMPORARY USE OF ON-LINE NON-DOWNLOADABLE USER INTERFACE SOFTWARE FOR USE WITH ENROLLING PARTICIPANTS IN BENEFITS PACKAGES, GROUP INSURANCE, 401(K), MEDICAL INSURANCE, DENTAL INSURANCE, SHORT-TERM CARE INSURANCE, DISABILITY INSURANCE, HEALTH INSURANCE, MEDICARE SUPPLEMENT INSURANCE, PAYROLL INSURANCE, FOR RECEIVING, PROCESSING, TRANSMITTING AND DISPLAYING DATA, IN CLASS 42 (U.S. CLS. 100 AND 101).

FIRST USE 12-30-2011; IN COMMERCE 12-30-2011.

THE MARK CONSISTS OF STANDARD CHARACTERS WITHOUT CLAIM TO ANY PARTICULAR FONT, STYLE, SIZE, OR COLOR.

SN 85-291,436, FILED 4-11-2011.

ELLEN B. AWRICH, EXAMINING ATTORNEY



*David J. Kyros*

Director of the United States Patent and Trademark Office

# United States of America

United States Patent and Trademark Office

PROVIDING AROUND THE WORLD  
VALUES SINCE 1963

**Reg. No. 4,136,841**

**Registered May 1, 2012**

**Int. Cl.: 35**

**SERVICE MARK**

**PRINCIPAL REGISTER**

LTD COMMODITIES LLC (DELAWARE LIMITED LIABILITY COMPANY)  
2800 LAKESIDE DRIVE  
BANNOCKBURN, IL 60015

FOR: CATALOG ORDERING SERVICE FEATURING GENERAL MERCHANDISE, CONSUMER HOUSEHOLD ITEMS AND APPAREL; ON-LINE ORDERING SERVICES FEATURING GENERAL MERCHANDISE, CONSUMER HOUSEHOLD ITEMS AND APPAREL, IN CLASS 35 (U.S. CLS. 100, 101 AND 102).

FIRST USE 3-22-2011; IN COMMERCE 3-22-2011.

THE MARK CONSISTS OF STANDARD CHARACTERS WITHOUT CLAIM TO ANY PARTICULAR FONT, STYLE, SIZE, OR COLOR.

NO CLAIM IS MADE TO THE EXCLUSIVE RIGHT TO USE "SINCE 1963", APART FROM THE MARK AS SHOWN.

SN 85-291,984, FILED 4-11-2011.

ALICE BENMAMAN, EXAMINING ATTORNEY



*David J. Kybas*

Director of the United States Patent and Trademark Office

**United States of America**  
United States Patent and Trademark Office

# FREEFOOT

**Reg. No. 4,136,842**

**Registered May 1, 2012**

**Int. Cl.: 15**

**TRADEMARK**

**PRINCIPAL REGISTER**

JARED B. REDDICK (FLORIDA LIMITED LIABILITY COMPANY), DBA FREEFOOT, LLC,  
18084 SW 65TH LOOP  
P O BOX 2572  
DUNNELLON, FL 34430

FOR: DRUM PEDALS; DRUMS, IN CLASS 15 (U.S. CLS. 2, 21 AND 36).

FIRST USE 4-11-2011; IN COMMERCE 4-11-2011.

THE MARK CONSISTS OF STANDARD CHARACTERS WITHOUT CLAIM TO ANY PARTICULAR FONT, STYLE, SIZE, OR COLOR.

SN 85-292,356, FILED 4-11-2011.

MATTHEW EINSTEIN, EXAMINING ATTORNEY



*David J. Kyffers*

Director of the United States Patent and Trademark Office



**United States of America**  
United States Patent and Trademark Office

# STERIGEAR

**Reg. No. 4,136,843**

**Registered May 1, 2012**

**Int. Cl.: 10**

**TRADEMARK**

**PRINCIPAL REGISTER**

STERIGEAR, LLC (UTAH LIMITED LIABILITY COMPANY)  
362 SOUTH UNIVERSITY AVENUE  
PROVO, UT 84601

FOR: COVERINGS FOR MEDICAL DEVICE EQUIPMENT AND MEDICAL DEVICES; BAG FOR COLLECTION OF BODILY FLUIDS AND WASTE, IN CLASS 10 (U.S. CLS. 26, 39 AND 44).

FIRST USE 4-26-2007; IN COMMERCE 4-26-2007.

THE MARK CONSISTS OF STANDARD CHARACTERS WITHOUT CLAIM TO ANY PARTICULAR FONT, STYLE, SIZE, OR COLOR.

SN 85-292,850, FILED 4-12-2011.

SHAUNIA CARLYLE, EXAMINING ATTORNEY



*David J. Kyros*

Director of the United States Patent and Trademark Office

# United States of America

United States Patent and Trademark Office

## USIM AUTO TRENDS

**Reg. No. 4,136,844**

US INTERNATIONAL MEDIA, LLC (DELAWARE LIMITED LIABILITY COMPANY)  
1201 ALTA LOMA ROAD  
LOS ANGELES, CA 90069

**Registered May 1, 2012**

**Int. Cl.: 35**

FOR: MEDIA PLANNING AND MEDIA BUYING SERVICES, NAMELY, INFORMATION AND DATA COMPILATION AND ANALYSIS RELATING TO BUSINESS MANAGEMENT, BUSINESS MARKETING AND BUSINESS PLANNING SPECIFICALLY FOR THE AUTOMOBILE INDUSTRY, IN CLASS 35 (U.S. CLS. 100, 101 AND 102).

**SERVICE MARK**

**PRINCIPAL REGISTER**

FIRST USE 4-0-2011; IN COMMERCE 4-0-2011.

THE MARK CONSISTS OF STANDARD CHARACTERS WITHOUT CLAIM TO ANY PARTICULAR FONT, STYLE, SIZE, OR COLOR.

OWNER OF U.S. REG. NOS. 3,173,016, 3,546,437, AND OTHERS.

NO CLAIM IS MADE TO THE EXCLUSIVE RIGHT TO USE "AUTO TRENDS", APART FROM THE MARK AS SHOWN.

SN 85-293,341, FILED 4-12-2011.

STEVEN R. FINE, EXAMINING ATTORNEY



*David J. Kybas*

Director of the United States Patent and Trademark Office

# United States of America

United States Patent and Trademark Office

# AFFINITY

**Reg. No. 4,136,845**

**Registered May 1, 2012**

**Int. Cl.: 9**

**TRADEMARK**

**PRINCIPAL REGISTER**

ELECTROLUX HOME PRODUCTS, INC. (DELAWARE CORPORATION)  
10200 DAVID TAYLOR DRIVE  
CHARLOTTE, NC 28262

FOR: CLOTHES IRONS, IN CLASS 9 (U.S. CLS. 21, 23, 26, 36 AND 38).

FIRST USE 8-22-2011; IN COMMERCE 8-22-2011.

THE MARK CONSISTS OF STANDARD CHARACTERS WITHOUT CLAIM TO ANY PARTICULAR FONT, STYLE, SIZE, OR COLOR.

OWNER OF U.S. REG. NOS. 3,262,752 AND 3,262,753.

SN 85-293,716, FILED 4-13-2011.

ANGELA M. MICHELI, EXAMINING ATTORNEY



*David J. Kybas*

Director of the United States Patent and Trademark Office

# United States of America

United States Patent and Trademark Office

## SOLA LIGHT ENGINE

**Reg. No. 4,136,846**

**Registered May 1, 2012**

**Int. Cl.: 9**

**TRADEMARK**

**PRINCIPAL REGISTER**

LUMENCOR, INC. (OREGON CORPORATION)  
14964 NW GREENBRIER PARKWAY  
BEAVERTON, OR 97006

FOR: LIGHT ENGINE AND LIGHT SOURCE, NAMELY, A LIGHT ENGINE SUBSYSTEM CONSISTING OF LIGHT EMITTING DIODES, LIGHT PIPE LAMP MODULES, AND DELIVERY OPTICS, IN CLASS 9 (U.S. CLS. 21, 23, 26, 36 AND 38).

FIRST USE 6-28-2011; IN COMMERCE 8-19-2011.

THE MARK CONSISTS OF STANDARD CHARACTERS WITHOUT CLAIM TO ANY PARTICULAR FONT, STYLE, SIZE, OR COLOR.

OWNER OF U.S. REG. NOS. 3,628,537, 3,702,748, AND 3,755,468.

NO CLAIM IS MADE TO THE EXCLUSIVE RIGHT TO USE "LIGHT ENGINE", APART FROM THE MARK AS SHOWN.

SN 85-293,813, FILED 4-13-2011.

JOHN GARTNER, EXAMINING ATTORNEY



*David J. Kybas*

Director of the United States Patent and Trademark Office

# United States of America

United States Patent and Trademark Office

# MAKANA

**Reg. No. 4,136,847**

**Registered May 1, 2012**

**Int. Cl.: 3**

**TRADEMARK**

**PRINCIPAL REGISTER**

MAKANA LLC (MINNESOTA LIMITED LIABILITY COMPANY)  
18440 HIGHLAND AVENUE  
DEEPHAVEN, MN 55391

FOR: BEAUTY CREAMS FOR BODY CARE; FACE AND BODY LOTIONS; MOISTURIZING PREPARATIONS FOR THE SKIN, IN CLASS 3 (U.S. CLS. 1, 4, 6, 50, 51 AND 52).

FIRST USE 9-1-2011; IN COMMERCE 9-1-2011.

THE MARK CONSISTS OF STANDARD CHARACTERS WITHOUT CLAIM TO ANY PARTICULAR FONT, STYLE, SIZE, OR COLOR.

THE ENGLISH TRANSLATION OF "MAKANA" IN THE MARK IS "GIFT".

SN 85-293,936, FILED 4-13-2011.

THEODORE MCBRIDE, EXAMINING ATTORNEY



*David J. Kyros*

Director of the United States Patent and Trademark Office

# United States of America

United States Patent and Trademark Office

## VIVID EXPRESSIONS

**Reg. No. 4,136,848**

**Registered May 1, 2012**

**Int. Cl.: 16**

**TRADEMARK**

**PRINCIPAL REGISTER**

COLORTREND USA LLC (DELAWARE LIMITED LIABILITY COMPANY)  
2 TURNER PLACE  
PISCATAWAY, NJ 08854

FOR: PRINTED MERCHANDISING AIDS USED IN CONNECTION WITH THE SALE OF COLORANTS AND PROTECTIVE AND DECORATIVE SURFACE COATINGS NAMELY, FAN DECKS, COLOR ALBUMS, COLOR CARD SETS, FORMULATION GUIDES, ARCHITECTS' BINDERS AND ARCHITECTS' COLOR FILES, IN CLASS 16 (U.S. CLS. 2, 5, 22, 23, 29, 37, 38 AND 50).

FIRST USE 9-1-2011; IN COMMERCE 9-1-2011.

THE MARK CONSISTS OF STANDARD CHARACTERS WITHOUT CLAIM TO ANY PARTICULAR FONT, STYLE, SIZE, OR COLOR.

SN 85-294,816, FILED 4-14-2011.

RICHARD WHITE, EXAMINING ATTORNEY



*David J. Kybas*

Director of the United States Patent and Trademark Office

# United States of America

United States Patent and Trademark Office



**Reg. No. 4,136,849**

**Registered May 1, 2012**

**Int. Cl.: 35**

**SERVICE MARK**

**PRINCIPAL REGISTER**

WING HIP FUNG HERBAL & GINSENG, INC. (CALIFORNIA CORPORATION)  
722 E. VALLEY BLVD.  
SAN GABRIEL, CA 91776

FOR: ON-LINE RETAIL STORE SERVICES FEATURING DIETARY AND NUTRITIONAL SUPPLEMENTS, HERBAL PRODUCTS AND PRODUCTS MADE WITH GINSENG; RETAIL STORE SERVICES FEATURING DIETARY AND NUTRITIONAL SUPPLEMENTS, HERBAL PRODUCTS AND PRODUCTS MADE WITH GINSENG; WHOLESALE DISTRIBUTORSHIPS FEATURING DIETARY AND NUTRITIONAL SUPPLEMENTS, HERBAL PRODUCTS AND PRODUCTS MADE WITH GINSENG, IN CLASS 35 (U.S. CLS. 100, 101 AND 102).

FIRST USE 9-0-1994; IN COMMERCE 9-0-1994.

NO CLAIM IS MADE TO THE EXCLUSIVE RIGHT TO USE THE NON-LATIN CHARACTERS THAT TRANSLITERATE TO JIAN MY LANG FOR, APART FROM THE MARK AS SHOWN.

THE COLOR(S) GRAY, RED, AND YELLOW IS/ARE CLAIMED AS A FEATURE OF THE MARK.

THE NON-LATIN CHARACTERS IN THE MARK TRANSLITERATE TO JIAN MY LANG FOR, SHUN YUE BO JING AND THIS MEANS ONLY SELLS QUALITY GOODS; REPUTATION IS OUR GUARANTEE IN ENGLISH.

THE MARK CONSISTS OF A RED CIRCLE WITH IMAGES OF A ROOT, DEER, FLOWER, LEAVES, AND TWO BIRDS PRINTED IN THE COLOR YELLOW ALL SURROUNDED BY A YELLOW CIRCLE UPON WHICH THERE ARE FOUR RED ASIAN CHARACTERS AT THE TOP AND THE BOTTOM. THE EYES ON THE BIRDS, EYES ON THE DEER, AND THE SPOTS ON THE DEER ARE IN GRAY COLOR.

SN 85-296,302, FILED 4-15-2011.

TEJBIR SINGH, EXAMINING ATTORNEY



*David J. Kybas*

Director of the United States Patent and Trademark Office

# United States of America

United States Patent and Trademark Office

## AQUACEL EXTRA

**Reg. No. 4,136,850**

CONVATEC INC. (DELAWARE CORPORATION)  
200 HEADQUARTERS PARK DRIVE  
SKILLMAN, NJ 08558

**Registered May 1, 2012**

**Int. Cl.: 5**

FOR: MEDICAL DRESSINGS, IN CLASS 5 (U.S. CLS. 6, 18, 44, 46, 51 AND 52).

**TRADEMARK**

FIRST USE 12-31-2011; IN COMMERCE 12-31-2011.

**PRINCIPAL REGISTER**

THE MARK CONSISTS OF STANDARD CHARACTERS WITHOUT CLAIM TO ANY PARTICULAR FONT, STYLE, SIZE, OR COLOR.

OWNER OF U.S. REG. NOS. 2,048,097 AND 2,837,287.

SN 85-296,370, FILED 4-15-2011.

REBECCA SMITH, EXAMINING ATTORNEY



*David J. Kyffers*

Director of the United States Patent and Trademark Office



# United States of America

United States Patent and Trademark Office

Nipple  
Cheese

**Reg. No. 4,136,851**

**Registered May 1, 2012**

**Int. Cl.: 25**

**TRADEMARK**

**PRINCIPAL REGISTER**

NC PARTNERS (CALIFORNIA PARTNERSHIP)  
GLENCROFT RD  
GLENORA, CA 91740

FOR: HATS; SWEATSHIRTS; SWIMWEAR; T-SHIRTS, IN CLASS 25 (U.S. CLS. 22 AND 39).

FIRST USE 3-25-2011; IN COMMERCE 1-10-2012.

THE MARK CONSISTS OF THE STYLIZED TEXT "NIPPLE CHEESE". THE TWO "P'S" RESEMBLING A WOMENS BREAST IN A BIKINI. THE STYLIZED TEXT "CHEESE" HAS HOLES CUT INTO EACH LETTER RESEMBLING SWISS CHEESE.

SN 85-296,947, FILED 4-15-2011.

STEVEN JACKSON, EXAMINING ATTORNEY



*David J. Kybas*

Director of the United States Patent and Trademark Office

# United States of America

United States Patent and Trademark Office

# SOMOLEND

**Reg. No. 4,136,852**

**Registered May 1, 2012**

**Int. Cl.: 35**

**SERVICE MARK**

**PRINCIPAL REGISTER**

BAD GIRL VENTURES, LLC (OHIO LIMITED LIABILITY COMPANY)  
SUITE 5  
1220 VINE STREET  
CINCINNATI, OH 45202

FOR: MATCHING BORROWERS WITH POTENTIAL LENDERS IN THE FIELD OF BUSINESS START-UPS AND EMERGING BUSINESSES; BUSINESS-DEVELOPMENT SERVICES, NAMELY, PROVIDING START-UP SUPPORT FOR THE BUSINESSES OF OTHERS, IN CLASS 35 (U.S. CLS. 100, 101 AND 102).

FIRST USE 12-1-2011; IN COMMERCE 12-1-2011.

THE MARK CONSISTS OF STANDARD CHARACTERS WITHOUT CLAIM TO ANY PARTICULAR FONT, STYLE, SIZE, OR COLOR.

SN 85-297,460, FILED 4-18-2011.

SAMUEL E. SHARPER JR., EXAMINING ATTORNEY



*David J. Kyffers*

Director of the United States Patent and Trademark Office

# United States of America

United States Patent and Trademark Office

## BIG ED'S HEIRLOOM

**Reg. No. 4,136,853**

PIGTAIL BRANDS, LLC (SOUTH CAROLINA LIMITED LIABILITY COMPANY)  
4220 BLUFF ROAD  
ALLENDALE, SC 29810

**Registered May 1, 2012**

**Int. Cl.: 30**

FOR: BARBECUE SAUCE; BARBEQUE SAUCE; SAUCES; SAUCES FOR BARBECUE;  
BARBEQUE DRY RUB, IN CLASS 30 (U.S. CL. 46).

**TRADEMARK**

FIRST USE 3-3-2011; IN COMMERCE 3-3-2011.

**PRINCIPAL REGISTER**

THE MARK CONSISTS OF STANDARD CHARACTERS WITHOUT CLAIM TO ANY PARTICULAR FONT, STYLE, SIZE, OR COLOR.

SN 85-298,498, FILED 4-19-2011.

WON TEAK OH, EXAMINING ATTORNEY



*David J. Kyros*

Director of the United States Patent and Trademark Office

# United States of America

United States Patent and Trademark Office

## CrossLink Medical Resources

**Reg. No. 4,136,854**

**Registered May 1, 2012**

**Int. Cl.: 35**

**SERVICE MARK**

**PRINCIPAL REGISTER**

CROSSLINK MEDICAL RESOURCES (PENNSYLVANIA NON-PROFIT CORPORATION)  
103 E. VINE STREET  
HATFIELD, PA 19440

FOR: PROVIDING AN ON-LINE DIRECTORY INFORMATION SERVICE FEATURING INFORMATION REGARDING HEALTH CARE BENEFITS, IN CLASS 35 (U.S. CLS. 100, 101 AND 102).

FIRST USE 4-16-2011; IN COMMERCE 6-1-2011.

THE MARK CONSISTS OF STANDARD CHARACTERS WITHOUT CLAIM TO ANY PARTICULAR FONT, STYLE, SIZE, OR COLOR.

NO CLAIM IS MADE TO THE EXCLUSIVE RIGHT TO USE "MEDICAL RESOURCES", APART FROM THE MARK AS SHOWN.

SN 85-298,694, FILED 4-19-2011.

ANTHONY RINKER, EXAMINING ATTORNEY



*David J. Kybas*

Director of the United States Patent and Trademark Office

# United States of America

United States Patent and Trademark Office



**Reg. No. 4,136,855**

**Registered May 1, 2012**

**Int. Cl.: 35**

**SERVICE MARK**

**PRINCIPAL REGISTER**

CROSSLINK MEDICAL RESOURCES (PENNSYLVANIA NON-PROFIT CORPORATION)  
103 E. VINE STREET  
HATFIELD, PA 19440

FOR: PROVIDING AN ON-LINE DIRECTORY INFORMATION SERVICE FEATURING INFORMATION REGARDING HEALTH CARE BENEFITS, IN CLASS 35 (U.S. CLS. 100, 101 AND 102).

FIRST USE 4-16-2011; IN COMMERCE 6-1-2011.

THE MARK CONSISTS OF THE DRAWING OF A DOVE, WITH OUTSTRETCHED WINGS HOLDING AN ANKH IN ITS BEAK.

SN 85-298,752, FILED 4-19-2011.

ANTHONY RINKER, EXAMINING ATTORNEY



*David J. Kybas*

Director of the United States Patent and Trademark Office

# United States of America

United States Patent and Trademark Office



**Reg. No. 4,136,856**

**Registered May 1, 2012**

**Int. Cl.: 41**

**SERVICE MARK**

**PRINCIPAL REGISTER**

RELAX LACROSSE CLUBS, INC. (PENNSYLVANIA CORPORATION)  
1241 WISTERIA DRIVE  
MALVERN, PA 19355

FOR: AMATEUR YOUTH SPORTS SERVICES, NAMELY, ORGANIZING AND PROVIDING YOUTH SPORTS ACTIVITIES, IN CLASS 41 (U.S. CLS. 100, 101 AND 107).

FIRST USE 4-14-2011; IN COMMERCE 4-14-2011.

THE MARK CONSISTS OF THE FOLLOWING: SMALL LETTERS "RE" AND "LAX" SHOWN IN THE COLOR BLUE AND OUTLINED IN YELLOW, WITH A BLUE, WHITE, AND BLACK LACROSSE STICK UNDERNEATH, AND A YELLOW PEACE SIGN APPEARING BETWEEN THE TERMS "RE" AND "LAX".

THE COLOR(S) BLUE, YELLOW, WHITE AND BLACK IS/ARE CLAIMED AS A FEATURE OF THE MARK.

SN 85-298,785, FILED 4-19-2011.

PAM WILLIS, EXAMINING ATTORNEY



*David J. Kybas*

Director of the United States Patent and Trademark Office

# United States of America

United States Patent and Trademark Office

## CRAYOLA CREATIONS

**Reg. No. 4,136,857**

**Registered May 1, 2012**

**Int. Cl.: 16**

**TRADEMARK**

**PRINCIPAL REGISTER**

CRAYOLA PROPERTIES, INC. (DELAWARE CORPORATION)  
1100 CHURCH LANE  
EASTON, PA 18042

FOR: CHILDREN'S CRAFT KITS COMPRISED PRIMARILY OF MARKERS, HIGHLIGHTERS, STENCIL SHEETS, STICKER SHEETS, GLITTER GLUE, COLORED PAPER, PATTERNED PAPER, ERASERS, NOTE PADS, CUTOUTS AND ACTIVITY BOOKLETS, IN CLASS 16 (U.S. CLS. 2, 5, 22, 23, 29, 37, 38 AND 50).

FIRST USE 7-30-2011; IN COMMERCE 7-30-2011.

THE MARK CONSISTS OF STANDARD CHARACTERS WITHOUT CLAIM TO ANY PARTICULAR FONT, STYLE, SIZE, OR COLOR.

OWNER OF U.S. REG. NOS. 1,173,166, 3,177,981, AND OTHERS.

SN 85-299,932, FILED 4-20-2011.

TOBY BULLOFF, EXAMINING ATTORNEY



*David J. Kyffers*

Director of the United States Patent and Trademark Office

# United States of America

United States Patent and Trademark Office



**Reg. No. 4,136,858**

**Registered May 1, 2012**

**Int. Cl.: 16**

**TRADEMARK**

**PRINCIPAL REGISTER**

CRAYOLA PROPERTIES, INC. (DELAWARE CORPORATION)  
1100 CHURCH LANE  
EASTON, PA 18042

FOR: CHILDREN'S CRAFT KITS COMPRISED PRIMARILY OF MARKERS, HIGHLIGHTERS, STENCIL SHEETS, STICKER SHEETS, GLITTER GLUE, COLORED PAPER, PATTERNED PAPER, ERASERS, NOTE PADS, CUTOUTS AND ACTIVITY BOOKLETS, IN CLASS 16 (U.S. CLS. 2, 5, 22, 23, 29, 37, 38 AND 50).

FIRST USE 7-30-2011; IN COMMERCE 7-30-2011.

OWNER OF U.S. REG. NOS. 1,173,166, 3,177,981, AND OTHERS.

THE MARK CONSISTS OF THE WORD "CRAYOLA" INSIDE A TILTED OVAL WITH THE WORD "CREATIONS" DEPICTED UNDERNEATH IN STYLIZED LETTERING, WHICH CONTAINS A HEART ABOVE THE LETTER "I".

SN 85-299,952, FILED 4-20-2011.

TOBY BULLOFF, EXAMINING ATTORNEY



*David J. Kyros*

Director of the United States Patent and Trademark Office



# United States of America

United States Patent and Trademark Office

# SUMMIT 6

**Reg. No. 4,136,859**

**Registered May 1, 2012**

**Int. Cls.: 9 and 45**

**TRADEMARK**

**SERVICE MARK**

**PRINCIPAL REGISTER**

SUMMIT 6 LLC (DELAWARE LIMITED LIABILITY COMPANY)  
4925 GREENVILLE AVENUE, SUITE 200  
DALLAS, TX 75206

FOR: SOFTWARE FOR PROVIDING MEDIA PROCESSING AND DATA TRANSMISSION OVER A NETWORK, NAMELY, PROCESSING AND FORMATTING OF MEDIA DATA FOR TRANSMISSION OVER A NETWORK AND DISTRIBUTION OF THE MEDIA DATA OVER A NETWORK, IN CLASS 9 (U.S. CLS. 21, 23, 26, 36 AND 38).

FIRST USE 5-26-2011; IN COMMERCE 5-26-2011.

FOR: LICENSING OF TECHNOLOGY AND SOFTWARE FOR PROVIDING MEDIA PROCESSING AND DATA TRANSMISSION OVER A NETWORK, IN CLASS 45 (U.S. CLS. 100 AND 101).

FIRST USE 7-0-2009; IN COMMERCE 7-0-2009.

THE MARK CONSISTS OF STANDARD CHARACTERS WITHOUT CLAIM TO ANY PARTICULAR FONT, STYLE, SIZE, OR COLOR.

SN 85-299,996, FILED 4-20-2011.

JOHN WILKE, EXAMINING ATTORNEY



*David J. Kyros*

Director of the United States Patent and Trademark Office

# United States of America

United States Patent and Trademark Office

# SUGAR PIE

**Reg. No. 4,136,860**

**Registered May 1, 2012**

**Int. Cl.: 33**

**TRADEMARK**

**PRINCIPAL REGISTER**

VINTAGE WINE ESTATES, INC. (CALIFORNIA CORPORATION)  
205 CONCOURSE BLVD.  
SANTA ROSA, CA 95403

FOR: WINES, IN CLASS 33 (U.S. CLS. 47 AND 49).

FIRST USE 10-5-2011; IN COMMERCE 10-5-2011.

THE MARK CONSISTS OF STANDARD CHARACTERS WITHOUT CLAIM TO ANY PARTICULAR FONT, STYLE, SIZE, OR COLOR.

SN 85-300,839, FILED 4-21-2011.

NICHOLAS COLEMAN, EXAMINING ATTORNEY



*David J. Kyffers*

Director of the United States Patent and Trademark Office

# United States of America

United States Patent and Trademark Office

## HONEY BUNCH

**Reg. No. 4,136,861**

**Registered May 1, 2012**

**Int. Cl.: 33**

**TRADEMARK**

**PRINCIPAL REGISTER**

VINTAGE WINE ESTATES, INC. (CALIFORNIA CORPORATION)  
205 CONCOURSE BLVD.  
SANTA ROSA, CA 95403

FOR: WINES, IN CLASS 33 (U.S. CLS. 47 AND 49).

FIRST USE 10-5-2011; IN COMMERCE 10-5-2011.

THE MARK CONSISTS OF STANDARD CHARACTERS WITHOUT CLAIM TO ANY PARTICULAR FONT, STYLE, SIZE, OR COLOR.

SN 85-300,847, FILED 4-21-2011.

NICHOLAS COLEMAN, EXAMINING ATTORNEY



*David J. Kyffers*

Director of the United States Patent and Trademark Office

# United States of America

United States Patent and Trademark Office

 **universalseries**

**Reg. No. 4,136,862**

**Registered May 1, 2012**

**Int. Cl.: 8**

**TRADEMARK**

**PRINCIPAL REGISTER**

DART INDUSTRIES INC. (DELAWARE CORPORATION)  
14901 S. ORANGE BLOSSOM TRAIL  
ORLANDO, FL 32837

FOR: KNIVES, IN CLASS 8 (U.S. CLS. 23, 28 AND 44).

FIRST USE 9-30-2011; IN COMMERCE 9-30-2011.

OWNER OF U.S. REG. NO. 3,873,296.

THE MARK CONSISTS OF A STYLIZED CAPITAL "U" FOLLOWED BY THE STYLIZED WORDS "UNIVERSALSERIES".

SN 85-300,880, FILED 4-21-2011.

JULIE GUTTADAURO, EXAMINING ATTORNEY



*David J. Kyffers*

Director of the United States Patent and Trademark Office

# United States of America

United States Patent and Trademark Office

# FOLD & GO

**Reg. No. 4,136,863**

**Registered May 1, 2012**

**Int. Cl.: 30**

**TRADEMARK**

**PRINCIPAL REGISTER**

HERSHEY CHOCOLATE & CONFECTIONERY CORPORATION (DELAWARE CORPORATION)  
4860 ROBB STREET, SUITE 204  
WHEAT RIDGE, CO 80033

FOR: CANDY; CANDY SOLD IN RECLOSEABLE FLEXIBLE PLASTIC PACKAGING; RE-CLOSEABLE PACKAGING OFFERED AS A FEATURE OF THE PACKAGED CANDY , IN CLASS 30 (U.S. CL. 46).

FIRST USE 6-1-2011; IN COMMERCE 6-1-2011.

THE MARK CONSISTS OF STANDARD CHARACTERS WITHOUT CLAIM TO ANY PARTICULAR FONT, STYLE, SIZE, OR COLOR.

SN 85-300,907, FILED 4-21-2011.

KATINA MISTER, EXAMINING ATTORNEY



*David J. Kyffers*

Director of the United States Patent and Trademark Office

# United States of America

United States Patent and Trademark Office

# DR. COLE

**Reg. No. 4,136,864**

**Registered May 1, 2012**

**Int. Cl.: 3**

**TRADEMARK**

**PRINCIPAL REGISTER**

PHYSICIANS HAIR TRANSPLANT CENTER, INC. (GEORGIA CORPORATION), AKA  
INTERNATIONAL HAIR TRANSPLANT INSTITUTE,  
1070 POWERS PLACE  
ALPHARETTA, GA 30004

FOR: HAIR CARE PREPARATIONS, IN CLASS 3 (U.S. CLS. 1, 4, 6, 50, 51 AND 52).

FIRST USE 3-14-2011; IN COMMERCE 3-14-2011.

THE MARK CONSISTS OF STANDARD CHARACTERS WITHOUT CLAIM TO ANY PARTICULAR FONT, STYLE, SIZE, OR COLOR.

OWNER OF U.S. REG. NO. 3,986,114.

THE NAME(S), PORTRAIT(S), AND/OR SIGNATURE(S) SHOWN IN THE MARK IDENTIFIES DR JOHN COLE, WHOSE CONSENT(S) TO REGISTER IS MADE OF RECORD.

SN 85-301,011, FILED 4-21-2011.

SHAILA SETTLES, EXAMINING ATTORNEY



*David J. Kybas*

Director of the United States Patent and Trademark Office

# United States of America

United States Patent and Trademark Office

# stoked & broke

**Reg. No. 4,136,865**

**Registered May 1, 2012**

**Int. Cls.: 9 and 25**

**TRADEMARK**

**PRINCIPAL REGISTER**

SUTTON, CYRUS (UNITED STATES INDIVIDUAL)  
1330 KEYSTONE WAY  
SUITE A  
VISTA, CA 92081

FOR: DIGITAL MATERIALS, NAMELY, DVDS, CDS, DOWNLOADABLE MOVIES FEATURING GENERAL ENTERTAINMENT, IN CLASS 9 (U.S. CLS. 21, 23, 26, 36 AND 38).

FIRST USE 1-1-2010; IN COMMERCE 1-1-2010.

FOR: BEANIES; HATS; JACKETS; PANTS; SHIRTS; SOCKS; SWEAT PANTS; SWEAT SHIRTS; SWEATERS; T-SHIRTS; UNDERWEAR, IN CLASS 25 (U.S. CLS. 22 AND 39).

FIRST USE 6-10-2009; IN COMMERCE 1-12-2010.

THE MARK CONSISTS OF STANDARD CHARACTERS WITHOUT CLAIM TO ANY PARTICULAR FONT, STYLE, SIZE, OR COLOR.

SN 85-301,511, FILED 4-21-2011.

DANNEAN HETZEL, EXAMINING ATTORNEY



*David J. Kypos*

Director of the United States Patent and Trademark Office

# United States of America

United States Patent and Trademark Office

## SUMNER STREET HOME HARDWARE

**Reg. No. 4,136,866**

BLASER DIE CASTING CO. (WASHINGTON CORPORATION), DBA CONTINENTAL BRASS,  
PO BOX 30839  
PORTLAND, OR 97294

**Registered May 1, 2012**

**Int. Cl.: 6**

FOR: DECORATIVE FURNITURE HARDWARE, NAMELY, METAL PULLS, IN CLASS 6  
(U.S. CLS. 2, 12, 13, 14, 23, 25 AND 50).

**TRADEMARK**

FIRST USE 1-1-2011; IN COMMERCE 1-1-2011.

**PRINCIPAL REGISTER**

THE MARK CONSISTS OF STANDARD CHARACTERS WITHOUT CLAIM TO ANY PAR-  
TICULAR FONT, STYLE, SIZE, OR COLOR.

NO CLAIM IS MADE TO THE EXCLUSIVE RIGHT TO USE "HOME HARDWARE", APART  
FROM THE MARK AS SHOWN.

SN 85-301,609, FILED 4-21-2011.

HANNO RITTNER, EXAMINING ATTORNEY



*David J. Kyffers*

Director of the United States Patent and Trademark Office



# United States of America

United States Patent and Trademark Office

## THE COLOR OF HAPPINESS

**Reg. No. 4,136,867**

**Registered May 1, 2012**

**Int. Cl.: 41**

**SERVICE MARK**

**PRINCIPAL REGISTER**

EFFECTIVE COMMUNICATIONS LLC (COLORADO LIMITED LIABILITY COMPANY),  
DBA THE COLOR OF HAPPINESS,  
P.O. BOX 10423  
COLORADO SPRINGS, CO 809321423

FOR: EDUCATIONAL SERVICES, NAMELY, MOTIVATIONAL SPEAKING, LECTURING AND CONDUCTING SEMINARS, WORKSHOPS AND CLASSES IN THE FIELD OF SELF-AWARENESS AND SELF-IMPROVEMENT AND DISTRIBUTION OF PRINTED MATERIALS IN CONNECTION THEREWITH; EDUCATIONAL SERVICES, NAMELY, MENTORING IN THE FIELD OF SELF-AWARENESS AND SELF-IMPROVEMENT; LIFE COACHING IN THE FIELD OF SELF-AWARENESS AND SELF-IMPROVEMENT, IN CLASS 41 (U.S. CLS. 100, 101 AND 107).

FIRST USE 4-0-2011; IN COMMERCE 5-21-2011.

THE MARK CONSISTS OF STANDARD CHARACTERS WITHOUT CLAIM TO ANY PARTICULAR FONT, STYLE, SIZE, OR COLOR.

SN 85-302,172, FILED 4-22-2011.

LESLEY LAMOTHE, EXAMINING ATTORNEY



*David J. Kyros*

Director of the United States Patent and Trademark Office

# United States of America

United States Patent and Trademark Office

## NOCHE DE PERROS

**Reg. No. 4,136,868**

UNIVISION COMMUNICATIONS INC. (DELAWARE CORPORATION)  
5999 CENTER DRIVE  
LOS ANGELES, CA 90045

**Registered May 1, 2012**

**Int. Cl.: 41**

FOR: ENTERTAINMENT SERVICES, NAMELY, AN ONGOING LATE NIGHT TELEVISION TALK SHOW, IN CLASS 41 (U.S. CLS. 100, 101 AND 107).

**SERVICE MARK**

FIRST USE 10-31-2011; IN COMMERCE 10-31-2011.

**PRINCIPAL REGISTER**

THE MARK CONSISTS OF STANDARD CHARACTERS WITHOUT CLAIM TO ANY PARTICULAR FONT, STYLE, SIZE, OR COLOR.

THE ENGLISH TRANSLATION OF "NOCHE DE PERROS" IN THE MARK IS NIGHT OF DOGS.

SN 85-302,397, FILED 4-22-2011.

ZACHARY BELLO, EXAMINING ATTORNEY



*David J. Kyros*

Director of the United States Patent and Trademark Office

# United States of America

United States Patent and Trademark Office

## PACTRUST BANK

**Reg. No. 4,136,869**

**Registered May 1, 2012**

**Int. Cl.: 36**

PACIFIC TRUST BANK, A FEDERAL SAVINGS BANK (UNITED STATES CHARTERED BANK)  
11TH FLOOR  
18500 VON KARMAN  
IRVINE, CA 92612

**SERVICE MARK**

**PRINCIPAL REGISTER**

FOR: BANKING SERVICES; ON-LINE BANKING SERVICES; CHECKING ACCOUNT SERVICES; SAVINGS ACCOUNT SERVICES; ELECTRONIC FUND TRANSFER SERVICES; DEBIT CARD SERVICES; TRAVELER'S AND CASHIER'S CHECK ISSUING SERVICES; MONEY ORDER SERVICES; MONETARY EXCHANGE SERVICES; CREDIT CARD SERVICES; AUTOMATED TELLER MACHINE SERVICES; SAFE DEPOSIT BOX SERVICES; ADMINISTRATION OF INDIVIDUAL RETIREMENT ACCOUNTS; FUND INVESTMENT CONSULTATION; INVESTMENT CONSULTATION; COMMERCIAL LENDING SERVICES; CONSUMER LENDING SERVICES; MORTGAGE LENDING SERVICES; LEASE FINANCING SERVICES; EQUIPMENT FINANCING SERVICES; FINANCIAL PLANNING AND INVESTMENT ADVISORY AND CONSULTATION SERVICES; FINANCIAL SERVICES, NAMELY, WEALTH MANAGEMENT AND TRUST ACCOUNT SERVICES; INDIVIDUAL RETIREMENT ACCOUNT SERVICES; ELECTRONIC PAYMENTS, NAMELY, ELECTRONIC PROCESSING AND TRANSMISSION OF BILL PAYMENT DATA; BILL PAYMENT SERVICES PROVIDED THROUGH A WEBSITE; PROVIDING BANK ACCOUNT INFORMATION BY TELEPHONE; BANKING SERVICES PROVIDED BY MOBILE TELEPHONE CONNECTIONS; CASH MANAGEMENT SERVICES, NAMELY, REMOTE DEPOSIT CAPTURE SERVICES, ACH ORIGINATION TRANSACTION PROCESSING SERVICES, WIRE TRANSFER SERVICES IN THE NATURE OF ELECTRONIC FUNDS TRANSFER SERVICES, SWEEP ACCOUNT SERVICES, MERCHANT BANKING SERVICES, BUSINESS CREDIT CARD SERVICES; PROVIDING ON-LINE FINANCIAL CALCULATORS; PROVIDING ELECTRONIC PROCESSING OF ELECTRONIC FUNDS TRANSFER, ACH, CREDIT CARD, DEBIT CARD, ELECTRONIC CHECK AND ELECTRONIC PAYMENTS; PROVIDING INFORMATION AND ADVICE IN THE FIELD OF FINANCE, FINANCIAL INVESTMENTS, FINANCIAL VALUATIONS, AND THE FINANCIAL ASPECTS OF RETIREMENT; INFORMATION, ADVISORY, CONSULTANCY AND RESEARCH SERVICES RELATING TO FINANCE AND INVESTMENTS, IN CLASS 36 (U.S. CLS. 100, 101 AND 102).



*David J. Kyros*

Director of the United States Patent and Trademark Office

FIRST USE 5-31-2011; IN COMMERCE 5-31-2011.

THE MARK CONSISTS OF STANDARD CHARACTERS WITHOUT CLAIM TO ANY PARTICULAR FONT, STYLE, SIZE, OR COLOR.

**Reg. No. 4,136,869** NO CLAIM IS MADE TO THE EXCLUSIVE RIGHT TO USE "BANK", APART FROM THE MARK AS SHOWN.

SN 85-304,050, FILED 4-25-2011.

BARBARA GAYNOR, EXAMINING ATTORNEY

# United States of America

United States Patent and Trademark Office



**Reg. No. 4,136,870**

**Registered May 1, 2012**

**Int. Cl.: 45**

**SERVICE MARK**

**PRINCIPAL REGISTER**

REDFLAG SOFTWARE, INC. (DELAWARE CORPORATION)  
C/O 720 NORTH POST OAK RD STE 300  
HOUSTON, TX 77024

FOR: ONLINE PRIVACY AND SECURITY SERVICES IN THE FIELD OF SOCIAL NETWORKING, NAMELY, THE IDENTIFICATION OF POTENTIALLY DANGEROUS OR DECEPTIVE SOCIAL-NETWORKING CONTACTS AND THE PROVISION OF INFORMATION AND REPORTS ABOUT SUCH CONTACTS TO ONLINE SOCIAL-NETWORKING USERS, THEIR PARENTS AND/OR GUARDIANS, IN CLASS 45 (U.S. CLS. 100 AND 101).

FIRST USE 12-7-2011; IN COMMERCE 12-7-2011.

THE MARK CONSISTS OF A TRIANGLE SURROUNDING A FLAG.

SN 85-306,006, FILED 4-27-2011.

REBECCA EISINGER, EXAMINING ATTORNEY



*David J. Kybas*

Director of the United States Patent and Trademark Office

# United States of America

United States Patent and Trademark Office

# SOFTOPIA

**Reg. No. 4,136,871**

**Registered May 1, 2012**

**Int. Cl.: 16**

**TRADEMARK**

**PRINCIPAL REGISTER**

TOTAL PAPER AND PACKAGING, INC. (CALIFORNIA CORPORATION)  
21130 SUPERIOR STREET  
CHATSWORTH, CA 91311

FOR: TOILET PAPER, PAPER TOWELS, FACIAL TISSUES AND PAPER NAPKINS, IN CLASS  
16 (U.S. CLS. 2, 5, 22, 23, 29, 37, 38 AND 50).

FIRST USE 1-3-2012; IN COMMERCE 1-3-2012.

THE MARK CONSISTS OF STANDARD CHARACTERS WITHOUT CLAIM TO ANY PAR-  
TICULAR FONT, STYLE, SIZE, OR COLOR.

SN 85-306,282, FILED 4-27-2011.

SUNG IN, EXAMINING ATTORNEY



*David J. Kyros*

Director of the United States Patent and Trademark Office

# United States of America

United States Patent and Trademark Office



**Reg. No. 4,136,872**

**Registered May 1, 2012**

**Int. Cl.: 9**

**TRADEMARK**

**PRINCIPAL REGISTER**

STAND FOR STUFF LLC (WASHINGTON LIMITED LIABILITY COMPANY)  
607 32ND AVE.  
SEATTLE, WA 98122

FOR: STANDS AND CASES FOR TABLET COMPUTERS AND ELECTRONIC BOOK READERS, IN CLASS 9 (U.S. CLS. 21, 23, 26, 36 AND 38).

FIRST USE 11-8-2011; IN COMMERCE 11-8-2011.

THE MARK CONSISTS OF A CLOSED, RAISED FIST HOLDING THE WORDS "STAND FOR STUFF". THE WORDS ANGLE UP AND TO THE RIGHT.

SN 85-306,564, FILED 4-27-2011.

GEORGE LORENZO, EXAMINING ATTORNEY



*David J. Kyffers*

Director of the United States Patent and Trademark Office

# United States of America

United States Patent and Trademark Office

**Puro sabor Nacional**

**Reg. No. 4,136,873**

**Registered May 1, 2012**

**Int. Cl.: 32**

**TRADEMARK**

**PRINCIPAL REGISTER**

BALORU S.A. (ECUADOR SOCIEDAD ANONIMA (SA))  
KM. 16 1/2 VIA DAULE  
GUAYAQUIL, ECUADOR

FOR: SOFT DRINKS, IN CLASS 32 (U.S. CLS. 45, 46 AND 48).

FIRST USE 0-0-1994; IN COMMERCE 0-0-2007.

OWNER OF U.S. REG. NO. 1,474,395.

NO CLAIM IS MADE TO THE EXCLUSIVE RIGHT TO USE "PURO SABOR", APART FROM THE MARK AS SHOWN.

THE MARK CONSISTS OF THE WORDING "PURO SABOR NACIONAL", ALL IN LOWER CASE EXCEPT THE "N" IN "NACIONAL" WITH THE WORDS ARRANGED IN A WAVE SHAPE.

THE ENGLISH TRANSLATION OF "PURO SABOR NACIONAL" IN THE MARK IS "REAL NATIONAL FLAVOR".

SN 85-306,888, FILED 4-28-2011.

ANNE E. GUSTASON, EXAMINING ATTORNEY



*David J. Kyffers*

Director of the United States Patent and Trademark Office



# United States of America

United States Patent and Trademark Office

## PURO SABOR NACIONAL

**Reg. No. 4,136,874**

**Registered May 1, 2012**

**Int. Cl.: 32**

**TRADEMARK**

**PRINCIPAL REGISTER**

BALORU S.A. (ECUADOR SOCIEDAD ANONIMA (SA))  
KM. 16 1/2 VIA DAULE  
GUAYAQUIL, ECUADOR

FOR: SOFT DRINKS, IN CLASS 32 (U.S. CLS. 45, 46 AND 48).

FIRST USE 0-0-1971; IN COMMERCE 0-0-1994.

THE MARK CONSISTS OF STANDARD CHARACTERS WITHOUT CLAIM TO ANY PARTICULAR FONT, STYLE, SIZE, OR COLOR.

OWNER OF U.S. REG. NO. 1,474,395.

NO CLAIM IS MADE TO THE EXCLUSIVE RIGHT TO USE "PURO SABOR", APART FROM THE MARK AS SHOWN.

THE ENGLISH TRANSLATION OF "PURO SABOR NACIONAL" IN THE MARK IS "REAL NATIONAL FLAVOR".

SN 85-306,996, FILED 4-28-2011.

ANNE E. GUSTASON, EXAMINING ATTORNEY



*David J. Kyros*

Director of the United States Patent and Trademark Office

# United States of America

United States Patent and Trademark Office

# TUSK

**Reg. No. 4,136,875**

**Registered May 1, 2012**

**Int. Cl.: 7**

**TRADEMARK**

**PRINCIPAL REGISTER**

TUNDRA EQUIPMENT COMPANY (DELAWARE CORPORATION)  
4520 MAIN ST., SUITE 1100  
C/O SNR REGISTERED AGENT SERVICES  
KANSAS CITY, MO 64111

FOR: FLOOR CLEANING MACHINES; FLOOR MACHINES FOR BUFFING, BURNISHING, POLISHING, SCRUBBING AND STRIPPING; DRYING MACHINES FOR CARPETS AND FLOORS, IN CLASS 7 (U.S. CLS. 13, 19, 21, 23, 31, 34 AND 35).

FIRST USE 9-30-2011; IN COMMERCE 9-30-2011.

THE MARK CONSISTS OF STANDARD CHARACTERS WITHOUT CLAIM TO ANY PARTICULAR FONT, STYLE, SIZE, OR COLOR.

SN 85-307,187, FILED 4-28-2011.

JULIE GUTTADAURO, EXAMINING ATTORNEY



*David J. Kybas*

Director of the United States Patent and Trademark Office

# United States of America

United States Patent and Trademark Office

## OBRA NEGRA

**Reg. No. 4,136,876**

**Registered May 1, 2012**

**Int. Cl.: 43**

**SERVICE MARK**

**PRINCIPAL REGISTER**

GUILLERMO, OLGUIN (UNITED STATES INDIVIDUAL)  
174 ELIZABETH STREET  
NEW YORK, NY 10012

FOR: RESTAURANT SERVICES; BAR SERVICES, IN CLASS 43 (U.S. CLS. 100 AND 101).

FIRST USE 5-0-2011; IN COMMERCE 5-0-2011.

THE MARK CONSISTS OF STANDARD CHARACTERS WITHOUT CLAIM TO ANY PARTICULAR FONT, STYLE, SIZE, OR COLOR.

THE ENGLISH TRANSLATION OF "OBRA NEGRA" IN THE MARK IS "BLACK WORK".

SN 85-307,232, FILED 4-28-2011.

ZHALEH DELANEY, EXAMINING ATTORNEY



*David J. Kybas*

Director of the United States Patent and Trademark Office

# United States of America

United States Patent and Trademark Office



**Reg. No. 4,136,877**

**Registered May 1, 2012**

**Int. Cl.: 3**

**TRADEMARK**

**PRINCIPAL REGISTER**

ROMO, JOSE ISMAEL (MEXICO INDIVIDUAL)  
CIRCUITO LOMA NORTE 9109  
TONALA JALISCO, MEXICO 45418

FOR: ANTI-AGING CREAM; BODY CREAMS; CLEANSING CREAMS; HAIR CONDITIONER;  
HAIR SHAMPOO, IN CLASS 3 (U.S. CLS. 1, 4, 6, 50, 51 AND 52).

FIRST USE 10-10-2011; IN COMMERCE 10-10-2011.

THE MARK CONSISTS OF THE FOLLOWING: GRAY RECTANGLE WITH THE LETTERS  
"REL" IN BLACK, THE LETTER "O" IN WHITE INSIDE A BLACK SQUARE ABOVE THE  
WORD "INNOVATION" IN GRAY AND A RED RIBBON.

THE COLOR(S) GRAY, WHITE, RED AND BLACK IS/ARE CLAIMED AS A FEATURE OF  
THE MARK.

SN 85-307,285, FILED 4-28-2011.

WON TEAK OH, EXAMINING ATTORNEY



*David J. Kybas*

Director of the United States Patent and Trademark Office

# United States of America

United States Patent and Trademark Office

## ADVANCING YOUR SAFETY

**Reg. No. 4,136,878**

**Registered May 1, 2012**

**Int. Cl.: 9**

**TRADEMARK**

**PRINCIPAL REGISTER**

RPB, LTD. (NEW ZEALAND CORPORATION)  
5450 WEST 83RD STREET  
LOS ANGELES, CA 90045

FOR: RESPIRATORS FOR NON-MEDICAL USE; AIR FILTERS FOR RESPIRATORY MASKS NOT USED FOR MEDICAL PURPOSES; AIR MONITORS NOT FOR MEDICAL USE, IN CLASS 9 (U.S. CLS. 21, 23, 26, 36 AND 38).

FIRST USE 4-20-2011; IN COMMERCE 4-20-2011.

THE MARK CONSISTS OF STANDARD CHARACTERS WITHOUT CLAIM TO ANY PARTICULAR FONT, STYLE, SIZE, OR COLOR.

SN 85-308,914, FILED 4-29-2011.

JEFFREY LOOK, EXAMINING ATTORNEY



*David J. Kybas*

Director of the United States Patent and Trademark Office

# United States of America

United States Patent and Trademark Office



**Reg. No. 4,136,879**

**Registered May 1, 2012**

**Int. Cls.: 9 and 41**

**TRADEMARK**

**SERVICE MARK**

**PRINCIPAL REGISTER**

CLEAR COMPASS MEDIA, LLC (CALIFORNIA LIMITED LIABILITY COMPANY)  
1840 41ST AVE  
SUITE 102-243  
CAPITOLA, CA 95010

FOR: DIGITAL MEDIA, NAMELY, PRE-RECORDED VIDEO TAPES, CDS, DVDS, OPTICAL AND MAGNETO-OPTICAL DISCS FEATURING AUDIOVISUAL WORKS IN THE NATURE OF DOCUMENTARY FILMS; DOWNLOADABLE RING TONES FOR MOBILE PHONES; DOWNLOADABLE AUDIOVISUAL AND AUDIO FILES IN THE NATURE OF DOCUMENTARY FILMS, IN CLASS 9 (U.S. CLS. 21, 23, 26, 36 AND 38).

FIRST USE 11-11-2011; IN COMMERCE 11-11-2011.

FOR: ENTERTAINMENT SERVICES, NAMELY, PRODUCTION AND DISTRIBUTION OF MOTION PICTURE FILMS ON A WIDE VARIETY OF THEMES; DISTRIBUTION OF DIGITAL AND ELECTRONIC MEDIA IN THE NATURE OF VIDEOS, MOVIES, PICTURES, IMAGES, TEXT, PHOTOS FEATURING MULTIMEDIA AND AUDIO CONTENT ABOUT DOCUMENTARY FILMS AND RELATED ENTERTAINMENT INFORMATION VIA THE INTERNET AND OTHER COMMUNICATIONS NETWORKS, NAMELY, PROVISION OF NON-DOWNLOADABLE DOCUMENTARY FILMS AND MOVIES VIA A VIDEO-ON-DEMAND SERVICE, IN CLASS 41 (U.S. CLS. 100, 101 AND 107).

FIRST USE 1-1-2011; IN COMMERCE 11-11-2011.

NO CLAIM IS MADE TO THE EXCLUSIVE RIGHT TO USE "MEDIA", APART FROM THE MARK AS SHOWN.

THE COLOR(S) BLACK, BLUE, GREEN, ORANGE, PURPLE, YELLOW, AND WHITE IS/ARE CLAIMED AS A FEATURE OF THE MARK.

THE MARK CONSISTS OF THE STYLIZED WHITE WORDING "CLEAR COMPASS MEDIA" AND GLOBE AND ARROW DESIGNS ON A BLACK BACKGROUND. THE GLOBE WITH CONTINENTS HAS BLUE OCEANS, WHITE CLOUDS, AND ORANGE, GREEN, AND YELLOW HIGHLIGHTS ON THE CONTINENTS. THE GLOBE IS WITHIN A PURPLE CIRCLE. THERE IS A BLUE VERTICAL ARROW AND BLUE CIRCLE WITH BLUE ARROW HEADS.



*David J. Kyros*

Director of the United States Patent and Trademark Office

SN 85-309,222, FILED 4-30-2011.

**Reg. No. 4,136,879** BRIAN PINO, EXAMINING ATTORNEY

# United States of America

United States Patent and Trademark Office



**Reg. No. 4,136,880**

**Registered May 1, 2012**

**Int. Cls.: 14, 20, and 25**

**TRADEMARK**

**PRINCIPAL REGISTER**

ANDERSON, COLLEEN (UNITED STATES INDIVIDUAL), DBA DEFEAT NOT ALLOWED,  
1508 S OGDEN DRIVE  
LOS ANGELES, CA 90019

FOR: COSTUME JEWELRY, IN CLASS 14 (U.S. CLS. 2, 27, 28 AND 50).

FIRST USE 10-13-2011; IN COMMERCE 11-18-2011.

FOR: ACCENT PILLOWS, IN CLASS 20 (U.S. CLS. 2, 13, 22, 25, 32 AND 50).

FIRST USE 10-13-2001; IN COMMERCE 11-18-2011.

FOR: BASEBALL CAPS AND HATS; BELTS; SHORT-SLEEVED OR LONG-SLEEVED T-SHIRTS; T-SHIRTS; T-SHIRTS FOR WOMEN, MEN, CHILDREN, IN CLASS 25 (U.S. CLS. 22 AND 39).

FIRST USE 10-13-2011; IN COMMERCE 11-18-2011.

THE MARK CONSISTS OF THE TERM "DNA" IN LIGHT PINK IN WHICH THE "A" IS FORMED BY A RIBBON, ABOVE THE WORDING "DEFEAT NOT ALLOWED" IN LIGHT PINK.

THE COLOR(S) LIGHT PINK IS/ARE CLAIMED AS A FEATURE OF THE MARK.

SN 85-309,302, FILED 5-1-2011.

LEIGH CAROLINE CASE, EXAMINING ATTORNEY



*David J. Kybas*

Director of the United States Patent and Trademark Office



# United States of America

United States Patent and Trademark Office



Recipes: *Collect. Organize. Share.*

**Reg. No. 4,136,881**

**Registered May 1, 2012**

**Int. Cl.: 43**

**SERVICE MARK**

**PRINCIPAL REGISTER**

SUZANNE FLOREK, INC. (ILLINOIS CORPORATION)  
3907 WOODLAND AVENUE  
WESTERN SPRINGS, IL 60558

FOR: PROVIDING A WEBSITE FEATURING A SEARCHABLE DATABASE OF RECIPES, FOOD-RELATED PHOTOGRAPHS AND COOKING INFORMATION, IN CLASS 43 (U.S. CLS. 100 AND 101).

FIRST USE 7-13-2011; IN COMMERCE 7-13-2011.

THE MARK CONSISTS OF THE WORDS "SALTY FIG RECIPES: COLLECT. ORGANIZE. SHARE." ALONG WITH A FANCIFUL SILHOUETTE OF A FIG WITH A STAR DESIGN.

SN 85-309,856, FILED 5-2-2011.

MARK SHINER, EXAMINING ATTORNEY



*David J. Kyffers*

Director of the United States Patent and Trademark Office

# United States of America

United States Patent and Trademark Office

## EVENLY RADIANT

**Reg. No. 4,136,882**

**Registered May 1, 2012**

**Int. Cl.: 3**

**TRADEMARK**

**PRINCIPAL REGISTER**

STEARN'S PRODUCTS, INC. (CALIFORNIA CORPORATION)  
4485 RUNWAY STREET  
SIMI VALLEY, CA 93063

FOR: SKIN CARE PREPARATIONS, NAMELY, CREAMS, LOTIONS, BODY AND FACIAL SCRUBS, SKIN PEELS, EYE CREAM, TONERS, CLEANSERS, COSMETIC ASTRINGENTS, MASKS, MAKE-UP REMOVER, SUN SCREEN LOTION AND BODY WASH, IN CLASS 3 (U.S. CLS. 1, 4, 6, 50, 51 AND 52).

FIRST USE 2-16-2012; IN COMMERCE 2-16-2012.

THE MARK CONSISTS OF STANDARD CHARACTERS WITHOUT CLAIM TO ANY PARTICULAR FONT, STYLE, SIZE, OR COLOR.

SN 85-310,386, FILED 5-2-2011.

ANTHONY RINKER, EXAMINING ATTORNEY



*David J. Kyffers*

Director of the United States Patent and Trademark Office

# United States of America

United States Patent and Trademark Office

## ThinkBreatheLive

**Reg. No. 4,136,883**

**Registered May 1, 2012**

**Int. Cls.: 35 and 41**

**SERVICE MARK**

**PRINCIPAL REGISTER**

BREATHE EDITING, INC. (NEW YORK CORPORATION)  
12 WEST 21ST STREET  
10TH FLOOR  
NEW YORK, NY 10010

FOR: ADVERTISING AGENCIES; ADVERTISING AND ADVERTISEMENT SERVICES; ADVERTISING AND MARKETING; ADVERTISING AND MARKETING SERVICES PROVIDED BY MEANS OF INDIRECT METHODS OF MARKETING COMMUNICATIONS, NAMELY, SOCIAL MEDIA, SEARCH ENGINE MARKETING, INQUIRY MARKETING, INTERNET MARKETING, MOBILE MARKETING, BLOGGING AND OTHER FORMS OF PASSIVE, SHARABLE OR VIRAL COMMUNICATIONS CHANNELS; ADVERTISING AND PROMOTION SERVICES AND RELATED CONSULTING; MEDIA PLANNING, NAMELY, ADVISING THE CLIENT ON THE CORRECT TIMES AND STATIONS TO ADVERTISE BASED ON MEDIA ANALYSIS OF THE MARKET FOR THAT MEDIA; POST-PRODUCTION EDITING SERVICES FOR VIDEO AND AUDIO COMMERCIALS , IN CLASS 35 (U.S. CLS. 100, 101 AND 102).

FIRST USE 5-5-2011; IN COMMERCE 5-5-2011.

FOR: POST-PRODUCTION EDITING SERVICES IN THE FIELD OF MUSIC, VIDEOS AND FILM; PRODUCTION OF MUSICAL VIDEOS; PRODUCTION OF VISUAL EFFECTS FOR VIDEOS, DVDS, TELEVISION AND FOR INTERNET WEB SITES, IN CLASS 41 (U.S. CLS. 100, 101 AND 107).

FIRST USE 5-5-2011; IN COMMERCE 5-5-2011.

THE MARK CONSISTS OF STANDARD CHARACTERS WITHOUT CLAIM TO ANY PARTICULAR FONT, STYLE, SIZE, OR COLOR.

SN 85-310,995, FILED 5-3-2011.

JILL C. ALT, EXAMINING ATTORNEY



*David J. Kyffers*

Director of the United States Patent and Trademark Office

# United States of America

United States Patent and Trademark Office

## JUICY TROPICAL

**Reg. No. 4,136,884**

**Registered May 1, 2012**

**Int. Cl.: 30**

**TRADEMARK**

**PRINCIPAL REGISTER**

WM. WRIGLEY JR. COMPANY (DELAWARE CORPORATION)  
410 N. MICHIGAN AVENUE  
CHICAGO, IL 60611

FOR: CHEWING GUM, IN CLASS 30 (U.S. CL. 46).

FIRST USE 12-0-2011; IN COMMERCE 12-0-2011.

THE MARK CONSISTS OF STANDARD CHARACTERS WITHOUT CLAIM TO ANY PARTICULAR FONT, STYLE, SIZE, OR COLOR.

OWNER OF U.S. REG. NOS. 105,032, 2,836,550, AND OTHERS.

SN 85-311,054, FILED 5-3-2011.

ANNE E. GUSTASON, EXAMINING ATTORNEY



*David J. Kyffers*

Director of the United States Patent and Trademark Office

# United States of America

United States Patent and Trademark Office

## Ultimate Kleen

**Reg. No. 4,136,885**

ULTIMATE UNITY, INC. (INDIANA CORPORATION)  
8555 W.US HIGHWAY 20 W.  
MICHIGAN CITY, IN 46360

**Registered May 1, 2012**

**Int. Cl.: 1**

FOR: CHEMICAL PREPARATIONS, NAMELY, DEGREASING AND CLEANING SOLVENTS,  
IN CLASS 1 (U.S. CLS. 1, 5, 6, 10, 26 AND 46).

**TRADEMARK**

FIRST USE 11-1-2011; IN COMMERCE 11-1-2011.

**PRINCIPAL REGISTER**

THE MARK CONSISTS OF STANDARD CHARACTERS WITHOUT CLAIM TO ANY PAR-  
TICULAR FONT, STYLE, SIZE, OR COLOR.

NO CLAIM IS MADE TO THE EXCLUSIVE RIGHT TO USE "CLEAN", APART FROM THE  
MARK AS SHOWN.

SN 85-312,051, FILED 5-4-2011.

H. M. FISHER, EXAMINING ATTORNEY



*David J. Kybas*

Director of the United States Patent and Trademark Office

# United States of America

United States Patent and Trademark Office

## FIRE UP YOUR FEET!

**Reg. No. 4,136,886**

**Registered May 1, 2012**

**Int. Cls.: 35 and 36**

**SERVICE MARK**

**PRINCIPAL REGISTER**

BIKES BELONG COALITION, LTD (WISCONSIN NON-STOCK CORPORATION)  
207 CANYON BLVD, SUITE 202  
BOULDER, CO 80302

FOR: PROMOTING PUBLIC AWARENESS OF CHILDHOOD PHYSICAL FITNESS AND EXERCISE, NAMELY, BICYCLING AND WALKING; PUBLIC ADVOCACY TO PROMOTE AND ENCOURAGE CHILDHOOD PHYSICAL FITNESS AND EXERCISE, NAMELY, BICYCLING AND WALKING; PROVIDING INFORMATION ABOUT CHILDHOOD PHYSICAL FITNESS AND EXERCISE, NAMELY, BICYCLING AND WALKING, VIA THE INTERNET, IN CLASS 35 (U.S. CLS. 100, 101 AND 102).

FIRST USE 8-22-2011; IN COMMERCE 8-22-2011.

FOR: PROVIDING GRANTS FOR CHILDHOOD PHYSICAL FITNESS AND EXERCISE PROGRAMS, NAMELY, BICYCLING AND WALKING; CHARITABLE FUNDRAISING TO SUPPORT CHILDHOOD PHYSICAL FITNESS AND EXERCISE PROGRAMS, NAMELY, BICYCLING AND WALKING, IN CLASS 36 (U.S. CLS. 100, 101 AND 102).

FIRST USE 8-22-2011; IN COMMERCE 8-22-2011.

THE MARK CONSISTS OF STANDARD CHARACTERS WITHOUT CLAIM TO ANY PARTICULAR FONT, STYLE, SIZE, OR COLOR.

SN 85-312,241, FILED 5-4-2011.

JEFF DEFORD, EXAMINING ATTORNEY



*David J. Kybas*

Director of the United States Patent and Trademark Office

# United States of America

United States Patent and Trademark Office

# GiftAShare

**Reg. No. 4,136,887**

BAUER, PHILLIP, A (UNITED STATES INDIVIDUAL)  
2970 GALE ROAD  
WILLOUGHBY, OH 44094

**Registered May 1, 2012**

**Int. Cl.: 36**

FOR: STOCK BROKERAGE SERVICES, IN CLASS 36 (U.S. CLS. 100, 101 AND 102).

**SERVICE MARK**

FIRST USE 11-27-2011; IN COMMERCE 12-24-2011.

**PRINCIPAL REGISTER**

THE MARK CONSISTS OF STANDARD CHARACTERS WITHOUT CLAIM TO ANY PARTICULAR FONT, STYLE, SIZE, OR COLOR.

SN 85-312,620, FILED 5-4-2011.

SHANNON TWOHIG, EXAMINING ATTORNEY



*David J. Kyffers*

Director of the United States Patent and Trademark Office

# United States of America

United States Patent and Trademark Office

## SUITE PERFECTION

**Reg. No. 4,136,888**

**Registered May 1, 2012**

**Int. Cl.: 24**

**TRADEMARK**

**PRINCIPAL REGISTER**

HOME SOURCE INTERNATIONAL (GEORGIA CORPORATION)  
SUITE 120  
1100 WESTLAKE PARKWAY  
ATLANTA, GA 30336

FOR: BEACH TOWELS, BATH TOWELS, KITCHEN TOWELS, TABLECLOTHS, TABLE RUNNERS ALL MADE OF FABRIC; VINYL TABLECLOTHS, TABLE MATS MADE OF FABRIC, BED SHEETS, PILLOWCASES, COMFORTERS, IN CLASS 24 (U.S. CLS. 42 AND 50).

FIRST USE 1-1-2012; IN COMMERCE 1-1-2012.

THE MARK CONSISTS OF STANDARD CHARACTERS WITHOUT CLAIM TO ANY PARTICULAR FONT, STYLE, SIZE, OR COLOR.

OWNER OF U.S. REG. NOS. 2,976,137, 3,797,059, AND 3,929,104.

SN 85-312,650, FILED 5-4-2011.

TARA PATE, EXAMINING ATTORNEY



*David J. Kybas*

Director of the United States Patent and Trademark Office



# United States of America

United States Patent and Trademark Office

## PAWS GALORE

**Reg. No. 4,136,889**

**Registered May 1, 2012**

**Int. Cl.: 9**

**TRADEMARK**

**PRINCIPAL REGISTER**

AINSWORTH GAME TECHNOLOGY LIMITED (AUSTRALIA LIMITED LIABILITY COMPANY)  
10 HOLKER STREET  
NEWINGTON, AUSTRALIA

FOR: COMPUTER SOFTWARE AND FIRMWARE FOR GAMES OF CHANCE ON ANY COMPUTERIZED PLATFORM, INCLUDING DEDICATED GAMING CONSOLES, VIDEO BASED SLOT MACHINES, REEL BASED SLOT MACHINES, AND VIDEO LOTTERY TERMINALS, IN CLASS 9 (U.S. CLS. 21, 23, 26, 36 AND 38).

FIRST USE 2-12-2012; IN COMMERCE 2-12-2012.

THE MARK CONSISTS OF STANDARD CHARACTERS WITHOUT CLAIM TO ANY PARTICULAR FONT, STYLE, SIZE, OR COLOR.

SN 85-312,834, FILED 5-5-2011.

JOHN HWANG, EXAMINING ATTORNEY



*David J. Kyffers*

Director of the United States Patent and Trademark Office

# United States of America

United States Patent and Trademark Office

## PARTS FOR A CAUSE

**Reg. No. 4,136,890**

**Registered May 1, 2012**

**Int. Cl.: 35**

**SERVICE MARK**

**PRINCIPAL REGISTER**

PARTS FOR A CAUSE, INC. (GEORGIA CORPORATION)  
460 HORIZON DRIVE, SUITE 100  
SUWANEE, GA 300243114

FOR: ONLINE RETAIL AND WHOLESALE DISTRIBUTORSHIP SERVICES IN THE FIELD OF AUTOMOBILE AND LIGHT TRUCK REPLACEMENT PARTS AND ACCESSORIES; ELECTRONIC, MAIL ORDER, AND WEB BASED CATALOG SERVICES IN THE FIELD OF AUTOMOBILE AND LIGHT TRUCK REPLACEMENT PARTS AND ACCESSORIES, IN CLASS 35 (U.S. CLS. 100, 101 AND 102).

FIRST USE 11-0-2011; IN COMMERCE 11-0-2011.

THE MARK CONSISTS OF STANDARD CHARACTERS WITHOUT CLAIM TO ANY PARTICULAR FONT, STYLE, SIZE, OR COLOR.

NO CLAIM IS MADE TO THE EXCLUSIVE RIGHT TO USE "PARTS", APART FROM THE MARK AS SHOWN.

SN 85-313,343, FILED 5-5-2011.

COLLEEN DOMBROW, EXAMINING ATTORNEY



*David J. Kyros*

Director of the United States Patent and Trademark Office

# United States of America

United States Patent and Trademark Office

# StayToday

**Reg. No. 4,136,891**

**Registered May 1, 2012**

**Int. Cl.: 42**

**SERVICE MARK**

**PRINCIPAL REGISTER**

STAYTODAY, LLC (ILLINOIS LIMITED LIABILITY COMPANY)  
9654 W 131ST ST #311  
PALOS PARK, IL 60464

FOR: PROVIDING A WEBSITE FEATURING TECHNOLOGY THAT ENABLES USERS TO INTERACT FOR THE RENTAL OF VACATION AND SHORT-TERM PROPERTIES, IN CLASS 42 (U.S. CLS. 100 AND 101).

FIRST USE 12-1-2011; IN COMMERCE 12-1-2011.

THE MARK CONSISTS OF STANDARD CHARACTERS WITHOUT CLAIM TO ANY PARTICULAR FONT, STYLE, SIZE, OR COLOR.

SN 85-313,522, FILED 5-5-2011.

JAY BESCH, EXAMINING ATTORNEY



*David J. Kyros*

Director of the United States Patent and Trademark Office

# United States of America

United States Patent and Trademark Office



**Reg. No. 4,136,892**

**Registered May 1, 2012**

**Int. Cl.: 35**

**SERVICE MARK**

**PRINCIPAL REGISTER**

LAWRENCE EXECUTIVE ALLIANCE OF PROFESSIONALS, LLC (D.C. LIMITED LIABILITY COMPANY)  
WWW.LEAP4STAFFING.COM  
1111 23RD ST, NW SUITE 2G  
WASHINGTON, DC 20037

FOR: PROFESSIONAL STAFFING AND RECRUITING SERVICES, IN CLASS 35 (U.S. CLS. 100, 101 AND 102).

FIRST USE 8-20-2007; IN COMMERCE 8-20-2007.

NO CLAIM IS MADE TO THE EXCLUSIVE RIGHT TO USE "PROVIDING STAFFING SOLUTIONS", APART FROM THE MARK AS SHOWN.

THE COLOR(S) OLIVE, LIGHT GREEN, DARK GREEN, BLACK, WHITE, GRAY AND BROWN IS/ARE CLAIMED AS A FEATURE OF THE MARK.

THE MARK CONSISTS OF THE WORDING "LEAP PROVIDING STAFFING SOLUTIONS" WITH A DESIGN OF A FROG AND A MAN JUMPING, WITH A LINE RUNNING THROUGH THE WORD "LEAP". THE COLOR OLIVE APPEARS IN THE LETTERS "L" AND "P" IN THE WORD "LEAP". THE COLOR LIGHT GREEN APPEARS IN THE LETTERS "E" AND "A" IN THE WORD "LEAP", AND IN THE LINE. THE COLOR DARK GREEN APPEARS IN THE WORDING "PROVIDING STAFFING SOLUTIONS", IN THE FROG, AND IN THE LINE. THE COLOR BLACK APPEARS IN THE OUTLINE OF THE FROG AND IN THE DEPICTION OF A MAN JUMPING. THE COLOR WHITE AND THE COLOR BROWN APPEAR IN THE MAN. THE COLOR GRAY APPEARS IN THE PATH FROM THE FROG TO THE MAN.

SN 85-313,640, FILED 5-5-2011.

NICHOLAS ALTREE, EXAMINING ATTORNEY



*David J. Kypos*

Director of the United States Patent and Trademark Office

# United States of America

United States Patent and Trademark Office

# Torment

**Reg. No. 4,136,893**

**Registered May 1, 2012**

**Int. Cl.: 42**

**SERVICE MARK**

**PRINCIPAL REGISTER**

DE CARVALHO VALLE, RAMON (BRAZIL INDIVIDUAL)  
RUA JOAQUIM MAXIMO SOARES, 297 CASA 18  
NILOPOLIS, RJ, BRAZIL 26510-193

FOR: RESEARCH AND DEVELOPMENT OF COMPUTER SOFTWARE, IN CLASS 42 (U.S. CLS. 100 AND 101).

FIRST USE 1-12-2012; IN COMMERCE 1-12-2012.

THE MARK CONSISTS OF STANDARD CHARACTERS WITHOUT CLAIM TO ANY PARTICULAR FONT, STYLE, SIZE, OR COLOR.

SN 85-313,888, FILED 5-5-2011.

DAWN FELDMAN, EXAMINING ATTORNEY



*David J. Kybas*

Director of the United States Patent and Trademark Office

# United States of America

United States Patent and Trademark Office

## LINCOLN ROOTER

**Reg. No. 4,136,894**

**Registered May 1, 2012**

**Int. Cl.: 37**

**SERVICE MARK**

**PRINCIPAL REGISTER**

LINCOLN ROOTER LLC (COLORADO LIMITED LIABILITY COMPANY)  
3755 S. LOOKOUT HILL STREET  
WATKINS, CO 80137

FOR: DRAIN AND SEWER CLEANING SERVICES, PLUMBING SERVICES, AND INSTALLATION OF SEWERS, IN CLASS 37 (U.S. CLS. 100, 103 AND 106).

FIRST USE 1-23-2012; IN COMMERCE 1-23-2012.

THE MARK CONSISTS OF STANDARD CHARACTERS WITHOUT CLAIM TO ANY PARTICULAR FONT, STYLE, SIZE, OR COLOR.

NO CLAIM IS MADE TO THE EXCLUSIVE RIGHT TO USE "ROOTER", APART FROM THE MARK AS SHOWN.

SN 85-314,958, FILED 5-6-2011.

CURTIS FRENCH, EXAMINING ATTORNEY



*David J. Kybas*

Director of the United States Patent and Trademark Office

# United States of America

United States Patent and Trademark Office

## ROOTER TOWN

**Reg. No. 4,136,895**

**Registered May 1, 2012**

**Int. Cl.: 37**

**SERVICE MARK**

**PRINCIPAL REGISTER**

ROOTER TOWN LLC (COLORADO LIMITED LIABILITY COMPANY)  
728 CHEROKEE STREET  
STRASBURG, CO 80136

FOR: DRAIN AND SEWER CLEANING SERVICES, PLUMBING SERVICES, AND INSTALLATION OF SEWERS, IN CLASS 37 (U.S. CLS. 100, 103 AND 106).

FIRST USE 6-10-2011; IN COMMERCE 6-10-2011.

THE MARK CONSISTS OF STANDARD CHARACTERS WITHOUT CLAIM TO ANY PARTICULAR FONT, STYLE, SIZE, OR COLOR.

NO CLAIM IS MADE TO THE EXCLUSIVE RIGHT TO USE "ROOTER", APART FROM THE MARK AS SHOWN.

SN 85-314,965, FILED 5-6-2011.

ELLEN PERKINS, EXAMINING ATTORNEY



*David J. Kybas*

Director of the United States Patent and Trademark Office

# United States of America

United States Patent and Trademark Office

# CAT FRESH

**Reg. No. 4,136,896**

**Registered May 1, 2012**

**Int. Cl.: 5**

**TRADEMARK**

**PRINCIPAL REGISTER**

GENERAL NUTRITION INVESTMENT COMPANY (ARIZONA CORPORATION)  
1002 SOUTH 63RD AVENUE AT BUCKEYE  
PHOENIX, AZ 85043

FOR: DIETARY SUPPLEMENTS FOR PETS, IN CLASS 5 (U.S. CLS. 6, 18, 44, 46, 51 AND 52).

FIRST USE 9-30-2011; IN COMMERCE 9-30-2011.

THE MARK CONSISTS OF STANDARD CHARACTERS WITHOUT CLAIM TO ANY PARTICULAR FONT, STYLE, SIZE, OR COLOR.

NO CLAIM IS MADE TO THE EXCLUSIVE RIGHT TO USE "CAT", APART FROM THE MARK AS SHOWN.

SN 85-315,717, FILED 5-9-2011.

ELISSA GARBER KON, EXAMINING ATTORNEY



*David J. Kyffers*

Director of the United States Patent and Trademark Office



# United States of America

United States Patent and Trademark Office

## MAKE LIFE SWEET

**Reg. No. 4,136,897**

**Registered May 1, 2012**

**Int. Cl.: 30**

**TRADEMARK**

**PRINCIPAL REGISTER**

LAC O'SEASONS RESORT, INC. (MICHIGAN CORPORATION)  
176 STANLEY LAKE DRIVE  
IRON RIVER, MI 49935

FOR: BARBEQUE AND BASTING SAUCE, IN CLASS 30 (U.S. CL. 46).

FIRST USE 12-15-2011; IN COMMERCE 12-15-2011.

THE MARK CONSISTS OF STANDARD CHARACTERS WITHOUT CLAIM TO ANY PARTICULAR FONT, STYLE, SIZE, OR COLOR.

SN 85-315,748, FILED 5-9-2011.

APRIL HESIK, EXAMINING ATTORNEY



*David J. Kyffers*

Director of the United States Patent and Trademark Office

# United States of America

United States Patent and Trademark Office

## Weed Out Hate

**Reg. No. 4,136,898**

**Registered May 1, 2012**

**Int. Cl.: 8**

**TRADEMARK**

**PRINCIPAL REGISTER**

EUROSENSATIONS, INC. (IOWA CORPORATION)  
4001 LAVENDER LANE  
SPRINGFIELD, IL 62711

FOR: LAWN AND GARDEN TOOLS, NAMELY, WEED EXTRACTORS, IN CLASS 8 (U.S. CLS. 23, 28 AND 44).

FIRST USE 1-10-2012; IN COMMERCE 1-10-2012.

THE MARK CONSISTS OF STANDARD CHARACTERS WITHOUT CLAIM TO ANY PARTICULAR FONT, STYLE, SIZE, OR COLOR.

SN 85-316,727, FILED 5-10-2011.

JEAN IM, EXAMINING ATTORNEY



*David J. Kybas*

Director of the United States Patent and Trademark Office

# United States of America

United States Patent and Trademark Office



**Reg. No. 4,136,899**

**Registered May 1, 2012**

**Int. Cl.: 25**

**TRADEMARK**

**PRINCIPAL REGISTER**

ANGRY GIRL, INC. (VIRGINIA CORPORATION)  
26055 ELEYS FORD ROAD  
LIGNUM, VA 22726

FOR: HATS; JACKETS; SHIRTS; SHOES; SWEAT SHIRTS, IN CLASS 25 (U.S. CLS. 22 AND 39).

FIRST USE 9-30-2011; IN COMMERCE 9-30-2011.

THE MARK CONSISTS OF A LINE DRAWING OF A YOUNG GIRL WITH A FROWN AND EXPRESSION OF ANGER IN THE EYES WITH HAIR STYLED IN TWO PIG TAILS ON EITHER SIDE OF HEAD TIED WITH BOWS.

SN 85-317,202, FILED 5-10-2011.

ESTHER BELENKER, EXAMINING ATTORNEY



*David J. Kybas*

Director of the United States Patent and Trademark Office

# United States of America

United States Patent and Trademark Office

## ALLIANT-HAS

**Reg. No. 4,136,900**

**Registered May 1, 2012**

**Int. Cl.: 35**

**SERVICE MARK**

**PRINCIPAL REGISTER**

BLUE MANAGEMENT SERVICES, LLC (KENTUCKY LIMITED LIABILITY COMPANY)  
SUITE 310  
2650 EASTPOINT PARKWAY  
LOUISVILLE, KY 40223

FOR: PROCUREMENT, NAMELY, GROUP PURCHASING SERVICES FOR ALL TYPES OF HEALTHCARE FACILITIES AND OTHER NON-HEALTHCARE ORGANIZATIONS, NAMELY, COLLEGES AND UNIVERSITIES; CONSULTING SERVICES INVOLVING THE SELECTION, IMPLEMENTATION, AND FINANCIAL IMPLICATIONS OF NATIONAL AND REGIONAL PROCUREMENT CONTRACTS FOR THE PURCHASE OF GOODS AND SERVICES, IN CLASS 35 (U.S. CLS. 100, 101 AND 102).

FIRST USE 7-8-2011; IN COMMERCE 7-8-2011.

THE MARK CONSISTS OF STANDARD CHARACTERS WITHOUT CLAIM TO ANY PARTICULAR FONT, STYLE, SIZE, OR COLOR.

SN 85-317,652, FILED 5-11-2011.

MICHAEL WIENER, EXAMINING ATTORNEY



*David J. Kyros*

Director of the United States Patent and Trademark Office

# United States of America

United States Patent and Trademark Office

## RealityImaging.net

**Reg. No. 4,136,901**

**Registered May 1, 2012**

**Int. Cl.: 44**

**SERVICE MARK**

**PRINCIPAL REGISTER**

MUNN, CHARLES SAMSON (UNITED STATES INDIVIDUAL), DBA  
REALITYIMAGING.NET,  
14 WINTER STREET  
LINCOLN, MA 017733402

FOR: MEDICAL RADIOLOGY SERVICES, IN CLASS 44 (U.S. CLS. 100 AND 101).

FIRST USE 1-2-2012; IN COMMERCE 1-2-2012.

THE MARK CONSISTS OF STANDARD CHARACTERS WITHOUT CLAIM TO ANY PARTICULAR FONT, STYLE, SIZE, OR COLOR.

SN 85-317,742, FILED 5-11-2011.

LIEF MARTIN, EXAMINING ATTORNEY



*David J. Kybas*

Director of the United States Patent and Trademark Office

# United States of America

United States Patent and Trademark Office



**Reg. No. 4,136,902**

**Registered May 1, 2012**

**Int. Cl.: 41**

**SERVICE MARK**

**PRINCIPAL REGISTER**

ANDERSON UNIVERSITY, INC. (INDIANA NON-PROFIT CORPORATION)  
1100 EAST 5TH STREET  
ANDERSON, IN 46012

FOR: EDUCATIONAL SERVICES IN THE NATURE OF COURSES AT THE UNIVERSITY LEVEL AND DISTRIBUTION OF MULTI-MEDIA TRAINING MATERIALS IN CONNECTION THEREWITH; ENTERTAINMENT SERVICES, NAMELY, ARRANGING AND CONDUCTING CONCERTS, IN CLASS 41 (U.S. CLS. 100, 101 AND 107).

FIRST USE 8-22-2011; IN COMMERCE 8-22-2011.

NO CLAIM IS MADE TO THE EXCLUSIVE RIGHT TO USE "UNIVERSITY", APART FROM THE MARK AS SHOWN.

THE MARK CONSISTS OF A FLAME OVER A CURVEY LINE WITH THE WORDS "ANDERSON UNIVERSITY" UNDERNEATH THE LINE.

SN 85-317,803, FILED 5-11-2011.

ZHALEH DELANEY, EXAMINING ATTORNEY



*David J. Kybas*

Director of the United States Patent and Trademark Office

# United States of America

United States Patent and Trademark Office

# SPORTSBUM

**Reg. No. 4,136,903**

**Registered May 1, 2012**

**Int. Cl.: 25**

**TRADEMARK**

**PRINCIPAL REGISTER**

MCKOY, HOWARD (UNITED STATES INDIVIDUAL)  
3118 ARIZONA ST.  
OAKLAND, CA 94602

FOR: CLOTHING, NAMELY, T-SHIRTS, SWEATSHIRTS, TANK TOPS, WOVEN SHIRTS, SWEATERS, CARDIGANS, VESTS, JACKETS, PANTS, SWEATPANTS, SHORTS, HATS, CAPS, COATS, SHOES, SOCKS, AND UNDERWEAR, SKIRTS, DRESSES, BLOUSES, IN CLASS 25 (U.S. CLS. 22 AND 39).

FIRST USE 2-15-2012; IN COMMERCE 2-15-2012.

THE MARK CONSISTS OF STANDARD CHARACTERS WITHOUT CLAIM TO ANY PARTICULAR FONT, STYLE, SIZE, OR COLOR.

SN 85-318,078, FILED 5-11-2011.

MARTHA FROMM, EXAMINING ATTORNEY



*David J. Kyffers*

Director of the United States Patent and Trademark Office

# United States of America

United States Patent and Trademark Office

## THE SPIRIT CHURCH

**Reg. No. 4,136,904**

**Registered May 1, 2012**

**Int. Cl.: 45**

**SERVICE MARK**

**PRINCIPAL REGISTER**

SPIRIT OF THE LORD FAMILY CHURCH, INC. (MISSOURI CORPORATION)  
12923 CONWAY ROAD  
ST. LOUIS, MO 63141

FOR: CHRISTIAN MINISTRY SERVICES; CONDUCTING RELIGIOUS PRAYER SERVICES; RELIGIOUS AND SPIRITUAL SERVICES, NAMELY, PROVIDING GATHERINGS AND RETREATS TO DEVELOP AND ENHANCE THE SPIRITUAL LIVES OF INDIVIDUALS, IN CLASS 45 (U.S. CLS. 100 AND 101).

FIRST USE 8-12-2007; IN COMMERCE 6-1-2008.

THE MARK CONSISTS OF STANDARD CHARACTERS WITHOUT CLAIM TO ANY PARTICULAR FONT, STYLE, SIZE, OR COLOR.

NO CLAIM IS MADE TO THE EXCLUSIVE RIGHT TO USE "CHURCH", APART FROM THE MARK AS SHOWN.

SN 85-318,910, FILED 5-12-2011.

MARLENE BELL, EXAMINING ATTORNEY



*David J. Kyros*

Director of the United States Patent and Trademark Office



# United States of America

United States Patent and Trademark Office

# OCIUS

**Reg. No. 4,136,905**

**Registered May 1, 2012**

**Int. Cl.: 11**

**TRADEMARK**

**PRINCIPAL REGISTER**

YCC PRODUCTS INC. (CALIFORNIA CORPORATION)  
1740 BARCELONA CIRCLE,  
PLACENTIA, CA 92870

FOR: ULTRAVIOLET LAMPS NOT FOR MEDICAL PURPOSES; ULTRA-VIOLET RADIATORS NOT FOR MOTORS AND ENGINES; ELECTRIC FANS; ELECTRIC HEATING FANS; ELECTRONIC FACIAL STEAMERS; HAIR DRYING MACHINES FOR BEAUTY SALON USE; HAIR STEAMERS FOR BEAUTY SALON USE; LAMPS; SAUNAS; AND CABINETS USED TO CONTROL TEMPERATURE AND HUMIDITY FOR HEATING AND PROOFING FOOD GOODS, IN CLASS 11 (U.S. CLS. 13, 21, 23, 31 AND 34).

FIRST USE 1-8-2002; IN COMMERCE 1-8-2002.

THE MARK CONSISTS OF STANDARD CHARACTERS WITHOUT CLAIM TO ANY PARTICULAR FONT, STYLE, SIZE, OR COLOR.

THE WORD "OCIUS" HAS NO MEANING IN A FOREIGN LANGUAGE.

SN 85-319,527, FILED 5-12-2011.

DAVID ELTON, EXAMINING ATTORNEY



*David J. Kyffers*

Director of the United States Patent and Trademark Office

# United States of America

United States Patent and Trademark Office

WE COUNT. YOU MATTER.

**Reg. No. 4,136,906**

**Registered May 1, 2012**

**Int. Cl.: 35**

**SERVICE MARK**

**PRINCIPAL REGISTER**

FROST, RUTTENBERG AND ROTHBLATT, P.C. (ILLINOIS CORPORATION)  
111 PFINGSTEN ROAD  
SUITE 300  
DEERFIELD, IL 60015

FOR: BUSINESS INFORMATION AND ACCOUNTING ADVISORY SERVICES; CONSULTING AND INFORMATION CONCERNING ACCOUNTING; TAX ADVISORY SERVICES , IN CLASS 35 (U.S. CLS. 100, 101 AND 102).

FIRST USE 8-0-2011; IN COMMERCE 8-0-2011.

THE MARK CONSISTS OF STANDARD CHARACTERS WITHOUT CLAIM TO ANY PARTICULAR FONT, STYLE, SIZE, OR COLOR.

SN 85-322,092, FILED 5-16-2011.

MIDGE BUTLER, EXAMINING ATTORNEY



*David J. Kyffers*

Director of the United States Patent and Trademark Office

# United States of America

United States Patent and Trademark Office

# gleepet

**Reg. No. 4,136,907**

**Registered May 1, 2012**

**Int. Cl.: 20**

**TRADEMARK**

**PRINCIPAL REGISTER**

CHEN, SUFEN (UNITED STATES INDIVIDUAL)  
4 PARTRIDGE CT  
CRANBURY, NJ 08512

FOR: BEDS FOR HOUSEHOLD PETS; PET FURNITURE, IN CLASS 20 (U.S. CLS. 2, 13, 22, 25, 32 AND 50).

FIRST USE 10-1-2011; IN COMMERCE 10-1-2011.

THE MARK CONSISTS OF STANDARD CHARACTERS WITHOUT CLAIM TO ANY PARTICULAR FONT, STYLE, SIZE, OR COLOR.

SN 85-322,524, FILED 5-17-2011.

DOMINICK J. SALEMI, EXAMINING ATTORNEY



*David J. Kybas*

Director of the United States Patent and Trademark Office

# United States of America

United States Patent and Trademark Office



**Reg. No. 4,136,908**

**Registered May 1, 2012**

**Int. Cl.: 3**

**TRADEMARK**

**PRINCIPAL REGISTER**

MILANO HAIR PRODUCTS INC. (NEW YORK CORPORATION)  
11 SHEER PLAZA  
PLAINVIEW, NY 11803

FOR: HAIR CARE PREPARATIONS, NAMELY, SHAMPOOS, CONDITIONERS, STYLING PREPARATIONS, AND HAIR DYING PREPARATIONS, IN CLASS 3 (U.S. CLS. 1, 4, 6, 50, 51 AND 52).

FIRST USE 7-15-2011; IN COMMERCE 7-15-2011.

OWNER OF U.S. REG. NO. 3,660,068.

THE MARK CONSISTS OF SIDE VIEW OF BUTTERFLY WITH THE WORD "KISMER" ACROSS THE BUTTERFLY'S WING.

THE WORDING "KISMER" HAS NO MEANING IN A FOREIGN LANGUAGE.

SN 85-322,792, FILED 5-17-2011.

EDWARD NELSON, EXAMINING ATTORNEY



*David J. Kybas*

Director of the United States Patent and Trademark Office

# United States of America

United States Patent and Trademark Office

# TOUR 25

**Reg. No. 4,136,909**

EATON CORPORATION (OHIO CORPORATION)  
1111 SUPERIOR AVENUE  
CLEVELAND, OH 44114

**Registered May 1, 2012**

**Int. Cl.: 28**

FOR: HAND GRIPS FOR GOLF CLUBS; GOLF CLUB GRIPS, IN CLASS 28 (U.S. CLS. 22, 23, 38 AND 50).

**TRADEMARK**

FIRST USE 1-13-2012; IN COMMERCE 1-13-2012.

**PRINCIPAL REGISTER**

THE MARK CONSISTS OF STANDARD CHARACTERS WITHOUT CLAIM TO ANY PARTICULAR FONT, STYLE, SIZE, OR COLOR.

SN 85-322,801, FILED 5-17-2011.

HELENE LIWINSKI, EXAMINING ATTORNEY



*David J. Kyffers*

Director of the United States Patent and Trademark Office

# United States of America

United States Patent and Trademark Office

THE GOOD JAVA

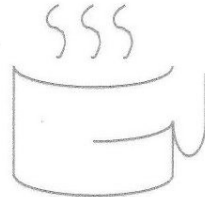

COMPANY

**Reg. No. 4,136,910**

**Registered May 1, 2012**

**Int. Cl.: 30**

**TRADEMARK**

**PRINCIPAL REGISTER**

JONATHAN HALL BATES (UNITED STATES INDIVIDUAL)  
141 COBBLESTONE LANE  
LANCASTER, PA 17601

FOR: COFFEE, IN CLASS 30 (U.S. CL. 46).

FIRST USE 1-3-2012; IN COMMERCE 1-5-2012.

NO CLAIM IS MADE TO THE EXCLUSIVE RIGHT TO USE "THE GOOD JAVA COMPANY",  
APART FROM THE MARK AS SHOWN.

THE MARK CONSISTS OF THE WORDS "THE GOOD JAVA COMPANY" WITH THE  
STYLIZED LETTERS "G" AND "J" IN THE FORM A STEAMING COFFEE CUP.

SN 85-322,867, FILED 5-17-2011.

COLLEEN DOMBROW, EXAMINING ATTORNEY



*David J. Kybas*

Director of the United States Patent and Trademark Office

# United States of America

United States Patent and Trademark Office

## STUDIO COLLECTION

**Reg. No. 4,136,911**

**Registered May 1, 2012**

**Int. Cl.: 10**

**TRADEMARK**

**PRINCIPAL REGISTER**

MOMENTUM MANAGEMENT, LLC (CALIFORNIA LIMITED LIABILITY COMPANY), DBA  
BUSHMAN PRODUCTS,  
1206 W. JON STREET  
TORRANCE, CA 90502

FOR: ADULT SEXUAL AIDS, NAMELY, VIBRATING RUBBER RINGS FOR THE PENIS,  
VIBRATORS AND CONDOMS, IN CLASS 10 (U.S. CLS. 26, 39 AND 44).

FIRST USE 11-11-2011; IN COMMERCE 11-11-2011.

THE MARK CONSISTS OF STANDARD CHARACTERS WITHOUT CLAIM TO ANY PAR-  
TICULAR FONT, STYLE, SIZE, OR COLOR.

NO CLAIM IS MADE TO THE EXCLUSIVE RIGHT TO USE "COLLECTION", APART FROM  
THE MARK AS SHOWN.

SN 85-323,017, FILED 5-17-2011.

ANNE E. GUSTASON, EXAMINING ATTORNEY



*David J. Kybas*

Director of the United States Patent and Trademark Office

# United States of America

United States Patent and Trademark Office

## LOYAL LOANS

**Reg. No. 4,136,912**

LOYAL LOANS HOLDING CO., L.L.C. (OKLAHOMA LIMITED LIABILITY COMPANY)  
1010 EAST MACARTHUR  
SHAWNEE, OK 74804

**Registered May 1, 2012**

**Int. Cl.: 36**

FOR: FINANCING SERVICES, NAMELY, PERSONAL INSTALLMENT LOANS, IN CLASS 36 (U.S. CLS. 100, 101 AND 102).

**SERVICE MARK**

FIRST USE 8-29-2011; IN COMMERCE 8-29-2011.

**PRINCIPAL REGISTER**

THE MARK CONSISTS OF STANDARD CHARACTERS WITHOUT CLAIM TO ANY PARTICULAR FONT, STYLE, SIZE, OR COLOR.

NO CLAIM IS MADE TO THE EXCLUSIVE RIGHT TO USE "LOANS", APART FROM THE MARK AS SHOWN.

SN 85-323,041, FILED 5-17-2011.

MIDGE BUTLER, EXAMINING ATTORNEY



*David J. Kyffers*

Director of the United States Patent and Trademark Office



# United States of America

United States Patent and Trademark Office



**Reg. No. 4,136,913**

**Registered May 1, 2012**

**Int. Cl.: 3**

**TRADEMARK**

**PRINCIPAL REGISTER**

KENDRICK, KIM (UNITED STATES INDIVIDUAL)  
1922 FRANKLIN ST  
KEOKUK, IA 52632

FOR: MAKE-UP, IN CLASS 3 (U.S. CLS. 1, 4, 6, 50, 51 AND 52).

FIRST USE 4-25-2011; IN COMMERCE 4-25-2011.

THE MARK CONSISTS OF A CROWN WITH THE STYLIZED TEXT "SHEAR ROYALTY".

SN 85-323,758, FILED 5-18-2011.

ROBIN CHOSID, EXAMINING ATTORNEY



*David J. Kybas*

Director of the United States Patent and Trademark Office

# United States of America

United States Patent and Trademark Office

## Project ALTO-D

**Reg. No. 4,136,914**

**Registered May 1, 2012**

**Int. Cl.: 44**

**SERVICE MARK**

**PRINCIPAL REGISTER**

SAN FERNANDO COMMUNITY HOSPITAL INC. (CALIFORNIA CORPORATION), DBA  
MISSION COMMUNITY HOSPITAL,  
14850 ROSCOE BLVD  
PANORAMA CITY, CA 90045

FOR: PROVIDING INFORMATION IN THE FIELD OF DIABETES, IN CLASS 44 (U.S. CLS.  
100 AND 101).

FIRST USE 11-1-2005; IN COMMERCE 11-1-2005.

THE MARK CONSISTS OF STANDARD CHARACTERS WITHOUT CLAIM TO ANY PAR-  
TICULAR FONT, STYLE, SIZE, OR COLOR.

NO CLAIM IS MADE TO THE EXCLUSIVE RIGHT TO USE "PROJECT", APART FROM THE  
MARK AS SHOWN.

SN 85-326,431, FILED 5-20-2011.

JEFFREY LOOK, EXAMINING ATTORNEY



*David J. Kybas*

Director of the United States Patent and Trademark Office

# United States of America

United States Patent and Trademark Office

## Las Vegas Hookup

**Reg. No. 4,136,915**

**Registered May 1, 2012**

**Int. Cl.: 45**

**SERVICE MARK**

**PRINCIPAL REGISTER**

KROSS UNLIMITED, LLC (NEVADA LIMITED LIABILITY COMPANY)  
# 140  
3172 NORTH RAINBOW BLVD.  
LAS VEGAS, NV 89108

FOR: ON-LINE SOCIAL NETWORKING SERVICES, IN CLASS 45 (U.S. CLS. 100 AND 101).

FIRST USE 6-1-2010; IN COMMERCE 1-1-2011.

THE MARK CONSISTS OF STANDARD CHARACTERS WITHOUT CLAIM TO ANY PARTICULAR FONT, STYLE, SIZE, OR COLOR.

NO CLAIM IS MADE TO THE EXCLUSIVE RIGHT TO USE "LAS VEGAS", APART FROM THE MARK AS SHOWN.

SN 85-326,806, FILED 5-21-2011.

Laurie Mayes, Examining Attorney



*David J. Kyros*

Director of the United States Patent and Trademark Office

# United States of America

United States Patent and Trademark Office

# K147

**Reg. No. 4,136,916**

**Registered May 1, 2012**

**Int. Cl.: 34**

**TRADEMARK**

**PRINCIPAL REGISTER**

FAIRMONT HOLDINGS, INC. (FLORIDA CORPORATION)  
3400 S.W. 26TH TERRACE  
#A-1  
DANIA, FL 33312

FOR: CIGARS, TOBACCO, CIGAR BOXES, CIGAR CUTTERS AND CIGAR TUBES, IN CLASS 34 (U.S. CLS. 2, 8, 9 AND 17).

FIRST USE 9-15-2011; IN COMMERCE 9-15-2011.

THE MARK CONSISTS OF STANDARD CHARACTERS WITHOUT CLAIM TO ANY PARTICULAR FONT, STYLE, SIZE, OR COLOR.

SN 85-327,293, FILED 5-23-2011.

TINA BROWN, EXAMINING ATTORNEY



*David J. Kyffers*

Director of the United States Patent and Trademark Office

# United States of America

United States Patent and Trademark Office

## SIMPLY CLEAN

**Reg. No. 4,136,917**

**Registered May 1, 2012**

**Int. Cl.: 3**

**TRADEMARK**

**PRINCIPAL REGISTER**

KIMBERLY-CLARK WORLDWIDE, INC. (DELAWARE CORPORATION)  
2300 WINCHESTER ROAD  
NEENAH, WI 54956

FOR: DISPOSABLE BABY WIPES, IN CLASS 3 (U.S. CLS. 1, 4, 6, 50, 51 AND 52).

FIRST USE 2-6-2012; IN COMMERCE 2-6-2012.

THE MARK CONSISTS OF STANDARD CHARACTERS WITHOUT CLAIM TO ANY PARTICULAR FONT, STYLE, SIZE, OR COLOR.

SN 85-328,607, FILED 5-24-2011.

JOHN HWANG, EXAMINING ATTORNEY



*David J. Kyffers*

Director of the United States Patent and Trademark Office

# United States of America

United States Patent and Trademark Office



**Reg. No. 4,136,918**

**Registered May 1, 2012**

**Int. Cl.: 39**

**SERVICE MARK**

**PRINCIPAL REGISTER**

ENERGIA LOGISTICS LTD (DELAWARE CORPORATION)  
2700 NIMITZ ROAD  
LONG BEACH, CA 90802

FOR: LAUNCHING SERVICES, NAMELY, TRANSPORT, INTEGRATION, MONITORING, LAUNCHING AND PLACEMENT IN PRESCRIBED ORBIT OF SATELLITES, ROCKETS AND SPACECRAFTS OF OTHERS AS A CONTRACTOR, IN CLASS 39 (U.S. CLS. 100 AND 105).

FIRST USE 6-1-2011; IN COMMERCE 6-1-2011.

NO CLAIM IS MADE TO THE EXCLUSIVE RIGHT TO USE "LOGISTICS", APART FROM THE MARK AS SHOWN.

THE MARK CONSISTS OF THE WORDS "ENERGIA LOGISTICS" AGAINST A SWIRL RUNNING VERTICALLY THROUGH THE WORD "ENERGIA" WITH A SMALL CIRCLE AT THE TOP OF THE VERTICAL SWIRL. THE SMALL CIRCLE HAS A TINY SOLID CIRCLE AT ITS TOP BORDER WITH THREE LINES EMANATING FROM THE SOLID CIRCLE THAT FALLS WITHIN THE SMALL CIRCLE.

THE ENGLISH TRANSLATION OF THE WORD "ENERGIA" IN THE MARK IS "ENERGY".

SN 85-328,914, FILED 5-24-2011.

SHAUNIA CARLYLE, EXAMINING ATTORNEY



*David J. Kyros*

Director of the United States Patent and Trademark Office

# United States of America

United States Patent and Trademark Office

# Robopop

**Reg. No. 4,136,919**

**Registered May 1, 2012**

**Int. Cl.: 11**

**TRADEMARK**

**PRINCIPAL REGISTER**

BUSINESS RUSSIA, LLC (RUSSIAN FED. LIMITED LIABILITY COMPANY)  
5 CHERNYAHOVSKY STREET, BUILDING 1  
MOSCOW, RUSSIAN FED.

FOR: POPCORN POPPING MACHINE, IN CLASS 11 (U.S. CLS. 13, 21, 23, 31 AND 34).

FIRST USE 9-12-2011; IN COMMERCE 1-16-2012.

THE MARK CONSISTS OF STANDARD CHARACTERS WITHOUT CLAIM TO ANY PARTICULAR FONT, STYLE, SIZE, OR COLOR.

SN 85-329,419, FILED 5-25-2011.

PAULA MAHONEY, EXAMINING ATTORNEY



*David J. Kyffers*

Director of the United States Patent and Trademark Office

# United States of America

United States Patent and Trademark Office

## CHRISTENGEL GLÜHWEIN

**Reg. No. 4,136,920**

**Registered May 1, 2012**

**Int. Cl.: 33**

**TRADEMARK**

**PRINCIPAL REGISTER**

INTERCONTINENTAL PACKAGING CO. (MINNESOTA CORPORATION)  
1999 SHEPARD ROAD  
ST. PAUL, MN 55116

FOR: SPICED WINE, IN CLASS 33 (U.S. CLS. 47 AND 49).

FIRST USE 4-1-2006; IN COMMERCE 7-1-2006.

THE MARK CONSISTS OF STANDARD CHARACTERS WITHOUT CLAIM TO ANY PARTICULAR FONT, STYLE, SIZE, OR COLOR.

NO CLAIM IS MADE TO THE EXCLUSIVE RIGHT TO USE "GLÜHWEIN", APART FROM THE MARK AS SHOWN.

THE ENGLISH TRANSLATION OF "CHRISTENGEL GLÜHWEIN" IN THE MARK IS "CHRISTIAN ANGEL SPICED WINE".

SN 85-330,052, FILED 5-25-2011.

PAUL E. FAHRENKOPF, EXAMINING ATTORNEY



*David J. Kyffers*

Director of the United States Patent and Trademark Office



# United States of America

United States Patent and Trademark Office

## TREND SYNC

**Reg. No. 4,136,921**

TRENDSYNC, LLC (TEXAS LIMITED LIABILITY COMPANY)  
5310 HARVEST HILL LANE, #191 LB 135  
DALLAS, TX 75230

**Registered May 1, 2012**

**Int. Cl.: 36**

FOR: FINANCIAL AND INVESTMENT ADVISORY SERVICES, IN CLASS 36 (U.S. CLS. 100, 101 AND 102).

**SERVICE MARK**

FIRST USE 5-27-2011; IN COMMERCE 5-27-2011.

**PRINCIPAL REGISTER**

THE MARK CONSISTS OF STANDARD CHARACTERS WITHOUT CLAIM TO ANY PARTICULAR FONT, STYLE, SIZE, OR COLOR.

SN 85-330,870, FILED 5-26-2011.

KAPIL BHANOT, EXAMINING ATTORNEY



*David J. Kybas*

Director of the United States Patent and Trademark Office

# United States of America

United States Patent and Trademark Office

## AUDIOSTATUS

**Reg. No. 4,136,922**

**Registered May 1, 2012**

**Int. Cl.: 38**

**SERVICE MARK**

**PRINCIPAL REGISTER**

YOUMICRO, S.L. (SPAIN LIMITED LIABILITY COMPANY)  
LAS FLAUTAS N° 48 3°D  
MADRID, SPAIN 28054

FOR: AUDIO AND VIDEO BROADCASTING SERVICES OVER THE INTERNET; BROADCASTING OF VIDEO AND AUDIO PROGRAMMING OVER THE INTERNET; COMMUNICATION SERVICES, NAMELY, TRANSMISSION OF VOICE, AUDIO, VISUAL IMAGES AND DATA BY TELECOMMUNICATIONS NETWORKS, WIRELESS COMMUNICATION NETWORKS, THE INTERNET, INFORMATION SERVICES NETWORKS AND DATA NETWORKS; ELECTRONIC TRANSMISSION OF INFORMATION POSTED TO USENET NEWSGROUPS AND DISCUSSION GROUPS VIA A GLOBAL COMPUTER NETWORK; INFORMATION TRANSMISSION VIA ELECTRONIC COMMUNICATIONS NETWORKS; TELECOMMUNICATION CONSULTATION IN THE NATURE OF TECHNICAL CONSULTING IN THE FIELD OF AUDIO, TEXT AND VISUAL DATA TRANSMISSION AND COMMUNICATION; TELECOMMUNICATION SERVICES, NAMELY, TRANSMISSION OF VOICE, DATA, GRAPHICS, IMAGES, AUDIO AND VIDEO BY MEANS OF TELECOMMUNICATIONS NETWORKS, WIRELESS COMMUNICATION NETWORKS, AND THE INTERNET; VIDEO BROADCASTING SERVICES OVER THE INTERNET OR OTHER COMMUNICATIONS NETWORK FEATURING THE UPLOADED, POSTED AND TAGGED VIDEOS OF OTHERS, IN CLASS 38 (U.S. CLS. 100, 101 AND 104).

FIRST USE 12-21-2011; IN COMMERCE 12-21-2011.

THE MARK CONSISTS OF STANDARD CHARACTERS WITHOUT CLAIM TO ANY PARTICULAR FONT, STYLE, SIZE, OR COLOR.

SN 85-331,075, FILED 5-26-2011.

STEVEN R. FINE, EXAMINING ATTORNEY



*David J. Kyros*

Director of the United States Patent and Trademark Office

# United States of America

United States Patent and Trademark Office

# Annelore

**Reg. No. 4,136,923**

**Registered May 1, 2012**

**Int. Cls.: 18 and 25**

**TRADEMARK**

**PRINCIPAL REGISTER**

CHO, JULIANA (UNITED STATES INDIVIDUAL)  
APT. 2-B  
31 WEST 69TH STREET  
NEW YORK, NY 10023

FOR: LEATHER AND IMITATION LEATHER GOODS, NAMELY, BOXES OF LEATHER OR IMITATION LEATHER FOR PACKAGING AND CARRYING GOODS, TRUNKS, SUITCASES, LEATHER TRAVELING SETS CONSISTING OF LUGGAGE, TRAVELING BAGS, LUGGAGE, GARMENT BAGS FOR TRAVEL, HAT BOXES, VANITY CASES SOLD EMPTY, TOILETRY BAGS SOLD EMPTY, BACKPACKS, SATCHELS, HANDBAGS, BEACH BAGS, LEATHER SHOPPING BAGS, TEXTILE SHOPPING BAGS, SHOULDER-STRAP BAGS, CARRIER BAGS, SHOULDER BAGS, WAIST BAGS, PURSES, ATTACHÉ CASES, LEATHER BRIEFCASES, SCHOOL BAGS, DOCUMENT CASES, CLUTCH BAGS, TOTE BAGS, DUFFLE BAGS, WALLETS, CHANGE PURSES, KEY CASES, BUSINESS AND CREDIT CARD CASES, ALL OF THE FOREGOING MADE OF LEATHER OR IMITATION LEATHER; UMBRELLAS, IN CLASS 18 (U.S. CLS. 1, 2, 3, 22 AND 41).

FIRST USE 8-1-2002; IN COMMERCE 8-1-2002.

FOR: CLOTHING, NAMELY, SHIRTS, T-SHIRTS, UNDER SHIRTS, NIGHT SHIRTS, RUGBY SHIRTS, POLO SHIRTS, CARDIGANS, JERSEYS, UNIFORMS, PANTS, TROUSERS, SUITS, BLAZERS, DRESS SHIRTS, SLACKS, JEANS, DENIM JEANS, CULOTTES, CARGO PANTS, OVERALLS, COVERALLS, JUMPERS, JUMP SUITS, SHORTS, BOXER SHORTS, TOPS, CROP TOPS, TANK TOPS, HALTER TOPS, SWEAT SHIRTS, SWEAT SHORTS, SWEAT PANTS, WRAPS, WARM-UP SUITS, JOGGING SUITS, TRACK SUITS, PLAY SUITS, BLOUSES, SKIRTS, DRESSES, GOWNS, SWEATERS, VESTS, FLEECE VESTS, PULLOVERS, SNOW SUITS, PARKAS, CAPES, ANORAKS, PONCHOS, JACKETS, SPORTS JACKETS, REVERSIBLE JACKETS, FLEECE JACKETS, COATS, TURTLENECKS, CLOTH SKI BIBS, BEACHWEAR, TENNIS WEAR, SURF WEAR, SKI WEAR, LAYETTES, INFANT WEAR, INFANTS SLEEPERS, BOOTIES, BABY BIBS NOT OF PAPER, CLOTH DIAPERS, CAPS, SWIM CAPS, BERETS, BEANIES, HATS, VISORS, HEADBANDS, WRIST BANDS, SWEAT BANDS, HEADWEAR, EAR MUFFS, APRONS, SCARVES, BANDANAS, BELTS, SUSPENDERS, NECKWEAR, NECKERCHIEFS, ASCOTS, UNDERWEAR, THERMAL UNDERWEAR, LONG UNDERWEAR, BRIEFS, SWIM AND BATHING TRUNKS, BRAS, SPORTS BRAS, BRASSIERES, BUSTIERS, CORSETS, PANTIES, THONGS, GARTERS AND GARTER BELTS, TEDDIES, GIRDLES, FOUNDATION GARMENTS, LOUNGEWEAR, ROBES, SMOCKS, UNDERCLOTHES, PAJAMAS, SLEEPWEAR, NIGHTWEAR, NIGHT GOWNS, LINGERIE,



*David J. Kybas*

Director of the United States Patent and Trademark Office

**Reg. No. 4,136,923** CAMISOLES, NEGLIGEES, CHEMISES, CHEMISETTES, SLIPS, SARONGS, LEG WARMERS, PANTYHOSE, BODY STOCKINGS, KNEE HIGHS, LEGGINGS, TIGHTS, LEOTARDS, BODY SUITS, UNITARDS, BODY SHAPERS, GLOVES, MITTENS, RAINWEAR, SNEAKERS, BOOTS, GALOSHES, SANDALS, FLIP-FLOPS, AND SLIPPERS; FOOTWEAR, SHOES, HOSIERY, SOCKS, AND SWIMWEAR; MEN'S FORMALWEAR, NAMELY, SUITS, BLAZERS, JACKETS, TROUSERS, DRESS SHIRTS, TIES, COATS, RAIN COATS AND TRENCH COATS, IN CLASS 25 (U.S. CLS. 22 AND 39).

FIRST USE 8-1-2002; IN COMMERCE 8-1-2002.

THE MARK CONSISTS OF STANDARD CHARACTERS WITHOUT CLAIM TO ANY PARTICULAR FONT, STYLE, SIZE, OR COLOR.

SN 85-331,308, FILED 5-26-2011.

ZACHARY BELLO, EXAMINING ATTORNEY

# United States of America

United States Patent and Trademark Office

# EVERLAST

**Reg. No. 4,136,924**

**Registered May 1, 2012**

**Int. Cl.: 15**

**TRADEMARK**

**PRINCIPAL REGISTER**

ERNIE BALL, INC. (CALIFORNIA CORPORATION)  
53973 POLK STREET  
COACHELLA, CA 92236

FOR: GUITAR PICKS, GUITAR STRINGS, GUITAR SLIDES, GUITAR STRAPS AND CAPOS,  
IN CLASS 15 (U.S. CLS. 2, 21 AND 36).

FIRST USE 1-19-2012; IN COMMERCE 1-19-2012.

THE MARK CONSISTS OF STANDARD CHARACTERS WITHOUT CLAIM TO ANY PAR-  
TICULAR FONT, STYLE, SIZE, OR COLOR.

SN 85-332,472, FILED 5-27-2011.

JACQUELINE A. LAVINE, EXAMINING ATTORNEY



*David J. Kybas*

Director of the United States Patent and Trademark Office

# United States of America

United States Patent and Trademark Office



**Reg. No. 4,136,925**

**Registered May 1, 2012**

**Int. Cls.: 3 and 44**

**TRADEMARK**

**SERVICE MARK**

**PRINCIPAL REGISTER**

CAYO, JAMI (UNITED STATES INDIVIDUAL)  
3615 N. 24TH ST.  
TACOMA, WA 98406

FOR: SKIN AND BODY LOTIONS, CREAMS AND OILS FOR PERSONAL USE, IN CLASS 3 (U.S. CLS. 1, 4, 6, 50, 51 AND 52).

FIRST USE 6-1-2011; IN COMMERCE 10-1-2011.

FOR: HEALTH SPA SERVICES FOR HEALTH AND WELLNESS OF THE BODY AND SPIRIT, NAMELY, PROVIDING MASSAGE, FACIAL AND BODY TREATMENT SERVICES, COSMETIC BODY CARE SERVICES, IN CLASS 44 (U.S. CLS. 100 AND 101).

FIRST USE 10-1-2011; IN COMMERCE 10-1-2011.

THE MARK CONSISTS OF A DRAWING OF A LOTUS FLOWER ABOVE THE WORD "BODHI", WITH THE "D" SERVING AS THE STEM OF THE FLOWER.

THE ENGLISH TRANSLATION OF "BODHI" IN THE MARK IS "AWAKENED".

SN 85-332,710, FILED 5-27-2011.

SIMON TENG, EXAMINING ATTORNEY



*David J. Kybas*

Director of the United States Patent and Trademark Office

# United States of America

United States Patent and Trademark Office

## IAMS SPORTING 29/18

**Reg. No. 4,136,926**

**Registered May 1, 2012**

**Int. Cl.: 31**

**TRADEMARK**

**PRINCIPAL REGISTER**

IAMS COMPANY, THE (OHIO CORPORATION)  
ONE PROCTER & GAMBLE PLAZA  
CINCINNATI, OH 45202

FOR: PET FOOD, IN CLASS 31 (U.S. CLS. 1 AND 46).

FIRST USE 9-19-2011; IN COMMERCE 9-19-2011.

THE MARK CONSISTS OF STANDARD CHARACTERS WITHOUT CLAIM TO ANY PARTICULAR FONT, STYLE, SIZE, OR COLOR.

OWNER OF U.S. REG. NOS. 1,317,225, 3,851,517, AND OTHERS.

SN 85-333,591, FILED 5-31-2011.

MAYUR VAGHANI, EXAMINING ATTORNEY



*David J. Kybas*

Director of the United States Patent and Trademark Office

# United States of America

United States Patent and Trademark Office

# SQUATSHOT

**Reg. No. 4,136,927**

NEWMAN, DENICE (UNITED STATES INDIVIDUAL)  
29113 FARWELL ST.  
CHESTERFIELD, MI 48047

**Registered May 1, 2012**

**Int. Cl.: 11**

FOR: PORTABLE TOILETS, IN CLASS 11 (U.S. CLS. 13, 21, 23, 31 AND 34).

**TRADEMARK**

FIRST USE 1-1-2012; IN COMMERCE 1-16-2012.

**PRINCIPAL REGISTER**

THE MARK CONSISTS OF STANDARD CHARACTERS WITHOUT CLAIM TO ANY PARTICULAR FONT, STYLE, SIZE, OR COLOR.

SN 85-334,030, FILED 5-31-2011.

APRIL HESIK, EXAMINING ATTORNEY



*David J. Kyffers*

Director of the United States Patent and Trademark Office



# United States of America

United States Patent and Trademark Office



**Reg. No. 4,136,928**

MINUTEMAN PRESS INTERNATIONAL, INC. (NEW YORK CORPORATION)  
61 EXECUTIVE BOULEVARD  
FARMINGDALE, NY 11735

**Registered May 1, 2012**

**Int. Cl.: 42**

FOR: COMPUTER SERVICES, NAMELY, ELECTRONIC DIGITIZING OF PHOTOGRAPHIC IMAGES, SLIDES AND DOCUMENTS, IN CLASS 42 (U.S. CLS. 100 AND 101).

**SERVICE MARK**

FIRST USE 6-24-2011; IN COMMERCE 6-24-2011.

**PRINCIPAL REGISTER**

OWNER OF U.S. REG. NOS. 1,755,929, 3,304,742, AND OTHERS.

THE MARK CONSISTS OF THE WORD "MINUTESCAN" SUPERIMPOSED ON PARALLEL WAVY RIBBON-LIKE LINES. TO THE LEFT OF THE PARALLEL RIBBON-LIKE LINES IS A STYLIZED DOT OVER THE LETTER "I" CONSISTING OF A PARTIALLY SHADED SQUARE AND TO THE RIGHT OF THE PARALLEL RIBBON-LIKE LINES IS A REPRESENTATION OF A COMPUTER DISC.

SN 85-334,911, FILED 6-1-2011.

BARBARA A. GOLD, EXAMINING ATTORNEY



*David J. Kyros*

Director of the United States Patent and Trademark Office

**United States of America**  
United States Patent and Trademark Office

# LABELX

**Reg. No. 4,136,929**

**Registered May 1, 2012**

**Int. Cl.: 9**

**TRADEMARK**

**PRINCIPAL REGISTER**

EMX INDUSTRIES INC. (OHIO CORPORATION)  
4564 JOHNSTON PARKWAY  
CLEVELAND, OH 44128

FOR: PHOTOELECTRIC SENSORS, IN CLASS 9 (U.S. CLS. 21, 23, 26, 36 AND 38).

FIRST USE 11-29-2011; IN COMMERCE 12-24-2011.

THE MARK CONSISTS OF STANDARD CHARACTERS WITHOUT CLAIM TO ANY PARTICULAR FONT, STYLE, SIZE, OR COLOR.

SN 85-335,338, FILED 6-1-2011.

KATHERINE STOIDES, EXAMINING ATTORNEY



*David J. Kybas*

Director of the United States Patent and Trademark Office

**United States of America**  
United States Patent and Trademark Office

# SQUIRKY

**Reg. No. 4,136,930**

BB NOVELTY, LLC (INDIANA LIMITED LIABILITY COMPANY)  
1703 WASHINGTON AVE.  
VINCENNES, IN 47591

**Registered May 1, 2012**

**Int. Cl.: 28**

FOR: STUFFED AND PLUSH DOLLS; STUFFED AND PLUSH TOY ANIMALS; STUFFED AND PLUSH TOY NOVELTIES, IN CLASS 28 (U.S. CLS. 22, 23, 38 AND 50).

**TRADEMARK**

FIRST USE 2-1-2012; IN COMMERCE 2-1-2012.

**PRINCIPAL REGISTER**

THE MARK CONSISTS OF STANDARD CHARACTERS WITHOUT CLAIM TO ANY PARTICULAR FONT, STYLE, SIZE, OR COLOR.

SN 85-335,660, FILED 6-1-2011.

KATHERINE CHANG, EXAMINING ATTORNEY



*David J. Kybas*

Director of the United States Patent and Trademark Office

# United States of America

United States Patent and Trademark Office

## Winfield Good Old Days

**Reg. No. 4,136,931**

WINFIELD LIONS CLUB (ILLINOIS NON-PROFIT ORGANIZATION)  
P.O. BOX 252  
WINFIELD, IL 60190

**Registered May 1, 2012**

**Int. Cl.: 41**

FOR: ORGANIZING COMMUNITY FESTIVALS FEATURING PRIMARILY FOOD TASTING, LIVE DEMONSTRATION AND PERFORMANCE ENTERTAINMENT, A BEER GARDEN AND ALSO PROVIDING A CARNIVAL, LIVE MUSIC AND CONCERTS, AND GAMES FOR ADULTS AND CHILDREN AND A PARADE, IN CLASS 41 (U.S. CLS. 100, 101 AND 107).

**SERVICE MARK**

**PRINCIPAL REGISTER**

FIRST USE 9-7-1972; IN COMMERCE 9-7-1972.

THE MARK CONSISTS OF STANDARD CHARACTERS WITHOUT CLAIM TO ANY PARTICULAR FONT, STYLE, SIZE, OR COLOR.

NO CLAIM IS MADE TO THE EXCLUSIVE RIGHT TO USE "WINFIELD", APART FROM THE MARK AS SHOWN.

SN 85-335,695, FILED 6-1-2011.

KAREN BRACEY, EXAMINING ATTORNEY



*David J. Kybas*

Director of the United States Patent and Trademark Office

# United States of America

United States Patent and Trademark Office

## SugarFree Kids

**Reg. No. 4,136,932**

**Registered May 1, 2012**

**Int. Cl.: 36**

**SERVICE MARK**

**PRINCIPAL REGISTER**

ANTUNA, EDWARD A. (UNITED STATES INDIVIDUAL)  
848 N. RAINBOW BLVD  
SUITE 304  
LAS VEGAS, NV 89107

FOR: CHARITABLE FUNDRAISING TO SUPPORT CHILDREN WITH DIABETES, IN CLASS 36 (U.S. CLS. 100, 101 AND 102).

FIRST USE 12-31-2010; IN COMMERCE 1-12-2012.

THE MARK CONSISTS OF STANDARD CHARACTERS WITHOUT CLAIM TO ANY PARTICULAR FONT, STYLE, SIZE, OR COLOR.

NO CLAIM IS MADE TO THE EXCLUSIVE RIGHT TO USE "KIDS", APART FROM THE MARK AS SHOWN.

SN 85-335,851, FILED 6-1-2011.

SUNG IN, EXAMINING ATTORNEY



*David J. Kyffers*

Director of the United States Patent and Trademark Office

# United States of America

United States Patent and Trademark Office

# RPA

**Reg. No. 4,136,933**

**Registered May 1, 2012**

**Int. Cls.: 35 and 36**

**SERVICE MARK**

**PRINCIPAL REGISTER**

RESTRUCTURING PARTNERS & ASSOCIATES, LLC (DELAWARE LIMITED LIABILITY COMPANY)  
45 EISENHOWER DRIVE  
PARAMUS, NJ 07652

FOR: STRATEGIC BUSINESS PLANNING SERVICES; BUSINESS RISK MANAGEMENT SERVICES, IN CLASS 35 (U.S. CLS. 100, 101 AND 102).

FIRST USE 8-31-2011; IN COMMERCE 8-31-2011.

FOR: FINANCIAL AND BUSINESS ADVISORY SERVICES; FINANCIAL CONSULTATION IN THE FIELD OF BUSINESS RESTRUCTURING; BUSINESS LIQUIDATION SERVICES; CASH MANAGEMENT SERVICES; ARRANGING FOR DEBTOR-IN-POSSESSION FINANCING AND BRIDGE FINANCING FOR BUSINESSES, IN CLASS 36 (U.S. CLS. 100, 101 AND 102).

FIRST USE 8-31-2011; IN COMMERCE 8-31-2011.

THE MARK CONSISTS OF STANDARD CHARACTERS WITHOUT CLAIM TO ANY PARTICULAR FONT, STYLE, SIZE, OR COLOR.

SN 85-336,225, FILED 6-2-2011.

CHARLES L. JENKINS, EXAMINING ATTORNEY



*David J. Kybas*

Director of the United States Patent and Trademark Office

# United States of America

United States Patent and Trademark Office

## NEW BRIGHTON EXCHANGE

**Reg. No. 4,136,934**

**Registered May 1, 2012**

**Int. Cl.: 35**

**SERVICE MARK**

**PRINCIPAL REGISTER**

CITY OF NEW BRIGHTON (MINNESOTA MUNICIPAL CORPORATION)  
803 OLD HIGHWAY 8 NW  
NEW BRIGHTON, MN 55112

FOR: PROMOTING THE ECONOMIC, COMMERCIAL, CIVIC, COMMUNITY, CULTURAL,  
AND MUNICIPAL INTERESTS OF THE CITY OF NEW BRIGHTON, MINNESOTA, IN CLASS  
35 (U.S. CLS. 100, 101 AND 102).

FIRST USE 4-12-2011; IN COMMERCE 6-9-2011.

THE MARK CONSISTS OF STANDARD CHARACTERS WITHOUT CLAIM TO ANY PAR-  
TICULAR FONT, STYLE, SIZE, OR COLOR.

NO CLAIM IS MADE TO THE EXCLUSIVE RIGHT TO USE "NEW BRIGHTON", APART  
FROM THE MARK AS SHOWN.

SN 85-336,371, FILED 6-2-2011.

AMY HELLA, EXAMINING ATTORNEY



*David J. Kybas*

Director of the United States Patent and Trademark Office

# United States of America

United States Patent and Trademark Office

**DtE**  
in California

**Reg. No. 4,136,935**

**Registered May 1, 2012**

**Int. Cl.: 25**

**TRADEMARK**

**PRINCIPAL REGISTER**

THE CIRCLE GROUP INC. (CALIFORNIA CORPORATION)  
#1024  
112 WEST 9TH ST.  
LOS ANGELES, CA 90015

FOR: CLOTHING, NAMELY, HEADWEAR, T-SHIRTS, SHORTS, SWEAT PANTS, SWEAT SHIRTS, SWIMWEAR, JACKETS, WET SUITS, BELTS, JEANS, SLACKS, SHIRTS, TANK TOPS, AND SOCKS, IN CLASS 25 (U.S. CLS. 22 AND 39).

FIRST USE 12-17-2009; IN COMMERCE 4-1-2010.

NO CLAIM IS MADE TO THE EXCLUSIVE RIGHT TO USE "CALIFORNIA", APART FROM THE MARK AS SHOWN.

THE MARK CONSISTS OF THE WORDS "DTE IN CALIFORNIA" HAVING "DTE" ON TOP, STACKED WITH "IN CALIFORNIA" IN A TYPEWRITER STYLE FONT TYPEFACE.

SN 85-336,884, FILED 6-2-2011.

YAT SYE, LEE, EXAMINING ATTORNEY



*David J. Kyros*

Director of the United States Patent and Trademark Office



# United States of America

United States Patent and Trademark Office

# G-Drops

**Reg. No. 4,136,936**

SERENIGY GLOBAL, INC. (FLORIDA CORPORATION)  
201 SOUTH BISCAYNE BOULEARD, SUITE 2800  
MIAMI, FL 33131

**Registered May 1, 2012**

**Int. Cl.: 5**

FOR: MINERAL, VITAMIN, AND NUTRITIONALLY ENHANCED WATER WITH GANO-  
DERMA HERB, IN CLASS 5 (U.S. CLS. 6, 18, 44, 46, 51 AND 52).

**TRADEMARK**

FIRST USE 6-12-2011; IN COMMERCE 6-12-2011.

**PRINCIPAL REGISTER**

THE MARK CONSISTS OF STANDARD CHARACTERS WITHOUT CLAIM TO ANY PAR-  
TICULAR FONT, STYLE, SIZE, OR COLOR.

SN 85-336,931, FILED 6-2-2011.

SUSAN RICHARDS, EXAMINING ATTORNEY



*David J. Kybas*

Director of the United States Patent and Trademark Office

# United States of America

United States Patent and Trademark Office

## THE OFFICIAL DESTINATION FOR GIRLFRIENDS GETAWAYS

**Reg. No. 4,136,937**

SEVIERVILLE CHAMBER OF COMMERCE, INC. (TENNESSEE CORPORATION)  
110 GARY WADE BLVD.  
SEVIERVILLE, TN 37862

**Registered May 1, 2012**

**Int. Cl.: 35**

FOR: CHAMBER OF COMMERCE SERVICES, NAMELY, PROMOTING BUSINESS AND TOURISM IN SEVIERVILLE, TENNESSEE, IN CLASS 35 (U.S. CLS. 100, 101 AND 102).

**SERVICE MARK**

FIRST USE 7-1-2011; IN COMMERCE 7-1-2011.

**PRINCIPAL REGISTER**

THE MARK CONSISTS OF STANDARD CHARACTERS WITHOUT CLAIM TO ANY PARTICULAR FONT, STYLE, SIZE, OR COLOR.

SN 85-338,579, FILED 6-6-2011.

LAURIE KAUFMAN, EXAMINING ATTORNEY



*David J. Kyffers*

Director of the United States Patent and Trademark Office

**United States of America**  
United States Patent and Trademark Office

**FIN·S**

**Reg. No. 4,136,938**

**Registered May 1, 2012**

**Int. Cl.: 28**

**TRADEMARK**

**PRINCIPAL REGISTER**

FIN-S TECH LLC (FLORIDA LIMITED LIABILITY COMPANY)  
919 FOXPOINT CIRCLE  
DELRAY BEACH, FL 33445

FOR: SURFBOARD FINS, IN CLASS 28 (U.S. CLS. 22, 23, 38 AND 50).

FIRST USE 9-1-2010; IN COMMERCE 9-27-2011.

THE MARK CONSISTS OF STANDARD CHARACTERS WITHOUT CLAIM TO ANY PARTICULAR FONT, STYLE, SIZE, OR COLOR.

SN 85-338,605, FILED 6-6-2011.

JASON BLAIR, EXAMINING ATTORNEY



*David J. Kyffers*

Director of the United States Patent and Trademark Office

# United States of America

United States Patent and Trademark Office

## PATRIOT BY FIREKING

**Reg. No. 4,136,939**

**Registered May 1, 2012**

**Int. Cl.: 20**

**TRADEMARK**

**PRINCIPAL REGISTER**

FIRE KING INTERNATIONAL, LLC (INDIANA LIMITED LIABILITY COMPANY)  
101 SECURITY PARKWAY  
NEW ALBANY, IN 47150

FOR: FILING CABINETS, IN CLASS 20 (U.S. CLS. 2, 13, 22, 25, 32 AND 50).

FIRST USE 10-25-2011; IN COMMERCE 10-25-2011.

THE MARK CONSISTS OF STANDARD CHARACTERS WITHOUT CLAIM TO ANY PARTICULAR FONT, STYLE, SIZE, OR COLOR.

OWNER OF U.S. REG. NOS. 2,388,560, 2,833,666, AND OTHERS.

SN 85-338,708, FILED 6-6-2011.

GIANCARLO CASTRO, EXAMINING ATTORNEY



*David J. Kyffers*

Director of the United States Patent and Trademark Office

# United States of America

United States Patent and Trademark Office

# SOLARITY

**Reg. No. 4,136,940**

**Registered May 1, 2012**

**Int. Cl.: 36**

**SERVICE MARK**

**PRINCIPAL REGISTER**

SOLARITY CREDIT UNION (WASHINGTON CORPORATION)  
110 NORTH FIFTH AVENUE  
YAKIMA, WA 98902

FOR: CREDIT UNION SERVICES, IN CLASS 36 (U.S. CLS. 100, 101 AND 102).

FIRST USE 10-3-2011; IN COMMERCE 10-14-2011.

THE MARK CONSISTS OF STANDARD CHARACTERS WITHOUT CLAIM TO ANY PARTICULAR FONT, STYLE, SIZE, OR COLOR.

SN 85-339,215, FILED 6-6-2011.

ODESSA BIBBINS, EXAMINING ATTORNEY



*David J. Kyffers*

Director of the United States Patent and Trademark Office

# United States of America

United States Patent and Trademark Office



**Reg. No. 4,136,941**

**Registered May 1, 2012**

**Int. Cl.: 35**

**SERVICE MARK**

**PRINCIPAL REGISTER**

SECURE DENT, INC. (TEXAS CORPORATION)  
SUITE 220  
13611 SKINNER ROAD  
CYPRESS, TX 77429

FOR: DENTAL COST MANAGEMENT, NAMELY, PROVIDING AND ADMINISTERING DISCOUNT DENTAL CARE MEMBERSHIP PROGRAMS TO ENABLE PARTICIPANT MEMBERS TO OBTAIN DISCOUNTS ON DENTAL CARE RELATED GOODS AND SERVICES FROM CONTRACTED DENTAL CARE PROVIDERS, IN CLASS 35 (U.S. CLS. 100, 101 AND 102).

FIRST USE 1-25-2012; IN COMMERCE 1-27-2012.

THE MARK CONSISTS OF A CIRCLE WITH AN INNER CIRCLE OF SMALLER WIDTH AND THE WORDING "SECUREDENT" PRESENTED IN STYLIZED FONT IN THE CENTER OF THE CIRCLES.

SN 85-339,322, FILED 6-6-2011.

GRETCHEN ULRICH, EXAMINING ATTORNEY



*David J. Kyffers*

Director of the United States Patent and Trademark Office

# United States of America

United States Patent and Trademark Office



**Reg. No. 4,136,942**

**Registered May 1, 2012**

**Int. Cl.: 28**

**TRADEMARK**

**PRINCIPAL REGISTER**

FUN HORIZON LIMITED (HONG KONG LIMITED LIABILITY COMPANY)  
RM 511-14, HUNGHOM COMMERCIAL CENTRE  
TOWER A, 39 MA TAU WAI ROAD  
HUNGHOM, KOWLOON, HONG KONG

FOR: THREE DIMENSIONAL MODELS FOR EDUCATIONAL PURPOSES; ACTION SKILL GAMES; AMUSEMENT GAME MACHINES; APPARATUS FOR ELECTRONIC GAMES OTHER THAN THOSE ADAPTED FOR USE WITH AN EXTERNAL DISPLAY SCREEN OR MONITOR; ARCADE GAME MACHINES; BABY MULTIPLE ACTIVITY TOYS; BABY RATTLES; BALLS FOR GAMES; BALL-JOINTED DOLLS; BATH TOYS; BATTERY OPERATED ACTION TOYS; BOARD GAMES; BUILDING GAMES; CHILDREN'S MULTIPLE ACTIVITY TOYS; CONSTRUCTION TOYS; DOLLS AND DOLL ACCESSORIES, NAMELY, CLOTHING FOR DOLLS, DOLL ROOMS, DOLL BEDS, DOLL HOUSES, TOY FABRICS AND LINENS FOR DOLLS AND STROLLERS FOR DOLLS; EDUCATIONAL CARD GAMES; ELECTRONIC ACTION TOYS; INFANT DEVELOPMENT TOYS; INFANT TOYS; INFLATABLE SWIMMING POOLS; JIGSAW AND MANIPULATIVE PUZZLES; MUSICAL TOYS; PARTY GAMES; PLUSH DOLLS; PUZZLES; REMOTE CONTROL TOYS, NAMELY, CARS, RACE CARS, AIRPLANES, BOATS; TALKING TOYS; TOY VEHICLES, IN CLASS 28 (U.S. CLS. 22, 23, 38 AND 50).

FIRST USE 6-1-2011; IN COMMERCE 6-1-2011.

THE MARK CONSISTS OF THE STYLIZED WORDS "FUN HORIZON" SUPERIMPOSED ON TWO STAR-LIKE DESIGNS.

THE WORDING "FUN HORIZON" HAS NO MEANING IN A FOREIGN LANGUAGE.

SN 85-339,473, FILED 6-7-2011.

CHRISTINA SOBRAL, EXAMINING ATTORNEY



*David J. Kyros*

Director of the United States Patent and Trademark Office

# United States of America

United States Patent and Trademark Office



**Reg. No. 4,136,943**

**Registered May 1, 2012**

**Int. Cl.: 41**

**SERVICE MARK**

**PRINCIPAL REGISTER**

MURPHEY, JASON R. (HAWAII LIMITED LIABILITY COMPANY), DBA ROOTSTIME PRODUCTION,  
P.O. BOX 664  
HALEIWA, HI 96712

FOR: AUDIO RECORDING AND PRODUCTION; COMPOSITION OF MUSIC FOR OTHERS; EDITING OR RECORDING OF SOUNDS AND IMAGES; ENTERTAINMENT SERVICES BY A MUSICAL ARTIST AND PRODUCER, NAMELY, MUSICAL COMPOSITION FOR OTHERS AND PRODUCTION OF MUSICAL SOUND RECORDINGS; ENTERTAINMENT SERVICES IN THE NATURE OF RECORDING, PRODUCTION AND POST-PRODUCTION SERVICES IN THE FIELD OF MUSIC; MULTIMEDIA ENTERTAINMENT SERVICES IN THE NATURE OF RECORDING, PRODUCTION AND POST-PRODUCTION SERVICES IN THE FIELDS OF MUSIC, VIDEO, AND FILMS; MUSIC COMPOSITION FOR OTHERS; MUSIC PRODUCTION SERVICES; POST-PRODUCTION EDITING SERVICES IN THE FIELD OF MUSIC, VIDEOS AND FILM; PRODUCTION OF AUDIO RECORDING; PRODUCTION OF MUSICAL SOUND RECORDING; PRODUCTION OF SOUND RECORDINGS; RECORD MASTER PRODUCTION; RECORD MASTERING; RECORD PRODUCTION; RECORDING STUDIO SERVICES; RECORDING STUDIOS, IN CLASS 41 (U.S. CLS. 100, 101 AND 107).

FIRST USE 1-2-2012; IN COMMERCE 1-2-2012.

NO CLAIM IS MADE TO THE EXCLUSIVE RIGHT TO USE "PRODUCTION", APART FROM THE MARK AS SHOWN.

THE MARK CONSISTS OF THE STYLIZED WORDING "ROOTSTIME PRODUCTION" WITH THE DESIGN OF LAMB STANDING IN FRONT OF A LION TO THE LEFT OF THE WORDING.

SN 85-340,391, FILED 6-7-2011.

JAY BESCH, EXAMINING ATTORNEY



*David J. Kyffers*

Director of the United States Patent and Trademark Office



# United States of America

United States Patent and Trademark Office

## SYSTEMS MD

**Reg. No. 4,136,944**

**Registered May 1, 2012**

**Int. Cl.: 36**

**SERVICE MARK**

**PRINCIPAL REGISTER**

CROSS COUNTRY HOME SERVICES, INC. (DELAWARE CORPORATION)  
1625 NW 136TH AVENUE, #200  
FT. LAUDERDALE, FL 33323

FOR: PROVIDING EXTENDED WARRANTY AND HOME SERVICE CONTRACTS IN THE  
FIELDS OF HOME HEATING, COOLING, VENTILATION, ELECTRICAL AND PLUMBING  
SYSTEMS AND ON HOME APPLIANCES, IN CLASS 36 (U.S. CLS. 100, 101 AND 102).

FIRST USE 11-0-2011; IN COMMERCE 11-0-2011.

THE MARK CONSISTS OF STANDARD CHARACTERS WITHOUT CLAIM TO ANY PAR-  
TICULAR FONT, STYLE, SIZE, OR COLOR.

SN 85-340,399, FILED 6-7-2011.

LAURIE MAYES, EXAMINING ATTORNEY



*David J. Kyros*

Director of the United States Patent and Trademark Office

# United States of America

United States Patent and Trademark Office



**Reg. No. 4,136,945**

**Registered May 1, 2012**

**Int. Cl.: 28**

**TRADEMARK**

**PRINCIPAL REGISTER**

FUN HORIZON LIMITED (HONG KONG LIMITED LIABILITY COMPANY)  
RM 511-14, HUNGHOM COMMERCIAL CENTRE  
TOWER A, 39 MA TAU WAI ROAD  
HUNGHOM, KOWLOON, HONG KONG

FOR: THREE DIMENSIONAL MODELS FOR EDUCATIONAL PURPOSES; ACTION SKILL GAMES; AMUSEMENT GAME MACHINES; APPARATUS FOR ELECTRONIC GAMES OTHER THAN THOSE ADAPTED FOR USE WITH AN EXTERNAL DISPLAY SCREEN OR MONITOR; ARCADE GAME MACHINES; BABY MULTIPLE ACTIVITY TOYS; BABY RATTLES; BALLS FOR GAMES; BALL-JOINTED DOLLS; BATH TOYS; BATTERY OPERATED ACTION TOYS; BOARD GAMES; BUILDING GAMES; CHILDREN'S MULTIPLE ACTIVITY TOYS; CONSTRUCTION TOYS; DOLLS AND DOLL ACCESSORIES, NAMELY, CLOTHING FOR DOLLS, DOLL ROOMS, DOLL BEDS, DOLL HOUSES, TOY FABRICS AND LINENS FOR DOLLS AND STROLLERS FOR DOLLS; EDUCATIONAL CARD GAMES; ELECTRONIC ACTION TOYS; INFANT DEVELOPMENT TOYS; INFANT TOYS; INFLATABLE SWIMMING POOLS; JIGSAW AND MANIPULATIVE PUZZLES; MUSICAL TOYS; PARTY GAMES; PLUSH DOLLS; PUZZLES; REMOTE CONTROL TOYS, NAMELY, CARS, RACE CARS, AIRPLANES, BOATS; TALKING TOYS; TOY VEHICLES, IN CLASS 28 (U.S. CLS. 22, 23, 38 AND 50).

FIRST USE 6-1-2011; IN COMMERCE 6-1-2011.

THE MARK CONSISTS OF THE STYLIZED WORDS "BUILD-A POWER" SUPERIMPOSED ON A CURVED RECTANGLE.

THE WORDING "BUILD A POWER" HAS NO MEANING IN A FOREIGN LANGUAGE.

SN 85-340,607, FILED 6-8-2011.

CHRISTINA SOBRAL, EXAMINING ATTORNEY



*David J. Kybas*

Director of the United States Patent and Trademark Office

# United States of America

United States Patent and Trademark Office

# HOT SPOT

**Reg. No. 4,136,946**

**Registered May 1, 2012**

**Int. Cl.: 21**

**TRADEMARK**

**PRINCIPAL REGISTER**

WEST CHESTER HOLDINGS, INC. (OHIO CORPORATION)  
100 CORRIDOR PARK DRIVE  
MONROE, OH 45050

FOR: WORK GLOVES, IN CLASS 21 (U.S. CLS. 2, 13, 23, 29, 30, 33, 40 AND 50).

FIRST USE 9-30-2011; IN COMMERCE 9-30-2011.

THE MARK CONSISTS OF STANDARD CHARACTERS WITHOUT CLAIM TO ANY PARTICULAR FONT, STYLE, SIZE, OR COLOR.

SN 85-340,731, FILED 6-8-2011.

CHRISTINE COOPER, EXAMINING ATTORNEY



*David J. Kybas*

Director of the United States Patent and Trademark Office

# United States of America

United States Patent and Trademark Office



**Reg. No. 4,136,947**

**Registered May 1, 2012**

**Int. Cl.: 30**

**TRADEMARK**

**PRINCIPAL REGISTER**

KEFFA COFFEE LLC (MARYLAND LIMITED LIABILITY COMPANY)  
3405 SALUDA RD  
NOTTINGHAM, MD 21236

FOR: COFFEE BEANS, IN CLASS 30 (U.S. CL. 46).

FIRST USE 5-10-2006; IN COMMERCE 5-10-2006.

NO CLAIM IS MADE TO THE EXCLUSIVE RIGHT TO USE "COFFEE LLC", APART FROM THE MARK AS SHOWN.

THE COLOR(S) BURGUNDY RED, WHITE, AND GRAY IS/ARE CLAIMED AS A FEATURE OF THE MARK.

THE MARK CONSISTS OF THE WORDING "KEFFA COFFEE LLC GOOD PEOPLE, GREAT COFFEE" IN WHITE ON A BURGUNDY RED CIRCLE, AND THE DESIGN OF A GOAT'S HEAD WITH A COFFEE PLANT IN ITS MOUTH IN BURGUNDY RED, WITH GRAY DROP SHADOWS, ON AN INTERIOR WHITE FIELD.

SN 85-340,824, FILED 6-8-2011.

HANNO RITTNER, EXAMINING ATTORNEY



*David J. Kyfos*

Director of the United States Patent and Trademark Office

# United States of America

United States Patent and Trademark Office

# ISOCOIL

**Reg. No. 4,136,948**

**Registered May 1, 2012**

**Int. Cl.: 6**

**TRADEMARK**

**PRINCIPAL REGISTER**

QUALITY EDGE, INC. (DELAWARE CORPORATION)  
2712 WALKENT DRIVE, N.W.  
WALKER, MI 49544

FOR: METAL EXTERIOR TRIM FOR BUILDINGS, IN CLASS 6 (U.S. CLS. 2, 12, 13, 14, 23, 25 AND 50).

FIRST USE 7-29-2011; IN COMMERCE 7-29-2011.

THE MARK CONSISTS OF STANDARD CHARACTERS WITHOUT CLAIM TO ANY PARTICULAR FONT, STYLE, SIZE, OR COLOR.

SN 85-341,094, FILED 6-8-2011.

NORA BUCHANAN WILL, EXAMINING ATTORNEY



*David J. Kybas*

Director of the United States Patent and Trademark Office

# United States of America

United States Patent and Trademark Office

## NO-MAR Q5000

**Reg. No. 4,136,949**

QUALITY EDGE, INC. (DELAWARE CORPORATION)  
2712 WALKENT DRIVE, N.W.  
WALKER, MI 49544

**Registered May 1, 2012**

**Int. Cl.: 6**

FOR: METAL EXTERIOR TRIM FOR BUILDINGS, IN CLASS 6 (U.S. CLS. 2, 12, 13, 14, 23, 25 AND 50).

**TRADEMARK**

FIRST USE 7-29-2011; IN COMMERCE 7-29-2011.

**PRINCIPAL REGISTER**

THE MARK CONSISTS OF STANDARD CHARACTERS WITHOUT CLAIM TO ANY PARTICULAR FONT, STYLE, SIZE, OR COLOR.

SN 85-341,110, FILED 6-8-2011.

NORA BUCHANAN WILL, EXAMINING ATTORNEY



*David J. Kybas*

Director of the United States Patent and Trademark Office

# United States of America

United States Patent and Trademark Office

# WASD

**Reg. No. 4,136,950**

**Registered May 1, 2012**

**Int. Cl.: 42**

**SERVICE MARK**

**PRINCIPAL REGISTER**

WASD GAME SERVERS, LLC (WISCONSIN LIMITED LIABILITY COMPANY)  
SUITE 219  
800 WISCONSIN STREET, BUILDING D02  
EAU CLAIRE, WI 54703

FOR: RENTAL OF WEB SERVERS; RENTAL OF GAME SERVERS; RENTAL OF VIRTUAL MACHINES; RENTAL OF VOICE OVER INTERNET PROTOCOL (VOIP) SERVERS; VIRTUAL SERVER SERVICES, NAMELY, HOSTING OF DIGITAL CONTENT OF OTHERS ON DEDICATED VIRTUAL SERVERS; HOSTING WEBSITES OF OTHERS, IN CLASS 42 (U.S. CLS. 100 AND 101).

FIRST USE 11-15-2011; IN COMMERCE 11-15-2011.

THE MARK CONSISTS OF STANDARD CHARACTERS WITHOUT CLAIM TO ANY PARTICULAR FONT, STYLE, SIZE, OR COLOR.

SN 85-341,310, FILED 6-8-2011.

ADA HAN, EXAMINING ATTORNEY



*David J. Kyffers*

Director of the United States Patent and Trademark Office

# United States of America

United States Patent and Trademark Office

## A TASTE OF THERAPY

**Reg. No. 4,136,951**

A TASTE OF THERAPY, LLC (VIRGINIA LIMITED LIABILITY COMPANY)  
P.O. BOX 8856  
RICHMOND, VA 23225

**Registered May 1, 2012**

**Int. Cl.: 41**

FOR: EDUCATION SERVICES, NAMELY, PROVIDING CLASSES IN THE FIELD OF COOKING AS THERAPY, IN CLASS 41 (U.S. CLS. 100, 101 AND 107).

**SERVICE MARK**

FIRST USE 7-0-2011; IN COMMERCE 7-0-2011.

**PRINCIPAL REGISTER**

THE MARK CONSISTS OF STANDARD CHARACTERS WITHOUT CLAIM TO ANY PARTICULAR FONT, STYLE, SIZE, OR COLOR.

SN 85-342,175, FILED 6-9-2011.

HAI-LY LAM, EXAMINING ATTORNEY



*David J. Kyffers*

Director of the United States Patent and Trademark Office



# United States of America

United States Patent and Trademark Office

# SPINFOCUS

**Reg. No. 4,136,952**

**Registered May 1, 2012**

**Int. Cl.: 9**

**TRADEMARK**

**PRINCIPAL REGISTER**

SPINFOCUS SPORT LTD. (CANADA CORPORATION)  
TOWNHOUSE 2- 1650 BAYSHORE DRIVE  
VANCOUVER, BC, CANADA V6G3K2

FOR: DIGITAL MATERIALS, NAMELY, PRE-RECORDED CDS AND DVDS, AND DOWNLOADABLE AUDIO AND VIDEO RECORDINGS FEATURING INDOOR CYCLING INSTRUCTION, EXERCISE INSTRUCTION, YOGA INSTRUCTION AND GENERAL FITNESS INSTRUCTION, IN CLASS 9 (U.S. CLS. 21, 23, 26, 36 AND 38).

FIRST USE 11-15-2011; IN COMMERCE 11-15-2011.

THE MARK CONSISTS OF STANDARD CHARACTERS WITHOUT CLAIM TO ANY PARTICULAR FONT, STYLE, SIZE, OR COLOR.

SN 85-342,448, FILED 6-9-2011.

BRENDAN MCCAULEY, EXAMINING ATTORNEY



*David J. Kyffers*

Director of the United States Patent and Trademark Office

# United States of America

United States Patent and Trademark Office

## Fantastic Fountain

**Reg. No. 4,136,953**

**Registered May 1, 2012**

**Int. Cl.: 32**

**TRADEMARK**

**PRINCIPAL REGISTER**

FANTASTIC FOUNTAIN, INC. (NEVADA CORPORATION)  
NA  
3225MCLEOD DRIVE, SUITE 100  
LAS VEGAS, NV 89121

FOR: CONCENTRATES, SYRUPS OR POWDERS USED IN THE PREPARATION OF SPORTS AND ENERGY DRINKS; ENERGY DRINKS; NON-ALCOHOLIC DRINKS, NAMELY, ENERGY SHOTS; SPORTS DRINKS, NAMELY, ENERGY DRINKS, IN CLASS 32 (U.S. CLS. 45, 46 AND 48).

FIRST USE 1-9-2012; IN COMMERCE 1-9-2012.

THE MARK CONSISTS OF STANDARD CHARACTERS WITHOUT CLAIM TO ANY PARTICULAR FONT, STYLE, SIZE, OR COLOR.

SN 85-342,480, FILED 6-9-2011.

ZACHARY BELLO, EXAMINING ATTORNEY



*David J. Kyffers*

Director of the United States Patent and Trademark Office

# United States of America

United States Patent and Trademark Office

# Little Squirts

**Reg. No. 4,136,954**

**Registered May 1, 2012**

**Int. Cl.: 21**

**TRADEMARK**

**PRINCIPAL REGISTER**

STEPHEN JOSEPH, INC. (TEXAS CORPORATION)  
4302 IRONTON  
LUBBOCK, TX 79407

FOR: REUSABLE PLASTIC WATER BOTTLES SOLD EMPTY; COLLAPSIBLE PLASTIC WATER BOTTLES HAVING NOVELTY DESIGNS, SOLD EMPTY, IN CLASS 21 (U.S. CLS. 2, 13, 23, 29, 30, 33, 40 AND 50).

FIRST USE 12-15-2011; IN COMMERCE 12-15-2011.

THE MARK CONSISTS OF STANDARD CHARACTERS WITHOUT CLAIM TO ANY PARTICULAR FONT, STYLE, SIZE, OR COLOR.

SN 85-342,970, FILED 6-10-2011.

ANDREW RHIM, EXAMINING ATTORNEY



*David J. Kyros*

Director of the United States Patent and Trademark Office

# United States of America

United States Patent and Trademark Office

## EVERYBODYISART

**Reg. No. 4,136,955**

**Registered May 1, 2012**

**Int. Cl.: 35**

**SERVICE MARK**

**PRINCIPAL REGISTER**

M & A VENTURES, LTD. (COLORADO CORPORATION)  
1633 CLERMONT ST.  
DENVER, CO 80220

FOR: ON-LINE RETAIL STORE SERVICES FEATURING ARTWORK IN ALL MEDIUMS, NAMELY, PHOTOGRAPHS, VIDEOS, FILMS, PAINTINGS, SCULPTURE, BODY PAINTING, PERFORMANCE ART, GRAPHICAL WORKS, RECORDINGS, FILMS AND GIFTS, IN CLASS 35 (U.S. CLS. 100, 101 AND 102).

FIRST USE 9-1-2011; IN COMMERCE 9-1-2011.

THE MARK CONSISTS OF STANDARD CHARACTERS WITHOUT CLAIM TO ANY PARTICULAR FONT, STYLE, SIZE, OR COLOR.

SN 85-342,998, FILED 6-10-2011.

SUZANNE BLANE, EXAMINING ATTORNEY



*David J. Kyros*

Director of the United States Patent and Trademark Office

# United States of America

United States Patent and Trademark Office

**GREASE  
MONKEY**  
**Oil Changes & More**

**Reg. No. 4,136,956**

**Registered May 1, 2012**

**Int. Cl.: 37**

**SERVICE MARK**

**PRINCIPAL REGISTER**

GREASE MONKEY INTERNATIONAL, INC. (COLORADO CORPORATION)  
7450 E. PROGRESS PLACE  
GREENWOOD VILLAGE, CO 80111

FOR: VEHICLE REPAIR AND MAINTENANCE SERVICES, IN CLASS 37 (U.S. CLS. 100, 103 AND 106).

FIRST USE 10-14-2011; IN COMMERCE 10-14-2011.

OWNER OF U.S. REG. NOS. 3,116,868, 3,145,105, AND OTHERS.

SEC. 2(F).

NO CLAIM IS MADE TO THE EXCLUSIVE RIGHT TO USE "OIL CHANGES & MORE", APART FROM THE MARK AS SHOWN.

THE MARK CONSISTS OF THE WORDS "GREASE MONKEY" IN STYLIZED BUBBLE LETTERS AND THE WORDS "OIL CHANGES & MORE".

SN 85-343,100, FILED 6-10-2011.

KRISTIN DAHLING, EXAMINING ATTORNEY



*David J. Kybas*

Director of the United States Patent and Trademark Office

# United States of America

United States Patent and Trademark Office

## RASPBERRY SLIM

**Reg. No. 4,136,957**

**Registered May 1, 2012**

**Int. Cl.: 5**

**TRADEMARK**

**PRINCIPAL REGISTER**

WINDMILL HEALTH PRODUCTS, LLC (NEW JERSEY LIMITED LIABILITY COMPANY)  
6 HENDERSON DRIVE  
WEST CALDWELL, NJ 07006

FOR: DIETARY AND NUTRITIONAL SUPPLEMENTS CONTAINING RASPBERRY, IN CLASS 5 (U.S. CLS. 6, 18, 44, 46, 51 AND 52).

FIRST USE 10-10-2011; IN COMMERCE 10-10-2011.

THE MARK CONSISTS OF STANDARD CHARACTERS WITHOUT CLAIM TO ANY PARTICULAR FONT, STYLE, SIZE, OR COLOR.

NO CLAIM IS MADE TO THE EXCLUSIVE RIGHT TO USE "RASPBERRY", APART FROM THE MARK AS SHOWN.

SN 85-343,382, FILED 6-10-2011.

ROBIN CHOSID, EXAMINING ATTORNEY



*David J. Kybas*

Director of the United States Patent and Trademark Office

# United States of America

United States Patent and Trademark Office

# CHOZEN

**Reg. No. 4,136,958**

**Registered May 1, 2012**

**Int. Cl.: 9**

**TRADEMARK**

**PRINCIPAL REGISTER**

CHOZEN INC. (NEVADA CORPORATION)  
#170-74  
11700 W.CHARLESTON BLVD.  
LAS VEGAS, NV 89135

FOR: SUNGLASSES, IN CLASS 9 (U.S. CLS. 21, 23, 26, 36 AND 38).

FIRST USE 2-16-2012; IN COMMERCE 2-16-2012.

THE MARK CONSISTS OF STANDARD CHARACTERS WITHOUT CLAIM TO ANY PARTICULAR FONT, STYLE, SIZE, OR COLOR.

OWNER OF U.S. REG. NOS. 3,525,560, 3,951,808, AND OTHERS.

SN 85-343,970, FILED 6-11-2011.

JENNIFER DIXON, EXAMINING ATTORNEY



*David J. Kybas*

Director of the United States Patent and Trademark Office

# United States of America

United States Patent and Trademark Office

# Tears of Ra

**Reg. No. 4,136,959**

**Registered May 1, 2012**

**Int. Cl.: 30**

**TRADEMARK**

**PRINCIPAL REGISTER**

SNYDER, BARBARA (UNITED STATES INDIVIDUAL)  
BARBARA SNYDER  
2322 RT. 44  
PLEASANT VALLEY, NY 12569

FOR: HONEY, IN CLASS 30 (U.S. CL. 46).

FIRST USE 10-15-2011; IN COMMERCE 10-15-2011.

THE MARK CONSISTS OF STANDARD CHARACTERS WITHOUT CLAIM TO ANY PARTICULAR FONT, STYLE, SIZE, OR COLOR.

SN 85-344,056, FILED 6-12-2011.

SOPHIA S. KIM, EXAMINING ATTORNEY



*David J. Kyros*

Director of the United States Patent and Trademark Office



# United States of America

United States Patent and Trademark Office

## AMINO FREAK

**Reg. No. 4,136,960**

**Registered May 1, 2012**

**Int. Cl.: 5**

**TRADEMARK**

**PRINCIPAL REGISTER**

PHARMAFREAK HOLDINGS INC. (CANADA CORPORATION)  
SUITE 400  
542 MOUNT PLEASANT ROAD  
TORONTO, ONTARIO, CANADA M4S2M7

FOR: DIETARY AND NUTRITIONAL SUPPLEMENTS CONTAINING AMINO ACIDS, IN CLASS 5 (U.S. CLS. 6, 18, 44, 46, 51 AND 52).

FIRST USE 10-0-2011; IN COMMERCE 10-0-2011.

THE MARK CONSISTS OF STANDARD CHARACTERS WITHOUT CLAIM TO ANY PARTICULAR FONT, STYLE, SIZE, OR COLOR.

OWNER OF U.S. REG. NOS. 3,932,856 AND 3,942,640.

NO CLAIM IS MADE TO THE EXCLUSIVE RIGHT TO USE "AMINO", APART FROM THE MARK AS SHOWN.

SN 85-344,445, FILED 6-13-2011.

KARANENDRA S. CHHINA, EXAMINING ATTORNEY



*David J. Kyffers*

Director of the United States Patent and Trademark Office

# United States of America

United States Patent and Trademark Office

## WORLD'S SEXIEST SHEETS

**Reg. No. 4,136,961**

**Registered May 1, 2012**

**Int. Cl.: 24**

**TRADEMARK**

**PRINCIPAL REGISTER**

CMN INTERNATIONAL LLC (CALIFORNIA LIMITED LIABILITY COMPANY)  
SUITE # 203  
2001 OMEGA ROAD  
SAN RAMON, CA 94583

FOR: BABY BEDDING, NAMELY, BUNDLE BAGS, SWADDLING BLANKETS, CRIB BUMPERS, FITTED CRIB SHEETS, CRIB SKIRTS, CRIB BLANKETS, AND DIAPER CHANGING PAD COVERS NOT OF PAPER; BABY BLANKETS; BATH SHEETS; BATH TOWELS; BEACH TOWELS; BEAVER SKIN BLANKET THROWS; BED BLANKETS; BED SHEETS; BED SHEETS, FITTED BED SHEET COVERS, BED FLAT SHEETS, AND PILLOW CASES USED IN THE BEDDING, HEALTH CARE, HOME-HEALTH CARE AND NURSING HOME INDUSTRIES MADE OF BIODEGRADABLE FILM CREATED FROM RENEWABLE BIO-POLYMER RESOURCES; BED THROWS; BLANKET THROWS; BLANKETS FOR OUTDOOR USE; CASHMERE BLANKETS; CHILDREN'S BLANKETS; CHILDREN'S TOWELS; COMFORTERS; CONTOUR SHEETS; COVERLETS; CURTAINS AND TOWELS; DUVET COVERS; DUVETS; FABRICS USED IN HOME DECORATIVE ITEMS WITH INSPIRATIONAL MESSAGES IMPRINTED OR WOVEN INTO THE FABRICS; FACE TOWELS; FACE TOWELS OF TEXTILES; FITTED BED SHEETS; FITTED BED SHEETS FOR PETS; FLAT BED SHEETS; HAND TOWELS; HAND TOWELS OF TEXTILE; HAND-TOWELS MADE OF TEXTILE FABRICS; HOUSEHOLD LINEN, INCLUDING FACE TOWELS; KITCHEN TOWELS; LAP BLANKETS; LARGE BATH TOWELS; MOISTURE ABSORBENT MICROFIBER TEXTILE FABRICS FOR USE IN THE MANUFACTURE OF ATHLETIC APPAREL, NAMELY, SHIRTS, PANTS, SHORTS, JACKETS, BAGS, TOWELS AND ATHLETIC UNIFORMS; PILLOW SHAMS; PILLOWCASES; QUILT COVERS; QUILTS; QUILTS OF TEXTILE; QUILTS OF TOWELS; RECEIVING BLANKETS; SHAMS; SHEET SETS; SILK BED BLANKETS; SILK BLANKETS; SLEEPING BAGS IN THE NATURE OF SHEETING; TERRY TOWELS; TEXTILE GOODS, NAMELY, A SYNTHETIC SHEET WITH FRAGRANCE FOR THE PURPOSE OF INSERTING INTO PILLOW SLIP AND UNDER FITTED SHEET TO EMIT FRAGRANCE; TEXTILE PRINTERS' BLANKETS; THROWS; THROWS DESIGNED TO ALSO BE WRAPPED AROUND A PERSON; THROWS FOR TRAVELING; TOWEL SETS; TOWEL SHEET; TOWELLING COVERLETS; TOWELS; TOWELS MADE OF TEXTILE MATERIALS; TOWELS THAT MAY BE WORN AS A DRESS OR SIMILAR GARMENT; TRAVELLING BLANKETS; WOOLLEN BLANKETS, IN CLASS 24 (U.S. CLS. 42 AND 50).



*David J. Kyros*

FIRST USE 9-21-2011; IN COMMERCE 9-21-2011.

**Reg. No. 4,136,961** THE MARK CONSISTS OF STANDARD CHARACTERS WITHOUT CLAIM TO ANY PARTICULAR FONT, STYLE, SIZE, OR COLOR.

NO CLAIM IS MADE TO THE EXCLUSIVE RIGHT TO USE "WORLD'S" AND "SHEETS", APART FROM THE MARK AS SHOWN.

SN 85-344,988, FILED 6-13-2011.

SKYE YOUNG, EXAMINING ATTORNEY

# United States of America

United States Patent and Trademark Office

# BOBCAT

**Reg. No. 4,136,962**

**Registered May 1, 2012**

**Int. Cl.: 9**

**TRADEMARK**

**PRINCIPAL REGISTER**

DIAGNOSTIC HYBRIDS, INC. (OHIO CORPORATION)  
1055 E. STATE ST.  
SUITE 100  
ATHENS, OH 45701

FOR: AUTOMATED FLUORESCENT-BASED MICROSCOPY SYSTEM COMPRISING HIGH INTENSITY LIGHT-EMITTING DIODES (LED), OBJECTIVE LENS, DIGITAL CAMERA CHARGE-COUPLED DEVICE (CCD), CUSTOMIZED MICROSCOPY SLIDES, MOTORIZED SLIDE CARRIER, DETECTION AND/OR IDENTIFICATION STAINING REAGENTS, ASSOCIATED QUALITY CONTROL REAGENTS, AND DIAGNOSTIC SOFTWARE FOR DATA REDUCTION ALL SOLD TOGETHER AS A UNIT, IN CLASS 9 (U.S. CLS. 21, 23, 26, 36 AND 38).

FIRST USE 6-28-2011; IN COMMERCE 6-28-2011.

THE MARK CONSISTS OF STANDARD CHARACTERS WITHOUT CLAIM TO ANY PARTICULAR FONT, STYLE, SIZE, OR COLOR.

SN 85-345,051, FILED 6-13-2011.

JAMES MACFARLANE, EXAMINING ATTORNEY



*David J. Kyros*

Director of the United States Patent and Trademark Office

# United States of America

United States Patent and Trademark Office

## PACIFIC VALUE SELECT

**Reg. No. 4,136,963**

**Registered May 1, 2012**

**Int. Cl.: 36**

**SERVICE MARK**

**PRINCIPAL REGISTER**

PACIFIC LIFE INSURANCE COMPANY (NEBRASKA CORPORATION)  
700 NEWPORT CENTER DRIVE  
NEWPORT BEACH, CA 92660

FOR: INSURANCE AND FINANCIAL SERVICES, NAMELY, LIFE INSURANCE AND ANNUITY UNDERWRITING, INSURANCE AND ANNUITY ADMINISTRATION, FINANCIAL MANAGEMENT AND BROKERAGE SERVICES FOR ALL TYPES OF INSURANCE, REINSURANCE UNDERWRITING; INSURANCE CLAIMS ADMINISTRATION AND PROCESSING; INSURANCE CONSULTATION; ANNUITY SERVICES, NAMELY, ACCOUNT AND INVESTMENT ADMINISTRATION AND THE INVESTMENT AND DISTRIBUTION OF ANNUITIES, IN CLASS 36 (U.S. CLS. 100, 101 AND 102).

FIRST USE 9-6-2011; IN COMMERCE 9-6-2011.

THE MARK CONSISTS OF STANDARD CHARACTERS WITHOUT CLAIM TO ANY PARTICULAR FONT, STYLE, SIZE, OR COLOR.

OWNER OF U.S. REG. NOS. 2,411,140, 3,618,552, AND OTHERS.

SN 85-345,055, FILED 6-13-2011.

JANICE KIM, EXAMINING ATTORNEY



*David J. Kyros*

Director of the United States Patent and Trademark Office

# United States of America

United States Patent and Trademark Office

## CENTERLIGHT

**Reg. No. 4,136,964**

**Registered May 1, 2012**

**Int. Cl.: 44**

**SERVICE MARK**

**PRINCIPAL REGISTER**

BETHCO CORPORATION (NEW YORK NON-PROFIT CORPORATION)  
612 ALLERTON AVENUE  
BRONX, NY 10467

FOR: HEALTH CARE SERVICES; MEDICAL SERVICES; HOME HEALTH CARE SERVICES;  
REHABILITATION PATIENT CARE SERVICES; LONG TERM RESIDENTIAL HEALTH  
CARE SERVICES, IN CLASS 44 (U.S. CLS. 100 AND 101).

FIRST USE 2-1-2012; IN COMMERCE 2-1-2012.

THE MARK CONSISTS OF STANDARD CHARACTERS WITHOUT CLAIM TO ANY PAR-  
TICULAR FONT, STYLE, SIZE, OR COLOR.

SN 85-345,068, FILED 6-13-2011.

MATTHEW MCDOWELL, EXAMINING ATTORNEY



*David J. Kyros*

Director of the United States Patent and Trademark Office

# United States of America

United States Patent and Trademark Office

## DOCK-ALERT

**Reg. No. 4,136,965**

**Registered May 1, 2012**

**Int. Cl.: 19**

**TRADEMARK**

**PRINCIPAL REGISTER**

HI-TEC EQUIPMENT COMPANY, LLC (NORTH CAROLINA LIMITED LIABILITY COMPANY)  
POST OFFICE BOX 14040  
GREENSBORO, NC 27415

FOR: NON-METAL PEDESTRIAN TRAFFIC CONTROL BARRIER, IN CLASS 19 (U.S. CLS. 1, 12, 33 AND 50).

FIRST USE 8-19-2011; IN COMMERCE 8-19-2011.

THE MARK CONSISTS OF STANDARD CHARACTERS WITHOUT CLAIM TO ANY PARTICULAR FONT, STYLE, SIZE, OR COLOR.

SN 85-345,706, FILED 6-14-2011.

CHRISTOPHER BUONGIORNO, EXAMINING ATTORNEY



*David J. Kyffers*

Director of the United States Patent and Trademark Office

# United States of America

United States Patent and Trademark Office

## CLICK-N-CARVE

**Reg. No. 4,136,966**

COLOVOS COMPANY (ILLINOIS CORPORATION)  
4444 WEST OHIO STREET  
CHICAGO, IL 60624

**Registered May 1, 2012**

**Int. Cl.: 7**

FOR: POWER TOOLS, NAMELY, COMPUTER NUMERIC CONTROLLED ENGRAVER AND ROUTER, IN CLASS 7 (U.S. CLS. 13, 19, 21, 23, 31, 34 AND 35).

**TRADEMARK**

FIRST USE 7-20-2011; IN COMMERCE 7-20-2011.

**PRINCIPAL REGISTER**

THE MARK CONSISTS OF STANDARD CHARACTERS WITHOUT CLAIM TO ANY PARTICULAR FONT, STYLE, SIZE, OR COLOR.

SN 85-345,730, FILED 6-14-2011.

DANNEAN HETZEL, EXAMINING ATTORNEY



*David J. Kybas*

Director of the United States Patent and Trademark Office



# United States of America

United States Patent and Trademark Office

# SimpleSaver

**Reg. No. 4,136,967**

**Registered May 1, 2012**

**Int. Cl.: 36**

**SERVICE MARK**

**PRINCIPAL REGISTER**

COLORADO STATE EMPLOYEES CREDIT UNION (COLORADO CREDIT UNION), DBA  
CREDIT UNION OF COLORADO,  
1390 LOGAN STREET  
DENVER, CO 80203

FOR: CHECKING ACCOUNT SERVICES; DEBIT CARD SERVICES, IN CLASS 36 (U.S. CLS.  
100, 101 AND 102).

FIRST USE 7-20-2011; IN COMMERCE 7-20-2011.

THE MARK CONSISTS OF STANDARD CHARACTERS WITHOUT CLAIM TO ANY PAR-  
TICULAR FONT, STYLE, SIZE, OR COLOR.

SN 85-346,075, FILED 6-14-2011.

SETH A. RAPPAPORT, EXAMINING ATTORNEY



*David J. Kyros*

Director of the United States Patent and Trademark Office

# United States of America

United States Patent and Trademark Office

## BALANCE IT DHA Omega-3

**Reg. No. 4,136,968**

**Registered May 1, 2012**

**Int. Cl.: 5**

**TRADEMARK**

**PRINCIPAL REGISTER**

DAVIS VETERINARY MEDICAL CONSULTING, INC. (CALIFORNIA CORPORATION)  
606 PENA DRIVE, SUITE 700  
DAVIS, CA 95618

FOR: NUTRITIONAL SUPPLEMENTS CONTAINING DHA AND OMEGA-3 ACIDS, IN CLASS  
5 (U.S. CLS. 6, 18, 44, 46, 51 AND 52).

FIRST USE 9-21-2011; IN COMMERCE 9-21-2011.

THE MARK CONSISTS OF STANDARD CHARACTERS WITHOUT CLAIM TO ANY PAR-  
TICULAR FONT, STYLE, SIZE, OR COLOR.

OWNER OF U.S. REG. NO. 3,094,401.

NO CLAIM IS MADE TO THE EXCLUSIVE RIGHT TO USE "DHA OMEGA-3", APART  
FROM THE MARK AS SHOWN.

SN 85-346,327, FILED 6-14-2011.

CAROLINE WOOD, EXAMINING ATTORNEY



*David J. Kyros*

Director of the United States Patent and Trademark Office

# United States of America

United States Patent and Trademark Office

## MIDNIGHT COLLECTION

**Reg. No. 4,136,969**

CHURCH & DWIGHT CO., INC. (DELAWARE CORPORATION)  
469 NORTH HARRISON STREET LAW DEPARTMENT  
PRINCETON, NJ 08543

**Registered May 1, 2012**

**Int. Cl.: 10**

FOR: ADULT SEXUAL STIMULATION AIDS, NAMELY, PERSONAL VIBRATORS, IN CLASS 10 (U.S. CLS. 26, 39 AND 44).

**TRADEMARK**

FIRST USE 12-8-2011; IN COMMERCE 12-8-2011.

**PRINCIPAL REGISTER**

THE MARK CONSISTS OF STANDARD CHARACTERS WITHOUT CLAIM TO ANY PARTICULAR FONT, STYLE, SIZE, OR COLOR.

NO CLAIM IS MADE TO THE EXCLUSIVE RIGHT TO USE "COLLECTION", APART FROM THE MARK AS SHOWN.

SN 85-346,464, FILED 6-15-2011.

MELISSA VALLILLO, EXAMINING ATTORNEY



*David J. Kyjars*

Director of the United States Patent and Trademark Office

# United States of America

United States Patent and Trademark Office

## BACTERIA SHIELD

**Reg. No. 4,136,970**

**Registered May 1, 2012**

**Int. Cl.: 11**

**TRADEMARK**

**PRINCIPAL REGISTER**

FREIJE TREATMENT SYSTEMS, INC. (INDIANA FOR PROFIT CORPORATION)  
4202 N. AWNING COURT  
GREENFIELD, IN 46140

FOR: WATER TREATMENT EQUIPMENT, NAMELY, ULTRAVIOLET STERILIZATION UNITS, IN CLASS 11 (U.S. CLS. 13, 21, 23, 31 AND 34).

FIRST USE 10-7-2011; IN COMMERCE 10-7-2011.

THE MARK CONSISTS OF STANDARD CHARACTERS WITHOUT CLAIM TO ANY PARTICULAR FONT, STYLE, SIZE, OR COLOR.

NO CLAIM IS MADE TO THE EXCLUSIVE RIGHT TO USE "BACTERIA", APART FROM THE MARK AS SHOWN.

SN 85-347,054, FILED 6-15-2011.

MARIA-VICTORIA SUAREZ, EXAMINING ATTORNEY



*David J. Kyros*

Director of the United States Patent and Trademark Office

# United States of America

United States Patent and Trademark Office

## GUIDE TO YOUR PERFECT RIDE

**Reg. No. 4,136,971**

**Registered May 1, 2012**

**Int. Cl.: 35**

**SERVICE MARK**

**PRINCIPAL REGISTER**

ENTERPRISE HOLDINGS, INC. (MISSOURI CORPORATION)  
600 CORPORATE PARK DRIVE  
ST. LOUIS, MO 63105

FOR: AUTOMOBILE DEALERSHIP SERVICES, IN CLASS 35 (U.S. CLS. 100, 101 AND 102).

FIRST USE 9-1-2011; IN COMMERCE 9-1-2011.

THE MARK CONSISTS OF STANDARD CHARACTERS WITHOUT CLAIM TO ANY PARTICULAR FONT, STYLE, SIZE, OR COLOR.

SN 85-347,135, FILED 6-15-2011.

WILLIAM BRECKENFELD, EXAMINING ATTORNEY



*David J. Kyfos*

Director of the United States Patent and Trademark Office

# United States of America

United States Patent and Trademark Office

## BREAKING & ENTERING

**Reg. No. 4,136,972**

**Registered May 1, 2012**

**Int. Cl.: 33**

**TRADEMARK**

**PRINCIPAL REGISTER**

DOPPELGANGER, INC. (CALIFORNIA CORPORATION)  
300 MONTGOMERY ST. #639  
SAN FRANCISCO, CA 94104

FOR: ALCOHOLIC BEVERAGES EXCEPT BEERS, IN CLASS 33 (U.S. CLS. 47 AND 49).

FIRST USE 8-0-2011; IN COMMERCE 8-0-2011.

THE MARK CONSISTS OF STANDARD CHARACTERS WITHOUT CLAIM TO ANY PARTICULAR FONT, STYLE, SIZE, OR COLOR.

SN 85-347,399, FILED 6-15-2011.

DAVID HOFFMAN, EXAMINING ATTORNEY



*David J. Kyffers*

Director of the United States Patent and Trademark Office

# United States of America

United States Patent and Trademark Office



**Reg. No. 4,136,973**

**Registered May 1, 2012**

**Int. Cl.: 44**

**SERVICE MARK**

**PRINCIPAL REGISTER**

BETHCO CORPORATION (NEW YORK NON-PROFIT CORPORATION)  
612 ALLERTON AVENUE  
BRONX, NY 10467

FOR: HEALTH CARE SERVICES; MEDICAL SERVICES; HOME HEALTH CARE SERVICES;  
REHABILITATION PATIENT CARE SERVICES; LONG TERM RESIDENTIAL HEALTH  
CARE SERVICES, IN CLASS 44 (U.S. CLS. 100 AND 101).

FIRST USE 2-1-2012; IN COMMERCE 2-1-2012.

THE MARK CONSISTS OF A POLYGON WITH SIX POINTS IN THE OVERALL SHAPE OF  
A PINWHEEL WITH LIGHTER SHADING ON THE INTERIOR FORMING A STAR WITH  
SIX POINTS WITHIN THE OVERALL POLYGON SHAPE.

SN 85-347,411, FILED 6-15-2011.

MATTHEW MCDOWELL, EXAMINING ATTORNEY



*David J. Kybas*

Director of the United States Patent and Trademark Office

# United States of America

United States Patent and Trademark Office

## TOXIN GUARD

**Reg. No. 4,136,974**

**Registered May 1, 2012**

**Int. Cl.: 11**

**TRADEMARK**

**PRINCIPAL REGISTER**

FREIJE TREATMENT SYSTEMS, INC. (INDIANA FOR PROFIT CORPORATION)  
4202 N. AWNING COURT  
GREENFIELD, IN 46140

FOR: WATER FILTERS SOLD AS A COMPONENT PART OF WATER FILTRATION AND PURIFICATION UNITS; WATER PURIFICATION AND FILTRATION APPARATUS , IN CLASS 11 (U.S. CLS. 13, 21, 23, 31 AND 34).

FIRST USE 10-7-2011; IN COMMERCE 10-7-2011.

THE MARK CONSISTS OF STANDARD CHARACTERS WITHOUT CLAIM TO ANY PARTICULAR FONT, STYLE, SIZE, OR COLOR.

NO CLAIM IS MADE TO THE EXCLUSIVE RIGHT TO USE "TOXIN", APART FROM THE MARK AS SHOWN.

SN 85-348,195, FILED 6-16-2011.

MARIA-VICTORIA SUAREZ, EXAMINING ATTORNEY



*David J. Kyros*

Director of the United States Patent and Trademark Office



# United States of America

United States Patent and Trademark Office

# JSM

**Reg. No. 4,136,975**

**Registered May 1, 2012**

**Int. Cl.: 9**

**TRADEMARK**

**PRINCIPAL REGISTER**

JSMG WORLDWIDE, INC. (DELAWARE CORPORATION)  
3401 SW 160TH AVENUE, SUITE 430  
MIRAMAR, FL 33027

FOR: WIRELESS COMMUNICATION DEVICE FOR TRANSMITTING LOCATION BASED MESSAGES, NAMELY, A WIRELESS TELECOMMUNICATIONS TRANSMITTER FOR SENDING LOCATION BASED ELECTRONIC MESSAGES, IN CLASS 9 (U.S. CLS. 21, 23, 26, 36 AND 38).

FIRST USE 6-22-2011; IN COMMERCE 6-22-2011.

THE MARK CONSISTS OF STANDARD CHARACTERS WITHOUT CLAIM TO ANY PARTICULAR FONT, STYLE, SIZE, OR COLOR.

SN 85-348,296, FILED 6-16-2011.

MICHAEL TANNER, EXAMINING ATTORNEY



*David J. Kybas*

Director of the United States Patent and Trademark Office

# United States of America

United States Patent and Trademark Office

## NEUTRALIZERPLUS+...THE ANTI-BAD BREATH TOOTHBRUSH

**Reg. No. 4,136,976**

JAKSHA, STEVEN (UNITED STATES INDIVIDUAL)  
13618 TORREY HILL CT.  
SAN DIEGO, CA 92130

**Registered May 1, 2012**

**Int. Cl.: 21**

FOR: TOOTHBRUSHES, IN CLASS 21 (U.S. CLS. 2, 13, 23, 29, 30, 33, 40 AND 50).

**TRADEMARK**

FIRST USE 12-0-2011; IN COMMERCE 12-0-2011.

**PRINCIPAL REGISTER**

THE MARK CONSISTS OF STANDARD CHARACTERS WITHOUT CLAIM TO ANY PARTICULAR FONT, STYLE, SIZE, OR COLOR.

NO CLAIM IS MADE TO THE EXCLUSIVE RIGHT TO USE "TOOTHBRUSH", APART FROM THE MARK AS SHOWN.

SN 85-348,338, FILED 6-16-2011.

EMILY CARLSEN, EXAMINING ATTORNEY



*David J. Kyffers*

Director of the United States Patent and Trademark Office

# United States of America

United States Patent and Trademark Office

## NEUTRALIZERPLUS+...THE TOOTHBRUSH THAT MAKES FRIENDS

**Reg. No. 4,136,977**

JAKSHA, STEVEN (UNITED STATES INDIVIDUAL)  
13618 TORREY HILL CT.  
SAN DIEGO, CA 92130

**Registered May 1, 2012**

**Int. Cl.: 21**

FOR: TOOTHBRUSHES, IN CLASS 21 (U.S. CLS. 2, 13, 23, 29, 30, 33, 40 AND 50).

**TRADEMARK**

FIRST USE 12-0-2011; IN COMMERCE 12-0-2011.

**PRINCIPAL REGISTER**

THE MARK CONSISTS OF STANDARD CHARACTERS WITHOUT CLAIM TO ANY PARTICULAR FONT, STYLE, SIZE, OR COLOR.

NO CLAIM IS MADE TO THE EXCLUSIVE RIGHT TO USE "TOOTHBRUSH", APART FROM THE MARK AS SHOWN.

SN 85-348,350, FILED 6-16-2011.

EMILY CARLSEN, EXAMINING ATTORNEY



*David J. Kybas*

Director of the United States Patent and Trademark Office

# United States of America

United States Patent and Trademark Office

## INVISIBLE GLASS CLARITY

**Reg. No. 4,136,978**

**Registered May 1, 2012**

**Int. Cl.: 12**

**TRADEMARK**

**PRINCIPAL REGISTER**

STONER, INCORPORATED (PENNSYLVANIA CORPORATION)  
1070 ROBERT FULTON HIGHWAY  
QUARRYVILLE, PA 17566

FOR: VEHICLE PARTS, NAMELY, WINDSHIELD WIPERS, IN CLASS 12 (U.S. CLS. 19, 21, 23, 31, 35 AND 44).

FIRST USE 1-12-2012; IN COMMERCE 1-12-2012.

THE MARK CONSISTS OF STANDARD CHARACTERS WITHOUT CLAIM TO ANY PARTICULAR FONT, STYLE, SIZE, OR COLOR.

OWNER OF U.S. REG. NOS. 2,207,320 AND 3,909,340.

SN 85-348,897, FILED 6-17-2011.

AISHA CLARKE, EXAMINING ATTORNEY



*David J. Kyffers*

Director of the United States Patent and Trademark Office

# United States of America

United States Patent and Trademark Office

# Carbosential

**Reg. No. 4,136,979**

ADVANCED TURF SOLUTIONS, INC. (INDIANA CORPORATION)  
12840 FORD DRIVE  
FISHERS, IN 46038

**Registered May 1, 2012**

**Int. Cl.: 1**

FOR: CHEMICALS, NAMELY, FERTILIZERS, AND MICRO-NUTRIENTS, AMINO ACIDS, AND BIO-STIMULANTS ALL FOR USE AS PLANT GROWTH NUTRIENTS, ALL THE AFORESAID FOR DOMESTIC OR COMMERCIAL USES FOR TURF, INCLUDING SPORTS TURF, GOLF COURSES AND LAWNS, IN CLASS 1 (U.S. CLS. 1, 5, 6, 10, 26 AND 46).

**TRADEMARK**

**PRINCIPAL REGISTER**

FIRST USE 8-31-2011; IN COMMERCE 8-31-2011.

THE MARK CONSISTS OF STANDARD CHARACTERS WITHOUT CLAIM TO ANY PARTICULAR FONT, STYLE, SIZE, OR COLOR.

SN 85-350,091, FILED 6-20-2011.

ANTHONY RINKER, EXAMINING ATTORNEY



*David J. Kyffers*

Director of the United States Patent and Trademark Office

# United States of America

United States Patent and Trademark Office

# QWIIQQ

**Reg. No. 4,136,980**

**Registered May 1, 2012**

**Int. Cls.: 9 and 35**

**TRADEMARK**

**SERVICE MARK**

**PRINCIPAL REGISTER**

QWIIQQ, INC. (DELAWARE CORPORATION)  
1202 SEAGLER RD., APT. 65  
HOUSTON, TX 77042

FOR: COMPUTER APPLICATION SOFTWARE FOR MOBILE DIGITAL DEVICES, MOBILE PHONES, PORTABLE MEDIA PLAYERS, PERSONAL DIGITAL ASSISTANTS, AND HANDHELD, TABLET, LAPTOP, AND DESKTOP COMPUTERS, NAMELY, SOFTWARE THAT ALLOWS USERS AND MERCHANTS TO SHARE AND VIEW INFORMATION ABOUT SALES AND DISCOUNTS; COMPUTER SOFTWARE TO ENABLE UPLOADING, DOWNLOADING, ACCESSING, POSTING, DISPLAYING, BLOGGING, SHARING OR OTHERWISE PROVIDING ELECTRONIC MEDIA OR INFORMATION VIA GLOBAL COMPUTER, INFORMATION, AND COMMUNICATION NETWORKS, IN CLASS 9 (U.S. CLS. 21, 23, 26, 36 AND 38).

FIRST USE 8-9-2011; IN COMMERCE 8-9-2011.

FOR: PROMOTING THE GOODS AND SERVICES OF OTHERS VIA GLOBAL COMPUTER, INFORMATION, AND COMMUNICATION NETWORKS FEATURING SALES AND DISCOUNT INFORMATION; PROVISION OF ADVERTISING SPACE BY ELECTRONIC MEANS AND GLOBAL INFORMATION NETWORKS; MARKETING, ADVERTISING AND PROMOTION SERVICES, IN CLASS 35 (U.S. CLS. 100, 101 AND 102).

FIRST USE 8-9-2011; IN COMMERCE 8-9-2011.

THE MARK CONSISTS OF STANDARD CHARACTERS WITHOUT CLAIM TO ANY PARTICULAR FONT, STYLE, SIZE, OR COLOR.

SN 85-350,453, FILED 6-20-2011.

ADA HAN, EXAMINING ATTORNEY



*David J. Kyros*

Director of the United States Patent and Trademark Office

# United States of America

United States Patent and Trademark Office

## TRISTAR POWERSPORT PROTECTION

**Reg. No. 4,136,981**

**Registered May 1, 2012**

**Int. Cl.: 36**

**SERVICE MARK**

**PRINCIPAL REGISTER**

TRISTAR INDEMNITY LLC (OHIO LIMITED LIABILITY COMPANY)  
6951 CINTAS BOULEVARD  
MASON, OH 45040

FOR: INSURANCE SERVICES, NAMELY, ADMINISTRATION OF ANTI-THEFT WARRANTY CONTRACTS, GUARANTEED ASSET-PROTECTION CONTRACTS, AND TIRE-AND-WHEEL HAZARD-SERVICE CONTRACTS, ALL FOR MOTORCYCLES, IN CLASS 36 (U.S. CLS. 100, 101 AND 102).

FIRST USE 4-30-2011; IN COMMERCE 4-30-2011.

THE MARK CONSISTS OF STANDARD CHARACTERS WITHOUT CLAIM TO ANY PARTICULAR FONT, STYLE, SIZE, OR COLOR.

OWNER OF U.S. REG. NOS. 2,572,173, 3,905,252, AND 3,936,988.

NO CLAIM IS MADE TO THE EXCLUSIVE RIGHT TO USE "POWERSPORT PROTECTION", APART FROM THE MARK AS SHOWN.

SN 85-351,615, FILED 6-21-2011.

NICHOLAS ALTREE, EXAMINING ATTORNEY



*David J. Kyros*

Director of the United States Patent and Trademark Office

# United States of America

United States Patent and Trademark Office

# TRUAIR

**Reg. No. 4,136,982**

**Registered May 1, 2012**

**Int. Cl.: 19**

**TRADEMARK**

**PRINCIPAL REGISTER**

QUALITY EDGE, INC. (DELAWARE CORPORATION)  
2712 WALKENT DRIVE, N.W.  
WALKER, MI 49544

FOR: NON-METAL ROOF VENTS FOR VENTILATION IN RESIDENTIAL AND COMMERCIAL BUILDINGS, IN CLASS 19 (U.S. CLS. 1, 12, 33 AND 50).

FIRST USE 11-4-2011; IN COMMERCE 11-4-2011.

THE MARK CONSISTS OF STANDARD CHARACTERS WITHOUT CLAIM TO ANY PARTICULAR FONT, STYLE, SIZE, OR COLOR.

SN 85-351,621, FILED 6-21-2011.

NORA BUCHANAN WILL, EXAMINING ATTORNEY



*David J. Kybas*

Director of the United States Patent and Trademark Office



# United States of America

United States Patent and Trademark Office

## TXT CELLARS

**Reg. No. 4,136,983**

**Registered May 1, 2012**

**Int. Cl.: 25**

**TRADEMARK**

**PRINCIPAL REGISTER**

VISION WINE & SPIRITS LLC (NEW JERSEY LIMITED LIABILITY COMPANY)  
2ND FLOOR  
700 PLAZA DRIVE  
SECAUCUS, NJ 07094

FOR: CLOTHING, NAMELY, CAPS, HATS, T-SHIRTS, SWEATSHIRTS, SHORTS, GOLF SHIRTS, SWEAT PANTS, PANTS, JACKETS, WIND-RESISTANT JACKETS, HEAD AND WRIST BANDS, SOCKS, GLOVES, SCARVES, MITTENS, IN CLASS 25 (U.S. CLS. 22 AND 39).

FIRST USE 9-15-2011; IN COMMERCE 9-15-2011.

THE MARK CONSISTS OF STANDARD CHARACTERS WITHOUT CLAIM TO ANY PARTICULAR FONT, STYLE, SIZE, OR COLOR.

SN 85-351,726, FILED 6-21-2011.

TEJBIR SINGH, EXAMINING ATTORNEY



*David J. Kybas*

Director of the United States Patent and Trademark Office

# United States of America

United States Patent and Trademark Office

## FUNCTION IN TREND

**Reg. No. 4,136,984**

**Registered May 1, 2012**

**Int. Cl.: 9**

**TRADEMARK**

**PRINCIPAL REGISTER**

FUNCTION IN TREND TECHNOLOGY LIMITED (CANADA LIMITED COMPANY (LTD.))  
35 LOCKDARE STREET  
TORONTO, CANADA

FOR: HEADSETS FOR USE WITH MOBILE PHONES AND COMPUTERS, EARBUDS, WIRELESS HEADSETS FOR MOBILE PHONES, COMPUTER MOUSE, KEYBOARD, DIGITAL MEMORY CARD, ELECTRONIC CABLES, MP3 PLAYERS, AUDIO SPEAKERS, POWER CHARGERS IN THE NATURE OF BATTERY CHARGER, POWER ADAPTERS, IN CLASS 9 (U.S. CLS. 21, 23, 26, 36 AND 38).

FIRST USE 6-20-2011; IN COMMERCE 2-1-2012.

THE MARK CONSISTS OF STANDARD CHARACTERS WITHOUT CLAIM TO ANY PARTICULAR FONT, STYLE, SIZE, OR COLOR.

SN 85-351,763, FILED 6-21-2011.

WON TEAK OH, EXAMINING ATTORNEY



*David J. Kyffers*

Director of the United States Patent and Trademark Office

# United States of America

United States Patent and Trademark Office



**Reg. No. 4,136,985**

**Registered May 1, 2012**

**Int. Cl.: 31**

**TRADEMARK**

**PRINCIPAL REGISTER**

K9 NATURAL FOOD LTD. (NEW ZEALAND CORPORATION)  
P.O. BOX 11 367, 6 HALWYN DRIVE  
CHRISTCHURCH, NEW ZEALAND

FOR: CAT FOOD; CAT TREATS, IN CLASS 31 (U.S. CLS. 1 AND 46).

FIRST USE 10-0-2011; IN COMMERCE 10-0-2011.

OWNER OF U.S. REG. NO. 3,952,491.

NO CLAIM IS MADE TO THE EXCLUSIVE RIGHT TO USE "FELINE NATURAL", APART FROM THE MARK AS SHOWN.

THE MARK CONSISTS OF A SILHOUETTE OF A CAT TO THE LEFT OF THE WORDS "FELINE NATURAL", ALL CONTAINED WITHIN A DESIGN OF A RECTANGLE WITH ROUNDED CORNERS.

SN 85-352,507, FILED 6-22-2011.

CHRISTOPHER BUONGIORNO, EXAMINING ATTORNEY



*David J. Kybas*

Director of the United States Patent and Trademark Office

# United States of America

United States Patent and Trademark Office

## Predictive Pruning

**Reg. No. 4,136,986**

**Registered May 1, 2012**

**Int. Cl.: 42**

**SERVICE MARK**

**PRINCIPAL REGISTER**

BRITTON, GERARD (UNITED STATES INDIVIDUAL)  
60 MOUNTAIN AVE  
MILLBURN, NJ 07041

FOR: SOFTWARE AS A SERVICE (SAAS) SERVICES FEATURING SOFTWARE FOR CONDUCTING ELECTRONIC LEGAL DISCOVERY, NAMELY, PROVIDING AUTOMATED REVIEW OF ELECTRONICALLY STORED INFORMATION FOR USE AS EVIDENCE AND MANAGING ASSOCIATED WORKFLOW IN THE DISCOVERY PROCESS, IN CLASS 42 (U.S. CLS. 100 AND 101).

FIRST USE 6-10-2011; IN COMMERCE 2-16-2012.

THE MARK CONSISTS OF STANDARD CHARACTERS WITHOUT CLAIM TO ANY PARTICULAR FONT, STYLE, SIZE, OR COLOR.

NO CLAIM IS MADE TO THE EXCLUSIVE RIGHT TO USE "PREDICTIVE", APART FROM THE MARK AS SHOWN.

SN 85-352,562, FILED 6-22-2011.

KAREN BRACEY, EXAMINING ATTORNEY



*David J. Kyros*

Director of the United States Patent and Trademark Office

# United States of America

United States Patent and Trademark Office

## ROCK CASTLE

**Reg. No. 4,136,987**

**Registered May 1, 2012**

**Int. Cl.: 34**

**TRADEMARK**

**PRINCIPAL REGISTER**

NATIONAL TOBACCO COMPANY, L.P. (DELAWARE LIMITED PARTNERSHIP)  
5201 INTERCHANGE WAY  
LOUISVILLE, KY 40229

FOR: CIGARS; SMOKING TOBACCO; TOBACCO, IN CLASS 34 (U.S. CLS. 2, 8, 9 AND 17).

FIRST USE 1-27-2012; IN COMMERCE 1-27-2012.

THE MARK CONSISTS OF STANDARD CHARACTERS WITHOUT CLAIM TO ANY PARTICULAR FONT, STYLE, SIZE, OR COLOR.

SN 85-353,760, FILED 6-23-2011.

ROBERT C. CLARK JR., EXAMINING ATTORNEY



*David J. Kyffers*

Director of the United States Patent and Trademark Office

# United States of America

United States Patent and Trademark Office

# THE VIBE

**Reg. No. 4,136,988**

**Registered May 1, 2012**

**Int. Cl.: 25**

**TRADEMARK**

**PRINCIPAL REGISTER**

WEST CHESTER HOLDINGS, INC. (OHIO CORPORATION)  
100 CORRIDOR PARK DRIVE  
MONROE, OH 45050

FOR: GLOVES, IN CLASS 25 (U.S. CLS. 22 AND 39).

FIRST USE 12-20-2011; IN COMMERCE 12-20-2011.

THE MARK CONSISTS OF STANDARD CHARACTERS WITHOUT CLAIM TO ANY PARTICULAR FONT, STYLE, SIZE, OR COLOR.

SN 85-354,625, FILED 6-23-2011.

HAI-LY LAM, EXAMINING ATTORNEY



*David J. Kybas*

Director of the United States Patent and Trademark Office

# United States of America

United States Patent and Trademark Office

# SureTag

**Reg. No. 4,136,989**

AGILENT TECHNOLOGIES, INC. (DELAWARE CORPORATION)  
5301 STEVENS CREEK BLVD.  
SANTA CLARA, CA 95051

**Registered May 1, 2012**

**Int. Cl.: 1**

FOR: LABORATORY REAGENTS FOR USE IN SCIENTIFIC RESEARCH, MOLECULAR BIOLOGY AND DNA LABELING, IN CLASS 1 (U.S. CLS. 1, 5, 6, 10, 26 AND 46).

**TRADEMARK**

FIRST USE 10-0-2011; IN COMMERCE 10-0-2011.

**PRINCIPAL REGISTER**

THE MARK CONSISTS OF STANDARD CHARACTERS WITHOUT CLAIM TO ANY PARTICULAR FONT, STYLE, SIZE, OR COLOR.

SN 85-354,989, FILED 6-24-2011.

JOHN E. MICHOS, EXAMINING ATTORNEY



*David J. Kybas*

Director of the United States Patent and Trademark Office

# United States of America

United States Patent and Trademark Office

## Aggregation. Transparency. Control.

**Reg. No. 4,136,990**

**Registered May 1, 2012**

**Int. Cl.: 42**

**SERVICE MARK**

**PRINCIPAL REGISTER**

FTEN, INC. (DELAWARE CORPORATION)  
SUITE 900  
143 UNION BOULEVARD  
LAKEWOOD, CO 80228

FOR: SOFTWARE AS A SERVICE (SAAS) SERVICES FEATURING SOFTWARE FOR USE IN FINANCIAL RISK MANAGEMENT, NAMELY, FOR HIGH SPEED, LOW LATENCY FINANCIAL SECURITIES TRADING, IN CLASS 42 (U.S. CLS. 100 AND 101).

FIRST USE 6-20-2011; IN COMMERCE 11-28-2011.

THE MARK CONSISTS OF STANDARD CHARACTERS WITHOUT CLAIM TO ANY PARTICULAR FONT, STYLE, SIZE, OR COLOR.

SN 85-355,605, FILED 6-24-2011.

LAURA KOVALSKY, EXAMINING ATTORNEY



*David J. Kyros*

Director of the United States Patent and Trademark Office



# United States of America

United States Patent and Trademark Office

## METAL GOURMET

**Reg. No. 4,136,991**

AIRTRONICS METAL PRODUCTS, INC. (CALIFORNIA CORPORATION)  
1991 SENTER ROAD  
SAN JOSE, CA 95112

**Registered May 1, 2012**

**Int. Cl.: 12**

FOR: FOOD SERVICE CARTS AND TRAILERS MADE IN WHOLE OR SIGNIFICANT PART OF METAL, IN CLASS 12 (U.S. CLS. 19, 21, 23, 31, 35 AND 44).

**TRADEMARK**

FIRST USE 1-0-2012; IN COMMERCE 1-0-2012.

**PRINCIPAL REGISTER**

THE MARK CONSISTS OF STANDARD CHARACTERS WITHOUT CLAIM TO ANY PARTICULAR FONT, STYLE, SIZE, OR COLOR.

NO CLAIM IS MADE TO THE EXCLUSIVE RIGHT TO USE "METAL", APART FROM THE MARK AS SHOWN.

SN 85-355,868, FILED 6-24-2011.

BRENDAN MCCAULEY, EXAMINING ATTORNEY



*David J. Kybas*

Director of the United States Patent and Trademark Office

# United States of America

United States Patent and Trademark Office

# VIZION

**Reg. No. 4,136,992**

THOR TECH, INC. (NEVADA CORPORATION)  
419 WEST PIKE STREET  
JACKSON CENTER, OH 45334

**Registered May 1, 2012**

**Int. Cl.: 12**

FOR: RECREATIONAL VEHICLES, NAMELY, FIFTH WHEEL TRAILERS, AND SPORT UTILITY TRAILERS, IN CLASS 12 (U.S. CLS. 19, 21, 23, 31, 35 AND 44).

**TRADEMARK**

FIRST USE 0-0-2011; IN COMMERCE 0-0-2011.

**PRINCIPAL REGISTER**

THE MARK CONSISTS OF STANDARD CHARACTERS WITHOUT CLAIM TO ANY PARTICULAR FONT, STYLE, SIZE, OR COLOR.

SN 85-356,007, FILED 6-24-2011.

JIM RINGLE, EXAMINING ATTORNEY



*David J. Kyffers*

Director of the United States Patent and Trademark Office

# United States of America

United States Patent and Trademark Office

## CHEER BUDDIES

**Reg. No. 4,136,993**

MYERS, SUZANNE (UNITED STATES INDIVIDUAL)  
9905 PINEHURST CIRCLE  
OMAHA, NE 68124

**Registered May 1, 2012**

**Int. Cl.: 25**

FOR: NOVELTY GAG CLOTHING CONSISTING OF A SLEEVE WITH POM POMS ATTACHED TO THE FOREARM, IN CLASS 25 (U.S. CLS. 22 AND 39).

**TRADEMARK**

FIRST USE 6-3-2009; IN COMMERCE 1-15-2012.

**PRINCIPAL REGISTER**

THE MARK CONSISTS OF STANDARD CHARACTERS WITHOUT CLAIM TO ANY PARTICULAR FONT, STYLE, SIZE, OR COLOR.

SN 85-356,245, FILED 6-25-2011.

DOUGLAS LEE, EXAMINING ATTORNEY



*David J. Kyffers*

Director of the United States Patent and Trademark Office

# United States of America

United States Patent and Trademark Office

# GadgitKids

**Reg. No. 4,136,994**

**Registered May 1, 2012**

**Int. Cl.: 41**

**SERVICE MARK**

**PRINCIPAL REGISTER**

GADGITKIDS, LLC (FLORIDA LIMITED LIABILITY COMPANY)  
10823 SEMINOLE BLVD., SUITE 2A  
LARGO, FL 33778

FOR: EDUCATION SERVICES, NAMELY, PROVIDING TEACHING AND INSTRUCTION IN THE USE AND OPERATION OF PORTABLE CONSUMER ELECTRONIC DEVICES, IN CLASS 41 (U.S. CLS. 100, 101 AND 107).

FIRST USE 8-1-2011; IN COMMERCE 8-1-2011.

THE MARK CONSISTS OF STANDARD CHARACTERS WITHOUT CLAIM TO ANY PARTICULAR FONT, STYLE, SIZE, OR COLOR.

SN 85-358,032, FILED 6-28-2011.

JOHN WILKE, EXAMINING ATTORNEY



*David J. Kyros*

Director of the United States Patent and Trademark Office

# United States of America

United States Patent and Trademark Office

# XALT

**Reg. No. 4,136,995**

**Registered May 1, 2012**

**Int. Cl.: 5**

**TRADEMARK**

**PRINCIPAL REGISTER**

COMPLETE NUTRITION IP, LLC (SOUTH DAKOTA LIMITED LIABILITY COMPANY)  
17220 WRIGHT STREET  
SUITE 200  
OMAHA, NE 68130

FOR: DIETARY SUPPLEMENTS, IN CLASS 5 (U.S. CLS. 6, 18, 44, 46, 51 AND 52).

FIRST USE 7-19-2011; IN COMMERCE 7-19-2011.

THE MARK CONSISTS OF STANDARD CHARACTERS WITHOUT CLAIM TO ANY PARTICULAR FONT, STYLE, SIZE, OR COLOR.

SN 85-358,249, FILED 6-28-2011.

KAREN SEVERSON, EXAMINING ATTORNEY



*David J. Kybas*

Director of the United States Patent and Trademark Office

# United States of America

United States Patent and Trademark Office

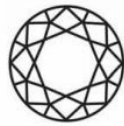

# CLARUS

**Reg. No. 4,136,996**

**Registered May 1, 2012**

**Int. Cl.: 9**

**TRADEMARK**

**PRINCIPAL REGISTER**

GORDON J. GOW TECHNOLOGIES, INC. (FLORIDA CORPORATION)  
6448 PINECASTLE BLVD  
#101  
ORLANDO, FL 32809

FOR: INTERCONNECTING CABLES AND CABLE CONNECTORS FOR USE IN CONNECTION WITH VIDEO, AUDIO AND DIGITAL EQUIPMENT; COMPUTER CABLES; AND AC POWER CABLES AND CONNECTORS, IN CLASS 9 (U.S. CLS. 21, 23, 26, 36 AND 38).

FIRST USE 1-11-2012; IN COMMERCE 1-11-2012.

THE MARK CONSISTS OF THE WORD MARK "CLARUS" IN COMBINATION WITH A CIRCULAR LOGO DESIGN WHICH INCORPORATES A GEOMETRIC DESIGN ELEMENT.

THE ENGLISH TRANSLATION OF "CLARUS" IN THE MARK IS DISTINCT.

SN 85-358,435, FILED 6-28-2011.

JENNY PARK, EXAMINING ATTORNEY



*David J. Kybas*

Director of the United States Patent and Trademark Office

# United States of America

United States Patent and Trademark Office

# Stud Life

**Reg. No. 4,136,997**

**Registered May 1, 2012**

**Int. Cl.: 25**

**TRADEMARK**

**PRINCIPAL REGISTER**

MEDINA, THOMAS (UNITED STATES INDIVIDUAL)  
3024 DA VINCI CT  
MODESTO, CA 95355

FOR: T-SHIRTS, SHIRTS, SHORT-SLEEVED SHIRTS, LONG-SLEEVED SHIRTS, SWEAT-SHIRTS, JEANS, HATS, JACKETS, BELTS, SHOES, SOCKS, HEADWEAR, GLOVES, SWEATERS AND TOPS, IN CLASS 25 (U.S. CLS. 22 AND 39).

FIRST USE 9-1-2009; IN COMMERCE 3-1-2010.

THE MARK CONSISTS OF STANDARD CHARACTERS WITHOUT CLAIM TO ANY PARTICULAR FONT, STYLE, SIZE, OR COLOR.

SN 85-358,581, FILED 6-28-2011.

JEFF DEFORD, EXAMINING ATTORNEY



*David J. Kybas*

Director of the United States Patent and Trademark Office

# United States of America

United States Patent and Trademark Office

## UNLIMITED VALUE

**Reg. No. 4,136,998**

**Registered May 1, 2012**

**Int. Cl.: 38**

**SERVICE MARK**

**PRINCIPAL REGISTER**

T-MOBILE USA, INC. (DELAWARE CORPORATION)  
12920 S.E. 38TH STREET  
BELLEVUE, WA 98006

FOR: TELECOMMUNICATIONS SERVICES, NAMELY, VOICE AND DATA TRANSMISSION, TWO WAY TRANSMISSION OF EMAIL AND TEXT BETWEEN WIRELESS TELECOMMUNICATION TERMINALS AND COMPUTERS, AND PROVIDING MULTIPLE-USER ACCESS TO A GLOBAL COMPUTER NETWORK, IN CLASS 38 (U.S. CLS. 100, 101 AND 104).

FIRST USE 7-24-2011; IN COMMERCE 7-24-2011.

THE MARK CONSISTS OF STANDARD CHARACTERS WITHOUT CLAIM TO ANY PARTICULAR FONT, STYLE, SIZE, OR COLOR.

SN 85-360,421, FILED 6-30-2011.

LINDSEY RUBIN, EXAMINING ATTORNEY



*David J. Kybas*

Director of the United States Patent and Trademark Office



# United States of America

United States Patent and Trademark Office

# FUZZYHEADS

**Reg. No. 4,136,999**

**Registered May 1, 2012**

**Int. Cl.: 20**

**TRADEMARK**

**PRINCIPAL REGISTER**

BEAR IN MIND COMPANY (TEXAS CORPORATION)  
10900 SOUTH STONELAKE BLVD.  
QUARRY OAKS BUILDING A, SUITE A-320  
AUSTIN, TX 78759

FOR: ACCENT PILLOWS; BED PILLOWS; BEDS, MATTRESSES, PILLOWS AND BOLSTERS;  
NOVELTY PILLOWS; PILLOWS, IN CLASS 20 (U.S. CLS. 2, 13, 22, 25, 32 AND 50).

FIRST USE 10-14-2011; IN COMMERCE 10-14-2011.

THE MARK CONSISTS OF STANDARD CHARACTERS WITHOUT CLAIM TO ANY PARTICULAR FONT, STYLE, SIZE, OR COLOR.

SN 85-360,520, FILED 6-30-2011.

ANNE E. GUSTASON, EXAMINING ATTORNEY



*David J. Kybas*

Director of the United States Patent and Trademark Office

# United States of America

United States Patent and Trademark Office

# HANDSPRING

**Reg. No. 4,137,000**

**Registered May 1, 2012**

**Int. Cl.: 20**

**TRADEMARK**

**PRINCIPAL REGISTER**

BEAR IN MIND COMPANY (TEXAS CORPORATION)  
10900 SOUTH STONELAKE BLVD.  
QUARRY OAKS BUILDING A, SUITE A-320  
AUSTIN, TX 78759

FOR: HEAD SUPPORTING PILLOWS; PILLOWS, IN CLASS 20 (U.S. CLS. 2, 13, 22, 25, 32 AND 50).

FIRST USE 10-14-2011; IN COMMERCE 10-14-2011.

THE MARK CONSISTS OF STANDARD CHARACTERS WITHOUT CLAIM TO ANY PARTICULAR FONT, STYLE, SIZE, OR COLOR.

SN 85-360,526, FILED 6-30-2011.

ANNE E. GUSTASON, EXAMINING ATTORNEY



*David J. Kyffers*

Director of the United States Patent and Trademark Office

# United States of America

United States Patent and Trademark Office

## MAKE YOUR WORLD GO

**Reg. No. 4,137,001**

**Registered May 1, 2012**

**Int. Cl.: 36**

**SERVICE MARK**

**PRINCIPAL REGISTER**

XLIT LTD. (CAYMAN ISLANDS CORPORATION)  
1 HATCH STREET  
DUBLIN, IRELAND

FOR: INSURANCE UNDERWRITING SERVICES IN THE FIELDS OF PROPERTY AND CASUALTY; REINSURANCE UNDERWRITING SERVICES, IN CLASS 36 (U.S. CLS. 100, 101 AND 102).

FIRST USE 10-1-2011; IN COMMERCE 10-1-2011.

THE MARK CONSISTS OF STANDARD CHARACTERS WITHOUT CLAIM TO ANY PARTICULAR FONT, STYLE, SIZE, OR COLOR.

SN 85-360,746, FILED 6-30-2011.

LAURIE MAYES, EXAMINING ATTORNEY



*David J. Kyffers*

Director of the United States Patent and Trademark Office

# United States of America

United States Patent and Trademark Office

WE'RE WITH YOU EVERY  
STITCH OF THE WAY

**Reg. No. 4,137,002**

**Registered May 1, 2012**

**Int. Cl.: 23**

**TRADEMARK**

**PRINCIPAL REGISTER**

ORCHARD YARN AND THREAD COMPANY, INC. (NEW YORK CORPORATION), DBA  
LION BRAND YARN COMPANY,  
34 WEST 15TH STREET  
NEW YORK, NY 10011

FOR: YARN, IN CLASS 23 (U.S. CL. 43).

FIRST USE 1-3-2012; IN COMMERCE 1-3-2012.

THE MARK CONSISTS OF STANDARD CHARACTERS WITHOUT CLAIM TO ANY PARTICULAR FONT, STYLE, SIZE, OR COLOR.

SN 85-360,979, FILED 6-30-2011.

COURTNEY ALVAREZ, EXAMINING ATTORNEY



*David J. Kybas*

Director of the United States Patent and Trademark Office

# United States of America

United States Patent and Trademark Office



**Reg. No. 4,137,003**  
**Registered May 1, 2012**

BULKIN, DMITRY (RUSSIAN FED. INDIVIDUAL), AKA DIMA SHINE,  
7107 DURANGO DRIVE  
LAS VEGAS, NV 89113

**Int. Cl.: 41**

FOR: PHYSICAL FITNESS STUDIO SERVICES, NAMELY, PROVIDING EXERCISE CLASSES,  
BODY SCULPTING CLASSES, AND GROUP FITNESS CLASSES, IN CLASS 41 (U.S. CLS.  
100, 101 AND 107).

**SERVICE MARK**

FIRST USE 6-25-2011; IN COMMERCE 1-1-2012.

**PRINCIPAL REGISTER**

NO CLAIM IS MADE TO THE EXCLUSIVE RIGHT TO USE "ALTERNATIVE FITNESS",  
APART FROM THE MARK AS SHOWN.

THE MARK CONSISTS OF THE WORD "SHINE" IN ITALICS, THE DOT OVER THE "I"  
BEING SIMILAR TO A SUNBURST WHOSE RAYS PROJECT THROUGH THE LETTERS IN  
THE WORD "SHINE". THE WORDS "ALTERNATIVE FITNESS" ARE LOCATED BELOW  
THE "N" AND "E" IN "SHINE" AND ARE RIGHT JUSTIFIED.

SN 85-361,010, FILED 6-30-2011.

DAVID C. REIHNER, EXAMINING ATTORNEY



*David J. Kyffers*

Director of the United States Patent and Trademark Office

# United States of America

United States Patent and Trademark Office

# HUMIDICON

**Reg. No. 4,137,004**

**Registered May 1, 2012**

**Int. Cl.: 9**

**TRADEMARK**

**PRINCIPAL REGISTER**

HONEYWELL INTERNATIONAL INC. (DELAWARE CORPORATION)  
101 COLUMBIA ROAD  
MORRISTOWN, NJ 07962

FOR: DIGITAL HUMIDITY AND TEMPERATURE SENSOR, IN CLASS 9 (U.S. CLS. 21, 23, 26, 36 AND 38).

FIRST USE 8-8-2011; IN COMMERCE 1-27-2012.

THE MARK CONSISTS OF STANDARD CHARACTERS WITHOUT CLAIM TO ANY PARTICULAR FONT, STYLE, SIZE, OR COLOR.

SN 85-361,591, FILED 7-1-2011.

LINDA E. BLOHM, EXAMINING ATTORNEY



*David J. Kyffers*

Director of the United States Patent and Trademark Office

# United States of America

United States Patent and Trademark Office

## BEHIND THE PAW

**Reg. No. 4,137,005**

**Registered May 1, 2012**

**Int. Cl.: 35**

**SERVICE MARK**

**PRINCIPAL REGISTER**

JOHN PAUL PRODUCTS, LLC (NEVADA LIMITED LIABILITY COMPANY)  
1183 PITTSFIELD LANE  
VENTURA, CA 93001

FOR: PROMOTING THE CHARITABLE SERVICES OF OTHERS, NAMELY, PROVIDING INDIVIDUALS WITH INFORMATION ABOUT VARIOUS CHARITIES FOR THE PURPOSE OF MAKING DONATIONS TO CHARITIES; PROMOTIONAL SERVICES, NAMELY, PROMOTING THE CHARITIES OF OTHERS, IN CLASS 35 (U.S. CLS. 100, 101 AND 102).

FIRST USE 11-11-2011; IN COMMERCE 11-11-2011.

THE MARK CONSISTS OF STANDARD CHARACTERS WITHOUT CLAIM TO ANY PARTICULAR FONT, STYLE, SIZE, OR COLOR.

SN 85-362,157, FILED 7-1-2011.

WON TEAK OH, EXAMINING ATTORNEY



*David J. Kyffers*

Director of the United States Patent and Trademark Office

# United States of America

United States Patent and Trademark Office

## Ewe Can Count

**Reg. No. 4,137,006**

**Registered May 1, 2012**

**Int. Cl.: 9**

**TRADEMARK**

**PRINCIPAL REGISTER**

KAMPRATH, MICHAEL F. (UNITED STATES INDIVIDUAL), DBA CLAIREWARE  
SOFTWARE,  
1945 MONTECITO AVE  
MOUNTAIN VIEW, CA 94043

FOR: CHILDREN'S EDUCATIONAL SOFTWARE; COMPUTER GAME PROGRAMS; COMPUTER GAME SOFTWARE; COMPUTER GAME SOFTWARE FOR USE ON MOBILE AND CELLULAR PHONES, IN CLASS 9 (U.S. CLS. 21, 23, 26, 36 AND 38).

FIRST USE 12-6-2011; IN COMMERCE 12-6-2011.

THE MARK CONSISTS OF STANDARD CHARACTERS WITHOUT CLAIM TO ANY PARTICULAR FONT, STYLE, SIZE, OR COLOR.

SN 85-362,391, FILED 7-2-2011.

MEGHAN REINHART, EXAMINING ATTORNEY



*David J. Kybas*

Director of the United States Patent and Trademark Office



# United States of America

United States Patent and Trademark Office

## TANDA PEARL

**Reg. No. 4,137,007**

**Registered May 1, 2012**

**Int. Cl.: 3**

**TRADEMARK**

**PRINCIPAL REGISTER**

SYNERON BEAUTY INC. (CANADA CORPORATION)  
SUITE #11  
380 JAMIESON PARKWAY  
CAMBRIDGE, ONTARIO, CANADA N3C4N4

FOR: TEETH WHITENING KITS; TOOTH WHITENING GELS, IN CLASS 3 (U.S. CLS. 1, 4, 6, 50, 51 AND 52).

FIRST USE 1-3-2012; IN COMMERCE 1-3-2012.

THE MARK CONSISTS OF STANDARD CHARACTERS WITHOUT CLAIM TO ANY PARTICULAR FONT, STYLE, SIZE, OR COLOR.

SN 85-362,430, FILED 7-2-2011.

SARA BENJAMIN, EXAMINING ATTORNEY



*David J. Kyffers*

Director of the United States Patent and Trademark Office

# United States of America

United States Patent and Trademark Office

# JUGGERNAUT

**Reg. No. 4,137,008**

**Registered May 1, 2012**

**Int. Cl.: 32**

**TRADEMARK**

**PRINCIPAL REGISTER**

RLED, LLC (CALIFORNIA LIMITED LIABILITY COMPANY)  
8000 WHEATLAND, AVE. UNIT J  
SUN VALLEY, CA 91352

FOR: CONCENTRATES, SYRUPS OR POWDERS USED IN THE PREPARATION OF SPORTS AND ENERGY DRINKS; ENERGY DRINKS, IN CLASS 32 (U.S. CLS. 45, 46 AND 48).

FIRST USE 1-30-2012; IN COMMERCE 1-30-2012.

THE MARK CONSISTS OF STANDARD CHARACTERS WITHOUT CLAIM TO ANY PARTICULAR FONT, STYLE, SIZE, OR COLOR.

SN 85-362,673, FILED 7-4-2011.

JAMES GRIFFIN, EXAMINING ATTORNEY



*David J. Kyffers*

Director of the United States Patent and Trademark Office

# United States of America

United States Patent and Trademark Office



**Reg. No. 4,137,009**

**Registered May 1, 2012**

**Int. Cl.: 41**

**SERVICE MARK**

**PRINCIPAL REGISTER**

RAMCHARRAN, RAM (UNITED STATES INDIVIDUAL)  
242 RUE DES CHATEAUX  
TARPON SPRINGS, FL 34688

FOR: ENTERTAINMENT IN THE NATURE OF A COOKING FESTIVAL FEATURING CURRY AND OTHER SPICES, IN CLASS 41 (U.S. CLS. 100, 101 AND 107).

FIRST USE 9-17-2011; IN COMMERCE 9-17-2011.

NO CLAIM IS MADE TO THE EXCLUSIVE RIGHT TO USE "TAMPA BAY INTERNATIONAL CURRY FESTIVAL", APART FROM THE MARK AS SHOWN.

THE MARK CONSISTS OF A PARTIAL CIRCULAR BAND ENCIRCLING THE DESIGN OF TWO PEPPERS AND A SHEAF OF GRAIN WITH THE STYLIZED WORDS "CURRY FESTIVAL" IN THE MIDDLE. A STYLIZED SPLASHING CURRY SAUCE IS AROUND THE LETTERS "C" AND "Y" IN "CURRY." THE WORDS "TAMPA BAY INTERNATIONAL" APPEAR INSIDE THE TOP OF THE CIRCULAR BAND.

SN 85-362,973, FILED 7-5-2011.

IRA J. GOODSaid, EXAMINING ATTORNEY



*David J. Kyffers*

Director of the United States Patent and Trademark Office

# United States of America

United States Patent and Trademark Office

# TRIALATOR

**Reg. No. 4,137,010**

**Registered May 1, 2012**

**Int. Cl.: 10**

**TRADEMARK**

**PRINCIPAL REGISTER**

MEDSHAPE SOLUTIONS, INC. (GEORGIA CORPORATION)  
1575 NORTHSIDE DRIVE NW  
SUITE 440  
ATLANTA, GA 30318

FOR: SURGICAL INSTRUMENTS FOR USE IN ORTHOPEDIC SURGERY, IN CLASS 10  
(U.S. CLS. 26, 39 AND 44).

FIRST USE 1-0-2012; IN COMMERCE 1-0-2012.

THE MARK CONSISTS OF STANDARD CHARACTERS WITHOUT CLAIM TO ANY PARTICULAR FONT, STYLE, SIZE, OR COLOR.

SN 85-363,419, FILED 7-5-2011.

JACLYN KIDWELL WALKER, EXAMINING ATTORNEY



*David J. Kybas*

Director of the United States Patent and Trademark Office

# United States of America

United States Patent and Trademark Office

## EYE OF THE SEA

**Reg. No. 4,137,011**

**Registered May 1, 2012**

**Int. Cl.: 14**

**TRADEMARK**

**PRINCIPAL REGISTER**

EYE OF THE SEA LLC (NEW YORK LIMITED LIABILITY COMPANY)  
#4  
434 HUDSON STREET  
NEW YORK, NY 10014

FOR: JEWELRY, IN CLASS 14 (U.S. CLS. 2, 27, 28 AND 50).

FIRST USE 7-30-2011; IN COMMERCE 7-30-2011.

THE MARK CONSISTS OF STANDARD CHARACTERS WITHOUT CLAIM TO ANY PARTICULAR FONT, STYLE, SIZE, OR COLOR.

SN 85-363,817, FILED 7-6-2011.

SALLY SHIH, EXAMINING ATTORNEY



*David J. Kybas*

Director of the United States Patent and Trademark Office

# United States of America

United States Patent and Trademark Office

# TUTU CUTE

**Reg. No. 4,137,012**

**Registered May 1, 2012**

**Int. Cl.: 35**

**SERVICE MARK**

**PRINCIPAL REGISTER**

PERFORM GROUP, LLC (DELAWARE LIMITED LIABILITY COMPANY)  
333 E. SEVENTH AVENUE  
YORK, PA 17404

FOR: COMPUTERIZED ON-LINE RETAIL STORE SERVICES IN THE FIELD OF CHILDREN'S APPAREL AND DANCE APPAREL; MAIL ORDER CATALOG SERVICES FEATURING CHILDREN'S APPAREL AND DANCE APPAREL, IN CLASS 35 (U.S. CLS. 100, 101 AND 102).

FIRST USE 8-10-2011; IN COMMERCE 8-10-2011.

THE MARK CONSISTS OF STANDARD CHARACTERS WITHOUT CLAIM TO ANY PARTICULAR FONT, STYLE, SIZE, OR COLOR.

SN 85-364,136, FILED 7-6-2011.

KAELIE KUNG, EXAMINING ATTORNEY



*David J. Kybas*

Director of the United States Patent and Trademark Office

# United States of America

United States Patent and Trademark Office

## "Loving Pet Care When You're Not There"

**Reg. No. 4,137,013**

ANDERSON, RICHARD (UNITED STATES INDIVIDUAL)  
P.O. BOX 16170  
LONG BEACH, CA 90806

**Registered May 1, 2012**

**Int. Cl.: 45**

FOR: PET SITTING, IN CLASS 45 (U.S. CLS. 100 AND 101).

**SERVICE MARK**

FIRST USE 4-5-2007; IN COMMERCE 4-5-2007.

**PRINCIPAL REGISTER**

THE MARK CONSISTS OF STANDARD CHARACTERS WITHOUT CLAIM TO ANY PARTICULAR FONT, STYLE, SIZE, OR COLOR.

SN 85-364,139, FILED 7-6-2011.

KAELIE KUNG, EXAMINING ATTORNEY



*David J. Kybas*

Director of the United States Patent and Trademark Office

# United States of America

United States Patent and Trademark Office

## SCURRY AND SCARE

**Reg. No. 4,137,014**

**Registered May 1, 2012**

**Int. Cl.: 28**

**TRADEMARK**

**PRINCIPAL REGISTER**

UNCLE MILTON INDUSTRIES, INC. (CALIFORNIA CORPORATION)  
31186 LA BAYA DRIVE  
WESTLAKE VILLAGE, CA 91362

FOR: BATTERY OPERATED ACTION TOYS; CHILDREN'S MULTIPLE ACTIVITY TOYS;  
ELECTRONIC ACTION TOYS; PLASTIC CHARACTER TOYS; TOY ACTION FIGURES;  
TOY ANIMALS; TOY FIGURES, IN CLASS 28 (U.S. CLS. 22, 23, 38 AND 50).

FIRST USE 6-30-2011; IN COMMERCE 6-30-2011.

THE MARK CONSISTS OF STANDARD CHARACTERS WITHOUT CLAIM TO ANY PAR-  
TICULAR FONT, STYLE, SIZE, OR COLOR.

SN 85-365,783, FILED 7-7-2011.

SANJEEV VOHRA, EXAMINING ATTORNEY



*David J. Kyffers*

Director of the United States Patent and Trademark Office



# United States of America

United States Patent and Trademark Office

# EZCODE

**Reg. No. 4,137,015**

EXPORT MANAGEMENT SYSTEM INC (CALIFORNIA CORPORATION)  
13532 HAWTHORNE BLVD  
HAWTHORNE, CA 90250

**Registered May 1, 2012**

**Int. Cl.: 9**

FOR: REMOTE CONTROL TRANSMITTER FOR OPENING AND CLOSING GARAGE DOORS,  
IN CLASS 9 (U.S. CLS. 21, 23, 26, 36 AND 38).

**TRADEMARK**

FIRST USE 11-1-2011; IN COMMERCE 11-1-2011.

**PRINCIPAL REGISTER**

THE MARK CONSISTS OF STANDARD CHARACTERS WITHOUT CLAIM TO ANY PARTICULAR FONT, STYLE, SIZE, OR COLOR.

SN 85-365,972, FILED 7-7-2011.

MEGHAN REINHART, EXAMINING ATTORNEY



*David J. Kybas*

Director of the United States Patent and Trademark Office

# United States of America

United States Patent and Trademark Office

# SMART FUN

**Reg. No. 4,137,016**

**Registered May 1, 2012**

**Int. Cls.: 41 and 43**

**SERVICE MARK**

**PRINCIPAL REGISTER**

KIDS 'R' KIDS, INC. (GEORGIA CORPORATION)  
1625 EXECUTIVE DRIVE SOUTH  
DULUTH, GA 30096

FOR: EDUCATION SERVICES IN THE NATURE OF EARLY CHILDHOOD INSTRUCTION,  
IN CLASS 41 (U.S. CLS. 100, 101 AND 107).

FIRST USE 8-0-2011; IN COMMERCE 8-0-2011.

FOR: CHILD CARE SERVICES, IN CLASS 43 (U.S. CLS. 100 AND 101).

FIRST USE 8-0-2011; IN COMMERCE 8-0-2011.

THE MARK CONSISTS OF STANDARD CHARACTERS WITHOUT CLAIM TO ANY PARTICULAR FONT, STYLE, SIZE, OR COLOR.

SN 85-366,576, FILED 7-8-2011.

ANDREW LEASER, EXAMINING ATTORNEY



*David J. Kyros*

Director of the United States Patent and Trademark Office

# United States of America

United States Patent and Trademark Office

## LADY RADIANT

**Reg. No. 4,137,017**

**Registered May 1, 2012**

**Int. Cl.: 35**

**SERVICE MARK**

**PRINCIPAL REGISTER**

ENERGY REBELLION, INC. (CALIFORNIA CORPORATION)  
SUITE 300  
5000 BIRCH STREET  
NEWPORT BEACH, CA 92660

FOR: PROMOTING PUBLIC AWARENESS OF ENVIRONMENTAL ISSUES, IN CLASS 35  
(U.S. CLS. 100, 101 AND 102).

FIRST USE 8-18-2011; IN COMMERCE 8-18-2011.

THE MARK CONSISTS OF STANDARD CHARACTERS WITHOUT CLAIM TO ANY PARTICULAR FONT, STYLE, SIZE, OR COLOR.

SN 85-366,874, FILED 7-8-2011.

TARAH HARDY, EXAMINING ATTORNEY



*David J. Kybas*

Director of the United States Patent and Trademark Office

United States of America  
United States Patent and Trademark Office

# FOILMAN

**Reg. No. 4,137,018**

ENERGY REBELLION (CALIFORNIA CORPORATION)  
1800 PARK NEWPORT #409  
NEWPORT BEACH, CA 92660

**Registered May 1, 2012**

**Int. Cl.: 35**

FOR: PROMOTING PUBLIC AWARENESS OF ENVIRONMENTAL ISSUES, IN CLASS 35  
(U.S. CLS. 100, 101 AND 102).

**SERVICE MARK**

FIRST USE 8-18-2011; IN COMMERCE 8-18-2011.

**PRINCIPAL REGISTER**

THE MARK CONSISTS OF STANDARD CHARACTERS WITHOUT CLAIM TO ANY PARTICULAR FONT, STYLE, SIZE, OR COLOR.

SN 85-366,926, FILED 7-8-2011.

THEODORE MCBRIDE, EXAMINING ATTORNEY



*David J. Kybas*

Director of the United States Patent and Trademark Office

# United States of America

United States Patent and Trademark Office



**Reg. No. 4,137,019**

**Registered May 1, 2012**

**Int. Cl.: 43**

**SERVICE MARK**

**PRINCIPAL REGISTER**

SARJU FINANCIAL AND INVESTMENT, INC. (MINNESOTA CORPORATION)  
2020 WILSON AVENUE  
SOUTH ST. PAUL, MN 55075

FOR: HOTEL AND MOTEL SERVICES, IN CLASS 43 (U.S. CLS. 100 AND 101).

FIRST USE 2-21-2012; IN COMMERCE 2-21-2012.

NO CLAIM IS MADE TO THE EXCLUSIVE RIGHT TO USE "INN & SUITES", APART FROM THE MARK AS SHOWN.

THE MARK CONSISTS OF THE ELEMENT "VALUSTAY" AND THE WORDING "INN & SUITES" APPEARING DIRECTLY UNDERNEATH; ALL OF THE ELEMENTS ARE INSIDE OF A DOUBLE-LINED RECTANGLE WITH A BAND OF EIGHT STARS APPEARING HORIZONTALLY ACROSS THE TOP OF THE RECTANGLE AND THE LETTER "S" LOCATED INSIDE THE LETTER "V" SET FORTH IN THE MIDDLE OF THE BAND INSIDE OF A PARTIAL OVAL WITH TWO STARS APPEARING ON AN ANGLE ON EACH SIDE OF THE LETTER "V".

SN 85-367,653, FILED 7-11-2011.

CHRISTOPHER BUONGIORNO, EXAMINING ATTORNEY



*David J. Kybas*

Director of the United States Patent and Trademark Office

# United States of America

United States Patent and Trademark Office

# Hero Huggers

**Reg. No. 4,137,020**

**Registered May 1, 2012**

**Int. Cl.: 25**

**TRADEMARK**

**PRINCIPAL REGISTER**

SUPERFLY MANUFACTURING CO. (MICHIGAN CORPORATION)  
34029 SCHOOLCRAFT ROAD  
LIVONIA, MI 48150

FOR: BELTS MADE OUT OF CLOTH; BELTS OF TEXTILE; CHILDREN'S AND INFANT'S APPAREL, NAMELY, JUMPERS, OVERALL SLEEPWEAR, PAJAMAS, ROMPERS AND ONE-PIECE GARMENTS; COSTUMES FOR USE IN CHILDREN'S DRESS UP PLAY; FABRIC BELTS; T-SHIRTS; WAIST BELTS; APPAREL FOR DANCERS, NAMELY, TEE SHIRTS, SWEATSHIRTS, PANTS, LEGGINGS, SHORTS AND JACKETS; ATHLETIC APPAREL, NAMELY, SHIRTS, PANTS, JACKETS, FOOTWEAR, HATS AND CAPS, ATHLETIC UNIFORMS; CLOTHING FOR BABIES, TODDLERS AND CHILDREN, TREATED WITH FIRE AND HEAT RETARDANTS, NAMELY, PAJAMAS, JACKETS, SHIRTS, PANTS, JUMPERS; PANTS, IN CLASS 25 (U.S. CLS. 22 AND 39).

FIRST USE 2-1-2011; IN COMMERCE 6-1-2011.

THE MARK CONSISTS OF STANDARD CHARACTERS WITHOUT CLAIM TO ANY PARTICULAR FONT, STYLE, SIZE, OR COLOR.

SN 85-367,881, FILED 7-11-2011.

MICHAEL SOUDERS, EXAMINING ATTORNEY



*David J. Kyros*

Director of the United States Patent and Trademark Office

# United States of America

United States Patent and Trademark Office

# Moonspell

**Reg. No. 4,137,021**

**Registered May 1, 2012**

**Int. Cl.: 33**

**TRADEMARK**

**PRINCIPAL REGISTER**

BERGEVIN LANE VINEYARDS, LLC (WASHINGTON LIMITED LIABILITY COMPANY)  
1215 W. POPLAR STREET  
WALLA WALLA, WA 99362

FOR: FORTIFIED WINES; PORT WINES; RED WINE; RED WINES; ROSE WINE; TABLE WINES; WINE; WINES, IN CLASS 33 (U.S. CLS. 47 AND 49).

FIRST USE 10-29-2011; IN COMMERCE 10-29-2011.

THE MARK CONSISTS OF STANDARD CHARACTERS WITHOUT CLAIM TO ANY PARTICULAR FONT, STYLE, SIZE, OR COLOR.

SN 85-367,911, FILED 7-11-2011.

COURTNEY ALVAREZ, EXAMINING ATTORNEY



*David J. Kybas*

Director of the United States Patent and Trademark Office

# United States of America

United States Patent and Trademark Office

## ARTVENTIVE EOS

**Reg. No. 4,137,022**

ARTVENTIVE MEDICAL GROUP, INC. (NEVADA CORPORATION)  
2766 GATEWAY ROAD  
CARLSBAD, CA 92009

**Registered May 1, 2012**

**Int. Cl.: 10**

FOR: MEDICAL DEVICES, NAMELY, ENDOLUMINAL OCCLUSION DEVICES, IN CLASS 10 (U.S. CLS. 26, 39 AND 44).

**TRADEMARK**

FIRST USE 6-17-2011; IN COMMERCE 6-17-2011.

**PRINCIPAL REGISTER**

THE MARK CONSISTS OF STANDARD CHARACTERS WITHOUT CLAIM TO ANY PARTICULAR FONT, STYLE, SIZE, OR COLOR.

SN 85-368,415, FILED 7-11-2011.

DOMINIC FATHY, EXAMINING ATTORNEY



*David J. Kybas*

Director of the United States Patent and Trademark Office



# United States of America

United States Patent and Trademark Office

# BAKARI

**Reg. No. 4,137,023**

**Registered May 1, 2012**

**Int. Cl.: 28**

**TRADEMARK**

**PRINCIPAL REGISTER**

FLIP2BFIT (VERMONT CORPORATION)  
330 HAVEN AVENUE #1M  
NEW YORK, NY 10033

FOR: CARD GAMES, IN CLASS 28 (U.S. CLS. 22, 23, 38 AND 50).

FIRST USE 7-10-2011; IN COMMERCE 1-5-2012.

THE MARK CONSISTS OF STANDARD CHARACTERS WITHOUT CLAIM TO ANY PARTICULAR FONT, STYLE, SIZE, OR COLOR.

THE WORDING "BAKARI" HAS NO MEANING IN A FOREIGN LANGUAGE.

SN 85-369,118, FILED 7-12-2011.

JOHN WILKE, EXAMINING ATTORNEY



*David J. Kybas*

Director of the United States Patent and Trademark Office

# United States of America

United States Patent and Trademark Office

# ENCARVA

**Reg. No. 4,137,024**

**Registered May 1, 2012**

**Int. Cl.: 31**

**TRADEMARK**

**PRINCIPAL REGISTER**

ACG PRODUCTS LTD. (WISCONSIN CORPORATION), DBA ACG PRODUCTS LTD.,  
3505 N. 124TH STREET, LOWER LEVEL  
BROOKFIELD, WI 53005

FOR: NON-NUTRITIONAL ANIMAL FEED ADDITIVE, IN CLASS 31 (U.S. CLS. 1 AND 46).

FIRST USE 1-5-2012; IN COMMERCE 1-5-2012.

THE MARK CONSISTS OF STANDARD CHARACTERS WITHOUT CLAIM TO ANY PARTICULAR FONT, STYLE, SIZE, OR COLOR.

SN 85-369,132, FILED 7-12-2011.

MIDGE BUTLER, EXAMINING ATTORNEY



*David J. Kyros*

Director of the United States Patent and Trademark Office

# United States of America

United States Patent and Trademark Office

# RETRO RISER

**Reg. No. 4,137,025**

**Registered May 1, 2012**

**Int. Cl.: 19**

**TRADEMARK**

**PRINCIPAL REGISTER**

YOUNG MANUFACTURING COMPANY, INC. (KENTUCKY CORPORATION)  
521 SOUTH MAIN STREET  
BEAVER DAM, KY 423200167

FOR: STAIR TREADS NOT OF METAL, IN CLASS 19 (U.S. CLS. 1, 12, 33 AND 50).

FIRST USE 11-30-2011; IN COMMERCE 11-30-2011.

THE MARK CONSISTS OF STANDARD CHARACTERS WITHOUT CLAIM TO ANY PARTICULAR FONT, STYLE, SIZE, OR COLOR.

SN 85-369,856, FILED 7-13-2011.

KATINA MISTER, EXAMINING ATTORNEY



*David J. Kyffers*

Director of the United States Patent and Trademark Office

# United States of America

United States Patent and Trademark Office



**Reg. No. 4,137,026**

**Registered May 1, 2012**

**Int. Cl.: 9**

**TRADEMARK**

**PRINCIPAL REGISTER**

MUNICIPAL MARKING DISTRIBUTORS, INC. (ILLINOIS CORPORATION)  
POST OFFICE BOX 221  
17 GALLIGAN ROAD  
GILBERTS, IL 60136

FOR: LEVELLING RODS; SURVEYING CHAINS; SURVEYING COMPASS NEEDLES;  
SURVEYING INSTRUMENTS; SURVEYING MACHINES AND INSTRUMENTS; TRANSITS;  
TRIPODS, IN CLASS 9 (U.S. CLS. 21, 23, 26, 36 AND 38).

FIRST USE 1-31-2007; IN COMMERCE 1-31-2007.

THE MARK CONSISTS OF A BULLDOG HOLDING A SURVEYING STAKE WITH THE  
LETTERS "MMD" THERE BELOW.

SN 85-371,432, FILED 7-14-2011.

ROBERT C. CLARK JR., EXAMINING ATTORNEY



*David J. Kybas*

Director of the United States Patent and Trademark Office

# United States of America

United States Patent and Trademark Office

## CLUTTER STOPPERS

**Reg. No. 4,137,027**

**Registered May 1, 2012**

**Int. Cl.: 45**

**SERVICE MARK**

**PRINCIPAL REGISTER**

R. TODD SWEET (UNITED STATES INDIVIDUAL)  
2046 WALFIELD DRIVE  
LANCASTER, PA 17601

FOR: ORGANIZATIONAL SERVICES FOR HOME OR PERSONAL PURPOSES, NAMELY, ORGANIZING PERSONAL LIVING SPACE, HOME OFFICES, CLOSET SPACE, AND PERSONAL ITEMS, IN CLASS 45 (U.S. CLS. 100 AND 101).

FIRST USE 9-14-2011; IN COMMERCE 9-14-2011.

THE MARK CONSISTS OF STANDARD CHARACTERS WITHOUT CLAIM TO ANY PARTICULAR FONT, STYLE, SIZE, OR COLOR.

SN 85-371,549, FILED 7-14-2011.

DEIRDRE ROBERTSON, EXAMINING ATTORNEY



*David J. Kybas*

Director of the United States Patent and Trademark Office

# United States of America

United States Patent and Trademark Office

# ASCENDAS

**Reg. No. 4,137,028**

ALL ABOUT TRAVEL, INC. (MISSOURI CORPORATION)  
5331 JOHNSON DRIVE  
MISSION, KS 66205

**Registered May 1, 2012**

**Int. Cls.: 35, 39, and 43**

FOR: TRAVEL MANAGEMENT, IN CLASS 35 (U.S. CLS. 100, 101 AND 102).

**SERVICE MARK**

FIRST USE 1-3-2012; IN COMMERCE 1-3-2012.

**PRINCIPAL REGISTER**

FOR: ARRANGING AND COORDINATING TRAVEL ARRANGEMENTS FOR INDIVIDUALS AND GROUPS, NAMELY, DESTINATIONS STAYS, HONEYMOONS, FAMILY VACATIONS, AND DESTINATION WEDDINGS; TRAVEL AGENCY SERVICES, NAMELY, MAKING RESERVATIONS AND BOOKINGS FOR TRANSPORTATION, IN CLASS 39 (U.S. CLS. 100 AND 105).

FIRST USE 1-3-2012; IN COMMERCE 1-3-2012.

FOR: TRAVEL AGENCY SERVICES, NAMELY, MAKING RESERVATIONS AND BOOKING FOR TEMPORARY LODGING, IN CLASS 43 (U.S. CLS. 100 AND 101).

FIRST USE 1-3-2012; IN COMMERCE 1-3-2012.

THE MARK CONSISTS OF STANDARD CHARACTERS WITHOUT CLAIM TO ANY PARTICULAR FONT, STYLE, SIZE, OR COLOR.

THE WORDING "ASCENDAS" HAS NO MEANING IN A FOREIGN LANGUAGE.

SN 85-371,641, FILED 7-14-2011.

HENRY S. ZAK, EXAMINING ATTORNEY



*David J. Kypos*

Director of the United States Patent and Trademark Office

# United States of America

United States Patent and Trademark Office

# CITRAVET

**Reg. No. 4,137,029**

**Registered May 1, 2012**

**Int. Cl.: 5**

**TRADEMARK**

**PRINCIPAL REGISTER**

PEGASUS LABORATORIES, INC. (MISSOURI CORPORATION)  
1217 WEST 12TH STREET  
KANSAS CITY, MO 64101

FOR: DIETARY SUPPLEMENTS FOR PETS, IN CLASS 5 (U.S. CLS. 6, 18, 44, 46, 51 AND 52).

FIRST USE 10-14-2011; IN COMMERCE 10-14-2011.

THE MARK CONSISTS OF STANDARD CHARACTERS WITHOUT CLAIM TO ANY PARTICULAR FONT, STYLE, SIZE, OR COLOR.

OWNER OF U.S. REG. NO. 3,676,459.

SN 85-371,725, FILED 7-14-2011.

HANNO RITTNER, EXAMINING ATTORNEY



*David J. Kyffers*

Director of the United States Patent and Trademark Office

# United States of America

United States Patent and Trademark Office

## EDUCATIONAL EXCELLENCE AT EVERY AGE

**Reg. No. 4,137,030**

**Registered May 1, 2012**

**Int. Cls.: 41 and 43**

**SERVICE MARK**

**PRINCIPAL REGISTER**

KIDS 'R' KIDS, INC. (GEORGIA CORPORATION)  
1625 EXECUTIVE DRIVE SOUTH  
DULUTH, GA 30096

FOR: EDUCATION SERVICES IN THE NATURE OF EARLY CHILDHOOD INSTRUCTION,  
IN CLASS 41 (U.S. CLS. 100, 101 AND 107).

FIRST USE 8-0-2011; IN COMMERCE 8-0-2011.

FOR: CHILD CARE SERVICES, IN CLASS 43 (U.S. CLS. 100 AND 101).

FIRST USE 8-0-2011; IN COMMERCE 8-0-2011.

THE MARK CONSISTS OF STANDARD CHARACTERS WITHOUT CLAIM TO ANY PAR-  
TICULAR FONT, STYLE, SIZE, OR COLOR.

SN 85-375,087, FILED 7-19-2011.

ANDREW LEASER, EXAMINING ATTORNEY



*David J. Kyros*

Director of the United States Patent and Trademark Office



# United States of America

United States Patent and Trademark Office

## GLOBAL INSIGHT

**Reg. No. 4,137,031**

**Registered May 1, 2012**

**Int. Cls.: 35 and 36**

**SERVICE MARK**

**PRINCIPAL REGISTER**

COVENTRY HEALTH CARE WORKERS COMPENSATION, INC. (DELAWARE CORPORATION)  
8TH FLOOR  
6720 B ROCKLEDGE DRIVE  
BETHESDA, MD 20817

FOR: MEDICAL COST MANAGEMENT SERVICES AND MEDICAL UTILIZATION REVIEW SERVICES; PHARMACEUTICAL COST MANAGEMENT SERVICES AND DRUG UTILIZATION REVIEW SERVICES, IN CLASS 35 (U.S. CLS. 100, 101 AND 102).

FIRST USE 4-0-2011; IN COMMERCE 6-0-2011.

FOR: ADMINISTRATION OF PREPAID HEALTH CARE BENEFIT PROGRAMS, IN CLASS 36 (U.S. CLS. 100, 101 AND 102).

FIRST USE 4-0-2011; IN COMMERCE 6-0-2011.

THE MARK CONSISTS OF STANDARD CHARACTERS WITHOUT CLAIM TO ANY PARTICULAR FONT, STYLE, SIZE, OR COLOR.

NO CLAIM IS MADE TO THE EXCLUSIVE RIGHT TO USE "GLOBAL", APART FROM THE MARK AS SHOWN.

SN 85-375,723, FILED 7-20-2011.

KAREN BRACEY, EXAMINING ATTORNEY



*David J. Kyjars*

Director of the United States Patent and Trademark Office

# United States of America

United States Patent and Trademark Office



**Reg. No. 4,137,032**

**Registered May 1, 2012**

**Int. Cl.: 3**

**TRADEMARK**

**PRINCIPAL REGISTER**

BB ENDEAVORS LLC (NEW YORK LIMITED LIABILITY COMPANY)  
P.O. BOX 2088  
NEW YORK, NY 10013

FOR: SKINCARE PRODUCTS, NAMELY, FACIAL CLEANSERS, FACIAL EXFOLIANTS, FACIAL TONERS, FACIAL CREAMS, FACIAL LOTIONS, FACIAL MOISTURIZERS, FACIAL EMULSIONS, FACIAL MASKS, FACIAL SCRUBS, ANTI-AGING CREAMS AND LOTIONS, ANTI-WRINKLE CREAMS, LOTIONS AND SKIN CONDITIONERS; LIP GLOSS; MAKE-UP; AROMATIC BODY CARE PRODUCTS, NAMELY, BODY LOTION, SHOWER GEL, NON-MEDICATED LIP BALM, SOAP, BODY POLISH, BODY AND FOOT SCRUB; BODY AND BEAUTY CARE COSMETICS; FACE AND BODY CREAMS AND BODY OILS; FRAGRANCES AND PERFUMES; BUBBLE BATH, IN CLASS 3 (U.S. CLS. 1, 4, 6, 50, 51 AND 52).

FIRST USE 11-21-2011; IN COMMERCE 11-21-2011.

THE MARK CONSISTS OF A GIRL WITH HER HAIR IN A PONYTAIL WEARING A BELTED DRESS AND HOLDING IN HER LEFT HAND A BABY PACIFIER, AND HER RIGHT HAND IS ON THE HANDLE OF A BABY CARRIAGE.

SN 85-376,617, FILED 7-20-2011.

KELLEY WELLS, EXAMINING ATTORNEY



*David J. Kyros*

Director of the United States Patent and Trademark Office

# United States of America

United States Patent and Trademark Office

# Coupaw

**Reg. No. 4,137,033**

**Registered May 1, 2012**

**Int. Cl.: 35**

**SERVICE MARK**

**PRINCIPAL REGISTER**

DICE SOLUTIONS LLC (NEW YORK LIMITED LIABILITY COMPANY)  
SUITE 305  
17 BARSTOW ROAD  
GREAT NECK, NY 11021

FOR: PROMOTING THE GOODS AND SERVICES OF OTHERS BY PROVIDING A WEBSITE FEATURING PET RELATED COUPONS, REBATES, PRICE-COMPARISON INFORMATION, PRODUCT REVIEWS, LINKS TO THE RETAIL WEBSITES OF OTHERS, AND DISCOUNT INFORMATION, IN CLASS 35 (U.S. CLS. 100, 101 AND 102).

FIRST USE 8-15-2011; IN COMMERCE 8-15-2011.

THE MARK CONSISTS OF STANDARD CHARACTERS WITHOUT CLAIM TO ANY PARTICULAR FONT, STYLE, SIZE, OR COLOR.

SN 85-376,733, FILED 7-20-2011.

B. PARADEWELAI, EXAMINING ATTORNEY



*David J. Kybas*

Director of the United States Patent and Trademark Office

# United States of America

United States Patent and Trademark Office

BUY STUFF. GET STUFF FREE!

**Reg. No. 4,137,034**

**Registered May 1, 2012**

**Int. Cl.: 35**

**SERVICE MARK**

**PRINCIPAL REGISTER**

NORTHERN TIER RETAIL LLC (DELAWARE LIMITED LIABILITY COMPANY)  
2060 CENTER POINT BOULEVARD  
SUITE 1  
MENDOTA HEIGHTS, MN 55120

FOR: PROVIDING INCENTIVE AWARD PROGRAM FOR CUSTOMERS THROUGH THE  
ISSUANCE AND PROCESSING OF LOYALTY POINTS, IN CLASS 35 (U.S. CLS. 100, 101  
AND 102).

FIRST USE 8-6-2011; IN COMMERCE 9-5-2011.

THE MARK CONSISTS OF STANDARD CHARACTERS WITHOUT CLAIM TO ANY PAR-  
TICULAR FONT, STYLE, SIZE, OR COLOR.

SN 85-379,973, FILED 7-25-2011.

AISHA CLARKE, EXAMINING ATTORNEY



*David J. Kyffers*

Director of the United States Patent and Trademark Office

# United States of America

United States Patent and Trademark Office

# LIL' FUZZYS

**Reg. No. 4,137,035**

**Registered May 1, 2012**

**Int. Cl.: 20**

**TRADEMARK**

**PRINCIPAL REGISTER**

BEAR IN MIND COMPANY (TEXAS CORPORATION)  
10900 SOUTH STONELAKE BLVD.  
QUARRY OAKS BUILDING A, SUITE A-320  
AUSTIN, TX 78759

FOR: ACCENT PILLOWS; BED PILLOWS; BEDS, MATTRESSES, PILLOWS AND BOLSTERS;  
NOVELTY PILLOWS; PILLOWS, IN CLASS 20 (U.S. CLS. 2, 13, 22, 25, 32 AND 50).

FIRST USE 10-14-2011; IN COMMERCE 10-14-2011.

THE MARK CONSISTS OF STANDARD CHARACTERS WITHOUT CLAIM TO ANY PARTICULAR FONT, STYLE, SIZE, OR COLOR.

SN 85-380,212, FILED 7-25-2011.

ANNE E. GUSTASON, EXAMINING ATTORNEY



*David J. Kyffers*

Director of the United States Patent and Trademark Office

# United States of America

United States Patent and Trademark Office



**Reg. No. 4,137,036**

**Registered May 1, 2012**

**Int. Cl.: 33**

**TRADEMARK**

**PRINCIPAL REGISTER**

DOPPELGANGER, INC. (CALIFORNIA CORPORATION)  
300 MONTGOMERY ST. #639  
SAN FRANCISCO, CA 94104

FOR: ALCOHOLIC BEVERAGES EXCEPT BEERS, IN CLASS 33 (U.S. CLS. 47 AND 49).

FIRST USE 9-0-2011; IN COMMERCE 9-0-2011.

THE MARK CONSISTS OF "B&E" WITH THE AMPERSAND APPEARING IN THE FOREGROUND AND THE LETTERS "B" AND "E" IN THE BACKGROUND.

SN 85-381,656, FILED 7-26-2011.

DAVID HOFFMAN, EXAMINING ATTORNEY



*David J. Kyffers*

Director of the United States Patent and Trademark Office

# United States of America

United States Patent and Trademark Office

## WonderMattress

**Reg. No. 4,137,037**

ZINUS INC. (CALIFORNIA CORPORATION)  
30799 WIEGMAN RD.  
HAYWARD, CA 94544

**Registered May 1, 2012**

**Int. Cl.: 20**

FOR: BEDS, MATTRESSES, PILLOWS AND BOLSTERS; MATTRESS TOPPERS, IN CLASS 20 (U.S. CLS. 2, 13, 22, 25, 32 AND 50).

**TRADEMARK**

FIRST USE 12-15-2011; IN COMMERCE 1-15-2012.

**PRINCIPAL REGISTER**

THE MARK CONSISTS OF STANDARD CHARACTERS WITHOUT CLAIM TO ANY PARTICULAR FONT, STYLE, SIZE, OR COLOR.

SN 85-381,719, FILED 7-26-2011.

JEFFREY LOOK, EXAMINING ATTORNEY



*David J. Kyffers*

Director of the United States Patent and Trademark Office

# United States of America

United States Patent and Trademark Office

## INTERIOR IMAGE

**Reg. No. 4,137,038**

**Registered May 1, 2012**

**Int. Cl.: 20**

**TRADEMARK**

**PRINCIPAL REGISTER**

DEFLECTO, LLC (DELAWARE LIMITED LIABILITY COMPANY)  
7035 EAST 86TH STREET  
INDIANAPOLIS, IN 46250

FOR: NON-METAL HOLDERS FOR THE DISPLAY OF PRINTED MATERIALS, NAMELY,  
SIGNS, IN CLASS 20 (U.S. CLS. 2, 13, 22, 25, 32 AND 50).

FIRST USE 12-11-2011; IN COMMERCE 12-11-2011.

THE MARK CONSISTS OF STANDARD CHARACTERS WITHOUT CLAIM TO ANY PAR-  
TICULAR FONT, STYLE, SIZE, OR COLOR.

SN 85-382,530, FILED 7-27-2011.

JOHN WILKE, EXAMINING ATTORNEY



*David J. Kybas*

Director of the United States Patent and Trademark Office



# United States of America

United States Patent and Trademark Office

# Clean First

**Reg. No. 4,137,039**

ZINUS INC. (CALIFORNIA CORPORATION)  
30799 WIEGMAN RD.  
HAYWARD, CA 94544

**Registered May 1, 2012**

**Int. Cls.: 20 and 24**

FOR: BEDS, MATTRESSES, PILLOWS AND BOLSTERS; BUNK BEDS, IN CLASS 20 (U.S. CLS. 2, 13, 22, 25, 32 AND 50).

**TRADEMARK**

FIRST USE 12-15-2011; IN COMMERCE 1-5-2012.

**PRINCIPAL REGISTER**

FOR: MATTRESS COVERS, IN CLASS 24 (U.S. CLS. 42 AND 50).

FIRST USE 11-20-2011; IN COMMERCE 1-5-2012.

THE MARK CONSISTS OF STANDARD CHARACTERS WITHOUT CLAIM TO ANY PARTICULAR FONT, STYLE, SIZE, OR COLOR.

SN 85-385,118, FILED 7-29-2011.

JEFFREY LOOK, EXAMINING ATTORNEY



*David J. Kypos*

Director of the United States Patent and Trademark Office

# United States of America

United States Patent and Trademark Office

*LuChae* 

**Reg. No. 4,137,040**

BACKLIT INCORPORATED (CALIFORNIA CORPORATION)  
1279 HEARST DRIVE  
PLEASANTON, CA 94566

**Registered May 1, 2012**

**Int. Cl.: 11**

FOR: ELECTRIC LIGHTING FIXTURES; FLAT PANEL LIGHTING APPARATUS FOR ILLUMINATING WORKS OF ART, IN CLASS 11 (U.S. CLS. 13, 21, 23, 31 AND 34).

**TRADEMARK**

FIRST USE 11-1-2011; IN COMMERCE 11-1-2011.

**PRINCIPAL REGISTER**

THE MARK CONSISTS OF A SCRIPT REPRESENTATION OF THE WORD "LUCHAE" WITH A RIBBON FROM THE UPPERCASE LETTER "L" PASSING THROUGH THE LOWERCASE "H" AND ENDING AS A STARBURST ABOVE THE LOWER CASE "E".

SN 85-385,438, FILED 7-30-2011.

THEODORE MCBRIDE, EXAMINING ATTORNEY



*David J. Kybas*

Director of the United States Patent and Trademark Office

# United States of America

United States Patent and Trademark Office

## OLD HILLSIDE

**Reg. No. 4,137,041**

**Registered May 1, 2012**

**Int. Cl.: 34**

**TRADEMARK**

**PRINCIPAL REGISTER**

NATIONAL TOBACCO COMPANY, L.P. (DELAWARE LIMITED PARTNERSHIP)  
5201 INTERCHANGE WAY  
LOUISVILLE, KY 40229

FOR: TOBACCO; SMOKING TOBACCO; CIGARS, IN CLASS 34 (U.S. CLS. 2, 8, 9 AND 17).

FIRST USE 1-10-2000; IN COMMERCE 1-10-2000.

THE MARK CONSISTS OF STANDARD CHARACTERS WITHOUT CLAIM TO ANY PARTICULAR FONT, STYLE, SIZE, OR COLOR.

OWNER OF U.S. REG. NO. 3,167,449.

SN 85-386,151, FILED 8-1-2011.

ROBERT C. CLARK JR., EXAMINING ATTORNEY



*David J. Kyffers*

Director of the United States Patent and Trademark Office

# United States of America

United States Patent and Trademark Office

# OUR PRIDE

**Reg. No. 4,137,042**

**Registered May 1, 2012**

**Int. Cl.: 34**

**TRADEMARK**

**PRINCIPAL REGISTER**

NATIONAL TOBACCO COMPANY, L.P. (DELAWARE LIMITED PARTNERSHIP)  
5201 INTERCHANGE WAY  
LOUISVILLE, KY 40229

FOR: TOBACCO; CIGARS; SMOKING TOBACCO, IN CLASS 34 (U.S. CLS. 2, 8, 9 AND 17).

FIRST USE 9-1-1989; IN COMMERCE 9-1-1989.

THE MARK CONSISTS OF STANDARD CHARACTERS WITHOUT CLAIM TO ANY PARTICULAR FONT, STYLE, SIZE, OR COLOR.

OWNER OF U.S. REG. NO. 3,028,098.

SN 85-386,745, FILED 8-2-2011.

ROBERT C. CLARK JR., EXAMINING ATTORNEY



*David J. Kyffers*

Director of the United States Patent and Trademark Office

# United States of America

United States Patent and Trademark Office

## SUPERSTAY 14HR LIPSTICK

**Reg. No. 4,137,043**

**Registered May 1, 2012**

**Int. Cl.: 3**

**TRADEMARK**

**PRINCIPAL REGISTER**

L'OREAL USA CREATIVE, INC. (DELAWARE CORPORATION)  
575 FIFTH AVENUE  
NEW YORK, NY 10017

FOR: LIP COLOR, IN CLASS 3 (U.S. CLS. 1, 4, 6, 50, 51 AND 52).

FIRST USE 1-0-2012; IN COMMERCE 1-0-2012.

THE MARK CONSISTS OF STANDARD CHARACTERS WITHOUT CLAIM TO ANY PARTICULAR FONT, STYLE, SIZE, OR COLOR.

OWNER OF U.S. REG. NOS. 3,131,107, 3,971,333, AND OTHERS.

NO CLAIM IS MADE TO THE EXCLUSIVE RIGHT TO USE "14HR LIPSTICK", APART FROM THE MARK AS SHOWN.

SN 85-388,512, FILED 8-3-2011.

JIM RINGLE, EXAMINING ATTORNEY



*David J. Kyffers*

Director of the United States Patent and Trademark Office

# United States of America

United States Patent and Trademark Office

## MANGO THIN

**Reg. No. 4,137,044**

**Registered May 1, 2012**

**Int. Cl.: 5**

**TRADEMARK**

**PRINCIPAL REGISTER**

WINDMILL HEALTH PRODUCTS, LLC (NEW JERSEY LIMITED LIABILITY COMPANY)  
6 HENDERSON DRIVE  
NORTH CALDWELL, NJ 07006

FOR: DIETARY AND NUTRITIONAL SUPPLEMENTS CONTAINING MANGO, IN CLASS  
5 (U.S. CLS. 6, 18, 44, 46, 51 AND 52).

FIRST USE 10-5-2011; IN COMMERCE 10-5-2011.

THE MARK CONSISTS OF STANDARD CHARACTERS WITHOUT CLAIM TO ANY PAR-  
TICULAR FONT, STYLE, SIZE, OR COLOR.

NO CLAIM IS MADE TO THE EXCLUSIVE RIGHT TO USE "MANGO", APART FROM THE  
MARK AS SHOWN.

SN 85-394,458, FILED 8-10-2011.

ROBIN CHOSID, EXAMINING ATTORNEY



*David J. Kybas*

Director of the United States Patent and Trademark Office

# United States of America

United States Patent and Trademark Office



**Reg. No. 4,137,045**

**Registered May 1, 2012**

**Int. Cl.: 41**

**SERVICE MARK**

**PRINCIPAL REGISTER**

SECOND CITY, INC. (NEVADA CORPORATION)  
1616 N. WELLS STREET  
CHICAGO, IL 60614

FOR: ENTERTAINMENT SERVICES, NAMELY, PROVIDING LIVE SHOWS, LIVE PROGRAMS, AND LIVE VARIETY SHOWS IN THE NATURE OF LIVE COMEDY PRODUCTIONS, SKETCH AND IMPROVISATIONAL COMEDY REVUES, COMEDIC PLAYS, MUSICAL PRODUCTIONS, AND CHILDREN'S THEATRICAL SHOWS; TELEVISION PROGRAMMING FEATURING VARIETY AND COMEDY PERFORMANCES, IN CLASS 41 (U.S. CLS. 100, 101 AND 107).

FIRST USE 12-26-2011; IN COMMERCE 12-26-2011.

NO CLAIM IS MADE TO THE EXCLUSIVE RIGHT TO USE "COMEDY CLUB", APART FROM THE MARK AS SHOWN.

THE MARK CONSISTS OF THE WORD "UP", IN LARGE LETTERS POSITIONED ABOVE THE WORDS "COMEDY CLUB".

SN 85-395,586, FILED 8-11-2011.

ALICIA COLLINS, EXAMINING ATTORNEY



*David J. Kyros*

Director of the United States Patent and Trademark Office

# United States of America

United States Patent and Trademark Office



**Reg. No. 4,137,046**

**Registered May 1, 2012**

**Int. Cl.: 36**

**SERVICE MARK**

**PRINCIPAL REGISTER**

XLIT LTD. (CAYMAN ISLANDS CORPORATION)  
1 HATCH STREET  
DUBLIN, IRELAND

FOR: INSURANCE UNDERWRITING SERVICES IN THE FIELDS OF PROPERTY AND CASUALTY; REINSURANCE UNDERWRITING SERVICES, IN CLASS 36 (U.S. CLS. 100, 101 AND 102).

FIRST USE 10-1-2011; IN COMMERCE 10-1-2011.

OWNER OF U.S. REG. NOS. 2,158,446, 2,167,224, AND OTHERS.

THE MARK CONSISTS OF THE STYLIZED LETTERS "XL", WITH THE "X" FORMED BY TWO "V" SHAPES, ONE OF WHICH IS INVERTED, WHICH MEET IN THE CENTER, AND THE LETTER "L" TO THE RIGHT.

SN 85-396,560, FILED 8-12-2011.

LAURIE MAYES, EXAMINING ATTORNEY



*David J. Kyffers*

Director of the United States Patent and Trademark Office



# United States of America

United States Patent and Trademark Office

## Flying is our Passion, Safety is our Mission

**Reg. No. 4,137,047**

**Registered May 1, 2012**

**Int. Cl.: 39**

**SERVICE MARK**

**PRINCIPAL REGISTER**

ERA GROUP INC. (DELAWARE CORPORATION)  
600 AIRPORT SERVICE ROAD  
LAKE CHARLES, LA 70606

FOR: AIR TRANSPORTATION SERVICES, NAMELY, HELICOPTER AND AIRPLANE CHARTER SERVICES, SCHEDULED AIRLINE SERVICES AND TRANSPORTATION OF PASSENGERS AND GOODS BY AIR, IN CLASS 39 (U.S. CLS. 100 AND 105).

FIRST USE 10-1-2011; IN COMMERCE 10-1-2011.

THE MARK CONSISTS OF STANDARD CHARACTERS WITHOUT CLAIM TO ANY PARTICULAR FONT, STYLE, SIZE, OR COLOR.

SN 85-399,095, FILED 8-16-2011.

TINA BROWN, EXAMINING ATTORNEY



*David J. Kyjars*

Director of the United States Patent and Trademark Office

# United States of America

United States Patent and Trademark Office

The logo for the Ping brand, featuring the word "Ping" in a bold, stylized, sans-serif font. The letter "P" is significantly larger than the other letters, and the "i" has a dot. The "n" and "g" are also stylized, with the "g" having a thick, rounded bottom.

**Reg. No. 4,137,048**

**Registered May 1, 2012**

**Int. Cl.: 28**

**TRADEMARK**

**PRINCIPAL REGISTER**

KARSTEN MANUFACTURING CORPORATION (ARIZONA CORPORATION)  
2201 WEST DESERT COVE  
PHOENIX, AZ 85029

FOR: GOLF BAGS, IN CLASS 28 (U.S. CLS. 22, 23, 38 AND 50).

FIRST USE 9-20-2010; IN COMMERCE 9-20-2010.

OWNER OF U.S. REG. NOS. 704,552, 1,632,445, AND 2,923,069.

THE MARK CONSISTS OF A STYLIZED "PING".

SN 85-399,500, FILED 8-16-2011.

AMY C. KEAN, EXAMINING ATTORNEY



*David J. Kappas*

Director of the United States Patent and Trademark Office

# United States of America

United States Patent and Trademark Office

# MARGIN HUB

**Reg. No. 4,137,049**

**Registered May 1, 2012**

**Int. Cl.: 9**

**TRADEMARK**

**PRINCIPAL REGISTER**

BANK OF AMERICA CORPORATION (DELAWARE CORPORATION)  
100 NORTH TRYON STREET  
CHARLOTTE, NC 28255

FOR: COMPUTER FINANCIAL MANAGEMENT SOFTWARE; DOWNLOADABLE COMPUTER FINANCIAL MANAGEMENT SOFTWARE, IN CLASS 9 (U.S. CLS. 21, 23, 26, 36 AND 38).

FIRST USE 12-0-2011; IN COMMERCE 12-0-2011.

THE MARK CONSISTS OF STANDARD CHARACTERS WITHOUT CLAIM TO ANY PARTICULAR FONT, STYLE, SIZE, OR COLOR.

SN 85-400,114, FILED 8-17-2011.

FRANK LATTUCA, EXAMINING ATTORNEY



*David J. Kyffers*

Director of the United States Patent and Trademark Office

# United States of America

United States Patent and Trademark Office

## RENEE & BELLE

**Reg. No. 4,137,050**

SHK ENTERPRISE INC (NEW JERSEY CORPORATION)  
533 DIVISION ST.  
ELIZABETH, NJ 07201

**Registered May 1, 2012**

**Int. Cl.: 25**

FOR: CAPRIS; JACKETS; PANTS; SHORTS; TOPS, IN CLASS 25 (U.S. CLS. 22 AND 39).

**TRADEMARK**

FIRST USE 10-1-2011; IN COMMERCE 10-1-2011.

**PRINCIPAL REGISTER**

THE MARK CONSISTS OF STANDARD CHARACTERS WITHOUT CLAIM TO ANY PARTICULAR FONT, STYLE, SIZE, OR COLOR.

THE NAME "RENEE & BELLE" DOES NOT IDENTIFY A LIVING INDIVIDUAL.

SN 85-404,394, FILED 8-23-2011.

SUSAN RICHARDS, EXAMINING ATTORNEY



*David J. Kyffers*

Director of the United States Patent and Trademark Office

# United States of America

United States Patent and Trademark Office

## AG QUICK TICKET

**Reg. No. 4,137,051**

AMERICAN INTERNATIONAL GROUP, INC. (DELAWARE CORPORATION)  
180 MAIDEN LANE  
NEW YORK, NY 10038

**Registered May 1, 2012**

**Int. Cl.: 36**

FOR: LIFE INSURANCE UNDERWRITING, IN CLASS 36 (U.S. CLS. 100, 101 AND 102).

**SERVICE MARK**

FIRST USE 1-17-2012; IN COMMERCE 1-17-2012.

**PRINCIPAL REGISTER**

THE MARK CONSISTS OF STANDARD CHARACTERS WITHOUT CLAIM TO ANY PARTICULAR FONT, STYLE, SIZE, OR COLOR.

OWNER OF U.S. REG. NOS. 3,076,515, 3,722,173, AND OTHERS.

SN 85-421,493, FILED 9-13-2011.

GEOFFREY FOSDICK, EXAMINING ATTORNEY



*David J. Kybas*

Director of the United States Patent and Trademark Office

# United States of America

United States Patent and Trademark Office

## Empowering Your Drive

**Reg. No. 4,137,052**

**Registered May 1, 2012**

**Int. Cl.: 36**

**SERVICE MARK**

**PRINCIPAL REGISTER**

STATE FARM MUTUAL AUTOMOBILE INSURANCE COMPANY (ILLINOIS CORPORATION)  
ONE STATE FARM PLAZA  
A-3  
BLOOMINGTON, IL 61710

FOR: INSURANCE SERVICES, NAMELY, UNDERWRITING AUTOMOBILE INSURANCE, IN CLASS 36 (U.S. CLS. 100, 101 AND 102).

FIRST USE 9-15-2011; IN COMMERCE 9-15-2011.

THE MARK CONSISTS OF STANDARD CHARACTERS WITHOUT CLAIM TO ANY PARTICULAR FONT, STYLE, SIZE, OR COLOR.

SN 85-429,612, FILED 9-22-2011.

JULIE WATSON, EXAMINING ATTORNEY



*David J. Kyffers*

Director of the United States Patent and Trademark Office

# United States of America

United States Patent and Trademark Office

# DUVETTE

**Reg. No. 4,137,053**

**Registered May 1, 2012**

**Int. Cl.: 21**

**TRADEMARK**

**PRINCIPAL REGISTER**

DUVETTE INC. (NEW YORK CORPORATION)  
POST OFFICE BOX 778  
C/O CRM  
NEW YORK, NY 10013

FOR: TEXTILE AND FABRIC STORAGE CONTAINERS FOR HOUSEHOLD USE, IN CLASS 21 (U.S. CLS. 2, 13, 23, 29, 30, 33, 40 AND 50).

FIRST USE 5-1-2011; IN COMMERCE 5-1-2011.

THE MARK CONSISTS OF STANDARD CHARACTERS WITHOUT CLAIM TO ANY PARTICULAR FONT, STYLE, SIZE, OR COLOR.

SN 85-975,293, FILED 7-27-2010.

KAREN K. BUSH, EXAMINING ATTORNEY



*David J. Kyffers*

Director of the United States Patent and Trademark Office

**United States of America**  
United States Patent and Trademark Office

# BLACK OPS

**Reg. No. 4,137,054**

**Registered May 1, 2012**

**Int. Cl.: 3**

**TRADEMARK**

**PRINCIPAL REGISTER**

ARCHER MANUFACTURING, INC. (CALIFORNIA CORPORATION)  
9000 CROW CANYON ROAD, SUITE S#329  
DANVILLE, CA 94506

FOR: ALL PURPOSE CLEANING PREPARATIONS, IN CLASS 3 (U.S. CLS. 1, 4, 6, 50, 51 AND 52).

FIRST USE 6-29-2011; IN COMMERCE 6-29-2011.

THE MARK CONSISTS OF STANDARD CHARACTERS WITHOUT CLAIM TO ANY PARTICULAR FONT, STYLE, SIZE, OR COLOR.

OWNER OF U.S. REG. NO. 2,495,513.

SN 85-975,494, FILED 1-10-2011.

JASON TURNER, EXAMINING ATTORNEY



*David J. Kyffers*

Director of the United States Patent and Trademark Office



# United States of America

United States Patent and Trademark Office

# TDX

**Reg. No. 4,137,055**

**Registered May 1, 2012**

**Int. Cl.: 27**

**TRADEMARK**

**PRINCIPAL REGISTER**

TANDUS FLOORING US, LLC (DELAWARE LIMITED LIABILITY COMPANY)  
311 SMITH INDUSTRIAL BOULEVARD  
DALTON, GA 307218661

FOR: NYLON FIBER SOLD INCORPORATED INTO CARPETS, CARPET TILES, AND FLOOR COVERINGS, IN CLASS 27 (U.S. CLS. 19, 20, 37, 42 AND 50).

FIRST USE 12-31-2004; IN COMMERCE 12-31-2004.

THE MARK CONSISTS OF STANDARD CHARACTERS WITHOUT CLAIM TO ANY PARTICULAR FONT, STYLE, SIZE, OR COLOR.

SN 85-976,221, FILED 2-28-2011.

DAVID I, EXAMINING ATTORNEY



*David J. Kyffers*

Director of the United States Patent and Trademark Office

# United States of America

United States Patent and Trademark Office

## YOUR CONNECTION TO BEAUTY INSPIRATION

**Reg. No. 4,137,056**

**Registered May 1, 2012**

**Int. Cl.: 21**

**TRADEMARK**

**PRINCIPAL REGISTER**

PARIS PRESENTS INCORPORATED (ILLINOIS CORPORATION)  
3800 SWANSON COURT  
GURNEE, IL 60031

FOR: COSMETIC BRUSHES; COSMETIC CASES SOLD FILLED WITH COSMETIC BRUSHES,  
IN CLASS 21 (U.S. CLS. 2, 13, 23, 29, 30, 33, 40 AND 50).

FIRST USE 3-31-2011; IN COMMERCE 3-31-2011.

THE MARK CONSISTS OF STANDARD CHARACTERS WITHOUT CLAIM TO ANY PAR-  
TICULAR FONT, STYLE, SIZE, OR COLOR.

SN 85-976,246, FILED 4-18-2011.

SCOTT BIBB, EXAMINING ATTORNEY



*David J. Kybas*

Director of the United States Patent and Trademark Office

# United States of America

United States Patent and Trademark Office

## EVERYTHINGOCEANS

**Reg. No. 4,137,057**

**Registered May 1, 2012**

**Int. Cls.: 35 and 42**

**SERVICE MARK**

**PRINCIPAL REGISTER**

EVERYTHINGOCEANS, INC. (CALIFORNIA CORPORATION)  
1001 AVENIDA PICO  
SUITE C #624  
SAN CLEMENTE, CA 92673

FOR: PROMOTING PUBLIC AWARENESS OF THE OCEANS AND OCEAN-RELATED ISSUES, IN CLASS 35 (U.S. CLS. 100, 101 AND 102).

FIRST USE 5-17-2011; IN COMMERCE 5-17-2011.

FOR: COMPUTER SERVICES, NAMELY, CREATING AN ON-LINE COMMUNITY FOR REGISTERED USERS TO PARTICIPATE IN DISCUSSIONS, GET FEEDBACK FROM THEIR PEERS, FORM VIRTUAL COMMUNITIES, AND ENGAGE IN SOCIAL NETWORKING; COMPUTER SERVICES, NAMELY, CREATING INDEXES OF INFORMATION, SITES AND OTHER RESOURCES AVAILABLE ON COMPUTER NETWORKS; COMPUTER SERVICES, NAMELY, HOSTING AND MAINTAINING AN ON-LINE WEB SITE FOR OTHERS TO SHARE INFORMATION RELATED TO THE OCEANS; PROVIDING CUSTOMIZED ON-LINE WEB PAGES AND DATA FEEDS FEATURING USER-DEFINED INFORMATION, WHICH INCLUDES BLOG POSTS, NEW MEDIA CONTENT, OTHER ON-LINE CONTENT, AND ON-LINE WEB LINKS TO OTHER WEBSITES, IN CLASS 42 (U.S. CLS. 100 AND 101).

FIRST USE 11-1-2011; IN COMMERCE 11-1-2011.

THE MARK CONSISTS OF STANDARD CHARACTERS WITHOUT CLAIM TO ANY PARTICULAR FONT, STYLE, SIZE, OR COLOR.

SN 85-976,289, FILED 1-19-2011.

DOMINIC FATHY, EXAMINING ATTORNEY



*David J. Kyros*

Director of the United States Patent and Trademark Office

# United States of America

United States Patent and Trademark Office

## CODEXPORTER

**Reg. No. 4,137,058**

**Registered May 1, 2012**

**Int. Cl.: 40**

**SERVICE MARK**

**PRINCIPAL REGISTER**

CODEXIS, INC. (DELAWARE CORPORATION)  
200 PENOBSCOT DRIVE  
REDWOOD CITY, CA 94063

FOR: MANUFACTURING SERVICES FOR OTHERS IN THE FIELD OF ENZYMES, IN CLASS 40 (U.S. CLS. 100, 103 AND 106).

FIRST USE 10-21-2011; IN COMMERCE 10-21-2011.

THE MARK CONSISTS OF STANDARD CHARACTERS WITHOUT CLAIM TO ANY PARTICULAR FONT, STYLE, SIZE, OR COLOR.

SN 85-976,295, FILED 3-15-2011.

ALLISON HOLTZ, EXAMINING ATTORNEY



*David J. Kybas*

Director of the United States Patent and Trademark Office

# United States of America

United States Patent and Trademark Office

## purple suitcase

**Reg. No. 4,137,059**

**Registered May 1, 2012**

**Int. Cls.: 39, 41, 42, and 45**

**SERVICE MARK**

**PRINCIPAL REGISTER**

PURPLE SUITCASE LLC (MASSACHUSETTS LIMITED LIABILITY COMPANY)  
45 PINE ROAD  
CHESTNUT HILL, MA 02467

FOR: PROVIDING A WEB SITE FEATURING TRAVEL INFORMATION AND COMMENTARY; PROVIDING A WEBSITE FEATURING INFORMATION ON TRAVEL; PROVIDING INFORMATION, NEWS AND COMMENTARY IN THE FIELD OF TRAVEL; PROVISION OF TRAVEL INFORMATION; TRAVEL INFORMATION, IN CLASS 39 (U.S. CLS. 100 AND 105).

FIRST USE 12-22-2011; IN COMMERCE 12-22-2011.

FOR: EDUCATIONAL SERVICES, NAMELY, CONDUCTING INFORMAL PROGRAMS IN THE FIELDS OF DIVERSE HUMAN CULTURES, BELIEFS, AND LIFESTYLES, USING ON-LINE ACTIVITIES AND INTERACTIVE EXHIBITS, AND PRINTABLE MATERIALS DISTRIBUTED THEREWITH; EDUCATIONAL SERVICES, NAMELY, CONDUCTING ON-LINE EXHIBITIONS AND DISPLAYS AND INTERACTIVE EXHIBITS IN THE FIELD OF DIVERSE HUMAN CULTURES, BELIEFS, AND LIFESTYLES; EDUCATIONAL SERVICES, NAMELY, PROVIDING ON-LINE INFORMAL PROGRAMS IN THE FIELDS OF DIVERSE HUMAN CULTURES, BELIEFS, AND LIFESTYLES; ENTERTAINMENT SERVICES, NAMELY, PROVIDING ON-LINE COMPUTER GAMES; ENTERTAINMENT SERVICES, NAMELY, PROVIDING TEMPORARY USE OF NON-DOWNLOADABLE INTERACTIVE GAMES; PROVIDING A WEBSITE FEATURING INFORMATION IN THE FIELDS OF EDUCATION AND ENTERTAINMENT FOR CHILDREN; ENTERTAINMENT SERVICES, NAMELY, PROVIDING TEMPORARY USE OF NON-DOWNLOADABLE INTERACTIVE GAMES IN THE FIELD OF DIVERSE PEOPLES AND CULTURES, IN CLASS 41 (U.S. CLS. 100, 101 AND 107).

FIRST USE 1-23-2012; IN COMMERCE 1-23-2012.

FOR: COMPUTER SERVICES, NAMELY, HOSTING AND MAINTAINING AN ON-LINE WEB SITE FOR OTHERS TO LEARN ABOUT DIVERSE PEOPLES AND CULTURES; HOSTING AN ON-LINE COMMUNITY WEB SITE FEATURING DIVERSE HUMAN CULTURES, BELIEFS, AND LIFESTYLES, IN CLASS 42 (U.S. CLS. 100 AND 101).

FIRST USE 12-22-2011; IN COMMERCE 12-22-2011.



*David J. Kyros*

Director of the United States Patent and Trademark Office

**Reg. No. 4,137,059** FOR: PROVIDING INFORMATION RELATING TO DIVERSE HUMAN CULTURES, BELIEFS, AND LIFESTYLES; PROVIDING EDUCATIONAL INFORMATION IN THE FIELD OF DIVERSE HUMAN CULTURES, BELIEFS, AND LIFESTYLES, IN CLASS 45 (U.S. CLS. 100 AND 101).

FIRST USE 12-22-2011; IN COMMERCE 12-22-2011.

THE MARK CONSISTS OF STANDARD CHARACTERS WITHOUT CLAIM TO ANY PARTICULAR FONT, STYLE, SIZE, OR COLOR.

SN 85-976,296, FILED 2-8-2011.

TEJBIR SINGH, EXAMINING ATTORNEY

# United States of America

United States Patent and Trademark Office

## SNOW LOGIC

**Reg. No. 4,137,060**

**Registered May 1, 2012**

**Int. Cl.: 11**

**TRADEMARK**

**PRINCIPAL REGISTER**

SNOW LOGIC, INC. (UTAH CORPORATION)  
P.O. BOX 680910  
PARK CITY, UT 84068

FOR: SNOW-MAKING MACHINES, IN CLASS 11 (U.S. CLS. 13, 21, 23, 31 AND 34).

FIRST USE 6-29-2011; IN COMMERCE 7-6-2011.

THE MARK CONSISTS OF STANDARD CHARACTERS WITHOUT CLAIM TO ANY PARTICULAR FONT, STYLE, SIZE, OR COLOR.

NO CLAIM IS MADE TO THE EXCLUSIVE RIGHT TO USE "SNOW", APART FROM THE MARK AS SHOWN.

SN 85-976,298, FILED 9-30-2010.

TEJBIR SINGH, EXAMINING ATTORNEY



*David J. Kyffers*

Director of the United States Patent and Trademark Office

# United States of America

United States Patent and Trademark Office

## MANDRAKE - BASADO EN LA OBRA DE RUBEM FONSECA

**Reg. No. 4,137,061**

**Registered May 1, 2012**

**Int. Cl.: 9**

**TRADEMARK**

**PRINCIPAL REGISTER**

HBO OLE PARTNERS (NEW YORK PARTNERSHIP)  
4000 PONCE DE LEON BLVD., SUITE 800  
CORAL GABLES, FL 33146

FOR: PRE-RECORDED DVDS FEATURING AN ONGOING DRAMATIC TELEVISION SERIES,  
IN CLASS 9 (U.S. CLS. 21, 23, 26, 36 AND 38).

FIRST USE 1-31-2010; IN COMMERCE 7-26-2011.

THE MARK CONSISTS OF STANDARD CHARACTERS WITHOUT CLAIM TO ANY PAR-  
TICULAR FONT, STYLE, SIZE, OR COLOR.

NO CLAIM IS MADE TO THE EXCLUSIVE RIGHT TO USE "BASADO EN LA OBRA DE  
RUBEM FONSECA", APART FROM THE MARK AS SHOWN.

THE NAME(S), PORTRAIT(S), AND/OR SIGNATURE(S) SHOWN IN THE MARK IDENTIFIES  
"RUBEM FONSECA", WHOSE CONSENT(S) TO REGISTER IS MADE OF RECORD.

THE ENGLISH TRANSLATION OF "BASADO EN LA OBRA DE RUBEM FONSECA" IN  
THE MARK IS "BASED ON THE WORK BY RUBEM FONSECA".

SN 85-976,315, FILED 7-1-2010.

PAM WILLIS, EXAMINING ATTORNEY



*David J. Kyros*

Director of the United States Patent and Trademark Office



# United States of America

United States Patent and Trademark Office

# MISOFISHY

**Reg. No. 4,137,062**

**Registered May 1, 2012**

**Int. Cl.: 43**

**SERVICE MARK**

**PRINCIPAL REGISTER**

SOLOHAY, INC. (CALIFORNIA CORPORATION), DBA MISOFISHY,  
1100 WILSHIRE BLVD.  
# 3205  
LOS ANGELES, CA 90017

FOR: RESTAURANT AND BAR SERVICES, INCLUDING RESTAURANT CARRYOUT  
SERVICES RESTAURANT, BAR AND CATERING SERVICES, IN CLASS 43 (U.S. CLS. 100  
AND 101).

FIRST USE 10-28-2009; IN COMMERCE 10-28-2009.

THE MARK CONSISTS OF STANDARD CHARACTERS WITHOUT CLAIM TO ANY PAR-  
TICULAR FONT, STYLE, SIZE, OR COLOR.

SN 85-976,321, FILED 3-15-2011.

PATRICIA EVANKO, EXAMINING ATTORNEY



*David J. Kybas*

Director of the United States Patent and Trademark Office

# United States of America

United States Patent and Trademark Office

# 3NET

**Reg. No. 4,137,063**

**Registered May 1, 2012**

**Int. Cls.: 38 and 41**

**SERVICE MARK**

**PRINCIPAL REGISTER**

3D NETCO LLC (DELAWARE JOINT VENTURE)  
ONE DISCOVERY PLACE  
SILVER SPRING, MD 20910

FOR: COMMUNICATIONS SERVICES, NAMELY, TRANSMITTING STREAMED SOUND AND AUDIO-VISUAL RECORDINGS VIA THE INTERNET, CABLE NETWORKS, WIRELESS NETWORKS, SATELLITE, OR INTERACTIVE MULTIMEDIA NETWORKS; AUDIO AND VIDEO BROADCASTING SERVICES OVER THE INTERNET; TELEVISION BROADCASTING SERVICES; CABLE TELEVISION BROADCASTING; SATELLITE TELEVISION BROADCASTING; MOBILE MEDIA SERVICES IN THE NATURE OF ELECTRONIC TRANSMISSION OF ENTERTAINMENT MEDIA CONTENT; PODCASTING SERVICES; WEBCASTING SERVICES; VIDEO-ON-DEMAND TRANSMISSION SERVICES; PROVIDING ON-LINE CHAT ROOMS AND ELECTRONIC BULLETIN BOARDS FOR TRANSMISSION OF MESSAGES AMONG USERS IN THE FIELD OF GENERAL HUMAN INTEREST, IN CLASS 38 (U.S. CLS. 100, 101 AND 104).

FIRST USE 2-13-2011; IN COMMERCE 2-13-2011.

FOR: ENTERTAINMENT SERVICES, NAMELY, MULTIMEDIA PROGRAMS IN THE FIELD OF GENERAL HUMAN INTEREST, DISTRIBUTED VIA VARIOUS PLATFORMS ACROSS MULTIPLE FORMS OF TRANSMISSION MEDIA; PROVIDING ENTERTAINMENT INFORMATION REGARDING ONGOING TELEVISION PROGRAMS VIA A GLOBAL COMPUTER NETWORK; PRODUCTION OF TELEVISION PROGRAMS; PRODUCTION OF MULTIMEDIA PROGRAMS, IN CLASS 41 (U.S. CLS. 100, 101 AND 107).

FIRST USE 2-13-2011; IN COMMERCE 2-13-2011.

THE MARK CONSISTS OF STANDARD CHARACTERS WITHOUT CLAIM TO ANY PARTICULAR FONT, STYLE, SIZE, OR COLOR.

SN 85-976,369, FILED 12-22-2010.

ANNE E. GUSTASON, EXAMINING ATTORNEY



*David J. Kyffers*

Director of the United States Patent and Trademark Office

**United States of America**  
United States Patent and Trademark Office

# OLLOCLIP

**Reg. No. 4,137,064**

**Registered May 1, 2012**

**Int. Cl.: 9**

**TRADEMARK**

**PRINCIPAL REGISTER**

PREMIER SYSTEMS USA, INC. (CALIFORNIA CORPORATION)  
9062 CARROLLTOWN DRIVE  
HUNTINGTON BEACH, CA 92646

FOR: LENSES FOR CAMERAS; LENSES FOR CAMERAS INCORPORATED IN MOBILE ELECTRONIC DEVICES, IN CLASS 9 (U.S. CLS. 21, 23, 26, 36 AND 38).

FIRST USE 7-0-2011; IN COMMERCE 7-0-2011.

THE MARK CONSISTS OF STANDARD CHARACTERS WITHOUT CLAIM TO ANY PARTICULAR FONT, STYLE, SIZE, OR COLOR.

SN 85-976,375, FILED 6-21-2011.

JAMES STEIN, EXAMINING ATTORNEY



*David J. Kyffers*

Director of the United States Patent and Trademark Office

# United States of America

United States Patent and Trademark Office



**Reg. No. 4,137,065**

**Registered May 1, 2012**

**Int. Cl.: 41**

**SERVICE MARK**

**PRINCIPAL REGISTER**

PDB SPORTS, LTD. (COLORADO LIMITED PARTNERSHIP)  
13655 BRONCOS PARKWAY  
ENGLEWOOD, CO 80111

FOR: ENTERTAINMENT IN THE NATURE OF A FAN CLUB TO PROMOTE AN AFFILIATION OR ASSOCIATION WITH A PROFESSIONAL FOOTBALL TEAM, IN CLASS 41 (U.S. CLS. 100, 101 AND 107).

FIRST USE 9-17-2010; IN COMMERCE 9-17-2010.

OWNER OF U.S. REG. NOS. 921,750, 3,762,711, AND OTHERS.

NO CLAIM IS MADE TO THE EXCLUSIVE RIGHT TO USE "FAN CLUB FOR WOMEN", APART FROM THE MARK AS SHOWN.

THE MARK CONSISTS OF THE WORDS "CRUSH BRONCOS FAN CLUB FOR WOMEN" IN SCRIPT WRITING WITH A HORSE HEAD LOGO ON TOP.

SN 85-976,381, FILED 10-1-2010.

JASON BLAIR, EXAMINING ATTORNEY



*David J. Kybas*

Director of the United States Patent and Trademark Office

# United States of America

United States Patent and Trademark Office

# LOVE FURY

**Reg. No. 4,137,066**

**Registered May 1, 2012**

**Int. Cl.: 3**

**TRADEMARK**

**PRINCIPAL REGISTER**

NINE WEST DEVELOPMENT CORPORATION (DELAWARE CORPORATION)  
SUITE 225  
1007 ORANGE STREET  
WILMINGTON, DE 19801

FOR: EAU DE PARFUM; EAU DE TOILETTE; LOTIONS FOR FACE, BODY, HANDS, IN CLASS 3 (U.S. CLS. 1, 4, 6, 50, 51 AND 52).

FIRST USE 2-3-2012; IN COMMERCE 2-3-2012.

THE MARK CONSISTS OF STANDARD CHARACTERS WITHOUT CLAIM TO ANY PARTICULAR FONT, STYLE, SIZE, OR COLOR.

SN 85-976,406, FILED 2-8-2011.

HANNO RITTNER, EXAMINING ATTORNEY



*David J. Kyffers*

Director of the United States Patent and Trademark Office

# United States of America

United States Patent and Trademark Office

## BEYOND YELLOW

**Reg. No. 4,137,067**

**Registered May 1, 2012**

**Int. Cls.: 16, 35, and 42**

**TRADEMARK**

**SERVICE MARK**

**PRINCIPAL REGISTER**

YELLOWBOOK INC. (DELAWARE CORPORATION)  
398 RXR PLAZA  
UNIONDALE, NY 11556

FOR: PRINTED CLASSIFIED YELLOW PAGES TELEPHONE DIRECTORIES FEATURING INFORMATION AND ADVERTISING ABOUT LOCAL BUSINESSES AND INDIVIDUALS, IN CLASS 16 (U.S. CLS. 2, 5, 22, 23, 29, 37, 38 AND 50).

FIRST USE 3-0-2011; IN COMMERCE 3-0-2011.

FOR: ADVERTISING AND MARKETING SERVICES; BRANDING SERVICES, NAMELY, CONSULTING, DEVELOPMENT, MANAGEMENT AND MARKETING OF BRANDS FOR BUSINESSES; ONLINE ADVERTISING AND MARKETING SERVICES; PROVIDING CLASSIFIED DIRECTORY INFORMATION SERVICES VIA THE INTERNET, WIRELESS NETWORKS AND TO MOBILE COMMUNICATIONS DEVICES; PROVIDING ONLINE CLASSIFIED DIRECTORIES FEATURING INFORMATION AND ADVERTISING ABOUT LOCAL BUSINESSES AND INDIVIDUALS, IN CLASS 35 (U.S. CLS. 100, 101 AND 102).

FIRST USE 7-30-2010; IN COMMERCE 7-30-2010.

FOR: COMPUTER SERVICES, NAMELY, SEARCH ENGINE OPTIMIZATION; DESIGN, DEVELOPMENT, CREATION, HOSTING, MAINTENANCE AND OPTIMIZATION OF WEBSITES FOR OTHERS, IN CLASS 42 (U.S. CLS. 100 AND 101).

FIRST USE 7-30-2010; IN COMMERCE 7-30-2010.

THE MARK CONSISTS OF STANDARD CHARACTERS WITHOUT CLAIM TO ANY PARTICULAR FONT, STYLE, SIZE, OR COLOR.

OWNER OF U.S. REG. NOS. 3,756,368, 3,756,369, AND 3,791,740.

SN 85-976,412, FILED 7-1-2010.

COLLEEN KEARNEY, EXAMINING ATTORNEY



*David J. Kyros*

Director of the United States Patent and Trademark Office

# United States of America

United States Patent and Trademark Office

# GUNS

**Reg. No. 4,137,068**

**Registered May 1, 2012**

**Int. Cl.: 25**

**TRADEMARK**

**PRINCIPAL REGISTER**

KUMAR, RISHI S. (UNITED STATES INDIVIDUAL)  
3069 GRANDOAKS DRIVE  
WESTLAKE VILLAGE, CA 91361

FOR: WEARABLE GARMENTS AND CLOTHING, NAMELY, SHIRTS, IN CLASS 25 (U.S. CLS. 22 AND 39).

FIRST USE 1-31-2010; IN COMMERCE 7-29-2011.

THE MARK CONSISTS OF STANDARD CHARACTERS WITHOUT CLAIM TO ANY PARTICULAR FONT, STYLE, SIZE, OR COLOR.

SN 85-976,455, FILED 6-7-2010.

JULIE VEPPUMTHARA, EXAMINING ATTORNEY



*David J. Kybas*

Director of the United States Patent and Trademark Office

# United States of America

United States Patent and Trademark Office



**Reg. No. 4,137,069**

**Registered May 1, 2012**

**Int. Cl.: 28**

**TRADEMARK**

**PRINCIPAL REGISTER**

INSIGNIA ATHLETICS, LLC (MASSACHUSETTS LIMITED LIABILITY COMPANY)  
60 FREMONT ST  
WORCESTER, MA 01603

FOR: BASEBALL BAT BAGS; BASEBALL BAT CASES; BASEBALL BATS; BASEBALL BATTING GLOVES; BASEBALL GLOVES; BASEBALL MITTS; BASEBALLS; SOFTBALL BAT BAGS; SOFTBALL BAT RACKS; SOFTBALL BATS; SOFTBALL GLOVES; SOFTBALL MITTS; SOFTBALLS, IN CLASS 28 (U.S. CLS. 22, 23, 38 AND 50).

FIRST USE 2-1-2011; IN COMMERCE 2-1-2011.

THE MARK CONSISTS OF A STYLIZED STICK FIGURE.

SN 85-976,472, FILED 7-29-2010.

MARTHA FROMM, EXAMINING ATTORNEY



*David J. Kybas*

Director of the United States Patent and Trademark Office



# United States of America

United States Patent and Trademark Office

## TOENAIL FUNGUS ENDS HERE

**Reg. No. 4,137,070**

**Registered May 1, 2012**

**Int. Cl.: 44**

**SERVICE MARK**

**PRINCIPAL REGISTER**

NOVONAIL LLC (VIRGINIA LIMITED LIABILITY COMPANY)  
1412 SACHEM PLACE  
SUITE 201  
CHARLOTTESVILLE, VA 22901

FOR: TREATMENT OF NAIL DISEASES AND CONDITIONS, IN CLASS 44 (U.S. CLS. 100 AND 101).

FIRST USE 6-15-2011; IN COMMERCE 6-15-2011.

THE MARK CONSISTS OF STANDARD CHARACTERS WITHOUT CLAIM TO ANY PARTICULAR FONT, STYLE, SIZE, OR COLOR.

NO CLAIM IS MADE TO THE EXCLUSIVE RIGHT TO USE "TOENAIL FUNGUS", APART FROM THE MARK AS SHOWN.

SN 85-976,477, FILED 7-20-2011.

HENRY S. ZAK, EXAMINING ATTORNEY



*David J. Kybas*

Director of the United States Patent and Trademark Office

# United States of America

United States Patent and Trademark Office

## STURDYSTYLE

**Reg. No. 4,137,071**

HOFFMASTER GROUP, INC. (DELAWARE CORPORATION)  
2920 N. MAIN STREET  
OSHKOSH, WI 54903

**Registered May 1, 2012**

**Int. Cl.: 21**

FOR: DISPOSABLE PAPER PLATES, AND PLATTERS, IN CLASS 21 (U.S. CLS. 2, 13, 23, 29, 30, 33, 40 AND 50).

**TRADEMARK**

FIRST USE 1-0-2012; IN COMMERCE 1-0-2012.

**PRINCIPAL REGISTER**

THE MARK CONSISTS OF STANDARD CHARACTERS WITHOUT CLAIM TO ANY PARTICULAR FONT, STYLE, SIZE, OR COLOR.

SN 85-976,488, FILED 4-13-2011.

LINDA ORNDORFF, EXAMINING ATTORNEY



*David J. Kyffers*

Director of the United States Patent and Trademark Office

# United States of America

United States Patent and Trademark Office

## FLORENCE

**Reg. No. 4,137,072**

**Registered May 1, 2012**

**Int. Cl.: 19**

**TRADEMARK**

**SUPPLEMENTAL REGISTER**

MARME, INC. (TEXAS CORPORATION)  
13130 HEMPSTEAD ROAD  
HOUSTON, TX 77040

FOR: BUILDING AND CONSTRUCTION GOODS MADE OF TRAVERTINE IN VARIOUS PATTERNS, NAMELY, VERSAILLES AND COLLOSAL, AND VARIOUS FINISHES, NAMELY, FILLED/HONED, TUMBLED, FILLED/POLISHED, UNFILLED/HONED, UNFILLED/BRUSHED, AND UNFILLED/BRUSHED/CHISELED, NAMELY, INDIVIDUAL PLANAR TRAVERTINE STONES USED FOR CONSTRUCTING FLOORS, WALLS, DECKS, COUNTERTOPS, TABLETOPS, POOLS, PAYERS, DRIVEWAYS, WALKWAYS AND SIDEWALKS, IN CLASS 19 (U.S. CLS. 1, 12, 33 AND 50).

FIRST USE 2-1-2001; IN COMMERCE 2-1-2001.

THE MARK CONSISTS OF STANDARD CHARACTERS WITHOUT CLAIM TO ANY PARTICULAR FONT, STYLE, SIZE, OR COLOR.

SER. NO. 76-693,541, FILED P.R. 10-15-2008; AM. S.R. 2-10-2012.

SCOTT BIBB, EXAMINING ATTORNEY



*David J. Kyffers*

Director of the United States Patent and Trademark Office

# United States of America

United States Patent and Trademark Office

## SMART ROBOTS

**Reg. No. 4,137,073**

SMART ROBOTS, INC. (COLORADO CORPORATION)  
92 RIVERVIEW DRIVE  
DALTON, MA 01226

**Registered May 1, 2012**

**Int. Cl.: 28**

FOR: MOBILE AND STATIONARY TOY ROBOTS, IN CLASS 28 (U.S. CLS. 22, 23, 38 AND 50).

**TRADEMARK**

FIRST USE 2-4-2012; IN COMMERCE 2-20-2012.

**SUPPLEMENTAL REGISTER**

THE MARK CONSISTS OF STANDARD CHARACTERS WITHOUT CLAIM TO ANY PARTICULAR FONT, STYLE, SIZE, OR COLOR.

OWNER OF U.S. REG. NOS. 2,289,682 AND 2,293,745.

NO CLAIM IS MADE TO THE EXCLUSIVE RIGHT TO USE "ROBOTS", APART FROM THE MARK AS SHOWN.

SER. NO. 76-701,847, FILED P.R. 3-1-2010; AM. S.R. 2-29-2012.

DAVID ELTON, EXAMINING ATTORNEY



*David J. Kyros*

Director of the United States Patent and Trademark Office

# United States of America

United States Patent and Trademark Office

## AERO-POSSUM

**Reg. No. 4,137,074**

BANTON, RONALD E. (UNITED STATES INDIVIDUAL)  
1300 LAKE RIDGE SQUARE  
JOHNSON CITY, TN 37601

**Registered May 1, 2012**

**Int. Cl.: 25**

FOR: T-SHIRT, CAPS, HATS, SWEAT SHIRTS, PANTS, SOCKS, BELTS AND JEANS, IN CLASS 25 (U.S. CLS. 22 AND 39).

**TRADEMARK**

FIRST USE 6-4-2011; IN COMMERCE 6-4-2011.

**SUPPLEMENTAL REGISTER**

THE MARK CONSISTS OF STANDARD CHARACTERS WITHOUT CLAIM TO ANY PARTICULAR FONT, STYLE, SIZE, OR COLOR.

SER. NO. 76-702,960, FILED P.R. 5-13-2010; AM. S.R. 3-13-2012.

MATTHEW EINSTEIN, EXAMINING ATTORNEY



*David J. Kyros*

Director of the United States Patent and Trademark Office

# United States of America

United States Patent and Trademark Office

## YOGA ACROSS AMERICA

**Reg. No. 4,137,075**

YOGA ACROSS AMERICA, CORP. (CALIFORNIA NOT FOR PROFIT CORPORATION)  
4433 I STREET  
SACRAMENTO, CA 95819

**Registered May 1, 2012**

**Int. Cl.: 41**

FOR: YOGA AND WELLNESS EDUCATIONAL PROGRAMS, IN CLASS 41 (U.S. CLS. 100, 101 AND 107).

**SERVICE MARK**

FIRST USE 7-14-2011; IN COMMERCE 7-14-2011.

**SUPPLEMENTAL REGISTER**

THE MARK CONSISTS OF STANDARD CHARACTERS WITHOUT CLAIM TO ANY PARTICULAR FONT, STYLE, SIZE, OR COLOR.

SER. NO. 76-709,387, FILED P.R. 10-13-2011; AM. S.R. 3-5-2012.

CHRISIE B. KING, EXAMINING ATTORNEY



*David J. Kyffers*

Director of the United States Patent and Trademark Office

# United States of America

United States Patent and Trademark Office

## TWISTED CHIPS

**Reg. No. 4,137,076**

O'CHARLEY'S MANAGEMENT COMPANY, INC. (TENNESSEE CORPORATION)  
3038 SIDCO DRIVE  
NASHVILLE, TN 37204

**Registered May 1, 2012**

**Int. Cl.: 29**

FOR: FOOD PRODUCTS, NAMELY, PROCESSED POTATO PIECES SERVED AS AN APPETIZER, IN CLASS 29 (U.S. CL. 46).

**TRADEMARK**

FIRST USE 10-19-2009; IN COMMERCE 10-19-2009.

**SUPPLEMENTAL REGISTER**

THE MARK CONSISTS OF STANDARD CHARACTERS WITHOUT CLAIM TO ANY PARTICULAR FONT, STYLE, SIZE, OR COLOR.

NO CLAIM IS MADE TO THE EXCLUSIVE RIGHT TO USE "CHIPS", APART FROM THE MARK AS SHOWN.

SER. NO. 77-461,303, FILED P.R. 4-29-2008; AM. S.R. 3-14-2012.

MARCIE MILONE, EXAMINING ATTORNEY



*David J. Kybas*

Director of the United States Patent and Trademark Office

# United States of America

United States Patent and Trademark Office

## CONTINUITY

**Reg. No. 4,137,077**

**Registered May 1, 2012**

**Int. Cl.: 9**

**TRADEMARK**

**SUPPLEMENTAL REGISTER**

BELDEN INC. (DELAWARE CORPORATION)  
7733 FORSYTH BOULEVARD  
SUITE 800  
ST. LOUIS, MO 63105

FOR: LOW VOLTAGE COAXIAL CABLE CONNECTORS, IN CLASS 9 (U.S. CLS. 21, 23, 26, 36 AND 38).

FIRST USE 4-21-2009; IN COMMERCE 4-21-2009.

THE MARK CONSISTS OF STANDARD CHARACTERS WITHOUT CLAIM TO ANY PARTICULAR FONT, STYLE, SIZE, OR COLOR.

SER. NO. 77-519,042, FILED P.R. 7-10-2008; AM. S.R. 2-9-2012.

SARA BENJAMIN, EXAMINING ATTORNEY



*David J. Kyffers*

Director of the United States Patent and Trademark Office



# United States of America

United States Patent and Trademark Office

# IPWORLDTV

**Reg. No. 4,137,078**

**Registered May 1, 2012**

**Int. Cl.: 9**

**TRADEMARK**

**SUPPLEMENTAL REGISTER**

IPWORLD TV INC (CALIFORNIA CORPORATION)  
5 HUTTON CENTRE  
SUITE 130  
SANTA ANA, CA 92707

FOR: AUDIO AND VIDEO RECORDINGS FEATURING TELEVISION PROGRAMS; DIGITAL ENTERTAINMENT SYSTEMS FOR WATCHING, STORING AND SHARING DIGITAL CONTENT ON A HOME COMPUTER NETWORK; DIGITAL MUSIC DOWNLOADABLE FROM THE INTERNET; DOWNLOADABLE MULTIMEDIA FILE CONTAINING ARTWORK, TEXT, AUDIO, VIDEO, GAMES, AND INTERNET WEB LINKS RELATING TO TELEVISION PROGRAMS; INTEROPERABLE COMMUNICATION SYSTEM DESIGNED TO PROVIDE RADIO, STREAMING VIDEO, WIRELESS INTERNET, AND VOIP PHONE; TELECOMMUNICATIONS HARDWARE AND SOFTWARE FOR MONITORING AND ALERTING REMOTE SENSOR STATUS VIA THE INTERNET; WIRELESS TELEVISION SET FOR PROVIDING VIDEO CONFERENCING AND TELEPHONE SERVICE OVER THE INTERNET, IN CLASS 9 (U.S. CLS. 21, 23, 26, 36 AND 38).

FIRST USE 4-0-2005; IN COMMERCE 4-0-2005.

THE MARK CONSISTS OF STANDARD CHARACTERS WITHOUT CLAIM TO ANY PARTICULAR FONT, STYLE, SIZE, OR COLOR.

SER. NO. 77-552,027, FILED P.R. 8-20-2008; AM. S.R. 2-14-2012.

NANCY CLARKE, EXAMINING ATTORNEY



*David J. Kybas*

Director of the United States Patent and Trademark Office

# United States of America

United States Patent and Trademark Office

# MDTV

**Reg. No. 4,137,079**

**Registered May 1, 2012**

**Int. Cl.: 41**

WEST VIRGINIA UNIVERSITY BOARD OF GOVERNORS (WEST VIRGINIA STATE UNIVERSITY)  
105 STEWART HALL  
P.O. BOX 6201  
MORGANTOWN, WV 26506

**SERVICE MARK**

**SUPPLEMENTAL REGISTER**

FOR: CONTINUING MEDICAL EDUCATIONAL SERVICES FOR PHYSICIANS, NURSES, AND ALLIED HEALTH PROFESSIONALS, NAMELY, CONDUCTING CLASSES IN THE FIELD OF MEDICINE MADE AVAILABLE TO MEDICAL PROFESSIONALS LOCATED PRIMARILY IN AND AROUND WEST VIRGINIA THROUGH A CLOSED-CIRCUIT TELEVISION COMMUNICATIONS NETWORK ACCESSIBLE AT MEMBER SITES OF APPLICANT, IN CLASS 41 (U.S. CLS. 100, 101 AND 107).

FIRST USE 10-1-1991; IN COMMERCE 10-1-1991.

THE MARK CONSISTS OF STANDARD CHARACTERS WITHOUT CLAIM TO ANY PARTICULAR FONT, STYLE, SIZE, OR COLOR.

SER. NO. 77-580,928, FILED P.R. 9-29-2008; AM. S.R. 2-14-2011.

SUE LAWRENCE, EXAMINING ATTORNEY



*David J. Kyjars*

Director of the United States Patent and Trademark Office

# United States of America

United States Patent and Trademark Office

# Cobia Tube

**Reg. No. 4,137,080**

**Registered May 1, 2012**

**Int. Cl.: 17**

**TRADEMARK**

**SUPPLEMENTAL REGISTER**

BOGGS, JOHN (UNITED STATES INDIVIDUAL)  
209 EAST FOURTH ST.  
PANAMA CITY, FL 32401

FOR: PVC AND PLASTIC TUBES FOR THE PURPOSE OF PUMPING SALTWATER FROM THE BOAT'S WATER PUMPING SYSTEM TAKING THE WATER DIRECTLY FROM THE LOCAL BODY OF WATER THROUGH THE TUBES TO KEEP FISH ALIVE FOR EXTENDED PERIODS OF TIME WHILE IN CAPTIVITY FOR THE PURPOSE OF MEASURING AND WEIGHING THE FISH BEFORE THE FISH IS RELEASED, IN CLASS 17 (U.S. CLS. 1, 5, 12, 13, 35 AND 50).

FIRST USE 6-5-2009; IN COMMERCE 12-10-2011.

THE MARK CONSISTS OF STANDARD CHARACTERS WITHOUT CLAIM TO ANY PARTICULAR FONT, STYLE, SIZE, OR COLOR.

NO CLAIM IS MADE TO THE EXCLUSIVE RIGHT TO USE "TUBE", APART FROM THE MARK AS SHOWN.

SER. NO. 77-753,685, FILED P.R. 6-5-2009; AM. S.R. 2-6-2012.

DARRYL SPRUILL, EXAMINING ATTORNEY



*David J. Kyros*

Director of the United States Patent and Trademark Office

# United States of America

United States Patent and Trademark Office

## SILK ROUTE MUSEUM

**Reg. No. 4,137,081**

**Registered May 1, 2012**

**Int. Cls.: 36 and 41**

**SERVICE MARK**

**SUPPLEMENTAL REGISTER**

EQUITY ART CORP LTD (CALIFORNIA LIMITED LIABILITY COMPANY), DBA SILK ROUTE MUSEUM,  
805 VETERANS BLVD. # 228  
REDWOOD CITY, CA 94063

FOR: ART APPRAISAL; ART BROKERAGE; CONSULTATION IN ART AS AN INVESTMENT, IN CLASS 36 (U.S. CLS. 100, 101 AND 102).

FIRST USE 10-1-2007; IN COMMERCE 10-28-2009.

FOR: ART EXHIBITIONS, IN CLASS 41 (U.S. CLS. 100, 101 AND 107).

FIRST USE 10-1-2007; IN COMMERCE 10-28-2009.

THE MARK CONSISTS OF STANDARD CHARACTERS WITHOUT CLAIM TO ANY PARTICULAR FONT, STYLE, SIZE, OR COLOR.

NO CLAIM IS MADE TO THE EXCLUSIVE RIGHT TO USE "MUSEUM", APART FROM THE MARK AS SHOWN.

SER. NO. 77-762,626, FILED 6-18-2009.

JENNIFER MARTIN, EXAMINING ATTORNEY



*David J. Kybas*

Director of the United States Patent and Trademark Office

# United States of America

United States Patent and Trademark Office

# Skinny Gum

**Reg. No. 4,137,082**

GOSSETT, GREGORY (UNITED STATES INDIVIDUAL)  
1891 EAST 20TH  
OGDEN, UT 84401

**Registered May 1, 2012**

**Int. Cl.: 5**

FOR: MEDICATED CHEWING GUM, IN CLASS 5 (U.S. CLS. 6, 18, 44, 46, 51 AND 52).

**TRADEMARK**

FIRST USE 1-8-2009; IN COMMERCE 1-8-2009.

**SUPPLEMENTAL REGISTER**

THE MARK CONSISTS OF STANDARD CHARACTERS WITHOUT CLAIM TO ANY PARTICULAR FONT, STYLE, SIZE, OR COLOR.

NO CLAIM IS MADE TO THE EXCLUSIVE RIGHT TO USE "GUM", APART FROM THE MARK AS SHOWN.

SER. NO. 77-822,593, FILED P.R. 9-9-2009; AM. S.R. 1-19-2010.

SUSAN STIGLITZ, EXAMINING ATTORNEY



*David J. Kyffers*

Director of the United States Patent and Trademark Office

# United States of America

United States Patent and Trademark Office

## Westport Residential

**Reg. No. 4,137,083**

**Registered May 1, 2012**

**Int. Cl.: 36**

**SERVICE MARK**

**SUPPLEMENTAL REGISTER**

WESTPORT RESIDENTIAL, LLC (CONNECTICUT LIMITED LIABILITY COMPANY)  
95 POST ROAD WEST  
WESTPORT, CT 06880

FOR: REAL ESTATE SERVICES, NAMELY, REAL ESTATE AGENCIES, REAL ESTATE LISTING AND RENTAL OF RESIDENTIAL REAL ESTATE PROPERTIES, IN CLASS 36 (U.S. CLS. 100, 101 AND 102).

FIRST USE 1-1-2006; IN COMMERCE 1-1-2006.

THE MARK CONSISTS OF STANDARD CHARACTERS WITHOUT CLAIM TO ANY PARTICULAR FONT, STYLE, SIZE, OR COLOR.

NO CLAIM IS MADE TO THE EXCLUSIVE RIGHT TO USE "RESIDENTIAL", APART FROM THE MARK AS SHOWN.

SER. NO. 78-784,215, FILED P.R. 1-3-2006; AM. S.R. 2-22-2012.

ANNE FARRELL, EXAMINING ATTORNEY



*David J. Kyros*

Director of the United States Patent and Trademark Office

# United States of America

United States Patent and Trademark Office

## RUMSFELD FOUNDATION

**Reg. No. 4,137,084**

**Registered May 1, 2012**

**Int. Cl.: 36**

**SERVICE MARK**

**SUPPLEMENTAL REGISTER**

RUMSFELD FOUNDATION (DELAWARE CORPORATION)  
SUITE 366  
1718 M STREET, NW  
WASHINGTON, DC 20036

FOR: CHARITABLE FOUNDATION SERVICES, NAMELY, FUNDING ORGANIZATIONS TO ASSIST MEMBERS OF THE U.S. MILITARY, VETERANS, AND THEIR FAMILIES; PROVIDING FUNDING IN SUPPORT OF MICROFINANCE EFFORTS WORLDWIDE, NAMELY, PROVIDING SUPPLEMENTAL FUNDING, CAPITAL IMPROVEMENT FUNDING, AND FINANCIAL ASSISTANCE FOR PROGRAMS AND SERVICES OF OTHERS; FINANCIAL SERVICES, NAMELY, AWARDED FELLOWSHIPS IN THE NATURE OF EDUCATIONAL SCHOLARSHIPS FOR U.S. GRADUATE STUDENTS INTERESTED IN PUBLIC SERVICE, IN CLASS 36 (U.S. CLS. 100, 101 AND 102).

FIRST USE 4-0-2008; IN COMMERCE 4-0-2008.

THE MARK CONSISTS OF STANDARD CHARACTERS WITHOUT CLAIM TO ANY PARTICULAR FONT, STYLE, SIZE, OR COLOR.

NO CLAIM IS MADE TO THE EXCLUSIVE RIGHT TO USE "FOUNDATION", APART FROM THE MARK AS SHOWN.

THE NAME(S), PORTRAIT(S), AND/OR SIGNATURE(S) SHOWN IN THE MARK IDENTIFIES "DONALD RUMSFELD", WHOSE CONSENT(S) TO REGISTER IS MADE OF RECORD.

SER. NO. 85-024,327, FILED P.R. 4-27-2010; AM. S.R. 3-7-2012.

JESSICA A. POWERS, EXAMINING ATTORNEY



*David J. Kybas*

Director of the United States Patent and Trademark Office

# United States of America

United States Patent and Trademark Office

## TELOMERE NUTRITION

**Reg. No. 4,137,085**

DREAM MASTER, LLC (NEVADA LIMITED LIABILITY COMPANY)  
6935 SOUTH SAPPHIRE WAY  
CHANDLER, AZ 85249

**Registered May 1, 2012**

**Int. Cl.: 5**

FOR: NUTRITIONAL SUPPLEMENTS, IN CLASS 5 (U.S. CLS. 6, 18, 44, 46, 51 AND 52).

**TRADEMARK**

FIRST USE 8-15-2011; IN COMMERCE 8-15-2011.

**SUPPLEMENTAL REGISTER**

THE MARK CONSISTS OF STANDARD CHARACTERS WITHOUT CLAIM TO ANY PARTICULAR FONT, STYLE, SIZE, OR COLOR.

NO CLAIM IS MADE TO THE EXCLUSIVE RIGHT TO USE "TELOMERE", APART FROM THE MARK AS SHOWN.

SER. NO. 85-053,183, FILED P.R. 6-2-2010; AM. S.R. 1-6-2012.

JILL C. ALT, EXAMINING ATTORNEY



*David J. Kybas*

Director of the United States Patent and Trademark Office



# United States of America

United States Patent and Trademark Office

## TELOMERASE NUTRITION

**Reg. No. 4,137,086**

DREAM MASTER, LLC (NEVADA LIMITED LIABILITY COMPANY)  
6935 SOUTH SAPPHIRE WAY  
CHANDLER, AZ 85249

**Registered May 1, 2012**

**Int. Cl.: 5**

FOR: NUTRITIONAL SUPPLEMENTS, IN CLASS 5 (U.S. CLS. 6, 18, 44, 46, 51 AND 52).

**TRADEMARK**

FIRST USE 8-15-2011; IN COMMERCE 8-15-2011.

**SUPPLEMENTAL REGISTER**

THE MARK CONSISTS OF STANDARD CHARACTERS WITHOUT CLAIM TO ANY PARTICULAR FONT, STYLE, SIZE, OR COLOR.

NO CLAIM IS MADE TO THE EXCLUSIVE RIGHT TO USE "TELOMERASE", APART FROM THE MARK AS SHOWN.

SER. NO. 85-053,188, FILED P.R. 6-2-2010; AM. S.R. 1-6-2012.

JILL C. ALT, EXAMINING ATTORNEY



*David J. Kyffers*

Director of the United States Patent and Trademark Office

# United States of America

United States Patent and Trademark Office

## SCHMIDT BROS.

**Reg. No. 4,137,087**

BROTHERS BRANDS, INC. (NEW JERSEY CORPORATION)  
15 PARK AVENUE  
WESTWOOD, NJ 07675

**Registered May 1, 2012**

**Int. Cls.: 8 and 21**

FOR: CUTLERY, IN CLASS 8 (U.S. CLS. 23, 28 AND 44).

**TRADEMARK**

FIRST USE 8-1-2010; IN COMMERCE 8-1-2010.

**SUPPLEMENTAL REGISTER**

FOR: KITCHEN AND HOUSEHOLD UTENSILS, NAMELY, SPATULAS, STRAINERS AND TONGS, IN CLASS 21 (U.S. CLS. 2, 13, 23, 29, 30, 33, 40 AND 50).

FIRST USE 8-1-2010; IN COMMERCE 8-1-2010.

THE MARK CONSISTS OF STANDARD CHARACTERS WITHOUT CLAIM TO ANY PARTICULAR FONT, STYLE, SIZE, OR COLOR.

NO CLAIM IS MADE TO THE EXCLUSIVE RIGHT TO USE "BROS.", APART FROM THE MARK AS SHOWN.

SER. NO. 85-059,204, FILED P.R. 6-10-2010; AM. S.R. 3-16-2011.

ANTHONY RINKER, EXAMINING ATTORNEY



*David J. Kybas*

Director of the United States Patent and Trademark Office

# United States of America

United States Patent and Trademark Office

## BUCK OR BUST

**Reg. No. 4,137,088**

SAMMY LEE ENTERPRISES, INC. (ALABAMA CORPORATION)  
3215 GLASGOW CIRCLE  
BIRMINGHAM, AL 35242

**Registered May 1, 2012**

**Int. Cl.: 25**

FOR: FOOTWEAR; HEADWEAR; PANTS; SHIRTS, IN CLASS 25 (U.S. CLS. 22 AND 39).

**TRADEMARK**

FIRST USE 7-24-2010; IN COMMERCE 7-24-2010.

**SUPPLEMENTAL REGISTER**

THE MARK CONSISTS OF STANDARD CHARACTERS WITHOUT CLAIM TO ANY PARTICULAR FONT, STYLE, SIZE, OR COLOR.

SER. NO. 85-074,077, FILED P.R. 6-29-2010; AM. S.R. 3-20-2012.

REGINA DRUMMOND, EXAMINING ATTORNEY



*David J. Kyffers*

Director of the United States Patent and Trademark Office

# United States of America

United States Patent and Trademark Office

# ConDreams

**Reg. No. 4,137,089**

SANA ULLAH (UNITED STATES INDIVIDUAL)  
624 BIRCH LEAF DR.  
ANAHEIM, CA 92804

**Registered May 1, 2012**

**Int. Cl.: 25**

FOR: CLOTHING, NAMELY, SHIRTS, T-SHIRTS, HATS, PANTS, SOCKS AND SHORTS, IN CLASS 25 (U.S. CLS. 22 AND 39).

**TRADEMARK**

FIRST USE 5-15-2011; IN COMMERCE 5-15-2011.

**SUPPLEMENTAL REGISTER**

THE MARK CONSISTS OF STANDARD CHARACTERS WITHOUT CLAIM TO ANY PARTICULAR FONT, STYLE, SIZE, OR COLOR.

SER. NO. 85-083,373, FILED P.R. 7-13-2010; AM. S.R. 3-20-2012.

BILL DAWE, EXAMINING ATTORNEY



*David J. Kyffers*

Director of the United States Patent and Trademark Office

# United States of America

United States Patent and Trademark Office

# ArtisanFish

**Reg. No. 4,137,090**

**Registered May 1, 2012**

**Int. Cl.: 29**

ARTISANFISH LLC (FLORIDA LIMITED LIABILITY COMPANY)  
SUITE 780  
20533 BISCAYNE BLVD  
AVENTURA, FL 33180

FOR: FISH; FISH FILLETS; SEAFOOD; SHELLFISH, IN CLASS 29 (U.S. CL. 46).

**TRADEMARK**

FIRST USE 9-1-2010; IN COMMERCE 9-1-2010.

**SUPPLEMENTAL REGISTER**

THE MARK CONSISTS OF STANDARD CHARACTERS WITHOUT CLAIM TO ANY PARTICULAR FONT, STYLE, SIZE, OR COLOR.

NO CLAIM IS MADE TO THE EXCLUSIVE RIGHT TO USE "FISH", APART FROM THE MARK AS SHOWN.

SER. NO. 85-107,893, FILED P.R. 8-16-2010; AM. S.R. 12-29-2011.

H. M. FISHER, EXAMINING ATTORNEY



*David J. Kyros*

Director of the United States Patent and Trademark Office

# United States of America

United States Patent and Trademark Office

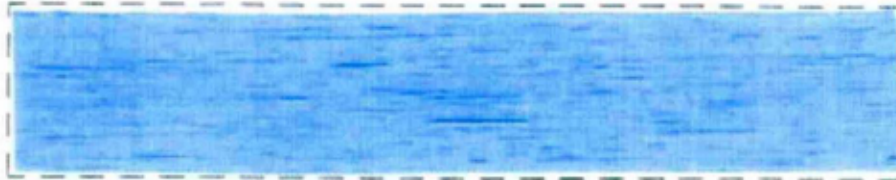

**Reg. No. 4,137,091**

THE MILL-ROSE COMPANY (OHIO CORPORATION)  
7310 CORPORATE BLVD.  
MENTOR, OH 44060

**Registered May 1, 2012**

**Int. Cl.: 17**

FOR: POLYTETRAFLUOROETHYLENE (PTFE) THREAD SEALING TAPE FOR PIPE JOINTS,  
IN CLASS 17 (U.S. CLS. 1, 5, 12, 13, 35 AND 50).

**TRADEMARK**

FIRST USE 11-1-2009; IN COMMERCE 11-1-2009.

**SUPPLEMENTAL REGISTER**

THE MARK CONSISTS OF THE COLOR MEDIUM-LIGHT BLUE APPLIED TO THREAD SEALANT TAPE. THE DOTTED LINES INDICATE PLACEMENT OF THE MARK ON THE PACKAGING FOR THE GOODS AND ARE NOT PART OF THE MARK.

THE COLOR(S) MEDIUM-LIGHT BLUE IS/ARE CLAIMED AS A FEATURE OF THE MARK.

SER. NO. 85-113,484, FILED P.R. 8-23-2010; AM. S.R. 3-16-2012.

CHARISMA HAMPTON, EXAMINING ATTORNEY



*David J. Kybas*

Director of the United States Patent and Trademark Office

# United States of America

United States Patent and Trademark Office

## GLOBAL PREPARATORY ACADEMY

**Reg. No. 4,137,092**

LIN, KEVIN (UNITED STATES INDIVIDUAL)  
2969 BELLA DRIVE  
CONCORD, CA 94519

**Registered May 1, 2012**

**Int. Cl.: 41**

FOR: EDUCATION SERVICES, NAMELY, PRESCHOOLS, AND KINDERGARTENS IN THE NATURE OF LANGUAGE INSTRUCTION THROUGH IMMERSION, IN CLASS 41 (U.S. CLS. 100, 101 AND 107).

**SERVICE MARK**

FIRST USE 10-23-2009; IN COMMERCE 12-15-2009.

**SUPPLEMENTAL REGISTER**

THE MARK CONSISTS OF STANDARD CHARACTERS WITHOUT CLAIM TO ANY PARTICULAR FONT, STYLE, SIZE, OR COLOR.

NO CLAIM IS MADE TO THE EXCLUSIVE RIGHT TO USE "ACADEMY", APART FROM THE MARK AS SHOWN.

SER. NO. 85-122,443, FILED P.R. 9-3-2010; AM. S.R. 6-18-2011.

PAUL MORENO, EXAMINING ATTORNEY



*David J. Kyros*

Director of the United States Patent and Trademark Office

# United States of America

United States Patent and Trademark Office

## ZEVIN ASSET MANAGEMENT

**Reg. No. 4,137,093**

**Registered May 1, 2012**

**Int. Cl.: 36**

**SERVICE MARK**

**SUPPLEMENTAL REGISTER**

ZEVIN ASSET MANAGEMENT INC. (MASSACHUSETTS LIMITED LIABILITY COMPANY)  
50 CONGRESS STREET, SUITE 1040  
BOSTON, MA 02109

FOR: FINANCIAL SERVICES, NAMELY, INVESTMENT ADVICE, INVESTMENT MANAGEMENT, INVESTMENT CONSULTATION AND INVESTMENT OF FUNDS FOR OTHERS, INCLUDING PRIVATE AND PUBLIC EQUITY AND DEBT INVESTMENT SERVICES; FINANCIAL PORTFOLIO MANAGEMENT AND ANALYSIS SERVICES, IN CLASS 36 (U.S. CLS. 100, 101 AND 102).

FIRST USE 1-1-2011; IN COMMERCE 1-1-2011.

THE MARK CONSISTS OF STANDARD CHARACTERS WITHOUT CLAIM TO ANY PARTICULAR FONT, STYLE, SIZE, OR COLOR.

NO CLAIM IS MADE TO THE EXCLUSIVE RIGHT TO USE "ASSET MANAGEMENT", APART FROM THE MARK AS SHOWN.

SER. NO. 85-128,059, FILED P.R. 9-13-2010; AM. S.R. 3-2-2012.

ESTHER BELENKER, EXAMINING ATTORNEY



*David J. Kybas*

Director of the United States Patent and Trademark Office



# United States of America

United States Patent and Trademark Office

## BODY PROTECTION FOR THE GLASS INDUSTRY

**Reg. No. 4,137,094**

BANOM, INC. (PENNSYLVANIA CORPORATION)  
BOX 687  
WAYNE, PA 19087

**Registered May 1, 2012**

**Int. Cl.: 9**

FOR: PROTECTIVE CUT-RESISTANT CLOTHING, NAMELY, SWEATERS AND CAPE SLEEVES WITH ATTACHED APRONS, FOR INDUSTRIAL USE, IN CLASS 9 (U.S. CLS. 21, 23, 26, 36 AND 38).

**TRADEMARK**

FIRST USE 2-24-2012; IN COMMERCE 2-24-2012.

**SUPPLEMENTAL REGISTER**

THE MARK CONSISTS OF STANDARD CHARACTERS WITHOUT CLAIM TO ANY PARTICULAR FONT, STYLE, SIZE, OR COLOR.

SER. NO. 85-142,295, FILED P.R. 9-30-2010; AM. S.R. 3-9-2012.

DAVID C. REIHNER, EXAMINING ATTORNEY



*David J. Kyffers*

Director of the United States Patent and Trademark Office

# United States of America

United States Patent and Trademark Office

# Deaf Cruise

**Reg. No. 4,137,095**

VIP TRAVEL NETWORK LLC (ARIZONA LIMITED LIABILITY COMPANY)  
14700 N. FRANK LLOYD WRIGHT BLVD #157  
SCOTTSDALE, AZ 85260

**Registered May 1, 2012**

**Int. Cl.: 39**

FOR: TRAVEL AGENCY SERVICES; ARRANGING OF TOURS AND CRUISES, IN CLASS 39 (U.S. CLS. 100 AND 105).

**SERVICE MARK**

FIRST USE 10-31-2005; IN COMMERCE 10-31-2005.

**SUPPLEMENTAL REGISTER**

THE MARK CONSISTS OF STANDARD CHARACTERS WITHOUT CLAIM TO ANY PARTICULAR FONT, STYLE, SIZE, OR COLOR.

NO CLAIM IS MADE TO THE EXCLUSIVE RIGHT TO USE "CRUISE", APART FROM THE MARK AS SHOWN.

SER. NO. 85-143,519, FILED P.R. 10-1-2010; AM. S.R. 2-9-2012.

LINDA M. KING, EXAMINING ATTORNEY



*David J. Kyffers*

Director of the United States Patent and Trademark Office

# United States of America

United States Patent and Trademark Office

## THE LEADER IN LIFELONG LEARNING

**Reg. No. 4,137,096**

**Registered May 1, 2012**

**Int. Cls.: 9 and 16**

**TRADEMARK**

**SUPPLEMENTAL REGISTER**

THE TEACHING COMPANY, LLC (DELAWARE LIMITED LIABILITY COMPANY)  
4840 WESTFIELDS BOULEVARD  
SUITE 500  
CHANTILLY, VA 20151

FOR: PRERECORDED CDS AND DVDS IN A VARIETY OF EDUCATIONAL SUBJECTS, NAMELY, SOCIAL SCIENCES, PSYCHOLOGY, HISTORY, LAW, LITERATURE, FINE ARTS, COSMOLOGY, SCIENCE, PHYSICAL SCIENCE, BIOLOGICAL SCIENCE, PHILOSOPHY, INTELLECTUAL HISTORY, LANGUAGE, LINGUISTICS, RELIGION, THEOLOGY, MATHEMATICS, BUSINESS, ECONOMICS, BETTER LIVING, PROFESSIONAL SKILLS, MUSIC AND PERFORMING ARTS, IN CLASS 9 (U.S. CLS. 21, 23, 26, 36 AND 38).

FIRST USE 5-0-2006; IN COMMERCE 5-0-2006.

FOR: PRINTED EDUCATIONAL MATERIALS IN THE NATURE OF COURSE TRANSCRIPTS, COURSE GUIDEBOOKS AND WORKBOOKS IN A VARIETY OF EDUCATIONAL SUBJECTS, NAMELY, SOCIAL SCIENCES, PSYCHOLOGY, HISTORY, LAW, LITERATURE, FINE ARTS, COSMOLOGY, SCIENCE, PHYSICAL SCIENCE, BIOLOGICAL SCIENCE, PHILOSOPHY, INTELLECTUAL HISTORY, LANGUAGE, LINGUISTICS, RELIGION, THEOLOGY, MATHEMATICS, BUSINESS, ECONOMICS, BETTER LIVING, PROFESSIONAL SKILLS, MUSIC AND PERFORMING ARTS, IN CLASS 16 (U.S. CLS. 2, 5, 22, 23, 29, 37, 38 AND 50).

FIRST USE 5-0-2006; IN COMMERCE 5-0-2006.

THE MARK CONSISTS OF STANDARD CHARACTERS WITHOUT CLAIM TO ANY PARTICULAR FONT, STYLE, SIZE, OR COLOR.

SER. NO. 85-144,198, FILED P.R. 10-4-2010; AM. S.R. 2-2-2012.

DANIEL CAPSHAW, EXAMINING ATTORNEY



*David J. Kyros*

Director of the United States Patent and Trademark Office

# United States of America

United States Patent and Trademark Office

ABCDEFGHI  
JKLMNOPQR  
STUVWXYZ  
abcdefghijklmnopqrstuvwxy  
*abcdefghijklmnopqrstuvwxy*  
1234567890

**Reg. No. 4,137,097**

ASSOULINE PUBLISHING INC (NEW YORK CORPORATION)  
601 W 26TH STREET, SUITE 1810  
NEW YORK, NY 10001

**Registered May 1, 2012**

**Int. Cls.: 24 and 27**

FOR: CASHMERE BLANKETS, IN CLASS 24 (U.S. CLS. 42 AND 50).

**TRADEMARK**

FIRST USE 9-7-2006; IN COMMERCE 9-7-2006.

**SUPPLEMENTAL REGISTER**

FOR: CARPETS AND RUGS , IN CLASS 27 (U.S. CLS. 19, 20, 37, 42 AND 50).

FIRST USE 9-7-2006; IN COMMERCE 6-8-2009.

THE MARK CONSISTS OF THE ENGLISH ALPHABET IN THE DIDOT FONT IN ROWS:  
FIRST IN CAPITALIZED LETTERS (LETTERS A-I, J-R, S-Z), THEN THE ALPHABET IN ITS  
ENTIRETY IN LOWER CASE, THEN ITALICIZED LOWER CASE, THEN NUMBERS "1 2 3  
4 5 6 7 8 9 0".

SER. NO. 85-146,578, FILED P.R. 10-6-2010; AM. S.R. 2-29-2012.

ANNE FARRELL, EXAMINING ATTORNEY



*David J. Kybas*

Director of the United States Patent and Trademark Office

# United States of America

United States Patent and Trademark Office

# REITMANS

**Reg. No. 4,137,098**

**Registered May 1, 2012**

**Int. Cls.: 14, 18, and 25**

REITMANS (CANADA) LIMITED (CANADA CORPORATION)  
250 SAUVE STREET WEST  
MONTREAL H3L 1Z2, CANADA

FOR: COSTUME JEWELRY, IN CLASS 14 (U.S. CLS. 2, 27, 28 AND 50).

FOR: UMBRELLAS; HANDBAGS; WALLETS, IN CLASS 18 (U.S. CLS. 1, 2, 3, 22 AND 41).

**TRADEMARK**

**SUPPLEMENTAL REGISTER**

FOR: WOMEN'S AND YOUNG WOMEN'S CLOTHING, NAMELY, COATS, RAINCOATS, JACKETS, VESTS, SUITS, DRESSES, BLAZERS, SKIRTS, PANTS, JEANS, SHORTS, SHIRTS, TOPS, TANK TOPS, HALTER TOPS, BLOUSES, T-SHIRTS, SWEATERS, BODY SUITS; WOMEN'S AND YOUNG WOMEN'S LOUNGEWEAR, NAMELY, HOUSECOATS, LOUNGING PAJAMAS; WOMEN'S AND YOUNG WOMEN'S SLEEPWEAR, NAMELY, NEGLIGEEES; WOMEN'S AND YOUNG WOMEN'S UNDERWEAR, NAMELY, BRASSIERES, SLIPS, HALF-SLIPS, CAMISOLES, PANTIES; WOMEN'S AND YOUNG WOMEN'S SWIMWEAR, NAMELY, SWIMSUITS; WOMEN'S AND YOUNG WOMEN'S ACTIVE WEAR, NAMELY, BODY SUITS, JEANS, SHORTS, SHIRTS, TANK TOPS, HALTER TOPS, T-SHIRTS, SWEATSHIRTS, JUMP SUITS; WOMEN'S AND YOUNG WOMEN'S LINGERIE, NAMELY, NEGLIGEEES, CAMISOLES, PANTIES, HALF SLIPS; WOMEN'S AND YOUNG WOMEN'S FASHION ACCESSORIES, NAMELY, HOSIERY, SOCKS, PANTY-HOSE, TIGHTS, CAPS, HATS, SCARVES, BELTS, GLOVES, IN CLASS 25 (U.S. CLS. 22 AND 39).

THE MARK CONSISTS OF STANDARD CHARACTERS WITHOUT CLAIM TO ANY PARTICULAR FONT, STYLE, SIZE, OR COLOR.

OWNER OF CANADA REG. NO. TMA289954, DATED 4-19-1984, EXPIRES 4-19-2014.

OWNER OF CANADA REG. NO. TMA178682, DATED 10-8-1971, EXPIRES 10-8-2016.

SER. NO. 85-147,689, FILED P.R. 10-7-2010; AM. S.R. 3-1-2012.

MARGARET POWER, EXAMINING ATTORNEY



*David J. Kyffers*

Director of the United States Patent and Trademark Office

# United States of America

United States Patent and Trademark Office

# Reitmans

**Reg. No. 4,137,099**

**Registered May 1, 2012**

**Int. Cls.: 3, 14, 18, and 25**

**TRADEMARK**

**SUPPLEMENTAL REGISTER**

REITMANS (CANADA) LIMITED (CANADA CORPORATION)  
250 SAUVE STREET WEST  
MONTREAL H3L 1Z2, CANADA

FOR: SKIN SOAPS; BODY LOTIONS; PERFUME; MAKE-UP, NAMELY, LIPSTICK, AND NAIL POLISH, IN CLASS 3 (U.S. CLS. 1, 4, 6, 50, 51 AND 52).

FOR: COSTUME JEWELRY, IN CLASS 14 (U.S. CLS. 2, 27, 28 AND 50).

FOR: UMBRELLAS; PURSES; HANDBAGS; WALLETS; BACKPACKS, IN CLASS 18 (U.S. CLS. 1, 2, 3, 22 AND 41).

FOR: WOMEN'S AND YOUNG WOMEN'S CLOTHING, NAMELY, COATS, RAINCOATS, JACKETS, VESTS, SUITS, DRESSES, BLAZERS, SKIRTS, PANTS, JEANS, SHORTS, SHIRTS, TOPS, TANK TOPS, HALTER TOPS, BLOUSES, T-SHIRTS, SWEATERS, CARDIGANS, BODY SUITS; WOMEN'S AND YOUNG WOMEN'S LOUNGEWEAR, NAMELY, HOUSECOATS, LOUNGING PAJAMAS, BATHROBES, CAFTANS, DRESSING GOWNS, ROBES; WOMEN'S AND YOUNG WOMEN'S SLEEPWEAR, NAMELY, NEGLIGEEES, KIMONOS, SLEEP SHIRTS, NIGHT SHIRTS; WOMEN'S AND YOUNG WOMEN'S UNDERWEAR, NAMELY, BRASSIERES, SLIPS, HALF-SLIPS, PANTIES, BOXER SHORTS; WOMEN'S AND YOUNG WOMEN'S SWIMWEAR, NAMELY, SWIMSUITS, SWIMSUIT COVER-UPS; WOMEN'S AND YOUNG WOMEN'S ACTIVE WEAR, NAMELY, BODY SUITS, BOXER SHORTS, JEANS, SHORTS, SHIRTS, TANK TOPS, HALTER TOPS, T-SHIRTS, SWEATSHIRTS, SWEAT PANTS, JUMP SUITS; WOMEN'S AND YOUNG WOMEN'S LINGERIE, NAMELY, NEGLIGEEES, KIMONOS, SLEEP SHIRTS, PANTIES, BOXER SHORTS, HALF SLIPS, CAFTANS, NIGHT SHIRTS; WOMEN'S AND YOUNG WOMEN'S FASHION ACCESSORIES, NAMELY, HOSIERY, SOCKS, PANTY-HOSE, SOCKLETS, SLIPPERS, TIGHTS, CAPS, HATS, SCARVES, BELTS, GLOVES, TIES; WOMEN'S AND YOUNG WOMEN'S FOOTWEAR, NAMELY, SHOES, BOOTS, SANDALS, IN CLASS 25 (U.S. CLS. 22 AND 39).



OWNER OF CANADA REG. NO. TMA517317, DATED 9-29-1999, EXPIRES 9-29-2014.

THE MARK CONSISTS OF THE WORD "REITMANS" IN STYLIZED FONT.

SER. NO. 85-147,705, FILED P.R. 10-7-2010; AM. S.R. 3-1-2012.

MARGARET POWER, EXAMINING ATTORNEY

*David J. Kyros*

Director of the United States Patent and Trademark Office

# United States of America

United States Patent and Trademark Office

## INTERACTBOOKS

**Reg. No. 4,137,100**

**Registered May 1, 2012**

**Int. Cl.: 9**

**TRADEMARK**

**SUPPLEMENTAL REGISTER**

INTERACTBOOKS, LLC (TEXAS LIMITED LIABILITY COMPANY)  
791 E. PROSPECT RD.  
JEFFERSON, TX 75657

FOR: DOWNLOADABLE COMPUTER PROGRAMS, DELIVERED VIA EXISTING AND FUTURE COMPUTER DEVICES FOR ACCESS AND DELIVERY OF INTERACTIVE ELECTRONIC BOOKS, COMPUTER GAMES AND OTHER INTERACTIVE MEDIA FORMATS ALL RELATING TO STORYTELLING IN AN INTERACTIVE FORMAT THAT INCLUDES COMPUTER GRAPHICS, AUDIO AND TACTILE LEARNING, IN CLASS 9 (U.S. CLS. 21, 23, 26, 36 AND 38).

FIRST USE 7-24-2010; IN COMMERCE 9-10-2010.

THE MARK CONSISTS OF STANDARD CHARACTERS WITHOUT CLAIM TO ANY PARTICULAR FONT, STYLE, SIZE, OR COLOR.

SER. NO. 85-151,188, FILED P.R. 10-13-2010; AM. S.R. 2-10-2012.

LINDA ESTRADA, EXAMINING ATTORNEY



*David J. Kybas*

Director of the United States Patent and Trademark Office

# United States of America

United States Patent and Trademark Office



**Reg. No. 4,137,101**

**Registered May 1, 2012**

**Int. Cl.: 5**

**TRADEMARK**

**SUPPLEMENTAL REGISTER**

SHENZHEN LADY COMMODITY CO., LTD. (CHINA LIMITED LIABILITY COMPANY)  
RM 1507 HAIYAN BUILDING  
JIABIN ROAD, LUOHU DISTRICT  
SHENZHEN CITY, CHINA

FOR: DISINFECTANTS FOR HYGIENE PURPOSES; DISINFECTANTS FOR MEDICAL INSTRUMENTS; INCONTINENCE DIAPERS; MENSTRUATION BANDAGES; MENSTRUATION TAMPONS; PANTY LINERS; PANTY SHIELDS; PHARMACEUTICAL PREPARATIONS, NAMELY, A BLOOD CLOTTING AID AND DELIVERY SYSTEM FOR USE IN HUMAN AND VETERINARY MEDICINE; PHARMACEUTICAL SKIN LOTIONS; SANITARY NAPKINS; SANITARY PADS; SANITARY PANTIES, IN CLASS 5 (U.S. CLS. 6, 18, 44, 46, 51 AND 52).

FIRST USE 9-10-2007; IN COMMERCE 10-28-2009.

THE MARK CONSISTS OF THE STYLIZED WORDING "LADY" SET INSIDE A DESIGN ELEMENT COMPRISED OF THREE OVERLAPPING CIRCLES.

SER. NO. 85-156,642, FILED P.R. 10-20-2010; AM. S.R. 3-7-2012.

MICHAEL GAFFAR, EXAMINING ATTORNEY



*David J. Kybas*

Director of the United States Patent and Trademark Office



# United States of America

United States Patent and Trademark Office

# Softwell

**Reg. No. 4,137,102**

**Registered May 1, 2012**

**Int. Cl.: 9**

**TRADEMARK**

**SUPPLEMENTAL REGISTER**

MATRIGEN LLC (CALIFORNIA LIMITED LIABILITY COMPANY)  
#201-343  
2500 EAST IMPERIAL HWY  
BREA, CA 92821

FOR: PLATES, GLASS SLIDES OR CHIPS HAVING MULTI-WELL ARRAYS THAT CAN BE USED IN CHEMICAL ANALYSIS, BIOLOGICAL ANALYSIS OR PATTERNING FOR SCIENTIFIC, LABORATORY OR MEDICAL RESEARCH USE, IN CLASS 9 (U.S. CLS. 21, 23, 26, 36 AND 38).

FIRST USE 9-25-2011; IN COMMERCE 9-25-2011.

THE MARK CONSISTS OF STANDARD CHARACTERS WITHOUT CLAIM TO ANY PARTICULAR FONT, STYLE, SIZE, OR COLOR.

SER. NO. 85-160,804, FILED P.R. 10-25-2010; AM. S.R. 3-20-2012.

ALLISON HOLTZ, EXAMINING ATTORNEY



*David J. Kyros*

Director of the United States Patent and Trademark Office

# United States of America

United States Patent and Trademark Office

## E-WALLWASH

**Reg. No. 4,137,103**

**Registered May 1, 2012**

**Int. Cl.: 11**

**TRADEMARK**

**SUPPLEMENTAL REGISTER**

ACOLYTE TECHNOLOGIES CORPORATION (NEW YORK CORPORATION)  
44 EAST 32ND STREET  
NEW YORK, NY 10016

FOR: LIGHTING DEVICES FOR EVENT DESIGN, NAMELY, LIGHTING FIXTURES IN THE NATURE OF LIGHTED BASES FOR ILLUMINATING VASES AND OTHER DECORATIVE OBJECTS, IN CLASS 11 (U.S. CLS. 13, 21, 23, 31 AND 34).

FIRST USE 3-0-2010; IN COMMERCE 3-0-2010.

THE MARK CONSISTS OF STANDARD CHARACTERS WITHOUT CLAIM TO ANY PARTICULAR FONT, STYLE, SIZE, OR COLOR.

SER. NO. 85-171,212, FILED 11-8-2010.

ANDREA K. NADELMAN, EXAMINING ATTORNEY



*David J. Kybas*

Director of the United States Patent and Trademark Office

# United States of America

United States Patent and Trademark Office

# SPECENGINE

**Reg. No. 4,137,104**

**Registered May 1, 2012**

**Int. Cl.: 9**

**TRADEMARK**

**SUPPLEMENTAL REGISTER**

KRUEGER INTERNATIONAL, INC. (WISCONSIN CORPORATION)  
1330 BELLEVUE STREET  
GREEN BAY, WI 54302

FOR: COMPUTER SOFTWARE FOR COMPUTER AIDED DESIGN AND ENGINEERING IN THE FIELD OF OFFICE AND INSTITUTIONAL FURNITURE, WALL SYSTEMS AND WORKSTATIONS , IN CLASS 9 (U.S. CLS. 21, 23, 26, 36 AND 38).

FIRST USE 6-15-2009; IN COMMERCE 6-15-2009.

THE MARK CONSISTS OF STANDARD CHARACTERS WITHOUT CLAIM TO ANY PARTICULAR FONT, STYLE, SIZE, OR COLOR.

SER. NO. 85-171,218, FILED P.R. 11-8-2010; AM. S.R. 3-5-2012.

LOURDES AYALA, EXAMINING ATTORNEY



*David J. Kyffers*

Director of the United States Patent and Trademark Office

# United States of America

United States Patent and Trademark Office

# E-RISER

**Reg. No. 4,137,105**

**Registered May 1, 2012**

**Int. Cl.: 11**

**TRADEMARK**

**SUPPLEMENTAL REGISTER**

ACOLYTE TECHNOLOGIES CORPORATION (NEW YORK CORPORATION)  
44 EAST 32ND STREET  
NEW YORK, NY 10016

FOR: LIGHTING DEVICES FOR EVENT DESIGN, NAMELY, LIGHTING FIXTURES IN THE NATURE OF LIGHTED BASES FOR ILLUMINATING VASES AND OTHER DECORATIVE OBJECTS, IN CLASS 11 (U.S. CLS. 13, 21, 23, 31 AND 34).

FIRST USE 1-0-2008; IN COMMERCE 1-0-2008.

THE MARK CONSISTS OF STANDARD CHARACTERS WITHOUT CLAIM TO ANY PARTICULAR FONT, STYLE, SIZE, OR COLOR.

SER. NO. 85-171,223, FILED P.R. 11-8-2010; AM. S.R. 3-16-2012.

ANDREA K. NADELMAN, EXAMINING ATTORNEY



*David J. Kyffers*

Director of the United States Patent and Trademark Office

# United States of America

United States Patent and Trademark Office

## BRIDGED COMMUNITIES

**Reg. No. 4,137,106**

**Registered May 1, 2012**

**Int. Cls.: 35 and 42**

**SERVICE MARK**

**SUPPLEMENTAL REGISTER**

TOUCHSTONE RESEARCH INC. (CONNECTICUT CORPORATION)  
500 EAST MAIN STREET, SUITE 322  
BRANFORD, CT 06422

FOR: MARKETING RESEARCH SERVICES UTILIZING TECHNOLOGY THAT CONNECTS SOCIAL MEDIA WEB SITE INTERFACES WITH ONLINE MARKETING RESEARCH DATA , IN CLASS 35 (U.S. CLS. 100, 101 AND 102).

FIRST USE 9-10-2010; IN COMMERCE 9-10-2010.

FOR: COMPUTER SERVICES, NAMELY, PROVIDING TEMPORARY USE OF ONLINE NON-DOWNLOADABLE SOFTWARE FEATURING TECHNOLOGY THAT CONNECTS SOCIAL MEDIA INTERFACES FOR USE IN ONLINE MARKETING RESEARCH, IN CLASS 42 (U.S. CLS. 100 AND 101).

FIRST USE 9-10-2010; IN COMMERCE 9-10-2010.

THE MARK CONSISTS OF STANDARD CHARACTERS WITHOUT CLAIM TO ANY PARTICULAR FONT, STYLE, SIZE, OR COLOR.

SER. NO. 85-174,553, FILED P.R. 11-11-2010; AM. S.R. 3-22-2012.

MELISSA VALLILLO, EXAMINING ATTORNEY



*David J. Kybas*

Director of the United States Patent and Trademark Office

**United States of America**  
United States Patent and Trademark Office

# APPCHAIN

**Reg. No. 4,137,107**

**Registered May 1, 2012**

**Int. Cl.: 9**

**TRADEMARK**

**SUPPLEMENTAL REGISTER**

4DD HOLDINGS LLC (DELAWARE LIMITED LIABILITY COMPANY)  
17609 DARNESTOWN ROAD  
BOYDS, MD 20841

FOR: COMPUTER SOFTWARE FOR DATA FLOW PROCESS BUILDERS THAT ALLOWS PEOPLE TO VISUALLY CREATE, CONFIGURE, DEPLOY AND MONITOR OTHER COMPUTER SOFTWARE APPLICATIONS, IN CLASS 9 (U.S. CLS. 21, 23, 26, 36 AND 38).

FIRST USE 4-1-2010; IN COMMERCE 4-1-2010.

THE MARK CONSISTS OF STANDARD CHARACTERS WITHOUT CLAIM TO ANY PARTICULAR FONT, STYLE, SIZE, OR COLOR.

SER. NO. 85-177,256, FILED P.R. 11-15-2010; AM. S.R. 3-6-2012.

DAVID YONTEF, EXAMINING ATTORNEY



*David J. Kyffers*

Director of the United States Patent and Trademark Office

# United States of America

United States Patent and Trademark Office

# OCTAVE

**Reg. No. 4,137,108**

SHAND, EUAN C (UNITED KINGDOM INDIVIDUAL), TA THE SPIRITS EMBASSY LLC,  
165 ANITA DRIVE  
PASADENA, CA 91105

**Registered May 1, 2012**

**Int. Cl.: 33**

FOR: ALCOHOLIC BEVERAGES, NAMELY, FLAVOR-INFUSED WHISKEY; WHISKEY, IN  
CLASS 33 (U.S. CLS. 47 AND 49).

**TRADEMARK**

FIRST USE 3-12-2007; IN COMMERCE 3-12-2007.

**SUPPLEMENTAL REGISTER**

THE MARK CONSISTS OF STANDARD CHARACTERS WITHOUT CLAIM TO ANY PAR-  
TICULAR FONT, STYLE, SIZE, OR COLOR.

SER. NO. 85-185,039, FILED P.R. 11-24-2010; AM. S.R. 3-15-2012.

JACLYN KIDWELL WALKER, EXAMINING ATTORNEY



*David J. Kyros*

Director of the United States Patent and Trademark Office

# United States of America

United States Patent and Trademark Office

# Smart share

**Reg. No. 4,137,109**

**Registered May 1, 2012**

**Int. Cl.: 9**

**TRADEMARK**

**SUPPLEMENTAL REGISTER**

LG ELECTRONICS INC. (REPUBLIC OF KOREA CORPORATION)  
20 YEOUIDO-DONG YEONGDEUNGPO-GU  
SEOUL 150-721, REPUBLIC OF KOREA

FOR: TELEVISION RECEIVERS ALLOWING CONNECTIVITY AND COMPATIBILITY WITH COMPUTER HARDWARE AND SOFTWARE; MOBILE PHONES ALLOWING CONNECTIVITY AND COMPATIBILITY WITH COMPUTER HARDWARE AND SOFTWARE; COMPUTER APPLICATION SOFTWARE FOR CONTROLLING THE OPERATION OF TELEVISIONS ALLOWING CONNECTIVITY AND COMPATIBILITY WITH COMPUTER HARDWARE AND SOFTWARE; COMPUTER APPLICATION SOFTWARE FOR CONTROLLING THE OPERATION OF MOBILE PHONES ALLOWING CONNECTIVITY AND COMPATIBILITY WITH COMPUTER HARDWARE AND SOFTWARE; SETTOP BOXES ALLOWING CONNECTIVITY AND COMPATIBILITY WITH COMPUTER HARDWARE AND SOFTWARE, IN CLASS 9 (U.S. CLS. 21, 23, 26, 36 AND 38).

THE MARK CONSISTS OF STANDARD CHARACTERS WITHOUT CLAIM TO ANY PARTICULAR FONT, STYLE, SIZE, OR COLOR.

PRIORITY CLAIMED UNDER SEC. 44(D) ON REPUBLIC OF KOREA APPLICATION NO. 40-2010-0048, FILED 9-13-2010.

OWNER OF ERPN CMNTY TM OFC REG. NO. 009600974, DATED 4-26-2011, EXPIRES 4-26-2021.

SER. NO. 85-189,446, FILED P.R. 12-2-2010; AM. S.R. 3-9-2012.

TOBY BULLOFF, EXAMINING ATTORNEY



*David J. Kyros*

Director of the United States Patent and Trademark Office



# United States of America

United States Patent and Trademark Office

## Emergency Room Quick Information Kit

**Reg. No. 4,137,110**

**Registered May 1, 2012**

**Int. Cl.: 16**

**TRADEMARK**

**SUPPLEMENTAL REGISTER**

LLM SOLUTIONS, LLC (OREGON LIMITED LIABILITY COMPANY)  
12123 SUMMIT LOOP ROAD  
TURNER, OR 973920734

FOR: PRINTED PAMPHLETS, BROCHURES, MANUALS, BOOKS, BOOKLETS, LEAFLETS, FLYERS, INFORMATIONAL SHEETS AND NEWSLETTERS, ADHESIVE BACKED STICKERS, AND KITS COMPRISING ONE OR MORE OF THE FOREGOING MATERIALS IN THE FIELD OF MEDICAL INFORMATION, IN CLASS 16 (U.S. CLS. 2, 5, 22, 23, 29, 37, 38 AND 50).

FIRST USE 2-26-2010; IN COMMERCE 12-1-2010.

THE MARK CONSISTS OF STANDARD CHARACTERS WITHOUT CLAIM TO ANY PARTICULAR FONT, STYLE, SIZE, OR COLOR.

NO CLAIM IS MADE TO THE EXCLUSIVE RIGHT TO USE "INFORMATION KIT", APART FROM THE MARK AS SHOWN.

SER. NO. 85-190,640, FILED P.R. 12-3-2010; AM. S.R. 7-26-2011.

NANCY CLARKE, EXAMINING ATTORNEY



*David J. Kyros*

Director of the United States Patent and Trademark Office

# United States of America

United States Patent and Trademark Office



**Reg. No. 4,137,111**

**Registered May 1, 2012**

**Int. Cl.: 35**

**SERVICE MARK**

**SUPPLEMENTAL REGISTER**

U.S. PAIN INC. (CALIFORNIA CORPORATION)  
#650  
450 NEWPORT CENTER DRIVE  
NEWPORT BEACH, CA 92660

FOR: HEALTHCARE MANAGEMENT SERVICE ORGANIZATION (MSO) SERVICES, NAMELY, PROVIDING PRACTICE ORGANIZATION, MANAGEMENT AND ADMINISTRATIVE SUPPORT SERVICES TO INDIVIDUAL PHYSICIANS OR SMALL GROUP PRACTICES, IN CLASS 35 (U.S. CLS. 100, 101 AND 102).

FIRST USE 4-1-2010; IN COMMERCE 4-1-2010.

THE MARK CONSISTS OF THE TEXT "US PAIN" INSIDE A BOX.

SER. NO. 85-207,971, FILED P.R. 12-30-2010; AM. S.R. 2-13-2012.

LAKEISHA LEWIS, EXAMINING ATTORNEY



*David J. Kyffers*

Director of the United States Patent and Trademark Office

# United States of America

United States Patent and Trademark Office

# Vintage Rib

**Reg. No. 4,137,112**

CO BUILDING SYSTEMS, INC (UTAH CORPORATION)  
320 WEST COLLEGE AVE  
EPHRAIM, UT 84627

**Registered May 1, 2012**

**Int. Cl.: 6**

FOR: METAL ROOFING; METAL ROOFING PANELS; WALL PANELS OF METAL, IN CLASS 6 (U.S. CLS. 2, 12, 13, 14, 23, 25 AND 50).

**TRADEMARK**

FIRST USE 1-15-2011; IN COMMERCE 1-15-2011.

**SUPPLEMENTAL REGISTER**

THE MARK CONSISTS OF STANDARD CHARACTERS WITHOUT CLAIM TO ANY PARTICULAR FONT, STYLE, SIZE, OR COLOR.

NO CLAIM IS MADE TO THE EXCLUSIVE RIGHT TO USE "RIB", APART FROM THE MARK AS SHOWN.

SER. NO. 85-213,364, FILED P.R. 1-7-2011; AM. S.R. 3-21-2012.

RONALD DELGIZZI, EXAMINING ATTORNEY



*David J. Kyros*

Director of the United States Patent and Trademark Office

# United States of America

United States Patent and Trademark Office

# SOBER UP

**Reg. No. 4,137,113**

**Registered May 1, 2012**

**Int. Cl.: 35**

**SERVICE MARK**

**SUPPLEMENTAL REGISTER**

EQUILIBRIUM HOLDINGS, LLC (DELAWARE LIMITED LIABILITY COMPANY)  
7745 GELDING DRIVE, SUITE B-102  
SCOTTSDALE, AZ 85260

FOR: ON-LINE WHOLESALE AND RETAIL STORE SERVICES FEATURING DIETARY AND NUTRITIONAL SUPPLEMENTS AND DIETARY AND NUTRITIONAL SUPPLEMENT DRINKS , IN CLASS 35 (U.S. CLS. 100, 101 AND 102).

FIRST USE 2-29-2012; IN COMMERCE 2-29-2012.

THE MARK CONSISTS OF STANDARD CHARACTERS WITHOUT CLAIM TO ANY PARTICULAR FONT, STYLE, SIZE, OR COLOR.

SER. NO. 85-223,281, FILED P.R. 1-21-2011; AM. S.R. 3-8-2012.

JEFF DEFORD, EXAMINING ATTORNEY



*David J. Kyffers*

Director of the United States Patent and Trademark Office

# United States of America

United States Patent and Trademark Office

## Everyday Energy Shots

**Reg. No. 4,137,114**

**Registered May 1, 2012**

**Int. Cl.: 5**

**TRADEMARK**

**SUPPLEMENTAL REGISTER**

MALPEDE, MATTHEW (UNITED STATES INDIVIDUAL), DBA EVERYDAY ENERGY SHOTS,  
136 S. CATHERINE AVE.  
LA GRANGE, IL 60525

FOR: DIETARY SUPPLEMENTAL DRINKS; DIETARY SUPPLEMENTAL DRINKS IN THE NATURE OF VITAMIN AND MINERAL BEVERAGES; NUTRITIONAL SUPPLEMENTS FOR ENERGY BOOSTING; POWDERED FRUIT-FLAVORED DIETARY SUPPLEMENT DRINK MIX; POWDERED NUTRITIONAL SUPPLEMENT DRINK MIX, IN CLASS 5 (U.S. CLS. 6, 18, 44, 46, 51 AND 52).

FIRST USE 7-15-2010; IN COMMERCE 9-20-2010.

THE MARK CONSISTS OF STANDARD CHARACTERS WITHOUT CLAIM TO ANY PARTICULAR FONT, STYLE, SIZE, OR COLOR.

NO CLAIM IS MADE TO THE EXCLUSIVE RIGHT TO USE "ENERGY SHOTS", APART FROM THE MARK AS SHOWN.

SER. NO. 85-223,413, FILED P.R. 1-21-2011; AM. S.R. 3-1-2012.

KATHERINE E. HALMEN, EXAMINING ATTORNEY



*David J. Kybas*

Director of the United States Patent and Trademark Office

# United States of America

United States Patent and Trademark Office

## RETAIN YOUR GAINS

**Reg. No. 4,137,115**

**Registered May 1, 2012**

**Int. Cl.: 36**

**SERVICE MARK**

**SUPPLEMENTAL REGISTER** FIRST USE 1-0-2008; IN COMMERCE 1-0-2008.

DEJOHN, STEVEN R. (UNITED STATES INDIVIDUAL)  
1600 GOLF RD, STE. 1200  
ROLLING MEADOWS, IL 60008

FOR: FINANCIAL AND INVESTMENT ADVICE AND CONSULTANCY SERVICES;  
PROVIDING INFORMATION IN THE FIELD OF FINANCE AND INVESTMENT ADVICE;  
PROVIDING A WEBSITE FEATURING INFORMATION IN THE FIELD OF FINANCE AND  
INVESTMENT ADVICE, IN CLASS 36 (U.S. CLS. 100, 101 AND 102).

THE MARK CONSISTS OF STANDARD CHARACTERS WITHOUT CLAIM TO ANY PARTICULAR FONT, STYLE, SIZE, OR COLOR.

SER. NO. 85-259,837, FILED P.R. 3-7-2011; AM. S.R. 3-8-2012.

JEFFREY LOOK, EXAMINING ATTORNEY



*David J. Kyffers*

Director of the United States Patent and Trademark Office

# United States of America

United States Patent and Trademark Office

## RETAIN YOUR GAINS

**Reg. No. 4,137,116**

**Registered May 1, 2012**

**Int. Cl.: 41**

**SERVICE MARK**

**SUPPLEMENTAL REGISTER**

STEVEN R. DEJOHN (UNITED STATES INDIVIDUAL)  
1600 GOLF RD, STE. 1200  
ROLLING MEADOWS, IL 60008

FOR: EDUCATIONAL SERVICES, NAMELY, PROVIDING CLASSES, SEMINARS AND WORKSHOPS IN THE FIELD OF FINANCE AND INVESTMENT, IN CLASS 41 (U.S. CLS. 100, 101 AND 107).

FIRST USE 1-0-2008; IN COMMERCE 1-0-2008.

THE MARK CONSISTS OF STANDARD CHARACTERS WITHOUT CLAIM TO ANY PARTICULAR FONT, STYLE, SIZE, OR COLOR.

SER. NO. 85-259,851, FILED P.R. 3-7-2011; AM. S.R. 3-8-2012.

JEFFREY LOOK, EXAMINING ATTORNEY



*David J. Kybas*

Director of the United States Patent and Trademark Office

# United States of America

United States Patent and Trademark Office

# Click-Tips

**Reg. No. 4,137,117**

**Registered May 1, 2012**

**Int. Cl.: 16**

**TRADEMARK**

**SUPPLEMENTAL REGISTER**

CHANNING BETE COMPANY, INC. (MASSACHUSETTS CORPORATION)  
ONE COMMUNITY PLACE  
SOUTH DEERFIELD, MA 01373

FOR: PENS, IN CLASS 16 (U.S. CLS. 2, 5, 22, 23, 29, 37, 38 AND 50).

FIRST USE 8-5-2008; IN COMMERCE 8-5-2008.

THE MARK CONSISTS OF STANDARD CHARACTERS WITHOUT CLAIM TO ANY PARTICULAR FONT, STYLE, SIZE, OR COLOR.

SER. NO. 85-259,980, FILED P.R. 3-7-2011; AM. S.R. 3-22-2012.

ODESSA BIBBINS, EXAMINING ATTORNEY



*David J. Kyffers*

Director of the United States Patent and Trademark Office



# United States of America

United States Patent and Trademark Office

## MobileSolutions

**Reg. No. 4,137,118**

**Registered May 1, 2012**

**Int. Cl.: 42**

**SERVICE MARK**

**SUPPLEMENTAL REGISTER**

GOLF AND CORPORATE SOLUTIONS LLC (WASHINGTON LIMITED LIABILITY COMPANY), DBA GOLF AND CORPORATE SOLUTIONS LLC,  
1751 NW MARKET ST. SW #514  
SEATTLE, WA 98107

FOR: PROVIDING A WEBSITE FEATURING TEMPORARY USE OF NON-DOWNLOADABLE SOFTWARE THAT PROVIDES INTERACTIVE SCORING INFORMATION TO GOLFERS, TOURNAMENT DIRECTORS, AND FANS VIA THE INTERNET, IN CLASS 42 (U.S. CLS. 100 AND 101).

FIRST USE 1-1-2010; IN COMMERCE 1-1-2010.

THE MARK CONSISTS OF STANDARD CHARACTERS WITHOUT CLAIM TO ANY PARTICULAR FONT, STYLE, SIZE, OR COLOR.

SER. NO. 85-285,447, FILED 4-4-2011.

MARK SHINER, EXAMINING ATTORNEY



*David J. Kyffers*

Director of the United States Patent and Trademark Office

# United States of America

United States Patent and Trademark Office

# SEVE

**Reg. No. 4,137,119**

**Registered May 1, 2012**

**Int. Cl.: 30**

**TRADEMARK**

**SUPPLEMENTAL REGISTER**

SEVE, RICHARD (FRANCE INDIVIDUAL)  
62, AVENUE DE LANESSAN  
CHAMPAGNE AU MONT D'OR, FRANCE 69410 AND

SEVE, GAELLE NEE REPELIN (FRANCE INDIVIDUAL)  
62, AVENUE DE LANESSAN  
CHAMPAGNE AU MONT D'OR, FRANCE 69410

FOR: CHOCOLATES; CONFECTIONERY, NAMELY, PASTRIES, CANDIES, CANDIES OF FRUIT PASTE, CHOCOLATE CANDIES, CHOCOLATE BARS, ICE CREAM, MACAROONS, GANACHE, FONDANT, PASTILLES, FRUIT JELLIES; CHOCOLATE, PETIT FOURS, FLAVORED ICES, NOUGAT, NON-MEDICATED LOZENGES, SWEETS, PRALINES, CAKES, FRUIT ICES, COFFEE, SUGAR, BAKERY PRODUCTS, NAMELY, CUP CAKES, COOKIES, BROWNIES, MARRONS GLADES, CROQUANTS, TUILES, ORANGETTES; TEA, IN CLASS 30 (U.S. CL. 46).

THE MARK CONSISTS OF STANDARD CHARACTERS WITHOUT CLAIM TO ANY PARTICULAR FONT, STYLE, SIZE, OR COLOR.

OWNER OF FRANCE REG. NO. 053368035, DATED 6-30-2005, EXPIRES 6-30-2015.

SER. NO. 85-290,178, FILED P.R. 4-8-2011; AM. S.R. 1-17-2012.

KATINA MISTER, EXAMINING ATTORNEY



*David J. Kybas*

Director of the United States Patent and Trademark Office

# United States of America

United States Patent and Trademark Office

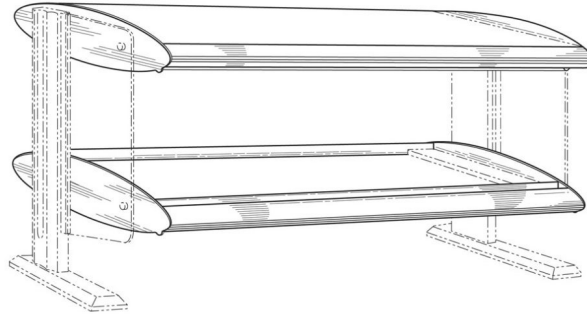

**Reg. No. 4,137,120**

**Registered May 1, 2012**

**Int. Cl.: 11**

**TRADEMARK**

**SUPPLEMENTAL REGISTER** FIRST USE 12-12-2011; IN COMMERCE 12-12-2011.

HATCO CORPORATION (WISCONSIN CORPORATION)  
635 S. 28TH STREET  
MILWAUKEE, WI 53215

FOR: ELECTRIC FOOD WARMERS FOR HOLDING FOOD AT SERVING TEMPERATURE, PORTABLE FOOD WARMERS, HOLDING AND DISPLAY WARMERS, BUFFET WARMERS, HEATED SHELVES, ALL FOR COMMERCIAL USE, IN CLASS 11 (U.S. CLS. 13, 21, 23, 31 AND 34).

THE MARK CONSISTS OF A THREE-DIMENSIONAL CONFIGURATION OF END PANELS, SHELF AND TOP IN A PORTABLE ELECTRIC FOOD WARMER. THE END PANELS HAVE AN ELLIPTICAL SHAPE AND THE SHELF AND TOP HAVE TAPERED FRONT EDGES AND ARE ORIENTED IN A GENERALLY HORIZONTAL POSITION. THE PORTION OF THE MARK SHOWN IN DOTTED LINES IS NOT PART OF THE MARK AND SERVES ONLY TO SHOW POSITIONING OR PLACEMENT OF THE MARK.

SER. NO. 85-290,622, FILED P.R. 4-8-2011; AM. S.R. 1-17-2012.

JEFF DEFORD, EXAMINING ATTORNEY



*David J. Kyros*

Director of the United States Patent and Trademark Office

# United States of America

United States Patent and Trademark Office

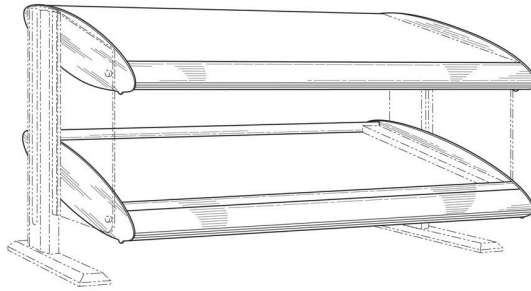

**Reg. No. 4,137,121**

**Registered May 1, 2012**

**Int. Cl.: 11**

**TRADEMARK**

**SUPPLEMENTAL REGISTER** FIRST USE 12-12-2011; IN COMMERCE 12-12-2011.

HATCO CORPORATION (WISCONSIN CORPORATION)  
635 S. 28TH STREET  
MILWAUKEE, WI 53215

FOR: ELECTRIC FOOD WARMERS FOR HOLDING FOOD AT SERVING TEMPERATURE, PORTABLE FOOD WARMERS, HOLDING AND DISPLAY WARMERS, BUFFET WARMERS, HEATED SHELVES, ALL FOR COMMERCIAL USE, IN CLASS 11 (U.S. CLS. 13, 21, 23, 31 AND 34).

THE MARK CONSISTS OF A THREE-DIMENSIONAL CONFIGURATION OF END PANELS, SHELF AND TOP IN A PORTABLE ELECTRIC FOOD WARMER. THE END PANELS HAVE AN ELLIPTICAL SHAPE AND THE SHELF AND TOP HAVE TAPERED FRONT EDGES AND ARE ORIENTED IN A 35 DEGREE APPROXIMATE ANGLED POSITION. THE PORTION OF THE MARK SHOWN IN DOTTED LINES IS NOT PART OF THE MARK AND SERVES ONLY TO SHOW POSITIONING OR PLACEMENT OF THE MARK.

SER. NO. 85-290,641, FILED P.R. 4-8-2011; AM. S.R. 1-17-2012.

JEFF DEFORD, EXAMINING ATTORNEY



*David J. Kyffers*

Director of the United States Patent and Trademark Office

# United States of America

## United States Patent and Trademark Office

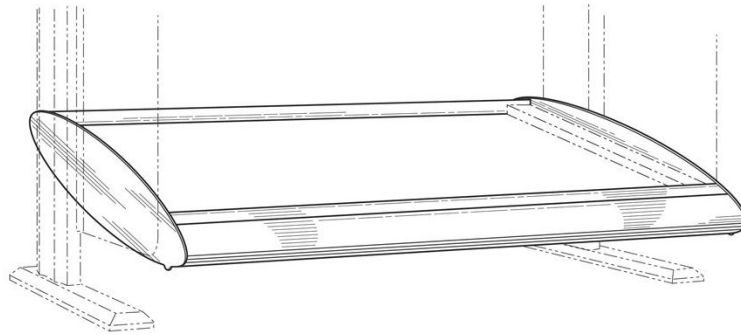

**Reg. No. 4,137,122**

**Registered May 1, 2012**

**Int. Cl.: 11**

**TRADEMARK**

**SUPPLEMENTAL REGISTER** FIRST USE 12-12-2011; IN COMMERCE 12-12-2011.

HATCO CORPORATION (WISCONSIN CORPORATION)  
635 S. 28TH STREET  
MILWAUKEE, WI 53215

FOR: ELECTRIC FOOD WARMERS FOR HOLDING FOOD AT SERVING TEMPERATURE, PORTABLE FOOD WARMERS, HOLDING AND DISPLAY WARMERS, BUFFET WARMERS, HEATED SHELVES, ALL FOR COMMERCIAL USE, IN CLASS 11 (U.S. CLS. 13, 21, 23, 31 AND 34).

THE MARK CONSISTS OF A THREE-DIMENSIONAL CONFIGURATION OF END PANELS AND SHELF IN A PORTABLE ELECTRIC FOOD WARMER. THE END PANELS HAVE AN ELLIPTICAL SHAPE AND THE SHELF HAS A TAPERED FRONT EDGE AND IS ORIENTED IN A 35 DEGREE APPROXIMATE ANGLED POSITION. THE PORTION OF THE MARK SHOWN IN DOTTED LINES IS NOT PART OF THE MARK AND SERVES ONLY TO SHOW POSITIONING OR PLACEMENT OF THE MARK.

SER. NO. 85-290,652, FILED P.R. 4-8-2011; AM. S.R. 1-17-2012.

JEFF DEFORD, EXAMINING ATTORNEY



*David J. Kyros*

Director of the United States Patent and Trademark Office

# United States of America

United States Patent and Trademark Office

# DINNERDATE

**Reg. No. 4,137,123**

**Registered May 1, 2012**

**Int. Cl.: 42**

**SERVICE MARK**

**SUPPLEMENTAL REGISTER**

DINNER DATE, LTD (MALTA PRIVATE LIMITED COMPANY)  
TOWER STREET  
TOWER BUSINESS CENTRE SUITE 2 ROOM 2  
SWATAR, MALTA BKR 4013

FOR: COMPUTER SERVICE, NAMELY, HOSTING ONLINE WEB FACILITY FOR OTHERS FOR ORGANIZING INTERACTIVE DISCUSSIONS; PROVIDING TEMPORARY USE OF NON-DOWNLOADABLE SOFTWARE APPLICATIONS FOR SOCIAL NETWORKING, BLOGGING, PHOTO SHARING, VIDEO SHARING, INFORMATION SHARING, SHARING OF CLASSIFIEDS, SHARING OF INFORMATION ABOUT BUSINESS ORGANIZATIONS AND TRANSMISSION OF EVENT DETAILS, PARTICIPATING VENUE LOCATIONS, CUSTOMER REVIEWS; PROVIDING INFORMATION ABOUT ONLINE VIRTUAL COMMUNITIES OFFERED FOR PURPOSES OF SOCIAL NETWORKING, IN CLASS 42 (U.S. CLS. 100 AND 101).

FIRST USE 3-20-2012; IN COMMERCE 3-20-2012.

THE MARK CONSISTS OF STANDARD CHARACTERS WITHOUT CLAIM TO ANY PARTICULAR FONT, STYLE, SIZE, OR COLOR.

SER. NO. 85-295,651, FILED P.R. 4-14-2011; AM. S.R. 3-21-2012.

TINA L. SNAPP, EXAMINING ATTORNEY



*David J. Kyffers*

Director of the United States Patent and Trademark Office

# United States of America

United States Patent and Trademark Office

# DINNERDATE

**Reg. No. 4,137,124**

**Registered May 1, 2012**

**Int. Cls.: 41 and 45**

**SERVICE MARK**

**SUPPLEMENTAL REGISTER**

DINNER DATE, LTD (MALTA PRIVATE LIMITED COMPANY)  
TOWER STREET  
TOWER BUSINESS CENTRE SUITE 2 ROOM 2  
SWATAR, MALTA BKR 4013

FOR: PROVIDING ON-LINE COMPUTER DATABASES AND ON-LINE SEARCHABLE DATABASES IN THE FIELD OF ORGANIZED DATING EVENTS FEATURING PARTIES FOR THE PURPOSES OF DATING AND SOCIAL INTRODUCTION FOR ADULTS, IN CLASS 41 (U.S. CLS. 100, 101 AND 107).

FIRST USE 3-20-2012; IN COMMERCE 3-20-2012.

FOR: COMPUTER DATING SERVICES VIA PERSONAL ADVERTISEMENTS AND SOCIAL NETWORKING ON THE INTERNET AND MOBILE DEVICES, IN CLASS 45 (U.S. CLS. 100 AND 101).

FIRST USE 3-20-2012; IN COMMERCE 3-20-2012.

THE MARK CONSISTS OF STANDARD CHARACTERS WITHOUT CLAIM TO ANY PARTICULAR FONT, STYLE, SIZE, OR COLOR.

SER. NO. 85-295,679, FILED P.R. 4-14-2011; AM. S.R. 3-21-2012.

TINA L. SNAPP, EXAMINING ATTORNEY



*David J. Kypos*

Director of the United States Patent and Trademark Office

# United States of America

United States Patent and Trademark Office

## DINNERDATE.COM

**Reg. No. 4,137,125**

**Registered May 1, 2012**

**Int. Cls.: 41 and 45**

**SERVICE MARK**

**SUPPLEMENTAL REGISTER**

DINNER DATE, LTD (MALTA PRIVATE LIMITED COMPANY)  
TOWER STREET  
TOWER BUSINESS CENTRE SUITE 2 ROOM 2  
SWATAR, MALTA BKR 4013

FOR: PROVIDING ON-LINE COMPUTER DATABASES AND ON-LINE SEARCHABLE DATABASES IN THE FIELD OF ORGANIZED DATING EVENTS FEATURING PARTIES FOR THE PURPOSES OF DATING AND SOCIAL INTRODUCTION FOR ADULTS, IN CLASS 41 (U.S. CLS. 100, 101 AND 107).

FIRST USE 3-20-2012; IN COMMERCE 3-20-2012.

FOR: COMPUTER DATING SERVICES VIA PERSONAL ADVERTISEMENTS AND SOCIAL NETWORKING ON THE INTERNET AND MOBILE DEVICES, IN CLASS 45 (U.S. CLS. 100 AND 101).

FIRST USE 3-20-2012; IN COMMERCE 3-20-2012.

THE MARK CONSISTS OF STANDARD CHARACTERS WITHOUT CLAIM TO ANY PARTICULAR FONT, STYLE, SIZE, OR COLOR.

SER. NO. 85-295,685, FILED P.R. 4-14-2011; AM. S.R. 3-21-2012.

TINA L. SNAPP, EXAMINING ATTORNEY



*David J. Kybas*

Director of the United States Patent and Trademark Office



# United States of America

United States Patent and Trademark Office

# DINNERDATE

**Reg. No. 4,137,126**

**Registered May 1, 2012**

**Int. Cl.: 38**

**SERVICE MARK**

**SUPPLEMENTAL REGISTER** FIRST USE 3-20-2012; IN COMMERCE 3-20-2012.

DINNER DATE, LTD (MALTA PRIVATE LIMITED COMPANY)  
TOWER STREET  
TOWER BUSINESS CENTRE SUITE 2 ROOM 2  
SWATAR, MALTA BKR 4013

FOR: PROVIDING EMAIL AND INSTANT MESSAGING SERVICES FOR USERS ONLINE CONCERNING DATING, MATCHMAKING, CLASSIFIEDS, VIRTUAL COMMUNITY AND SOCIAL NETWORKING, IN CLASS 38 (U.S. CLS. 100, 101 AND 104).

THE MARK CONSISTS OF STANDARD CHARACTERS WITHOUT CLAIM TO ANY PARTICULAR FONT, STYLE, SIZE, OR COLOR.

SER. NO. 85-296,220, FILED P.R. 4-15-2011; AM. S.R. 3-21-2012.

TINA L. SNAPP, EXAMINING ATTORNEY



*David J. Kyffers*

Director of the United States Patent and Trademark Office

# United States of America

United States Patent and Trademark Office

## DINNERDATE.COM

**Reg. No. 4,137,127**

**Registered May 1, 2012**

**Int. Cl.: 38**

**SERVICE MARK**

**SUPPLEMENTAL REGISTER** FIRST USE 3-20-2012; IN COMMERCE 3-20-2012.

DINNER DATE, LTD (MALTA PRIVATE LIMITED COMPANY)  
TOWER STREET  
TOWER BUSINESS CENTRE SUITE 2 ROOM 2  
SWATAR, MALTA BKR 4013

FOR: PROVIDING EMAIL AND INSTANT MESSAGING SERVICES FOR USERS ONLINE CONCERNING DATING, MATCHMAKING, CLASSIFIEDS, VIRTUAL COMMUNITY AND SOCIAL NETWORKING, IN CLASS 38 (U.S. CLS. 100, 101 AND 104).

THE MARK CONSISTS OF STANDARD CHARACTERS WITHOUT CLAIM TO ANY PARTICULAR FONT, STYLE, SIZE, OR COLOR.

SER. NO. 85-296,275, FILED P.R. 4-15-2011; AM. S.R. 3-21-2012.

TINA L. SNAPP, EXAMINING ATTORNEY



*David J. Kyffers*

Director of the United States Patent and Trademark Office

# United States of America

United States Patent and Trademark Office

## Waste Caddie

**Reg. No. 4,137,128**

HAUL JUNK, INC. (MARYLAND CORPORATION)  
1917 MIKE'S WAY  
OWINGS, MD 20736

**Registered May 1, 2012**

**Int. Cls.: 39 and 40**

FOR: GARBAGE COLLECTION; JUNK, TRASH AND DEBRIS REMOVAL, IN CLASS 39  
(U.S. CLS. 100 AND 105).

**SERVICE MARK**

FIRST USE 1-3-2011; IN COMMERCE 1-3-2011.

**SUPPLEMENTAL REGISTER**

FOR: RECYCLING OF WASTE AND RUBBISH; RECYCLING OF WASTE AND TRASH, IN  
CLASS 40 (U.S. CLS. 100, 103 AND 106).

FIRST USE 1-3-2011; IN COMMERCE 1-3-2011.

THE MARK CONSISTS OF STANDARD CHARACTERS WITHOUT CLAIM TO ANY PAR-  
TICULAR FONT, STYLE, SIZE, OR COLOR.

SER. NO. 85-300,256, FILED P.R. 4-20-2011; AM. S.R. 2-17-2012.

BRIAN CALLAGHAN, EXAMINING ATTORNEY



*David J. Kypos*

Director of the United States Patent and Trademark Office

# United States of America

United States Patent and Trademark Office

## TECHNOLOGY SERIES

**Reg. No. 4,137,129**

**Registered May 1, 2012**

**Int. Cls.: 3, 7, and 9**

**TRADEMARK**

**SUPPLEMENTAL REGISTER**

CARRIER ENTERPRISES, LLC (FLORIDA LIMITED LIABILITY COMPANY)  
2000 PARKS OAKS AVENUE  
ORLANDO, FL 32808

FOR: EVAPORATOR COIL CHEMICAL CLEANERS AND CONDENSER COIL CHEMICAL CLEANERS FOR USE WITH HVAC EQUIPMENT FOR BUILDINGS, IN CLASS 3 (U.S. CLS. 1, 4, 6, 50, 51 AND 52).

FIRST USE 4-18-2011; IN COMMERCE 4-18-2011.

FOR: PARTS FOR HVAC UNITS FOR BUILDINGS, NAMELY, ELECTRIC MOTORS, IN CLASS 7 (U.S. CLS. 13, 19, 21, 23, 31, 34 AND 35).

FIRST USE 4-18-2011; IN COMMERCE 4-18-2011.

FOR: ELECTRICAL PARTS FOR HVAC UNITS FOR BUILDINGS, NAMELY, LIGHTING BALLASTS, IN CLASS 9 (U.S. CLS. 21, 23, 26, 36 AND 38).

FIRST USE 4-18-2011; IN COMMERCE 4-18-2011.

THE MARK CONSISTS OF STANDARD CHARACTERS WITHOUT CLAIM TO ANY PARTICULAR FONT, STYLE, SIZE, OR COLOR.

NO CLAIM IS MADE TO THE EXCLUSIVE RIGHT TO USE "SERIES", APART FROM THE MARK AS SHOWN.

SER. NO. 85-303,202, FILED P.R. 4-25-2011; AM. S.R. 3-26-2012.

SUNG IN, EXAMINING ATTORNEY



*David J. Kypos*

Director of the United States Patent and Trademark Office

# United States of America

United States Patent and Trademark Office



**Reg. No. 4,137,130**

**Registered May 1, 2012**

**Int. Cls.: 3, 7, and 9**

**TRADEMARK**

**SUPPLEMENTAL REGISTER**

CARRIER ENTERPRISES, LLC (FLORIDA LIMITED LIABILITY COMPANY)  
2000 PARKS OAKS AVENUE  
ORLANDO, FL 32808

FOR: EVAPORATOR COIL CHEMICAL CLEANERS AND CONDENSER COIL CHEMICAL CLEANERS FOR USE WITH HVAC EQUIPMENT FOR BUILDINGS, IN CLASS 3 (U.S. CLS. 1, 4, 6, 50, 51 AND 52).

FIRST USE 4-18-2011; IN COMMERCE 4-18-2011.

FOR: PARTS FOR HVAC UNITS FOR BUILDINGS, NAMELY, ELECTRIC MOTORS, IN CLASS 7 (U.S. CLS. 13, 19, 21, 23, 31, 34 AND 35).

FIRST USE 4-18-2011; IN COMMERCE 4-18-2011.

FOR: ELECTRICAL PARTS FOR HVAC UNITS FOR BUILDINGS, NAMELY, LIGHTING BALLASTS, IN CLASS 9 (U.S. CLS. 21, 23, 26, 36 AND 38).

FIRST USE 4-18-2011; IN COMMERCE 4-18-2011.

NO CLAIM IS MADE TO THE EXCLUSIVE RIGHT TO USE "SERIES", APART FROM THE MARK AS SHOWN.

THE MARK CONSISTS OF STYLIZED LETTERS FOR PHRASE "TECHNOLOGY SERIES".

SER. NO. 85-303,204, FILED P.R. 4-25-2011; AM. S.R. 3-26-2012.

SUNG IN, EXAMINING ATTORNEY



*David J. Kypos*

Director of the United States Patent and Trademark Office

# United States of America

United States Patent and Trademark Office

## Institute for Sustainable Infrastructure

**Reg. No. 4,137,131**

**Registered May 1, 2012**

**Int. Cls.: 35, 41, and 42**

**SERVICE MARK**

**SUPPLEMENTAL REGISTER**

INSTITUTE FOR SUSTAINABLE INFRASTRUCTURE, INC. (VIRGINIA CORPORATION)  
1275 K STREET, NW, SUITE 750  
WASHINGTON, DC 20005

FOR: ASSOCIATION SERVICES, NAMELY, PROMOTING THE INTERESTS OF INDIVIDUALS, CORPORATIONS, AND ORGANIZATIONS IN ADVANCING THE CONCEPTION, DESIGN, OPERATION AND MAINTENANCE OF SUSTAINABLE SOLUTIONS FOR THE BUILT AND NATURAL ENVIRONMENT, IN CLASS 35 (U.S. CLS. 100, 101 AND 102).

FIRST USE 12-1-2010; IN COMMERCE 3-30-2011.

FOR: EDUCATIONAL SERVICES, NAMELY, CONDUCTING CLASSES, SEMINARS, WEBINARS, AND WORKSHOPS IN THE FIELD OF CONCEPTION, DESIGN, OPERATION AND MAINTENANCE OF SUSTAINABLE PROJECTS AND PROGRAMS, AND DISTRIBUTION OF COURSE MATERIALS IN CONNECTION THEREWITH, IN CLASS 41 (U.S. CLS. 100, 101 AND 107).

FIRST USE 1-31-2012; IN COMMERCE 1-31-2012.

FOR: TESTING, ANALYSIS AND EVALUATION OF THE GOODS AND SERVICES OF OTHERS FOR THE PURPOSE OF CERTIFICATION IN THE FIELD OF ENVIRONMENTAL, SOCIAL AND ECONOMIC SUSTAINABILITY, IN CLASS 42 (U.S. CLS. 100 AND 101).

FIRST USE 12-1-2010; IN COMMERCE 3-30-2011.

THE MARK CONSISTS OF STANDARD CHARACTERS WITHOUT CLAIM TO ANY PARTICULAR FONT, STYLE, SIZE, OR COLOR.

NO CLAIM IS MADE TO THE EXCLUSIVE RIGHT TO USE "INSTITUTE" , APART FROM THE MARK AS SHOWN.

SER. NO. 85-306,450, FILED P.R. 4-27-2011; AM. S.R. 2-9-2012.

NANCY CLARKE, EXAMINING ATTORNEY



*David J. Kyjars*

Director of the United States Patent and Trademark Office

# United States of America

United States Patent and Trademark Office

# OTIWTI

**Reg. No. 4,137,132**

QUALITROL COMPANY LLC (DELAWARE LIMITED LIABILITY COMPANY)  
1385 FAIRPORT ROAD  
FAIRPORT, NY 14450

**Registered May 1, 2012**

**Int. Cl.: 9**

FOR: THERMOMETERS AND TEMPERATURE MONITORS FOR USE IN ELECTRIC POWER TRANSMISSION AND DISTRIBUTION, IN CLASS 9 (U.S. CLS. 21, 23, 26, 36 AND 38).

**TRADEMARK**

FIRST USE 2-10-2012; IN COMMERCE 2-10-2012.

**SUPPLEMENTAL REGISTER**

THE MARK CONSISTS OF STANDARD CHARACTERS WITHOUT CLAIM TO ANY PARTICULAR FONT, STYLE, SIZE, OR COLOR.

SER. NO. 85-307,248, FILED P.R. 4-28-2011; AM. S.R. 2-13-2012.

JESSICA A. POWERS, EXAMINING ATTORNEY



*David J. Kyffers*

Director of the United States Patent and Trademark Office

# United States of America

United States Patent and Trademark Office

## LatAm Direct

**Reg. No. 4,137,133**

**Registered May 1, 2012**

**Int. Cl.: 35**

**SERVICE MARK**

**SUPPLEMENTAL REGISTER**

BANYAN PROFESSIONAL SERVICES, LLC (FLORIDA LIMITED LIABILITY COMPANY)  
P.O. BOX 332162  
MIAMI, FL 33233

FOR: DISTRIBUTORSHIP SERVICES IN THE FIELD OF COMPUTER SOFTWARE AND TECHNOLOGY SOLUTIONS SERVICES, AND PROFESSIONAL BUSINESS CONSULTATION SERVICES RELATING TO TECHNOLOGY SOLUTIONS IN THE FIELDS OF BUSINESS, EDUCATION, HEALTHCARE AND GOVERNMENT PROVIDED THROUGHOUT LATIN AMERICA, THE CARIBBEAN AND NORTH AMERICA, IN CLASS 35 (U.S. CLS. 100, 101 AND 102).

FIRST USE 6-1-2010; IN COMMERCE 6-1-2010.

THE MARK CONSISTS OF STANDARD CHARACTERS WITHOUT CLAIM TO ANY PARTICULAR FONT, STYLE, SIZE, OR COLOR.

NO CLAIM IS MADE TO THE EXCLUSIVE RIGHT TO USE "DIRECT", APART FROM THE MARK AS SHOWN.

SER. NO. 85-310,704, FILED P.R. 5-3-2011; AM. S.R. 3-9-2012.

DARRYL SPRUILL, EXAMINING ATTORNEY



*David J. Kyros*

Director of the United States Patent and Trademark Office



# United States of America

United States Patent and Trademark Office

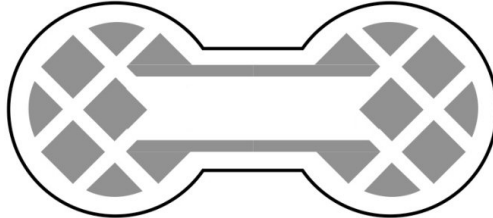

**Reg. No. 4,137,134**

**Registered May 1, 2012**

**Int. Cl.: 31**

**TRADEMARK**

**SUPPLEMENTAL REGISTER**

JANENE BRAY (UNITED STATES INDIVIDUAL)  
5600 HOLE IN ONE DRIVE  
PRESCOTT, AZ 86301

FOR: DOG TREATS, IN CLASS 31 (U.S. CLS. 1 AND 46).

FIRST USE 3-9-2011; IN COMMERCE 3-26-2011.

THE MARK CONSISTS OF THE DESIGN OF THE GOODS, WHICH IS IN THE SHAPE OF  
A BONE WITH A CRISSCROSS PATTERN ON THE ENDS.

SER. NO. 85-311,534, FILED P.R. 5-3-2011; AM. S.R. 2-15-2012.

STEVEN R. FINE, EXAMINING ATTORNEY



*David J. Kybas*

Director of the United States Patent and Trademark Office

# United States of America

United States Patent and Trademark Office

# BinderBond

**Reg. No. 4,137,135**

PATHWAY POLYMERS INC. (DELAWARE CORPORATION)  
2003 CURTAIN POLE ROAD  
CHATTANOOGA, TN 37406

**Registered May 1, 2012**

**Int. Cl.: 1**

FOR: ADHESIVES FOR USE IN THE MANUFACTURE OF CARPET PADDING, IN CLASS 1 (U.S. CLS. 1, 5, 6, 10, 26 AND 46).

**TRADEMARK**

FIRST USE 1-6-2011; IN COMMERCE 1-20-2011.

**SUPPLEMENTAL REGISTER**

THE MARK CONSISTS OF STANDARD CHARACTERS WITHOUT CLAIM TO ANY PARTICULAR FONT, STYLE, SIZE, OR COLOR.

SER. NO. 85-312,647, FILED P.R. 5-4-2011; AM. S.R. 2-24-2012.

TARA PATE, EXAMINING ATTORNEY



*David J. Kyffers*

Director of the United States Patent and Trademark Office

# United States of America

United States Patent and Trademark Office

# Desimag

**Reg. No. 4,137,136**

**Registered May 1, 2012**

**Int. Cls.: 35 and 41**

**SERVICE MARK**

**SUPPLEMENTAL REGISTER**

SYED, NATASHA (UNITED KINGDOM INDIVIDUAL)  
1 REGENCY WAY  
PETERBOROUGH, UNITED KINGDOM PE36HJ

FOR: ADVERTISING, MARKETING AND PROMOTION SERVICES, IN CLASS 35 (U.S. CLS. 100, 101 AND 102).

FIRST USE 1-1-2008; IN COMMERCE 1-1-2008.

FOR: ENTERTAINMENT SERVICES, NAMELY, PROVIDING A WEB SITE FEATURING PHOTOGRAPHIC, AUDIO, VIDEO AND PROSE PRESENTATIONS FEATURING INFORMATION ON CURRENT EVENTS, ENTERTAINMENT AND SPORTS, IN CLASS 41 (U.S. CLS. 100, 101 AND 107).

FIRST USE 1-1-2008; IN COMMERCE 1-1-2008.

THE MARK CONSISTS OF STANDARD CHARACTERS WITHOUT CLAIM TO ANY PARTICULAR FONT, STYLE, SIZE, OR COLOR.

SER. NO. 85-313,910, FILED P.R. 5-6-2011; AM. S.R. 2-28-2012.

HEATHER THOMPSON, EXAMINING ATTORNEY



*David J. Kybas*

Director of the United States Patent and Trademark Office

# United States of America

United States Patent and Trademark Office

# CODEEVAL

**Reg. No. 4,137,137**

**Registered May 1, 2012**

**Int. Cl.: 42**

**SERVICE MARK**

**SUPPLEMENTAL REGISTER**

CODEEVAL INC. (DELAWARE CORPORATION)  
152 LOMBARD ST, #208  
SAN FRANCISCO, CA 94111

FOR: APPLICATION SERVICE PROVIDER (ASP) FEATURING SOFTWARE USED FOR EVALUATING COMPUTER CODING WRITTEN BY EMPLOYEE CANDIDATES, IN CLASS 42 (U.S. CLS. 100 AND 101).

FIRST USE 11-1-2009; IN COMMERCE 5-1-2010.

THE MARK CONSISTS OF STANDARD CHARACTERS WITHOUT CLAIM TO ANY PARTICULAR FONT, STYLE, SIZE, OR COLOR.

SER. NO. 85-313,954, FILED P.R. 5-6-2011; AM. S.R. 3-16-2012.

ESTHER BELENKER, EXAMINING ATTORNEY



*David J. Kybas*

Director of the United States Patent and Trademark Office

# United States of America

United States Patent and Trademark Office

## BABY TEETH

**Reg. No. 4,137,138**

**Registered May 1, 2012**

**Int. Cl.: 5**

**TRADEMARK**

**SUPPLEMENTAL REGISTER**

ANAGALLIS HERBS LLC (DELAWARE LIMITED LIABILITY COMPANY)  
P.O. BOX 1205  
CASTLETON, VT 05735

FOR: HERBAL TOPICAL CREAMS, GELS, SALVES, SPRAYS, POWDER, BALMS, LINIMENT  
AND OINTMENTS FOR THE RELIEF OF ACHES AND PAIN, IN CLASS 5 (U.S. CLS. 6, 18,  
44, 46, 51 AND 52).

FIRST USE 9-30-2009; IN COMMERCE 9-30-2009.

THE MARK CONSISTS OF STANDARD CHARACTERS WITHOUT CLAIM TO ANY PAR-  
TICULAR FONT, STYLE, SIZE, OR COLOR.

SER. NO. 85-316,234, FILED P.R. 5-9-2011; AM. S.R. 2-16-2012.

BILL DAWE, EXAMINING ATTORNEY



*David J. Kyffers*

Director of the United States Patent and Trademark Office

# United States of America

United States Patent and Trademark Office

## FUNCTIONAL INTEGRATED THERAPY

**Reg. No. 4,137,139**

**Registered May 1, 2012**

**Int. Cls.: 9, 16, and 44**

**TRADEMARK**

**SERVICE MARK**

**SUPPLEMENTAL REGISTER**

1057697 ONTARIO INC. (CANADA CORPORATION)  
4465 DRUMMOND ROAD  
UNIT 12  
NIAGARA FALLS, ON, CANADA L2H6C5

FOR: PRERECORDED DIGITAL VIDEO DISCS, DIGITAL VERSATILE DISCS AND COMPACT DISCS FEATURING INSTRUCTIONAL INFORMATION RELATING TO THE EVALUATION AND TREATMENT OF MUSCULAR AND SKELETAL CONDITIONS, AND ORGAN FUNCTION, AND THERAPY FOR TREATMENT OF ASSOCIATED AILMENTS, IN CLASS 9 (U.S. CLS. 21, 23, 26, 36 AND 38).

FOR: MANUALS AND TEXT BOOKS FEATURING INSTRUCTIONAL INFORMATION RELATING TO THE EVALUATION AND TREATMENT OF MUSCULAR AND SKELETAL CONDITIONS, AND ORGAN FUNCTION, AND THERAPY FOR TREATMENT OF ASSOCIATED AILMENTS, IN CLASS 16 (U.S. CLS. 2, 5, 22, 23, 29, 37, 38 AND 50).

FOR: MEDICAL SERVICES, NAMELY, EVALUATION OF MUSCULAR AND SKELETAL CONDITIONS, AND ORGAN FUNCTION, AND PROVIDING THERAPY TO TREAT ASSOCIATED AILMENTS USING ONE OR MORE OF ACUPUNCTURE, TISSUE TENSION RELEASE TECHNIQUES, AND SPINE AND JOINT MANIPULATION, IN CLASS 44 (U.S. CLS. 100 AND 101).

THE MARK CONSISTS OF STANDARD CHARACTERS WITHOUT CLAIM TO ANY PARTICULAR FONT, STYLE, SIZE, OR COLOR.

OWNER OF CANADA REG. NO. TMA605,119, DATED 3-15-2004, EXPIRES 3-15-2019.

OWNER OF U.S. REG. NO. 2,896,437.

NO CLAIM IS MADE TO THE EXCLUSIVE RIGHT TO USE "THERAPY", APART FROM THE MARK AS SHOWN.

SER. NO. 85-316,545, FILED 5-10-2011.

KEVIN CORWIN, EXAMINING ATTORNEY



*David J. Kyffers*

Director of the United States Patent and Trademark Office

# United States of America

United States Patent and Trademark Office

## WORLD'S BEST AUTHOR

**Reg. No. 4,137,140**

**Registered May 1, 2012**

**Int. Cl.: 41**

**SERVICE MARK**

**SUPPLEMENTAL REGISTER**

TOM BIRD SEMINARS, INC. (ARIZONA CORPORATION)  
280 FOOTHILLS SOUTH DR.  
SEDONA, AZ 86336

FOR: ENTERTAINMENT IN THE NATURE OF COMPETITIONS IN THE FIELD OF WRITING, NAMELY, AN INTERNATIONAL BOOK WRITING COMPETITION FOR AUTHORS AND PROSPECTIVE AUTHORS AGES 5 AND UP, IN CLASS 41 (U.S. CLS. 100, 101 AND 107).

FIRST USE 3-24-2011; IN COMMERCE 4-8-2011.

THE MARK CONSISTS OF STANDARD CHARACTERS WITHOUT CLAIM TO ANY PARTICULAR FONT, STYLE, SIZE, OR COLOR.

SER. NO. 85-317,622, FILED P.R. 5-11-2011; AM. S.R. 2-28-2012.

ROBIN MITTLER, EXAMINING ATTORNEY



*David J. Kybas*

Director of the United States Patent and Trademark Office

# United States of America

United States Patent and Trademark Office



**Reg. No. 4,137,141**

**Registered May 1, 2012**

**Int. Cl.: 9**

**TRADEMARK**

**SUPPLEMENTAL REGISTER**

SERIOUS PIMP, INC. (CALIFORNIA CORPORATION)  
4000 MACARTHUR BLVD., WT SUITE 1000  
NEWPORT BEACH, CA 92660

FOR: SUNGLASSES, IN CLASS 9 (U.S. CLS. 21, 23, 26, 36 AND 38).

FIRST USE 9-1-2001; IN COMMERCE 9-1-2001.

THE MARK CONSISTS OF A UNIQUE PATTERN OF FANCY TEAR DROP, ALMOND, AND PEAR SHAPES ARRANGED IN A SYMMETRICAL MANNER, WHICH IS DEPICTED ON THE SIDE ARMS OF SUNGLASSES.

SER. NO. 85-318,419, FILED P.R. 5-11-2011; AM. S.R. 3-2-2012.

ANDREW LEASER, EXAMINING ATTORNEY



*David J. Kybas*

Director of the United States Patent and Trademark Office



# United States of America

United States Patent and Trademark Office

## Virtual Organist

**Reg. No. 4,137,142**

**Registered May 1, 2012**

**Int. Cl.: 42**

**SERVICE MARK**

**SUPPLEMENTAL REGISTER**

CHURCH MUSIC SOLUTIONS, INC. (ILLINOIS CORPORATION)  
20 BURDICK CREEK ROAD  
COLLINSVILLE, IL 622343800

FOR: PLATFORM AS A SERVICE (PAAS) FEATURING COMPUTER SOFTWARE PLATFORMS FOR DELIVERY AND EXECUTION OF DIGITAL MUSIC, IN CLASS 42 (U.S. CLS. 100 AND 101).

FIRST USE 6-1-2005; IN COMMERCE 6-1-2005.

THE MARK CONSISTS OF STANDARD CHARACTERS WITHOUT CLAIM TO ANY PARTICULAR FONT, STYLE, SIZE, OR COLOR.

SER. NO. 85-318,877, FILED P.R. 5-12-2011; AM. S.R. 3-1-2012.

LEIGH LOWRY, EXAMINING ATTORNEY



*David J. Kyffers*

Director of the United States Patent and Trademark Office

# United States of America

United States Patent and Trademark Office

## COORDINATED TRANSPORTATION MODEL

**Reg. No. 4,137,143**

**Registered May 1, 2012**

**Int. Cls.: 35 and 39**

**SERVICE MARK**

**SUPPLEMENTAL REGISTER**

AMERICAN LOGISTICS COMPANY, LLC (CALIFORNIA LIMITED LIABILITY COMPANY)  
520 W DYER ROAD  
SANTA ANA, CA 92707

FOR: MONITORING, TRACKING, AND LOCATING FOR OTHERS OF PEOPLE BEING TRANSPORTED THROUGH CHARTER, SHUTTLE, NON-EMERGENCY MEDICAL TRANSPORTATION, SCHOOL BUS/PUPIL TRANSPORTATION, AND PARATRANSIT OPERATIONS; PROVISION TO OTHERS OF ELECTRONIC MONITORING, TRACKING, AND LOCATING INFORMATION CONCERNING PEOPLE BEING TRANSPORTED THROUGH CHARTER, SHUTTLE, NON-EMERGENCY MEDICAL TRANSPORTATION, SCHOOL BUS/PUPIL TRANSPORTATION, AND PARATRANSIT OPERATIONS, IN CLASS 35 (U.S. CLS. 100, 101 AND 102).

FIRST USE 6-0-2010; IN COMMERCE 6-0-2010.

FOR: PASSENGER TRANSPORTATION SERVICES FOR OTHERS, NAMELY, CHARTER, SHUTTLE, NON-EMERGENCY MEDICAL TRANSPORTATION, SCHOOL BUS/PUPIL TRANSPORTATION, AND PARATRANSIT OPERATIONS IN THE NATURE OF TRANSPORTATION OF PASSENGERS BY LAND VEHICLES, IN CLASS 39 (U.S. CLS. 100 AND 105).

FIRST USE 6-0-2010; IN COMMERCE 6-0-2010.

THE MARK CONSISTS OF STANDARD CHARACTERS WITHOUT CLAIM TO ANY PARTICULAR FONT, STYLE, SIZE, OR COLOR.

SER. NO. 85-319,288, FILED P.R. 5-12-2011; AM. S.R. 2-28-2012.

KAREN K. BUSH, EXAMINING ATTORNEY



*David J. Kyros*

Director of the United States Patent and Trademark Office

# United States of America

United States Patent and Trademark Office

## PRESEASON NATIONALS

**Reg. No. 4,137,144**

ALL-AMERICAN WRESTLING, INC. (IOWA CORPORATION)  
5651 DEER CREEK FALLS COURT  
LAS VEGAS, NV 89118

**Registered May 1, 2012**

**Int. Cl.: 41**

FOR: ENTERTAINMENT SERVICES, NAMELY, THE PRODUCTION AND EXHIBITION OF AMATEUR WRESTLING EVENTS RENDERED LIVE AND THROUGH A GLOBAL COMPUTER NETWORK; PROVIDING WRESTLING INFORMATION VIA A GLOBAL COMPUTER NETWORK, IN CLASS 41 (U.S. CLS. 100, 101 AND 107).

**SERVICE MARK**

**SUPPLEMENTAL REGISTER** FIRST USE 3-1-2008; IN COMMERCE 7-1-2008.

THE MARK CONSISTS OF STANDARD CHARACTERS WITHOUT CLAIM TO ANY PARTICULAR FONT, STYLE, SIZE, OR COLOR.

SER. NO. 85-319,320, FILED P.R. 5-12-2011; AM. S.R. 2-29-2012.

HOWARD SMIGA, EXAMINING ATTORNEY



*David J. Kybas*

Director of the United States Patent and Trademark Office

# United States of America

United States Patent and Trademark Office

## The Physician Research Model

**Reg. No. 4,137,145**

**Registered May 1, 2012**

**Int. Cl.: 42**

**SERVICE MARK**

**SUPPLEMENTAL REGISTER**

VINCE & ASSOCIATES CLINICAL RESEARCH, INC. (DELAWARE CORPORATION)  
10103 METCALF AVE.  
OVERLAND PARK, KS 66212

FOR: MEDICAL AND SCIENTIFIC RESEARCH, NAMELY, CONDUCTING CLINICAL TRIALS, IN CLASS 42 (U.S. CLS. 100 AND 101).

FIRST USE 3-4-2010; IN COMMERCE 3-4-2010.

THE MARK CONSISTS OF STANDARD CHARACTERS WITHOUT CLAIM TO ANY PARTICULAR FONT, STYLE, SIZE, OR COLOR.

SER. NO. 85-320,068, FILED P.R. 5-13-2011; AM. S.R. 3-2-2012.

MICHAEL WIENER, EXAMINING ATTORNEY



*David J. Kybas*

Director of the United States Patent and Trademark Office

**United States of America**  
United States Patent and Trademark Office

# COGHLAN

**Reg. No. 4,137,146**

COGHLAN VINEYARD LLC (CALIFORNIA LIMITED LIABILITY COMPANY)  
2366 ALAMO PINTADO AVENUE  
LOS OLIVOS, CA 93441

**Registered May 1, 2012**

**Int. Cls.: 33 and 41**

FOR: WINE, IN CLASS 33 (U.S. CLS. 47 AND 49).

FIRST USE 5-31-2011; IN COMMERCE 5-31-2011.

**TRADEMARK**

FOR: ENTERTAINMENT SERVICES, NAMELY, CONDUCTING WINE TASTINGS, IN CLASS 41 (U.S. CLS. 100, 101 AND 107).

**SERVICE MARK**

**SUPPLEMENTAL REGISTER** FIRST USE 5-31-2011; IN COMMERCE 5-31-2011.

THE MARK CONSISTS OF STANDARD CHARACTERS WITHOUT CLAIM TO ANY PARTICULAR FONT, STYLE, SIZE, OR COLOR.

SER. NO. 85-322,536, FILED P.R. 5-17-2011; AM. S.R. 3-2-2012.

HENRY S. ZAK, EXAMINING ATTORNEY



*David J. Kybas*

Director of the United States Patent and Trademark Office

# United States of America

United States Patent and Trademark Office

## ARTSMEMPHIS

**Reg. No. 4,137,147**

**Registered May 1, 2012**

**Int. Cls.: 36 and 41**

**SERVICE MARK**

**SUPPLEMENTAL REGISTER**

ARTSMEMPHIS (TENNESSEE CORPORATION)  
575 SOUTH MENDENHALL  
MEMPHIS, TN 38117

FOR: CHARITABLE FUND RAISING; CHARITABLE FUNDRAISING SERVICES TO RAISE, ACCEPT AND ADMINISTER FUNDS FOR SUPPORT OF THE ARTS THROUGH GRANTS AND NON PROFIT COMMUNITY EVENTS; AND SPONSORSHIP OF COMMUNITY EVENTS, ALL FOR FUNDRAISING AND PROMOTION OF THE ARTS, IN CLASS 36 (U.S. CLS. 100, 101 AND 102).

FIRST USE 9-1-2007; IN COMMERCE 9-1-2007.

FOR: EDUCATION SERVICES, NAMELY, PROVIDING PROGRAMS, CLASSES, CAMPS, SEMINARS AND WORKSHOPS IN THE FIELDS OF MUSIC, DANCE, THEATER AND THE ARTS; ENTERTAINMENT SERVICES IN THE FIELDS OF MUSIC, DANCE, THEATER, FILE AND VISUAL ARTS, NAMELY, THEATER PRODUCTIONS OF A MUSIC SHOW, ART EXHIBITIONS, ORGANIZING AND ARRANGING EXHIBITIONS FOR ENTERTAINMENT PURPOSES TO FURTHERING THE ARTS, IN CLASS 41 (U.S. CLS. 100, 101 AND 107).

FIRST USE 9-1-2007; IN COMMERCE 9-1-2007.

THE MARK CONSISTS OF STANDARD CHARACTERS WITHOUT CLAIM TO ANY PARTICULAR FONT, STYLE, SIZE, OR COLOR.

OWNER OF U.S. REG. NOS. 3,451,568 AND 3,451,569.

SER. NO. 85-323,004, FILED P.R. 5-17-2011; AM. S.R. 2-24-2012.

MAYUR VAGHANI, EXAMINING ATTORNEY



*David J. Kypos*

Director of the United States Patent and Trademark Office

# United States of America

United States Patent and Trademark Office

## UNIFORM STANDARD

**Reg. No. 4,137,148**

**Registered May 1, 2012**

**Int. Cls.: 9 and 41**

**TRADEMARK**

**SERVICE MARK**

**SUPPLEMENTAL REGISTER**

UNIFORM STANDARD (CALIFORNIA PARTNERSHIP)  
PO BOX 1561  
ALAMEDA, CA 94501

FOR: MUSICAL SOUND RECORDINGS; VIDEO RECORDINGS FEATURING MUSIC AND DRAMATIC AND NON-DRAMATIC PERFORMANCES; DOWNLOADABLE MUSICAL SOUND RECORDINGS; DOWNLOADABLE VIDEO RECORDINGS FEATURING MUSIC AND MUSIC-BASED ENTERTAINMENT, IN CLASS 9 (U.S. CLS. 21, 23, 26, 36 AND 38).

FIRST USE 10-16-2010; IN COMMERCE 3-27-2011.

FOR: ENTERTAINMENT SERVICES, NAMELY, LIVE MUSICAL PERFORMANCES; PROVIDING A WEBSITE FEATURING ENTERTAINMENT INFORMATION ON A RECORDING ARTIST AND ITS TOURS, PERFORMANCES, APPEARANCES, NEWS, BIOGRAPHIES, NON-DOWNLOADABLE AUDIO AND AUDIOVISUAL RECORDINGS FEATURING MUSIC AND MUSICAL-BASED ENTERTAINMENT, PHOTOGRAPHS, AND OTHER ENTERTAINMENT INFORMATION; ONLINE JOURNALS, NAMELY, BLOGS FEATURING INFORMATION ON A RECORDING ARTIST, IN CLASS 41 (U.S. CLS. 100, 101 AND 107).

FIRST USE 10-16-2010; IN COMMERCE 3-27-2011.

THE MARK CONSISTS OF STANDARD CHARACTERS WITHOUT CLAIM TO ANY PARTICULAR FONT, STYLE, SIZE, OR COLOR.

SER. NO. 85-324,097, FILED P.R. 5-18-2011; AM. S.R. 3-9-2012.

PATRICIA EVANKO, EXAMINING ATTORNEY



*David J. Kyffers*

Director of the United States Patent and Trademark Office

# United States of America

United States Patent and Trademark Office

## America's Document Shredder

**Reg. No. 4,137,149**

CHADIMA, MICHAEL J. (UNITED STATES INDIVIDUAL)  
3141 HANSBORO AVE.  
DALLAS, TX 75233

**Registered May 1, 2012**

**Int. Cl.: 40**

FOR: DOCUMENT SHREDDING SERVICES, IN CLASS 40 (U.S. CLS. 100, 103 AND 106).

**SERVICE MARK**

FIRST USE 10-31-2010; IN COMMERCE 1-19-2011.

**SUPPLEMENTAL REGISTER**

THE MARK CONSISTS OF STANDARD CHARACTERS WITHOUT CLAIM TO ANY PARTICULAR FONT, STYLE, SIZE, OR COLOR.

NO CLAIM IS MADE TO THE EXCLUSIVE RIGHT TO USE "DOCUMENT SHREDDER", APART FROM THE MARK AS SHOWN.

SER. NO. 85-324,839, FILED P.R. 5-19-2011; AM. S.R. 3-5-2012.

CHRISTINE MARTIN, EXAMINING ATTORNEY



*David J. Kybas*

Director of the United States Patent and Trademark Office



# United States of America

United States Patent and Trademark Office



**Reg. No. 4,137,150**

**Registered May 1, 2012**

**Int. Cl.: 33**

**TRADEMARK**

**SUPPLEMENTAL REGISTER**

DISTILLERIES GROUP TOORANK B.V. (NETHERLANDS BESLOTEN VENNOOTSCHAP  
(B.V.))  
EDISONSTRAAT 80  
6902 PK ZEVENAAR, NETHERLANDS

FOR: ALCOHOLIC BEVERAGES, NAMELY, PREPARED ALCOHOLIC COCKTAILS AND  
DISTILLED SPIRITS, IN CLASS 33 (U.S. CLS. 47 AND 49).

PRIORITY CLAIMED UNDER SEC. 44(D) ON BENELUX APPLICATION NO. 1224437, FILED  
4-29-2011, REG. NO. 0899783, DATED 5-6-2011, EXPIRES 4-29-2021.

OWNER OF U.S. REG. NOS. 3,291,115 AND 3,294,268.

NO CLAIM IS MADE TO THE EXCLUSIVE RIGHT TO USE "COCKTAILS", APART FROM  
THE MARK AS SHOWN.

THE MARK CONSISTS OF A THREE-DIMENSIONAL BOTTLE DESIGN WITH THE LITERAL  
ELEMENT "COPPA COCKTAILS".

THE ENGLISH TRANSLATION OF "COPPA" IN THE MARK IS "CUP".

SER. NO. 85-324,998, FILED P.R. 5-19-2011; AM. S.R. 2-22-2012.

RUSS HERMAN, EXAMINING ATTORNEY



*David J. Kybas*

Director of the United States Patent and Trademark Office

# United States of America

United States Patent and Trademark Office

## Motion Processing Library

**Reg. No. 4,137,151**

**Registered May 1, 2012**

**Int. Cl.: 9**

**TRADEMARK**

**SUPPLEMENTAL REGISTER**

INVENSENSE (CALIFORNIA CORPORATION), DBA INVENSENSE, INC.,  
1197 BORREGAS AVENUE  
SUNNYVALE, CA 94089

FOR: HANDHELD ELECTRONIC DEVICES, NAMELY, HANDHELD TELEPHONES, SMARTPHONES, TABLET COMPUTERS, WIRELESS REMOTE CONTROLS FOR TELEVISIONS AND STREAMING PLAYERS, TELEVISION REMOTE CONTROLS, SET-TOP BOX REMOTE CONTROLS, 3-D REMOTE CONTROLS, GAMING CONSOLES, AND GAMING CONTROLLERS; HANDHELD ELECTROMECHANICAL DEVICES, NAMELY, HANDHELD TELEPHONES, SMARTPHONES, WIRELESS REMOTE CONTROLS FOR TELEVISIONS AND STREAMING PLAYERS, TELEVISION REMOTE CONTROLS, SET-TOP BOX REMOTE CONTROLS, GAMING CONSOLES, AND GAMING CONTROLLERS; INTEGRATED CIRCUIT CHIPS FOR HANDHELD ELECTRONIC DEVICES AND HANDHELD ELECTROMECHANICAL DEVICES; AND INTEGRATED CIRCUITS, IN CLASS 9 (U.S. CLS. 21, 23, 26, 36 AND 38).

FIRST USE 4-6-2010; IN COMMERCE 4-6-2010.

THE MARK CONSISTS OF STANDARD CHARACTERS WITHOUT CLAIM TO ANY PARTICULAR FONT, STYLE, SIZE, OR COLOR.

SER. NO. 85-325,219, FILED P.R. 5-19-2011; AM. S.R. 2-29-2012.

KAPIL BHANOT, EXAMINING ATTORNEY



*David J. Kyffers*

Director of the United States Patent and Trademark Office

# United States of America

United States Patent and Trademark Office

## Digital Motion Processor

**Reg. No. 4,137,152**

**Registered May 1, 2012**

**Int. Cl.: 9**

**TRADEMARK**

**SUPPLEMENTAL REGISTER**

INVENSENSE (CALIFORNIA CORPORATION), DBA INVENSENSE, INC.,  
1197 BORREGAS AVENUE  
SUNNYVALE, CA 94089

FOR: HANDHELD ELECTRONIC DEVICES, NAMELY, HANDHELD TELEPHONES, SMARTPHONES, TABLET COMPUTERS, WIRELESS REMOTE CONTROLS FOR TELEVISIONS AND STREAMING PLAYERS, TELEVISION REMOTE CONTROLS, SET-TOP BOX REMOTE CONTROLS, 3-D REMOTE CONTROLS, GAMING CONSOLES, AND GAMING CONTROLLERS; HANDHELD ELECTROMECHANICAL DEVICES, NAMELY, HANDHELD TELEPHONES, SMARTPHONES, WIRELESS REMOTE CONTROLS FOR TELEVISIONS AND STREAMING PLAYERS, TELEVISION REMOTE CONTROLS, SET-TOP BOX REMOTE CONTROLS, GAMING CONSOLES, AND GAMING CONTROLLERS; INTEGRATED CIRCUIT CHIPS FOR HANDHELD ELECTRONIC DEVICES AND HANDHELD ELECTROMECHANICAL DEVICES; AND INTEGRATED CIRCUITS, IN CLASS 9 (U.S. CLS. 21, 23, 26, 36 AND 38).

FIRST USE 4-6-2010; IN COMMERCE 4-6-2010.

THE MARK CONSISTS OF STANDARD CHARACTERS WITHOUT CLAIM TO ANY PARTICULAR FONT, STYLE, SIZE, OR COLOR.

SER. NO. 85-325,262, FILED P.R. 5-19-2011; AM. S.R. 2-29-2012.

KAPIL BHANOT, EXAMINING ATTORNEY



*David J. Kybas*

Director of the United States Patent and Trademark Office

# United States of America

United States Patent and Trademark Office

## Motion Processing Unit

**Reg. No. 4,137,153**

**Registered May 1, 2012**

**Int. Cl.: 9**

**TRADEMARK**

**SUPPLEMENTAL REGISTER**

INVENSENSE (CALIFORNIA CORPORATION), DBA INVENSENSE, INC.,  
1197 BORREGAS AVENUE  
SUNNYVALE, CA 94089

FOR: HANDHELD ELECTRONIC DEVICES, NAMELY, HANDHELD TELEPHONES, SMARTPHONES, TABLET COMPUTERS, WIRELESS REMOTE CONTROLS FOR TELEVISIONS AND STREAMING PLAYERS, TELEVISION REMOTE CONTROLS, SET-TOP BOX REMOTE CONTROLS, 3-D REMOTE CONTROLS, GAMING CONSOLES, AND GAMING CONTROLLERS; HANDHELD ELECTROMECHANICAL DEVICES, NAMELY, HANDHELD TELEPHONES, SMARTPHONES, WIRELESS REMOTE CONTROLS FOR TELEVISIONS AND STREAMING PLAYERS, TELEVISION REMOTE CONTROLS, SET-TOP BOX REMOTE CONTROLS, GAMING CONSOLES, AND GAMING CONTROLLERS; INTEGRATED CIRCUIT CHIPS FOR HANDHELD ELECTRONIC DEVICES AND HANDHELD ELECTROMECHANICAL DEVICES; AND INTEGRATED CIRCUITS, IN CLASS 9 (U.S. CLS. 21, 23, 26, 36 AND 38).

FIRST USE 4-6-2010; IN COMMERCE 4-6-2010.

THE MARK CONSISTS OF STANDARD CHARACTERS WITHOUT CLAIM TO ANY PARTICULAR FONT, STYLE, SIZE, OR COLOR.

SER. NO. 85-325,268, FILED P.R. 5-19-2011; AM. S.R. 2-29-2012.

KAPIL BHANOT, EXAMINING ATTORNEY



*David J. Kybas*

Director of the United States Patent and Trademark Office

# United States of America

United States Patent and Trademark Office

## AGENT2AGENTLINK.COM

**Reg. No. 4,137,154**

**Registered May 1, 2012**

**Int. Cl.: 36**

**SERVICE MARK**

**SUPPLEMENTAL REGISTER**

AGENT 2 AGENT LINK, INC. (CALIFORNIA CORPORATION)  
P.O. BOX 723  
WINDSOR, CA 95492

FOR: PROVIDING A SECURED ACCESS, MEMBERS ONLY WEBSITE ALLOWING LICENSED REAL ESTATE AGENTS TO EXCHANGE INFORMATION ABOUT SELLERS' LISTINGS AND BUYERS' WANTS IN THE NATURE OF A DATABASE OF INFORMATION ABOUT RESIDENTIAL REAL ESTATE LISTINGS IN DIFFERENT NEIGHBORHOODS AND COMMUNITIES, IN CLASS 36 (U.S. CLS. 100, 101 AND 102).

FIRST USE 2-1-2010; IN COMMERCE 2-1-2010.

THE MARK CONSISTS OF STANDARD CHARACTERS WITHOUT CLAIM TO ANY PARTICULAR FONT, STYLE, SIZE, OR COLOR.

SER. NO. 85-325,427, FILED P.R. 5-19-2011; AM. S.R. 3-7-2012.

JESSICA A. POWERS, EXAMINING ATTORNEY



*David J. Kyjars*

Director of the United States Patent and Trademark Office

# United States of America

United States Patent and Trademark Office

## Web Design Automation

**Reg. No. 4,137,155**

**Registered May 1, 2012**

**Int. Cl.: 9**

**TRADEMARK**

**SUPPLEMENTAL REGISTER**

I-RADEK, LLC (NEVADA LIMITED LIABILITY COMPANY), DBA I-RADEK, LLC,  
26 SPUR CROSS CIRCLE HENDERSON NV, 89012  
26 SPUR CROSS CIRCLE  
HENDERSON, NV 89012

FOR: COMPUTER SOFTWARE FOR AUTOMATED WEBSITE DESIGN, IN CLASS 9 (U.S.  
CLS. 21, 23, 26, 36 AND 38).

FIRST USE 6-11-2008; IN COMMERCE 5-15-2011.

THE MARK CONSISTS OF STANDARD CHARACTERS WITHOUT CLAIM TO ANY PAR-  
TICULAR FONT, STYLE, SIZE, OR COLOR.

SER. NO. 85-325,474, FILED P.R. 5-19-2011; AM. S.R. 3-8-2012.

TINA MAI, EXAMINING ATTORNEY



*David J. Kybas*

Director of the United States Patent and Trademark Office

# United States of America

United States Patent and Trademark Office

## New Venture Prep

**Reg. No. 4,137,156**

NEW VENTURE PREP LLC (DELAWARE LIMITED LIABILITY COMPANY)  
16192 COASTAL HWY  
LEWES, DE 19958

**Registered May 1, 2012**

**Int. Cl.: 41**

FOR: EDUCATION SERVICES, NAMELY, PROVIDING CLASSES, SEMINARS, AND WORKSHOPS IN THE FIELD OF BUSINESS AND ENTREPRENEURSHIP, IN CLASS 41 (U.S. CLS. 100, 101 AND 107).

**SERVICE MARK**

FIRST USE 4-29-2011; IN COMMERCE 4-29-2011.

**SUPPLEMENTAL REGISTER**

THE MARK CONSISTS OF STANDARD CHARACTERS WITHOUT CLAIM TO ANY PARTICULAR FONT, STYLE, SIZE, OR COLOR.

SER. NO. 85-325,825, FILED P.R. 5-20-2011; AM. S.R. 3-7-2012.

DOUGLAS LEE, EXAMINING ATTORNEY



*David J. Kyffers*

Director of the United States Patent and Trademark Office

# United States of America

United States Patent and Trademark Office

# Nano Yield

**Reg. No. 4,137,157**

**Registered May 1, 2012**

**Int. Cl.: 9**

**TRADEMARK**

**SUPPLEMENTAL REGISTER**

JINAN PROPLUS ELECTRONICS CO. LTD. (CHINA CORPORATION), DBA KHAI-LONG  
PROPLUS,  
B-5, NO. 1768 XINLUO AVE., HIGH-TECH ZON  
JINAN, CHINA 250101

FOR: COMPUTER AIDED DESIGN SOFTWARE USED FOR SEMICONDUCTOR INDUSTRY  
TO ANALYZE AND OPTIMIZE INTEGRATED CIRCUIT DESIGNS FOR BETTER YIELD  
AND/OR THE TRADE OFF OF YIELD AND PERFORMANCE, IN CLASS 9 (U.S. CLS. 21, 23,  
26, 36 AND 38).

FIRST USE 7-31-2011; IN COMMERCE 7-31-2011.

THE MARK CONSISTS OF STANDARD CHARACTERS WITHOUT CLAIM TO ANY PAR-  
TICULAR FONT, STYLE, SIZE, OR COLOR.

SER. NO. 85-326,348, FILED P.R. 5-20-2011; AM. S.R. 3-13-2012.

JERI J. FICKES, EXAMINING ATTORNEY



*David J. Kyros*

Director of the United States Patent and Trademark Office



# United States of America

United States Patent and Trademark Office

# NanoSpice

**Reg. No. 4,137,158**

**Registered May 1, 2012**

**Int. Cl.: 9**

**TRADEMARK**

**SUPPLEMENTAL REGISTER**

JINAN PROPLUS ELECTRONICS CO. LTD. (CHINA CORPORATION), DBA KHAI-LONG  
PROPLUS,  
B-5, NO. 1768 XINLUO AVE., HIGH-TECH ZON  
JINAN, CHINA 250101

FOR: COMPUTER AIDED DESIGN SOFTWARE FOR SEMICONDUCTOR INDUSTRY TO  
SIMULATE AND VERIFY FUNCTION, TIMING, POWER, NOISE, WAVEFORM AND OTHER  
PERFORMANCE OF INTEGRATED CIRCUITS, IN CLASS 9 (U.S. CLS. 21, 23, 26, 36 AND  
38).

FIRST USE 7-31-2011; IN COMMERCE 7-31-2011.

THE MARK CONSISTS OF STANDARD CHARACTERS WITHOUT CLAIM TO ANY PAR-  
TICULAR FONT, STYLE, SIZE, OR COLOR.

SER. NO. 85-326,385, FILED P.R. 5-20-2011; AM. S.R. 3-13-2012.

JERI J. FICKES, EXAMINING ATTORNEY



*David J. Kyros*

Director of the United States Patent and Trademark Office

# United States of America

United States Patent and Trademark Office



**Reg. No. 4,137,159**

**Registered May 1, 2012**

**Int. Cl.: 11**

PANASIAN MICROVENT TECH (CHANGZHOU) CO., LTD. (CHINA LIMITED LIABILITY COMPANY)  
NO. 28-8 LIBAN ROAD  
LIJIA TOWN, WUJIN DISTRICT  
CHANGZHOU, JIANGSU, CHINA

**TRADEMARK**

**SUPPLEMENTAL REGISTER**

FOR: SIGNAL LANTERNS; WATERPROOF AND MICRO-VENTILATION MEMBRANE FOR USE WITH AUTOMOTIVE LIGHTING; WATERPROOF DUSTPROOF AND MICRO-VENTILATION PROTECTIVE DEVICES, NAMELY, WATERPROOF AND MICRO-VENTILATION EXPANDED POLYTETRAFLUORETHYLENE MEMBRANE PATCH FOR USE WITH AUTOMOTIVE LIGHTING, LAMPS AND AIR CONDITIONING APPARATUS; WATERPROOF AND MICRO-VENTILATION MEMBRANE FOR LED LAMPS; LIGHTS FOR VEHICLES; HEADLIGHTS FOR AUTOMOBILES; LIGHTS FOR AUTOMOBILES; STANDARD LAMPS; AIR CONDITIONING APPARATUS; AIR FILTERS OF HOUSEHOLD AND INDUSTRIAL DEVICES, IN CLASS 11 (U.S. CLS. 13, 21, 23, 31 AND 34).

FIRST USE 5-31-2011; IN COMMERCE 2-11-2012.

THE MARK CONSISTS OF THE STYLIZED TERM "MICROVENT" WITH AN OVAL.

SER. NO. 85-326,971, FILED P.R. 5-23-2011; AM. S.R. 3-5-2012.

DEIRDRE ROBERTSON, EXAMINING ATTORNEY



*David J. Kybas*

Director of the United States Patent and Trademark Office

# United States of America

United States Patent and Trademark Office

## AUDIO SOLUTIONS

**Reg. No. 4,137,160**

**Registered May 1, 2012**

**Int. Cl.: 16**

**TRADEMARK**

**SUPPLEMENTAL REGISTER**

GUITAR CENTER, INC. (DELAWARE CORPORATION)  
5795 LINDERO CANYON ROAD  
WESTLAKE VILLAGE, CA 91362

FOR: MUSIC TRADE MAGAZINE PROVIDING INFORMATION ON ALL ASPECTS OF RECORDING MUSIC, NAMELY, RECORDING, LIVE SOUND, POST PRODUCTION, INSTALLATIONS AND AUDIO EQUIPMENT, IN CLASS 16 (U.S. CLS. 2, 5, 22, 23, 29, 37, 38 AND 50).

FIRST USE 1-1-2010; IN COMMERCE 1-1-2010.

THE MARK CONSISTS OF STANDARD CHARACTERS WITHOUT CLAIM TO ANY PARTICULAR FONT, STYLE, SIZE, OR COLOR.

SER. NO. 85-327,789, FILED P.R. 5-23-2011; AM. S.R. 3-8-2012.

JAMES LOVELACE, EXAMINING ATTORNEY



*David J. Kyros*

Director of the United States Patent and Trademark Office

# United States of America

United States Patent and Trademark Office

## Jupiter Island Trading

**Reg. No. 4,137,161**

MILLER, ROBERT MARTIN (UNITED STATES INDIVIDUAL)  
80 WILLOW ROAD  
TEQUESTA, FL 33469

**Registered May 1, 2012**

**Int. Cl.: 35**

FOR: ON-LINE RETAIL STORE SERVICES FEATURING ANTIQUES, ARTWORK, JEWELRY, CLOTHING, AND ACCESSORIES, IN CLASS 35 (U.S. CLS. 100, 101 AND 102).

**SERVICE MARK**

FIRST USE 4-20-2009; IN COMMERCE 4-20-2009.

**SUPPLEMENTAL REGISTER**

THE MARK CONSISTS OF STANDARD CHARACTERS WITHOUT CLAIM TO ANY PARTICULAR FONT, STYLE, SIZE, OR COLOR.

NO CLAIM IS MADE TO THE EXCLUSIVE RIGHT TO USE "TRADING", APART FROM THE MARK AS SHOWN.

SER. NO. 85-327,943, FILED 5-23-2011.

DEIRDRE ROBERTSON, EXAMINING ATTORNEY



*David J. Kybas*

Director of the United States Patent and Trademark Office

# United States of America

United States Patent and Trademark Office

## SHOWER SKETCH

**Reg. No. 4,137,162**

**Registered May 1, 2012**

**Int. Cl.: 16**

**TRADEMARK**

**SUPPLEMENTAL REGISTER** FIRST USE 9-20-2011; IN COMMERCE 3-8-2012.

HOINS, THORSTEN (FED REP GERMANY INDIVIDUAL)  
PO BOX 887  
PASADENA, CA 91102

FOR: DRAWING TABLETS; LAP BOARDS FOR READING AND WRITING; PLASTIC SHEETS FOR WRITING, PRINTING, AND MARKING; SKETCH PADS; SLATE BOARDS FOR WRITING; STICK-ON WHITEBOARDS AND DRY-ERASE BOARDS; WRITING SLATES; WRITING TABLETS, IN CLASS 16 (U.S. CLS. 2, 5, 22, 23, 29, 37, 38 AND 50).

THE MARK CONSISTS OF STANDARD CHARACTERS WITHOUT CLAIM TO ANY PARTICULAR FONT, STYLE, SIZE, OR COLOR.

SER. NO. 85-331,233, FILED P.R. 5-26-2011; AM. S.R. 3-21-2012.

MICHAEL ENGEL, EXAMINING ATTORNEY



*David J. Kyffers*

Director of the United States Patent and Trademark Office

# United States of America

United States Patent and Trademark Office

## CLASSIC MACHINES

**Reg. No. 4,137,163**

**Registered May 1, 2012**

**Int. Cl.: 28**

**TRADEMARK**

**SUPPLEMENTAL REGISTER**

MATTEL, INC. (DELAWARE CORPORATION)  
M1-1518  
333 CONTINENTAL BOULEVARD  
EL SEGUNDO, CA 90245

FOR: TOY VEHICLES AND ACCESSORIES THEREFOR, IN CLASS 28 (U.S. CLS. 22, 23, 38 AND 50).

FIRST USE 11-21-2011; IN COMMERCE 11-21-2011.

THE MARK CONSISTS OF STANDARD CHARACTERS WITHOUT CLAIM TO ANY PARTICULAR FONT, STYLE, SIZE, OR COLOR.

SER. NO. 85-332,218, FILED P.R. 5-27-2011; AM. S.R. 3-1-2012.

LESLIE RICHARDS, EXAMINING ATTORNEY



*David J. Kyffers*

Director of the United States Patent and Trademark Office

# United States of America

United States Patent and Trademark Office

## Off Duty Workers

**Reg. No. 4,137,164**

**Registered May 1, 2012**

**Int. Cl.: 35**

**SERVICE MARK**

**SUPPLEMENTAL REGISTER**

ROBERT BRYAN (UNITED STATES INDIVIDUAL)  
7637 E. 21 PLACE  
TULSA, OK 74129

FOR: PROVIDING AN INTERNET WEBSITE PORTAL FEATURING PROMOTION AND ADVERTISING FOR BUSINESSES OWNED OR OPERATED BY CURRENT OR FORMER POLICEMAN, FIREMEN, EMERGENCY MEDICAL TECHNICIANS, AND OTHER LAW ENFORCEMENT AND EMERGENCY RESPONDERS, IN CLASS 35 (U.S. CLS. 100, 101 AND 102).

FIRST USE 5-20-2011; IN COMMERCE 5-20-2011.

THE MARK CONSISTS OF STANDARD CHARACTERS WITHOUT CLAIM TO ANY PARTICULAR FONT, STYLE, SIZE, OR COLOR.

SER. NO. 85-332,743, FILED P.R. 5-27-2011; AM. S.R. 3-7-2012.

SHAILA SETTLES, EXAMINING ATTORNEY



*David J. Kyffers*

Director of the United States Patent and Trademark Office

# United States of America

United States Patent and Trademark Office

# mom trusted

**Reg. No. 4,137,165**

**Registered May 1, 2012**

**Int. Cl.: 35**

**SERVICE MARK**

**SUPPLEMENTAL REGISTER**

DISPARATE THINKINK LLC (OHIO LIMITED LIABILITY COMPANY), DBA MOM TRUSTED,  
P.O. BOX 663  
MENLO PARK, CA 94026

FOR: PROMOTING THE GOODS AND SERVICES OF OTHERS BY PROVIDING A COMMUNITY-DRIVEN WEB SITE FEATURING USER-SUBMITTED CONTENT IN THE NATURE OF RATINGS, REVIEWS AND RECOMMENDATIONS ON PRODUCTS IN THE FIELD OF EARLY EDUCATION AND CHILD CARE BUSINESS ORGANIZATIONS, SERVICE PROVIDERS, AND OTHER RESOURCES; PROVIDING BUSINESS INFORMATION, NAMELY, COMPILATION OF STATISTICS, RATINGS, REVIEWS AND RECOMMENDATIONS OF THE CONSUMER GOODS AND SERVICES OF OTHERS IN THE FIELD OF RELATING TO EARLY EDUCATION AND CHILD CARE BUSINESS ORGANIZATIONS, SERVICE PROVIDERS, AND OTHER RESOURCES USING A GLOBAL COMPUTER NETWORK; REFERRALS IN THE FIELD OF EARLY EDUCATION AND CHILD CARE BUSINESS ORGANIZATIONS, IN CLASS 35 (U.S. CLS. 100, 101 AND 102).

FIRST USE 12-1-2009; IN COMMERCE 4-1-2010.

THE MARK CONSISTS OF STANDARD CHARACTERS WITHOUT CLAIM TO ANY PARTICULAR FONT, STYLE, SIZE, OR COLOR.

SER. NO. 85-333,425, FILED P.R. 5-30-2011; AM. S.R. 3-6-2012.

LINDA ORNDORFF, EXAMINING ATTORNEY



*David J. Kyffers*

Director of the United States Patent and Trademark Office



# United States of America

United States Patent and Trademark Office

## BOOKDEPOT.com

**Reg. No. 4,137,166**

**Registered May 1, 2012**

**Int. Cl.: 35**

**SERVICE MARK**

**SUPPLEMENTAL REGISTER**

BOOK DEPOT PARTNERSHIP (CANADA PARTNERSHIP)  
67 FRONT STREET NORTH  
THOROLD, CANADA L2V1X3

FOR: ONLINE WHOLESALE STORE SERVICES FEATURING BOOKS, IN CLASS 35 (U.S. CLS. 100, 101 AND 102).

FIRST USE 9-0-1998; IN COMMERCE 9-0-1998.

THE MARK CONSISTS OF STANDARD CHARACTERS WITHOUT CLAIM TO ANY PARTICULAR FONT, STYLE, SIZE, OR COLOR.

PRIORITY CLAIMED UNDER SEC. 44(D) ON CANADA APPLICATION NO. 1526071, FILED 5-3-2011.

SER. NO. 85-333,799, FILED P.R. 5-31-2011; AM. S.R. 3-16-2012.

ANDREA HACK, EXAMINING ATTORNEY



*David J. Kybas*

Director of the United States Patent and Trademark Office

# United States of America

United States Patent and Trademark Office

## COMMUNITY HEALTH TALKS

**Reg. No. 4,137,167**

**Registered May 1, 2012**

**Int. Cl.: 41**

**SERVICE MARK**

**SUPPLEMENTAL REGISTER**

THREEWIRE, INC. (MINNESOTA CORPORATION)  
10250 VALLEY VIEW ROAD, SUITE 145  
EDEN PRAIRIE, MN 55344

FOR: ARRANGING AND CONDUCTING SEMINARS DESIGNED TO INFORM POTENTIAL CANDIDATES ABOUT CLINICAL TRIALS OR NEW HEALTH CARE PRODUCTS BEING MARKETED DIRECT TO PATIENTS, IN CLASS 41 (U.S. CLS. 100, 101 AND 107).

FIRST USE 4-29-2003; IN COMMERCE 4-29-2003.

THE MARK CONSISTS OF STANDARD CHARACTERS WITHOUT CLAIM TO ANY PARTICULAR FONT, STYLE, SIZE, OR COLOR.

NO CLAIM IS MADE TO THE EXCLUSIVE RIGHT TO USE "HEALTH", APART FROM THE MARK AS SHOWN.

SER. NO. 85-335,354, FILED P.R. 6-1-2011; AM. S.R. 3-9-2012.

CARYN GLASSER, EXAMINING ATTORNEY



*David J. Kybas*

Director of the United States Patent and Trademark Office

# United States of America

United States Patent and Trademark Office

## Risk Death Daily

**Reg. No. 4,137,168**

SARNA, DANIEL (UNITED STATES INDIVIDUAL)  
3516 ADELIN ST. A  
OAKLAND, CA 94608

**Registered May 1, 2012**

**Int. Cl.: 25**

FOR: ATHLETIC APPAREL, NAMELY, SHIRTS, PANTS, JACKETS, FOOTWEAR, HATS AND CAPS, ATHLETIC UNIFORMS, IN CLASS 25 (U.S. CLS. 22 AND 39).

**TRADEMARK**

FIRST USE 4-2-2011; IN COMMERCE 4-2-2011.

**SUPPLEMENTAL REGISTER**

THE MARK CONSISTS OF STANDARD CHARACTERS WITHOUT CLAIM TO ANY PARTICULAR FONT, STYLE, SIZE, OR COLOR.

SER. NO. 85-340,248, FILED P.R. 6-7-2011; AM. S.R. 3-19-2012.

TRICIA SONNEBORN, EXAMINING ATTORNEY



*David J. Kyffers*

Director of the United States Patent and Trademark Office

# United States of America

United States Patent and Trademark Office

# DIAGNOMICS

**Reg. No. 4,137,169**

LEE, MIN SEOB (UNITED STATES INDIVIDUAL)  
7824 VISTA LAZANJA  
SAN DIEGO, CA 92127

**Registered May 1, 2012**

**Int. Cl.: 42**

FOR: BIOMEDICAL RESEARCH SERVICES, IN CLASS 42 (U.S. CLS. 100 AND 101).

**SERVICE MARK**

FIRST USE 12-15-2010; IN COMMERCE 5-1-2011.

**SUPPLEMENTAL REGISTER**

THE MARK CONSISTS OF STANDARD CHARACTERS WITHOUT CLAIM TO ANY PARTICULAR FONT, STYLE, SIZE, OR COLOR.

SER. NO. 85-341,760, FILED P.R. 6-9-2011; AM. S.R. 2-7-2012.

RUDY R. SINGLETON, EXAMINING ATTORNEY



*David J. Kyffers*

Director of the United States Patent and Trademark Office

# United States of America

United States Patent and Trademark Office

## MOBILITY CAPTURED

**Reg. No. 4,137,170**

LANDAIRSEA SYSTEMS, INC. (ILLINOIS CORPORATION)  
2040 DILLARD COURT  
WOODSTOCK, IL 60098

**Registered May 1, 2012**

**Int. Cl.: 9**

FOR: GLOBAL POSITIONING SYSTEM (GPS) TRACKING DEVICE, ACTIVATED ON DEMAND, IN CLASS 9 (U.S. CLS. 21, 23, 26, 36 AND 38).

**TRADEMARK**

FIRST USE 2-28-2011; IN COMMERCE 2-28-2011.

**SUPPLEMENTAL REGISTER**

THE MARK CONSISTS OF STANDARD CHARACTERS WITHOUT CLAIM TO ANY PARTICULAR FONT, STYLE, SIZE, OR COLOR.

SER. NO. 85-343,880, FILED P.R. 6-11-2011; AM. S.R. 2-23-2012.

JERI J. FICKES, EXAMINING ATTORNEY



*David J. Kyffers*

Director of the United States Patent and Trademark Office

# United States of America

United States Patent and Trademark Office

## HIM Entrance Exam

**Reg. No. 4,137,171**

**Registered May 1, 2012**

**Int. Cl.: 41**

**SERVICE MARK**

**SUPPLEMENTAL REGISTER**

BUTLER, AMELIA L. (UNITED STATES INDIVIDUAL)  
P.O. BOX 3388  
FEDERAL WAY, WA 98063

FOR: PREPARING, ADMINISTERING, AND SCORING A SERIES OF EXAMINATIONS USED AS AN AID IN DETERMINING ADMISSION TO SCHOOLS, EDUCATION PROGRAMS AND TRAINING PROGRAMS IN THE FIELDS OF HEALTHCARE, HEALTH INFORMATION MANAGEMENT, HEALTH, HEALTHCARE INFORMATION TECHNOLOGY, HEALTH ADMINISTRATION, HEALTHCARE INFORMATION TECHNOLOGY, HEALTHCARE INFORMATION MANAGEMENT, HEALTHCARE COMPUTER INFORMATION TECHNOLOGY, INFORMATION SOFTWARE SYSTEMS, EDUCATION, BUSINESS, RESEARCH, COMMUNICATION, INFORMATION MANAGEMENT, INFORMATION SYSTEMS, TELECOMMUNICATIONS, MANAGEMENT, ENGINEERING, HEALTH CARE INSTITUTIONS; PERFORMING RESEARCH IN THE FIELD OF EDUCATION, IN CLASS 41 (U.S. CLS. 100, 101 AND 107).

FIRST USE 6-13-2011; IN COMMERCE 6-13-2011.

THE MARK CONSISTS OF STANDARD CHARACTERS WITHOUT CLAIM TO ANY PARTICULAR FONT, STYLE, SIZE, OR COLOR.

NO CLAIM IS MADE TO THE EXCLUSIVE RIGHT TO USE "ENTRANCE EXAM", APART FROM THE MARK AS SHOWN.

SER. NO. 85-344,442, FILED P.R. 6-13-2011; AM. S.R. 11-21-2011.

SHARON MEIER, EXAMINING ATTORNEY



*David J. Kyffers*

Director of the United States Patent and Trademark Office

# United States of America

United States Patent and Trademark Office

## GREASE LOCKER

**Reg. No. 4,137,172**

XLCO TECHNOLOGY GROUP, L.L.C. (LOUISIANA LIMITED LIABILITY COMPANY)  
2721 ST. CHARLES AVE 2B  
NEW ORLEANS, LA 70130

**Registered May 1, 2012**

**Int. Cl.: 21**

FOR: COMMERCIAL WASTE CONTAINER MADE OF METAL FOR STORING COOKING OILS, FATS, OILS, AND GREASE, IN CLASS 21 (U.S. CLS. 2, 13, 23, 29, 30, 33, 40 AND 50).

**TRADEMARK**

FIRST USE 8-1-2011; IN COMMERCE 8-1-2011.

**SUPPLEMENTAL REGISTER**

THE MARK CONSISTS OF STANDARD CHARACTERS WITHOUT CLAIM TO ANY PARTICULAR FONT, STYLE, SIZE, OR COLOR.

SER. NO. 85-346,198, FILED P.R. 6-14-2011; AM. S.R. 3-21-2012.

BERNICE MIDDLETON, EXAMINING ATTORNEY



*David J. Kyffers*

Director of the United States Patent and Trademark Office

# United States of America

United States Patent and Trademark Office

## CHAPMAN PARTNERSHIP

**Reg. No. 4,137,173**

**Registered May 1, 2012**

**Int. Cls.: 35, 36, 41, 43,  
44, and 45**

**SERVICE MARK**

**SUPPLEMENTAL REGISTER**

COMMUNITY PARTNERSHIP FOR HOMELESS, INC. (FLORIDA CORPORATION)  
1550 N. MIAMI AVE.  
MIAMI, FL 33136

FOR: BUSINESS SERVICES, NAMELY, ASSISTING OTHERS IN THE ESTABLISHMENT OF CHARITABLE ORGANIZATIONS; ORGANIZING AND CONDUCTING VOLUNTEER PROGRAMS AND COMMUNITY SERVICE PROJECTS; EMPLOYMENT COUNSELING SERVICES FOR THOSE LIVING IN POVERTY IN THE AREAS OF PREPARING FOR, OBTAINING, MAINTAINING AND ADVANCING IN EMPLOYMENT OPPORTUNITIES, IN CLASS 35 (U.S. CLS. 100, 101 AND 102).

FIRST USE 9-15-2011; IN COMMERCE 9-15-2011.

FOR: CHARITABLE FUND RAISING SERVICES; ACCEPTING AND ADMINISTERING MONETARY CHARITABLE CONTRIBUTIONS, IN CLASS 36 (U.S. CLS. 100, 101 AND 102).

FIRST USE 9-15-2011; IN COMMERCE 9-15-2011.

FOR: CHARITABLE SERVICES, NAMELY, PROVIDING TOYS AND SCHOOL SUPPLIES TO NEEDY CHILDREN; PROVIDING ACADEMIC MENTORING OF SCHOOL AGE CHILDREN; PROVIDING VOCATIONAL TRAINING IN THE FIELD OF THE CULINARY ARTS, ENVIRONMENT, NAMELY HYDROPONICS, AND SECURITY GUARD SERVICES; CHARITABLE SERVICES, NAMELY, PROVIDING BOOKS TO THE INDIGENT, AND VOCATIONAL GUIDANCE AND CAREER COUNSELING IN THE NATURE OF ADVICE CONCERNING EDUCATION OPTIONS TO PURSUE CAREER OPPORTUNITIES TO INDIGENT PERSONS SEEKING EMPLOYMENT, IN CLASS 41 (U.S. CLS. 100, 101 AND 107).

FIRST USE 9-15-2011; IN COMMERCE 9-15-2011.

FOR: CHARITABLE SERVICES, NAMELY, PROVIDING FOOD, BLANKETS, AND HOUSEHOLD FURNISHINGS FOR THE HOME IN THE NATURE OF FURNITURE AND UTENSILS, TO NEEDY PERSONS, AND PROVIDING TEMPORARY SHELTER FOR THE HOMELESS, IN CLASS 43 (U.S. CLS. 100 AND 101).

FIRST USE 9-15-2011; IN COMMERCE 9-15-2011.



*David J. Kyros*

Director of the United States Patent and Trademark Office



**Reg. No. 4,137,173** FOR: CHARITABLE SERVICES, PROVIDING CARE PACKAGES CONSISTING PRIMARILY OF PERSONAL CARE ITEMS , IN CLASS 44 (U.S. CLS. 100 AND 101).

FIRST USE 9-15-2011; IN COMMERCE 9-15-2011.

FOR: CHARITABLE SERVICES, NAMELY, PROVIDING LEGAL SERVICES TO HOMELESS PEOPLE, IN CLASS 45 (U.S. CLS. 100 AND 101).

FIRST USE 9-15-2011; IN COMMERCE 9-15-2011.

THE MARK CONSISTS OF STANDARD CHARACTERS WITHOUT CLAIM TO ANY PARTICULAR FONT, STYLE, SIZE, OR COLOR.

NO CLAIM IS MADE TO THE EXCLUSIVE RIGHT TO USE "PARTNERSHIP", APART FROM THE MARK AS SHOWN.

SER. NO. 85-348,430, FILED P.R. 6-16-2011; AM. S.R. 1-4-2012.

STEVEN PEREZ, EXAMINING ATTORNEY

# United States of America

United States Patent and Trademark Office

## KITCHEN SKETCH

**Reg. No. 4,137,174**

**Registered May 1, 2012**

**Int. Cl.: 9**

**TRADEMARK**

**SUPPLEMENTAL REGISTER**

CORNWELL, LARRY (UNITED STATES INDIVIDUAL)  
#105-632  
6965 EL CAMINO REAL  
CARLSBAD, CA 92009

FOR: COMPUTER SOFTWARE PROGRAM FOR DESIGNING, DISPLAYING, AND MANUFACTURING KITCHEN CABINETS AND KITCHEN LAYOUTS, IN CLASS 9 (U.S. CLS. 21, 23, 26, 36 AND 38).

FIRST USE 9-18-2010; IN COMMERCE 6-30-2011.

THE MARK CONSISTS OF STANDARD CHARACTERS WITHOUT CLAIM TO ANY PARTICULAR FONT, STYLE, SIZE, OR COLOR.

SER. NO. 85-350,066, FILED P.R. 6-20-2011; AM. S.R. 2-17-2012.

RONALD AIKENS, EXAMINING ATTORNEY



*David J. Kybas*

Director of the United States Patent and Trademark Office

# United States of America

United States Patent and Trademark Office

# VapeTV

**Reg. No. 4,137,175**

MANENTE, LUCIANO (UNITED STATES INDIVIDUAL)  
2 WOODS WAY  
WHITE PLAINS, NY 10605

**Registered May 1, 2012**

**Int. Cls.: 38 and 42**

FOR: AUDIO AND VIDEO BROADCASTING SERVICES OVER THE INTERNET; PROVIDING ON-LINE CHAT ROOMS AND ELECTRONIC BULLETIN BOARDS FOR TRANSMISSION OF MESSAGES AMONG USERS IN THE FIELD OF ELECTRONIC CIGARETTES, IN CLASS 38 (U.S. CLS. 100, 101 AND 104).

**SERVICE MARK**

**SUPPLEMENTAL REGISTER** FIRST USE 2-1-2010; IN COMMERCE 2-1-2010.

FOR: PROVIDING A WEBSITE THAT GIVES USERS THE ABILITY TO REVIEW VARIOUS PRINT, PHOTOGRAPHIC, GRAPHIC IMAGE AND AUDIO AND VIDEO CONTENT AND UTILIZE A CUSTOM TEMPLATE TO PROVIDE INPUT, LIKES, DISLIKES, EDITS, CHANGES, MODIFICATIONS, OPINIONS, SUGGESTIONS AND COMMENTS AND ENGAGE IN SOCIAL, BUSINESS AND COMMUNITY NETWORKING, IN CLASS 42 (U.S. CLS. 100 AND 101).

FIRST USE 2-1-2010; IN COMMERCE 2-1-2010.

THE MARK CONSISTS OF STANDARD CHARACTERS WITHOUT CLAIM TO ANY PARTICULAR FONT, STYLE, SIZE, OR COLOR.

SER. NO. 85-350,444, FILED P.R. 6-20-2011; AM. S.R. 3-8-2012.

ELLEN PERKINS, EXAMINING ATTORNEY



*David J. Kybas*

Director of the United States Patent and Trademark Office

# United States of America

United States Patent and Trademark Office

## Executive Readiness

**Reg. No. 4,137,176**

**Registered May 1, 2012**

**Int. Cl.: 41**

**SERVICE MARK**

**SUPPLEMENTAL REGISTER**

MCCRAY, STEPHANIE (ILLINOIS SOLE PROPRIETORSHIP)  
408 SOUTH WISCONSIN  
#302  
OAK PARK, IL 60302

FOR: EDUCATION SERVICES, NAMELY, PROVIDING GROUP COACHING PROGRAMS, WORKSHOPS, AND KEYNOTE PRESENTATIONS IN THE FIELD OF BUSINESS MANAGEMENT AND INDIVIDUAL AND ORGANIZATIONAL DEVELOPMENT, IN CLASS 41 (U.S. CLS. 100, 101 AND 107).

FIRST USE 8-15-2010; IN COMMERCE 8-15-2010.

THE MARK CONSISTS OF STANDARD CHARACTERS WITHOUT CLAIM TO ANY PARTICULAR FONT, STYLE, SIZE, OR COLOR.

SER. NO. 85-352,641, FILED P.R. 6-22-2011; AM. S.R. 3-2-2012.

DEBORAH LOBO, EXAMINING ATTORNEY



*David J. Kyffers*

Director of the United States Patent and Trademark Office

# United States of America

United States Patent and Trademark Office

## 365 THINGS TO DO IN PASADENA

**Reg. No. 4,137,177**

**Registered May 1, 2012**

**Int. Cl.: 41**

**SERVICE MARK**

**SUPPLEMENTAL REGISTER**

IRINA NETCHAEV (UNITED STATES INDIVIDUAL)  
40 WEST GREEN STREET  
PASADENA, CA 91105

FOR: PROVIDING ON-LINE JOURNALS, NAMELY, BLOGS FEATURING INFORMATION ABOUT LOCATIONS OF INTEREST, EVENTS OF INTEREST, TRAVEL, RELOCATION, AND REAL ESTATE; PROVIDING ON-LINE PUBLICATIONS IN THE NATURE OF RESOURCE GUIDES ABOUT LOCATIONS OF INTEREST, EVENTS OF INTEREST, TRAVEL, RELOCATION, AND REAL ESTATE; PROVIDING A WEBSITE FEATURING BLOGS AND NON-DOWNLOADABLE PUBLICATIONS IN THE NATURE OF ARTICLES FEATURING COMMENTARY, PHOTOGRAPHS, AND INFORMATION ABOUT LOCATIONS OF INTEREST, EVENTS OF INTEREST, TRAVEL, RELOCATION, AND REAL ESTATE, IN CLASS 41 (U.S. CLS. 100, 101 AND 107).

FIRST USE 5-14-2010; IN COMMERCE 5-14-2010.

THE MARK CONSISTS OF STANDARD CHARACTERS WITHOUT CLAIM TO ANY PARTICULAR FONT, STYLE, SIZE, OR COLOR.

SER. NO. 85-353,221, FILED P.R. 6-22-2011; AM. S.R. 3-7-2012.

ELLEN B. AWRICH, EXAMINING ATTORNEY



*David J. Kyros*

Director of the United States Patent and Trademark Office

# United States of America

United States Patent and Trademark Office

## STRUCTURAL FORENSIC RESTORATION

**Reg. No. 4,137,178**

BIO-SHEEN SERVICES, LLC (OKLAHOMA LIMITED LIABILITY COMPANY)  
350 S. VERMONT, SUITE 218  
OKLAHOMA CITY, OK 73108

**Registered May 1, 2012**

**Int. Cl.: 37**

FOR: BIO-HAZARD BIOLOGICAL CLEAN-UP SERVICES; CRIME SCENE CLEAN-UP SERVICES, IN CLASS 37 (U.S. CLS. 100, 103 AND 106).

**SERVICE MARK**

FIRST USE 12-31-2010; IN COMMERCE 2-13-2011.

**SUPPLEMENTAL REGISTER**

THE MARK CONSISTS OF STANDARD CHARACTERS WITHOUT CLAIM TO ANY PARTICULAR FONT, STYLE, SIZE, OR COLOR.

SER. NO. 85-358,655, FILED P.R. 6-28-2011; AM. S.R. 2-24-2012.

ESTHER BELENKER, EXAMINING ATTORNEY



*David J. Kyffers*

Director of the United States Patent and Trademark Office

# United States of America

United States Patent and Trademark Office

## COLD SENSOR

**Reg. No. 4,137,179**

**Registered May 1, 2012**

**Int. Cl.: 21**

**TRADEMARK**

**SUPPLEMENTAL REGISTER**

OLIVET INTERNATIONAL INC. (CALIFORNIA CORPORATION)  
11015 HOPKINS STREET  
MIRA LOMA, CA 91752

FOR: PORTABLE COOLERS, IN CLASS 21 (U.S. CLS. 2, 13, 23, 29, 30, 33, 40 AND 50).

FIRST USE 7-6-2011; IN COMMERCE 7-6-2011.

THE MARK CONSISTS OF STANDARD CHARACTERS WITHOUT CLAIM TO ANY PARTICULAR FONT, STYLE, SIZE, OR COLOR.

SER. NO. 85-369,781, FILED P.R. 7-12-2011; AM. S.R. 3-3-2012.

KATHY DE JONGE, EXAMINING ATTORNEY



*David J. Kyffers*

Director of the United States Patent and Trademark Office

# United States of America

United States Patent and Trademark Office

## Gakushu Robot

**Reg. No. 4,137,180**

**Registered May 1, 2012**

**Int. Cls.: 7 and 9**

FANUC CORPORATION (JAPAN CORPORATION)  
3580, SHIBOKUSA AZA-KOMANBA  
OSHINO-MURA, MINAMITSURU-GUN  
YAMANASHI, JAPAN

FOR: ROBOTS, IN CLASS 7 (U.S. CLS. 13, 19, 21, 23, 31, 34 AND 35).

**TRADEMARK**

FOR: CONTROLLERS FOR ROBOTS , IN CLASS 9 (U.S. CLS. 21, 23, 26, 36 AND 38).

**SUPPLEMENTAL REGISTER**

THE MARK CONSISTS OF STANDARD CHARACTERS WITHOUT CLAIM TO ANY PARTICULAR FONT, STYLE, SIZE, OR COLOR.

PRIORITY CLAIMED UNDER SEC. 44(D) ON JAPAN APPLICATION NO. 2011-047328, FILED 7-6-2011, REG. NO. 5465252, DATED 1-20-2012, EXPIRES 1-20-2022.

NO CLAIM IS MADE TO THE EXCLUSIVE RIGHT TO USE "ROBOT", APART FROM THE MARK AS SHOWN.

THE ENGLISH TRANSLATION OF "GAKUSHU" IN THE MARK IS "STUDY" OR "LEARNING".

SER. NO. 85-369,876, FILED P.R. 7-13-2011; AM. S.R. 3-19-2012.

CAROLYN CATALDO, EXAMINING ATTORNEY



*David J. Kybas*

Director of the United States Patent and Trademark Office



# United States of America

United States Patent and Trademark Office

## FAIRFIELD MAGAZINE

**Reg. No. 4,137,181**

**Registered May 1, 2012**

**Int. Cl.: 16**

**TRADEMARK**

**SUPPLEMENTAL REGISTER** FIRST USE 2-1-2009; IN COMMERCE 2-1-2009.

MORRIS MEDIA GROUP, INC. (CONNECTICUT CORPORATION)  
386 MAIN STREET  
RIDGEFIELD, CT 06877

FOR: PRINTED, PERIODICAL MAGAZINE IN THE FIELDS OF LIFESTYLE, BOOK AND RESTAURANT REVIEWS, FEATURE INTERVIEWS, FASHION, COMMUNITY EVENTS, CURRENT EVENTS, HOME DECOR, TRAVEL AND ENTERTAINMENT, LOCAL AND REGIONAL PUBLIC AFFAIRS, IN CLASS 16 (U.S. CLS. 2, 5, 22, 23, 29, 37, 38 AND 50).

THE MARK CONSISTS OF STANDARD CHARACTERS WITHOUT CLAIM TO ANY PARTICULAR FONT, STYLE, SIZE, OR COLOR.

NO CLAIM IS MADE TO THE EXCLUSIVE RIGHT TO USE "MAGAZINE", APART FROM THE MARK AS SHOWN.

SER. NO. 85-372,111, FILED P.R. 7-15-2011; AM. S.R. 3-7-2012.

MAUREEN DALL, EXAMINING ATTORNEY



*David J. Kybas*

Director of the United States Patent and Trademark Office

# United States of America

United States Patent and Trademark Office

## GREECE DEBT-FREE

**Reg. No. 4,137,182**

**Registered May 1, 2012**

**Int. Cl.: 36**

**SERVICE MARK**

**SUPPLEMENTAL REGISTER** FIRST USE 2-0-2012; IN COMMERCE 3-7-2012.

PYC CORP. (LIBERIA CORPORATION)  
C/O PETROS M. NOMIKOS AE  
29 VASSILISSIS SOPHIAS  
ATHENS, GREECE

FOR: CHARITABLE FUNDRAISING SERVICES BY MEANS OF SELLING GOODS AND SERVICES TO RAISE FUNDS FOR GREEK DEBT RELIEF, IN CLASS 36 (U.S. CLS. 100, 101 AND 102).

THE MARK CONSISTS OF STANDARD CHARACTERS WITHOUT CLAIM TO ANY PARTICULAR FONT, STYLE, SIZE, OR COLOR.

SER. NO. 85-374,670, FILED P.R. 7-19-2011; AM. S.R. 3-8-2012.

DAVID H. STINE, EXAMINING ATTORNEY



*David J. Kyros*

Director of the United States Patent and Trademark Office

# United States of America

United States Patent and Trademark Office

## Digital Pharma

**Reg. No. 4,137,183**

**Registered May 1, 2012**

**Int. Cl.: 35**

**SERVICE MARK**

**SUPPLEMENTAL REGISTER**

EXL EVENTS, INC. (NEW JERSEY CORPORATION), AKA EXL PHARMA, INC.,  
555 8TH AVENUE SUITE 1703  
NEW YORK, NY 10018

FOR: ARRANGING AND CONDUCTING CONFERENCES FOR COMPANIES THAT PROVIDE  
ONLINE MARKETING SERVICES TO THE PHARMACEUTICAL INDUSTRY, IN CLASS 35  
(U.S. CLS. 100, 101 AND 102).

FIRST USE 10-1-2007; IN COMMERCE 10-1-2007.

THE MARK CONSISTS OF STANDARD CHARACTERS WITHOUT CLAIM TO ANY PAR-  
TICULAR FONT, STYLE, SIZE, OR COLOR.

SER. NO. 85-377,333, FILED P.R. 7-21-2011; AM. S.R. 3-14-2012.

DAVID MURRAY, EXAMINING ATTORNEY



*David J. Kyffers*

Director of the United States Patent and Trademark Office

# United States of America

United States Patent and Trademark Office

## WATCH JOURNAL

**Reg. No. 4,137,184**

SANDOW MEDIA LLC (DELAWARE LIMITED LIABILITY COMPANY)  
3731 N.W. 8TH AVE.  
BOCA RATON, FL 33431

**Registered May 1, 2012**

**Int. Cl.: 41**

FOR: PROVIDING ON-LINE MAGAZINES AND JOURNALS FEATURING INFORMATION  
IN THE FIELD OF WATCHES, IN CLASS 41 (U.S. CLS. 100, 101 AND 107).

**SERVICE MARK**

FIRST USE 9-30-2009; IN COMMERCE 9-30-2009.

**SUPPLEMENTAL REGISTER**

THE MARK CONSISTS OF STANDARD CHARACTERS WITHOUT CLAIM TO ANY PARTICULAR FONT, STYLE, SIZE, OR COLOR.

OWNER OF U.S. REG. NO. 3,735,429.

NO CLAIM IS MADE TO THE EXCLUSIVE RIGHT TO USE "JOURNAL", APART FROM THE MARK AS SHOWN.

SER. NO. 85-377,448, FILED P.R. 7-21-2011; AM. S.R. 3-9-2012.

DARRYL SPRUILL, EXAMINING ATTORNEY



*David J. Kybas*

Director of the United States Patent and Trademark Office

# United States of America

United States Patent and Trademark Office

## INTERNATIONAL PSYCHIC ASSOCIATION

**Reg. No. 4,137,185**

**Registered May 1, 2012**

**Int. Cl.: 45**

**SERVICE MARK**

**SUPPLEMENTAL REGISTER**

VS MEDIA, INC. (CALIFORNIA CORPORATION)  
26672 AGOURA ROAD  
CALABASAS, CA 91302

FOR: PROVIDING A WEBSITE FEATURING INFORMATION IN THE FIELD OF PSYCHIC SERVICES; PROVIDING A WEBSITE FOR ENTERTAINMENT PURPOSES FEATURING PSYCHIC READINGS, IN CLASS 45 (U.S. CLS. 100 AND 101).

FIRST USE 5-1-2011; IN COMMERCE 5-1-2011.

THE MARK CONSISTS OF STANDARD CHARACTERS WITHOUT CLAIM TO ANY PARTICULAR FONT, STYLE, SIZE, OR COLOR.

SER. NO. 85-378,404, FILED P.R. 7-22-2011; AM. S.R. 2-21-2012.

SUE LAWRENCE, EXAMINING ATTORNEY



*David J. Kyros*

Director of the United States Patent and Trademark Office

# United States of America

United States Patent and Trademark Office

## Eyelash Artistry

**Reg. No. 4,137,186**

**Registered May 1, 2012**

**Int. Cl.: 44**

**SERVICE MARK**

**SUPPLEMENTAL REGISTER**

WINDFALL ENTERPRISES, INC. (WASHINGTON CORPORATION), DBA EYELASH  
ARTISTRY,  
922 S. COWLEY, #4  
SPOKANE, WA 99202

FOR: HEALTH SPA SERVICES FOR HEALTH AND WELLNESS OF THE BODY AND SPIRIT; HEALTH SPA SERVICES FOR HEALTH AND WELLNESS OF THE BODY AND SPIRIT, NAMELY, PROVIDING MASSAGE, FACIAL AND BODY TREATMENT SERVICES, COSMETIC BODY CARE SERVICES; HEALTH SPA SERVICES, NAMELY, COSMETIC BODY CARE SERVICES; HEALTH SPA SERVICES, NAMELY, LASER TREATMENTS FOR ACNE, REJUVENATION, SCARS, TATTOO REMOVAL AND FOR FACIALS AND MASSAGE, IN CLASS 44 (U.S. CLS. 100 AND 101).

FIRST USE 6-14-2007; IN COMMERCE 6-14-2007.

THE MARK CONSISTS OF STANDARD CHARACTERS WITHOUT CLAIM TO ANY PARTICULAR FONT, STYLE, SIZE, OR COLOR.

SER. NO. 85-379,119, FILED P.R. 7-22-2011; AM. S.R. 3-1-2012.

RAMONA ORTIGA, EXAMINING ATTORNEY



*David J. Kyffers*

Director of the United States Patent and Trademark Office

# United States of America

United States Patent and Trademark Office

## SCAR FREE GUARANTEE

**Reg. No. 4,137,187**

**Registered May 1, 2012**

**Int. Cl.: 37**

AMERICAN RESIDENTIAL SERVICES L.L.C. (DELAWARE LIMITED LIABILITY COMPANY)  
SUITE 201  
965 RIDGE LAKE BOULEVARD  
MEMPHIS, TN 38120

**SERVICE MARK**

FOR: INSTALLATION AND REPLACEMENT OF SEWERS, IN CLASS 37 (U.S. CLS. 100, 103 AND 106).

**SUPPLEMENTAL REGISTER** FIRST USE 8-0-2011; IN COMMERCE 8-0-2011.

THE MARK CONSISTS OF STANDARD CHARACTERS WITHOUT CLAIM TO ANY PARTICULAR FONT, STYLE, SIZE, OR COLOR.

NO CLAIM IS MADE TO THE EXCLUSIVE RIGHT TO USE "GUARANTEE", APART FROM THE MARK AS SHOWN.

SER. NO. 85-389,813, FILED P.R. 8-4-2011; AM. S.R. 3-7-2012.

DAVID H. STINE, EXAMINING ATTORNEY



*David J. Kyffers*

Director of the United States Patent and Trademark Office

# United States of America

United States Patent and Trademark Office

## 24HR SAFETY

**Reg. No. 4,137,188**

**Registered May 1, 2012**

**Int. Cls.: 35, 37, 39, 42,  
and 45**

**SERVICE MARK**

**SUPPLEMENTAL REGISTER**

24HR SAFETY (TEXAS LIMITED LIABILITY COMPANY)  
4912 RAILROAD STREET  
DEER PARK, TX 77536

FOR: DISTRIBUTORSHIP SERVICES IN THE FIELD OF JOBSITE SAFETY EQUIPMENT, NAMELY, HAND CLEANER, RAGS, CONFINED SPACE EQUIPMENT INCLUDING FANS, PUMPS, MANHOLE COVER REMOVAL EQUIPMENT, MANHOLE FALL PREVENTION EQUIPMENT, WORK TENTS, EMERGENCY WASH STATIONS, KNEE PADS, BACK SUPPORTS, FALL PROTECTION EQUIPMENT, FIRST AID KITS AND STATIONS, SAFETY BOOTS, GLOVES, HAZARDOUS STORAGE EQUIPMENT, HEAD AND FACE PROTECTION EQUIPMENT, HEARING PROTECTION EQUIPMENT, HEAT STRESS PREVENTION EQUIPMENT AND SUPPLEMENTS, REFLECTIVE SAFETY APPAREL, HAZARD IDENTIFICATION SIGNS, GAS DETECTION EQUIPMENT, FLASHLIGHTS, LOCK-OUT TAG-OUT EQUIPMENT, PROTECTIVE CLOTHING, RESPIRATORY EQUIPMENT, SAFETY EYEWEAR, SORBENT PADS AND BOOMS, FLOTATION VESTS AND SUITS, COLD WEATHER RESCUE SUITS, TRAFFIC CONES, TRAFFIC BARRICADES, BARRICADE LIGHTS, WELDING GLOVES, WELDING GOGGLES, WELDING HELMETS, WELDING BLANKETS, AND WELDING CURTAINS; ON-LINE RETAIL STORE SERVICES FEATURING JOBSITE SAFETY EQUIPMENT, NAMELY, HAND CLEANER, RAGS, CONFINED SPACE EQUIPMENT INCLUDING FANS, PUMPS, MANHOLE COVER REMOVAL EQUIPMENT, MANHOLE FALL PREVENTION EQUIPMENT, WORK TENTS, EMERGENCY WASH STATIONS, KNEE PADS, BACK SUPPORTS, FALL PROTECTION EQUIPMENT, FIRST AID KITS AND STATIONS, SAFETY BOOTS, GLOVES, HAZARDOUS STORAGE EQUIPMENT, HEAD AND FACE PROTECTION EQUIPMENT, HEARING PROTECTION EQUIPMENT, HEAT STRESS PREVENTION EQUIPMENT AND SUPPLEMENTS, REFLECTIVE SAFETY APPAREL, HAZARD IDENTIFICATION SIGNS, GAS DETECTION EQUIPMENT, FLASHLIGHTS, LOCK-OUT TAG-OUT EQUIPMENT, PROTECTIVE CLOTHING, RESPIRATORY EQUIPMENT, SAFETY EYEWEAR, SORBENT PADS AND BOOMS, FLOTATION VESTS AND SUITS, COLD WEATHER RESCUE SUITS, TRAFFIC CONES, TRAFFIC BARRICADES, BARRICADE LIGHTS, WELDING GLOVES, WELDING GOGGLES, WELDING HELMETS, WELDING BLANKETS, AND WELDING CURTAINS, IN CLASS 35 (U.S. CLS. 100, 101 AND 102).



FIRST USE 11-1-2005; IN COMMERCE 11-1-2005.

*David J. Kypos*

Director of the United States Patent and Trademark Office

FOR: MAINTENANCE AND/OR REPAIR OF JOBSITE SAFETY EQUIPMENT INCLUDING GAS DETECTION EQUIPMENT, FALL PROTECTION EQUIPMENT, AND BREATHING AIR EQUIPMENT, IN CLASS 37 (U.S. CLS. 100, 103 AND 106).



**Reg. No. 4,137,188** FIRST USE 11-1-2005; IN COMMERCE 11-1-2005.

FOR: RESCUE SERVICES, IN CLASS 39 (U.S. CLS. 100 AND 105).

FIRST USE 1-1-2008; IN COMMERCE 1-1-2008.

FOR: TESTING, ANALYSIS, AND EVALUATION OF THE KNOWLEDGE, SKILLS AND ABILITIES OF OTHERS FOR THE PURPOSE OF CERTIFICATION AND RE-CERTIFICATION IN THE FIELD OF CPR, HAZWOPER, CONFINED SPACE ENTRY, BLOOD BORNE PATHOGENS, LOCK OUT TAG OUT, FORKLIFT SAFETY, RESPIRATORY PROTECTION, AND FALL PROTECTION, IN CLASS 42 (U.S. CLS. 100 AND 101).

FIRST USE 11-1-2005; IN COMMERCE 11-1-2005.

FOR: RENTAL OF PROTECTIVE CLOTHING AND EQUIPMENT FOR SAFETY PURPOSES, IN CLASS 45 (U.S. CLS. 100 AND 101).

FIRST USE 11-1-2005; IN COMMERCE 11-1-2005.

THE MARK CONSISTS OF STANDARD CHARACTERS WITHOUT CLAIM TO ANY PARTICULAR FONT, STYLE, SIZE, OR COLOR.

SER. NO. 85-392,394, FILED P.R. 8-8-2011; AM. S.R. 3-6-2012.

JENNIFER VASQUEZ, EXAMINING ATTORNEY

# United States of America

United States Patent and Trademark Office

## BOLT ON MUSCLE

**Reg. No. 4,137,189**

**Registered May 1, 2012**

**Int. Cl.: 35**

**SERVICE MARK**

**SUPPLEMENTAL REGISTER**

TAP WORLDWIDE, LLC (DELAWARE LIMITED LIABILITY COMPANY)  
400 WEST ARTESIA BOULEVARD  
COMPTON, CA 90220

FOR: ON-LINE RETAIL STORE SERVICES, WHOLESAL E DISTRIBUTORSHIP SERVICE, RETAIL STORE SERVICES, CATALOG MAIL ORDER SERVICES AND TELEPHONE ORDER SERVICES ALL IN THE FIELDS OF AUTOMOTIVE PARTS, SUPPLIES, TOOLS AND ACCESSORIES; PROVIDING INFORMATION VIA A WEBSITE ON A GLOBAL COMPUTER NETWORK ON AUTOMOTIVE PARTS, SUPPLIES TOOLS AND ACCESSORIES FOR SALE, IN CLASS 35 (U.S. CLS. 100, 101 AND 102).

FIRST USE 12-1-2011; IN COMMERCE 12-1-2011.

THE MARK CONSISTS OF STANDARD CHARACTERS WITHOUT CLAIM TO ANY PARTICULAR FONT, STYLE, SIZE, OR COLOR.

SER. NO. 85-393,169, FILED P.R. 8-9-2011; AM. S.R. 2-8-2012.

KELLEY WELLS, EXAMINING ATTORNEY



*David J. Kyffers*

Director of the United States Patent and Trademark Office

# United States of America

United States Patent and Trademark Office

## Doctor's Formula

**Reg. No. 4,137,190**

**Registered May 1, 2012**

**Int. Cl.: 3**

**TRADEMARK**

**SUPPLEMENTAL REGISTER**

VALLEY OF THE SUN COSMETICS LLC (CALIFORNIA LIMITED LIABILITY COMPANY)  
535 PATRICE PLACE  
GARDENA, CA 90248

FOR: COSMETIC PREPARATIONS, NAMELY, ANTI-WRINKLE CREAMS, SKIN WHITENING CREAMS, TOOTH WHITENING CREAMS, MASSAGE CREAMS, BATH LOTION, BODY SCRUBS, FACIAL SCRUBS, FACIAL BEAUTY MASKS, BEAUTY CREAMS FOR BODY CARE, FACIAL LOTION, SHAVING LOTION, AFTERSHAVE PREPARATIONS, HAIR REMOVING CREAMS, NON-MEDICATED MASSAGE OILS, PERFUMES, NON-MEDICATED FOOT SCRUBS, NON-MEDICATED FOOT CREAMS, SCENTED BODY SPRAY; HAIR PREPARATIONS, NAMELY, HAIR SHAMPOOS, HAIR GELS, HAIR CREAMS, HAIR OILS, IN CLASS 3 (U.S. CLS. 1, 4, 6, 50, 51 AND 52).

FIRST USE 10-1-2011; IN COMMERCE 10-1-2011.

THE MARK CONSISTS OF STANDARD CHARACTERS WITHOUT CLAIM TO ANY PARTICULAR FONT, STYLE, SIZE, OR COLOR.

SER. NO. 85-393,890, FILED P.R. 8-9-2011; AM. S.R. 3-3-2012.

JOHN SCHUYLER YARD, EXAMINING ATTORNEY



*David J. Kyfos*

Director of the United States Patent and Trademark Office

# United States of America

United States Patent and Trademark Office

## ENERGYFROMSHALE

**Reg. No. 4,137,191**

AMERICAN PETROLEUM INSTITUTE (D.C. CORPORATION)  
1220 L STREET, N.W.  
WASHINGTON, DC 20005

**Registered May 1, 2012**

**Int. Cl.: 35**

FOR: PROVIDING A WEBSITE TO RAISE PUBLIC AWARENESS OF ISSUES RELATING TO ENERGY AND OIL PRODUCTION, IN CLASS 35 (U.S. CLS. 100, 101 AND 102).

**SERVICE MARK**

FIRST USE 8-1-2011; IN COMMERCE 8-1-2011.

**SUPPLEMENTAL REGISTER**

THE MARK CONSISTS OF STANDARD CHARACTERS WITHOUT CLAIM TO ANY PARTICULAR FONT, STYLE, SIZE, OR COLOR.

SER. NO. 85-397,713, FILED P.R. 8-15-2011; AM. S.R. 3-7-2012.

JENNIFER MARTIN, EXAMINING ATTORNEY



*David J. Kybas*

Director of the United States Patent and Trademark Office

# United States of America

United States Patent and Trademark Office

## COLLECTORS SHOWROOM

**Reg. No. 4,137,192**

**Registered May 1, 2012**

**Int. Cl.: 35**

**SERVICE MARK**

**SUPPLEMENTAL REGISTER**

RICK FLEURY COLLECTOR'S SHOWROOM (MASSACHUSETTS SOLE PROPRIETORSHIP)  
615 BELLEVILLE AVE.  
NEW BEDFORD, MA 02745

FOR: ADVERTISING AND BUSINESS MANAGEMENT CONSULTANCY; ADVERTISING SERVICES, NAMELY, PROMOTING PROPERTIES FOR SALE BY OWNER VIA THE INTERNET; ADVERTISING, MARKETING AND PROMOTIONAL SERVICES RELATED TO ALL INDUSTRIES FOR THE PURPOSE OF FACILITATING NETWORKING AND SOCIALIZING OPPORTUNITIES FOR BUSINESS PURPOSES; ADVICE AND INFORMATION CONCERNING COMMERCIAL BUSINESS MANAGEMENT; ADVICE IN THE FIELD OF BUSINESS MANAGEMENT AND MARKETING; ADVICE RELATING TO THE ORGANISATION AND MANAGEMENT OF BUSINESS; ADVISORY SERVICE FOR ORGANIZATIONAL ISSUES AND BUSINESS ADMINISTRATION, WITH AND WITHOUT THE HELP OF ELECTRONIC DATA BASES; ADVISORY SERVICES FOR OTHERS FOR BUSINESS PURPOSES IN THE FIELDS OF ARCHITECTURE, INTERIOR DESIGN AND URBAN PLANNING DESIGN; ARRANGING AND CONDUCTING TRADE SHOW EXHIBITIONS IN THE FIELD OF FINE ART, ARTISAN AND DESIGN; ARRANGING AND CONDUCTION OF AUCTION SALES; ARRANGING OF AUCTION SALES; ART GALLERIES; ART GALLERY SERVICES; ASSISTANCE IN BUSINESS MANAGEMENT AND PRODUCT COMMERCIALIZATION, WITHIN THE FRAMEWORK OF A FRANCHISE CONTRACT; ASSISTANCE IN FRANCHISED COMMERCIAL BUSINESS MANAGEMENT; ASSISTANCE TO INDUSTRIAL OR COMMERCIAL ENTERPRISES IN THE RUNNING OF THEIR BUSINESS; ASSISTANCE WITH BUSINESS MANAGEMENT AND PLANNING; ASSISTANCE, ADVISORY SERVICES AND CONSULTANCY WITH REGARD TO BUSINESS PLANNING, BUSINESS ANALYSIS, BUSINESS MANAGEMENT, AND BUSINESS ORGANIZATION; BRANDING SERVICES, NAMELY, CONSULTING, DEVELOPMENT, MANAGEMENT AND MARKETING OF BRANDS FOR BUSINESSES; BUSINESS ACQUISITION AND MERGER CONSULTATION; BUSINESS ADMINISTRATION AND MANAGEMENT; BUSINESS ADMINISTRATION AND OFFICE WORK; BUSINESS ADMINISTRATION ASSISTANCE; BUSINESS ADMINISTRATION CONSULTANCY; BUSINESS ADMINISTRATION SERVICES FOR PROCESSING SALES MADE ON THE INTERNET; BUSINESS ADVICE AND ANALYSIS OF MARKETS; BUSINESS ADVICE AND INFORMATION; BUSINESS ADVICE AND INFORMATION RELATING TO LOANS, FINANCE AND CAPITAL; BUSINESS CONSULTATION; BUSINESS CONSULTATION SERVICES; BUSINESS CONSULTING AND INFORMATION SERVICES; BUSINESS MANAGEMENT; BUSINESS MANAGEMENT AND CONSULTATION; BUSINESS MANAGEMENT AND CONSULTATION IN THE FIELD OF DIRECT FINE ART, ARTISAN AND DESIGN SALES; BUSINESS MANAGEMENT AND ENTERPRISE ORGANIZATION CONSULTANCY;



*David J. Kybas*

Director of the United States Patent and Trademark Office

**Reg. No. 4,137,192** BUSINESS MANAGEMENT ASSISTANCE AND PARTICULARLY CARRYING OUT TASKS NECESSARY FOR THE SMOOTH CONDUCT OF SALES BY AUCTION; BUSINESS MANAGEMENT CONSULTANCY SERVICES; BUSINESS MANAGEMENT CONSULTATION; BUSINESS MANAGEMENT CONSULTATION IN THE FIELD OF FINE ART, ARTISAN AND DESIGN; BUSINESS MANAGEMENT CONSULTING WITH RELATION TO STRATEGY, MARKETING, PRODUCTION, PERSONNEL AND RETAIL SALE MATTERS; BUSINESS MANAGEMENT FOR SHOPS; BUSINESS MANAGEMENT PLANNING; BUSINESS MANAGEMENT SERVICES, NAMELY, ADMINISTRATION OF BUSINESS ENGAGED IN FINE ART, ARTISAN AND DESIGN; BUSINESS MANAGEMENT SERVICES, NAMELY, ADMINISTRATION OF COMPETITIONS FOR FINE ART, ARTISAN AND DESIGN; BUSINESS SUPPORT SERVICES, NAMELY, BUSINESS CONSULTING TO FREELANCERS, STARTUPS, EXISTING BUSINESSES AND NON-PROFIT ORGANIZATIONS; COMMERCIAL ADMINISTRATION OF THE LICENSING OF THE GOODS AND SERVICES OF OTHERS; COMMERCIAL ADMINISTRATION OF THE LICENSING OF DIRECT FINE ART, ARTISAN AND DESIGN SHOPS AND SHOWROOMS OF OTHERS; CONCEPT AND BRAND DEVELOPMENT IN THE FINE ART, ARTISAN AND DESIGN, IN CLASS 35 (U.S. CLS. 100, 101 AND 102).

FIRST USE 8-15-2011; IN COMMERCE 8-20-2011.

THE MARK CONSISTS OF STANDARD CHARACTERS WITHOUT CLAIM TO ANY PARTICULAR FONT, STYLE, SIZE, OR COLOR.

NO CLAIM IS MADE TO THE EXCLUSIVE RIGHT TO USE "SHOWROOM", APART FROM THE MARK AS SHOWN.

SER. NO. 85-402,990, FILED P.R. 8-20-2011; AM. S.R. 12-13-2011.

DAVID MURRAY, EXAMINING ATTORNEY

# United States of America

United States Patent and Trademark Office

# iTech

**Reg. No. 4,137,193**

**Registered May 1, 2012**

**Int. Cl.: 37**

**SERVICE MARK**

**SUPPLEMENTAL REGISTER**

ICRACKED HOLDINGS, LLC (DELAWARE LIMITED LIABILITY COMPANY), DBA  
ICRACKED,  
4925 GREENVILLE AVE, SUITE 1400  
DALLAS, TX 75206

FOR: INSTALLATION, MAINTENANCE AND REPAIR OF CELL PHONE RELATED  
HARDWARE; MAINTENANCE AND REPAIR OF TELECOMMUNICATIONS NETWORKING  
HARDWARE, APPARATUS, AND INSTRUMENTS; TECHNICAL SUPPORT SERVICES,  
NAMELY, TECHNICAL ADVICE RELATED TO THE REPAIR OF CELL PHONES; TECHNICAL  
SUPPORT SERVICES, NAMELY, TROUBLESHOOTING IN THE NATURE OF THE RE-  
PAIR OF COMPUTER HARDWARE, IN CLASS 37 (U.S. CLS. 100, 103 AND 106).

FIRST USE 12-25-2010; IN COMMERCE 12-25-2010.

THE MARK CONSISTS OF STANDARD CHARACTERS WITHOUT CLAIM TO ANY PAR-  
TICULAR FONT, STYLE, SIZE, OR COLOR.

SER. NO. 85-403,152, FILED 8-21-2011.

PAULA MAHONEY, EXAMINING ATTORNEY



*David J. Kybas*

Director of the United States Patent and Trademark Office

# United States of America

United States Patent and Trademark Office

## USA Mixed Martial Arts

**Reg. No. 4,137,194**

**Registered May 1, 2012**

**Int. Cl.: 41**

**SERVICE MARK**

**SUPPLEMENTAL REGISTER**

UNITED STATES AMATEUR MIXED MARTIAL ARTS (FLORIDA CORPORATION)  
12156 HAVBURG DR.  
PENSACOLA, FL 36532

FOR: ENCOURAGING AMATEUR SPORTS AND PHYSICAL EDUCATION BY ORGANIZING, SANCTIONING, CONDUCTING, REGULATING AND GOVERNING AMATEUR ATHLETIC PROGRAMS AND ACTIVITIES, IN CLASS 41 (U.S. CLS. 100, 101 AND 107).

FIRST USE 7-1-2011; IN COMMERCE 7-1-2011.

THE MARK CONSISTS OF STANDARD CHARACTERS WITHOUT CLAIM TO ANY PARTICULAR FONT, STYLE, SIZE, OR COLOR.

NO CLAIM IS MADE TO THE EXCLUSIVE RIGHT TO USE "MIXED MARTIAL ARTS", APART FROM THE MARK AS SHOWN.

SER. NO. 85-409,087, FILED P.R. 8-27-2011; AM. S.R. 2-23-2012.

DAWN HAN, EXAMINING ATTORNEY



*David J. Kybas*

Director of the United States Patent and Trademark Office



# United States of America

United States Patent and Trademark Office

## ART OF EIGHT

**Reg. No. 4,137,195**

**Registered May 1, 2012**

**Int. Cl.: 41**

**SERVICE MARK**

**SUPPLEMENTAL REGISTER**

JAVA FOOD, INC. (CALIFORNIA CORPORATION)  
2002 JIMMY DURANTE BLVD. STE. 100  
DEL MAR, CA 92014

FOR: PROVIDING TRAINING CENTERS FACILITIES FOCUSED IN THE FIELDS OF GENERAL FITNESS, EXERCISE, AND MIXED MARTIAL ARTS; PROVIDING CLASSES, WORKSHOPS, SEMINARS AND CAMPS IN THE FIELDS OF FITNESS, EXERCISE, BOXING, KICK BOXING AND MIXED MARTIAL ARTS; INTERNET BASED SEMINARS AND CLASSES FOR FITNESS, BOXING, KICK BOXING AND MIXED MARTIAL ARTS, IN CLASS 41 (U.S. CLS. 100, 101 AND 107).

FIRST USE 6-1-2011; IN COMMERCE 6-1-2011.

THE MARK CONSISTS OF STANDARD CHARACTERS WITHOUT CLAIM TO ANY PARTICULAR FONT, STYLE, SIZE, OR COLOR.

SER. NO. 85-409,642, FILED P.R. 8-29-2011; AM. S.R. 3-9-2012.

ALICE BENMAMAN, EXAMINING ATTORNEY



*David J. Kyros*

Director of the United States Patent and Trademark Office

# United States of America

United States Patent and Trademark Office

## social therapy magazine

**Reg. No. 4,137,196**

**Registered May 1, 2012**

**Int. Cl.: 41**

**SERVICE MARK**

**SUPPLEMENTAL REGISTER**

DUPREE EVANS (UNITED STATES INDIVIDUAL)  
10 POWELL DRIVE APT 313  
SICKLERVILLE, NJ 08081

FOR: PROVIDING ON-LINE MAGAZINE IN THE FIELD OF ENTERTAINMENT, LOVE, FINANCE, HEALTH, FASHION, POETRY, ART, POLITICS, EDUCATION AND MUSIC ARTISTS, IN CLASS 41 (U.S. CLS. 100, 101 AND 107).

FIRST USE 1-1-2012; IN COMMERCE 1-1-2012.

THE MARK CONSISTS OF STANDARD CHARACTERS WITHOUT CLAIM TO ANY PARTICULAR FONT, STYLE, SIZE, OR COLOR.

NO CLAIM IS MADE TO THE EXCLUSIVE RIGHT TO USE "MAGAZINE", APART FROM THE MARK AS SHOWN.

SER. NO. 85-410,137, FILED P.R. 8-30-2011; AM. S.R. 3-22-2012.

TRACY CROSS, EXAMINING ATTORNEY



*David J. Kybas*

Director of the United States Patent and Trademark Office

# United States of America

United States Patent and Trademark Office

## 8 Minute Detox

**Reg. No. 4,137,197**

**Registered May 1, 2012**

**Int. Cl.: 10**

**TRADEMARK**

**SUPPLEMENTAL REGISTER**

COMMERCIAL BARGAINS INC (WISCONSIN CORPORATION)  
2005 S 54TH STREET  
WEST ALLIS, WI 53219

FOR: DETOXIFICATION APPARATUS, NAMELY, AN IONIC DETOXIFICATION FOOT SPA UNIT FOR CLEANSING AND HYDROTHERAPY PURPOSES, IN CLASS 10 (U.S. CLS. 26, 39 AND 44).

FIRST USE 8-2-2010; IN COMMERCE 10-2-2010.

THE MARK CONSISTS OF STANDARD CHARACTERS WITHOUT CLAIM TO ANY PARTICULAR FONT, STYLE, SIZE, OR COLOR.

SER. NO. 85-411,628, FILED P.R. 8-31-2011; AM. S.R. 2-23-2012.

DAVID TAYLOR, EXAMINING ATTORNEY



*David J. Kyffers*

Director of the United States Patent and Trademark Office

# United States of America

United States Patent and Trademark Office

## 1 STEP CRIMPER

**Reg. No. 4,137,198**

DPG USA INC. (ILLINOIS CORPORATION), DBA BEAD BUDDY,  
305 WILDBERRY COURT, SUITE B-1  
SCHAUMBURG, IL 60193

**Registered May 1, 2012**

**Int. Cl.: 8**

FOR: HAND TOOLS, NAMELY, CRIMPER FOR TUBING USED IN BEADING, IN CLASS 8  
(U.S. CLS. 23, 28 AND 44).

**TRADEMARK**

FIRST USE 4-1-2008; IN COMMERCE 9-1-2010.

**SUPPLEMENTAL REGISTER**

THE MARK CONSISTS OF STANDARD CHARACTERS WITHOUT CLAIM TO ANY PARTICULAR FONT, STYLE, SIZE, OR COLOR.

NO CLAIM IS MADE TO THE EXCLUSIVE RIGHT TO USE "CRIMPER", APART FROM THE MARK AS SHOWN.

SER. NO. 85-414,179, FILED P.R. 9-2-2011; AM. S.R. 2-23-2012.

CHARLOTTE CORWIN, EXAMINING ATTORNEY



*David J. Kybas*

Director of the United States Patent and Trademark Office

# United States of America

United States Patent and Trademark Office

## Black Coffee Roasting Co.

**Reg. No. 4,137,199**

BLACK COFFEE ROASTING COMPANY, LLC (MONTANA LIMITED LIABILITY COMPANY)  
1515 WYOMING STREET, SUITE 200  
MISSOULA, MT 59801

**Registered May 1, 2012**

**Int. Cl.: 40**

FOR: COFFEE ROASTING AND PROCESSING, IN CLASS 40 (U.S. CLS. 100, 103 AND 106).

**SERVICE MARK**

FIRST USE 8-17-2010; IN COMMERCE 8-17-2010.

**SUPPLEMENTAL REGISTER**

THE MARK CONSISTS OF STANDARD CHARACTERS WITHOUT CLAIM TO ANY PARTICULAR FONT, STYLE, SIZE, OR COLOR.

NO CLAIM IS MADE TO THE EXCLUSIVE RIGHT TO USE "COFFEE ROASTING CO.", APART FROM THE MARK AS SHOWN.

SER. NO. 85-419,362, FILED P.R. 9-9-2011; AM. S.R. 2-17-2012.

DAWN HAN, EXAMINING ATTORNEY



*David J. Kyffers*

Director of the United States Patent and Trademark Office

# United States of America

United States Patent and Trademark Office

## EXPRESS CNA TRAINING

**Reg. No. 4,137,200**

**Registered May 1, 2012**

**Int. Cl.: 41**

**SERVICE MARK**

**SUPPLEMENTAL REGISTER**

MARTIN CONSULTING GROUP, INC. (NORTH CAROLINA CORPORATION), DBA EXPRESS  
CNA TRAINING,  
101 EAST CABARRUS AVENUE  
CONCORD, NC 28025

FOR: EDUCATIONAL TRAINING IN THE FIELD OF NURSING, IN CLASS 41 (U.S. CLS.  
100, 101 AND 107).

FIRST USE 3-28-2009; IN COMMERCE 3-28-2009.

THE MARK CONSISTS OF STANDARD CHARACTERS WITHOUT CLAIM TO ANY PAR-  
TICULAR FONT, STYLE, SIZE, OR COLOR.

NO CLAIM IS MADE TO THE EXCLUSIVE RIGHT TO USE "CNA TRAINING", APART  
FROM THE MARK AS SHOWN.

SER. NO. 85-422,319, FILED P.R. 9-14-2011; AM. S.R. 2-8-2012.

HEATHER BIDDULPH, EXAMINING ATTORNEY



*David J. Kyffers*

Director of the United States Patent and Trademark Office

# United States of America

United States Patent and Trademark Office

# CHIA CARD

**Reg. No. 4,137,201**

**Registered May 1, 2012**

**Int. Cl.: 16**

**TRADEMARK**

**SUPPLEMENTAL REGISTER** FIRST USE 10-0-2011; IN COMMERCE 10-0-2011.

SMITHCORP, INC. (CALIFORNIA CORPORATION), DBA GREEN FIELD PAPER CO.,  
7196 CLAIREMONT MESA BOULEVARD  
SAN DIEGO, CA 92111

FOR: GREETING CARDS, STATIONERY, NOTE CARDS AND PAPER, CONSTRUCTED TO INCLUDE SEEDS AND RESULTING IN PAPER PRODUCTS WHICH SEEDS CAN BE DIRECTLY GERMINATED; SEED EMBEDDED RECYCLED PAPER, IN CLASS 16 (U.S. CLS. 2, 5, 22, 23, 29, 37, 38 AND 50).

THE MARK CONSISTS OF STANDARD CHARACTERS WITHOUT CLAIM TO ANY PARTICULAR FONT, STYLE, SIZE, OR COLOR.

NO CLAIM IS MADE TO THE EXCLUSIVE RIGHT TO USE "CARD", APART FROM THE MARK AS SHOWN.

SER. NO. 85-426,183, FILED P.R. 9-19-2011; AM. S.R. 2-29-2012.

CURTIS FRENCH, EXAMINING ATTORNEY



*David J. Kyffers*

Director of the United States Patent and Trademark Office

# United States of America

United States Patent and Trademark Office

## Oregon Criminal Defense Lawyers Association

**Reg. No. 4,137,202**

**Registered May 1, 2012**

**Int. Cl.: 41**

**SERVICE MARK**

**SUPPLEMENTAL REGISTER**

OREGON CRIMINAL DEFENSE LAWYERS ASSOCIATION (OREGON NON-PROFIT ASSOCIATION)  
96 EAST BROADWAY, SUITE 5  
EUGENE, OR 97401

FOR: CONTINUING EDUCATION SERVICES, NAMELY, PROVIDING LIVE AND ON-LINE CONTINUING PROFESSIONAL EDUCATION SEMINARS IN THE FIELD OF CRIMINAL AND JUVENILE LAW, IN CLASS 41 (U.S. CLS. 100, 101 AND 107).

FIRST USE 10-23-1980; IN COMMERCE 10-23-1980.

THE MARK CONSISTS OF STANDARD CHARACTERS WITHOUT CLAIM TO ANY PARTICULAR FONT, STYLE, SIZE, OR COLOR.

SER. NO. 85-428,545, FILED P.R. 9-21-2011; AM. S.R. 3-8-2012.

TINA MAI, EXAMINING ATTORNEY



*David J. Kyjars*

Director of the United States Patent and Trademark Office



# United States of America

United States Patent and Trademark Office

## AFENMAI WORLD CONGRESS

**Reg. No. 4,137,203**

**Registered May 1, 2012**

**Int. Cl.: 35**

**SERVICE MARK**

**SUPPLEMENTAL REGISTER**

AFENMAI WORLD CONGRESS (TEXAS CORPORATION)  
C/O SONNIE BRAIH  
4912 53RD AVENUE NORTH  
MINNEAPOLIS, MN 55429

FOR: ASSOCIATION SERVICES, NAMELY, PROMOTING THE INTERESTS OF AFENMAI SONS AND DAUGHTERS, NAMELY, PROMOTING NETWORKING FOR AFENMAI SONS AND DAUGHTERS, AND PROMOTING GOODWILL AMONG AFENMAI CITIZENS FOR THE ADVANCEMENT OF AFENMAI PEOPLE, IN CLASS 35 (U.S. CLS. 100, 101 AND 102).

FIRST USE 1-1-2007; IN COMMERCE 1-1-2007.

THE MARK CONSISTS OF STANDARD CHARACTERS WITHOUT CLAIM TO ANY PARTICULAR FONT, STYLE, SIZE, OR COLOR.

SER. NO. 85-431,103, FILED P.R. 9-23-2011; AM. S.R. 3-6-2012.

PATRICIA EVANKO, EXAMINING ATTORNEY



*David J. Kybas*

Director of the United States Patent and Trademark Office

# United States of America

United States Patent and Trademark Office

## Williams Fluorescent Lighting

**Reg. No. 4,137,204**

**Registered May 1, 2012**

**Int. Cl.: 11**

H.E. WILLIAMS, INC. (MISSOURI CORPORATION)  
PO BOX 837  
831 W. FAIRVIEW  
CARTHAGE, MO 64836

FOR: LIGHTING FIXTURES, IN CLASS 11 (U.S. CLS. 13, 21, 23, 31 AND 34).

**TRADEMARK**

FIRST USE 4-3-2009; IN COMMERCE 4-3-2009.

**SUPPLEMENTAL REGISTER**

THE MARK CONSISTS OF STANDARD CHARACTERS WITHOUT CLAIM TO ANY PARTICULAR FONT, STYLE, SIZE, OR COLOR.

OWNER OF U.S. REG. NOS. 3,638,745, 3,677,774, AND OTHERS.

NO CLAIM IS MADE TO THE EXCLUSIVE RIGHT TO USE "FLUORESCENT LIGHTING", APART FROM THE MARK AS SHOWN.

SER. NO. 85-432,097, FILED P.R. 9-26-2011; AM. S.R. 2-1-2012.

TARA PATE, EXAMINING ATTORNEY



*David J. Kybas*

Director of the United States Patent and Trademark Office

# United States of America

United States Patent and Trademark Office



**Reg. No. 4,137,205**

**Registered May 1, 2012**

**Int. Cl.: 25**

**TRADEMARK**

**SUPPLEMENTAL REGISTER**

SOUND CITY INC (CALIFORNIA CORPORATION)  
15456 CABRITO ROAD  
VAN NUYS, CA 91406

FOR: ATHLETIC APPAREL, NAMELY, SHIRTS, PANTS, JACKETS, FOOTWEAR, HATS AND CAPS, ATHLETIC UNIFORMS, IN CLASS 25 (U.S. CLS. 22 AND 39).

FIRST USE 4-1-1979; IN COMMERCE 4-1-1979.

THE MARK CONSISTS OF THE WORD "SOUND" CENTERED ABOVE THE WORD "CITY", ABOVE A GRAPHIC REPRESENTATION OF TWO AUDIO TAPE REELS, WHICH ARE JOINED TO THE WORDING BY A GRAPHIC REPRESENTATION OF AN AUDIO TAPE MACHINE HEAD, AND ALL FRAMED BY A BORDER REPRESENTING MAGNETIC RECORDING TAPE.

SER. NO. 85-432,106, FILED P.R. 9-26-2011; AM. S.R. 2-8-2012.

TARA PATE, EXAMINING ATTORNEY



*David J. Kybas*

Director of the United States Patent and Trademark Office

# United States of America

United States Patent and Trademark Office

## NANO TECHNOLOGY BRAZILIAN KERATIN

**Reg. No. 4,137,206**

**Registered May 1, 2012**

**Int. Cl.: 3**

**TRADEMARK**

**SUPPLEMENTAL REGISTER** FIRST USE 1-0-2011; IN COMMERCE 1-0-2011.

GLOBAL MARKETING EXPORT LLC (FLORIDA LIMITED LIABILITY COMPANY)  
620 ISLEBAY DRIVE  
APOLLO BEACH, FL 33572

FOR: HAIR CARE KITS COMPRISING NON-MEDICATED HAIR CARE PREPARATIONS, NAMELY, STRAIGHTENING SHAMPOO AND CONDITIONER, HAIR STRAIGHTENING PREPARATIONS, ALL OF THE FOREGOING CONTAINING BRAZILIAN KERATIN, IN CLASS 3 (U.S. CLS. 1, 4, 6, 50, 51 AND 52).

THE MARK CONSISTS OF STANDARD CHARACTERS WITHOUT CLAIM TO ANY PARTICULAR FONT, STYLE, SIZE, OR COLOR.

NO CLAIM IS MADE TO THE EXCLUSIVE RIGHT TO USE "BRAZILIAN KERATIN", APART FROM THE MARK AS SHOWN.

SER. NO. 85-432,656, FILED P.R. 9-27-2011; AM. S.R. 2-8-2012.

EMILY CHUO, EXAMINING ATTORNEY



*David J. Kyros*

Director of the United States Patent and Trademark Office

# United States of America

United States Patent and Trademark Office

# Campus Spa

**Reg. No. 4,137,207**

**Registered May 1, 2012**

**Int. Cl.: 44**

**SERVICE MARK**

**SUPPLEMENTAL REGISTER**

CHAIR MASSAGE ON THE GO, LLC (TENNESSEE LIMITED LIABILITY COMPANY), DBA  
CAMPUS SPA,  
2818 SAINT CHARLES PL.  
PIGEON FORGE, TN 37863

FOR: AIRBRUSH SKIN TANNING SERVICES FOR HUMANS FOR COSMETIC PURPOSES; AROMATHERAPY SERVICES; ARTIFICIAL SUNTANNING SERVICES; BEAUTY CONSULTATION SERVICES; BEAUTY SPA SERVICES, NAMELY, COSMETIC BODY CARE; BODYWORK THERAPY SERVICES, NAMELY, STRUCTURAL INTEGRATION THERAPY AND MOVEMENT THERAPY; CONSULTING IN THE FIELD OF HEALTH AND WELLNESS TO BRING ABOUT PERSONAL HAPPINESS; CONSULTING SERVICES IN THE FIELD OF HEALTH; CONSULTING SERVICES IN THE FIELD OF MENTAL FITNESS; CONSULTING SERVICES IN THE FIELD OF MENTAL HEALTH AND WELLNESS; CONSULTING SERVICES IN THE FIELD OF WOMEN'S HEALTH; CONSULTING SERVICES IN THE FIELDS OF HEALTH AND NUTRITION; COUNSELING SERVICES IN THE FIELDS OF HEALTH, NUTRITION AND LIFESTYLE WELLNESS; HEALTH SPA SERVICES FOR HEALTH AND WELLNESS OF THE BODY AND SPIRIT; HEALTH SPA SERVICES FOR HEALTH AND WELLNESS OF THE BODY AND SPIRIT, NAMELY, PROVIDING MASSAGE, FACIAL AND BODY TREATMENT SERVICES, COSMETIC BODY CARE SERVICES; HEALTH SPA SERVICES FOR HEALTH AND WELLNESS OF THE MIND, BODY AND SPIRIT OFFERED IN OR FROM A REMOTE, MOBILE OR TEMPORARY ON-SITE LOCATION; MASSAGE THERAPY SERVICES; OXYGEN BAR SERVICES; PROVIDING WELLNESS SERVICES, NAMELY, PERSONAL ASSESSMENTS, PERSONALIZED ROUTINES, MAINTENANCE SCHEDULES, AND COUNSELING; SKIN TANNING SERVICE FOR HUMANS FOR COSMETIC PURPOSES; WELLNESS AND HEALTH-RELATED CONSULTING SERVICES, IN CLASS 44 (U.S. CLS. 100 AND 101).



FIRST USE 8-9-2011; IN COMMERCE 8-9-2011.

THE MARK CONSISTS OF STANDARD CHARACTERS WITHOUT CLAIM TO ANY PARTICULAR FONT, STYLE, SIZE, OR COLOR.

NO CLAIM IS MADE TO THE EXCLUSIVE RIGHT TO USE "SPA", APART FROM THE MARK AS SHOWN.

SER. NO. 85-433,277, FILED P.R. 9-27-2011; AM. S.R. 3-5-2012.

*David J. Kyros*

Director of the United States Patent and Trademark Office

**Reg. No. 4,137,207** JENNIFER VASQUEZ, EXAMINING ATTORNEY

# United States of America

United States Patent and Trademark Office

# GROOM PRO

**Reg. No. 4,137,208**

WAHL CLIPPER CORPORATION (ILLINOIS CORPORATION)  
2900 NORTH LOCUST STREET  
STERLING, IL 610810578

**Registered May 1, 2012**

**Int. Cl.: 8**

FOR: ELECTRIC HAIR CLIPPERS; ELECTRIC HAIR TRIMMERS, IN CLASS 8 (U.S. CLS. 23, 28 AND 44).

**TRADEMARK**

FIRST USE 3-0-2010; IN COMMERCE 3-0-2010.

**SUPPLEMENTAL REGISTER**

THE MARK CONSISTS OF STANDARD CHARACTERS WITHOUT CLAIM TO ANY PARTICULAR FONT, STYLE, SIZE, OR COLOR.

SER. NO. 85-436,096, FILED P.R. 9-30-2011; AM. S.R. 3-19-2012.

TASNEEM HUSSAIN, EXAMINING ATTORNEY



*David J. Kybas*

Director of the United States Patent and Trademark Office

# United States of America

United States Patent and Trademark Office

# He Exists

**Reg. No. 4,137,209**

THERIAULT, KYLE (UNITED STATES INDIVIDUAL)  
40 GORMAN LANE  
SPRINGFIELD, MA 01118

**Registered May 1, 2012**

**Int. Cl.: 16**

FOR: BUMPER STICKERS; STICKERS, IN CLASS 16 (U.S. CLS. 2, 5, 22, 23, 29, 37, 38 AND 50).

**TRADEMARK**

FIRST USE 10-1-2010; IN COMMERCE 10-1-2010.

**SUPPLEMENTAL REGISTER**

THE MARK CONSISTS OF THE STYLIZED WORDS, "HE EXISTS" WITH EACH LETTER REPLACED WITH A SYMBOL - THREE SPIKES MAKE UP THE LETTER H; A FISH OUTLINE MAKES UP THE TOP PART OF THE "E"; A FLYING BIRD FACING LEFT MAKES UP THE "E" IN THE "EXISTS"; A RIGHT FACING FLAG IS POSITIONED VERTICALLY OVER THE "X"; A SWORD WITH A 6-POINT STAR ABOVE IT MAKES UP THE I; A S-SHAPED DIRT PATH MAKES UP THE LETTER S, A LATIN CROSS MAKES UP THE T, AND A FLAME DESIGN MAKES UP THE FINAL S.

SER. NO. 85-440,561, FILED P.R. 10-6-2011; AM. S.R. 3-7-2012.

MAYUR VAGHANI, EXAMINING ATTORNEY



*David J. Kybas*

Director of the United States Patent and Trademark Office



# United States of America

United States Patent and Trademark Office

## BRADDOCK METRO CENTER

**Reg. No. 4,137,210**

**Registered May 1, 2012**

**Int. Cl.: 36**

THE TRUSTEES OF THE WASHINGTON REAL ESTATE INVESTMENT TRUST (MARYLAND TRUST)  
SUITE 800  
6110 EXECUTIVE BOULEVARD  
ROCKVILLE, MD 20852

**SERVICE MARK**

**SUPPLEMENTAL REGISTER**

FOR: ASSESSMENT AND MANAGEMENT OF REAL ESTATE; LEASING OF REAL ESTATE; FINANCING OF REAL ESTATE DEVELOPMENT PROJECTS; REAL ESTATE MANAGEMENT SERVICES; REAL ESTATE SERVICES, NAMELY, RENTAL, BROKERAGE, LEASING AND MANAGEMENT OF COMMERCIAL PROPERTY, OFFICES AND OFFICE SPACE, IN CLASS 36 (U.S. CLS. 100, 101 AND 102).

FIRST USE 10-6-2011; IN COMMERCE 10-6-2011.

THE MARK CONSISTS OF STANDARD CHARACTERS WITHOUT CLAIM TO ANY PARTICULAR FONT, STYLE, SIZE, OR COLOR.

NO CLAIM IS MADE TO THE EXCLUSIVE RIGHT TO USE "METRO CENTER", APART FROM THE MARK AS SHOWN.

SER. NO. 85-440,564, FILED P.R. 10-6-2011; AM. S.R. 2-24-2012.

DEBORAH LOBO, EXAMINING ATTORNEY



*David J. Kybas*

Director of the United States Patent and Trademark Office

# United States of America

United States Patent and Trademark Office

## THE RETAIL GATEWAY

**Reg. No. 4,137,211**

**Registered May 1, 2012**

**Int. Cl.: 35**

**SERVICE MARK**

**SUPPLEMENTAL REGISTER**

MERCURY RETAIL SERVICES, LLC (TEXAS LIMITED LIABILITY COMPANY)  
5130 COMMERCE PARKWAY  
BUILDING 19  
SAN ANTONIO, TX 78218

FOR: PROMOTING THE GOODS AND SERVICES OF OTHERS BY PROVIDING A WEBSITE FEATURING CONSUMER AND MARKETING INFORMATION ABOUT THE PRODUCTS OF OTHERS, NAMELY, CONSUMER PRODUCT INFORMATION AND REVIEWS, NEWS AND EVENTS RELATING TO THE PRODUCTS, AS WELL AS OTHER INFORMATION AS TO WHY BUYERS SHOULD PLACE THE PRODUCTS IN THEIR RETAIL BUSINESSES, AND, WHICH GIVES BUYERS THE ABILITY TO BROWSE AND ORDER SAMPLES OF THE PRODUCTS, IN CLASS 35 (U.S. CLS. 100, 101 AND 102).

FIRST USE 3-7-2012; IN COMMERCE 3-7-2012.

THE MARK CONSISTS OF STANDARD CHARACTERS WITHOUT CLAIM TO ANY PARTICULAR FONT, STYLE, SIZE, OR COLOR.

SER. NO. 85-442,416, FILED P.R. 10-7-2011; AM. S.R. 3-26-2012.

ELISSA GARBER KON, EXAMINING ATTORNEY



*David J. Kybas*

Director of the United States Patent and Trademark Office

# United States of America

United States Patent and Trademark Office



**Reg. No. 4,137,212**

**Registered May 1, 2012**

**Int. Cl.: 25**

**TRADEMARK**

**SUPPLEMENTAL REGISTER**

A.V. DENIM INC. (NEW YORK CORPORATION), DBA A&V DENIM, INC.,  
1407 BROADWAY, SUITE 3200  
NEW YORK, NY 10018

FOR: BELTS; JACKETS; JEANS; PANTS; SHIRTS; SHOES; SOCKS, IN CLASS 25 (U.S. CLS. 22 AND 39).

FIRST USE 11-12-2010; IN COMMERCE 11-12-2010.

THE MARK CONSISTS OF THREE PARALLEL LINES, INCREASING IN THICKNESS WITH THE TOP LINE BEING THE MOST THIN AND THE BOTTOM LINE BEING THE MOST THICK, STARTING FROM THE LEFT AND HEADING STRAIGHT INWARD BEFORE STOPPING AND HEADING DOWNWARD AT AN ANGLE, THEN STOPPING AGAIN AND CURVING FURTHER DOWNWARD BEFORE STOPPING AND HEADING STRAIGHT INWARD AGAIN, ONLY TO HEAD UPWARD IN AN ENTIRELY SYMMETRICAL FASHION. BENEATH THE LAST LINE, IN THE SAME THICKNESS, IS ANOTHER SYMMETRICAL DESIGN, CONSISTING OF TWO LINES CURVING DOWNWARD AND MEETING IN THE CENTER BEFORE BRIEFLY JUTTING OUTWARD AGAIN, AND CONTAINING A TRIANGULAR ARROWHEAD DESIGN EMANATING FROM THE BOTTOM.

SER. NO. 85-442,796, FILED P.R. 10-8-2011; AM. S.R. 2-6-2012.

TARA PATE, EXAMINING ATTORNEY



*David J. Kyffers*

Director of the United States Patent and Trademark Office

# United States of America

United States Patent and Trademark Office

## THE ULTIMATE ARMBAND

**Reg. No. 4,137,213**

**Registered May 1, 2012**

**Int. Cl.: 9**

**TRADEMARK**

**SUPPLEMENTAL REGISTER**

ARMPOCKET ENTERPRISES, LLC (FLORIDA LIMITED LIABILITY COMPANY)  
17428 SW 36TH ST.  
MIRAMAR, FL 33029

FOR: ARMBANDS SPECIALLY DESIGNED FOR AND HOLDERS FOR CELLULAR PHONES  
AND PORTABLE AND HANDHELD DIGITAL ELECTRONIC DEVICES, IN CLASS 9 (U.S.  
CLS. 21, 23, 26, 36 AND 38).

FIRST USE 5-20-2011; IN COMMERCE 6-23-2011.

THE MARK CONSISTS OF STANDARD CHARACTERS WITHOUT CLAIM TO ANY PAR-  
TICULAR FONT, STYLE, SIZE, OR COLOR.

NO CLAIM IS MADE TO THE EXCLUSIVE RIGHT TO USE "ARMBAND", APART FROM  
THE MARK AS SHOWN.

SER. NO. 85-444,309, FILED P.R. 10-11-2011; AM. S.R. 2-24-2012.

LEIGH CAROLINE CASE, EXAMINING ATTORNEY



*David J. Kyffers*

Director of the United States Patent and Trademark Office

# United States of America

United States Patent and Trademark Office

## American-Filipino Kun Tao

**Reg. No. 4,137,214**

**Registered May 1, 2012**

**Int. Cl.: 41**

**SERVICE MARK**

**SUPPLEMENTAL REGISTER**

SERRANO, DREW (UNITED STATES INDIVIDUAL)  
344 CHIPMAN STREET EXTENSION  
WATERBURY, CT 06708 AND

BERGAMO, RALPH (UNITED STATES INDIVIDUAL)  
17 BROOKSHIRE DR  
PROSPECT, CT 06712 AND

HEBERT, MEL (UNITED STATES INDIVIDUAL)  
15960 LETOURNEAU LANE  
GRASS VALLEY, CA 95949

FOR: MARTIAL ARTS INSTRUCTION, IN CLASS 41 (U.S. CLS. 100, 101 AND 107).

FIRST USE 10-1-1997; IN COMMERCE 10-1-1997.

THE MARK CONSISTS OF STANDARD CHARACTERS WITHOUT CLAIM TO ANY PARTICULAR FONT, STYLE, SIZE, OR COLOR.

NO CLAIM IS MADE TO THE EXCLUSIVE RIGHT TO USE "KUN TAO", APART FROM THE MARK AS SHOWN.

THE ENGLISH TRANSLATION OF THE WORD "KUN TAO" IN THE MARK IS FIGHTING ART.

SER. NO. 85-446,018, FILED P.R. 10-12-2011; AM. S.R. 2-23-2012.

CURTIS FRENCH, EXAMINING ATTORNEY



*David J. Kybas*

Director of the United States Patent and Trademark Office

# United States of America

United States Patent and Trademark Office

## FLEX POLE TECHNOLOGY

**Reg. No. 4,137,215**

THRILLWORKS, INC. (CALIFORNIA CORPORATION)  
9198-B RIDGE ROAD  
NEWCASTLE, CA 95658

**Registered May 1, 2012**

**Int. Cl.: 28**

FOR: AMUSEMENT DEVICES, NAMELY, APPARATUSES FOR SPRINGING INDIVIDUALS INTO THE AIR, IN CLASS 28 (U.S. CLS. 22, 23, 38 AND 50).

**TRADEMARK**

FIRST USE 0-0-2007; IN COMMERCE 0-0-2007.

**SUPPLEMENTAL REGISTER**

THE MARK CONSISTS OF STANDARD CHARACTERS WITHOUT CLAIM TO ANY PARTICULAR FONT, STYLE, SIZE, OR COLOR.

SER. NO. 85-446,934, FILED P.R. 10-13-2011; AM. S.R. 2-12-2012.

SANI KHOURI, EXAMINING ATTORNEY



*David J. Kybas*

Director of the United States Patent and Trademark Office

# United States of America

United States Patent and Trademark Office

## WALL 2 WALL

**Reg. No. 4,137,216**

WALL TO WALL CLEANING SERVICES LLC (MISSOURI LIMITED LIABILITY COMPANY)  
101 SERENE MEADOWS CT.  
ST. CHARLES, MO 63304

**Registered May 1, 2012**

**Int. Cl.: 37**

FOR: CLEANING OF BUILDINGS; CLEANING OF RESIDENTIAL HOUSES; CLEANING OF GUTTERS AND DRYER VENTS; PRESSURE WASHING SERVICES; WINDOW CLEANING , IN CLASS 37 (U.S. CLS. 100, 103 AND 106).

**SERVICE MARK**

FIRST USE 3-0-2009; IN COMMERCE 3-0-2009.

**SUPPLEMENTAL REGISTER**

THE MARK CONSISTS OF STANDARD CHARACTERS WITHOUT CLAIM TO ANY PARTICULAR FONT, STYLE, SIZE, OR COLOR.

SER. NO. 85-448,331, FILED P.R. 10-15-2011; AM. S.R. 2-24-2012.

LAKEISHA LEWIS, EXAMINING ATTORNEY



*David J. Kyros*

Director of the United States Patent and Trademark Office

# United States of America

United States Patent and Trademark Office

## Bacon Croutons

**Reg. No. 4,137,217**

**Registered May 1, 2012**

**Int. Cl.: 30**

J&D'S DOWN HOME ENTERPRISES, INC. (DELAWARE CORPORATION), DBA J&D'S  
FOODS, INC.,  
309 S. CLOVERDALE #D10  
SEATTLE, WA 98108

FOR: BACON FLAVORED CROUTONS, IN CLASS 30 (U.S. CL. 46).

**TRADEMARK**

FIRST USE 6-1-2011; IN COMMERCE 8-1-2011.

**SUPPLEMENTAL REGISTER**

THE MARK CONSISTS OF STANDARD CHARACTERS WITHOUT CLAIM TO ANY PARTICULAR FONT, STYLE, SIZE, OR COLOR.

NO CLAIM IS MADE TO THE EXCLUSIVE RIGHT TO USE "CROUTONS", APART FROM THE MARK AS SHOWN.

SER. NO. 85-449,319, FILED 10-17-2011.

NAPOLEON SHARMA, EXAMINING ATTORNEY



*David J. Kybas*

Director of the United States Patent and Trademark Office



# United States of America

United States Patent and Trademark Office

## GreenExamEducation

**Reg. No. 4,137,218**

**Registered May 1, 2012**

**Int. Cl.: 35**

**SERVICE MARK**

**SUPPLEMENTAL REGISTER**

CHEN, GANG (UNITED STATES INDIVIDUAL)  
4881 FLAGSTAR CIRCLE  
IRVINE, CA 92604

FOR: ON-LINE RETAIL STORE SERVICES FEATURING A WIDE VARIETY OF CONSUMER GOODS OF OTHERS; ON-LINE RETAIL STORE SERVICES FEATURING BOOKS ON ENVIRONMENTALLY FRIENDLY ARCHITECTURE AND ENVIRONMENTALLY FRIENDLY ARCHITECTURE EXAMINATION PREPARATION, IN CLASS 35 (U.S. CLS. 100, 101 AND 102).

FIRST USE 4-4-2010; IN COMMERCE 4-4-2010.

THE MARK CONSISTS OF STANDARD CHARACTERS WITHOUT CLAIM TO ANY PARTICULAR FONT, STYLE, SIZE, OR COLOR.

SER. NO. 85-450,524, FILED P.R. 10-19-2011; AM. S.R. 3-5-2012.

JIM RINGLE, EXAMINING ATTORNEY



*David J. Kybas*

Director of the United States Patent and Trademark Office

# United States of America

United States Patent and Trademark Office

# O&P Social

**Reg. No. 4,137,219**

1OANDP, LLC (VIRGINIA LIMITED LIABILITY COMPANY)  
493 BLACKWELL ROAD, SUITE 115  
WARRENTON, VA 20186

**Registered May 1, 2012**

**Int. Cl.: 45**

FOR: ONLINE SOCIAL NETWORKING SERVICES IN THE FIELD OF HEALTH CARE AND MEDICAL DEVICES , IN CLASS 45 (U.S. CLS. 100 AND 101).

**SERVICE MARK**

FIRST USE 10-17-2011; IN COMMERCE 10-17-2011.

**SUPPLEMENTAL REGISTER**

THE MARK CONSISTS OF STANDARD CHARACTERS WITHOUT CLAIM TO ANY PARTICULAR FONT, STYLE, SIZE, OR COLOR.

SER. NO. 85-450,833, FILED P.R. 10-19-2011; AM. S.R. 3-7-2012.

SIMON TENG, EXAMINING ATTORNEY



*David J. Kybas*

Director of the United States Patent and Trademark Office

# United States of America

United States Patent and Trademark Office

# TIRE AID

**Reg. No. 4,137,220**

**Registered May 1, 2012**

**Int. Cl.: 1**

**TRADEMARK**

**SUPPLEMENTAL REGISTER**

MARATHON INDUSTRIES, INC. (WASHINGTON CORPORATION)  
7925 SOUTH 196TH STREET  
KENT, WA 98032

FOR: TIRE SEALING COMPOUNDS, IN CLASS 1 (U.S. CLS. 1, 5, 6, 10, 26 AND 46).

FIRST USE 12-0-2011; IN COMMERCE 12-0-2011.

THE MARK CONSISTS OF STANDARD CHARACTERS WITHOUT CLAIM TO ANY PARTICULAR FONT, STYLE, SIZE, OR COLOR.

NO CLAIM IS MADE TO THE EXCLUSIVE RIGHT TO USE "TIRE", APART FROM THE MARK AS SHOWN.

SER. NO. 85-451,510, FILED P.R. 10-19-2011; AM. S.R. 2-23-2012.

AISHA SALEM, EXAMINING ATTORNEY



*David J. Kyffers*

Director of the United States Patent and Trademark Office

# United States of America

United States Patent and Trademark Office

## BX THE BUSINESS EXCHANGE

**Reg. No. 4,137,221**

**Registered May 1, 2012**

**Int. Cl.: 36**

**SERVICE MARK**

**SUPPLEMENTAL REGISTER**

THE BUSINESS GROUP, INC (ILLINOIS CORPORATION)  
12 MAPLEHURST DRIVE  
ROCHESTER, IL 62563

FOR: BUSINESS BROKERAGE SERVICES AND RELATED CONSULTING PERTAINING TO BUSINESS SALES, MERGERS, ACQUISITIONS AND BUSINESS VALUATIONS; FINANCIAL INVESTMENT BROKERAGE SERVICES; REAL ESTATE BROKERAGE SERVICES; FINANCIAL CONSULTING AND ADVISING IN THE FIELD OF MERGERS AND ACQUISITIONS, IN CLASS 36 (U.S. CLS. 100, 101 AND 102).

FIRST USE 11-1-2011; IN COMMERCE 11-1-2011.

THE MARK CONSISTS OF STANDARD CHARACTERS WITHOUT CLAIM TO ANY PARTICULAR FONT, STYLE, SIZE, OR COLOR.

NO CLAIM IS MADE TO THE EXCLUSIVE RIGHT TO USE "BUSINESS", APART FROM THE MARK AS SHOWN.

SER. NO. 85-451,633, FILED P.R. 10-20-2011; AM. S.R. 3-2-2012.

JEFFREY LOOK, EXAMINING ATTORNEY



*David J. Kypos*

Director of the United States Patent and Trademark Office

# United States of America

United States Patent and Trademark Office

## Business Agents

**Reg. No. 4,137,222**

**Registered May 1, 2012**

**Int. Cl.: 35**

**SERVICE MARK**

**SUPPLEMENTAL REGISTER**

DNA CONSULTING LLC (FLORIDA LIMITED LIABILITY COMPANY)

2

520 N. ORLANDO AVENUE  
WINTER PARK, FL 32789

FOR: MANAGEMENT AGENCY SERVICES, NAMELY, REPRESENTING BUSINESS PROFESSIONALS IN THE BUSINESS MANAGEMENT OF THEIR BUSINESS AFFAIRS, SPEAKING ENGAGEMENTS, PUBLIC APPEARANCES, AND PROMOTIONAL SPONSORSHIP OPPORTUNITIES; PUBLICITY CONSULTING; BRANDING SERVICES, NAMELY, CONSULTING, DEVELOPMENT, MANAGEMENT OF BRANDS FOR OTHERS; COMMERCIAL ADMINISTRATION OF THE LICENSING OF GOODS AND SERVICES OF OTHERS; BUSINESS MANAGEMENT CONSULTANCY SERVICES, IN CLASS 35 (U.S. CLS. 100, 101 AND 102).

FIRST USE 11-1-2011; IN COMMERCE 11-1-2011.

THE MARK CONSISTS OF STANDARD CHARACTERS WITHOUT CLAIM TO ANY PARTICULAR FONT, STYLE, SIZE, OR COLOR.

SER. NO. 85-452,169, FILED P.R. 10-20-2011; AM. S.R. 2-28-2012.

TINA MAI, EXAMINING ATTORNEY



*David J. Kybas*

Director of the United States Patent and Trademark Office

**United States of America**  
United States Patent and Trademark Office

**SALON SPA**

**Reg. No. 4,137,223**

ZHADANOV, ELI (UNITED STATES INDIVIDUAL)  
1315 EAST ELIZABETH AVE  
LINDEN, NJ 07036

**Registered May 1, 2012**

**Int. Cl.: 11**

FOR: HAND HELD SHOWER HEADS; HAND SHOWERS; HAND-HELD SHOWERS; SHOWER HEAD SPRAYERS; SHOWER HEADS, IN CLASS 11 (U.S. CLS. 13, 21, 23, 31 AND 34).

**TRADEMARK**

FIRST USE 3-9-2011; IN COMMERCE 3-9-2011.

**SUPPLEMENTAL REGISTER**

THE MARK CONSISTS OF STANDARD CHARACTERS WITHOUT CLAIM TO ANY PARTICULAR FONT, STYLE, SIZE, OR COLOR.

SER. NO. 85-453,049, FILED 10-21-2011.

MICHAEL TANNER, EXAMINING ATTORNEY



*David J. Kybas*

Director of the United States Patent and Trademark Office

# United States of America

United States Patent and Trademark Office

## LUXURY HOME SPA

**Reg. No. 4,137,224**

ZHADANOV, ELI (UNITED STATES INDIVIDUAL)  
1315 EAST ELIZABETH AVE  
LINDEN, NJ 07036

**Registered May 1, 2012**

**Int. Cl.: 11**

FOR: HAND HELD SHOWER HEADS; HAND SHOWERS; HAND-HELD SHOWERS; SHOWER HEAD SPRAYERS; SHOWER HEADS; SHOWERS, IN CLASS 11 (U.S. CLS. 13, 21, 23, 31 AND 34).

**TRADEMARK**

FIRST USE 7-25-2011; IN COMMERCE 7-25-2011.

**SUPPLEMENTAL REGISTER**

THE MARK CONSISTS OF STANDARD CHARACTERS WITHOUT CLAIM TO ANY PARTICULAR FONT, STYLE, SIZE, OR COLOR.

SER. NO. 85-453,080, FILED P.R. 10-21-2011; AM. S.R. 2-9-2012.

MICHAEL TANNER, EXAMINING ATTORNEY



*David J. Kyffers*

Director of the United States Patent and Trademark Office

# United States of America

United States Patent and Trademark Office

## BUSINESS SUCCESS ACTION PLAN

**Reg. No. 4,137,225**

TECHNOLOGY BUSINESS SERVICES, INC. (SOUTH CAROLINA CORPORATION)  
723 OLDE CENTRAL WAY  
MOUNT PLEASANT, SC 29464

**Registered May 1, 2012**

**Int. Cl.: 41**

FOR: PROFESSIONAL COACHING SERVICES IN THE FIELD OF BUSINESS PLANNING  
AND IMPLEMENTATION, IN CLASS 41 (U.S. CLS. 100, 101 AND 107).

**SERVICE MARK**

FIRST USE 3-10-2010; IN COMMERCE 3-10-2010.

**SUPPLEMENTAL REGISTER**

THE MARK CONSISTS OF STANDARD CHARACTERS WITHOUT CLAIM TO ANY PAR-  
TICULAR FONT, STYLE, SIZE, OR COLOR.

SER. NO. 85-453,771, FILED P.R. 10-21-2011; AM. S.R. 2-23-2012.

JANICE KIM, EXAMINING ATTORNEY



*David J. Kyros*

Director of the United States Patent and Trademark Office



# United States of America

United States Patent and Trademark Office

## COVERAGE CHECKER

**Reg. No. 4,137,226**

**Registered May 1, 2012**

**Int. Cl.: 36**

**SERVICE MARK**

**SUPPLEMENTAL REGISTER**

PROGRESSIVE CASUALTY INSURANCE COMPANY (OHIO CORPORATION)  
6300 WILSON MILLS ROAD  
MAYFIELD VILLAGE, OH 44143

FOR: INSURANCE SERVICES, NAMELY, PROVIDING GUIDANCE IN SELECTING APPROPRIATE INSURANCE, LIMITS, AND DEDUCTIBLES, IN CLASS 36 (U.S. CLS. 100, 101 AND 102).

FIRST USE 9-20-2011; IN COMMERCE 9-20-2011.

THE MARK CONSISTS OF STANDARD CHARACTERS WITHOUT CLAIM TO ANY PARTICULAR FONT, STYLE, SIZE, OR COLOR.

NO CLAIM IS MADE TO THE EXCLUSIVE RIGHT TO USE "COVERAGE", APART FROM THE MARK AS SHOWN.

SER. NO. 85-454,076, FILED P.R. 10-24-2011; AM. S.R. 3-7-2012.

ANDREA HACK, EXAMINING ATTORNEY



*David J. Kybas*

Director of the United States Patent and Trademark Office

# United States of America

United States Patent and Trademark Office

## Combi Shade

**Reg. No. 4,137,227**

KIM, ESTHER (UNITED STATES INDIVIDUAL)  
20957 CURRIER RD #G  
WALNUT, CA 91789

**Registered May 1, 2012**

**Int. Cl.: 20**

FOR: WINDOW SHADES, IN CLASS 20 (U.S. CLS. 2, 13, 22, 25, 32 AND 50).

**TRADEMARK**

FIRST USE 4-1-2008; IN COMMERCE 4-1-2008.

**SUPPLEMENTAL REGISTER**

THE MARK CONSISTS OF STANDARD CHARACTERS WITHOUT CLAIM TO ANY PARTICULAR FONT, STYLE, SIZE, OR COLOR.

NO CLAIM IS MADE TO THE EXCLUSIVE RIGHT TO USE "SHADE", APART FROM THE MARK AS SHOWN.

SER. NO. 85-454,864, FILED P.R. 10-24-2011; AM. S.R. 3-10-2012.

KELLY TRUSILO, EXAMINING ATTORNEY



*David J. Kyffers*

Director of the United States Patent and Trademark Office

# United States of America

United States Patent and Trademark Office

## SCHOOL SAFETY ADVOCACY COUNCIL

**Reg. No. 4,137,228**

**Registered May 1, 2012**

**Int. Cl.: 41**

**SERVICE MARK**

**SUPPLEMENTAL REGISTER**

SCHOOL SAFETY ADVOCACY COUNCIL, INC (FLORIDA CORPORATION)  
PO BOX 384  
VENICE, FL 34284

FOR: EDUCATION SERVICES, NAMELY, PROVIDING CLASSES, SEMINARS, TRAINING,  
AND WORKSHOPS IN THE FIELD OF SAFETY AND SECURITY, IN CLASS 41 (U.S. CLS.  
100, 101 AND 107).

FIRST USE 5-1-2005; IN COMMERCE 5-1-2005.

THE MARK CONSISTS OF STANDARD CHARACTERS WITHOUT CLAIM TO ANY PAR-  
TICULAR FONT, STYLE, SIZE, OR COLOR.

NO CLAIM IS MADE TO THE EXCLUSIVE RIGHT TO USE "COUNCIL", APART FROM  
THE MARK AS SHOWN.

SER. NO. 85-454,868, FILED P.R. 10-24-2011; AM. S.R. 3-7-2012.

MYRIAH HABEEB, EXAMINING ATTORNEY



*David J. Kyjars*

Director of the United States Patent and Trademark Office

# United States of America

United States Patent and Trademark Office

## INFORMATION FOR YOUR HEALTH

**Reg. No. 4,137,229**

**Registered May 1, 2012**

**Int. Cls.: 35 and 44**

**SERVICE MARK**

**SUPPLEMENTAL REGISTER**

LDM GROUP, LLC (MISSOURI LIMITED LIABILITY COMPANY)  
SUITE 308  
10845 OLIVE BOULEVARD  
ST. LOUIS, MO 631417760

FOR: ADVERTISING AND MARKETING SERVICES, NAMELY, PROMOTING THE GOODS AND SERVICES OF OTHERS IN THE FIELD OF HEALTH CARE, IN CLASS 35 (U.S. CLS. 100, 101 AND 102).

FIRST USE 9-23-2003; IN COMMERCE 9-23-2003.

FOR: PROVIDING HEALTHCARE AND MEDICAL INFORMATION; PROVIDING INFORMATION TO PATIENTS IN THE FIELD OF ADMINISTERING MEDICATIONS, IN CLASS 44 (U.S. CLS. 100 AND 101).

FIRST USE 9-23-2003; IN COMMERCE 9-23-2003.

THE MARK CONSISTS OF STANDARD CHARACTERS WITHOUT CLAIM TO ANY PARTICULAR FONT, STYLE, SIZE, OR COLOR.

OWNER OF U.S. REG. NO. 3,618,122.

SER. NO. 85-455,307, FILED P.R. 10-25-2011; AM. S.R. 1-5-2012.

SUSAN STIGLITZ, EXAMINING ATTORNEY



*David J. Kybas*

Director of the United States Patent and Trademark Office

# United States of America

United States Patent and Trademark Office

## SCIENCE APPLIED TO SECURITY

**Reg. No. 4,137,230**

**Registered May 1, 2012**

**Int. Cl.: 35**

**SERVICE MARK**

**SUPPLEMENTAL REGISTER**

STROZ FRIEDBERG, LLC (NEW YORK LIMITED LIABILITY COMPANY)  
160 FEDERAL STREET, SUITE 901  
BOSTON, MA 02110

FOR: BUSINESS ADVISORY SERVICES, CONSULTANCY AND INFORMATION, IN CLASS  
35 (U.S. CLS. 100, 101 AND 102).

FIRST USE 10-24-2011; IN COMMERCE 10-24-2011.

THE MARK CONSISTS OF STANDARD CHARACTERS WITHOUT CLAIM TO ANY PAR-  
TICULAR FONT, STYLE, SIZE, OR COLOR.

NO CLAIM IS MADE TO THE EXCLUSIVE RIGHT TO USE "SECURITY", APART FROM  
THE MARK AS SHOWN.

SER. NO. 85-455,637, FILED P.R. 10-25-2011; AM. S.R. 2-13-2012.

BARBARA A. GOLD, EXAMINING ATTORNEY



*David J. Kybas*

Director of the United States Patent and Trademark Office

# United States of America

United States Patent and Trademark Office

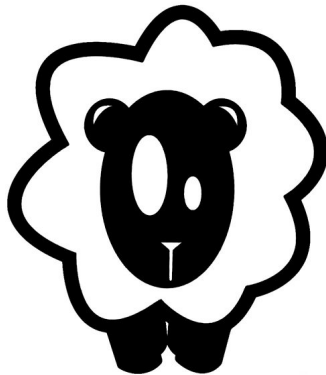

**Reg. No. 4,137,231**

FLOKS & FIELDS (FLORIDA LIMITED LIABILITY COMPANY)  
500 NW 179 STREET  
MIAMI, FL 33169

**Registered May 1, 2012**

**Int. Cl.: 25**

FOR: HOODED SWEATSHIRTS; SHIRTS; SHORT-SLEEVED OR LONG-SLEEVED T-SHIRTS;  
SWEATERS; SWEATSHIRTS; T-SHIRTS, IN CLASS 25 (U.S. CLS. 22 AND 39).

**TRADEMARK**

FIRST USE 7-1-2011; IN COMMERCE 7-1-2011.

**SUPPLEMENTAL REGISTER**

THE MARK CONSISTS OF A STYLIZED DESIGN OF A SHEEP HAVING A LARGER LEFT EYE THAN THE RIGHT EYE.

SER. NO. 85-456,485, FILED P.R. 10-26-2011; AM. S.R. 2-29-2012.

JEFF DEFORD, EXAMINING ATTORNEY



*David J. Kybas*

Director of the United States Patent and Trademark Office

# United States of America

United States Patent and Trademark Office

It's a bad day to be a  
fish.

**Reg. No. 4,137,232**

SILENT HUNTER, LLC (FLORIDA LIMITED LIABILITY COMPANY)  
9200 AVIATION BLVD.  
MARATHON, FL 33050

**Registered May 1, 2012**

**Int. Cl.: 25**

FOR: SHORT-SLEEVED OR LONG-SLEEVED T-SHIRTS, IN CLASS 25 (U.S. CLS. 22 AND 39).

**TRADEMARK**

FIRST USE 1-1-2011; IN COMMERCE 10-1-2011.

**SUPPLEMENTAL REGISTER**

THE MARK CONSISTS OF STANDARD CHARACTERS WITHOUT CLAIM TO ANY PARTICULAR FONT, STYLE, SIZE, OR COLOR.

SER. NO. 85-460,004, FILED P.R. 10-31-2011; AM. S.R. 2-23-2012.

LOURDES AYALA, EXAMINING ATTORNEY



*David J. Kyffers*

Director of the United States Patent and Trademark Office

# United States of America

United States Patent and Trademark Office

# Celtic Solo

**Reg. No. 4,137,233**

LEE GROUP INTERNATIONAL, INC. (ILLINOIS CORPORATION)  
910 W. VAN BUREN ST., #191  
CHICAGO, IL 60607

**Registered May 1, 2012**

**Int. Cl.: 25**

FOR: DANCE COSTUMES, IN CLASS 25 (U.S. CLS. 22 AND 39).

**TRADEMARK**

FIRST USE 6-1-2010; IN COMMERCE 6-1-2010.

**SUPPLEMENTAL REGISTER**

THE MARK CONSISTS OF STANDARD CHARACTERS WITHOUT CLAIM TO ANY PARTICULAR FONT, STYLE, SIZE, OR COLOR.

NO CLAIM IS MADE TO THE EXCLUSIVE RIGHT TO USE "SOLO", APART FROM THE MARK AS SHOWN.

SER. NO. 85-462,664, FILED P.R. 11-2-2011; AM. S.R. 2-23-2012.

MARC LEIPZIG, EXAMINING ATTORNEY



*David J. Kyffers*

Director of the United States Patent and Trademark Office



# United States of America

United States Patent and Trademark Office

## American Gasser

**Reg. No. 4,137,234**

**Registered May 1, 2012**

**Int. Cl.: 40**

**SERVICE MARK**

**SUPPLEMENTAL REGISTER**

SHELTON, JOHN (UNITED STATES INDIVIDUAL)  
8834 NORWALK RD.  
LITCHFIELD, OH 44253

FOR: MOLDING AND FABRICATING ROLLING CHASSIS, UNFINISHED CARS, AND COMPLETE TURNKEY CARS, NAMELY, CUSTOM MANUFACTURING OF REPLICA GASSER ERA CARS AND THEIR PARTS; MOLDING AND FABRICATING AUTO RELATED ITEMS, NAMELY, MANUFACTURING OF CARS TO THE ORDER AND/OR SPECIFICATION OF OTHERS; CUSTOM BUILDING OF ROLLING CHASSIS, UNFINISHED CARS, AND COMPLETE TURNKEY CARS, IN CLASS 40 (U.S. CLS. 100, 103 AND 106).

FIRST USE 7-1-2008; IN COMMERCE 7-1-2008.

THE MARK CONSISTS OF STANDARD CHARACTERS WITHOUT CLAIM TO ANY PARTICULAR FONT, STYLE, SIZE, OR COLOR.

SER. NO. 85-463,431, FILED P.R. 11-3-2011; AM. S.R. 3-6-2012.

MARK SHINER, EXAMINING ATTORNEY



*David J. Kyffers*

Director of the United States Patent and Trademark Office

# United States of America

United States Patent and Trademark Office

## AMERICAN RAT CONTROL

**Reg. No. 4,137,235**

AMERICAN RAT CONTROL, INC. (CALIFORNIA CORPORATION)  
11216 GREENLAWN AVE.  
CULVER CITY, CA 90230

**Registered May 1, 2012**

**Int. Cl.: 37**

FOR: PEST CONTROL AND EXTERMINATION OTHER THAN FOR AGRICULTURAL PURPOSES, IN CLASS 37 (U.S. CLS. 100, 103 AND 106).

**SERVICE MARK**

FIRST USE 9-21-2011; IN COMMERCE 9-21-2011.

**SUPPLEMENTAL REGISTER**

THE MARK CONSISTS OF STANDARD CHARACTERS WITHOUT CLAIM TO ANY PARTICULAR FONT, STYLE, SIZE, OR COLOR.

NO CLAIM IS MADE TO THE EXCLUSIVE RIGHT TO USE "RAT CONTROL", APART FROM THE MARK AS SHOWN.

SER. NO. 85-463,564, FILED P.R. 11-3-2011; AM. S.R. 3-8-2012.

ALEX KEAM, EXAMINING ATTORNEY



*David J. Kyros*

Director of the United States Patent and Trademark Office

# United States of America

United States Patent and Trademark Office

## CALIFORNIA CANDY FESTIVAL

**Reg. No. 4,137,236**

**Registered May 1, 2012**

**Int. Cl.: 36**

**SERVICE MARK**

**SUPPLEMENTAL REGISTER**

FAIRFIELD AND SUISUN PUBLIC EDUCATION FOUNDATION (CALIFORNIA PUBLIC BENEFIT CORPORATION)  
1261 TRAVIS BOULEVARD, SUITE 350  
FAIRFIELD, CA 94533

FOR: CHARITABLE FUNDRAISING TO SUPPORT THE FAIRFIELD AND SUISUN PUBLIC EDUCATION FOUNDATION; CHARITABLE SERVICES, NAMELY, ORGANIZING FUNDRAISING SERVICES AND EVENTS TO RAISE FUNDS IN THE FIELD OF PUBLIC EDUCATION; FUNDRAISING SERVICES, NAMELY, ORGANIZING FUNDRAISERS FOR SCHOOLS AND OTHER GROUPS, IN CLASS 36 (U.S. CLS. 100, 101 AND 102).

FIRST USE 9-1-2011; IN COMMERCE 9-1-2011.

THE MARK CONSISTS OF STANDARD CHARACTERS WITHOUT CLAIM TO ANY PARTICULAR FONT, STYLE, SIZE, OR COLOR.

SER. NO. 85-463,940, FILED P.R. 11-3-2011; AM. S.R. 3-4-2012.

SHAUNIA CARLYLE, EXAMINING ATTORNEY



*David J. Kyffers*

Director of the United States Patent and Trademark Office

# United States of America

United States Patent and Trademark Office

## MAGNET LEARNING COMMUNITIES

**Reg. No. 4,137,237**

**Registered May 1, 2012**

**Int. Cl.: 41**

**SERVICE MARK**

**SUPPLEMENTAL REGISTER**

AMERICAN NURSES CREDENTIALING CENTER (MARYLAND CORPORATION)  
8515 GEORGIA AVENUE, SUITE 400  
SILVER SPRING, MD 20910

FOR: EDUCATION SERVICES, NAMELY, PROVIDING LIVE AND ON-LINE DISCUSSION AND LEARNING THROUGH SEMINARS FROM MAGNET DESIGNATED FACILITIES IN THE FIELD OF HEALTH AND PATIENT CARE AND DISTRIBUTION OF TRAINING MATERIALS THEREWITH; EDUCATIONAL SERVICES, NAMELY, PROVIDING ON-LINE SEMINARS FOR LEARNING THE SHARED BEST PRACTICES, RESOURCES, RESEARCH, EXPERIENCE, AND STRATEGIES IN THE FIELD OF NURSING PRACTICE AND DISTRIBUTION OF TRAINING MATERIALS THEREWITH; PROVIDING INFORMATION IN THE FIELD OF NURSING EDUCATION VIA THE INTERNET, IN CLASS 41 (U.S. CLS. 100, 101 AND 107).

FIRST USE 9-1-2011; IN COMMERCE 9-1-2011.

THE MARK CONSISTS OF STANDARD CHARACTERS WITHOUT CLAIM TO ANY PARTICULAR FONT, STYLE, SIZE, OR COLOR.

SER. NO. 85-467,094, FILED P.R. 11-8-2011; AM. S.R. 3-7-2012.

MAYUR VAGHANI, EXAMINING ATTORNEY



*David J. Kyffers*

Director of the United States Patent and Trademark Office

# United States of America

United States Patent and Trademark Office

## BRANDED CONSUMER EXPERIENCES

**Reg. No. 4,137,238**

**Registered May 1, 2012**

**Int. Cl.: 35**

**SERVICE MARK**

**SUPPLEMENTAL REGISTER**

BRAND CONNECTIONS, LLC (NEW JERSEY LIMITED LIABILITY COMPANY)  
20TH FLOOR  
561 SEVENTH AVENUE  
NEW YORK, NY 10018

FOR: ADVERTISING AGENCY SPECIALIZING IN THE DESIGN AND EXECUTION OF WORD OF MOUTH, VIRAL, BUZZ, EXPERIENTIAL AND VENUE-BASED MARKETING PROGRAMS; ADVERTISING AND MARKETING SERVICES, NAMELY, PROMOTING THE GOODS AND SERVICES OF OTHERS; ARRANGING AND CONDUCTING SPECIAL EVENTS AND VENUE-BASED EVENTS FOR COMMERCIAL, PROMOTIONAL OR ADVERTISING PURPOSES, IN CLASS 35 (U.S. CLS. 100, 101 AND 102).

FIRST USE 8-0-2011; IN COMMERCE 8-0-2011.

THE MARK CONSISTS OF STANDARD CHARACTERS WITHOUT CLAIM TO ANY PARTICULAR FONT, STYLE, SIZE, OR COLOR.

SER. NO. 85-467,816, FILED P.R. 11-9-2011; AM. S.R. 3-8-2012.

MEGHAN REINHART, EXAMINING ATTORNEY



*David J. Kyros*

Director of the United States Patent and Trademark Office

# United States of America

United States Patent and Trademark Office

## Active Sync Smart Technology

**Reg. No. 4,137,239**

**Registered May 1, 2012**

**Int. Cl.: 9**

**TRADEMARK**

**SUPPLEMENTAL REGISTER**

TAW~GLOBAL, LLC (MICHIGAN LIMITED LIABILITY COMPANY)  
SUITE 211  
8135 COX'S DR.  
PORTAGE, MI 49002

FOR: ACTIVE SHUTTER UNIVERSAL SOLD AS A FEATURE OF 3D GLASSES, IN CLASS  
9 (U.S. CLS. 21, 23, 26, 36 AND 38).

FIRST USE 4-1-2011; IN COMMERCE 4-1-2011.

THE MARK CONSISTS OF STANDARD CHARACTERS WITHOUT CLAIM TO ANY PAR-  
TICULAR FONT, STYLE, SIZE, OR COLOR.

SER. NO. 85-468,577, FILED P.R. 11-9-2011; AM. S.R. 3-8-2012.

JAMES A. RAUEN, EXAMINING ATTORNEY



*David J. Kyffers*

Director of the United States Patent and Trademark Office

# United States of America

United States Patent and Trademark Office

# TechBldrs

**Reg. No. 4,137,240**

**Registered May 1, 2012**

**Int. Cl.: 42**

**SERVICE MARK**

**SUPPLEMENTAL REGISTER**

TECHBLDRS INC (PENNSYLVANIA CORPORATION)  
120 E UWCHLAN AVE  
EXTON, PA 19341

FOR: COMPUTER PROGRAMMING AND RENTAL OF COMPUTER PROGRAMS; COMPUTER PROGRAMMING AND SOFTWARE DESIGN; COMPUTER SERVICES, NAMELY, REMOTE AND ON-SITE MANAGEMENT OF THE INFORMATION TECHNOLOGY (IT) SYSTEMS OF OTHERS; CONSULTING IN THE FIELD OF IT PROJECT MANAGEMENT; CONSULTING SERVICES IN THE FIELD OF OFFICE AND WORKPLACE AUTOMATION; IT CONSULTING SERVICES, IN CLASS 42 (U.S. CLS. 100 AND 101).

FIRST USE 7-1-2008; IN COMMERCE 7-1-2008.

THE MARK CONSISTS OF STANDARD CHARACTERS WITHOUT CLAIM TO ANY PARTICULAR FONT, STYLE, SIZE, OR COLOR.

SER. NO. 85-470,177, FILED P.R. 11-11-2011; AM. S.R. 3-8-2012.

MEGHAN REINHART, EXAMINING ATTORNEY



*David J. Kyjars*

Director of the United States Patent and Trademark Office

# United States of America

United States Patent and Trademark Office

## American Journal of Managed Oncology

**Reg. No. 4,137,241**

**Registered May 1, 2012**

**Int. Cls.: 9, 16, and 41**

**TRADEMARK**

**SERVICE MARK**

**SUPPLEMENTAL REGISTER**

INTELLISPHERE, LLC (DELAWARE LIMITED LIABILITY COMPANY)  
BUILDING 300  
666 PLAINSBORO ROAD  
PLAINSBORO, NJ 08536

FOR: DOWNLOADABLE ELECTRONIC PUBLICATIONS IN THE NATURE OF JOURNALS AND ARTICLES IN THE FIELD OF ONCOLOGY, IN CLASS 9 (U.S. CLS. 21, 23, 26, 36 AND 38).

FIRST USE 11-10-2011; IN COMMERCE 11-10-2011.

FOR: PUBLICATIONS, NAMELY, JOURNALS IN THE FIELDS OF ONCOLOGY, IN CLASS 16 (U.S. CLS. 2, 5, 22, 23, 29, 37, 38 AND 50).

FIRST USE 10-26-2011; IN COMMERCE 10-26-2011.

FOR: PROVIDING A WEBSITE FEATURING NON-DOWNLOADABLE PUBLICATIONS IN THE NATURE OF JOURNALS AND ARTICLES IN THE FIELD OF ONCOLOGY, IN CLASS 41 (U.S. CLS. 100, 101 AND 107).

FIRST USE 11-10-2011; IN COMMERCE 11-10-2011.

THE MARK CONSISTS OF STANDARD CHARACTERS WITHOUT CLAIM TO ANY PARTICULAR FONT, STYLE, SIZE, OR COLOR.

NO CLAIM IS MADE TO THE EXCLUSIVE RIGHT TO USE "JOURNAL", APART FROM THE MARK AS SHOWN.

SER. NO. 85-471,057, FILED 11-12-2011.

CHRISTOPHER SIDOTI, EXAMINING ATTORNEY



*David J. Kybas*

Director of the United States Patent and Trademark Office



# United States of America

United States Patent and Trademark Office

## Oncology Business News

**Reg. No. 4,137,242**

**Registered May 1, 2012**

**Int. Cls.: 9, 16, and 41**

**TRADEMARK**

**SERVICE MARK**

**SUPPLEMENTAL REGISTER**

INTELLISPHERE, LLC (DELAWARE LIMITED LIABILITY COMPANY)  
BUILDING 300  
666 PLAINSBORO ROAD  
PLAINSBORO, NJ 08535

FOR: DOWNLOADABLE ELECTRONIC PUBLICATIONS IN THE NATURE OF JOURNALS AND ARTICLES IN THE FIELD OF ONCOLOGY, IN CLASS 9 (U.S. CLS. 21, 23, 26, 36 AND 38).

FIRST USE 11-10-2011; IN COMMERCE 11-10-2011.

FOR: PUBLICATIONS, NAMELY, JOURNALS AND ARTICLES IN THE FIELDS OF ONCOLOGY, IN CLASS 16 (U.S. CLS. 2, 5, 22, 23, 29, 37, 38 AND 50).

FIRST USE 10-26-2011; IN COMMERCE 10-26-2011.

FOR: PROVIDING A WEBSITE FEATURING NON-DOWNLOADABLE PUBLICATIONS IN THE NATURE OF JOURNALS AND ARTICLES IN THE FIELD OF ONCOLOGY, IN CLASS 41 (U.S. CLS. 100, 101 AND 107).

FIRST USE 11-10-2011; IN COMMERCE 11-10-2011.

THE MARK CONSISTS OF STANDARD CHARACTERS WITHOUT CLAIM TO ANY PARTICULAR FONT, STYLE, SIZE, OR COLOR.

NO CLAIM IS MADE TO THE EXCLUSIVE RIGHT TO USE "NEWS", APART FROM THE MARK AS SHOWN.

SER. NO. 85-471,071, FILED 11-12-2011.

CHRISTOPHER SIDOTI, EXAMINING ATTORNEY



*David J. Kyffers*

Director of the United States Patent and Trademark Office

# United States of America

United States Patent and Trademark Office



**Reg. No. 4,137,243**

**Registered May 1, 2012**

**Int. Cl.: 37**

**SERVICE MARK**

**SUPPLEMENTAL REGISTER**

DEFALCO, GUS (UNITED STATES INDIVIDUAL)  
204 COLUMBIA  
NEWPORT BEACH, CA 92663 AND

DEFALCO, JENNIFER (UNITED STATES INDIVIDUAL)  
204 COLUMBIA  
NEWPORT BEACH, CA 92663

FOR: REFINISHING OF HARDWOOD FLOORS, IN CLASS 37 (U.S. CLS. 100, 103 AND 106).

FIRST USE 1-1-2000; IN COMMERCE 1-1-2000.

THE MARK CONSISTS OF A RECTANGLE CONTAINING THE STYLIZED TEXT "OC ORANGE COUNTY DUST FREE DUST FREE HARDWOOD FLOOR REFINISHING". THE PHRASE "OC DUST FREE" IS IN THE CENTER ABOVE THE PHRASE "DUST FREE HARDWOOD FLOOR REFINISHING". IN THE UPPER RIGHT OF THE RECTANGLE ARE THE WORDS "ORANGE COUNTY".

SER. NO. 85-471,428, FILED P.R. 11-14-2011; AM. S.R. 3-5-2012.

MARGERY A. TIERNEY, EXAMINING ATTORNEY



*David J. Kybas*

Director of the United States Patent and Trademark Office

# United States of America

United States Patent and Trademark Office

## NATIONAL TELEMETRY ASSOCIATION

**Reg. No. 4,137,244**

**Registered May 1, 2012**

**Int. Cls.: 16 and 35**

**TRADEMARK**

**SERVICE MARK**

**SUPPLEMENTAL REGISTER**

NATIONAL TELEMETRY ASSOCIATION, LLC (MICHIGAN LIMITED LIABILITY COMPANY)  
6184 NORTH NORBORNE COURT  
DEARBORN, MI 48127

FOR: EDUCATIONAL PUBLICATIONS, NAMELY, EDUCATIONAL LEARNING CARDS, FLASH CARDS, ACTIVITY CARDS, WORKBOOKS, TEXTBOOKS, ACTIVITY BOOKS, STORY BOOKS, PUZZLE BOOKS, PRINTED PUZZLES, TEACHER GUIDES, MANUALS, POSTERS AND EDUCATIONAL BOOKLETS IN THE FIELD OF MEDICAL TELEMETRY; EDUCATIONAL PUBLICATIONS, NAMELY, TRAINING MANUALS IN THE FIELD OF MEDICAL TELEMETRY; EDUCATIONAL PUBLICATIONS, NAMELY, STUDY GUIDES IN THE FIELDS OF MEDICAL TELEMETRY; GUIDE BOOKS FEATURING MEDICAL TELEMETRY; PRINTED EDUCATIONAL MATERIALS IN THE FIELD OF MEDICAL TELEMETRY; PRINTED GUIDES FOR MEDICAL TELEMETRY; PRINTED LESSONS ON FOR MEDICAL TELEMETRY; STUDY GUIDES, IN CLASS 16 (U.S. CLS. 2, 5, 22, 23, 29, 37, 38 AND 50).

FIRST USE 8-1-2011; IN COMMERCE 8-1-2011.

FOR: ASSOCIATION SERVICES, NAMELY, PROMOTING THE INTERESTS OF THOSE WORKING TOWARD CERTIFICATION AS A TELEMETRY TECHNICIAN; BUSINESS SERVICES, NAMELY, DESIGN, DEVELOPMENT AND ANALYSIS OF TESTS FOR TESTING PROFESSIONAL COMPETENCY; TESTING TO DETERMINE JOB COMPETENCY; TESTING TO DETERMINE PROFESSIONAL COMPETENCY, IN CLASS 35 (U.S. CLS. 100, 101 AND 102).

FIRST USE 8-1-2011; IN COMMERCE 8-1-2011.

THE MARK CONSISTS OF STANDARD CHARACTERS WITHOUT CLAIM TO ANY PARTICULAR FONT, STYLE, SIZE, OR COLOR.

NO CLAIM IS MADE TO THE EXCLUSIVE RIGHT TO USE "ASSOCIATION", APART FROM THE MARK AS SHOWN.

SER. NO. 85-472,076, FILED P.R. 11-14-2011; AM. S.R. 3-7-2012.

HOWARD SMIGA, EXAMINING ATTORNEY



*David J. Kypos*

Director of the United States Patent and Trademark Office

# United States of America

United States Patent and Trademark Office

# ResalesDVC

**Reg. No. 4,137,245**

**Registered May 1, 2012**

**Int. Cl.: 36**

**SERVICE MARK**

**SUPPLEMENTAL REGISTER**

GARDEN VIEWS REALTY, INC (FLORIDA CORPORATION), DBA RESALES DVC.COM,  
213 HARBOR DR  
WINTER GARDEN, FL 34787

FOR: PROVIDING REAL ESTATE LISTINGS AND REAL ESTATE INFORMATION VIA THE  
INTERNET; VACATION REAL ESTATE TIMESHARE SERVICES, IN CLASS 36 (U.S. CLS.  
100, 101 AND 102).

FIRST USE 10-0-2007; IN COMMERCE 10-0-2007.

THE MARK CONSISTS OF STANDARD CHARACTERS WITHOUT CLAIM TO ANY PAR-  
TICULAR FONT, STYLE, SIZE, OR COLOR.

SER. NO. 85-473,257, FILED P.R. 11-15-2011; AM. S.R. 11-15-2011.

ROBIN CHOSID, EXAMINING ATTORNEY



*David J. Kyffers*

Director of the United States Patent and Trademark Office

# United States of America

United States Patent and Trademark Office

## CITY SUPPORT

**Reg. No. 4,137,246**

CITY SUPPORT, LLC (TEXAS LIMITED LIABILITY COMPANY)  
P.O. BOX 868  
HOWE, TX 75459

**Registered May 1, 2012**

**Int. Cl.: 35**

FOR: MANAGING ALARM BILLING FOR MUNICIPALITIES, IN CLASS 35 (U.S. CLS. 100, 101 AND 102).

**SERVICE MARK**

FIRST USE 9-1-2009; IN COMMERCE 9-1-2009.

**SUPPLEMENTAL REGISTER**

THE MARK CONSISTS OF STANDARD CHARACTERS WITHOUT CLAIM TO ANY PARTICULAR FONT, STYLE, SIZE, OR COLOR.

SER. NO. 85-473,756, FILED P.R. 11-16-2011; AM. S.R. 3-6-2012.

KIM MONINGHOFF, EXAMINING ATTORNEY



*David J. Kybas*

Director of the United States Patent and Trademark Office

# United States of America

United States Patent and Trademark Office

## 200COLUMBUS

**Reg. No. 4,137,247**

**Registered May 1, 2012**

**Int. Cls.: 35 and 41**

COLUMBUS BICENTENNIAL 2012, INC. (AFGHANISTAN CORPORATION), DBA 200 COLUMBUS,  
C/O J. GREEN/ACP VISIONING+PLANNING, LTD  
1269 GRANDVIEW AVENUE  
COLUMBUS, OH 43212

**SERVICE MARK**

**SUPPLEMENTAL REGISTER**

FOR: ADVERTISING AND MARKETING SERVICES PROVIDED BY MEANS OF INDIRECT METHODS OF MARKETING COMMUNICATIONS, NAMELY, SOCIAL MEDIA, SEARCH ENGINE MARKETING, INQUIRY MARKETING, INTERNET MARKETING, MOBILE MARKETING, BLOGGING AND OTHER FORMS OF PASSIVE, SHARABLE OR VIRAL COMMUNICATIONS CHANNELS; PROMOTING THE ECONOMIC DEVELOPMENT IN THE CITY OF COLUMBUS; PROVIDING MARKETING AND PROMOTION OF SPECIAL EVENTS; SPECIAL EVENT PLANNING FOR BUSINESS PURPOSES; SPECIAL EVENT PLANNING FOR COMMERCIAL, PROMOTIONAL OR ADVERTISING PURPOSES, IN CLASS 35 (U.S. CLS. 100, 101 AND 102).

FIRST USE 2-8-2011; IN COMMERCE 2-8-2011.

FOR: ACADEMIC ENRICHMENT PROGRAMS IN THE FIELD(S) OF COLUMBUS, OHIO HISTORY; ARRANGING AND CONDUCTING SPECIAL EVENTS FOR SOCIAL ENTERTAINMENT PURPOSES; ORGANIZING COMMUNITY FESTIVALS FEATURING PRIMARILY EXHIBITIONS FOR COLUMBUS' BICENTENNIAL CELEBRATION AND ALSO PROVIDING COMMUNITY SPORTING EVENTS AND CULTURAL AND ARTS EVENTS, IN CLASS 41 (U.S. CLS. 100, 101 AND 107).

FIRST USE 2-8-2011; IN COMMERCE 2-8-2011.

THE MARK CONSISTS OF STANDARD CHARACTERS WITHOUT CLAIM TO ANY PARTICULAR FONT, STYLE, SIZE, OR COLOR.

SER. NO. 85-473,819, FILED 11-16-2011.

MICHELE SWAIN, EXAMINING ATTORNEY



*David J. Kyros*

Director of the United States Patent and Trademark Office

# United States of America

United States Patent and Trademark Office

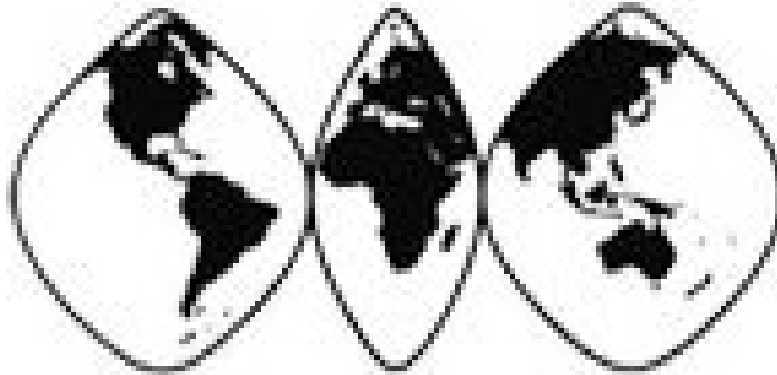

**Reg. No. 4,137,248**

**Registered May 1, 2012**

**Int. Cl.: 18**

**TRADEMARK**

**SUPPLEMENTAL REGISTER**

WORLD TRADE CENTERS ASSOCIATION, INC. (DELAWARE NON-PROFIT CORPORATION)  
420 LEXINGTON AVENUE, SUITE 518  
NEW YORK, NY 10170

FOR: LEATHER BINDERS FOR TRAVEL PURPOSES, WALLETS INCLUDING CARD HOLDERS/WITH CARD COMPARTMENTS, STRAPS FOR CARRYING CASES, UMBRELLAS , IN CLASS 18 (U.S. CLS. 1, 2, 3, 22 AND 41).

FIRST USE 5-0-1973; IN COMMERCE 5-0-1973.

OWNER OF U.S. REG. NOS. 1,011,720, 1,469,489, AND 1,749,086.

THE MARK CONSISTS OF THREE CONJOINED OVAL MAPS.

SER. NO. 85-474,018, FILED 11-16-2011.

PATRICIA EVANKO, EXAMINING ATTORNEY



*David J. Kyffers*

Director of the United States Patent and Trademark Office

# United States of America

United States Patent and Trademark Office

## THE MOST TRUSTED PLACE TO BUY TRAVERTINE

**Reg. No. 4,137,249**

WHOLESALE STONE LLC (FLORIDA LIMITED LIABILITY COMPANY)  
940 LINCOLN ROAD, SUITE 207  
MIAMI BEACH, FL 33139

**Registered May 1, 2012**

**Int. Cl.: 35**

FOR: ON-LINE WHOLESALE AND RETAIL STORE SERVICES FEATURING TRAVERTINE  
AND MARBLE NATURAL STONE PRODUCTS, IN CLASS 35 (U.S. CLS. 100, 101 AND 102).

**SERVICE MARK**

FIRST USE 11-14-2011; IN COMMERCE 11-14-2011.

**SUPPLEMENTAL REGISTER**

THE MARK CONSISTS OF STANDARD CHARACTERS WITHOUT CLAIM TO ANY PAR-  
TICULAR FONT, STYLE, SIZE, OR COLOR.

NO CLAIM IS MADE TO THE EXCLUSIVE RIGHT TO USE "TRAVERTINE", APART FROM  
THE MARK AS SHOWN.

SER. NO. 85-474,218, FILED P.R. 11-16-2011; AM. S.R. 3-8-2012.

BARBARA GAYNOR, EXAMINING ATTORNEY



*David J. Kybas*

Director of the United States Patent and Trademark Office



# United States of America

United States Patent and Trademark Office

## KidsComics.com

**Reg. No. 4,137,250**

**Registered May 1, 2012**

**Int. Cl.: 41**

**SERVICE MARK**

**SUPPLEMENTAL REGISTER**

DIAMOND COMIC DISTRIBUTORS, INC. (MARYLAND CORPORATION)  
SUITE 300  
1966 GREENSPRING DRIVE  
TIMONIUM, MD 21093

FOR: EDUCATION AND ENTERTAINMENT SERVICES, NAMELY, PROVIDING A WEBSITE IN THE FIELD OF KID-FRIENDLY COMIC BOOKS FEATURING NEWS, STORY SUMMARIES, ONLINE GAMES AND ONLINE NONDOWNLOADABLE KID-FRIENDLY COMIC BOOKS, IN CLASS 41 (U.S. CLS. 100, 101 AND 107).

FIRST USE 3-15-2010; IN COMMERCE 3-15-2010.

THE MARK CONSISTS OF STANDARD CHARACTERS WITHOUT CLAIM TO ANY PARTICULAR FONT, STYLE, SIZE, OR COLOR.

SER. NO. 85-474,800, FILED P.R. 11-16-2011; AM. S.R. 3-6-2012.

ELLEN BURNS, EXAMINING ATTORNEY



*David J. Kybas*

Director of the United States Patent and Trademark Office

# United States of America

United States Patent and Trademark Office

## Human Liberty Campaign

**Reg. No. 4,137,251**

**Registered May 1, 2012**

**Int. Cl.: 36**

**SERVICE MARK**

**SUPPLEMENTAL REGISTER** FIRST USE 10-1-2011; IN COMMERCE 11-13-2011.

COMMON GOOD (VIRGINIA CORPORATION), DBA GOOD OF ALL,  
P.O. BOX 2490  
MERRIFIELD, VA 22116

FOR: CHARITABLE SERVICES, NAMELY, COLLABORATIVE CHARITABLE FUNDRAISING THROUGHOUT THE WORLD TO PROVIDE AID AND RELIEF TO VICTIMS OF POVERTY, SLAVERY, HUMAN TRAFFICKING, CHILD LABOR, VIOLENCE AND OTHER HUMAN DEGRADATION, IN CLASS 36 (U.S. CLS. 100, 101 AND 102).

THE MARK CONSISTS OF STANDARD CHARACTERS WITHOUT CLAIM TO ANY PARTICULAR FONT, STYLE, SIZE, OR COLOR.

NO CLAIM IS MADE TO THE EXCLUSIVE RIGHT TO USE "CAMPAIGN", APART FROM THE MARK AS SHOWN.

SER. NO. 85-474,875, FILED 11-17-2011.

FRED CARL, EXAMINING ATTORNEY



*David J. Kyffers*

Director of the United States Patent and Trademark Office

# United States of America

United States Patent and Trademark Office

# 6:1

**Reg. No. 4,137,252**

**Registered May 1, 2012**

**Int. Cl.: 5**

**TRADEMARK**

**SUPPLEMENTAL REGISTER**

LETHI, LLC (CALIFORNIA LIMITED LIABILITY COMPANY)  
C/O NATIONAL REGISTERED AGENTS, INC.  
23586 CALABASAS ROAD-STE 102  
CALABASAS, CA 91302

FOR: NUTRITIONAL FOOD BARS FOR USE AS A MEAL REPLACEMENT; NUTRITIONAL SUPPLEMENTS; DIETARY AND NUTRITIONAL SUPPLEMENTS, IN CLASS 5 (U.S. CLS. 6, 18, 44, 46, 51 AND 52).

FIRST USE 3-1-2012; IN COMMERCE 3-1-2012.

THE MARK CONSISTS OF STANDARD CHARACTERS WITHOUT CLAIM TO ANY PARTICULAR FONT, STYLE, SIZE, OR COLOR.

OWNER OF U.S. REG. NOS. 3,797,736 AND 3,862,289.

SER. NO. 85-475,488, FILED P.R. 11-17-2011; AM. S.R. 3-12-2012.

KEVIN DINALLO, EXAMINING ATTORNEY



*David J. Kyffers*

Director of the United States Patent and Trademark Office

# United States of America

United States Patent and Trademark Office

## COLORADO INSTITUTE FOR MATERNAL & FETAL HEALTH

**Reg. No. 4,137,253**

CHILDREN'S HOSPITAL COLORADO (COLORADO NON-PROFIT CORPORATION)  
13123 EAST 16TH AVENUE  
AURORA, CO 80045

**Registered May 1, 2012**

**Int. Cl.: 44**

FOR: HEALTH CARE, IN CLASS 44 (U.S. CLS. 100 AND 101).

**SERVICE MARK**

FIRST USE 6-11-2011; IN COMMERCE 6-11-2011.

**SUPPLEMENTAL REGISTER**

THE MARK CONSISTS OF STANDARD CHARACTERS WITHOUT CLAIM TO ANY PARTICULAR FONT, STYLE, SIZE, OR COLOR.

NO CLAIM IS MADE TO THE EXCLUSIVE RIGHT TO USE "INSTITUTE", APART FROM THE MARK AS SHOWN.

SER. NO. 85-475,554, FILED P.R. 11-17-2011; AM. S.R. 3-6-2012.

ELLEN B. AWRICH, EXAMINING ATTORNEY



*David J. Kyffers*

Director of the United States Patent and Trademark Office

# United States of America

United States Patent and Trademark Office

## WEIGHT LOSS 18 MINUTES

**Reg. No. 4,137,254**

**Registered May 1, 2012**

**Int. Cl.: 9**

**TRADEMARK**

**SUPPLEMENTAL REGISTER**

WEIGHT LOSS 18 MINUTES, INC. (CALIFORNIA CORPORATION)  
199 E. LINDA MESA, SUITE 3  
DANVILLE, CA 94526

FOR: DOWNLOADABLE AUDIO FILES, MULTIMEDIA FILES, TEXT FILES AND E-MAILS  
IN THE FIELD OF SELF-HELP FOR NUTRITION AND DIETING, IN CLASS 9 (U.S. CLS. 21,  
23, 26, 36 AND 38).

FIRST USE 4-15-2011; IN COMMERCE 10-25-2011.

THE MARK CONSISTS OF STANDARD CHARACTERS WITHOUT CLAIM TO ANY PAR-  
TICULAR FONT, STYLE, SIZE, OR COLOR.

NO CLAIM IS MADE TO THE EXCLUSIVE RIGHT TO USE "WEIGHT LOSS", APART FROM  
THE MARK AS SHOWN.

SER. NO. 85-475,975, FILED 11-17-2011.

JAY FLOWERS, EXAMINING ATTORNEY



*David J. Kybas*

Director of the United States Patent and Trademark Office

# United States of America

United States Patent and Trademark Office

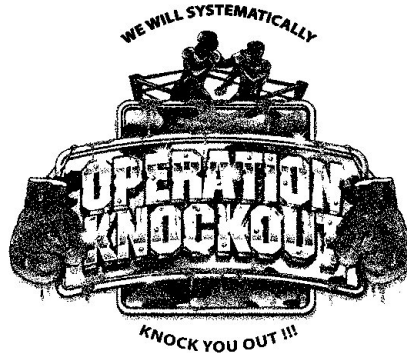

**Reg. No. 4,137,255**

**Registered May 1, 2012**

**Int. Cl.: 25**

**TRADEMARK**

**SUPPLEMENTAL REGISTER**

BAILEY, MARTIN (UNITED STATES INDIVIDUAL)  
3731 RAINOVER DR.  
DECATUR, GA 30034

FOR: BOOTS; HATS; JACKETS; SHIRTS; SHORTS; TRUNKS, IN CLASS 25 (U.S. CLS. 22 AND 39).

FIRST USE 6-30-2011; IN COMMERCE 6-30-2011.

THE STIPLING IS FOR SHADING PURPOSES ONLY.

THE MARK CONSISTS OF AN IMAGE OF TWO MEN FIGHTING IN A BOXING RING. THE MAN ON THE LEFT HAS A PATCH ON THE BACK OF HIS HEAD AND IS PUNCHING THE MAN ON THE RIGHT WITH HIS LEFT HAND. BLOOD IS SPILLING OUT OF THE RING. THERE IS A ROUNDED SQUARE WITH A BORDER AROUND IT BELOW THE BOXING RING. ACROSS THE SQUARE IS A ROUNDED RECTANGLE THAT DISPLAYS THE STYLIZED TEXT "OPERATION" ABOVE THE STYLIZED TEXT "KNOCKOUT". THERE IS A BOXING GLOVE ON EACH SIDE OF THE RECTANGLE. BLOOD IS DRIPPING FROM THE BOXING RING, DOWN ACROSS ALL THE TEXT AND IMAGES BELOW IT. ARCHING ABOVE THE BOXING RING IS THE STYLIZED TEXT "WE WILL SYSTEMATICALLY" AND ARCHING BELOW THE ROUNDED SQUARE IS THE STYLIZED TEXT "KNOCK YOU OUT!!!".

SER. NO. 85-476,341, FILED P.R. 11-18-2011; AM. S.R. 3-6-2012.

JAMES LOVELACE, EXAMINING ATTORNEY



*David J. Kyffers*

Director of the United States Patent and Trademark Office

# United States of America

United States Patent and Trademark Office

## THE FLYING CHEF

**Reg. No. 4,137,256**

**Registered May 1, 2012**

**Int. Cls.: 41 and 43**

**SERVICE MARK**

**SUPPLEMENTAL REGISTER**

TRAILSIDE GOURMET LLC (ALASKA LIMITED LIABILITY COMPANY)  
9138 ARLON ST # A3-107  
ANCHORAGE, AK 99507

FOR: EDUCATION SERVICES, NAMELY, PROVIDING ON-LINE NON-DOWNLOADABLE INSTRUCTIONAL VIDEOS IN THE FIELD OF GOURMET COOKING AND COOKING; ENTERTAINMENT, NAMELY, A CONTINUING GOURMET COOKING AND COOKING SHOW BROADCAST OVER TELEVISION, SATELLITE, AUDIO, AND VIDEO MEDIA; PROVIDING ON-LINE PUBLICATIONS IN THE NATURE OF ON-LINE NON-DOWNLOADABLE INSTRUCTIONAL VIDEOS AND ARTICLES IN THE FIELD OF GOURMET COOKING AND COOKING, IN CLASS 41 (U.S. CLS. 100, 101 AND 107).

FIRST USE 8-15-2008; IN COMMERCE 8-15-2008.

FOR: CATERING SERVICES, IN CLASS 43 (U.S. CLS. 100 AND 101).

FIRST USE 8-15-2008; IN COMMERCE 8-15-2008.

THE MARK CONSISTS OF STANDARD CHARACTERS WITHOUT CLAIM TO ANY PARTICULAR FONT, STYLE, SIZE, OR COLOR.

SER. NO. 85-478,396, FILED P.R. 11-21-2011; AM. S.R. 3-7-2012.

ALEX KEAM, EXAMINING ATTORNEY



*David J. Kybas*

Director of the United States Patent and Trademark Office

United States of America  
United States Patent and Trademark Office

# LYSHOLM

**Reg. No. 4,137,257**

**Registered May 1, 2012**

**Int. Cl.: 7**

AIRPOWER GROUP, INC. (CALIFORNIA CORPORATION)  
LEGAL DEPARTMENT  
1650 PACIFIC AVENUE  
OXNARD, CA 93033

FOR: AIR COMPRESSORS, IN CLASS 7 (U.S. CLS. 13, 19, 21, 23, 31, 34 AND 35).

**TRADEMARK**

FIRST USE 7-31-2010; IN COMMERCE 7-31-2010.

**SUPPLEMENTAL REGISTER**

THE MARK CONSISTS OF STANDARD CHARACTERS WITHOUT CLAIM TO ANY PARTICULAR FONT, STYLE, SIZE, OR COLOR.

SER. NO. 85-479,243, FILED 11-22-2011.

DOMINIC J. FERRAIUOLO, EXAMINING ATTORNEY



*David J. Kybas*

Director of the United States Patent and Trademark Office



# United States of America

United States Patent and Trademark Office

# Texas Springs

**Reg. No. 4,137,258**

**Registered May 1, 2012**

**Int. Cl.: 32**

**TRADEMARK**

**SUPPLEMENTAL REGISTER**

D.B. MILLER, INC. (TEXAS CORPORATION)  
9333 B BROWN LANE  
AUSTIN, TX 78754

FOR: BOTTLED DRINKING WATER, IN CLASS 32 (U.S. CLS. 45, 46 AND 48).

FIRST USE 12-5-2011; IN COMMERCE 3-5-2012.

THE MARK CONSISTS OF STANDARD CHARACTERS WITHOUT CLAIM TO ANY PARTICULAR FONT, STYLE, SIZE, OR COLOR.

NO CLAIM IS MADE TO THE EXCLUSIVE RIGHT TO USE "SPRINGS", APART FROM THE MARK AS SHOWN.

SER. NO. 85-487,234, FILED P.R. 12-5-2011; AM. S.R. 3-18-2012.

CHRISIE B. KING, EXAMINING ATTORNEY



*David J. Kyffers*

Director of the United States Patent and Trademark Office

# United States of America

United States Patent and Trademark Office

## Research in Gerontological Nursing

**Reg. No. 4,137,259**

THE WYANOKE GROUP, INC. (NEW JERSEY CORPORATION)  
6900 GROVE ROAD  
THOROFARE, NH 08086

**Registered May 1, 2012**

**Int. Cl.: 16**

FOR: JOURNALS CONCERNING MEDICINE, IN CLASS 16 (U.S. CLS. 2, 5, 22, 23, 29, 37, 38 AND 50).

**TRADEMARK**

FIRST USE 9-1-2007; IN COMMERCE 9-1-2007.

**SUPPLEMENTAL REGISTER**

THE MARK CONSISTS OF STANDARD CHARACTERS WITHOUT CLAIM TO ANY PARTICULAR FONT, STYLE, SIZE, OR COLOR.

SER. NO. 85-492,358, FILED P.R. 12-11-2011; AM. S.R. 3-2-2012.

ELI HELLMAN, EXAMINING ATTORNEY



*David J. Kyffers*

Director of the United States Patent and Trademark Office

# United States of America

United States Patent and Trademark Office

## THE GLOBAL LEADER IN COMPLIANCE

**Reg. No. 4,137,260**

**Registered May 1, 2012**

**Int. Cl.: 36**

**SERVICE MARK**

**SUPPLEMENTAL REGISTER**

GOULD & LAMB, LLC (FLORIDA LIMITED LIABILITY COMPANY)  
101 RIVERFRONT BLVD., SUITE 100  
BRADENTON, FL 34205

FOR: INSURANCE SERVICES, NAMELY, PROVIDING INFORMATION AND ONLINE COMPUTER INTERFACES FOR THE PURPOSE OF REVIEW AND VERIFICATION OF MEDICARE ELIGIBILITY; INSURANCE SERVICES, NAMELY, MEDICARE COMPLIANCE SETTLEMENT CONSULTING SERVICES; REPORTING SERVICES, NAMELY, PROVIDING INFORMATION IN INSURANCE MATTERS, SPECIFICALLY IN THE FIELD OF MEDICARE COMPLIANCE, IN CLASS 36 (U.S. CLS. 100, 101 AND 102).

FIRST USE 4-10-2011; IN COMMERCE 4-10-2011.

THE MARK CONSISTS OF STANDARD CHARACTERS WITHOUT CLAIM TO ANY PARTICULAR FONT, STYLE, SIZE, OR COLOR.

SER. NO. 85-494,953, FILED 12-14-2011.

KEVON CHISOLM, EXAMINING ATTORNEY



*David J. Kyffers*

Director of the United States Patent and Trademark Office

# United States of America

United States Patent and Trademark Office

## UNIVERSAL FIT

**Reg. No. 4,137,261**

**Registered May 1, 2012**

**Int. Cl.: 12**

**TRADEMARK**

**SUPPLEMENTAL REGISTER**

MARATHON INDUSTRIES, INC. (WASHINGTON CORPORATION)  
7925 S 196TH STREET  
KENT, WA 98032

FOR: TIRES, IN CLASS 12 (U.S. CLS. 19, 21, 23, 31, 35 AND 44).

FIRST USE 4-0-2006; IN COMMERCE 4-0-2006.

THE MARK CONSISTS OF STANDARD CHARACTERS WITHOUT CLAIM TO ANY PARTICULAR FONT, STYLE, SIZE, OR COLOR.

OWNER OF U.S. REG. NOS. 3,170,307, 3,407,569, AND OTHERS.

SER. NO. 85-503,154, FILED P.R. 12-23-2011; AM. S.R. 2-14-2012.

AISHA SALEM, EXAMINING ATTORNEY



*David J. Kyffers*

Director of the United States Patent and Trademark Office

# United States of America

United States Patent and Trademark Office

## FILM TECHNOLOGY SUMMIT

**Reg. No. 4,137,262**

**Registered May 1, 2012**

**Int. Cl.: 35**

**SERVICE MARK**

**SUPPLEMENTAL REGISTER**

REED ELSEVIER PROPERTIES INC. (DELAWARE CORPORATION)  
1105 NORTH MARKET STREET  
WILMINGTON, DE 19801

FOR: ORGANIZING AND CONDUCTING CONFERENCES FOR BUSINESS PURPOSES IN THE FIELD OF ENTERTAINMENT, NAMELY, MOTION PICTURE, TELEVISION AND VIDEO PRODUCTION, FINANCING, DISTRIBUTION, PROGRAMMING, LICENSING, TECHNOLOGY, AND MULTIMEDIA ENTERTAINMENT, IN CLASS 35 (U.S. CLS. 100, 101 AND 102).

FIRST USE 10-5-2011; IN COMMERCE 10-5-2011.

THE MARK CONSISTS OF STANDARD CHARACTERS WITHOUT CLAIM TO ANY PARTICULAR FONT, STYLE, SIZE, OR COLOR.

NO CLAIM IS MADE TO THE EXCLUSIVE RIGHT TO USE "SUMMIT", APART FROM THE MARK AS SHOWN.

SER. NO. 85-507,153, FILED 1-2-2012.

LAURIE MAYES, EXAMINING ATTORNEY



*David J. Kyffers*

Director of the United States Patent and Trademark Office

# United States of America

United States Patent and Trademark Office

## FUTURE OF FILM SUMMIT

**Reg. No. 4,137,263**

**Registered May 1, 2012**

**Int. Cl.: 35**

**SERVICE MARK**

**SUPPLEMENTAL REGISTER**

REED ELSEVIER PROPERTIES INC. (DELAWARE CORPORATION)  
1105 NORTH MARKET STREET  
WILMINGTON, DE 19801

FOR: ORGANIZING AND CONDUCTING CONFERENCES FOR BUSINESS PURPOSES IN THE FIELD OF ENTERTAINMENT, NAMELY, MOTION PICTURE, TELEVISION AND VIDEO PRODUCTION, FINANCING, DISTRIBUTION, PROGRAMMING, LICENSING, TECHNOLOGY, AND MULTIMEDIA ENTERTAINMENT, IN CLASS 35 (U.S. CLS. 100, 101 AND 102).

FIRST USE 11-5-2009; IN COMMERCE 11-5-2009.

THE MARK CONSISTS OF STANDARD CHARACTERS WITHOUT CLAIM TO ANY PARTICULAR FONT, STYLE, SIZE, OR COLOR.

NO CLAIM IS MADE TO THE EXCLUSIVE RIGHT TO USE "SUMMIT", APART FROM THE MARK AS SHOWN.

SER. NO. 85-507,161, FILED 1-2-2012.

Laurie Mayes, Examining Attorney



*David J. Kyffers*

Director of the United States Patent and Trademark Office

# United States of America

United States Patent and Trademark Office

## FILM MARKETING SUMMIT

**Reg. No. 4,137,264**

**Registered May 1, 2012**

**Int. Cl.: 35**

**SERVICE MARK**

**SUPPLEMENTAL REGISTER**

REED ELSEVIER PROPERTIES INC. (DELAWARE CORPORATION)  
1105 NORTH MARKET STREET  
WILMINGTON, DE 19801

FOR: ORGANIZING AND CONDUCTING CONFERENCES FOR BUSINESS PURPOSES IN THE FIELD OF ENTERTAINMENT, NAMELY, MOTION PICTURE, TELEVISION AND VIDEO PRODUCTION, FINANCING, DISTRIBUTION, PROGRAMMING, LICENSING, TECHNOLOGY, AND MULTIMEDIA ENTERTAINMENT, IN CLASS 35 (U.S. CLS. 100, 101 AND 102).

FIRST USE 7-22-2010; IN COMMERCE 7-22-2010.

THE MARK CONSISTS OF STANDARD CHARACTERS WITHOUT CLAIM TO ANY PARTICULAR FONT, STYLE, SIZE, OR COLOR.

NO CLAIM IS MADE TO THE EXCLUSIVE RIGHT TO USE "SUMMIT", APART FROM THE MARK AS SHOWN.

SER. NO. 85-507,180, FILED 1-2-2012.

LAURIE MAYES, EXAMINING ATTORNEY



*David J. Kybas*

Director of the United States Patent and Trademark Office

# United States of America

United States Patent and Trademark Office

# CHEW EATZ

**Reg. No. 4,137,265**

FLP, LLC (ARIZONA LIMITED LIABILITY COMPANY)  
2415 SOUTH ROOSEVELT STREET, SUITE 104  
TEMPE, AZ 85282

**Registered May 1, 2012**

**Int. Cl.: 31**

FOR: DOG TREATS; PET TREATS, IN CLASS 31 (U.S. CLS. 1 AND 46).

**TRADEMARK**

FIRST USE 1-1-2012; IN COMMERCE 1-1-2012.

**SUPPLEMENTAL REGISTER**

THE MARK CONSISTS OF STANDARD CHARACTERS WITHOUT CLAIM TO ANY PARTICULAR FONT, STYLE, SIZE, OR COLOR.

SER. NO. 85-513,927, FILED P.R. 1-11-2012; AM. S.R. 2-27-2012.

BARNEY CHARLON, EXAMINING ATTORNEY



*David J. Kyffers*

Director of the United States Patent and Trademark Office



# United States of America

United States Patent and Trademark Office

# Health Spa

**Reg. No. 4,137,266**

**Registered May 1, 2012**

**Int. Cl.: 11**

**TRADEMARK**

**SUPPLEMENTAL REGISTER**

ZHADANOV, ELI (UNITED STATES INDIVIDUAL)  
1315 EAST ELIZABETH AVE.  
LINDEN, NJ 07036

FOR: HAND HELD SHOWER HEADS; HAND SHOWERS; HAND-HELD SHOWERS; PLUMBING FIXTURES, NAMELY, SHOWER SPRAYERS; PORTABLE SHOWERS; SHOWER HEAD SPRAYERS; SHOWER HEADS; SHOWER PANELS; SHOWER STANDS; SHOWER-HEADS AND COMPONENTS THEREOF; SHOWERS, IN CLASS 11 (U.S. CLS. 13, 21, 23, 31 AND 34).

FIRST USE 9-29-2011; IN COMMERCE 9-29-2011.

THE MARK CONSISTS OF STANDARD CHARACTERS WITHOUT CLAIM TO ANY PARTICULAR FONT, STYLE, SIZE, OR COLOR.

SER. NO. 85-517,845, FILED 1-17-2012.

MICHAEL TANNER, EXAMINING ATTORNEY



*David J. Kyffers*

Director of the United States Patent and Trademark Office

# United States of America

United States Patent and Trademark Office

## Stay-warm Mist

**Reg. No. 4,137,267**

ZHADANOV, ELI (UNITED STATES INDIVIDUAL)  
1315 EAST ELIZABETH AVE.  
LINDEN, NJ 07036

**Registered May 1, 2012**

**Int. Cl.: 11**

FOR: HAND HELD SHOWER HEADS; HAND SHOWERS; HAND-HELD SHOWERS; PLUMBING FIXTURES, NAMELY, SHOWER SPRAYERS; PORTABLE SHOWERS; SHOWER HEAD SPRAYERS; SHOWER HEADS; SHOWER PANELS; SHOWERHEADS AND COMPONENTS THEREOF; SHOWERS, IN CLASS 11 (U.S. CLS. 13, 21, 23, 31 AND 34).

**TRADEMARK**

**SUPPLEMENTAL REGISTER** FIRST USE 11-14-2011; IN COMMERCE 11-14-2011.

THE MARK CONSISTS OF STANDARD CHARACTERS WITHOUT CLAIM TO ANY PARTICULAR FONT, STYLE, SIZE, OR COLOR.

SER. NO. 85-517,904, FILED 1-17-2012.

MICHAEL TANNER, EXAMINING ATTORNEY



*David J. Kybas*

Director of the United States Patent and Trademark Office

# United States of America

United States Patent and Trademark Office

## VIRGINIA GOLF TRAIL

**Reg. No. 4,137,268**

**Registered May 1, 2012**

**Int. Cls.: 39 and 41**

**SERVICE MARK**

**SUPPLEMENTAL REGISTER**

THE VIRGINIA GOLF TRAIL, LLC (VIRGINIA LIMITED LIABILITY COMPANY)  
9000 CELEBRATE VIRGINIA PARKWAY  
FREDERICKSBURG, VA 22406

FOR: COORDINATING TRAVEL ARRANGEMENTS FOR INDIVIDUALS AND FOR GROUPS;  
ONLINE TRIP AND TRAVEL RESERVATION SERVICES; ORGANISATION OF TRAVEL;  
PROVIDING A WEBSITE FEATURING INFORMATION ON TRAVEL; TRAVEL BOOKING  
AGENCIES, IN CLASS 39 (U.S. CLS. 100 AND 105).

FIRST USE 10-7-2010; IN COMMERCE 10-7-2010.

FOR: PROVIDING A WEB SITE THROUGH WHICH GOLFERS RESERVE TEE TIMES AT  
GOLF COURSES, IN CLASS 41 (U.S. CLS. 100, 101 AND 107).

FIRST USE 10-7-2010; IN COMMERCE 10-7-2010.

THE MARK CONSISTS OF STANDARD CHARACTERS WITHOUT CLAIM TO ANY PAR-  
TICULAR FONT, STYLE, SIZE, OR COLOR.

NO CLAIM IS MADE TO THE EXCLUSIVE RIGHT TO USE "GOLF TRAIL", APART FROM  
THE MARK AS SHOWN.

SER. NO. 85-976,453, FILED P.R. 10-8-2010; AM. S.R. 2-8-2012.

JOHN E. MICHOS, EXAMINING ATTORNEY



*David J. Kybas*

Director of the United States Patent and Trademark Office