

1/16/2006

HR 70-14

264



CENTRAL INTELLIGENCE AGENCY
WASHINGTON 25, D. C.

15 MAR 1952

MEMORANDUM FOR: The Director of Central Intelligence

SUBJECT : MILITARY NEWS: "Firing from a Moving Armored
Personnel Carrier", by Major-General S.
Savchenko and Col. A. Grechikhin

1. Enclosed is a verbatim translation of an article which appeared in the Soviet Ministry of Defense publication Collection of Articles of the Journal Military News (Voyenny Vestnik). This publication is classified SECRET by the Soviets, and the issue in which this article appeared was distributed to officers from regimental commander upward.

2. In the interests of protecting our source, this material should be handled on a need-to-know basis within your office. Requests for extra copies of this report or for utilization of any part of this document in any other form should be addressed to the originating office.

Richard Helms

Richard Helms
Deputy Director (Plans)

Enclosure

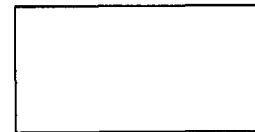
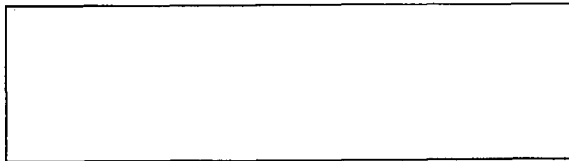

~~SECRET~~



~~SECRET~~

[Redacted]

Original: The Director of Central Intelligence

cc: Military Representative of the President

Special Assistant to the President for
National Security Affairs

The Director of Intelligence and Research,
Department of State

The Director, Defense Intelligence Agency

The Director for Intelligence,
The Joint Staff

The Assistant Chief of Staff for Intelligence,
Department of the Army

The Director of Naval Intelligence,
Department of the Navy

The Assistant Chief of Staff, Intelligence
U. S. Air Force

The Director, National Security Agency

Director, Division of Intelligence
Atomic Energy Commission

National Indications Center

Chairman, Guided Missiles and Astronautics
Intelligence Committee

The Deputy Director of Central Intelligence

Deputy Director for Intelligence

Assistant Director for National Estimates

Assistant Director for Current Intelligence

Assistant Director for Research and Reports

Assistant Director for Scientific Intelligence

[Redacted]

~~SECRET~~

[Redacted]

[Redacted]

28 February 1962

[Redacted]

DISTRIBUTION:

- DCI - Copy #1
- EXO/[Redacted] - Copy #2
- EXO/[Redacted] - Copy #3
- State - Copies #4 and 5
- DIA - Copies #6 and 7
- JCS - Copies #8 and 9
- Army - Copies #10, 11, 12, 13, 14, and 15
- Navy - Copy #16
- Air - Copies #17, 18, 19, 20, 21, and 22
- NSA - Copy #23
- AEC - Copy #24
- NIC - Copy #25
- GMAIC - Copy #26
- SecDef/ISA - Copy #27
- DDCI - Copy #28
- DDI - Copy #29
- AD/NE - Copy #30
- AD/CI - Copy #31
- AD/RR - Copies #32 and 33
- AD/SI - Copies #34 and 35
- DDP - Copy #36
- CFI - Copy #37
- CSR - Copy #38
- SR/Rp - Copies #39, 40, 41, 42, 43, 44, 45, 46, 47, 48, 49, and 50

[Redacted]

[Redacted]

~~SECRET~~

COUNTRY: USSR

SUBJECT: MILITARY NEWS: "Firing from a Moving Armored Personnel Carrier", by Major-General S. Savchenko and Col. A. Grechikhin

DATE OF INFO: January 1961

APPRAISAL OF CONTENT: Documentary

SOURCE: A reliable source (B)

Following is a verbatim translation of an article entitled "Firing from a Moving Armored Personnel Carrier", by Major-General S. Savchenko and Col. A. Grechikhin. . This article appeared in Issue No. 34, 1961, of the Soviet military publication Collection of Articles of the Journal Military News (Voyenny Vestnik). This publication is classified SECRET by the Soviets and is published by the USSR Ministry of Defense.

According to the Preface, Issue No. 34 was sent for typesetting on 14 December 1960 and released to the printer on 25 January 1961. The Preface states that articles express the opinions of their authors and are published as a form of discussion. Distribution of Issue No. 34 was to officers from regimental commander upward.

-1-

~~SECRET~~

~~TOP SECRET~~

[REDACTED]

[REDACTED]

Firing from a Moving Armored Personnel Carrier

by

Major-General S. Savchenko

and

Col. A. Grechikhin

In training troops to fire from a moving armored personnel carrier (APC) it is essential to take into consideration certain characteristics which affect the rules of firing.

First characteristic. The constant swaying of the APC renders observation of the battlefield more difficult, especially through the ports, inasmuch as they limit the field of view. To obtain better conditions for observation the men must be placed as near the ports as possible.

Second characteristic. The range to the target is constantly changing irrespective of the movement of the vehicle in relation to the target.

Therefore pointblank range should be utilized to the full, as in battle it will be impossible to change the sights often from one setting to another.

Third characteristic. During a flank movement across the target (*flangovoye dvizheniye*) and oblique movement by the APC, each bullet deviates in the direction of the movement. This deflection is caused because a bullet leaving the barrel at a given muzzle velocity retains, owing to inertia, the speed of the vehicle at the moment of firing. The importance of angular deflection (*uglovoye otkloneniye*) grows with the increase of speed and of the angle of approach (*kursovoy ugol*) of the APC. The table below

[REDACTED]

~~TOP SECRET~~

[REDACTED]

[REDACTED]

[REDACTED]

gives, in round numbers, the deflection in mils (tysyachnaya) during a flank movement of the vehicle (at 90° to the plane of fire).

Type of Weapon	Speed of the vehicle in kph			
	5	10	15	20
AK (AKM) RPD (RPK)	2	4	6	8
RP-46, SGMB	1.5	3	4.5	6

It will be seen from the table that when the vehicle is moving at (for example) 20 kph, the angular deflection of a bullet fired from a submachine gun (avtomat) or light machine gun (ruchnoy pulemet) will equal 8 mils. Therefore, if the aim is taken directly at a stationary or bobbing (poyavlyayushchiy) target, then at a range of 200 meters the bullet will be deflected 160 cm from the target and will not strike it. Therefore, to increase the accuracy of fire it is necessary to allow for the deflection by shifting the point of aim a corresponding distance in the opposite direction to the movement of the vehicle.

It should be noted that the above recommendation is of practical significance only when the vehicle is not swaying much, so that it does not hamper the taking of aim. Given considerable swaying, it would be impossible in practice to take accurate aim. Experimental firing has shown that even at an average combat speed (about 10 kph) errors in aiming reach 20 mils. Therefore, when moving over uneven ground, especially at high speed, changing the point of aim is not to be recommended. Under these conditions directional (napravlenny) fire should be used.

It may be asked whether, since the swaying of the vehicle leads to gross errors in aiming, it would not be better to compensate for it by firing long bursts. To improve the accuracy of fire it is essential that the bursts should be aimed. The swaying of the vehicle

[REDACTED]

permits the holding of the line of aim with comparative accuracy only for a short time (a moment). Therefore, aimed bursts under these circumstances can only be short ones. Firing long bursts, as was shown by experimental firing, reduces the results 1.5-2 times as compared with firing short bursts (using the same number of rounds).

During a flank movement by the APC and the target in the same direction (parallel to each other) at equal speeds there is no need to change the point of aim. The point of aim during lateral movement in this case will be the center of the target. If, however, the APC and the target are moving in different directions, then lead for the movement of the target must be added to the correction for the movement of the vehicle.

Fourth characteristic. The swaying of the moving APC has an adverse effect on the steadiness of the firer and of his weapon. The scattering of shots is increased and consequently the accuracy of fire is reduced. To reduce the swaying of the vehicle the driver must select the most suitable route (level stretches) in a particular direction. The effectiveness of fire grows if firing is carried out at the most favorable time, when the vehicle sways the least. The trainees should, therefore, develop a "feel for the vehicle" and carry out the firing drill in the shortest possible time.

To determine what should be included in training let us consider when, with what weapons, and how it is possible to fire from, for example, the BTR-152K, APC.

While crossing a contaminated sector of an area in battle in a town, in woods, in the mountains and when under intense enemy fire, firing is done with submachine guns (SMG), light machine-guns (LMG), and company machine guns (CMG) through the ports. The hatches in the roof of the APC should, as a rule, be closed.

The ports in the right and left sides permit fire over a sector of approximately 90°. Consequently they are used chiefly during flank and partly during oblique movement (with an angle of approach to the BTR of up to 45°) of the APC. The right and left ports in the back plate (stern) are used for firing to the rear. Finally, the top ports are used for firing upwards.

[REDACTED]

[REDACTED]

In some cases (for example, in pursuit of the enemy, destroying descending parachutists during a parachute landing, and also when the enemy's defense is broken and he no longer offers organized resistance), firing by the SMG, the Kalashnikov LMG, and heavy machine gun (stankovyy pulemet) can be carried out over the sides. In this case the hatch covers in the roof are kept open. It is not safe to fire the Degtyarev LMG or the CMG over the side of the vehicle, as their great weight renders them insufficiently stable. The infantry antitank grenade launcher (ruchnoy protivotankovyy granatomet) can also be fired from an APC, over the side. In this case one roof hatch cover, either the front or the rear, is kept open and the others are closed to protect the personnel in the APC from the exhaust gases when a round is fired.

Let us consider the best methods of firing the various types of small arms from a moving BTR-152K.

Firing with SMG through the ports in the left (right) side is carried out as shown in Photographs 1a and b. For greater steadiness the firer presses his left side into the back of the seat, the right foot is placed under the opposite seat and rests against the floor of the APC; the left hand grips the SMG by the magazine with the left arm behind the back of the seat and pressed against it from the back; the right hand grips the SMG by the pistol grip, the right arm also being pressed to the back of the seat. Inside the port the SMG is laid on the strap to protect the fore stock (tsevye) from shocks.

When firing the LMG through the ports in the left or right side (Photo 1c) the position of the machine gunner is different from that of the submachine gunner. First, his left hand retains the machine gun by the butt and is placed behind the back of the seat; second, the right hand is not pressed against the back of the seat, but for greater steadiness the right hand is held touching the left hand, thus forming the so-called "lock" ("zamok"). The barrel is pushed through the port till the recoil guide key (polozok) is pressed against the side of the PAC from the inside and the legs of the bipod are folded. The position of the LMG in the port can

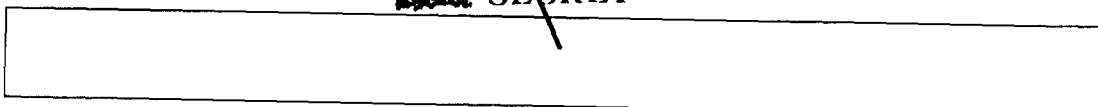
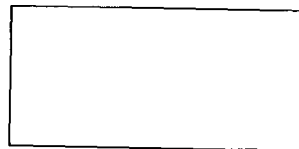

~~SECRET~~

be shown in photograph 1b. In this case, either the strap or the cover of the LMG should be placed under the fore stock (tsevye).

The CMG is fired through the ports on the left or right sides from basically the same positions as the LMG, the difference being that the CMG can be fired through a port only with the bipod open. In addition, the CMG is of considerable length and therefore it is impossible to get it at 90° to the side in a horizontal plane. Because of this the gunner using the CMG must take his place farther to the left (in relation to the port) compared with one firing the LMG.

It is most convenient to fire through the middle or rear port on the left side. When firing through the middle port on the right side the gunner kneels on the floor of the APC and support his left elbow on the back of the right-hand seat, as shown in photograph 2.

The belt box is placed behind the back of the seat, on the seat, or on the floor of the APC, depending on which port is used. In movement the box is supported by the assistant gunner, who takes his place wherever it is most convenient for him.

Forward fire from the SMG, LMG, and CMG is best carried out from the third (rear) port on the left side, from the left small (rear) seat (Photo No. 3). The submachine (machine) gunner sits with his left side to the side of the PAC. His right hand, gripping the pistol grip, rests on the back of the side bench or is raised. To fire the SMG, the gunner holds the SMG by the magazine with his left hand and presses it against the back of the small seat. The machine gunner supports the butt with his left hand, pressing or placing the elbow on the corner of the side seat. The right leg is extended and rests against the right side seat, and the left leg is bent at the knee, shin resting against the left bench.

Fire through the ports in the back panel (stern) is carried out from right and left side seats using the SMG, the LMG, or the CMG. Firing from the right-hand seat, the submachine gunner (machine gunner) presses his left side to the back of the seat, bends both

~~SECRET~~

~~SECRET~~

legs at the knee, pressing his left shin against the small right-hand seat (Photo 4).

Firing from the left-hand seat, the gunner rests his right armpit on the back of the seat. The left elbow either drops free or rests on the right knee. Both legs are bent at the knee with feet resting on the floor of the APC.

The SMG can also be fired to the rear from the right small seat, but it is advisable that in such cases the gunner be a short man, as a tall man would have to assume an uncomfortable position, bending his back.

Fire through the upper ports can only be carried out with SMGs. It is used against windows of upper stories of buildings, against the enemy in trees and on upper slopes of hills, and also against descending parachutists, from the position shown in photograph 5.

Fire over the sides can be carried out with the SMG, the Kalashnikov LMG, the HMG mounted on the APC, and the infantry antitank grenade launcher.

Fire from the SMG (and also the Kalashnikov LMG) is carried out from the shoulder. A soldier of medium height (as in photograph 6) standing on the floor of the APC can, for greater steadiness, rest his legs against the seats, place his left elbow on the roof, and press the right forearm against the inner edge of the roof. A tall man using the SMG can place both his elbows on the roof and fire from the position used in trenches. A soldier of short stature will be forced to stand on the seats. This will enable him to fire resting both elbows on the roof. Notwithstanding this, the position is unsafe, given any considerable swaying of the APC or any sudden alterations of its speed. Therefore short men should not be detailed to fire over the sides, or else they should be stationed at the corners of the hatch where greater steadiness can be achieved.

~~SECRET~~

GROUND USE ONLY

~~SECRET~~

The Degtyarev LMG and the HMG cannot be fired over the side from the shoulder, as it is impossible to hold them firmly during movement. It is also unsafe to use them with the bipod, as it is difficult to hold the MG on the slippery metal surface of the roof of the APC while in movement.

Fire from the Degtyarev LMG, CMG, and HMG over the side is possible from the front and rear mounting, using special adaptors. The most effective is the fire from the HMG. It is fired with the transversing and elevating gear disconnected.



Firing the LMG and the CMG from the mounting does not give such good results as when they are fired through the ports. This is due to the position being less comfortable and not so steady when firing from the mounting. Consequently LMG and CMG should, as a rule, be fired through the ports.

The infantry antitank launcher is fired over the sides, at a halt (s mesta), and is safe when only one cover of the roof hatch of the APC is open (either front or rear). The man firing must assume such a position (photo 7) that when the launcher is fired the rear exhaust gases are directed over the side. The man firing the launcher stands on the floor of the PAC and rests his back against the edge of the hatch and of the hatch cover. It is most convenient to open the rear hatch cover for firing.

Therefore, 14 men can fire simultaneously from a BTR-152K APC, five over the right and left sides, six through the ports in the right and left sides, two through the ports in the back panel, and one firing the SGMB machine gun installed on brackets.

To train personnel in methods of firing from an APC, it is necessary to have special equipment located at a small arms training center near the unit's range. Equipment of this type held by one of the large units in the Leningrad Military District permits simultaneous training in firing from an APC of a group of 18 men (armed with SMG's and LMG's) or of a platoon of infantry with its standard weapons.

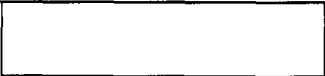
~~SECRET~~



The first training point holds a cutaway mock-up of an APC (photo 8). The body of the model is made of angle iron and is the same size as the BTR-152K. The mock-up is fitted inside with seats and flooring. For better observation of the trainees, the left side, the back panel, and the greater part of the roof are not covered. The body of the mock-up is covered only on the right side and partly from above (to provide rest for elbows when training to fire over the sides). The ports are cut out on the right side and on the left are represented by rings held by struts welded to the body.

The mock-up at this training point is stationary. Here a rifle squad or a group of soldiers can work out the drill following the commands "Fall in by the vehicles" ("k mashinam") and "take places" ("po mestam") and carry out preliminary training in methods of firing through the ports and over the sides. Observation of the accuracy of fire from SMGs and MGs can be carried out by an orthoscope (ortoskop) with colored lenses (steklo) (one of the instruments in the Commander's Box, 1956 model).

To check the accuracy of the aim at the moment the trigger is pressed, a training sighting device (přitselnyy stanok) PS-54 is used, which has been electrified by extended-service Sergeant Bolenko. Privates Ulyanov and Poheguyev suggested using the electrified sighting device in conjunction with automatic target installation EPM-2, which they modified slightly (fig. 9). Firstly the "control" wire is put in phase and the "release" wire is connected to the RKM coil; secondly, the pick ups (datchik) are bypassed and the sockets closed. The automatic target installation EPM-2, working together with the electrified PS-54, permits the training of personnel in firing from an APC at both bobbing and moving targets.

To set up the electrified PS-54 for operation, the submachine gun, for example, must be fastened to it, the screw-clamp (strubtsina) of the firing mechanism of the PS-54 must be attached to the trigger guard of the SMG, and the tension of its control linkage so adjusted that when the trigger is pressed the screen of the PS-54 is set in

motion and the contact plate is pricked by the needle. Having done this, it is necessary to remove the canting of the weapon, fasten the iron ring on the breech-operating cam lever by means of the clamping screw, bring the indicator of the cant-registering mechanism against the graduation mark on the scale, and set the screen in the rear position (at this point current is supplied), the relay MKU-48 comes into action, the motor starts up and raises the target and the end switch (koptsevoy pereklyuchatel) fixes the target in the raised position. Then the sights are set at graduation mark "P" (or "Z"), the breech-operating cam is secured and the needle is brought in line with the center of the contact plate. The PS-54 is secured in the position where the submachine gun is fixed on the point of aim, for example, the middle of the target.

In order to check the setting of the electrified PS-54 for operation, the commander frees the breech-operating cam from the "rigid" position and then, without changing the setting of the PS-54 in the mock-up of the APC, aims the weapon at the point of aim and presses the trigger. If the aim is correct, the needle must hit the contact plate and the target must drop (the RKM relay comes into action and breaks the feed circuit to relay MKU-48, the motor starts up and lowers the target, the end switch then fixes the target in the lowered position).

The light target installation AML-1 may be used instead of EPM-2, with the use of an attachment developed by Privates Fedotov and Lado (fig. 10). The attachment is of simple construction and does not require any adjustment (naladka) during operation. It includes an RKM relay, a selenium resistor (selenovoy stolbik), a condenser, and a direct current supply. The rectified current is fed through the dropping resistor (gasyashcheye soprotivleniye) to the contacts of the sighting devices, and across the normally closed contacts (NZ-normalno zamknut) of the relays a current from the phase is fed to the third terminal of the target installation. While the contacts of the sighting device are open (razomknuty) the target remains in the raised position. The closing of the contacts feeds the current into the circuit of the coil of the RKM relay, the relay armature is pulled up, breaks the normally closed contacts, and the target is lowered. The attachment may be operated with

[REDACTED]

[REDACTED]

target installations moving on rails (on a narrow-gauge railway) as well as with stationary installations.

The second training point is equipped with a swaying platform brought into motion by an electric motor developing 2.8 kilowatts at 1420 rpm. A reduction gear turns the eccentrics and also the cams imparting the vertical and the horizontal swaying motion.

An APC, or a mock-up of one, similar to that at the first training point, is mounted on the swaying platform. In order that the mock-up should provide the best facilities for observing the action of the trainees and give training in firing under conditions approaching those in a standard APC, it is necessary to prepare from sheets of plywood, parts of an APC with which the whole body of the mock-up could rapidly be covered at the required time.

At this training point the men are taught firing from a stationary APC (the electric motor of the swaying platform is not switched on). Later on, using the swaying device, which is set in motion by an electric motor or by hand, the oscillating movements of the target (in one or several directions) are produced. These oscillating movements are similar to those experienced by a soldier during firing from a moving APC.

The oscillating device, on the supplementary screen (dopolnitelnyy ekran) of which a reduced target or targets are fixed, is set up approximately 10 meters away from the weapon. Training in firing is carried out with the aid of a sighting device PS-51, which, together with the weapon, is made fast to the roof of the mock-up or the back of the seat so that the barrel of the SMG (LMG) is pointed at the supplementary screen of the swaying device through one of the ports of the mock-up.

To register the hits, an automatic pricking device is employed. This is fixed to an inverted L-shaped post (i. e., cyrillic G7). When the trigger is pressed on the weapon, the needle of the pricking device makes a prick on the main screen (osnovnoy ekran) of the oscillating device set before it. The action of the piercing device is based on the use of a solenoid, which at the moment of the closing of the electrical

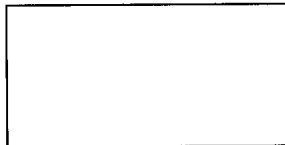

[REDACTED]

[REDACTED]

circuit, operates a plunger with a needle fixed to it. To cause the circuit to close when the trigger of the weapon is pressed, a contact insulated from the metal of the weapon is mounted on the trigger guard (behind the trigger). A wire is led from it to some metal part of the weapon, for example, the cleaning rod (shompol). The current is supplied from a 24 v battery.

The swaying platform is used to train in firing at effective ranges (deystvitelnaya dalnost). The accuracy of fire from the SMG (LMG) is checked with the aid of an orthoscope.

The third training point is equipped with two mock-ups of APC, moving along a narrow-gauge railway. Each mock-up is powered by an electric motor and can be propelled along the rails at varying speeds by the use of reduction gears.

One of the mock-ups has no springs, moves along a level track, and is used for preliminary training in firing from a moving APC.

The other mock-up differs from the first, inasmuch as it is fitted with springs and the track on which it moves is uneven (in places, metal is welded to the rails), thus creating more difficult conditions for firing.

The situation created at the third training point closely approximates the conditions of the exercise for which the men are being trained. Thus, for example, if the men are being trained to carry out the first exercise, then running figures (target no. 8) are set at a given range on both sides of the narrow-gauge track. This permits the men to be trained simultaneously in firing through the ports and over the sides on both the right and the left side, in the course of one trip.

The personnel of rifle (reconnaissance) subunits should be trained to fire from an APC after they have completed corresponding training in firing on the ground. For example, they should have completed training in "Firing the SMG (LMG) at Bobbing Targets by Day" followed by training in "Firing the SMG (LMG) from an APC at Bobbing Targets, by Day".

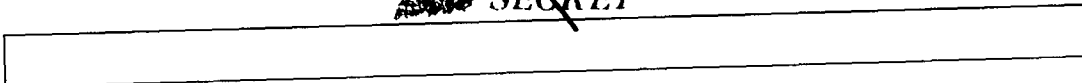

~~SECRET~~

[REDACTED]

[REDACTED]

During the first stage, when the stationary and swaying mock-ups of an APC are used for training in firing through the ports, it is essential to insist that the trainees carry out the following requirements: in the interests of safety, loading and unloading must be carried out only when the barrel of the weapon is pointing through the port; after loading, the safety catch must be applied; a firing position must be assumed which ensures that the gunner is steady and his aiming position is firm; fire at isolated targets must, as a rule, be carried out in short bursts. When training in firing over the sides, the commander's chief concern should be the attainment by the trainees of a position which ensures the steadiness of the gunner, and consequently, of his weapon.

When using the moving mock-ups of the APC, it is necessary to insist that when firing through the ports or over the sides, the trainees should be able to change the positions of their weapons and of their own bodies while firing on the move at a target.

The knowledge and skills acquired by the men during weapon training must be consolidated and improved with the men in standard APCs. Every opportunity to do so should be utilized, including the time spent in moving to or from training or exercises. For example, during this time the men can be trained in battlefield observation and in estimation of distances. To do this, the commander should measure beforehand, by a more exact method, the distance to objects and landmarks from points along the route from which the men will have to estimate the distance by eye. Later on, this training should be carried out during special exercises and combined with other tasks, such as the selection of settings for sights and rear sights (*ustanovka pritsela i tselika*) and also the selection of the point of aim and the conduct of firing.

So far as the organization of firing training is concerned, it is essential to stress that the training should be carried out, as a rule, at company level and by types of weapons. The training should be so organized that the trainees acquire new knowledge and new skills from year to year. This can only be achieved if the year of the men's service is taken into consideration. For example,

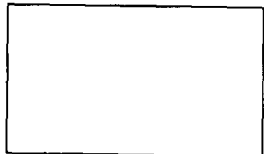

~~SECRET~~

~~SECRET~~

[REDACTED]

[REDACTED]

during their first year the men should be taught shooting at bobbing targets from an APC by day and do the first exercise in single-shot firing (uprazhneniye odinochnykh strelb - UOS) from an APC; men in their second year should be taught shooting at bobbing targets at night and do the second exercise in single-shot firing from an APC, and finally, in their third year, the men should be taught to fire at moving targets and do the third exercise in single-shot firing from an APC. This system of training not only promotes a steady growth of the knowledge and skills of the men for each year of service but permits combat firing to be carried out by sections or platoons at any time during the training year.

~~SECRET~~

[REDACTED]

~~SECRET~~

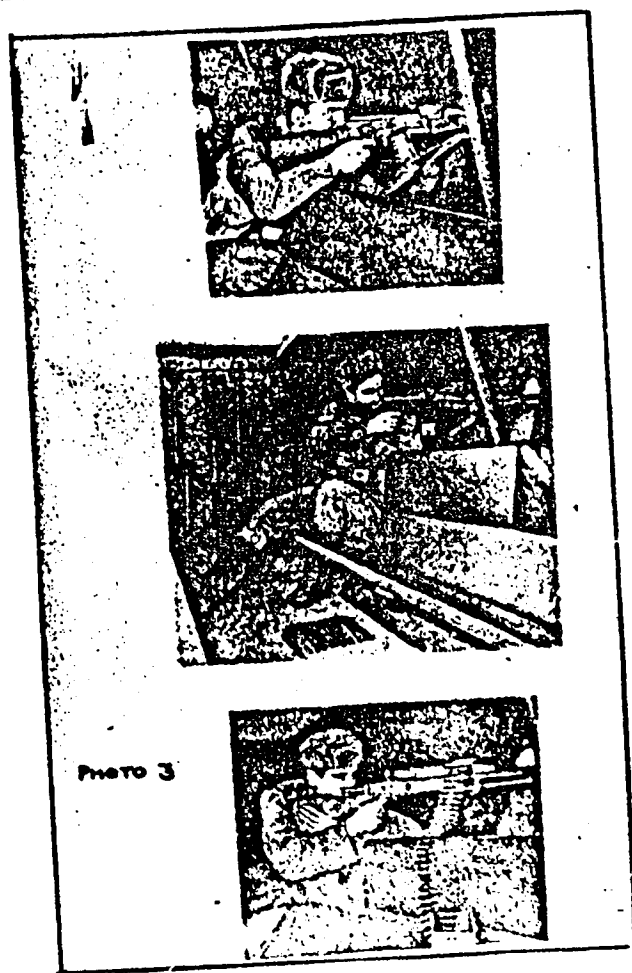
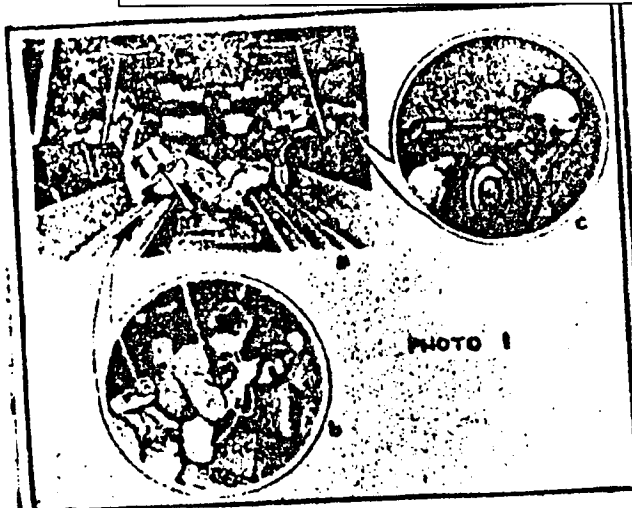

-15L

~~SECRET~~

~~SECRET~~

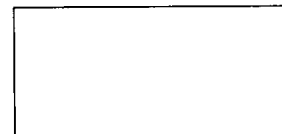
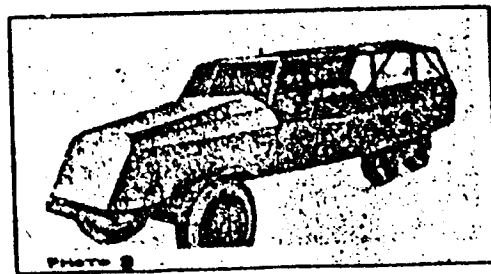
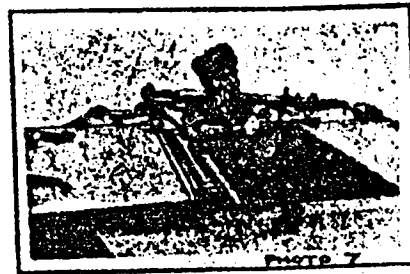
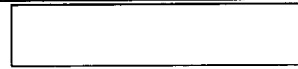

~~SECRET~~

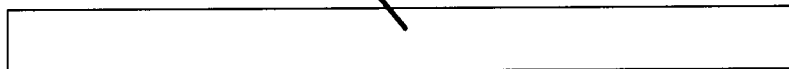

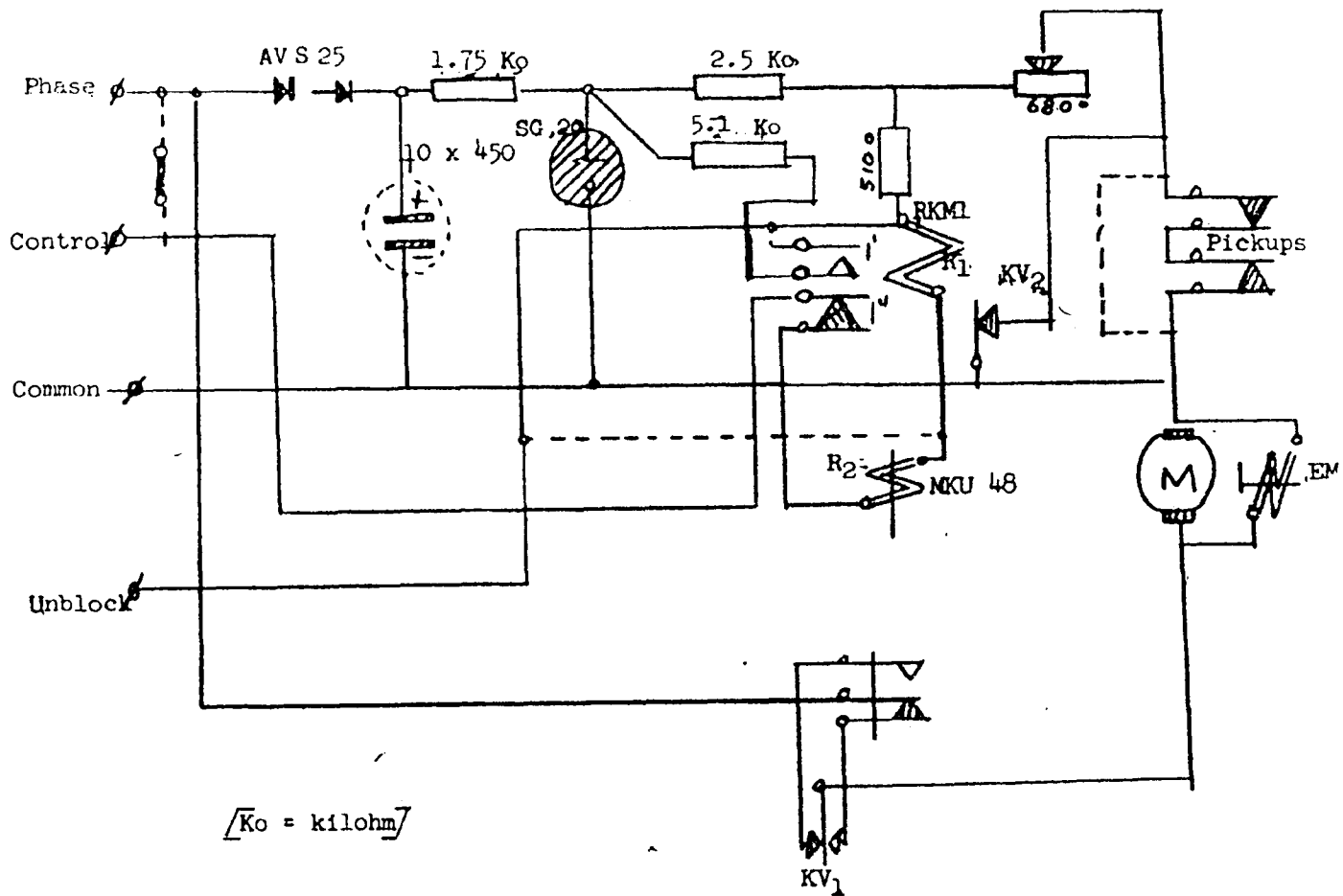

Fig. 9. Basic diagram of operation of the EPM-2 with the electrified PS-54 sighting device (dotted lines indicate modifications).

~~SECRET~~

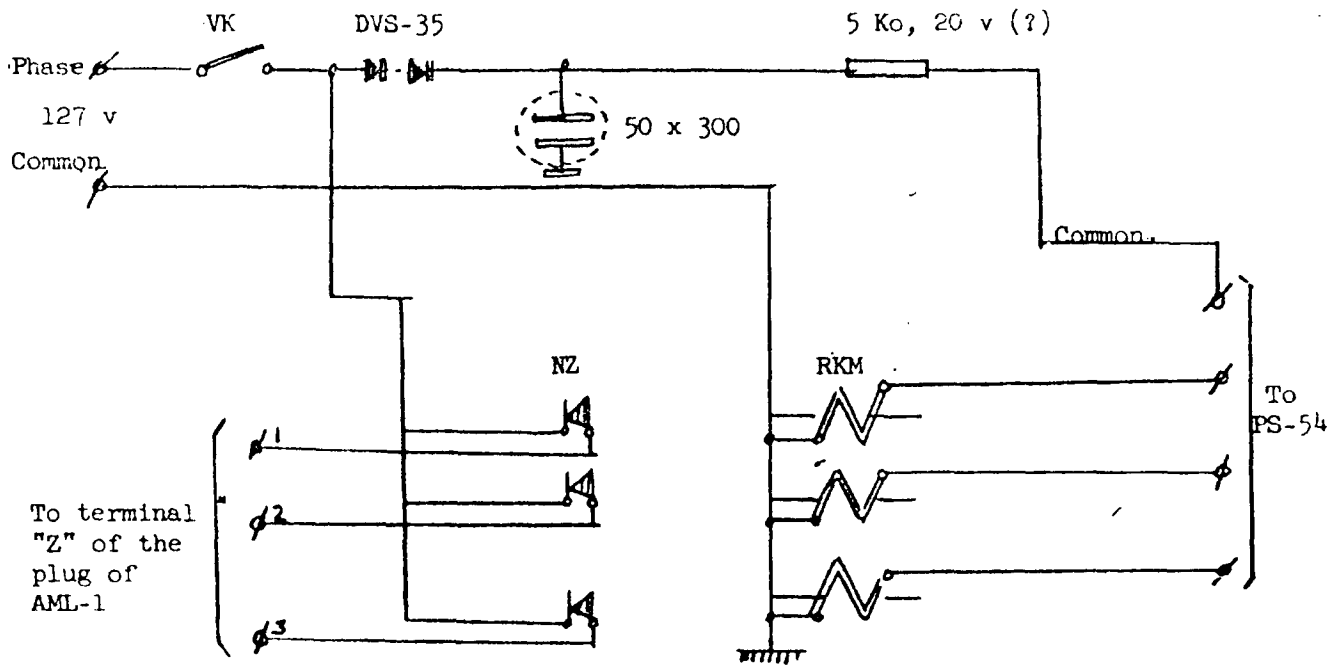

Fig. 10. Basic diagram of connections of three PS-54 electrified sighting devices to automatic target AML-1

~~SECRET~~

~~SECRET~~

1961/1st

NAME: LISYUTIN, V. S.

RANK: Rear Admiral

LAST KNOWN ASSIGNMENT: Unknown

DATE AND PLACE OF BIRTH: Unknown

CAREER: No information available

REMARKS: LISYUTIN signed the obituary of V. A. PAVLOV, Chief of a Chair at the Voroshilov Naval Academy (Soviet Fleet 11 Oct 1958) and the obituary of A. N. IVANOV, Chief of a Chair at the same Naval Academy, (Soviet Fleet 6 May 1959) indicating that he may be associated with this institution. He has written an article entitled "Bases for the Categorization of Modern Naval Warfare," in Morskoy Sbornik, January 1961.