

# Joint Service Chemical and Biological Defense Program FY 08-09 Overview

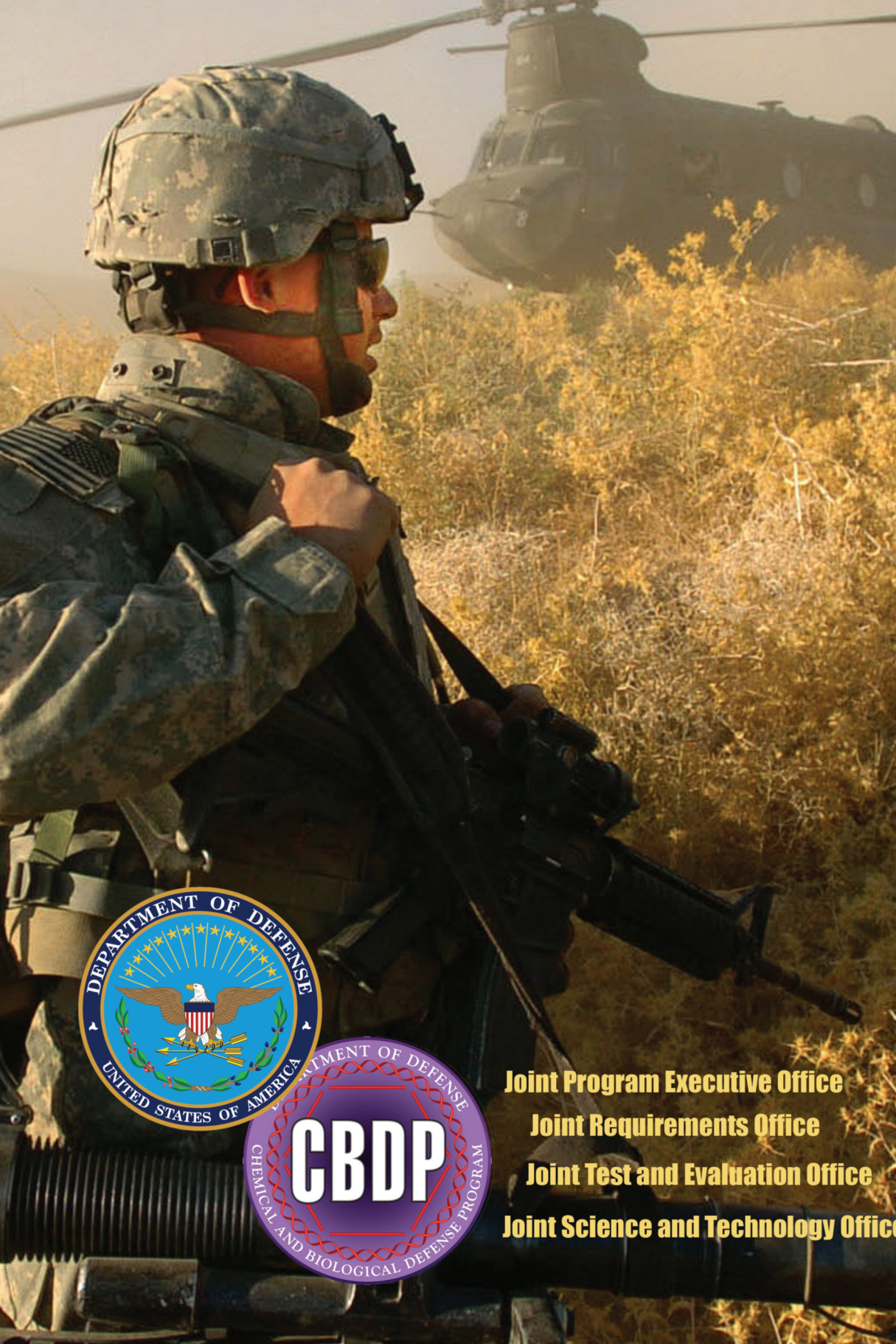

**Joint Program Executive Office**  
**Joint Requirements Office**  
**Joint Test and Evaluation Office**  
**Joint Science and Technology Office**

**T**he mission of the U.S. Department of Defense's (DOD) Joint Chemical and Biological Defense Program (CBDP) is to provide chemical and biological defense capabilities in support of the national military strategies. To accomplish this mission, the CBDP works with other federal agencies, state and local governments, Congress, and the private sector. This document provides an overview of the current and future programs that enable our troops to protect themselves and our nation from CBRN threat.

The current environment demands a CBDP that is visionary, able to respond quickly to warfighter and national security needs, and streamlined with authority and accountability vested in specific executives. The Department will continuously assess its progress, ever striving to ensure that the U.S. military has the capabilities and information to operate effectively and decisively in the face of CBRN threats, in warfighter and homeland security missions, today and through the challenges of tomorrow.

Additionally, the DOD Annual Report to Congress on the Chemical and Biological Defense Program provides a more detailed overview of the CBDP, as well as a more detailed examination of the program's objectives for the future.



**JEAN D. REED**  
SPECIAL ASSISTANT  
CHEMICAL AND BIOLOGICAL DEFENSE AND CHEMICAL DEMILITARIZATION PROGRAMS





# Table of Contents

<b>Chemical and Biological Defense Program (CBDP) Overview</b>	
CBDP Vision and Mission.....	3
CBDP Joint Management Structure .....	4
CBDP Funding.....	7
Chemical, Biological, Radiological, and Nuclear (CBRN) Capabilities .....	9
<b>Joint Requirements Office</b> .....	13
<b>Science &amp; Technology</b>	
Medical Science and Technology Division	
Transformational Medical Technologies Initiative .....	20
Diagnostics Capability Area .....	21
Pretreatments Capability Area.....	23
Therapeutics Capability Area .....	24
Physical Science and Technology Division	
Basic Research Program.....	26
Detection Capability Area .....	28
Information Systems Technology Capability Area.....	30
Protection and Hazard Reduction Capability Area.....	33
Threat Agent Science Capability Area.....	35
Special Projects Office.....	36
Applied Technology Division	
Futures.....	40
Homeland Defense.....	42
Warfighter Enhancement.....	45
<b>Sense</b>	
Joint Service Lightweight Standoff Chemical Agent Detector (JLSCAD) .....	49
Joint Biological Standoff Detector System (JBSDS) .....	50
Joint Biological Point Detection System (JBPDS) .....	51
Joint Chemical Agent Detector (JCAD).....	52
Nuclear Biological Chemical Reconnaissance Vehicle (NBCRV).....	53
Joint Biological Agent Identification and Diagnostic System (JBAIDS).....	54
Major Defense Acquisition Programs Support Program (MDAP SPRT) .....	55
<b>Shape</b>	
Joint Warning and Reporting Network (JWARN) .....	59
Joint Effects Model (JEM) and Joint Operational Effects Federation (JOEF) .....	60

<b>Shield</b>	
Protective Clothing: Chemical and Biological Protective Ground Ensemble .....	63
Protective Clothing: Joint Chemical and Biological Aviation Ensemble.....	65
Chemical Biological Protective Shelter (CBPS) .....	67
Collective Protection System Backfit (CPSBKFT).....	68
Critical Reagents Program (CRP).....	69
Medical Chemical Defense (MEDCHEM).....	70
Medical Biological Defense (MEDBIO).....	71
Medical Radiological Defense (MEDRAD).....	72
<b>Sustain</b>	
Joint Service Personnel/Skin Decontamination Systems (JSPDS).....	75
Joint Service Transportable Decontamination System—Small Scale (JSTDS-SS).....	76
Joint Material Decontamination System (JMDS).....	77
<b>Homeland Defense</b>	
Installation Protection Program (IPP) .....	81
Weapons of Mass Destruction-Civil Support Teams (WMD-CST) .....	83
<b>CBDP Functions</b>	
Test and Evaluation.....	87
Experimentation .....	92
<b>References</b>	
Acronym List.....	95
Web Sites .....	99
Consolidated Program Locator Map .....	103

CBDP Overview

CBDP Overview

CBDP Overview

CBDP Overview

CBDP Overview

CBDP Overview

CBDP Overview

CBDP Overview

CBDP Overview

**CBDP Overview**

**CBDP Overview**

**CBDP Overview**

**CBDP Overview**

**CBDP Overview**

**CBDP Overview**

**CBDP Overview**

**CBDP Overview**

**CBDP Overview**

**CBDP Overview**



Whether engaged in civil support operations, homeland defense, or on a traditional battlefield, U.S. military forces face complex and varied chemical and biological (CB) threats. The Chemical and Biological Defense Program (CBDP) seeks to ensure a mission is not deterred by a CB threat.

**CBDP VISION: Ensure DOD Operations are Unconstrained by Chemical and Biological Effects**

The vision is not focused on any specific chemical or biological threat. While it is focused on those CB agents that may be employed intentionally, it addresses classical threat agents as well as novel and emerging threats. The vision also encompasses various methods of delivery.

Currently, CB defense capabilities impose some degree of burden on the user. The vision points forward to the development of capabilities free of such constraints and providing effective defensive capabilities that are transparent to the users.

**CBDP MISSION: Provide Chemical and Biological Defense Capabilities in Support of the National Military Strategies**

Research, development, and acquisition (RDA) programs within the U.S. Department of Defense (DOD) CBDP aim to provide U.S. forces with the best equipment to ensure their survivability and mission accomplishment on any future battlefield where chemical or biological agents may be employed. ■

# Chemical and Biological Defense Program (CBDP) Vision and Mission





# CBDP Joint Management Structure

In accord with 50 United States Code, Section 1522, the single office charged with overseeing the Chemical and Biological Defense Program (CBDP) is the Assistant to the Secretary of Defense for Nuclear and Chemical and Biological Defense Programs [ATSD(NCB)]. The figure on page 5 depicts the key organizational relationships within CBDP management structure:

- Oversight
- Requirements
- Science and Technology
- Test and Evaluation
- Program Integration
- Advanced Development and Acquisition

## Key Personnel and Offices

- Under Secretary of Defense for Acquisition, Technology & Logistics, USD(AT&L)
- Under Secretary of Defense for Policy, USD(Policy)
- Assistant to the Secretary of Defense for Nuclear and Chemical and Biological Defense Programs, ATSD(NCB)
- Special Assistant for Chemical and Biological Defense and Chemical Demilitarization Programs, SA(CBD&CDP)
- Joint Requirements Office for Chemical, Biological, Radiological, and Nuclear Defense (JRO-CBRND)
- Military Departments (Army, Air Force, and Navy, including the Marine Corps)
- Army as Executive Agent
- Joint Program Executive Office for Chemical and Biological Defense (JPEO-CBD)
- Program Analysis and Integration Office (PAIO)
- CBDP Test & Evaluation (T&E) Executive
- Joint Combat Developer for CBRN Defense (JCD-CBRND)
- Defense Threat Reduction Agency (DTRA) Program and Budget Division
- DTRA Chemical and Biological Defense Directorate, DTRA(CB), also designated as the Joint Science and Technology Office for Chemical and Biological Defense (JSTO-CBD)

## Roles and Responsibilities

### Under Secretary of Defense for Acquisition, Technology & Logistics

- Serves as the Defense Acquisition Executive (DAE) for the CBDP

### Under Secretary of Defense for Policy

- Serves as policy advisor for the CBDP

### Assistant to the Secretary of Defense for Nuclear and Chemical and Biological Defense Programs

- Serves as the single focal point within the Office of the Secretary of Defense (OSD) for the CBDP
- Responsible for overall oversight, coordination, and integration of the CBDP

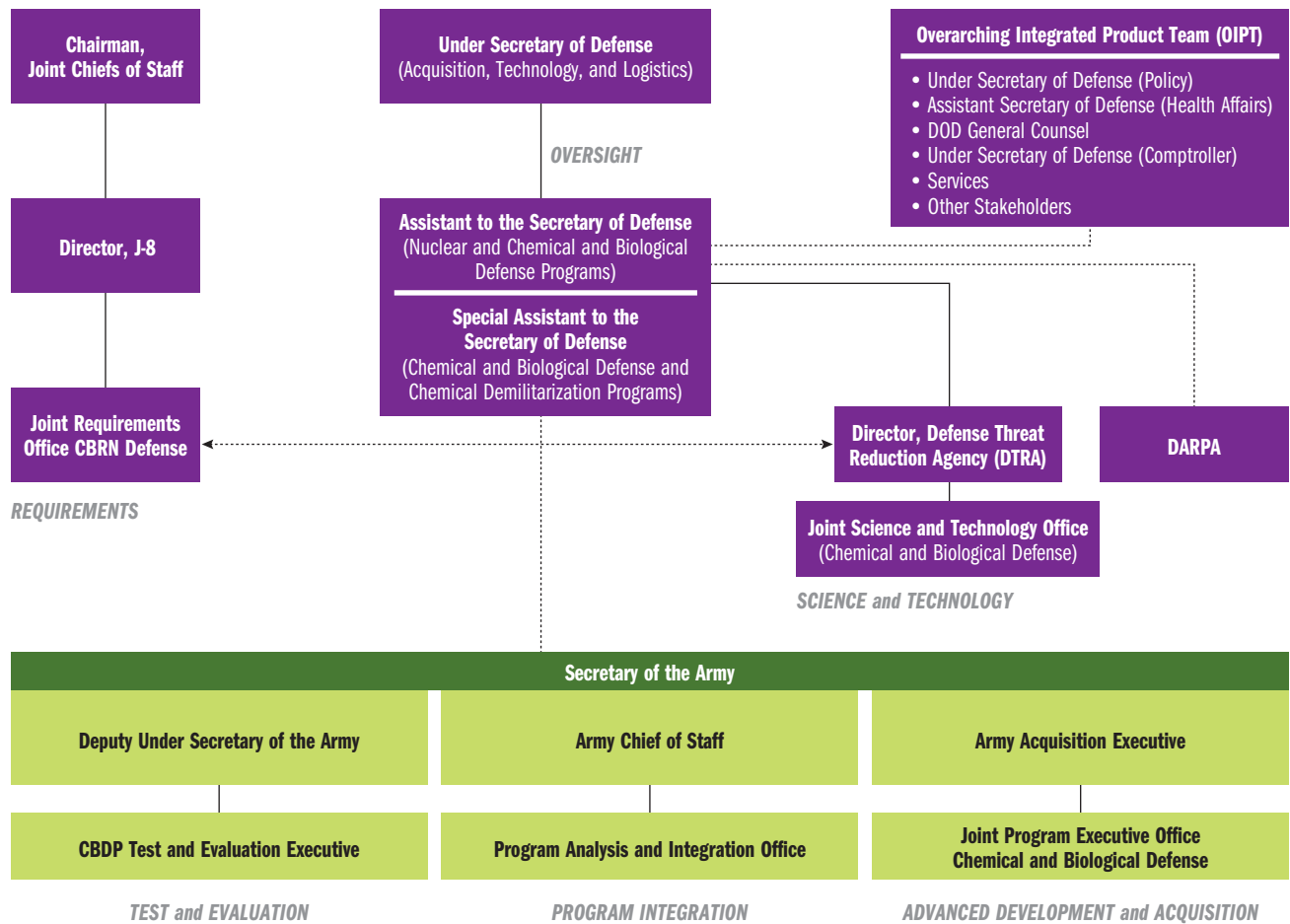

**Special Assistant for Chemical and Biological Defense and Chemical Demilitarization Programs**

- Serves as principal deputy for CBDP matters and the primary staff action office for ATSD(NCB) responsibilities
- Supports the USD(AT&L) in carrying out its oversight responsibilities for the CBDP
- Permanent chair of the CBDP Overarching Integrated Process Team

**Joint Requirements Office for Chemical, Biological, Radiological, and Nuclear Defense**

- Coordinates with combatant commands (COCOMs) and Services to develop Joint CBRN requirements, an overarching CBRN defense architecture, and a Joint capabilities roadmap
- Leads Program Objective Memorandum (POM) development for the CBDP

**Military Departments (Army, Air Force, and Navy, including the Marine Corps)**

- Coordinate with all levels of CBDP management structure
- Plan and execute CBRN defense programs from basic research through procurement and sustainment
- Provide personnel with unique scientific, technical, and management expertise
- Provide laboratory and test facilities

**Army as Executive Agent**

- Coordinates and integrates research, development, T&E, and acquisition requirements of the military departments

**Joint Program Executive Office for Chemical and Biological Defense**

- Serves as the CBDP materiel developer
- Oversees life-cycle acquisition management for assigned system acquisition programs within the CBDP

- Provides centralized program management and Joint Service acquisition program integration for all assigned nonmedical and medical chemical and biological defense (CBD) programs

#### **Program Analysis and Integration Office**

- Provides independent analysis to decision makers to inform review and recommendations concerning impacts to the overall integrated CBDP

#### **CBDP Test & Evaluation Executive**

- Oversees CBDP T&E infrastructure to ensure that adequate T&E is conducted for CBDP systems
- Establishes test standards, processes, and procedures

#### **Joint Combat Developer for CBRN Defense**

- Coordinates and oversees execution of Joint and multi-Service experiments used to validate the Joint Integrating Concept for CBRN defense
- Systematically explores new and innovative combinations of medical and nonmedical doctrine, organization, training, materiel, leadership and education, personnel, and facilities (DOTMLPF) capabilities

#### **DTRA Program and Budget Division**

- Conducts funds management of the integrated CBDP under the oversight of the ATSD(NCB)

#### **DTRA Chemical and Biological Defense Directorate, also designated as the Joint Science and Technology Office for Chemical and Biological Defense**

- Manages and integrates CB defense science and technology (S&T) base program
- Works with JPEO-CBD to ensure effective transition of S&T efforts to advanced development ■

# CBDP Funding

The CBDP Fiscal Year 2008 (FY08) President's Budget request is \$1.570 billion. The figure below breaks out the total by the research, development, test, and evaluation budget activities and procurement appropriation.

## FY08 CBDP Budget Activities

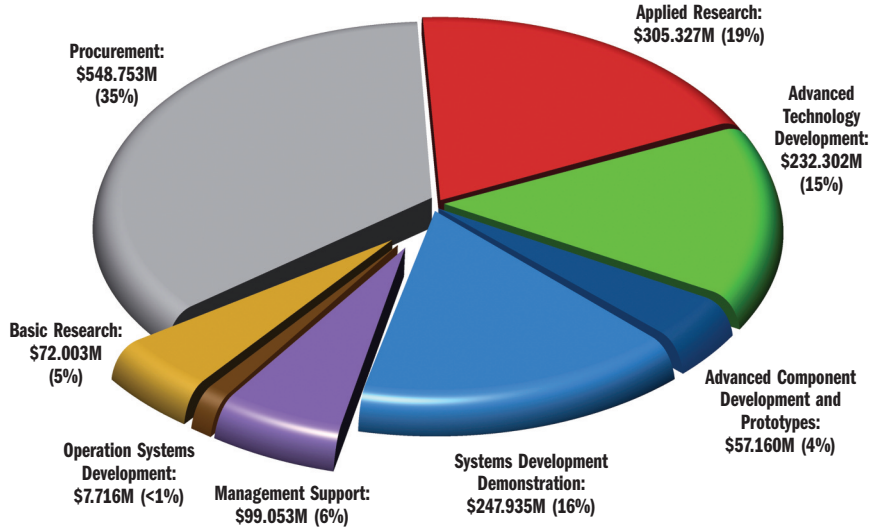

The figure below breaks out the CBDP FY08 President's Budget request by the percentages that fund the functional CBDP areas, including Sense, Shape, Shield, Sustain, Homeland Defense, and other. "Other" includes funding for S&T funds that may be applicable to two or more of the functional areas and management support funding that includes the Dugway Proving Ground Major Range and Test Facility Base costs.

## FY08 Functional Areas

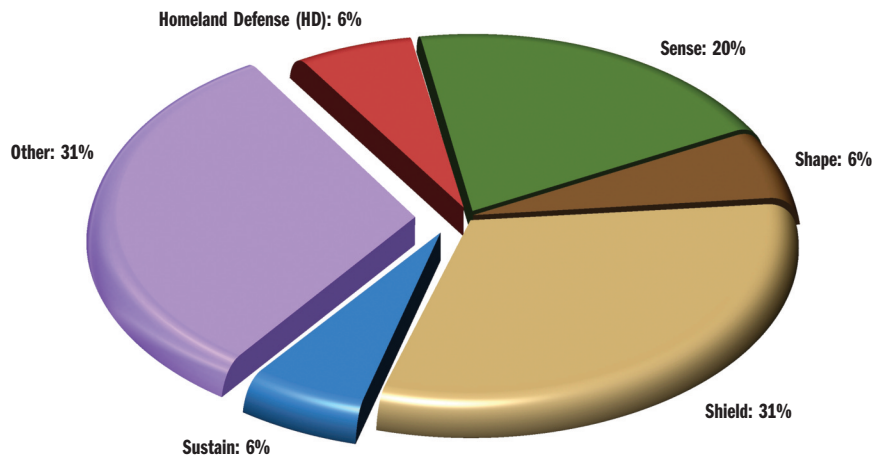

The figure below shows the CBDP appropriated values for FY06 and FY07 and the President's Budget Request for FY08–13 broken out by procurement, advanced development, and S&T funds. ■

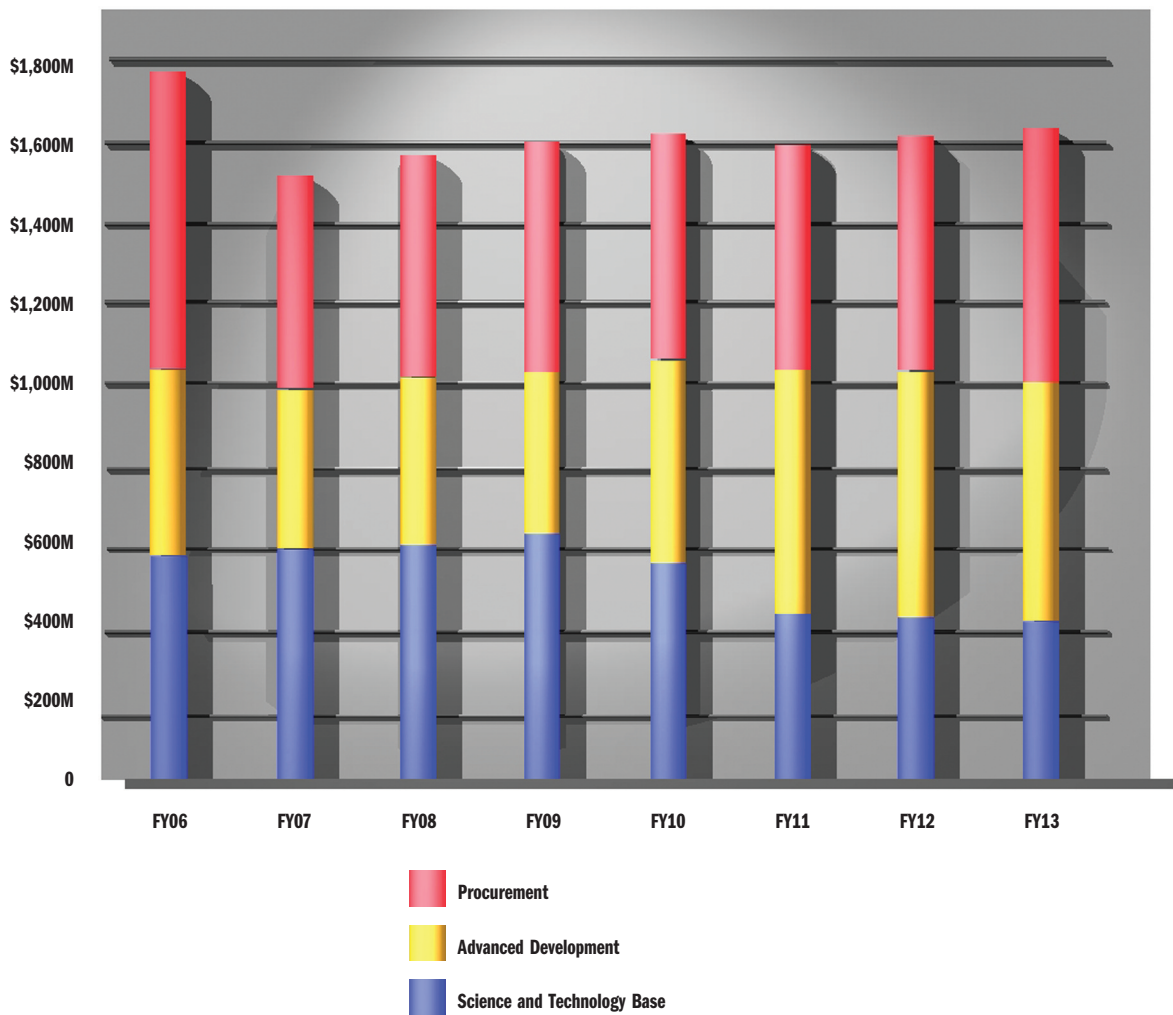

# Chemical, Biological, Radiological and Nuclear (CBRN) Capabilities

To face the evolving and complex threats of the 21st century, DOD has embraced a new “capabilities-based” approach to defense, which requires overall readiness for a variety of potential threats to the nation’s security.

The CBDP contributes to the capability of “Force Protection.” This overview provides key information about the equipment being developed and deployed that meets the CBDP mission of providing CB defense capabilities in support of the National Military Strategies. Each program in this overview supports one of four essential CBRN defense functions:

## Sense

- Provide essential information about a CBRN situation
- Detect, identify, and quantify CBRN hazards—
  - in air, in water, on land, on personnel, equipment, or facilities
  - in all physical states—solid, liquid, and gas

## Shape

- Characterize the CBRN hazard to the force commander
- Develop a clear understanding of the current and predicted CBRN situation; collect and assimilate information from sensors, intelligence, medical, etc. in near real time to—
  - inform personnel with actual and potential impacts of CBRN hazards
  - envision critical Sense, Shield, and Sustain end states to allow forces to prepare for operations
  - visualize the sequence of events that moves the force from its current state to those end states

## Shield

- Shield the force from harm caused by CBRN hazards
- Prevent or reduce individual and collective exposures

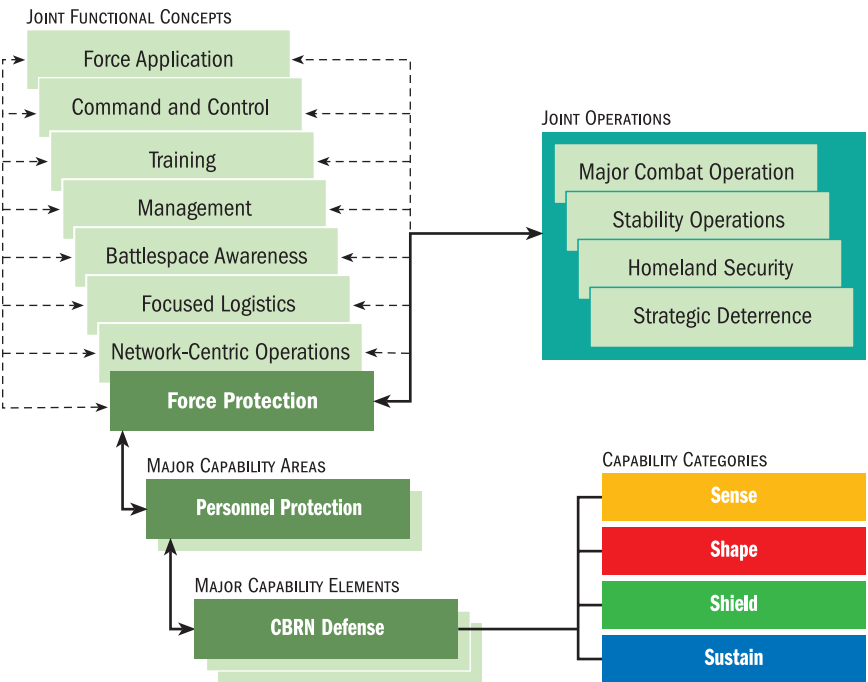

- Apply prophylaxis to prevent or mitigate negative physiological effects
- Protect critical equipment

## **Sustain**

- Conduct decontamination and medical actions that enable the quick restoration of combat power
- Maintain and recover essential functions that are free from the effects of CBRN hazards
- Facilitate the return to preincident operational capability as soon as possible

JRO

JRO

JRO

JRO

JRO

JRO

JRO

JRO

JRO

**JRO**

**JRO**

**JRO**

**JRO**

**JRO**

**JRO**

**JRO**

**JRO**

**JRO**

**JRO**





JRO-CBRND is the single office within DOD responsible for the planning, coordination, and oversight of Joint CBRN defense operational requirements. This office is primarily responsible for the following:

- Developing and maintaining the CBRN defense Overarching Operational Concept and the CBRND Modernization Plan
- Representing the Services and Combatant Commanders in the requirements generation process and acting as their proponent for coordinating and integrating CBRND operational capabilities
- Developing DOD CBDP POM with acquisition community support
- Facilitating the development and integration of Joint doctrine and training and sponsoring the development of multi-Service medical and nonmedical CBRN defense doctrine

### **Program Description**

JRO-CBRND serves as the Chairman, Joint Chiefs of Staff single source of expertise to address all issues involving CBRN defense within passive defense, consequence management, force protection, and homeland security. JRO-CBRND directly supports the CBDP, in particular, the development of CBRN defense capability requirements and the improvements of CBRN defense-related doctrine, education, training, and awareness at the Joint and Service levels. Within the scope of the Joint Capabilities Integration and Development System (JCIDS), JRO-CBRND does the following:

- Conducts Capabilities-Based Assessments (Functional Area, Functional Needs, and Functional Solutions Analyses) and concept experimentation
- Serves as the sponsor to develop and coordinate CBRN defense capabilities documents (Initial Capabilities Documents, Capability Development Documents, Capability Production Documents, and DOTMLPF Change Recommendations)
- Integrates solutions from Capabilities-Based Assessments into Joint, multinational, and multi-Service doctrine and Joint education and training
- Through participation in and support to Joint exercises, identifies CBRN defense capability gaps and policy shortfalls through the Functional Capabilities Board (FCB) process
- Leads the Combating Weapons of Mass Destruction Working Group to adjudicate JCIDS-related comments and CBDP issues; takes issues forward to the Force Protection Functional Capabilities Board as appropriate

JRO-CBRND comprises three branches: Mission Area Integration; Capabilities Integration; and Concepts, Studies, and Analysis.

### **Doctrine**

Conduct CBRND SME technical reviews of CBRN-specific Joint Doctrine and selected draft Joint doctrinal materials to ensure CBRN defense is adequately addressed and integrated. Assist the Lead Agent and Primary Review Authority as the Joint Staff Doctrine Sponsor in the development of Joint doctrine. Provide applicable Capabilities-Based Assessment solutions to the doctrine writer to use and integrate into Joint Publications.

Coordinate and execute the JRO's CBRN defense Multi-Service Tactics, Techniques, and Procedures (MTTP) development program consisting of 11 nonmedical and 4 medical MTTP manuals. Facilitate integration of Capabilities-Based Assessment solutions into MTTPs.



## **Joint Requirements Office**

Mission Area Integration	Capabilities Integration	Concepts, Studies, and Analysis
<ul style="list-style-type: none"> <li>• Develop Modernization Plan</li> <li>• Coordinate Combating WMD Working Group</li> <li>• Lead POM development</li> <li>• Develop Strategic Plan</li> <li>• Conduct Program Reviews and Readiness Reviews</li> <li>• Coordinate liaison support</li> <li>• Installation Protection and Homeland Security coordination</li> <li>• DAsD-CT, GWOT &amp; CP International CPWG Bi lats support</li> <li>• Joint Capability Area coordination</li> <li>• Support/synchronization Force Protection Functional Capability Board (FCB)</li> </ul>	<ul style="list-style-type: none"> <li>• Identify, describe, and document capability solutions across the DOTMLPF domains</li> <li>• Develop and sponsor JCIDS documentation for CBRN Passive Defense, Consequence Management, Interdiction, and Elimination</li> <li>• Advocate for materiel and non-materiel solutions to identified gaps</li> <li>• Lead Integrated Concept Teams to identify Service needs and develop JCIDS products; staff in KM/DS and take forward through FCB/JCB/Joint Requirements Oversight Council for approval</li> <li>• Provide warfighter advocacy to PMs, T&amp;E, and S&amp;T organizations</li> <li>• Coordinate the development and integration of Joint, multi-Service, and multinational doctrine</li> <li>• Coordinate and integrate Joint and Service education through curriculum enhancements, wargames, tabletop exercises, subject matter expert guest speakers and curriculum development</li> <li>• Coordinate and integrate Joint training through support to COCOM exercises, senior leader seminars, tabletop exercises, and Mobile Training Teams</li> <li>• Participate in development and implementation of multinational agreements with NATO, CANUKUS, and ABCA</li> </ul>	<ul style="list-style-type: none"> <li>• Develop operational concepts</li> <li>• Conduct Capabilities-Based Assessments</li> <li>• Participate in experiments, demonstrations, and Joint Concept Technology Demonstrations</li> <li>• Oversee Joint Combat Developer for Experimentation</li> <li>• Develop/manage studies</li> <li>• Provide advocacy for S&amp;T M&amp;S</li> <li>• Coordinate Threat Capability Assessments</li> <li>• Develop Analytic Agenda</li> </ul>

Review and analyze Joint Concept Technology Demonstrations (JCTD) concept of operations (CONOPS) and develop relevant changes to doctrine (Joint Publications and MTTPs). Monitor and assess the methodology used for tactics, techniques, and procedures (TTP) data collection, lessons learned, and reports during the operational testing of the Advanced Concept Technology Demonstration (ACTD)/JCTD for integration into Joint or multi-Service doctrine.

## Education

Coordinate subject matter expert guest speaker support for Service/Joint intermediate- and senior-level colleges and senior enlisted academies. Support is focused on CBRN/weapons of mass destruction (WMD)/consequence management (CM) learning areas. JRO maintains a robust speaker list with specific areas of expertise.

Facilitate curriculum reviews at Service/Joint intermediate- and senior-level colleges and senior enlisted academies for integration of CBRN/WMD topics into existing programs of instruction.

Coordinate and provide oversight to faculty development at Service/Joint intermediate- and senior-level colleges and enlisted academies through the facilitation of the CBRN Faculty Curriculum Developers Course. This flexible four- to eight-hour course is designed to provide staff and faculty with an overview of several CBRN/WMD topics to assist them with integration into their respective curricula.

Coordinate and provide oversight for wargame/exercise support to Service/Joint intermediate- and senior-level colleges. This support covers operational concept, learning objectives, and scenario development as well as subject matter experts for execution, after-action consolidation, and recommendations for the next evolution.

Coordinate the execution of the JRO-sponsored Joint Senior Leaders' Course (JSLC) conducted at the U.S. Army Chemical School in Ft Leonard Wood. Target audience is O5 and above or civilian equivalent and E9 with a focus on CBRN/WMD operational and strategic level topics. The Chemical Defense Training Facility for Toxic Agent Training is part of the JSLC.

Co-chair with JPEO the Joint Training Working Group (JTWG), a subgroup of the JPEO-sponsored Joint Logistic Advisory Council. Members of the group include JPEO, JRO, Joint Program Managers, Service representatives, and others as required. The JTWG addresses training issues that affect new equipment development, fielding, and sustainment.

## Training/Exercise Support

JRO plans, coordinates, and provides CBRN defense training and exercise support to combatant command (COCOM) and Joint Task Force (JTF)-level staffs to enhance these staffs' capabilities to perform their CBRN defense missions and to provide a key mechanism by which capability gaps can be identified and addressed.

Preexercise support includes exercise Concept and Scenario Development, Vignette and Master Scenario Event List Drafting, and exercise Collection Management Plan writing. These products are largely based on the supported COCOM/JTF Joint Mission-Essential Tasks and exercise objectives. During the exercise event, support includes providing JRO observer/trainers, analysts, senior mentors and subject matter expertise to the Joint Exercise Control Group and/or White Cell. Post-exercise support includes writing the lessons learned/after-action report and providing CBRN defense-related analysis for inclusion in the command's post-exercise "hot-wash" brief.

The JRO has CBRND exercise planners who work on site with the Joint Forces Command (JFCOM) Joint Force Trainer (J7) to improve current and emerging Joint force warfighting capabilities in a CBRN environment. Working with JFCOM, JRO plays a significant role in the integration of CBRN defense consideration into JFCOM-sponsored exercises and assisting Geographic and Functional Combatant Commanders with CBRN-related tasks/missions in each of the four phases of the Joint Training System: requirements, plans, execution, and assessment.

JRO training support also includes the planning and execution of the Joint CBRN Familiarization Course (JCBRNFC) Mobile Training Team and online course, as well as COCOM and JTF tabletop exercises (TTXs) and Senior Leader Seminars (SLSs). The JCBRNFC presents definitions, terminology, and information associated with Joint operations in a CBRN environment and relevant strategies/policies to deter and combat the proliferation/use of WMD. The target audience is O4/O5-level officers on COCOM and Joint Staffs. Support to TTXs and SLSs includes training objective, scenario, academic package, and gamebook development prior to the training event. During the event, JRO provides facilitation and senior mentor support. Post-training event activities include assisting the supported command in writing the after-action report. ■







## Medical Science and Technology Division

The JSTO-CBD Medical Science and Technology Division is responsible for science and technology efforts that lead to the development of pretreatments for chemical warfare agent exposure, methods for timely diagnosis of specific exposures, and treatments to sustain individual health and force strength in the event of attack.

This multifaceted charge contains significant challenges:

- Threat agents can be engineered to act quickly yet be imperceptible to human senses.
- Threat agents are already numerous and can proliferate through discovery, invention, and natural or engineered mutation.
- Exploiting opportunities to block or reverse agent effects requires the mastery of complex chemical reactions and biological process by experts in very specialized fields.
- Processes involving research, development, testing, and finally fielding pharmaceuticals in the United States are governed by stringent U.S. Food and Drug Administration (FDA) protocols designed to protect experimental subjects and the beneficiaries of the approved product. These take significant time.

The Medical Division's three capability areas and the Transformational Medical Technologies Initiative (TMTI) support warfighter needs by addressing pretreatments, diagnostics, and therapeutics:

- **TMTI** is dedicated to anticipating future, genetically modified/emerging threats and developing strategies and treatments that will enable effective broad-spectrum medical countermeasures. TMTI seeks to shorten the timeline for development of products using novel scientific approaches and streamlined business practices.
- The **Diagnostics** Capability Area is dedicated to developing improved screening procedures and analytical methods to verify exposure and determine effects of exposure to chemical and biological warfare agents (CWAs and BWAs).
- The **Pretreatments** Capability Area is dedicated to research and development (R&D) of vaccines and technologies given to Service members prior to potential exposure to biological agents. The goal is to reduce or prevent entirely adverse effects of exposure.
- The **Therapeutics** Capability Area is dedicated to providing medical solutions for military requirements to sustain and protect the force in chemical and biological environments. Therapeutics deals primarily with medical countermeasures to bacterial, viral, toxin, and chemical agent exposure. ■



## Medical S&T

# Transformational Medical Technologies Initiative

Beyond the development of broad-spectrum countermeasures, TMTI will revolutionize DOD drug development processes and technology for rapid response for the warfighter and to the nation. TMTI benefits include the following:

- At least two new technology platforms for rapid response
- At least two broad-spectrum countermeasures leading to investigational new drugs within five years
- Genetic sequences for pertinent threats
- A more expedient approach to drug development, including shorter timelines from discovery to advanced development to fielding
- Bioinformatics and novel information platforms to analyze genes and proteins at the molecular level

### GOVERNMENT PERFORMERS

- Federally Funded Research and Development Centers
- Naval Medical Research Center
- Armed Forces Institute of Pathology
- U.S. Army Medical Research Institute of Infectious Diseases

### Program Description

In 2006, DOD pioneered TMTI to enhance and accelerate the medical research, development, test, and evaluation (RDT&E) efforts for broad-spectrum defenses against potential biological warfare (BW) attacks that could endanger our Service members. This initiative also addresses a number of goals of Homeland Security Presidential Directive 18, including the threat of emerging and advanced biological agents.

Technological and medical innovations of the past conquered many diseases and extended human lives. Ironically, some of these same innovations also paved the way for the advanced weaponization of BW agents. Biological weapons have proved to be effective—their use can produce mass casualties and interrupt operations. They are relatively inexpensive to produce and increasingly easy to design, build, and disseminate. Thus, the threat to United States and allied forces, and indeed the nation, is real.

TMTI's innovative approach of developing broad countermeasures against a wide range of agents will transform and strengthen DOD's ability to protect the warfighter and the nation against BW threats, now and in the future. TMTI fosters defensive and life-saving solutions for the future warfighter and the nation through the following:

- **Accelerated medical research** to identify several “high-payoff” medical technologies and solutions to protect the warfighter from disease, particularly exposure to biological agents
- **Cross-cutting novel technologies** for the rapid development of broad-spectrum countermeasures
- **Broad-spectrum countermeasures** that are regulatory compliant, robust, and highly effective
- **Improved coordination and collaboration with partners** through routine, proactive communication processes
- A **selective and rigorous milestone-driven management process** to ensure selection of only the highest-quality performers and best-value products aligned with the program mission
- Development of early- and late-stage projects for a **diversified product portfolio**
- Parallel development of **alternative technologies** ■

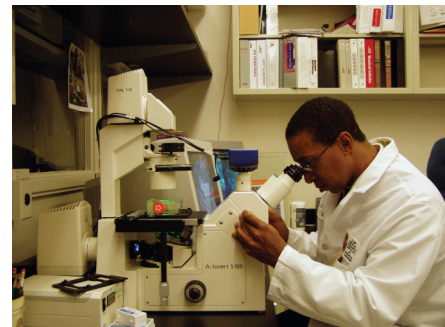

## Program Description

The Diagnostics Capability Area develops analytical tests and test systems to definitively identify exposure to biological and chemical agents in clinical sample matrices. Because early and definitive diagnosis enables prompt, effective therapy and rapid return to duty, the focus is on the early, presymptomatic stage. Coupled with effective medical countermeasures, an enhanced diagnostic capability deters the use of these agents by denying adversaries the operational advantage of using such weapons.

The Diagnostics S&T base assesses promising diagnostic platforms, investigates improved nucleic acid extraction methods, and develops assays and reagent sets for deployed platforms that will be employed to assist in clinical decisions. All products are developed with the intent of pursuing FDA approval. Collaboration with advanced developers, other government agencies, industry, academia, and allies is actively pursued. This capability area is divided into two thrust areas: Biological Diagnostics (including Emerging Threats) and Chemical Diagnostics.

## Biological Diagnostics

Biological Diagnostics addresses the diagnosis of infections caused by exposure to bacterial, viral, or toxin agents. The largest effort supported by this thrust area is the Joint Biological Agent Identification and Diagnostic System (JBAIDS) program. Biological diagnostics has four subthrust areas:

- **Technology Assessment** identifies promising new and, preferably, relatively mature technologies and conducts investigations to determine military and/or clinical utility. Evaluation centers use consistent and objective decision parameters. Current pursuits include deoxyribonucleic acid (DNA) (oligonucleotide and resequencing) microarrays, whole genome and multiplexed amplification, broad pathogen detection, and proteomic/bioinformatics methods. This area directly supports the JBAIDS program.
- **Assay Development** develops clinical assays for new and existing technologies, specifically nucleic acid-based (including antibiotic resistance) and immunodiagnostic (antibody-based) assays. Novel approaches—such as those using proteomics to identify new targets and recombinant technologies to enhance reagent robustness and uniformity—are being actively pursued. Investigation of more efficient sample preparation methods is included in this area. This area directly supports the JBAIDS program.

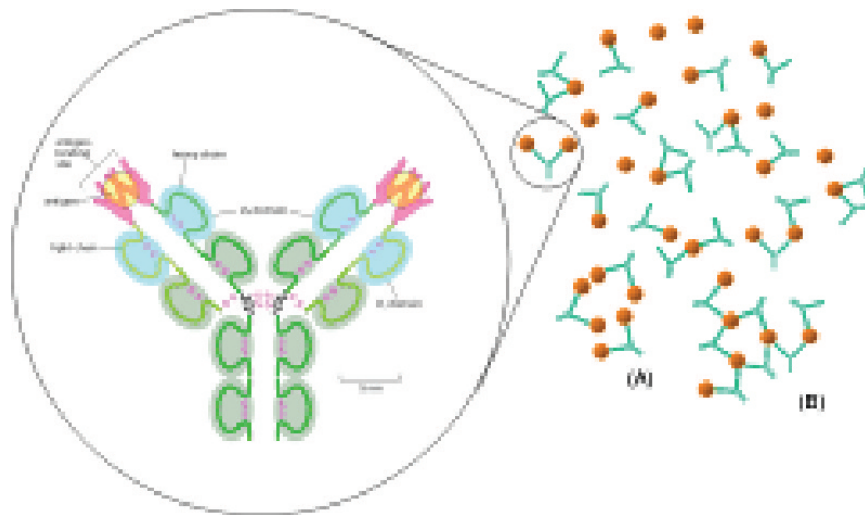

## Medical S&T

# Diagnostics Capability Area

- Identify novel biomarkers/targets; design/develop diagnostic assays for determining the presence of, or exposure to, biological and chemical agents in clinical samples
- Develop standardized methods, requirements, and documentation for assay and reagent verification and regulatory approval
- Support programs of record, for example, the Joint Biological Agent Identification and Diagnostic System
- Identifying screening strategies to identify emerging threats: rapid detection, threat assessment, and attribution of genetically engineered bioterror organisms using microarray-based resequencing technologies

## GOVERNMENT PERFORMERS

- U.S. Army Medical Research Institute of Infectious Diseases
- Navy Medical Research Center
- Walter Reed Army Institute of Research
- Armed Forces Institute of Pathology
- Naval Research Laboratory
- Air Force Research Laboratory
- U.S. Army Medical Research Institute of Chemical Defense

- **Identification of Novel Biomarkers** identifies novel agent-/host-specific markers that could prove useful in identifying the presence of, or exposure to, biological agents. Areas of emphasis include identification of early, intermediate, and late markers of infection, host and agent response, and agent biology (including molecular epidemiology, genomics, proteomics).
- **Test and Evaluation** develops animal model systems for pathologic and toxicokinetic verification and field studies to test DOD-developed diagnostic assays and platforms. This area directly contributes to development of concepts of operation and directly supports the JBAIDS program.

## Chemical Diagnostics

Chemical Diagnostics seeks to develop improved assays, including screening procedures and definitive analytical methods, for verification of chemical agents in biomedical samples. Due to the short window before symptoms appear (24–48 hours) in clinical samples, “real-time” agent detection and diagnosis are difficult. Thus, the current program focuses on agent/metabolite detection “after the fact” (forensics).

Through the Emerging Threats Subthrust Area, the Diagnostics Capability Area addresses requirements for medical countermeasures and diagnostic tests directed against genetically modified threat pathogens. The purpose is to support the development and application of systems biology tools (genomics, proteomics, and bioinformatics) that can be applied to the other capability areas in the Medical S&T program. This area also exploits advancements in host and pathogen genomics information and identifies key pathogenesis pathways. These can then be applied to the development of broad-spectrum countermeasures against genetically engineered pathogens and define best target/biomarker for development. ■



## Program Description

The Pretreatments Capability Area conducts basic and applied research leading to the development of vaccines against validated biological threat agents (viruses, bacteria, and toxins) and pretreatments that protect against exposure to validated threat chemical agents. Emphasis is placed on technologies and approaches leading to the next generation of biodefense vaccines, including multiagent vaccines, molecular vaccines, new vaccine platforms and adjuvants, and alternative (needle-less) delivery methods. The Pretreatments Capability Area has four associated thrust areas:

- **Multiagent Vaccine Development** signals a change in strategic direction, from development of vaccines against single or closely related pathogens to development of vaccines that simultaneously target multiple biothreat pathogens or toxins through a single immunization series. Multiagent vaccines will greatly reduce the medical logistics burden, minimize costs associated with use of biodefense vaccines, and enhance user compliance.
- **Vaccine Research Support Studies** directly support the transition of vaccine candidates to advanced development. Concurrently, basic research studies develop new insights into pathogen genetics, virulence factors, host-pathogen interactions, pathogenic mechanisms, and host immunity using the new tools of systems biology (proteomics, genomics, and bioinformatics). These studies will identify new candidate vaccine targets that will be employed in the development of advanced or next-generation molecular and multiagent vaccines. Studies currently focus on toxins, as well as bacterial and viral pathogens.
- **Technology Development** is divided into molecular vaccines and molecular immunology. Efforts in molecular vaccines research involve exploring gene-based vaccine technologies and validating the effectiveness of candidate vaccine platforms—including engineered viruses, recombinant or fusion proteins, molecular vaccines, and new adjuvants that will be applicable to the development of next-generation multiagent biodefense vaccines. These vaccine platforms should permit insertion of new immunogenic cassettes, facilitating rapid development of vaccines effective against new threat agents (genetically engineered threats or emerging infectious diseases). The goal of molecular immunology efforts is to investigate molecular mechanisms of protective immunity to rationally design and develop next-generation biodefense vaccines.
- **Chemical Warfare Agents Pretreatments** address the requirement for effective pretreatments against chemical nerve agents. Bioscavengers are plasma-derived proteins that bind nerve agents. Two bioscavengers, a human plasma-derived butyrylcholinesterase (pBuChE) and a recombinant form of pBuChE, have passed Milestone A and have transitioned to advanced development. The plasma-derived pBuChE will be developed for use by the U.S. Department of Health and Human Services (DHHS) under interagency agreement. Current research in bioscavenger proteins is developing catalytic bioscavengers that will protect against both organophosphate nerve agents and novel threat agents. ■

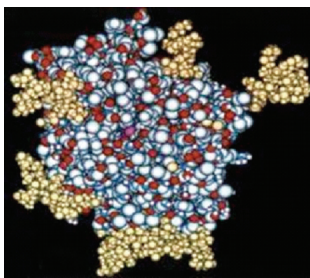

Molecular model of human plasma-derived butyrylcholinesterase

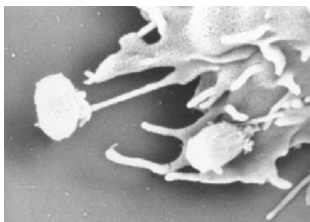

Electronmicrograph of bacillus spores adhering to cell membrane processes

## Medical S&T

# Pretreatments Capability Area

- Develop FDA-approved vaccines against viral, bacterial, and toxin threat agents
- Develop molecular/DNA vaccines, vaccine platforms, and adjuvants
- Develop multiple-agent vaccines
- Develop novel needle-less vaccination systems
- Develop FDA-approved, broadly effective pretreatments against nerve agents, without significant adverse reactions or operational impact

### GOVERNMENT PERFORMERS

- U.S. Army Medical Research Institute of Infectious Diseases
- Walter Reed Army Institute of Research
- U.S. Army Medical Research Institute of Chemical Defense
- Navy Medical Research Center

## Medical S&T

# Therapeutics Capability Area

- Develop FDA-licensable drugs to treat personnel exposed to validated biological and chemical warfare agents
- Develop broad-spectrum and rapidly acting therapeutics strategies based on intervention in common pathogenic mechanisms
- Develop novel antiviral compounds for hemorrhagic virus and poxvirus treatment
- Augment existing chemical nerve agent defense countermeasures with improved neuroprotection and anticonvulsant compounds
- Identify efficacy of novel antimicrobial compounds against bacterial threats
- Rescue nerve cells from the effects of botulinum neurotoxin exposure
- Identify common mechanisms of agent-mediated injury and design therapeutics effective against whole classes of threat agents, including nontraditional agents

### GOVERNMENT PERFORMERS

- U.S. Army Medical Research and Materiel Command laboratories:
  - U.S. Army Medical Research Institute of Chemical Defense
  - U.S. Army Medical Research Institute of Infectious Diseases
  - Walter Reed Army Institute of Research
- Air Force Research Laboratory
- Naval Research Laboratory
- U.S. Navy Medical Research Center
- Armed Forces Institute of Pathology
- Uniformed Services University for Health Sciences

### Program Description

The Therapeutics Capability Area supports basic and applied R&D leading to safe, effective medical treatments to counteract the effects of bacterial, viral, toxin, and chemical threat agents. Efforts in this area emphasize R&D that will lead to pharmaceuticals effective against single agents as opposed to the Transformational Medical Technologies Initiative which is designed to address entire classes of agents. JSTO-CBD researchers are probing the genetic and molecular bases of microbial and toxin virulence; pathogenic and toxic mechanisms; and the keys to resistance, repair, and recovery. Progress depends on the development of valid animal models and surrogates for human efficacy, as these are required for ultimate FDA approval. The strategy includes both evaluating FDA-approved drugs for new uses and identifying new therapeutic targets for advanced and next-generation treatments. Efforts are divided into four thrust areas:

- **Bacterial Therapeutics** will identify new therapeutic targets to be used in developing advanced or next-generation treatments for bacterial infection and disease. Emphasis is placed on the mechanisms of antimicrobial resistance and development of therapeutic technologies that will reduce reliance on conventional antibiotics. In addition, current FDA-approved drugs and therapeutics are being evaluated for novel uses against bacterial threat agents.
- **Viral Therapeutics** efforts have led to maturing therapeutic technologies targeting orthopoxviruses and filoviruses. Current efforts are focused on transitioning these technologies to advanced development. This thrust area also continues to support identification of new therapeutic targets for next-generation treatments for viral infection and disease and the evaluation of FDA-approved drugs and therapeutics against viral threat agents.
- **Toxin Therapeutics** will define toxin-receptor bindings, explore biochemical activities of toxins, and identify events cascading from those biochemical activities. These efforts will lead to identification of new therapeutic targets to be used in developing advanced or next-generation treatments for intoxication by biological toxins. In addition, current FDA-approved drugs and therapeutics are being evaluated for new uses against toxin agents.
- **Chemical Agent Therapeutics** aim to develop therapeutic countermeasures against traditional and nontraditional chemical threat agents and to evaluate the effectiveness of countermeasures to respiratory, cutaneous, systemic, and ocular chemical agent exposure. Basic research efforts in this area will delineate the underlying mechanisms of chemical agent-induced injury at subcellular levels, identifying molecular target interactions and biochemical activities of CWAs. These interactions and activities can be exploited to develop new therapeutic approaches and assist in rational drug design. In addition, current FDA-approved drugs and therapeutics are being evaluated for use as treatment for chemical nerve and vesicant agent exposure. ■

## Physical Science and Technology Division

The JSTO-CBD Physical Science and Technology Division (CBT) research emphasizes innovation in managing multidisciplinary basic and applied research to meet the technology needs and capability gaps defined and prioritized by the Joint Requirements Office (JRO). CBT also ensures the effective transition of resulting technologies to Joint acquisition programs and new insights into policy and doctrine.

CBT investments reflect a sound balance between the pull of requirements and the push of technological advances and our posture reflects an organization that must remain forward-looking even as we support transitional technologies and nearer-term objectives. While our program remains influenced by the pull of requirements, we have also included higher-risk/high-reward technology pushes to build our technology base to meet future threats.

- The mission of the **Basic Research Program** is to fund fundamental research with broad, long-term potential applications in CB defense. The program funds innovative fundamental scientific efforts across the physical sciences in government, industry, and academia that could lead to high payoff for CB defense applications into the Physical S&T functional capability areas' core program.
- The **Detection Capability Area** is directed at developing CB sensor components and systems for standoff applications, BWA point identification, lightweight integrated identification, and detection of CB agents in water. This area emphasizes early warning applications and identification to provide situational awareness of the total battlespace CB threat.
- The **Information Systems Technology Capability Area** is directed at giving the warfighter and combatant commanders advanced hazard assessment methods and models, providing optimized data fusion to leverage in decision making across networks, and providing visualization of network sensor responses. The area also uses information on weapons effects and insights in conflict simulations and distributed information systems to address operational effects and processes.
- The **Protection and Hazard Reduction Capability Area** is directed at providing technologies that shield the Service member from harm caused by chemical, biological, radiological, and nuclear (CBRN) hazards and allow decontamination of individuals and equipment. Technologies that prevent or reduce individual and collective exposures and limit the effects on critical equipment can also prevent or mitigate negative physiological effects on the Service member.
- The **Threat Agent Sciences Capability Area** is dedicated to increasing knowledge of CB agents and current, nontraditional, and emerging CB threats as well as the simulants used to test the efficacy of systems. Developing predictive models of CB agent behavior and gaining further understanding of the physiological effects of exposure improve the scientific underpinnings needed to develop rational CB policies, tactics, and procedures.
- The **Special Projects Office** seeks to identify and leverage leading-edge basic research to achieve revolutionary, integrated, and cross-cutting applications for the chemical and biological defense of future combat systems. The focus is on the multidisciplinary application of revolutionary new concepts in the fields of nanoscience, biotechnology, information technology, and the cognitive sciences to support the needs of the future warfighter. ■

## Physical S&T

# Basic Research Program

- Supports fundamental research with broad, long-term potential applications in CB defense.
- Funds efforts across the physical sciences with high-payoff potential for CB defense applications.
- Balances short-term and long-term strategies to maximize the benefit to warfighter and the potential of scientific leaps in the long-term.

### GOVERNMENT PERFORMERS

- Naval Surface Warfare Center – Dahlgren
- Naval Research Laboratory, Washington
- Air Force Research Laboratory, Tyndall Air Force Base
- Natick Soldier Center
- Army Research Laboratory, Aberdeen Proving Ground
- Edgewood Chemical and Biological Center

### Program Description

The mission of the Basic Research Program is to fund fundamental research with broad long-term potential applications in CB defense. The program is aligned with the DOD definition of basic research and the recommendations of the 2005 Report from the National Research Council's Committee on DOD Basic Research Division on Engineering and Physical Science—"Assessment of Basic Research." Per Recommendation 1 in that assessment, "Basic research is systematic study directed toward greater knowledge or understanding the fundamental aspects of phenomena, and has the potential for broad rather than specific, application."

The Basic Research Program funds innovative fundamental scientific efforts across the physical sciences in government, industry, and academia that could lead to high payoff for CB defense applications in the Physical S&T functional capability areas' core program and seeks to develop a balanced investment across the scientific disciplines for long-term and short-term impact on CB defense. The investment includes need-based, basic research supporting underlying fundamental science relevant to CB defense and opportunities-based research to develop revolutionary new S&T that may significantly enhance warfighter protection and lethality through the following:

- The development of molecular-level self-assembly and directed assembly to obtain exceptionally stable, useful, and highly functional abiotic supramolecules, systems, and materials that can behave as true artificial enzymes and give living-system-like responses
- Fundamental studies on the formation of metal oxide particles precipitated together with biocidal agents and agent reactive enzymes using a biomimetic-based synthesis—potential applications exist in decontamination and protection
- Development of a fundamental understanding of biophysical fluid dynamics at nanosensor surfaces in microfluidic systems and how biomolecules and labels interact with functionalized surfaces under laminar flow, which could lead to develop sensors with enhanced performance

Short-term, basic-research investments include investigations into the following areas:

- **Biomimetic Living System**—Controlled functionalization of surfaces with biological molecules and advanced catalysts, stimuli-responsive architecture, stabilized inorganic/organic interfaces, and engineered nanomaterials
- **Biomolecular Recognition and Catalysis**—Mechanisms of biomolecular recognition, predictive tools for molecular recognition, and catalysis and mechanisms of synthetic catalyst-substrate interactions including multimetallic catalysts

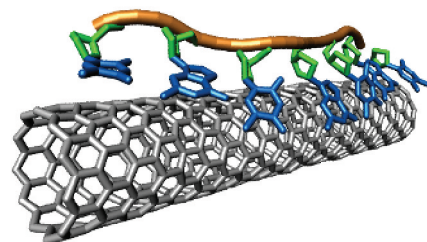
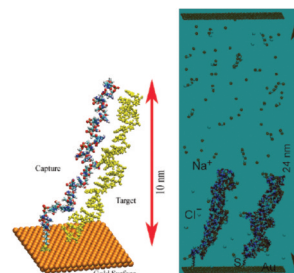
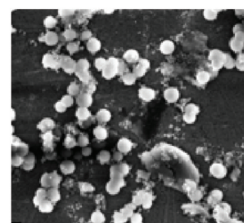
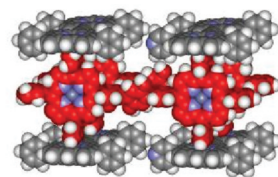

- **Molecular Recognition Signatures in the Electromagnetic Spectrum**—Computational evaluation of energy levels and vibrational modes present in biomolecules; predictive modeling of the interaction between terahertz energy with threat agents; and development of materials for source, detector, and optics to validate new spectral signature models
- **Permeability of Protective Material or Living Tissue**—Transport models through human tissue, development and characterization of skin models, fundamental studies to determine mechanisms of membrane permeability, and the development of synthetic membranes
- **Chemical Reactivity and Physicochemical Properties of Interrelated Fiber Components**—Characterization and interrelationships among surface morphology, surface energy, physicochemical, and reactive chemical properties and the development of an empirical approach to determining mass accommodation coefficient, diffusion coefficient, reaction-limited uptake, and uptake coefficient
- **Ab Initio Approach to Increasing Material Interactions with High-Energy Photons**—Modeling-enhanced energy coupling; electromagnetic energetics and decoupling; advanced radiation theory; and high-density, condensed matter
- **Uncertainty Quantification, Interpretation, and Communication for Probabilistic Fluid Transport and Dispersion**—New ensemble and perturbation methods that maximize spread among members of numerical weather prediction models and mathematical techniques to optimally couple variance information, human assimilation, and interpretation of risk and uncertainty

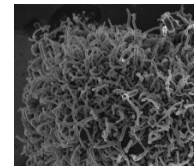

Long-term investment strategies include advancing the following areas of research due to their potential for high-reward improvements in CB defense capabilities:

- **Nanoscience**—Develop a fundamental understanding of the synthesis, structure, and function of new emerging classes of nanomaterials and their interactions with surfaces and agents
- **Multifunctional “Smart” Materials**—Combine multiple technologies into a common system able to detect an agent, give some type of warning indication, and respond to the stimulus to either inactivate or protect against the threat

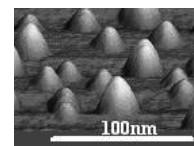

Ultimately, the goal of this program is to maintain a diverse basic research program supporting both needs-based and opportunity-based research with applicability across multiple capability areas. ■



## Physical S&T

# Detection Capability Area

- Develop the capability to provide early warning to CB hazards
- Develop the capability to detect contamination in the air, on surfaces, and in water
- Develop sensor systems that can be integrated into fabrics, paints, and surfaces
- Develop the capability to sequence whole genomes
- Integrate detection of toxic industrial chemicals (TICs) into CB warfare agents sensor systems
- Increase sensitivity and selectivity performance to meet “How clean is safe?” levels

### GOVERNMENT PERFORMERS

- Federally Funded Research and Development Centers
- Edgewood Chemical and Biological Center
- Army Research Laboratory
- Naval Research Laboratory
- U.S. Army Medical Research Institute of Infectious Diseases
- Naval Surface Warfare Center-Panama City
- Defense Threat Reduction Agency

## Program Description

The Detection Capability Area develops CB sensor components and systems for standoff applications, BWA point identification, lightweight integrated identification, and detection of CB agents in water to enable contamination avoidance. Emphasis is placed on early-warning applications, which include capabilities for CB reconnaissance, detection, and identification to provide situational awareness of the total battlespace CB threat. For fixed sites where contamination cannot be avoided or for missions requiring operations in a contaminated environment, reconnaissance, detection, and identification are critical to ensure forces can assume the appropriate protective posture to sustain operations and to rapidly identify affected areas, equipment, and personnel to initiate decontamination and medical intervention, if possible or necessary. This capability area is also developing sensors for the individual Service member and systems capable of detecting multiple agents and characterizing new agents to provide situational awareness for battlespace management decisions. The heightened operational tempo of future battlespaces demands responsive detection and warning capabilities to reduce force degradation caused by CB-contaminated environments. These capabilities—which encompass reconnaissance, detection, identification, and reporting—are critical for force readiness and will continue to be emphasized by the DOD community in the near and far term. Early detection and warning are keys to avoiding CB hazards.

The Detection Capability Area is divided into thrust areas to manage efforts that address specific aspects of CB detection:

- **Standoff Detection**—The goals of this spectroscopy-intensive thrust area are to increase discrimination of threat vs. nonthreat agents; reduce the rate of false alarms; and reduce size, weight, power, and cost of fielded systems.
- The **Biological Agents Point Identification** thrust area focuses on reducing the response time for BWA identification, reducing the logistical burden required by point detection systems, and increasing the understanding of the biological variability of BWAs.
- The **Lightweight Integrated Identification** thrust area integrates BWA and CWA detection technology into small, handheld systems capable of rapidly identifying agents with limited or no use of consumable items.

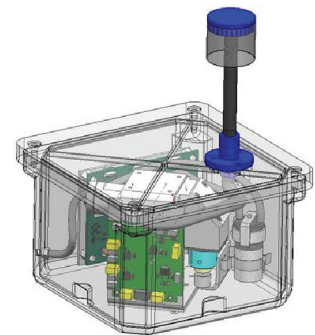

Engineering model of a low-cost BW detection system

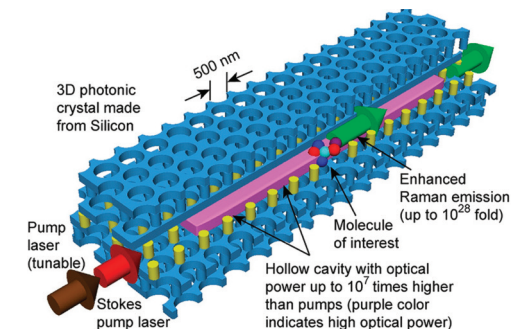

Development of nanoscale Raman cavity sensor elements in crystal chips

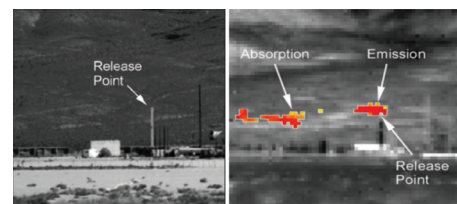

Research in improved standoff detection of chemical threats

- The **Detection of Chemical and Biological Agents in Water** thrust area focuses on creation of a field capability for detection of CB agents in source, purified, and distributed potable water.
- The **Test and Evaluation Realism** thrust area seeks to develop a better understanding of the operational environment to allow more accurate depiction of real-world challenges during instrument development and testing. This effort includes such tasks as increasing our understanding of the background and developing the appropriate simulants for various instrument development tasks. ■

# Physical S&T Information Systems Technology Capability Area

- Network architectures and integration
- Medical surveillance and modeling
- Hazard and environmental modeling
- Simulation, analysis, and planning
- Warfighter decision support
- Systems performance modeling
- Decision support tools for CBDP resource allocation and program investment analyses
- Other Major Defense Acquisition Program IST/CB support

## GOVERNMENT PERFORMERS

- Service Laboratories and Agencies
- National Laboratories
- Federally Funded Research and Development Centers

## Program Description

In support of battlespace information and related systems, the Information Systems Technology (IST) Capability Area provides information collection, fusion, and rapid knowledge generation for all CB defense assets throughout the battlespace. Collaborating with the CBDP's Joint Effects Model (JEM), Joint Operational Effects Federation (JOEF), the Joint Warning and Reporting Network (JWARN), and other programs of record, IST provides scientific knowledge, technology insights, data, and a variety of software products.

IST delivers capabilities that enable CB situational awareness and hazard warning and prediction within the battlespace. IST S&T efforts support the integration of threat information, CB sensor and reconnaissance data, protective-posture data, environmental conditions, medical surveillance, and related data capabilities. These capabilities rapidly provide the warfighter and decision makers at every level of command with the ability to quickly analyze courses of action prior to or during operations. Aspects of decision support IST capabilities for CB defense include Joint force protection, restoration of operational tempo, casualty care treatment, and intelligent resource-allocation support. Warning and reporting IST capabilities provide the hardware and software to connect detection systems into the overall command and control architecture.

IST also aids in the assessment of Joint- and multi-Service doctrine, materiel development, and equipment design (simulation-based acquisition). IST also supports warfighter and battlestaff training using larger conflict simulations and can perform support analyses of CB defense operations within the context of larger military operations. These efforts also support simulation-based acquisition in the development of critical CB defense capabilities.

The IST Capability Area accomplishes its work through the execution of projects in 12 S&T thrusts, each of which has an assigned Thrust Area Manager:

- The **Battlespace Management**

thrust area develops configurable battle management modules for data acquisition, sensor integration, early warning and reporting, and mission impact to enhance JWARN capabilities. This technology improves integrated early warning and provides a common operational picture for enhanced decision making.

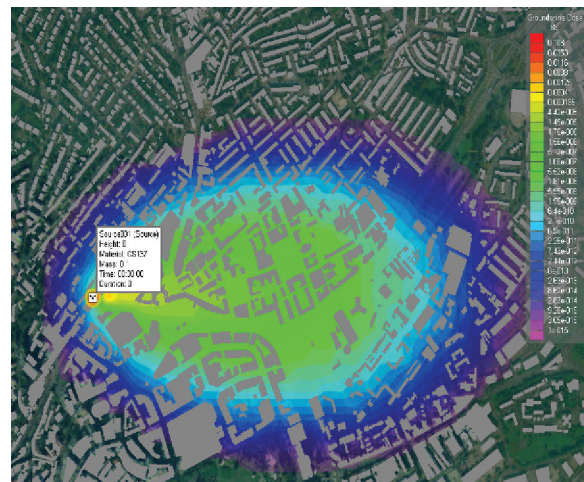

Virtual battlespace

- The **S&T Data Backbone** thrust area investigates the feasibility of, and potential architectures for, constructing a CBRN database that is validated, Web-based, and interactive. It will answer questions such as what data exist, as well as location, users, reliability, and related issues. The Data Backbone's long-term goal is to provide a means of accessing, maintaining, and safeguarding all CBRN data while providing rapid access, ease of entry for new data, and a way to validate data.

- The **Transport and Dispersion** thrust area develops the science behind transport, dispersion, and deposition technologies by improving analysis tools and modules for JEM. This area also examines source characteristics and urban and indoor modeling. Combined with environmental inputs, these tools will enhance JEM capabilities.
- The **Environmental Sciences** thrust area advances high-fidelity weather-modeling capability for high altitudes, complex terrain, and coastal and urban areas. It will also develop a global waterborne transport capability for riverine and coastal areas. Combined with the JEM transport and dispersion (T&D) modules, these technologies will improve battlespace analysis by identifying and quantifying environmental hazards for bypass or mitigation.
- The **Rapid Assimilation of Sensor Information Research** thrust area develops scientific techniques to fuse CB sensor information and local meteorology and environmental data with T&D algorithms for source term characterization, hazard prediction refinement, and optimization of sensor networks. These efforts will enhance the capabilities of JEM, JOEF, and JWARN by improving battlespace awareness during CB events.
- The **Basic Research** thrust area advances the fundamental understanding of basic physical and dynamic processes associated with T&D in a variety of fluid environments. Results of basic research projects will ultimately feed into applied and advanced research and development efforts.
- The **Medical Surveillance Systems** thrust area combines medical surveillance, modeling/simulation, early warning detection, and real-time epidemiology to develop science-based technologies and infectious disease predictive models. These efforts will improve battlefield awareness, minimizing warfighter casualties because of infectious diseases and, in particular, biological WMDs, while providing increased awareness of medical impacts on warfighters to decision makers, allowing for informed planning.
- The **Medical Effects Modeling** thrust area is an interdisciplinary program to assess, apply, and develop medical effects modeling, focusing on identification of existing model capabilities and their match with end-user requirements, scenario-based modeling exercise assessment, gap analysis and S&T roadmap development, and model integration.
- The **Effects on Operations** thrust area develops the science behind the modeling and simulation of operations in a CB environment at fixed facilities as well as mobile operations. It develops the tools and modules for modeling operations of airfields, ports, depots, combat units, and support personnel such as medical and logistics for planning and vulnerability analysis in a CB environment to enhance JOEF capabilities. This technology improves battlespace management by providing tools in which decision makers plan, simulate, and execute operations.
- The **Decision Support Tools and Methodologies** thrust area develops the science behind tools for decision making and human knowledge management across the CBDP. It develops tools and modules for investment/portfolio decision support, virtual prototyping, knowledge management, collaboration, and emerging technology exploration for inclusion in the Joint S&T program. These tools will improve the quality of the products, technologies, and capabilities supplied to the warfighter at a reasonable cost.

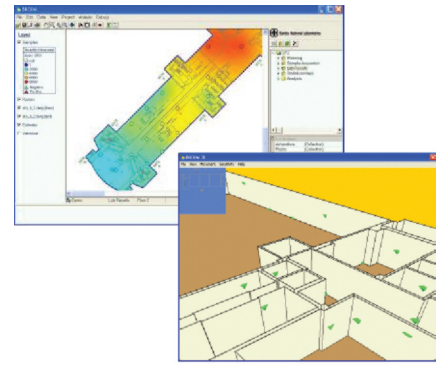

Indoor modeling

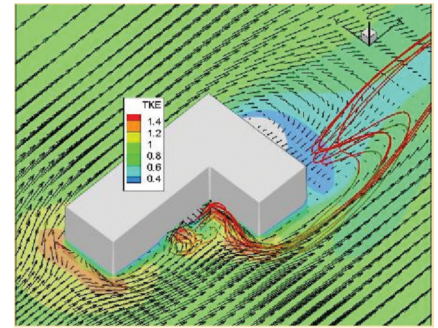

Sensor placement analysis

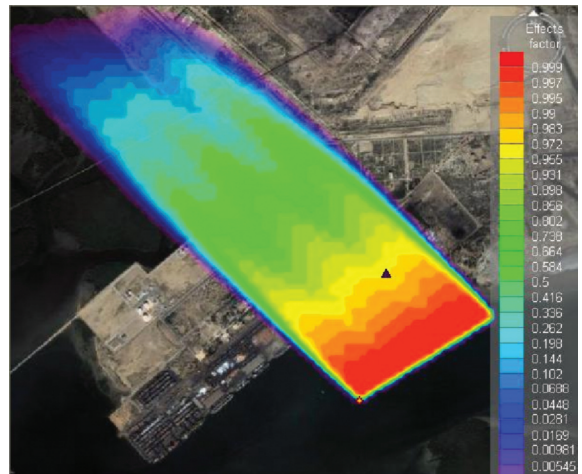

Effects on port operations

- The **Test and Evaluation** thrust area develops the science behind the modeling and simulation tools that assist the T&E community in evaluating CB technologies in collective protection, individual protection, detection, and decontamination equipment, and in supporting developmental and operational testing of CBDP end items.
- The **MDAP Modeling and Simulation (M&S) Support** thrust area develops and transitions supporting CB M&S S&T for Major Defense Acquisition Programs and other acquisition programs. This thrust area develops supporting tools and techniques needed to integrate CBRN M&S capabilities and transfers technologies to acquisition programs. This thrust area supports acquisition programs that have a CB survivability requirement or key performance parameters. Current projects of interest include Future Combat Systems, Expeditionary Fighting Vehicle, Littoral Combat Ship, DD(X), Amphibious Assault Ship, Aircraft Carrier (CVN21), Joint High-Speed Vehicle, Joint Maritime Assault Connector, Maritime Pre-Positioning Force, Joint Strike Fighter, Theater High-Altitude Defense, and the Comprehensive Force Protection Initiative. ■

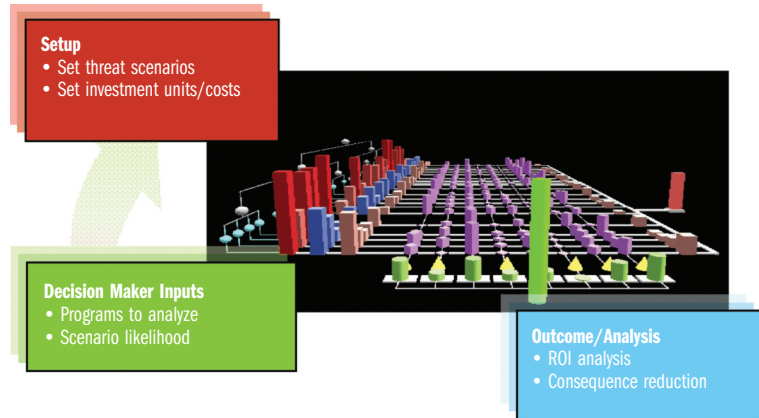

Decision support tools

## Program Description

The Protection and Hazard Reduction Capability Area aligns with the Shield functional concept, providing the capability to shield the force from harm caused by CBRN hazards by preventing or reducing individual and collective exposures to prevent or mitigate negative physiological effects, protecting critical equipment, and reducing hazards after CBRN weapons are employed to restore the capability of units that become contaminated. The S&T program is closely aligned with current and future acquisition programs:

- The **Future Protective Ensemble** thrust area goal is to produce revolutionary capability improvements for individual protection. Transition of these technologies to an acquisition program is anticipated in the FY10–12 time frame.
- The **Deployable Collective Protection** thrust area transitions technologies over the near term (FY06–08) to support the Joint Expeditionary Collective Protection (JECP) program.
- The **Decontamination** thrust area develops technologies for the detoxification and rapid restoration of contaminated personnel, materiel, and essential operation areas subsequent to chemical or biological attack.
- The **Test and Evaluation Methodologies** thrust area develops methodologies and standards that support the development of new test range capabilities. Methodology development runs concurrently with S&T development so that a test range capability is ready to support testing in the acquisition program.

The Protection and Hazard Reduction Capability Area contributes to a number of S&T efforts. These contributions are measured by the transition of new capabilities to the warfighter. Some of these efforts are listed below:

- **Air Purification**—CB filters remove particulates (solid and liquid aerosols) as well as adsorb selected gases to provide safe air. Current systems are based on technologies that have been used for more than 50 years. Although many gains have been made in these technologies throughout the decades, these technologies are limited in effectiveness when certain modern BW agents and toxic industrial chemicals are employed. Additionally, these materials can have high life-cycle costs. JSTO-CBD is investing in new technologies to reduce life-cycle costs and increase performance. Approaches will focus on the development of novel adsorbent materials, including microporous materials with potential as broad-spectrum adsorbents, and computer models that will predict a fabric's performance based on its ability to exclude small

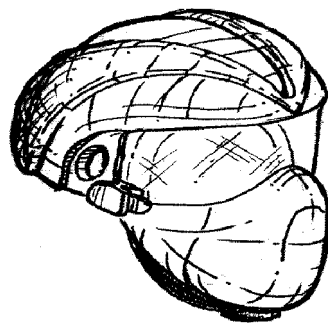

Future Protective Mask Concept



Whole body aerosol scan

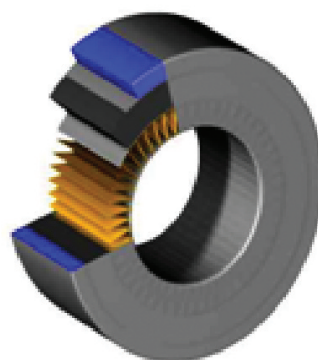

Radial Flow CBR/TIC Filter

## Physical S&T Protection and Hazard Reduction Capability Area

- Aligns with the Shield functional concept.
- Prevents or reduces individual and collective exposures to prevent or mitigate negative physiological effects.
- Addresses air purification, surface and solution chemistries, self-detoxifying and intelligent materials, polymer technologies, and human performance.

### GOVERNMENT PERFORMERS

- Air Force Research Laboratory
- Dugway Proving Ground
- Edgewood Chemical and Biological Center
- Eglin Air Force Base
- Federally Funded Research and Development Centers
- Naval Air Warfare Center–Patuxent River
- Naval Research Laboratory
- Natick Soldier Center
- Naval Surface Warfare Center–Dahlgren Division
- Naval Surface Warfare Center–Panama City

particulates. An example of another research effort is the examination of nano-charged droplets to improve the performance of filtration materials.

- **Surface and Solution Detoxification Chemistries**—This area focuses on developing nontoxic, neutral pH, solid- and solution-based chemistries, and dissemination techniques for effective neutralization of CBRN threats. It includes research to characterize the reactions that occur during various decontamination processes, development of analytical and predictive models, and development of technologies that will provide verification of post-decontamination safety.
- **Self-Detoxifying Materials**—Research is being funded to provide a suite of robust, polymer-incorporable catalysts, enzymes, and threat-agent reactive compounds that can be incorporated into a variety of protection thrust areas to increase protection, reduce thermal burden, and instill a self-detoxifying component. These include photocatalysts, nanoceramic-supported enzymes, and biocides/sporicides. Researchers will also pursue technologies leading to the controlled and organized assembly of reactive nanocomposite systems, as well as technologies leading to stabilization of reactive systems in working environments.
- **Intelligent Materials**—S&T efforts in this arena are moving toward material components of protective systems that can also act as sensors and actuators and integrate with command and control networks. This research will ultimately increase battlespace awareness and allow forces to automatically respond to a threat. Efforts in this area are aimed at self-indicating materials and coatings that show the area of contamination and residual-life indicators that can report the projected remaining service life of in-use expendable media or detect the presence of an agent. A number of technologies are being examined.
- **Polymer Technologies**—This area emphasizes the development of novel, selective permeable membranes which function as barriers to liquids, agent vapors, and submicron aerosols, while increasing water vapor permeation to decrease thermal load. Additionally, high-strength and ultrathin materials are needed to replace current materials used in protective ensembles and systems. S&T research is also being done in barrier material coatings. For example, it may be possible to apply a fast-setting coating to a non-CB-hardened structure to provide rapid interim protection, or a contaminated area could be sealed to restore military operations.
- **Human Performance**—This effort will define optimum human performance parameters for various warfighter subgroups in the performance of their mission while using CB-protective systems. It is recognized that protection factor and overall mission performance vary greatly in CB environments, depending on differences in warfighter mission, comfort level, stress level, body physique, gender, facial differences, etc. The human performance area encompasses projects designed to identify causes and quantify differences in protection factor and mission performance among various subgroups and seeks to provide material or engineering design solutions for optimizing human performance within CB-protective systems. ■

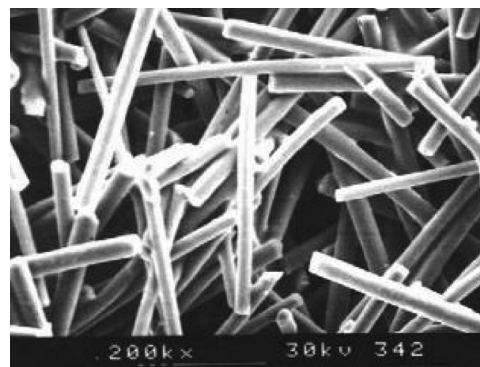

Carbon monolith for electro-swing adsorption

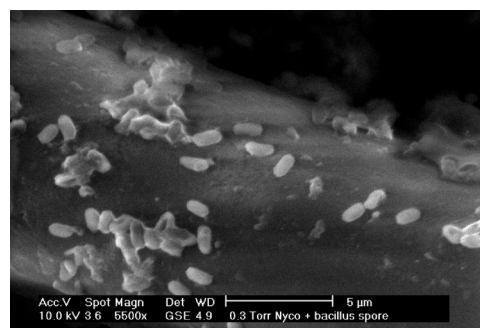

*Bacillus globigii* spores collecting on an antimicrobial fiber



Expedient Encapsulation for Building Protection

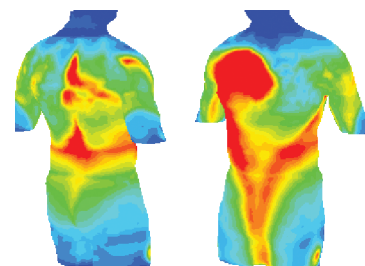

Airflow mapping

## Program Description

The Threat Agent Science (TAS) Capability Area identifies and addresses gaps in the understanding of CBRN-toxic industrial material (TIM) threat agents and materials, including their physical and chemical behavior, environmental stability and transport, and toxicological properties. These studies facilitate detection, protection, and decontamination countermeasures, improve warfighter decision support tools, and provide a sound scientific basis for doctrine and policy development. TAS comprises four thrust areas and a number of subordinate areas of emphasis.

- **Computational Chemistry**

develops and applies quantitative, first-principle chemistry and quantitative biology techniques and tools to provide accurate technical threat agent understanding and prediction.

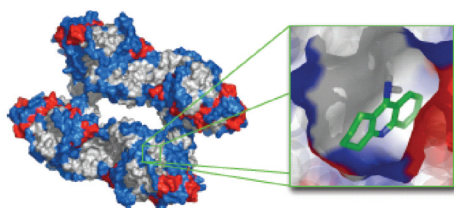

Computational chemistry can assess CB agent and molecular target structures and binding energies

- **Agent Characterization and Simulant Development**

expands our knowledge of current and emerging threat agents and materials and their chemical and physical properties and develops new simulants to improve field-testing of technologies.



Bacterial agent characterization

- **Agent Fate** develops detailed understanding of the evolution of CBRN-TIM agents and materials following their release into the operationally relevant environment and climate, quantifies amount of material on surfaces, and enhances predictive tools with these data.



Chemical agent penetration into operationally relevant materials

- **Low-Level Toxicology** is a joint medical and physical science and technology area to enhance our understanding of the physiological effects of sublethal exposures to classical and novel/nontraditional threat agents by operationally relevant routes of exposure. ■

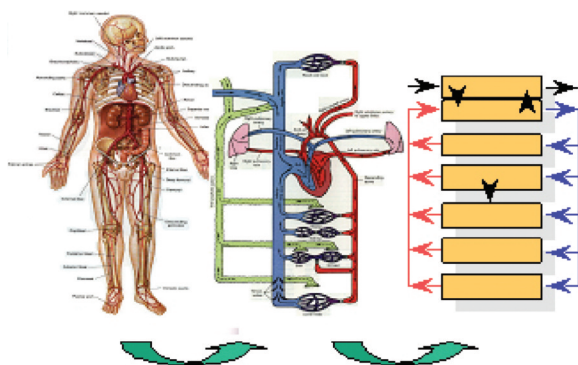

Physiologically based pharmacokinetic modeling

## Physical S&T

# Threat Agent Science Capability Area

- Provide sound scientific and technical CBRN-TIM models, data, and reachback expertise coordinated across the community by serving DOD core capabilities
- Identify and address gaps in the understanding of CBRN-TIM threat agents and materials
- Develop and apply first-principle quantitative chemistry and quantitative biology techniques, tools, and protocols
- Expand knowledge base of current and emerging threat agents
- Understand the evolution of CBRN-TIM agents and materials following their release into the environment
- Enhance understanding of the physiological effects of sublethal exposures to classical and novel threat agents
- Facilitate detection, protection, and decontamination countermeasures
- Improve warfighter decision support tools

### GOVERNMENT PERFORMERS

- Armed Forces Institute of Pathology
- National Defense University
- Naval Research Laboratory
- Multinational Planning Augmentation Team, Pacific Command
- Edgewood Chemical and Biological Center
- Air Force Operational Test and Evaluation Command
- Air Force Research Laboratory
- Dugway Proving Ground
- Naval Surface Warfare Center
- Federally Funded Research and Development Centers



## Physical S&T

# Special Projects Office



### Program Description

The Special Project Office (SPO) monitors innovative or revolutionary scientific efforts funded by government, industry, and academia (U.S. and international) to identify, leverage, and transition new technologies that demonstrate high-payoff potential for CB defense applications, into the functional legacy capability areas of the core program and the new Transformational Countermeasure Technology Initiative (TCTI).

The SPO:

- Monitors leading-edge transformational basic and applied research efforts in emerging technology areas that demonstrate the potential for “paradigm shifting” applications in the CB defense arena. The SPO administrator actively coordinates with representatives from funding entities currently engaged in such technologies, including the Defense Advanced Research Projects Agency (DARPA), Air Force Office of Scientific Research (AFOSR), Office of Naval Research (ONR), Army Research Office (ARO), National Science Foundation (NSF), National Aeronautics and Space Administration (NASA), U.S. Department of Energy (DOE), National Institute of Standards and Technology (NIST), academia, industry, state economic development offices, private institutes and consortia, and international counterparts. By performing this task, SPO can accelerate novel ideas from concept to reality.
- Identifies candidate technologies at the basic and/or applied research level to coordinate CB requirements with the funding agency whenever possible and leverage funding when necessary in support of CBDP goals. The plan is to identify funded efforts that support CB requirements within the TCTI scope, participate in the steering committees of these programs to help direct the efforts in a way that supports our goals, or provide supplemental funding to add CB-related aspects to ongoing projects.
- Pursues mature technologies via advanced technology and other demonstrations to assess their suitability to CBDP needs. SPO identifies candidate technologies for inclusion into readiness and/or performance evaluations.
- Manages Technology Transition efforts for DARPA-funded technologies that have reached the appropriate Technology Readiness Level for inclusion in to the CBDP core program.
- Manage the JSTO-CBDP Nanotechnology Initiative to capitalize on recent advancements in the fields of nanomaterials, nanoscience, and nanotechnology. SPO oversees a two-year effort to conduct an extensive survey of basic research projects and

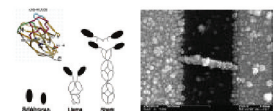
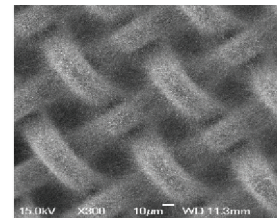
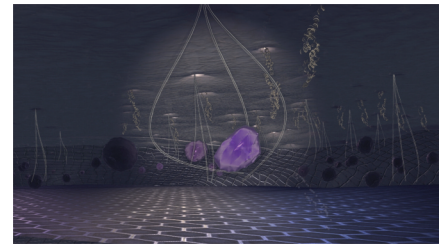

### Department of Energy Nanoscience Centers

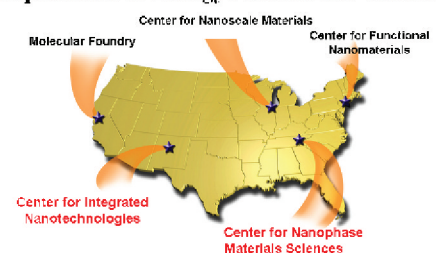

commercial-off-the-shelf technologies with potential applications to all aspects of CB defense. SPO also works to leverage ongoing research efforts in government, industry, and academia. The Nanotechnology Initiative will serve as the scientific and management foundation for an expanded TCTI effort scheduled to begin in FY08. To transform the current paradigm of incremental improvements, we need to leap ahead and embrace truly revolutionary concepts as well as revolutionary, integrated, and cross-cutting technologies such as combining recent dramatic advances in nanotechnology, biotechnology, information technology, and cognitive sciences convergence.

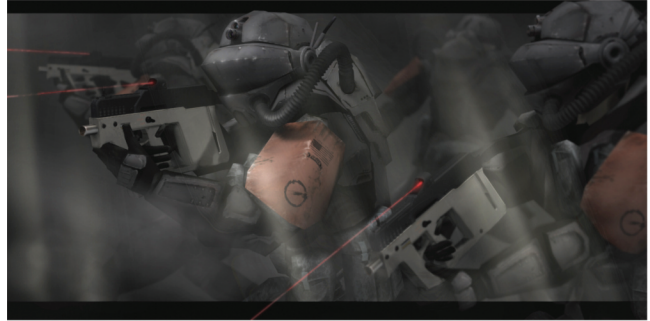

- Acts as the liaison element between JSTO CBT and other organizations actively involved in CB-related technologies in the areas of agent defeat:
    - Defense Threat Reduction Agency (DTRA-Technology Development [Directorate], DTRA-Combat Support),
    - Special Operations Command (SOCOM),
    - Strategic Command (STRATCOM), and
    - Technical Support Working Group (TSWG)
- and consequence management:
- Chemical/Biological Incident Response Force (CBIRF),
  - Weapons of Mass Destruction–Civil Support Teams (WMD-CSTs),
  - Guardian,
  - Department of Homeland Security/Homeland Security Advanced Research Projects Agency (DHS/HSARPA), and
  - U.S. Environmental Protection Agency (EPA).

Ultimately, the SPO aims to maintain an aggressive technology watch to identify transformational/disruptive technologies (“Next” Big Thing) with applicability across multiple capability areas. ■



The Applied Technology Division is responsible for technology experimentation, demonstrations, exercises, S&T support to PM Guardian, and coordination with the Joint Requirement Offices. The Applied Technology Division is organized in four branches: Futures, Warfighter Enhancement, Homeland Defense, and the newly created Unmanned Systems Branch. The division also serves as the principal JSTO lead for CB Joint Concept and Technology Demonstrations: CB Joint Warfighter Experimentation (JWE), CB Advanced Concept Technology Demonstrations (ACTDs), and CB Advanced Technology Demonstrations (ATDs).

**Joint Warfighter Experimentation** is necessary to identify and assess those interdependent areas of Joint warfare that will leverage Service warfighting capabilities to transform the conduct of future U.S. Armed Forces operations. JWE facilitates the development of new joint doctrine, organizations, training and education, materiel, leadership, and personnel to ensure that the U.S. Armed Forces can meet future challenges across the full range of military operations.

**Advanced Concept Technology Demonstrations** are designed to accelerate the formal acquisition process by providing more timely solutions to validated warfighter requirements. The planning and coordination required for ACTD approval accomplishes three things:

- The proposed ACTD must address and validate a Joint requirement.
- The ACTD must identify a mature technology with potential to satisfy that requirement.
- The ACTD must coordinate a transition plan with a formal acquisition program manager to ensure that, if successfully demonstrated, the candidate technology will be accepted into an appropriate program of record.

Once these criteria are met, the proposed ACTD is submitted to the Deputy Under Secretary of Defense for Advanced Systems and Concepts [DUSD(AS&C)] for consideration and approval by the Joint Requirements Oversight Council as a new ACTD start in the next fiscal year. Normally, an ACTD consists of a one- to three-year demonstration phase and a two-year residual support phase. ACTDs are managed and executed jointly by a representative of the developer community, such as JSTO, and a warfighting user/sponsor, often a COCOM. At the conclusion of an ACTD, successfully demonstrated technologies with proven military utility can either be accepted into advanced stages of the formal acquisition process, proceed directly into limited or full-scale production, or be returned to the technical base for further development.

**Advanced Technology Demonstrations** validate high-risk/high-payoff technologies that could significantly improve warfighter capabilities. They cover integrating and assessing technology in a realistic operational environment. ATDs seek to demonstrate the potential for enhanced military operational capability and/or cost-effectiveness, offering an opportunity to identify and move emerging technologies efficiently from laboratory experiments to acquisition programs. ■

## Applied S&T

# Futures

- Execute the CBDP's Advanced Concept Technology Demonstration, Advanced Technology Demonstration, and experimentation-generation process
- Represent the CBDP in DTRA and Joint Forces Command's (JFCOM) Joint concept development and experimentation efforts
- Understand CBRN capability needs, examine relevant current and future technology applications to meet those needs, and manage a process for developing new projects that provide development and demonstration of new or improved CBRN preparedness capabilities

### GOVERNMENT PERFORMERS

- Edgewood Chemical and Biological Center
- Air Force Research Lab
- U.S. Marine Corps Systems Command
- U.S. Department of Energy, National Nuclear Security Administration Kansas City Plant

### Program Description

Applied S&T Futures efforts concentrate on identifying appropriate candidate technologies and approaches that comprise the experiments, ACTDs, and ATDs conducted by the Applied S&T Division. These then enable the warfighter to evaluate CBRN experimental capabilities and concepts of operation prior to the commitment of an acquisition program. Materiel and non-materiel solutions that address warfighter capability gaps are developed through demonstrations. The Futures Branch is responsible for understanding CBRN capability needs, examines current and future technology applications to meet those needs, and manages a process for developing new projects that show promise in CB defense. These provide fundamental value by identifying practical, operational information on how a technology will function in the field. Non-materiel solutions include improvements in doctrine, CONOPS, and TTP.



PacBot UGV robot in field testing

The following summaries provide an overview of Futures activities:

- **Coalition Chemical, Biological, Radiological and Nuclear Information Interoperability Study**—This effort investigates overall U.S. COCOM needs for coalition forces collaborative situational assessment (SA) and CM in response to CBRN incidents. Performers identify specific data exchange and interoperability requirements to enable successful development and deployment of technologies supporting automated SA and CM. Coalition forces include multinational coalitions and task forces as well as domestic civilian agencies, nongovernmental agencies, and international agencies.
- **Military Applications in Reconnaissance and Surveillance (MARS) using Manned/Unmanned Aerial Vehicles (M/UAV) for CBRN Sensing**—In recent combat operations, UAVs have been demonstrated as critical assets on the battlefield not only to reduce the risk of endangering soldiers but also to increase the efficiency of surveillance and reconnaissance. While the U.S. military has introduced UAVs with mission-specific payload packages to conduct a variety of operations, to this point, no CBRN-specific UAV-based sensor packages have been operationally employed. Improvement in U.S. forces' CBRN sensing capabilities would increase an operational commander's ability to quickly detect and assess these threats, thereby improving operational effectiveness. Currently, mature technologies are available to fulfill portions of the aerial CBRN sensing mission; however, there are no guidelines, standards, or test procedures and protocol for introducing this type of technology into an acquisition program. The MARS M/UAV project will inform the Joint community on CBRN-sensing capabilities on M/UAVs and the full spectrum of related issues, building the foundation for aerial CBRN sensing by facilitating the development of standardized test protocols, procedures, and employment concepts supporting CONOPS development. Additionally, the MARS M/UAV project will review mature CBRN-sensing technologies for use in aerial platforms to fill existing warfighter capability gaps. Promising technologies will be tested and evaluated for possible transition to acquisition. The

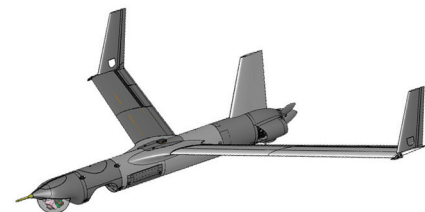

Finder UAV

Futures Branch is working closely with the newly created Unmanned Systems Branch, which has the lead on this effort.

- **Special Platform Interior Decontamination and Equipment Restoration (SPIDER) Limited-Objective Experiment**—Experimentation is demonstrating the safety procedures, military utility, and practicality of new decontamination procedures for biological decontamination of aircraft interiors, which includes the flight deck, cargo bay, and environmental control system. Extensive testing and data analysis will document technical effectiveness and safety procedures used on the aircraft. Data collected and analyses performed may support one or more novel biological decontamination employment concepts such as the potential elimination of extensive biological sampling procedures and materials compatibility testing documentation that will support an Air Force–accepted Technical Order (TO) for the decontamination procedures. The TO will be a publication that contains instructions for operational and maintenance instructions for the newly developed decontamination procedures. The limited-objective experiment will also demonstrate procedures for military users and establish the procedures for biological decontamination methods and lessons learned.
- **Study of Automating Thorough Level, Detailed Equipment Decontamination (DED) for Land Vehicles with a Systems Engineering Approach**—Using analysis and venues such as coordination with the U.S. Army Chemical School and other relevant, military decontamination operations specialists, insights into doctrinally based chemical agent decontamination will provide focused solution recommendations to improve DED. Materiel and non-materiel processes will be considered that can significantly improve DED effectiveness while focusing on reducing personnel contamination risks and secondarily on seeking to reduce decontamination resource requirements. The Thorough Decontamination process, by its nature, exposes not only contaminated unit personnel, but also all supporting units, to contamination risks until the unit completes detailed equipment decontamination. The DED decontamination process considered in this effort includes an evaluation of the existing DED processes, an analysis approach to improving vehicle decontamination, and the removal of all contamination affecting supporting units and areas. Additionally, all elements of the DED’s vehicle decontamination process will be considered: decontaminant effects, detection capabilities, thoroughness of contamination removal, and the like. The ability to confirm the presence or absence of CBRN contamination hazards following DED will also be considered that includes effects of hazard reduction as a product of decontamination and natural weathering processes.



Vaporous decontamination technologies

## Applied S&T

# Homeland Defense

- Manage transition of CB defense equipment from the S&T phase into acquisition programs in support of military Services installation CBRN preparedness objectives

### GOVERNMENT PERFORMERS

- Edgewood Chemical and Biological Center
- Los Alamos National Laboratory
- Sandia National Laboratories

### Program Description

The Homeland Defense Branch manages the transition of CB defense equipment from the S&T phase into acquisition programs in support of military Services installation CBRN preparedness objectives. Joint Project Manager (PM) Guardian (JPMG) is supported directly by S&T support from the Homeland Defense Branch. Within Guardian is housed PM Installation Protection, PM Army Force Protection, and PM Consequence Management (i.e., survey and rapid response teams, 20th Support Command, and the WMD-CSTs). The Homeland Defense Branch supports these teams through three main processes:

- **Studies**—Review processes, methods, and concepts of operation to determine military utility, achieve broader perspectives, determine capabilities gaps using current technologies, and leverage complementary efforts ongoing with other federal agencies and allies.
- **Demonstrations**—Establish demonstration and evaluation processes that support the migration of existing or emergent technologies into the JPMG family of systems (FoS). Demonstrations focus on a particular aspect of consequence management, protection, and/or detection technologies with outcomes intended to inform procurement, deployment, and sustainment actions
- **Equipment Validation**—Generate system performance data to aid users in equipment selection, capability gap identification, and concept of operation development.

A number of studies, demonstrations, and equipment validation efforts are underway, including the following:

- **National Academies Study for Immune Building**—The Immune Building Program was initiated by DARPA to determine whether interior threat monitoring and subsequent containment/mitigation of chemical or biological agents is a viable option for collective protection in built structures. The program focus was protecting military buildings from attack by chemical or biological agents from an internal or external release.

In anticipation of transitioning the Immune Building program from DARPA to DTRA, Capabilities Area Project Office—Homeland Defense (CAPO-HD) convened the National Research Council to review the program. The review analyzed existing military and civilian studies on preventing and mitigating the effects of a chemical or biological release or infiltration into a built structure. The investigation's findings, general principles that can be derived from these studies and existing testbeds, and the cost/benefit of various possible protection schemes are being prepared.

- **Meteorological Stations**—The Modular Meteorological Station Utility for Improved Plume Modeling demonstration is managed by CAPO-HD for JPMG. This demonstration will improve existing plume modeling capabilities by incorporating robust, real-time modular weather station data. A modular weather sensor developed through DTRA under a previously-funded Small Business Innovation Research project is being used as the meteorological data collection portion of the system. Recent system development work includes software for data management and formatting, guidelines for sensor deployment on a military installation, and hardware that provides a data interface for rapid inclusion into atmospheric plume modeling systems.



Modular weather sensor

The weather sensor system being demonstrated consists of a handful of weather sensor pods placed at specific locations on a military installation, based on area criticality and unique localized weather patterns. The weather sensor pods send real-time meteorological data to a nearby satellite pod using wireless modems operating in the 900MHz band. The satellite pod transmits sensor data via the Iridium Satellite network to a remote, Web-based server. The weather data are then downloaded by a designated internet-accessible PC, formatted by the system software, and ingested into the atmospheric plume modeling tool already being used at the military installation Emergency Operations Center or other first-responder command area. This weather sensor system is first being tested at Buckley Air Force Base (AFB), in preparation for a live demonstration at Andrews AFB and eventual inclusion into the JPMG FoS at Andrews AFB.

- Next-Generation Firefighter Ensemble**—Clothing that provides CBRN protection to firefighters does not meet the day-to-day rigors of firefighting activities. The current generation of personal protective equipment (PPE) worn by firefighters is primarily designed to provide protection against the thermal and physical hazards associated with structural firefighting and not CBRN hazards. With the potential for release of CB agents during terrorist incidents, firefighters now face additional risks of exposure. The International Association of Fire Fighters (IAFF), Globe Firefighters Suits, and Morning Pride are designing equipment that will provide protection consistent with the high standards of the National Fire Protection Association (NFPA) for both structural firefighting protection (NFPA 1971) and CB protection (NFPA 1994). These next-generation garments will provide dramatically enhanced protection against CB agents while improving the flexibility, weight, durability, heat-stress reduction, service life, and costs associated with currently available protective gear. In 2002, IAFF initiated “Project HEROES” (Homeland Emergency Response Operational and Equipment Systems) to capitalize on the technological advances of the last 20 years as well as emerging technologies. The Project HEROES ensemble will optimize the firefighter’s protective equipment for all homeland emergency responses, which could include structural firefighting, search and rescue, industrial hazardous materials, biological materials, and other WMD response. Involvement in this effort will ensure that DOD firefighters receive the best CBRN protection available as they perform their normal firefighting duties at home and abroad.



Next-generation firefighter ensemble

- Military Applications in Reconnaissance and Surveillance Unmanned Ground Vehicles**—MARS Unmanned Ground Vehicle (MARS UGV) seeks out mature government and commercial products to create CB sensor packages for use by the CBRN Unmanned Ground Reconnaissance (CUGR) ACTD or other compatible, small robotic platform. The MARS UGV demonstrates enhanced CBRN sensor capability beyond the baseline CUGR. The MARS UGV project first obtained and archived the CUGR ACTD UGV–relevant information on the design, construction, hardware, and software integration of CBRN sensors onto the CUGR ACTD robotic platform. Recent sensor payload development and integration efforts include optical recognition of biological materials, ultraviolet fluorescence detection of biological materials, Raman spectroscopy for chemical agent and TIC detection, a vapor collection canister for obtaining and transporting vapor samples, and an interface box for integrating sensor payload power and communication directly into the existing UGV platform wiring backbone.

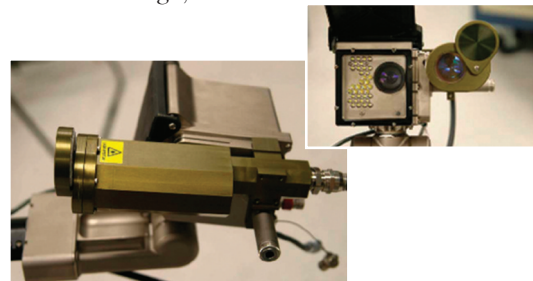

Raman-based spectrograph for surface chemical sensing

Another goal of the MARS UGV project is the coordination and active participation with other programs of record seeking ground robotics use for CBRN sensing missions. DTRA, JPMG PM Force Protection Systems, and Edgewood Chemical and Biological Center are working together to conduct a demonstration showing interoperability between the Mobile Detection Assessment and Response System (MDARS) UGV and the CUGR UGV (CUGV) robot platform for MARS UGV sensor payloads. The demonstration involves using the MDARS UGV in an autonomous physical site security role, detection of an intrusion event, and human-in-the-loop control where the UGV operator suspects a CBRNE incident and sends out the CUGV to investigate. Follow-on collaboration efforts involving the MARS UGV project may include applying the experience gained with CBRNE sensor payload integration directly to MDARS, Army Future Combat Systems or any other ground robotics platform.

- Commercial Off-the-Shelf (COTS) Equipment Modernization, Recovery of Biomaterials**—DTRA is working with Edgewood Chemical and Biological Center on the Development of Techniques and Evaluations to Improve the



Recovery of Biomaterials effort under the COTS Modernization program. The reported total recovery levels from biological sampling materials such as Dacron and cotton swabs, or from sponge collection materials such as the BiSkit sampling kit, range 11%–43% using current, wet-application methods. More accurately representing how an agent deposits on a surface, this study proposes using a dry deposition chamber to make a true assessment of upgraded swab materials and to determine the nature of biosampling efficiency/adhesion for five sampling collection materials. These materials include Dacron (Critical Reagents Program), gauze, cellulose (next-generations material), macrofoam, and polyester felt (Dry Filter Unit). Four different sampling surfaces are being looked at in this study. The end goal is to provide JPMG and the WMD-CSTs better handheld assay and Dry Filter Unit results, yielding actionable data in the event of an analyzed “positive” sample.

- Nondestructive Evaluation Equipment**—A radioisotope identifier laboratory testing and military utility assessment effort is being conducted in conjunction with JPEO-CBD PM Consequence Management. The radioisotope identifier must meet PM Consequence Management requirements for use by WMD-CSTs, including identifying multiple isotopes, identifying an isotope where two or more isotopes are present, detecting neutron sources, quickly identifying an isotope, and ease of use for the WMD-CSTs while operating in PPE. Nine radioisotope identifiers were selected from a recently completed Los Alamos National Laboratory market survey of more than 50 candidate radioisotope identifier technologies.



WMD CST Unified Command Suite (UCS)

- Information Systems Development for JPM Guardian**—The Installation Protection Program ATDs are intended to align low-risk, high-payoff applied technology initiatives that help frame, and ultimately satisfy, requirements for the Guardian Program. To this end, ATDs have been identified by leadership within the Guardian Program as a necessary link to rapidly align and transition mature technologies into the Guardian FoS. One of the CAPO-HD’s primary missions is to help bridge the gaps the Guardian Program’s R&D gaps and establish links that deliver needed capabilities. To accomplish this mission, CAPO-HD, in concert with JPMG and Joint Project Manager Information Systems (JPM IS), used a series of technology demonstrations designed to rapidly determine the utility of deploying tactical CBRN situational awareness and characterization solutions in the Guardian FoS for subsequent deployment and operation in a military installation operational environment.

The Guardian Incident Management System (IMS) demonstration involved the integration of JEM and JWARN into the existing Guardian IMS. This demonstration replaced selected components of the Guardian IMS with tactical command, control, and interoperability toolsets that provide emergency management center personnel and first responders with the capabilities to visualize, characterize, and prepare for an appropriate response to a possible CBRNE incident. The primary thrust for this effort was to reduce procurement and sustainment costs for the Guardian IMS through the leveraging of existing programs of record (JEM and JWARN).

Overall, the Guardian IMS demonstration was very successful in achieving the objectives established. Also, the demonstration brought together a government and contractor team that accomplished a number of technically complex goals related to reducing the overall acquisition and sustainment costs for the Guardian IMS and established closer working relationships among various project offices. Their collective efforts greatly improved information sharing crucial to evaluate, control, respond to, and recover from CBRNE events.

- Interagency Biological Restoration Demonstration (IBRD)** is a partnership between DTRA, DHS (S&T), and the Seattle Urban Area Security Initiative aimed at developing policies, methods, plans, and applied technologies to restore large urban areas, DOD installations, and critical infrastructures following the release of a biological agent. Much work has been accomplished over recent years in the initial response phase of a biological release event in the areas of detection, characterization, and coordination. However, little has been explored concerning the wide-area remediation and restoration of military installations, critical infrastructures, and large urban areas. IBRD is principally sponsored from a policy perspective by the Assistant Secretary of Defense for Homeland Defense. JPEO-CBD will be named the transition manager through JPMG. ■



Seattle IBRD demonstration site

## Program Description

The Warfighter Enhancement Branch is responsible for executing the CBDP's approved ACTDs and ATDs to demonstrate and assess mature technologies addressing urgent warfighter requirements in realistic environments, emphasizing technology assessment and integration rather than development, and for developing CONOPS and TTP for technologies that are under consideration. When possible, the Warfighter Enhancement Branch provides an interim, limited capability to combatant commanders with the ultimate goal being technology transitions to field or core acquisition programs.

## CBRN Unmanned Ground Reconnaissance (CUGR)

- **SPONSOR**—Pacific Command
- **OBJECTIVE**—The CUGR ACTD seeks to bridge the identified capability gaps by exploiting next-generation sensor technology to demonstrate the enhanced capability for existing mounted reconnaissance platforms and military utility of unmanned ground reconnaissance systems for CBRN missions.
- **THRUST AREA 1**—The ACTD will meet its first objective by equipping the Joint Service Lightweight Nuclear Biological Chemical Reconnaissance System (JSLNBCRS) High-Mobility Multipurpose Wheeled Vehicle (HMMWV) variant with an advanced sensor suite for near-real-time chemical detection and identification. The Joint Contaminated Surface Detector (JCSD) is the advanced sensor suite that will allow the reconnaissance system to maintain the operational tempo, enabling early surface contamination detection, thereby minimizing the risk of CBRN exposure. The JSLNBCRS HMMWV variant will be modified with both hardware and software changes. The CUGR ACTD modifications to the JSLNBCRS HMMWV platform will maintain the original platform CBRN defense capabilities.
- **THRUST AREA 2**—The ACTD will meet its second objective by expanding the JSLNBCRS CBRN defense capability to conduct reconnaissance in restricted terrain and possible hostile or unknown hazard areas. This thrust area will combine current COTS and nondevelopmental chemical and radiological



JSLNBCRS HMMWV variant

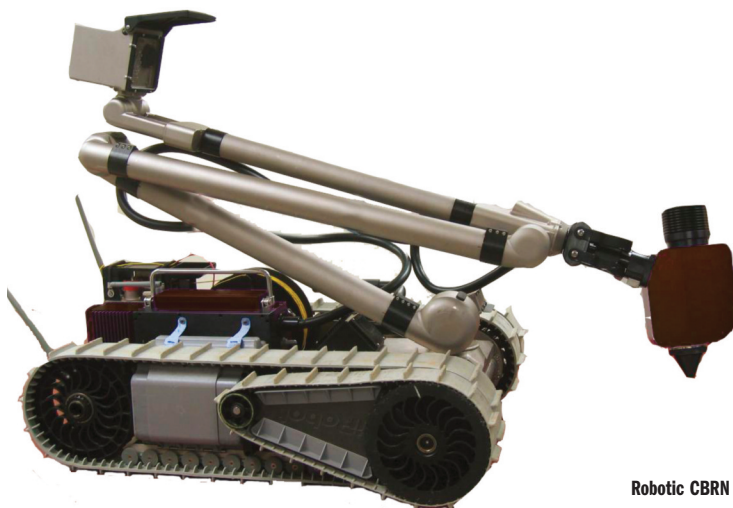

Robotic CBRN platform

## Applied S&T Warfighter Enhancement

- Execute the Chemical Biological Defense Program's approved ACTDs and ATDs
- Demonstrate and assess mature technologies to address urgent warfighter requirements in realistic environments
- Emphasize technology assessment and integration rather than technology development
- Develop CONOPS and TTP to employ technologies

### GOVERNMENT PERFORMERS

- Edgewood Chemical and Biological Center
- Marine Forces Systems Command

sensors onto an existing robotic platform, providing an unmanned detection/collection capability to investigate restricted terrain while keeping crews/systems out of the contamination.

### Advanced Technology Demonstrations

ATDs are typically integrated demonstrations of the maturity and potential of advanced technologies for enhanced military operational capability or cost-effectiveness. They provide a relatively low-cost approach for assessment of technical risks and uncertainties associated with critical technologies prior to the incorporation of these technologies into a system entering the formal acquisition process. They focus on evolving a specific element of technology nominally at the 6.3 Advanced Technology Development point (typically Technology Readiness Level 5–6) to reduce risk of implementation by an acquisition program or even feed to an ACTD. Typical requirements for an ATD are the following:

- A concept that addresses established S&T objectives and could provide a significant new or enhanced military capability or more cost-effective approach to providing the capability
- A fully planned and funded program with a limited duration (usually less than three years, with shorter durations being better)
- Exit criteria and a transition plan that is supported by the user representative and the systems developer

### Expeditionary Biological Detection ATD

- **BACKGROUND**—Existing Expeditionary Biological Detection (EBD) requirements have not been adequately identified and there are no existing capabilities. This capability gap leaves U.S. Marine Corps (USMC) Expeditionary Forces vulnerable to attack without indication until those exposed present symptoms. The EBD ATD addresses the continuing military requirement for a man-portable detector of aerosolized BWAs that is not currently being met.
- **OBJECTIVE**—To identify potential technologies that will give the USMC Expeditionary Forces BWA detection capabilities to warn and to treat exposed troops. Suitable technologies will be transferred to the Joint Biological Tactical Detection System (JBTD). The EBD ATD serves three purposes: develop Joint CONOPS for the use of man-portable, automated biological detectors and agent samplers; clarify and refine requirements for the JBTD Concept Development Document; and determine the military utility of current and next-generation man-portable biological detectors and samplers.

The initial focus for demonstration is envisioned to be operations at the company and battalion level. In each case, the Operational Manager will conduct these demonstrations using USMC doctrine as a baseline. The outcome of these evaluations will be the Military Utility Assessment of the specific ATD technology candidates, the development of a detailed CONOPS of deploying and employing biological detection capabilities at each level for each mission type, and an understanding of the tradeoffs and dependencies of system characteristics to operational utility (requirements). However, the desired outcome impacting the Joint force would be to exploit the products and lessons learned from the ATD for all Services.

The EBD ATD down-selected system(s) or family of systems should be able to detect aerosolized BW clouds and collect samples for presumptive and confirmatory identification. The ability to discriminate, classify, or identify the threat is desired. Targets of concern are initially limited to conventionally disseminated clouds of classical BWAs. Confirmatory identification samples should be compatible with JBAIDS. The entire EBD system should be deployable and employable by Marine expeditionary forces.

The initial configuration of the system will be used to provide detect to treat information to the using unit and warning to downwind and adjacent units. Masking and no-masking CONOPS will be explored based on false alarm rates. The objective is to detect the event, identify the exposed population, confirm the detection with a secondary technology, and facilitate initial treatment within 24–48 hours of an attack. This capability will reduce casualties as compared to treatment after the exposed population becomes symptomatic. ■

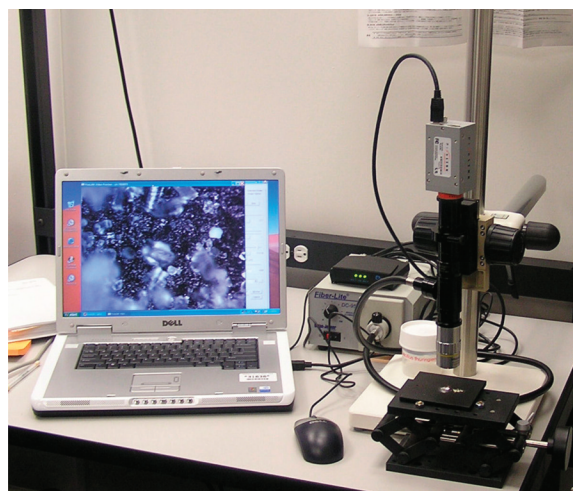

Portable detection

Sense

Sense

Sense

Sense

Sense

Sense

Sense

Sense

Sense

**Sense**

***ACQUISITION PROGRAM HIGHLIGHTS***

**Sense**

**Sense**

**Sense**

**Sense**

**Sense**

**Sense**

**Sense**

**Sense**



- Passive, standoff chemical vapor detection on ground reconnaissance platforms
- Detects agents out to 2 km
- Real-time, on-the-move operation
- Key chemical sensor for the digitized battlefield with automated reporting
- Lightweight (45-57 lbs)
- First-time ability to provide on-the-move, 360°, standoff detection of CW agents

### Program Description

The Joint Service Lightweight Standoff Chemical Agent Detector (JSLSCAD) is the first chemical vapor detection system to give 360°, on-the-move, standoff vapor detection at distances of up to 2 km. JSLSCAD will provide warfighters an early warning capability to avoid contaminated battlespaces or, if avoidance is not possible, time to don protective masks and clothing. JSLSCAD is a rugged, passive, infrared detection system that automatically searches for chemical agent vapor clouds. Upon detection of an agent, JSLSCAD identifies the agent cloud and alerts the warfighter with audible and/or visual alarms. It also indicates the direction and extent of the agent cloud on a graphical computer display and forwards the NBC report details through the Joint Warning and Reporting Network (JWARN). JSLSCAD Increment I applications include the Joint Service Light NBC Reconnaissance System (JSLNBCRS) and the Stryker NBC Reconnaissance Vehicle (NBCRV).

The JSLSCAD program will use an incremental acquisition approach. Increment I will provide an initial capability, used for ground mobile reconnaissance applications. Increment II pursued an evaluation of three commercially available systems, which provided the required capability beyond Increment I. As a result, Increment I will pursue Preplanned Product Improvements to increase capability. Increment III will assess the potential for integrating detection capabilities in aerial platforms. ■

# Joint Service Lightweight Standoff Chemical Agent Detector (JSLSCAD)

### INITIAL OPERATIONAL CAPABILITY (IOC)

2Q FY07

### FULL OPERATIONAL CAPABILITY (FOC)

4Q FY14

### CONTRACTORS

- General Dynamics Armament and Technical Products  
CHARLOTTE, NC



# Joint Biological Standoff Detector System (JBSDS)

## IOC

3Q FY08

## FOC

1Q FY10

## CONTRACTORS

- Science & Engineering Services  
COLUMBIA, MD

- An integrated, standoff system capable of providing near-real-time biological warfare detection
- Provides early warning to commanders supporting timely decision making
- Detects and tracks aerosol clouds out to 5 km
- Discriminates biological from nonbiological particles in aerosol clouds out to 1 km
- Operates at fixed site or in stationary mode from mobile platform
- Operationally skin- and eye-safe

## Program Description

The Joint Biological Standoff Detector System (JBSDS) is the first program standoff early warning biological detection (BD) system. The system will be capable of providing near real-time detection of biological attacks/incidents and standoff early warning detection/warning of BWAs at fixed sites or when mounted on multiple platforms, including nuclear, biological, and chemical (NBC) reconnaissance platforms. It will be capable of providing standoff detection, ranging, tracking, discrimination (manmade vs. naturally occurring aerosol) and generic detection (biological vs. nonbiological) of large-area BW aerosol clouds for advanced warning, reporting, and protection.

JBSDS will augment and integrate with existing BD systems to limit the effects of biological agent hazards against U.S. forces at the tactical and operational levels of war. JBSDS will have the flexibility to warn automatically or to allow for human intervention in the detection-to-alarm process. JBSDS will pass detection information and warnings through existing and planned communications networks. Commanders may integrate JBSDS outputs with information from intelligence, meteorological and oceanographic, radar, medical surveillance, local-area operations, and other available assets to increase force protection, mitigate the consequence of biological hazards, and maximize combat effectiveness. ■

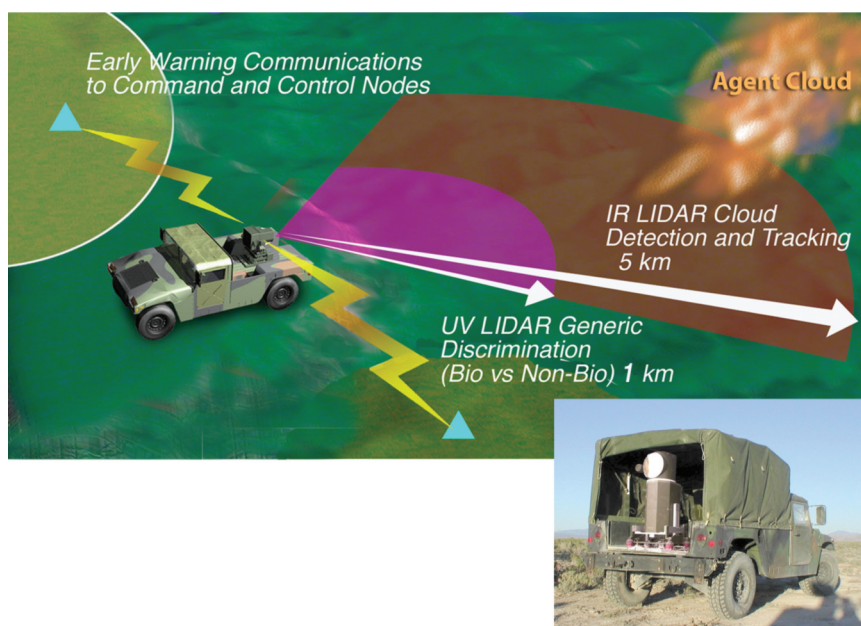

- Modular biological point detection suite integrated onto Service platforms
- Evolutionary acquisition approach to replace Interim Biological Agent Detection System (IBADS) and Biological Integrated Detection System (BIDS) systems
- Shelter, shipboard, man-portable, and trailer variants
- Point detection capability for all Services
- Increased reliability and maintainability
- Identifies 10 biological warfare agents simultaneously

# Joint Biological Point Detection System (JBPDS)

## Program Description

The Joint Biological Point Detection System (JBPDS) Acquisition Category II (ACAT II) program is the successor to the Army BIDS, Navy IBADS, and Air Force Service-specific development programs. The JBPDS will meet Service requirements as outlined in the Joint Operational Requirements Document (JORD) and consist of complementary trigger, sampler, detector, and identifier technologies to rapidly and automatically detect and identify biological threat agents. The suite will be capable of identifying BW agents listed in Category A of the International Task Force (ITF) 6 Report in less than 15 minutes. The suite will be integrated into each Service's platform (e.g., BIDS, surface ships, JSLNBCRS, and NBCRV) or installed on air bases and ports to provide a common detection and identification capability for Joint interoperability and supportability. The JBPDS will increase the number of BW agents that were identifiable by the BIDS and the IBADS, decrease detection and identification time, increase detection sensitivity, provide automated knowledge-based detection and identification, and provide a first-time point detection. ■

### IOC

1Q FY04

### FOC

2Q FY14

### CONTRACTORS

- General Dynamics Armament Technical Products  
CHARLOTTE, NC





# Joint Chemical Agent Detector (JCAD)

## IOC

2Q FY09 - Increment 1

1Q FY11 - Increment 2

## FOC

3Q FY11 - Increment 1

1Q FY18 - Increment 2

## CONTRACTORS

■ Smiths Detection  
EDGEWOOD, MD

- Real-time detection of nerve, blister, and blood agents
- Stores up to 72 hours of detection data
- Lightweight detector capable of being worn, hand-carried, or mounted

## Program Description

The Joint Chemical Agent Detector (JCAD) is an automatic, lightweight, man-portable monitoring and small-point sampling chemical agent detector for aircraft, shipboard, and individual soldier applications. The system includes simultaneous and automatic detection of chemical warfare agents by class (nerve, blister, and blood), identification and quantification of hazard levels, and a data communication interface. The Increment 1 JCAD systems will replace the Chemical Agent Monitor (CAM), Improved CAM (ICAM), Automatic Chemical Agent Detector and Alarm (ACADA or M22), and the M8A1 Automatic Chemical Agent Alarm.

The Increment 2 JCAD systems will expand upon the Increment 1 capability by providing ability to interface with the Joint Warning and Reporting Network (JWARN), detect low-level cumulative exposure, provide increased utility on multiple platforms, and expand the number and types of chemicals detected. ■



- Added biological detection
- Improved nuclear and chemical detection
- On-the-move, standoff chemical vapor detection
- On-the-move meteorological sensor
- Improved digital integration with situational awareness software

### Program Description

The Nuclear Biological Chemical Reconnaissance Vehicle (NBCRV) is a dedicated system of nuclear and chemical detection and warning equipment as well as biological sampling equipment. These capabilities are integrated into a high-speed, high-mobility, armored carrier that can perform NBC reconnaissance on primary, secondary, or cross-country routes throughout the battlefield. The NBCRV will be able to detect and collect chemical and biological contamination in its immediate environment and on the move, conduct point detection via the Chemical Biological Mass Spectrometer (CBMS) and Joint Biological Point Detection System (JBPDS), and conduct standoff detection operations at a distance through the use of the Joint Service Lightweight Standoff Chemical Agent Detector (JSLSCAD). It automatically integrates contamination information from detectors with input from onboard navigation and meteorological systems and automatically transmits digital NBC warning messages through the Maneuver Control System (MCS) to warn follow-on forces. ■



# Nuclear Biological Chemical Reconnaissance Vehicle (NBCRV)

**IOC**  
4Q FY06

**FOC**  
4Q FY14

#### CONTRACTORS

- Battelle Memorial Institute  
*ABERDEEN, MD*
- CACI  
*MANASSAS, VA*
- Hamilton Sundstrand Sensor Systems  
*POMONA, CA*
- General Dynamics Land System  
*DETROIT, MI*

# Joint Biological Agent Identification and Diagnostic System (JBAIDS)

## IOC

1Q FY06

## FOC

3Q FY08

## CONTRACTORS

- Idaho Technology, Inc.  
SALT LAKE CITY, UT

- Single DOD-accepted platform for both identification and diagnostic confirmation of biological agents
- Operation in fixed medical laboratories and deployed medical units
- Operates as a stand-alone system; future development increments to be interoperable with Theater Medical Information Program (TMIP)
- Provides simultaneous identification of multiple biological agents
- Rapid identification—within 40 minutes of sample preparation
- FDA clearance will allow medical professionals to make immediate diagnostic confirmation of infection without waiting 24–48 hours for culture using current accepted methods

## Program Description

The Joint Biological Agent Identification and Diagnostic System (JBAIDS) is an integrated system for rapid identification and diagnostic confirmation of biological agent exposure or infection. Based on commercial technology, JBAIDS is man-portable and reusable and will be capable of the simultaneous identification of multiple biological warfare agents and other pathogens of operational concern. The system consists of the hardware platform to perform sample analysis, a laptop computer for readout display, and assay reagent test kits. ■



- Integrates and synchronizes support of CBRN capabilities development across all Services
- Leads development of common architecture for efficient Joint CBRN capabilities

### Program Description

Major Defense Acquisition Program Support (MDAP SPRT) integrates system of systems (SoS) solutions across the Services for MDAPs having CBRN-survivability requirements. The program will employ modular, net-centric, plug-n-play capabilities across a range of Service platforms and missions. This integrated CBRN SoS will allow warfighters to complete their missions unencumbered by CBRN hazards.

Major Defense Acquisition Programs currently supported include the following:

- Army Future Combat Systems
- Navy Littoral Combat Ship
- Navy DDG-1000 Destroyer
- Navy Aircraft Carrier CVN-78
- Marine Expeditionary Fighting Vehicle
- Air Force Joint Strike Fighter
- Air Force KC-X Tanker Program
- Army Joint Lightweight Tactical Vehicle ■

# Major Defense Acquisition Program Support Program (MDAP SPRT)

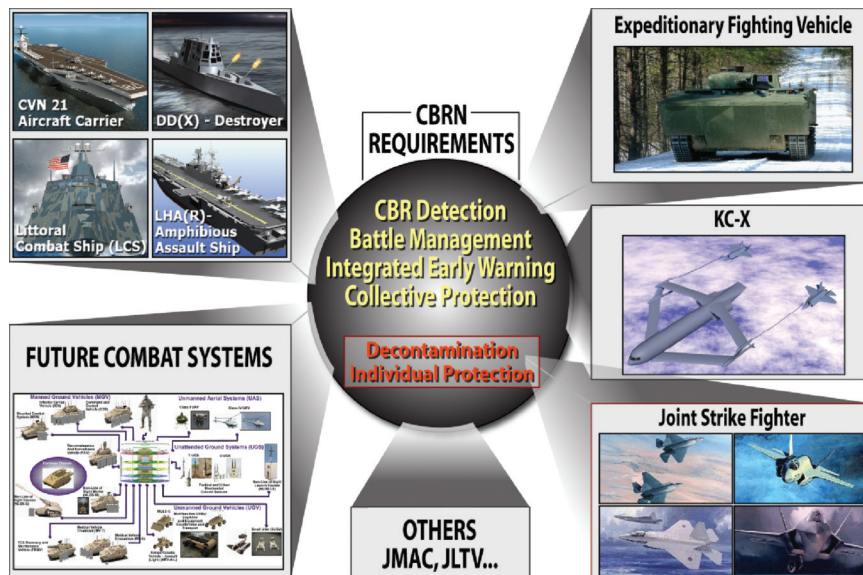



Shape

Shape

Shape

Shape

Shape

Shape

Shape

Shape

Shape

**Shape**

*ACQUISITION PROGRAM HIGHLIGHTS*

**Shape**

**Shape**

**Shape**

**Shape**

**Shape**

**Shape**

**Shape**

**Shape**



- Two-way interface with current and planned individual Service
- Command, control, communication, computers, intelligence, surveillance, and reconnaissance (C4ISR) hardware and software
- Provides overlays of hazardous areas
- Block I—Initial acquisition and fielding of COTS and government off-the-shelf (GOTS) software as standard for Armed Services
- Block II—Integration of NBC legacy and future detector modules, and NBC Battlefield Management modules
- Rapidly predicts downwind hazardous areas
- Resides on mobile/fixed platforms
- Built-in communication module
- Compatible with Allied Technological Publication (ATP)-45

# Joint Warning and Reporting Network (JWARN)

**IOC**  
2Q FY09

**FOC**  
3Q FY10

**CONTRACTORS**

- Bruhn-Newtech  
COLUMBIA, MD
- Northrop Grumman  
WINTERPARK, FL

## Program Description

The Joint Warning and Reporting Network (JWARN) will provide Joint forces with a comprehensive analysis and response capability to minimize the effects of hostile NBC attacks or accidents/incidents. Compatible and integrated with Joint Services C4ISR systems, JWARN will provide the operational capability to employ NBC warning technology that will collect, analyze, identify, locate, report, and disseminate NBC warnings. JWARN will be located in Command and Control Centers at the appropriate level and employed by NBC defense specialists and other designated personnel. Data will be automatically transferred from and to the actual detectors/sensors and provide commanders with analyzed data for decisions for disseminating warnings down to the lowest level on the battlefield. JWARN will provide additional data processing, production of plans and reports, and access to specific NBC information to improve the efficiency of limited NBC personnel assets. ■

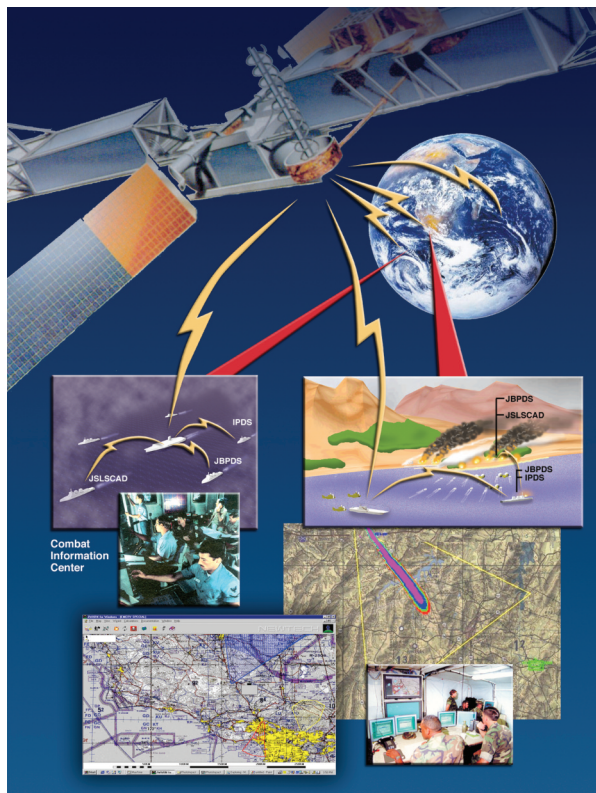



# Joint Effects Model (JEM) and Joint Operational Effects Federation (JOEF)

## JEM

### IOC

4Q FY08

### FOC

1Q FY10

### CONTRACTORS

- SPAWAR Systems Center  
SAN DIEGO, CA

## JOEF

### IOC

4Q FY08

### FOC

1Q FY10

### CONTRACTORS

- Cubic Applications, Inc.  
LACY, WA
- SPAWAR Systems Center  
SAN DIEGO, CA

- Capable of modeling hazards in various scenarios, including counterforce, passive defense, accident and/or incidents, high-altitude releases, urban environments, building interiors, and human performance degradation
- Resides on and interfaces with C4I systems, which will use JEM to predict hazard areas and provide warning to U.S. forces within those areas
- JOEF will provide a computer-based software system capable of providing modeling and simulation and analysis supporting the development of CBRN operation requirements and near-real-time decision making in a combat environment

## Program Description

JEM will provide a single, validated capability to predict and track CBRN and TIC/TIM events and effects.

JOEF is a Joint Service program endorsed by DOD that provides an operational requirements modeling and simulation system to enable warfighters and war planners to accurately predict CB environment effects on personnel, equipment, and operations. JOEF provides both a near-term requirement for advance planning and analysis and far-term requirement for near-real-time decision-making capabilities. ■

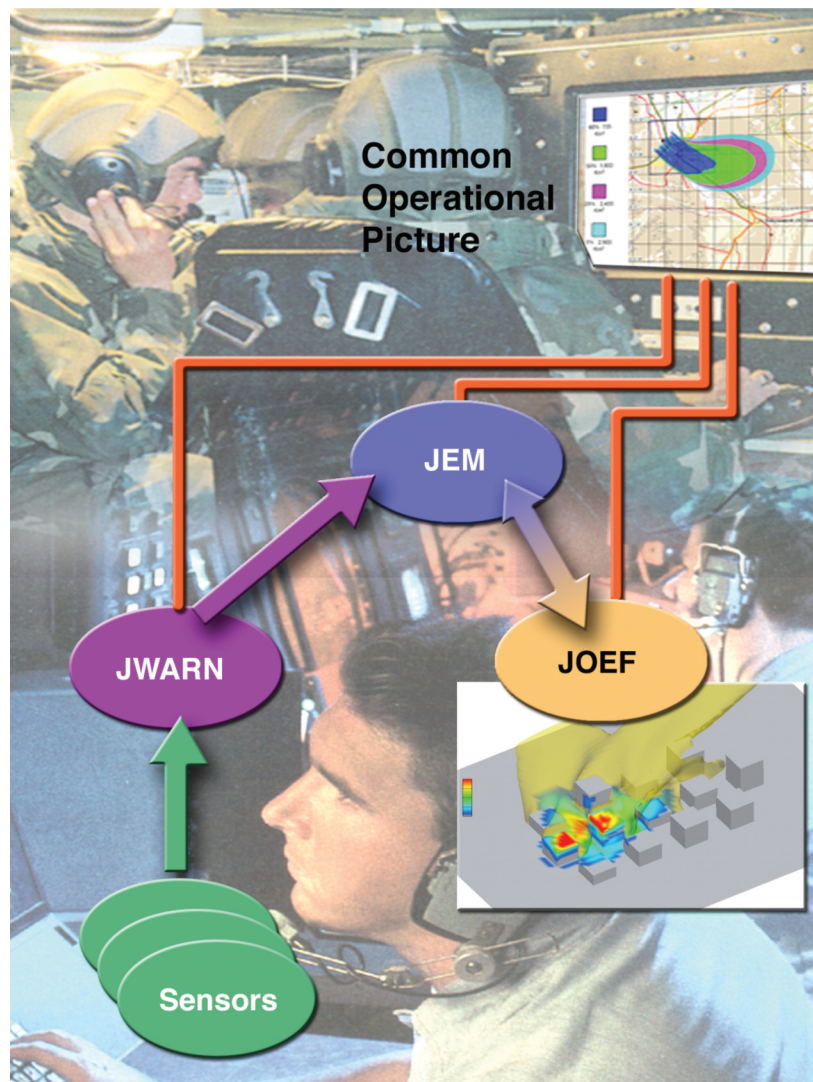





- Consists of CB-protective mask, overgarment, gloves, and footwear
- Overgarment provides 50% more wear time and 17% less heat stress and weighs 1 pound less than legacy protective garments
- Components are fully compatible with one another, providing complete percutaneous, respiratory, and ocular protection

## Program Description

**RESPIRATORY AND OCULAR PROTECTION:** The Joint Service General Purpose Mask (JSGPM) is a lightweight protective-mask system (consisting of mask, carrier, and accessories) incorporating state-of-the-art technology to protect U.S. forces from anticipated threats, including TICs. The JSGPM will improve field of view and

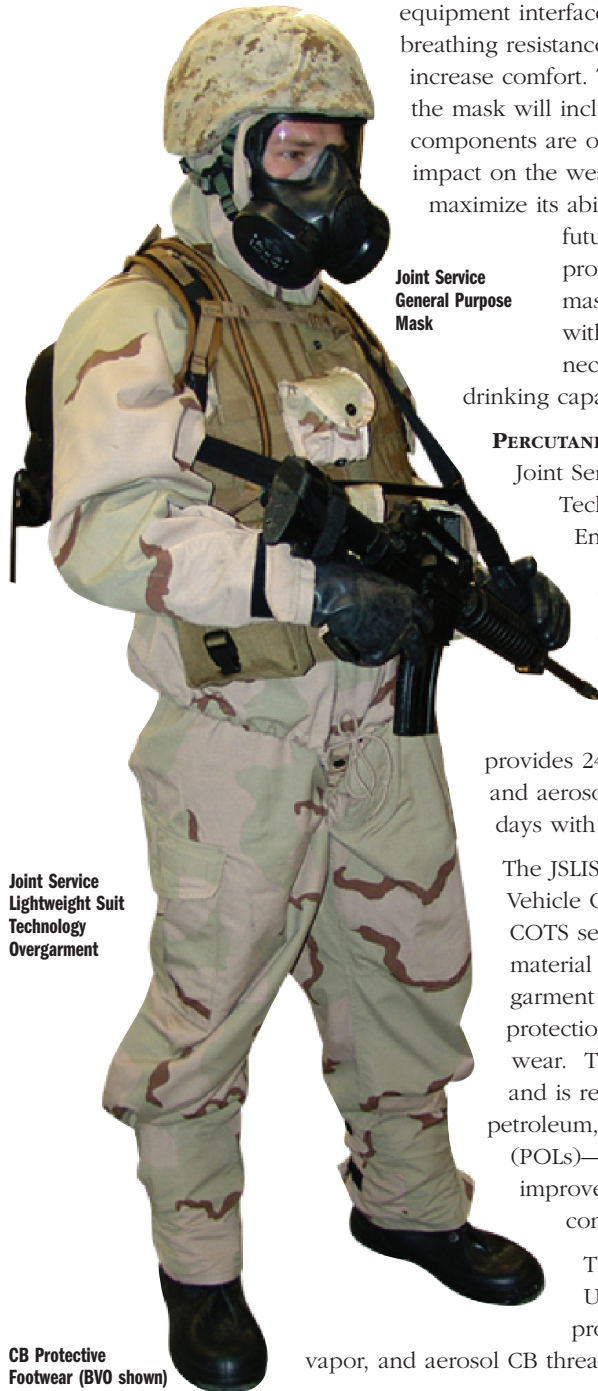

Joint Service  
General Purpose  
Mask

Joint Service  
Lightweight Suit  
Technology  
Overgarment

CB Protective  
Footwear (BVO shown)

equipment interface, provide 50% less breathing resistance than legacy masks, and increase comfort. The carrier's protection of the mask will include TIM. Mask components are optimized to minimize impact on the wearer's performance and to maximize its ability to interface with future Service equipment and protective clothing. The mask provides the wearer with continuous above-the-neck protection and a drinking capability.

**PERCUTANEOUS PROTECTION:** The Joint Service Lightweight Suit Technology (JSLIST)

Ensemble overgarment is a two-piece garment (trousers and coat), available hooded and nonhooded. It

provides 24 hours of liquid, vapor, and aerosol protection for up to 45 days with six launderings.

The JSLIST CB Coverall for Combat Vehicle Crewman (JC3) uses a COTS selectively permeable material in a government-designed garment to provide 16 hours of protection for up to 30 days of wear. The JC3 is flame-resistant and is resistant to degradation by petroleum, oil, and lubricants (POLs)—significant capability improvements for the armor community.

The JSLIST Block II Glove Upgrade (JB2GU) provides protection against liquid, vapor, and aerosol CB threats after 30 days of wear,

# Protective Clothing: Chemical and Biological Protective Ground Ensemble

## IOC

JSLIST Overgarment - 1997  
JSGPM - 1Q FY08  
IFS - FY 07  
AFS - 1Q FY08  
JB2GU - FY07  
JC3 - FY08

## FOC

JSLIST Overgarment - 4Q FY08  
JSGPM - FY13

## CONTRACTORS

### JSLIST:

- NISH (Overgarment)  
MAINE, TEXAS
- ACTON, Inc. (AFS, JB2GU nFR)  
ACTON VALE, QUEBEC, CANADA
- Hawkeye Glove, (JB2GU FR)  
FORT DODGE, IA
- Tennessee Apparel (IFS)  
OTTAWA, ONTARIO, CANADA
- Creative Apparel (Overgarment)  
BELFAST, ME

### JSGPM:

- Avon Protection Systems  
CADILLAC, MI

with greater tactility, dexterity, and durability than legacy gloves. It comes in two variants—butyl rubber non-flame-resistant (nFR) primarily for ground forces and a flame-resistant (FR) variant consisting of a chemical protective liner with flame-resistant overglove for aviators and combat vehicle crewmen.

The Alternative Footwear System (AFS) is a lightweight, low-volume overboot for use by ground and shipboard forces, featuring improved traction, mobility, and agility and reduced combat load. AFS attained Milestone (MS) C in 3Q FY07 and is already in use by the U.S. Marine Corps under an Urgent Need Statement.

The Integrated Footwear System (IFS) is a chemical-protective insert worn under the duty boot for use by aviation, combat vehicle crew, and special mission personnel. IFS attained MS C in 1Q FY07. ■



- Improved CB ensemble for crew members on rotary and fixed-wing aircraft
- Resists ignition and self-extinguishes if ignited
- Thermal protection for emergency egress from burning aircraft
- Increased wear time, enabling missions of longer duration
- Mask portion can be donned and doffed in-flight
- Increased CB protection
- Simultaneous CB and antigravity protection
- Improved heat stress, comfort
- Less physiological burdened for Joint Service aircrew

### Program Description

**RESPIRATORY AND OCULAR PROTECTION:** The Joint Service Aircrew Mask (JSAM) will be a lightweight CB-protective mask that will be worn as CB protection for all Army, Air Force, Navy, and Marine rotary and fixed-wing aircrew. The fixed-wing (FW) variant will be the first CB-protective mask in the DOD inventory that can provide anti-G protection up to 9 Gz for aircrew in high-performance aircraft. JSAM will be compatible with all below-the-neck CB ensembles and existing aircrew life support equipment. It will include a protective hood assembly, CB filter, blower assembly, and an intercom for ground communication. It will provide flame and thermal protection, hypoxia protection to 60,000 feet, demist/emergency demist and antidrown features. Some variants will be capable of being donned in flight.

**PERCUTANEOUS PROTECTION:** The Joint Protective Aircrew Ensemble (JPACE) is an improved protective ensemble for aircrews to replace the Navy MK1 undergarment, Army ABDU-BDO system, and Air Force CWU-66/P Overgarment. JPACE will provide aviators with improvements in protection, reduced heat stress in CB environments, and extended wear and service life. JPACE will be compatible with legacy aviation mask systems and codevelopmental masks, such as the JSAM. This operational capability will support all Services. To complete the ensemble, aviators will also be equipped with the JB2GU and IFS. ■



Rotary Wing Variant Type I



Apache Variant Type IA



Fixed Wing Type II

# Protective Clothing: Joint Chemical and Biological Aviation Ensemble

## IOC

JPACE – 1Q FY08

JSAM – Rotary Wing: FY09, Fixed Wing: FY11

IFS – FY 07

JB2GU – FY08

## FOC

JPACE – FY12

JSAM – Rotary Wing: FY11, Fixed Wing: FY13

## CONTRACTORS

### JPACE

■ Creative Apparel  
BELFAST, ME

■ NCTRF  
NATICK, MA

### JSAM

■ RW/Apache: AVOX  
LANCASTER, NY

### FW

■ GENTEX RP  
RANCHO CUCAMONGA, CA

### IFS

■ Tennessee Apparel  
TULLAHOMA, TN

### JB2GU

■ Hawkeye Glove  
FORT DODGE, IA

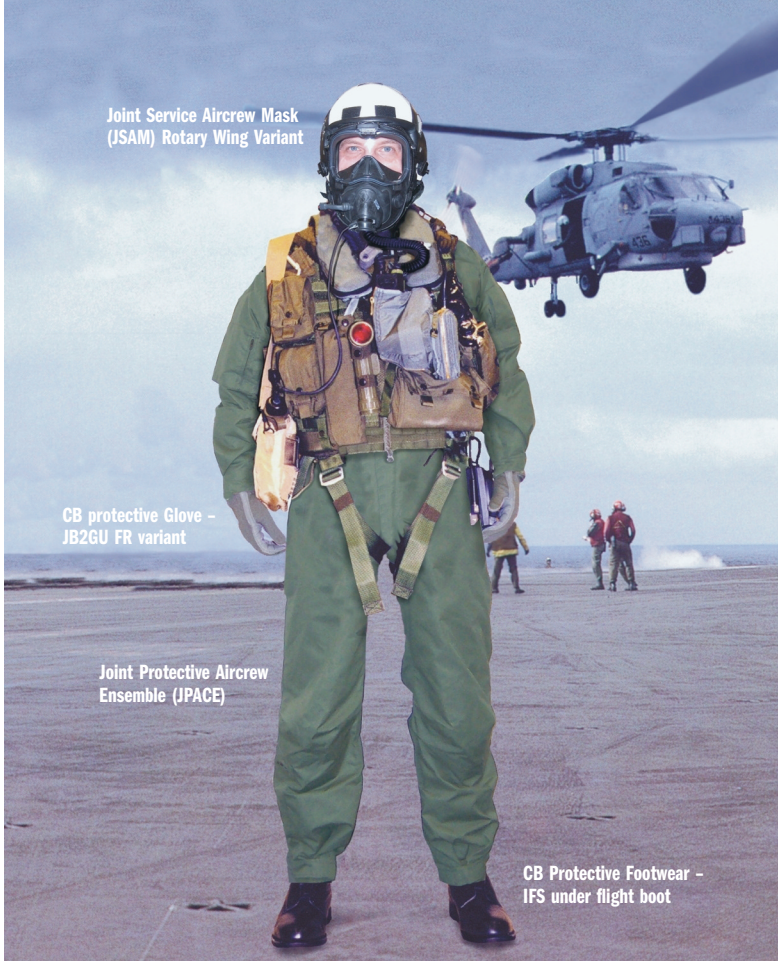

JB2GU (FR)



IFS

- NBC protection for Battalion Aid Station for forward battle areas
- Provides an integrated, environmentally controlled, self-contained collective protection system in mobile or static modes with either internal or external power sources
- Provides 72 hours of continuous protection in a chemical, biological, and radiological (CBR) environment

### Program Description

The Collective Biological Protective Shelter (CBPS), which replaces the M51 Collective Protection Shelter, consists of a collective protection shelter modularized and integrated into a Service-selected prime mover. Completely self-contained, self-powered, mobile, and adaptable to a variety of missions, the CBPS provides 72 hours of contamination-free, environmentally controlled working area, relieving medical, combat service, and combat service support personnel from the need to continuously wear individual CB protective clothing. ■



# Chemical Biological Protective Shelter (CBPS)

**IOC**  
2Q FY03

**FOC**  
TBD

#### CONTRACTORS

- DRS Sustainment Systems, Inc.  
ST. LOUIS, MO
- Smiths Detection  
EDGEWOOD, MD



# Collective Protection System Backfit (CPSBKFT)

## IOC

Not Applicable

## FOC

Not Applicable

## CONTRACTORS

- American Fan Company  
FAIRFIELD, OH
- Anderson Metal Industries, Inc.  
FRANKLIN, PA
- National Steel and Shipbuilding Company (NASSCO)  
SAN DIEGO, CA
- New World Associates  
FREDERICKSBURG, VA
- Norfolk Shipbuilding Company  
NORFOLK, VA
- BAE Systems Norfolk Ship Repair  
NORFOLK, VA

- Provides collective protection zones within in-service amphibious ships
- Air filters and pressurization of spaces prevent entry of NBC contaminants
- Eliminates need to wear protective suits and masks in protected areas
- Increases ship's ability to perform mission critical/sustaining operations in an NBC-contaminated environment

## Program Description

The shipboard Collective Protection System Backfit (CPSBKFT) Program was created for in-service Amphibious Class ships as a defensive measure against WMDs to protect personnel and vital ship spaces from toxic chemicals, biological agents, and radioactive fallout. The collective protection system (CPS) is integrated with the ship's heating, ventilation, and air-conditioning (HVAC) systems and provides a filter air supply air for overpressurization of specified shipboard zones to keep toxic contamination from entering protected spaces. CPS eliminates the need for the ship's crew to wear protective gear (suits and masks). CPS will be installed on high-priority ships and is adaptable to any ship airflow requirements. ■

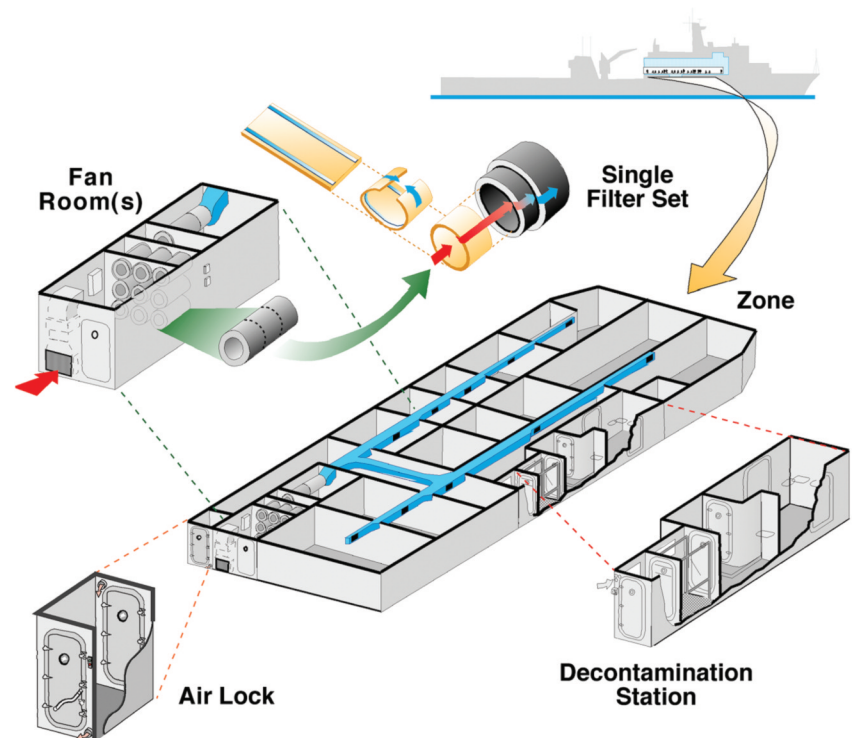

- Provides quality detection and diagnostic assays
- Provides critical resources (raw ingredients used in building assays) for medical diagnostics

### Program Description

The Critical Reagents Program (CRP) products, such as antibodies, select agent antigens, nucleic acid panels, electrochemiluminescence immunoassays, polymerase chain reaction assays, handheld assays, and biological sampling kits, are crucial to the mission of all current and future DOD BWA detection and medical diagnostic systems. As a supporting program of both biological defense detection and medical diagnostic systems and a provider of stand-alone detection products, CRP supports the warfighter and the nation.



## Critical Reagents Program (CRP)

### CONTRACTORS

- Dugway Proving Ground  
DUGWAY, UT
- U.S. Army Medical Research Institute of Infectious Diseases  
FREDERICK, MD
- Air Force Institute of Pathology  
WASHINGTON, DC
- Naval Medical Research Center  
SILVER SPRING, MD
- Edgewood Chemical Biological Center  
EDGEWOOD, MD
- Air Force Institute of Operational Health  
SAN ANTONIO, TX
- BioVeris Corporation  
GAITHERSBURG, MD
- San Antonio Scientific  
SAN ANTONIO, TX
- Murtech  
BALTIMORE, MD
- Midwest Research Institute  
KANSAS CITY, MO
- Camber Corporation (Oak Ridge Conformance Test Laboratory)  
OAK RIDGE, TN

## Medical

# Medical Chemical Defense (MEDCHEM)

### CONTRACTORS

- Fisher BioServices  
ROCKVILLE, MD
- PharmAthene, Inc.  
ANNAPOLIS, MD
- SRI International  
MENLO PARK, CA
- Dynport Vaccine Company  
FREDERICK, MD
- Southwest Research Institute  
SAN ANTONIO, TX
- Meridian Medical Technologies  
COLUMBIA, MD
- Valeant Pharmaceuticals International  
MONTREAL, QUEBEC CANADA
- Battelle Memorial Institute  
COLUMBUS, OH

- Antidotes against chemical warfare

### Program Description

MEDCHEM funds the development of medical materiel and other medical equipment items necessary to provide an effective capability for medical defense prophylaxis, pretreatment, and treatment against chemical warfare agent threats facing U.S. forces in the field. This project supports system development and fielding of prophylactic pretreatment and therapeutic drugs, post-exposure treatment, diagnostic equipment, and other life-support equipment for protection against and management of chemical warfare agent intoxication.

Fielded MEDCHEM Products:

- Soman Nerve Agent Pretreatment Pyridostigmine (SNAPP)
- Skin Exposure Reduction Paste Against Chemical Warfare Agents (SERPACWA)
- Antidote Treatment Nerve Agent Autoinjector (ATNAA)
- Convulsant Antidote for Nerve Agents (CANA)
- Medical Aerosolized Nerve Agent Antidote (MANAA)

MEDCHEM Products in Development:

- Improved Nerve Agent Treatment System (INATS)
- Advanced Anticonvulsant System (AAS)
- Plasma Bioscavenger (pBSCAV)
- Bioscavenger Increment II (BSCAV II)

MEDCHEM Support:

- Chemical Surety Facility (CSF) ■

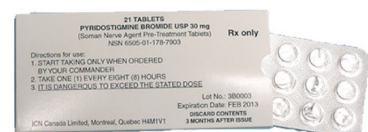

- Vaccines and other medical products that provide prophylactic protection against BW agents

### Program Description

Medical Biological Defense (MEDBIO) funds the Joint Vaccine Acquisition Program (JVAP) and other activities involving the development, licensure, and production of vaccines directed against validated BWAs, including bacteria, viruses, and toxins.

MEDBIO product development involves expanded clinical, nonclinical, and manufacturing efforts to evaluate the products' safety and efficacy. These efforts are required to support the application for FDA licensure. Another role for the JVAP is to procure FDA-licensed products in support of the Secretary of Defense's immunization programs for anthrax and smallpox.

MEDBIO Products:

- Plague vaccine
- Recombinant botulinum vaccine
- Smallpox system—vaccine and vaccinia immune globulin
- Anthrax vaccine adsorbed ■

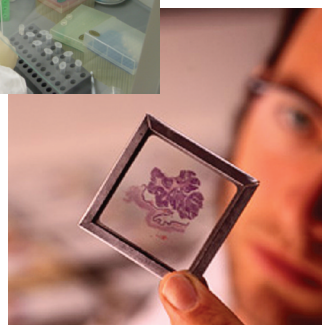

## Medical Biological Defense (MEDBIO)

### CONTRACTORS

- DynPort Vaccine Company  
*FREDERICK, MD*
- Emergent Biosolutions  
*LANSING, MI*
- Cangene Corporation  
*WINNIPEG, MANITOBA, CANADA*
- Avecia Biotechnology  
*FREDERICK, MD*

## Medical

# Medical Radiological Defense (MEDRAD)

- Therapeutic and/or prophylactic medical countermeasures to mitigate exposure to nuclear or radiological attacks

### Program Description

Medical Radiological Defense (MEDRAD) funds the advanced development of candidate therapeutic and/or prophylactic medical countermeasures to mitigate the consequences of exposure to ionizing radiation due to nuclear or radiological attacks. Exposure to ionizing radiation causes damage to the hematopoietic (blood-forming) and gastrointestinal systems, leading to Acute Radiation Syndrome (ARS). Development and fielding of prophylactic and therapeutic drugs requires FDA approval. Testing the efficacy of candidate drugs against lethal radiation exposure cannot be conducted in humans; therefore, surrogate animal models must be used to obtain FDA approval. This project allows the Joint forces to operate safely, over the long term, and at near normal levels of effectiveness while in a contaminated environment.

Medical radiation countermeasures (MRADC) efforts include multiple countermeasures to restore U.S. forces injured by radiation exposure to preexposure health. MRADC shall reverse or limit radiation injury, resulting in increased survival, decreased incapacity, and sustained operational effectiveness. In addition, MRADC shall be effective against a broad range of radiation sources and types and shall be usable in the battlespace, including during evacuation. ■

Sustain  
Sustain  
Sustain  
Sustain  
Sustain  
Sustain  
Sustain  
Sustain  
Sustain  
Sustain

**Sustain**

*ACQUISITION PROGRAM HIGHLIGHTS*

**Sustain**

**Sustain**

**Sustain**

**Sustain**

**Sustain**

**Sustain**

**Sustain**

**Sustain**



- Effective decontaminant for CB agents and TIC/TIMs
- FDA-approved for use on skin
- Compatible with detectors, other decontaminants, POL, and other material found on the battlefield
- Suitable for use on casualties and individual equipment and in mortuary affairs

**Program Description**

The Joint Service Personnel/Skin Decontamination Systems (JSPDS) will be fielded in addition to the current M291 Skin Decontamination Kit. The JSPDS will provide the warfighter the ability to decontaminate the skin, individual equipment, weapons, and casualties, including those with wounds after exposure to CB warfare agents, in support of thorough personnel decontamination operations. JSPDS will provide operational capabilities equal to and efficacy capabilities greater than the currently fielded M291. It will immediately reduce morbidity and mortality resulting from CBRN contamination of the skin. ■



# Joint Service Personnel/Skin Decontamination Systems (JSPDS)

**IOC**  
4Q FY10

**FOC**  
4Q FY13

**CONTRACTORS**

- E-Z-EM, Inc. and Canadian Commercial Corporations  
MONTREAL, QUEBEC, CANADA



# Joint Service Transportable Decontamination System—Small Scale (JSTDS-SS)

## IOC

4Q FY12

## FOC

2Q FY15

## CONTRACTORS

- DRS Sustainment Systems, Inc.  
ST. LOUIS, MO

- Provide tactical vehicle and equipment decontamination in close proximity to combat operations
- Adaptable to multiple missions
- Transportable off-road over any terrain on HMMWV and larger vehicles (no dedicated platform)
- Set up and operational in 30 minutes by two personnel
- Hourly throughput of eight medium-sized vehicles or one aircraft (F/A-18, E/CH-53 equivalent)

## Program Description

Transportable Decontamination System—Small Scale (JSTDS-SS) will provide the warfighter with the capability to conduct operational and thorough decontamination operations to sustain combat effectiveness. JSTDS-SS will consist of a transportable applicator module system, accessories, and decontaminant. JSTDS-SS will focus on fielding hardware systems that improve upon the capability and replace the currently fielded M17 Lightweight Decontamination System. ■



- Nonaqueous decontaminant solution
- Tactical mission capability maintained through rapid decontamination
- Easily refilled and discharged
- Timely decontamination of sensitive equipment
- The return of items to unrestricted use
- No reforming or condensing of contaminate in cracks or crevices

# Joint Material Decontamination System (JMDS)

## Program Description

The Joint Material Decontamination System (JMDS) will fill a need to decontaminate CB warfare agents from sensitive equipment, vehicle and aircraft interiors, and associated cargo, as defined by the Capability Development Documents for the Joint Service Sensitive Equipment Decontamination (JSSED) and Joint Platform Interior Decontamination (JPID). The program will concentrate on aircraft/vehicle interiors, and sensitive equipment. ■

**IOC**  
3Q FY12

**FOC**  
3Q FY14

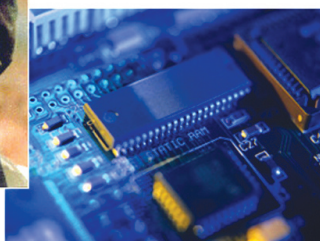



Homeland Defense

Homeland Defense

Homeland Defense

Homeland Defense

Homeland Defense

Homeland Defense

Homeland Defense

Homeland Defense

Homeland Defense

**Homeland Defense**

**Homeland Defense**

**Homeland Defense**

**Homeland Defense**

**Homeland Defense**

**Homeland Defense**

**Homeland Defense**

**Homeland Defense**

**Homeland Defense**

**Homeland Defense**



## Program Description

In response to the events of September 11, 2001, an antiterrorism task force was formed to come up with emergency lists for equipment for the Installation Protection Program (IPP), Army Emergency First Responder Program, and Homeland Security Biological Detection initiative.

The task force decisions resulted in PBD 289, which required a pilot program to outfit nine installations—three each for the Army, the Air Force, and the Navy/Marine Corps. The PBD stated that biological and chemical detection only is required. The installations included Warner-Robbins AFB, Pope AFB, Barksdale AFB, Ft. Campbell, Ft. Lewis, Ft. Gordon, Naval Surface Warfare Center (NSWC) Dahlgren, Naval Base San Diego, and Camp Lejeune, U.S. Marine Corps.

The Joint Service Installation Pilot Program (JSIPP) demonstrated the efficacy of an integrated suite of highly effective chemical and biological sensors and support equipment installed at the previously identified installations. The suite provided tiered sampling/collection, detection, identification, and warning response capabilities. It was designed to provide early indoor/outdoor collection, detection, presumptive identification, and warning capabilities and proved the need to expand this concept.

## Homeland Defense Installation Protection Program (IPP)

- The Joint Project Manager Guardian's Installation Protection Program is an integrated and optimized suite of highly effective chemical, biological, and radiological detection; identification; warning; information management; individual and collective protection; decontamination; and medical surveillance, protection, and response capabilities.
- Ensures adequate and effective CBRN consequence management and mission assurance at 135 installations.

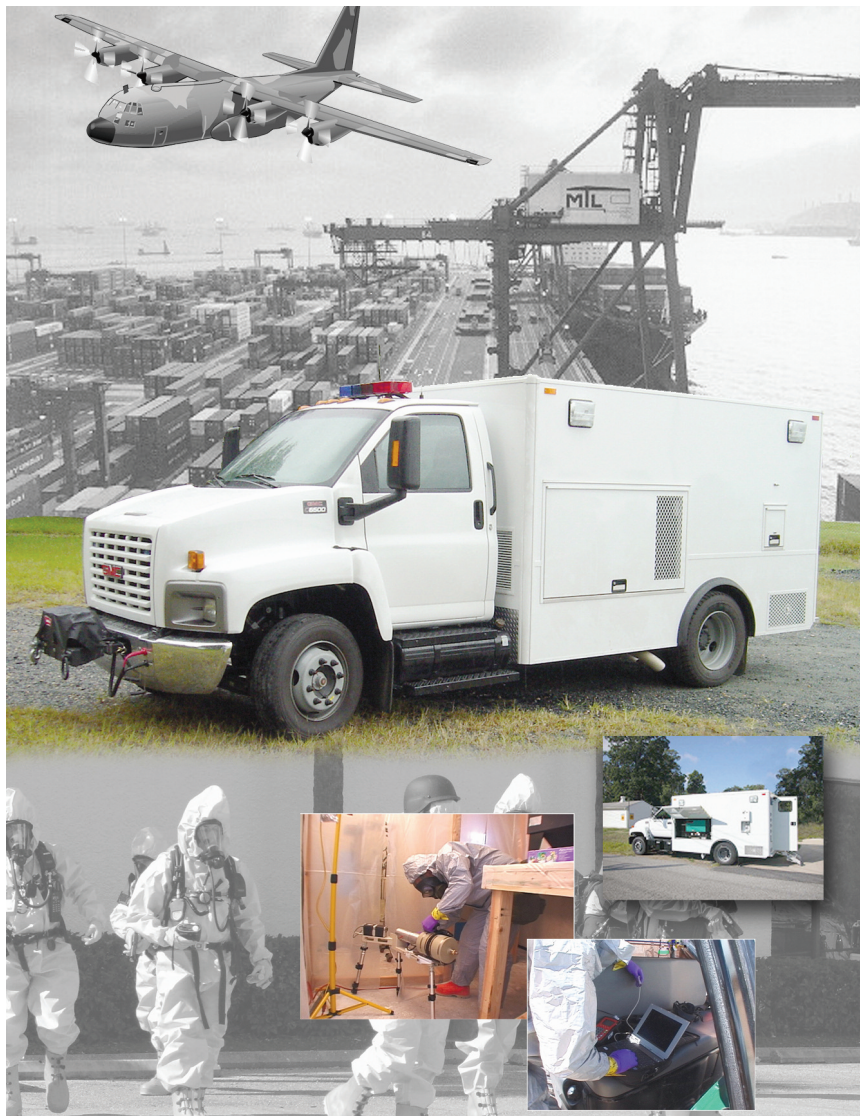

The JPMG IPP consists of a highly effective and integrated CBR installation protection and response capability, including detection, identification, warning, information management, individual and collective protection, restoration, and medical surveillance, protection, and response. The communications network will leverage existing capabilities and be integrated into the base operational command and control infrastructure. JPMG will procure and field an effective and optimized CBR installation protection and response capability at 135 DOD installations FY06–12. ■

- Equip Weapons of Mass Destruction—Civil Support Teams (WMD-CST) and U.S. Army Reserve (USAR) Reconnaissance decontamination teams for response to a CBRN event.

### Program Description

This program funds the acquisition of CBRN equipment as outlined in the Defense Reform Directive #25 for Weapons of Mass Destruction—Civil Support Teams (WMD-CSTs). This effort will allow selected National Guard and Reserve Component units to respond to and contain the effects of CBRN incidents within the continental United States.

The program also funds the design, enhancement, testing, fielding, and sustainment of the Analytical Laboratory System (ALS) Increment 1 and the Unified Command Suite (UCS) Increment 1 for the WMD-CSTs. The ALS Increment 1 provides advanced technologies with enhanced sensitivity and selectivity in the detection and identification of CWAs, BWAs, TICs, and TIMs. The UCS provides communication interoperability with federal, state, and local emergency responders at a WMD incident.

JPEO-CBD provides centralized program management and Joint Service CBDP acquisition program integration for the WMD-CSTs through the JPMG's Consequence Management program. ■



## Homeland Defense Weapons of Mass Destruction— Civil Support Teams (WMD- CST)

- The Joint Project Manager Guardian's Product Manager Consequence Management equips WMD-CSTs and USAR Reconnaissance/Decontamination elements for response to CBRN events or Homeland Security incidents.

### IOC

ALS Increment 1-2QFY08  
UCS Increment 1-3QFY07

### FOC

ALS Increment 1-3QFY08  
UCS Increment 1-3QFY08

### CONTRACTOR

- EAI Corp.  
ABINGDON, MD
- Naval Air Warfare Center Aircraft  
ST. INIGOES, MD
- Wolf Coach  
AUBURN, MA









# Test and Evaluation

The reorganization of the CBDP in 2003 to create centralized functions included the creation of the CBDP Test and Evaluation (T&E) Executive. The T&E Executive ensures the adequacy of T&E through oversight of T&E infrastructure planning and investment, early involvement of the T&E community, and oversight of T&E over the life cycles of programs. This role is based on the integral nature of T&E activities throughout the CBDP for nonmedical systems. During technology development, research includes bench-level and demonstration testing to obtain data for evaluation of technology maturity. During acquisition, T&E is expanded to test full systems in multiphased developmental testing (DT) and multi-Service operational testing (OT). Thus T&E supports all phases in the life cycle of a system (see figure below). The T&E Executive is responsible for establishing T&E capabilities needs, T&E standards, processes, and procedures early that are used to plan for and obtain valid, comparable, and complementary data through all phases.

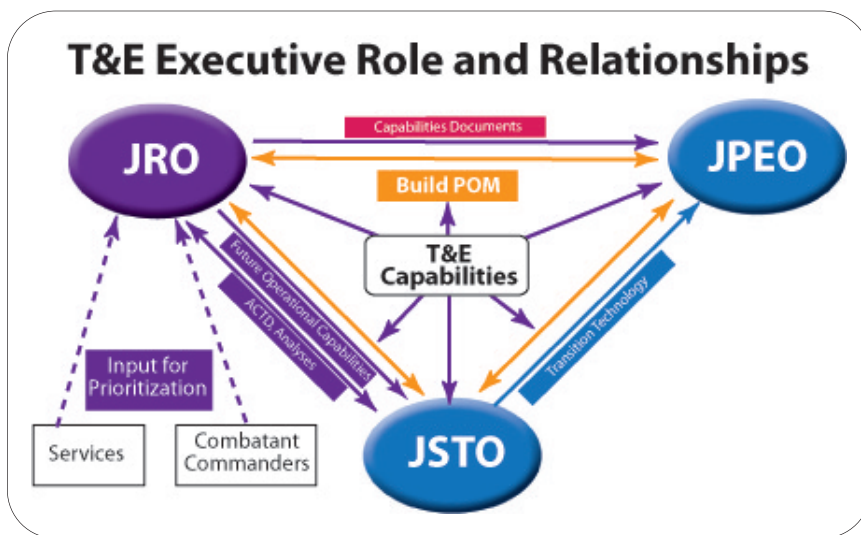

The T&E Executive provides oversight of the CBDP T&E infrastructure and investments to ensure that adequate T&E can be planned for future CBDP systems. T&E infrastructure is defined as those facilities and capabilities that support developmental, operational, and related T&E and does not include S&T laboratory infrastructure. The T&E Executive defines the T&E capabilities required for adequate testing and thus the directions of T&E infrastructure investments. The Project Director for Test Equipment, Strategy, and Support (PD-TESS) was created in January 2005 to execute the acquisition of T&E Executive-directed infrastructure capabilities. A key T&E Executive role is to establish and document the levels of T&E methodologies and capabilities needed, based on input from the T&E, S&T, and acquisition community stakeholders.

The T&E Executive works closely with the S&T and acquisition communities to ensure adequate testing throughout program life cycles and to support OSD T&E oversight for current programs. The T&E Executive participates in and/or leads Integrated Product Teams (IPTs) and working groups as required to expedite approval of T&E Master Plans (TEMPs) and other acquisition documents. The T&E Executive's focus is on these current, ongoing programs and also on ensuring adequacy of testing for the future.

In FY05, the T&E Executive conducted a five-month effort to identify T&E shortfalls in current capabilities. A series of meetings was held jointly among T&E and program manager representatives for each commodity area to discuss currently available capabilities and what capabilities were needed for future and

improved T&E. Two primary objectives were addressed: to improve operational realism of testing and to provide T&E capabilities for evolving threats. The figure below depicts the FY05 status of available T&E capabilities and methodologies.

Many valid materials/component level tests are available; however, there are severe shortfalls in full system tests, both with live agents and with simulants that are meaningful in terms of live agent system performance and threat realism. Also, it is currently not possible to establish the links among the levels of tests. Several T&E M&S development projects are ongoing during FY06–08 to provide physics-based T&E models for the Sense, Shield, and Sustain commodity areas. Basic science data and methodologies are needed to characterize the interactions of numerous

variables which would allow prediction of performance from one level to another and support the validation and use of M&S. Significant efforts are ongoing to remedy these shortfalls to provide the series of tests integrated with M&S approaches which together constitute adequate testing. A robust T&E program for CBD systems requires a related continuum of tests from early R&D to DT to OT, with appropriate use of M&S to tailor testing according to greatest need and critical environment for each system under test, as intended to be used by military units across the spectrum of military operations.

The T&E budget submission for the FY08–13 POM supports those T&E capabilities required to establish that continuum of related tests and evaluation tools and to improve operational realism of tests and ability to address evolving threats. The T&E capabilities projects needs were aligned with JPEO acquisition programs in priority order in accord with the JRO Capabilities-Based Assessment (CBA) for passive defense, as were the technology insertions and transition demonstrations. Thus, the CBDP budget submission for the FY08–13 POM is an integrated S&T, T&E, and acquisition budget and establishes the baseline and process for all future CBDP budget submissions. By budgeting for not only the programs but the T&E capabilities necessary to test them, the programs are planned as executable programs. The early definition of T&E requirements is critical to establishing executable programs and planning for investments. Definition of basic key evaluation tenets also forms the baseline for building early T&E strategies for each program and TEMP.

T&E capabilities needs are based on evaluation data requirements. Investment planning must also consider capabilities of existing T&E facilities and must address location of future T&E capabilities. The evaluation tenets that were used as the basis for the FY08–13 POM are described below, along with discussion of T&E facilities capabilities and focus.

### Key Evaluation Tenets

Maximum use of design-of-experiments approaches will be used. This requires the use of common test processes and procedures starting in S&T. Evaluations require a related continuum of tests from early R&D to DT to OT, with appropriate use of M&S. Since data from many sources will be integrated into the overall evaluation, it is critical to establish well-documented, repeatable, and valid test processes, so that all data can be leveraged to the maximum extent possible.

The goal of evaluation is to establish the capabilities and limitations of each system in terms of live agent system performance with respect to realistic threat environments. Since it is not possible to conduct U.S. outdoor live agent tests

## Current Testing Capabilities of the CBDP

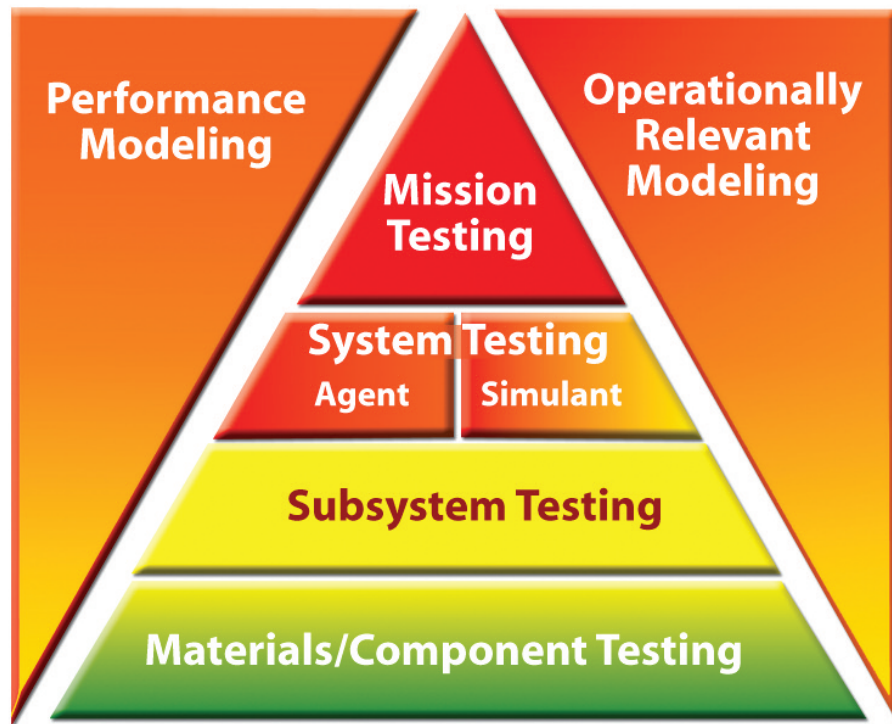

and since many chamber tests of large CBD systems and platforms cannot fully replicate the outdoor environment, a combination of simulant testing outdoors, live agent testing in chambers, and appropriate M&S and analysis techniques are used. All M&S and use of simulants must be validated by the developer and accredited by the Operational Test Agency (OTA) conducting the test. A key focus of the test and data collection planning for operational testing is to provide the ability to conduct an analysis of end-to-end unit mission success. The CBDP systems will be evaluated in terms of the ability of the warfighters to use them effectively to complete their units' missions.

Validation, accreditation, and utility of simulant data for evaluations are based on characterization of system under test in terms of agent performance related to system simulant performance. Physical properties of simulants are analyzed to identify types of simulants to test; however, actual system testing with both agents and simulants is required to validate the degree and nature of the simulant representation of each agent. Multiple simulants may be required to represent one or more agents; different simulants may be required for different technologies or performance aspects of each system under test. Agent performance and relation to simulants, as well as characterization of challenges and environments, are key data from DT that directly support OT and the operational evaluation.

Independent government DT/OT is required to establish full system performance: capabilities, limitations in terms of effectiveness, and suitability. Contractor or PM DT data can be used to support evaluations if planned as part of the overall test program with evaluator involvement. Operational evaluators will be involved early in DT planning so that maximum use of DT data is possible. DT will be planned to represent realistic threats and operational environments to the fullest extent possible. To present a realistic threat environment, the CONOPS and definition of threat parameters are input to T&E planning. DT and DT/OT data are used to establish readiness of the system to proceed to low-rate initial production and initial operational test and evaluation (IOT&E). IOT&E requires production representative test systems. All test events are planned for and funded under each individual acquisition program.

DT and DT/OT data include live agent component and system data. Future capabilities will develop the relationships among these data and expanded analytical methodologies so that M&S can be used to predict performance and maximize chance of successful test results while reducing cost. Evaluation of system effectiveness, capabilities, and limitations is primarily based on full-system live-agent performance.

Evaluations will include identifying limitations of testing and addressing these “So What?” questions:

- What are the impacts of system shortfalls?
- Is the capability demonstrated a militarily useful increment of capability?
- What improvements are required to provide a militarily useful increment of capability?

Evaluators require full definition and understanding of how each system works, including hardware and software. Critical elements of agent system performance must be analyzed to address the “So What?” questions above. This analysis is based on all data: materials, components, and system data. Thus, materials and components data are supporting data for system data and system evaluations.

## **T&E Facilities and Capabilities**

All Services conduct various types and phases of CBD T&E. Each Service has R&D laboratory resources (including Army—Edgewood Chemical and Biological Center [ECBC], Natick Soldier Center [NSC], and Army Research Laboratory [ARL]; Air Force—Air Force Research Laboratory [AFRL]; and Navy and Marines—NSWC Dahlgren and Naval Air Warfare Center [NAWC]). These labs are not considered part of CBDP T&E infrastructure, but they support T&E infrastructure and acquisition program DT processes. Additionally, T&E infrastructure investments may provide T&E capabilities at these sites. Thus, a core R&D-level test capability is required to be established in the labs that uses the same common test processes and procedures that will be used in follow-on phases of DT. T&E technologies and capabilities developments should be planned as partnering efforts among multi-Service R&D labs and DT and OT organizations so that these common test procedures are jointly established and “owned” by both labs and testers of all Services. T&E technologies development and small-scale R&D test capabilities will include upgrades in lab facilities as required. These upgrades in R&D facilities to support DT will be acquired under the auspices of the CBDP but will be sustained as part of the R&D infrastructure. Examples of this include BL-3 labs at ECBC and Dahlgren and simulant testing at ECBC, NSC, Dahlgren, and AFRL.

### **The CBDP funds a Major Range and Test Facility Base (MRTFB) at Dugway Proving Ground (DPG) to conduct DT, DT/OT, and support OT.**

Army Test and Evaluation Command (ATEC), the Air Force Operational Testing and Evaluation Command (AFOTEC), the Navy Operational T&E Force (OPTEVFOR), and the Marine Corps Operational T&E Activity (MCOTEA) are OTAs and

## FY08 T&E Activities

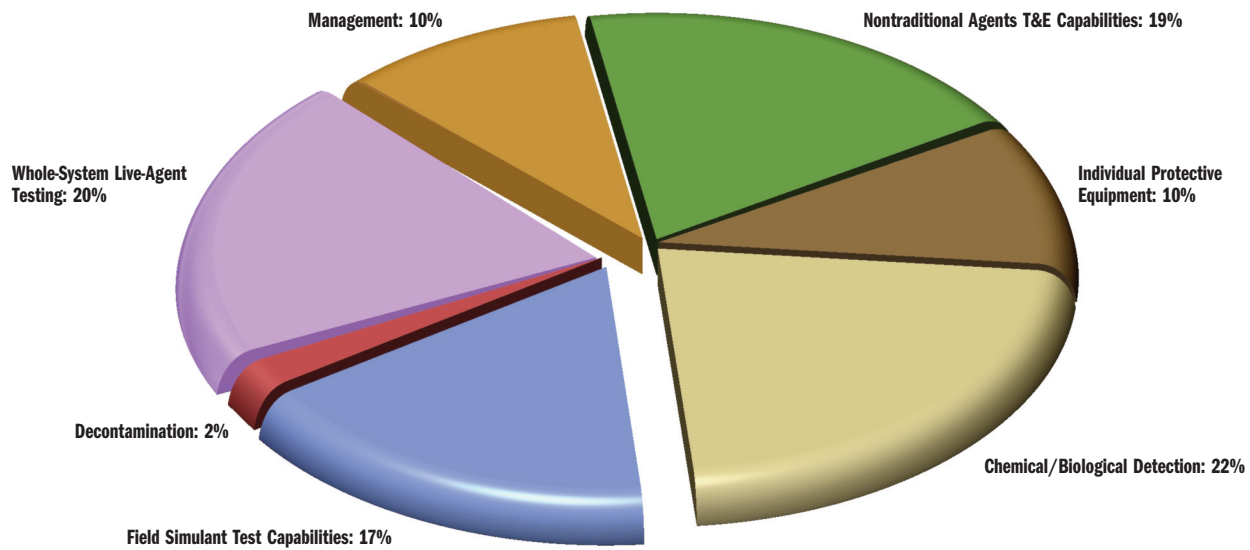

conduct OT of CBD systems. Multi-Service T&E teams are formed to plan an integrated series of tests to support the overall system evaluation, which includes assessments by each OTA regarding effectiveness and suitability of the system for each respective Service's mission(s).

### **NSWC, NAWC, and Eglin AFB have DT organizations and T&E capabilities which are used to support CBD.**

As the designated MRTFB Range for CB testing, DPG is the primary source and CBDP investment target for DT and DT/OT. Significant upgrades in T&E capabilities at DPG are ongoing during FY06–08, including a whole-system, live-agent test (WSLAT) chamber for biological point detection tests, improved vapor simulant field test instrumentation, and development of greater sensitivity sampling instrumentation to support chemical point detector and decontamination tests. Also, T&E capabilities for testing collective protection systems have been upgraded at Eglin AFB.

Other Services' DT and OT capabilities developments should be planned as partnering efforts among multi-Service DT and OT organizations so that these common test procedures are jointly established and accepted by testers of all Services. T&E capabilities development includes upgrades in DT and OT facilities and instrumentation at DPG and at other DT and OT organizations as workload indicates it is necessary and when it is cost-effective. These upgrades in non-MRTFB facilities were acquired under the auspices of the CBDP but will be sustained as part of that organization's current infrastructure and O&M costs. Similarly, upgrades in facilities funded outside the CBDP will be sustained as part of that organization's infrastructure and O&M costs, and not by the CBDP.

Many systems require full system testing in multiple geographic and mission environments. A core system performance test will be planned with excursions to address additional environments in a related fashion. The same procedures and instrumentation will be used among environments tested so that differences among data can be attributed to the environment and not confounded with test procedure/measurement differences. Improved T&E capabilities for outdoor simulant testing will be planned as an integrated set of instrumentation and methodologies. Challenge generation and characterization methodologies and instrumentation are required as a core capability of DPG as the MRTFB Range. Supplemental challenge generation and characterization capabilities by means of transportable equipment suites are required so that diverse geographic and mission environments can be tested using the same procedures across all environments to yield comparable and combined data sets.

The CBDP is supported by Service operational test activities headquartered in New Mexico and Virginia, which have subelements in the additional states of Florida, Hawaii, Maryland, Texas, and Utah. The T&E Executive coordinates the efforts of the test organizations in defining T&E infrastructure and requirements necessary to support CBDP programs. The T&E Executive also is responsible for standard T&E methods, processes, and procedures; leveraging current methods from all sources, including partners in Australia, the United Kingdom, and Canada; and developing and standardizing test procedures with industry and other agencies.

The focus of the T&E budget submission for the FY08–13 POM, an integrated with S&T and acquisition programs, is to address the two objectives of improving operational realism of tests and the ability to address evolving threats. T&E capabilities are planned to meet these two objectives and remedy the shortfalls as discussed above by means of acquiring a technologically advanced and methodologically sound continuum of related tests and evaluation tools that include all functional areas—Sense, Shield, Shape, and Sustain. In addition, several key T&E needs (nontraditional agents, simulants, threat agent science, and M&S) across all functional areas will be addressed by means of umbrella programs which include efforts to support all functional areas. The chart on page 90 shows the relative funding profiles for FY08 efforts by functional and cross areas. ■



# Experimentation

## IOC

Not applicable

## FOC

Not applicable

## CONTRACTORS

Numerous

Experimentation is an iterative process for developing and assessing solutions to identified capability gaps. Experimentation may take several forms:

- Seminar to review/develop CONOPS (tabletop exercise to validate CONOPS, define TTP, or conduct Suitability, Sustainability, and Maintainability Assessments)
- Live experiment with troops to demonstrate feasibility of the conceptual approach, help identify risks of the program, and validate TTP and compatibility of the CONOPS and the prototypes.
- Simulations/modeling focused on the testing, demonstration, support, and training strategies based on lessons learned from a live experiment.

## Program Description

Joint Experimentation is coordinated through JRO-CBRND. Experimentation for FY08–09 includes the following:

- Aviation Individual Protection Equipment
- Sensitive Site Exploitation
- Standoff Chemical Agent Detection
- Joint Expeditionary Collective Protection
- Joint Expeditionary Biological Detection
- Human Remains Decontamination
- Automated (Robotic) Decontamination
- Joint CBRN Dismountable Reconnaissance System
- Smart Base Protection
- Decontamination Solution 300
- System-of-Systems CBRN Detection for the Future Force
- Joint Biological Detection Up Armor Solutions

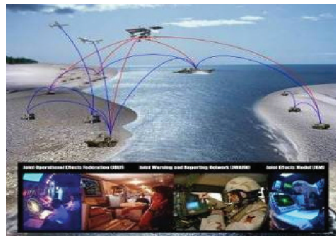

Up Armor Solutions

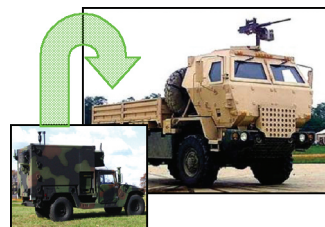

System-of-Systems Future Force



Dismountable Recon System

References

References

References

References

References

References

References

References

References

**References**

**References**

**References**

**References**

**References**

**References**

**References**

**References**

**References**

**References**



# Acronyms

<b>AAS</b>	Advanced Anticonvulsant System
<b>ABCA</b>	the armies of America, Britain, Canada, and Australia
<b>ACADA</b>	Automatic Chemical Agent Detector Alarm
<b>ACAT</b>	Acquisition Category
<b>ACTD</b>	Advanced Concept Technology Demonstration
<b>AFB</b>	Air Force Base
<b>AFOSR</b>	Air Force Office of Scientific Research
<b>AFOTEC</b>	Air Force Operational Test and Evaluation Command
<b>AFRL</b>	Air Force Research Laboratory
<b>AFS</b>	Alternative Footwear System
<b>ALS</b>	Analytical Laboratory System
<b>ARL</b>	Army Research Laboratory
<b>ARO</b>	Army Research Office
<b>ATD</b>	Advanced Technology Demonstration
<b>ATEC</b>	Army Test and Evaluation Command
<b>ATNAA</b>	Antidote Treatment Nerve Agent, Autoinjector
<b>ATP</b>	Allied Technical Publication
<b>ATSD(NCB)</b>	Assistant to the Secretary of Defense for Nuclear and Chemical and Biological Defense Programs
<b>BD</b>	biological detection
<b>BIDS</b>	Biological Integrated Detection System
<b>BSCAV II</b>	Bioscavenger Increment II
<b>BW</b>	biological warfare
<b>BWA</b>	biological warfare agent
<b>C4I</b>	command, control, communication, computers, and intelligence
<b>C4ISR</b>	command, control, communication, computers, intelligence, surveillance, and reconnaissance
<b>CAM</b>	Chemical Agent Monitor
<b>CANA</b>	Convulsant Antidote for Nerve Agents
<b>CANUKUS</b>	Canadian, United Kingdom, and United States Tripartite Agreement
<b>CAPO-HD</b>	Capabilities Area Project Office—Homeland Defense
<b>CB</b>	chemical and biological
<b>CBA</b>	Capabilities-Based Assessment
<b>CBD</b>	chemical and biological defense
<b>CBDP</b>	Chemical Biological Defense Program
<b>CBIRF</b>	Chemical/Biological Incident Response Force
<b>CBMS</b>	Chemical Biological Mass Spectrometer
<b>CBPS</b>	Chemical Biological Protective Shelter
<b>CBR</b>	chemical, biological, and radiological
<b>CBRN</b>	chemical, biological, radiological, and nuclear
<b>CBRND</b>	chemical, biological, radiological, and nuclear defense
<b>CBT</b>	Joint Science and Technology Office Physical Science and Technology Division
<b>CM</b>	consequence management
<b>COCOM</b>	combatant command
<b>CONOPS</b>	concept of operations
<b>COTS</b>	commercial off-the-shelf
<b>CPS</b>	collective protection system
<b>CPSBKFT</b>	Collective Protection System Backfit
<b>CPWG</b>	Counter Proliferation Working Group

**CRP** Critical Reagents Program

**CSF** Chemical Surety Facility

**CUGR** CBRN Unmanned Ground Reconnaissance

**CUGV** CBRN Unmanned Ground Vehicle

**CWA** chemical warfare agent

**DAE** Defense Acquisition Executive

**DARPA** Defense Advanced Research Projects Agency

**DASD-CT, GWOT & CP** Deputy Assistant to the Secretary of Defense for Counterterrorism, the Global War on Terror, and Counterproliferation

**DED** Detailed Equipment Decontamination

**HHHS** U.S. Department of Health and Human Services

**DHS/HSARPA** Department of Homeland Security/Homeland Security Advanced Research Projects Agency

**DNA** deoxyribonucleic acid

**DOD** U.S. Department of Defense

**DOE** U.S. Department of Energy

**DOTMLPF** doctrine, organization, training, materiel, leadership and education, personnel, and facilities

**DPG** Dugway Proving Ground

**DT** developmental test/testing

**DTRA** Defense Threat Reduction Agency

**DTRA(CB)** Defense Threat Reduction Agency, Chemical and Biological Defense Directorate

**DTRA(CS)** Defense Threat Reduction Agency-Combat Support

**DTRA(TD)** Defense Threat Reduction Agency-Technology Development [Directorate]

**DUSD(AS&C)** Deputy Under Secretary of Defense for Advanced Systems and Concepts

**EBD** Expeditionary Biological Detection

**ECBC** Edgewood Chemical and Biological Center

**EPA** U.S. Environmental Protection Agency

**FCB** Functional Capability Board

**FDA** U.S. Food and Drug Administration

**FOC** full operational capability

**FoS** family of systems

**FR** flame-resistant

**FW** fixed wing

**FY** fiscal year

**GOTS** government off-the-shelf

**HMMWV** High-Mobility Multipurpose Wheeled Vehicle

**HVAC** heating, ventilation, and air-conditioning

**IAFF** International Association of Fire Fighters

**IBADS** Interim Biological Agent Detection System

**IBRD** Interagency Biological Restoration Demonstration

**ICAM** Improved Chemical Agent Monitor

**IFS** Integrated Footwear System

**IMS** Incident Management System

**INATS** Improved Nerve Agent Treatment System

**IOC** initial operational capability

**IOT&E** initial operational test and evaluation

**IPP** Installation Protection Program

**IPT** Integrated Product Team

**IST** Information Systems Technology

**JBAIDS** Joint Biological Agent Identification and Diagnostic System

**JB2GU** JSLIST Block II Glove Upgrade

**JBPDS** Joint Biological Point Detection System

**JBSDS** Joint Biological Standoff Detector System

**JBTDS** Joint Biological Tactical Detection System

**JC3** JSLIST CB Coverall for Combat Vehicle Crewman

**JCAD** Joint Chemical Agent Detector

**JCB** Joint Capabilities Board

**JCBRNFC** Joint CBRN Familiarization Course

**JCD-CBRND** Joint Combat Developer for CBRN Defense

**JCIDS** Joint Capabilities Integration and Development System

**JCS** Joint Contaminated Surface Detector

**JCTD** Joint Concept Technology Demonstration

**JCEP** Joint Expeditionary Collective Protection

**JEM** Joint Effects Model

**JFCOM** Joint Forces Command

**JMDS** Joint Material Decontamination System

**JOEF** Joint Operational Effects Federation

**JORD** Joint Operational Requirements Document

**JPACE** Joint Protective Aircrew Ensemble

**JPEO-CBD** Joint Program Executive Office for Chemical and Biological Defense

**JPID** Joint Platform Interior Decontamination

**JPM** Joint Program Manager

**JPM-IS** Joint Project Manager—Information Systems

**JPMG** Joint Project Manager Guardian

**JRO** Joint Requirements Office

**JROC** Joint Requirements Oversight Council

**JRO-CBRND** Joint Requirements Office for Chemical, Biological, Radiological, and Nuclear Defense

**JSAM** Joint Service Aircrew Mask

**JSGPM** Joint Service General Purpose Mask

**JSIPP** Joint Service Installation Protection Program

**JSLC** Joint Senior Leaders' Course

**JSLIST** Joint Service Lightweight Integrated Suit Technology

**JSLNBCRS** Joint Service Light Nuclear Biological Chemical Reconnaissance System

**JSLSCAD** Joint Service Lightweight Standoff Chemical Agent Detector

**JSPDS** Joint Service Personnel/Skin Decontamination Systems

**JSSD** Joint Service Sensitive Equipment Decontamination

**JSTDS-SS** Joint Service Transportable Decontamination System—Small Scale

**JSTO-CBD** Joint Science and Technology Office for Chemical and Biological Defense

**JTF** Joint Task Force

**JTWG** Joint Training Working Group

**JVAP** Joint Vaccine Acquisition Program

**JWARN** Joint Warning and Reporting Network

**JWE** Joint Warfighter Experimentation

**M&S** modeling and simulation

**MANAA** Medical Aerosolized Nerve Agent Antidote

**MARS** Military Applications in Reconnaissance and Surveillance

**MAV** Manned Aerial Vehicle

**MCOTEA** Marine Corps Operational Test and Evaluation Activity

**MCS** Maneuver Control System

**MDA** Milestone Decision Authority

**MDAP** Major Defense Acquisition Program

**MDAP SPRT** Major Defense Acquisition Program Support

**MDARS** Mobile Detection Assessment and Response System

**MEDBIO** Medical Biological Defense

**MEDCHEM** Medical Chemical Defense

**MEDRAD** Medical Radiological Defense

**MRADC** medical radiation countermeasures

**MRTFB** Major Range and Test Facility Base

**MS** milestone

**MTTP** Multi-Service Tactics, Techniques, and Procedures

**NASA** National Aeronautics and Space Administration

**NATO** North Atlantic Treaty Organization

**NAWC** Naval Air Warfare Center

**NBC** nuclear, biological, and chemical

**NBCRV** Nuclear Biological Chemical Reconnaissance Vehicle

**NFPA** National Fire Protection Association

**nFR** non-flame-resistant

**NIST** National Institute of Standards and Technology

**NNSA** National Nuclear Security Administration

**NSC** Natick Soldier Center

**NSF** National Science Foundation

**NSWC** Naval Surface Warfare Center

**ONR** Office of Naval Research

**OPTEVFOR** Operational Test and Evaluation Force

**OSD** Office of the Secretary of Defense

**OT** operational test/testing

**OTA** Operational Test Agency

**PAIO** Program Analysis and Integration Office

**pBSCAV** Plasma Bioscavenger

**pBuChE** human plasma-derived butyrylcholinesterase

**PD-TESS** Project Director for Test Equipment, Strategy, and Support

**PM** Project Manager

**POL** petroleum, oil, and lubricants

**POM** Program Objective Memorandum

**PPE** personal protective equipment

**R&D** research and development

**RDA** research, development, and acquisition

**RDT&E** research, development, test, and evaluation

**S&T** science and technology

**SA** situational assessment

**SA(CBD&CDP)** Special Assistant for Chemical and Biological Defense and Chemical Demilitarization Programs

**SERPACWA** Skin Exposure Reduction Paste Against Chemical Warfare Agents

**SLS** Senior Leader Seminar

**SNAPP** Soman Nerve Agent Pyridostigmine Pretreatment

**SOCOM** Special Operations Command

**SoS** system of systems

**SPO** Special Projects Office

**SPIDER** Special Platform Interior Decontamination and Equipment Restoration

**STRATCOM** Strategic Command

**T&D** transport and dispersion

**T&E** test/testing and evaluation

**TAS** Threat Agent Science

**TBD** to be determined

**TCTI** Transformational Countermeasure Technology Initiative

**TEMP** Test and Evaluation Master Plan

**TIC** toxic industrial chemical

**TIM** toxic industrial material

**TMIP** Theater Medical Information Program

**TMTI** Transformational Medical Technologies Initiative

**TO** Technical Order

**TSWG** Technical Support Working Group

**TTP** tactics, techniques, and procedures

**TTX** tabletop exercise

**UAV** Unmanned Aerial Vehicle

**UCS** Unified Command Suite

**UGV** unmanned ground vehicle

**USAR** U.S. Army Reserve

**USD(AT&L)** Under Secretary of Defense for Acquisition, Technology, and Logistics

**USD(Policy)** Under Secretary of Defense for Policy

**USMC** U.S. Marine Corps

**WMD** weapon of mass destruction

**WMD-CST** Weapons of Mass Destruction—Civil Support Team

**WSLAT** whole-system, live-agent test



# CB Defense on the Web

## **Air Force Counterproliferation Web Resource (Secure Access)**

<https://www.xo.hq.af.mil/xon/xonp/counterproliferation/index.shtml>

XONP's Strategy and Concepts Branch is the focal point for all counterproliferation-related issues within the Air Staff. XONP develops counterproliferation policy and planning and is also the Office of Primary Responsibility for the Air Force in the Counterproliferation Joint Warfighting Capabilities Assessment (JWCA) and the Counterproliferation Review Committee (CPRC).

## **Air University: United States Air Force Counterproliferation Center (CPC)**

<http://cpc.au.af.mil/>

CPC directs counterproliferation research and education. This effort involves assessing nuclear, biological, chemical, and missile proliferation threats and the means of addressing those threats.

## **Anthrax Vaccine Immunization Program**

<http://www.anthrax.osd.mil/>

The anthrax vaccine was licensed by FDA in 1970. Each dose builds on the immune response from earlier doses. Currently, anthrax vaccinations are mandatory for uniformed personnel, emergency-essential, and comparable U.S. government civilian employees and contractors deployed (or deploying within 60 days) to U.S. Central Command or Korea areas of responsibility for 15 or more consecutive days. The vaccine is also required for certain uniformed personnel assigned to special units (such as forward-deployed forces) and units with biodefense-related missions.

## **Armed Forces Radiobiology Research Institute (AFRRI)**

<http://www.afri.usuhs.mil/>

AFRRI conducts research in the field of radiobiology and related matters essential to the operational and medical support of the U.S. Department of Defense and the military Services.

## **Bureau of Arms Control (archive site)**

<http://www.state.gov/www/global/arms/bureauac.html>

Archived Jan. 21, 2000: The Bureau of Arms Control is responsible for international agreements on conventional, chemical/biological, and strategic forces, treaty verification and compliance and supports ongoing negotiations, policy-making, and interagency implementation efforts.

## **Bureau of Nonproliferation (archive site)**

<http://www.state.gov/www/global/arms/bureaupn.html>

Archived Jan. 21, 2000: One of the highest foreign policy and national security priorities of the United States is preventing the spread of nuclear and other weapons of mass destruction and their means of delivery. The Bureau of Nonproliferation gives a new emphasis to a broad range of efforts to curb proliferation of weapons of mass destruction, their delivery systems, and advanced conventional weapons.

## **Bureau of Political-Military Affairs (archive site)**

<http://www.state.gov/www/global/arms/bureauapm.html>

Archived Jan. 21, 2000: The Bureau of Political-Military Affairs provides policy direction in the areas of international security, military coordination and peace operations, and arms trade. Its responsibilities include regional security policy, security assistance, arms transfers (both government-to-government and commercial), humanitarian demining programs, critical infrastructure protection, burden sharing, complex contingency operations and contingency planning.



#### **Bureau of Verification and Compliance (archive site)**

<http://www.state.gov/www/global/arms/bureauvc.html>

Archived Jan. 21, 2000: The Bureau of Verification and Compliance is responsible for overall supervision (including oversight of both policy and resources) of all matters relating to verification and compliance with international arms control, nonproliferation, and disarmament agreements and commitments.

#### **Chemical and Biological Defense Information Analysis Center (CBIAC)**

<http://www.cbiac.apgea.army.mil/>

CBIAC is a full-service (DOD) Information Analysis Center (IAC) under contract to the Office of the Secretary of Defense, Director of Defense Research and Engineering and administratively managed by the Defense Technical Information Center. CBIAC serves as the focal point for DOD CBRN defense scientific and technical information. It provides services to DOD organizations, other government groups, and their approved contractors.

#### **Chemical, Biological, Radiological and Nuclear Defense Integration**

<http://www.acq.osd.mil/cbrmintegration/>

The Office of Chemical, Biological, Radiological and Nuclear Integration is a function of the OSA(CBD&CDP).

#### **Cooperative Monitoring Center, Sandia National Laboratory**

<http://www.cmc.sandia.gov/>

Sandia's history includes a long-time involvement with U.S. treaty verification and monitoring programs, leadership in systems engineering for the U.S. nuclear weapons program, and leadership of U.S. nuclear stewardship activities. In combination with complementary expertise at other U.S. Department of Energy National Laboratories, these activities have resulted in a unique systems-level approach to problem solving and a broad spectrum of technology-based tools that can be applied to the challenges of cooperative monitoring.

#### **Defense Advanced Research Projects Agency (DARPA)**

<http://www.darpa.mil/>

DARPA, the central R&D organization for DOD, manages and directs selected basic and applied R&D projects for DOD and pursues research and technology where risk and payoff are both very high and where success may provide dramatic advances for traditional military roles and missions.

#### **Defense Technical Information Center (DTIC) Nonproliferation and Arms Control (NPAC) Technology Working Group (TWG)**

<http://www.dtic.mil/>

The purpose of NPAC TWG is to ensure effective coordination of R&D in the areas of arms control and nonproliferation and to guard against redundant arms control- and nonproliferation-related R&D and technology programs within and among departments and agencies.

#### **Department of Energy National Nuclear Security Administration (NNSA)**

<http://www.nnsa.doe.gov/>

NNSA is a semiautonomous agency within the U.S. Department of Energy responsible for enhancing national security through the military application of nuclear energy. NNSA maintains and enhances the safety, security, reliability, and performance of the U.S. nuclear weapons stockpile without nuclear testing; works to reduce global danger from weapons of mass destruction; provides the U.S. Navy with safe and effective nuclear propulsion; and responds to nuclear and radiological emergencies in the United States and abroad.

#### **Edgewood Chemical and Biological Center (ECBC)**

<http://www.edgewood.army.mil/>

ECBC is the nation's principal R&D center for nonmedical CB defense. ECBC develops technology in the areas of detection, protection, and decontamination and provides support over the entire life cycle, from basic research through technology development, engineering design, equipment evaluation, product support, sustainment, field operations, and disposal.

#### **International Atomic Energy Agency (IAEA)**

<http://www.iaea.org/>

IAEA serves as the world's central intergovernmental forum for scientific and technical cooperation in the nuclear field, and as the international inspectorate for the application of nuclear safeguards and verification measures covering civilian nuclear programs.

#### **Joint Program Executive Office for Chemical and Biological Defense (JPEO-CBD)**

<http://www.jpeocbd.osd.mil/>

JPEO-CBD is the principal advocate and single point of contact for all CBRN detection and vaccine and medical diagnostic acquisition efforts within the scope of the JPEO-CBD charter. The JPEO-CBD vision is to eliminate the biological warfare threat by protecting the warfighter and other users. JPEO-CBD provides biological warfare protection by rapidly developing, acquiring, and fielding the most effective biological detection, BD vaccines, and medical diagnostic equipment within cost, schedule, performance, and logistical parameters.

### Joint Requirements Office (JRO)

<https://jro-cbrnd.cbic.acpgea.army.mil/Home.aspx>

JRO is the single office within DOD responsible for the planning, coordination, and oversight of joint CBRN defense operational requirements. The office serves as the Chairman, Joint Chiefs of Staff's single source of expertise to address all issues involving CBRN defense within passive defense, consequence management, force protection, and homeland security.

### Missile Defense Agency (MDAlink)

<http://www.mda.mil>

The Missile Defense Agency's mission is to develop, test, and prepare for deployment a missile defense system. Using complementary interceptors; land-, sea-, air- and space-based sensors; and battle management command and control systems, the planned missile defense system will be able to engage all classes and ranges of ballistic missile threats.

### Naval Treaty Implementation Program

<http://www.nawcwpns.navy.mil/~treaty/>

The Naval Treaty Implementation Program (NT 00), Strategic Systems Programs, is responsible within the Department of the Navy for the development of plans and procedures to ensure compliance with nonstrategic treaties and agreements. This office is staffed with senior military and civilian personnel who have expertise with treaty implementation and compliance planning, policy, and preparation for treaty verification activities.

### NBC Industry Group

<http://www.nbcindustrygroup.com/>

The NBC Industry Group is composed of more than 140 companies, not-for-profit organizations, and consultants who support nuclear, chemical, and biological warfare defense activities. In addition to military defense against chemical and biological warfare, interests of the group encompass domestic preparedness against chemical and biological terrorism, as well as the Chemical Weapons Convention and other treaties.

### Office of the Special Assistant to the Secretary of Defense for Chemical and Biological Defense and Chemical Demilitarization Programs (OSA(CBD&CDP))

<http://www.acq.osd.mil/cp/>

The mission of the Office of the Special Assistant for Chemical and Biological Defense and Chemical Demilitarization Programs is to lead, guide, and integrate the CB defense program.

### Office of the Under Secretary of Defense for Acquisition, Technology & Logistics

<http://www.acq.osd.mil/>

### Research, Development, and Engineering Command (RDECOM)

<http://www.rdecom.army.mil>

RDECOM provides science and engineering services for developing, acquiring, supporting, and disposing of Army materiel. RDECOM provides additional support for conducting S&T research, engineering development, engineering support of deployed materiel, and its modernization. RDECOM's mission is to get the right integrated technologies into the hands of warfighters quicker.

### Treaty Compliance

<http://www.defenselink.mil/acq/acic/>

Treaty Compliance is a function of the Office of the Under Secretary of Defense for Acquisition, Technology and Logistics.

### U.S. Air Force Institute for National Security Studies (INSS)

<http://www.usafa.af.mil/df/inss/>

INSS serves as a locus for research related to security studies emphasizing topics in the fields of strategic security, international treaties and agreements, and combating proliferation; homeland defense and combating terrorism; regional and emerging issues; air and space issues and planning; and information operations and warfare. In addition to its research efforts, the Institute conducts a broad range of other activities, including workshop organization, curricula development, and scholarly publications.

### U.S. Army Chemical Materials Agency (CMA)

<http://www.cma.army.mil>

CMA is the world leader in programs to store, treat, and dispose of chemical weapons safely and effectively. The agency develops and uses technologies to safely store and eliminate chemical weapons while protecting the public, its workers, and the environment. CMA also provides support to National Defense and the American Soldier through its industrial base missions.

### U.S. Army Chemical School

<http://www.wood.army.mil/usacmls/>

The mission of the U.S. Army Chemical School is to protect the force and allow the Army to fight and win against a CBRN threat. The school develops doctrine, equipment, and training for CBRN defense that serve as deterrents to any adversary possessing weapons of mass destruction. The school also provides the Army with the combat multipliers of smoke, obscurant, and flame capabilities.

**U.S. Army Medical Research and Materiel Command (USMRMC)**  
<https://nrmc.amedd.army.mil>

USMRMC provides medical knowledge and materiel that support the warfighter across the full spectrum of health care missions worldwide. The command delivers, maintains, and disposes medical equipment and supplies and develops, deploys, operates, and sustains medical information management and information technology systems.

**U.S. Army Medical Research Institute of Infectious Diseases (USAMRIID)**  
<http://www.usamriid.army.mil>

USAMRIID has spearheaded research to develop medical solutions—vaccines, drugs, diagnostics, and information—to protect Service members from biological threats. The institute’s unique capabilities include biosafety level-3 and -4 laboratories, world-class expertise in the generation of biological aerosols for testing candidate vaccines and therapeutics, and fully accredited animal research facilities.

**U.S. Army Soldier Systems Center (SSC)**  
<http://www.ssc.army.mil>

SSC is the Army’s one-stop soldier-support organization. It is responsible for researching, developing, fielding, and managing food, clothing, shelters, airdrop systems, and soldier support items.

**U.S. Department of Energy Office of Defense Nuclear Nonproliferation**  
<http://www.nnsa.doe.gov/na-20>

The mission of the Office of Defense Nuclear Nonproliferation (DNN) is to detect, prevent, and reverse the proliferation of weapons of mass destruction, while mitigating the risks from nuclear operations.

**U.S. Department of State**  
<http://www.state.gov/>

The mission of the U.S. Department of State is to create a more secure, democratic, and prosperous world for the benefit of the American people and the international community.

# Consolidated Program Locator Map

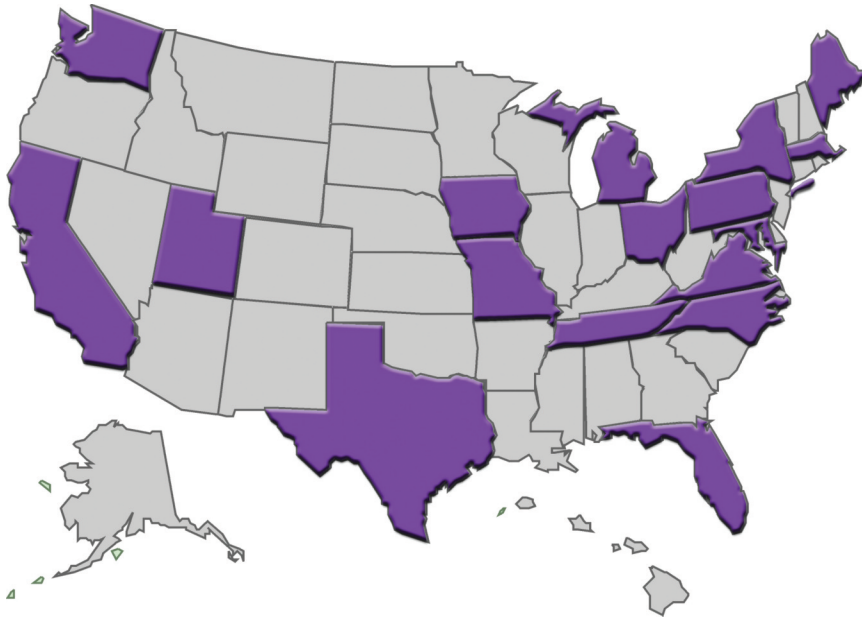

## CALIFORNIA

### GENTEX RP

Hamilton Sundstrand Sensor Systems  
National Steel and Shipbuilding Company (NASSCO)  
SPAWAR Systems Center  
SRI International

## FLORIDA

Northrop Grumman

## IOWA

Hawkeye Glove

## MAINE

Creative Apparel  
NISH

## MARYLAND

Avecia Biotechnology  
Battelle Memorial Institute  
BioVeris Corporation  
Bruhn-Newtech  
DynPort Vaccine Company  
EAI Corp.  
Edgewood Chemical Biological Center  
Fisher BioServices  
Meridian Medical Technologies  
Murtech  
Naval Air Warfare Center Aircraft  
Naval Medical Research Center  
PharmAthene, Inc.  
Science & Engineering Services  
Smiths Detection  
U.S. Army Medical Research Institute of Infectious Diseases

**MASSACHUSETTS**

NCTRF  
Wolf Coach

**MICHIGAN**

Emergent Biosolutions  
General Dynamics Land System  
Avon Protection Systems

**MISSOURI**

DRS Sustainment Systems, Inc.  
Midwest Research Institute

**NEW YORK**

AVOX

**NORTH CAROLINA**

General Dynamics Armament and Technical Products

**OHIO**

American Fan Company  
Battelle Memorial Institute

**PENNSYLVANIA**

Anderson Metal Industries, Inc.

**TENNESSEE**

Camber Corporation (Oak Ridge Conformance Test Laboratory)  
Tennessee Apparel

**TEXAS**

Air Force Institute of Operational Health  
NISH  
San Antonio Scientific

**UTAH**

Dugway Proving Ground  
Idaho Technology, Inc.

**VIRGINIA**

CACI  
New World Associates  
Norfolk Shipbuilding Company  
BAE Systems Norfolk Ship Repair

**WASHINGTON**

Cubic Applications, Inc.

**WASHINGTON, DC**

Air Force Institute of Pathology

**INTERNATIONAL PARTNERS****CANADA**

ACTON, Inc.  
Cangene Corporation  
E-Z-EM, Inc. and Canadian Commercial Corporations  
Tennessee Apparel  
Valeant Pharmaceuticals International



**Joint Service Chemical and Biological Defense Program  
FY08–09 Overview**

Requests for this document should be directed to:

**Office of the Special Assistant  
to the Secretary of Defense  
(Chemical Biological Defense)  
3050 Defense Pentagon, Room 3C257  
Washington, DC 20301-3050**