

Chapter 10

Night Operations



NIGHT VISION

Generally, most pilots are poorly informed about night vision. Human eyes never function as effectively at night as the eyes of animals with nocturnal habits, but if humans learn how to use their eyes correctly and know their limitations, night vision can be improved significantly. There are several reasons for training to use the eyes correctly.

One reason is the mind and eyes act as a team for a person to see well; both team members must be used effectively. The construction of the eyes is such that to see at night they are used differently than during the day. Therefore, it is important to understand the eye's construction and how the eye is affected by darkness.

Innumerable light-sensitive nerves, called "cones" and "rods," are located at the back of the eye or retina, a layer upon which all images are focused. These nerves connect to the cells of the optic nerve, which transmits messages directly to the brain. The cones are located in the center of the retina, and the rods are concentrated in a ring around the cones. [Figure 10-1]

The function of the cones is to detect color, details, and faraway objects. The rods function when something is seen out of the corner of the eye or peripheral vision. They detect objects, particularly those that are moving, but do not give detail or color—only shades of gray. Both the cones and the rods are used for vision during daylight.

Although there is not a clear-cut division of function, the rods make night vision possible. The rods and cones function in daylight and in moonlight, but in the absence of normal light, the process of night vision is placed almost entirely on the rods.

The fact that the rods are distributed in a band around the cones and do not lie directly behind the pupils makes off-center viewing (looking to one side of an object) important during night flight. During daylight, an object can be seen best by looking directly at it, but at night a scanning procedure to permit off-center viewing of the object is more effective. Therefore, the pilot should consciously practice this scanning procedure to improve night vision.

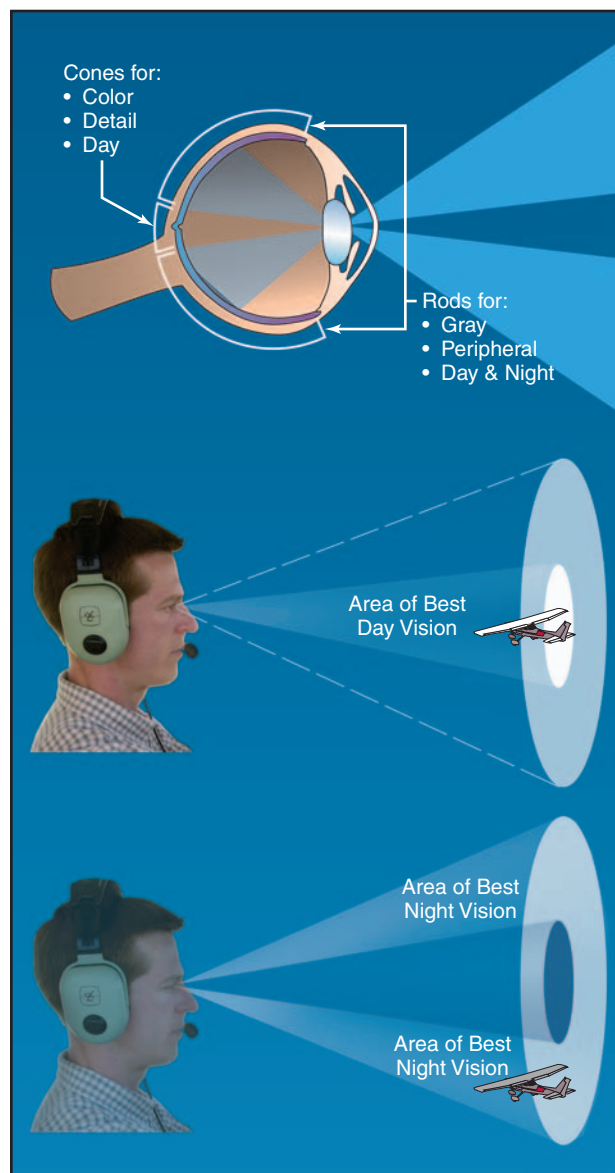
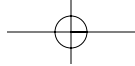

Figure 10-1. Rods and cones.

The eye's adaptation to darkness is another important aspect of night vision. When a dark room is entered, it is difficult to see anything until the eyes become adjusted to the darkness. Most everyone has experienced this after entering a darkened movie theater. In this process, the pupils of the eyes first enlarge to receive as much of the available light as possible. After approximately 5 to 10 minutes, the cones become adjusted to the dim light and the eyes become 100



times more sensitive to the light than they were before the dark room was entered. Much more time, about 30 minutes, is needed for the rods to become adjusted to darkness, but when they do adjust, they are about 100,000 times more sensitive to light than they were in the lighted area. After the adaptation process is complete, much more can be seen, especially if the eyes are used correctly.

After the eyes have adapted to the dark, the entire process is reversed when entering a lighted room. The eyes are first dazzled by the brightness, but become completely adjusted in a very few seconds, thereby losing their adaptation to the dark. Now, if the dark room is reentered, the eyes again go through the long process of adapting to the darkness.

The pilot before and during night flight must consider the adaptation process of the eyes. First, the eyes should be allowed to adapt to the low level of light and then they should be kept adapted. After the eyes have become adapted to the darkness, the pilot should avoid exposing them to any bright white light that will cause temporary blindness and could result in serious consequences.

Temporary blindness, caused by an unusually bright light, may result in illusions or after images until the eyes recover from the brightness. The brain creates these illusions reported by the eyes. This results in misjudging or incorrectly identifying objects, such as mistaking slanted clouds for the horizon or populated areas for a landing field. Vertigo is experienced as a feeling of dizziness and imbalance that can create or increase illusions. The illusions seem very real and pilots at every level of experience and skill can be affected. Recognizing that the brain and eyes can play tricks in this manner is the best protection for flying at night.

Good eyesight depends upon physical condition. Fatigue, colds, vitamin deficiency, alcohol, stimulants, smoking, or medication can seriously impair vision. Keeping these facts in mind and taking adequate precautions should safeguard night vision.

In addition to the principles previously discussed, the following items will aid in increasing night vision effectiveness.

- Adapt the eyes to darkness prior to flight and keep them adapted. About 30 minutes is needed to adjust the eyes to maximum efficiency after exposure to a bright light.
- If oxygen is available, use it during night flying. Keep in mind that a significant deterioration in night vision can occur at cabin altitudes as low as 5,000 feet.

- Close one eye when exposed to bright light to help avoid the blinding effect.
- Do not wear sunglasses after sunset.
- Move the eyes more slowly than in daylight.
- Blink the eyes if they become blurred.
- Concentrate on seeing objects.
- Force the eyes to view off center.
- Maintain good physical condition.
- Avoid smoking, drinking, and using drugs that may be harmful.

NIGHT ILLUSIONS

In addition to night vision limitations, pilots should be aware that night illusions could cause confusion and concerns during night flying. The following discussion covers some of the common situations that cause illusions associated with night flying.

On a clear night, distant stationary lights can be mistaken for stars or other aircraft. Even the northern lights can confuse a pilot and indicate a false horizon. Certain geometrical patterns of ground lights, such as a freeway, runway, approach, or even lights on a moving train can cause confusion. Dark nights tend to eliminate reference to a visual horizon. As a result, pilots need to rely less on outside references at night and more on flight and navigation instruments.

Visual autokinesis can occur when a pilot stares at a single light source for several seconds on a dark night. The result is that the light will appear to be moving. The autokinesis effect will not occur if the pilot expands the visual field. It is a good procedure not to become fixed on one source of light.

Distractions and problems can result from a flickering light in the cockpit, anticollision light, strobe lights, or other aircraft lights and can cause flicker vertigo. If continuous, the possible physical reactions can be nausea, dizziness, grogginess, unconsciousness, headaches, or confusion. The pilot should try to eliminate any light source causing blinking or flickering problems in the cockpit.

A black-hole approach occurs when the landing is made from over water or non-lighted terrain where the runway lights are the only source of light. Without peripheral visual cues to help, pilots will have trouble orientating themselves relative to Earth. The runway can seem out of position (downsloping or upsloping) and in the worse case, results in landing short of the

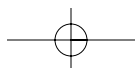

runway. If an electronic glide slope or visual approach slope indicator (VASI) is available, it should be used. If navigation aids (NAVAIDs) are unavailable, careful attention should be given to using the flight instruments to assist in maintaining orientation and a normal approach. If at any time the pilot is unsure of his or her position or attitude, a go-around should be executed.

Bright runway and approach lighting systems, especially where few lights illuminate the surrounding terrain, may create the illusion of less distance to the runway. In this situation, the tendency is to fly a higher approach. Also, when flying over terrain with only a few lights, it will make the runway recede or appear farther away. With this situation, the tendency is common to fly a lower-than-normal approach. If the runway has a city in the distance on higher terrain, the tendency will be to fly a lower-than-normal approach. A good review of the airfield layout and boundaries before initiating any approach will help the pilot maintain a safe approach angle.

Illusions created by runway lights result in a variety of problems. Bright lights or bold colors advance the runway, making it appear closer.

Night landings are further complicated by the difficulty of judging distance and the possibility of confusing approach and runway lights. For example, when a double row of approach lights joins the boundary lights of the runway, there can be confusion where the approach lights terminate and runway lights begin. Under certain conditions, approach lights can make the aircraft seem higher in a turn to final, than when its wings are level.

PILOT EQUIPMENT

Before beginning a night flight, carefully consider personal equipment that should be readily available during the flight. At least one reliable flashlight is recommended as standard equipment on all night flights. Remember to place a spare set of batteries in the flight kit. A D-cell size flashlight with a bulb switching mechanism that can be used to select white or red light is preferable. The white light is used while performing the preflight visual inspection of the airplane, and the red light is used when performing cockpit operations. Since the red light is nonglaring, it will not impair night vision. Some pilots prefer two flashlights, one with a white light for preflight, and the other a pen-light type with a red light. The latter can be suspended by a string from around the neck to ensure the light is always readily available. One word of caution; if a red light is used for reading an aeronautical chart, the red features of the chart will not show up.

Aeronautical charts are essential for night cross-country flight and, if the intended course is near the edge of the chart, the adjacent chart should also be available.

The lights of cities and towns can be seen at surprising distances at night, and if this adjacent chart is not available to identify those landmarks, confusion could result. Regardless of the equipment used, organization of the cockpit eases the burden on the pilot and enhances safety.

AIRPLANE EQUIPMENT AND LIGHTING

Title 14 of the Code of Federal Regulations (14 CFR) part 91 specifies the basic minimum airplane equipment required for night flight. This equipment includes only basic instruments, lights, electrical energy source, and spare fuses.

The standard instruments required for instrument flight under 14 CFR part 91 are a valuable asset for aircraft control at night. An anticollision light system, including a flashing or rotating beacon and position lights, is required airplane equipment. Airplane position lights are arranged similar to those of boats and ships. A red light is positioned on the left wingtip, a green light on the right wingtip, and a white light on the tail. [Figure 10-2]



Figure 10-2. Position lights.

This arrangement provides a means by which pilots can determine the general direction of movement of other airplanes in flight. If both a red and green light of another aircraft were observed, the airplane would be flying toward the pilot, and could be on a collision course.

Landing lights are not only useful for taxi, takeoffs, and landings, but also provide a means by which airplanes can be seen at night by other pilots. The Federal Aviation Administration (FAA) has initiated a voluntary pilot safety program called "Operation Lights ON." The "lights on" idea is to enhance the "see and be seen" concept of averting collisions both in the air

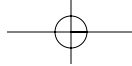

and on the ground, and to reduce the potential for bird strikes. Pilots are encouraged to turn on their landing lights when operating within 10 miles of an airport. This is for both day and night, or in conditions of reduced visibility. This should also be done in areas where flocks of birds may be expected.

Although turning on aircraft lights supports the see and be seen concept, pilots should not become complacent about keeping a sharp lookout for other aircraft. Most aircraft lights blend in with the stars or the lights of the cities at night and go unnoticed unless a conscious effort is made to distinguish them from other lights.

AIRPORT AND NAVIGATION LIGHTING AIDS

The lighting systems used for airports, runways, obstructions, and other visual aids at night are other important aspects of night flying.

Lighted airports located away from congested areas can be identified readily at night by the lights outlining the runways. Airports located near or within large cities are often difficult to identify in the maze of lights. It is important not to only know the exact location of an airport relative to the city, but also to be able to identify these airports by the characteristics of their lighting pattern.

Aeronautical lights are designed and installed in a variety of colors and configurations, each having its own purpose. Although some lights are used only during low ceiling and visibility conditions, this discussion includes only the lights that are fundamental to visual flight rules (VFR) night operation.

It is recommended that prior to a night flight, and particularly a cross-country night flight, the pilot check the availability and status of lighting systems at the destination airport. This information can be found on aeronautical charts and in the *Airport/Facility Directory*. The status of each facility can be determined by reviewing pertinent *Notices to Airmen* (NOTAMs).

A rotating beacon is used to indicate the location of most airports. The beacon rotates at a constant speed, thus producing what appears to be a series of light flashes at regular intervals. These flashes may be one or two different colors that are used to identify various types of landing areas. For example:

- Lighted civilian land airports—alternating white and green.
- Lighted civilian water airports—alternating white and yellow.
- Lighted military airports—alternating white and green, but are differentiated from civil airports

by dual peaked (two quick) white flashes, then green.

Beacons producing red flashes indicate obstructions or areas considered hazardous to aerial navigation. Steady burning red lights are used to mark obstructions on or near airports and sometimes to supplement flashing lights on en route obstructions. High intensity flashing white lights are used to mark some supporting structures of overhead transmission lines that stretch across rivers, chasms, and gorges. These high intensity lights are also used to identify tall structures, such as chimneys and towers.

As a result of the technological advancements in aviation, runway lighting systems have become quite sophisticated to accommodate takeoffs and landings in various weather conditions. However, the pilot whose flying is limited to VFR only needs to be concerned with the following basic lighting of runways and taxiways.

The basic runway lighting system consists of two straight parallel lines of runway-edge lights defining the lateral limits of the runway. These lights are aviation white, although aviation yellow may be substituted for a distance of 2,000 feet from the far end of the runway to indicate a caution zone. At some airports, the intensity of the runway-edge lights can be adjusted to satisfy the individual needs of the pilot. The length limits of the runway are defined by straight lines of lights across the runway ends. At some airports, the runway threshold lights are aviation green, and the runway end lights are aviation red.

At many airports, the taxiways are also lighted. A taxiway-edge lighting system consists of blue lights that outline the usable limits of taxi paths.

PREPARATION AND PREFLIGHT

Night flying requires that pilots be aware of, and operate within, their abilities and limitations. Although careful planning of any flight is essential, night flying demands more attention to the details of preflight preparation and planning.

Preparation for a night flight should include a thorough review of the available weather reports and forecasts with particular attention given to temperature/dewpoint spread. A narrow temperature/dewpoint spread may indicate the possibility of ground fog. Emphasis should also be placed on wind direction and speed, since its effect on the airplane cannot be as easily detected at night as during the day.

On night cross-country flights, appropriate aeronautical charts should be selected, including the

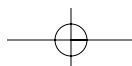

appropriate adjacent charts. Course lines should be drawn in black to be more distinguishable.

Prominently lighted checkpoints along the prepared course should be noted. Rotating beacons at airports, lighted obstructions, lights of cities or towns, and lights from major highway traffic all provide excellent visual checkpoints. The use of radio navigation aids and communication facilities add significantly to the safety and efficiency of night flying.

All personal equipment should be checked prior to flight to ensure proper functioning. It is very disconcerting to find, at the time of need, that a flashlight, for example, does not work.

All airplane lights should be turned ON momentarily and checked for operation. Position lights can be checked for loose connections by tapping the light fixture. If the lights blink while being tapped, further investigation to determine the cause should be made prior to flight.

The parking ramp should be examined prior to entering the airplane. During the day, it is quite easy to see stepladders, chuckholes, wheel chocks, and other obstructions, but at night it is more difficult. A check of the area can prevent taxiing mishaps.

STARTING, TAXIING, AND RUNUP

After the pilot is seated in the cockpit and prior to starting the engine, all items and materials to be used on the flight should be arranged in such a manner that they will be readily available and convenient to use.

Extra caution should be taken at night to assure the propeller area is clear. Turning the rotating beacon ON, or flashing the airplane position lights will serve to alert persons nearby to remain clear of the propeller. To avoid excessive drain of electrical current from the battery, it is recommended that unnecessary electrical equipment be turned OFF until after the engine has been started.

After starting and before taxiing, the taxi or landing light should be turned ON. Continuous use of the landing light with r.p.m. power settings normally used for taxiing may place an excessive drain on the airplane's electrical system. Also, overheating of the landing light could become a problem because of inadequate airflow to carry the heat away. Landing lights should be used as necessary while taxiing. When using landing lights, consideration should be given to not blinding other pilots. Taxi slowly, particularly in congested areas. If taxi lines are painted on the ramp or taxiway, these lines should be followed to ensure a proper path along the route.

The before takeoff and runup should be performed using the checklist. During the day, forward movement

of the airplane can be detected easily. At night, the airplane could creep forward without being noticed unless the pilot is alert for this possibility. Hold or lock the brakes during the runup and be alert for any forward movement.

TAKEOFF AND CLIMB

Night flying is very different from day flying and demands more attention of the pilot. The most noticeable difference is the limited availability of outside visual references. Therefore, flight instruments should be used to a greater degree in controlling the airplane. This is particularly true on night takeoffs and climbs. The cockpit lights should be adjusted to a minimum brightness that will allow the pilot to read the instruments and switches and yet not hinder the pilot's outside vision. This will also eliminate light reflections on the windshield and windows.

After ensuring that the final approach and runway are clear of other air traffic, or when cleared for takeoff by the tower, the landing lights and taxi lights should be turned ON and the airplane lined up with the centerline of the runway. If the runway does not have centerline lighting, use the painted centerline and the runway-edge lights. After the airplane is aligned, the heading indicator should be noted or set to correspond to the known runway direction. To begin the takeoff, the brakes should be released and the throttle smoothly advanced to maximum allowable power. As the airplane accelerates, it should be kept moving straight ahead between and parallel to the runway-edge lights.

The procedure for night takeoffs is the same as for normal daytime takeoffs except that many of the runway visual cues are not available. Therefore, the flight instruments should be checked frequently during the takeoff to ensure the proper pitch attitude, heading, and airspeed are being attained. As the airspeed reaches the normal lift-off speed, the pitch attitude should be adjusted to that which will establish a normal climb. This should be accomplished by referring to both outside visual references, such as lights, and to the flight instruments. [Figure 10-3]



Figure 10-3. Establish a positive climb.

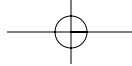

After becoming airborne, the darkness of night often makes it difficult to note whether the airplane is getting closer to or farther from the surface. To ensure the airplane continues in a positive climb, be sure a climb is indicated on the attitude indicator, vertical speed indicator (VSI), and altimeter. It is also important to ensure the airspeed is at best climb speed.

Necessary pitch and bank adjustments should be made by referencing the attitude and heading indicators. It is recommended that turns not be made until reaching a safe maneuvering altitude.

Although the use of the landing lights provides help during the takeoff, they become ineffective after the airplane has climbed to an altitude where the light beam no longer extends to the surface. The light can cause distortion when it is reflected by haze, smoke, or fog that might exist in the climb. Therefore, when the landing light is used for the takeoff, it may be turned off after the climb is well established provided other traffic in the area does not require its use for collision avoidance.

ORIENTATION AND NAVIGATION

Generally, at night it is difficult to see clouds and restrictions to visibility, particularly on dark nights or under overcast. The pilot flying under VFR must exercise caution to avoid flying into clouds or a layer of fog. Usually, the first indication of flying into restricted visibility conditions is the gradual disappearance of lights on the ground. If the lights begin to take on an appearance of being surrounded by a halo or glow, the pilot should use caution in attempting further flight in that same direction. Such a halo or glow around lights on the ground is indicative of ground fog. Remember that if a descent must be made through fog, smoke, or haze in order to land, the horizontal visibility is considerably less when looking through the restriction than it is when looking straight down through it from above. Under no circumstances should a VFR night-flight be made during poor or marginal weather conditions unless both the pilot and aircraft are certificated and equipped for flight under instrument flight rules (IFR).

The pilot should practice and acquire competency in straight-and-level flight, climbs and descents, level turns, climbing and descending turns, and steep turns. Recovery from unusual attitudes should also be practiced, but only on dual flights with a flight instructor. The pilot should also practice these maneuvers with all the cockpit lights turned OFF. This blackout training is necessary if the pilot experiences an electrical or instrument light failure. Training should also include using the navigation equipment and local NAVAIDs.

In spite of fewer references or checkpoints, night cross-country flights do not present particular problems if

preplanning is adequate, and the pilot continues to monitor position, time estimates, and fuel consumed. NAVAIDs, if available, should be used to assist in monitoring en route progress.

Crossing large bodies of water at night in single-engine airplanes could be potentially hazardous, not only from the standpoint of landing (ditching) in the water, but also because with little or no lighting the horizon blends with the water, in which case, depth perception and orientation become difficult. During poor visibility conditions over water, the horizon will become obscure, and may result in a loss of orientation. Even on clear nights, the stars may be reflected on the water surface, which could appear as a continuous array of lights, thus making the horizon difficult to identify.

Lighted runways, buildings, or other objects may cause illusions to the pilot when seen from different altitudes. At an altitude of 2,000 feet, a group of lights on an object may be seen individually, while at 5,000 feet or higher, the same lights could appear to be one solid light mass. These illusions may become quite acute with altitude changes and if not overcome could present problems in respect to approaches to lighted runways.

APPROACHES AND LANDINGS

When approaching the airport to enter the traffic pattern and land, it is important that the runway lights and other airport lighting be identified as early as possible. If the airport layout is unfamiliar to the pilot, sighting of the runway may be difficult until very close-in due to the maze of lights observed in the area. [Figure 10-4] The pilot should fly toward the rotating beacon until the lights outlining the runway are distinguishable. To fly a traffic pattern of proper size and direction, the runway threshold and runway-edge lights must be positively identified. Once the airport lights are seen, these lights should be kept in sight throughout the approach.

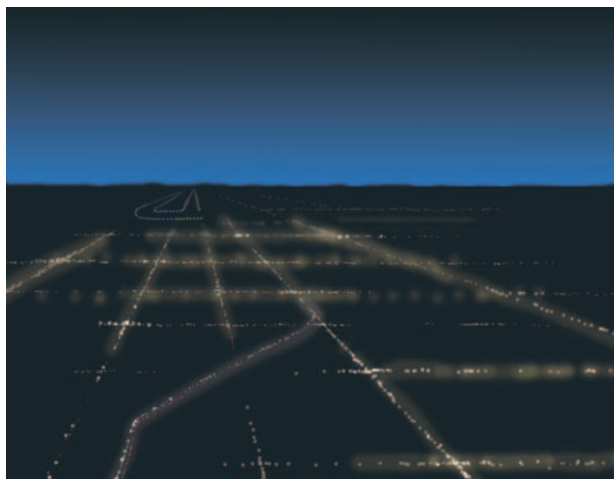
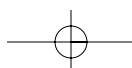

Figure 10-4. Use light patterns for orientation.



Distance may be deceptive at night due to limited lighting conditions. A lack of intervening references on the ground and the inability of the pilot to compare the size and location of different ground objects cause this. This also applies to the estimation of altitude and speed. Consequently, more dependence must be placed on flight instruments, particularly the altimeter and the airspeed indicator.

When entering the traffic pattern, allow for plenty of time to complete the before landing checklist. If the heading indicator contains a heading bug, setting it to the runway heading will be an excellent reference for the pattern legs.

Every effort should be made to maintain the recommended airspeeds and execute the approach and landing in the same manner as during the day. A low, shallow approach is definitely inappropriate during a night operation. The altimeter and VSI should be constantly cross-checked against the airplane's position along the base leg and final approach. A visual approach slope indicator (VASI) is an indispensable aid in establishing and maintaining a proper glidepath. [Figure 10-5]

After turning onto the final approach and aligning the airplane midway between the two rows of runway-edge lights, the pilot should note and correct for any wind drift. Throughout the final approach, pitch and power should be used to maintain a stabilized approach. Flaps should be used the same as in a normal approach. Usually, halfway through the final approach, the landing light should be turned on. Earlier use of the landing light may be necessary because of "Operation Lights ON" or for local traffic considerations. The landing light is sometimes ineffective since the light beam will usually not reach the ground from higher altitudes. The light may even be reflected back into the pilot's eyes by any existing haze, smoke, or fog. This disadvantage is overshadowed by the safety considerations provided by using the "Operation Lights ON" procedure around other traffic.

The roundout and touchdown should be made in the same manner as in day landings. At night, the judgment of height, speed, and sink rate is impaired by the scarcity of observable objects in the landing area. The inexperienced pilot may have a tendency to round out too high until attaining familiarity with the proper

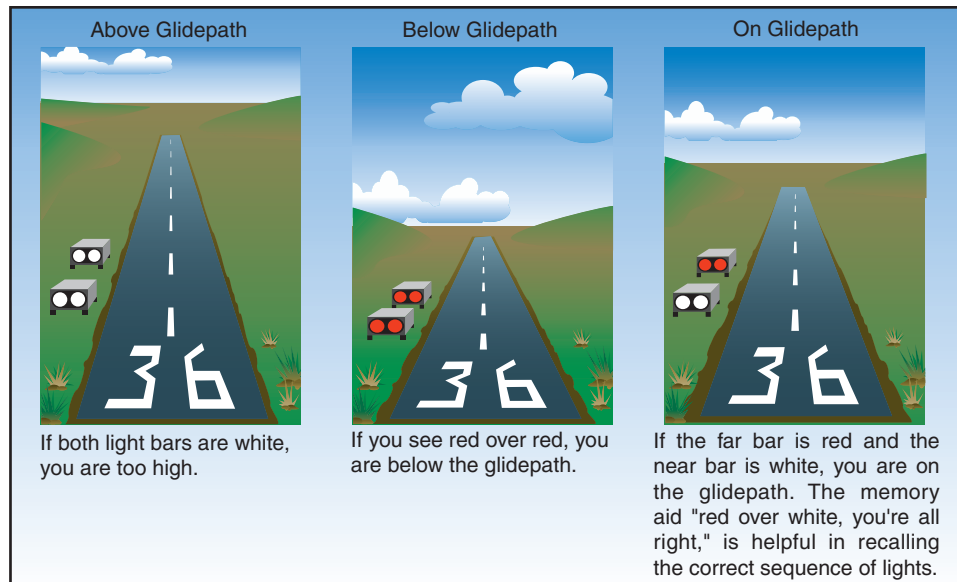

Figure 10-5. VASI.

height for the correct roundout. To aid in determining the proper roundout point, continue a constant approach descent until the landing lights reflect on the runway and tire marks on the runway can be seen clearly. At this point the roundout should be started smoothly and the throttle gradually reduced to idle as the airplane is touching down. [Figure 10-6] During landings without the use of landing lights, the roundout may be started when the runway lights at the

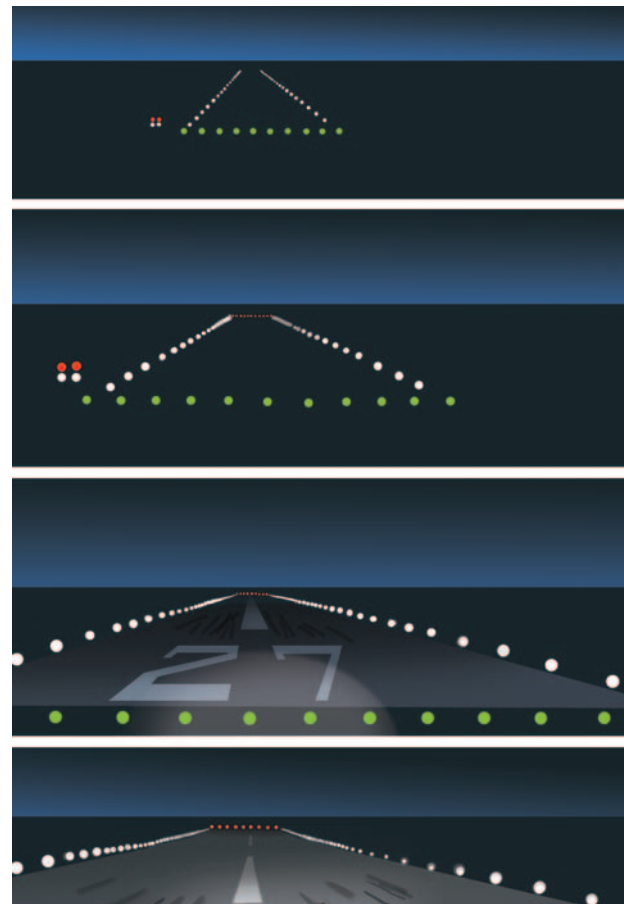
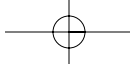

Figure 10-6. Roundout when tire marks are visible.



far end of the runway first appear to be rising higher than the nose of the airplane. This demands a smooth and very timely roundout, and requires that the pilot feel for the runway surface using power and pitch changes, as necessary, for the airplane to settle slowly to the runway. Blackout landings should always be included in night pilot training as an emergency procedure.

NIGHT EMERGENCIES

Perhaps the pilot's greatest concern about flying a single-engine airplane at night is the possibility of a complete engine failure and the subsequent emergency landing. This is a legitimate concern, even though continuing flight into adverse weather and poor pilot judgment account for most serious accidents.

If the engine fails at night, several important procedures and considerations to keep in mind are:

- Maintain positive control of the airplane and establish the best glide configuration and airspeed. Turn the airplane towards an airport or away from congested areas.
- Check to determine the cause of the engine malfunction, such as the position of fuel selectors, magneto switch, or primer. If possible, the cause of the malfunction should be corrected immediately and the engine restarted.
- Announce the emergency situation to Air Traffic Control (ATC) or UNICOM. If already in radio contact with a facility, do not change frequencies, unless instructed to change.
- If the condition of the nearby terrain is known, turn towards an unlighted portion of the area. Plan an emergency approach to an unlighted portion.
- Consider an emergency landing area close to public access if possible. This may facilitate rescue or help, if needed.
- Maintain orientation with the wind to avoid a downwind landing.
- Complete the before landing checklist, and check the landing lights for operation at altitude and turn ON in sufficient time to illuminate the terrain or obstacles along the flightpath. The landing should be completed in the normal landing attitude at the slowest possible airspeed. If the landing lights are unusable and outside visual references are not available, the airplane should be held in level-landing attitude until the ground is contacted.
- After landing, turn off all switches and evacuate the airplane as quickly as possible.

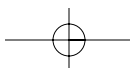

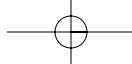

Chapter 11

Transition to Complex Airplanes



HIGH PERFORMANCE AND COMPLEX AIRPLANES

Transition to a complex airplane, or a high performance airplane, can be demanding for most pilots without previous experience. Increased performance and increased complexity both require additional planning, judgment, and piloting skills. Transition to these types of airplanes, therefore, should be accomplished in a systematic manner through a structured course of training administered by a qualified flight instructor.

A complex airplane is defined as an airplane equipped with a retractable landing gear, wing flaps, and a controllable-pitch propeller. For a seaplane to be considered complex, it is required to have wing flaps and a controllable-pitch propeller. A high performance airplane is defined as an airplane with an engine of more than 200 horsepower.

WING FLAPS

Airplanes can be designed to fly fast or slow. High speed requires thin, moderately **cambered** airfoils with a small wing area, whereas the high lift needed for low speeds is obtained with thicker highly cambered airfoils with a larger wing area. [Figure 11-1] Many

attempts have been made to compromise this conflicting requirement of high cruise and slow landing speeds.

Since an airfoil cannot have two different cambers at the same time, one of two things must be done. Either the airfoil can be a compromise, or a cruise airfoil can be combined with a device for increasing the camber of the airfoil for low-speed flight. One method for varying an airfoil's camber is the addition of trailing edge flaps. Engineers call these devices a high-lift system.

FUNCTION OF FLAPS

Flaps work primarily by changing the camber of the airfoil since deflection adds aft camber. Flap deflection does not increase the critical (stall) angle of attack, and in some cases flap deflection actually decreases the critical angle of attack.

Deflection of trailing edge control surfaces, such as the aileron, alters both lift and drag. With aileron deflection, there is asymmetrical lift (rolling moment) and drag (adverse yaw). Wing flaps differ in that deflection acts symmetrically on the airplane. There is no roll or yaw effect, and pitch changes depend on the airplane design.

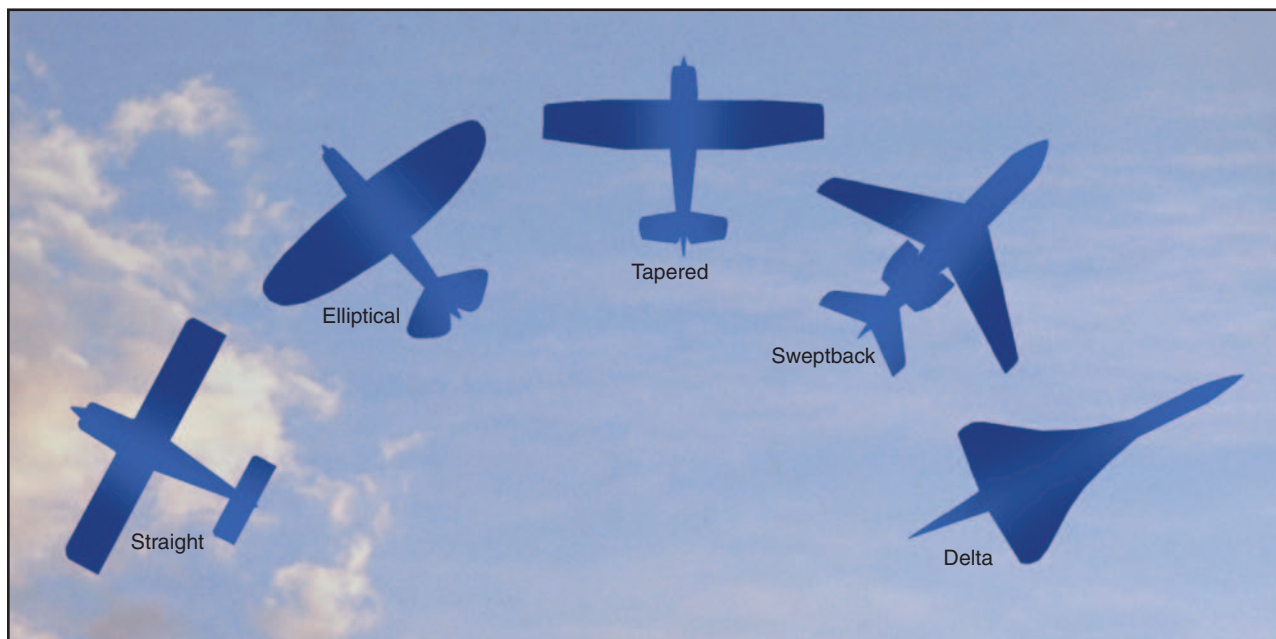
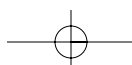

Figure 11-1. Airfoil types.



Pitch behavior depends on flap type, wing position, and horizontal tail location. The increased camber from flap deflection produces lift primarily on the rear portion of the wing. This produces a nosedown pitching moment; however, the change in tail load from the downwash deflected by the flaps over the horizontal tail has a significant influence on the pitching moment. Consequently, pitch behavior depends on the design features of the particular airplane.

Flap deflection of up to 15° primarily produces lift with minimal drag. The tendency to balloon up with initial flap deflection is because of lift increase, but the nosedown pitching moment tends to offset the balloon. Deflection beyond 15° produces a large increase in drag. Drag from flap deflection is **parasite drag**, and as such is proportional to the square of the speed. Also, deflection beyond 15° produces a significant noseup pitching moment in most high-wing airplanes because the resulting downwash increases the airflow over the horizontal tail.

FLAP EFFECTIVENESS

Flap effectiveness depends on a number of factors, but the most noticeable are size and type. For the purpose of this chapter, trailing edge flaps are classified as four basic types: plain (hinge), split, slotted, and Fowler. [Figure 11-2]

The plain or hinge flap is a hinged section of the wing. The structure and function are comparable to the other control surfaces—ailerons, rudder, and elevator. The split flap is more complex. It is the lower or underside portion of the wing; deflection of the flap leaves the trailing edge of the wing undisturbed. It is, however, more effective than the hinge flap because of greater lift and less pitching moment, but there is more drag. Split flaps are more useful for landing, but the partially deflected hinge flaps have the advantage in takeoff. The split flap has significant drag at small deflections, whereas the hinge flap does not because airflow remains “attached” to the flap.

The slotted flap has a gap between the wing and the leading edge of the flap. The slot allows high pressure airflow on the wing undersurface to energize the lower pressure over the top, thereby delaying flow separation. The slotted flap has greater lift than the hinge flap but less than the split flap; but, because of a higher lift-drag ratio, it gives better takeoff and climb performance. Small deflections of the slotted flap give a higher drag than the hinge flap but less than the split. This allows the slotted flap to be used for takeoff.

The Fowler flap deflects down and aft to increase the wing area. This flap can be multi-slotted making it the most complex of the trailing edge systems. This

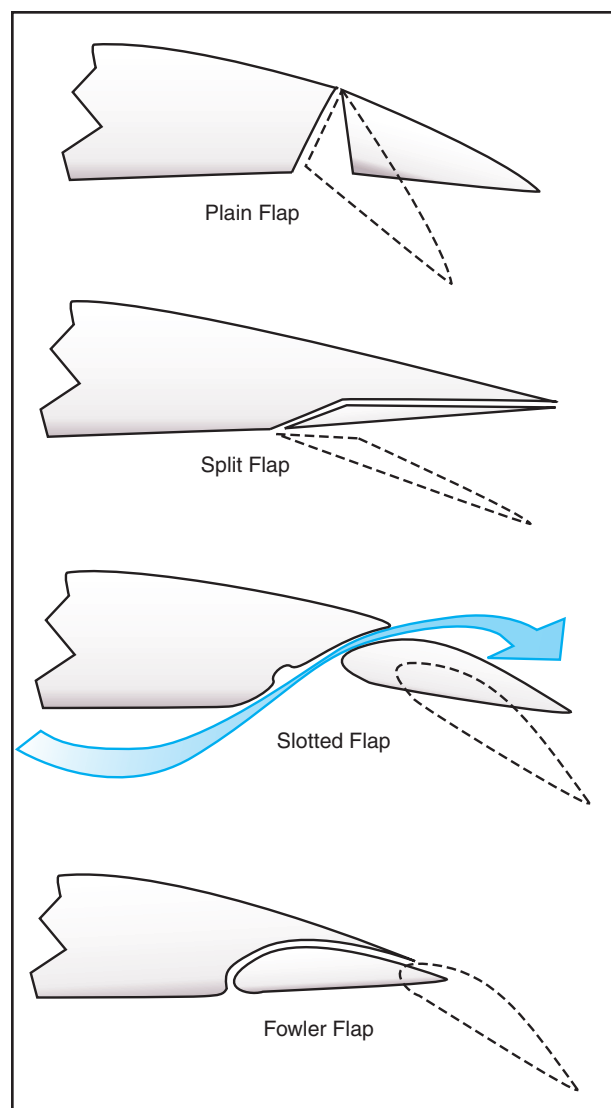

Figure 11-2. Four basic types of flaps.

system does, however, give the maximum **lift coefficient**. Drag characteristics at small deflections are much like the slotted flap. Because of structural complexity and difficulty in sealing the slots, Fowler flaps are most commonly used on larger airplanes.

OPERATIONAL PROCEDURES

It would be impossible to discuss all the many airplane design and flap combinations. This emphasizes the importance of the FAA-approved Airplane Flight Manual and/or Pilot's Operating Handbook (AFM/POH) for a given airplane. However, while some AFM/POHs are specific as to operational use of flaps, many are lacking. Hence, flap operation makes pilot judgment of critical importance. In addition, flap operation is used for landings and takeoffs, during which the airplane is in close proximity to the ground where the margin for error is small.

Since the recommendations given in the AFM/POH are based on the airplane and the flap design combination,

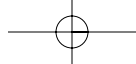

the pilot must relate the manufacturer's recommendation to aerodynamic effects of flaps. This requires that the pilot have a basic background knowledge of flap aerodynamics and geometry. With this information, the pilot must make a decision as to the degree of flap deflection and time of deflection based on runway and approach conditions relative to the wind conditions.

The time of flap extension and degree of deflection are related. Large flap deflections at one single point in the landing pattern produce large lift changes that require significant pitch and power changes in order to maintain airspeed and glide slope. Incremental deflection of flaps on downwind, base, and final approach allow smaller adjustment of pitch and power compared to extension of full flaps all at one time. This procedure facilitates a more stabilized approach.

A soft- or short-field landing requires minimal speed at touchdown. The flap deflection that results in minimal groundspeed, therefore, should be used. If obstacle clearance is a factor, the flap deflection that results in the steepest angle of approach should be used. It should be noted, however, that the flap setting that gives the minimal speed at touchdown does not necessarily give the steepest angle of approach; however, maximum flap extension gives the steepest angle of approach and minimum speed at touchdown. Maximum flap extension, particularly beyond 30 to 35°, results in a large amount of drag. This requires higher power settings than used with partial flaps. Because of the steep approach angle combined with power to offset drag, the flare with full flaps becomes critical. The drag produces a high sink rate that must be controlled with power, yet failure to reduce power at a rate so that the power is idle at touchdown allows the airplane to float down the runway. A reduction in power too early results in a hard landing.

Crosswind component is another factor to be considered in the degree of flap extension. The deflected flap presents a surface area for the wind to act on. In a crosswind, the "flapped" wing on the upwind side is more affected than the downwind wing. This is, however, eliminated to a slight extent in the crabbed approach since the airplane is more nearly aligned with the wind. When using a wing low approach, however, the lowered wing partially blankets the upwind flap, but the dihedral of the wing combined with the flap and wind make lateral control more difficult. Lateral control becomes more difficult as flap extension reaches maximum and the crosswind becomes perpendicular to the runway.

Crosswind effects on the "flapped" wing become more pronounced as the airplane comes closer to the ground. The wing, flap, and ground form a "container" that is filled with air by the crosswind. With the wind striking

the deflected flap and fuselage side and with the flap located behind the main gear, the upwind wing will tend to rise and the airplane will tend to turn into the wind. Proper control position, therefore, is essential for maintaining runway alignment. Also, it may be necessary to retract the flaps upon positive ground contact.

The go-around is another factor to consider when making a decision about degree of flap deflection and about where in the landing pattern to extend flaps. Because of the nosedown pitching moment produced with flap extension, trim is used to offset this pitching moment. Application of full power in the go-around increases the airflow over the "flapped" wing. This produces additional lift causing the nose to pitch up. The pitch-up tendency does not diminish completely with flap retraction because of the trim setting. Expedient retraction of flaps is desirable to eliminate drag, thereby allowing rapid increase in airspeed; however, flap retraction also decreases lift so that the airplane sinks rapidly.

The degree of flap deflection combined with design configuration of the horizontal tail relative to the wing requires that the pilot carefully monitor pitch and airspeed, carefully control flap retraction to minimize altitude loss, and properly use the rudder for coordination. Considering these factors, the pilot should extend the same degree of deflection at the same point in the landing pattern. This requires that a consistent traffic pattern be used. Therefore, the pilot can have a preplanned go-around sequence based on the airplane's position in the landing pattern.

There is no single formula to determine the degree of flap deflection to be used on landing, because a landing involves variables that are dependent on each other. The AFM/POH for the particular airplane will contain the manufacturer's recommendations for some landing situations. On the other hand, AFM/POH information on flap usage for takeoff is more precise. The manufacturer's requirements are based on the climb performance produced by a given flap design. Under no circumstances should a flap setting given in the AFM/POH be exceeded for takeoff.

CONTROLLABLE-PITCH PROPELLER

Fixed-pitch propellers are designed for best efficiency at one speed of rotation and forward speed. This type of propeller will provide suitable performance in a narrow range of airspeeds; however, efficiency would suffer considerably outside this range. To provide high propeller efficiency through a wide range of operation, the **propeller blade angle** must be controllable. The most convenient

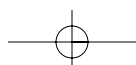

way of controlling the propeller blade angle is by means of a constant-speed governing system.

CONSTANT-SPEED PROPELLER

The constant-speed propeller keeps the blade angle adjusted for maximum efficiency for most conditions of flight. When an engine is running at constant speed, the torque (power) exerted by the engine at the propeller shaft must equal the opposing load provided by the resistance of the air. The r.p.m. is controlled by regulating the torque absorbed by the propeller—in other words by increasing or decreasing the resistance offered by the air to the propeller. In the case of a fixed-pitch propeller, the torque absorbed by the propeller is a function of speed, or r.p.m. If the power output of the engine is changed, the engine will accelerate or decelerate until an r.p.m. is reached at which the power delivered is equal to the power absorbed. In the case of a constant-speed propeller, the power absorbed is independent of the r.p.m., for by varying the **pitch** of the blades, the air resistance and hence the torque or load, can be changed without reference to propeller speed. This is accomplished with a constant-speed propeller by means of a governor. The governor, in most cases, is geared to the engine crankshaft and thus is sensitive to changes in engine r.p.m.

The pilot controls the engine r.p.m. indirectly by means of a propeller control in the cockpit, which is connected to the governor. For maximum takeoff power, the propeller control is moved all the way forward to the low pitch/high r.p.m. position, and the throttle is moved forward to the maximum allowable manifold pressure position. To reduce power for climb or cruise, manifold pressure is reduced to the desired value with the throttle, and the engine r.p.m. is reduced by moving the propeller control back toward the high pitch/low r.p.m. position until the desired r.p.m. is observed on the tachometer. Pulling back on the propeller control causes the propeller blades to move to a higher angle. Increasing the propeller blade angle (of attack) results in an increase in the resistance of the air. This puts a load on the engine so it slows down. In other words, the resistance of the air at the higher blade angle is greater than the torque, or power, delivered to the propeller by the engine, so it slows down to a point where the two forces are in balance.

When an airplane is nosed up into a climb from level flight, the engine will tend to slow down. Since the governor is sensitive to small changes in engine r.p.m., it will decrease the blade angle just enough to keep the engine speed from falling off. If the airplane is nosed down into a dive, the governor will increase the blade angle enough to prevent the engine from overspeeding. This allows the engine to maintain a constant r.p.m., and thus maintain the power output. Changes in

airspeed and power can be obtained by changing r.p.m. at a constant manifold pressure; by changing the manifold pressure at a constant r.p.m.; or by changing both r.p.m. and manifold pressure. Thus the constant-speed propeller makes it possible to obtain an infinite number of power settings.

TAKEOFF, CLIMB, AND CRUISE

During takeoff, when the forward motion of the airplane is at low speeds and when maximum power and thrust are required, the constant-speed propeller sets up a low propeller blade angle (pitch). The low blade angle keeps the angle of attack, with respect to the relative wind, small and efficient at the low speed. [Figure 11-3]

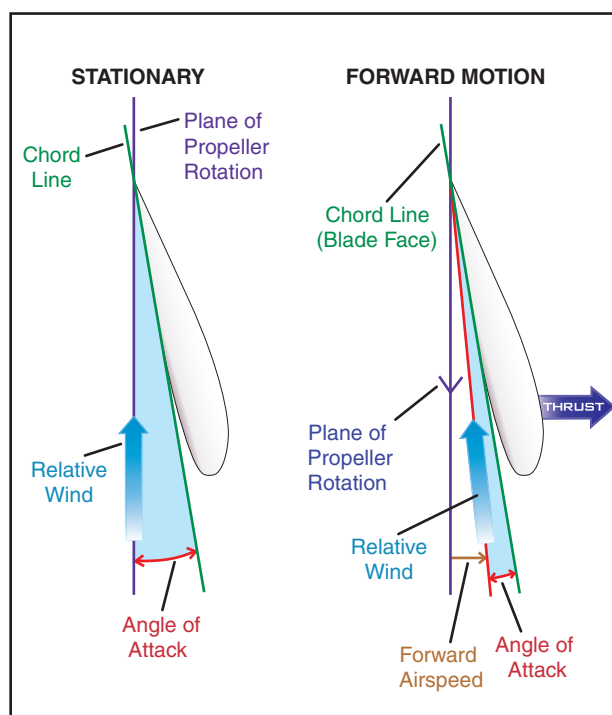
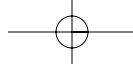

Figure 11-3. Propeller blade angle.

At the same time, it allows the propeller to “slice it thin” and handle a smaller mass of air per revolution. This light load allows the engine to turn at maximum r.p.m. and develop maximum power. Although the mass of air per revolution is small, the number of revolutions per minute is high. Thrust is maximum at the beginning of the takeoff and then decreases as the airplane gains speed and the airplane drag increases. Due to the high slipstream velocity during takeoff, the effective lift of the wing behind the propeller(s) is increased.

As the airspeed increases after lift-off, the load on the engine is lightened because of the small blade angle. The governor senses this and increases the blade angle slightly. Again, the higher blade angle, with the higher speeds, keeps the angle of attack with respect to the relative wind small and efficient.



For climb after takeoff, the power output of the engine is reduced to climb power by decreasing the manifold pressure and lowering r.p.m. by increasing the blade angle. At the higher (climb) airspeed and the higher blade angle, the propeller is handling a greater mass of air per second at a lower slipstream velocity. This reduction in power is offset by the increase in propeller efficiency. The angle of attack is again kept small by the increase in the blade angle with an increase in airspeed.

At cruising altitude, when the airplane is in level flight, less power is required to produce a higher airspeed than is used in climb. Consequently, engine power is again reduced by lowering the manifold pressure and increasing the blade angle (to decrease r.p.m.). The higher airspeed and higher blade angle enable the propeller to handle a still greater mass of air per second at still smaller slipstream velocity. At normal cruising speeds, propeller efficiency is at, or near maximum efficiency. Due to the increase in blade angle and airspeed, the angle of attack is still small and efficient.

BLADE ANGLE CONTROL

Once the pilot selects the r.p.m. settings for the propeller, the propeller governor automatically adjusts the blade angle to maintain the selected r.p.m. It does this by using oil pressure. Generally, the oil pressure used for pitch change comes directly from the engine lubricating system. When a governor is employed, engine oil is used and the oil pressure is usually boosted by a pump, which is integrated with the governor. The higher pressure provides a quicker blade angle change. The r.p.m. at which the propeller is to operate is adjusted in the governor head. The pilot changes this setting by changing the position of the governor rack through the cockpit propeller control.

On some constant-speed propellers, changes in pitch are obtained by the use of an inherent centrifugal twisting moment of the blades that tends to flatten the blades toward low pitch, and oil pressure applied to a hydraulic piston connected to the propeller blades which moves them toward high pitch. Another type of constant-speed propeller uses counterweights attached to the blade shanks in the hub. Governor oil pressure

and the blade twisting moment move the blades toward the low pitch position, and centrifugal force acting on the counterweights moves them (and the blades) toward the high pitch position. In the first case above, governor oil pressure moves the blades towards high pitch, and in the second case, governor oil pressure and the blade twisting moment move the blades toward low pitch. A loss of governor oil pressure, therefore, will affect each differently.

GOVERNING RANGE

The blade angle range for constant-speed propellers varies from about 11 1/2 to 40°. The higher the speed of the airplane, the greater the blade angle range. [Figure 11-4]

The range of possible blade angles is termed the propeller's governing range. The governing range is defined by the limits of the propeller blade's travel between high and low blade angle pitch stops. As long as the propeller blade angle is within the governing range and not against either pitch stop, a constant engine r.p.m. will be maintained. However, once the propeller blade reaches its pitch-stop limit, the engine r.p.m. will increase or decrease with changes in airspeed and propeller load similar to a fixed-pitch propeller. For example, once a specific r.p.m. is selected, if the airspeed decreases enough, the propeller blades will reduce pitch, in an attempt to maintain the selected r.p.m., until they contact their low pitch stops. From that point, any further reduction in airspeed will cause the engine r.p.m. to decrease. Conversely, if the airspeed increases, the propeller blade angle will increase until the high pitch stop is reached. The engine r.p.m. will then begin to increase.

CONSTANT-SPEED PROPELLER OPERATION

The engine is started with the propeller control in the low pitch/high r.p.m. position. This position reduces the load or drag of the propeller and the result is easier starting and warm-up of the engine. During warm-up, the propeller blade changing mechanism should be operated slowly and smoothly through a full cycle. This is done by moving the propeller control (with the

Aircraft Type	Design Speed (m.p.h.)	Blade Angle Range	Pitch	
			Low	High
Fixed Gear	160	11 1/2°	10 1/2°	22°
Retractable	180	15°	11°	26°
Turbo Retractable	225/240	20°	14°	34°
Turbine Retractable	250/300	30°	10°	40°
Transport Retractable	325	40°	10/15°	50/55°

Figure 11-4. Blade angle range (values are approximate).

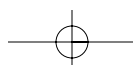

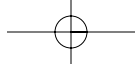

manifold pressure set to produce about 1,600 r.p.m.) to the high pitch/low r.p.m. position, allowing the r.p.m. to stabilize, and then moving the propeller control back to the low pitch takeoff position. This should be done for two reasons: to determine whether the system is operating correctly, and to circulate fresh warm oil through the propeller governor system. It should be remembered that the oil has been trapped in the propeller cylinder since the last time the engine was shut down. There is a certain amount of leakage from the propeller cylinder, and the oil tends to congeal, especially if the outside air temperature is low. Consequently, if the propeller isn't exercised before takeoff, there is a possibility that the engine may **overspeed** on takeoff.

An airplane equipped with a constant-speed propeller has better takeoff performance than a similarly powered airplane equipped with a fixed-pitch propeller. This is because with a constant-speed propeller, an airplane can develop its maximum rated horsepower (red line on the tachometer) while motionless. An airplane with a fixed-pitch propeller, on the other hand, must accelerate down the runway to increase airspeed and aerodynamically unload the propeller so that r.p.m. and horsepower can steadily build up to their maximum. With a constant-speed propeller, the tachometer reading should come up to within 40 r.p.m. of the red line as soon as full power is applied, and should remain there for the entire takeoff.

Excessive manifold pressure raises the cylinder compression pressure, resulting in high stresses within the engine. Excessive pressure also produces high engine temperatures. A combination of high manifold pressure and low r.p.m. can induce damaging **detonation**. In order to avoid these situations, the following sequence should be followed when making power changes.

- When increasing power, increase the r.p.m. first, and then the manifold pressure.
- When decreasing power, decrease the manifold pressure first, and then decrease the r.p.m.

It is a fallacy that (in non-turbocharged engines) the manifold pressure in inches of mercury (inches Hg) should never exceed r.p.m. in hundreds for cruise power settings. The cruise power charts in the AFM/POH should be consulted when selecting cruise power settings. Whatever the combinations of r.p.m. and manifold pressure listed in these charts—they have been flight tested and approved by the airframe and engine manufacturer. Therefore, if there are power settings such as 2,100 r.p.m. and 24 inches manifold pressure in the power chart, they are approved for use.

With a constant-speed propeller, a power descent can be made without overspeeding the engine. The system compensates for the increased airspeed of the descent by increasing the propeller blade angles. If the descent is too rapid, or is being made from a high altitude, the maximum blade angle limit of the blades is not sufficient to hold the r.p.m. constant. When this occurs, the r.p.m. is responsive to any change in throttle setting.

Some pilots consider it advisable to set the propeller control for maximum r.p.m. during the approach to have full horsepower available in case of emergency. If the governor is set for this higher r.p.m. early in the approach when the blades have not yet reached their minimum angle stops, the r.p.m. may increase to unsafe limits. However, if the propeller control is not readjusted for the takeoff r.p.m. until the approach is almost completed, the blades will be against, or very near their minimum angle stops and there will be little if any change in r.p.m. In case of emergency, both throttle and propeller controls should be moved to takeoff positions.

Many pilots prefer to feel the airplane respond immediately when they give short bursts of the throttle during approach. By making the approach under a little power and having the propeller control set at or near cruising r.p.m., this result can be obtained.

Although the governor responds quickly to any change in throttle setting, a sudden and large increase in the throttle setting will cause a momentary overspeeding of the engine until the blades become adjusted to absorb the increased power. If an emergency demanding full power should arise during approach, the sudden advancing of the throttle will cause momentary overspeeding of the engine beyond the r.p.m. for which the governor is adjusted. This temporary increase in engine speed acts as an emergency power reserve.

Some important points to remember concerning constant-speed propeller operation are:

- The red line on the tachometer not only indicates maximum allowable r.p.m.; it also indicates the r.p.m. required to obtain the engine's rated horsepower.
- A momentary propeller overspeed may occur when the throttle is advanced rapidly for takeoff. This is usually not serious if the rated r.p.m. is not exceeded by 10 percent for more than 3 seconds.
- The green arc on the tachometer indicates the normal operating range. When developing

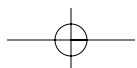

power in this range, the engine drives the propeller. Below the green arc, however, it is usually the **windmilling** propeller that powers the engine. Prolonged operation below the green arc can be detrimental to the engine.

- On takeoffs from low elevation airports, the manifold pressure in inches of mercury may exceed the r.p.m. This is normal in most cases. The pilot should consult the AFM/POH for limitations.
- All power changes should be made smoothly and slowly to avoid **overboosting** and/or overspeeding.

TURBOCHARGING

The turbocharged engine allows the pilot to maintain sufficient cruise power at high altitudes where there is less drag, which means faster true airspeeds and increased range with fuel economy. At the same time, the powerplant has flexibility and can be flown at a low altitude without the increased fuel consumption of a turbine engine. When attached to the standard powerplant, the turbocharger does not take any horsepower from the powerplant to operate; it is relatively simple mechanically, and some models can pressurize the cabin as well.

The turbocharger is an exhaust-driven device, which raises the pressure and density of the induction air delivered to the engine. It consists of two separate components: a compressor and a turbine connected by a common shaft. The compressor supplies pressurized air to the engine for high altitude operation. The compressor and its housing are between the ambient air intake and the induction air manifold. The turbine and its housing are part of the exhaust system and utilize the flow of exhaust gases to drive the compressor. [Figure 11-5]

The turbine has the capability of producing **manifold pressure** in excess of the maximum allowable for the particular engine. In order not to exceed the maximum allowable manifold pressure, a bypass or waste gate is used so that some of the exhaust will be diverted overboard before it passes through the turbine.

The position of the waste gate regulates the output of the turbine and therefore, the compressed air available to the engine. When the waste gate is closed, all of the exhaust gases pass through and drive the turbine. As the waste gate opens, some of the exhaust gases are routed around the turbine, through the exhaust bypass and overboard through the exhaust pipe.

The waste gate actuator is a spring-loaded piston, operated by engine oil pressure. The actuator, which adjusts the waste gate position, is connected to the waste gate by a mechanical linkage.

The control center of the turbocharger system is the pressure controller. This device simplifies turbocharging to one control: the throttle. Once the pilot has set the desired manifold pressure, virtually no throttle adjustment is required with changes in altitude. The controller senses compressor discharge requirements for various altitudes and controls the oil pressure to the waste gate actuator which adjusts the waste gate accordingly. Thus the turbocharger maintains only the manifold pressure called for by the throttle setting.

GROUND BOOSTING VS. ALTITUDE TURBOCHARGING

Altitude turbocharging (sometimes called “normalizing”) is accomplished by using a turbocharger that will maintain maximum allowable sea level manifold pressure (normally 29 – 30 inches Hg) up to a certain altitude. This altitude is specified by the airplane manufacturer and is referred to as the airplane’s **critical altitude**. Above the critical altitude,

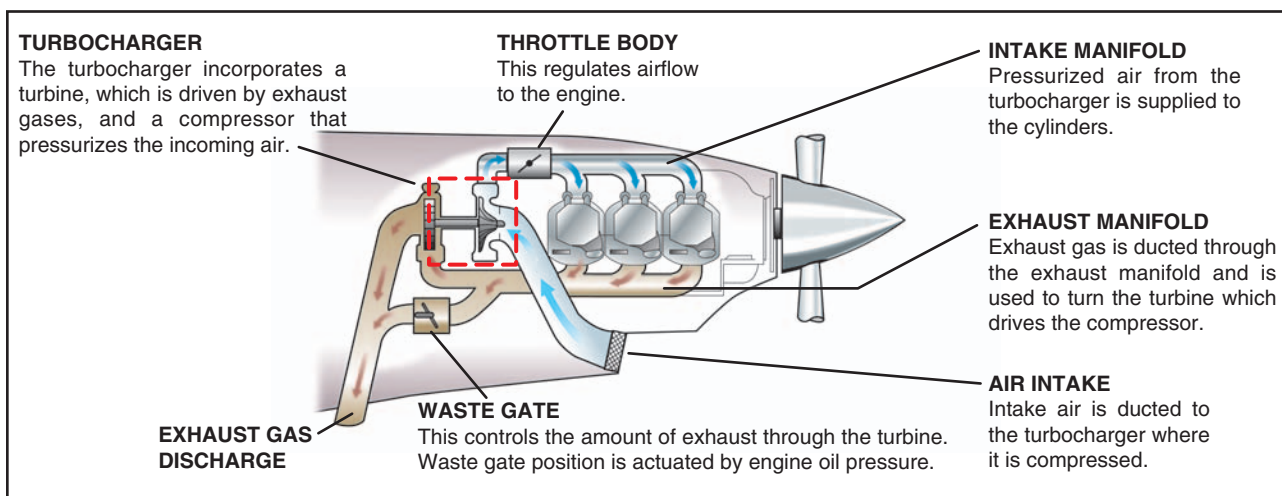
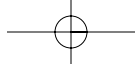

Figure 11-5. Turbocharging system.



the manifold pressure decreases as additional altitude is gained. Ground boosting, on the other hand, is an application of turbocharging where more than the standard 29 inches of manifold pressure is used in flight. In various airplanes using ground boosting, takeoff manifold pressures may go as high as 45 inches of mercury.

Although a sea level power setting and maximum r.p.m. can be maintained up to the critical altitude, this does not mean that the engine is developing sea level power. Engine power is not determined just by manifold pressure and r.p.m. Induction air temperature is also a factor. Turbocharged induction air is heated by compression. This temperature rise decreases induction air density which causes a power loss. Maintaining the equivalent horsepower output will require a somewhat higher manifold pressure at a given altitude than if the induction air were not compressed by turbocharging. If, on the other hand, the system incorporates an automatic density controller which, instead of maintaining a constant manifold pressure, automatically positions the waste gate so as to maintain constant air density to the engine, a near constant horsepower output will result.

OPERATING CHARACTERISTICS

First and foremost, all movements of the power controls on turbocharged engines should be slow and gentle. Aggressive and/or abrupt throttle movements increase the possibility of **overboosting**. The pilot should carefully monitor engine indications when making power changes.

When the waste gate is open, the turbocharged engine will react the same as a normally aspirated engine when the r.p.m. is varied. That is, when the r.p.m. is increased, the manifold pressure will decrease slightly. When the engine r.p.m. is decreased, the manifold pressure will increase slightly. However, when the waste gate is closed, manifold pressure variation with engine r.p.m. is just the opposite of the normally aspirated engine. An increase in engine r.p.m. will result in an increase in manifold pressure, and a decrease in engine r.p.m. will result in a decrease in manifold pressure.

Above the critical altitude, where the waste gate is closed, any change in airspeed will result in a corresponding change in manifold pressure. This is true because the increase in ram air pressure with an increase in airspeed is magnified by the compressor resulting in an increase in manifold pressure. The increase in manifold pressure creates a higher mass flow through the engine, causing higher turbine speeds and thus further increasing manifold pressure.

When running at high altitudes, aviation gasoline may tend to vaporize prior to reaching the cylinder. If this occurs in the portion of the fuel system between the fuel tank and the engine-driven fuel pump, an auxiliary positive pressure pump may be needed in the tank. Since engine-driven pumps pull fuel, they are easily vapor locked. A boost pump provides positive pressure—pushes the fuel—reducing the tendency to vaporize.

HEAT MANAGEMENT

Turbocharged engines must be thoughtfully and carefully operated, with continuous monitoring of pressures and temperatures. There are two temperatures that are especially important—turbine inlet temperature (TIT) or in some installations exhaust gas temperature (EGT), and cylinder head temperature. TIT or EGT limits are set to protect the elements in the hot section of the turbocharger, while cylinder head temperature limits protect the engine's internal parts.

Due to the heat of compression of the induction air, a turbocharged engine runs at higher operating temperatures than a non-turbocharged engine. Because turbocharged engines operate at high altitudes, their environment is less efficient for cooling. At altitude the air is less dense and therefore, cools less efficiently. Also, the less dense air causes the compressor to work harder. Compressor turbine speeds can reach 80,000 – 100,000 r.p.m., adding to the overall engine operating temperatures. Turbocharged engines are also operated at higher power settings a greater portion of the time.

High heat is detrimental to piston engine operation. Its cumulative effects can lead to piston, ring, and cylinder head failure, and place thermal stress on other operating components. Excessive cylinder head temperature can lead to detonation, which in turn can cause catastrophic engine failure. Turbocharged engines are especially heat sensitive. The key to turbocharger operation, therefore, is effective heat management.

The pilot monitors the condition of a turbocharged engine with manifold pressure gauge, tachometer, exhaust gas temperature/turbine inlet temperature gauge, and cylinder head temperature. The pilot manages the “heat system” with the throttle, propeller r.p.m., mixture, and cowl flaps. At any given cruise power, the mixture is the most influential control over the exhaust gas/turbine inlet temperature. The throttle regulates total fuel flow, but the mixture governs the fuel to air ratio. The mixture, therefore, controls temperature.

Exceeding temperature limits in an after takeoff climb is usually not a problem since a full rich mixture cools

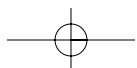

with excess fuel. At cruise, however, the pilot normally reduces power to 75 percent or less and simultaneously adjusts the mixture. Under cruise conditions, temperature limits should be monitored most closely because it's there that the temperatures are most likely to reach the maximum, even though the engine is producing less power. Overheating in an enroute climb, however, may require fully open cowl flaps and a higher airspeed.

Since turbocharged engines operate hotter at altitude than do normally aspirated engines, they are more prone to damage from cooling stress. Gradual reductions in power, and careful monitoring of temperatures are essential in the descent phase. The pilot may find it helpful to lower the landing gear to give the engine something to work against while power is reduced and provide time for a slow cool down. It may also be necessary to lean the mixture slightly to eliminate roughness at the lower power settings.

TURBOCHARGER FAILURE

Because of the high temperatures and pressures produced in the turbine exhaust systems, any malfunction of the turbocharger must be treated with extreme caution. In all cases of turbocharger operation, the manufacturer's recommended procedures should be followed. This is especially so in the case of turbocharger malfunction. However, in those instances where the manufacturer's procedures do not adequately describe the actions to be taken in the event of a turbocharger failure, the following procedures should be used.

OVERBOOST CONDITION

If an excessive rise in manifold pressure occurs during normal advancement of the throttle (possibly owing to faulty operation of the waste gate):

- Immediately retard the throttle smoothly to limit the manifold pressure below the maximum for the r.p.m. and mixture setting.
- Operate the engine in such a manner as to avoid a further overboost condition.

LOW MANIFOLD PRESSURE

Although this condition may be caused by a minor fault, it is quite possible that a serious exhaust leak has occurred creating a potentially hazardous situation:

- Shut down the engine in accordance with the recommended engine failure procedures, unless a greater emergency exists that warrants continued engine operation.
- If continuing to operate the engine, use the lowest power setting demanded by the situation and land as soon as practicable.

It is very important to ensure that corrective maintenance is undertaken following any turbocharger malfunction.

RETRACTABLE LANDING GEAR

The primary benefits of being able to retract the landing gear are increased climb performance and higher cruise airspeeds due to the resulting decrease in drag. Retractable landing gear systems may be operated either hydraulically or electrically, or may employ a combination of the two systems. Warning indicators are provided in the cockpit to show the pilot when the wheels are down and locked and when they are up and locked or if they are in intermediate positions. Systems for emergency operation are also provided. The complexity of the retractable landing gear system requires that specific operating procedures be adhered to and that certain operating limitations not be exceeded.

LANDING GEAR SYSTEMS

An **electrical** landing gear retraction system utilizes an electrically driven motor for gear operation. The system is basically an electrically driven jack for raising and lowering the gear. When a switch in the cockpit is moved to the UP position, the electric motor operates. Through a system of shafts, gears, adapters, an actuator screw, and a torque tube, a force is transmitted to the drag strut linkages. Thus, the gear retracts and locks. Struts are also activated that open and close the gear doors. If the switch is moved to the DOWN position, the motor reverses and the gear moves down and locks. Once activated the gear motor will continue to operate until an up or down limit switch on the motor's gearbox is tripped.

A **hydraulic** landing gear retraction system utilizes pressurized hydraulic fluid to actuate linkages to raise and lower the gear. When a switch in the cockpit is moved to the UP position, hydraulic fluid is directed into the gear up line. The fluid flows through sequenced valves and downlocks to the gear actuating cylinders. A similar process occurs during gear extension. The pump which pressurizes the fluid in the system can be either engine driven or electrically powered. If an electrically powered pump is used to pressurize the fluid, the system is referred to as an **electrohydraulic** system. The system also incorporates a hydraulic reservoir to contain excess fluid, and to provide a means of determining system fluid level.

Regardless of its power source, the hydraulic pump is designed to operate within a specific range. When a sensor detects excessive pressure, a relief valve within the pump opens, and hydraulic pressure is routed back to the reservoir. Another type of relief valve prevents excessive pressure that may result from thermal expansion. Hydraulic pressure is also regulated by limit



switches. Each gear has two limit switches—one dedicated to extension and one dedicated to retraction. These switches de-energize the hydraulic pump after the landing gear has completed its gear cycle. In the event of limit switch failure, a backup pressure relief valve activates to relieve excess system pressure.

CONTROLS AND POSITION INDICATORS

Landing gear position is controlled by a switch in the cockpit. In most airplanes, the gear switch is shaped like a wheel in order to facilitate positive identification and to differentiate it from other cockpit controls. [Figure 11-6]

Landing gear position indicators vary with different make and model airplanes. The most common types of landing gear position indicators utilize a group of lights. One type consists of a group of three green lights, which illuminate when the landing gear is down and locked. [Figure 11-6] Another type consists of one green light to indicate when the landing gear is down and an amber light to indicate when the gear is up. Still other systems incorporate a red or amber light to indicate when the gear is in transit or unsafe for landing. [Figure 11-7] The lights are usually of the “press to test” type, and the bulbs are interchangeable. [Figure 11-6]

Other types of landing gear position indicators consist of tab-type indicators with markings “UP” to indicate the gear is up and locked, a display of red and white diagonal stripes to show when the gear is unlocked, or a silhouette of each gear to indicate when it locks in the DOWN position.

LANDING GEAR SAFETY DEVICES

Most airplanes with a retractable landing gear have a gear warning horn that will sound when the airplane is configured for landing and the landing gear is not down and locked. Normally, the horn is linked to the throttle or flap position, and/or the airspeed indicator so that when the airplane is below a certain airspeed,

configuration, or power setting with the gear retracted, the warning horn will sound.

Accidental retraction of a landing gear may be prevented by such devices as mechanical downlocks, safety switches, and ground locks. Mechanical downlocks are built-in components of a gear retraction system and are operated automatically by the gear retraction system. To prevent accidental operation of the downlocks, and inadvertent landing gear retraction while the airplane is on the ground, electrically operated safety switches are installed.

A landing gear safety switch, sometimes referred to as a squat switch, is usually mounted in a bracket on one of the main gear shock struts. [Figure 11-8] When the strut is compressed by the weight of the airplane, the switch opens the electrical circuit to the motor or mechanism that powers retraction. In this way, if the landing gear switch in the cockpit is placed in the RETRACT position when weight is on the gear, the gear will remain extended, and the warning horn may sound as an alert to the unsafe condition. Once the weight is off the gear, however, such as on takeoff, the safety switch will release and the gear will retract.

Many airplanes are equipped with additional safety devices to prevent collapse of the gear when the airplane is on the ground. These devices are called ground locks. One common type is a pin installed in aligned holes drilled in two or more units of the landing gear support structure. Another type is a spring-loaded clip designed to fit around and hold two or more units of the support structure together. All types of ground locks usually have red streamers permanently attached to them to readily indicate whether or not they are installed.

EMERGENCY GEAR EXTENSION SYSTEMS

The emergency extension system lowers the landing gear if the main power system fails. Some airplanes



Figure 11-6. Typical landing gear switches and position indicators.



Figure 11-7. Typical landing gear switches and position indicators.

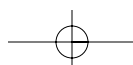

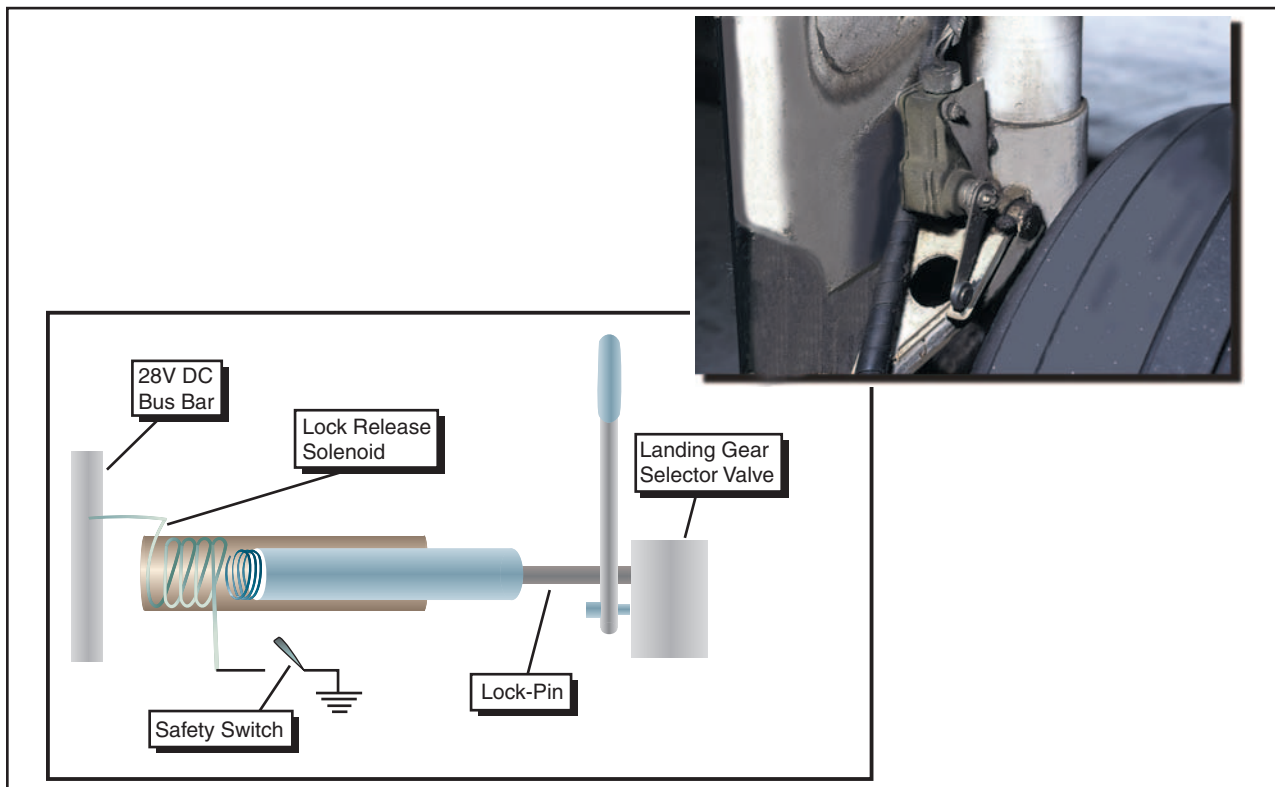
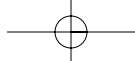

Figure 11-8. Landing gear safety switch.

have an emergency release handle in the cockpit, which is connected through a mechanical linkage to the gear uplocks. When the handle is operated, it

releases the uplocks and allows the gears to free fall, or extend under their own weight. [Figure 11-9]

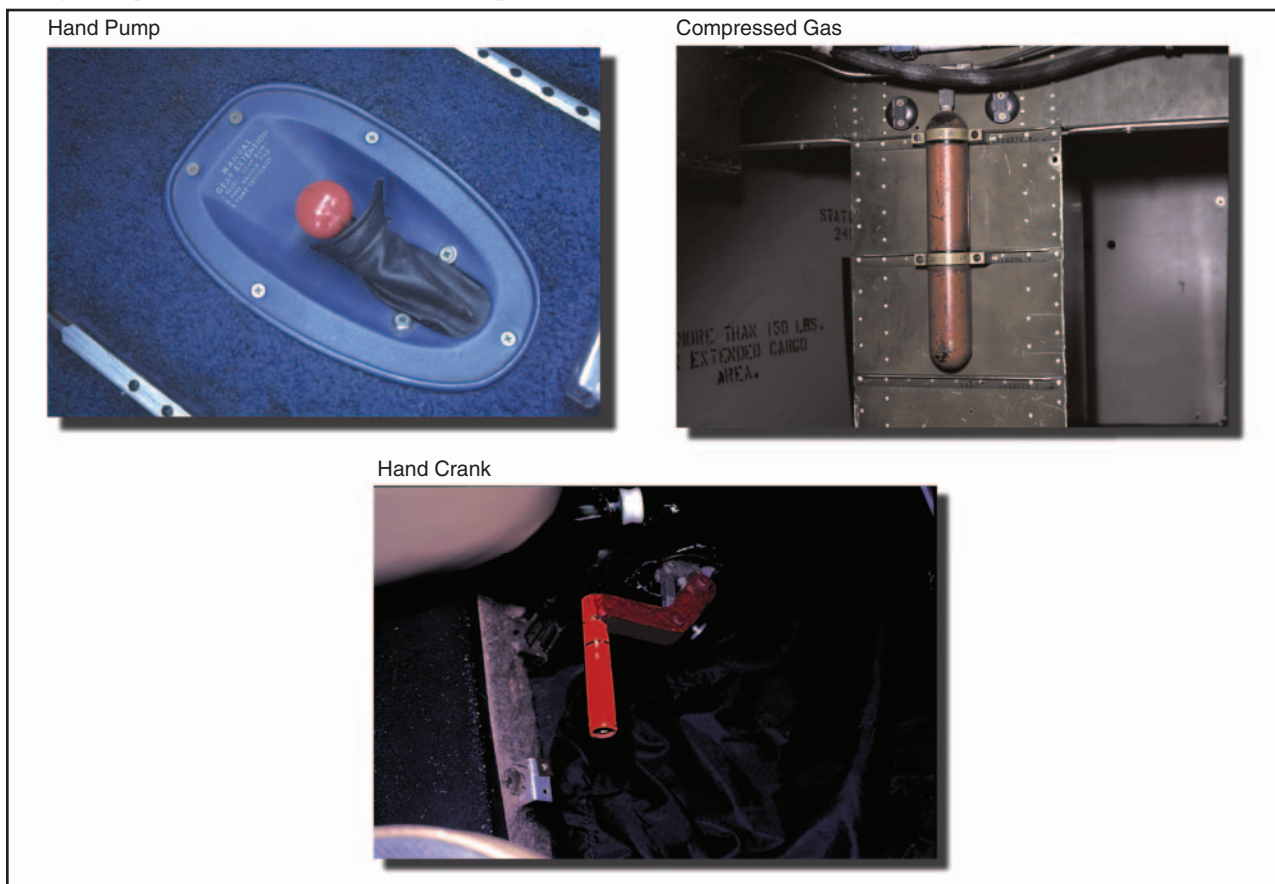
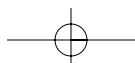

Figure 11-9. Typical emergency gear extension systems.



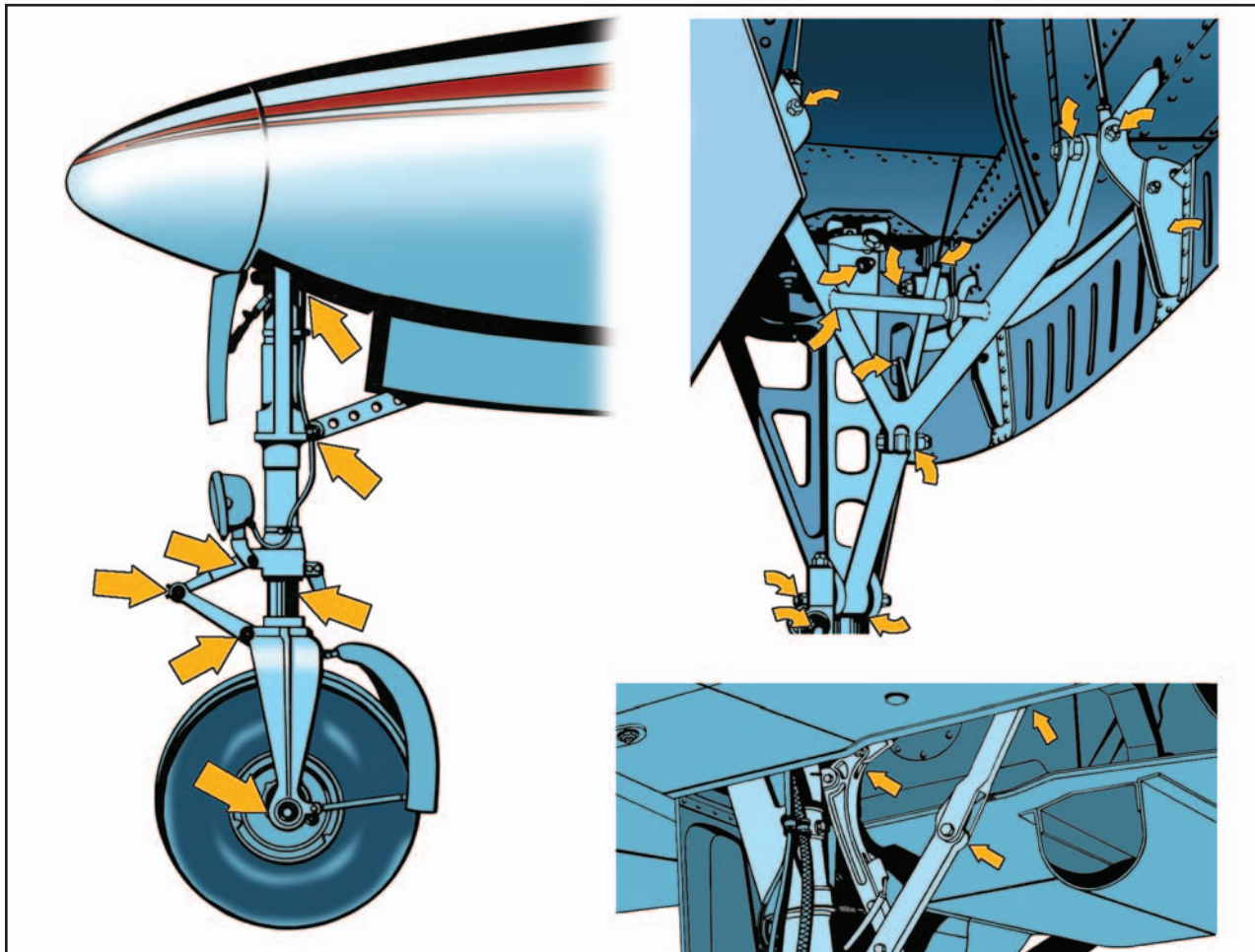
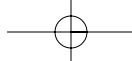

Figure 11-10. Retractable landing gear inspection checkpoints.

On other airplanes, release of the uplock is accomplished using compressed gas, which is directed to uplock release cylinders.

In some airplanes, design configurations make emergency extension of the landing gear by gravity and air loads alone impossible or impractical. In these airplanes, provisions are included for forceful gear extension in an emergency. Some installations are designed so that either hydraulic fluid or compressed gas provides the necessary pressure, while others use a manual system such as a hand crank for emergency gear extension. [Figure 11-9] Hydraulic pressure for emergency operation of the landing gear may be provided by an auxiliary hand pump, an accumulator, or an electrically powered hydraulic pump depending on the design of the airplane.

OPERATIONAL PROCEDURES PREFLIGHT

Because of their complexity, retractable landing gears demand a close inspection prior to every flight. The inspection should begin inside the cockpit. The pilot should first make certain that the landing gear selector switch is in the GEAR DOWN position. The pilot

should then turn on the battery master switch and ensure that the landing gear position indicators show that the gear is down and locked.

External inspection of the landing gear should consist of checking individual system components. [Figure 11-10] The landing gear, wheel well, and adjacent areas should be clean and free of mud and debris. Dirty switches and valves may cause false safe light indications or interrupt the extension cycle before the landing gear is completely down and locked. The wheel wells should be clear of any obstructions, as foreign objects may damage the gear or interfere with its operation. Bent gear doors may

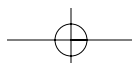

be an indication of possible problems with normal gear operation.

Shock struts should be properly inflated and the pistons clean. Main gear and nose gear uplock and downlock mechanisms should be checked for general condition. Power sources and retracting mechanisms should be checked for general condition, obvious defects, and security of attachment. Hydraulic lines should be checked for signs of chafing, and leakage at attach points. Warning system micro switches (squat switches) should be checked for cleanliness and security of attachment. Actuating cylinders, sprockets, universals, drive gears, linkages and any other accessible components should be checked for condition and obvious defects. The airplane structure to which the landing gear is attached should be checked for distortion, cracks, and general condition. All bolts and rivets should be intact and secure.

TAKEOFF AND CLIMB

Normally, the landing gear should be retracted after lift-off when the airplane has reached an altitude where, in the event of an engine failure or other emergency requiring an aborted takeoff, the airplane could no longer be landed on the runway. This procedure, however, may not apply to *all* situations. Landing gear retraction should be preplanned, taking into account the length of the runway, climb gradient, obstacle clearance requirements, the characteristics of the terrain beyond the departure end of the runway, and the climb characteristics of the particular airplane. For example, in some situations it may be preferable, in the event of an engine failure, to make an off airport forced landing with the gear extended in order to take advantage of the energy absorbing qualities of terrain (see Chapter 16). In which case, a delay in retracting the landing gear after takeoff from a short runway may be warranted. In other situations, obstacles in the climb path may warrant a timely gear retraction after takeoff. Also, in some airplanes the initial climb pitch attitude is such that any view of the runway remaining is blocked, making an assessment of the feasibility of touching down on the remaining runway difficult.

Premature landing gear retraction should be avoided. The landing gear should not be retracted until a positive rate of climb is indicated on the flight instruments. If the airplane has not attained a positive rate of climb, there is always the chance it may settle back onto the runway with the gear retracted. This is especially so in cases of premature lift-off. The pilot should also remember that leaning forward to reach the landing gear selector may result in inadvertent forward pressure on the yoke, which will cause the airplane to descend.

As the landing gear retracts, airspeed will increase and the airplane's pitch attitude may change. The gear may

take several seconds to retract. Gear retraction and locking (and gear extension and locking) is accompanied by sound and feel that are unique to the specific make and model airplane. The pilot should become familiar with the sounds and feel of normal gear retraction so that any abnormal gear operation can be readily discernable. Abnormal landing gear retraction is most often a clear sign that the gear extension cycle will also be abnormal.

APPROACH AND LANDING

The operating loads placed on the landing gear at higher airspeeds may cause structural damage due to the forces of the airstream. Limiting speeds, therefore, are established for gear operation to protect the gear components from becoming overstressed during flight. These speeds are not found on the airspeed indicator. They are published in the AFM/POH for the particular airplane and are usually listed on placards in the cockpit. [Figure 11-11] The maximum landing extended speed (V_{LE}) is the maximum speed at which the airplane can be flown with the landing gear extended. The maximum landing gear operating speed (V_{LO}) is the maximum speed at which the landing gear may be operated through its cycle.

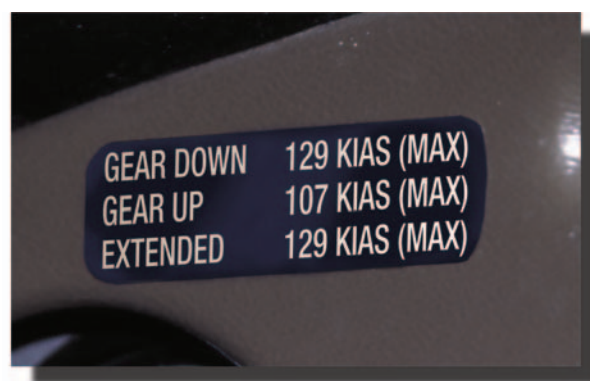
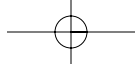

Figure 11-11. Placarded gear speeds in the cockpit.

The landing gear is extended by placing the gear selector switch in the GEAR DOWN position. As the landing gear extends, the airspeed will decrease and the pitch attitude may increase. During the several seconds it takes for the gear to extend, the pilot should be attentive to any abnormal sounds or feel. The pilot should confirm that the landing gear has extended and locked by the normal sound and feel of the system operation as well as by the gear position indicators in the cockpit. Unless the landing gear has been previously extended to aid in a descent to traffic pattern altitude, the landing gear should be extended by the time the airplane reaches a point on the downwind leg that is opposite the point of intended landing. The pilot should establish a standard procedure consisting of a specific position on the downwind leg at which to lower the landing gear. Strict adherence to this procedure will aid the pilot in avoiding unintentional gear up landings.



Operation of an airplane equipped with a retractable landing gear requires the deliberate, careful, and continued use of an appropriate checklist. When on the downwind leg, the pilot should make it a habit to **complete** the landing gear checklist for that airplane. This accomplishes two purposes. It ensures that action has been taken to lower the gear, and it increases the pilot's awareness so that the gear down indicators can be **rechecked** prior to landing.

Unless good operating practices dictate otherwise, the landing roll should be completed and the airplane clear of the runway before any levers or switches are operated. This will accomplish the following: The landing gear strut safety switches will be actuated, deactivating the landing gear retract system. After rollout and clearing the runway, the pilot will be able to focus attention on the after landing checklist and to identify the proper controls.

Pilots transitioning to retractable gear airplanes should be aware that the most common pilot operational factors involved in retractable gear airplane accidents are:

- Neglected to extend landing gear.
- Inadvertently retracted landing gear.
- Activated gear, but failed to check gear position.
- Misused emergency gear system.
- Retracted gear prematurely on takeoff.
- Extended gear too late.

In order to minimize the chances of a landing gear related mishap, the pilot should:

- Use an appropriate checklist. (A condensed checklist mounted in view of the pilot as a reminder for its use and easy reference can be especially helpful.)
- Be familiar with, and periodically review, the landing gear emergency extension procedures for the particular airplane.

- Be familiar with the landing gear warning horn and warning light systems for the particular airplane. Use the horn system to cross-check the warning light system when an unsafe condition is noted.
- Review the procedure for replacing light bulbs in the landing gear warning light displays for the particular airplane, so that you can properly replace a bulb to determine if the bulb(s) in the display is good. Check to see if spare bulbs are available in the airplane spare bulb supply as part of the preflight inspection.
- Be familiar with and aware of the sounds and feel of a properly operating landing gear system.

TRANSITION TRAINING

Transition to a complex airplane or a high performance airplane should be accomplished through a structured course of training administered by a competent and qualified flight instructor. The training should be accomplished in accordance with a ground and flight training syllabus. [Figure 11-12]

This sample syllabus for transition training is to be considered flexible. The arrangement of the subject matter may be changed and the emphasis may be shifted to fit the qualifications of the transitioning pilot, the airplane involved, and the circumstances of the training situation, provided the prescribed proficiency standards are achieved. These standards are contained in the practical test standards appropriate for the certificate that the transitioning pilot holds or is working towards.

The training times indicated in the syllabus are based on the capabilities of a pilot who is currently active and fully meets the present requirements for the issuance of at least a private pilot certificate. The time periods may be reduced for pilots with higher qualifications or increased for pilots who do not meet the current certification requirements or who have had little recent flight experience.

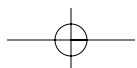

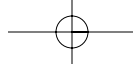

Ground Instruction	Flight Instruction	Directed Practice*
1 Hour	1 Hour	
<ol style="list-style-type: none"> 1. Operations sections of flight manual 2. Line inspection 3. Cockpit familiarization 	<ol style="list-style-type: none"> 1. Flight training maneuvers 2. Takeoffs, landings and go-arounds 	
1 Hour	1 Hour	1 Hour
<ol style="list-style-type: none"> 1. Aircraft loading, limitations and servicing 2. Instruments, radio and special equipment 3. Aircraft systems 	<ol style="list-style-type: none"> 1. Emergency operations 2. Control by reference to instruments 3. Use of radio and autopilot 	As assigned by flight instructor
1 Hour	1 Hour	1 Hour
<ol style="list-style-type: none"> 1. Performance section of flight manual 2. Cruise control 3. Review 	<ol style="list-style-type: none"> 1. Short and soft-field takeoffs and landings 2. Maximum performance operations 	As assigned by flight instructor
1 Hour—CHECKOUT		
* The directed practice indicated may be conducted solo or with a safety pilot at the discretion of the instructor.		

Figure 11-12. Transition training syllabus.

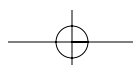

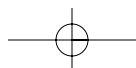
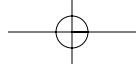



MULTIENGINE FLIGHT

This chapter is devoted to the factors associated with the operation of small multiengine airplanes. For the purpose of this handbook, a “small” multiengine airplane is a reciprocating or turbopropeller-powered airplane with a maximum certificated takeoff weight of 12,500 pounds or less. This discussion assumes a conventional design with two engines—one mounted on each wing. Reciprocating engines are assumed unless otherwise noted. The term “light-twin,” although not formally defined in the regulations, is used herein as a small multiengine airplane with a maximum certificated takeoff weight of 6,000 pounds or less.

There are several unique characteristics of multiengine airplanes that make them worthy of a separate class rating. Knowledge of these factors and proficient flight skills are a key to safe flight in these airplanes. This chapter deals extensively with the numerous aspects of one engine inoperative (OEI) flight. However, pilots are strongly cautioned not to place undue emphasis on mastery of OEI flight as the sole key to flying multiengine airplanes safely. The inoperative engine information that follows is extensive only because this chapter emphasizes the differences between flying multiengine airplanes as contrasted to single-engine airplanes.

The modern, well-equipped multiengine airplane can be remarkably capable under many circumstances. But, as with single-engine airplanes, it must be flown prudently by a current and competent pilot to achieve the highest possible level of safety.

This chapter contains information and guidance on the performance of certain maneuvers and procedures in small multiengine airplanes for the purposes of flight training and pilot certification testing. The final authority on the operation of a particular make and model airplane, however, is the airplane manufacturer. Both the flight instructor and the student should be aware that if any of the guidance in this handbook conflicts with the airplane manufacturer’s recommended procedures and guidance as contained in the FAA-approved Airplane Flight Manual and/or Pilot’s Operating Handbook (AFM/POH), it is the airplane manufacturer’s guidance and procedures that take precedence.

GENERAL

The basic difference between operating a multiengine airplane and a single-engine airplane is the potential problem involving an engine failure. The penalties for loss of an engine are twofold: performance and control. The most obvious problem is the loss of 50 percent of power, which reduces climb performance 80 to 90 percent, sometimes even more. The other is the control problem caused by the remaining thrust, which is now asymmetrical. Attention to both these factors is crucial to safe OEI flight. The performance and systems redundancy of a multiengine airplane is a safety advantage only to a trained and proficient pilot.

TERMS AND DEFINITIONS

Pilots of single-engine airplanes are already familiar with many performance “V” speeds and their definitions. Twin-engine airplanes have several additional V speeds unique to OEI operation. These speeds are differentiated by the notation “SE”, for single engine. A review of some key V speeds and several new V speeds unique to twin-engine airplanes follows.

- V_R – Rotation speed. The speed at which back pressure is applied to rotate the airplane to a take-off attitude.
- V_{LOF} – Lift-off speed. The speed at which the airplane leaves the surface. (Note: some manufacturers reference takeoff performance data to V_R , others to V_{LOF} .)
- V_X – Best angle of climb speed. The speed at which the airplane will gain the greatest altitude for a given distance of forward travel.
- V_{XSE} – Best angle-of-climb speed with one engine inoperative.
- V_Y – Best rate of climb speed. The speed at which the airplane will gain the most altitude for a given unit of time.
- V_{YSE} – Best rate-of-climb speed with one engine inoperative. Marked with a blue radial line on most airspeed indicators. Above the single-engine absolute ceiling, V_{YSE} yields the minimum rate of sink.
- V_{SSE} – Safe, intentional one-engine-inoperative speed. Originally known as safe single-engine

speed. Now formally defined in Title 14 of the Code of Federal Regulations (14 CFR) part 23, Airworthiness Standards, and required to be established and published in the AFM/POH. It is the minimum speed to intentionally render the critical engine inoperative.

- V_{MC} – Minimum control speed with the critical engine inoperative. Marked with a red radial line on most airspeed indicators. The minimum speed at which directional control can be maintained under a very specific set of circumstances outlined in 14 CFR part 23, Airworthiness Standards. Under the small airplane certification regulations currently in effect, the flight test pilot must be able to (1) stop the turn that results when the critical engine is suddenly made inoperative within 20° of the original heading, using maximum rudder deflection and a maximum of 5° bank, and (2) thereafter, maintain straight flight with not more than a 5° bank. There is no requirement in this determination that the airplane be capable of climbing at this airspeed. V_{MC} only addresses directional control. Further discussion of V_{MC} as determined during airplane certification and demonstrated in pilot training follows in minimum control airspeed (V_{MC}) demonstration. [Figure 12-1]



Figure 12-1. Airspeed indicator markings for a multiengine airplane.

Unless otherwise noted, when V speeds are given in the AFM/POH, they apply to sea level, standard day conditions at maximum takeoff weight. Performance speeds vary with aircraft weight, configuration, and atmospheric conditions. The speeds may be stated in statute miles per hour (m.p.h.) or knots (kts), and they may be given as calibrated airspeeds (CAS) or indicated airspeeds (IAS). As a general rule, the newer

AFM/POHs show V speeds in knots indicated airspeed (KIAS). Some V speeds are also stated in knots calibrated airspeed (KCAS) to meet certain regulatory requirements. Whenever available, pilots should operate the airplane from published indicated airspeeds.

With regard to climb performance, the multiengine airplane, particularly in the takeoff or landing configuration, may be considered to be a single-engine airplane with its powerplant divided into two units. There is nothing in 14 CFR part 23 that requires a multiengine airplane to maintain altitude while in the takeoff or landing configuration with one engine inoperative. In fact, many twins are not required to do this in any configuration, even at sea level.

The current 14 CFR part 23 single-engine climb performance requirements for reciprocating engine-powered multiengine airplanes are as follows.

- More than 6,000 pounds maximum weight and/or V_{SO} more than 61 knots: the single-engine rate of climb in feet per minute (f.p.m.) at 5,000 feet MSL must be equal to at least $.027 V_{SO}^2$. For airplanes type certificated February 4, 1991, or thereafter, the climb requirement is expressed in terms of a climb gradient, 1.5 percent. The climb gradient is not a direct equivalent of the $.027 V_{SO}^2$ formula. Do not confuse the date of type certification with the airplane's model year. The type certification basis of many multiengine airplanes dates back to CAR 3 (the Civil Aviation Regulations, forerunner of today's Code of Federal Regulations).
- 6,000 pounds or less maximum weight and V_{SO} 61 knots or less: the single-engine rate of climb at 5,000 feet MSL must simply be determined. The rate of climb could be a negative number. There is no requirement for a single-engine positive rate of climb at 5,000 feet or any other altitude. For light-twins type certificated February 4, 1991, or thereafter, the single-engine climb gradient (positive or negative) is simply determined.

Rate of climb is the altitude gain per unit of time, while climb gradient is the actual measure of altitude gained per 100 feet of horizontal travel, expressed as a percentage. An altitude gain of 1.5 feet per 100 feet of travel (or 15 feet per 1,000, or 150 feet per 10,000) is a climb gradient of 1.5 percent.

There is a dramatic performance loss associated with the loss of an engine, particularly just after takeoff. Any airplane's climb performance is a function of thrust horsepower which is in excess of that required

for level flight. In a hypothetical twin with each engine producing 200 thrust horsepower, assume that the total level-flight thrust horsepower required is 175. In this situation, the airplane would ordinarily have a reserve of 225 thrust horsepower available for climb. Loss of one engine would leave only 25 (200 minus 175) thrust horsepower available for climb, a drastic reduction. Sea level rate-of-climb performance losses of at least 80 to 90 percent, even under ideal circumstances, are typical for multiengine airplanes in OEI flight.

OPERATION OF SYSTEMS

This section will deal with systems that are generally found on multiengine airplanes. Multiengine airplanes share many features with complex single-engine airplanes. There are certain systems and features covered here, however, that are generally unique to airplanes with two or more engines.

PROPELLERS

The propellers of the multiengine airplane may outwardly appear to be identical in operation to the constant-speed propellers of many single-engine airplanes, but this is not the case. The propellers of multiengine airplanes are featherable, to minimize drag in the event of an engine failure. Depending upon single-engine performance, this feature often permits continued flight to a suitable airport following an engine failure. To feather a propeller is to stop engine rotation with the propeller blades streamlined with the airplane's relative wind, thus to minimize drag. [Figure 12-2]

Feathering is necessary because of the change in parasite drag with propeller blade angle. [Figure 12-3] When the propeller blade angle is in the feathered position, the change in parasite drag is at a minimum and, in the case of a typical multiengine airplane, the added parasite drag from a single feathered propeller is a relatively small contribution to the airplane total drag.

At the smaller blade angles near the flat pitch position, the drag added by the propeller is very large. At these small blade angles, the propeller windmilling at high r.p.m. can create such a tremendous amount of drag that the airplane may be uncontrollable. The propeller windmilling at high speed in the low range of blade angles can produce an increase in parasite drag which may be as great as the parasite drag of the basic airplane.

As a review, the constant-speed propellers on almost all single-engine airplanes are of the non-feathering, oil-pressure-to-increase-pitch design. In this design, increased oil pressure from the propeller governor drives the blade angle towards high pitch, low r.p.m.

In contrast, the constant-speed propellers installed on most multiengine airplanes are full feathering,

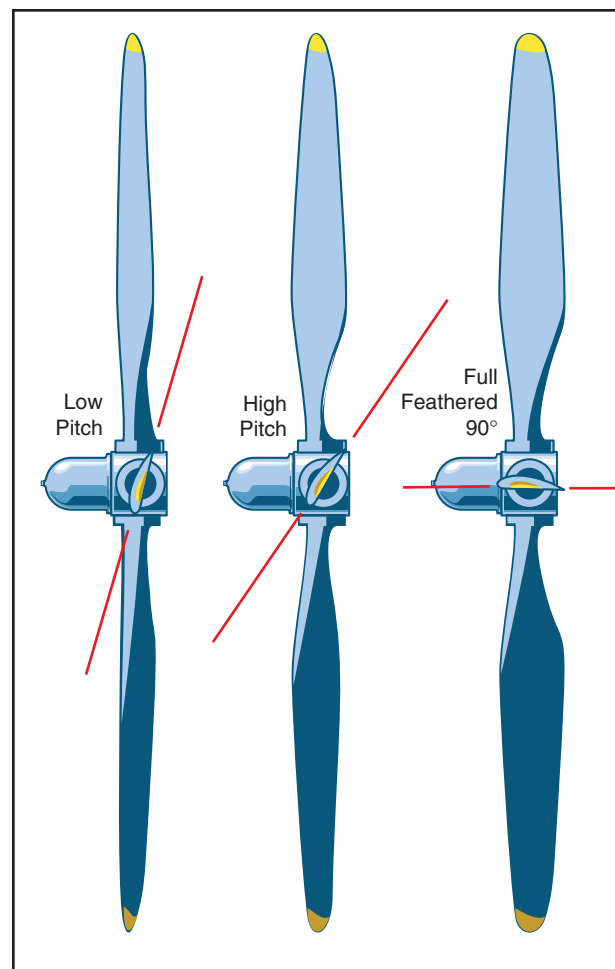

Figure 12-2. Feathered propeller.

counterweighted, oil-pressure-to-decrease-pitch designs. In this design, increased oil pressure from the propeller governor drives the blade angle towards low pitch, high r.p.m.—away from the feather blade angle. In effect, the only thing that keeps these propellers from feathering is a constant supply of high pressure engine oil. This is a necessity to enable propeller feathering in the event of a loss of oil pressure or a propeller governor failure.

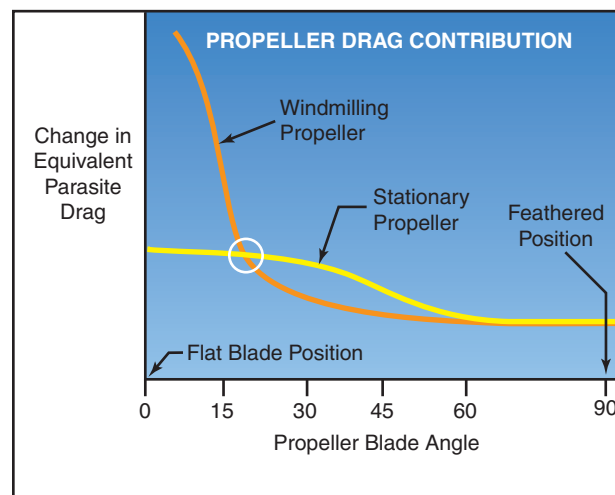
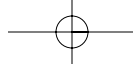

Figure 12-3. Propeller drag contribution.



The aerodynamic forces alone acting upon a windmilling propeller tend to drive the blades to low pitch, high r.p.m. Counterweights attached to the shank of each blade tend to drive the blades to high pitch, low r.p.m. Inertia, or apparent force called centrifugal force acting through the counterweights is generally slightly greater than the aerodynamic forces. Oil pressure from the propeller governor is used to counteract the counterweights and drives the blade angles to low pitch, high r.p.m. A reduction in oil pressure causes the r.p.m. to be reduced from the influence of the counterweights. [Figure 12-4]

To feather the propeller, the propeller control is brought fully aft. All oil pressure is dumped from the governor, and the counterweights drive the propeller blades towards feather. As centrifugal force acting on the counterweights decays from decreasing r.p.m., additional forces are needed to completely feather the blades. This additional force comes from either a spring or high pressure air stored in the propeller dome, which forces the blades into the feathered position. The entire process may take up to 10 seconds.

Feathering a propeller only alters blade angle and stops engine rotation. To completely secure the engine, the pilot must still turn off the fuel (mixture, electric boost pump, and fuel selector), ignition, alternator/generator, and close the cowl flaps. If the airplane is pressurized,

there may also be an air bleed to close for the failed engine. Some airplanes are equipped with firewall shutoff valves that secure several of these systems with a single switch.

Completely securing a failed engine may not be necessary or even desirable depending upon the failure mode, altitude, and time available. The position of the fuel controls, ignition, and alternator/generator switches of the failed engine has no effect on aircraft performance. There is always the distinct possibility of manipulating the incorrect switch under conditions of haste or pressure.

To unfeather a propeller, the engine must be rotated so that oil pressure can be generated to move the propeller blades from the feathered position. The ignition is turned on prior to engine rotation with the throttle at low idle and the mixture rich. With the propeller control in a high r.p.m. position, the starter is engaged. The engine will begin to windmill, start, and run as oil pressure moves the blades out of feather. As the engine starts, the propeller r.p.m. should be immediately reduced until the engine has had several minutes to warm up; the pilot should monitor cylinder head and oil temperatures.

Should the r.p.m. obtained with the starter be insufficient to unfeather the propeller, an increase in airspeed

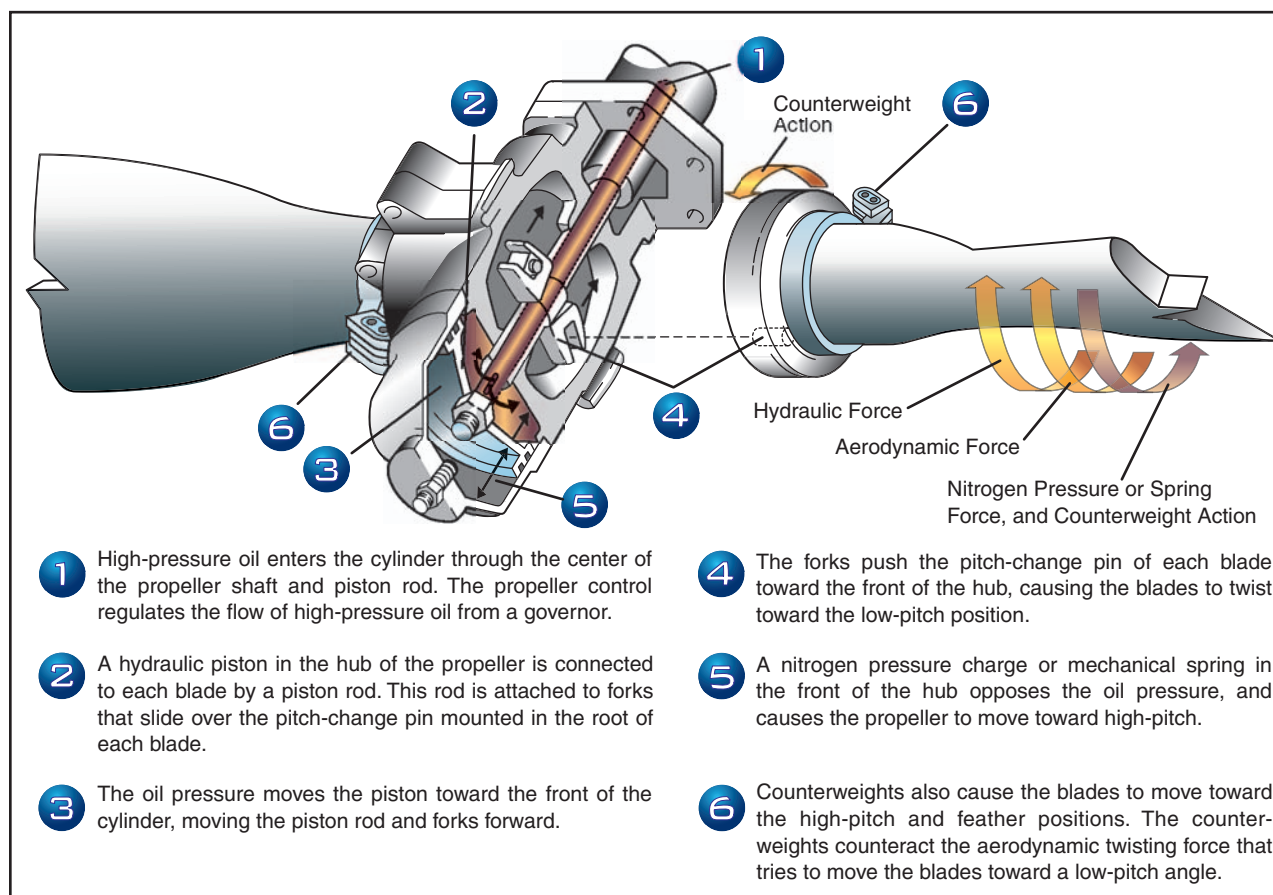
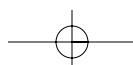
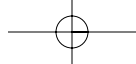

Figure 12-4. Pitch change forces.





from a shallow dive will usually help. In any event, the AFM/POH procedures should be followed for the exact unfeathering procedure. Both feathering and starting a feathered reciprocating engine on the ground are strongly discouraged by manufacturers due to the excessive stress and vibrations generated.

As just described, a loss of oil pressure from the propeller governor allows the counterweights, spring and/or dome charge to drive the blades to feather. Logically then, the propeller blades should feather every time an engine is shut down as oil pressure falls to zero. Yet, this does not occur. Preventing this is a small pin in the pitch changing mechanism of the propeller hub that will not allow the propeller blades to feather once r.p.m. drops below approximately 800. The pin senses a lack of centrifugal force from propeller rotation and falls into place, preventing the blades from feathering. Therefore, if a propeller is to be feathered, it must be done before engine r.p.m. decays below approximately 800. On one popular model of turboprop engine, the propeller blades do, in fact, feather with each shutdown. This propeller is not equipped with such centrifugally-operated pins, due to a unique engine design.

An unfeathering accumulator is an optional device that permits starting a feathered engine in flight without the use of the electric starter. An accumulator is any device that stores a reserve of high pressure. On multiengine airplanes, the unfeathering accumulator stores a small reserve of engine oil under pressure from compressed air or nitrogen. To start a feathered engine in flight, the pilot moves the propeller control out of the feather position to release the accumulator pressure. The oil flows under pressure to the propeller hub and drives the blades toward the high r.p.m., low pitch position, whereupon the propeller will usually begin to windmill. (On some airplanes, an assist from the electric starter may be necessary to initiate rotation and completely unfeather the propeller.) If fuel and ignition are present, the engine will start and run. For airplanes used in training, this saves much electric starter and battery wear. High oil pressure from the propeller governor recharges the accumulator just moments after engine rotation begins.

PROPELLER SYNCHRONIZATION

Many multiengine airplanes have a propeller synchronizer (prop sync) installed to eliminate the annoying “drumming” or “beat” of propellers whose r.p.m. are close, but not precisely the same. To use prop sync, the propeller r.p.m. are coarsely matched by the pilot and the system is engaged. The prop sync adjusts the r.p.m. of the “slave” engine to precisely match the r.p.m. of the “master” engine, and then maintains that relationship. The prop sync should be disengaged when the pilot selects a new propeller r.p.m., then re-engaged

after the new r.p.m. is set. The prop sync should always be off for takeoff, landing, and single-engine operation. The AFM/POH should be consulted for system description and limitations.

A variation on the propeller synchronizer is the propeller synchrophaser. Prop synchrophase acts much like a synchronizer to precisely match r.p.m., but the synchrophaser goes one step further. It not only matches r.p.m. but actually compares and adjusts the positions of the individual blades of the propellers in their arcs. There can be significant propeller noise and vibration reductions with a propeller synchrophaser. From the pilot’s perspective, operation of a propeller synchronizer and a propeller synchrophaser are very similar. A synchrophaser is also commonly referred to as prop sync, although that is not entirely correct nomenclature from a technical standpoint.

As a pilot aid to manually synchronizing the propellers, some twins have a small gauge mounted in or by the tachometer(s) with a propeller symbol on a disk that spins. The pilot manually fine tunes the engine r.p.m. so as to stop disk rotation, thereby synchronizing the propellers. This is a useful backup to synchronizing engine r.p.m. using the audible propeller beat. This gauge is also found installed with most propeller synchronizer and synchrophase systems. Some synchrophase systems use a knob for the pilot to control the phase angle.

FUEL CROSSFEED

Fuel crossfeed systems are also unique to multiengine airplanes. Using crossfeed, an engine can draw fuel from a fuel tank located in the opposite wing.

On most multiengine airplanes, operation in the crossfeed mode is an emergency procedure used to extend airplane range and endurance in OEI flight. There are a few models that permit crossfeed as a normal, fuel balancing technique in normal operation, but these are not common. The AFM/POH will describe crossfeed limitations and procedures, which vary significantly among multiengine airplanes.

Checking crossfeed operation on the ground with a quick repositioning of the fuel selectors does nothing more than ensure freedom of motion of the handle. To actually check crossfeed operation, a complete, functional crossfeed system check should be accomplished. To do this, each engine should be operated from its crossfeed position during the runup. The engines should be checked individually, and allowed to run at moderate power (1,500 r.p.m. minimum) for at least 1 minute to ensure that fuel flow can be established from the crossfeed source. Upon completion of the check, each engine should be operated for at least 1 minute at moderate power from the main (takeoff) fuel tanks to reconfirm fuel flow prior to takeoff.

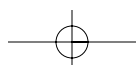

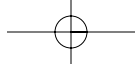

This suggested check is not required prior to every flight. Infrequently used, however, crossfeed lines are ideal places for water and debris to accumulate unless they are used from time to time and drained using their external drains during preflight. Crossfeed is ordinarily not used for completing single-engine flights when an alternate airport is readily at hand, and it is never used during takeoff or landings.

COMBUSTION HEATER

Combustion heaters are common on multiengine airplanes. A combustion heater is best described as a small furnace that burns gasoline to produce heated air for occupant comfort and windshield defogging. Most are thermostatically operated, and have a separate hour meter to record time in service for maintenance purposes. Automatic overtemperature protection is provided by a thermal switch mounted on the unit, which cannot be accessed in flight. This requires the pilot or mechanic to actually visually inspect the unit for possible heat damage in order to reset the switch.

When finished with the combustion heater, a cool down period is required. Most heaters require that outside air be permitted to circulate through the unit for at least 15 seconds in flight, or that the ventilation fan be operated for at least 2 minutes on the ground. Failure to provide an adequate cool down will usually trip the thermal switch and render the heater inoperative until the switch is reset.

FLIGHT DIRECTOR/AUTOPILOT

Flight director/autopilot (FD/AP) systems are common on the better-equipped multiengine airplanes. The system integrates pitch, roll, heading, altitude, and radio navigation signals in a computer. The outputs, called computed commands, are displayed on a flight command indicator, or FCI. The FCI replaces the conventional attitude indicator on the instrument panel. The FCI is occasionally referred to as a flight director indicator (FDI), or as an attitude director indicator (ADI). The entire flight director/autopilot system is sometimes called an integrated flight control system (IFCS) by some manufacturers. Others may use the term “automatic flight control system (AFCS).”

The FD/AP system may be employed at three different levels.

- Off (raw data).
- Flight director (computed commands).
- Autopilot.

With the system off, the FCI operates as an ordinary attitude indicator. On most FCIs, the command bars are biased out of view when the flight director is off.

The pilot maneuvers the airplane as though the system were not installed.

To maneuver the airplane using the flight director, the pilot enters the desired modes of operation (heading, altitude, nav intercept, and tracking) on the FD/AP mode controller. The computed flight commands are then displayed to the pilot through either a single-cue or dual-cue system in the FCI. On a single-cue system, the commands are indicated by “V” bars. On a dual-cue system, the commands are displayed on two separate command bars, one for pitch and one for roll. To maneuver the airplane using computed commands, the pilot “flies” the symbolic airplane of the FCI to match the steering cues presented.

On most systems, to engage the autopilot the flight director must first be operating. At any time thereafter, the pilot may engage the autopilot through the mode controller. The autopilot then maneuvers the airplane to satisfy the computed commands of the flight director.

Like any computer, the FD/AP system will only do what it is told. The pilot must ensure that it has been properly programmed for the particular phase of flight desired. The armed and/or engaged modes are usually displayed on the mode controller or separate annunciator lights. When the airplane is being hand-flown, if the flight director is not being used at any particular moment, it should be off so that the command bars are pulled from view.

Prior to system engagement, all FD/AP computer and trim checks should be accomplished. Many newer systems cannot be engaged without the completion of a self-test. The pilot must also be very familiar with various methods of disengagement, both normal and emergency. System details, including approvals and limitations, can be found in the supplements section of the AFM/POH. Additionally, many avionics manufacturers can provide informative pilot operating guides upon request.

YAW DAMPER

The yaw damper is a servo that moves the rudder in response to inputs from a gyroscope or accelerometer that detects yaw rate. The yaw damper minimizes motion about the vertical axis caused by turbulence. (Yaw dampers on sweptwing airplanes provide another, more vital function of damping dutch roll characteristics.) Occupants will feel a smoother ride, particularly if seated in the rear of the airplane, when the yaw damper is engaged. The yaw damper should be off for takeoff and landing. There may be additional restrictions against its use during single-engine operation. Most yaw dampers can be engaged independently of the autopilot.

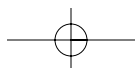

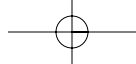

ALTERNATOR/GENERATOR

Alternator or generator paralleling circuitry matches the output of each engine's alternator/generator so that the electrical system load is shared equally between them. In the event of an alternator/generator failure, the inoperative unit can be isolated and the entire electrical system powered from the remaining one. Depending upon the electrical capacity of the alternator/generator, the pilot may need to reduce the electrical load (referred to as load shedding) when operating on a single unit. The AFM/POH will contain system description and limitations.

NOSE BAGGAGE COMPARTMENT

Nose baggage compartments are common on multiengine airplanes (and are even found on a few single-engine airplanes). There is nothing strange or exotic about a nose baggage compartment, and the usual guidance concerning observation of load limits applies. They are mentioned here in that pilots occasionally neglect to secure the latches properly, and therein lies the danger. When improperly secured, the door will open and the contents may be drawn out, usually into the propeller arc, and usually just after takeoff. Even when the nose baggage compartment is empty, airplanes have been lost when the pilot became distracted by the open door. Security of the nose baggage compartment latches and locks is a vital preflight item.

Most airplanes will continue to fly with a nose baggage door open. There may be some buffeting from the disturbed airflow and there will be an increase in noise. Pilots should never become so preoccupied with an open door (of any kind) that they fail to fly the airplane.

Inspection of the compartment interior is also an important preflight item. More than one pilot has been surprised to find a supposedly empty compartment packed to capacity or loaded with ballast. The tow bars, engine inlet covers, windshield sun screens, oil containers, spare chocks, and miscellaneous small hand tools that find their way into baggage compartments should be secured to prevent damage from shifting in flight.

ANTI-ICING/DEICING

Anti-icing/deicing equipment is frequently installed on multiengine airplanes and consists of a combination of different systems. These may be classified as either anti-icing or deicing, depending upon function. The presence of anti-icing and deicing equipment, even though it may appear elaborate and complete, does not necessarily mean that the airplane is approved for flight in icing conditions. The AFM/POH, placards, and even the manufacturer should be consulted for specific determination of approvals and limitations.

Anti-icing equipment is provided to prevent ice from forming on certain protected surfaces. Anti-icing equipment includes heated pitot tubes, heated or non-icing static ports and fuel vents, propeller blades with electrothermal boots or alcohol slingers, windshields with alcohol spray or electrical resistance heating, windshield defoggers, and heated stall warning lift detectors. On many turboprop engines, the "lip" surrounding the air intake is heated either electrically or with bleed air. In the absence of AFM/POH guidance to the contrary, anti-icing equipment is actuated prior to flight into known or suspected icing conditions.

Deicing equipment is generally limited to pneumatic boots on wing and tail leading edges. Deicing equipment is installed to remove ice that has already formed on protected surfaces. Upon pilot actuation, the boots inflate with air from the pneumatic pumps to break off accumulated ice. After a few seconds of inflation, they are deflated back to their normal position with the assistance of a vacuum. The pilot monitors the buildup of ice and cycles the boots as directed in the AFM/POH. An ice light on the left engine nacelle allows the pilot to monitor wing ice accumulation at night.

Other airframe equipment necessary for flight in icing conditions includes an alternate induction air source and an alternate static system source. Ice tolerant antennas will also be installed.

In the event of impact ice accumulating over normal engine air induction sources, carburetor heat (carbureted engines) or alternate air (fuel injected engines) should be selected. Ice buildup on normal induction sources can be detected by a loss of engine r.p.m. with fixed-pitch propellers and a loss of manifold pressure with constant-speed propellers. On some fuel injected engines, an alternate air source is automatically activated with blockage of the normal air source.

An alternate static system provides an alternate source of static air for the pitot-static system in the unlikely event that the primary static source becomes blocked. In non-pressurized airplanes, most alternate static sources are plumbed to the cabin. On pressurized airplanes, they are usually plumbed to a non-pressurized baggage compartment. The pilot must activate the alternate static source by opening a valve or a fitting in the cockpit. Upon activation, the airspeed indicator, altimeter, and the vertical speed indicator (VSI) will be affected and will read somewhat in error. A correction table is frequently provided in the AFM/POH.

Anti-icing/deicing equipment only eliminates ice from the protected surfaces. Significant ice accumulations may form on unprotected areas, even with proper use of anti-ice and deice systems. Flight at high angles of

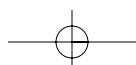

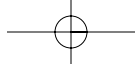

attack or even normal climb speeds will permit significant ice accumulations on lower wing surfaces, which are unprotected. Many AFM/POHs mandate minimum speeds to be maintained in icing conditions. Degradation of all flight characteristics and large performance losses can be expected with ice accumulations. Pilots should not rely upon the stall warning devices for adequate stall warning with ice accumulations.

Ice will accumulate unevenly on the airplane. It will add weight and drag (primarily drag), and decrease thrust and lift. Even wing shape affects ice accumulation; thin airfoil sections are more prone to ice accumulation than thick, highly-cambered sections. For this reason certain surfaces, such as the horizontal stabilizer, are more prone to icing than the wing. With ice accumulations, landing approaches should be made with a minimum wing flap setting (flap extension increases the angle of attack of the horizontal stabilizer) and with an added margin of airspeed. Sudden and large configuration and airspeed changes should be avoided.

Unless otherwise recommended in the AFM/POH, the autopilot should not be used in icing conditions. Continuous use of the autopilot will mask trim and handling changes that will occur with ice accumulation. Without this control feedback, the pilot may not be aware of ice accumulation building to hazardous levels. The autopilot will suddenly disconnect when it reaches design limits and the pilot may find the airplane has assumed unsatisfactory handling characteristics.

The installation of anti-ice/deice equipment on airplanes without AFM/POH approval for flight into icing conditions is to facilitate escape when such conditions are inadvertently encountered. Even with AFM/POH approval, the prudent pilot will avoid icing conditions to the maximum extent practicable, and avoid extended flight in any icing conditions. No multiengine airplane is approved for flight into severe icing conditions, and none are intended for indefinite flight in continuous icing conditions.

PERFORMANCE AND LIMITATIONS

Discussion of performance and limitations requires the definition of several terms.

- **Accelerate-stop distance** is the runway length required to accelerate to a specified speed (either V_R or V_{LOF} , as specified by the manufacturer), experience an engine failure, and bring the airplane to a complete stop.
- **Accelerate-go distance** is the horizontal distance required to continue the takeoff and climb to 50 feet, assuming an engine failure at V_R or V_{LOF} , as specified by the manufacturer.

- **Climb gradient** is a slope most frequently expressed in terms of altitude gain per 100 feet of horizontal distance, whereupon it is stated as a percentage. A 1.5 percent climb gradient is an altitude gain of one and one-half feet per 100 feet of horizontal travel. Climb gradient may also be expressed as a function of altitude gain per nautical mile, or as a ratio of the horizontal distance to the vertical distance (50:1, for example). Unlike rate of climb, climb gradient is affected by wind. Climb gradient is improved with a headwind component, and reduced with a tailwind component. [Figure 12-5]
- The **all-engine service ceiling** of multiengine airplanes is the highest altitude at which the airplane can maintain a steady rate of climb of 100 f.p.m. with both engines operating. The airplane has reached its **absolute ceiling** when climb is no longer possible.
- The **single-engine service ceiling** is reached when the multiengine airplane can no longer maintain a 50 f.p.m. rate of climb with one engine inoperative, and its **single-engine absolute ceiling** when climb is no longer possible.

The takeoff in a multiengine airplane should be planned in sufficient detail so that the appropriate action is taken in the event of an engine failure. The pilot should be thoroughly familiar with the airplane's performance capabilities and limitations in order to make an informed takeoff decision as part of the pre-flight planning. That decision should be reviewed as the last item of the "before takeoff" checklist.

In the event of an engine failure shortly after takeoff, the decision is basically one of continuing flight or landing, even off-airport. If single-engine climb performance is adequate for continued flight, and the airplane has been promptly and correctly configured, the climb after takeoff may be continued. If single-engine climb performance is such that climb is unlikely or impossible, a landing will have to be made in the most suitable area. To be avoided above all is attempting to continue flight when it is not within the airplane's performance capability to do so. [Figure 12-6]

Takeoff planning factors include weight and balance, airplane performance (both single and multiengine), runway length, slope and contamination, terrain and obstacles in the area, weather conditions, and pilot proficiency. Most multiengine airplanes have AFM/POH performance charts and the pilot should be highly proficient in their use. Prior to takeoff, the multiengine pilot should ensure that the weight and balance limitations have been observed, the runway

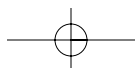

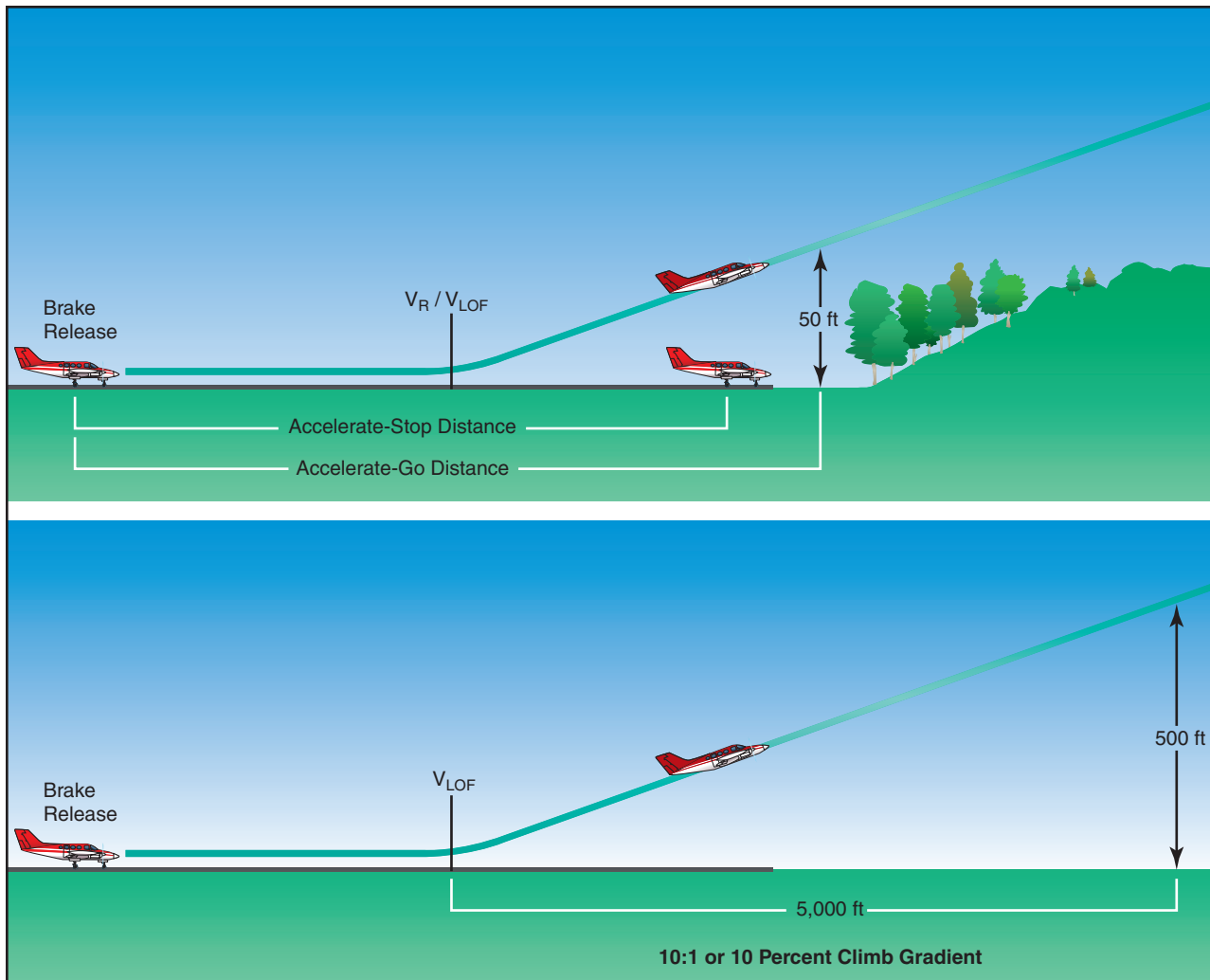

Figure 12-5. Accelerate-stop distance, accelerate-go distance, and climb gradient.

length is adequate, the normal flightpath will clear obstacles and terrain, and that a definitive course of action has been planned in the event of an engine failure.

The regulations do not specifically require that the runway length be equal to or greater than the accelerate-stop distance. Most AFM/POHs publish accelerate-stop distances only as an advisory. It

becomes a limitation only when published in the limitations section of the AFM/POH. Experienced multiengine pilots, however, recognize the safety margin of runway lengths in excess of the bare minimum required for normal takeoff. They will insist on runway lengths of at least accelerate-stop distance as a matter of safety and good operating practice.

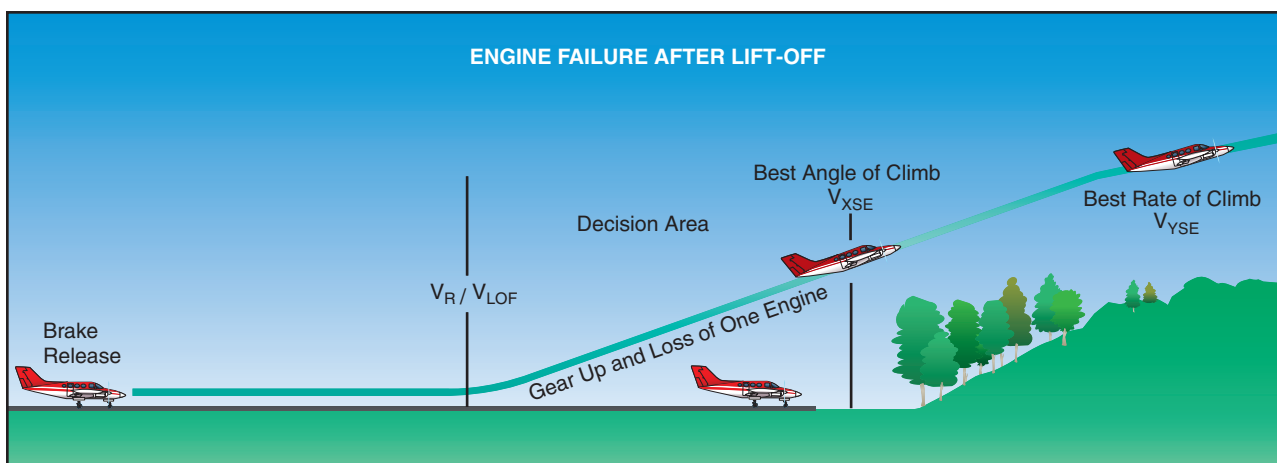
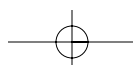
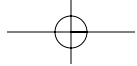

Figure 12-6. Area of decision.





The multiengine pilot must keep in mind that the accelerate-go distance, as long as it is, has only brought the airplane, under ideal circumstances, to a point a mere 50 feet above the takeoff elevation. To achieve even this meager climb, the pilot had to instantaneously recognize and react to an unanticipated engine failure, retract the landing gear, identify and feather the correct engine, all the while maintaining precise airspeed control and bank angle as the airspeed is nursed to V_{YSE} . Assuming flawless airmanship thus far, the airplane has now arrived at a point little more than one wingspan above the terrain, assuming it was absolutely level and without obstructions.

With (for the purpose of illustration) a net 150 f.p.m. rate of climb at a 90-knot V_{YSE} , it will take approximately 3 minutes to climb an additional 450 feet to reach 500 feet AGL. In doing so, the airplane will have traveled an additional 5 nautical miles beyond the original accelerate-go distance, with a climb gradient of about 1.6 percent. A turn of any consequence, such as to return to the airport, will seriously degrade the already marginal climb performance.

Not all multiengine airplanes have published accelerate-go distances in their AFM/POH, and fewer still publish climb gradients. When such information is published, the figures will have been determined under ideal flight testing conditions. It is unlikely that this performance will be duplicated in service conditions.

The point of the foregoing is to illustrate the marginal climb performance of a multiengine airplane that suffers an engine failure shortly after takeoff, even under ideal conditions. The prudent multiengine pilot should pick a point in the takeoff and climb sequence in advance. If an engine fails before this point, the takeoff should be rejected, even if airborne, for a landing on whatever runway or surface lies essentially ahead. If an engine fails after this point, the pilot should promptly execute the appropriate engine failure procedure and continue the climb, assuming the performance capability exists. As a general recommendation, if the landing gear has not been selected up, the takeoff should be rejected, even if airborne.

As a practical matter for planning purposes, the option of continuing the takeoff probably does not exist unless the published single-engine rate-of-climb performance is at least 100 to 200 f.p.m. Thermal turbulence, wind gusts, engine and propeller wear, or poor technique in airspeed, bank angle, and rudder control can easily negate even a 200 f.p.m. rate of climb.

WEIGHT AND BALANCE

The weight and balance concept is no different than that of a single-engine airplane. The actual execution, however, is almost invariably more complex due to a

number of new loading areas, including nose and aft baggage compartments, nacelle lockers, main fuel tanks, aux fuel tanks, nacelle fuel tanks, and numerous seating options in a variety of interior configurations. The flexibility in loading offered by the multiengine airplane places a responsibility on the pilot to address weight and balance prior to each flight.

The terms “empty weight, licensed empty weight, standard empty weight, and basic empty weight” as they appear on the manufacturer’s original weight and balance documents are sometimes confused by pilots.

In 1975, the General Aviation Manufacturers Association (GAMA) adopted a standardized format for AFM/POHs. It was implemented by most manufacturers in model year 1976. Airplanes whose manufacturers conform to the GAMA standards utilize the following terminology for weight and balance:

$$\begin{aligned} & \text{Standard empty weight} \\ & + \text{Optional equipment} \\ & = \text{Basic empty weight} \end{aligned}$$

Standard empty weight is the weight of the standard airplane, full hydraulic fluid, unusable fuel, and full oil. Optional equipment includes the weight of all equipment installed beyond standard. Basic empty weight is the standard empty weight plus optional equipment. Note that basic empty weight includes no usable fuel, but full oil.

Airplanes manufactured prior to the GAMA format generally utilize the following terminology for weight and balance, although the exact terms may vary somewhat:

$$\begin{aligned} & \text{Empty weight} \\ & + \text{Unusable fuel} \\ & = \text{Standard empty weight} \end{aligned}$$

$$\begin{aligned} & \text{Standard empty weight} \\ & + \text{Optional equipment} \\ & = \text{Licensed empty weight} \end{aligned}$$

Empty weight is the weight of the standard airplane, full hydraulic fluid and undrainable oil. Unusable fuel is the fuel remaining in the airplane not available to the engines. Standard empty weight is the empty weight plus unusable fuel. When optional equipment is added to the standard empty weight, the result is licensed empty weight. Licensed empty weight, therefore, includes the standard airplane, optional equipment, full hydraulic fluid, unusable fuel, and undrainable oil.

The major difference between the two formats (GAMA and the old) is that basic empty weight includes full oil, and licensed empty weight does not.

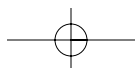

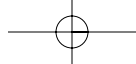

Oil must always be added to any weight and balance utilizing a licensed empty weight.

When the airplane is placed in service, amended weight and balance documents are prepared by appropriately rated maintenance personnel to reflect changes in installed equipment. The old weight and balance documents are customarily marked “superseded” and retained in the AFM/POH. Maintenance personnel are under no regulatory obligation to utilize the GAMA terminology, so weight and balance documents subsequent to the original may use a variety of terms. Pilots should use care to determine whether or not oil has to be added to the weight and balance calculations or if it is already included in the figures provided.

The multiengine airplane is where most pilots encounter the term “zero fuel weight” for the first time. Not all multiengine airplanes have a zero fuel weight limitation published in their AFM/POH, but many do. Zero fuel weight is simply the maximum allowable weight of the airplane and payload, assuming there is no usable fuel on board. The actual airplane is not devoid of fuel at the time of loading, of course. This is merely a calculation that assumes it was. If a zero fuel weight limitation is published, then all weight in excess of that figure must consist of usable fuel. The purpose of a zero fuel weight is to limit load forces on the wing spars with heavy fuselage loads.

Assume a hypothetical multiengine airplane with the following weights and capacities:

Basic empty weight	3,200 lb.
Zero fuel weight	4,400 lb.
Maximum takeoff weight	5,200 lb.
Maximum usable fuel	180 gal.

1. Calculate the useful load:

Maximum takeoff weight	5,200 lb.
Basic empty weight	<u>-3,200 lb.</u>
Useful load	2,000 lb.

The useful load is the maximum combination of usable fuel, passengers, baggage, and cargo that the airplane is capable of carrying.

2. Calculate the payload:

Zero fuel weight	4,400 lb.
------------------	-------	-----------

Basic empty weight	<u>-3,200 lb.</u>
Payload	1,200 lb.

The payload is the maximum combination of passengers, baggage, and cargo that the airplane is capable of carrying. A zero fuel weight, if published, is the limiting weight.

3. Calculate the fuel capacity at maximum payload (1,200 lb.):

Maximum takeoff weight	5,200 lb.
Zero fuel weight	<u>-4,400 lb.</u>
Fuel allowed	800 lb.

Assuming maximum payload, the only weight permitted in excess of the zero fuel weight must consist of usable fuel. In this case, 133.3 gallons.

4. Calculate the payload at maximum fuel capacity (180 gal.):

Basic empty weight	3,200 lb.
Maximum usable fuel	<u>+1,080 lb.</u>
Weight with max. fuel	4,280 lb.
Maximum takeoff weight	5,200 lb.
Weight with max. fuel	<u>-4,280 lb.</u>
Payload allowed	920 lb.

Assuming maximum fuel, the payload is the difference between the weight of the fueled airplane and the maximum takeoff weight.

Some multiengine airplanes have a ramp weight, which is in excess of the maximum takeoff weight. The ramp weight is an allowance for fuel that would be burned during taxi and runup, permitting a takeoff at full maximum takeoff weight. The airplane must weigh no more than maximum takeoff weight at the beginning of the takeoff roll.

A maximum landing weight is a limitation against landing at a weight in excess of the published value. This requires preflight planning of fuel burn to ensure that the airplane weight upon arrival at destination will be at or below the maximum landing weight. In the event of an emergency requiring an immediate landing, the pilot should recognize that the structural margins designed into the airplane are not fully available when over landing weight. An overweight landing inspection may be advisable—the service manual or manufacturer should be consulted.

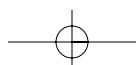

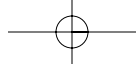

Although the foregoing problems only dealt with weight, the balance portion of weight and balance is equally vital. The flight characteristics of the multiengine airplane will vary significantly with shifts of the center of gravity (CG) within the approved envelope.

At forward CGs, the airplane will be more stable, with a slightly higher stalling speed, a slightly slower cruising speed, and favorable stall characteristics. At aft CGs, the airplane will be less stable, with a slightly lower stalling speed, a slightly faster cruising speed, and less desirable stall characteristics. Forward CG limits are usually determined in certification by elevator/stabilator authority in the landing round-out. Aft CG limits are determined by the minimum acceptable longitudinal stability. It is contrary to the airplane's operating limitations and the Code of Federal Regulations (CFR) to exceed any weight and balance parameter.

Some multiengine airplanes may require ballast to remain within CG limits under certain loading conditions. Several models require ballast in the aft baggage compartment with only a student and instructor on board to avoid exceeding the forward CG limit. When passengers are seated in the aft-most seats of some models, ballast or baggage may be required in the nose baggage compartment to avoid exceeding the aft CG limit. The pilot must direct the seating of passengers and placement of baggage and cargo to achieve a center of gravity within the approved envelope. Most multiengine airplanes have general loading recommendations in the weight and balance section of the AFM/POH. When ballast is added, it must be securely tied down and it must not exceed the maximum allowable floor loading.

Some airplanes make use of a special weight and balance plotter. It consists of several movable parts that can be adjusted over a plotting board on which the CG envelope is printed. The reverse side of the typical plotter contains general loading recommendations for the particular airplane. A pencil line plot can be made directly on the CG envelope imprinted on the working side of the plotting board. This plot can easily be erased and recalculated anew for each flight. This plotter is to be used only for the make and model airplane for which it was designed.

GROUND OPERATION

Good habits learned with single-engine airplanes are directly applicable to multiengine airplanes for pre-flight and engine start. Upon placing the airplane in motion to taxi, the new multiengine pilot will notice several differences, however. The most obvious is the increased wingspan and the need for even

greater vigilance while taxiing in close quarters. Ground handling may seem somewhat ponderous and the multiengine airplane will not be as nimble as the typical two- or four-place single-engine airplane. As always, use care not to ride the brakes by keeping engine power to a minimum. One ground handling advantage of the multiengine airplane over single-engine airplanes is the differential power capability. Turning with an assist from differential power minimizes both the need for brakes during turns and the turning radius.

The pilot should be aware, however, that making a sharp turn assisted by brakes and differential power can cause the airplane to pivot about a stationary inboard wheel and landing gear. This is abuse for which the airplane was not designed and should be guarded against.

Unless otherwise directed by the AFM/POH, all ground operations should be conducted with the cowl flaps fully open. The use of strobe lights is normally deferred until taxiing onto the active runway.

NORMAL AND CROSSWIND TAKEOFF AND CLIMB

With the "before takeoff" checklist complete and air traffic control (ATC) clearance received, the airplane should be taxied into position on the runway centerline. If departing from an airport without an operating control tower, a careful check for approaching aircraft should be made along with a radio advisory on the appropriate frequency. Sharp turns onto the runway combined with a rolling takeoff are not a good operating practice and may be prohibited by the AFM/POH due to the possibility of "unporting" a fuel tank pickup. (The takeoff itself may be prohibited by the AFM/POH under any circumstances below certain fuel levels.) The flight controls should be positioned for a crosswind, if present. Exterior lights such as landing and taxi lights, and wingtip strobes should be illuminated immediately prior to initiating the takeoff roll, day or night. If holding in takeoff position for any length of time, particularly at night, the pilot should activate all exterior lights upon taxiing into position.

Takeoff power should be set as recommended in the AFM/POH. With normally aspirated (non-turbocharged) engines, this will be full throttle. Full throttle is also used in most turbocharged engines. There are some turbocharged engines, however, that require the pilot to set a specific power setting, usually just below red line manifold pressure. This yields takeoff power with less than full throttle travel.

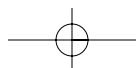

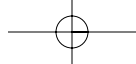

Turbocharged engines often require special consideration. Throttle motion with turbocharged engines should be exceptionally smooth and deliberate. It is acceptable, and may even be desirable, to hold the airplane in position with brakes as the throttles are advanced. Brake release customarily occurs after significant boost from the turbocharger is established. This prevents wasting runway with slow, partial throttle acceleration as the engine power is increased. If runway length or obstacle clearance is critical, full power should be set before brake release, as specified in the performance charts.

As takeoff power is established, initial attention should be divided between tracking the runway centerline and monitoring the engine gauges. Many novice multi-engine pilots tend to fixate on the airspeed indicator just as soon as the airplane begins its takeoff roll. Instead, the pilot should confirm that both engines are developing full-rated manifold pressure and r.p.m., and that the fuel flows, fuel pressures, exhaust gas temperatures (EGTs), and oil pressures are matched in their normal ranges. A directed and purposeful scan of the engine gauges can be accomplished well before the airplane approaches rotation speed. If a crosswind is present, the aileron displacement in the direction of the crosswind may be reduced as the airplane accelerates. The elevator/stabilator control should be held neutral throughout.

Full rated takeoff power should be used for every takeoff. Partial power takeoffs are not recommended. There is no evidence to suggest that the life of modern reciprocating engines is prolonged by partial power takeoffs. Paradoxically, excessive heat and engine wear can occur with partial power as the fuel metering system will fail to deliver the slightly over-rich mixture vital for engine cooling during takeoff.

There are several key airspeeds to be noted during the takeoff and climb sequence in any twin. The first speed to consider is V_{MC} . If an engine fails below V_{MC} while the airplane is on the ground, the takeoff must be rejected. Directional control can only be maintained by promptly closing both throttles and using rudder and brakes as required. If an engine fails below V_{MC} while airborne, directional control is not possible with the remaining engine producing takeoff power. On takeoffs, therefore, the airplane should never be airborne before the airspeed reaches and exceeds V_{MC} . Pilots should use the manufacturer's recommended rotation speed (V_R) or lift-off speed (V_{LOF}). If no such speeds are published, a minimum of V_{MC} plus 5 knots should be used for V_R .

The rotation to a takeoff pitch attitude is done smoothly. With a crosswind, the pilot should ensure

that the landing gear does not momentarily touch the runway after the airplane has lifted off, as a side drift will be present. The rotation may be accomplished more positively and/or at a higher speed under these conditions. However, the pilot should keep in mind that the AFM/POH performance figures for accelerate-stop distance, takeoff ground roll, and distance to clear an obstacle were calculated at the recommended V_R and/or V_{LOF} speed.

After lift-off, the next consideration is to gain altitude as rapidly as possible. After leaving the ground, altitude gain is more important than achieving an excess of airspeed. Experience has shown that excessive speed cannot be effectively converted into altitude in the event of an engine failure. Altitude gives the pilot time to think and react. Therefore, the airplane should be allowed to accelerate in a shallow climb to attain V_Y , the best all-engine rate-of-climb speed. V_Y should then be maintained until a safe single-engine maneuvering altitude, considering terrain and obstructions, is achieved.

To assist the pilot in takeoff and initial climb profile, some AFM/POHs give a "50-foot" or "50-foot barrier" speed to use as a target during rotation, lift-off, and acceleration to V_Y .

Landing gear retraction should normally occur after a positive rate of climb is established. Some AFM/POHs direct the pilot to apply the wheel brakes momentarily after lift-off to stop wheel rotation prior to landing gear retraction. If flaps were extended for takeoff, they should be retracted as recommended in the AFM/POH.

Once a safe single-engine maneuvering altitude has been reached, typically a minimum of 400-500 feet AGL, the transition to an enroute climb speed should be made. This speed is higher than V_Y and is usually maintained to cruising altitude. Enroute climb speed gives better visibility, increased engine cooling, and a higher groundspeed. Takeoff power can be reduced, if desired, as the transition to enroute climb speed is made.

Some airplanes have a climb power setting published in the AFM/POH as a recommendation (or sometimes as a limitation), which should then be set for enroute climb. If there is no climb power setting published, it is customary, but not a requirement, to reduce manifold pressure and r.p.m. somewhat for enroute climb. The propellers are usually synchronized after the first power reduction and the yaw damper, if installed, engaged. The AFM/POH may also recommend leaning

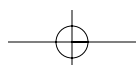

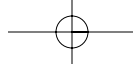

Figure 12-7. Takeoff and climb profile.

the mixtures during climb. The “climb” checklist should be accomplished as traffic and work load allow. [Figure 12-7]

LEVEL OFF AND CRUISE

Upon leveling off at cruising altitude, the pilot should allow the airplane to accelerate at climb power until cruising airspeed is achieved, then cruise power and r.p.m. should be set. To extract the maximum cruise performance from any airplane, the power setting tables provided by the manufacturer should be closely followed. If the cylinder head and oil temperatures are within their normal ranges, the cowl flaps may be closed. When the engine temperatures have stabilized, the mixtures may be leaned per AFM/POH recommendations. The remainder of the “cruise” checklist should be completed by this point.

Fuel management in multiengine airplanes is often more complex than in single-engine airplanes. Depending upon system design, the pilot may need to select between main tanks and auxiliary tanks, or even employ fuel transfer from one tank to another. In complex fuel systems, limitations are often found restricting the use of some tanks to level flight only, or requiring a reserve of fuel in the main tanks for descent and landing. Electric fuel pump operation can vary widely among different models also, particularly during tank switching or fuel transfer. Some fuel pumps are to be on for takeoff and landing; others are to be off. There is simply no substitute for thorough

systems and AFM/POH knowledge when operating complex aircraft.

NORMAL APPROACH AND LANDING

Given the higher cruising speed (and frequently, altitude) of multiengine airplanes over most single-engine airplanes, the descent must be planned in advance. A hurried, last minute descent with power at or near idle is inefficient and can cause excessive engine cooling. It may also lead to passenger discomfort, particularly if the airplane is unpressurized. As a rule of thumb, if terrain and passenger conditions permit, a maximum of a 500 f.p.m. rate of descent should be planned. Pressurized airplanes can plan for higher descent rates, if desired.

In a descent, some airplanes require a minimum EGT, or may have a minimum power setting or cylinder head temperature to observe. In any case, combinations of very low manifold pressure and high r.p.m. settings are strongly discouraged by engine manufacturers. If higher descent rates are necessary, the pilot should consider extending partial flaps or lowering the landing gear before retarding the power excessively. The “descent” checklist should be initiated upon leaving cruising altitude and completed before arrival in the terminal area. Upon arrival in the terminal area, pilots are encouraged to turn on their landing and recognition lights when operating below 10,000 feet, day or night, and especially when operating within 10 miles of any airport or in conditions of reduced visibility.

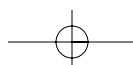

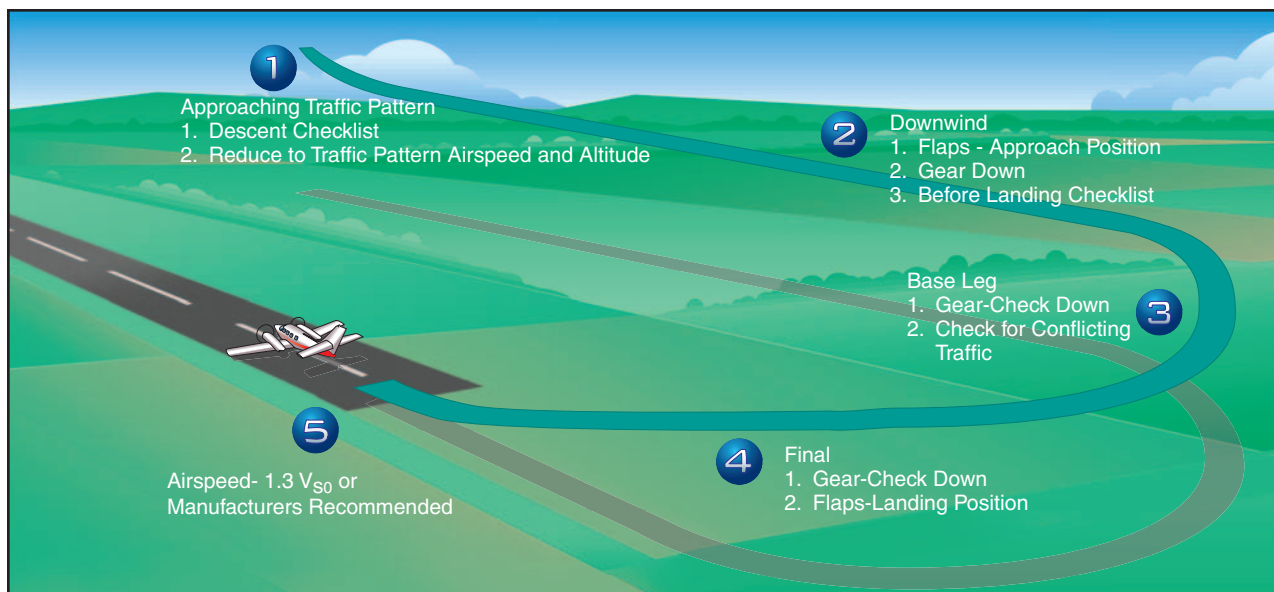

Figure 12-8. Normal two-engine approach and landing.

The traffic pattern and approach are typically flown at somewhat higher indicated airspeeds in a multiengine airplane contrasted to most single-engine airplanes. The pilot may allow for this through an early start on the “before landing” checklist. This provides time for proper planning, spacing, and thinking well ahead of the airplane. Many multiengine airplanes have partial flap extension speeds above V_{FE} , and partial flaps can be deployed prior to traffic pattern entry. Normally, the landing gear should be selected and confirmed down when abeam the intended point of landing as the downwind leg is flown. [Figure 12-8]

The Federal Aviation Administration (FAA) recommends a stabilized approach concept. To the greatest extent practical, on final approach and within 500 feet AGL, the airplane should be on speed, in trim, configured for landing, tracking the extended centerline of the runway, and established in a constant angle of descent towards an aim point in the touchdown zone. Absent unusual flight conditions, only minor corrections will be required to maintain this approach to the roundout and touchdown.

The final approach should be made with power and at a speed recommended by the manufacturer; if a recommended speed is not furnished, the speed should be no slower than the single-engine best rate-of-climb speed (V_{YSE}) until short final with the landing assured, but in no case less than critical engine-out minimum control speed (V_{MC}). Some multiengine pilots prefer to delay full flap extension to short final with the landing assured. This is an acceptable technique with appropriate experience and familiarity with the airplane.

In the roundout for landing, residual power is gradually reduced to idle. With the higher wing loading of multiengine airplanes and with the drag from two windmilling propellers, there will be minimal float.

Full stall landings are generally undesirable in twins. The airplane should be held off as with a high performance single-engine model, allowing touchdown of the main wheels prior to a full stall.

Under favorable wind and runway conditions, the nosewheel can be held off for best aerodynamic braking. Even as the nosewheel is gently lowered to the runway centerline, continued elevator back pressure will greatly assist the wheel brakes in stopping the airplane.

If runway length is critical, or with a strong crosswind, or if the surface is contaminated with water, ice or snow, it is undesirable to rely solely on aerodynamic braking after touchdown. The full weight of the airplane should be placed on the wheels as soon as practicable. The wheel brakes will be more effective than aerodynamic braking alone in decelerating the airplane.

Once on the ground, elevator back pressure should be used to place additional weight on the main wheels and to add additional drag. When necessary, wing flap retraction will also add additional weight to the wheels and improve braking effectivity. Flap retraction during the landing rollout is discouraged, however, unless there is a clear, operational need. It should not be accomplished as routine with each landing.

Some multiengine airplanes, particularly those of the cabin class variety, can be flown through the roundout and touchdown with a small amount of power. This is an acceptable technique to prevent high sink rates and to cushion the touchdown. The pilot should keep in mind, however, that the primary purpose in landing is to get the airplane down and stopped. This technique should only be attempted when there is a generous

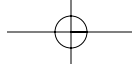

margin of runway length. As propeller blast flows directly over the wings, lift as well as thrust is produced. The pilot should taxi clear of the runway as soon as speed and safety permit, and then accomplish the “after landing” checklist. Ordinarily, no attempt should be made to retract the wing flaps or perform other checklist duties until the airplane has been brought to a halt when clear of the active runway. Exceptions to this would be the rare operational needs discussed above, to relieve the weight from the wings and place it on the wheels. In these cases, AFM/POH guidance should be followed. The pilot should not indiscriminately reach out for any switch or control on landing rollout. An inadvertent landing gear retraction while meaning to retract the wing flaps may result.

CROSSWIND APPROACH AND LANDING

The multiengine airplane is often easier to land in a crosswind than a single-engine airplane due to its higher approach and landing speed. In any event, the principles are no different between singles and twins. Prior to touchdown, the longitudinal axis must be aligned with the runway centerline to avoid landing gear side loads.

The two primary methods, crab and wing-low, are typically used in conjunction with each other. As soon as the airplane rolls out onto final approach, the crab angle to track the extended runway centerline is established. This is coordinated flight with adjustments to heading to compensate for wind drift either left or right. Prior to touchdown, the transition to a sideslip is made with the upwind wing lowered and opposite rudder applied to prevent a turn. The airplane touches down on the landing gear of the upwind wing first, followed by that of the downwind wing, and then the nose gear. Follow-through with the flight controls involves an increasing application of aileron into the wind until full control deflection is reached.

The point at which the transition from the crab to the sideslip is made is dependent upon pilot familiarity with the airplane and experience. With high skill and experience levels, the transition can be made during the roundout just before touchdown. With lesser skill

and experience levels, the transition is made at increasing distances from the runway. Some multiengine airplanes (as some single-engine airplanes) have AFM/POH limitations against slips in excess of a certain time period; 30 seconds, for example. This is to prevent engine power loss from fuel starvation as the fuel in the tank of the lowered wing flows towards the wingtip, away from the fuel pickup point. This time limit must be observed if the wing-low method is utilized.

Some multiengine pilots prefer to use differential power to assist in crosswind landings. The asymmetrical thrust produces a yawing moment little different from that produced by the rudder. When the upwind wing is lowered, power on the upwind engine is increased to prevent the airplane from turning. This alternate technique is completely acceptable, but most pilots feel they can react to changing wind conditions quicker with rudder and aileron than throttle movement. This is especially true with turbocharged engines where the throttle response may lag momentarily. The differential power technique should be practiced with an instructor familiar with it before being attempted alone.

SHORT-FIELD TAKEOFF AND CLIMB

The short-field takeoff and climb differs from the normal takeoff and climb in the airspeeds and initial climb profile. Some AFM/POHs give separate short-field takeoff procedures and performance charts that recommend specific flap settings and airspeeds. Other AFM/POHs do not provide separate short-field procedures. In the absence of such specific procedures, the airplane should be operated only as recommended in the AFM/POH. No operations should be conducted contrary to the recommendations in the AFM/POH.

On short-field takeoffs in general, just after rotation and lift-off, the airplane should be allowed to accelerate to V_X , making the initial climb over obstacles at V_X and transitioning to V_Y as obstacles are cleared. [Figure 12-9]

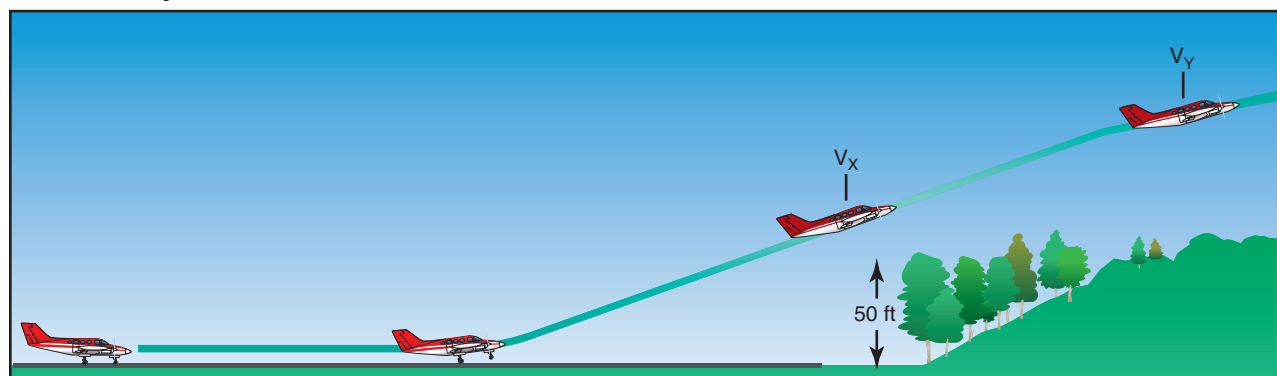
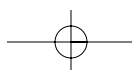

Figure 12-9. Short-field takeoff and climb.



When partial flaps are recommended for short-field takeoffs, many light-twins have a strong tendency to become airborne prior to V_{MC} plus 5 knots. Attempting to prevent premature lift-off with forward elevator pressure results in wheelbarrowing. To prevent this, allow the airplane to become airborne, but only a few inches above the runway. The pilot should be prepared to promptly abort the takeoff and land in the event of engine failure on takeoff with landing gear and flaps extended at airspeeds below V_X .

Engine failure on takeoff, particularly with obstructions, is compounded by the low airspeeds and steep climb attitudes utilized in short-field takeoffs. V_X and V_{XSE} are often perilously close to V_{MC} , leaving scant margin for error in the event of engine failure as V_{XSE} is assumed. If flaps were used for takeoff, the engine failure situation becomes even more critical due to the additional drag incurred. If V_X is less than 5 knots higher than V_{MC} , give strong consideration to reducing useful load or using another runway in order to increase the takeoff margins so that a short-field technique will not be required.

SHORT-FIELD APPROACH AND LANDING

The primary elements of a short-field approach and landing do not differ significantly from a normal approach and landing. Many manufacturers do not publish short-field landing techniques or performance charts in the AFM/POH. In the absence of specific short-field approach and landing procedures, the airplane should be operated as recommended in the AFM/POH. No operations should be conducted contrary to the AFM/POH recommendations.

The emphasis in a short-field approach is on configuration (full flaps), a stabilized approach with a constant angle of descent, and precise airspeed control. As part of a short-field approach and landing procedure, some AFM/POHs recommend a slightly slower than normal approach airspeed. If no such slower speed is published, use the AFM/POH-recommended normal approach speed.

Full flaps are used to provide the steepest approach angle. If obstacles are present, the approach should be planned so that no drastic power reductions are required after they are cleared. The power should be smoothly reduced to idle in the roundout prior to touchdown. Pilots should keep in mind that the propeller blast blows over the wings, providing some lift in addition to thrust. Significantly reducing power just after obstacle clearance usually results in a sudden, high sink rate that may lead to a hard landing.

After the short-field touchdown, maximum stopping effort is achieved by retracting the wing flaps, adding back pressure to the elevator/stabilator, and applying heavy braking. However, if the runway length permits, the wing flaps should be left in the extended position until the airplane has been stopped clear of the runway. There is always a significant risk of retracting the landing gear instead of the wing flaps when flap retraction is attempted on the landing rollout.

Landing conditions that involve either a short-field, high-winds or strong crosswinds are just about the only situations where flap retraction on the landing rollout should be considered. When there is an operational need to retract the flaps just after touchdown, it must be done deliberately, with the flap handle positively identified before it is moved.

GO-AROUND

When the decision to go around is made, the throttles should be advanced to takeoff power. With adequate airspeed, the airplane should be placed in a climb pitch attitude. These actions, which are accomplished simultaneously, will arrest the sink rate and place the airplane in the proper attitude for transition to a climb. The initial target airspeed will be V_Y , or V_X if obstructions are present. With sufficient airspeed, the flaps should be retracted from full to an intermediate position and the landing gear retracted when there is a positive rate of climb and no chance of runway contact. The remaining flaps should then be retracted. [Figure 12-10]

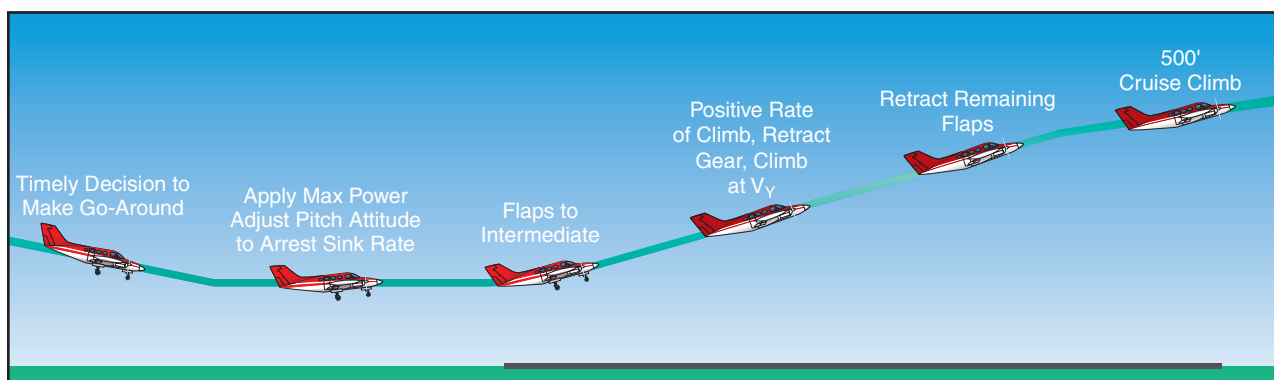
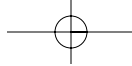

Figure 12-10. Go-around procedure.



If the go-around was initiated due to conflicting traffic on the ground or aloft, the pilot should maneuver to the side, so as to keep the conflicting traffic in sight. This may involve a shallow bank turn to offset and then parallel the runway/landing area.

If the airplane was in trim for the landing approach when the go-around was commenced, it will soon require a great deal of forward elevator/stabilator pressure as the airplane accelerates away in a climb. The pilot should apply appropriate forward pressure to maintain the desired pitch attitude. Trim should be commenced immediately. The “balked landing” checklist should be reviewed as work load permits.

Flaps should be retracted before the landing gear for two reasons. First, on most airplanes, full flaps produce more drag than the extended landing gear. Secondly, the airplane will tend to settle somewhat with flap retraction, and the landing gear should be down in the event of an inadvertent, momentary touchdown.

Many multiengine airplanes have a landing gear retraction speed significantly less than the extension speed. Care should be exercised during the go-around not to exceed the retraction speed. If the pilot desires to return for a landing, it is essential to re-accomplish the entire “before landing” checklist. An interruption to a pilot’s habit patterns, such as a go-around, is a classic scenario for a subsequent gear up landing.

The preceding discussion of go-arounds assumes that the maneuver was initiated from normal approach speeds or faster. If the go-around was initiated from a low airspeed, the initial pitch up to a climb attitude must be tempered with the necessity of maintaining adequate flying speed throughout the maneuver. Examples of where this applies include go-arounds initiated from the landing roundout or recovery from a bad bounce as well as a go-around initiated due to an inadvertent approach to a stall. The first priority is always to maintain control and obtain adequate flying speed. A few moments of level or near level flight may be required as the airplane accelerates up to climb speed.

REJECTED TAKEOFF

A takeoff can be rejected for the same reasons a takeoff in a single-engine airplane would be rejected. Once the decision to reject a takeoff is made, the pilot should promptly close both throttles and maintain directional control with the rudder, nosewheel steering, and brakes. Aggressive use of rudder, nosewheel steering, and brakes may be required to keep the airplane on the runway. Particularly, if an engine failure is not immediately recognized and accompanied by prompt closure of both throttles. However, the primary objective is not necessarily to stop the airplane in the shortest distance, but to maintain control of the airplane as it decelerates. In some situations, it

may be preferable to continue into the overrun area under control, rather than risk directional control loss, landing gear collapse, or tire/brake failure in an attempt to stop the airplane in the shortest possible distance.

ENGINE FAILURE AFTER LIFT-OFF

A takeoff or go-around is the most critical time to suffer an engine failure. The airplane will be slow, close to the ground, and may even have landing gear and flaps extended. Altitude and time will be minimal. Until feathered, the propeller of the failed engine will be windmilling, producing a great deal of drag and yawing tendency. Airplane climb performance will be marginal or even non-existent, and obstructions may lie ahead. Add the element of surprise and the need for a plan of action before every takeoff is obvious.

With loss of an engine, it is paramount to maintain airplane control and comply with the manufacturer’s recommended emergency procedures. Complete failure of one engine shortly after takeoff can be broadly categorized into one of three following scenarios.

1. **Landing gear down.** [Figure 12-11] If the engine failure occurs prior to selecting the landing gear to the UP position, close both throttles and land on the remaining runway or overrun. Depending upon how quickly the pilot reacts to the sudden yaw, the airplane may run off the side of the runway by the time action is taken. There are really no other practical options. As discussed earlier, the chances of maintaining directional control while retracting the flaps (if extended), landing gear, feathering the propeller, and accelerating are minimal. On some airplanes with a single-engine-driven hydraulic pump, failure of that engine means the only way to raise the landing gear is to allow the engine to windmill or to use a hand pump. This is not a viable alternative during takeoff.
2. **Landing gear control selected up, single-engine climb performance inadequate.** [Figure 12-12] When operating near or above the single-engine ceiling and an engine failure is experienced shortly after lift-off, a landing must be accomplished on whatever essentially lies ahead. There is also the option of continuing ahead, in a descent at V_{YSE} with the remaining engine producing power, as long as the pilot is not tempted to remain airborne beyond the airplane’s performance capability. Remaining airborne, bleeding off airspeed in a futile attempt to maintain altitude is almost invariably fatal. Landing under control is paramount. The greatest hazard in a single-engine takeoff is attempting to fly when it is not within the per-

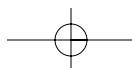

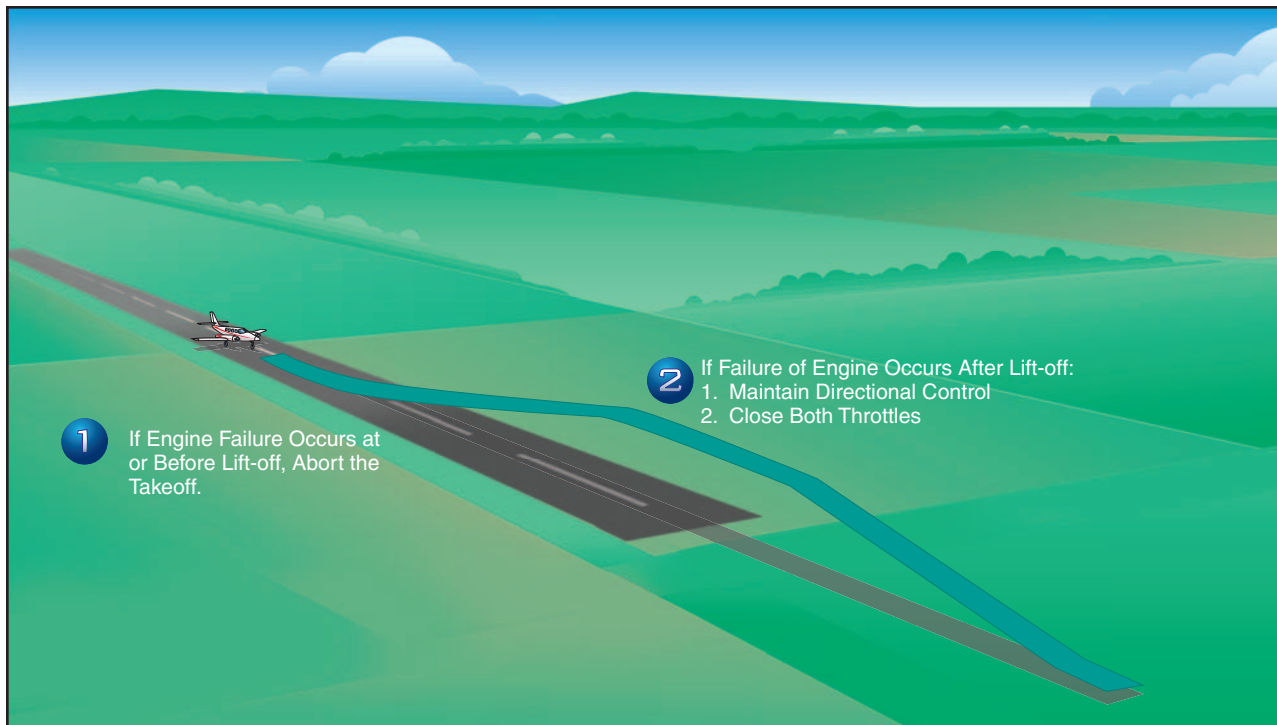
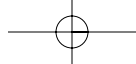

Figure 12-11. Engine failure on takeoff, landing gear down.

formance capability of the airplane to do so. An accident is inevitable.

Analysis of engine failures on takeoff reveals a very high success rate of off-airport engine inoperative landings when the airplane is landed under control. Analysis also reveals a very high fatality rate in stall-spin accidents when the pilot attempts flight beyond the performance capability of the airplane.

As mentioned previously, if the airplane's landing gear retraction mechanism is dependent upon hydraulic pressure from a certain engine-driven pump, failure of that engine can mean a loss of hundreds of feet of altitude as the pilot either windmills the engine to provide hydraulic pressure to raise the gear or raises it manually with a backup pump.

3. **Landing gear control selected up, single-engine climb performance adequate.** [Figure 12-13] If the single-engine rate of climb is adequate, the procedures for continued flight should be followed. There are four areas of concern: **control, configuration, climb, and checklist.**

- **CONTROL**— The first consideration following engine failure during takeoff is control of the airplane. Upon detecting an engine failure, aileron should be used to bank the airplane and rudder pressure applied, aggressively if necessary, to counteract the yaw and roll from asymmetrical thrust. The control forces, particularly on the rudder, may be high. The pitch attitude for V_{YSE} will have to be lowered from that of V_Y .

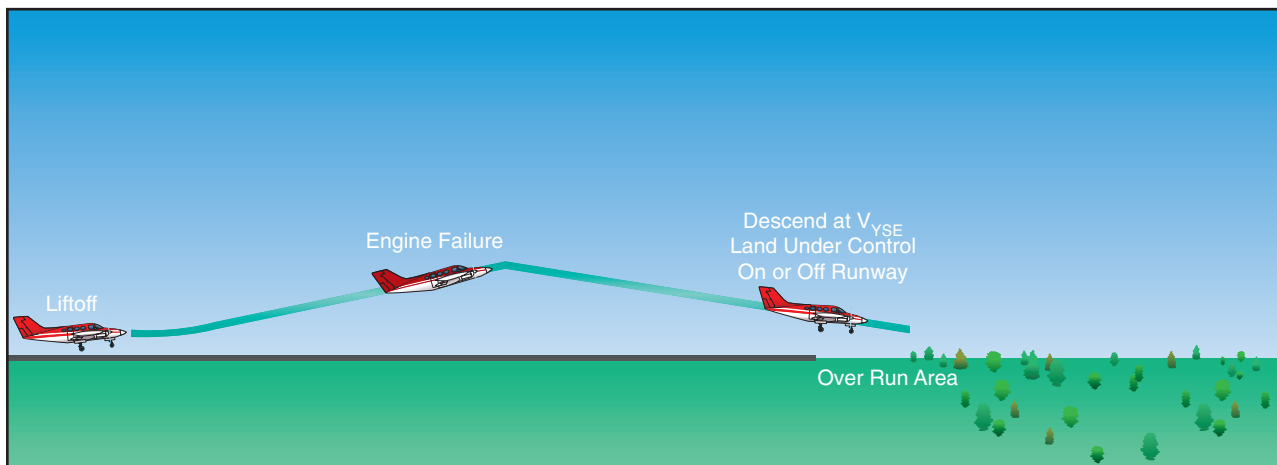
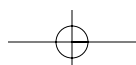

Figure 12-12. Engine failure on takeoff, inadequate climb performance.



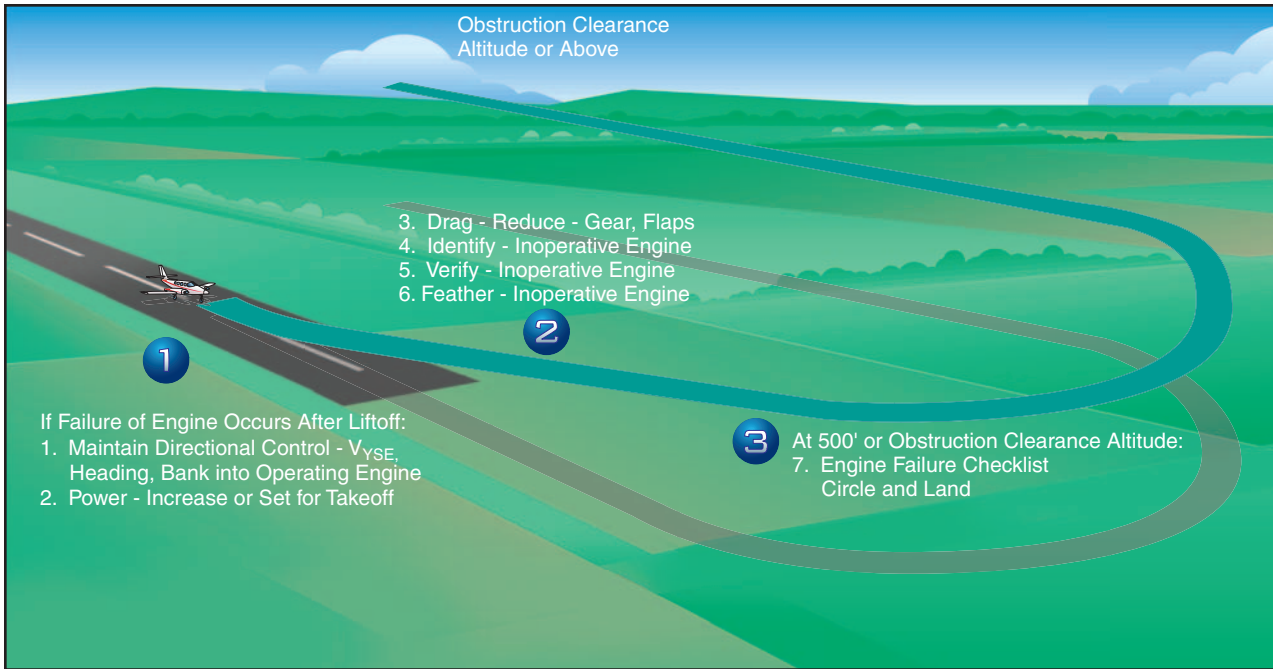
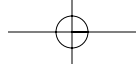

Figure 12-13. Landing gear up—adequate climb performance.

At least 5° of bank should be used, if necessary, to stop the yaw and maintain directional control. This initial bank input is held only momentarily, just long enough to establish or ensure directional control. Climb performance suffers when bank angles exceed approximately 2 or 3°, but obtaining and maintaining V_{YSE} and directional control are paramount. Trim should be adjusted to lower the control forces.

- CONFIGURATION**—The memory items from the “engine failure after takeoff” checklist [Figure 12-14] should be promptly executed to configure the airplane for climb. The specific procedures to follow will be found in the AFM/POH and checklist for the particular airplane. Most will direct the pilot to assume V_{YSE} , set takeoff power, retract the flaps and landing gear, identify, verify, and feather the failed engine. (On some airplanes, the landing gear is to be retracted before the flaps.)

The “identify” step is for the pilot to initially identify the failed engine. Confirmation on the engine gauges may or may not be possible, depending upon the failure mode. Identification should be primarily through the control inputs required to maintain straight flight, not the engine gauges. The “verify” step directs the pilot to retard the throttle of the engine thought to have failed. No change in performance when the suspected throttle is retarded is verification that the correct engine has been identified as failed. The corresponding propeller control should be brought fully aft to feather the engine.

ENGINE FAILURE AFTER TAKEOFF	
Airspeed	Maintain V_{YSE}
Mixtures	RICH
Propellers	HIGH RPM
Throttles	FULL POWER
Flaps	UP
Landing Gear	UP
Identify	Determine failed engine
Verify	Close throttle of failed engine
Propeller	FEATHER
Trim Tabs	ADJUST
Failed Engine	SECURE
As soon as practical	LAND
<p>Bold - faced items require immediate action and are to be accomplished from memory.</p>	

Figure 12-14. Typical “engine failure after takeoff” emergency checklist.

- CLIMB**—As soon as directional control is established and the airplane configured for climb, the bank angle should be reduced to that producing best climb performance. Without specific guidance for zero sideslip, a bank of 2° and one-third to one-half ball deflection on the slip/skid indicator is suggested. V_{YSE} is maintained with pitch control. As turning flight reduces climb performance, climb should be made straight ahead, or with shallow turns to avoid obstacles, to an altitude of at least 400 feet AGL before attempting a return to the airport.

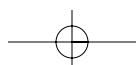

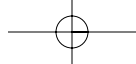

- CHECKLIST**—Having accomplished the memory items from the “engine failure after takeoff” checklist, the printed copy should be reviewed as time permits. The “securing failed engine” checklist [Figure 12-15] should then be accomplished. Unless the pilot suspects an engine fire, the remaining items should be accomplished deliberately and without undue haste. Airplane control should never be sacrificed to execute the remaining checklists. The priority items have already been accomplished from memory.

SECURING FAILED ENGINE	
Mixture	IDLE CUT OFF
Magnetos	OFF
Alternator	OFF
Cowl Flap	CLOSE
Boost Pump	OFF
Fuel Selector	OFF
Prop Sync	OFF
Electrical Load	Reduce
Crossfeed	Consider

Figure 12-15. Typical “securing failed engine” emergency checklist.

Other than closing the cowl flap of the failed engine, none of these items, if left undone, adversely affects airplane climb performance. There is a distinct possibility of actuating an incorrect switch or control if the procedure is rushed. The pilot should concentrate on flying the airplane and extracting maximum performance. If ATC facilities are available, an emergency should be declared.

The memory items in the “engine failure after takeoff” checklist may be redundant with the airplane’s existing configuration. For example, in the third takeoff scenario, the gear and flaps were assumed to already be retracted, yet the memory items included gear and flaps. This is not an oversight. The purpose of the memory items is to either initiate the appropriate action or to confirm that a condition exists. Action on each item may not be required in all cases. The memory items also apply to more than one circumstance. In an engine failure from a go-around, for example, the landing gear and flaps would likely be extended when the failure occurred.

The three preceding takeoff scenarios all include the landing gear as a key element in the decision to land or continue. With the landing gear selector in the DOWN position, for example, continued takeoff and climb is not recommended. This situation, however, is not justification to retract the landing gear the moment the airplane lifts off the surface on takeoff as a normal

procedure. The landing gear should remain selected down as long as there is usable runway or overrun available to land on. The use of wing flaps for takeoff virtually eliminates the likelihood of a single-engine climb until the flaps are retracted.

There are two time-tested memory aids the pilot may find useful in dealing with engine-out scenarios. The first, “Dead foot–dead engine” is used to assist in identifying the failed engine. Depending on the failure mode, the pilot won’t be able to consistently identify the failed engine in a timely manner from the engine gauges. In maintaining directional control, however, rudder pressure will be exerted on the side (left or right) of the airplane with the operating engine. Thus, the “dead foot” is on the same side as the “dead engine.” Variations on this saying include “Idle foot–idle engine” and “Working foot–working engine.”

The second memory aid has to do with climb performance. The phrase “Raise the dead” is a reminder that the best climb performance is obtained with a very shallow bank, about 2° toward the operating engine. Therefore, the inoperative, or “dead” engine should be “raised” with a very slight bank.

Not all engine power losses are complete failures. Sometimes the failure mode is such that partial power may be available. If there is a performance loss when the throttle of the affected engine is retarded, the pilot should consider allowing it to run until altitude and airspeed permit safe single-engine flight, if this can be done without compromising safety. Attempts to save a malfunctioning engine can lead to a loss of the entire airplane.

ENGINE FAILURE DURING FLIGHT

Engine failures well above the ground are handled differently than those occurring at lower speeds and altitudes. Cruise airspeed allows better airplane control, and altitude may permit time for a possible diagnosis and remedy of the failure. Maintaining airplane control, however, is still paramount. Airplanes have been lost at altitude due to apparent fixation on the engine problem to the detriment of flying the airplane.

Not all engine failures or malfunctions are catastrophic in nature (catastrophic meaning a major mechanical failure that damages the engine and precludes further engine operation). Many cases of power loss are related to fuel starvation, where restoration of power may be made with the selection of another tank. An orderly inventory of gauges and switches may reveal the problem. Carburetor heat or alternate air can be selected. The affected engine may run smoothly on just one magneto or at a lower power setting. Altering the

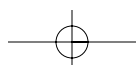

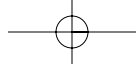

mixture may help. If fuel vapor formation is suspected, fuel boost pump operation may be used to eliminate flow and pressure fluctuations.

Although it is a natural desire among pilots to save an ailing engine with a precautionary shutdown, the engine should be left running if there is any doubt as to needing it for further safe flight. Catastrophic failure accompanied by heavy vibration, smoke, blistering paint, or large trails of oil, on the other hand, indicate a critical situation. The affected engine should be feathered and the “securing failed engine” checklist completed. The pilot should divert to the nearest suitable airport and declare an emergency with ATC for priority handling.

Fuel crossfeed is a method of getting fuel from a tank on one side of the airplane to an operating engine on the other. Crossfeed is used for extended single-engine operation. If a suitable airport is close at hand, there is no need to consider crossfeed. If prolonged flight on a single-engine is inevitable due to airport non-availability, then crossfeed allows use of fuel that would otherwise be unavailable to the operating engine. It also permits the pilot to balance the fuel consumption to avoid an out-of-balance wing heaviness.

AFM/POH procedures for crossfeed vary widely. Thorough fuel system knowledge is essential if crossfeed is to be conducted. Fuel selector positions and fuel boost pump usage for crossfeed differ greatly among multiengine airplanes. Prior to landing, crossfeed should be terminated and the operating engine returned to its main tank fuel supply.

If the airplane is above its single-engine absolute ceiling at the time of engine failure, it will slowly lose altitude. The pilot should maintain V_{YSE} to minimize the rate of altitude loss. This “drift down” rate will be greatest immediately following the failure and will decrease as the single-engine ceiling is approached. Due to performance variations caused by engine and propeller wear, turbulence, and pilot technique, the airplane may not maintain altitude even at its published single-engine ceiling. Any further rate of sink, however, would likely be modest.

An engine failure in a descent or other low power setting can be deceiving. The dramatic yaw and performance loss will be absent. At very low power settings, the pilot may not even be aware of a failure. If a failure is suspected, the pilot should advance both engine mixtures, propellers, and throttles significantly, to the takeoff settings if necessary, to correctly identify the failed engine. The power on the operative engine can always be reduced later.

ENGINE INOPERATIVE APPROACH AND LANDING

The approach and landing with one engine inoperative is essentially the same as a two-engine approach and landing. The traffic pattern should be flown at similar altitudes, airspeeds, and key positions as a two-engine approach. The differences will be the reduced power available and the fact that the remaining thrust is asymmetrical. A higher-than-normal power setting will be necessary on the operative engine.

With adequate airspeed and performance, the landing gear can still be extended on the downwind leg. In which case it should be confirmed DOWN no later than abeam the intended point of landing. Performance permitting, initial extension of wing flaps (10° , typically) and a descent from pattern altitude can also be initiated on the downwind leg. The airspeed should be no slower than V_{YSE} . The direction of the traffic pattern, and therefore the turns, is of no consequence as far as airplane controllability and performance are concerned. It is perfectly acceptable to make turns toward the failed engine.

On the base leg, if performance is adequate, the flaps may be extended to an intermediate setting (25° , typically). If the performance is inadequate, as measured by a decay in airspeed or high sink rate, delay further flap extension until closer to the runway. V_{YSE} is still the minimum airspeed to maintain.

On final approach, a normal, 3° glidepath to a landing is desirable. VASI or other vertical path lighting aids should be utilized if available. Slightly steeper approaches may be acceptable. However, a long, flat, low approach should be avoided. Large, sudden power applications or reductions should also be avoided. Maintain V_{YSE} until the landing is assured, then slow to $1.3 V_{SO}$ or the AFM/POH recommended speed. The final flap setting may be delayed until the landing is assured, or the airplane may be landed with partial flaps.

The airplane should remain in trim throughout. The pilot must be prepared, however, for a rudder trim change as the power of the operating engine is reduced to idle in the roundout just prior to touchdown. With drag from only one windmilling propeller, the airplane will tend to float more than on a two-engine approach. Precise airspeed control therefore is essential, especially when landing on a short, wet and/or slippery surface.

Some pilots favor resetting the rudder trim to neutral on final and compensating for yaw by holding rudder pressure for the remainder of the approach. This eliminates the rudder trim change close to the ground as

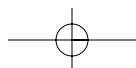

the throttle is closed during the roundout for landing. This technique eliminates the need for groping for the rudder trim and manipulating it to neutral during final approach, which many pilots find to be highly distracting. AFM/POH recommendations or personal preference should be used.

Single-engine go-arounds must be avoided. As a practical matter in single-engine approaches, once the airplane is on final approach with landing gear and flaps extended, it is committed to land. If not on the intended runway, then on another runway, a taxiway, or grassy infield. The light-twin does not have the performance to climb on one engine with landing gear and flaps extended. Considerable altitude will be lost while maintaining V_{YSE} and retracting landing gear and flaps. Losses of 500 feet or more are not unusual. If the landing gear has been lowered with an alternate means of extension, retraction may not be possible, virtually negating any climb capability.

ENGINE INOPERATIVE FLIGHT PRINCIPLES

Best single-engine climb performance is obtained at V_{YSE} with maximum available power and minimum drag. After the flaps and landing gear have been retracted and the propeller of the failed engine feathered, a key element in best climb performance is minimizing sideslip.

With a single-engine airplane or a multiengine airplane with both engines operative, sideslip is eliminated when the ball of the turn and bank instrument is centered. This is a condition of **zero sideslip**, and the airplane is presenting its smallest possible profile to the relative wind. As a result, drag is at its minimum. Pilots know this as coordinated flight.

In a multiengine airplane with an inoperative engine, the centered ball is no longer the indicator of zero sideslip due to asymmetrical thrust. In fact, there is no instrument at all that will directly tell the pilot the flight conditions for zero sideslip. In the absence of a **yaw string**, minimizing sideslip is a matter of placing the airplane at a predetermined bank angle and ball position. The AFM/POH performance charts for single-engine flight were determined at zero sideslip. If this performance is even to be approximated, the zero sideslip technique **must** be utilized.

There are two different control inputs that can be used to counteract the asymmetrical thrust of a failed engine: (1) yaw from the rudder, and (2) the horizontal component of lift that results from bank with the ailerons. Used individually, neither is correct. Used together in the proper combination, zero sideslip and best climb performance are achieved.

Three different scenarios of airplane control inputs are presented below. **Neither of the first two is correct.** They are presented to illustrate the reasons for the zero sideslip approach to best climb performance.

1. Engine inoperative flight with wings level and ball centered requires large rudder input towards the operative engine. [Figure 12-16] The result is a moderate sideslip towards the inoperative engine. Climb performance will be reduced by the moderate sideslip. With wings level, V_{MC} will be significantly higher than published as there is no horizontal component of lift available to help the rudder combat asymmetrical thrust.

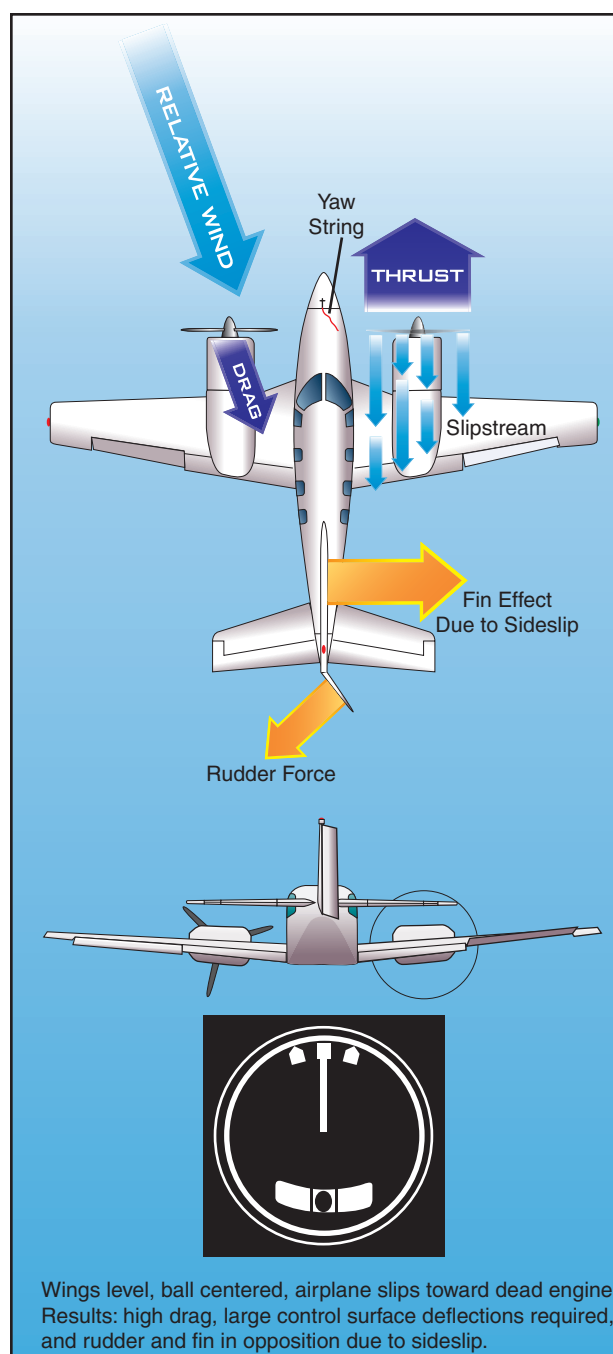
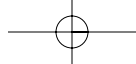

Figure 12-16. Wings level engine-out flight.



- Engine inoperative flight using ailerons alone requires an 8 - 10° bank angle towards the operative engine. [Figure 12-17] This assumes no rudder input. The ball will be displaced well towards the operative engine. The result is a large sideslip towards the operative engine. Climb performance will be greatly reduced by the large sideslip.

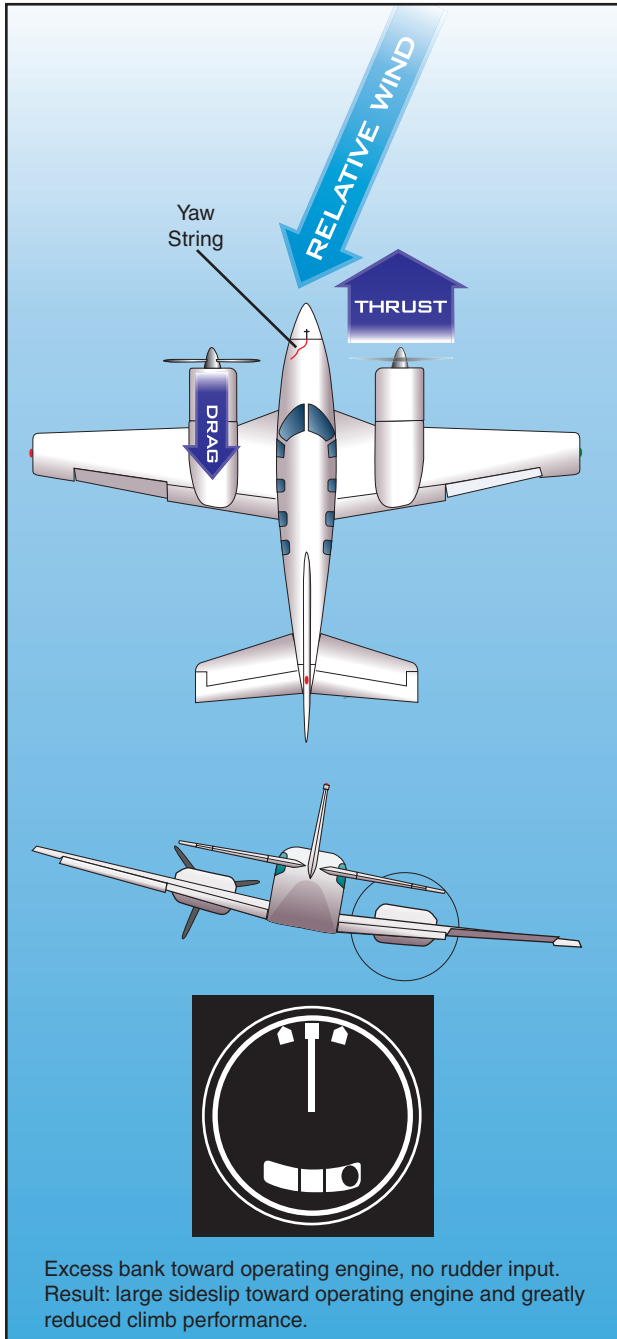

Figure 12-17. Excessive bank engine-out flight.

result is zero sideslip and maximum climb performance. [Figure 12-18] Any attitude other than zero sideslip increases drag, decreasing performance. V_{MC} under these circumstances will be higher than published, as less than the 5° bank certification limit is employed.

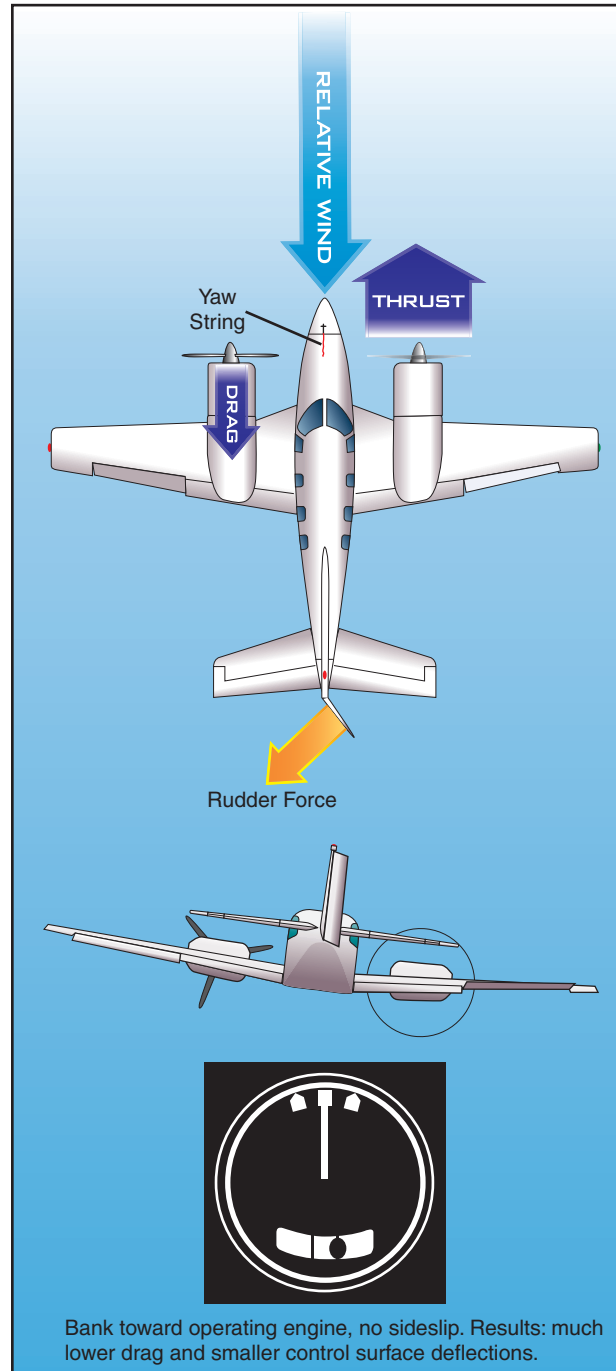
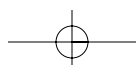

Figure 12-18. Zero sideslip engine-out flight.

- Rudder and ailerons used together in the proper combination will result in a bank of approximately 2° towards the operative engine. The ball will be displaced approximately one-third to one-half towards the operative engine. The

The precise condition of zero sideslip (bank angle and ball position) varies slightly from model to model, and with available power and airspeed. If the airplane is not equipped with counter-rotating propellers, it will also vary slightly with the engine failed due to P-factor. The foregoing zero sideslip recommendations apply to



reciprocating engine multiengine airplanes flown at V_{YSE} with the inoperative engine feathered. The zero sideslip ball position for straight flight is also the zero sideslip position for turning flight.

When bank angle is plotted against climb performance for a hypothetical twin, zero sideslip results in the best (however marginal) climb performance or the least rate of descent. Zero bank (all rudder to counteract yaw) degrades climb performance as a result of moderate sideslip. Using bank angle alone (no rudder) severely degrades climb performance as a result of a large sideslip.

The actual bank angle for zero sideslip varies among airplanes from one and one-half to two and one-half degrees. The position of the ball varies from one-third to one-half of a ball width from instrument center.

For any multiengine airplane, zero sideslip can be confirmed through the use of a yaw string. A yaw string is a piece of string or yarn approximately 18 to 36 inches in length, taped to the base of the windshield, or to the nose near the windshield, along the airplane centerline. In two-engine coordinated flight, the relative wind will cause the string to align itself with the longitudinal axis of the airplane, and it will position itself straight up the center of the windshield. This is zero sideslip. Experimentation with slips and skids will vividly display the location of the relative wind. Adequate altitude and flying speed must be maintained while accomplishing these maneuvers.

With an engine set to zero thrust (or feathered) and the airplane slowed to V_{YSE} , a climb with maximum power on the remaining engine will reveal the precise bank angle and ball deflection required for zero sideslip and best climb performance. Zero sideslip will again be indicated by the yaw string when it aligns itself vertically on the windshield. There will be very minor changes from this attitude depending upon the engine failed (with noncounter-rotating propellers), power available, airspeed and weight; but without more sensitive testing equipment, these changes are difficult to detect. The only significant difference would be the pitch attitude required to maintain V_{YSE} under different density altitude, power available, and weight conditions.

If a yaw string is attached to the airplane at the time of a V_{MC} demonstration, it will be noted that V_{MC} occurs under conditions of sideslip. V_{MC} was **not** determined under conditions of zero sideslip during aircraft certification and zero sideslip is **not** part of a V_{MC} demonstration for pilot certification.

To review, there are two different sets of bank angles used in one-engine-inoperative flight.

- To maintain directional control of a multiengine airplane suffering an engine failure at low speeds (such as climb), momentarily bank **at least** 5° , and a maximum of 10° towards the operative engine as the pitch attitude for V_{YSE} is set. This maneuver should be instinctive to the proficient multiengine pilot and take only 1 to 2 seconds to attain. It is held just long enough to assure directional control as the pitch attitude for V_{YSE} is assumed.
- To obtain the best climb performance, the airplane must be flown at V_{YSE} and zero sideslip, with the failed engine feathered and maximum available power from the operating engine. Zero sideslip is approximately 2° of bank toward the operating engine and a one-third to one-half ball deflection, also toward the operating engine. The precise bank angle and ball position will vary somewhat with make and model and power available. If above the airplane's single-engine ceiling, this attitude and configuration will result in the minimum rate of sink.

In OEI flight at low altitudes and airspeeds such as the initial climb after takeoff, pilots must operate the airplane so as to guard against the three major accident factors: (1) loss of directional control, (2) loss of performance, and (3) loss of flying speed. All have equal potential to be lethal. Loss of flying speed will not be a factor, however, when the airplane is operated with due regard for directional control and performance.

SLOW FLIGHT

There is nothing unusual about maneuvering during slow flight in a multiengine airplane. Slow flight may be conducted in straight-and-level flight, turns, in the clean configuration, landing configuration, or at any other combination of landing gear and flaps. Pilots should closely monitor cylinder head and oil temperatures during slow flight. Some high performance multiengine airplanes tend to heat up fairly quickly under some conditions of slow flight, particularly in the landing configuration.

Simulated engine failures should not be conducted during slow flight. The airplane will be well below V_{SSE} and very close to V_{MC} . Stability, stall warning or stall avoidance devices should not be disabled while maneuvering during slow flight.

STALLS

Stall characteristics vary among multiengine airplanes just as they do with single-engine airplanes, and therefore, it is important to be familiar with them. The application of power upon stall recovery, however, has a significantly greater effect during stalls in a

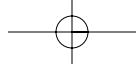

twin than a single-engine airplane. In the twin, an application of power blows large masses of air from the propellers directly over the wings, producing a significant amount of lift in addition to the expected thrust. The multiengine airplane, particularly at light operating weights, typically has a higher thrust-to-weight ratio, making it quicker to accelerate out of a stalled condition.

In general, stall recognition and recovery training in twins is performed similar to any high performance single-engine airplane. However, for twins, all stall maneuvers should be planned so as to be completed at least 3,000 feet AGL.

Single-engine stalls or stalls with significantly more power on one engine than the other should not be attempted due to the likelihood of a departure from controlled flight and possible spin entry. Similarly, simulated engine failures should not be performed during stall entry and recovery.

POWER-OFF STALLS (APPROACH AND LANDING)

Power-off stalls are practiced to simulate typical approach and landing scenarios. To initiate a power-off stall maneuver, the area surrounding the airplane should first be cleared for possible traffic. The airplane should then be slowed and configured for an approach and landing. A stabilized descent should be established (approximately 500 f.p.m.) and trim adjusted. The pilot should then transition smoothly from the stabilized descent attitude, to a pitch attitude that will induce a stall. Power is reduced further during this phase, and trimming should cease at speeds slower than takeoff.

When the airplane reaches a stalled condition, the recovery is accomplished by simultaneously reducing the angle of attack with coordinated use of the flight controls and smoothly applying takeoff or specified power. The flap setting should be reduced from full to approach, or as recommended by the manufacturer. Then with a positive rate of climb, the landing gear is selected up. The remaining flaps are then retracted as a climb has commenced. This recovery process should be completed with a minimum loss of altitude, appropriate to the aircraft characteristics.

The airplane should be accelerated to V_X (if simulated obstacles are present) or V_Y during recovery and climb. Considerable forward elevator/stabilator pressure will be required after the stall recovery as the airplane accelerates to V_X or V_Y . Appropriate trim input should be anticipated.

Power-off stalls may be performed with wings level, or from shallow and medium banked turns. When recovering from a stall performed from turning flight, the

angle of attack should be reduced prior to leveling the wings. Flight control inputs should be coordinated.

It is usually not advisable to execute full stalls in multiengine airplanes because of their relatively high wing loading. Stall training should be limited to approaches to stalls and when a stall condition occurs. Recoveries should be initiated at the onset, or decay of control effectiveness, or when the first physical indication of the stall occurs.

POWER-ON STALLS (TAKEOFF AND DEPARTURE)

Power-on stalls are practiced to simulate typical takeoff scenarios. To initiate a power-on stall maneuver, the area surrounding the airplane should always be cleared to look for potential traffic. The airplane is slowed to the manufacturer's recommended lift-off speed. The airplane should be configured in the takeoff configuration. Trim should be adjusted for this speed. Engine power is then increased to that recommended in the AFM/POH for the practice of power-on stalls. In the absence of a recommended setting, use approximately 65 percent of maximum available power while placing the airplane in a pitch attitude that will induce a stall. Other specified (reduced) power settings may be used to simulate performance at higher gross weights and density altitudes.

When the airplane reaches a stalled condition, the recovery is made by simultaneously lowering the angle of attack with coordinated use of the flight controls and applying power as appropriate.

However, if simulating limited power available for high gross weight and density altitude situations, the power during the recovery should be limited to that specified. The recovery should be completed with a minimum loss of altitude, appropriate to aircraft characteristics.

The landing gear should be retracted when a positive rate of climb is attained, and flaps retracted, if flaps were set for takeoff. The target airspeed on recovery is V_X if (simulated) obstructions are present, or V_Y . The pilot should anticipate the need for nosedown trim as the airplane accelerates to V_X or V_Y after recovery.

Power-on stalls may be performed from straight flight or from shallow and medium banked turns. When recovering from a power-on stall performed from turning flight, the angle of attack should be reduced prior to leveling the wings, and the flight control inputs should be coordinated.

SPIN AWARENESS

No multiengine airplane is approved for spins, and their spin recovery characteristics are generally very

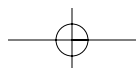

poor. It is therefore necessary to practice spin avoidance and maintain a high awareness of situations that can result in an inadvertent spin.

In order to spin any airplane, it must first be stalled. At the stall, a yawing moment must be introduced. In a multiengine airplane, the yawing moment may be generated by rudder input or asymmetrical thrust. It follows, then, that spin awareness be at its greatest during V_{MC} demonstrations, stall practice, slow flight, or any condition of high asymmetrical thrust, particularly at low speed/high angle of attack. Single-engine stalls are **not** part of any multiengine training curriculum.

A situation that may inadvertently degrade into a spin entry is a simulated engine failure introduced at an inappropriately low speed. No engine failure should ever be introduced below safe, intentional one-engine-inoperative speed (V_{SSE}). If no V_{SSE} is published, use V_{YSE} . The “necessity” of simulating engine failures at low airspeeds is erroneous. Other than training situations, the multiengine airplane is only operated below V_{SSE} for mere seconds just after lift-off or during the last few dozen feet of altitude in preparation for landing.

For spin avoidance when practicing engine failures, the flight instructor should pay strict attention to the maintenance of proper airspeed and bank angle as the student executes the appropriate procedure. The instructor should also be particularly alert during stall and slow flight practice. Forward center-of-gravity positions result in favorable stall and spin avoidance characteristics, but do not eliminate the hazard.

When performing a V_{MC} demonstration, the instructor should also be alert for any sign of an impending stall. The student may be highly focused on the directional control aspect of the maneuver to the extent that impending stall indications go unnoticed. If a V_{MC} demonstration cannot be accomplished under existing conditions of density altitude, it may, for training purposes, be done utilizing the rudder blocking technique described in the following section.

As very few twins have ever been spin-tested (none are required to), the recommended spin recovery techniques are based only on the best information available. The departure from controlled flight may be quite abrupt and possibly disorienting. The direction of an upright spin can be confirmed from the turn needle or the symbolic airplane of the turn coordinator, if necessary. Do not rely on the ball position or other instruments.

If a spin is entered, most manufacturers recommend immediately retarding both throttles to idle, applying

full rudder opposite the direction of rotation, and applying full forward elevator/stabilator pressure (with ailerons neutral). These actions should be taken as near simultaneously as possible. The controls should then be held in that position. Recovery, if possible, will take considerable altitude. The longer the delay from entry until taking corrective action, the less likely that recovery will be successful.

ENGINE INOPERATIVE—LOSS OF DIRECTIONAL CONTROL DEMONSTRATION

An engine inoperative—loss of directional control demonstration, often referred to as a “ V_{MC} demonstration,” is a required task on the practical test for a multiengine class rating. A thorough knowledge of the factors that affect V_{MC} , as well as its definition, is essential for multiengine pilots, and as such an essential part of that required task. V_{MC} is a speed established by the manufacturer, published in the AFM/POH, and marked on most airspeed indicators with a red radial line. The multiengine pilot must understand that V_{MC} is **not** a fixed airspeed under all conditions. V_{MC} is a fixed airspeed only for the very specific set of circumstances under which it was determined during aircraft certification. [Figure 12-19]

In reality, V_{MC} varies with a variety of factors as outlined below. The V_{MC} noted in practice and demonstration, or in actual single-engine operation, could be less or even greater than the published value, depending upon conditions and technique.

In aircraft certification, V_{MC} is the sea level calibrated airspeed at which, when the critical engine is suddenly made inoperative, it is possible to maintain control of the airplane with that engine still inoperative and then maintain straight flight at the same speed with an angle of bank of not more than 5° .

The foregoing refers to the determination of V_{MC} under “dynamic” conditions. This technique is only used by highly experienced flight test pilots during aircraft certification. It is never to be attempted outside of these circumstances.

In aircraft certification, there is also a determination of V_{MC} under “static,” or steady-state conditions. If there is a difference between the dynamic and static speeds, the higher of the two is published as V_{MC} . The static determination is simply the ability to maintain straight flight at V_{MC} with a bank angle of not more than 5° . This more closely resembles the V_{MC} demonstration required in the practical test for a multiengine class rating.

The AFM/POH-published V_{MC} is determined with the “critical” engine inoperative. The critical engine is the

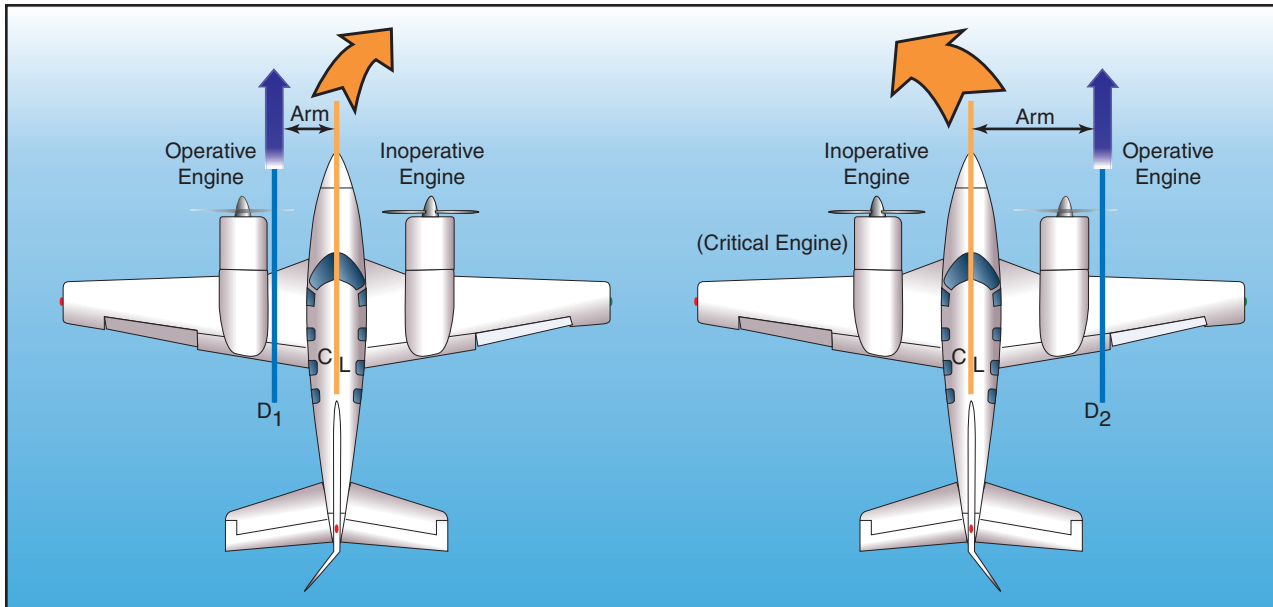

Figure 12-19. Forces created during single-engine operation.

engine whose failure has the most adverse effect on directional control. On twins with each engine rotating in conventional, clockwise rotation as viewed from the pilot's seat, the critical engine will be the left engine.

Multiengine airplanes are subject to P-factor just as single-engine airplanes are. The descending propeller blade of each engine will produce greater thrust than the ascending blade when the airplane is operated under power and at positive angles of attack. The descending propeller blade of the right engine is also a greater distance from the center of gravity, and therefore has a longer moment arm than the descending propeller blade of the left engine. As a result, failure of the left engine will result in the most asymmetrical thrust (adverse yaw) as the right engine will be providing the remaining thrust. [Figure 12-19]

Many twins are designed with a counter-rotating right engine. With this design, the degree of asymmetrical thrust is the same with either engine inoperative. No engine is more critical than the other, and a V_{MC} demonstration may be performed with either engine windmilling.

In aircraft certification, dynamic V_{MC} is determined under the following conditions.

- **Maximum available takeoff power.** V_{MC} increases as power is increased on the operating engine. With normally aspirated engines, V_{MC} is highest at takeoff power and sea level, and decreases with altitude. With turbocharged engines, takeoff power, and therefore V_{MC} , remains constant with increases in altitude up to the engine's critical altitude (the altitude where

the engine can no longer maintain 100 percent power). Above the critical altitude, V_{MC} decreases just as it would with a normally aspirated engine, whose critical altitude is sea level. V_{MC} tests are conducted at a variety of altitudes. The results of those tests are then extrapolated to a single, sea level value.

- **Windmilling propeller.** V_{MC} increases with increased drag on the inoperative engine. V_{MC} is highest, therefore, when the critical engine propeller is windmilling at the low pitch, high r.p.m. blade angle. V_{MC} is determined with the critical engine propeller windmilling in the takeoff position, unless the engine is equipped with an autofeather system.
- **Most unfavorable weight and center-of-gravity position.** V_{MC} increases as the center of gravity is moved aft. The moment arm of the rudder is reduced, and therefore its effectivity is reduced, as the center of gravity is moved aft. At the same time, the moment arm of the propeller blade is increased, aggravating asymmetrical thrust. Invariably, the aft-most CG limit is the most unfavorable CG position. Currently, 14 CFR part 23 calls for V_{MC} to be determined at the most unfavorable weight. For twins certificated under CAR 3 or early 14 CFR part 23, the weight at which V_{MC} was determined was not specified. V_{MC} increases as weight is reduced. [Figure 12-20]
- **Landing gear retracted.** V_{MC} increases when the landing gear is retracted. Extended landing gear aids directional stability, which tends to decrease V_{MC} .

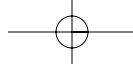

- **Wing flaps in the takeoff position.** For most twins, this will be 0° of flaps.
- **Cowl flaps in the takeoff position.**
- **Airplane trimmed for takeoff.**
- **Airplane airborne and the ground effect negligible.**
- **Maximum of 5° angle of bank.** V_{MC} is highly sensitive to bank angle. To prevent claims of an unrealistically low V_{MC} speed in aircraft certification, the manufacturer is permitted to use a maximum of a 5° bank angle toward the operative engine. The horizontal component of lift generated by the bank assists the rudder in counteracting the asymmetrical thrust of the operative engine. The bank angle works in the manufacturer's favor in lowering V_{MC} .

V_{MC} is reduced significantly with increases in bank angle. Conversely, V_{MC} increases significantly with decreases in bank angle. Tests have shown that V_{MC} may increase more than 3 knots for each degree of bank angle less than 5° . Loss of directional control may be experienced at speeds almost 20 knots above published V_{MC} when the wings are held level.

The 5° bank angle maximum is a regulatory limit imposed upon manufacturers in aircraft certification. The 5° bank does **not** inherently establish zero sideslip or best single-engine climb performance. Zero sideslip, and therefore best single-engine climb performance, occurs at bank angles significantly less than 5° . The determination of V_{MC} in certification is solely concerned with the minimum speed for directional control under a very specific set of circumstances, and has

nothing to do with climb performance, nor is it the optimum airplane attitude or configuration for climb performance.

During dynamic V_{MC} determination in aircraft certification, cuts of the critical engine using the mixture control are performed by flight test pilots while gradually reducing the speed with each attempt. V_{MC} is the minimum speed at which directional control could be maintained within 20° of the original entry heading when a cut of the critical engine was made. During such tests, the climb angle with both engines operating was high, and the pitch attitude following the engine cut had to be quickly lowered to regain the initial speed. Pilots should never attempt to demonstrate V_{MC} with an engine cut from high power, and never intentionally fail an engine at speeds less than V_{SSE} .

The actual demonstration of V_{MC} and recovery in flight training more closely resembles static V_{MC} determination in aircraft certification. For a demonstration, the pilot should select an altitude that will allow completion of the maneuver at least 3,000 feet AGL. The following description assumes a twin with noncounter-rotating engines, where the left engine is critical.

With the landing gear retracted and the flaps set to the takeoff position, the airplane should be slowed to approximately 10 knots above V_{SSE} or V_{YSE} (whichever is higher) and trimmed for takeoff. For the remainder of the maneuver, the trim setting should not be altered. An entry heading should be selected and high r.p.m. set on both propeller controls. Power on the left engine should be throttled back to idle as the right engine power is advanced to the takeoff setting. The landing gear warning horn will sound as long as a

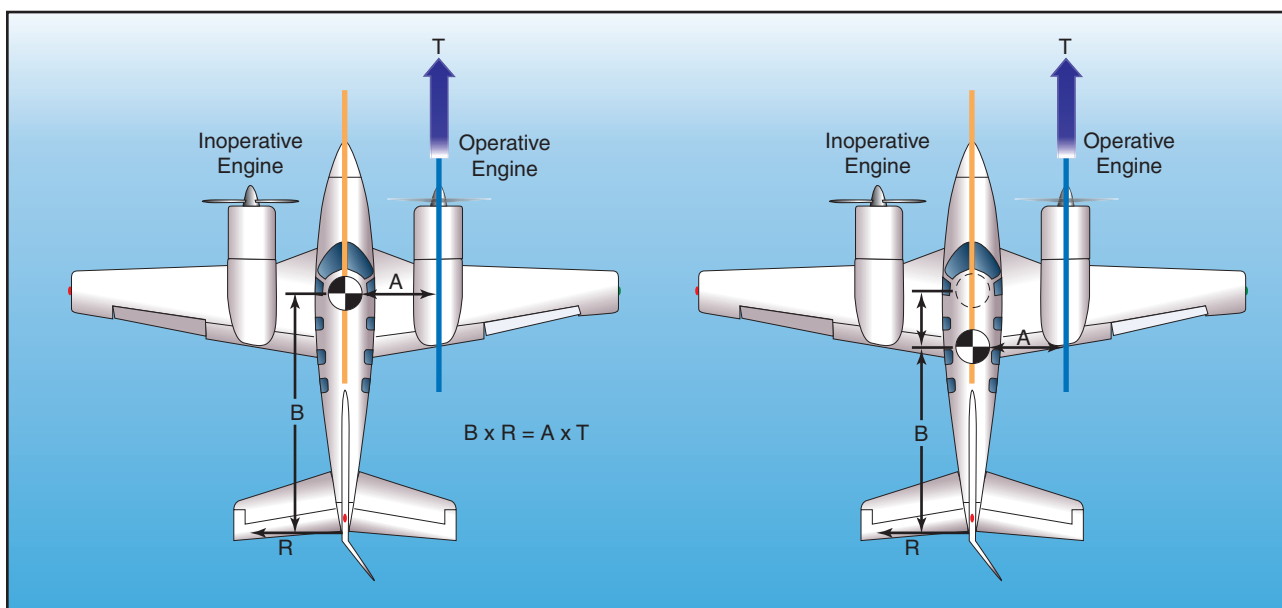
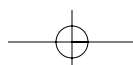

Figure 12-20. Effect of CG location on yaw.



throttle is retarded. The pilots should continue to carefully listen, however, for the stall warning horn, if so equipped, or watch for the stall warning light. The left yawing and rolling moment of the asymmetrical thrust is counteracted primarily with right rudder. A bank angle of 5° (a right bank, in this case) should also be established.

While maintaining entry heading, the pitch attitude is slowly increased to decelerate at a rate of 1 knot per second (no faster). As the airplane slows and control effectivity decays, the increasing yawing tendency should be counteracted with additional rudder pressure. Aileron displacement will also increase in order to maintain 5° of bank. An airspeed is soon reached where full right rudder travel and a 5° right bank can no longer counteract the asymmetrical thrust, and the airplane will begin to yaw uncontrollably to the left.

The moment the pilot first recognizes the uncontrollable yaw, or experiences **any** symptom associated with a stall, the operating engine throttle should be sufficiently retarded to stop the yaw as the pitch attitude is decreased. Recovery is made with a minimum loss of altitude to straight flight on the entry heading at V_{SSE} or V_{YSE} , before setting symmetrical power. The recovery should not be attempted by increasing power on the windmilling engine alone.

To keep the foregoing description simple, there were several important background details that were not covered. The rudder pressure during the demonstration can be quite high. In certification, 150 pounds of force is permitted before the limiting factor becomes rudder pressure, not rudder travel. Most twins will run out of rudder travel long before 150 pounds of pressure is required. Still, it will seem considerable.

Maintaining altitude is **not** a criterion in accomplishing this maneuver. This is a demonstration of controllability, not performance. Many airplanes will lose (or gain) altitude during the demonstration. Begin the maneuver at an altitude sufficient to allow completion by 3,000 feet AGL.

As discussed earlier, with normally aspirated engines, V_{MC} decreases with altitude. Stalling speed (V_S), however, remains the same. Except for a few models, published V_{MC} is almost always higher than V_S . At sea level, there is usually a margin of several knots between V_{MC} and V_S , but the margin decreases with altitude, and at some altitude, V_{MC} and V_S are the same. [Figure 12-21]

Should a stall occur while the airplane is under asymmetrical power, particularly high asymmetrical power, a spin entry is likely. The yawing moment induced from asymmetrical thrust is little different from that

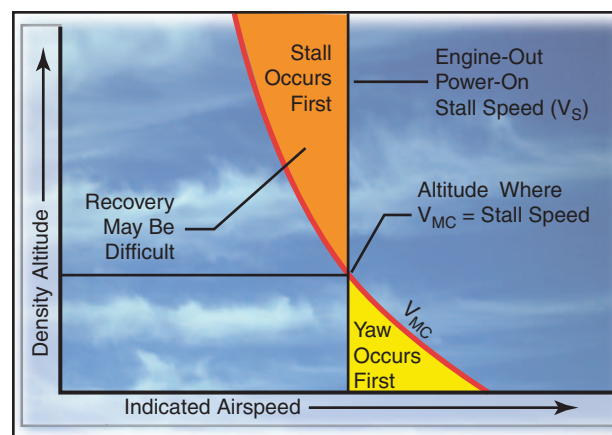

Figure 12-21. Graph depicting relationship of V_{MC} to V_S .

induced by full rudder in an intentional spin in the appropriate model of single-engine airplane. In this case, however, the airplane will depart controlled flight in the direction of the idle engine, not in the direction of the applied rudder. Twins are not required to demonstrate recoveries from spins, and their spin recovery characteristics are generally very poor.

Where V_S is encountered at or before V_{MC} , the departure from controlled flight may be quite sudden, with strong yawing and rolling tendencies to the inverted position, and a spin entry. Therefore, during a V_{MC} demonstration, if there are **any** symptoms of an impending stall such as a stall warning light or horn, airframe or elevator buffet, or rapid decay in control effectiveness, the maneuver should be terminated immediately, the angle of attack reduced as the throttle is retarded, and the airplane returned to the entry airspeed. It should be noted that if the pilots are wearing headsets, the sound of a stall warning horn will tend to be masked.

The V_{MC} demonstration only shows the earliest onset of a loss of directional control. It is not a loss of control of the airplane when performed in accordance with the foregoing procedures. A stalled condition should **never** be allowed to develop. Stalls should never be performed with asymmetrical thrust and the V_{MC} demonstration should never be allowed to degrade into a single-engine stall. A V_{MC} demonstration that is allowed to degrade into a single-engine stall with high asymmetrical thrust is very likely to result in a loss of control of the airplane.

An actual demonstration of V_{MC} may not be possible under certain conditions of density altitude, or with airplanes whose V_{MC} is equal to or less than V_S . Under those circumstances, as a training technique, a demonstration of V_{MC} may be safely conducted by artificially limiting rudder travel to simulate maximum available rudder. Limiting rudder travel should be accomplished at a speed well above V_S (approximately 20 knots).

The rudder limiting technique avoids the hazards of spinning as a result of stalling with high asymmetrical power, yet is effective in demonstrating the loss of directional control.

The V_{MC} demonstration should never be performed from a high pitch attitude with both engines operating and then reducing power on one engine. The preceding discussion should also give ample warning as to why engine failures are never to be performed at low airspeeds. An unfortunate number of airplanes and pilots have been lost from unwarranted simulated engine failures at low airspeeds that degenerated into loss of control of the airplane. V_{SSE} is the minimum airspeed at which any engine failure should be simulated.

MULTIENGINE TRAINING CONSIDERATIONS

Flight training in a multiengine airplane can be safely accomplished if both the instructor and the student are cognizant of the following factors.

- No flight should ever begin without a thorough preflight briefing of the objectives, maneuvers, expected student actions, and completion standards.
- A clear understanding must be reached as to how simulated emergencies will be introduced, and what action the student is expected to take.

The introduction, practice, and testing of emergency procedures has always been a sensitive subject. Surprising a multiengine student with an emergency without a thorough briefing beforehand has no place in flight training. Effective training must be carefully balanced with safety considerations. Simulated engine failures, for example, can very quickly become actual emergencies or lead to loss of the airplane when approached carelessly. Pulling circuit breakers can lead to a subsequent gear up landing. Stall-spin accidents in training for emergencies rival the number of stall-spin accidents from actual emergencies.

All normal, abnormal, and emergency procedures can and should be introduced and practiced in the airplane as it sits on the ground, power off. In this respect, the airplane is used as a cockpit procedures trainer (CPT), ground trainer, or simulator. The value of this training should never be underestimated. The engines do not have to be operating for real learning to occur. Upon completion of a training session, care should be taken to return items such as switches, valves, trim, fuel selectors, and circuit breakers to their normal positions.

Pilots who do not use a checklist effectively will be at a significant disadvantage in multiengine airplanes. Use of the checklist is essential to safe operation of

airplanes and no flight should be conducted without one. The manufacturer's checklist or an aftermarket checklist for the specific make, model, and model year should be used. If there is a procedural discrepancy between the checklist and AFM/POH, then the AFM/POH always takes precedence.

Certain immediate action items (such as the response to an engine failure in a critical phase of flight) should be committed to memory. After they are accomplished, and as work load permits, the pilot should verify the action taken with a printed checklist.

Simulated engine failures during the takeoff ground roll should be accomplished with the mixture control. The simulated failure should be introduced at a speed no greater than 50 percent of V_{MC} . If the student does not react promptly by retarding both throttles, the instructor can always pull the other mixture.

The FAA recommends that all in-flight simulated engine failures below 3,000 feet AGL be introduced with a smooth reduction of the throttle. Thus, the engine is kept running and is available for instant use, if necessary. Throttle reduction should be smooth rather than abrupt to avoid abusing the engine and possibly causing damage. All inflight engine failures must be conducted at V_{SSE} or above.

If the engines are equipped with dynamic crankshaft counterweights, it is essential to make throttle reductions for simulated failures smoothly. Other areas leading to dynamic counterweight damage include high r.p.m. and low manifold pressure combinations, overboosting, and propeller feathering. Severe damage or repetitive abuse to counterweights will eventually lead to engine failure. Dynamic counterweights are found on larger, more complex engines—instructors should check with maintenance personnel or the engine manufacturer to determine if their engines are so equipped.

When an instructor simulates an engine failure, the student should respond with the appropriate memory items and retard the propeller control towards the FEATHER position. Assuming zero thrust will be set, the instructor should promptly move the propeller control forward and set the appropriate manifold pressure and r.p.m. It is vital that the student be kept informed of the instructor's intentions. At this point the instructor may state words to the effect, "I have the right engine; you have the left. I have set zero thrust and the right engine is simulated feathered." There should never be any ambiguity as to who is operating what systems or controls.

Following a simulated engine failure, the instructor should continue to care for the "failed" engine just as the student cares for the operative engine. If zero thrust

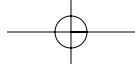

is set to simulate a feathered propeller, the cowl flap should be closed and the mixture leaned. An occasional clearing of the engine is also desirable. If possible, avoid high power applications immediately following a prolonged cool-down at a zero-thrust power setting. The flight instructor must impress on the student multiengine pilot the critical importance of feathering the propeller in a timely manner should an actual engine failure situation be encountered. A windmilling propeller, in many cases, has given the improperly trained multiengine pilot the mistaken perception that the failed engine is still developing useful thrust, resulting in a psychological reluctance to feather, as feathering results in the cessation of propeller rotation. The flight instructor should spend ample time demonstrating the difference in the performance capabilities of the airplane with a simulated feathered propeller (zero thrust) as opposed to a windmilling propeller.

All actual propeller feathering should be performed at altitudes and positions where safe landings on established airports could be readily accomplished. Feathering and restart should be planned so as to be completed no lower than 3,000 feet AGL. At certain elevations and with many popular multiengine training airplanes, this may be above the single-engine service ceiling, and level flight will not be possible.

Repeated feathering and unfeathering is hard on the engine and airframe, and should be done only as absolutely necessary to ensure adequate training. The FAA's practical test standards for a multiengine class rating requires the feathering and unfeathering of one propeller during flight in airplanes in which it is safe to do so.

While much of this chapter has been devoted to the unique flight characteristics of the multiengine airplane with one engine inoperative, the modern, well-maintained reciprocating engine is remarkably reliable. Simulated engine failures at extremely low altitudes (such as immediately after lift-off) and/or below V_{SSE} are undesirable in view of the non-existent safety margins involved. The high risk of simulating an engine failure below 200 feet AGL does not warrant practicing such maneuvers.

For training in maneuvers that would be hazardous in flight, or for initial and recurrent qualification in an advanced multiengine airplane, a simulator training center or manufacturer's training course should be

given consideration. Comprehensive training manuals and classroom instruction are available along with system training aids, audio/visuals, and flight training devices and simulators. Training under a wide variety of environmental and aircraft conditions is available through simulation. Emergency procedures that would be either dangerous or impossible to accomplish in an airplane can be done safely and effectively in a flight training device or simulator. The flight training device or simulator need not necessarily duplicate the specific make and model of airplane to be useful. Highly effective instruction can be obtained in training devices for other makes and models as well as generic training devices.

The majority of multiengine training is conducted in four to six-place airplanes at weights significantly less than maximum. Single-engine performance, particularly at low density altitudes, may be deceptively good. To experience the performance expected at higher weights, altitudes, and temperatures, the instructor should occasionally artificially limit the amount of manifold pressure available on the operative engine. Airport operations above the single-engine ceiling can also be simulated in this manner. Loading the airplane with passengers to practice emergencies at maximum takeoff weight is not appropriate.

The use of the touch-and-go landing and takeoff in flight training has always been somewhat controversial. The value of the learning experience must be weighed against the hazards of reconfiguring the airplane for takeoff in an extremely limited time as well as the loss of the follow-through ordinarily experienced in a full stop landing. Touch and goes are not recommended during initial aircraft familiarization in multiengine airplanes.

If touch and goes are to be performed at all, the student and instructor responsibilities need to be carefully briefed prior to each flight. Following touchdown, the student will ordinarily maintain directional control while keeping the left hand on the yoke and the right hand on the throttles. The instructor resets the flaps and trim and announces when the airplane has been reconfigured. The multiengine airplane needs considerably more runway to perform a touch and go than a single-engine airplane. A full stop-taxi back landing is preferable during initial familiarization. Solo touch and goes in twins are strongly discouraged.

