

Performance Comparison of Residential Hot Water Systems

**Period of Performance:
January 30, 2001 through July 29, 2002**

J. Wiehagen and J.L. Sikora
*NAHB Research Center
Upper Marlboro, Maryland*



NREL

National Renewable Energy Laboratory

1617 Cole Boulevard
Golden, Colorado 80401-3393

NREL is a U.S. Department of Energy Laboratory
Operated by Midwest Research Institute • Battelle • Bechtel

Contract No. DE-AC36-99-GO10337

Performance Comparison of Residential Hot Water Systems

**Period of Performance:
January 30, 2001 through July 29, 2002**

J. Wiehagen and J.L. Sikora
*NAHB Research Center
Upper Marlboro, Maryland*

NREL Technical Monitor: D. Barley

Prepared under Subcontract No. AAX-1-30482-01



NREL

National Renewable Energy Laboratory

1617 Cole Boulevard
Golden, Colorado 80401-3393

NREL is a U.S. Department of Energy Laboratory
Operated by Midwest Research Institute • Battelle • Bechtel

Contract No. DE-AC36-99-GO10337

NOTICE

This report was prepared as an account of work sponsored by an agency of the United States government. Neither the United States government nor any agency thereof, nor any of their employees, makes any warranty, express or implied, or assumes any legal liability or responsibility for the accuracy, completeness, or usefulness of any information, apparatus, product, or process disclosed, or represents that its use would not infringe privately owned rights. Reference herein to any specific commercial product, process, or service by trade name, trademark, manufacturer, or otherwise does not necessarily constitute or imply its endorsement, recommendation, or favoring by the United States government or any agency thereof. The views and opinions of authors expressed herein do not necessarily state or reflect those of the United States government or any agency thereof.

Available electronically at <http://www.osti.gov/bridge>

Available for a processing fee to U.S. Department of Energy
and its contractors, in paper, from:

U.S. Department of Energy
Office of Scientific and Technical Information
P.O. Box 62
Oak Ridge, TN 37831-0062
phone: 865.576.8401
fax: 865.576.5728
email: reports@adonis.osti.gov

Available for sale to the public, in paper, from:

U.S. Department of Commerce
National Technical Information Service
5285 Port Royal Road
Springfield, VA 22161
phone: 800.553.6847
fax: 703.605.6900
email: orders@ntis.fedworld.gov
online ordering: <http://www.ntis.gov/ordering.htm>



TABLE OF CONTENTS

Acknowledgements.....	iv
Executive Summary.....	1
1. Background.....	3
2. Experimental Test Apparatus.....	3
3. Instrumentation and Controls.....	7
4. Process Control.....	9
5. Data Acquisition.....	9
6. Experimental Operation.....	11
7. Methodology.....	11
7.1 Hot Water Data.....	11
7.2 Tests Conducted.....	13
7.3 Data Processing.....	13
7.3.1 Actual Flow Rate, Design Flow Rate, and Assigned Flow Rate.....	13
7.3.2 Energy and Efficiency Calculations.....	14
8. Calibration.....	15
9. Model Calibration.....	16
9.1 Effect of Cold Water Inlet Temperature Location.....	16
9.2 Environmental Conditions during Experimental Testing.....	17
9.3 Overall System Efficiency.....	17
9.4 Distribution Losses.....	19
9.5 Water Heater Efficiency.....	20
9.6 Delivery Temperature Performance.....	21
10. Results and Analysis—Annual Simulations.....	23
10.1 Annual Electrical Energy Consumption.....	24
10.2 Annual System Efficiency.....	25
10.3 Annual Delivered Outlet Energy.....	26
10.4 Normalized Electrical Energy Use.....	27
10.5 Simulation of System Design Options.....	28
11. Factors Affecting Hot-Water Energy Use.....	31
11.1 Water Purging from Hot-Water Pipe.....	31
11.2 Unintended Hot Water Use.....	32
12. Installed System Cost.....	33
12.1 Whole-House Demand Water Heater.....	33
12.2 Demand Water Heater at Each Outlet.....	33
13. Builder and Contractor Response to Demand Water Heaters.....	37
13.1 Typical Systems Used.....	37
13.2 Installed Cost.....	38
13.3 Installation Process.....	38
13.4 Reliability.....	39
13.5 Stability of Delivery Temperature.....	39
13.6 Maintenance.....	39
13.7 Customer Satisfaction.....	39
13.8 Performance.....	39
14. Homeowner Response to Demand Water Heaters.....	40
15. Conclusions.....	41
16. Recommendations for Further Research.....	44
Appendix A. Survey of Builder and Contractor Response to Demand Hot Water Systems.....	45
Appendix B. Hot Water Use Profile for High- and Low-Use Homes — Actual Data.....	47

LIST OF FIGURES

Figure 1. Diagram of experimental setup—tree-type system	4
Figure 2. Diagram of experimental apparatus—parallel piping system	4
Figure 3. Partial piping system showing PEX and copper distribution systems, drains, and outlet measurement systems.....	5
Figure 4. Inlet measurement system	7
Figure 5. Inlet pressure monitoring and regulation system	7
Figure 6. Outlet measurement system	8
Figure 7. Process control system	9
Figure 8. Data logger to collect flow and temperature data.....	10
Figure 9. Power meter used to measure water heater energy use	10
Figure 10. Schematic diagram of measurement points for energy calculations	14
Figure 11. Environmental conditions during testing	17
Figure 12. Experimental overall system efficiency (unadjusted)	18
Figure 13. Simulated overall system efficiency.....	19
Figure 14. Measured pipe losses as a percentage of electrical input energy (unadjusted)	19
Figure 15. Simulated pipe losses as a percentage of electrical input energy	20
Figure 16. Experimental water-heating equipment efficiency (unadjusted).....	20
Figure 17. Simulated water-heating equipment efficiency	21
Figure 18. Experimental maximum delivery temperatures for each outlet.....	22
Figure 19. Simulated maximum hot water delivery temperatures.....	22
Figure 20. Annual simulated system efficiency.....	25
Figure 21. Annual delivered outlet energy	26
Figure 22. Breakdown of electrical energy input.....	27
Figure 23. Electric energy input to hot water system with normalized output energy	27
Figure 24. Total annual cost (mortgage plus utility) for hot water systems.....	36
Figure 25. Annual net cash flow for hot water systems.....	36
Figure 26. Annual cash flow using normalized output energy	37
Figure 27. Average daily hot water consumption for homes used in simulations	48
Figure 28. Annual hourly hot water use, high-use home.....	49
Figure 29. Annual hourly hot water use, low-use home	49
Figure 30. ASHRAE hot water load profile applied to actual use in high- and low-use homes ...	50
Figure 31. Maximum daily flow rate, high-use home	51
Figure 32. Daily maximum flow rate, low-use home	51
Figure 33. Frequency of flow rates in high-use home.....	52
Figure 34. Frequency of flow rates in low-use home	52
Figure 35. Draw duration in high-use home.....	53
Figure 36. Draw duration in low-use home	53

LIST OF TABLES

Table 1.	Location of Piping Outlets in Test Apparatus—Tree System	6
Table 2.	Location of Piping Outlets in Test Apparatus—Parallel Piping System.....	6
Table 3:	Data Flow Rate Bins and Experimental Design Flow Rate for Laboratory Experiment and Subsequent Simulations	12
Table 4:	Description of Tests Conducted	13
Table 5:	Inputs to Annual Simulation.....	24
Table 6:	Summary of Annual Electrical Energy Consumption for Demand and Tank Systems	25
Table 7:	Summary of Annual Simulation Results for Point-of-Use System versus Tank System.....	28
Table 8:	Simulated Electrical Demand Data for Distributed Hot Water Systems	29
Table 9:	Configuration and Costs for Distributed Point-of-Use Water Heater System	30
Table 10:	Installed Cost for Various Hot Water Systems.....	34
Table 11:	Summary of Annual Energy Cost and Installed Cost for Various Systems	35
Table 12:	Summary Results – Energy Performance	42
Table 13:	Summary Results – Estimated Costs and Savings.....	43

Acknowledgements

The primary authors of this report were Joe Wiehagen and Jeannie Leggett Sikora of the NAHB Research Center. Chris Fennell provided overall project management support for the REEP program, and Tom Kenney and Chris Fennell provided in-house technical review. The researchers thank the National Renewable Energy Laboratory for research funding and technical oversight and the manufacturers that supplied water heaters for testing.

Executive Summary

This report by the NAHB Research Center is a continuation of past Renewables and Energy Efficiency Program (REEP) technical efforts sponsored by the National Renewable Energy Laboratory (NREL) through 1999 and 2000. This work was undertaken to verify the estimated energy savings for hot water systems. The test results presented here support water heating energy savings reported in 2001.

Results of weekly performance testing and annual simulations of electric water-heating systems are presented. A laboratory test experiment was conducted to measure the energy performance of two different types of water heaters—electric storage tank and demand (tankless)—in two types of plumbing distribution systems—copper piping in a tree configuration and cross-linked polyethylene (PEX) piping in a parallel configuration. Two water-usage patterns were used in the week-long experiments and in the annual simulations: one representing a high-usage home and the other representing a low-usage home.

Using the Transient Energy System Simulation Tool, TRNSYS¹, a simulation model was developed to estimate energy consumption for each hot water system and to further simulate other system design options. The simulation model was calibrated with heat-transfer coefficients determined by experimental results. Annual simulations showed an increase in overall system efficiency of 12% for the demand water heater with a parallel piping distribution system over the storage tank water heater with copper piping for the high-use home and an increased efficiency of 26% for the low-use home. When normalizing the total output energy for each system, the electrical energy savings of the demand water heaters with a parallel piping system over the standard tank with a tree-piping system (tank/tree system) was 34% for the low-use home and 14% for the high-use home.

In addition, the energy analysis indicates that a parallel piping system combined with either a tank or demand heater results in energy savings of 6% for the high-use home and 13% for the low-use home. Furthermore, an economic analysis shows a positive annual cash flow for the parallel piping system, when considering the mortgage payment and electricity costs, over a standard tree plumbing system, regardless of the heater type. These results are consistent for both the high- and low-use homes.

A point-of-use model was subsequently developed to simulate a hot water system having multiple demand heaters distributed at the outlets and served by a tree-type supply piping (cold only). Because the heaters are located at the outlets, lower delivery temperatures are required. Using the point-of-use model, simulations show that the system efficiencies are nearly 100% and annual energy consumption can be reduced by almost 50% for the low-use home and 28% for the high-use home over a storage-tank water heater with a tree-type distribution system.

When improving the energy efficiency of the overall water-heating system, especially in the reduction of piping losses, the environmental benefits extend beyond those of reducing use of electricity or other fuels. Reductions in water use, often significant, may be obtained if the

¹ University of Wisconsin-Madison, Solar Energy Lab, <http://sel.me.wisc.edu/TRNSYS/Default.htm>.

period of time to wait for hot water to arrive at the outlet is reduced as with the parallel piping system or even eliminated as with the distributed-heater system. Other energy benefits occur when low, but frequent, unintentional uses of hot water, such as a single-handle kitchen faucet set near the cold-water position, are eliminated with demand heaters that do not activate at low flow rates.

1. Background

Under previous work supported by the National Renewable Energy Laboratory (NREL)² the NAHB Research Center performed TRNSYS³ simulations of domestic hot water systems to quantify the energy use of demand and storage-tank water-heating equipment and copper and plastic plumbing distribution systems in single-family homes. The hypothetical performance of plumbing systems was simulated using actual hot water flow data from two research sites in Ohio—one single-family home having higher-than-average daily hot water consumption and one single-family home having lower-than-average daily hot water consumption. The simulated plumbing system consisted of seven outlets (kitchen, laundry, half bath, and two outlets in each full bath) that were assigned a portion of the hot water use depending on the time of day.

Simulated estimates of energy use from this earlier study showed that energy savings up to 35% were possible by replacing a hot water storage tank and copper tree-type distribution system (tank/tree system) with a centrally located demand heater and a smaller diameter cross-linked polyethylene (PEX) parallel distribution system. Because of these promising results, laboratory tests were commissioned to validate the simulation model and to quantify water-heater performance under varied draw patterns and system configurations.

The goals of the research project were to:

- 1) Conduct laboratory testing to validate and refine a TRNSYS hot water system simulation model,
- 2) Measure energy performance of tank versus demand water heater and tree-type copper piping versus PEX parallel piping, and
- 3) Use the new TRNSYS model to evaluate different hot water system designs on an annual basis.⁴

2. Experimental Test Apparatus

A laboratory model, modified slightly from the hot water system previously simulated, was constructed in the NAHB Research Center laboratory. The system was operated under two flow regimes in the following configurations: 1) with a tank or demand water heater, and 2) with a copper tree-type or PEX parallel piping system.

Five hot water delivery outlets were constructed to replicate five major hot water use areas in a typical home: laundry, kitchen, two full baths, and one half bath. Five outlets were selected because most of the piping losses are accounted for by the five outlets and because alternative system designs using point-of-use water heaters would be designed with five units supplying hot water at each of the major hot water use areas. The experimental configuration is shown in Figure 1, Figure 2, and Figure 3 and described in Table 1 and Table 2.

² NAHB Research Center, *REEP Task 3 Report – Hot Water Simulation Modeling*, July 2000.

³ TRNSYS is a thermal-energy transient simulation program developed through the Solar Energy Laboratory at the University of Wisconsin.

⁴ Though two different demand hot water heaters were used in the testing, the specific performance of any one heater model was not the objective of this testing.

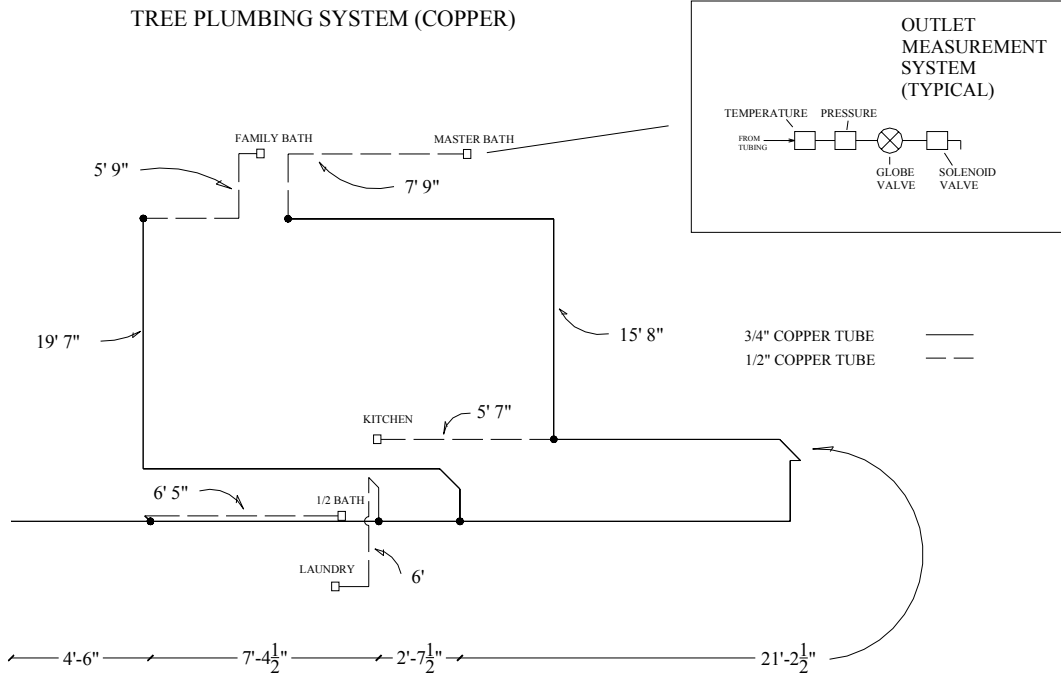

Figure 1. Diagram of experimental setup—tree-type system

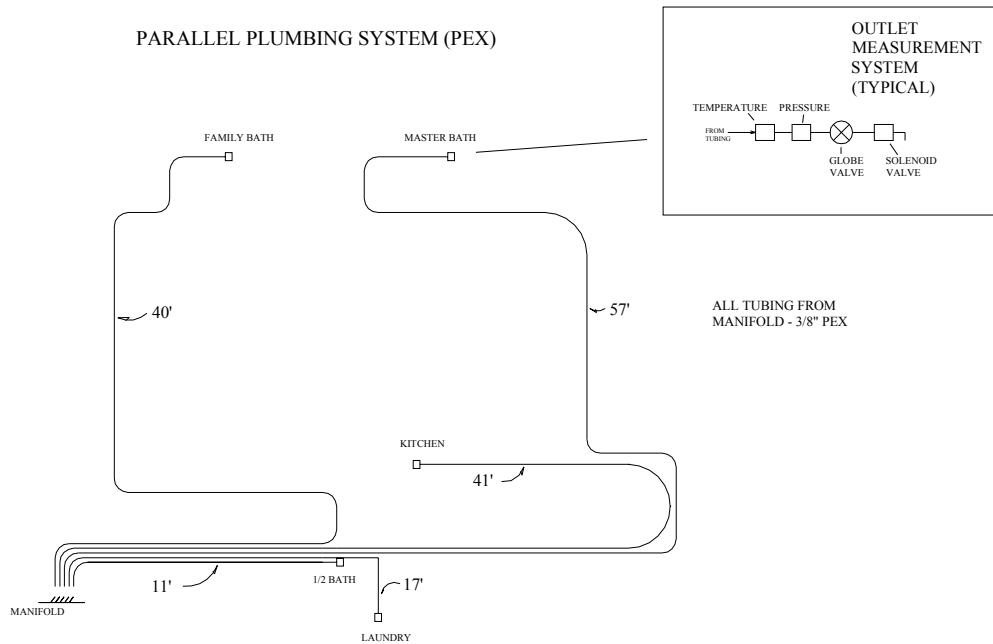

Figure 2. Diagram of experimental apparatus—parallel piping system



Figure 3. Partial piping system showing PEX and copper distribution systems, drains, and outlet measurement systems

The laboratory test apparatus included a full hot water piping system with five outlets and vertical and horizontal piping, as would be expected in a typical home. The entire apparatus covered an area of about 25 ft by 25 ft and included equipment to chill and heat water, measure and record temperatures and flow rate, and to automatically actuate valves on a 1-minute basis. The test system was instrumented as follows:

- Inlet water temperature (after chiller)
- Inlet water pressure
- Water-heater power use
- Total flow rate (through water heater)
- Temperature at outlet of water heater
- Temperature at each outlet
- Pressure at each outlet (to determine individual outlet flow rate)
- Solenoid valve (normally closed) at each outlet to control flow at each outlet
- Ambient temperatures.

Data collected included the following:

- Flow rate and temperature of inlet cold water
- Delivered hot water temperature at each outlet
- Hot water temperature from the water heater
- Power use of water heater.

The piping was protected from drafts by plastic sheeting during the winter months to reduce convective losses when the laboratory garage door was opened. The plastic sheeting was removed when outdoor temperatures warmed.

The water supply to the tank and demand water heaters was conditioned to maintain a constant temperature. A 5-kW chiller with a 45-gallon storage tank, capable of cooling the domestic water supply to 40°F, was used to regulate the temperature of the incoming water. A pump provided continuous pressure to the system. For each minute when hot water flow was initiated by a process controller, between one and five solenoid valves were activated to supply hot water flow to the outlets. Each outlet was assigned a design flow rate, which remained constant throughout the experiment. Design flow rates for each outlet are shown along with a description of the piping systems in Table 1 and Table 2. The apparatus was designed to be able to switch between tank and demand water heaters and tree-type copper and PEX parallel-pipe distribution systems. The tree system used 3/4-in. copper main branches and 1/2-in. copper secondary branches. For the parallel system, 3/8-in. PEX was used throughout.

Table 1. Location of Piping Outlets in Test Apparatus—Tree System

Outlet ID	Typical Home Location	3/4-in. Pipe Length (ft)	1/2-in. Pipe Length (ft)	Design Flow Rate (gpm)
1	Laundry or tub	11.75	6.0	3.5
2	Half bath (sink)	4.5	6.5	0.25
3	Kitchen (sink/dishwasher)	35.5	5.5	0.75
4	Family Bath (sink)	34.0	5.75	0.5
5	Master Bath (shower)	51.25	7.75	1.75

Table 2. Location of Piping Outlets in Test Apparatus—Parallel Piping System

Outlet ID	Typical Home Location	3/8-in. pipe length (ft)	Design Flow Rate (gpm)
1	Laundry or tub	17	3.5
2	Half bath (sink)	11	0.25
3	Kitchen (sink/dishwasher)	41	0.75
4	Family Bath (sink)	40	0.5
5	Master Bath (shower)	57	1.75

The demand water heaters are electric units designed to supply regulated hot water to a whole-house plumbing system. The maximum power use is 28 kilowatts. These units have electronic circuitry that regulates the power level to match the flow rate and desired outlet temperature up to its maximum. The power used at any instant may change because of changing inlet conditions and is infinitely variable.

3. Instrumentation and Controls

An inlet measurement system (Figure 4) was constructed to measure inlet pressure at two points (before and after pressure regulator), temperature, and flow rate. The pressure regulator was installed to stabilize the pressure throughout the hot water delivery system.

The pressure gauge and regulation portion of the inlet measurement system is pictured in Figure 5. Temperature, pressure, and flow rate were measured in-line after the pressure-reducing valve.

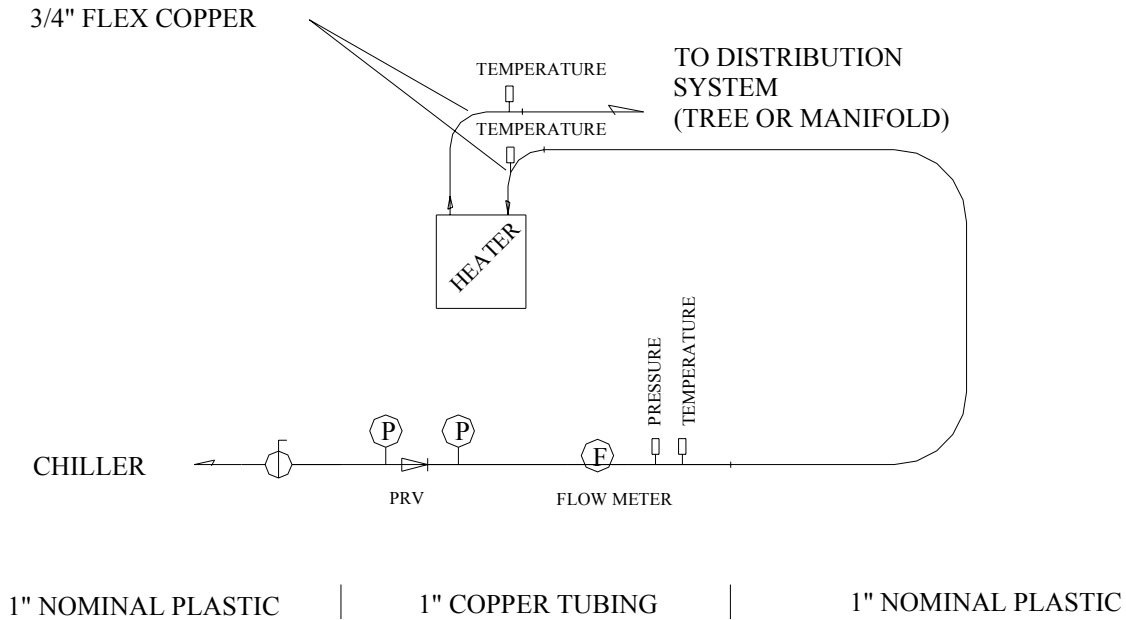

Figure 4. Inlet measurement system



Figure 5. Inlet pressure monitoring and regulation system

Each outlet was equipped with a measurement apparatus (Figure 6) consisting of a thermocouple, a pressure transducer, a globe valve to manually control outlet flow rate, and a normally closed solenoid valve to control flow (on-off). Thermocouples were used rather than thermistors or RTDs because of the superior response time of the thermocouples. Pressure transducers were installed as a method to obtain flow rates at each outlet. However, this method was deemed inappropriate because the pressure drop at low flow rates, either relative to the incoming pressure or atmosphere, fluctuated beyond acceptable limits.



Figure 6. Outlet measurement system

4. Process Control

To control flow at each outlet, a process control system was developed to read a data file and activate between one and five solenoid valves depending on the design flow rate specified in the data file (Figure 7).

LabTech™ software was used to read a data file featuring minute flow rates for a 1-week period. Two data files were used throughout the experiment: one for the high-use home and the other for the low-use home. Original minute flow data was processed into flow rate bins (Section 7.1), then further processed into relay codes, which actuated the specified solenoid valves through a relay board.

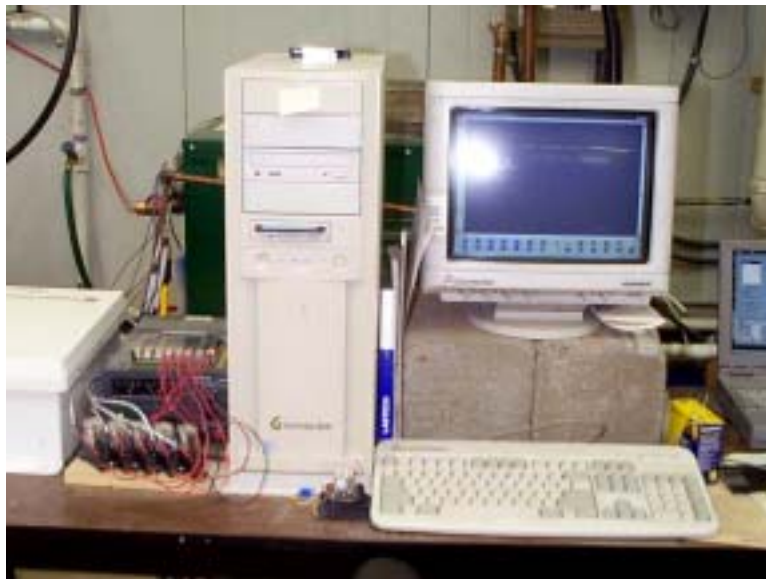

Figure 7. Process control system

5. Data Acquisition

A Campbell Scientific data logger with multiplexer (Figure 8) was programmed to receive flow, temperature, and pressure data and to perform energy calculations every 2 seconds. Temperatures and flow rates were averaged each minute. Energy calculations were totalized for each minute based on the 2-second data.

Water-heater power use was measured using an Enetics LM-5500 Power Meter (Figure 9). The power meter processes high speed current and voltage readings into real and reactive power components and is capable of storing 1-minute totals. This meter device was selected to accommodate the non-resistive power use of the demand water heaters.



Figure 8. Data logger to collect flow and temperature data



Figure 9. Power meter used to measure water heater energy use

Because the process control system was separate from the data acquisition system, synchronization of the systems was problematic. Consequently, if a valve was activated by the process control system, the data acquisition system might record performance characteristics (flow, temperature, etc.) for two partial minutes rather than one full minute. The result being that, when taking average flow rates over 1 minute, the flow rate for each minute was recorded as lower than actual flow. Although this was a negligible issue for energy calculations (which were summed every 2 seconds), it becomes an issue when using measured flow data as an input into simulations. This lack of synchronization, however, is only a problem for the first or last minute of a multiple-minute flow event or for a one-minute flow event. Overall energy use, measured or simulated, is relatively unaffected by this lack of synchronization.

6. Experimental Operation

At the start of each week's test, the process control system was configured to operate either the high- or low-use flow data. The laboratory apparatus was configured as necessary to use the tank or demand water heater and the copper-tree or parallel-PEX piping system. Current transducers were adjusted to monitor the appropriate water-heating equipment circuits.

The globe valves used to control flow rate during laboratory tests did not provide precise control over the flow rate, typical of normal household equipment performance. Therefore, in order to keep the total volumetric flow for each set of tests (high-use and low-use) somewhat consistent, the flow rate at each valve was checked and adjusted before starting a test, if necessary.

7. Methodology

7.1 Hot Water Data

Disaggregating water use according to specific fixture use from whole-house data is difficult. There are sources of hourly water-use profiles from ASHRAE⁵ and others. However, these hourly profiles tend to use average water flows divided over the course of a day. In real-world applications, water use can peak at times and rarely follows an even usage pattern. If published hourly draw profiles are used in laboratory or computer simulations, the lack of peaks or anomalous water draws can result in misleading performance data.

To overcome the limitations of hourly water-use profiles and other methods for simulating hot water draws, we chose to use minute hot water use data from a previous NAHB Research Center study.⁶ Water-usage patterns (for a representative week of data) from two homes were chosen for the study: one home having very low hot water usage and one having high hot water usage, in order to obtain the boundaries for expected system performance. For the representative week of data selected, on average, the low-use home used 41 gallons of hot water per day and the high-use home used 86 gallons per day. In perspective, national average hot water usage is approximately 62 gallons per day.⁷ A review of the hot water use profiles for the high- and low-use homes are shown in Appendix B. The weeks selected for laboratory simulation were chosen as representative of January use profiles for each home.

Because the hot water data did not indicate where hot water was used throughout the day, we chose to arbitrarily assign hot water flow to outlets based on the flow rate called for in the data file. The flow rate for each outlet was based on an educated guess about expected actual hot water flow rates—such as 3.5 gpm at the laundry, 0.75 gpm at the kitchen, etc. (Table 3).

Using five outlets in the laboratory experiment, each having a fixed flow rate, there could only be a discrete number of flow rates, although real flow rates can vary continuously. Therefore, to translate this variable flow rate from data files into distinct flow rates, the flow data from two

⁵ American Society of Heating, Refrigeration, and Air Conditioning Engineers

⁶ Cautley, D. and J. Wiehagen, *Measured performance of five residential geothermal systems*, NAHB Research Center, November 1999.

⁷ Wiehagen, J. and J.L. Sikora, *Residential Hot Water System Energy Efficiency Research*, literature review prepared for the National Renewable Energy Laboratory, June 2000.

homes was divided into bins of 0.25-gpm increments (Table 3). Between one and five solenoid valves were activated during each minute of flow based on the flow rate called for by the data file.

Flows at or below 0.03 gpm were ignored in the laboratory testing because these flow events would need to be set at 0.25 gpm for 1 minute (based on experimental capabilities), which would have overestimated total volumetric flow over the week. A cut-off level of 0.03 was chosen in order to keep the total experimental flow close to the total data file flow.

Table 3. Data Flow Rate Bins and Experimental Design Flow Rate for Laboratory Experiment and Subsequent Simulations

Flow rate from data set (gpm)	Experimental design flow rate (gpm)	Valves Actuated ⁸
0.030 ⁺ to 0.375	0.25	HB
0.375 ⁺ to 0.625	0.50	FB
0.625 ⁺ to 0.875	0.75	K
0.875 ⁺ to 1.125	1.00	HB+K
1.125 ⁺ to 1.375	1.25	FB+K
1.375 ⁺ to 1.625	1.50	FB+HB+K
1.625 ⁺ to 1.875	1.75	MB
1.875 ⁺ to 2.125	2.00	HB+MB
2.125 ⁺ to 2.375	2.25	FB+MB
2.375 ⁺ to 2.625	2.50	FB+HB+MB
2.625 ⁺ to 2.875	2.75	HB+K+MB
2.875 ⁺ to 3.125	3.00	FB+K+MB
3.125 ⁺ to 3.375	3.25	FB+HB+K+MB
3.375 ⁺ to 3.625	3.50	L
3.625 ⁺ to 3.875	3.75	HB+L
3.875 ⁺ to 4.125	4.00	FB+L
4.125 ⁺ to 4.375	4.25	K+L
4.375 ⁺ to 4.625	4.50	HB+K+L

The hot water outlet temperature was set at 130°F, and inlet cold water was set at approximately 44°F (but fluctuated during experiments between 45°F and 50°F). The cold water inlet temperature was selected as the coldest average incoming water temperature during the Ohio

⁸ FB = family bath, HB = half bath, K = kitchen, L = laundry, MB = master bath

study, which represented a worst-case scenario and tested the boundary of system operating conditions. The 130°F temperature was selected as the hot water temperature because this was the approximate setpoint observed at the two Ohio sites and because it represents a common hot water tank setpoint for a home.

7.2 Tests Conducted

Table 4 describes the eight tests that were conducted. Each test was operated for 1 week.

Table 4. Description of Tests Conducted

Type of Water Heater		Type of Distribution System		Water Usage	
Tank	Demand	Copper Tree	PEX Parallel	High Use	Low Use
X		X		X	
X		X			X
	X	X		X	
	X	X			X
X			X	X	
X			X		X
	X		X	X	
	X		X		X

7.3 Data Processing

7.3.1 Actual Flow Rate, Design Flow Rate, and Assigned Flow Rate

As described in Table 3, up to five outlets, each having a design flow rate, were activated based on the total flow called for by the data file. Because measured flow rate was not identical to design flow rate, and because exact flow rate at each outlet was unknown when multiple fixtures were activated, a flow ratio was calculated for each minute of flow.

$$\text{Flow Ratio} = \frac{\text{Measured Flow Rate}}{\text{Design Flow Rate}} \quad (1)$$

Assigned flow rate at an outlet (i), then, was calculated as

$$\text{Assigned Flow Rate}_i = \text{Flow Ratio} \times \text{Design Flow Rate}_i \quad (2)$$

For example (Table 3), if the design flow rate for a minute was 2.0 gpm, the half bath and master bath valves would be activated. If the actual (measured) flow rate was 1.8 gpm, then,

$$\text{Flow ratio} = \frac{1.8 \text{ gpm}}{2.0 \text{ gpm}} = 0.9$$

and

$$\begin{aligned} \text{Assigned Flow Rate}_{\text{master bath}} &= 0.9 * 1.75 \text{ gpm} = 1.575 \text{ gpm} \\ \text{Assigned Flow Rate}_{\text{half bath}} &= 0.9 * 0.25 \text{ gpm} = 0.225 \end{aligned}$$

The assigned flow rate at each outlet was subsequently used in the calculation of energy at each outlet (described in more detail in Section [7.3.2](#)).

7.3.2 Energy and Efficiency Calculations

The hot water system has, as its determinate variables, the following attributes:

- Cold water inlet temperature (T_{cw})
- Hot water temperature at the outlet of the water heater (T_{hw})
- Outlet temperature at each outlet ($T_{out,i}$)
- Total system flow rate (\dot{m}_T)
- Assigned flow rate at each outlet (\dot{m}_i)
- Electric energy into the heater (Q_{elec})
- Specific heat of water (C_p).

The preceding variables are used to calculate heater energy, (Q_{hw} = energy to heat the water from T_{cw} to T_{hw}) and energy delivered at each outlet ($Q_{out,i}$). These energy calculations are shown schematically in Figure 10.

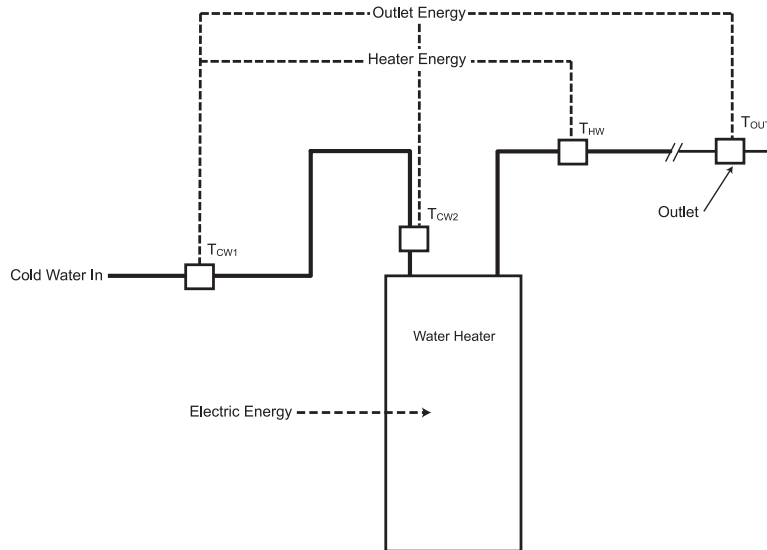

Figure 10. Schematic diagram of measurement points for energy calculations

The temperature of the cold water inlet is shown as measured in two locations, the purpose for which is discussed in Section 9.1. Energy calculations were based on T_{cw1} , but corrected to T_{cw2} location. For each minute of flow,

$$Q_{hw} = (T_{hw} - T_{cw}) \times \dot{m}_T C_p \quad (3)$$

and the total outlet energy (Q_{out}) is defined as

$$Q_{out} = \sum (T_{out,i} - T_{cw}) \times \dot{m}_i C_p \quad (4)$$

Therefore, piping losses are given by the difference between the heater and outlet energies:

$$Q_{L,pipe} = Q_{hw} - Q_{out} \quad (5)$$

Or, as a percentage of electrical input as $(Q_{hw} - Q_{out})/Q_{elec}$.

The heater efficiency (Eff_{wh}) is defined as the ratio of the hot water energy to the electric input energy.

$$Eff_{wh} = \frac{Q_{hw}}{Q_{elec}} \quad (6)$$

And the overall system efficiency (Eff_{sys}) is defined as:

$$Eff_{sys} = \frac{Q_{out}}{Q_{elec}} \quad (7)$$

8. Calibration

Each of the primary measurement devices was calibrated to assure the highest accuracy measurements possible with the equipment available. The flow meter was calibrated at high and low flow rates and was found to be well within the manufacturer's minimum specifications of $\pm 1\%$ of full-scale error. At the lower flow rates, this error was found to be no more than 2.5% of reading. The thermocouples are made with special limits-of-error wire and are grounded, resulting in a response time of about 1/4 second. With a thermocouple error of $\pm 0.5^\circ\text{C}$ ⁹, the maximum error of any energy calculation, based on temperature, would be less than 2%. Therefore, combining the maximum flow and temperature errors, the energy calculation error is no more than 3.2%¹⁰.

For each flow minute, the total flow rate at the meter is proportioned among the activated valves. This proportion is based on the design flow rate of the valve. Actual flow rates, however, depend on the exact setting of the valve and the change in flow rate as the temperature of the

⁹ A post-test calibration at 32°F indicated a 0.1°F standard deviation of all thermocouple sensors.

¹⁰ Based on the root-sum-of-squares methodology.

valve changes during any flow event. Each valve was operated for a sufficient time to achieve a high outlet temperature and then was set to its appropriate design flow rate. During the course of the testing, these settings were rechecked and adjusted if necessary.

Heat-to-flow calculations were based on measurements made every 2 seconds. At the low flow design of 0.25 gpm and a flow meter resolution of 174 pulses per gallon, the highest resolution achievable is 1.45 pulses per 2-second period. This translates into a minimum practical limit of either 1 or 2 pulses per 2-second period, an acceptable level of accuracy given the overall quantity of water used, or the relatively small amount of energy transferred at such a low flow rate.

Electric energy measurements are made using a meter that has an accuracy within approximately $\pm 3\%$ at low power levels near 100 watts, 0.6% at a power level of 4500 watts, and approximately 0.5% at higher power levels. The total maximum error for efficiency calculations then would be approximately 3.24%.

9. Model Calibration

Experimental and simulated results for 1-week tests are presented below. Experimental results were used to validate and refine the simulation model. The model was used to run annual simulations of each system. Once an acceptable level of confidence was established that the simulation model would accurately predict experimental results for all different systems and flow regimes, annual simulations were then used to provide detail on system performance across all seasons.

9.1 Effect of Cold Water Inlet Temperature Location

The location of the cold water inlet temperature sensor near the water heater is particularly important because of the effects of thermosiphoning and ambient conditions on the incoming water temperature and, hence, energy calculations. Initially, the cold water inlet sensor was located about 15 feet from the water heater to reduce thermosiphoning effects. However, demand water heater efficiencies greater than 100% indicated that the incoming cold water temperature at the heater inlet port was warmer than the temperature at the point of measurement. We hypothesized that the volume of water between the location of the cold water inlet sensor and the entrance to the water heater was being heated by thermosiphoning or by ambient conditions, thereby reducing the electrical needs for heating this particular volume of water (and, therefore, overestimating the efficiency of the water heating system). These effects, initially regarded as too minor to be of concern, were actually measurable. Our conclusion was that the cold-water inlet temperature should be measured at the heater inlet port with the net effect of thermosiphoning and ambient conditions included in the overall energy calculation.

The cold-water inlet temperature sensor was moved to a location near the water heater (identified as T_{cw2}) and was tested for three systems: the tank system at high and low water use and for the low-water-use demand system. The results of this testing—an approximate decrease of 3% in overall system efficiency—were incorporated into the simulation model to account for the actual temperature entering the water heater. The experimental results reported in the following sections were not adjusted for sensor location; therefore, system efficiencies are higher than actual and can be greater than 100%.

9.2 Environmental Conditions during Experimental Testing

Each test was performed for 1 week in order to measure realistic piping and heater standby losses. Though fairly well regulated, ambient temperatures and cold water inlet temperatures varied somewhat. Figure 11 shows average ambient temperatures (at the top and bottom of the experimental apparatus) and average cold water inlet temperature during one-minute flows, for the eight tests. Ambient temperatures and cold water inlet temperatures measured during laboratory testing were used as inputs into the simulation.

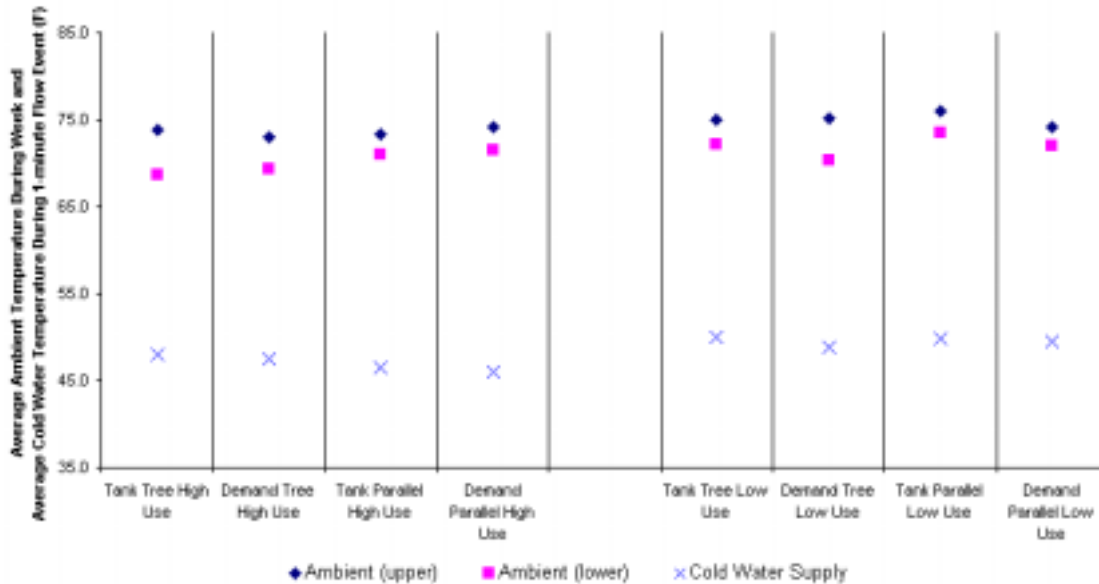

Figure 11. Environmental conditions during testing

9.3 Overall System Efficiency

The original goal of the testing was to determine energy savings based on various plumbing system configurations, flow rates, and water-heating equipment. Because hot water energy is useful only when delivered to an outlet, outlet energy was chosen as the basis for calculating overall system efficiency. Overall system efficiency is described by Equation (7) in Section [7.3.2](#).

Starting with the original simulations and inputting empirical data, such as piping heat-loss coefficients and measured flow rates, to the TRNSYS simulation model, we were able to closely match simulated system efficiency with measured system efficiency for the various flow regimes, heating equipment, and plumbing systems, as shown in Figure 12 and Figure 13.¹¹ The simulated overall system efficiency was approximately 3% lower than experimental overall system efficiency for all tests. This difference is attributed to the location of the cold water temperature sensor as discussed in Section 9.1.

Results from laboratory testing presented below are unadjusted for the effects of the cold water temperature sensor location and, hence, can have equipment efficiencies greater than 100%. They accurately reflect, however, comparative performance, consumption trends, and system efficiency and serve as a basis for the simulation model.

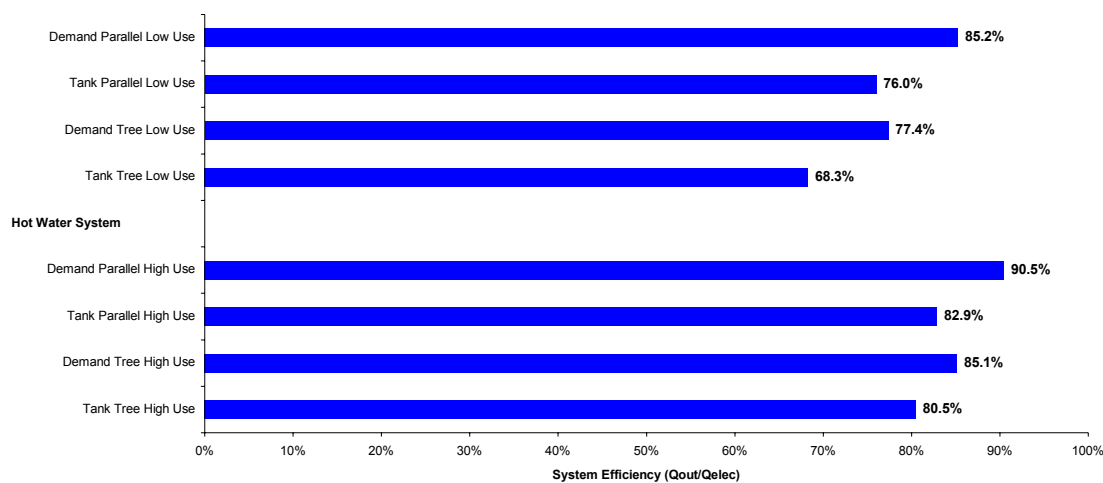

Figure 12. Experimental overall system efficiency (unadjusted)

¹¹ In order to match experimental and simulated results, the heat transfer coefficient was changed from about 1.2 to 1.5 Btu/hr·ft²·°F in the original simulations to 1.96 Btu/hr·ft²·°F for the copper tree system and to 6.9 Btu/hr·ft²·°F for the PEX parallel system. The increase in the heat transfer coefficient for the PEX tubing is about four (4) times as high as originally estimated and is unrealistically high based on factors directly related to heat loss from the pipe (such as geometry, orientation, diameter, air movement, radiation, and ambient temperature).

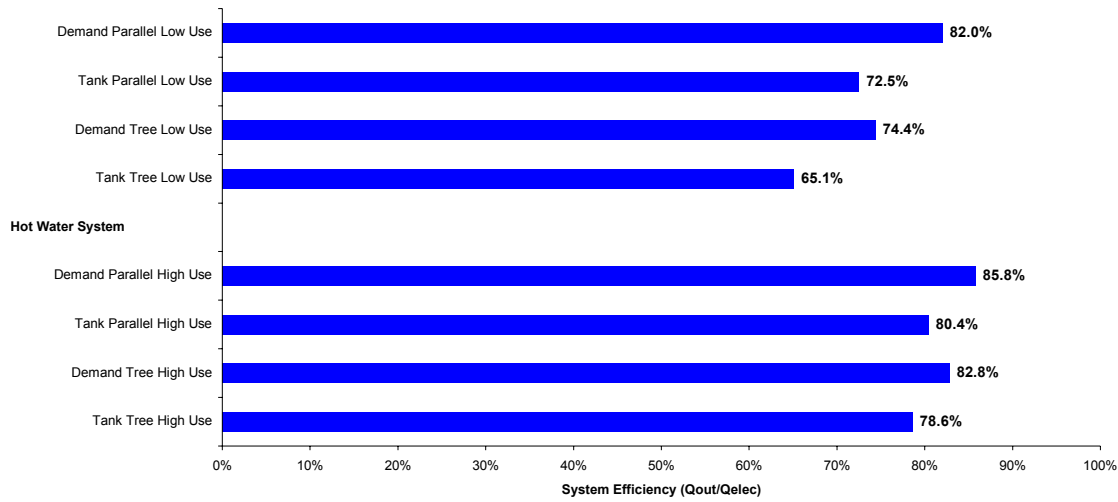

Figure 13. Simulated overall system efficiency

9.4 Distribution Losses

To determine the percentage of electrical energy that was consumed by the distribution system alone, piping losses were calculated for the experimental results and subsequently used to develop heat-transfer coefficients for the piping systems simulations. Piping losses in experimental results and simulations were within approximately 2% to 3% of each other—well within experimental error and expected differences between tests based on variations in ambient conditions.

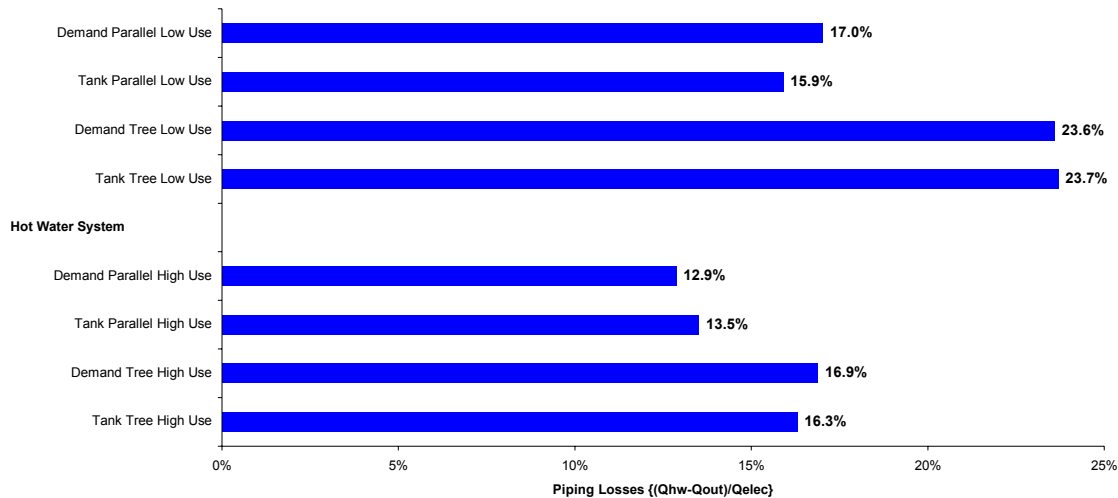

Figure 14. Measured pipe losses as a percentage of electrical input energy (unadjusted)

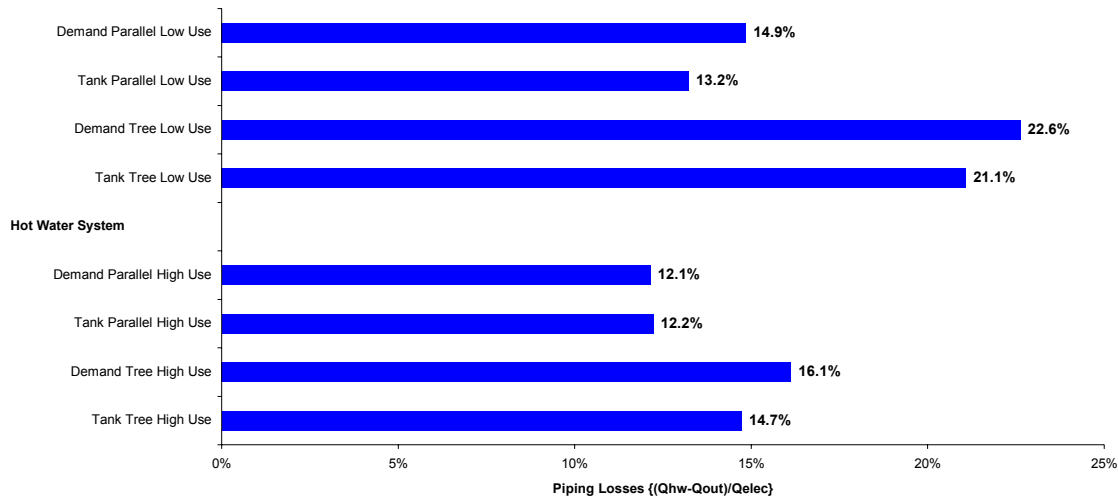

Figure 15. Simulated pipe losses as a percentage of electrical input energy

9.5 Water Heater Efficiency

Water heater efficiency, defined as the amount of heat supplied to the hot water divided by the electrical energy input (Q_{hw}/Q_{elec}), was first measured by experimental results (Figure 16). Of note in the chart (besides the difference in equipment efficiency) is that the demand water-heating tests show equipment efficiencies greater than 100%, as described in Section 9.1.

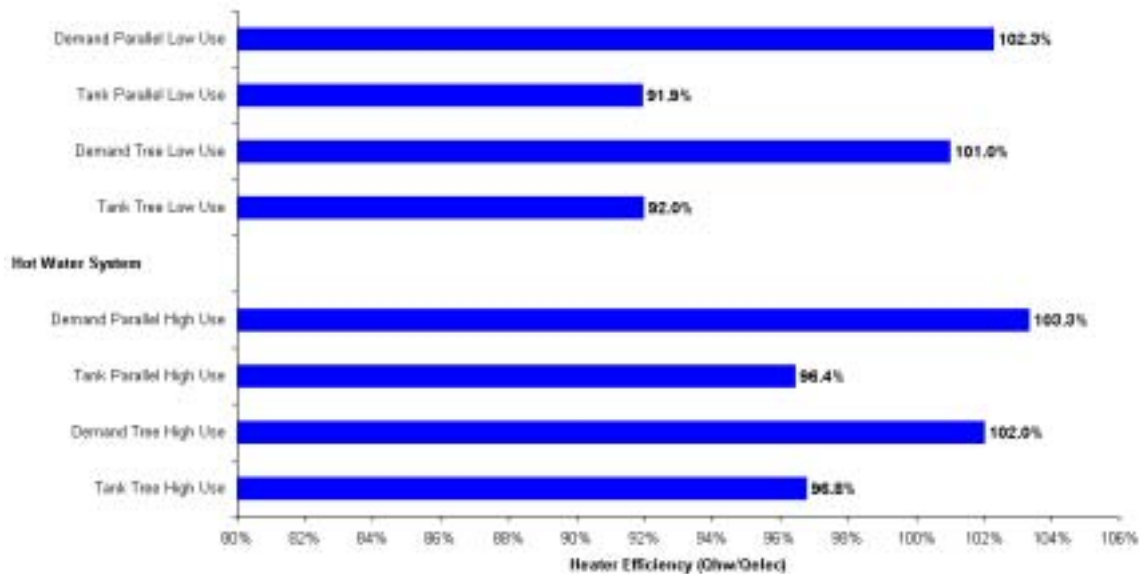

Figure 16. Experimental water-heating equipment efficiency (unadjusted)

To account for this overestimated equipment efficiency, we used the simulation program to calculate T_{cw2} , which is subsequently used in energy calculations and system and equipment efficiency calculations. Simulated water-heating equipment efficiency is shown in Figure 17. Differences occur in equipment efficiency for the same equipment operated under the same flow regime because actual water usage varied.

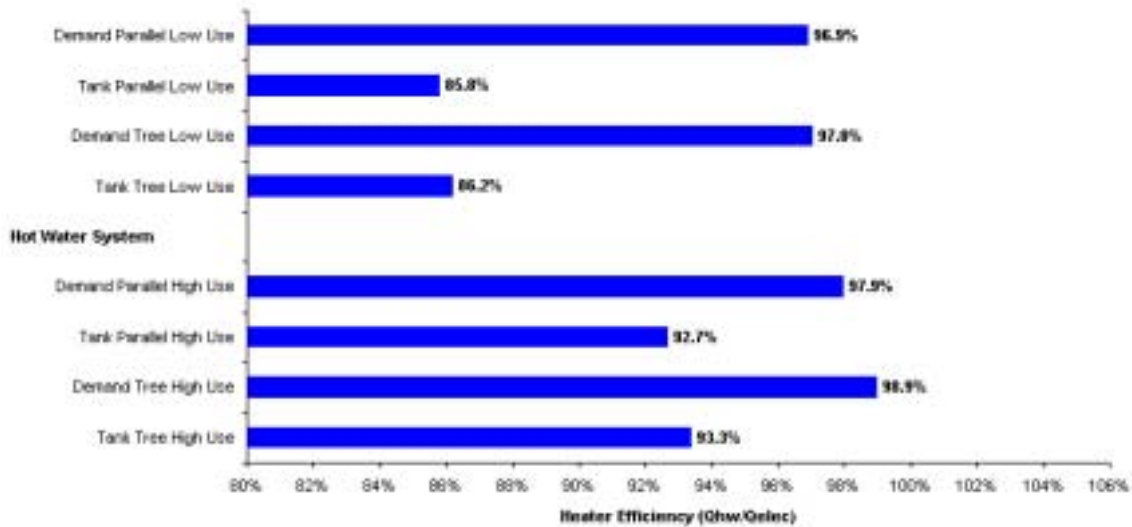

Figure 17. Simulated water-heating equipment efficiency

9.6 Delivery Temperature Performance

Maximum delivery temperature (from 1-minute average temperature data) from the water heaters and at each outlet is shown in Figure 18. Delivery temperatures for the bulk of the water use fell within the expected range for all systems. However, with the highest flow fixture (laundry), the demand heater could not match the hot water demand. Therefore, delivery temperatures fell to about 95°F during laundry flow. The effect of this loss in outlet energy is small, however, because flow at the laundry outlet represented only 3% of the entire week’s hot water use. Although this effect seems minimal, it may be unacceptable to consumers if it presents a thermal comfort issue or if the homeowner has to adjust their water usage patterns to accommodate the demand system (e.g., fill a bathtub at a lower flow rate).



Figure 18. Experimental maximum delivery temperatures for each outlet

Based on experimental measurements and calculated heat-loss coefficients, maximum delivery temperatures were simulated using the TRNSYS program and are shown in Figure 19. Note that the delivery temperature at the laundry outlet is significantly higher in the simulated results than the experimental results. The difference in measured and simulated temperatures is due in part to the actual performance of the demand heater versus the simulated performance. The simulated heater activates more quickly than the actual heater. Another portion of the difference is attributed to minute averages on which this data is based. These issues have minimum effect on calculated energy use. Based on delivery temperatures at the outlets the results indicate a good correlation between the measured and simulated performance of the water heating systems.



Figure 19. Simulated maximum hot water delivery temperatures

Given the very good correlation between the experimental results and the results as simulated in software, the simulation model is considered calibrated and is excellent in predicating actual energy use given the proper inputs of flow rate, ambient temperature, and incoming water temperature.

10. Results and Analysis—Annual Simulations

Annual simulations were performed using the calibrated models developed from the measured data. The primary goal was to simulate a full year’s worth of data to account for the differences in incoming water temperature, indoor air temperature, flow rate, and intervals between draw events. All of these factors affect energy efficiency results of the heater and the overall system. *While week-long experimental data are sufficient for validating models, annual simulations provide a much stronger performance comparison of different types of water heating systems under various ambient, flow, and cold-water inlet conditions.*

Using data from the two Ohio sites for an entire year, annual simulations were run for each of the eight hot-water systems. Annual simulations used real data that included variability in cold-water inlet temperature and water usage—both factors in overall system efficiency. Inputs for the annual simulations are listed in Table 5. Cold-water inlet temperature, selected from the data as the minimum (across the two homes) for each month, was kept constant for each month. Total water usage for each month and ambient temperatures were based on actual data from each home.

Inputs to the simulation were based on 1-minute data. These high-resolution data enable the energy-use estimates to accurately reflect the expected draw in a home. Two sets of data, one from a high-use home and one from a low-use home provided the upper and lower boundaries of expected performance.

A basic efficiency of 99% was assumed for the demand water heater. Information from manufacturers indicates up to 99.5% efficiency for some units in some cases, 99% in others. Some manufacturers do not list efficiency, whereas others indicate that, based on the electrical input and specified output, the unit is 100% efficient. Some units require a small amount of electrical energy to establish a constant temperature difference between the incoming and outgoing water streams. Some units have a digital display and circuit board monitoring temperatures and flow rate, all of which use a small amount of energy.

Table 5. Inputs to Annual Simulation

Month	T_{cw}	Low-Use Home Monthly Water Consumption (Total Gallons)	High-Use Home Monthly Water Consumption (Total Gallons)
January	46	1,183	2,248
February	44	432	2,491
March	45	726	2,644
April	51	758	2,243
May	57	448	2,260
June	63	636	2,534
July	67	668	2,553
August	67	1,088	2,064
September	69	1,167	1,964
October	64	858	2,304
November	57	869	2,216
December	51	1,081	2,235
Average	57	826	2,313
Total		9,914	27,756

10.1 Annual Electrical Energy Consumption

The annual simulations of demand and tank systems show a 21% reduction in energy use for the low-use home and an 8% reduction for the high-use home. These results are based on the same inputs (flow, cold water temperature) among high- and low-use data sets. However, they are not normalized to outlet energy. In other words, electrical energy savings do not account for differences in energy delivered at the outlets. Therefore, to normalize electrical energy savings to equal levels of outlet energy, a normalized electrical energy use was calculated for each system using the outlet energy supplied by the tank/tree system as a base (See Section [10.4](#)). The lower the hot water consumption in a home, the more beneficial it is to use a demand system that has little, if any, standby losses.

Table 6. Summary of Annual Electrical Energy Consumption for Demand and Tank Systems

	Q_{elec} (kWh/yr)	Savings
Demand Low-Use	1,573	21%
Tank Low-Use	1,995	
Demand High-Use	4,587	8%
Tank High-Use	4,986	

10.2 Annual System Efficiency

Annual overall system efficiency for each hot-water system is shown in Figure 20. The overall system efficiency shows the relative performance of each system—combining water heating equipment efficiency with distribution system efficiency.

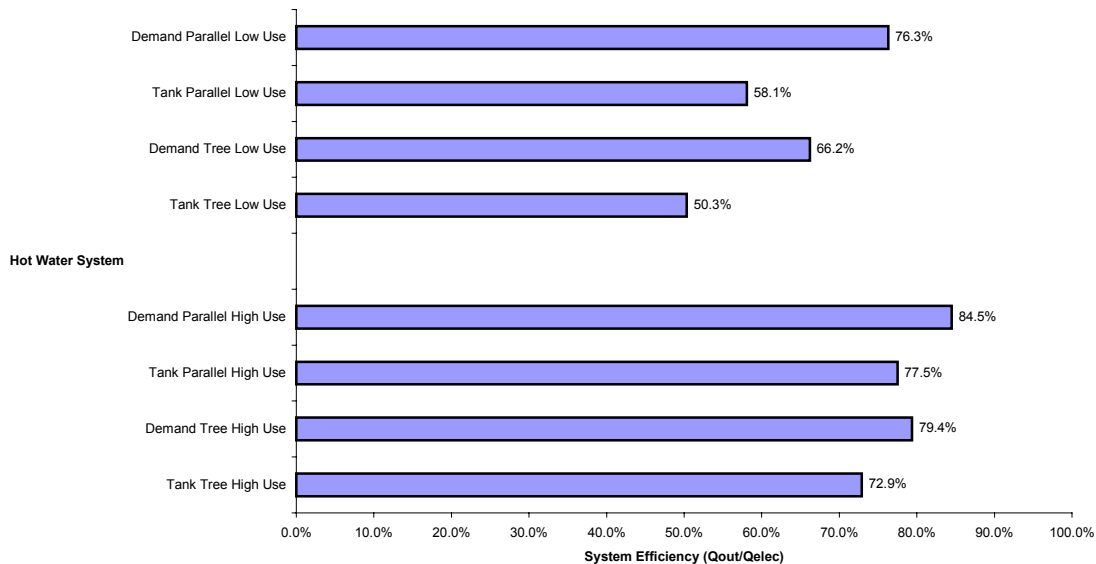

Figure 20. Annual simulated system efficiency

When compared with the data and simulations for 1e week of data in January, the annual simulations show lower system efficiency than the measured week data. The lower annual efficiency is most likely caused by two effects. First, extended periods of low or no use (vacations) increase standby losses. Second, extrapolating the week’s data into a full year (multiplying water use over the week by 52) overestimates actual flow for the year—31,460 gallons for the high-use home (versus 27,756 actual) and 15,028 for the low-use home (versus 9,914 actual). Therefore, the lower actual use over the year would be expected to include more piping and standby losses.

10.3 Annual Delivered Outlet Energy

Although efficiency for the demand systems is higher than the tank systems, system performance is defined by more than just efficiency. The question of performance arises (i.e., Does the demand system deliver as much energy at the outlets as the tank system? Is the demand system delivering lukewarm water at the taps?). To address these questions, Figure 21 shows the annual energy delivered at the outlet for each of the eight systems. The tank and demand heaters deliver roughly the same amount of energy at the outlets—demonstrating that the difference in overall system efficiency is not reflective of any general performance problems with the demand system. However, although annual outlet energy is comparable for demand and tank systems, there are discrete performance issues with both systems when one piece of equipment does not deliver the intended amount of outlet energy (e.g., during periods of high flow rate for the demand system or during extended periods of flow for the tank system).

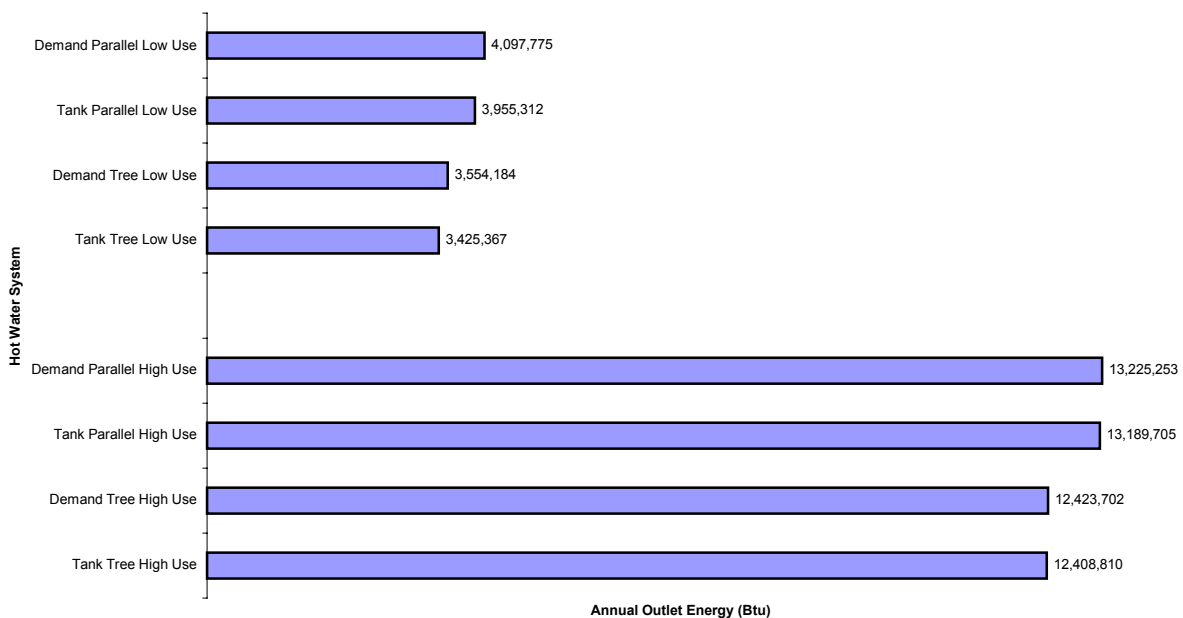

Figure 21. Annual delivered outlet energy

A comparison of systems in Figure 21 shows that, across both types of water heaters and both flow regimes, the parallel piping system delivers more energy to the outlets as a result of lower losses in the piping (distribution) system. This reduction in distribution losses is mainly attributable to the smaller diameter pipe retaining less hot water at the end of a draw.

Figure 22 shows the relative distribution of electrical energy input for each of the eight systems—and the relative breakout of component system consumption (i.e., how much is delivered at the outlets, how much is lost in distribution, and how much is heater loss).

The graph shows that, although electrical energy does not change for the same heater equipment and flow regime, the portion of electrical energy that becomes useful energy at the outlet is affected by the type of distribution system.

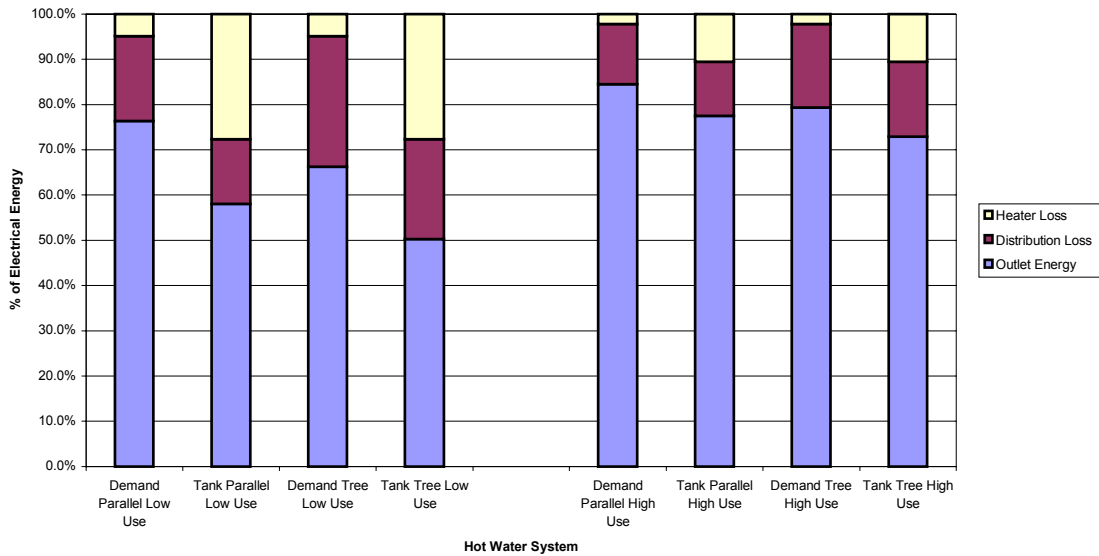

Figure 22. Breakdown of electrical energy input

10.4 Normalized Electrical Energy Use

Each hot-water system delivers a different quantity of energy at the outlet for the same electrical input due to distribution losses. To predict energy savings when the outlet energy was held constant at a base level, systems were normalized at the level of outlet energy supplied by the tank/tree system. Required electrical energy input to achieve a specified level of output energy for each system is shown in Figure 23.

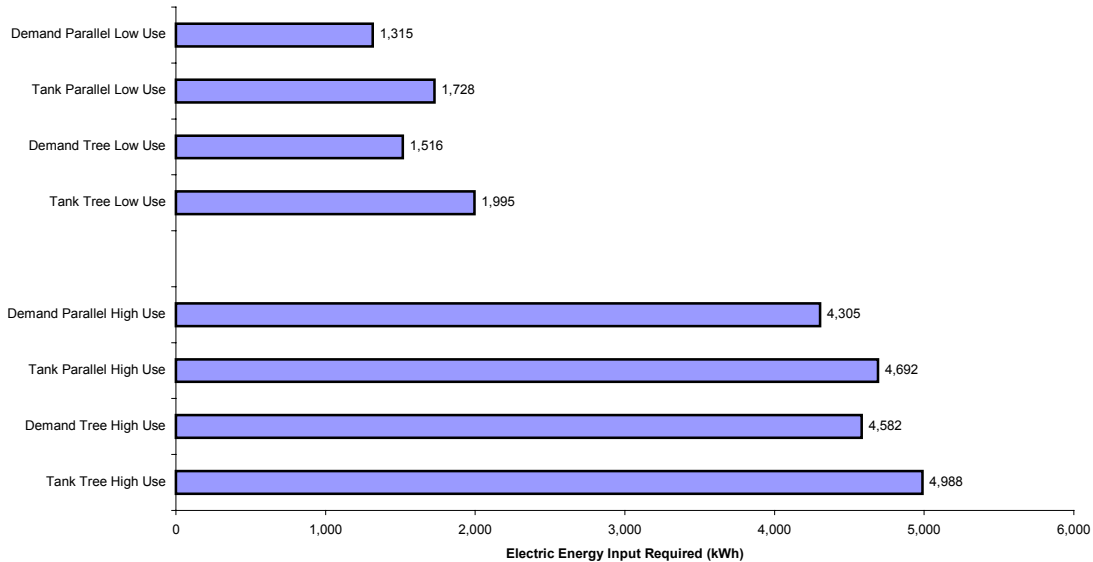

Figure 23. Electric energy input to hot water system with normalized output energy

When using normalized outlet energy, electrical energy savings for the demand parallel system over the tank/tree system were 34% for the low-use home and 14% for the high-use home.

10.5 Simulation of System Design Options

Using the refined simulation model, the performance of a point-of-use type system in which demand water heaters were placed at each outlet was analyzed. The piping system in this scenario would require only one supply to each outlet with a small length of pipe to serve both hot and cold water uses. This configuration places the hot water heating equipment at the location where the water is used. The model developed for this type of system is referred to as the distributed model.

Hot-water setpoints in the distributed model were set at levels shown in Table 9 for each outlet, because this system configuration allows for flexibility in temperature at each outlet and because distribution losses are negligible. Therefore, a setpoint of 130°F is unnecessary (or even dangerous) in the distributed configuration. Each of the demand heaters is simulated using the same cold water inlet temperature and flow rate as the tree system in the low- and high-use homes. The demand heaters operate in the same manner as in previous simulations and experimental tests in that they supply only the electricity needed to raise the temperature to the desired setpoint (they have infinitely variable electrical input).

In the distributed model, the maximum electrical energy input was unlimited to meet any demand, unlike the whole-house demand heater simulations in which the electrical energy was limited to 28 kW. Electrical energy was not limited so that results would show the periods when total demand from all outlets exceeded the 28-kW maximum.¹² However, to compare energy savings between all types of systems simulated, it was necessary to normalize the distributed system to 28 kW.

A summary of the annual data, shown in Table 7, compares electrical energy input, outlet energy, and system efficiency for the point-of-use system and tank/tree systems.

Table 7. Summary of Annual Simulation Results for Point-of-Use System versus Tank System

	Q_{elec} (kWh/yr)	Q_{outlet} (kWh/yr)	System Efficiency
<i>Low-Use</i>			
Distributed point-of-use	1,210	1,209	99.9%
Tank Tree	1,995	1,004	50.3%
<i>High-Use</i>			
Distributed point-of-use	3,529	3,549	100.5%
Tank Tree	4,986	3,635	72.9%

¹² This is a practical limit for discussion purposes in this study. If the electric service to a home is 300 or 400 amps, then demand water heating capacities larger than 28 kW are possible. A 150- or 200-amp service is most common in new homes today.

Very high system efficiencies indicate that all of the electric input is used at the outlet (i.e., there are no losses in the system).

In addition, for the high-use home, the distributed system used almost 30% less energy than the tank/tree system, while the low-use distributed system used nearly 40% less than the tank/tree system. These savings are based on limiting the total demand for any minute to 28 kW. The system efficiencies are much higher than with the other configurations because there are essentially no piping losses and, in fact, energy gains in the piping. Energy is added to the incoming cold water from the house ambient air as water travels to the outlets, reducing the load on the point-of-use heaters.

While conceptually achievable, the practical use of demand heaters at each outlet is limited. Most outlets have the potential to use the home’s full 28-kW heating limit for any given draw. Hence, simultaneous draws would easily exceed the electrical capacity for the house. However, the simulations provide some background for the potential to resolve this problem. Table 8 presents estimated electrical demand data for high- and low-use distributed systems.

Table 8. Simulated Electrical Demand Data for Distributed Hot Water Systems

	Low-Use Home Maximum Demand	Minutes > 28 kW	Minutes Draw (Total)	High-Use Home Maximum Demand	Minutes > 28 kW	Minutes Draw (Total)
Jan	29,070	2	4,241	69,184	47	3,740
Feb	24,434	0	1,572	92,499	58	3,783
Mar	25,463	0	2,781	64,325	45	4,459
Apr	34,430	2	2,911	44,785	31	3,781
May	18,618	0	1,495	48,904	24	4,328
Jun	18,750	0	2,333	32,129	16	5,021
Jul	16,231	0	2,666	46,689	9	4,894
Aug	29,829	3	3,848	45,837	6	3,938
Sep	17,209	0	4,434	28,198	2	3,682
Oct	19,038	0	3,381	36,009	13	4,039
Nov	21,757	0	3,113	53,401	29	4,016
Dec	22,932	0	3,612	41,653	30	3,988
Annual	34,430	7	36,387	92,499	310	49,669

Table 9. Configuration and Costs for Distributed Point-of-Use Water Heater System

	Flow Rate (gpm)	T _{cw}	T _{hw}	Unit	Cost/Unit	Water Heating Equipment Cost	Number of 30A Circuits
Laundry	3	60°F	120°F	28 kW	\$585 ¹³	\$585	4
Sinks (2)	0.5	60°F	110°F	2.5 gallon under sink	\$135 ¹⁴	\$405	0
Showers (2)	1.5	60°F	110°F	11 kW	\$385 ¹⁵	\$770	2 x 2 = 4
Kitchen	1	60°F	120°F	9 kW	\$175	\$175	2
Total						\$1,935	10

The maximum portion of time for any month in which a demand of 28 kW is exceeded in the high-use home is 1.5% of the total minutes of flow and less than 1% for the year. In the low-use home, 28 kW is exceeded less than 0.1% of the time for any month and 0.02% for the year. These results, based on actual flow data, indicate that there are minimal periods of time when the capacity of the demand heater will be insufficient to raise the temperature to the desired setpoint. The potential to use point-of-use heating systems without exceeding 28 kW is possible with little or no inconvenience to a homeowner. However, a set of controls would be required that limit the total demand from the set of heaters to the desired maximum. This technology does not exist yet — however, there are no technical barriers to its development.

More important is the need to carefully design a distributed water heating system in order to minimize the size of heaters in locations where the demand can be limited. For example, in a half bath, a small 2.5-gallon tank system may be sufficient to supply all the hot water demand of a sink. In effect, this unit would be treated as an appliance rather than as a water heater. At locations such as the kitchen, the demand heater size may be limited to 9 kW by restricting the flow rate. In addition, the setpoint for a distributed unit may be changed depending on the use (i.e., the dishwasher would use 140°F water, whereas normal kitchen use can be limited to 120°F).

¹³ For Seisco RA-28 Model (www.seisco.com)

¹⁴ For Ariston Model GL25 (www.plumbingsupply.com)

¹⁵ For Seisco RA-11 Model (www.seisco.com)

The simulation results indicate that there are no prohibitive issues to designing and comfortably using a point-of-use system throughout the house.

11. Factors Affecting Hot-Water Energy Use

Although this study evaluated the hot water system, other factors, primarily those that are consumer driven, affect the amount of hot water used and, hence, the energy required to heat and deliver the hot water to the outlet.

Two issues specifically are considered. The first is the amount of hot water run, but not used, while waiting for the temperature to increase to an acceptable level (i.e., cold water purge). The second involves the use of hot water, such as for hand washing, that is completed before the temperature rises at the outlet or the setting of a single-handled facet control that draws a small amount of hot water when primarily cold water is acceptable or intended (i.e., unintended use).

11.1 Water Purging from Hot-Water Pipe

Cold water purging occurs when the pipe supplying hot water to the outlet contains a volume of water at a temperature well below the acceptable hot water delivery temperature. This water volume is often “purged” from the line by letting the hot water run until the temperature of the hot water is acceptable. In the experimental setup described above, for example, the longest piping run is to the master bath outlet and is composed of 51.25 feet of $\frac{3}{4}$ -in. type-M copper tubing (0.81-in. i.d.) and 7.75 feet of $\frac{1}{2}$ -in. type-M copper tubing (0.57-in. i.d.) for the tree system and 57 feet of $\frac{3}{8}$ -in. PEX tubing (0.36-in. i.d.) for the parallel system. For the master bath outlet, the tree system has a volume of water from the water-heating equipment to the outlet of about 1.5 gallons and for the PEX system, about 0.30 gallons. If the master bath valve is opened and flows at its design rate of 1.75 gpm, it will take approximately 51 seconds to purge the pipe of water in the tree system and about 10 seconds in the parallel system. If the flow rate were 0.5 gpm, the time to purge the pipe in the tree system would be about 180 seconds (three minutes) and 36 seconds for the parallel piping system.

The wait-time to purge the pipe of unacceptable temperature water is, of course, dependent on consumer preference and may be more or less depending on the surrounding temperature of the air through which the piping system runs. Clearly the use of smaller diameter pipe reduces the wait-time for full temperature water to be delivered to the outlet. However, normal consumer activity may extend or decrease the wait time and, therefore, the amount of hot water “wasted” during this period.

The effect on energy use is directly proportional to the water use. Consumer behavior is the overriding factor in reducing the extra length of time that hot water is used and, hence, the hot water that is simply run from the outlet directly down the drain. But because the length of time to purge the pipe of cooler water is significantly reduced in one system over another, it is possible to reduce the overall amount of energy used for water heating by simply using less hot water.

This study accounts for this “benefit” of reduced volume of water, not by reducing the amount of hot water use, but by crediting the system performance based on the outlet energy. For all

system configurations in each of the use patterns (high or low), the flow rates are similar. The calculation of energy at the outlet then for any given flow rate for the specific period of time is based on the changing temperature during the flow period including the purging of water from the piping. The larger amount of purging required, the lower the outlet energy. The opposite is also true. Because the flow rate and length of time the flow is activated is the same, the system with the lower volume of water to the outlet will show the highest outlet temperature and, therefore, the higher outlet energy calculation for the flow period.

In this report, the normalization factor is based on the outlet energy for each system relative to its electric input energy. Therefore, systems that show higher outlet energy, in part because of the decreased volume of water in the piping system to each outlet, will result in a lower normalization factor, provided the electric input energy is less than or equal to the base system (storage tank with tree plumbing configuration). The normalization factor developed for each system is applied to the outlet energy for the base system to determine the relative performance of each system.

The normalization factor takes into account all system losses – those attributed to the heater and those attributed to the piping system. If, in fact, there is little piping or heater loss, as in the distributed system discussed above in Section 10.5, the necessity to purge water from the system is almost negligible. The benefit is evaluated here through the normalization factor, which accounts for all losses in the system, but it could just as well be accounted for by reducing the amount of hot water used overall. However, because of consumer preference, there is a possible benefit related to water purge with more efficient water-heating systems unaccounted for here, namely to reduce the overall amount of hot water consumed.

11.2 Unintended Hot Water Use

A second issue relating to hot water consumption and, therefore, hot water energy use, is that of unintended hot water draws. These draws are a result either of use of hot water for short periods of time that results in little useable hot water at the outlet or when hot water is used unintentionally, as with a single-handle faucet that is set to use cold and hot water when only cold water is desired. Both of these cases result in hot water being delivered to the piping system, but with no appreciable hot water delivered to the outlet by the time the draw is completed.

This issue is often ignored because relatively little energy is used in these draws. However, with a storage-tank system especially, these draws do result in hot water use. However, experimental results in other studies with demand heaters¹⁶ have shown that with demand heaters particularly, a minimum flow rate is necessary to activate the heater. This minimum flow rate does eliminate very small hot water draws that would result in energy use with a typical tank system, but not with a demand-heater system. No attempt is made here to separate out those flows that might have been unintended hot water use. However, using the annual data set for the simulations described in this report, both the high- and low-use homes show that at least two-thirds of all minutes in which water was used was at an average flow rate of less than 0.5 gpm for the minute. There appears to be ample opportunity to save unintended hot water use with the demand heater at very low flow rates.

¹⁶ Refer to the NAHB Research Center, PATH Field Evaluation reports.

12. Installed System Cost

12.1 Whole-House Demand Water Heater

For a central demand water heater, related NAHB Research Center work has shown that there is no additional plumbing cost for a demand water heater versus a tank-type water heater. There are, however, additional electrical costs for extra circuits, heavier gauge wire, and labor. Based on interviews summarized in Section 13, electrical costs increased by \$250 and \$350 for the demand unit (for running three extra 30A circuits). Equipment costs for whole-house electric demand water heaters range from about \$585 to \$850, whereas equipment costs for electric tank water heaters range from about \$200 (for low-end equipment) to \$600 (for a highly efficient water heater).

For a whole-house installation, estimated installed plumbing costs based on the experimental plumbing design (accounting for hot and cold water supply to the kitchen, laundry, three fixtures in each full bath, and two fixtures in the half bath) are \$999 for a PEX-plumbing manifold system and \$1,463 for a similar copper system.¹⁷ This is congruous with a previous NAHB Research Center study that analyzed the cost of PEX versus copper piping.¹⁸ PEX tubing costs about \$0.25 per foot; copper piping is about \$0.70 per foot for ¾-in. tubing and \$0.45 per foot for ½-in. tubing.¹⁹ Using this data, the combined system cost for a whole-house electric demand water heater with PEX piping system would be about \$1,984, whereas the tank-type water heater with copper plumbing system would be about \$1,763.²⁰ Annual savings for switching to a whole-house demand system with PEX piping is about \$36 per year for the low-use home and \$34 per year for the high-use home.²¹ The additional annual mortgage payment (30-year loan, 7.5%) for going to the higher efficiency system is \$18.48. See Figure 25 for a cash flow analysis of all the systems. Therefore, a homeowner would net a positive cash flow from going to the higher efficiency water-heating system.

12.2 Demand Water Heater at Each Outlet

Another system option is to place demand water heaters at each outlet and simply run cold water lines to each fixture. This configuration reduces plumbing costs, but increases water-heating equipment and electrical installation costs. In addition, the water heaters need to be controlled in such a way that the maximum amperage dedicated to water heating at any instant is no more than 120A (based on a typical new home service of 200A). In order to minimize control issues, we selected three 2.5-gallon under-sink water heaters (one each for the half bath, family bath, and master bath) for this analysis.

¹⁷ Using 2002 RS Means (Means and Contributing Authors, *Residential & Light Commercial Construction Standards*, Second Edition, Kingston, MA: R.S. Means Company, Inc. www.rsmeans.com.) and 2000 National Construction Estimator data for labor costs.

¹⁸ Grothe, Michael, *PATH 1999 Model remodel*, report prepared for U.S. Department of Housing and Urban Development, July 2000.

¹⁹ Based on national store pricing at time of report for L-type copper piping.

²⁰ Assuming a base-model water heater is used for comparison.

²¹ Using electric rates of \$0.085 per kWh.

Using an estimated cost of \$100 per 30A circuit, electrical installation cost for the distributed point-of-use scenario illustrated in Table 9 would be \$1,000. Plumbing costs would presumably be cut in half (because only cold lines would need to be run), and the water heating equipment would cost about \$1,935. Using the plumbing costs cited in the previous paragraph, installation cost for each system is described in Table 10.

Table 10. Installed Cost for Various Hot Water Systems

Water Heating System	Distribution System	Water Heating Equipment Cost	Plumbing Installation Cost	Electric Installation Cost	Total Installed Cost
Whole-House Demand	Copper	\$585	\$1,463	\$400	\$2,448
Whole-House Demand	PEX	\$585	\$999	\$400	\$1,984
Tank	Copper	\$200	\$1,463	\$100	\$1,763
Tank	PEX	\$200	\$999	\$100	\$1,299
Distributed Point-of-Use	Copper ²²	\$1,935	\$732	\$1,000	\$3,667

²² Distributed point-of-use heaters were not analyzed with parallel piping because this type of system is unnecessary with a point-of-use heating configuration.

Table 11. Summary of Annual Energy Cost and Installed Cost for Various Systems

Water Heating System	Distribution System	Electrical Energy Use (kWh/yr)	Annual Electric Cost²³ (\$/yr)	Installed Cost
<i>High-Use</i>				
Tank	Copper	4,986	\$424	\$1,763
Tank	PEX	4,986	\$424	\$1,299
Demand	Copper	4,587	\$390	\$2,448
Demand	PEX	4,587	\$390	\$1,984
Distributed Point-of-Use	Copper	3,528	\$300	\$3,667
<i>Low-Use</i>				
Tank	Copper	1,995	\$170	\$1,763
Tank	PEX	1,995	\$170	\$1,299
Demand	Copper	1,573	\$134	\$2,448
Demand	PEX	1,573	\$134	\$1,984
Distributed Point-of-Use	Copper	1,209	\$103	\$3,667

Going from a tank/tree system to a distributed point-of-use system with copper piping increases water-heating system cost by \$1,904 and reduces annual energy costs by \$67 (low-use) to \$124 (high-use) per year. Assuming the additional upfront cost of a water heating system is mortgaged for 30 years at 7.5%, the annual increase in mortgage cost would be about \$160. Using these assumptions, the distributed system does not present a net positive monthly cash flow. The breakeven point for monthly cash flow (at time 0) occurs at an electric rate of \$0.11 for the high-use home and \$0.21 for the low-use home.

Figure 24 shows the total annual cost (mortgage plus utility) for each of the simulated hot water systems. Mortgages were assumed to be 30 years at 7.5%, and utility costs were calculated at \$0.085 per kWh. When compared with a conventional hot water tank with copper-tree distribution system, the tank parallel system and demand parallel system have overall lower costs and, hence, net positive cash flow to the consumer (Figure 25). Although the distributed systems do not have net positive cash flow, they do offer the highest energy efficiency of any system.

Using the normalized outlet energy discussed in Section 10.4, the cash flow for each system is shown in Figure 26. Using normalized outlet energy, net cash flow for the demand parallel system more than doubled for both the high-use and low-use homes.

²³ Assuming an electric rate of \$0.085 per kWh.

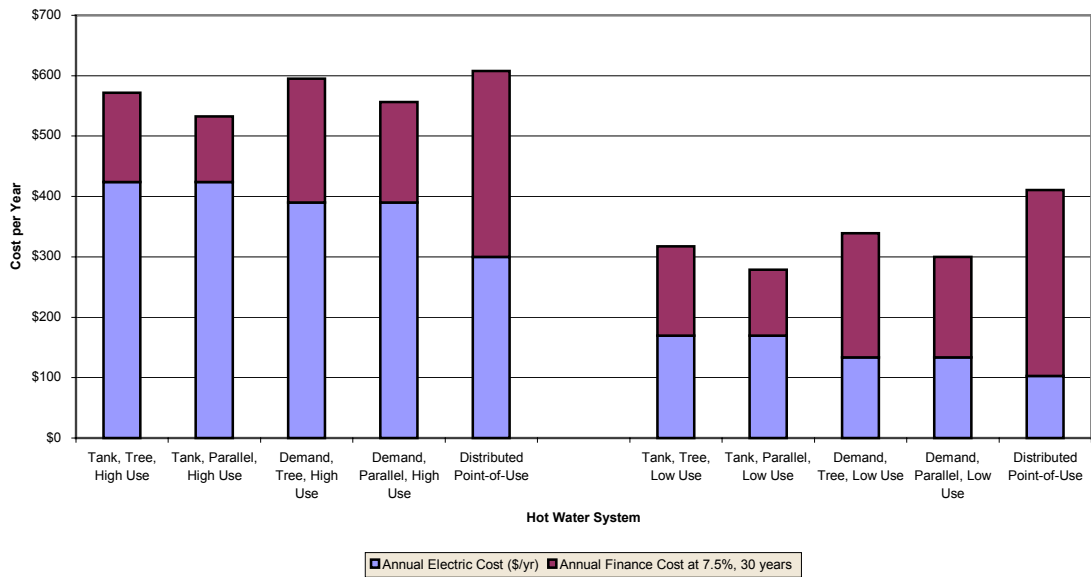

Figure 24. Total annual cost (mortgage plus utility) for hot water systems

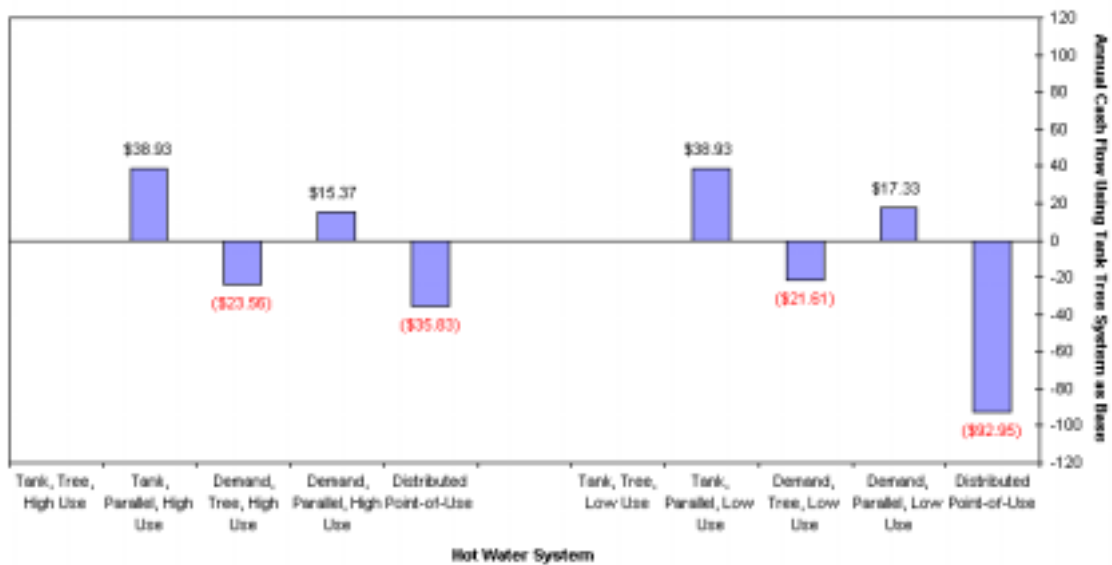

Figure 25. Annual net cash flow for hot water systems

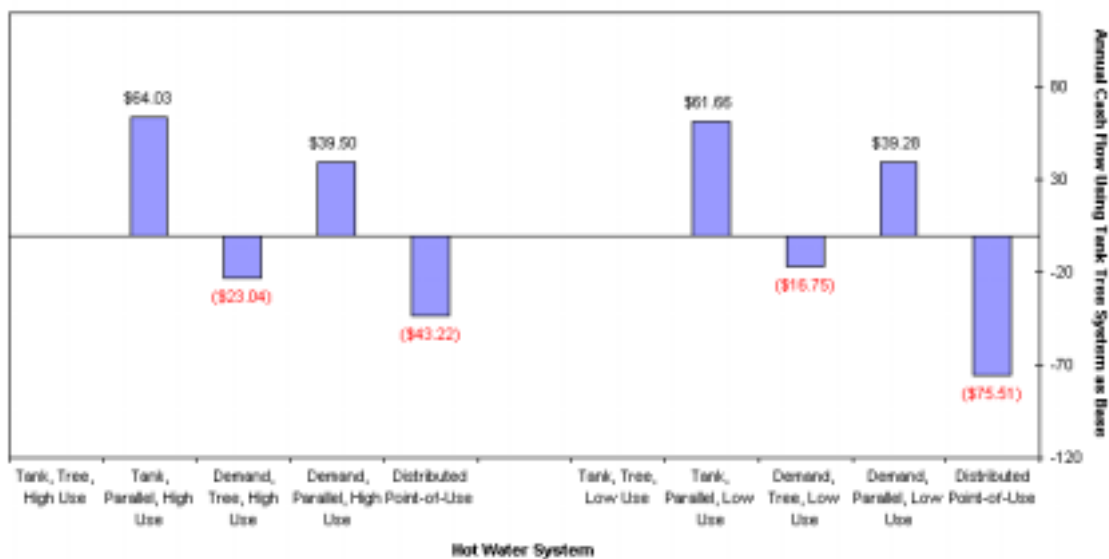

Figure 26. Annual cash flow using normalized output energy

13. Builder and Contractor Response to Demand Water Heaters

To evaluate builder and contractor response to the use of demand water heaters, a survey instrument was developed to get qualitative data about the use of demand water heaters in new home construction. Survey questions can be found in Appendix A.

Ten builders were identified that have experience using demand water heaters, and interviews were completed with six builders and one electrician. The builders were contacted via telephone and asked about their experience using demand water heaters, including ease of installation, cost, reliability, water delivery temperature, ease of maintenance, and overall satisfaction with the system.

13.1 Typical Systems Used

All the builders had experience using both electric and gas tank and demand water heaters. Most builders used copper plumbing, one also used CPVC, and one had experience using PEX piping.

Reasons given by builders for using demand water heaters included:

- Space savings, especially in affordable-housing market
- Environmental benefits
- Reduced liability, because there's no risk of tank failure
- Energy efficiency.

Some reasons given for not using demand water heaters included:

- Electric tanks are more common
- Most consumers don't know about the demand system
- Most commonly used by plumbers/homeowners
- Installed cost is high—can't afford to put demand heaters in every home.

None of the builders uses PEX on a primary basis. One builder remarked that his plumbers are commonly using PEX, and that by next year PEX may be the primary distribution system used by the builder.

Builders stated they used copper piping systems for the following reasons:

- Most commonly used by plumbers and homeowners
- Plumber's choice.

Two builders mainly used CPVC piping because it is the least expensive option.

13.2 Installed Cost

Of the three builders who shared cost information for demand water-heating equipment, equipment costs ranged between \$400 and \$900 (for a gas unit capable of operating two showers simultaneously). Most builders did not know the cost of demand water-heater installation because the cost was typically part of the plumber's package. The electrician estimated an installation cost of \$500 for a demand water heater versus \$150 for a tank-type installation. One builder estimated that the demand system costs an additional \$100 to install and another quoted an additional cost of \$250 over tank systems—for an average of \$230 additional electrical installation cost.

13.3 Installation Process

Builders were asked about the ease of the installation process for demand water heaters versus tank-type water heaters. They were asked to rate the process on a scale of 1 to 5, with 1 being extremely easy and 5 being extremely difficult. For one builder using electric systems, the ease of installation was rated identical (2) for tank and demand systems. Four builders average rating for ease of installation of demand water heaters was 3.5 and tank-type was 1.5. The electrician rated tank installation at 2 and demand at 3. The reasons given for demand water heaters being more difficult to install included:

- “[for gas] The venting takes the most time. You need a lot of combustion air and a metal vent. With a power-vented tank using a PVC vent pipe it's easier.”
- “It's more involved, about twice as difficult. It would be nearly impossible for a novice.”
- “It's a pain” (electrician)
- “There's a lack of knowledge [about installation procedures]”
- “You have to run four 30-amp circuits, rather than just one.”

13.4 Reliability

Interviewees were asked about the reliability of demand and tank water heaters (rated on the scale of 1 to 5, with 1 being extremely reliable and 5 being extremely unreliable):

- One builder rated both systems equally (2)
- Two rated demand water heaters higher than tanks (average 1 versus 2.5)
- One stated that demand water heaters were too new to know the reliability
- Two rated demand water heaters less reliable (average 3.5) than tank-type water heaters (average 1.5). Interestingly, it was the builder who uses demand water heaters exclusively that found them to be unreliable.

13.5 Stability of Delivery Temperature

All of the builders rated the stability of delivery temperature high (average 1.5) for demand water heaters. One builder commented that temperature stability depends on the flow rate, whereas another noted the technology was too new to tell. Stability of delivery temperature was rated an average of 2 for tank-type water heaters. One builder commented that the demand system rated higher because the demand unit is closer to outlets. Another ranked demand systems higher because there is no running out of hot water—noting that, *“it’s great for filling up a Jacuzzi.”*

13.6 Maintenance

Three builders indicated that maintenance had been required on demand water-heating systems they installed. One builder noted that he has encountered many bad units that needed replacement. Ease of maintenance was rated by two builders at 2 and 3, on a scale of 1 (extremely easy) to 5 (extremely difficult). It was noted that some maintenance (e.g., when the power goes out and the units need to be brought back online) was simple and could be done by the homeowner.

13.7 Customer Satisfaction

Five builders discussed their customers’ satisfaction with demand water heating systems. The builder that had experienced the most reliability problems believed that customers were either extremely satisfied (those whose equipment did not malfunction) or extremely dissatisfied (those whose equipment failed). One builder remarked that customers liked the instant hot water and the ability to take long showers without running out of hot water. One builder stated that their customers like the efficiency, and another said they’ve had no complaints—but the builder has installed only three or four systems.

13.8 Performance

All except for the builder who experienced multiple maintenance issues said that the performance of demand water heaters met their expectations. One builder remarked that electric bills were higher than expected.

14. Homeowner Response to Demand Water Heaters

Previous NAHB Research Center work on demand water heaters has included focus groups with homeowners, realtors, and appraisers. Information about homeowner response to these systems can be gleaned from this past experience. A focus group held in Madison, Wisconsin, sought to understand how homeowners view demand water-heating equipment. The perception of homeowners about demand water heaters, in most cases, was not positive. Key findings of this focus group are presented below:

- The conservation of water and energy was less important to participants than ensuring that ample hot water is available when they want it
- The cost savings benefits were not recognized by most of the participants
- Participants expressed concern over the resale value of a home because of the unusual system
- Participants were very concerned over the limitations a whole-house unit would place on simultaneous hot water use
- They felt they were an excellent idea for select, point-of-use locations in the home, especially if it ensured availability of hot water at all times, but thought the cost would be exorbitant
- They felt second homes would be the best application for demand water heaters.

“I can’t imagine anyone wanting this because of the simultaneous use problem.”

“Why in the world would I want it? ...sure, I don’t have any standby losses, yada yada...but if it can’t supply enough hot water, why would I want it?”

“You can buy an insulated tank...or have a blanket wrapped around it to help reduce the losses so...I don’t think it really has that kind of advantage.”

For select locations, the homeowners thought point-of-use water heaters were an excellent idea.

“I had a tankless water heater in my last house. It was ...under a Jacuzzi...I always appreciated the energy bills when it was off...it made a difference.”

“It starts to become practical if you don’t have many locations and then you can have one of these in each location.”

Despite the negative reactions by homeowners in the focus group, NAHB Research Center experience with consumers whose homes have demand water heaters (mainly through the PATH program) shows that consumers have not experienced problems with performance. There have been problems with equipment (specifically electrical) in the event of a power surge or outage.

15. Conclusions

Electric-resistance water-heating systems were tested for energy efficiency. System configurations included storage tank or demand heaters coupled with copper tree or plastic parallel piping distribution systems. In addition, two hot-water use regimes, one high-use and one low-use, were applied to the four system configurations for a total of eight hot water system performance tests. Annual simulations developed from weekly experimental data showed that demand water heaters with a parallel piping distribution system are the most efficient water-heating systems of the combinations evaluated. Energy savings are more pronounced among the low-use homes because of higher standby and distribution losses with tank systems.

A conventional water-heating system consisting of a hot-water storage tank and copper-tree piping system was the least efficient system evaluated. In a home that averages about 28 gallons per day of hot water, the conventional system delivered about 50% of the electrical energy input to the outlets. In a home that uses about 76 gallons per day, a conventional water-heating system achieved an efficiency of about 73%. When the systems are changed to a demand water heater with a parallel piping configuration, the system efficiency was about 76% and 85% for the low- and high-use homes, respectively. Given estimated installed costs for equipment and plumbing pipe, the demand-parallel systems were also less expensive to install and operate than conventional systems.

When comparing the demand-parallel system with the tank/tree system, annual system efficiency increased by 26% for the low-use home and 12% for high-use home. Because each hot water system has different outlet energy for the same electrical input (because of losses in the distribution system), systems were normalized to predict energy savings when the outlet energy was held constant at a base level (the outlet energy supplied by the tank/tree system). When using normalized outlet energy, electrical energy savings for the demand-parallel system over the tank/tree system were 34% for the low-use home and 14% for the high-use home. Table 12 summarizes the results of all the annual simulations.

Performance issues, however, exist for both types of systems. The tank system, while able to deliver higher flow rates of hot water, cannot sustain a high flow rate of hot water for extended periods. Demand heaters, on the other hand, can deliver hot water for indefinite periods, but have limited capacity and, therefore, may not be able to sufficiently heat water to a desired setpoint at a high flow rate. Limited capacity (i.e., inability to have simultaneous uses) seems to be a strong negative for consumers. Yet measured data indicates that for distributed systems in high-use homes, when the outlet temperatures are limited to 110°F in the baths and 120°F at the laundry and kitchen, there are relatively few minutes when the demand heater cannot meet the load—less than 2% of all minutes when water is used.

An economic analysis based on estimated installation costs indicates that a parallel piping system combined with either a tank or demand heater results in a positive annual cash flow, when considering the mortgage payment and electricity costs, over a standard tank/tree system. This result is consistent for both the high- and low-use homes. Table 13 summarizes the cost estimates for each system analyzed.

Table 12. Summary Results – Energy Performance

Heater, Piping, Use	System ¹ Efficiency Based on Electric In	Distribution ² System Loss Based On Electric In	Heater ³ Loss Based On Electric In	Estimated Annual Electric Use (kWh)	Outlet ⁴ Energy Annual Estimate MMBtu	Normalized ⁵ Electric Energy Use (kWh)	Savings Over Tank, Tree System Normalized
Tank, Tree, High-Use	72.92%	16.54%	10.54%	4,986	12.409	4,988	0.00%
Demand, Tree, High-Use	79.36%	18.40%	2.24%	4,587	12.424	4,582	8.12%
Tank, Parallel, High-Use	77.50%	11.95%	10.54%	4,986	13.190	4,692	5.92%
Demand, Parallel, High-Use	84.48%	13.28%	2.24%	4,587	13.225	4,305	13.69%
Distributed ⁶ , Demand High-Use	100.6%	—	—	3,529	12.108	3,619	27.49%
Tank, Tree, Low-Use	50.31%	22.07%	27.61%	1,995	3.425	1,995	0.00%
Demand, Tree, Low-Use	66.21%	28.90%	4.89%	1,573	3.554	1,516	24.02%
Tank, Parallel, Low-Use	58.10%	14.29%	27.61%	1,995	3.955	1,728	13.40%
Demand, Parallel, Low-Use	76.34%	18.77%	4.89%	1,573	4.098	1,315	34.09%
Distributed ⁶ , Demand Low-Use	100.0%	—	—	1,210	4.127	1,004	49.67%

¹ System efficiency to deliver heated cold water to the outlets relative to electric energy input; the distributed system benefits from heat gains in the house.

² Distribution system losses from the heater to the outlets relative to electric energy input.

³ Heater losses include the heater and a short section of connected piping, are relative to electric energy input.

⁴ Outlet energy to heat cold water and deliver to the outlets, in millions of Btu

⁵ Normalized values relative to tank, tree system for each use pattern. Normalizing the outlet energy enables a direct comparison between the systems and accounts for higher efficiency delivery and heating components.

⁶ The distributed (point-of-use) system is based on a theoretical system design with a demand heater at each outlet. The total power draw of all units during any minute of flow is normalized to 28 kW. The outlet temperatures are lower (110°F or 120°F, depending on the outlet) than the other systems (130°F).

Table 13. Summary Results – Estimated Costs and Savings

Heater, Piping, Use	Normalized ¹ Electric Energy Use (kWh)	Annual Electricity Cost Based On \$0.085/kWh	Annual ² Financed Cost For Installed System	Annual Net Cash Flow Relative to Base System ³
Tank, Tree, High-Use	4,988	\$423.94	\$147.93	\$0.00
Demand, Tree, High-Use	4,582	\$389.50	\$205.40	– \$23.04
Tank, Parallel, High-Use	4,692	\$398.84	\$108.99	\$64.03
Demand, Parallel, High-Use	4,305	\$365.90	\$166.47	\$39.50
Tank, Tree, Low-Use	1,995	\$169.60	\$147.93	\$0.00
Demand, Tree, Low-Use	1,516	\$128.87	\$205.40	– \$16.75
Tank, Parallel, Low-Use	1,728	\$146.88	\$108.99	\$61.66
Demand, Parallel, Low-Use	1,315	\$111.78	\$166.47	\$39.28

¹ Normalized values relative to Tank, Tree system for each use pattern. Normalizing the outlet energy enables a direct comparison between the systems and accounts for higher efficiency delivery and heating components.

² The annual financing cost based on a 30-year loan at 7.5% interest

³ Annual cash flow estimates the monthly cost of the system for installation and operation but without maintenance or repair costs included. Negative values indicate a net monthly increase in costs. Note: all positive cash flow values occur at \$0.0145/kWh in the high-use home and at \$0.012/kWh in the low-use home.

⁴ The distributed (point-of-use) system is based on a theoretical system design with a heater at each outlet. The total power draw at any minute of flow is normalized to 28 kW.

An alternative system design that uses a tree distribution system for cold water only, with demand heaters placed at each outlet, shows energy savings of nearly 30% for the high-use home and nearly 50% for the low-use home based on lower estimated delivery temperatures. However, because of the high cost of additional water-heating equipment, this configuration is not cost effective when comparing additional installation cost (mortgaged) with electricity cost savings. In addition, there are technical issues such as the need for interconnected controls to limit the total electricity demand, which still require resolution.

16. Recommendations for Further Research

The effort to evaluate potential energy savings for hot water systems began in 1999 when preliminary analyses showed the potential for significant energy savings based on demand water heaters and parallel piping configurations. The present work extended those results to verify the savings in the laboratory and to analyze the savings over a year. Based on the results from this second analysis that involved laboratory testing and calibrated simulations, the savings identified previously have been verified. Added to these savings, there exists the potential to increase energy savings by another 15% by developing a point-of-use water-heating system.

With the identified savings, the research now would be well served by moving from the laboratory to the field. Installed costs, field performance data, and consumer issues all remain to be clearly evaluated for the optimum systems described in this report. A logical next step would be to compare a parallel piping system with demand heater in one or more new homes with a conventional tank/tree system in a similar home or homes. The variations of homeowner use patterns, flow rates, and indoor air temperatures could be applied to the existing simulation models to further verify the assumptions and calculations.

Another important extension of this work would be to develop a point-of-use system design including identification of demand heater control issues that require limiting the total electrical demand of multiple units. Of particular interest is the sizing and location of heater units to minimize cost, while maintaining performance. This effort should be performed first as a design review using developed simulations and second as a laboratory test to check control algorithms and predicted results.

A third recommendation is to evaluate opportunities to increase the performance of the demand system through preheat methodologies, such as recovered energy from existing heat sources, tank tempering, and especially various types of inexpensive solar technologies.

Appendix A. Survey of Builder and Contractor Response to Demand Hot Water Systems

I am calling from the NAHB Research Center. We are conducting a short survey regarding builders and contractor perceptions of demand water-heater systems. Do you have a few minutes to answer some questions?

1. What types of equipment and materials have you used in hot water systems? Check all that apply.

Type of water heater

- Whole-house demand
- Remote demand (e.g., under sink)
- Tank

Type of fuel

- Gas
- Electric

Type of distribution system

- Copper plumbing
- CPVC
- Polybutylene
- PEX
- Tree-type plumbing system
- Manifold/Parallel Plumbing System

- 2a. Thinking about the past 12 months, what type of water heater [gas versus electric; tank versus demand; tree type versus manifold; whole-house versus remote] have you used most often?

What are some reasons why you have used this type of water heater most often?

- 2b. Thinking again about the past 12 months, what type of piping system [copper versus plastic versus PEX] have you used most often?

What are some reasons why you have used this type of piping system most often?

- 3a. Thinking about the past 12 months, how much have you typically paid for demand equipment (water heater only)?

- 3b. And about how much have you typically paid for traditional tank equipment?

For what size tank (in gallons)?

- 4a. Again thinking about the past 12 months, how much has the installation of the demand unit cost?

For what capacity unit (in kW)?

- 4b. And about how much has the installation of a traditional tank system cost?
- 5a. Now, using whole numbers on a scale of 1 to 5, where 1 is “extremely easy” and 5 is “extremely difficult,” please rate the installation process for a demand water heater.
- 5b. Using the same scale, how would you rate the installation process for a traditional tank-type water heater?
- 6a. Now, using whole numbers on a scale of 1 to 5, where 1 is “extremely reliable” and 5 is “extremely non-reliable,” please rate the reliability for a demand water heater.
- 6b. Using the same scale, how would you rate the reliability for a traditional tank-type water heater?
- 7a. Now, using whole numbers on a scale of 1 to 5, where 1 is “extremely stable” and 5 is “extremely unstable,” please rate the stability of delivery temperature for demand water heaters.
- 7b. Again using the same scale, how would you rate the stability of delivery temperature for traditional tank-type water heaters?
- If 7a and 7b are different, ask why the one is rated differently than the other in terms of stability of delivery temperature.
8. Has any maintenance been needed on the demand water heaters you have used?
 Yes IF YES, using whole numbers on a scale of 1 to 5, where 1 is “extremely easy” and 5 is “extremely difficult,” how would you rate the ease of maintenance?
 No
9. Using the same scale of whole numbers from 1 to 5, where 1 is “extremely satisfied” and 5 is “extremely unsatisfied,” in general, how would you rate customer satisfaction with demand water heater systems?
- What are some reasons why you think this is true?
- Did the performance meet your expectations for a hot water system?
10. Is there anyone else, such as your plumbing contractor, you could suggest we talk to regarding demand water heater performance?

Thank you for your time and opinions!

Appendix B. Hot Water Use Profile for High- and Low-Use Homes — Actual Data

In previous work supported by NREL and others, 1-minute water heater flow data was recorded over a year for five homes near Cleveland, Ohio. This data reflects various levels of household hot water use, from a high range of 60 to 85 gallons per day to a low range of 20 to 40 gallons per day. The two extreme cases were chosen for simulation — one data set from the highest volumetric use home and the other from the lowest volumetric use home — to provide a range of savings that can be expected. If it is found that savings apply to only one of the water use profiles, the plumbing system design may need to be modified or at least recommended for a certain type of housing. Both data sets are applied to the same simulated plumbing system. The data sets contain indoor air temperature, the minute average hot water flow, the inlet water temperature, and the water heater outlet temperature, among other data points. Of direct use in the simulation program is the minute flow data and the indoor air temperature. The flow data is applied directly to the water heating equipment and divided among specific outlets based on the time of day as described in Section [7.1](#). The indoor air temperature is used in calculations of piping losses. The average daily hot water consumption for the high- and low-use homes differs dramatically. As shown in Figure 27, the use is variable throughout the year.

A previous literature review (footnote 7 in Section [7.1](#)) indicates that the average daily household hot water consumption in the U.S. is somewhere between 45 and 66 gallons per day (GPD) depending on the time of year. Since hot water usage in the homes used in this analysis (range of 66 to 86 GPD for the high-use home and 15 to 41 GPD for the low-use home) are significantly different from the national rate, they offer opportunities to understand the boundaries of potential savings.

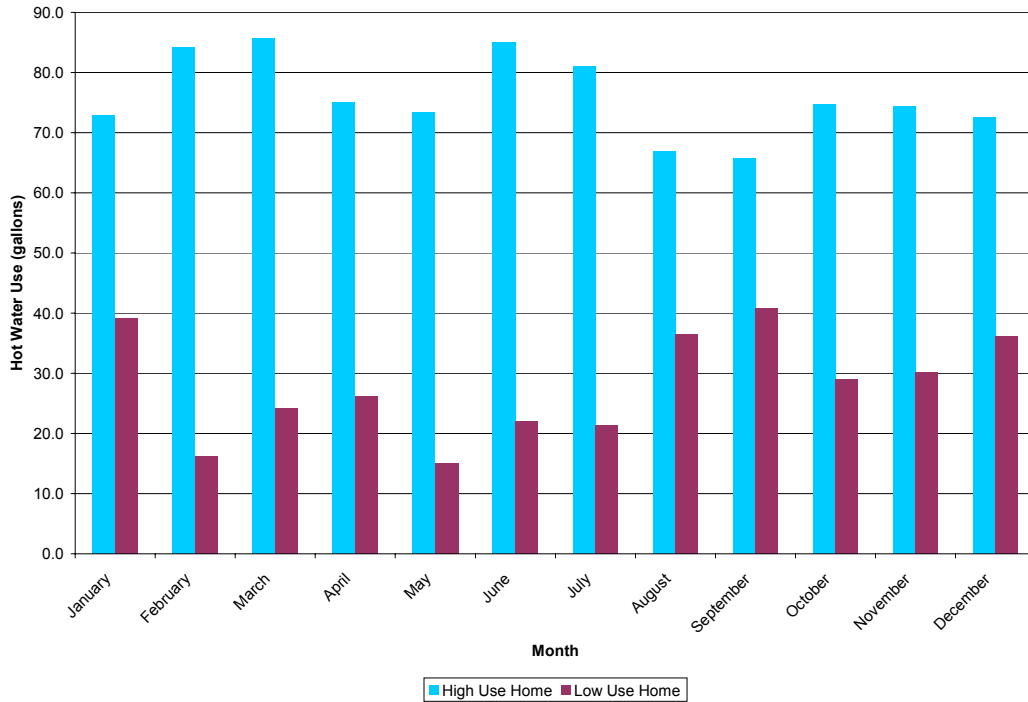

Figure 27. Average daily hot water consumption for homes used in simulations

Another aspect of the actual hot water consumption data is the time-of-use of hot water throughout the day. Though daily variations exist, the general trend is for peak water use in the morning, relatively low usage throughout the day, and elevated water use in the evening. Refer to Figure 28 and Figure 29 for a review of hourly hot water use at both the high and low hot water use homes. Each data column is read from the bottom (January) to the top (December) with the column total in numerical format.

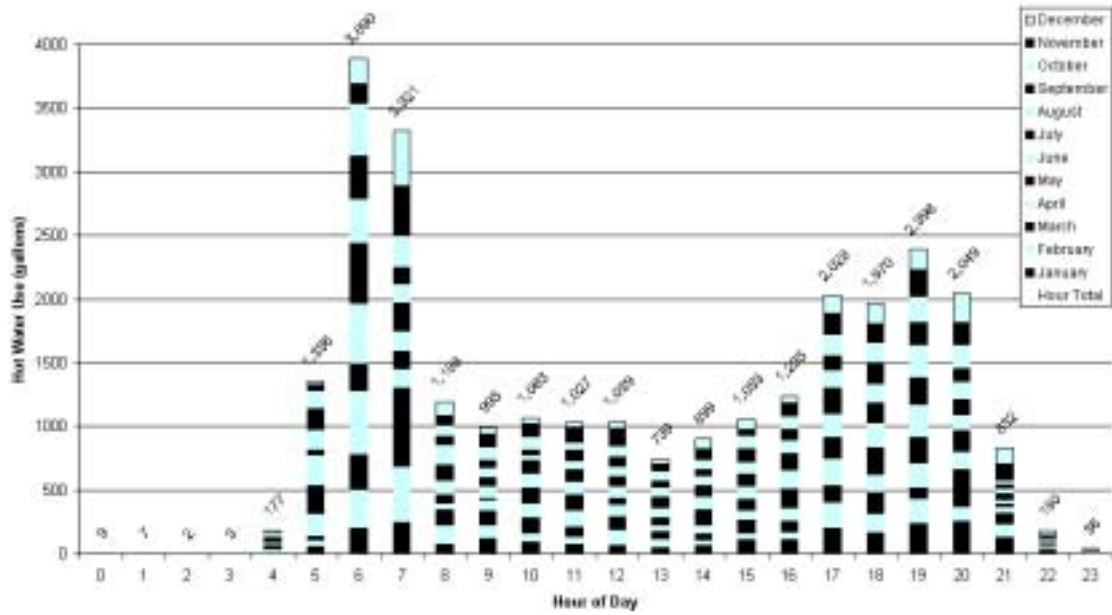

Figure 28. Annual hourly hot water use, high-use home

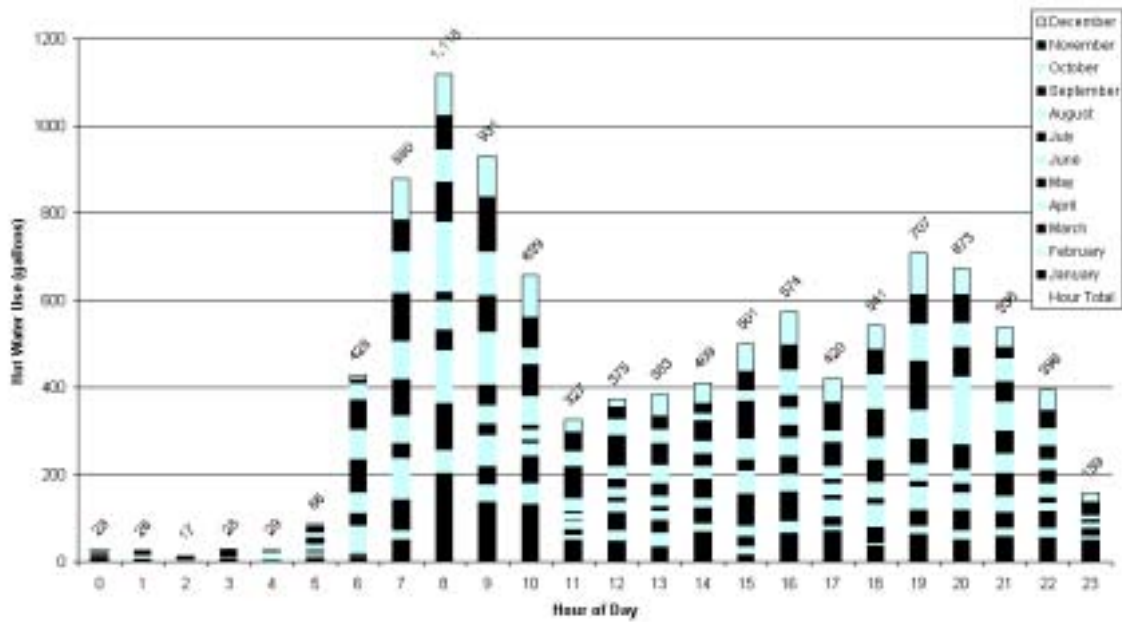

Figure 29. Annual hourly hot water use, low-use home

The American Society of Heating, Refrigeration and Air Conditioning Engineers (ASHRAE) publishes an hourly load profile for domestic hot water use.²⁴ Figure 30 shows this load profile applied to the actual daily water consumption at the two homes. Comparison of the ASHRAE derived distribution with the actual hourly consumption from the data, in Figure 28 and Figure 29, shows similar profiles. The primary difference between the actual and ASHRAE derived data is that the water usage is less evenly distributed in the actual data—there are higher peaks and lower troughs and much less use in the early morning hours in the actual data.

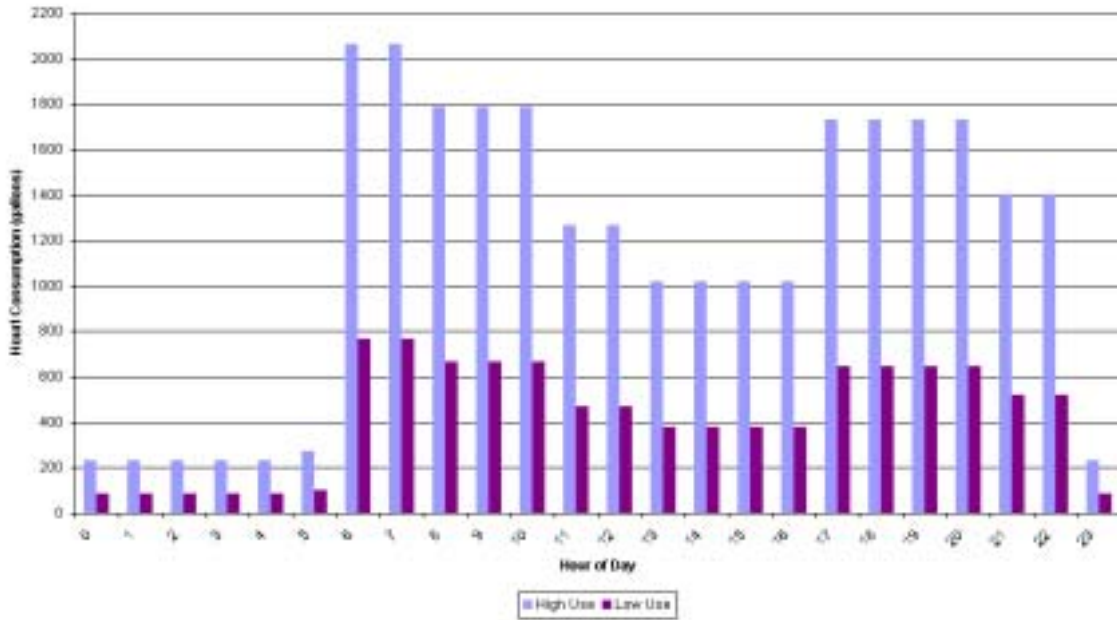

Figure 30. ASHRAE hot water load profile applied to actual use in high- and low-use homes

Another important factor in hot water system design and function is the maximum hot water flow rate. Figure 31 and 32 show the maximum daily hot water minute flow for each home with the average for the year. For the low use home, the average does not include days where there were no draws. For the high use home, there are seven instances when the flow rate exceeds 5e gpm and 208 days when the maximum flow rate exceeded 3 gpm. These periods of high flow are potentially problematic for the demand water heater, and if sustained over several minutes, will also be challenging to the tank system as well. For the low use home, there are only four instances when the maximum hot water flow rate exceeds 3 gpm. As a reference, a 28-kW demand heater can raise 45°F water to 130°F at a maximum flow rate of 2.25 gpm and 60°F inlet water temperature at a flow rate of 2.7 gpm.

²⁴ ASHRAE Standard 90.2-1993, published by the American Society of Heating, Refrigeration and Air-Conditioning Engineers, Inc.

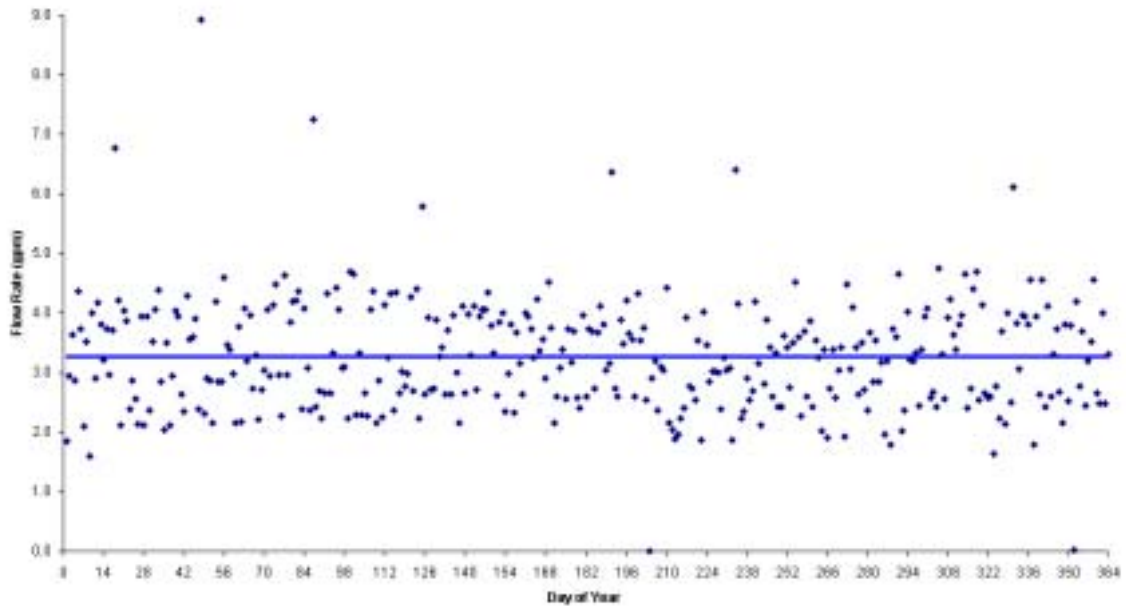

Figure 31. Maximum daily flow rate, high-use home

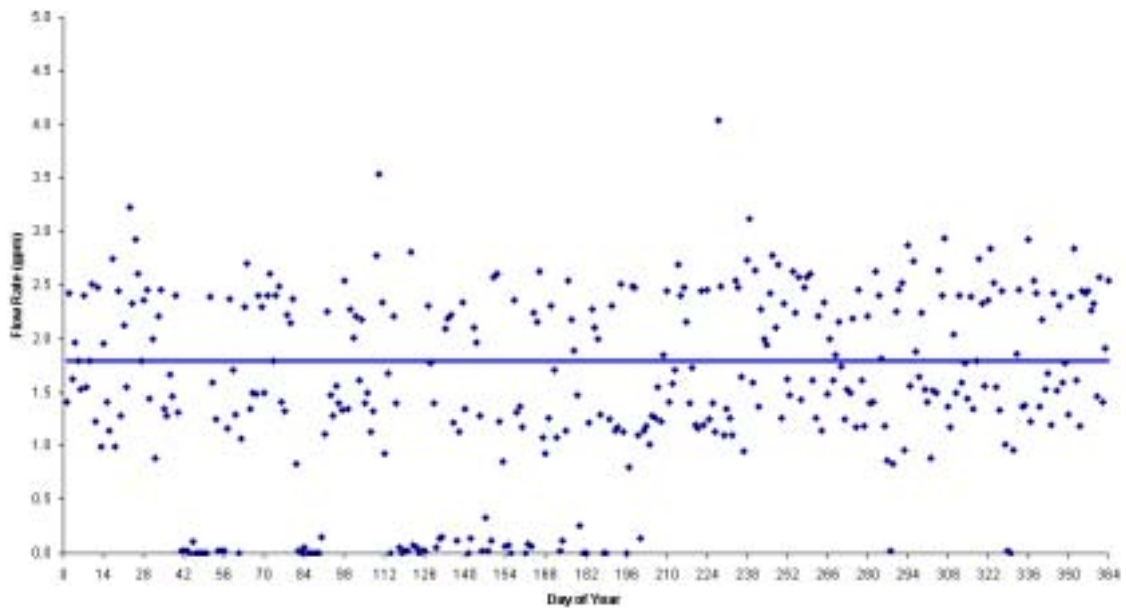

Figure 32. Daily maximum flow rate, low-use home

Other flow rate data are described in Figure 33 through Figure 36. The distribution of flow is dramatically different between homes; however, the general trend is clear and consistent. In the high-use home, higher flow rates are much more prevalent.

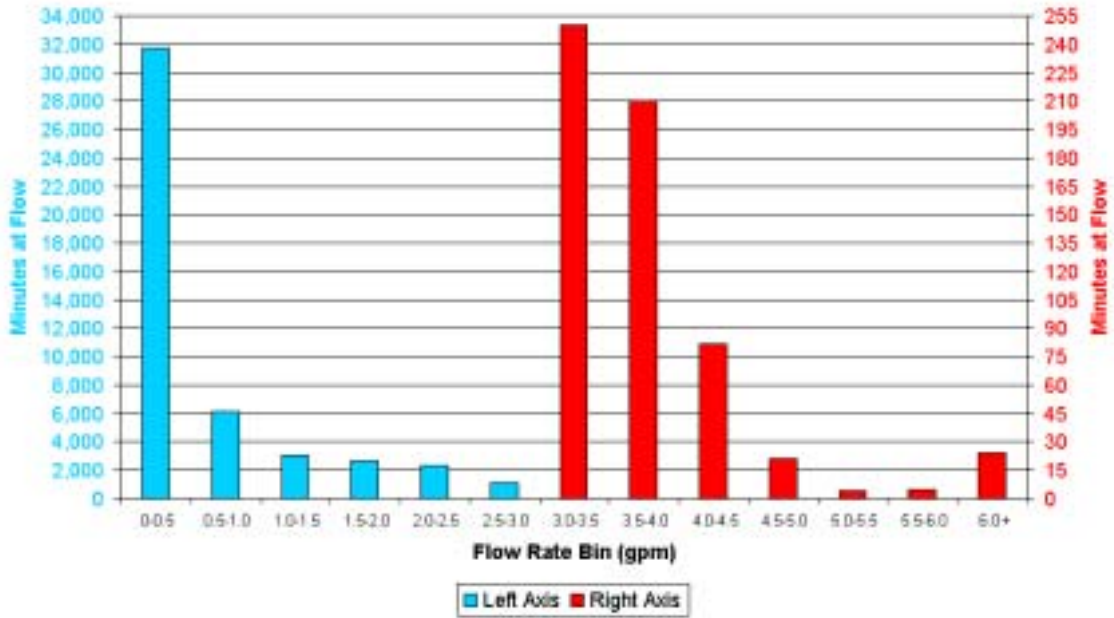

Figure 33. Frequency of flow rates in high-use home

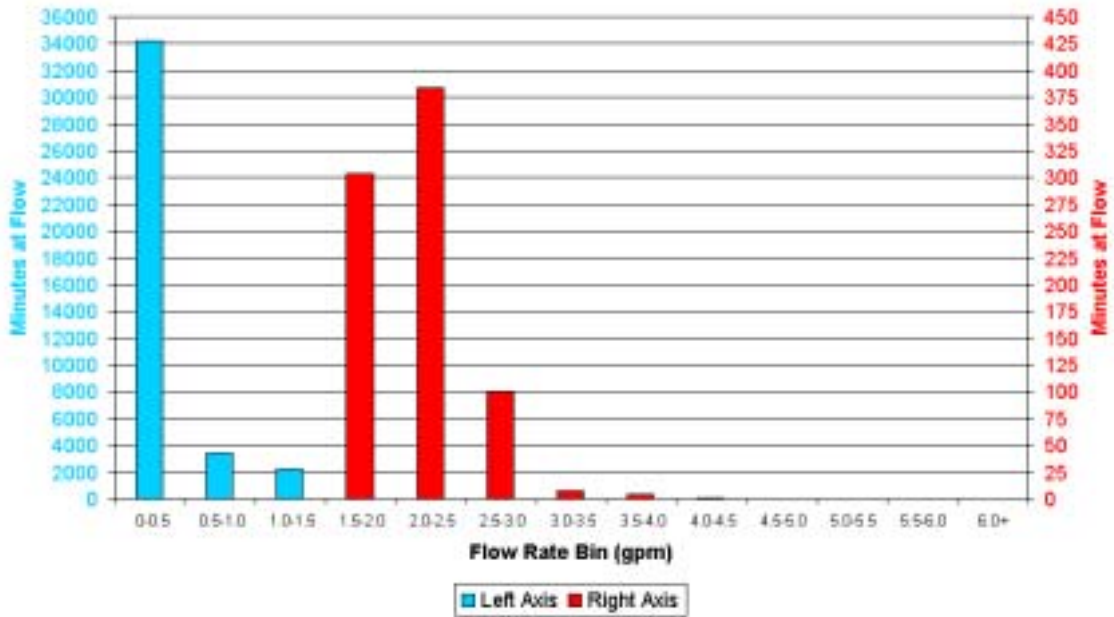

Figure 34. Frequency of flow rates in low-use home

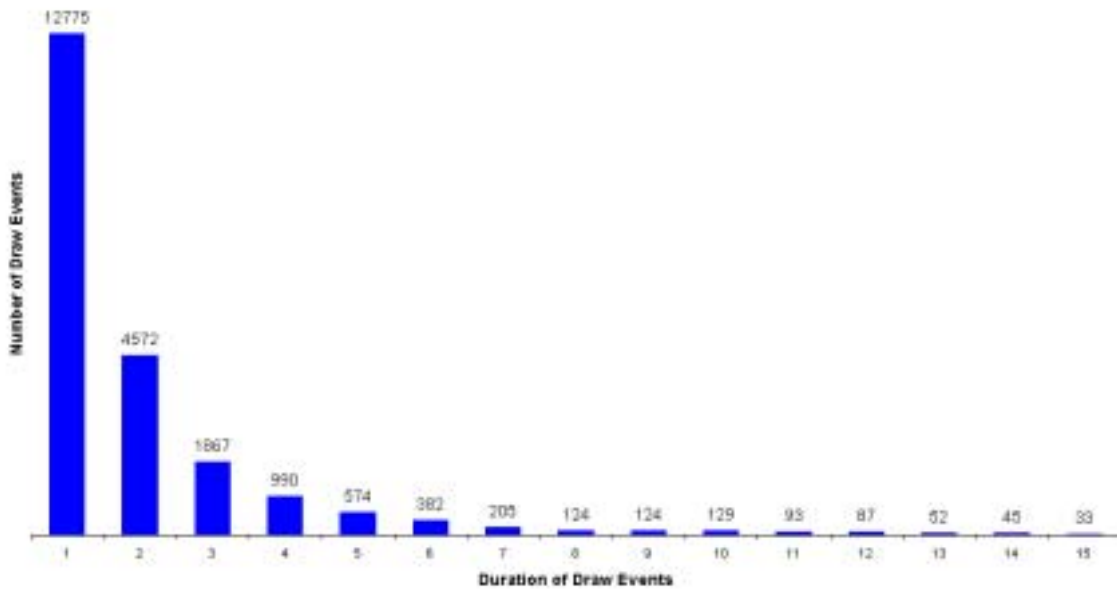

Figure 35. Draw duration in high-use home

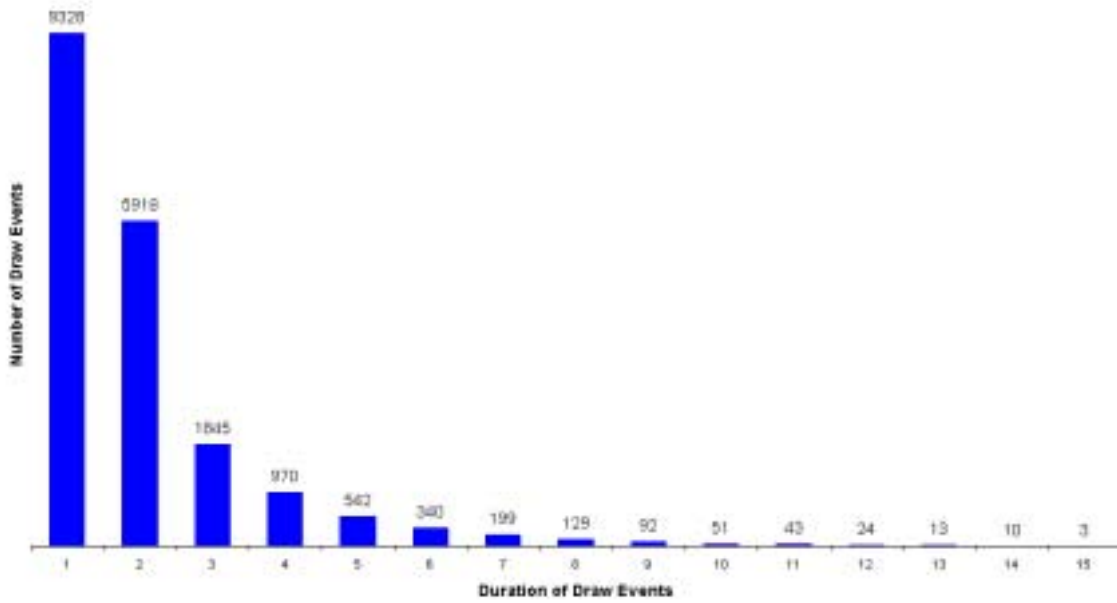

Figure 36. Draw duration in low-use home

REPORT DOCUMENTATION PAGE			Form Approved OMB NO. 0704-0188
Public reporting burden for this collection of information is estimated to average 1 hour per response, including the time for reviewing instructions, searching existing data sources, gathering and maintaining the data needed, and completing and reviewing the collection of information. Send comments regarding this burden estimate or any other aspect of this collection of information, including suggestions for reducing this burden, to Washington Headquarters Services, Directorate for Information Operations and Reports, 1215 Jefferson Davis Highway, Suite 1204, Arlington, VA 22202-4302, and to the Office of Management and Budget, Paperwork Reduction Project (0704-0188), Washington, DC 20503.			
1. AGENCY USE ONLY (Leave blank)	2. REPORT DATE March 2003	3. REPORT TYPE AND DATES COVERED Subcontract Report: January 30, 2001 — July 29, 2002	
4. TITLE AND SUBTITLE Performance Comparison of Residential Hot Water Systems		5. FUNDING NUMBERS CF: AAX-1-30482-01 TA: BET3.8004	
6. AUTHOR(S) J. Wiehagen and J.L. Sikora		8. PERFORMING ORGANIZATION REPORT NUMBER	
7. PERFORMING ORGANIZATION NAME(S) AND ADDRESS(ES) National Association of Homebuilders (NAHB) 400 Prince George's Boulevard Upper Marlboro, MD 20774-8731		10. SPONSORING/MONITORING AGENCY REPORT NUMBER NREL/SR-550-32922	
9. SPONSORING/MONITORING AGENCY NAME(S) AND ADDRESS(ES) National Renewable Energy Laboratory 1617 Cole Blvd. Golden, CO 80401-3393		11. SUPPLEMENTARY NOTES NREL Technical Monitor: Dennis Barley	
12a. DISTRIBUTION/AVAILABILITY STATEMENT National Technical Information Service U.S. Department of Commerce 5285 Port Royal Road Springfield, VA 22161		12b. DISTRIBUTION CODE	
13. ABSTRACT (Maximum 200 words) A laboratory test experiment was conducted to measure the energy performance of two different types of water heaters—electric storage tank and demand (tankless)—in two types of plumbing distribution systems—copper piping in a tree configuration and cross-linked polyethylene (PEX) piping in a parallel configuration. Two water-usage patterns were used in the week-long experiments and in the annual simulations: one representing a high-usage home and the other representing a low-usage home. Results of weekly performance testing and annual simulations of electric water-heating systems are presented.			
14. SUBJECT TERMS residential hot water systems; water-heating systems; electric storage tank; demand water storage; copper piping in tree configuration; cross-linked polyethylene piping		15. NUMBER OF PAGES	16. PRICE CODE
17. SECURITY CLASSIFICATION OF REPORT Unclassified	18. SECURITY CLASSIFICATION OF THIS PAGE Unclassified	19. SECURITY CLASSIFICATION OF ABSTRACT Unclassified	20. LIMITATION OF ABSTRACT UL